

GE076 NEUTRON ACER TENDL-2021 LIBRARY; T=293.6K

Principal cross sections

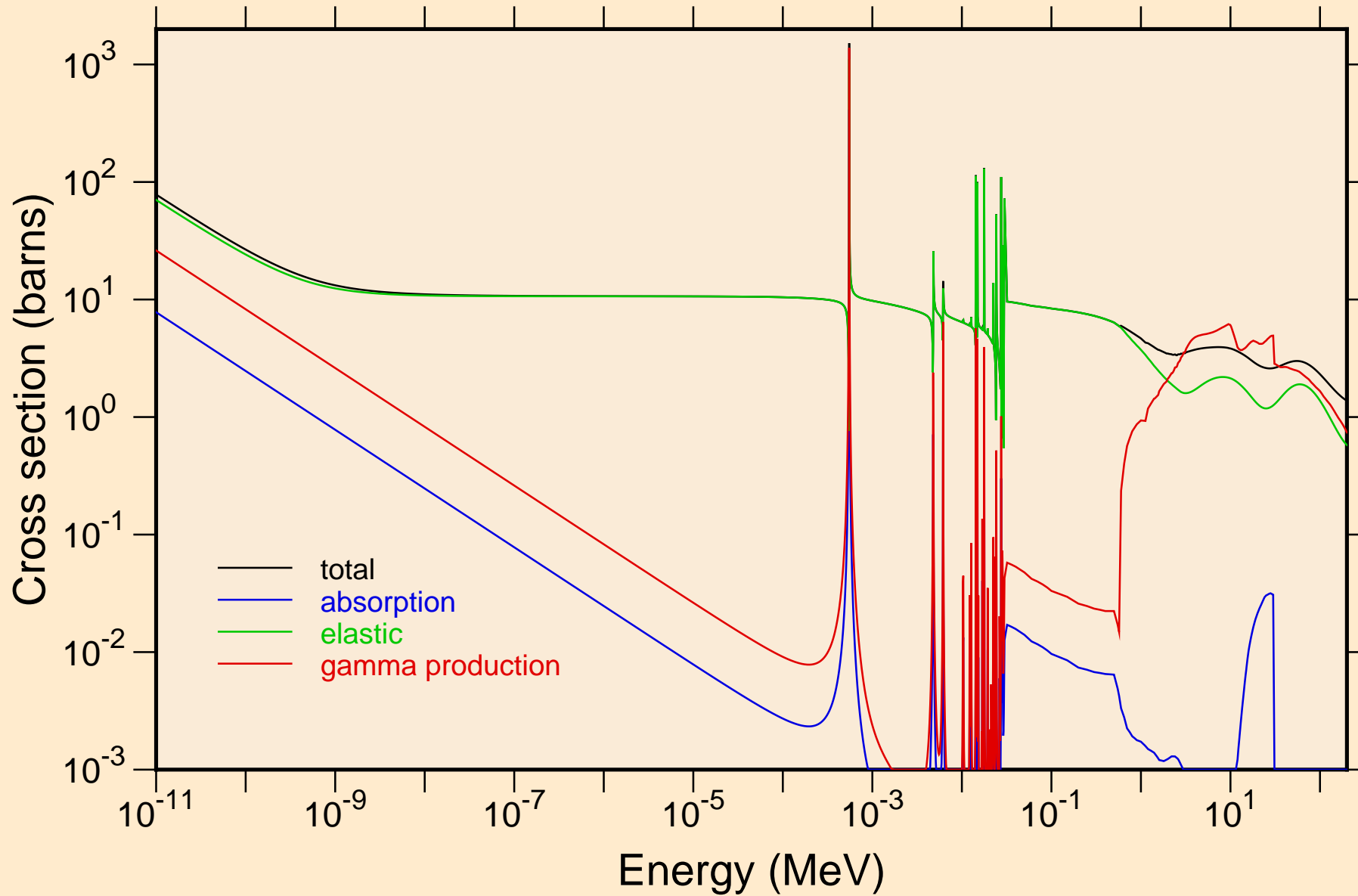

GE076 NEUTRON ACER TENDL-2021 LIBRARY; T=293.6K
resonance total cross section

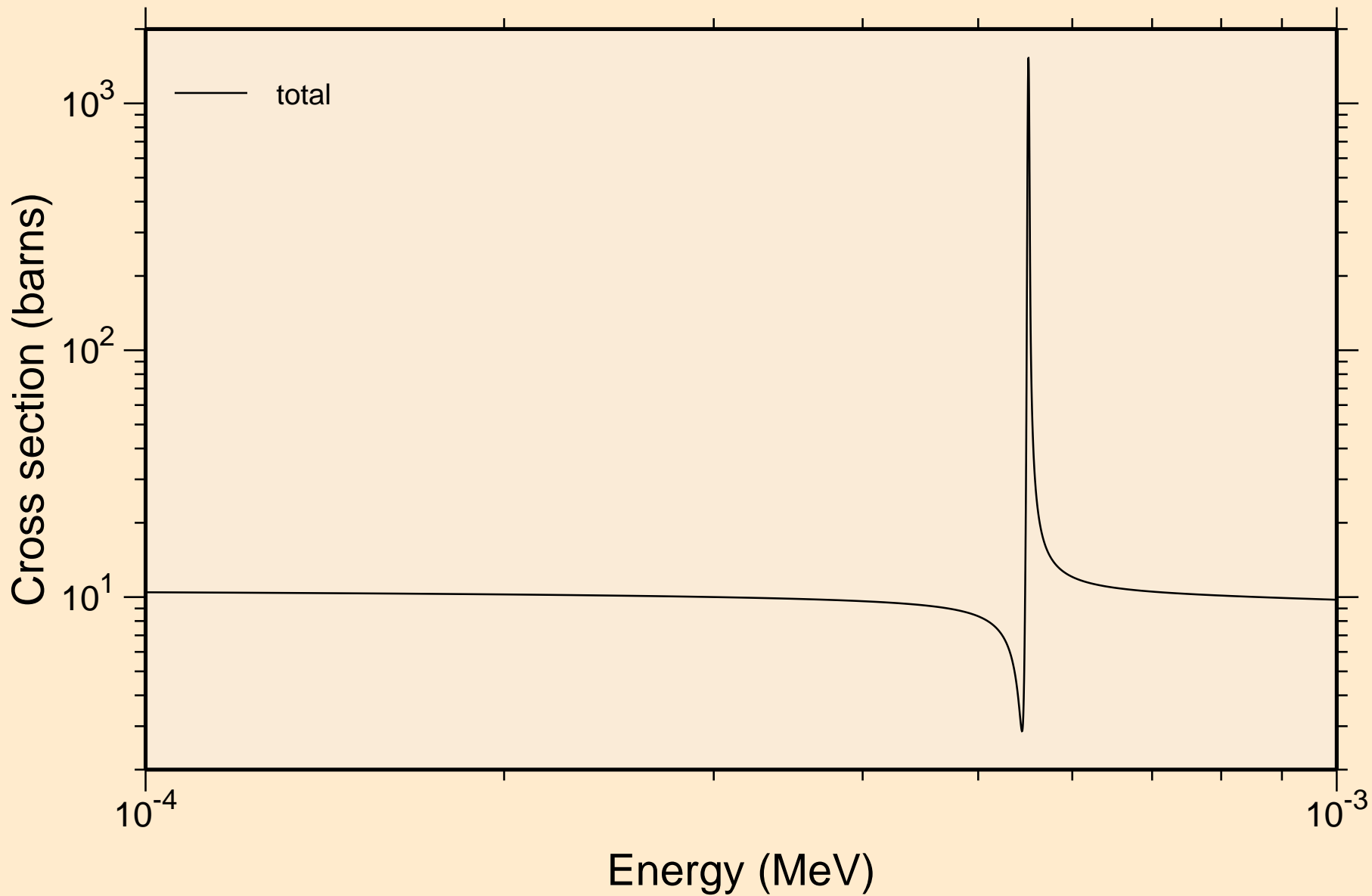

GE076 NEUTRON ACER TENDL-2021 LIBRARY; T=293.6K
resonance total cross section

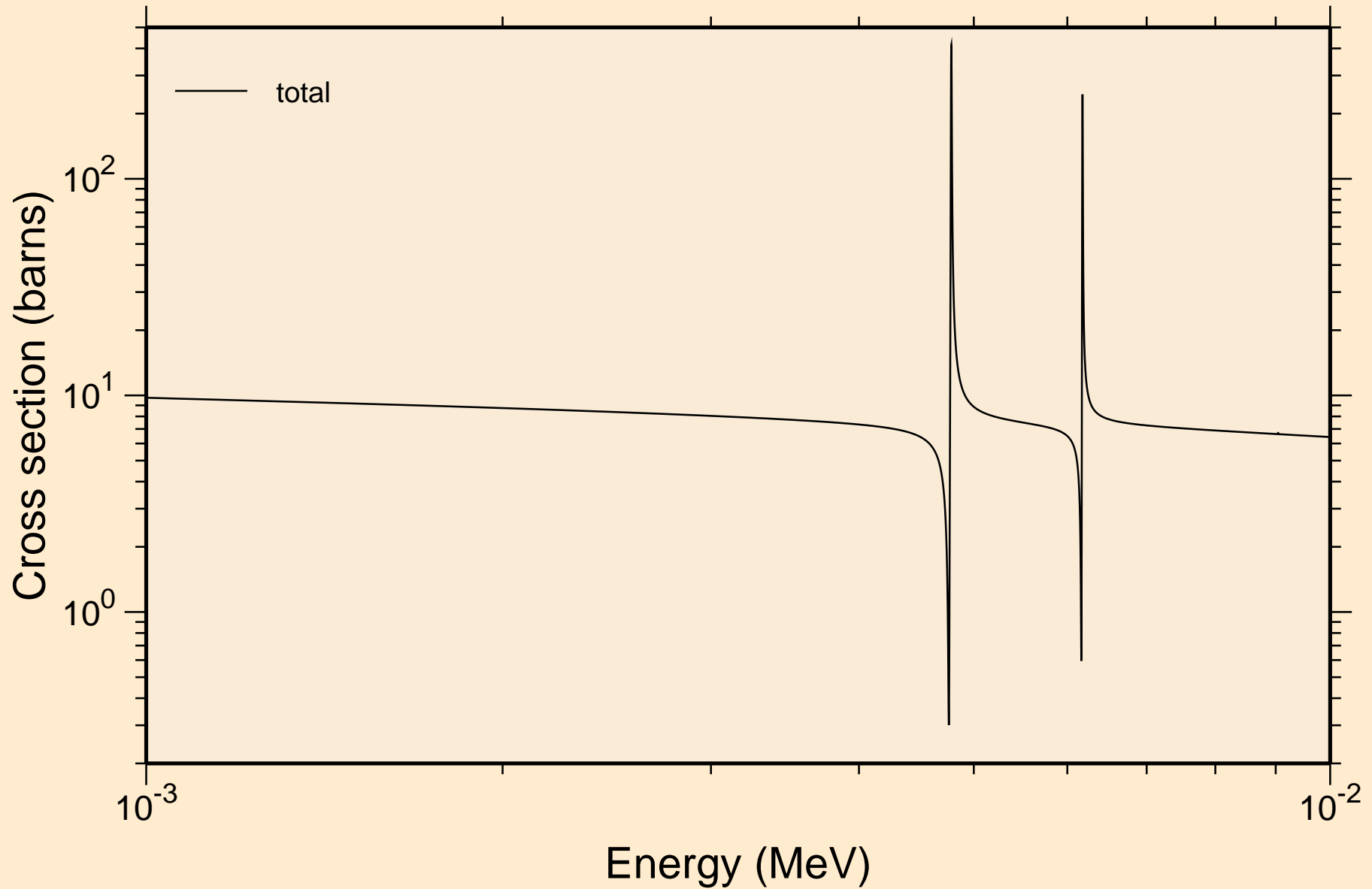

GE076 NEUTRON ACER TENDL-2021 LIBRARY; T=293.6K
resonance total cross section

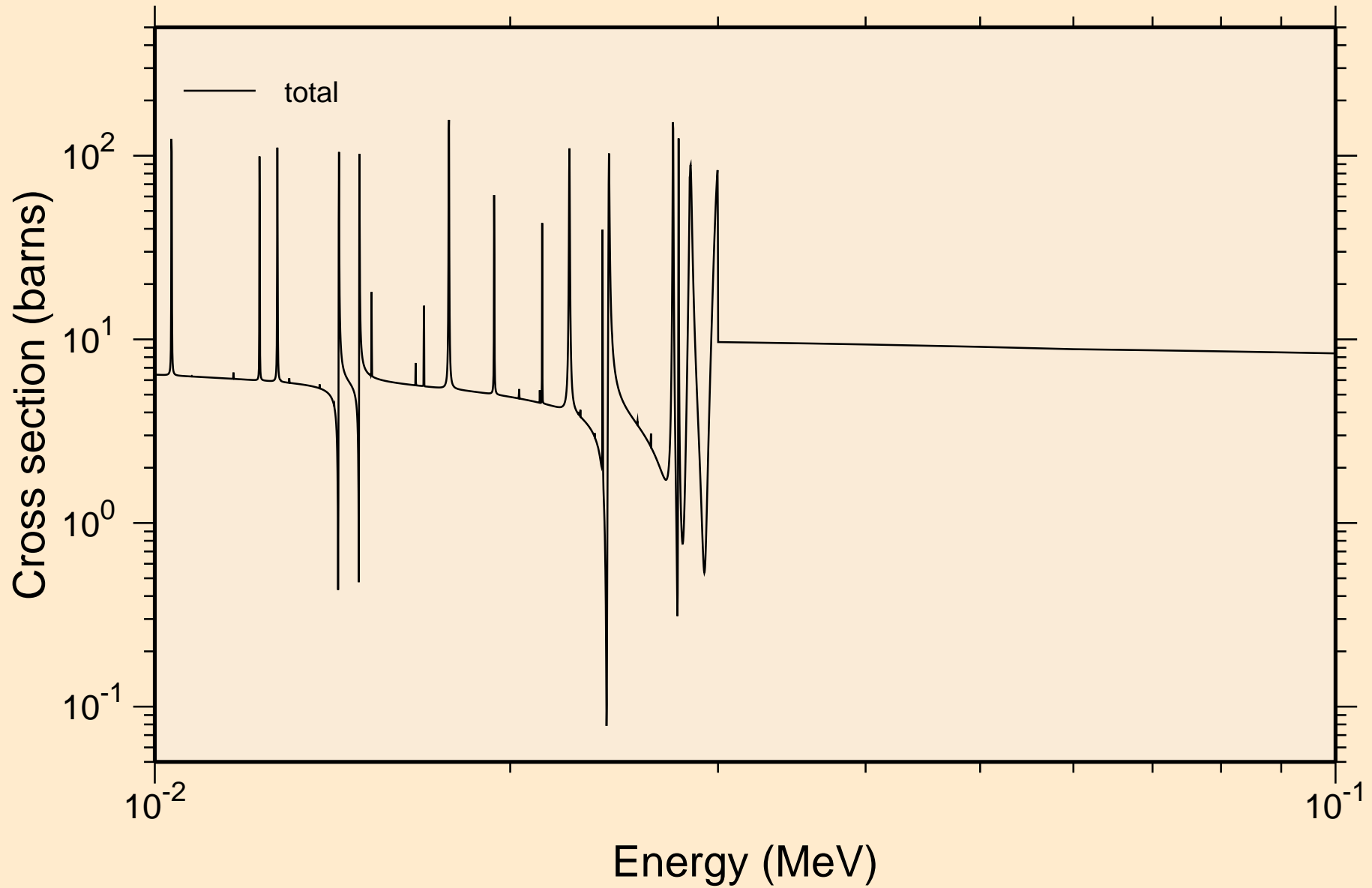

GE076 NEUTRON ACER TENDL-2021 LIBRARY; T=293.6K
resonance total cross section

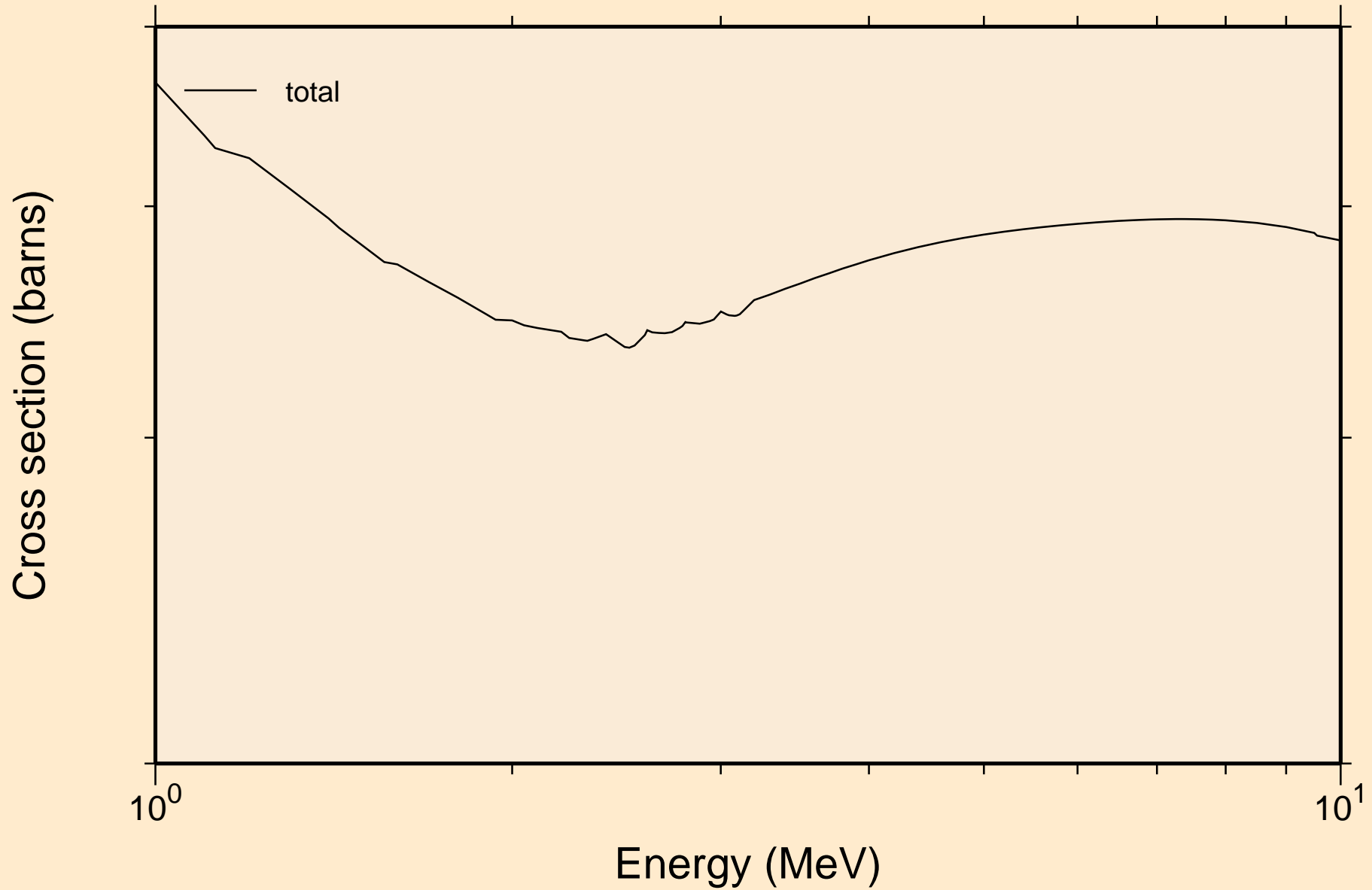

GE076 NEUTRON ACER TENDL-2021 LIBRARY; T=293.6K
resonance absorption cross sections

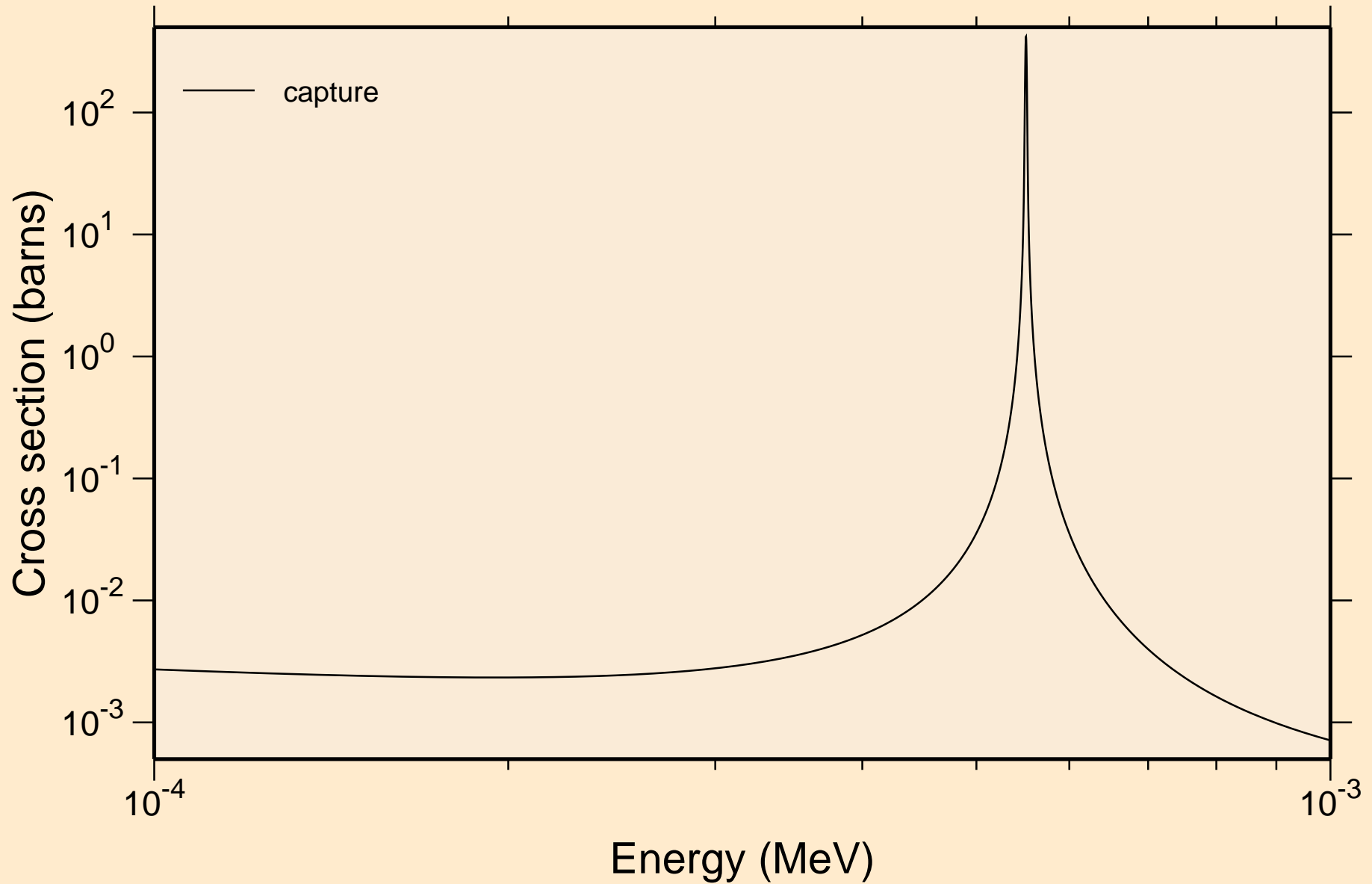

GE076 NEUTRON ACER TENDL-2021 LIBRARY; T=293.6K
resonance absorption cross sections

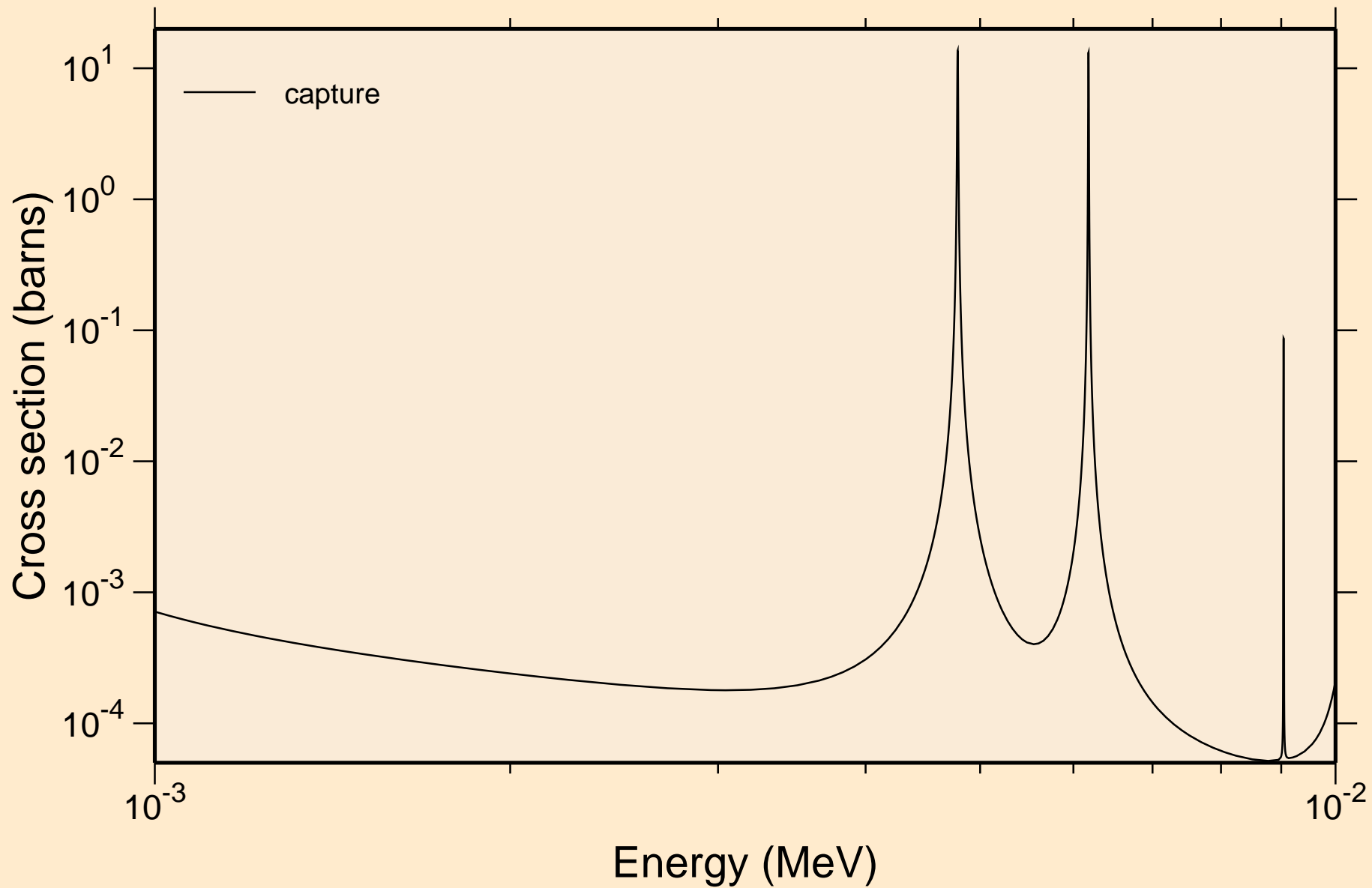

GE076 NEUTRON ACER TENDL-2021 LIBRARY; T=293.6K
resonance absorption cross sections

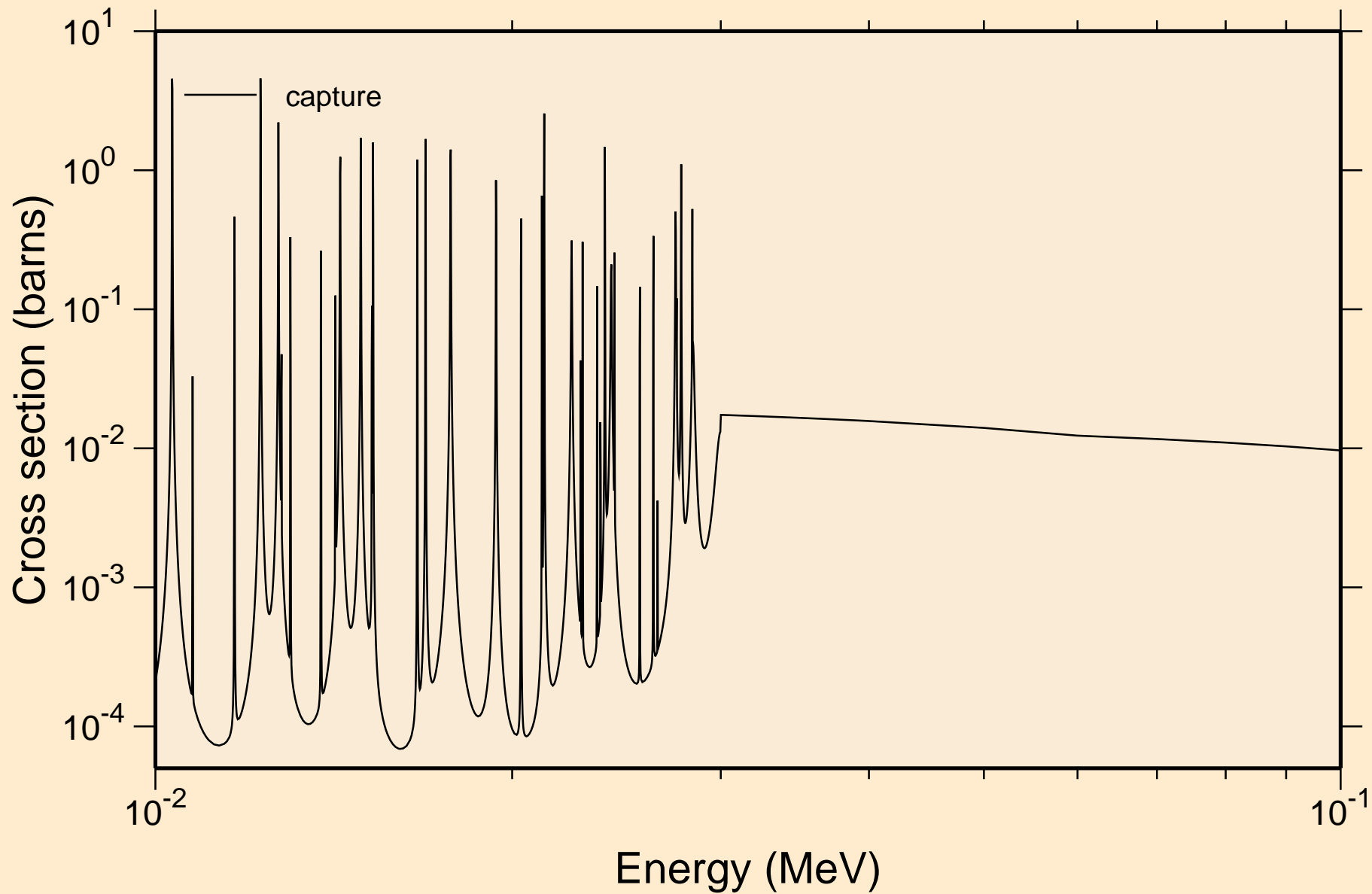

GE076 NEUTRON ACER TENDL-2021 LIBRARY; T=293.6K
resonance absorption cross sections

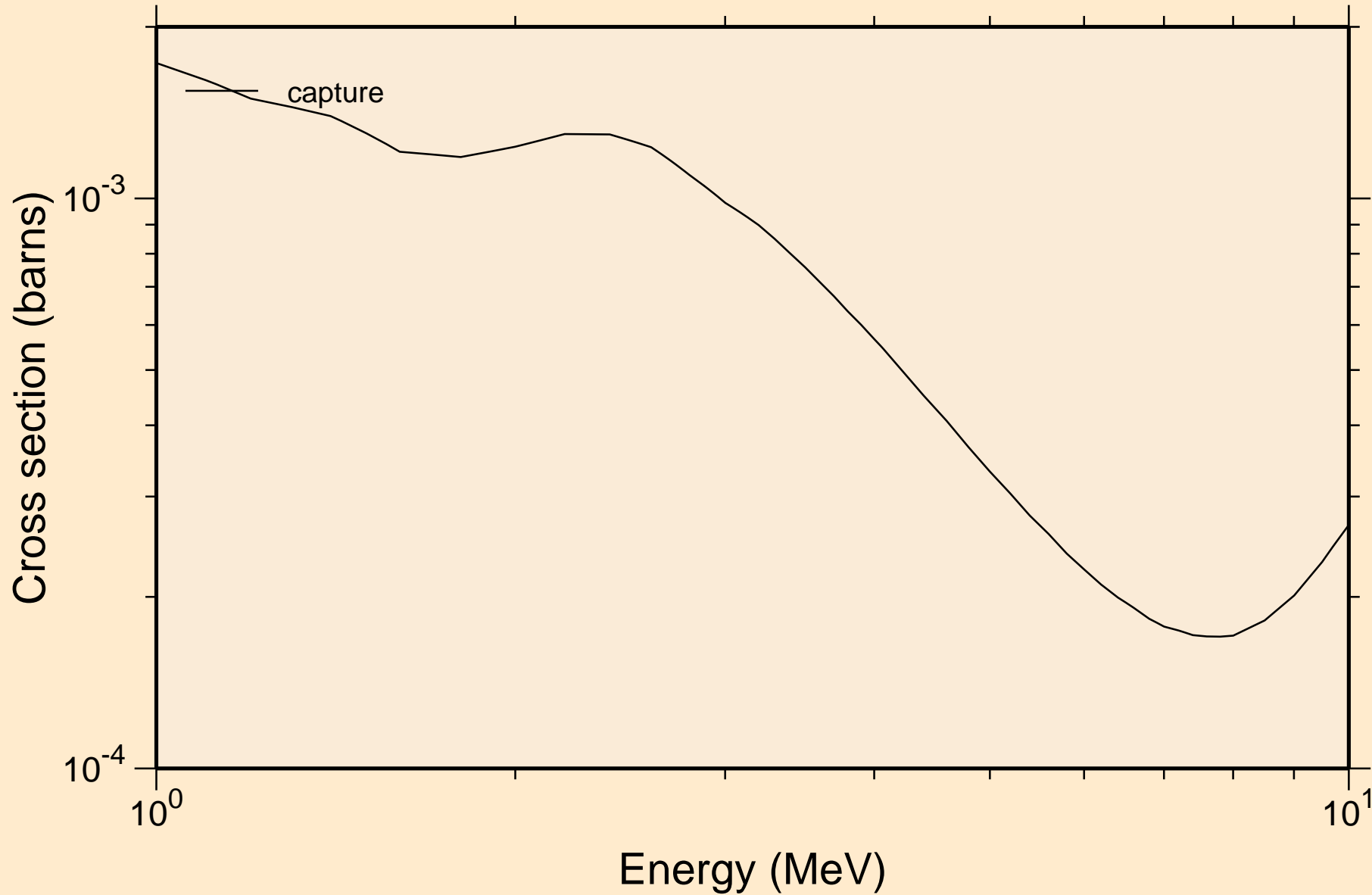

GE076 NEUTRON ACER TENDL-2021 LIBRARY; T=293.6K
Heating

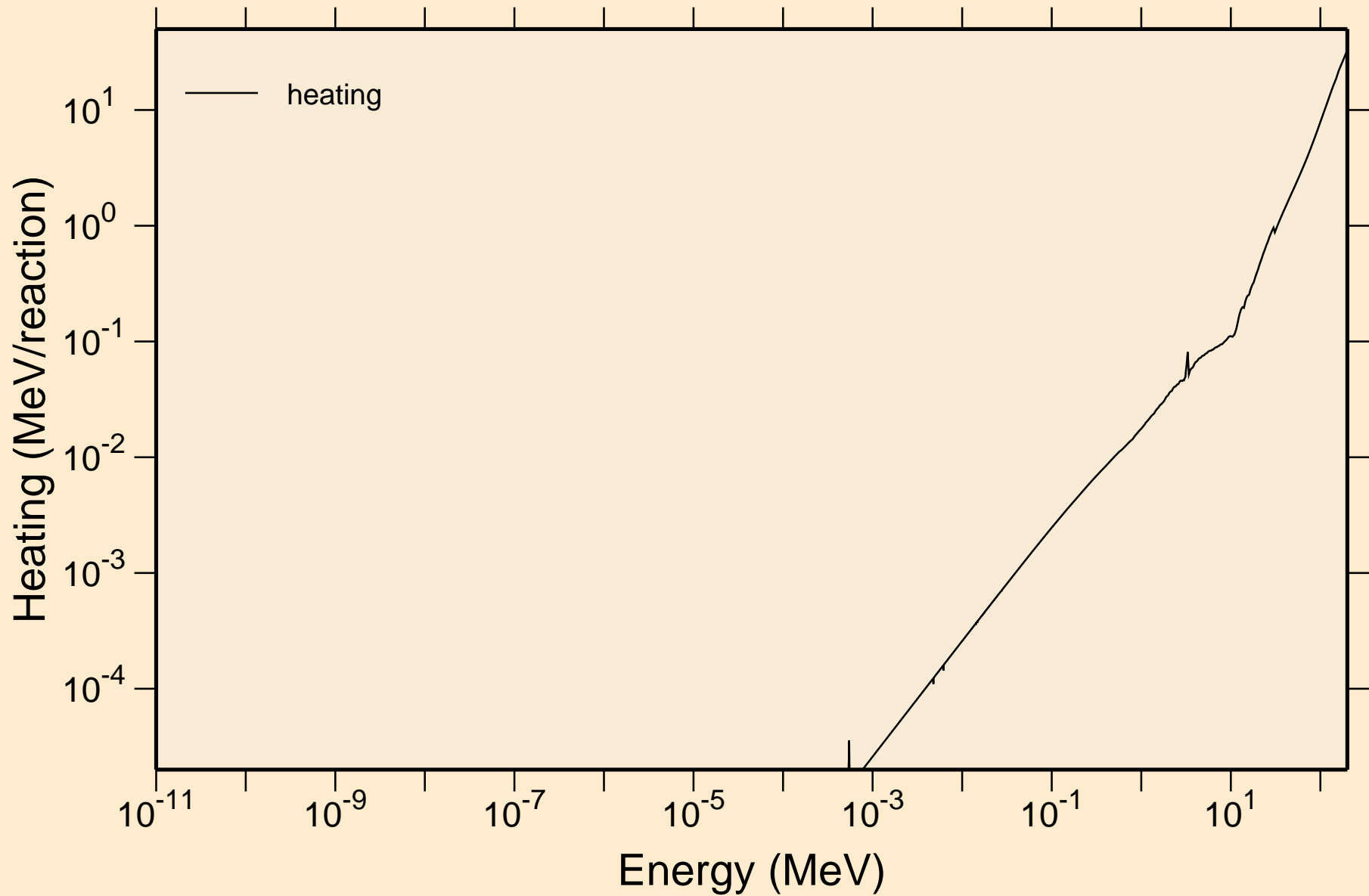

GE076 NEUTRON ACER TENDL-2021 LIBRARY; T=293.6K

Damage

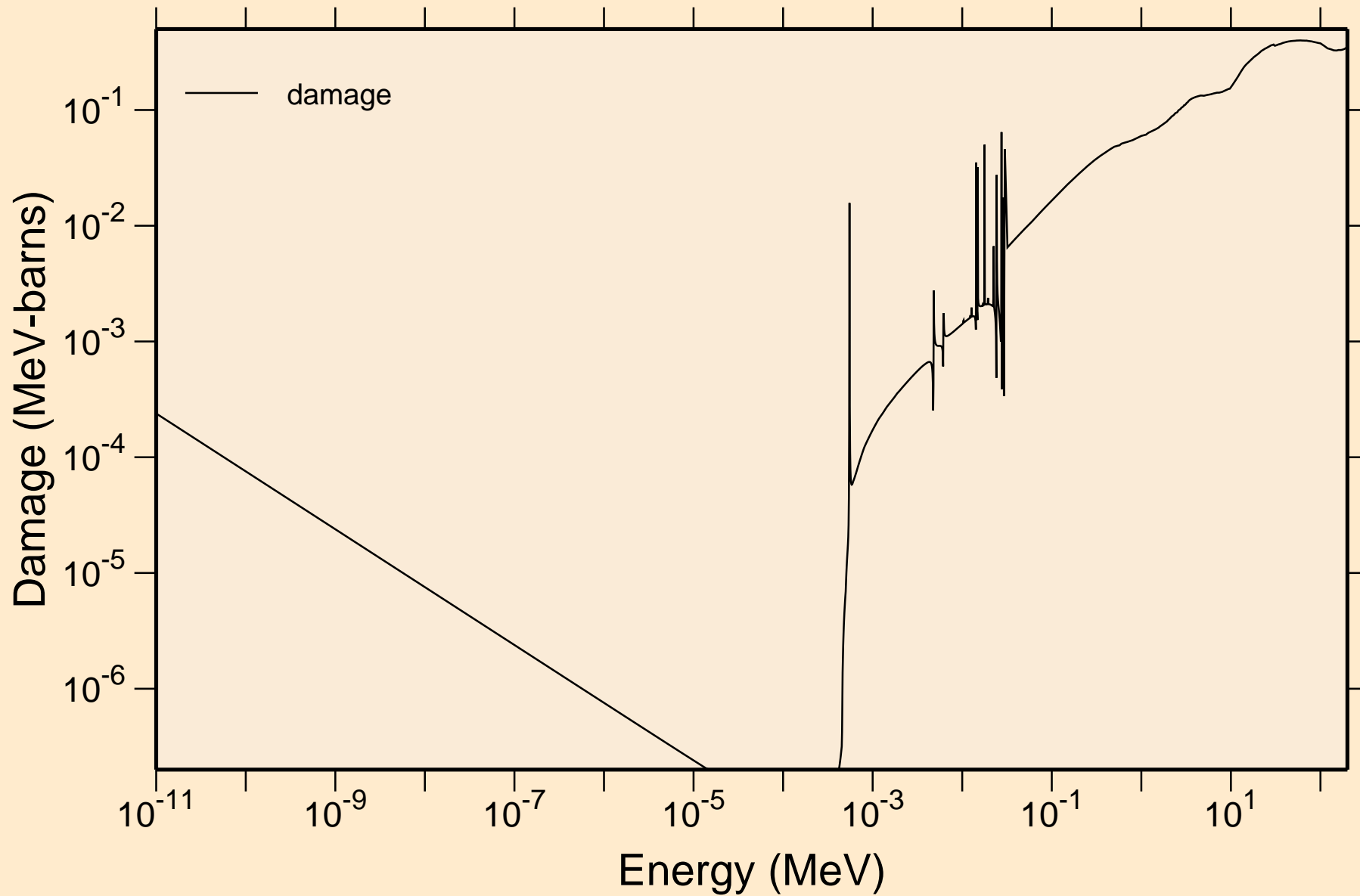

GE076 NEUTRON ACER TENDL-2021 LIBRARY; T=293.6K
Non-threshold reactions

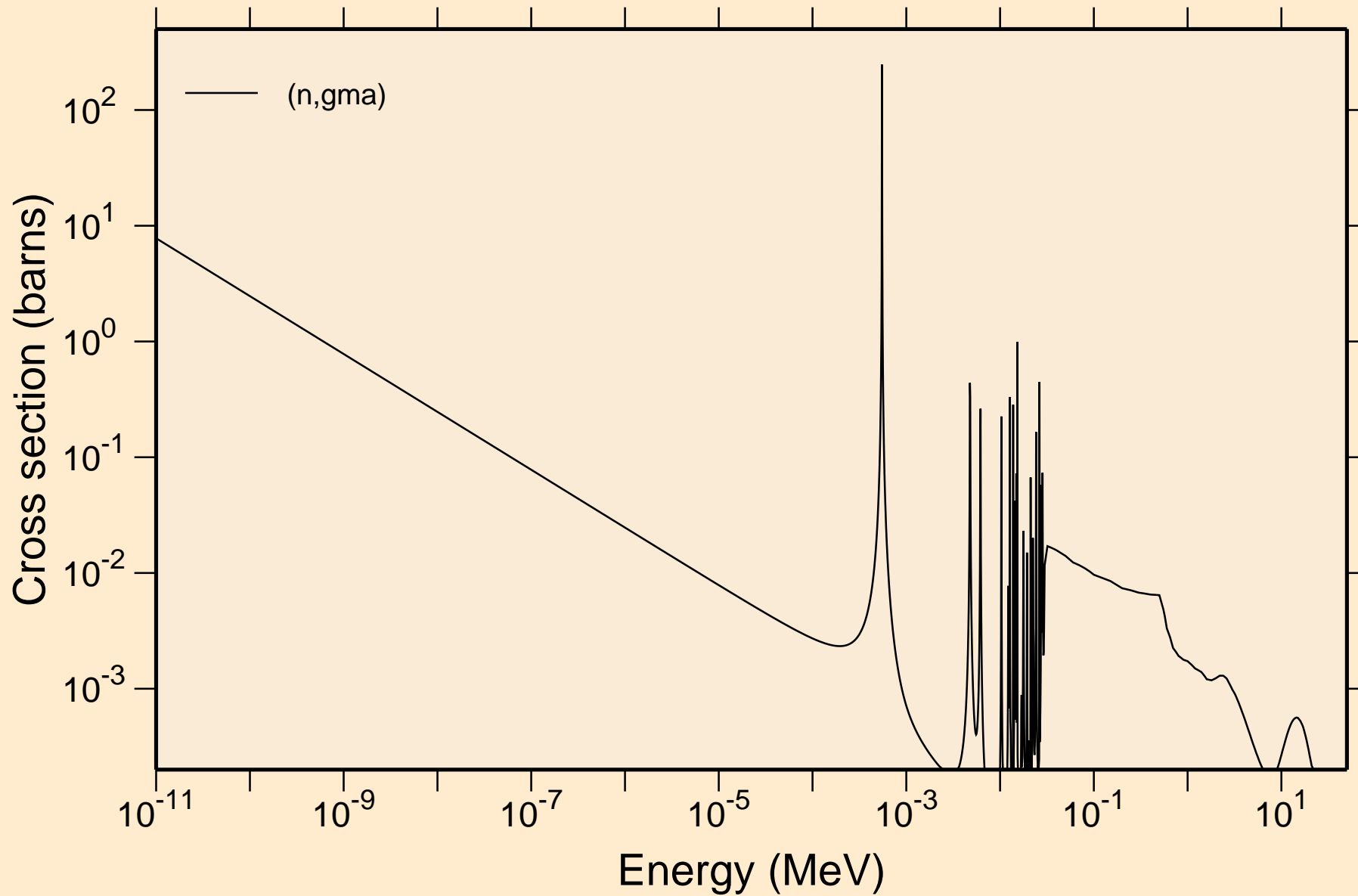

GE076 NEUTRON ACER TENDL-2021 LIBRARY; T=293.6K
Principal cross sections

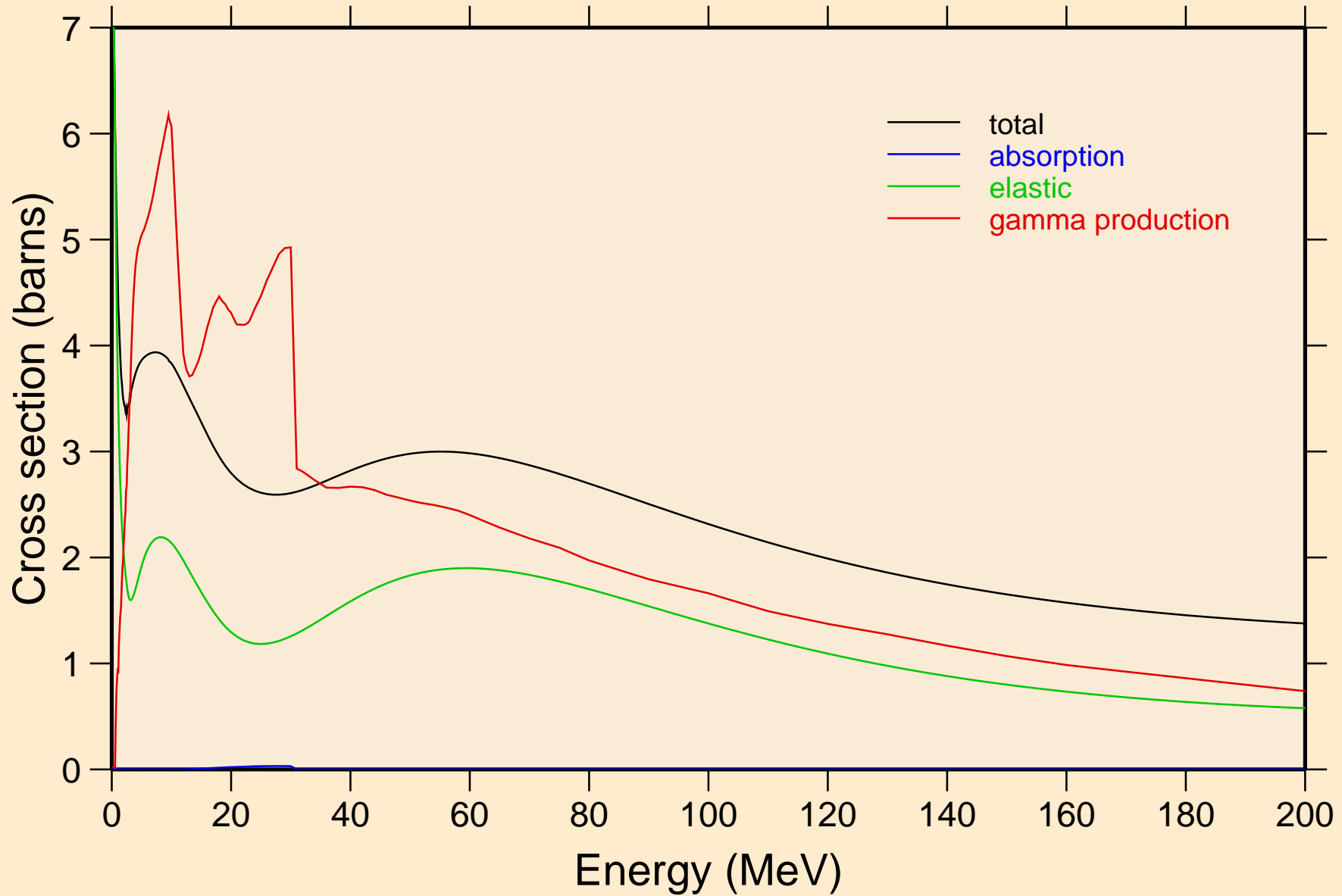

GE076 NEUTRON ACER TENDL-2021 LIBRARY; T=293.6K
Heating

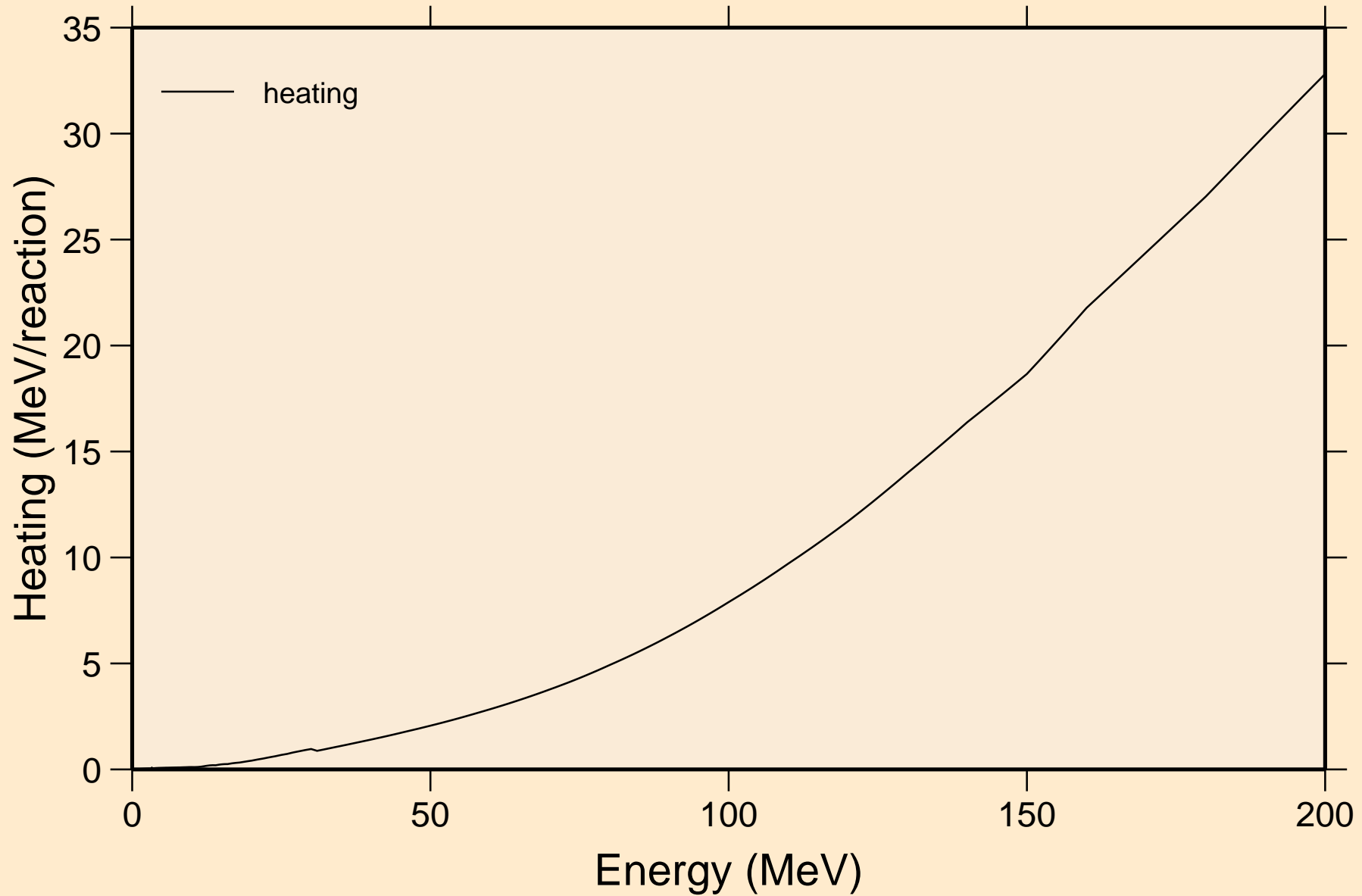

GE076 NEUTRON ACER TENDL-2021 LIBRARY; T=293.6K
Damage

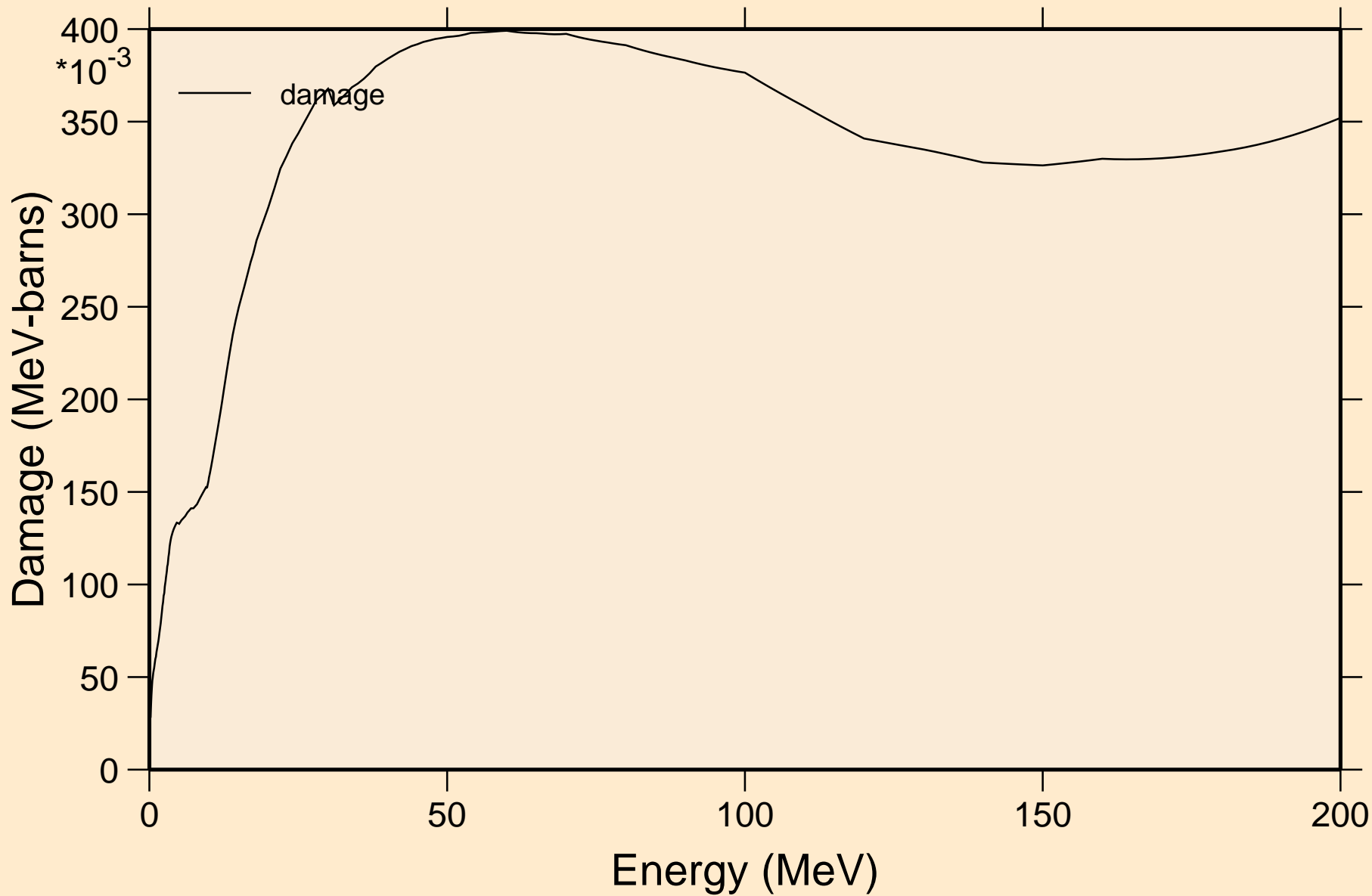

GE076 NEUTRON ACER TENDL-2021 LIBRARY; T=293.6K
Non-threshold reactions

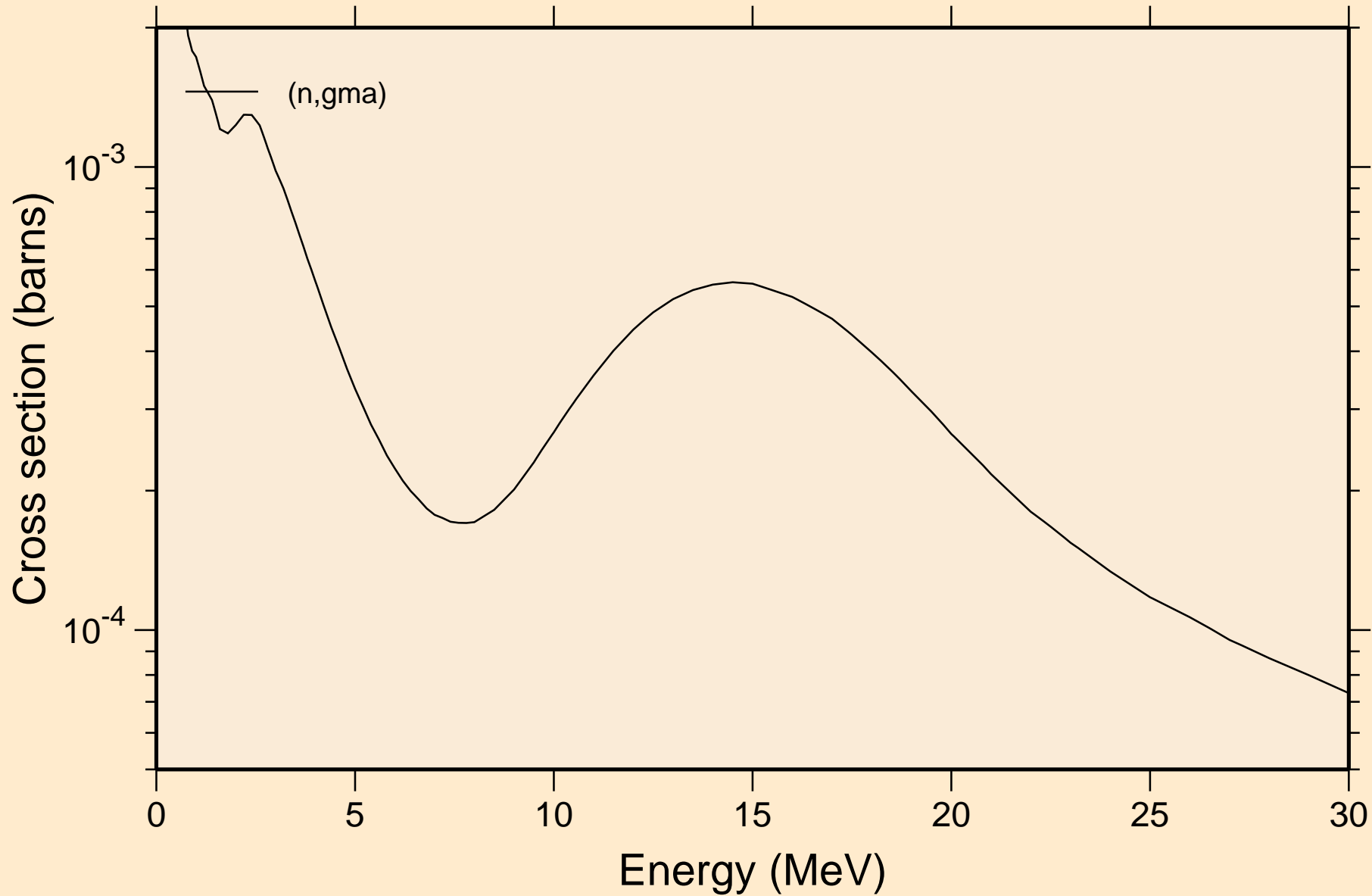

GE076 NEUTRON ACER TENDL-2021 LIBRARY; T=293.6K
Inelastic levels

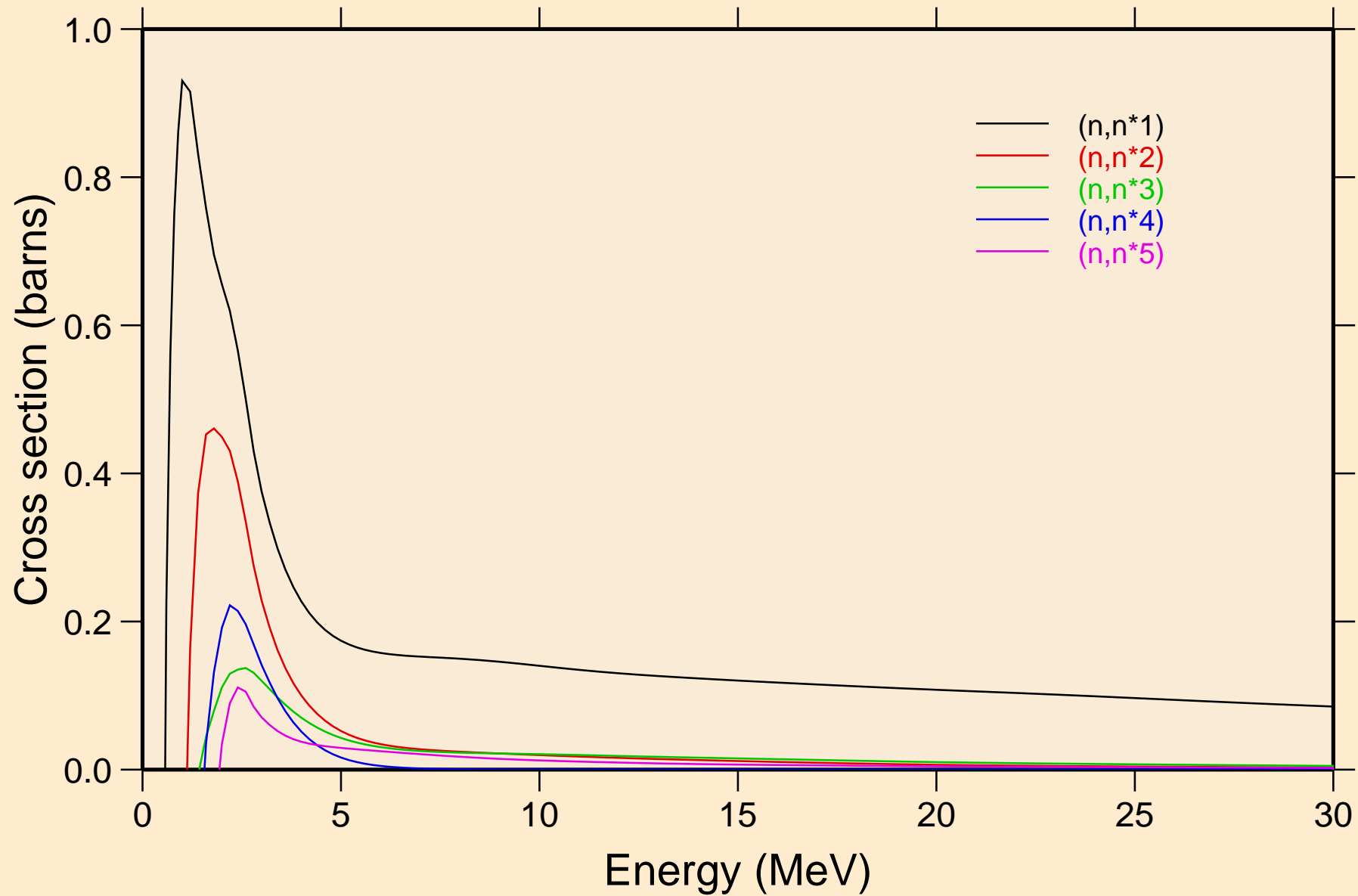

GE076 NEUTRON ACER TENDL-2021 LIBRARY; T=293.6K
Inelastic levels

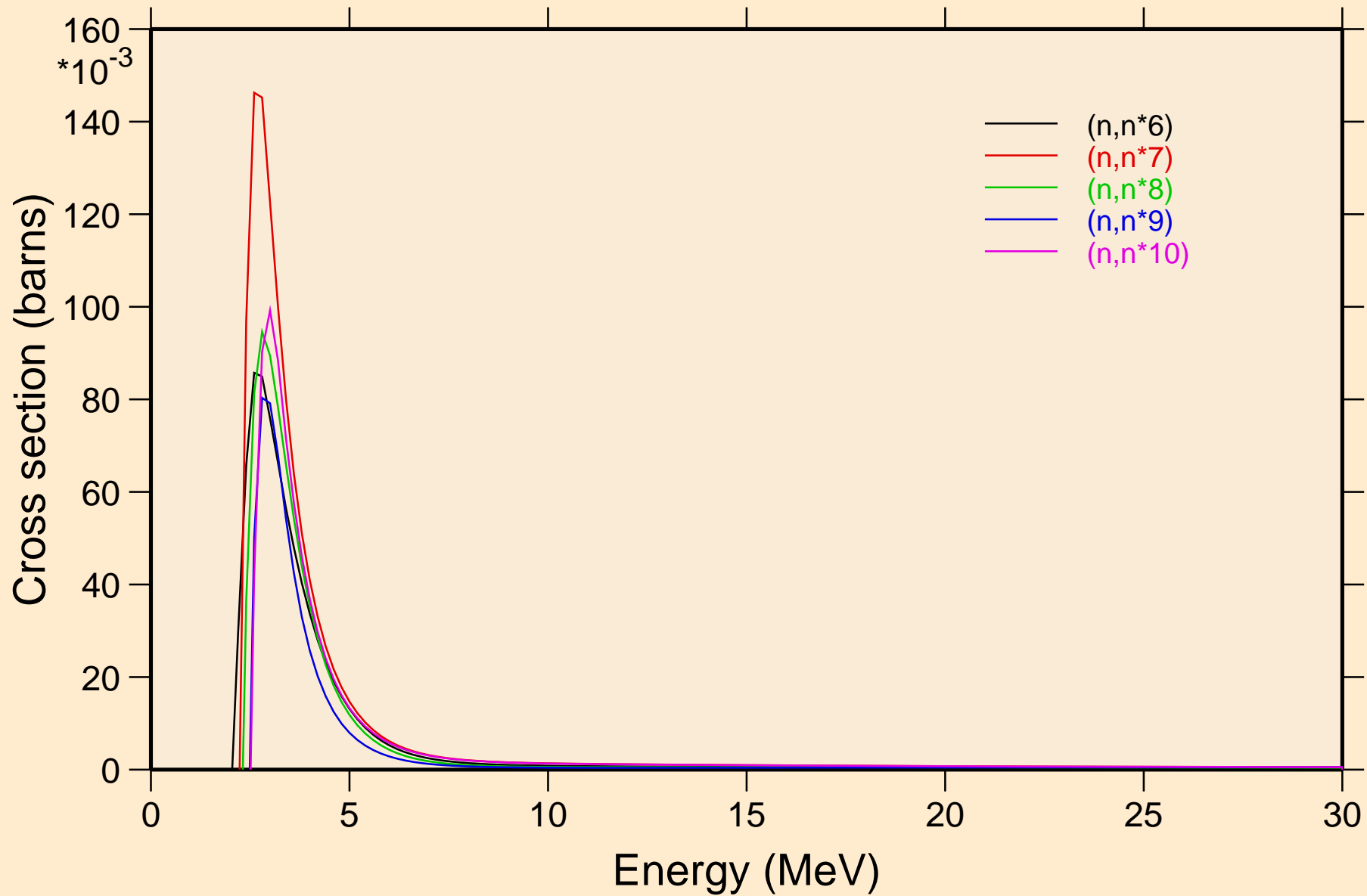

GE076 NEUTRON ACER TENDL-2021 LIBRARY; T=293.6K
Inelastic levels

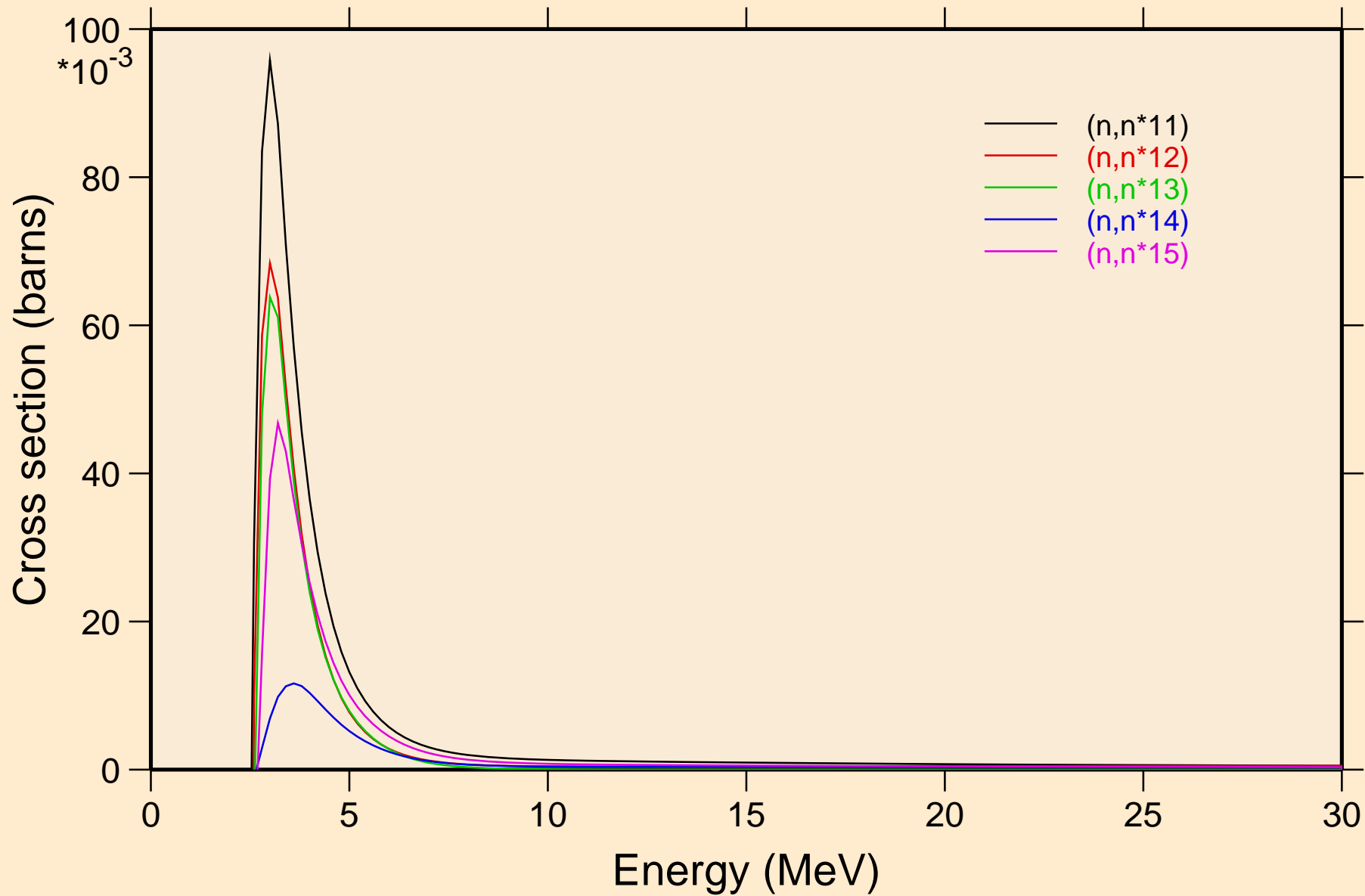

GE076 NEUTRON ACER TENDL-2021 LIBRARY; T=293.6K
Inelastic levels

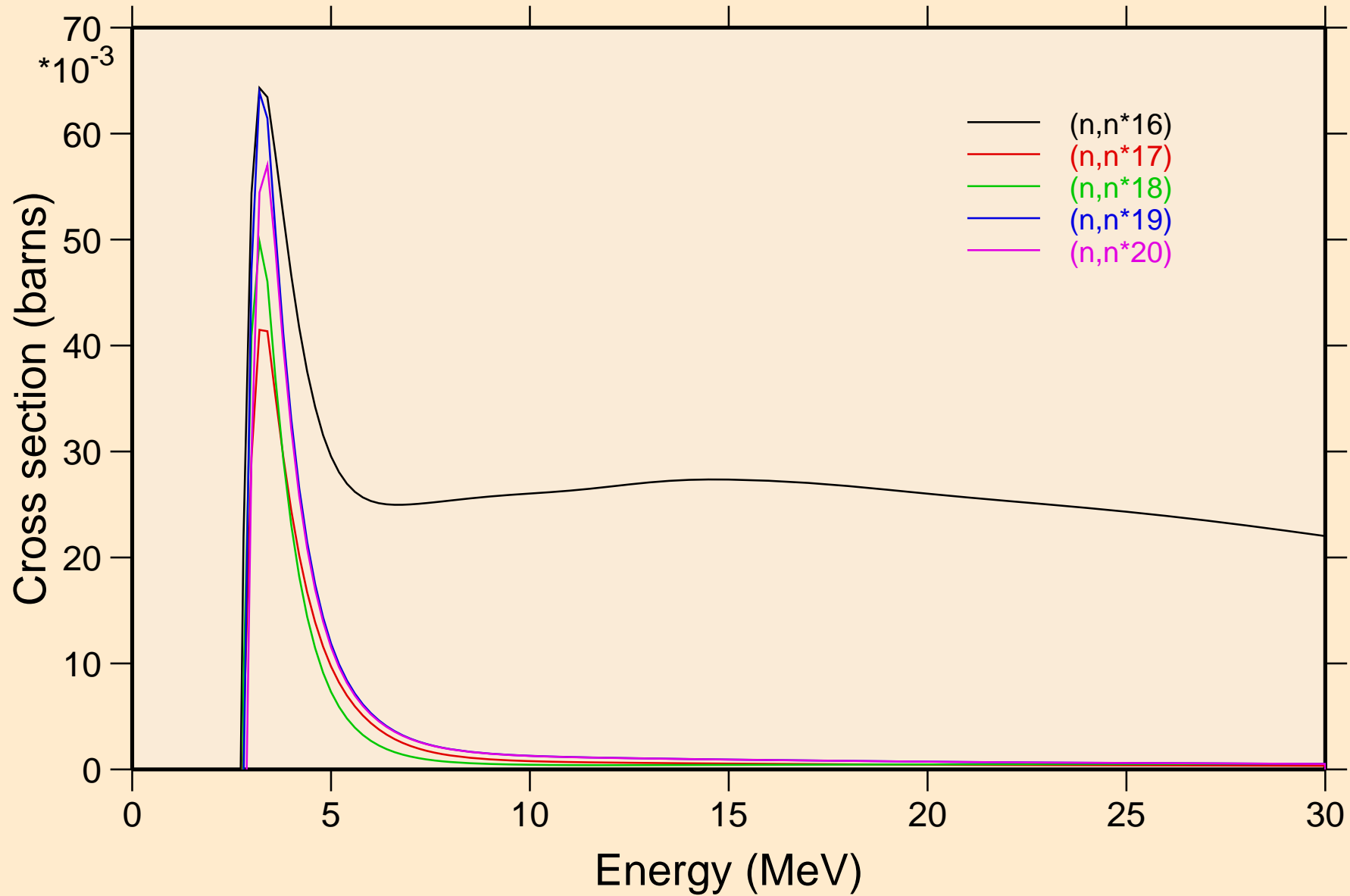

GE076 NEUTRON ACER TENDL-2021 LIBRARY; T=293.6K
Inelastic levels

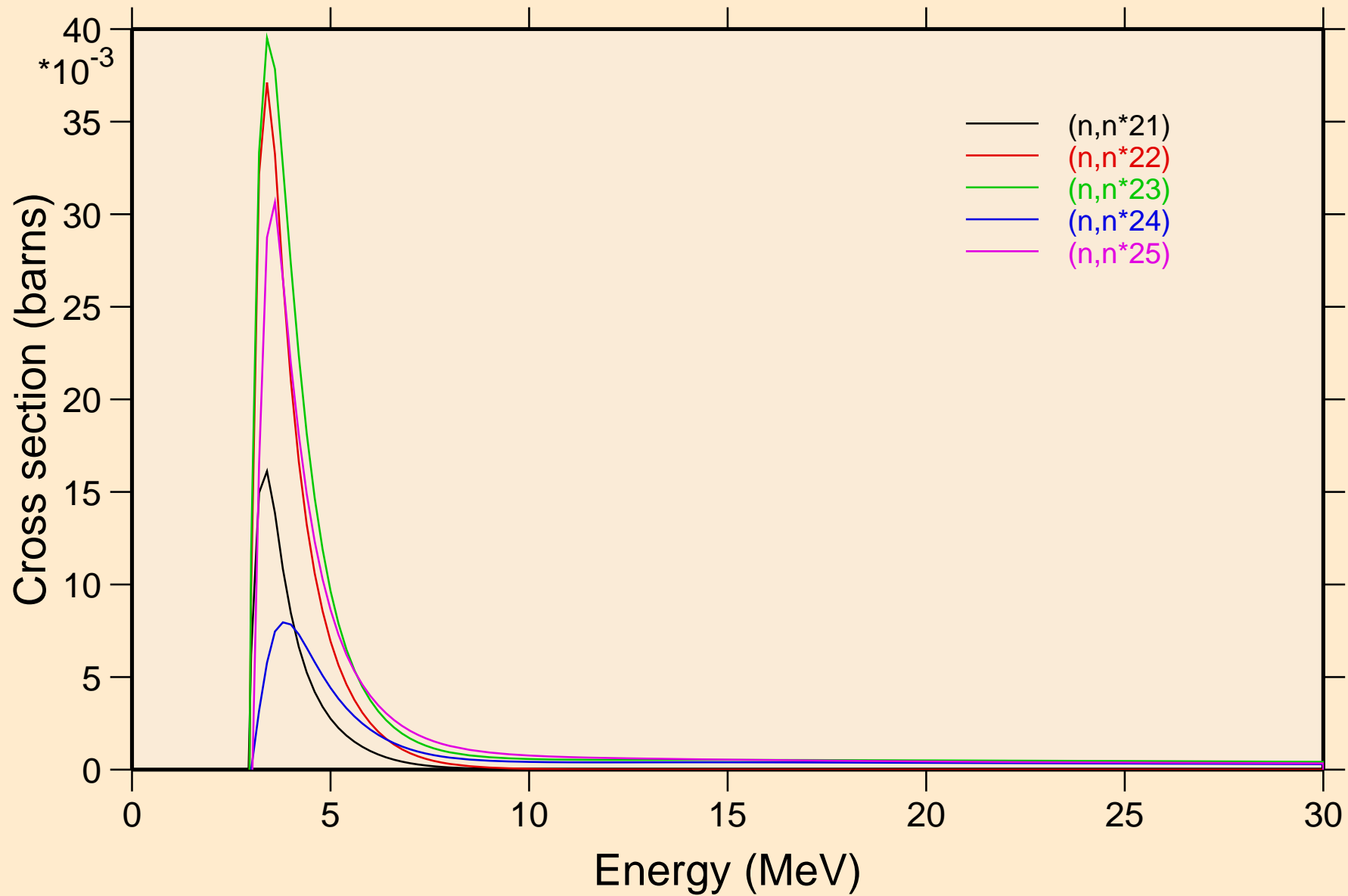

GE076 NEUTRON ACER TENDL-2021 LIBRARY; T=293.6K
Inelastic levels

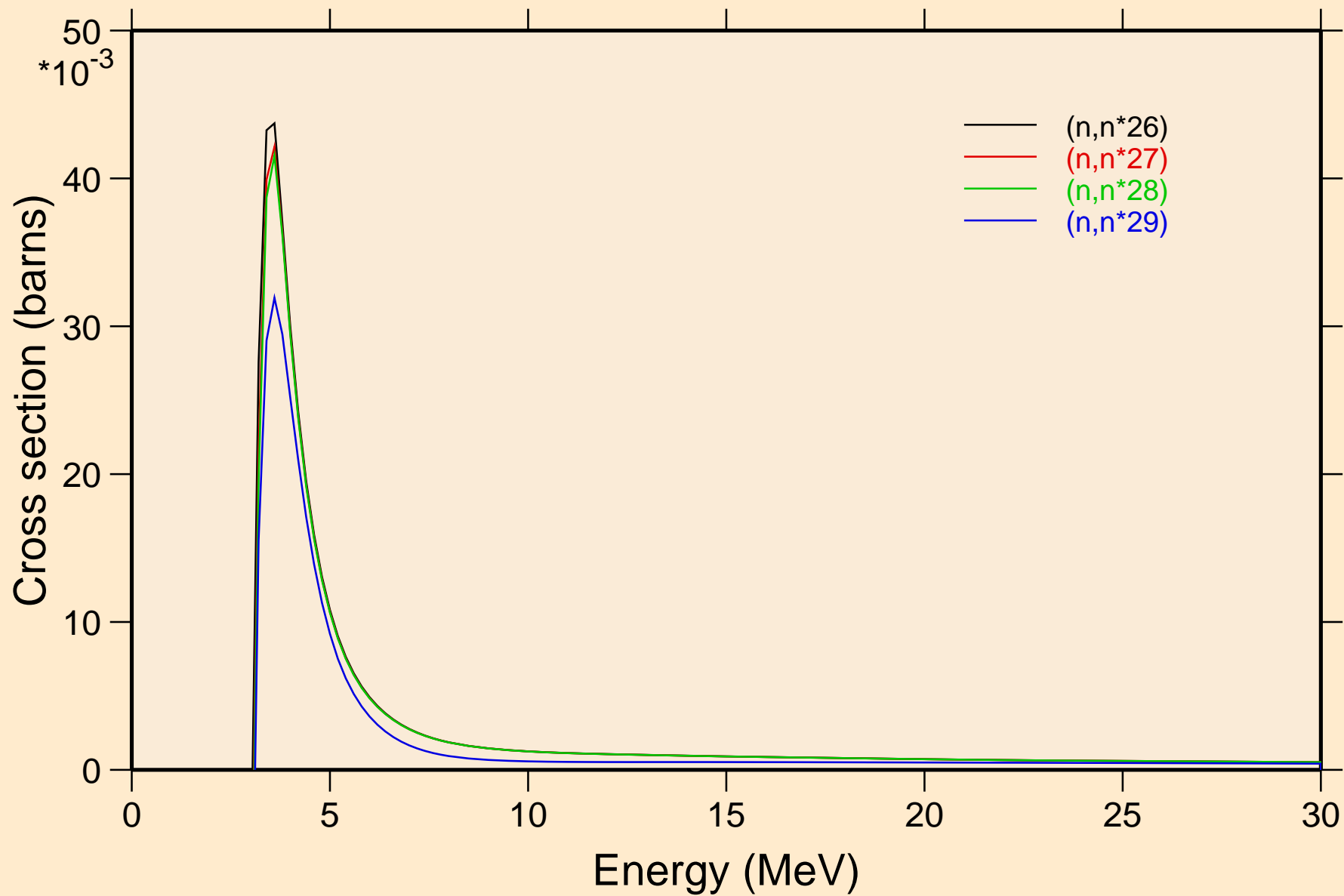

GE076 NEUTRON ACER TENDL-2021 LIBRARY; T=293.6K
Threshold reactions

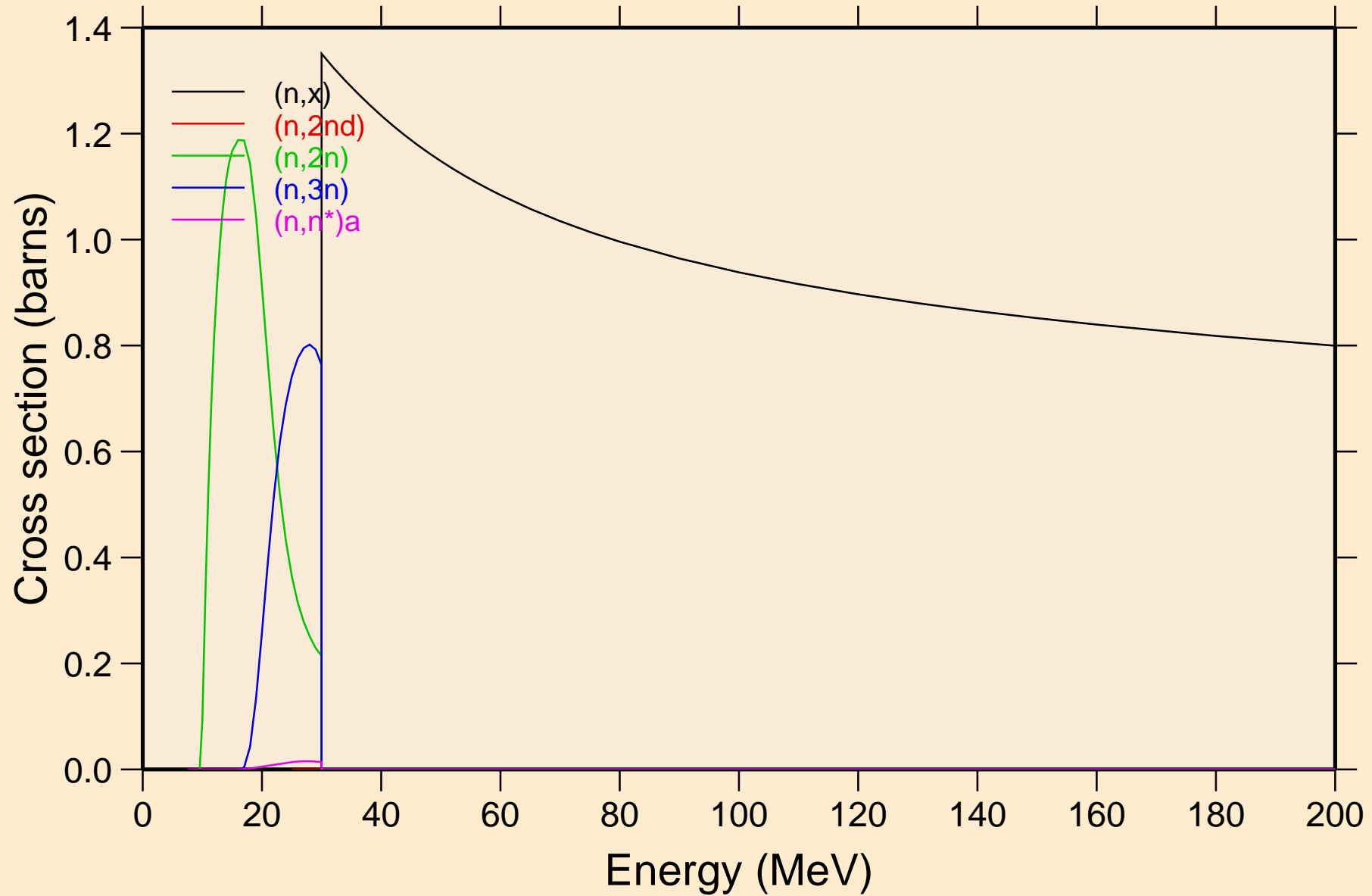

GE076 NEUTRON ACER TENDL-2021 LIBRARY; T=293.6K
Threshold reactions

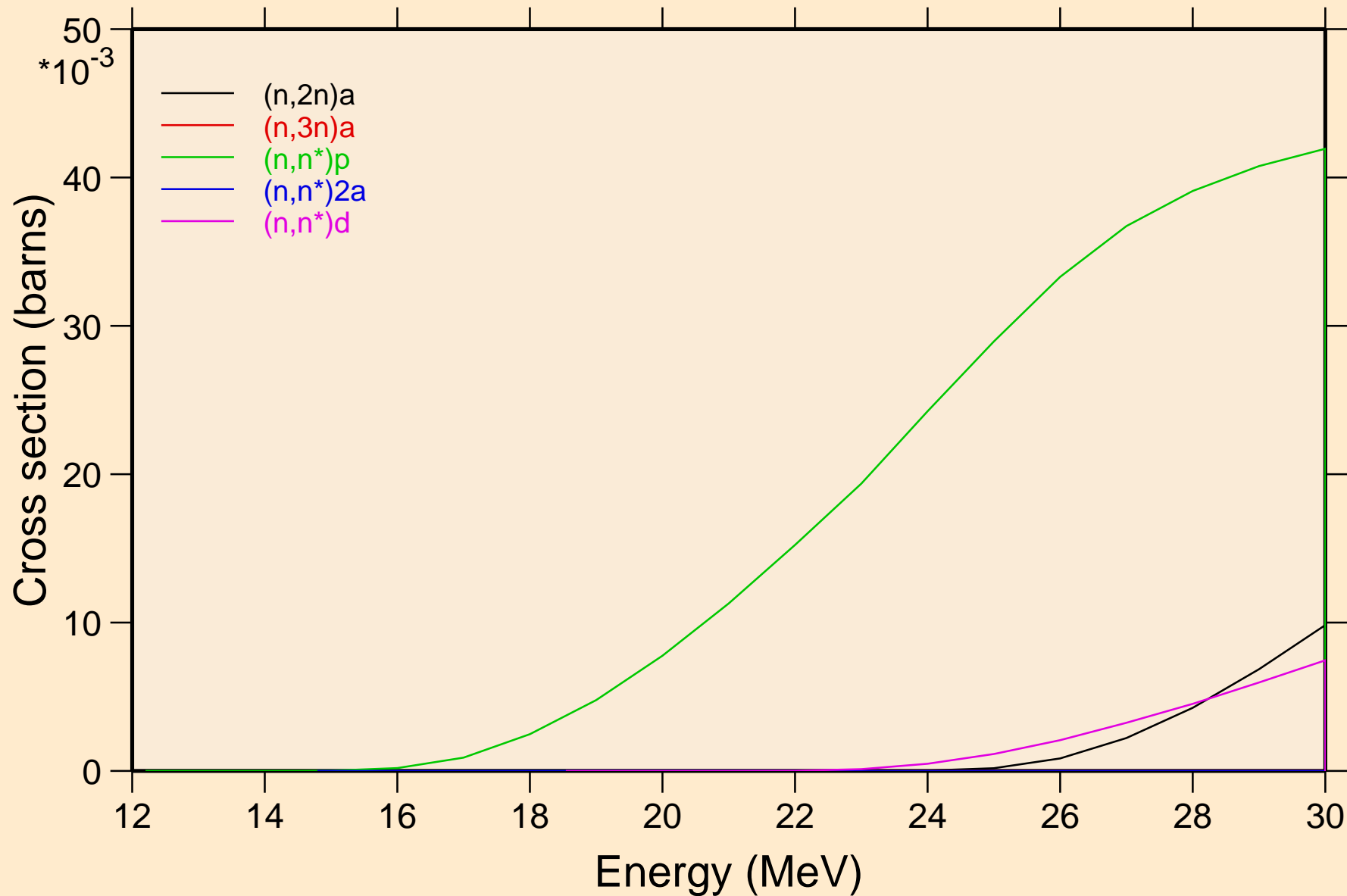

GE076 NEUTRON ACER TENDL-2021 LIBRARY; T=293.6K

Threshold reactions

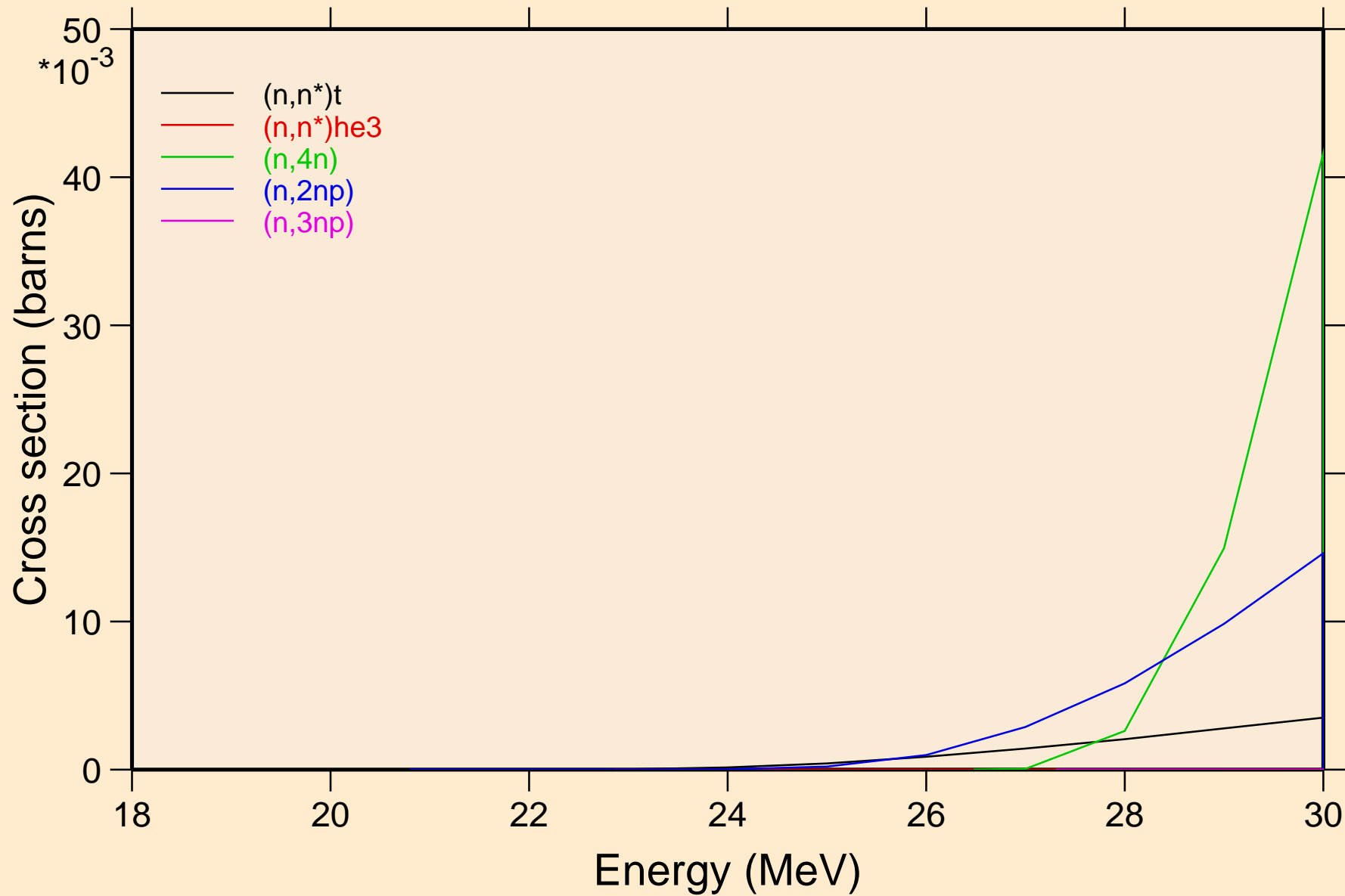

GE076 NEUTRON ACER TENDL-2021 LIBRARY; T=293.6K
Threshold reactions

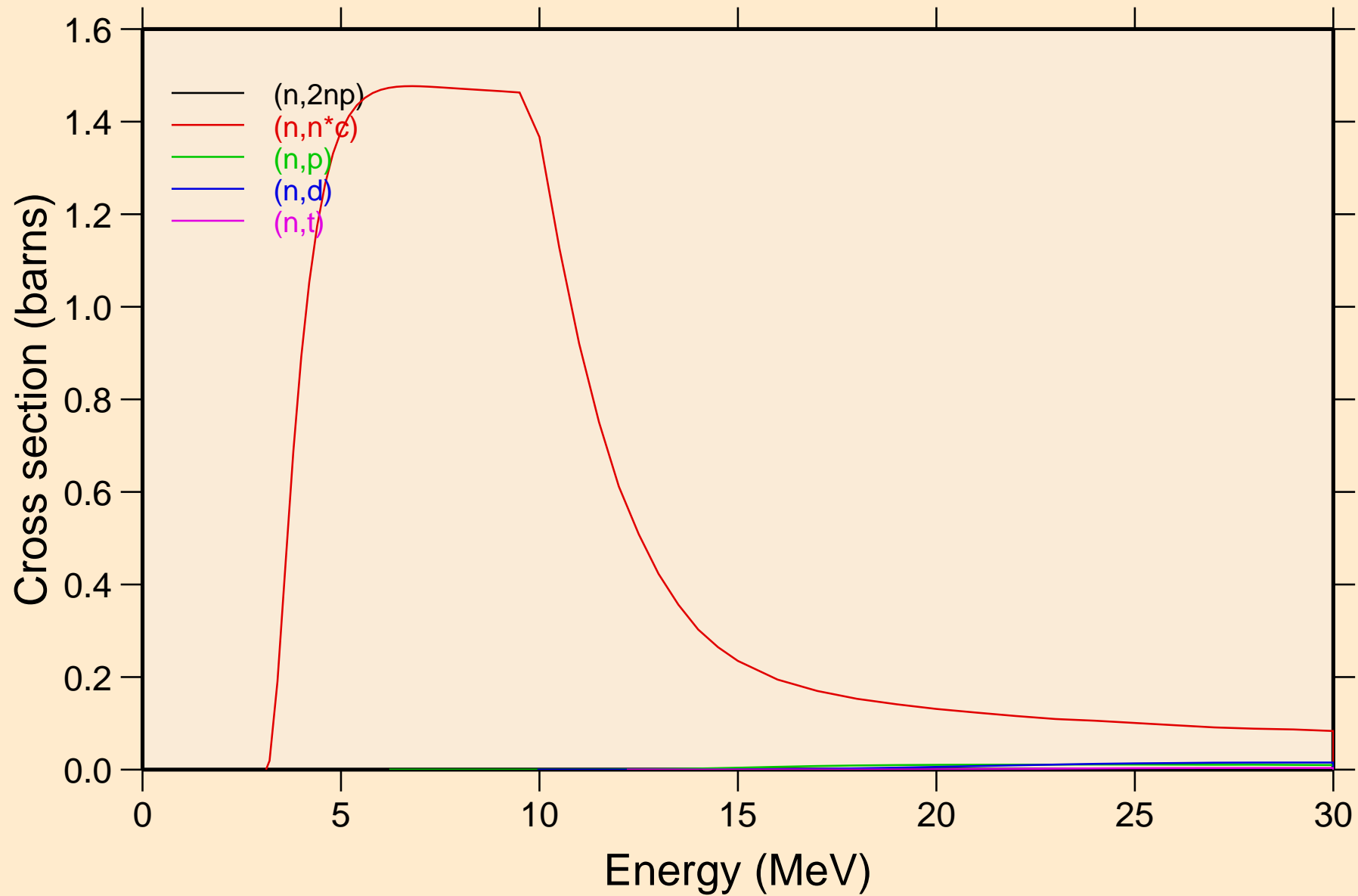

GE076 NEUTRON ACER TENDL-2021 LIBRARY; T=293.6K
Threshold reactions

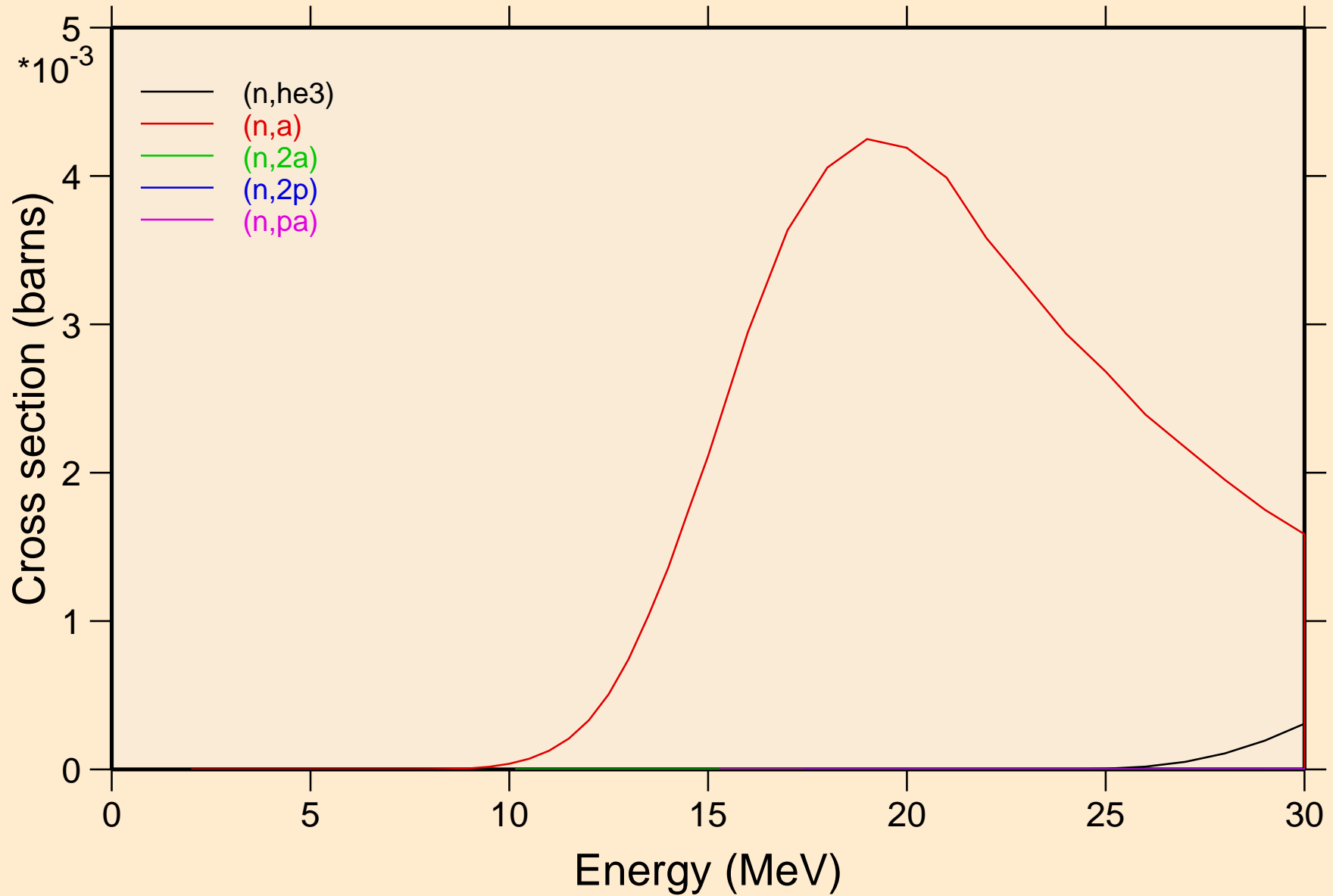

GE076 NEUTRON ACER TENDL-2021 LIBRARY; T=293.6K

Threshold reactions

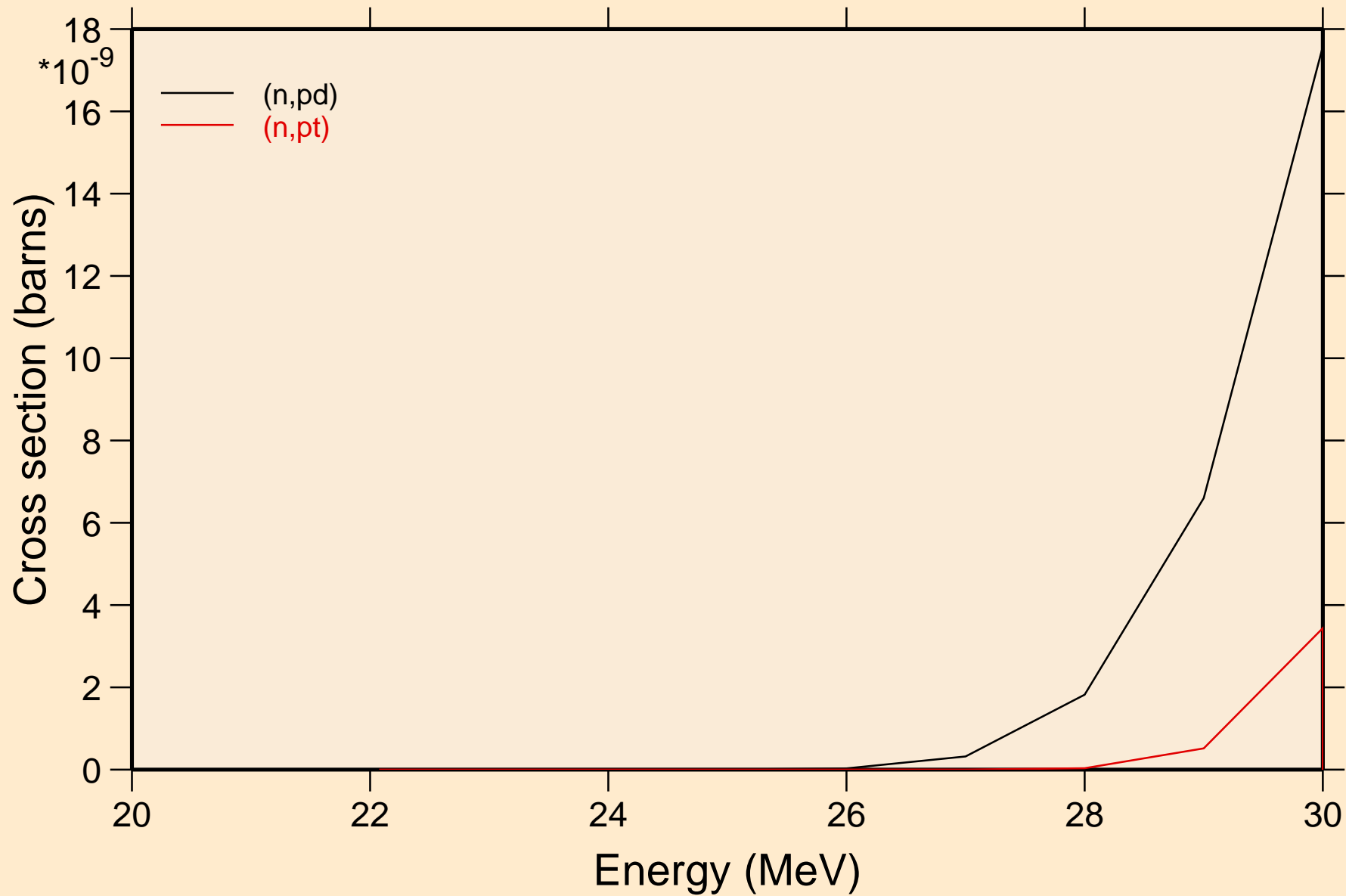

GE076 NEUTRON ACER TENDL-2021 LIBRARY; T=293.6K
Threshold reactions

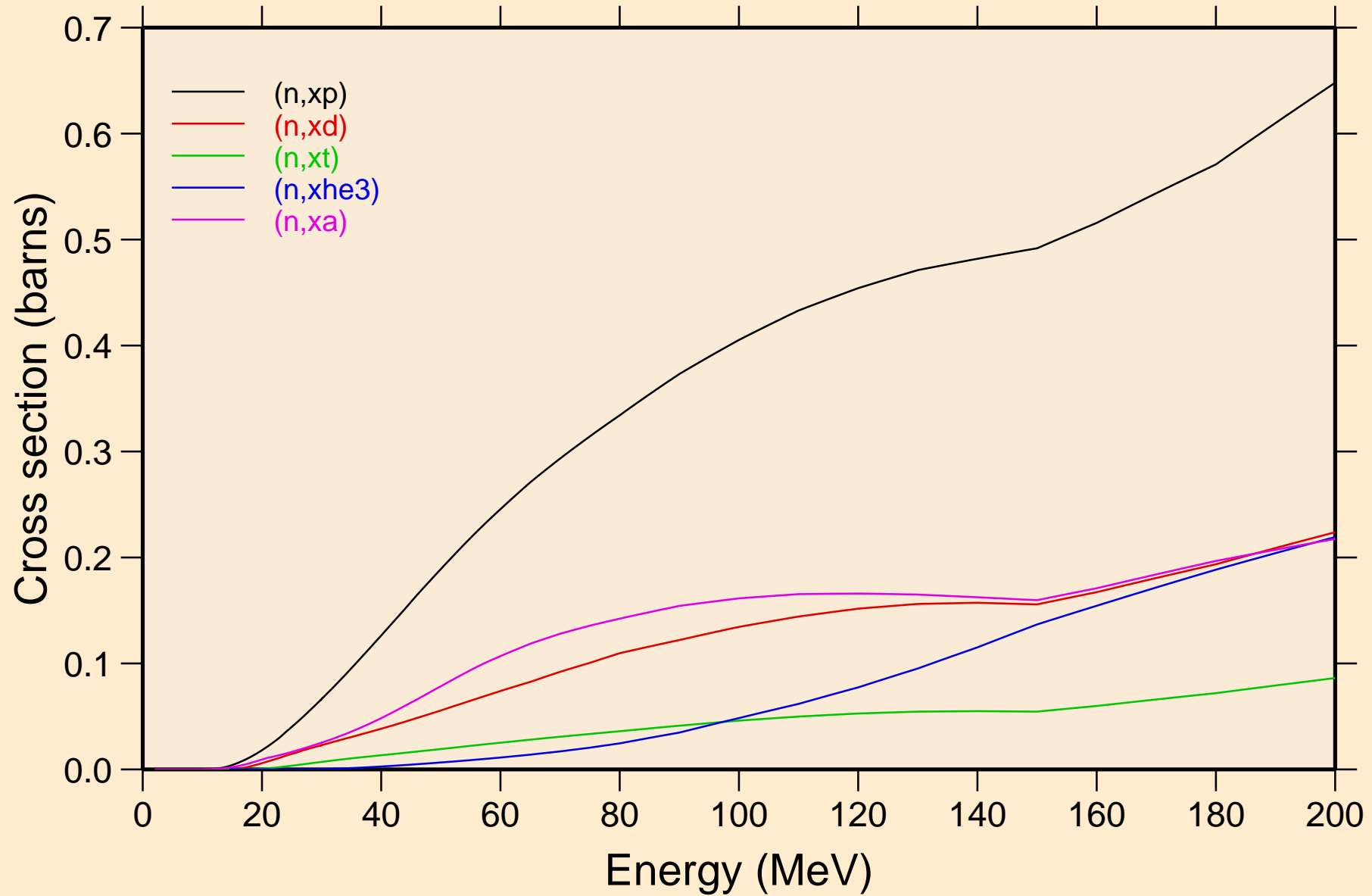

GE076 NEUTRON ACER TENDL-2021 LIBRARY; T=293.6K
angular distribution for elastic

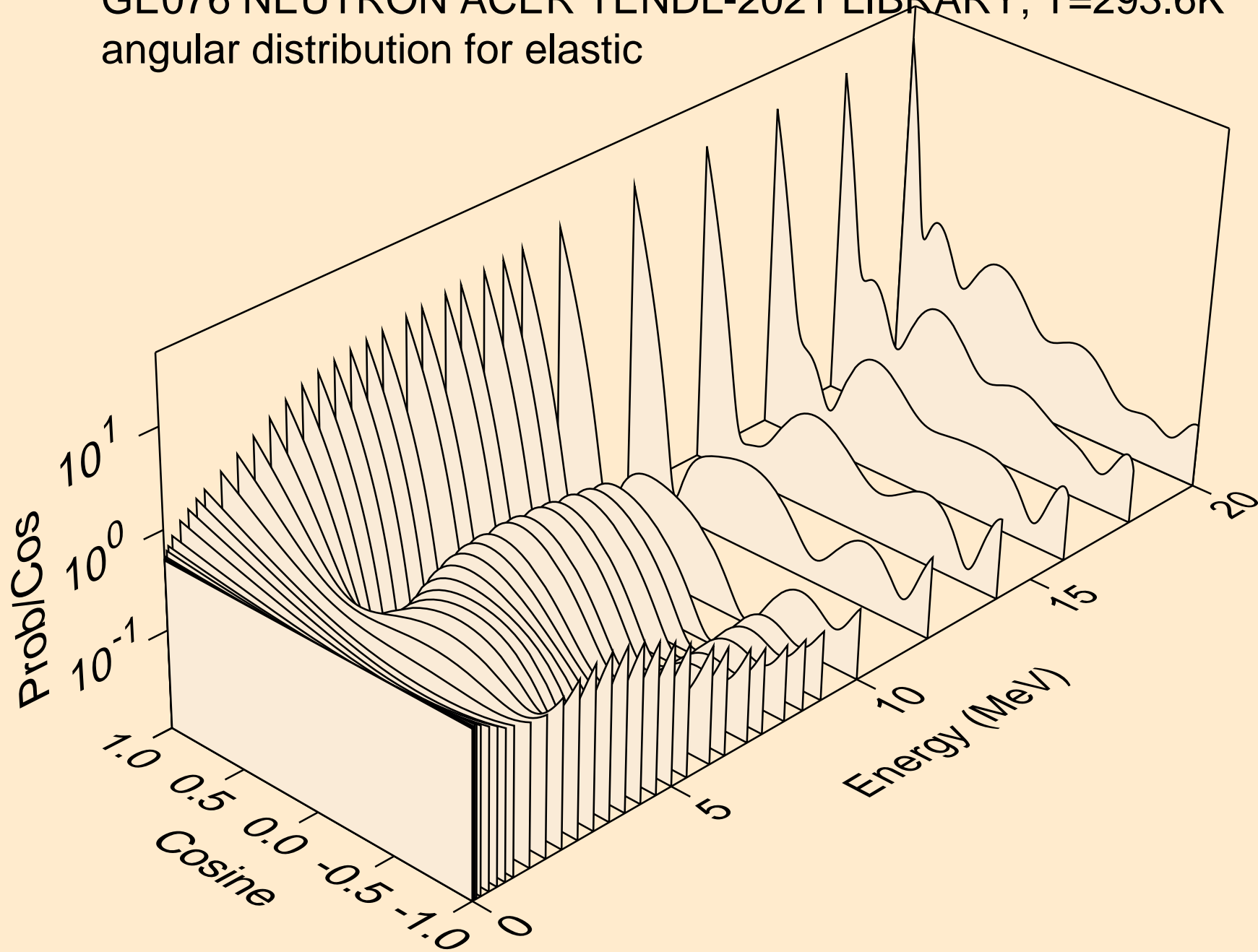

GE076 NEUTRON ACER TENDL-2021 LIBRARY; T=293.6K
angular distribution for elastic

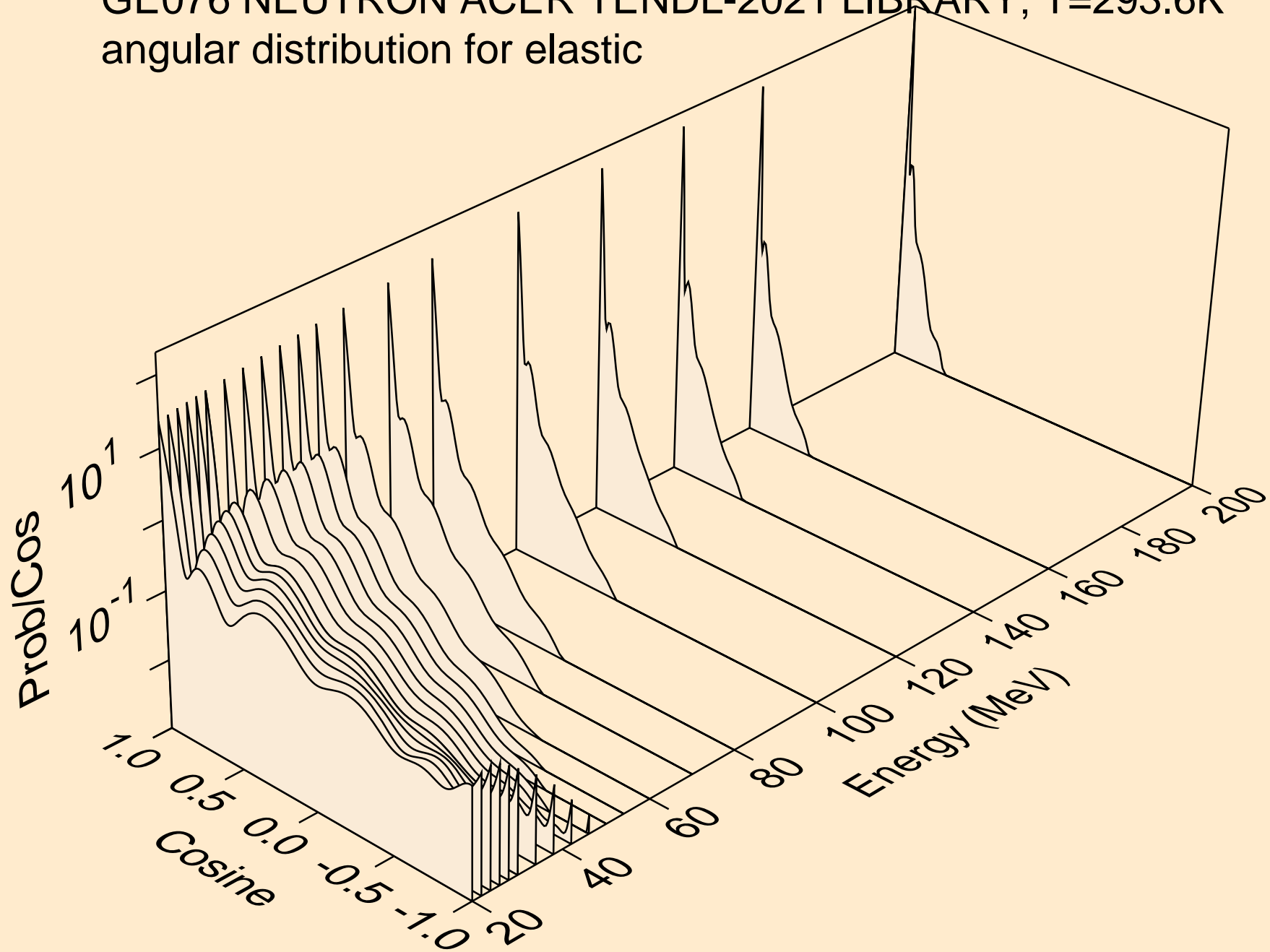

GE076 NEUTRON ACER TENDL-2021 LIBRARY; T=293.6K
angular distribution for (n,n*1)

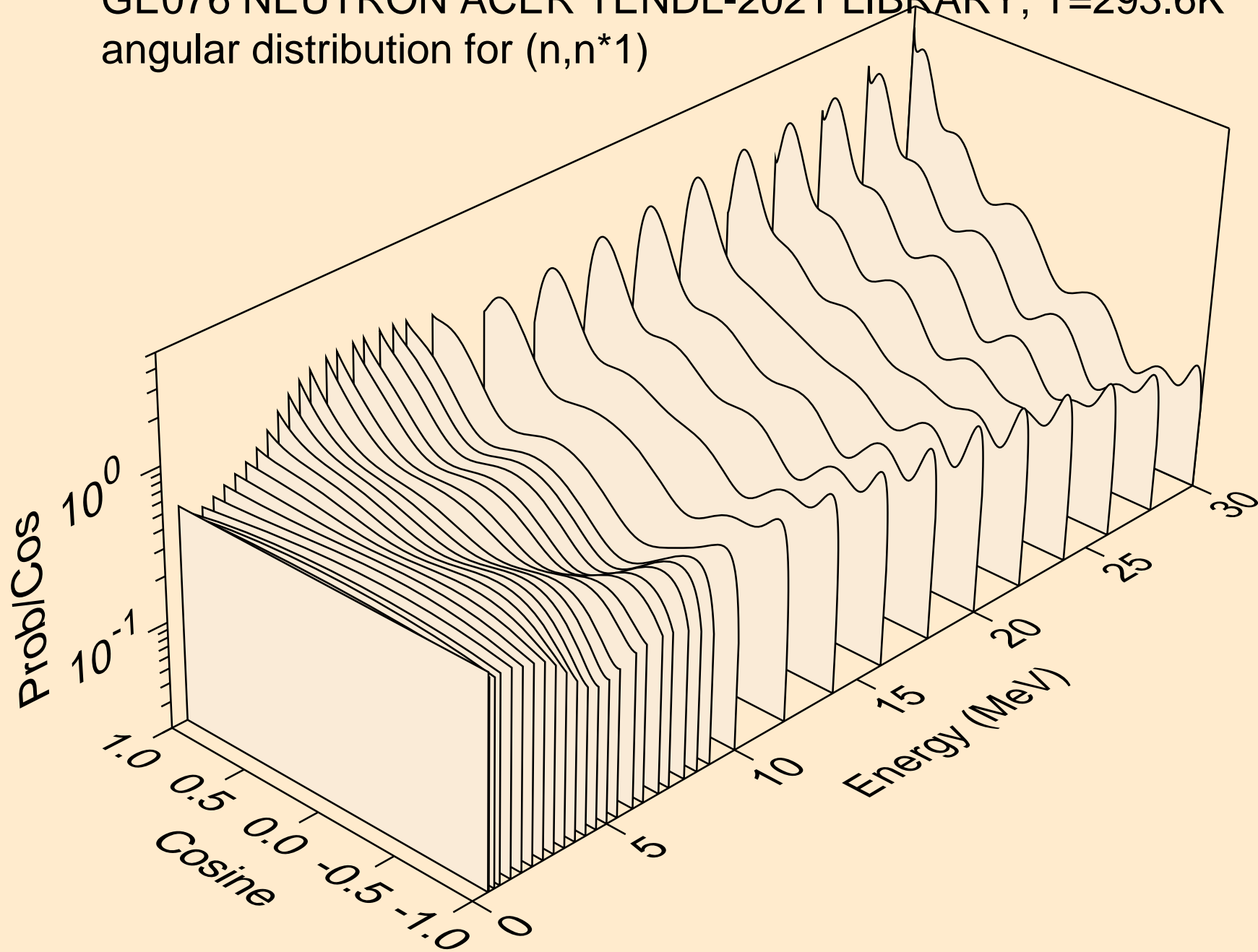

GE076 NEUTRON ACER TENDL-2021 LIBRARY; T=293.6K
angular distribution for (n,n*2)

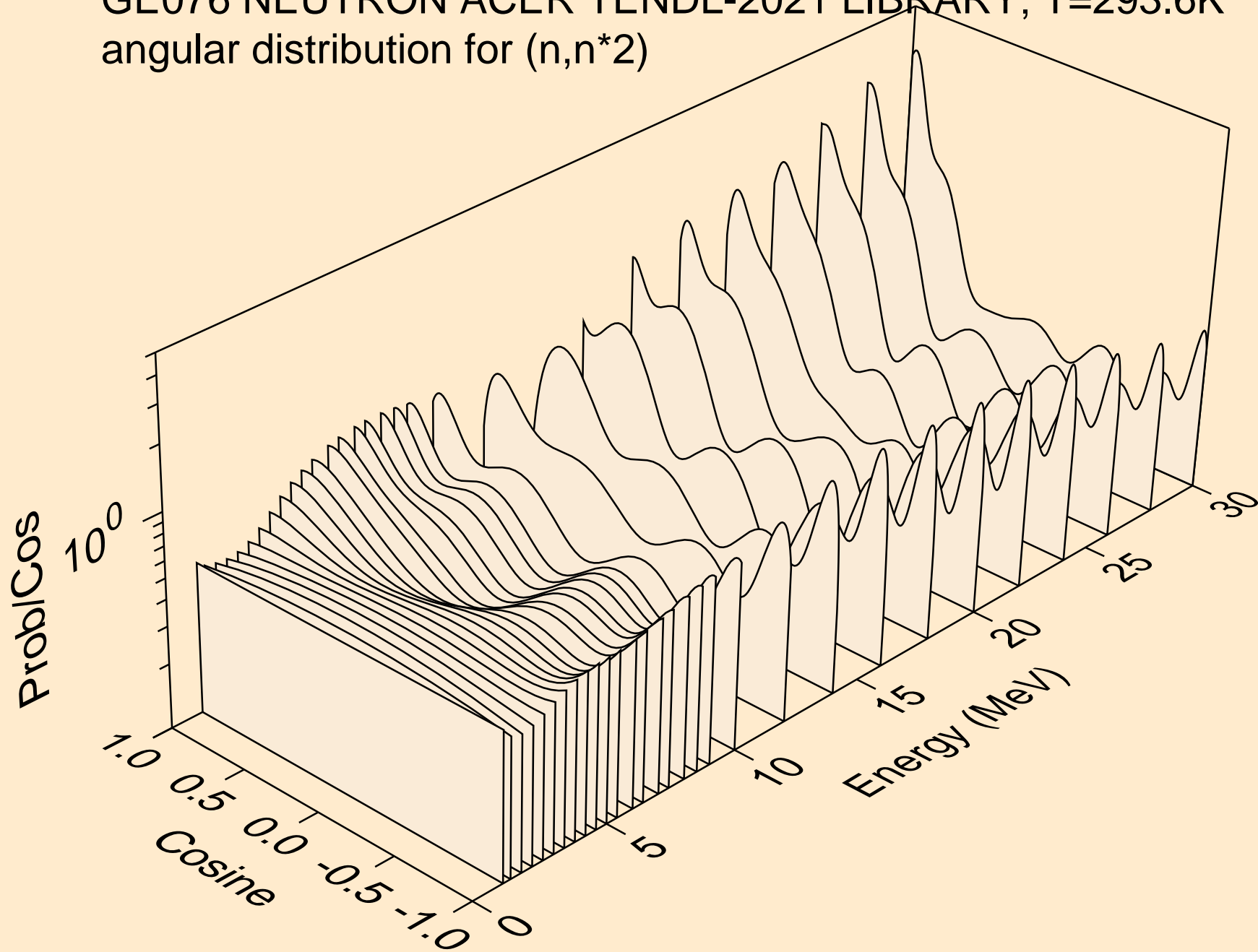

GE076 NEUTRON ACER TENDL-2021 LIBRARY; T=293.6K
angular distribution for (n,n*3)

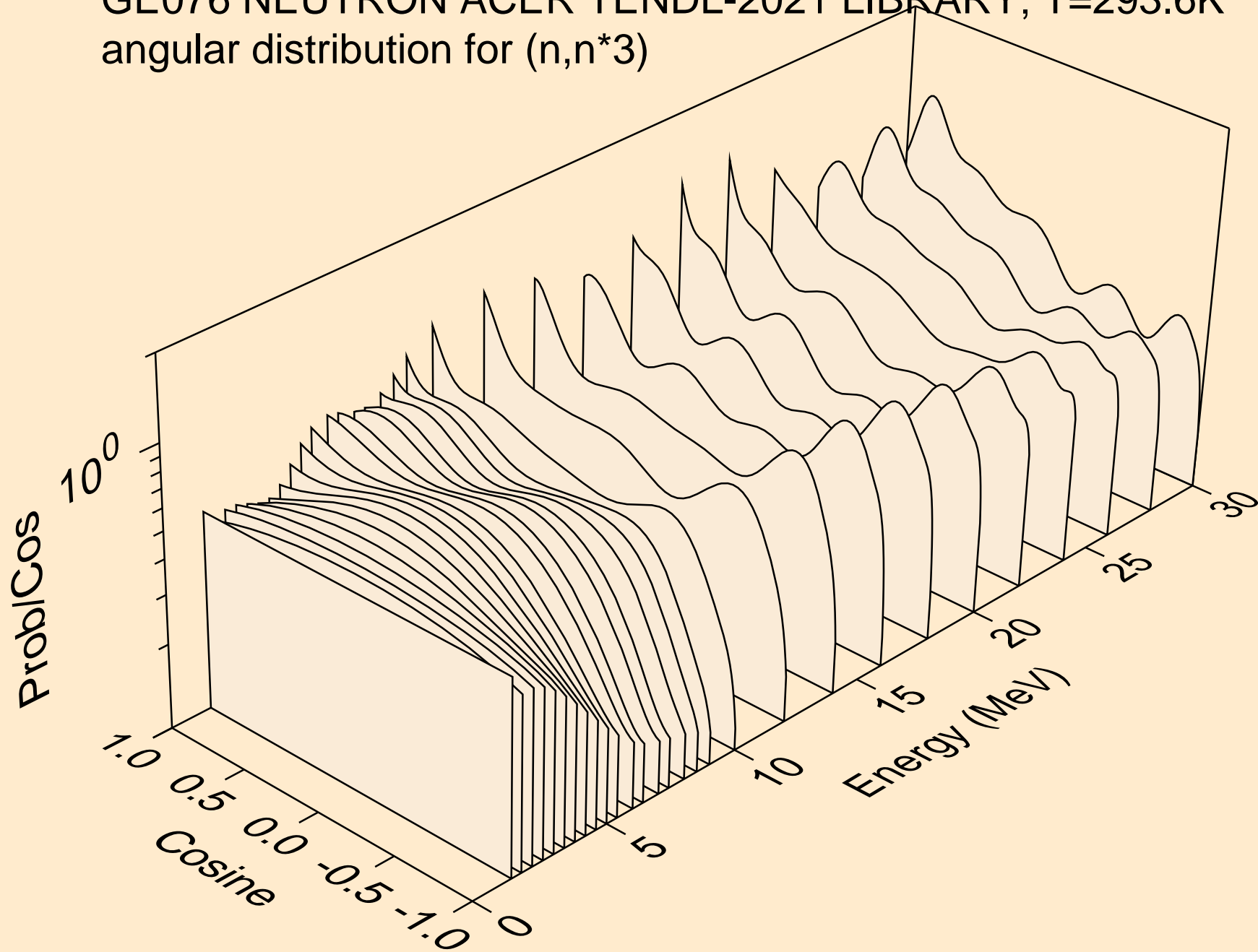

GE076 NEUTRON ACER TENDL-2021 LIBRARY; T=293.6K
angular distribution for (n,n*4)

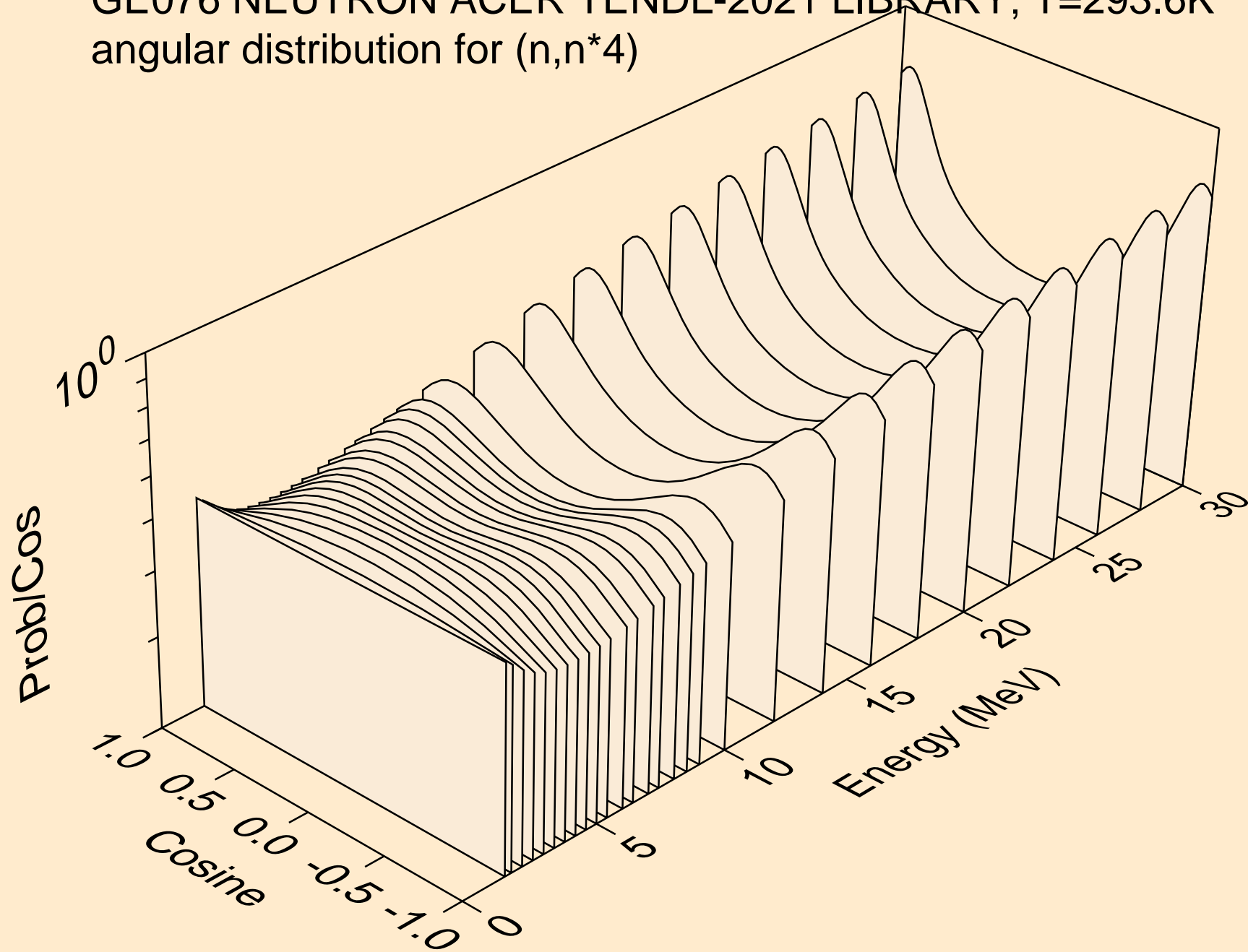

GE076 NEUTRON ACER TENDL-2021 LIBRARY; T=293.6K
angular distribution for (n,n*5)

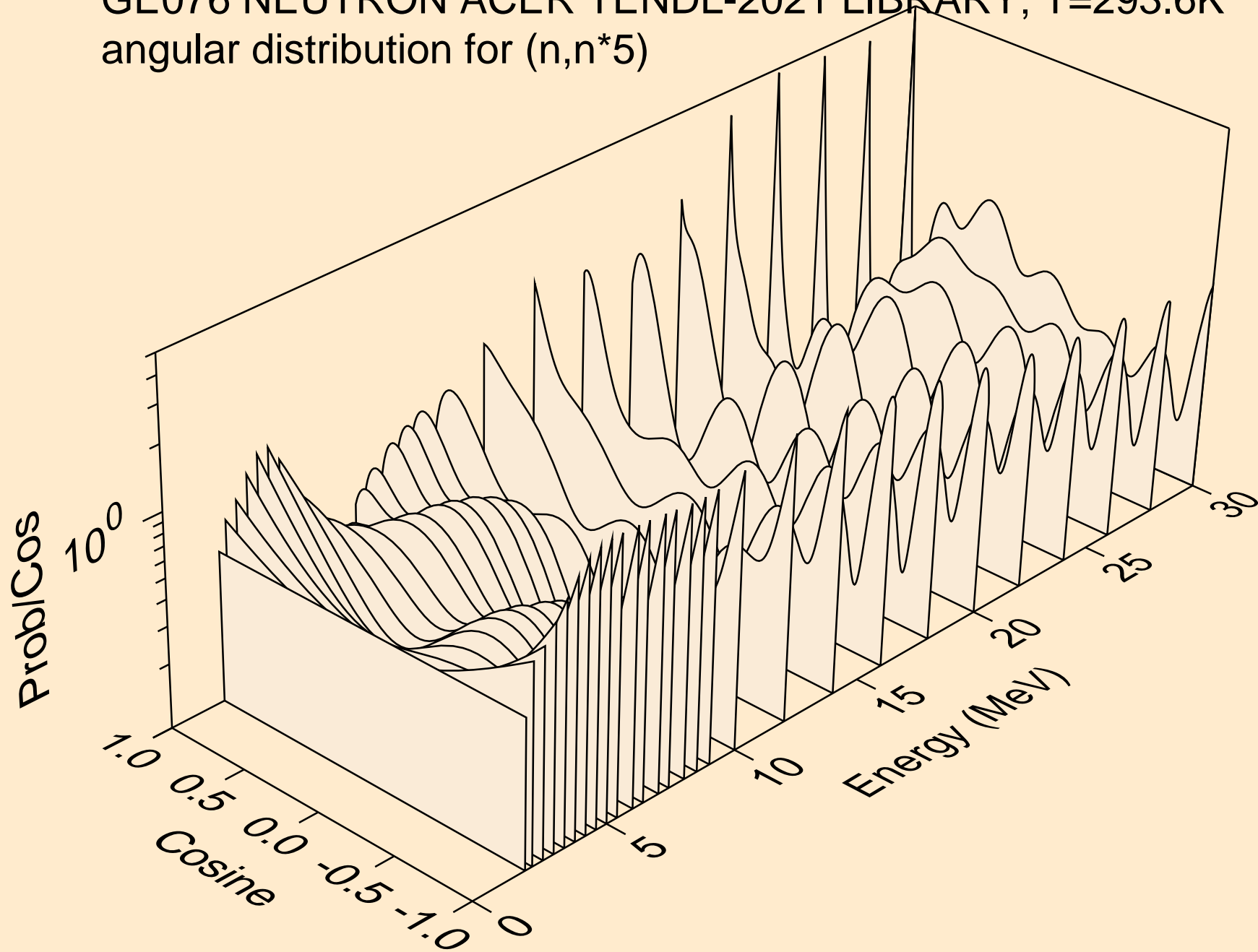

GE076 NEUTRON ACER TENDL-2021 LIBRARY; T=293.6K
angular distribution for (n,n*6)

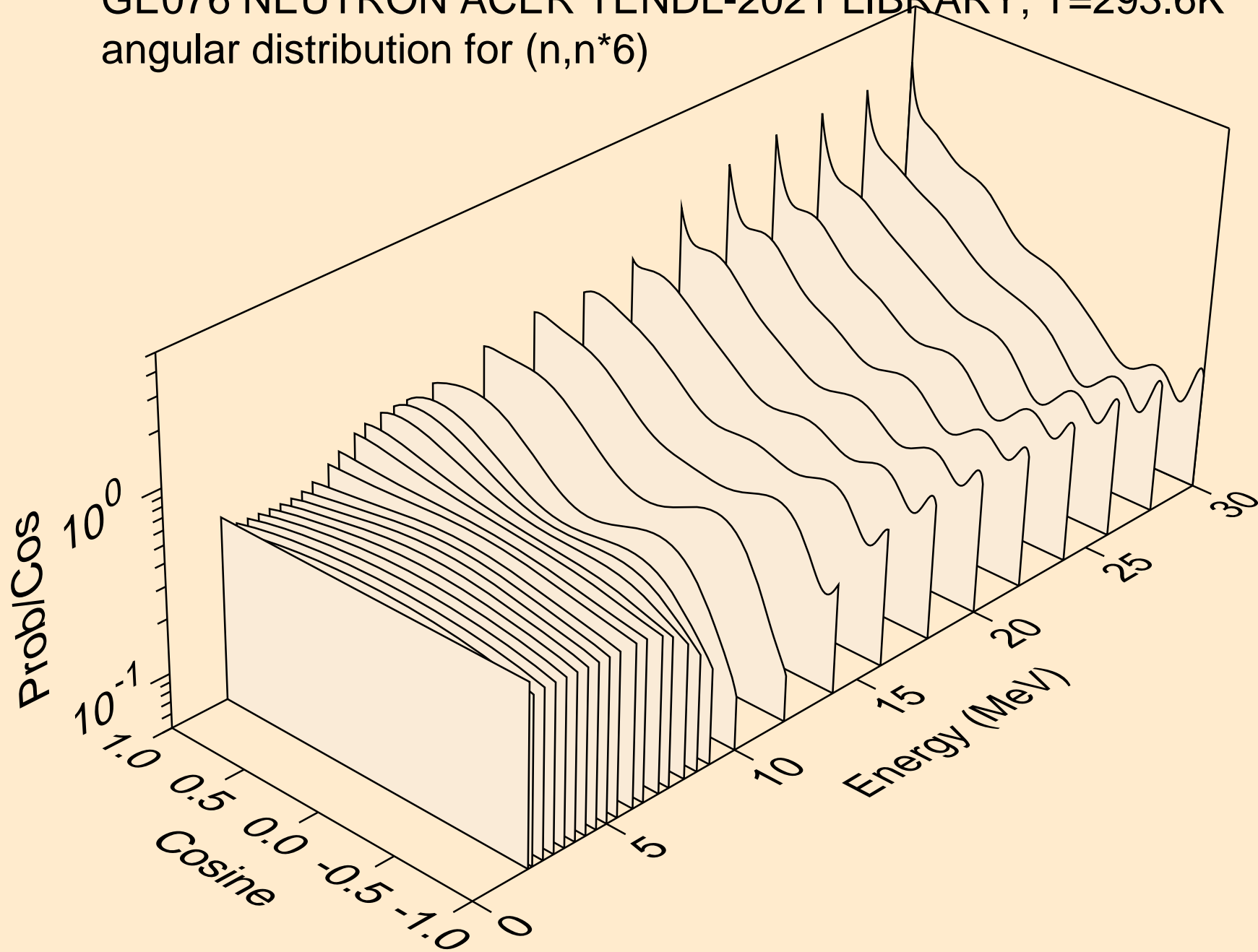

GE076 NEUTRON ACER TENDL-2021 LIBRARY; T=293.6K
angular distribution for (n,n*7)

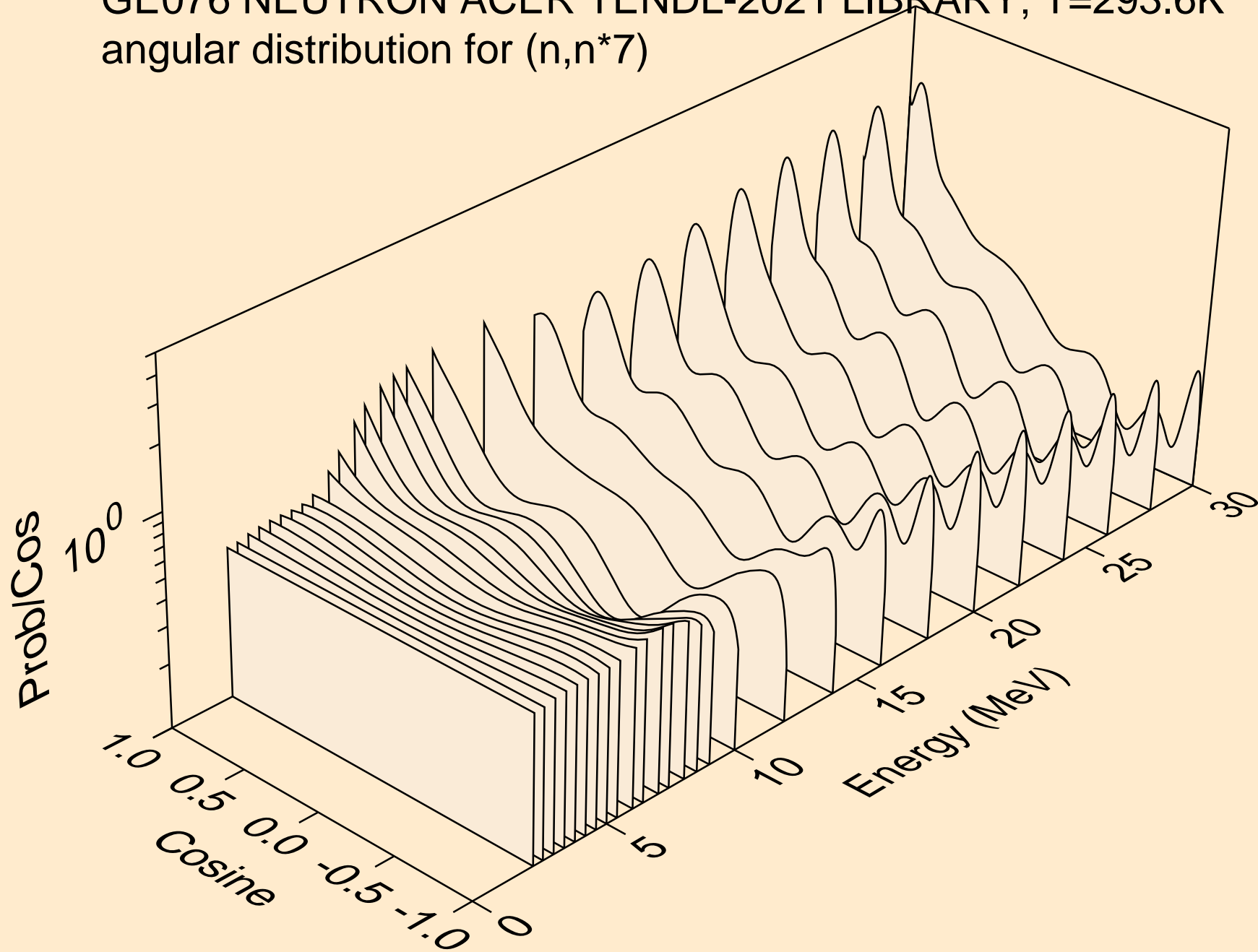

GE076 NEUTRON ACER TENDL-2021 LIBRARY; T=293.6K
angular distribution for (n,n*8)

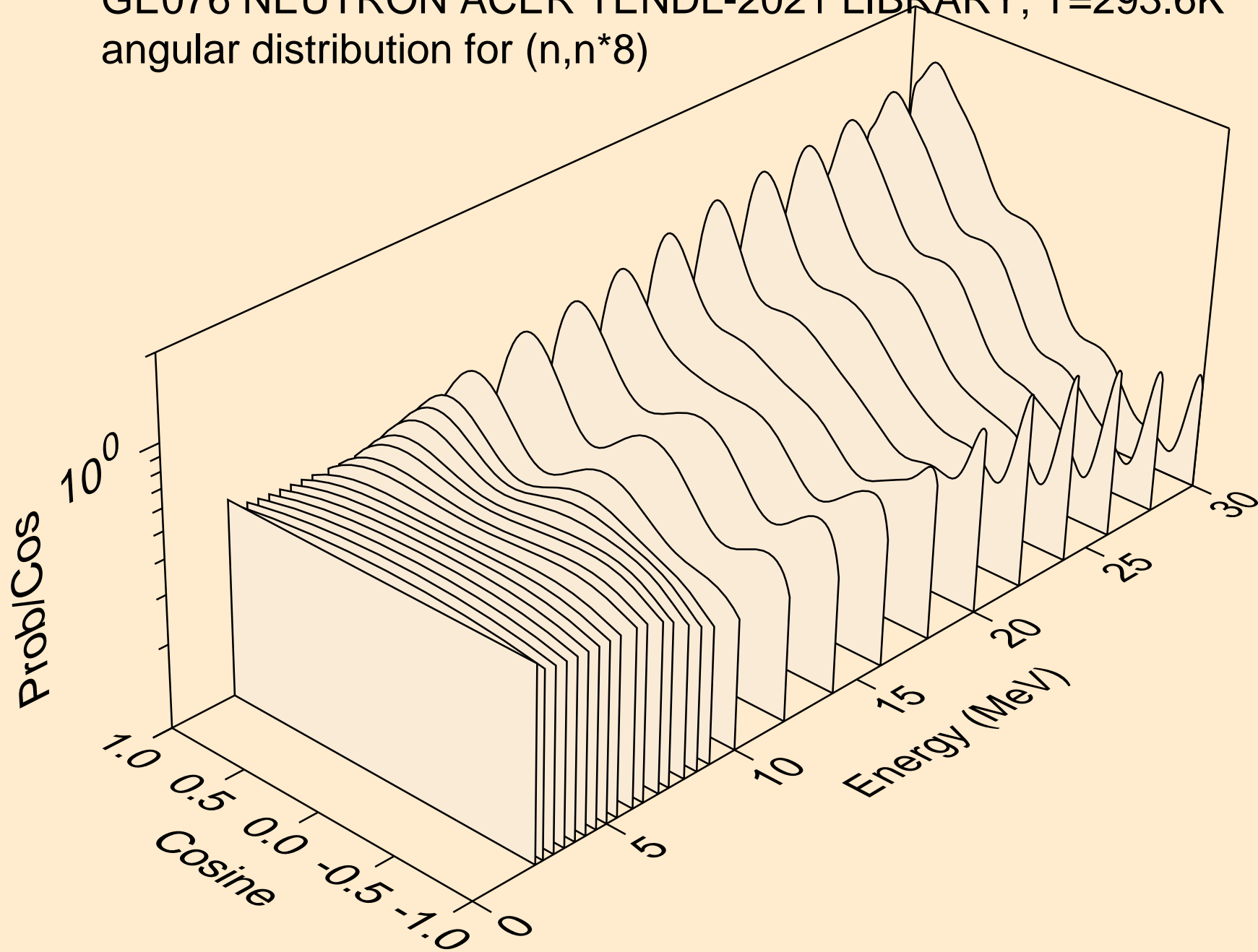

GE076 NEUTRON ACER TENDL-2021 LIBRARY; T=293.6K
angular distribution for (n,n*9)

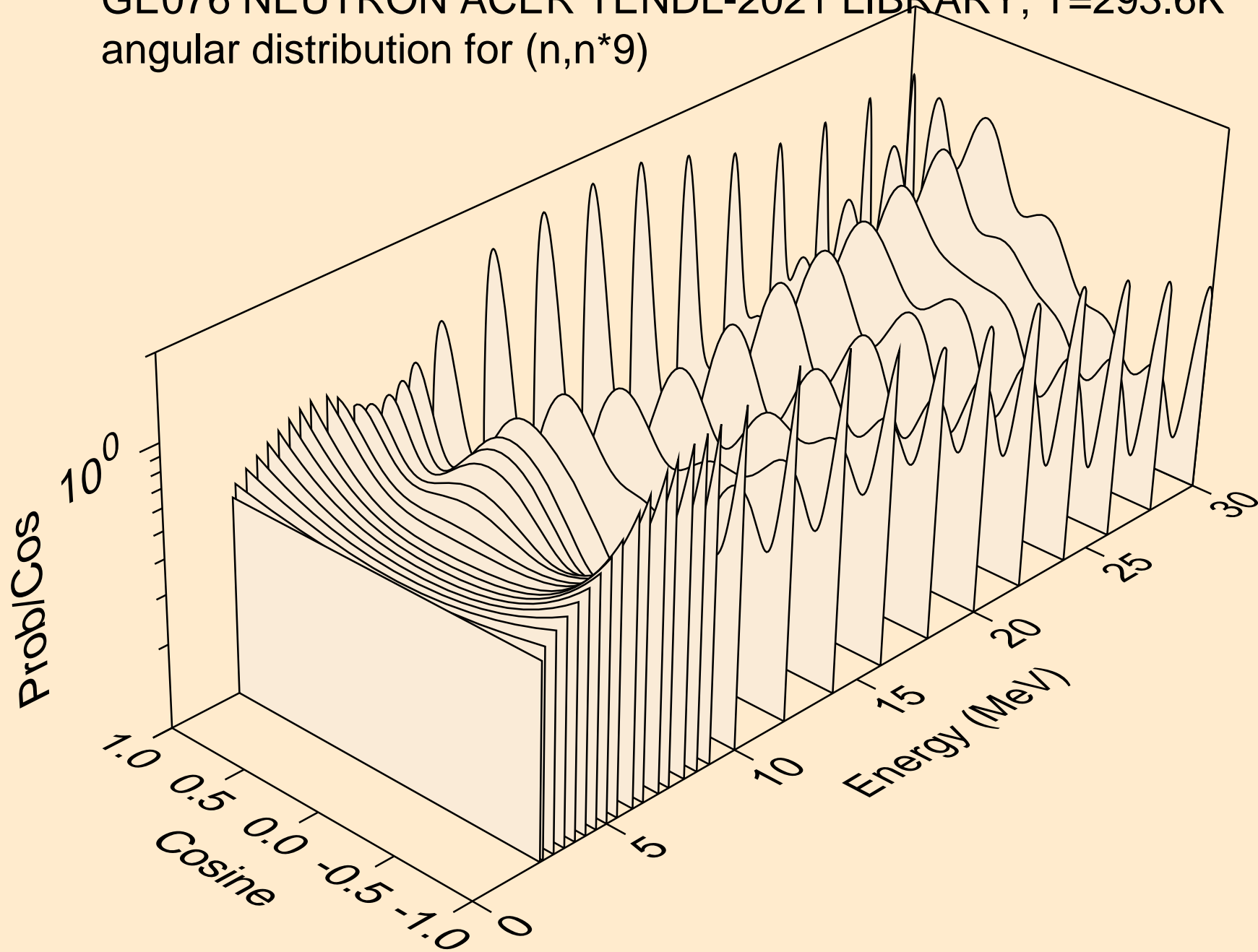

GE076 NEUTRON ACER TENDL-2021 LIBRARY; T=293.6K
angular distribution for (n,n*10)

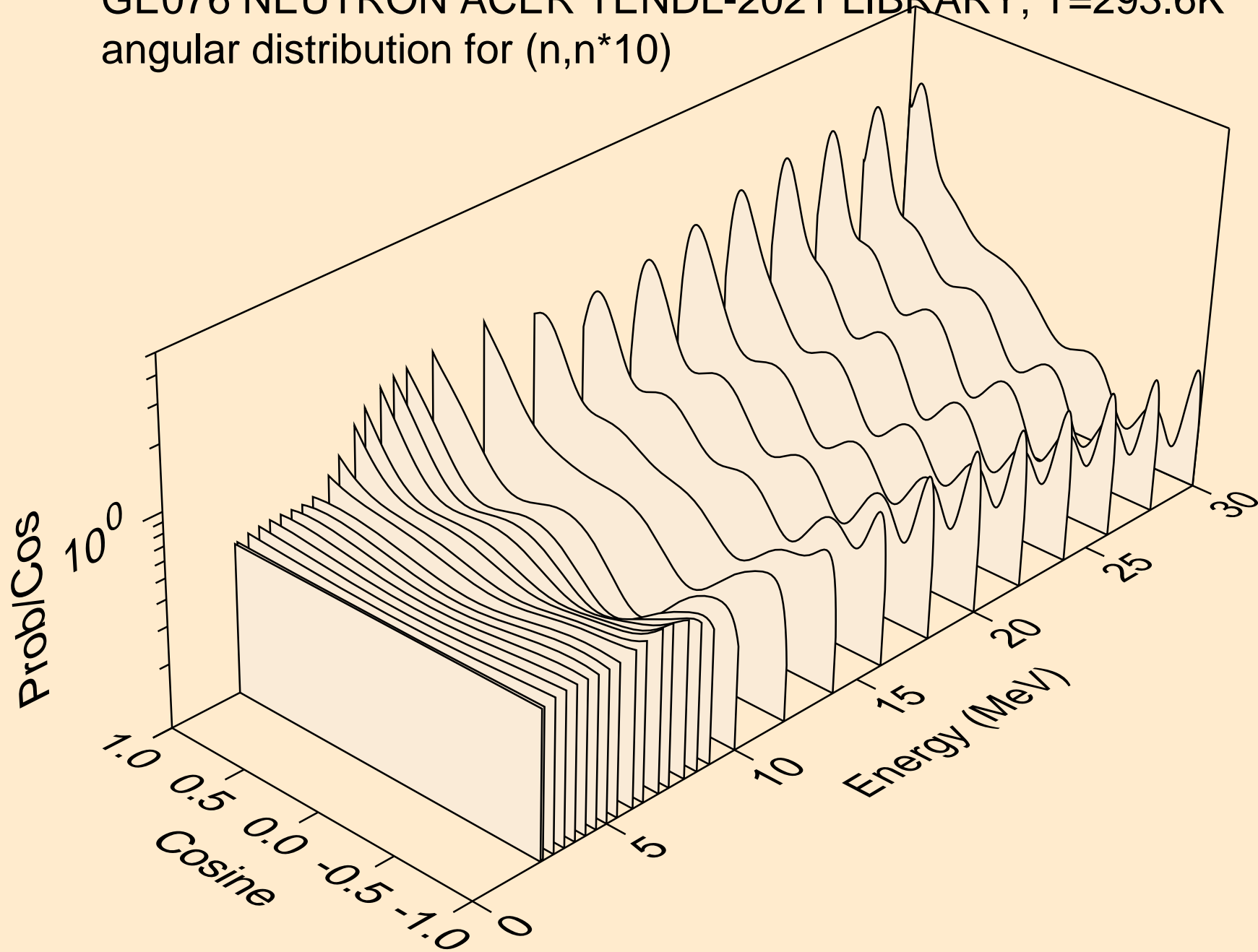

GE076 NEUTRON ACER TENDL-2021 LIBRARY; T=293.6K
angular distribution for (n,n*11)

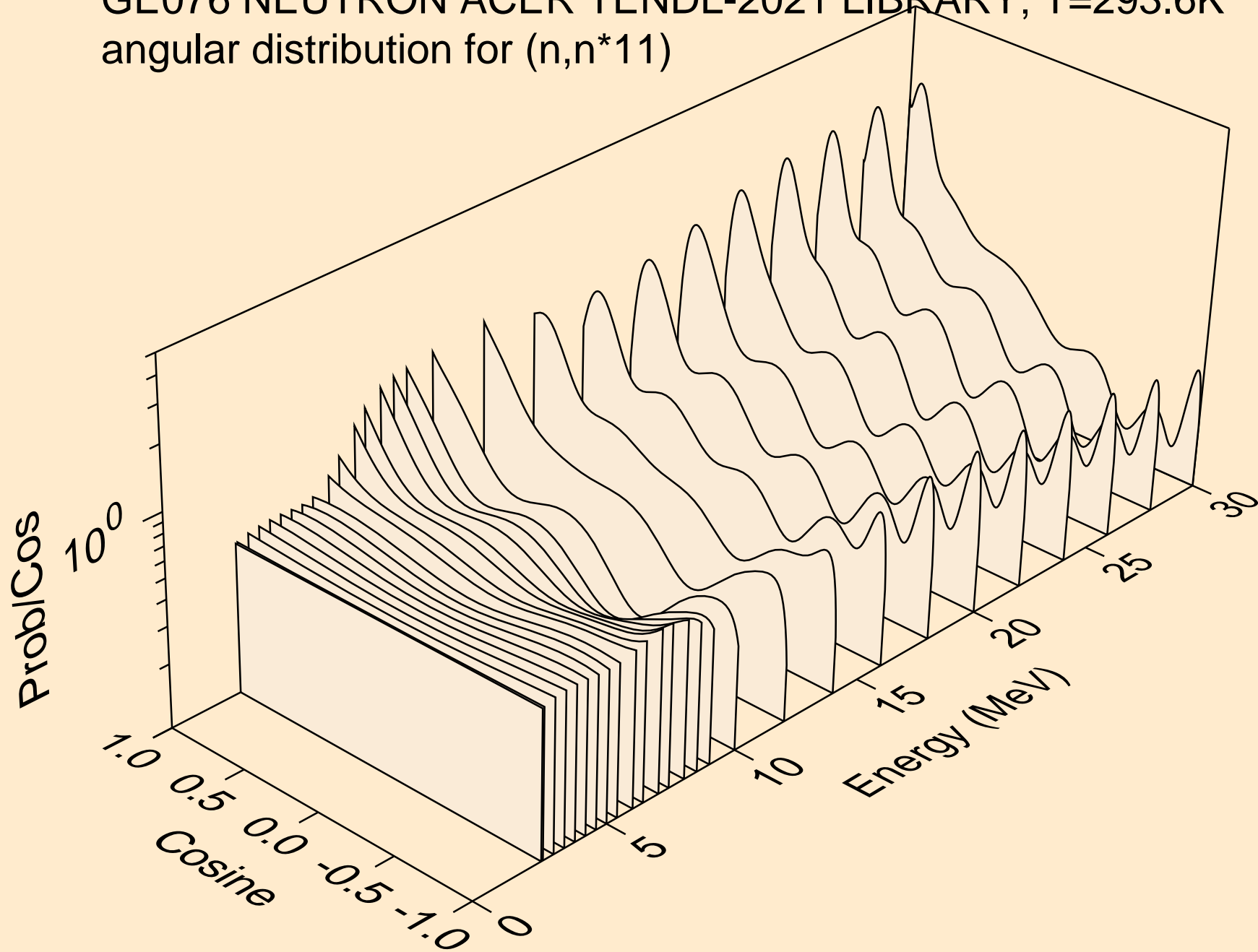

GE076 NEUTRON ACER TENDL-2021 LIBRARY; T=293.6K
angular distribution for (n,n*12)

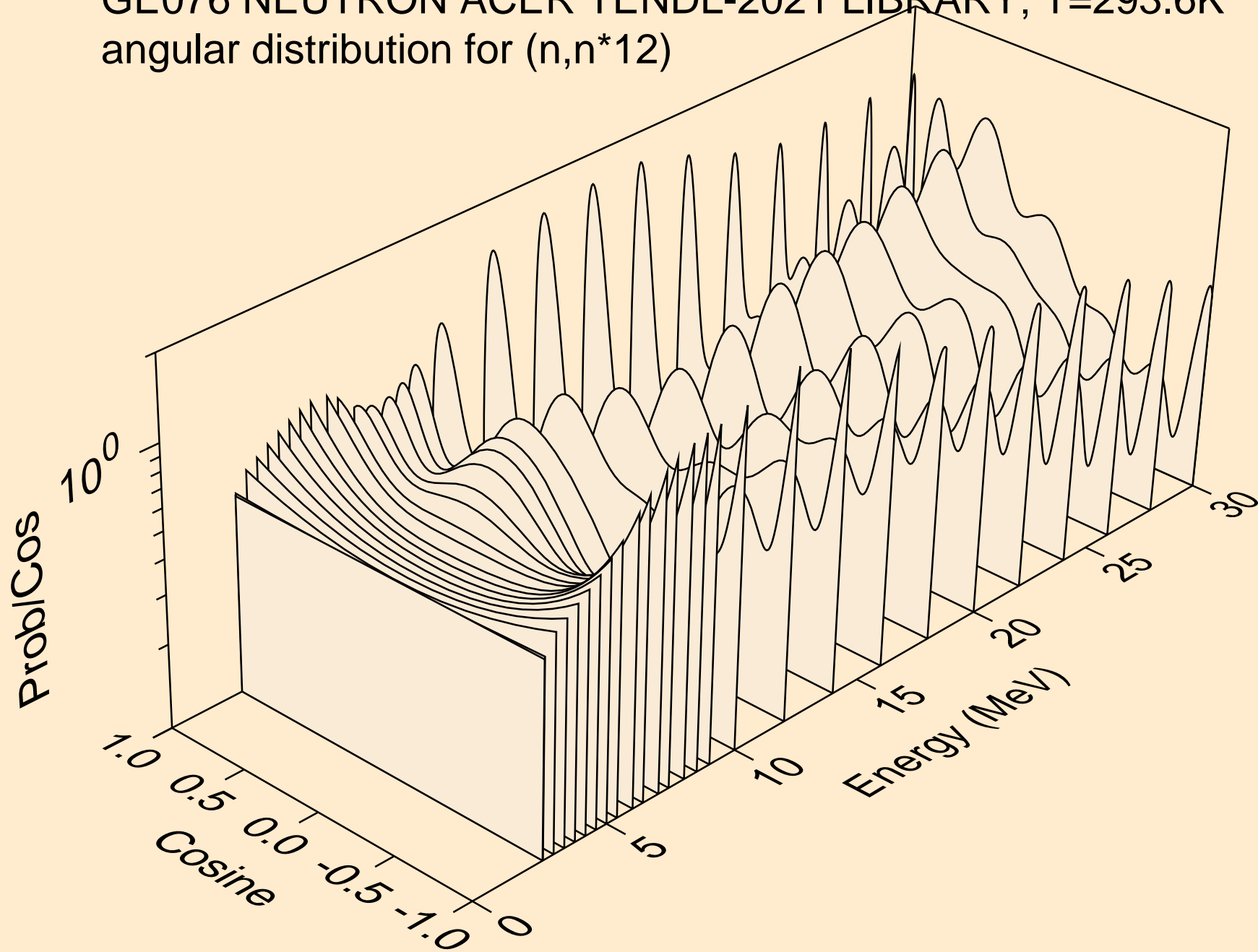

GE076 NEUTRON ACER TENDL-2021 LIBRARY; T=293.6K
angular distribution for (n,n*13)

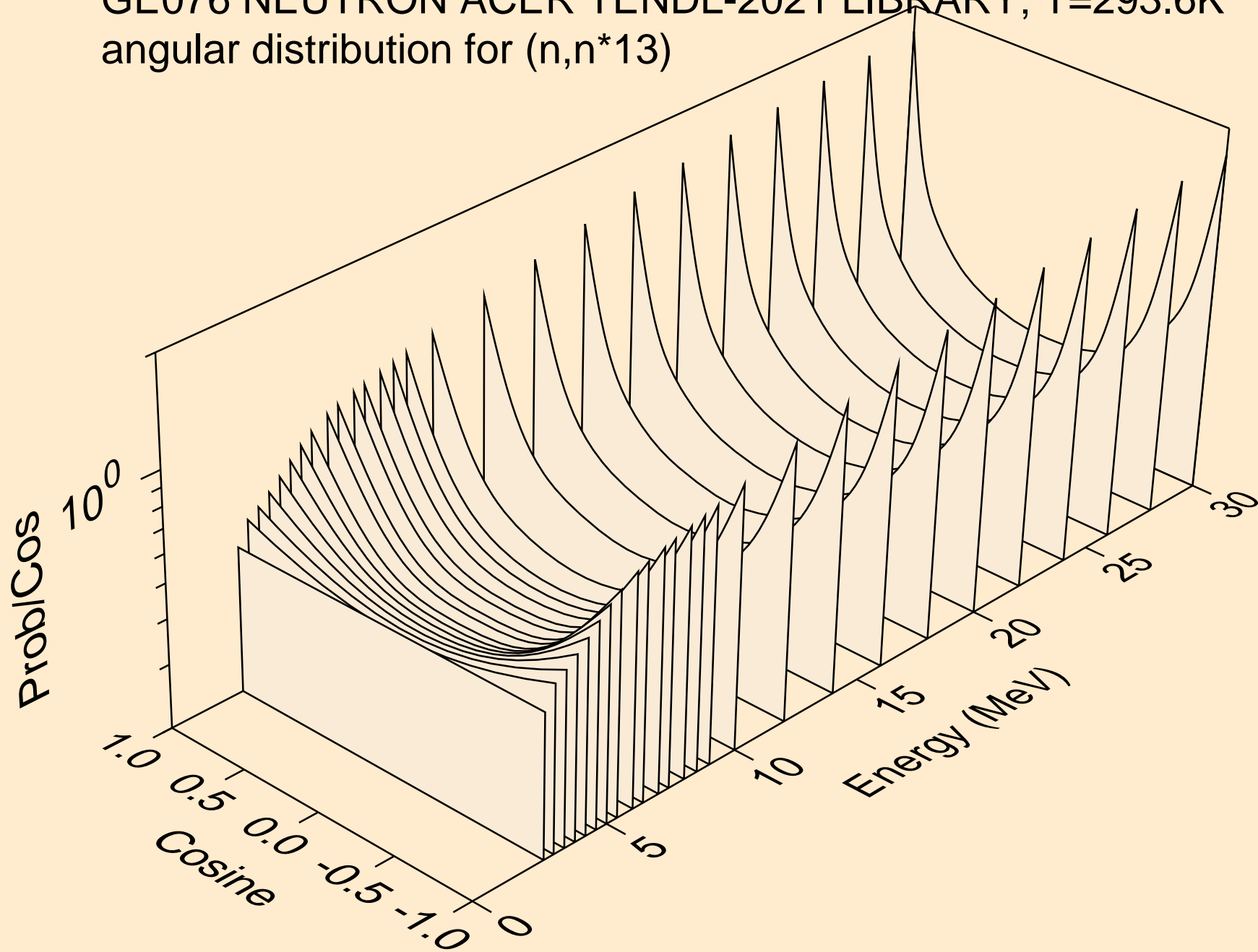

GE076 NEUTRON ACER TENDL-2021 LIBRARY; T=293.6K
angular distribution for (n,n*14)

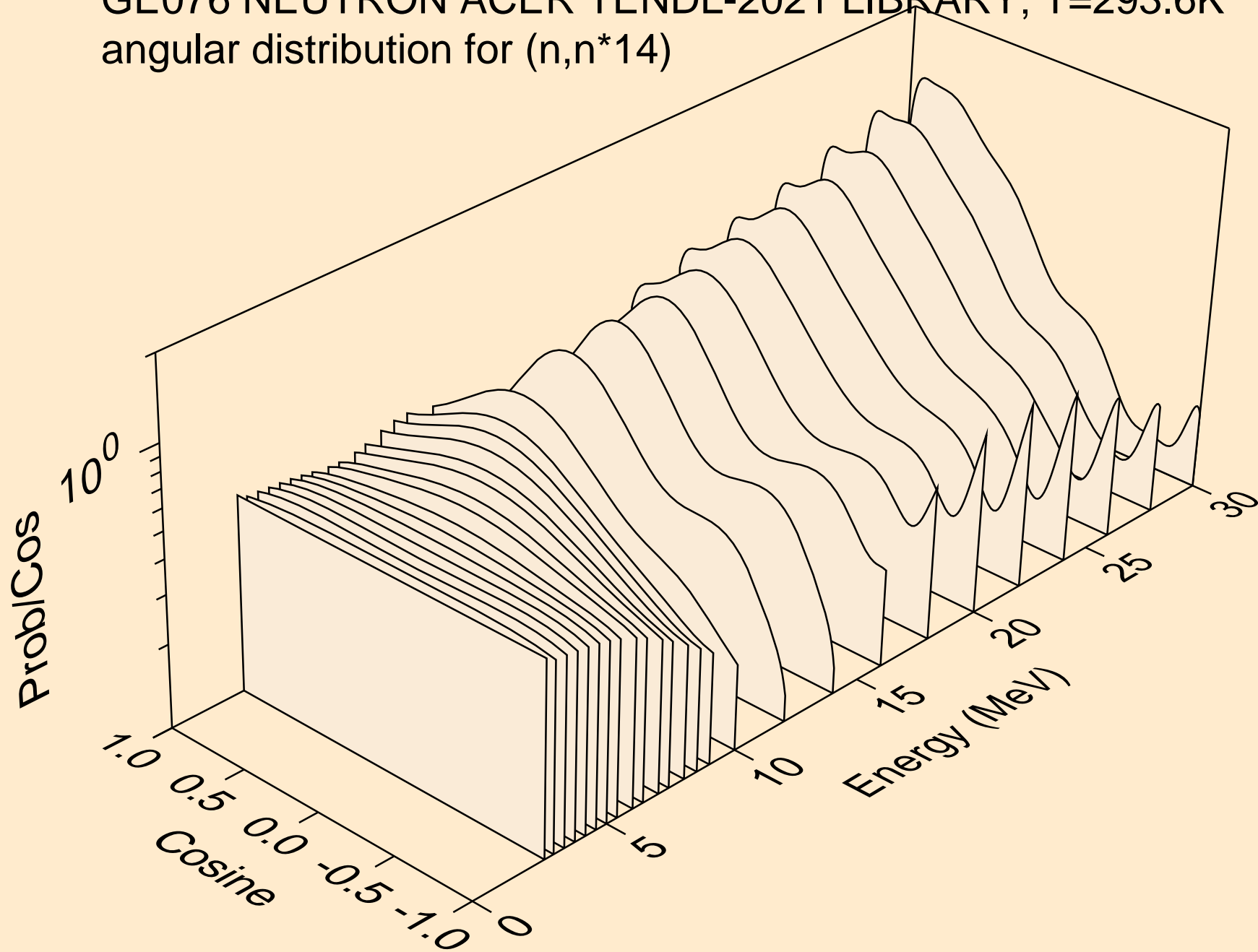

GE076 NEUTRON ACER TENDL-2021 LIBRARY; T=293.6K
angular distribution for (n,n*15)

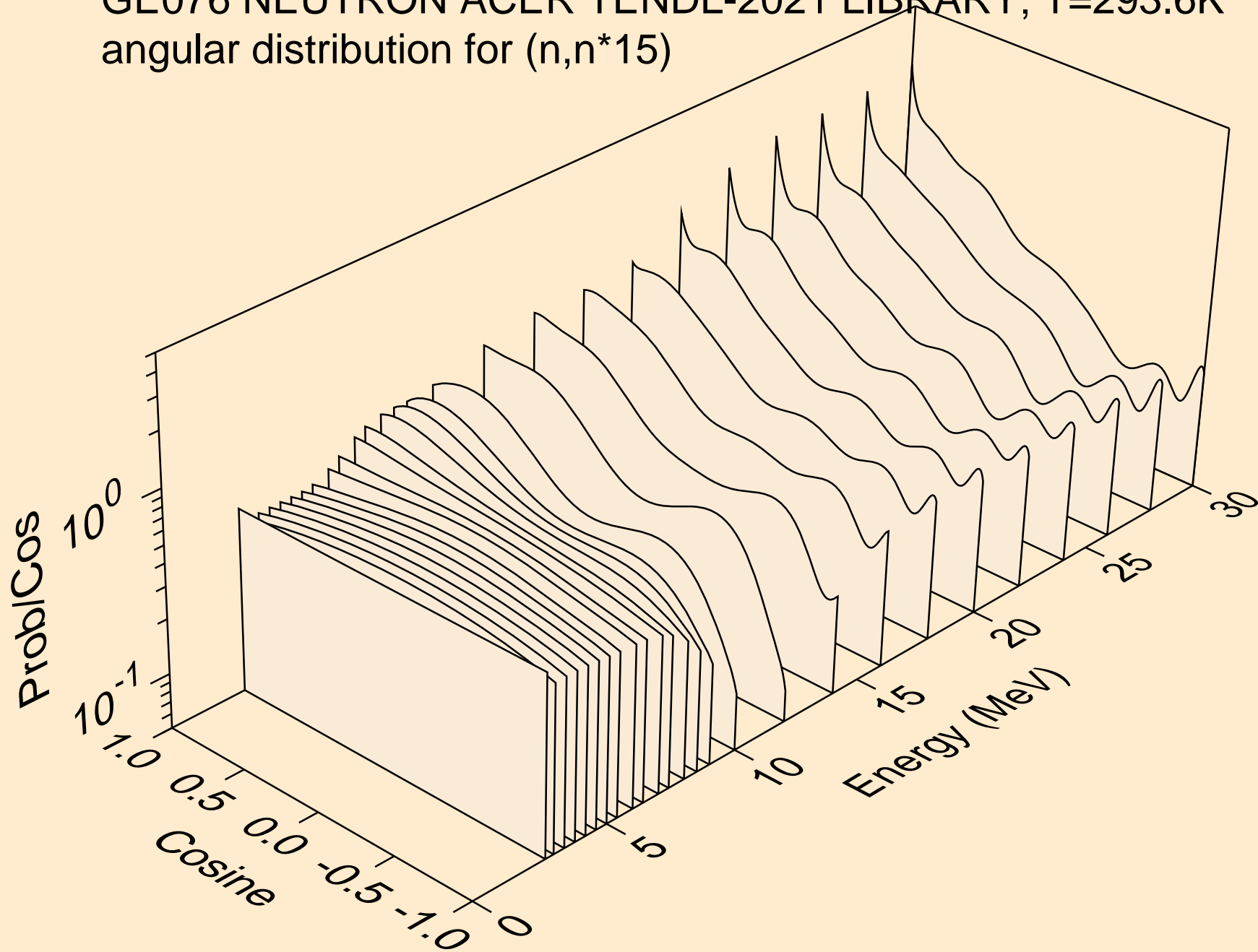

GE076 NEUTRON ACER TENDL-2021 LIBRARY; T=293.6K
angular distribution for (n,n*16)

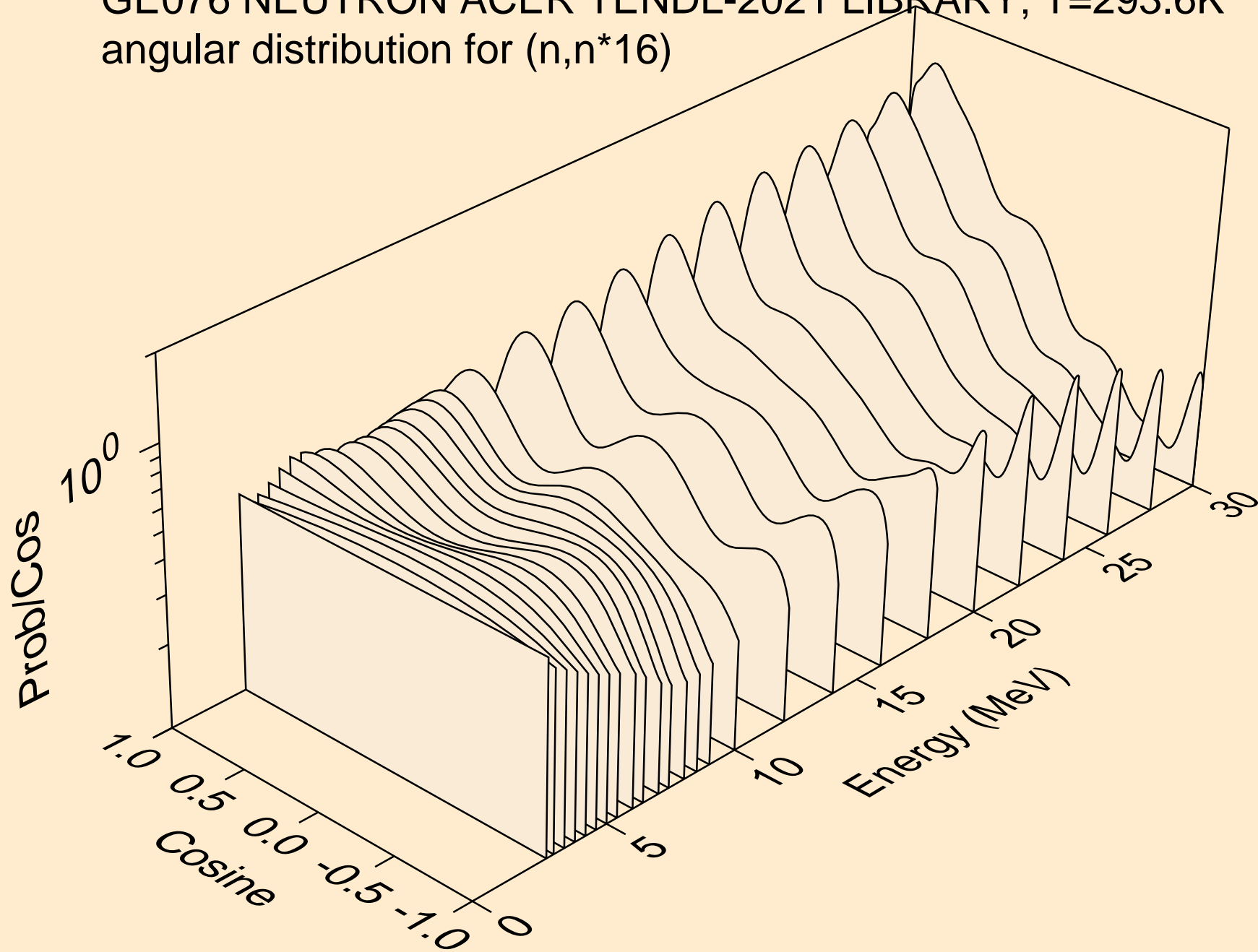

GE076 NEUTRON ACER TENDL-2021 LIBRARY; T=293.6K
angular distribution for (n,n*17)

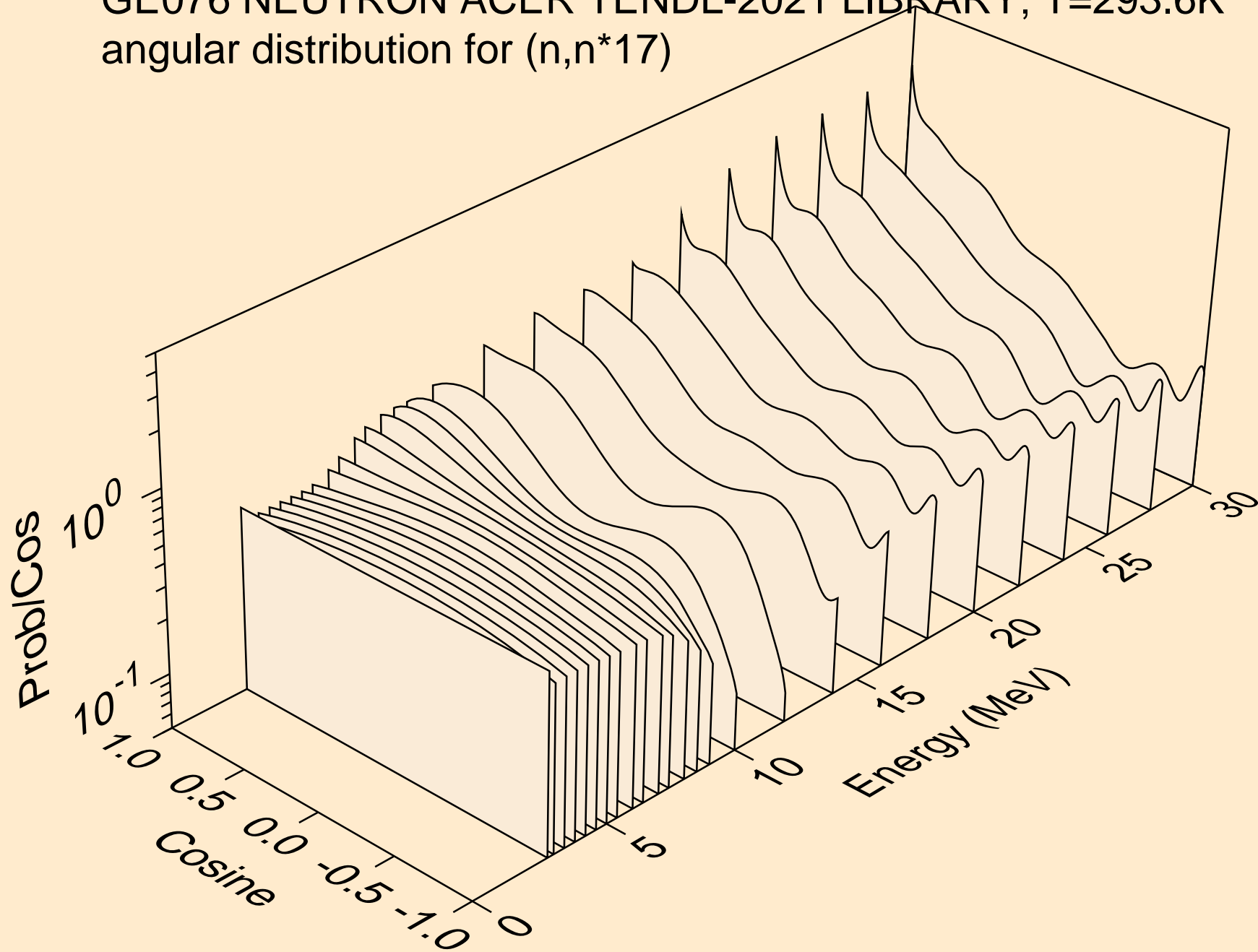

GE076 NEUTRON ACER TENDL-2021 LIBRARY; T=293.6K
angular distribution for (n,n*18)

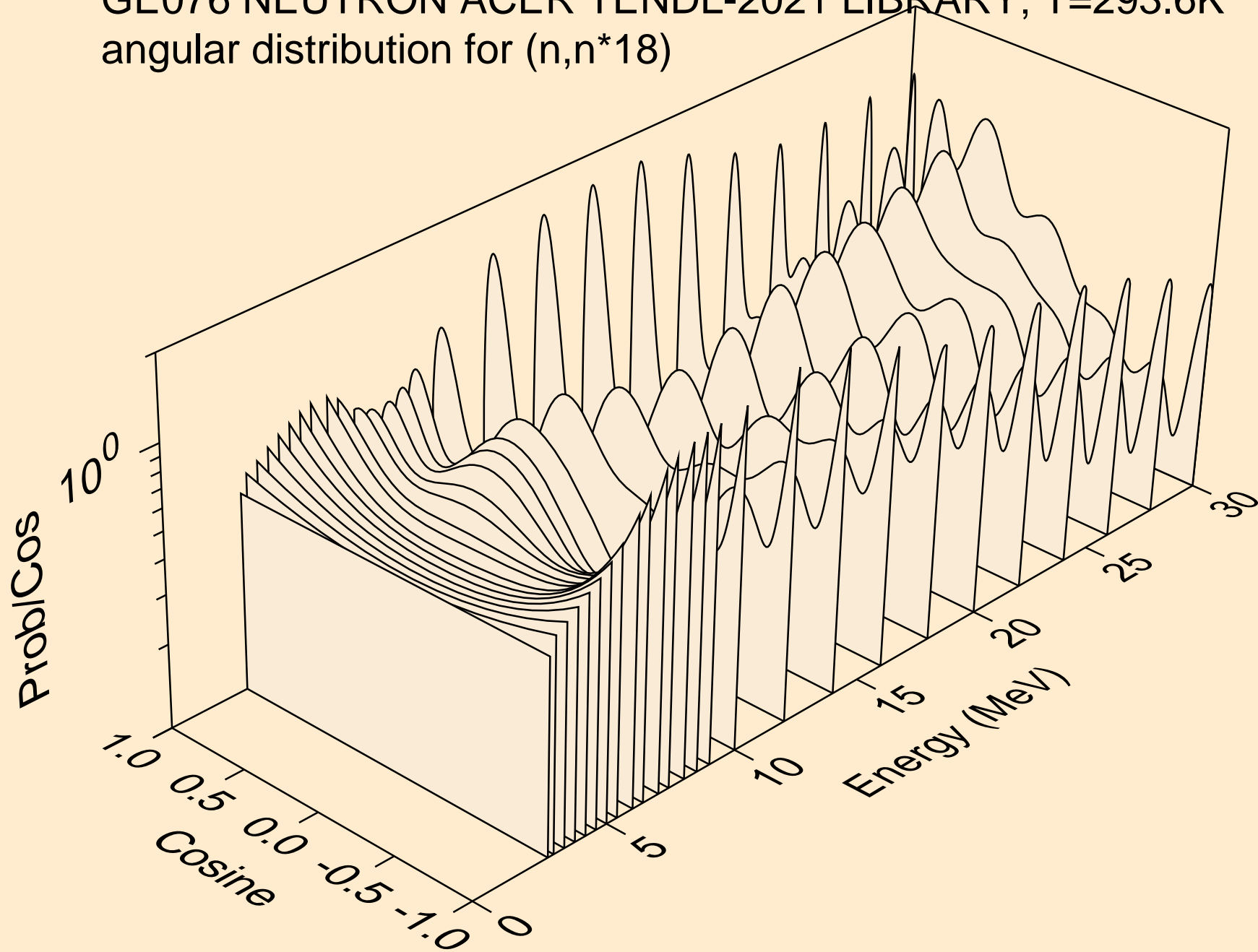

GE076 NEUTRON ACER TENDL-2021 LIBRARY; T=293.6K
angular distribution for (n,n*19)

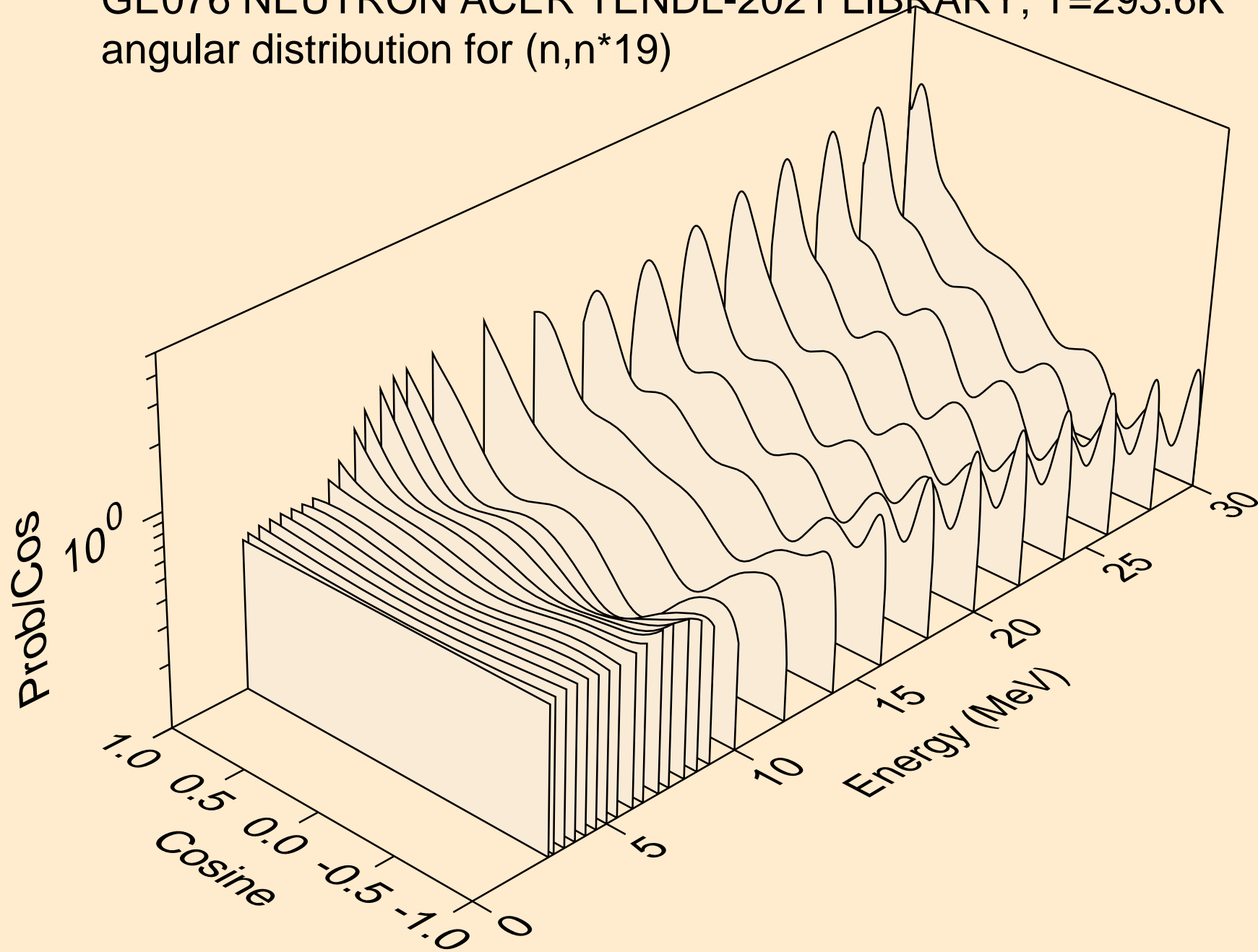

GE076 NEUTRON ACER TENDL-2021 LIBRARY; T=293.6K
angular distribution for (n,n*20)

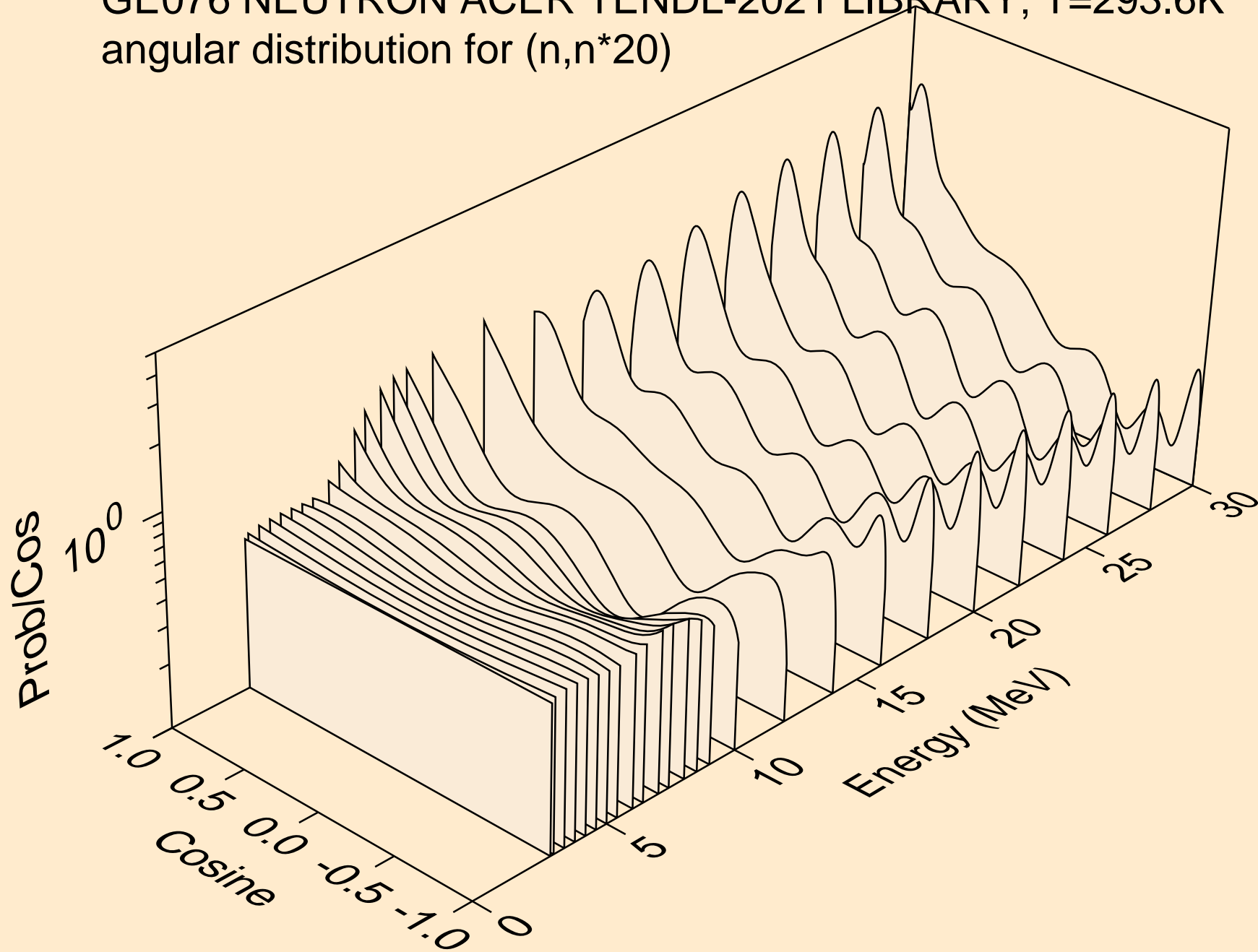

GE076 NEUTRON ACER TENDL-2021 LIBRARY; T=293.6K
angular distribution for (n,n*21)

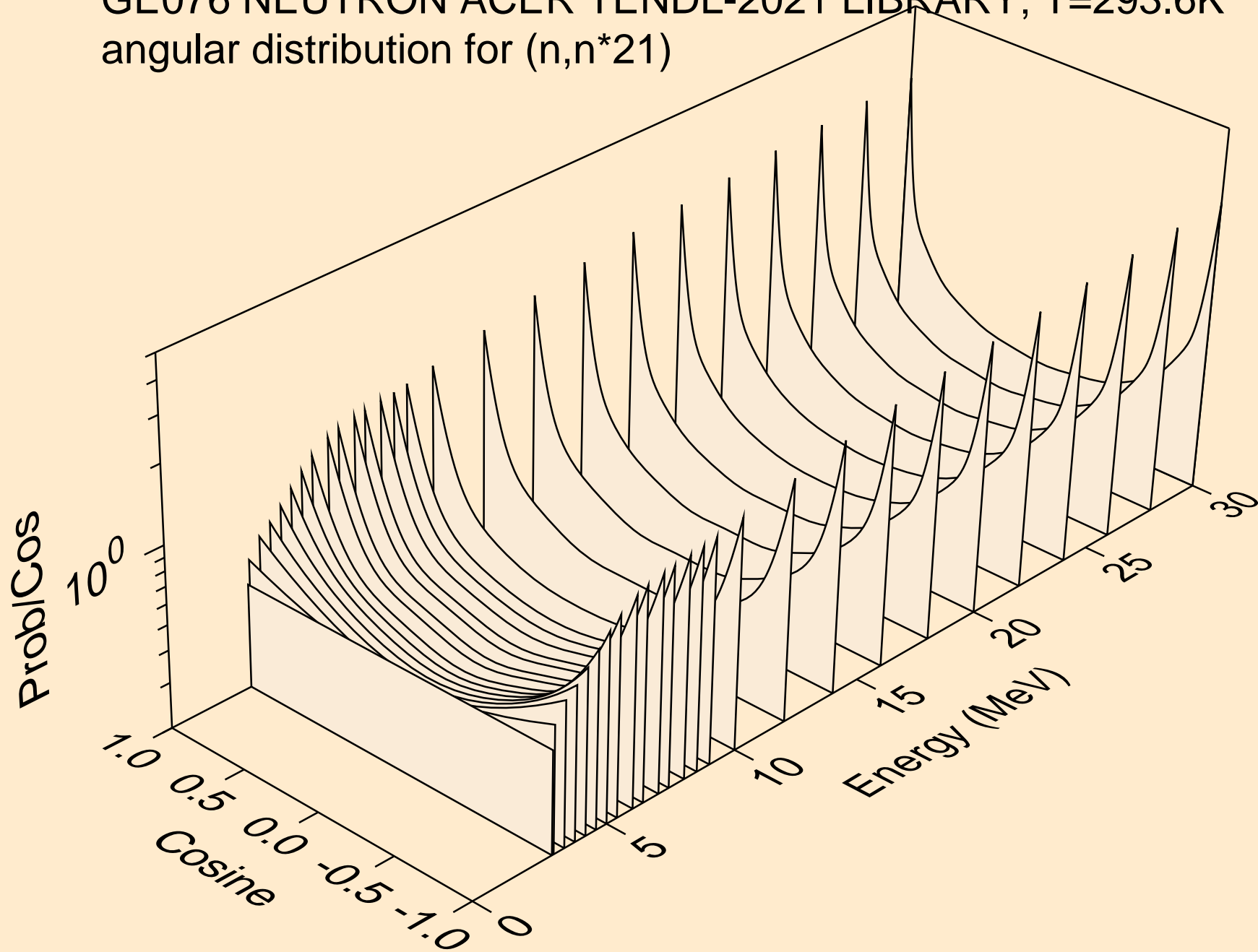

GE076 NEUTRON ACER TENDL-2021 LIBRARY; T=293.6K
angular distribution for (n,n*22)

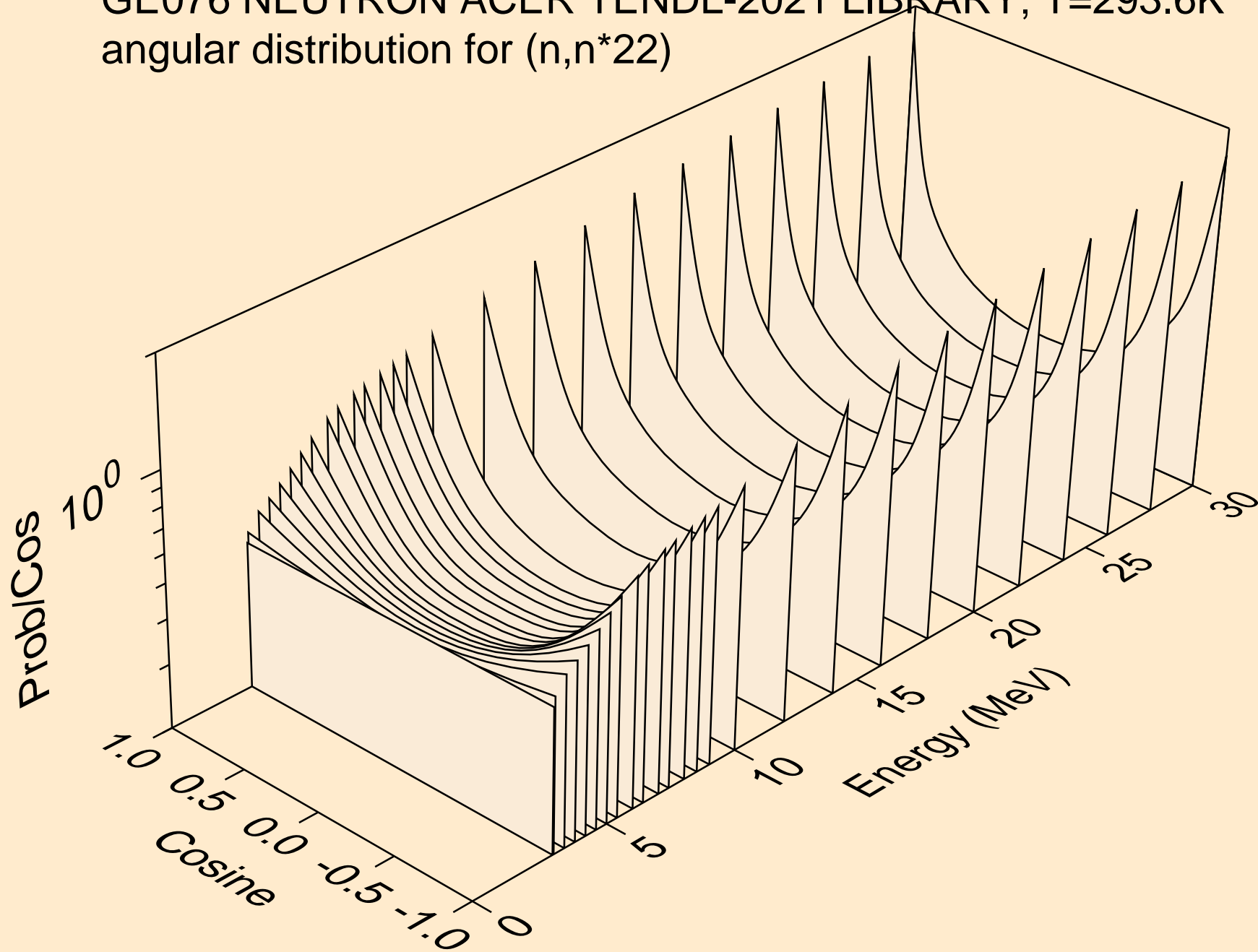

GE076 NEUTRON ACER TENDL-2021 LIBRARY; T=293.6K
angular distribution for (n,n*23)

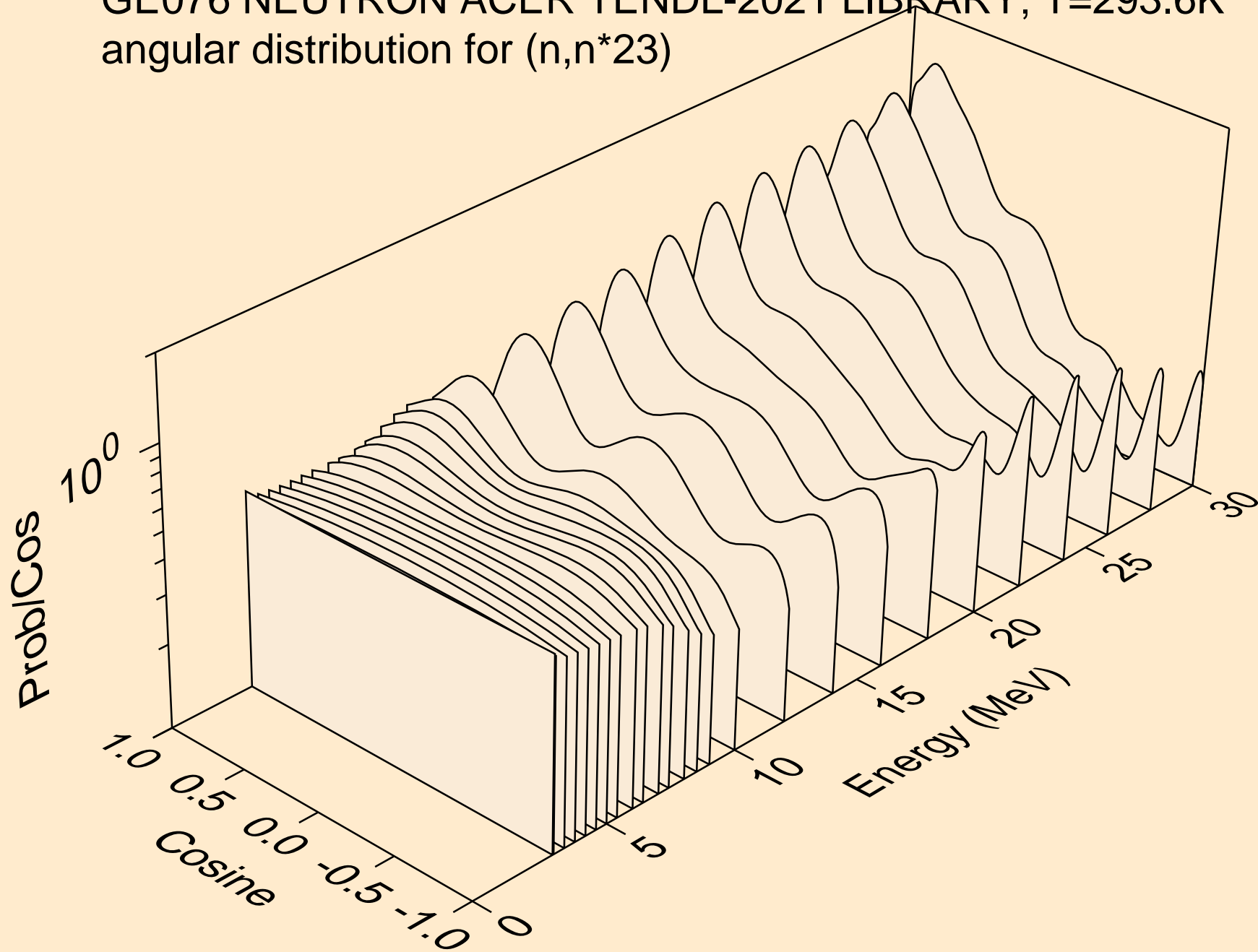

GE076 NEUTRON ACER TENDL-2021 LIBRARY; T=293.6K
angular distribution for (n,n*24)

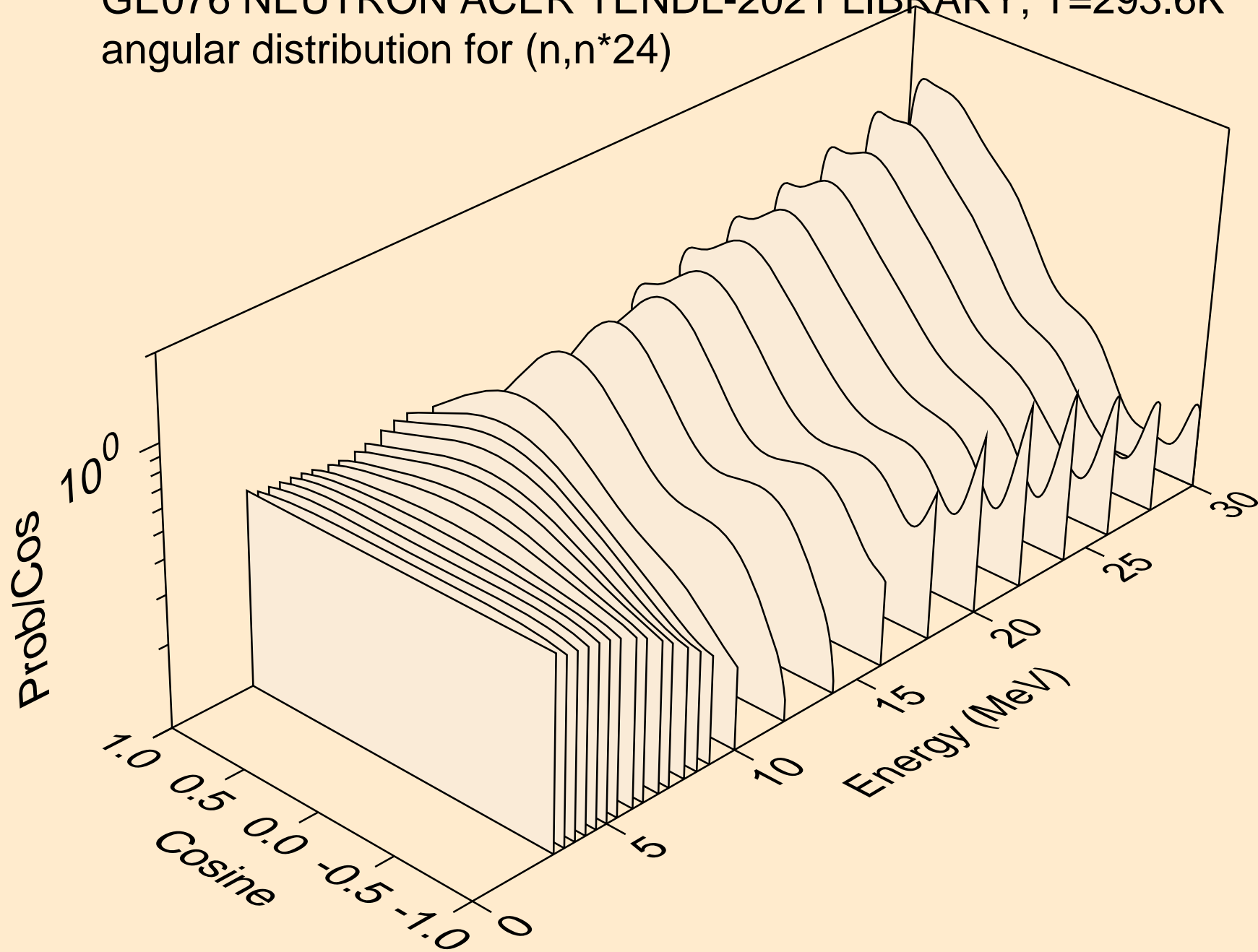

GE076 NEUTRON ACER TENDL-2021 LIBRARY; T=293.6K
angular distribution for (n,n*25)

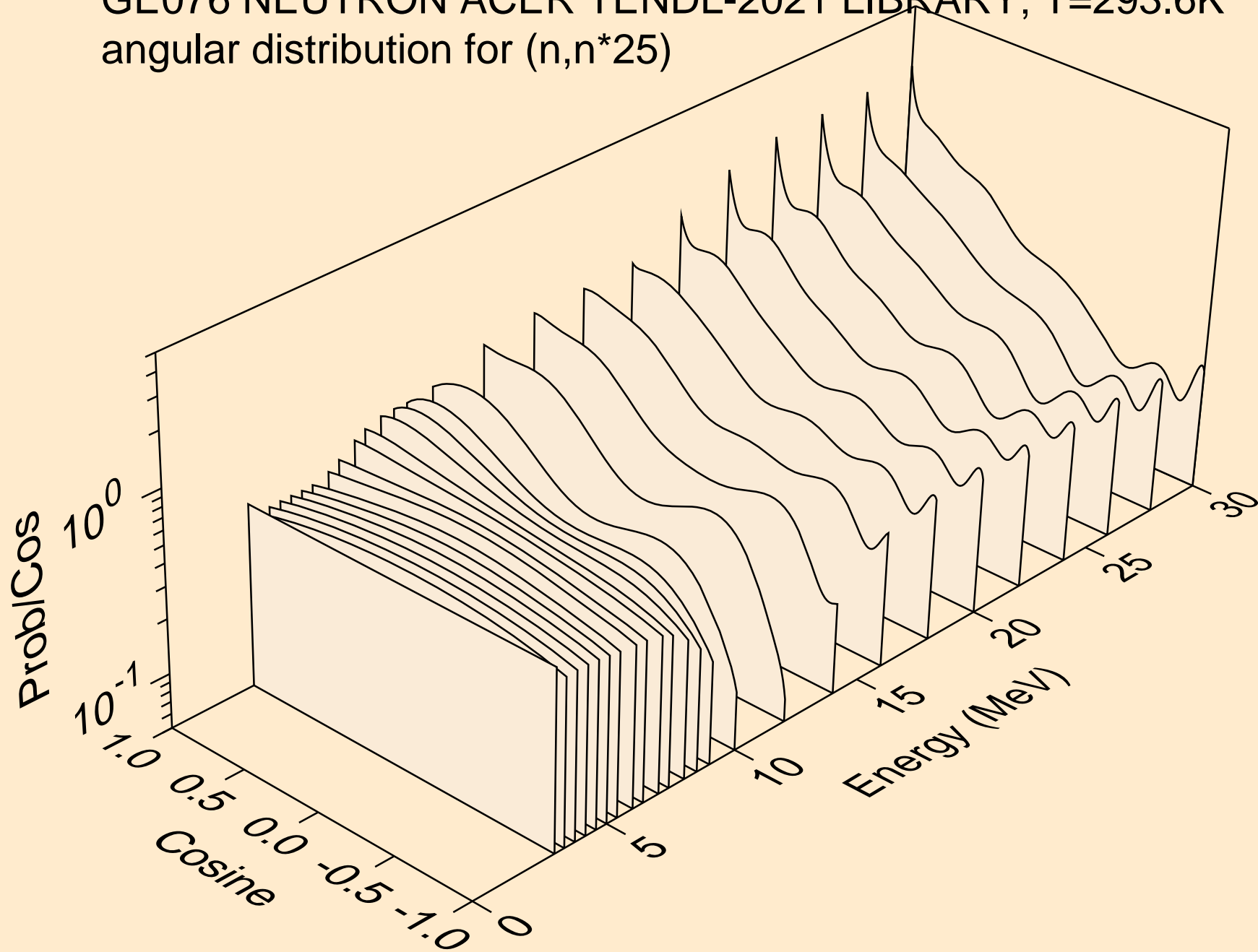

GE076 NEUTRON ACER TENDL-2021 LIBRARY; T=293.6K
angular distribution for (n,n*26)

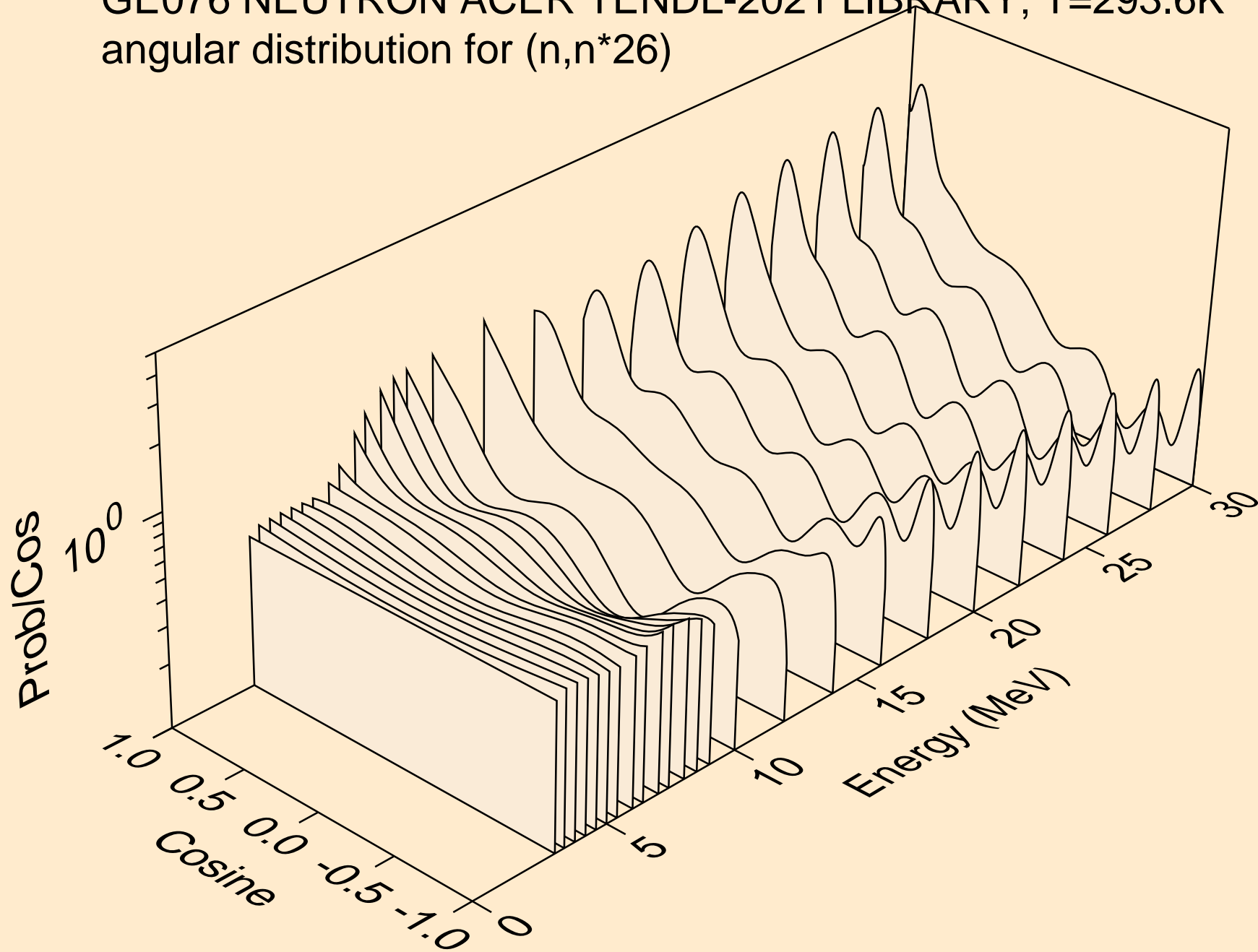

GE076 NEUTRON ACER TENDL-2021 LIBRARY; T=293.6K
angular distribution for (n,n*27)

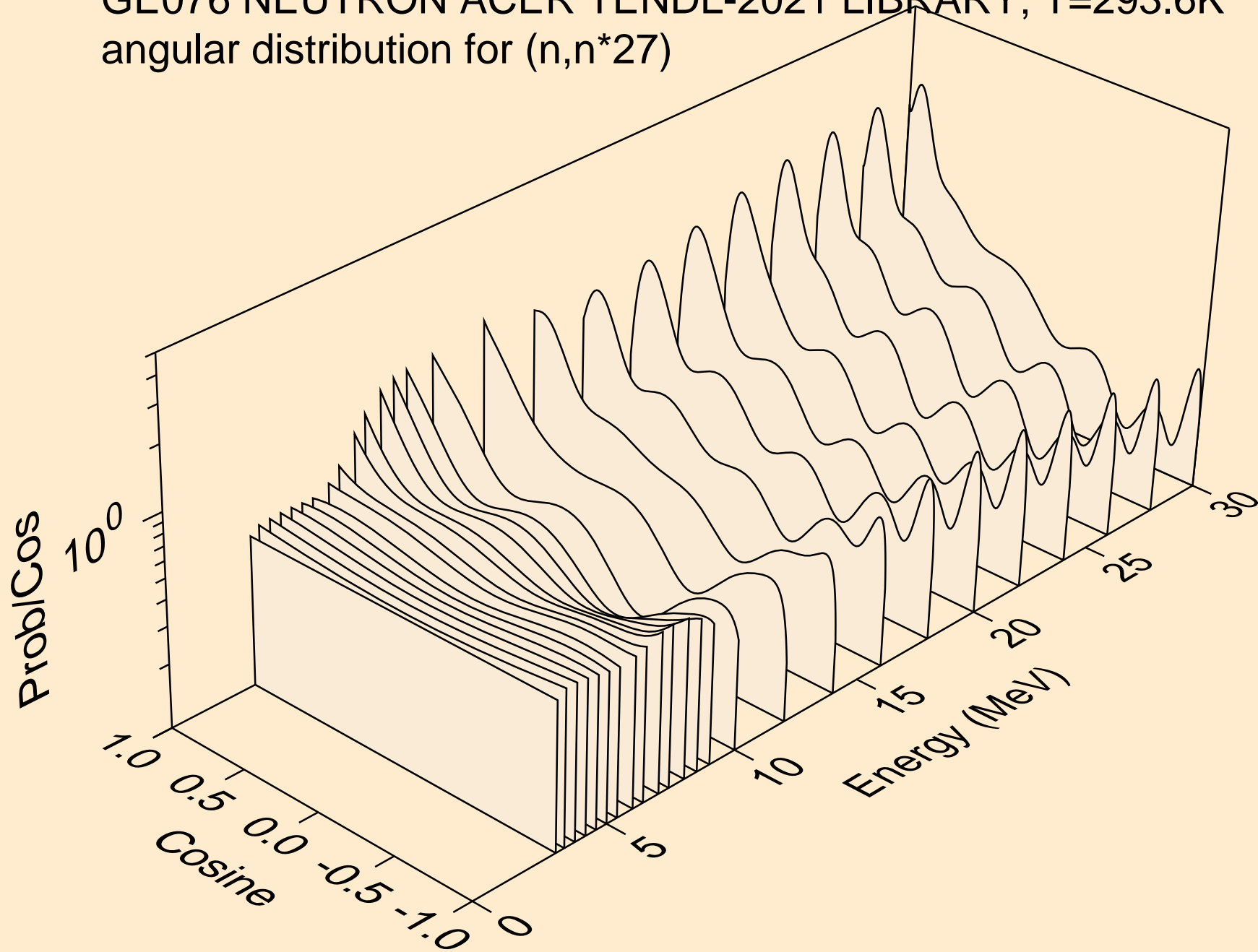

GE076 NEUTRON ACER TENDL-2021 LIBRARY; T=293.6K
angular distribution for (n,n*28)

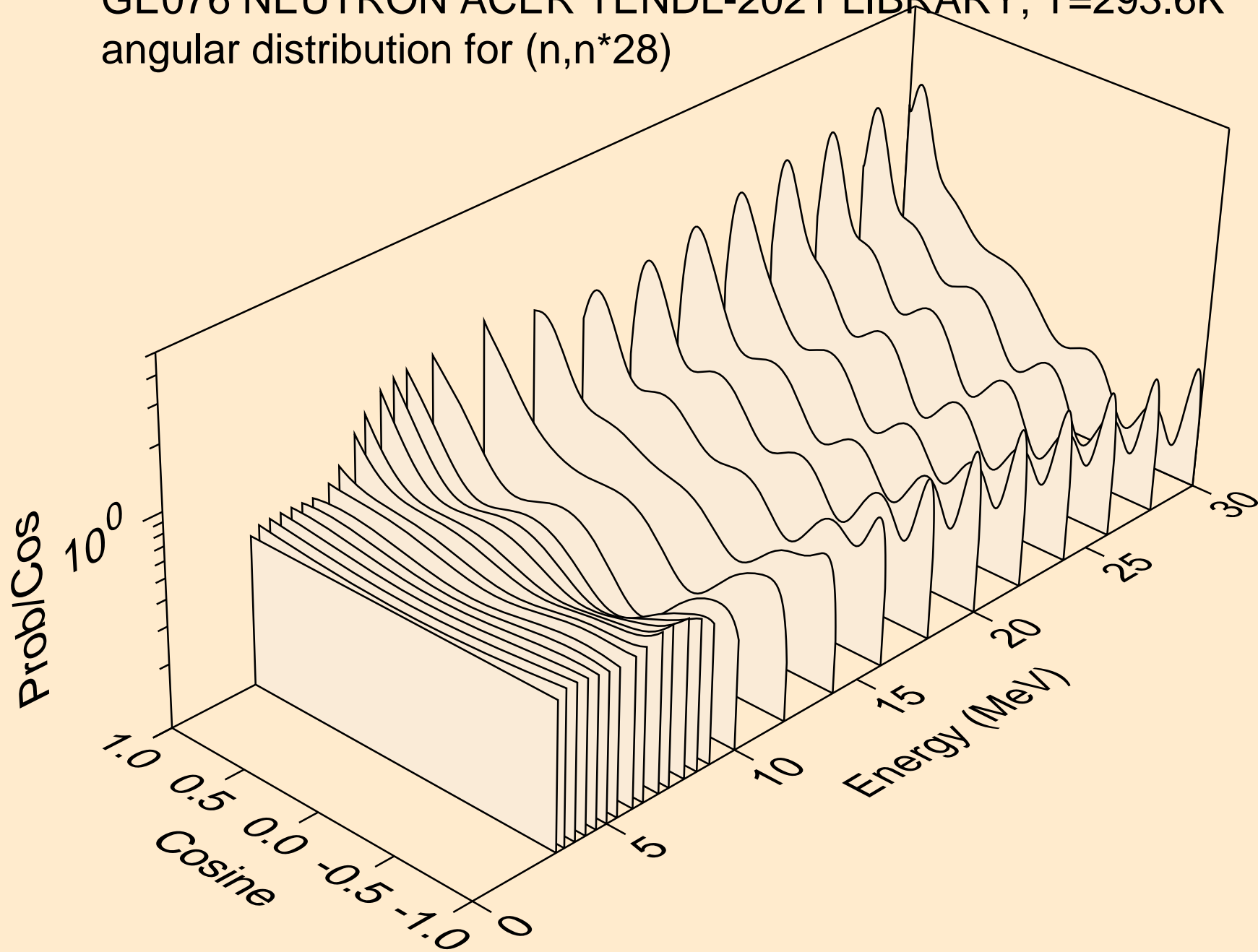

GE076 NEUTRON ACER TENDL-2021 LIBRARY; T=293.6K
angular distribution for (n,n*29)

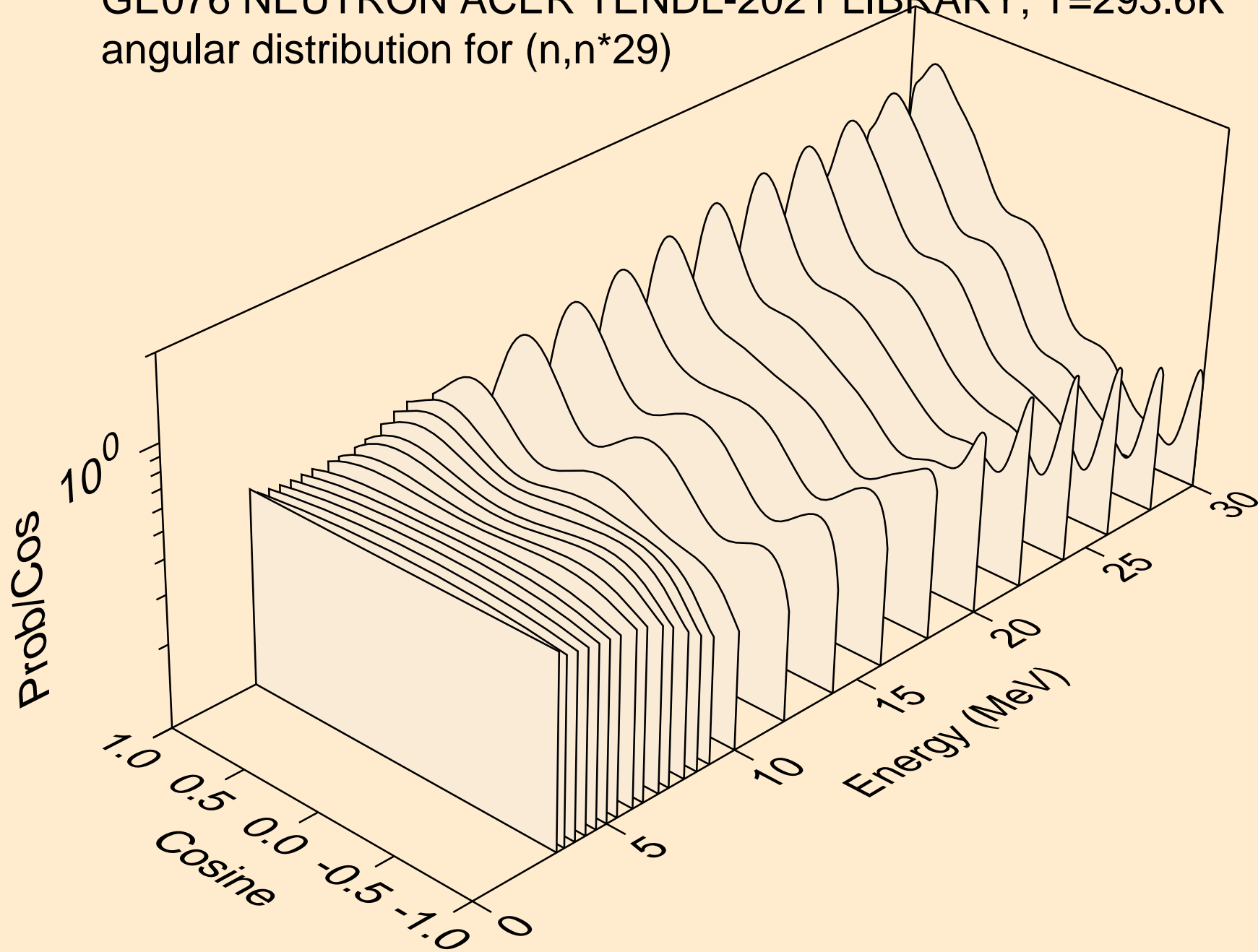

GE076 NEUTRON ACER TENDL-2021 LIBRARY; T=293.6K
Neutron emission for (n,x)

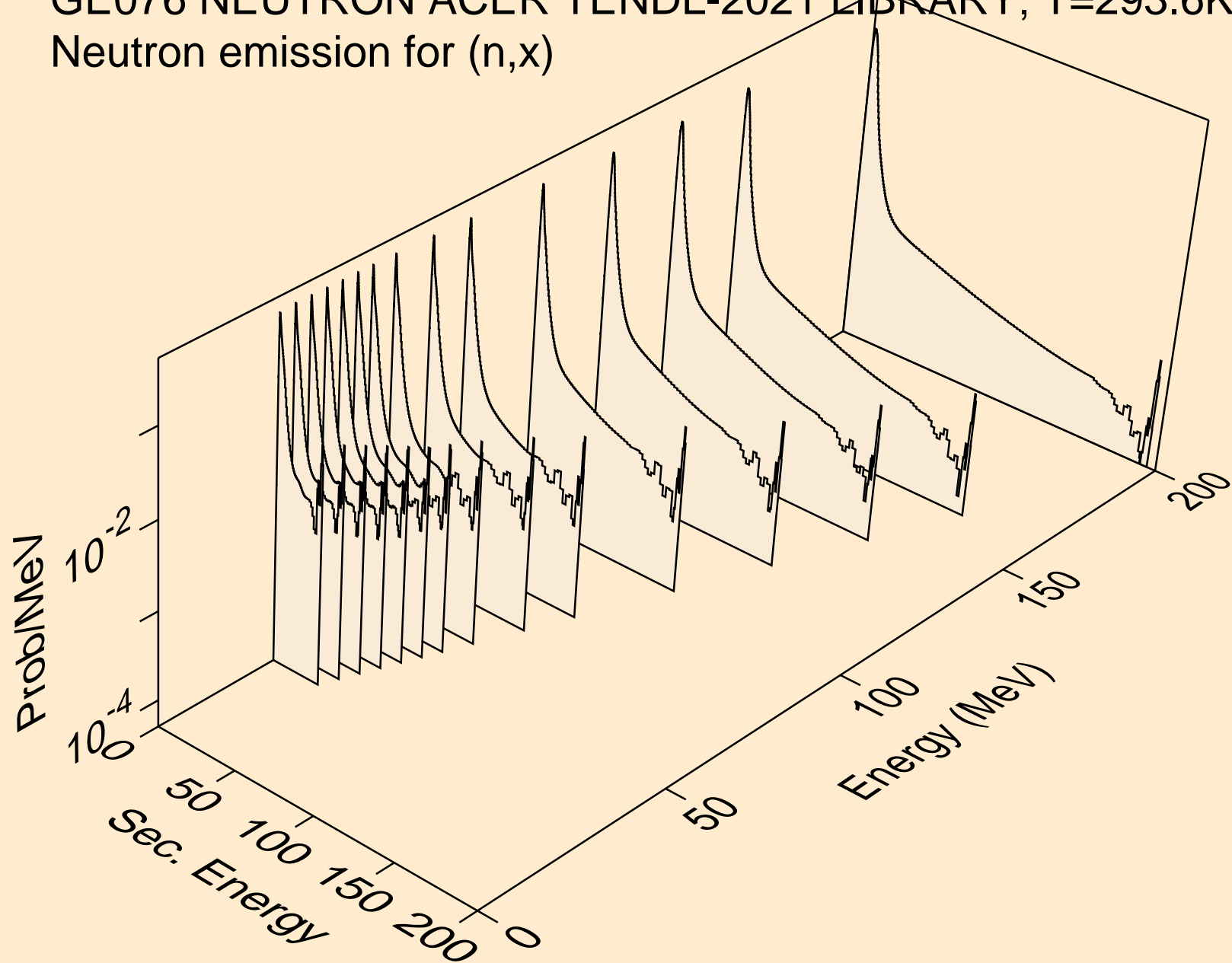

GE076 NEUTRON ACER TENDL-2021 LIBRARY; T=293.6K
Neutron emission for (n,2nd)

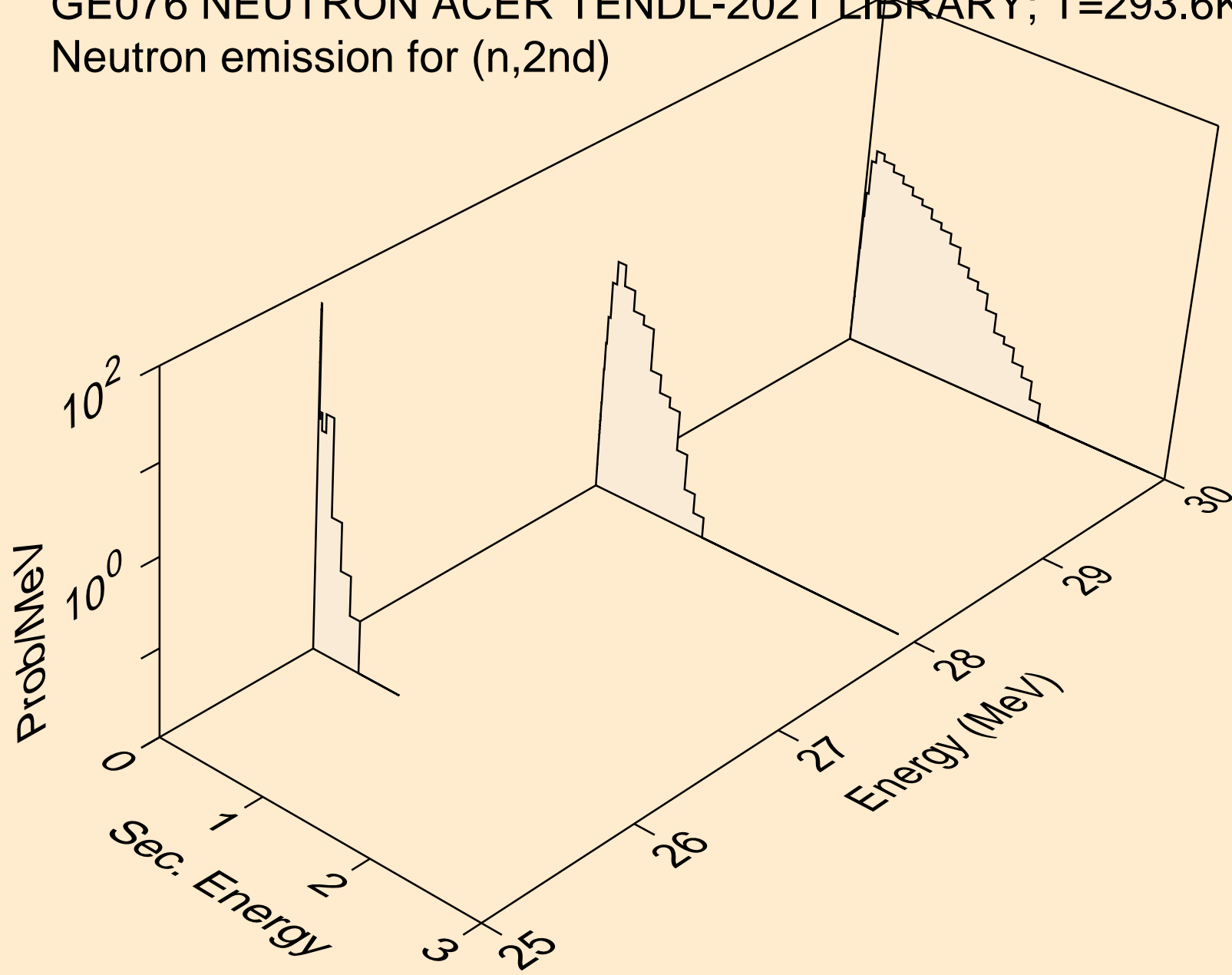

GE076 NEUTRON ACER TENDL-2021 LIBRARY; T=293.6K
Neutron emission for (n,2n)

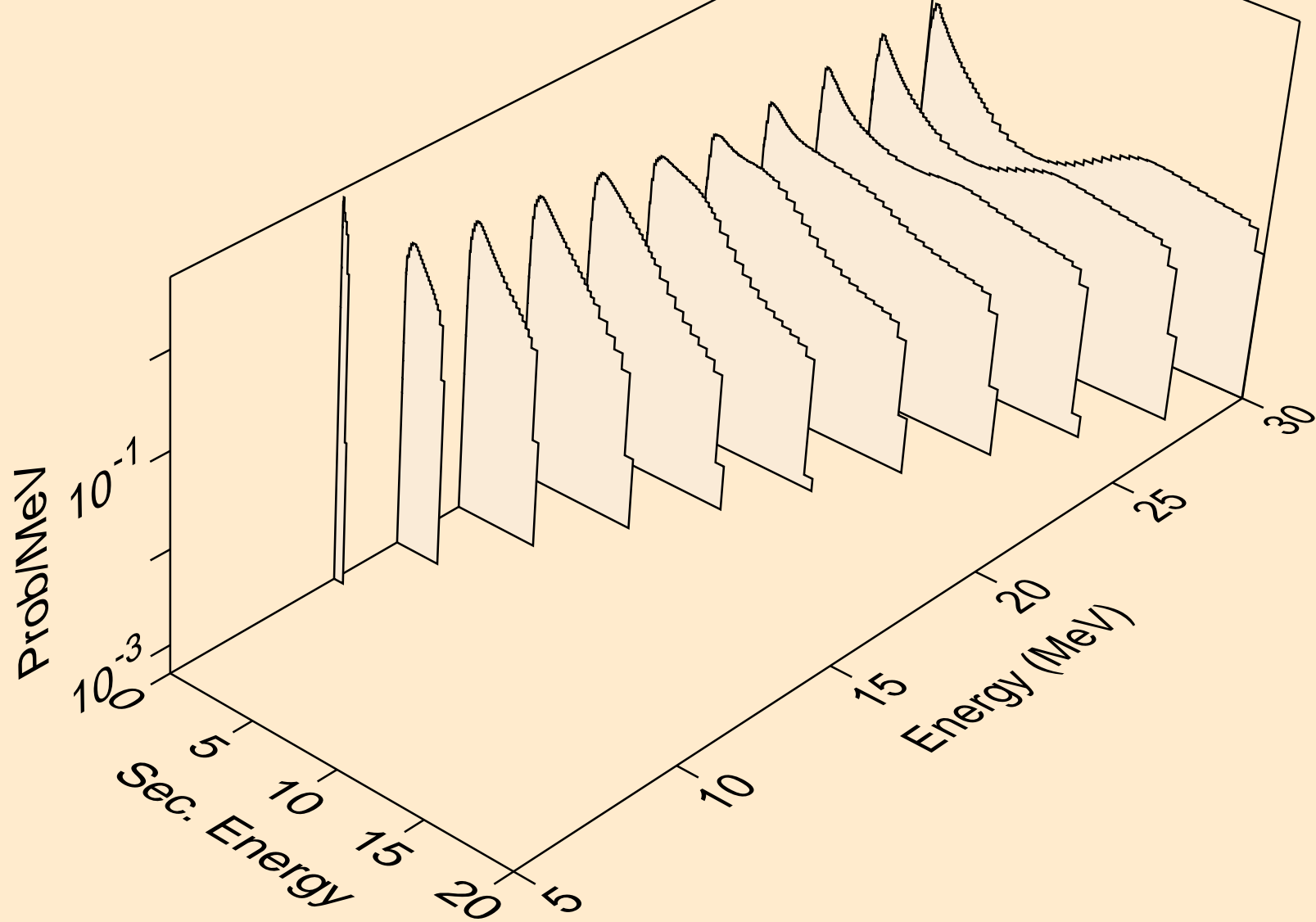

GE076 NEUTRON ACER TENDL-2021 LIBRARY; T=293.6K
Neutron emission for (n,3n)

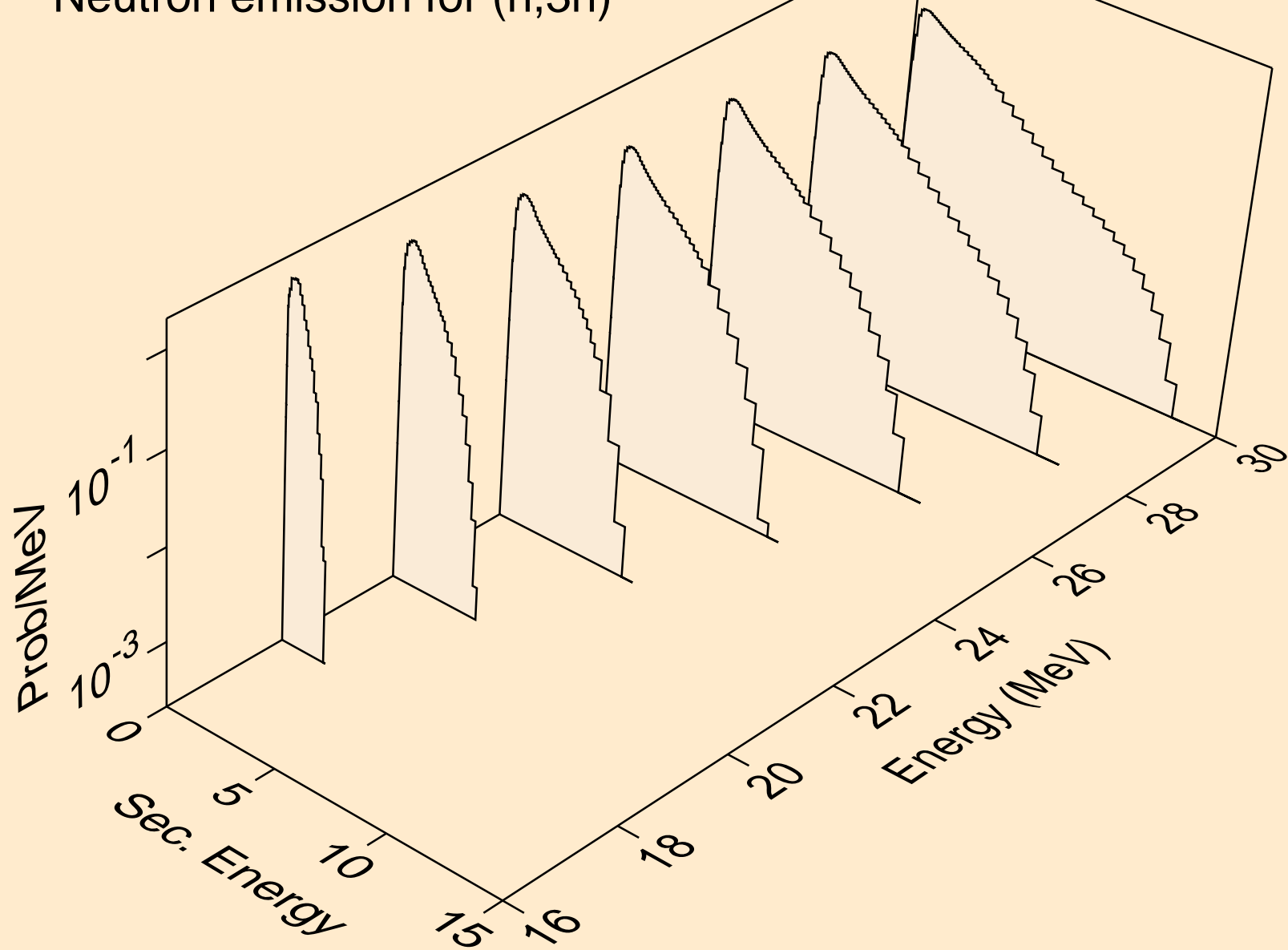

GE076 NEUTRON ACER TENDL-2021 LIBRARY; T=293.6K
Neutron emission for (n,n*)a

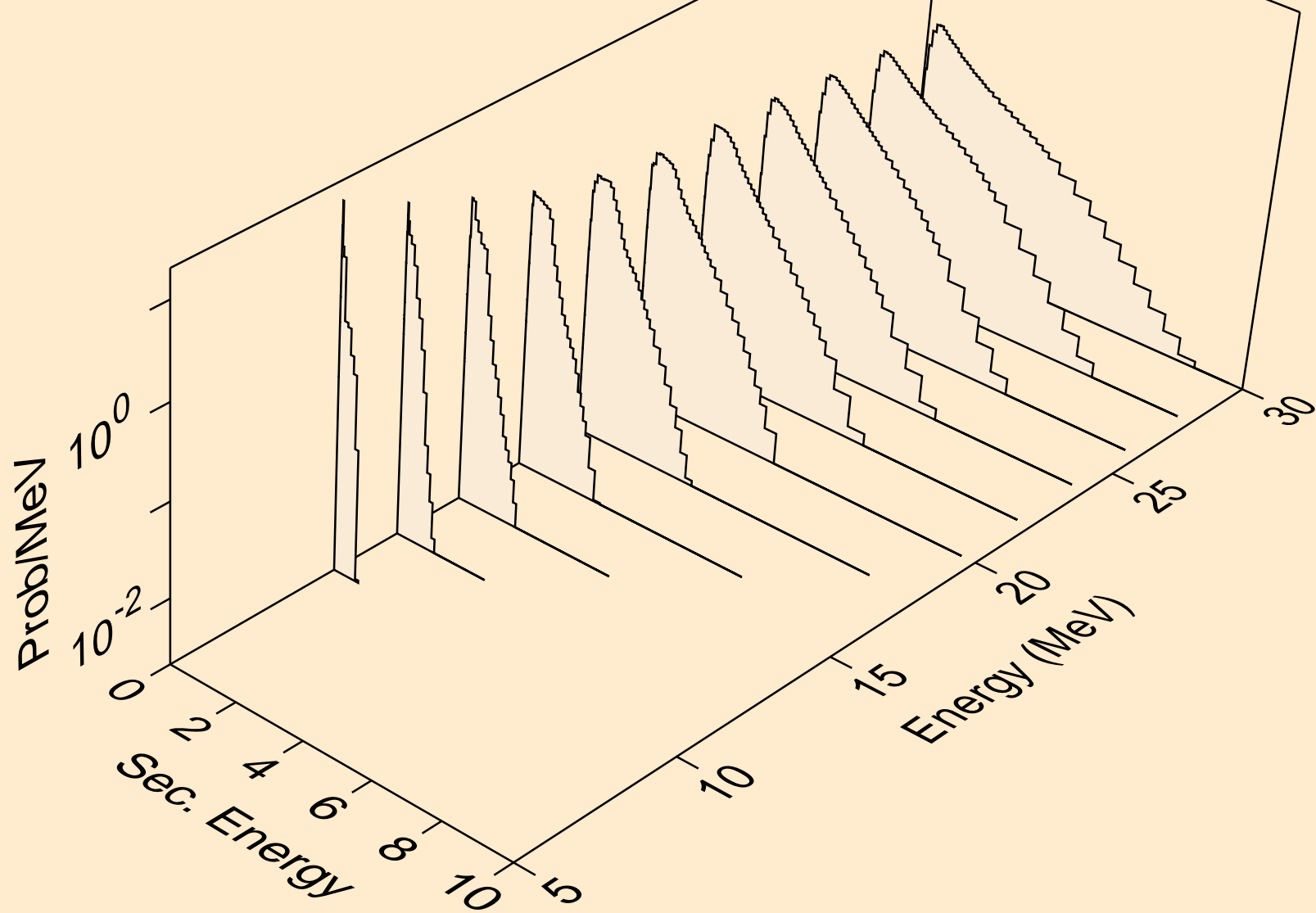

GE076 NEUTRON ACER TENDL-2021 LIBRARY; T=293.6K
Neutron emission for (n,2n)a

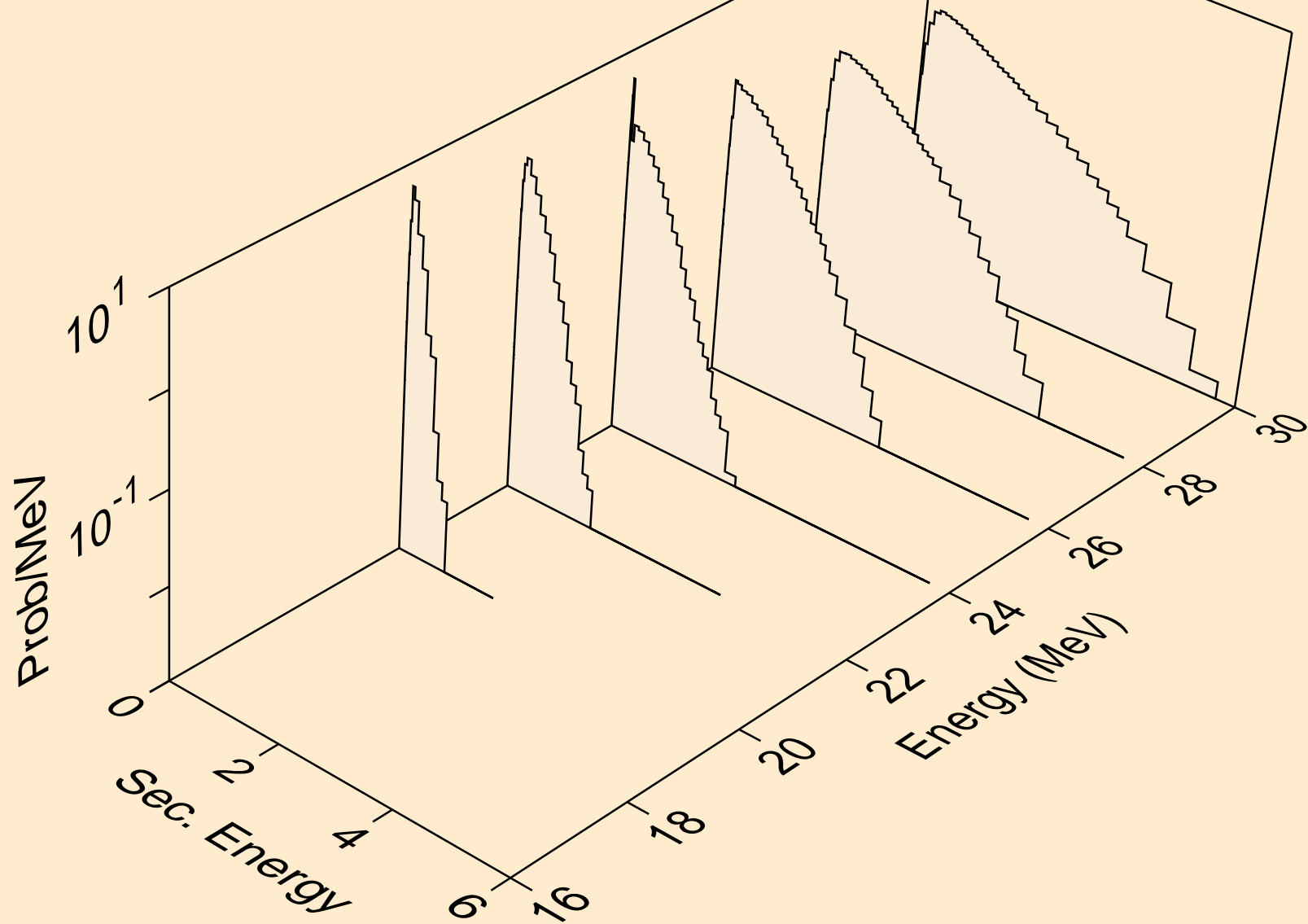

GE076 NEUTRON ACER TENDL-2021 LIBRARY; T=293.6K
Neutron emission for (n,3n)a

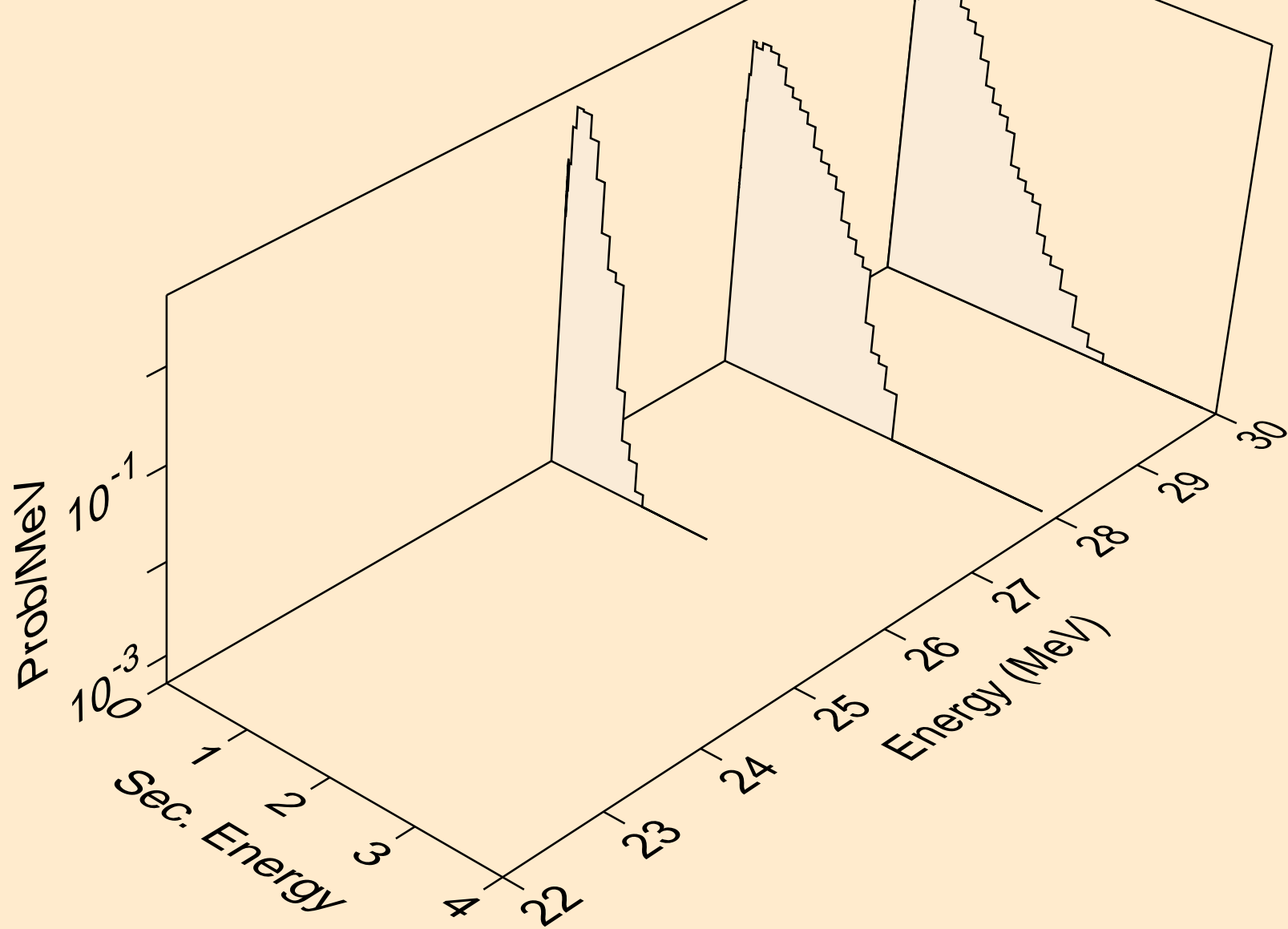

GE076 NEUTRON ACER TENDL-2021 LIBRARY; T=293.6K
Neutron emission for (n,n*)p

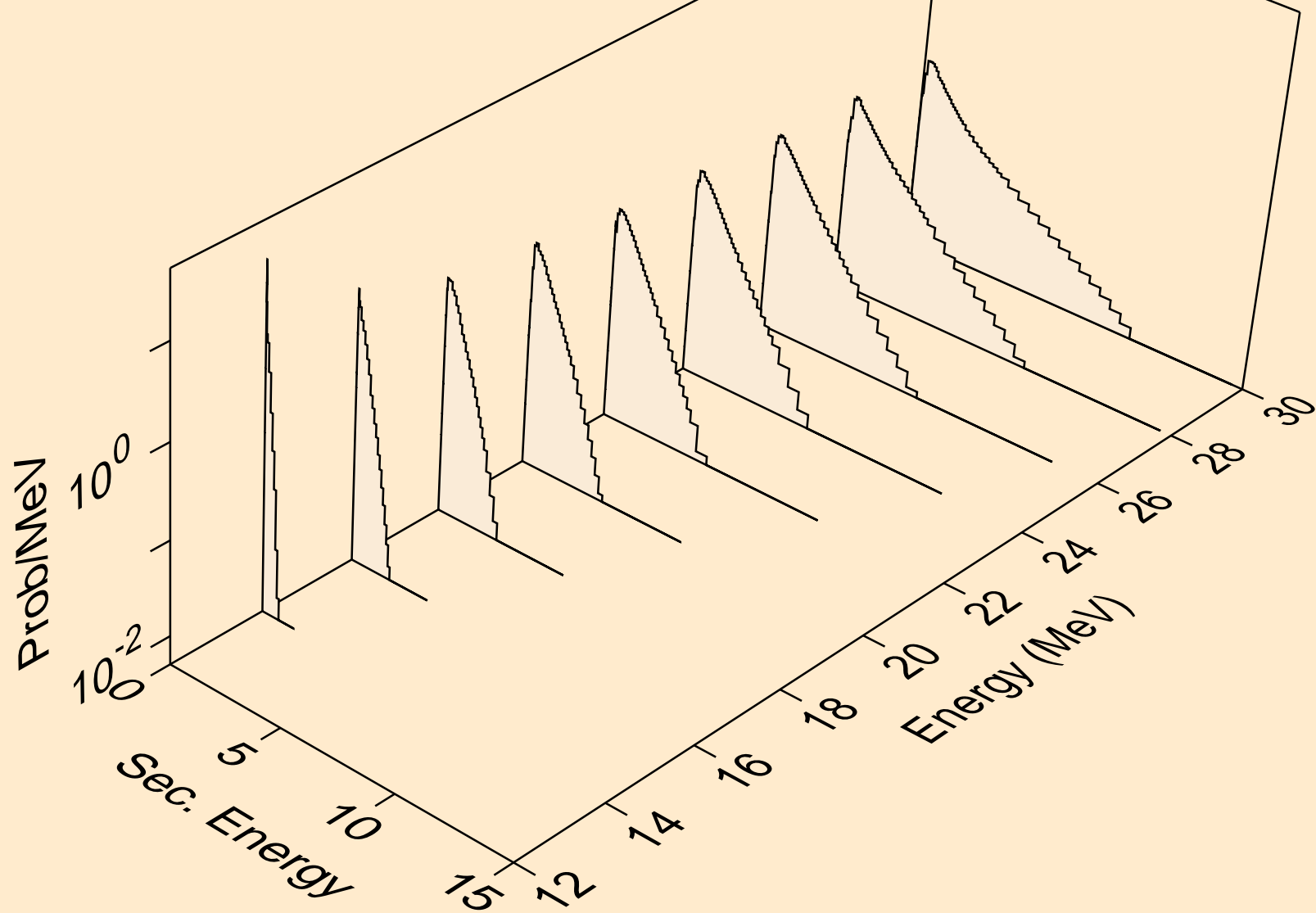

GE076 NEUTRON ACER TENDL-2021 LIBRARY; T=293.6K
Neutron emission for (n,n*)2a

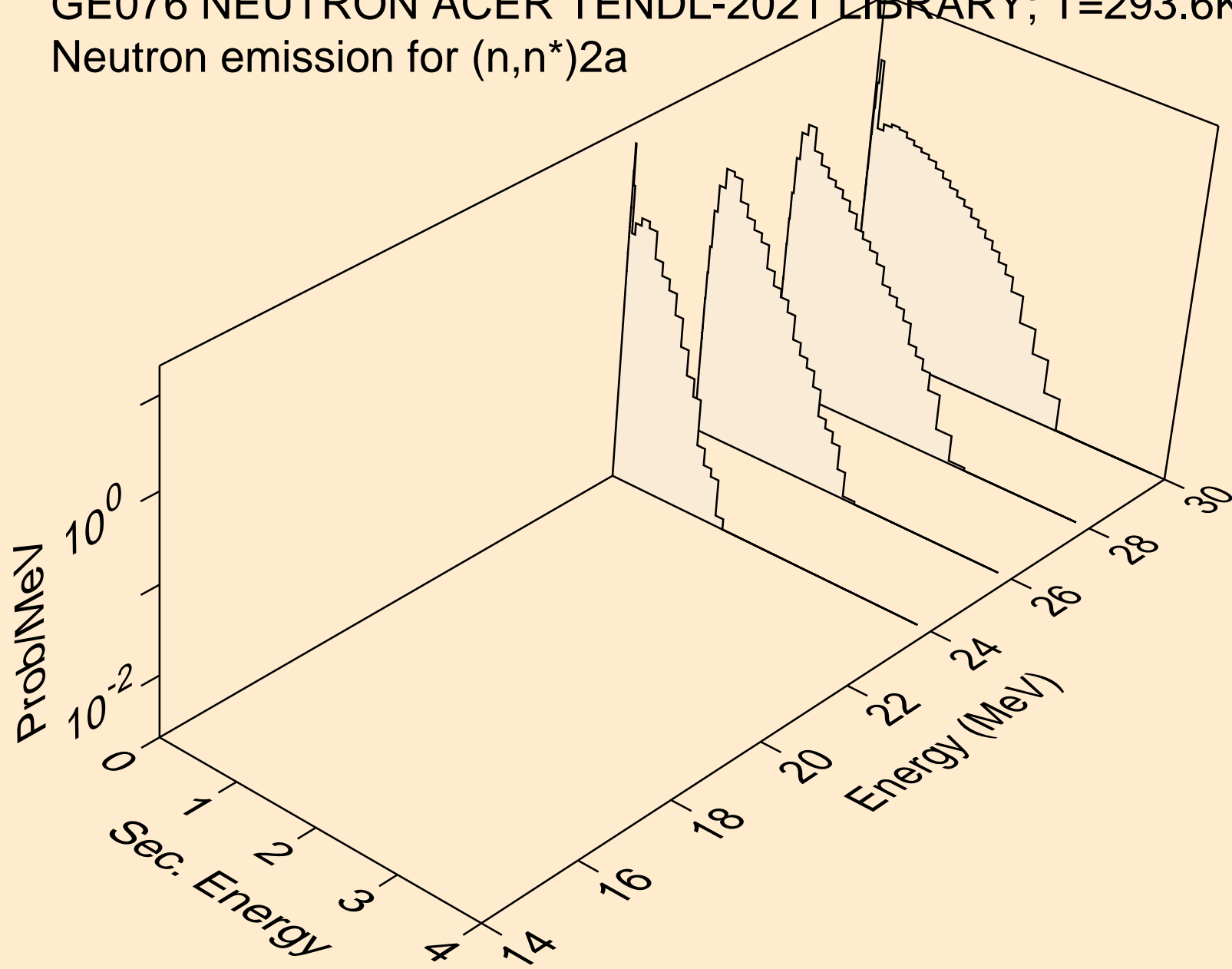

GE076 NEUTRON ACER TENDL-2021 LIBRARY; T=293.6K
Neutron emission for (n,n*)d

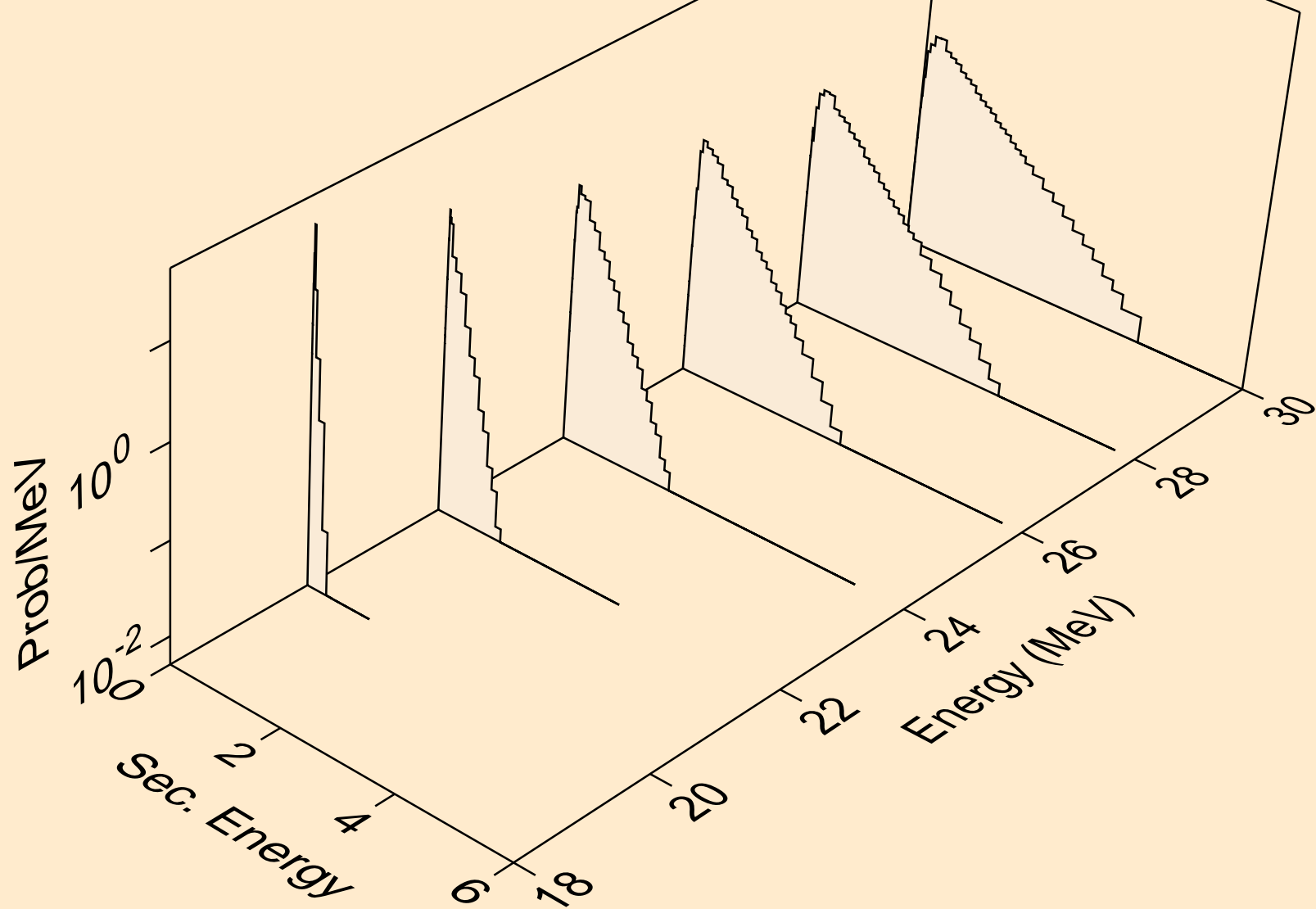

GE076 NEUTRON ACER TENDL-2021 LIBRARY; T=293.6K
Neutron emission for (n,n*)t

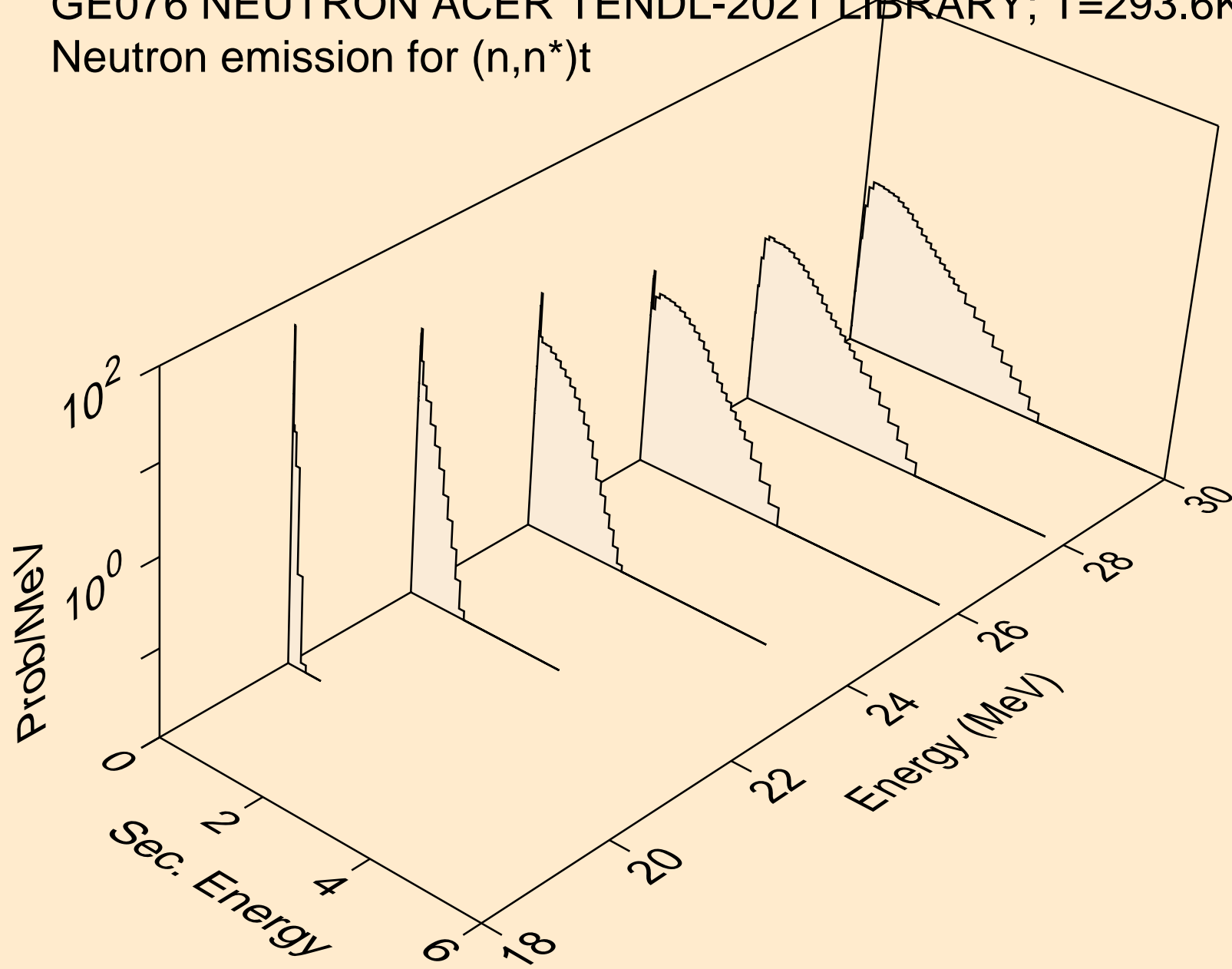

GE076 NEUTRON ACER TENDL-2021 LIBRARY; T=293.6K
Neutron emission for (n,n*)he3

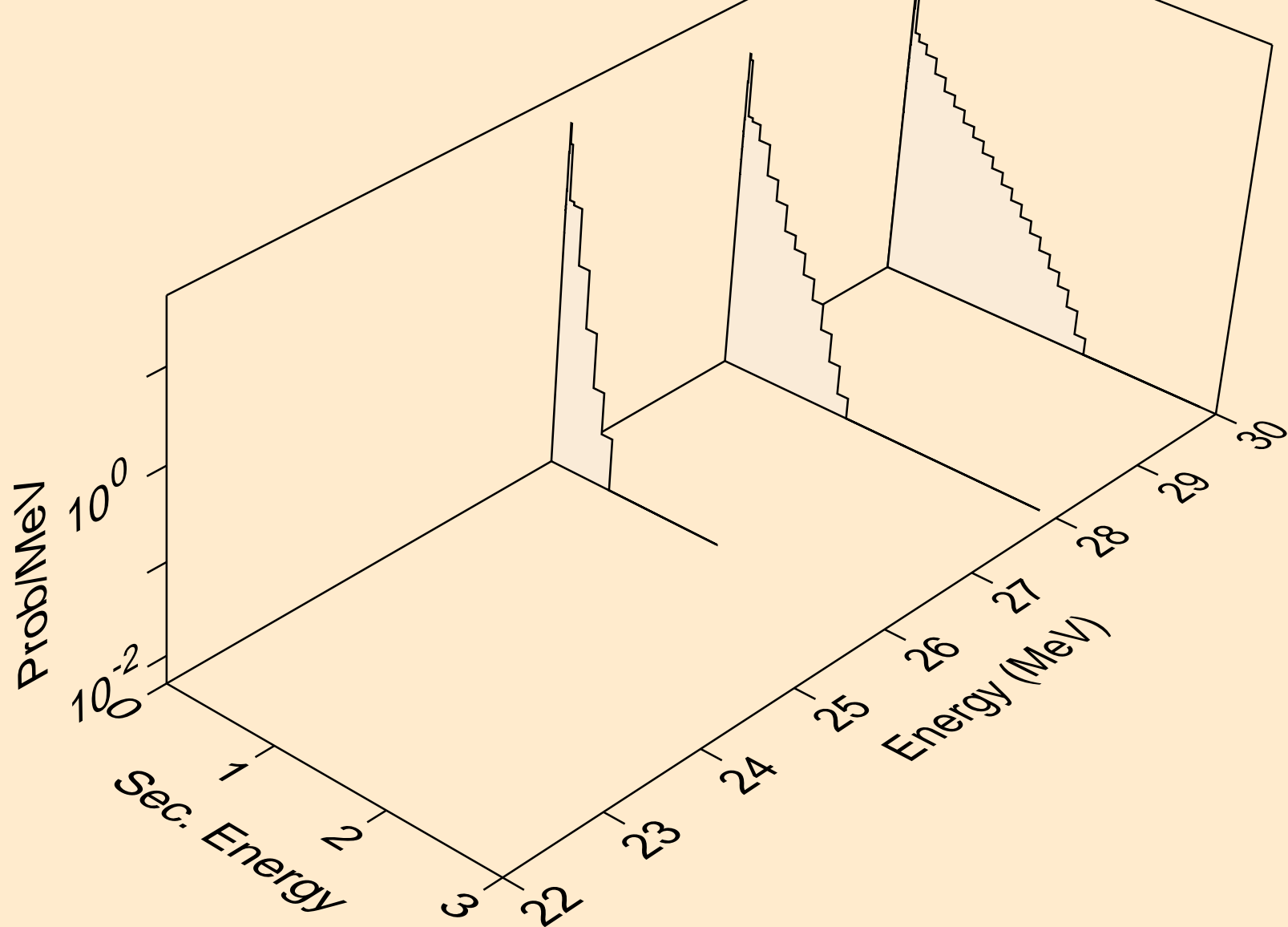

GE076 NEUTRON ACER TENDL-2021 LIBRARY; T=293.6K
Neutron emission for (n,4n)

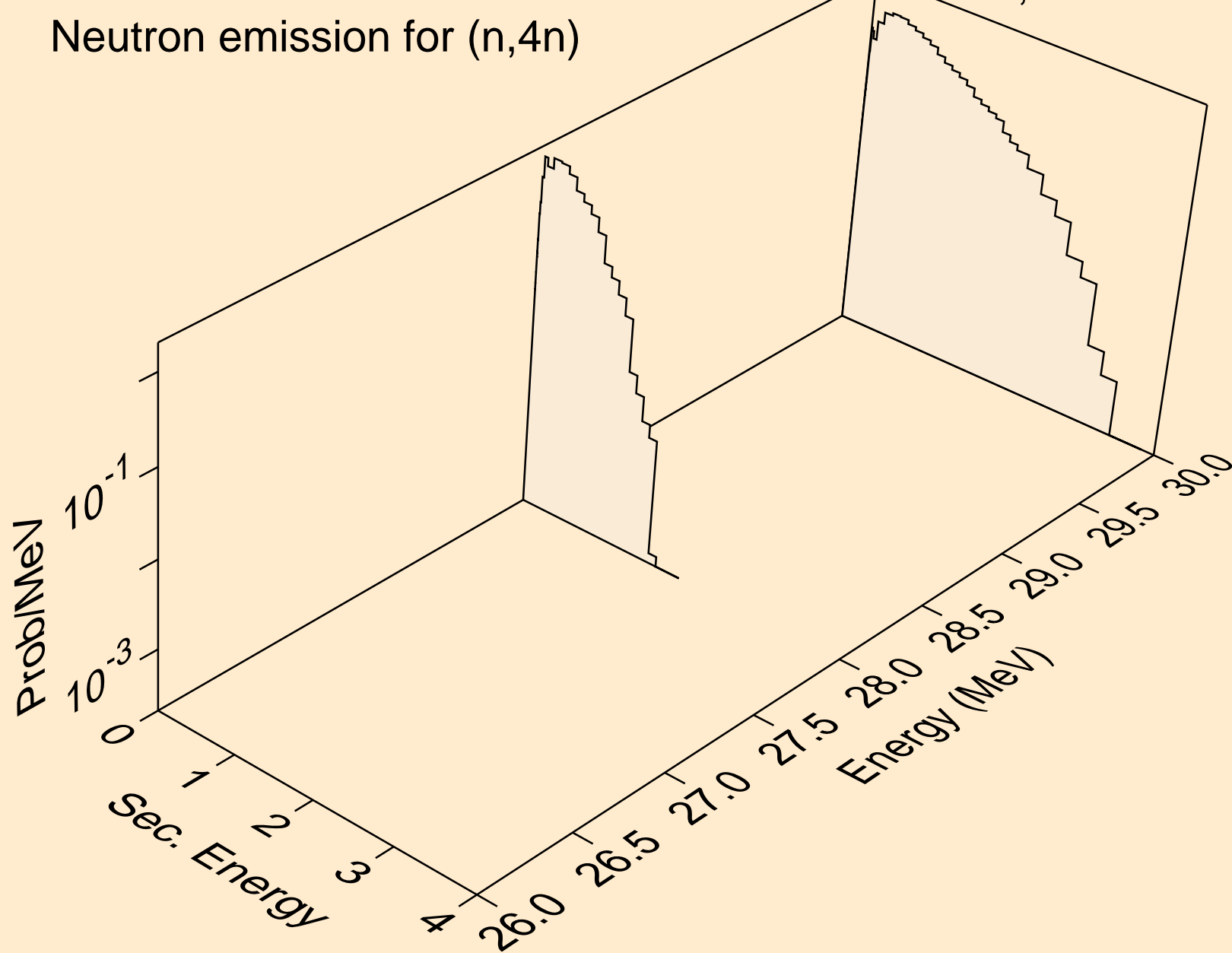

GE076 NEUTRON ACER TENDL-2021 LIBRARY; T=293.6K
Neutron emission for (n,2np)

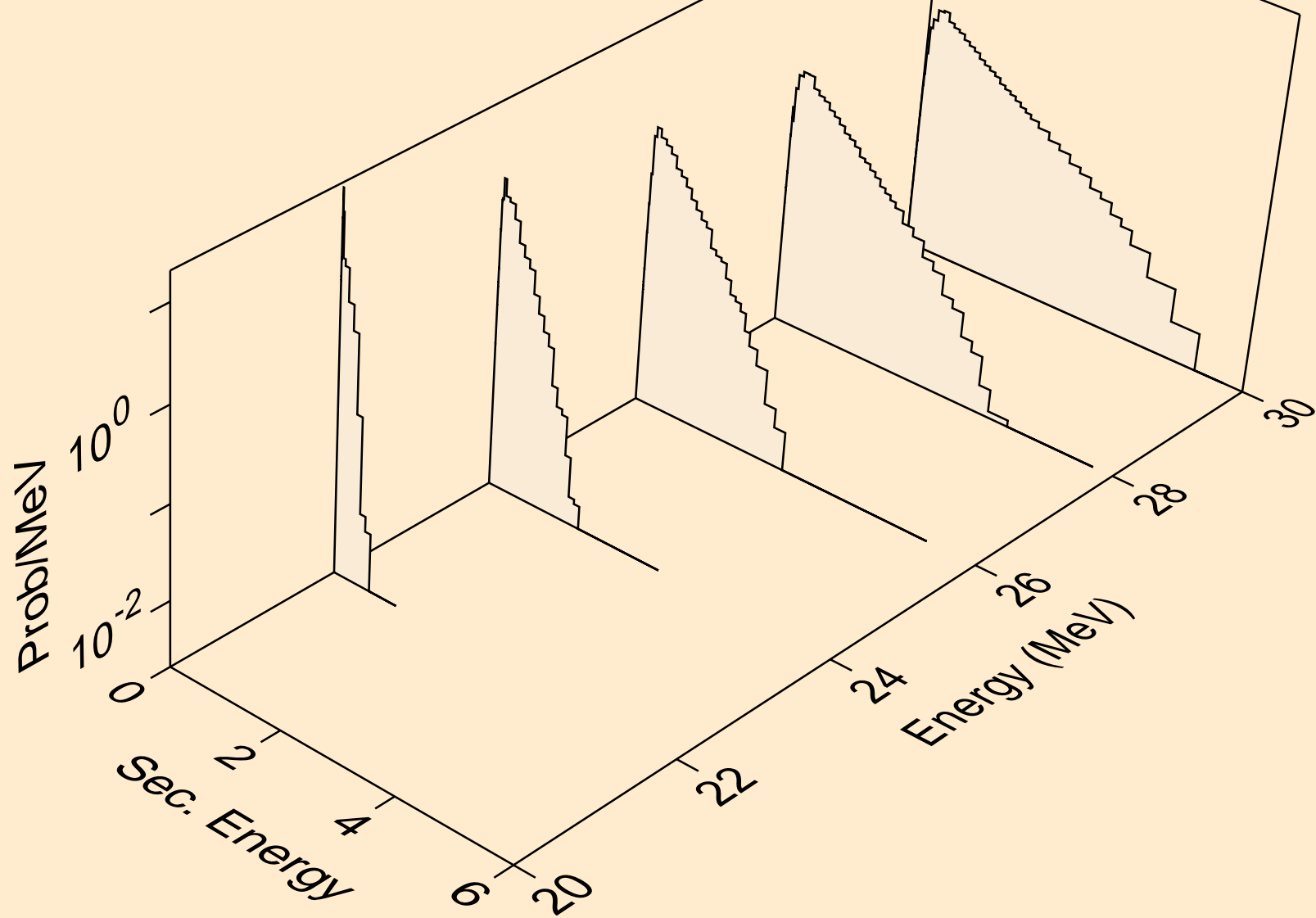

GE076 NEUTRON ACER TENDL-2021 LIBRARY; T=293.6K
Neutron emission for (n,3np)

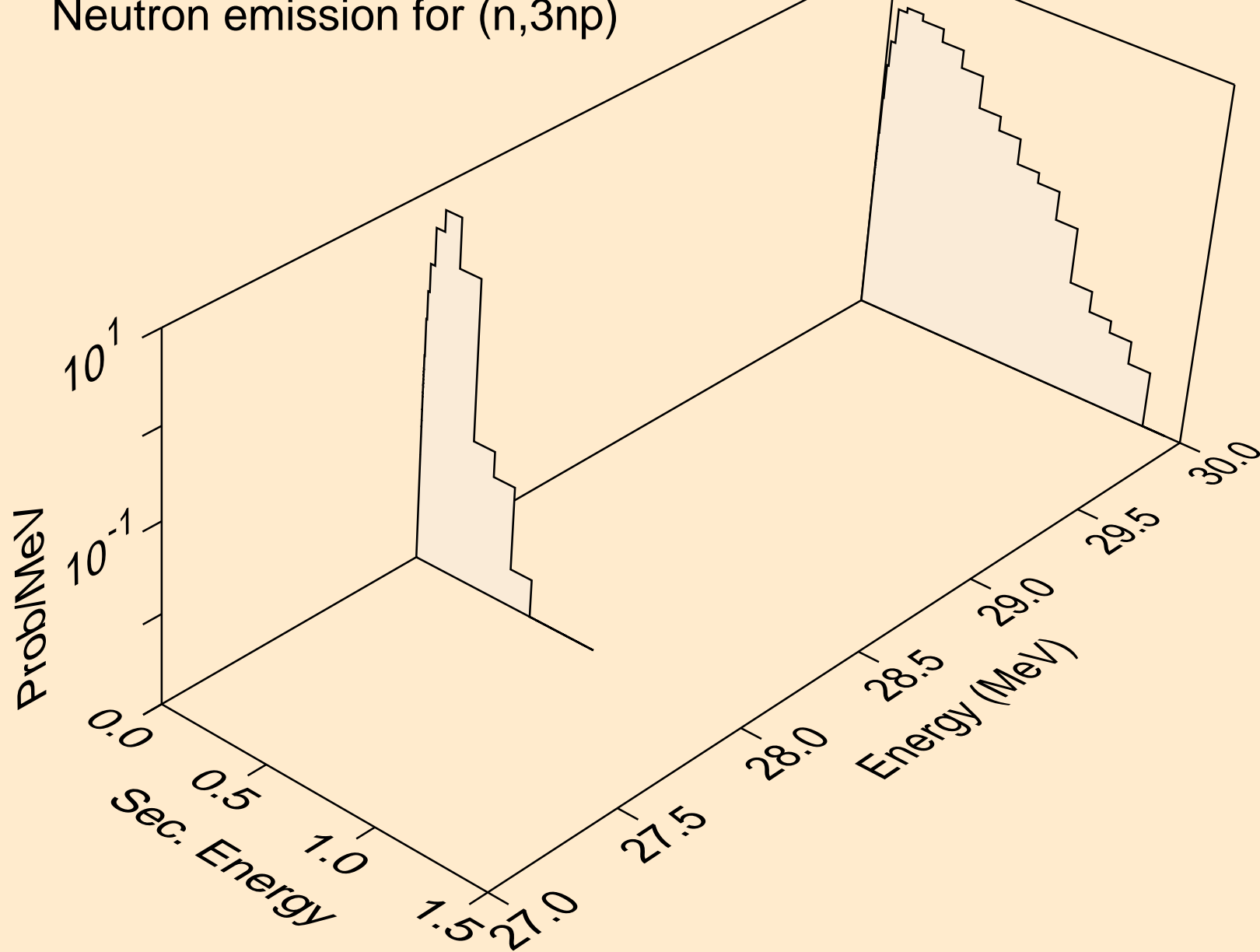

GE076 NEUTRON ACER TENDL-2021 LIBRARY; T=293.6K
Neutron emission for (n,2np)

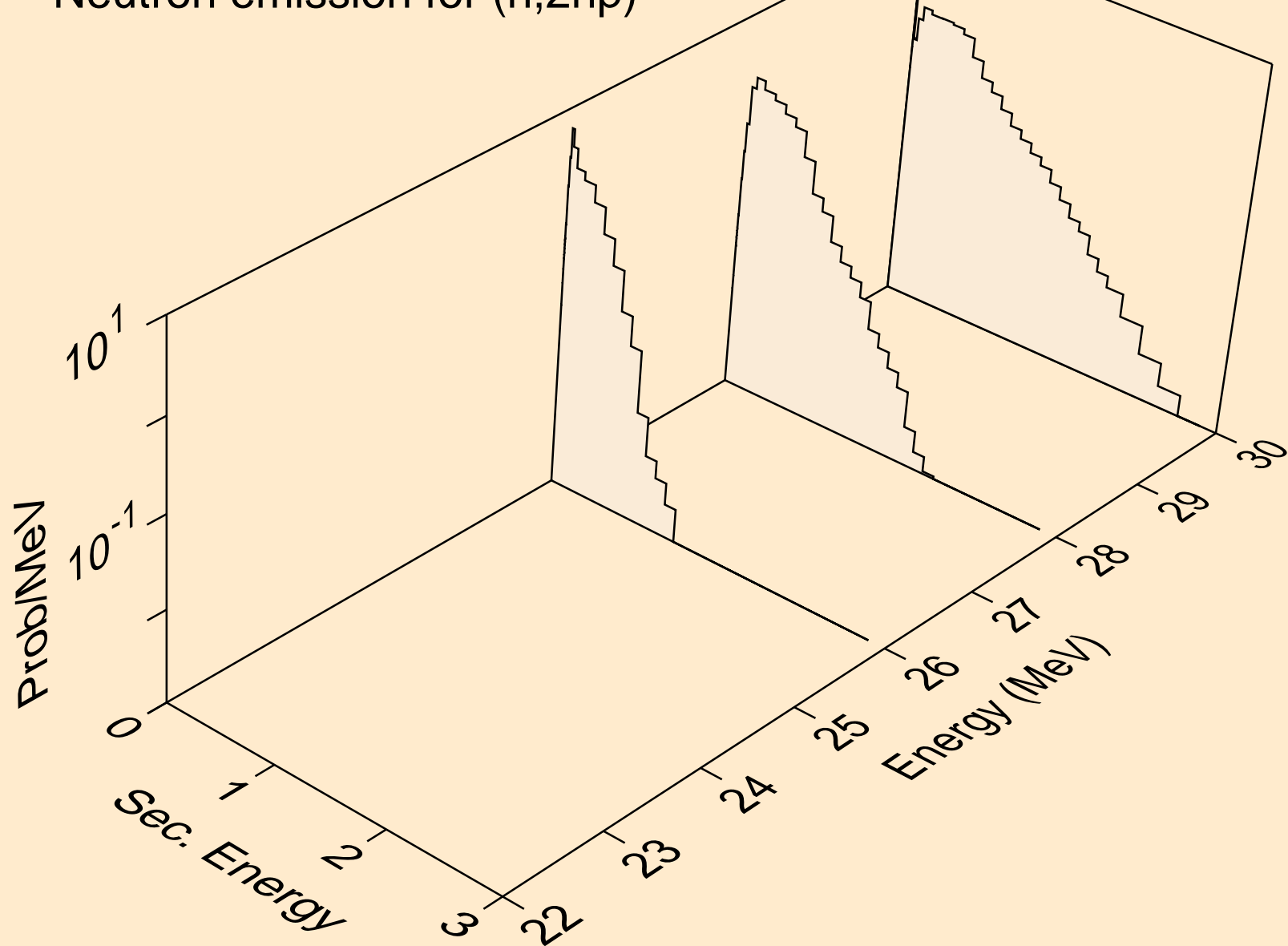

GE076 NEUTRON ACER TENDL-2021 LIBRARY; T=293.6K
Neutron emission for (n,n*c)

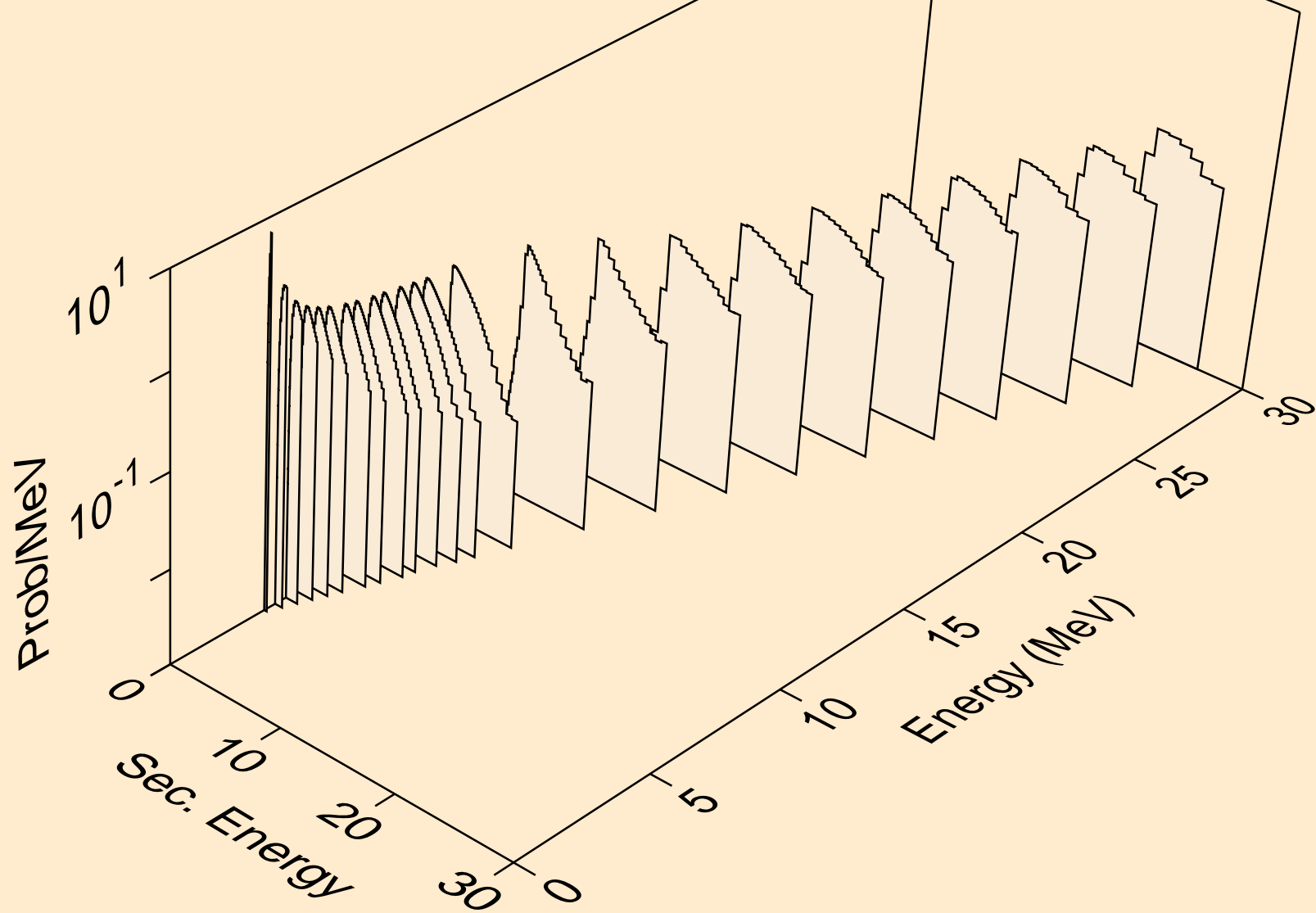

GE076 NEUTRON ACER TENDL-2021 LIBRARY; T=293.6K
Photon emission for (n,x)

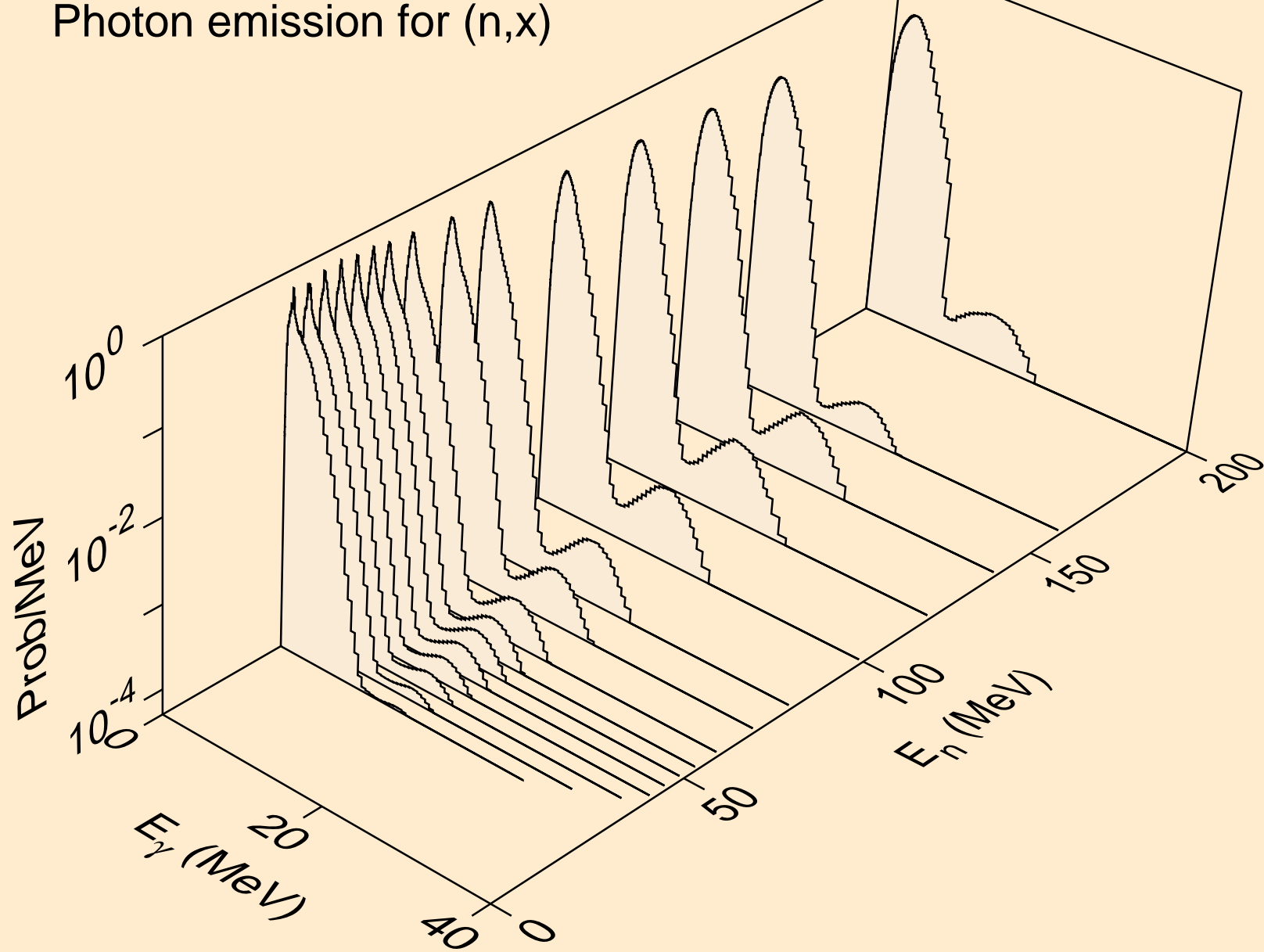

GE076 NEUTRON ACER TENDL-2021 LIBRARY; T=293.6K
Photon emission for (n,2nd)

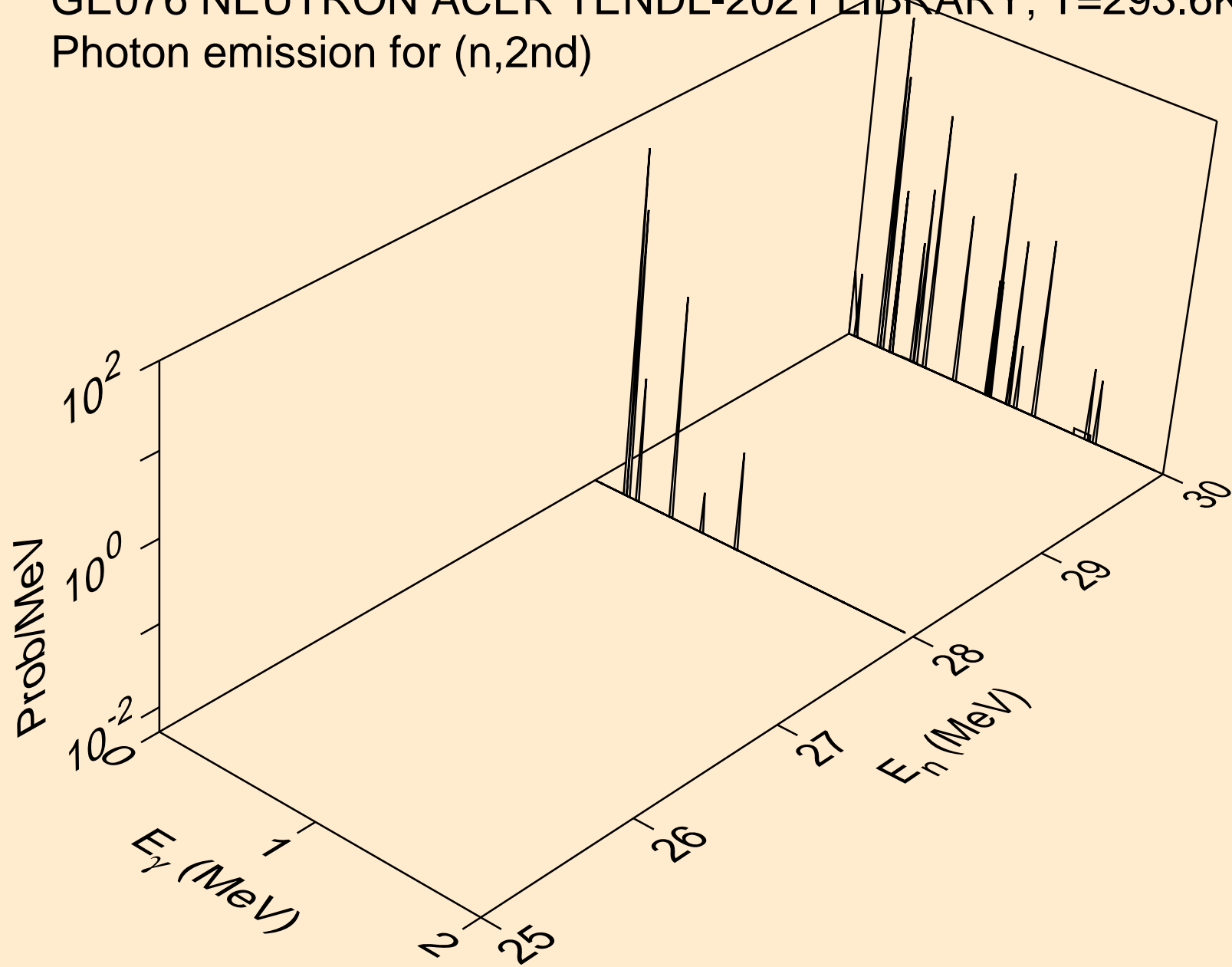

GE076 NEUTRON ACER TENDL-2021 LIBRARY; T=293.6K
Photon emission for (n,2n)

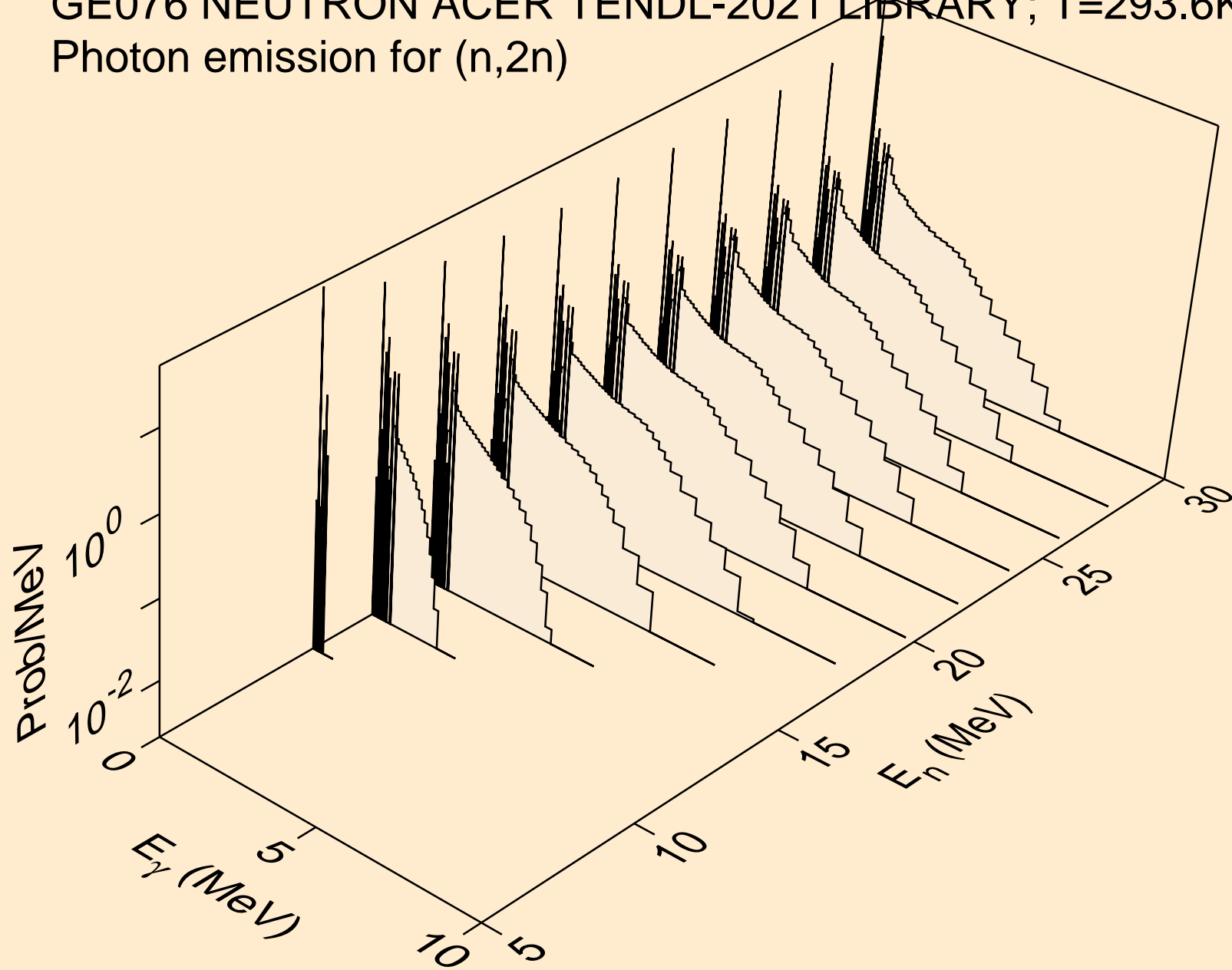

GE076 NEUTRON ACER TENDL-2021 LIBRARY; T=293.6K
Photon emission for (n,3n)

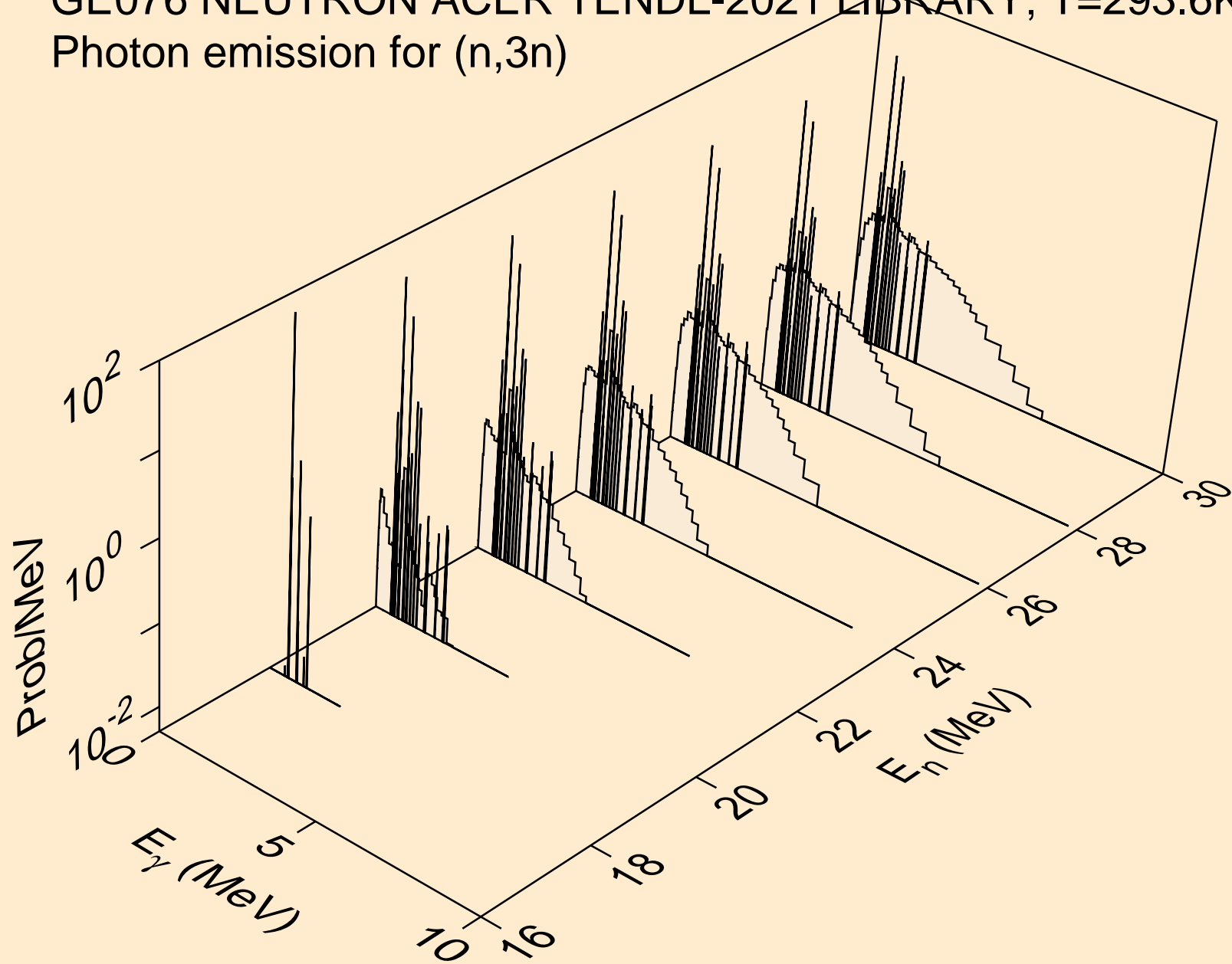

GE076 NEUTRON ACER TENDL-2021 LIBRARY; T=293.6K
Photon emission for (n,n*)a

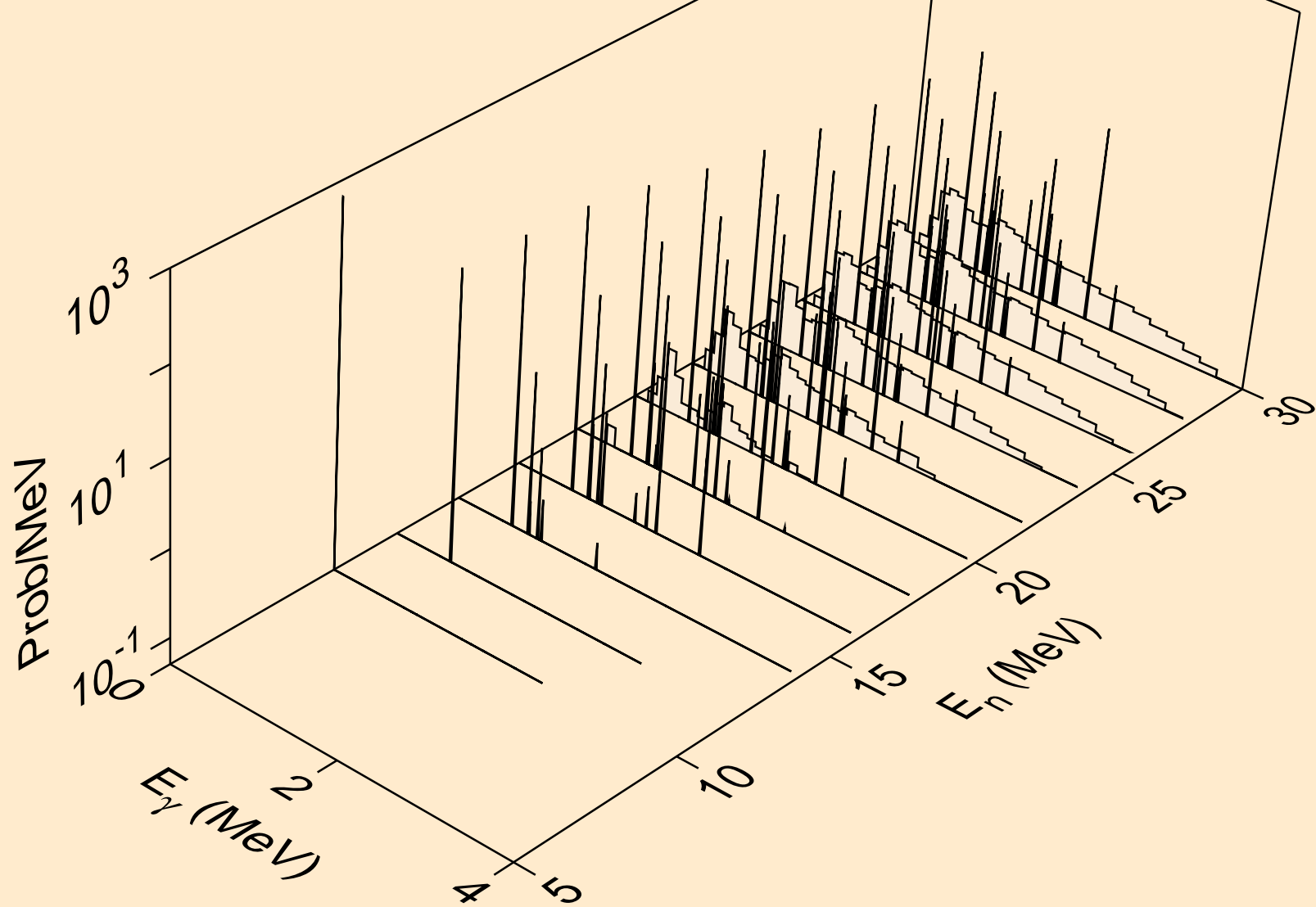

GE076 NEUTRON ACER TENDL-2021 LIBRARY; T=293.6K
Photon emission for (n,2n)a

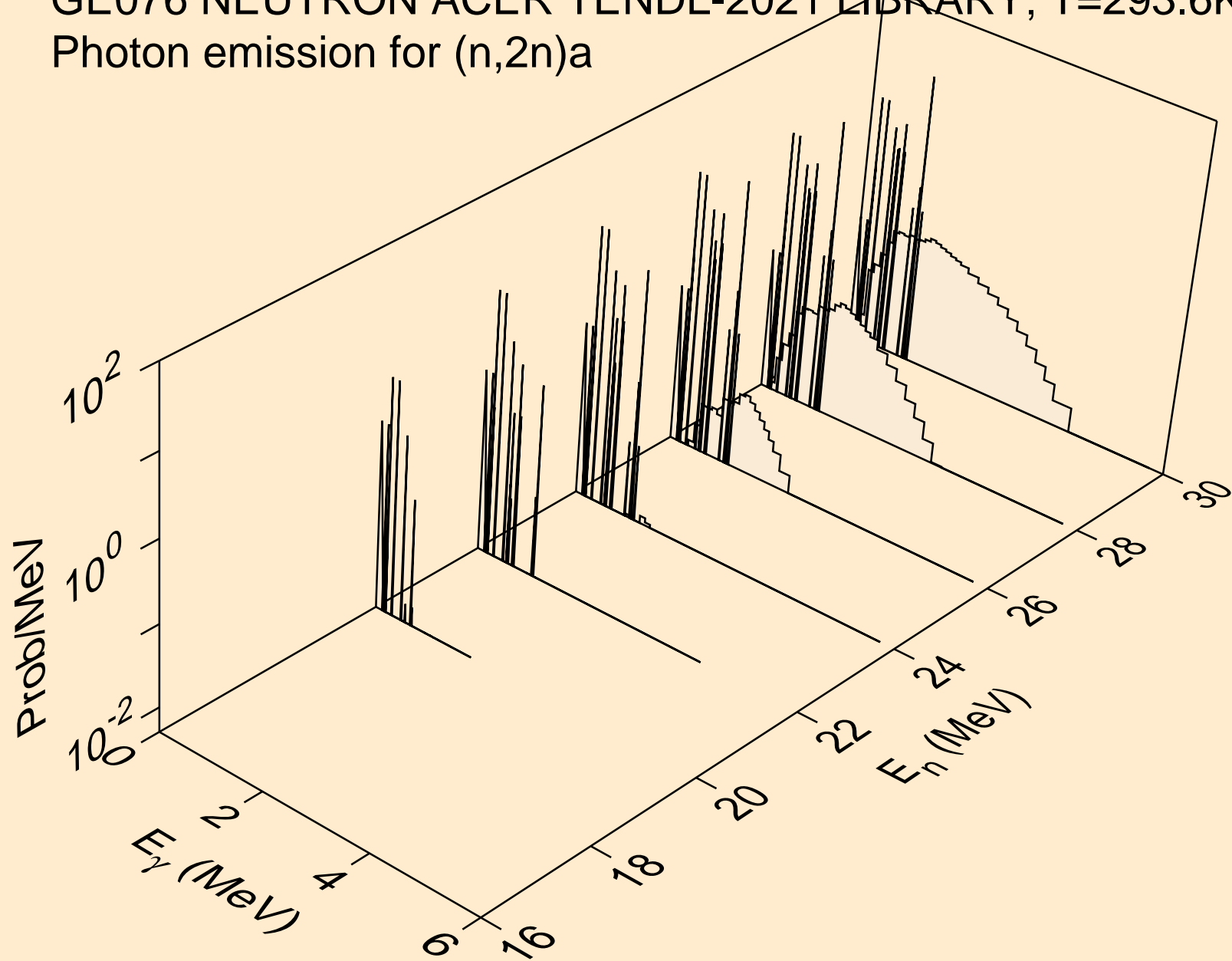

GE076 NEUTRON ACER TENDL-2021 LIBRARY; T=293.6K
Photon emission for (n,3n)a

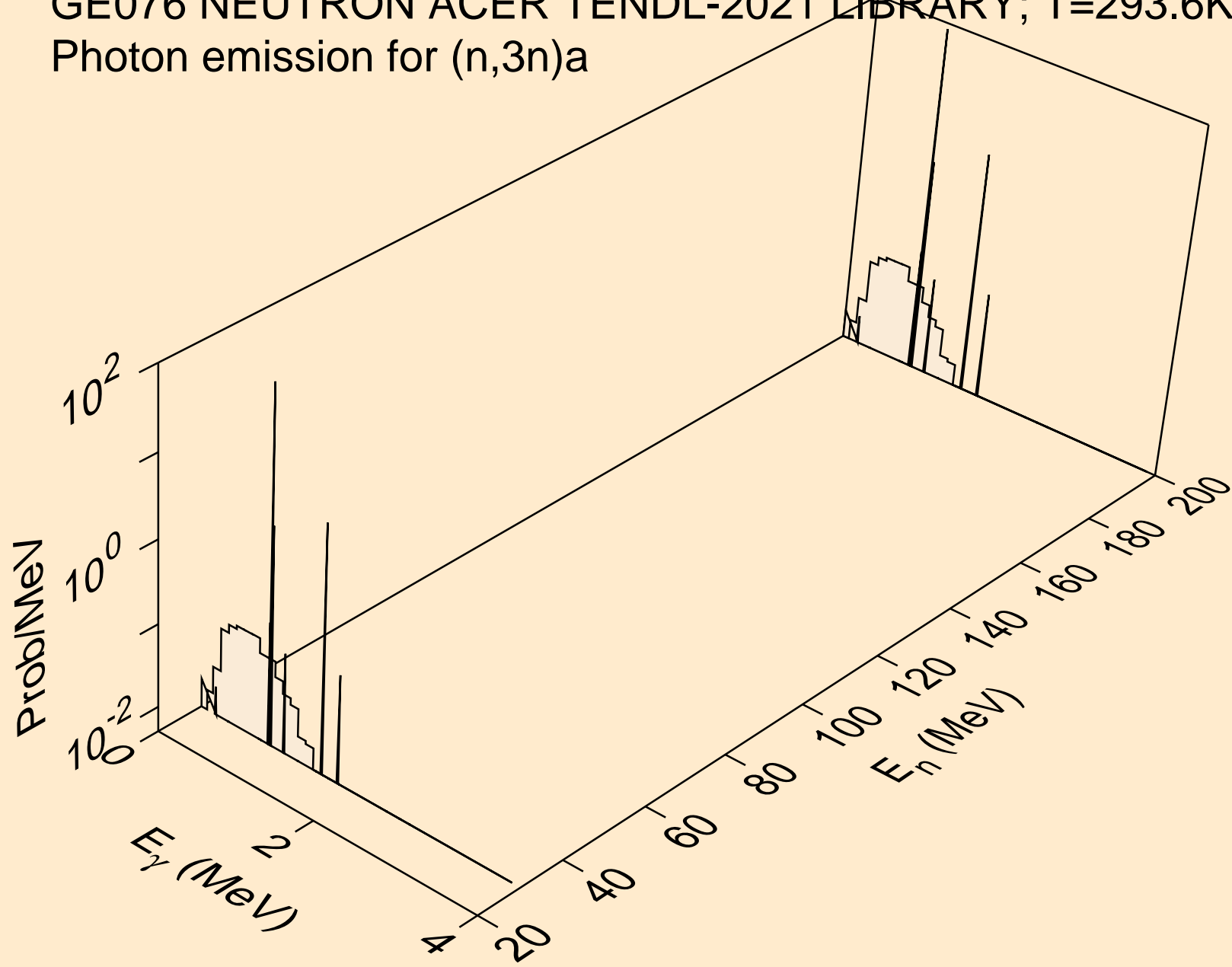

GE076 NEUTRON ACER TENDL-2021 LIBRARY; T=293.6K
Photon emission for (n,n*)p

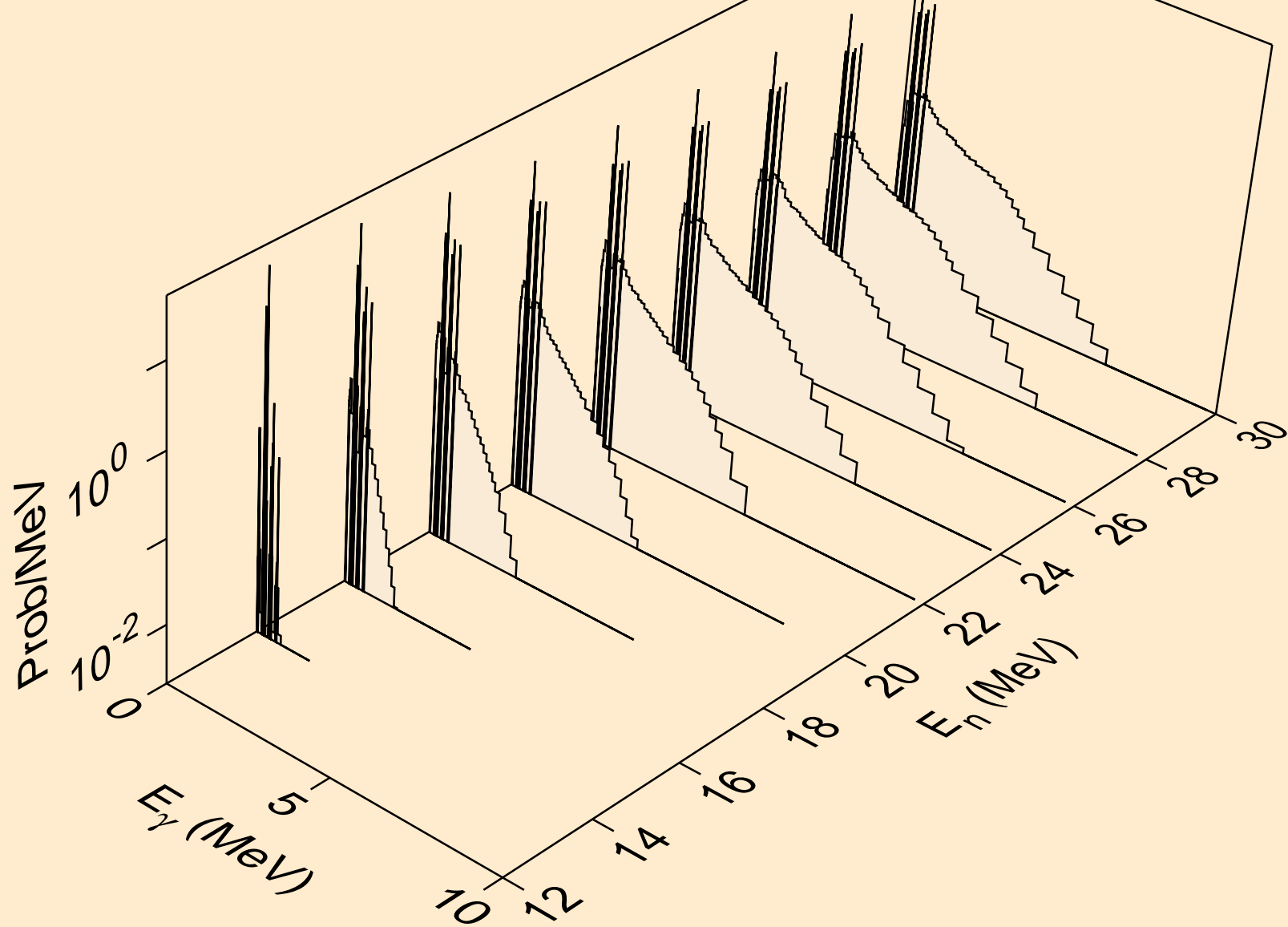

GE076 NEUTRON ACER TENDL-2021 LIBRARY; T=293.6K
Photon emission for (n,n*)2a

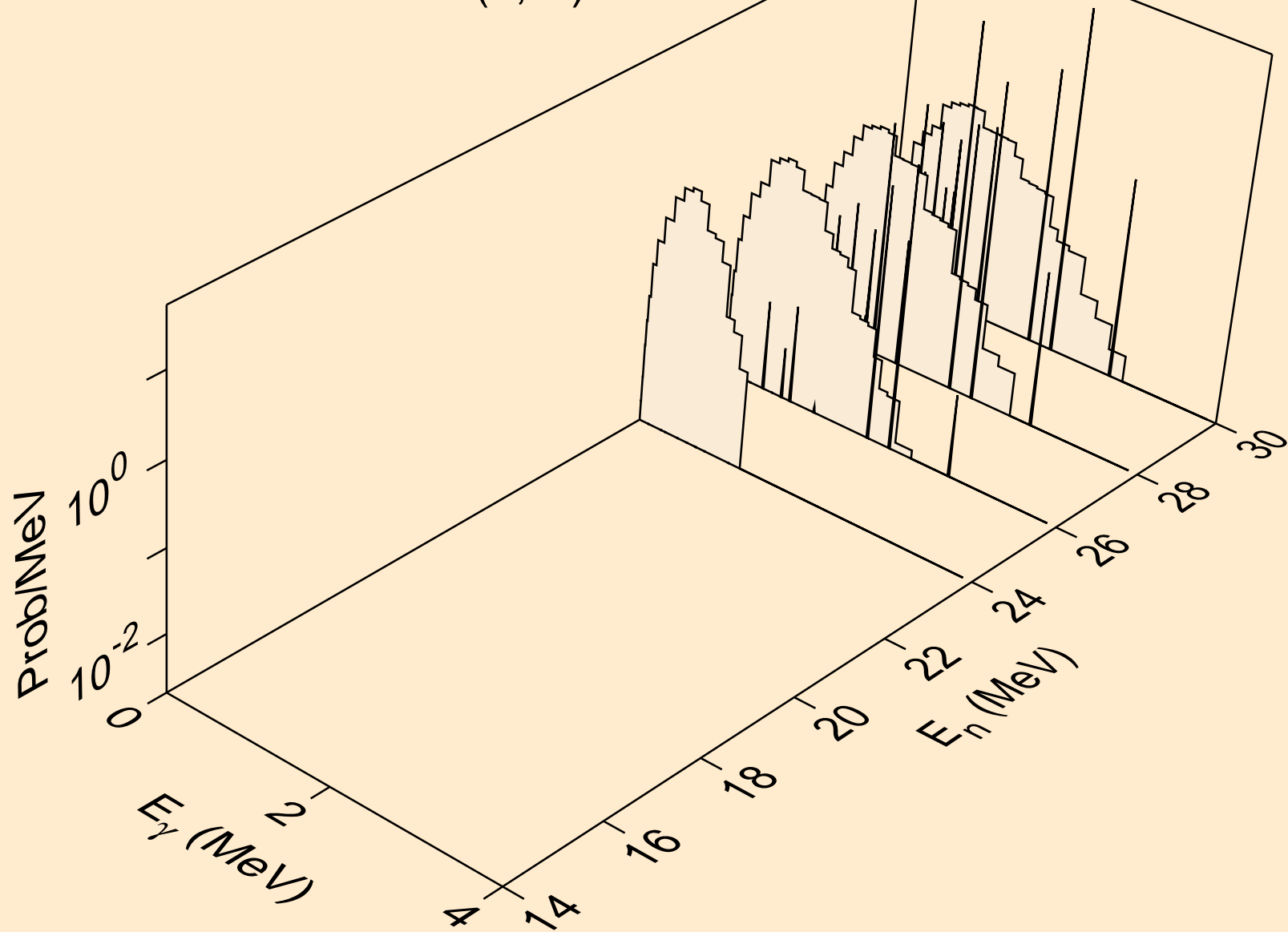

GE076 NEUTRON ACER TENDL-2021 LIBRARY; T=293.6K
Photon emission for (n,n*)d

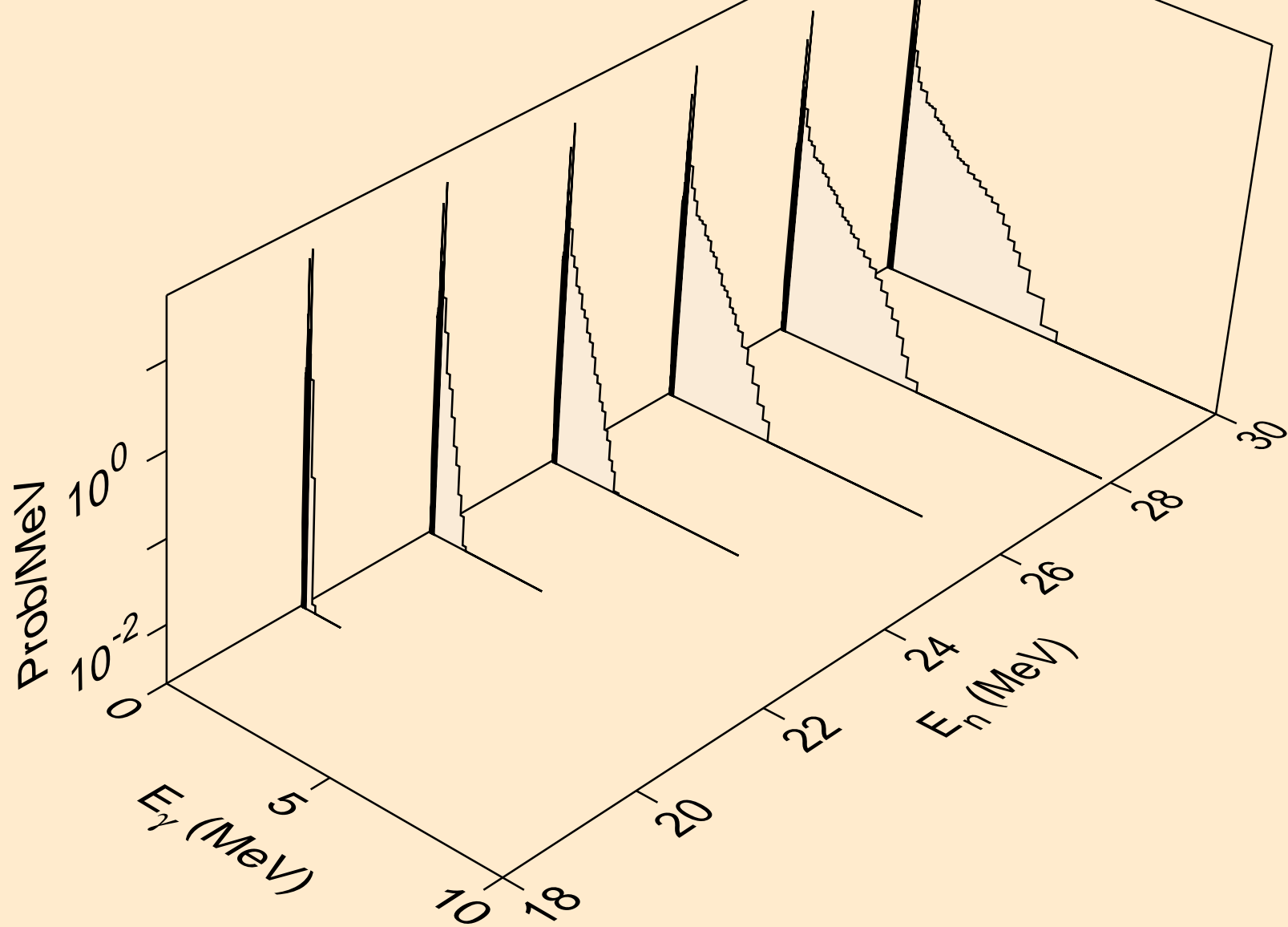

GE076 NEUTRON ACER TENDL-2021 LIBRARY; T=293.6K
Photon emission for (n,n*)t

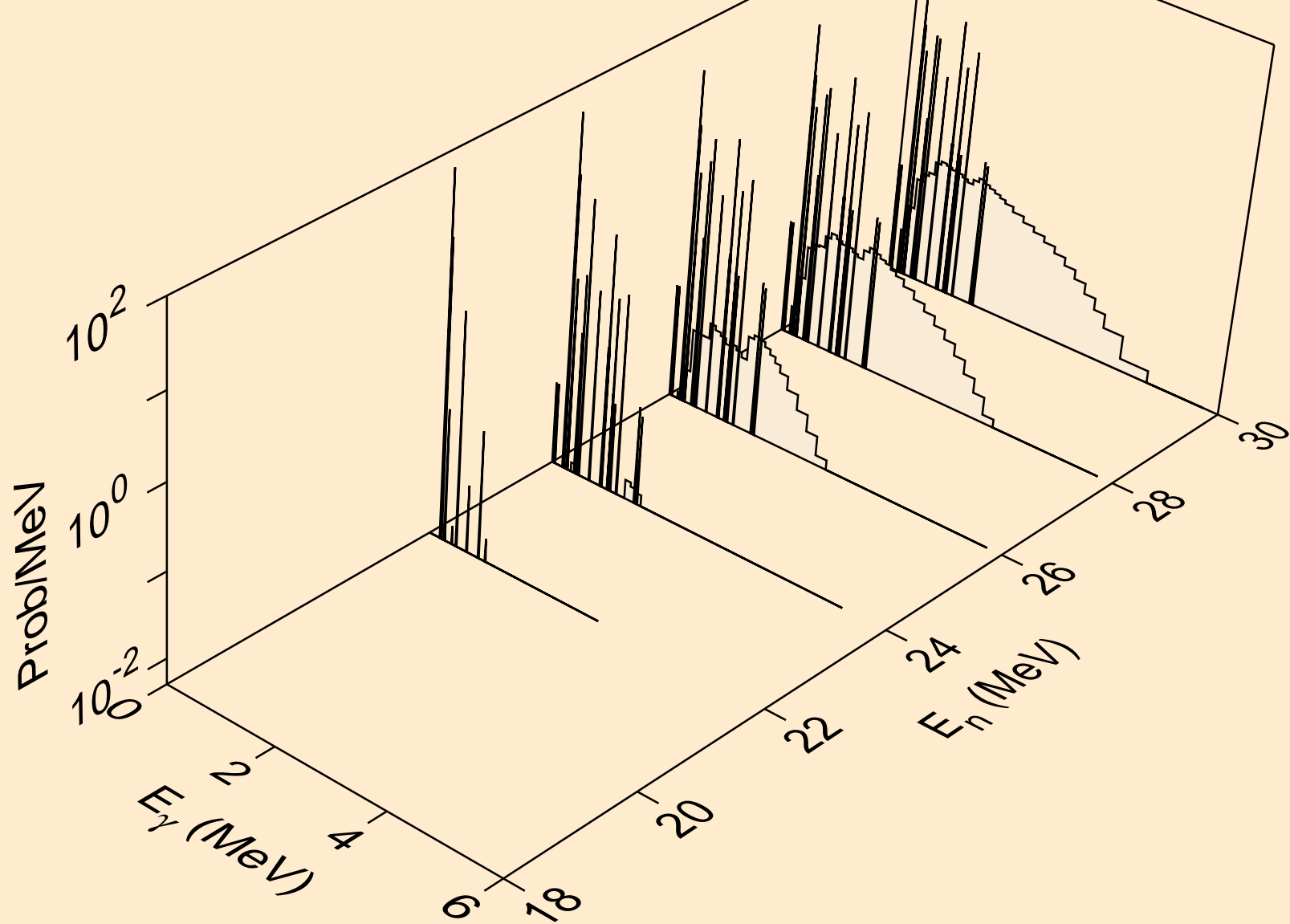

GE076 NEUTRON ACER TENDL-2021 LIBRARY; T=293.6K
Photon emission for (n,n*)he3

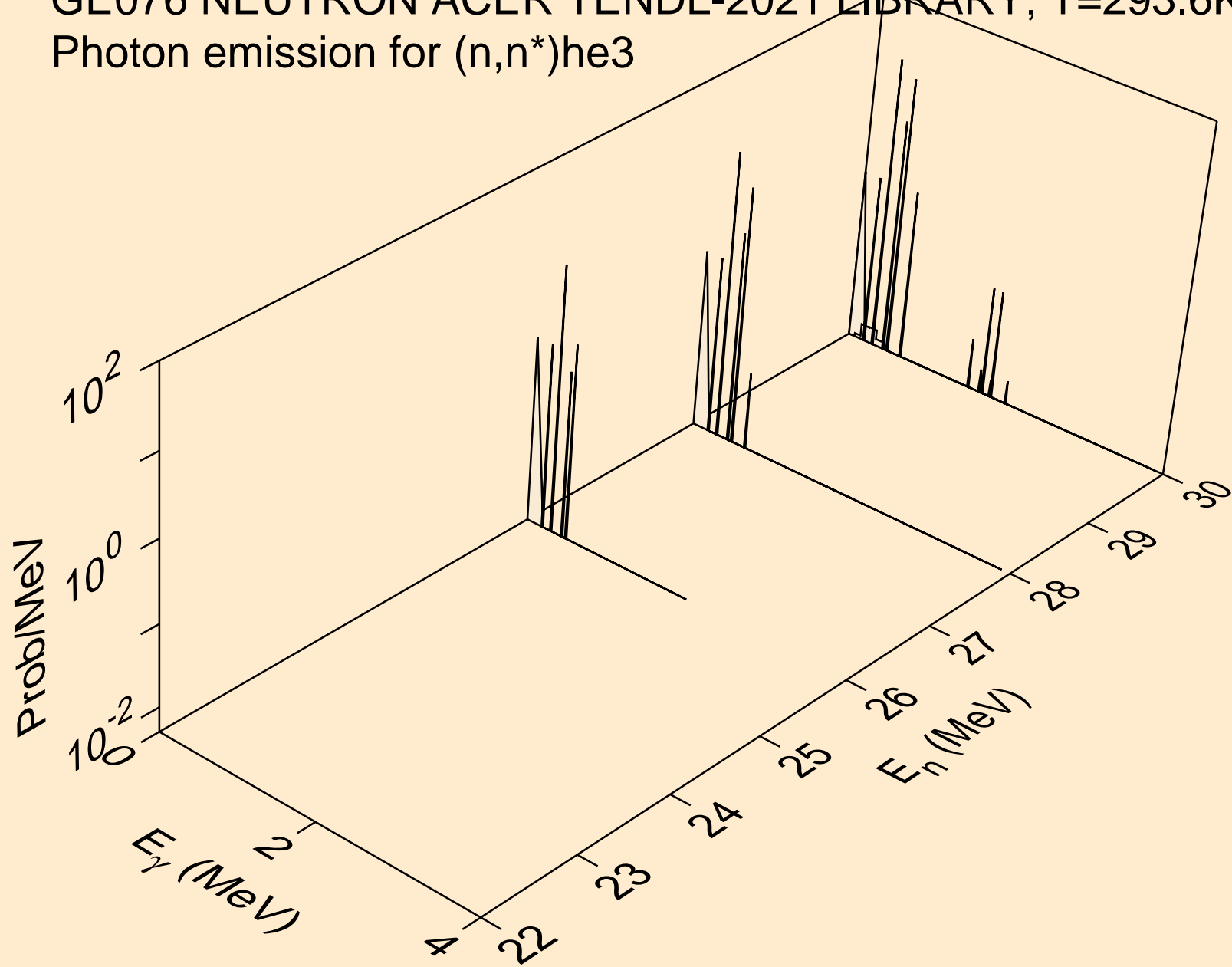

GE076 NEUTRON ACER TENDL-2021 LIBRARY; T=293.6K
Photon emission for (n,4n)

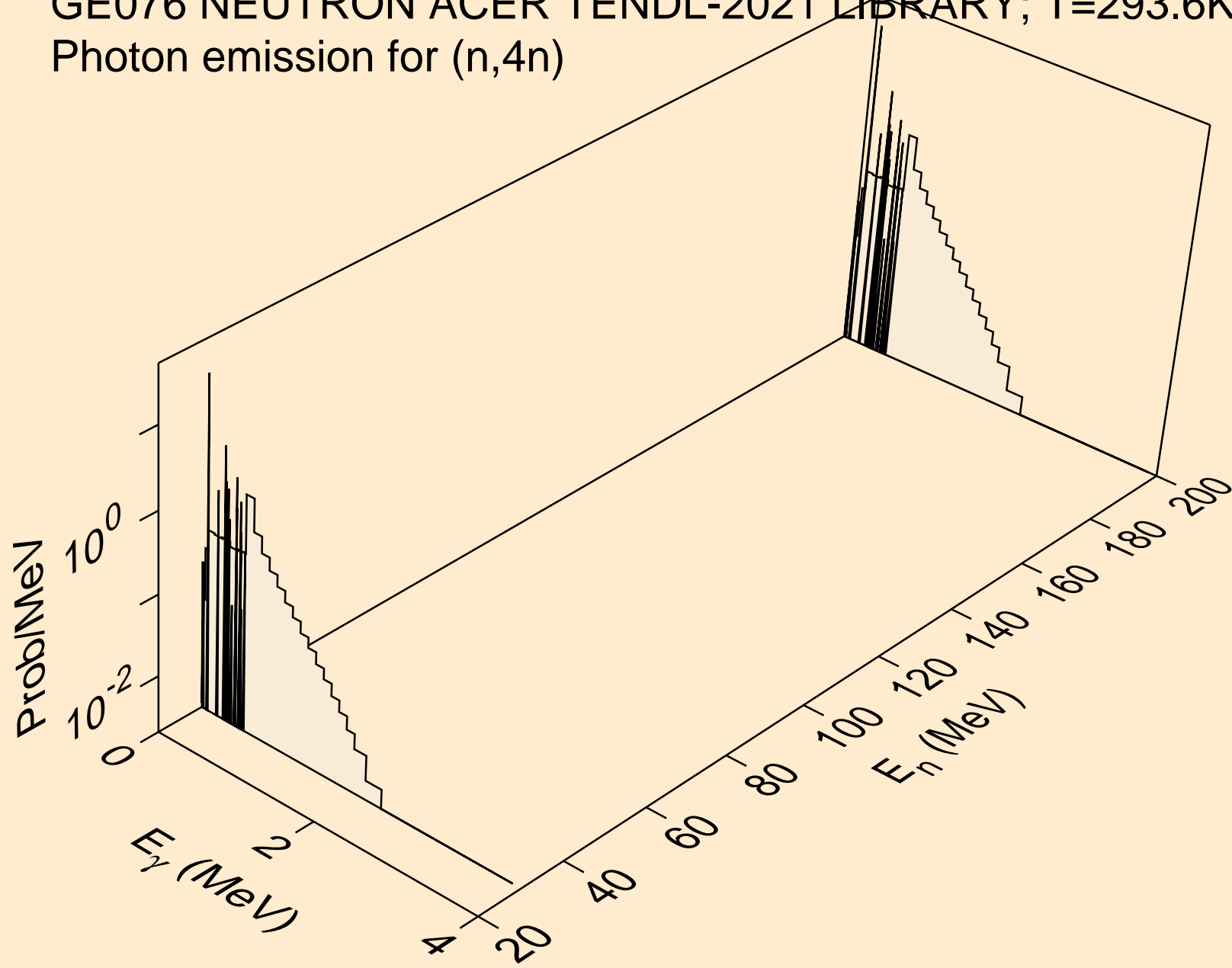

GE076 NEUTRON ACER TENDL-2021 LIBRARY; T=293.6K
Photon emission for (n,2np)

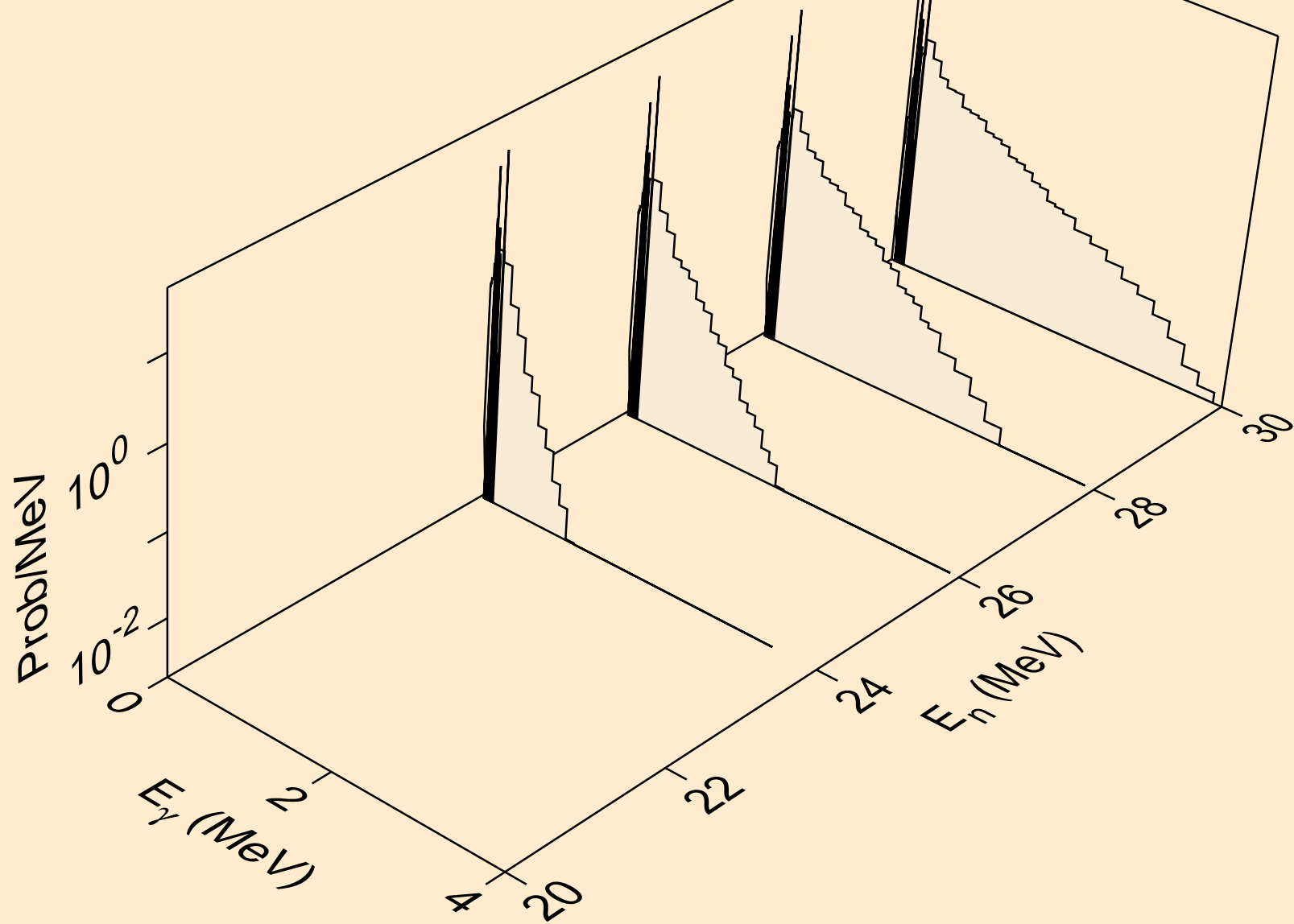

GE076 NEUTRON ACER TENDL-2021 LIBRARY; T=293.6K
Photon emission for (n,3np)

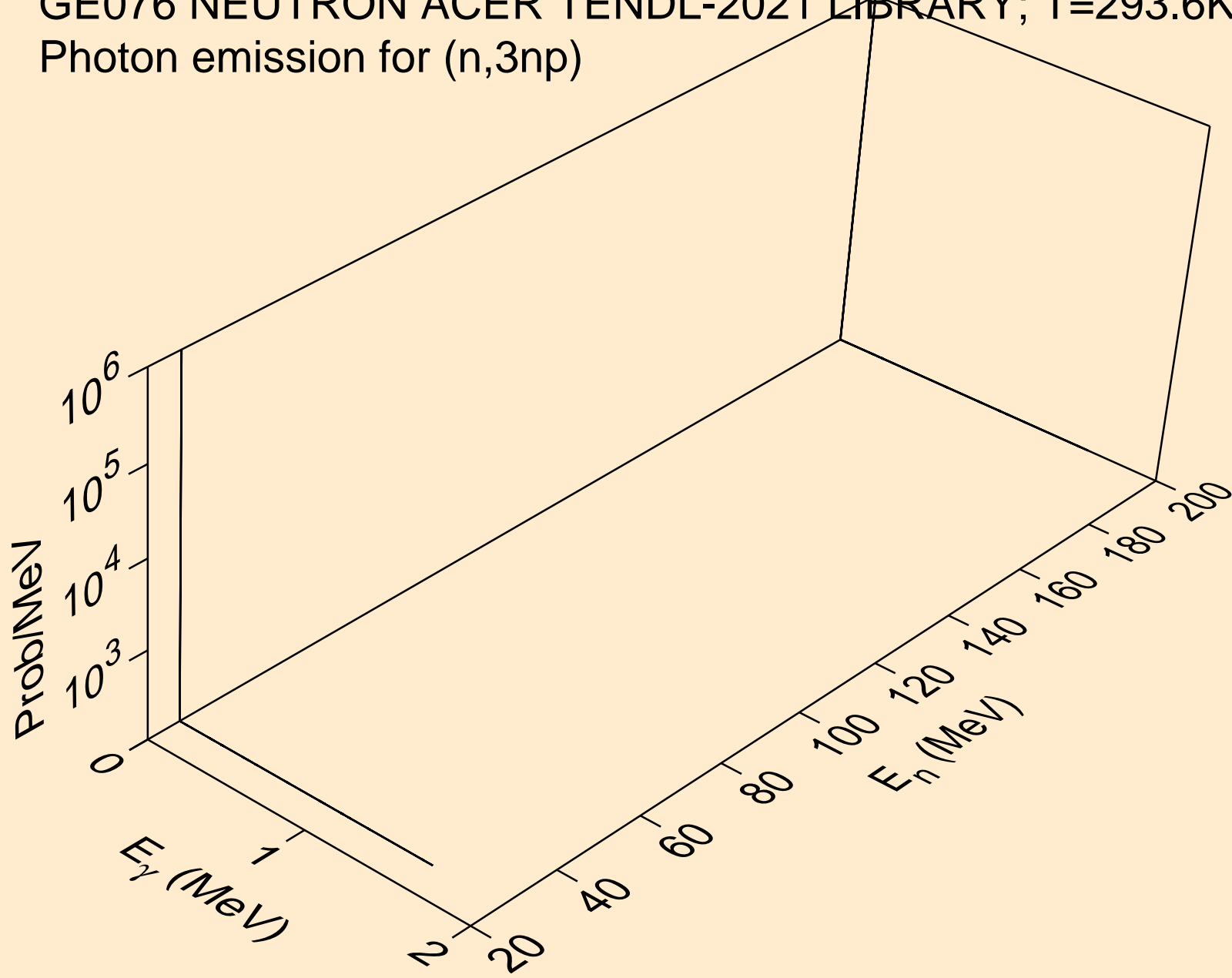

GE076 NEUTRON ACER TENDL-2021 LIBRARY; T=293.6K
Photon emission for (n,2np)

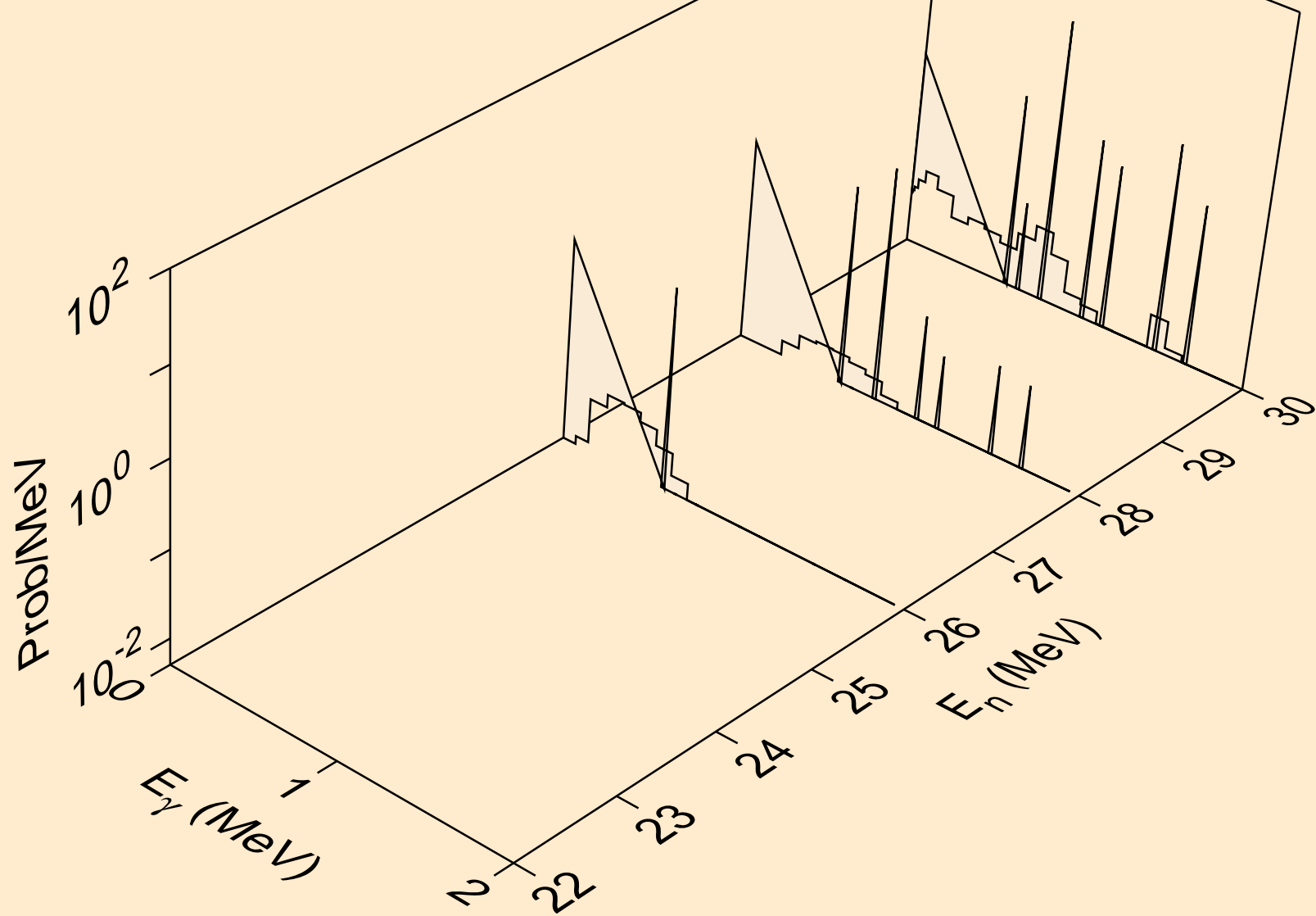

GE076 NEUTRON ACER TENDL-2021 LIBRARY; T=293.6K
Photon emission for (n,n*c)

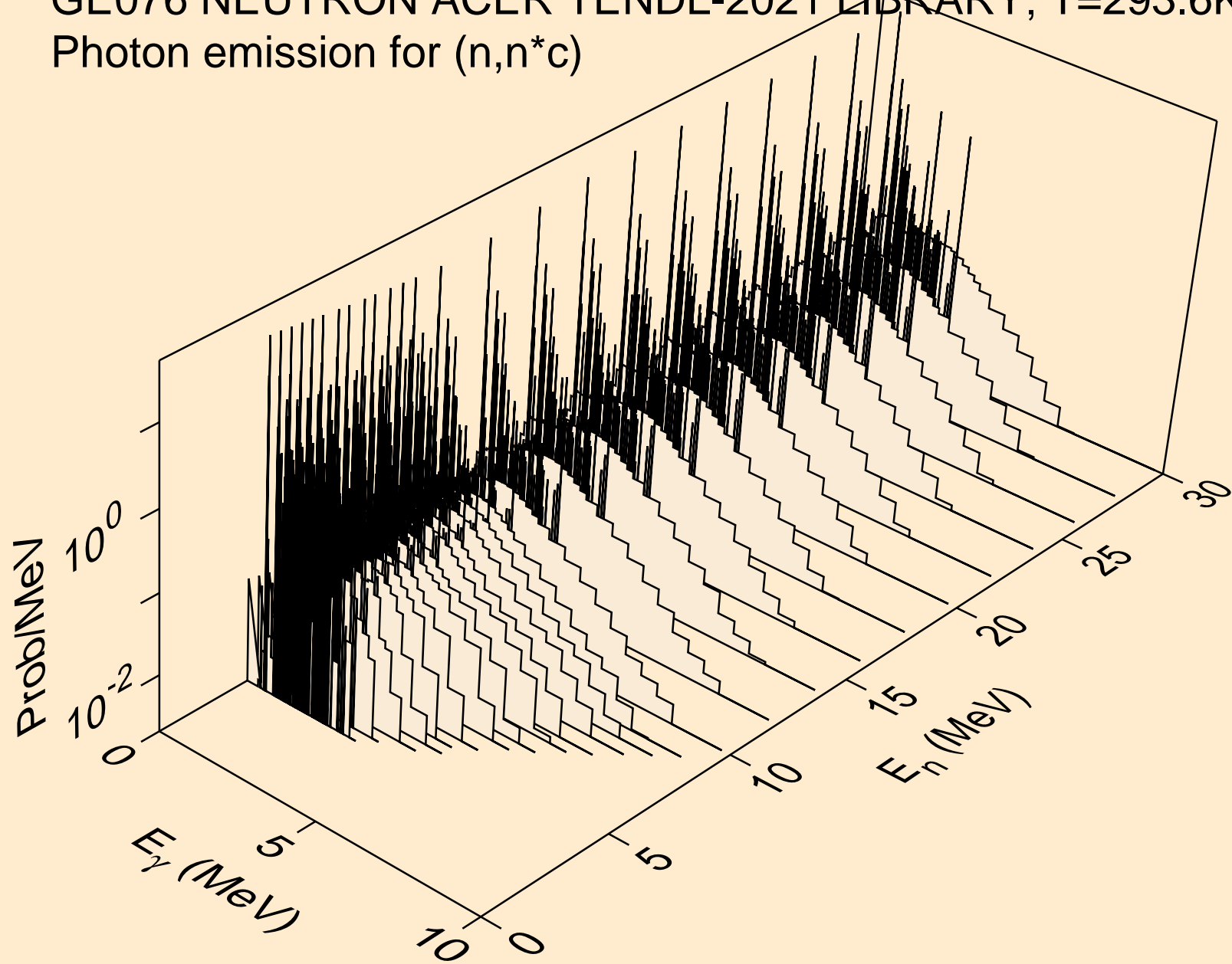

GE076 NEUTRON ACER TENDL-2021 LIBRARY; T=293.6K
Photon emission for (n,gma)

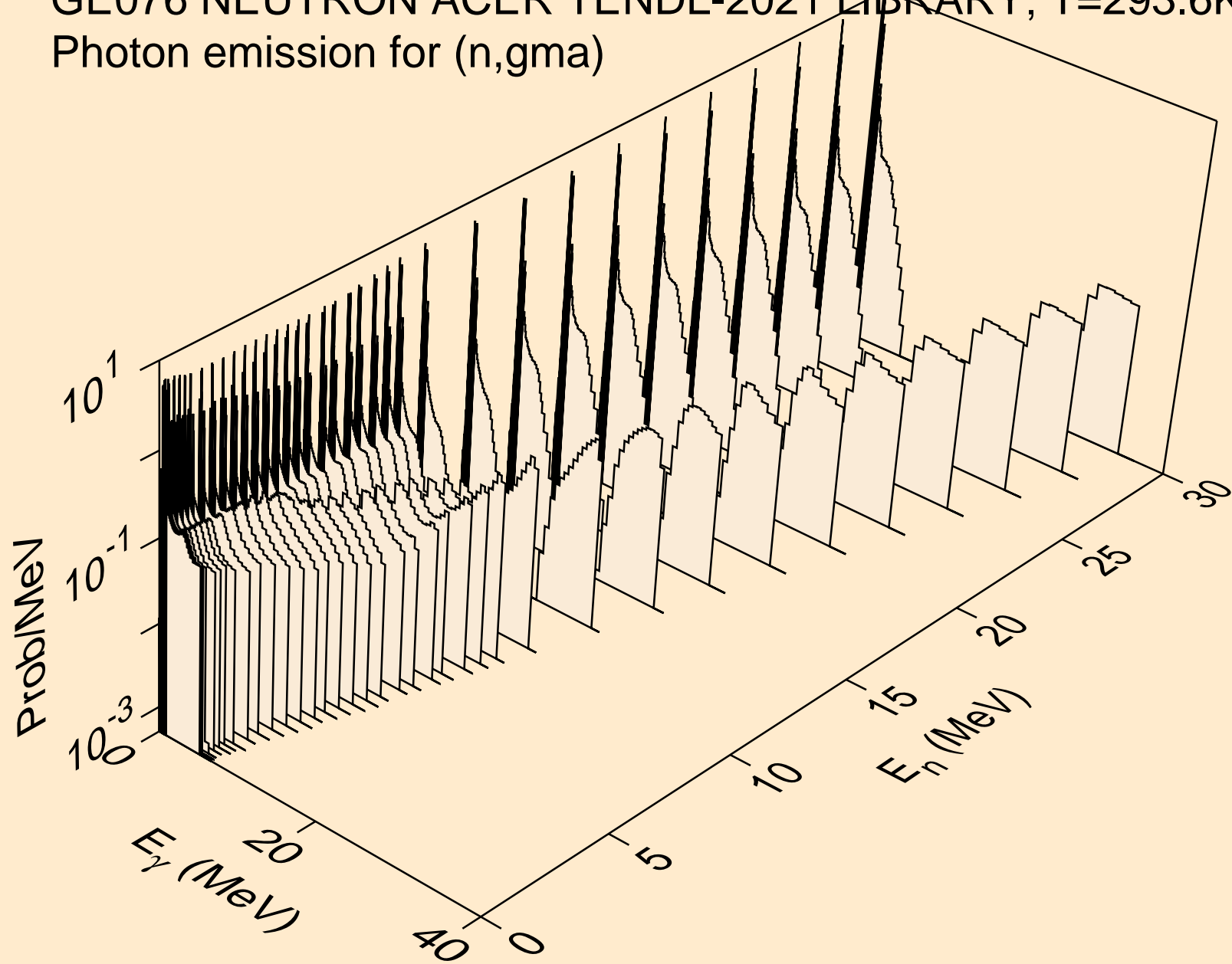

GE076 NEUTRON ACER TENDL-2021 LIBRARY; T=293.6K
Photon emission for (n,p)

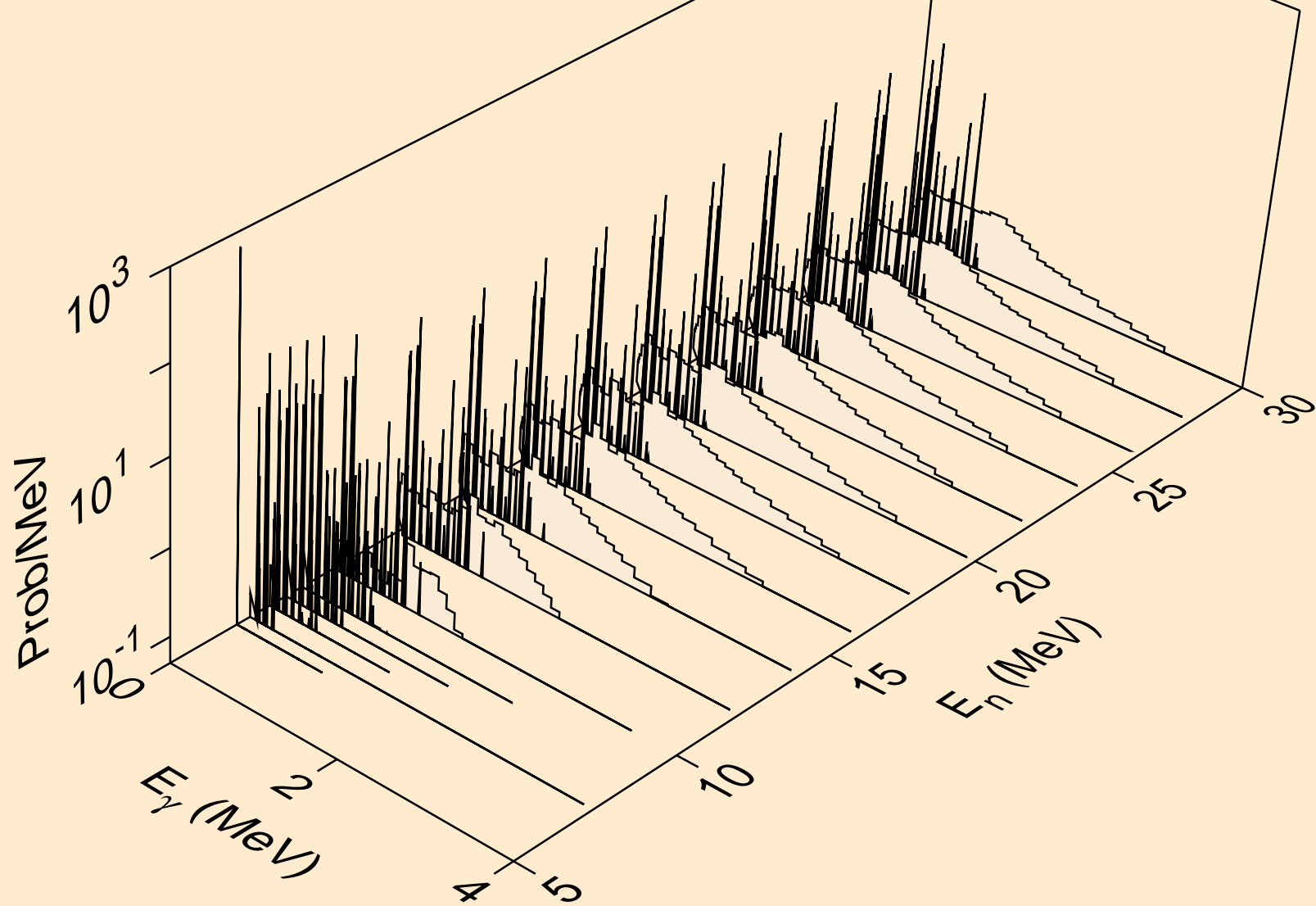

GE076 NEUTRON ACER TENDL-2021 LIBRARY; T=293.6K
Photon emission for (n,d)

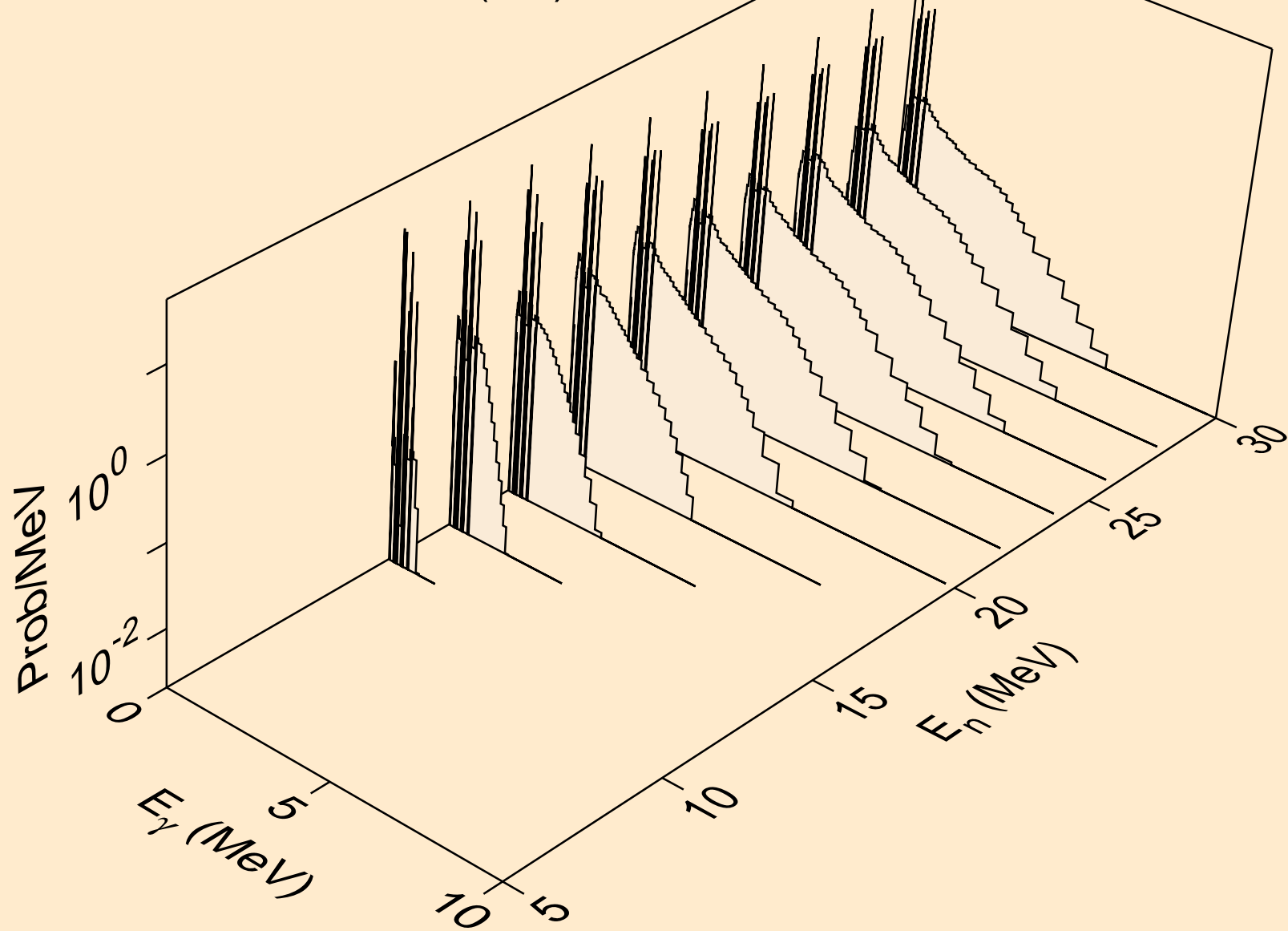

GE076 NEUTRON ACER TENDL-2021 LIBRARY; T=293.6K
Photon emission for (n,t)

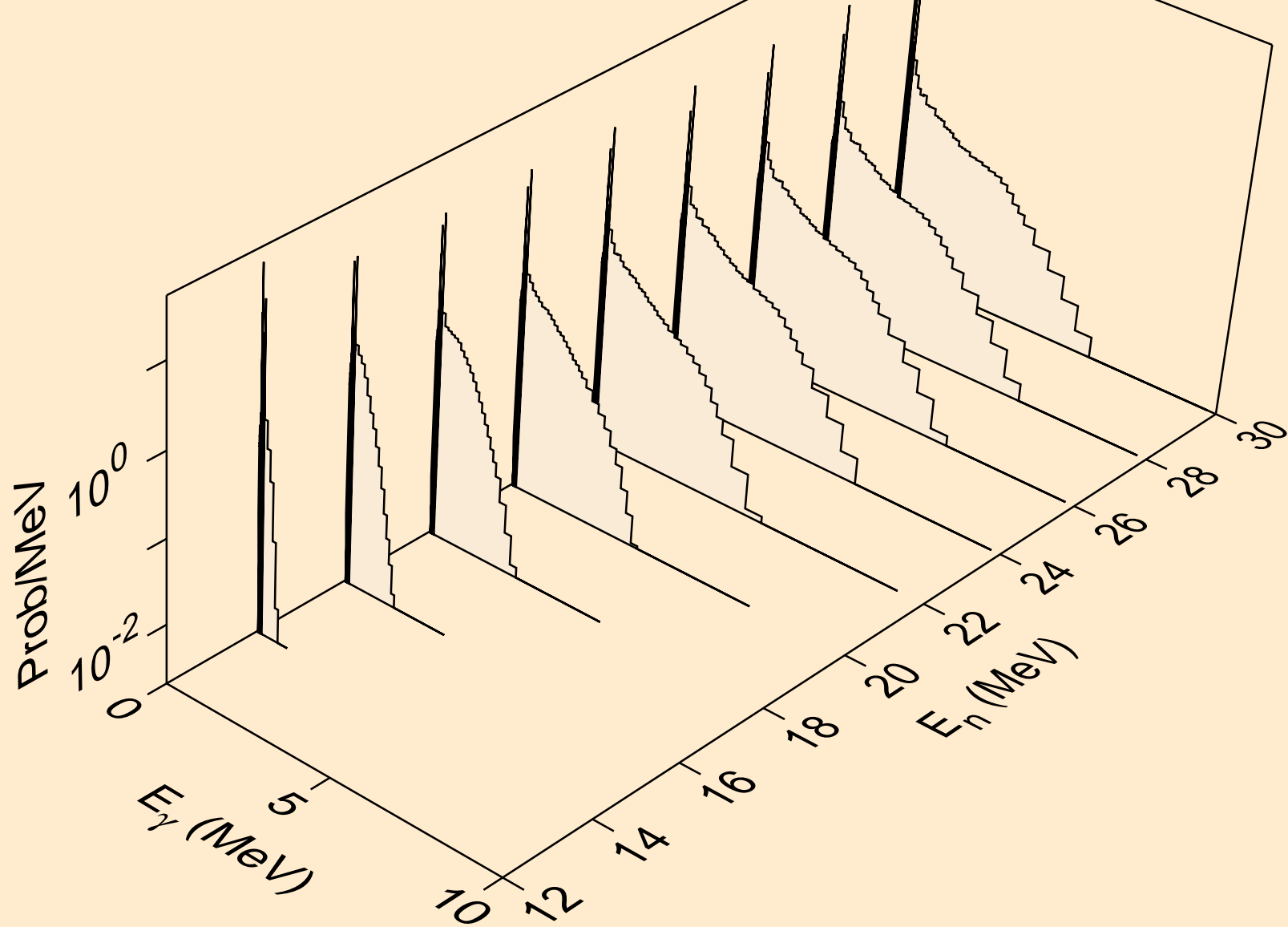

GE076 NEUTRON ACER TENDL-2021 LIBRARY; T=293.6K
Photon emission for (n,he3)

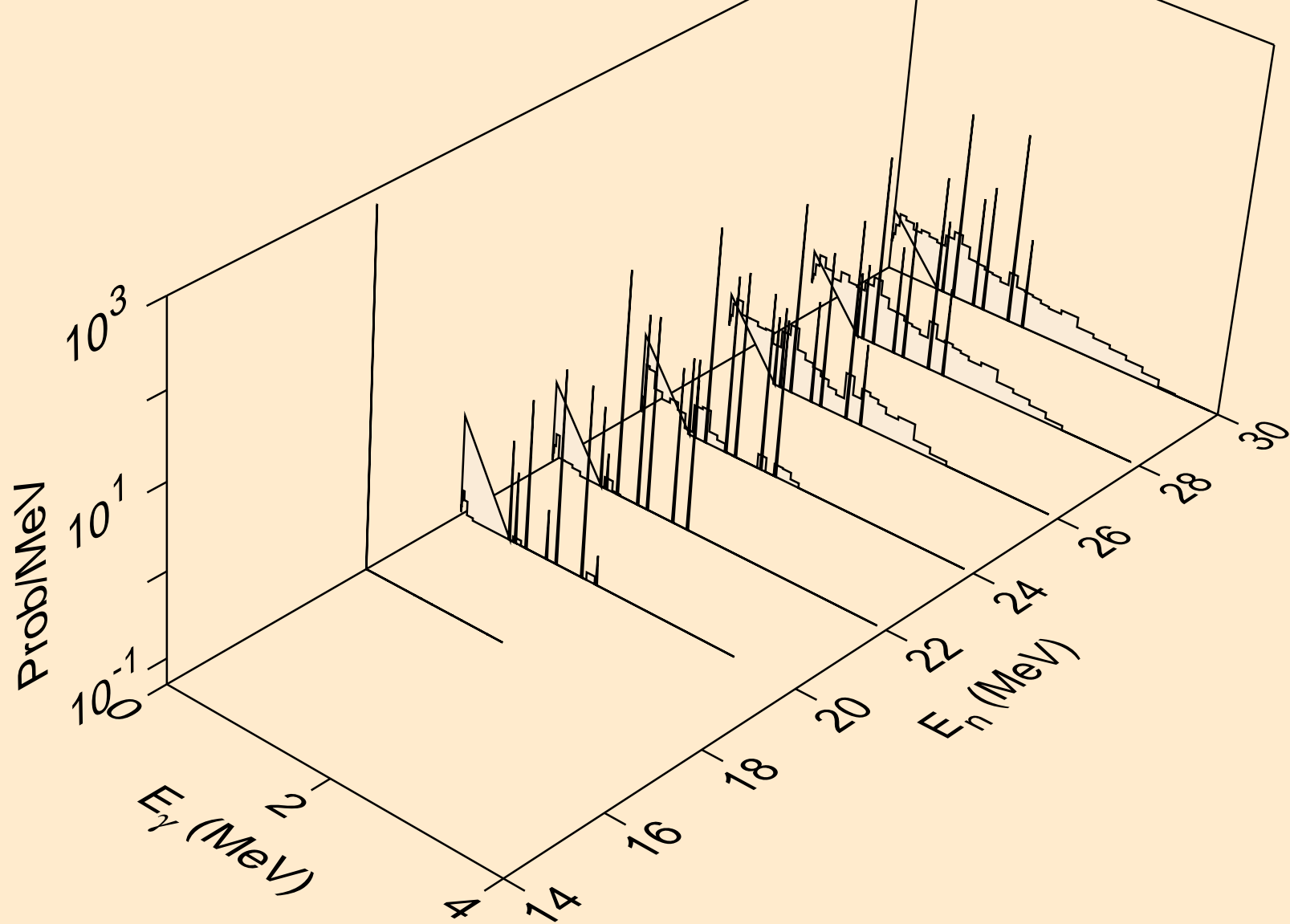

GE076 NEUTRON ACER TENDL-2021 LIBRARY; T=293.6K
Photon emission for (n,a)

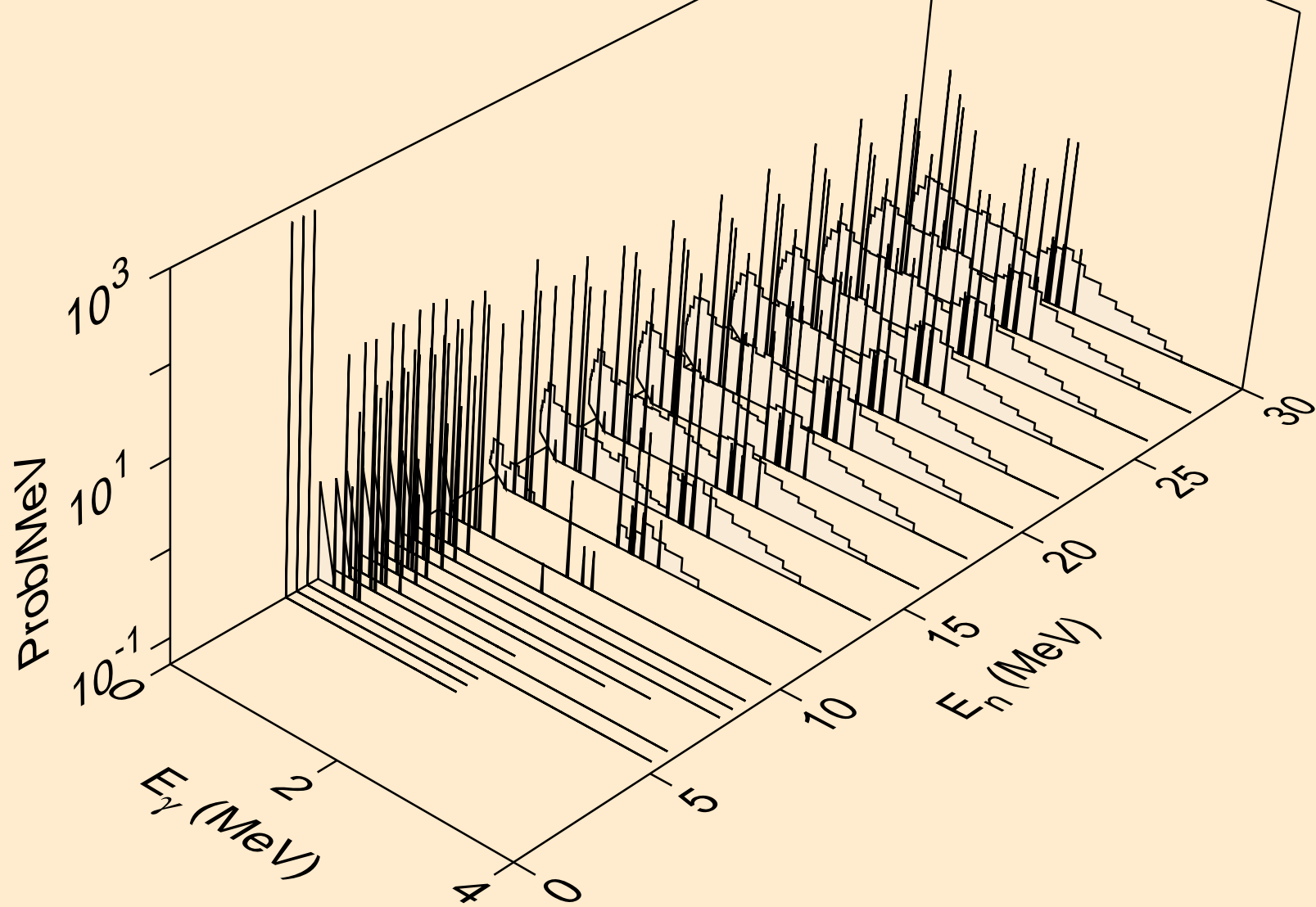

GE076 NEUTRON ACER TENDL-2021 LIBRARY; T=293.6K
Photon emission for (n,2a)

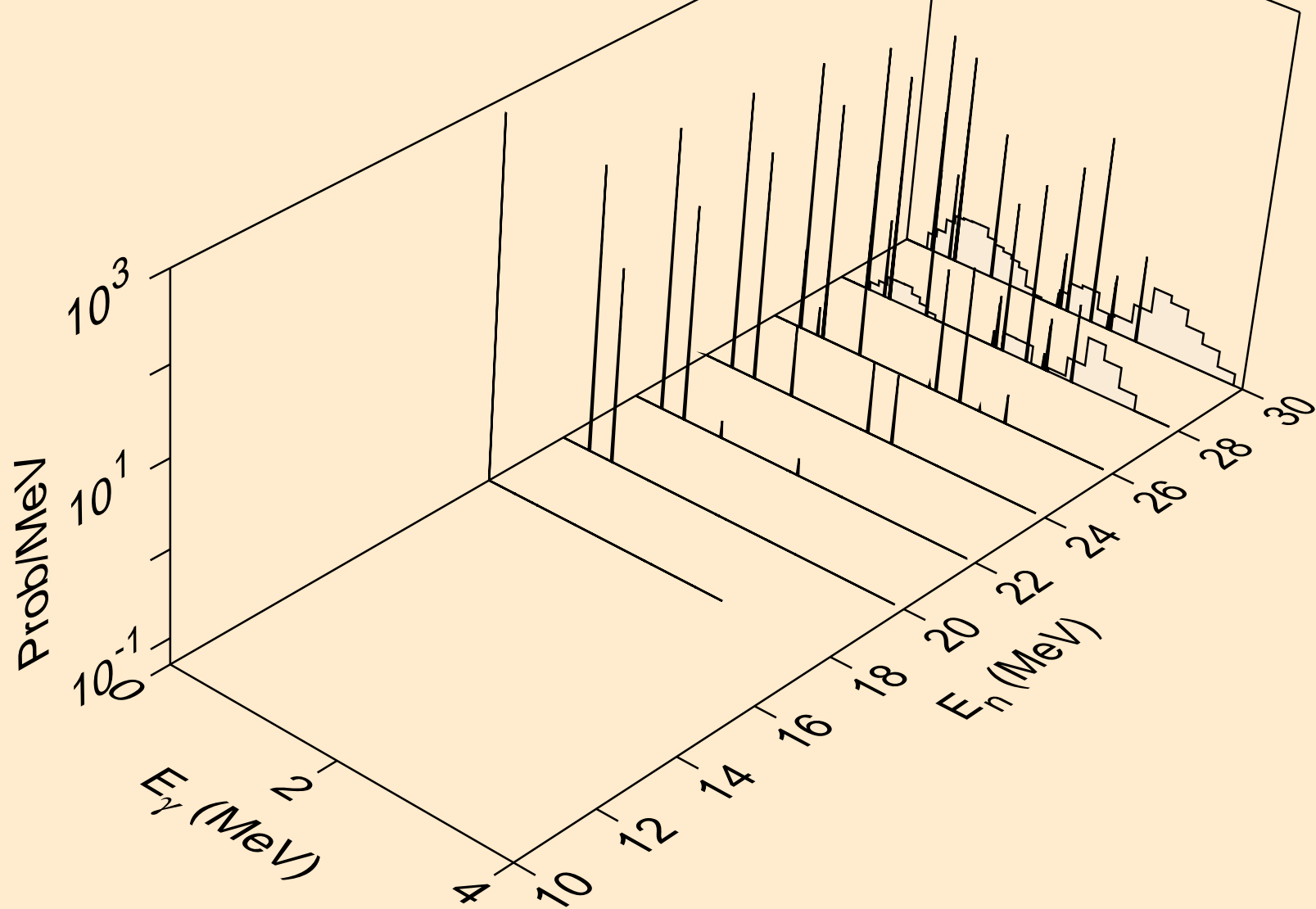

GE076 NEUTRON ACER TENDL-2021 LIBRARY; T=293.6K
Photon emission for (n,2p)

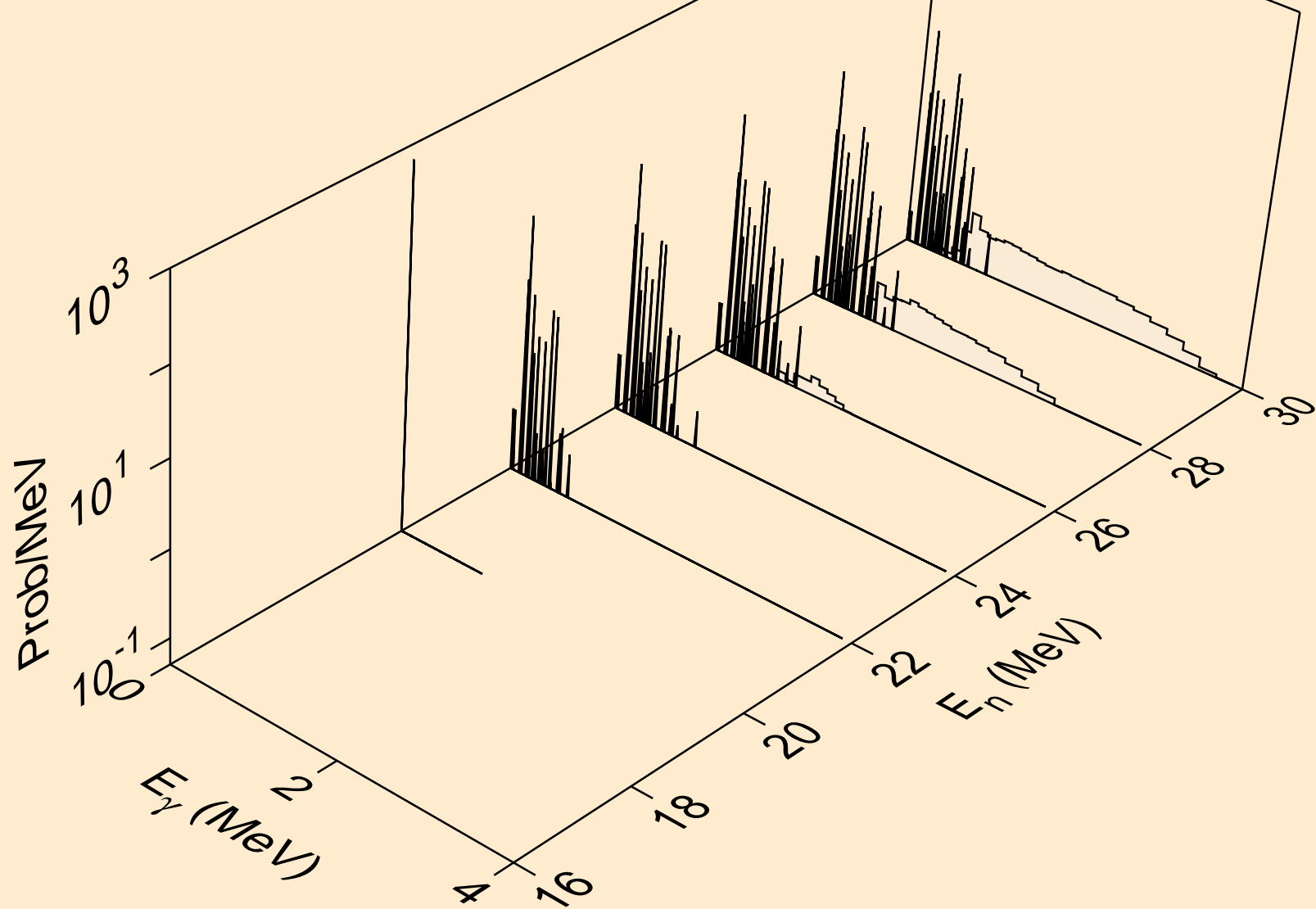

GE076 NEUTRON ACER TENDL-2021 LIBRARY; T=293.6K
Photon emission for (n,p α)

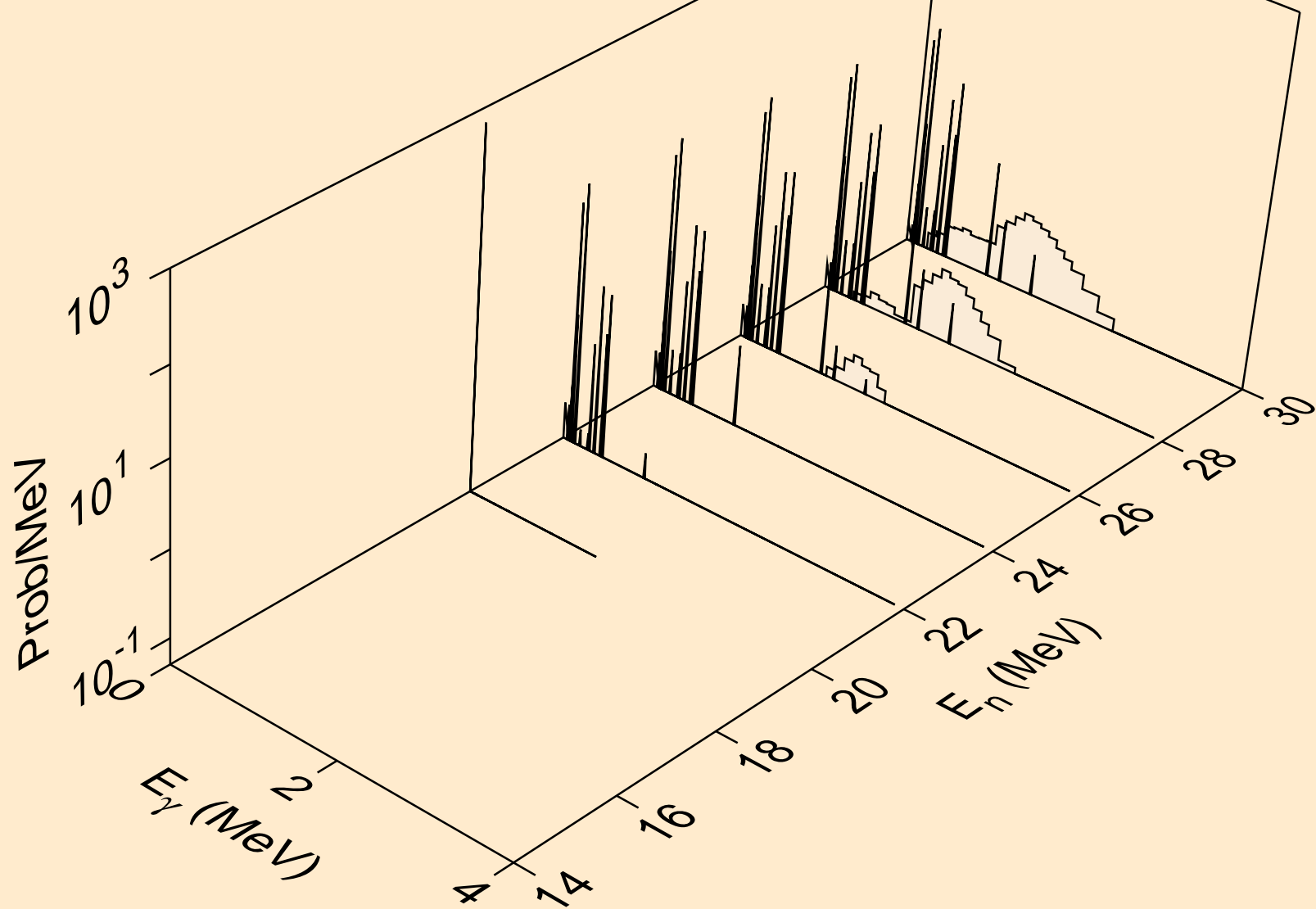

GE076 NEUTRON ACER TENDL-2021 LIBRARY; T=293.6K
Photon emission for (n,pd)

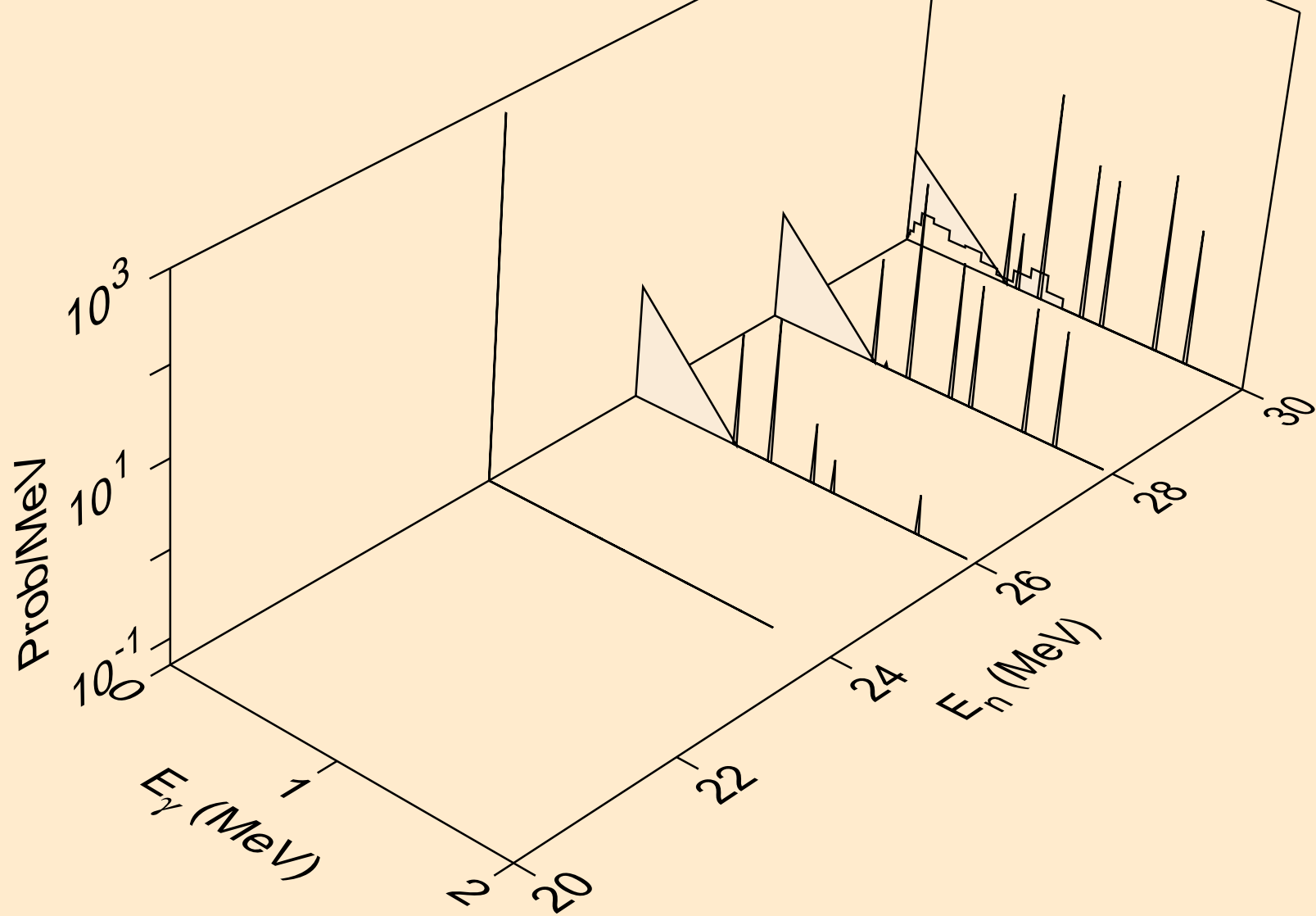

GE076 NEUTRON ACER TENDL-2021 LIBRARY; T=293.6K
Photon emission for (n,pt)

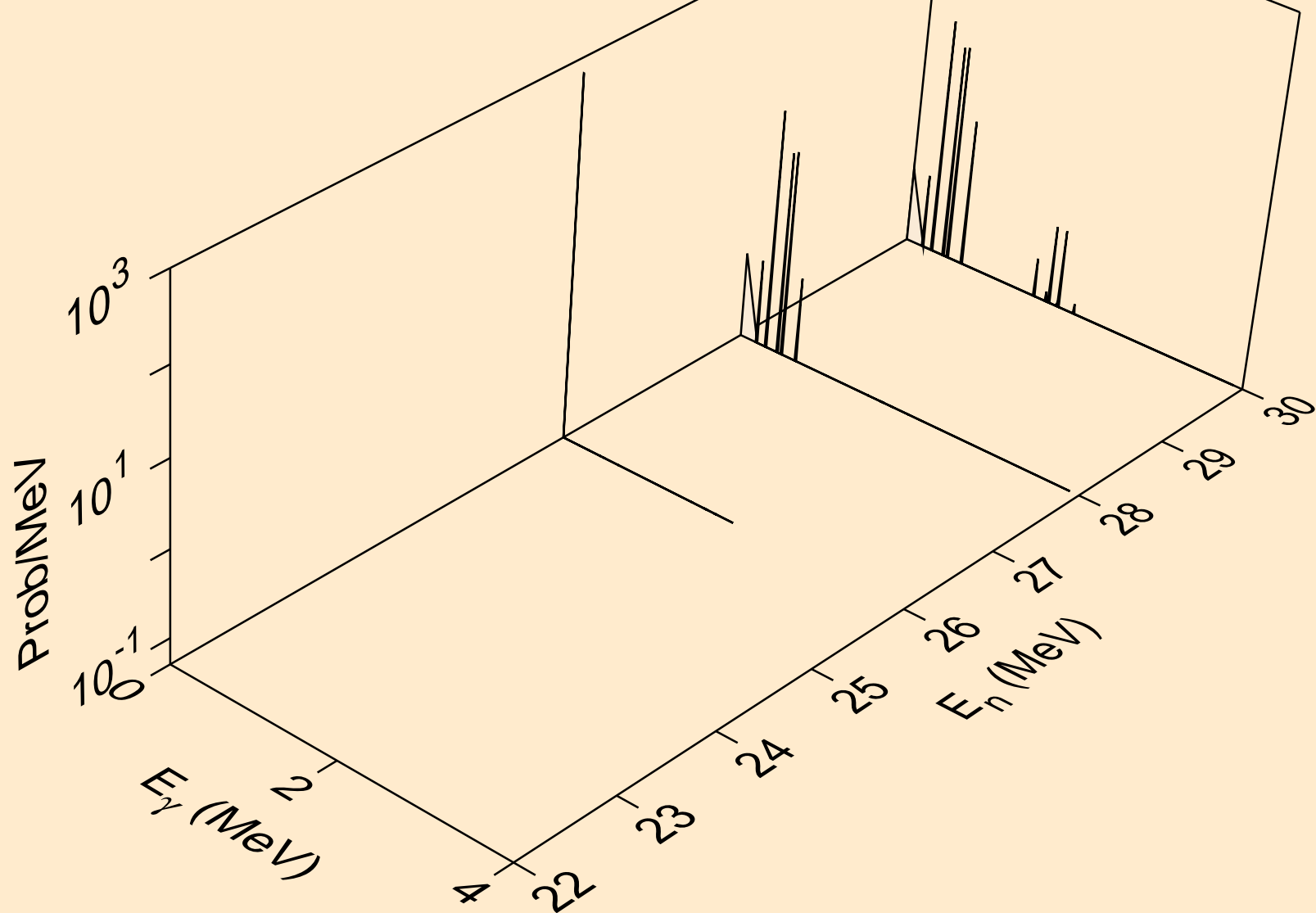

GE076 NEUTRON ACER TENDL-2021 LIBRARY; T=293.6K
thermal capture photon spectrum

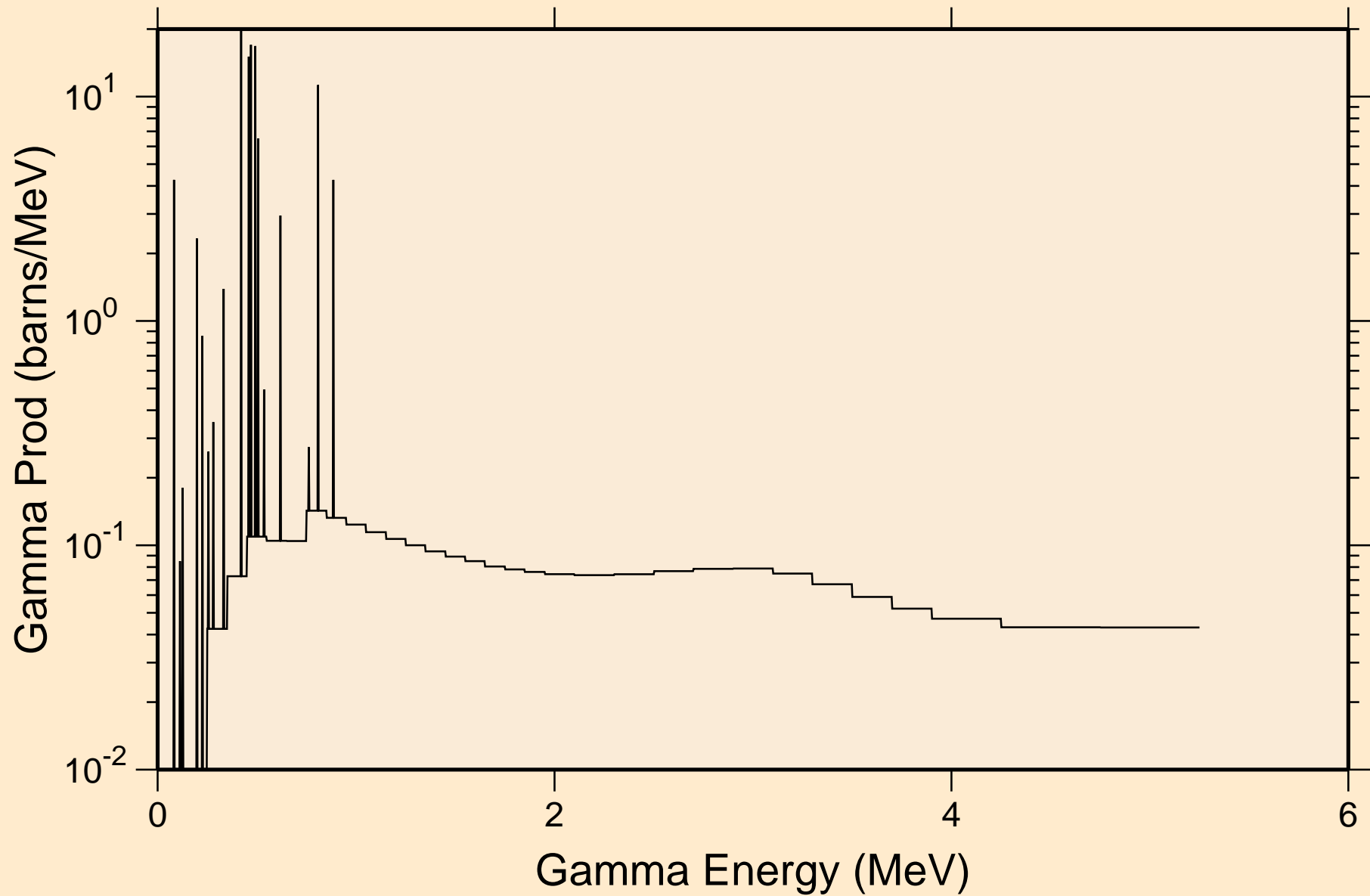

GE076 NEUTRON ACER TENDL-2021 LIBRARY; T=293.6K
14 MeV photon spectrum

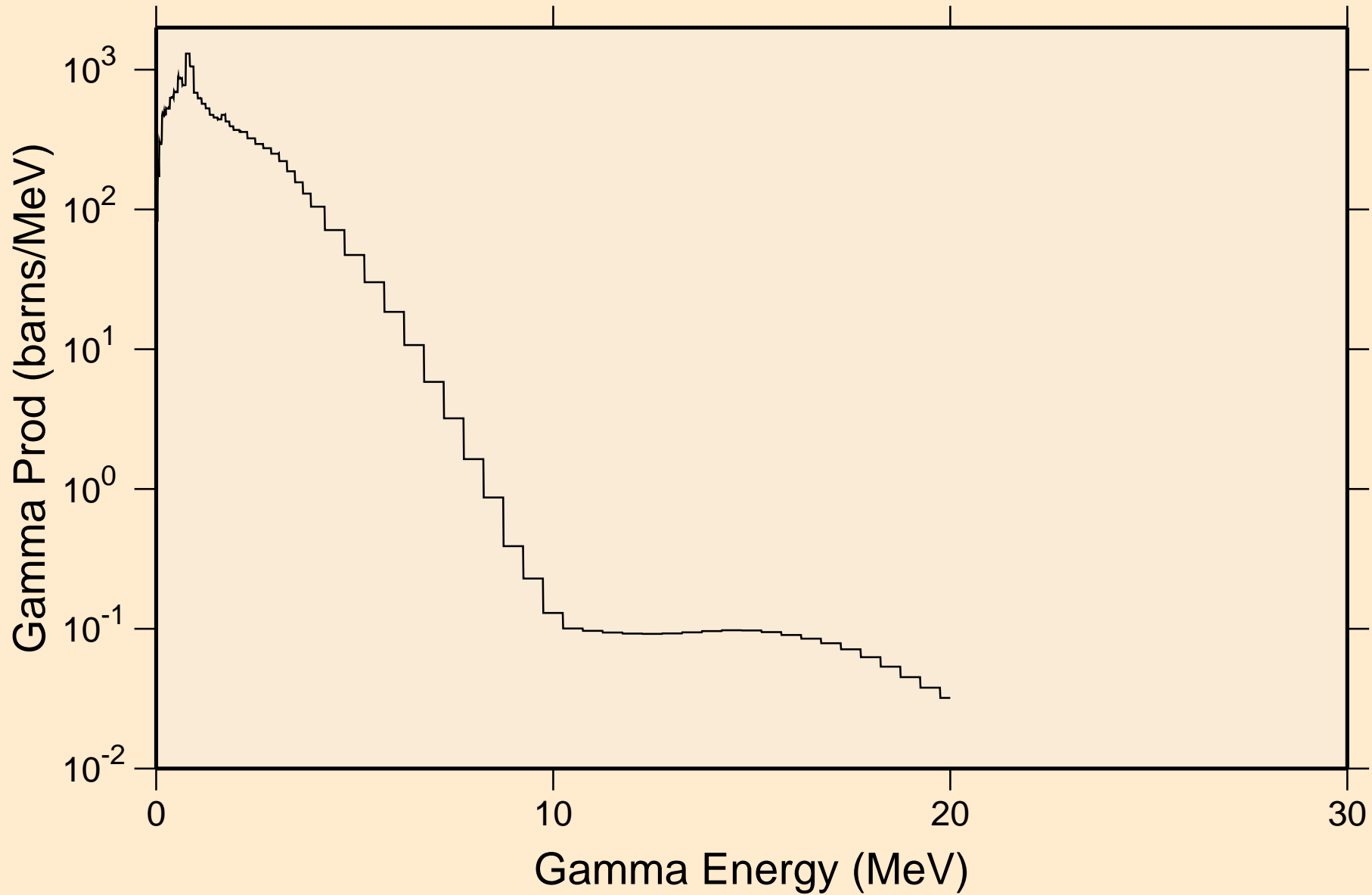

GE076 NEUTRON ACER TENDL-2021 LIBRARY; T=293.6K

Particle heating contributions

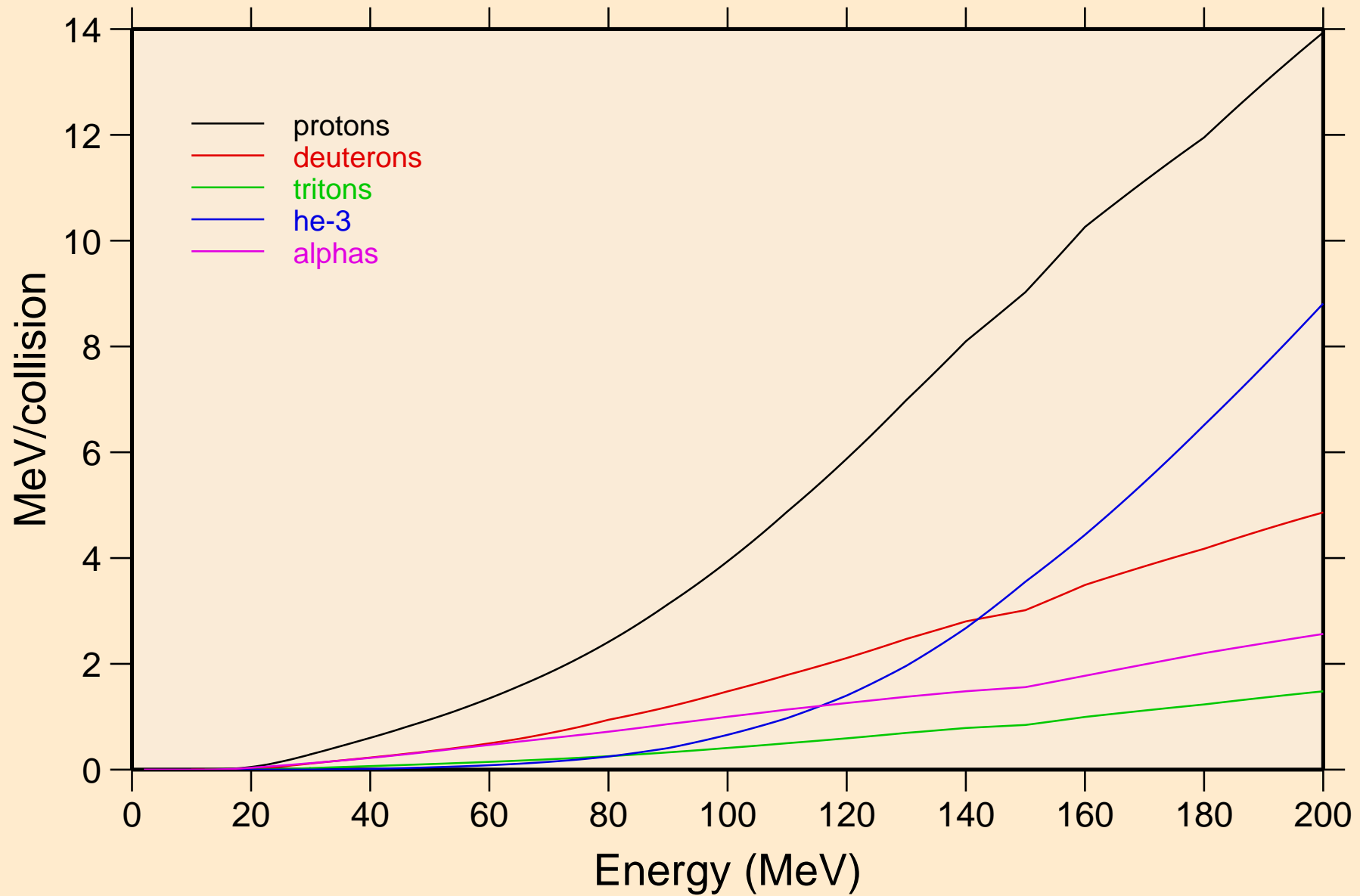

GE076 NEUTRON ACER TENDL-2021 LIBRARY; T=293.6K
Recoil Heating

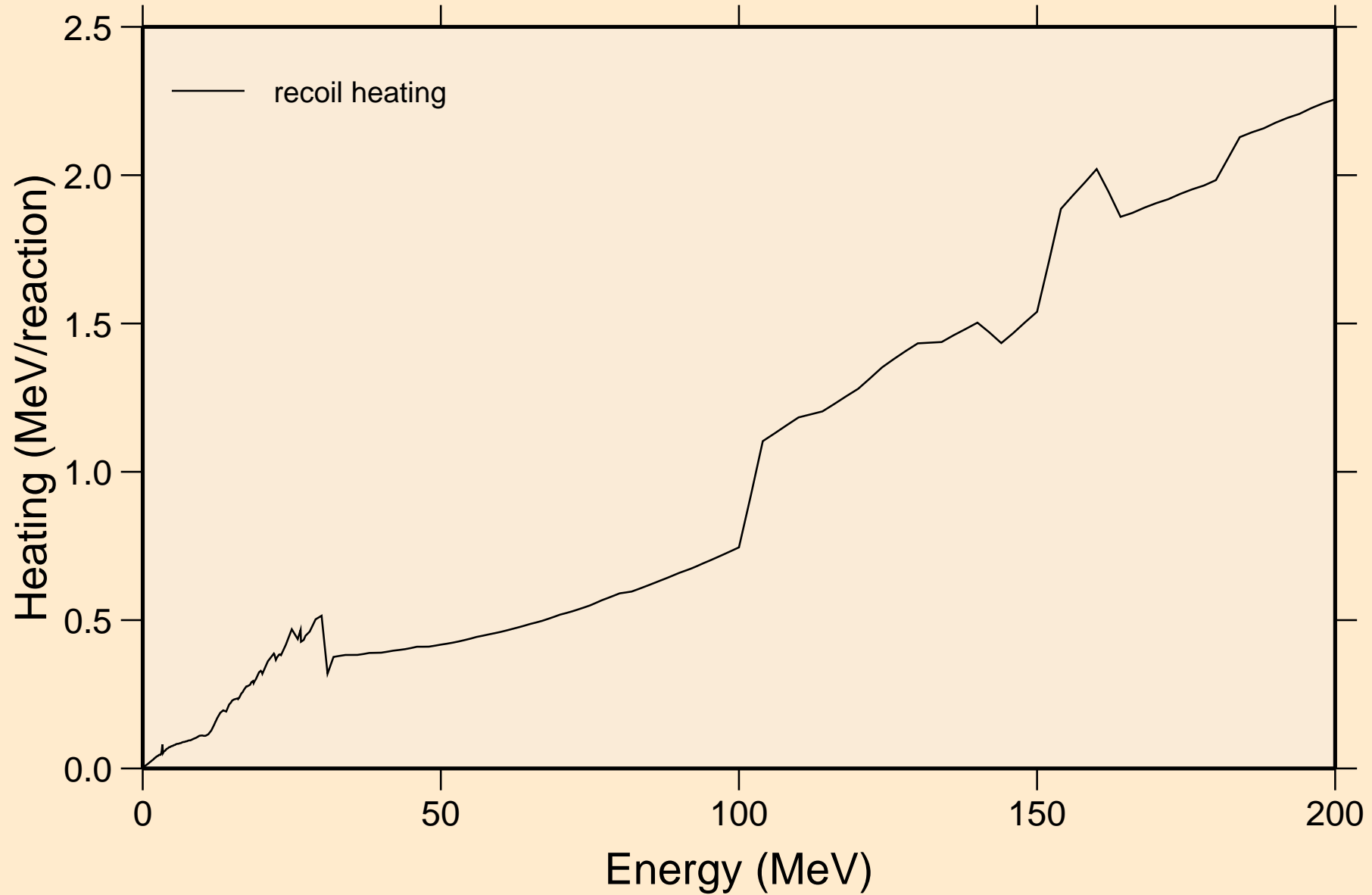

GE076 NEUTRON ACER TENDL-2021 LIBRARY; T=293.6K
Particle production cross sections

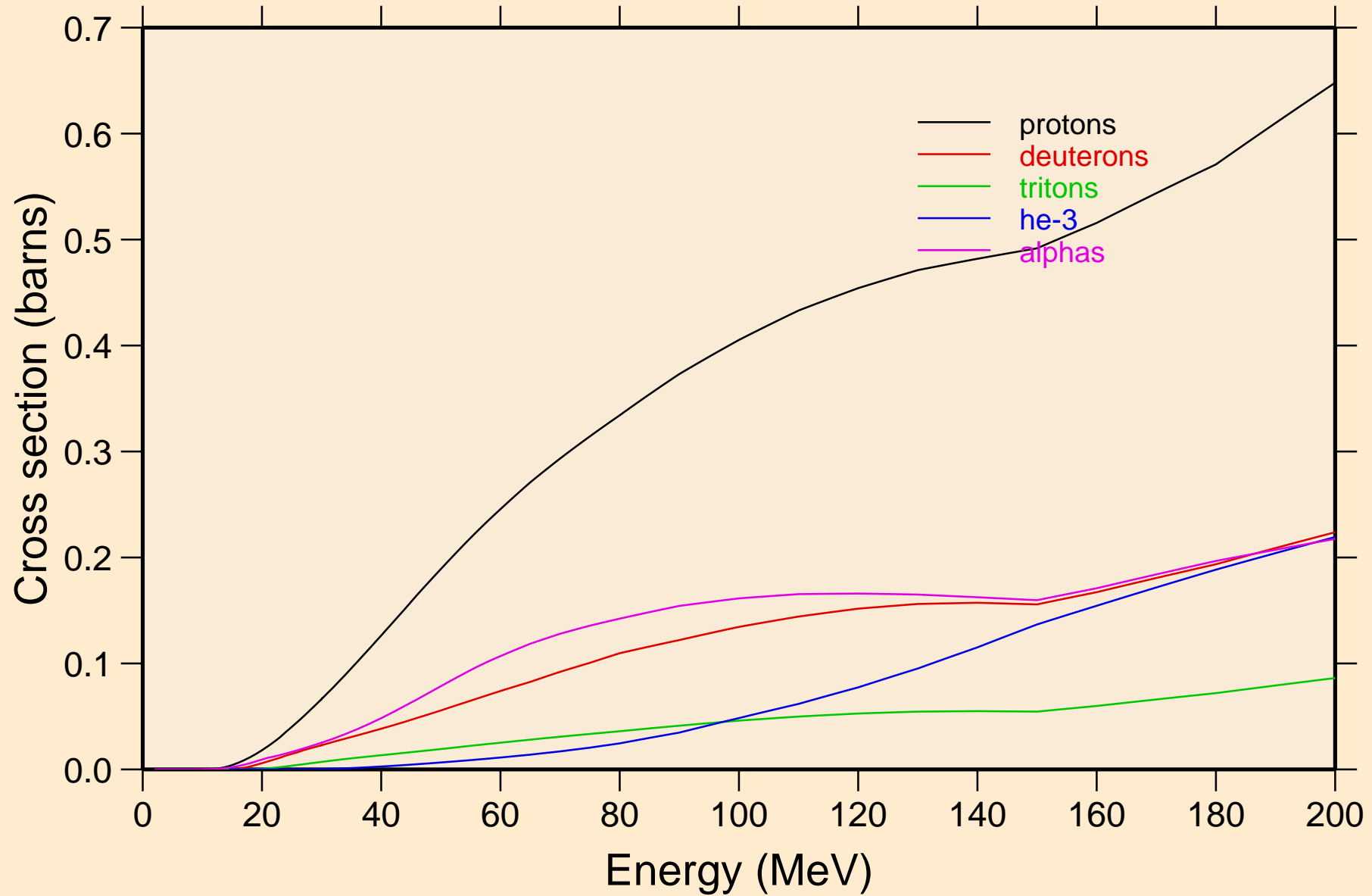

GE076 NEUTRON ACER TENDL-2021 LIBRARY; T=293.6K
protons from (n,x)

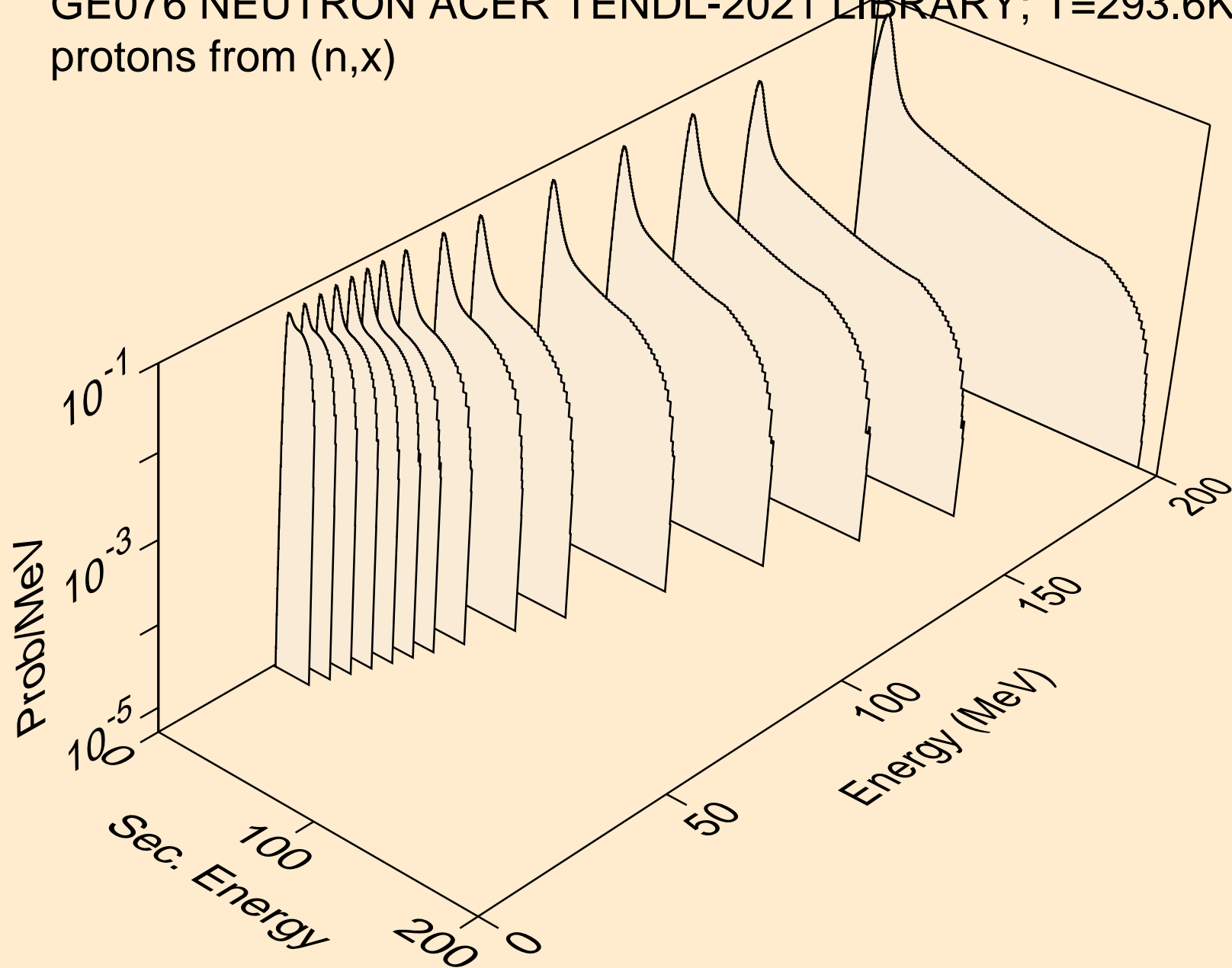

GE076 NEUTRON ACER TENDL-2021 LIBRARY; T=293.6K
protons from (n,n*)p

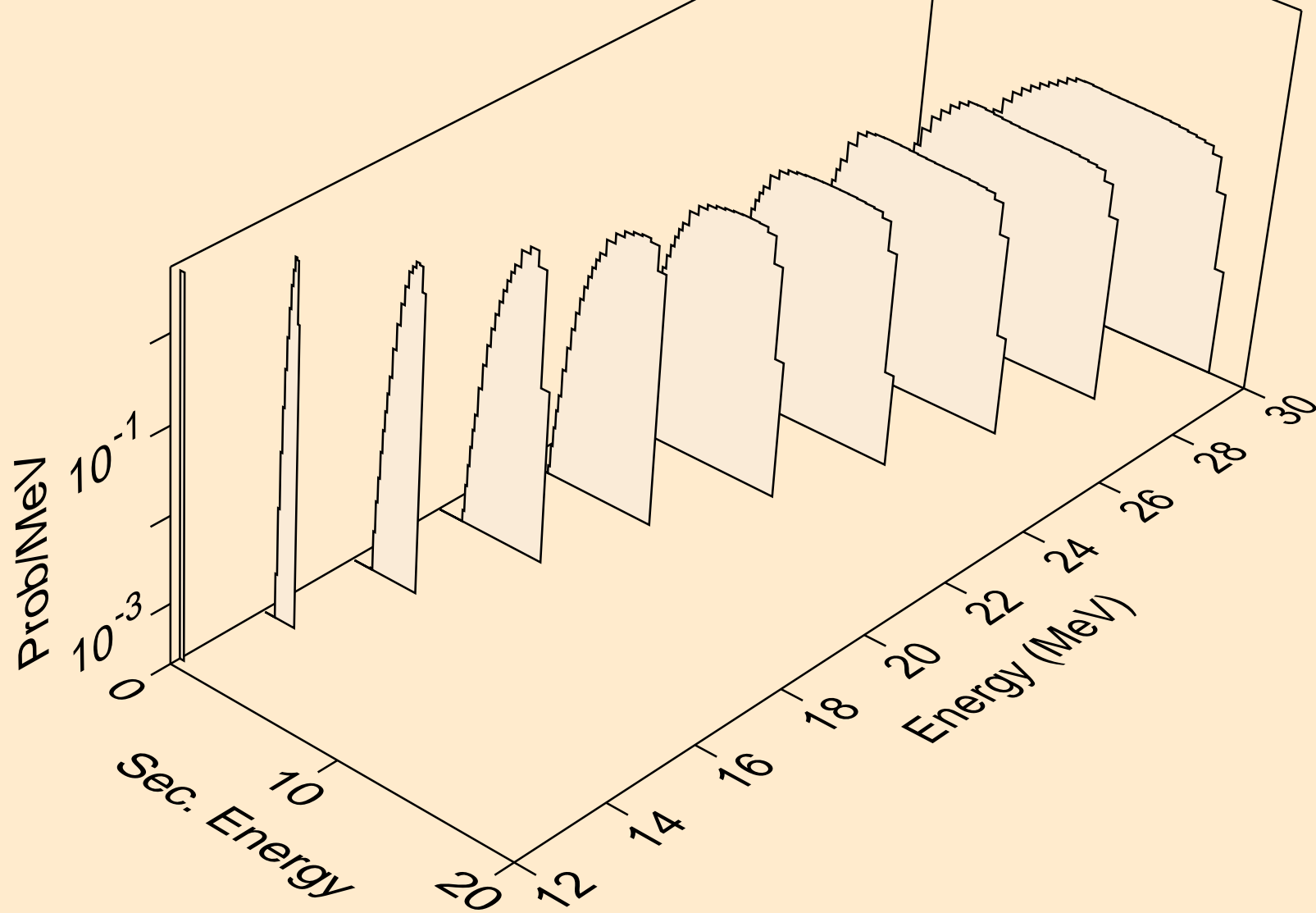

GE076 NEUTRON ACER TENDL-2021 LIBRARY; T=293.6K
protons from (n,2np)

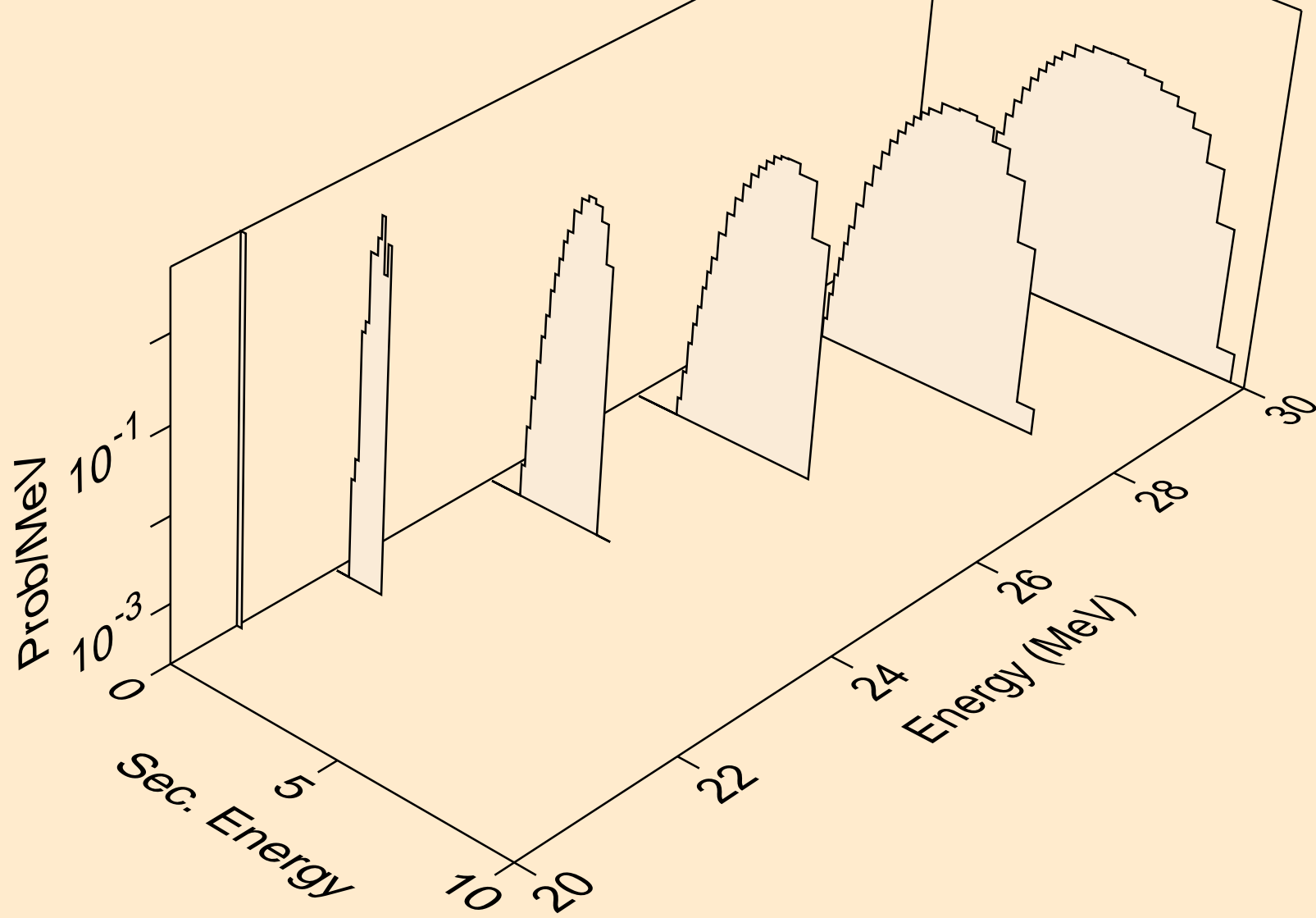

GE076 NEUTRON ACER TENDL-2021 LIBRARY; T=293.6K
protons from (n,3np)

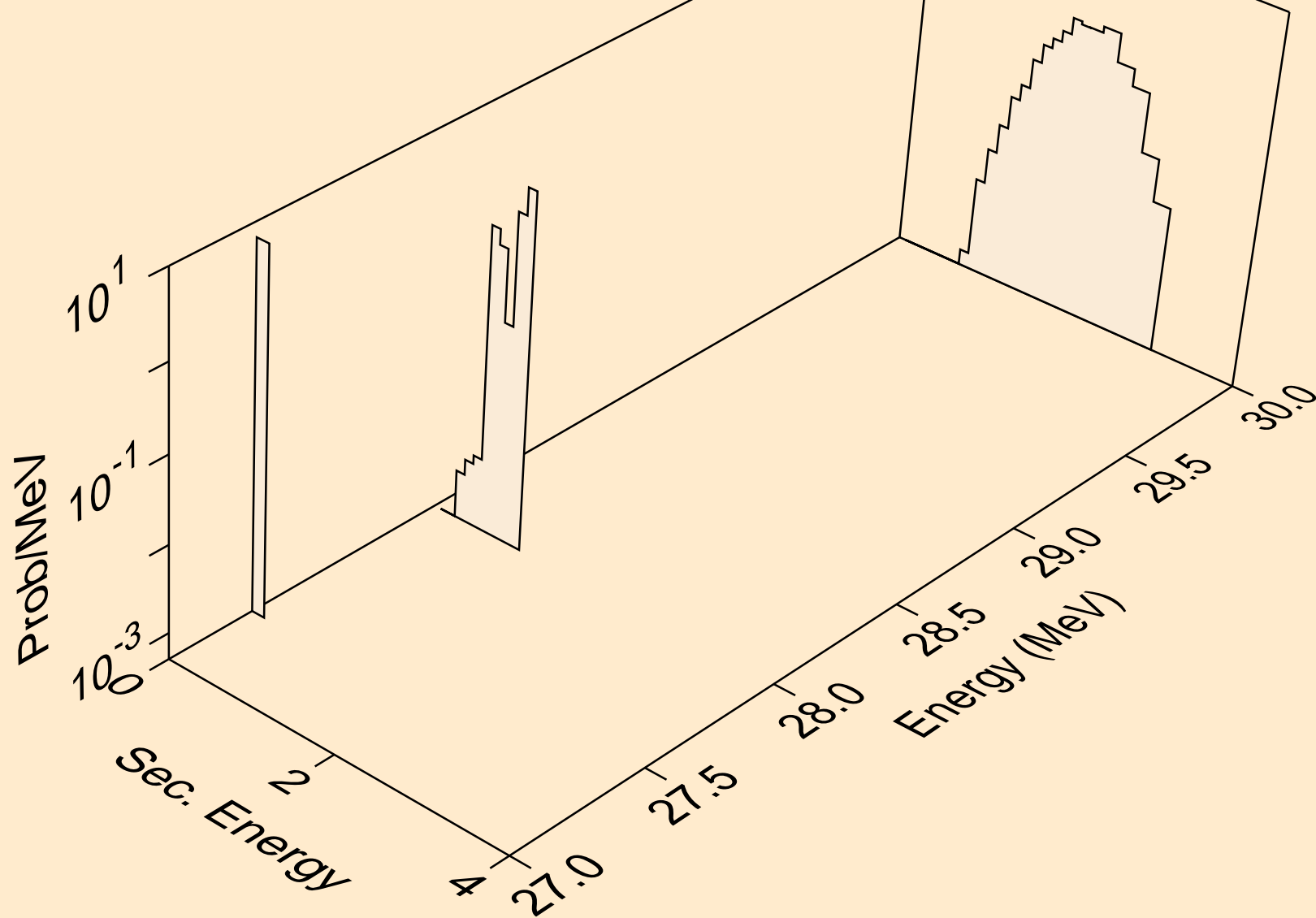

GE076 NEUTRON ACER TENDL-2021 LIBRARY; T=293.6K
protons from (n,2np)

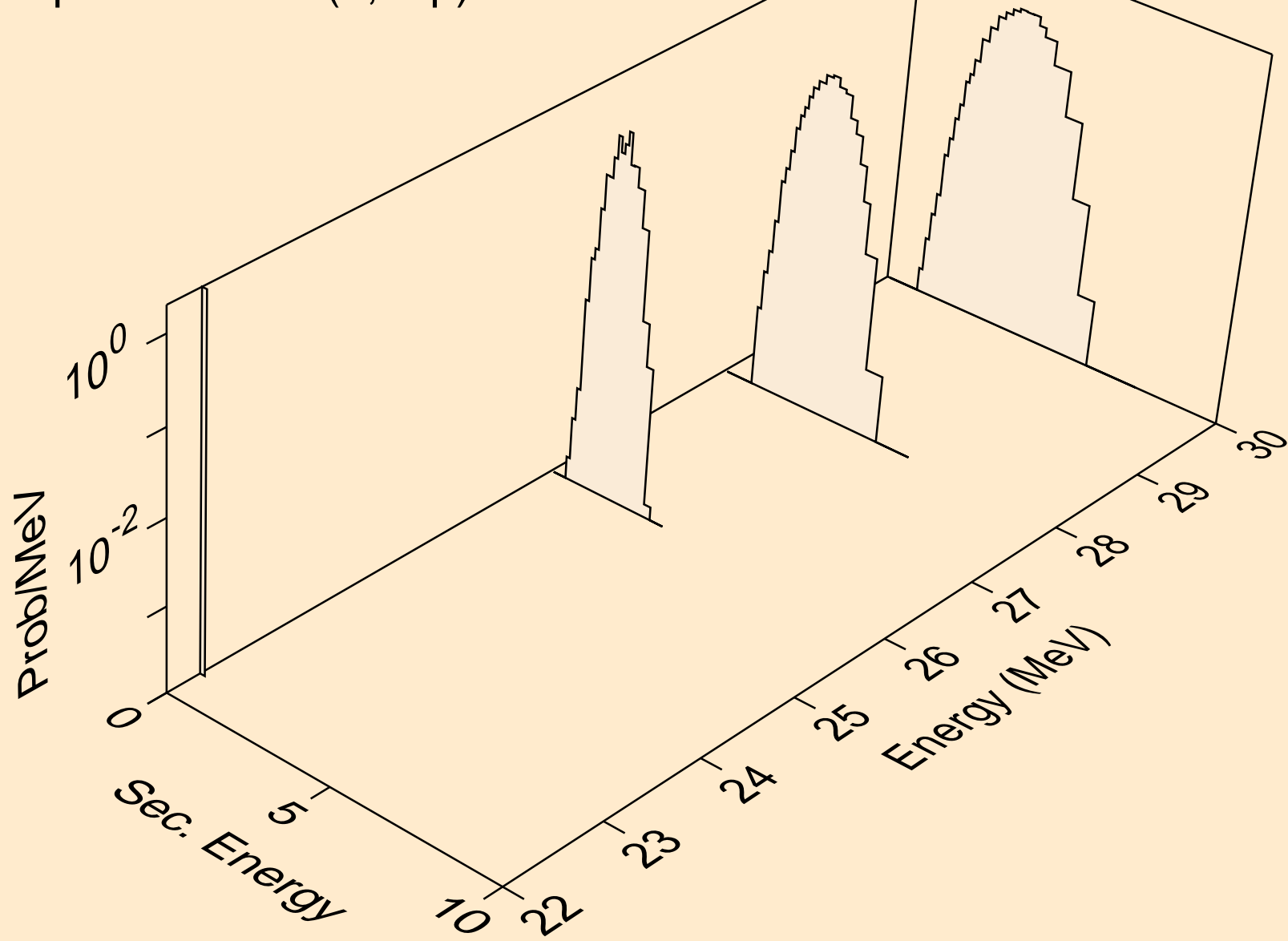

GE076 NEUTRON ACER TENDL-2021 LIBRARY; T=293.6K
protons from (n,p)

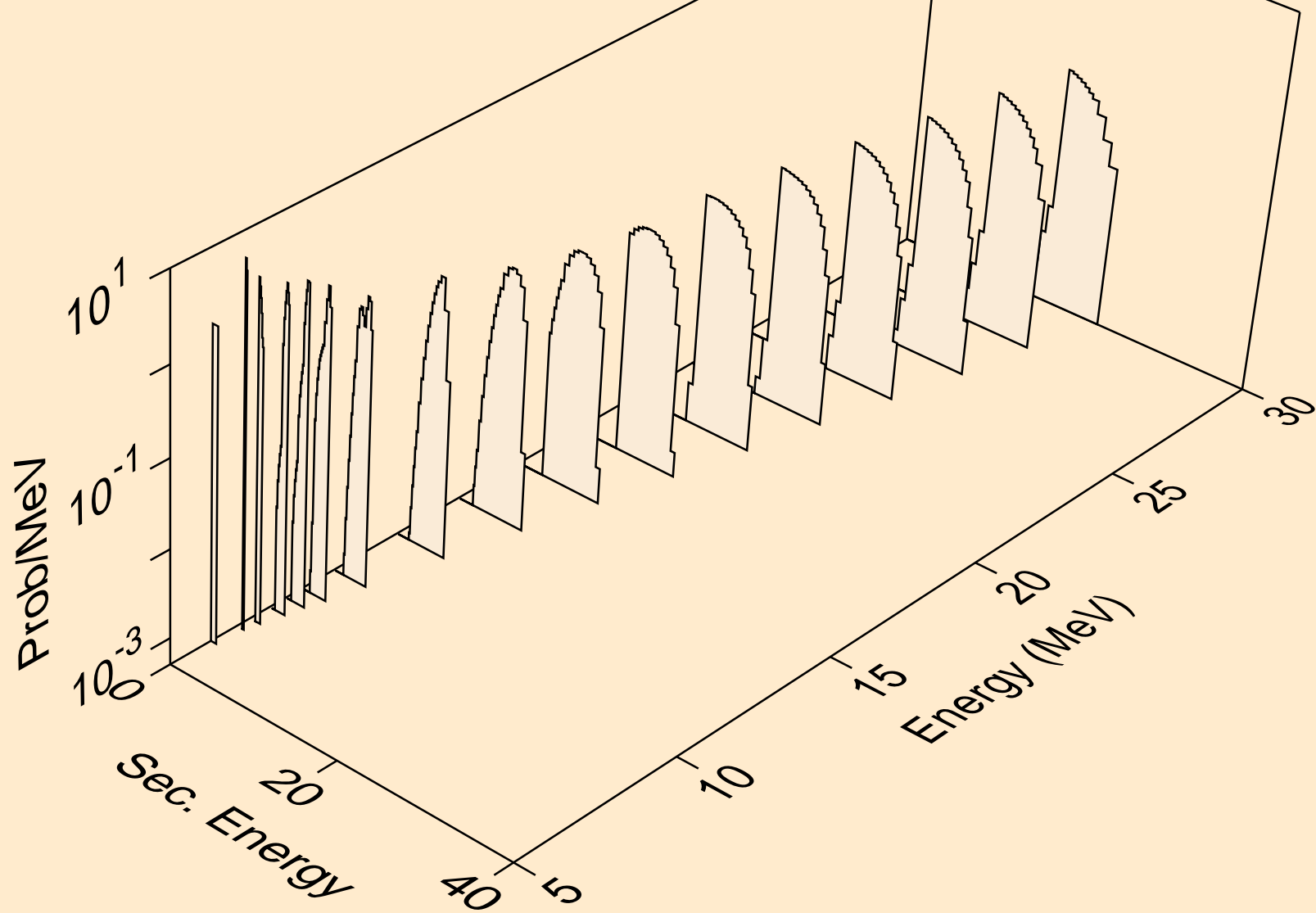

GE076 NEUTRON ACER TENDL-2021 LIBRARY; T=293.6K
protons from (n,2p)

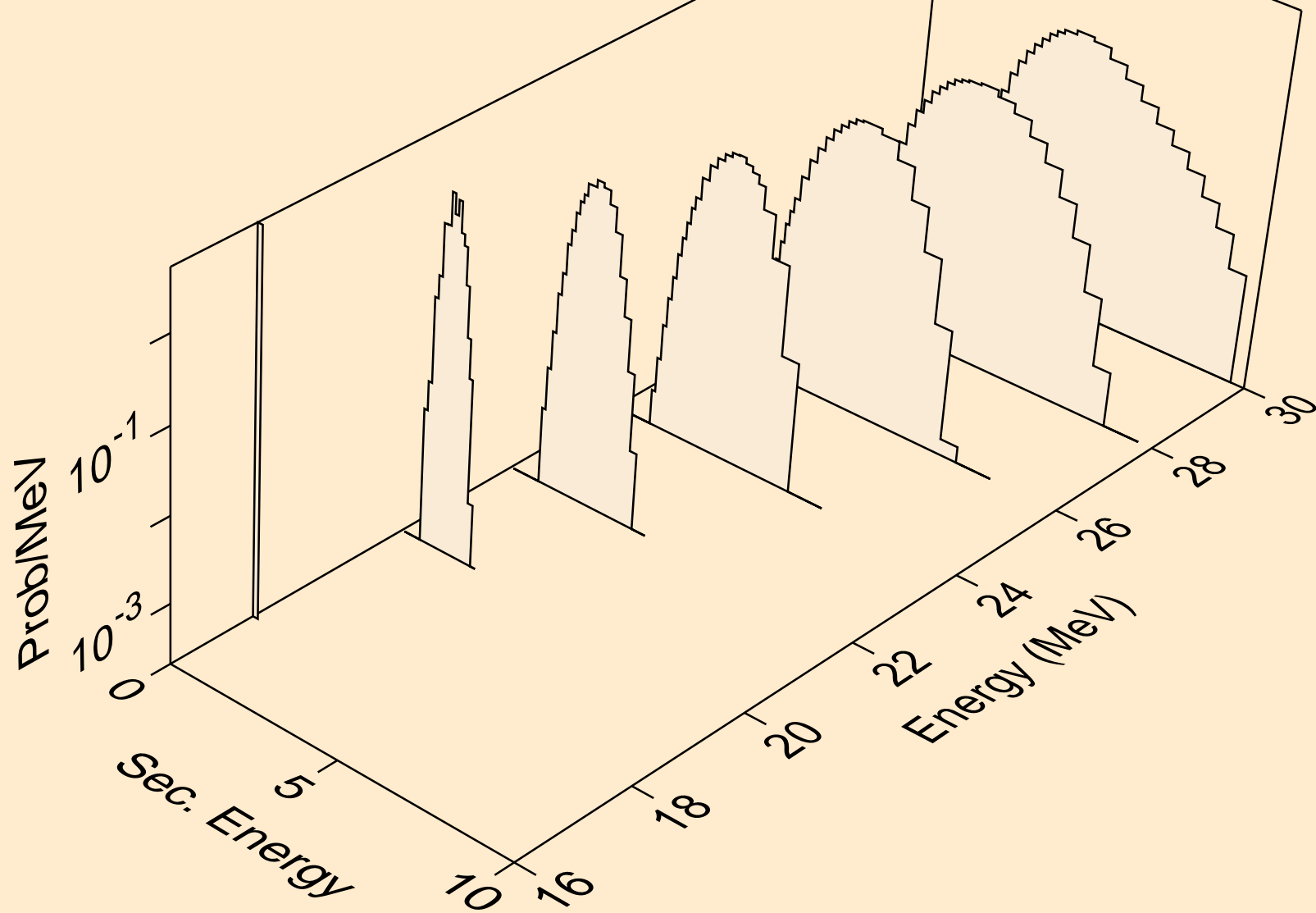

GE076 NEUTRON ACER TENDL-2021 LIBRARY; T=293.6K
protons from (n,p)

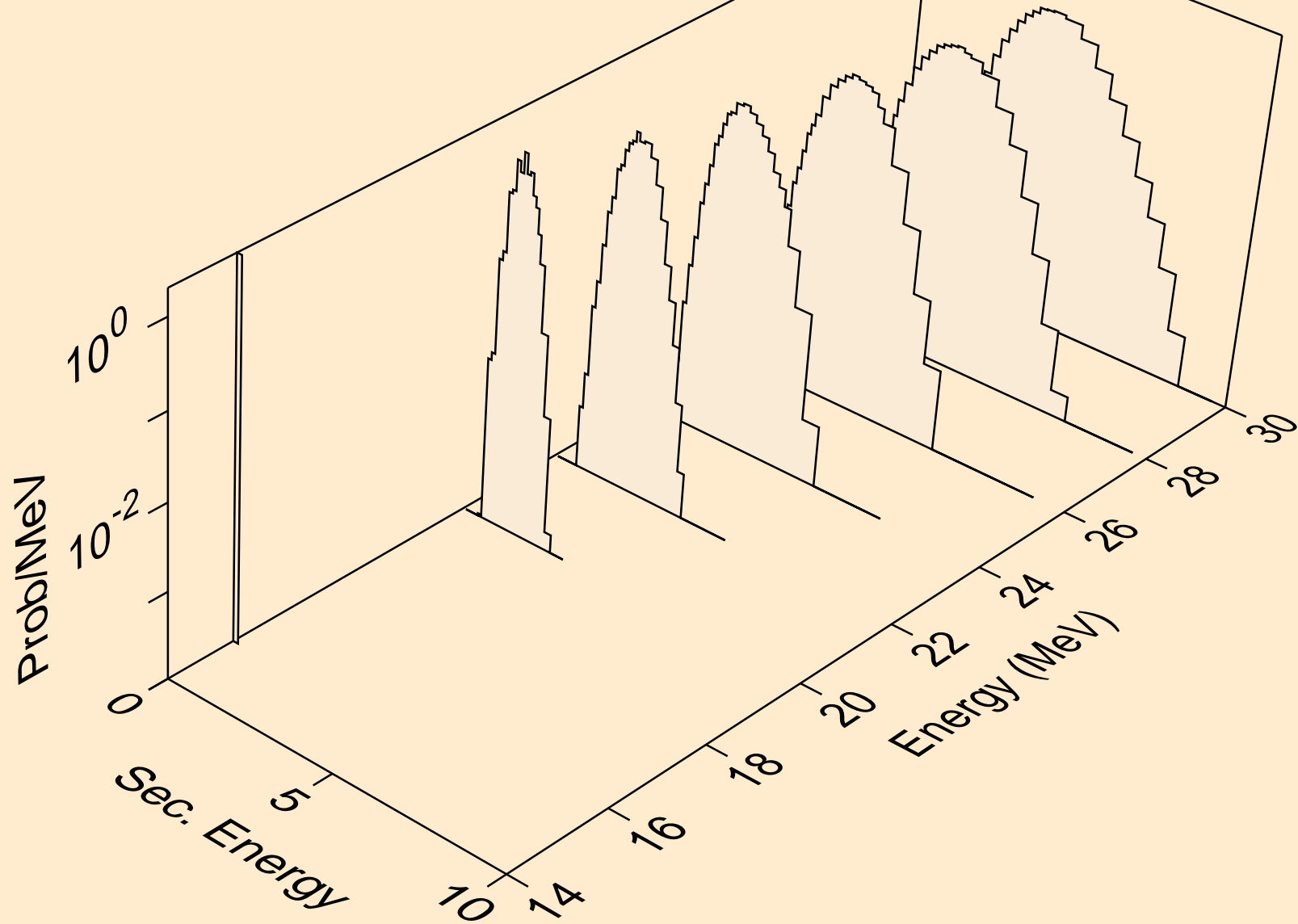

GE076 NEUTRON ACER TENDL-2021 LIBRARY; T=293.6K
protons from (n,pd)

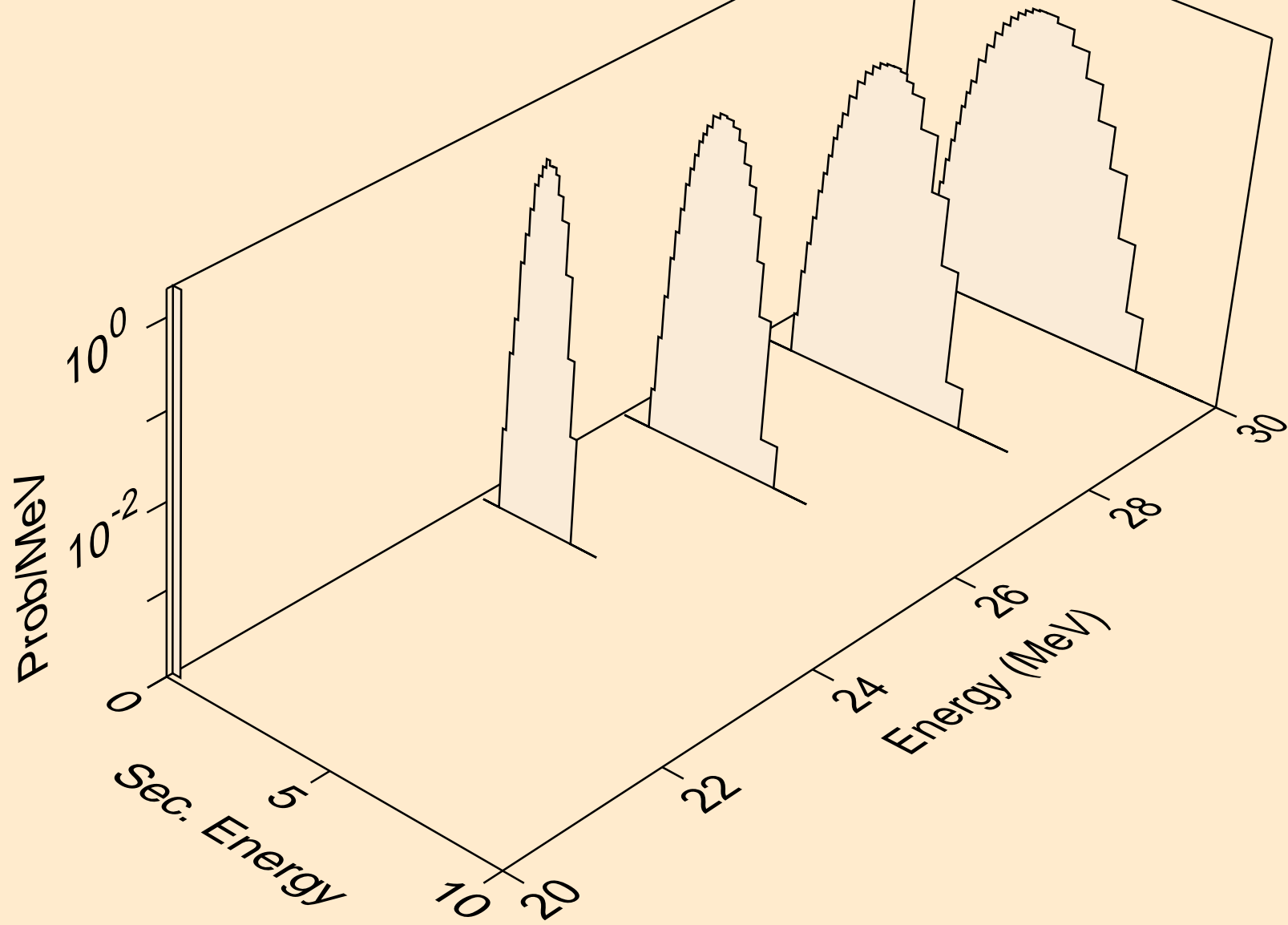

GE076 NEUTRON ACER TENDL-2021 LIBRARY; T=293.6K
protons from (n,pt)

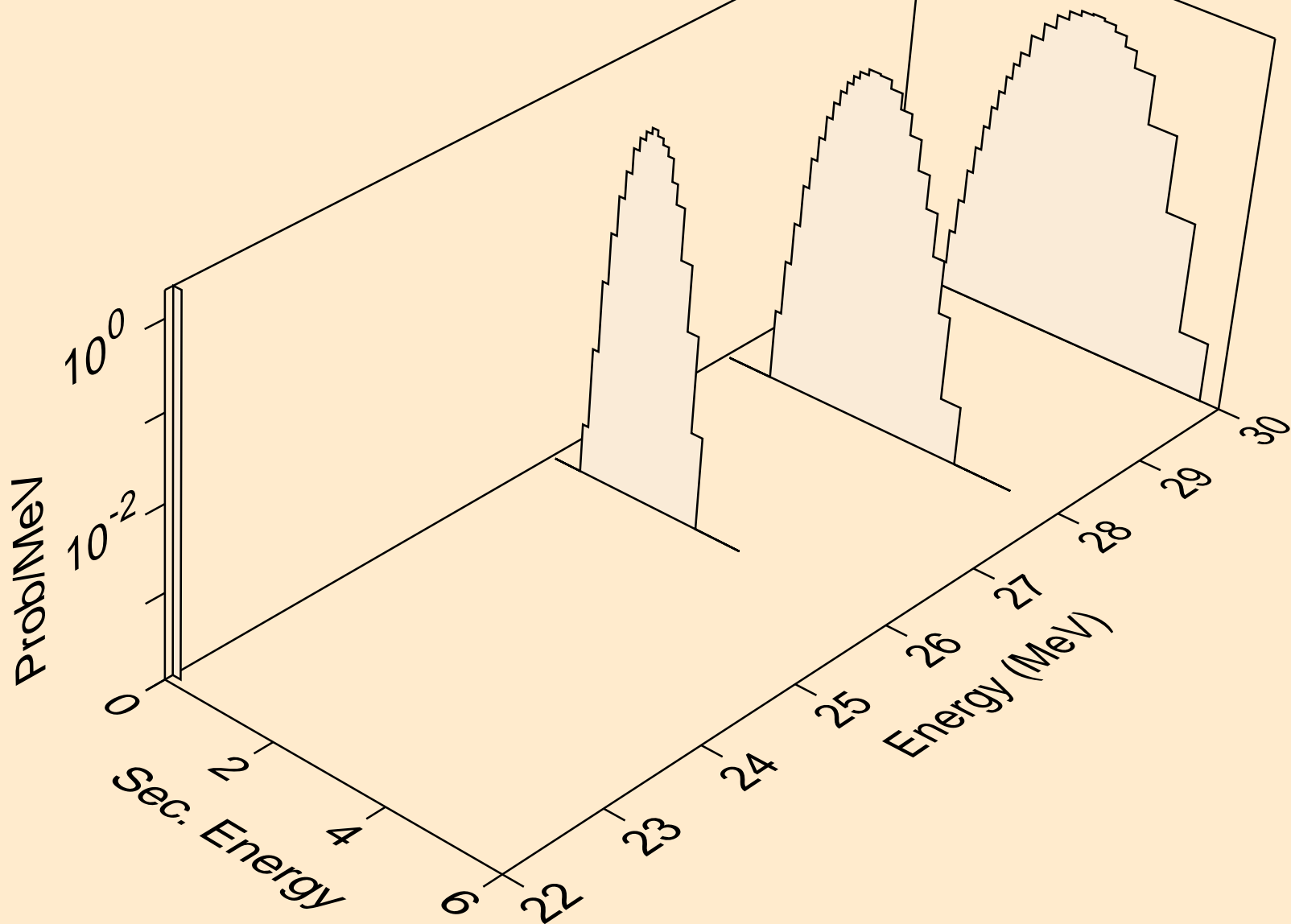

GE076 NEUTRON ACER TENDL-2021 LIBRARY; T=293.6K
deuterons from (n,x)

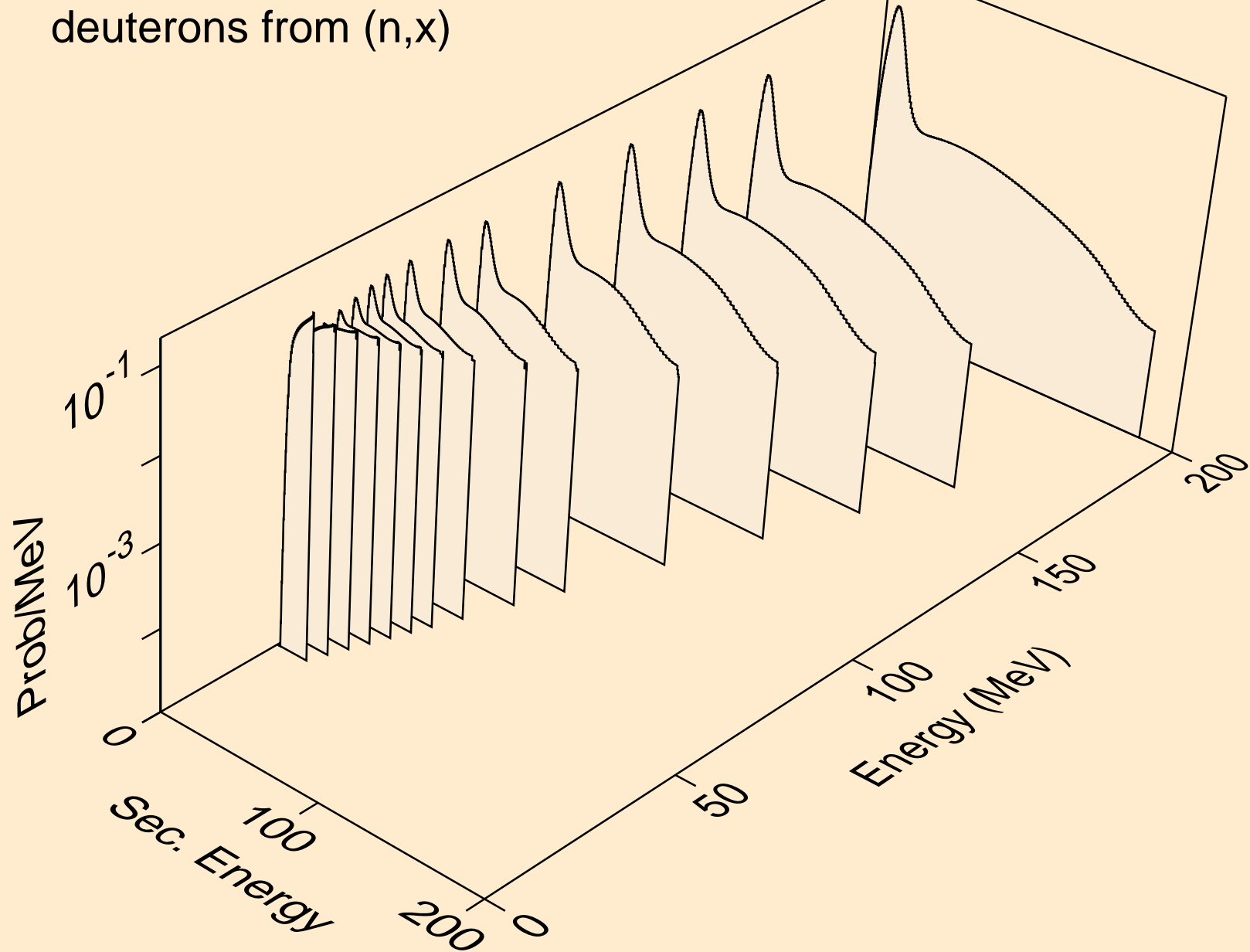

GE076 NEUTRON ACER TENDL-2021 LIBRARY; T=293.6K
deuterons from (n,2nd)

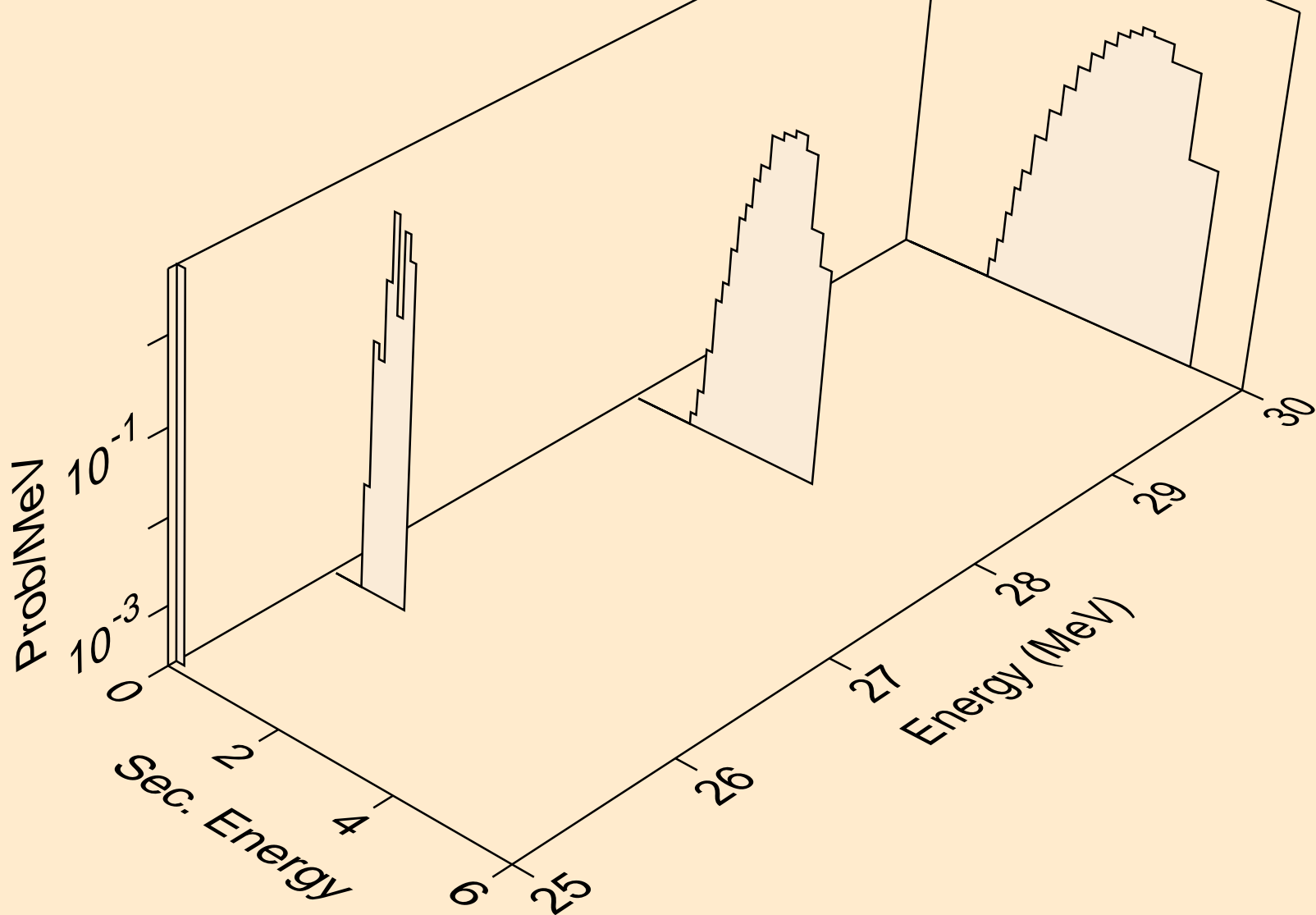

GE076 NEUTRON ACER TENDL-2021 LIBRARY; T=293.6K
deuterons from (n,n*)d

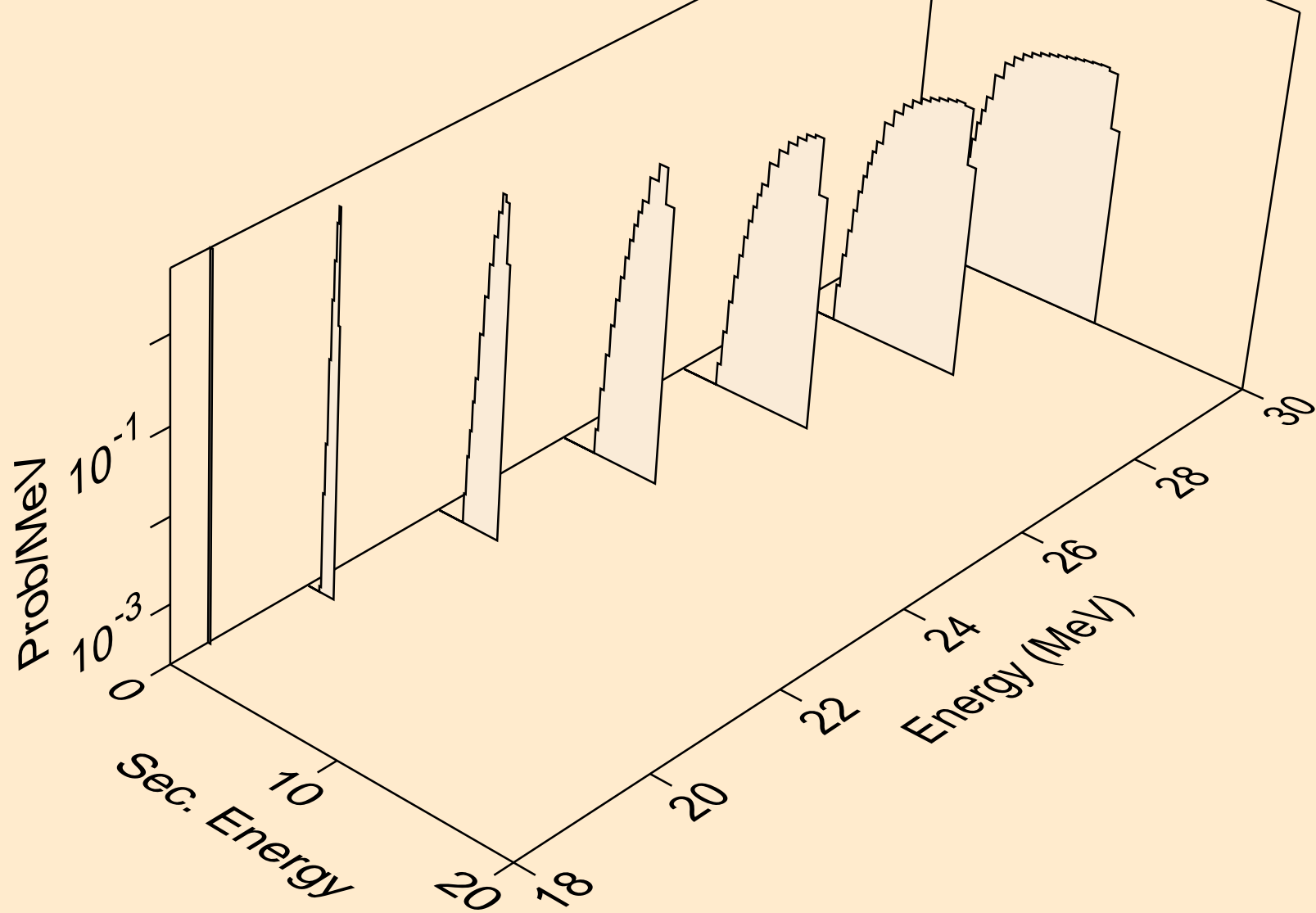

GE076 NEUTRON ACER TENDL-2021 LIBRARY; T=293.6K
deuterons from (n,d)

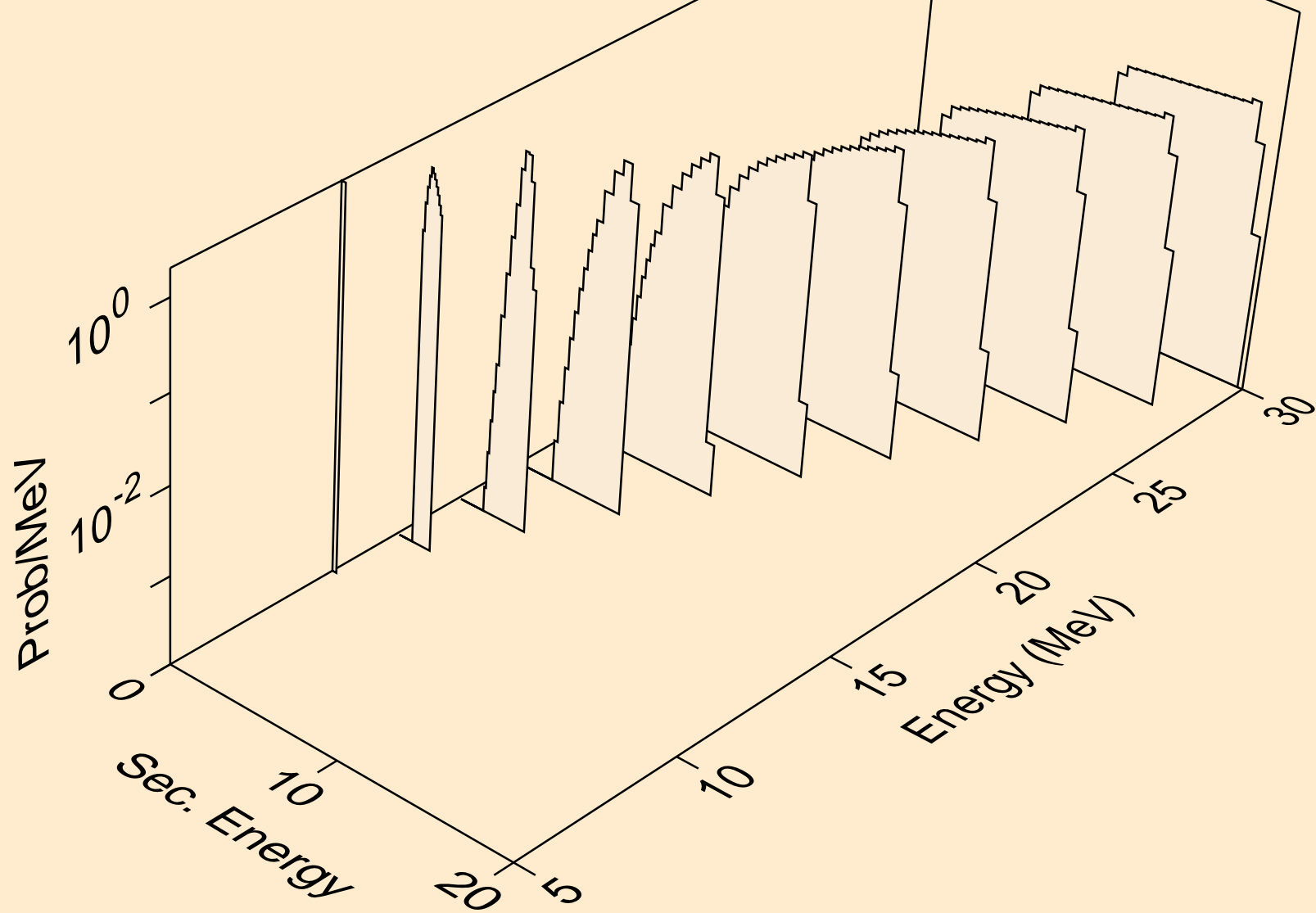

GE076 NEUTRON ACER TENDL-2021 LIBRARY; T=293.6K
deuterons from (n,pd)

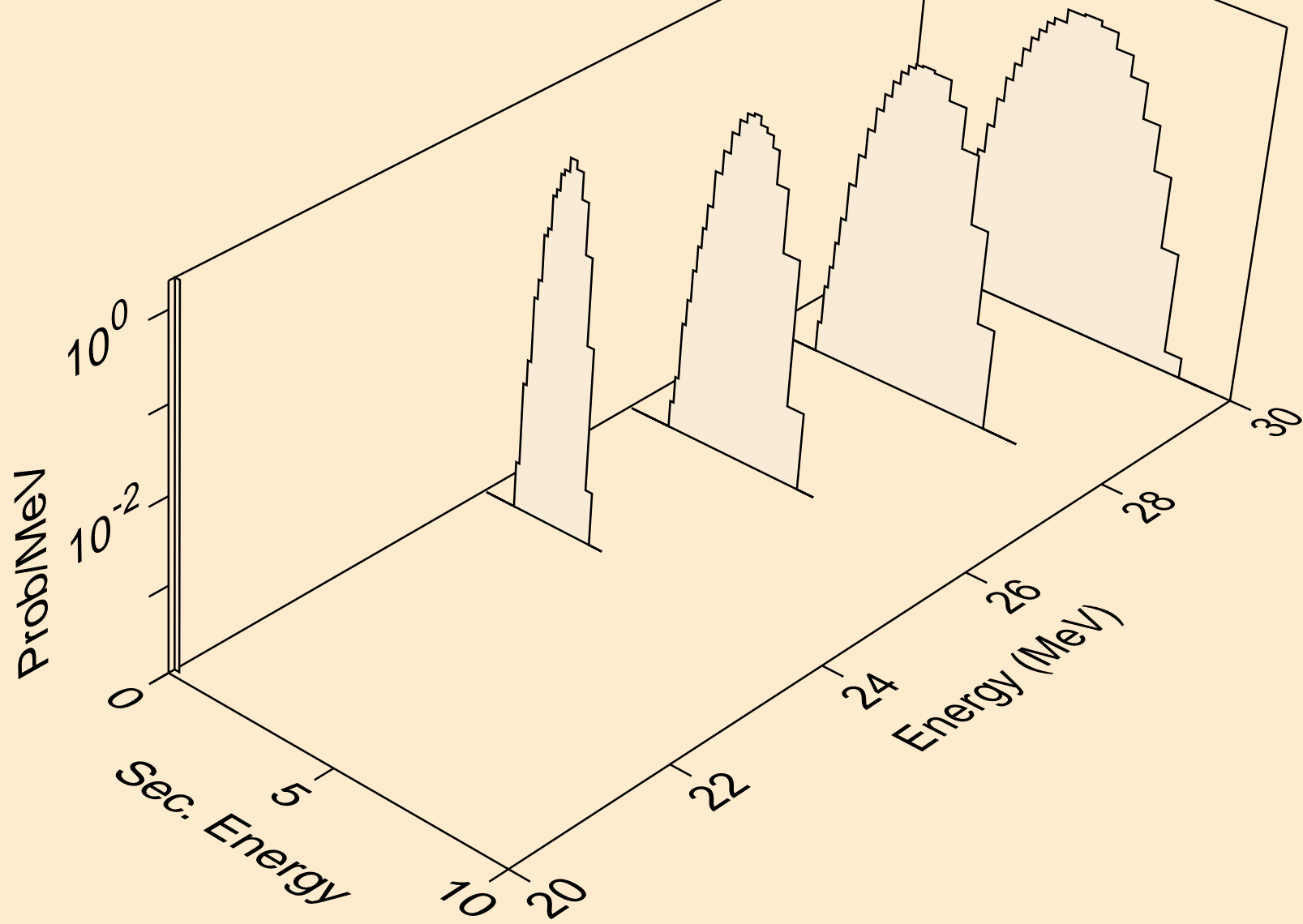

GE076 NEUTRON ACER TENDL-2021 LIBRARY; T=293.6K
tritons from (n,x)

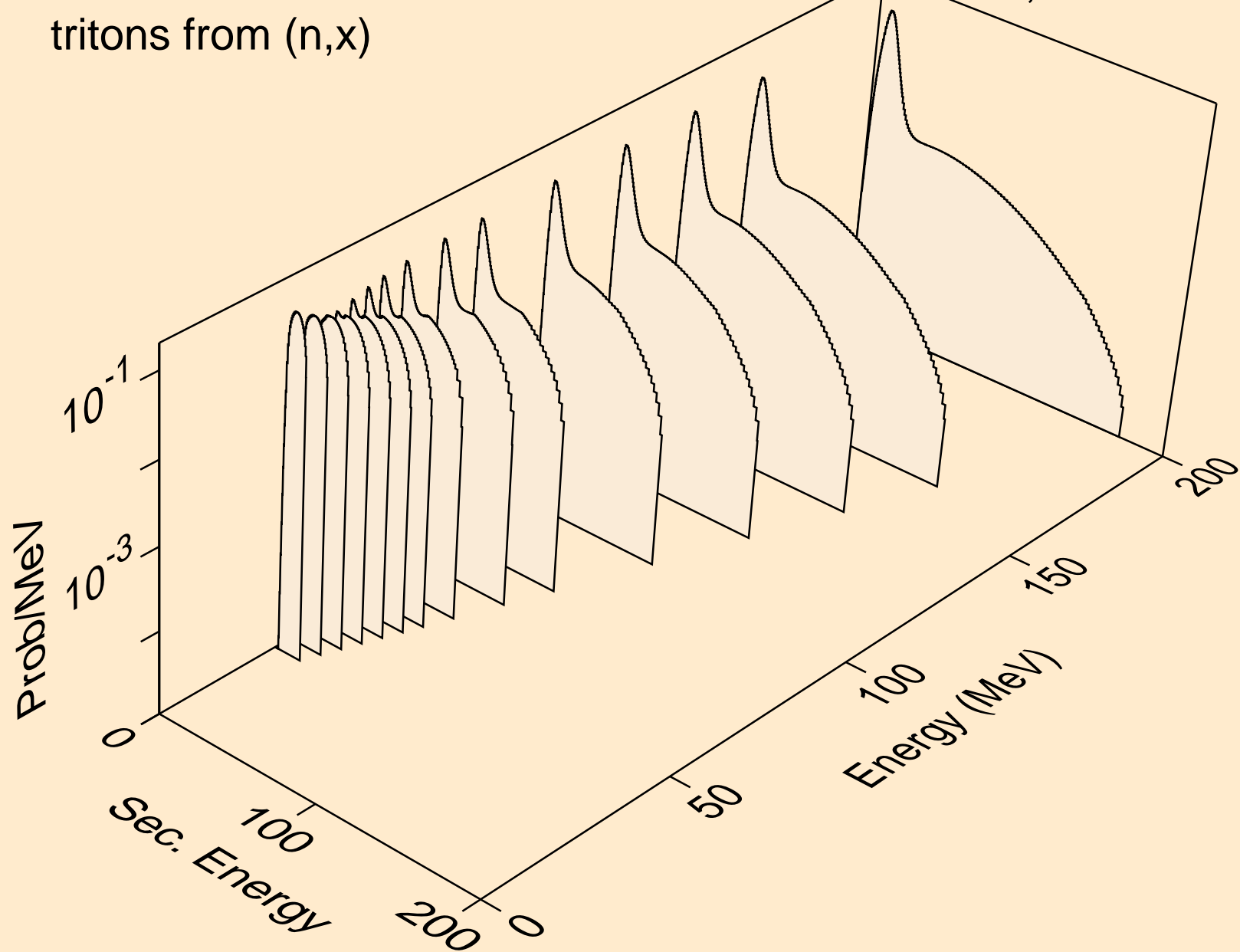

GE076 NEUTRON ACER TENDL-2021 LIBRARY; T=293.6K
tritons from (n,n*)t

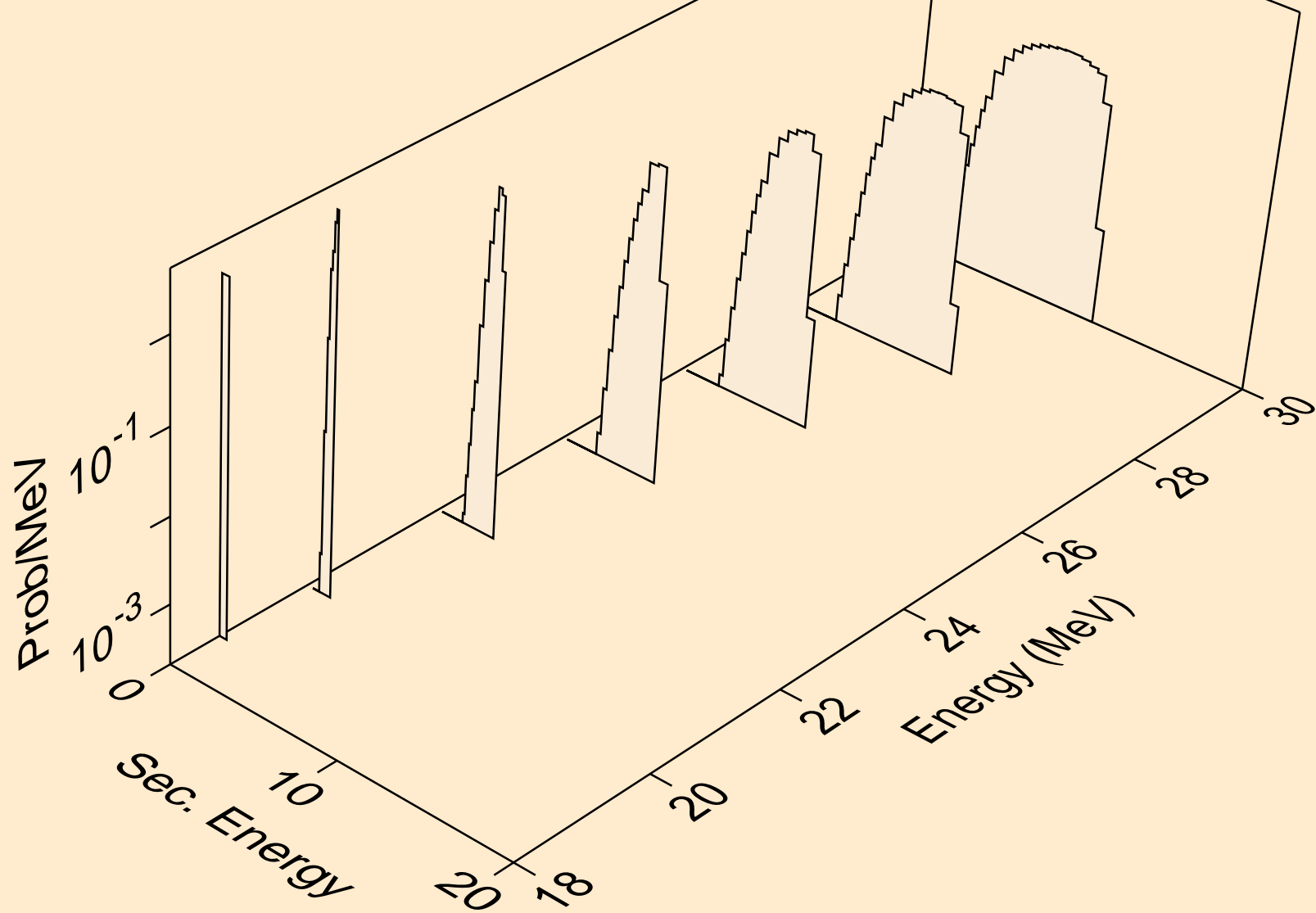

GE076 NEUTRON ACER TENDL-2021 LIBRARY; T=293.6K
tritons from (n,t)

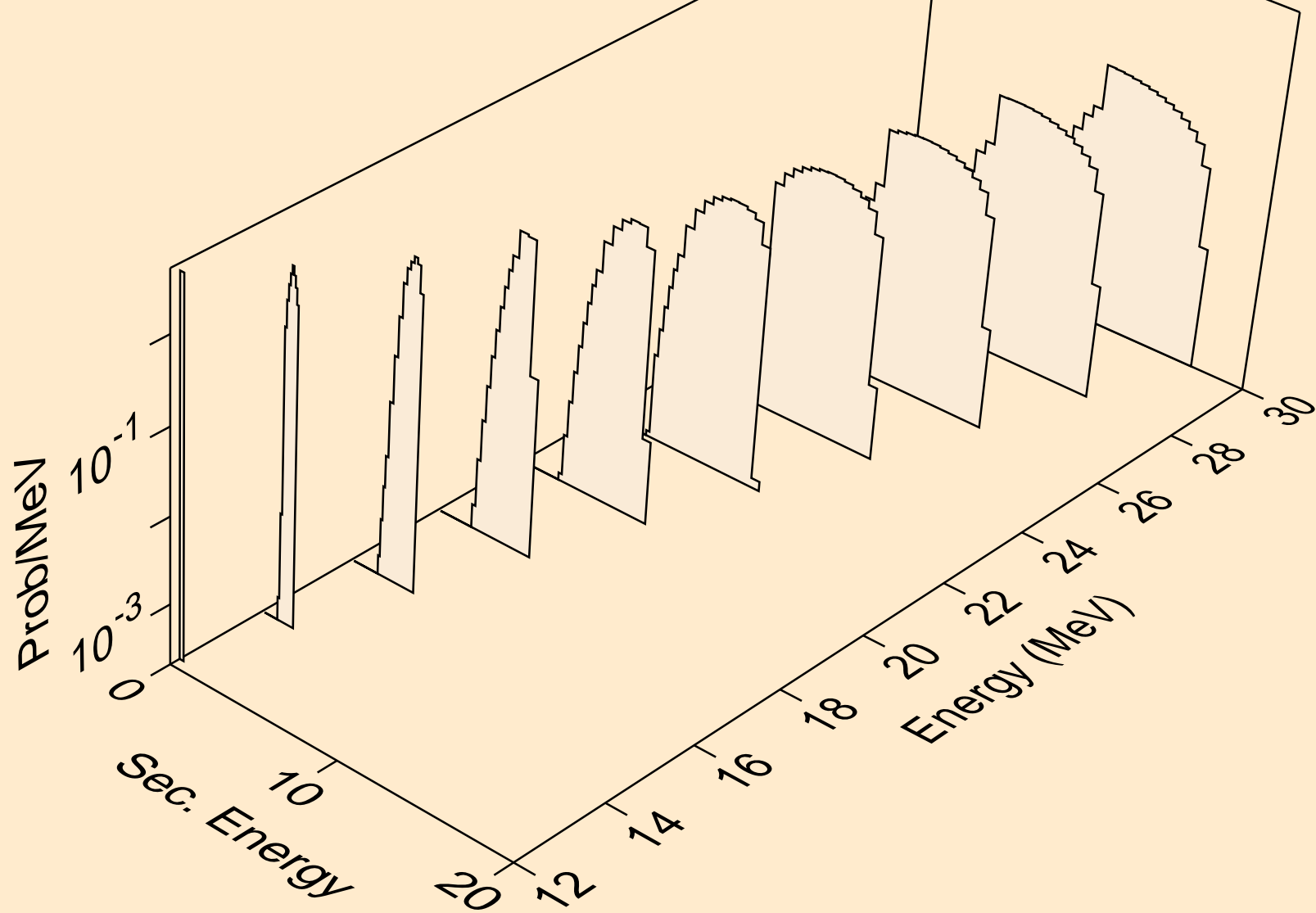

GE076 NEUTRON ACER TENDL-2021 LIBRARY; T=293.6K
tritons from (n,pt)

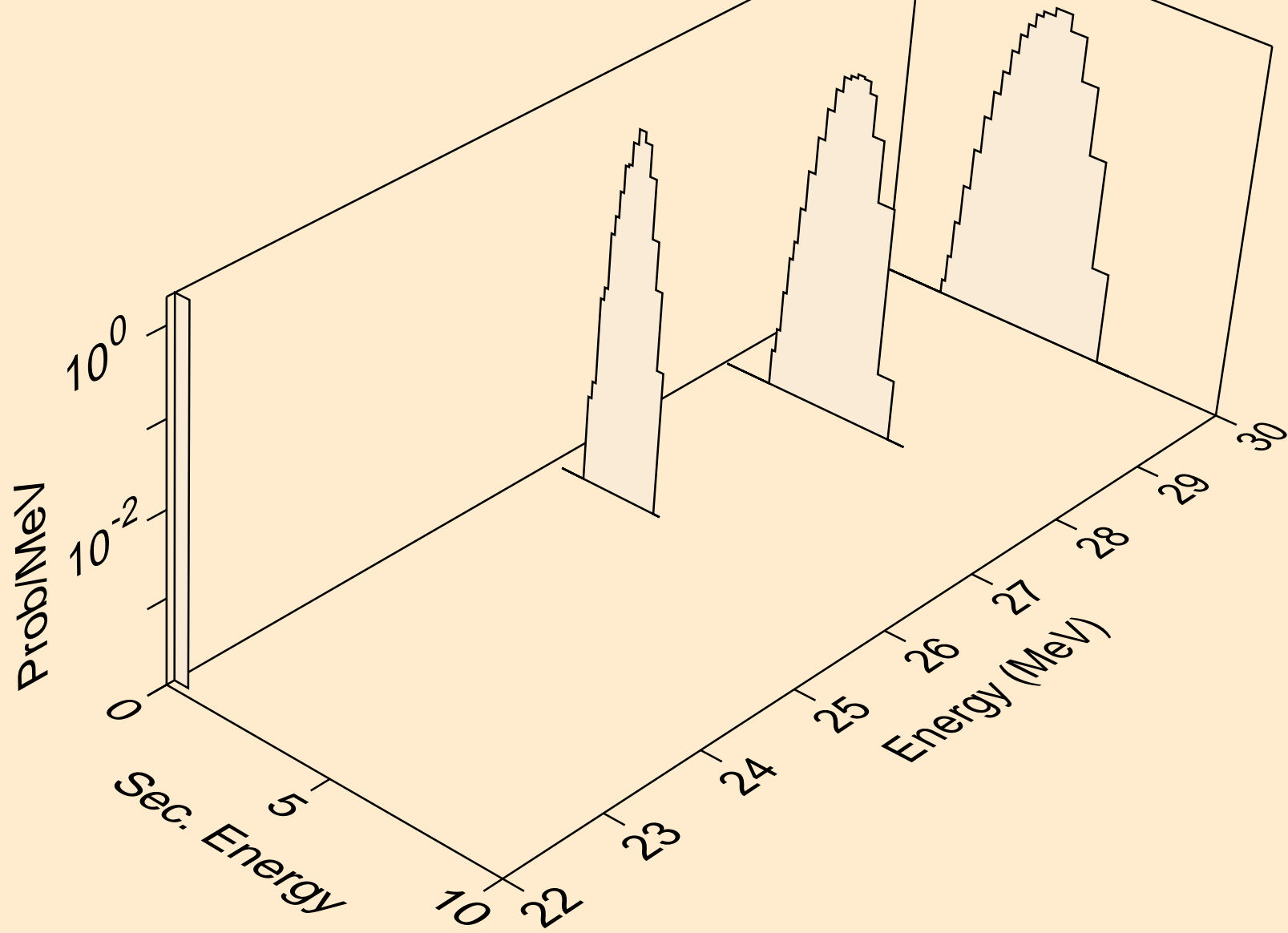

GE076 NEUTRON ACER TENDL-2021 LIBRARY; T=293.6K
he3s from (n,x)

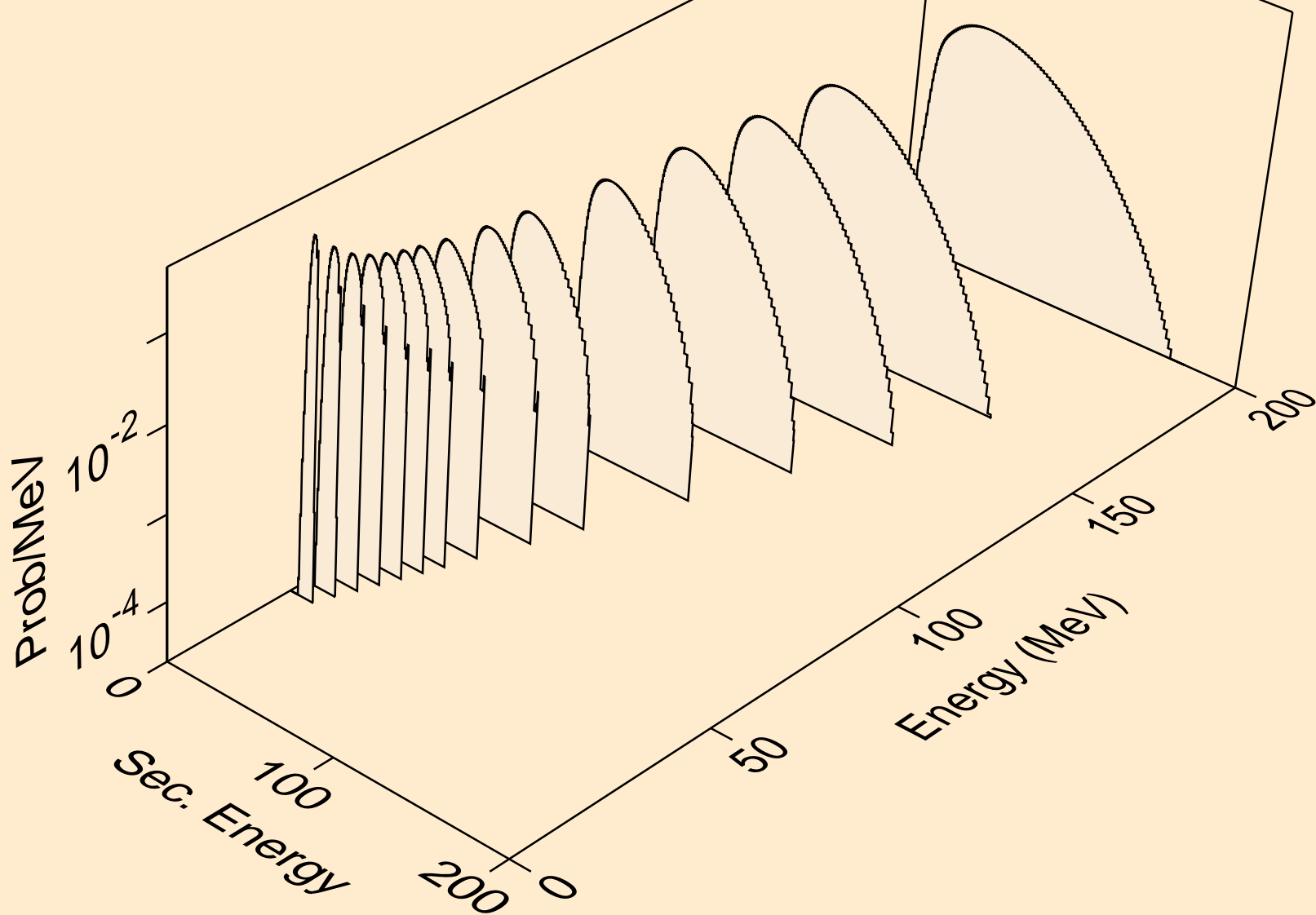

GE076 NEUTRON ACER TENDL-2021 LIBRARY; T=293.6K
he3s from (n,n*)he3

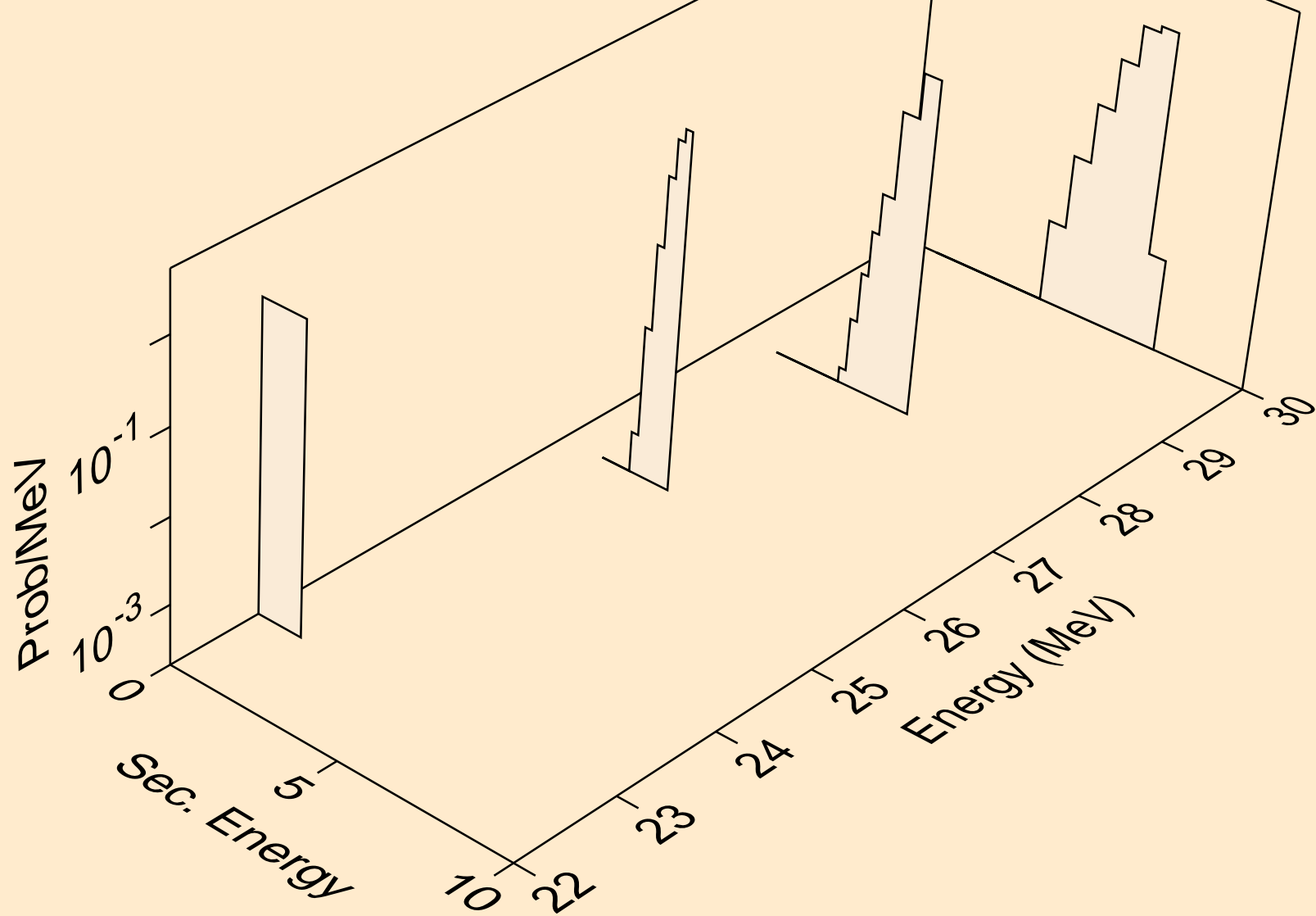

GE076 NEUTRON ACER TENDL-2021 LIBRARY; T=293.6K
he3s from (n,he3)

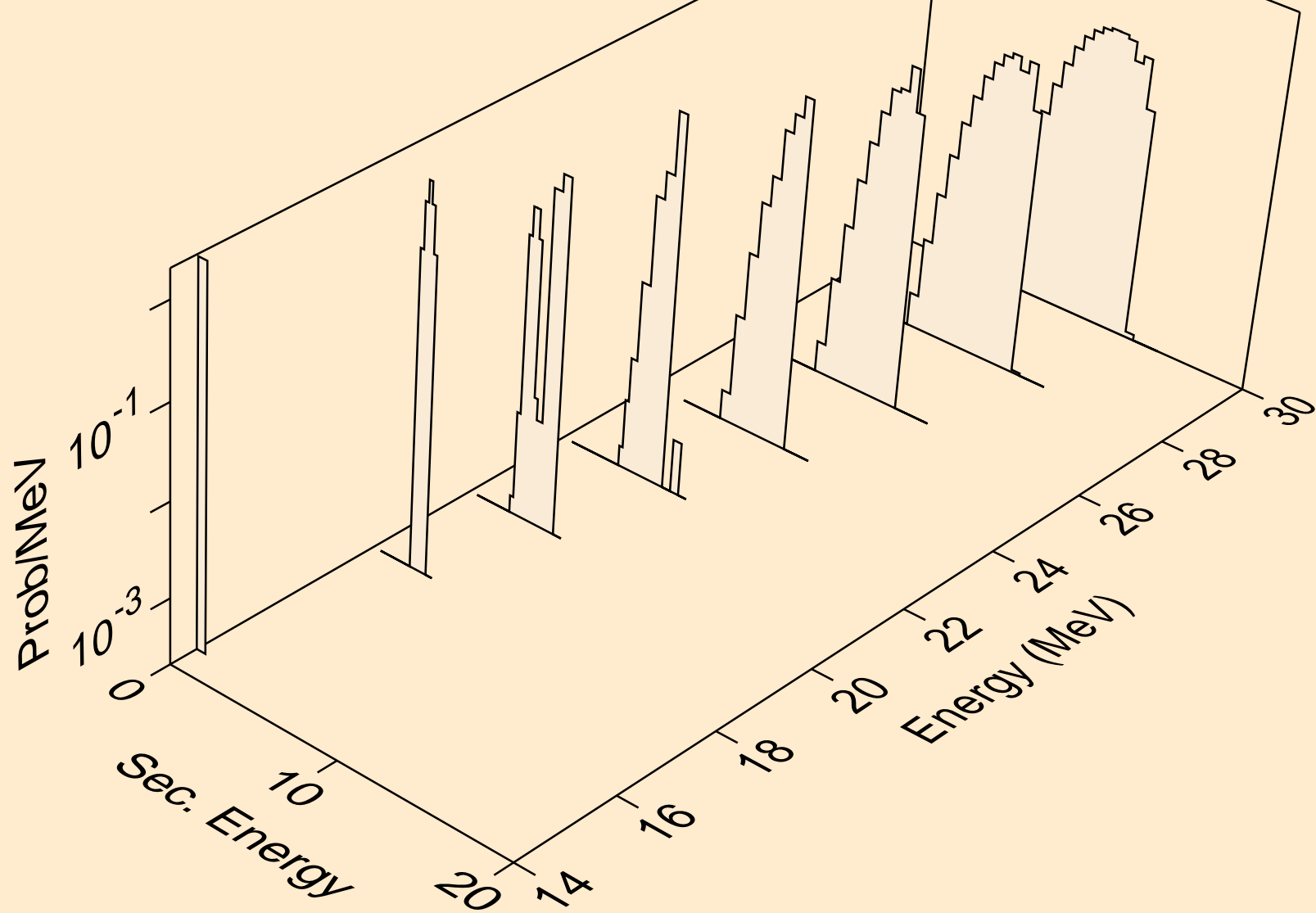

GE076 NEUTRON ACER TENDL-2021 LIBRARY; T=293.6K
alphas from (n,x)

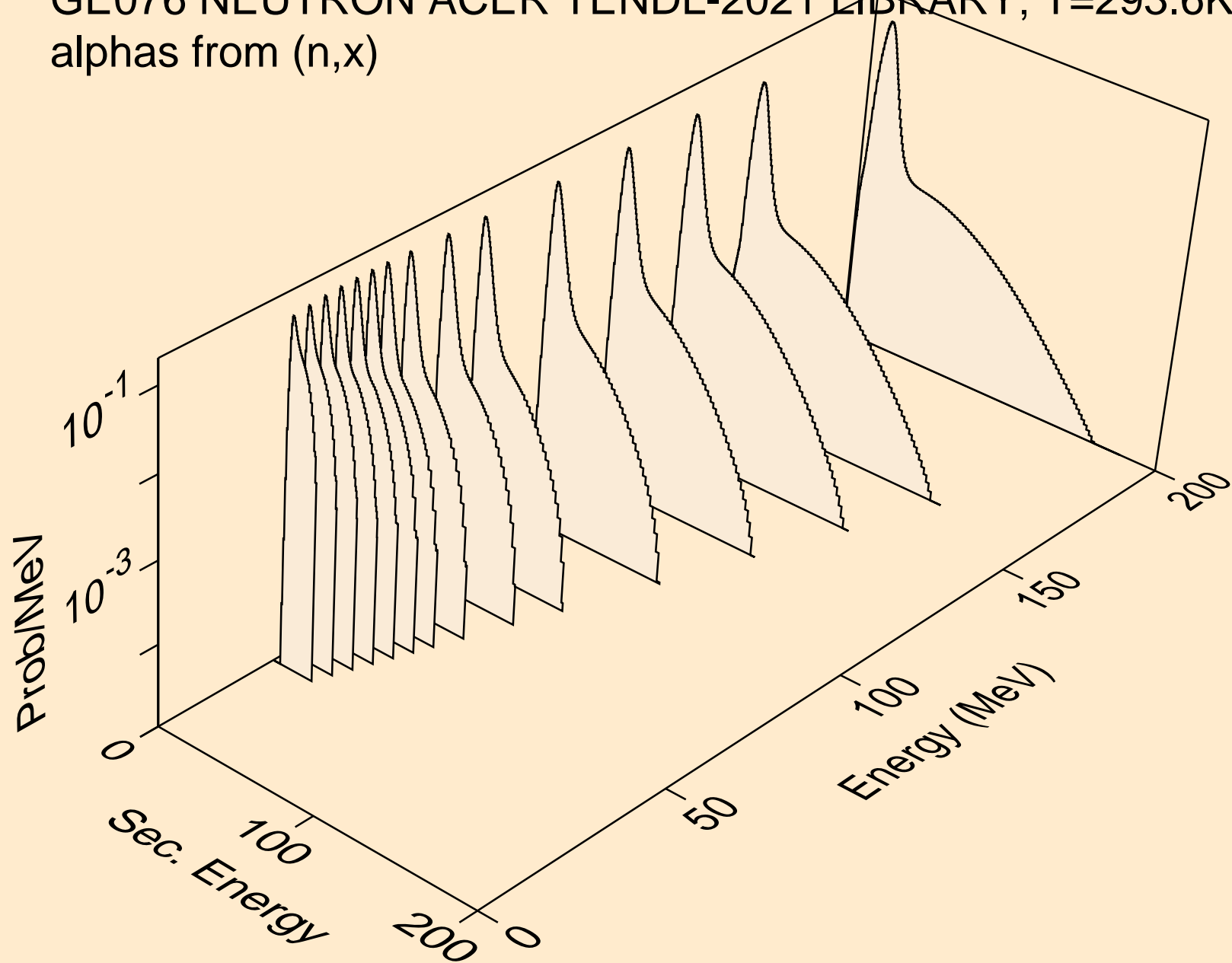

GE076 NEUTRON ACER TENDL-2021 LIBRARY; T=293.6K
alphas from (n,n*)a

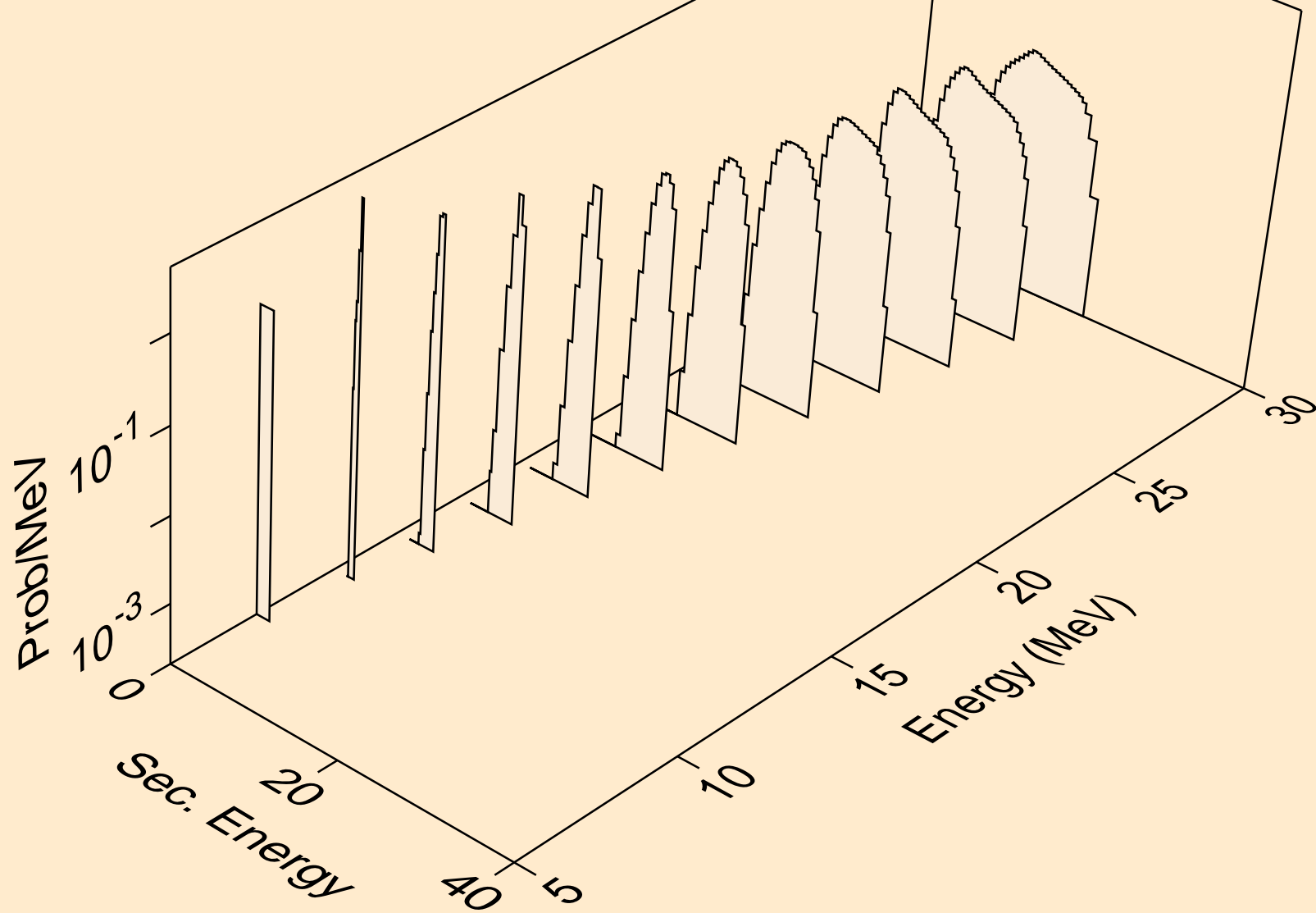

GE076 NEUTRON ACER TENDL-2021 LIBRARY; T=293.6K
alphas from (n,2n)a

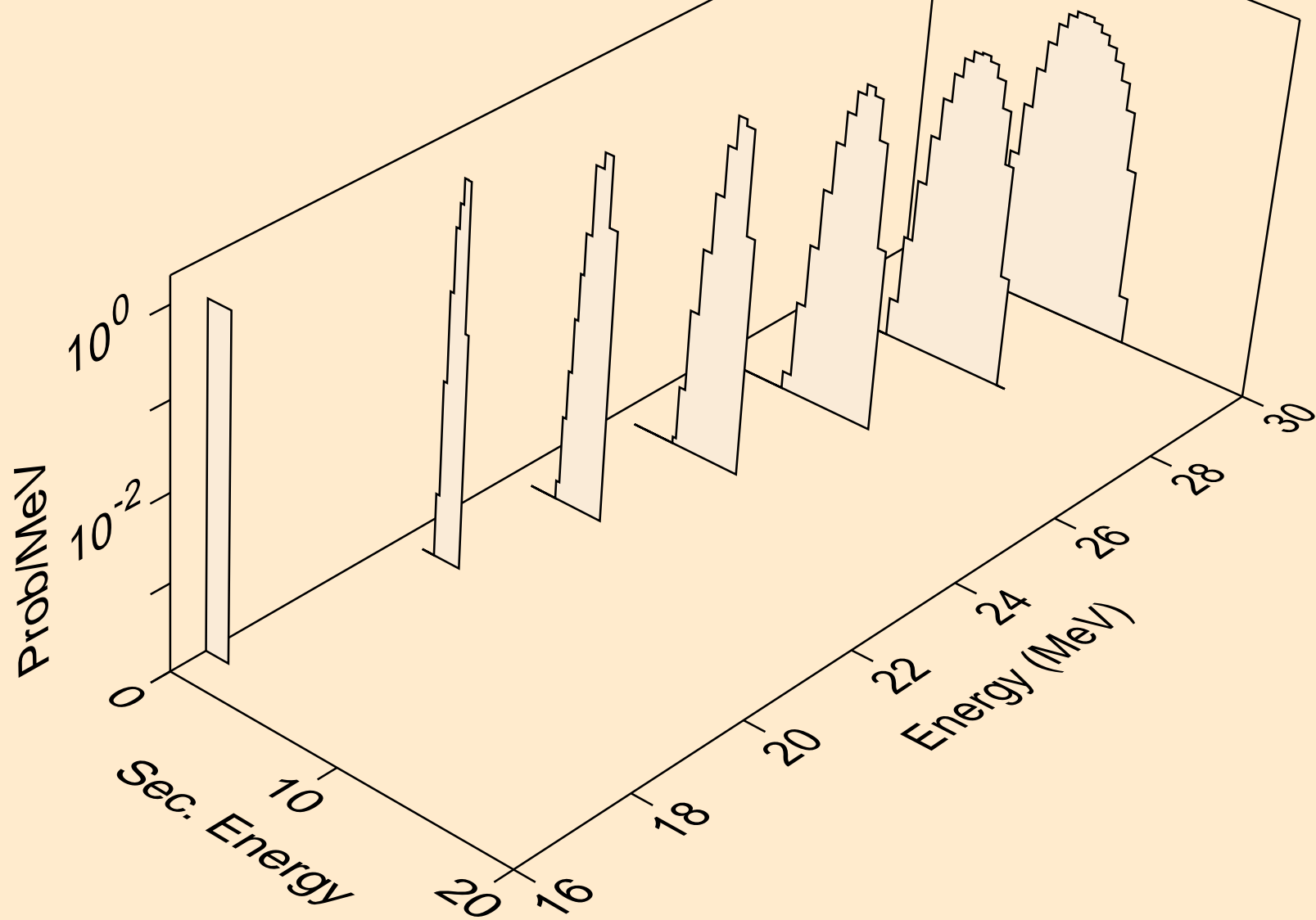

GE076 NEUTRON ACER TENDL-2021 LIBRARY; T=293.6K
alphas from (n,3n)a

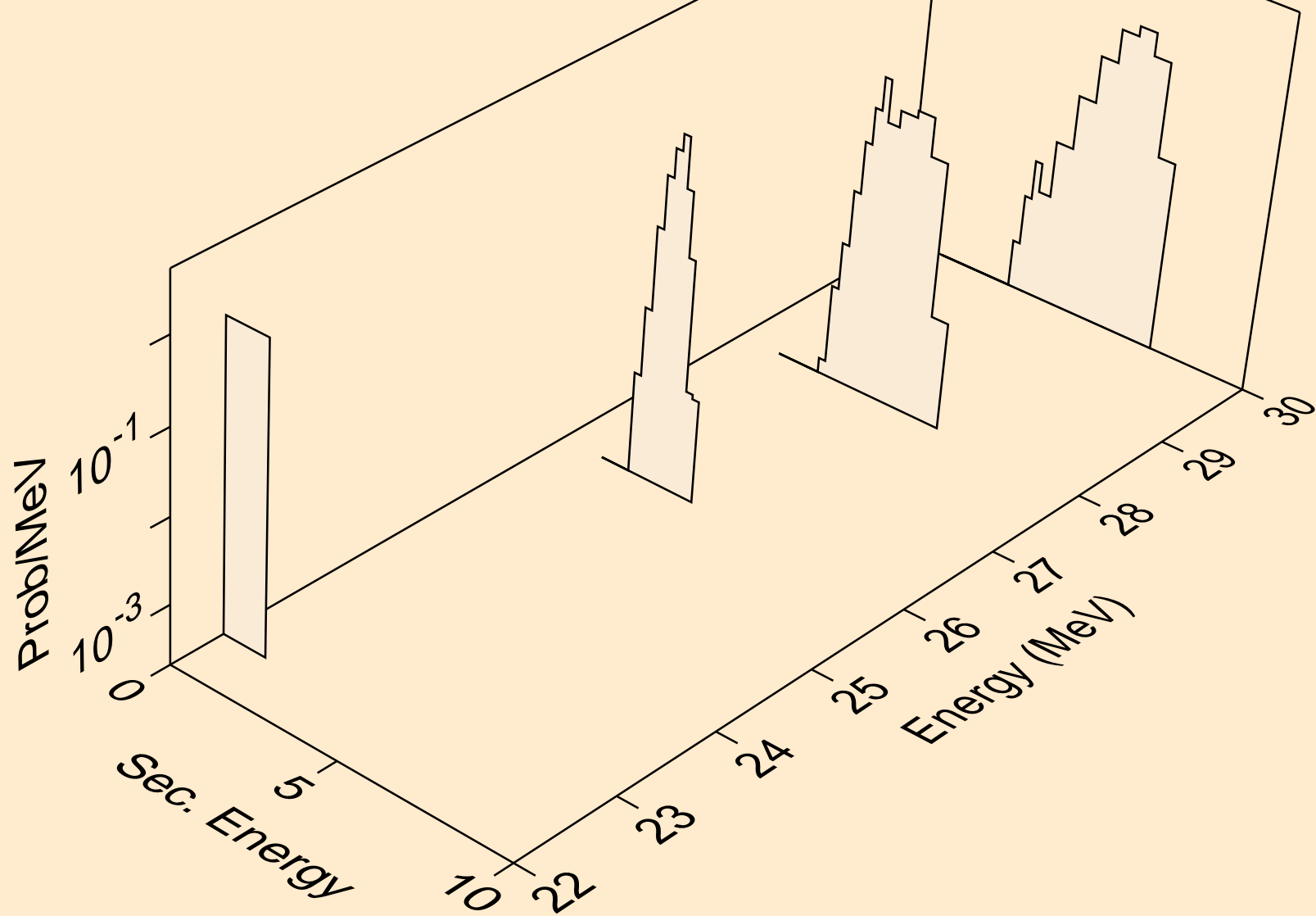

GE076 NEUTRON ACER TENDL-2021 LIBRARY; T=293.6K
alphas from (n,n*)2a

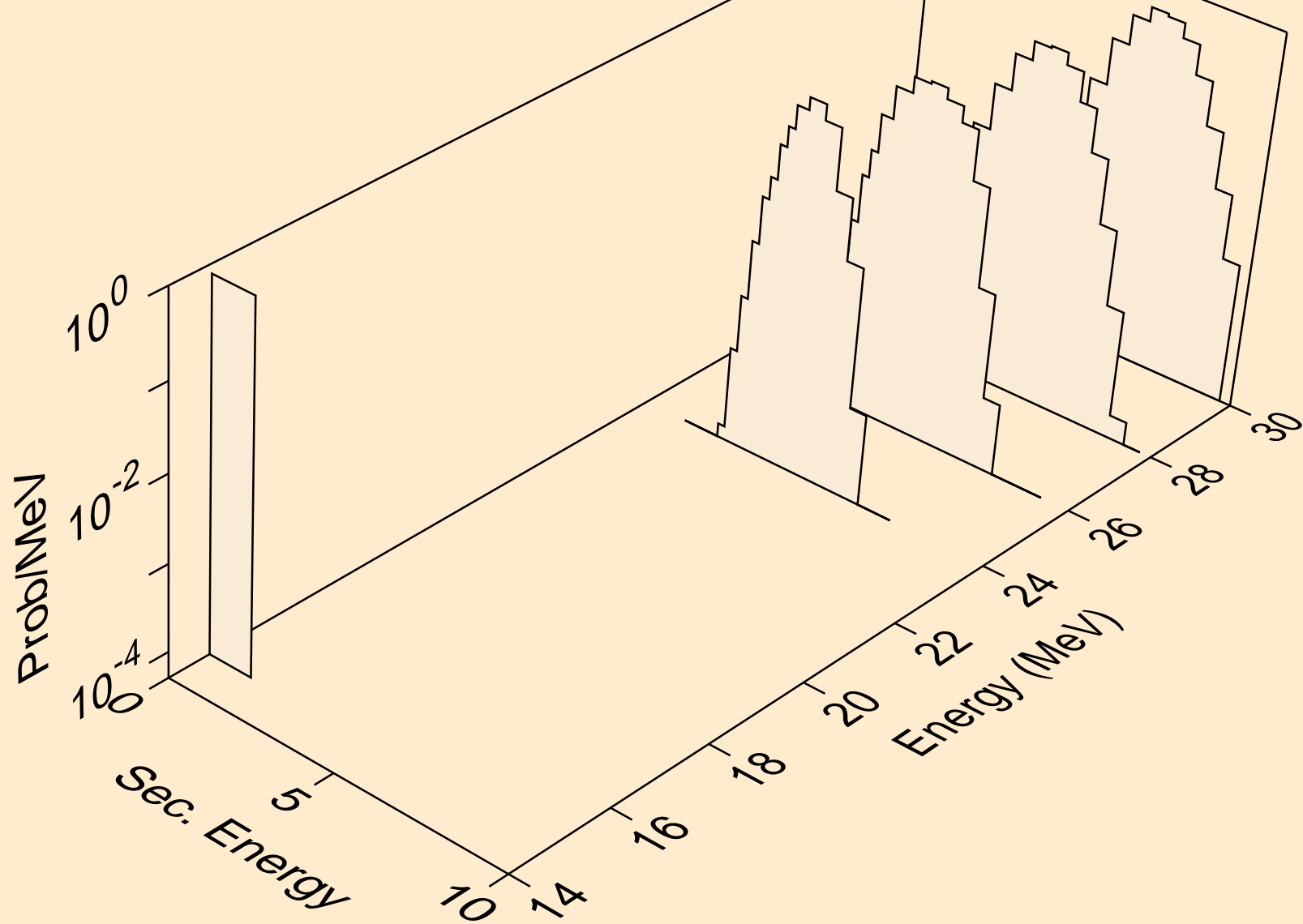

GE076 NEUTRON ACER TENDL-2021 LIBRARY; T=293.6K
alphas from (n,a)

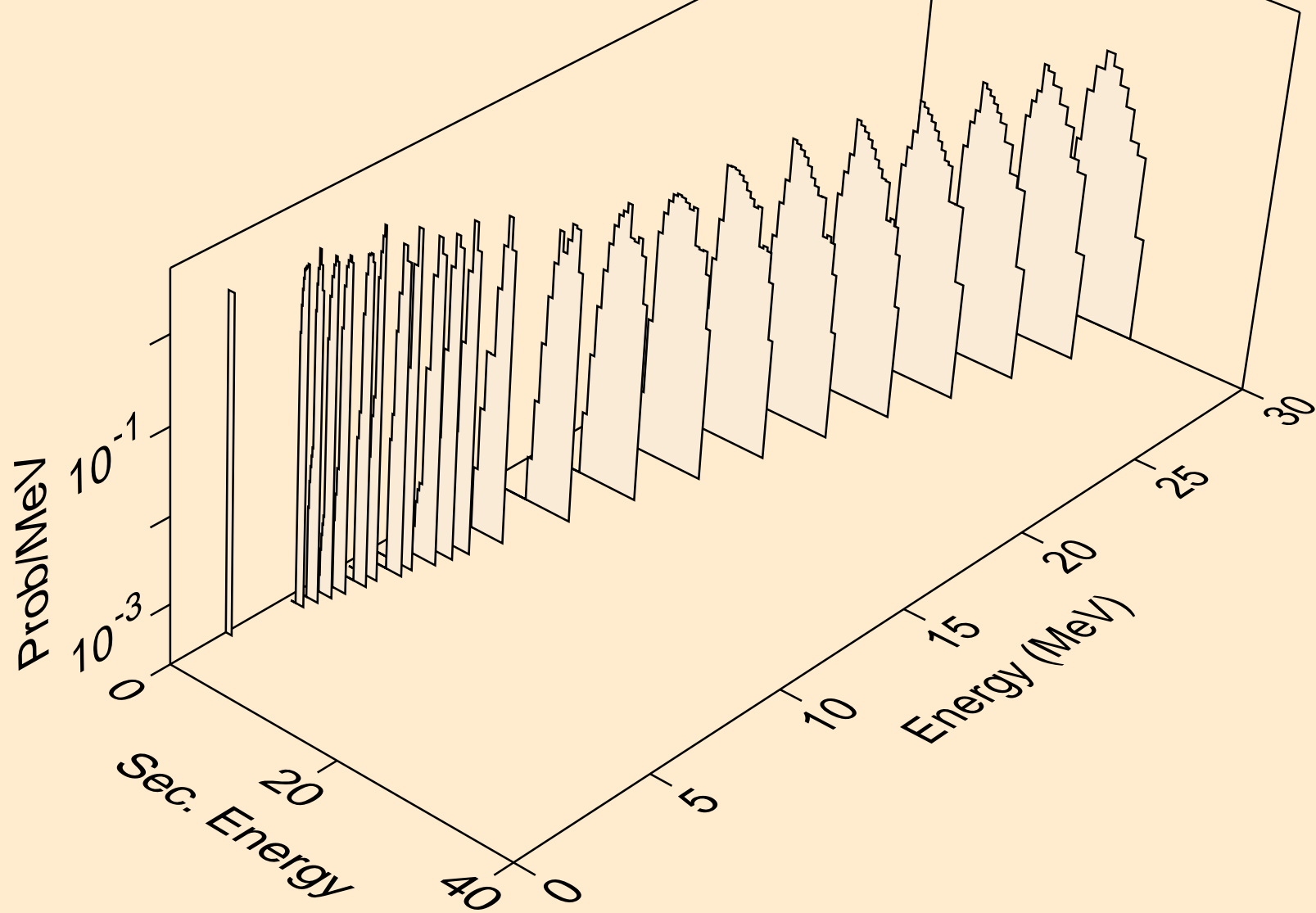

GE076 NEUTRON ACER TENDL-2021 LIBRARY; T=293.6K
alphas from (n,2a)

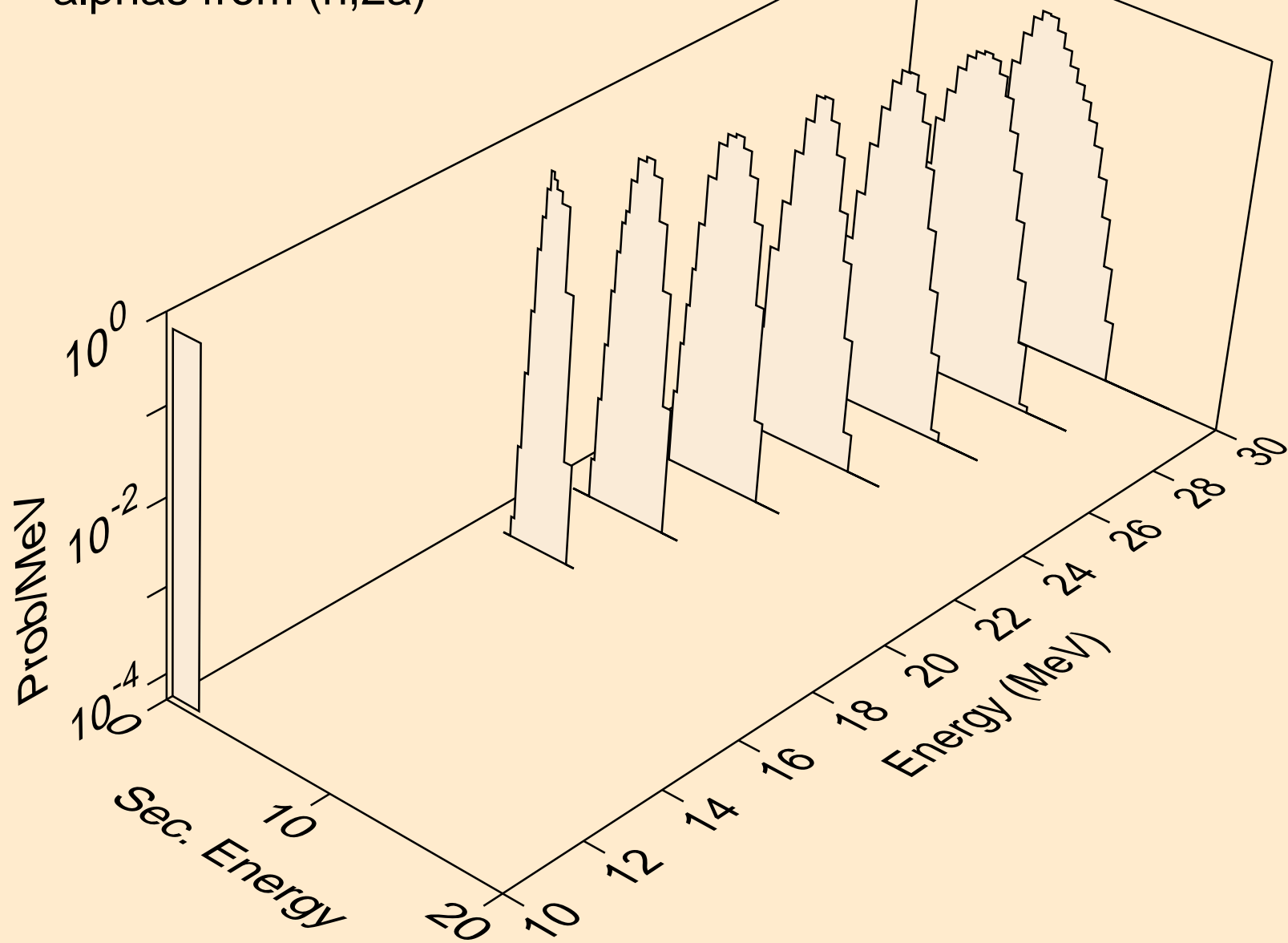

GE076 NEUTRON ACER TENDL-2021 LIBRARY; T=293.6K
alphas from (n,pa)

