

GE081M NEUTRON ACER TENDL-2021 LIBRARY; T=293.6K

Principal cross sections

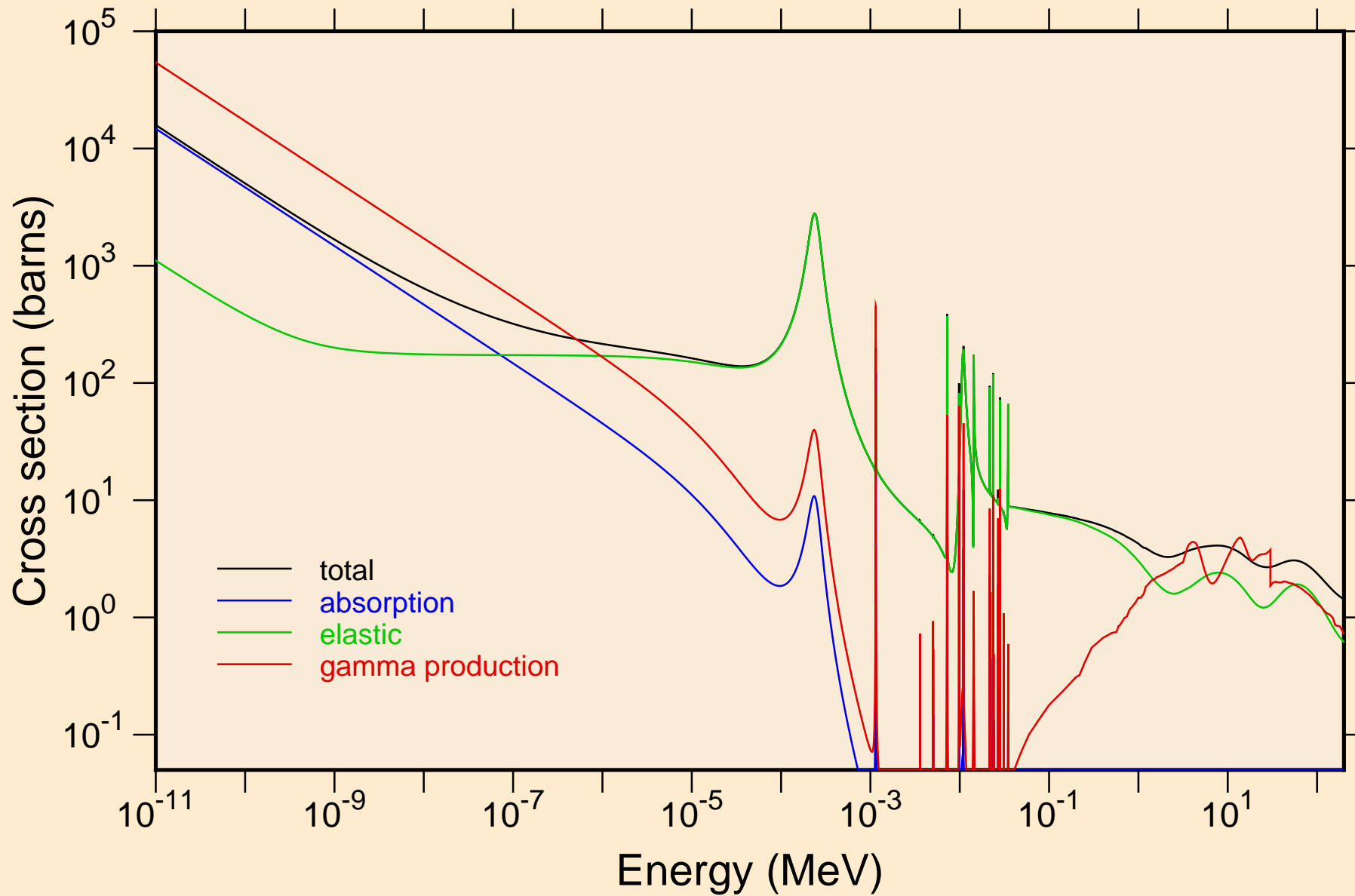

GE081M NEUTRON ACER TENDL-2021 LIBRARY; T=293.6K
resonance total cross section

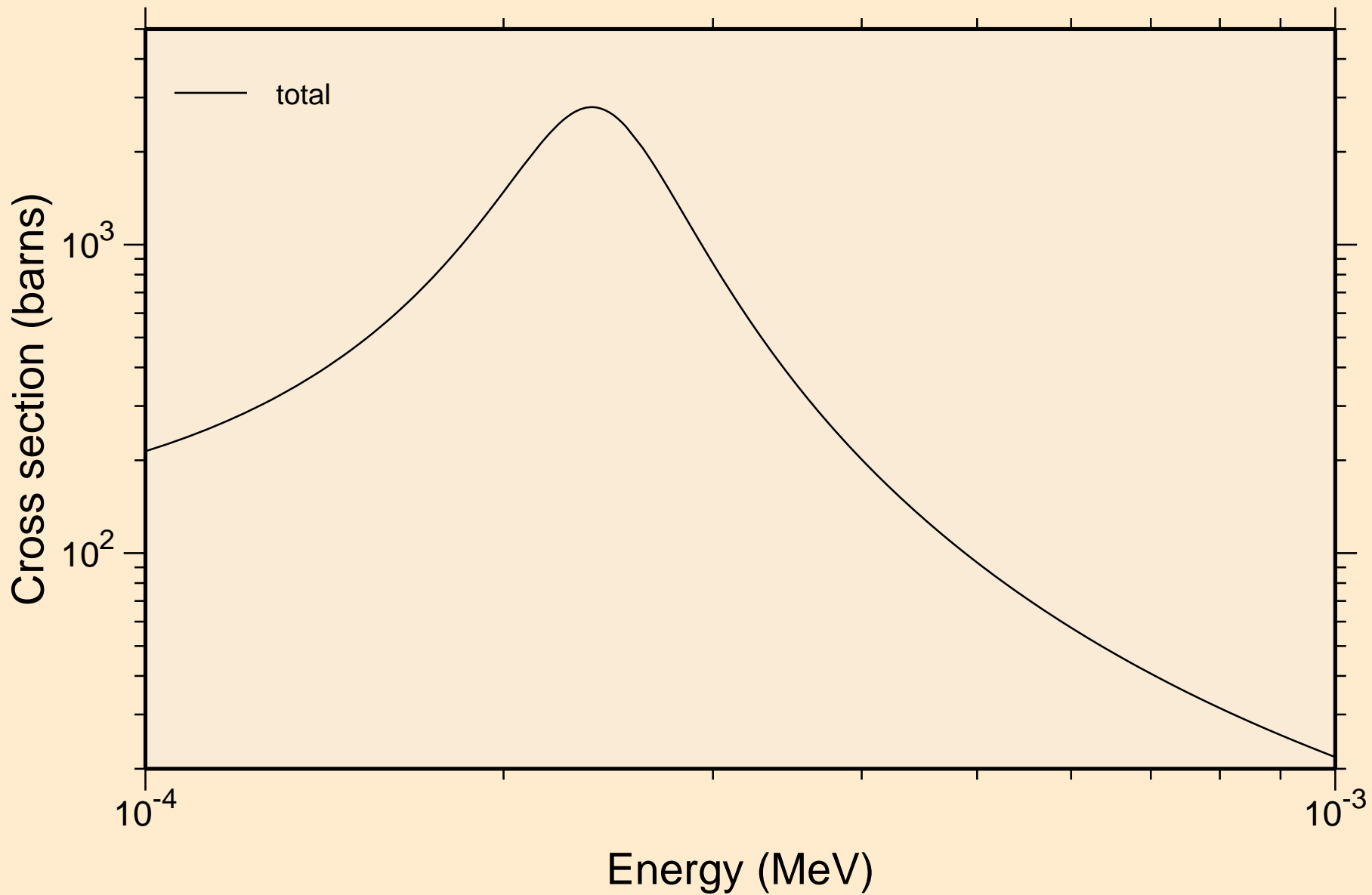

GE081M NEUTRON ACER TENDL-2021 LIBRARY; T=293.6K
resonance total cross section

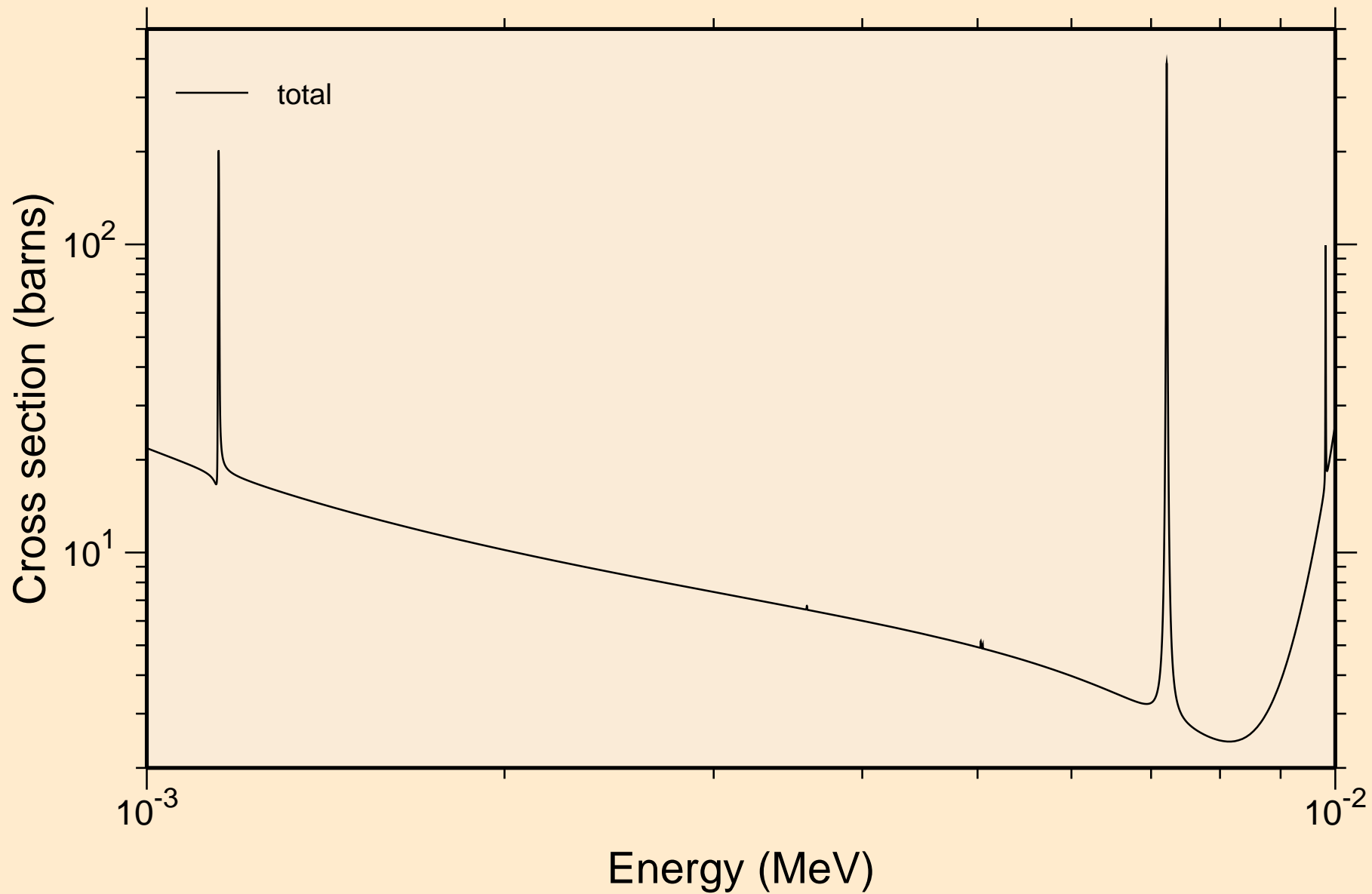

GE081M NEUTRON ACER TENDL-2021 LIBRARY; T=293.6K
resonance total cross section

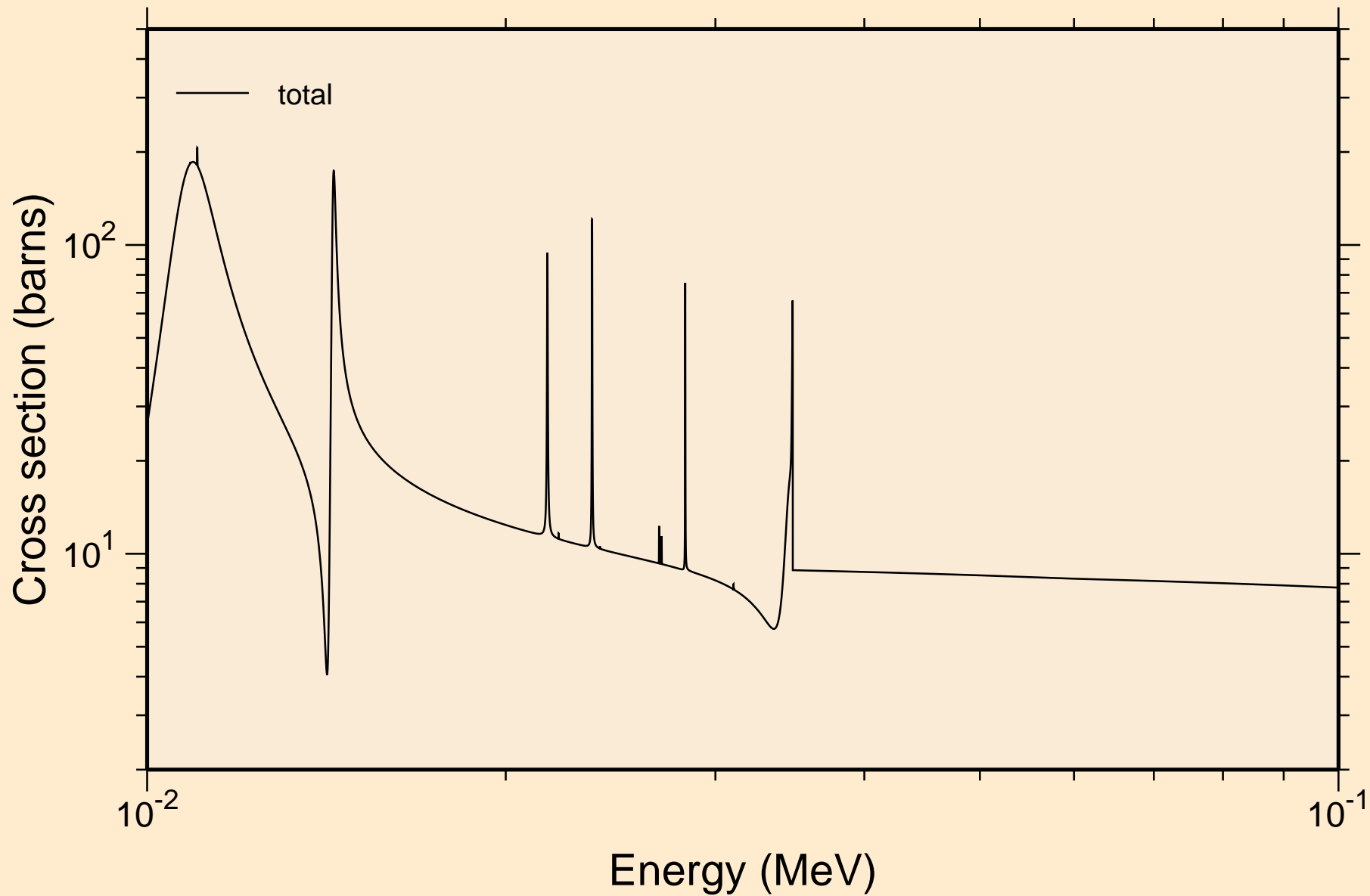

GE081M NEUTRON ACER TENDL-2021 LIBRARY; T=293.6K
resonance total cross section

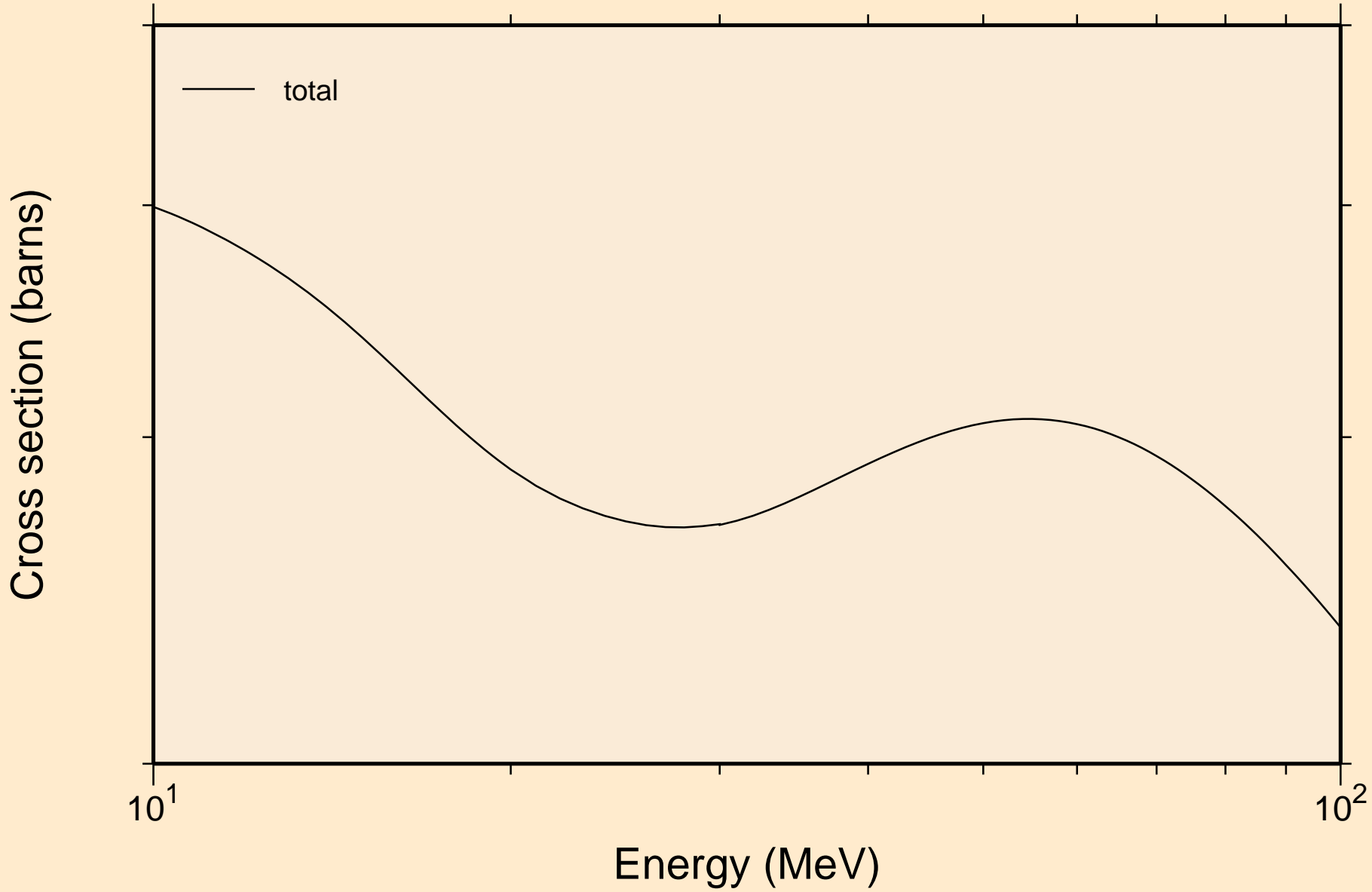

GE081M NEUTRON ACER TENDL-2021 LIBRARY; T=293.6K
resonance absorption cross sections

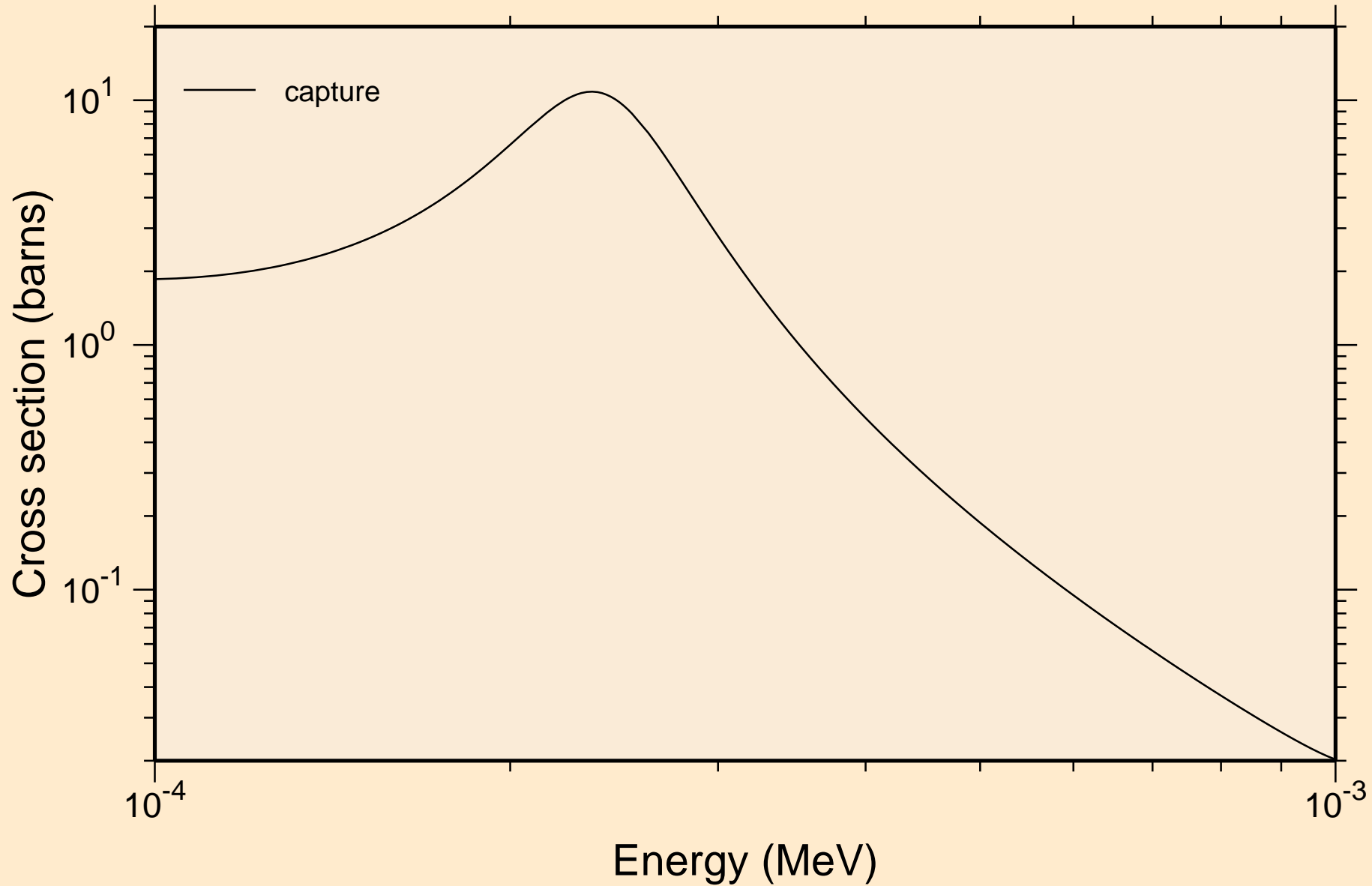

GE081M NEUTRON ACER TENDL-2021 LIBRARY; T=293.6K
resonance absorption cross sections

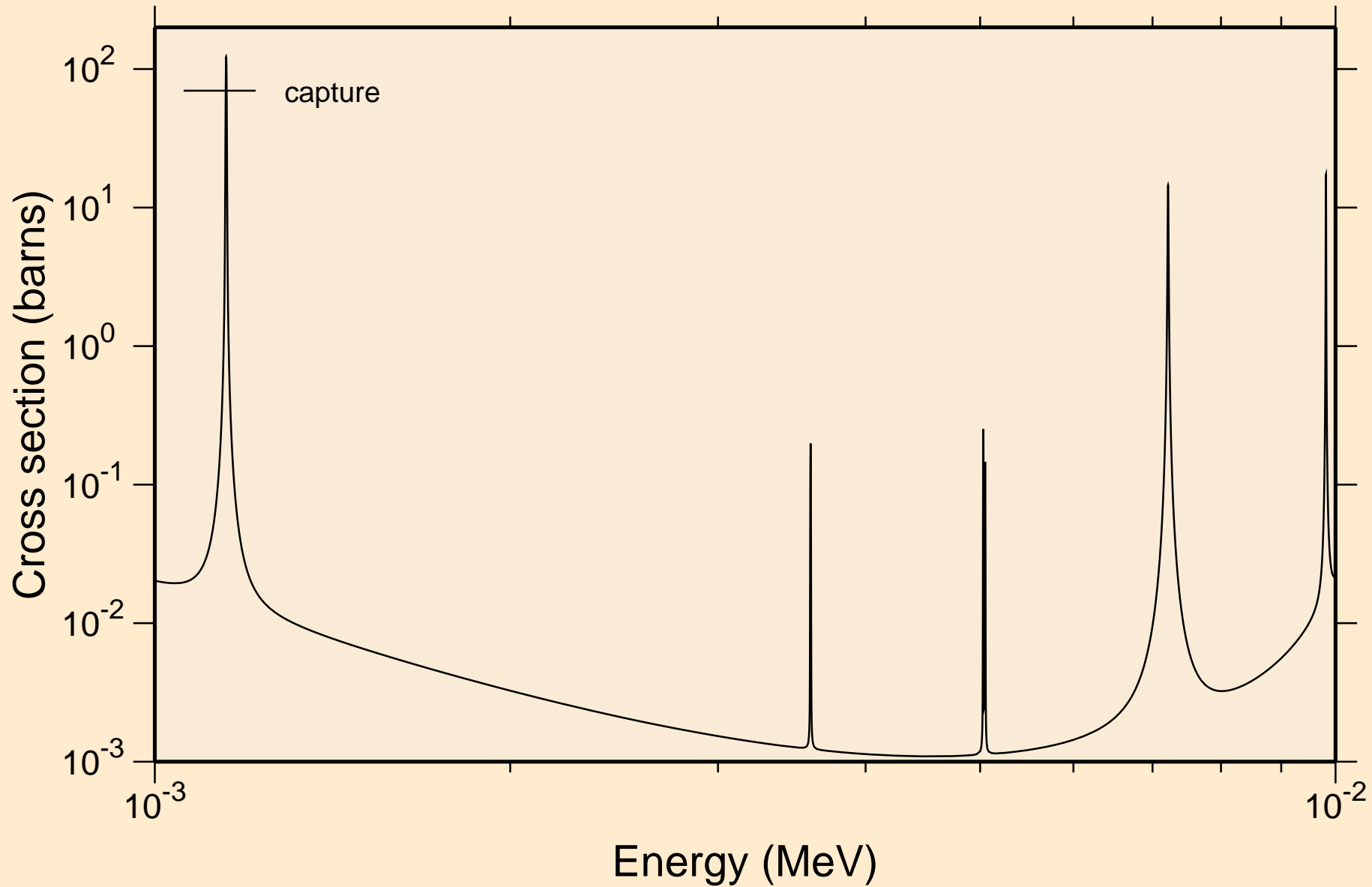

GE081M NEUTRON ACER TENDL-2021 LIBRARY; T=293.6K
resonance absorption cross sections

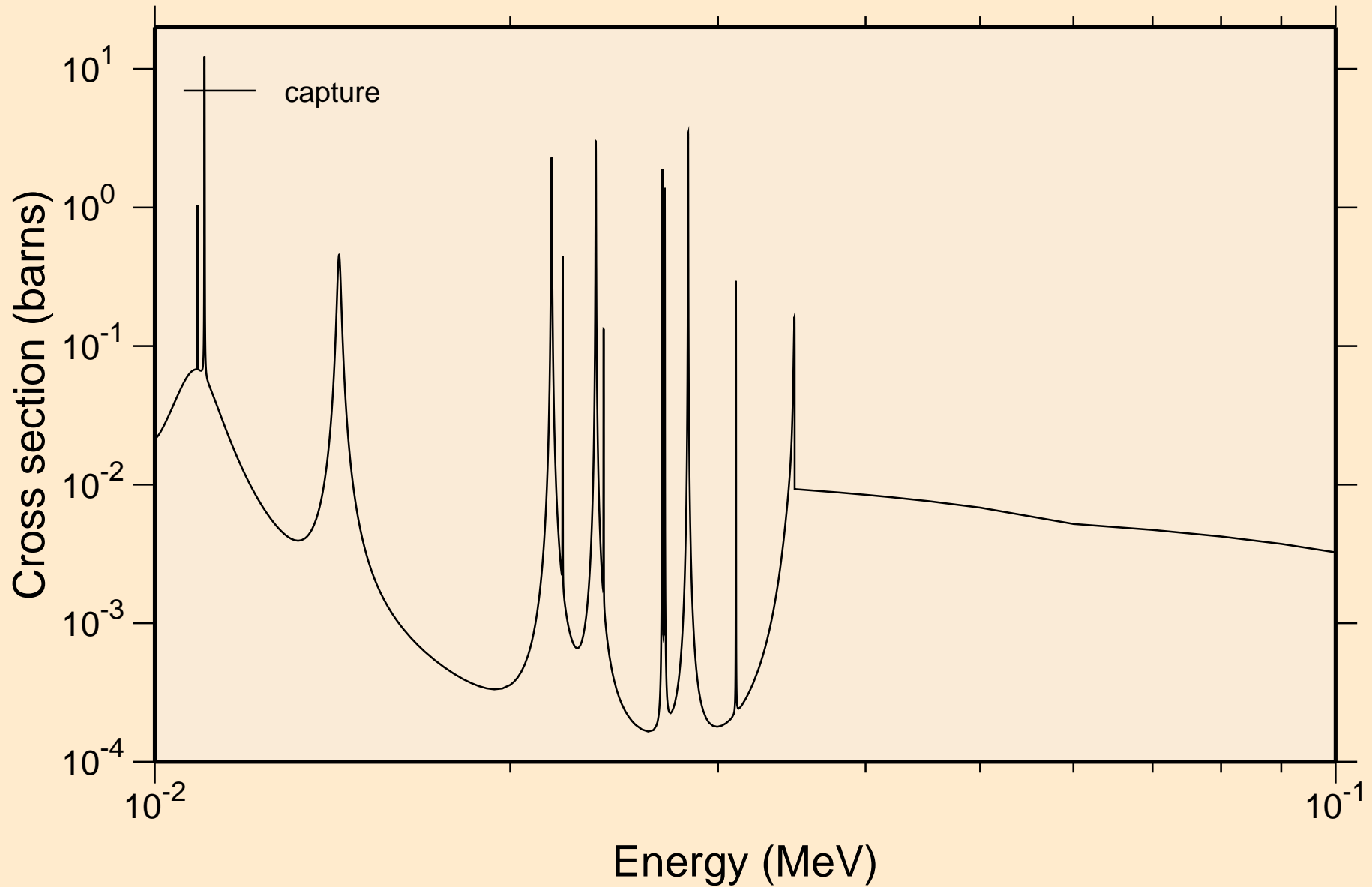

GE081M NEUTRON ACER TENDL-2021 LIBRARY; T=293.6K
resonance absorption cross sections

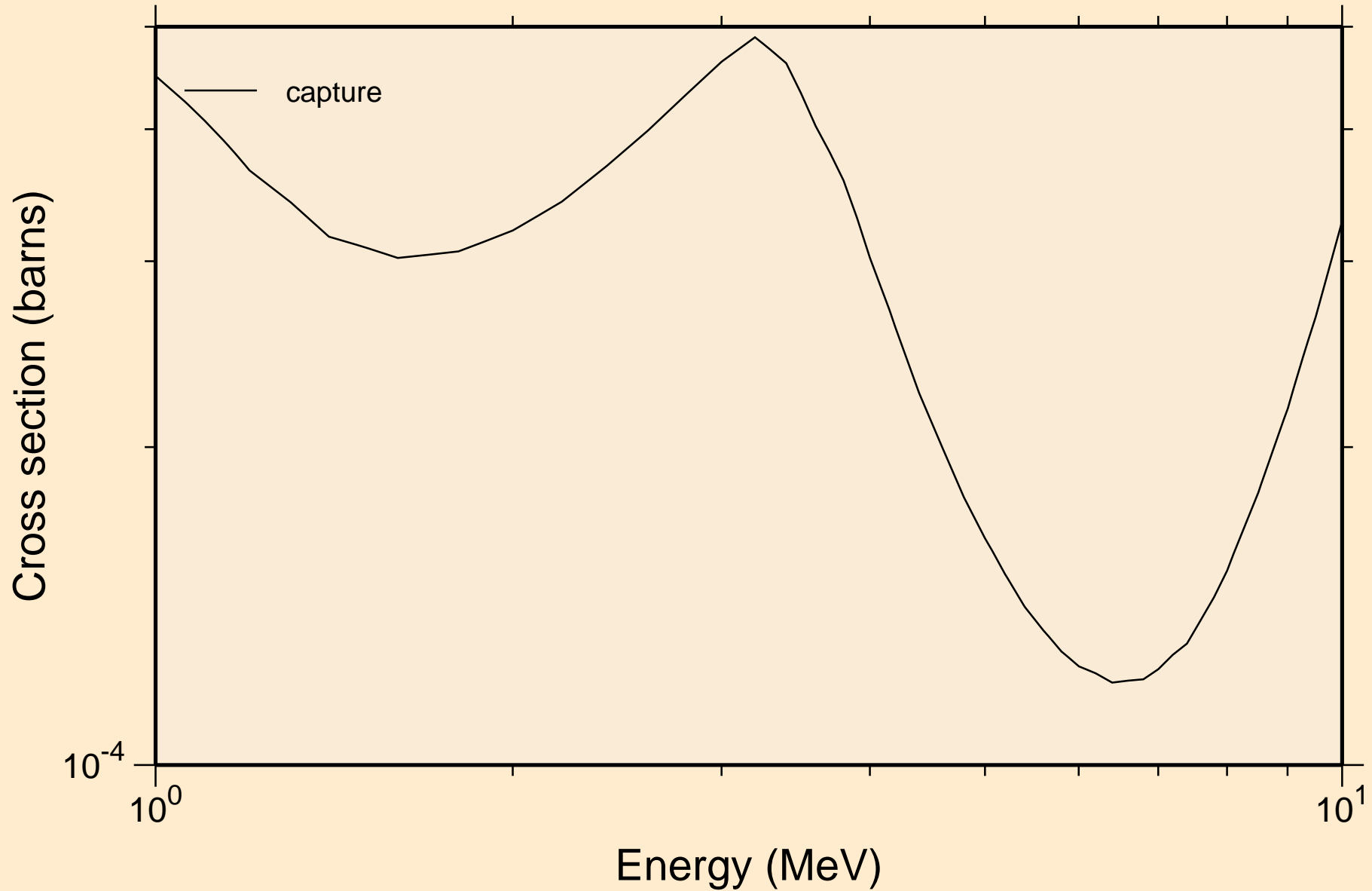

GE081M NEUTRON ACER TENDL-2021 LIBRARY; T=293.6K
Heating

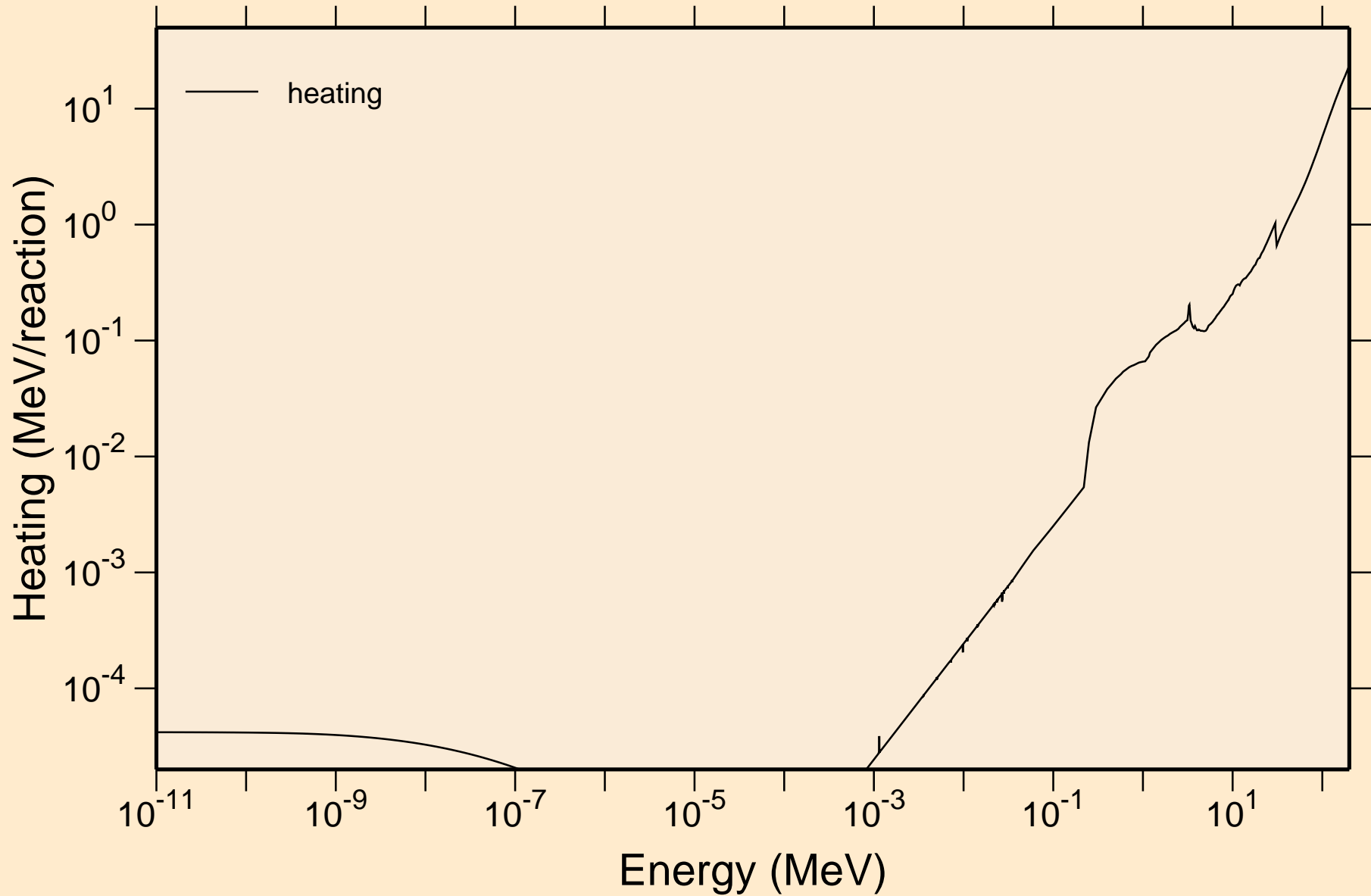

GE081M NEUTRON ACER TENDL-2021 LIBRARY; T=293.6K
Damage

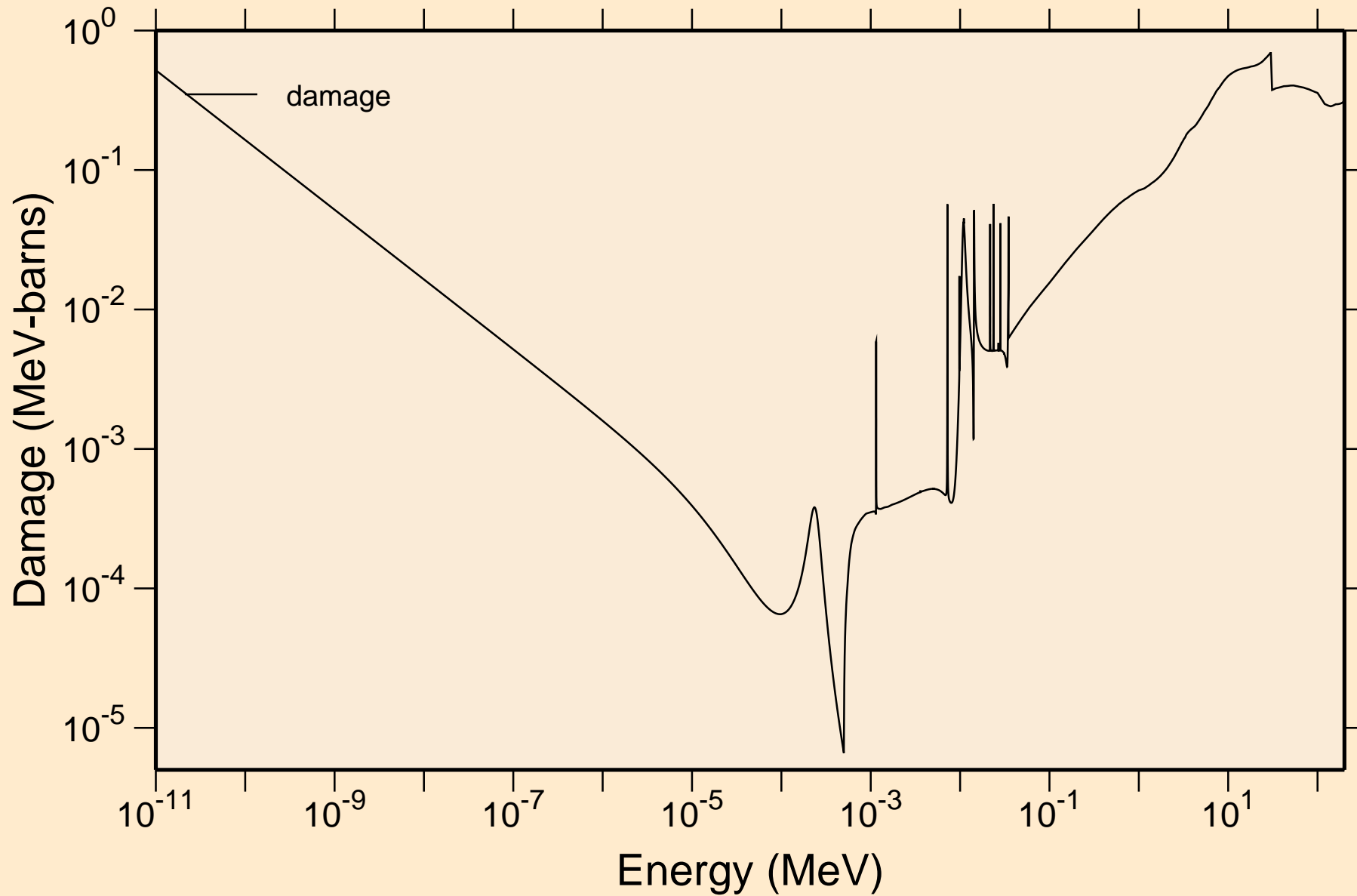

GE081M NEUTRON ACER TENDL-2021 LIBRARY; T=293.6K
Non-threshold reactions

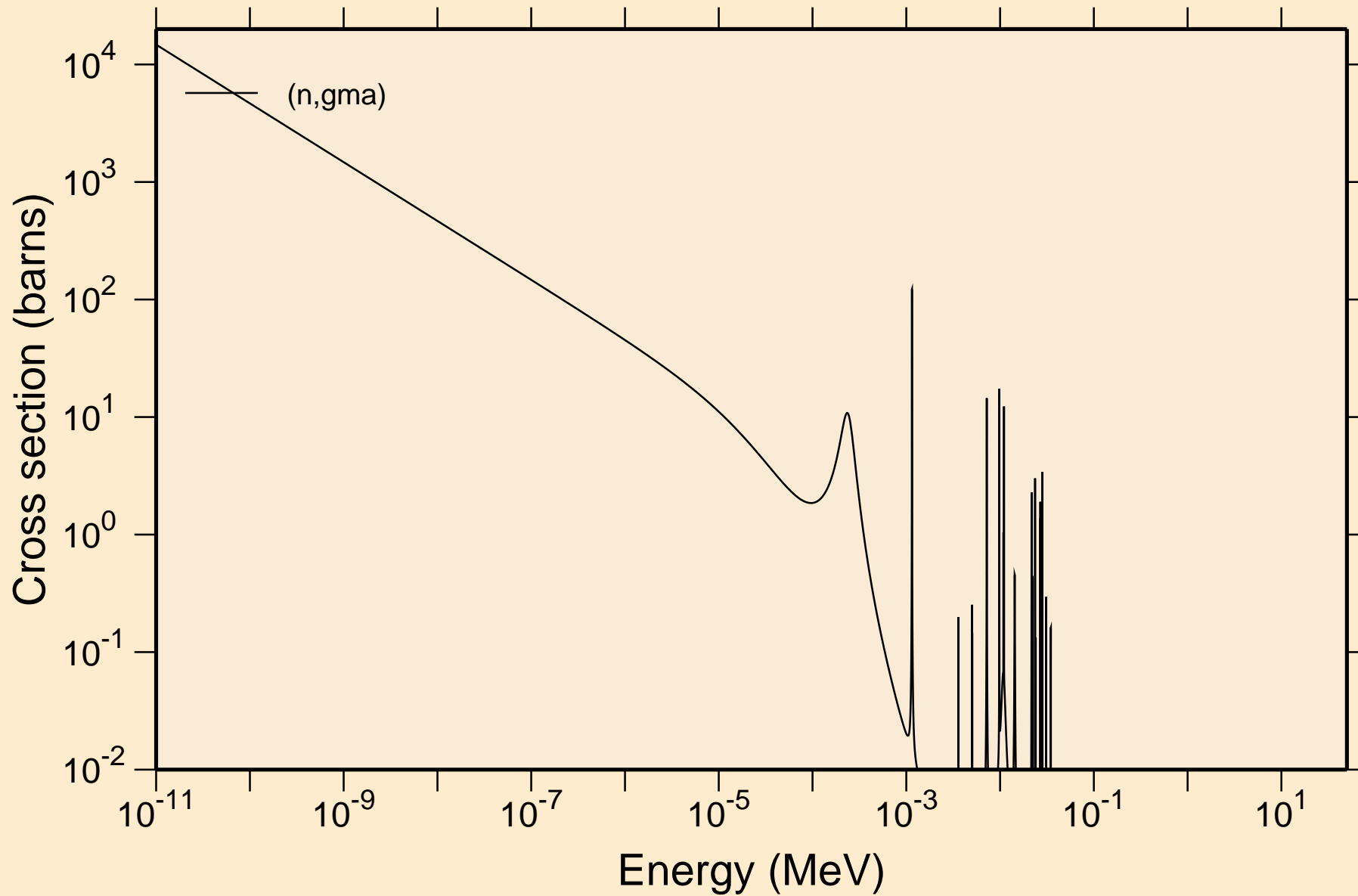

GE081M NEUTRON ACER TENDL-2021 LIBRARY; T=293.6K
Principal cross sections

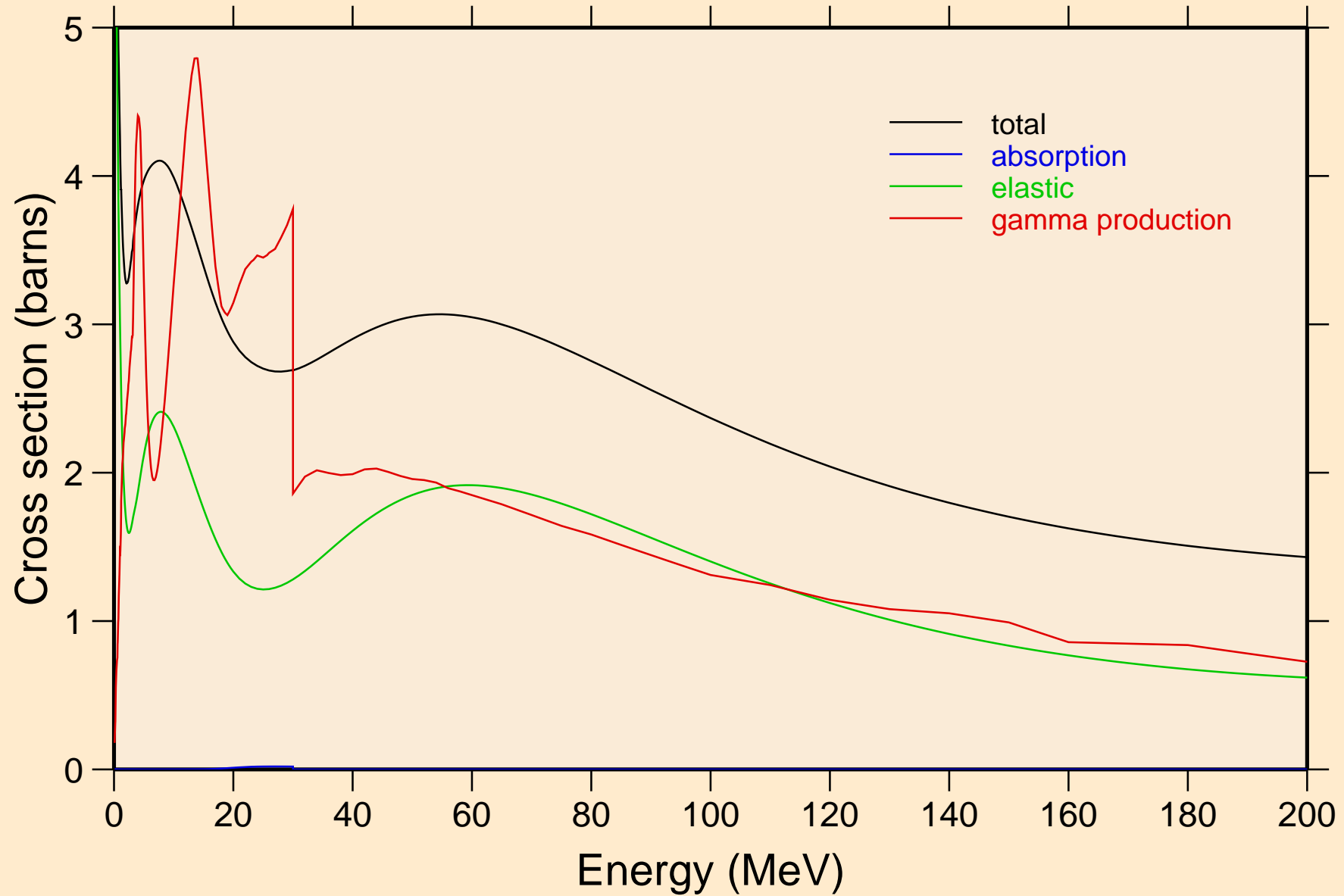

GE081M NEUTRON ACER TENDL-2021 LIBRARY; T=293.6K
Heating

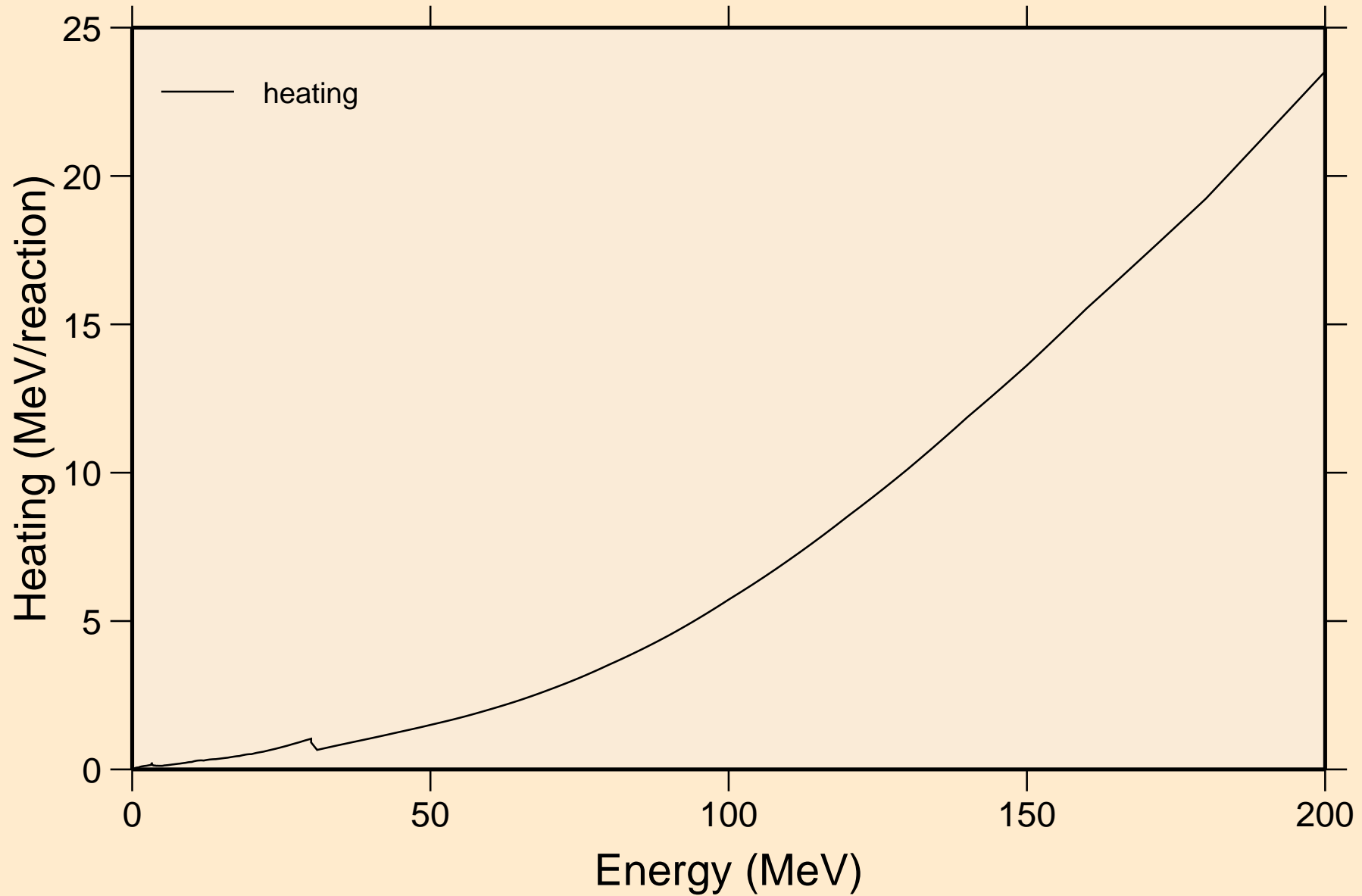

GE081M NEUTRON ACER TENDL-2021 LIBRARY; T=293.6K Damage

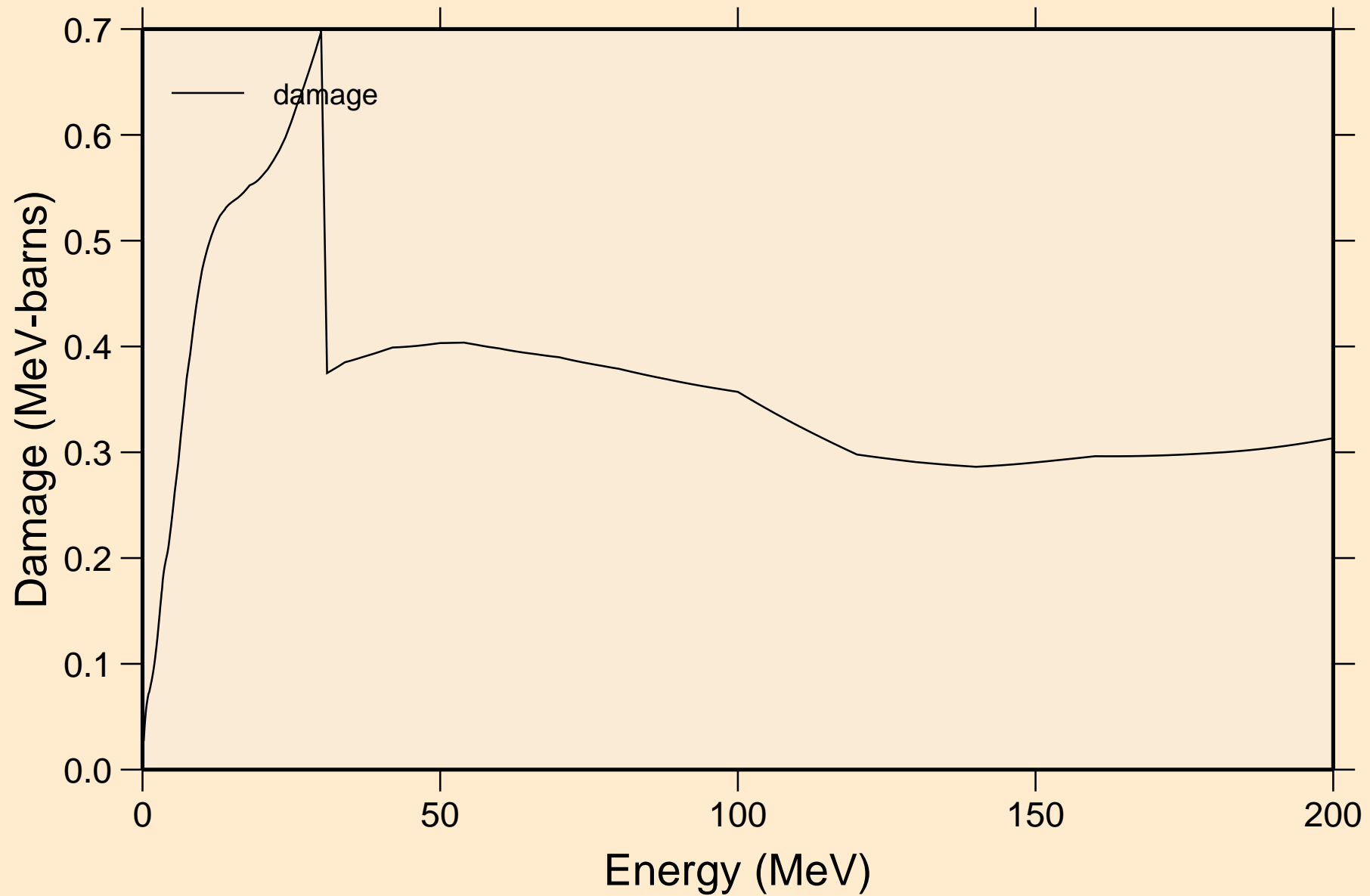

GE081M NEUTRON ACER TENDL-2021 LIBRARY; T=293.6K
Non-threshold reactions

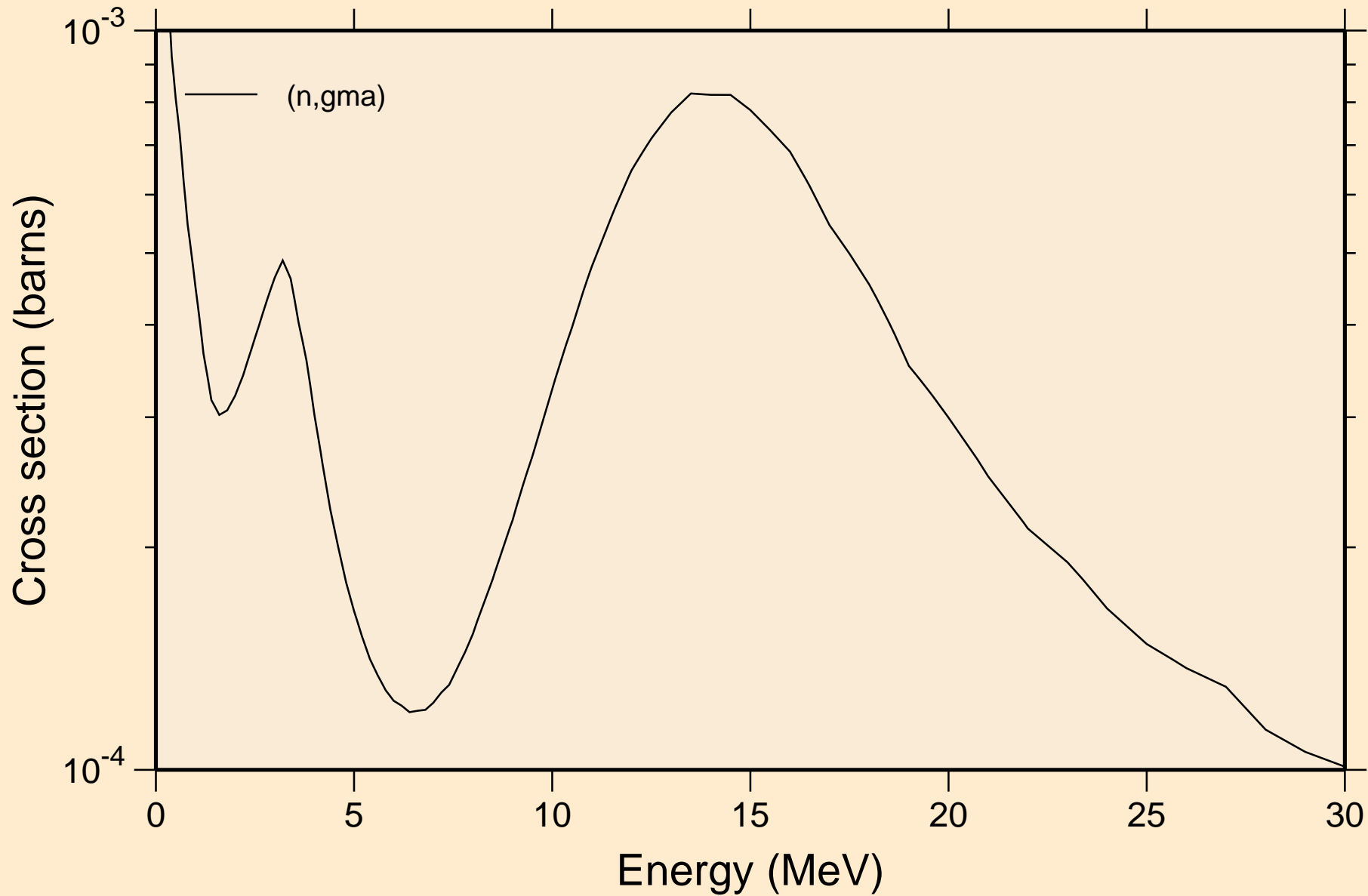

GE081M NEUTRON ACER TENDL-2021 LIBRARY; T=293.6K
Inelastic levels

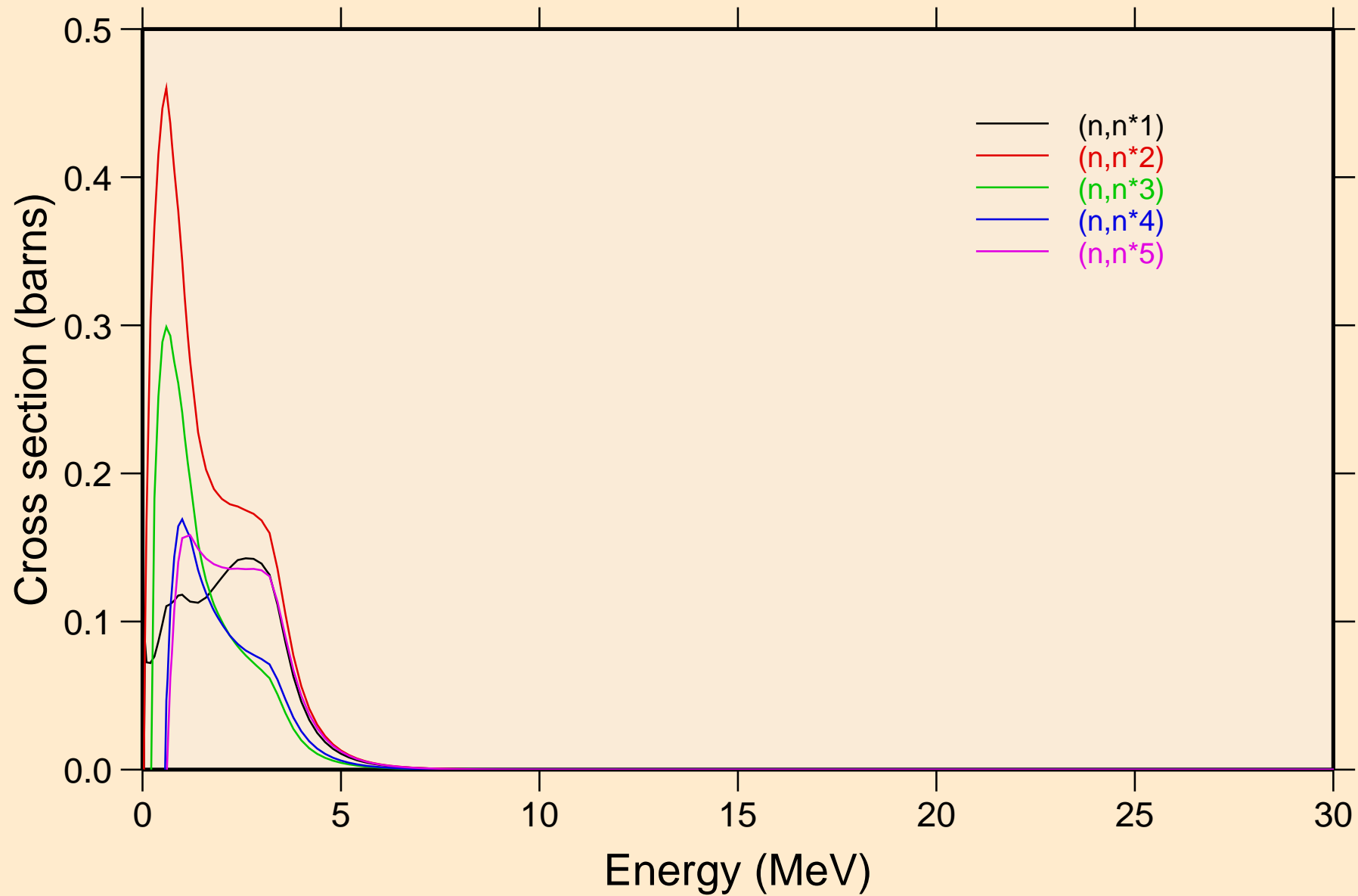

GE081M NEUTRON ACER TENDL-2021 LIBRARY; T=293.6K
Inelastic levels

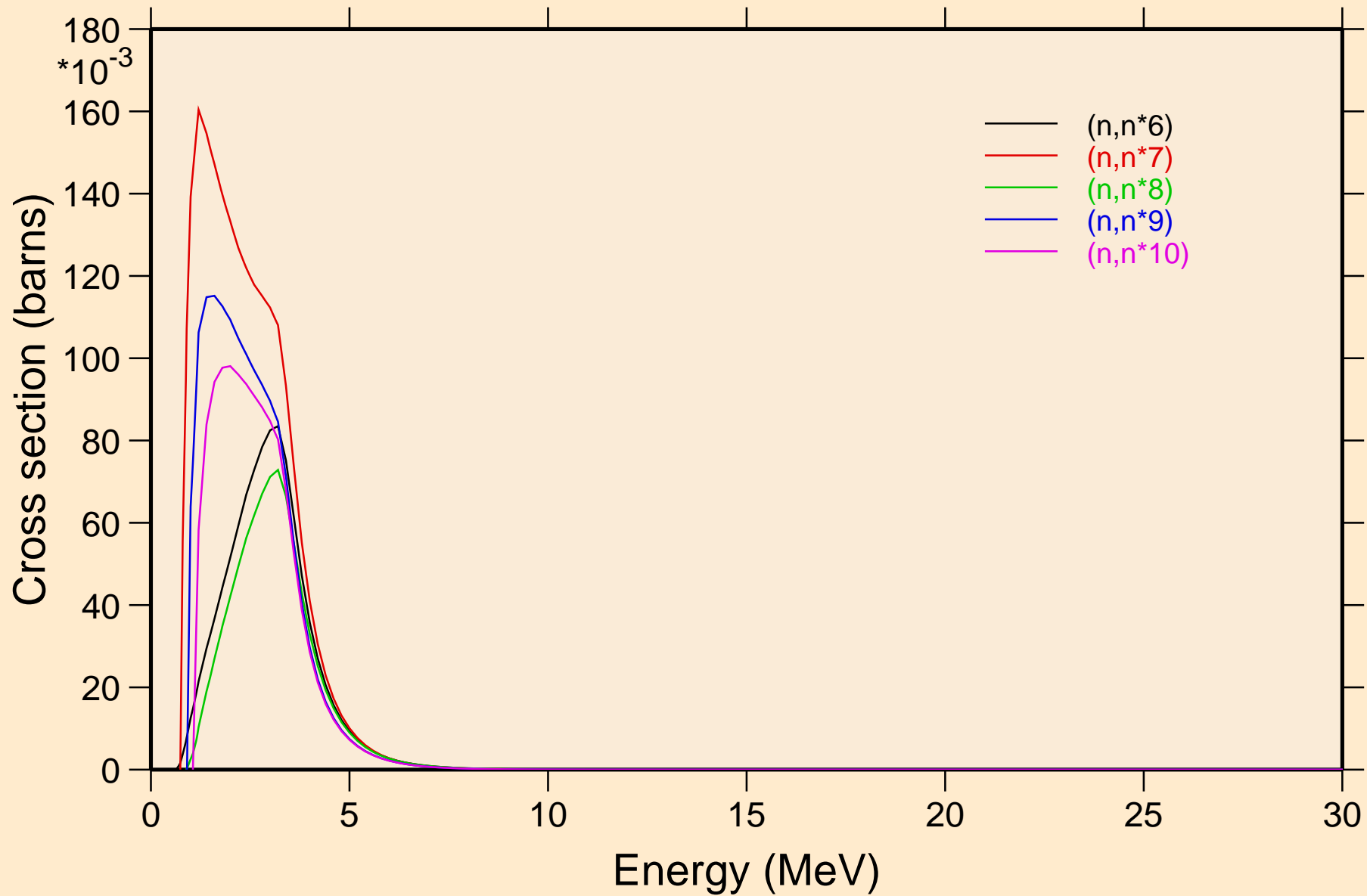

GE081M NEUTRON ACER TENDL-2021 LIBRARY; T=293.6K
Inelastic levels

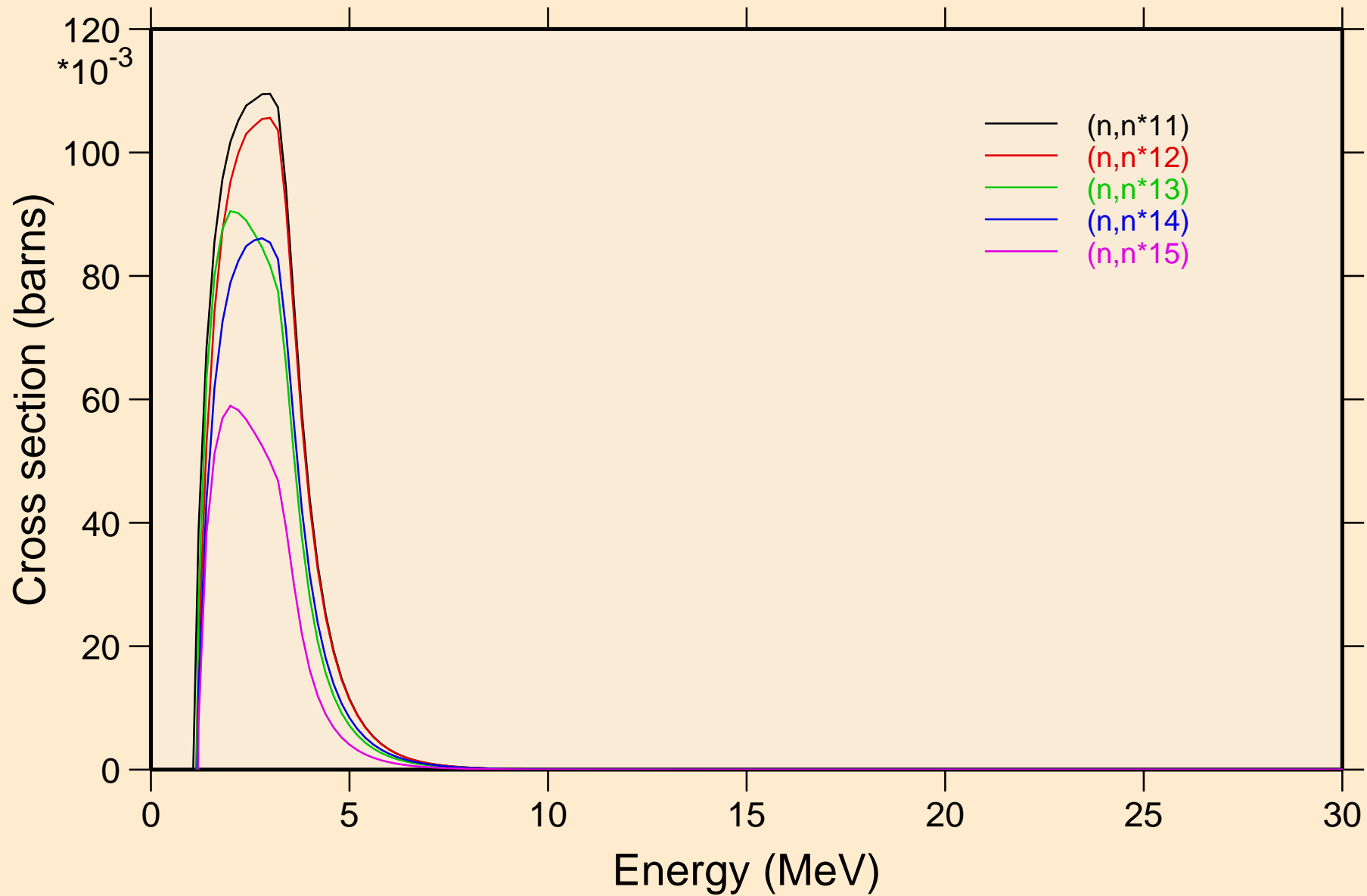

GE081M NEUTRON ACER TENDL-2021 LIBRARY; T=293.6K
Inelastic levels

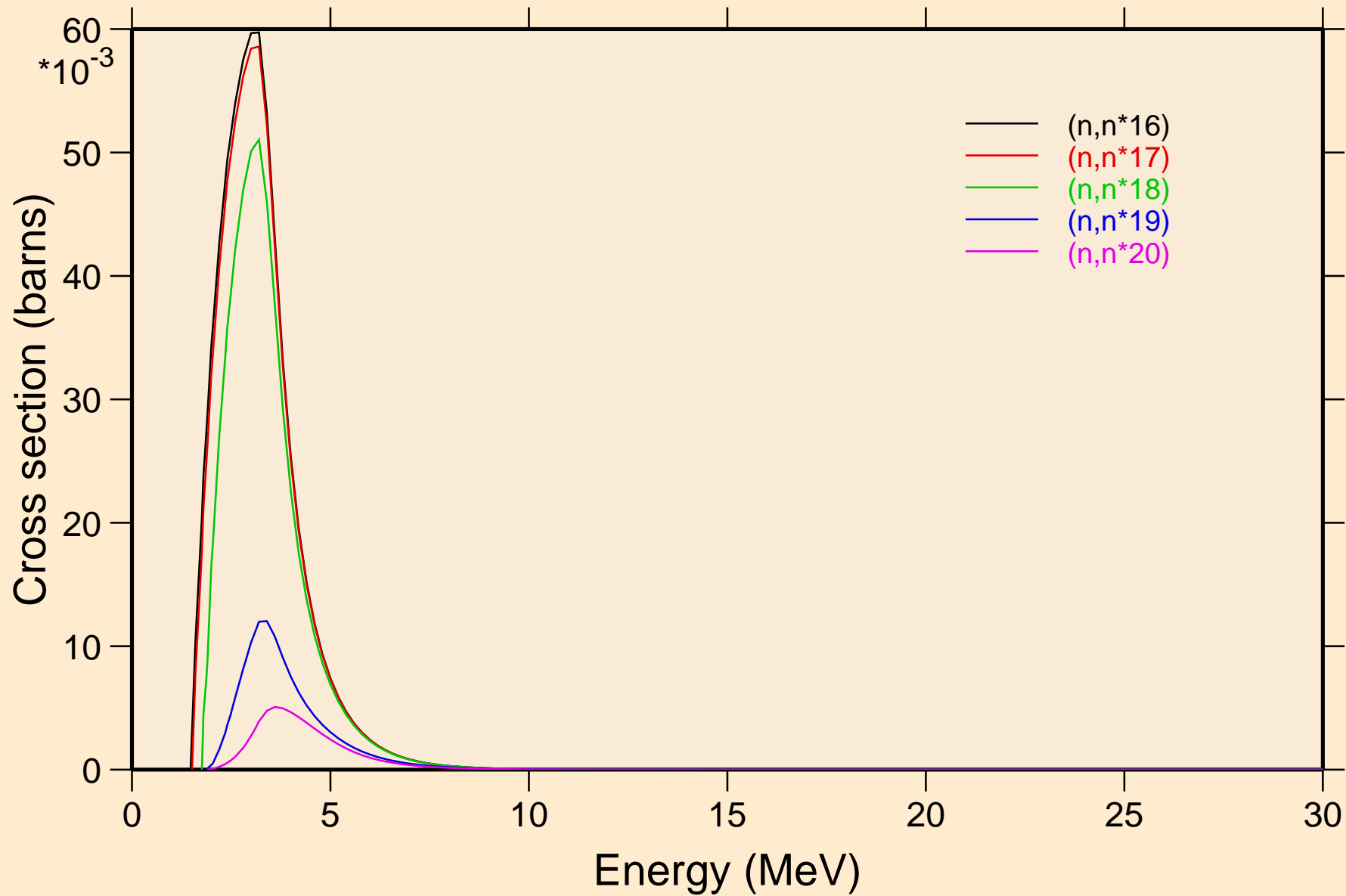

GE081M NEUTRON ACER TENDL-2021 LIBRARY; T=293.6K
Inelastic levels

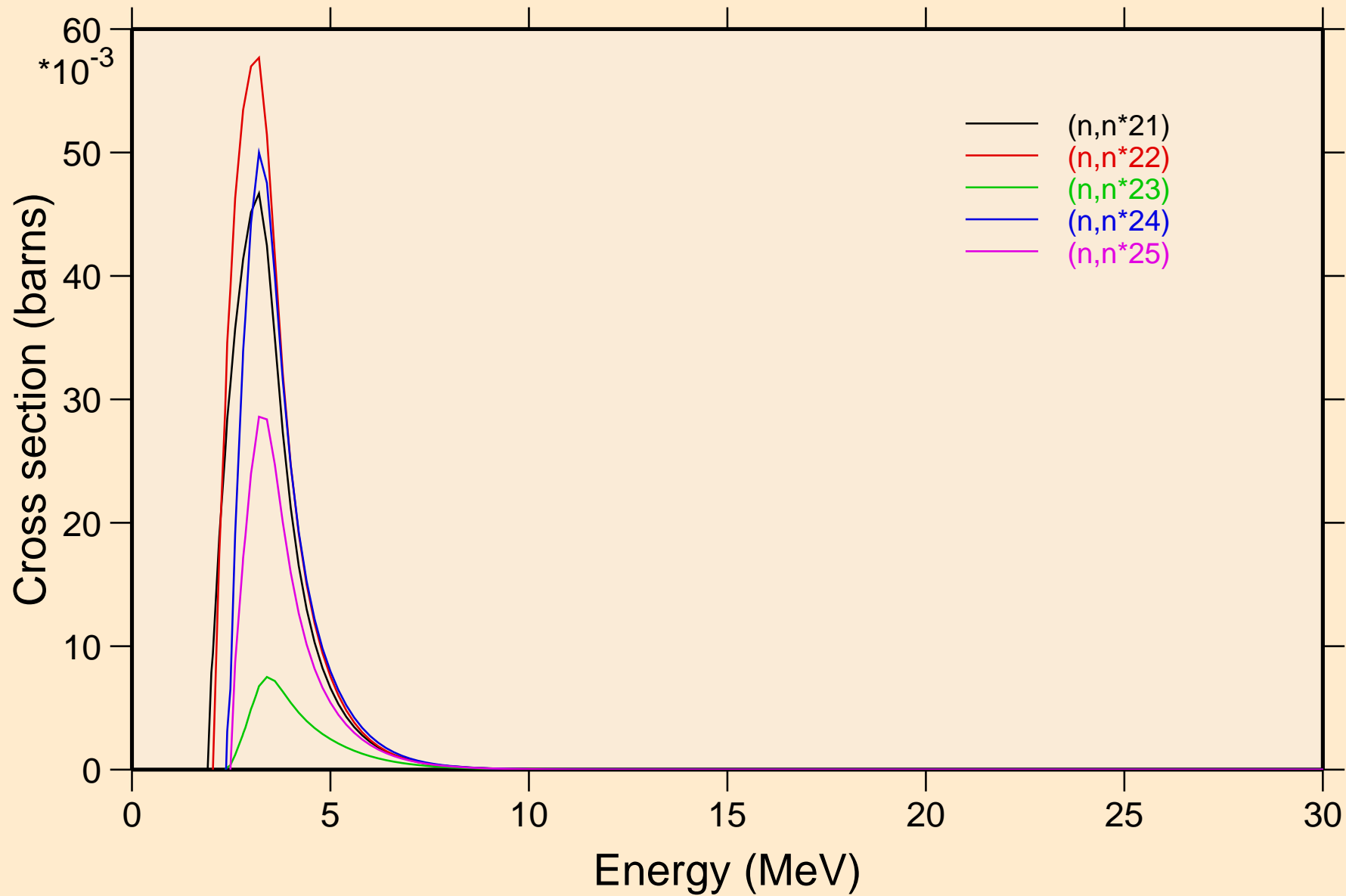

GE081M NEUTRON ACER TENDL-2021 LIBRARY; T=293.6K
Inelastic levels

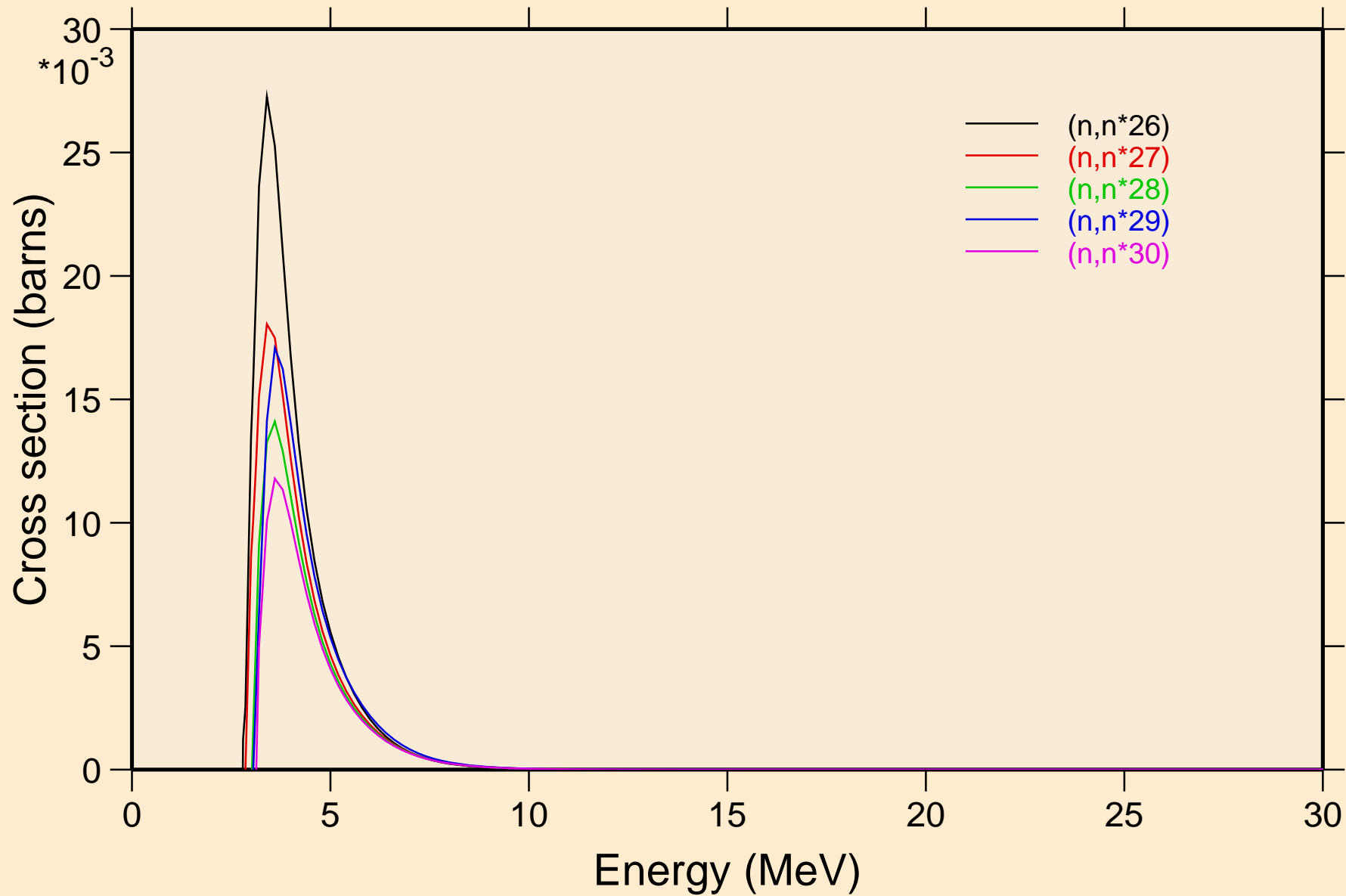

GE081M NEUTRON ACER TENDL-2021 LIBRARY; T=293.6K
Threshold reactions

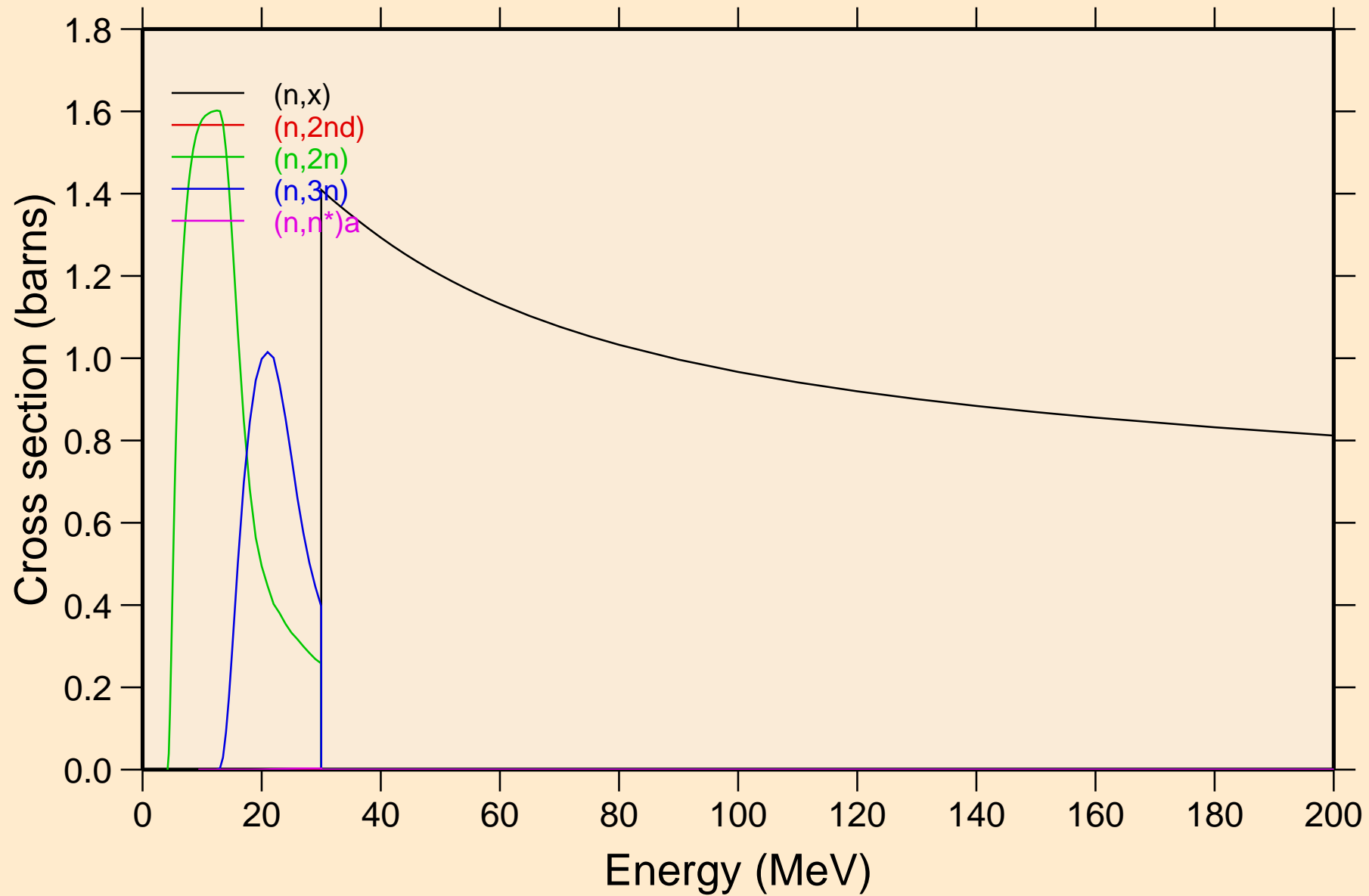

GE081M NEUTRON ACER TENDL-2021 LIBRARY; T=293.6K

Threshold reactions

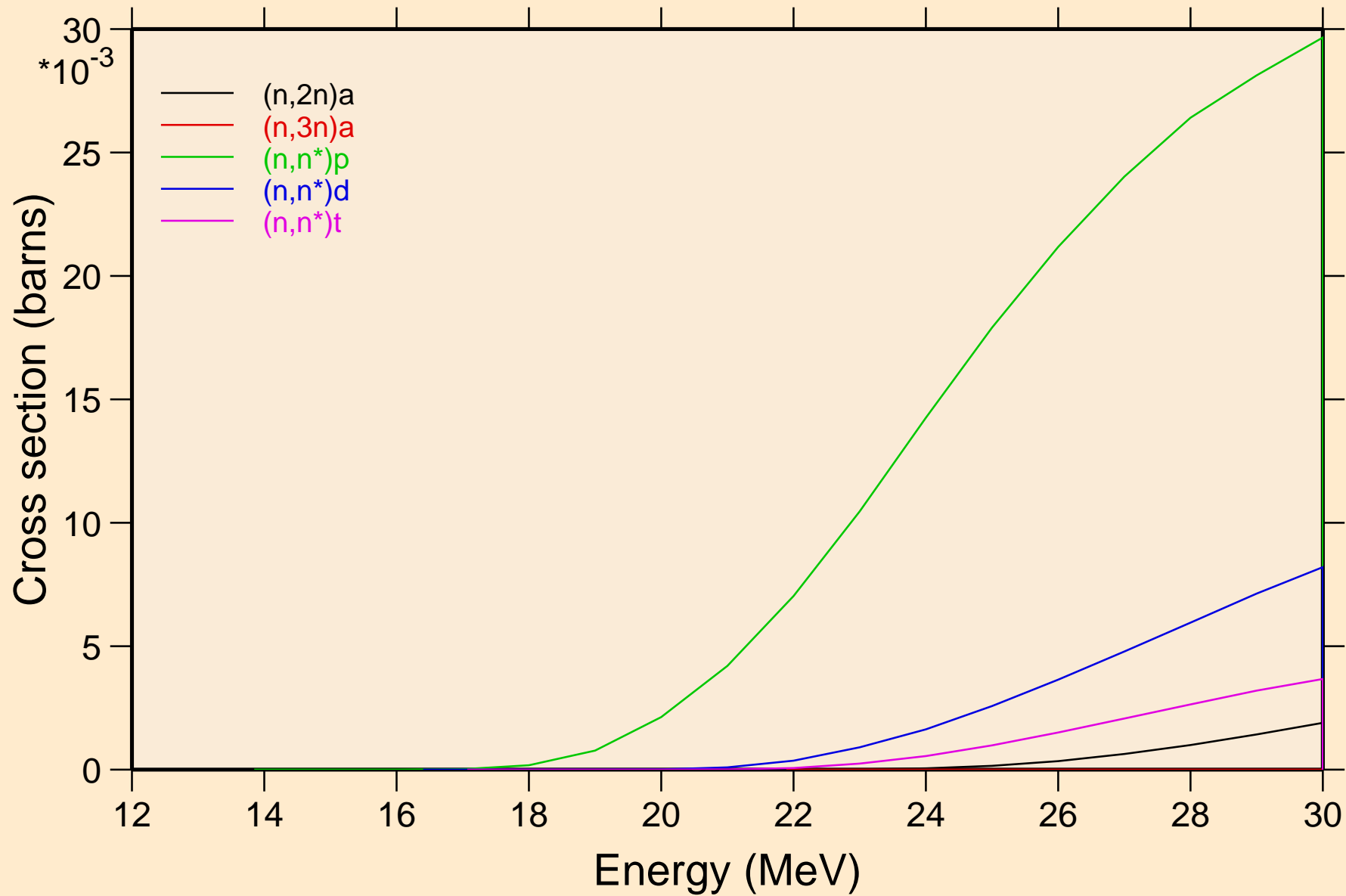

GE081M NEUTRON ACER TENDL-2021 LIBRARY; T=293.6K
Threshold reactions

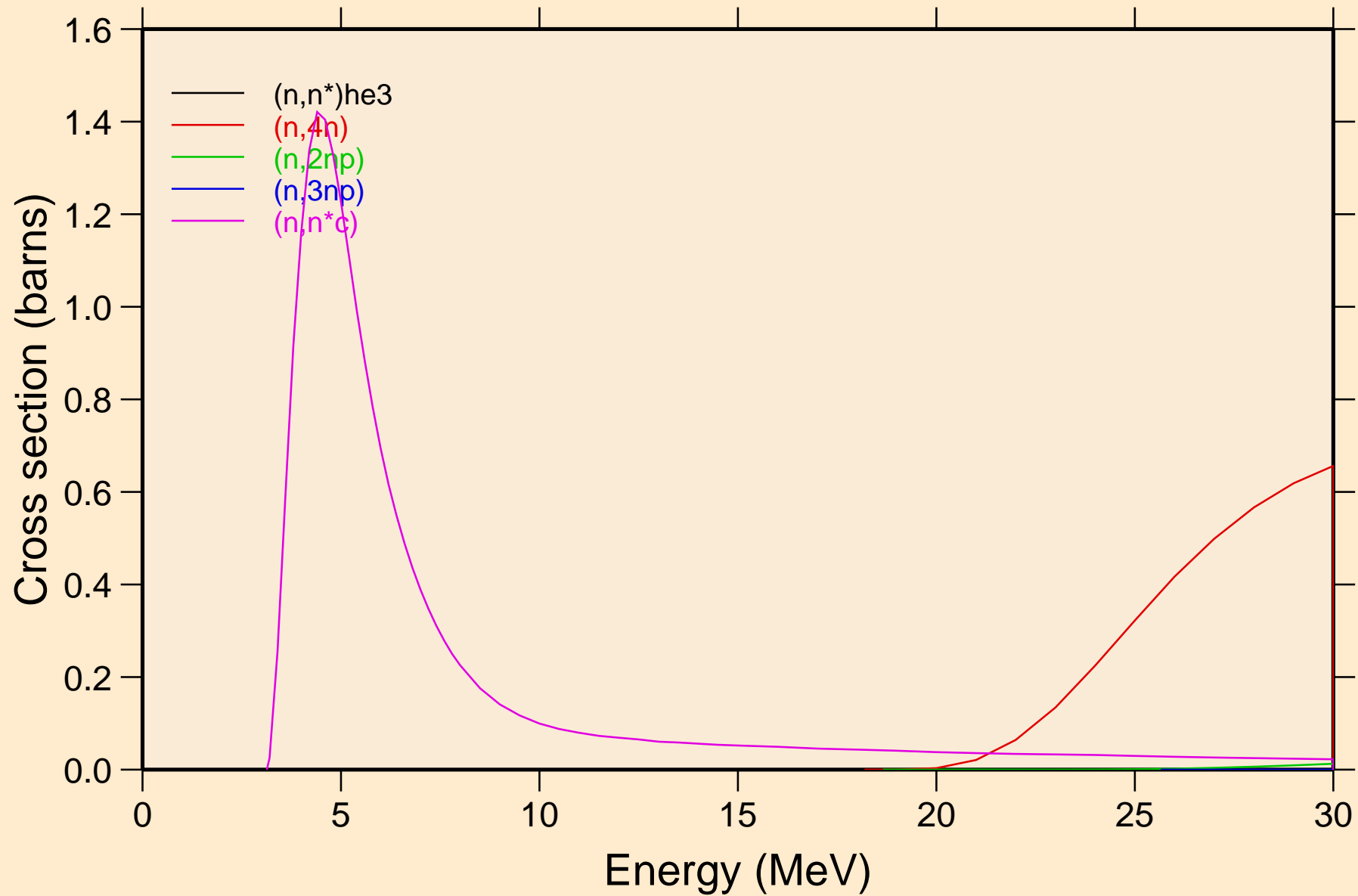

GE081M NEUTRON ACER TENDL-2021 LIBRARY; T=293.6K
Threshold reactions

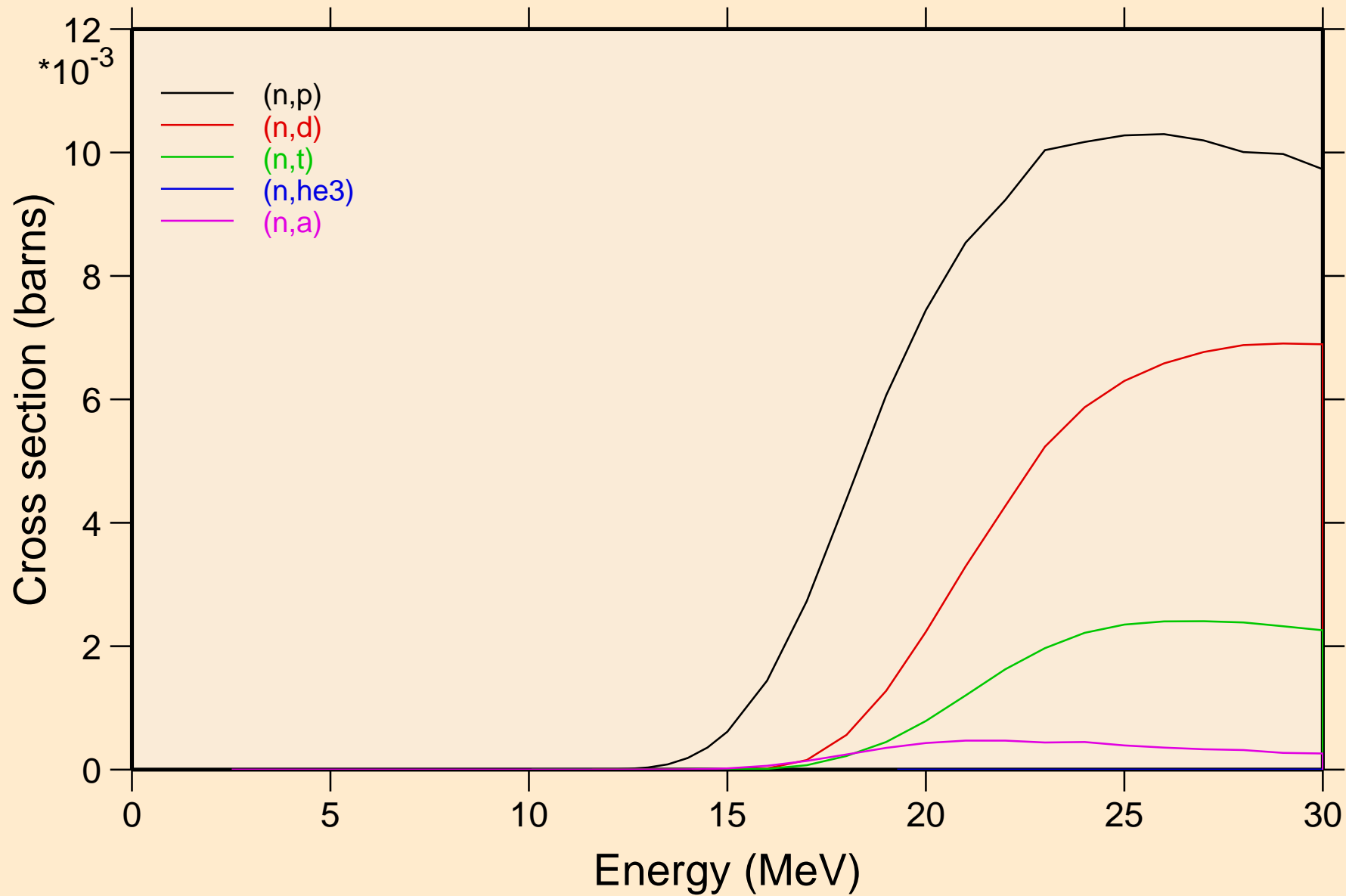

GE081M NEUTRON ACER TENDL-2021 LIBRARY; T=293.6K
Threshold reactions

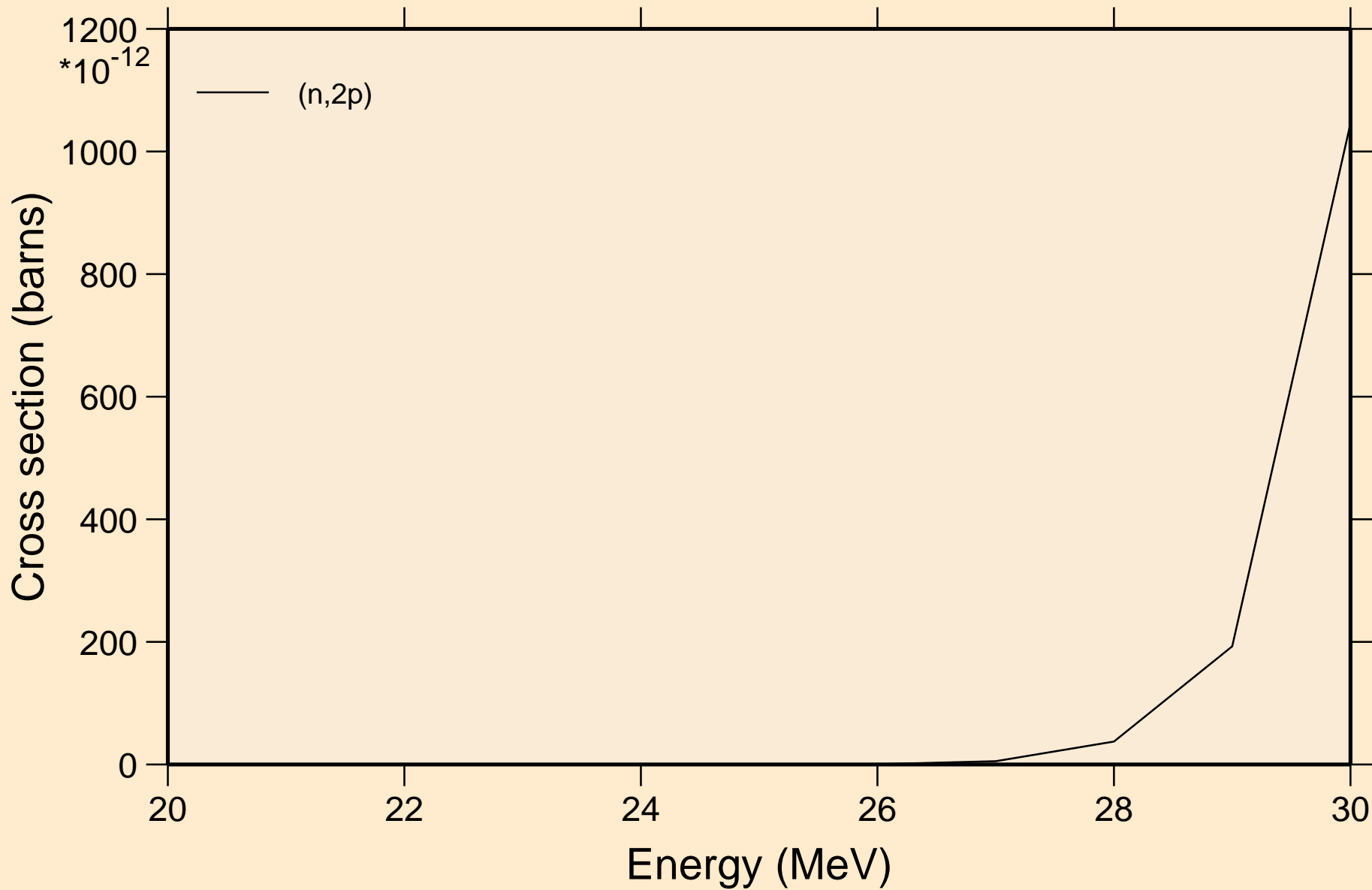

GE081M NEUTRON ACER TENDL-2021 LIBRARY; T=293.6K

Threshold reactions

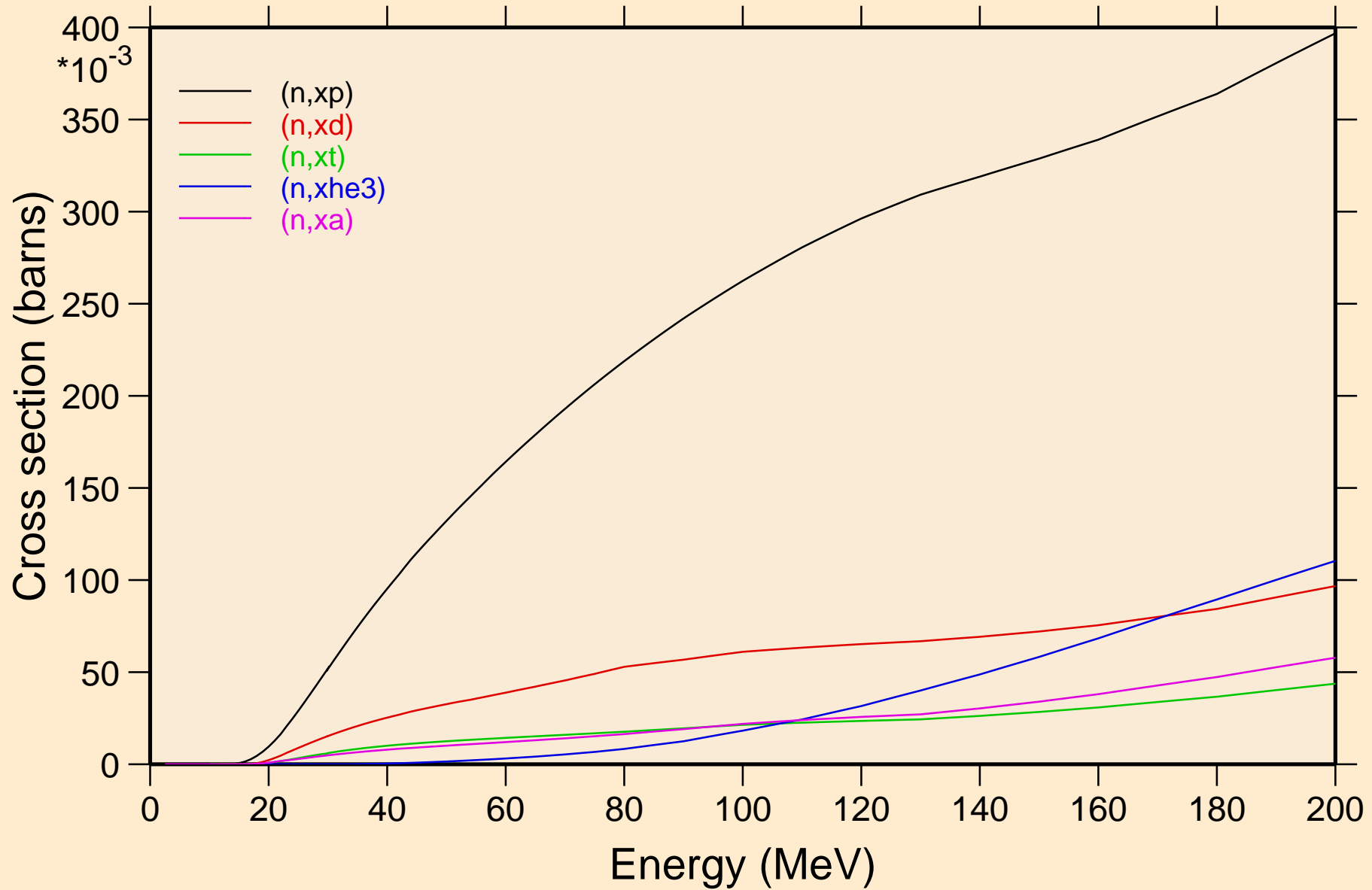

GE081M NEUTRON ACER TENDL-2021 LIBRARY; T=293.6K
angular distribution for elastic

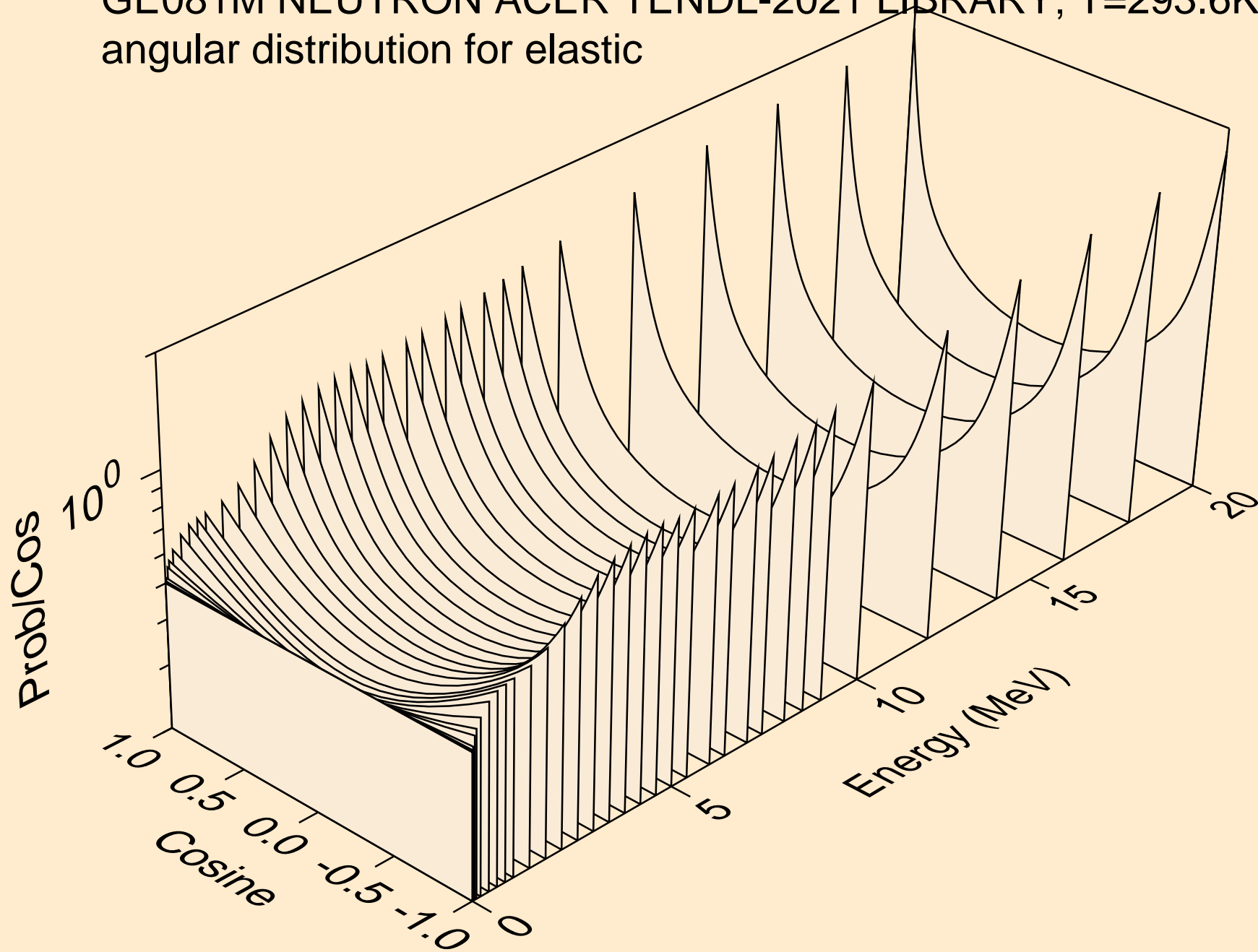

GE081M NEUTRON ACER TENDL-2021 LIBRARY; T=293.6K
angular distribution for elastic

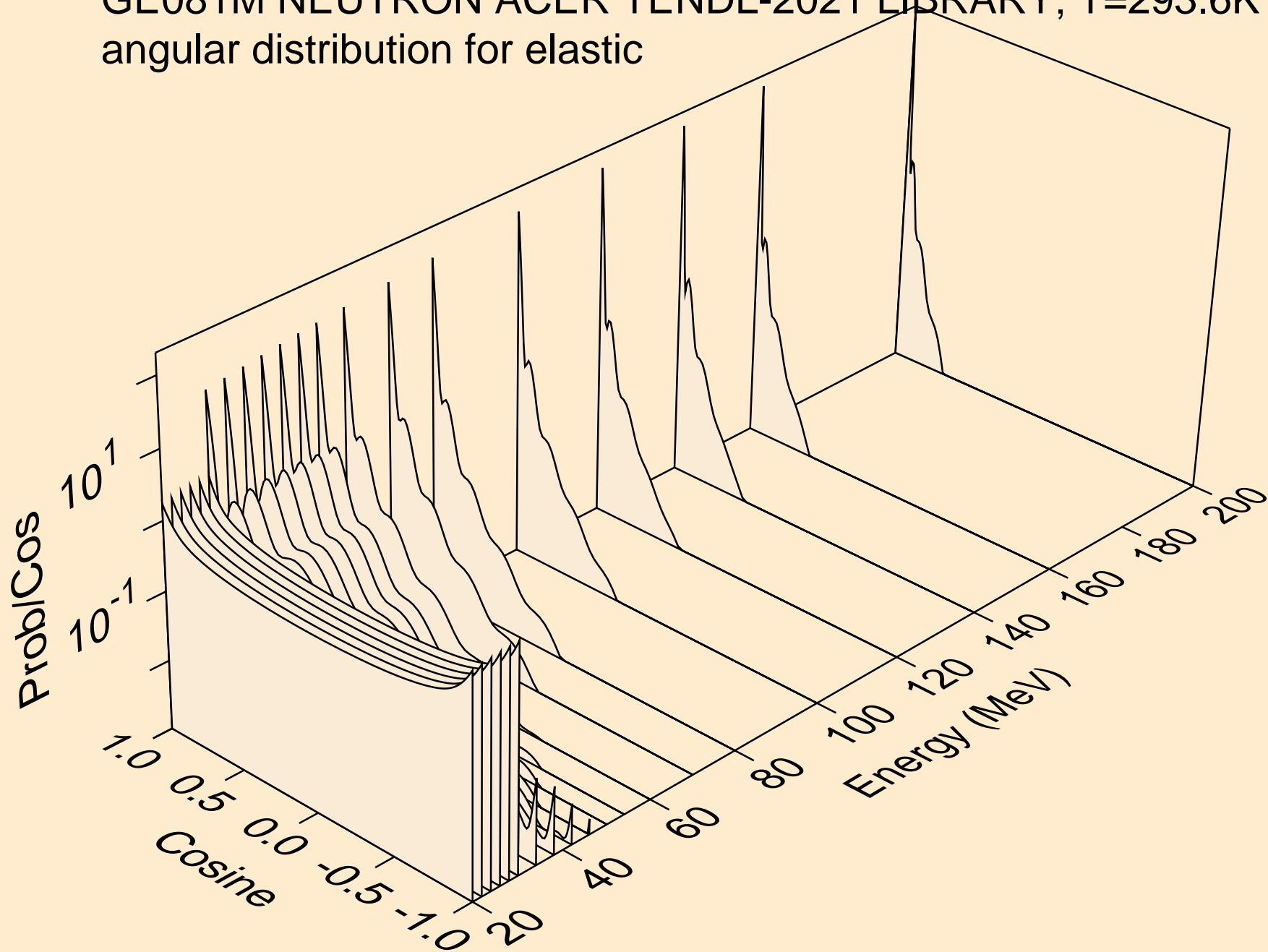

GE081M NEUTRON ACER TENDL-2021 LIBRARY; T=293.6K
angular distribution for (n,n*1)

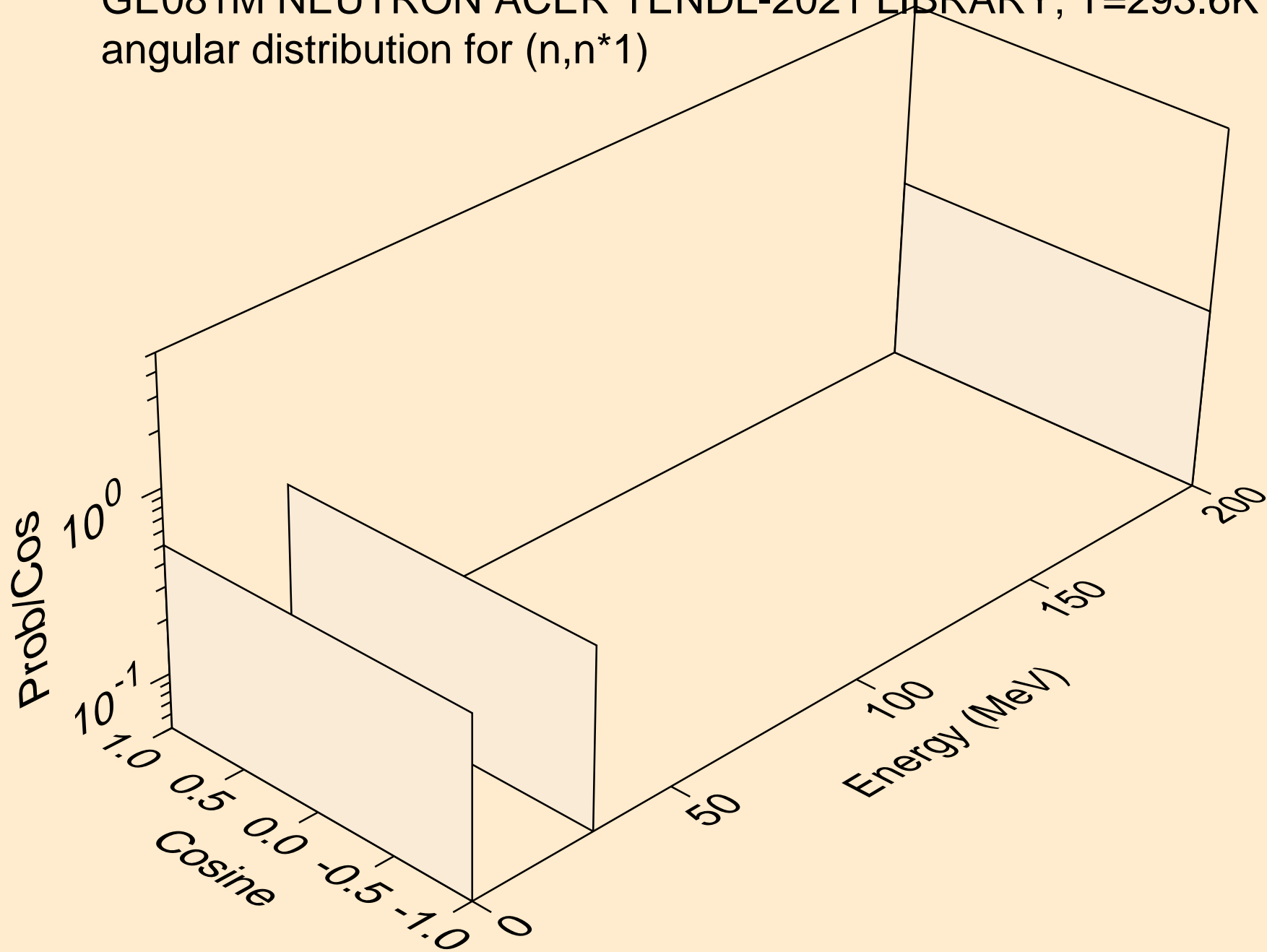

GE081M NEUTRON ACER TENDL-2021 LIBRARY; T=293.6K
angular distribution for (n,n*2)

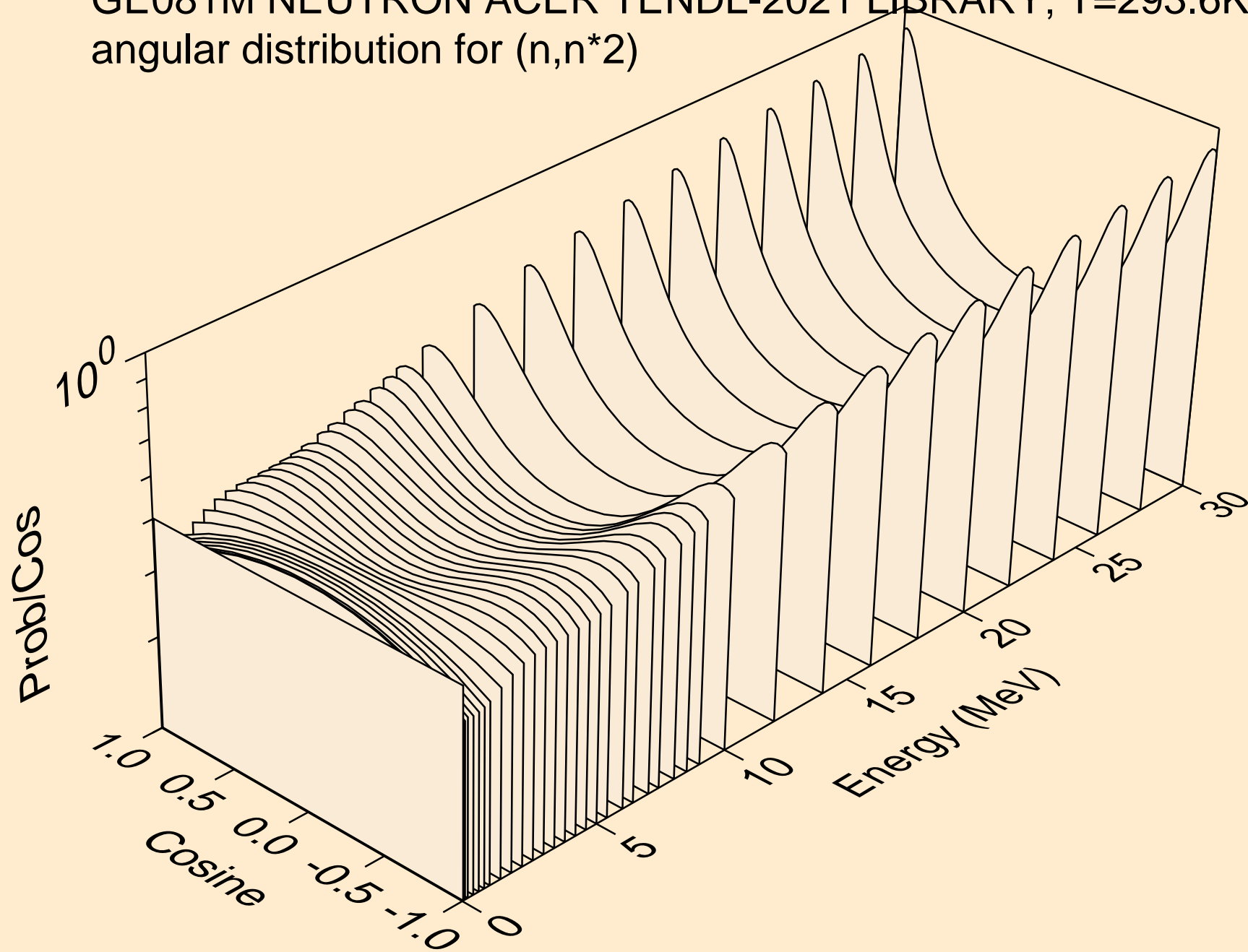

GE081M NEUTRON ACER TENDL-2021 LIBRARY; T=293.6K
angular distribution for (n,n*3)

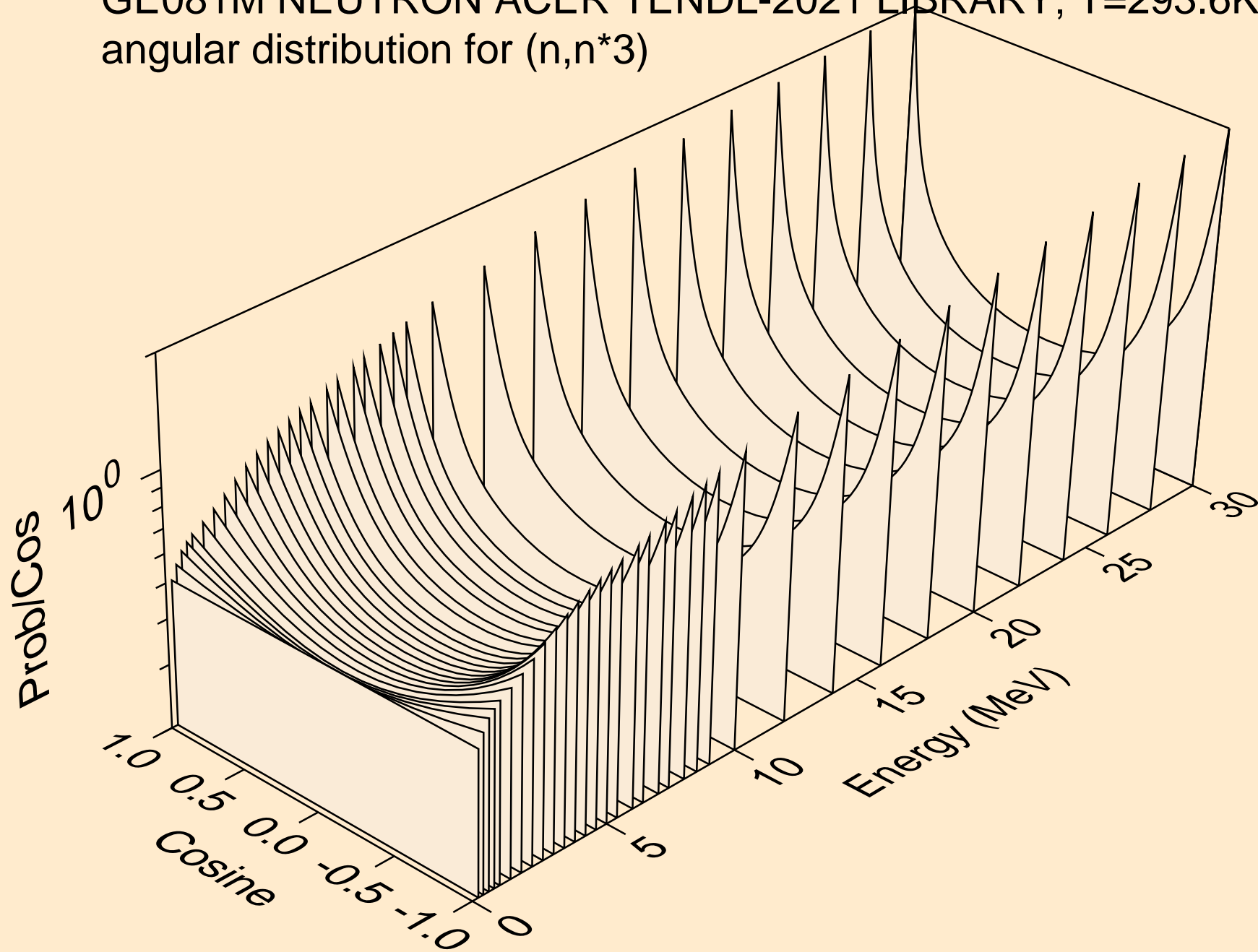

GE081M NEUTRON ACER TENDL-2021 LIBRARY; T=293.6K
angular distribution for (n,n*4)

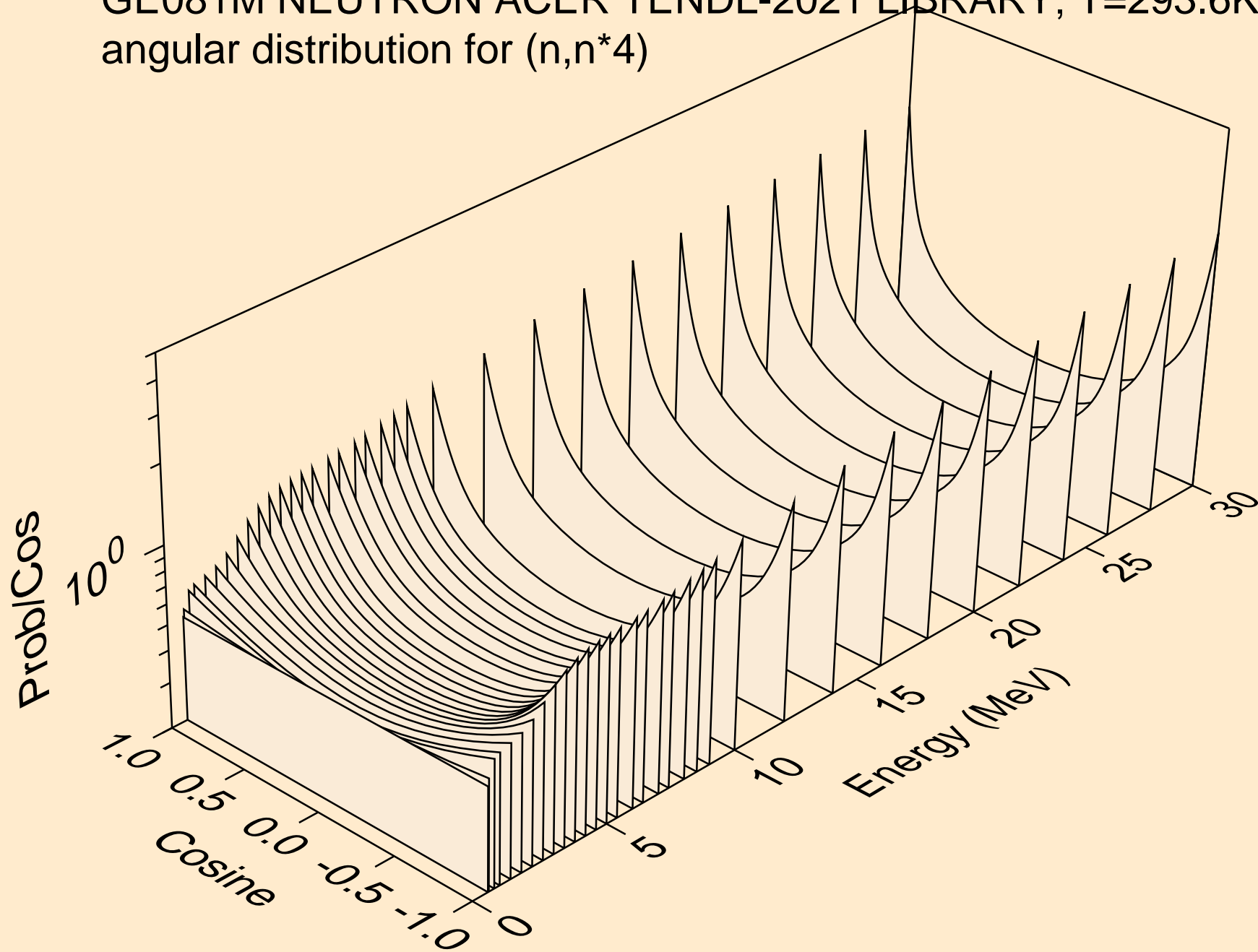

GE081M NEUTRON ACER TENDL-2021 LIBRARY; T=293.6K
angular distribution for (n,n*5)

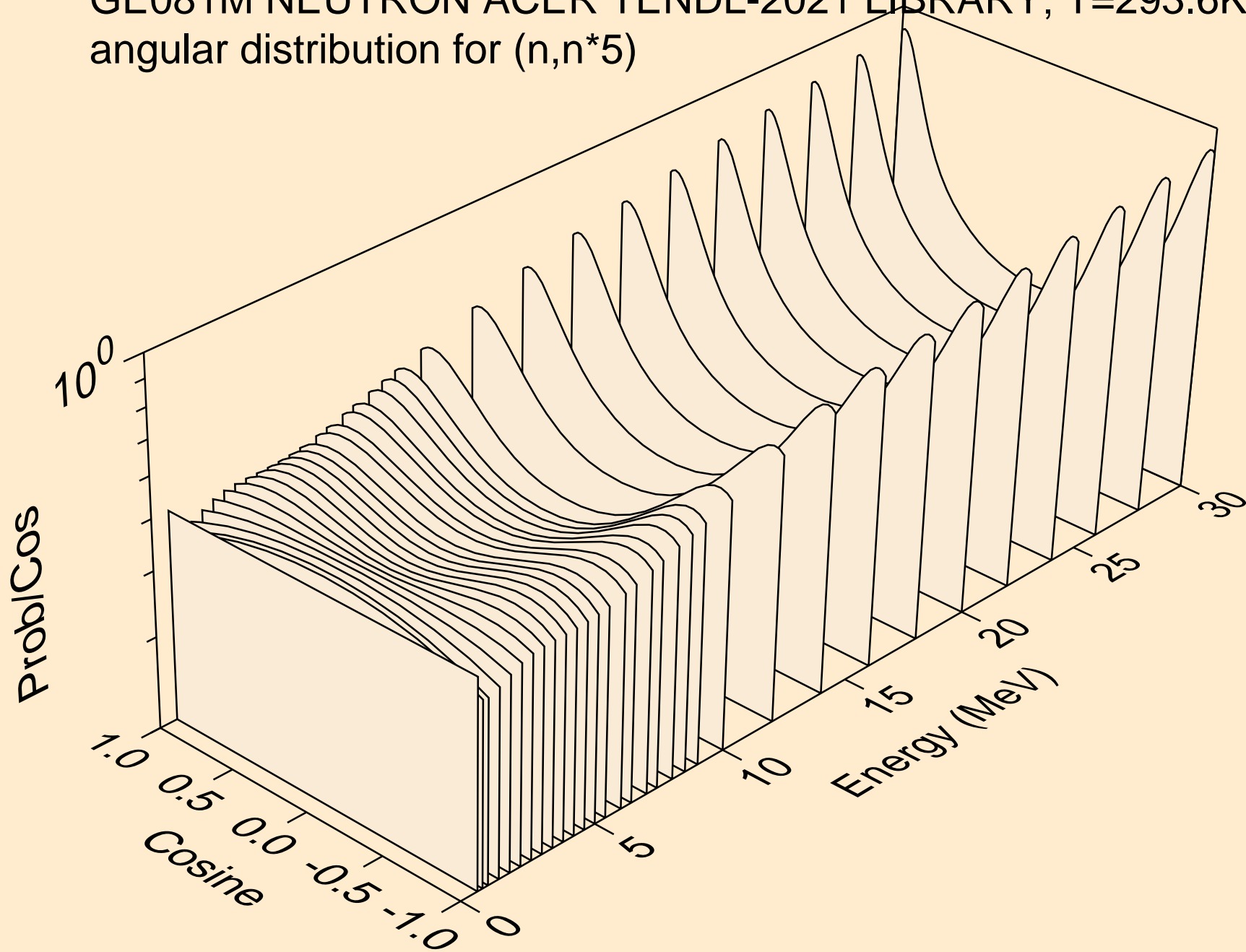

GE081M NEUTRON ACER TENDL-2021 LIBRARY; T=293.6K
angular distribution for (n,n*6)

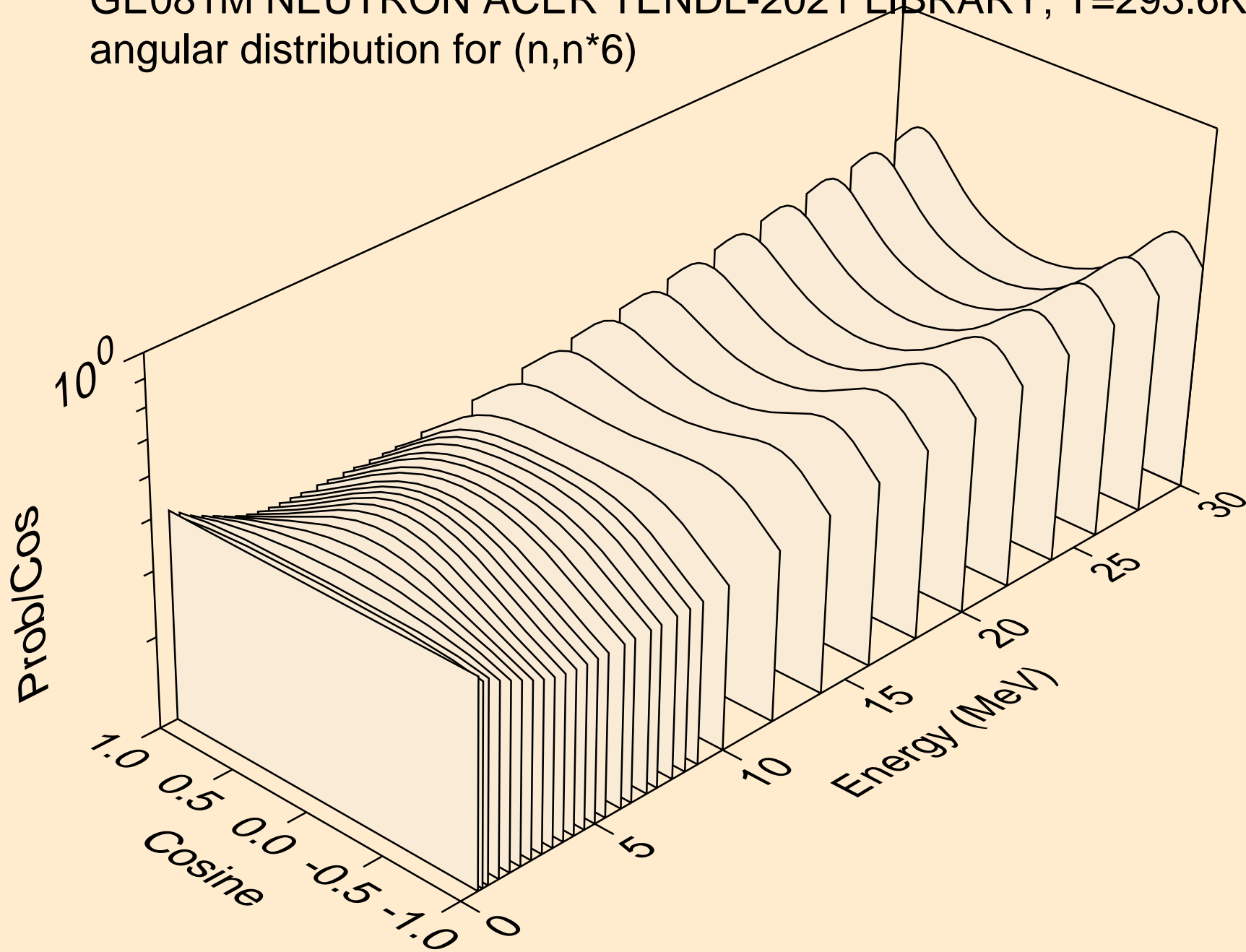

GE081M NEUTRON ACER TENDL-2021 LIBRARY; T=293.6K
angular distribution for (n,n*7)

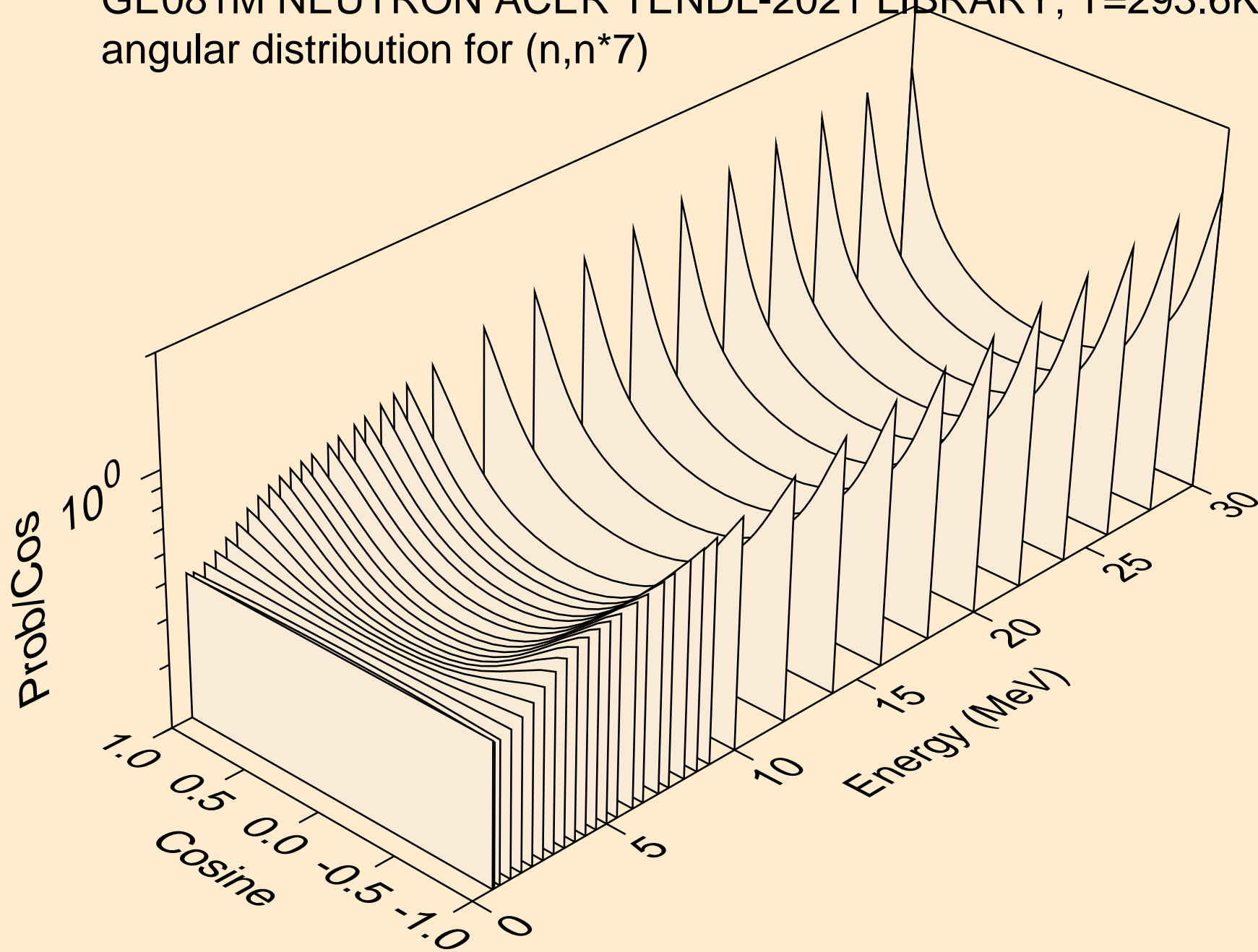

GE081M NEUTRON ACER TENDL-2021 LIBRARY; T=293.6K
angular distribution for (n,n*8)

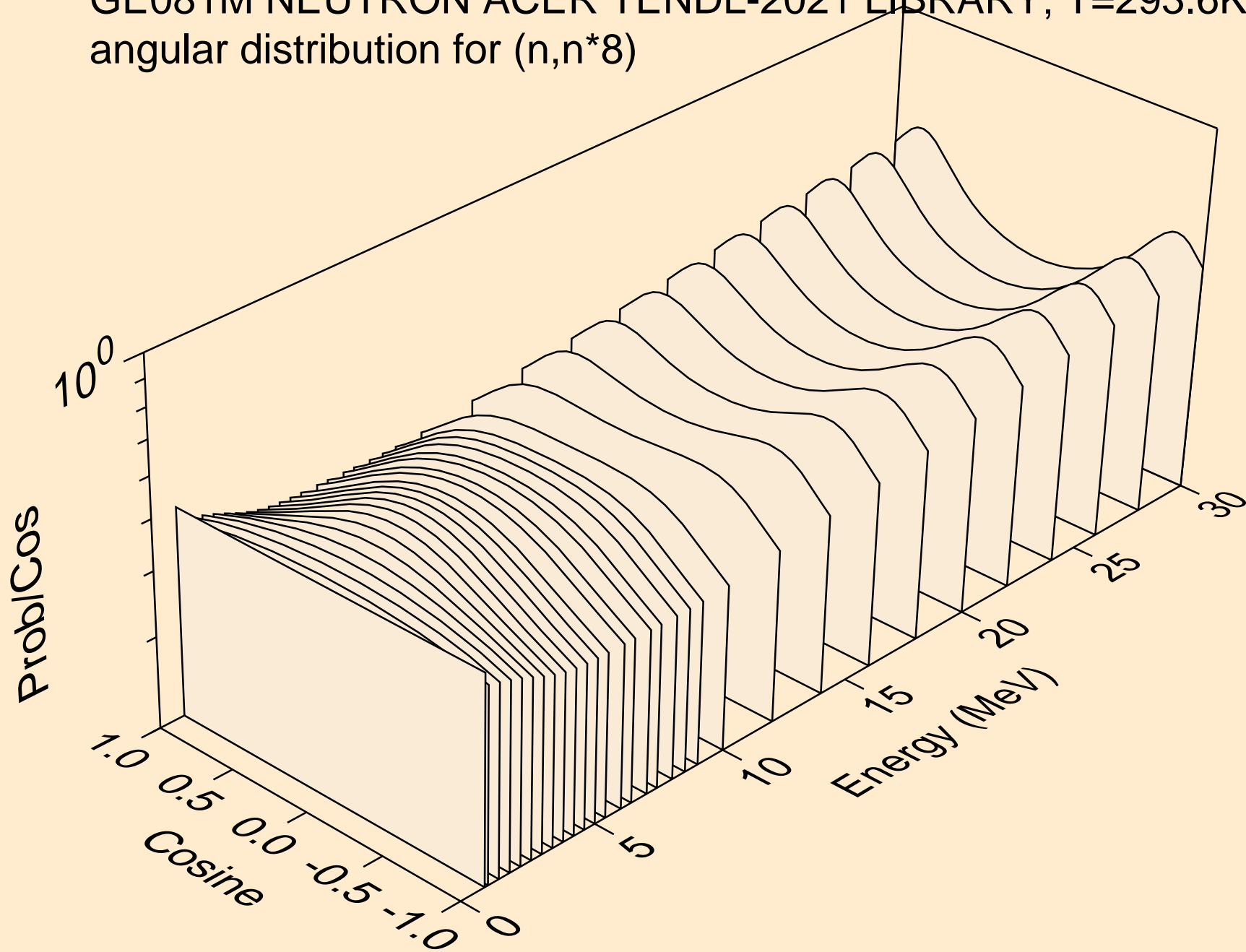

GE081M NEUTRON ACER TENDL-2021 LIBRARY; T=293.6K
angular distribution for (n,n*9)

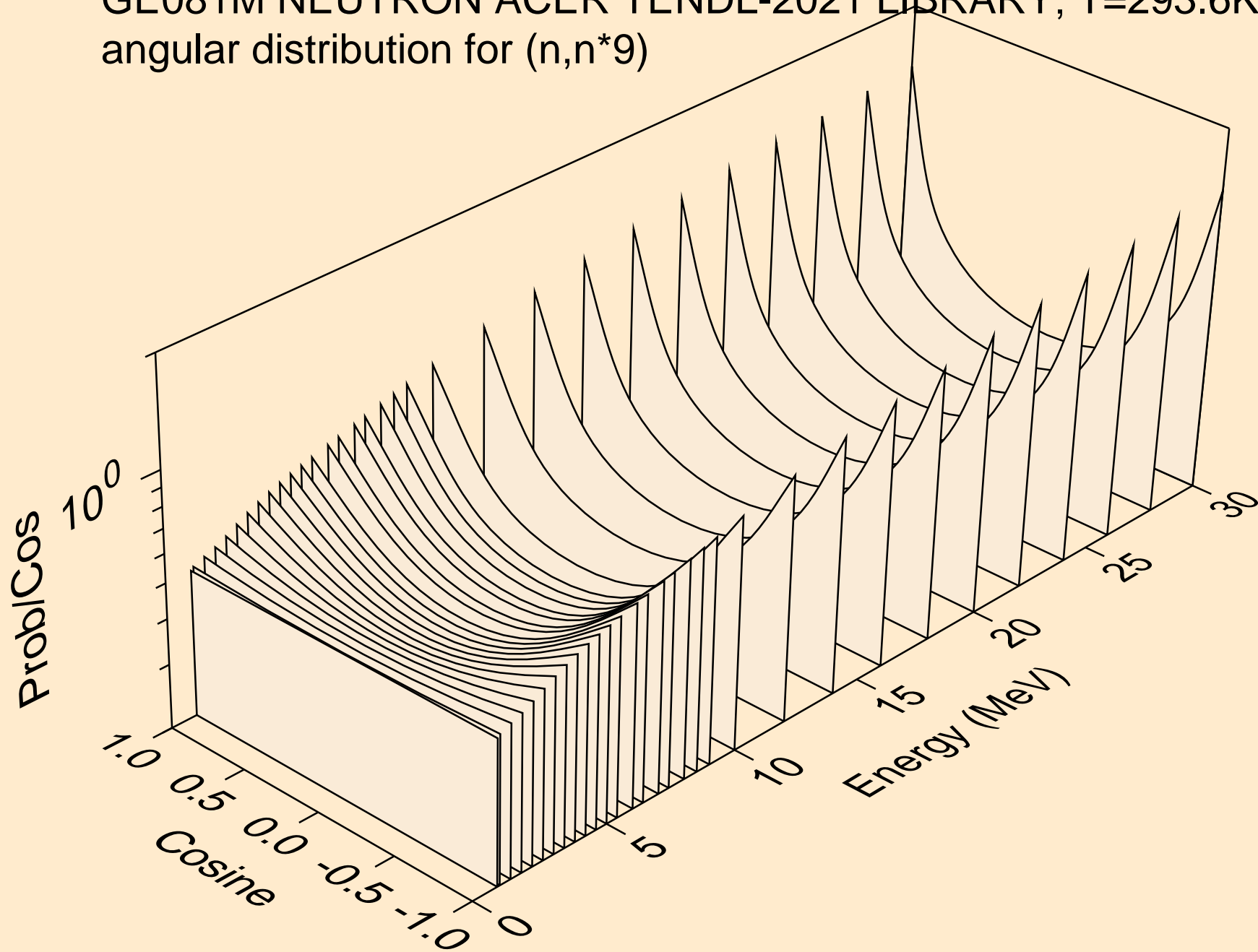

GE081M NEUTRON ACER TENDL-2021 LIBRARY; T=293.6K
angular distribution for (n,n*10)

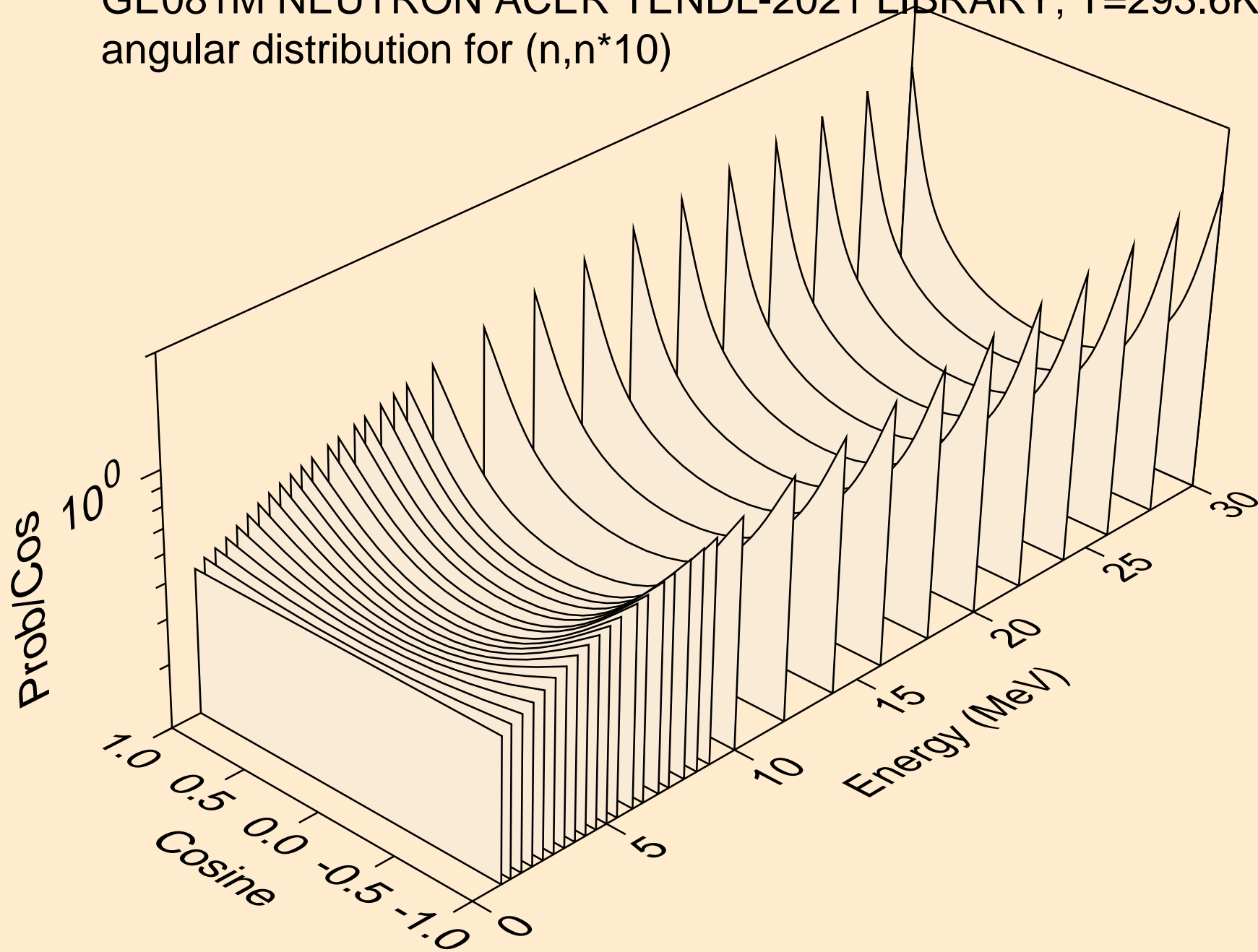

GE081M NEUTRON ACER TENDL-2021 LIBRARY; T=293.6K
angular distribution for (n,n*11)

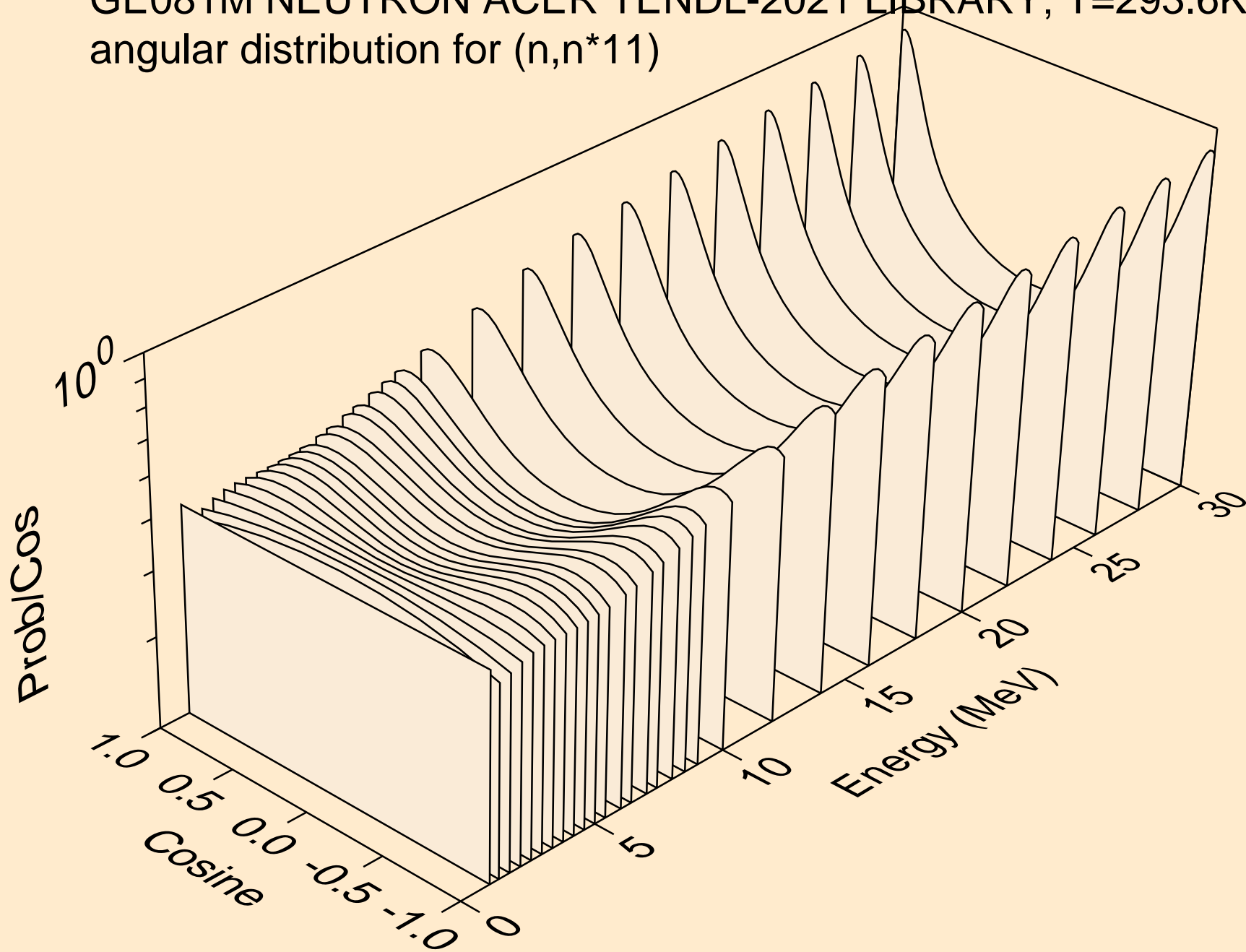

GE081M NEUTRON ACER TENDL-2021 LIBRARY; T=293.6K
angular distribution for (n,n*12)

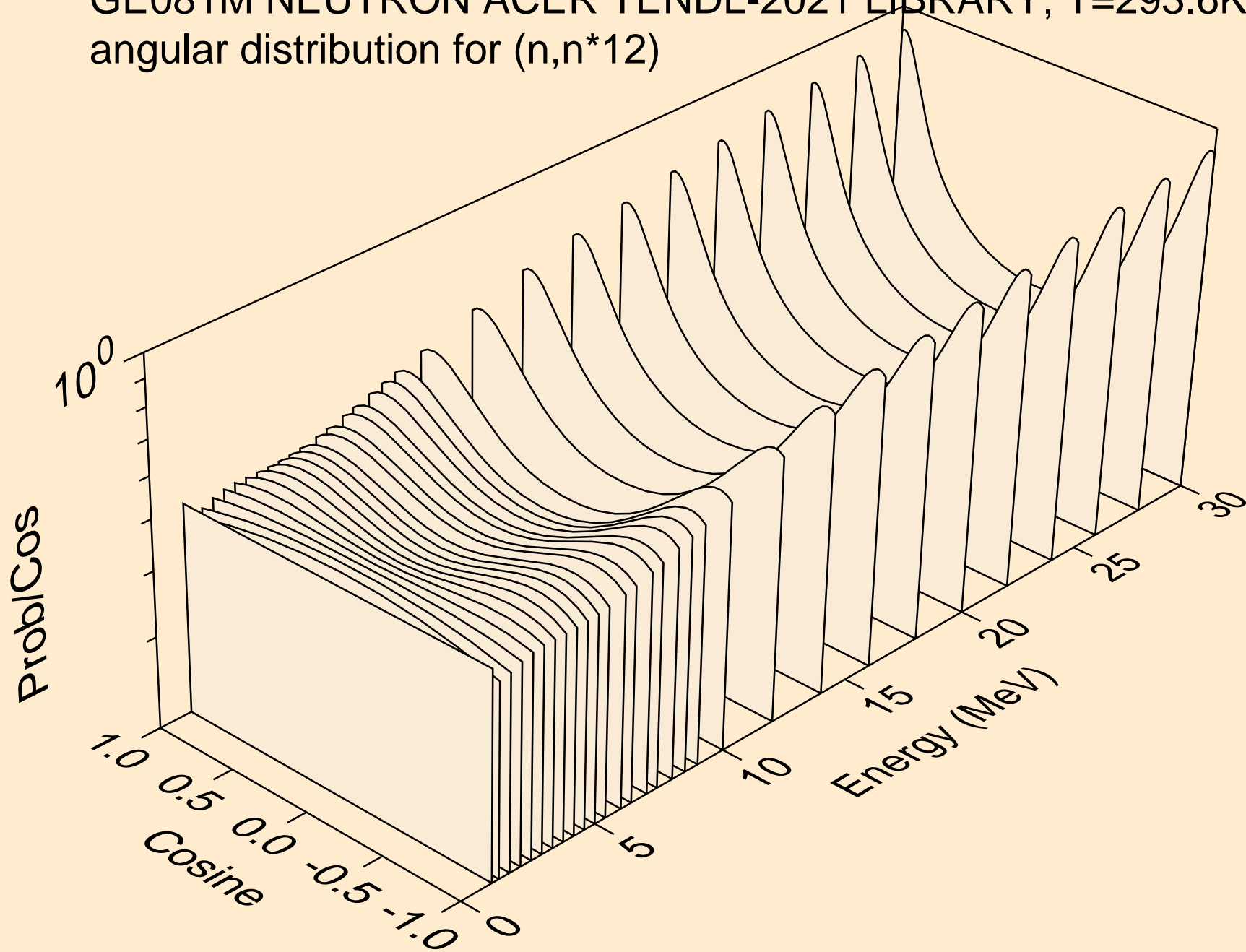

GE081M NEUTRON ACER TENDL-2021 LIBRARY; T=293.6K
angular distribution for (n,n*13)

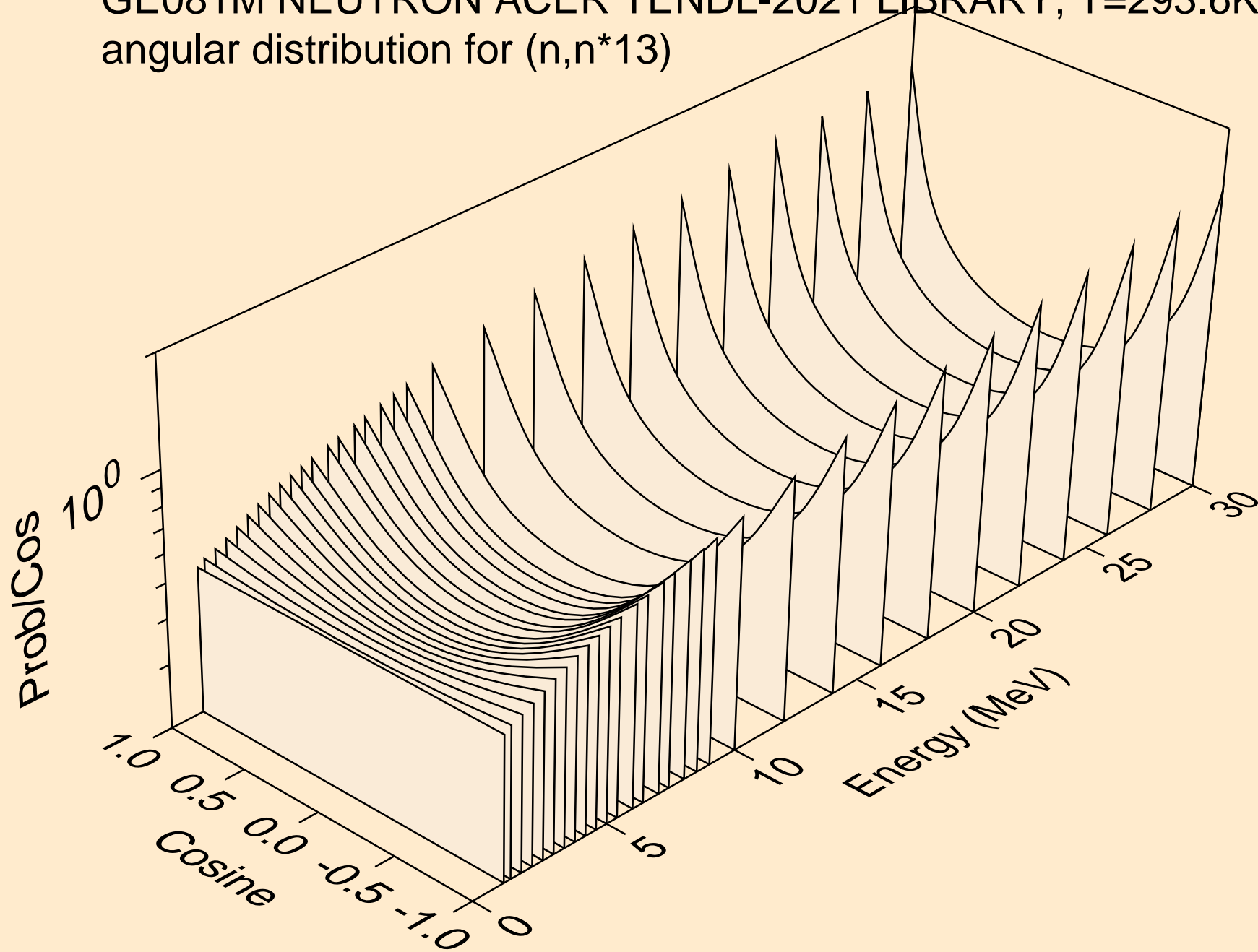

GE081M NEUTRON ACER TENDL-2021 LIBRARY; T=293.6K
angular distribution for (n,n*14)

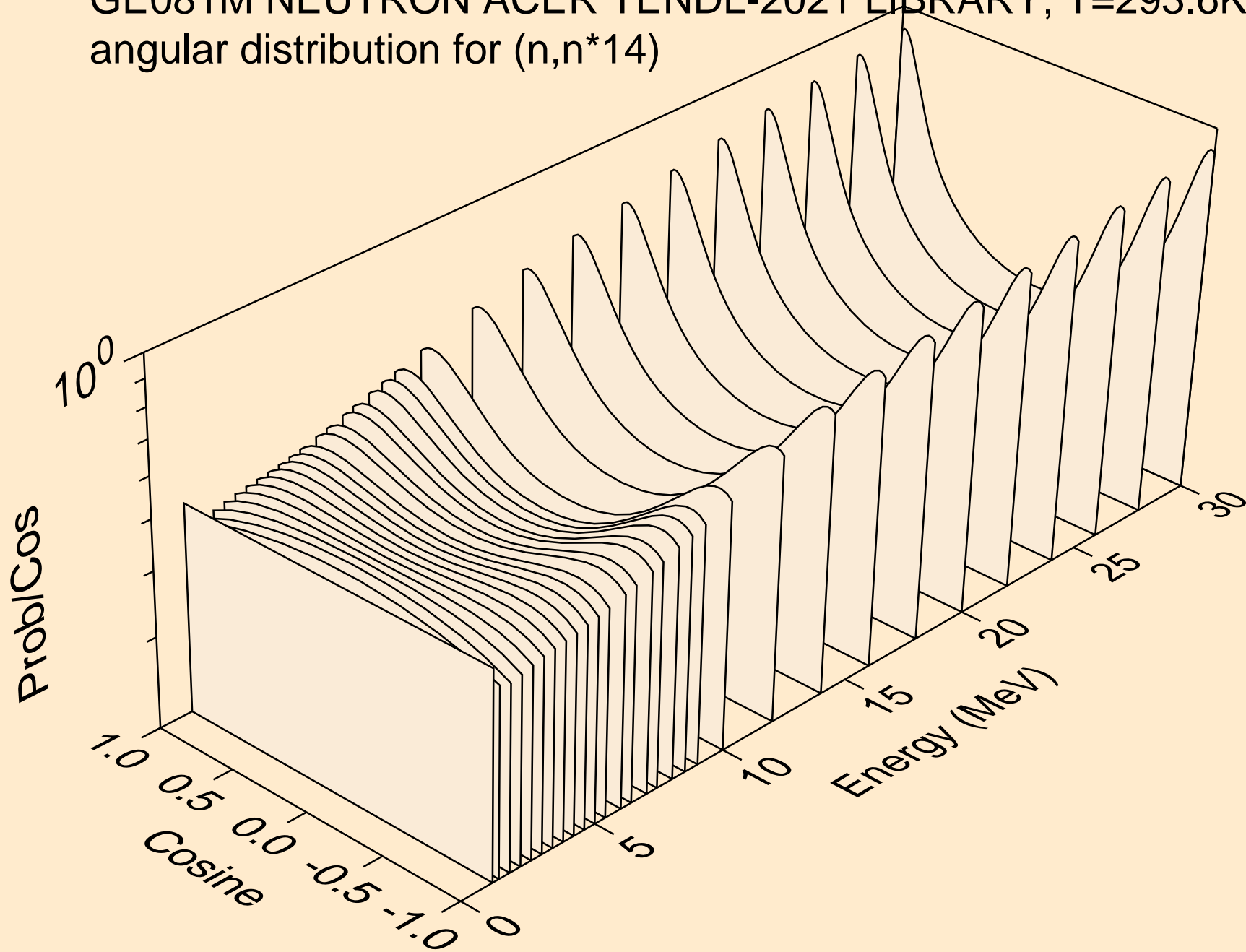

GE081M NEUTRON ACER TENDL-2021 LIBRARY; T=293.6K
angular distribution for (n,n*15)

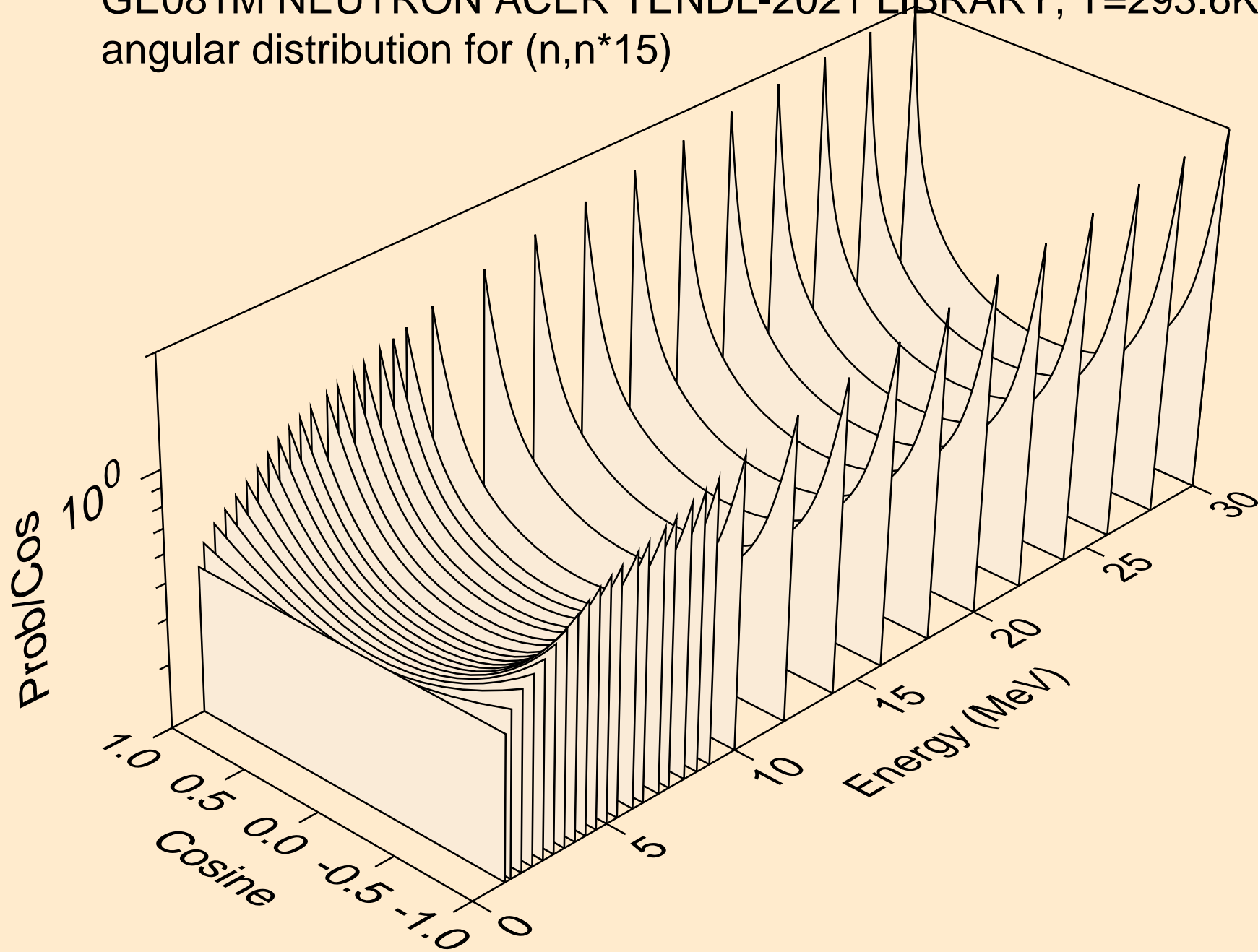

GE081M NEUTRON ACER TENDL-2021 LIBRARY; T=293.6K
angular distribution for (n,n*16)

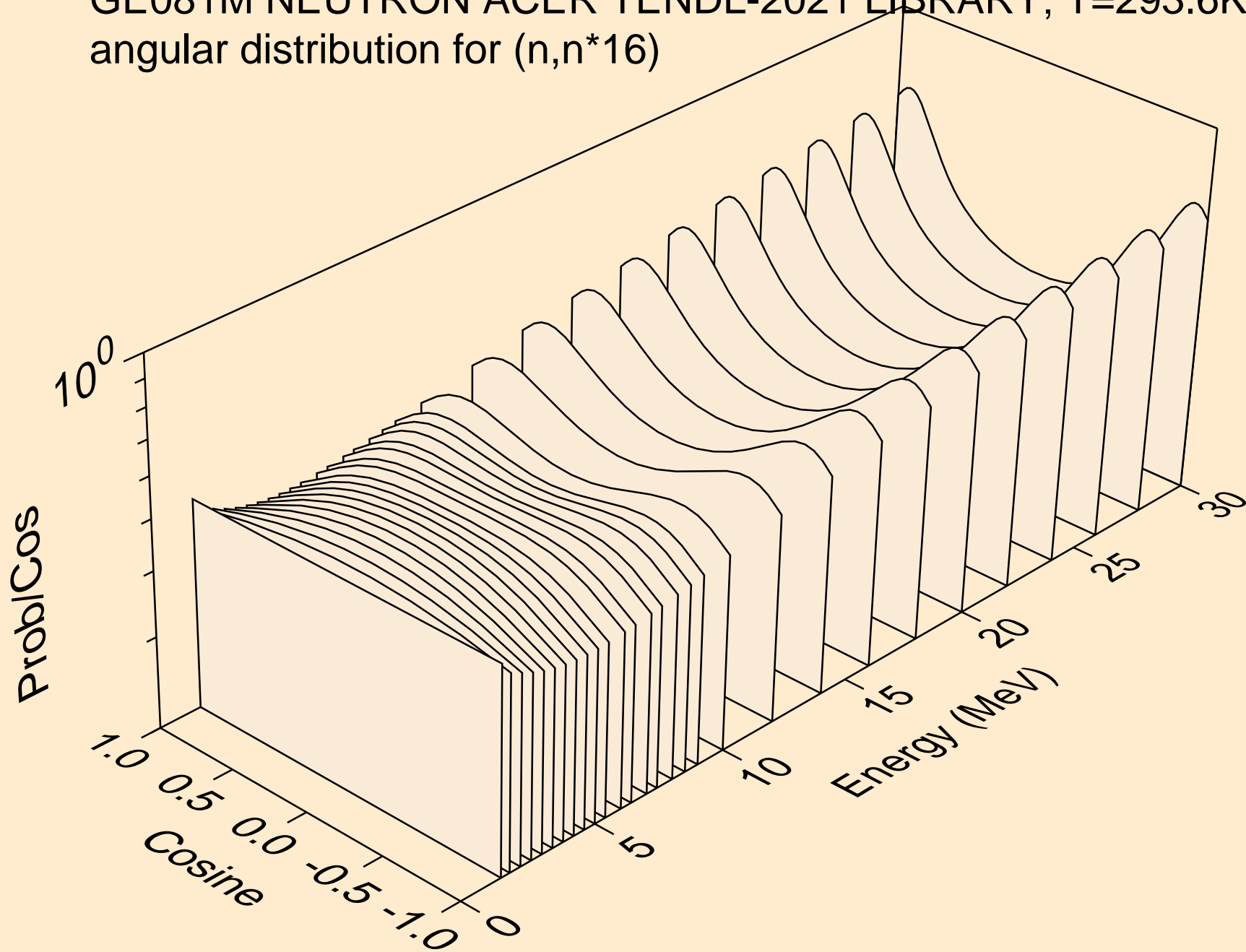

GE081M NEUTRON ACER TENDL-2021 LIBRARY; T=293.6K
angular distribution for (n,n*17)

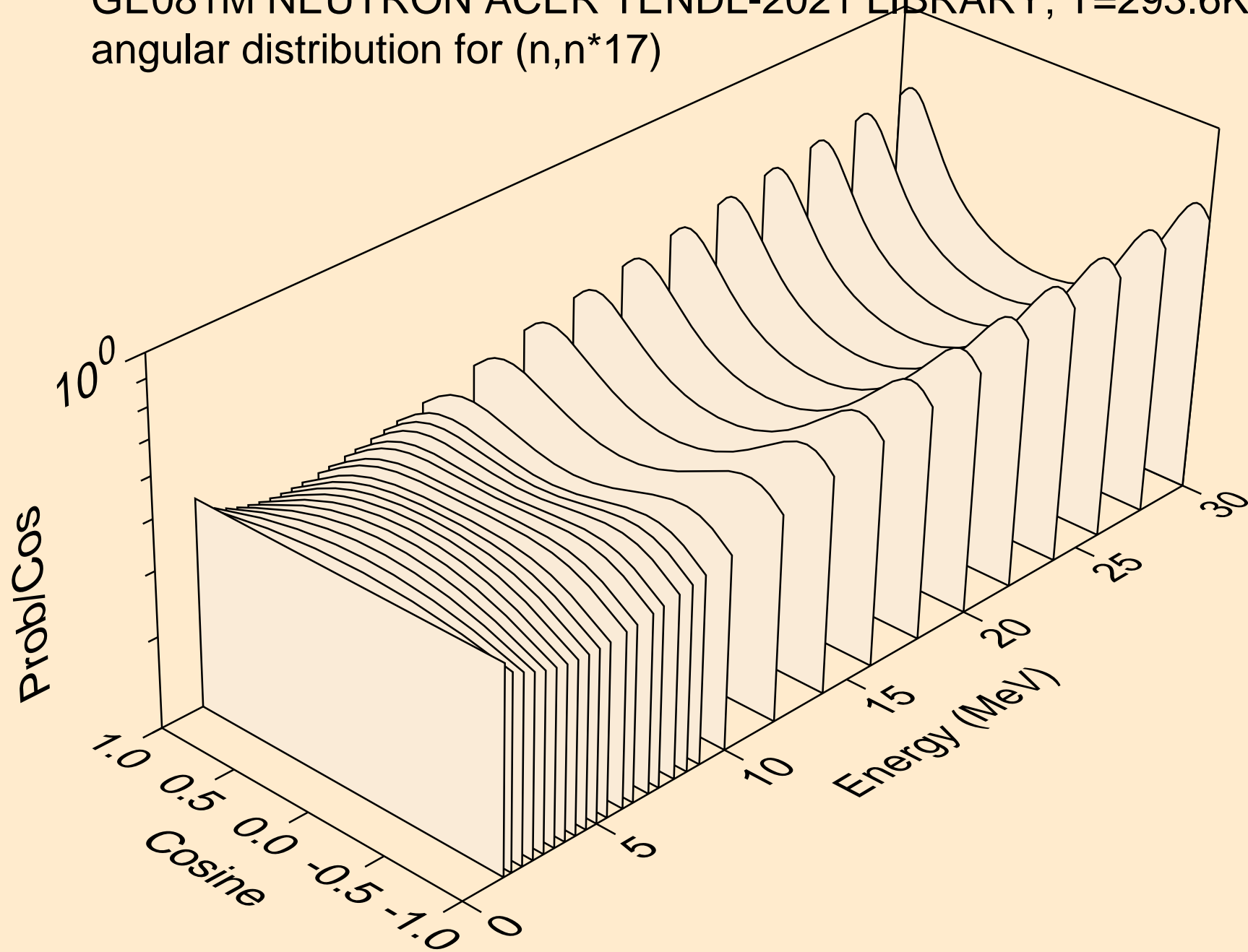

GE081M NEUTRON ACER TENDL-2021 LIBRARY; T=293.6K
angular distribution for (n,n*18)

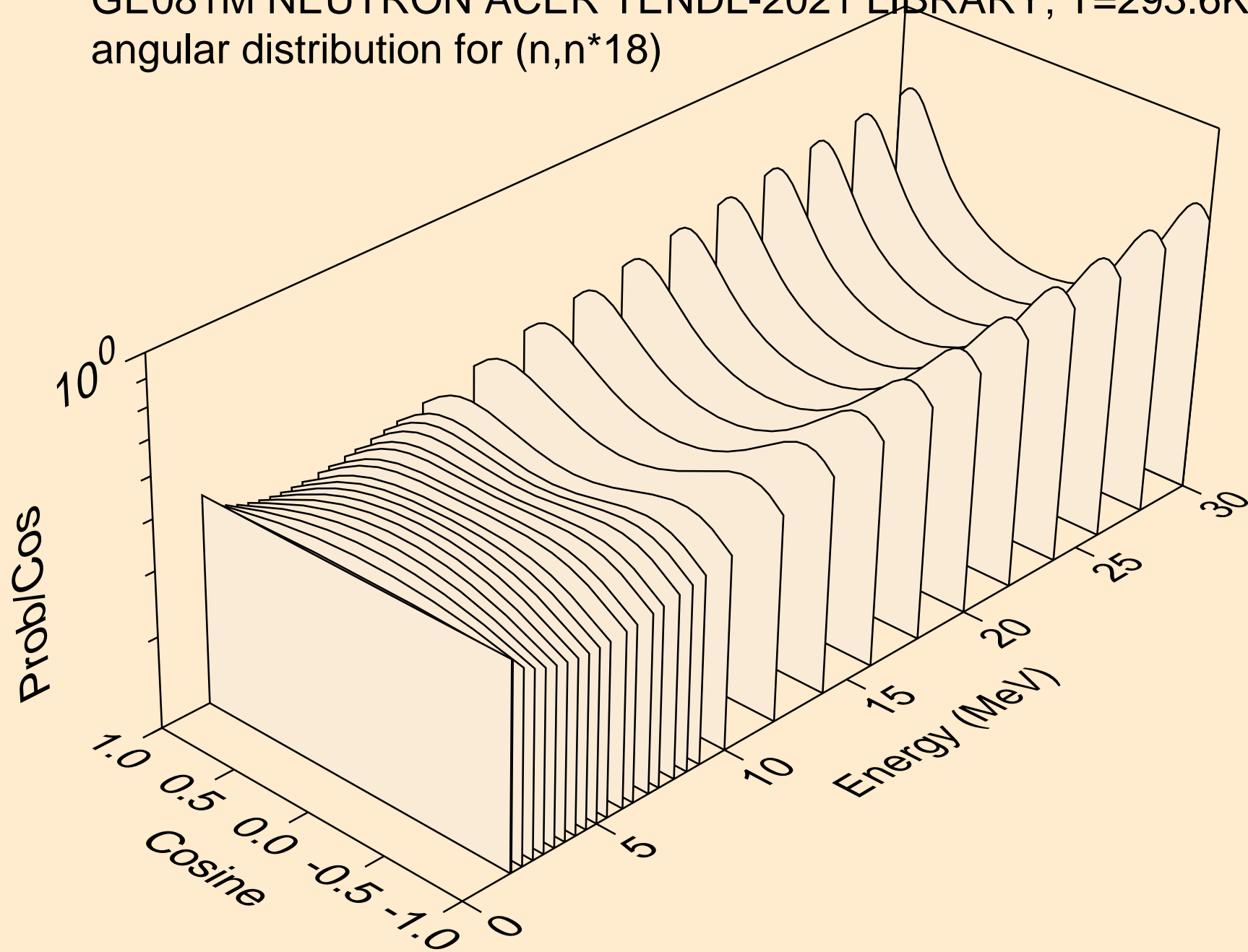

GE081M NEUTRON ACER TENDL-2021 LIBRARY; T=293.6K
angular distribution for (n,n*19)

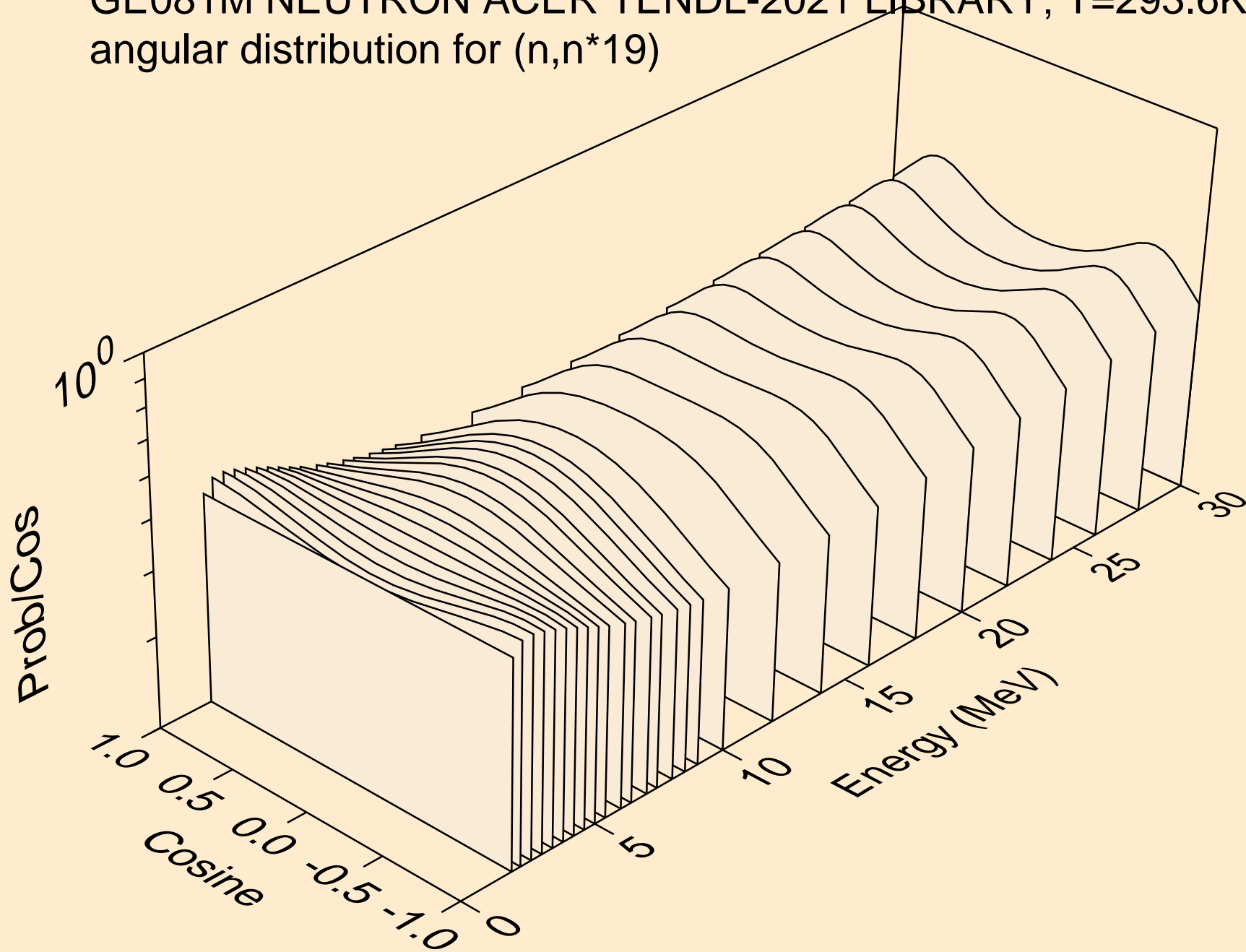

GE081M NEUTRON ACER TENDL-2021 LIBRARY; T=293.6K
angular distribution for (n,n*20)

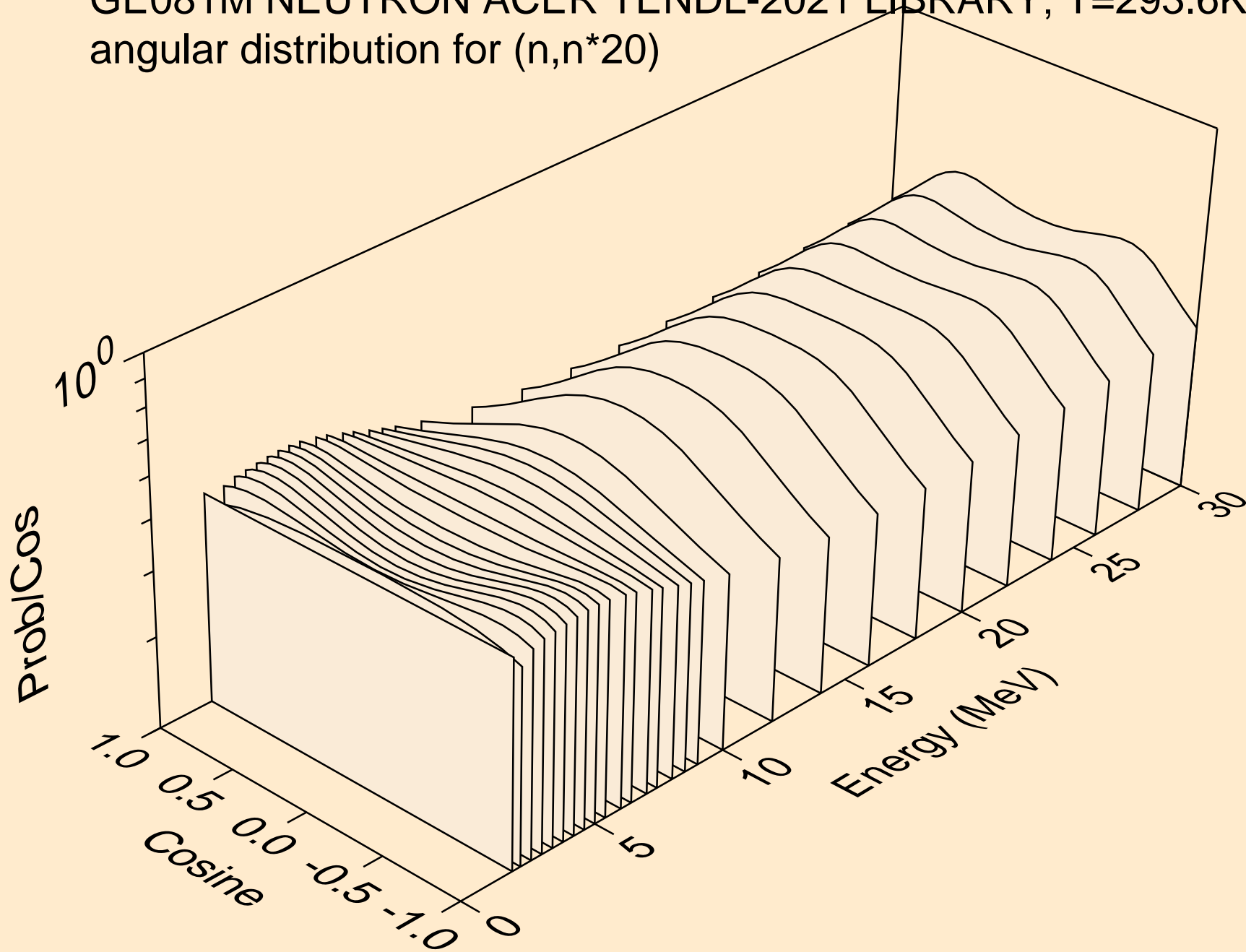

GE081M NEUTRON ACER TENDL-2021 LIBRARY; T=293.6K
angular distribution for (n,n*21)

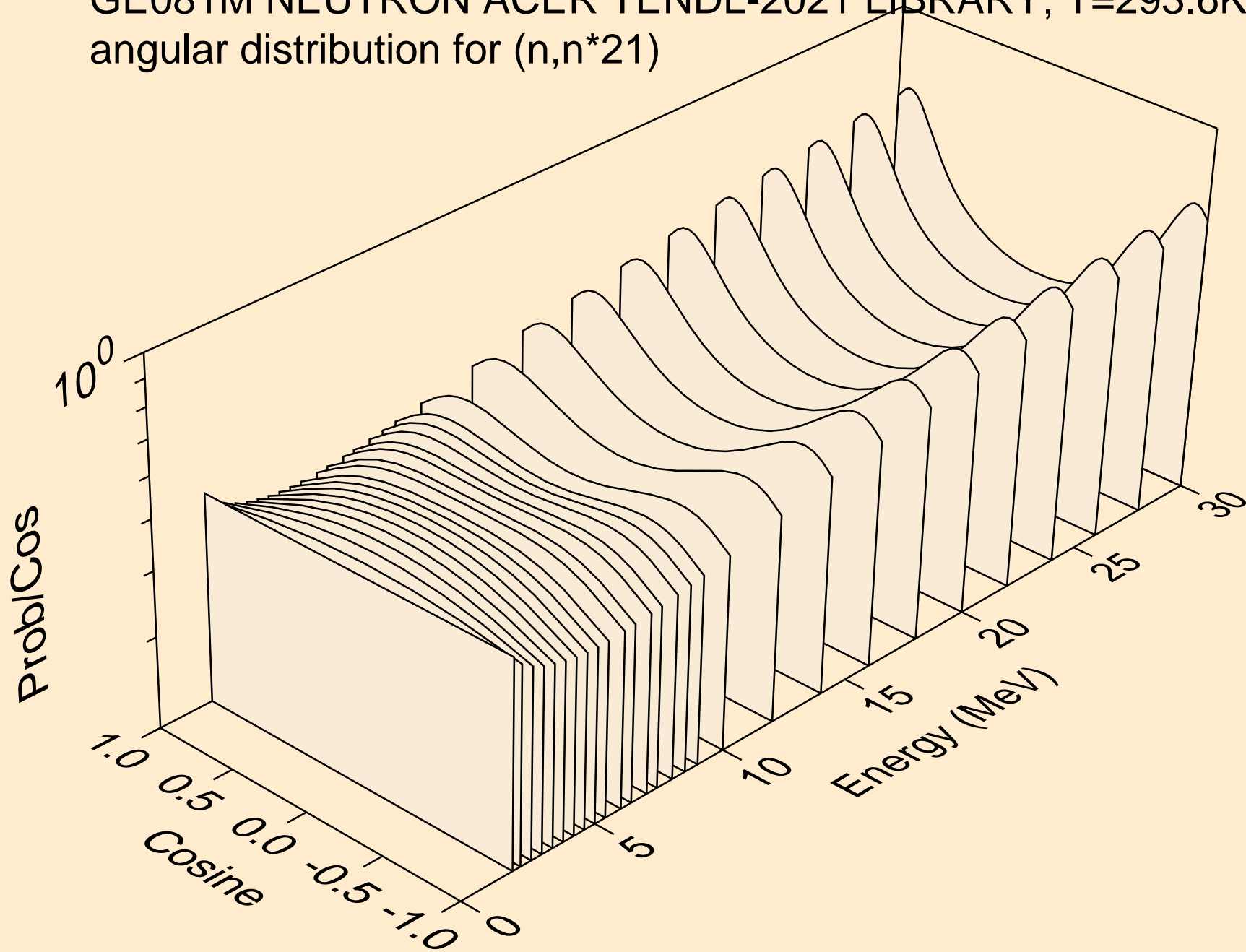

GE081M NEUTRON ACER TENDL-2021 LIBRARY; T=293.6K
angular distribution for (n,n*22)

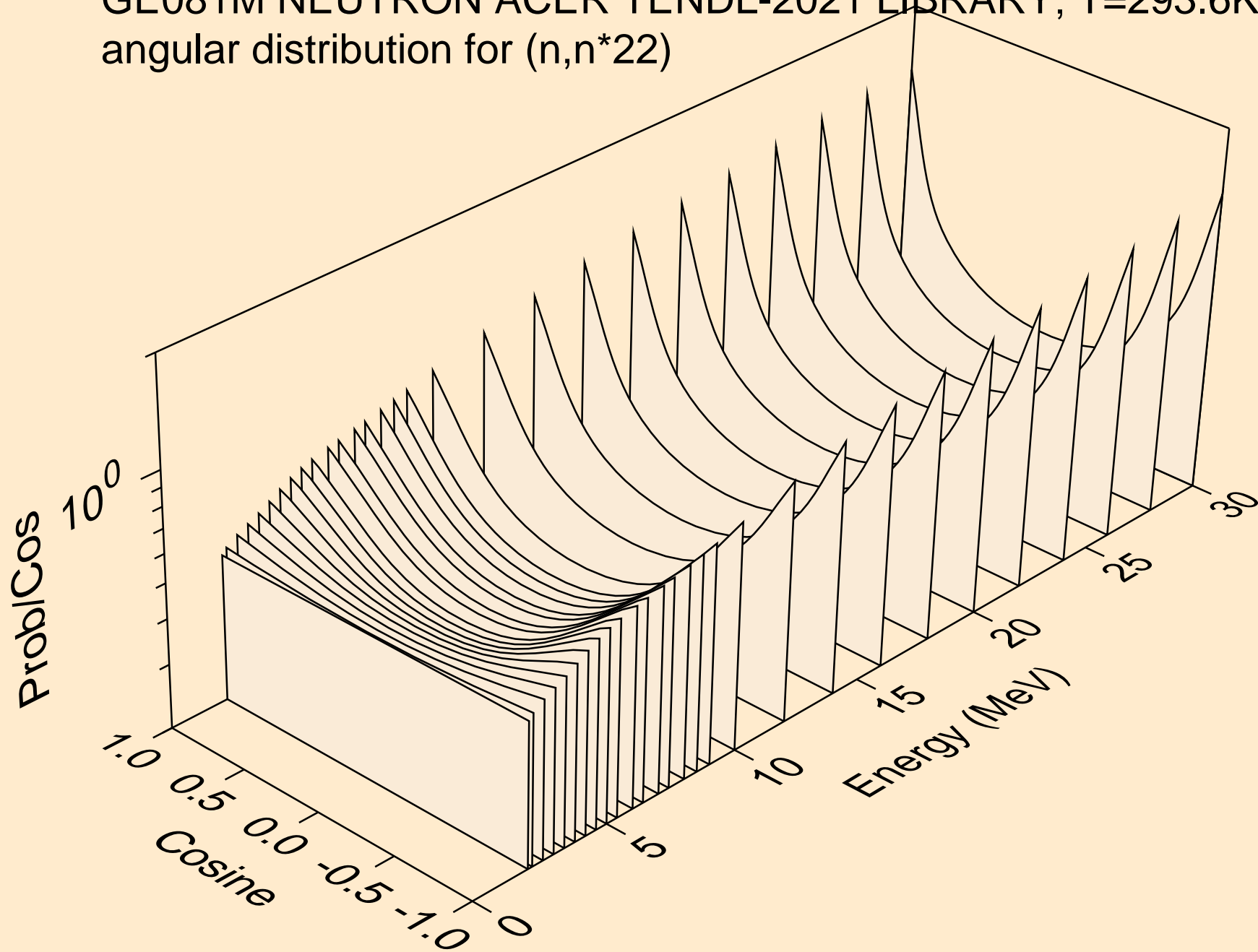

GE081M NEUTRON ACER TENDL-2021 LIBRARY; T=293.6K
angular distribution for (n,n*23)

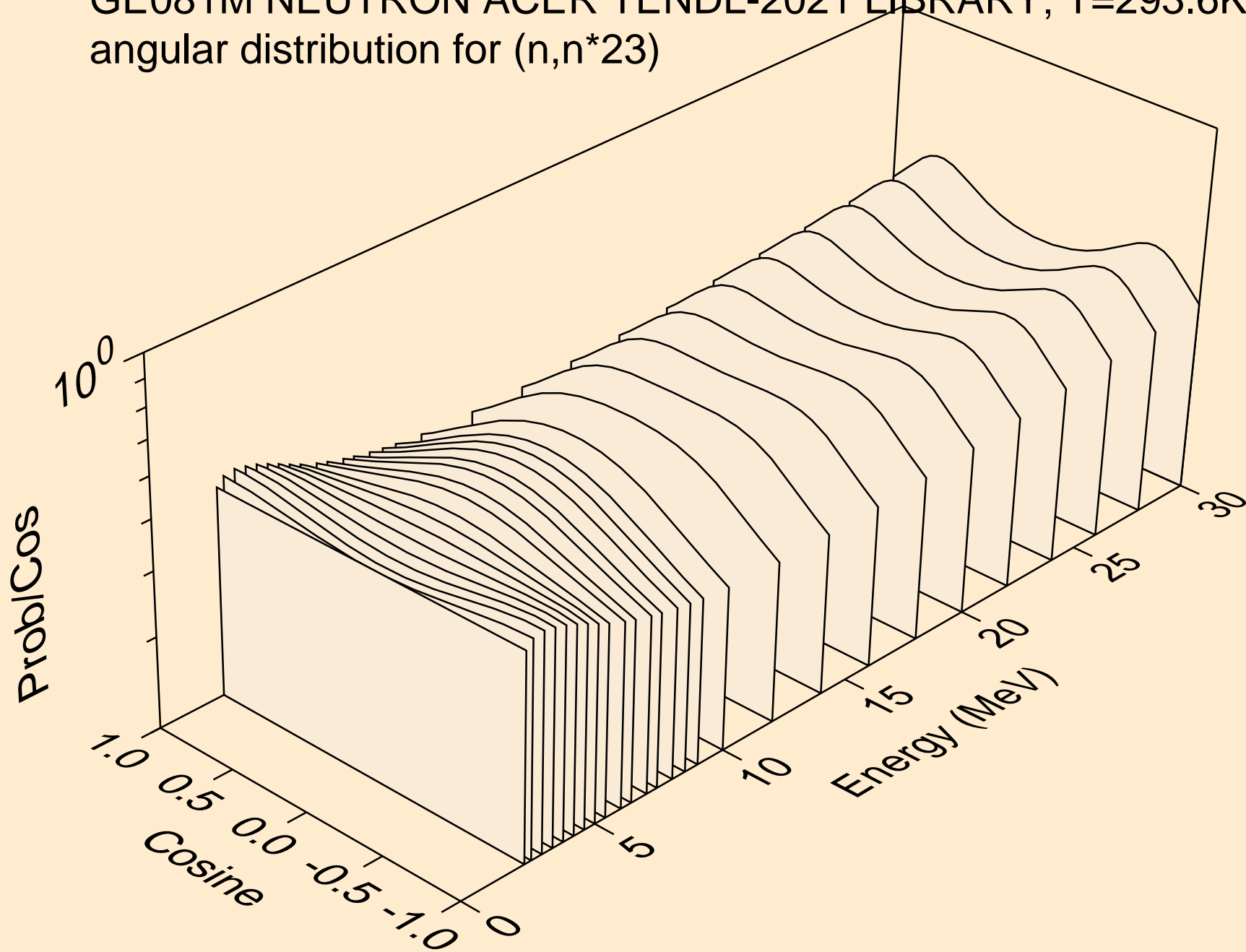

GE081M NEUTRON ACER TENDL-2021 LIBRARY; T=293.6K
angular distribution for (n,n*24)

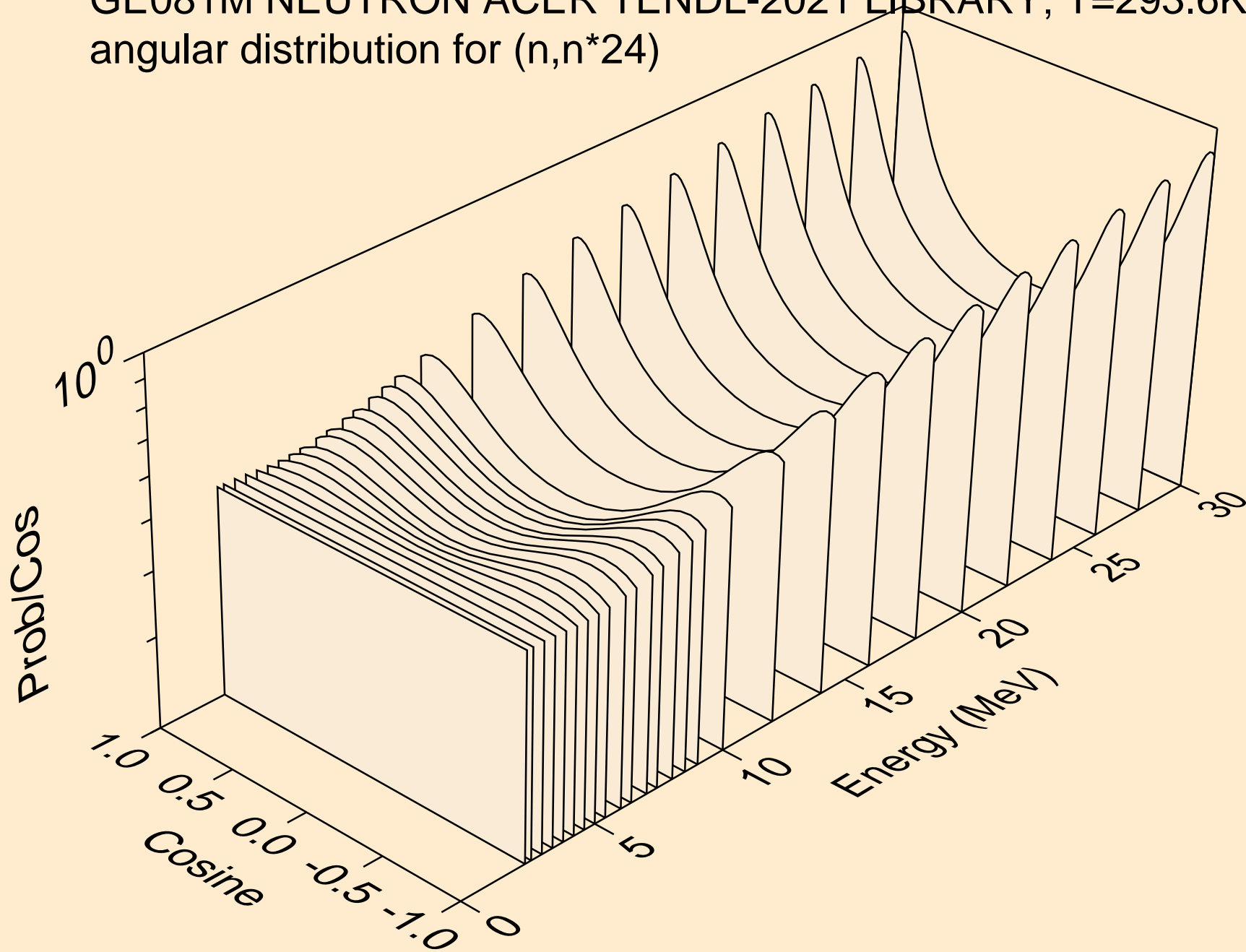

GE081M NEUTRON ACER TENDL-2021 LIBRARY; T=293.6K
angular distribution for (n,n*25)

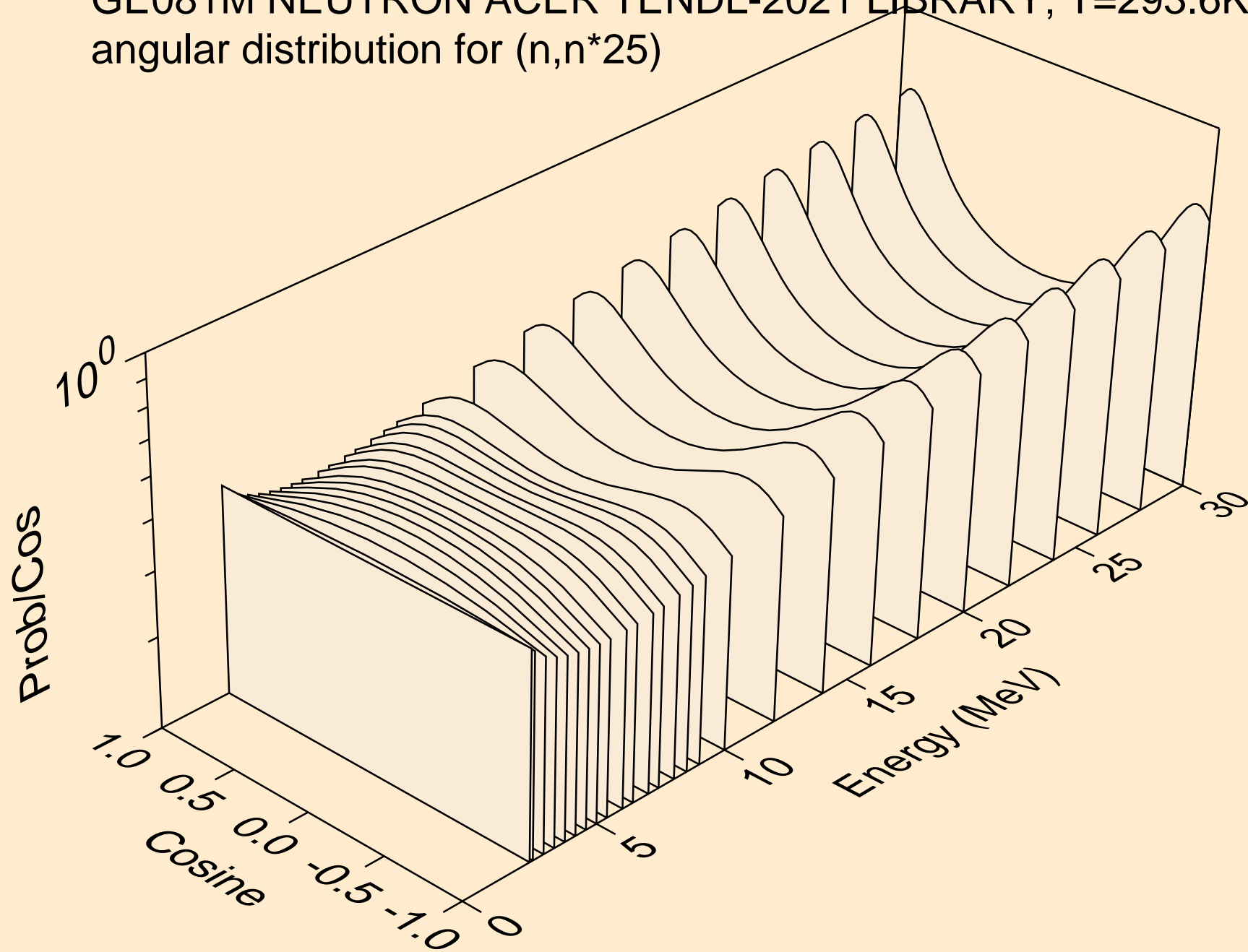

GE081M NEUTRON ACER TENDL-2021 LIBRARY; T=293.6K
angular distribution for (n,n*26)

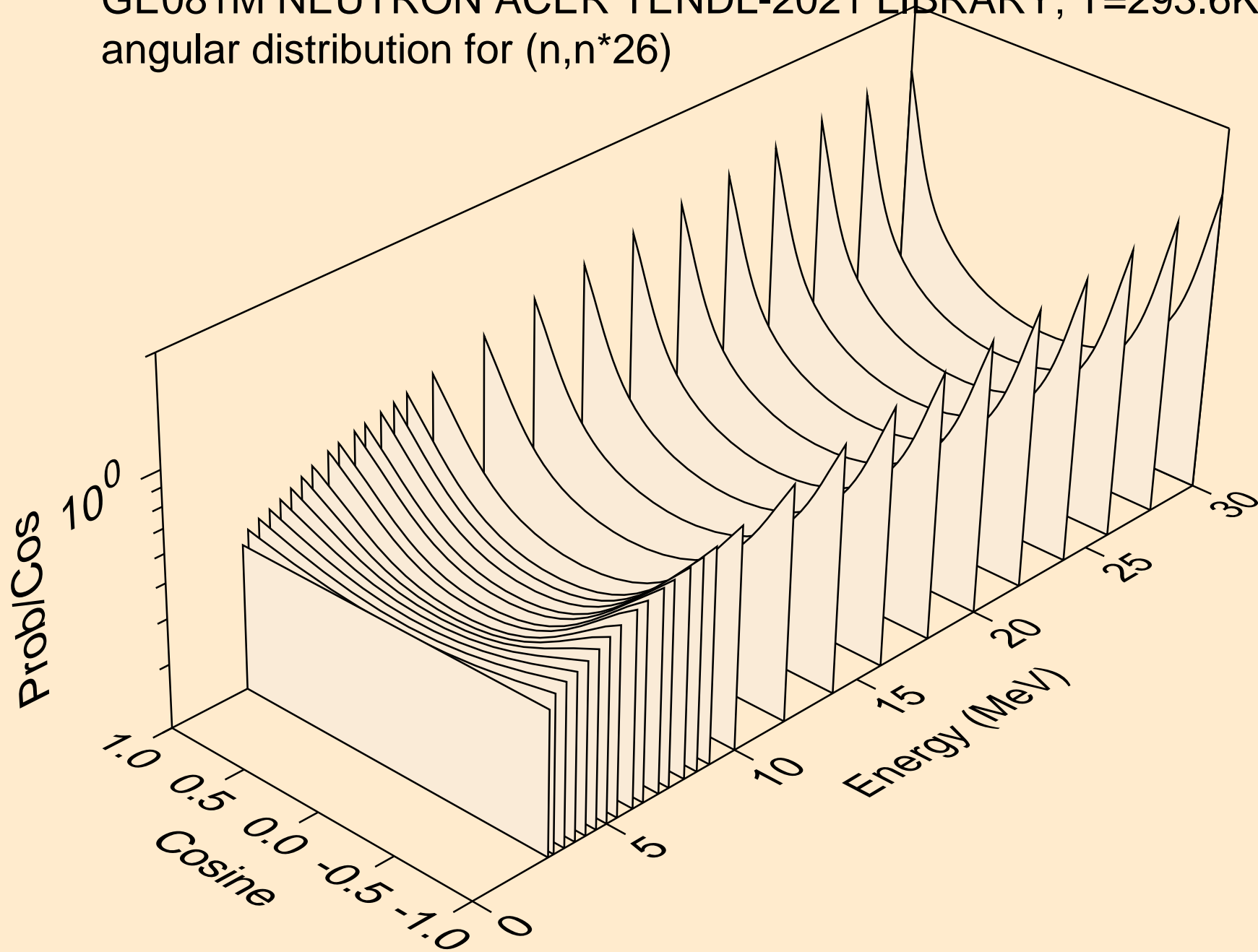

GE081M NEUTRON ACER TENDL-2021 LIBRARY; T=293.6K
angular distribution for (n,n*27)

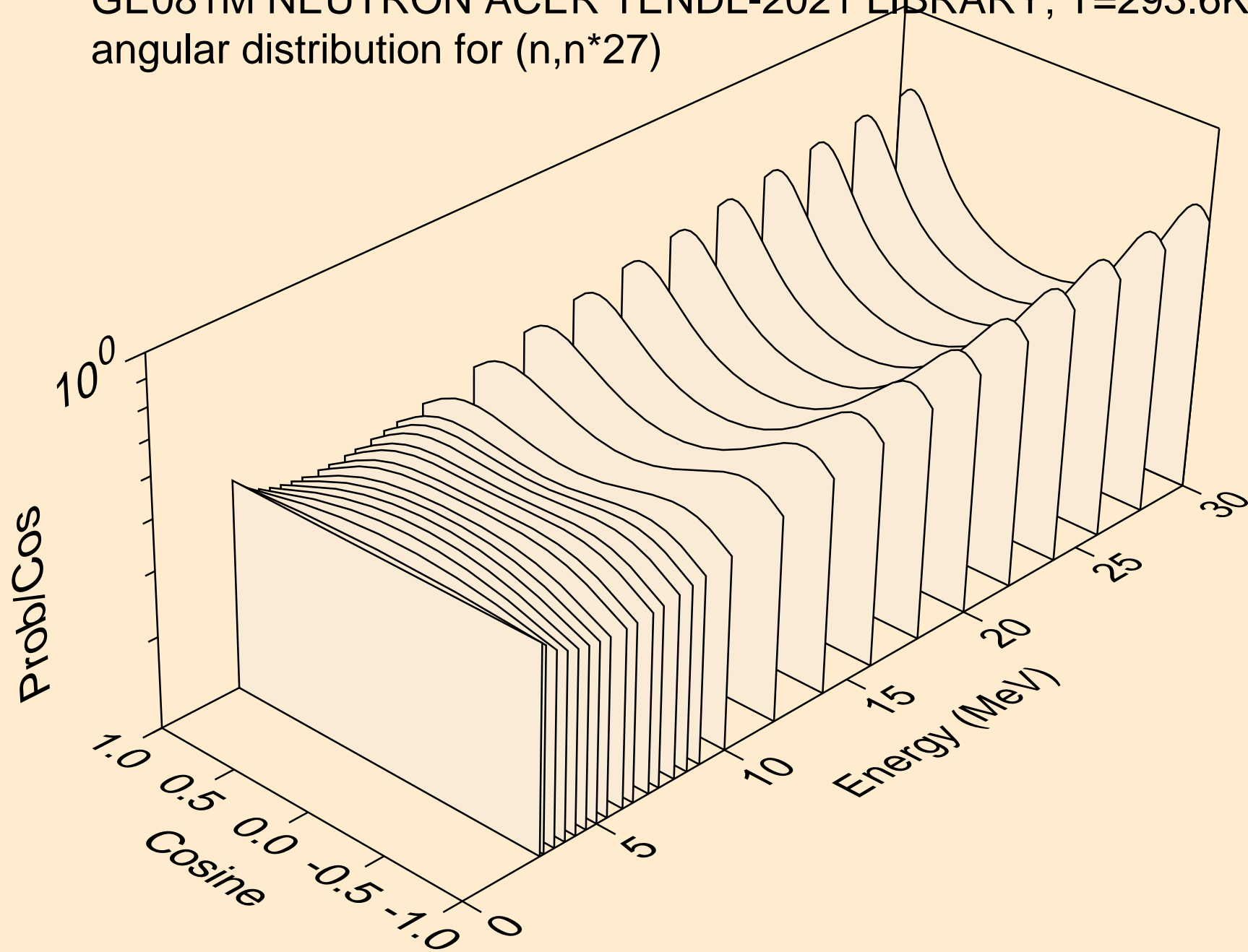

GE081M NEUTRON ACER TENDL-2021 LIBRARY; T=293.6K
angular distribution for (n,n*28)

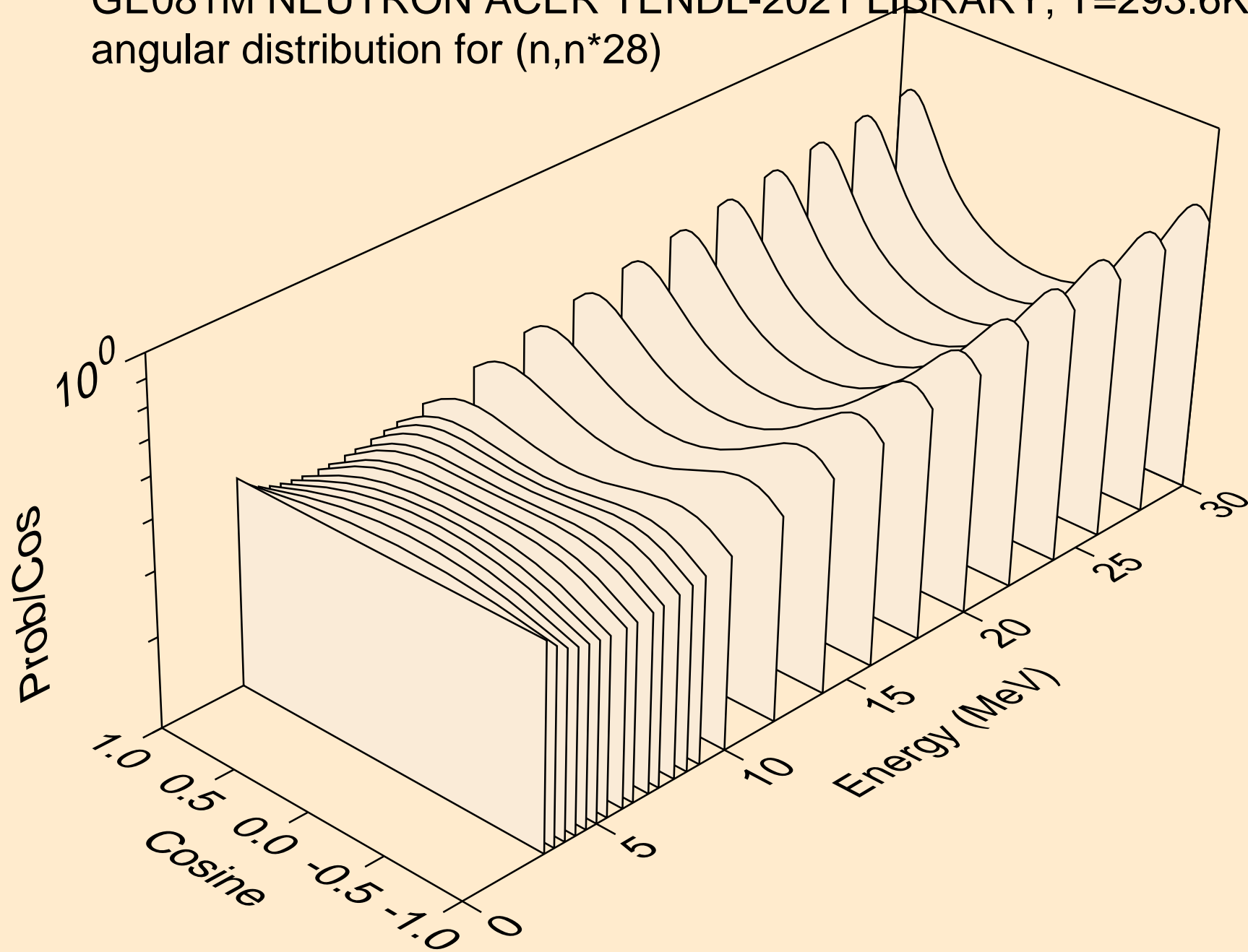

GE081M NEUTRON ACER TENDL-2021 LIBRARY; T=293.6K
angular distribution for (n,n*29)

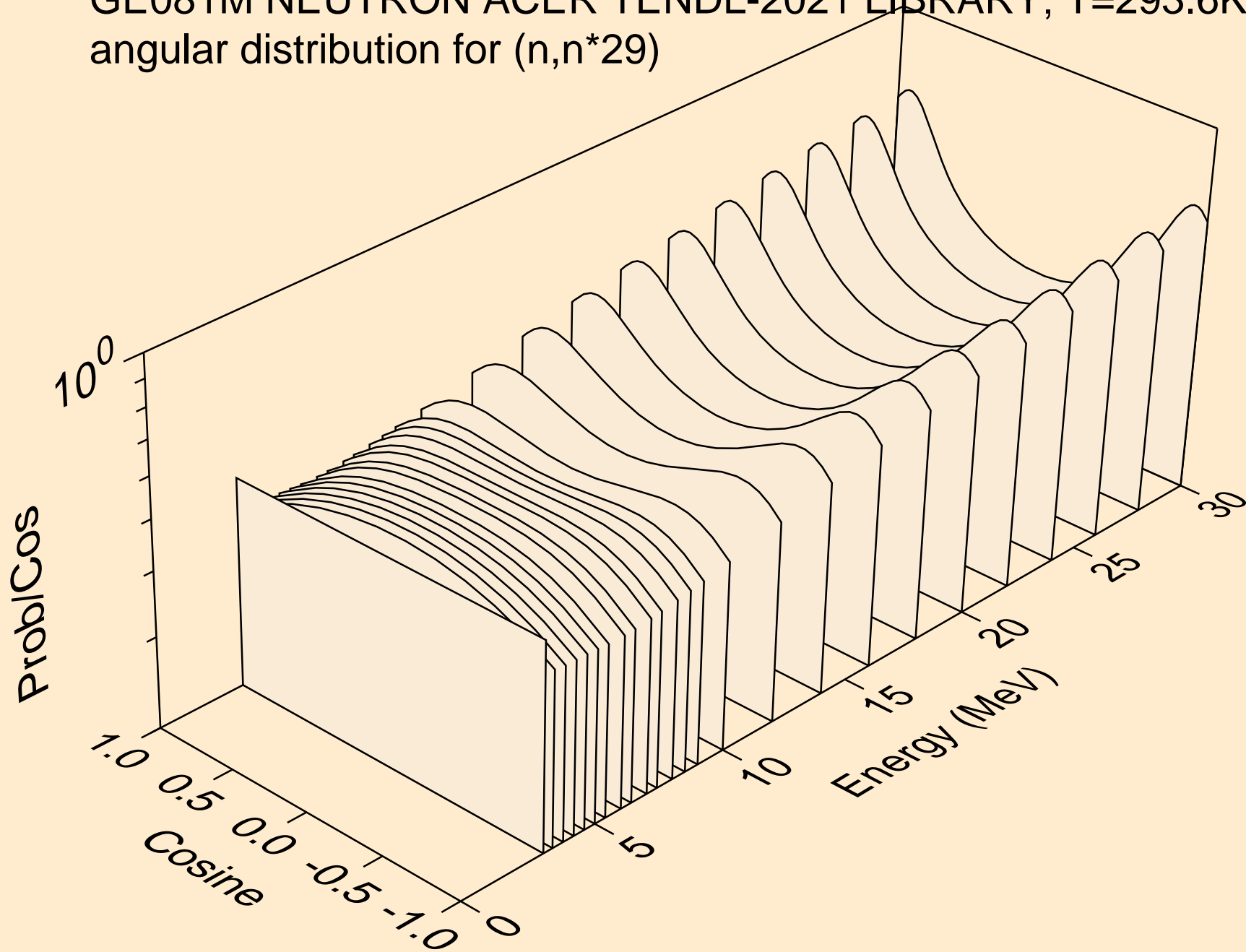

GE081M NEUTRON ACER TENDL-2021 LIBRARY; T=293.6K
angular distribution for (n,n*30)

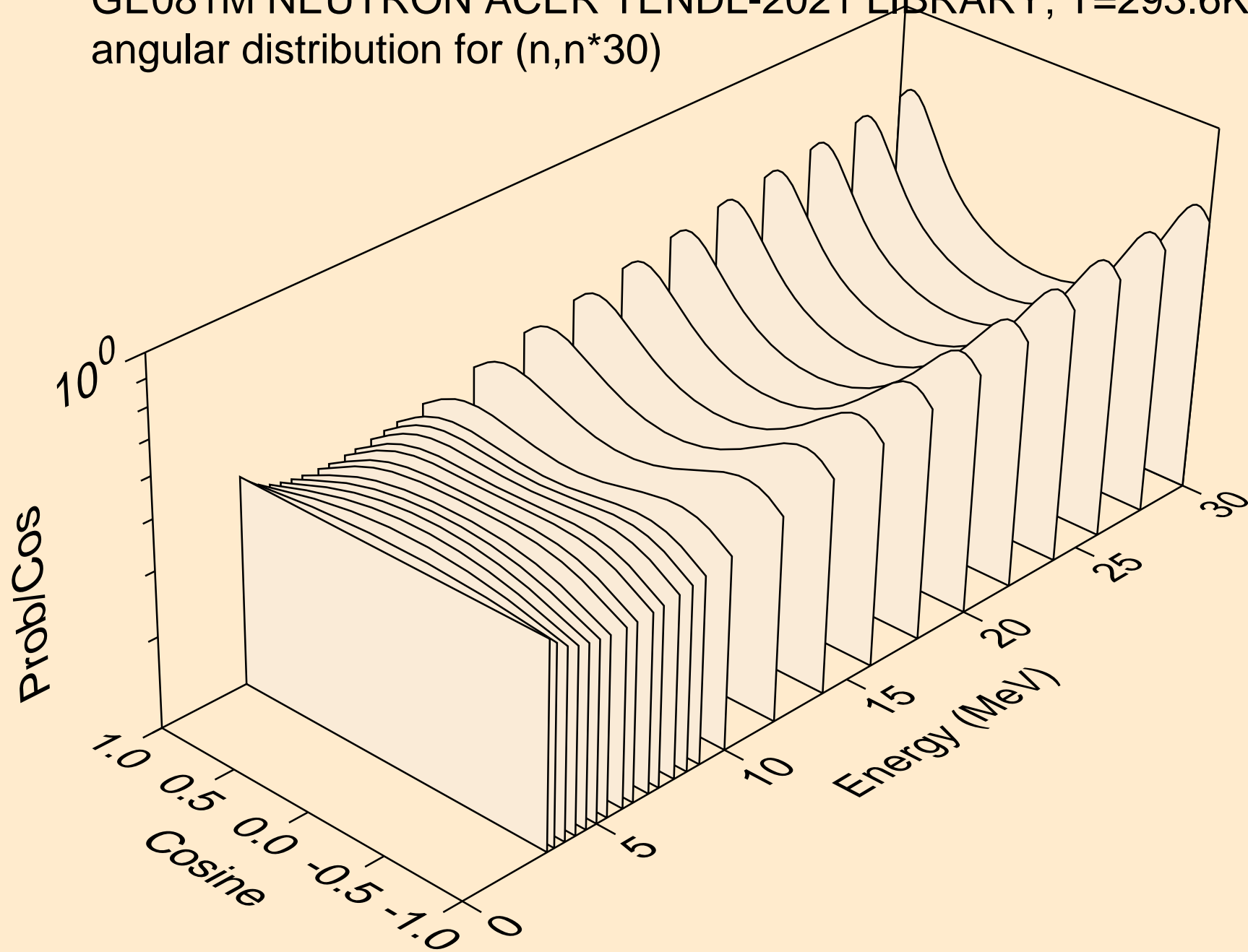

GE081M NEUTRON ACER TENDL-2021 LIBRARY; T=293.6K
Neutron emission for (n,x)

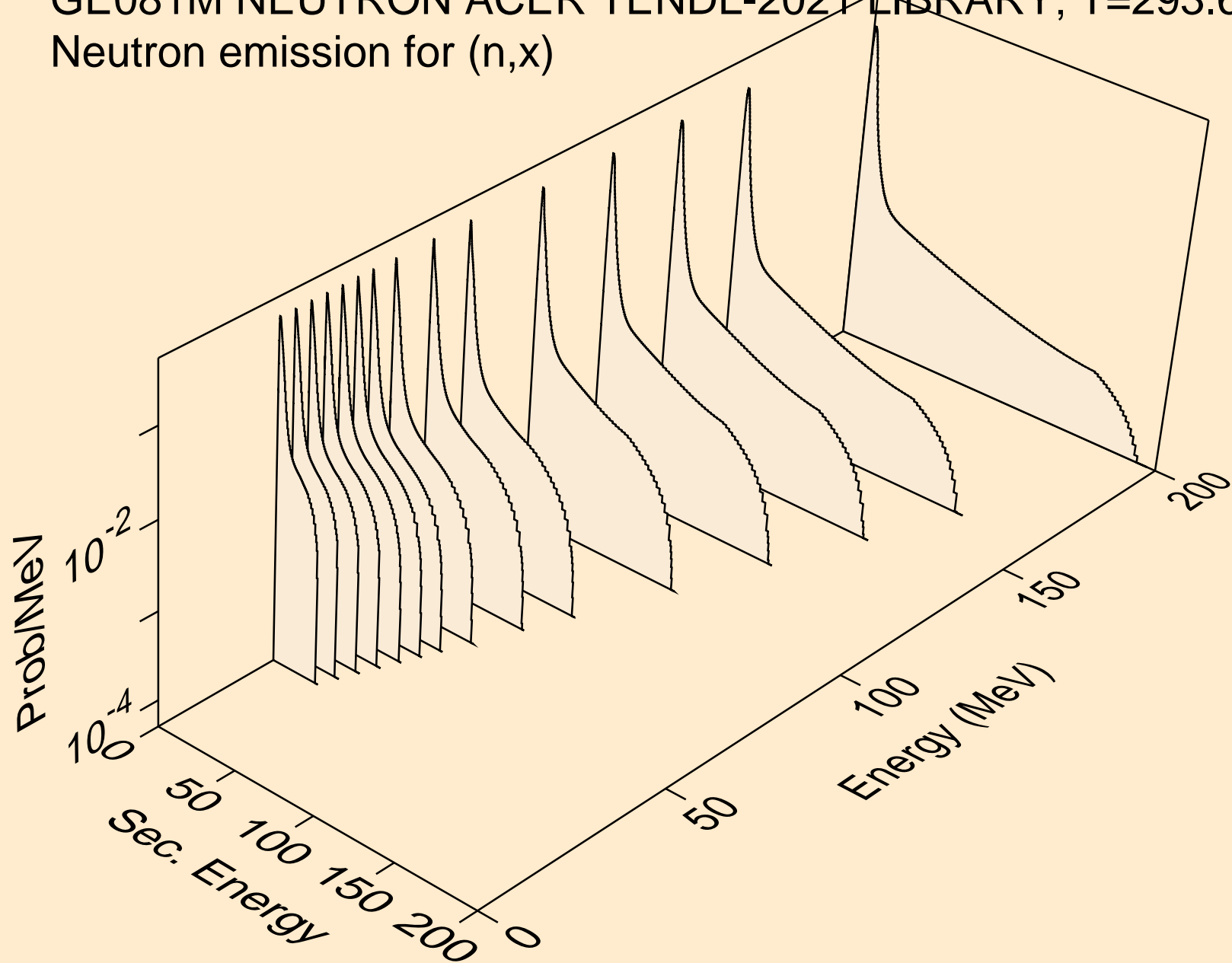

GE081M NEUTRON ACER TENDL-2021 LIBRARY; T=293.6K
Neutron emission for (n,2nd)

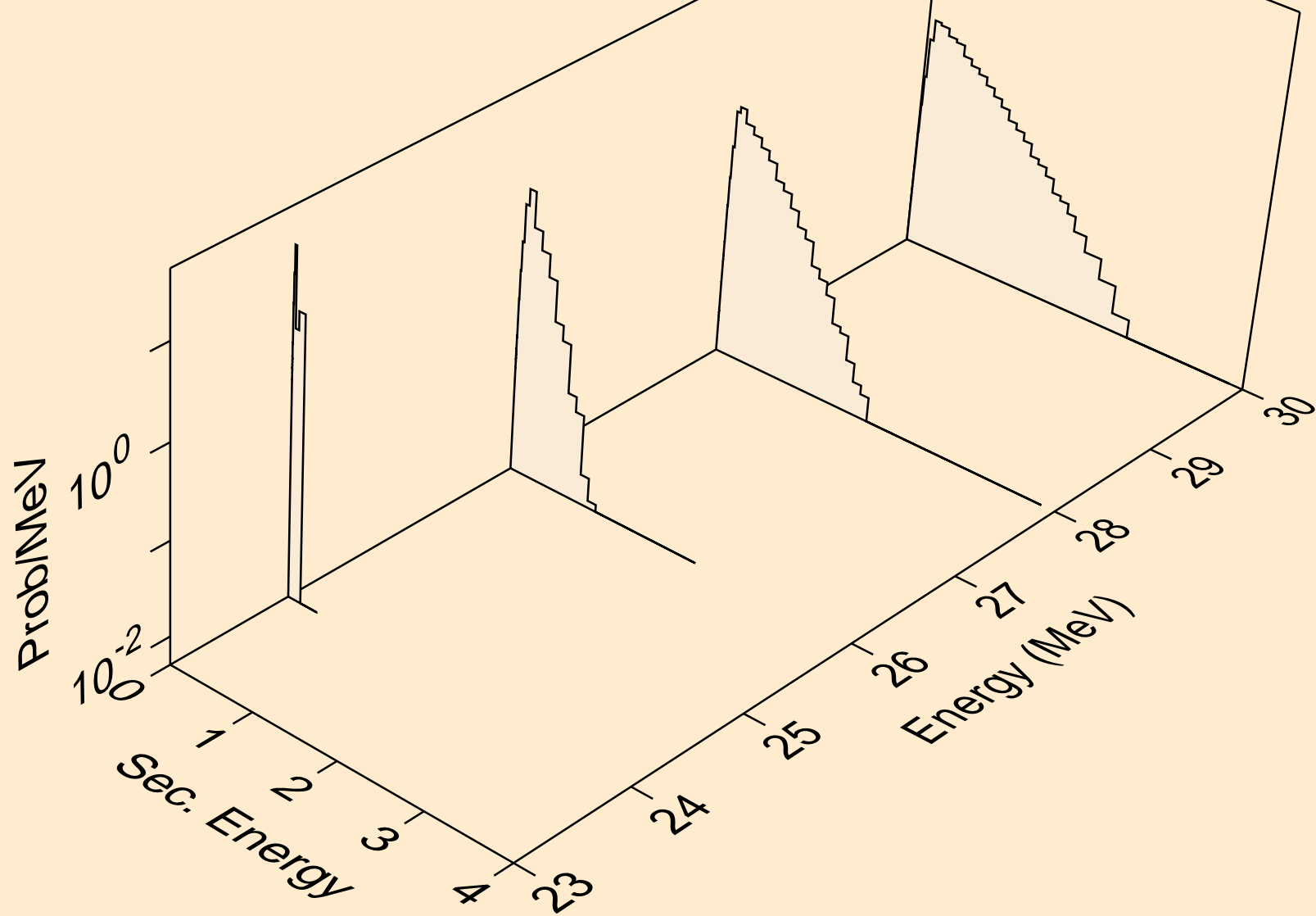

GE081M NEUTRON ACER TENDL-2021 LIBRARY; T=293.6K
Neutron emission for (n,2n)

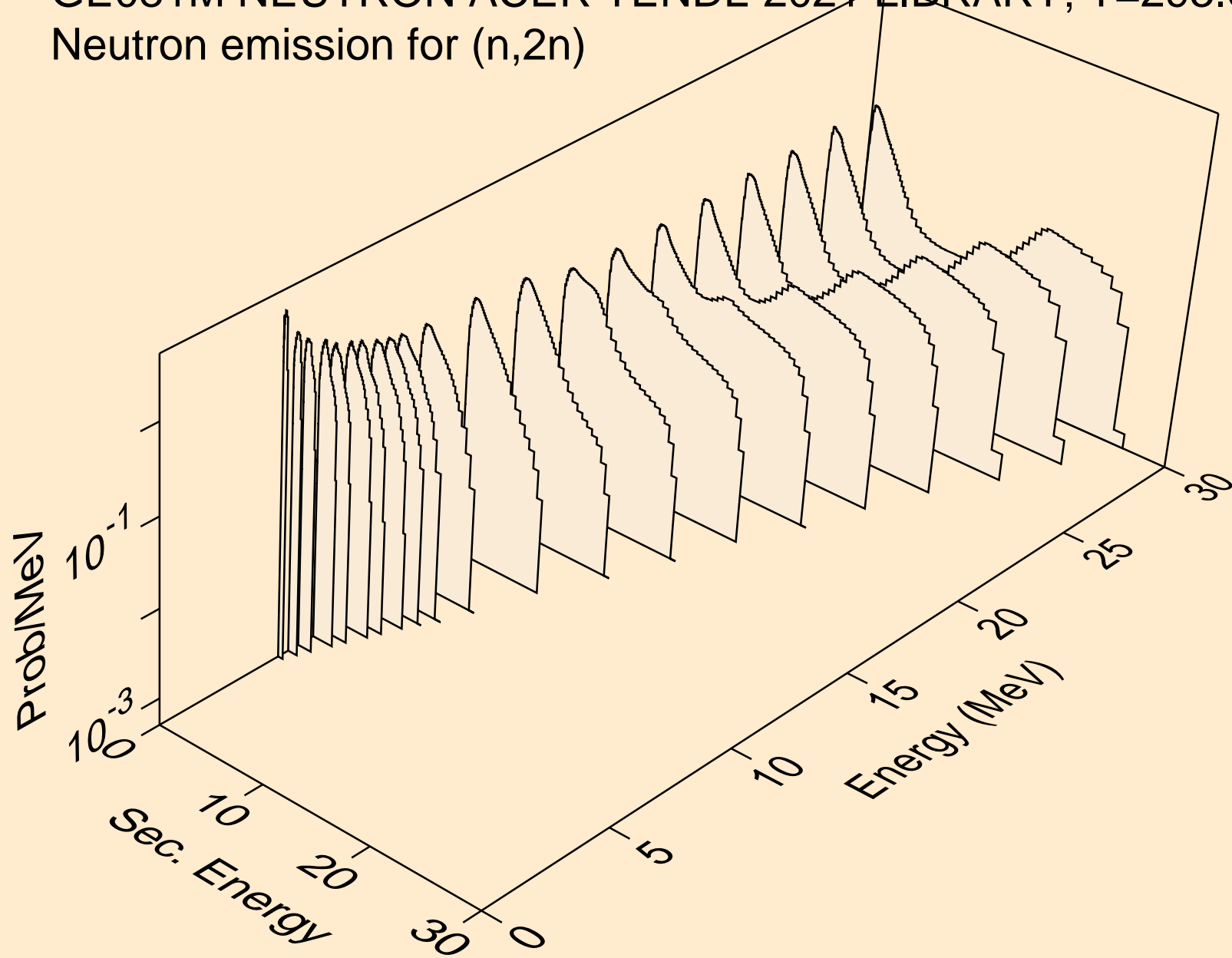

GE081M NEUTRON ACER TENDL-2021 LIBRARY; T=293.6K
Neutron emission for (n,3n)

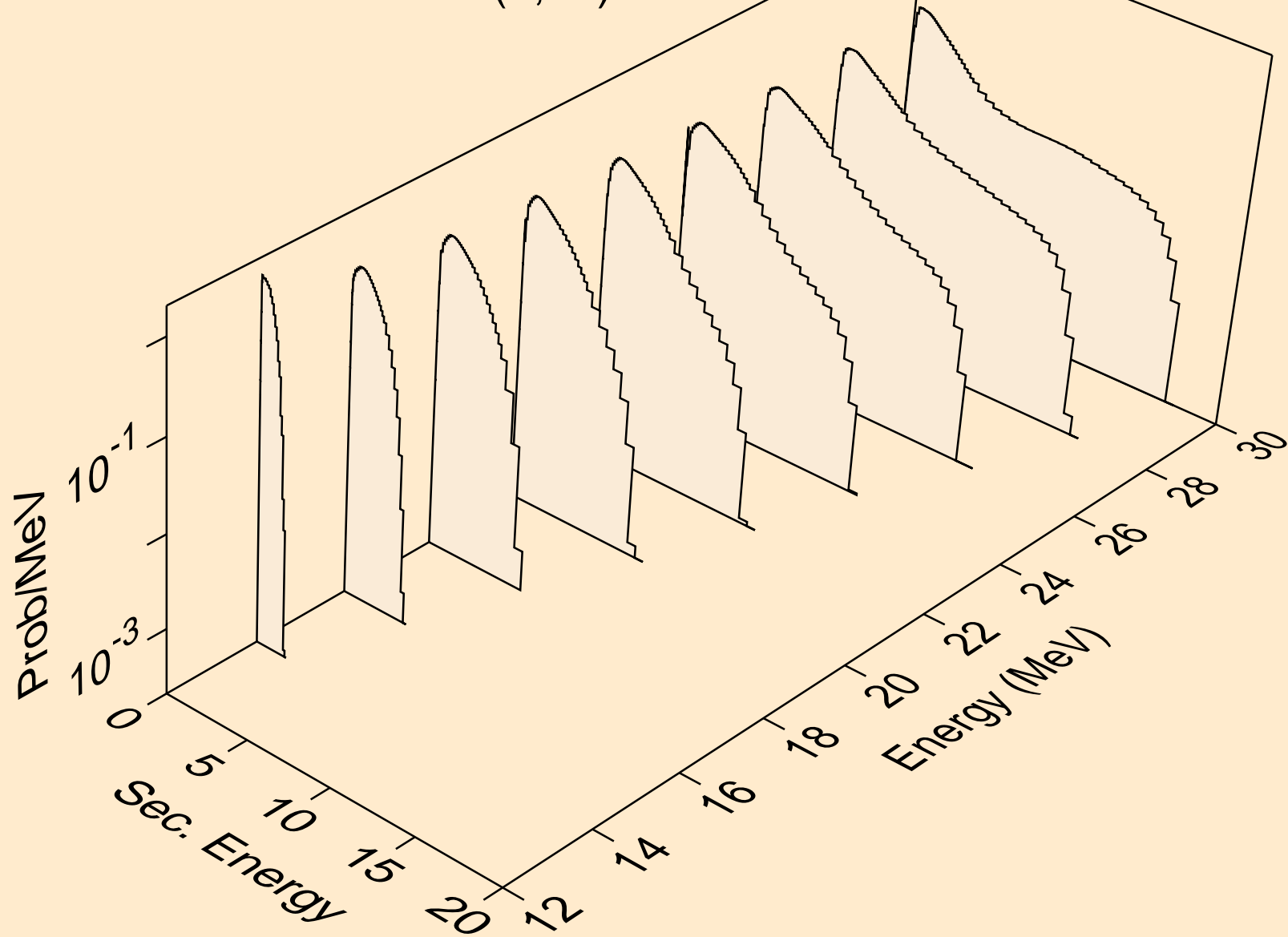

GE081M NEUTRON ACER TENDL-2021 LIBRARY; T=293.6K
Neutron emission for (n,n*)a

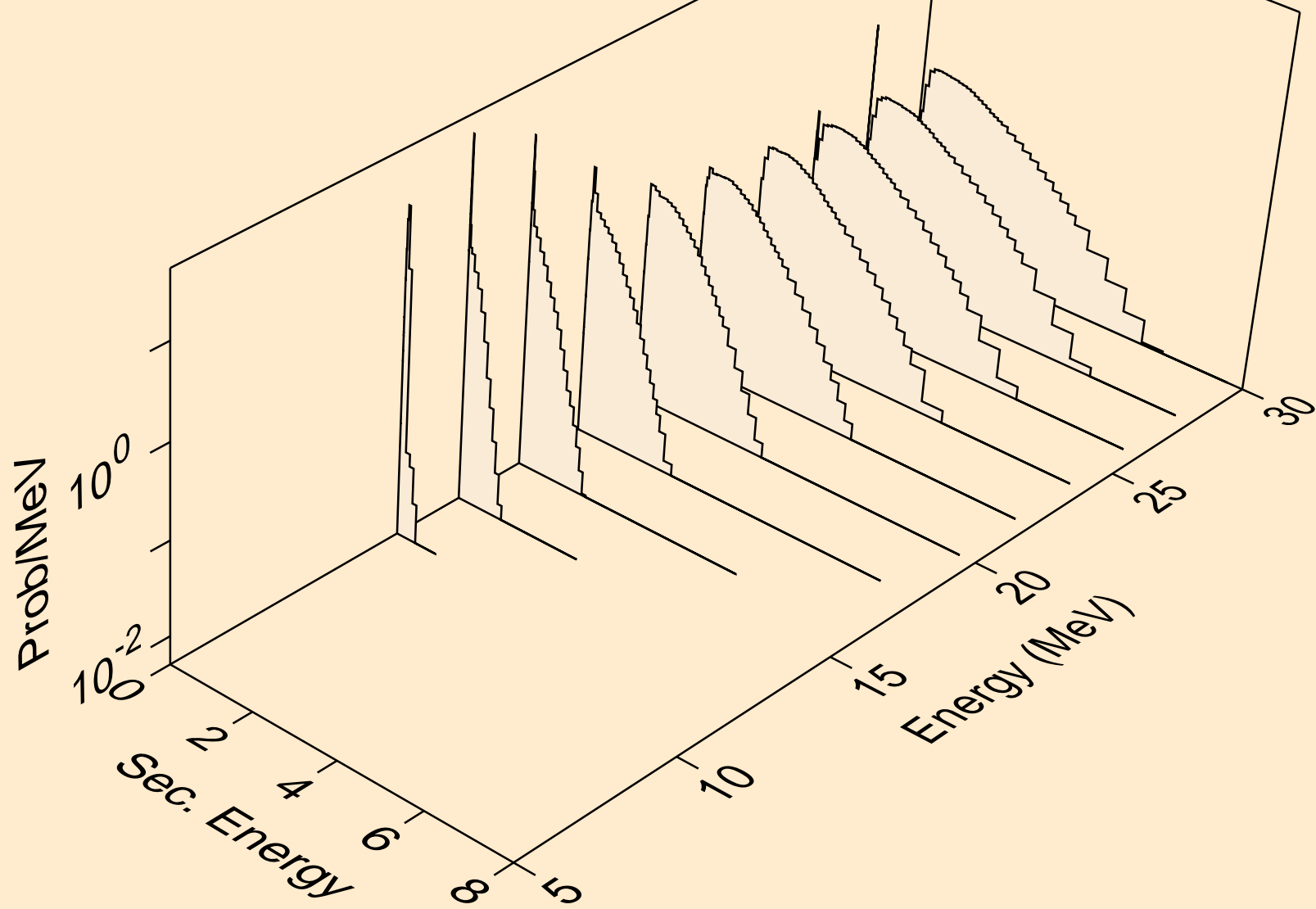

GE081M NEUTRON ACER TENDL-2021 LIBRARY; T=293.6K
Neutron emission for (n,2n)a

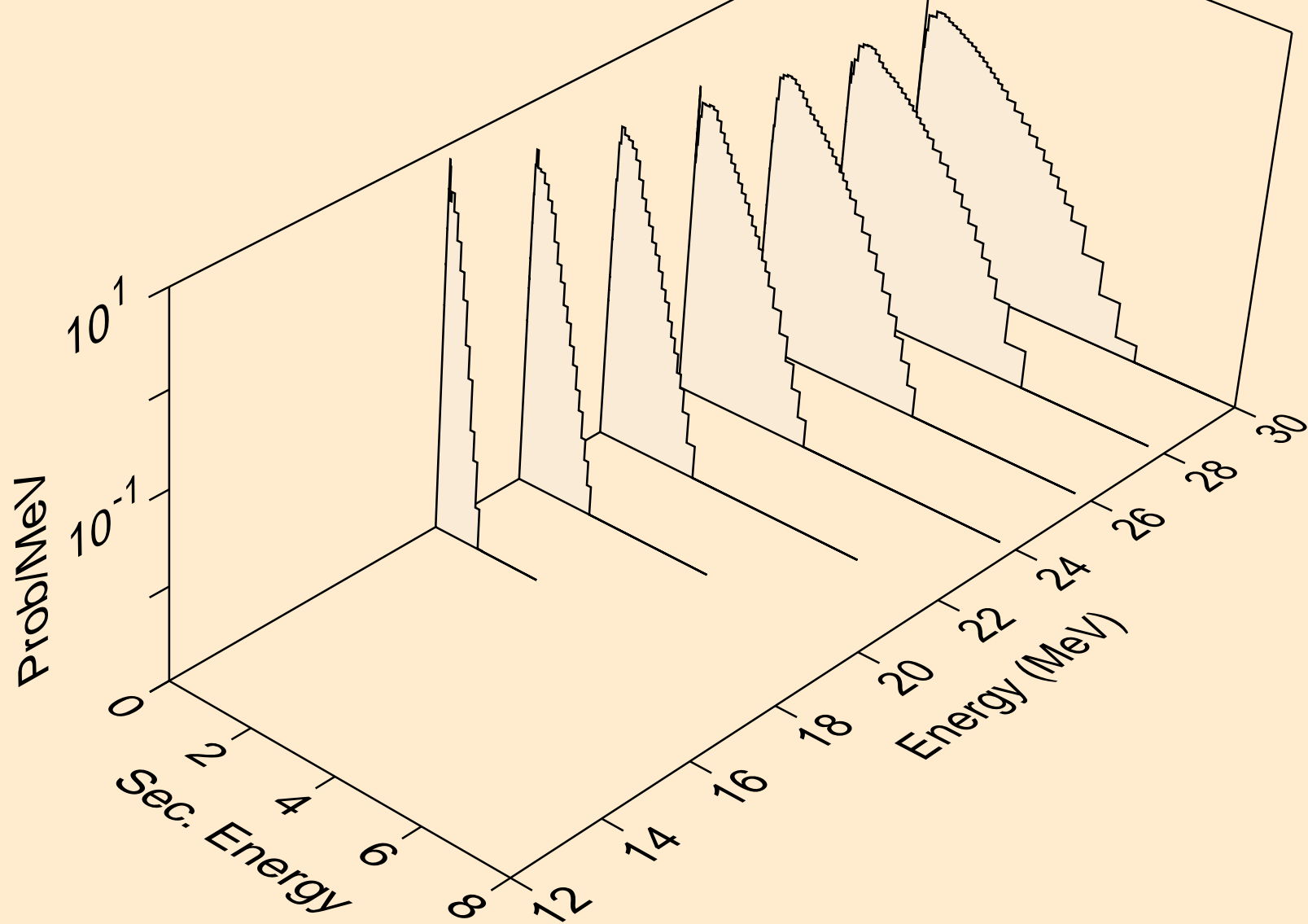

GE081M NEUTRON ACER TENDL-2021 LIBRARY; T=293.6K
Neutron emission for (n,3n)a

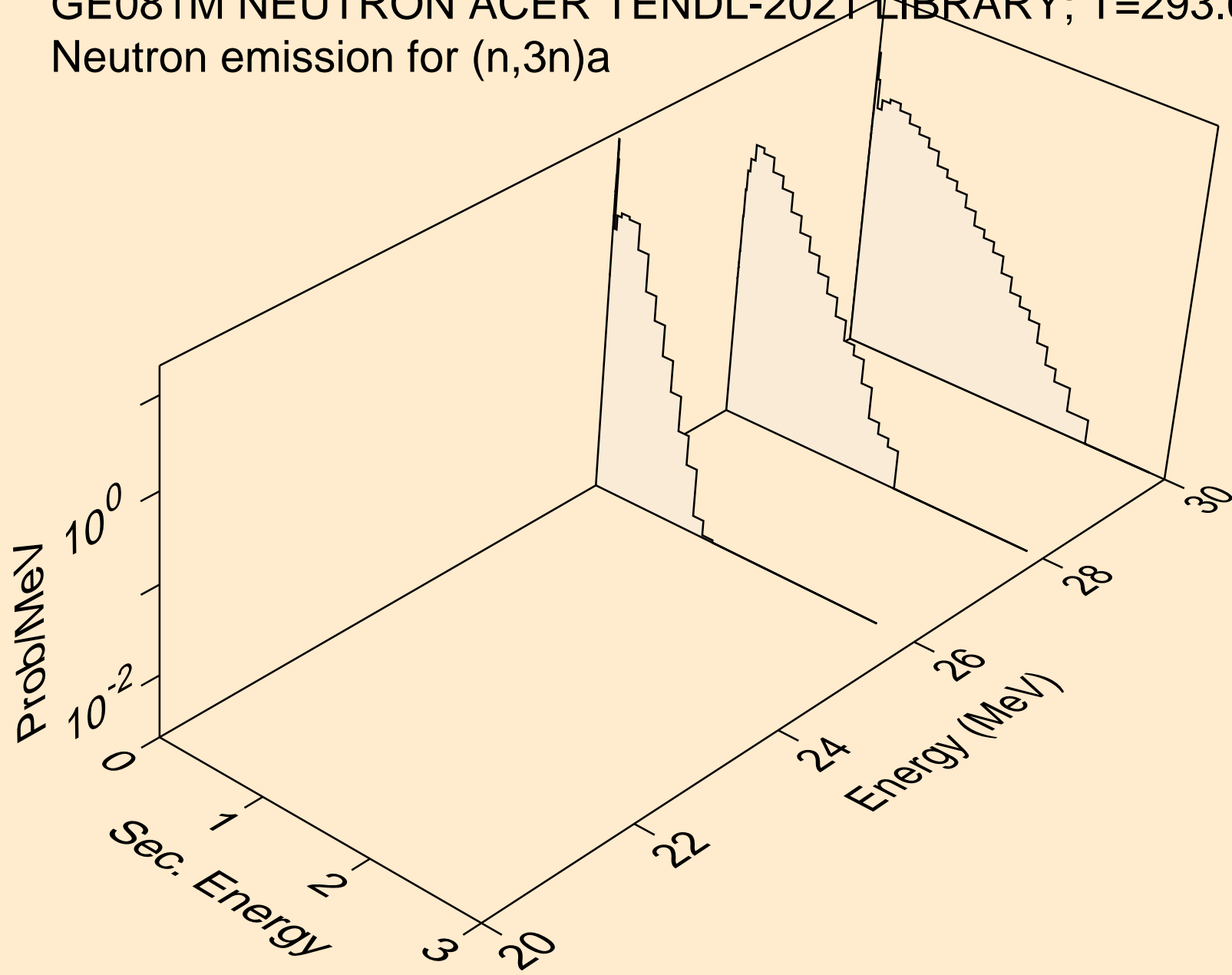

GE081M NEUTRON ACER TENDL-2021 LIBRARY; T=293.6K
Neutron emission for (n,n*)p

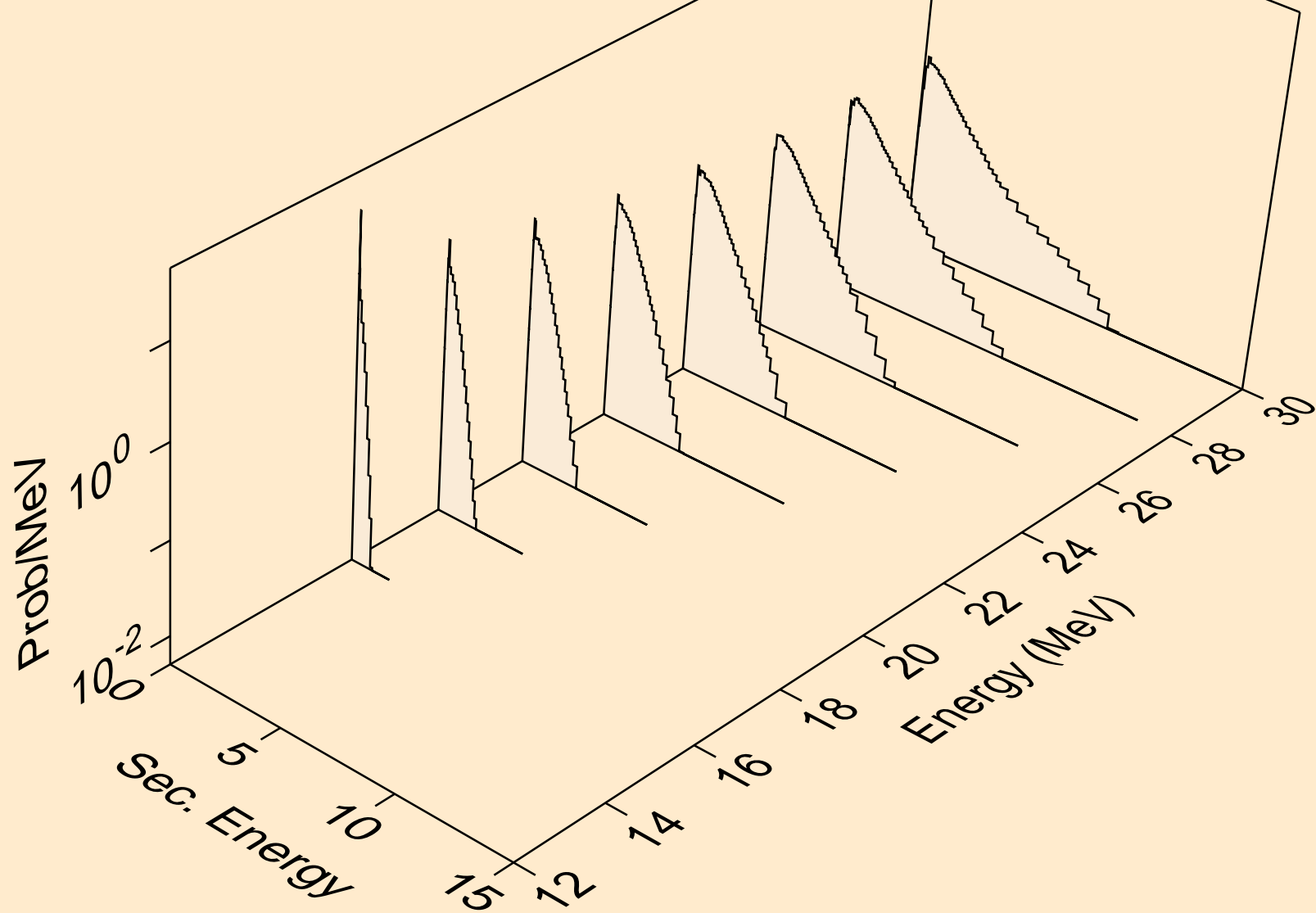

GE081M NEUTRON ACER TENDL-2021 LIBRARY; T=293.6K
Neutron emission for (n,n*)d

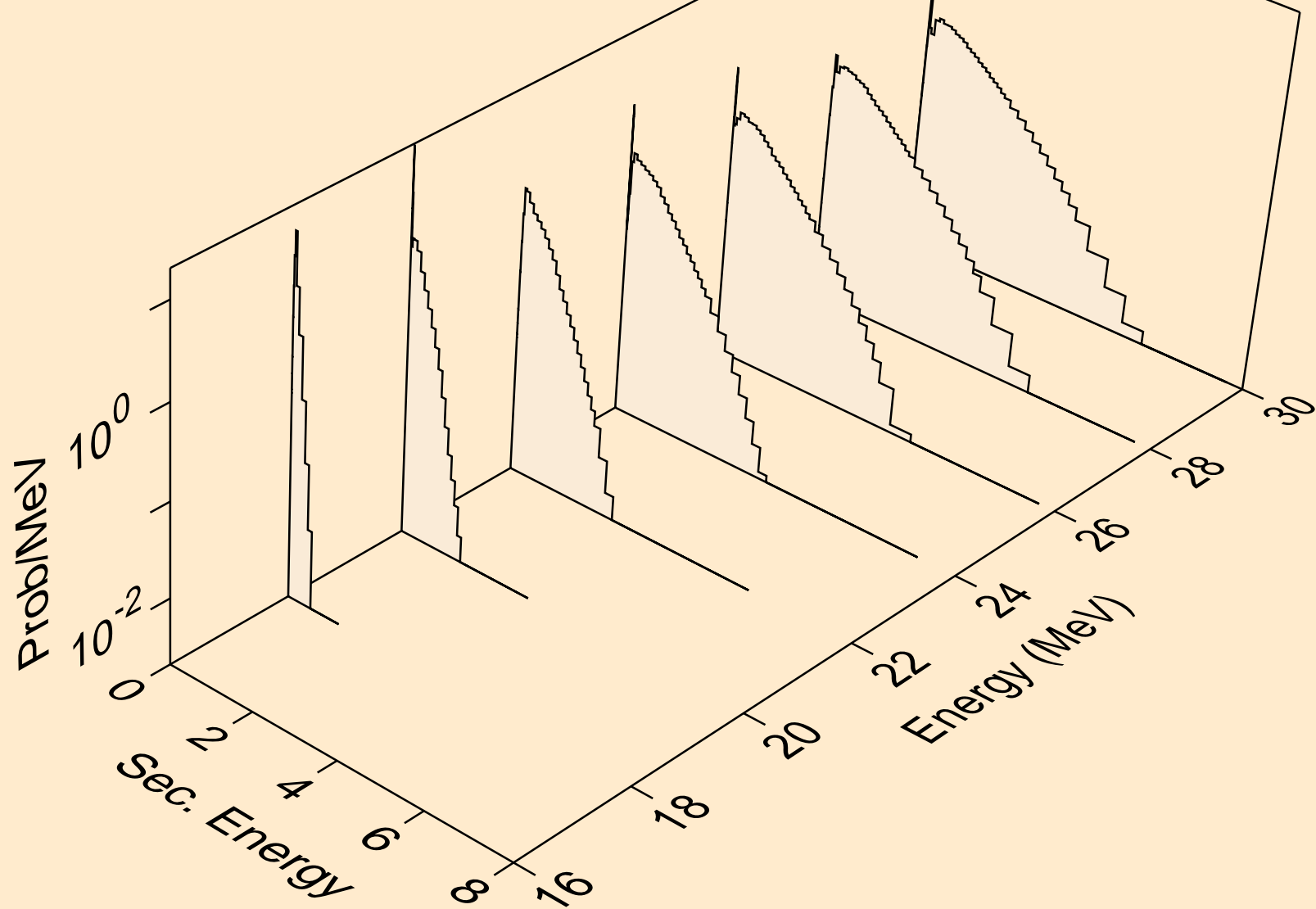

GE081M NEUTRON ACER TENDL-2021 LIBRARY; T=293.6K
Neutron emission for (n,n*)t

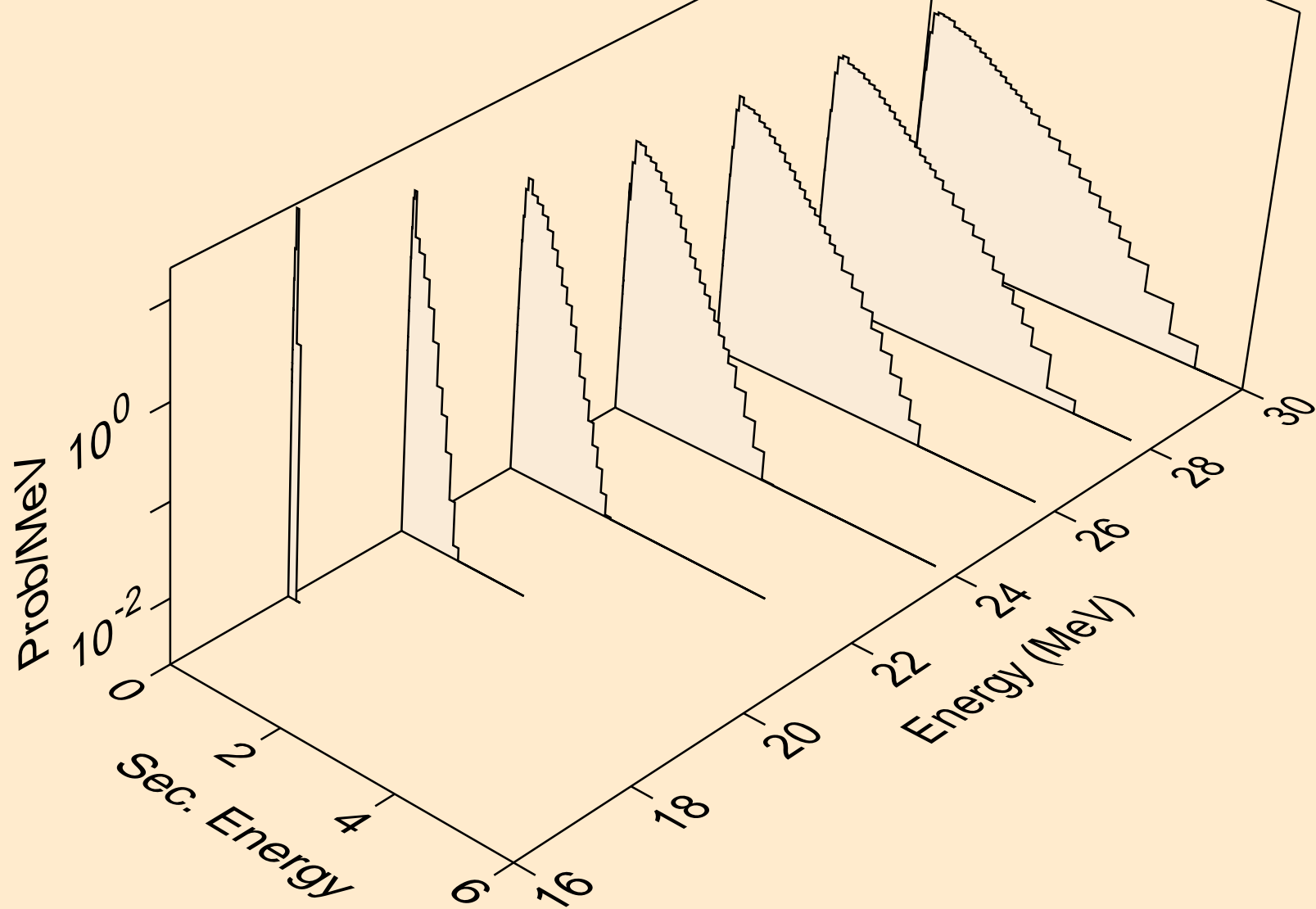

GE081M NEUTRON ACER TENDL-2021 LIBRARY; T=293.6K
Neutron emission for (n,n*)he3

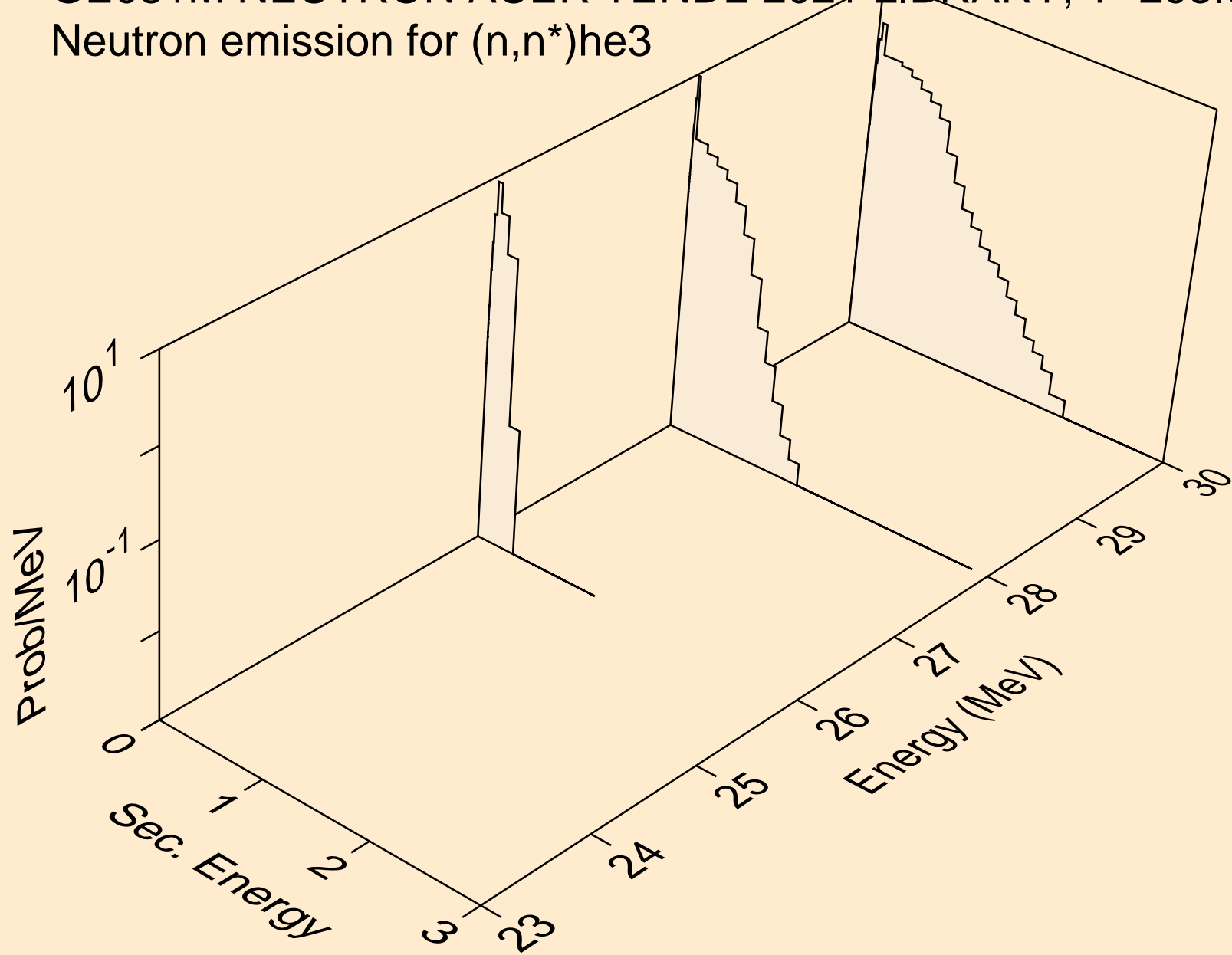

GE081M NEUTRON ACER TENDL-2021 LIBRARY; T=293.6K
Neutron emission for (n,4n)

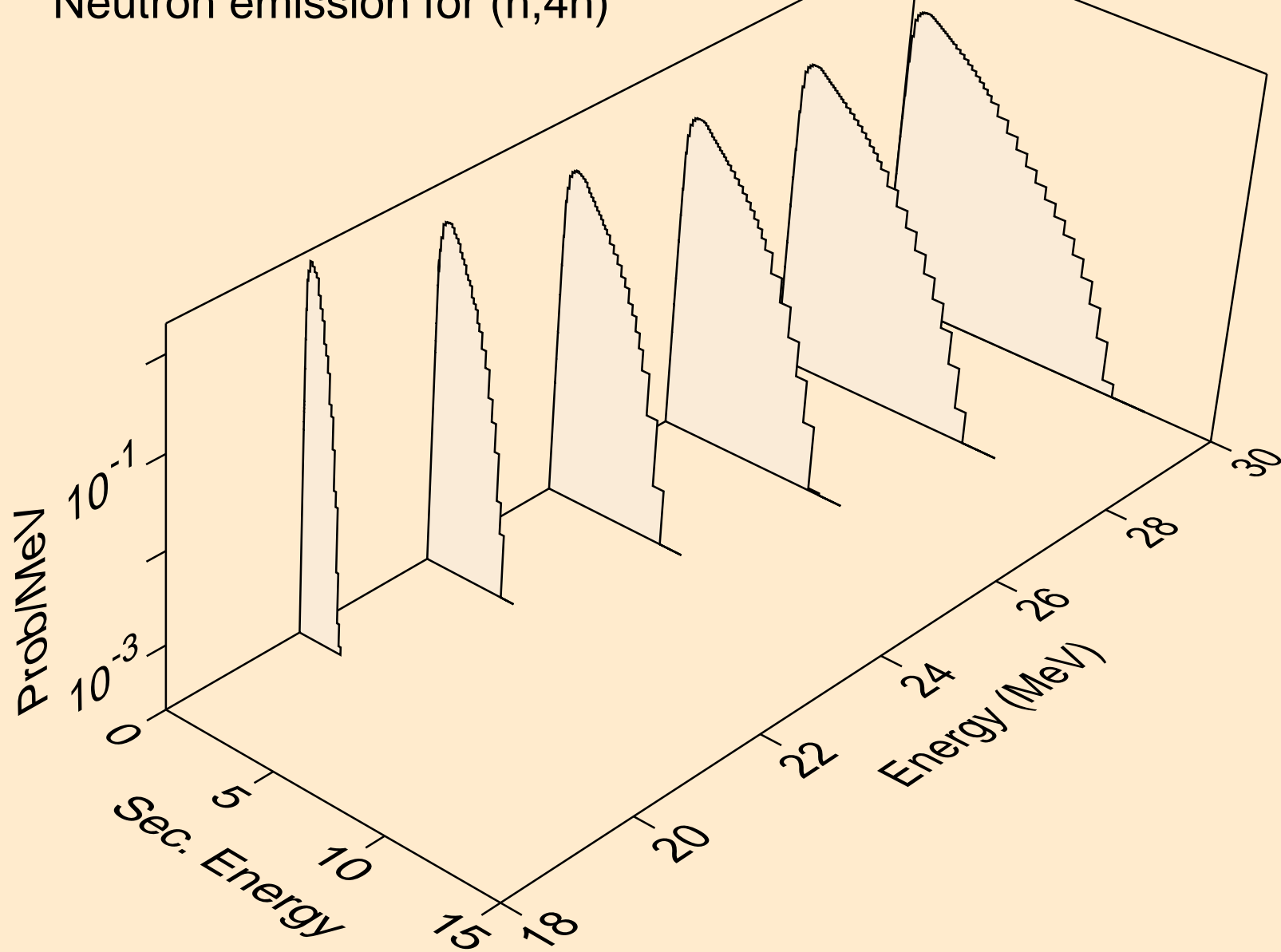

GE081M NEUTRON ACER TENDL-2021 LIBRARY; T=293.6K
Neutron emission for (n,2np)

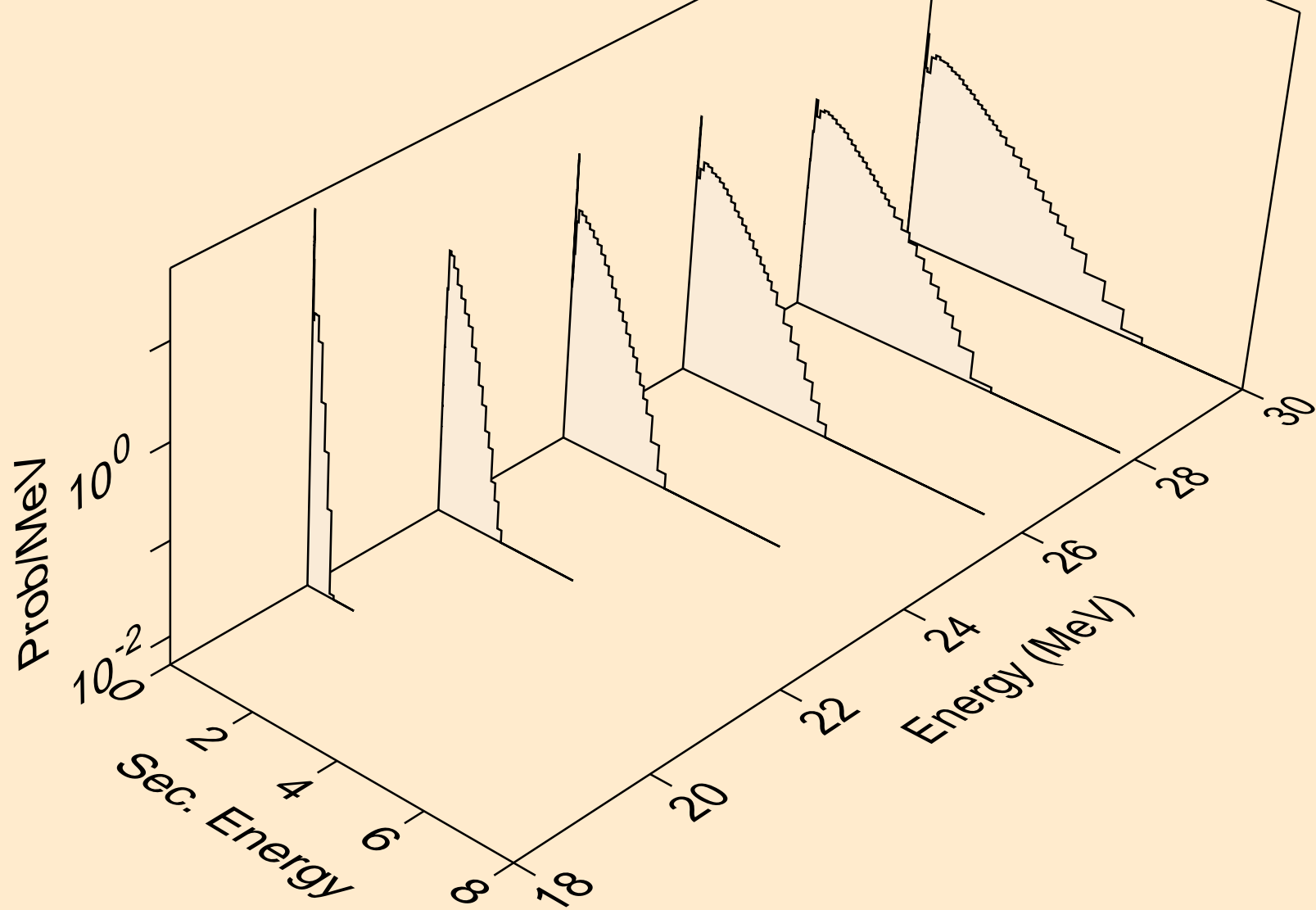

GE081M NEUTRON ACER TENDL-2021 LIBRARY; T=293.6K
Neutron emission for (n,3np)

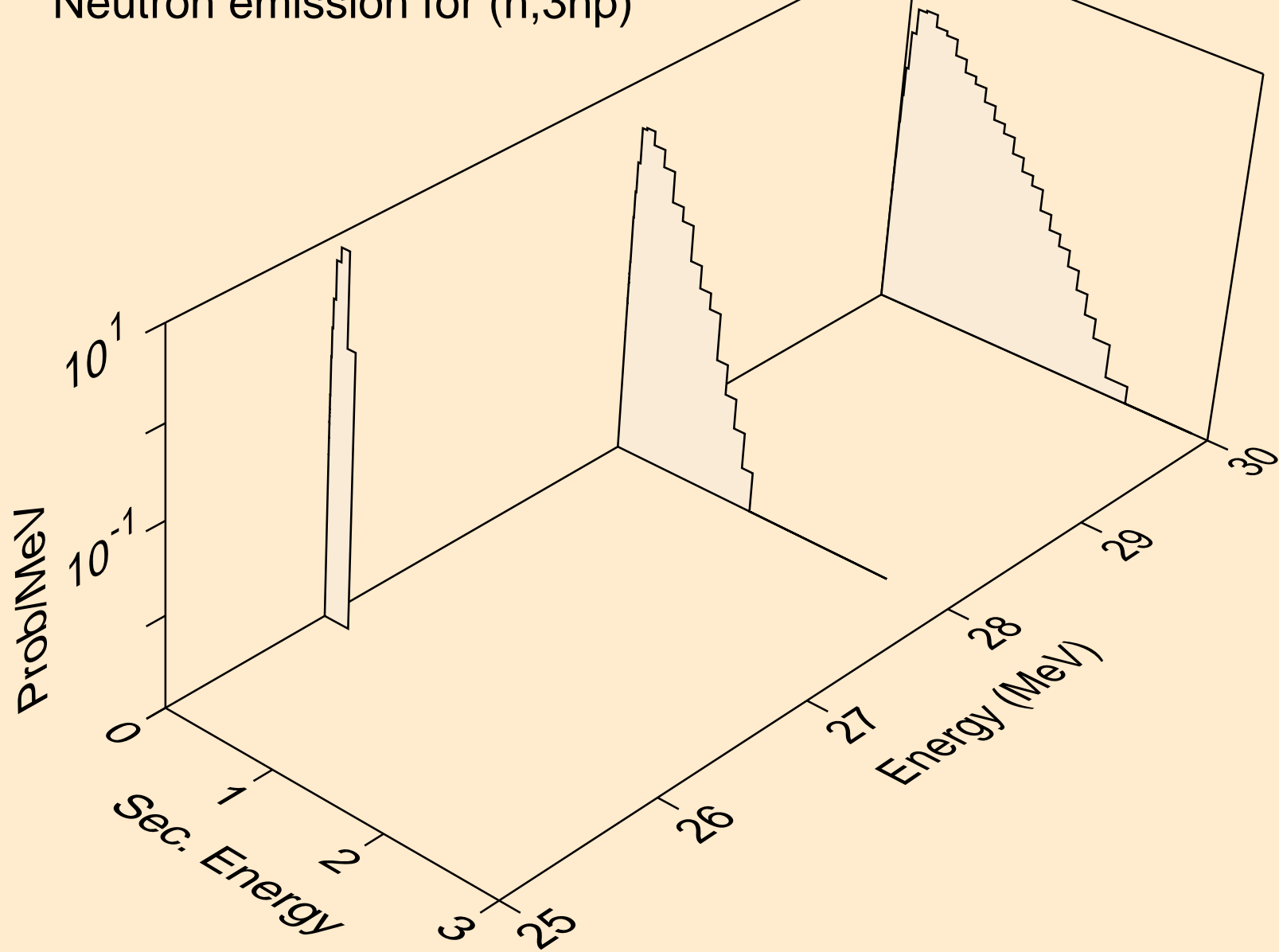

GE081M NEUTRON ACER TENDL-2021 LIBRARY; T=293.6K
Neutron emission for (n,n*c)

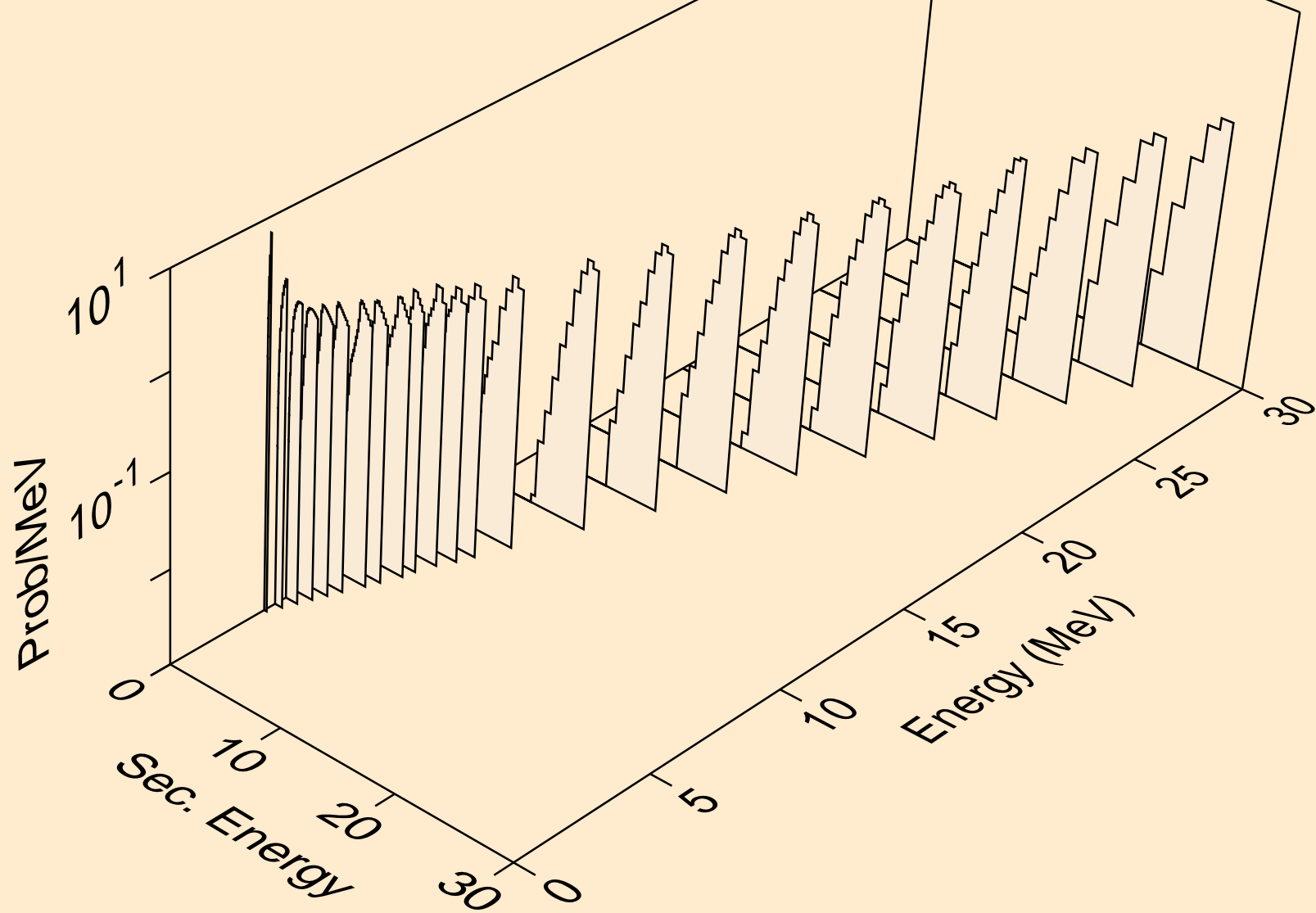

GE081M NEUTRON ACER TENDL-2021 LIBRARY; T=293.6K
Photon emission for (n,x)

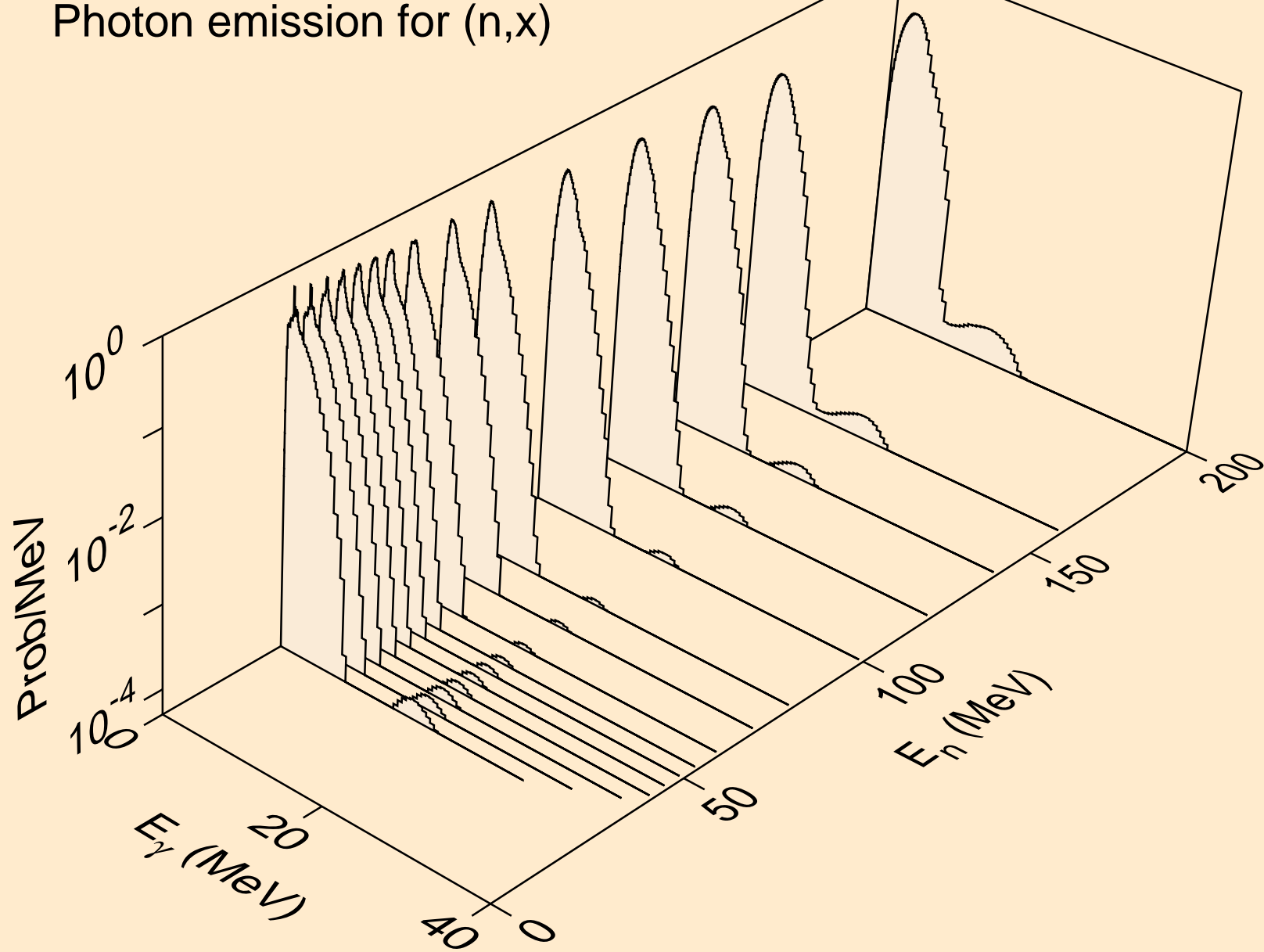

GE081M NEUTRON ACER TENDL-2021 LIBRARY; T=293.6K
Photon emission for (n,2nd)

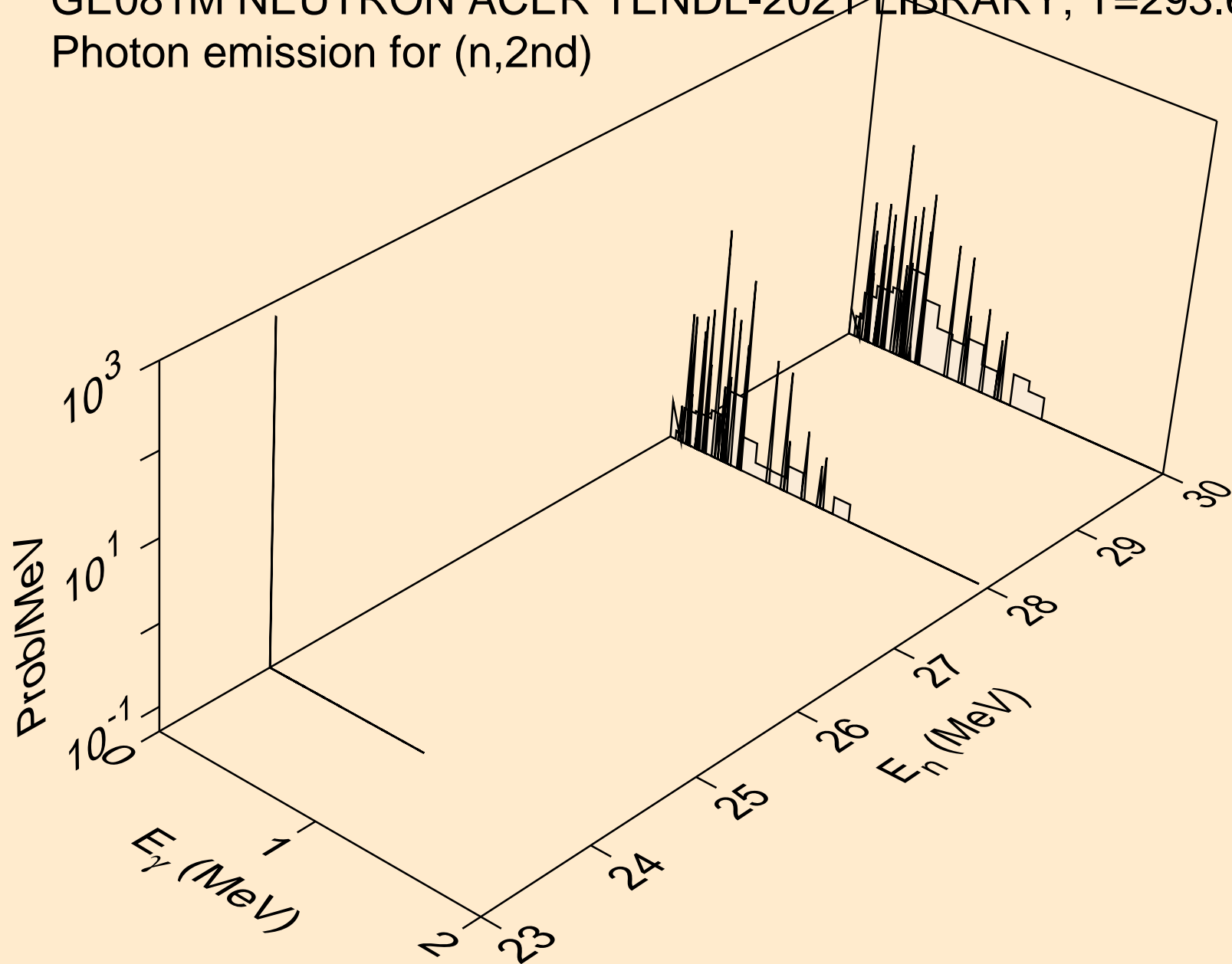

GE081M NEUTRON ACER TENDL-2021 LIBRARY; T=293.6K
Photon emission for (n,2n)

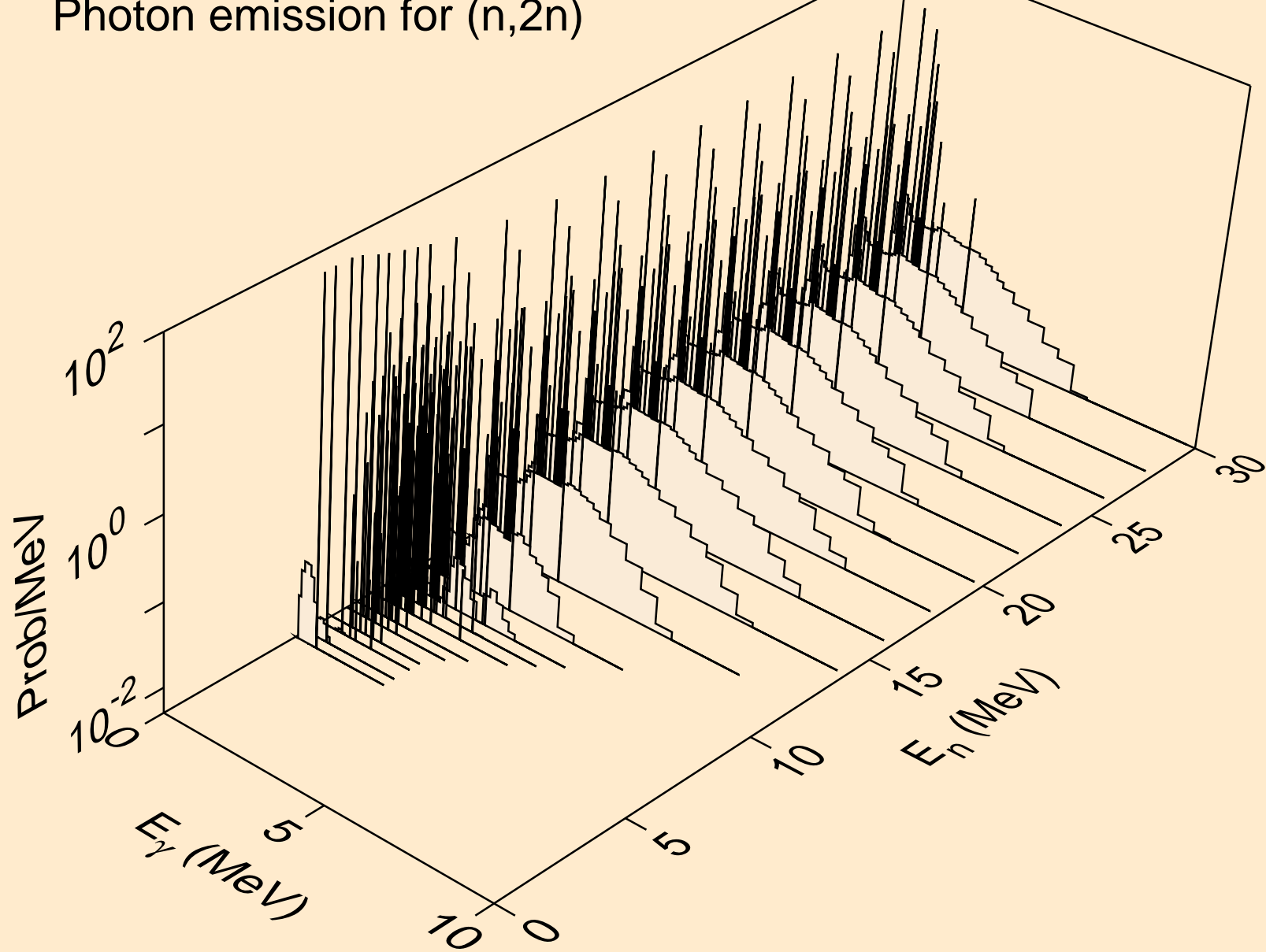

GE081M NEUTRON ACER TENDL-2021 LIBRARY; T=293.6K
Photon emission for (n,3n)

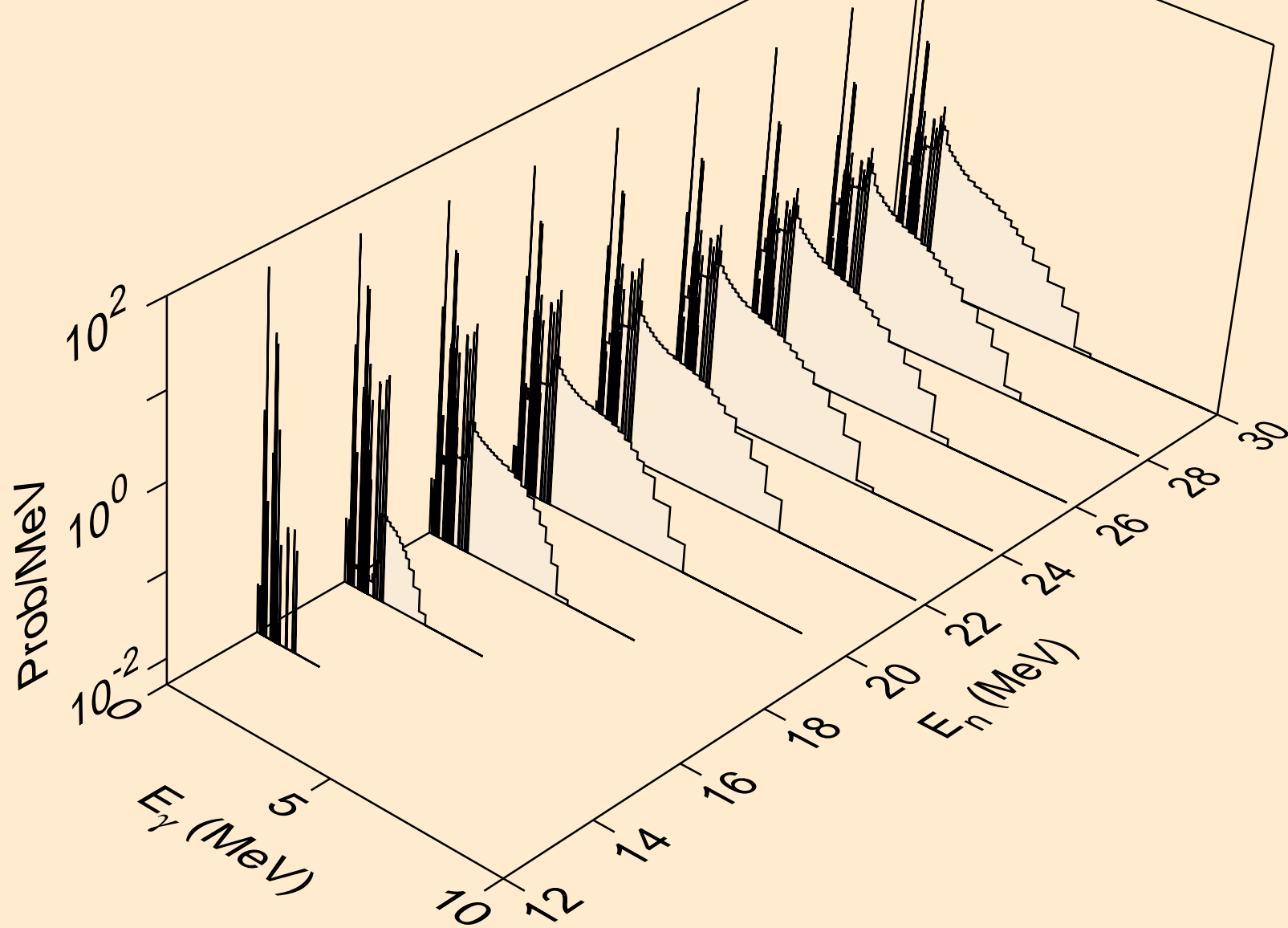

GE081M NEUTRON ACER TENDL-2021 LIBRARY; T=293.6K
Photon emission for (n,n*)a

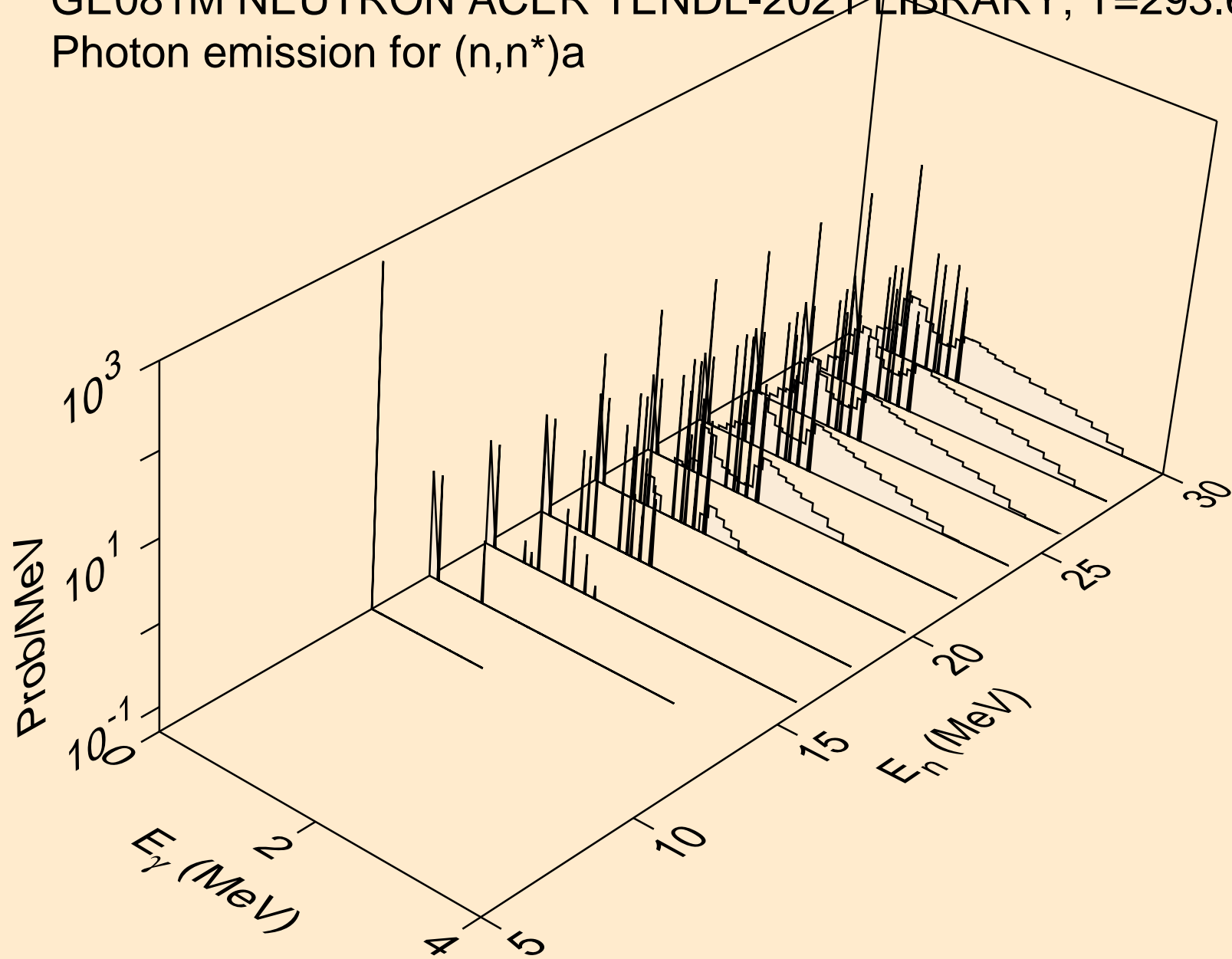

GE081M NEUTRON ACER TENDL-2021 LIBRARY; T=293.6K
Photon emission for (n,2n)a

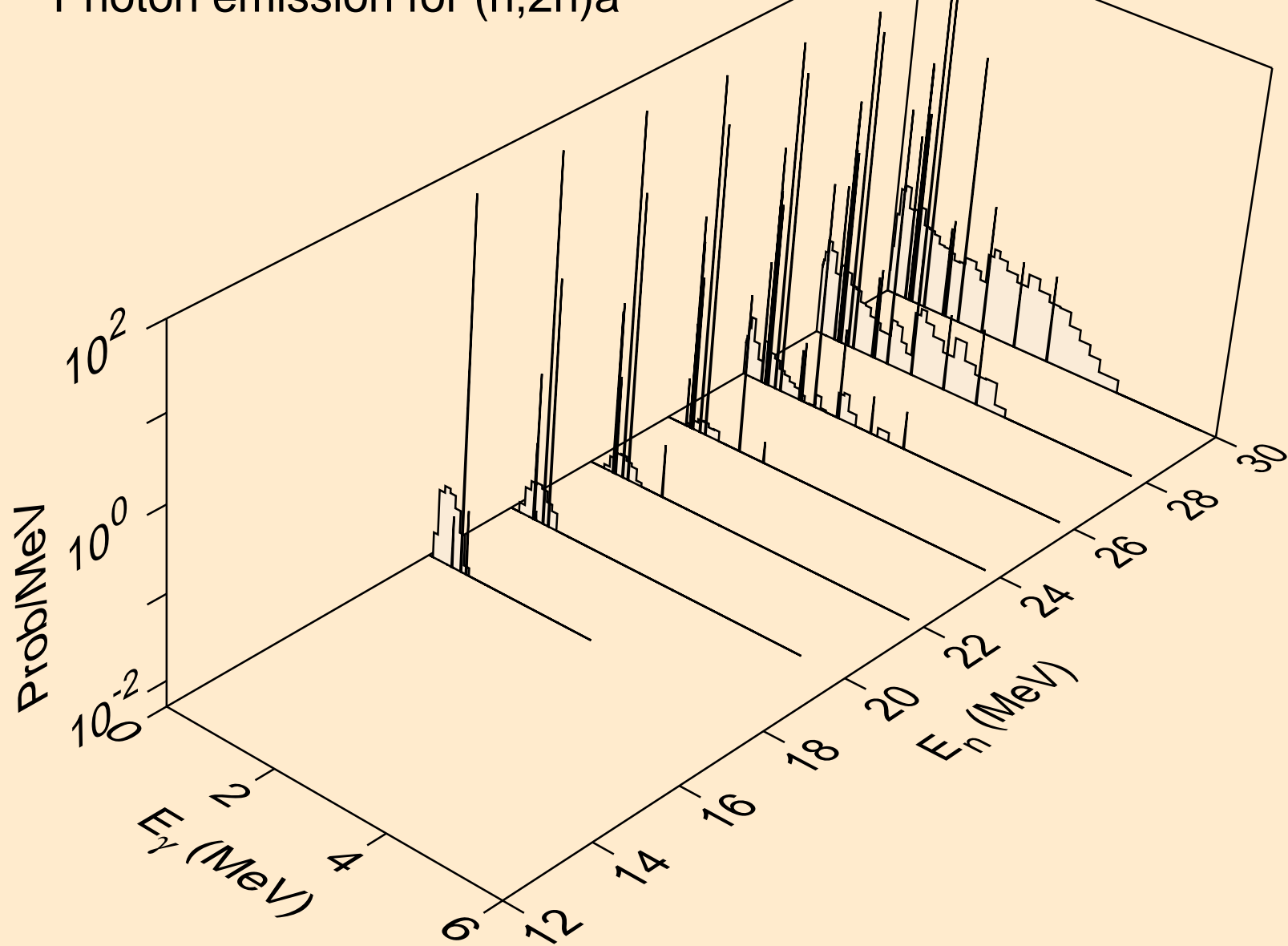

GE081M NEUTRON ACER TENDL-2021 LIBRARY; T=293.6K
Photon emission for (n,3n)a

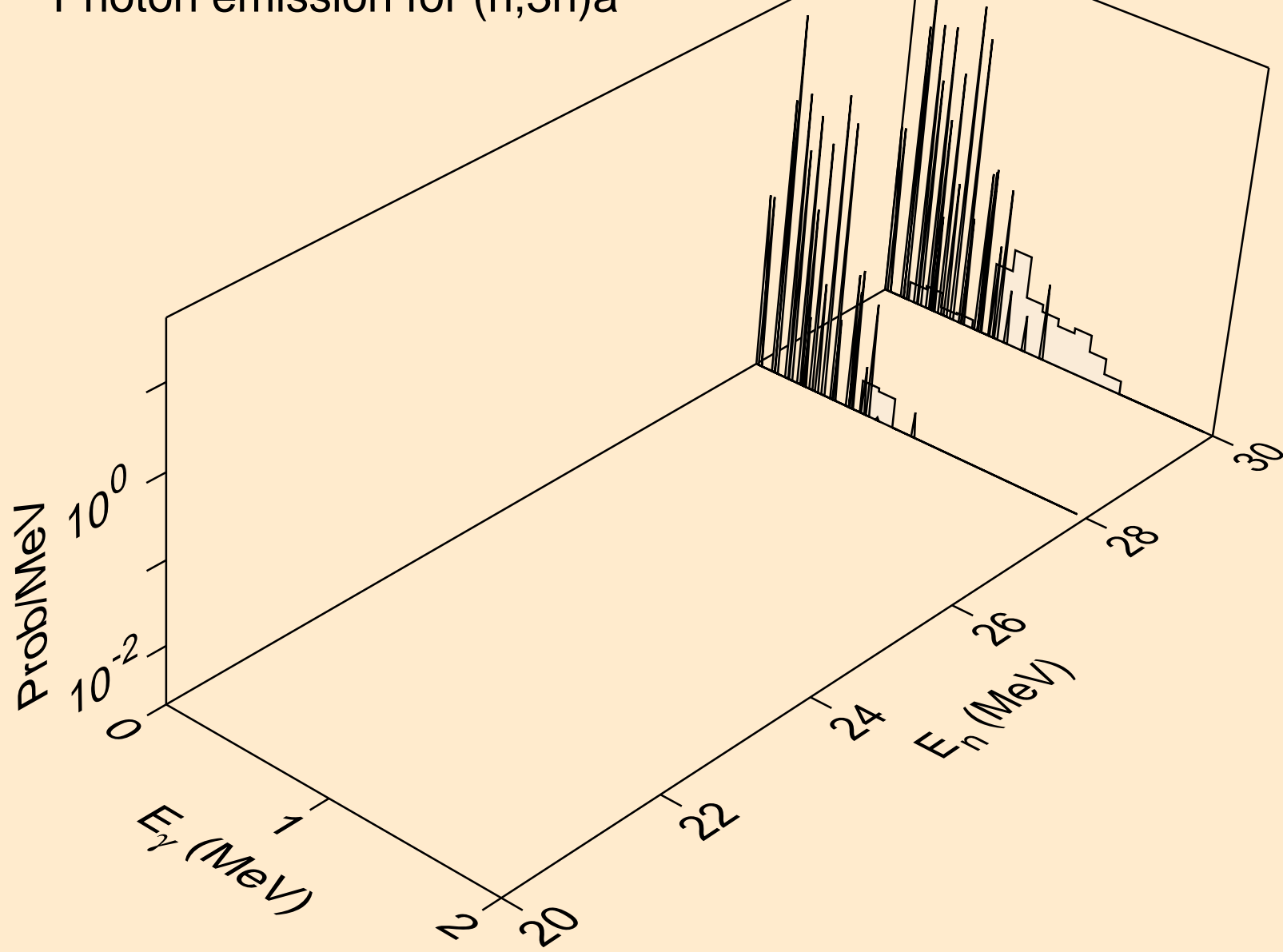

GE081M NEUTRON ACER TENDL-2021 LIBRARY; T=293.6K
Photon emission for (n,n*)p

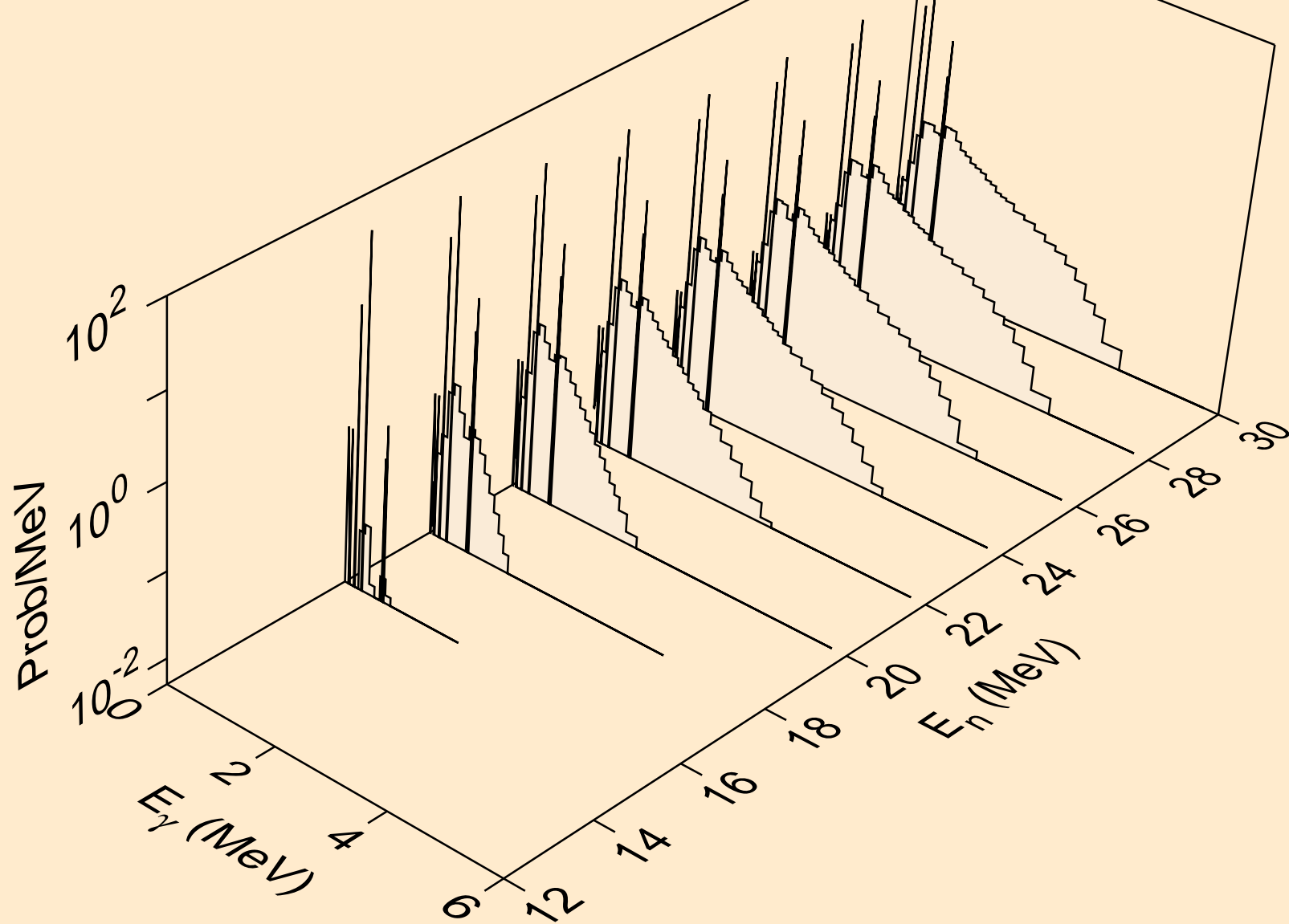

GE081M NEUTRON ACER TENDL-2021 LIBRARY; T=293.6K
Photon emission for (n,n*)d

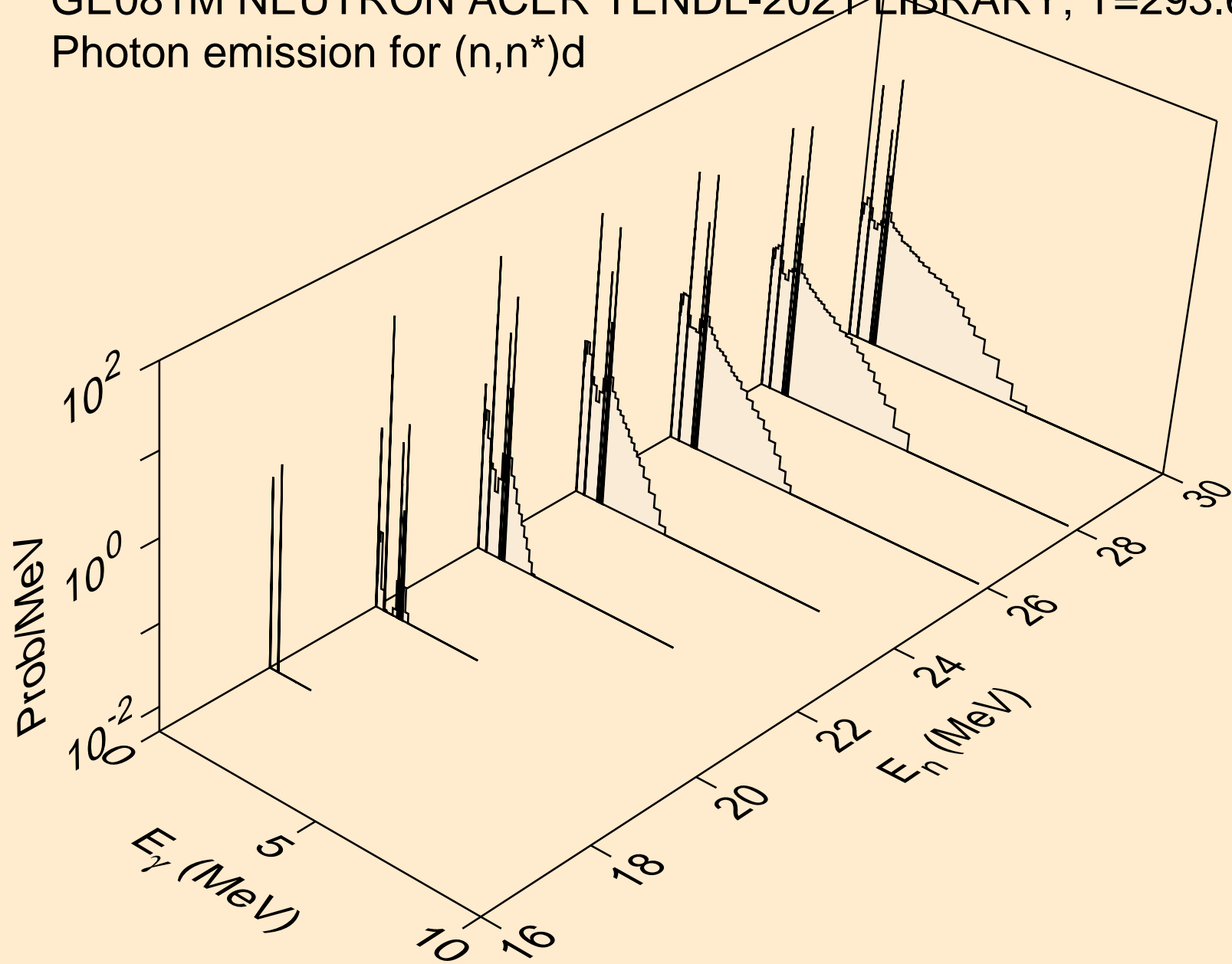

GE081M NEUTRON ACER TENDL-2021 LIBRARY; T=293.6K
Photon emission for (n,n*)t

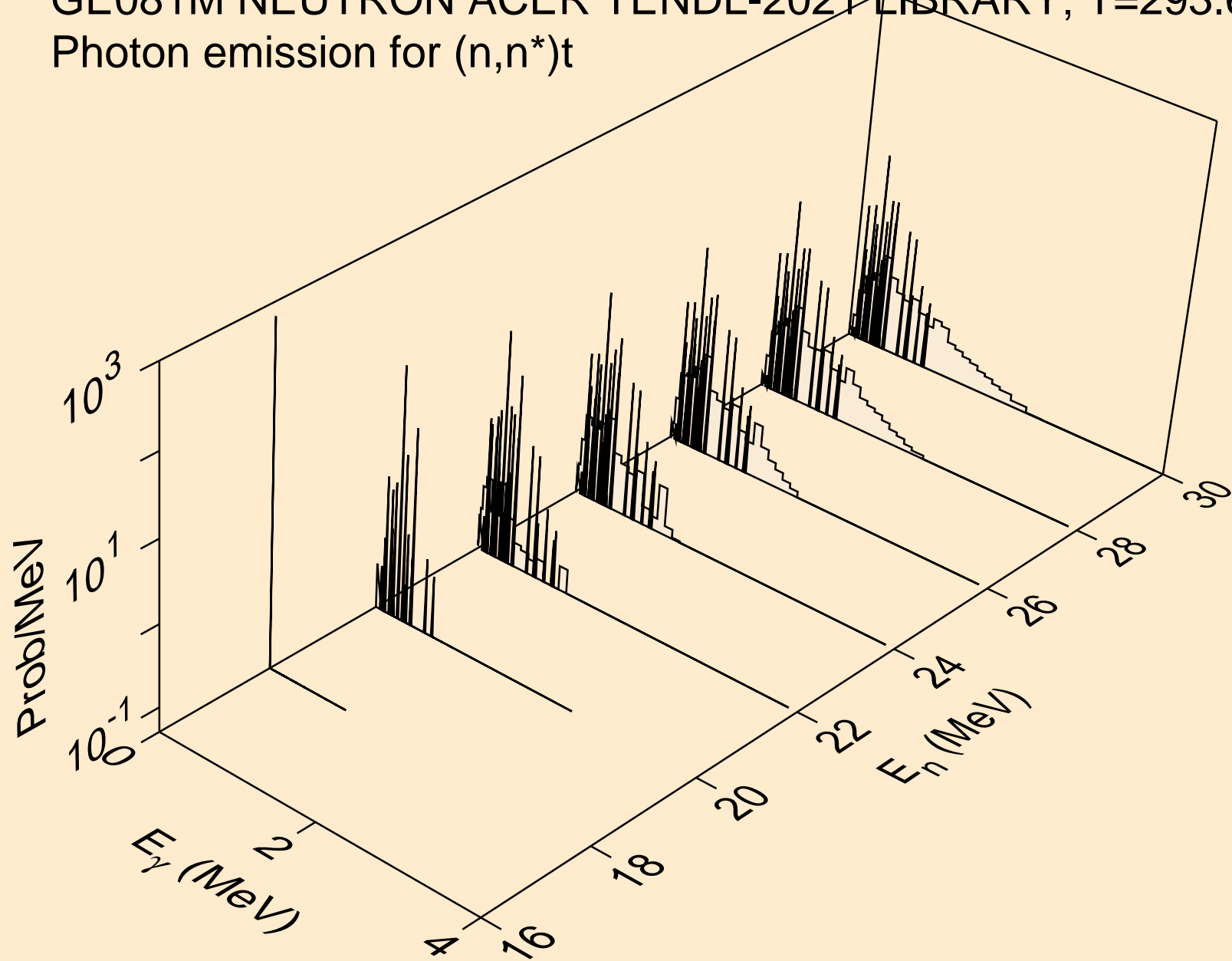

GE081M NEUTRON ACER TENDL-2021 LIBRARY; T=293.6K
Photon emission for (n,n*)he3

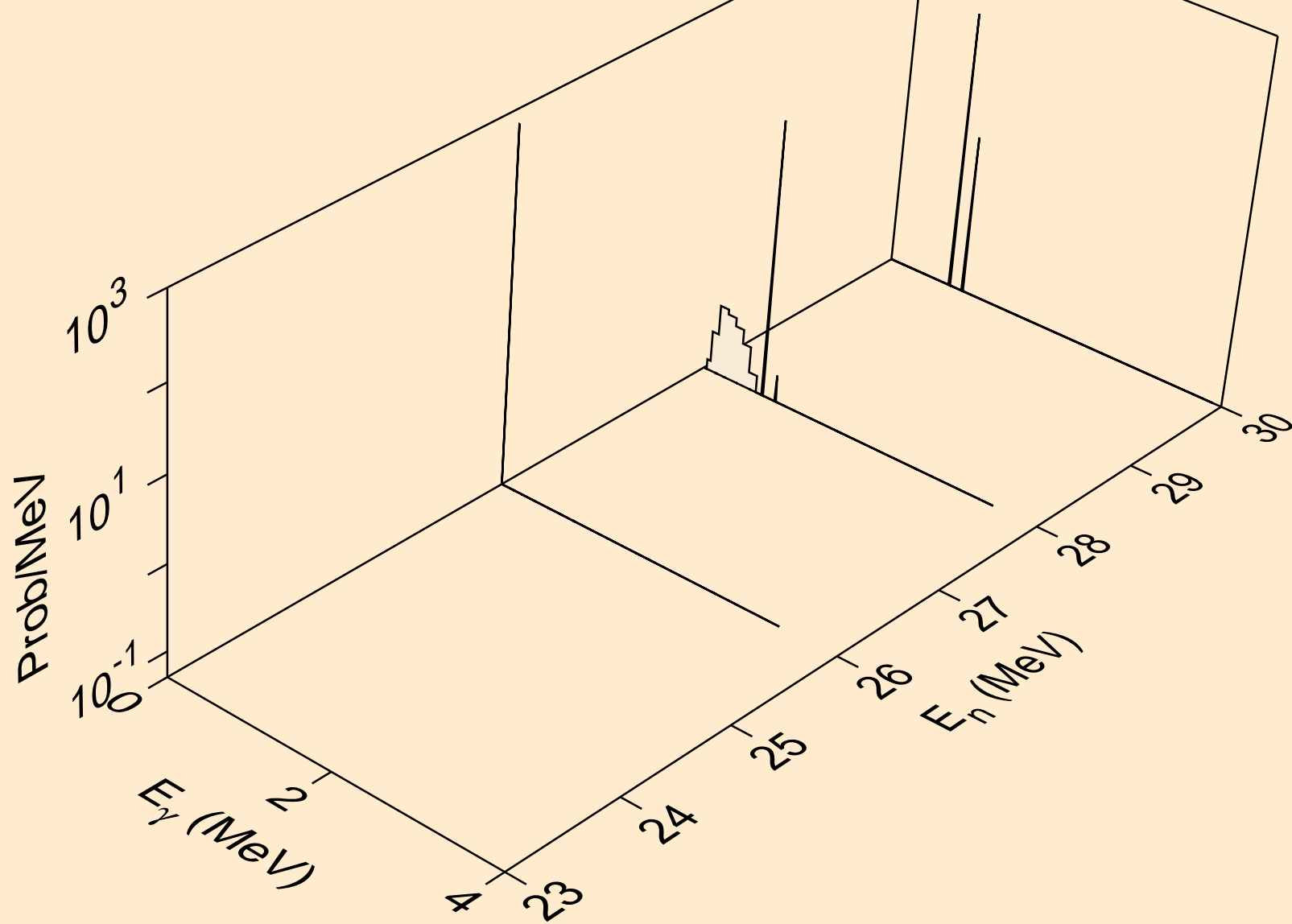

GE081M NEUTRON ACER TENDL-2021 LIBRARY; T=293.6K
Photon emission for (n,4n)

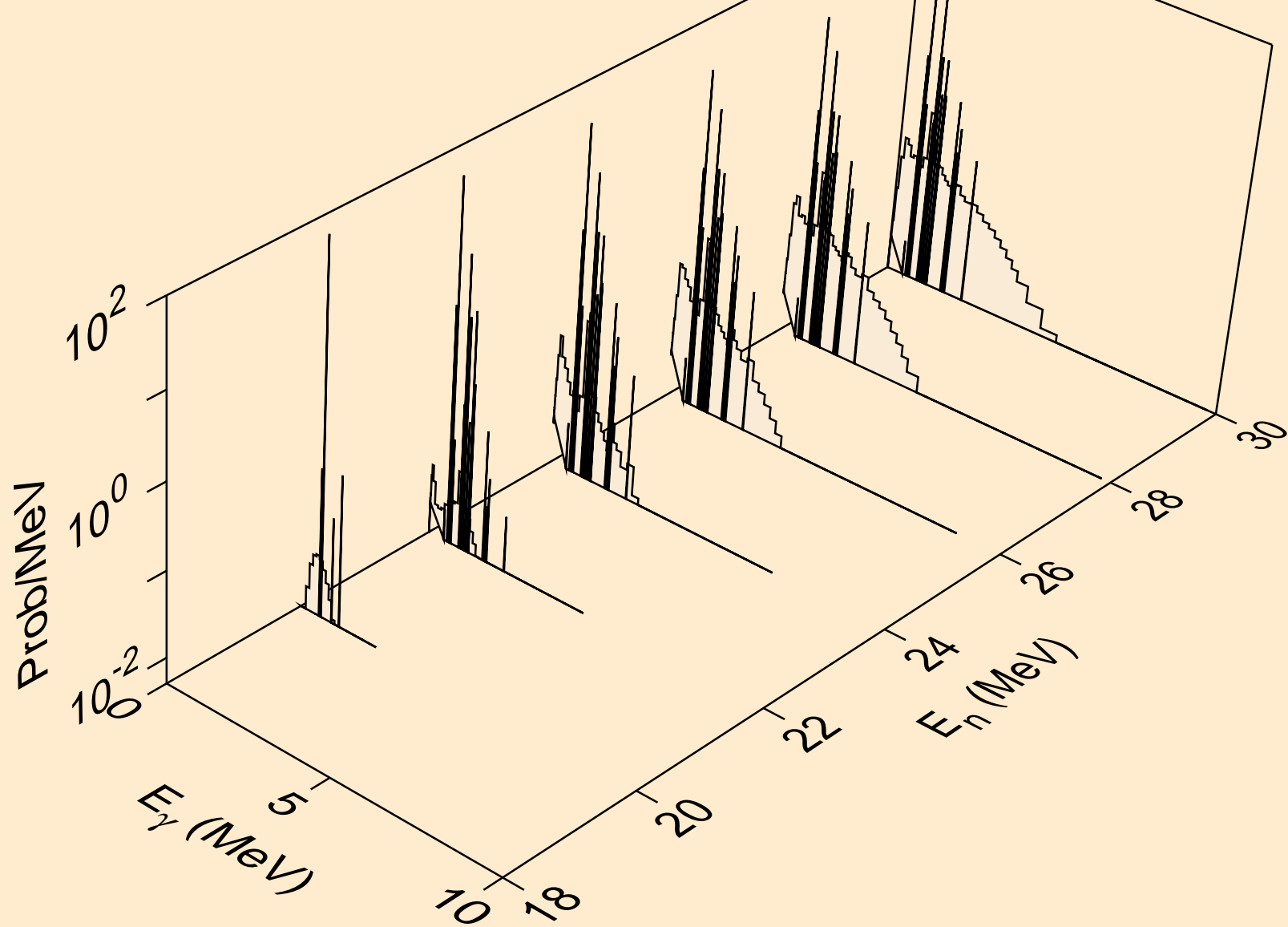

GE081M NEUTRON ACER TENDL-2021 LIBRARY; T=293.6K
Photon emission for (n,2np)

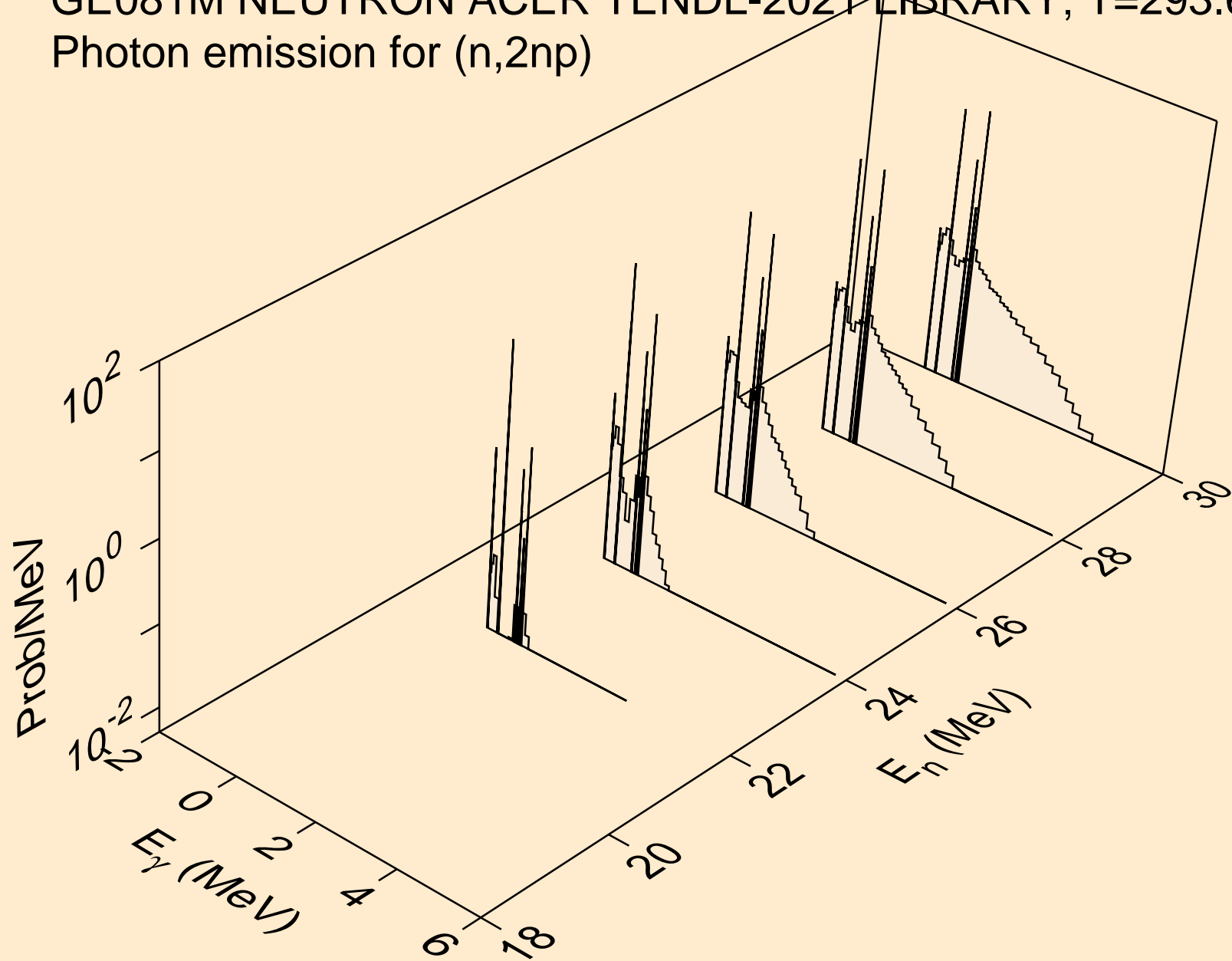

GE081M NEUTRON ACER TENDL-2021 LIBRARY; T=293.6K
Photon emission for (n,3np)

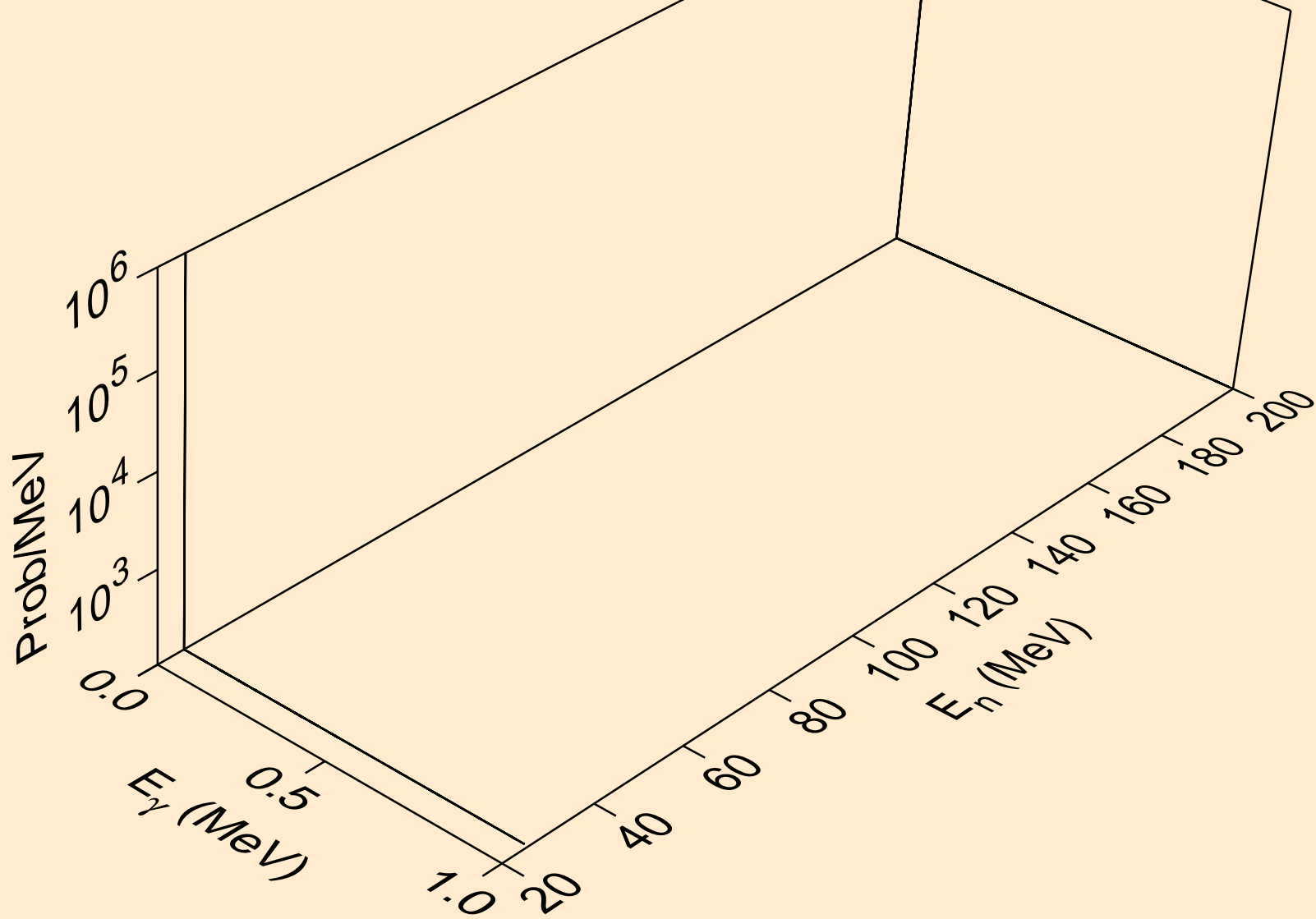

GE081M NEUTRON ACER TENDL-2021 LIBRARY; T=293.6K
Photon emission for (n,n*2)

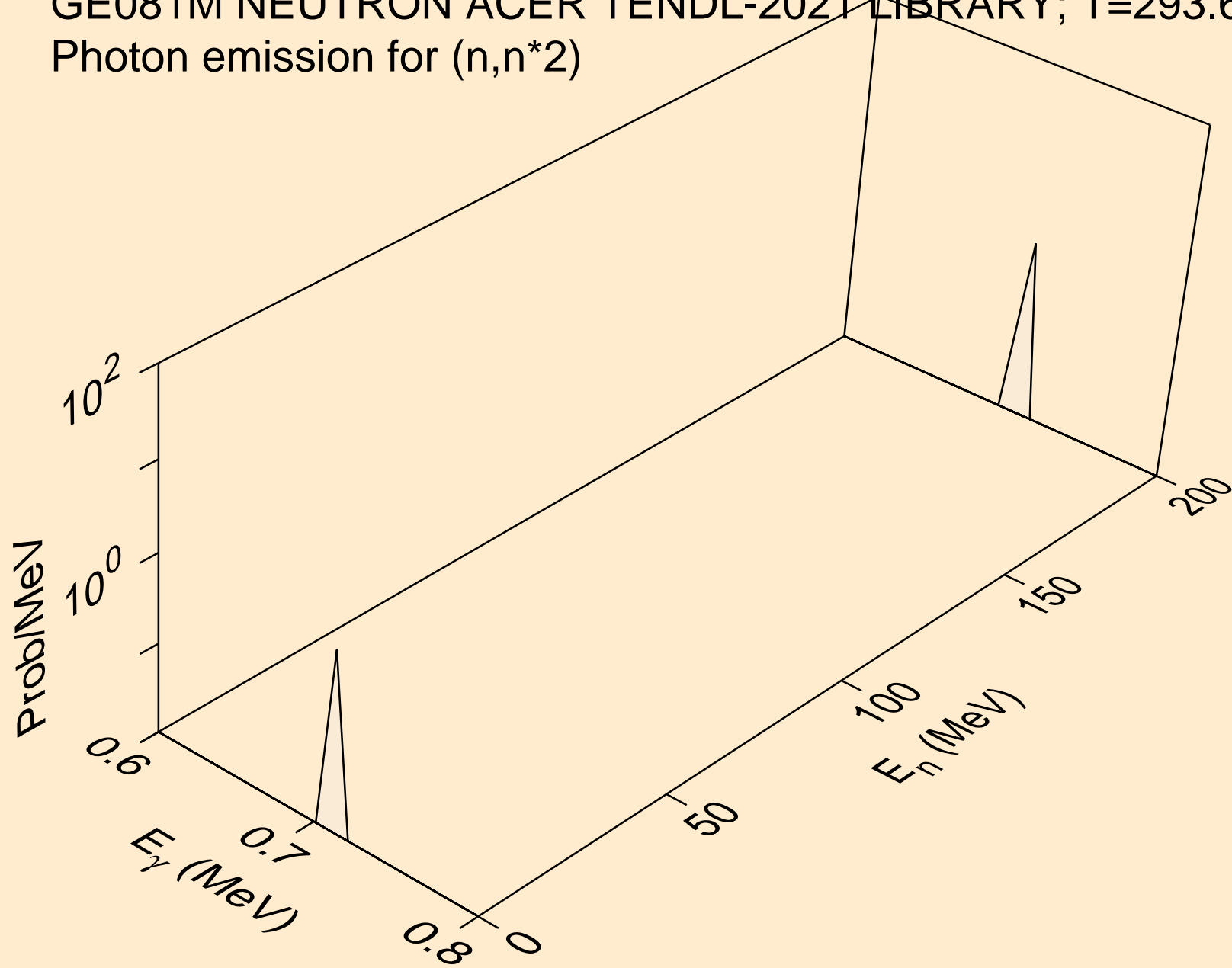

GE081M NEUTRON ACER TENDL-2021 LIBRARY; T=293.6K
Photon emission for (n,n*3)

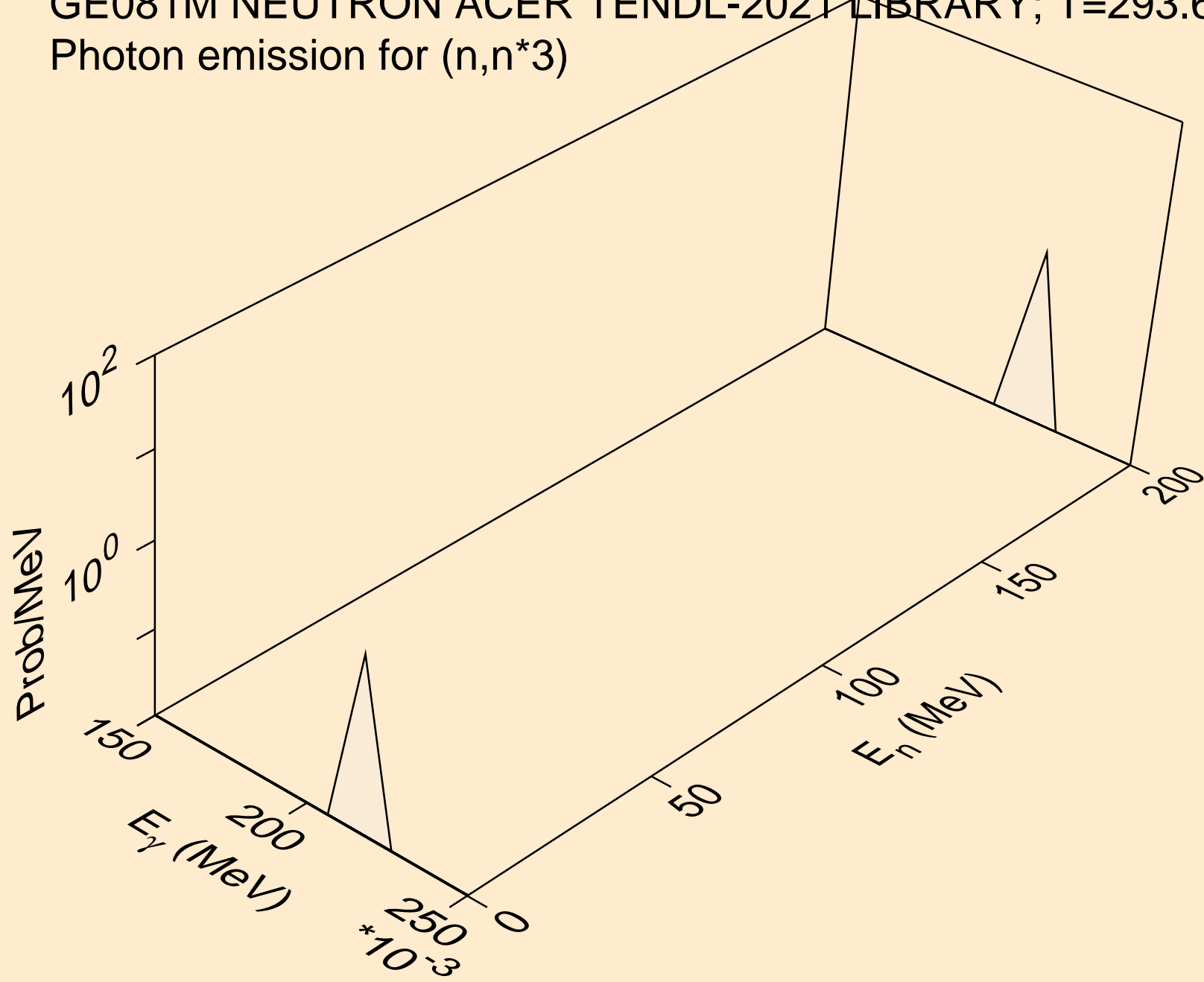

GE081M NEUTRON ACER TENDL-2021 LIBRARY; T=293.6K
Photon emission for (n,n*4)

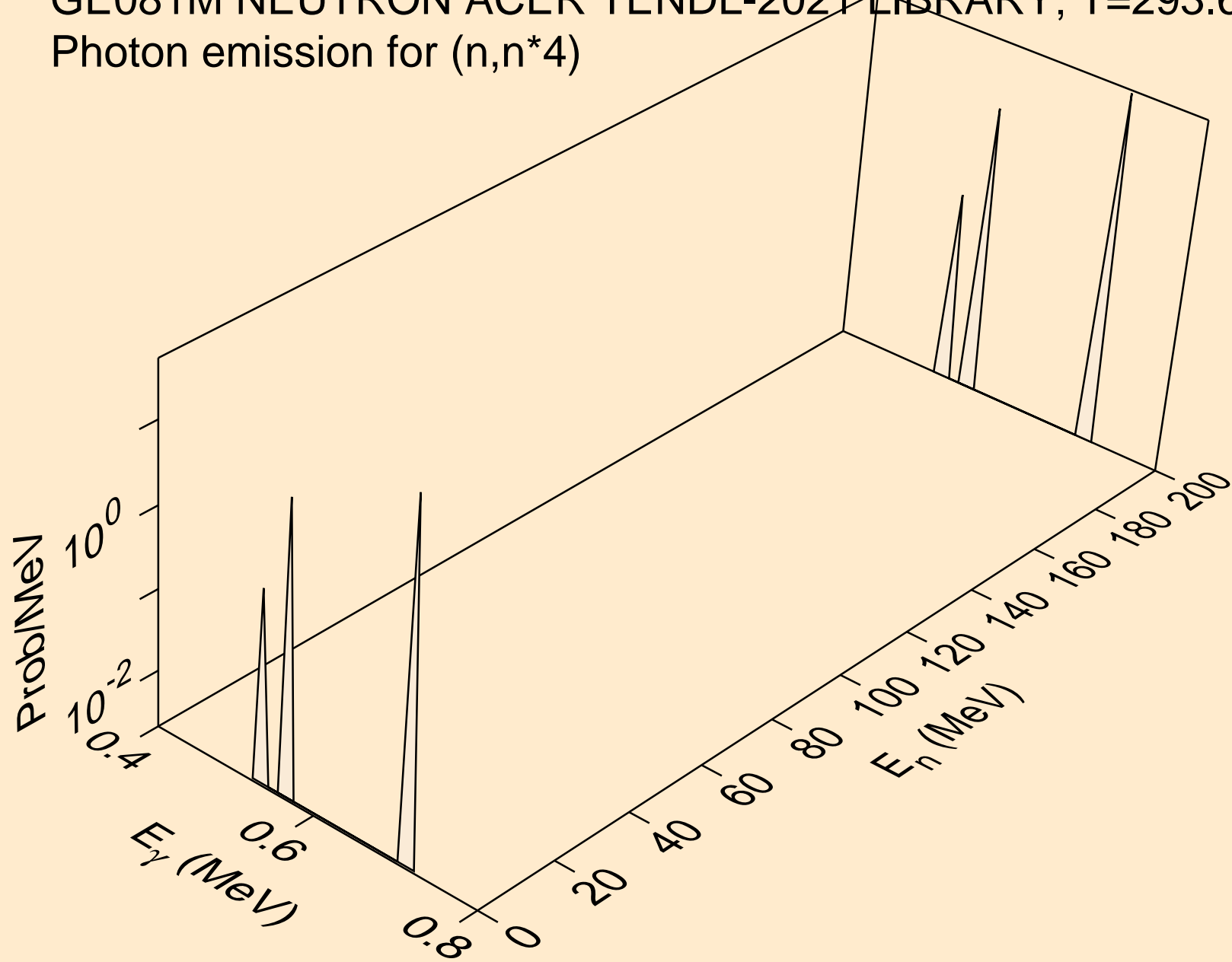

GE081M NEUTRON ACER TENDL-2021 LIBRARY; T=293.6K
Photon emission for (n,n*5)

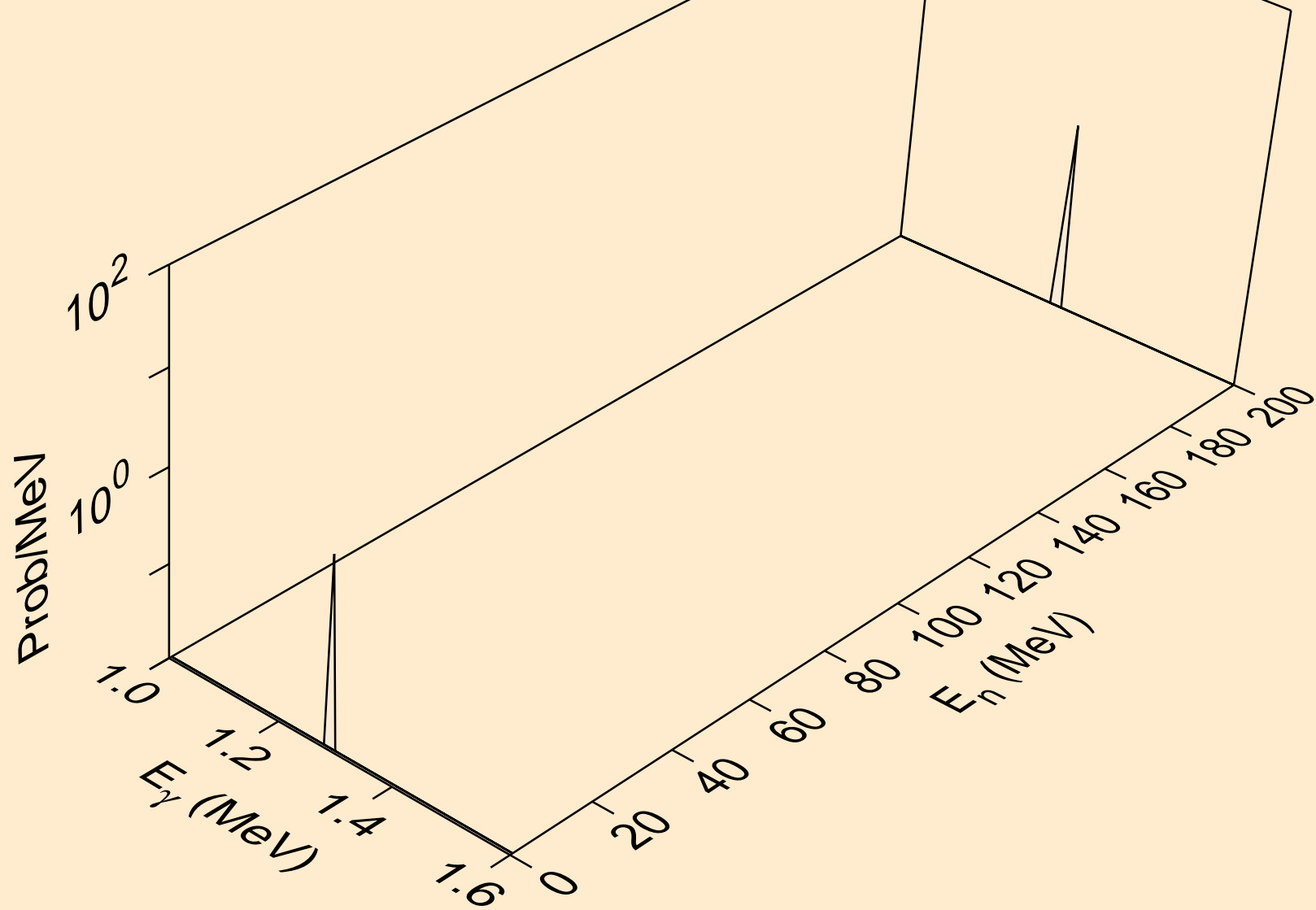

GE081M NEUTRON ACER TENDL-2021 LIBRARY; T=293.6K
Photon emission for (n,n*6)

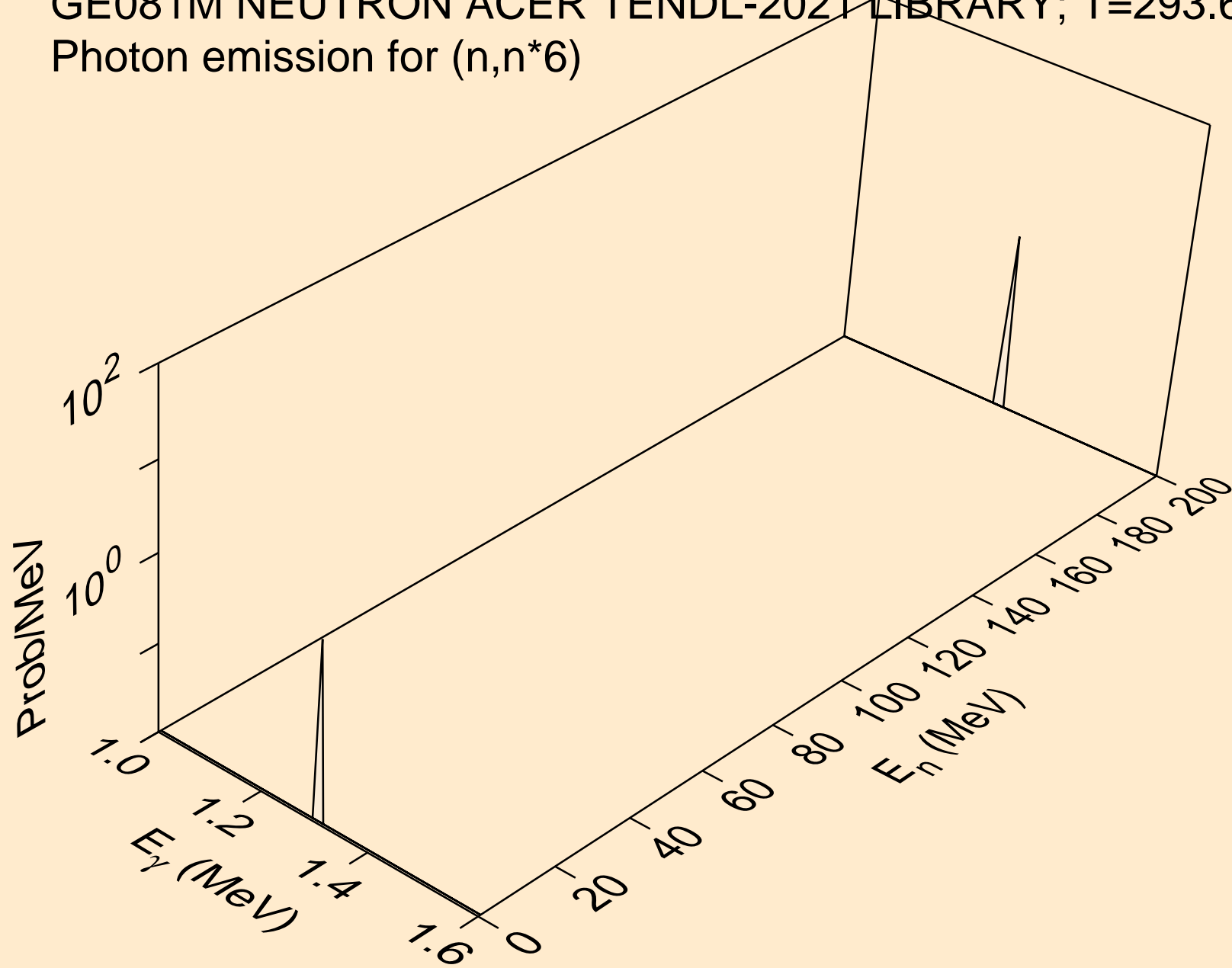

GE081M NEUTRON ACER TENDL-2021 LIBRARY; T=293.6K
Photon emission for (n,n*7)

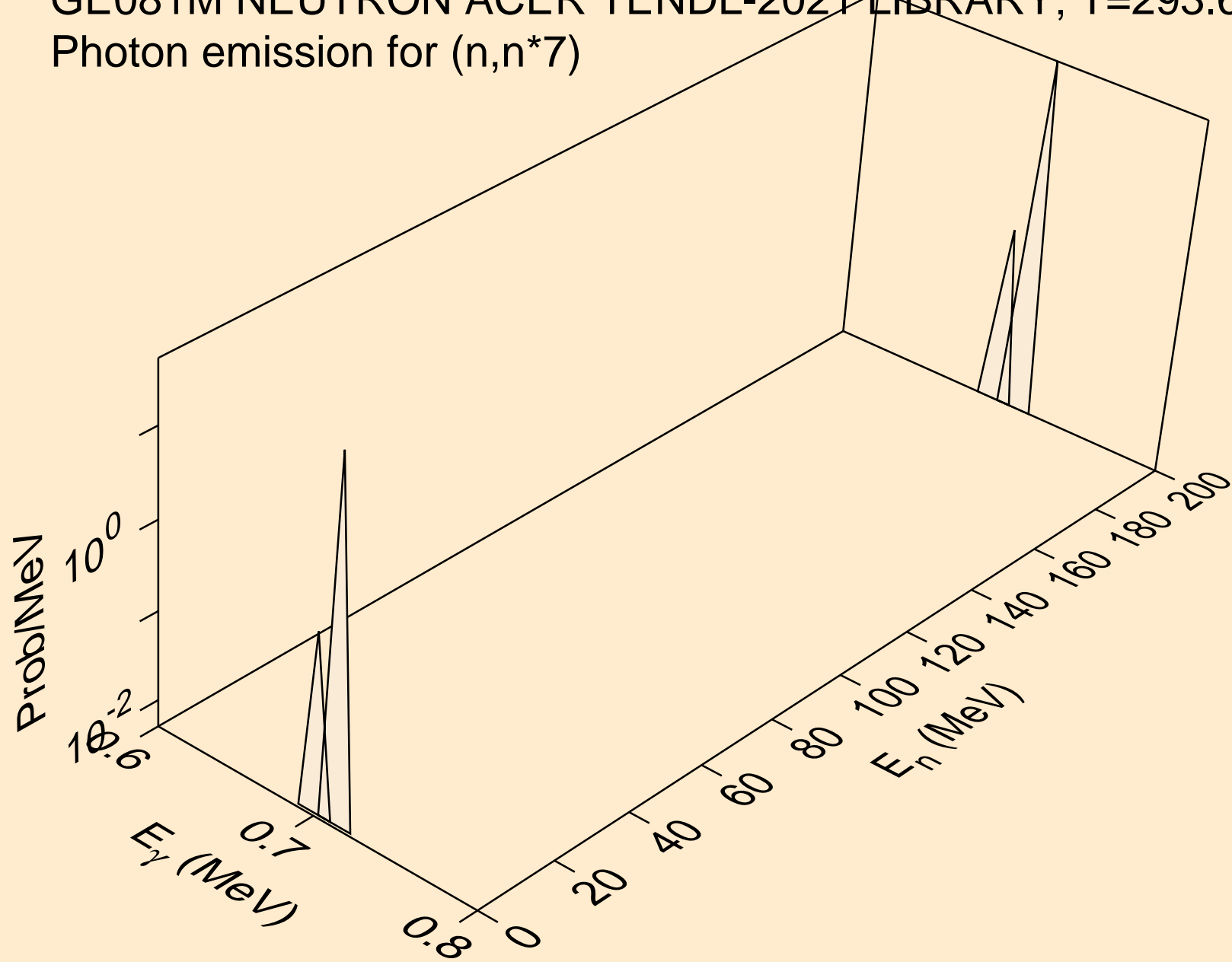

GE081M NEUTRON ACER TENDL-2021 LIBRARY; T=293.6K
Photon emission for (n,n*8)

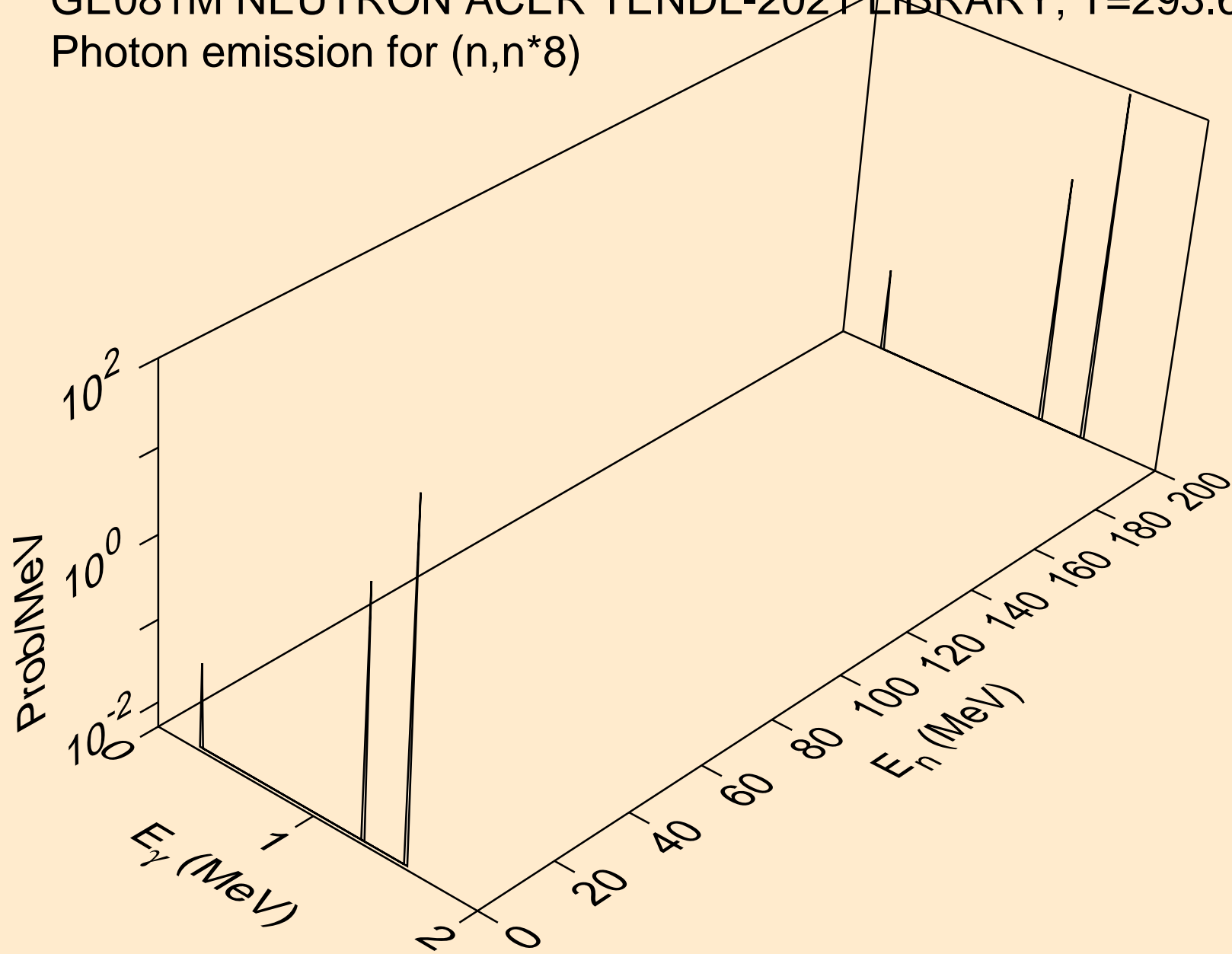

GE081M NEUTRON ACER TENDL-2021 LIBRARY; T=293.6K
Photon emission for (n,n*9)

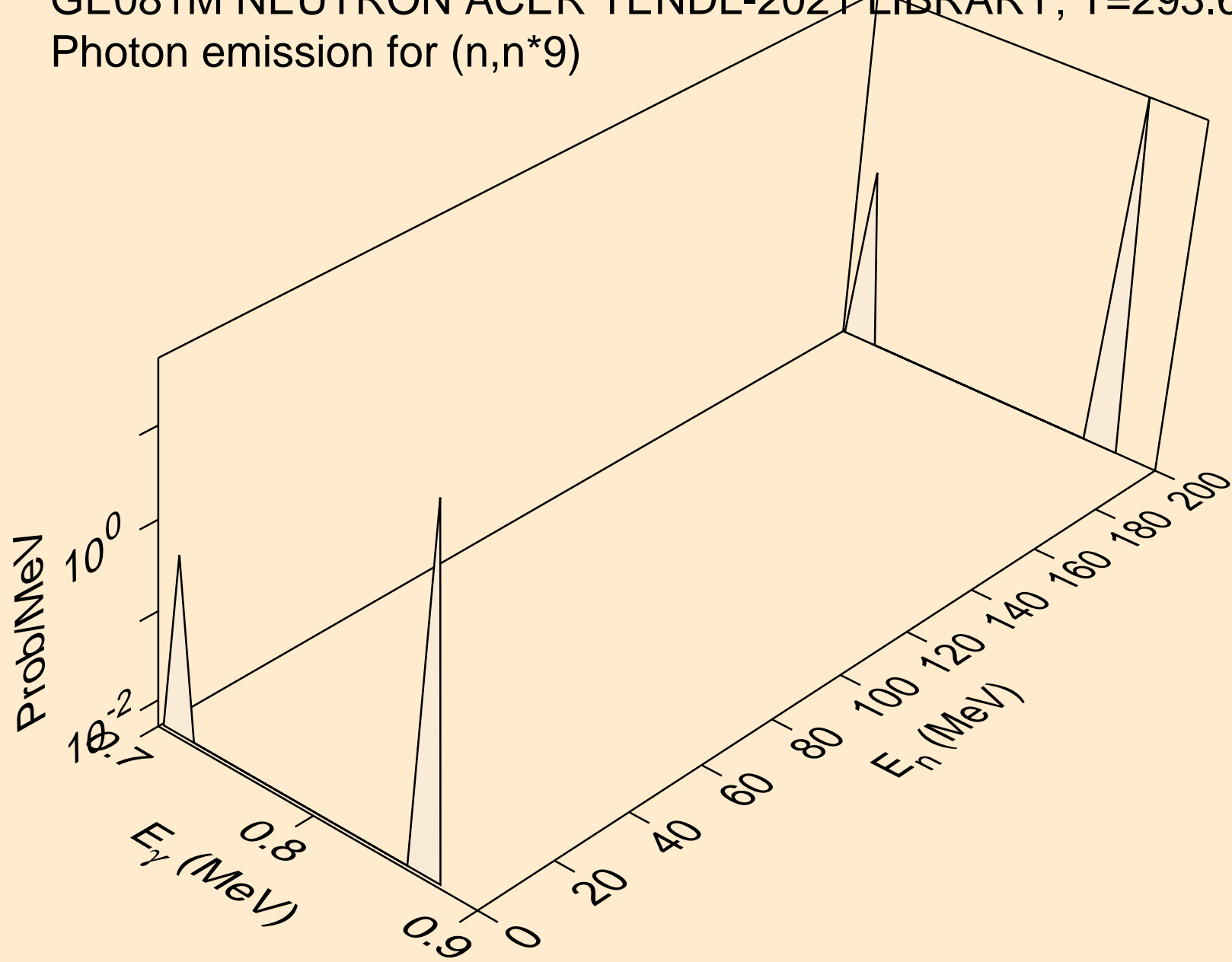

GE081M NEUTRON ACER TENDL-2021 LIBRARY; T=293.6K
Photon emission for (n,n*10)

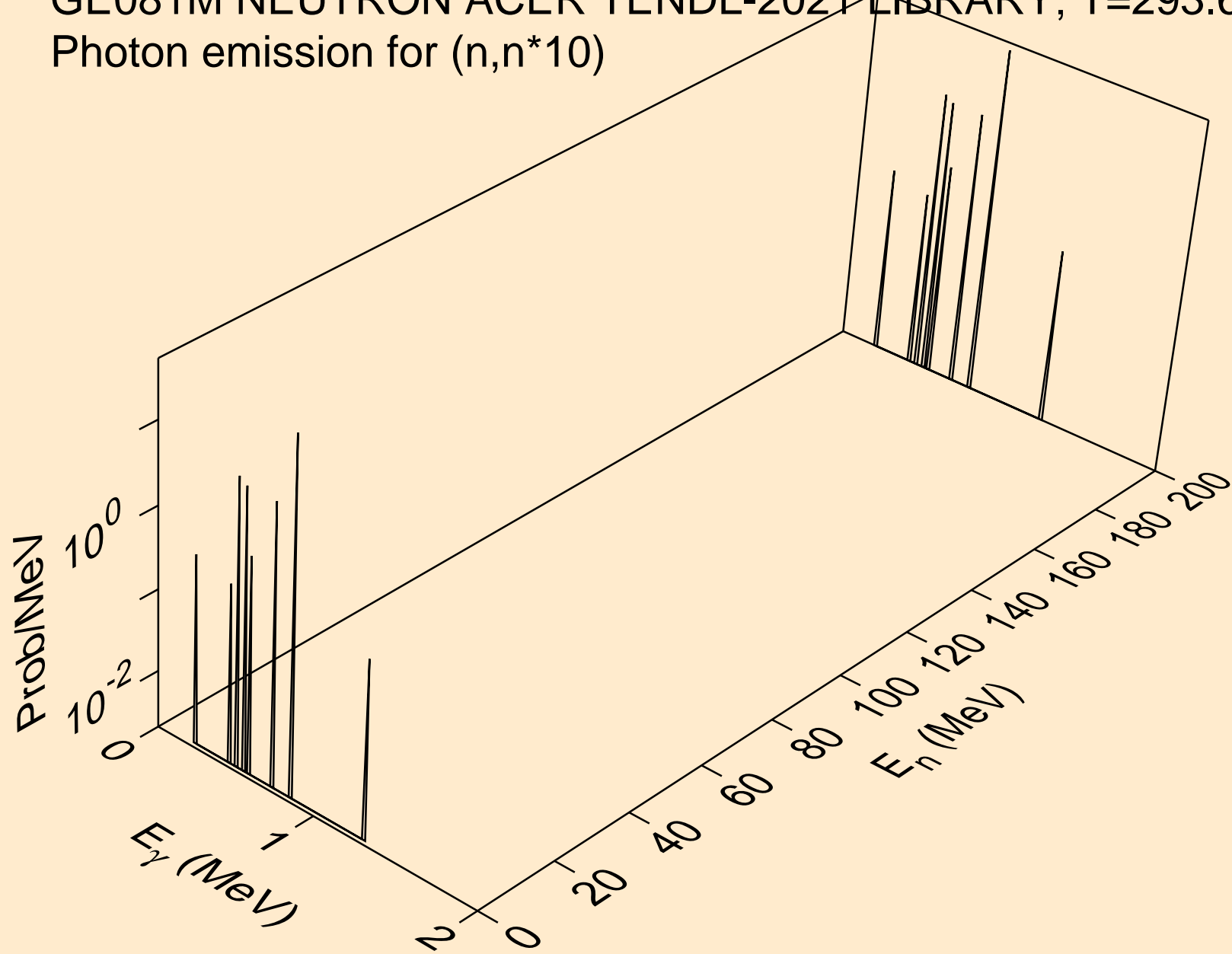

GE081M NEUTRON ACER TENDL-2021 LIBRARY; T=293.6K
Photon emission for (n,n*11)

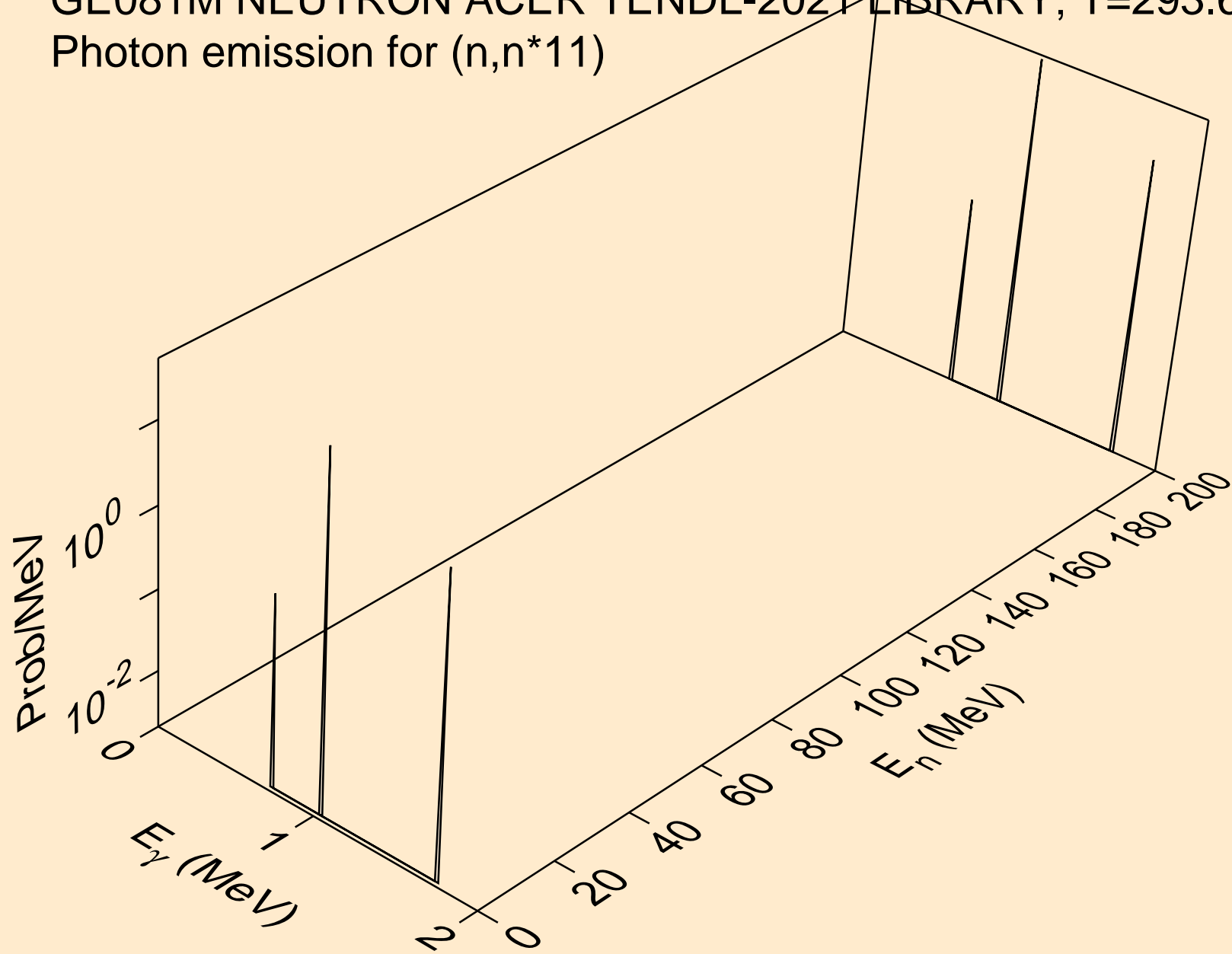

GE081M NEUTRON ACER TENDL-2021 LIBRARY; T=293.6K
Photon emission for (n,n*12)

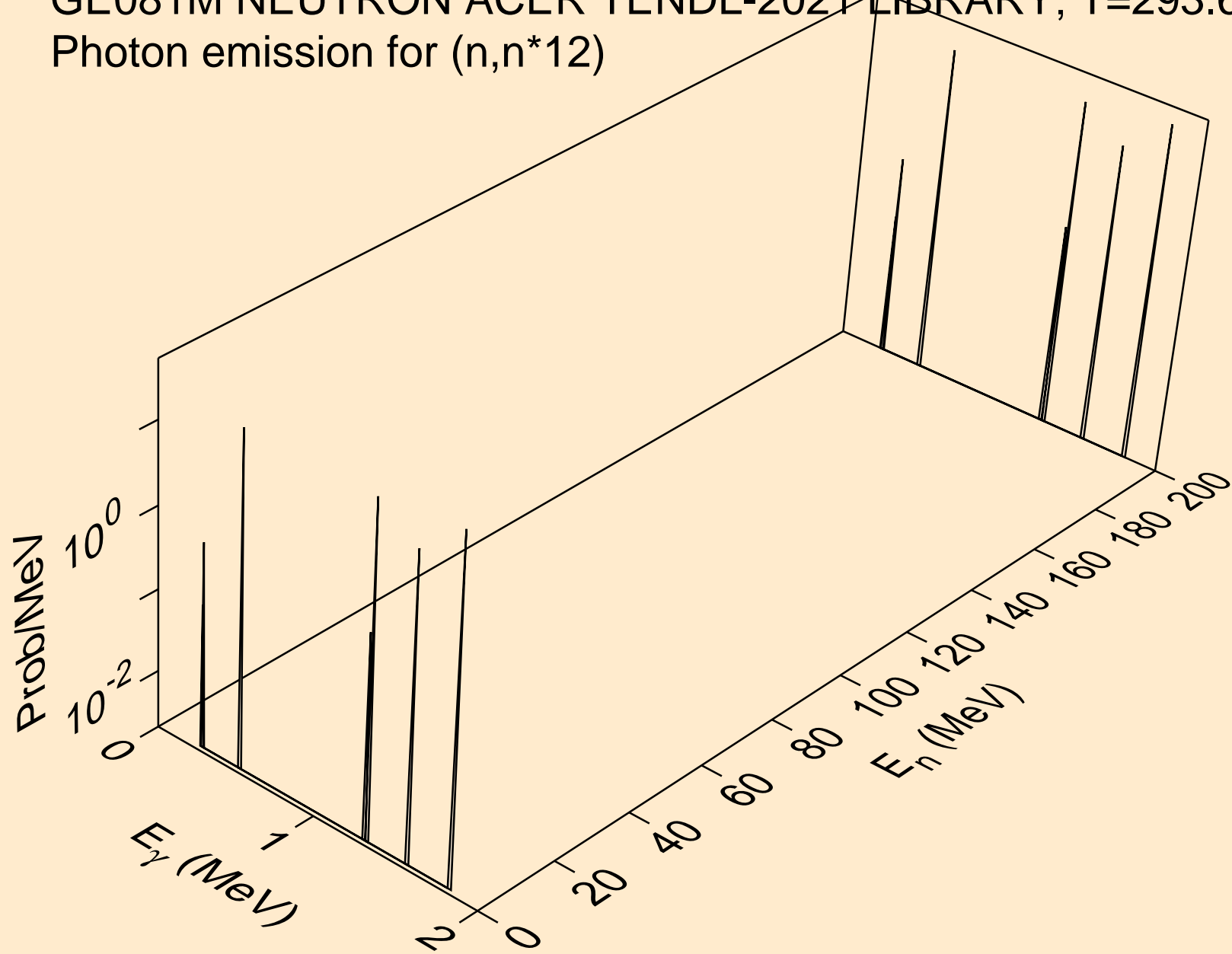

GE081M NEUTRON ACER TENDL-2021 LIBRARY; T=293.6K
Photon emission for (n,n*13)

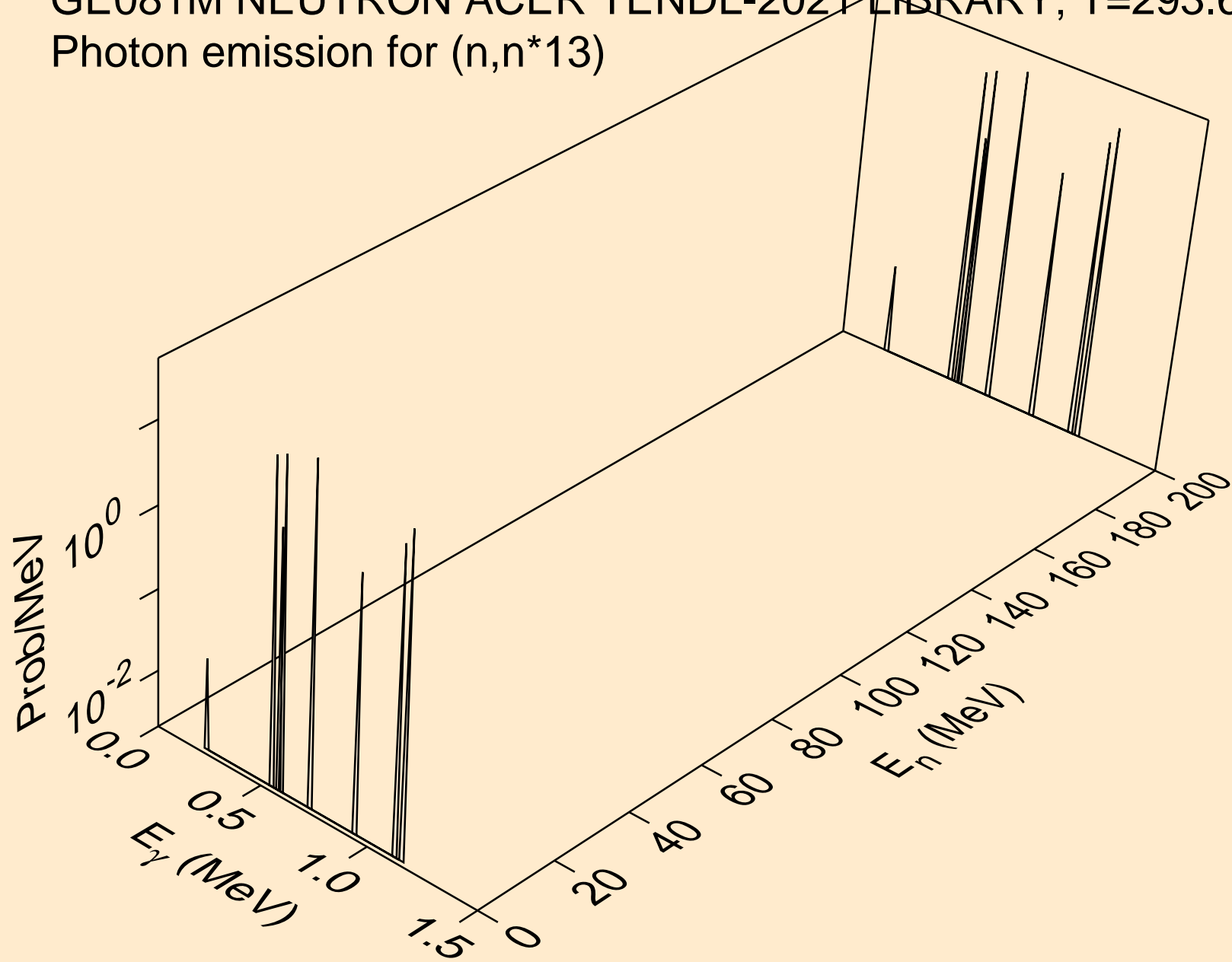

GE081M NEUTRON ACER TENDL-2021 LIBRARY; T=293.6K
Photon emission for (n,n*14)

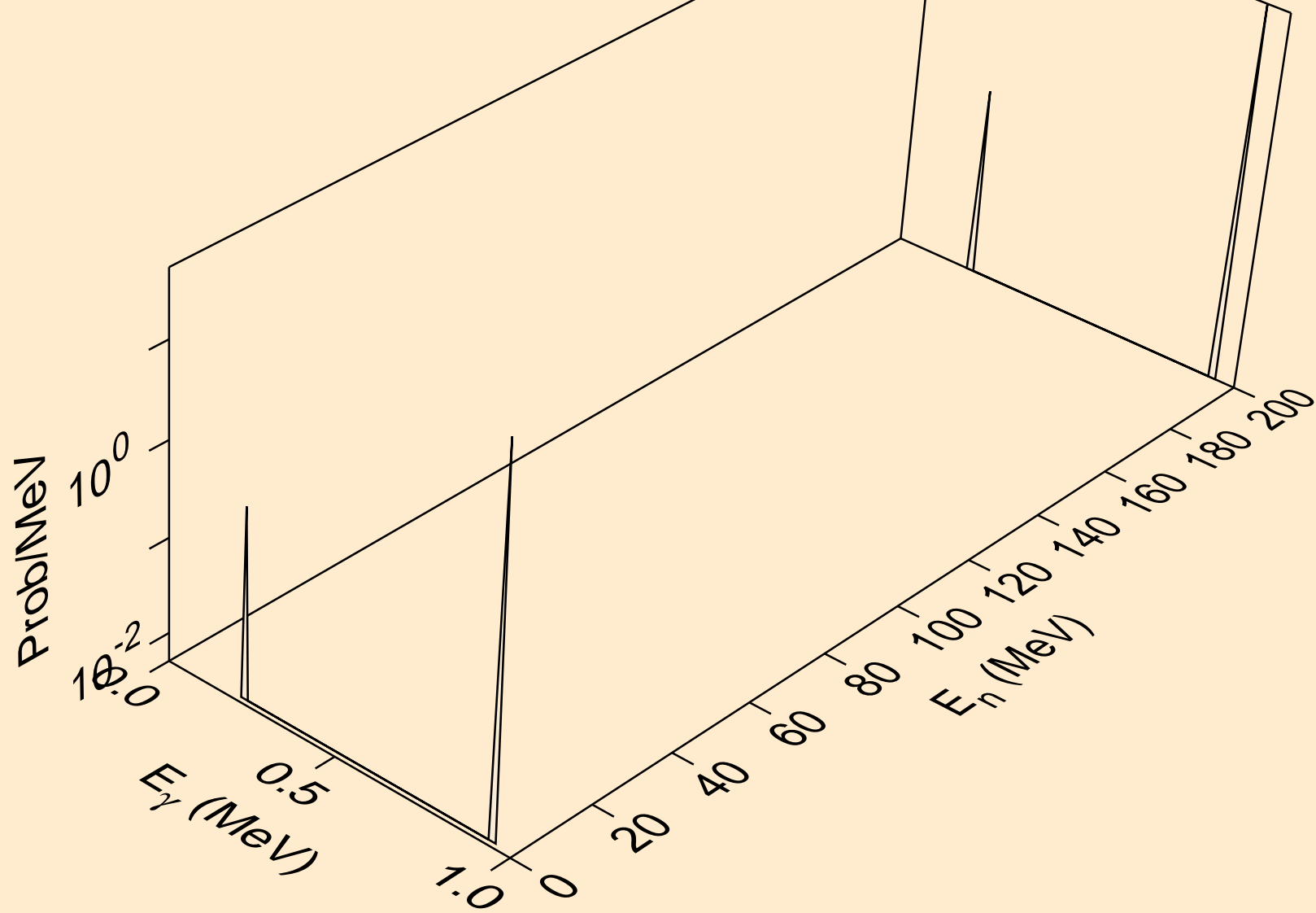

GE081M NEUTRON ACER TENDL-2021 LIBRARY; T=293.6K
Photon emission for (n,n*15)

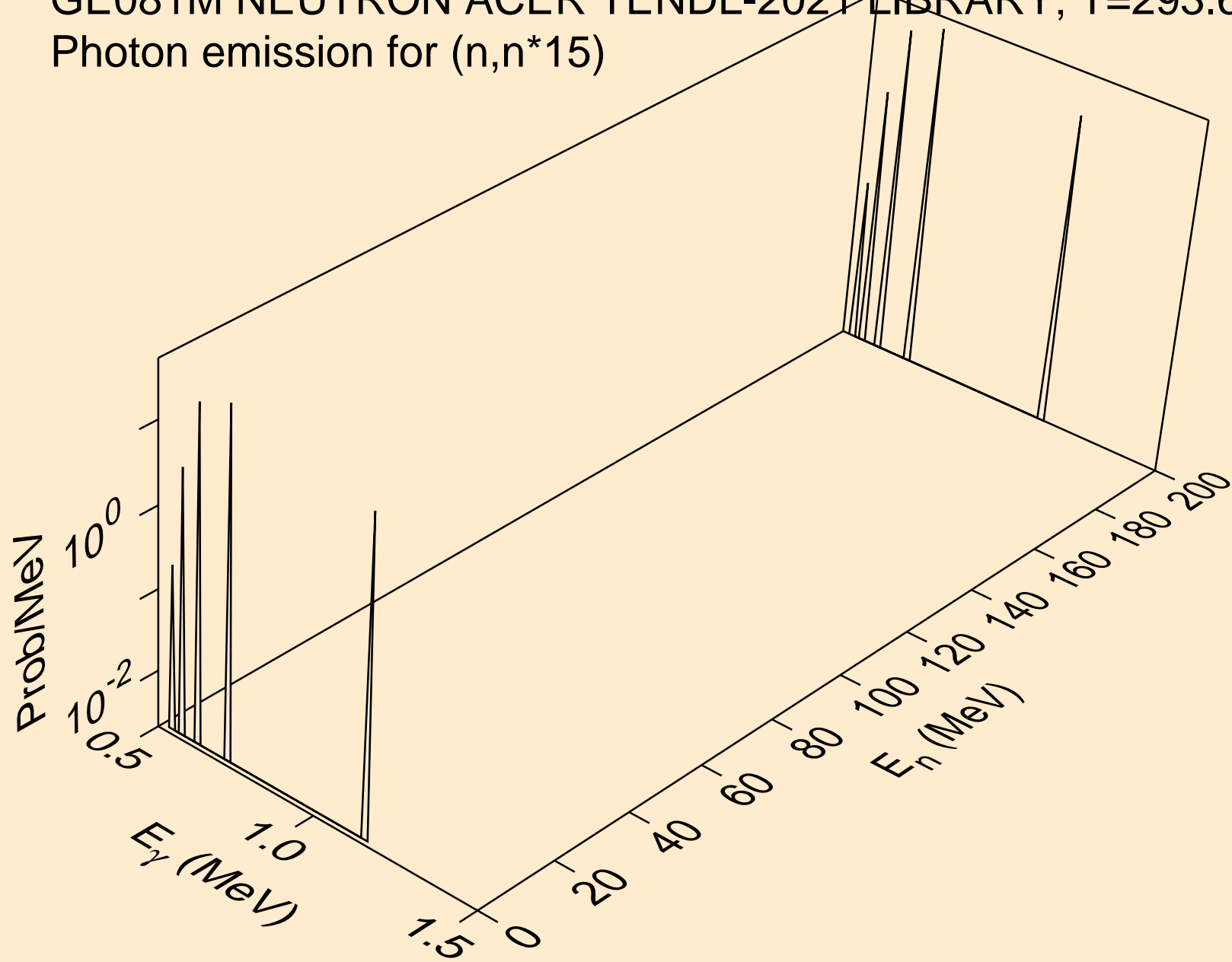

GE081M NEUTRON ACER TENDL-2021 LIBRARY; T=293.6K
Photon emission for (n,n*16)

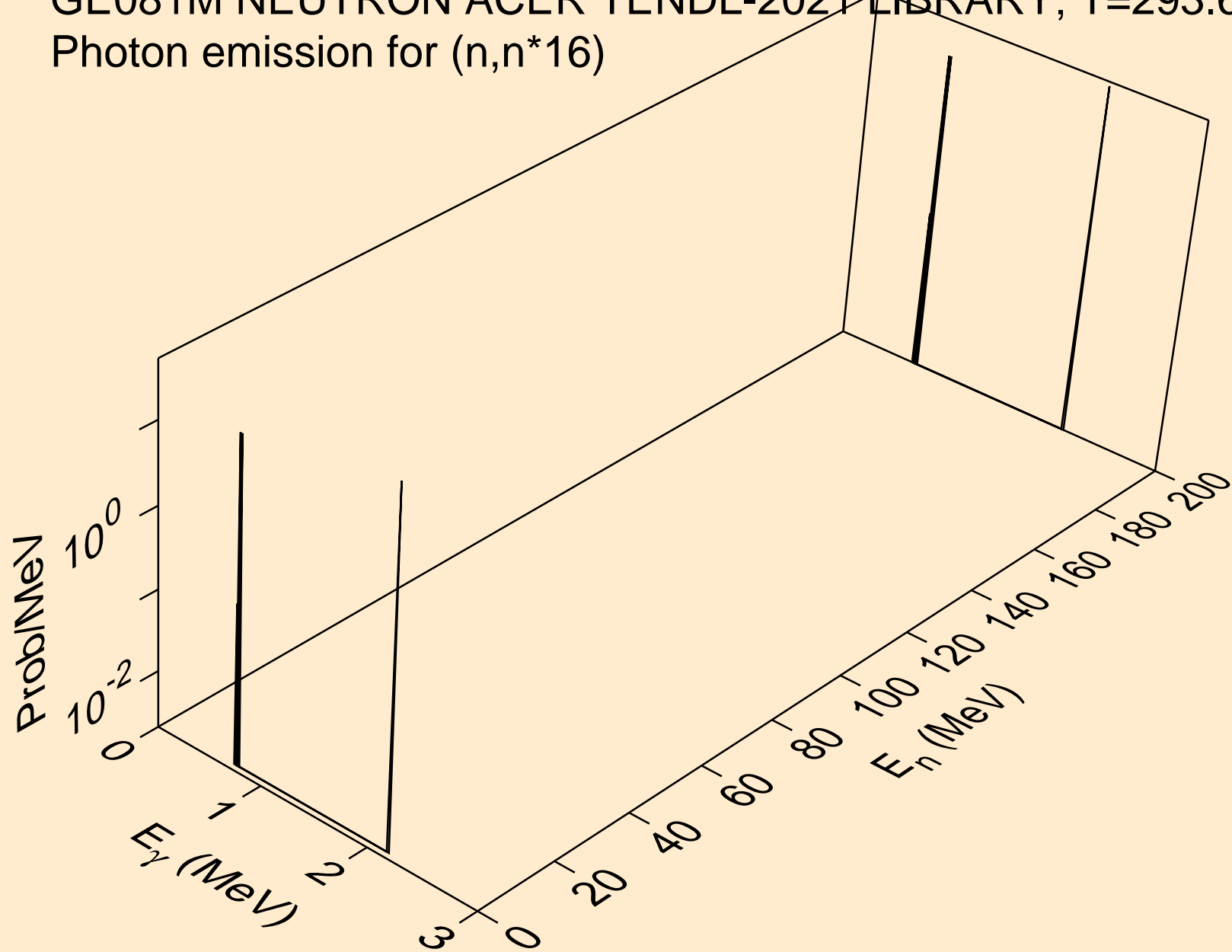

GE081M NEUTRON ACER TENDL-2021 LIBRARY; T=293.6K
Photon emission for (n,n*17)

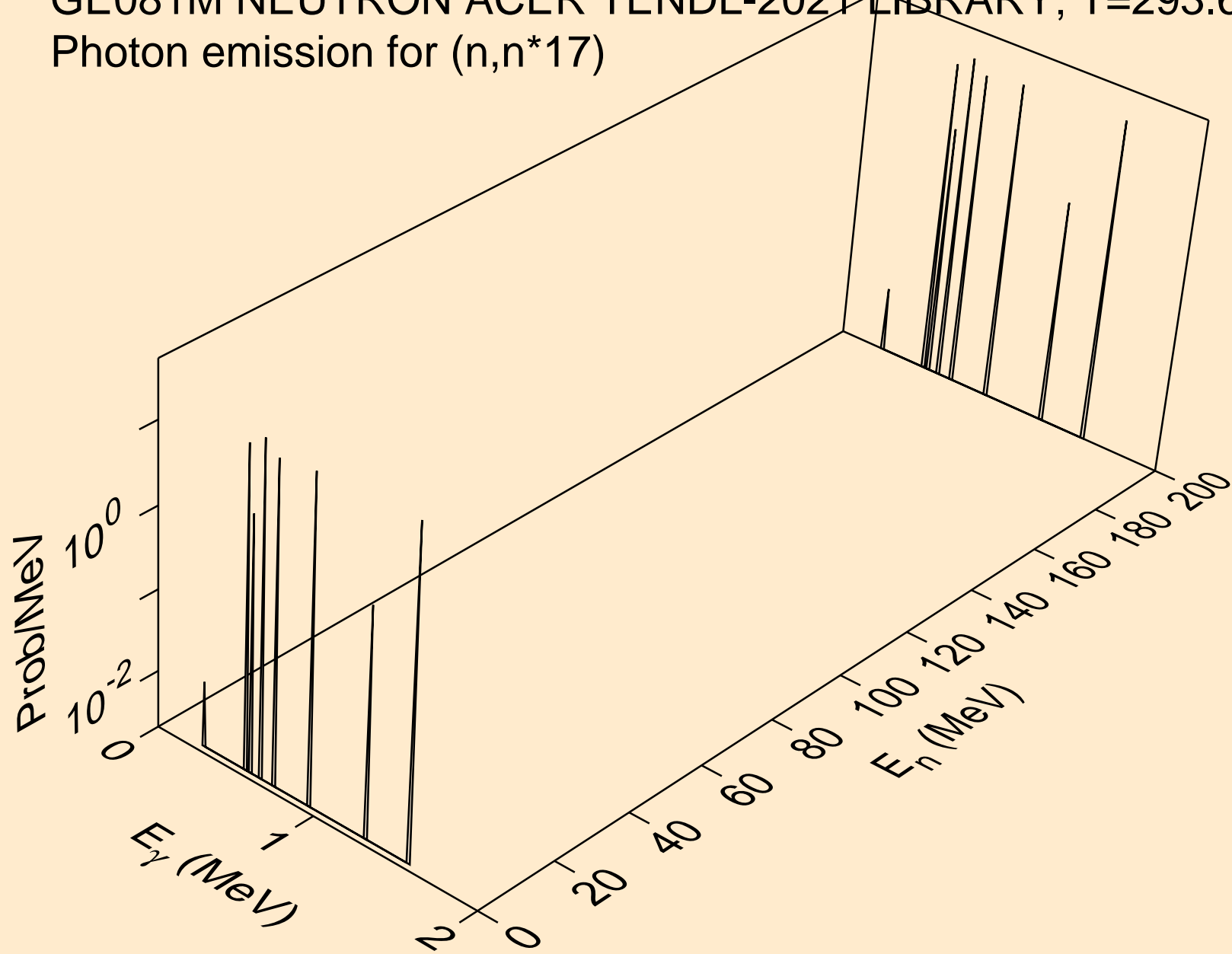

GE081M NEUTRON ACER TENDL-2021 LIBRARY; T=293.6K
Photon emission for (n,n*18)

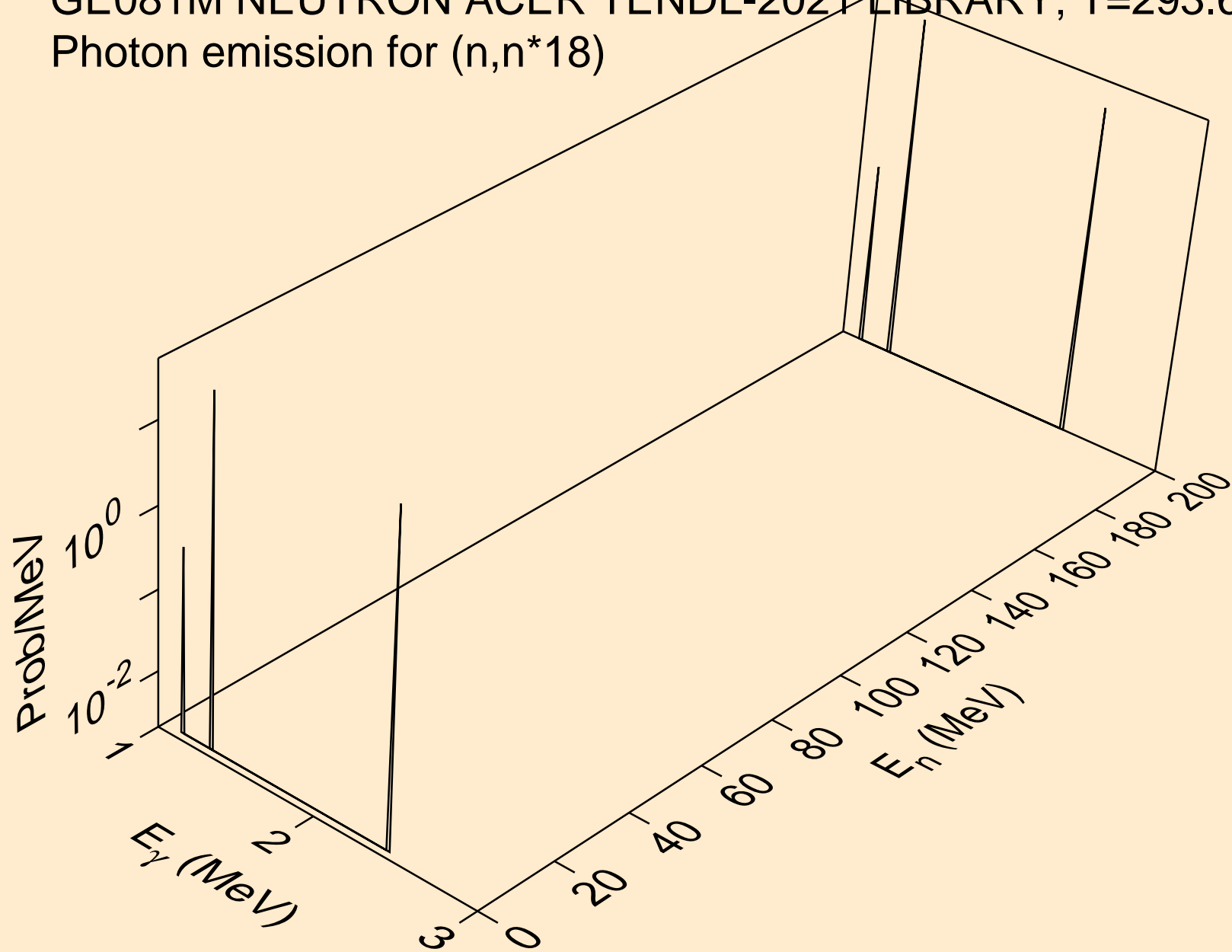

GE081M NEUTRON ACER TENDL-2021 LIBRARY; T=293.6K
Photon emission for (n,n*19)

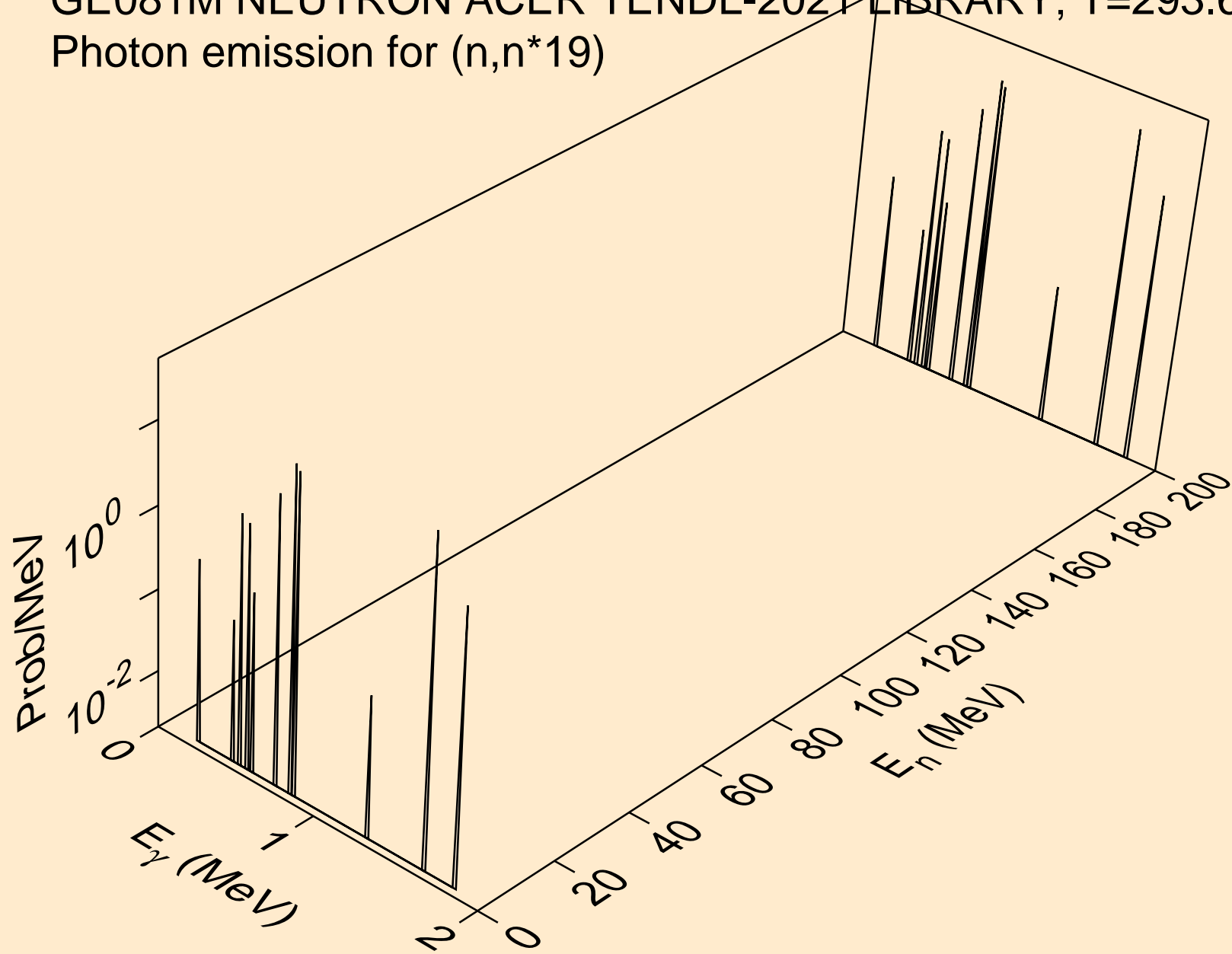

GE081M NEUTRON ACER TENDL-2021 LIBRARY; T=293.6K
Photon emission for (n,n*20)

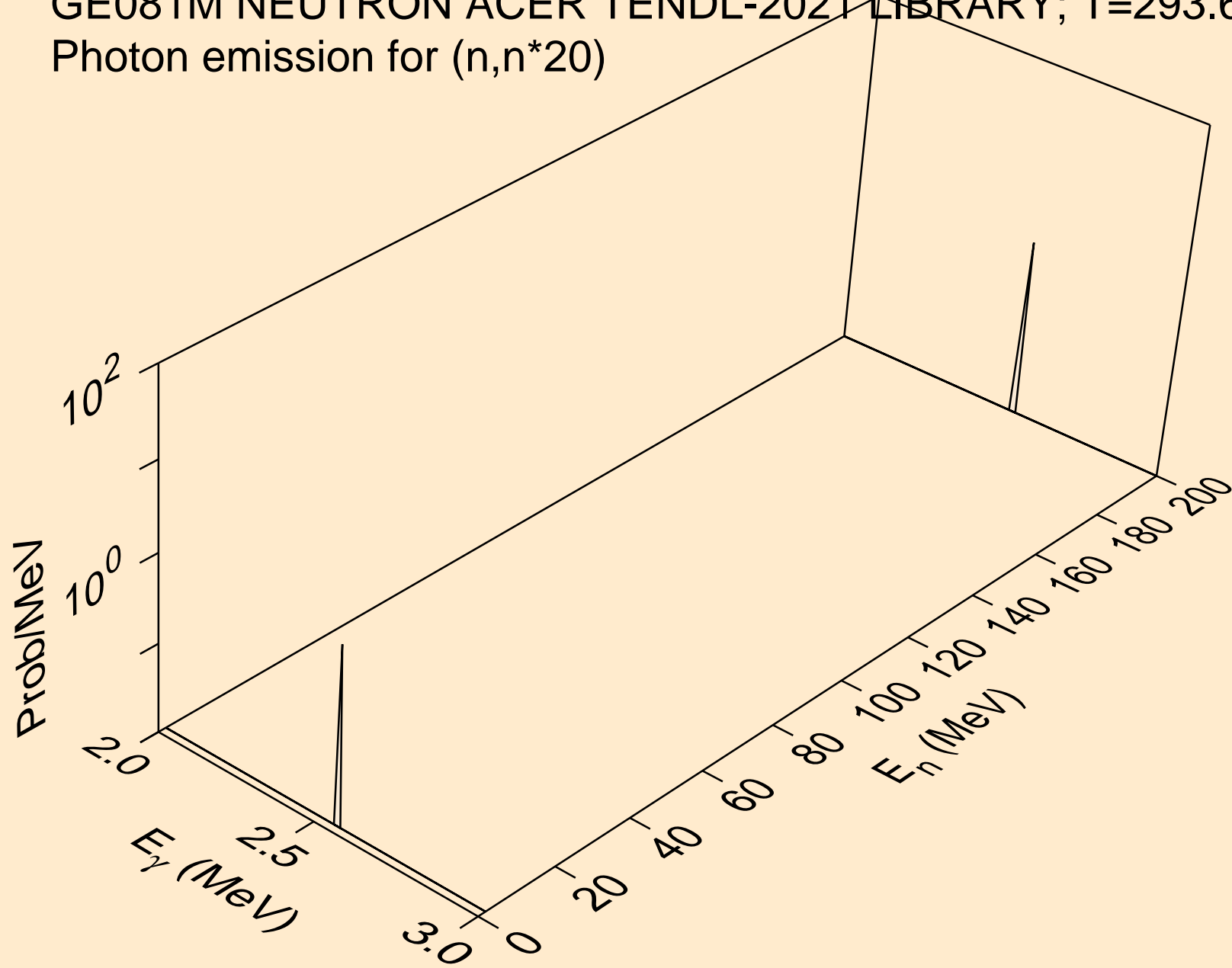

GE081M NEUTRON ACER TENDL-2021 LIBRARY; T=293.6K
Photon emission for (n,n*21)

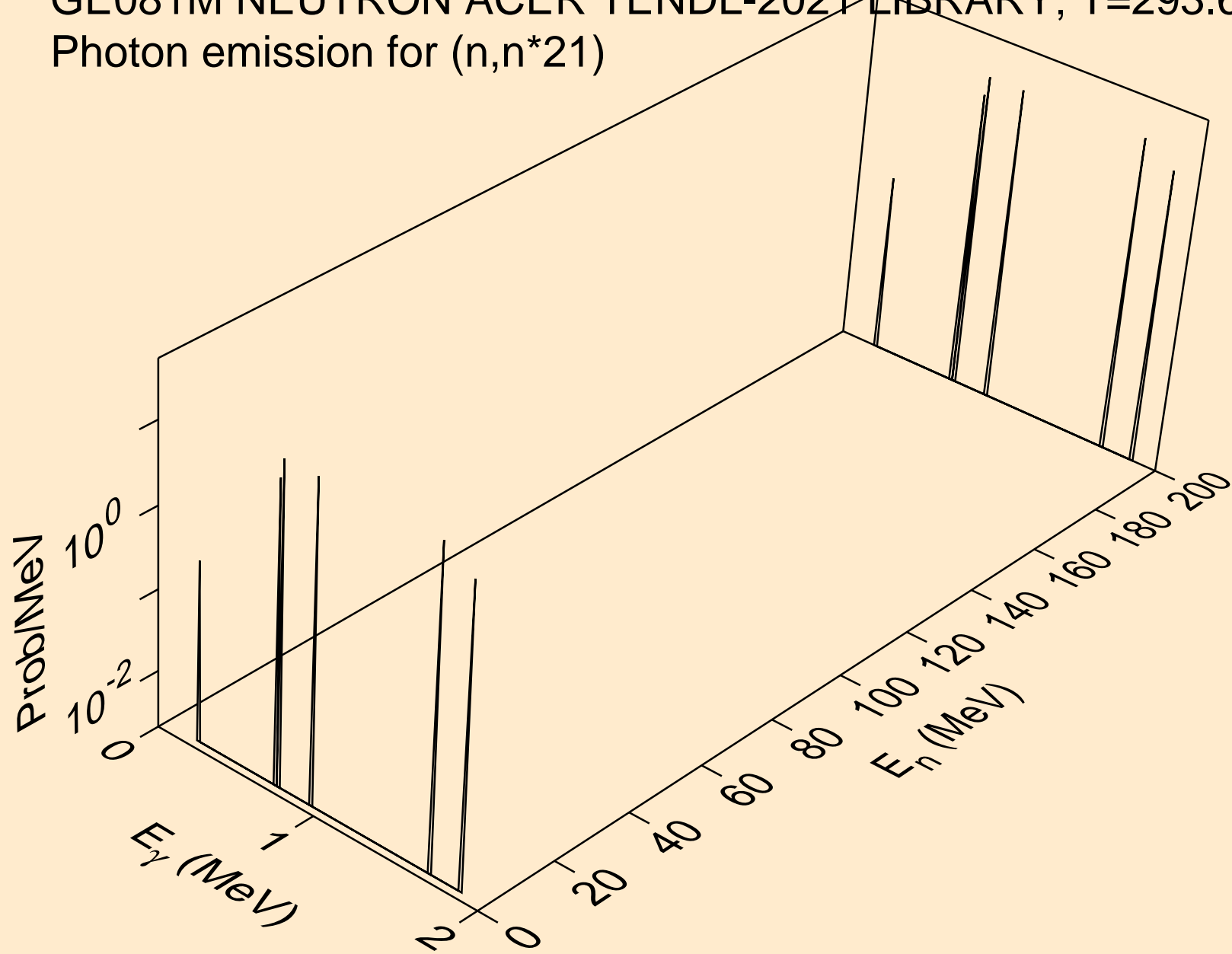

GE081M NEUTRON ACER TENDL-2021 LIBRARY; T=293.6K
Photon emission for (n,n*22)

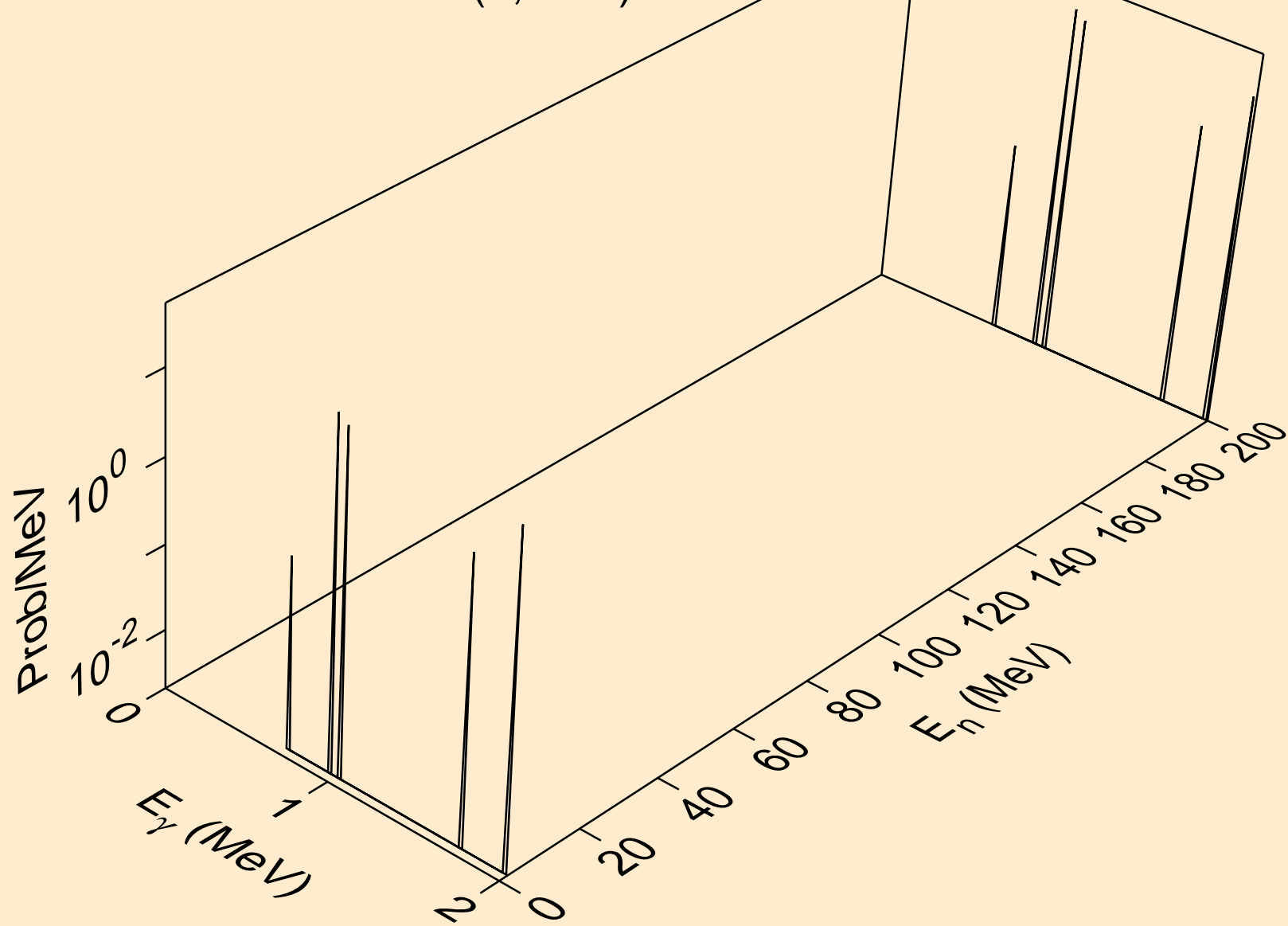

GE081M NEUTRON ACER TENDL-2021 LIBRARY; T=293.6K
Photon emission for (n,n*23)

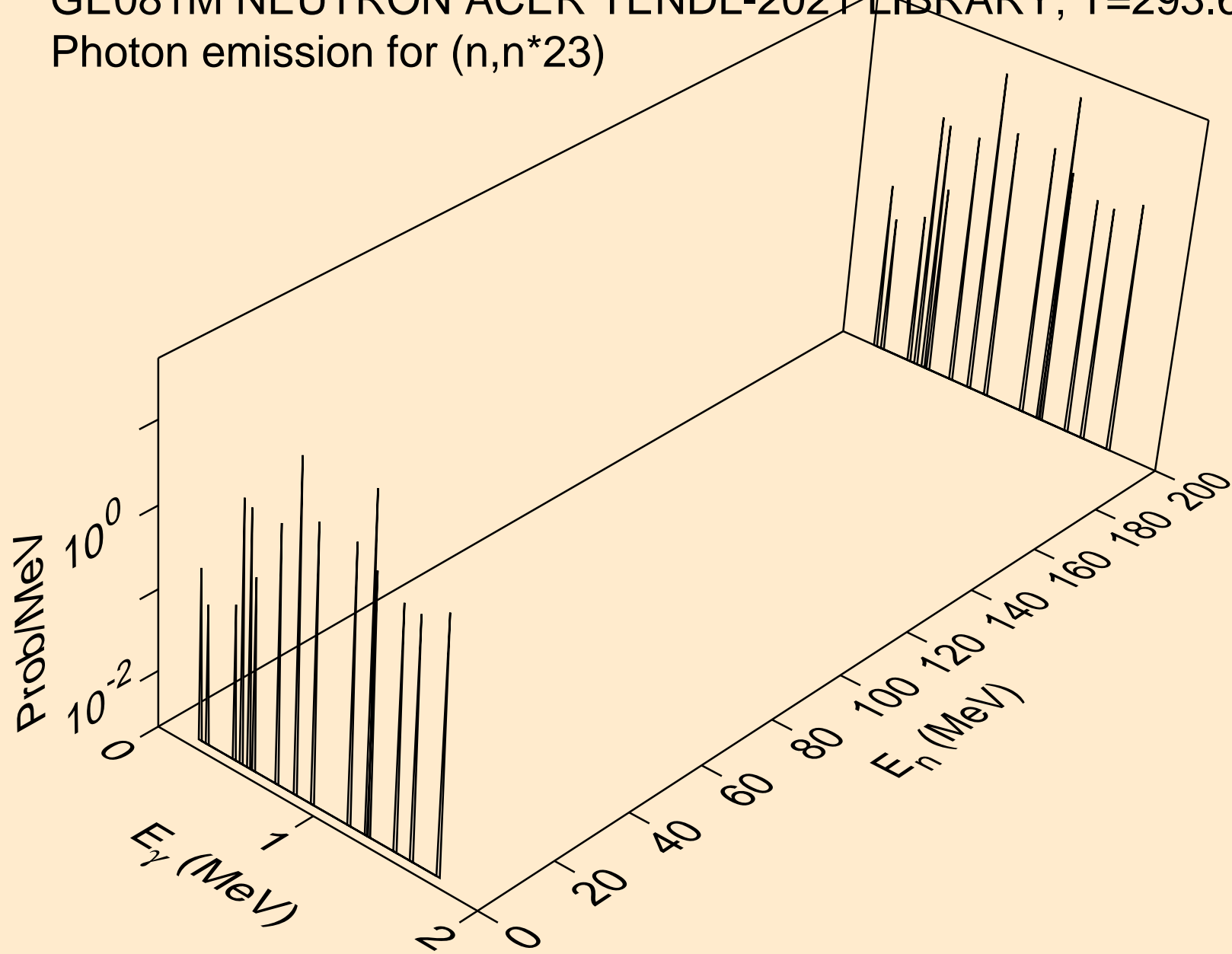

GE081M NEUTRON ACER TENDL-2021 LIBRARY; T=293.6K
Photon emission for (n,n*24)

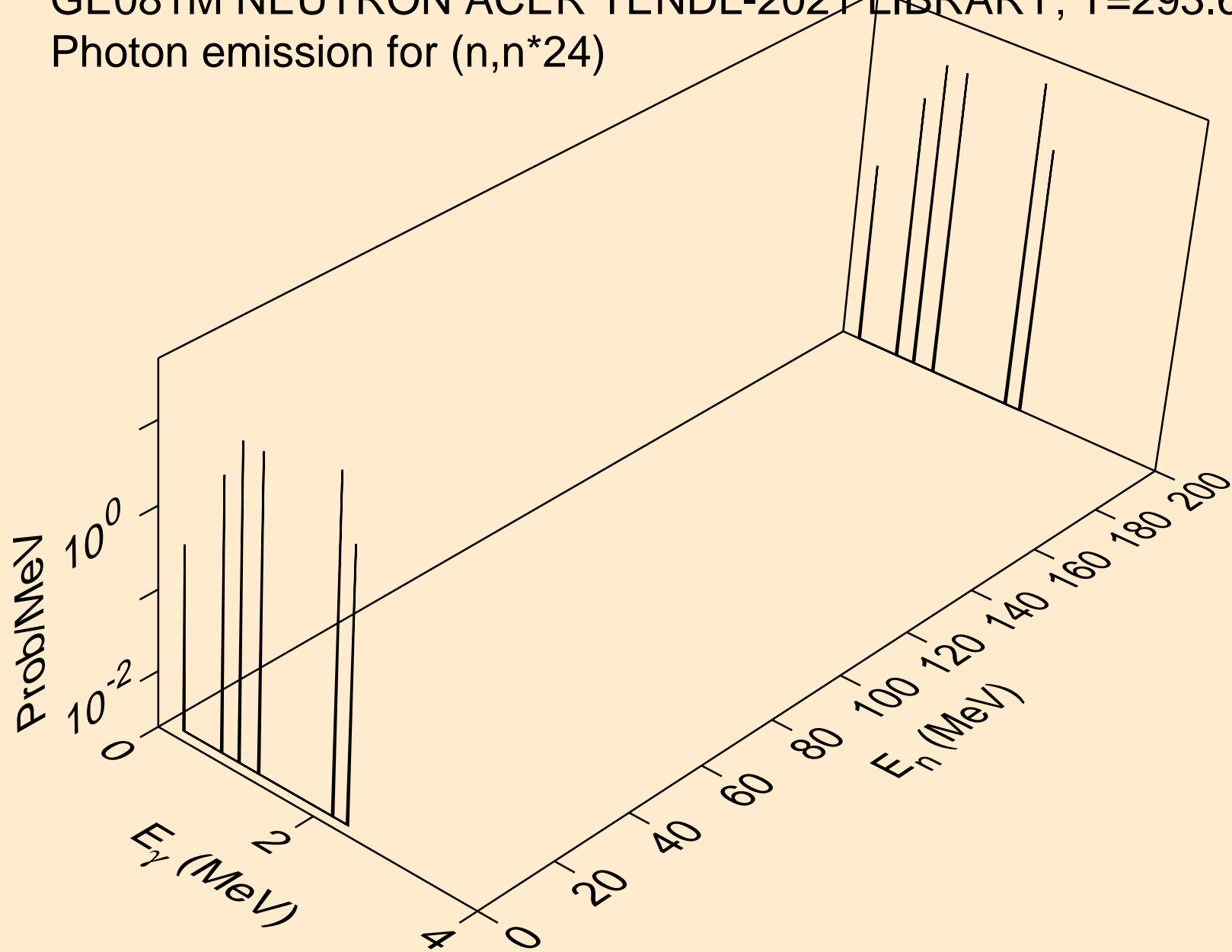

GE081M NEUTRON ACER TENDL-2021 LIBRARY; T=293.6K
Photon emission for (n,n*25)

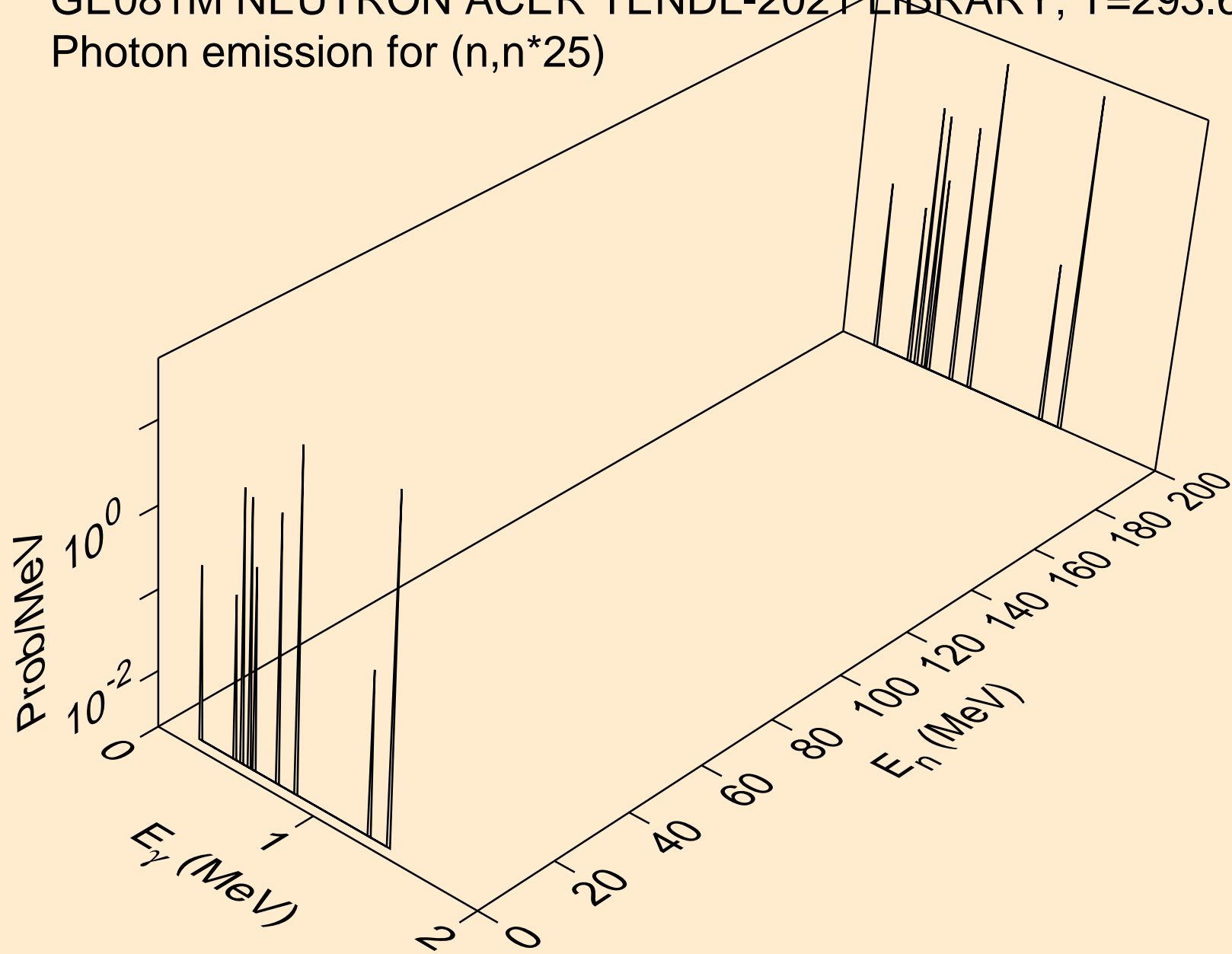

GE081M NEUTRON ACER TENDL-2021 LIBRARY; T=293.6K
Photon emission for (n,n*26)

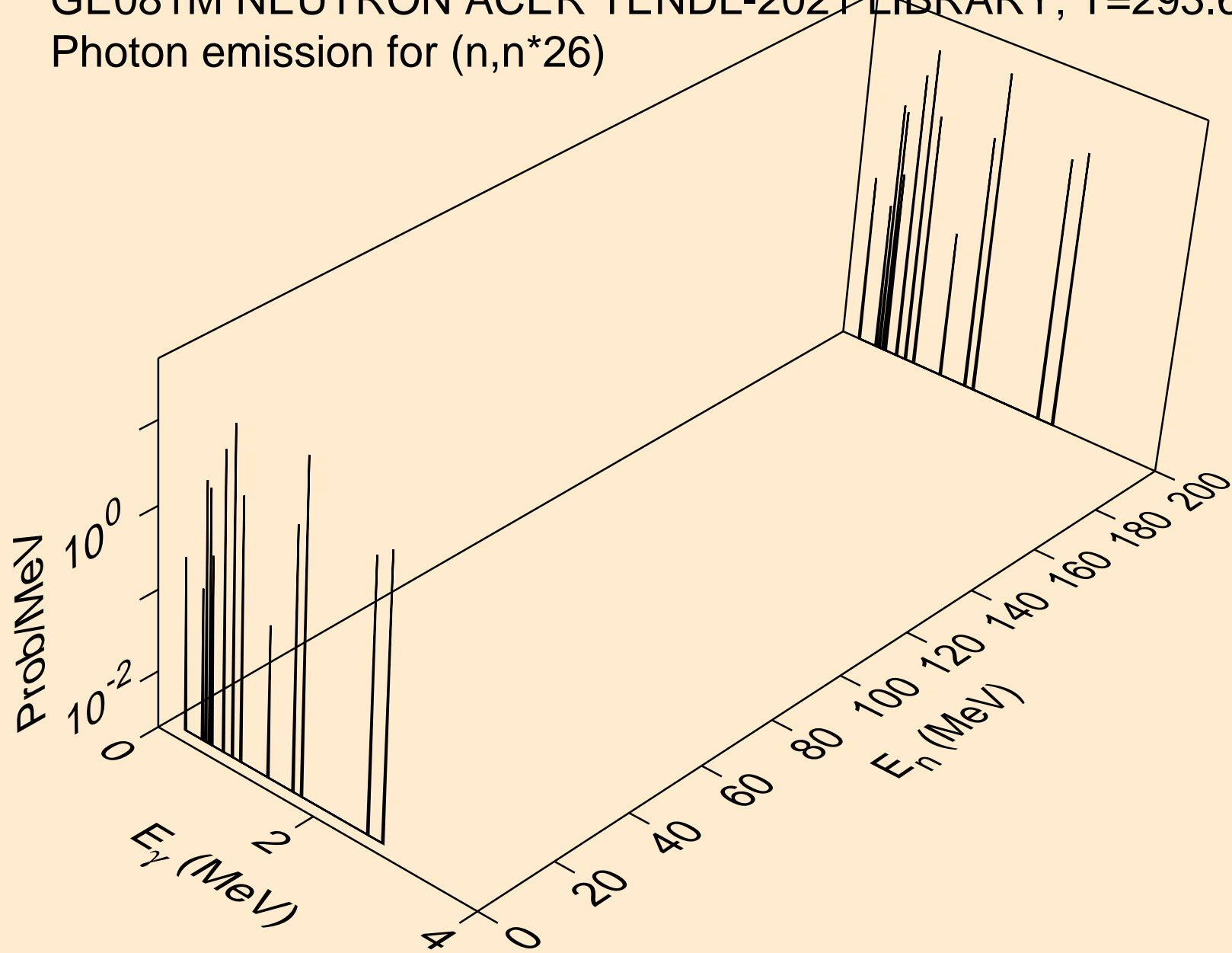

GE081M NEUTRON ACER TENDL-2021 LIBRARY; T=293.6K
Photon emission for (n,n*27)

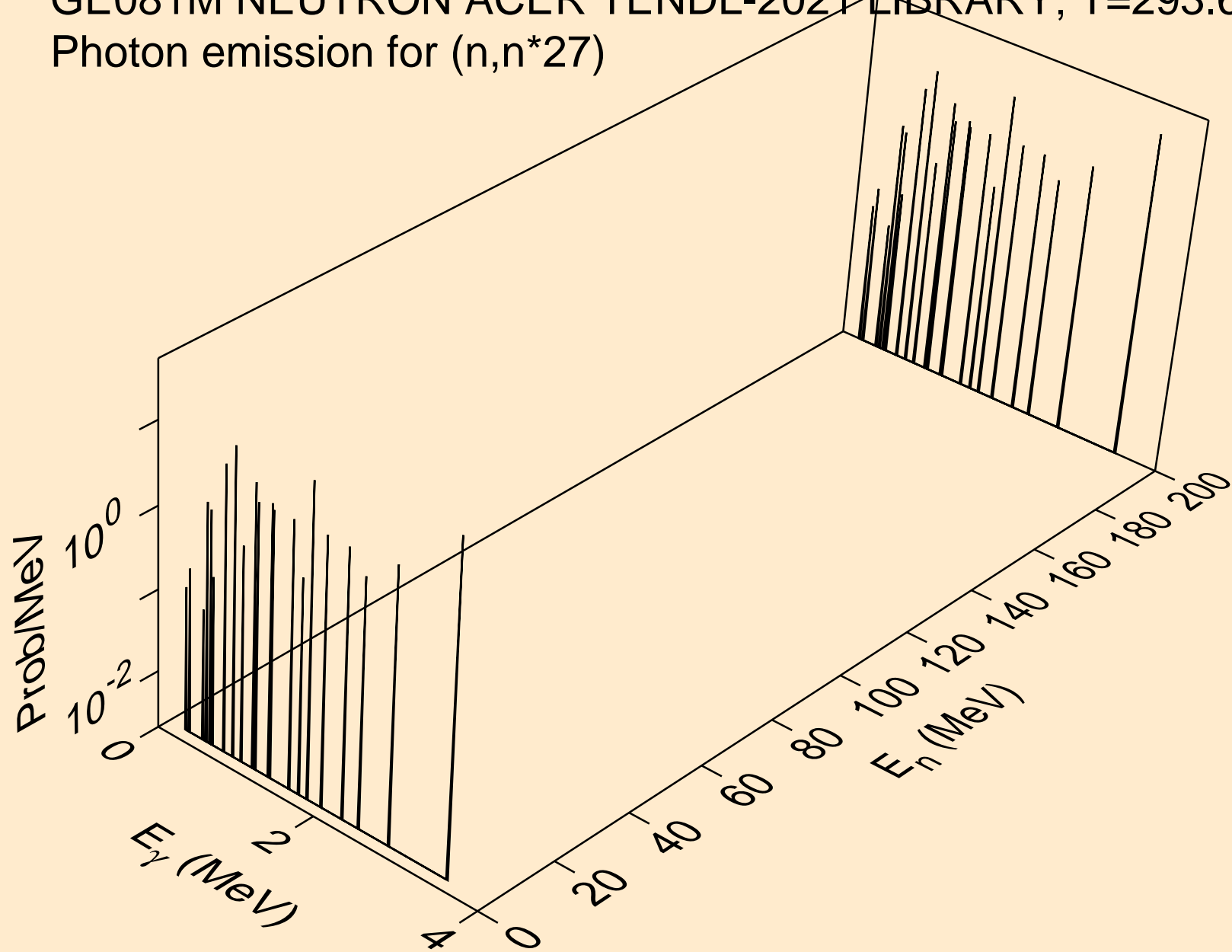

GE081M NEUTRON ACER TENDL-2021 LIBRARY; T=293.6K
Photon emission for (n,n*28)

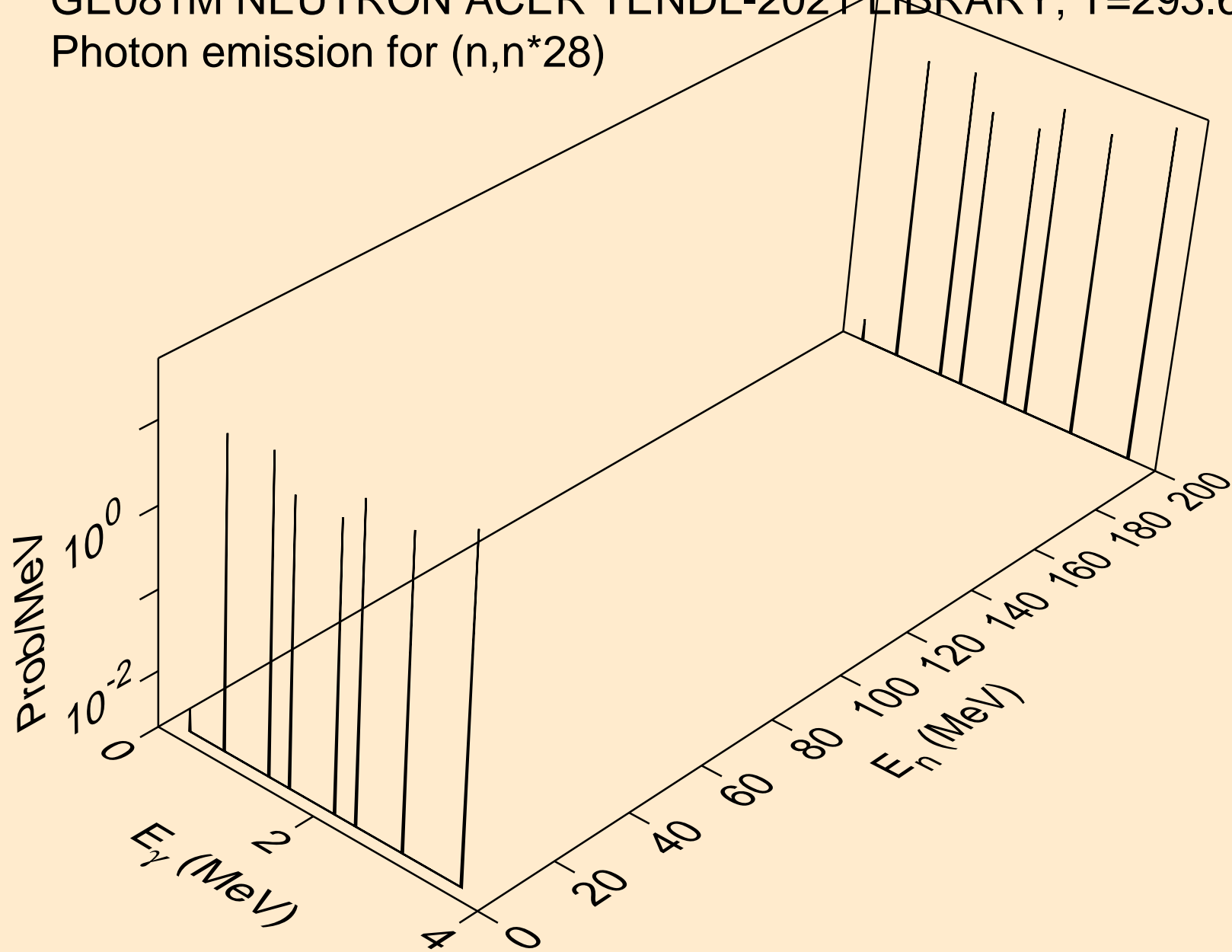

GE081M NEUTRON ACER TENDL-2021 LIBRARY; T=293.6K
Photon emission for (n,n*29)

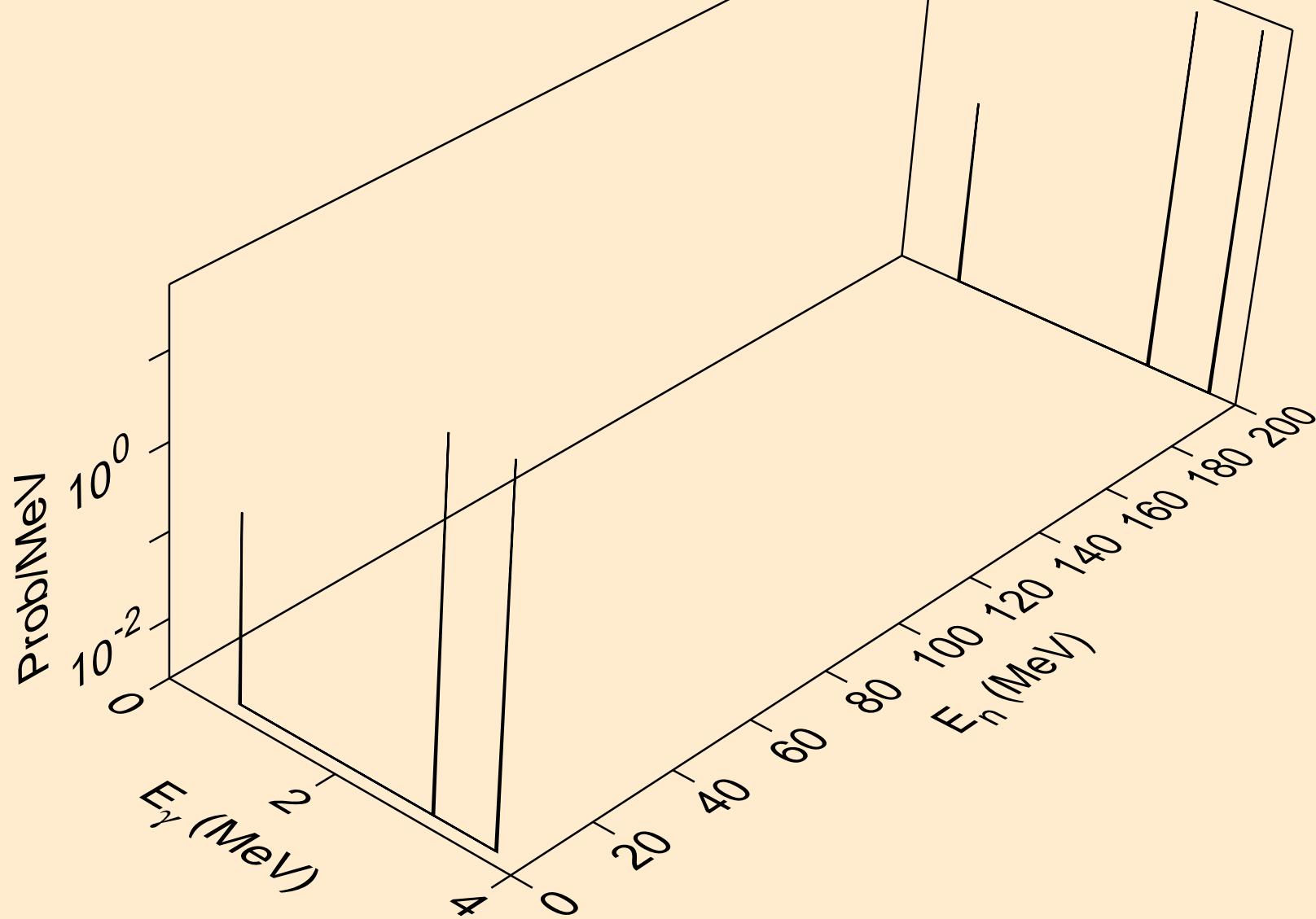

GE081M NEUTRON ACER TENDL-2021 LIBRARY; T=293.6K
Photon emission for (n,n*30)

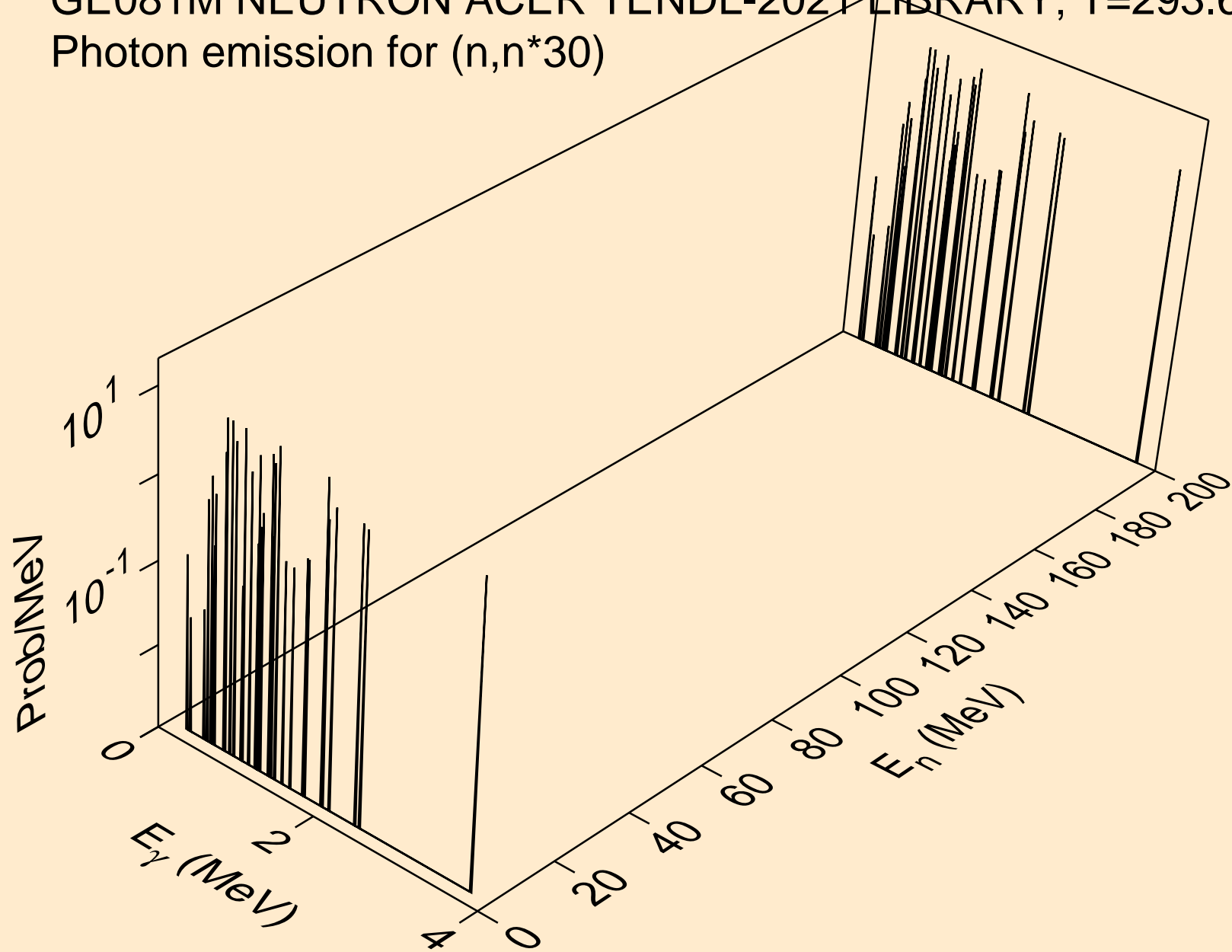

GE081M NEUTRON ACER TENDL-2021 LIBRARY; T=293.6K
Photon emission for (n,n*c)

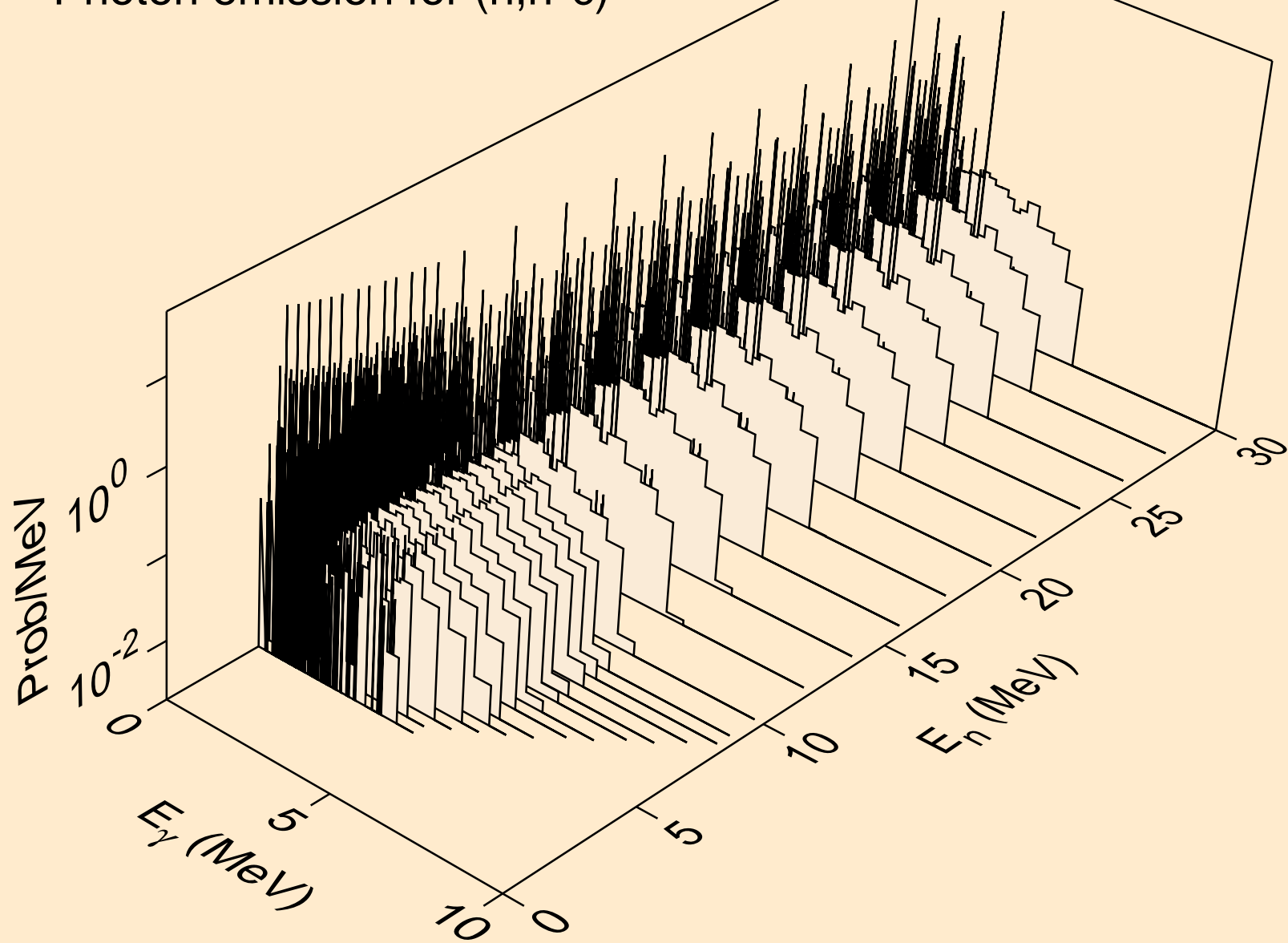

GE081M NEUTRON ACER TENDL-2021 LIBRARY; T=293.6K
Photon emission for (n,gma)

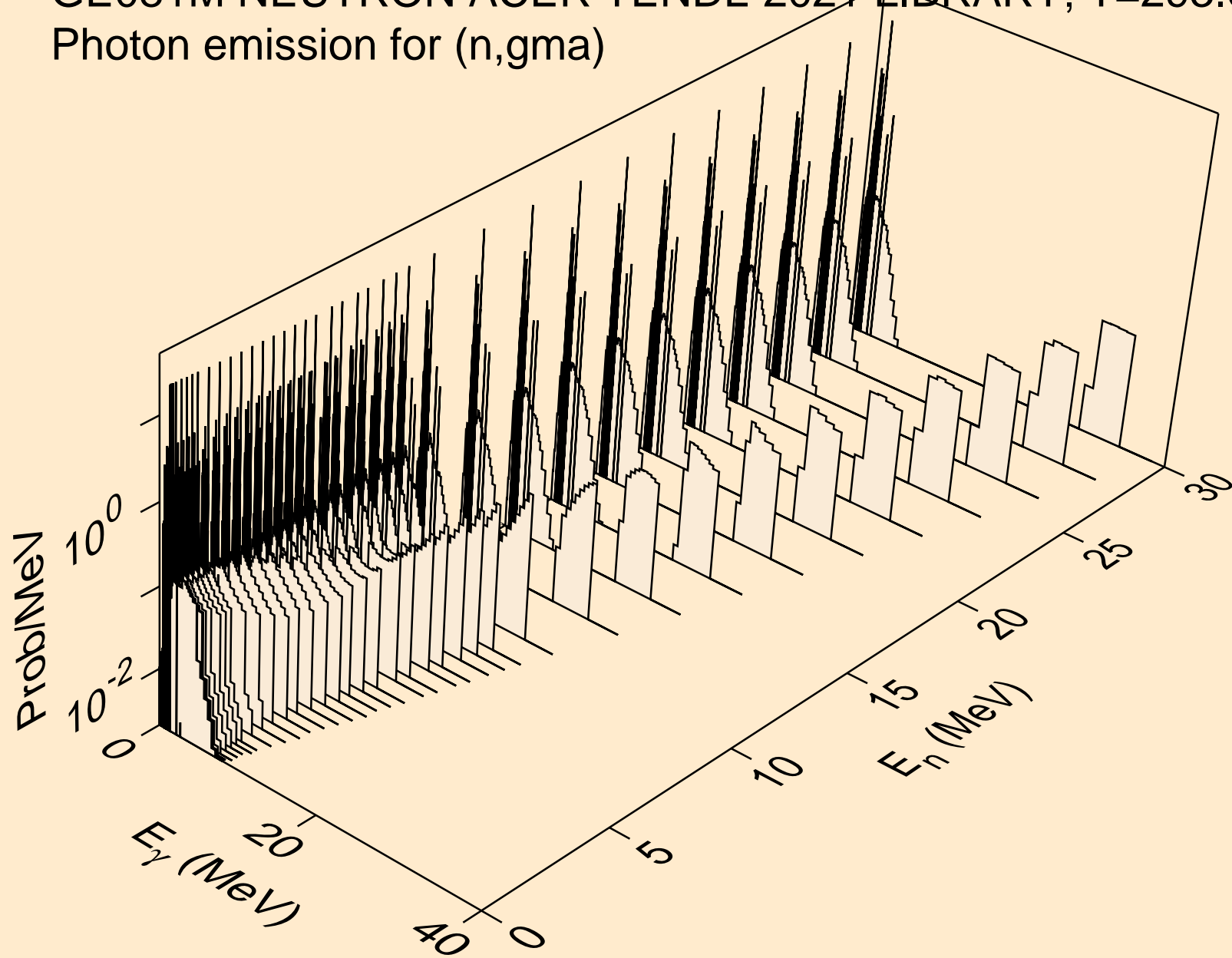

GE081M NEUTRON ACER TENDL-2021 LIBRARY; T=293.6K
Photon emission for (n,p)

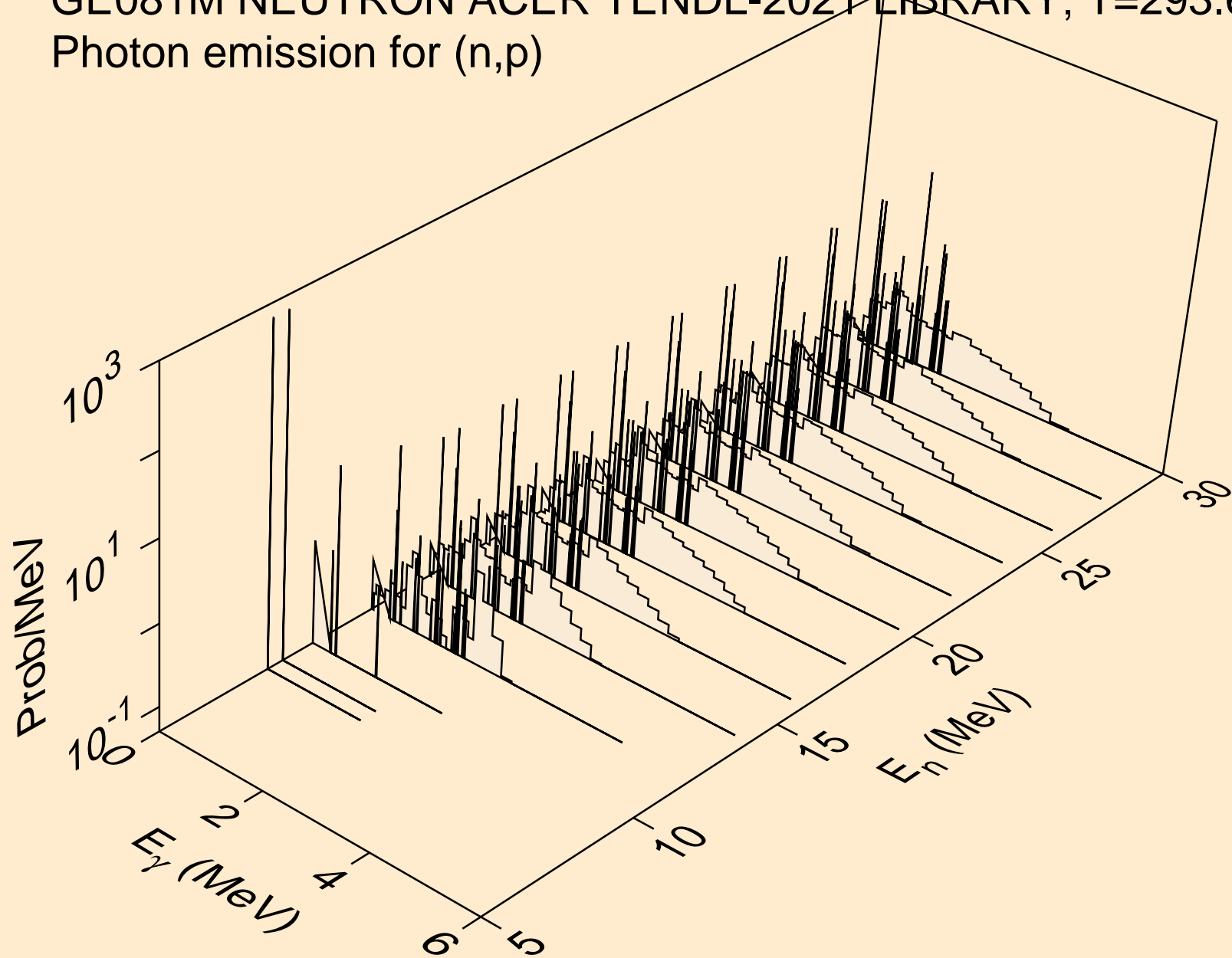

GE081M NEUTRON ACER TENDL-2021 LIBRARY; T=293.6K
Photon emission for (n,d)

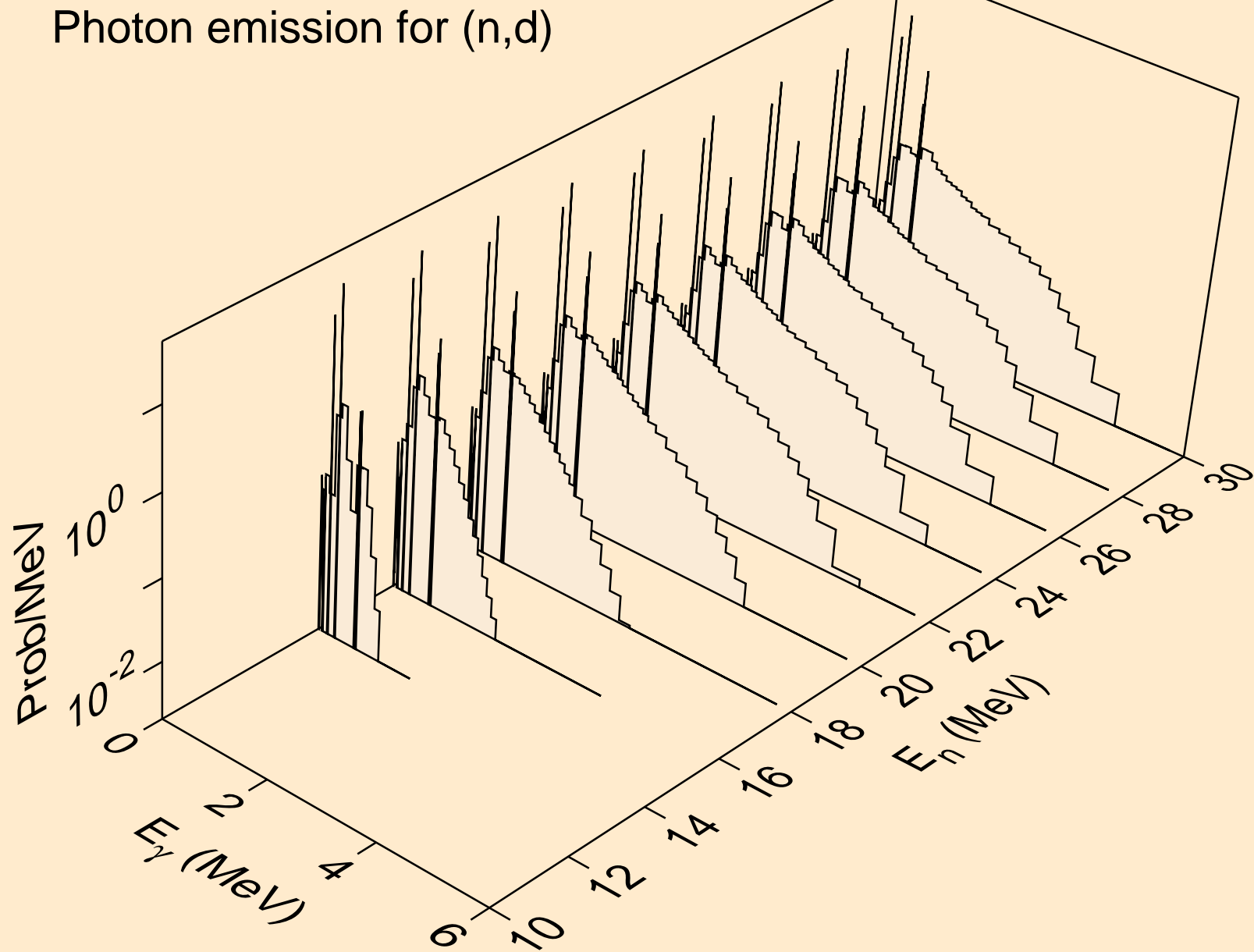

GE081M NEUTRON ACER TENDL-2021 LIBRARY; T=293.6K
Photon emission for (n,t)

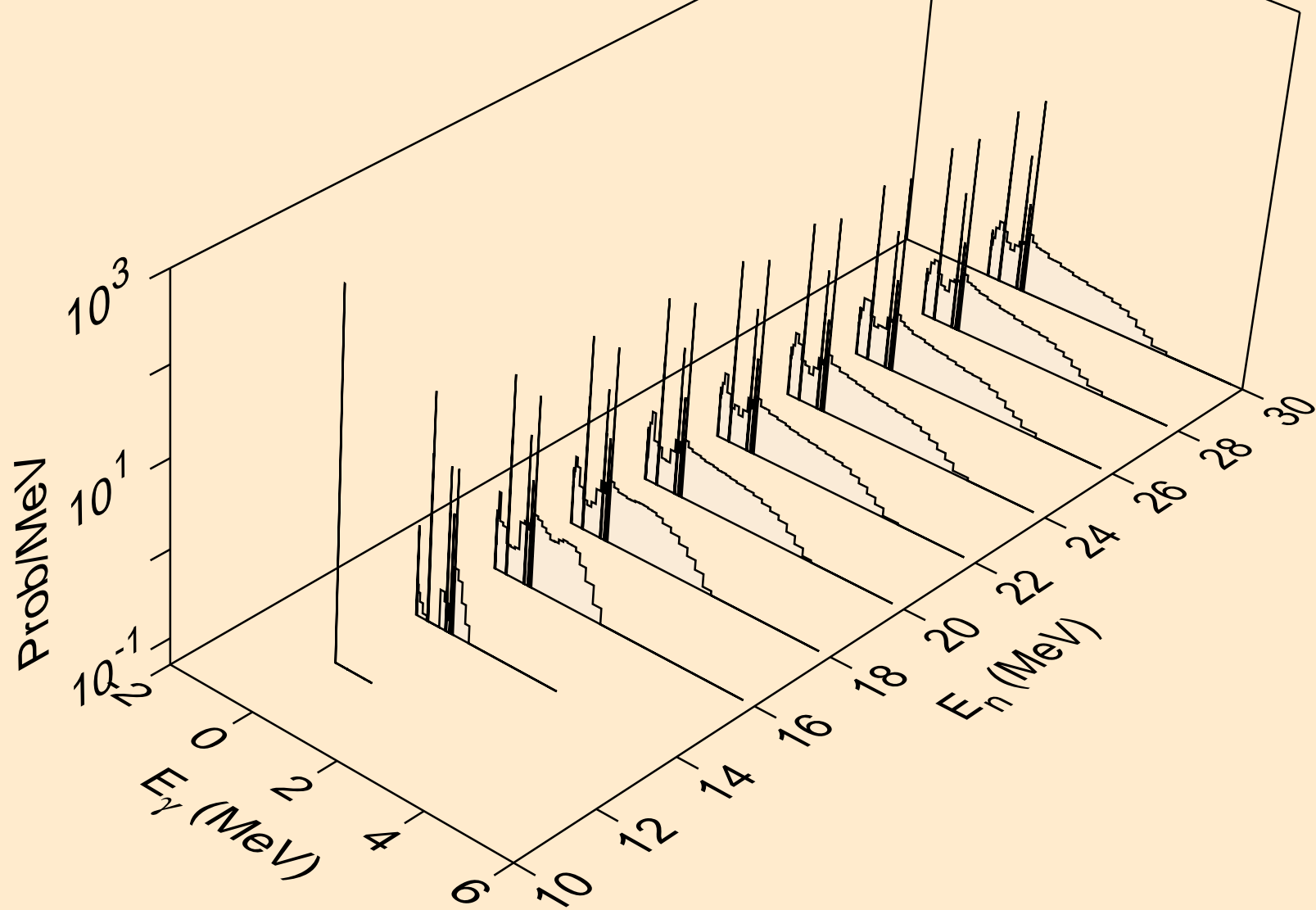

GE081M NEUTRON ACER TENDL-2021 LIBRARY; T=293.6K
Photon emission for (n,he3)

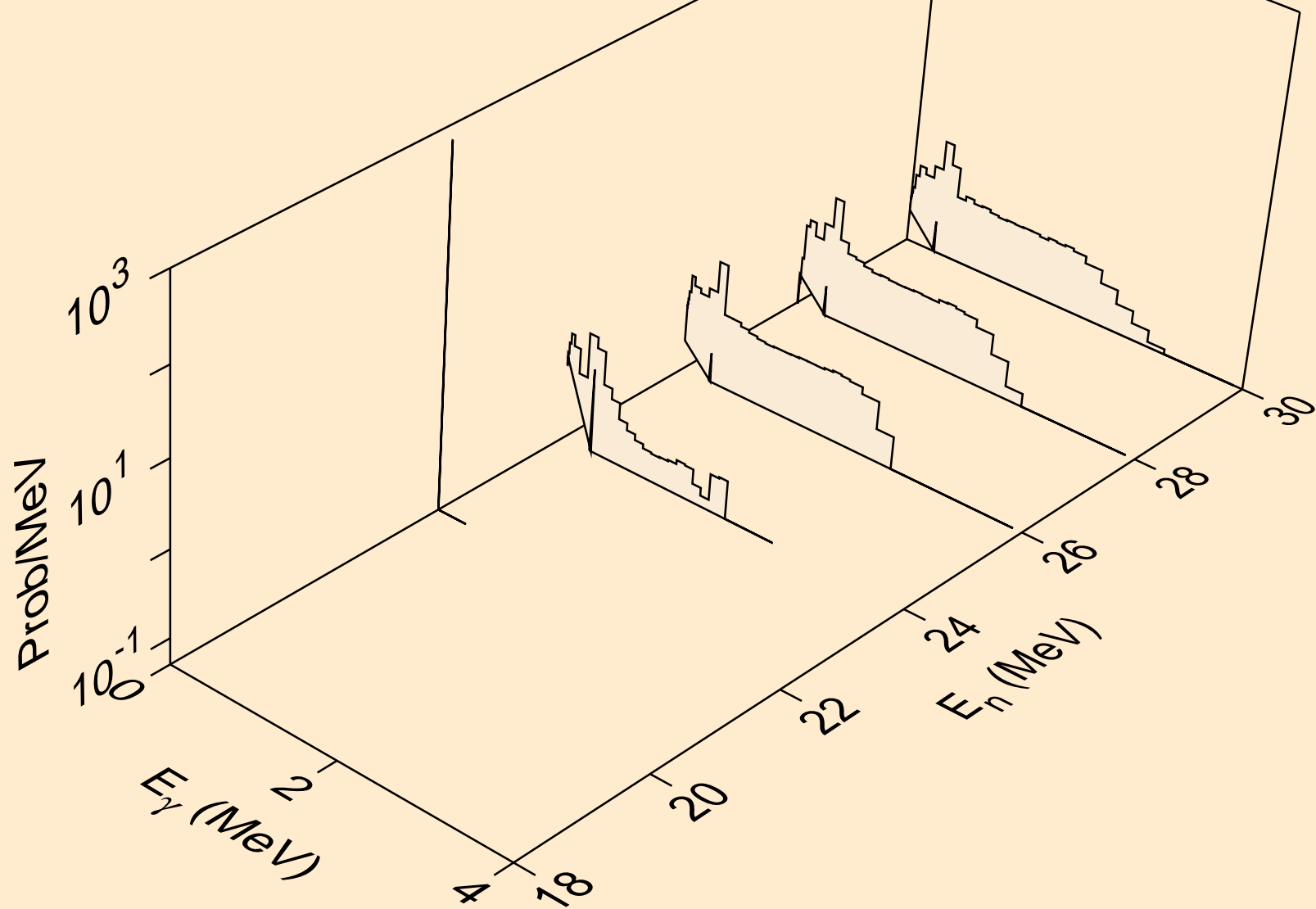

GE081M NEUTRON ACER TENDL-2021 LIBRARY; T=293.6K
Photon emission for (n,a)

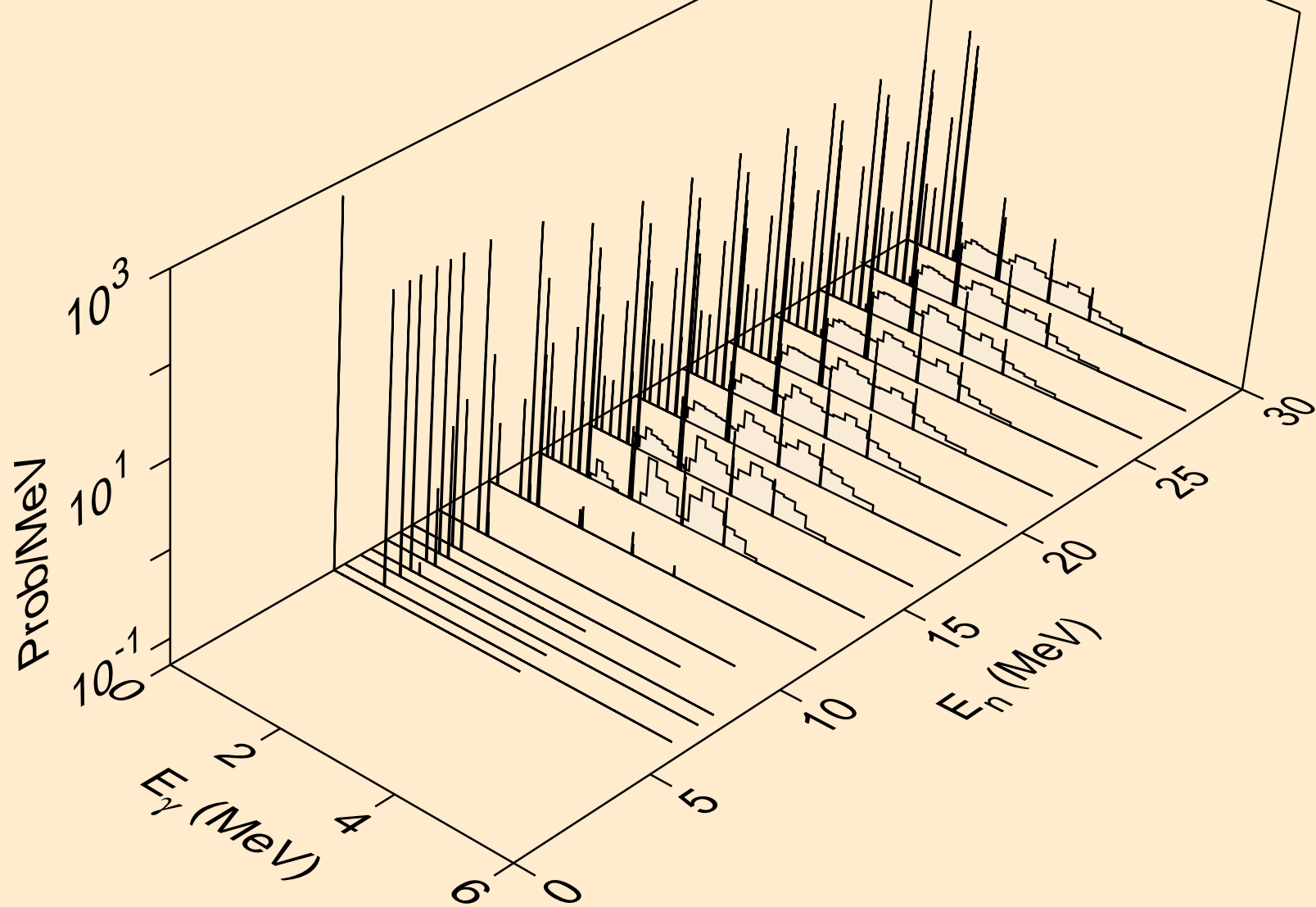

GE081M NEUTRON ACER TENDL-2021 LIBRARY; T=293.6K
Photon emission for (n,2p)

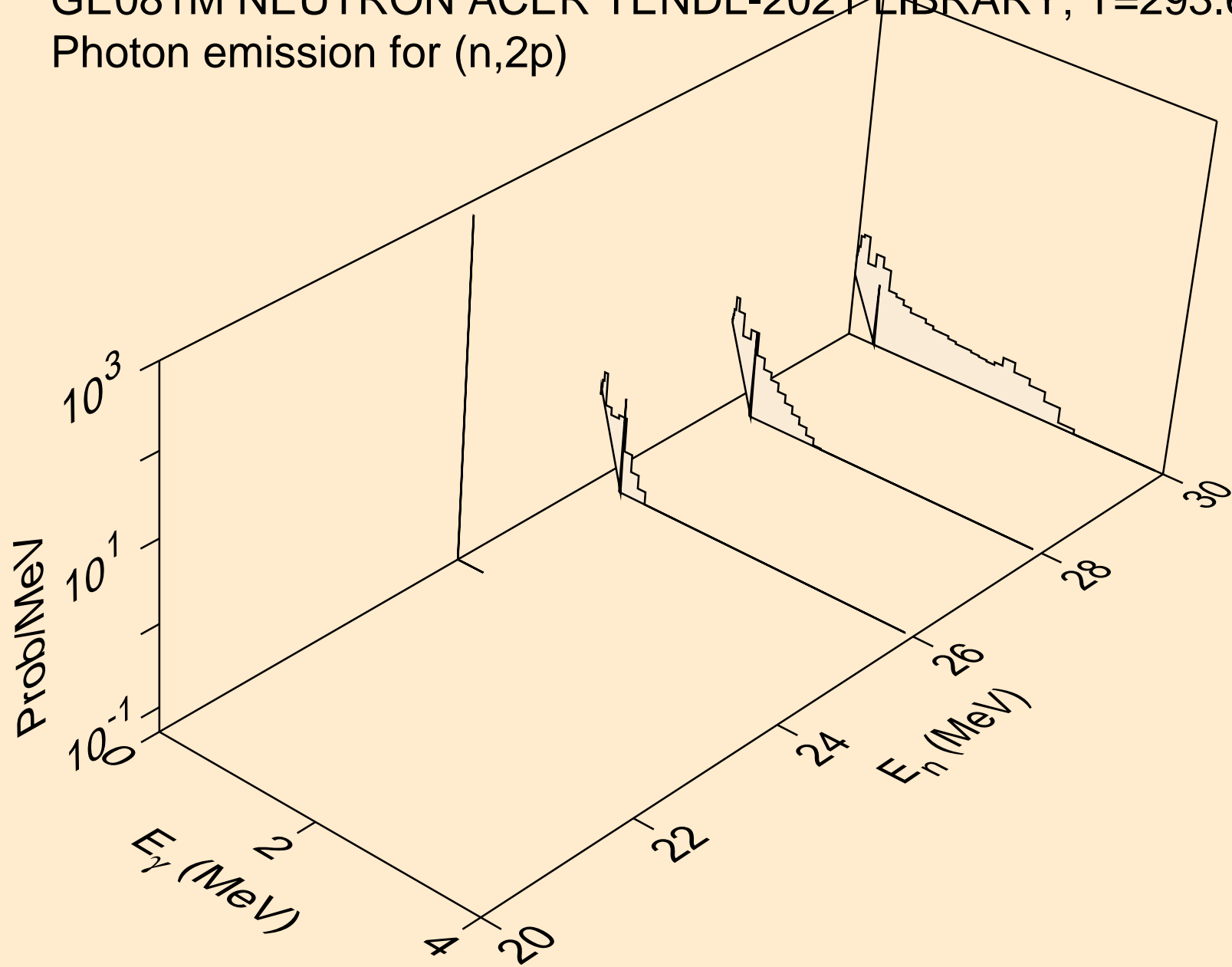

GE081M NEUTRON ACER TENDL-2021 LIBRARY; T=293.6K
thermal capture photon spectrum

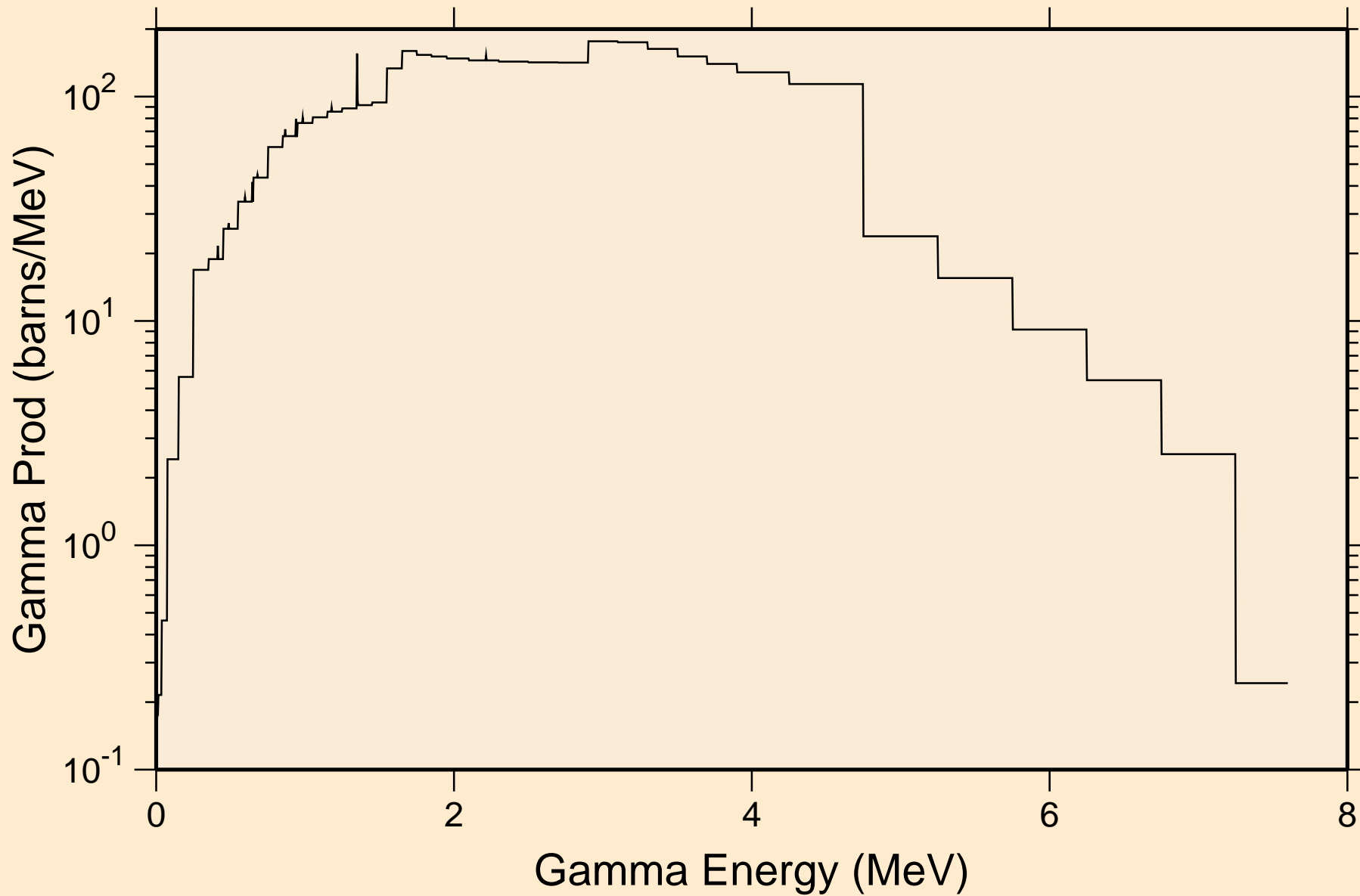

GE081M NEUTRON ACER TENDL-2021 LIBRARY; T=293.6K
14 MeV photon spectrum

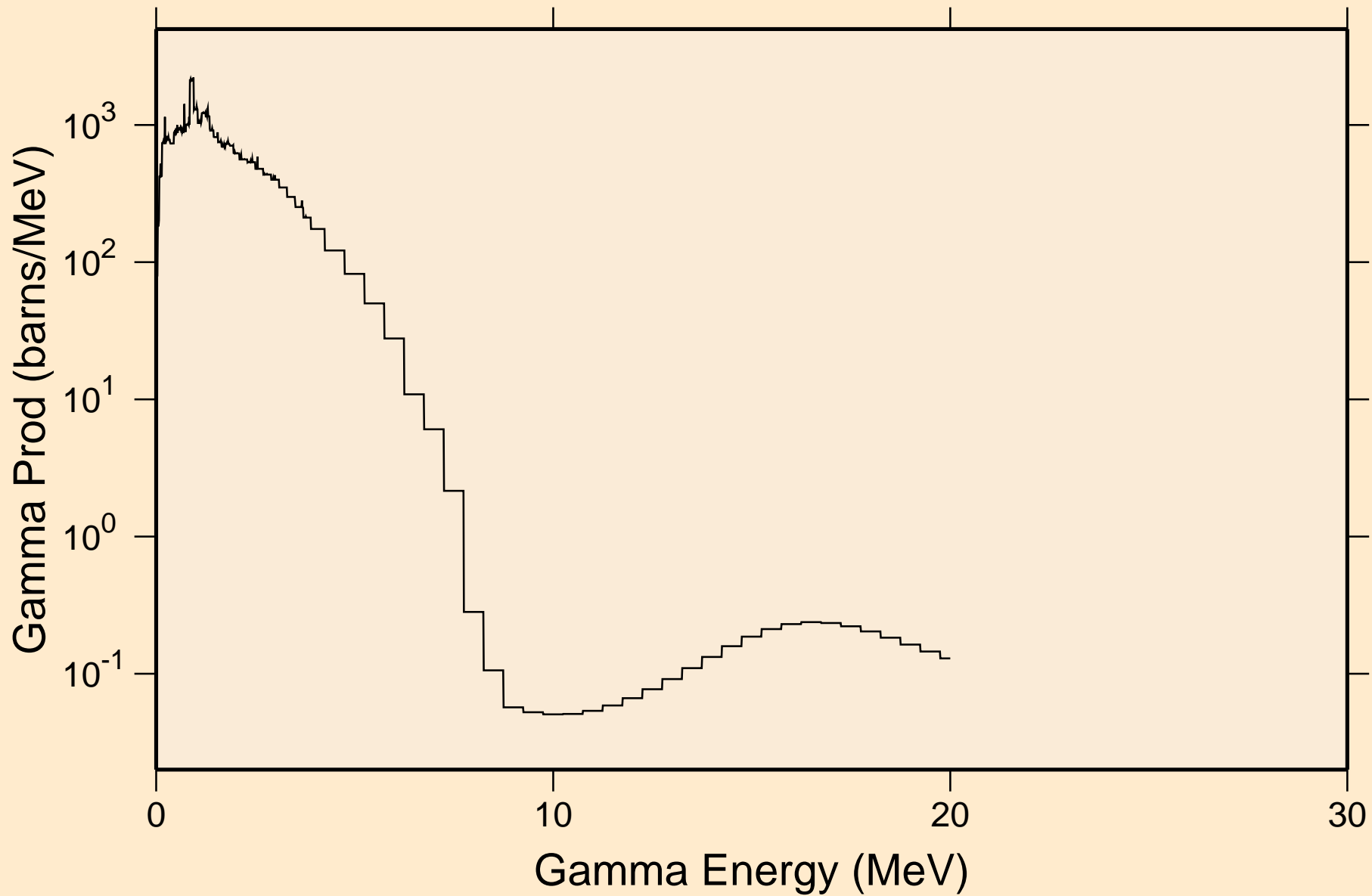

GE081M NEUTRON ACER TENDL-2021 LIBRARY; T=293.6K
Particle heating contributions

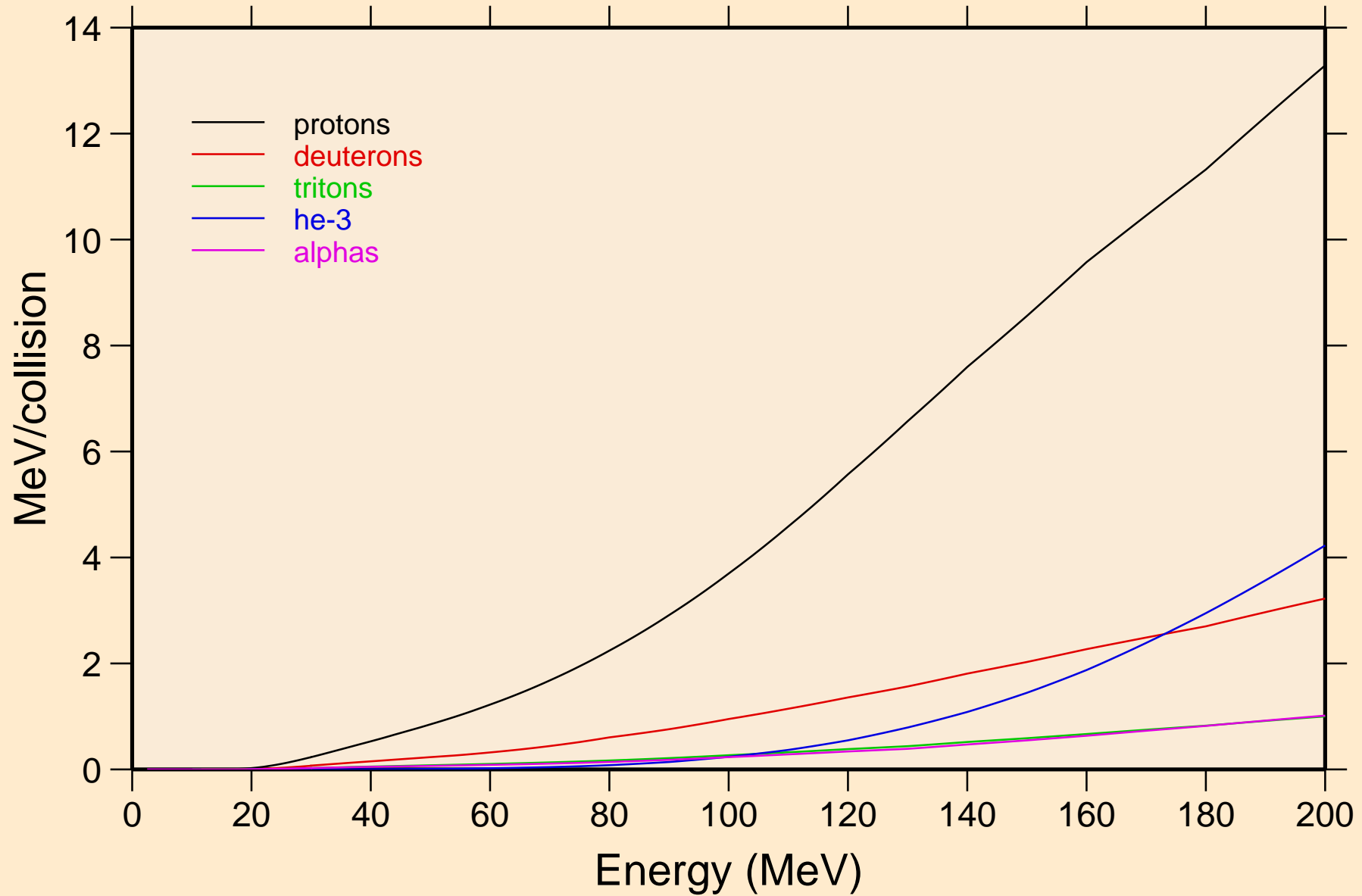

GE081M NEUTRON ACER TENDL-2021 LIBRARY; T=293.6K
Recoil Heating

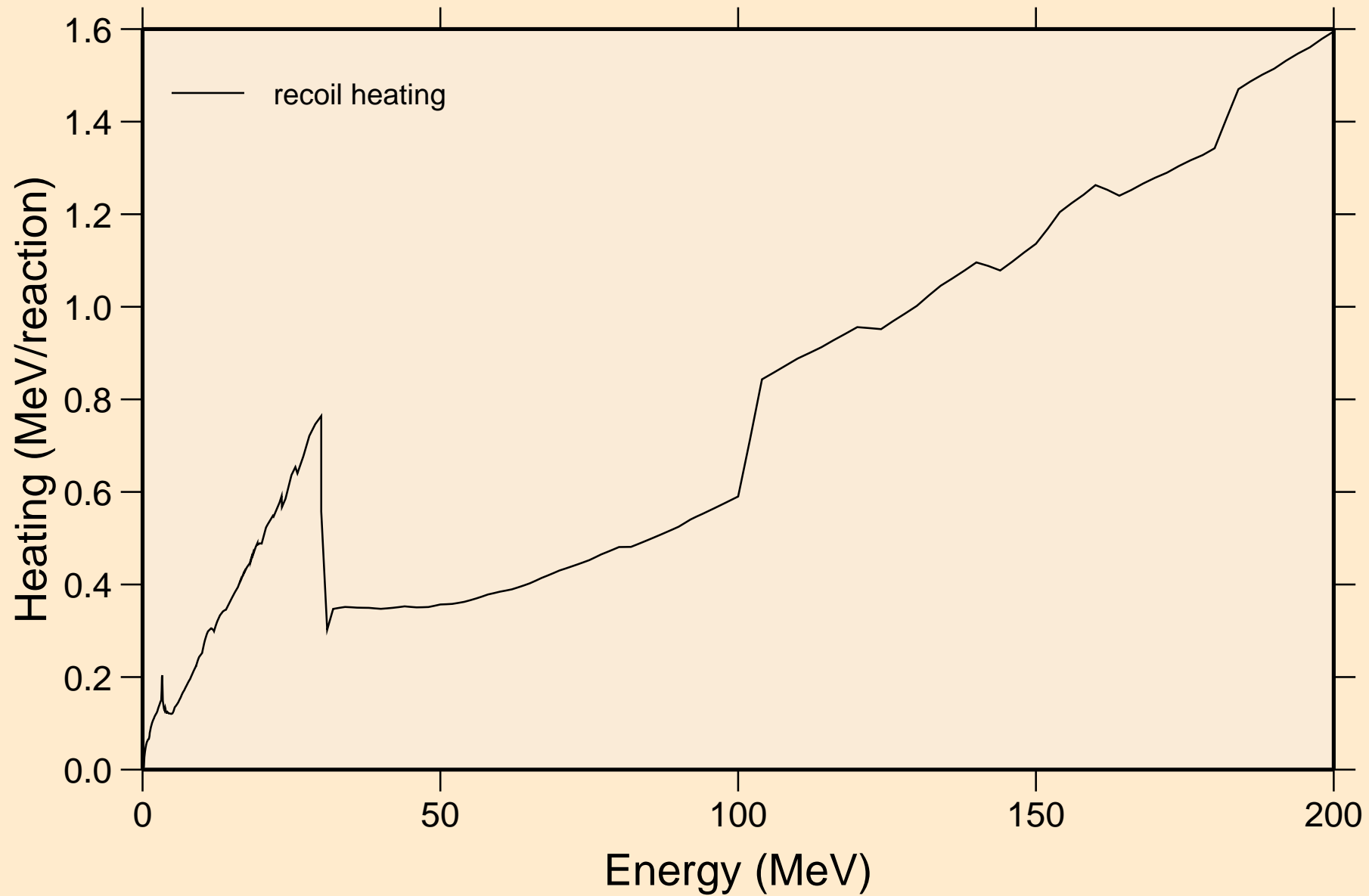

GE081M NEUTRON ACER TENDL-2021 LIBRARY; T=293.6K

Particle production cross sections

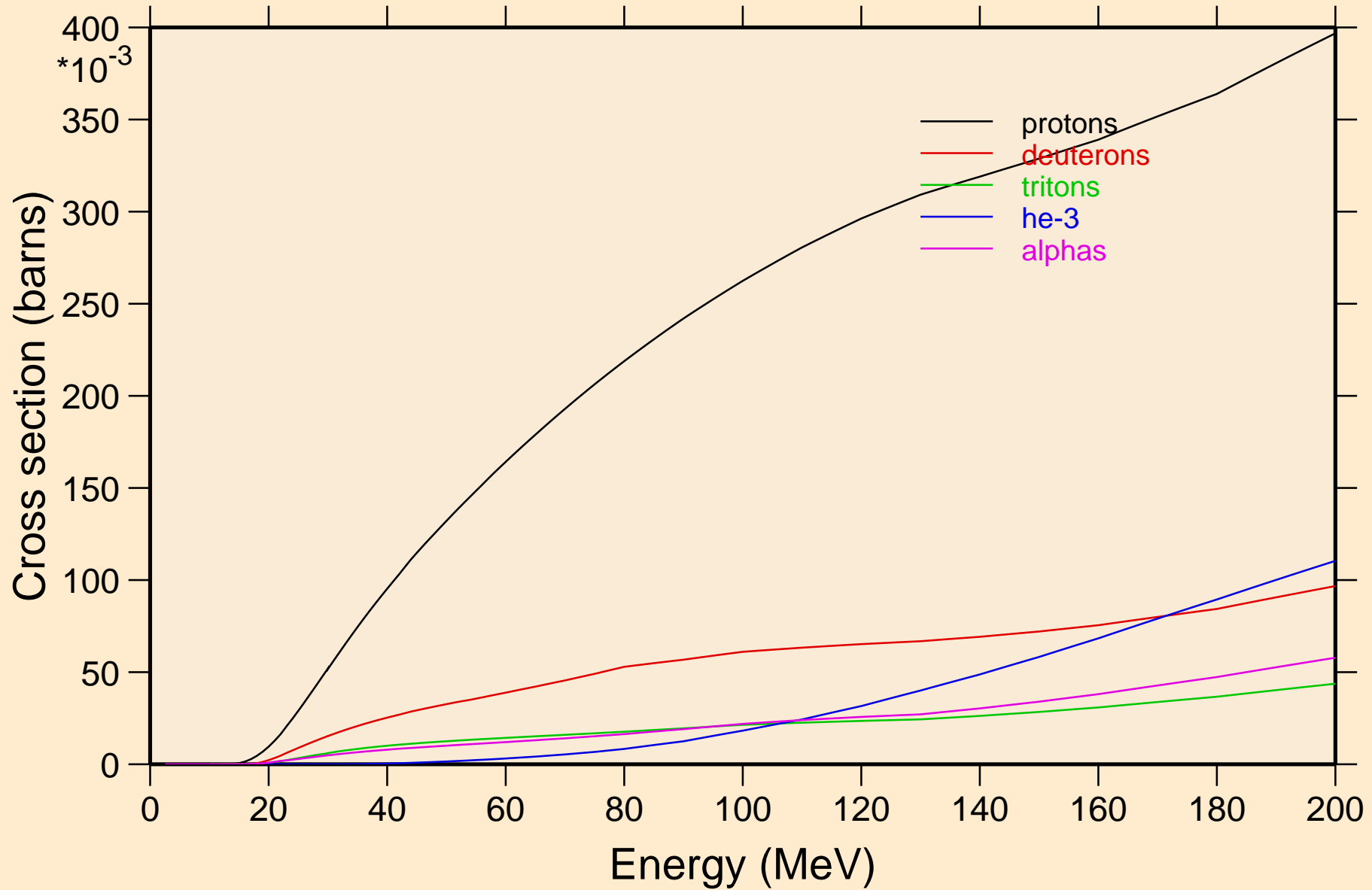

GE081M NEUTRON ACER TENDL-2021 LIBRARY; T=293.6K
protons from (n,x)

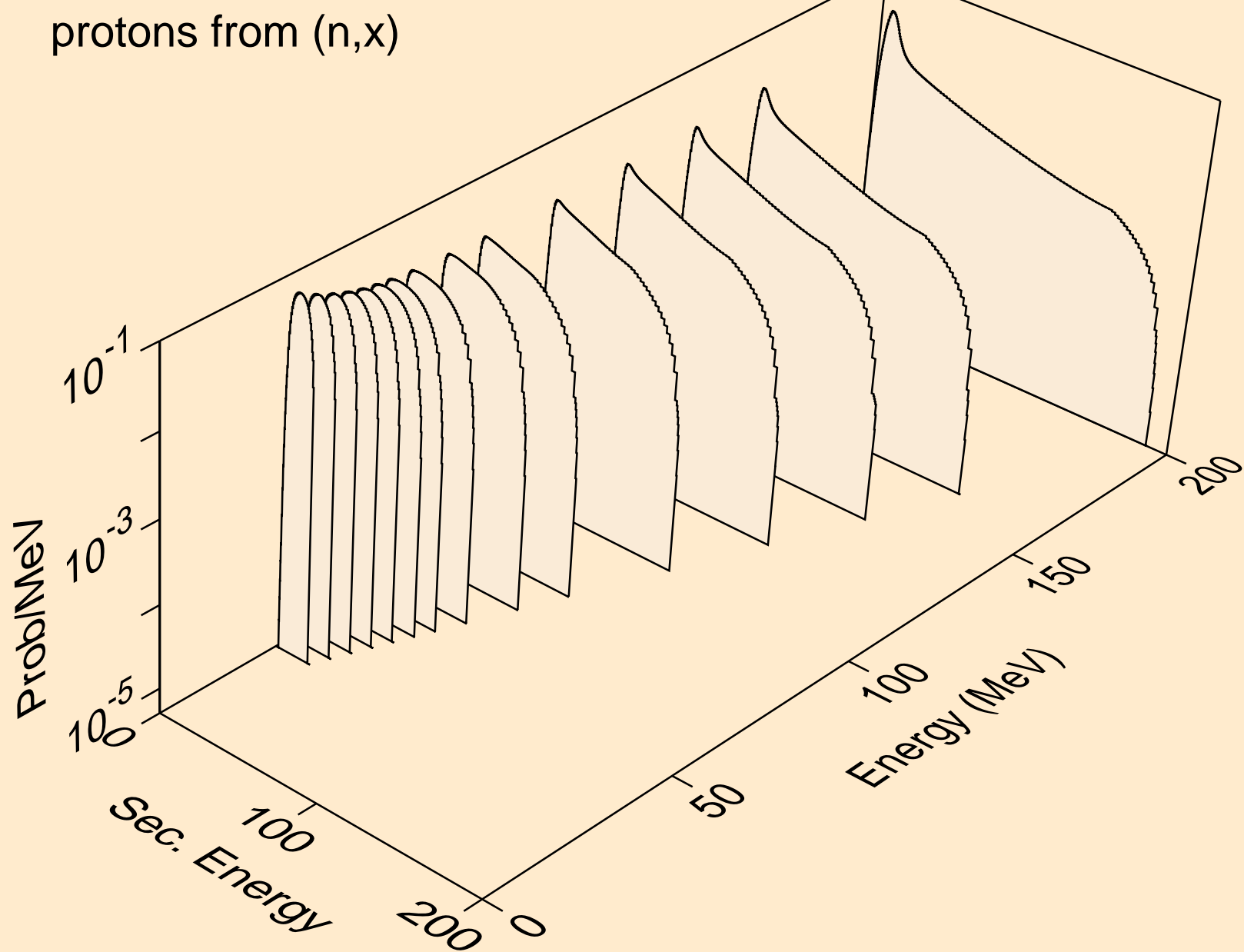

GE081M NEUTRON ACER TENDL-2021 LIBRARY; T=293.6K
protons from (n,n*)p

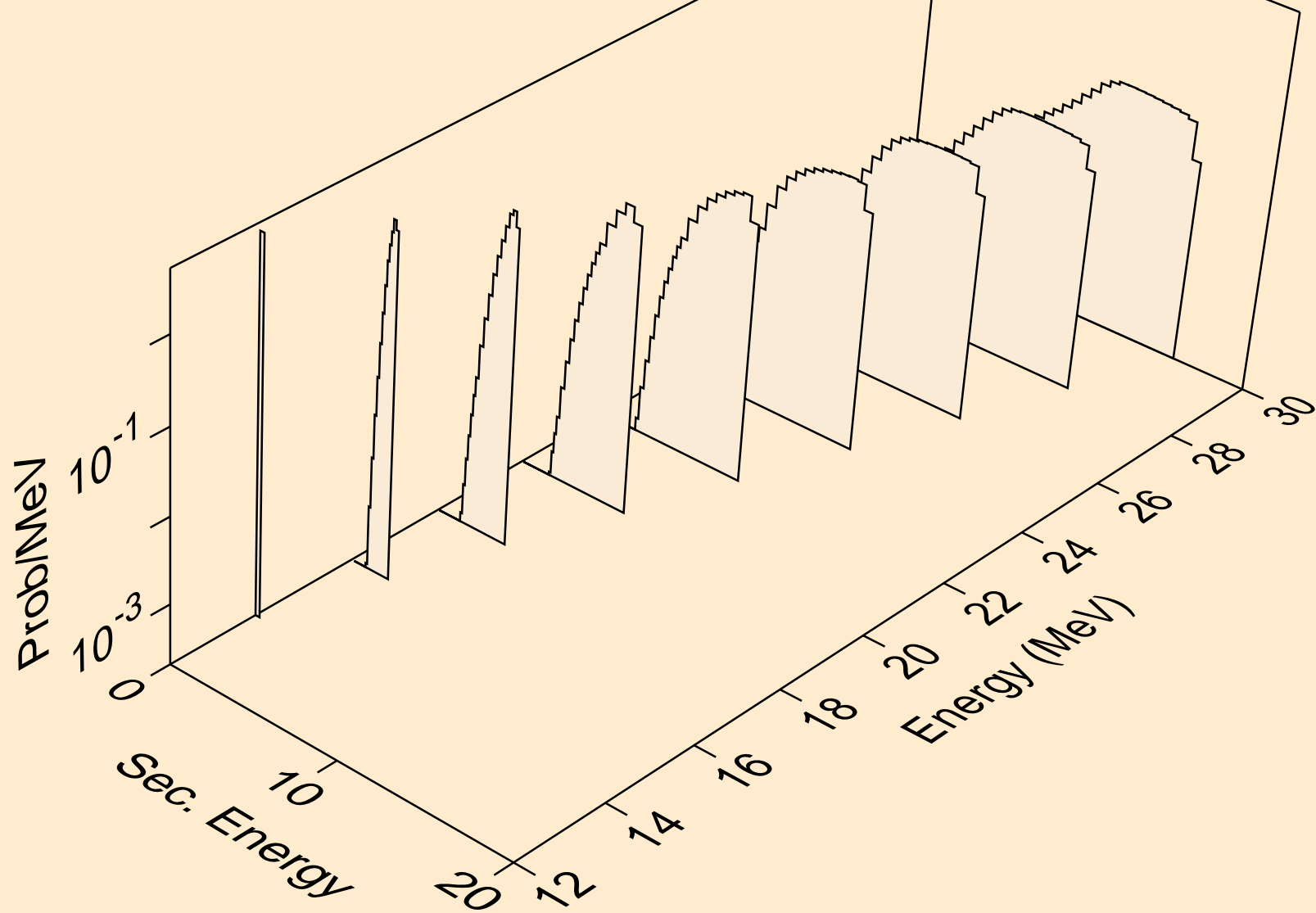

GE081M NEUTRON ACER TENDL-2021 LIBRARY; T=293.6K
protons from (n,2np)

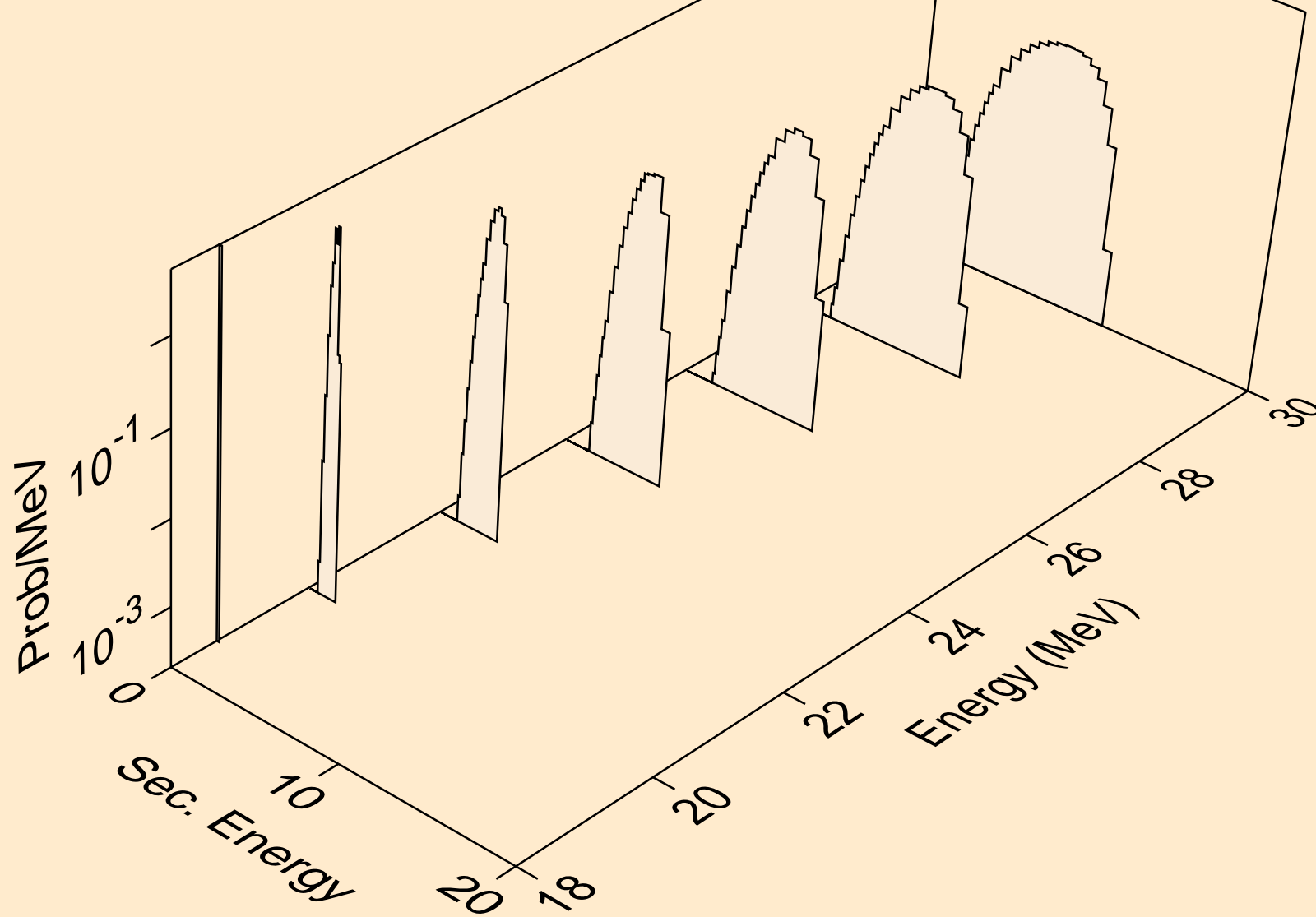

GE081M NEUTRON ACER TENDL-2021 LIBRARY; T=293.6K
protons from (n,3np)

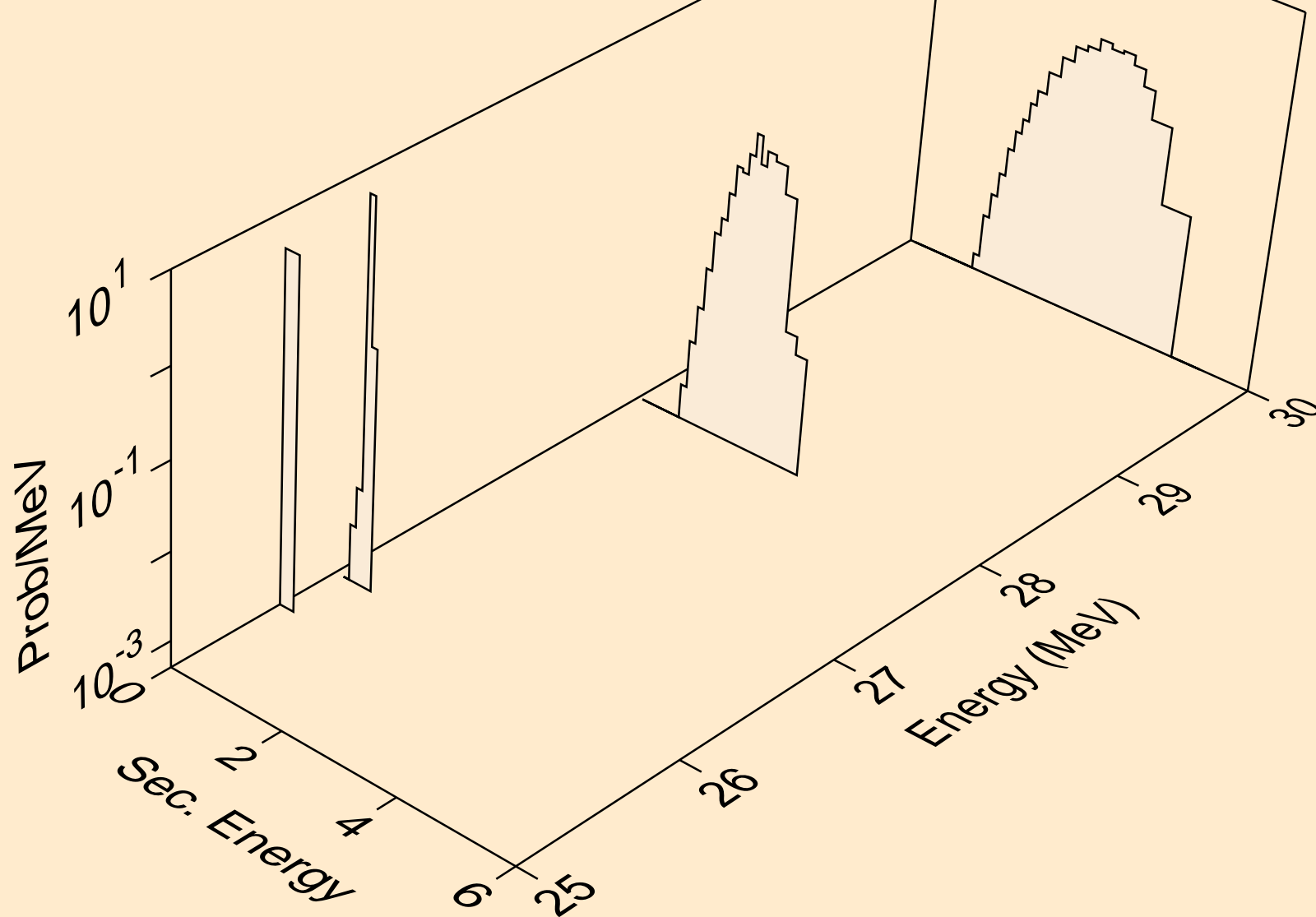

GE081M NEUTRON ACER TENDL-2021 LIBRARY; T=293.6K
protons from (n,p)

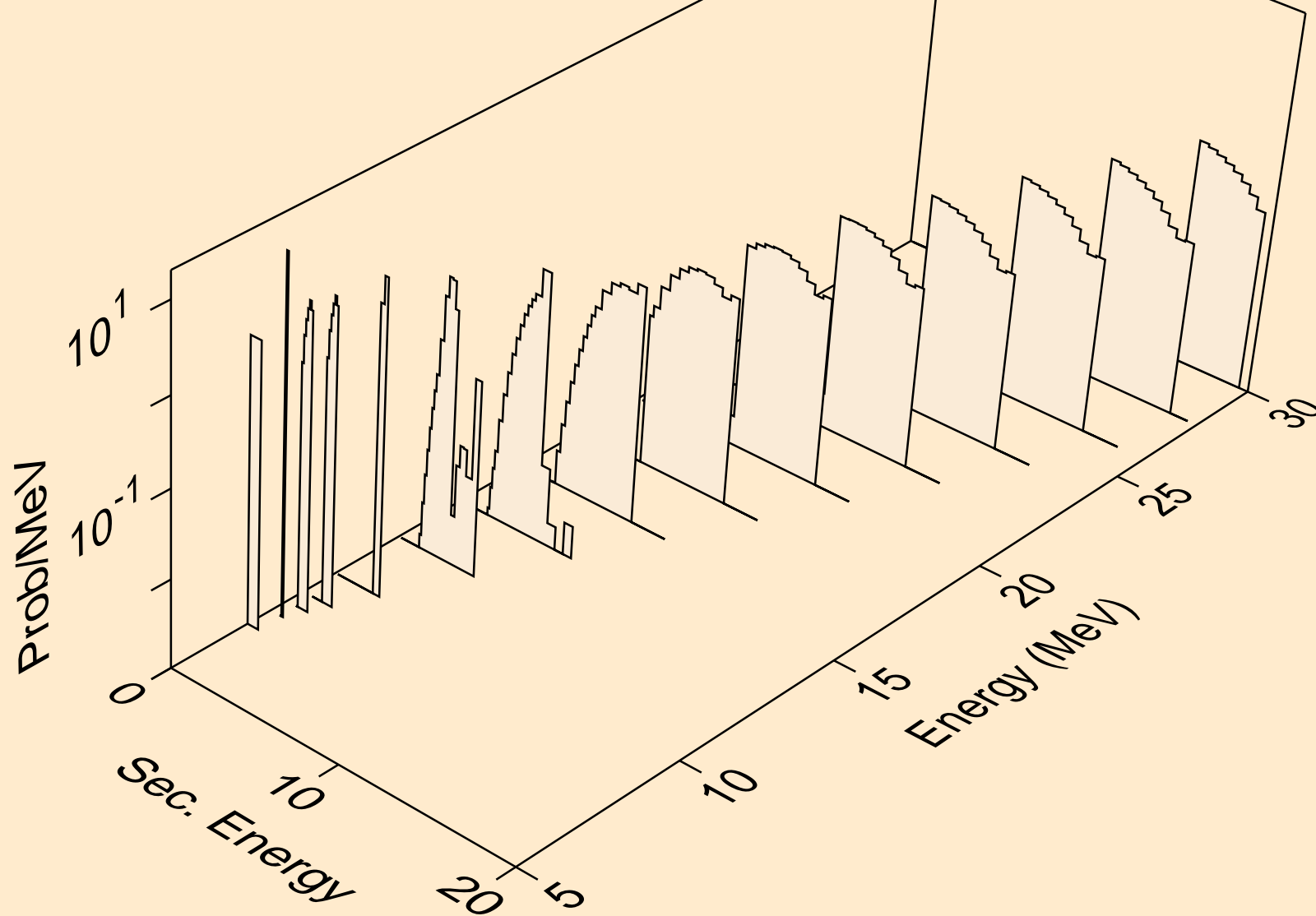

GE081M NEUTRON ACER TENDL-2021 LIBRARY; T=293.6K
protons from (n,2p)

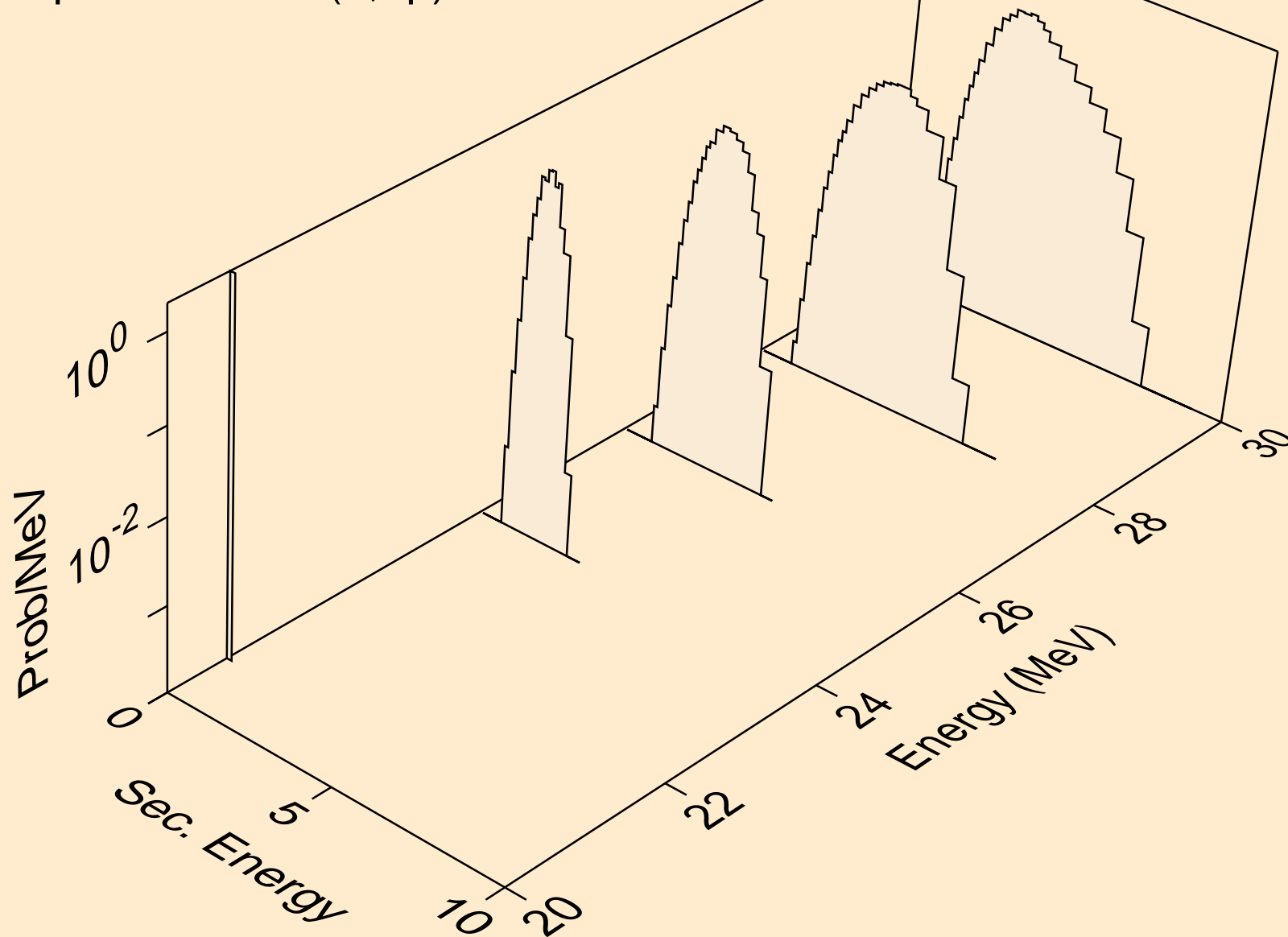

GE081M NEUTRON ACER TENDL-2021 LIBRARY; T=293.6K
deuterons from (n,x)

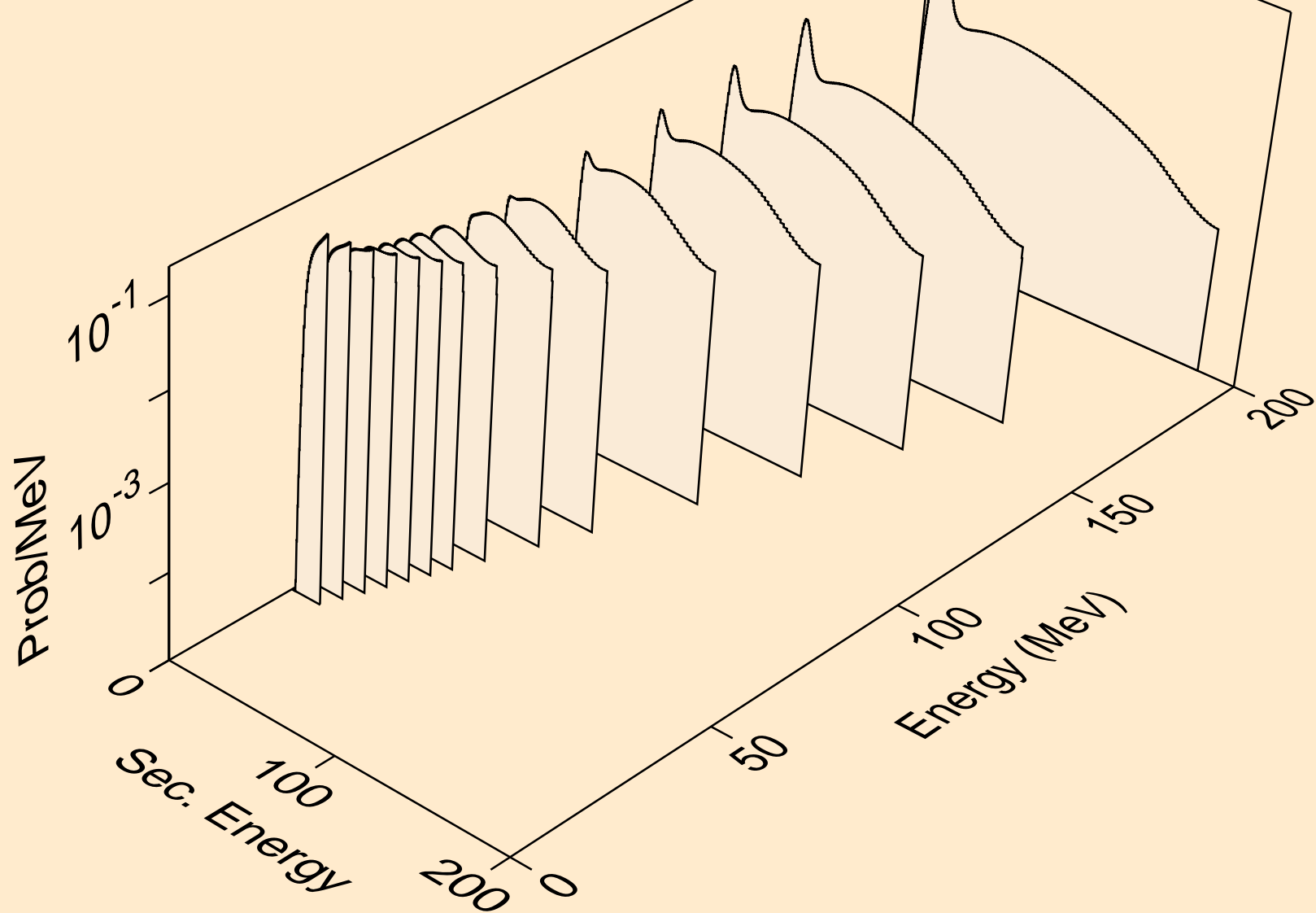

GE081M NEUTRON ACER TENDL-2021 LIBRARY; T=293.6K
deuterons from (n,2nd)

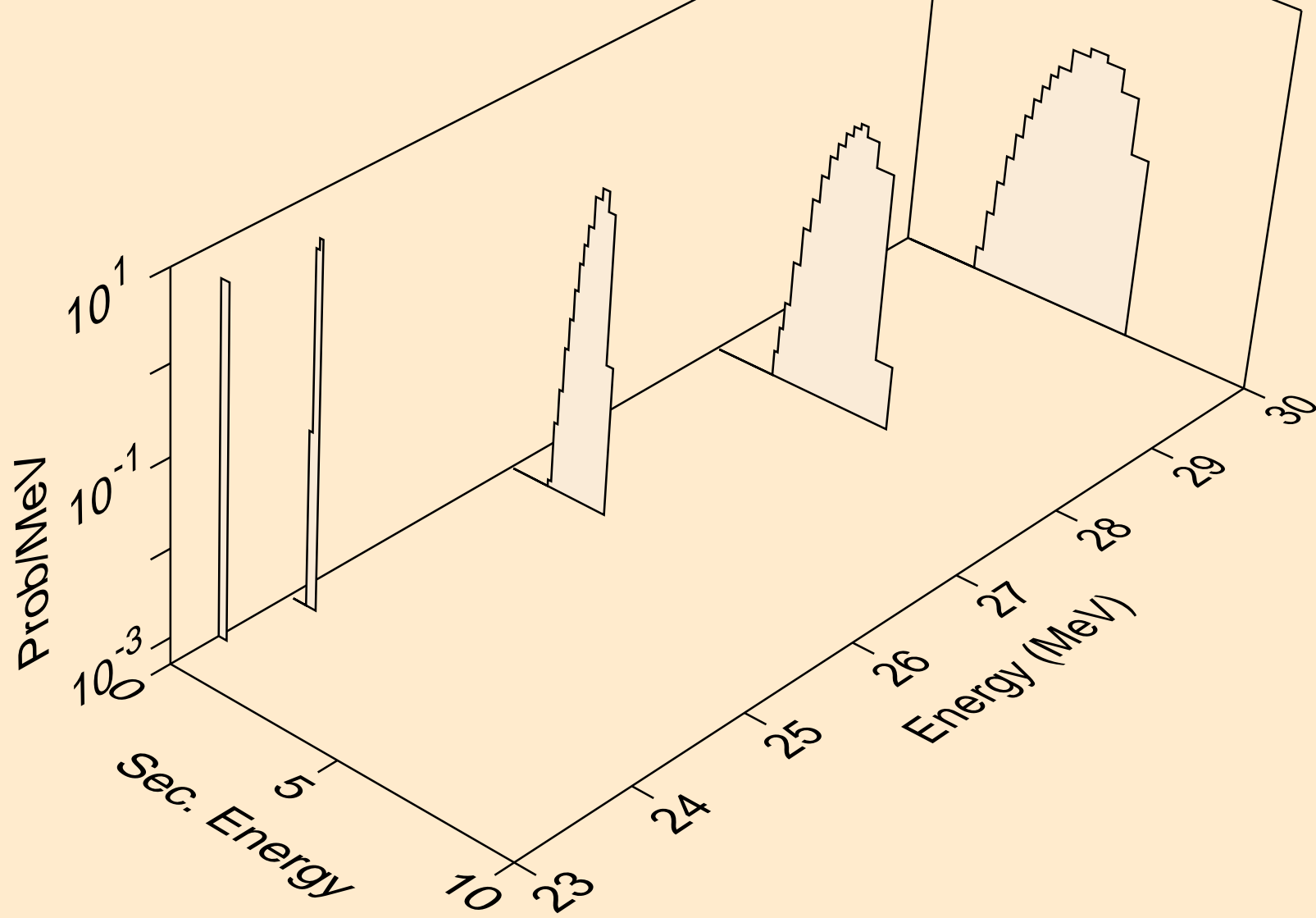

GE081M NEUTRON ACER TENDL-2021 LIBRARY; T=293.6K
deuterons from (n,n*)d

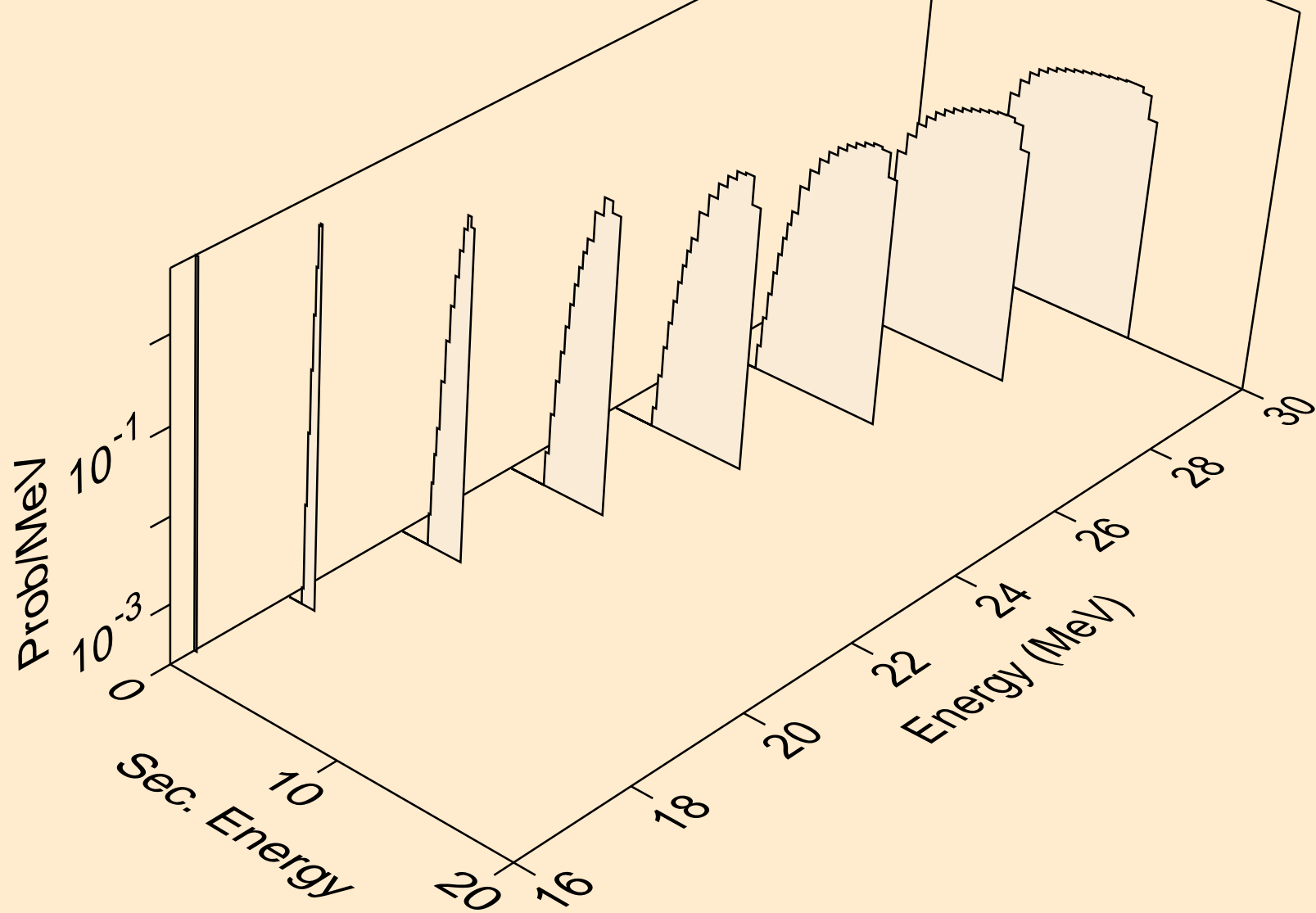

GE081M NEUTRON ACER TENDL-2021 LIBRARY; T=293.6K
deuterons from (n,d)

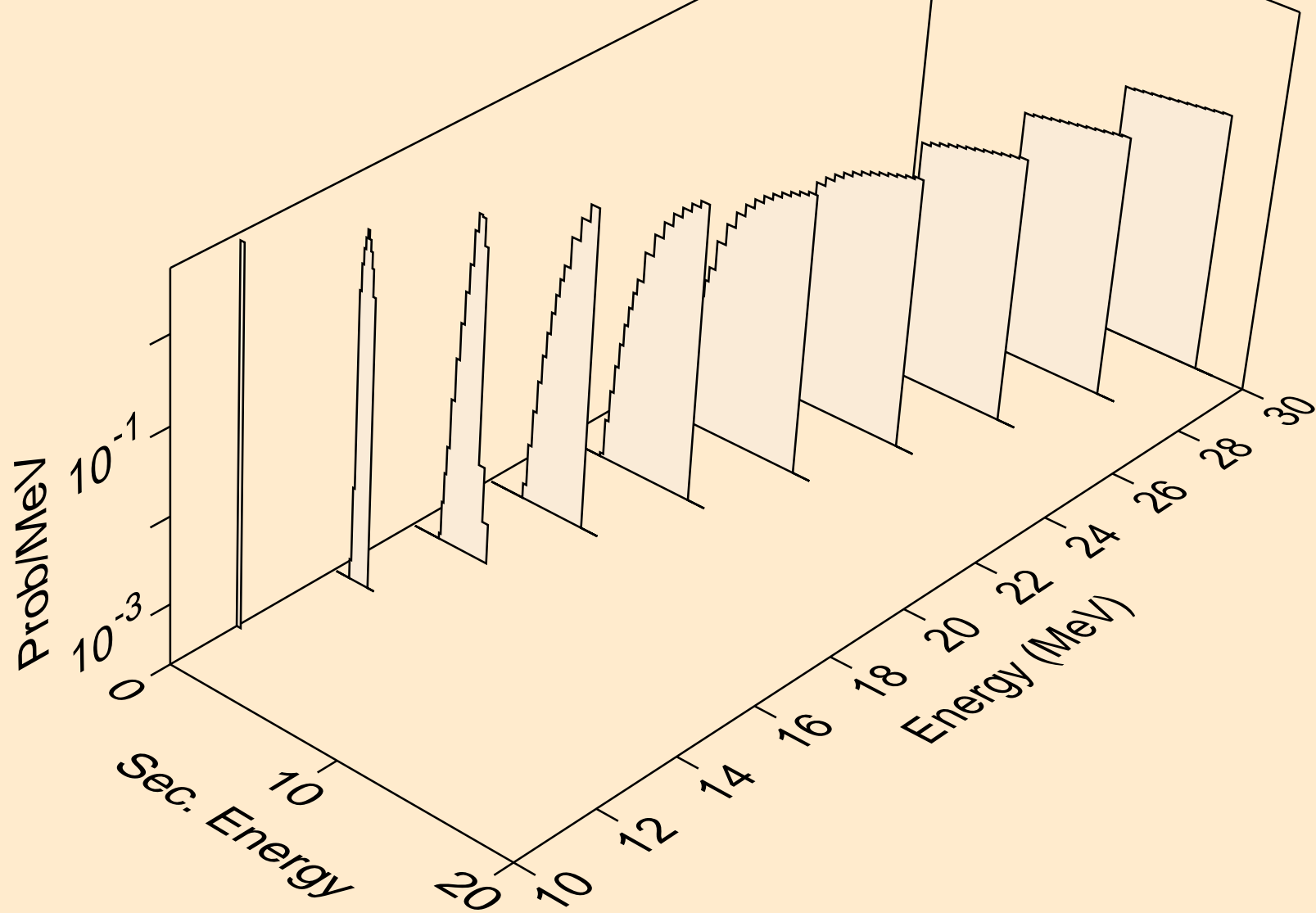

GE081M NEUTRON ACER TENDL-2021 LIBRARY; T=293.6K
tritons from (n,x)

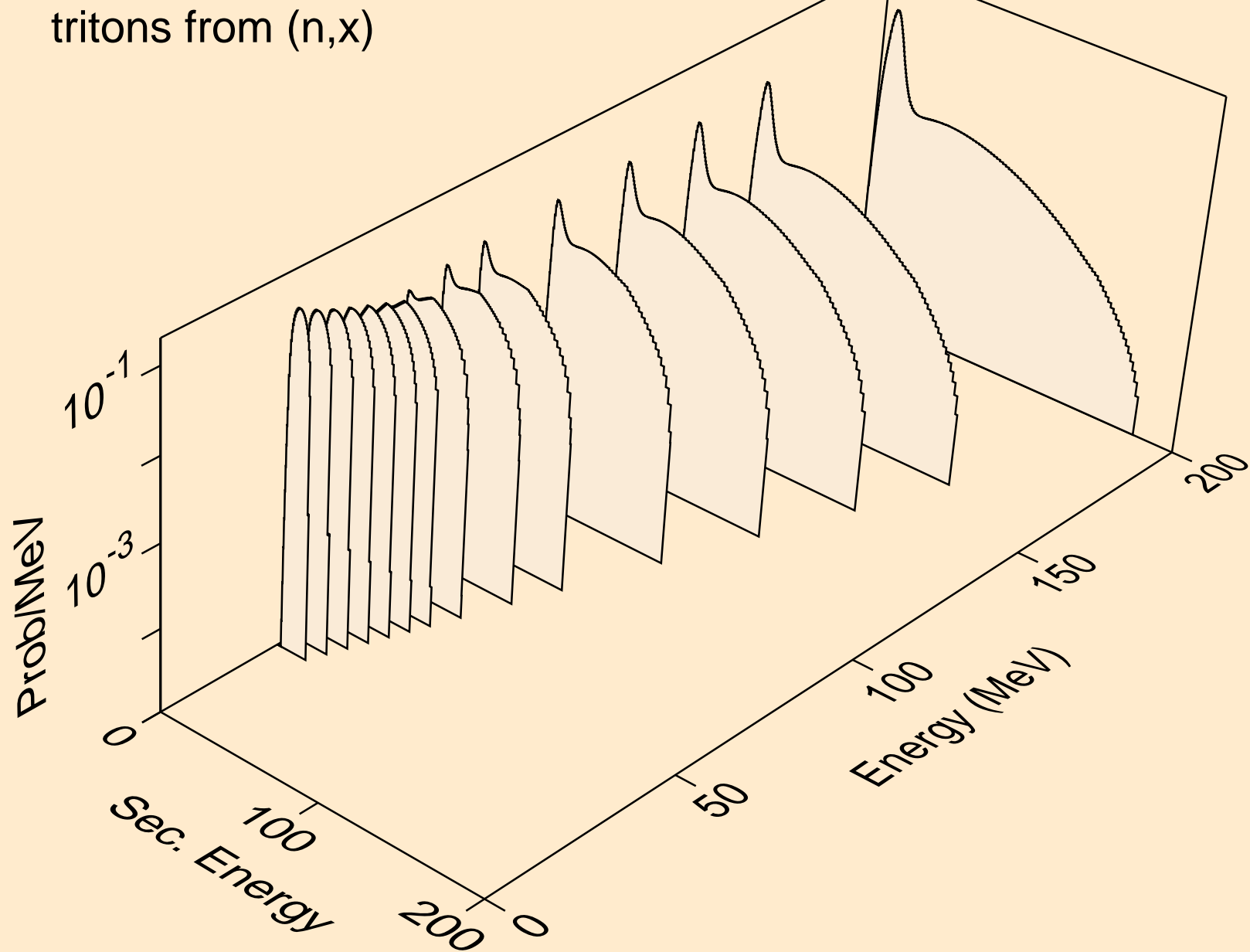

GE081M NEUTRON ACER TENDL-2021 LIBRARY; T=293.6K
tritons from (n,n*)t

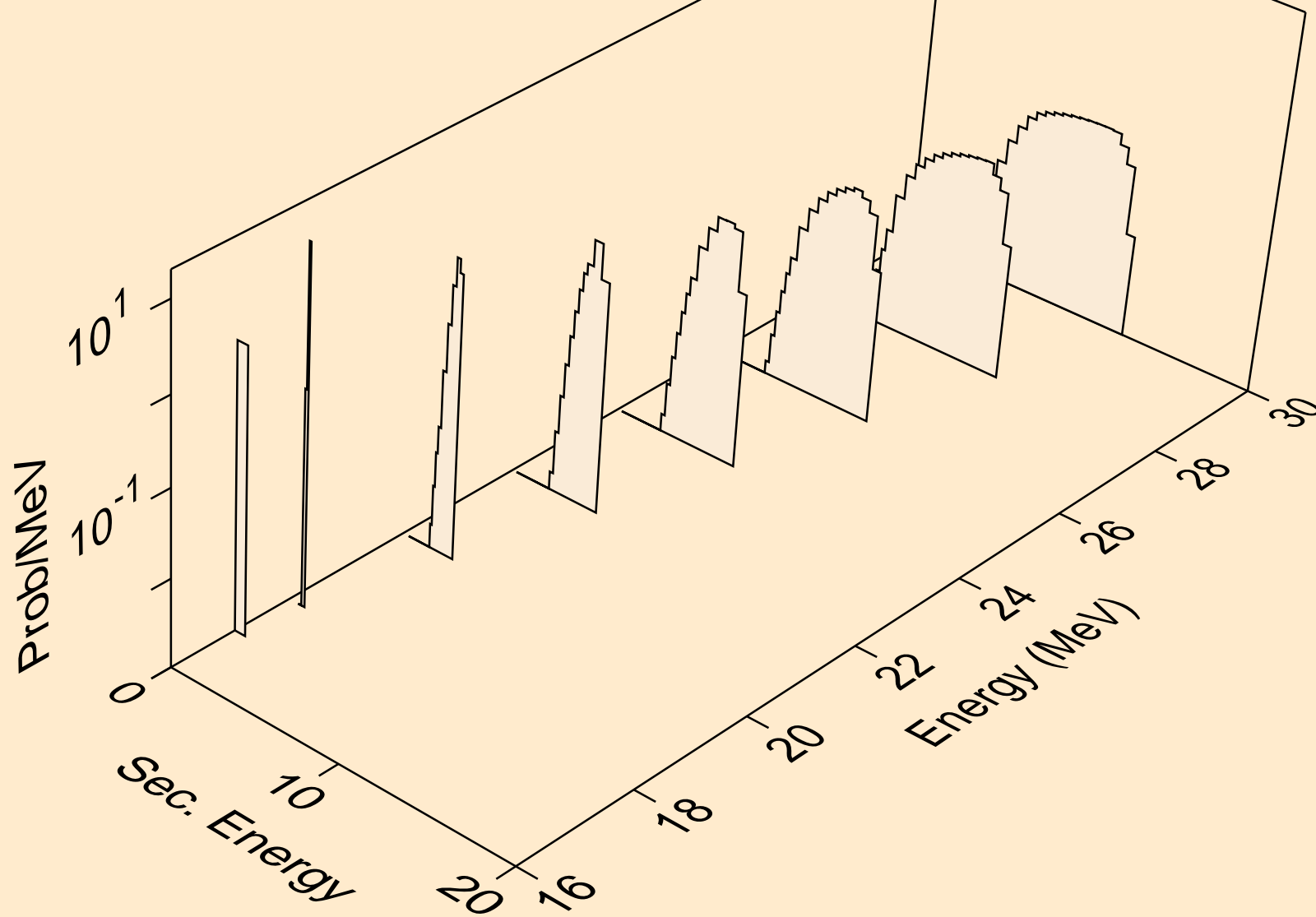

GE081M NEUTRON ACER TENDL-2021 LIBRARY; T=293.6K
tritons from (n,t)

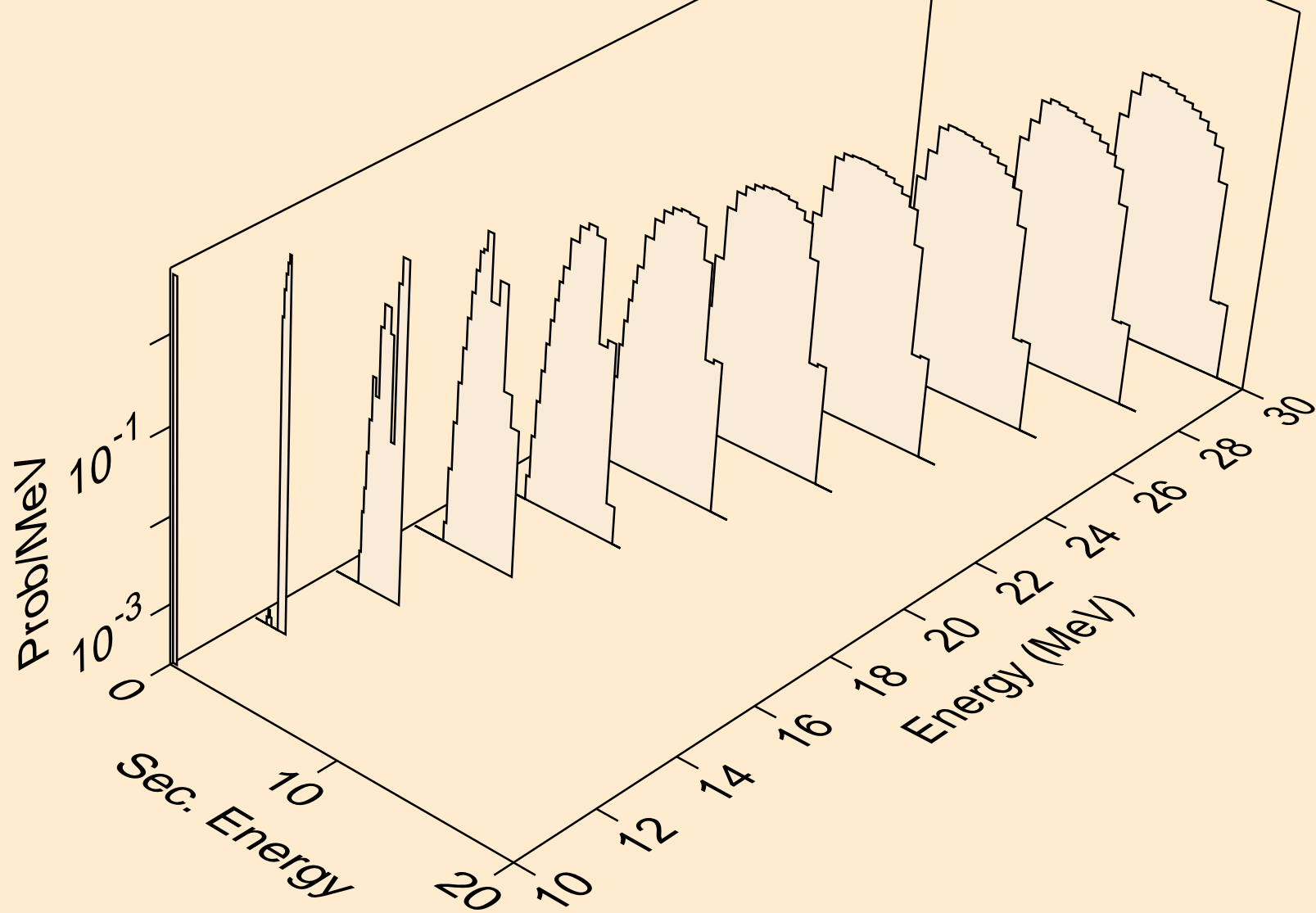

GE081M NEUTRON ACER TENDL-2021 LIBRARY; T=293.6K
he3s from (n,x)

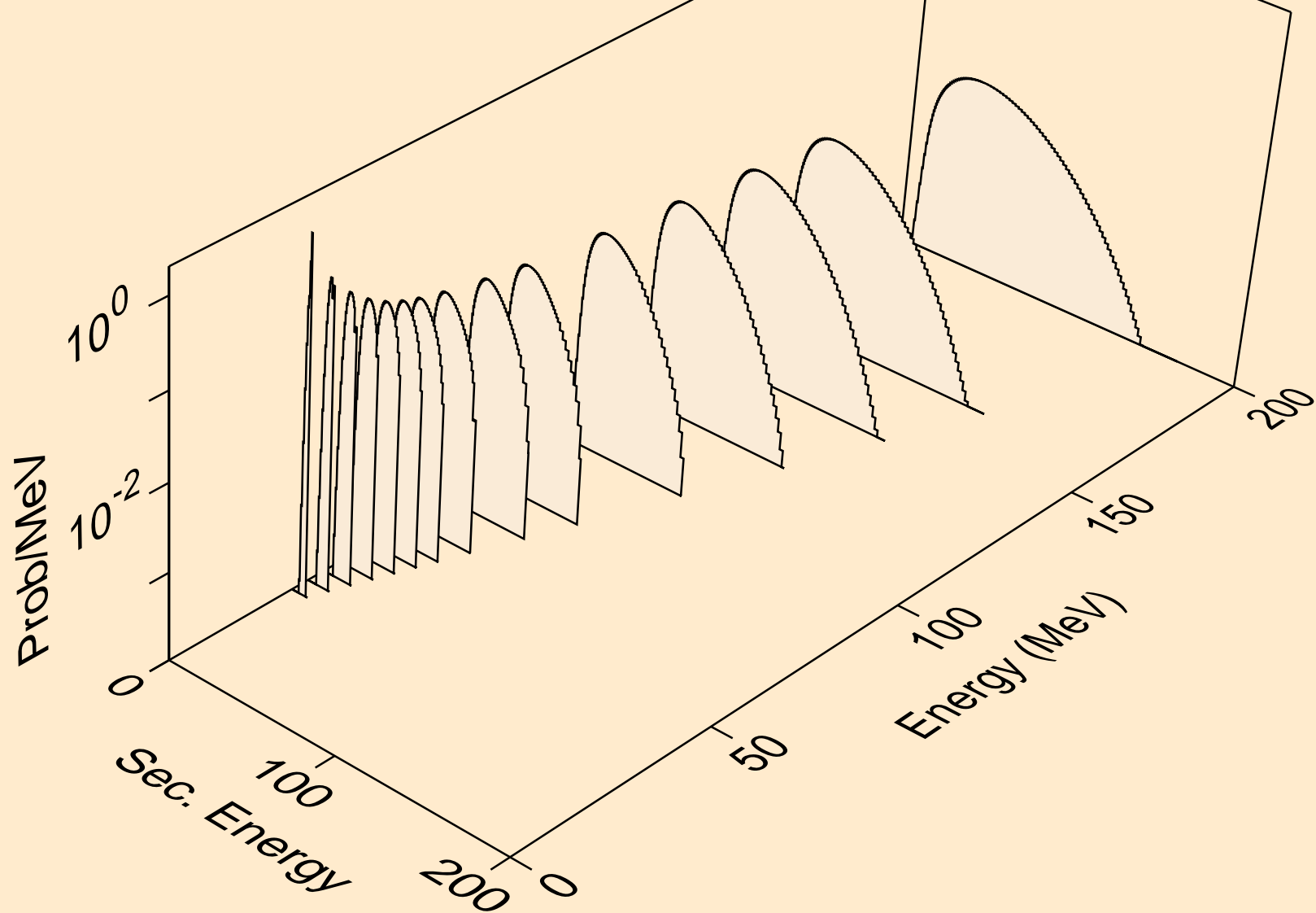

GE081M NEUTRON ACER TENDL-2021 LIBRARY; T=293.6K
he3s from (n,n*)he3

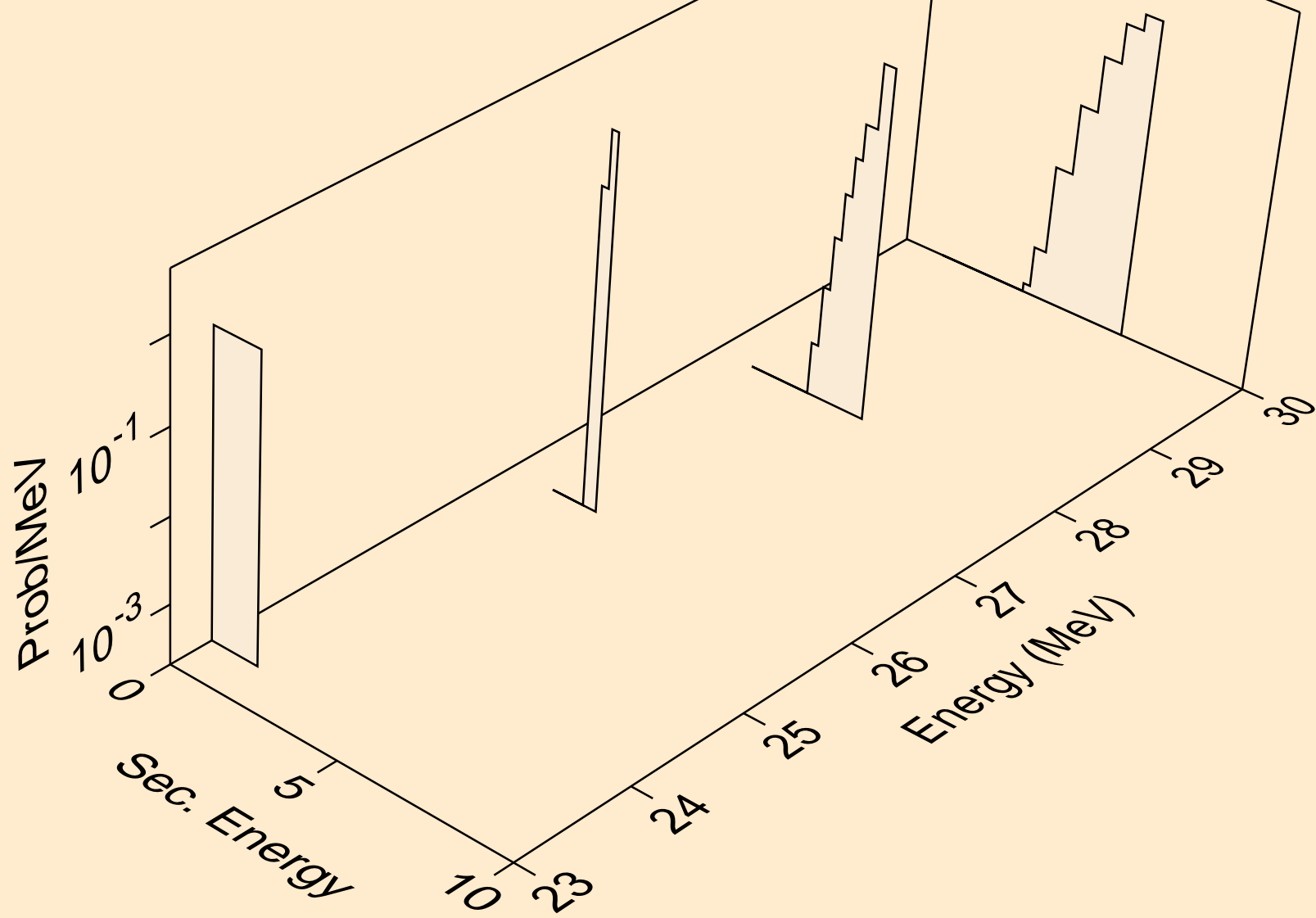

GE081M NEUTRON ACER TENDL-2021 LIBRARY; T=293.6K
he3s from (n,he3)

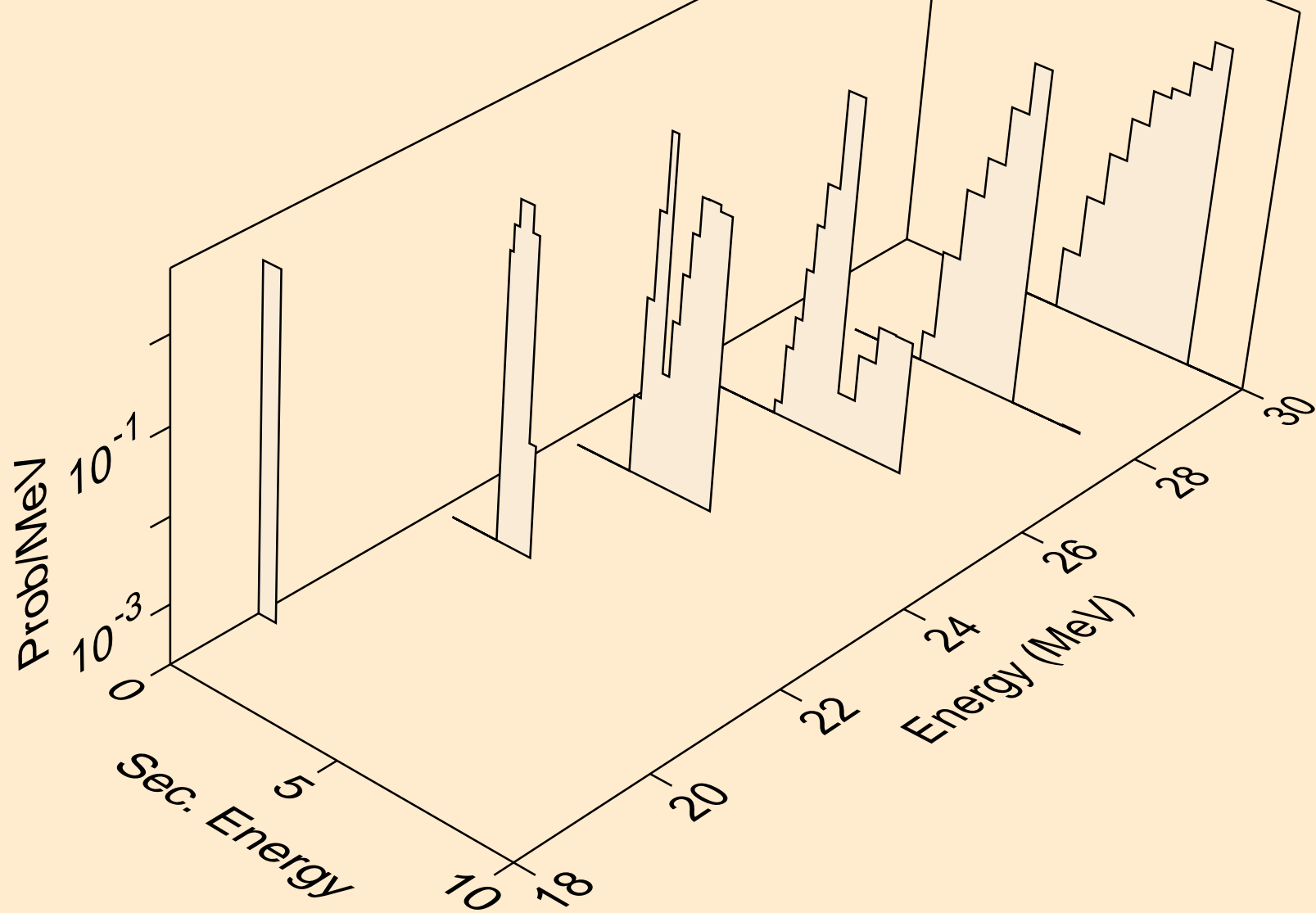

GE081M NEUTRON ACER TENDL-2021 LIBRARY; T=293.6K
alphas from (n,x)

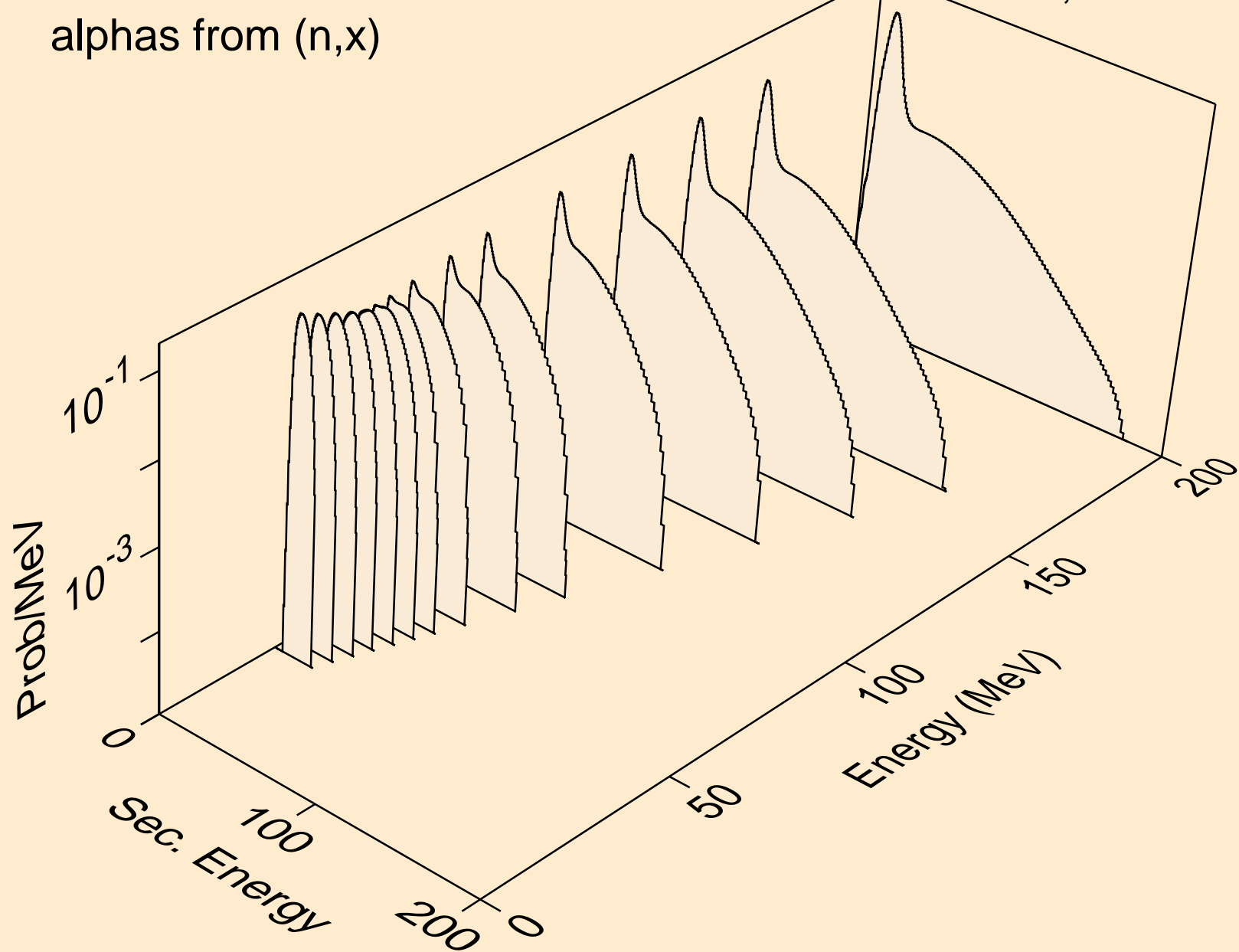

GE081M NEUTRON ACER TENDL-2021 LIBRARY; T=293.6K
alphas from (n,n*)a

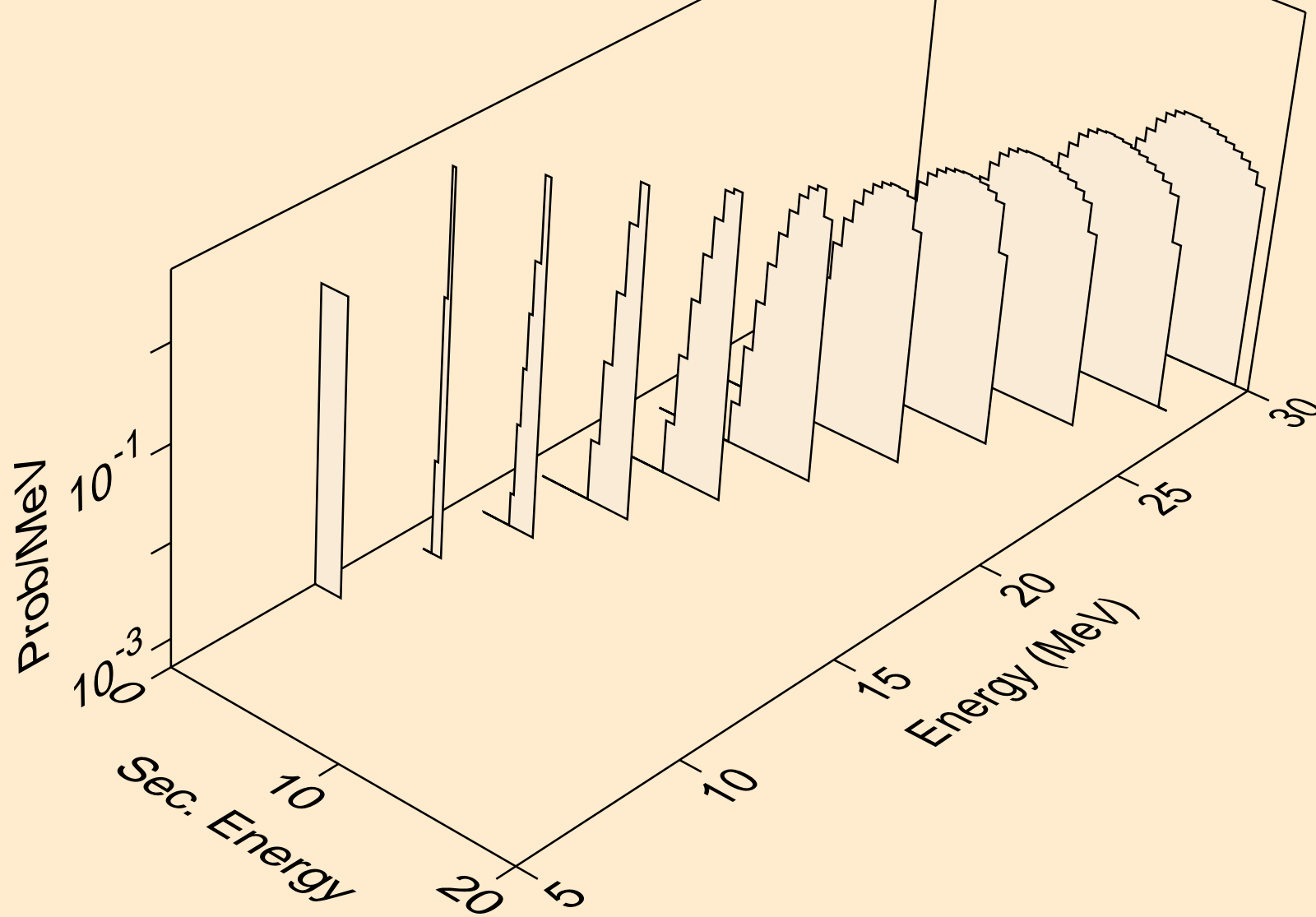

GE081M NEUTRON ACER TENDL-2021 LIBRARY; T=293.6K
alphas from (n,2n)a

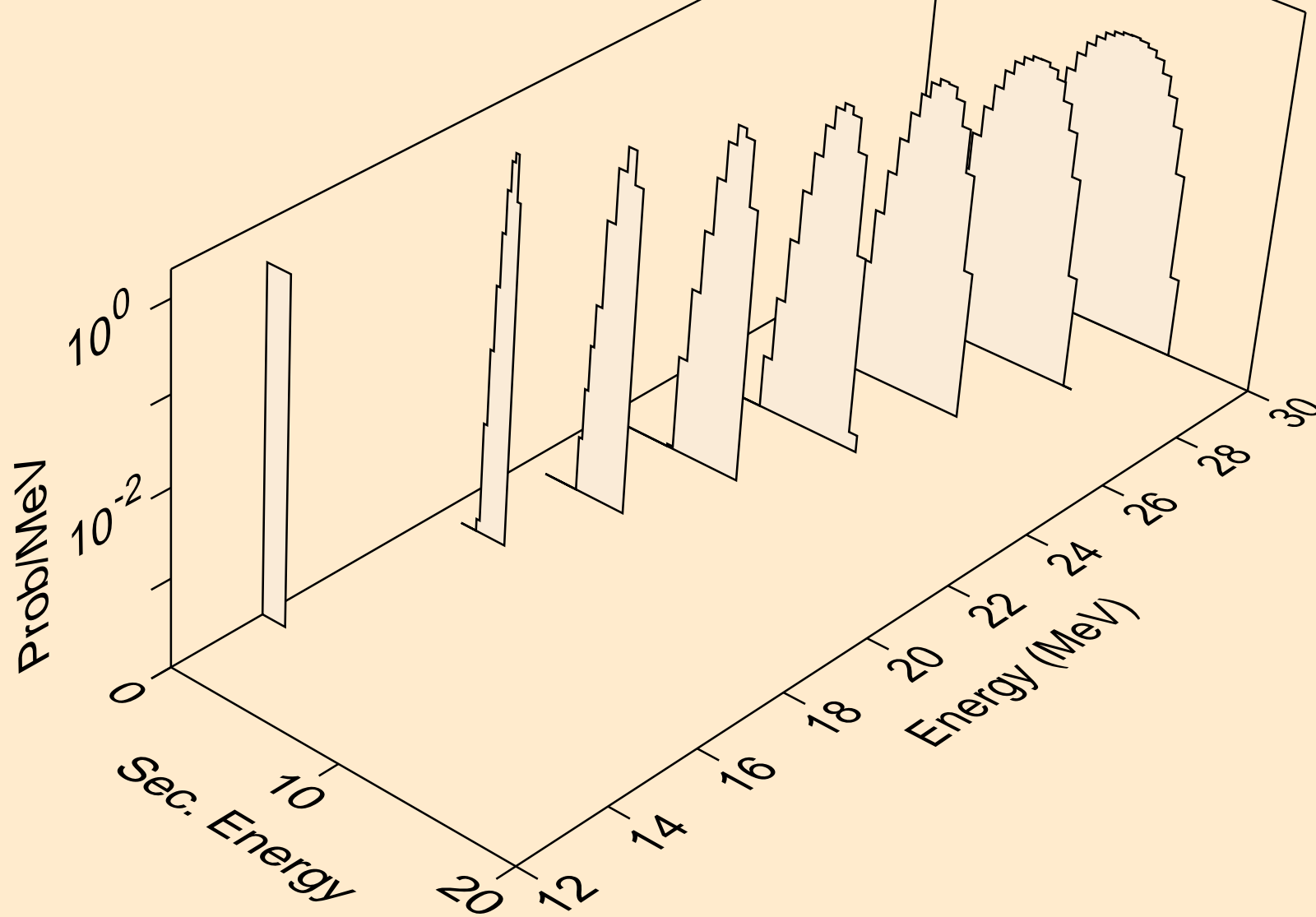

GE081M NEUTRON ACER TENDL-2021 LIBRARY; T=293.6K
alphas from (n,3n)a

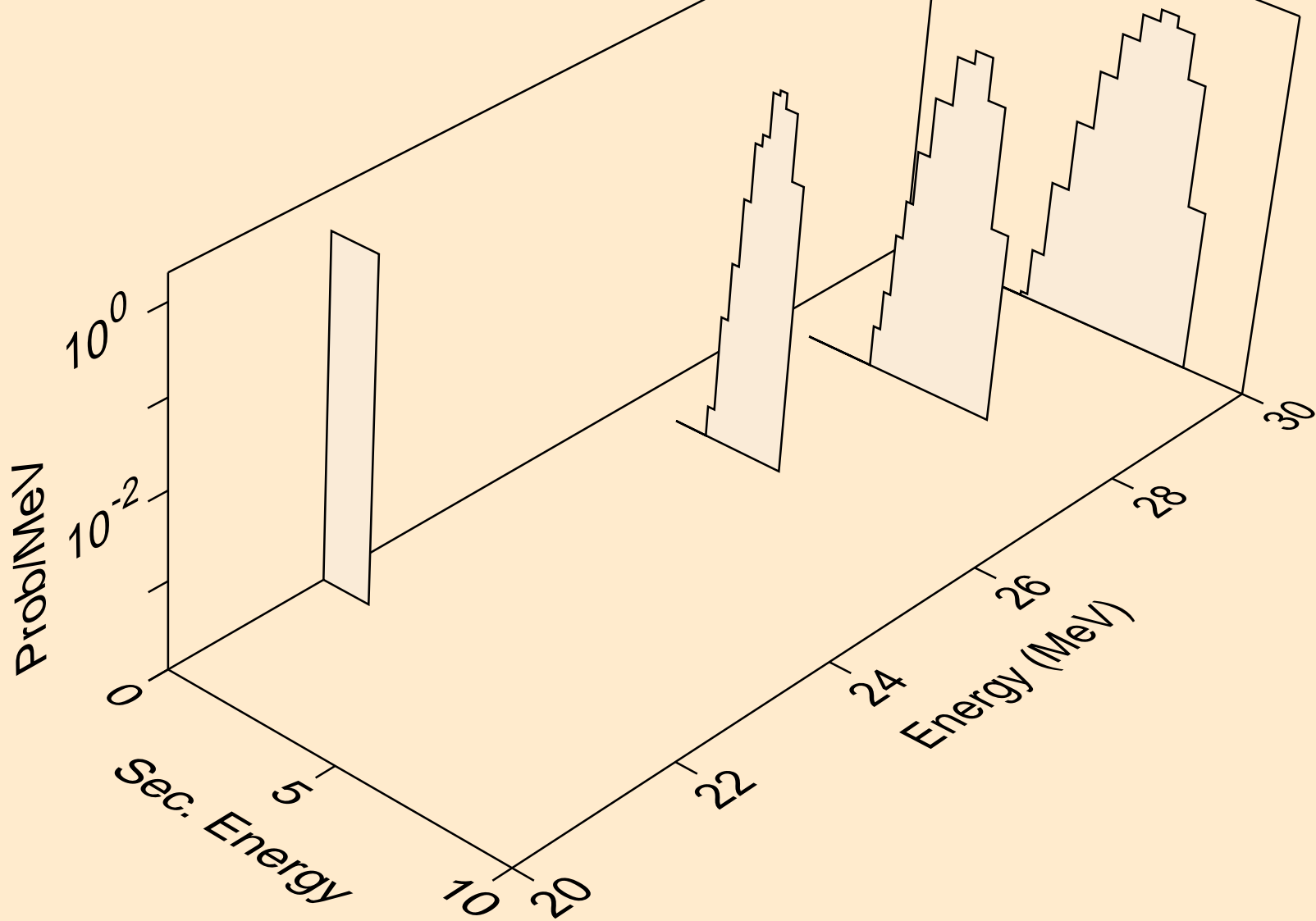

GE081M NEUTRON ACER TENDL-2021 LIBRARY; T=293.6K
alphas from (n,a)

