

# GE082 NEUTRON ACER TENDL-2021 LIBRARY; T=293.6K

## Principal cross sections

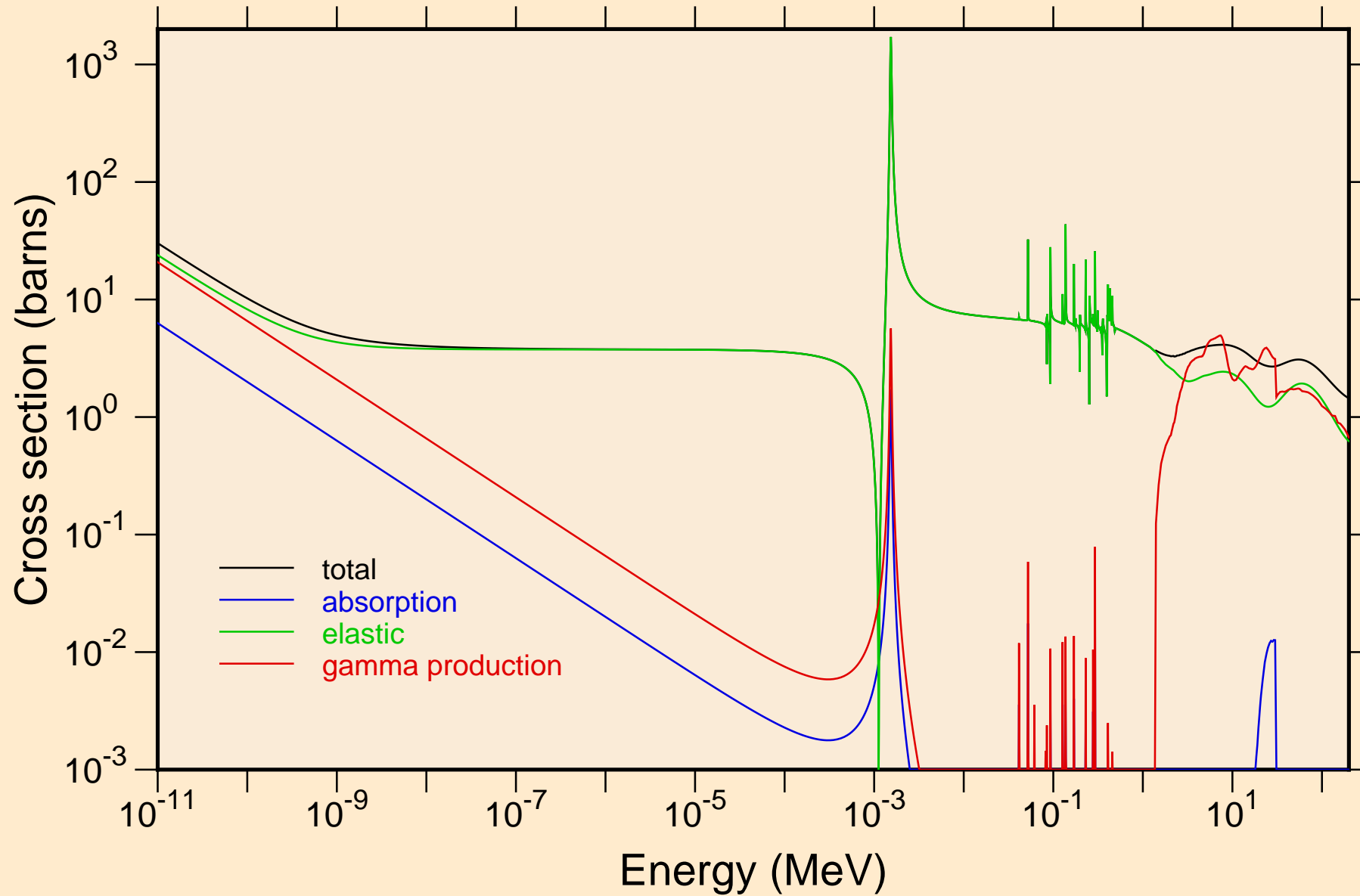

GE082 NEUTRON ACER TENDL-2021 LIBRARY; T=293.6K  
resonance total cross section

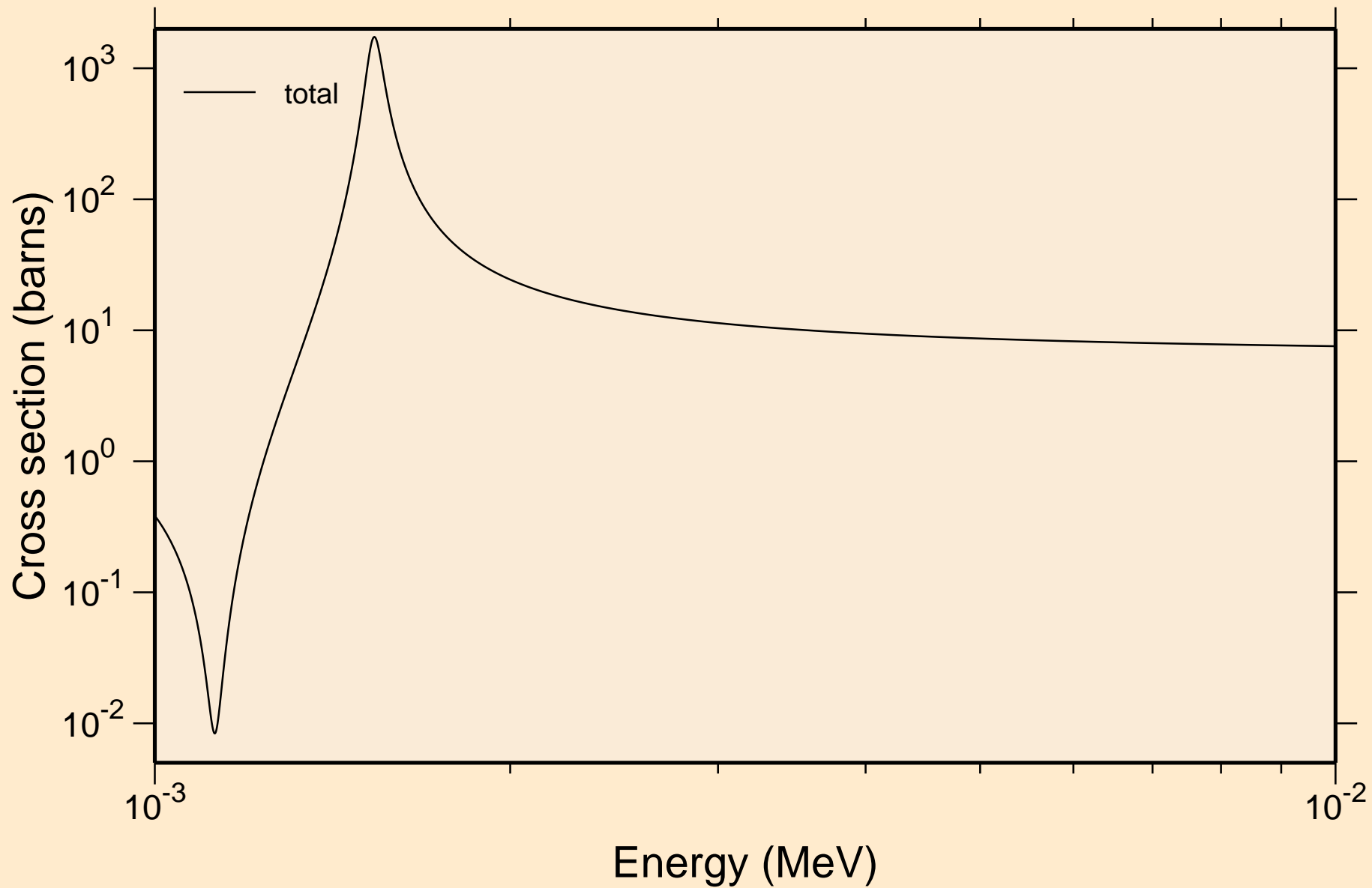

GE082 NEUTRON ACER TENDL-2021 LIBRARY; T=293.6K  
resonance total cross section

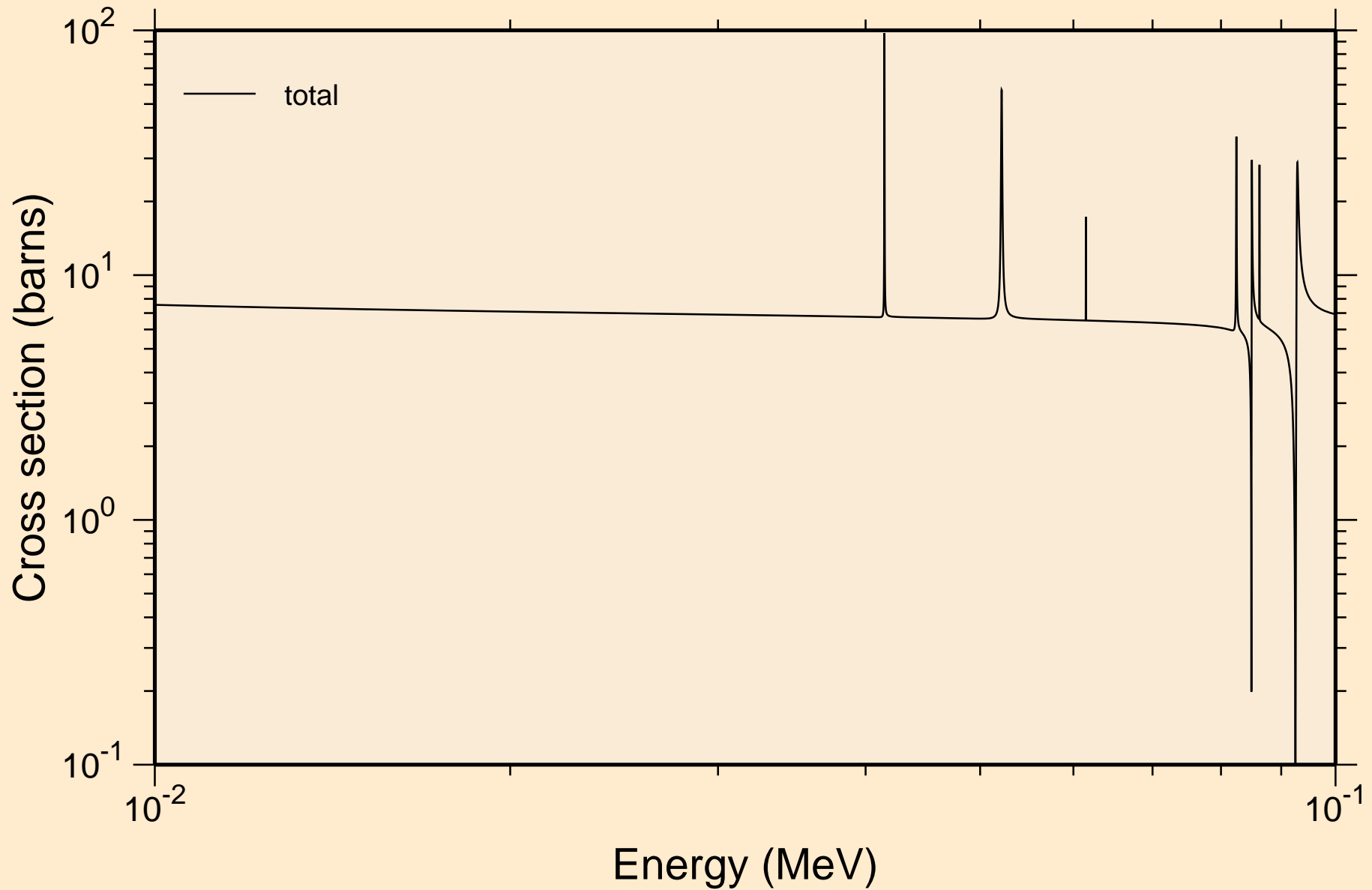

GE082 NEUTRON ACER TENDL-2021 LIBRARY; T=293.6K  
resonance total cross section

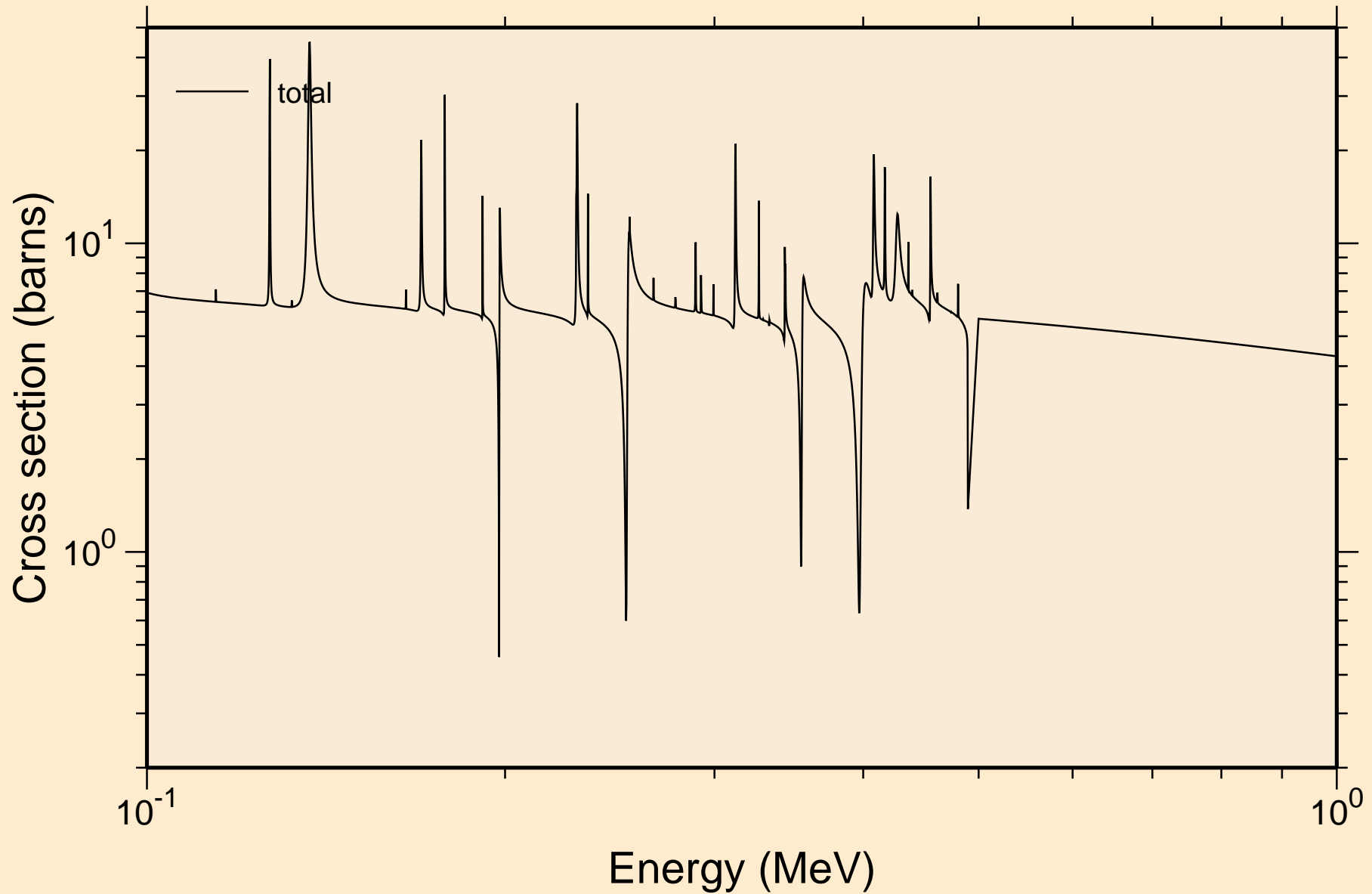

Ḡ082 NEUTRON ACER TENDL-2021 LIBRARY; T=293.6K  
resonance total cross section

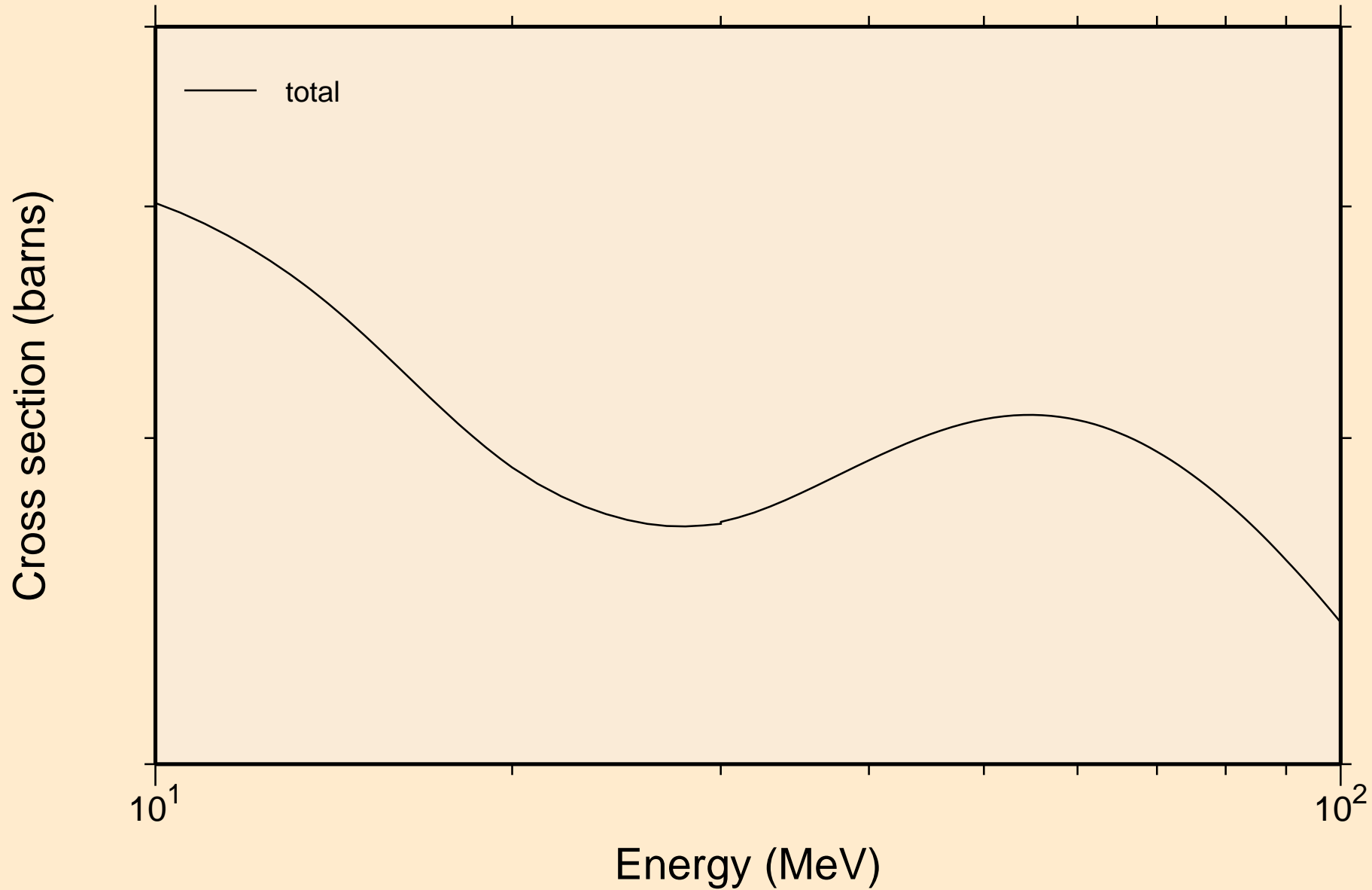

GE082 NEUTRON ACER TENDL-2021 LIBRARY; T=293.6K  
resonance absorption cross sections

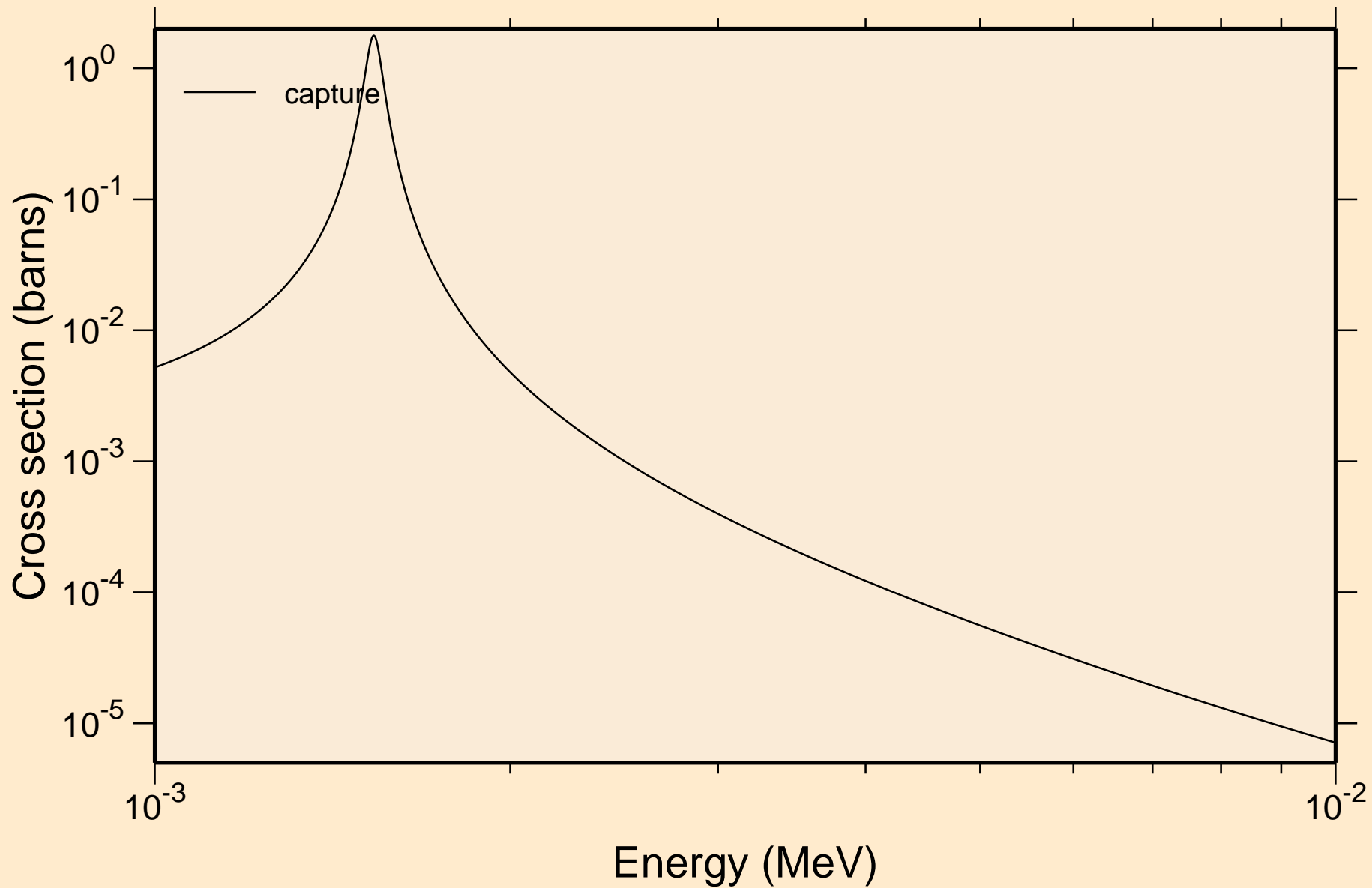

GE082 NEUTRON ACER TENDL-2021 LIBRARY; T=293.6K  
resonance absorption cross sections

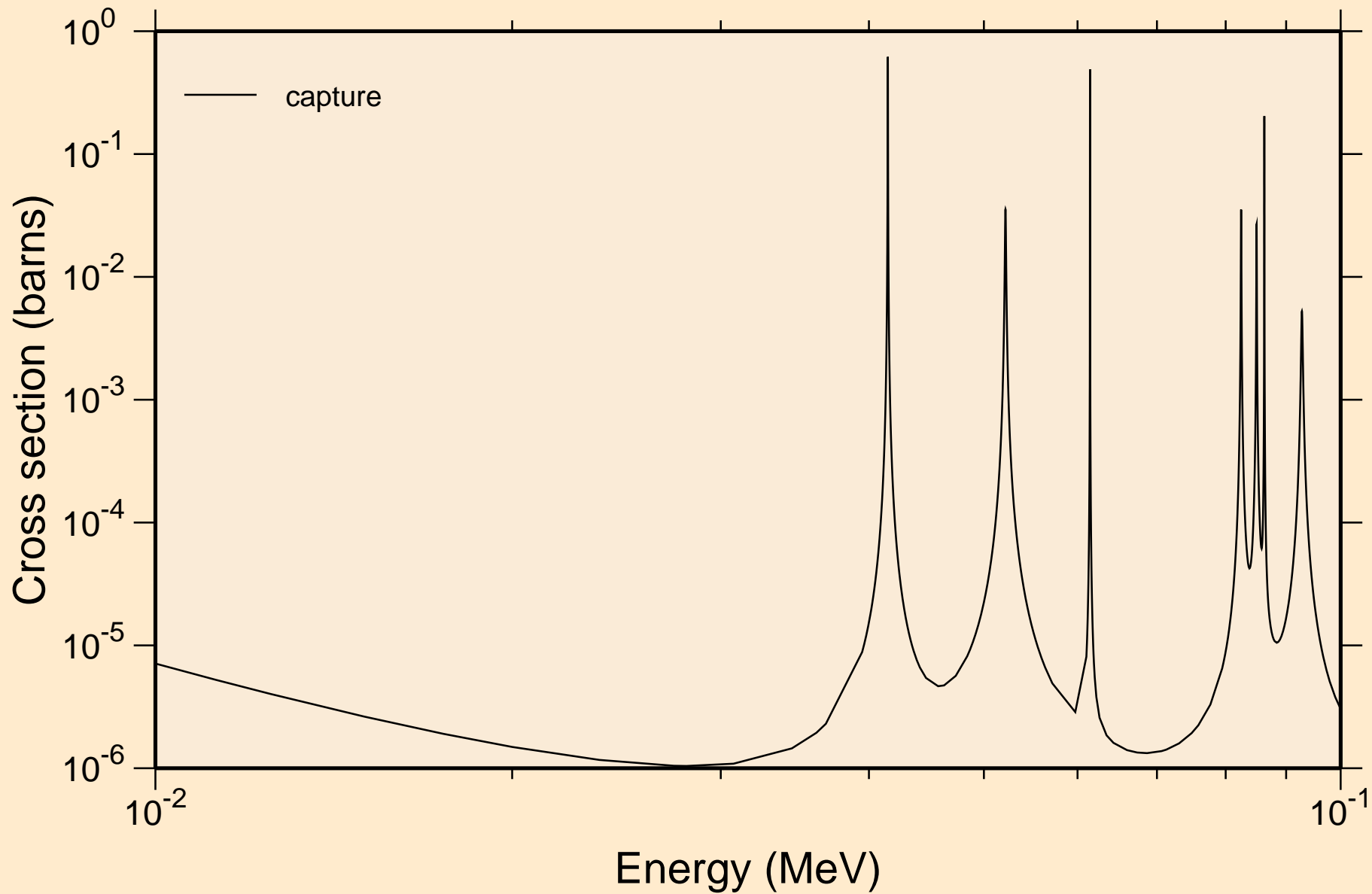

GE082 NEUTRON ACER TENDL-2021 LIBRARY; T=293.6K  
resonance absorption cross sections

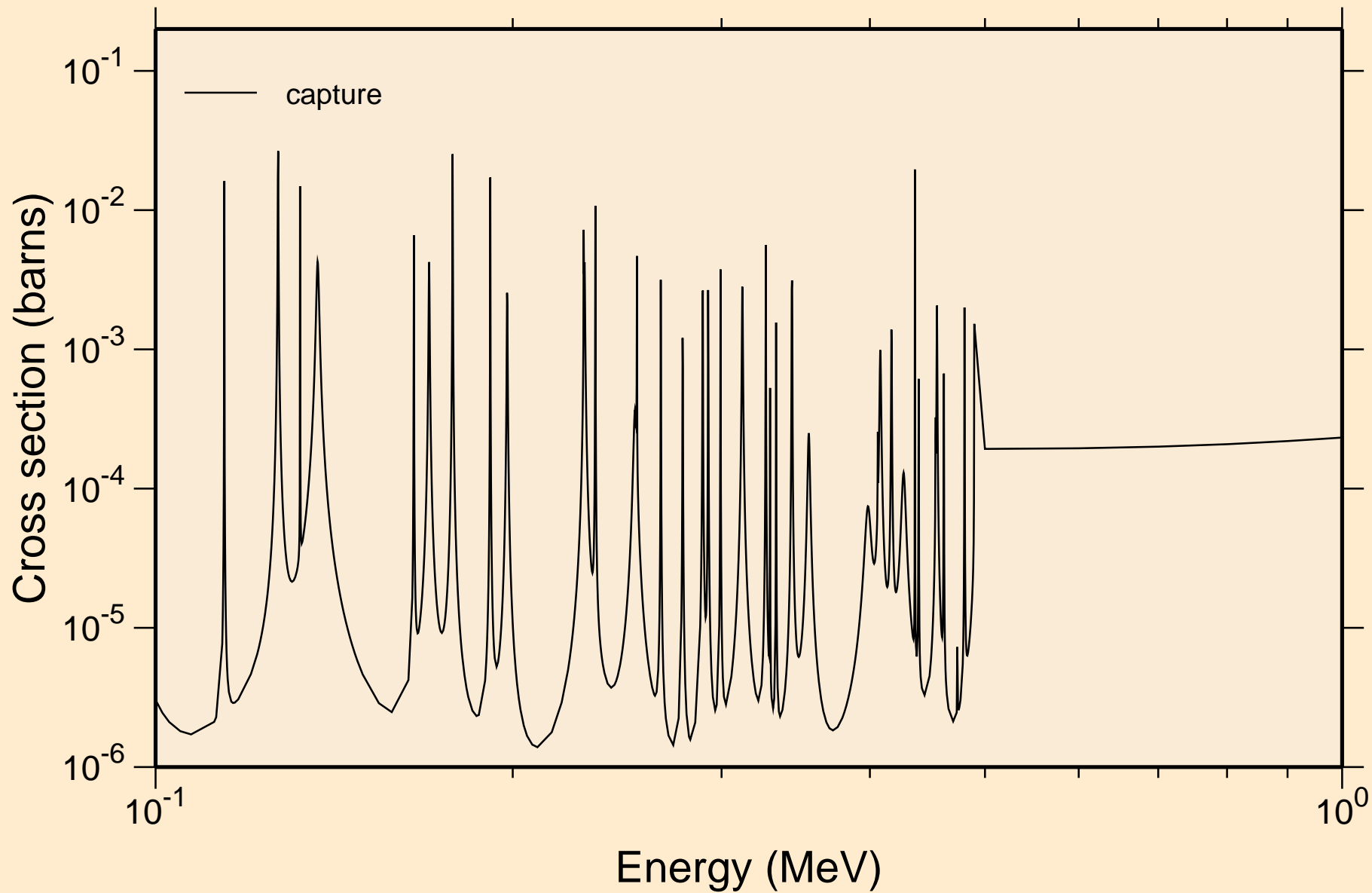



GE082 NEUTRON ACER TENDL-2021 LIBRARY; T=293.6K  
resonance absorption cross sections

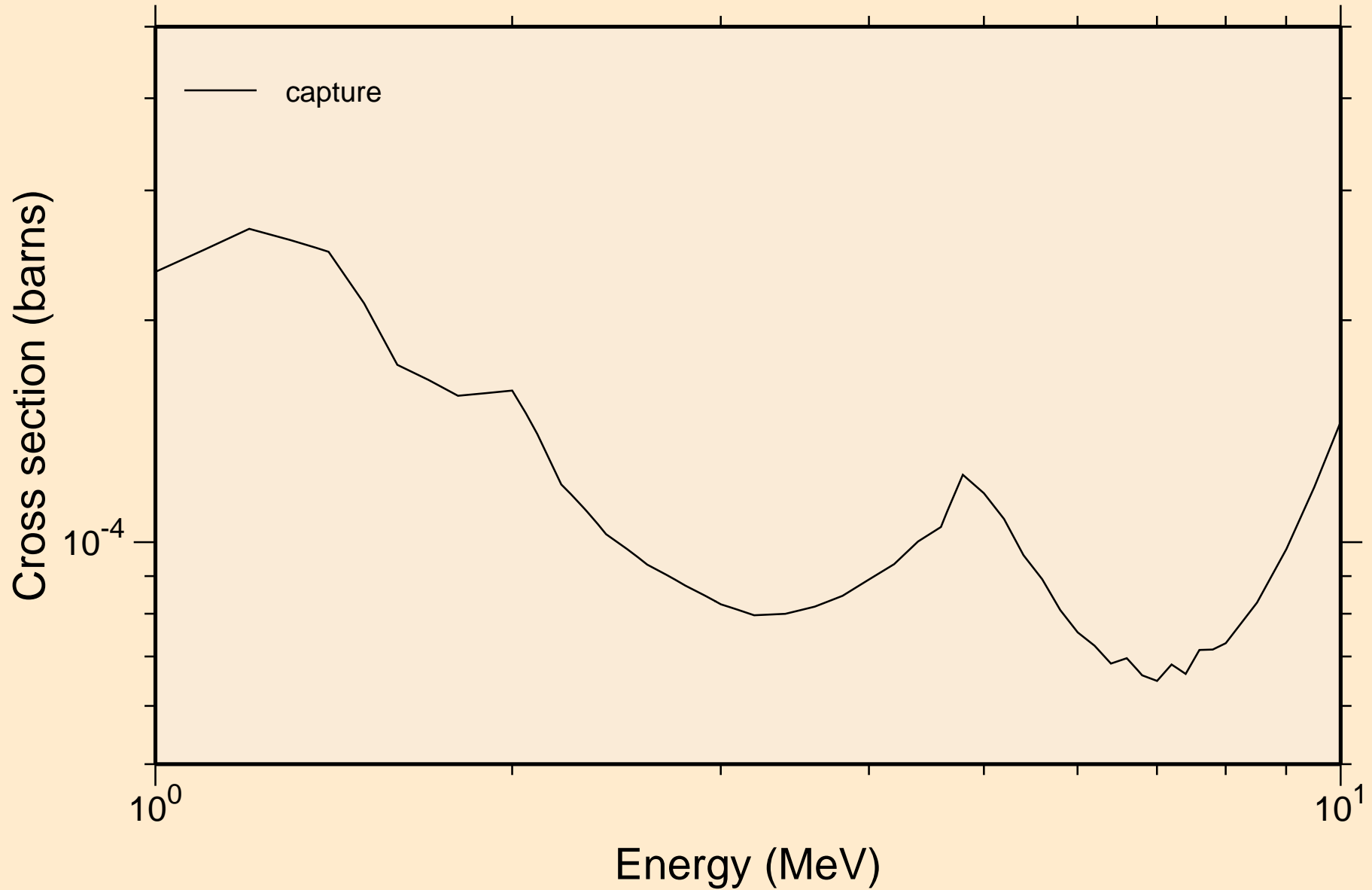

GE082 NEUTRON ACER TENDL-2021 LIBRARY; T=293.6K  
Heating

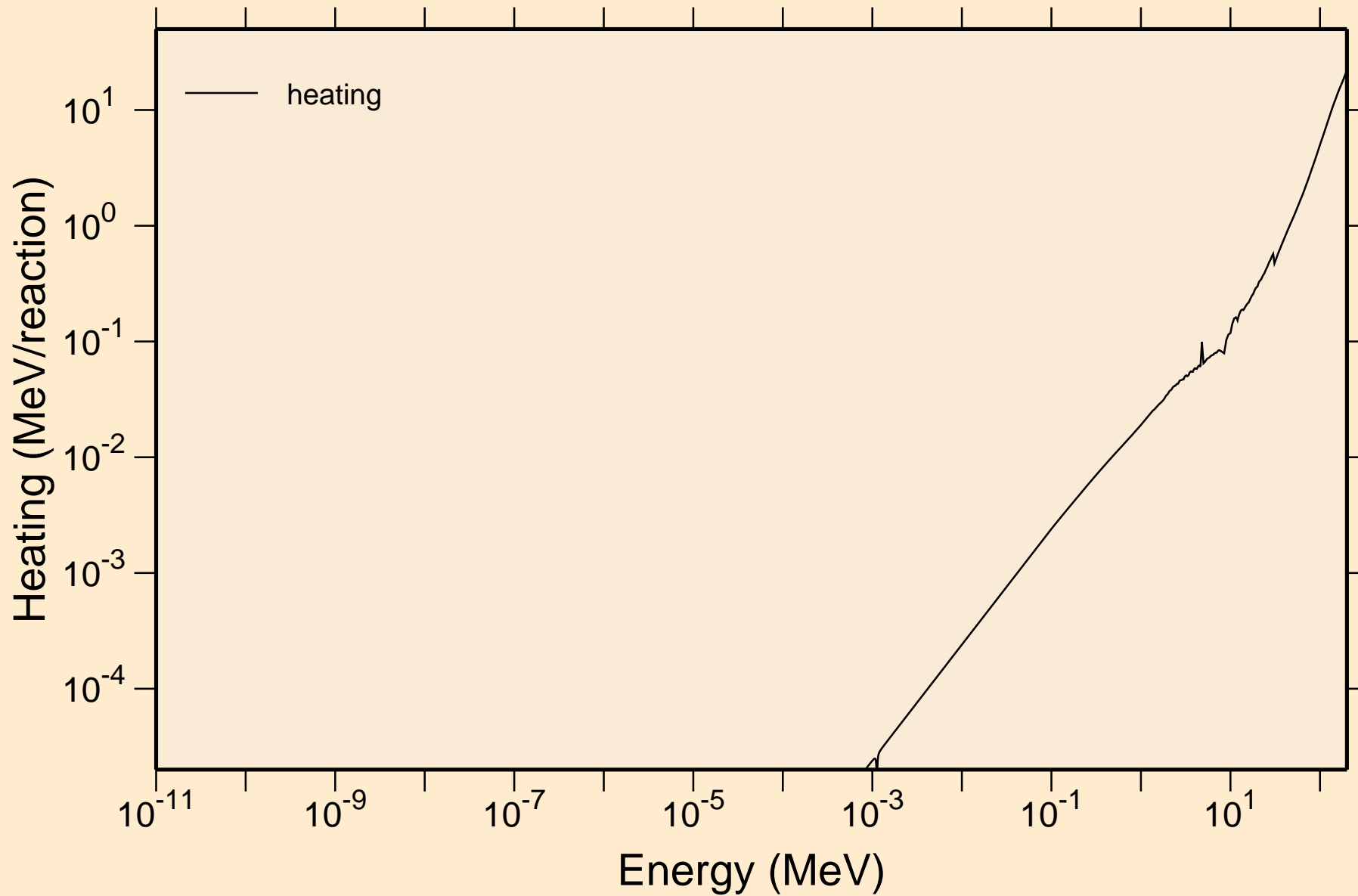

# GE082 NEUTRON ACER TENDL-2021 LIBRARY; T=293.6K

## Damage

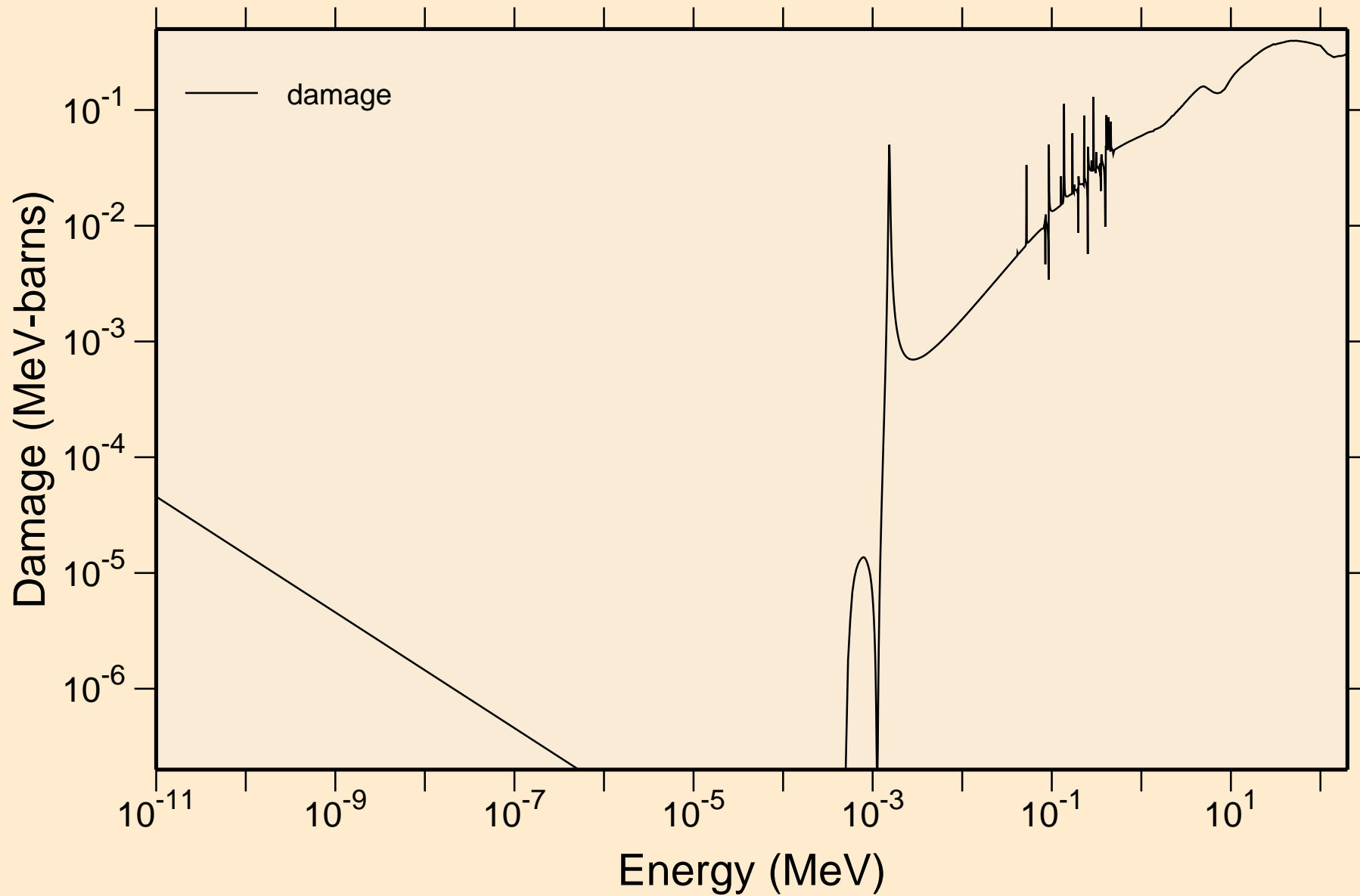

GE082 NEUTRON ACER TENDL-2021 LIBRARY; T=293.6K  
Non-threshold reactions

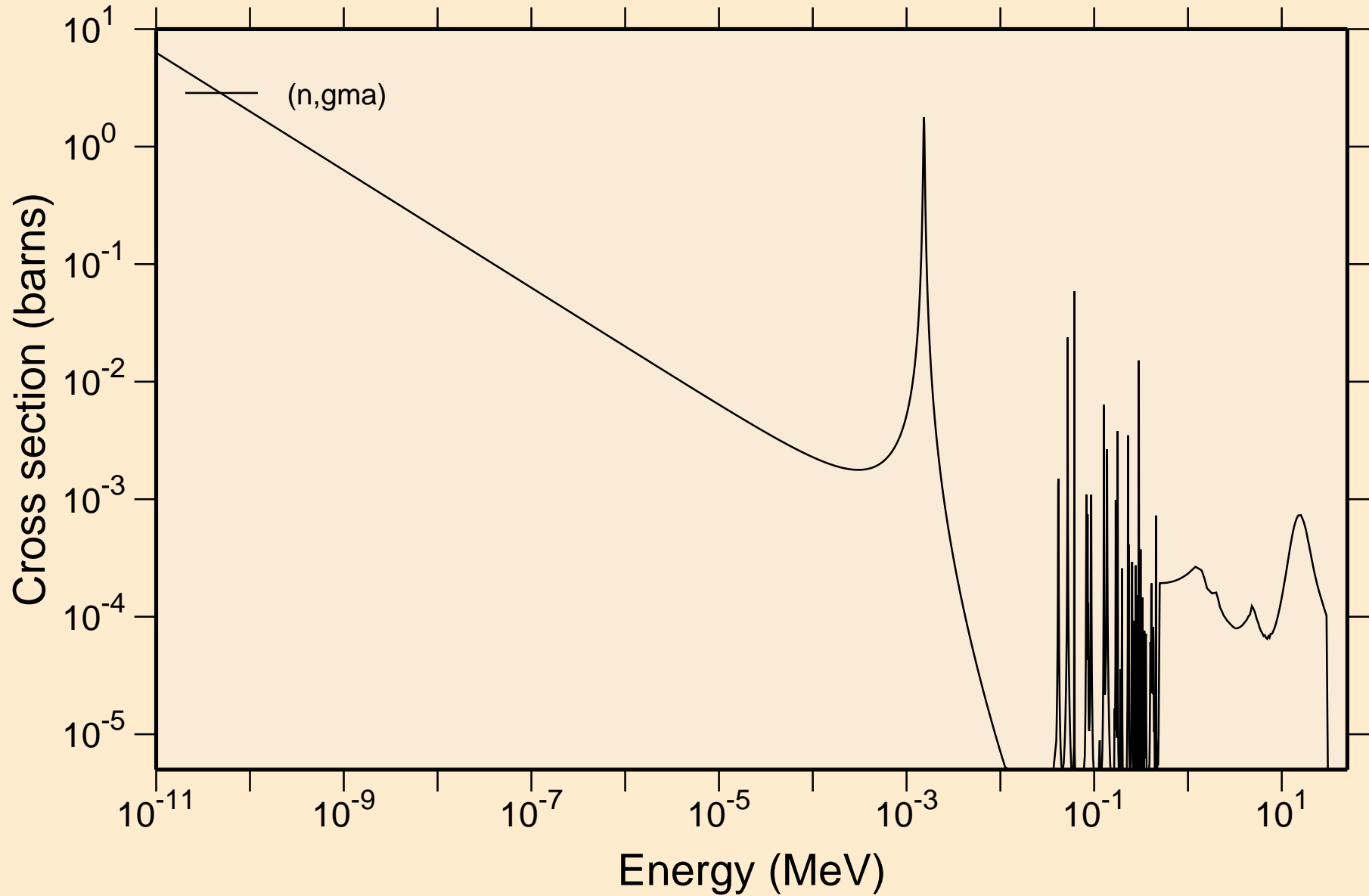

# GE082 NEUTRON ACER TENDL-2021 LIBRARY; T=293.6K

## Principal cross sections

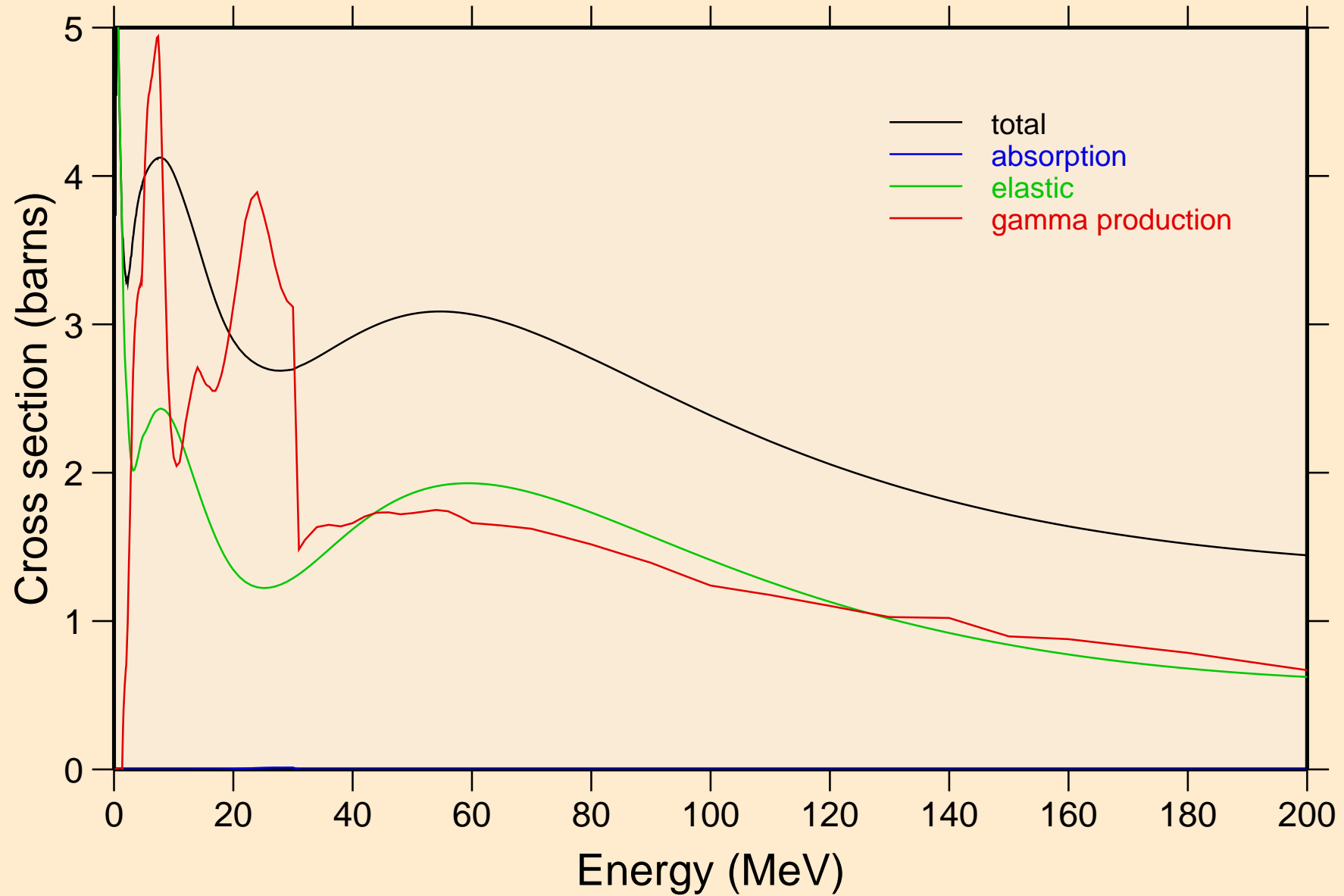

GE082 NEUTRON ACER TENDL-2021 LIBRARY; T=293.6K  
Heating

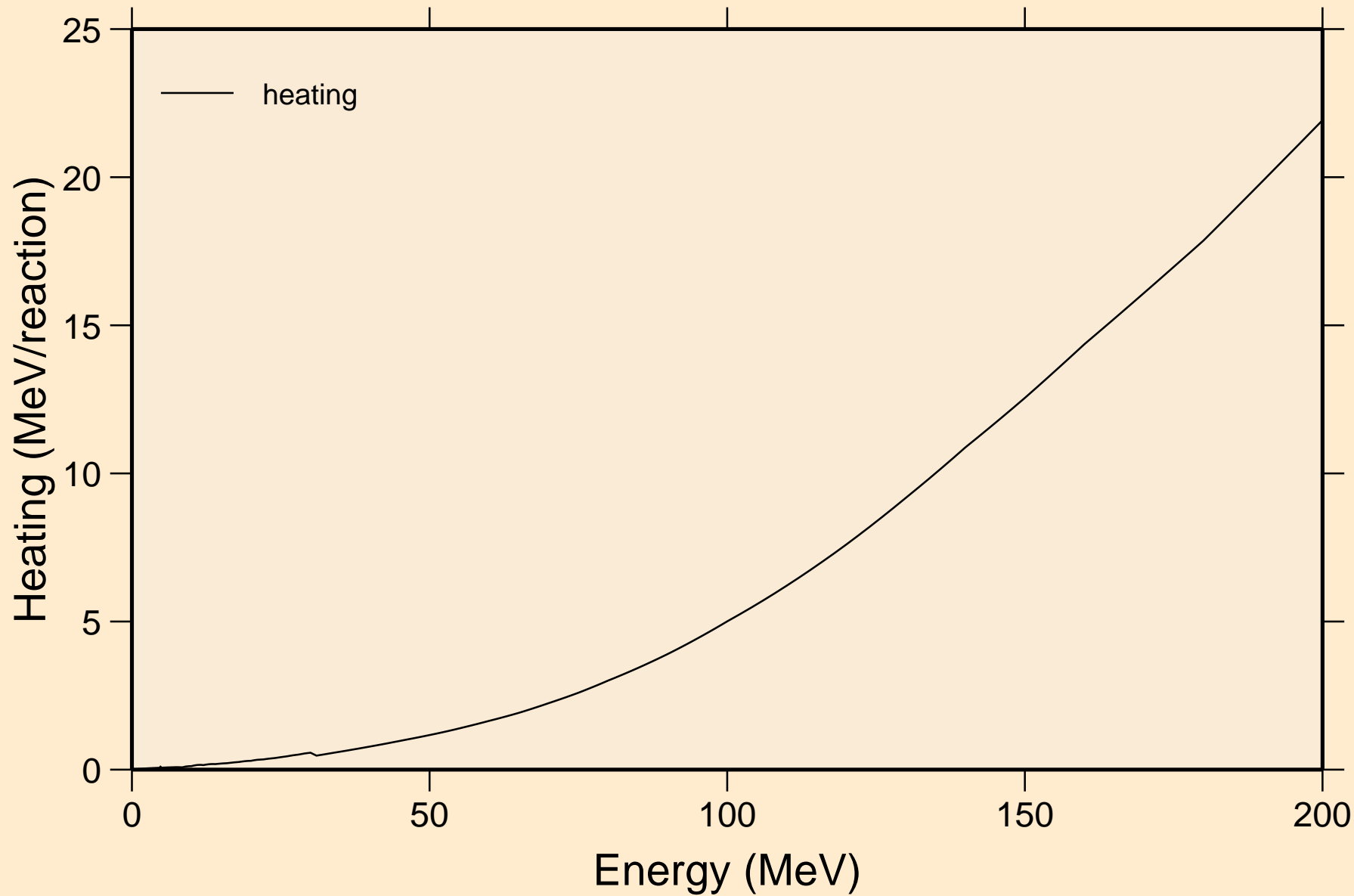

# GE082 NEUTRON ACER TENDL-2021 LIBRARY; T=293.6K

## Damage

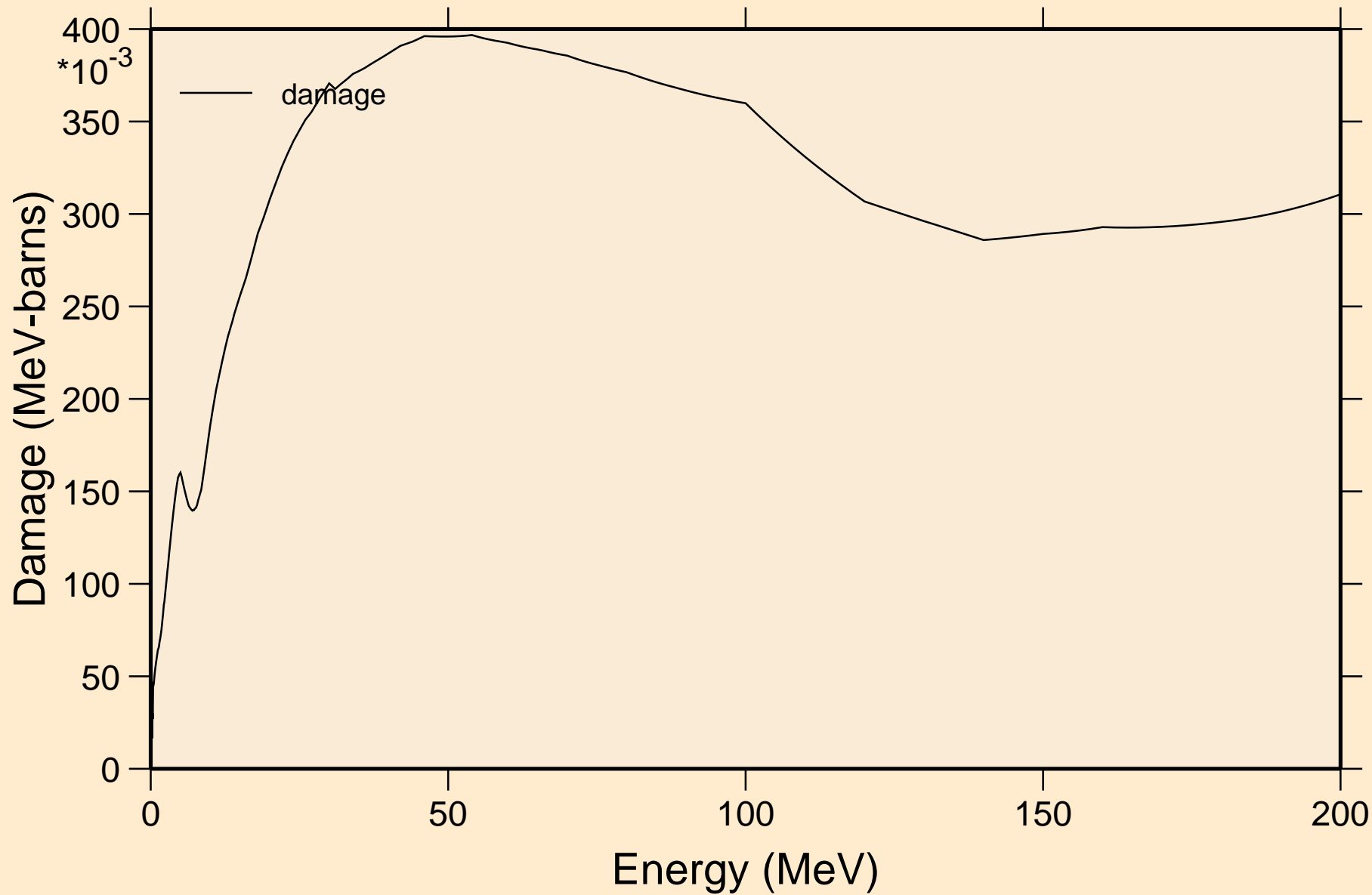

GE082 NEUTRON ACER TENDL-2021 LIBRARY; T=293.6K  
Non-threshold reactions

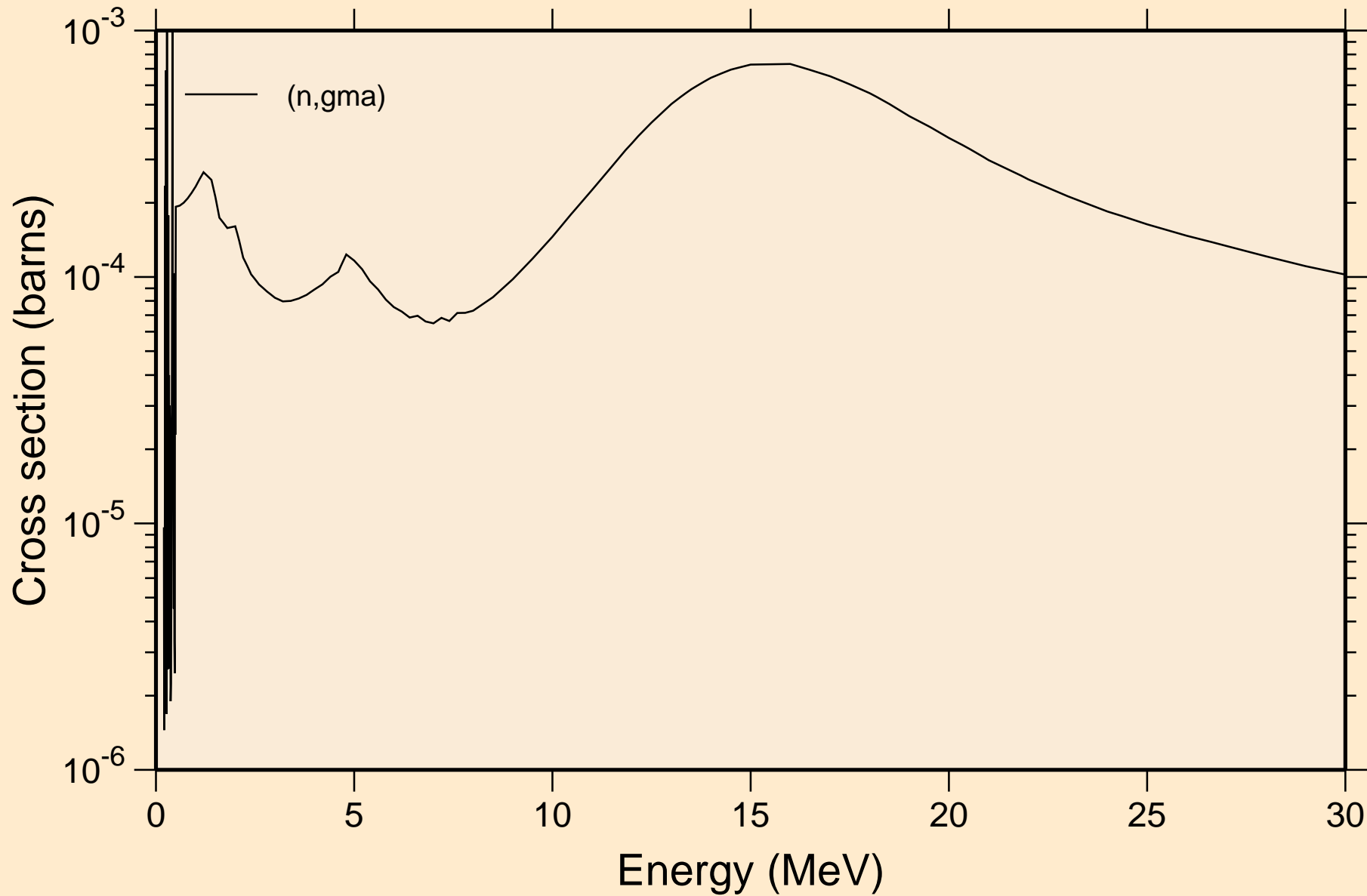



GE082 NEUTRON ACER TENDL-2021 LIBRARY; T=293.6K  
Inelastic levels

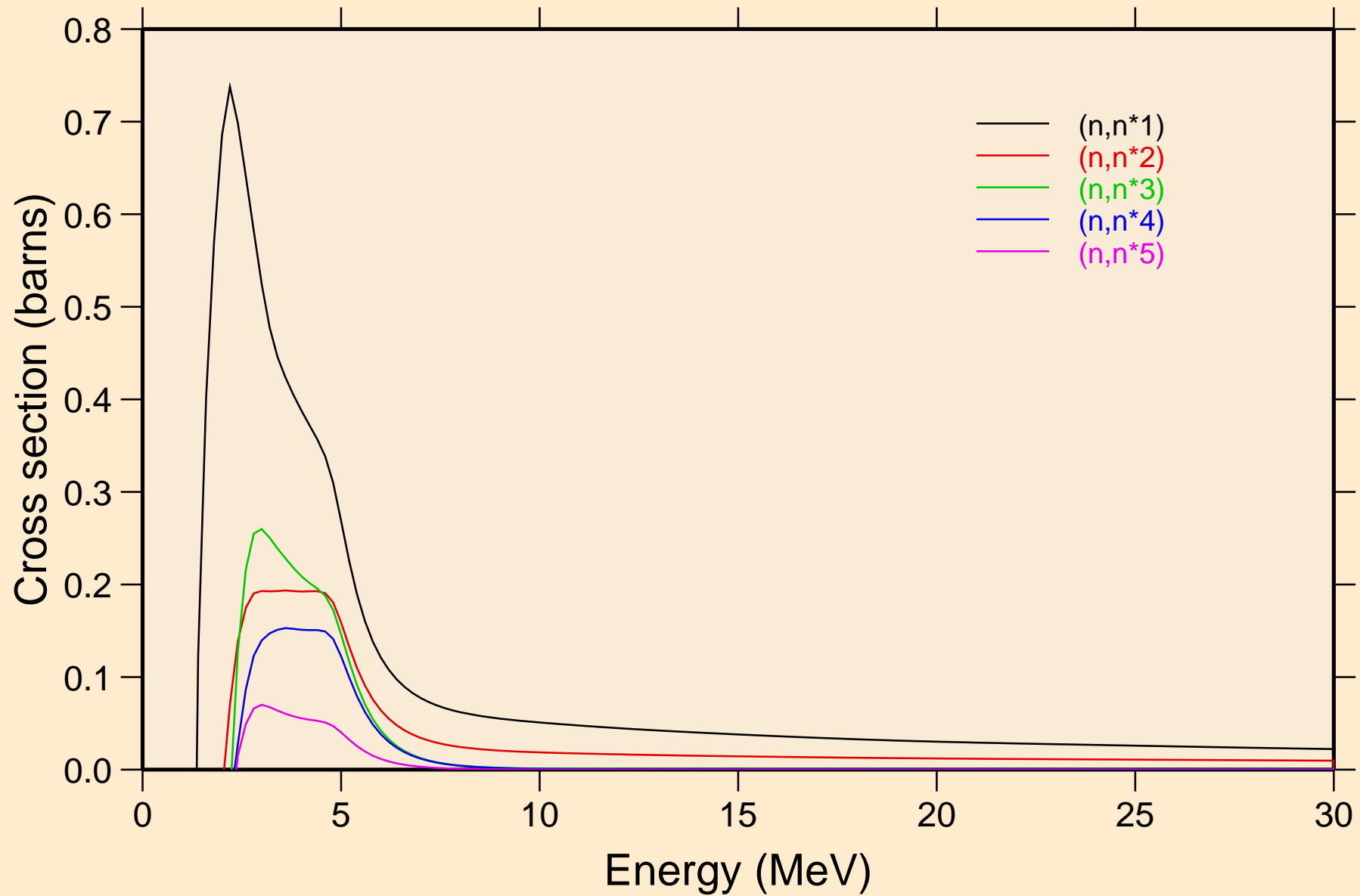

GE082 NEUTRON ACER TENDL-2021 LIBRARY; T=293.6K  
Inelastic levels

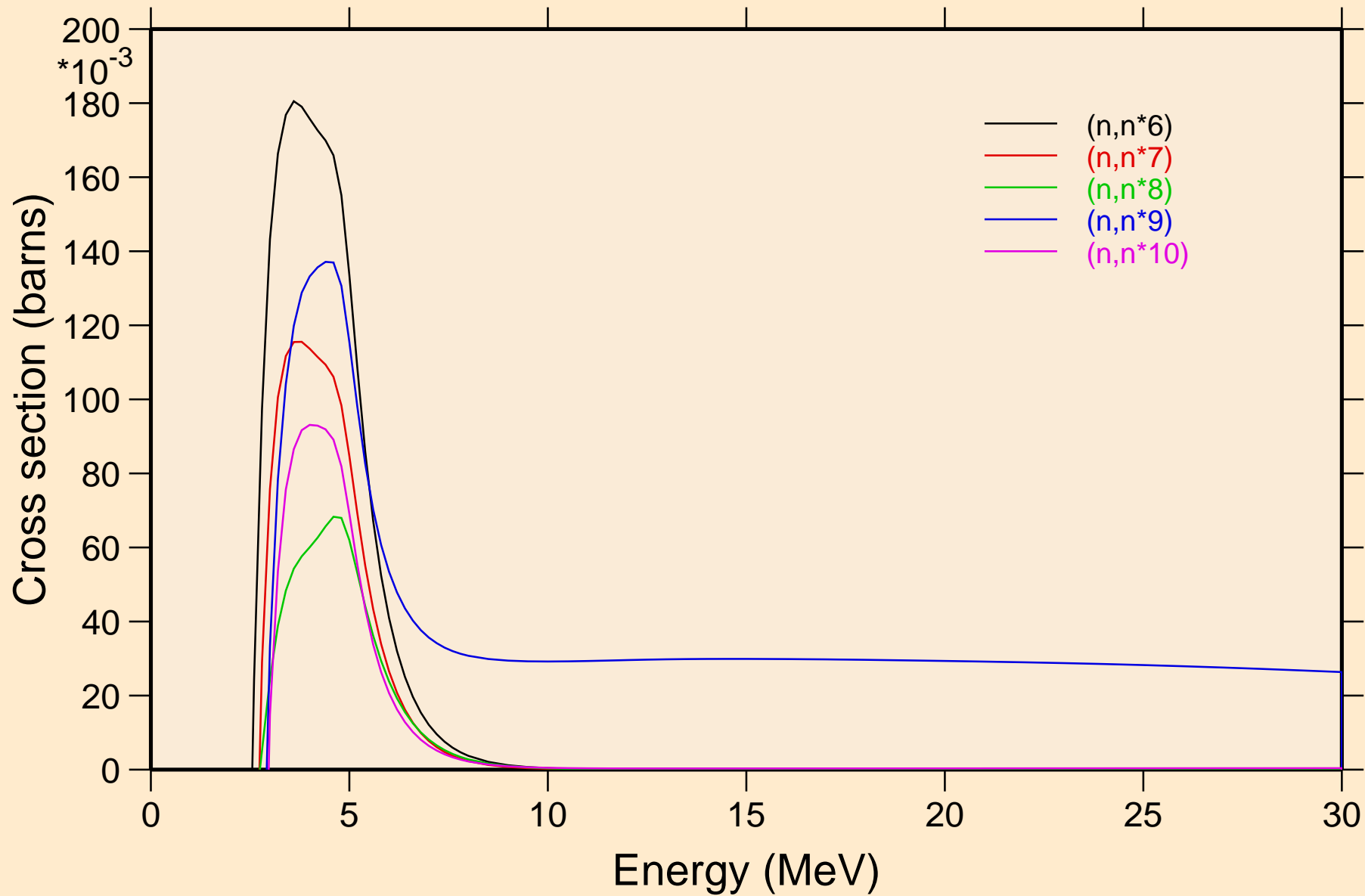

GE082 NEUTRON ACER TENDL-2021 LIBRARY; T=293.6K  
Inelastic levels

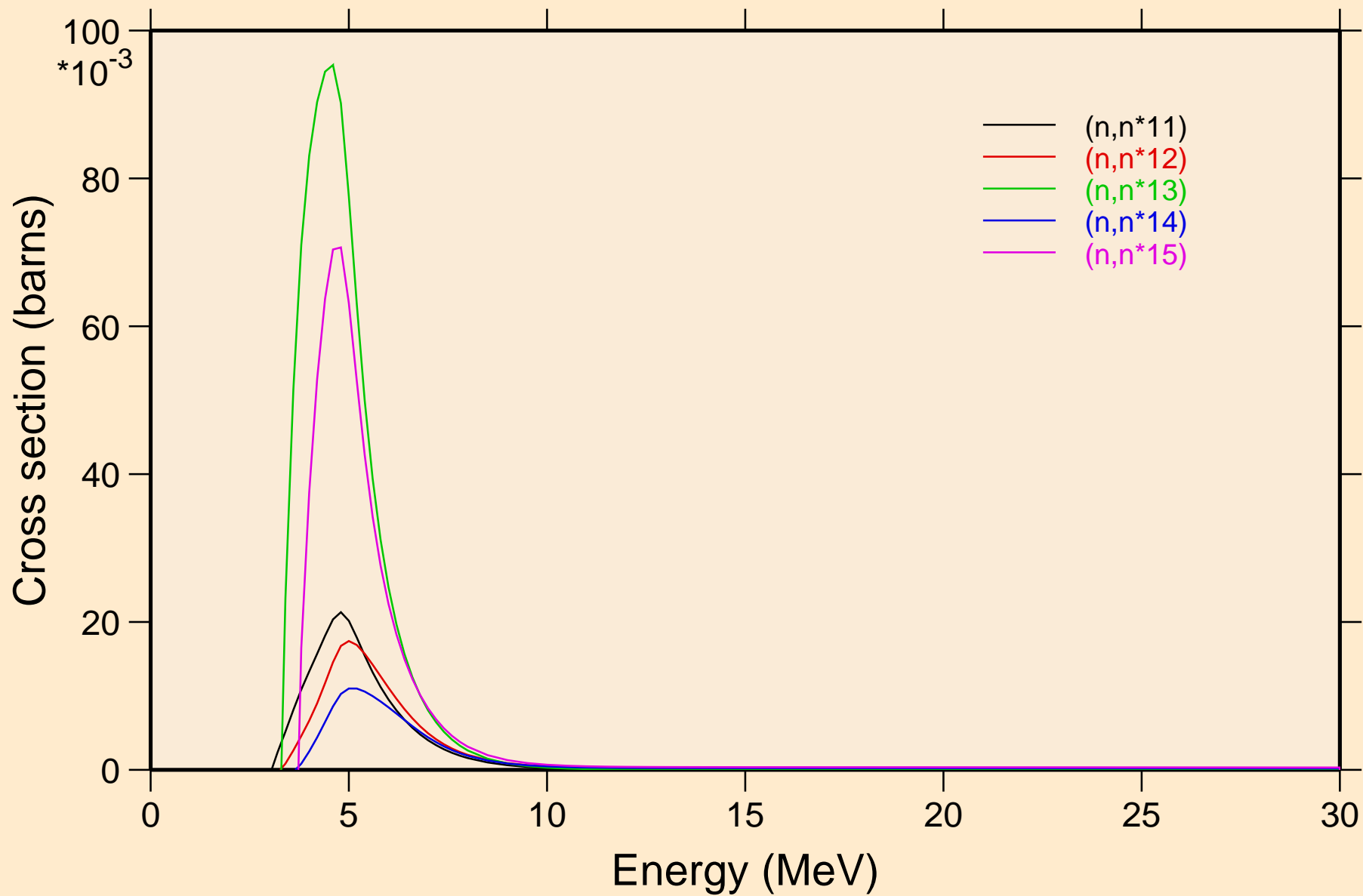

GE082 NEUTRON ACER TENDL-2021 LIBRARY; T=293.6K  
Inelastic levels

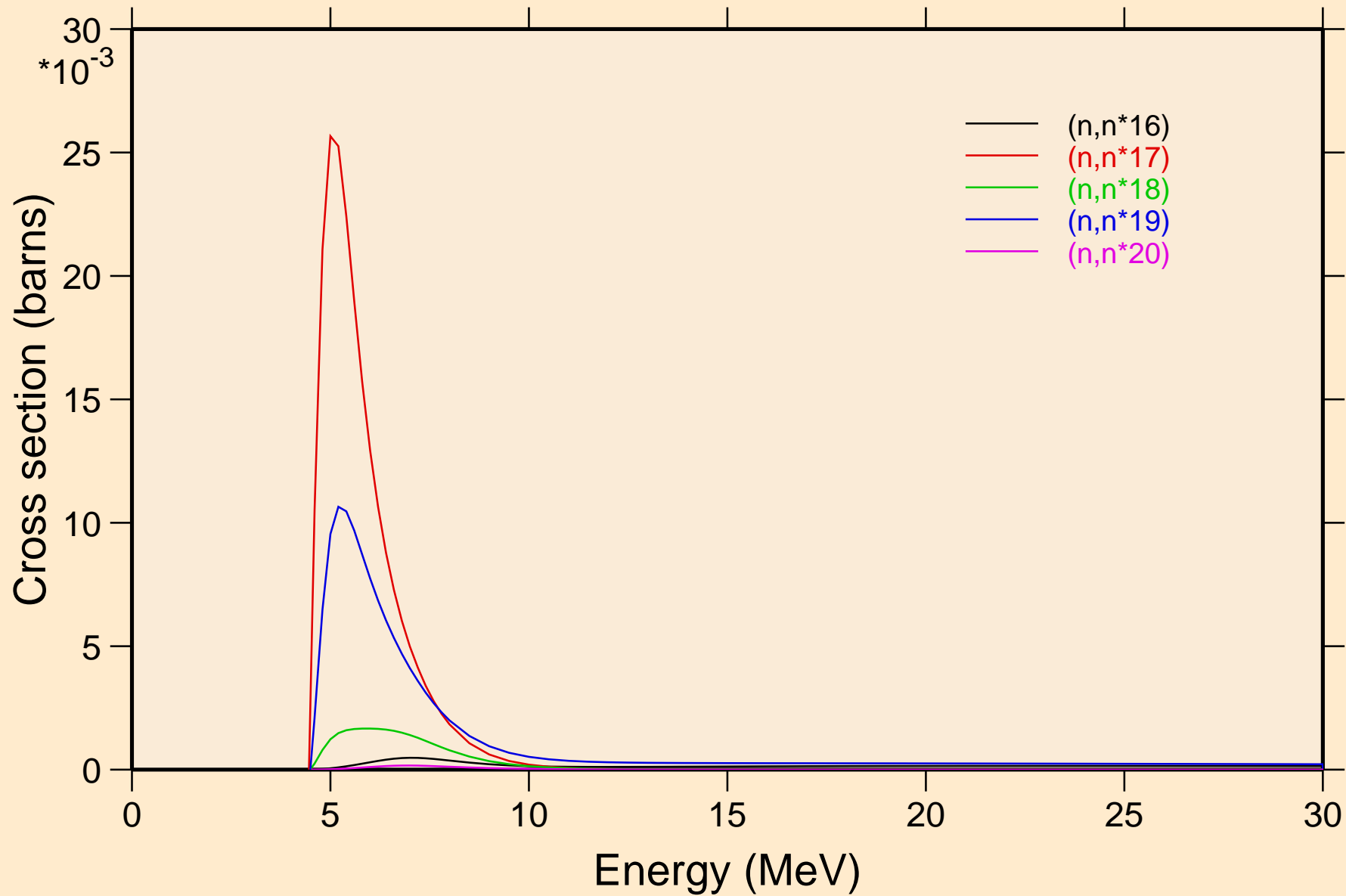

GE082 NEUTRON ACER TENDL-2021 LIBRARY; T=293.6K  
Inelastic levels

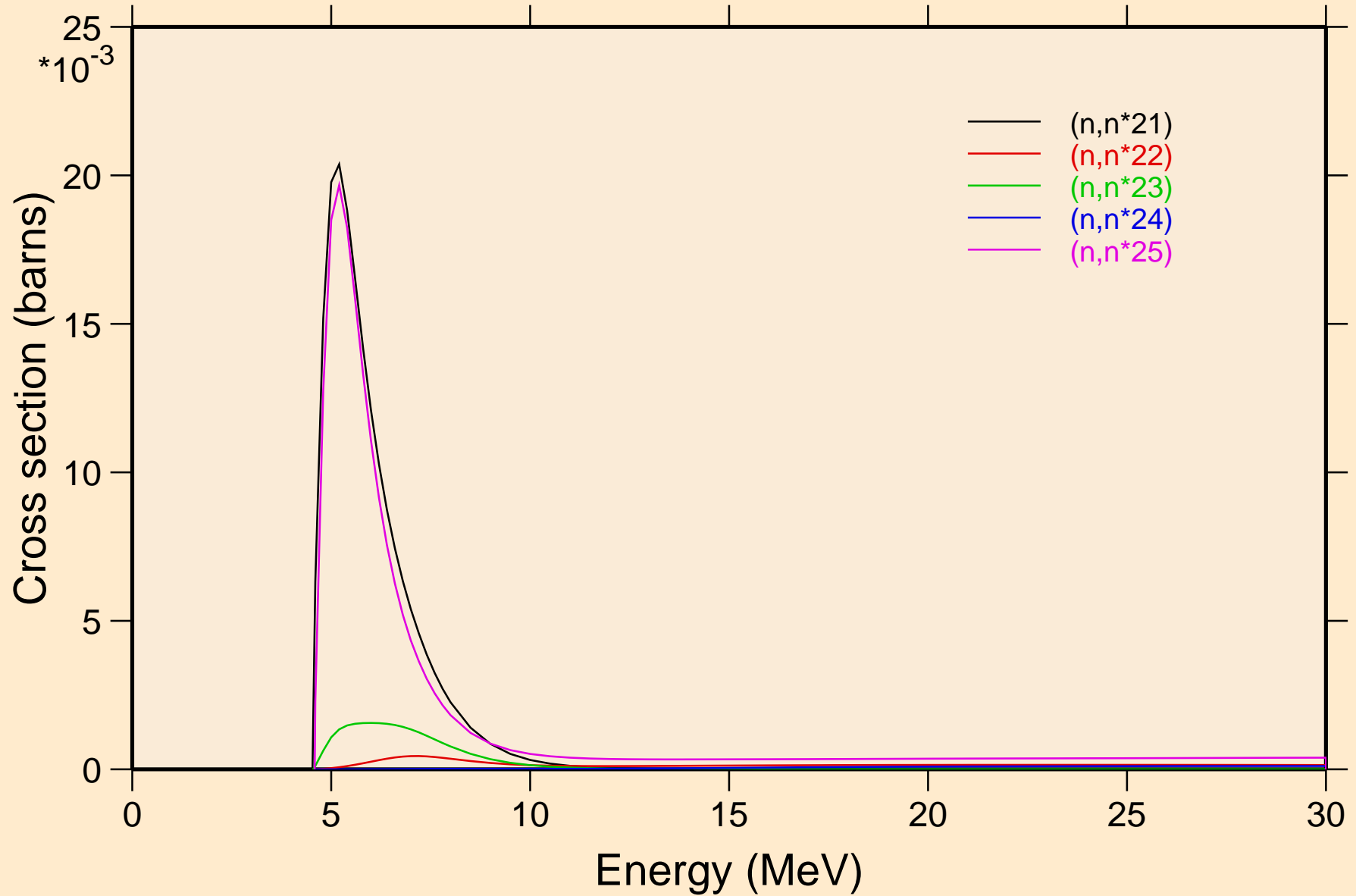

GE082 NEUTRON ACER TENDL-2021 LIBRARY; T=293.6K  
Inelastic levels

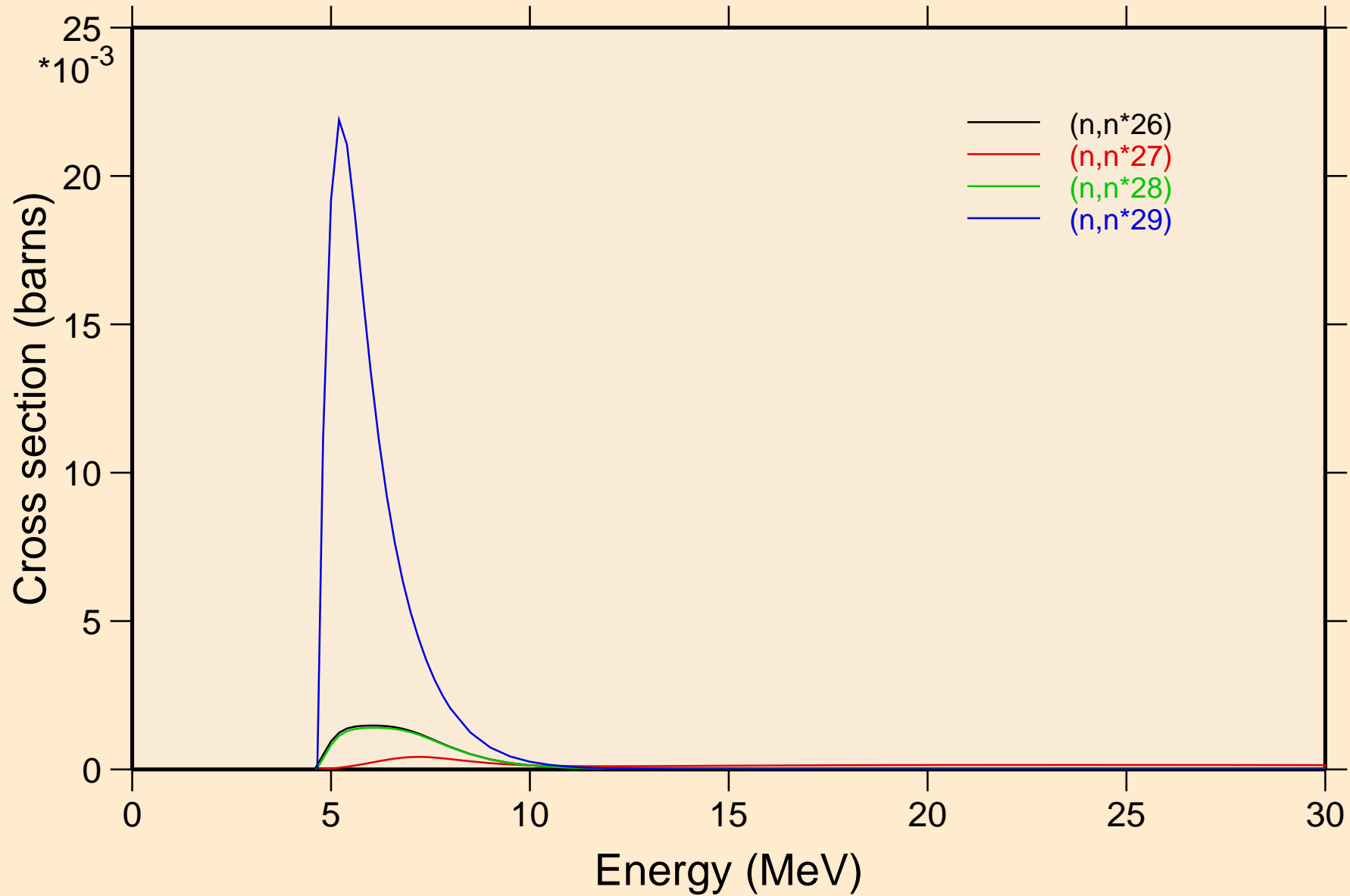

GE082 NEUTRON ACER TENDL-2021 LIBRARY; T=293.6K  
Threshold reactions

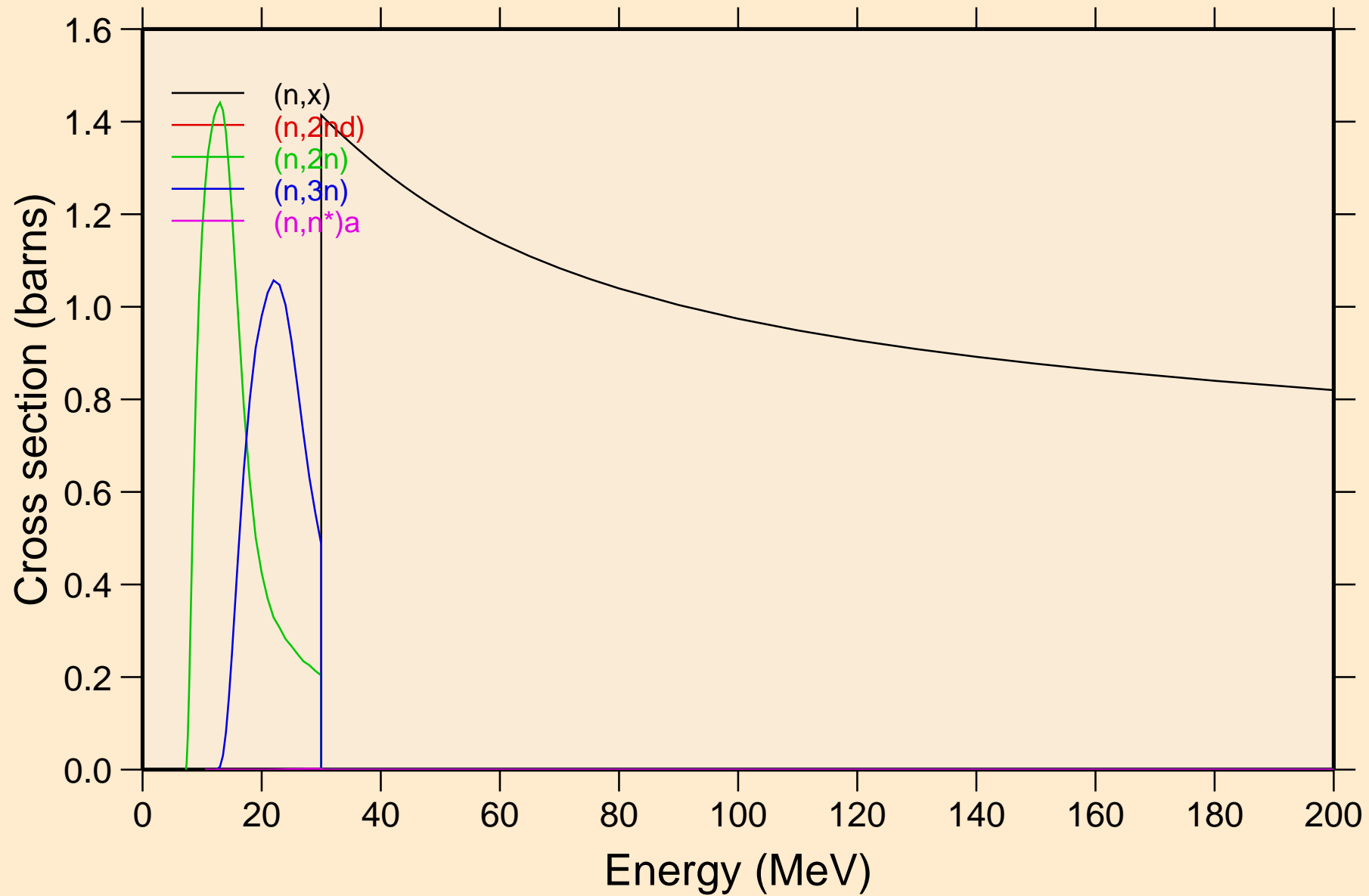

# GE082 NEUTRON ACER TENDL-2021 LIBRARY; T=293.6K

## Threshold reactions

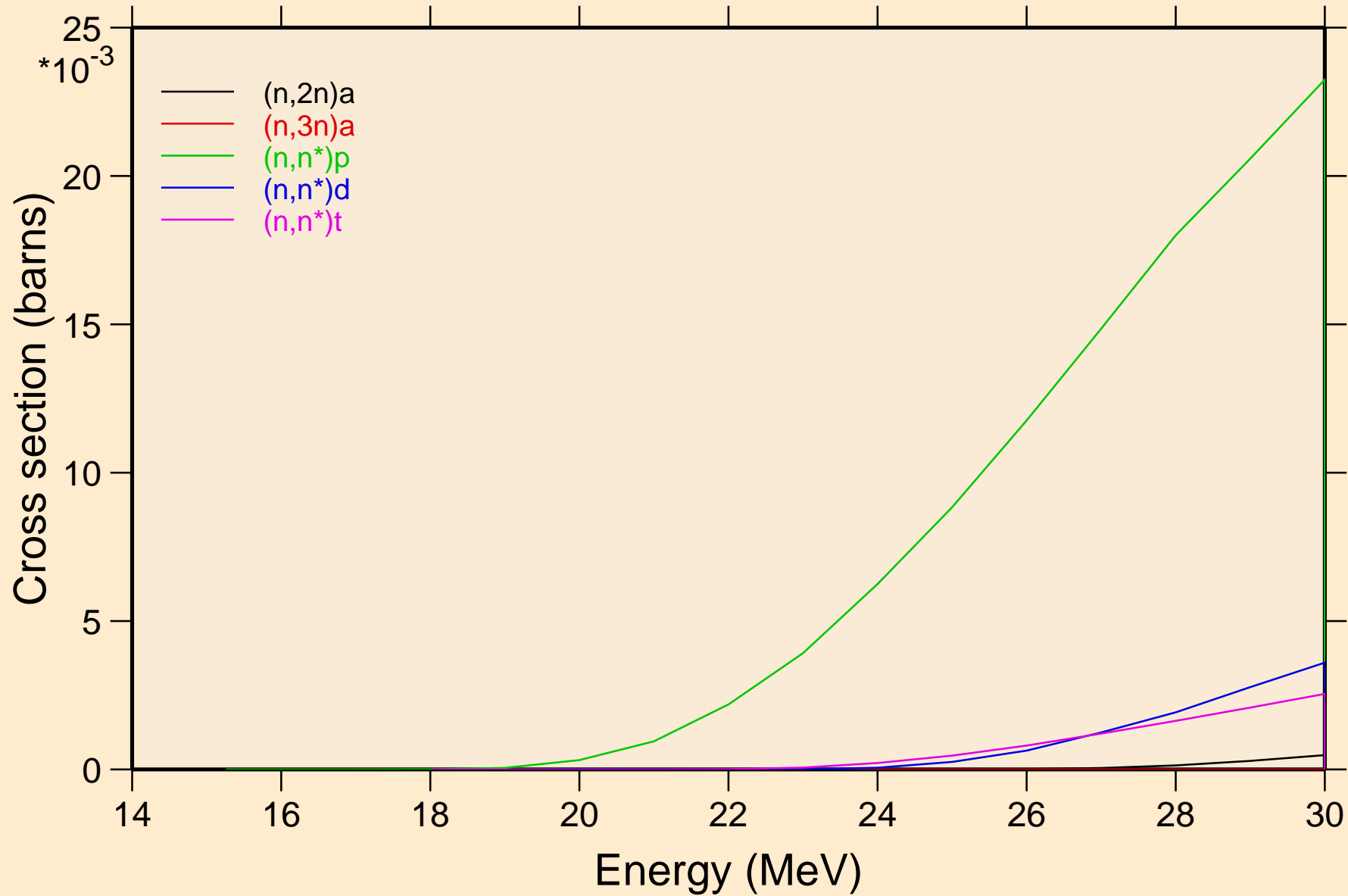



GE082 NEUTRON ACER TENDL-2021 LIBRARY; T=293.6K  
Threshold reactions

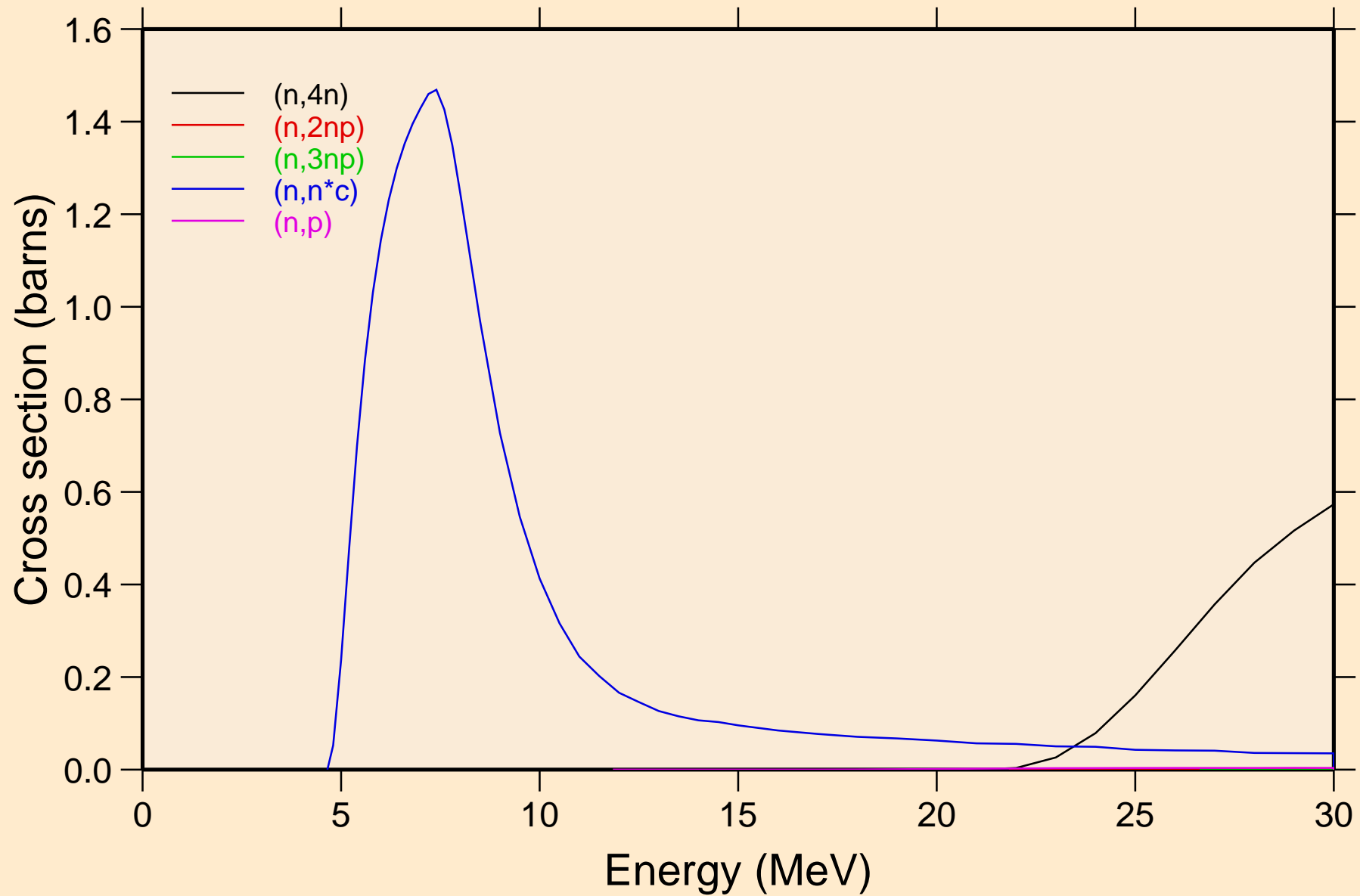

GE082 NEUTRON ACER TENDL-2021 LIBRARY; T=293.6K  
Threshold reactions

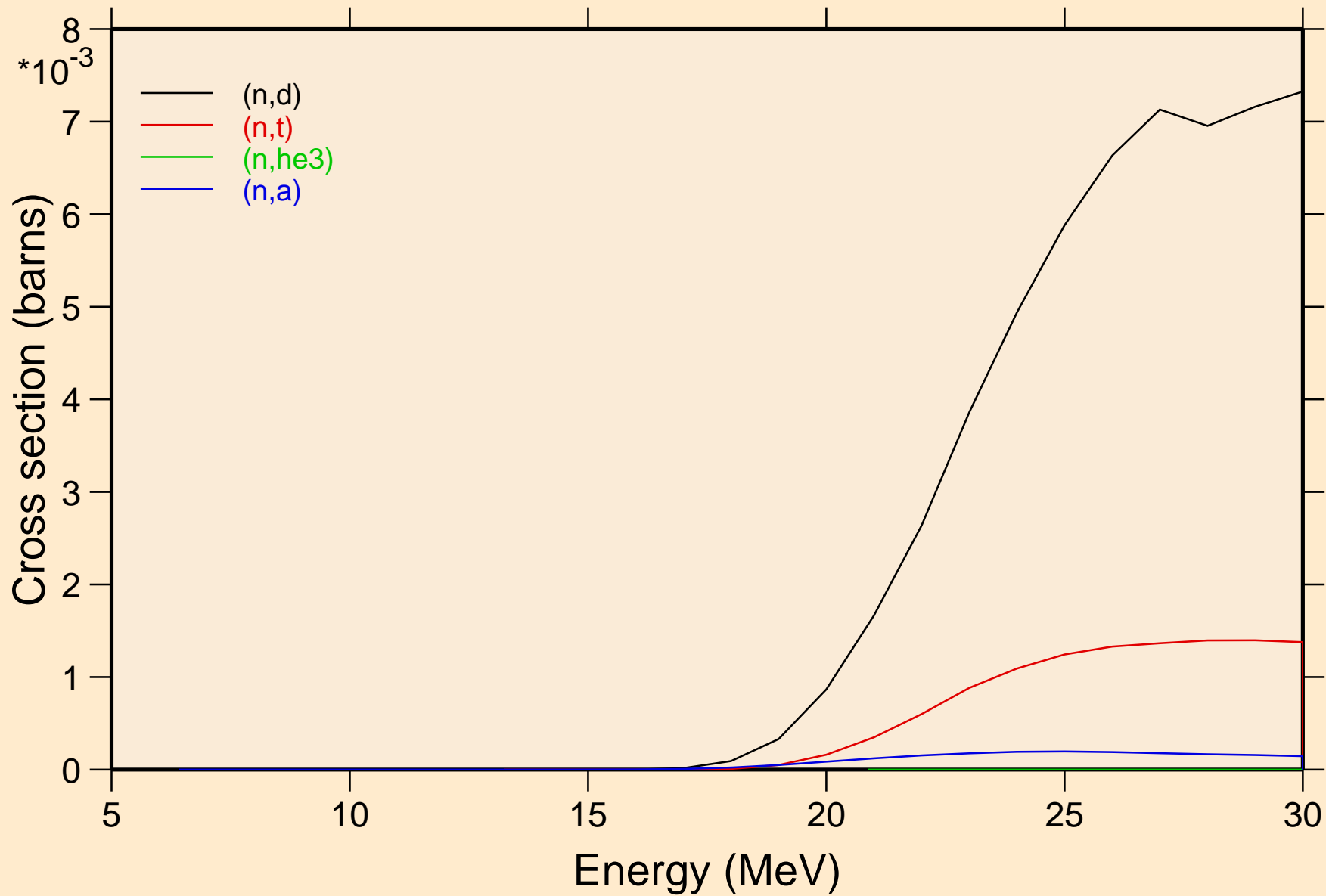

# GE082 NEUTRON ACER TENDL-2021 LIBRARY; T=293.6K

## Threshold reactions

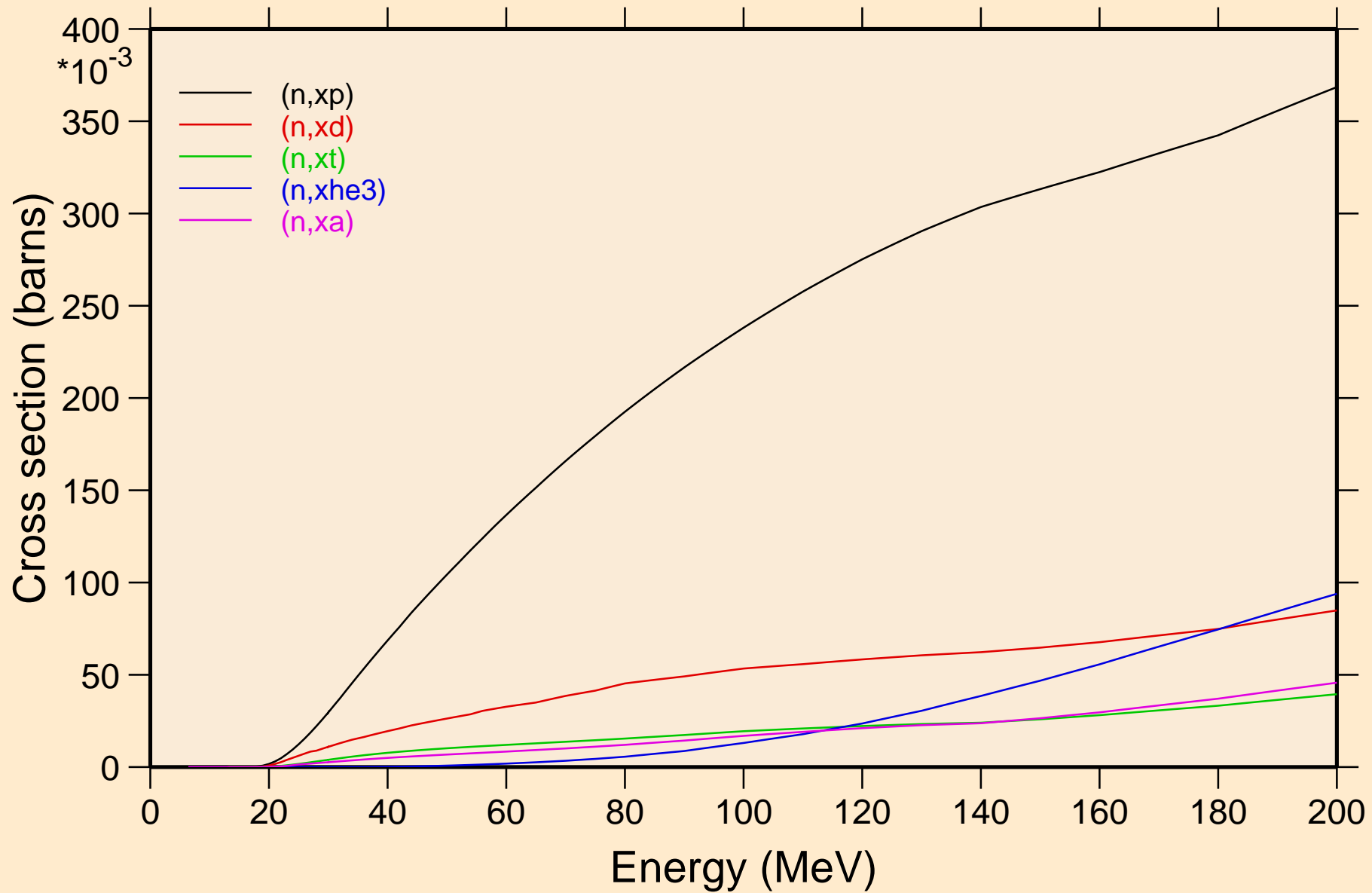

GE082 NEUTRON ACER TENDL-2021 LIBRARY; T=293.6K  
angular distribution for elastic

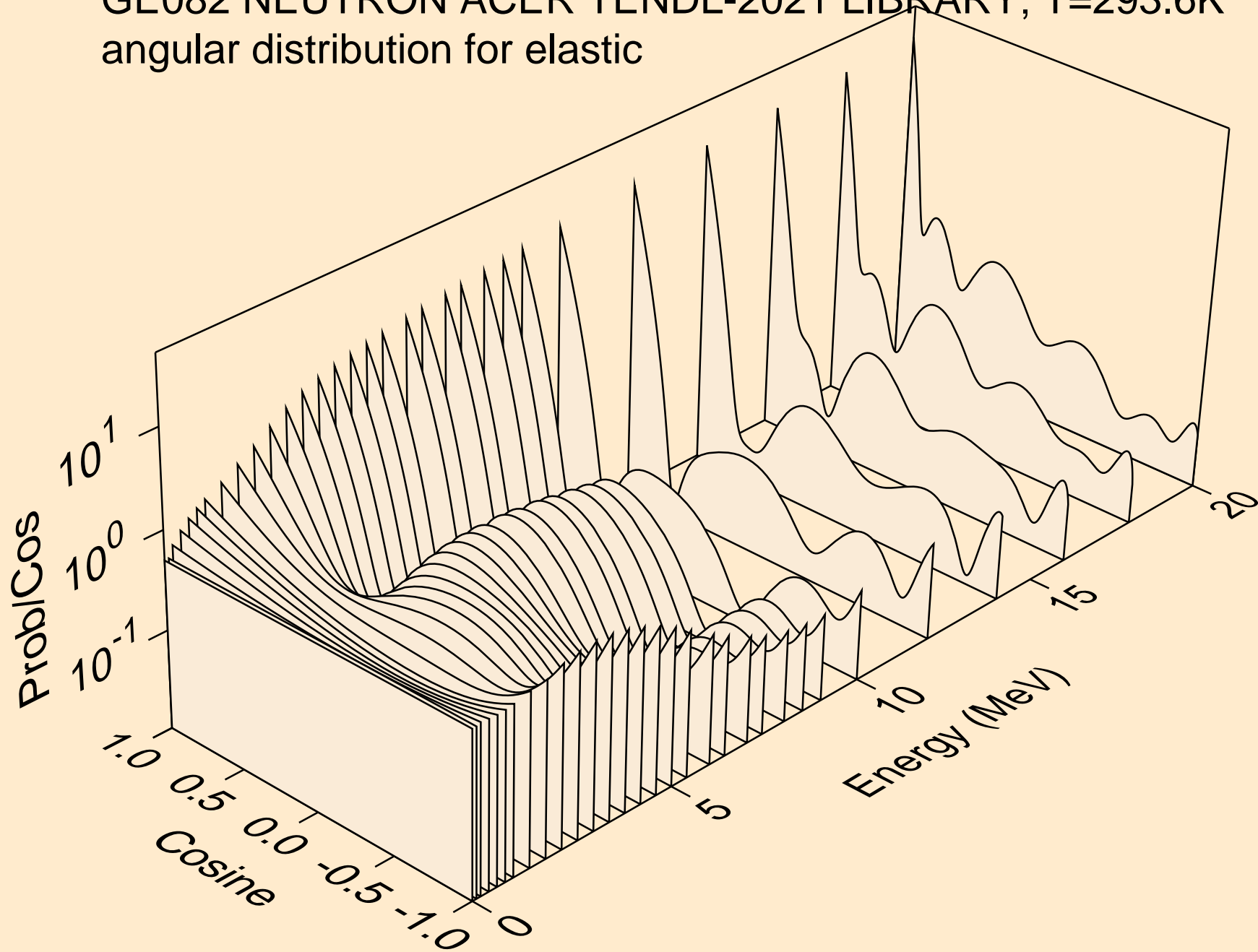

GE082 NEUTRON ACER TENDL-2021 LIBRARY; T=293.6K  
angular distribution for elastic

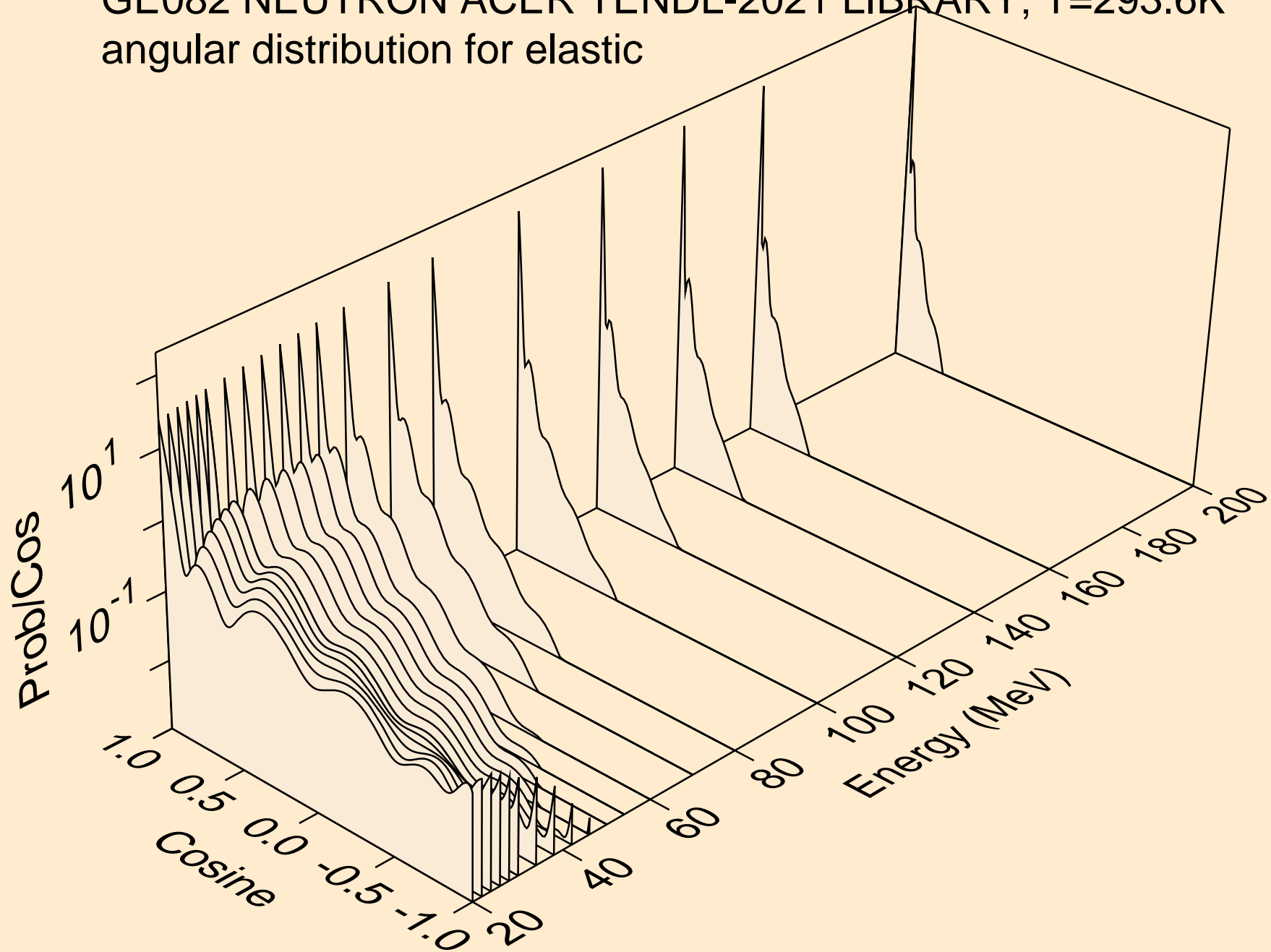

GE082 NEUTRON ACER TENDL-2021 LIBRARY; T=293.6K  
angular distribution for (n,n\*1)

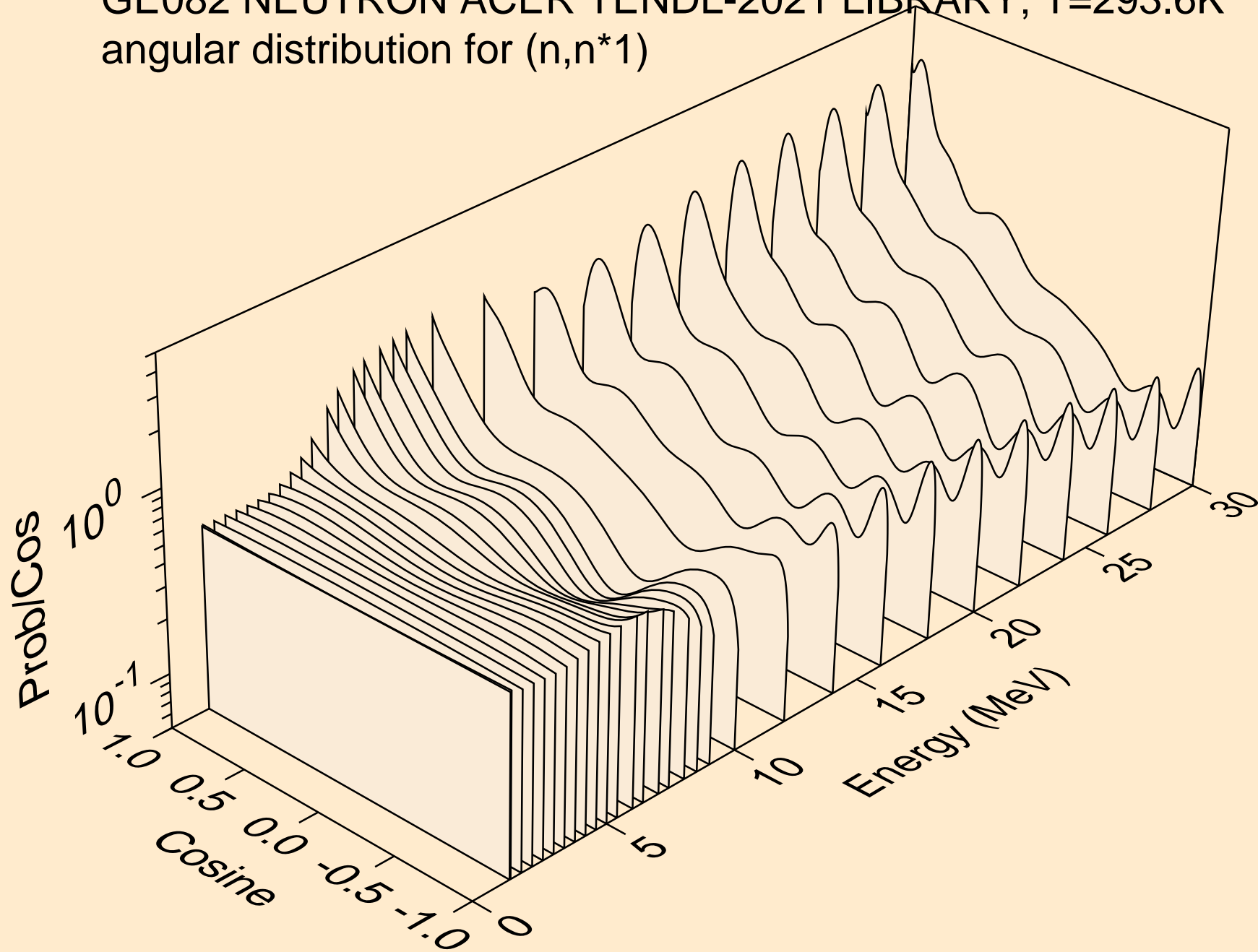

GE082 NEUTRON ACER TENDL-2021 LIBRARY; T=293.6K  
angular distribution for (n,n\*2)

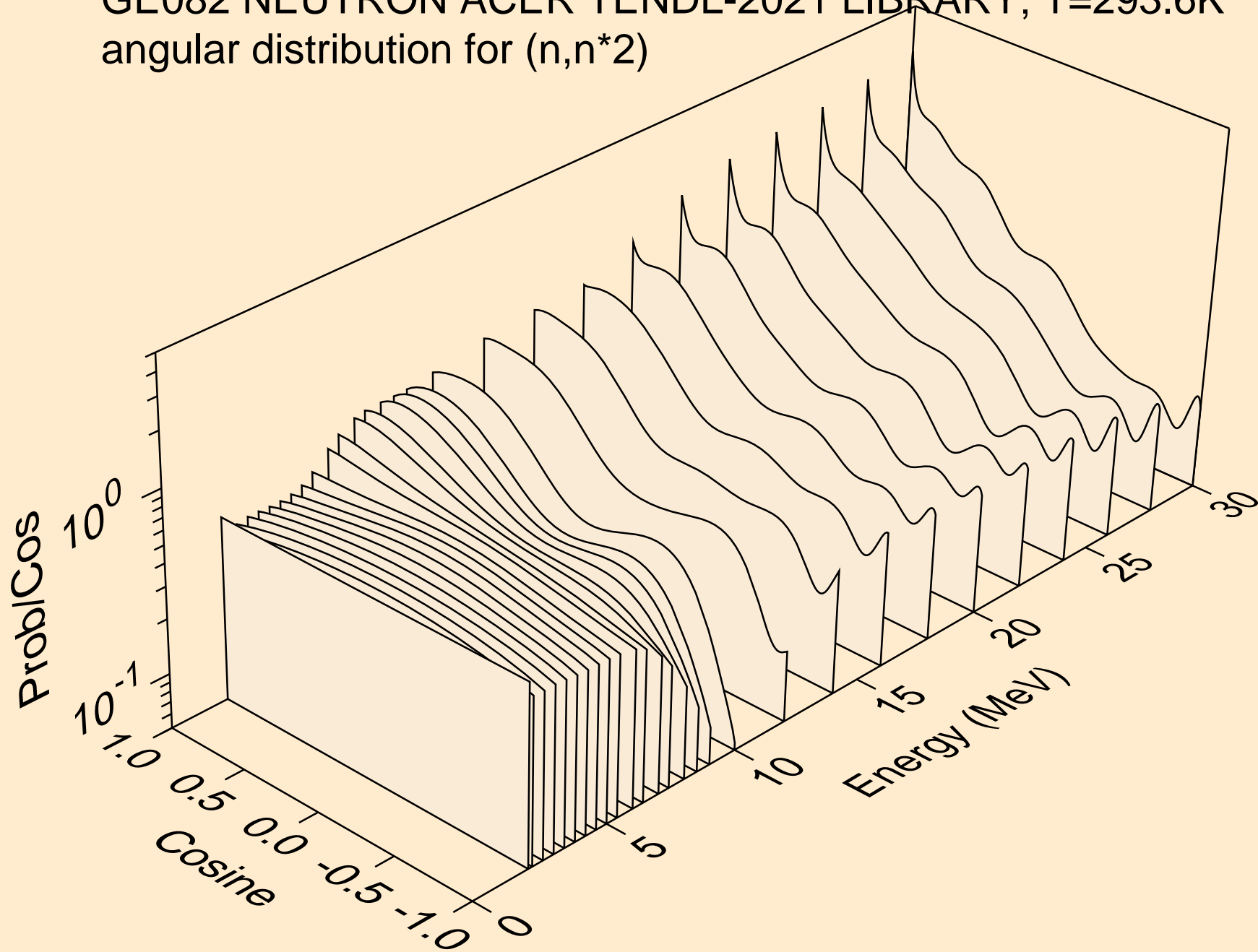

GE082 NEUTRON ACER TENDL-2021 LIBRARY; T=293.6K  
angular distribution for (n,n\*3)

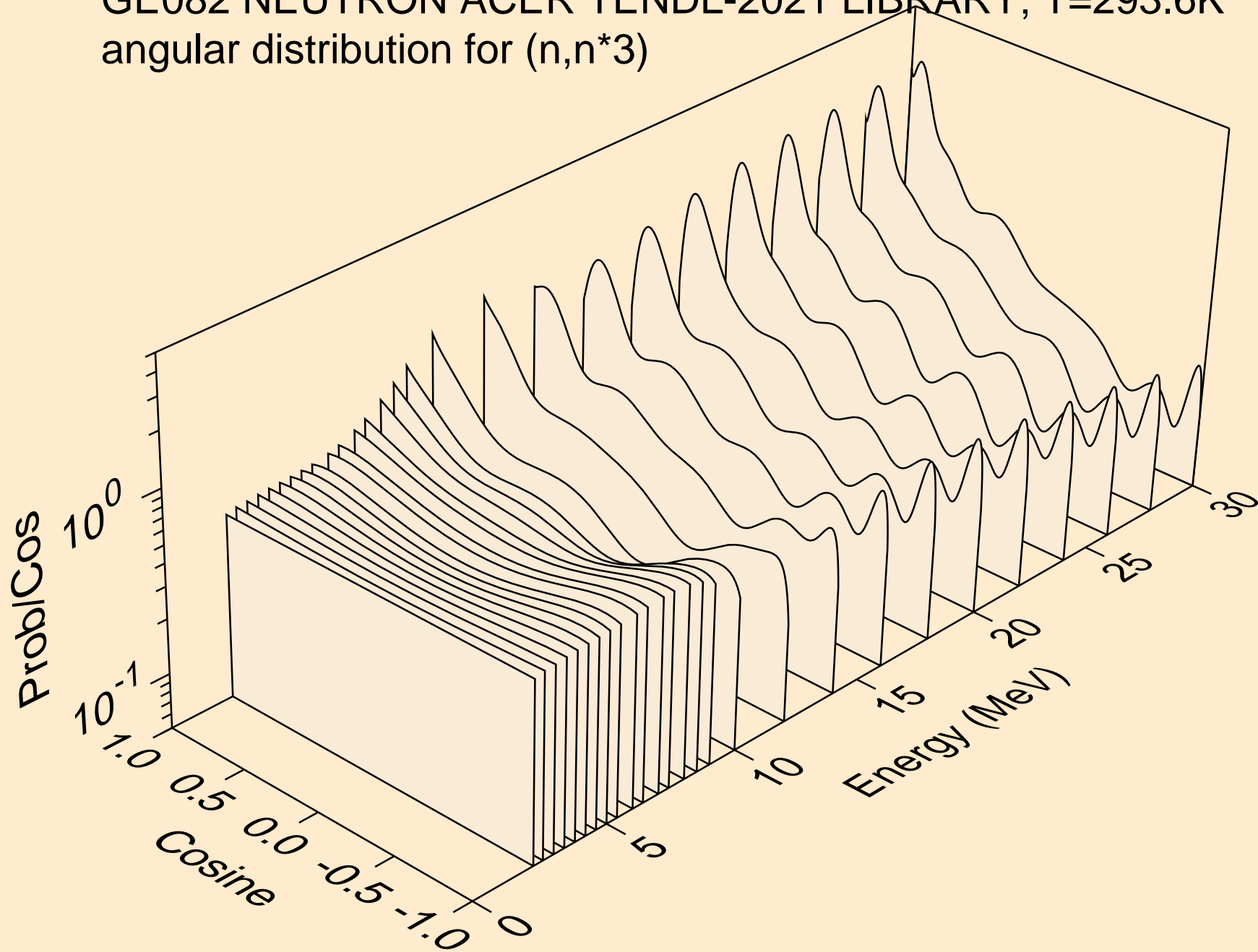



GE082 NEUTRON ACER TENDL-2021 LIBRARY; T=293.6K  
angular distribution for (n,n\*4)

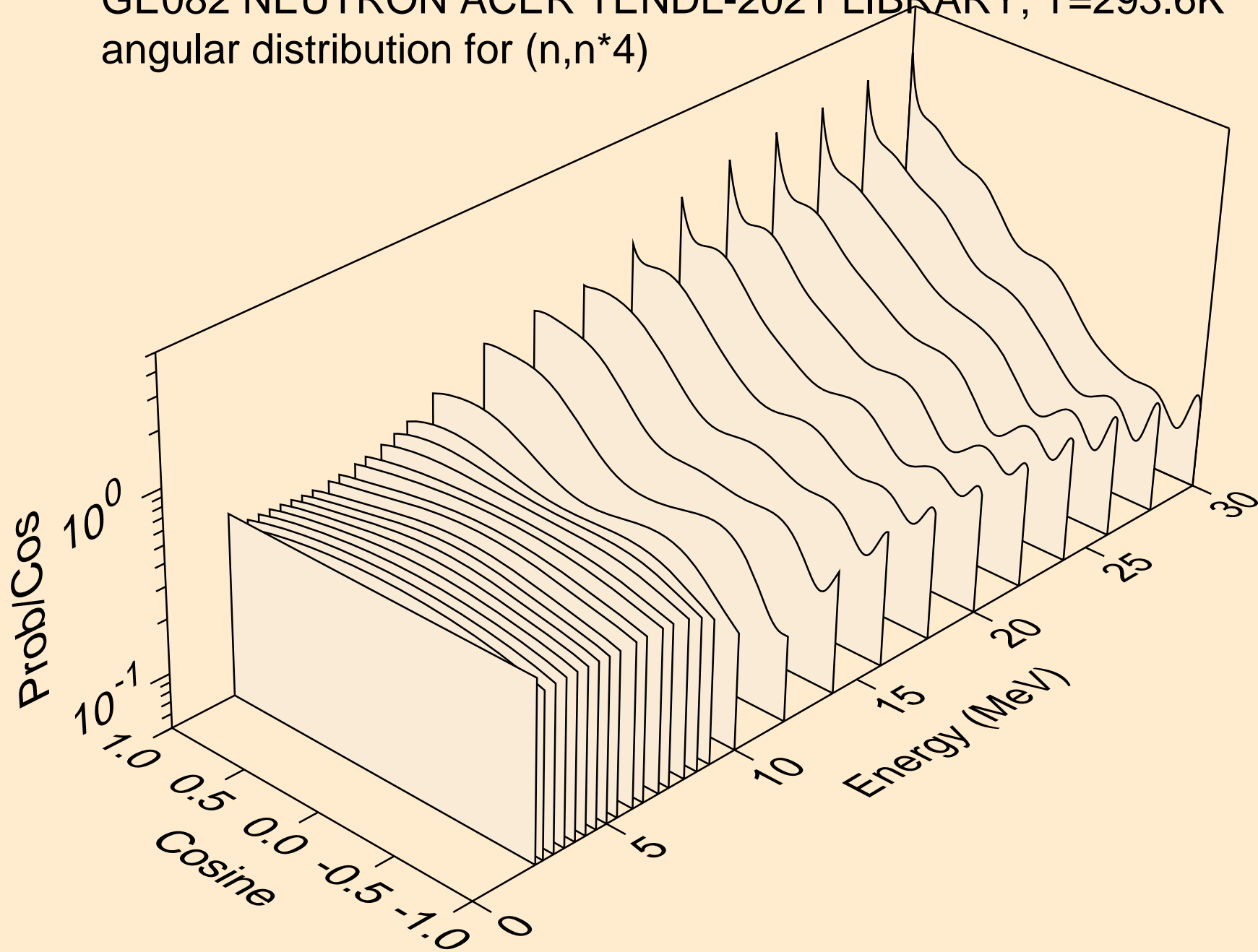

GE082 NEUTRON ACER TENDL-2021 LIBRARY; T=293.6K  
angular distribution for (n,n\*5)

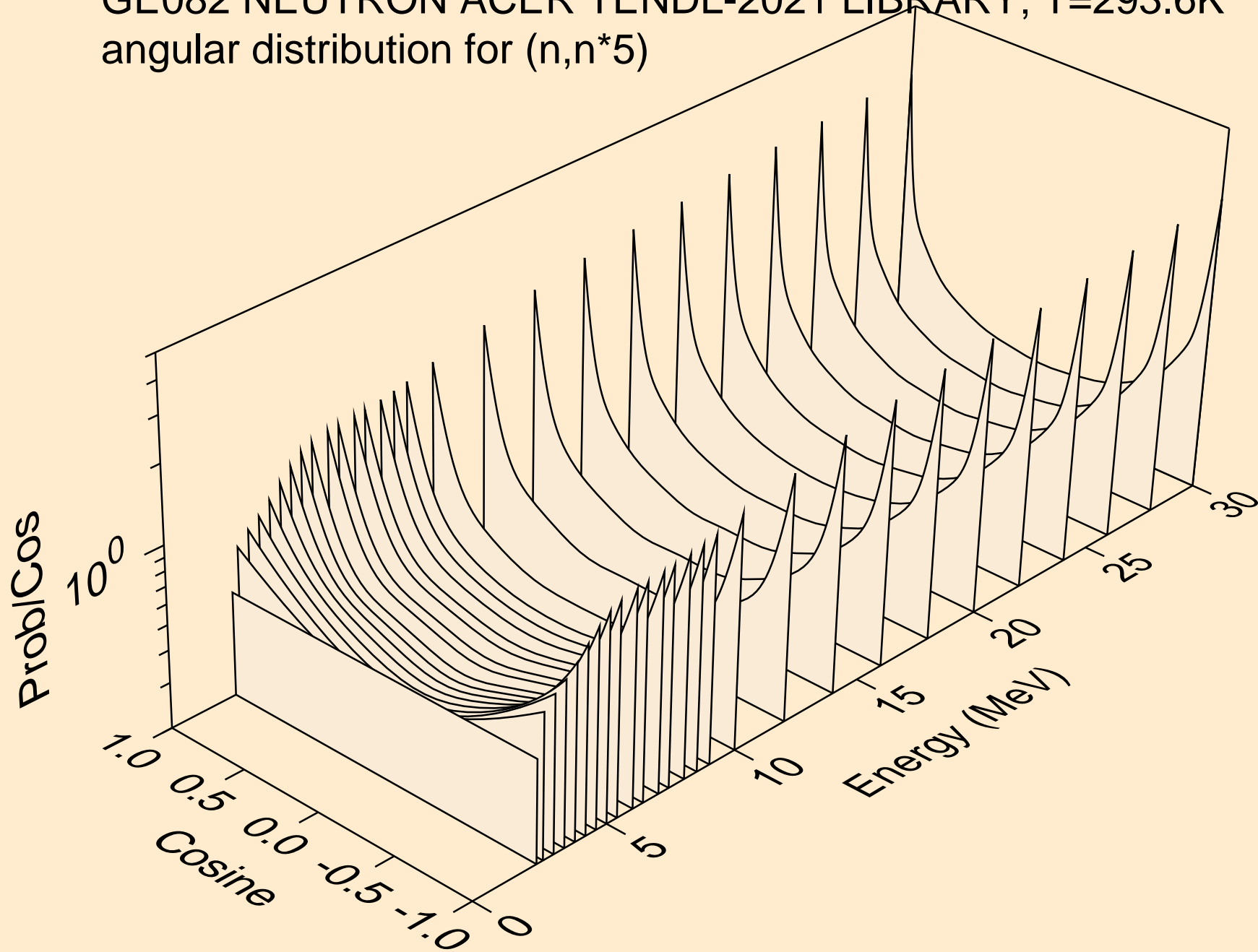

GE082 NEUTRON ACER TENDL-2021 LIBRARY; T=293.6K  
angular distribution for (n,n\*6)

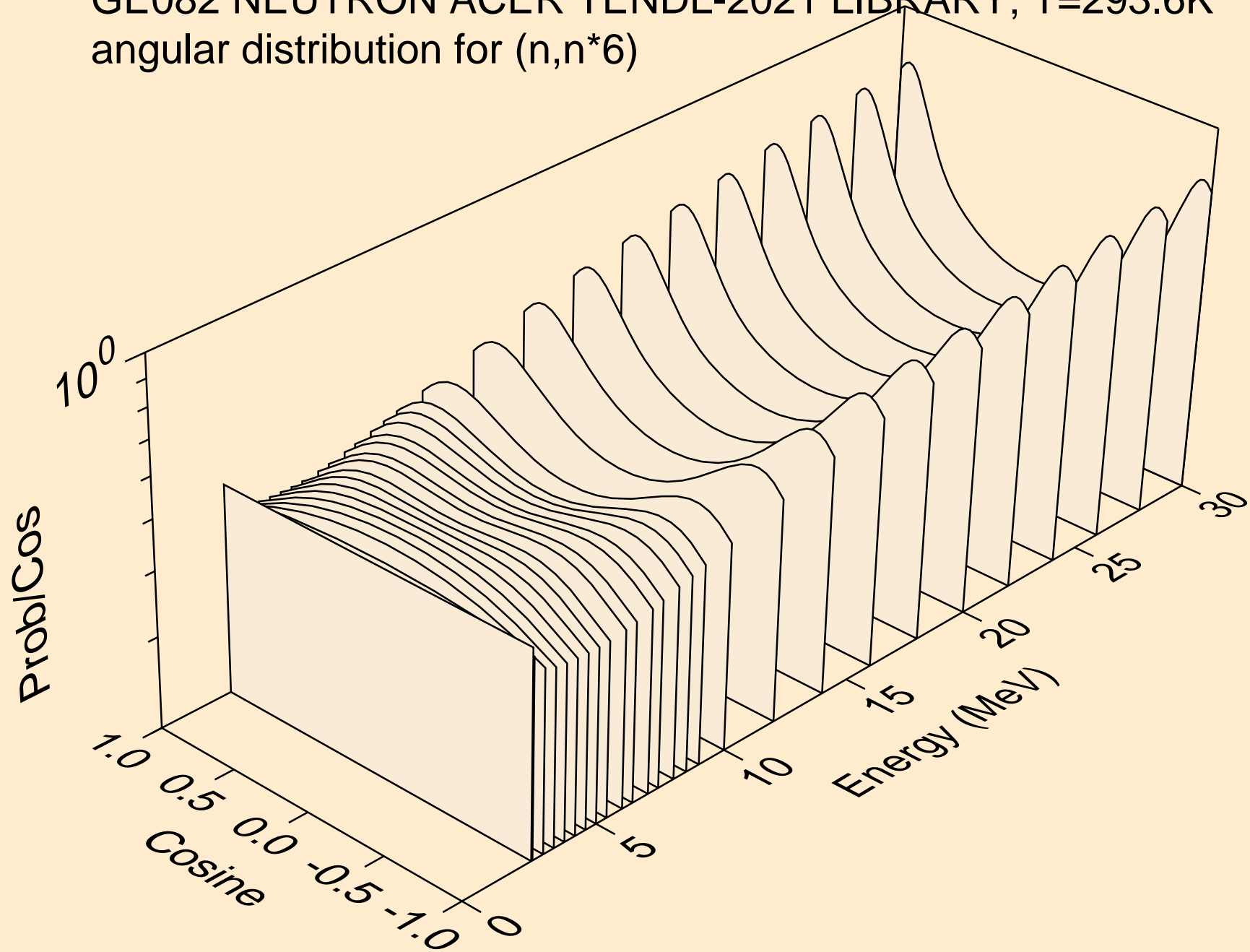

GE082 NEUTRON ACER TENDL-2021 LIBRARY; T=293.6K  
angular distribution for (n,n\*7)

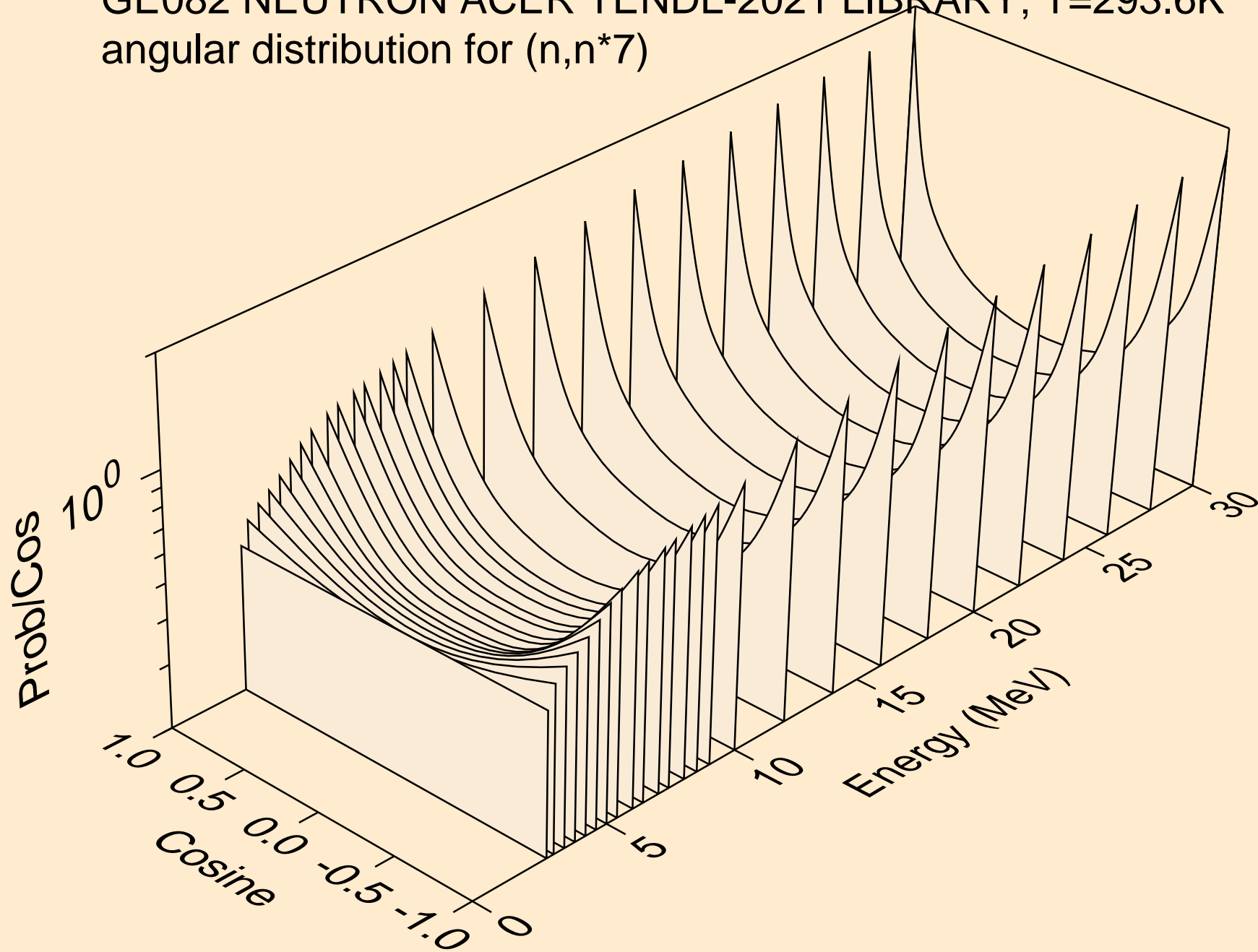

GE082 NEUTRON ACER TENDL-2021 LIBRARY; T=293.6K  
angular distribution for (n,n\*8)

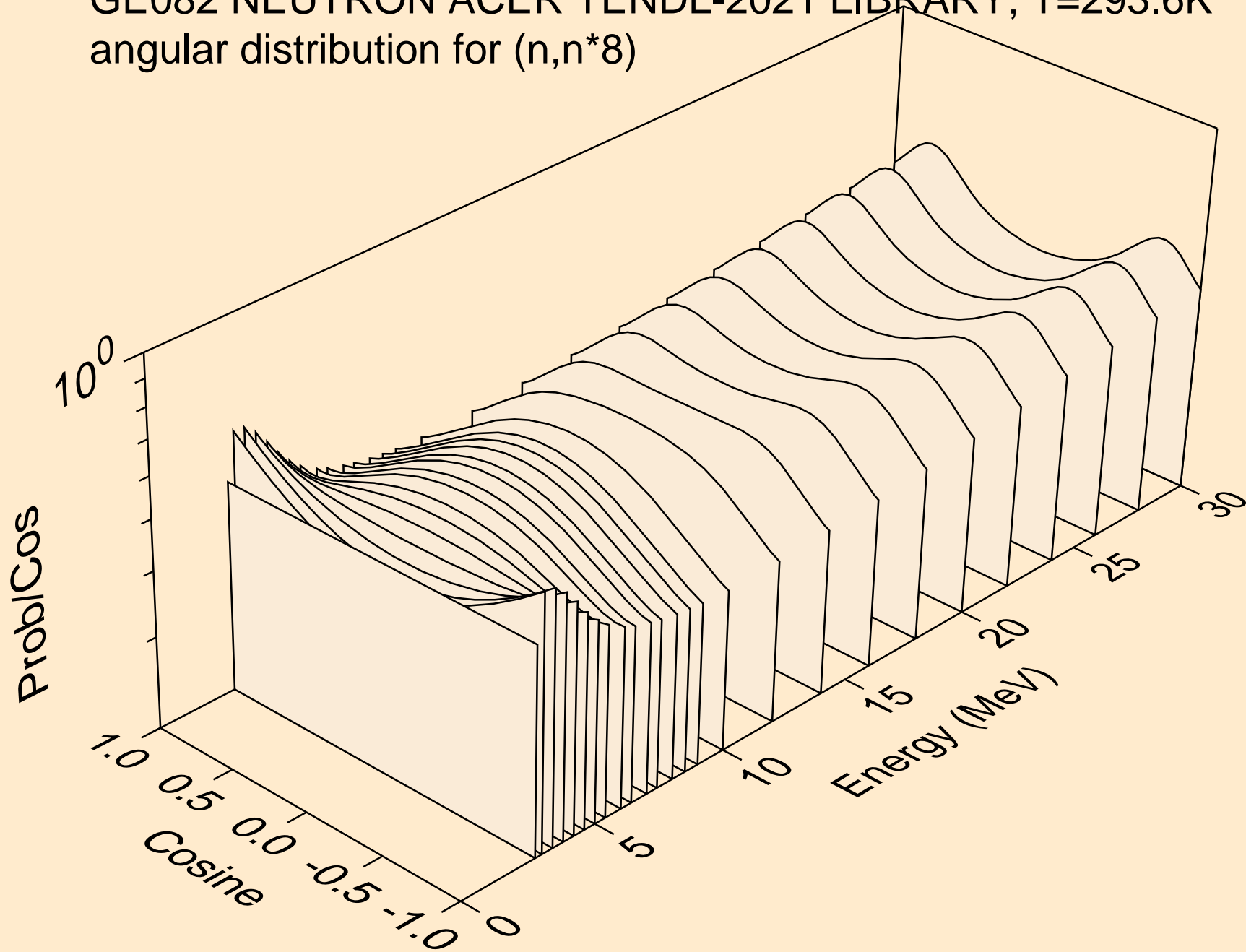

GE082 NEUTRON ACER TENDL-2021 LIBRARY; T=293.6K  
angular distribution for (n,n\*9)

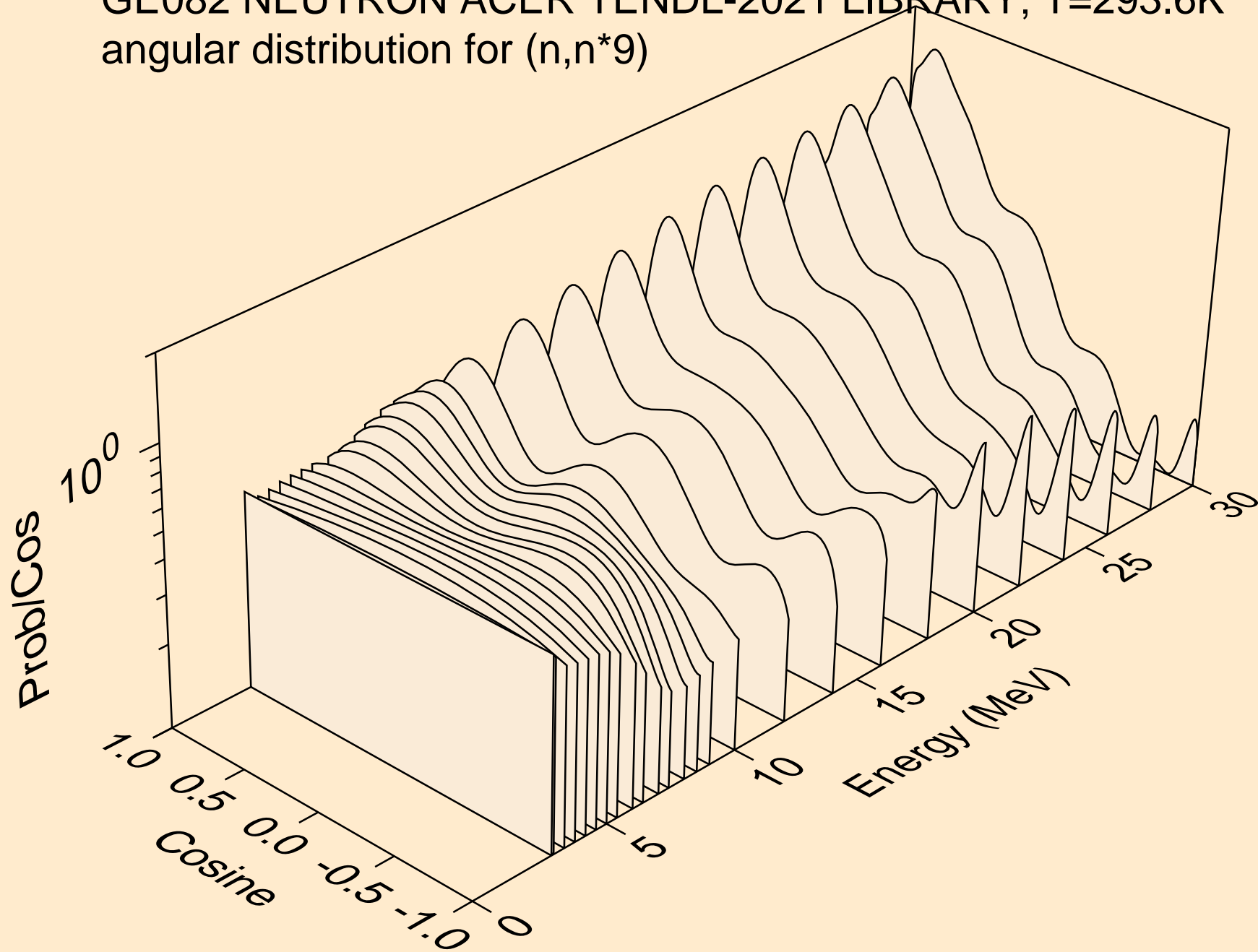

GE082 NEUTRON ACER TENDL-2021 LIBRARY; T=293.6K  
angular distribution for (n,n\*10)

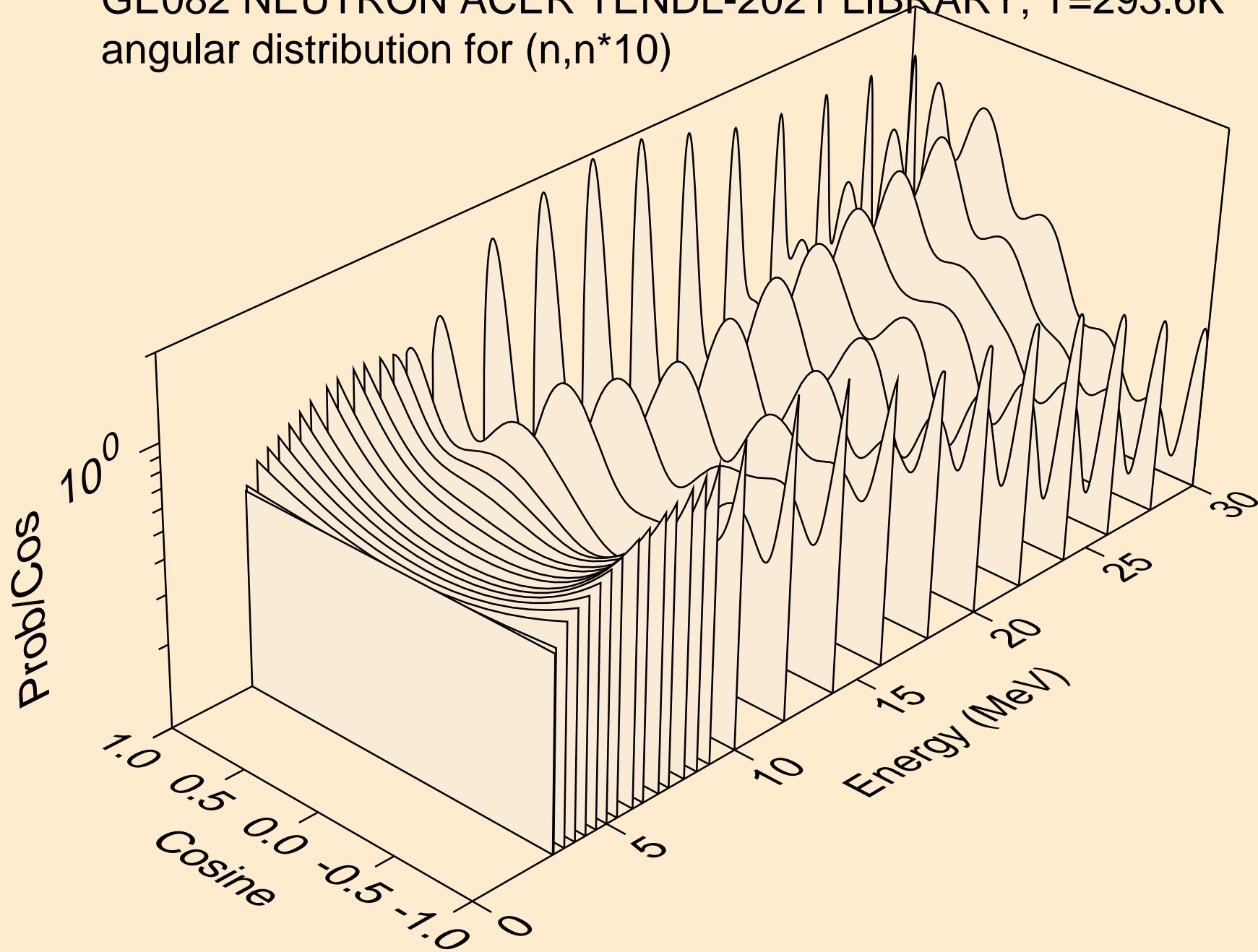

GE082 NEUTRON ACER TENDL-2021 LIBRARY; T=293.6K  
angular distribution for (n,n\*11)

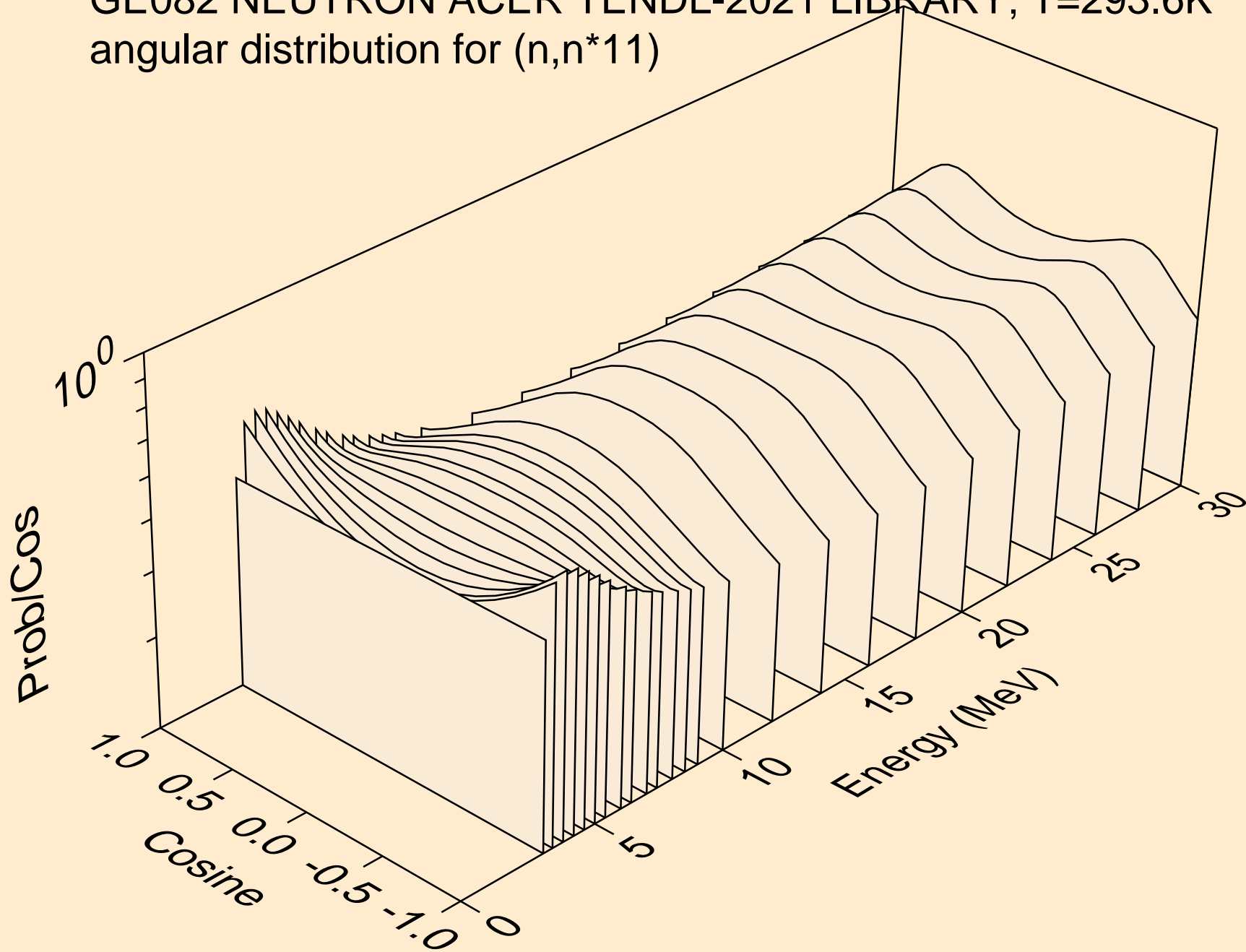



GE082 NEUTRON ACER TENDL-2021 LIBRARY; T=293.6K  
angular distribution for (n,n\*12)

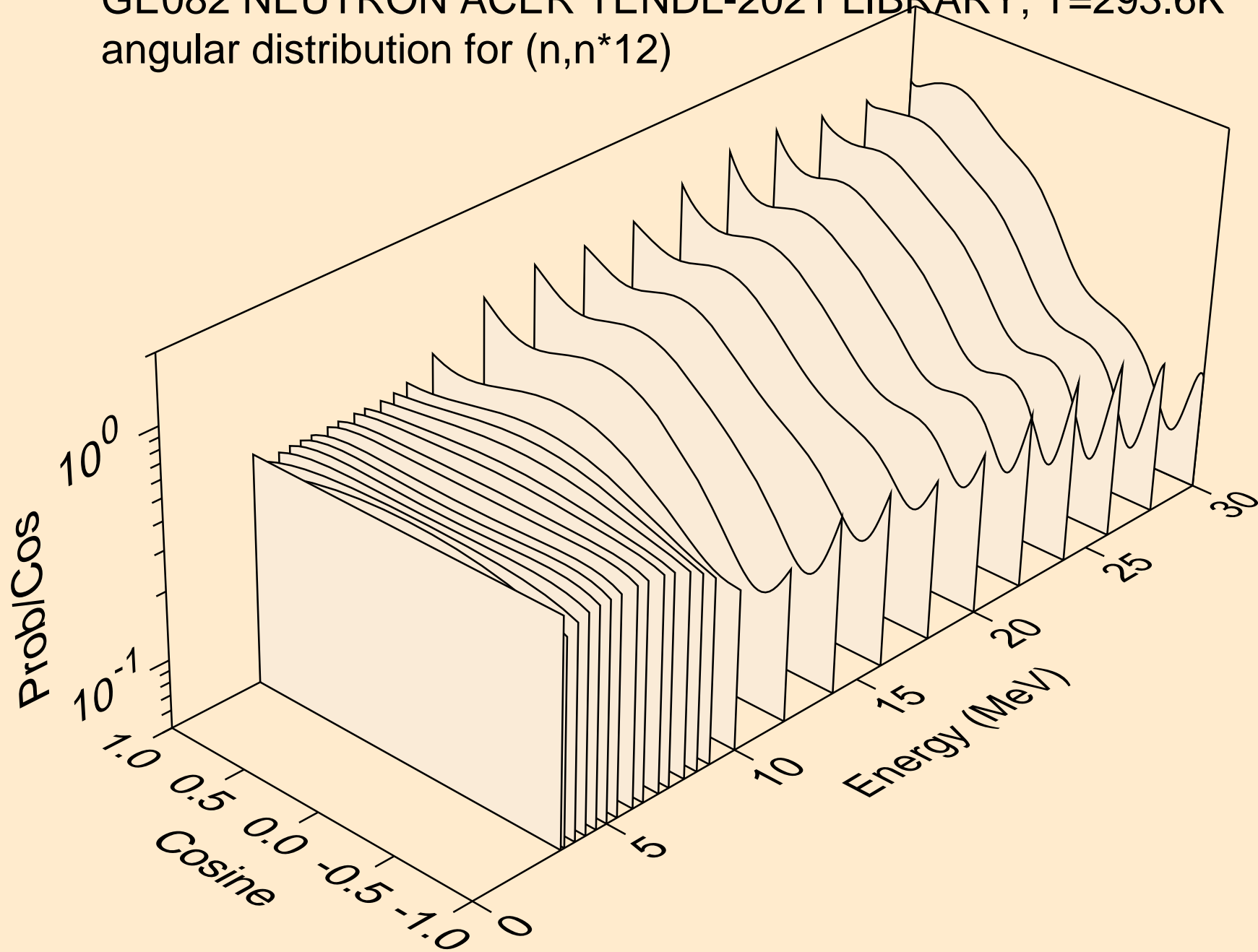

GE082 NEUTRON ACER TENDL-2021 LIBRARY; T=293.6K  
angular distribution for (n,n\*13)

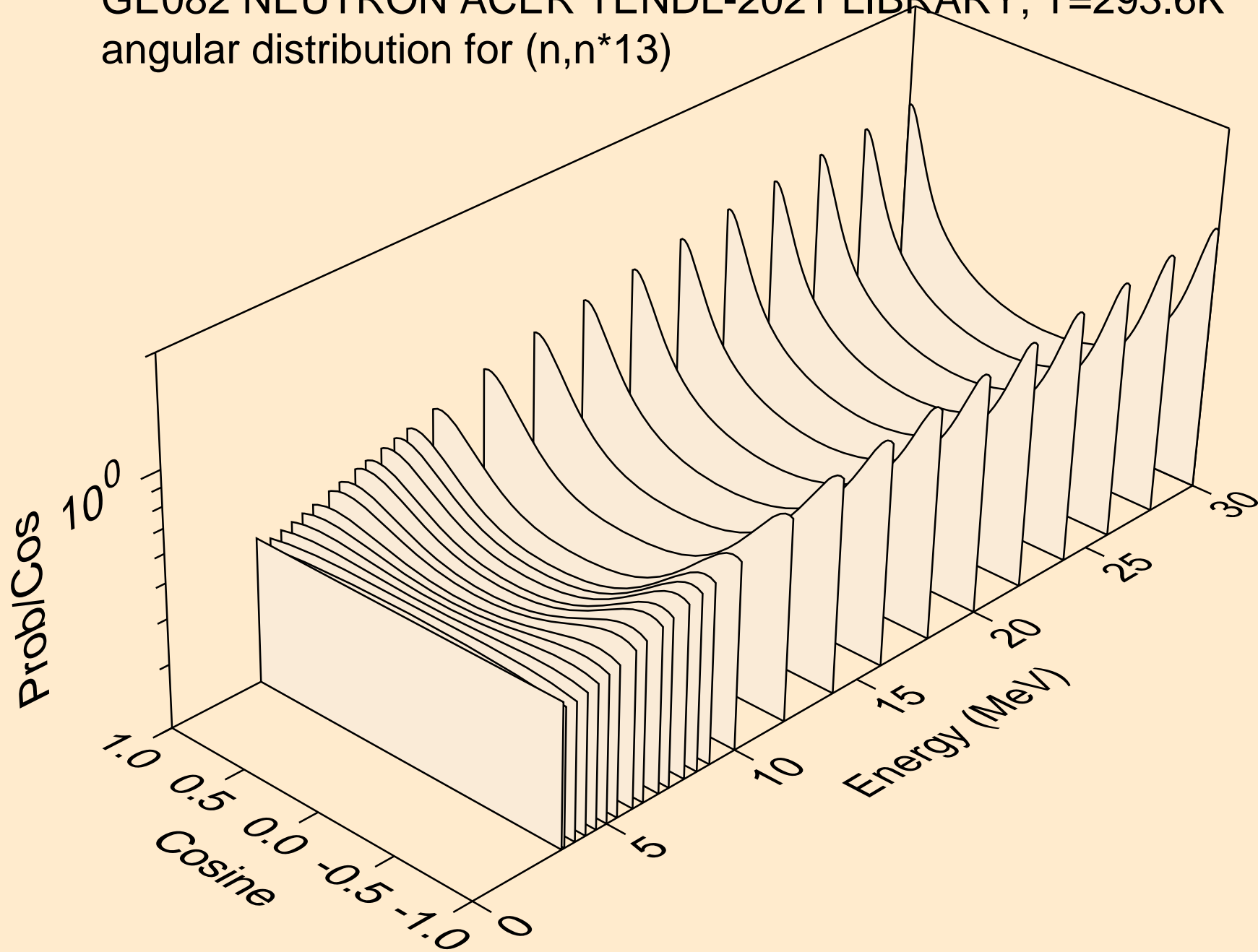

GE082 NEUTRON ACER TENDL-2021 LIBRARY; T=293.6K  
angular distribution for (n,n\*14)

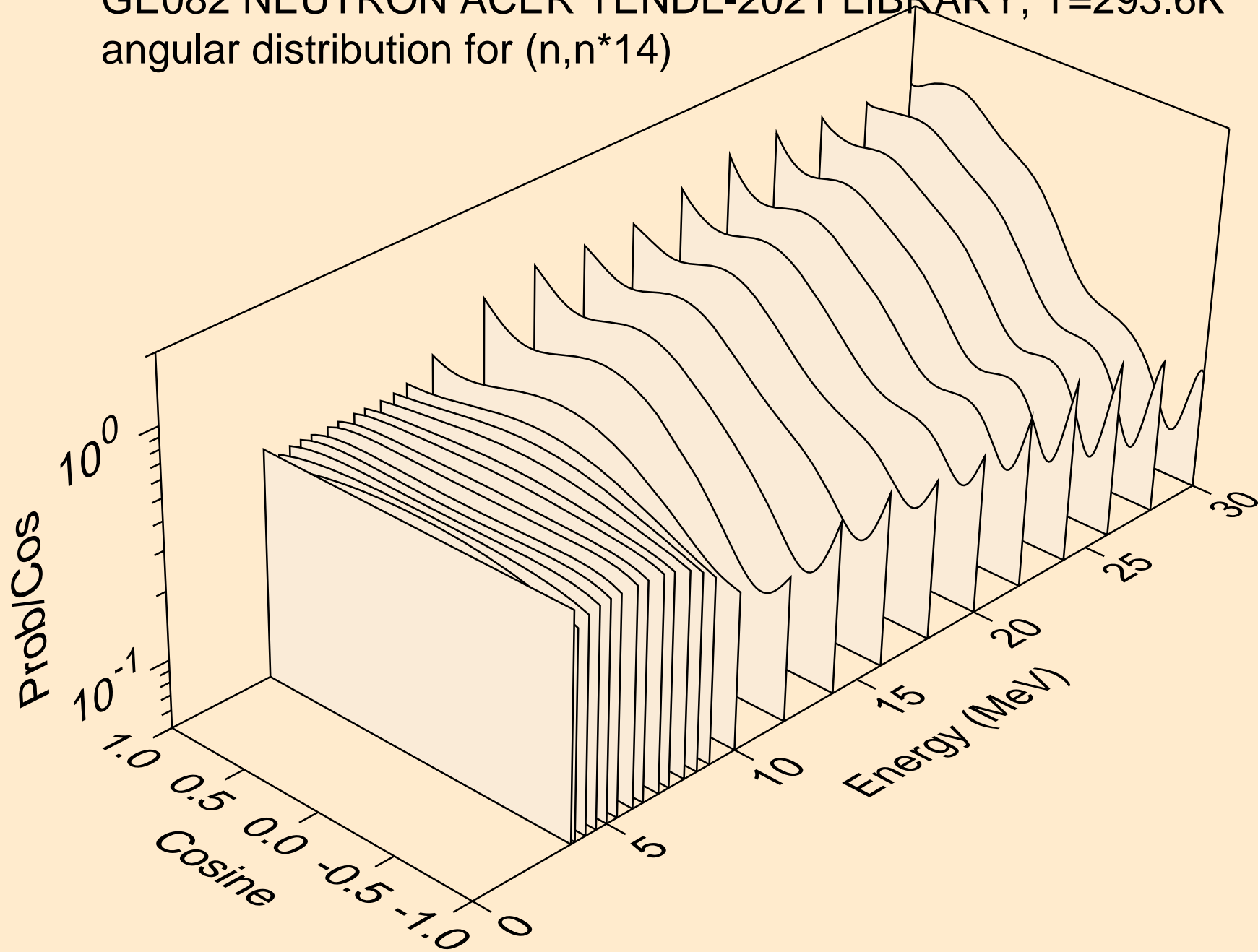

GE082 NEUTRON ACER TENDL-2021 LIBRARY; T=293.6K  
angular distribution for (n,n\*15)

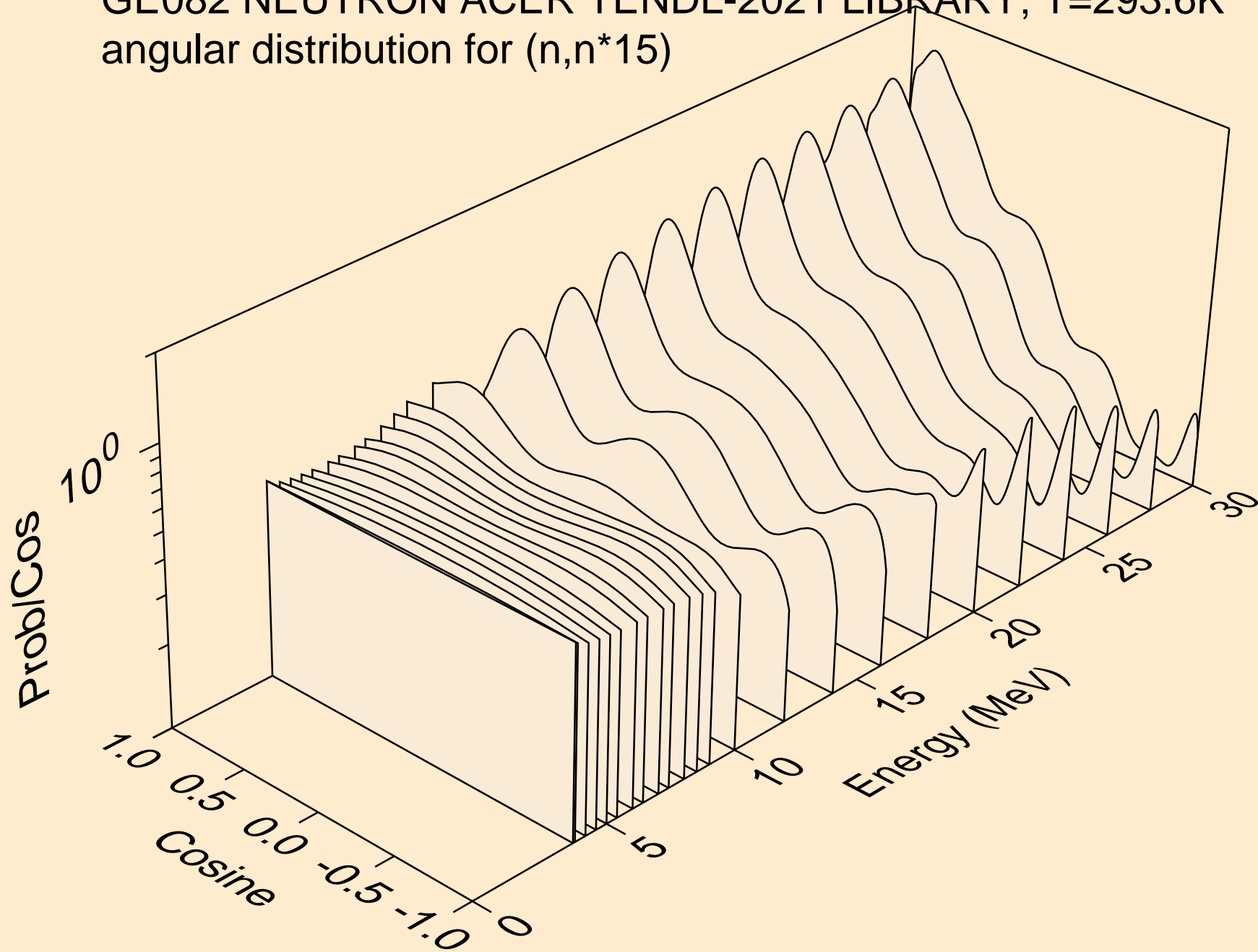

GE082 NEUTRON ACER TENDL-2021 LIBRARY; T=293.6K  
angular distribution for (n,n\*16)

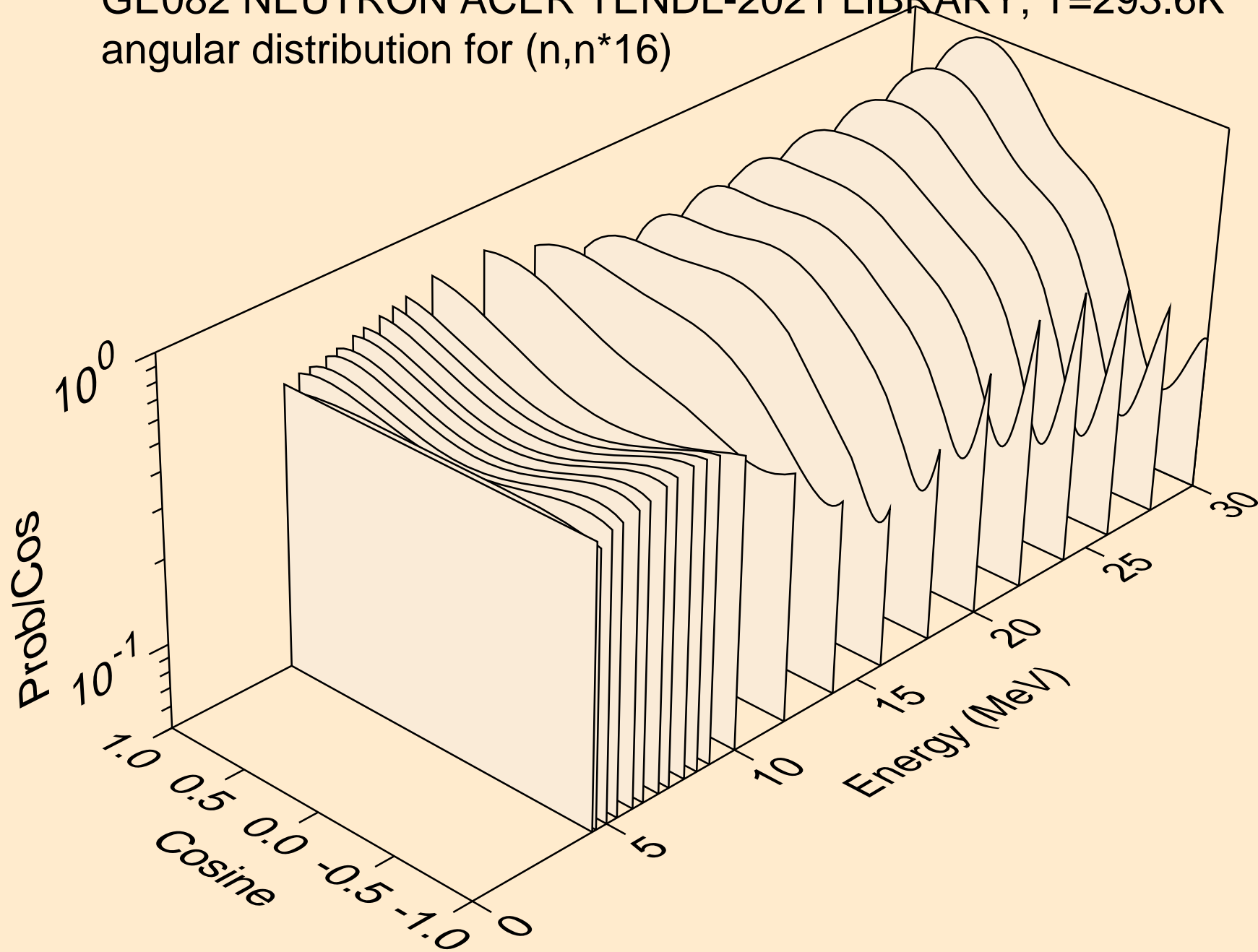

GE082 NEUTRON ACER TENDL-2021 LIBRARY; T=293.6K  
angular distribution for (n,n\*17)

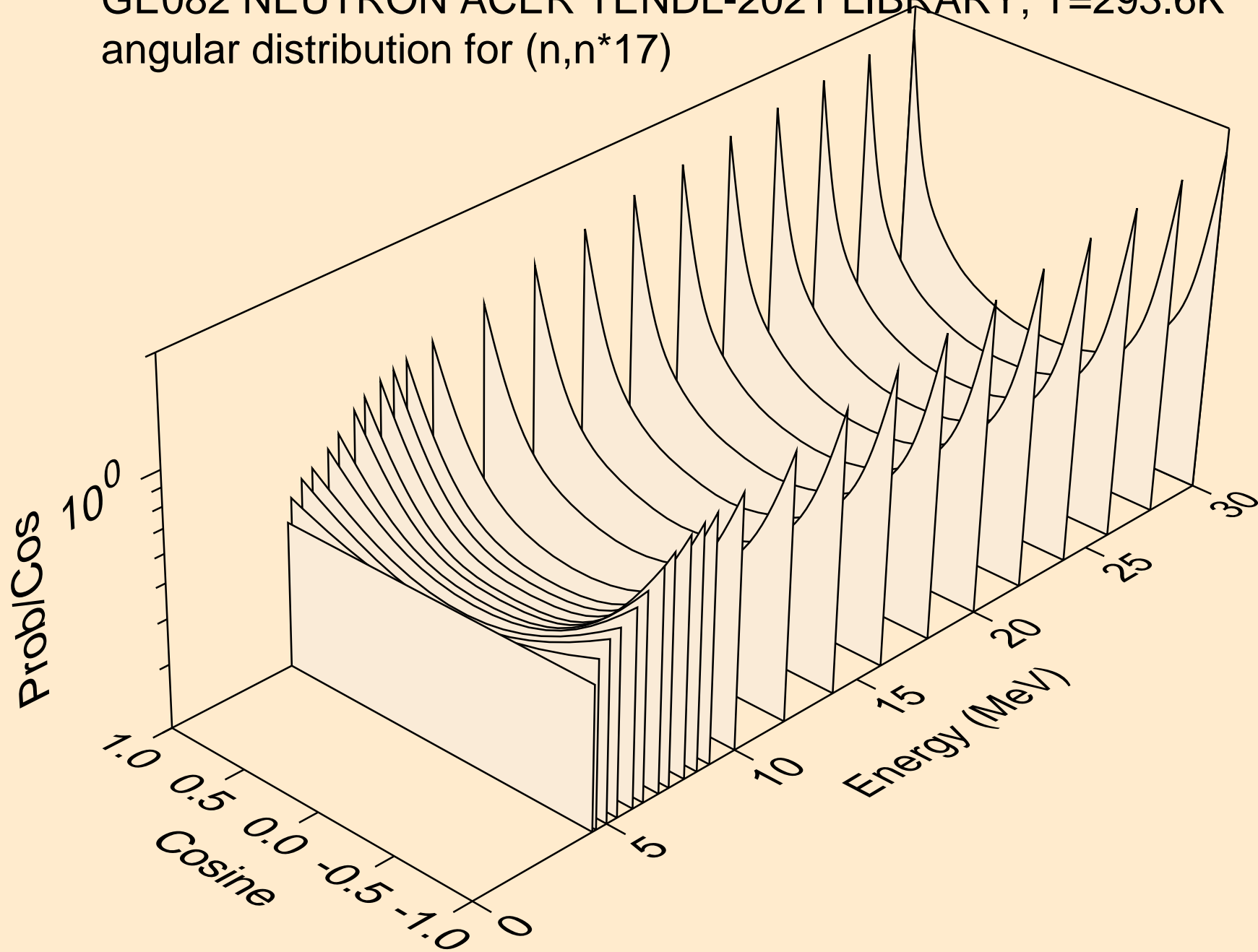

GE082 NEUTRON ACER TENDL-2021 LIBRARY; T=293.6K  
angular distribution for (n,n\*18)

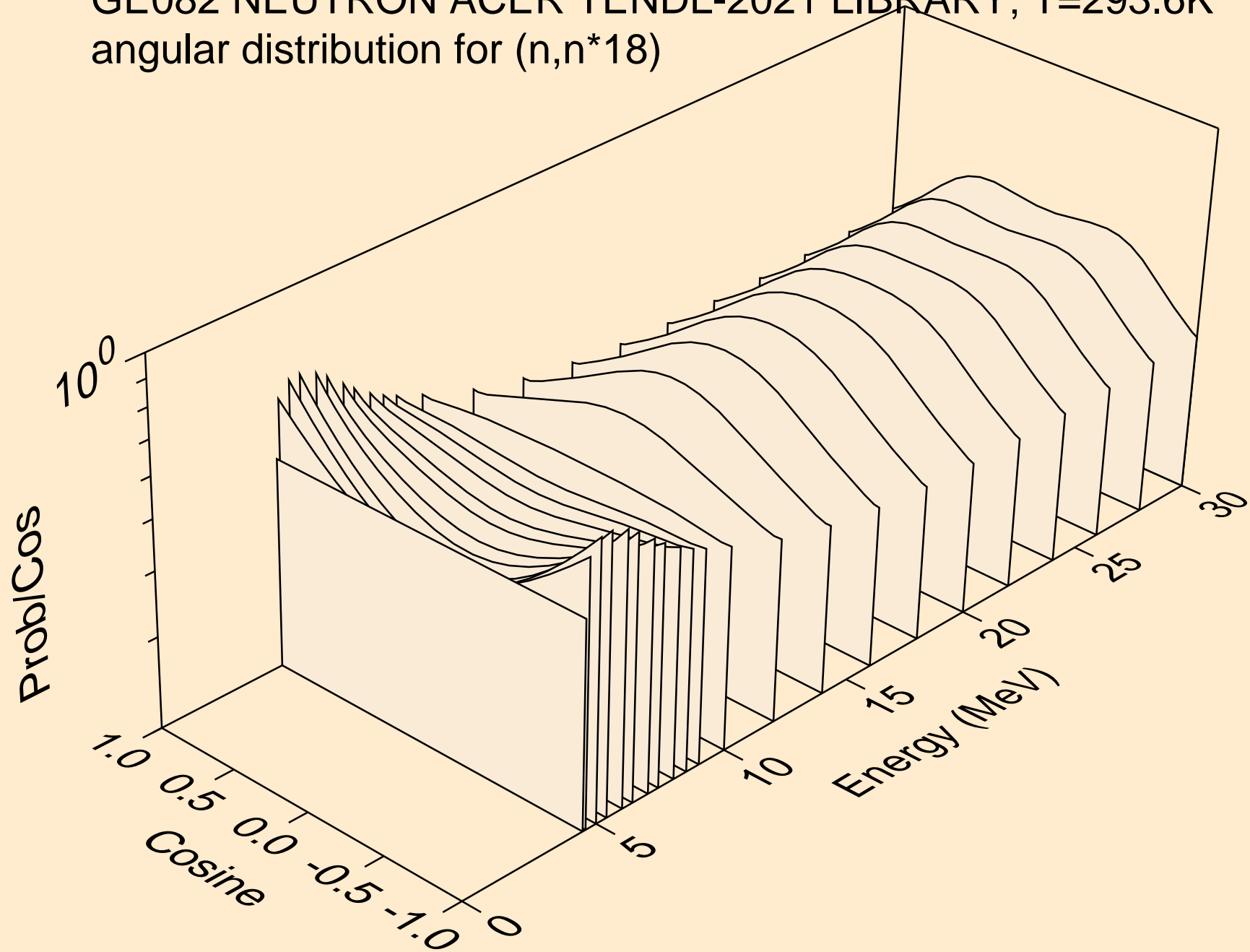

GE082 NEUTRON ACER TENDL-2021 LIBRARY; T=293.6K  
angular distribution for (n,n\*19)

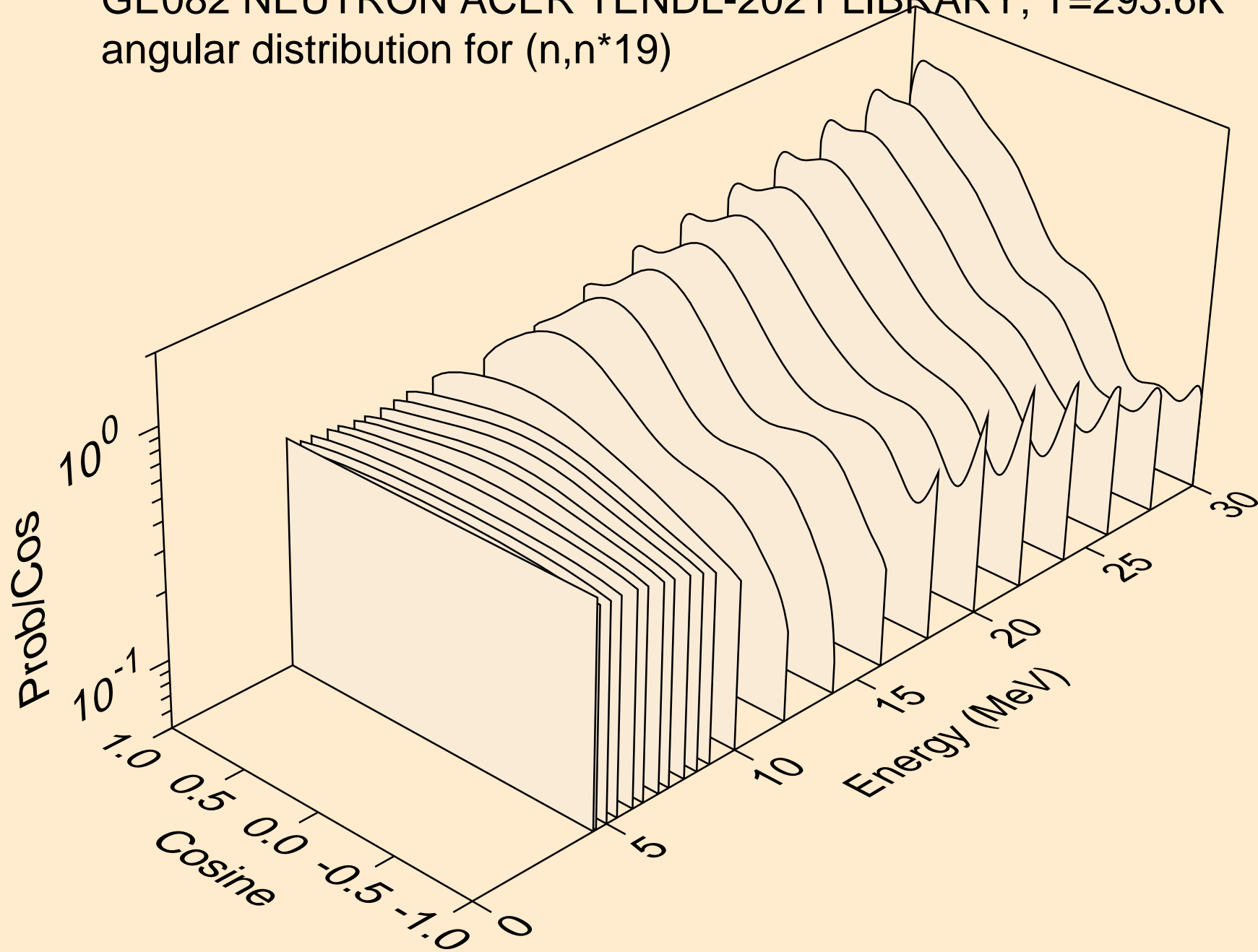



GE082 NEUTRON ACER TENDL-2021 LIBRARY; T=293.6K  
angular distribution for (n,n\*20)

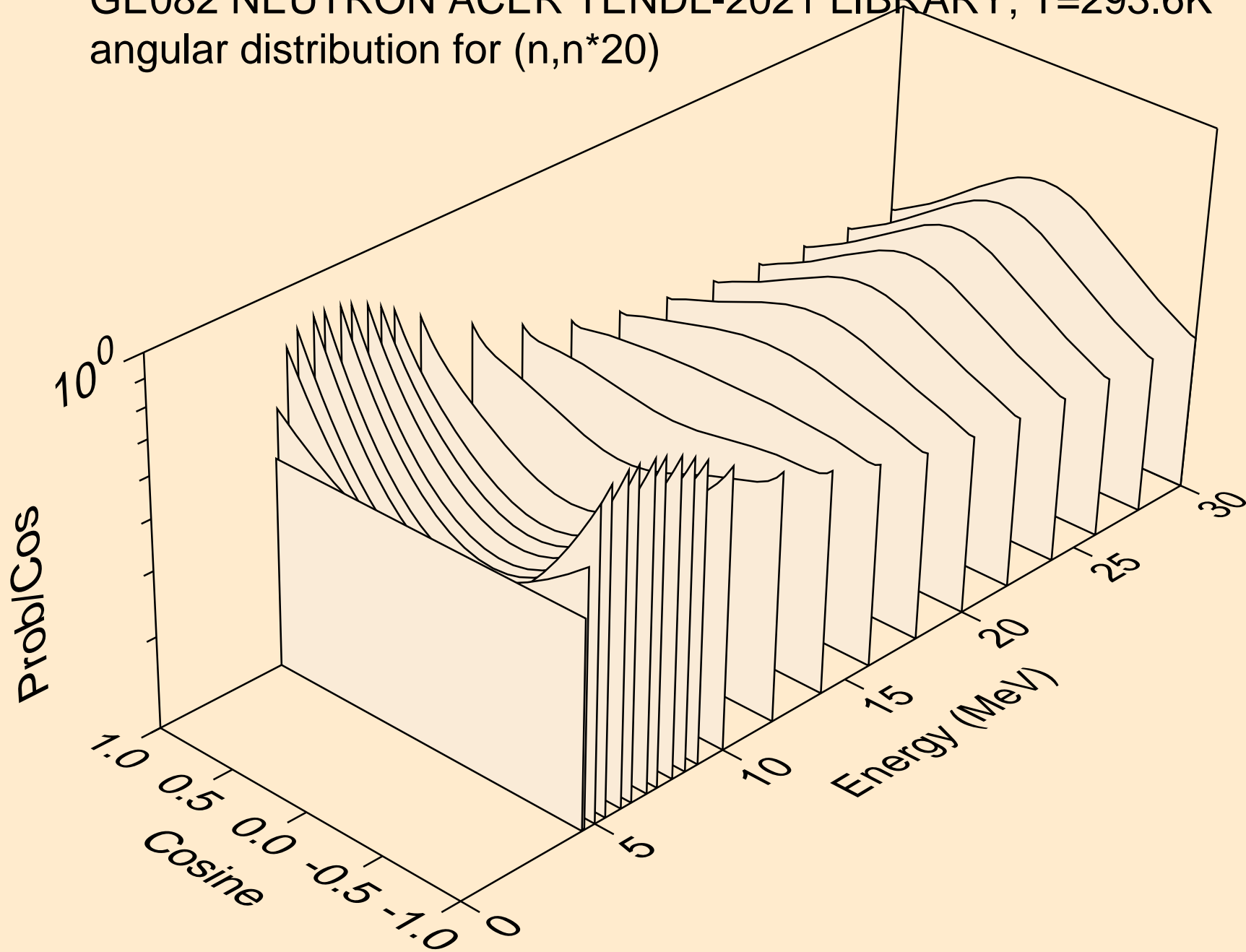

GE082 NEUTRON ACER TENDL-2021 LIBRARY; T=293.6K  
angular distribution for (n,n\*21)

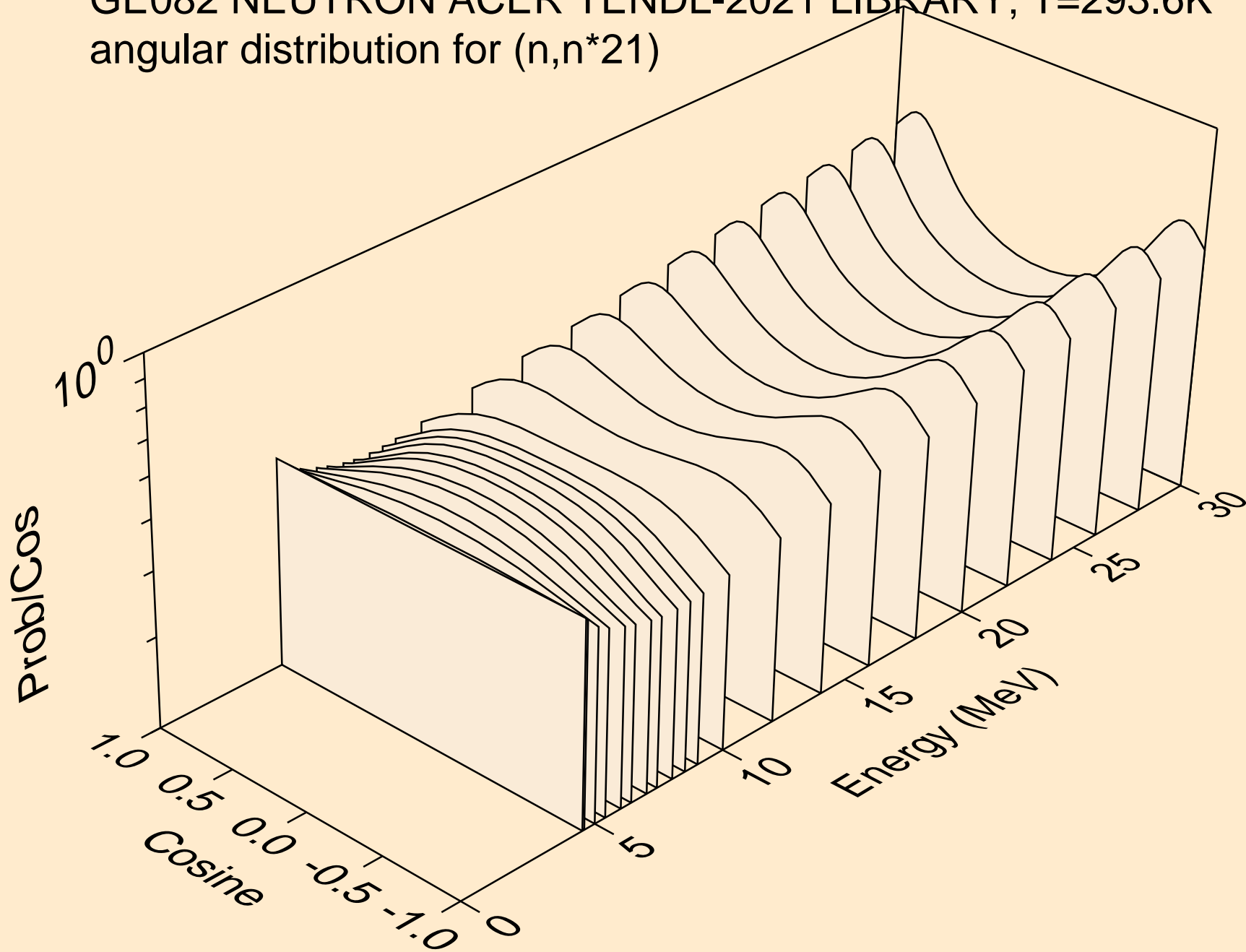

GE082 NEUTRON ACER TENDL-2021 LIBRARY; T=293.6K  
angular distribution for (n,n\*22)

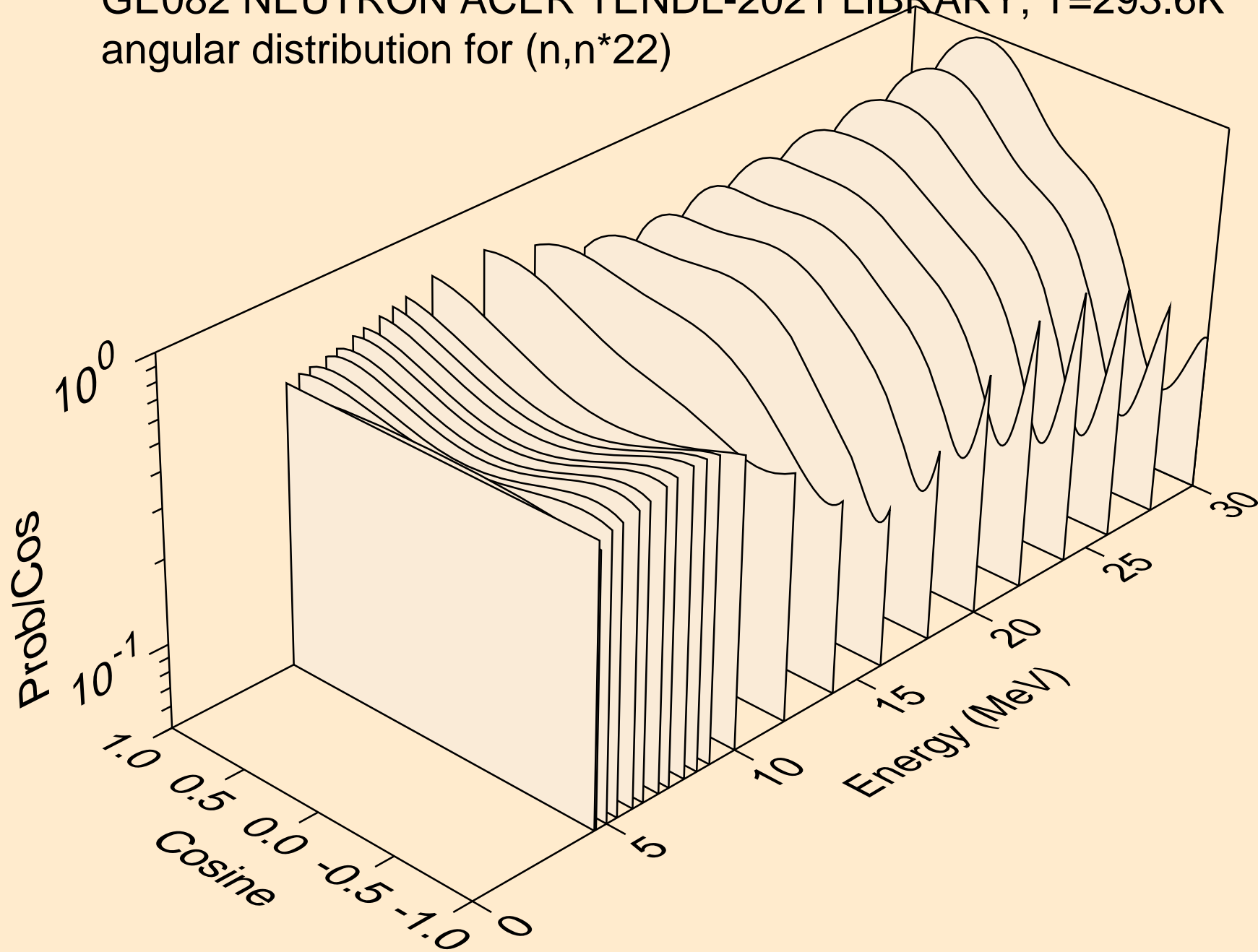

GE082 NEUTRON ACER TENDL-2021 LIBRARY; T=293.6K  
angular distribution for (n,n\*23)

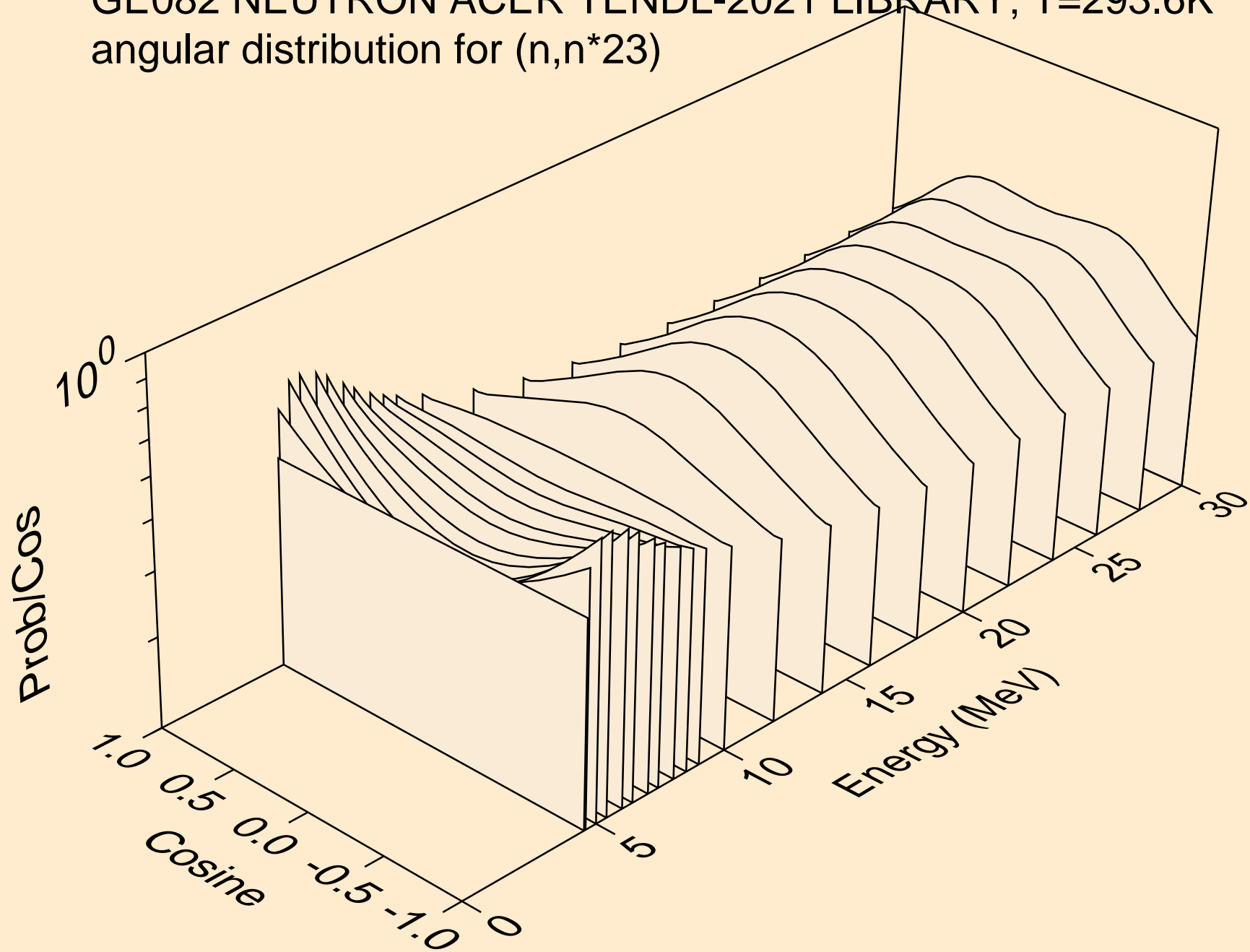

GE082 NEUTRON ACER TENDL-2021 LIBRARY; T=293.6K  
angular distribution for (n,n\*24)

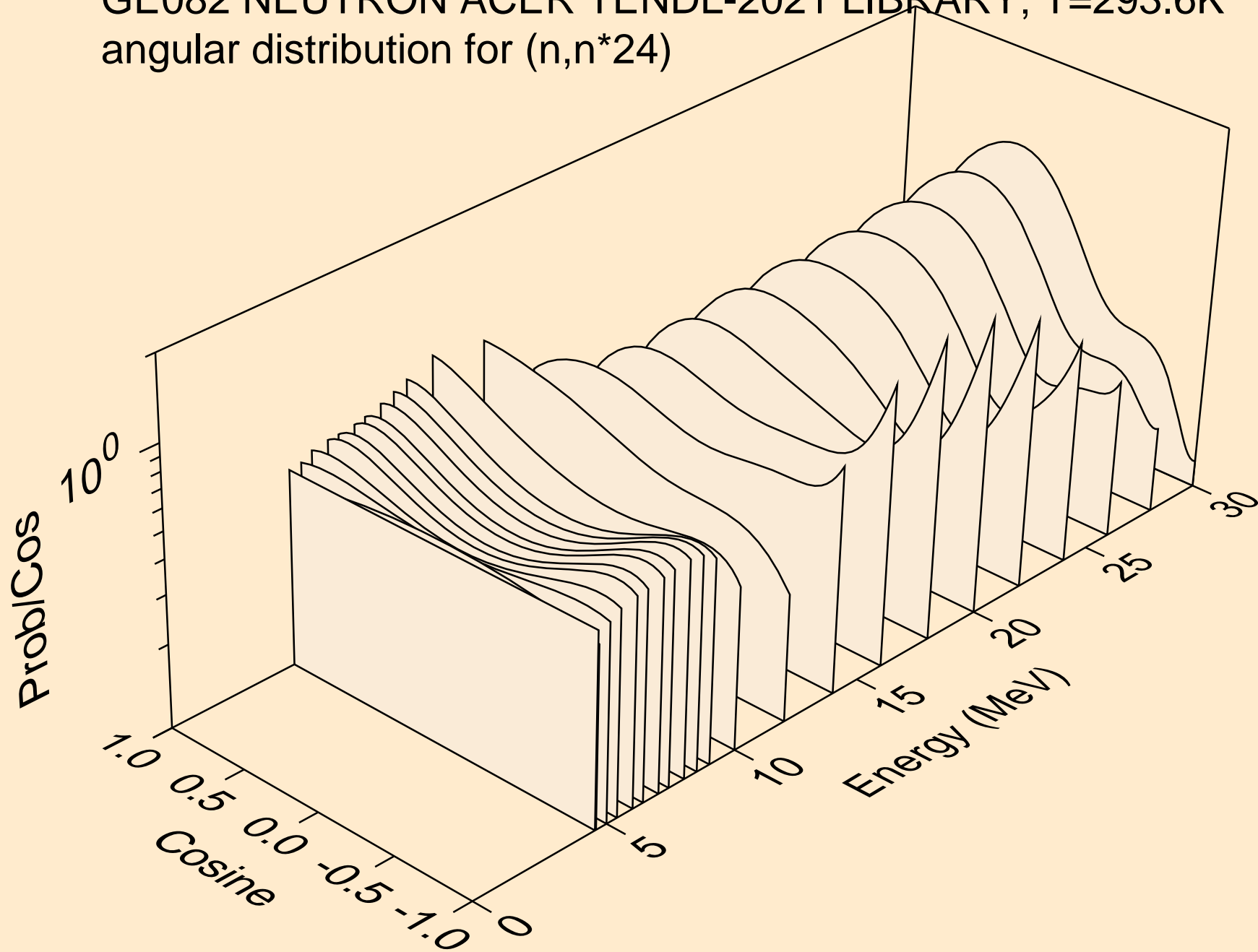

GE082 NEUTRON ACER TENDL-2021 LIBRARY; T=293.6K  
angular distribution for (n,n\*25)

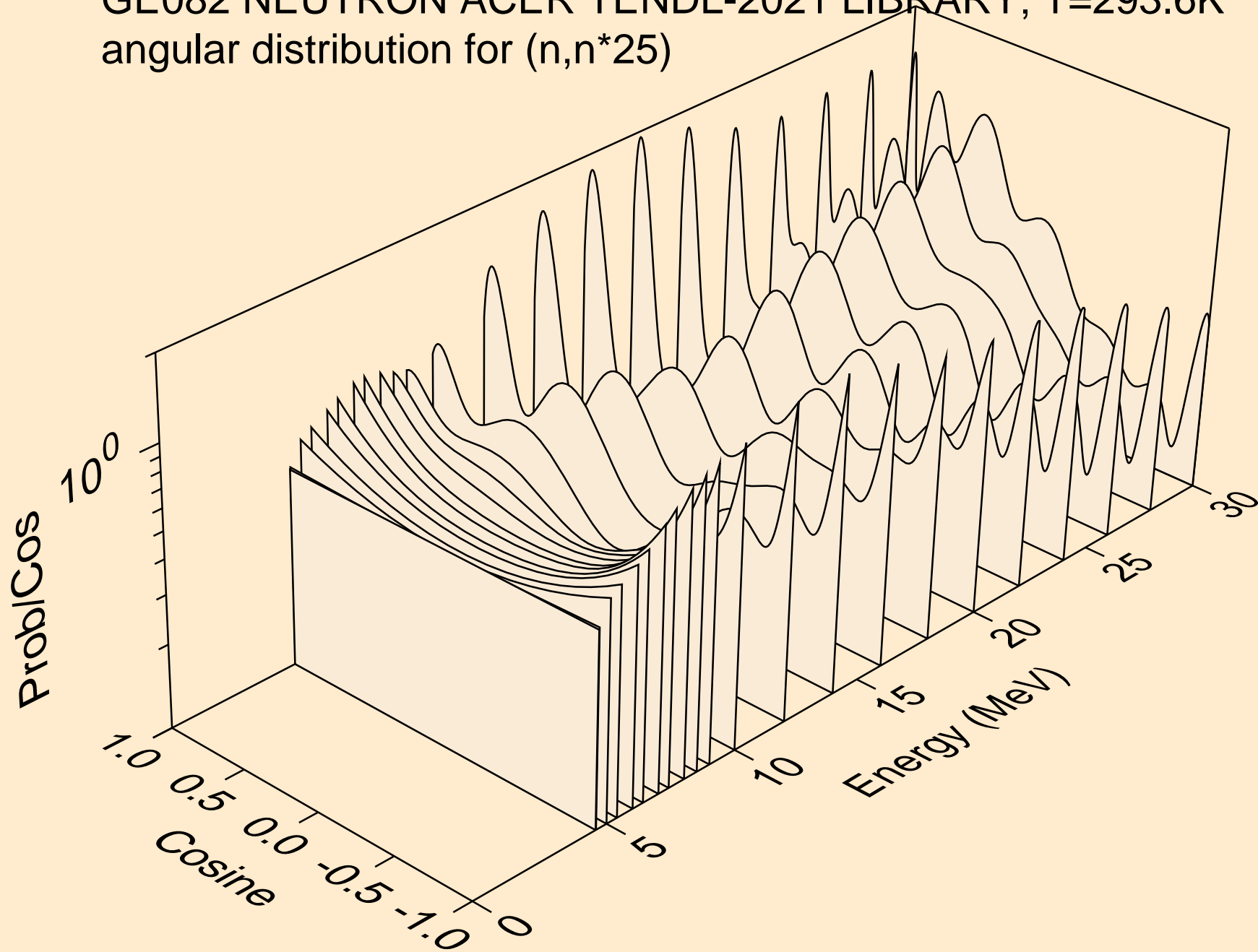

GE082 NEUTRON ACER TENDL-2021 LIBRARY; T=293.6K  
angular distribution for (n,n\*26)

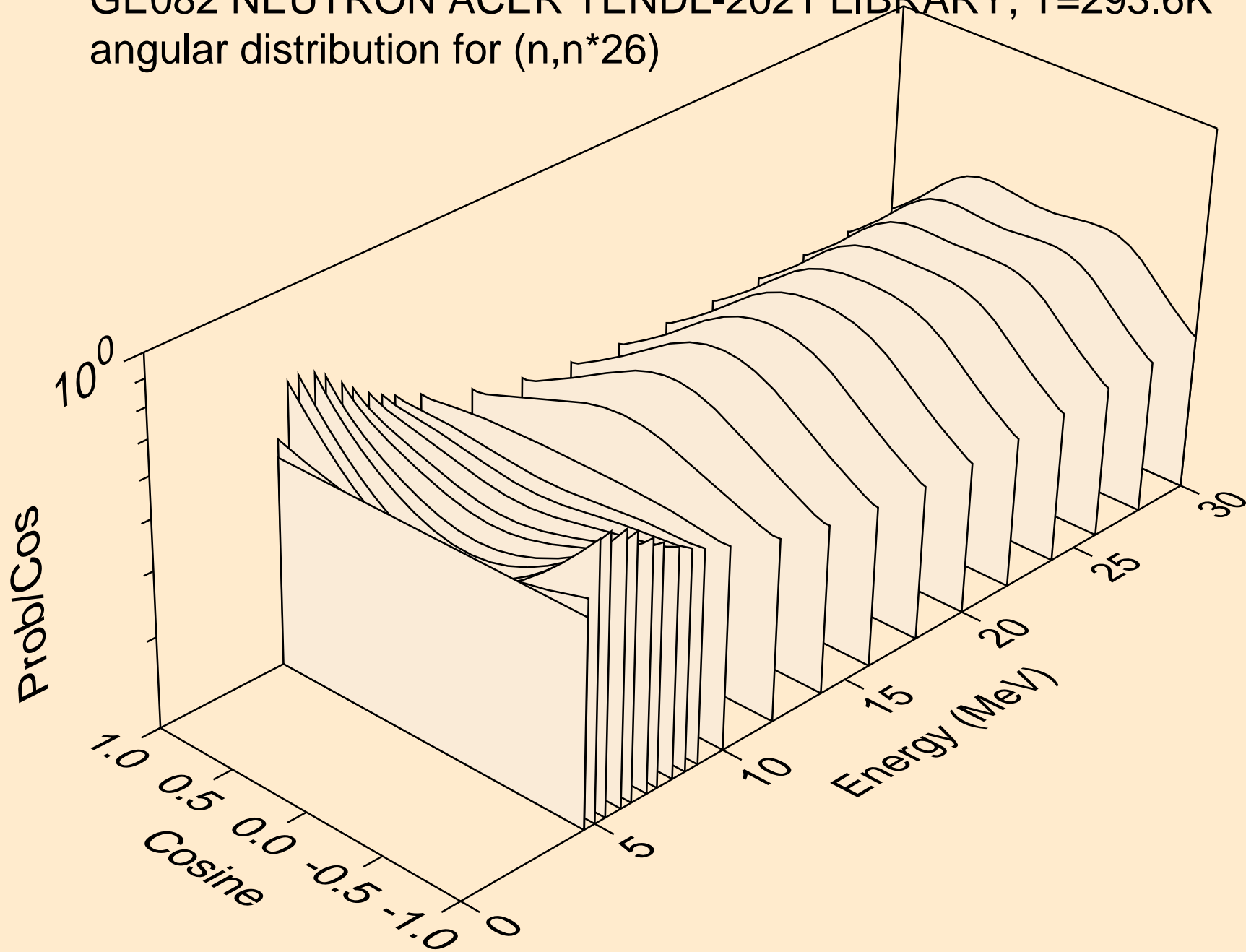

GE082 NEUTRON ACER TENDL-2021 LIBRARY; T=293.6K  
angular distribution for (n,n\*27)

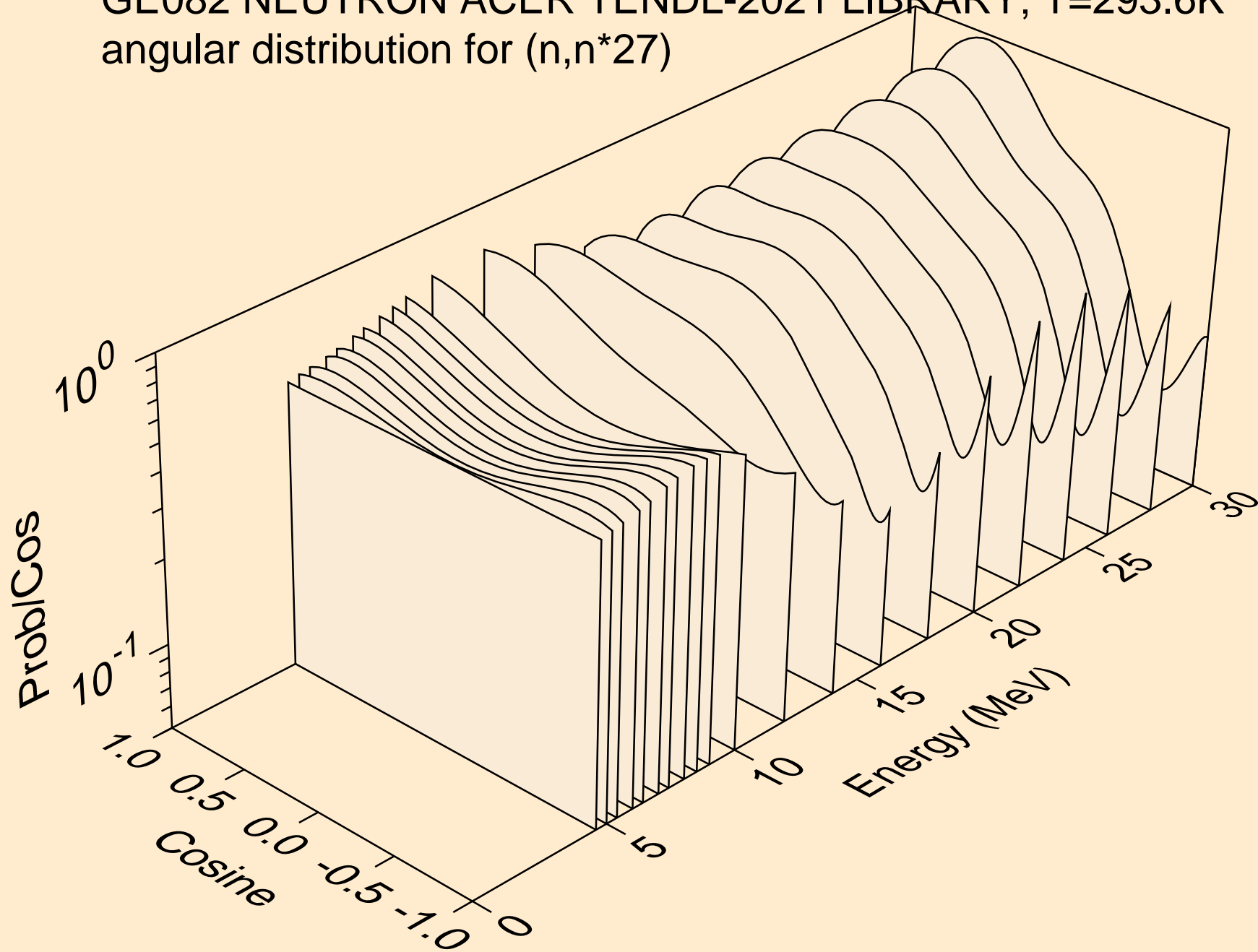



GE082 NEUTRON ACER TENDL-2021 LIBRARY; T=293.6K  
angular distribution for (n,n\*28)

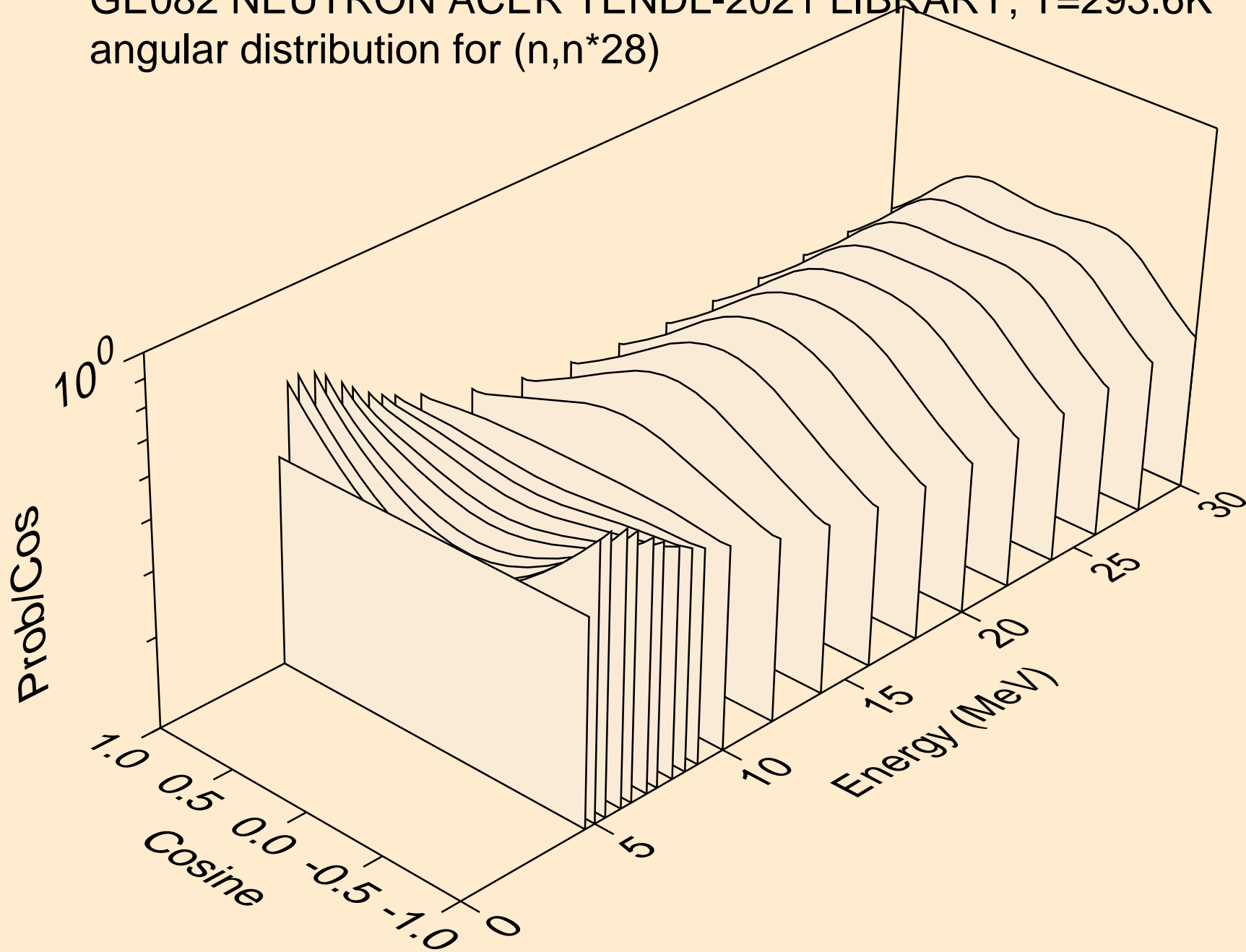

GE082 NEUTRON ACER TENDL-2021 LIBRARY; T=293.6K  
angular distribution for (n,n\*29)

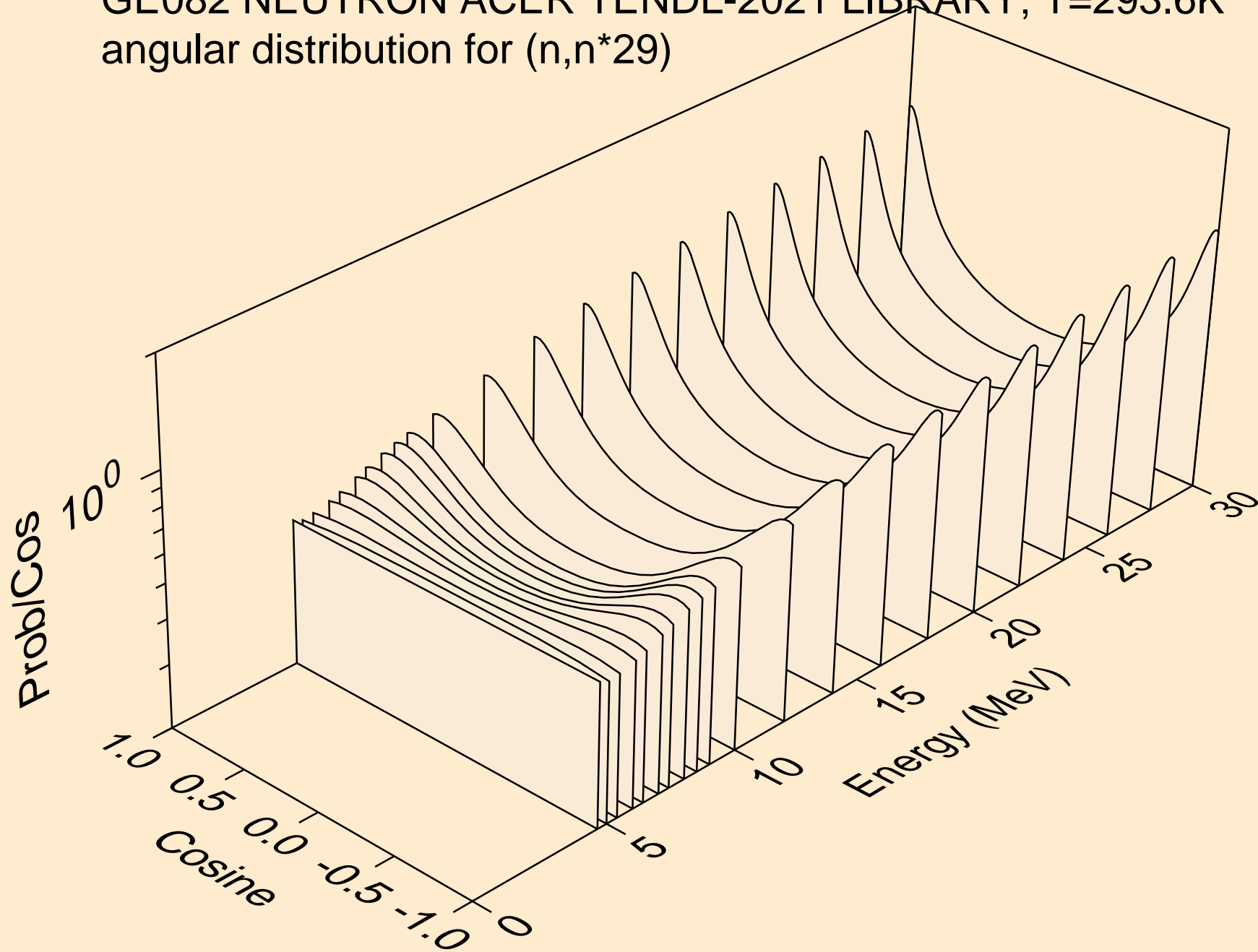

GE082 NEUTRON ACER TENDL-2021 LIBRARY; T=293.6K  
Neutron emission for (n,x)

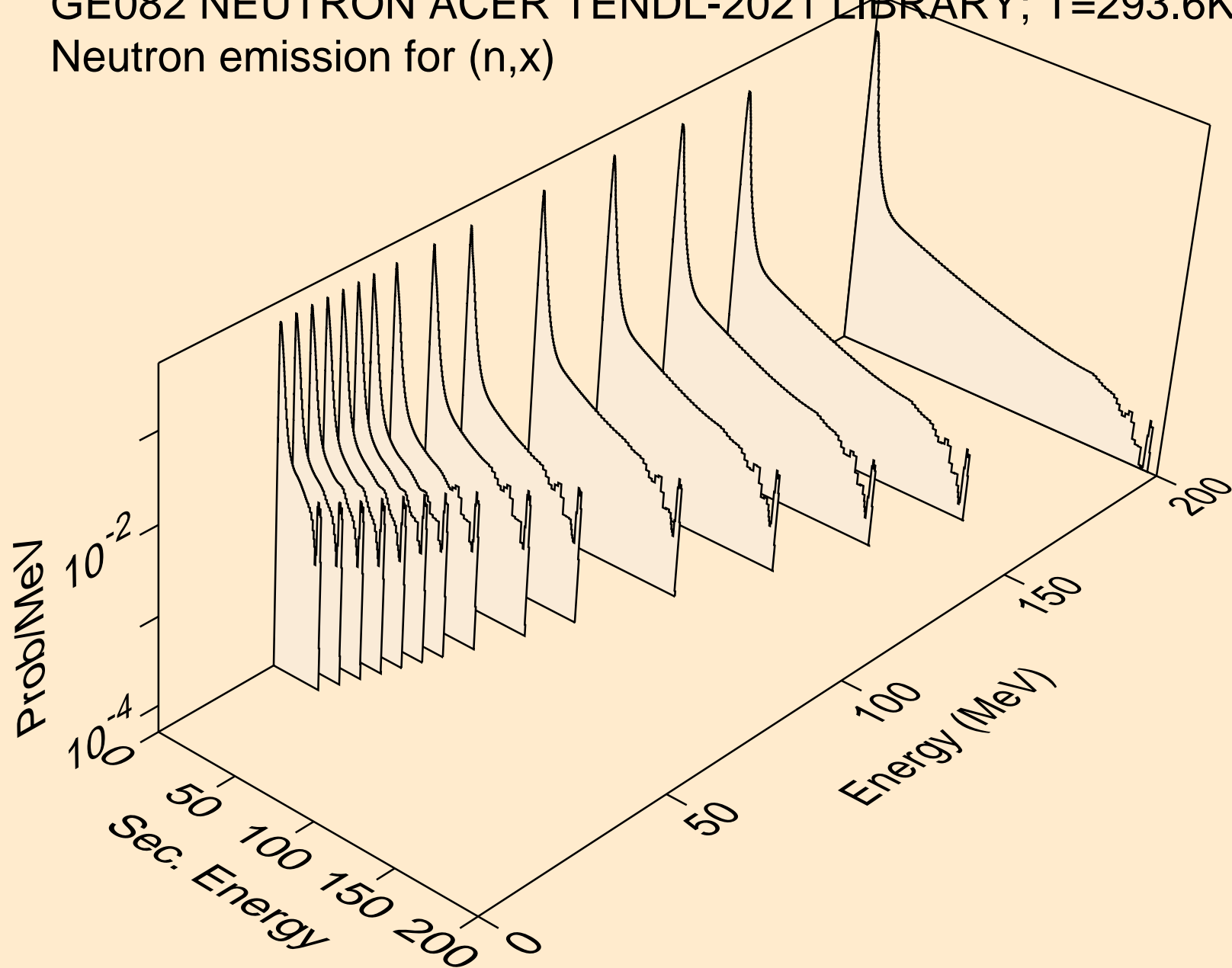

GE082 NEUTRON ACER TENDL-2021 LIBRARY; T=293.6K  
Neutron emission for (n,2nd)

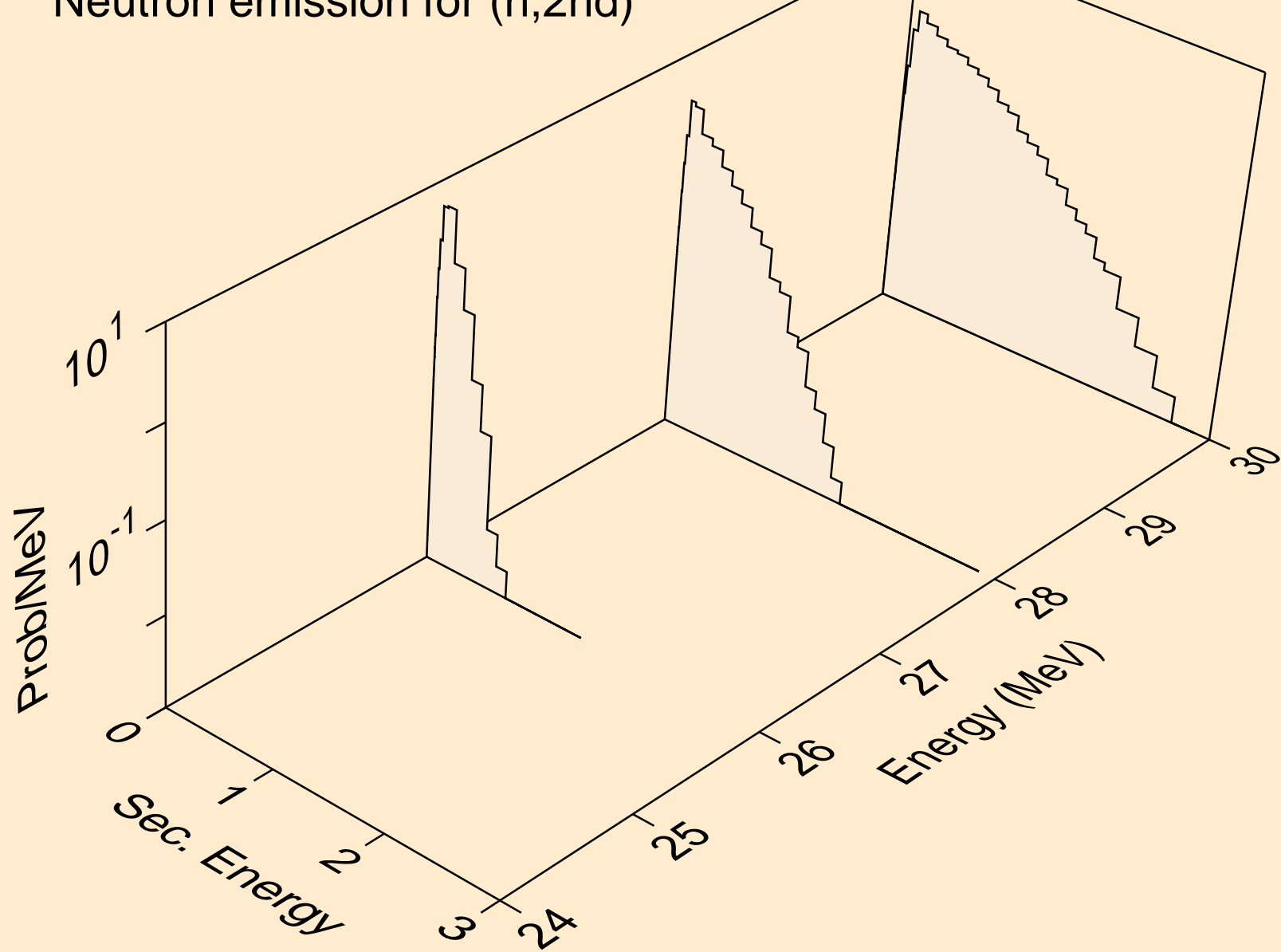

GE082 NEUTRON ACER TENDL-2021 LIBRARY; T=293.6K  
Neutron emission for (n,2n)

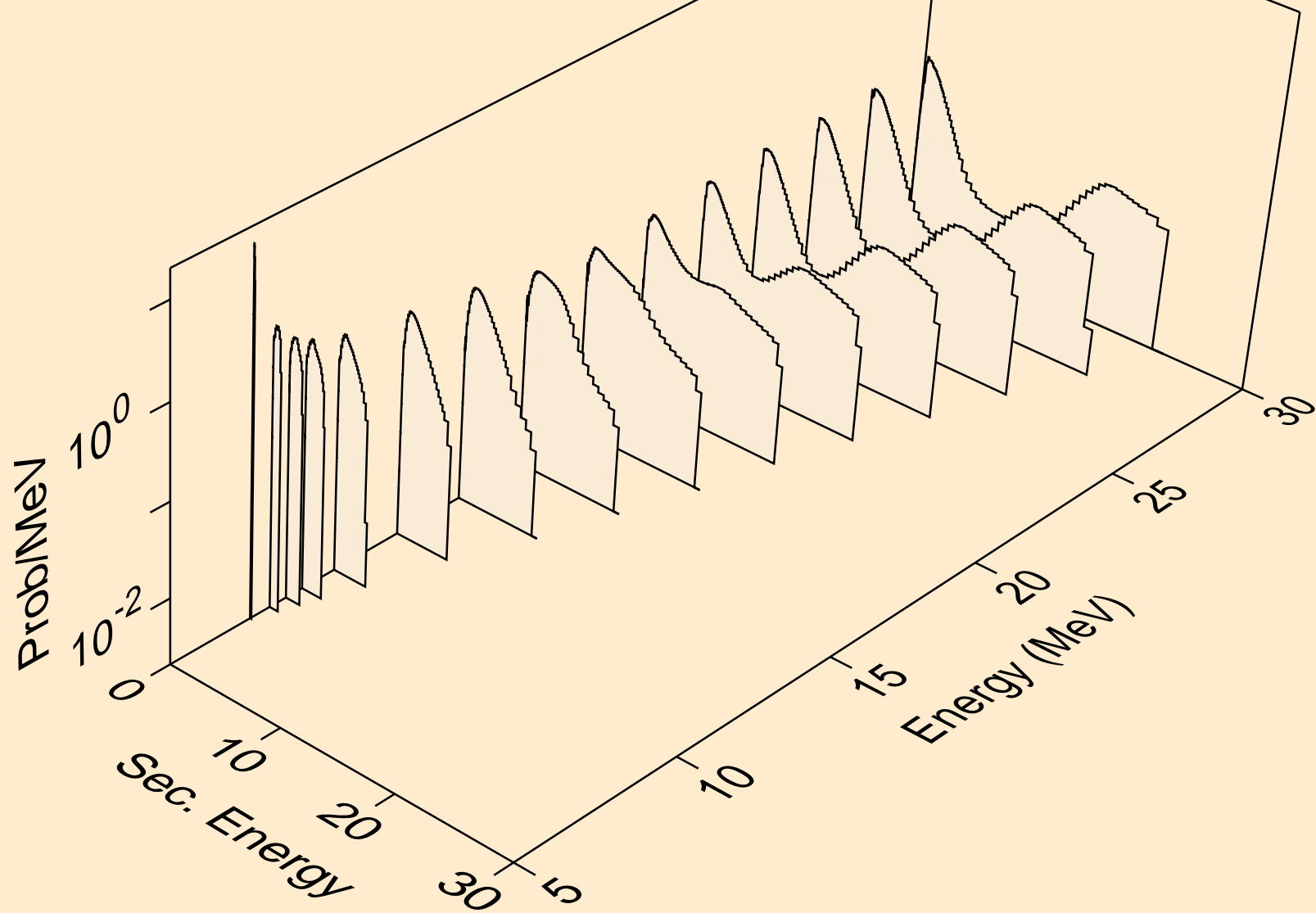

GE082 NEUTRON ACER TENDL-2021 LIBRARY; T=293.6K  
Neutron emission for (n,3n)

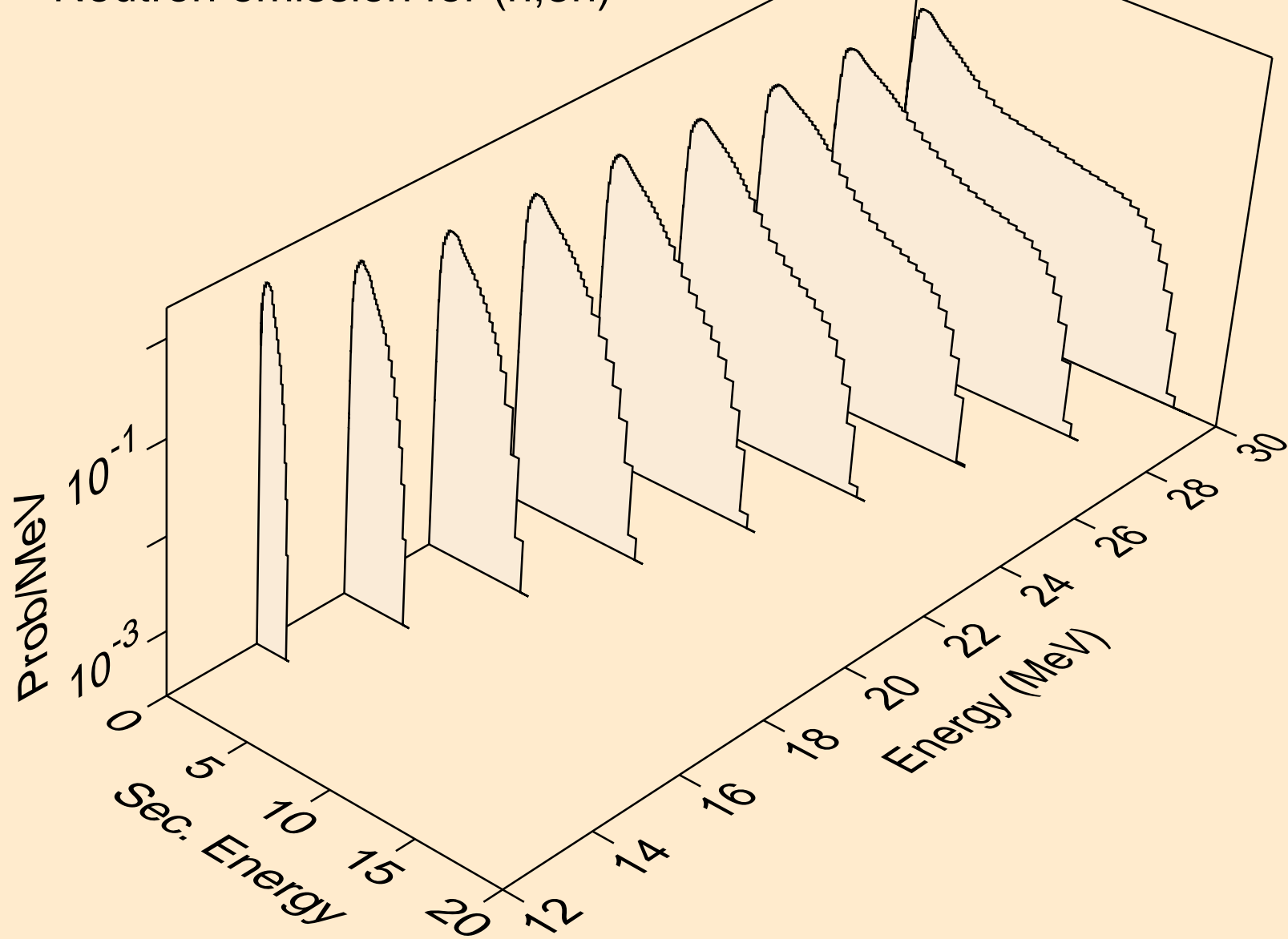

GE082 NEUTRON ACER TENDL-2021 LIBRARY; T=293.6K  
Neutron emission for (n,n\*)a

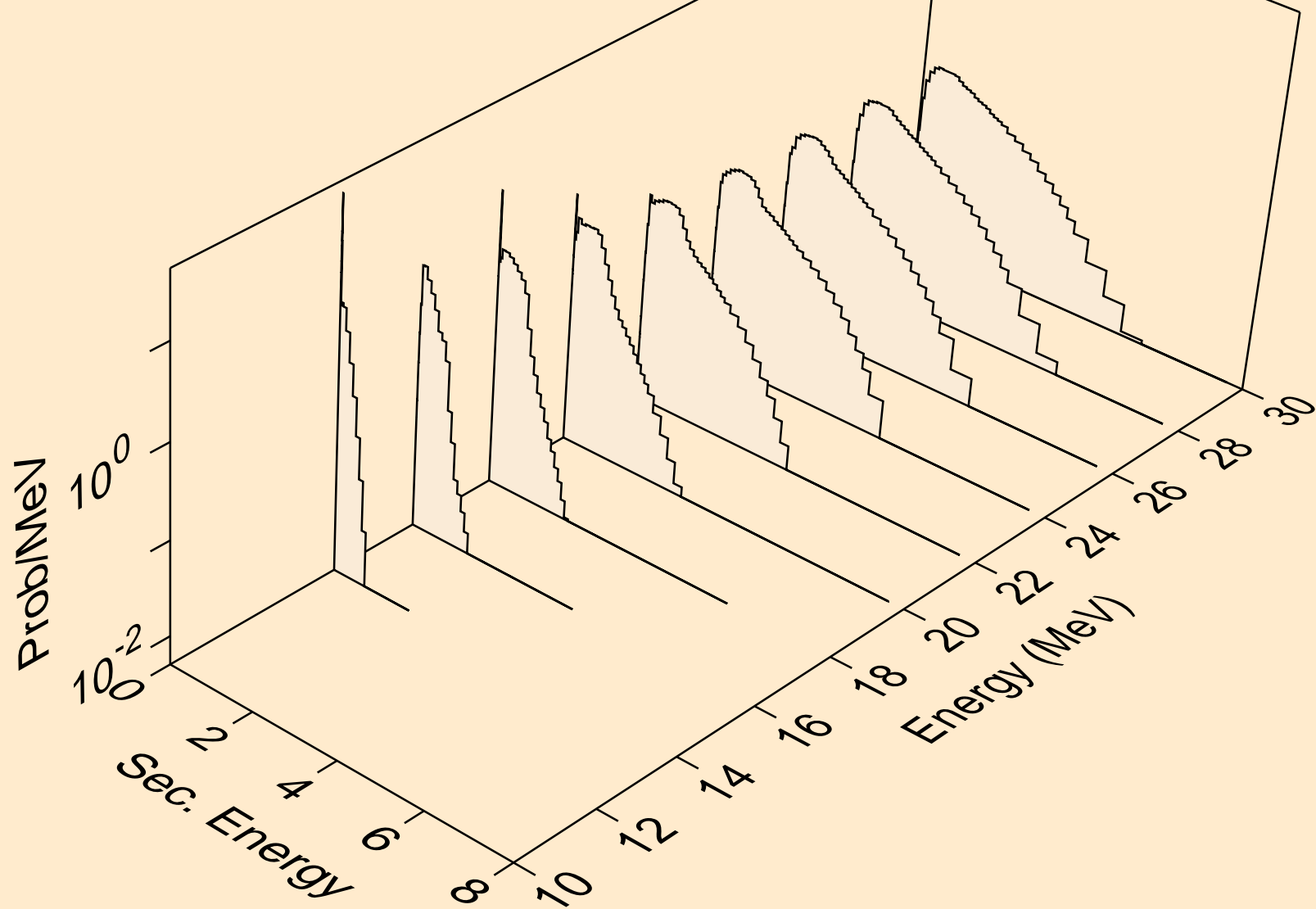

GE082 NEUTRON ACER TENDL-2021 LIBRARY; T=293.6K  
Neutron emission for (n,2n)a

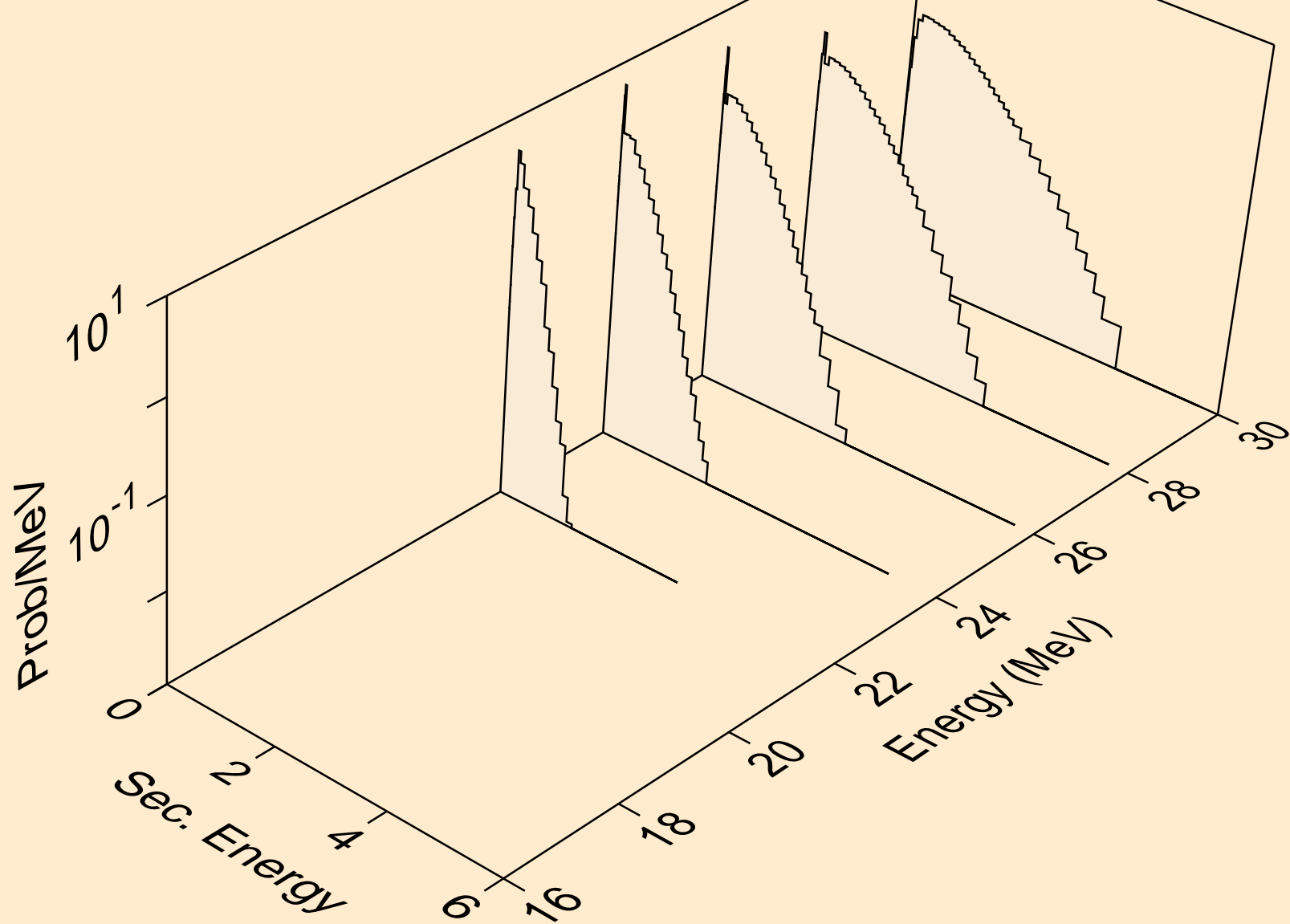



GE082 NEUTRON ACER TENDL-2021 LIBRARY; T=293.6K  
Neutron emission for (n,3n)a

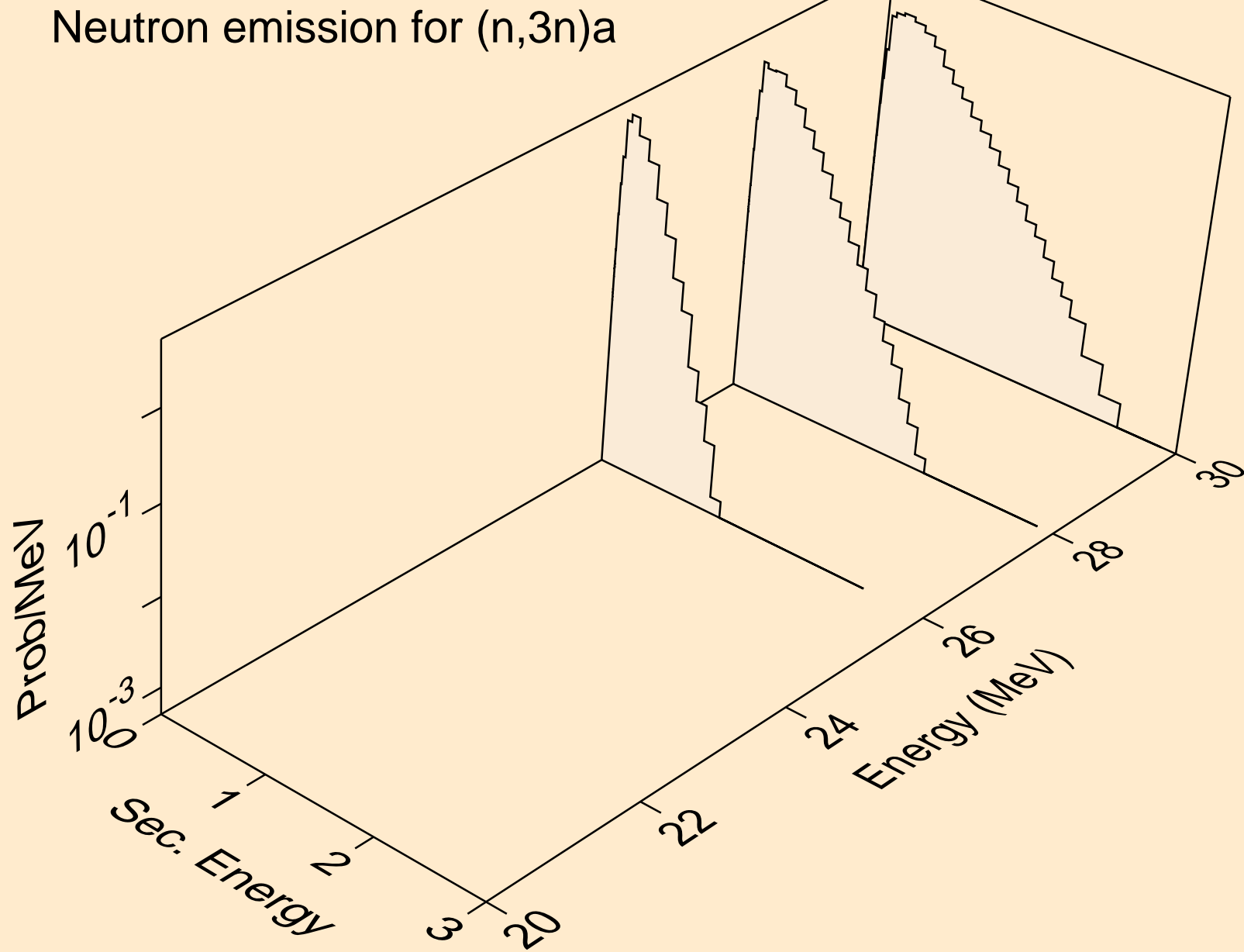

GE082 NEUTRON ACER TENDL-2021 LIBRARY; T=293.6K  
Neutron emission for (n,n\*)p

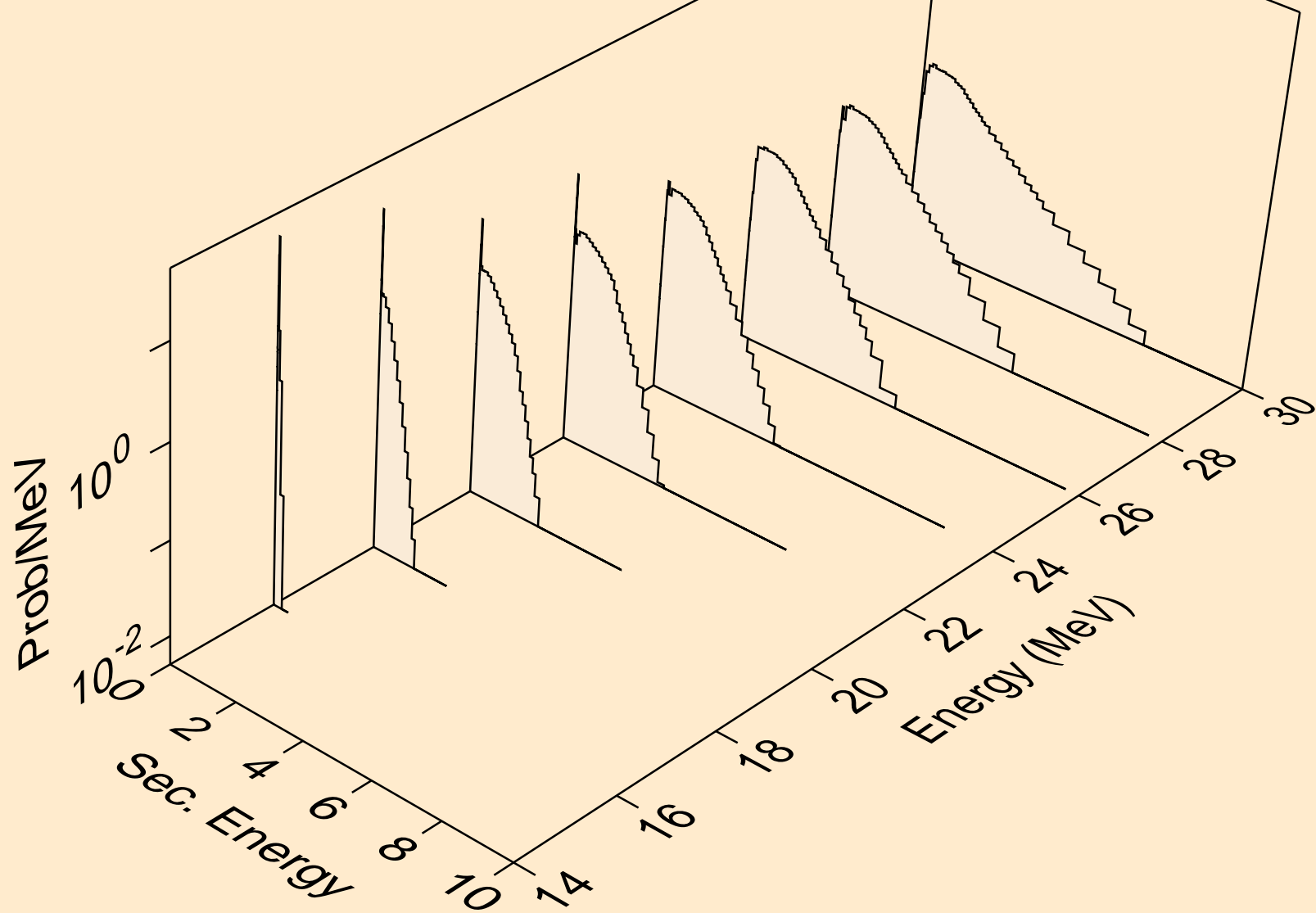

GE082 NEUTRON ACER TENDL-2021 LIBRARY; T=293.6K  
Neutron emission for (n,n\*)d

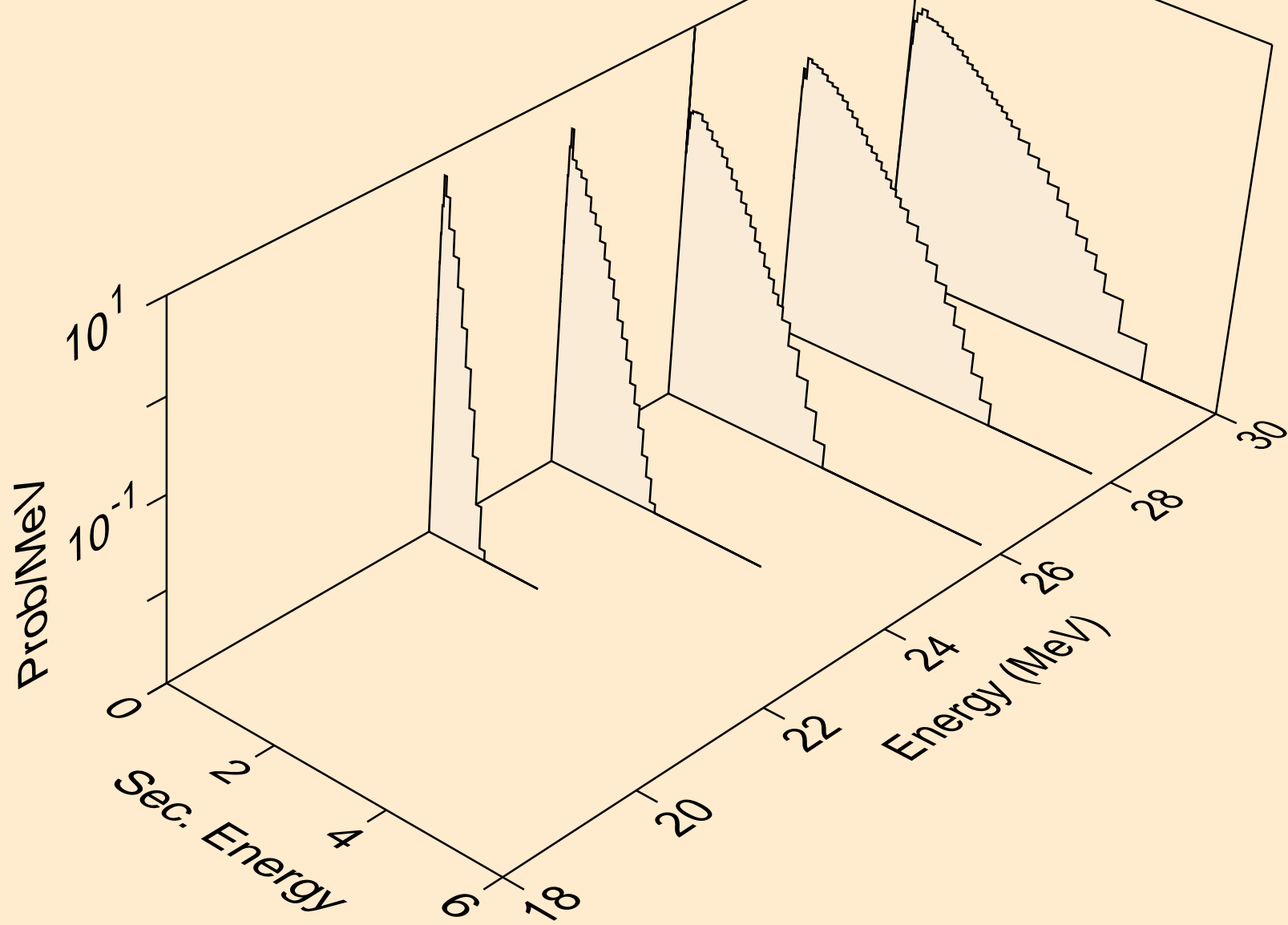

GE082 NEUTRON ACER TENDL-2021 LIBRARY; T=293.6K  
Neutron emission for (n,n\*)t

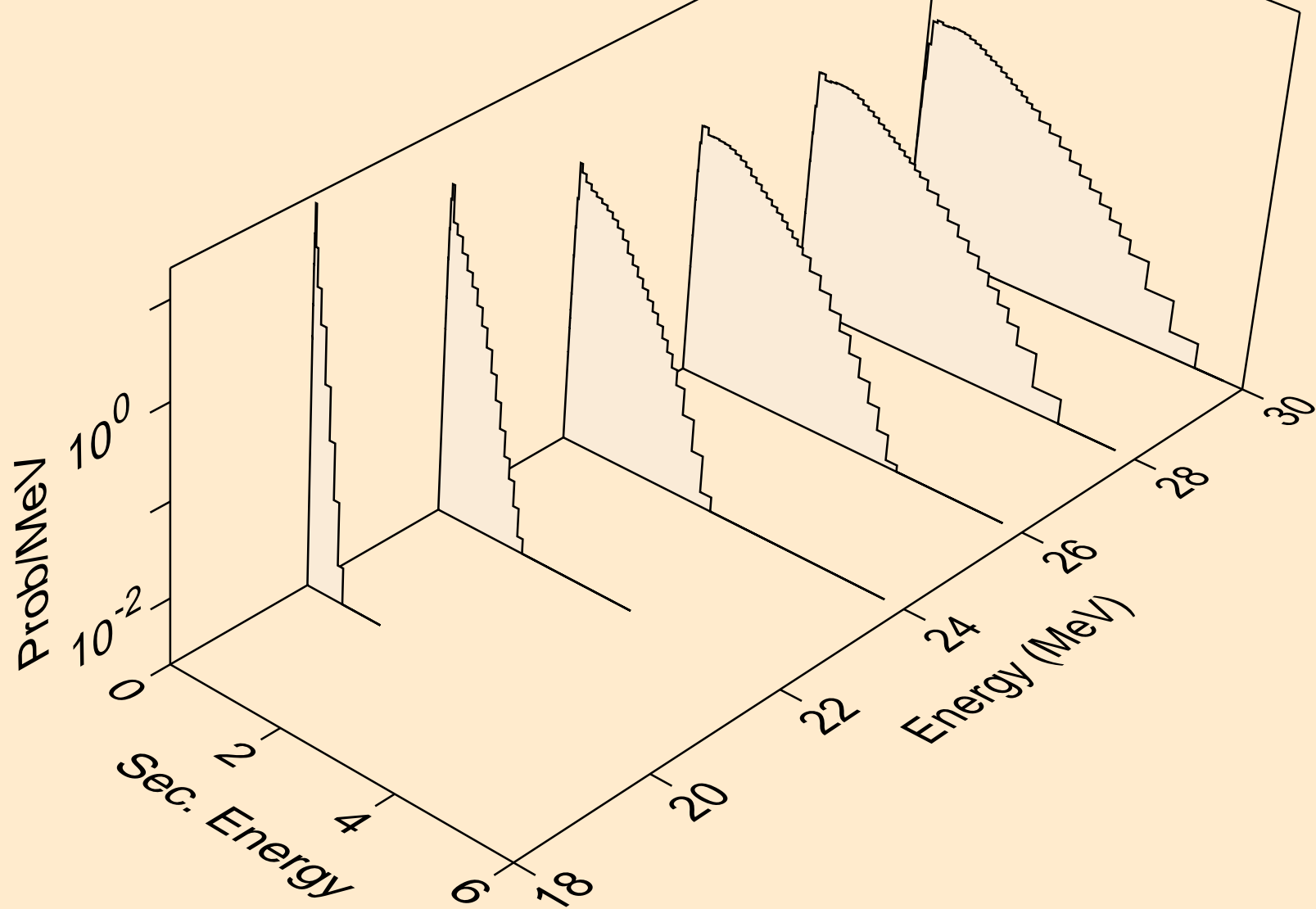

GE082 NEUTRON ACER TENDL-2021 LIBRARY; T=293.6K  
Neutron emission for (n,4n)

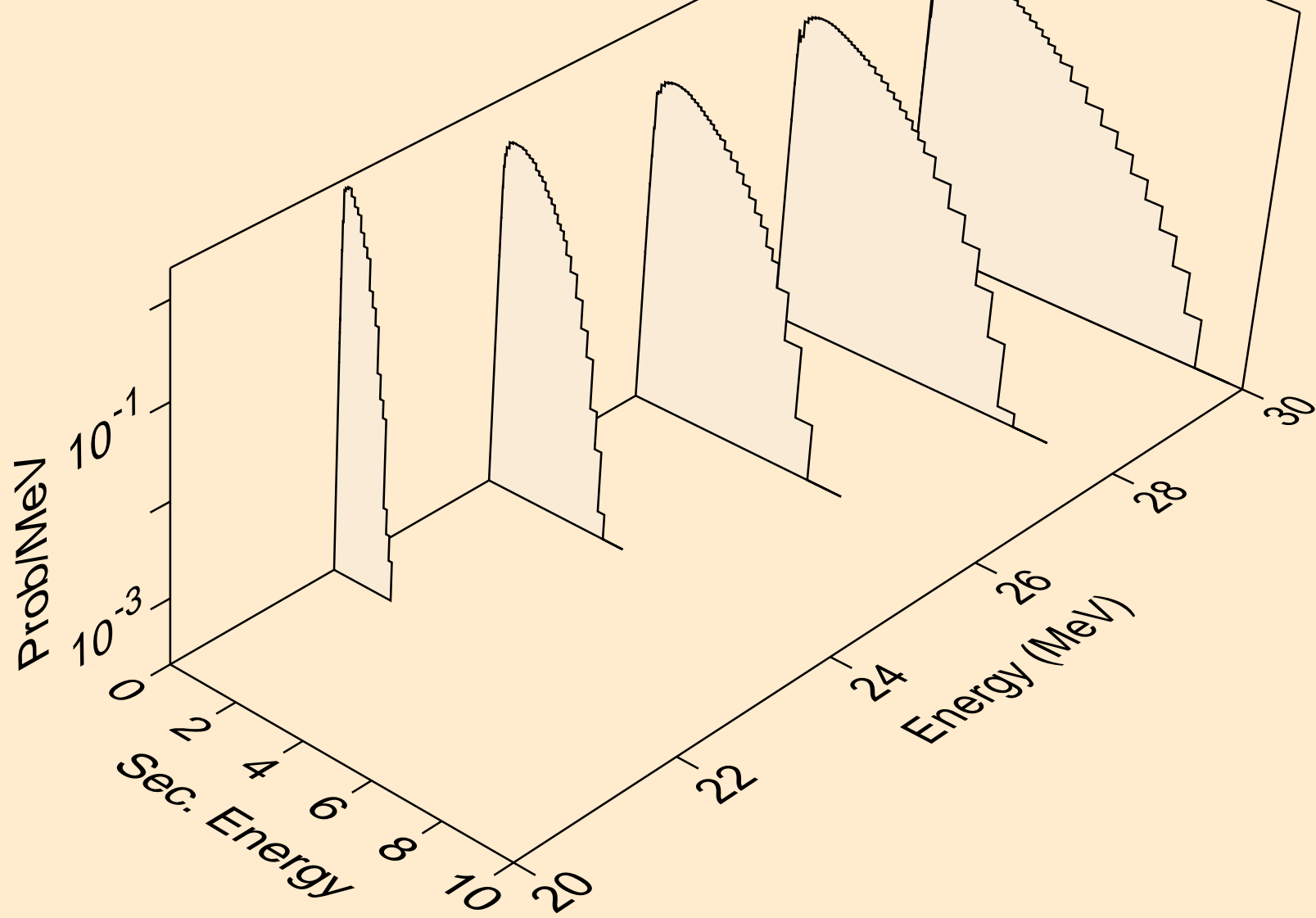

GE082 NEUTRON ACER TENDL-2021 LIBRARY; T=293.6K  
Neutron emission for (n,2np)

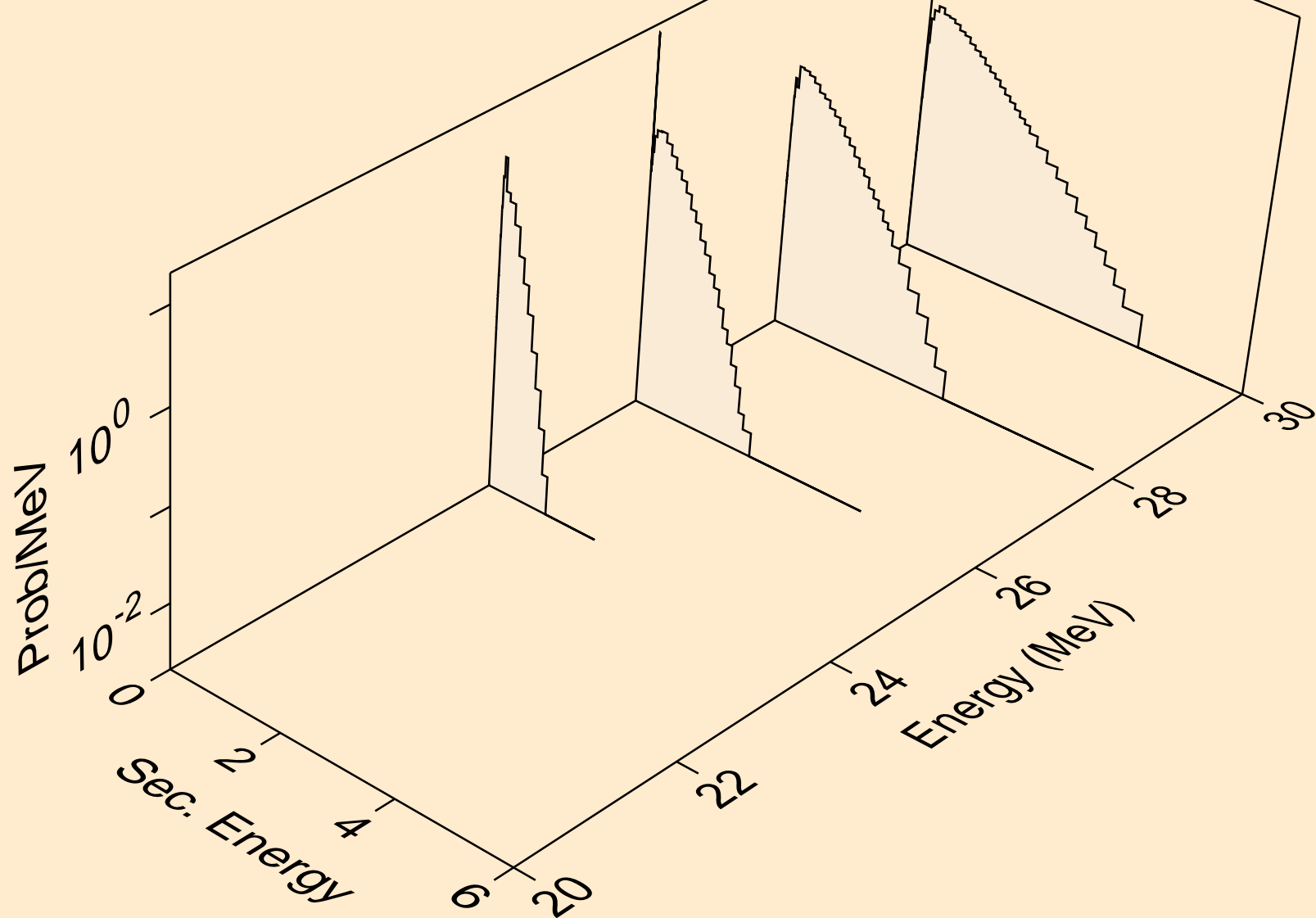

GE082 NEUTRON ACER TENDL-2021 LIBRARY; T=293.6K  
Neutron emission for (n,3np)

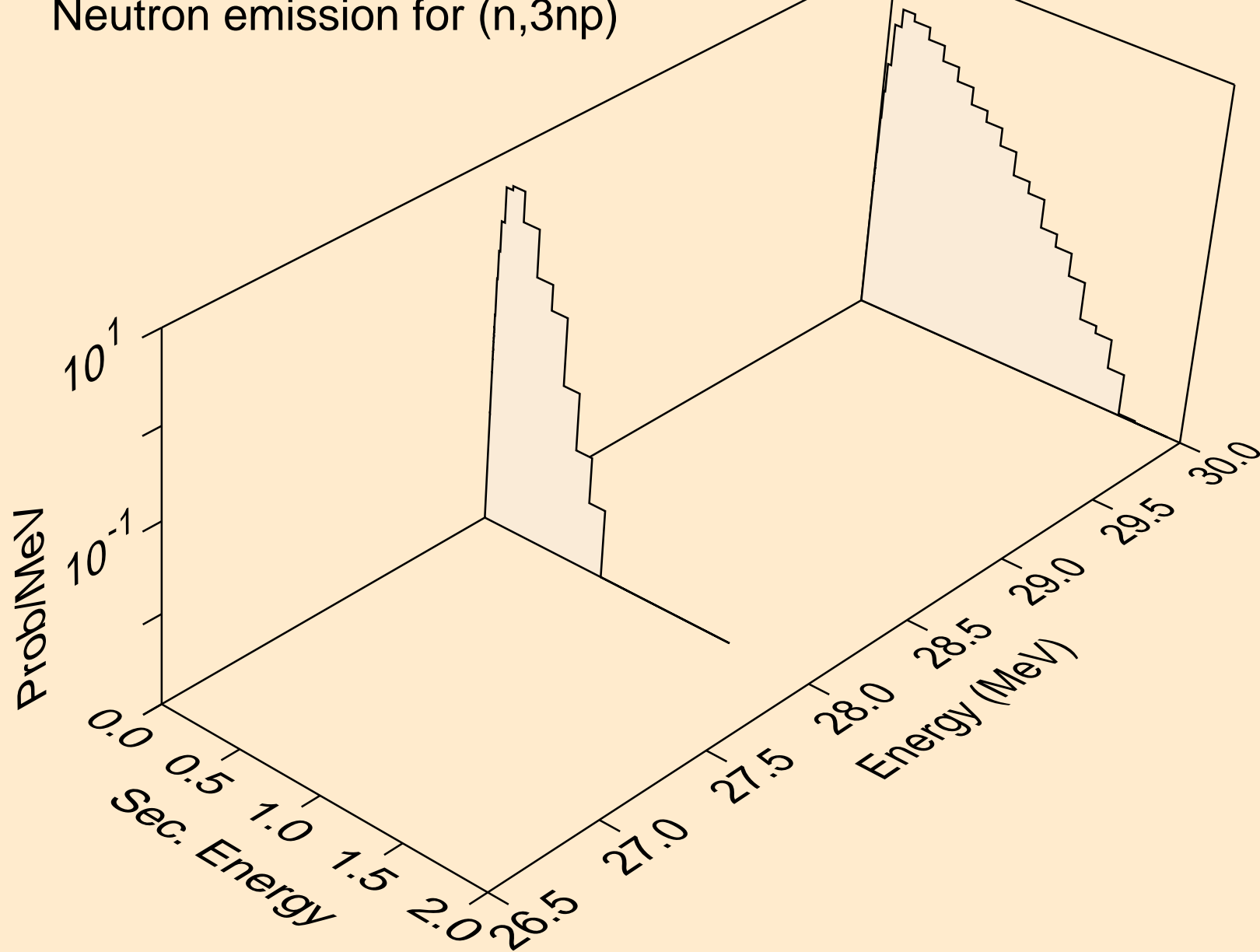

GE082 NEUTRON ACER TENDL-2021 LIBRARY; T=293.6K  
Neutron emission for (n,n\*c)

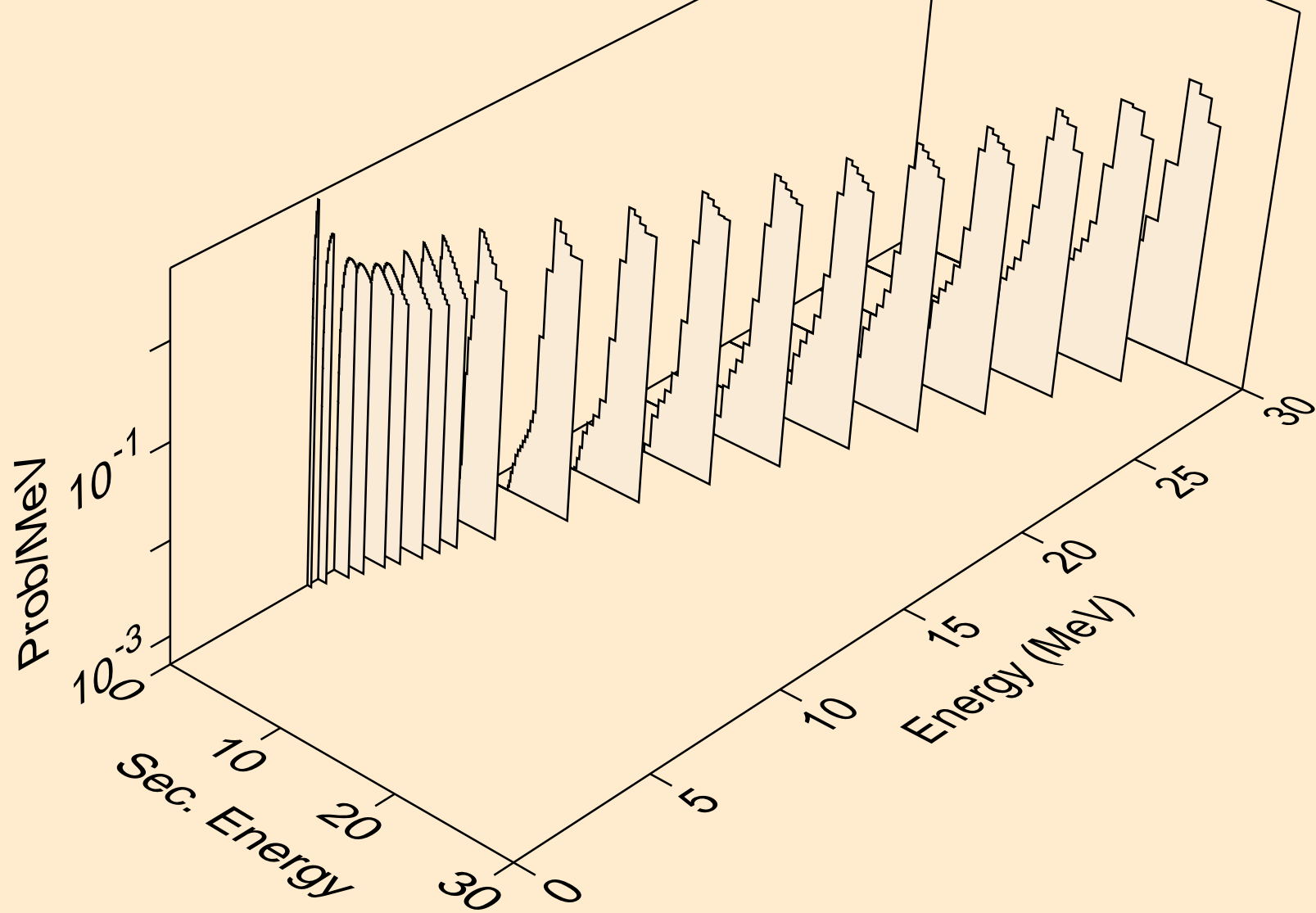



GE082 NEUTRON ACER TENDL-2021 LIBRARY; T=293.6K  
Photon emission for (n,x)

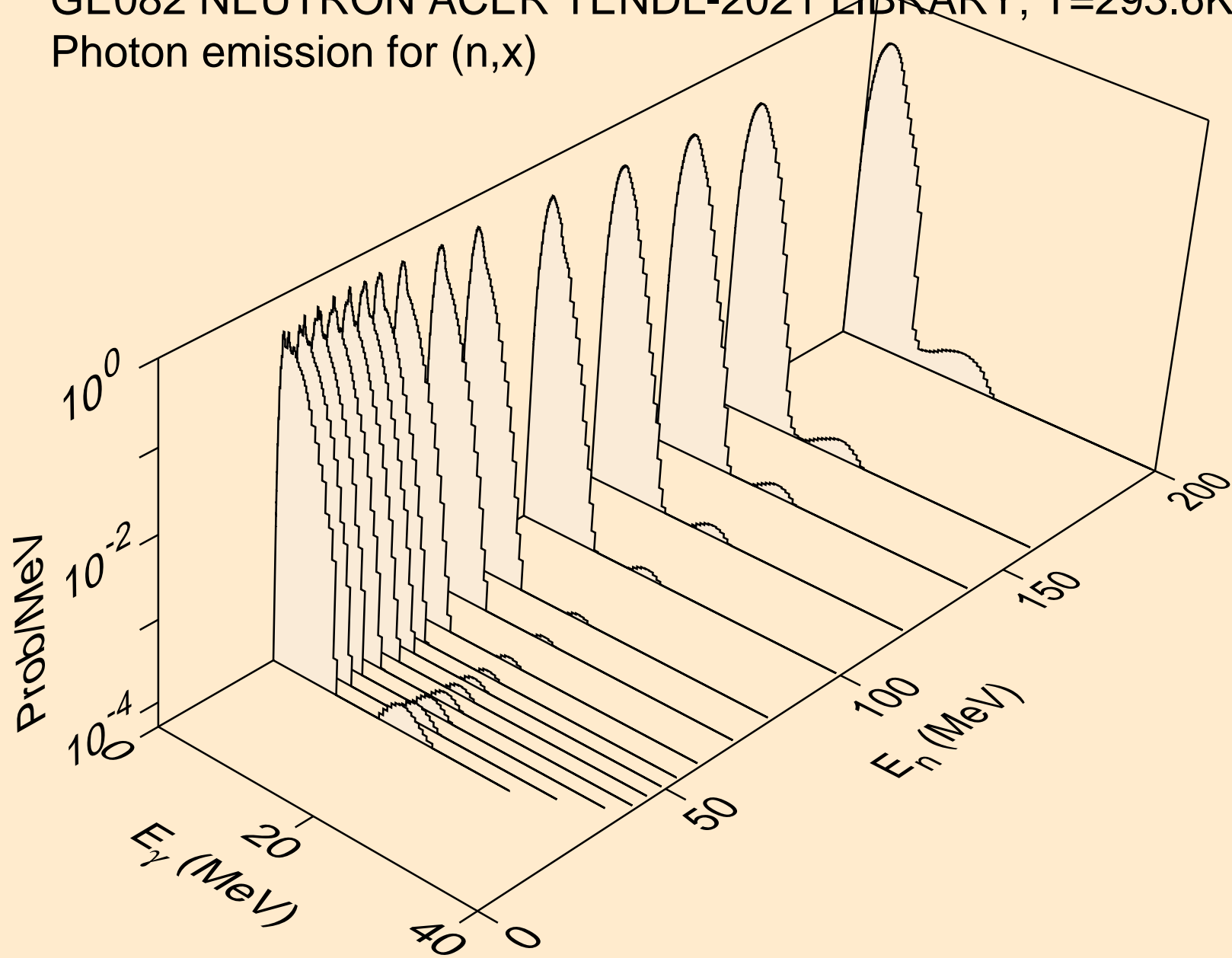

GE082 NEUTRON ACER TENDL-2021 LIBRARY; T=293.6K  
Photon emission for (n,2nd)

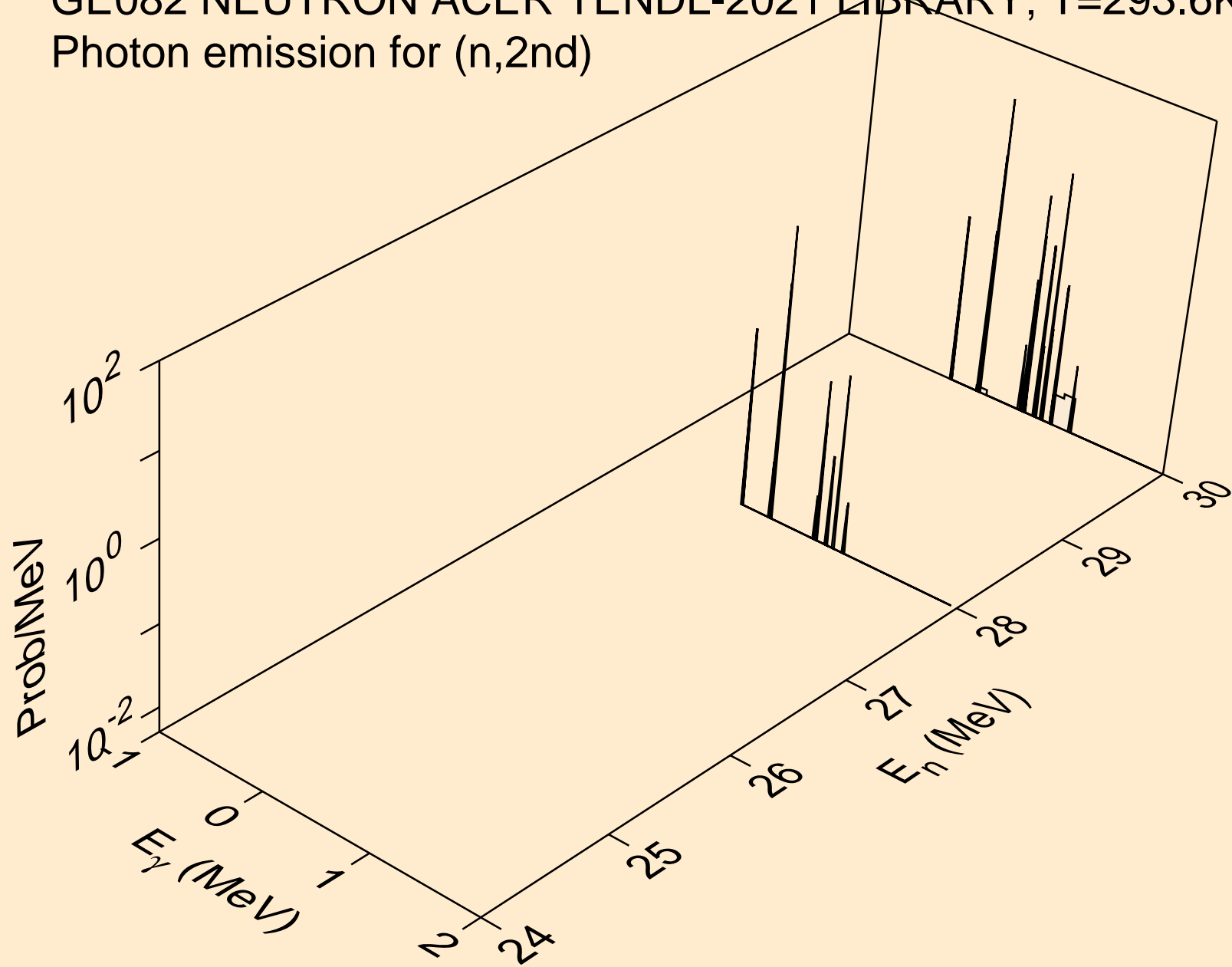

GE082 NEUTRON ACER TENDL-2021 LIBRARY; T=293.6K  
Photon emission for (n,2n)

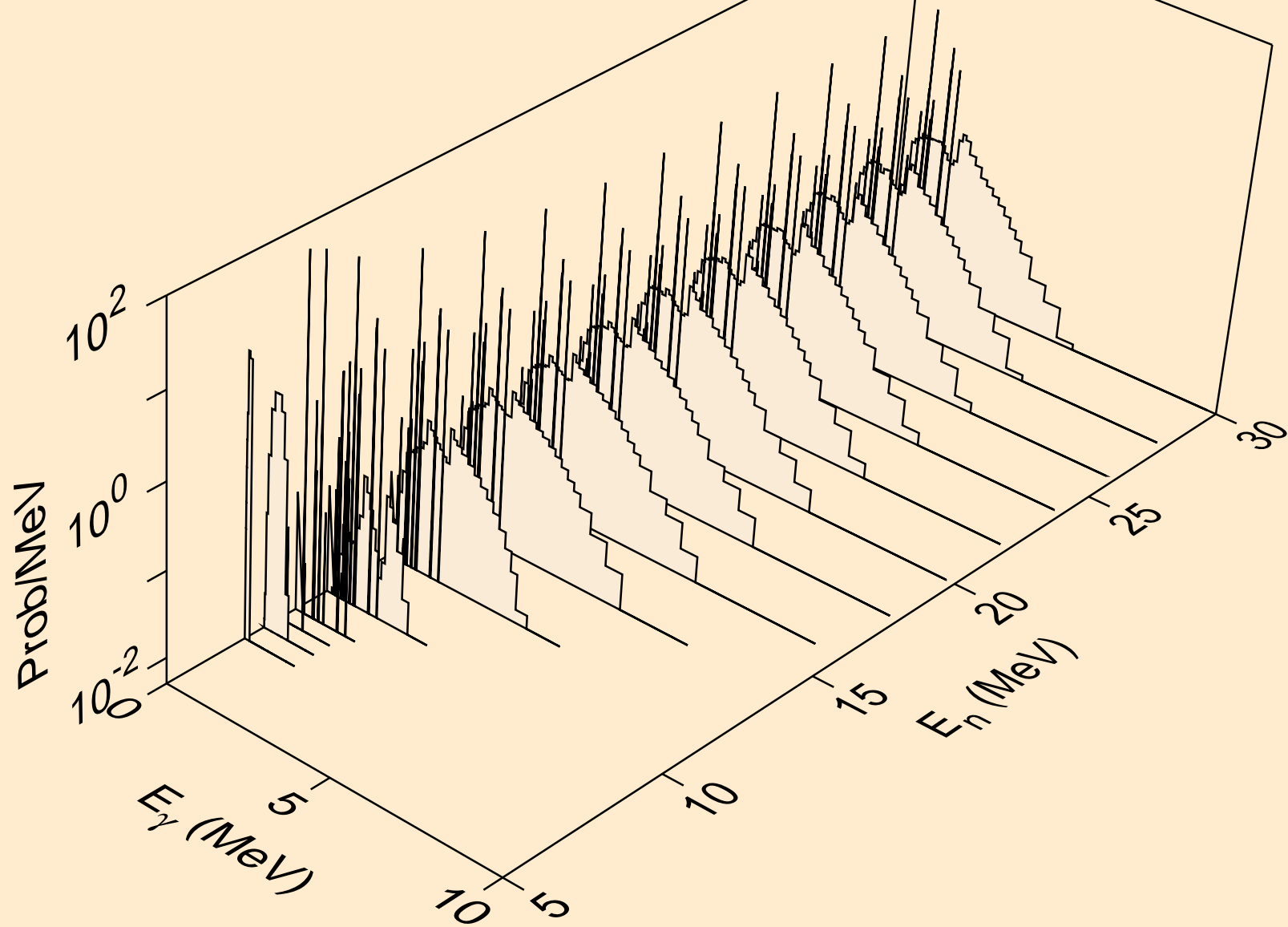

GE082 NEUTRON ACER TENDL-2021 LIBRARY; T=293.6K  
Photon emission for (n,3n)

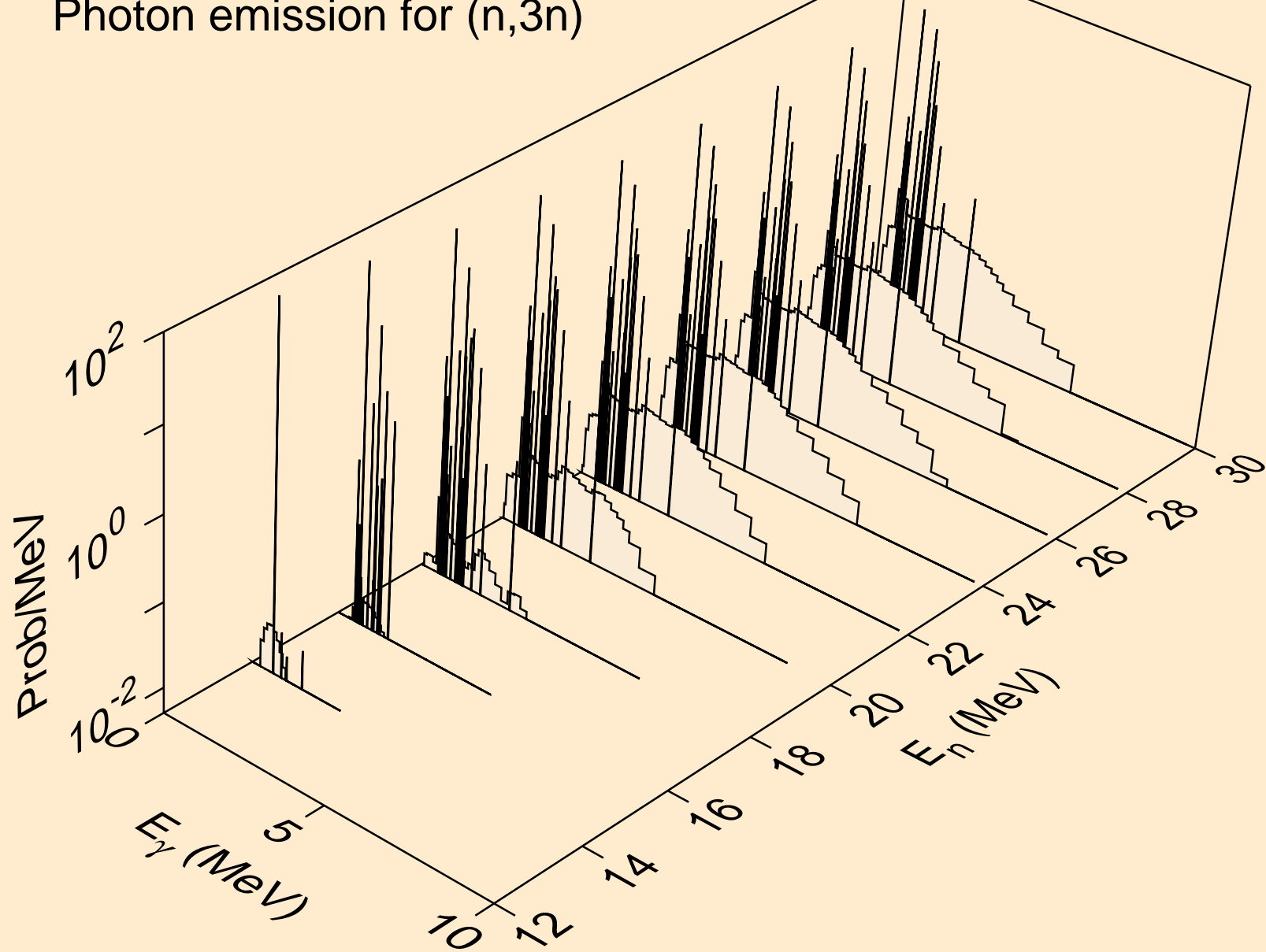

GE082 NEUTRON ACER TENDL-2021 LIBRARY; T=293.6K  
Photon emission for (n,n\*)a

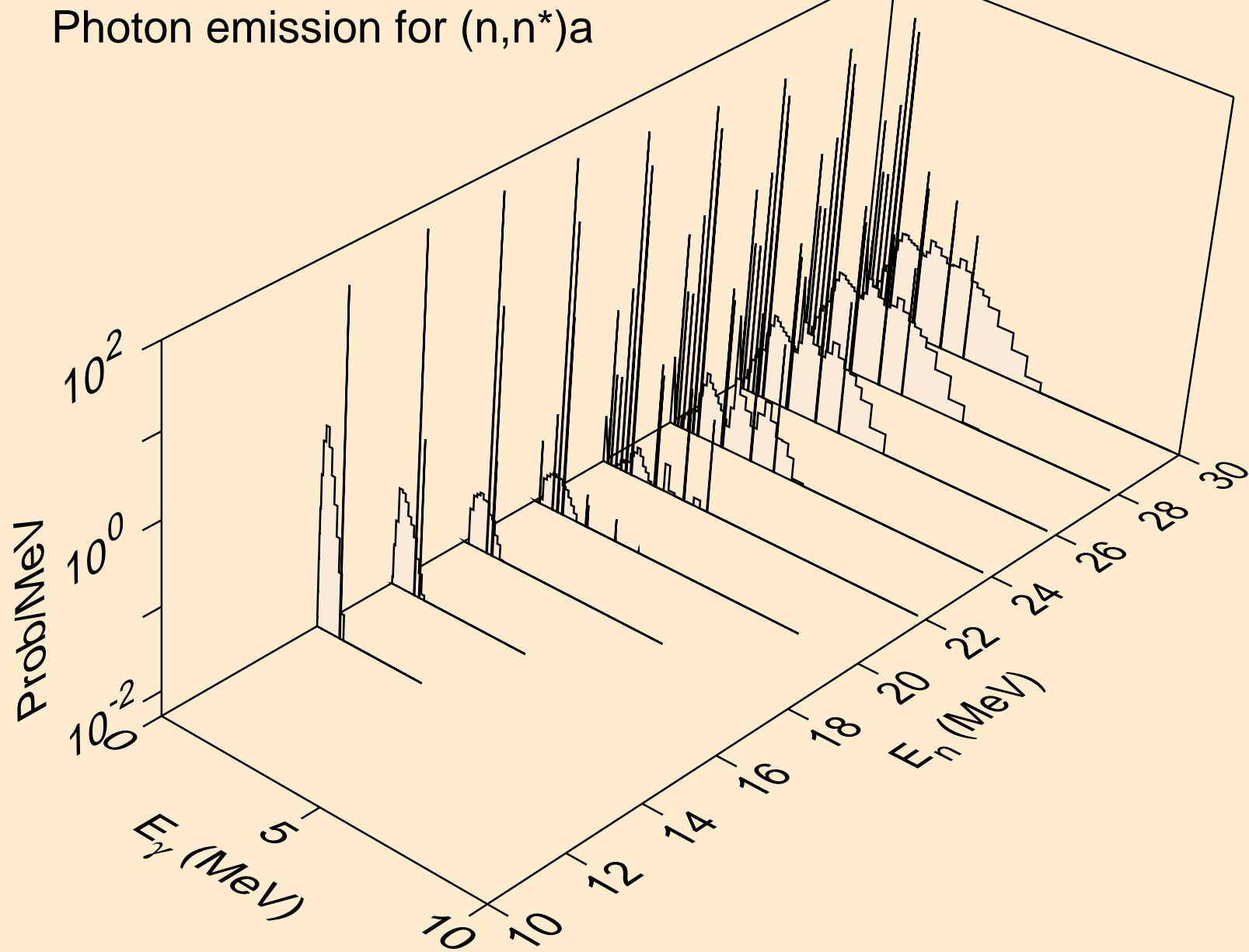

GE082 NEUTRON ACER TENDL-2021 LIBRARY; T=293.6K  
Photon emission for (n,2n)a

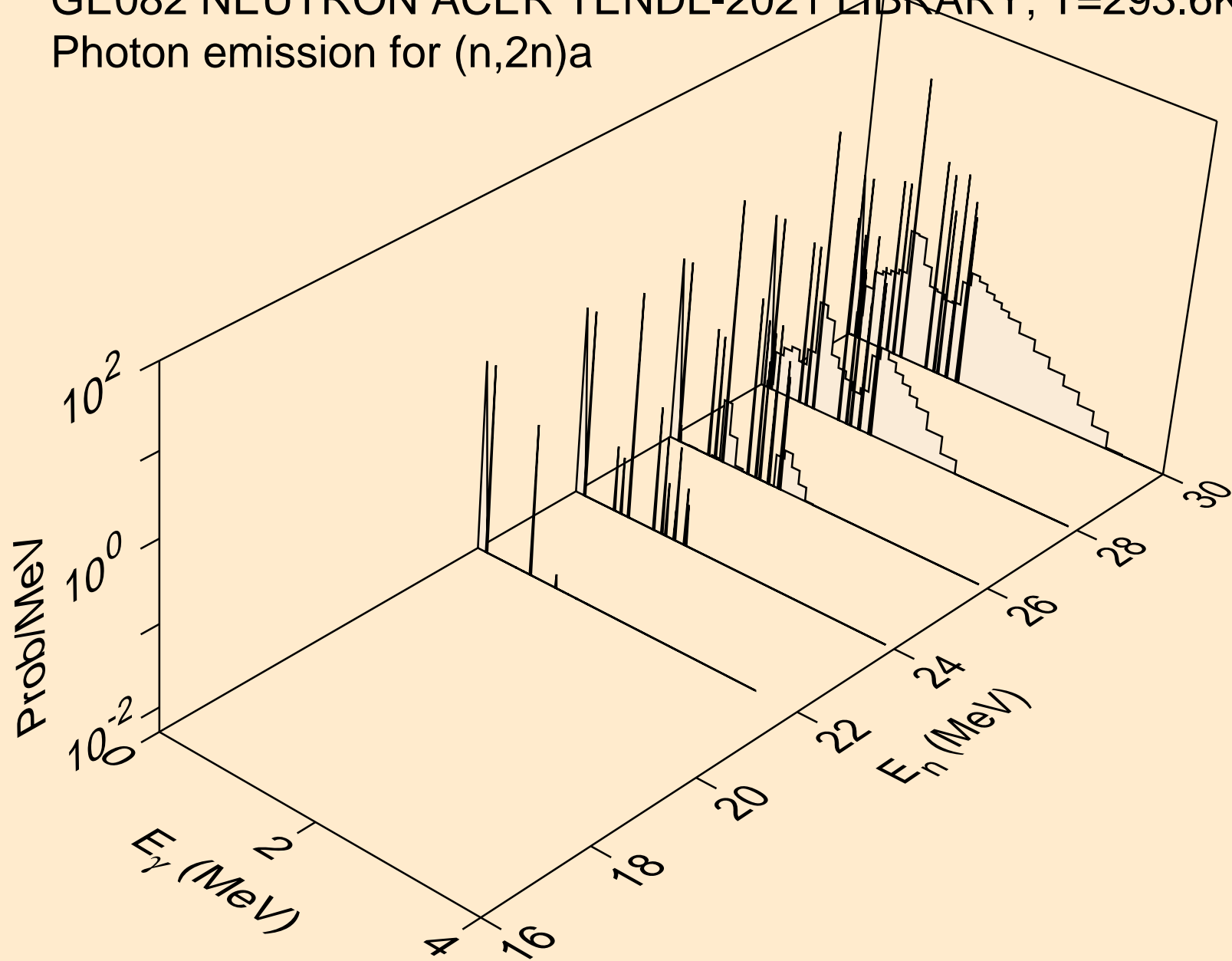

GE082 NEUTRON ACER TENDL-2021 LIBRARY; T=293.6K  
Photon emission for (n,3n)a

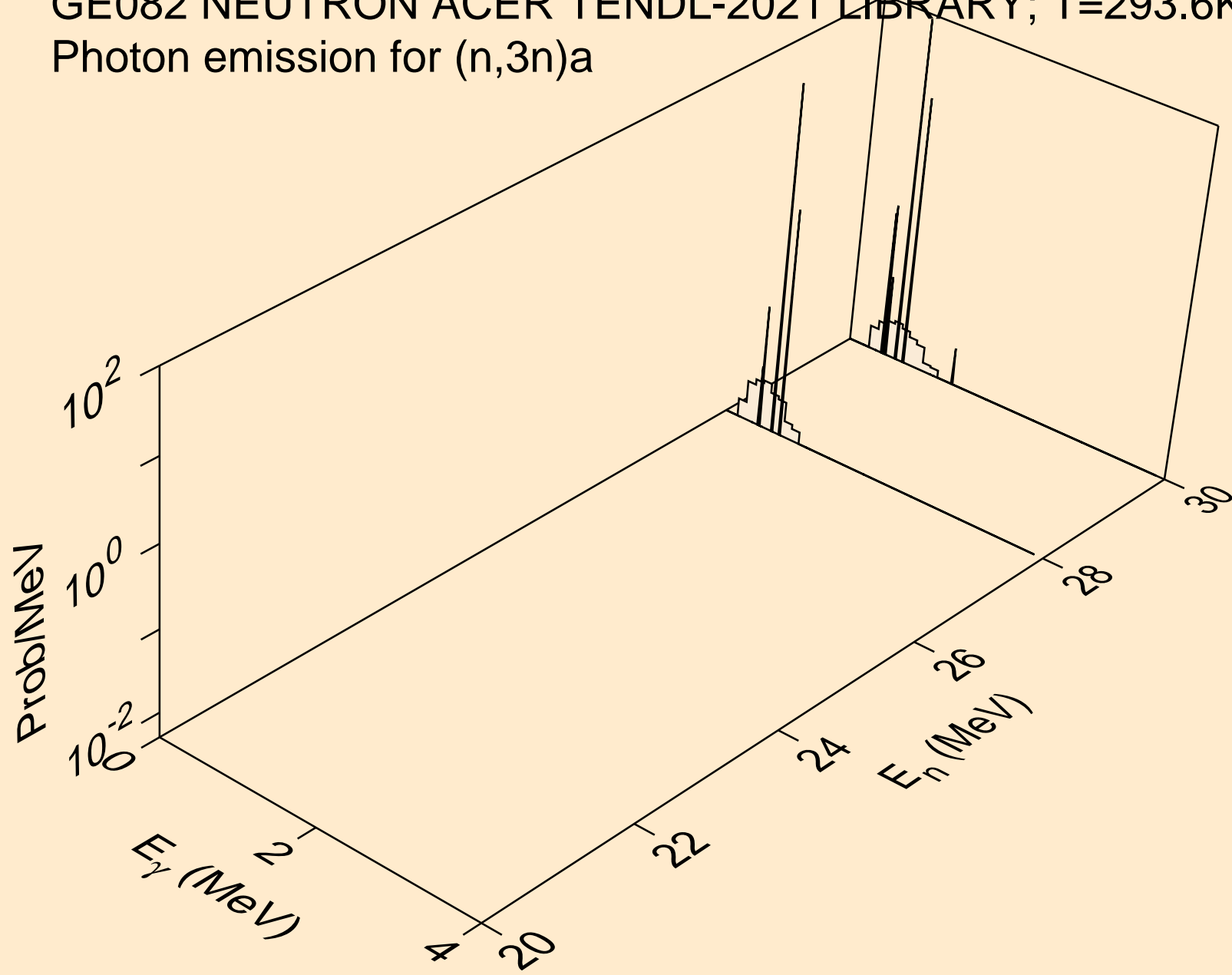

GE082 NEUTRON ACER TENDL-2021 LIBRARY; T=293.6K  
Photon emission for (n,n\*)p

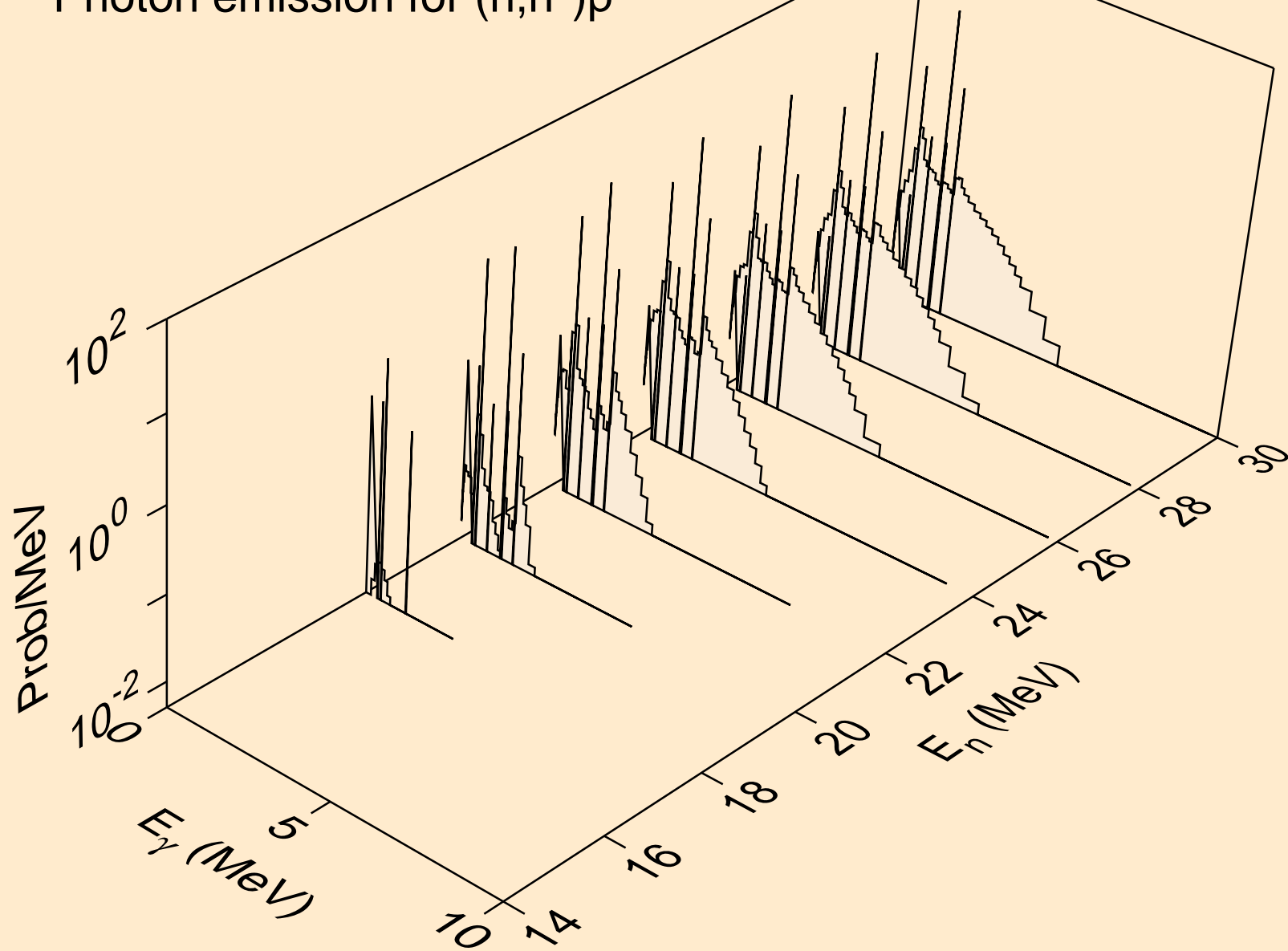



GE082 NEUTRON ACER TENDL-2021 LIBRARY; T=293.6K  
Photon emission for (n,n\*)d

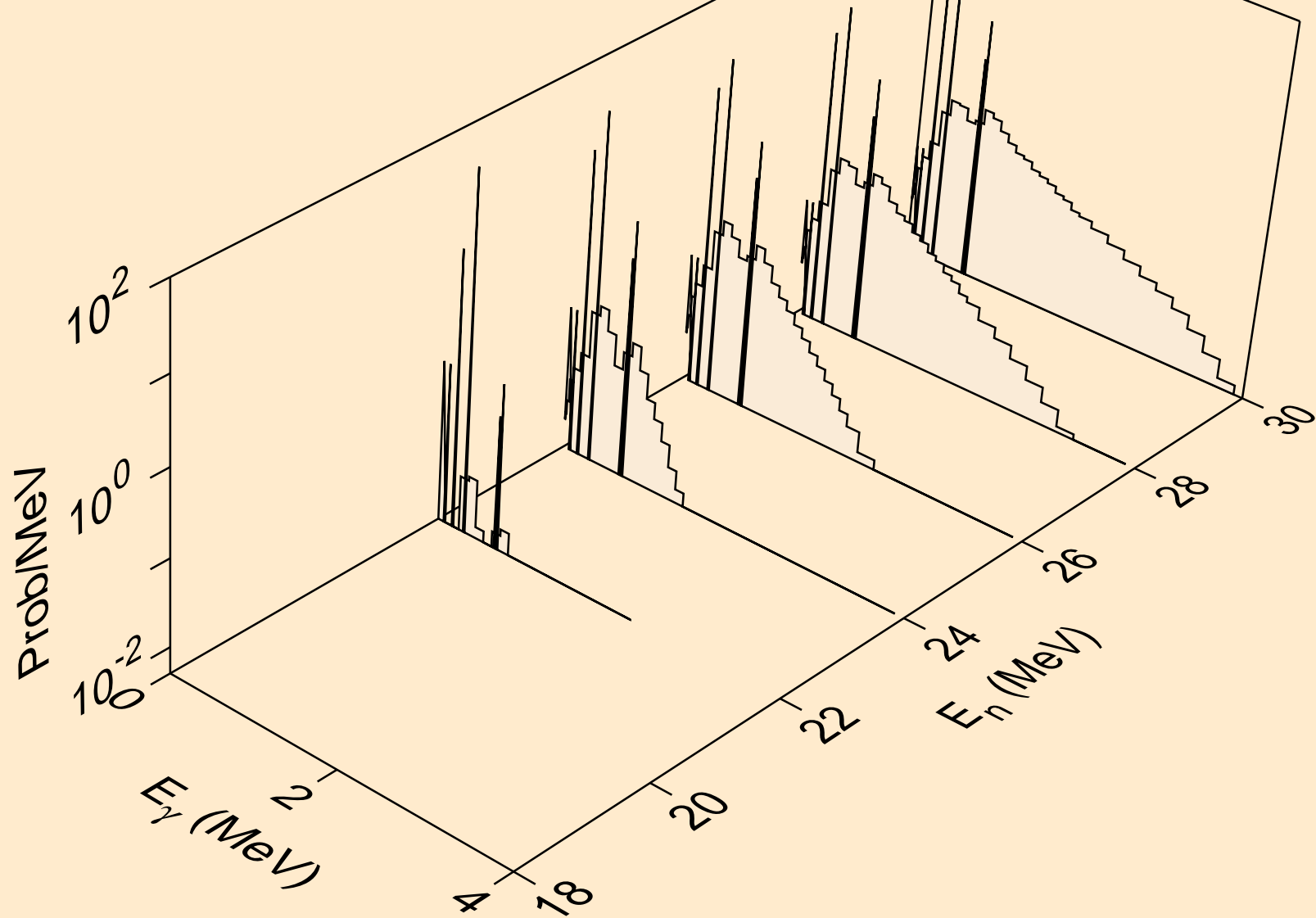

GE082 NEUTRON ACER TENDL-2021 LIBRARY; T=293.6K  
Photon emission for (n,n\*)t

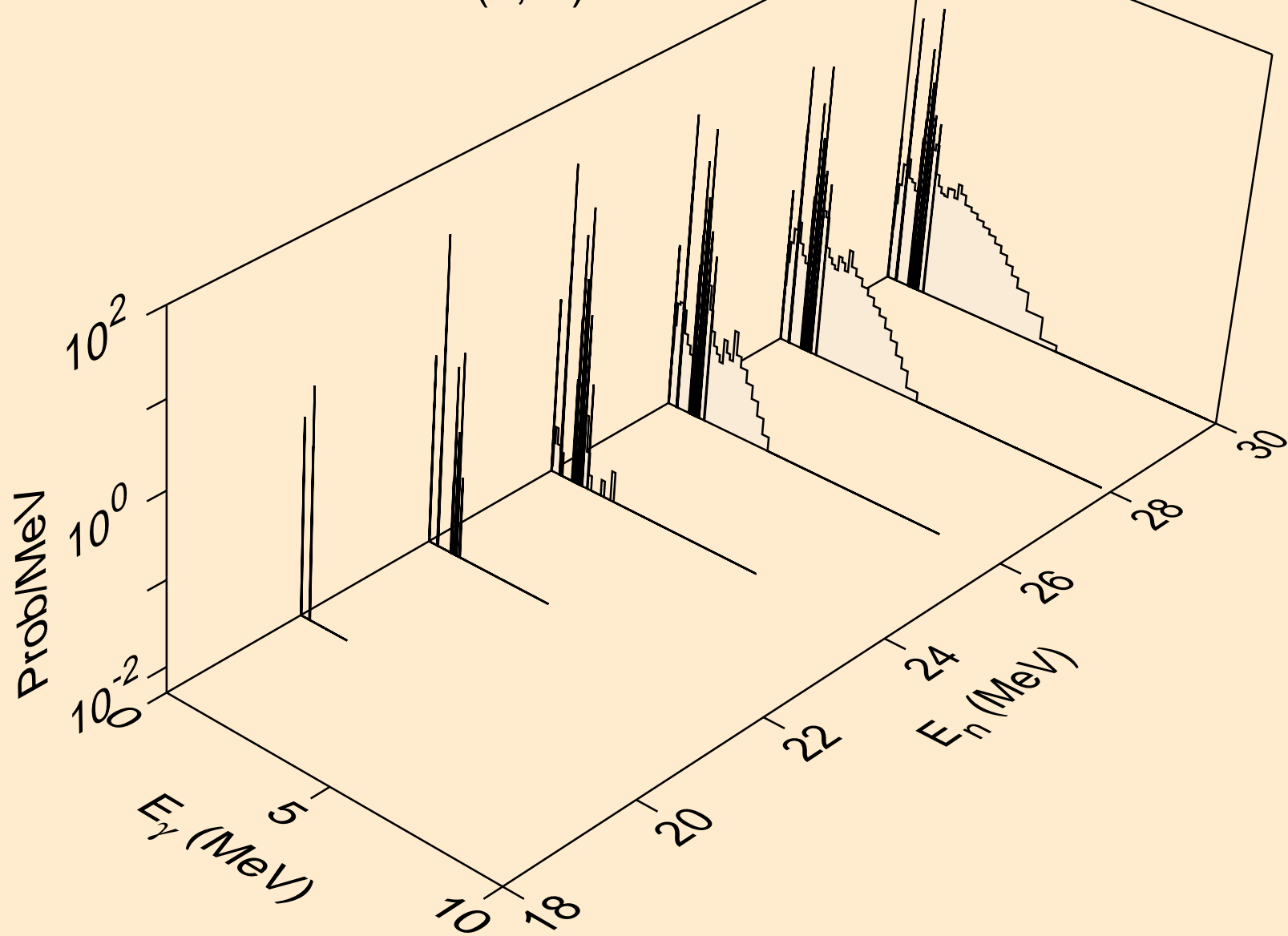

GE082 NEUTRON ACER TENDL-2021 LIBRARY; T=293.6K  
Photon emission for (n,4n)

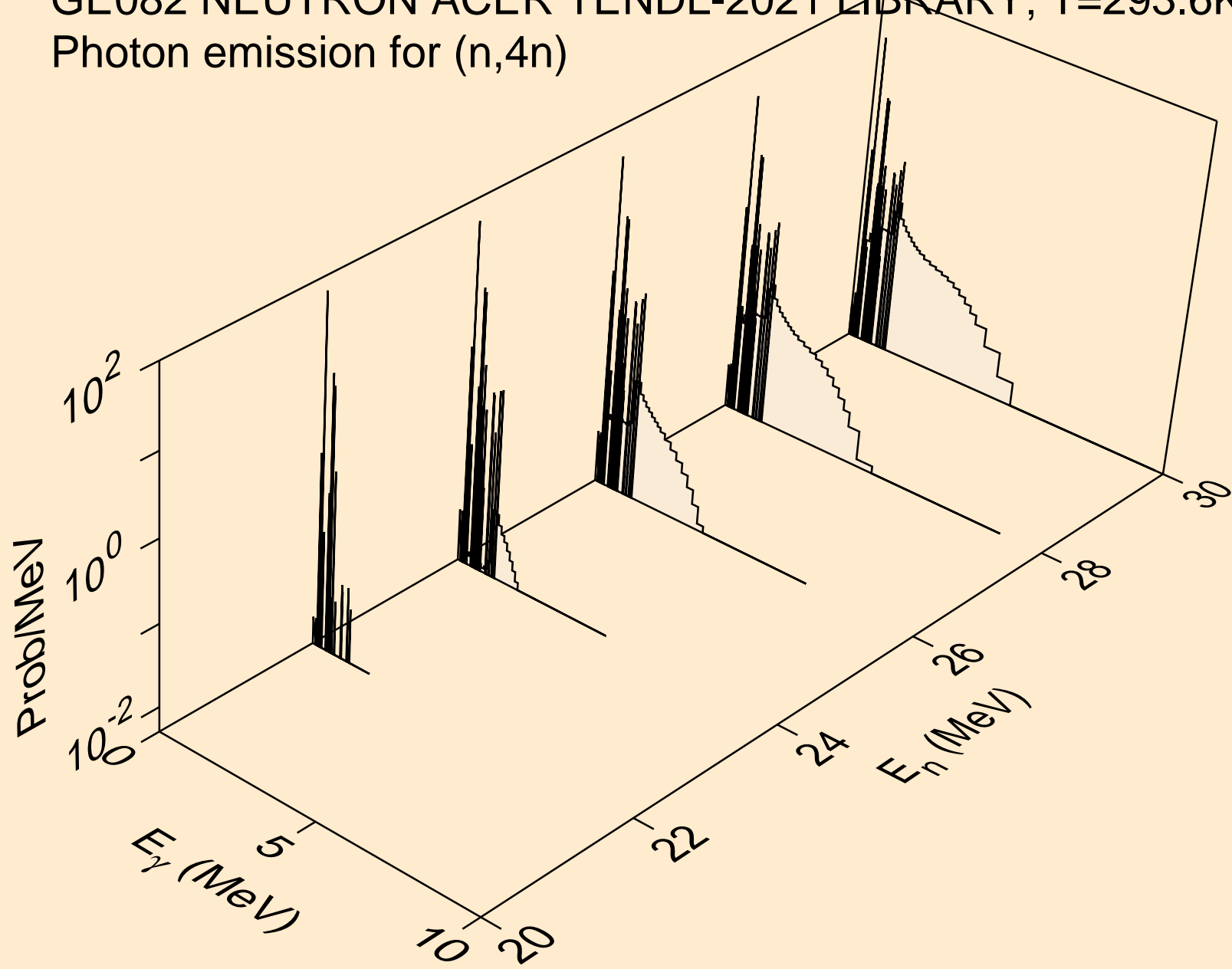

GE082 NEUTRON ACER TENDL-2021 LIBRARY; T=293.6K  
Photon emission for (n,2np)

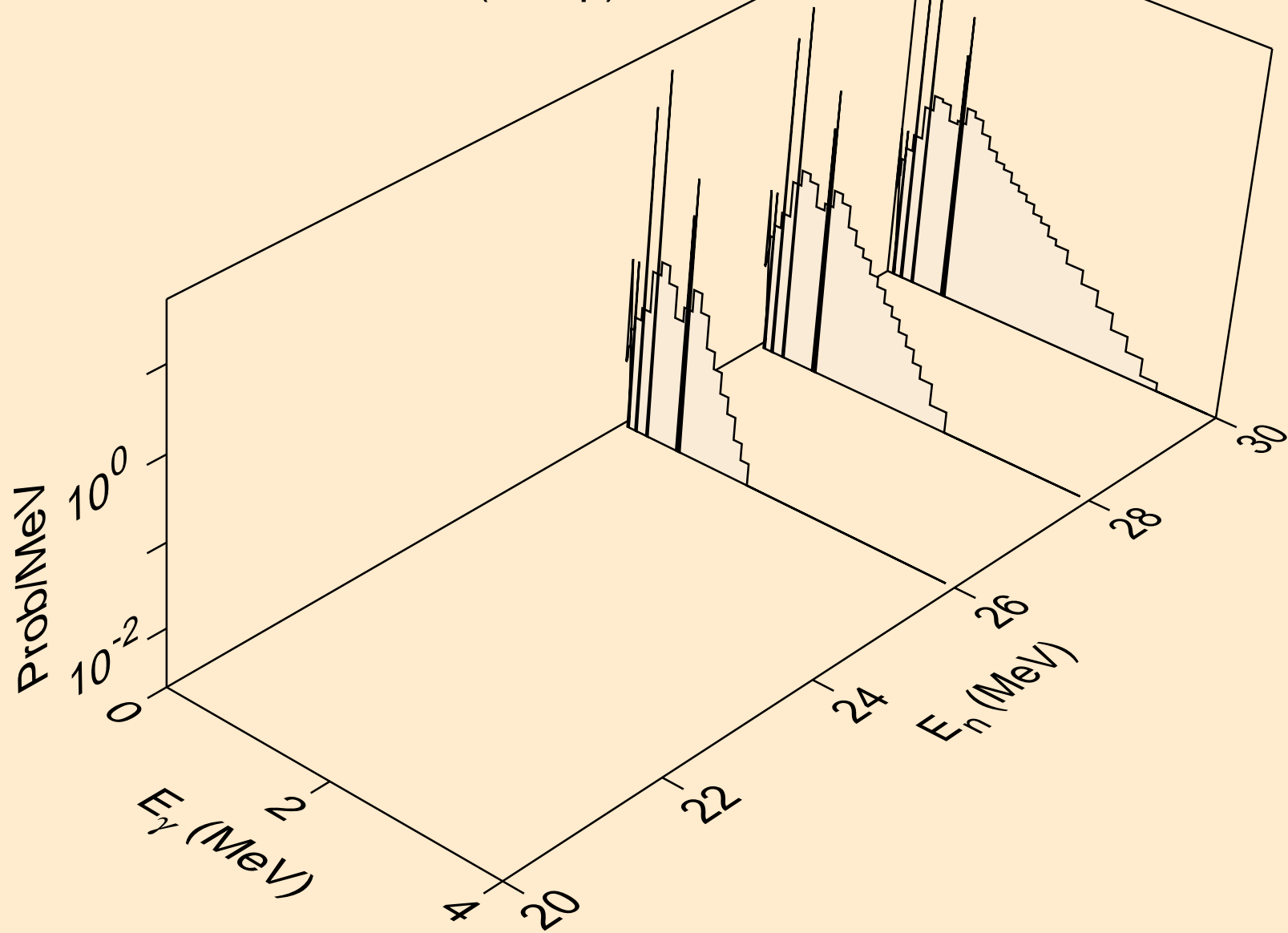

GE082 NEUTRON ACER TENDL-2021 LIBRARY; T=293.6K  
Photon emission for (n,3np)

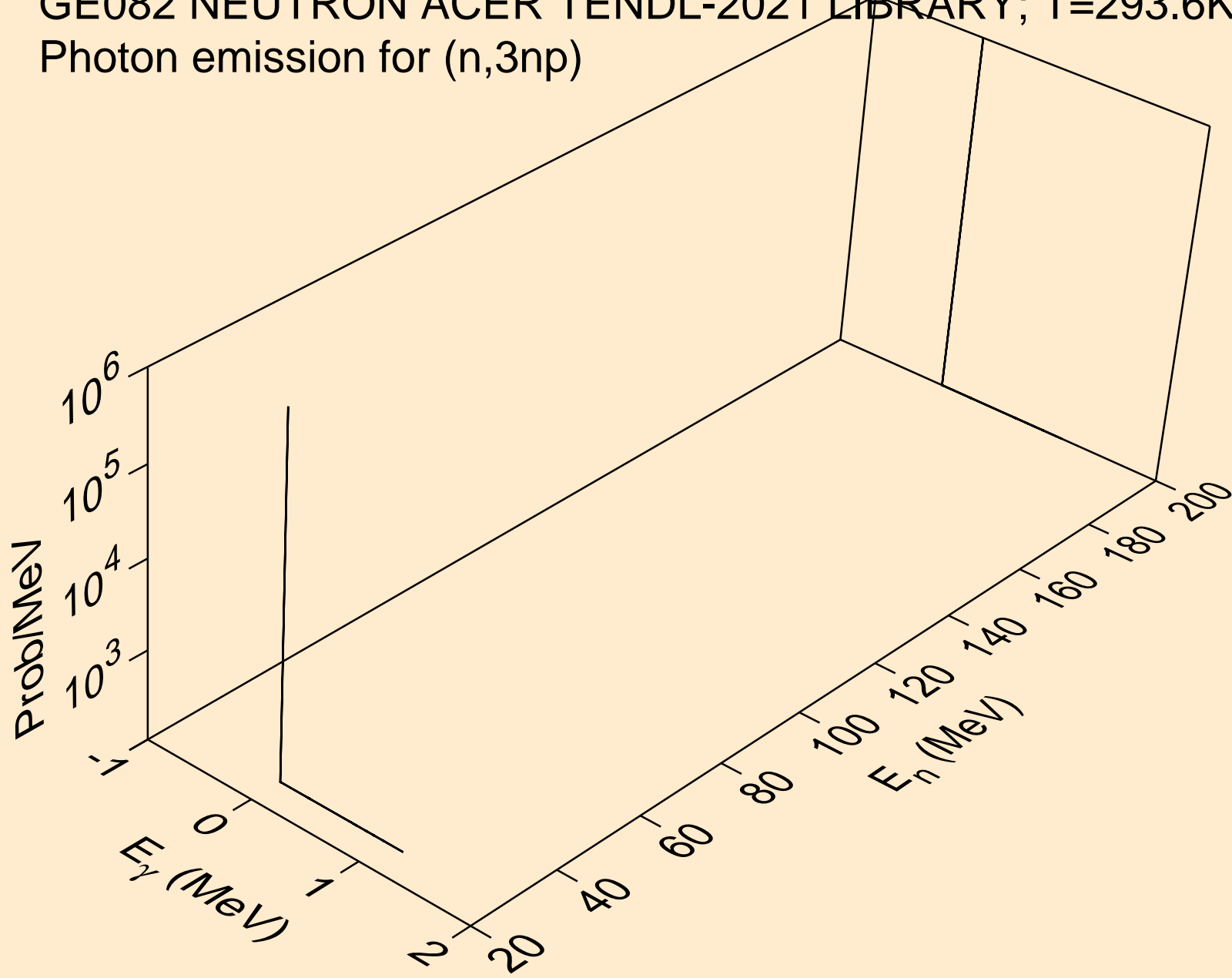

GE082 NEUTRON ACER TENDL-2021 LIBRARY; T=293.6K  
Photon emission for (n,n\*c)

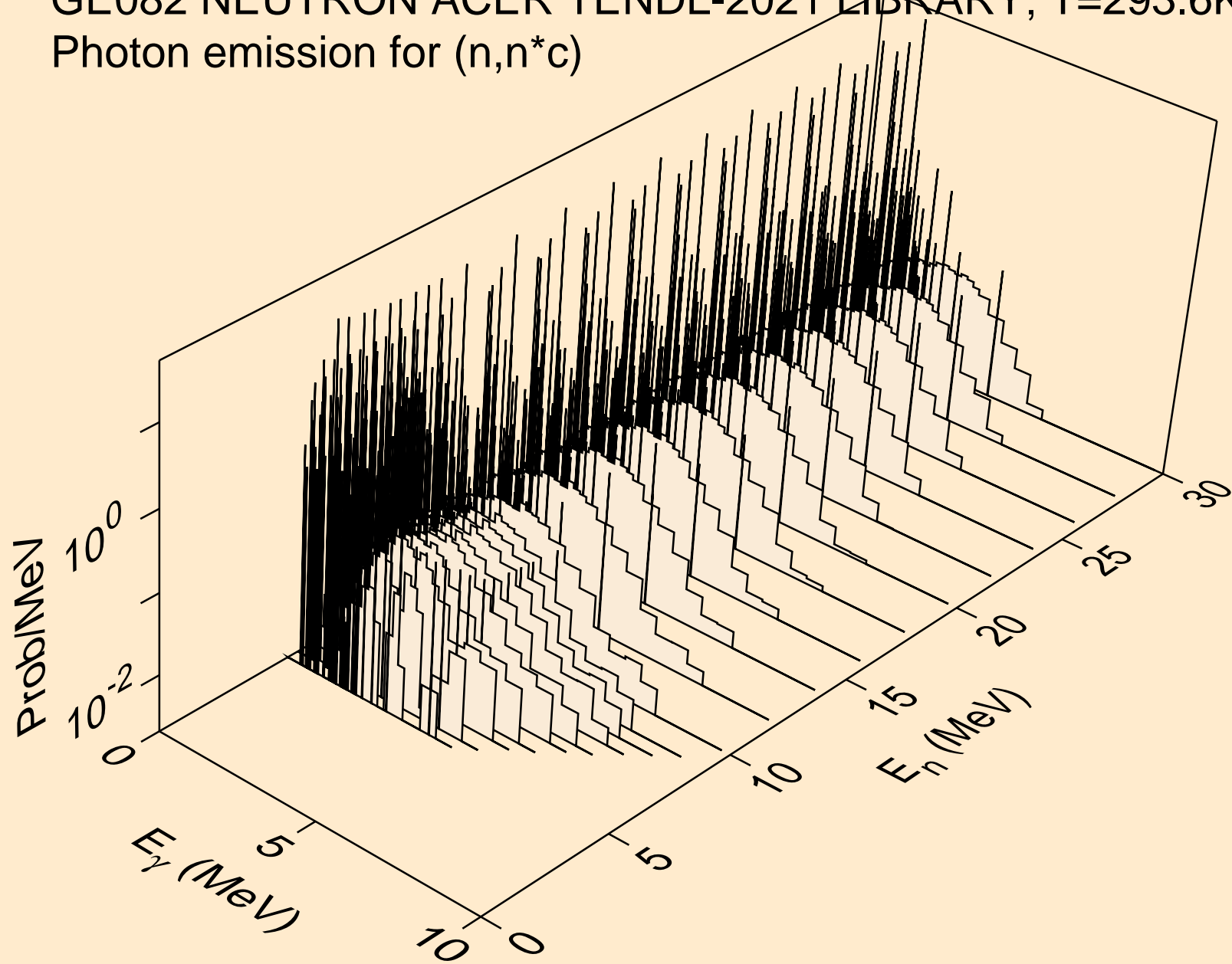

GE082 NEUTRON ACER TENDL-2021 LIBRARY; T=293.6K  
Photon emission for (n,gma)

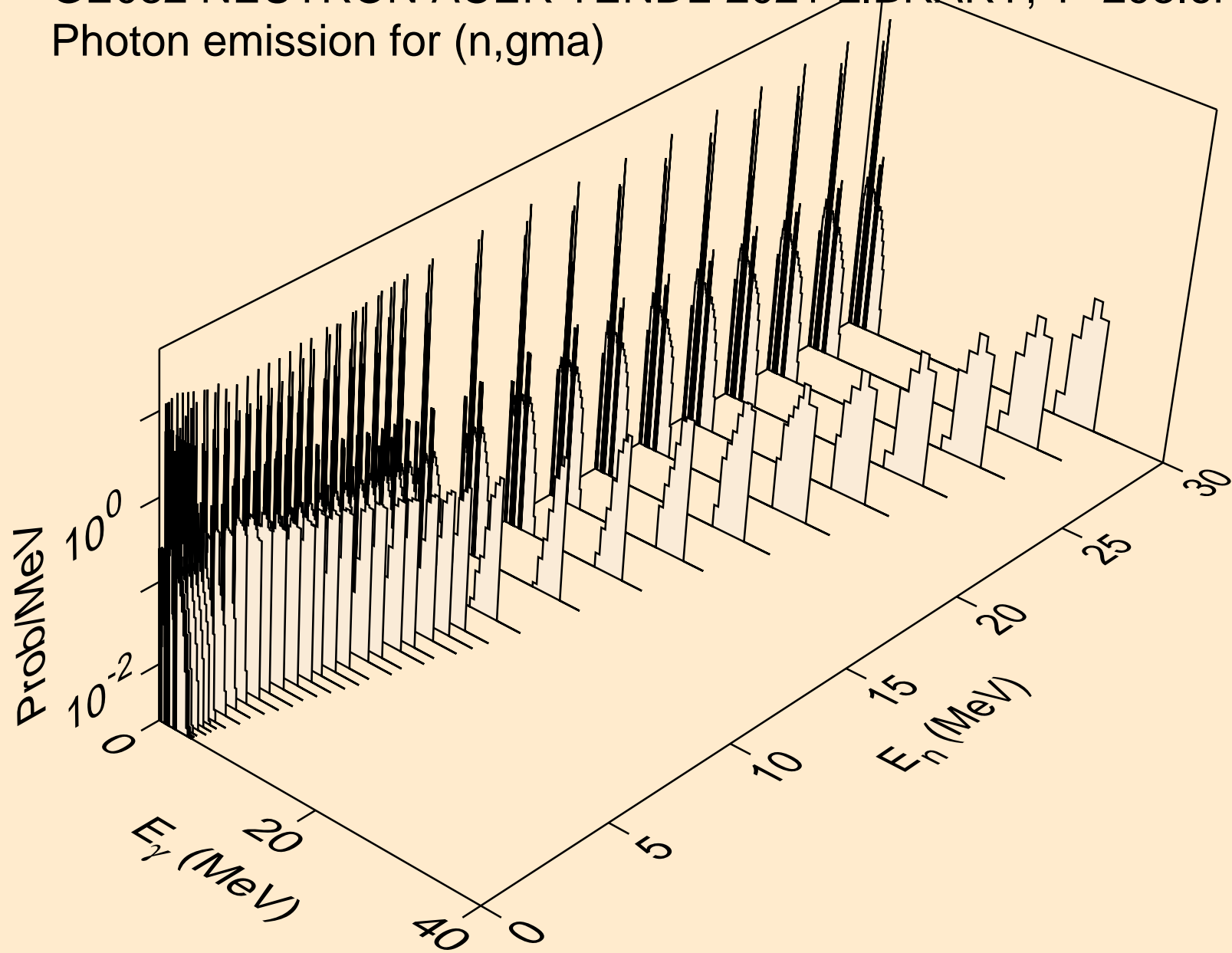

GE082 NEUTRON ACER TENDL-2021 LIBRARY; T=293.6K  
Photon emission for (n,p)

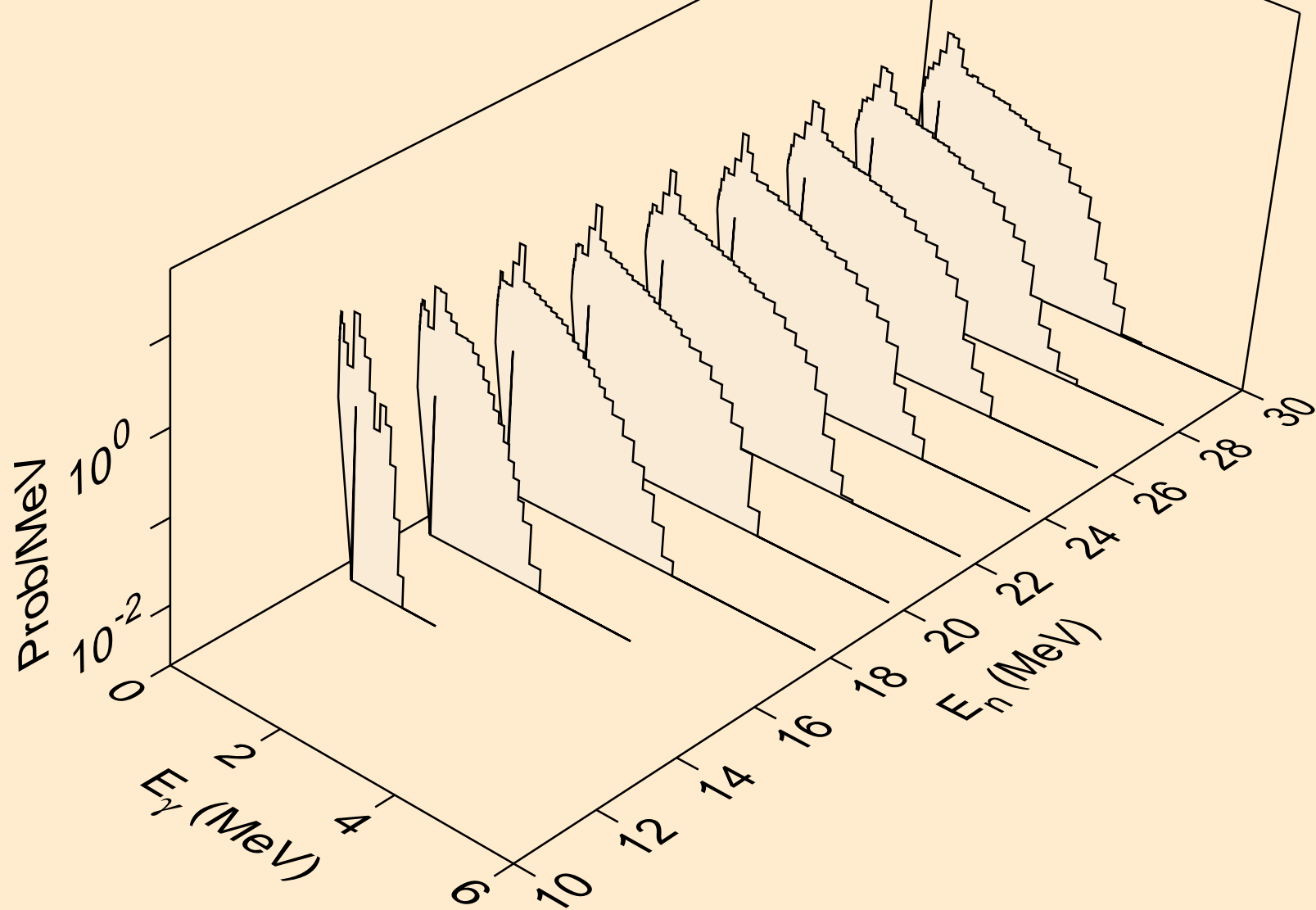



GE082 NEUTRON ACER TENDL-2021 LIBRARY; T=293.6K  
Photon emission for (n,d)

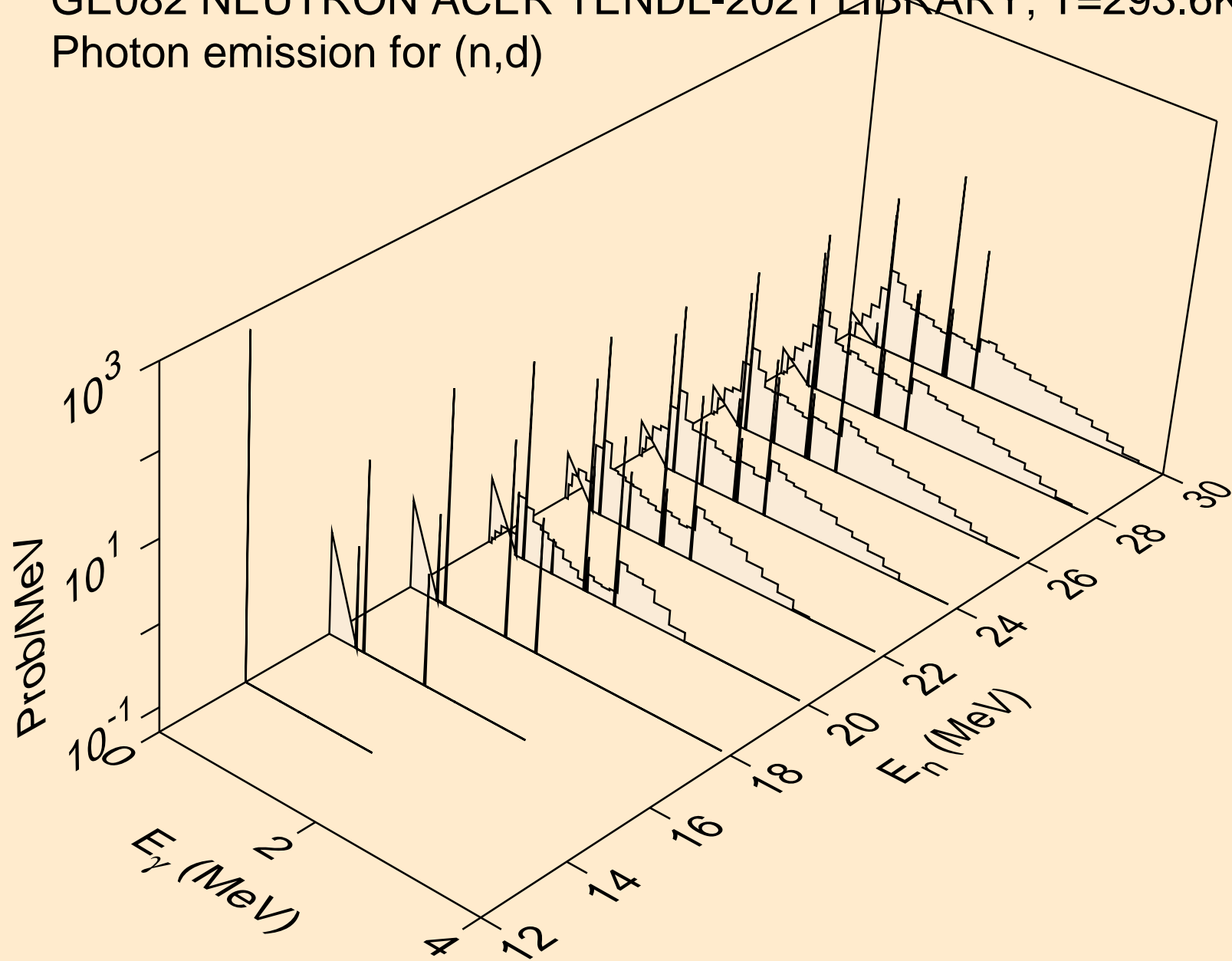

GE082 NEUTRON ACER TENDL-2021 LIBRARY; T=293.6K  
Photon emission for (n,t)

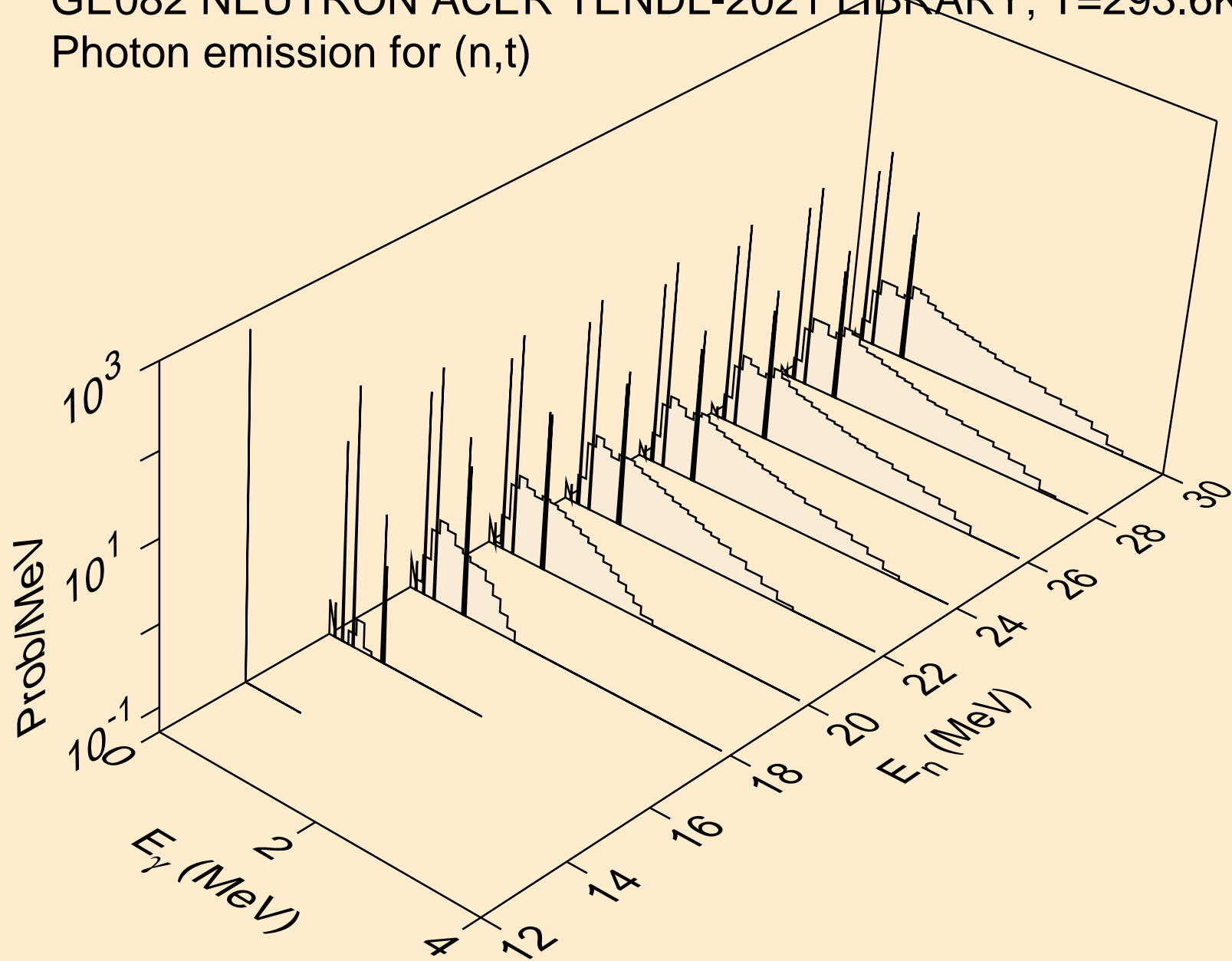

GE082 NEUTRON ACER TENDL-2021 LIBRARY; T=293.6K  
Photon emission for (n,he3)

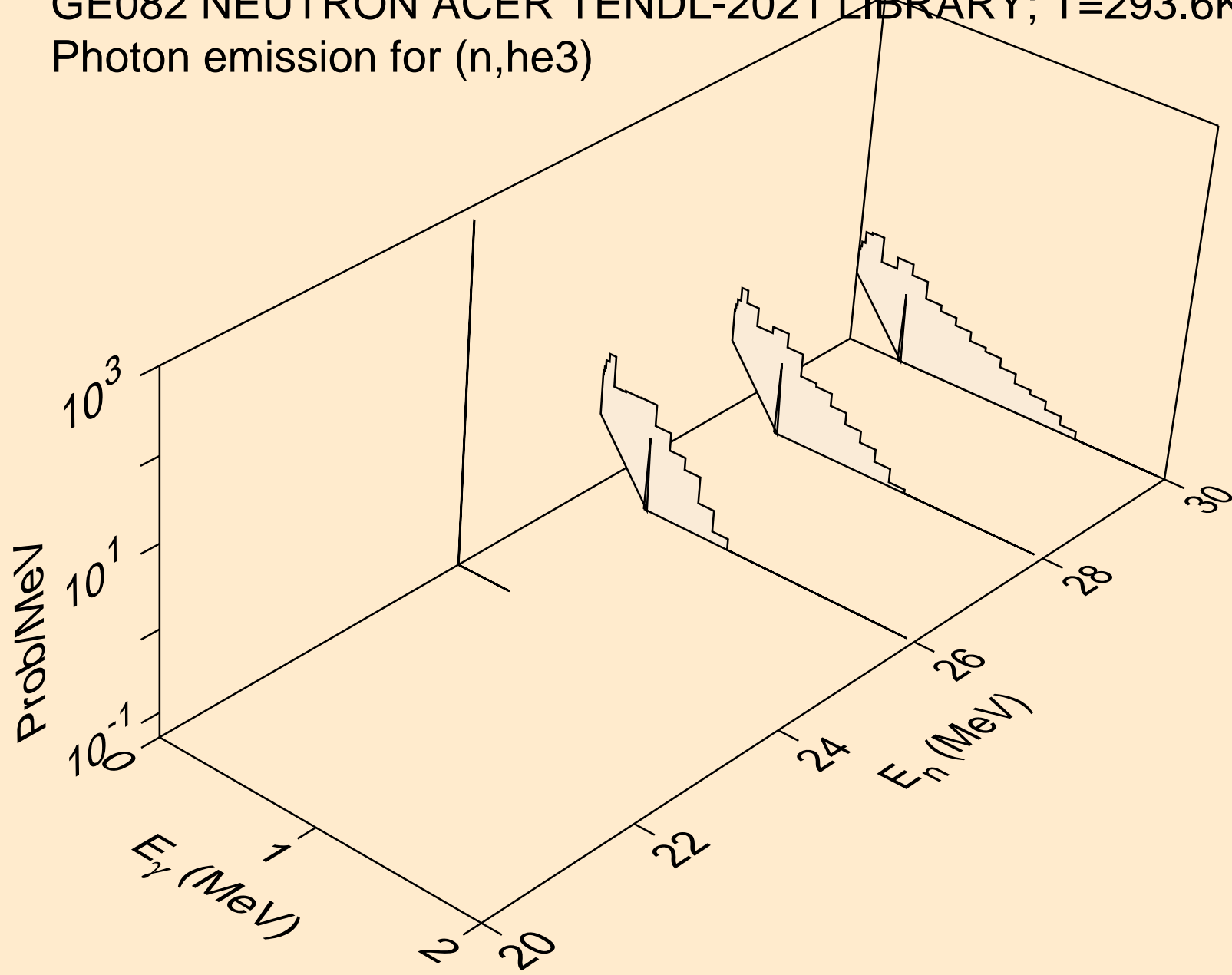

GE082 NEUTRON ACER TENDL-2021 LIBRARY; T=293.6K  
Photon emission for (n,a)

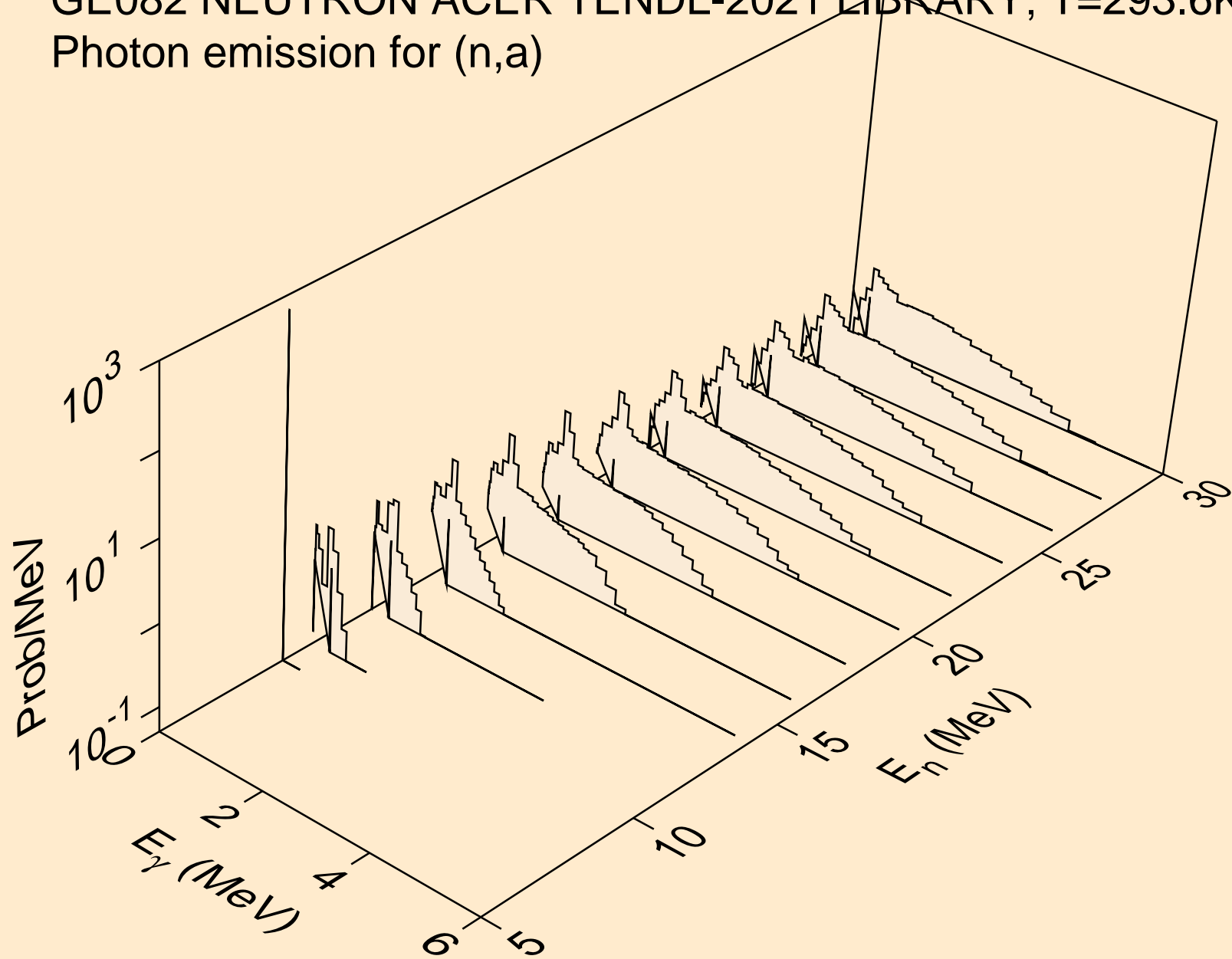

GE082 NEUTRON ACER TENDL-2021 LIBRARY; T=293.6K  
thermal capture photon spectrum

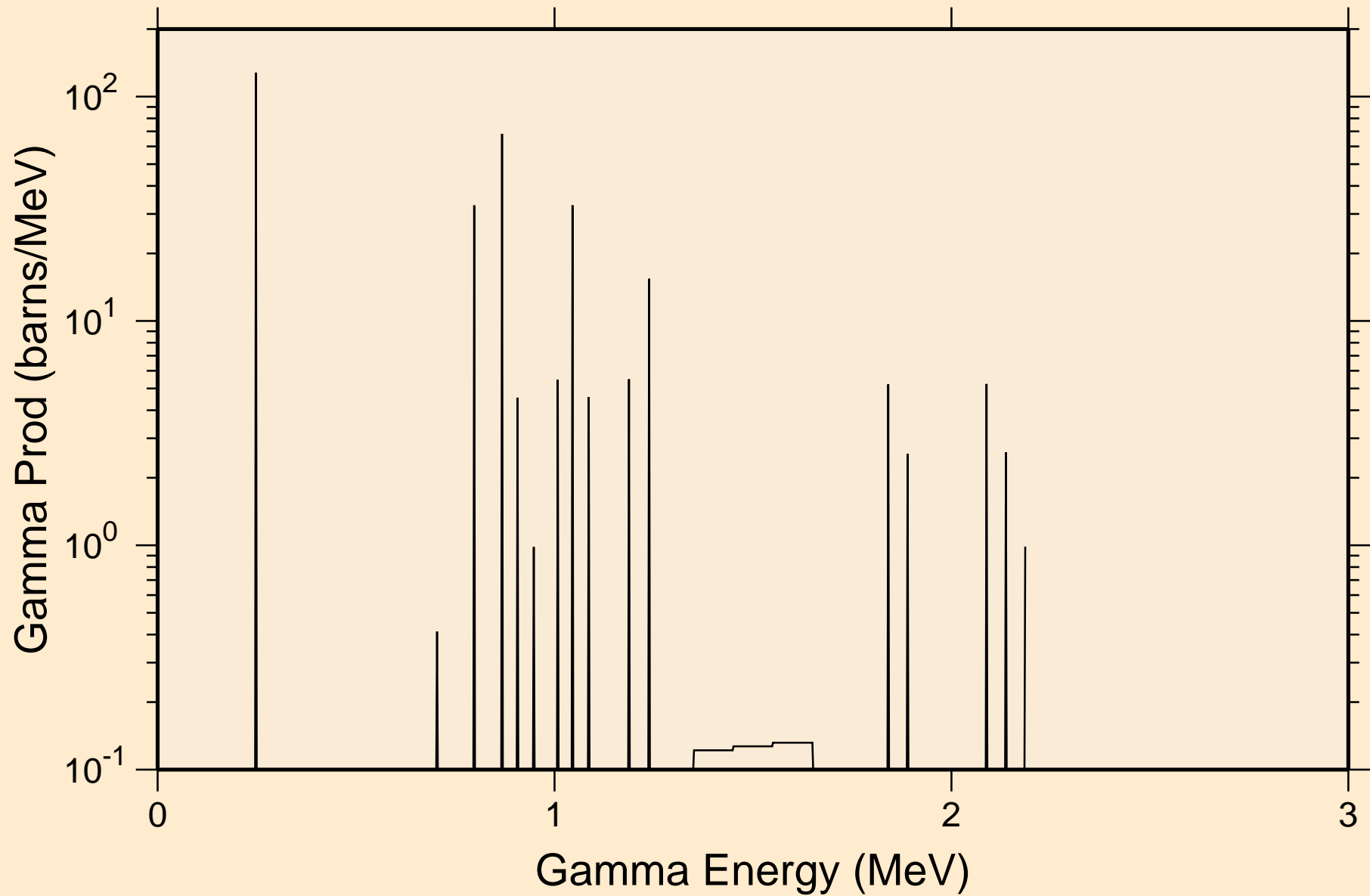

GE082 NEUTRON ACER TENDL-2021 LIBRARY; T=293.6K  
14 MeV photon spectrum

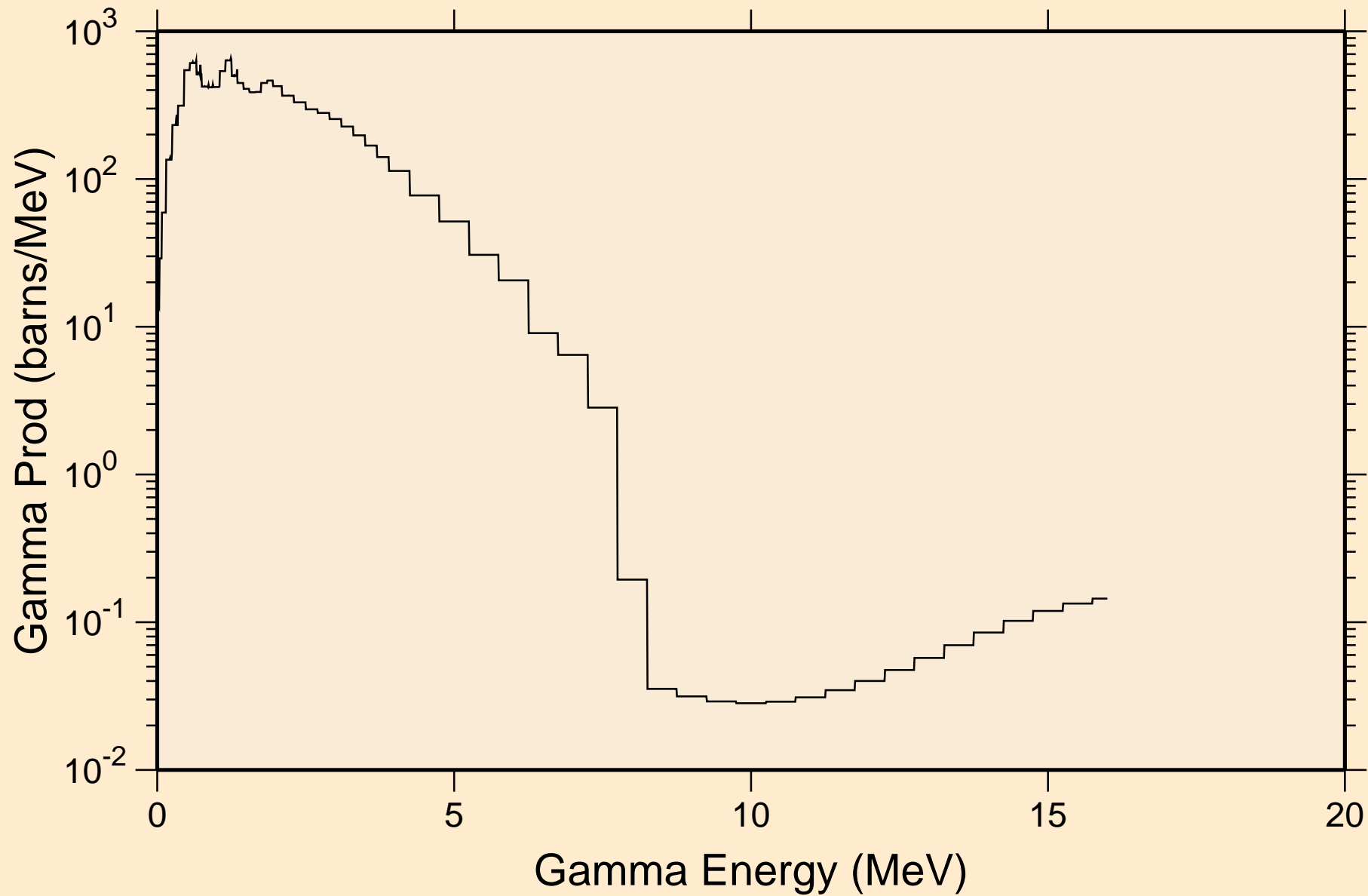

GE082 NEUTRON ACER TENDL-2021 LIBRARY; T=293.6K  
Particle heating contributions

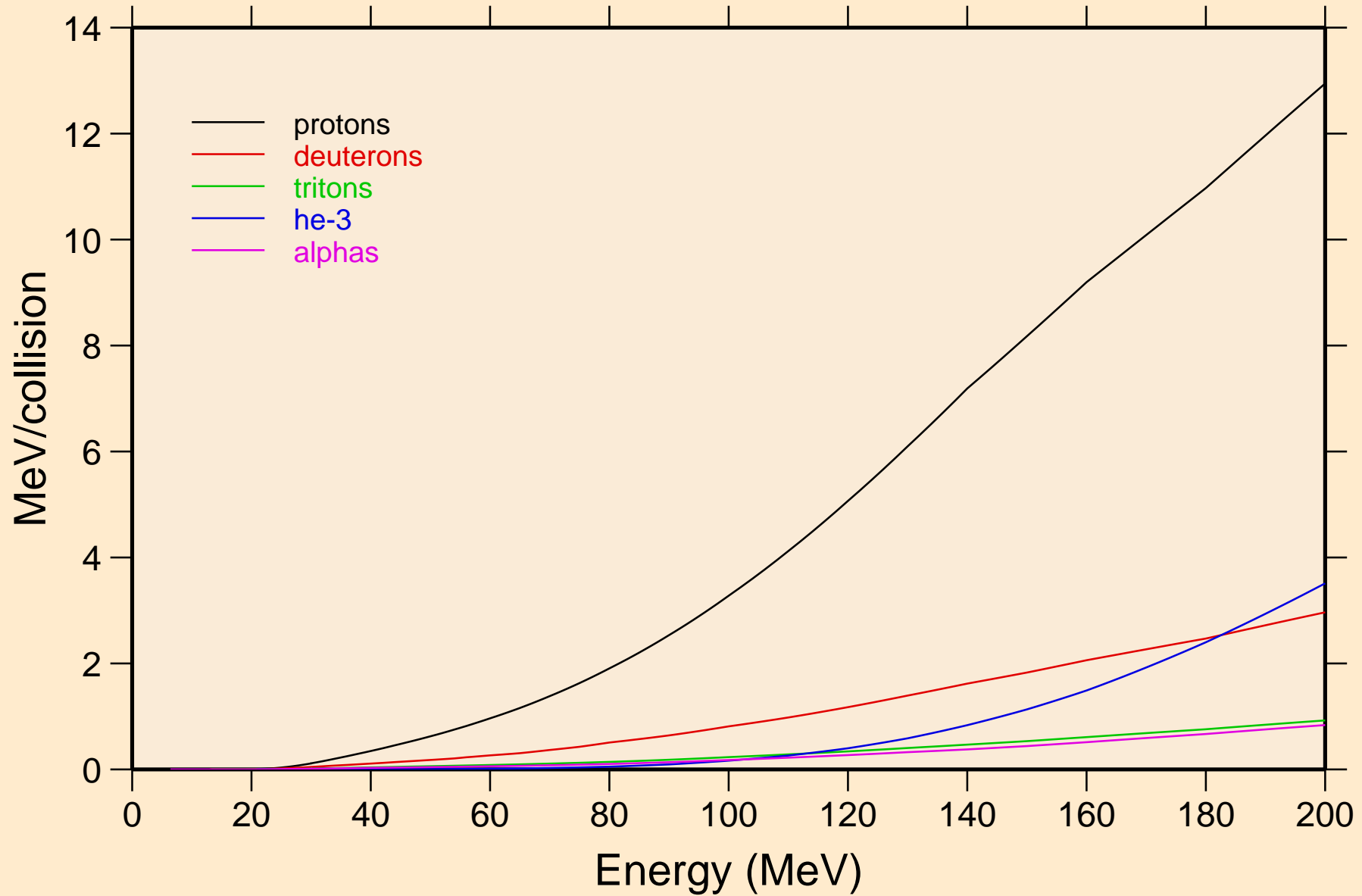

GE082 NEUTRON ACER TENDL-2021 LIBRARY; T=293.6K  
Recoil Heating

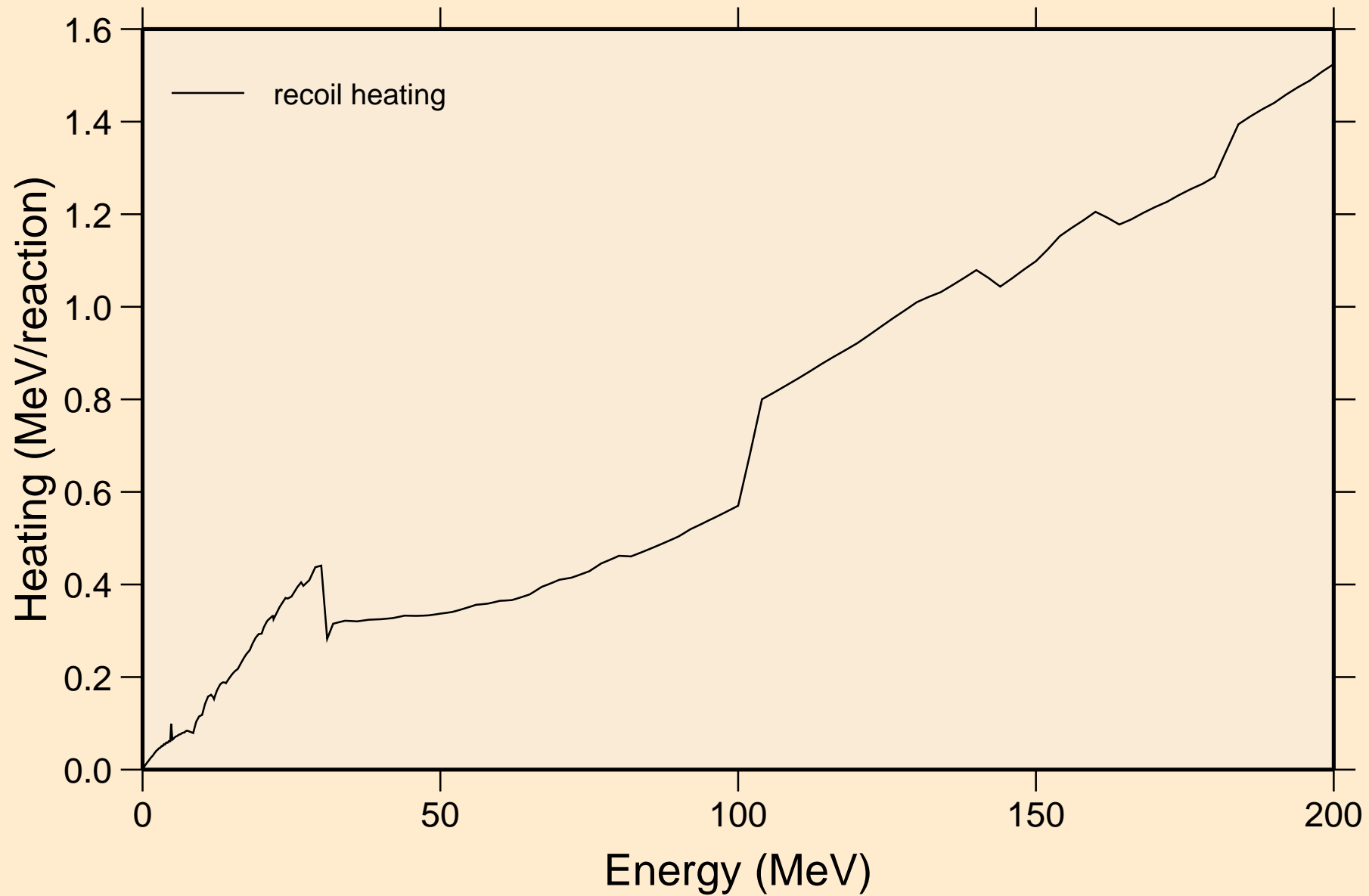



# GE082 NEUTRON ACER TENDL-2021 LIBRARY; T=293.6K

## Particle production cross sections

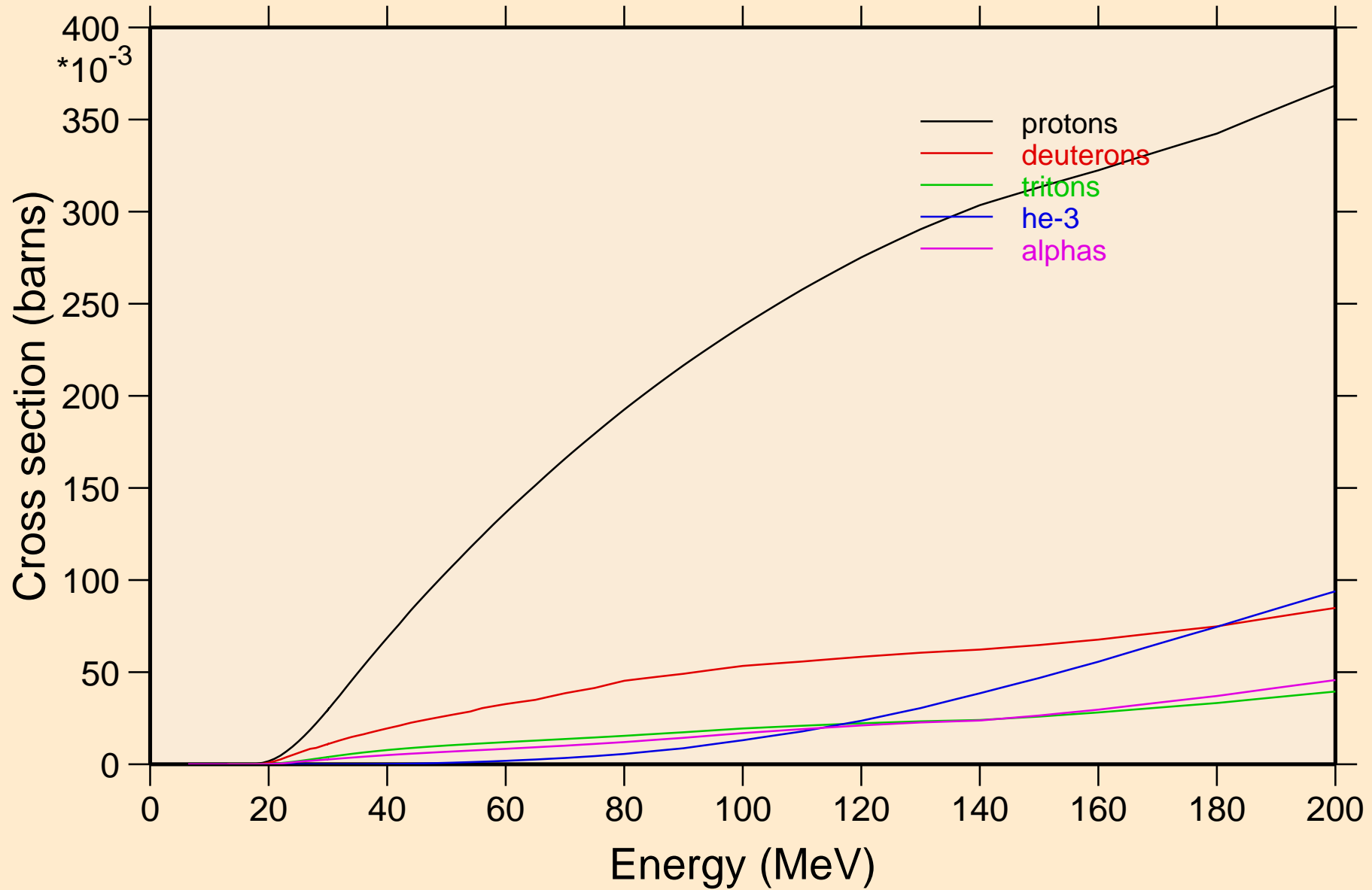

GE082 NEUTRON ACER TENDL-2021 LIBRARY; T=293.6K  
protons from (n,x)

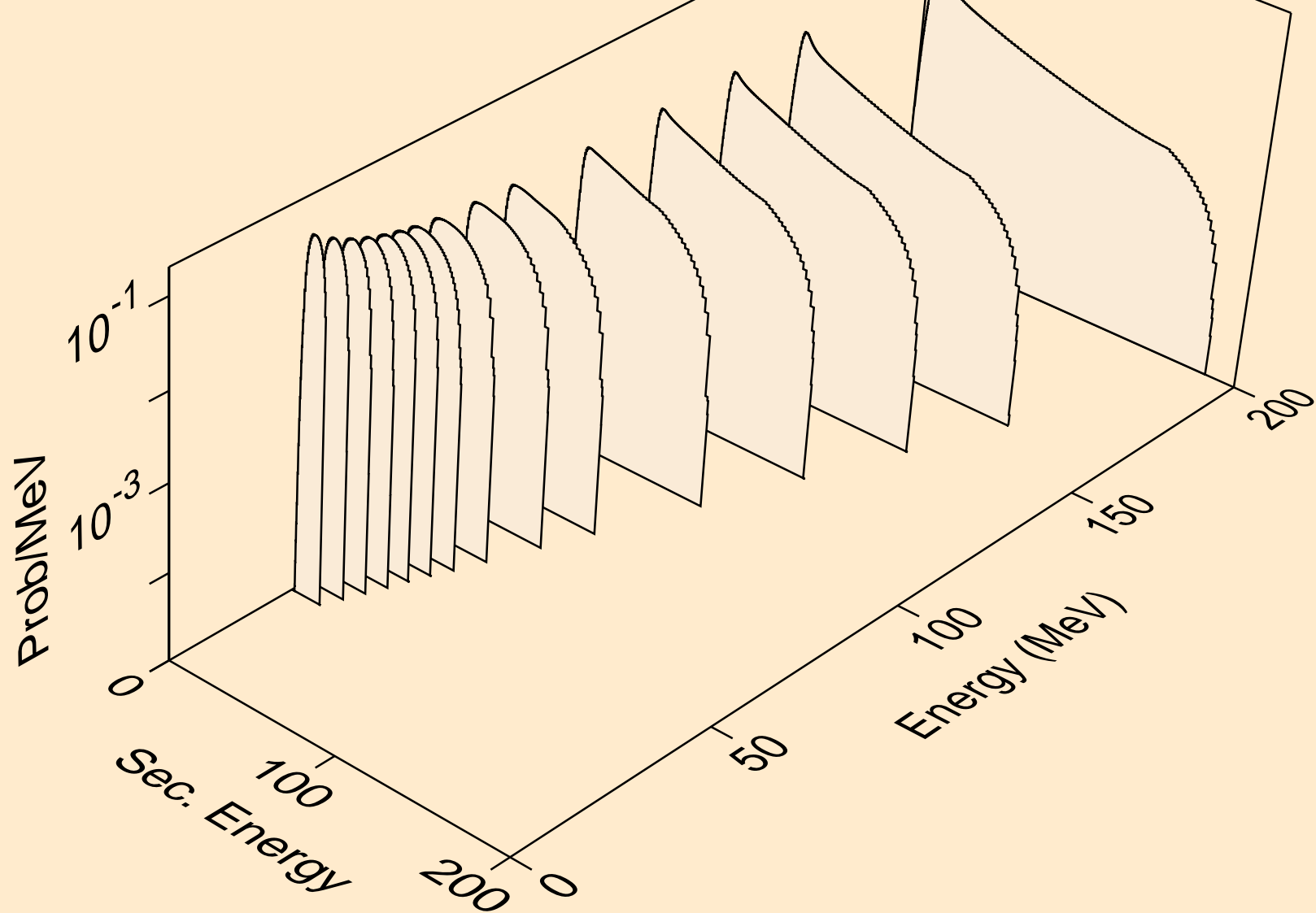

GE082 NEUTRON ACER TENDL-2021 LIBRARY; T=293.6K  
protons from (n,n\*)p

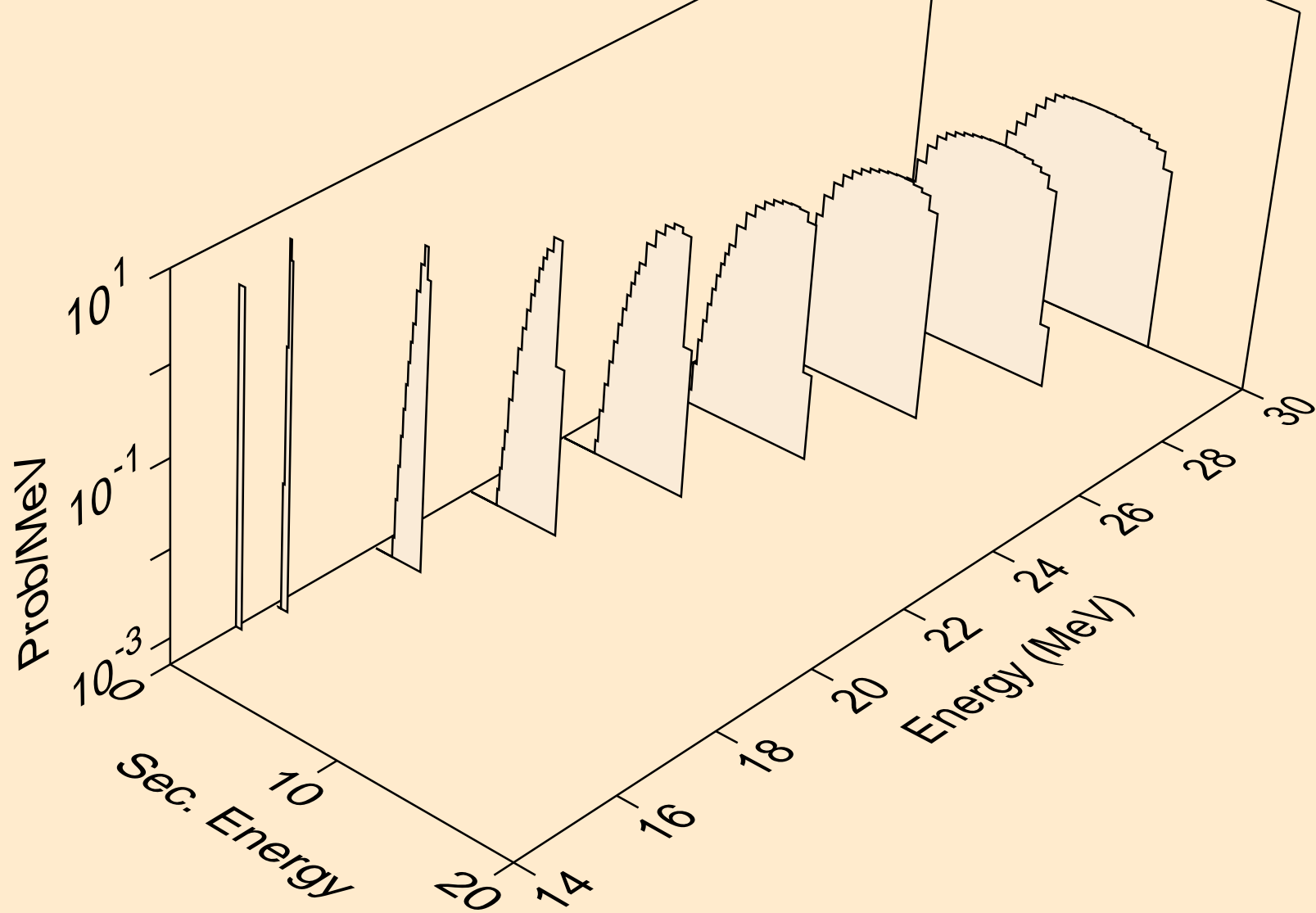

GE082 NEUTRON ACER TENDL-2021 LIBRARY; T=293.6K  
protons from (n,2np)

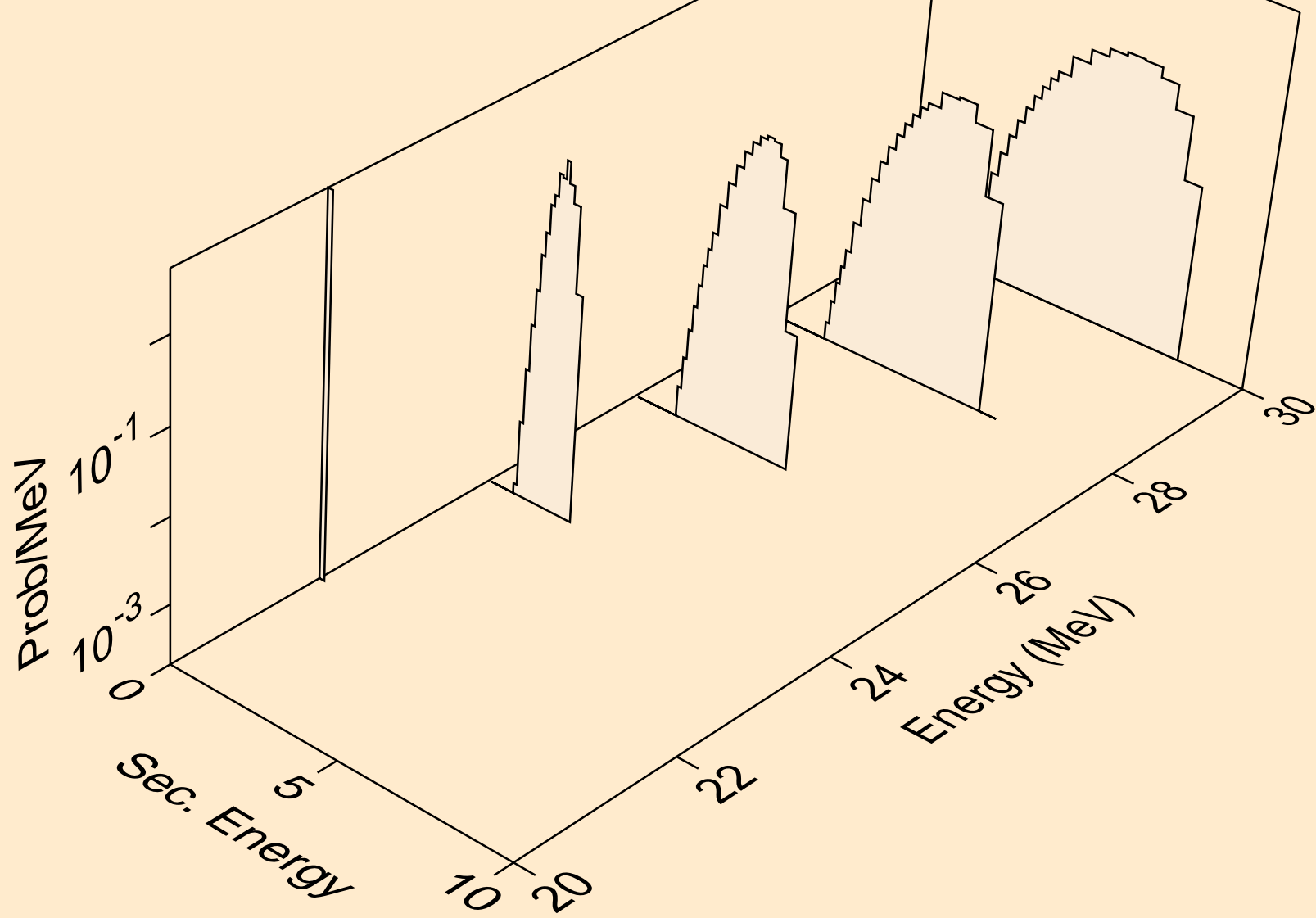

GE082 NEUTRON ACER TENDL-2021 LIBRARY; T=293.6K  
protons from (n,3np)

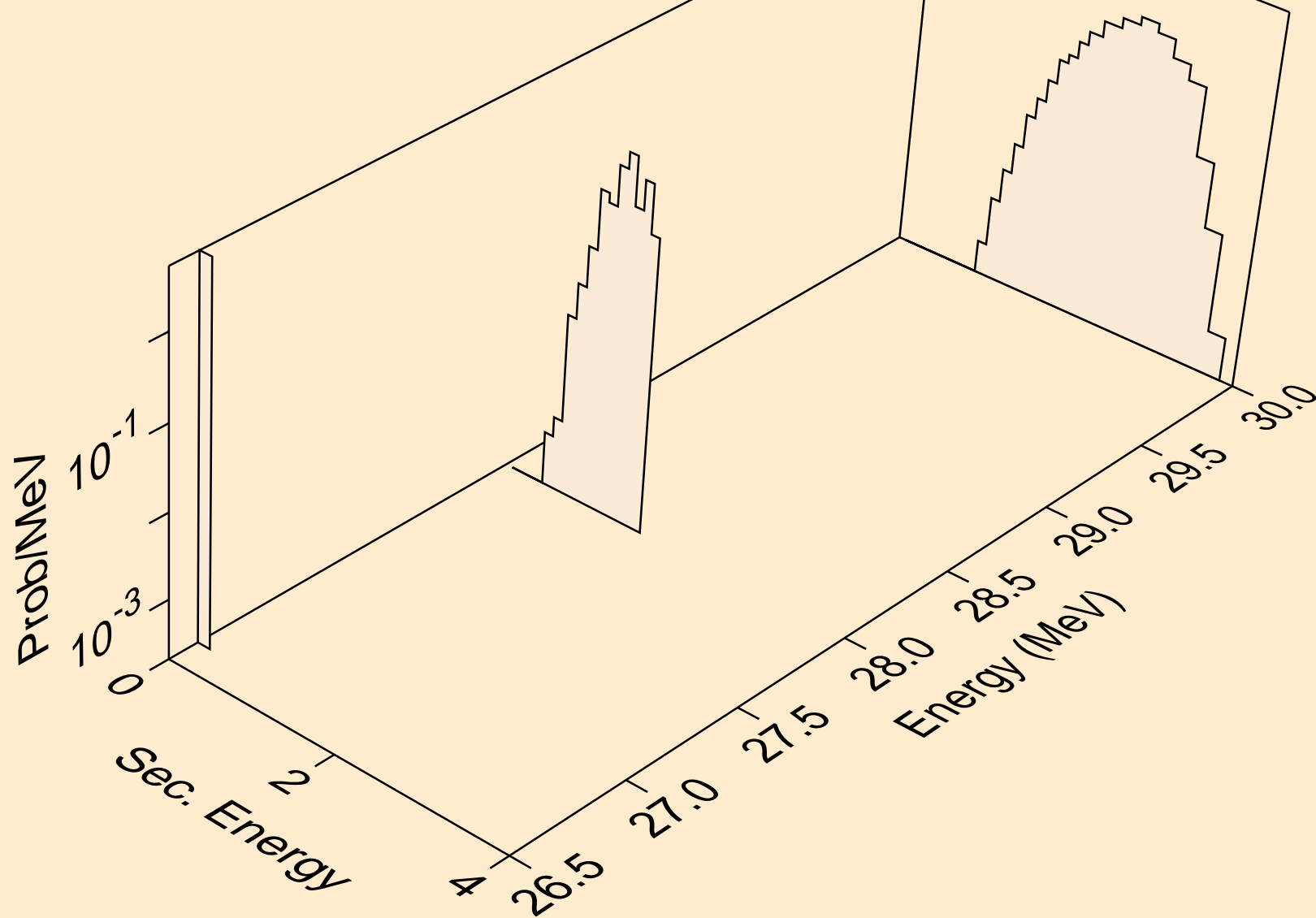

GE082 NEUTRON ACER TENDL-2021 LIBRARY; T=293.6K  
protons from (n,p)

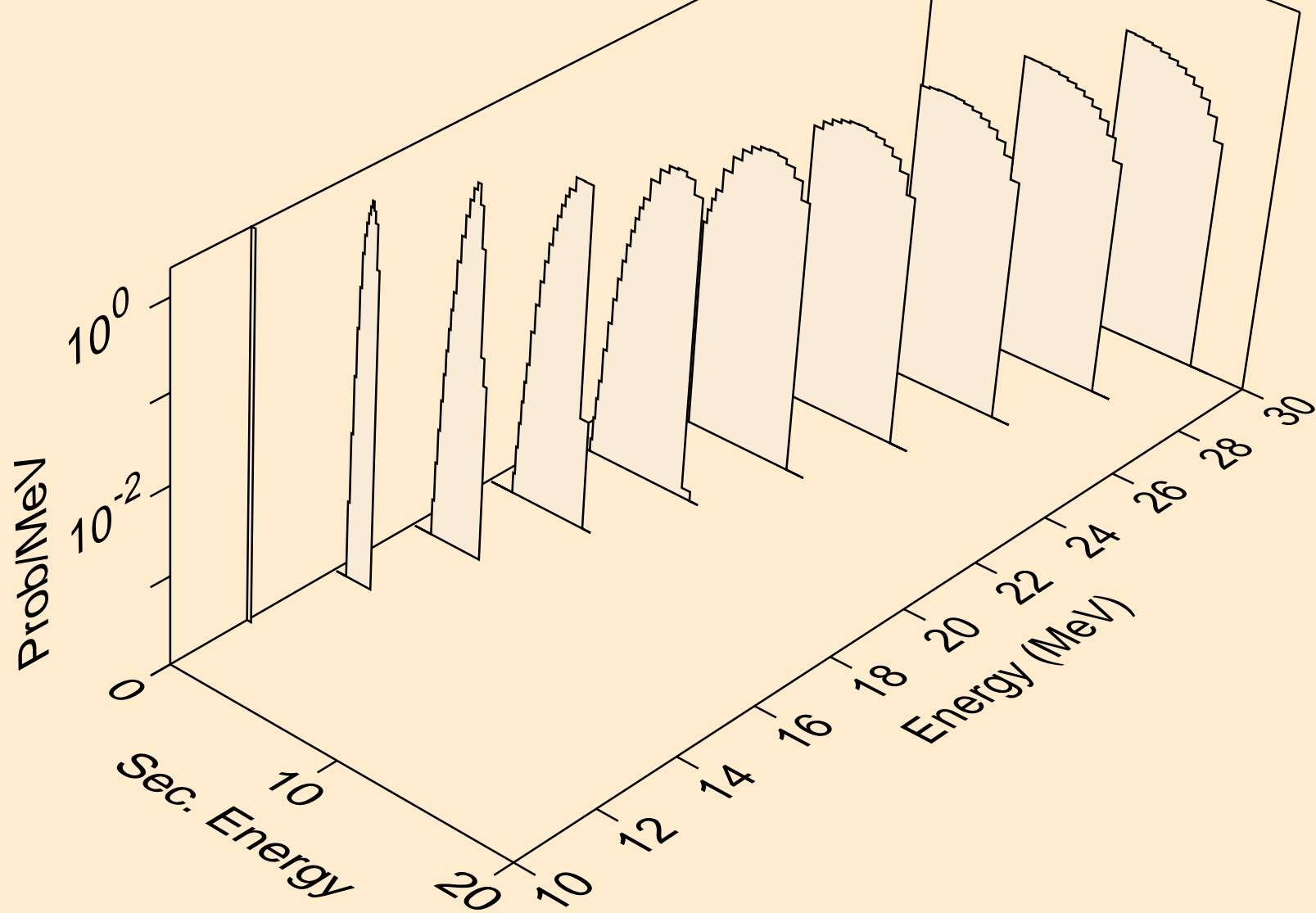

GE082 NEUTRON ACER TENDL-2021 LIBRARY; T=293.6K  
deuterons from (n,x)

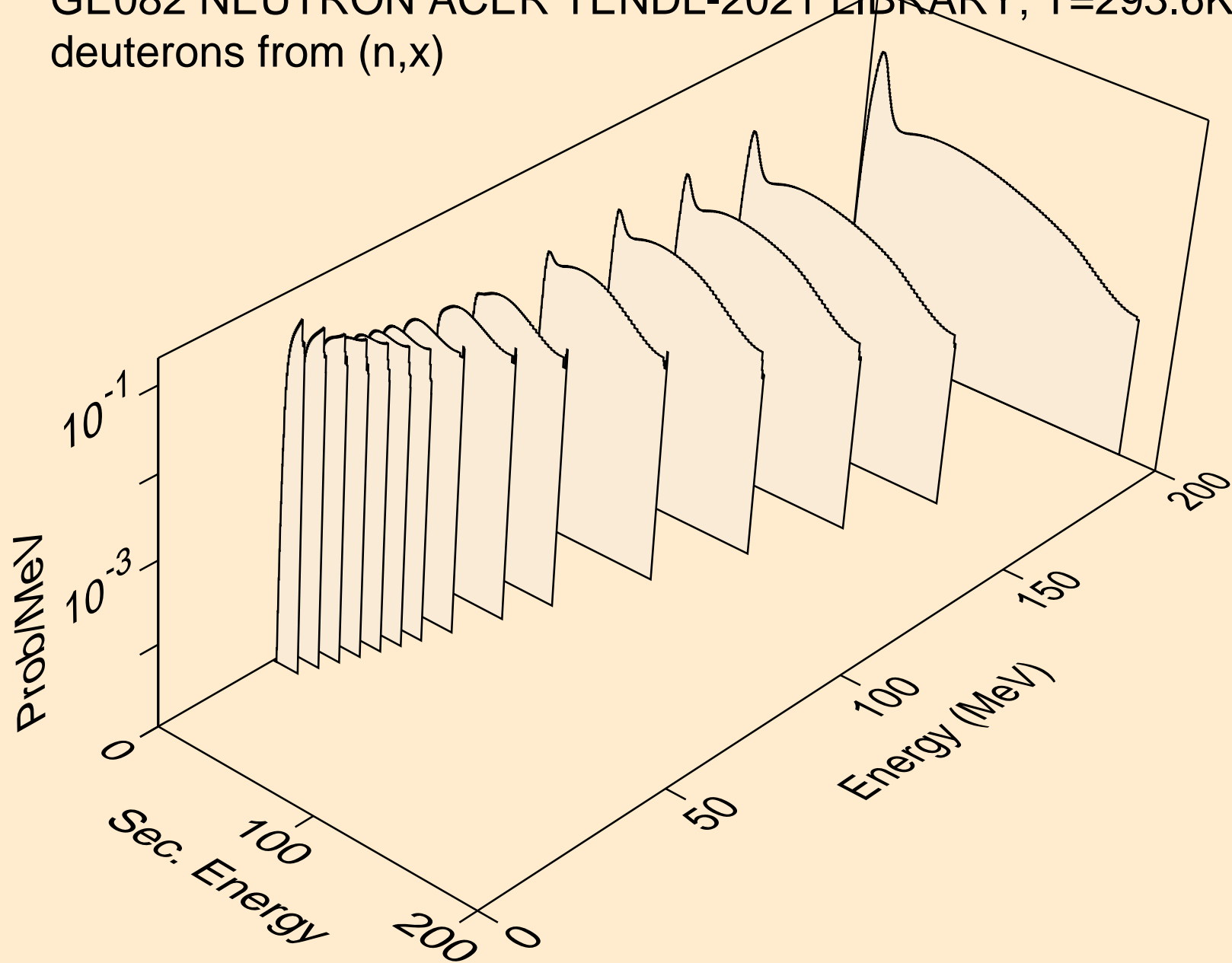

GE082 NEUTRON ACER TENDL-2021 LIBRARY; T=293.6K  
deuterons from (n,2nd)

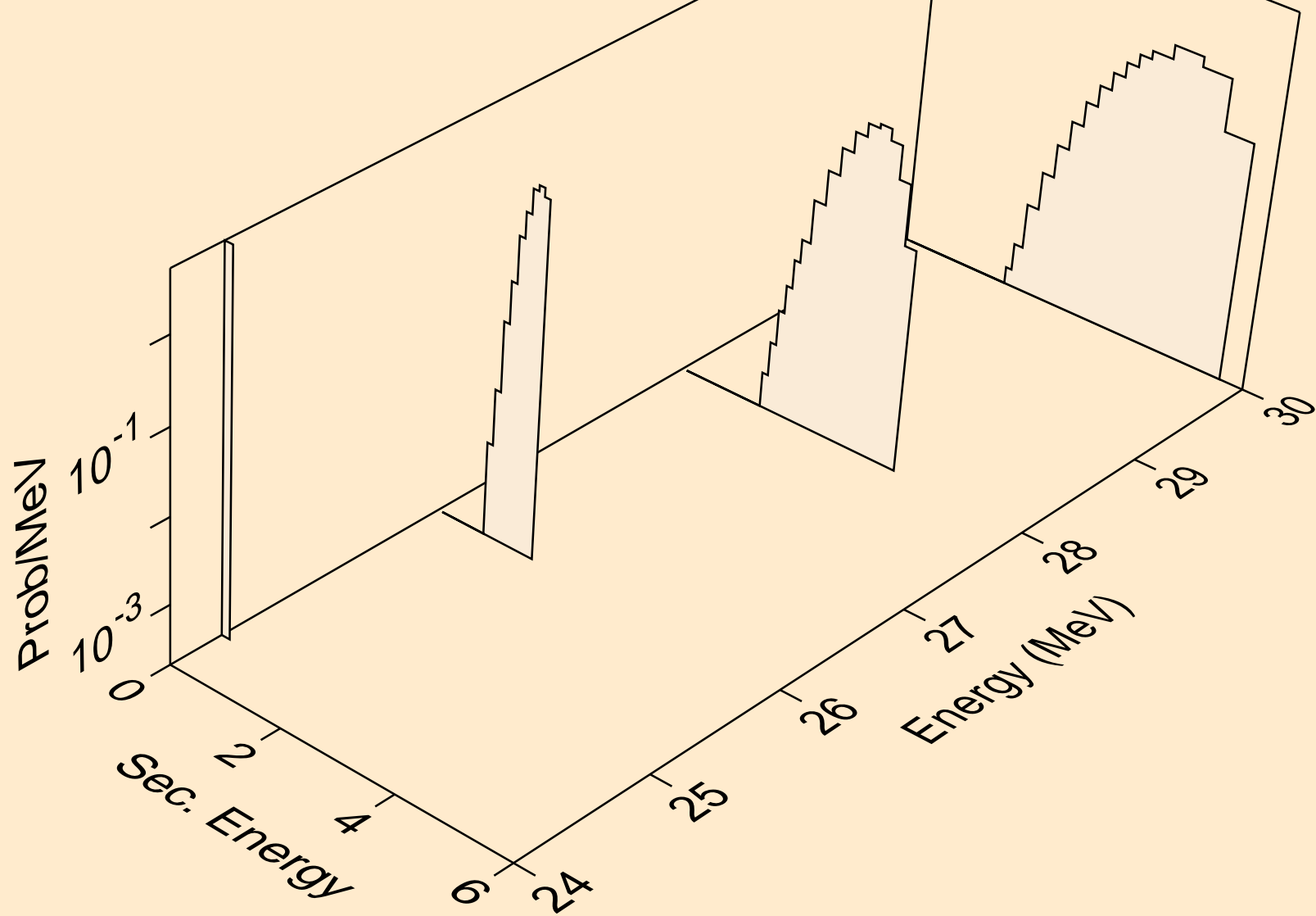



GE082 NEUTRON ACER TENDL-2021 LIBRARY; T=293.6K  
deuterons from (n,n\*)d

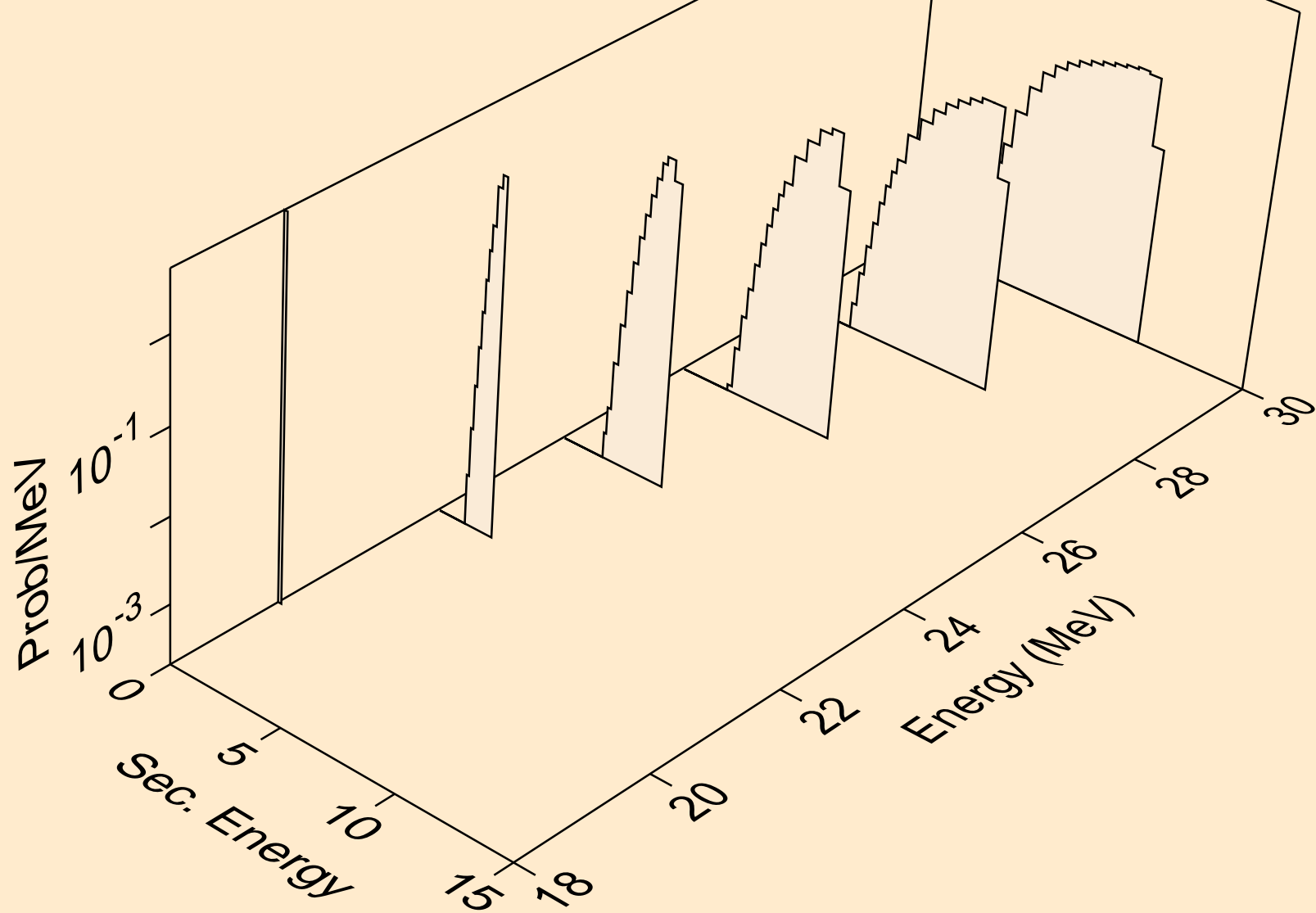

GE082 NEUTRON ACER TENDL-2021 LIBRARY; T=293.6K  
deuterons from (n,d)

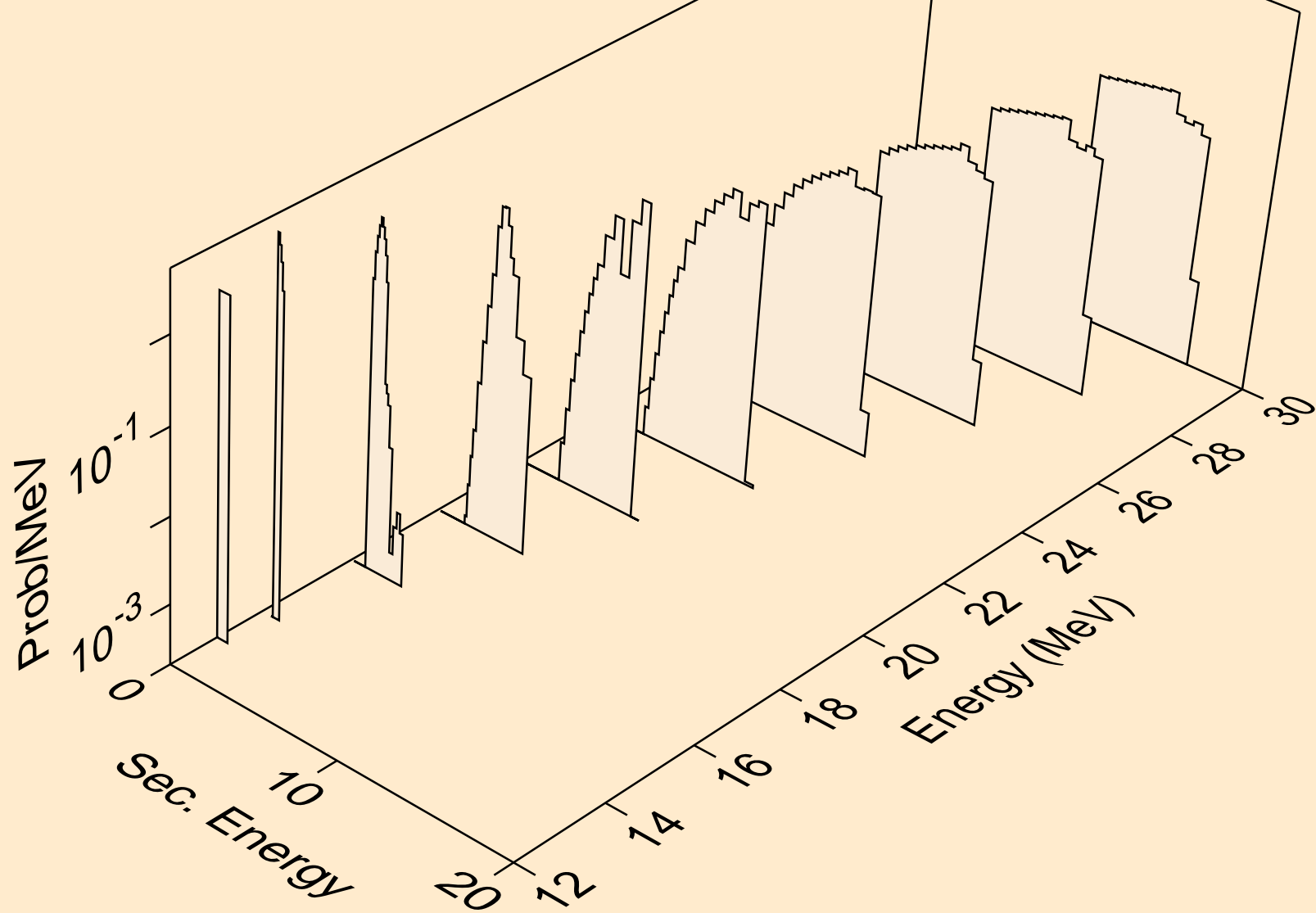

GE082 NEUTRON ACER TENDL-2021 LIBRARY; T=293.6K  
tritons from (n,x)

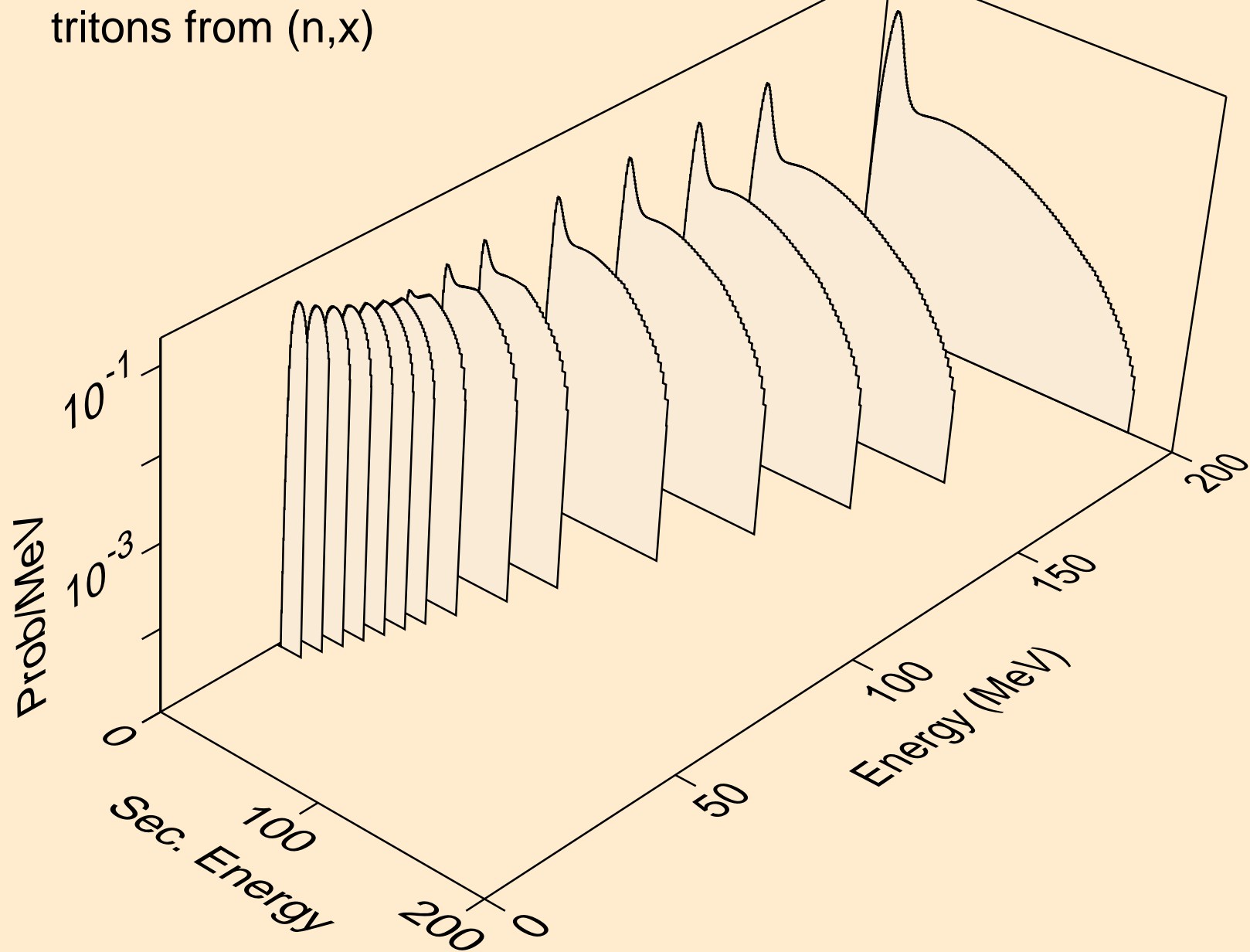

GE082 NEUTRON ACER TENDL-2021 LIBRARY; T=293.6K  
tritons from (n,n\*)t

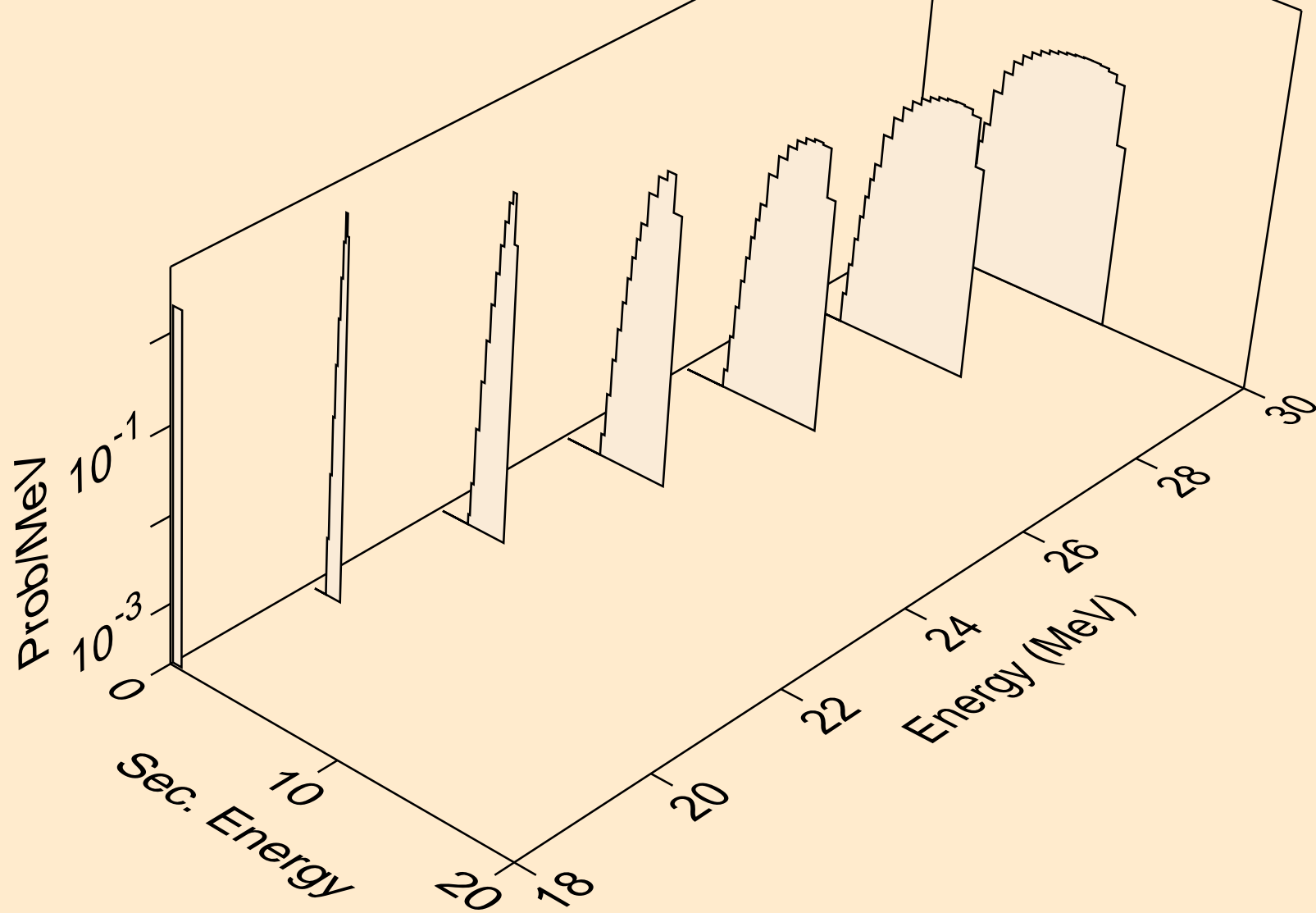

GE082 NEUTRON ACER TENDL-2021 LIBRARY; T=293.6K  
tritons from (n,t)

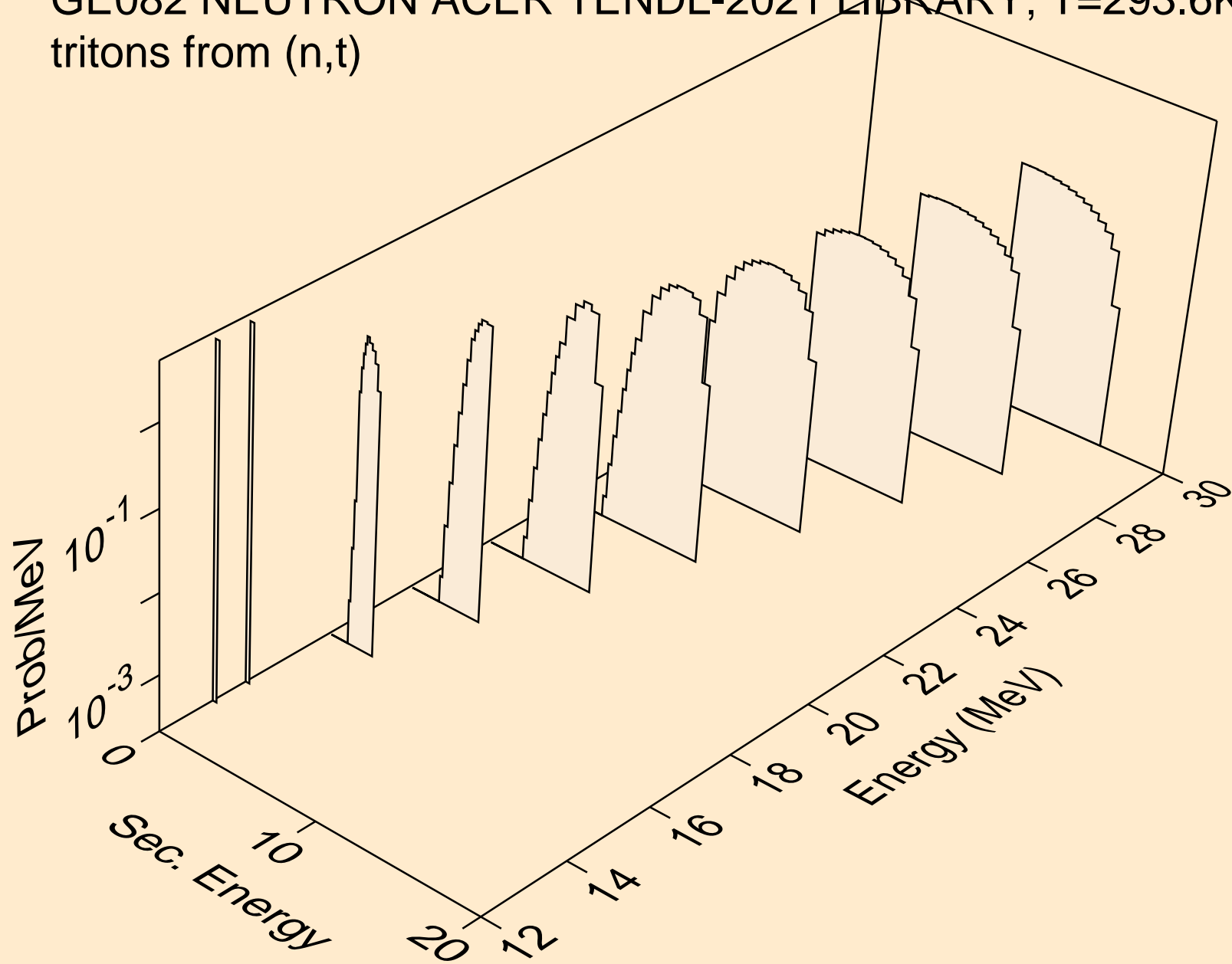

GE082 NEUTRON ACER TENDL-2021 LIBRARY; T=293.6K  
he3s from (n,x)

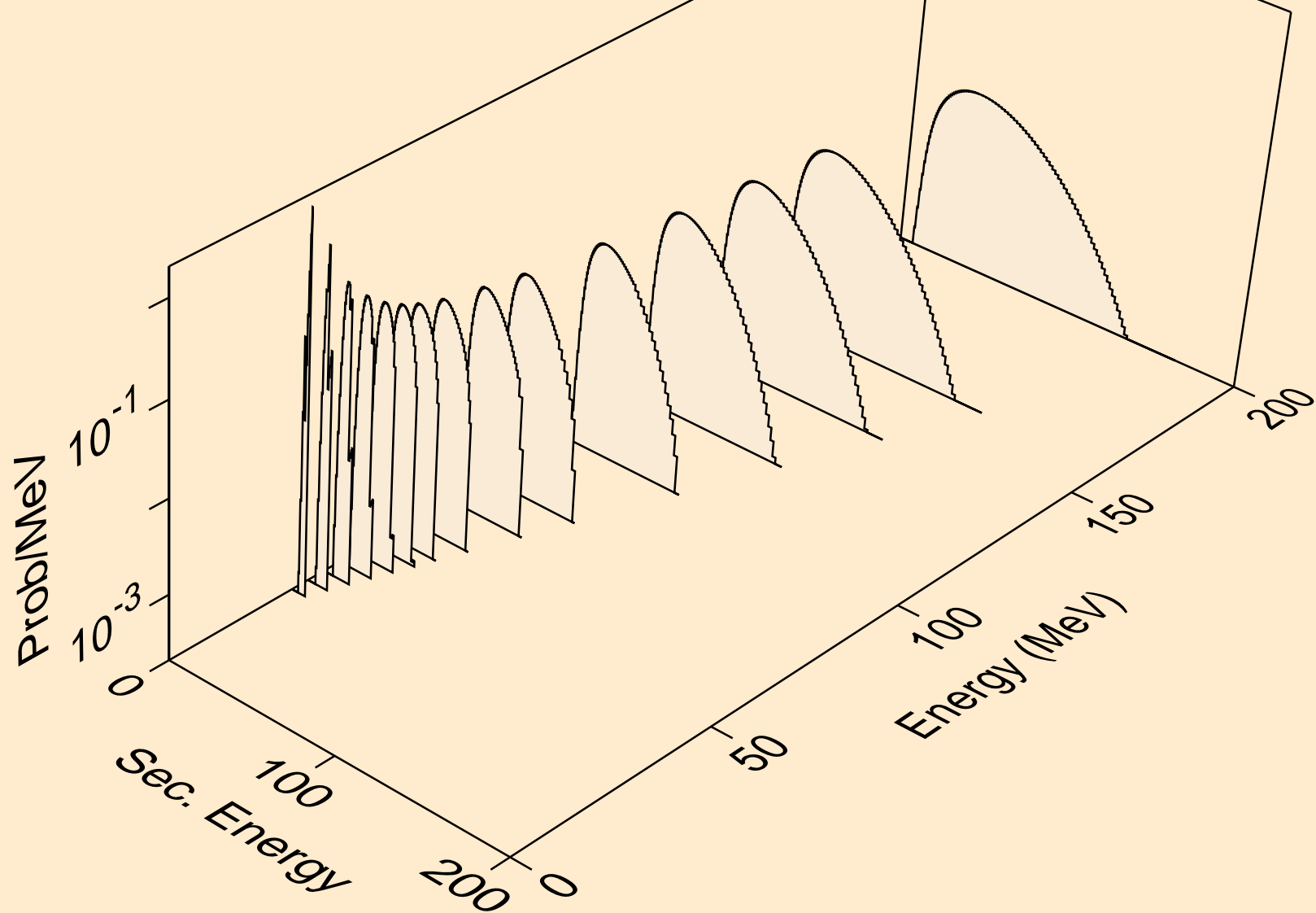

GE082 NEUTRON ACER TENDL-2021 LIBRARY; T=293.6K  
he3s from (n,he3)

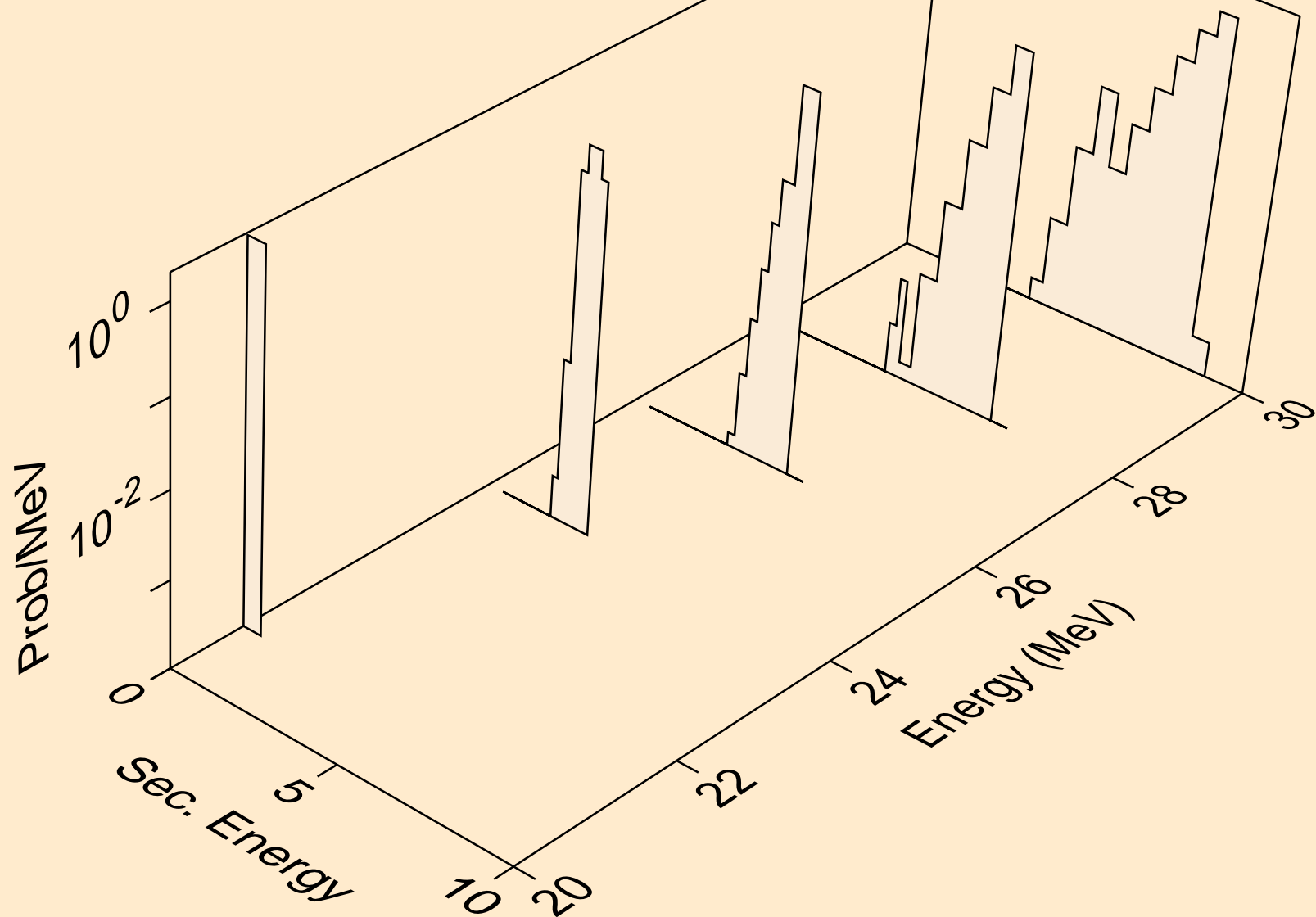

GE082 NEUTRON ACER TENDL-2021 LIBRARY; T=293.6K  
alphas from (n,x)

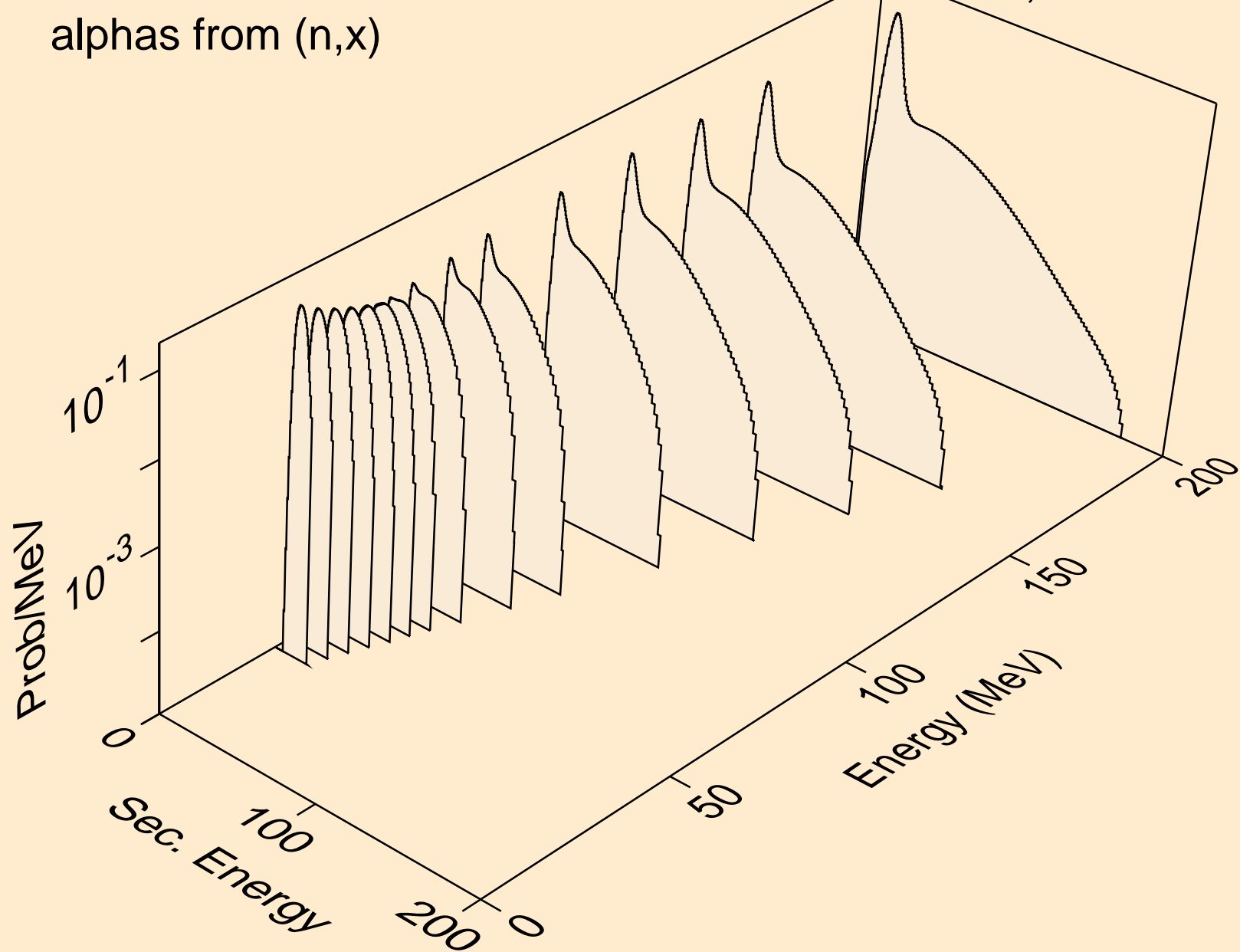



GE082 NEUTRON ACER TENDL-2021 LIBRARY; T=293.6K  
alphas from (n,n\*)a

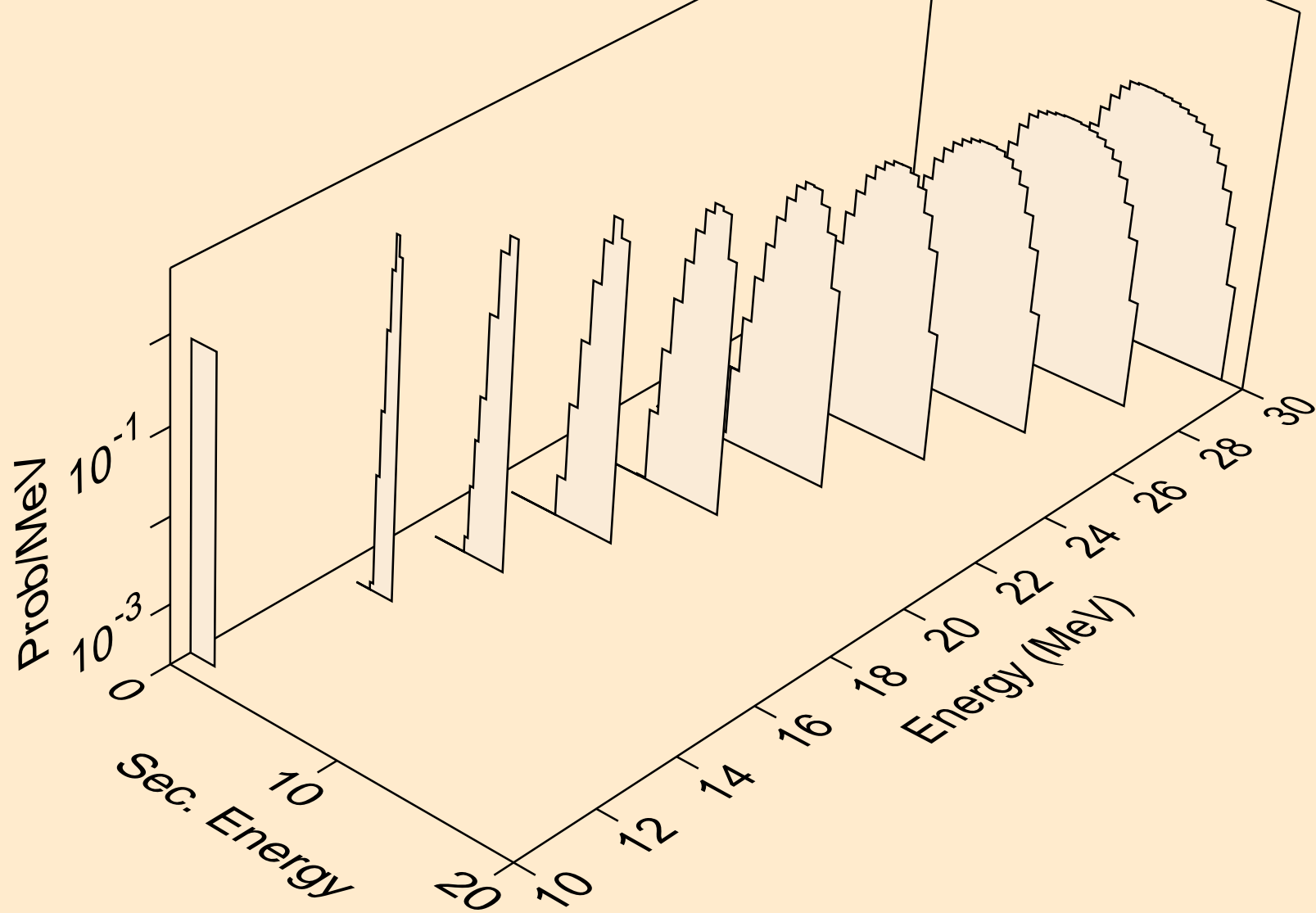

GE082 NEUTRON ACER TENDL-2021 LIBRARY; T=293.6K  
alphas from (n,2n)a

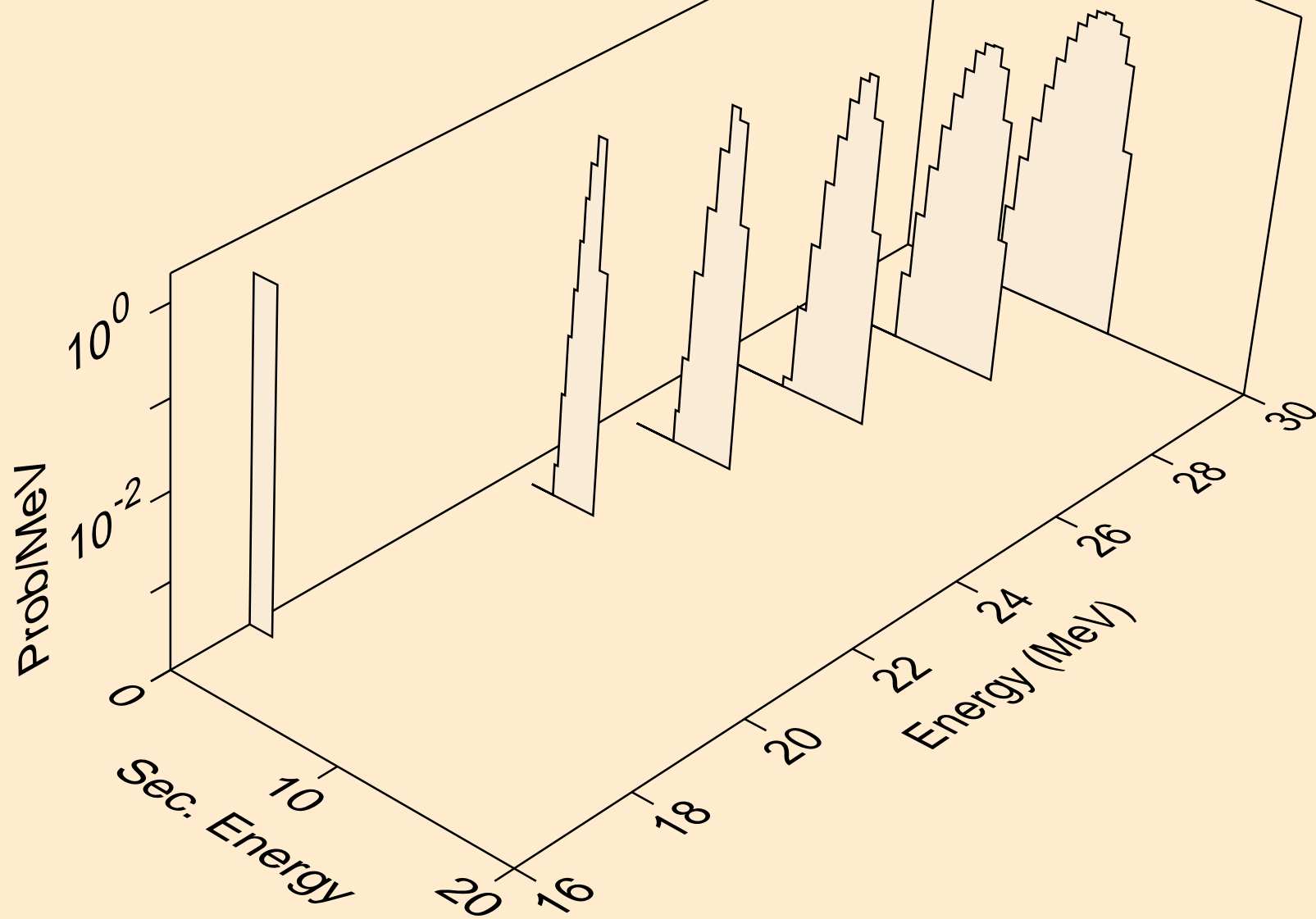

GE082 NEUTRON ACER TENDL-2021 LIBRARY; T=293.6K  
alphas from (n,3n)a

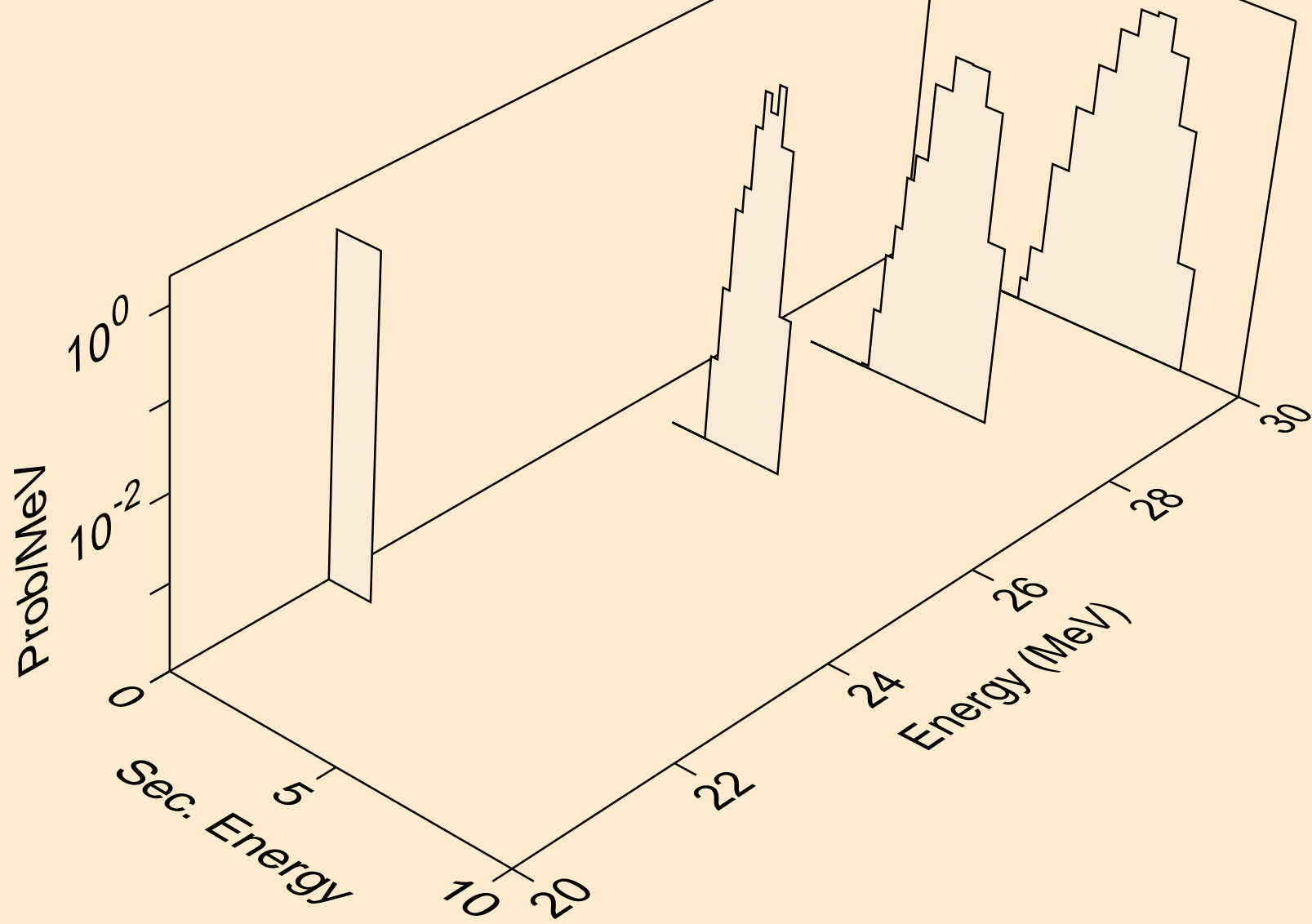

GE082 NEUTRON ACER TENDL-2021 LIBRARY; T=293.6K  
alphas from (n,a)

