

GE083 NEUTRON ACER TENDL-2021 LIBRARY; T=293.6K

Principal cross sections

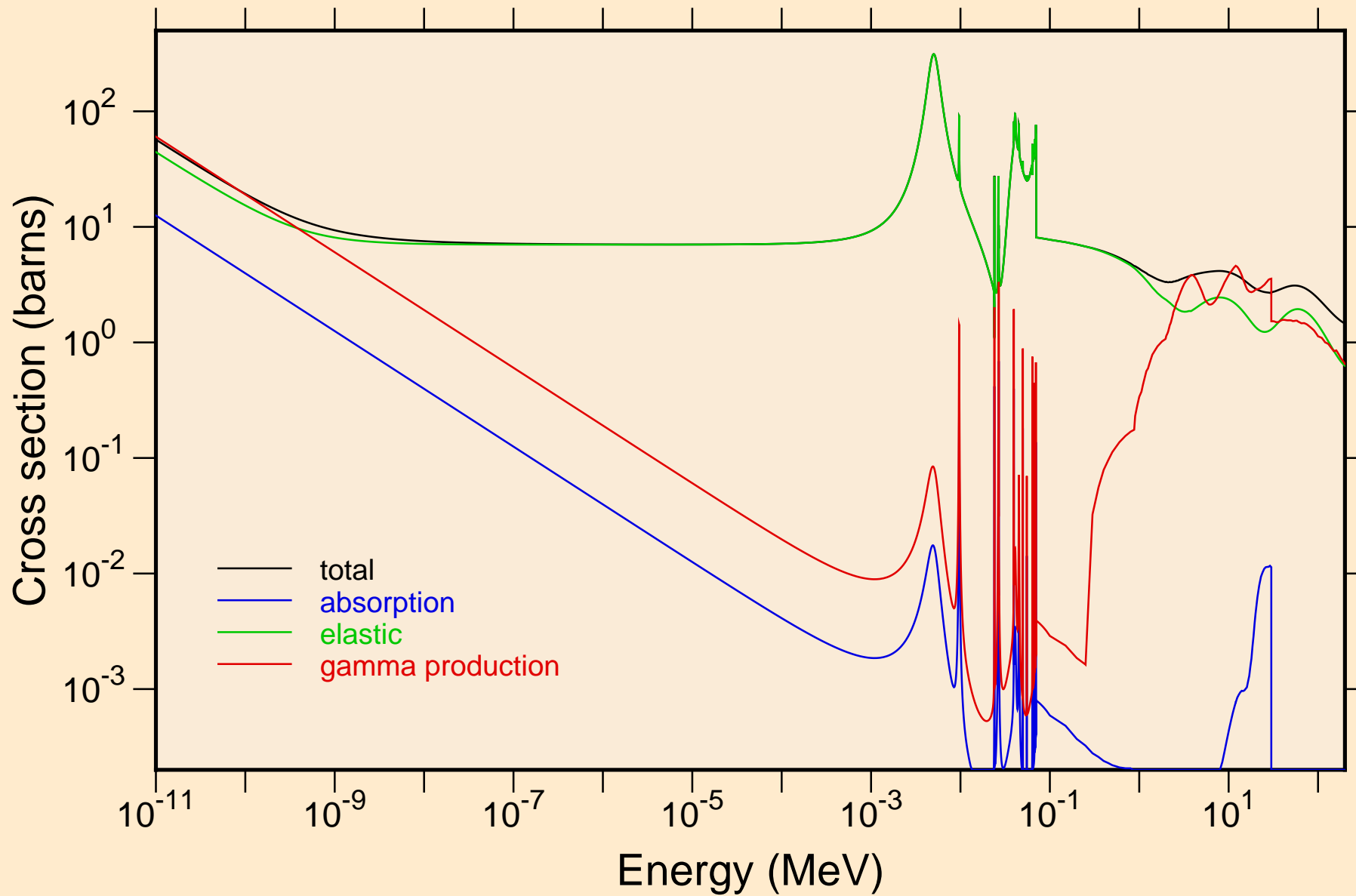

GE083 NEUTRON ACER TENDL-2021 LIBRARY; T=293.6K
resonance total cross section

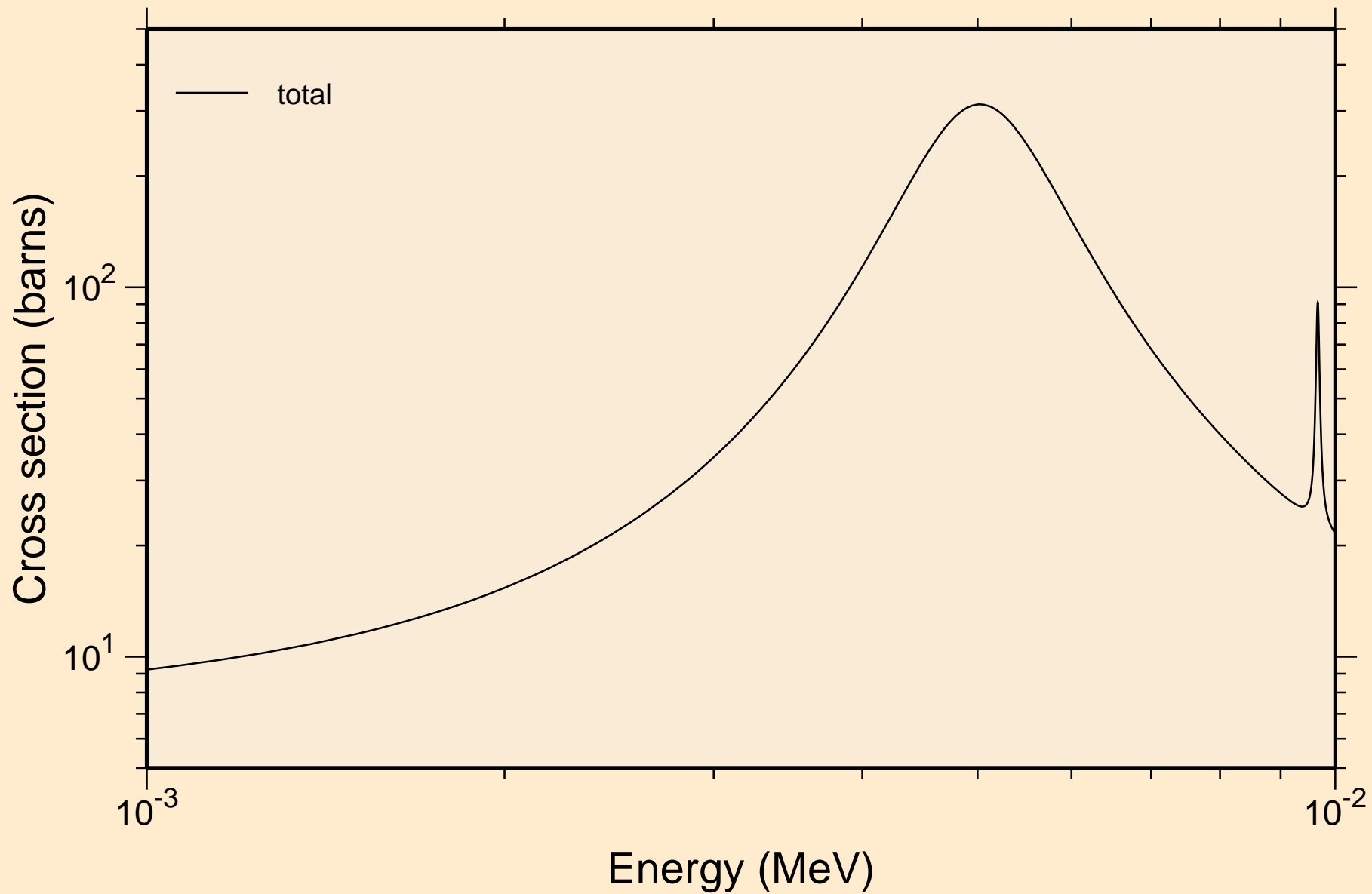

GE083 NEUTRON ACER TENDL-2021 LIBRARY; T=293.6K
resonance total cross section

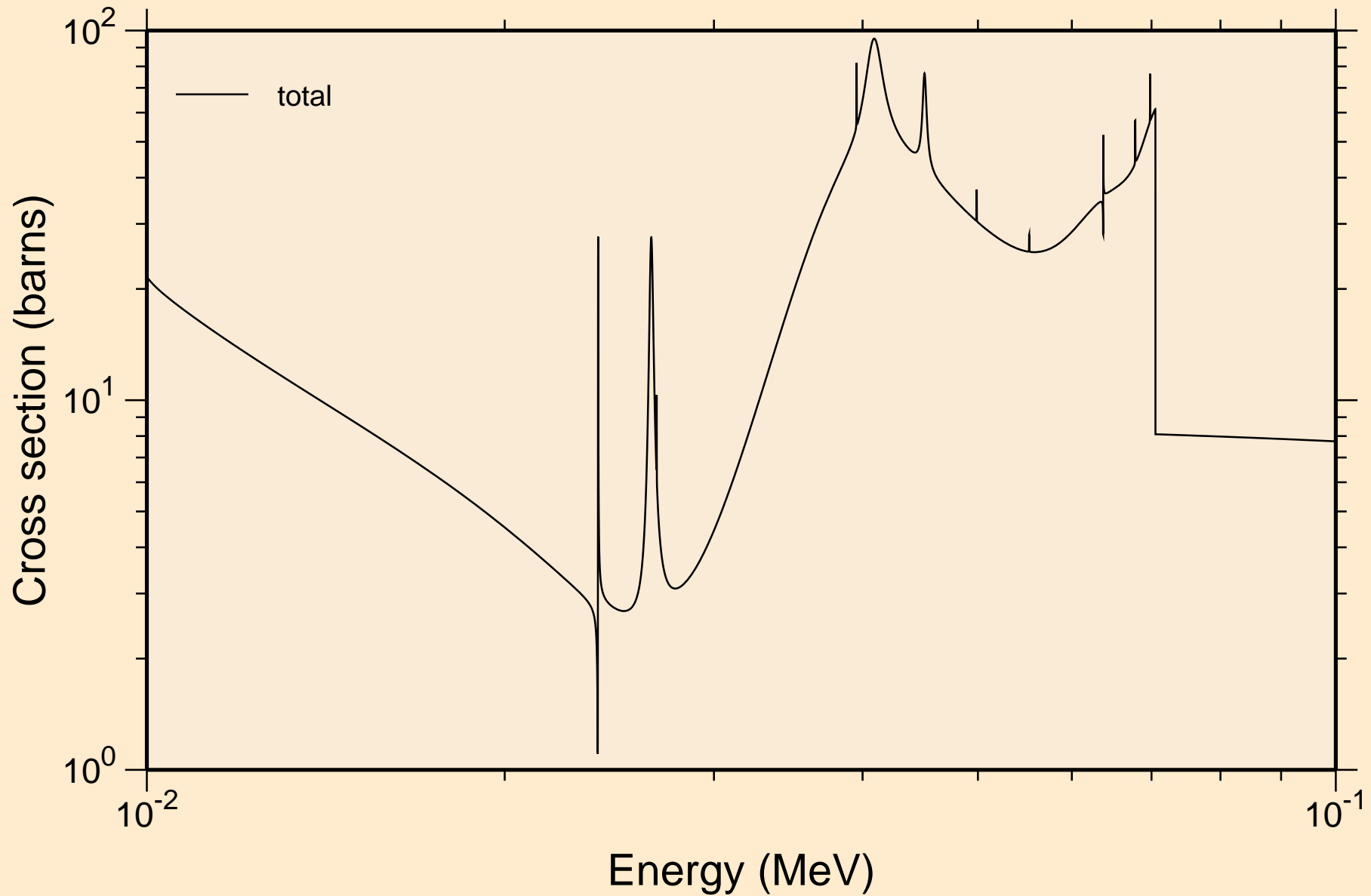

GÉ083 NEUTRON ACER TENDL-2021 LIBRARY; T=293.6K
resonance total cross section

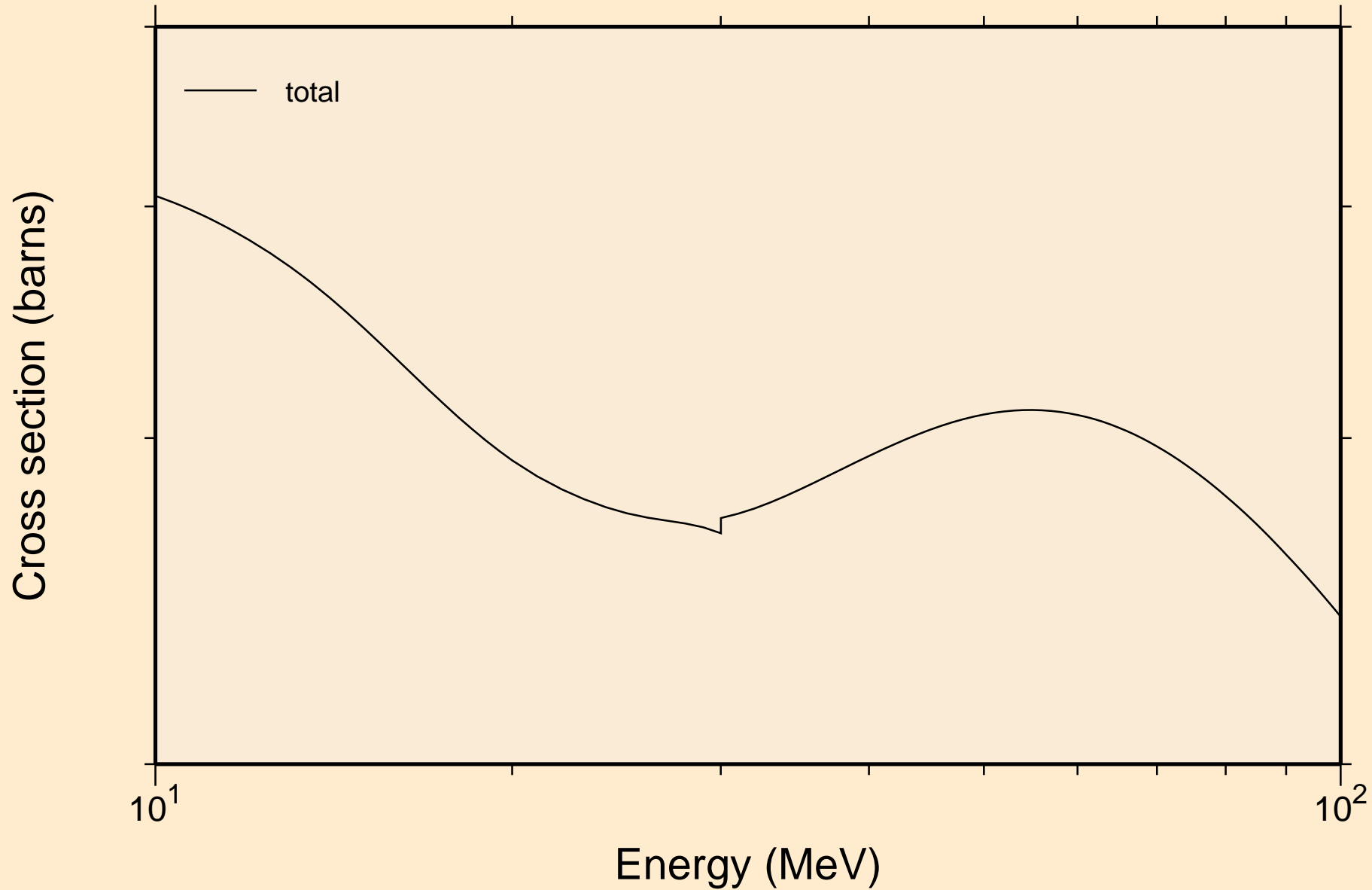

GE083 NEUTRON ACER TENDL-2021 LIBRARY; T=293.6K
resonance absorption cross sections

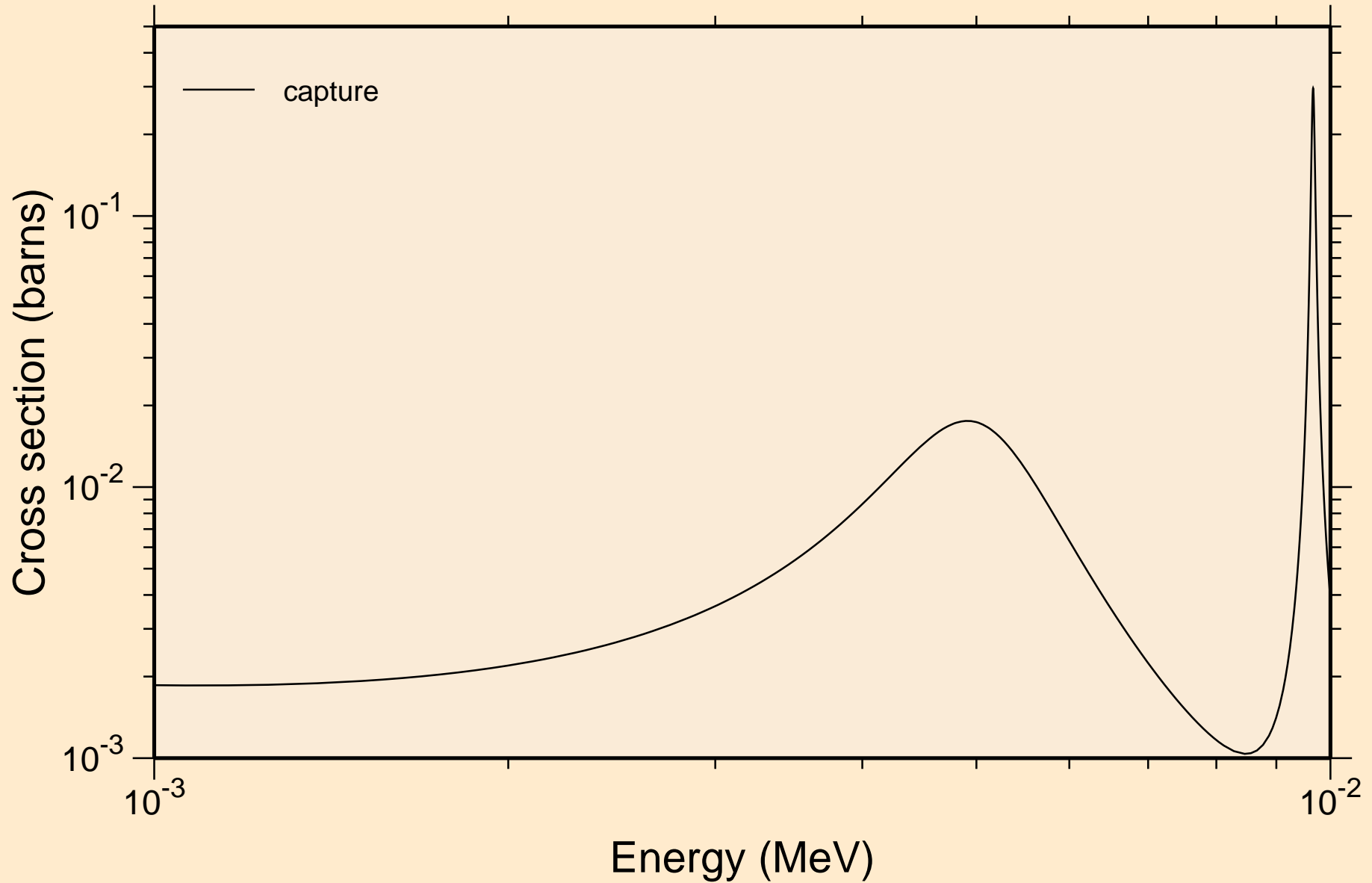

GE083 NEUTRON ACER TENDL-2021 LIBRARY; T=293.6K
resonance absorption cross sections

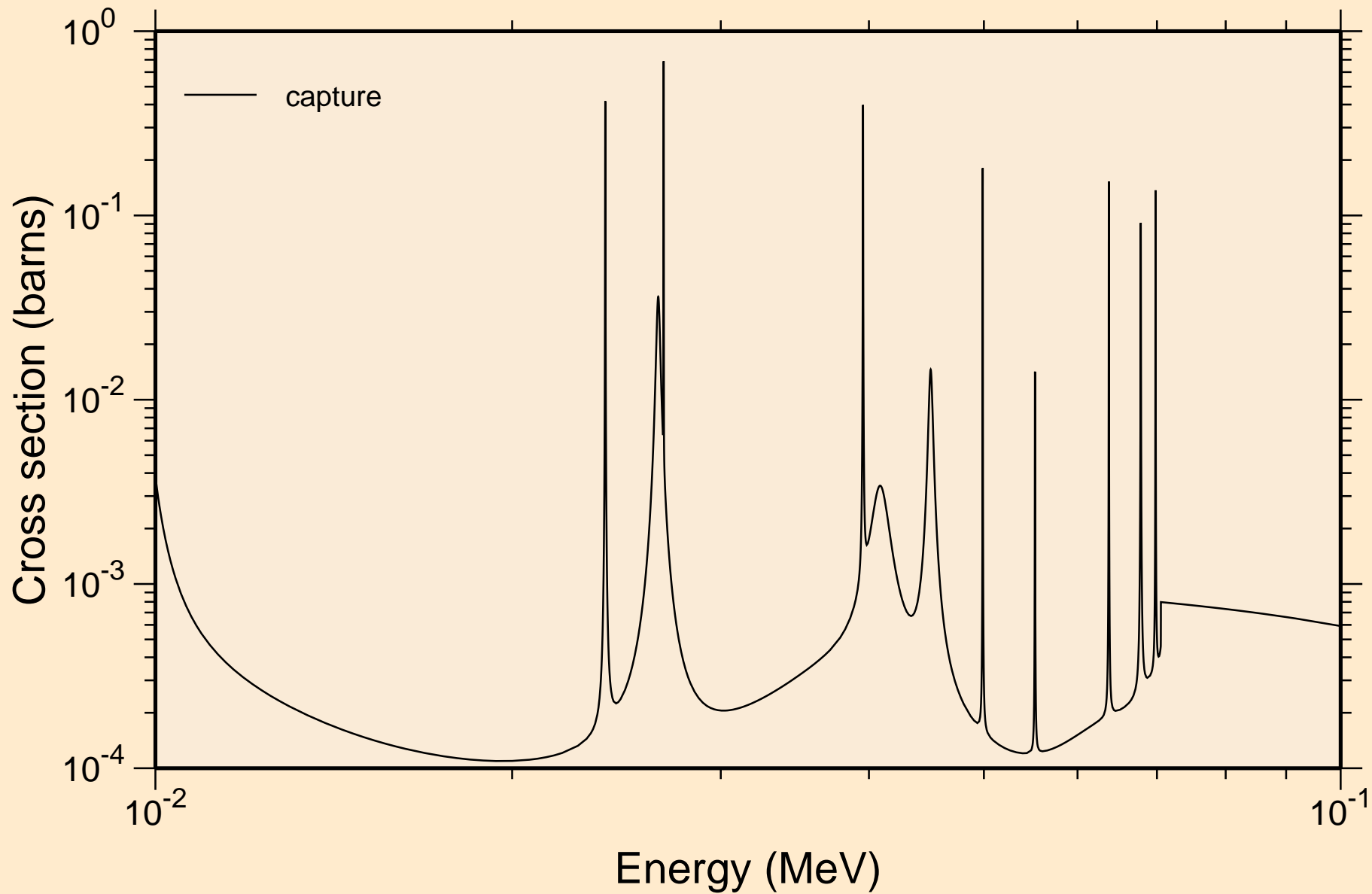

GE083 NEUTRON ACER TENDL-2021 LIBRARY; T=293.6K
resonance absorption cross sections

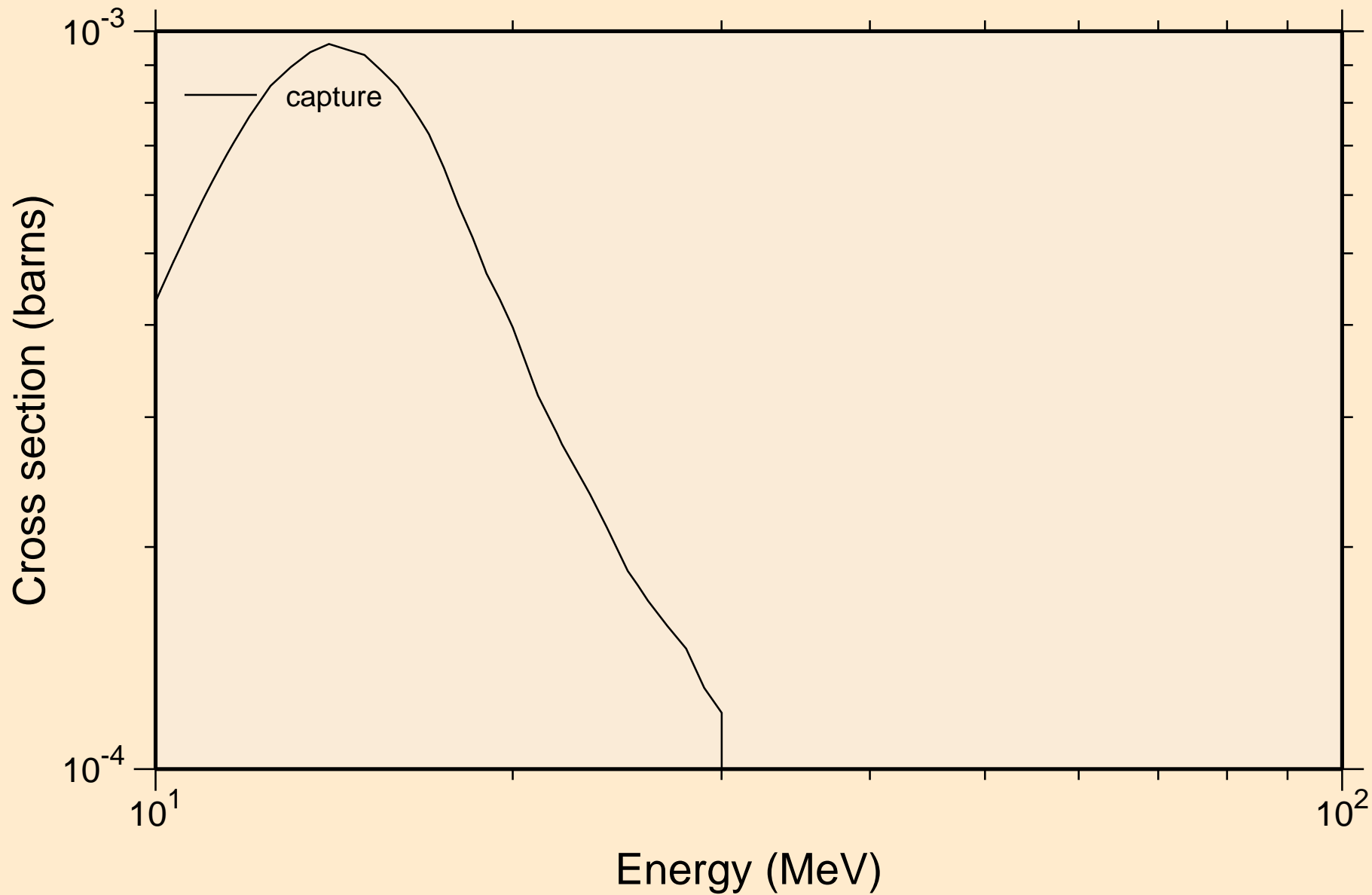

GE083 NEUTRON ACER TENDL-2021 LIBRARY; T=293.6K
Heating

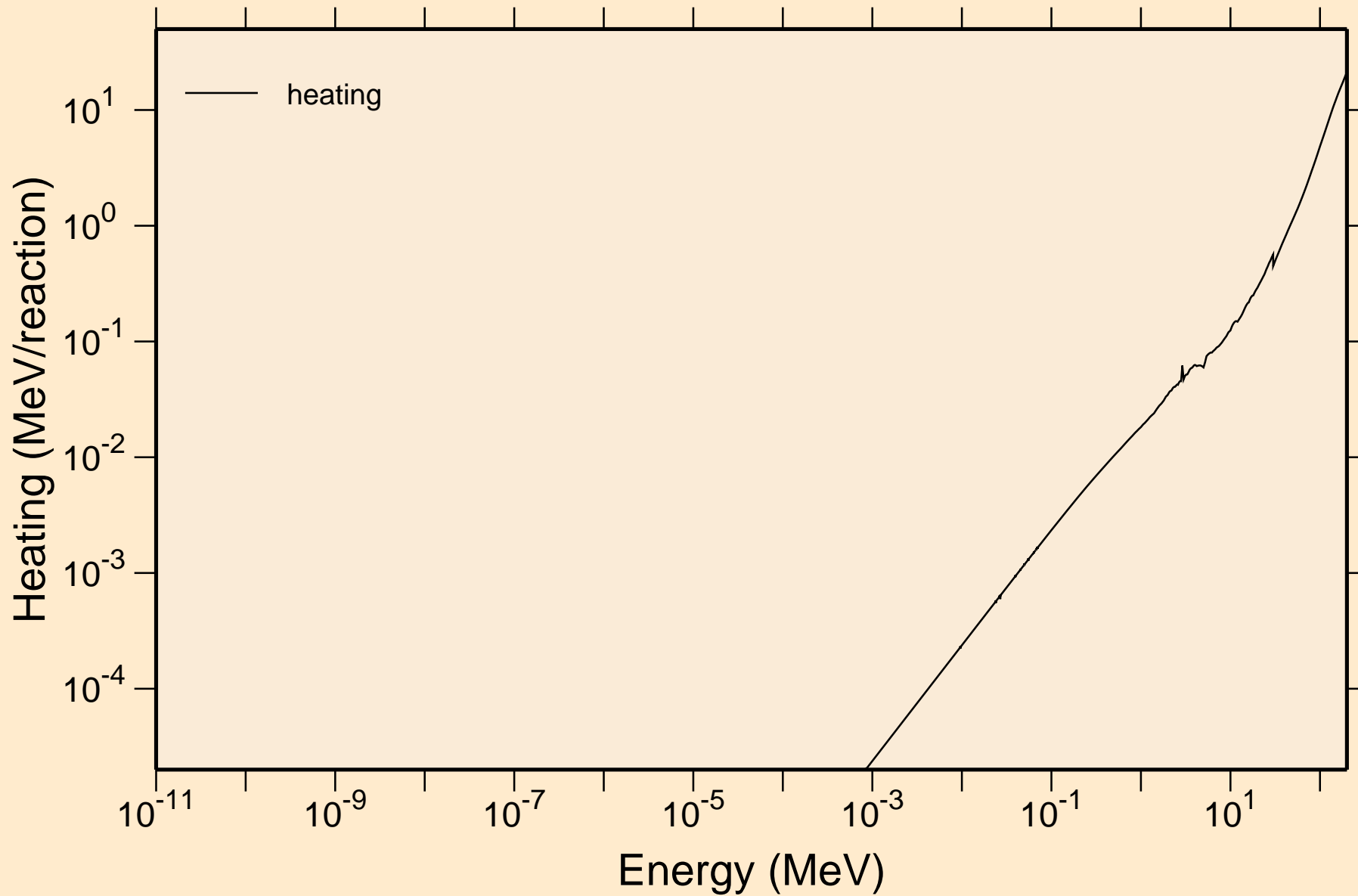

GE083 NEUTRON ACER TENDL-2021 LIBRARY; T=293.6K
Damage

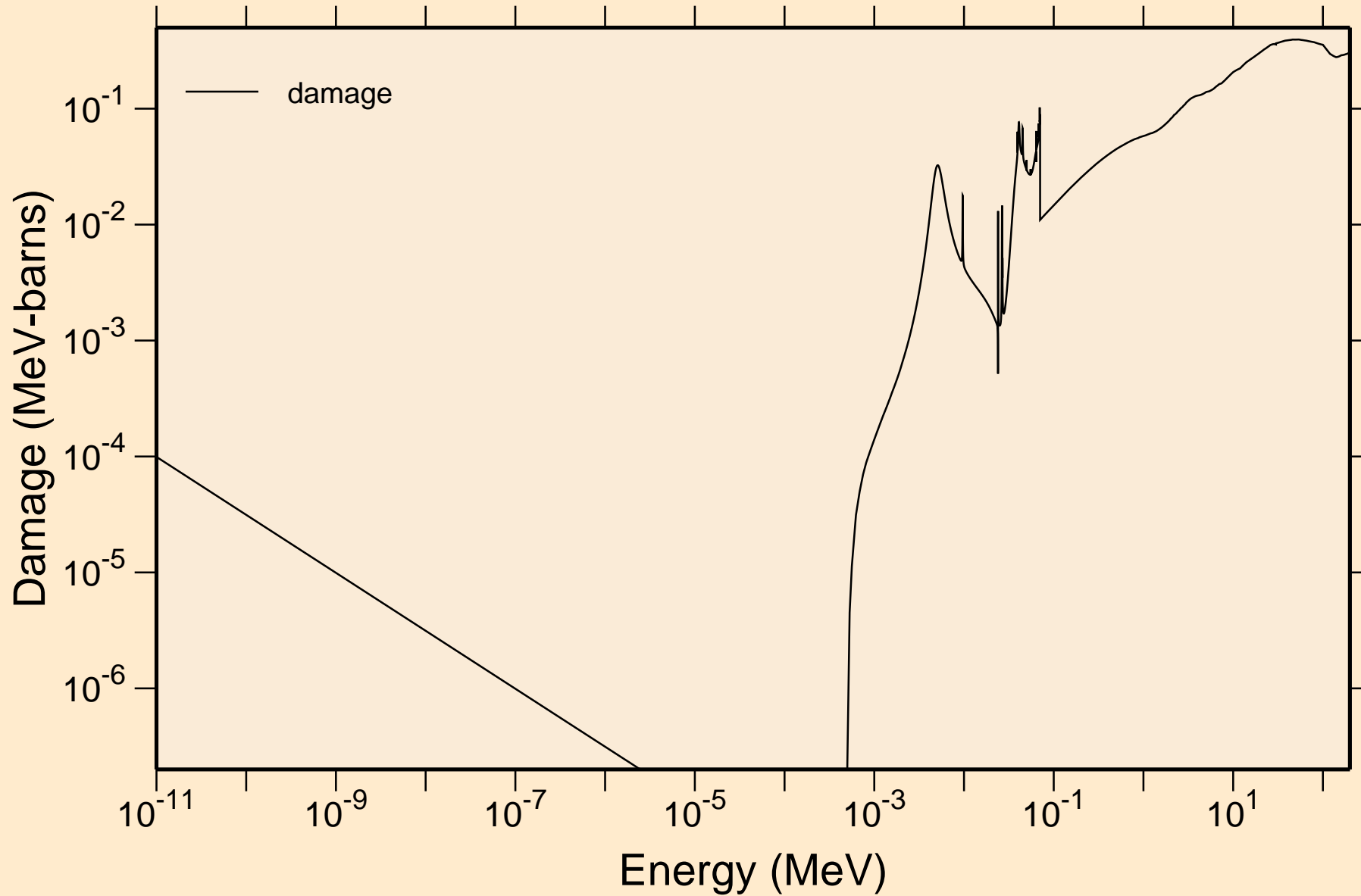

GE083 NEUTRON ACER TENDL-2021 LIBRARY; T=293.6K
Non-threshold reactions

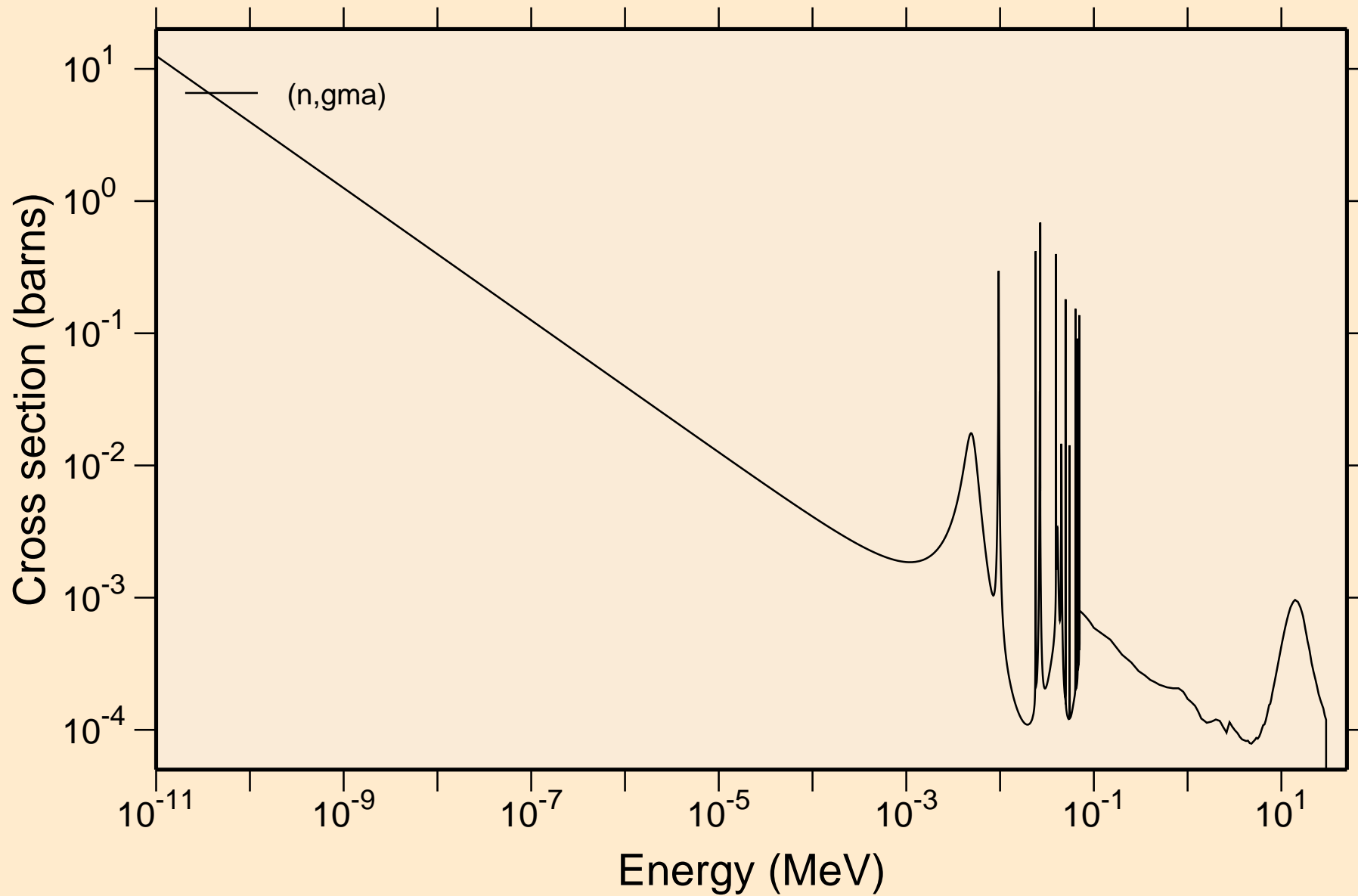

GE083 NEUTRON ACER TENDL-2021 LIBRARY; T=293.6K

Principal cross sections

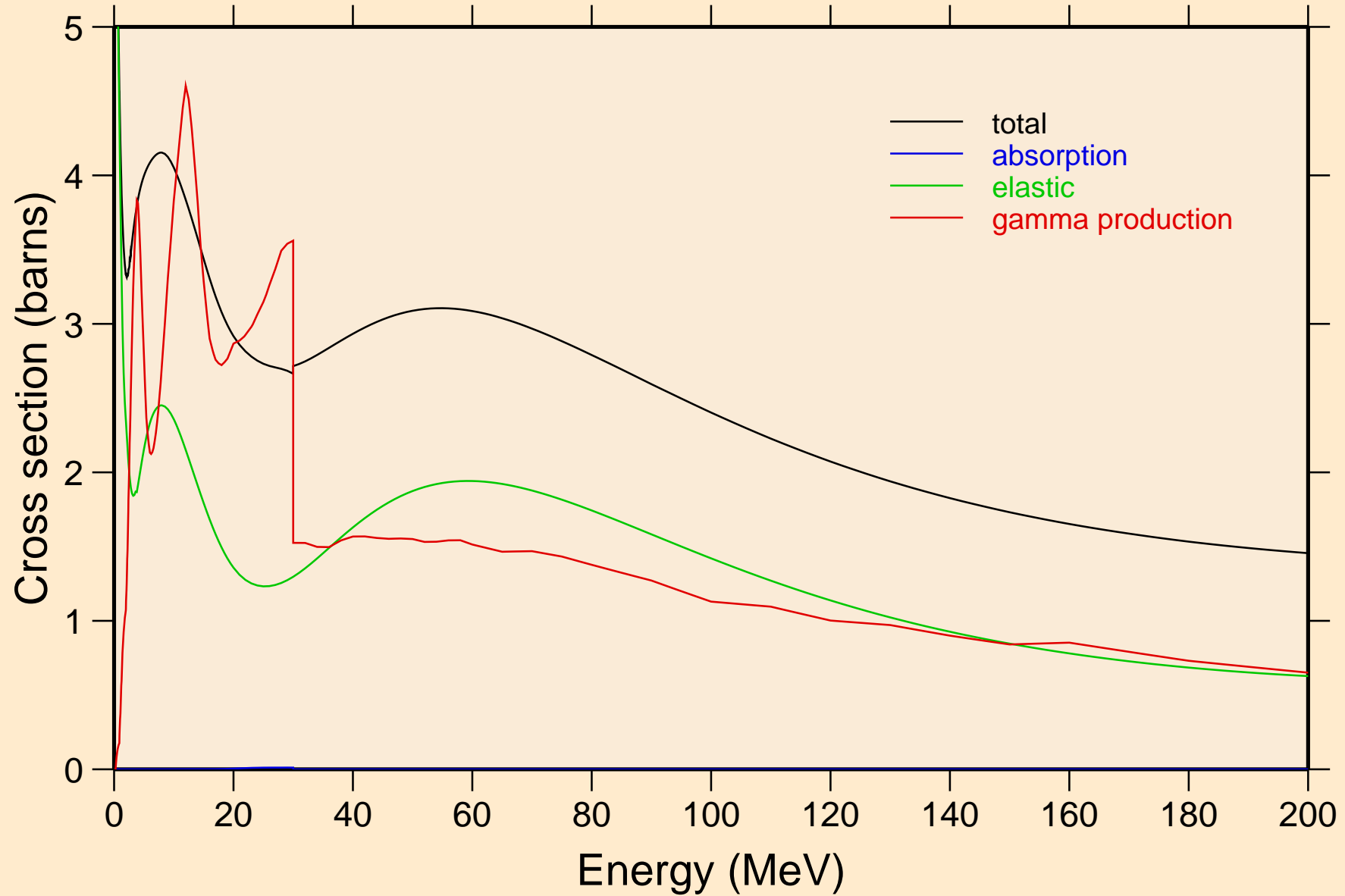

GE083 NEUTRON ACER TENDL-2021 LIBRARY; T=293.6K
Heating

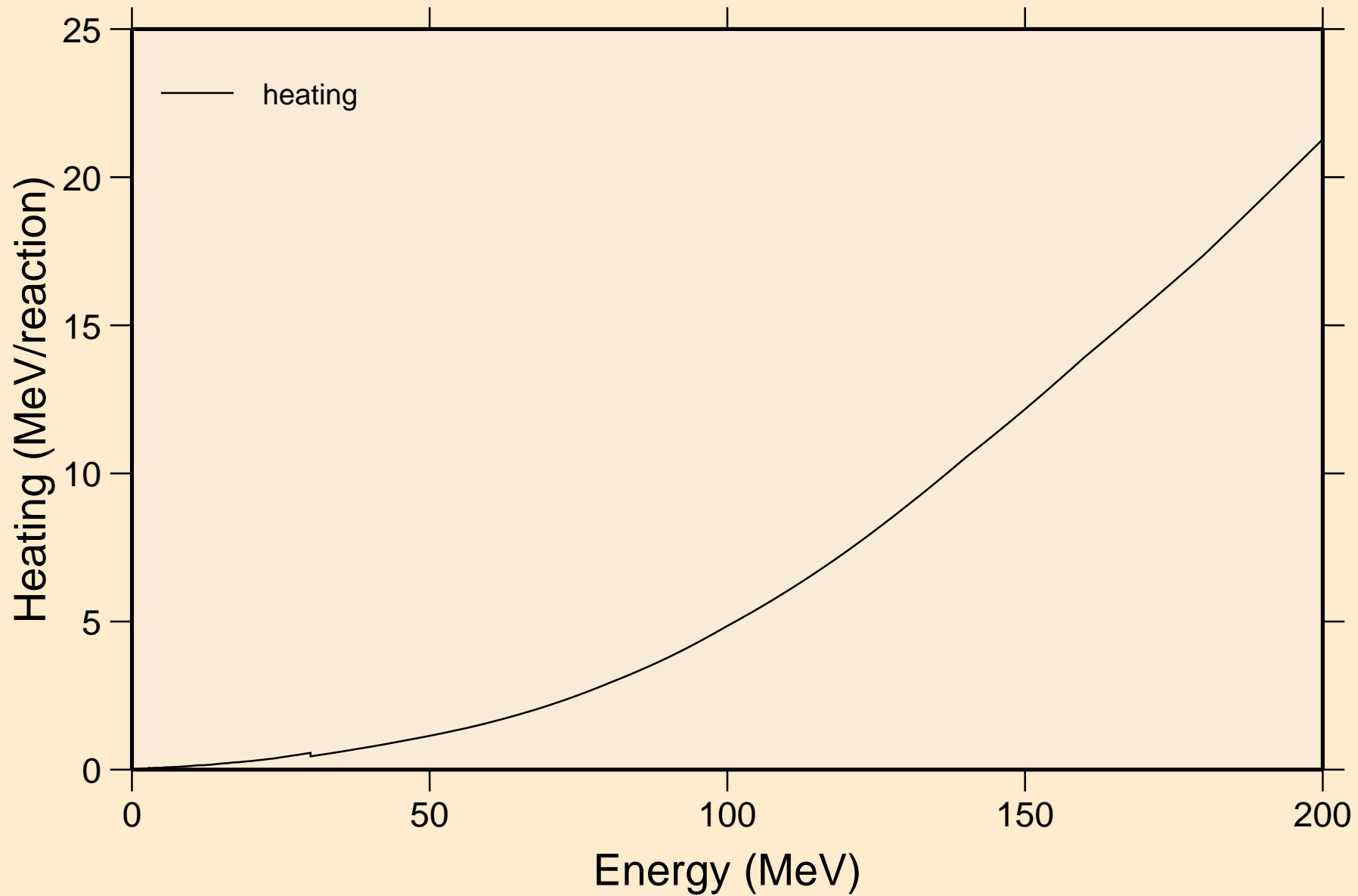

GE083 NEUTRON ACER TENDL-2021 LIBRARY; T=293.6K
Damage

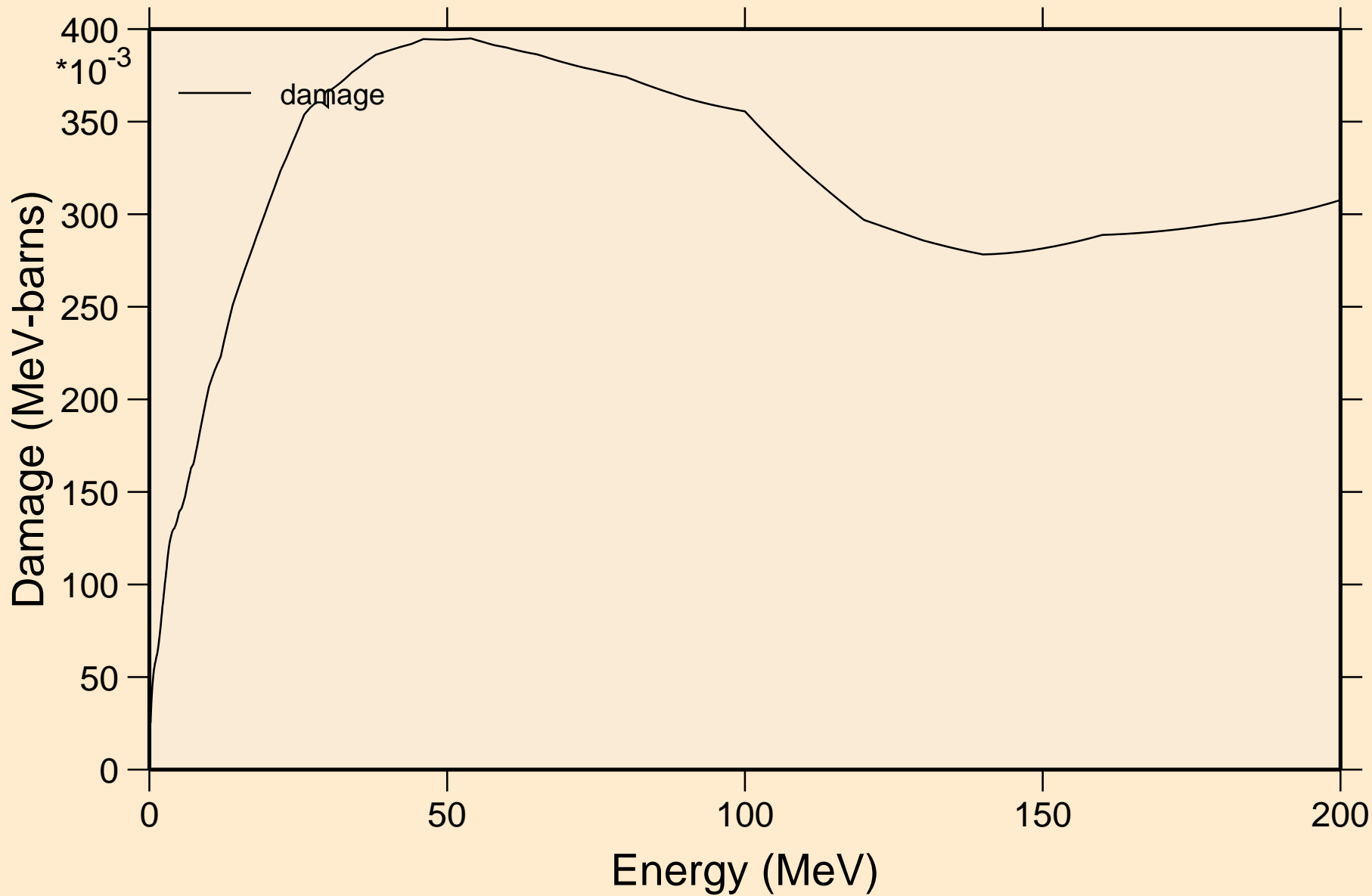

GE083 NEUTRON ACER TENDL-2021 LIBRARY; T=293.6K
Non-threshold reactions

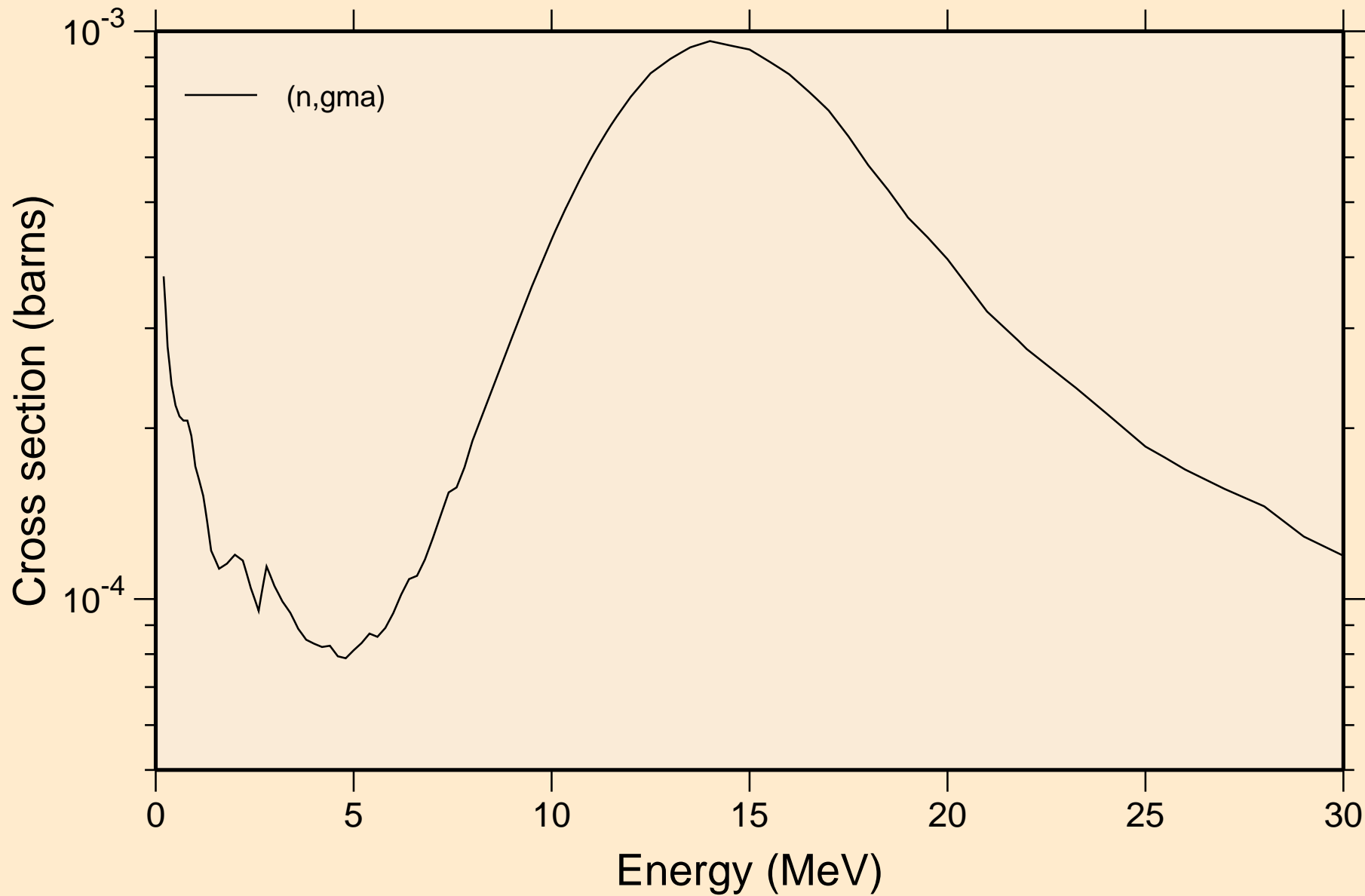

GE083 NEUTRON ACER TENDL-2021 LIBRARY; T=293.6K
Inelastic levels

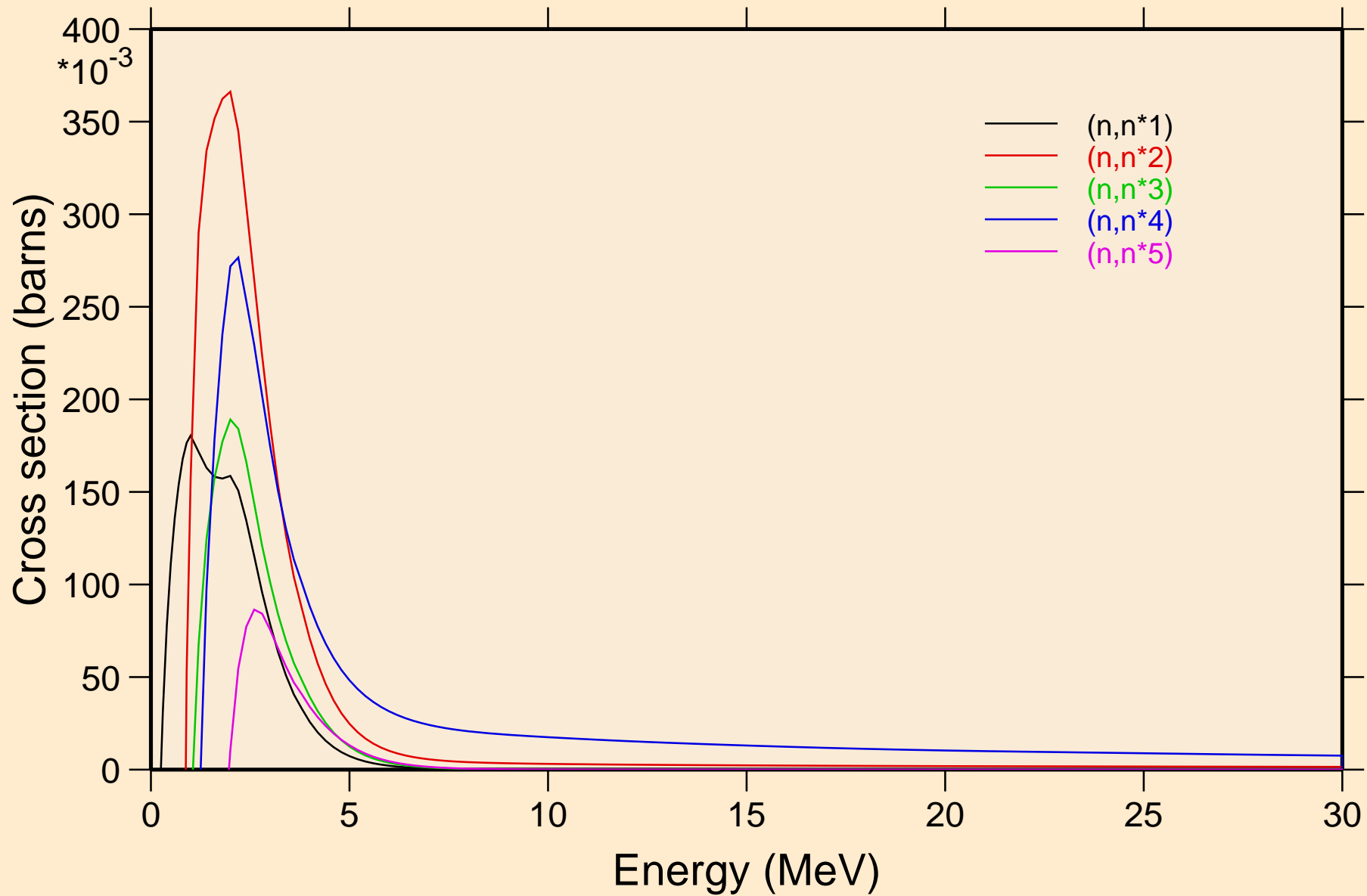

GE083 NEUTRON ACER TENDL-2021 LIBRARY; T=293.6K
Inelastic levels

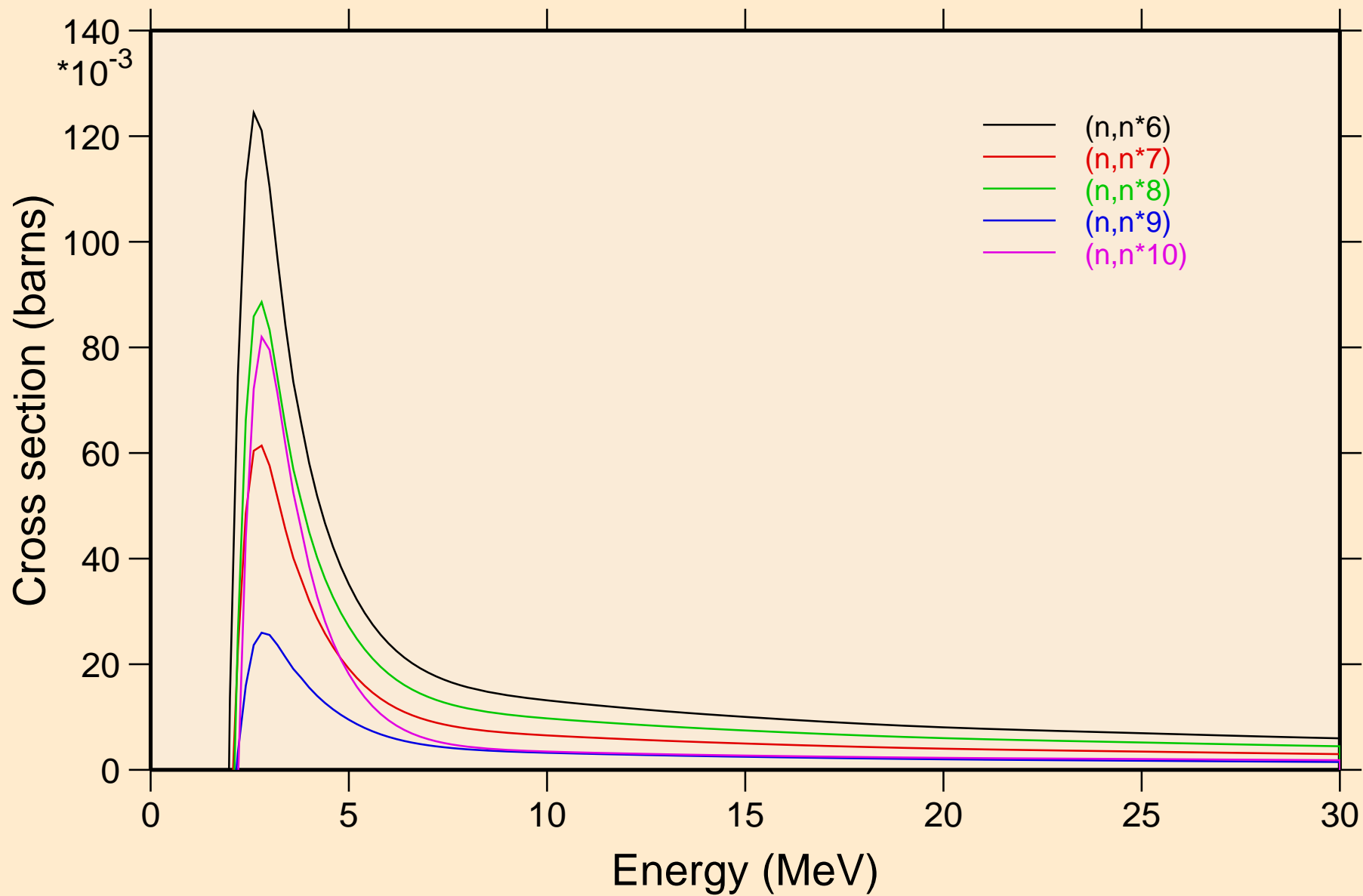

GE083 NEUTRON ACER TENDL-2021 LIBRARY; T=293.6K
Inelastic levels

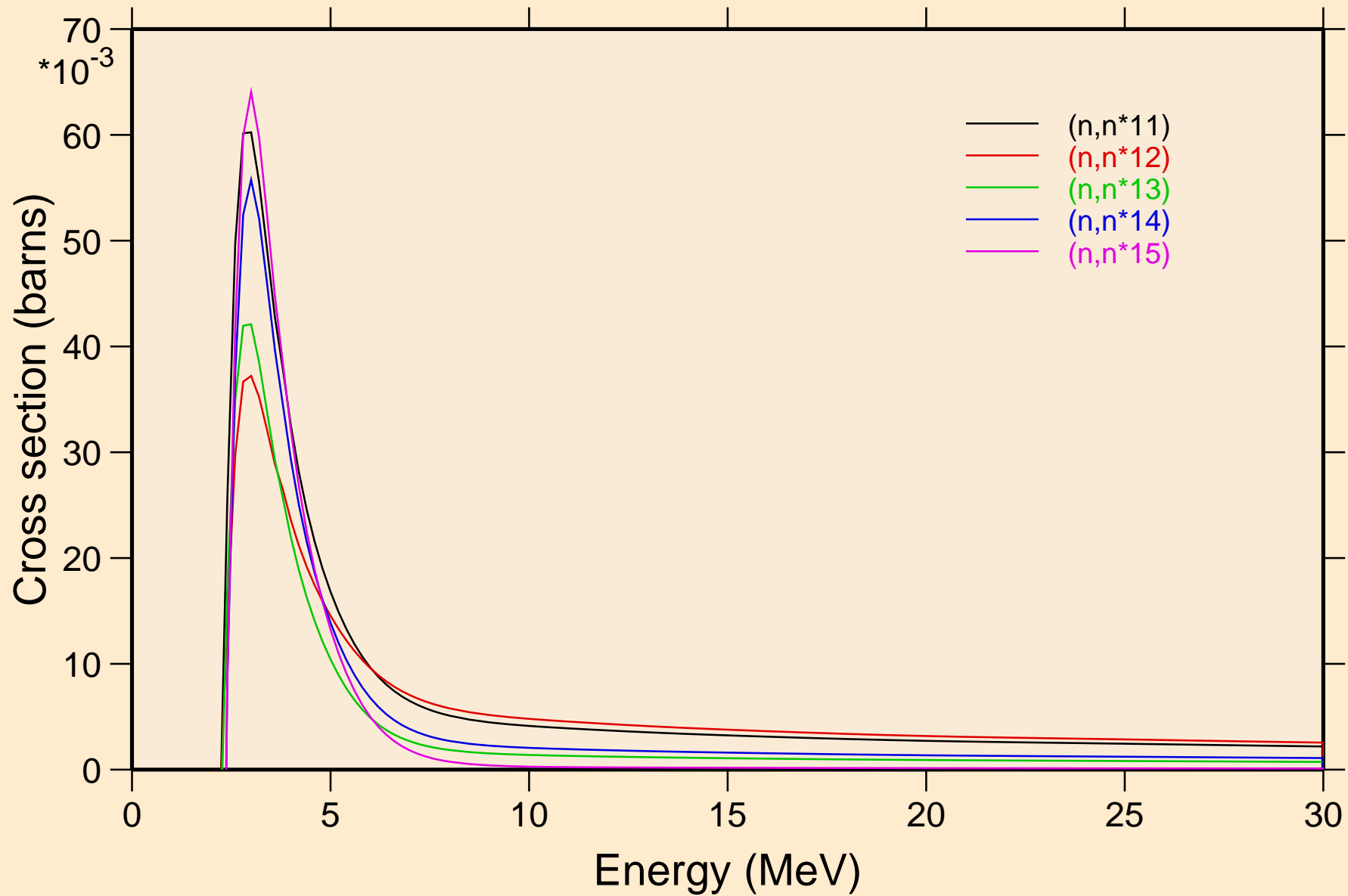

GE083 NEUTRON ACER TENDL-2021 LIBRARY; T=293.6K
Inelastic levels

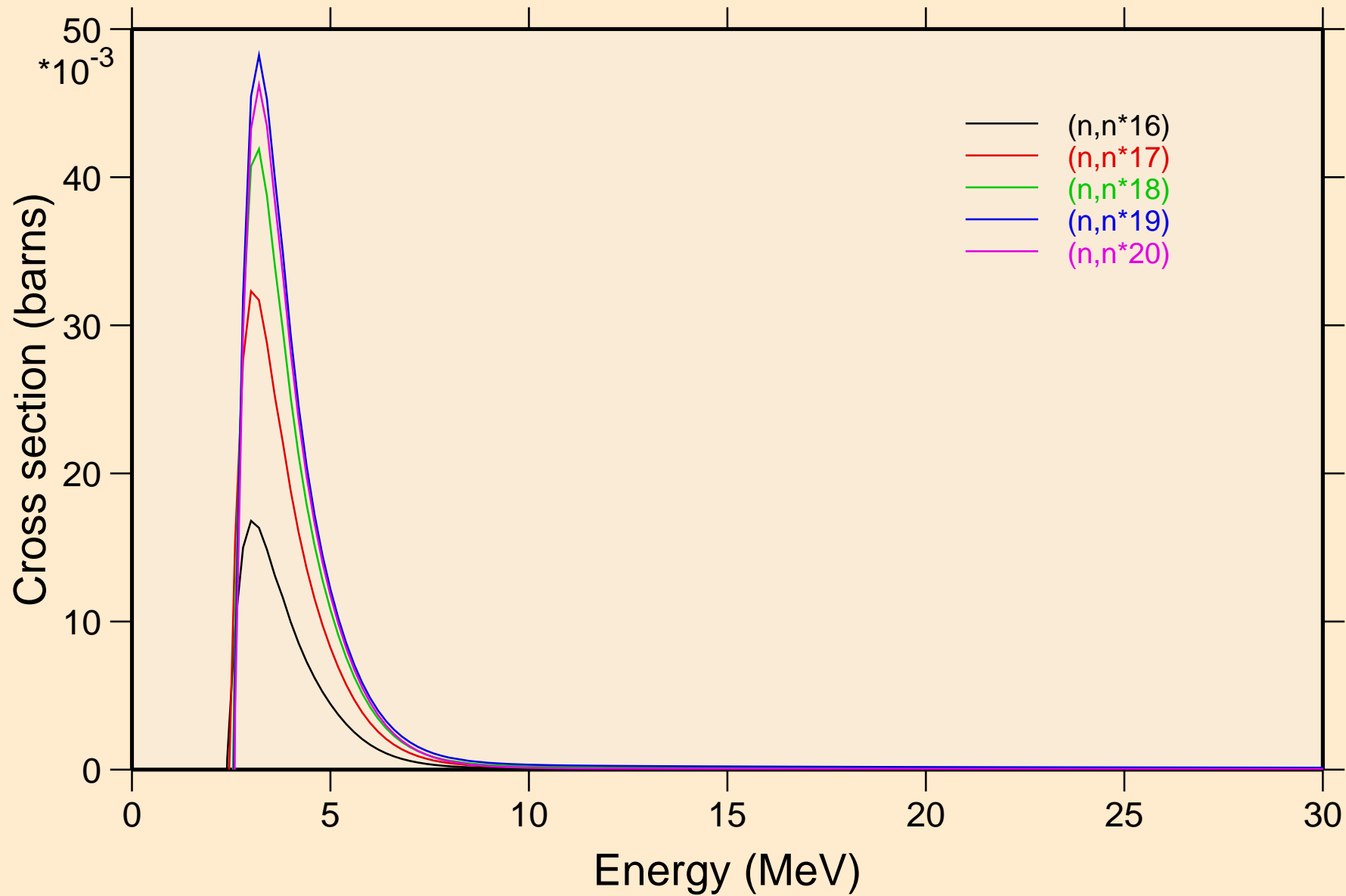

GE083 NEUTRON ACER TENDL-2021 LIBRARY; T=293.6K
Inelastic levels

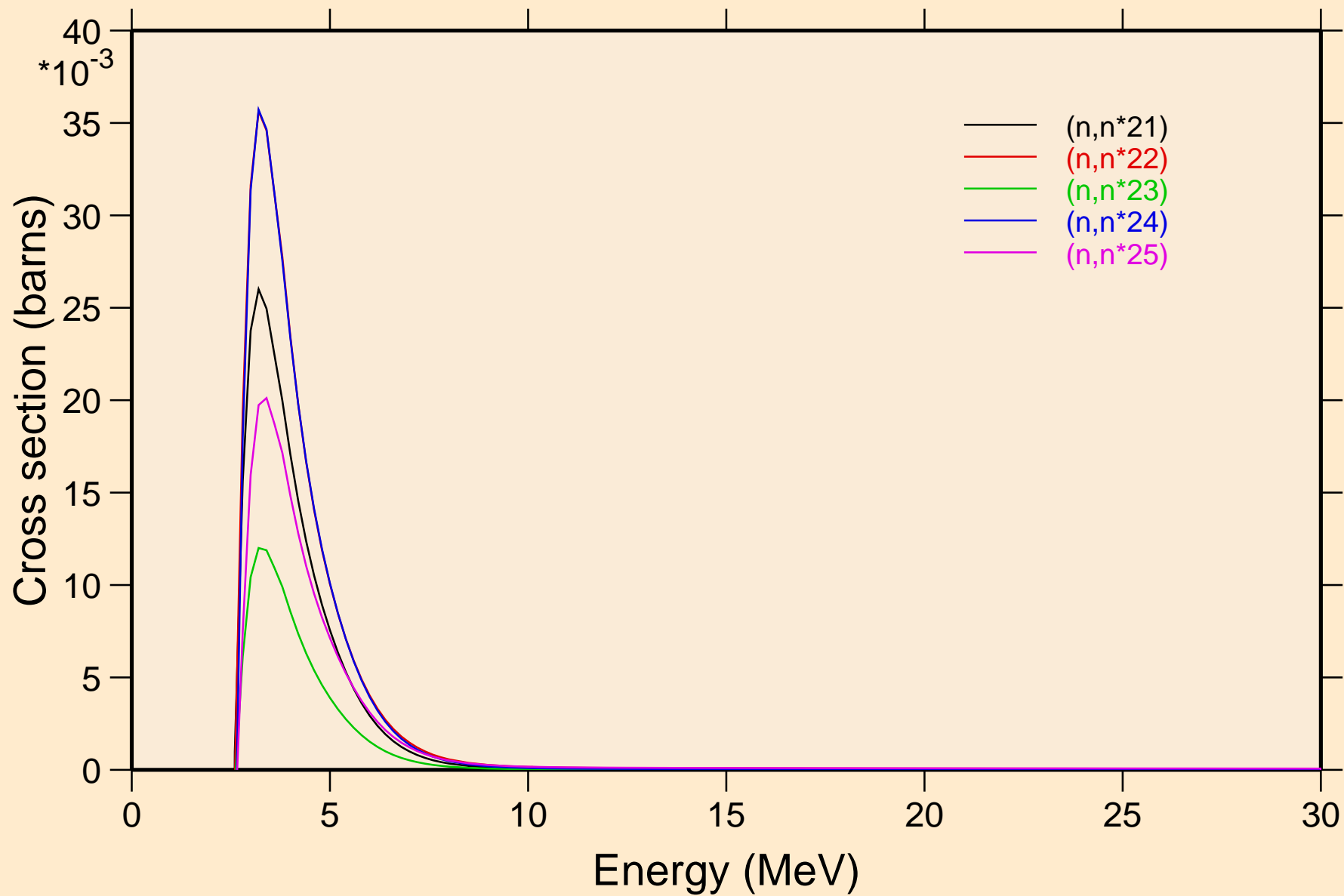

GE083 NEUTRON ACER TENDL-2021 LIBRARY; T=293.6K
Inelastic levels

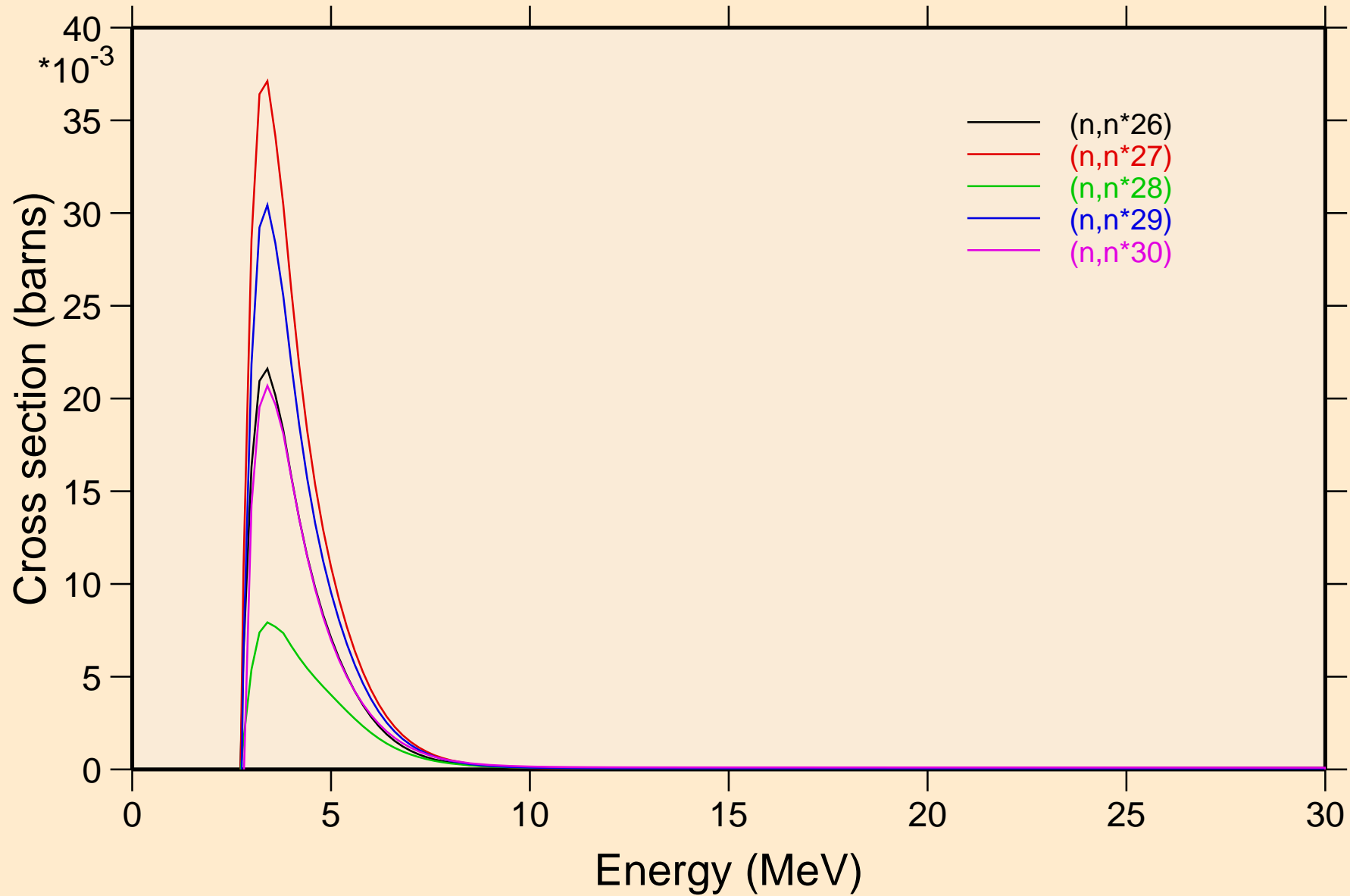

GE083 NEUTRON ACER TENDL-2021 LIBRARY; T=293.6K
Threshold reactions

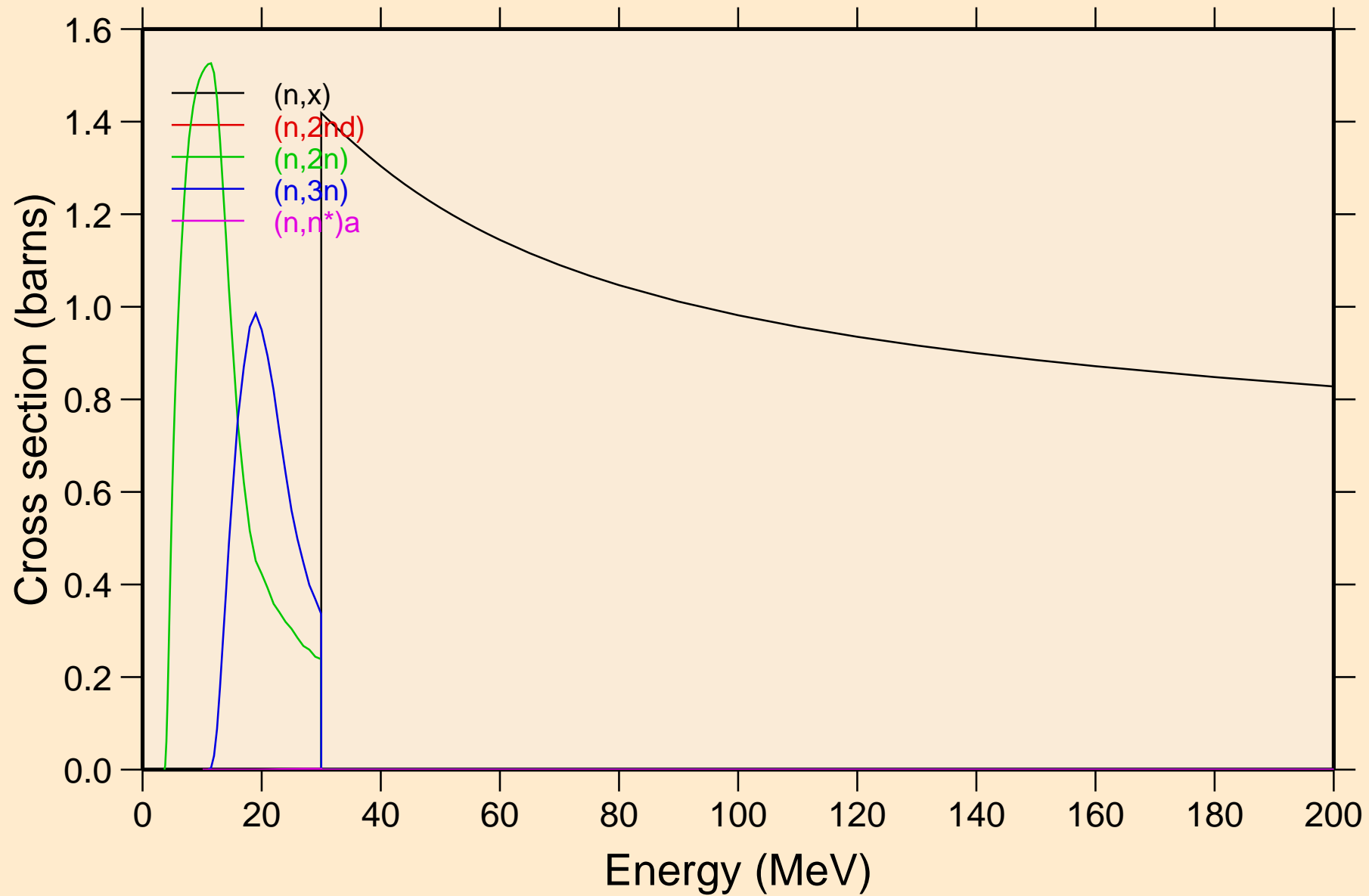

GE083 NEUTRON ACER TENDL-2021 LIBRARY; T=293.6K

Threshold reactions

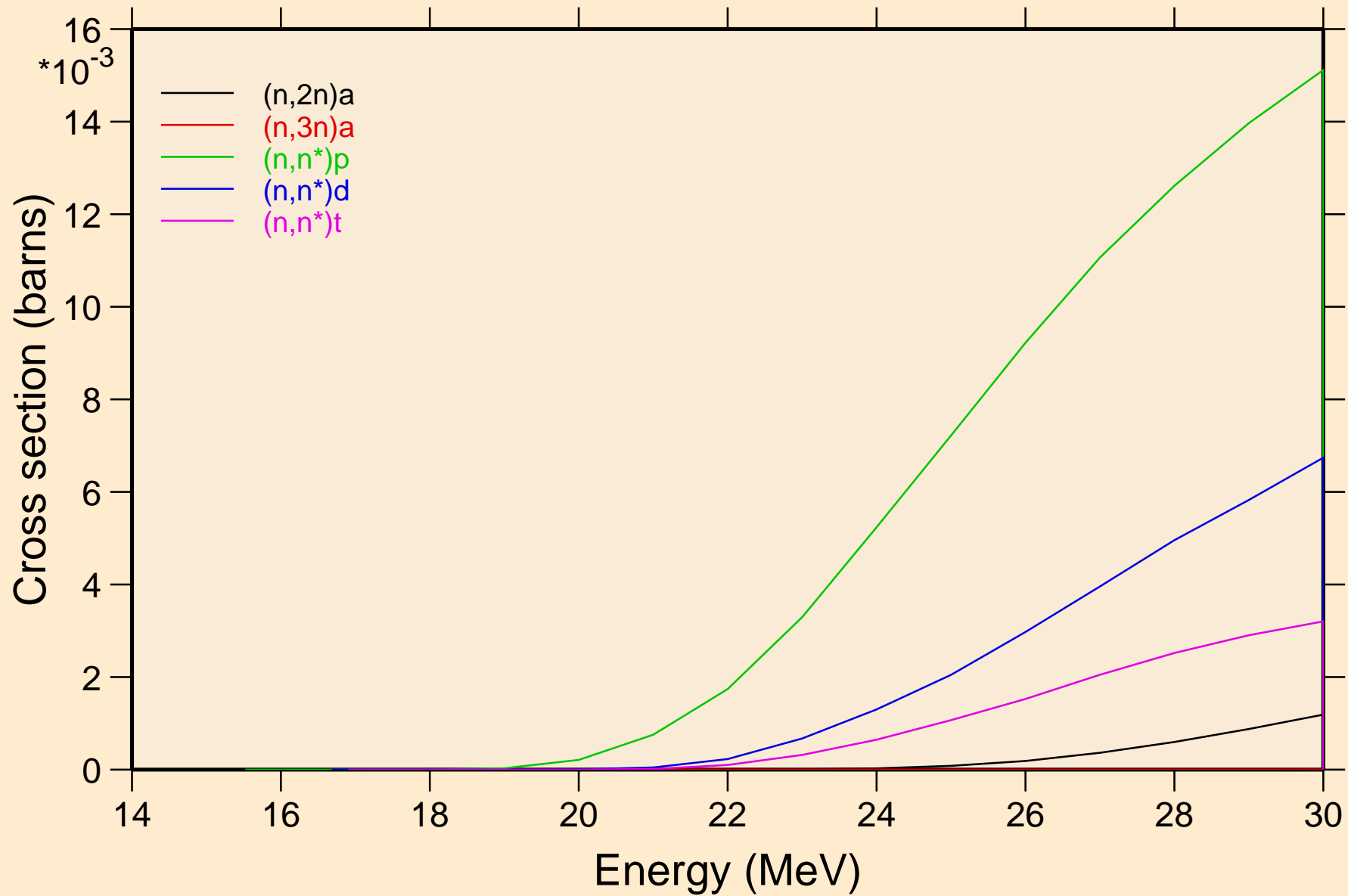

GE083 NEUTRON ACER TENDL-2021 LIBRARY; T=293.6K

Threshold reactions

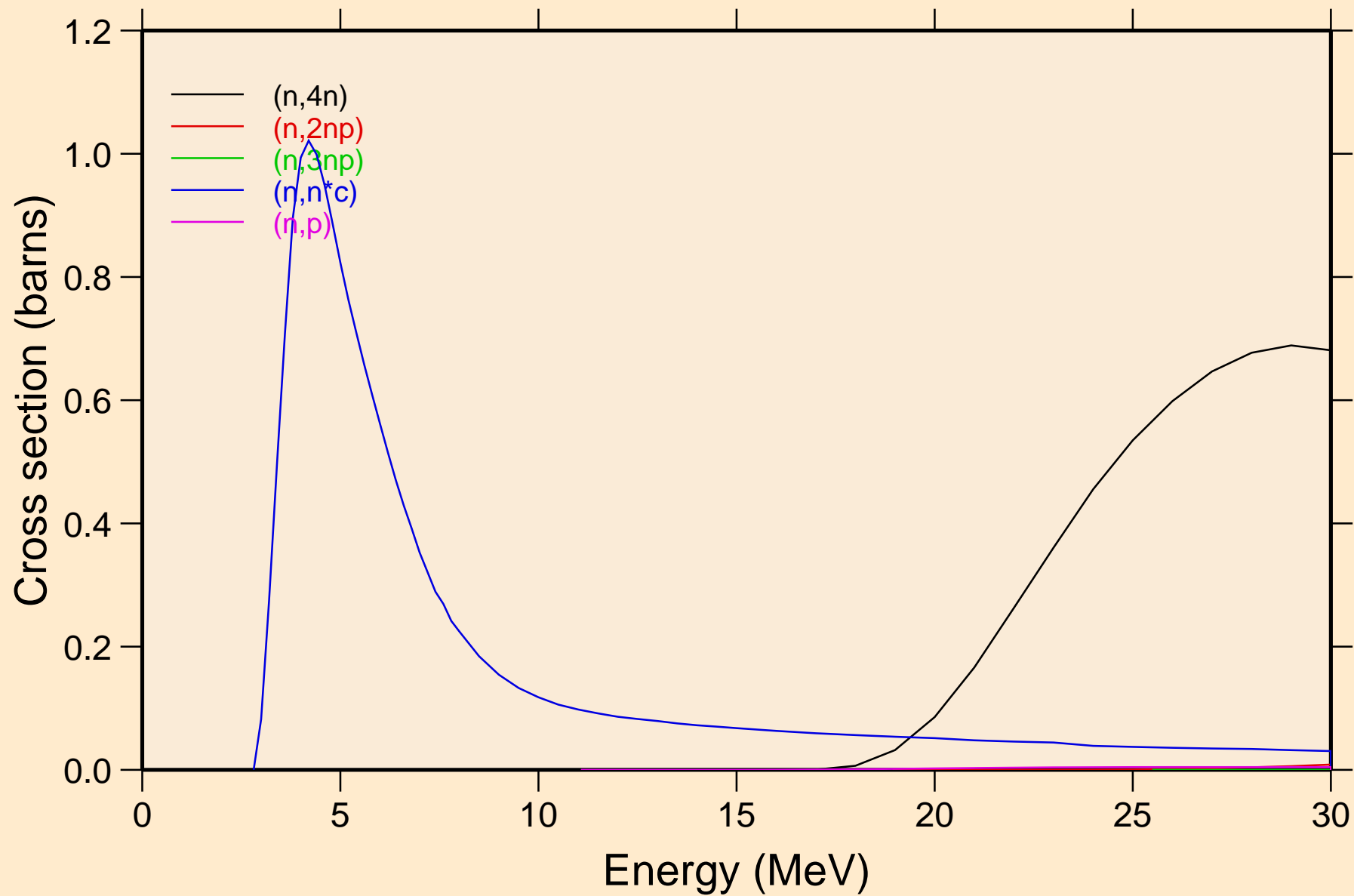

GE083 NEUTRON ACER TENDL-2021 LIBRARY; T=293.6K
Threshold reactions

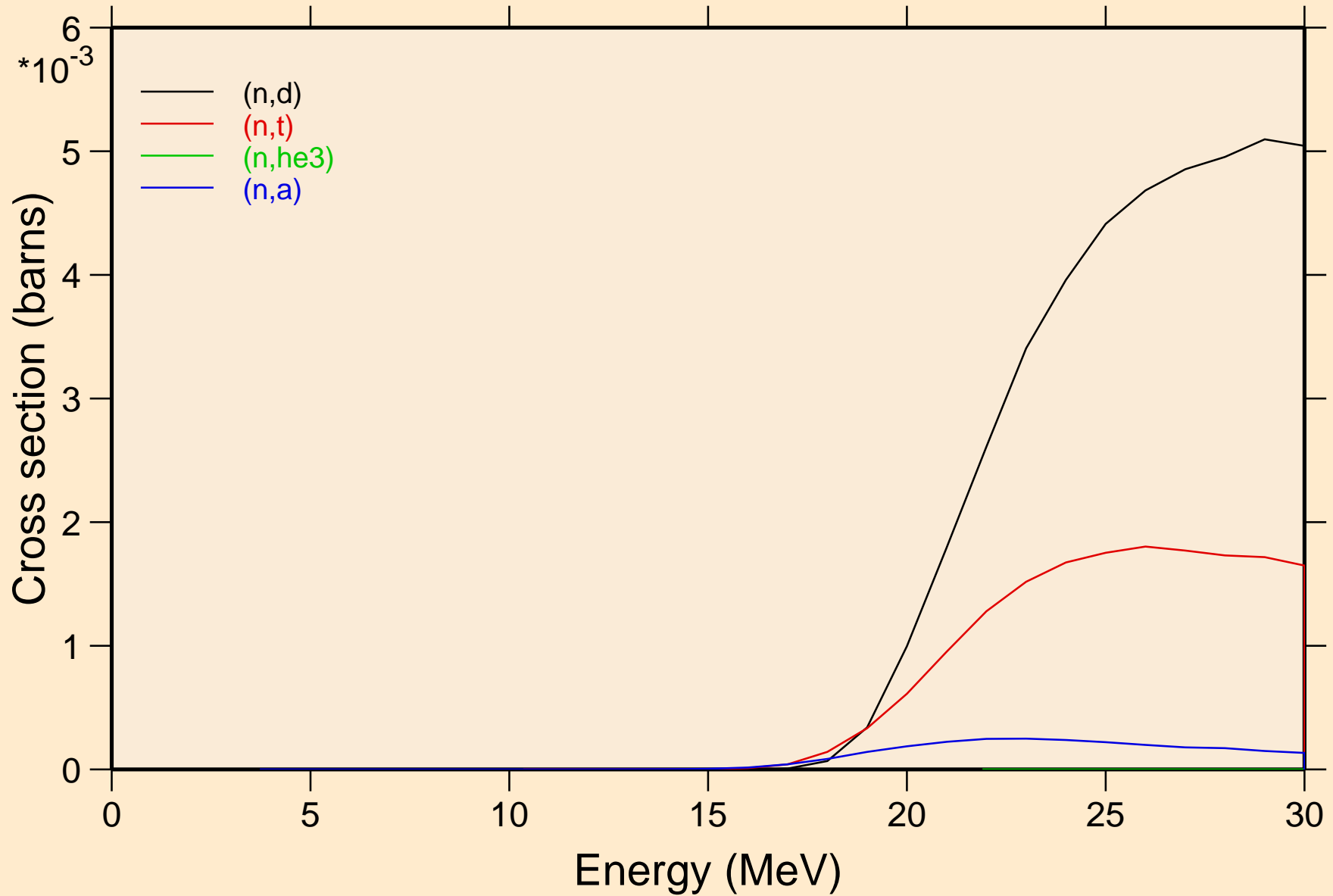

GE083 NEUTRON ACER TENDL-2021 LIBRARY; T=293.6K

Threshold reactions

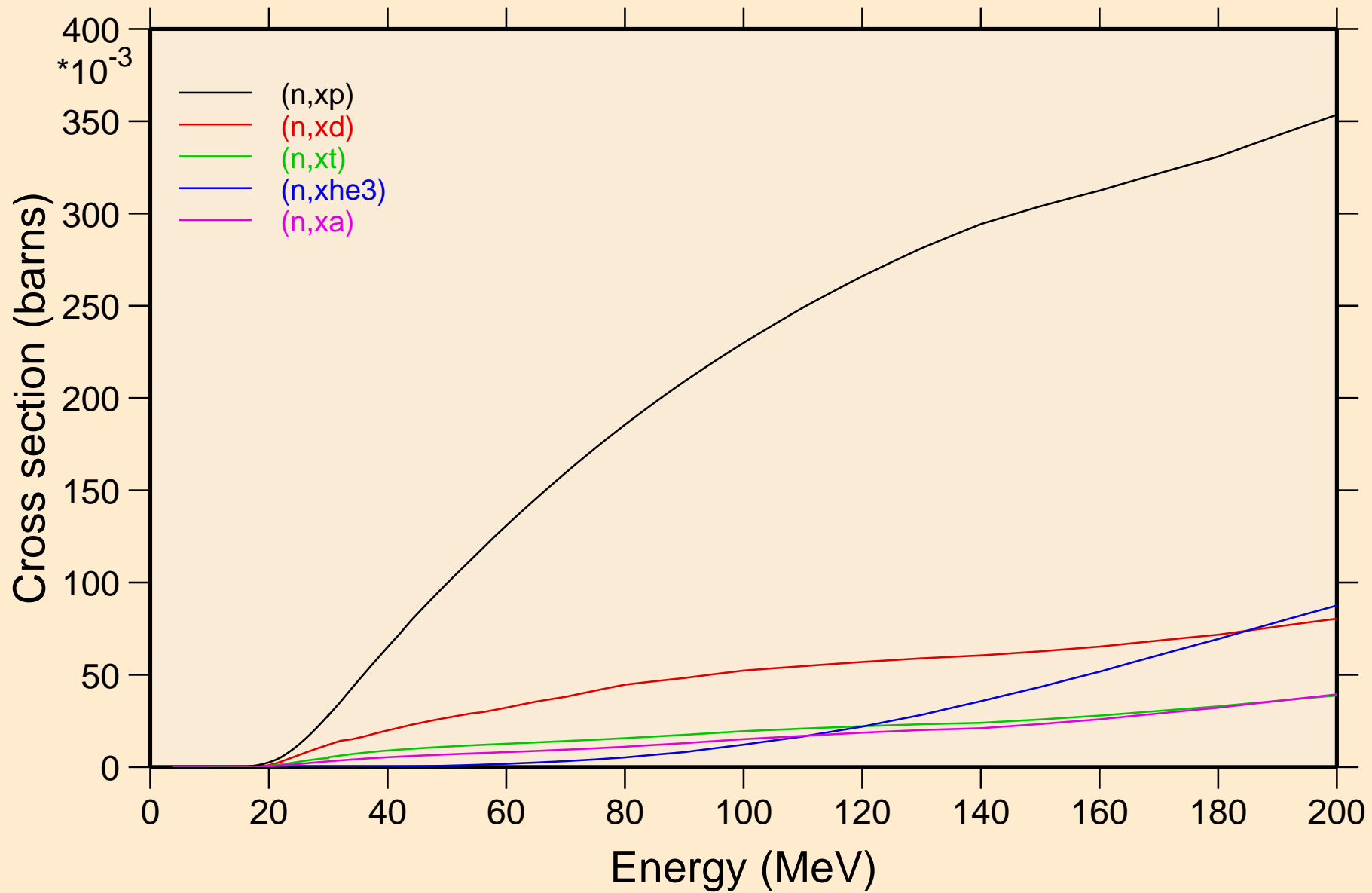

GE083 NEUTRON ACER TENDL-2021 LIBRARY; T=293.6K
angular distribution for elastic

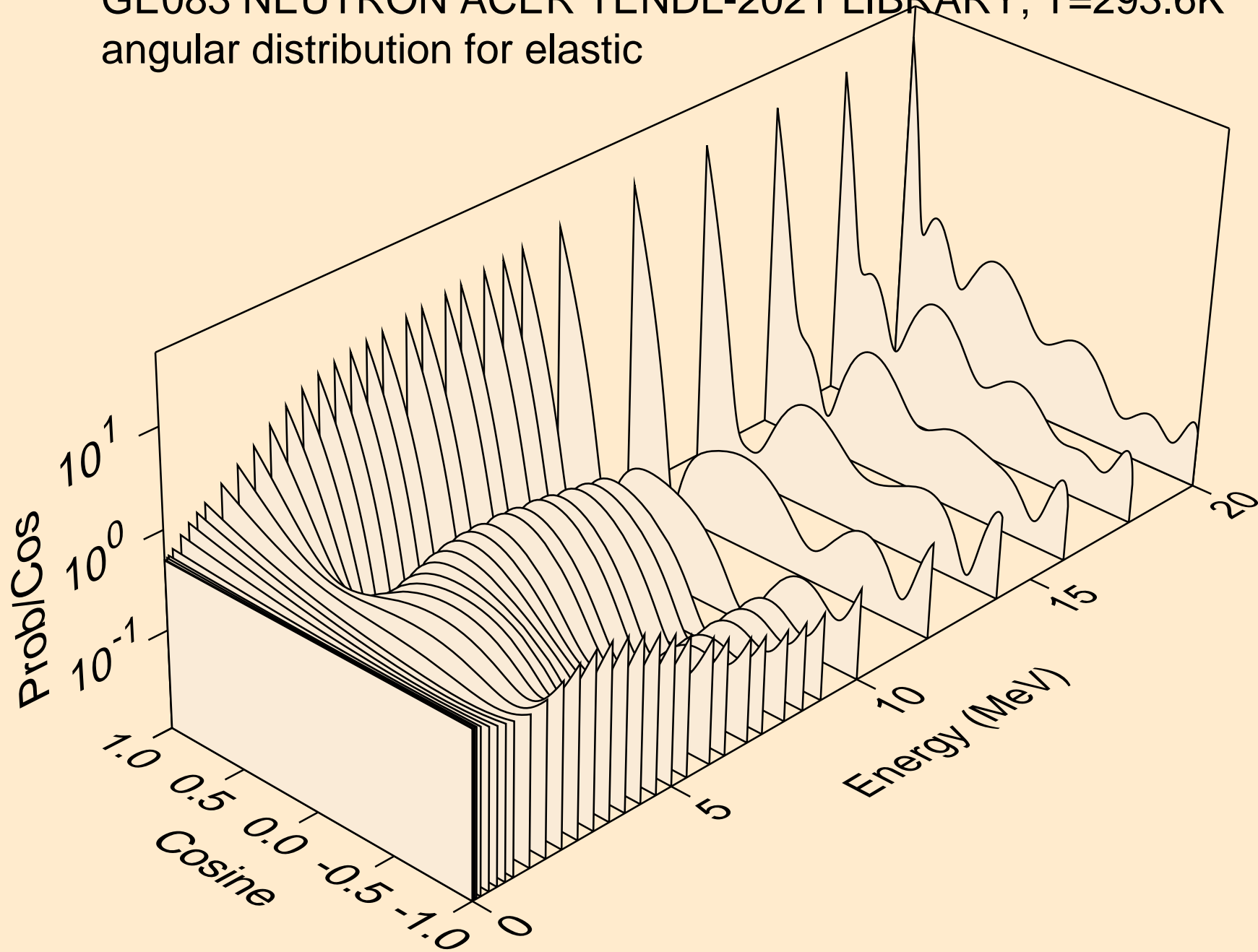

GE083 NEUTRON ACER TENDL-2021 LIBRARY; T=293.6K
angular distribution for elastic

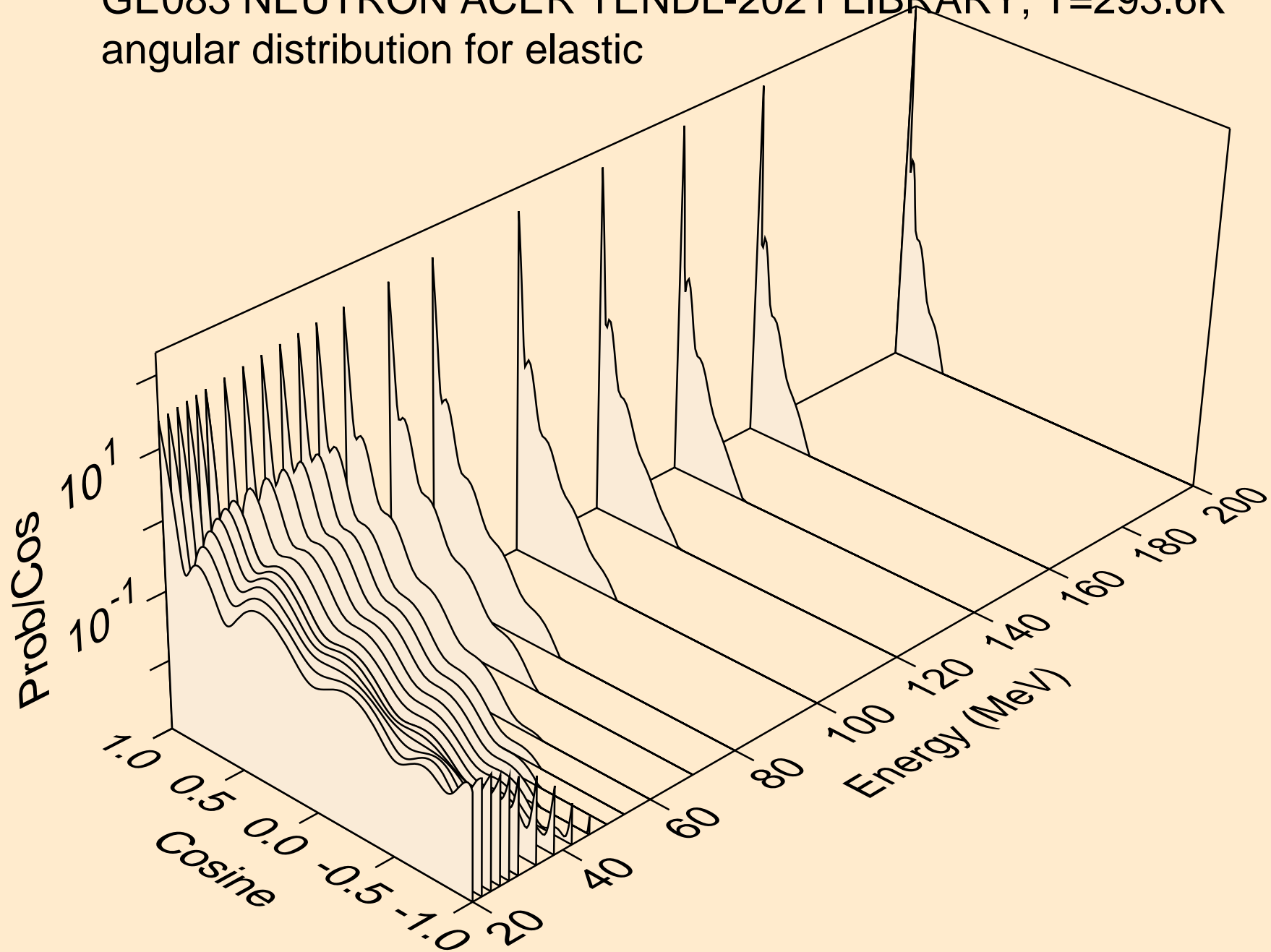

GE083 NEUTRON ACER TENDL-2021 LIBRARY; T=293.6K
angular distribution for (n,n*1)

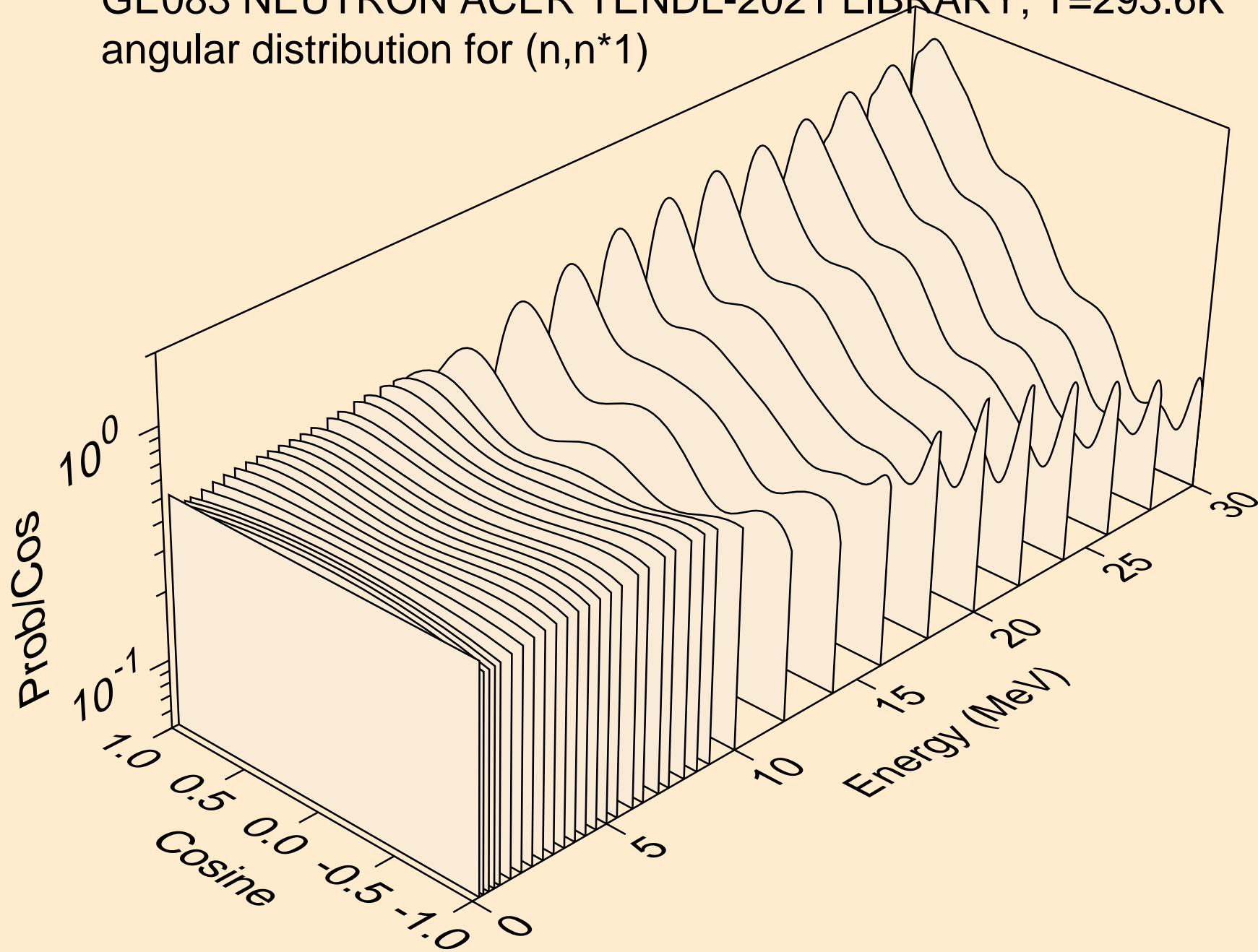

GE083 NEUTRON ACER TENDL-2021 LIBRARY; T=293.6K
angular distribution for (n,n*2)

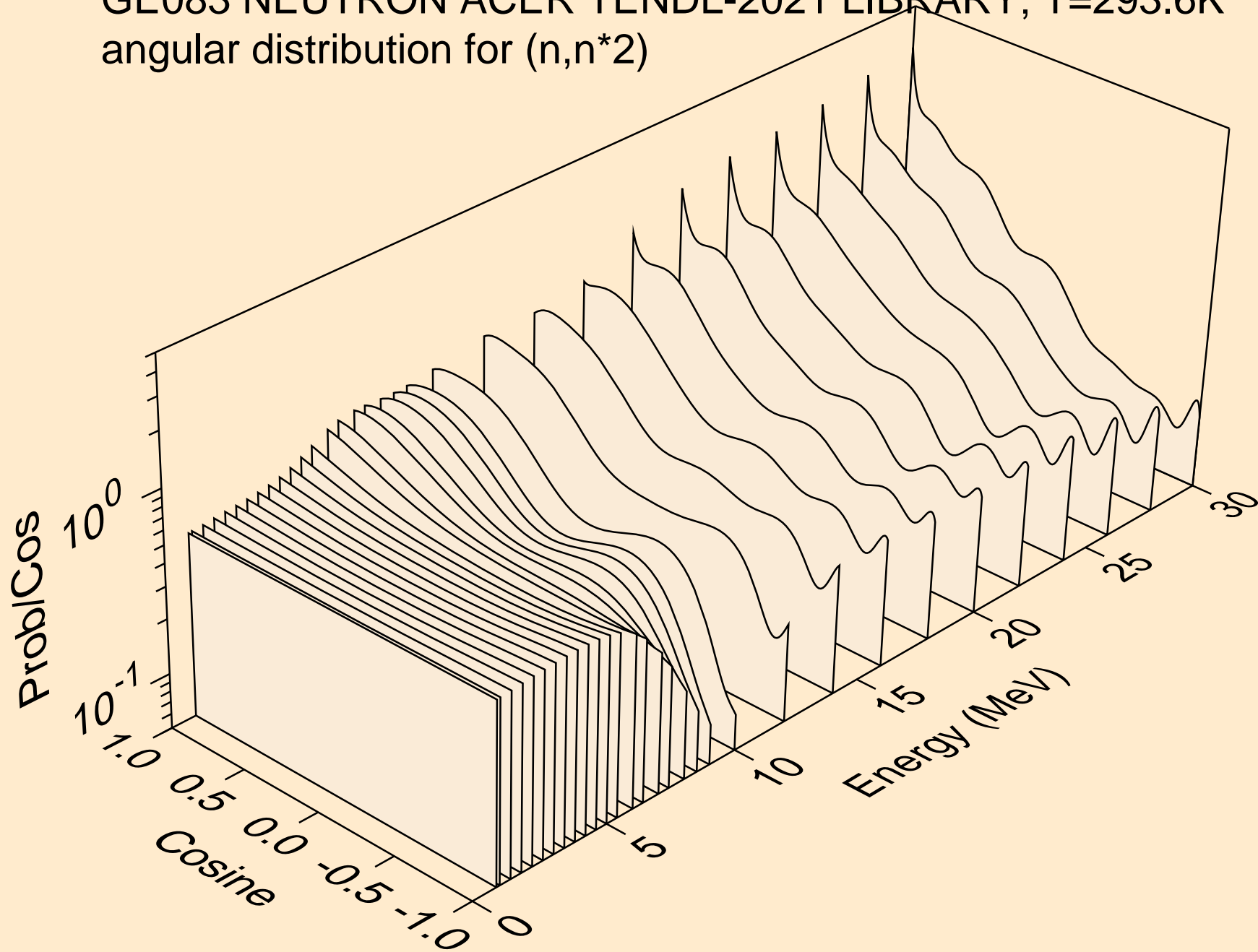

GE083 NEUTRON ACER TENDL-2021 LIBRARY; T=293.6K
angular distribution for (n,n*3)

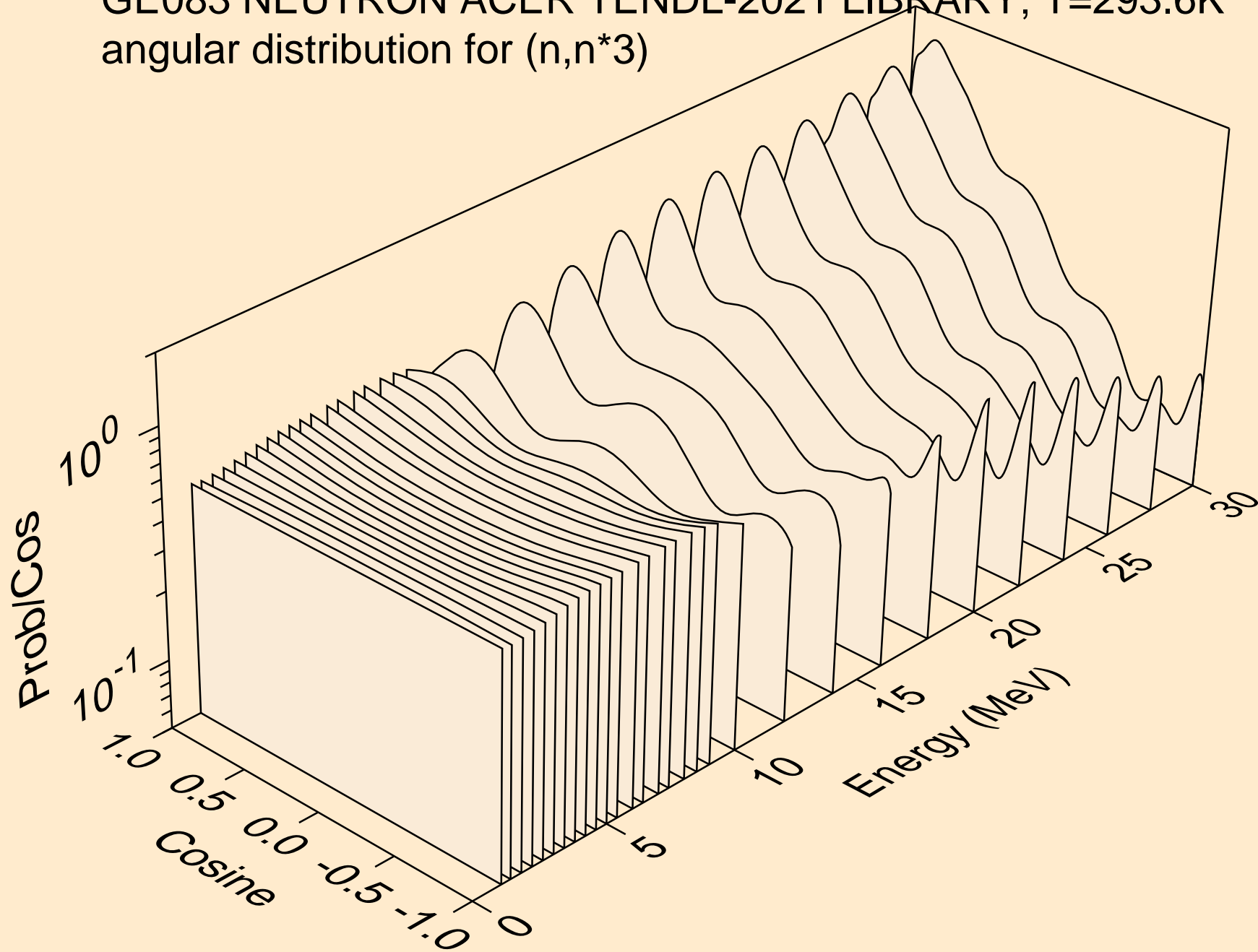

GE083 NEUTRON ACER TENDL-2021 LIBRARY; T=293.6K
angular distribution for (n,n*4)

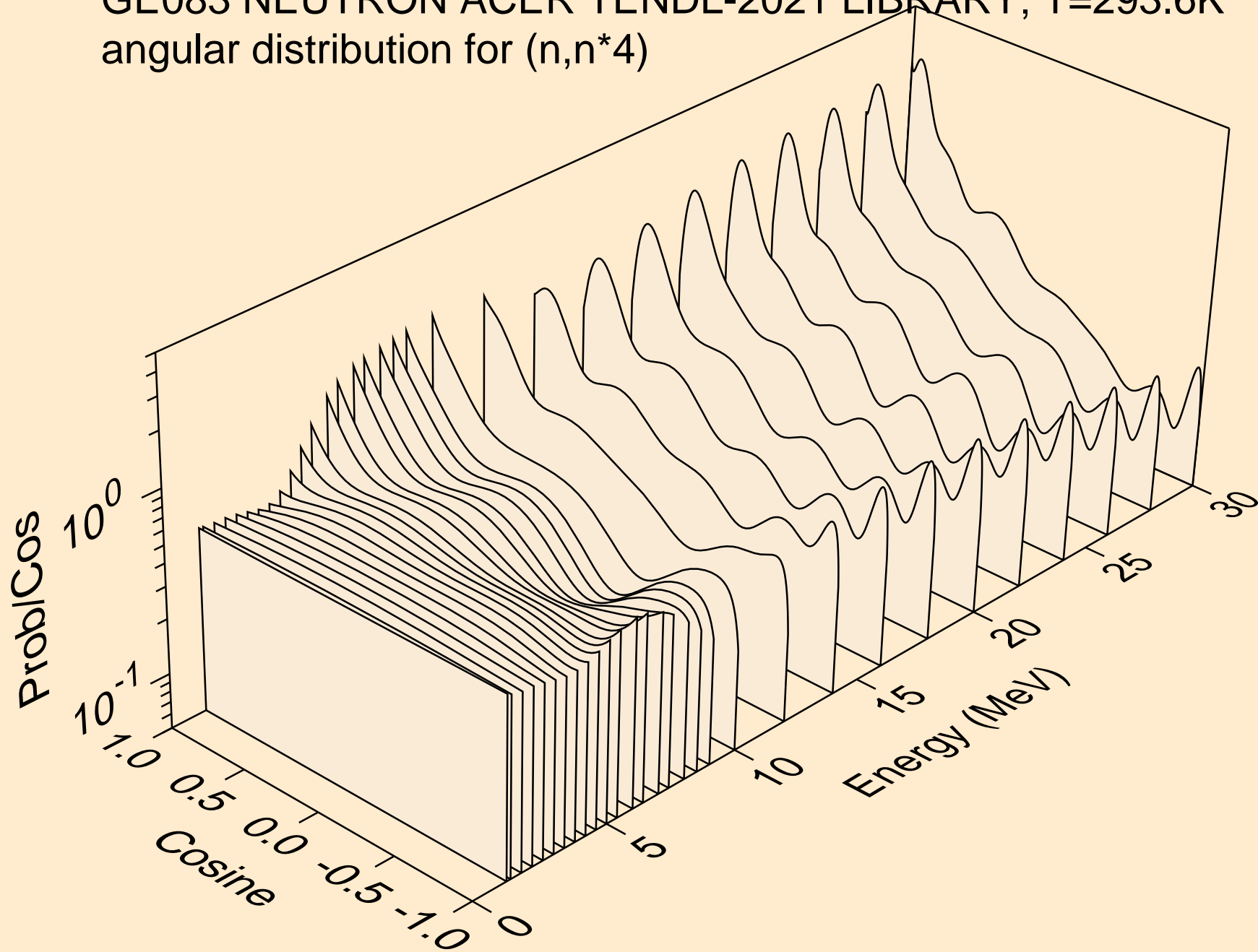

GE083 NEUTRON ACER TENDL-2021 LIBRARY; T=293.6K
angular distribution for (n,n*5)

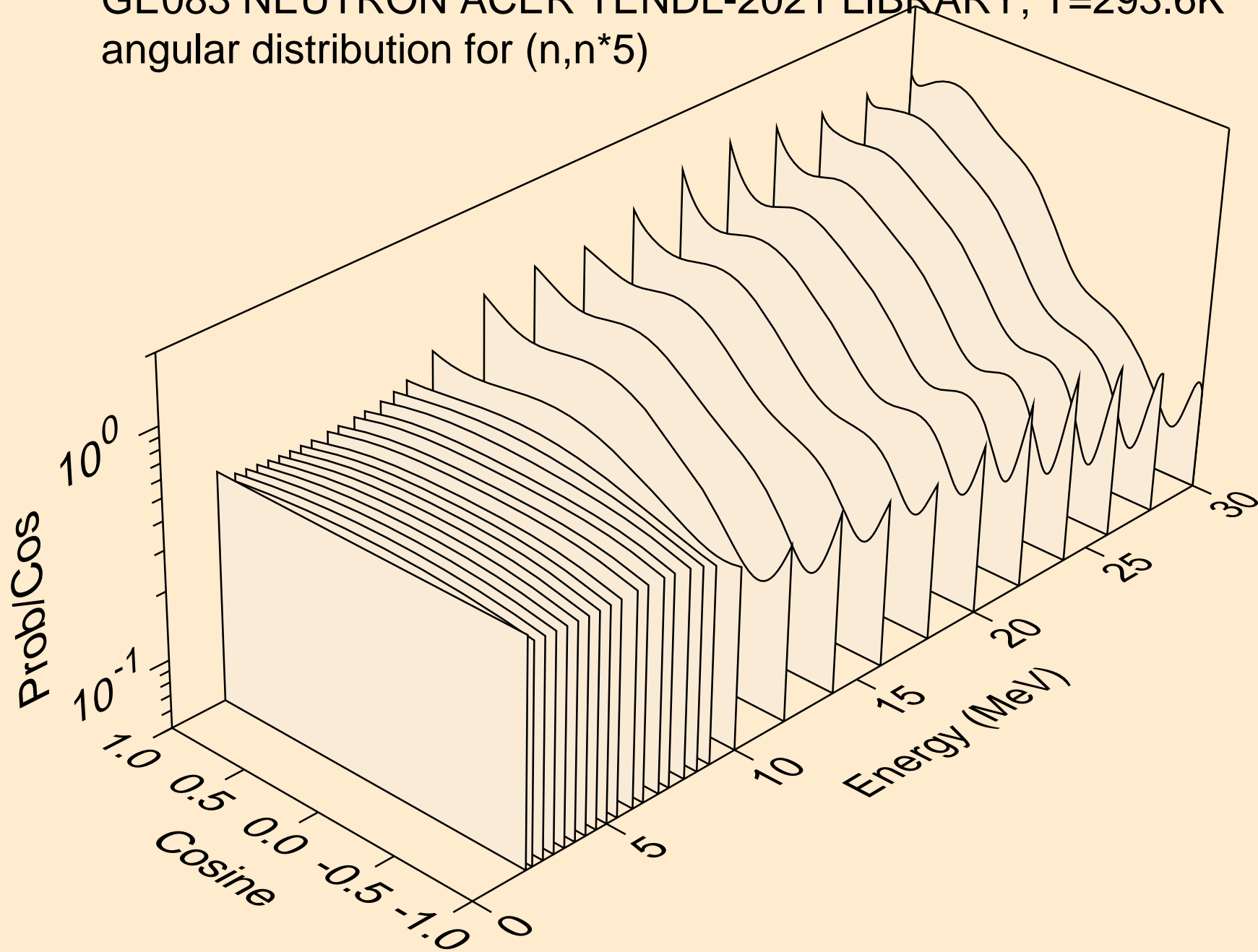

GE083 NEUTRON ACER TENDL-2021 LIBRARY; T=293.6K
angular distribution for (n,n*6)

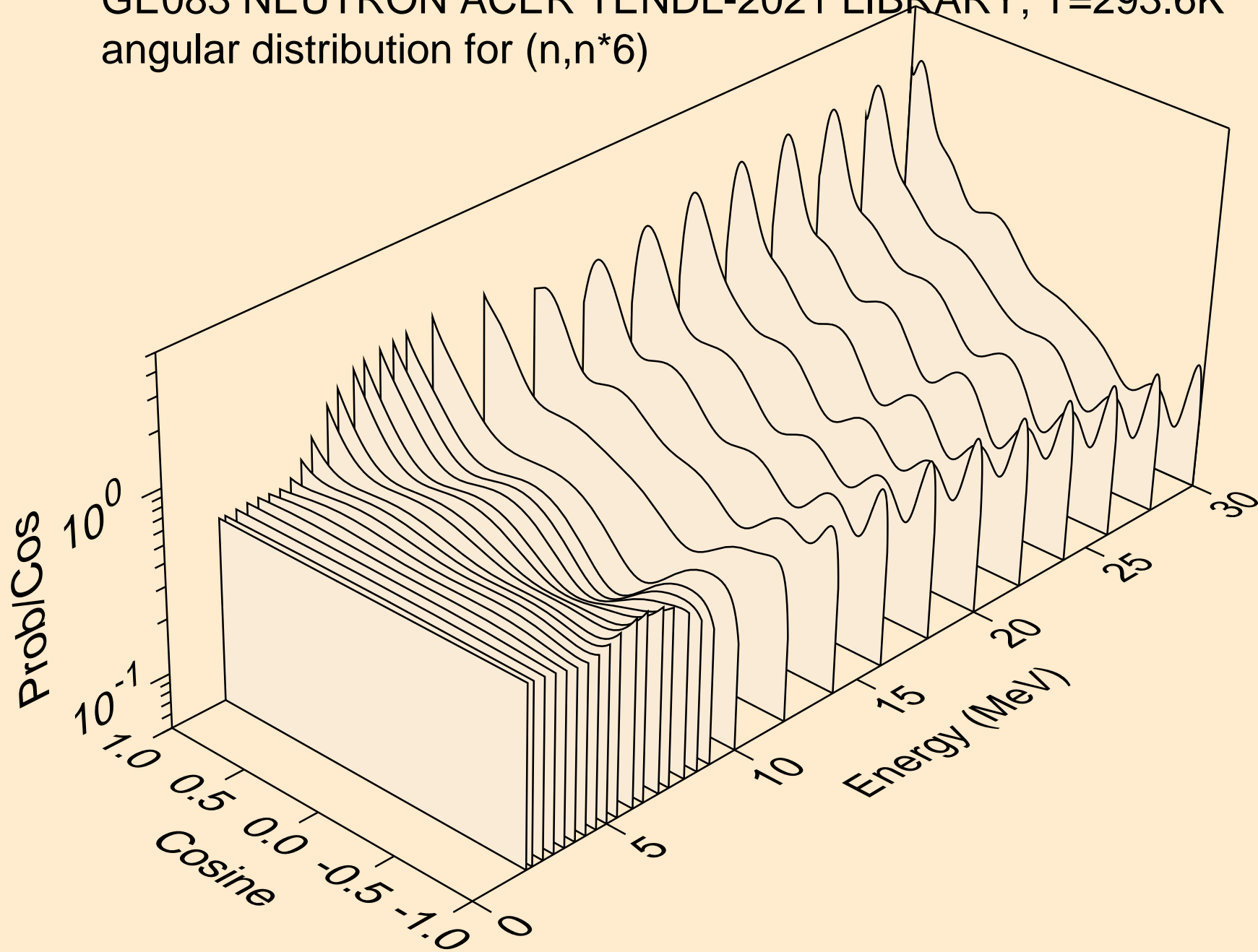

GE083 NEUTRON ACER TENDL-2021 LIBRARY; T=293.6K
angular distribution for (n,n*7)

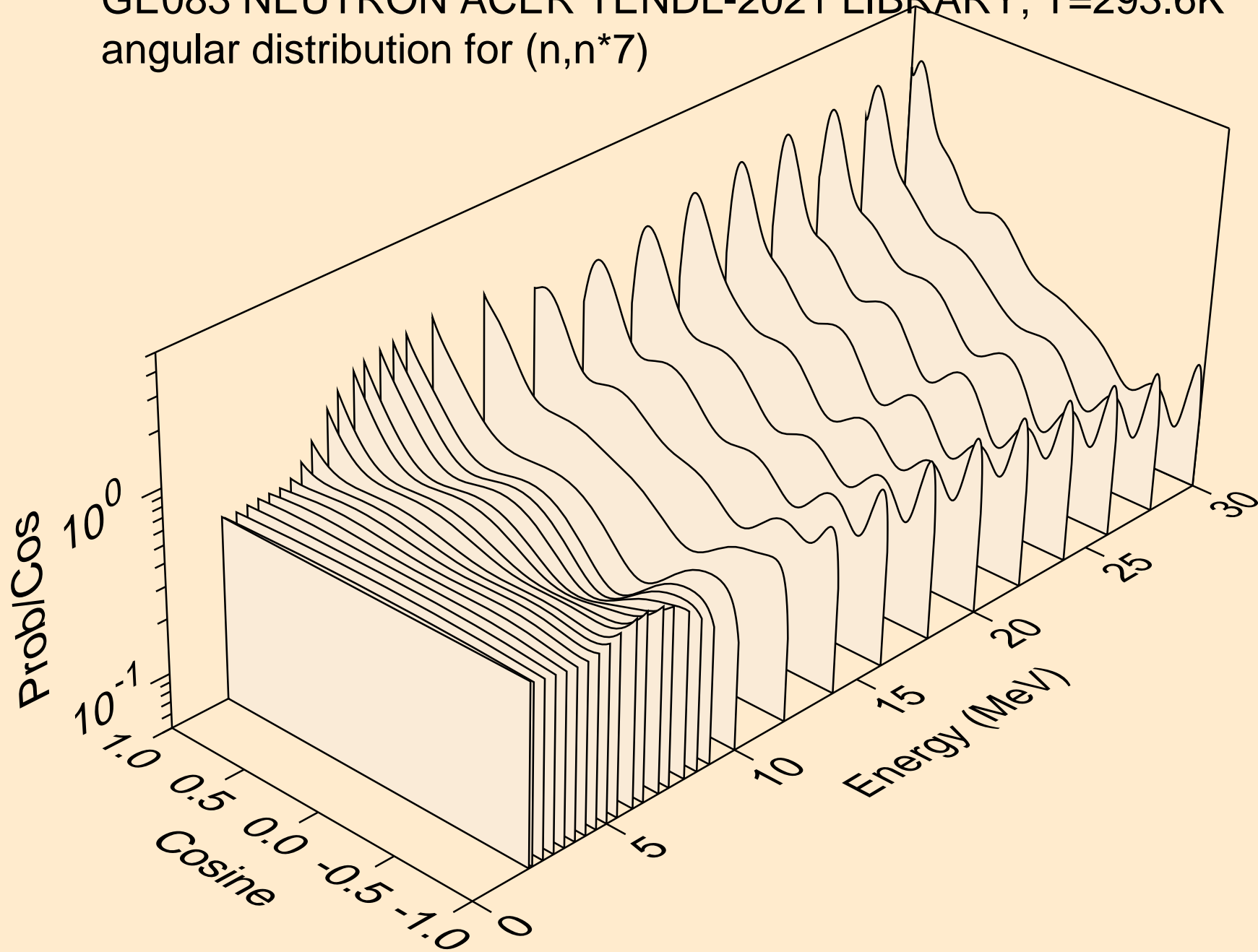

GE083 NEUTRON ACER TENDL-2021 LIBRARY; T=293.6K
angular distribution for (n,n*8)

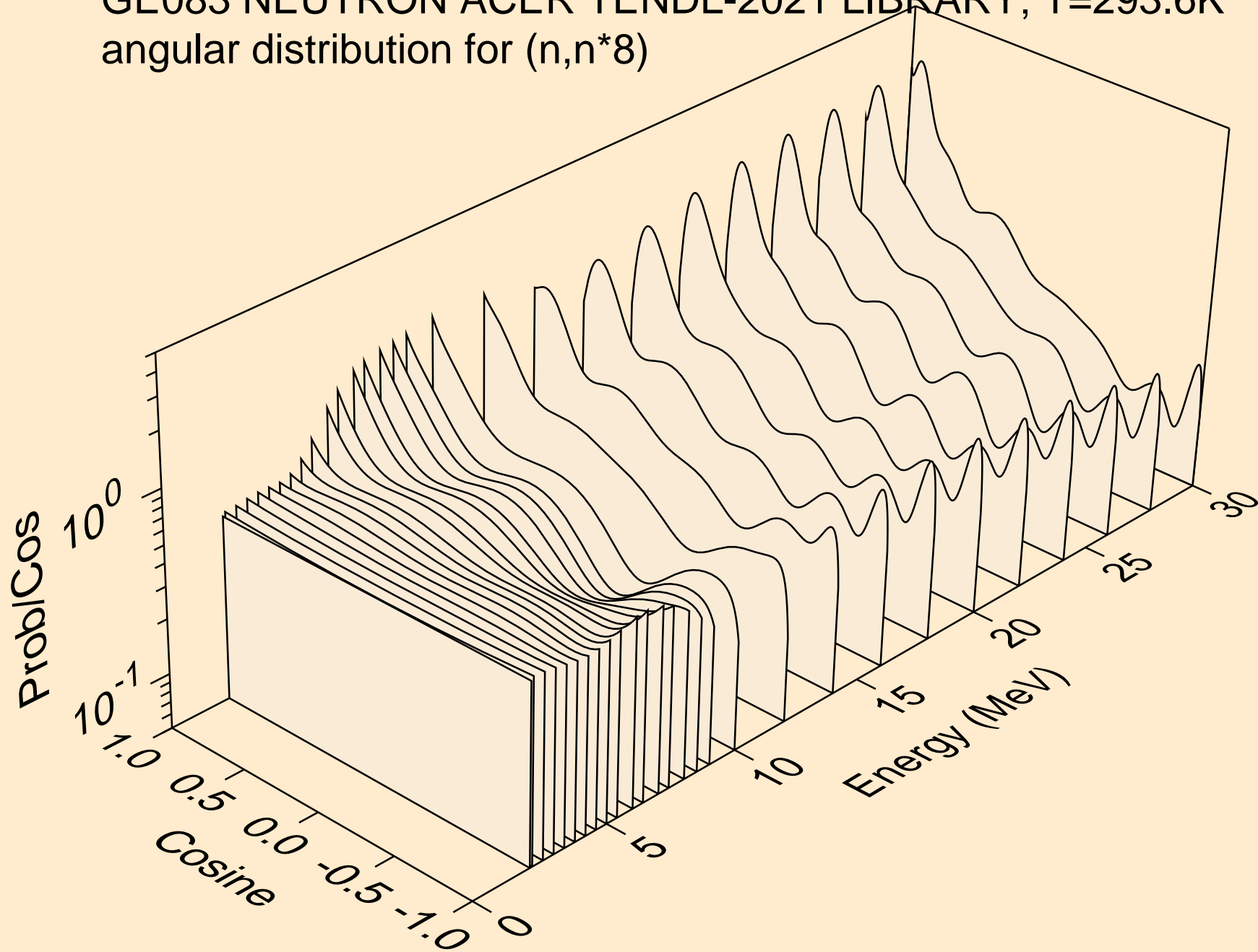

GE083 NEUTRON ACER TENDL-2021 LIBRARY; T=293.6K
angular distribution for (n,n*9)

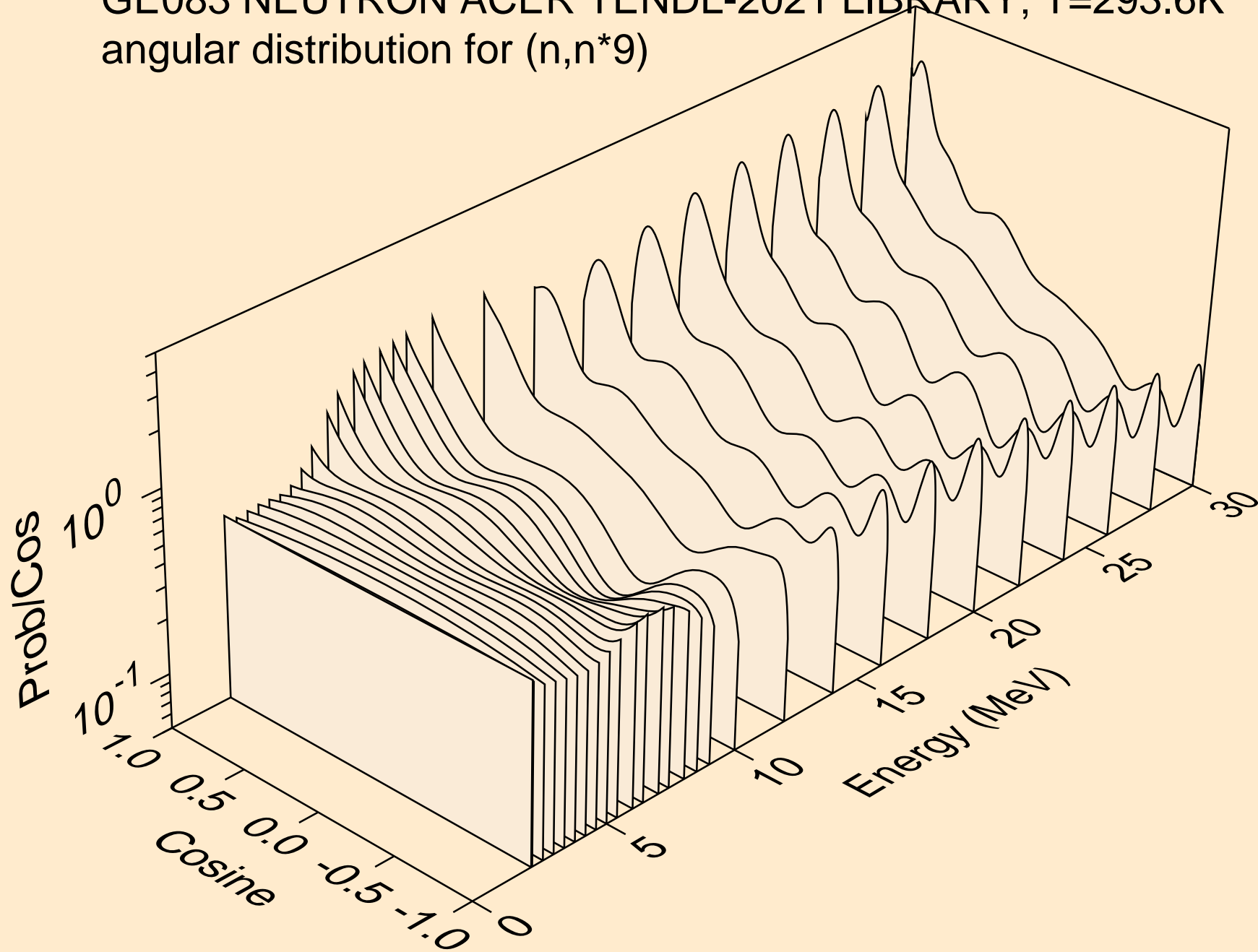

GE083 NEUTRON ACER TENDL-2021 LIBRARY; T=293.6K
angular distribution for (n,n*10)

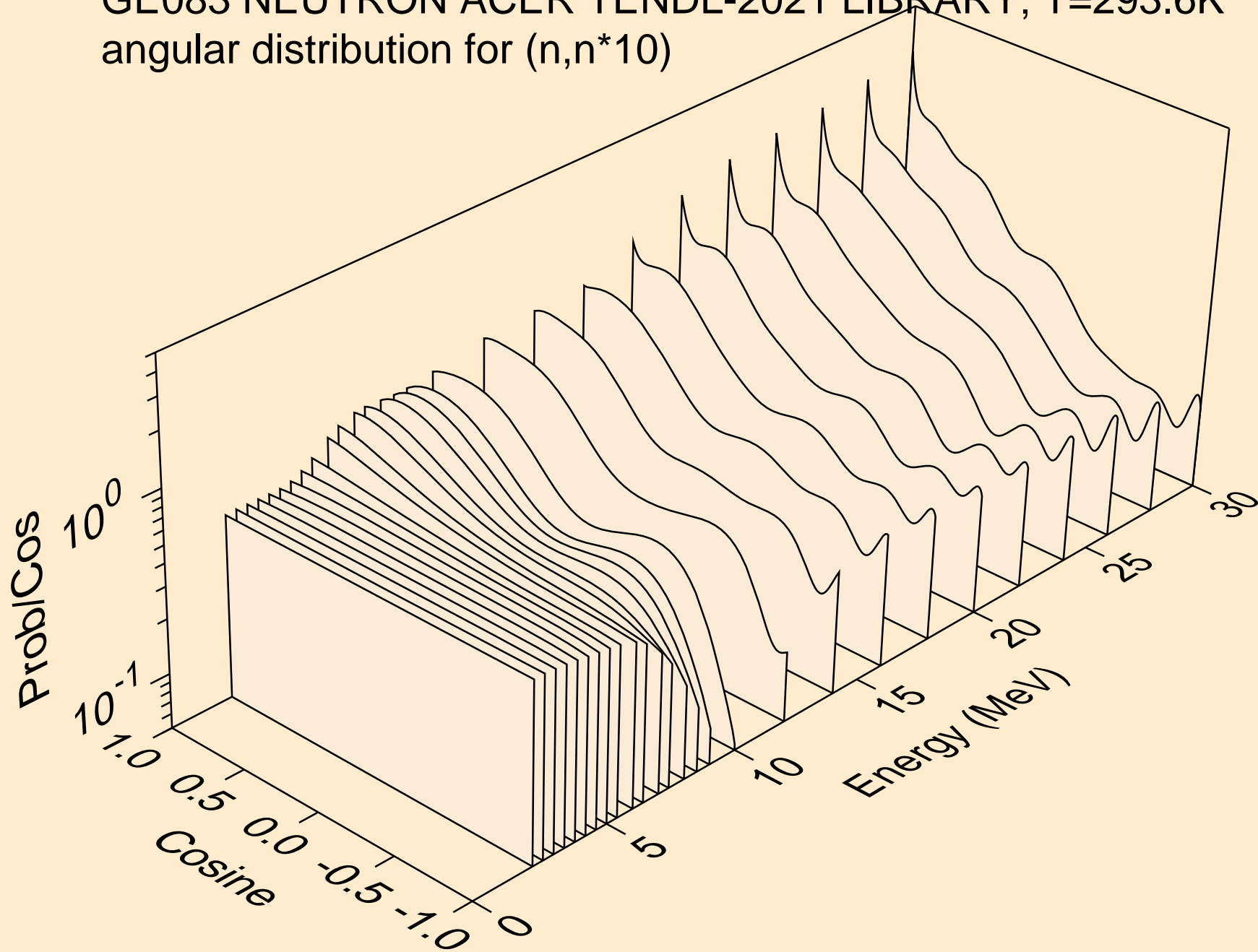

GE083 NEUTRON ACER TENDL-2021 LIBRARY; T=293.6K
angular distribution for (n,n*11)

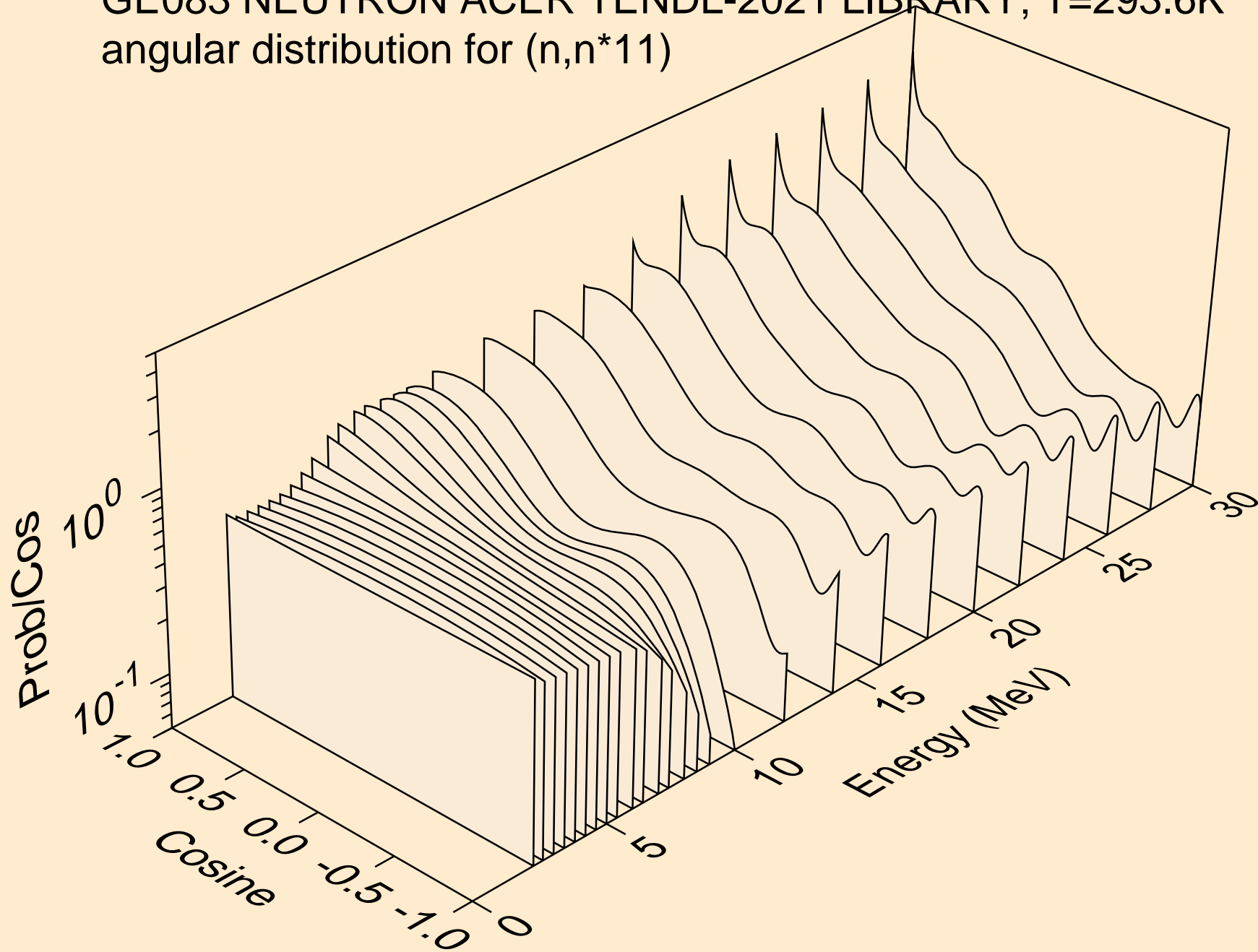

GE083 NEUTRON ACER TENDL-2021 LIBRARY; T=293.6K
angular distribution for (n,n*12)

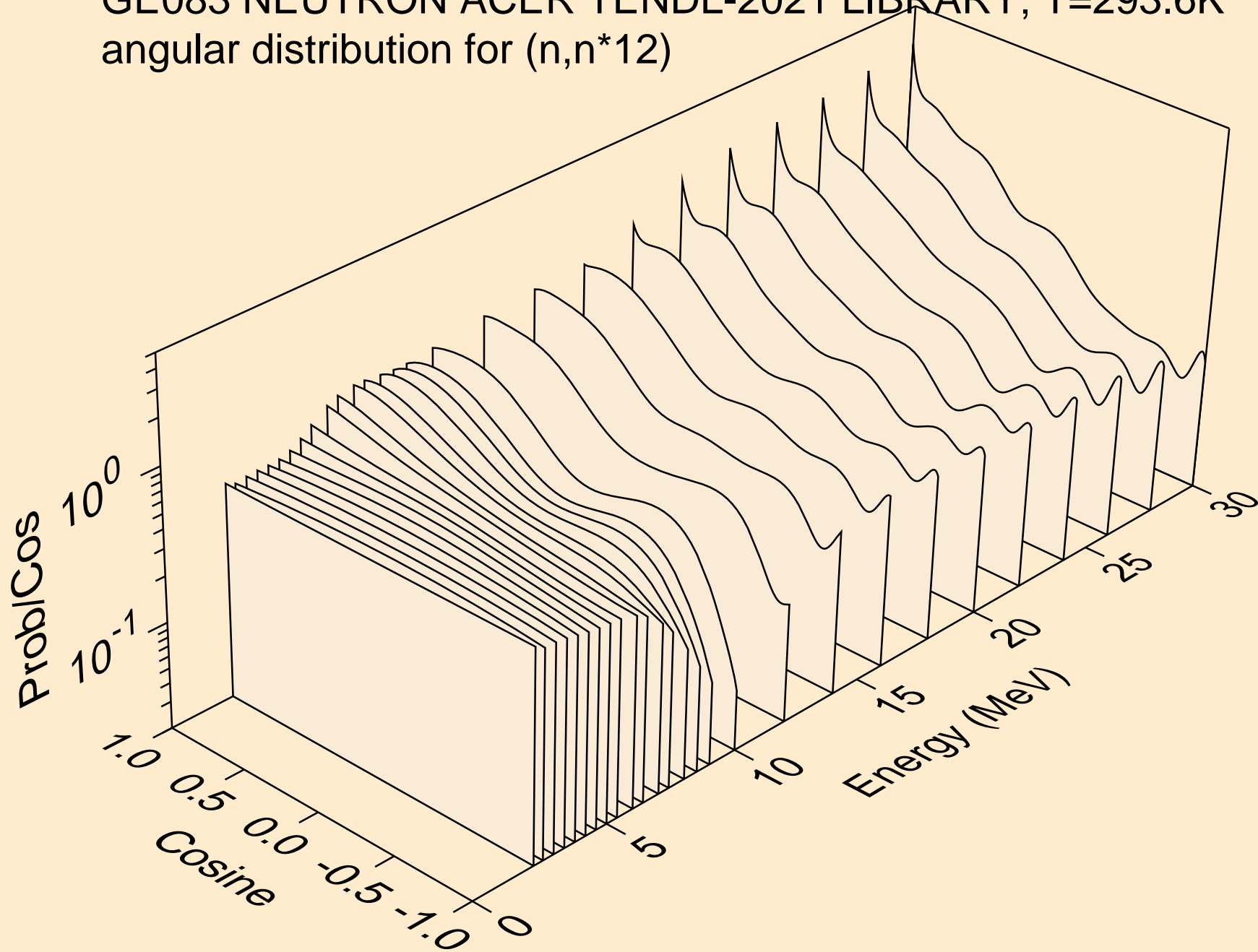

GE083 NEUTRON ACER TENDL-2021 LIBRARY; T=293.6K
angular distribution for (n,n*13)

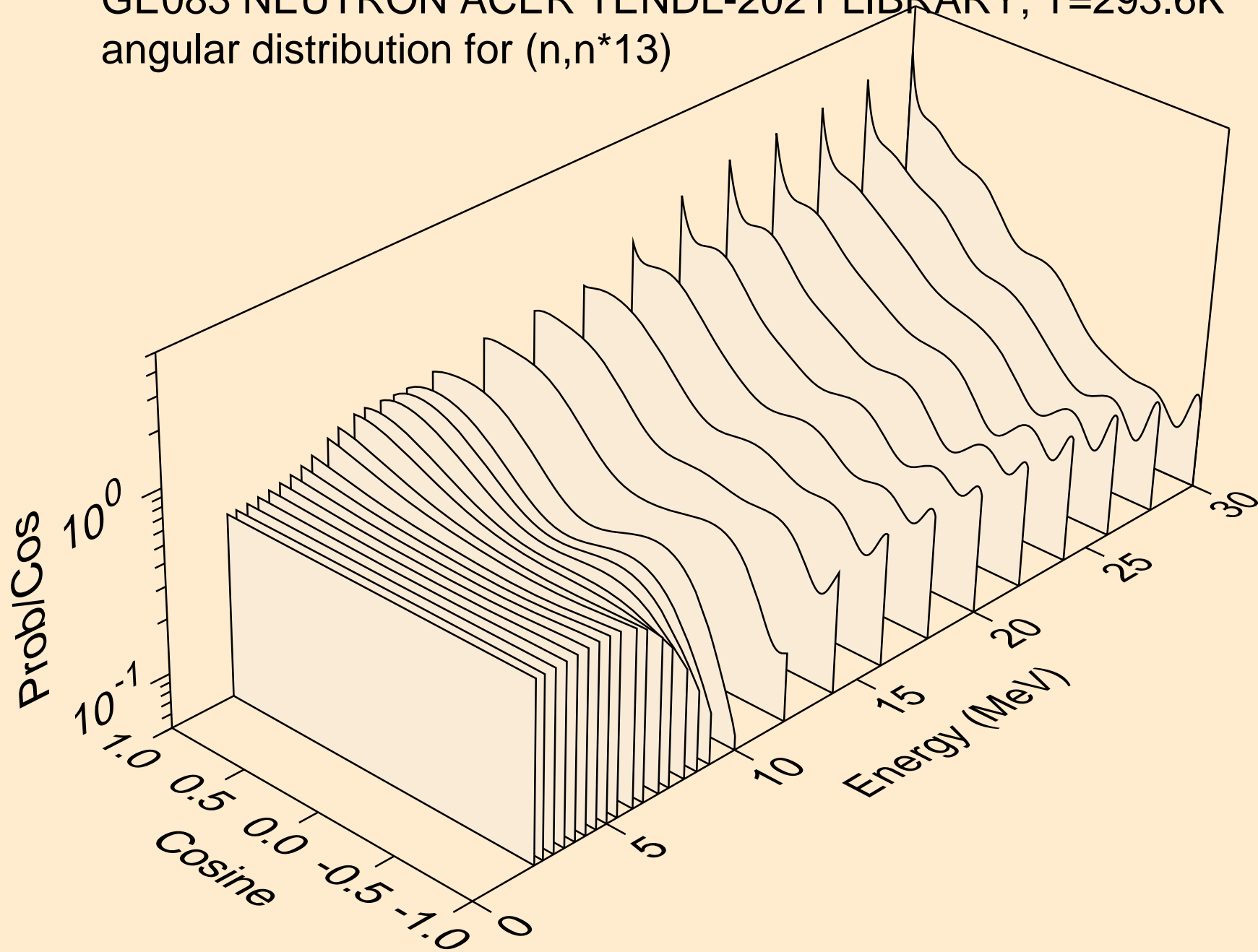

GE083 NEUTRON ACER TENDL-2021 LIBRARY; T=293.6K
angular distribution for (n,n*14)

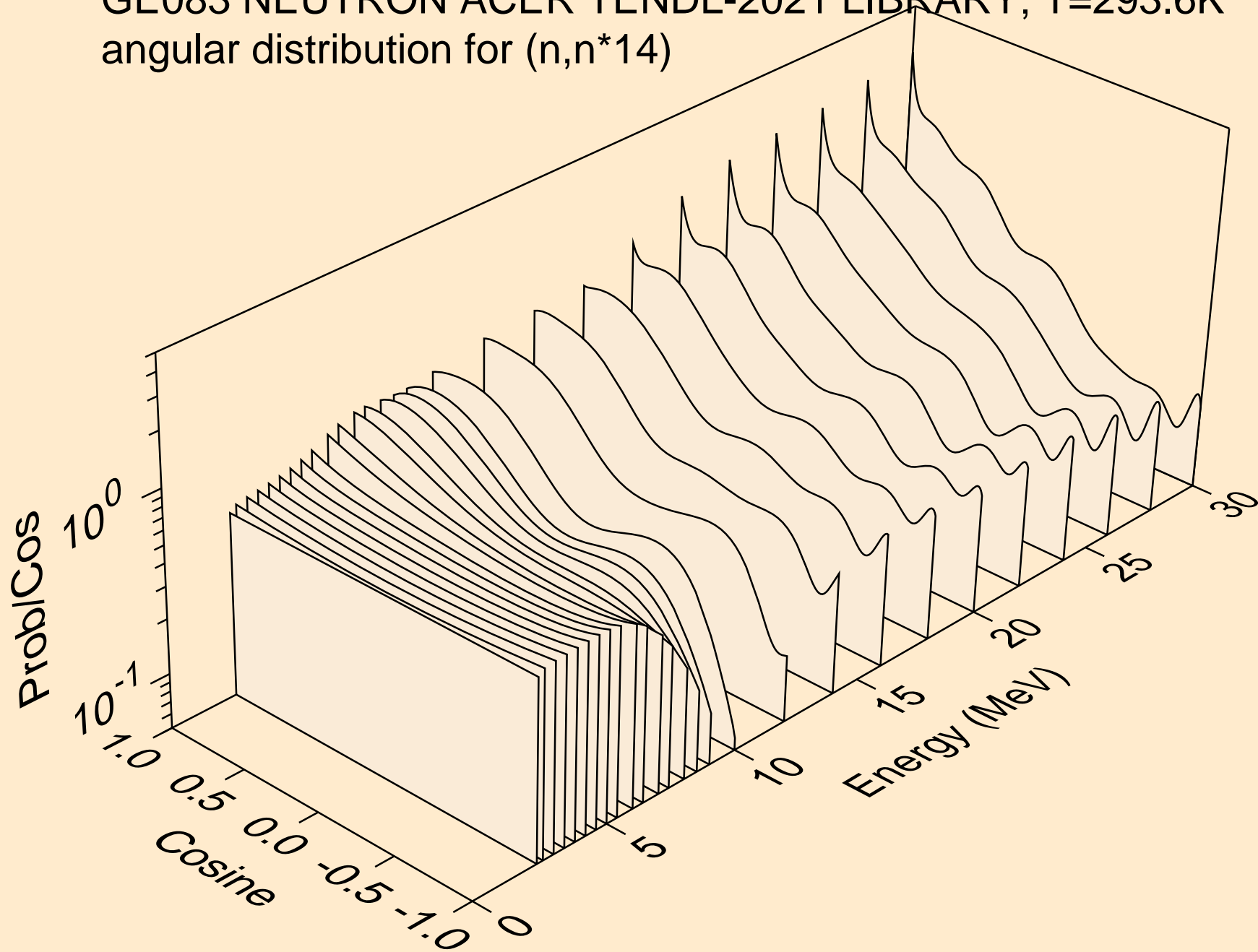

GE083 NEUTRON ACER TENDL-2021 LIBRARY; T=293.6K
angular distribution for (n,n*15)

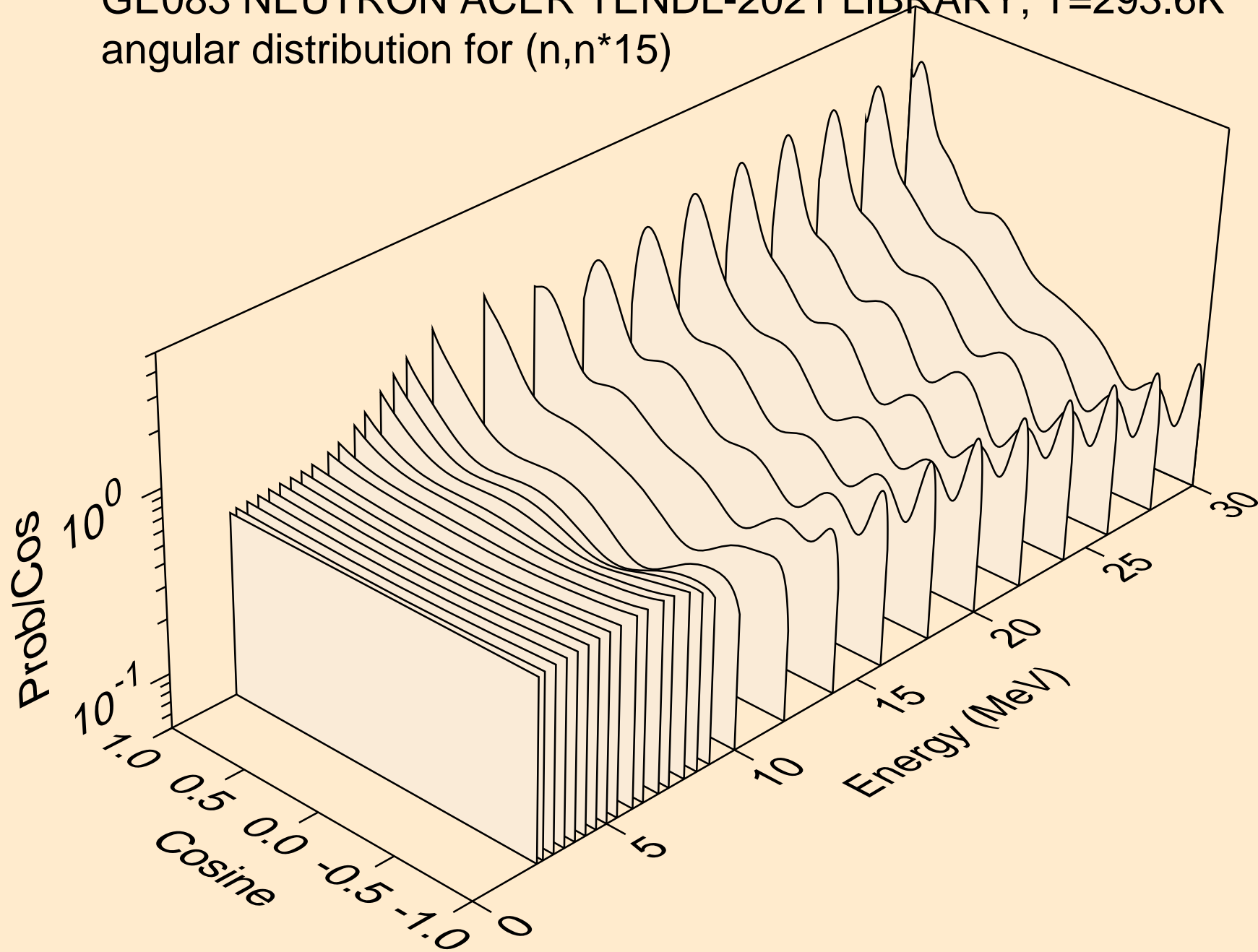

GE083 NEUTRON ACER TENDL-2021 LIBRARY; T=293.6K
angular distribution for (n,n*16)

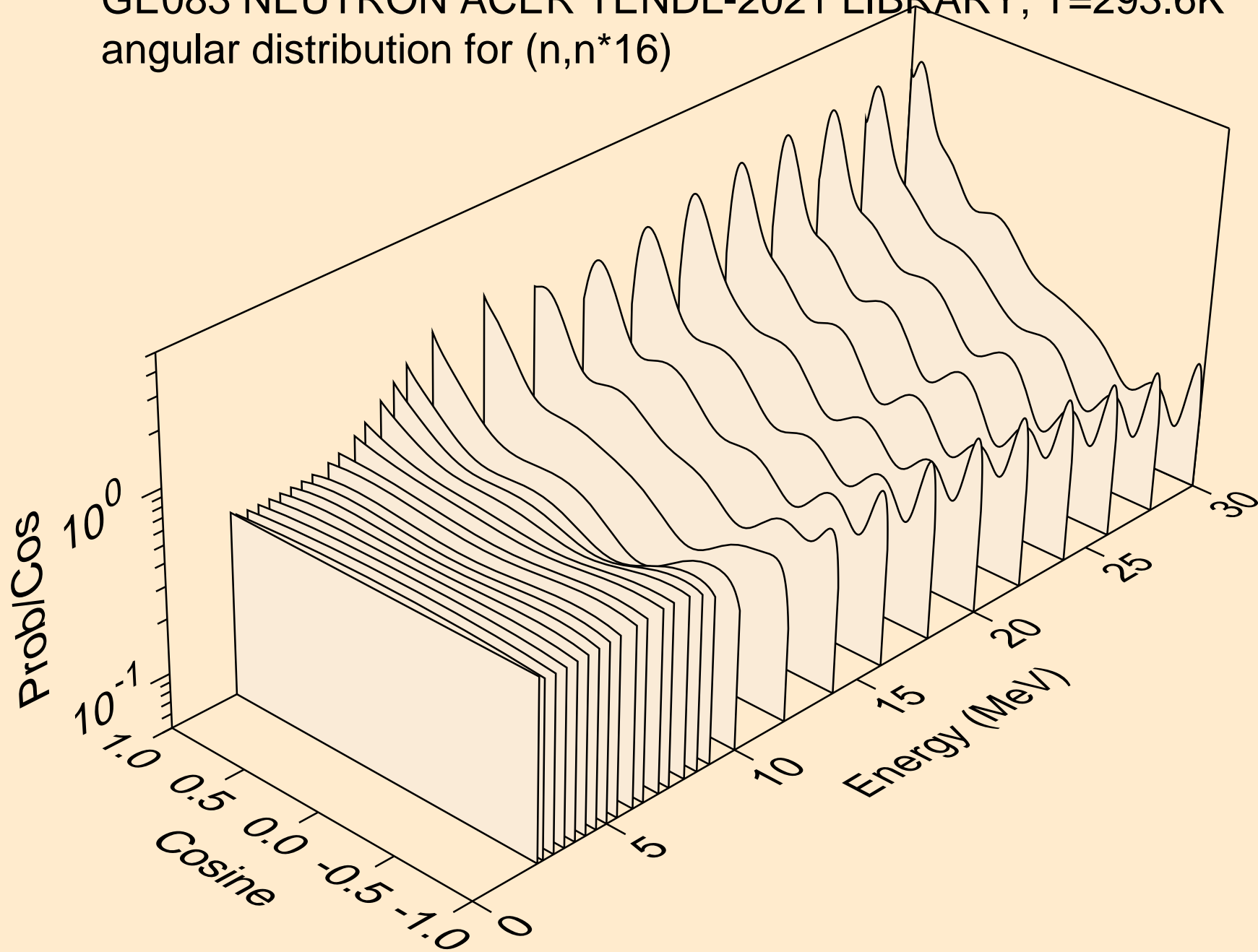

GE083 NEUTRON ACER TENDL-2021 LIBRARY; T=293.6K
angular distribution for (n,n*17)

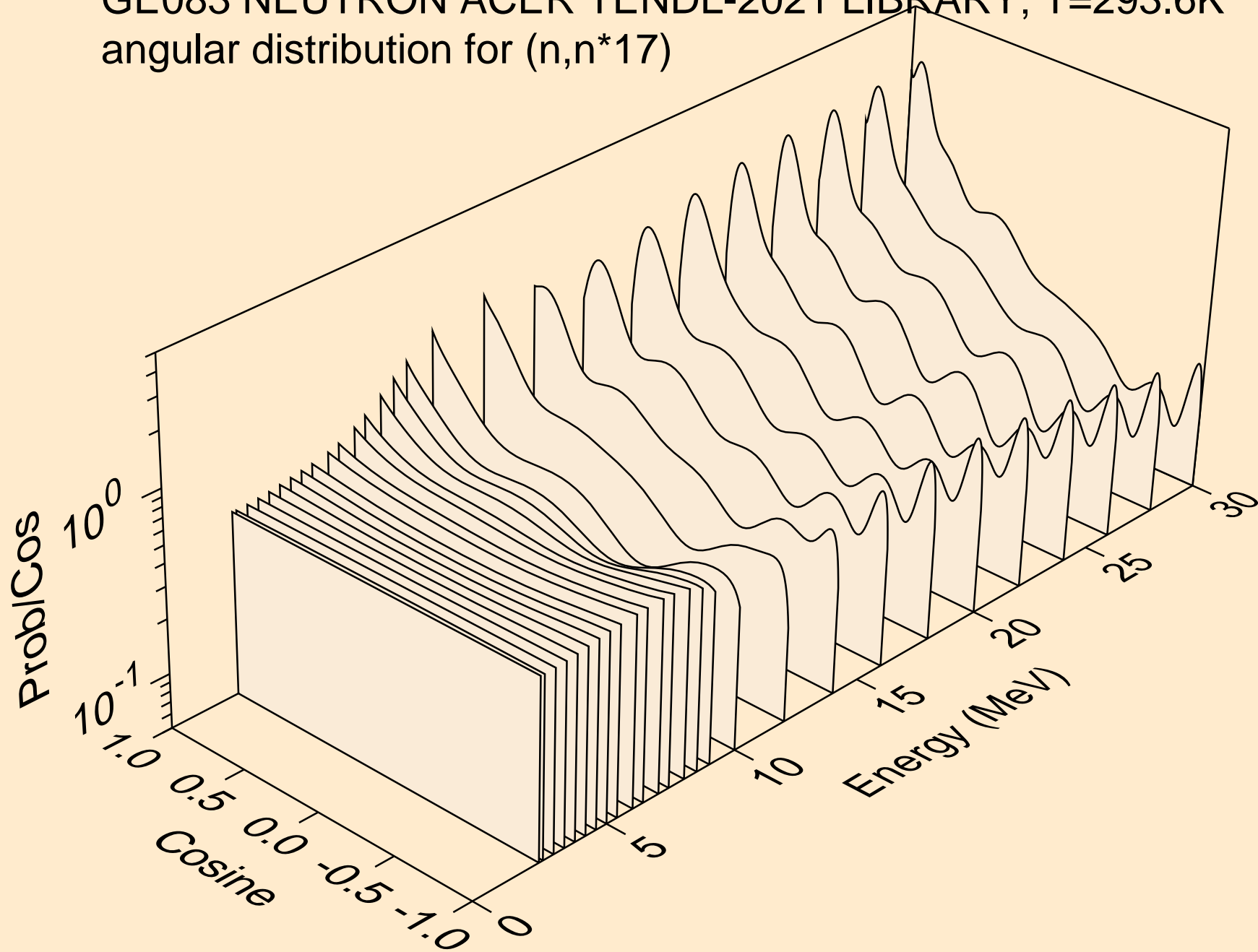

GE083 NEUTRON ACER TENDL-2021 LIBRARY; T=293.6K
angular distribution for (n,n*18)

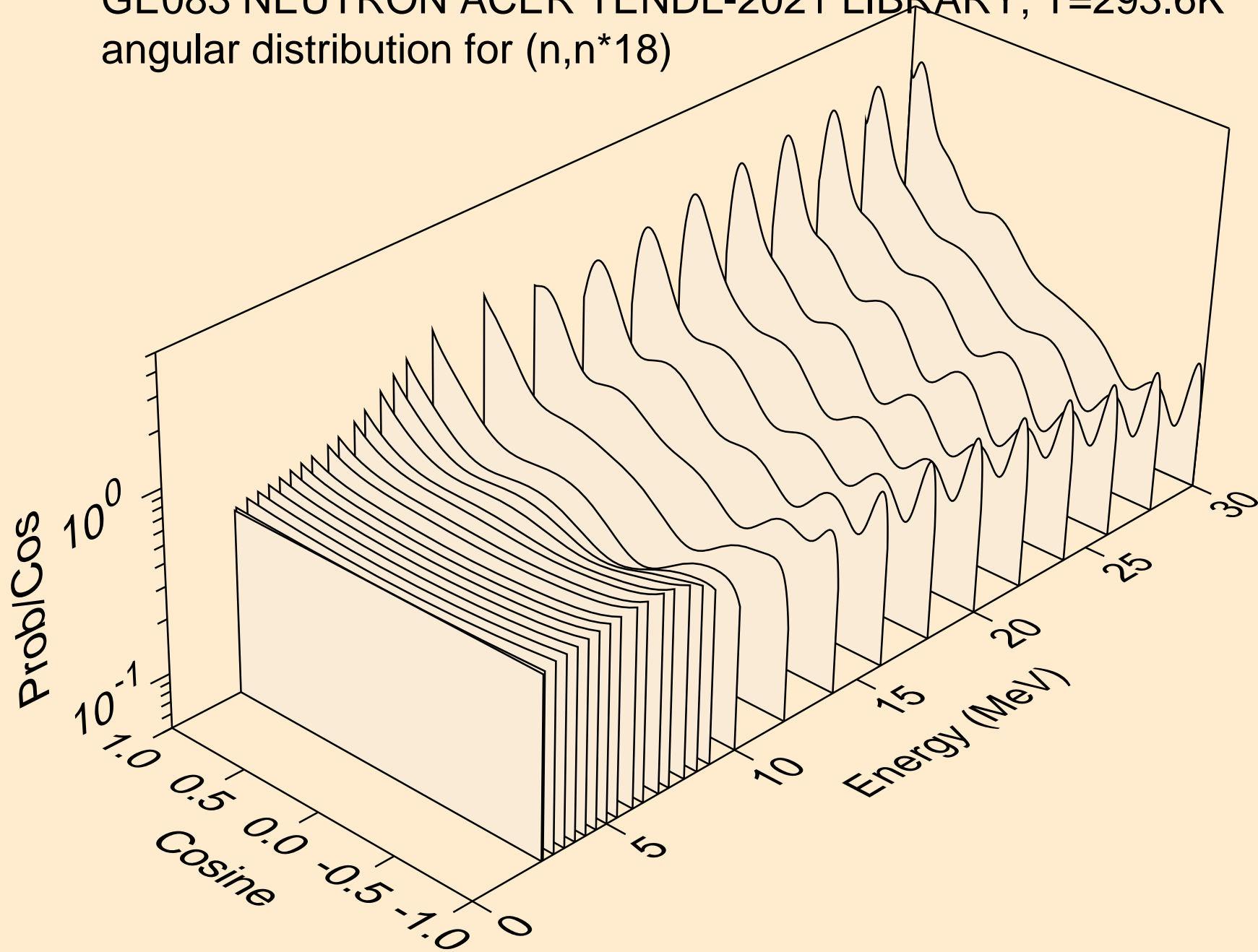

GE083 NEUTRON ACER TENDL-2021 LIBRARY; T=293.6K
angular distribution for (n,n*19)

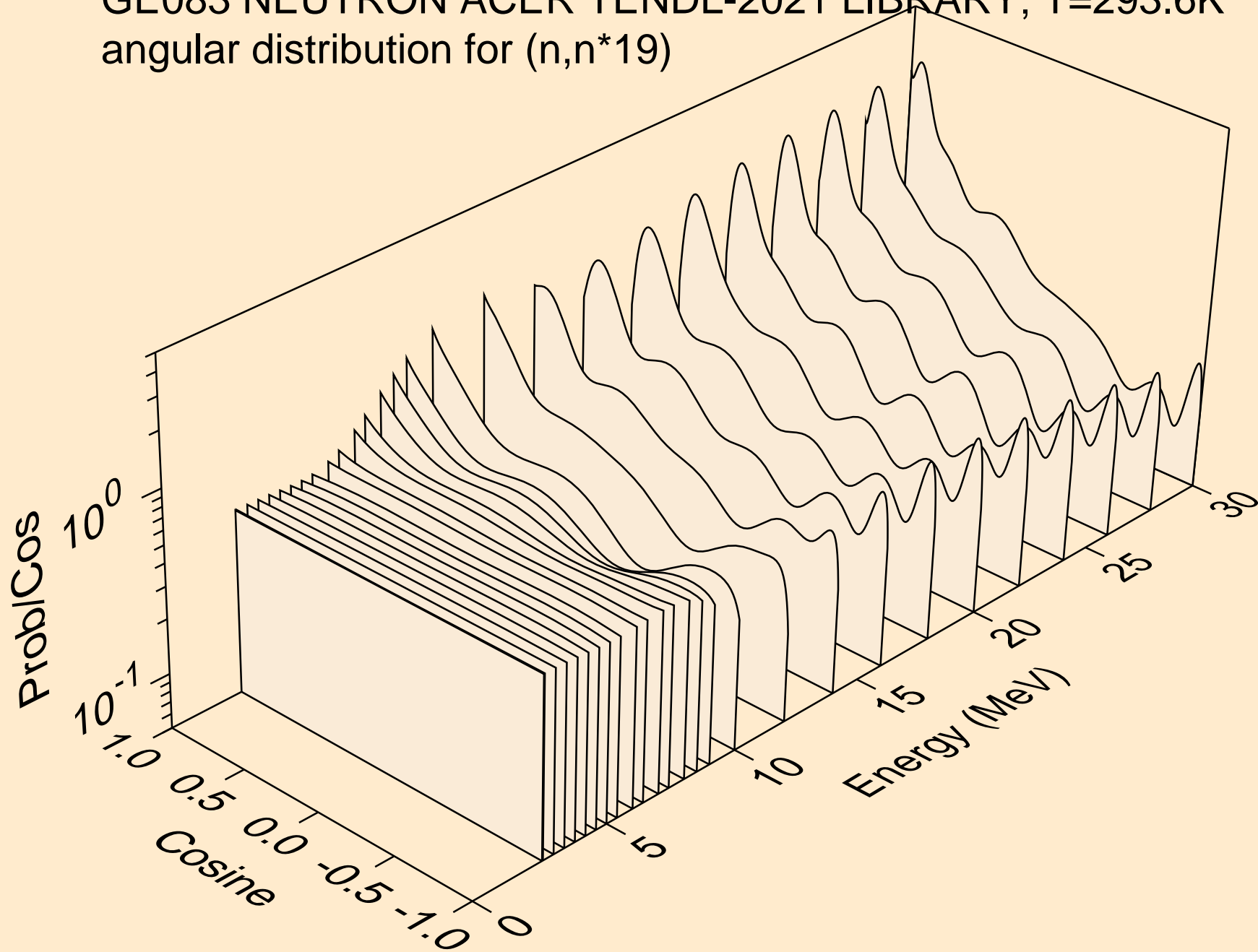

GE083 NEUTRON ACER TENDL-2021 LIBRARY; T=293.6K
angular distribution for (n,n*20)

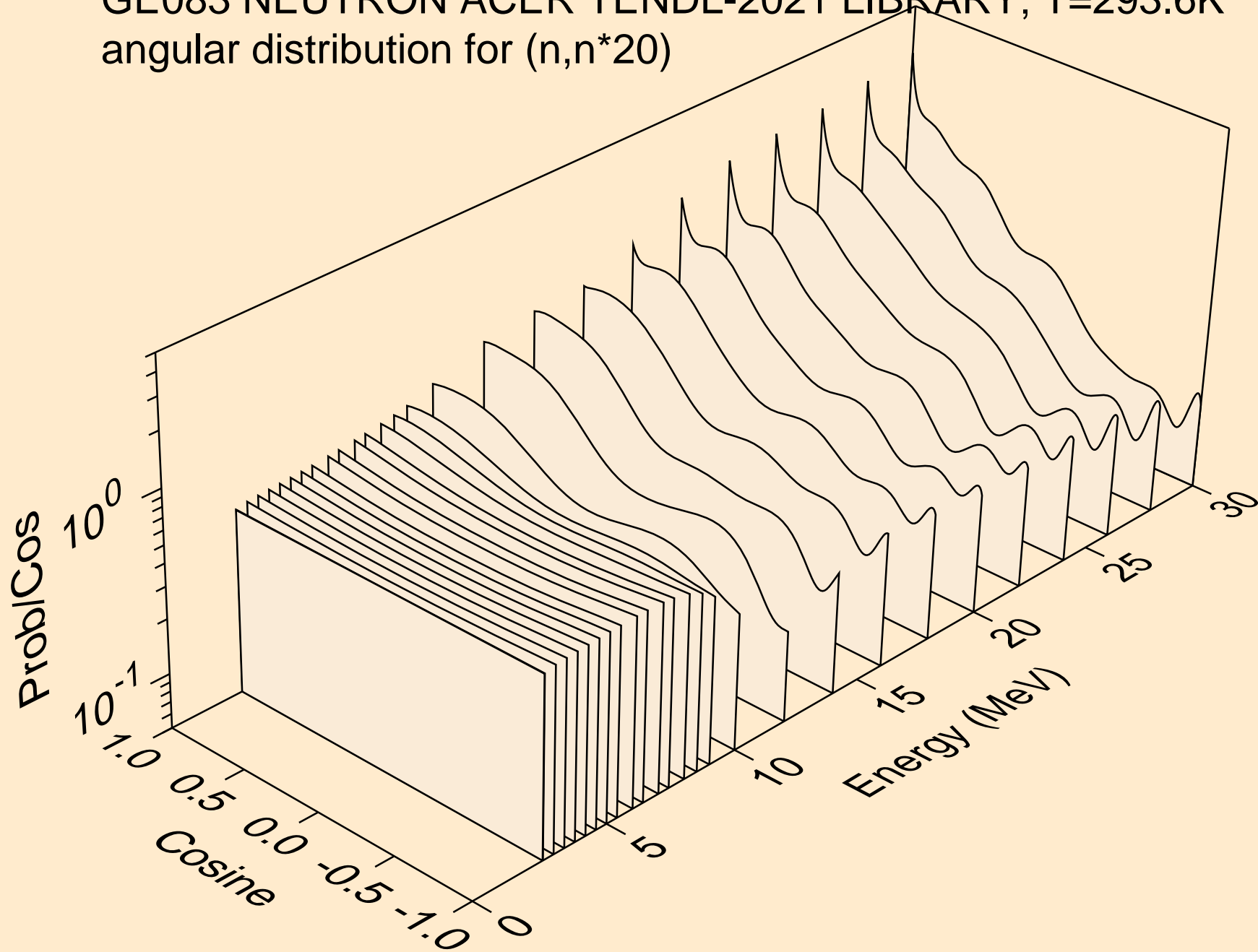

GE083 NEUTRON ACER TENDL-2021 LIBRARY; T=293.6K
angular distribution for (n,n*21)

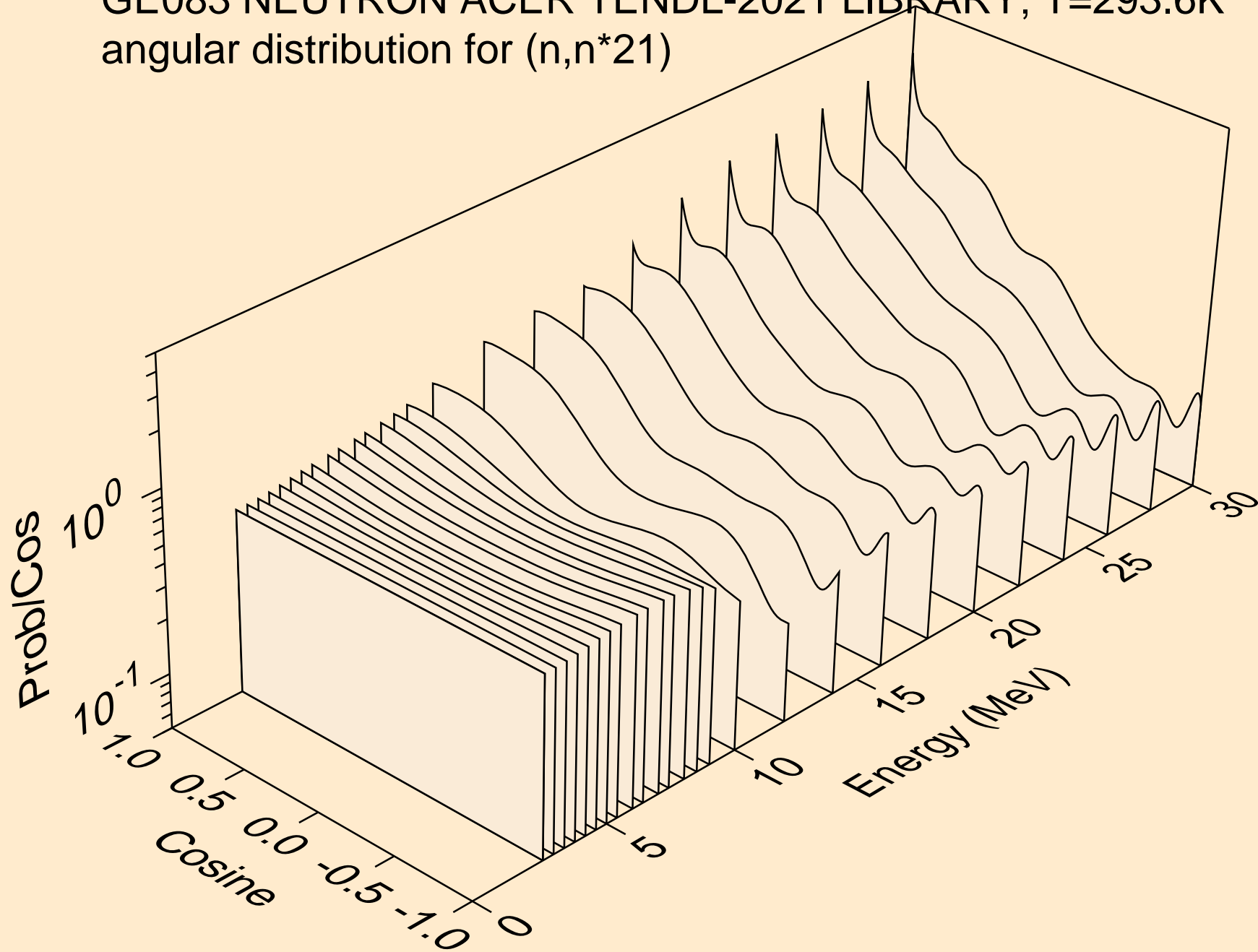

GE083 NEUTRON ACER TENDL-2021 LIBRARY; T=293.6K
angular distribution for (n,n*22)

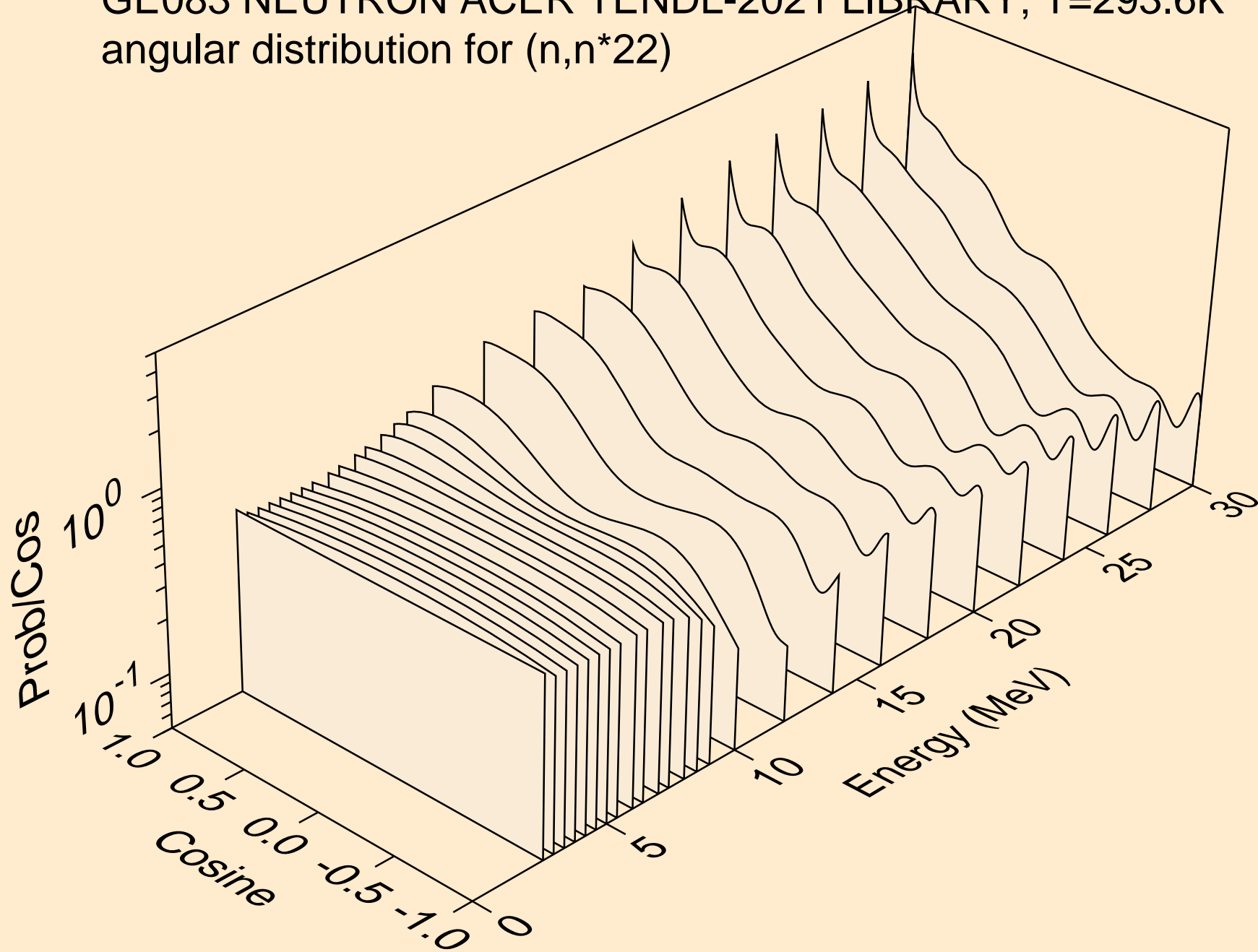

GE083 NEUTRON ACER TENDL-2021 LIBRARY; T=293.6K
angular distribution for (n,n*23)

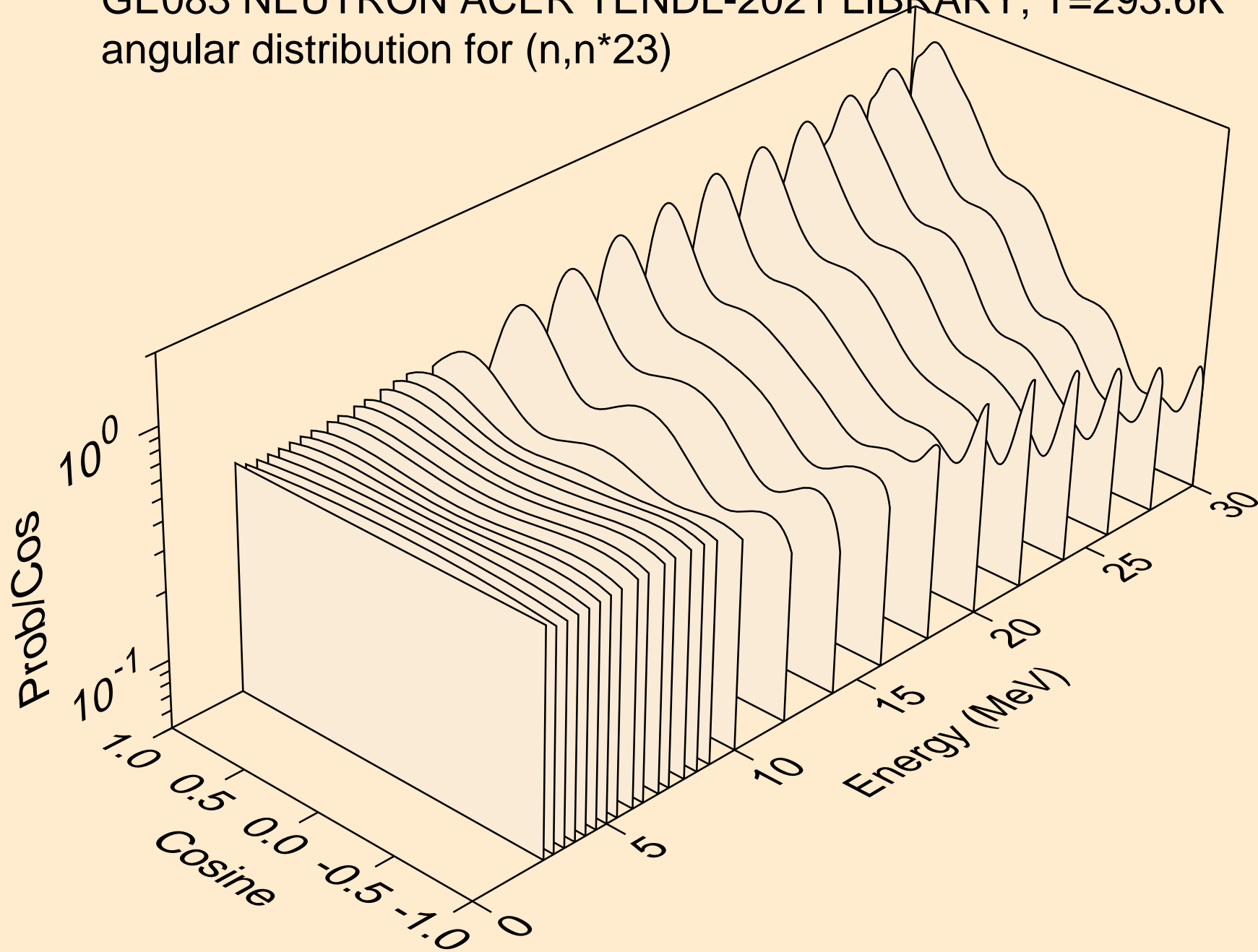

GE083 NEUTRON ACER TENDL-2021 LIBRARY; T=293.6K
angular distribution for (n,n*24)

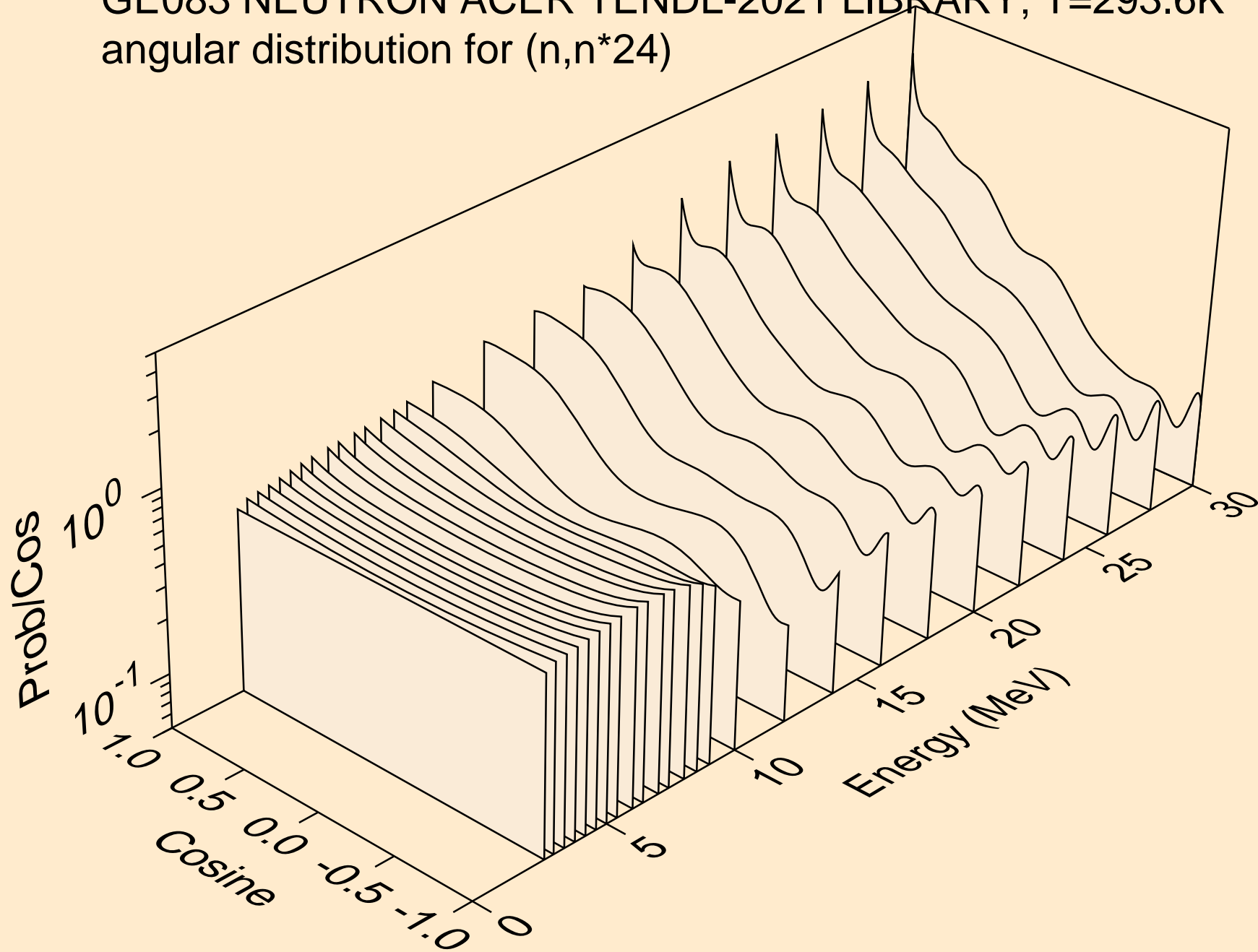

GE083 NEUTRON ACER TENDL-2021 LIBRARY; T=293.6K
angular distribution for (n,n*25)

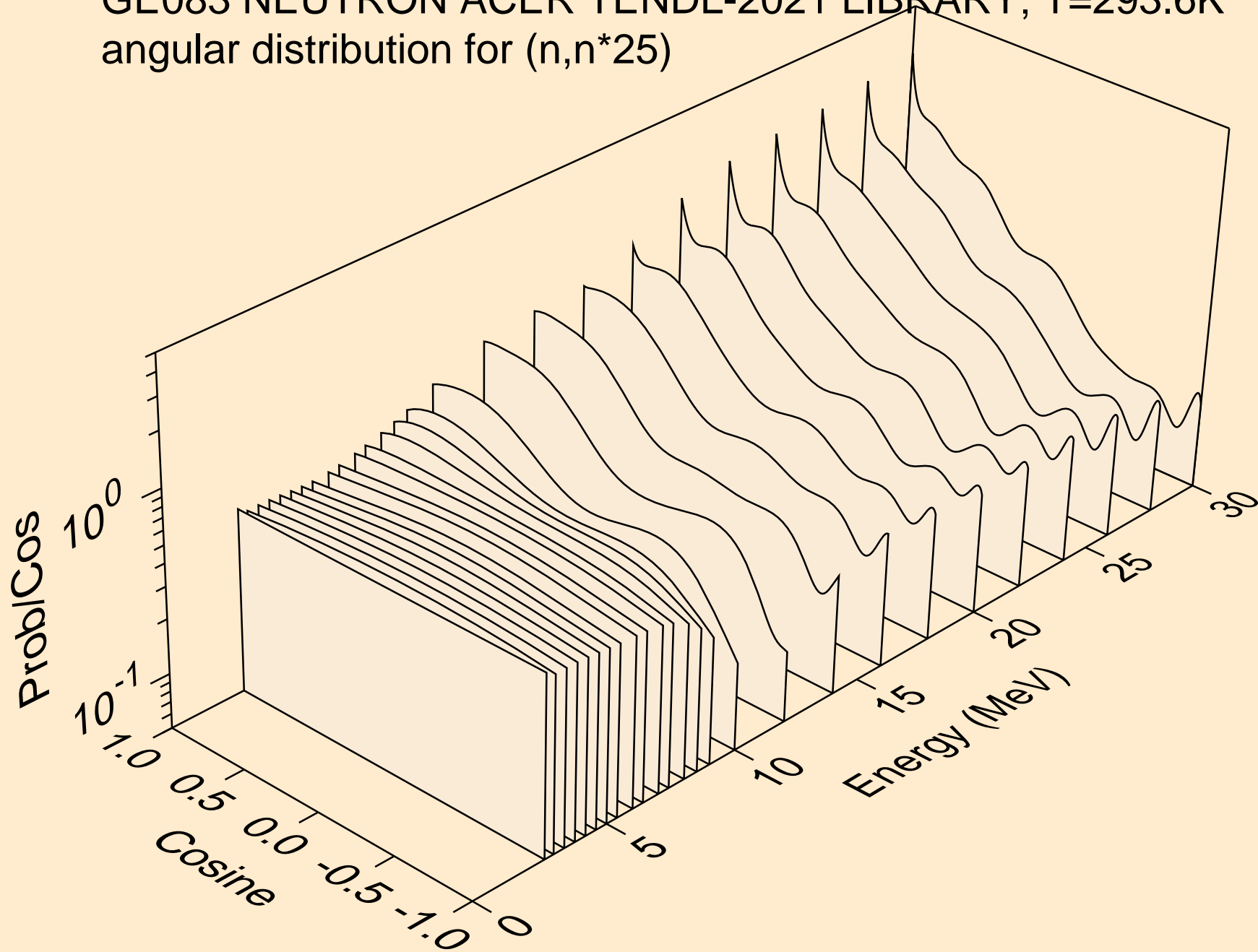

GE083 NEUTRON ACER TENDL-2021 LIBRARY; T=293.6K
angular distribution for (n,n*26)

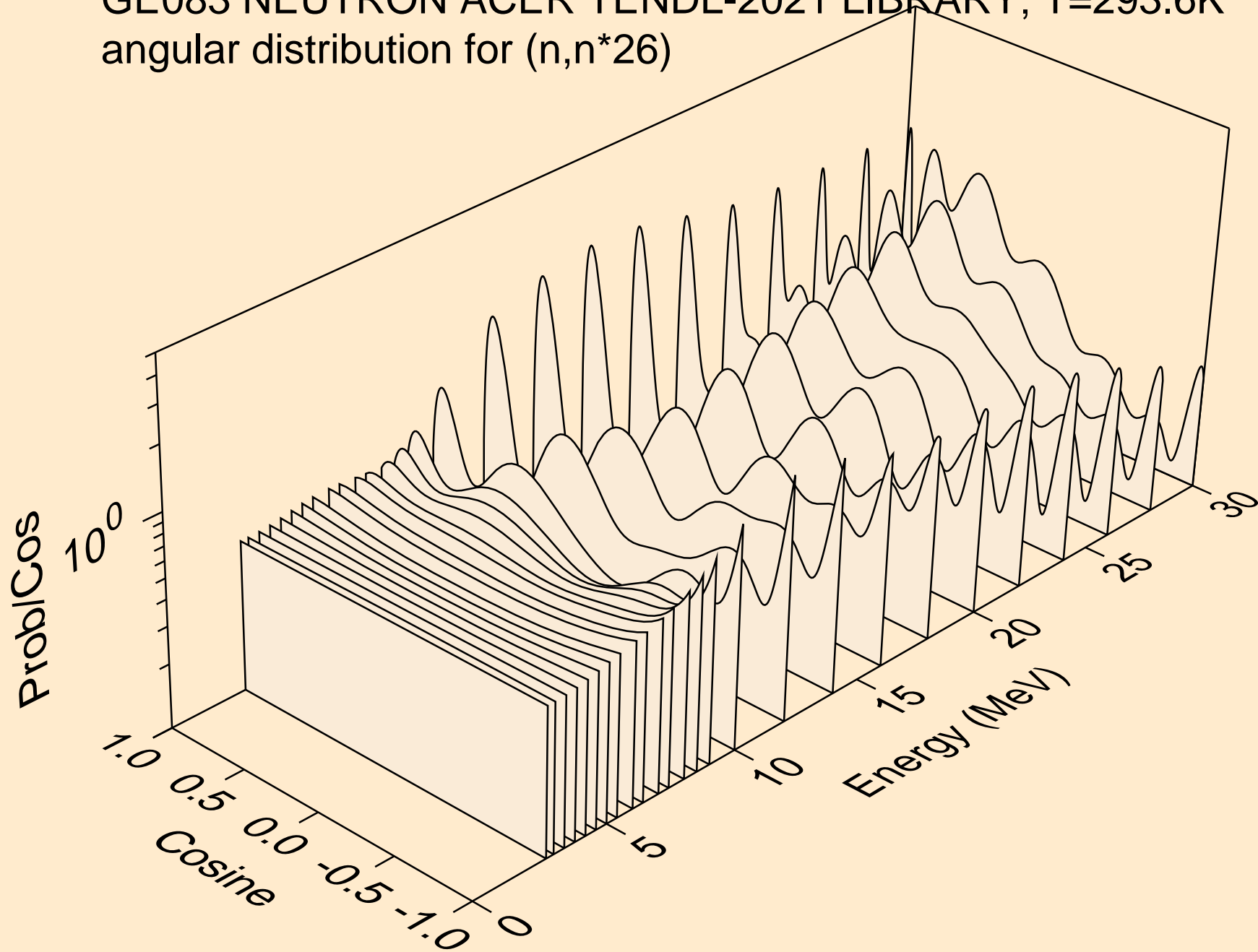

GE083 NEUTRON ACER TENDL-2021 LIBRARY; T=293.6K
angular distribution for (n,n*27)

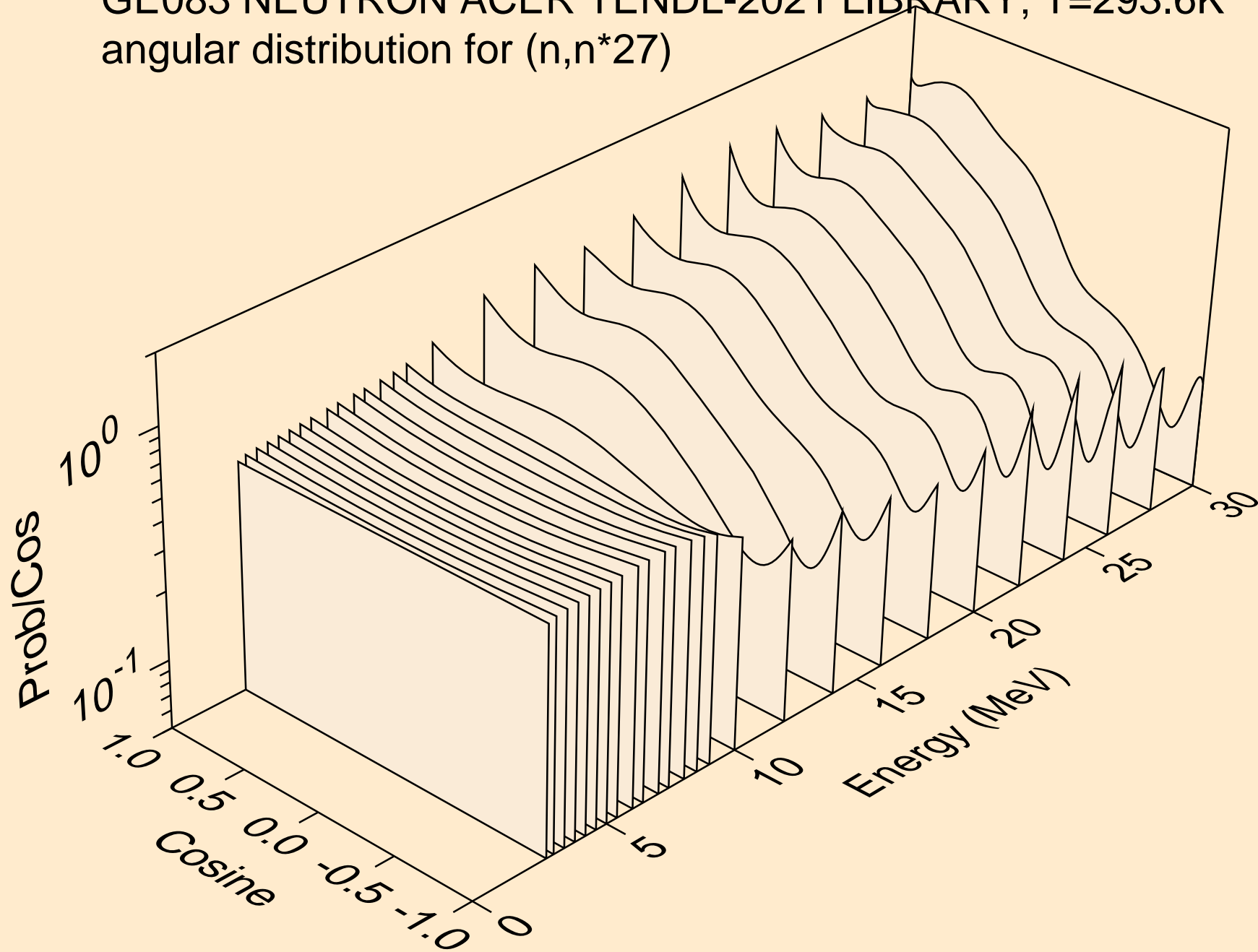

GE083 NEUTRON ACER TENDL-2021 LIBRARY; T=293.6K
angular distribution for (n,n*28)

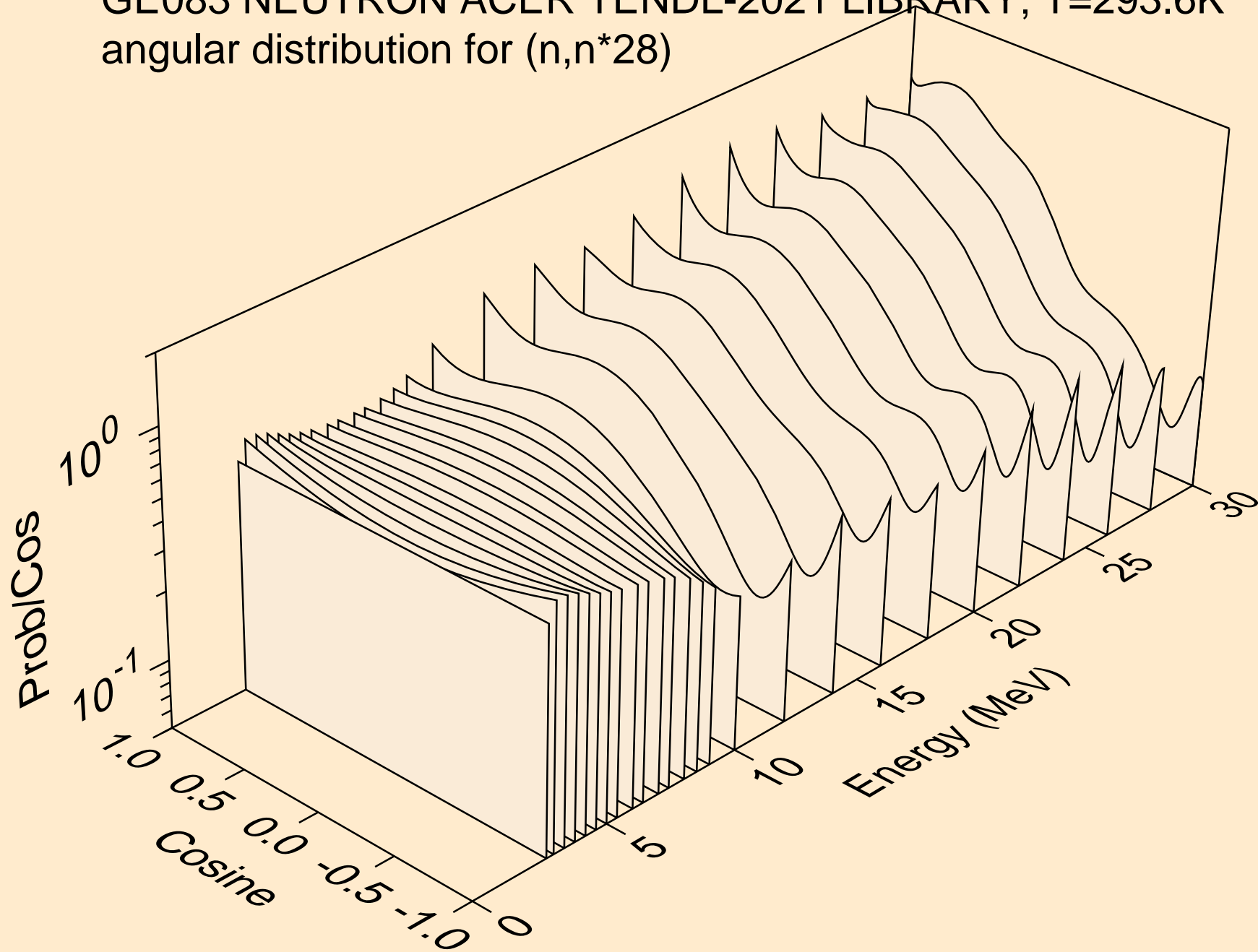

GE083 NEUTRON ACER TENDL-2021 LIBRARY; T=293.6K
angular distribution for (n,n*29)

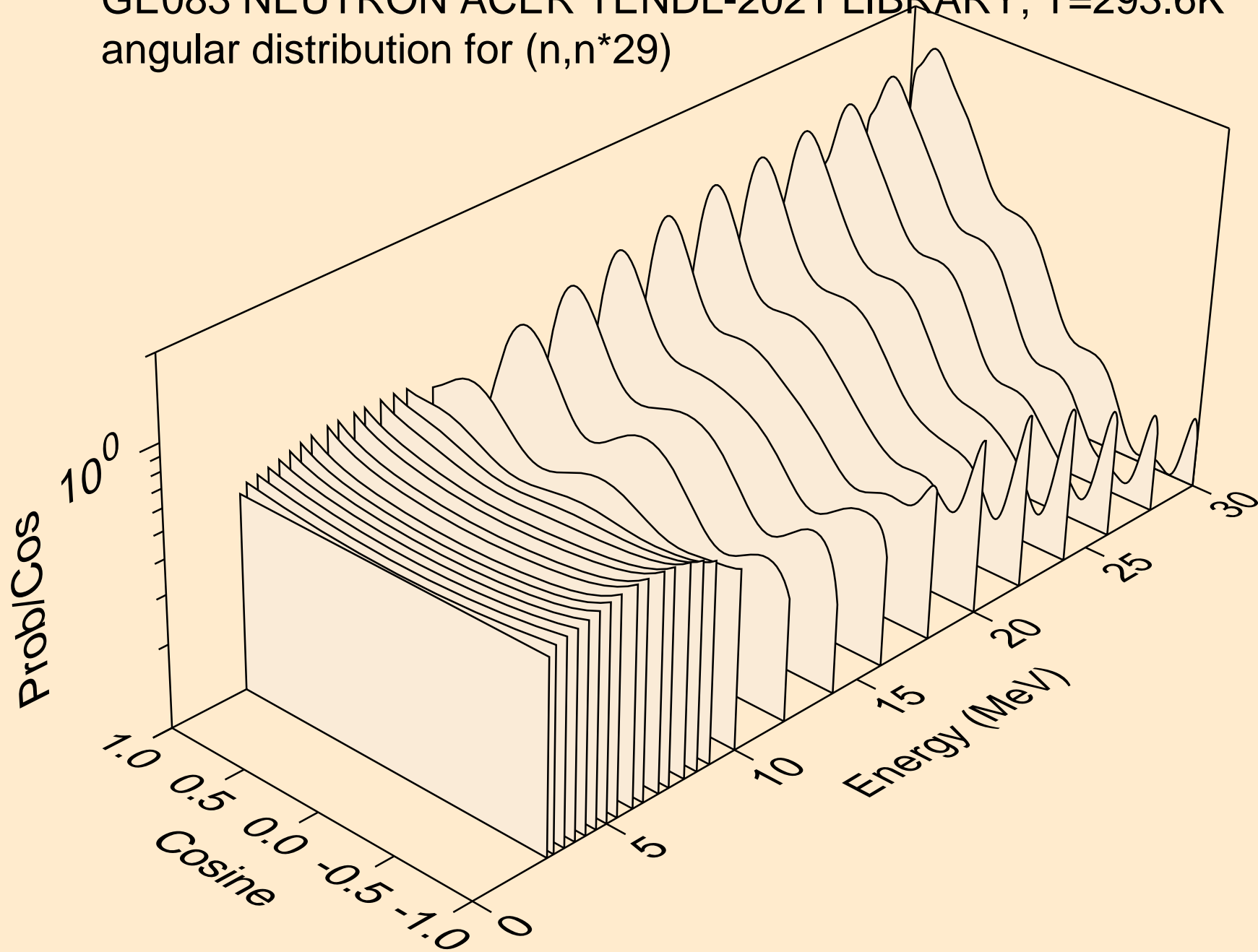

GE083 NEUTRON ACER TENDL-2021 LIBRARY; T=293.6K
angular distribution for (n,n*30)

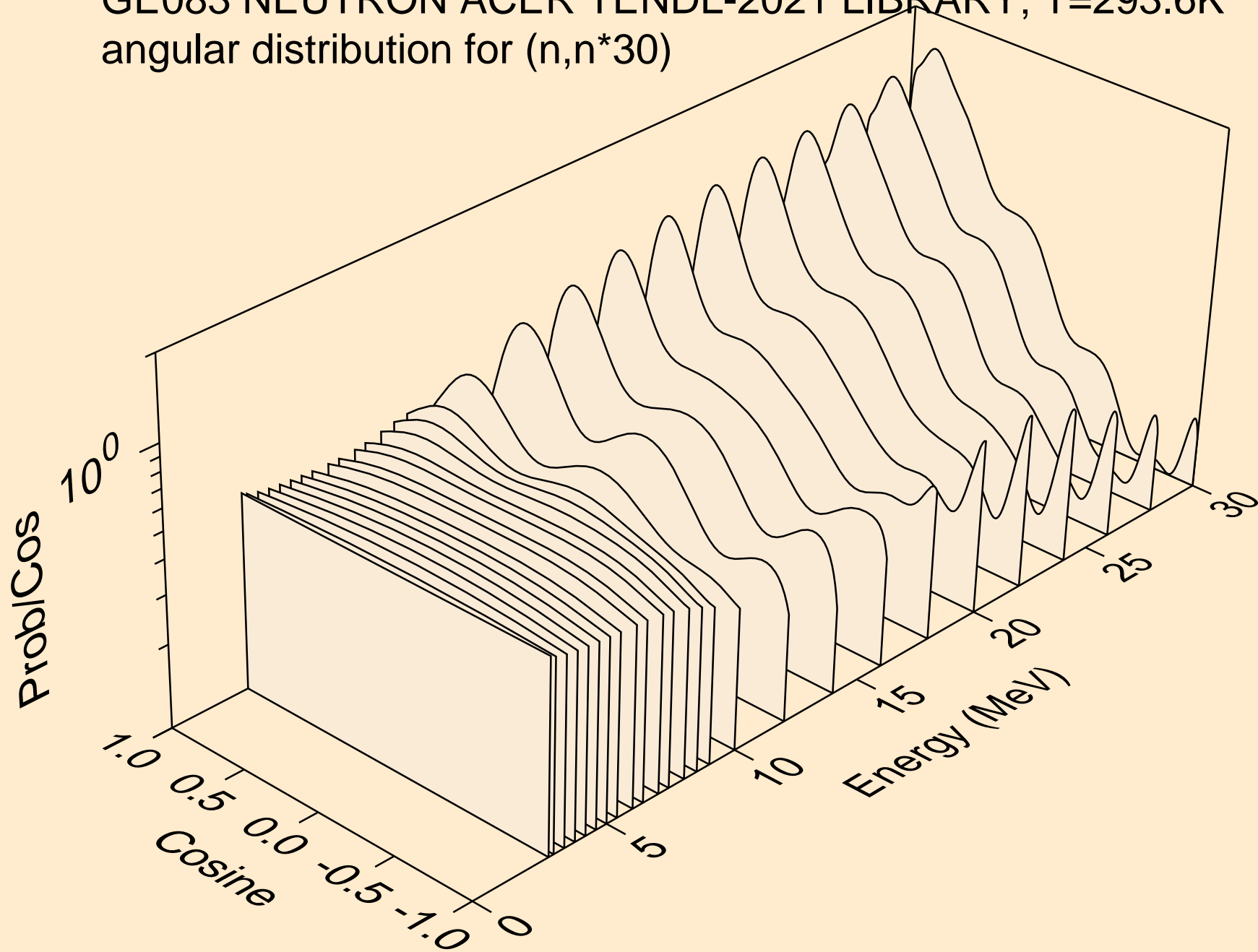

GE083 NEUTRON ACER TENDL-2021 LIBRARY; T=293.6K
Neutron emission for (n,x)

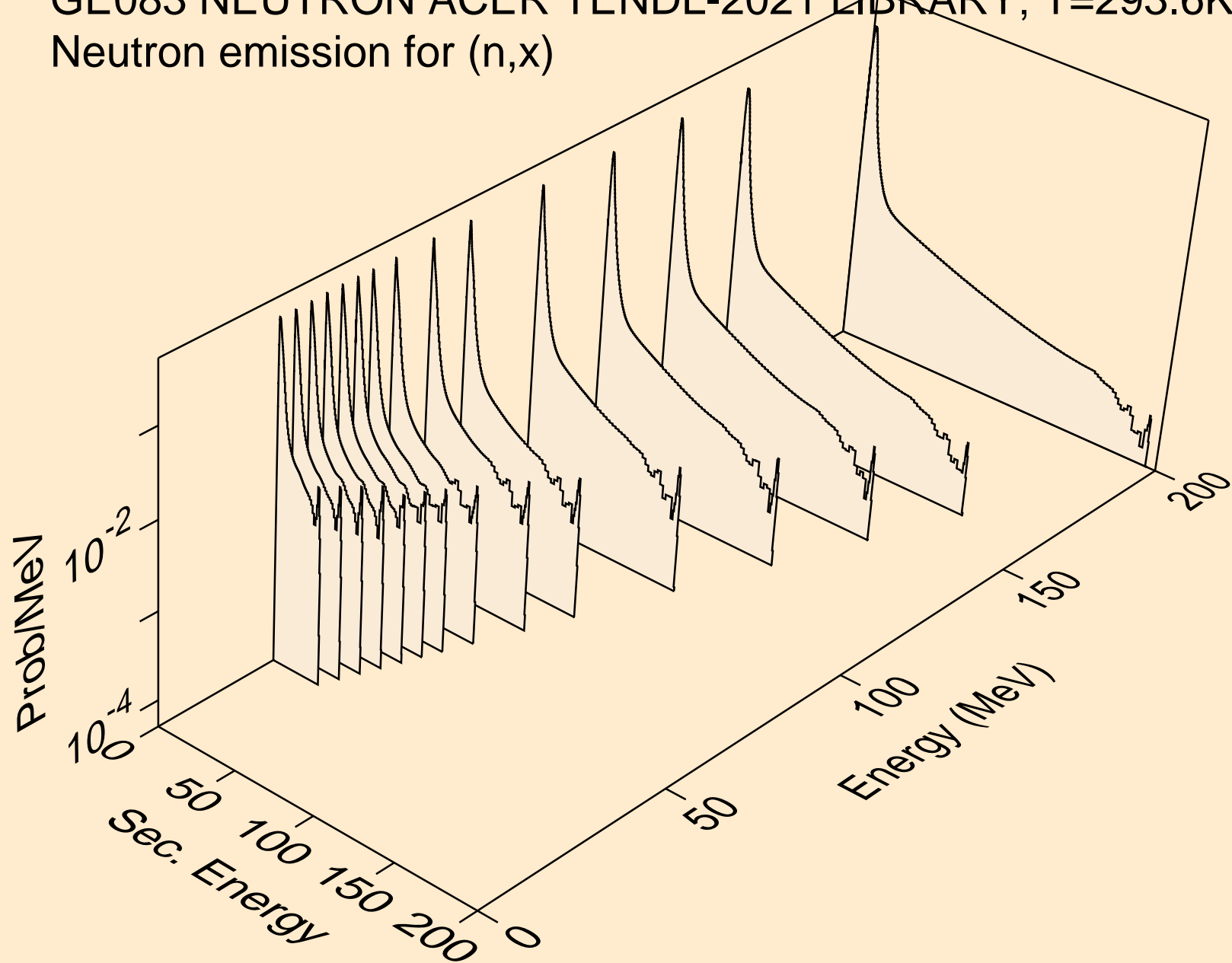

GE083 NEUTRON ACER TENDL-2021 LIBRARY; T=293.6K
Neutron emission for (n,2nd)

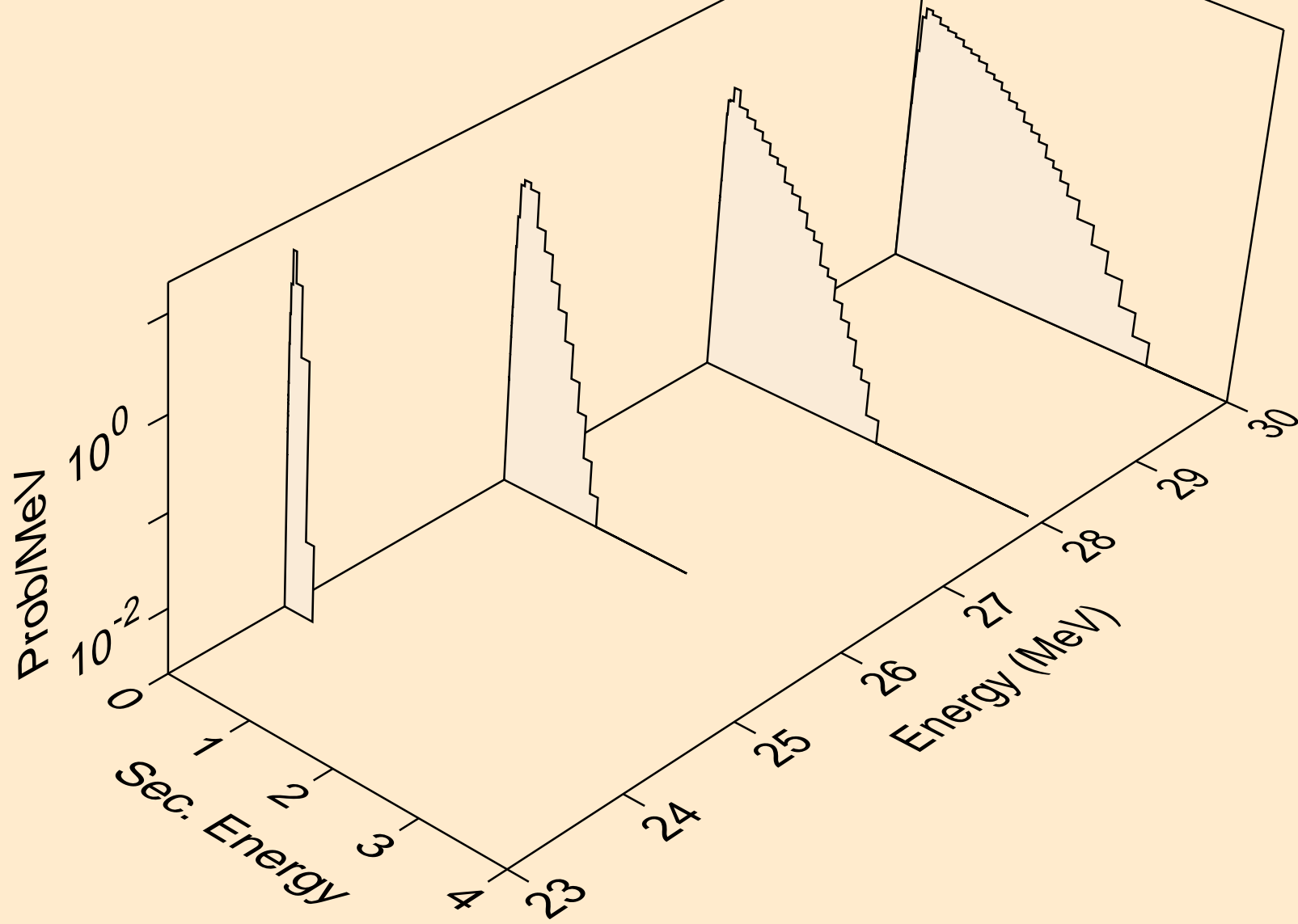

GE083 NEUTRON ACER TENDL-2021 LIBRARY; T=293.6K
Neutron emission for (n,2n)

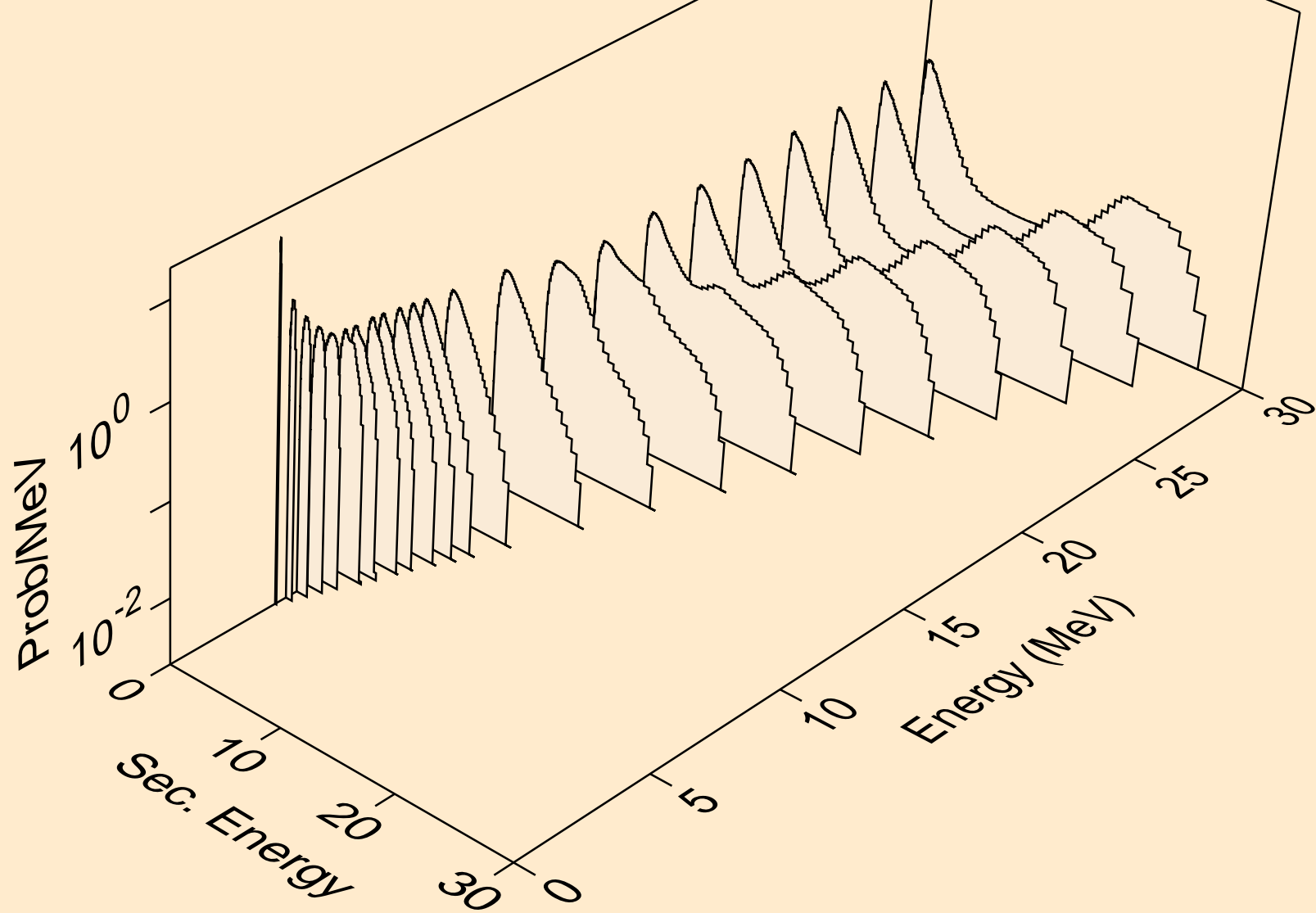

GE083 NEUTRON ACER TENDL-2021 LIBRARY; T=293.6K
Neutron emission for (n,3n)

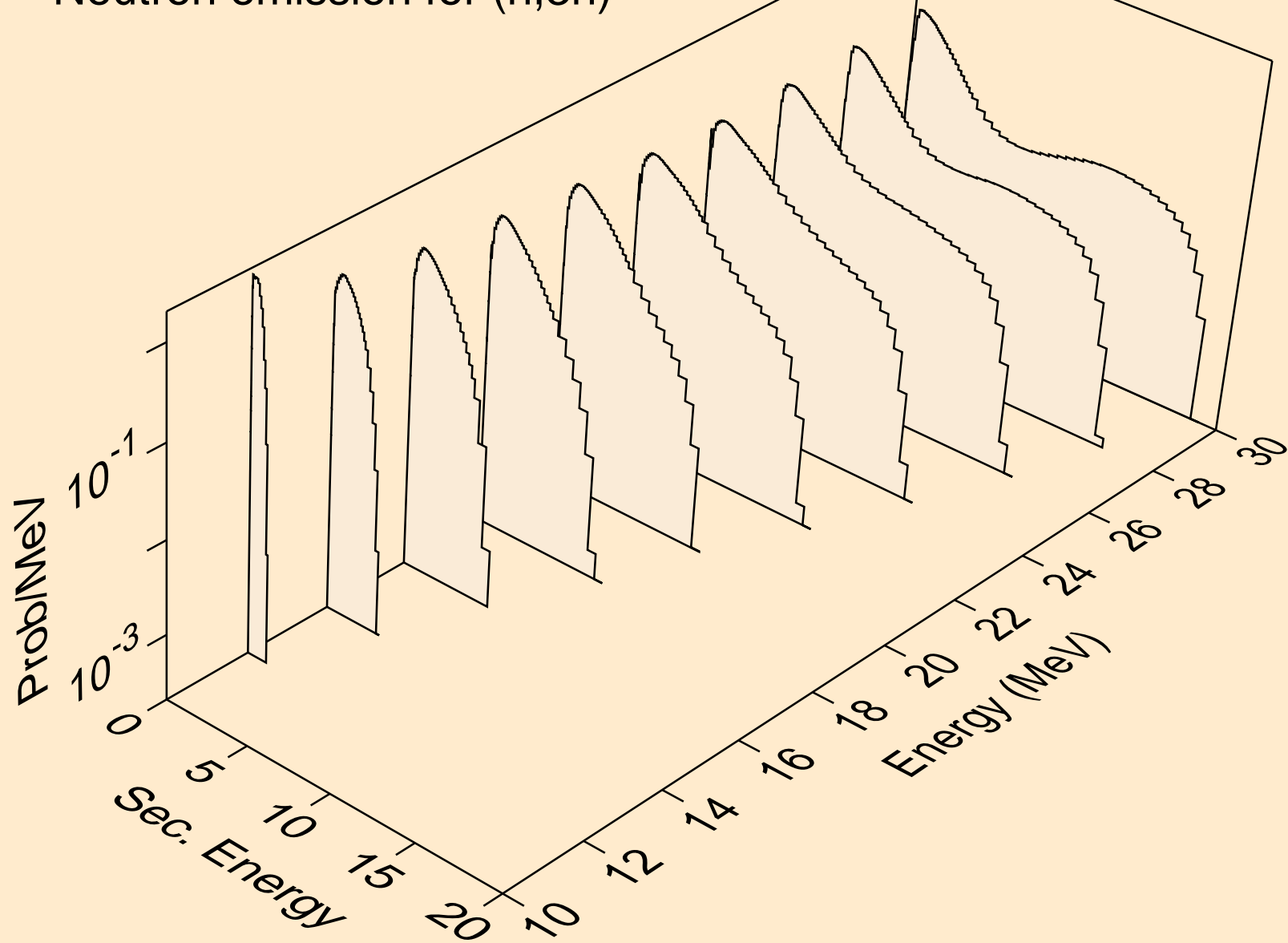

GE083 NEUTRON ACER TENDL-2021 LIBRARY; T=293.6K
Neutron emission for (n,n*)a

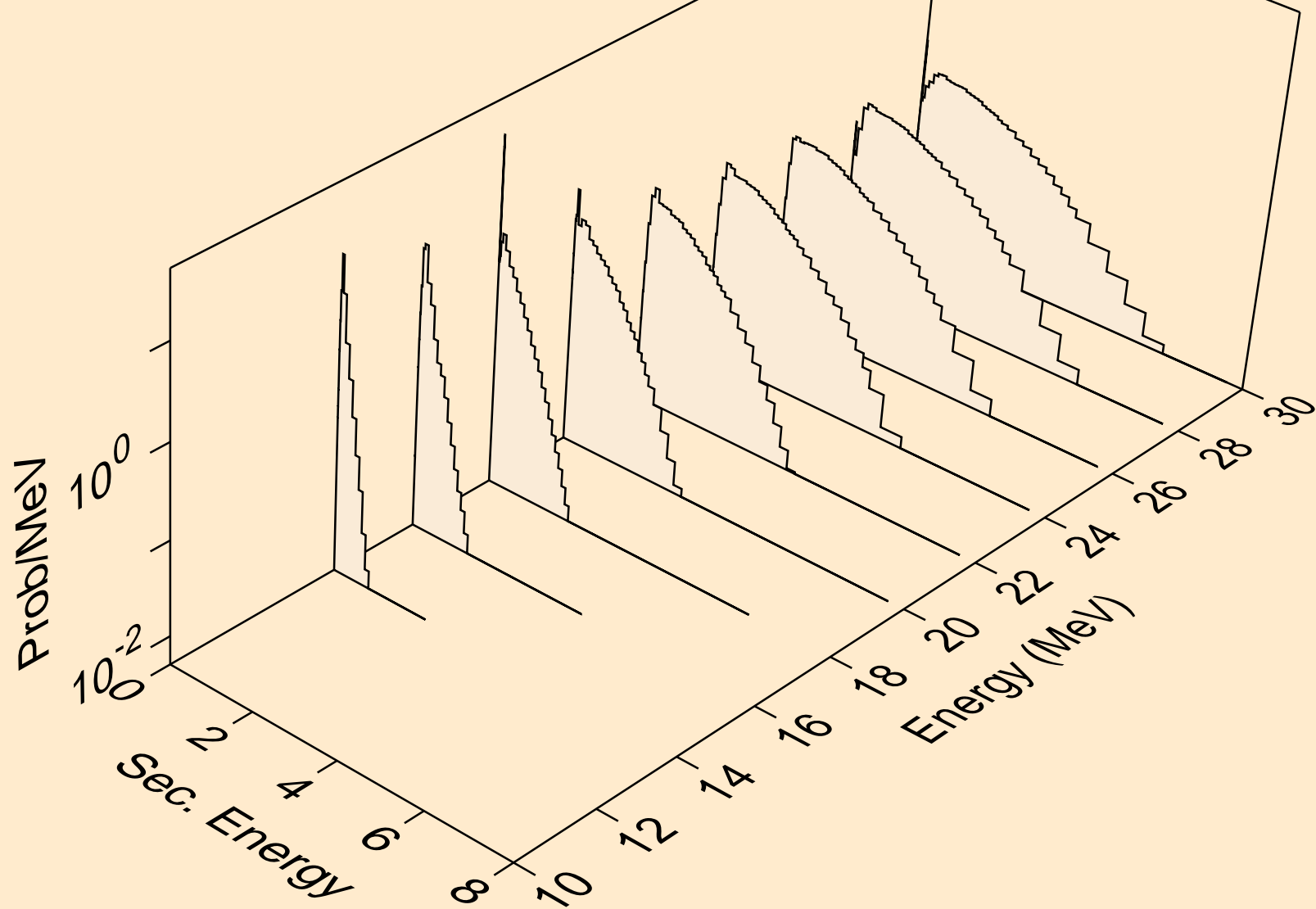

GE083 NEUTRON ACER TENDL-2021 LIBRARY; T=293.6K
Neutron emission for (n,2n)_a

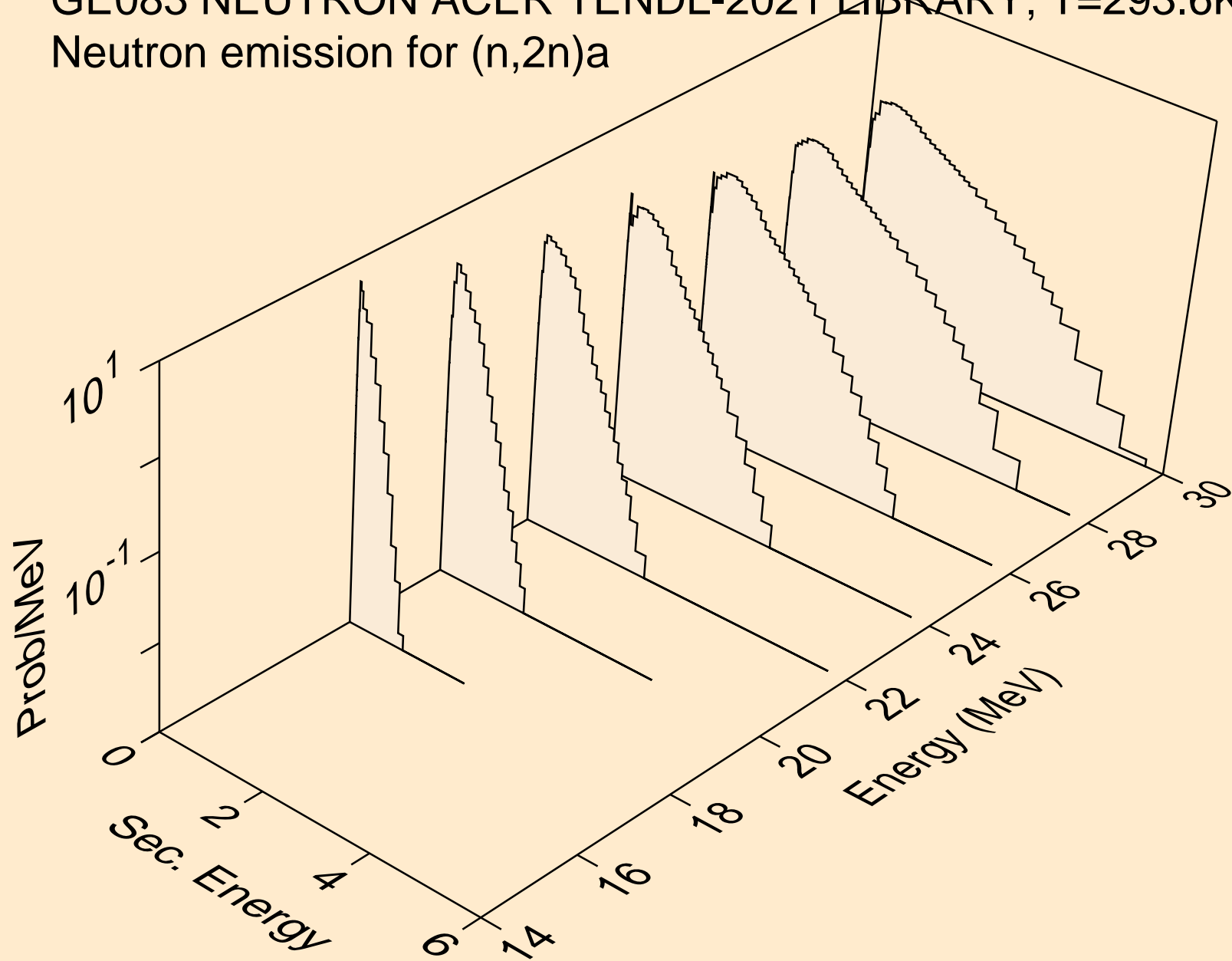

GE083 NEUTRON ACER TENDL-2021 LIBRARY; T=293.6K
Neutron emission for (n,3n)a

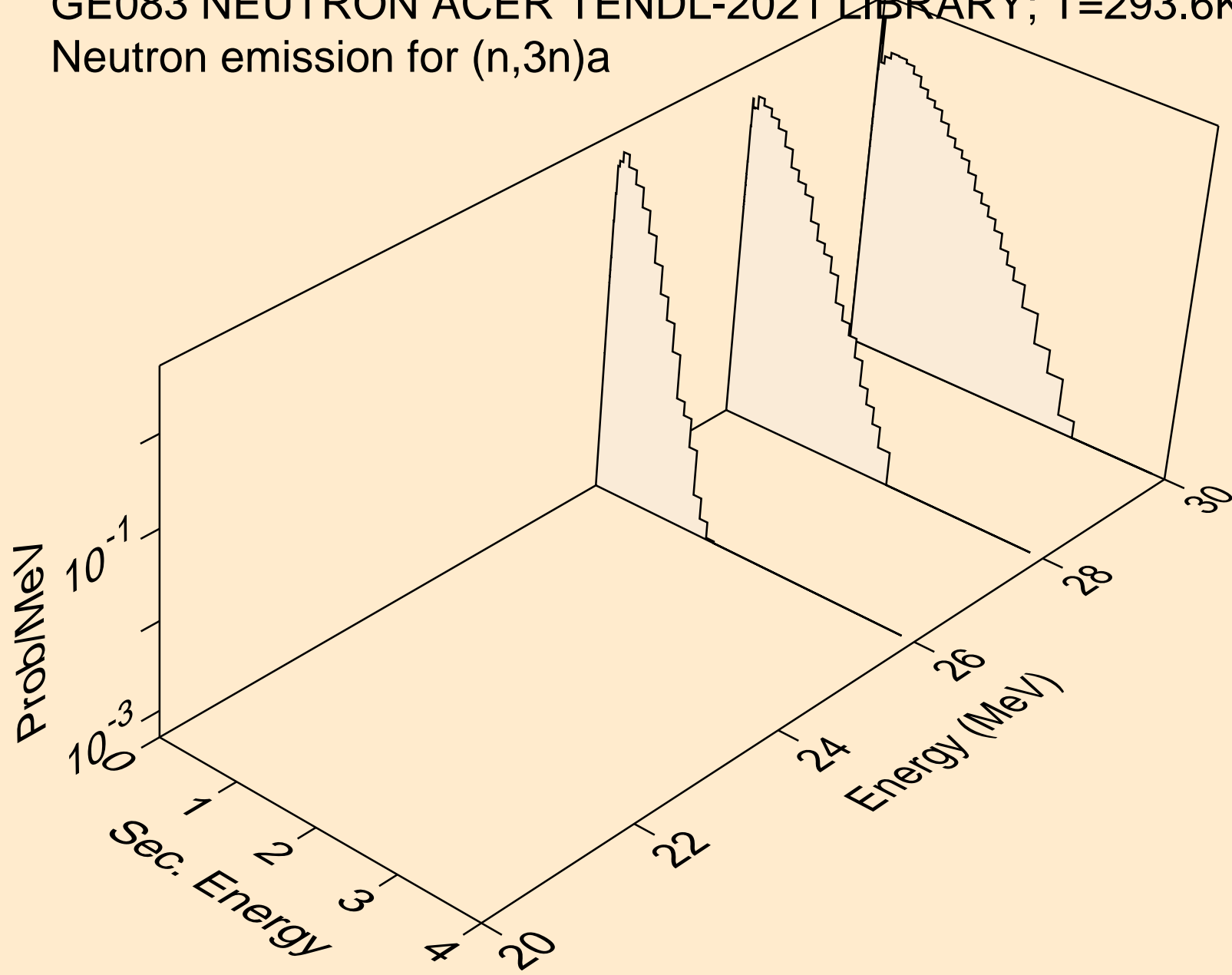

GE083 NEUTRON ACER TENDL-2021 LIBRARY; T=293.6K
Neutron emission for (n,n*)p

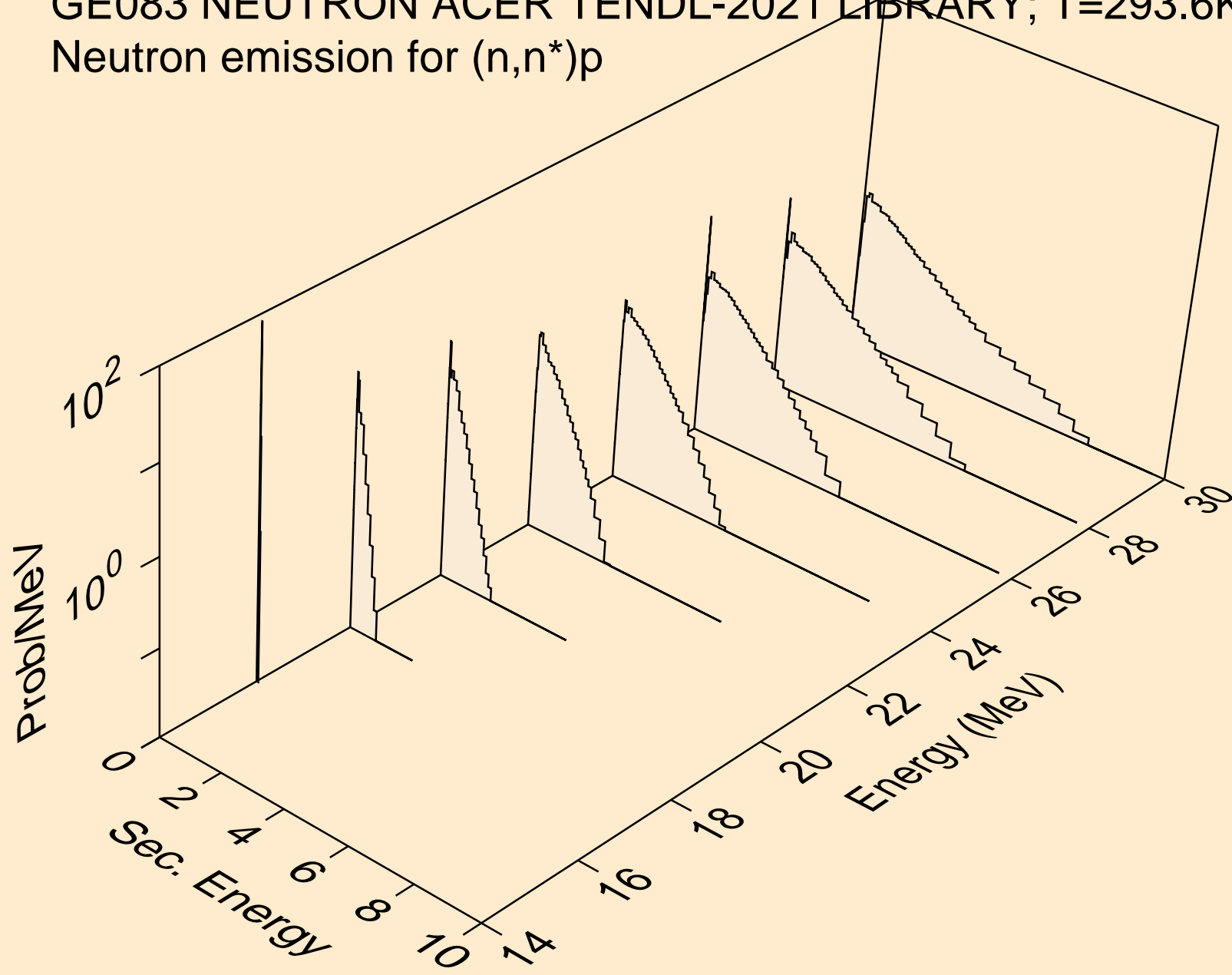

GE083 NEUTRON ACER TENDL-2021 LIBRARY; T=293.6K
Neutron emission for (n,n*)d

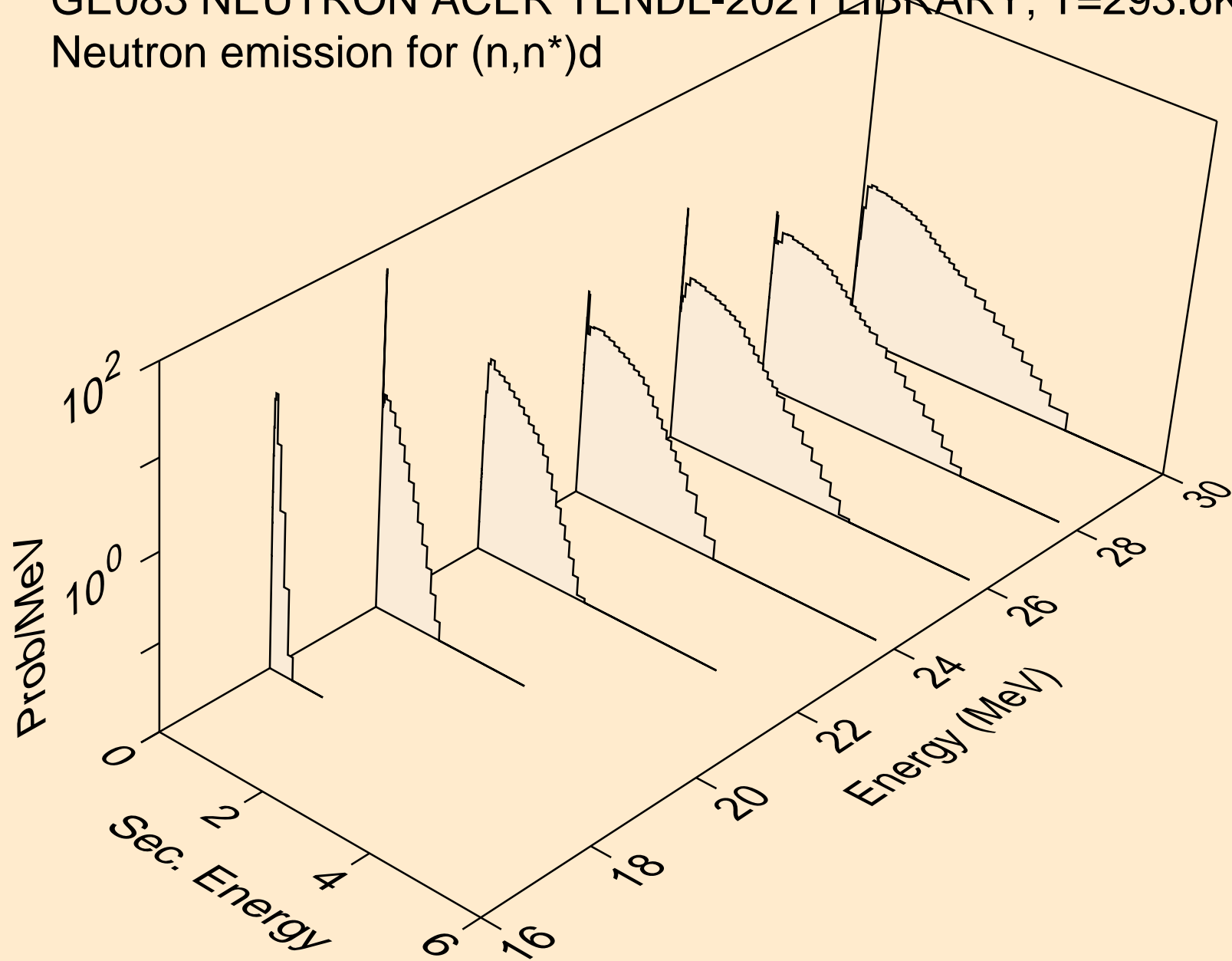

GE083 NEUTRON ACER TENDL-2021 LIBRARY; T=293.6K
Neutron emission for (n,n*)t

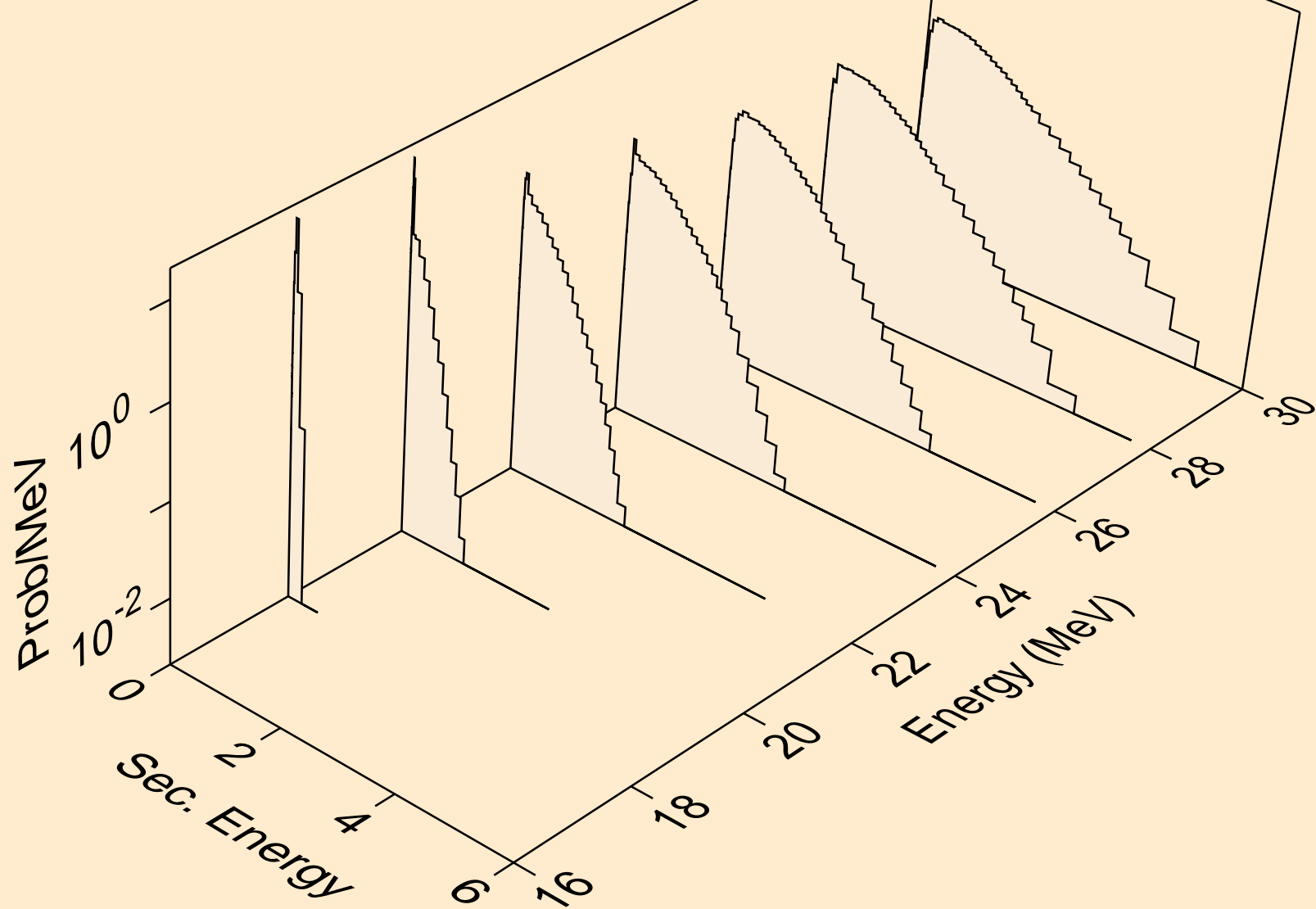

GE083 NEUTRON ACER TENDL-2021 LIBRARY; T=293.6K
Neutron emission for (n,4n)

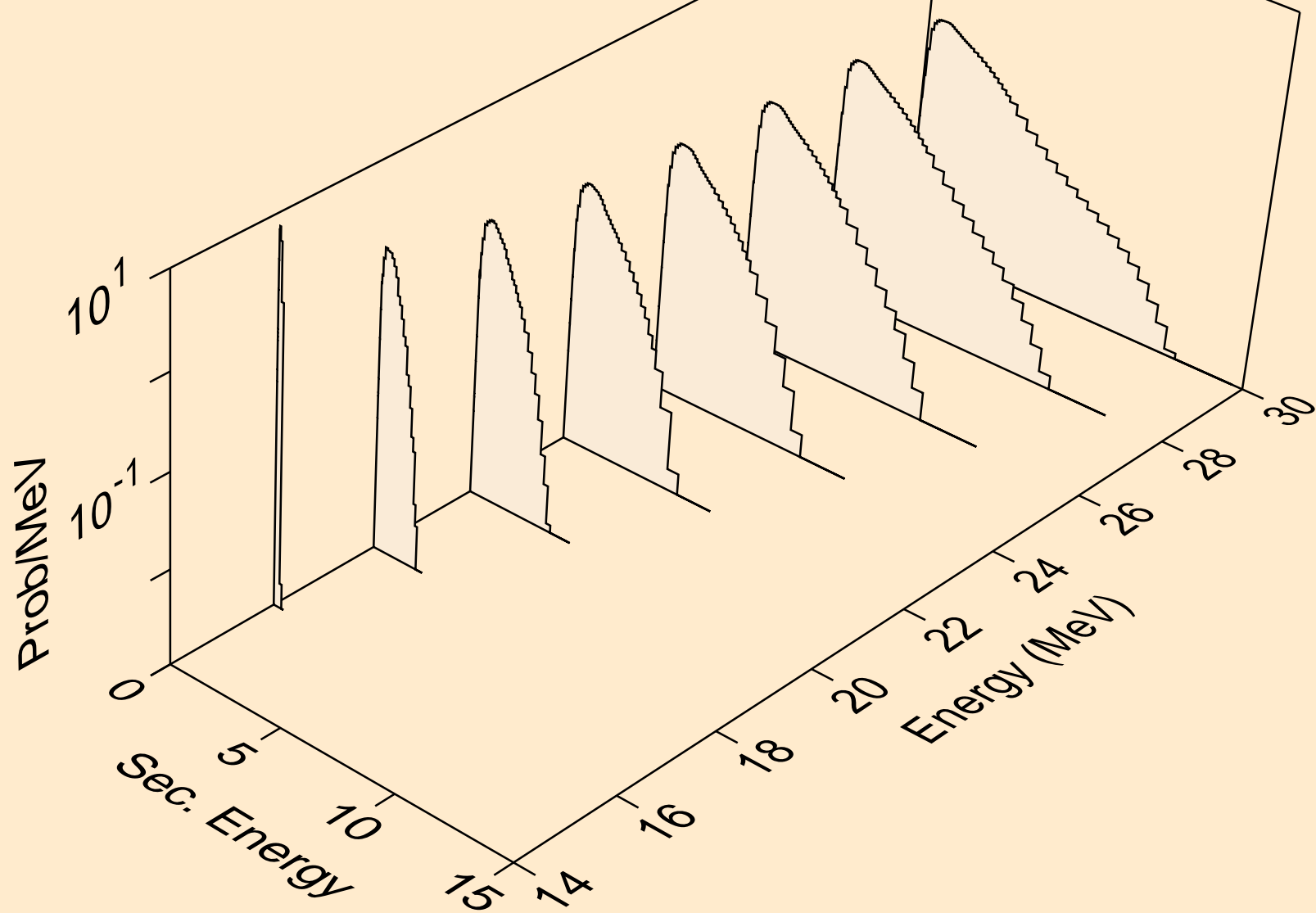

GE083 NEUTRON ACER TENDL-2021 LIBRARY; T=293.6K
Neutron emission for (n,2np)

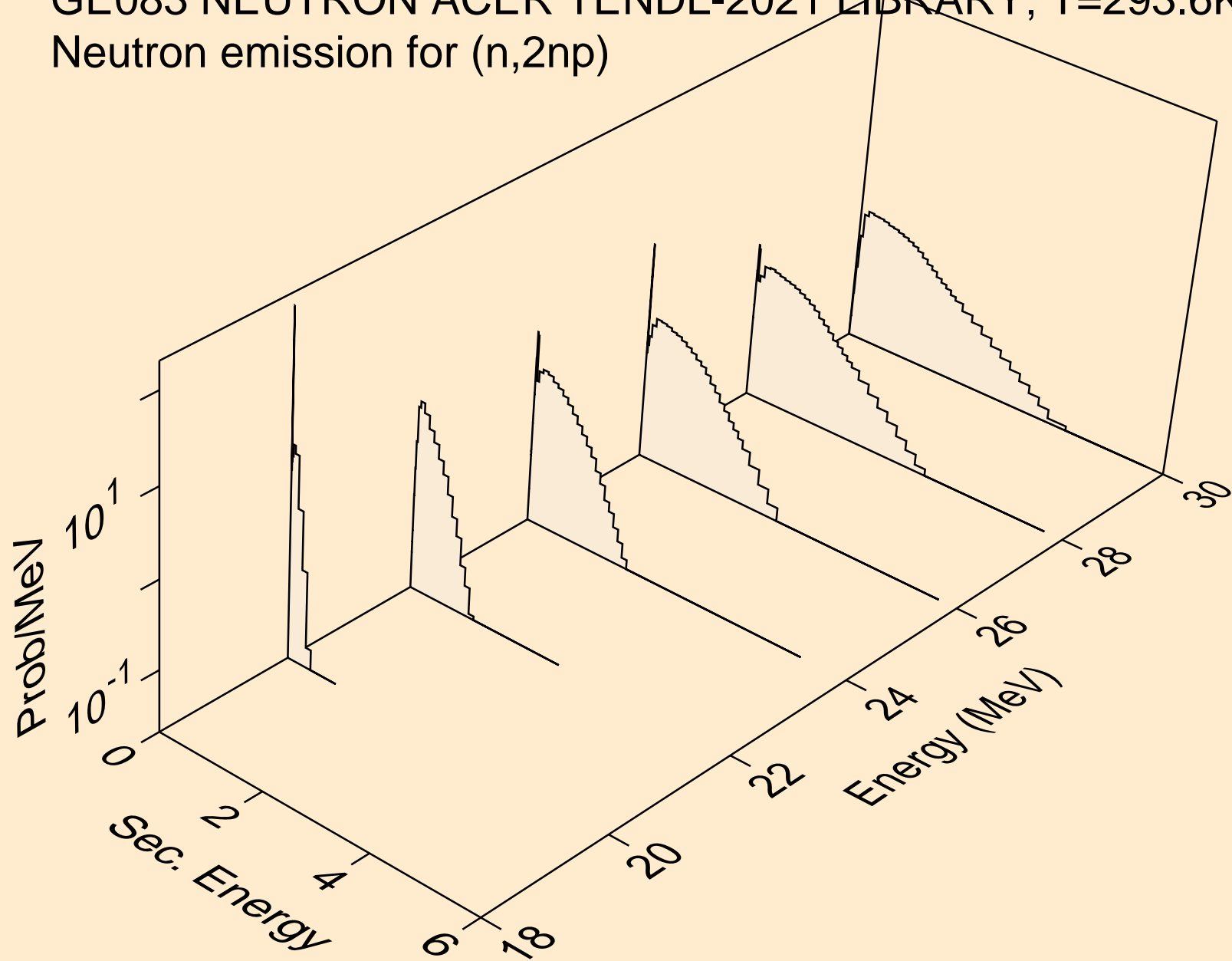

GE083 NEUTRON ACER TENDL-2021 LIBRARY; T=293.6K
Neutron emission for (n,3np)

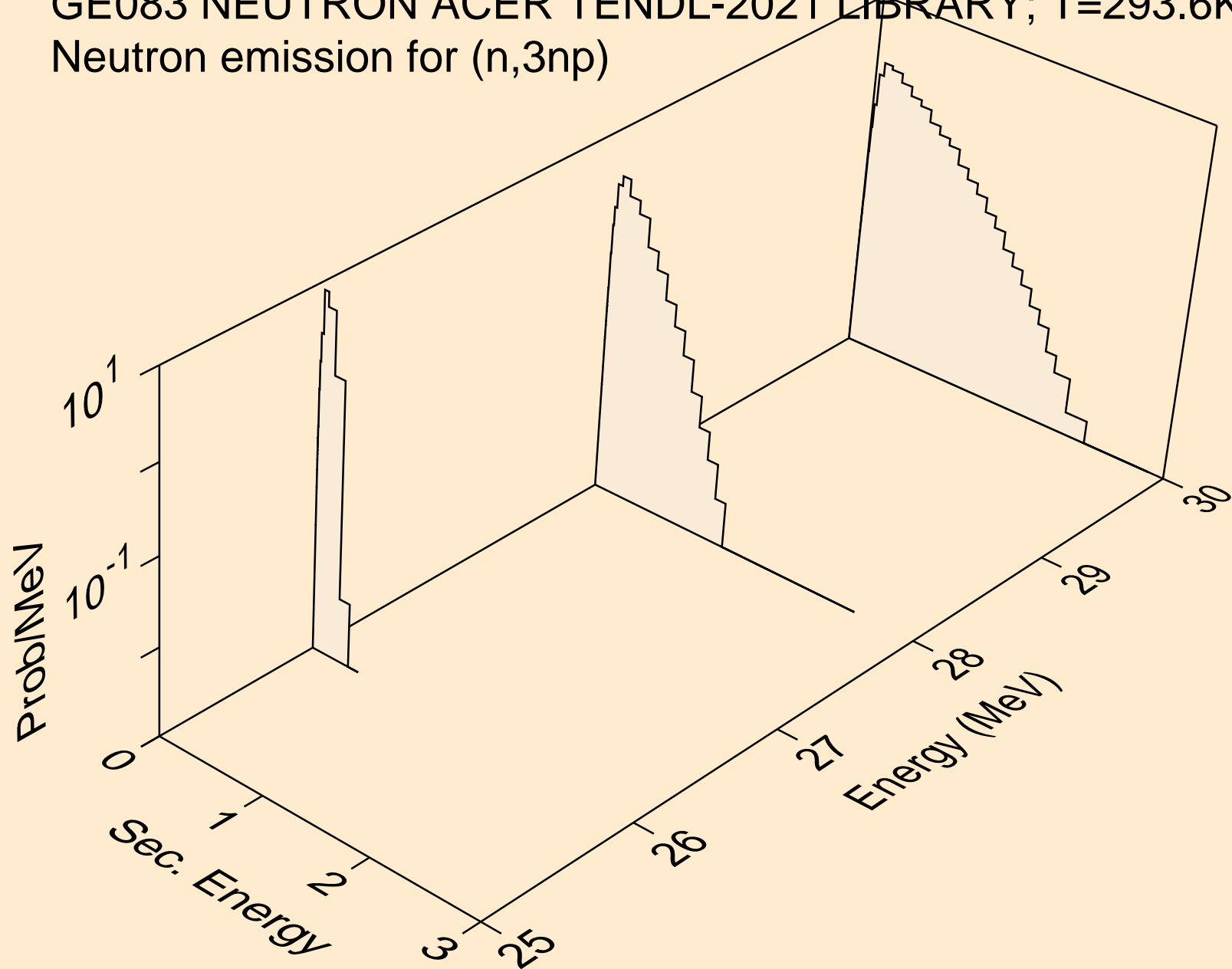

GE083 NEUTRON ACER TENDL-2021 LIBRARY; T=293.6K
Neutron emission for (n,n*c)

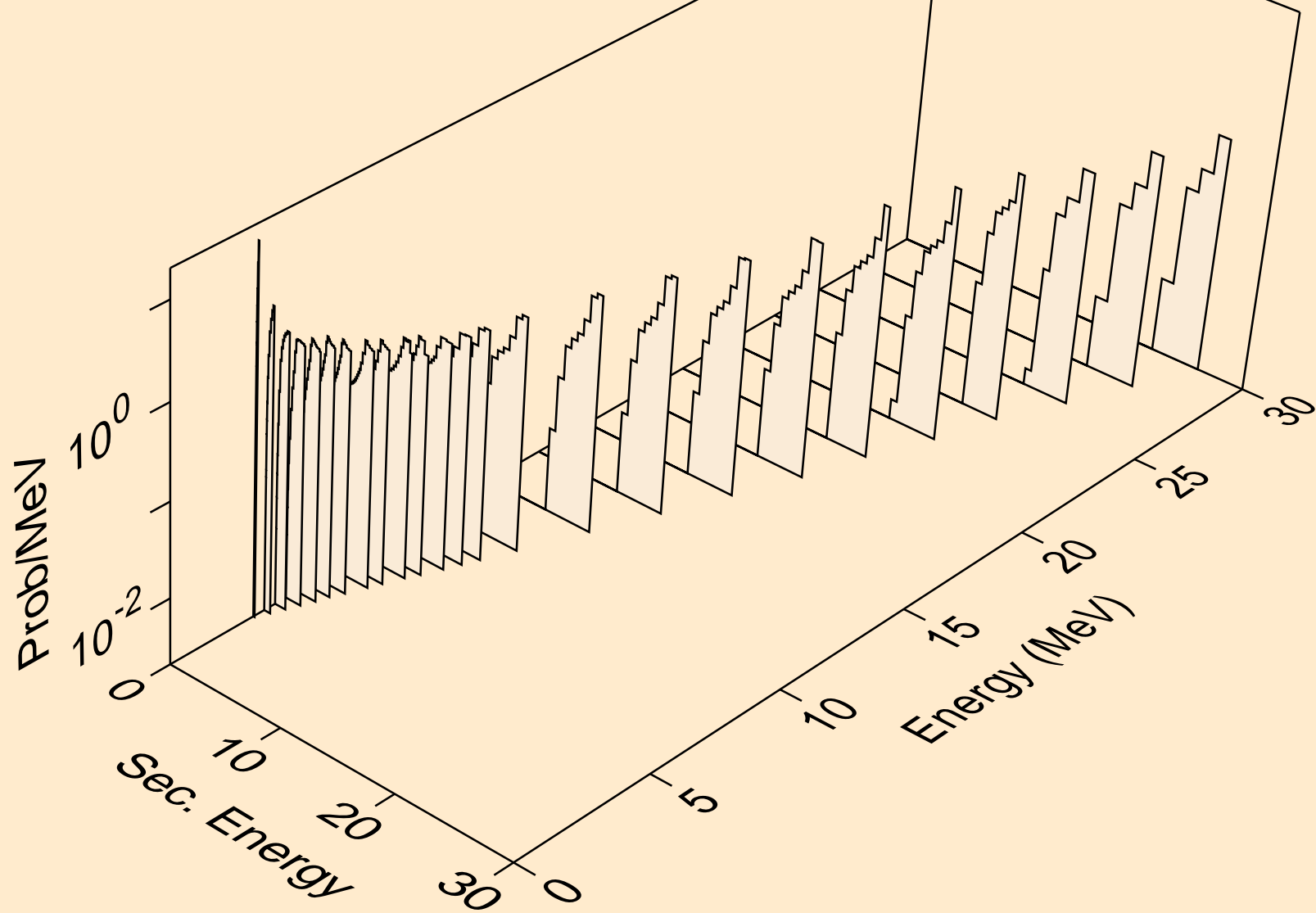

GE083 NEUTRON ACER TENDL-2021 LIBRARY; T=293.6K
Photon emission for (n,x)

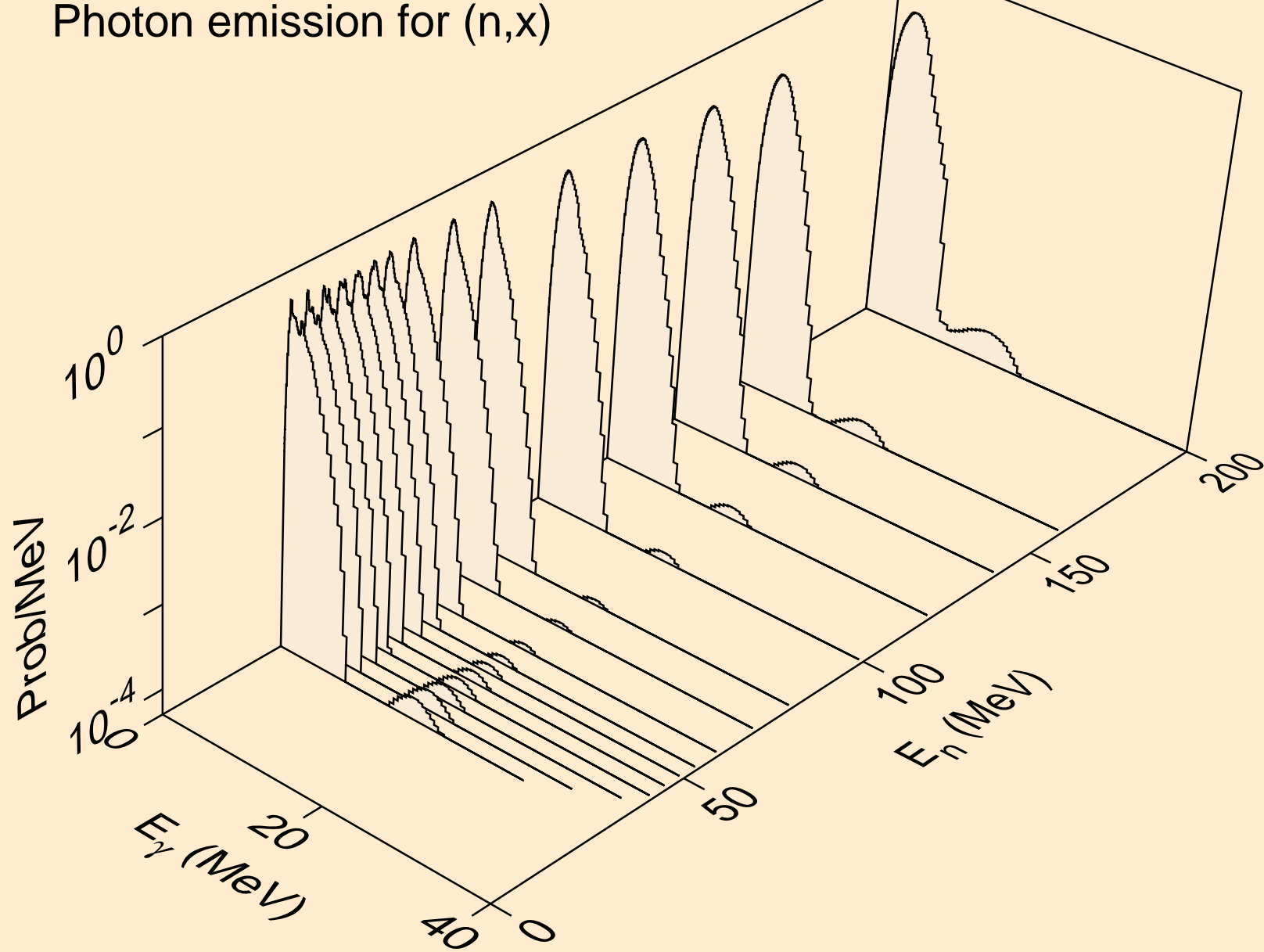

GE083 NEUTRON ACER TENDL-2021 LIBRARY; T=293.6K
Photon emission for (n,2nd)

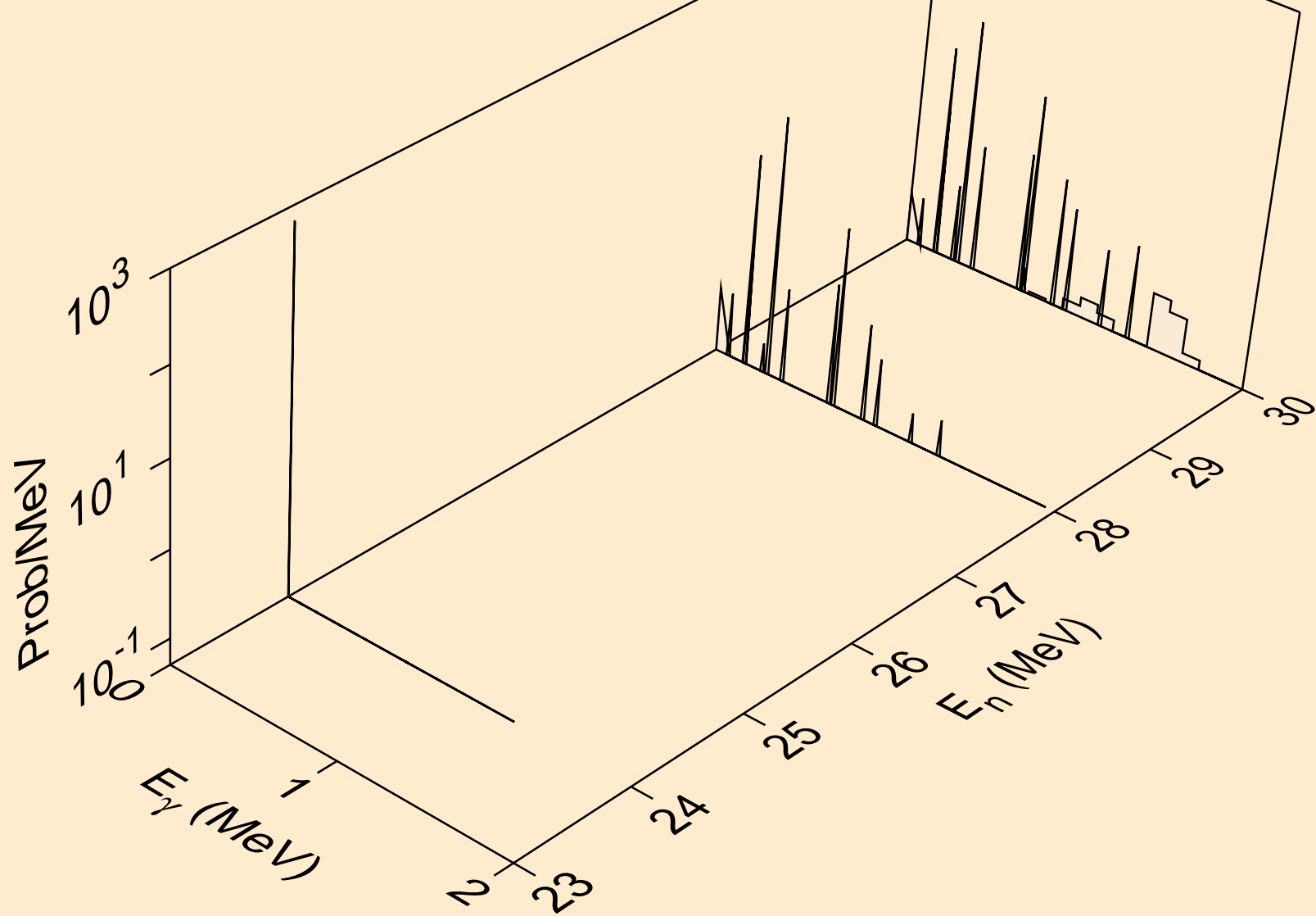

GE083 NEUTRON ACER TENDL-2021 LIBRARY; T=293.6K
Photon emission for (n,2n)

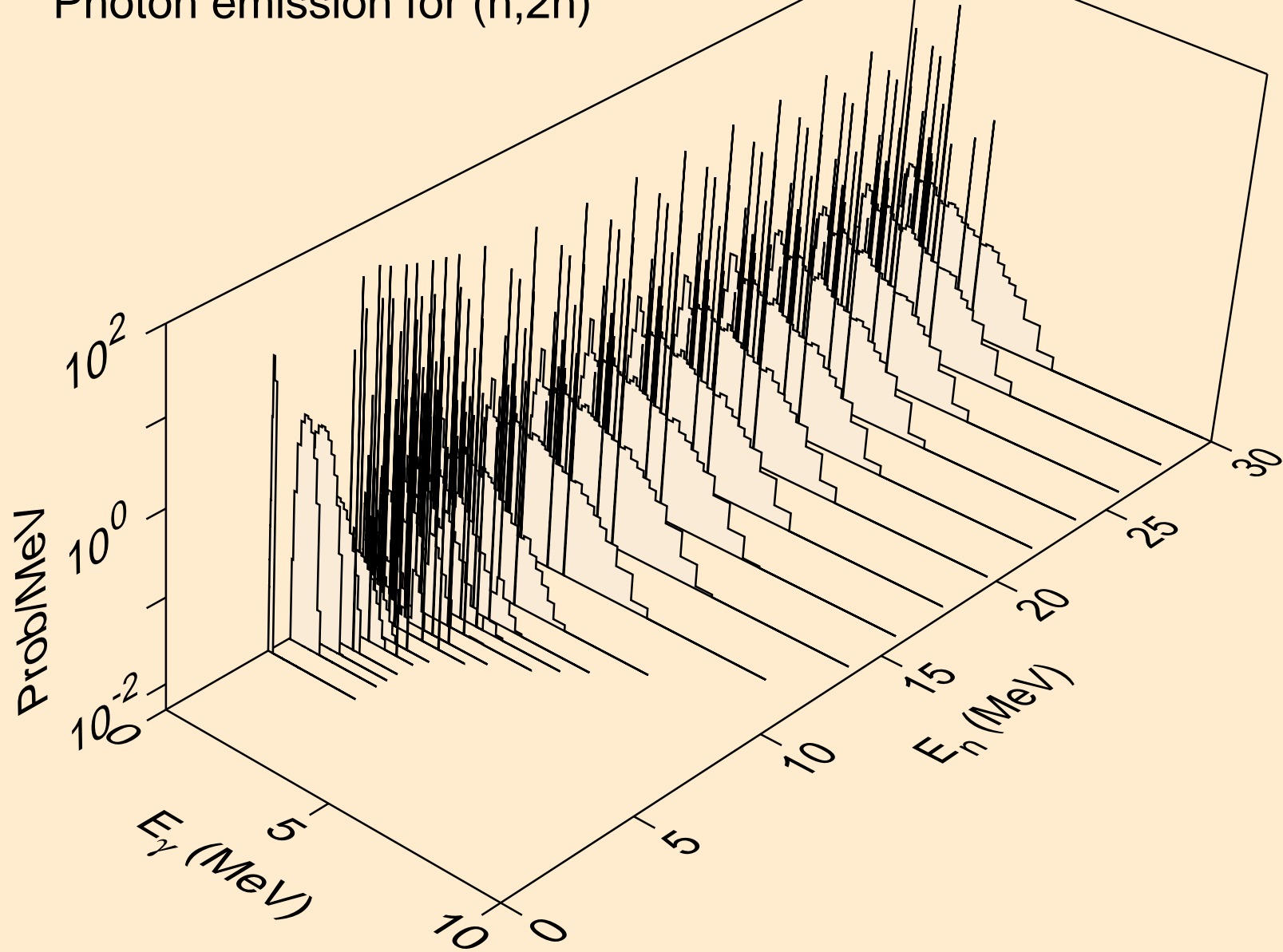

GE083 NEUTRON ACER TENDL-2021 LIBRARY; T=293.6K
Photon emission for (n,3n)

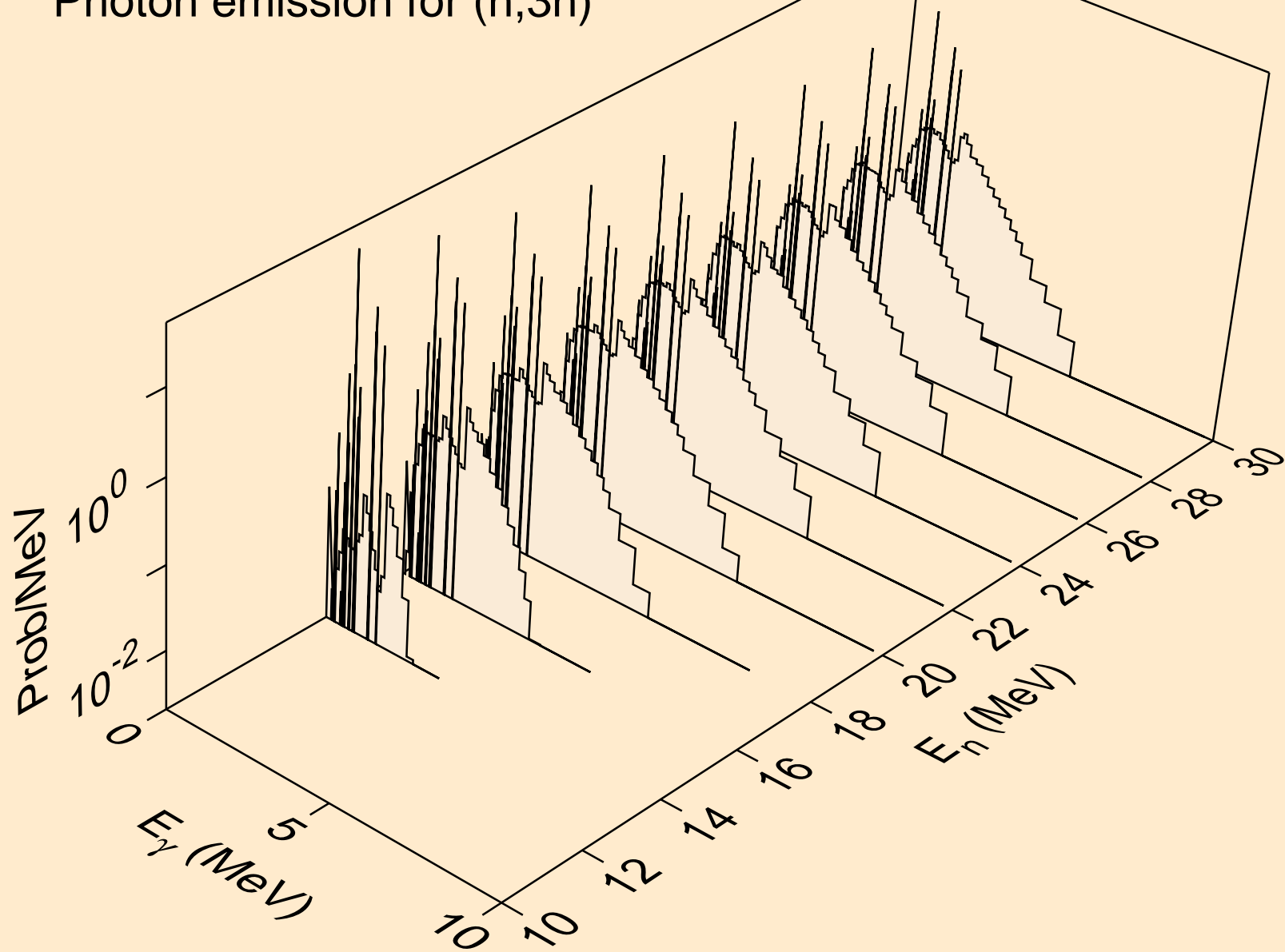

GE083 NEUTRON ACER TENDL-2021 LIBRARY; T=293.6K
Photon emission for (n,n*)a

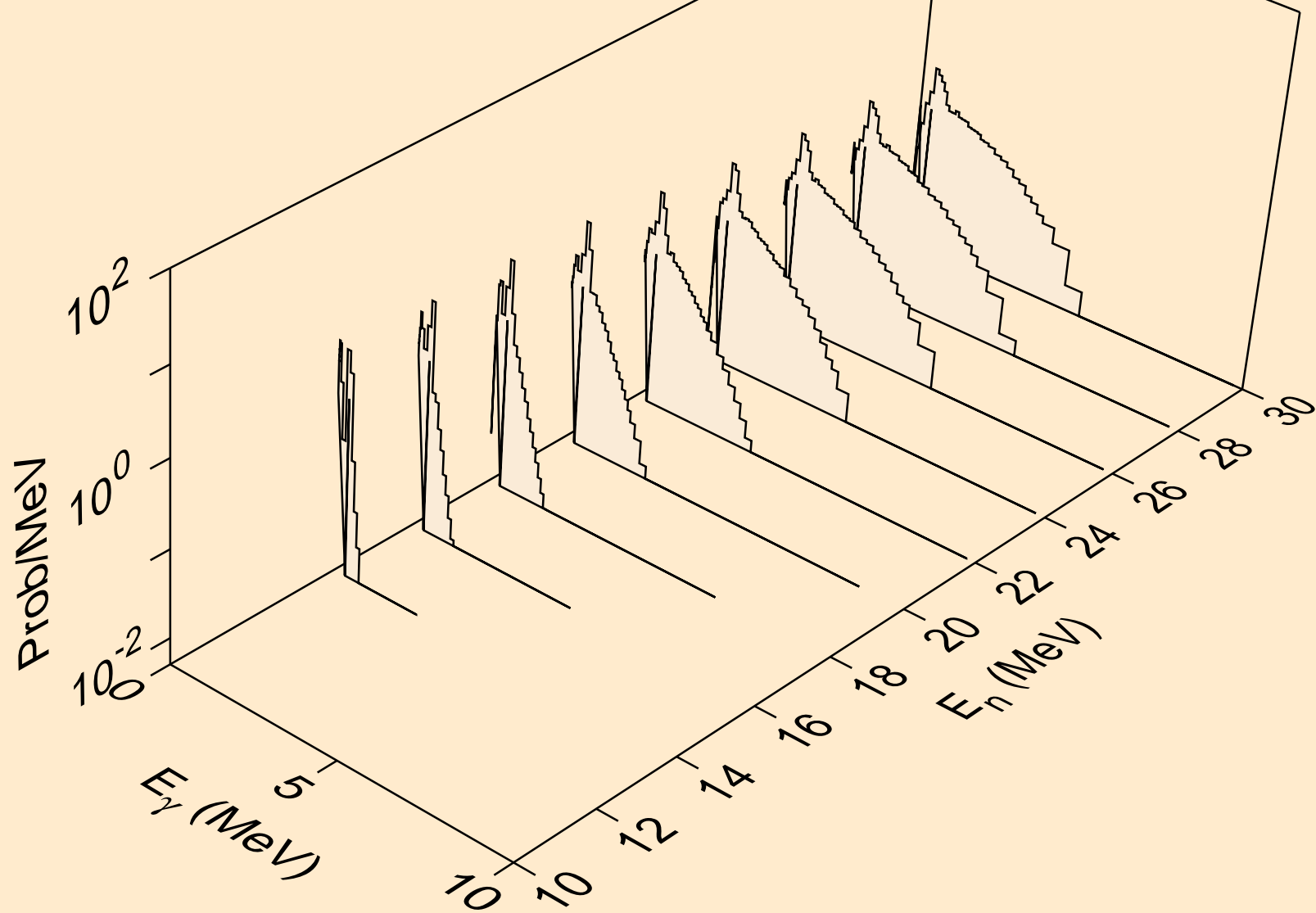

GE083 NEUTRON ACER TENDL-2021 LIBRARY; T=293.6K
Photon emission for (n,2n)a

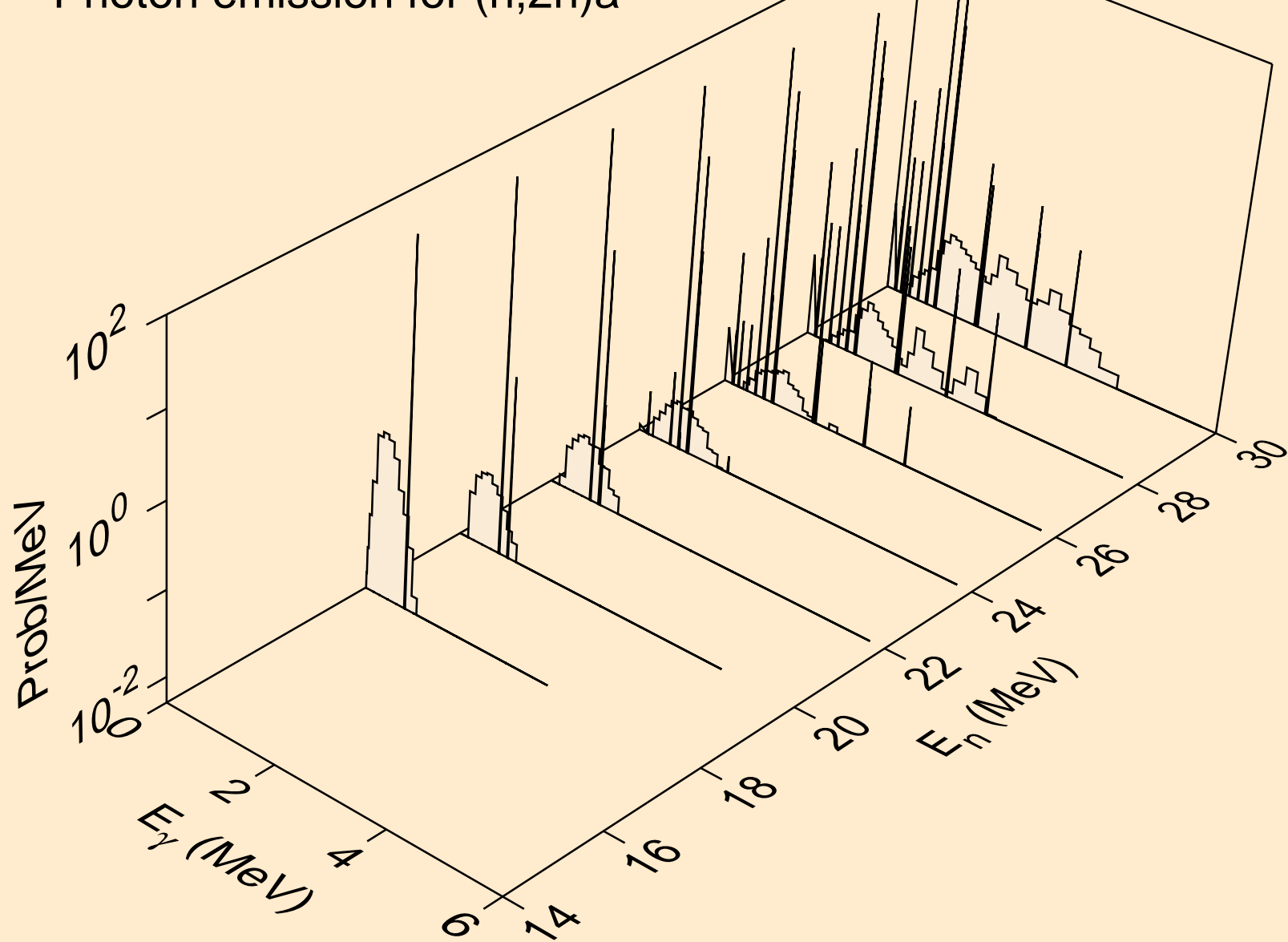

GE083 NEUTRON ACER TENDL-2021 LIBRARY; T=293.6K
Photon emission for (n,3n)a

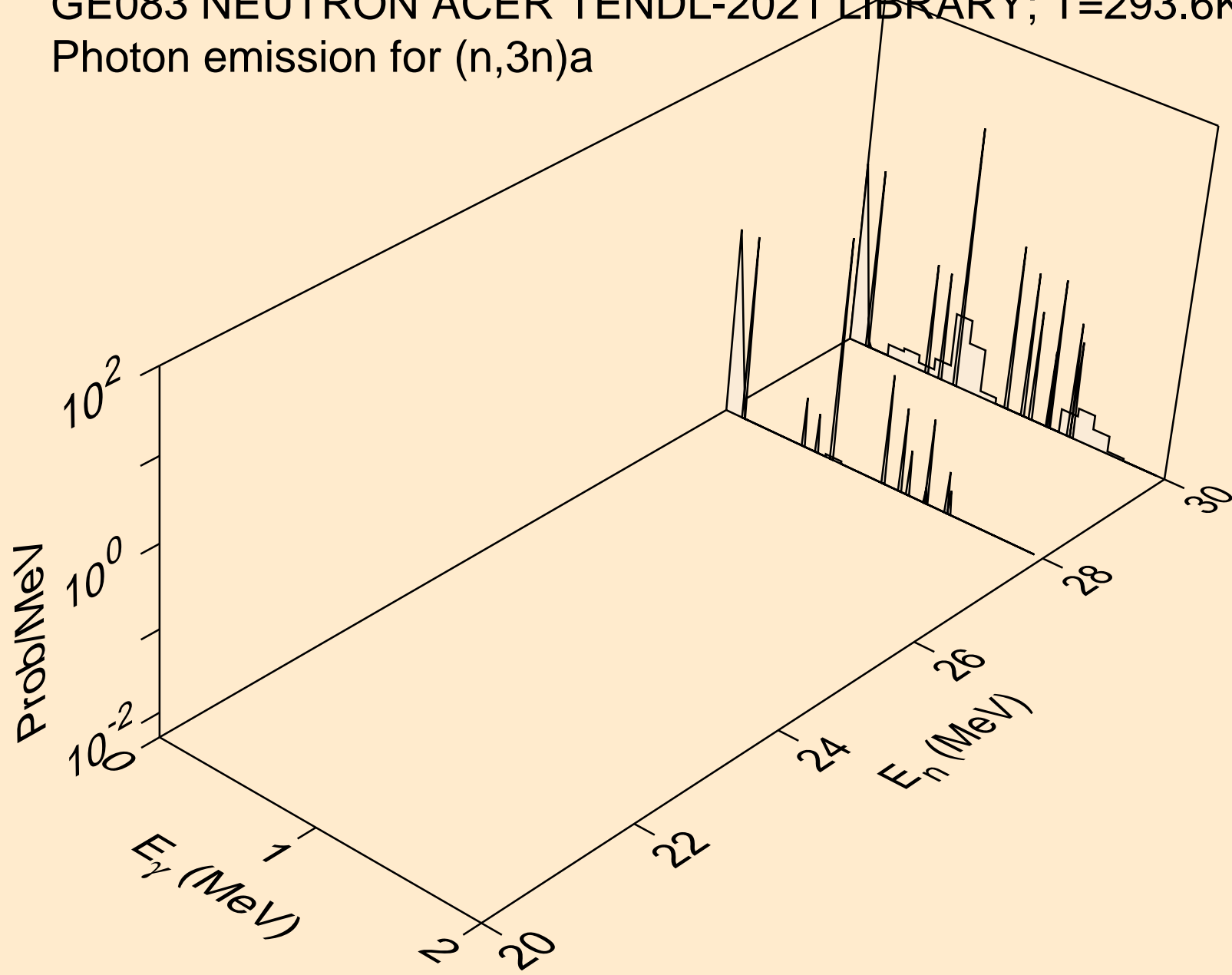

GE083 NEUTRON ACER TENDL-2021 LIBRARY; T=293.6K
Photon emission for (n,n*)p

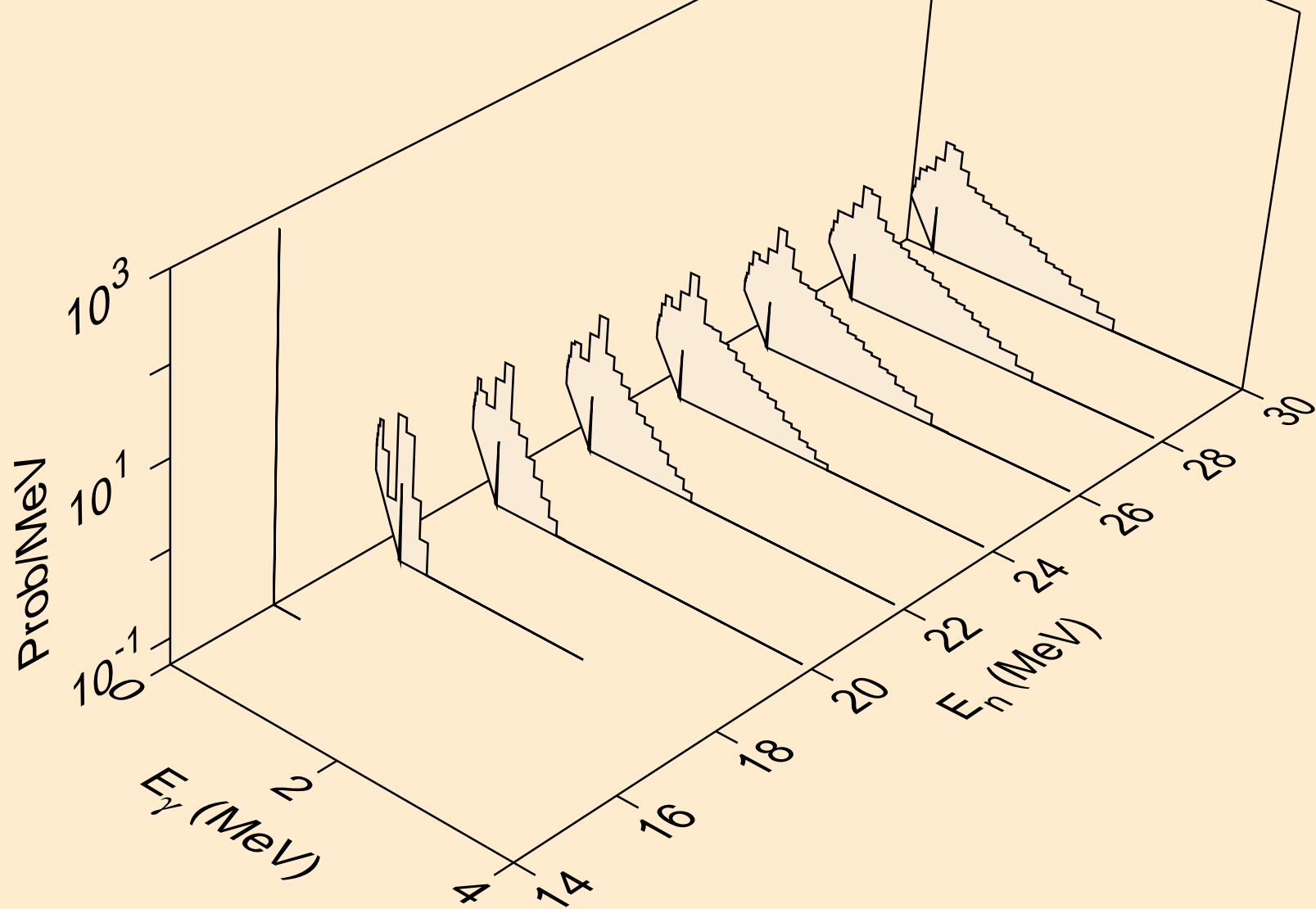

GE083 NEUTRON ACER TENDL-2021 LIBRARY; T=293.6K
Photon emission for (n,n*)d

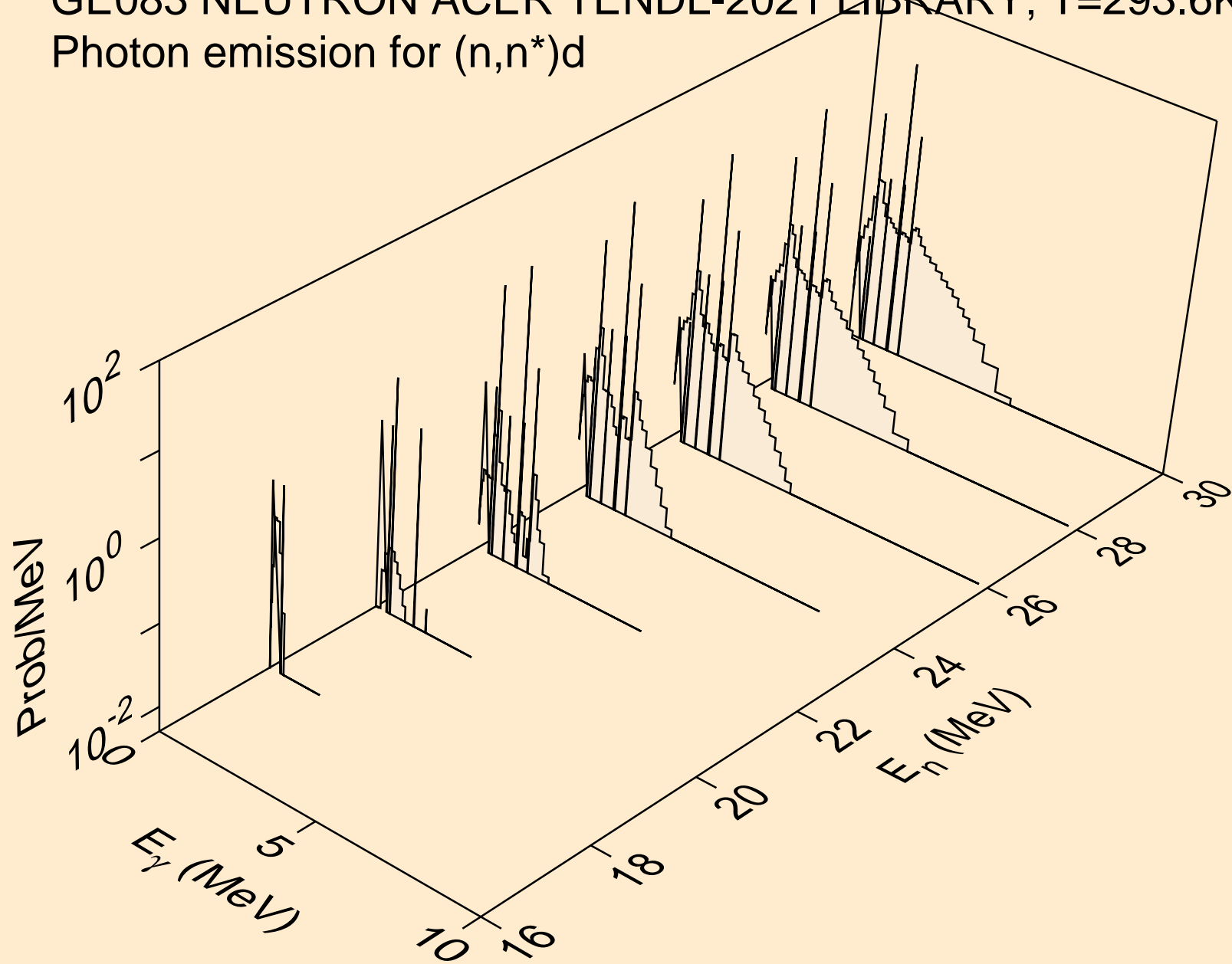

GE083 NEUTRON ACER TENDL-2021 LIBRARY; T=293.6K
Photon emission for (n,n*)t

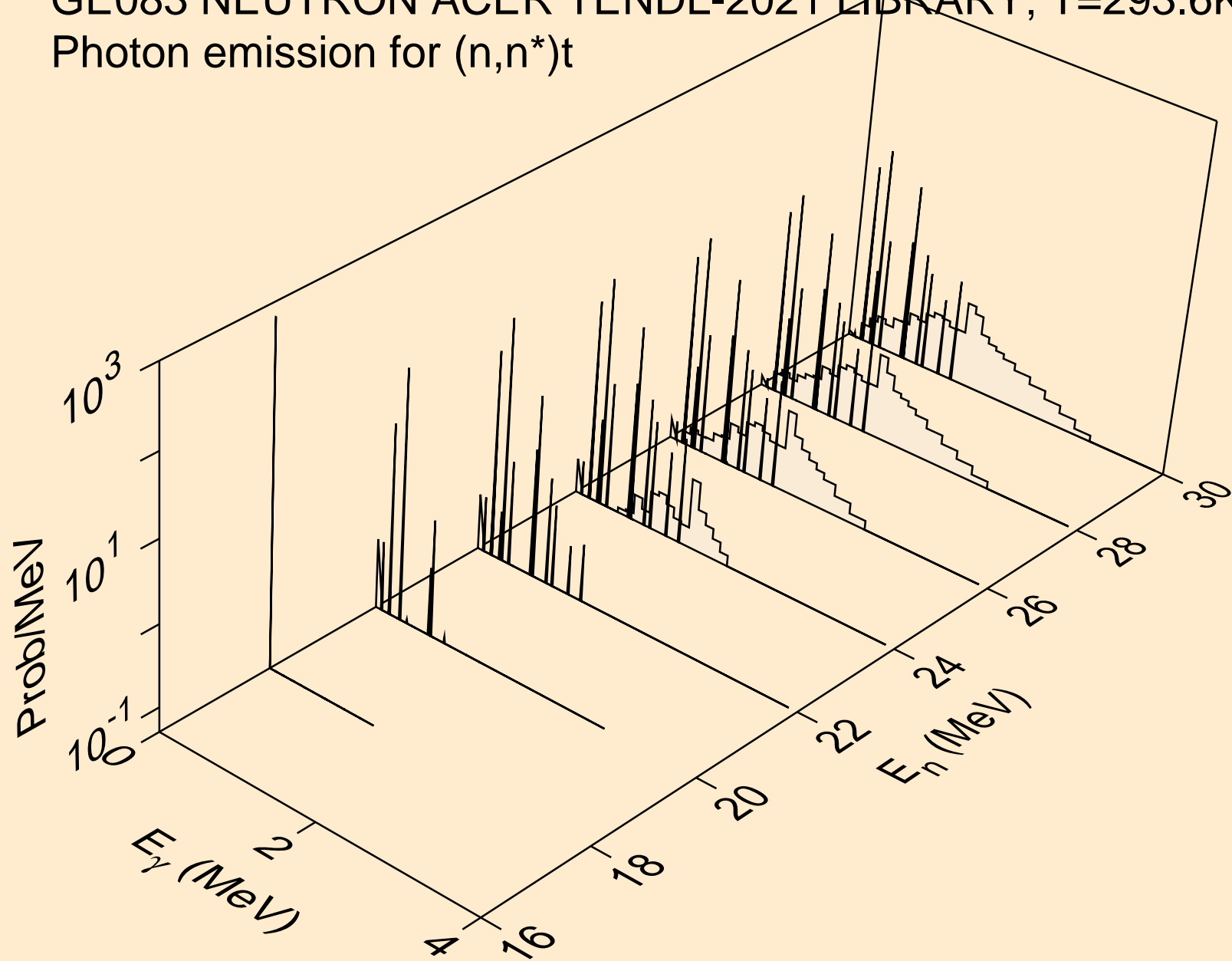

GE083 NEUTRON ACER TENDL-2021 LIBRARY; T=293.6K
Photon emission for (n,4n)

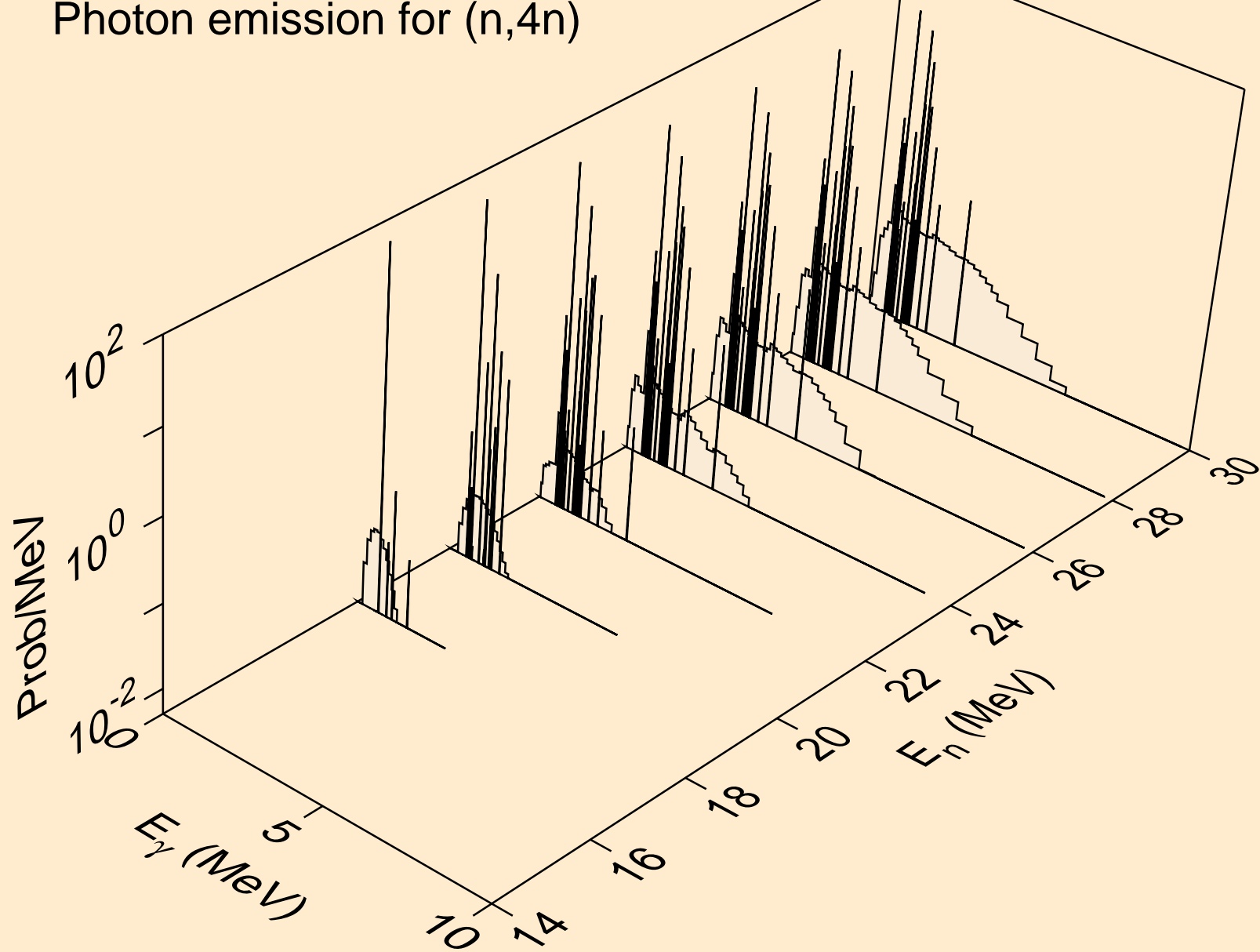

GE083 NEUTRON ACER TENDL-2021 LIBRARY; T=293.6K
Photon emission for (n,2np)

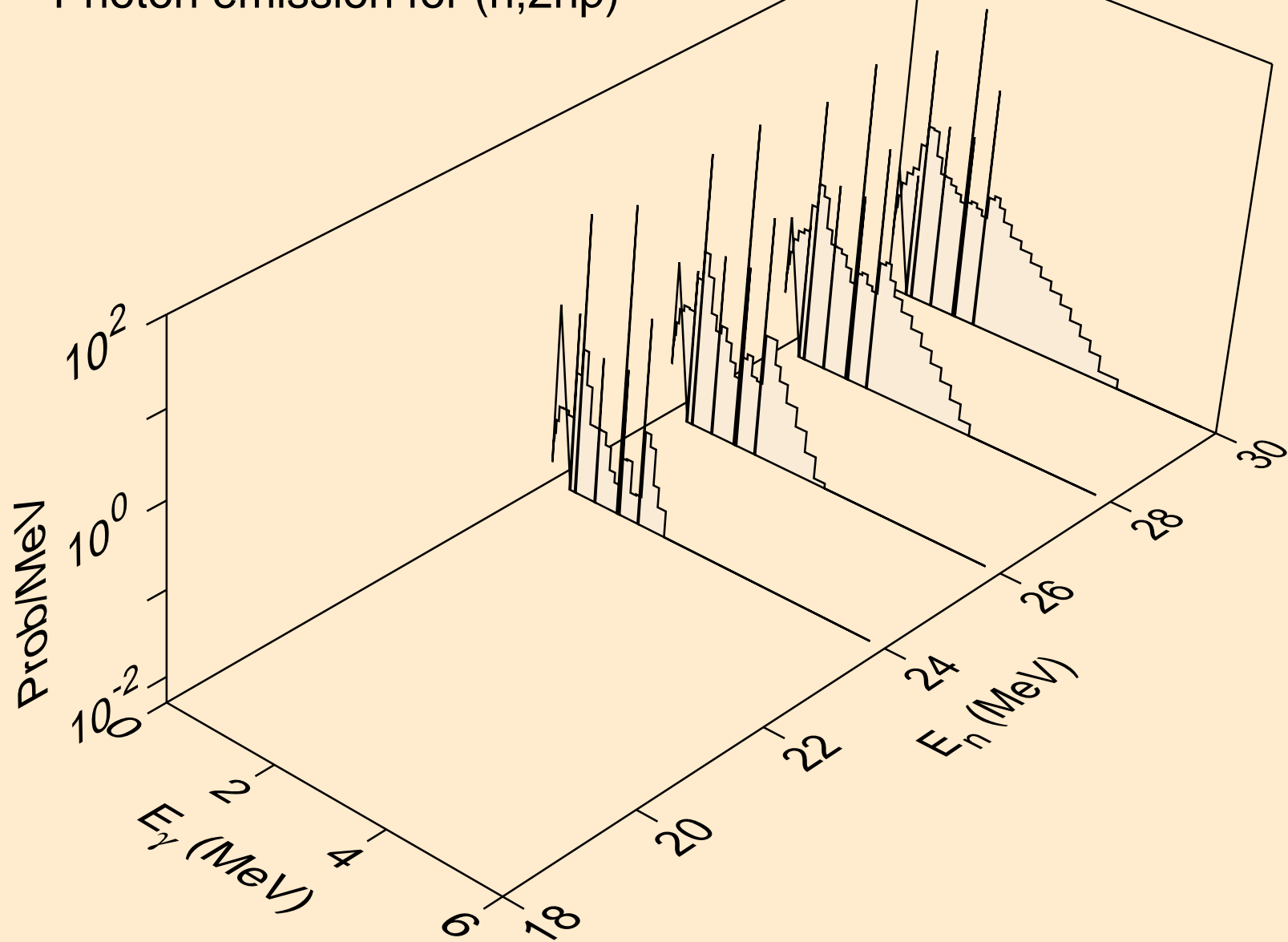

GE083 NEUTRON ACER TENDL-2021 LIBRARY; T=293.6K
Photon emission for (n,3np)

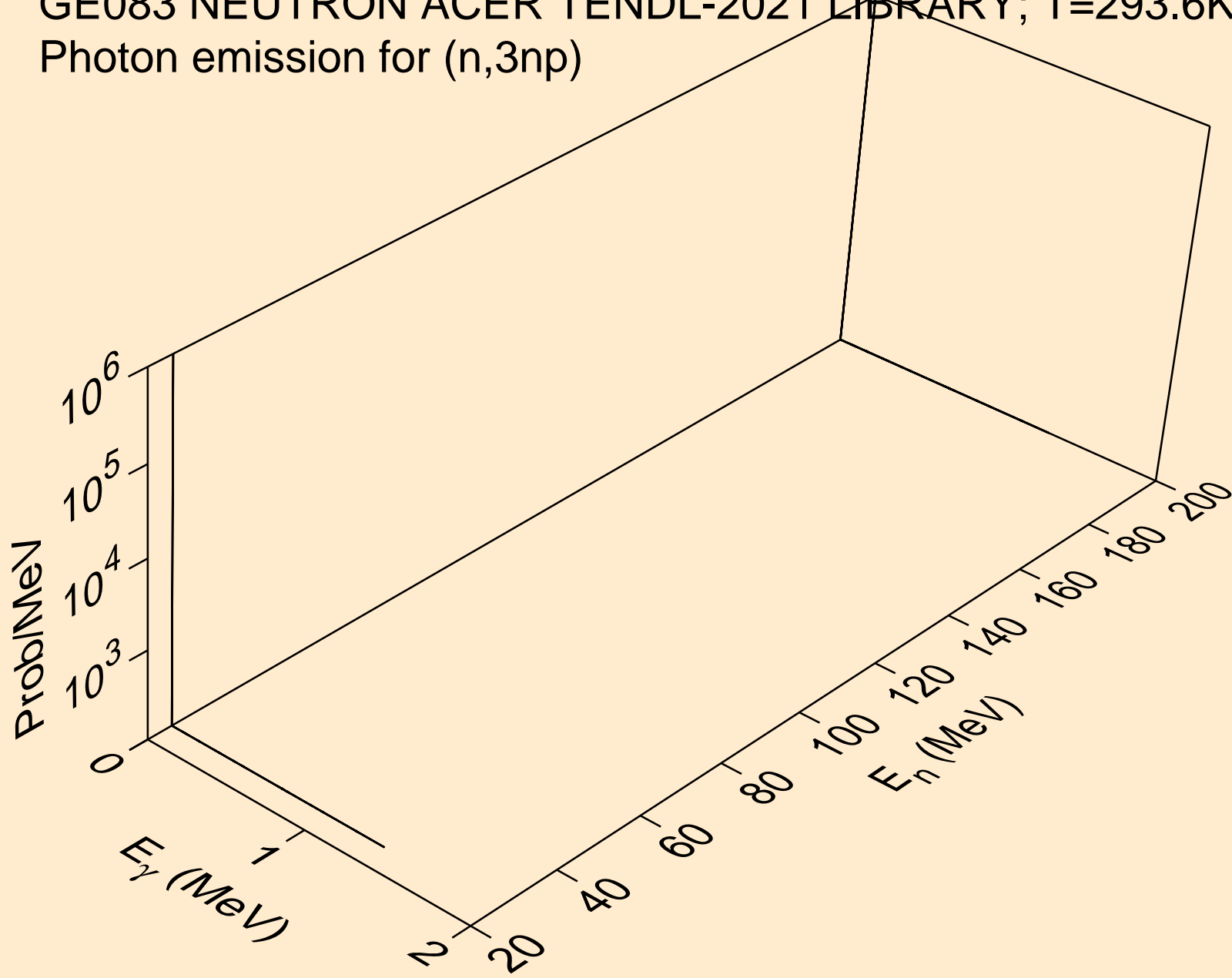

GE083 NEUTRON ACER TENDL-2021 LIBRARY; T=293.6K
Photon emission for (n,n*c)

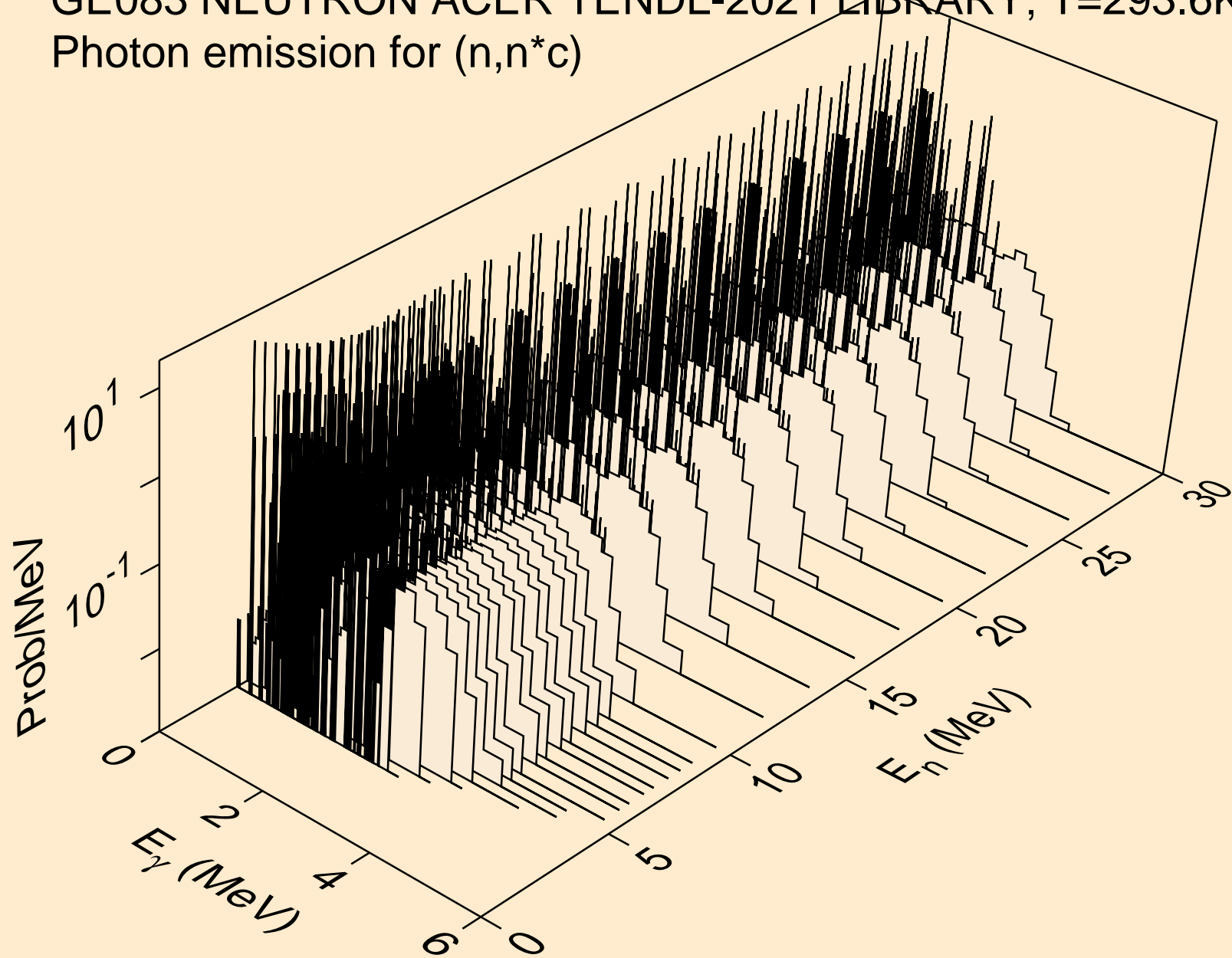

GE083 NEUTRON ACER TENDL-2021 LIBRARY; T=293.6K
Photon emission for (n,gma)

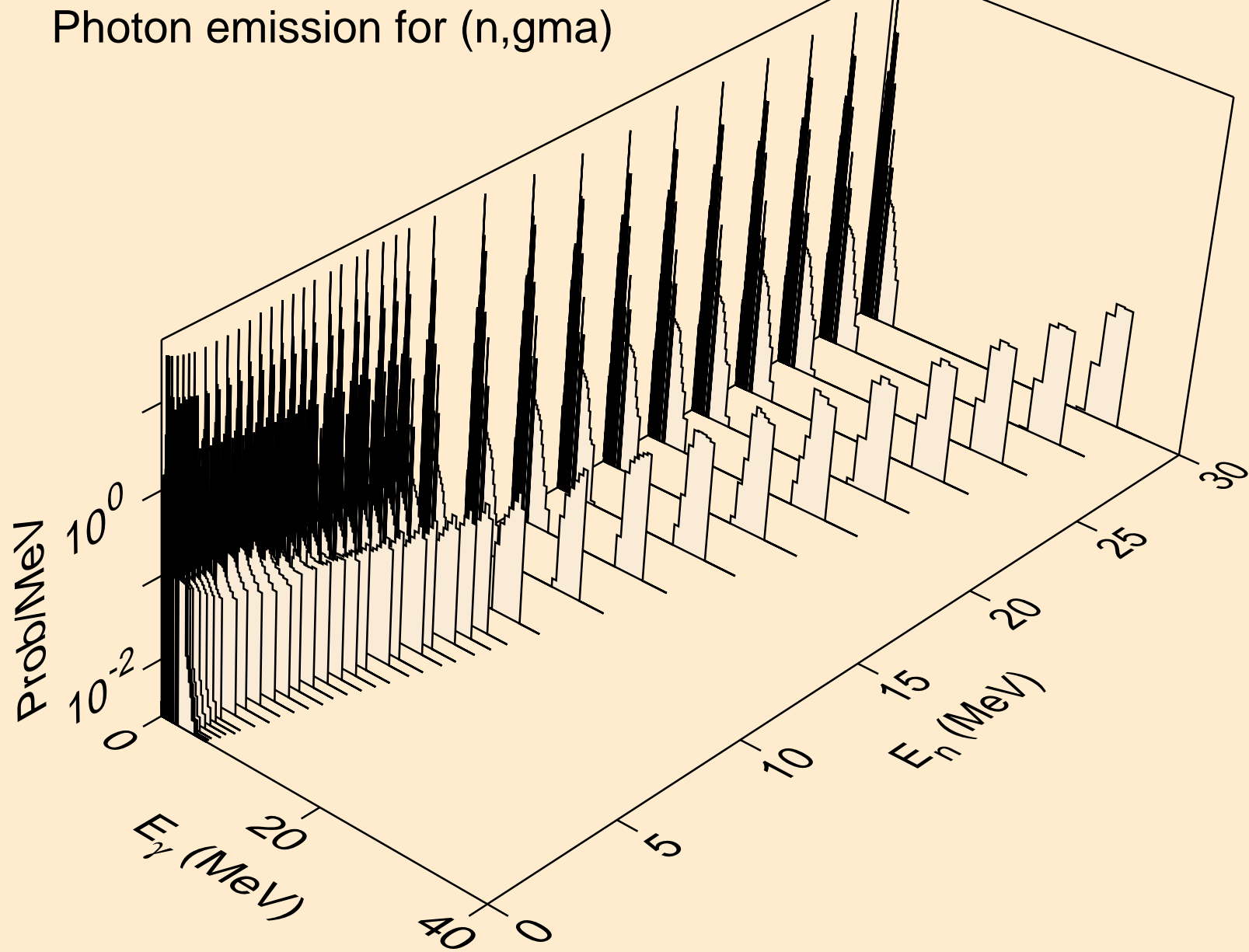

GE083 NEUTRON ACER TENDL-2021 LIBRARY; T=293.6K
Photon emission for (n,p)

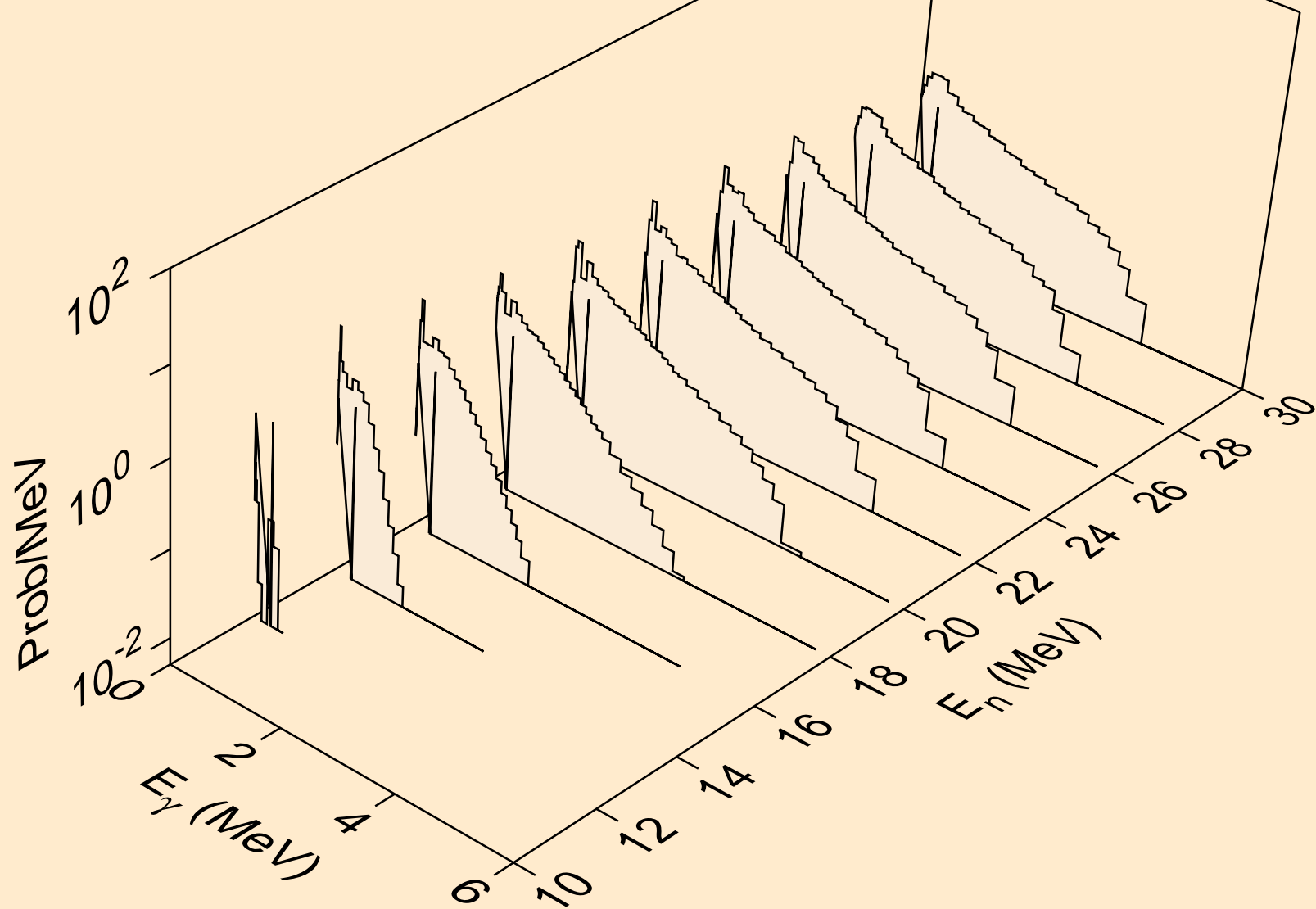

GE083 NEUTRON ACER TENDL-2021 LIBRARY; T=293.6K
Photon emission for (n,d)

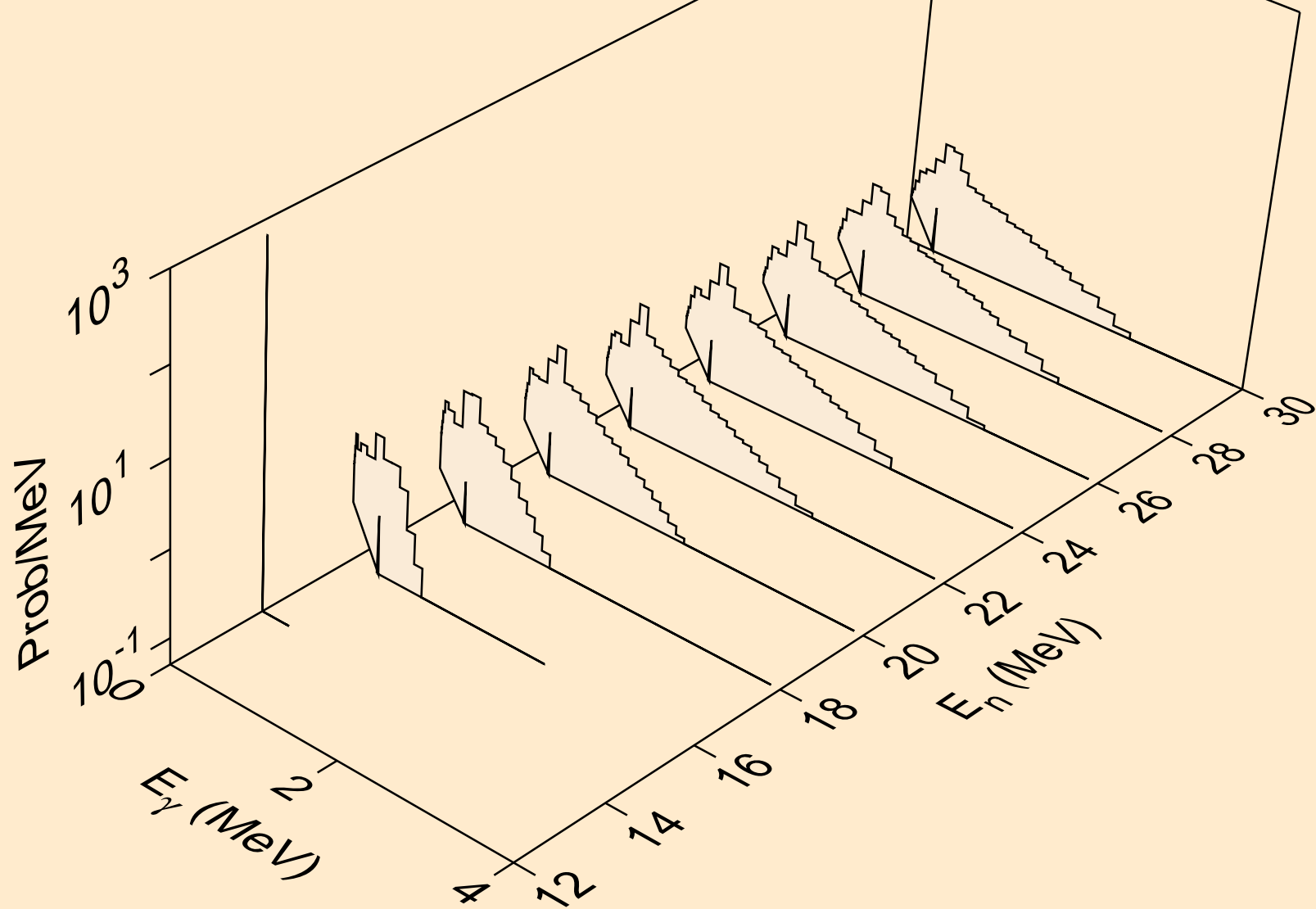

GE083 NEUTRON ACER TENDL-2021 LIBRARY; T=293.6K
Photon emission for (n,t)

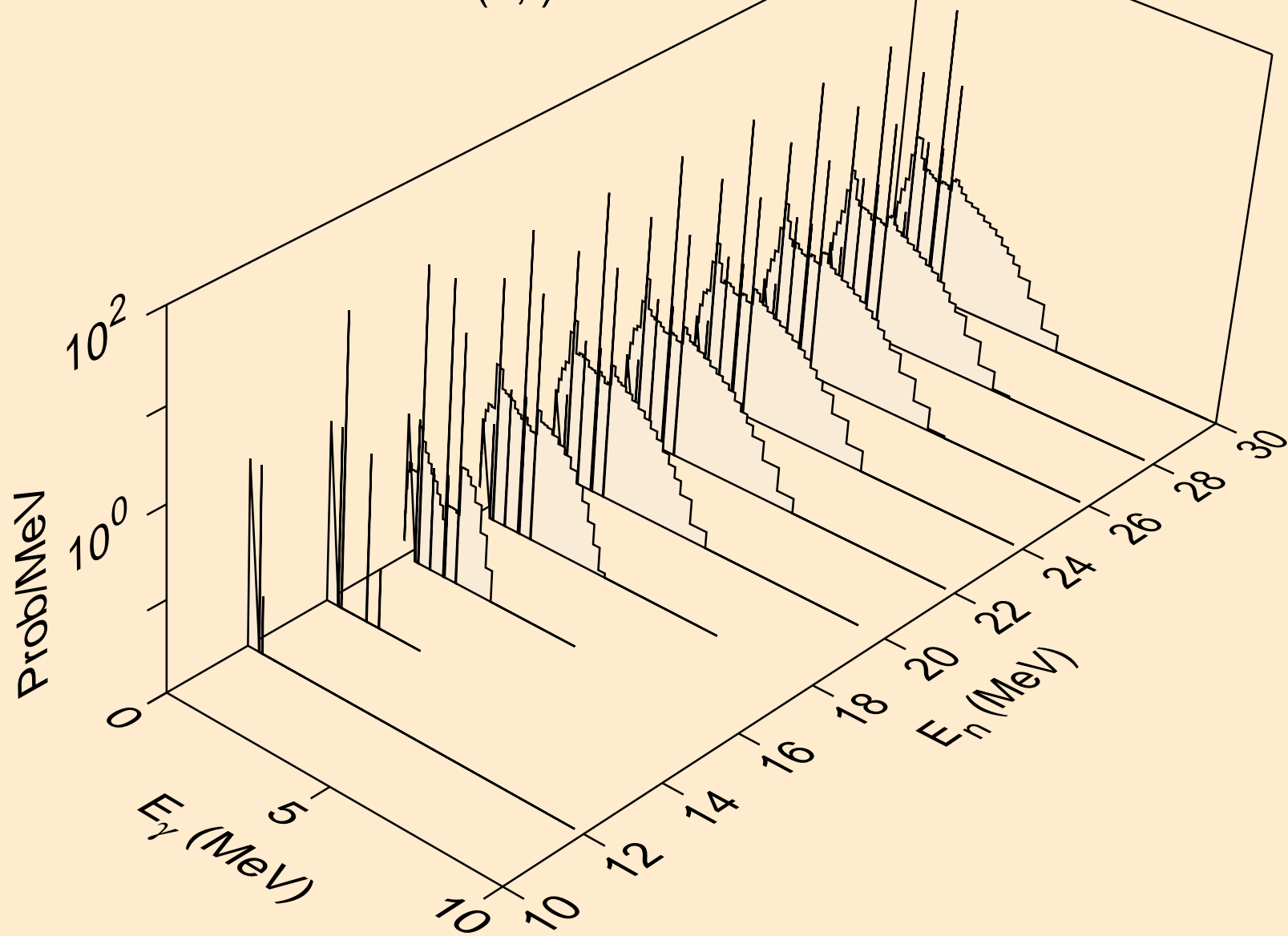

GE083 NEUTRON ACER TENDL-2021 LIBRARY; T=293.6K
Photon emission for (n,he3)

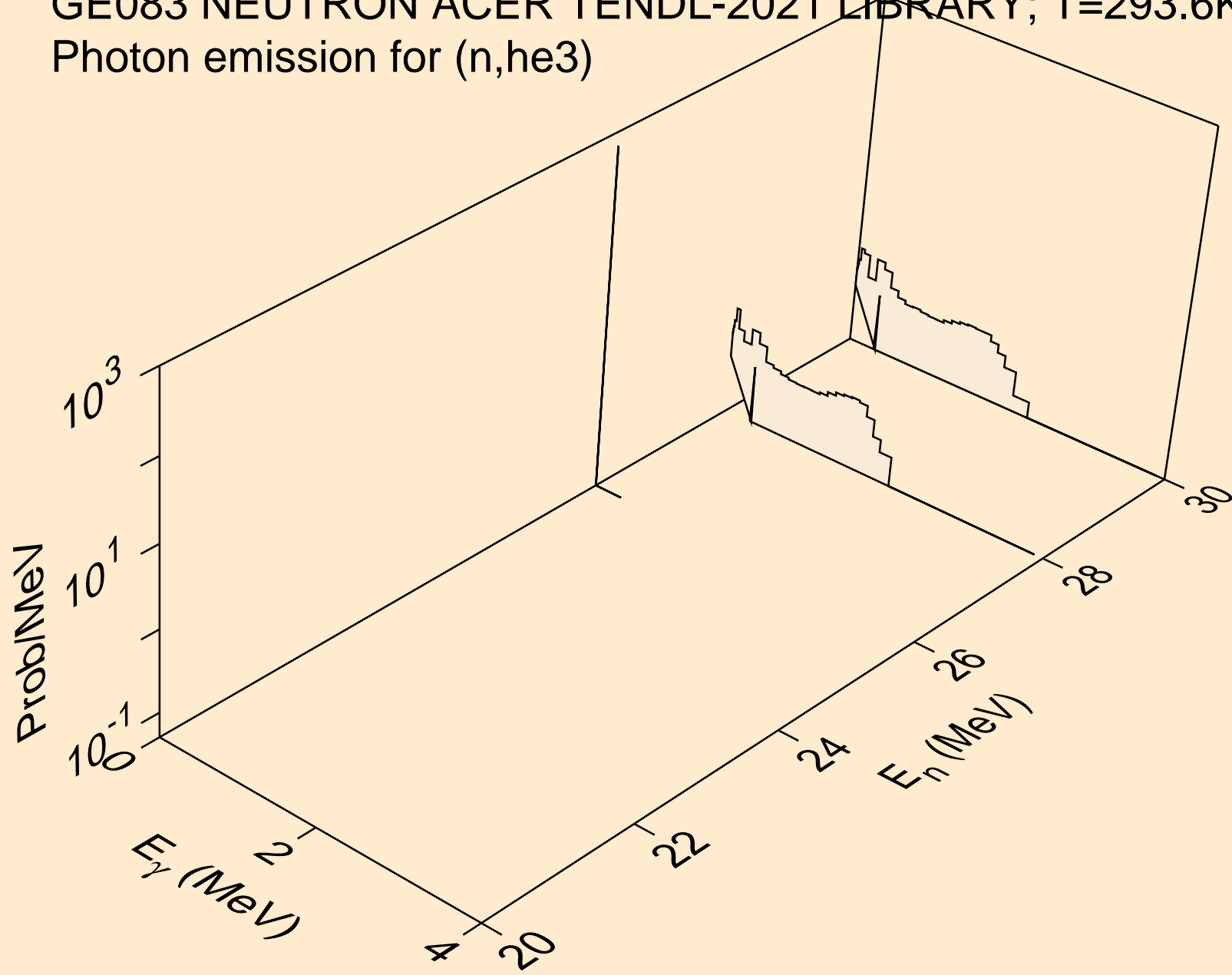

GE083 NEUTRON ACER TENDL-2021 LIBRARY; T=293.6K
Photon emission for (n,a)

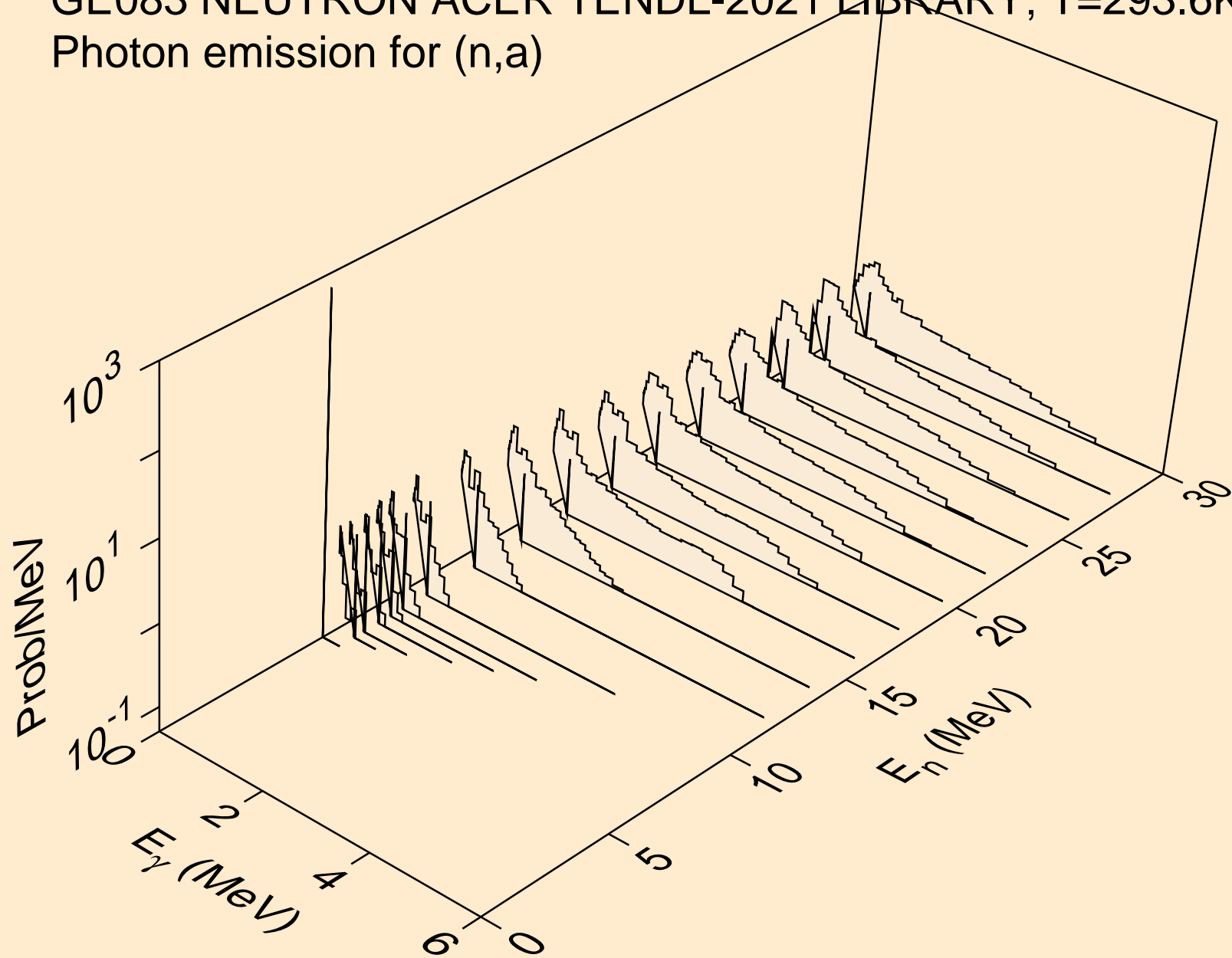

GE083 NEUTRON ACER TENDL-2021 LIBRARY; T=293.6K
thermal capture photon spectrum

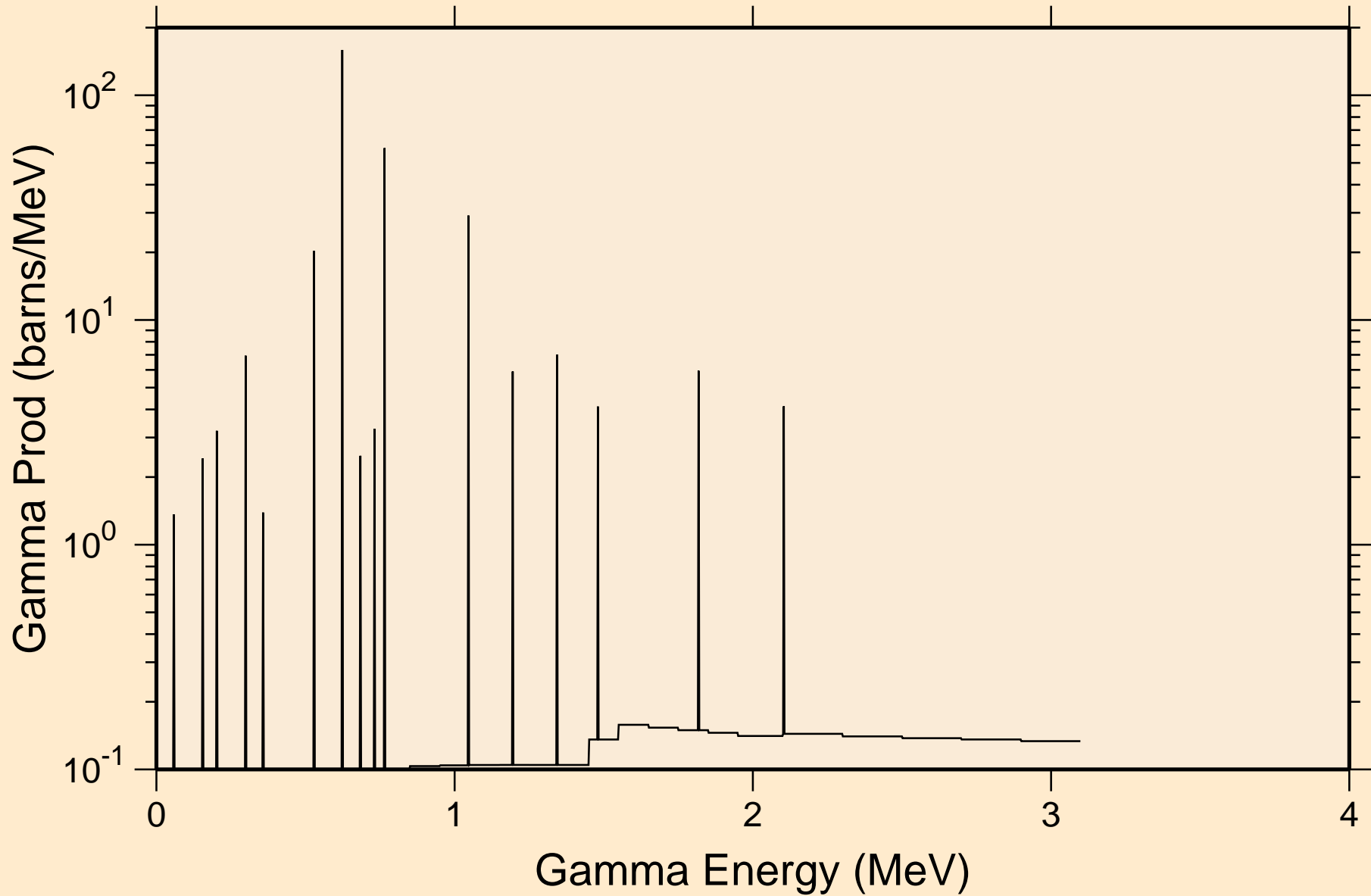

GE083 NEUTRON ACER TENDL-2021 LIBRARY; T=293.6K
14 MeV photon spectrum

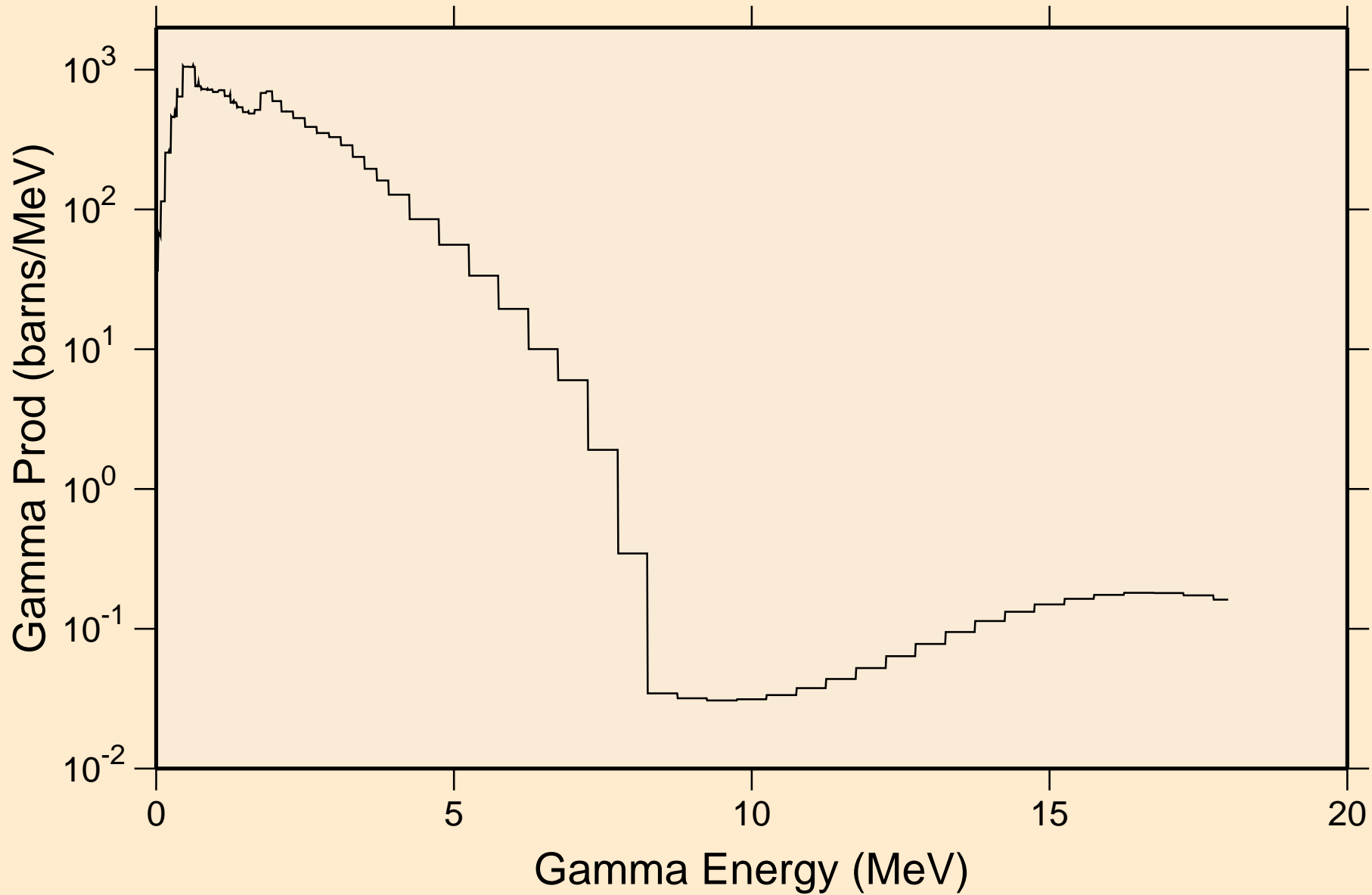

GE083 NEUTRON ACER TENDL-2021 LIBRARY; T=293.6K

Particle heating contributions

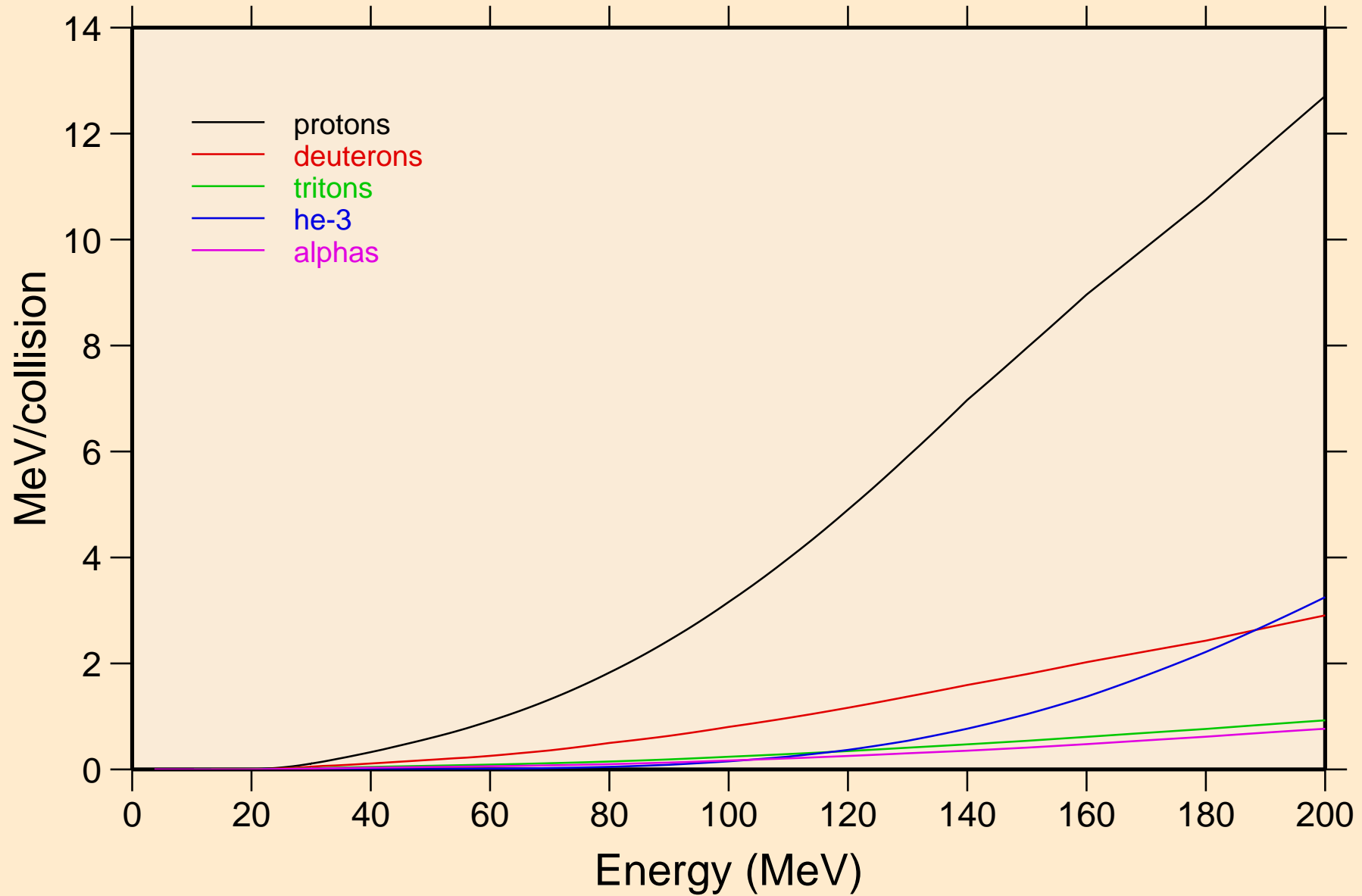

GE083 NEUTRON ACER TENDL-2021 LIBRARY; T=293.6K
Recoil Heating

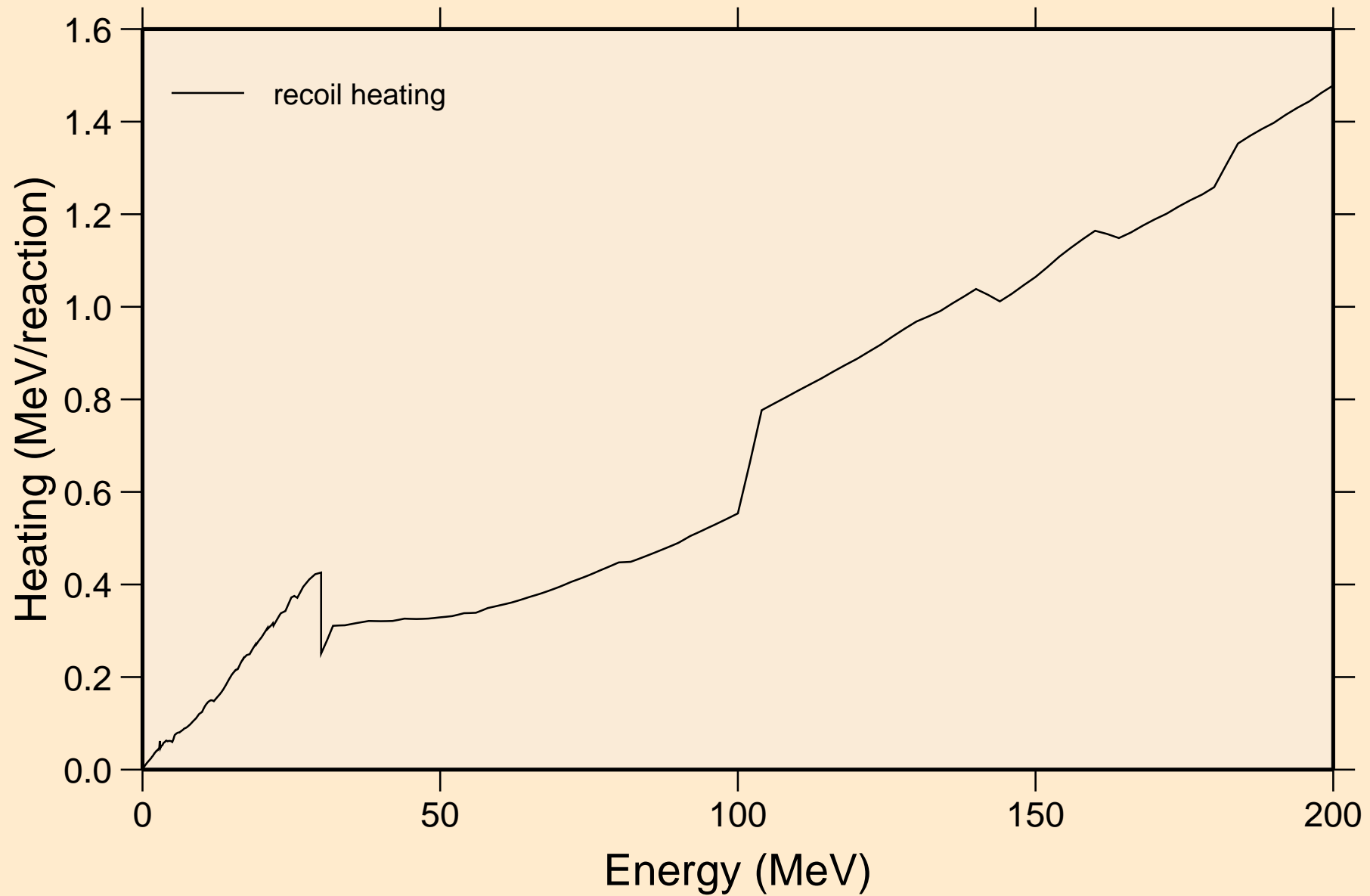

GE083 NEUTRON ACER TENDL-2021 LIBRARY; T=293.6K

Particle production cross sections

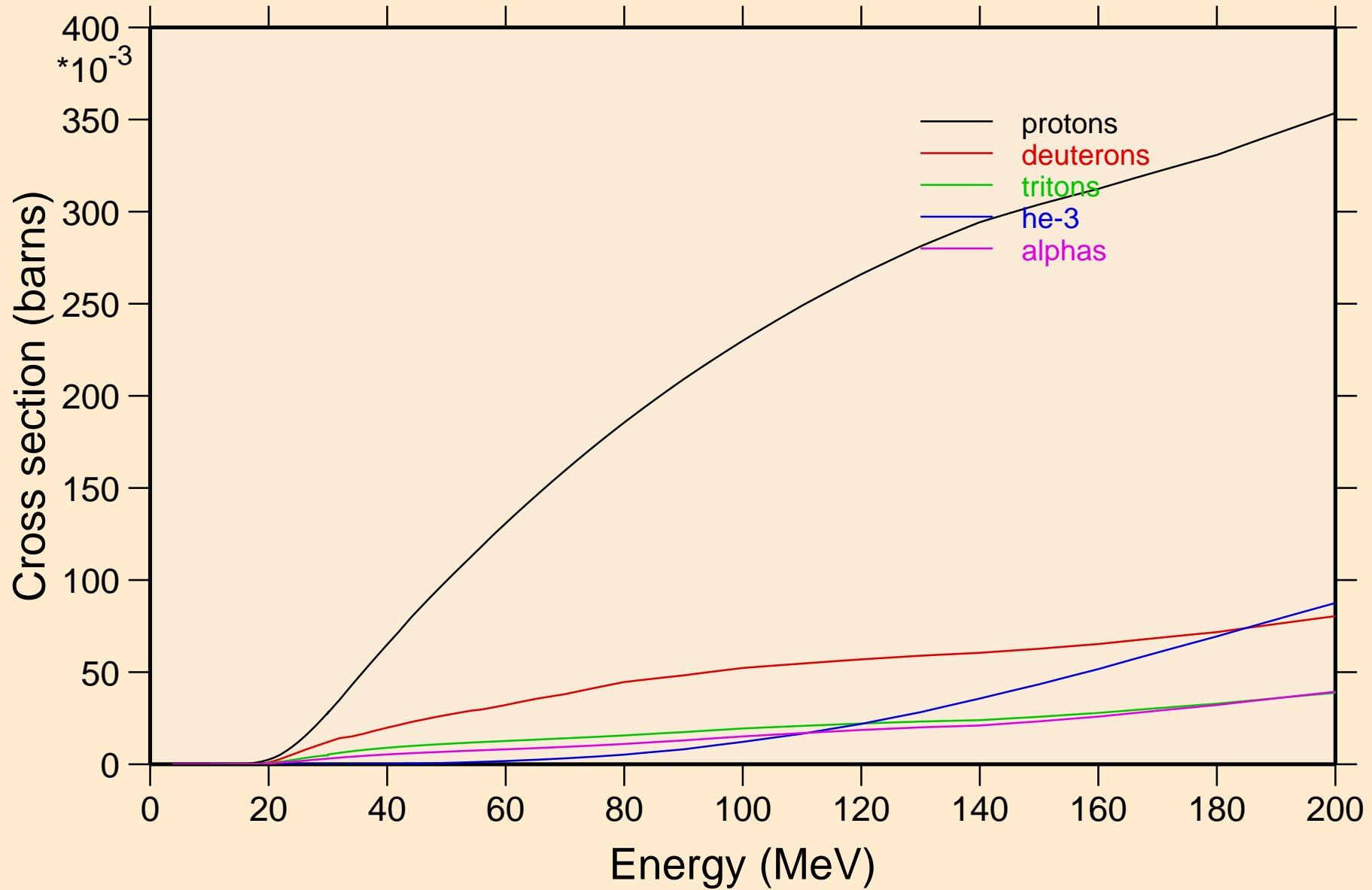

GE083 NEUTRON ACER TENDL-2021 LIBRARY; T=293.6K
protons from (n,x)

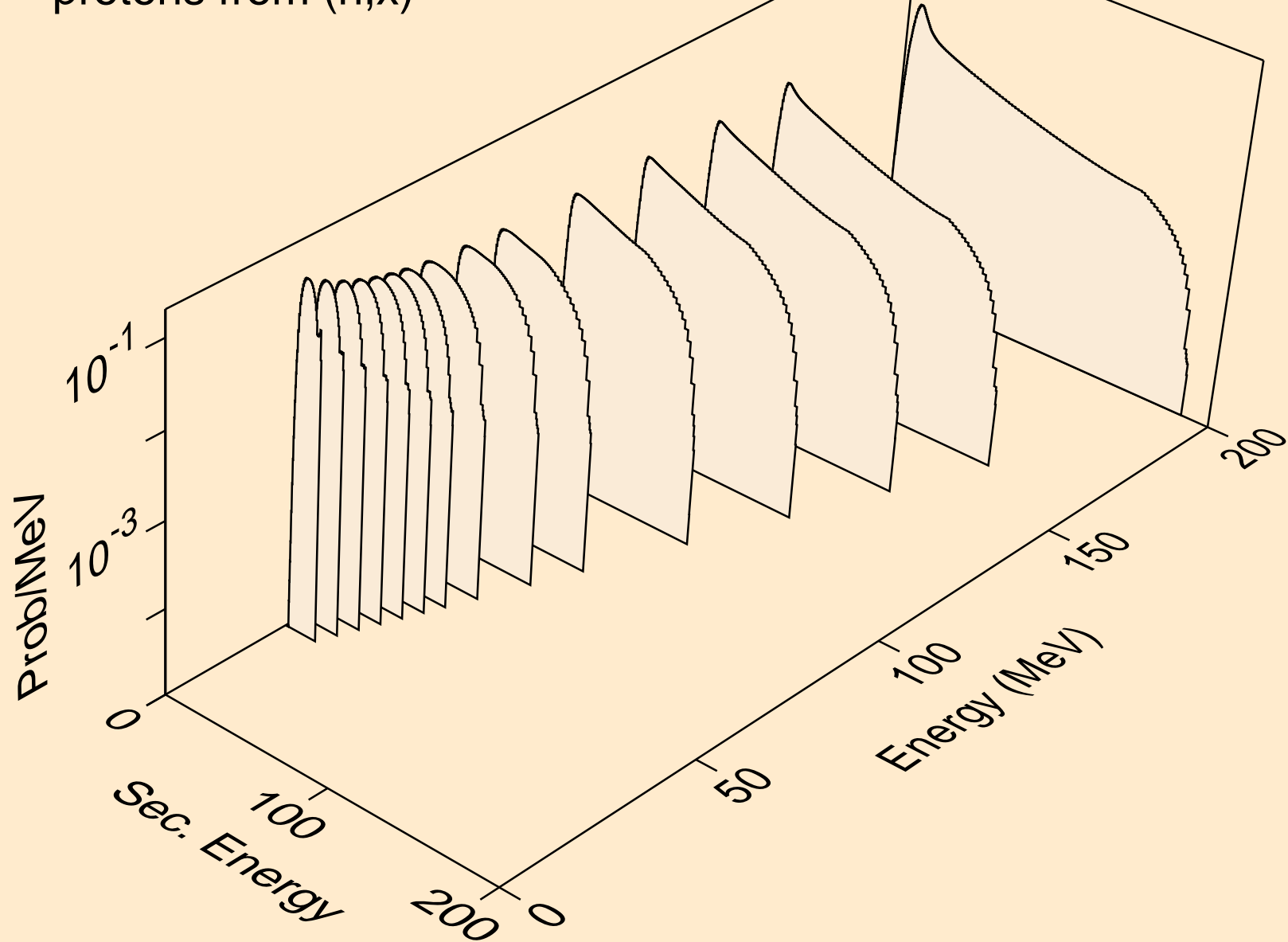

GE083 NEUTRON ACER TENDL-2021 LIBRARY; T=293.6K
protons from (n,n*)p

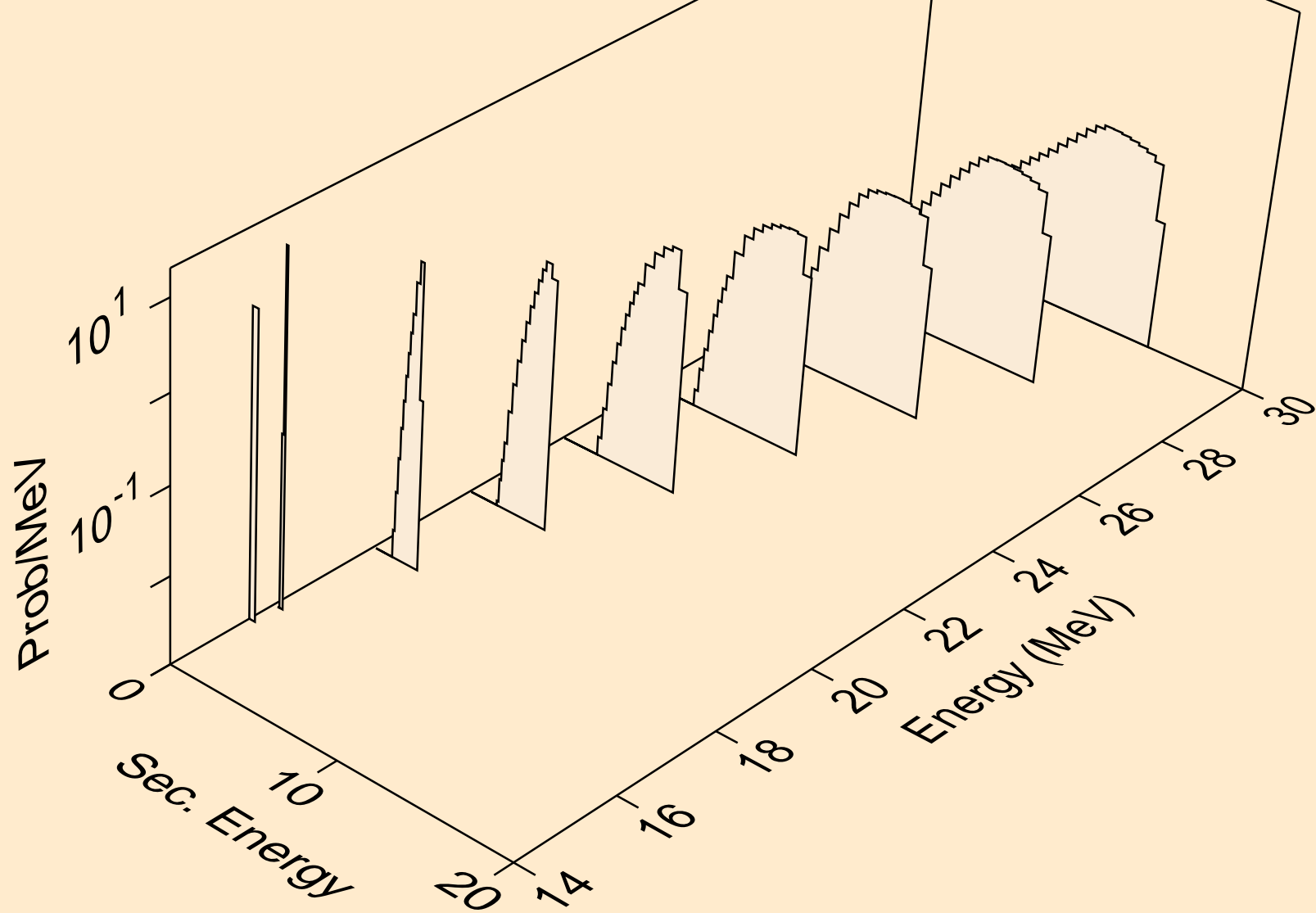

GE083 NEUTRON ACER TENDL-2021 LIBRARY; T=293.6K
protons from (n,2np)

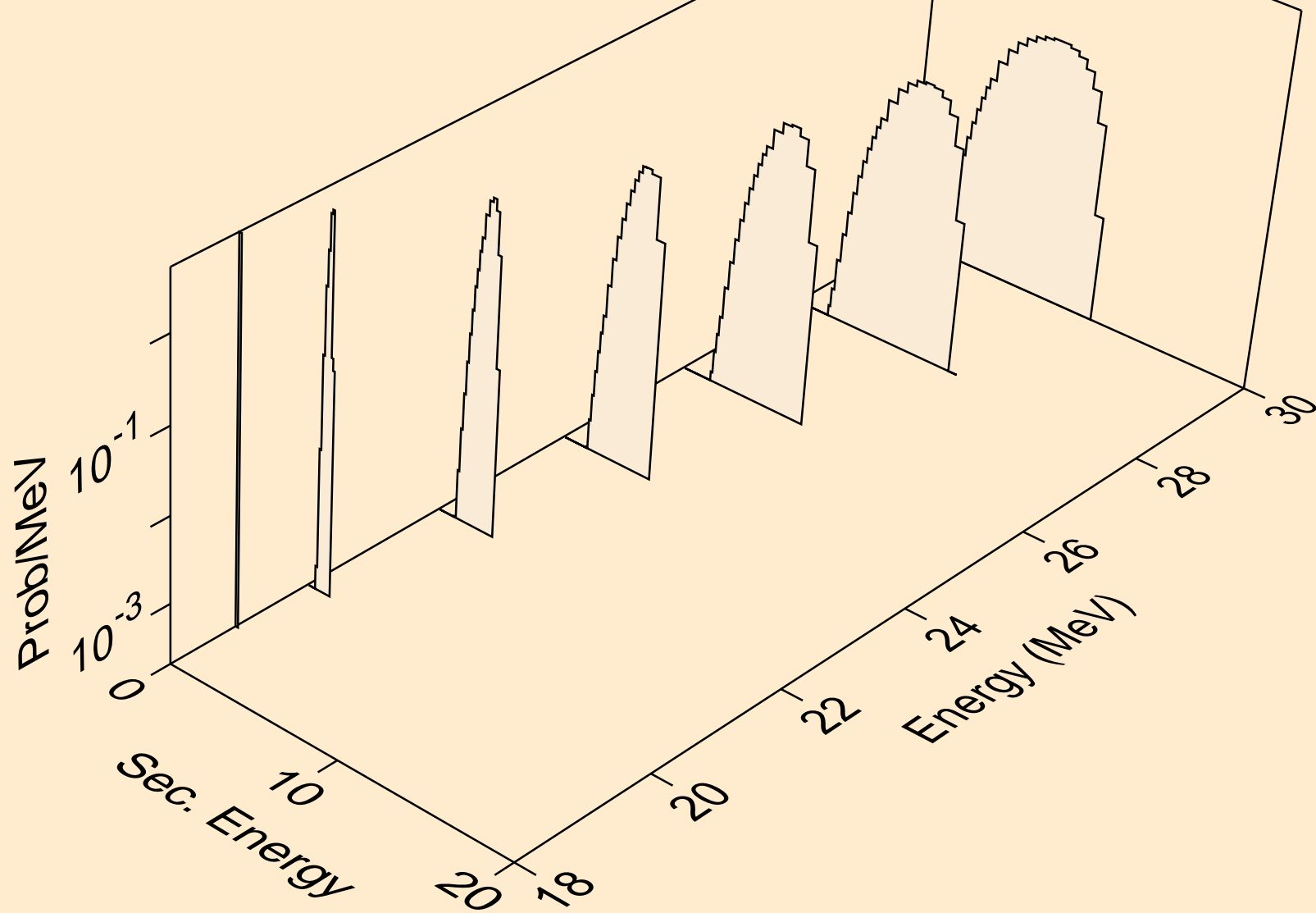

GE083 NEUTRON ACER TENDL-2021 LIBRARY; T=293.6K
protons from (n,3np)

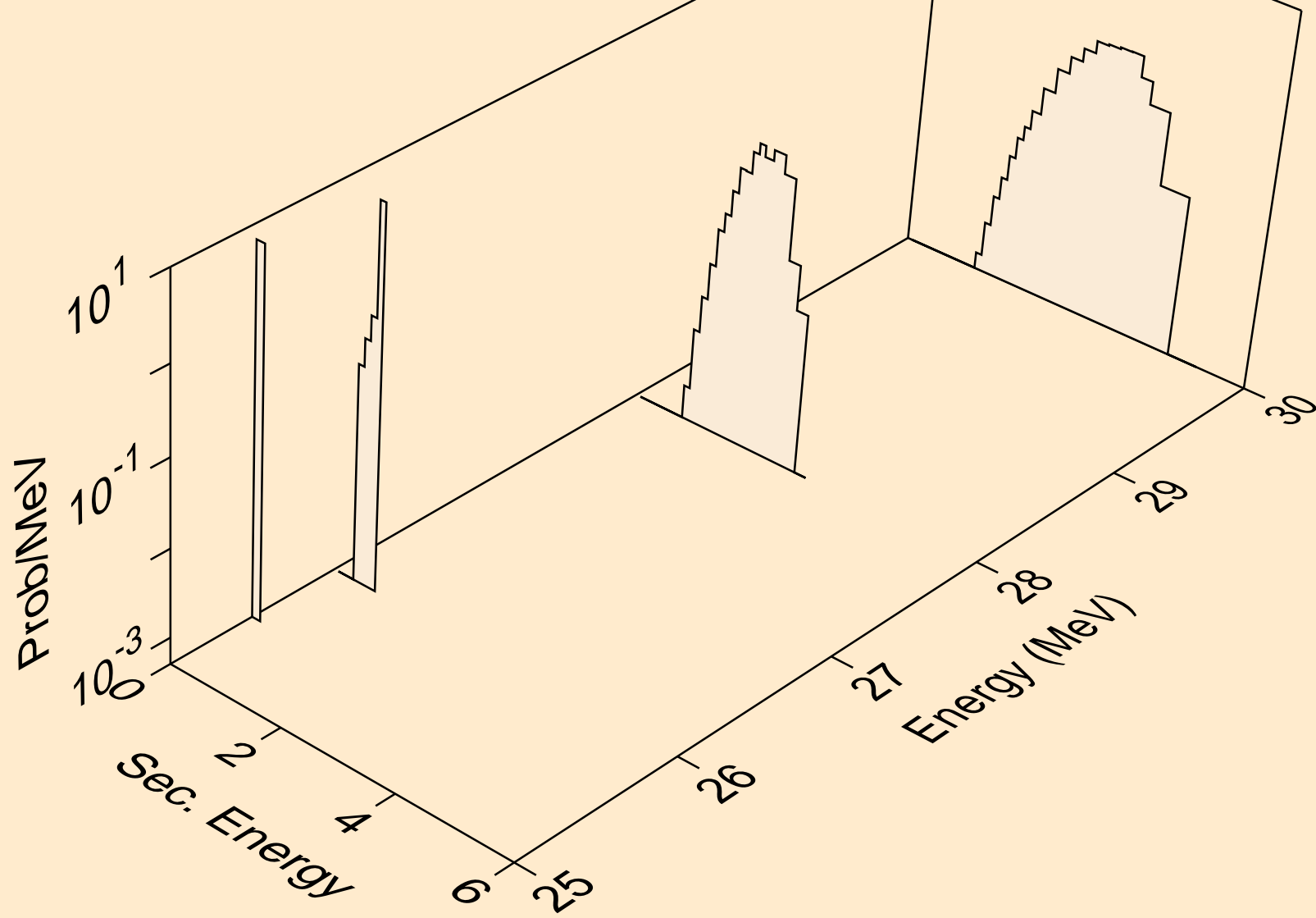

GE083 NEUTRON ACER TENDL-2021 LIBRARY; T=293.6K
protons from (n,p)

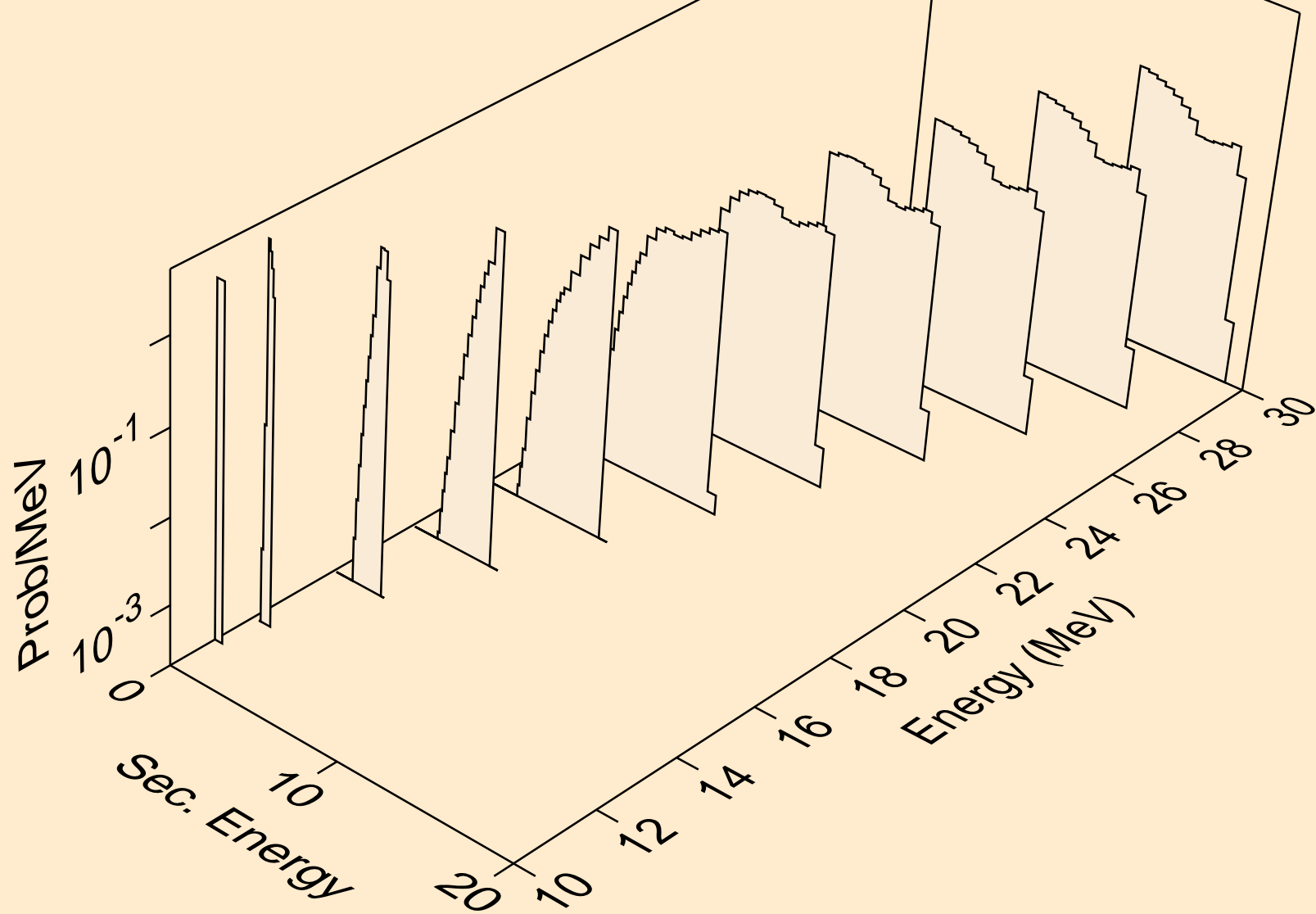

GE083 NEUTRON ACER TENDL-2021 LIBRARY; T=293.6K
deuterons from (n,x)

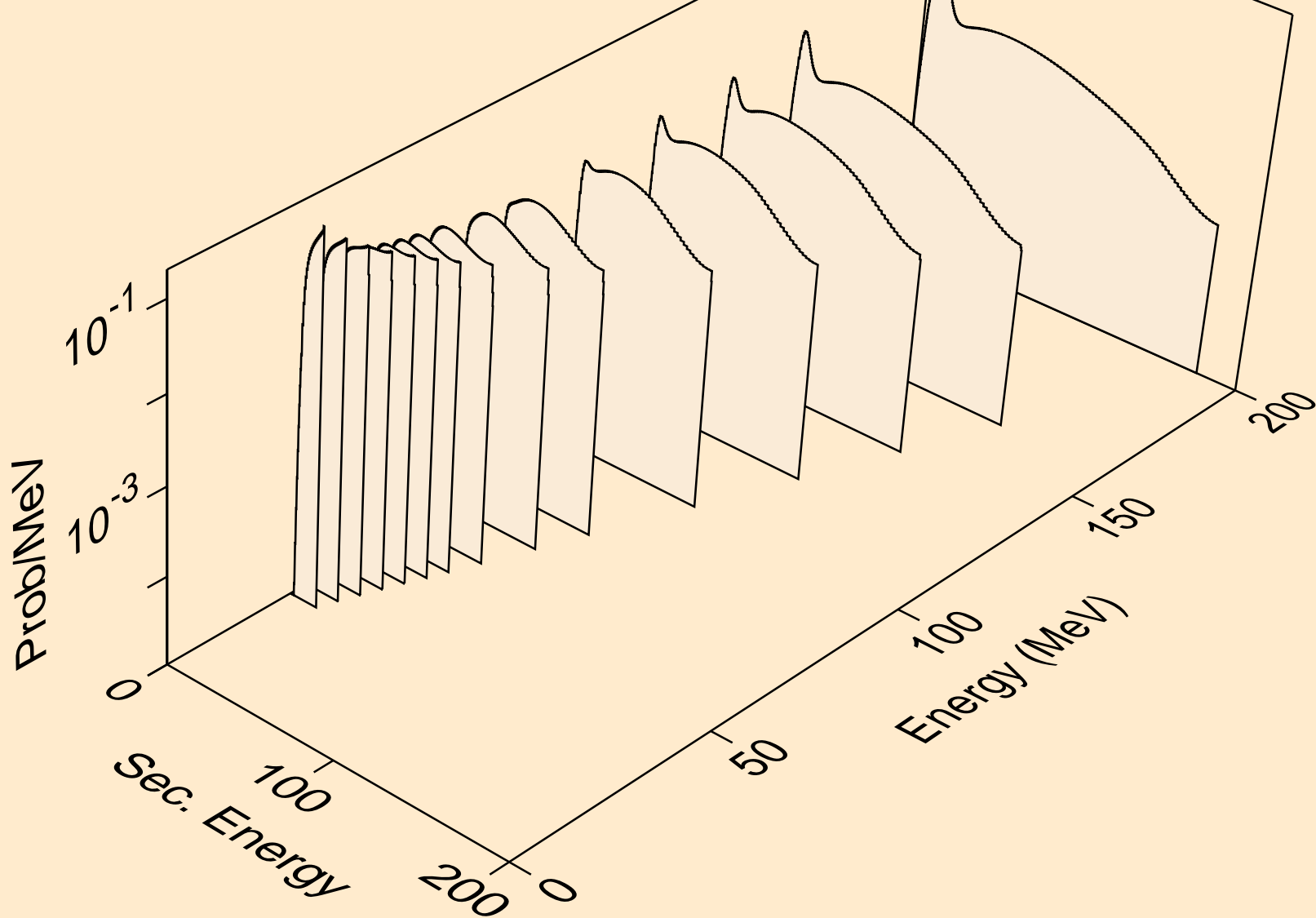

GE083 NEUTRON ACER TENDL-2021 LIBRARY; T=293.6K
deuterons from (n,2nd)

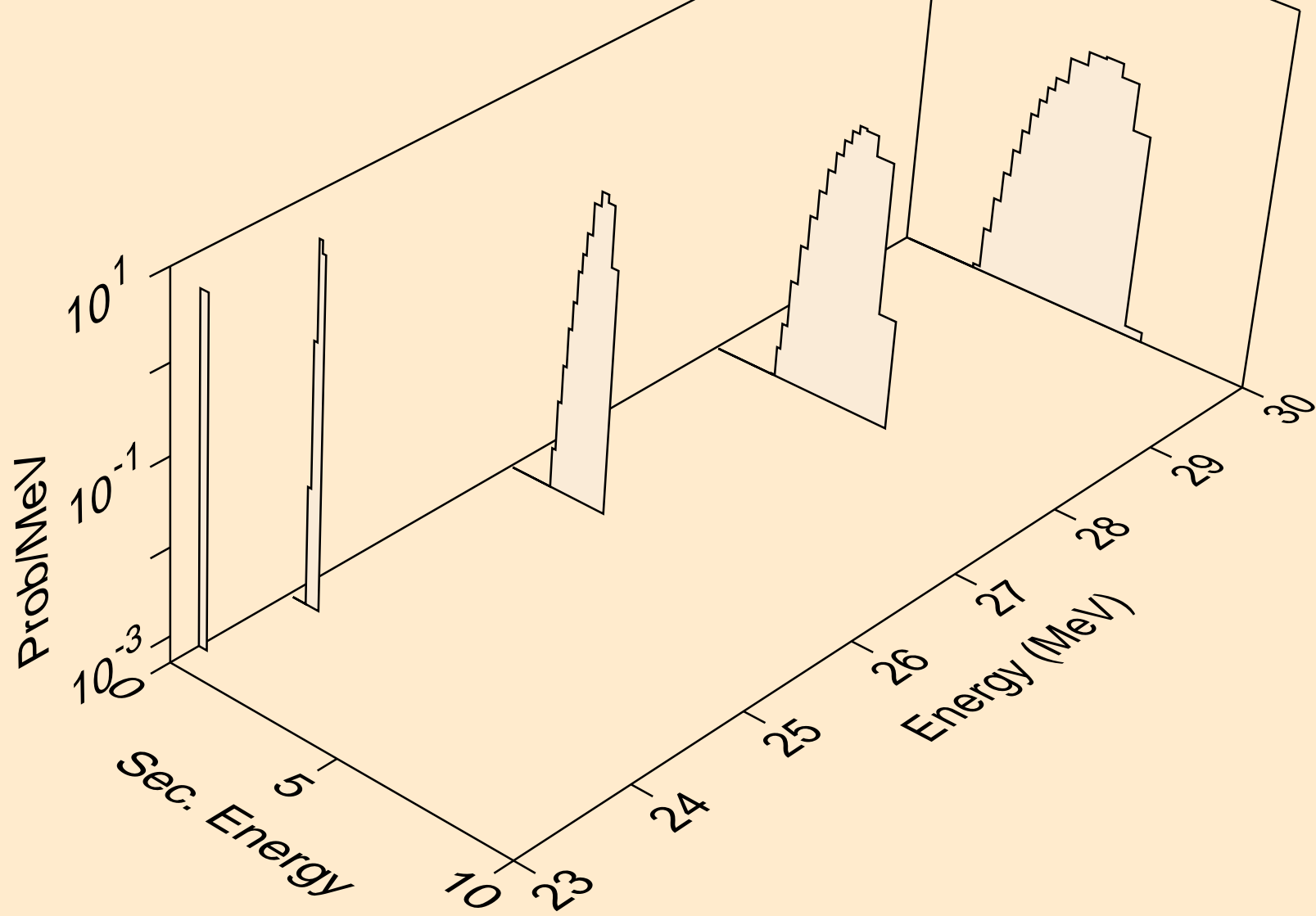

GE083 NEUTRON ACER TENDL-2021 LIBRARY; T=293.6K
deuterons from (n,n*)d

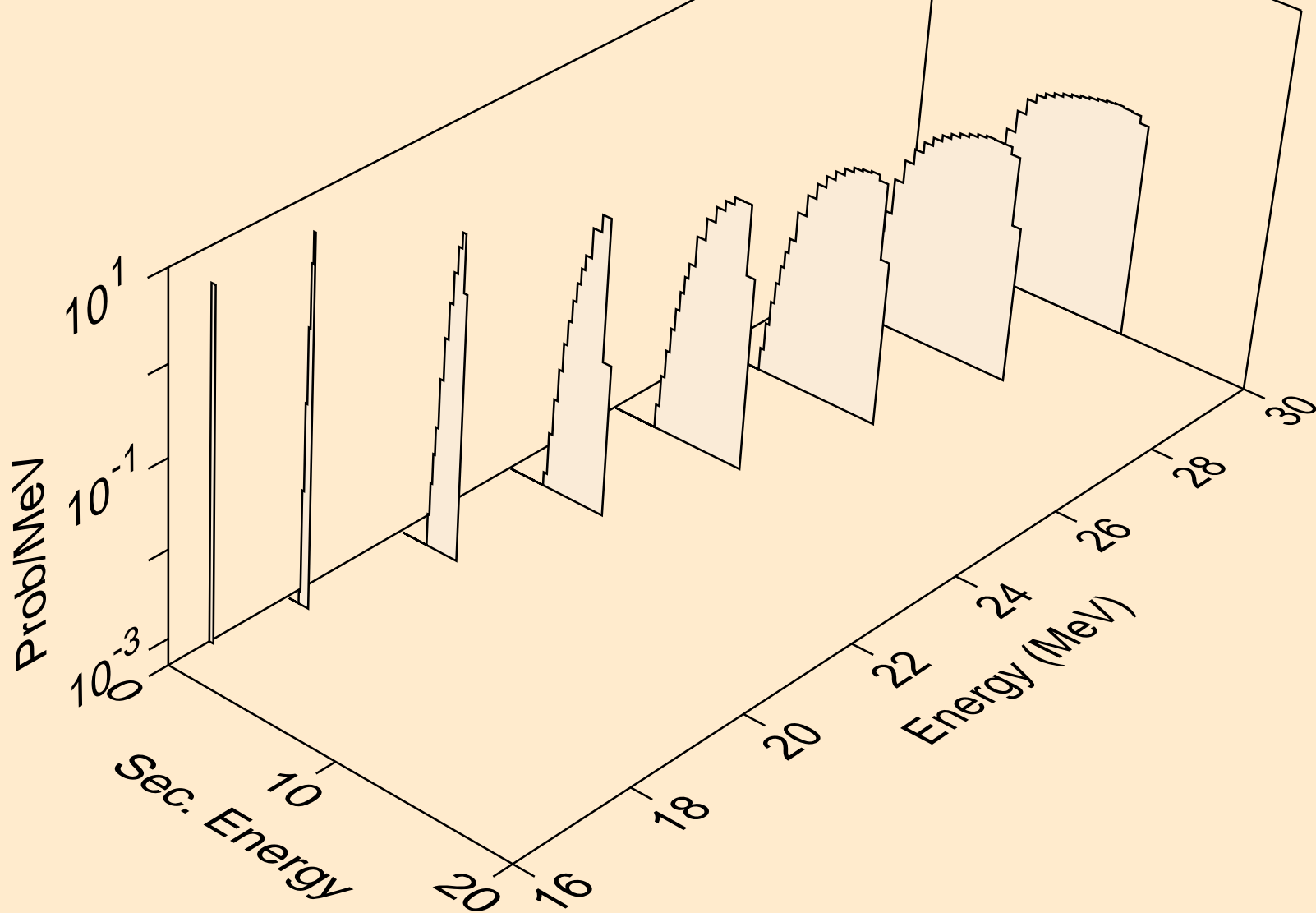

GE083 NEUTRON ACER TENDL-2021 LIBRARY; T=293.6K
deuterons from (n,d)

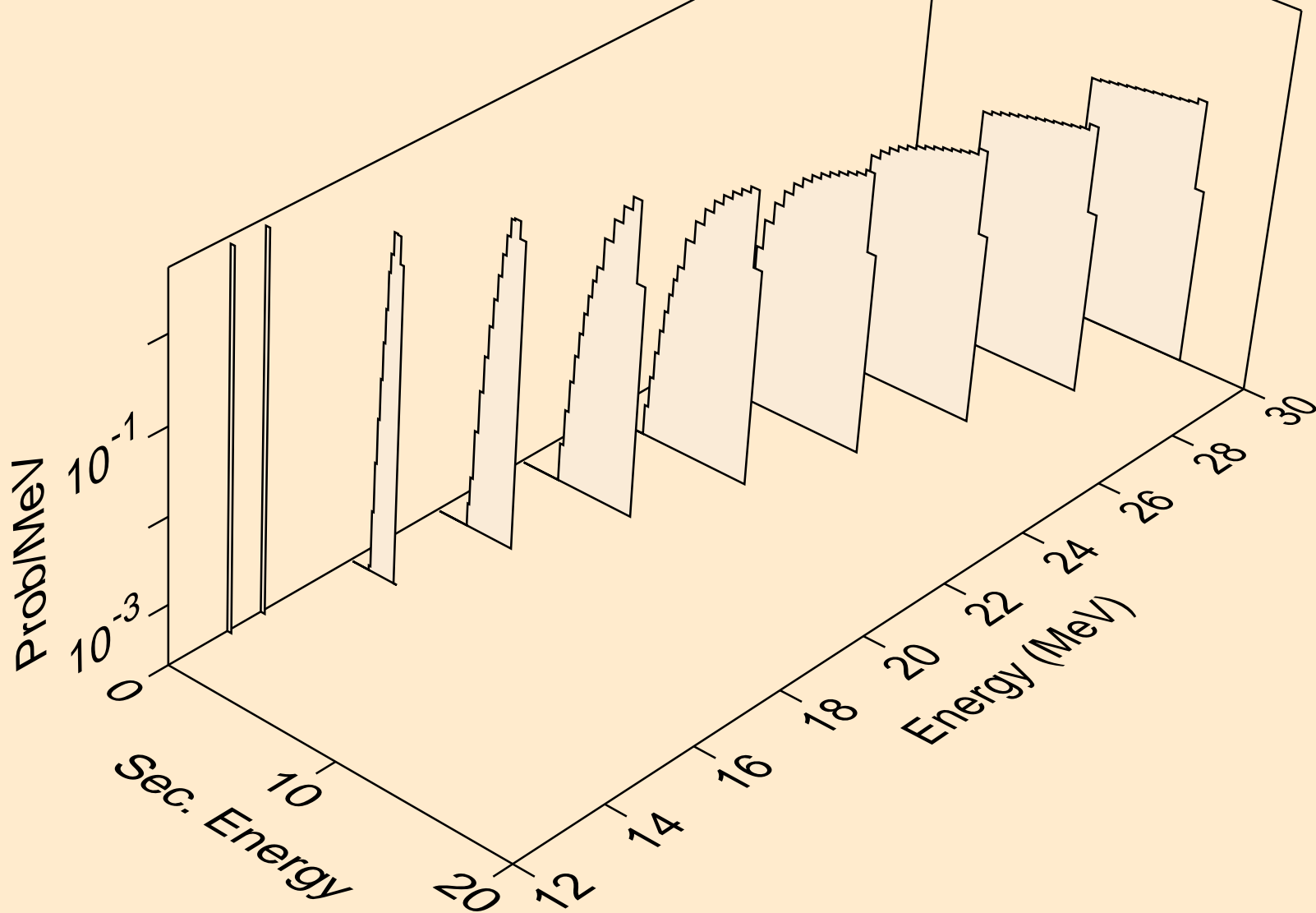

GE083 NEUTRON ACER TENDL-2021 LIBRARY; T=293.6K
tritons from (n,x)

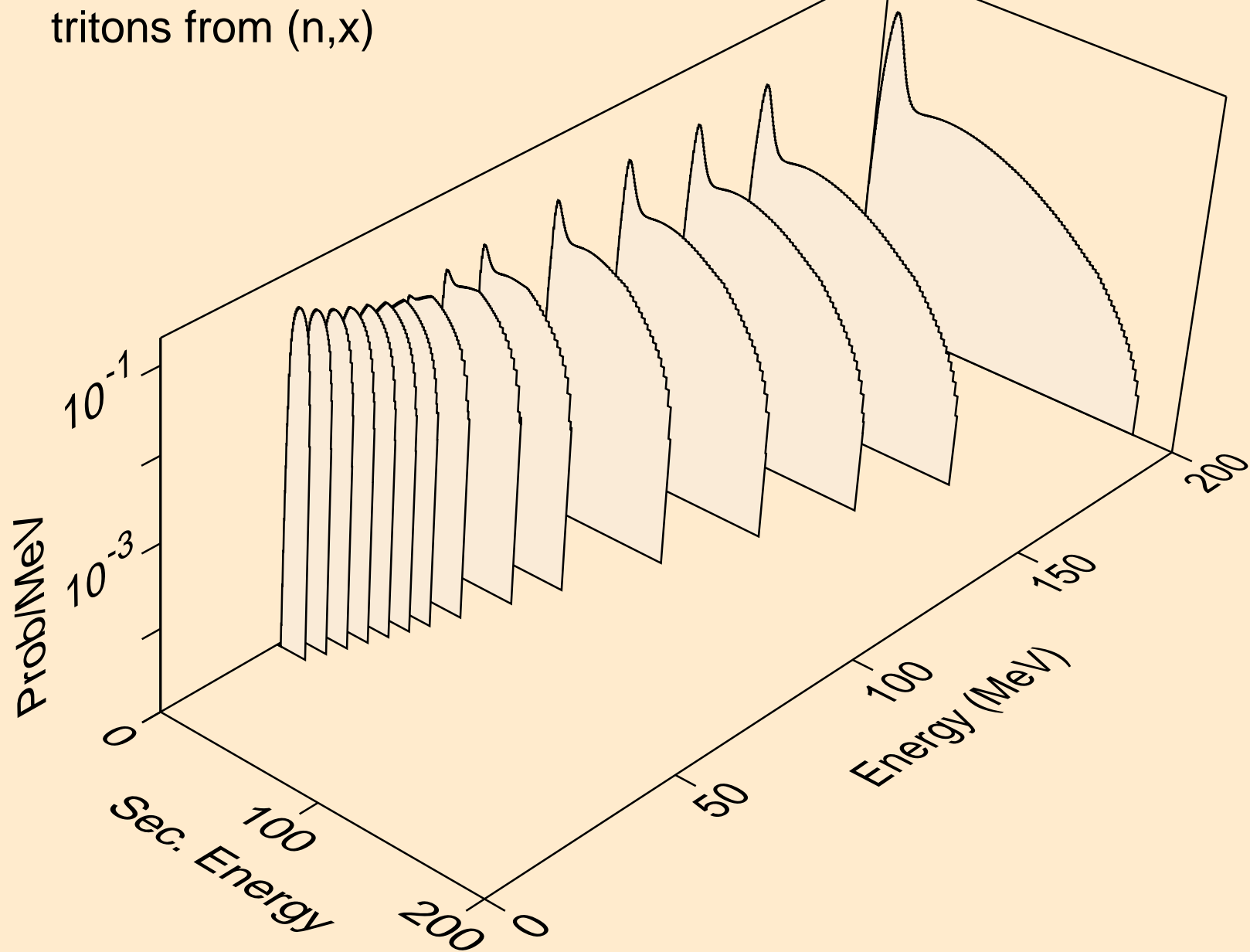

GE083 NEUTRON ACER TENDL-2021 LIBRARY; T=293.6K
tritons from (n,n*)t

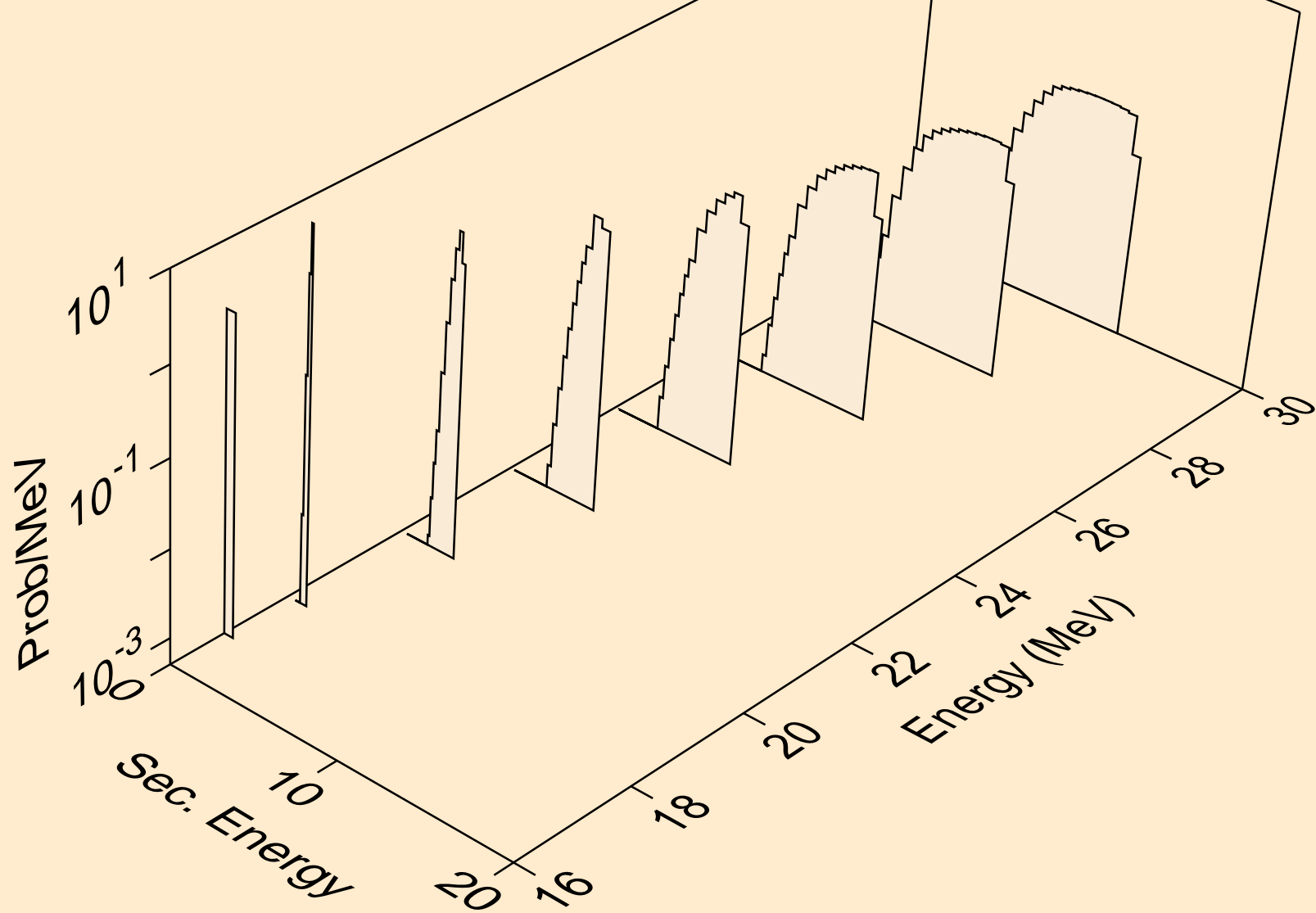

GE083 NEUTRON ACER TENDL-2021 LIBRARY; T=293.6K
tritons from (n,t)

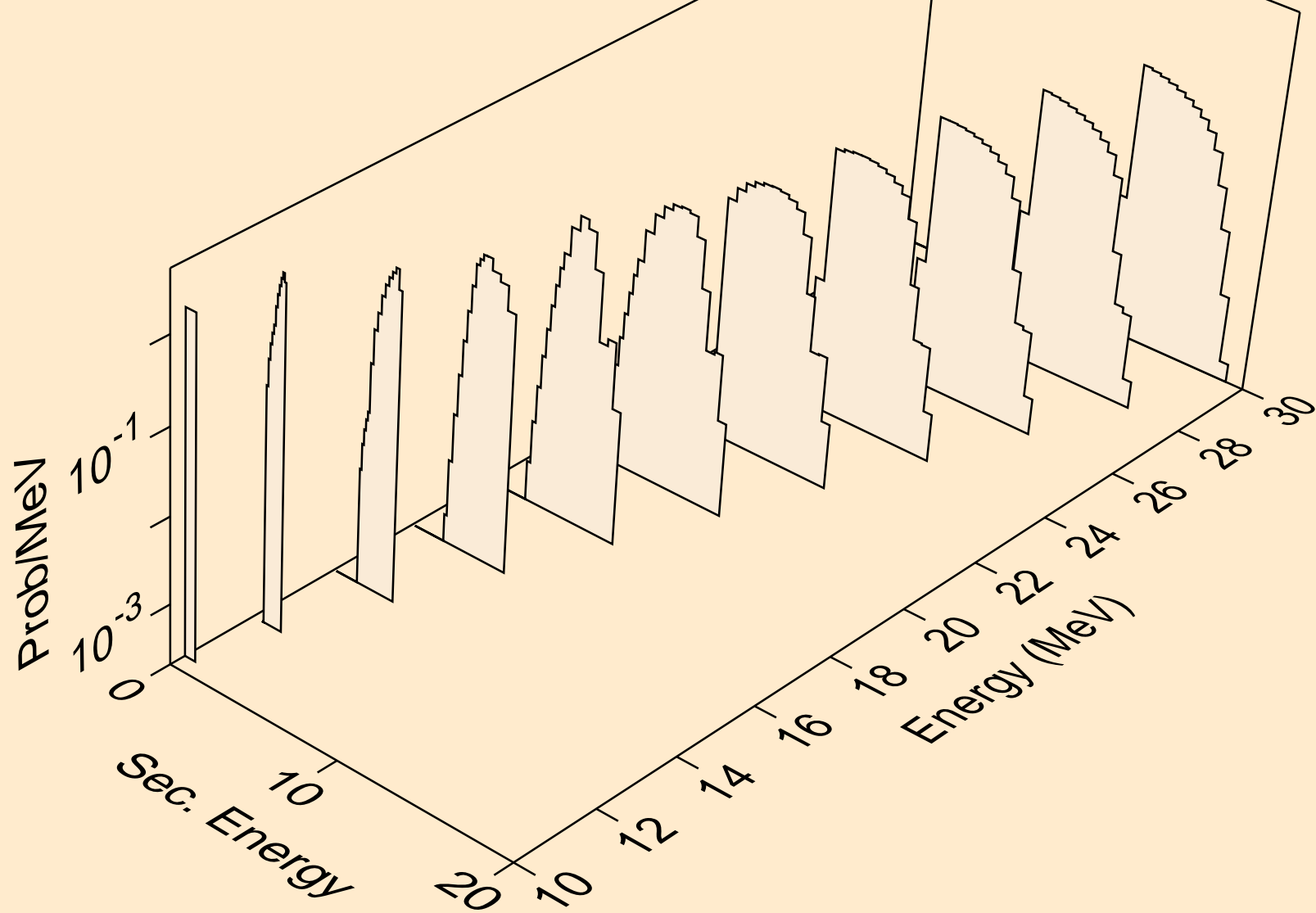

GE083 NEUTRON ACER TENDL-2021 LIBRARY; T=293.6K
he3s from (n,x)

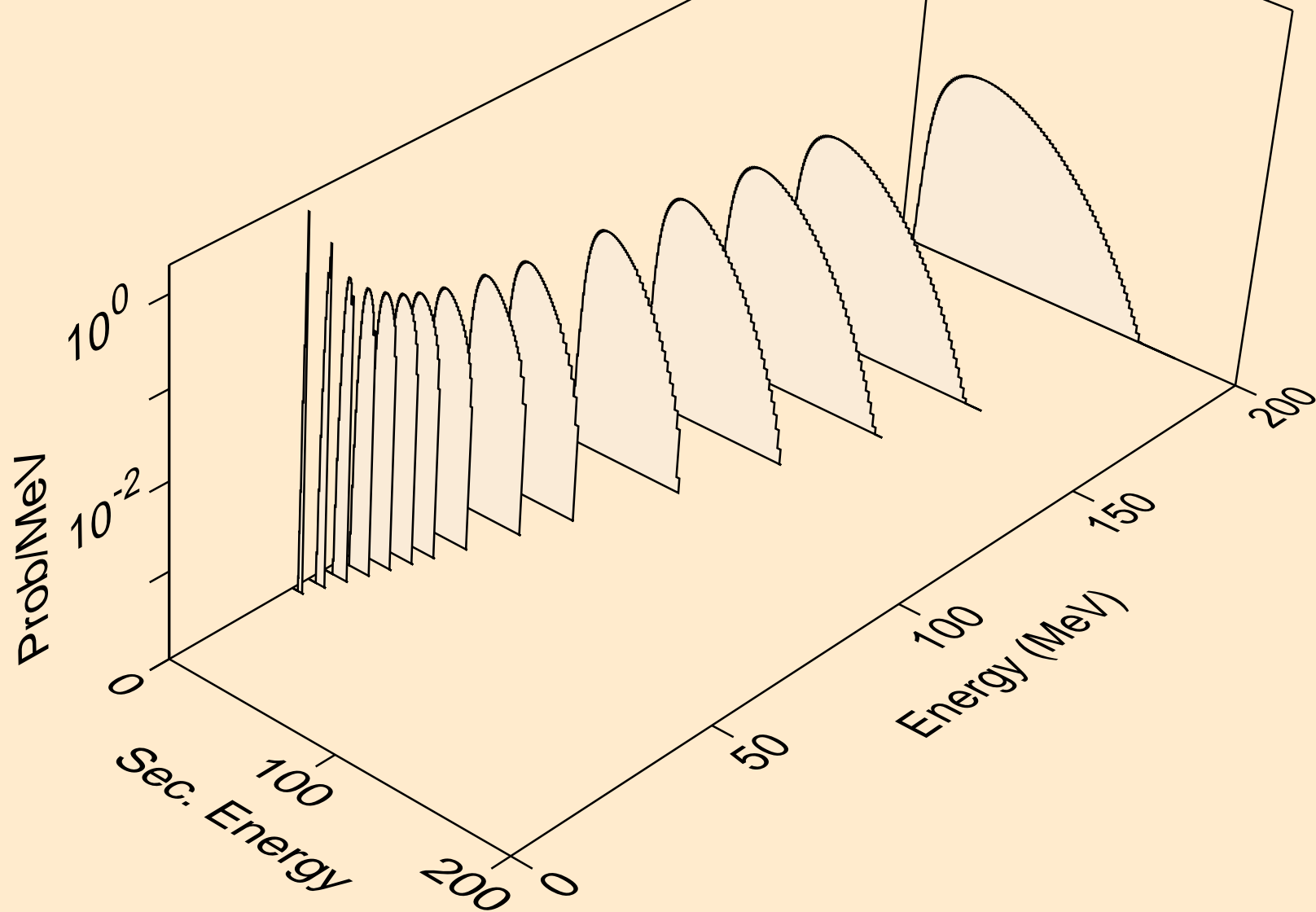

GE083 NEUTRON ACER TENDL-2021 LIBRARY; T=293.6K
he3s from (n,he3)

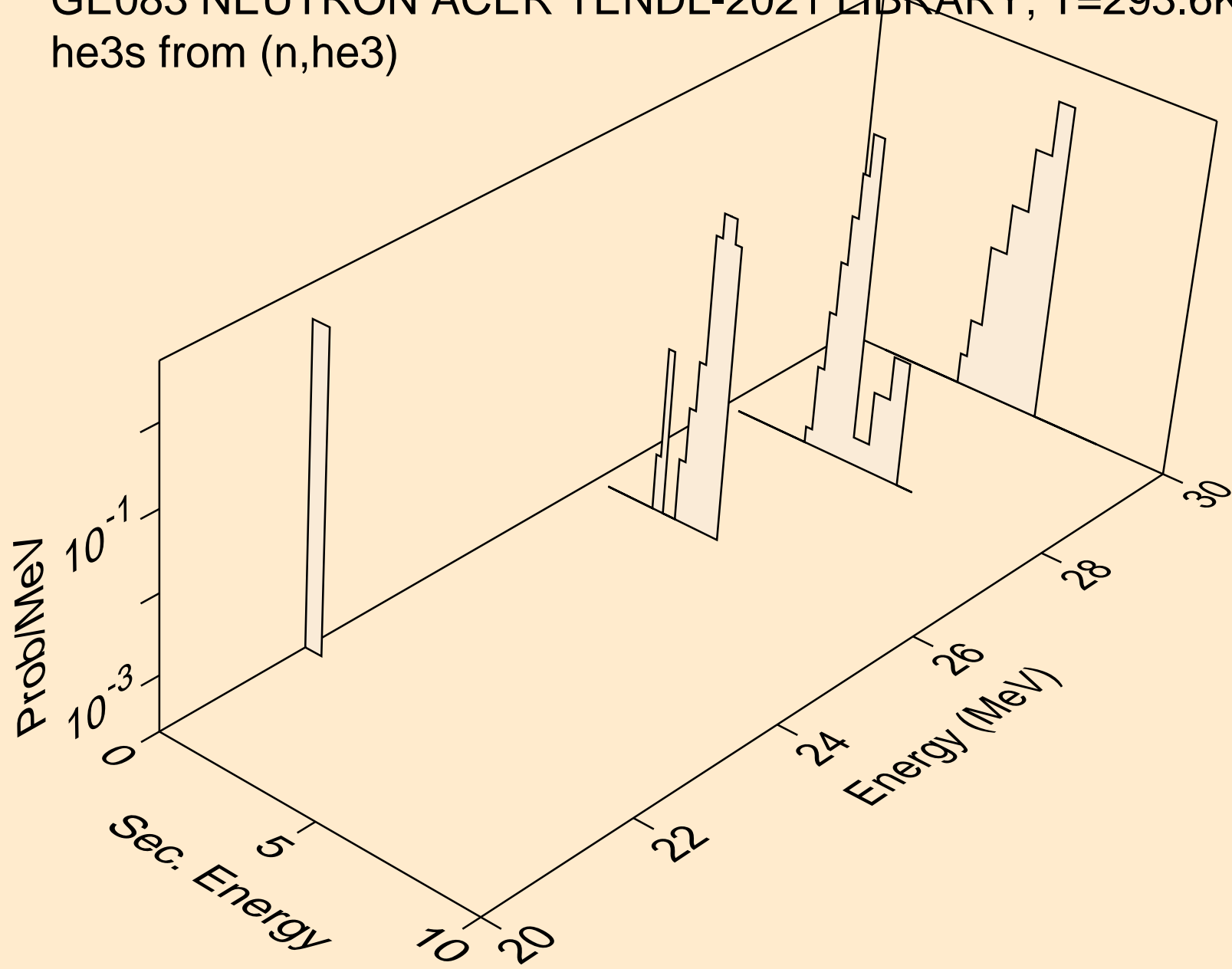

GE083 NEUTRON ACER TENDL-2021 LIBRARY; T=293.6K
alphas from (n,x)

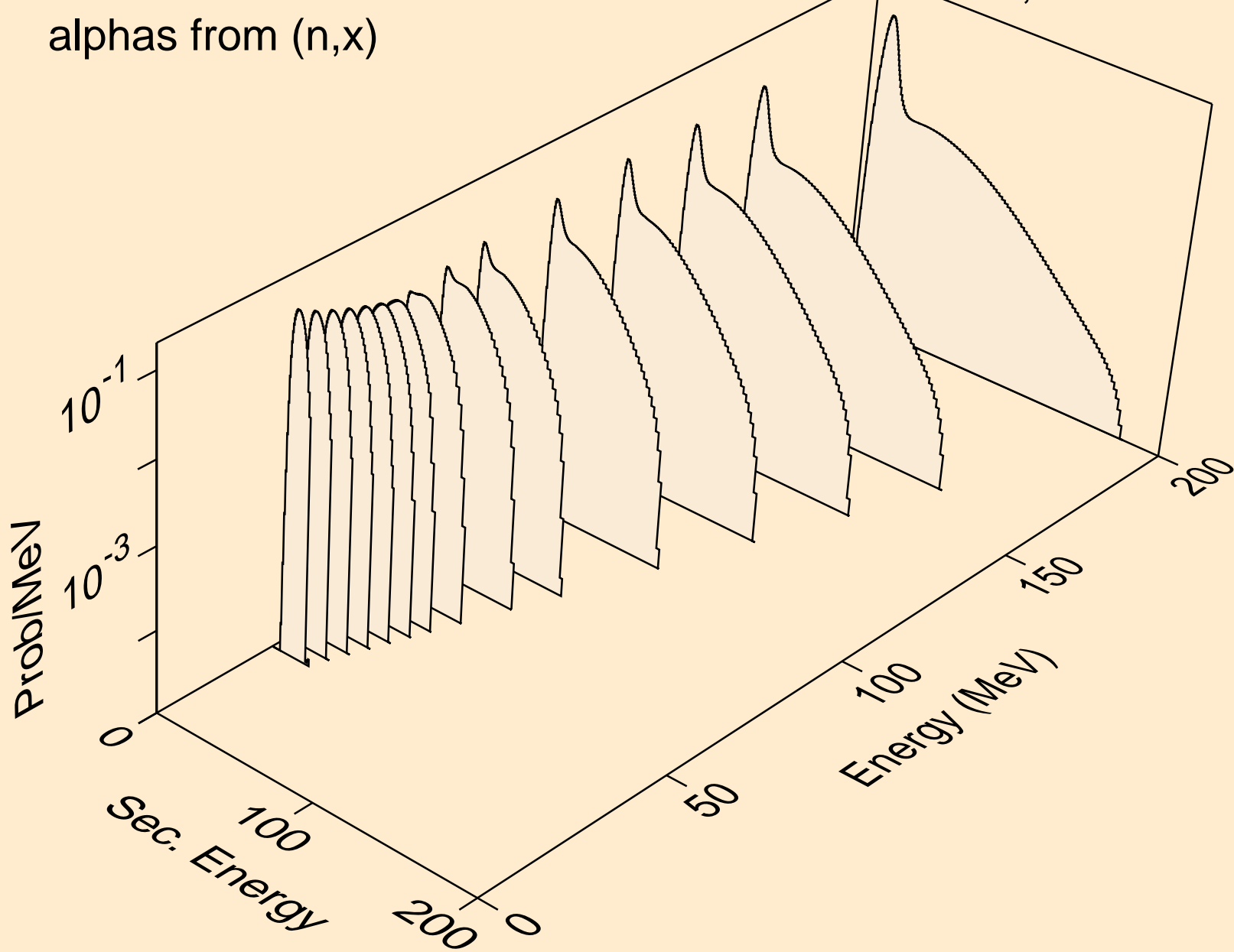

GE083 NEUTRON ACER TENDL-2021 LIBRARY; T=293.6K
alphas from (n,n*)a

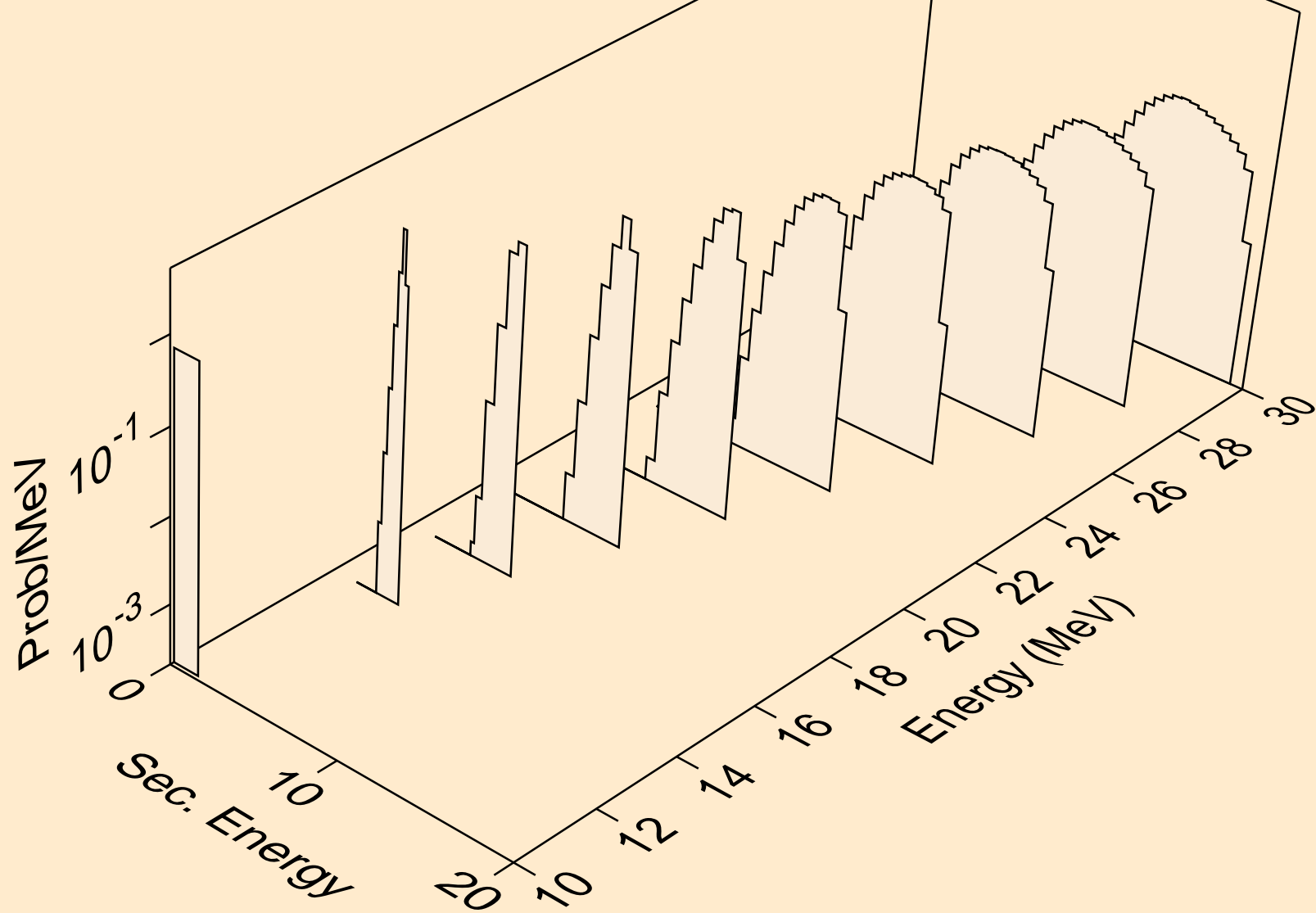

GE083 NEUTRON ACER TENDL-2021 LIBRARY; T=293.6K
alphas from (n,2n)a

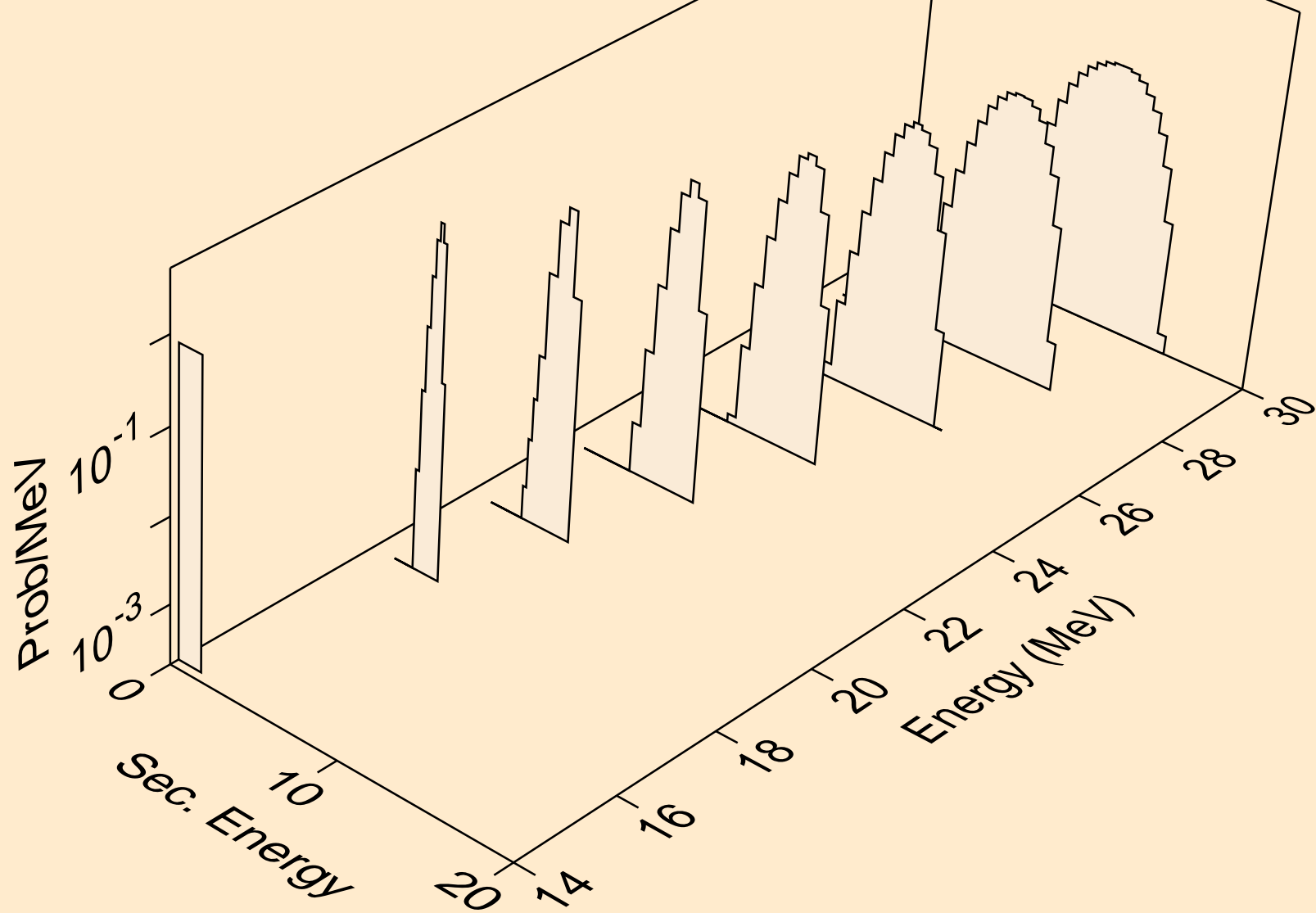

GE083 NEUTRON ACER TENDL-2021 LIBRARY; T=293.6K
alphas from (n,3n)a

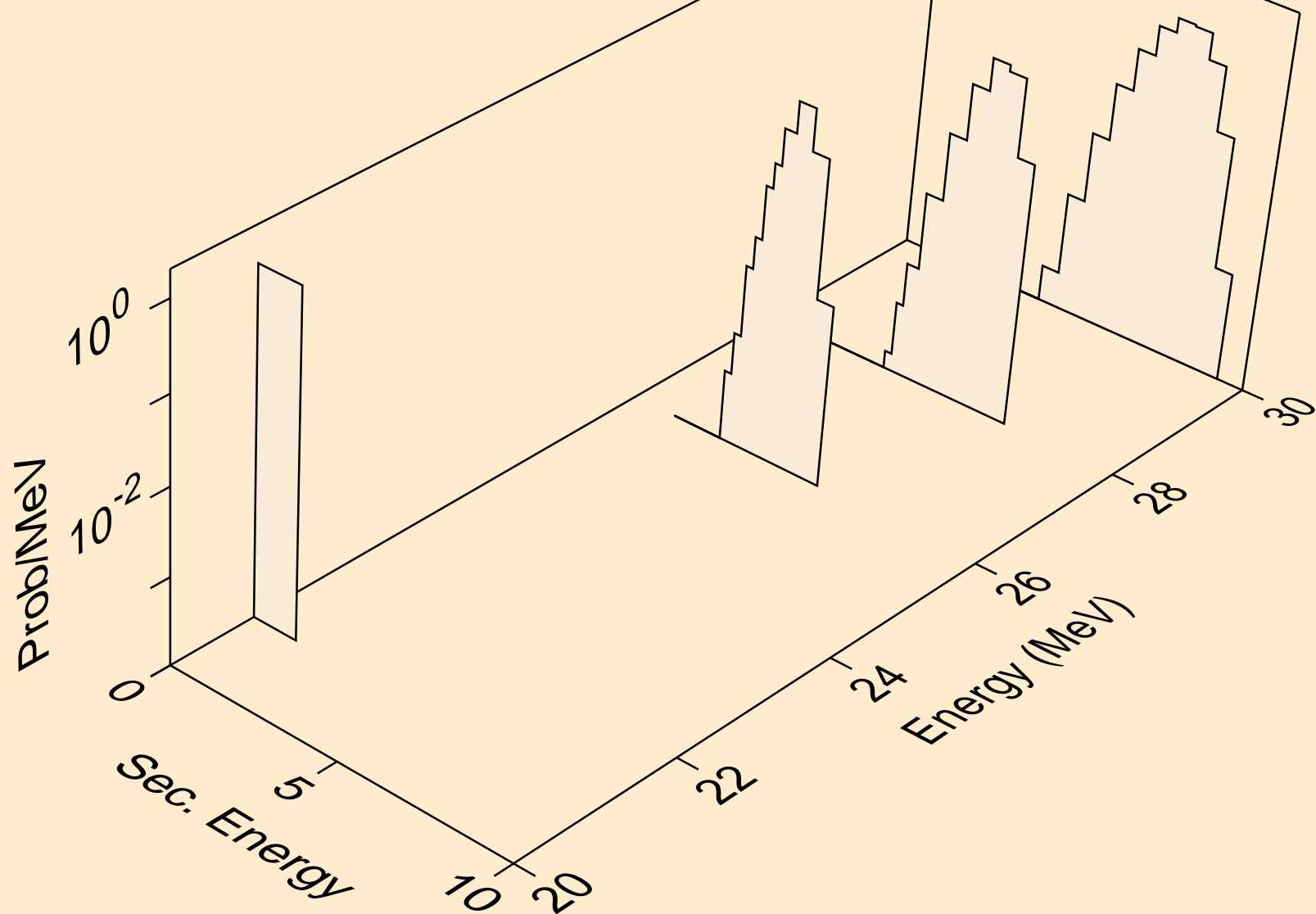

GE083 NEUTRON ACER TENDL-2021 LIBRARY; T=293.6K
alphas from (n,a)

