

HF168 NEUTRON ACER TENDL-2021 LIBRARY; T=293.6K

Principal cross sections

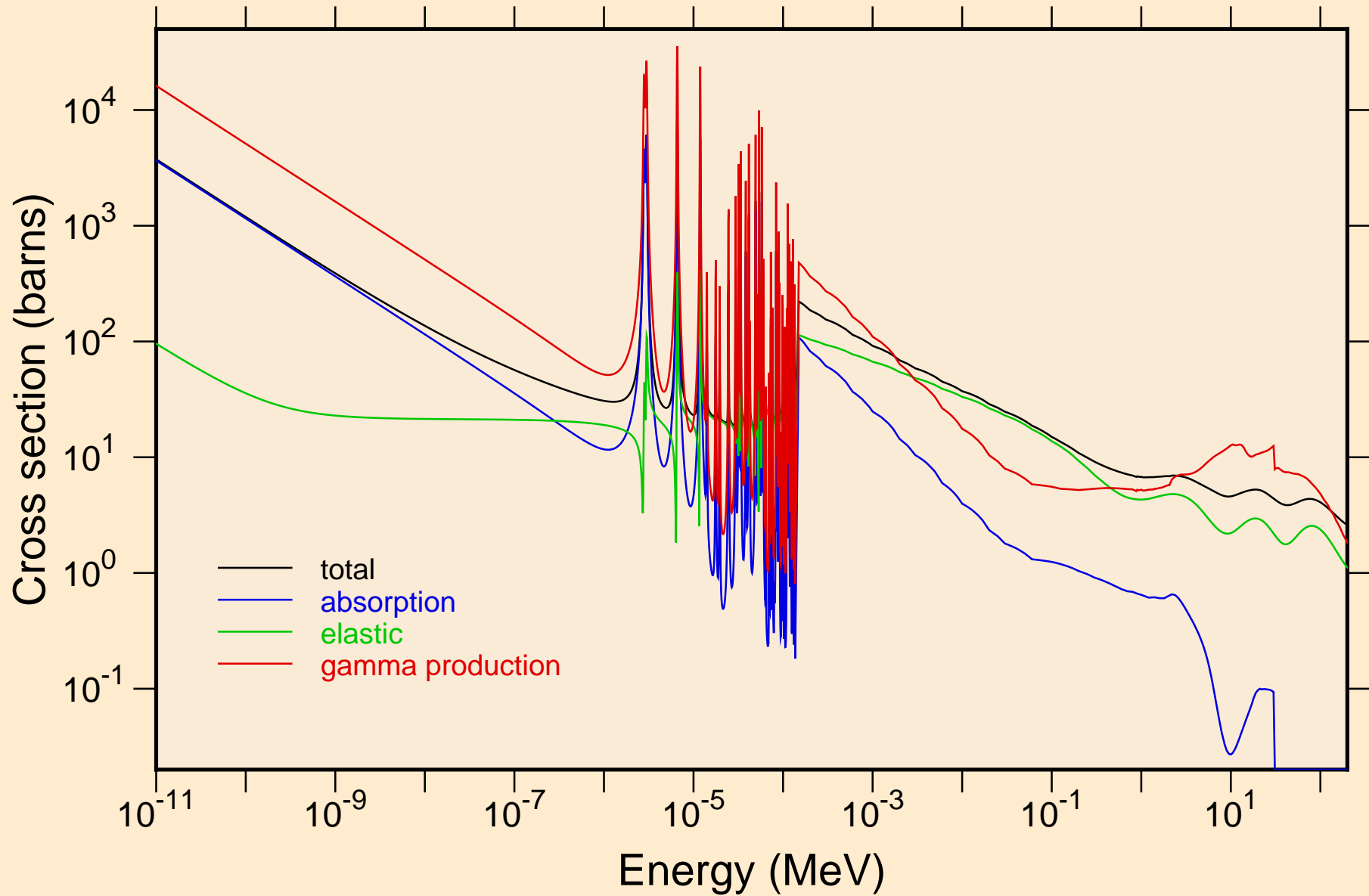

HF168 NEUTRON ACER TENDL-2021 LIBRARY; T=293.6K
resonance total cross section

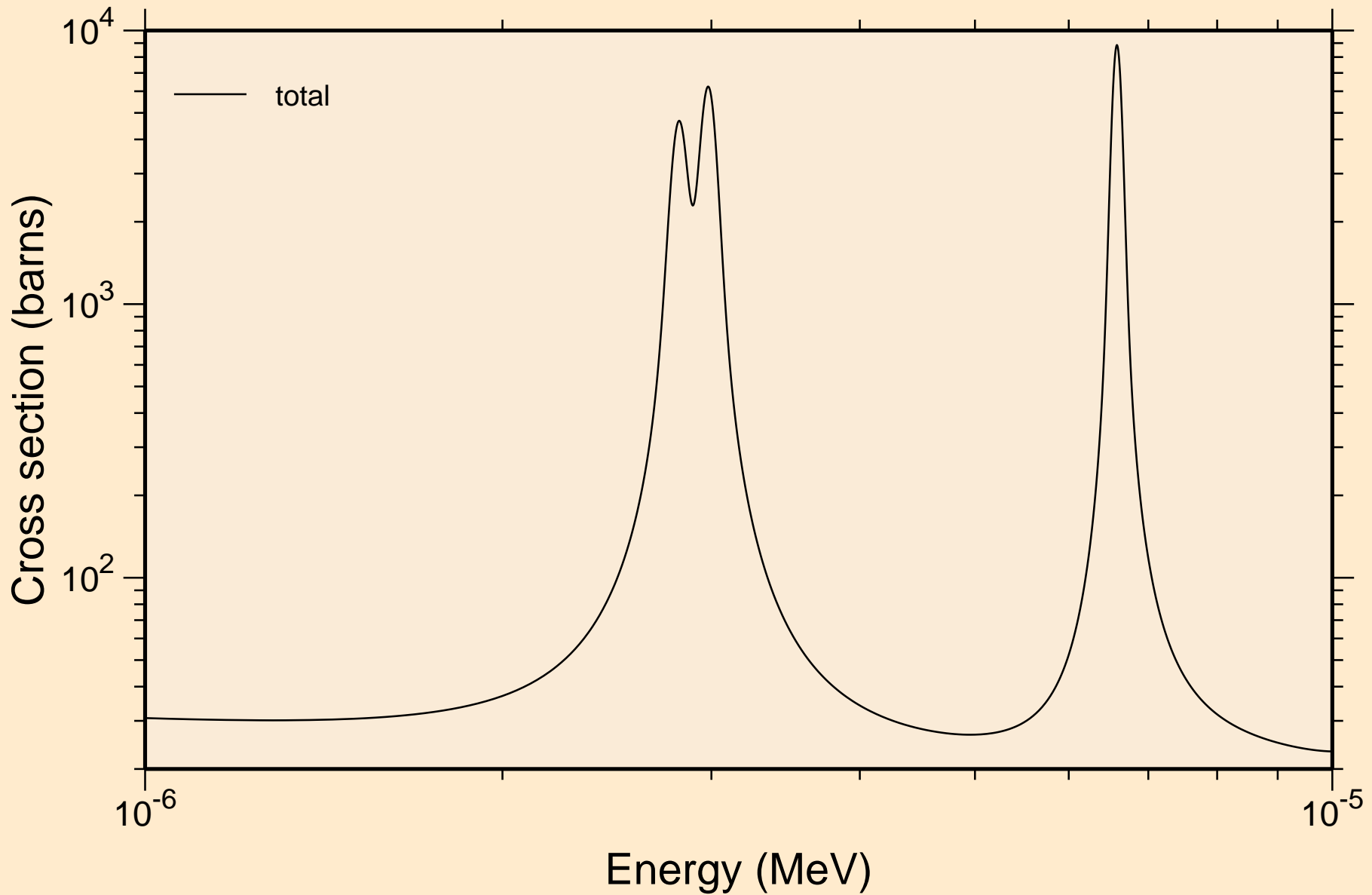

HF168 NEUTRON ACER TENDL-2021 LIBRARY; T=293.6K
resonance total cross section

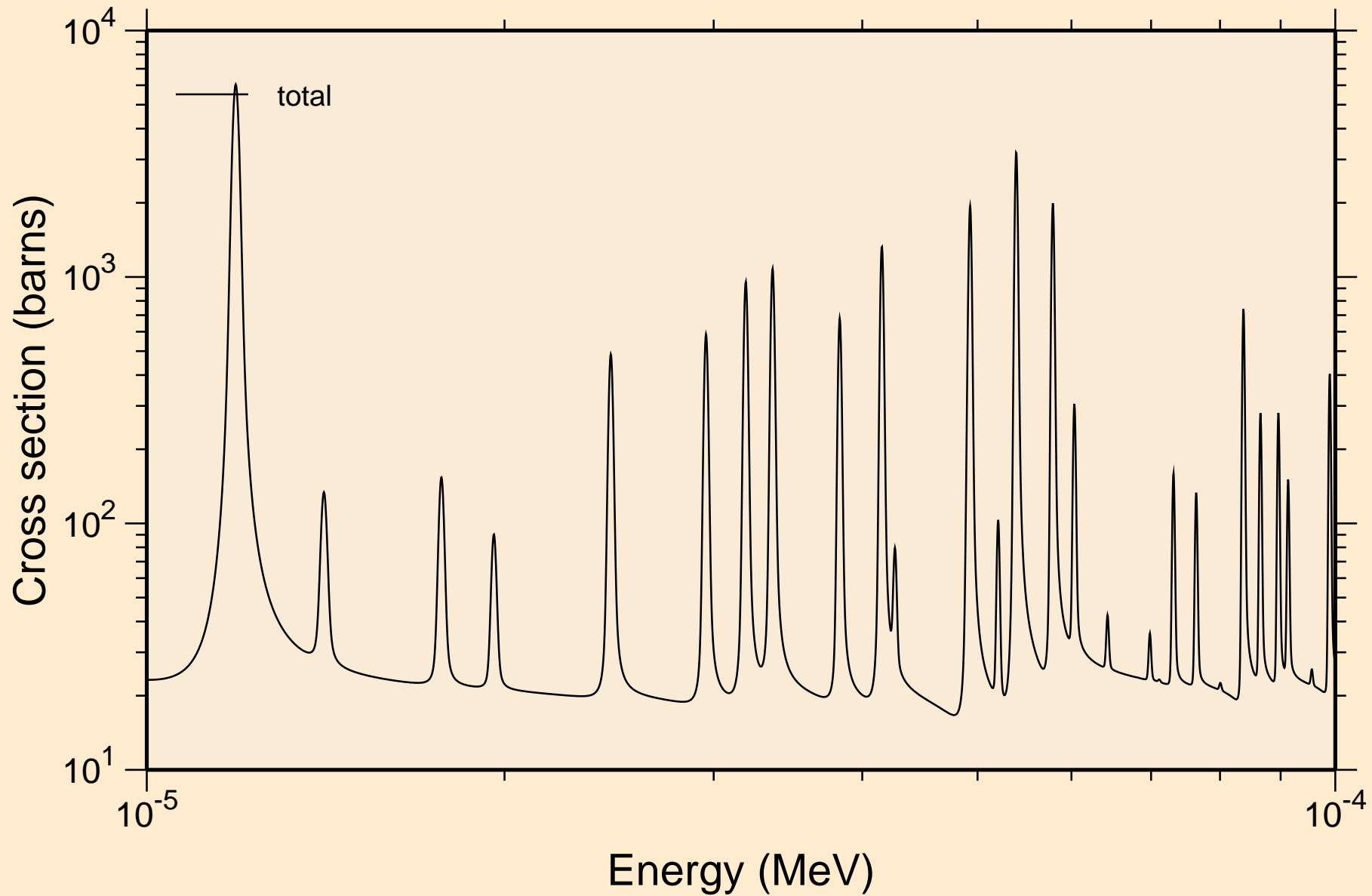

HF168 NEUTRON ACER TENDL-2021 LIBRARY; T=293.6K
resonance total cross section

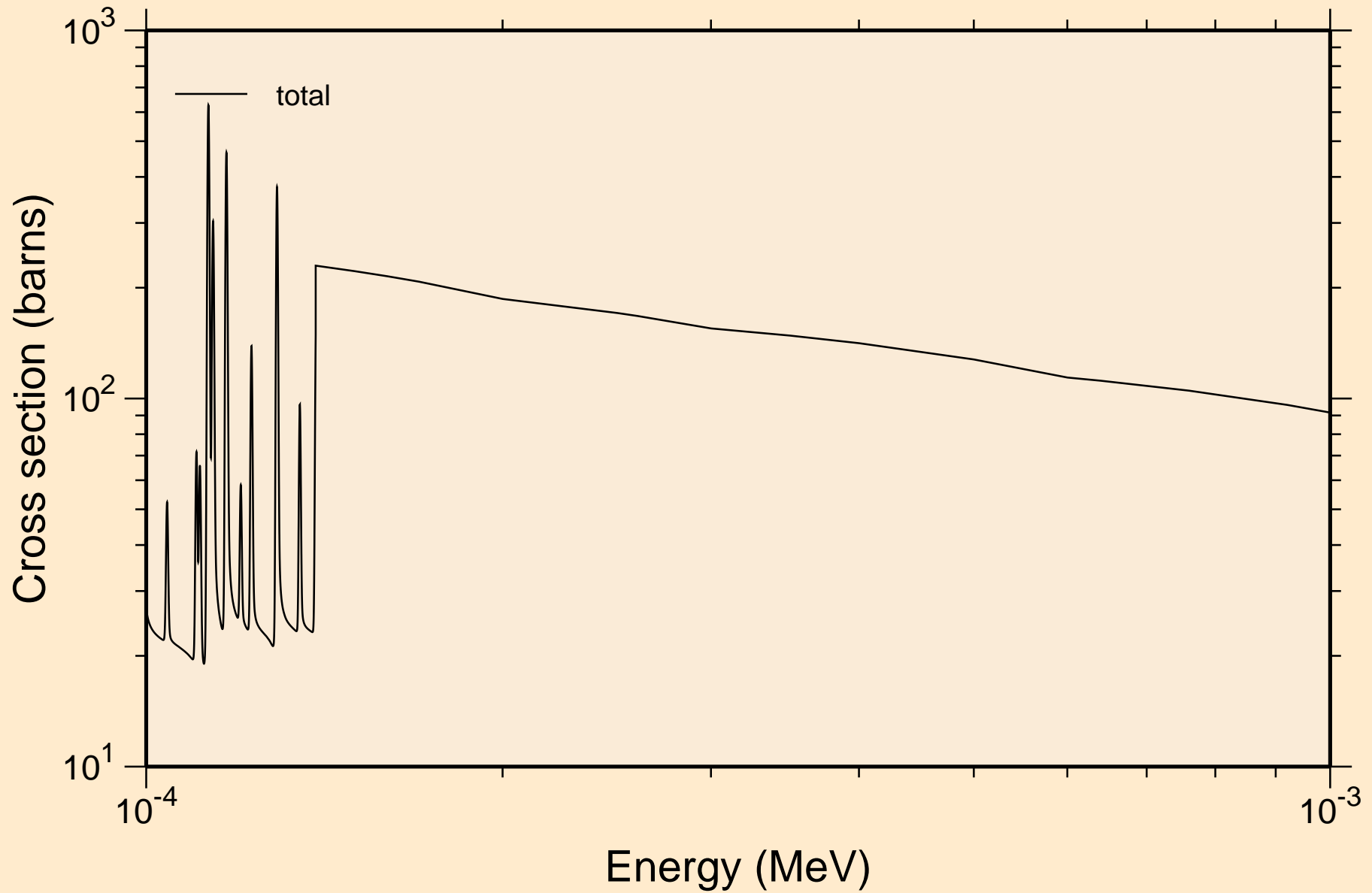

HF168 NEUTRON ACER TENDL-2021 LIBRARY; T=293.6K
resonance total cross section

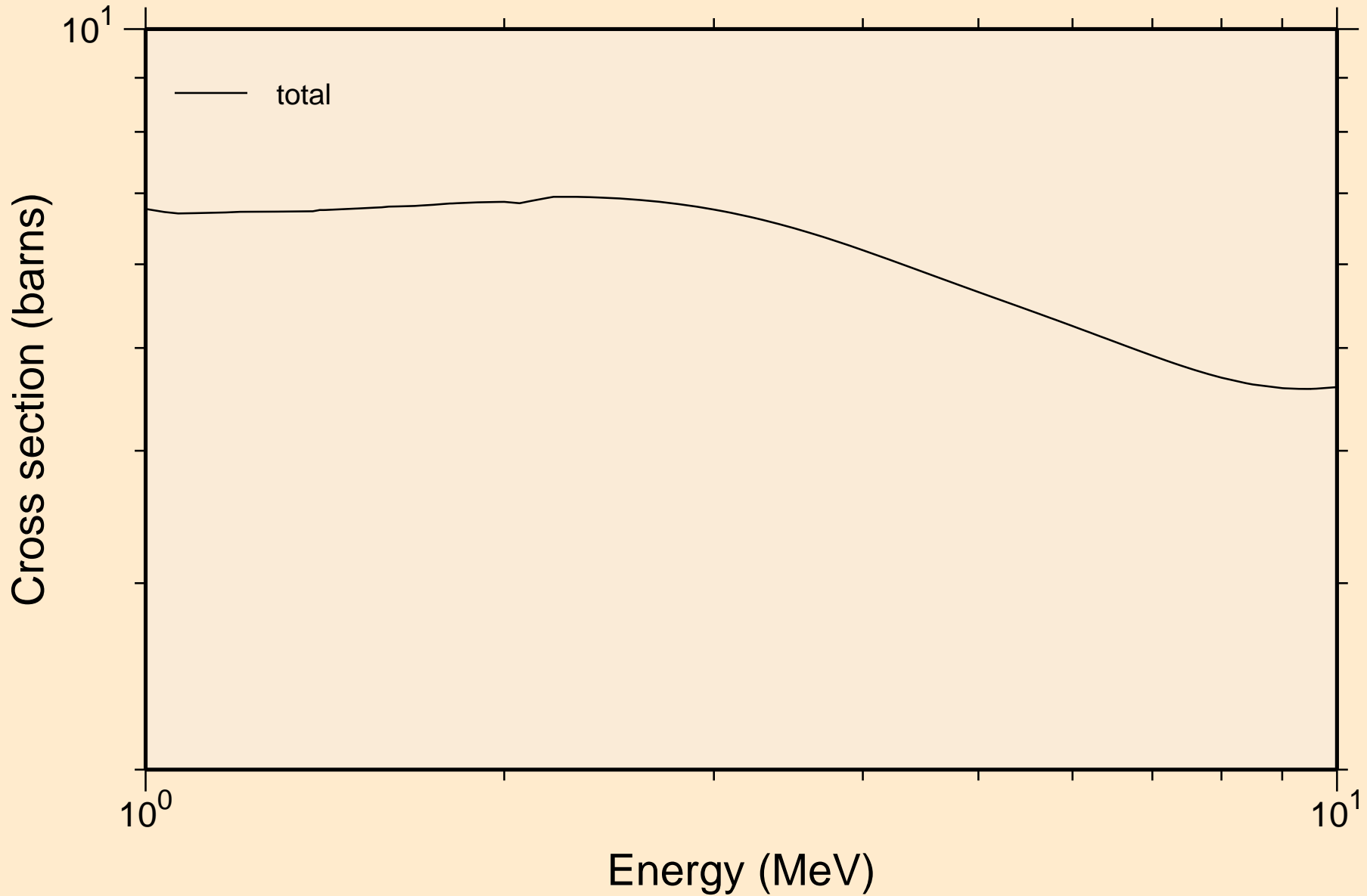

HF168 NEUTRON ACER TENDL-2021 LIBRARY; T=293.6K
resonance absorption cross sections

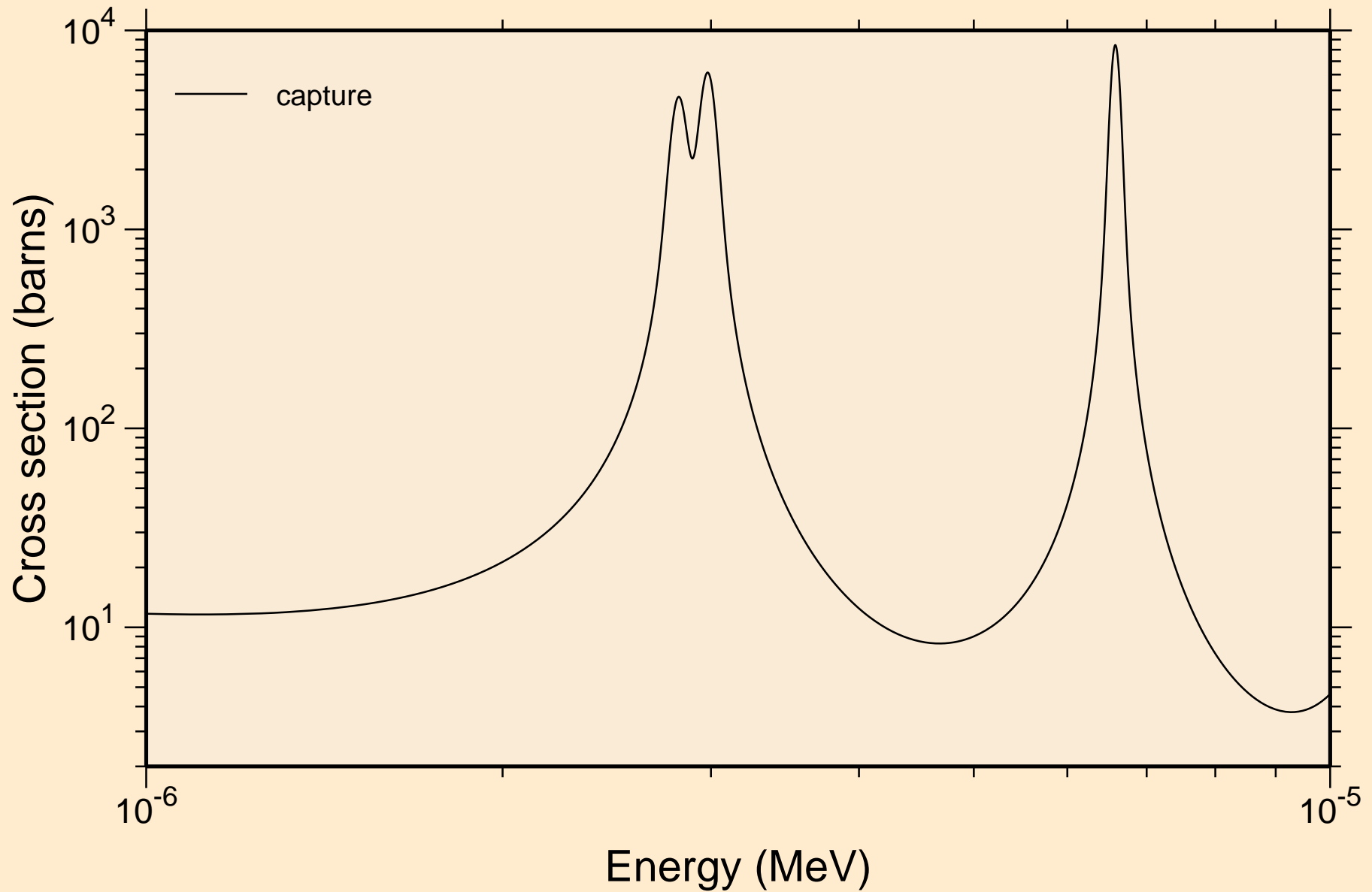

HF168 NEUTRON ACER TENDL-2021 LIBRARY; T=293.6K
resonance absorption cross sections

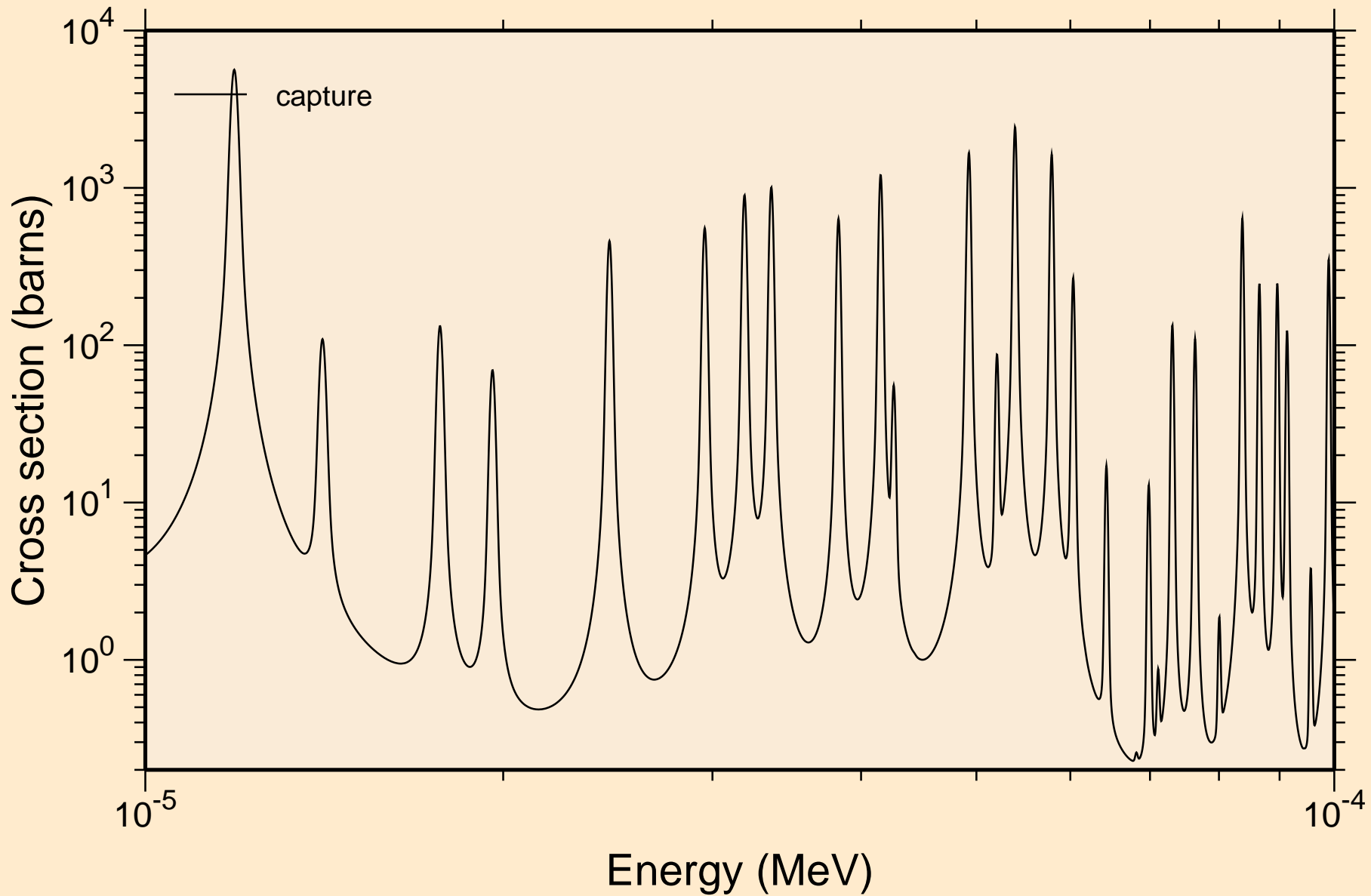

HF168 NEUTRON ACER TENDL-2021 LIBRARY; T=293.6K
resonance absorption cross sections

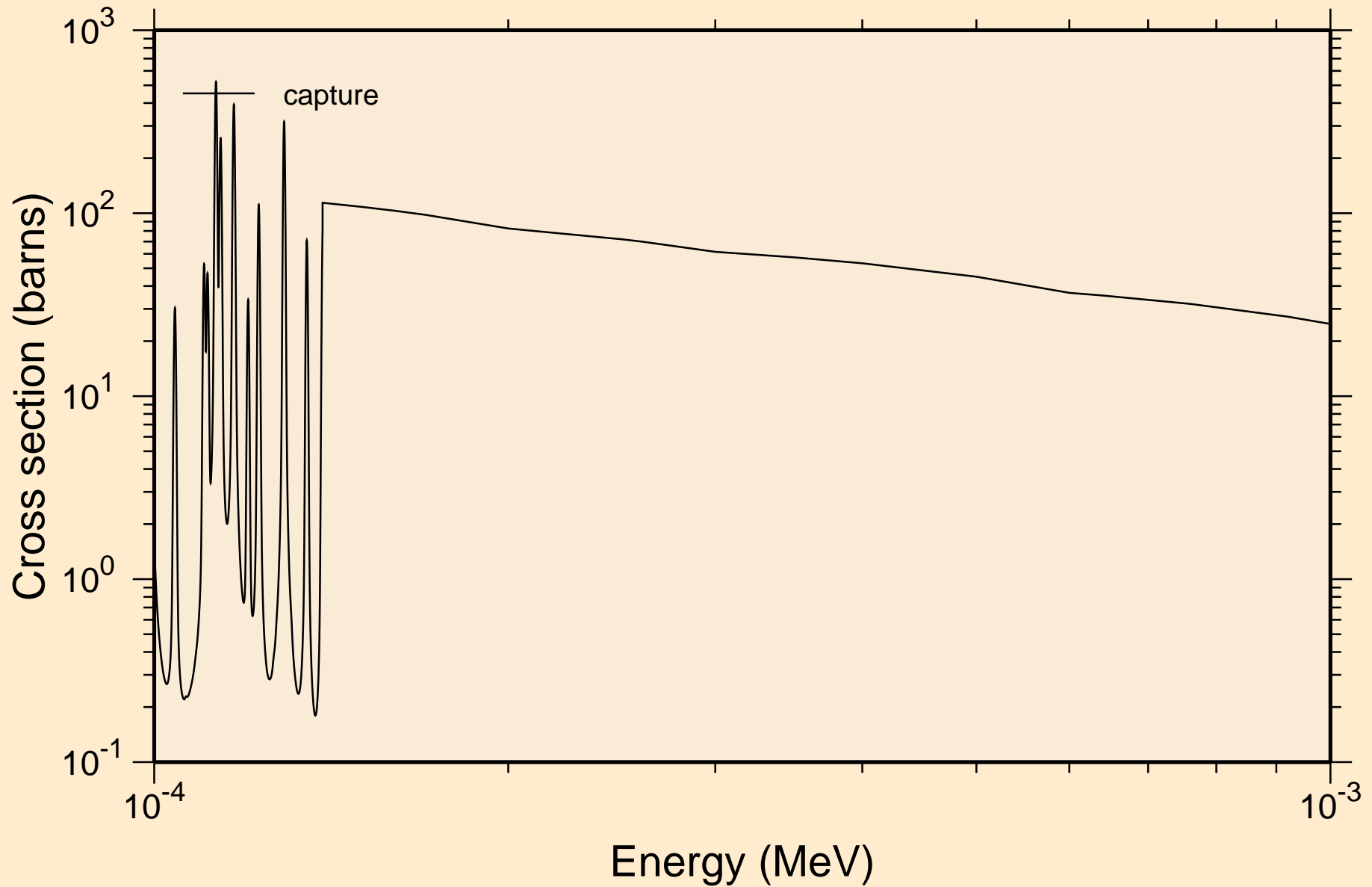

HF168 NEUTRON ACER TENDL-2021 LIBRARY; T=293.6K
resonance absorption cross sections

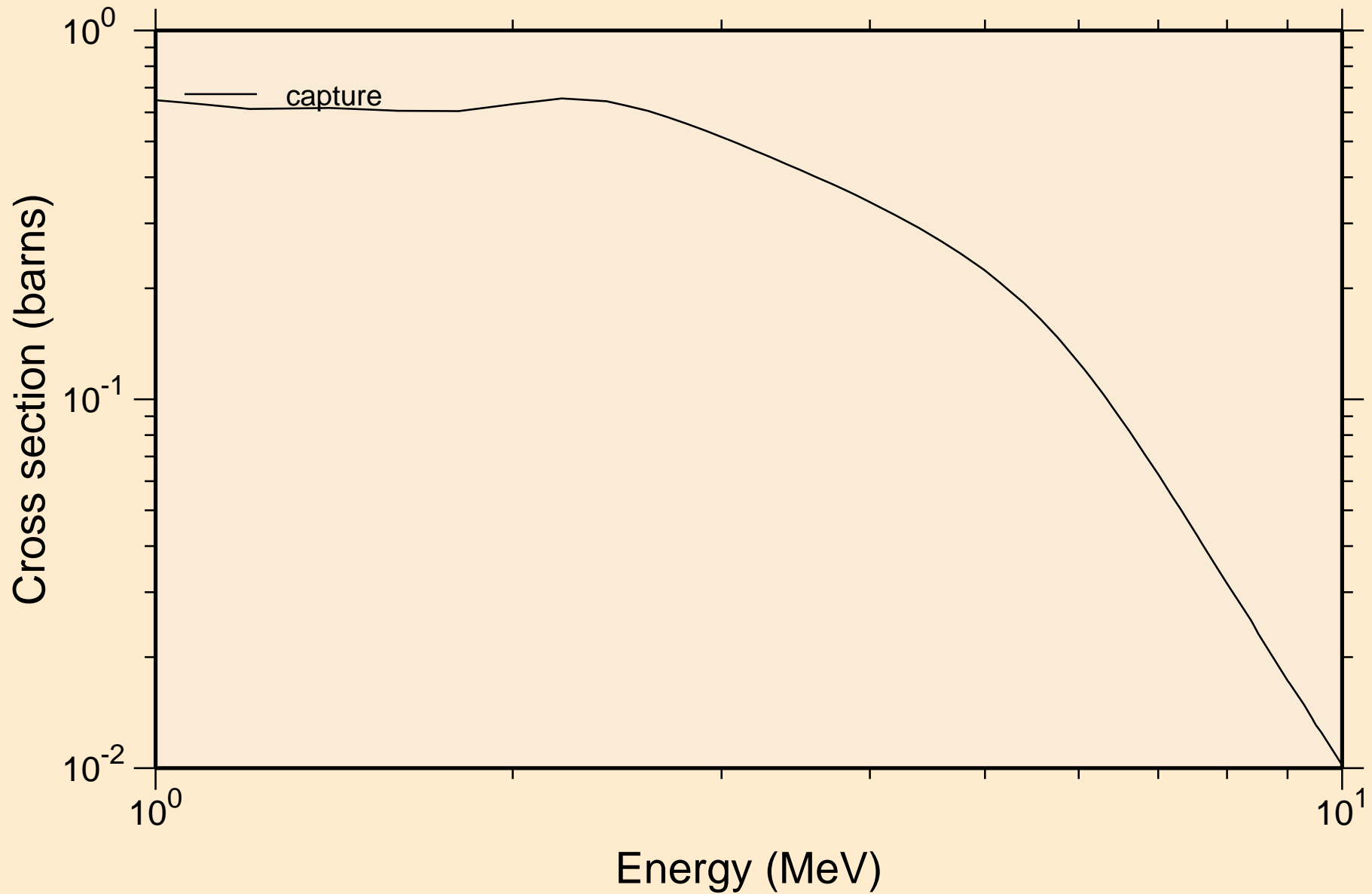

HF168 NEUTRON ACER TENDL-2021 LIBRARY; T=293.6K
Heating

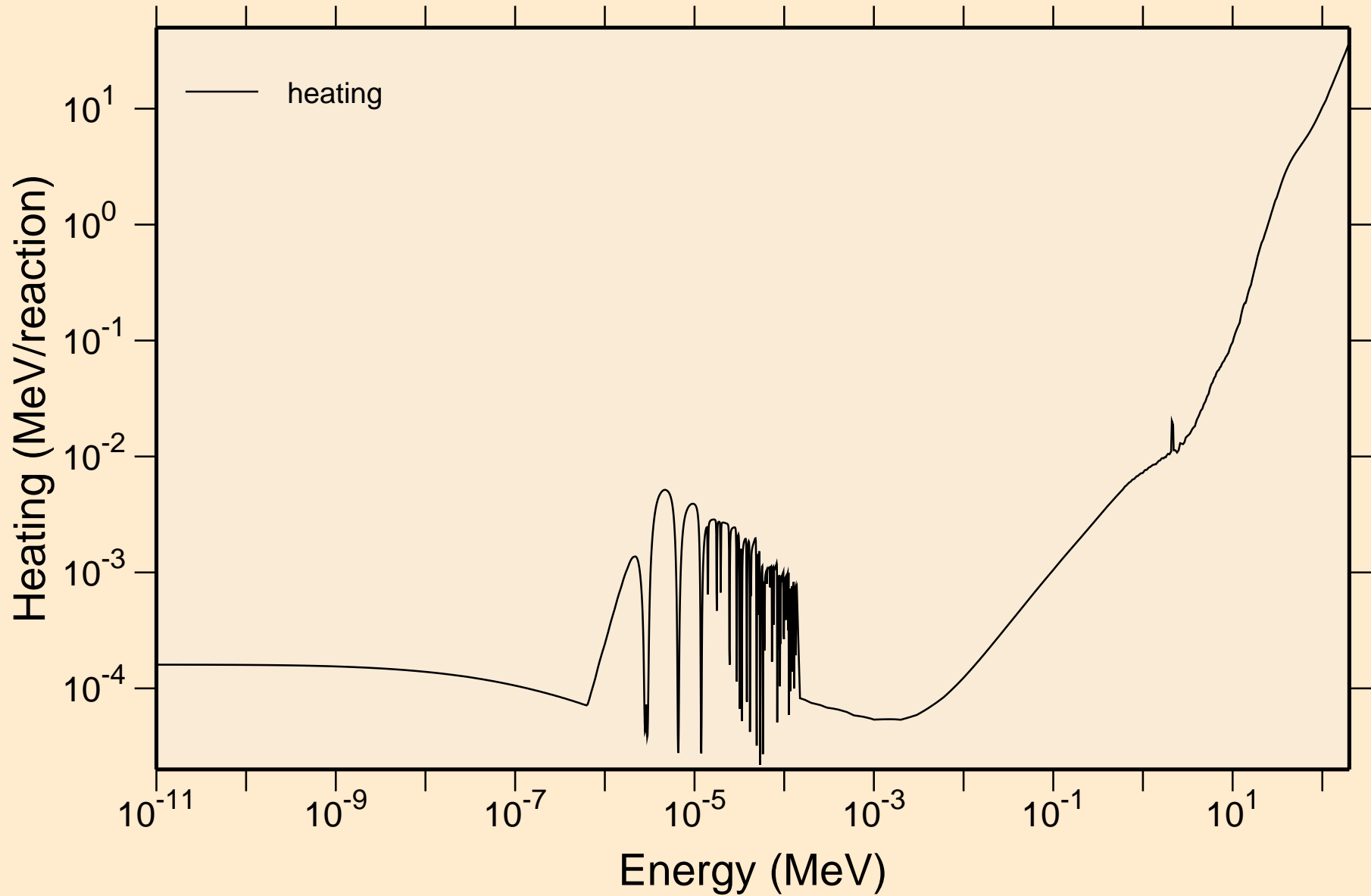

HF168 NEUTRON ACER TENDL-2021 LIBRARY; T=293.6K

Damage

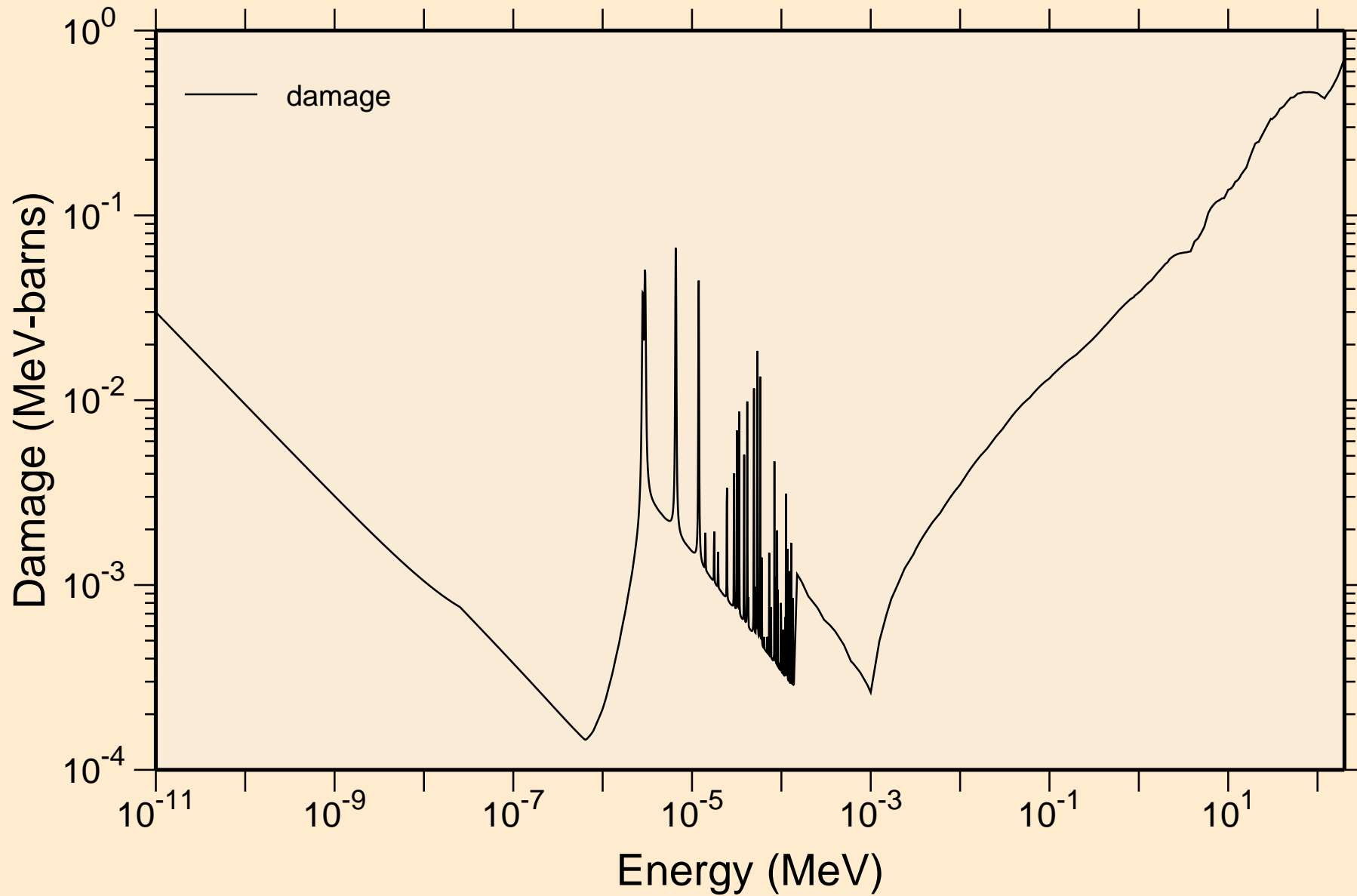

HF168 NEUTRON ACER TENDL-2021 LIBRARY; T=293.6K

Non-threshold reactions

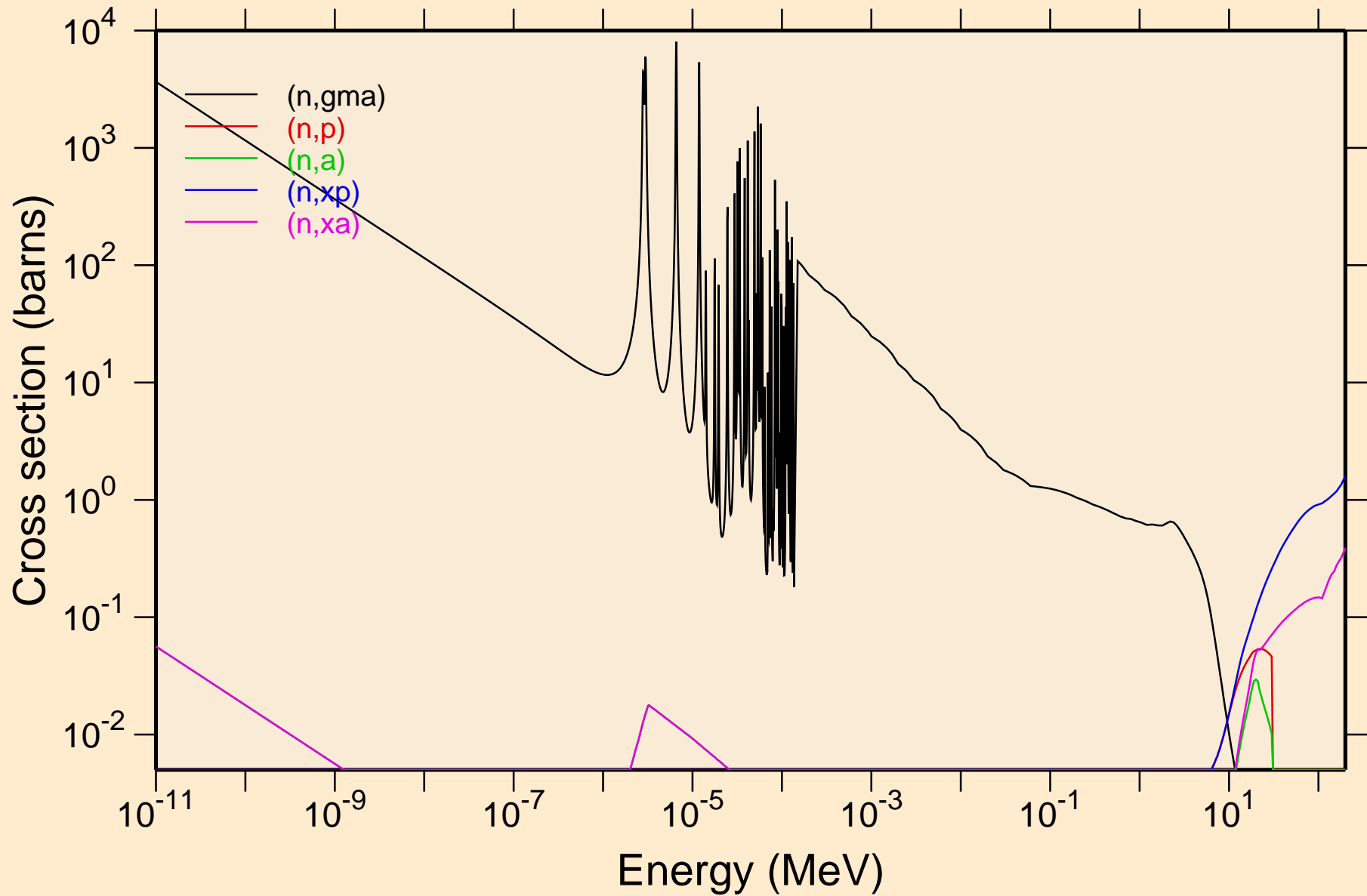

HF168 NEUTRON ACER TENDL-2021 LIBRARY; T=293.6K

Principal cross sections

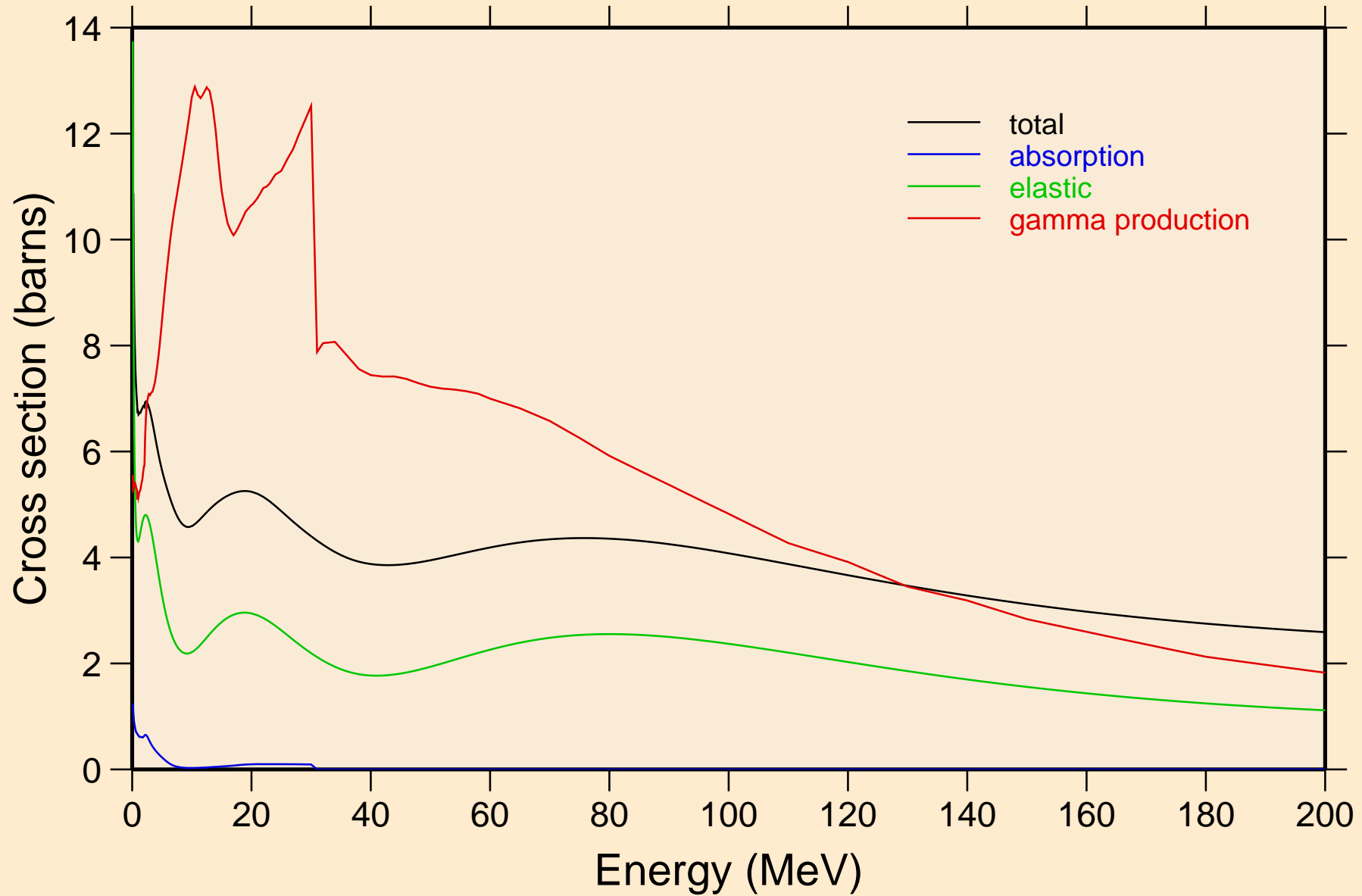

HF168 NEUTRON ACER TENDL-2021 LIBRARY; T=293.6K
Heating

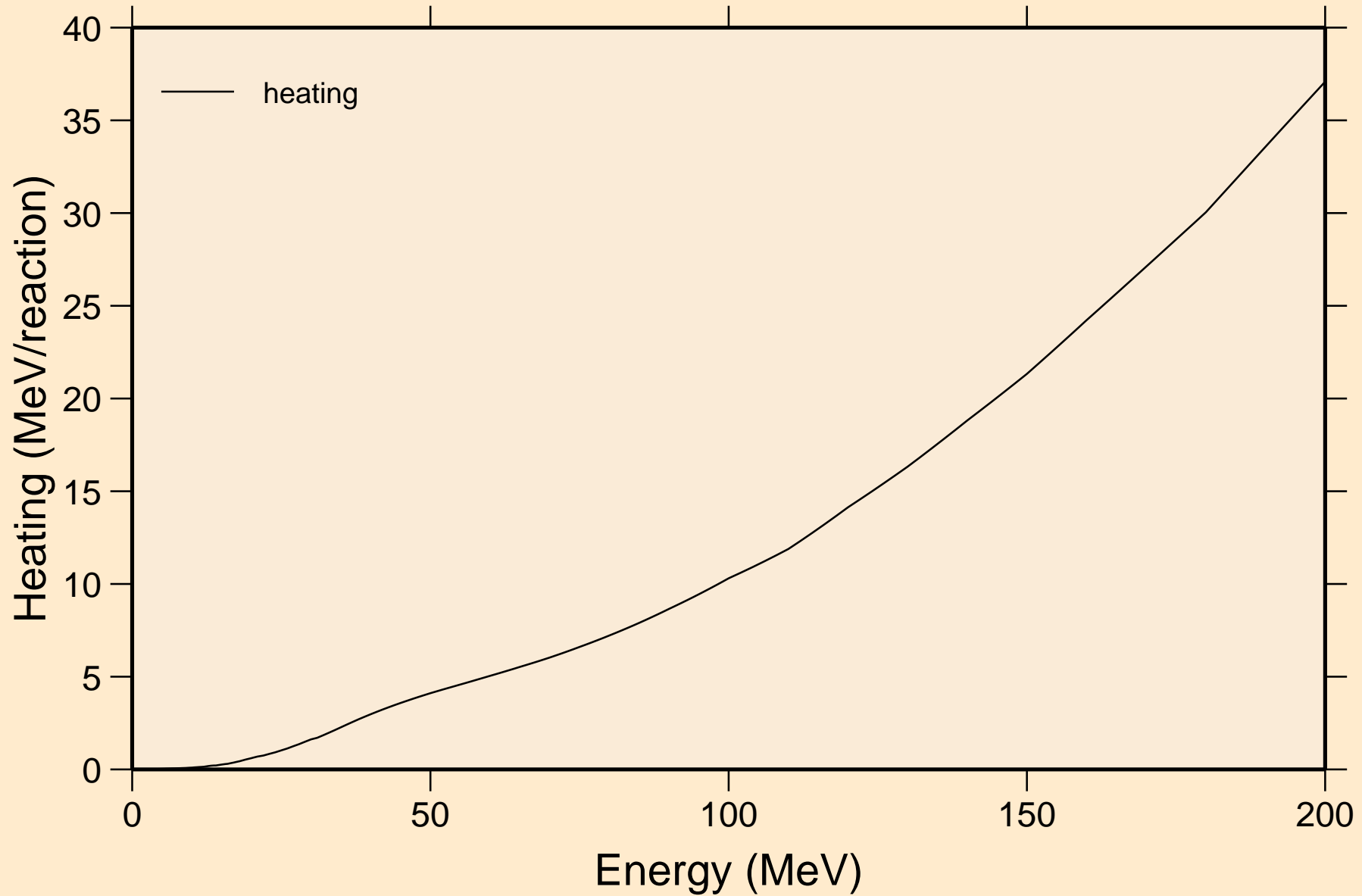

HF168 NEUTRON ACER TENDL-2021 LIBRARY; T=293.6K

Damage

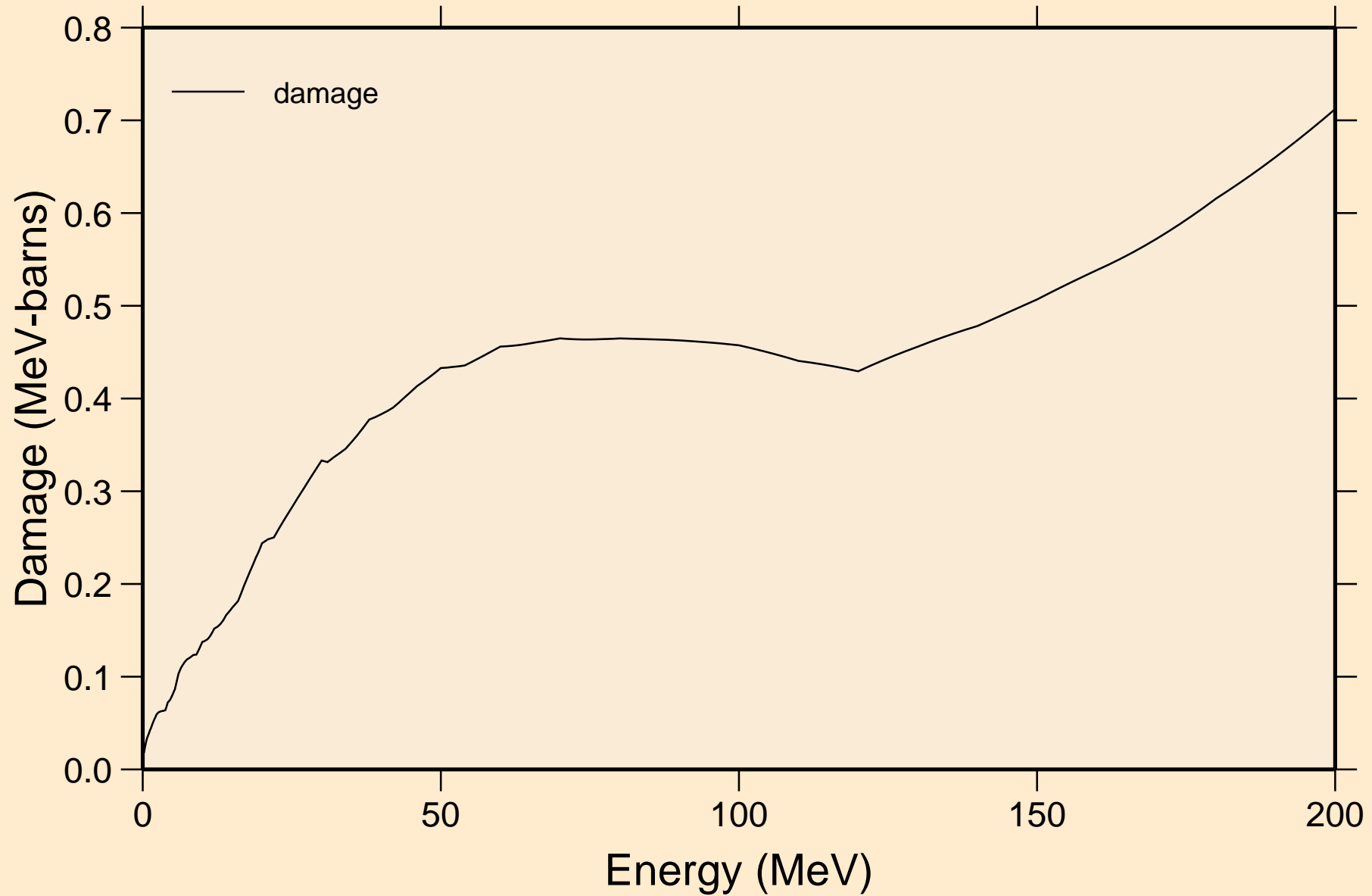

HF168 NEUTRON ACER TENDL-2021 LIBRARY; T=293.6K

Non-threshold reactions

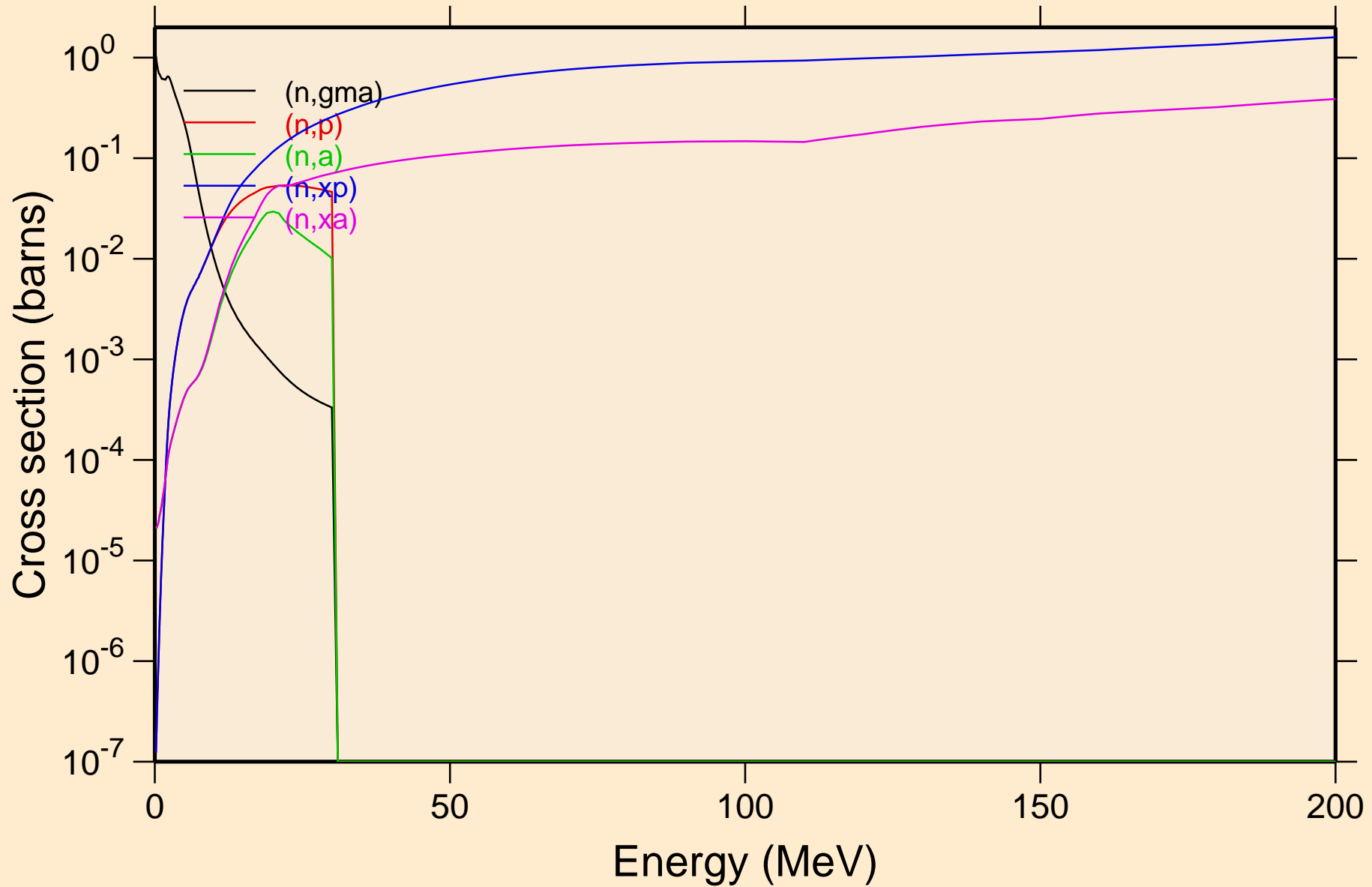

HF168 NEUTRON ACER TENDL-2021 LIBRARY; T=293.6K
Inelastic levels

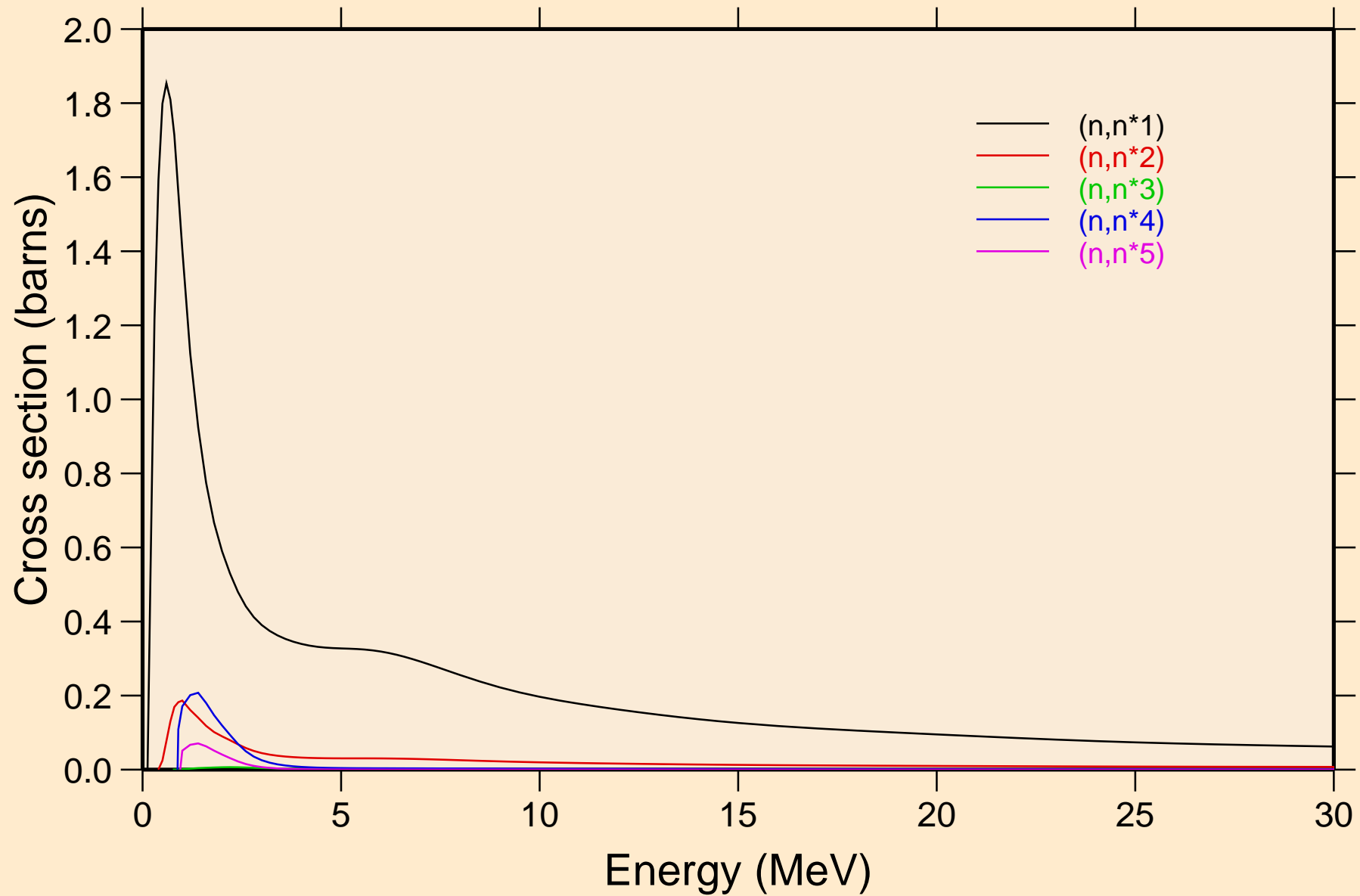

HF168 NEUTRON ACER TENDL-2021 LIBRARY; T=293.6K
Inelastic levels

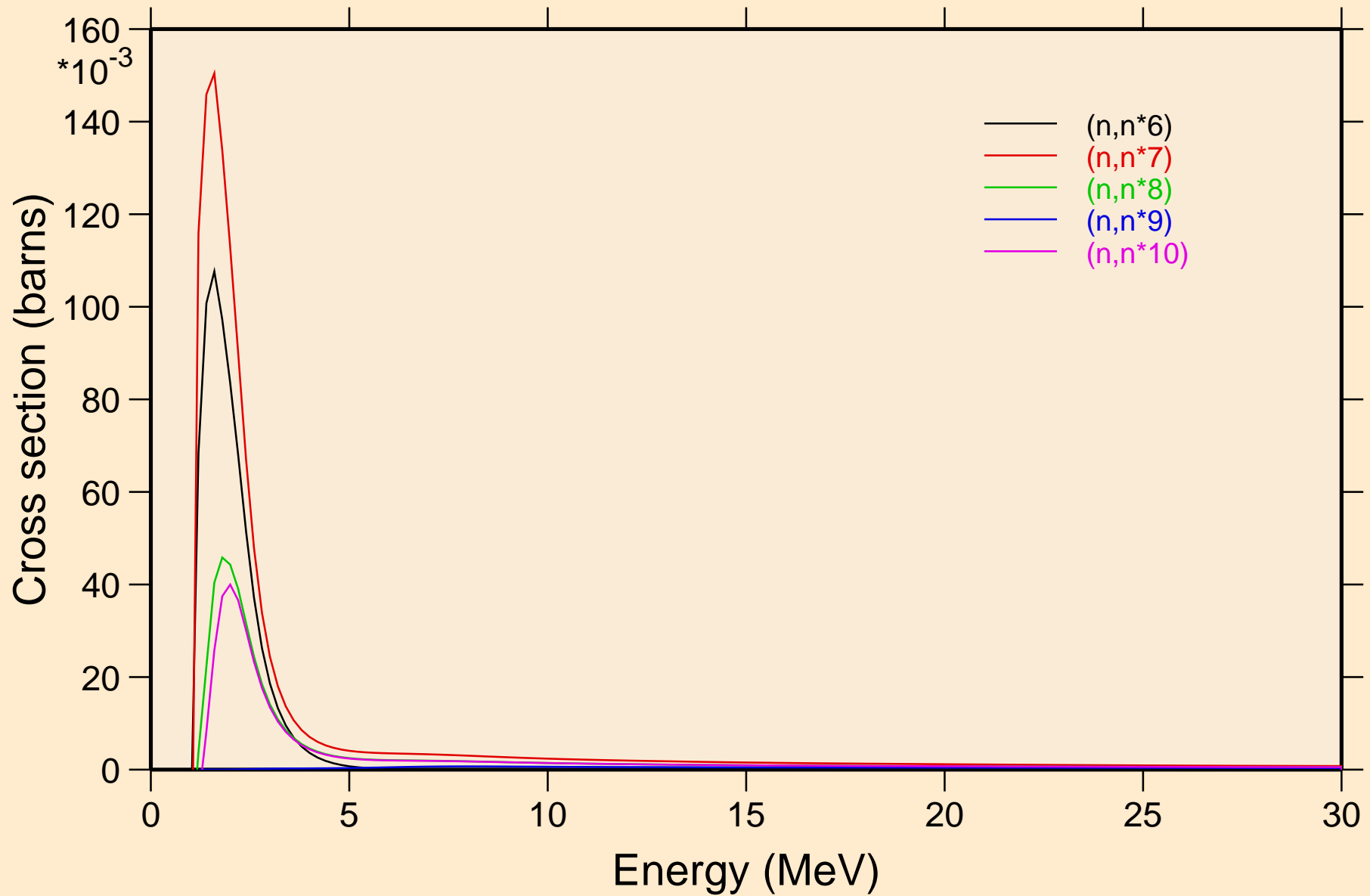

HF168 NEUTRON ACER TENDL-2021 LIBRARY; T=293.6K
Inelastic levels

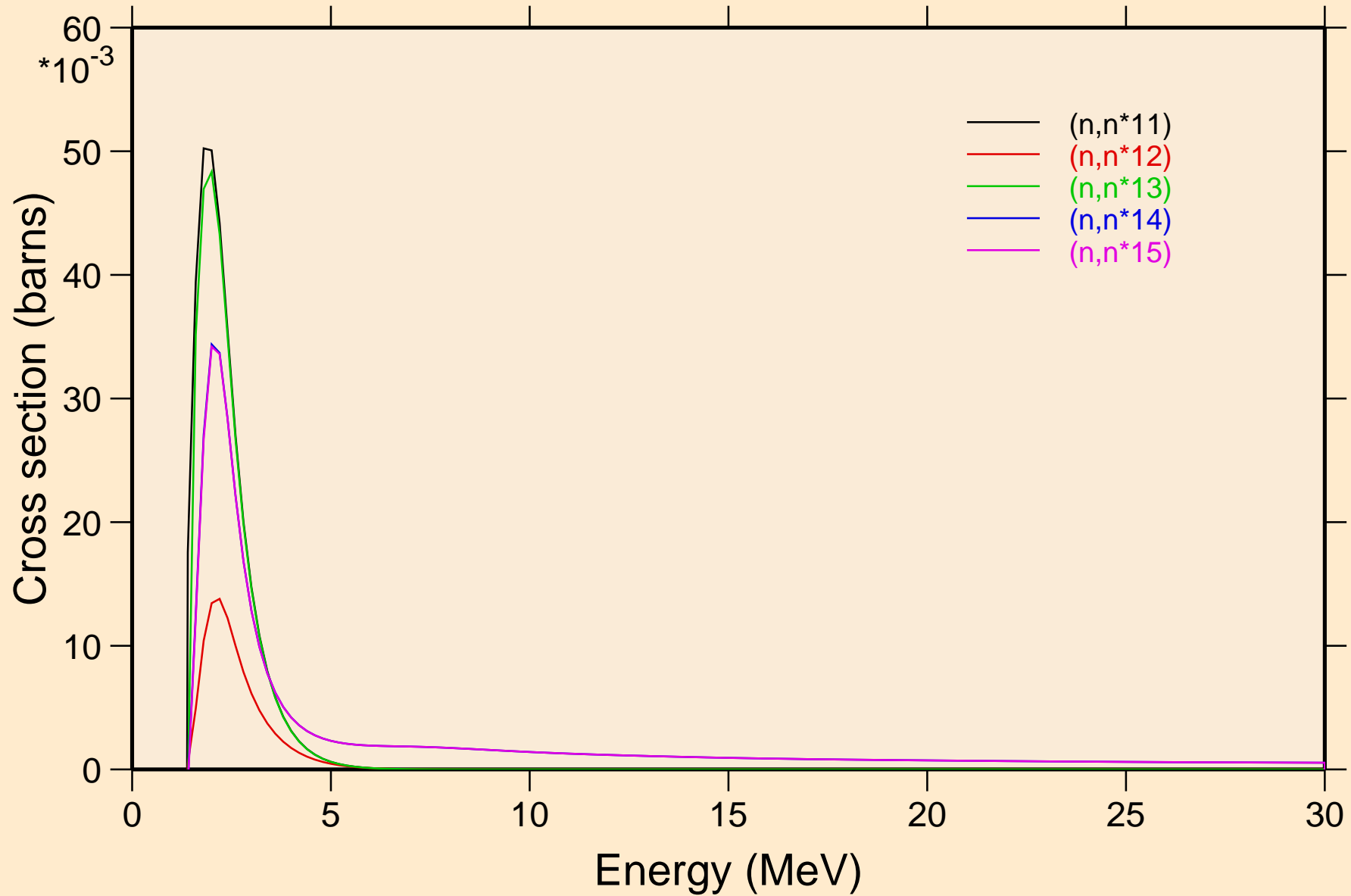

HF168 NEUTRON ACER TENDL-2021 LIBRARY; T=293.6K

Inelastic levels

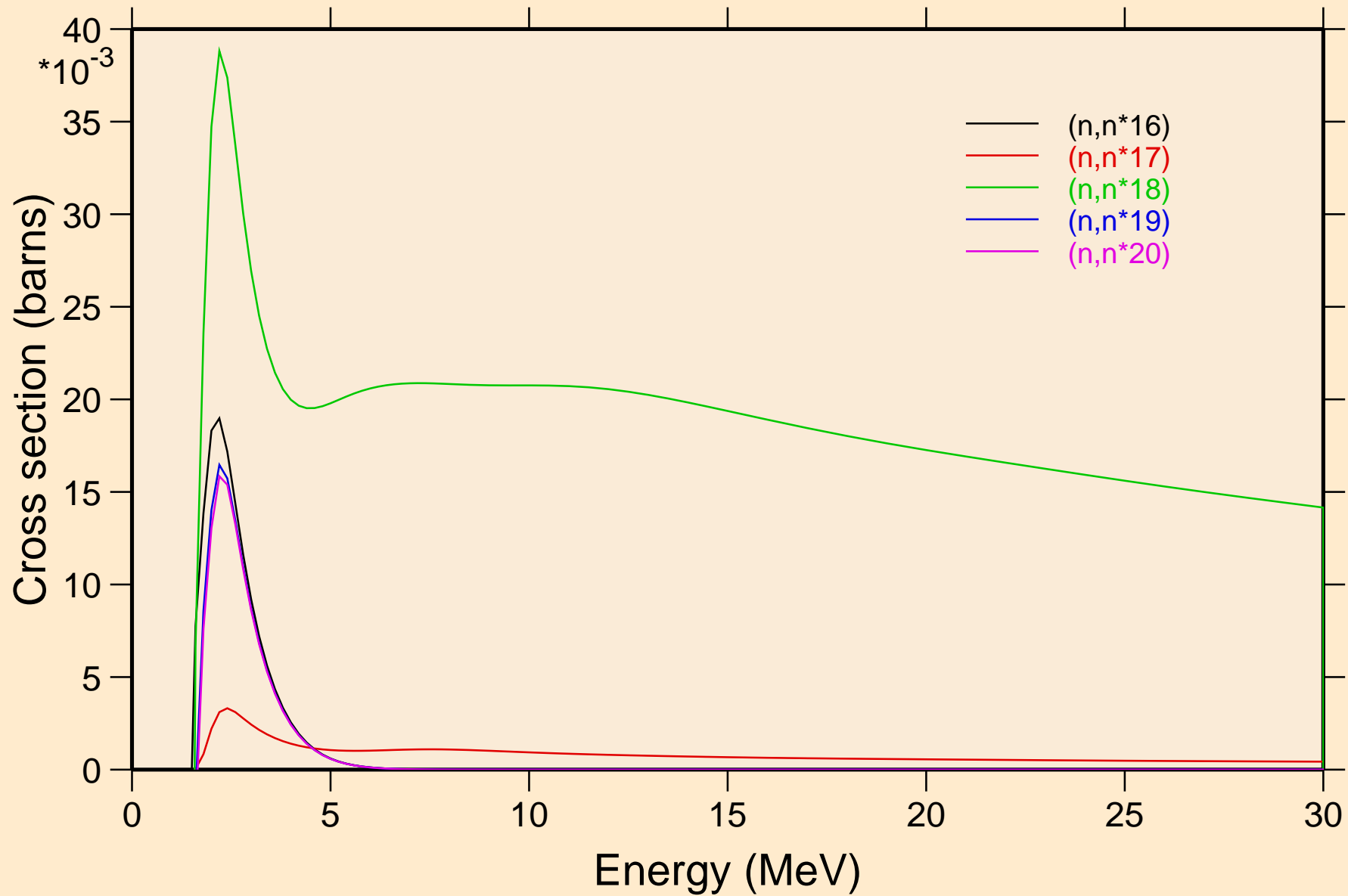

HF168 NEUTRON ACER TENDL-2021 LIBRARY; T=293.6K

Inelastic levels

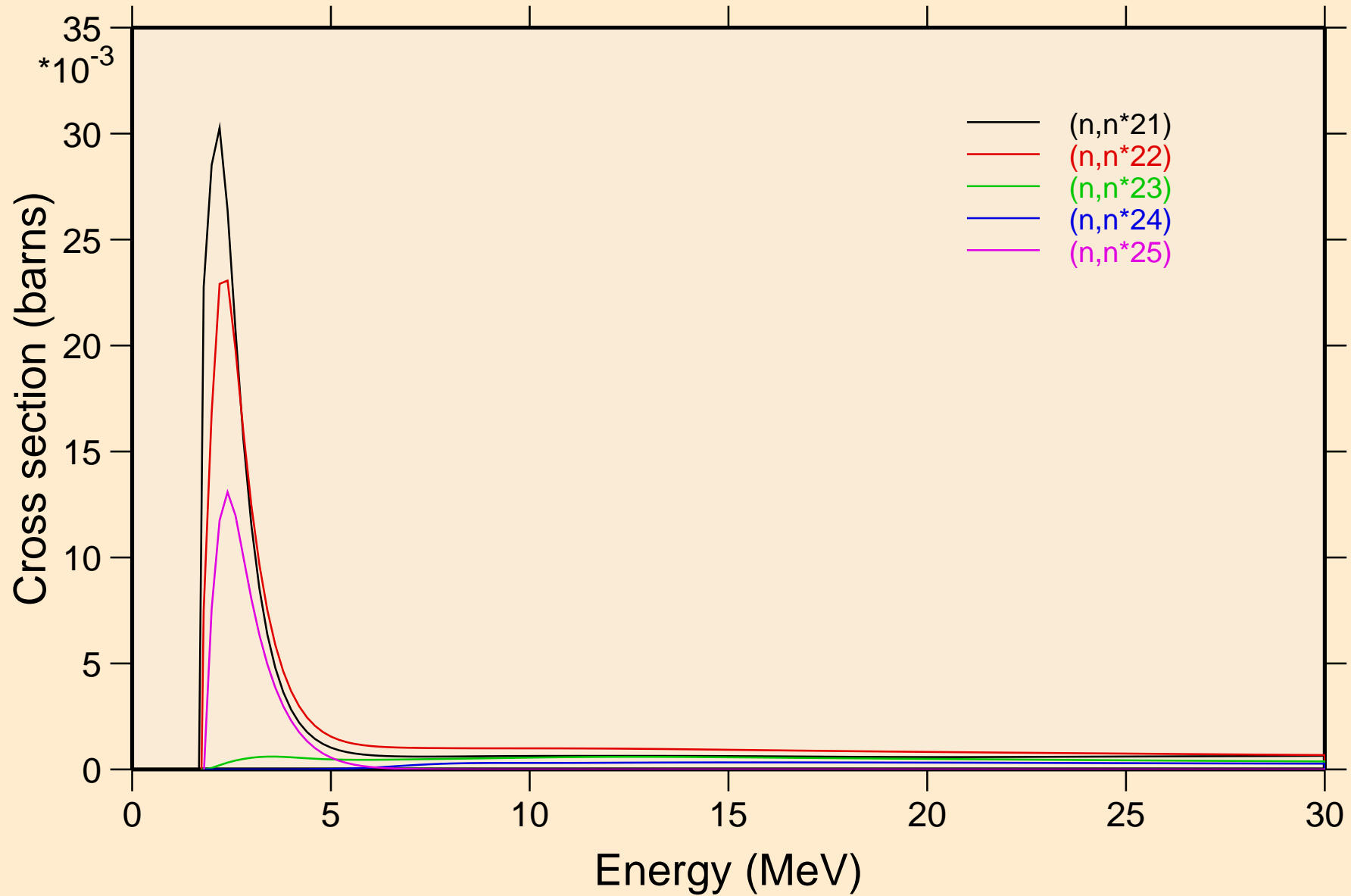

HF168 NEUTRON ACER TENDL-2021 LIBRARY; T=293.6K
Inelastic levels

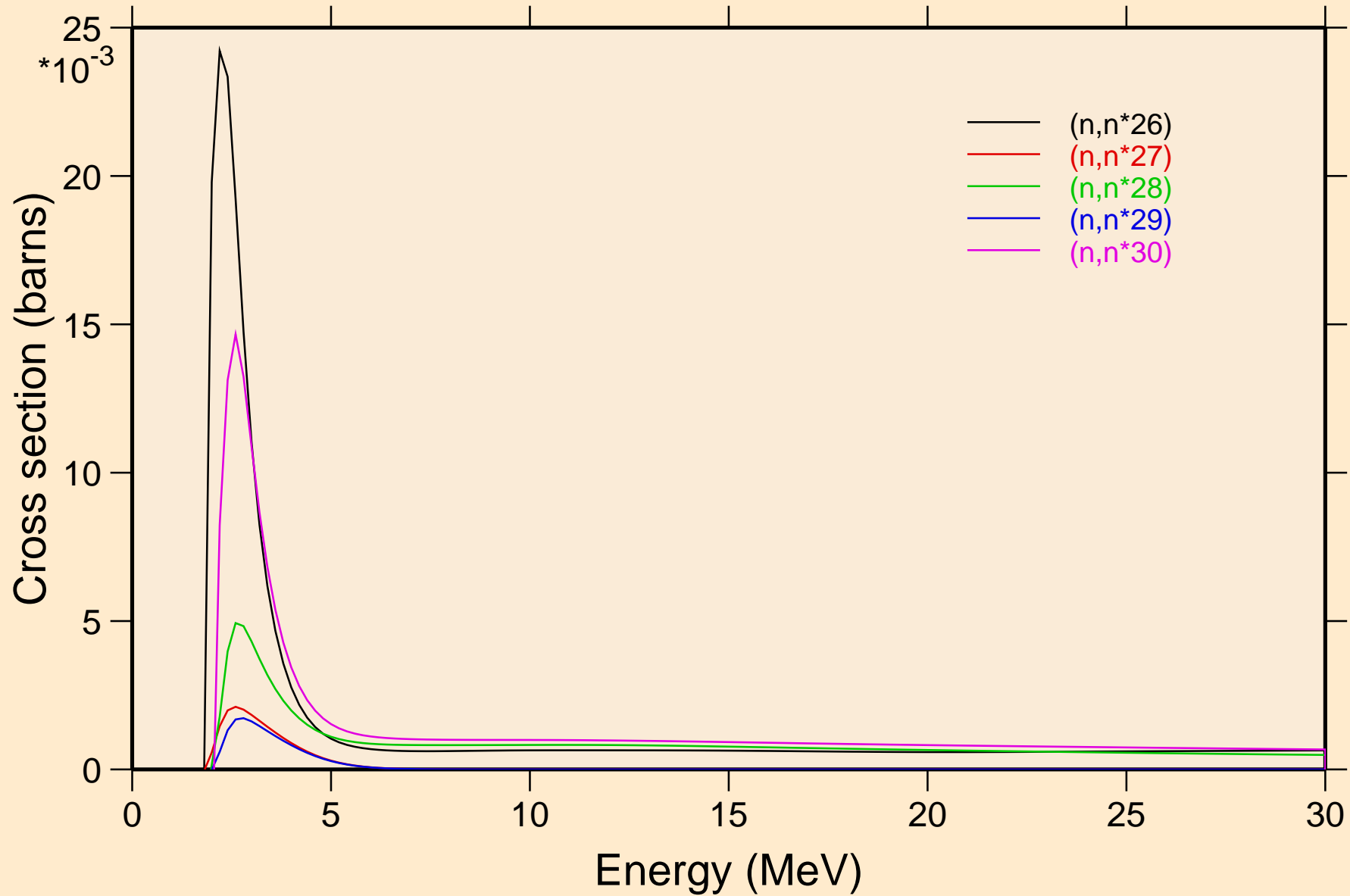

HF168 NEUTRON ACER TENDL-2021 LIBRARY; T=293.6K

Threshold reactions

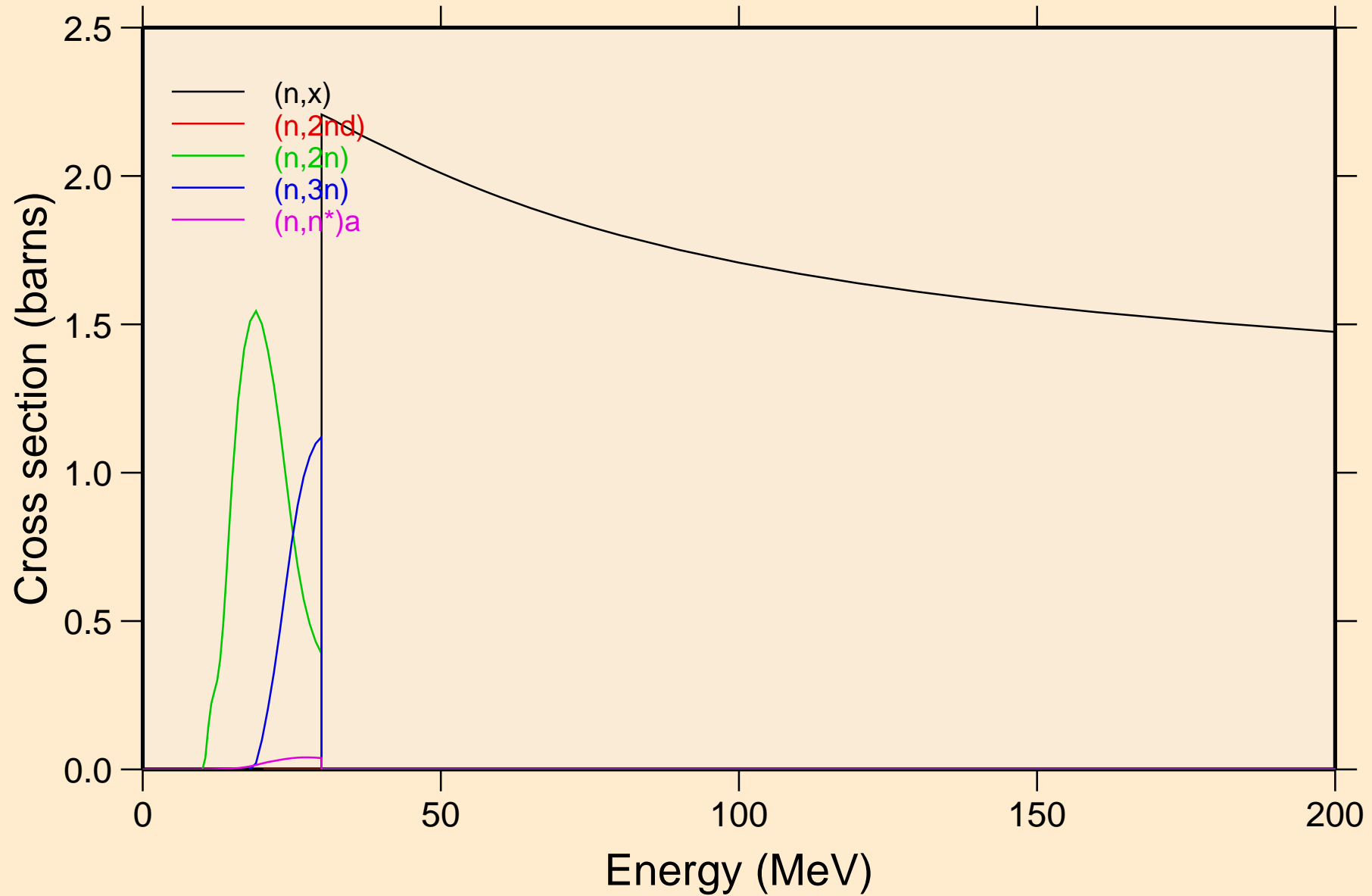

HF168 NEUTRON ACER TENDL-2021 LIBRARY; T=293.6K

Threshold reactions

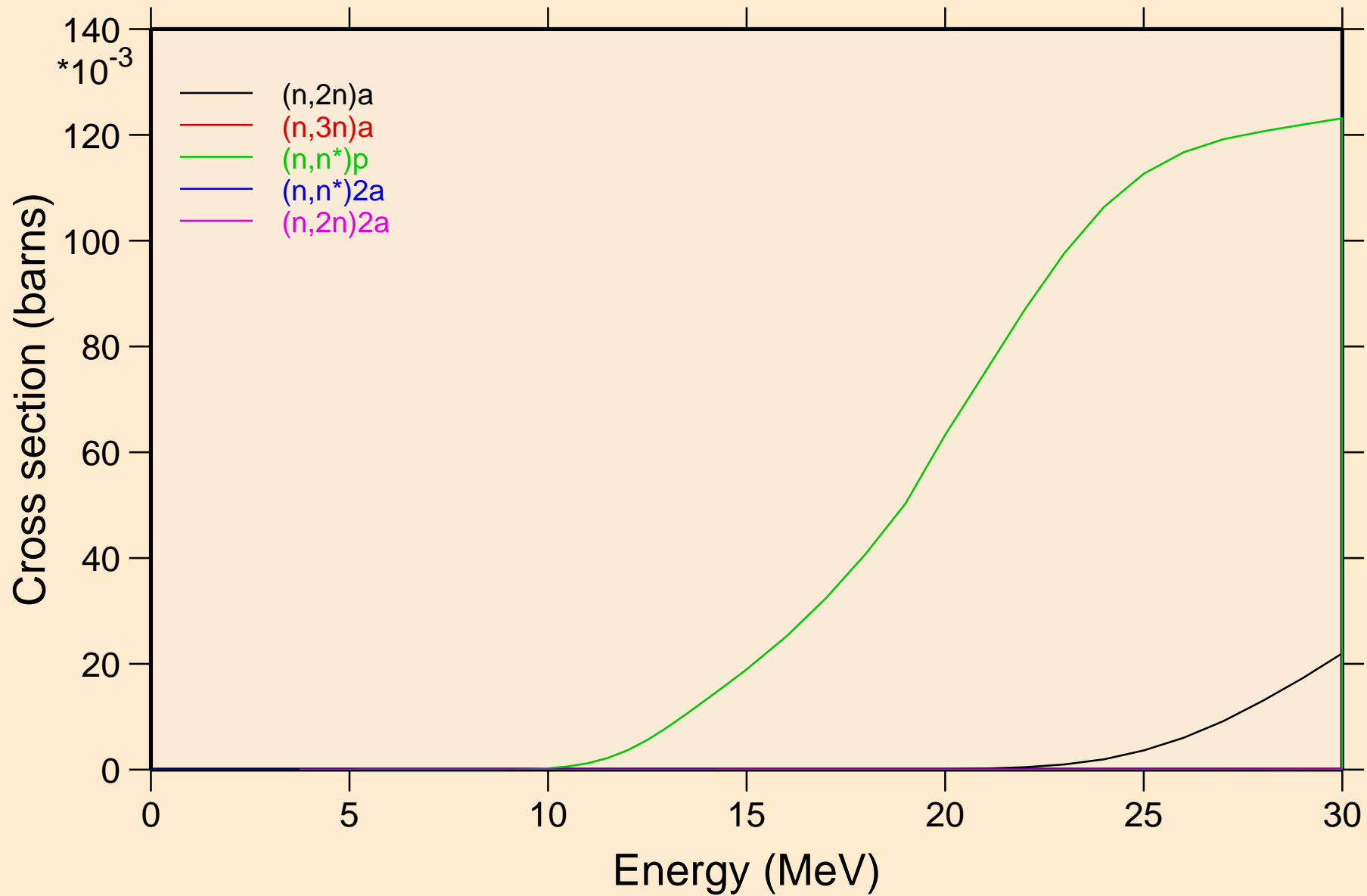

HF168 NEUTRON ACER TENDL-2021 LIBRARY; T=293.6K

Threshold reactions

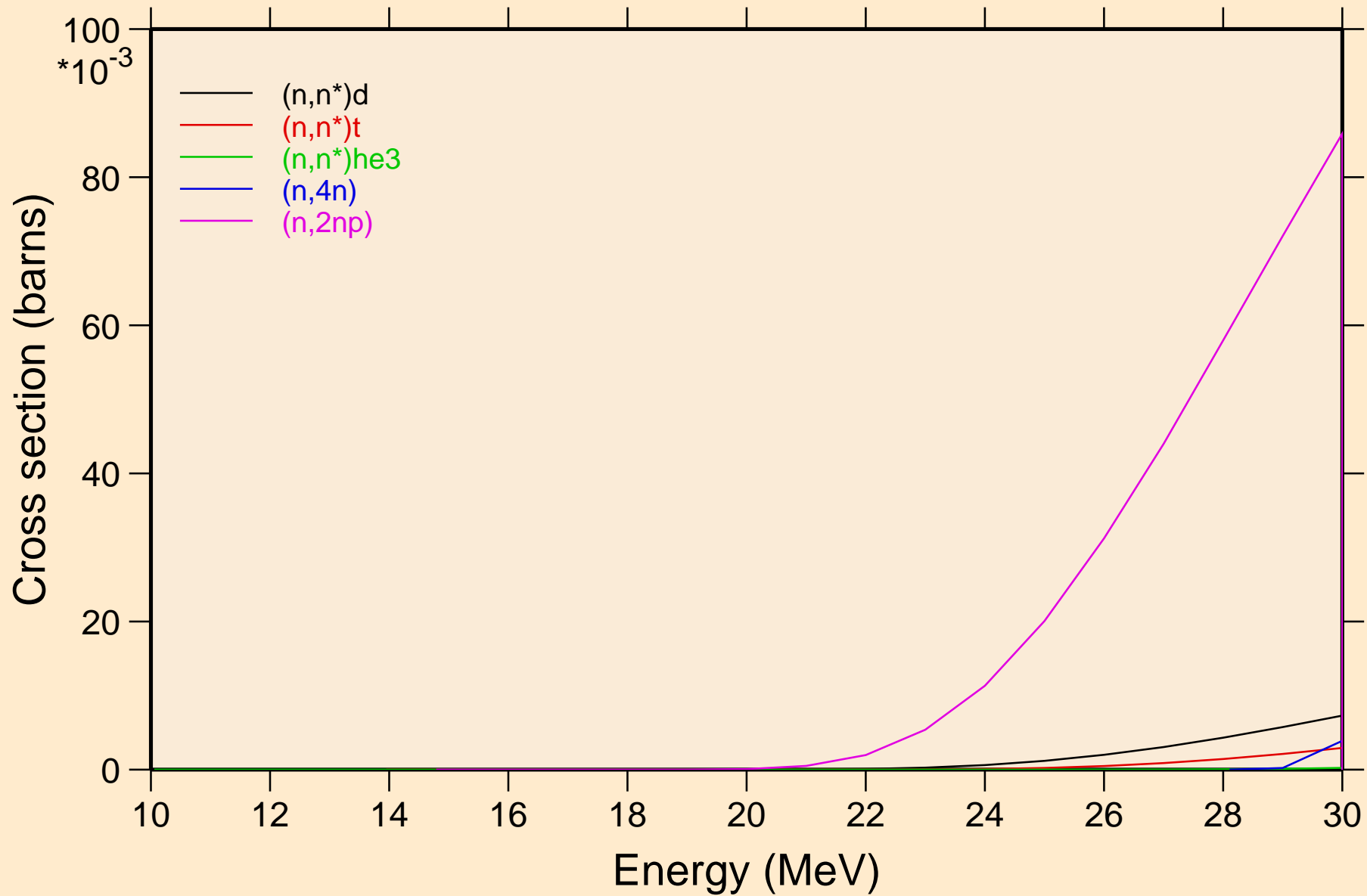

HF168 NEUTRON ACER TENDL-2021 LIBRARY; T=293.6K

Threshold reactions

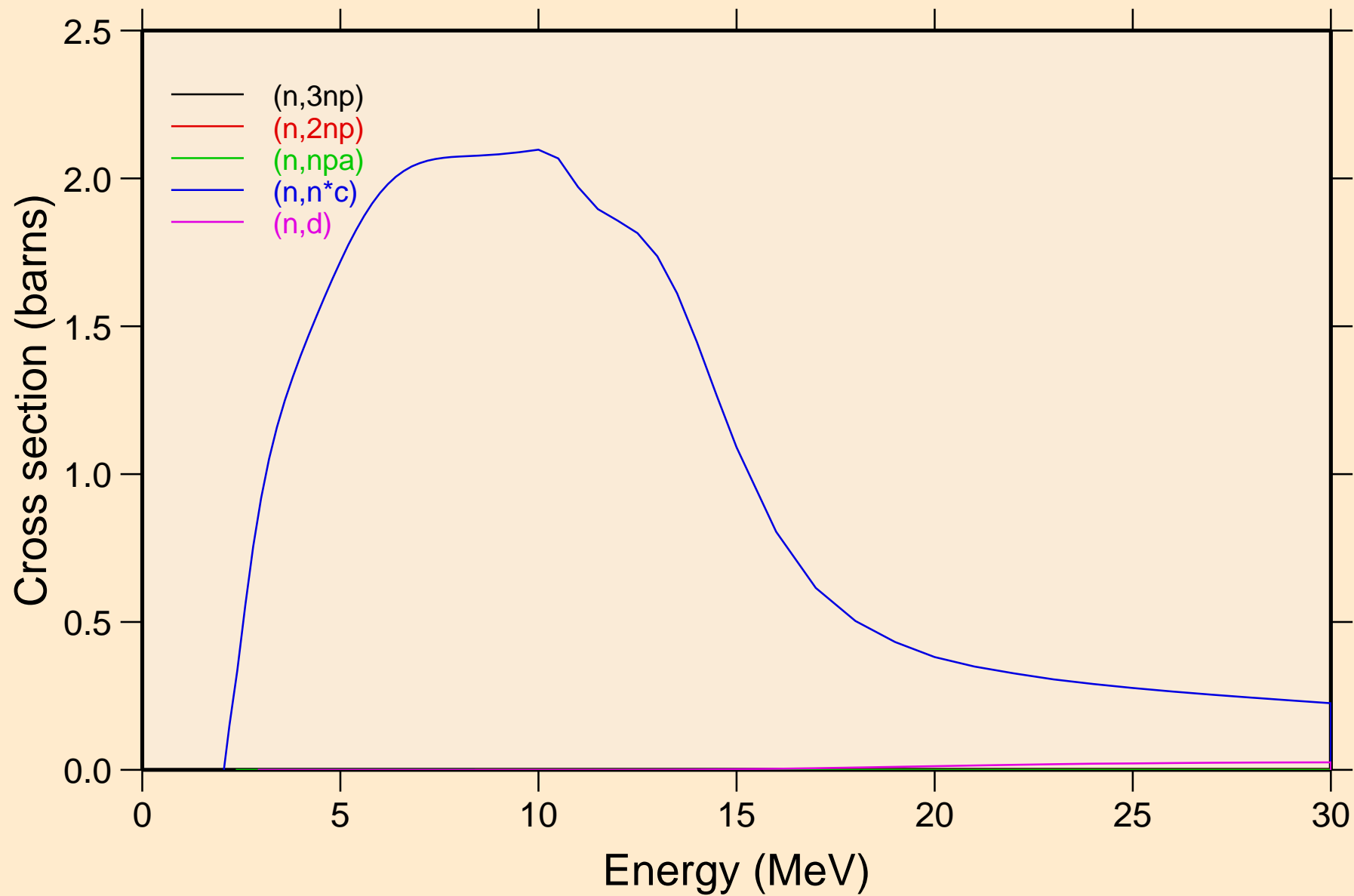

HF168 NEUTRON ACER TENDL-2021 LIBRARY; T=293.6K

Threshold reactions

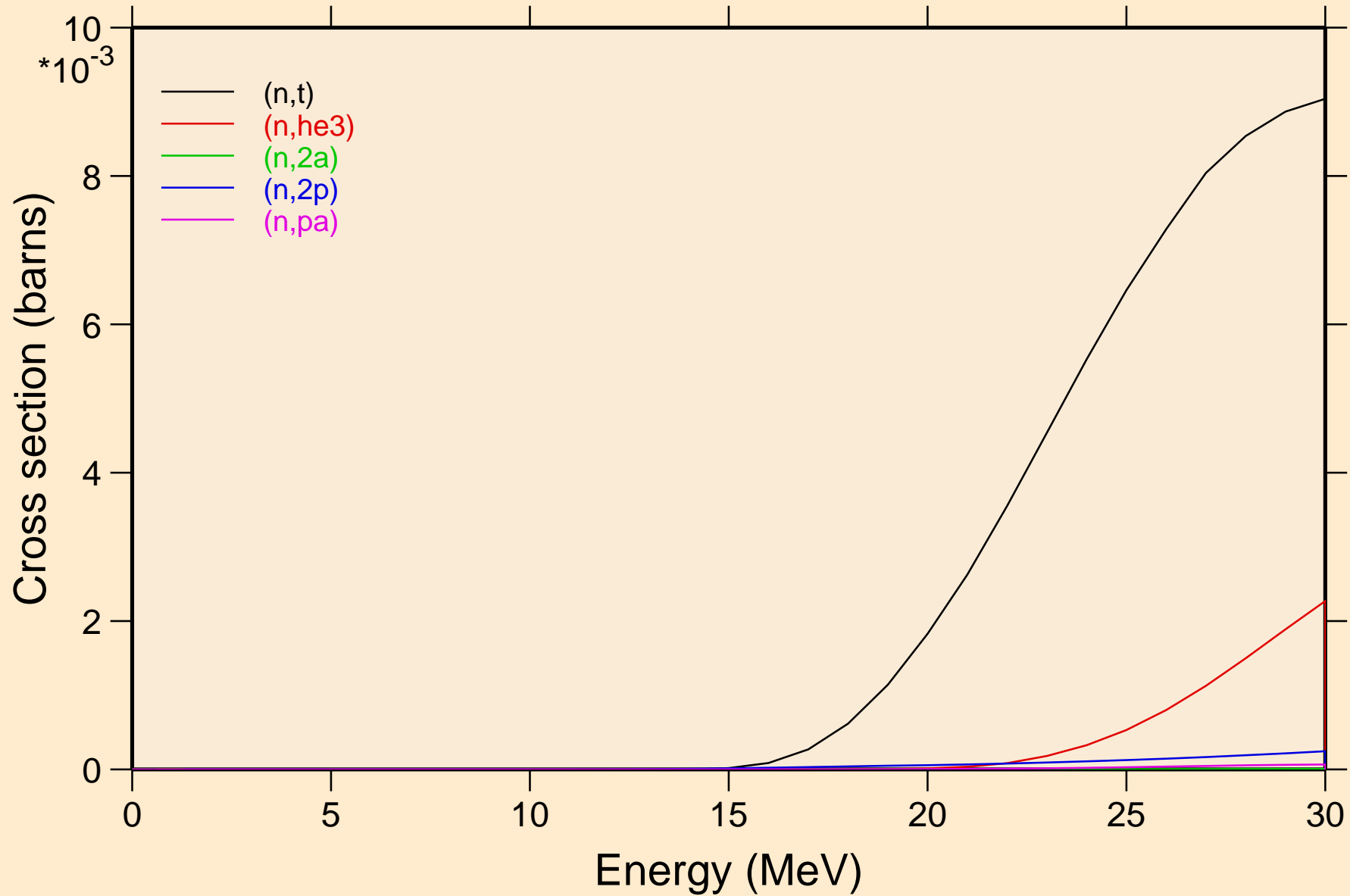

HF168 NEUTRON ACER TENDL-2021 LIBRARY; T=293.6K

Threshold reactions

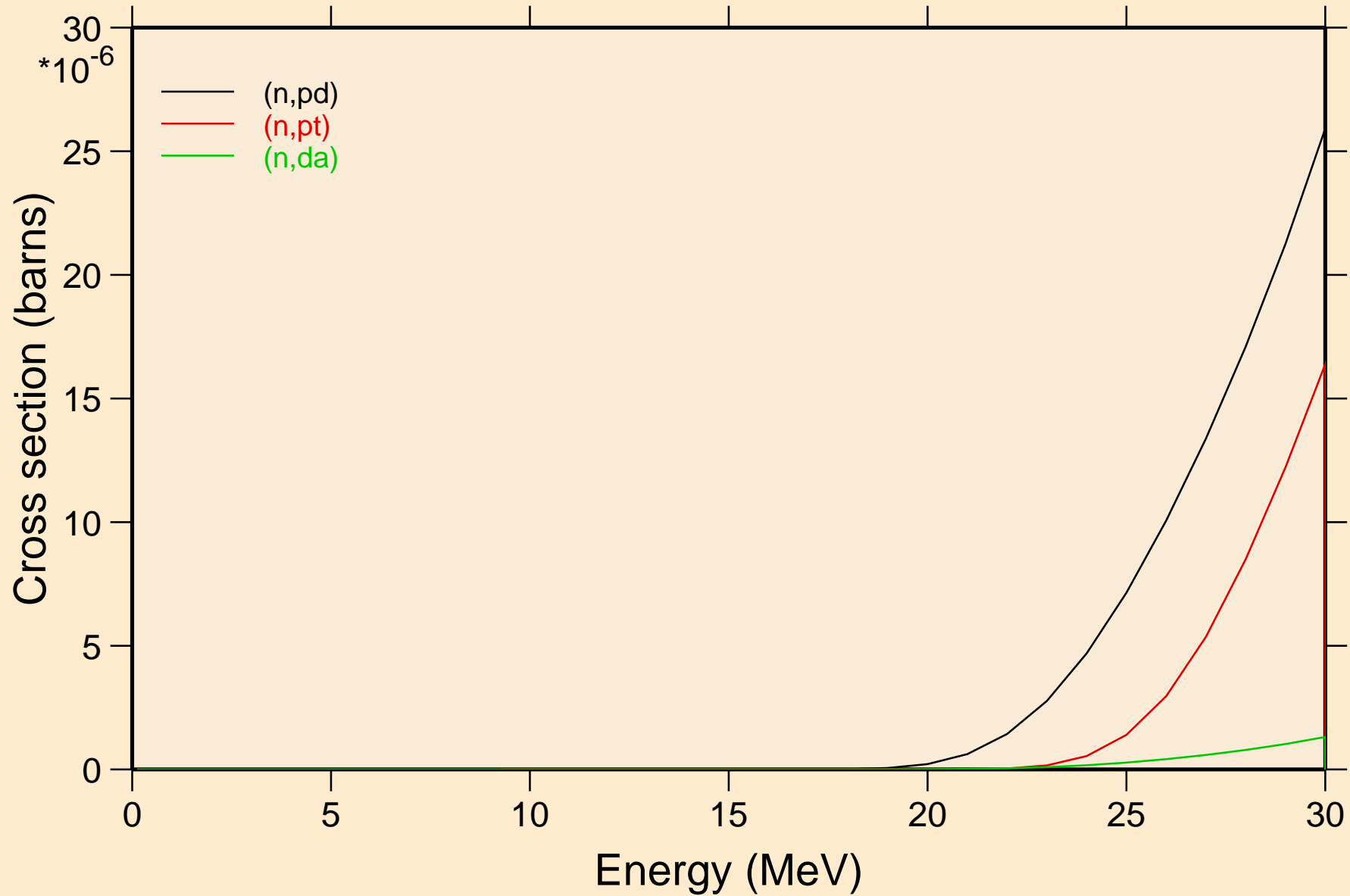

HF168 NEUTRON ACER TENDL-2021 LIBRARY; T=293.6K
Threshold reactions

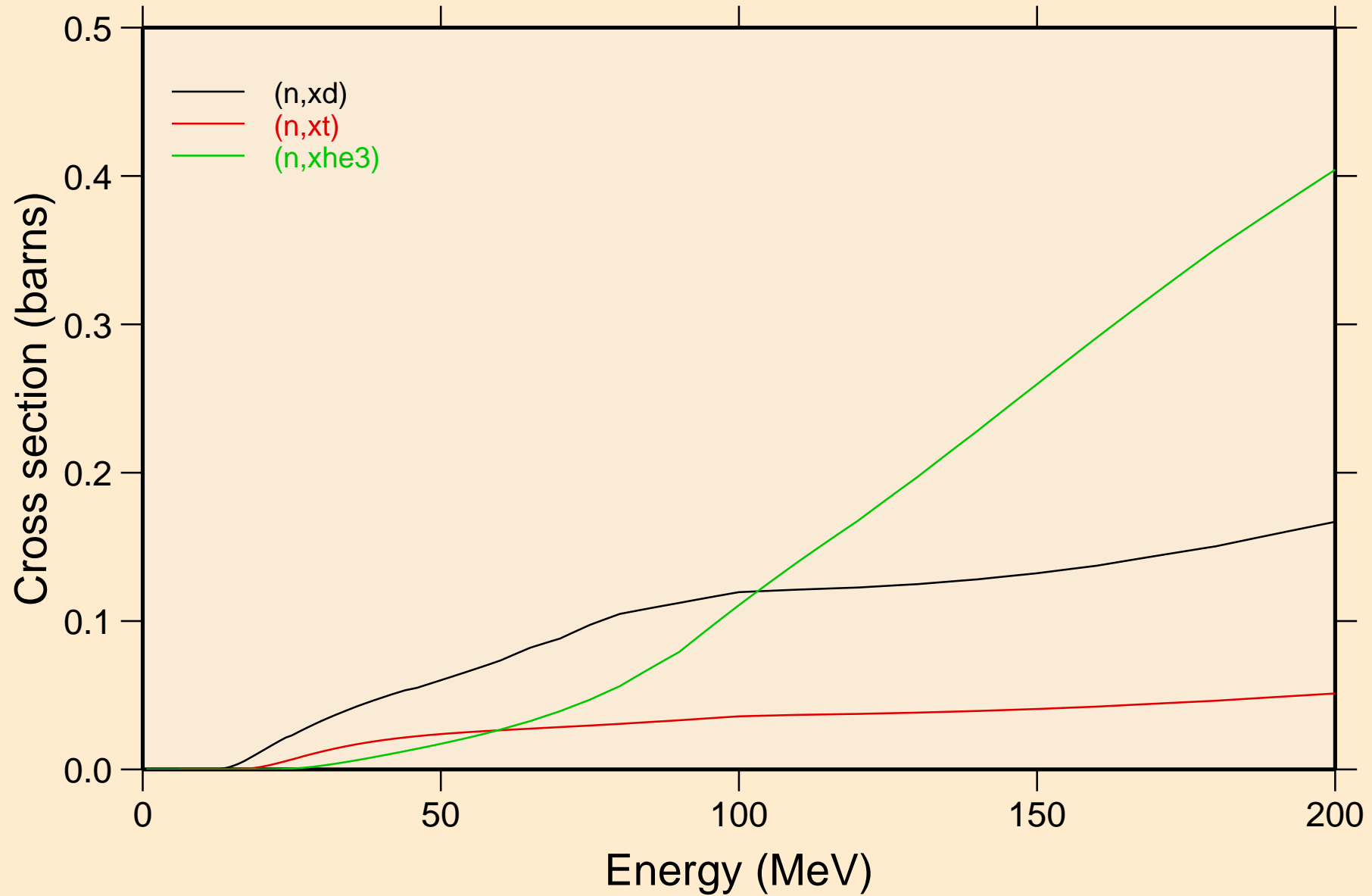

HF168 NEUTRON ACER TENDL-2021 LIBRARY; T=293.6K
angular distribution for elastic

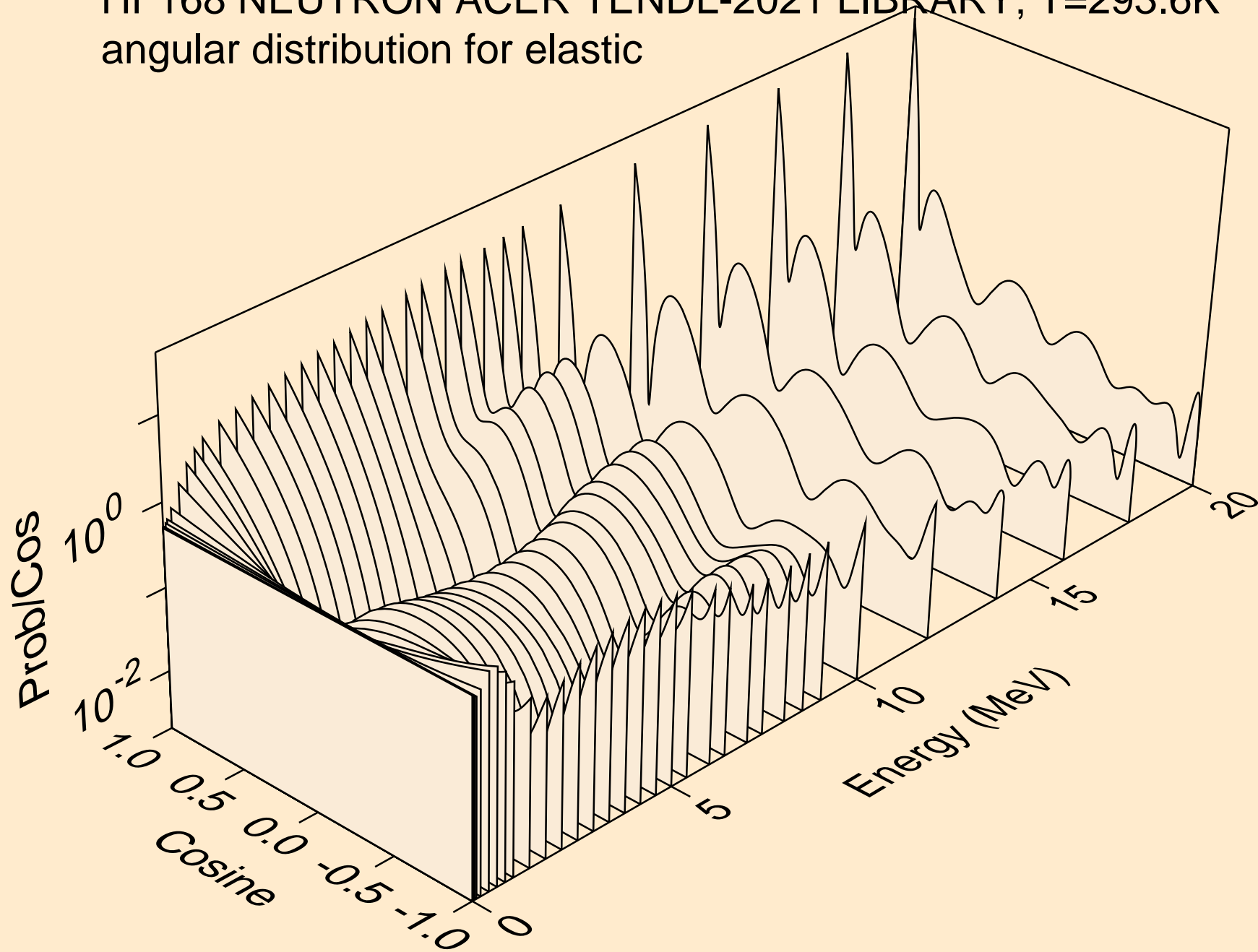

HF168 NEUTRON ACER TENDL-2021 LIBRARY; T=293.6K
angular distribution for elastic

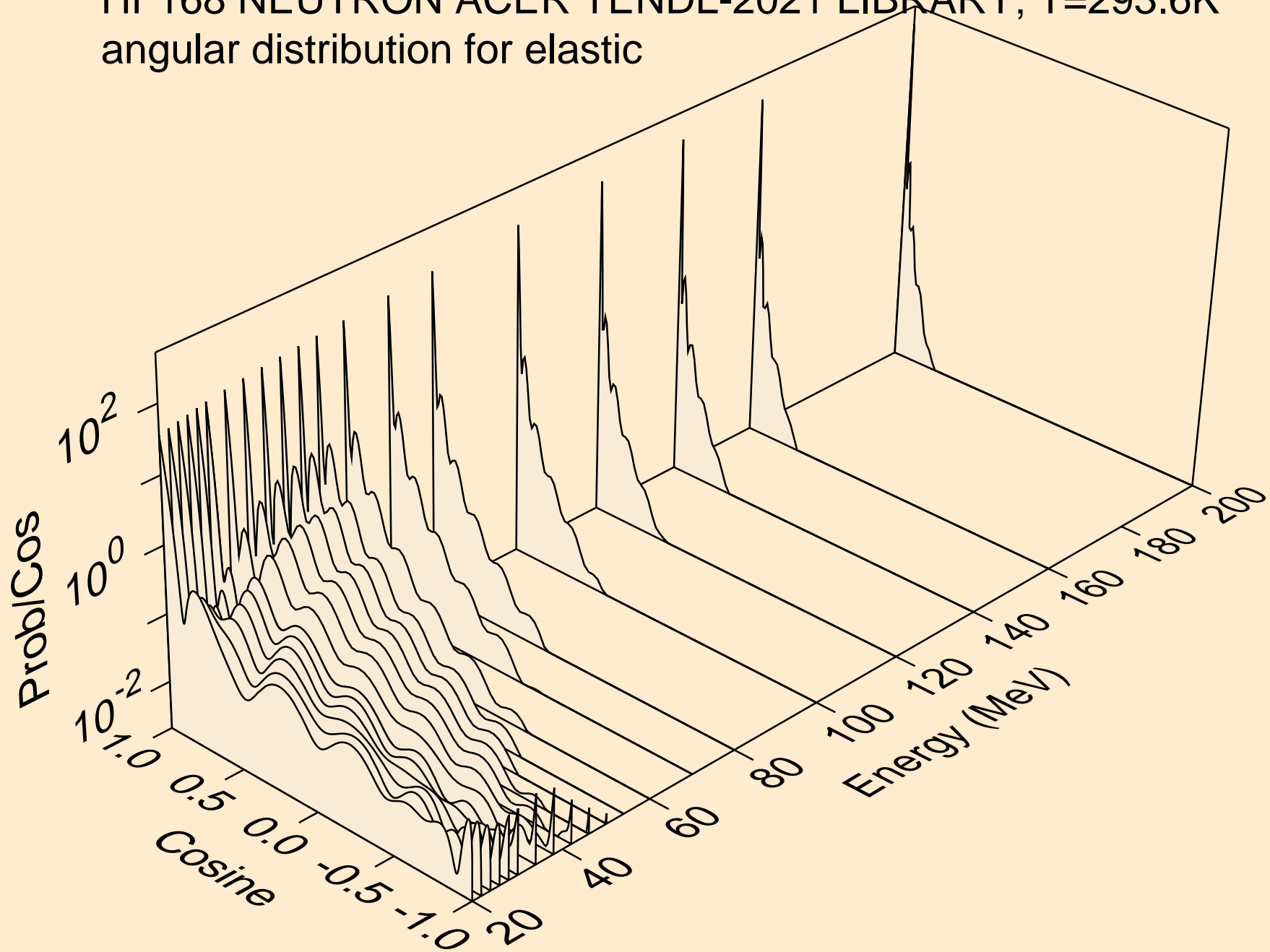

HF168 NEUTRON ACER TENDL-2021 LIBRARY; T=293.6K
angular distribution for (n,n*1)

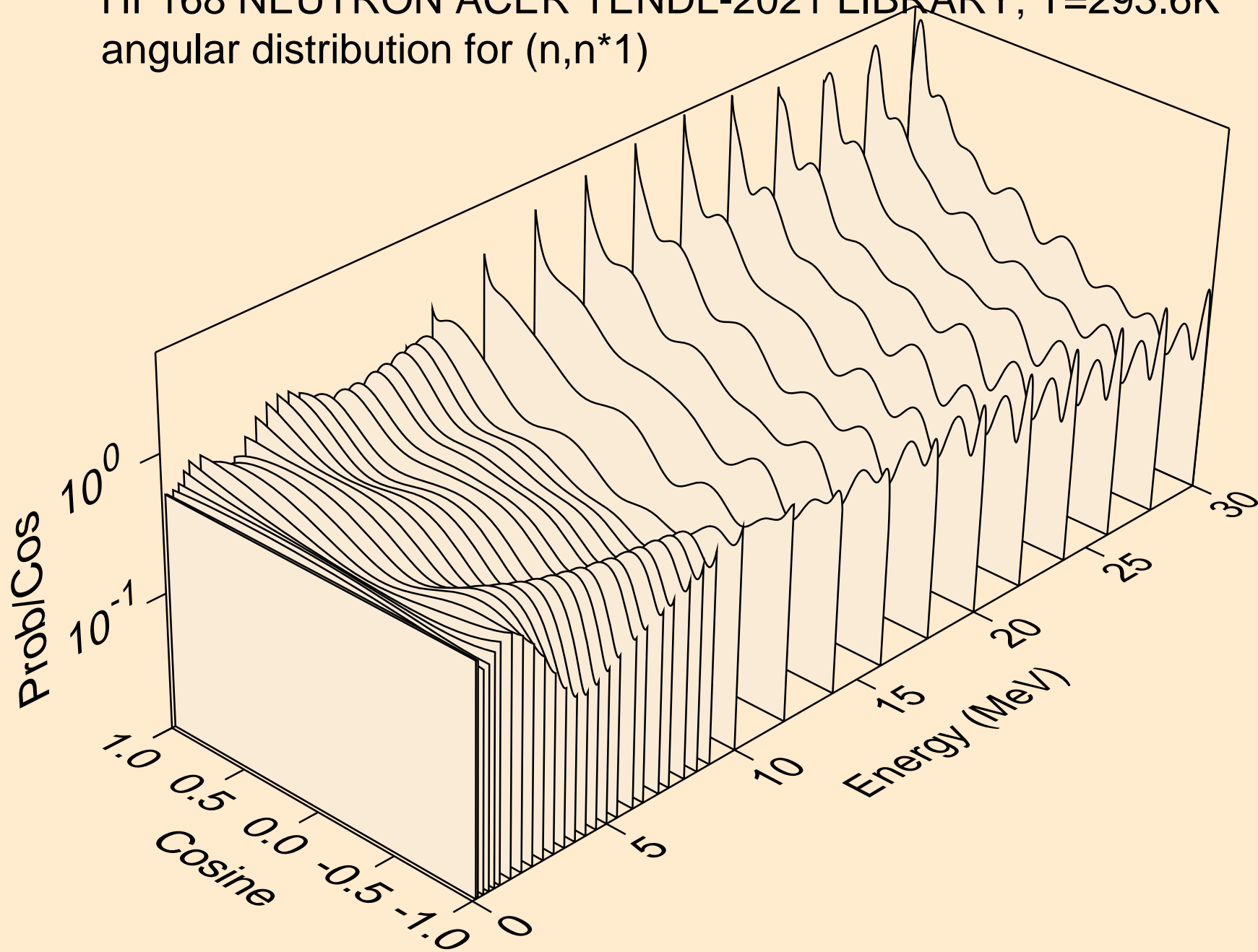

HF168 NEUTRON ACER TENDL-2021 LIBRARY; T=293.6K
angular distribution for (n,n*2)

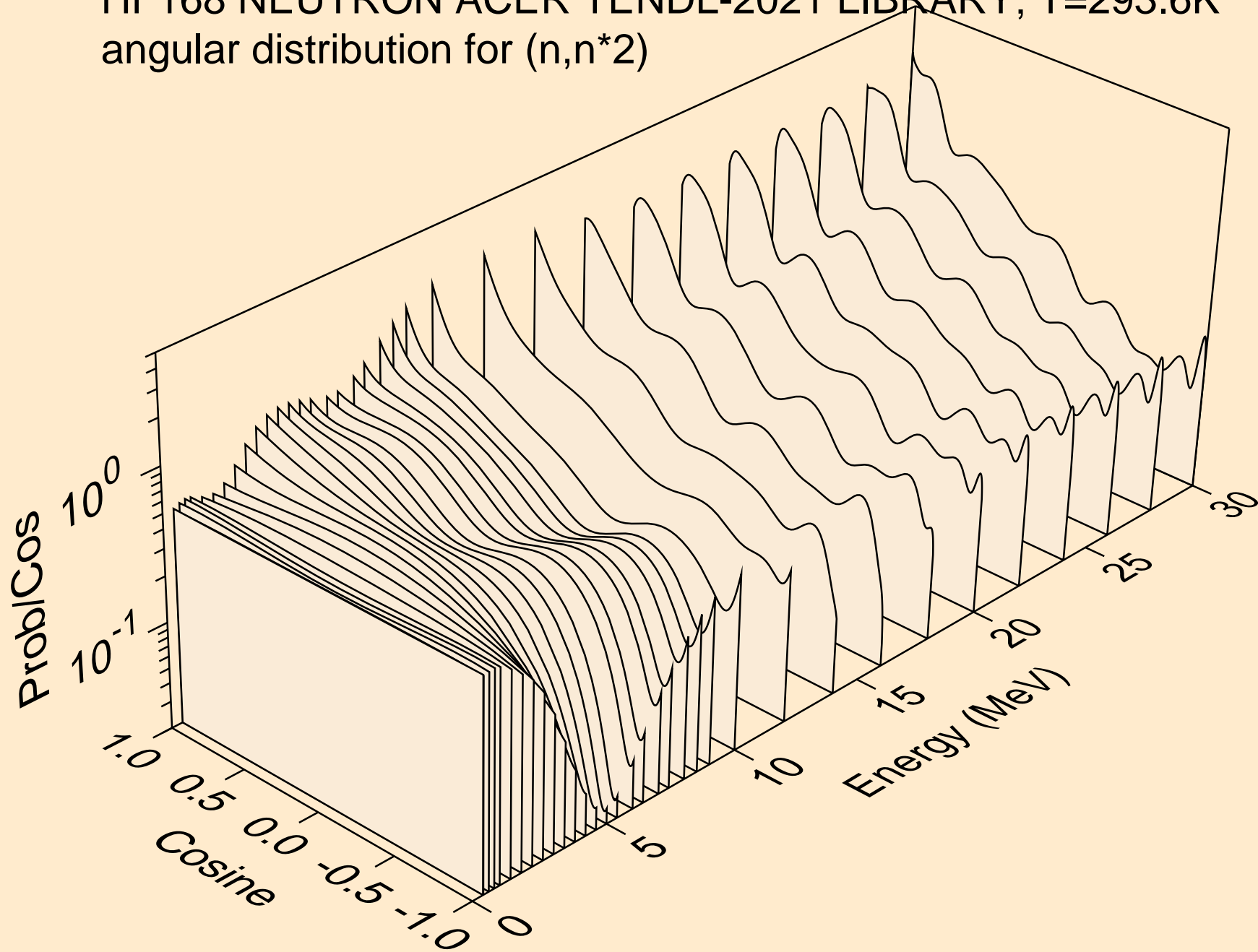

HF168 NEUTRON ACER TENDL-2021 LIBRARY; T=293.6K
angular distribution for (n,n*3)

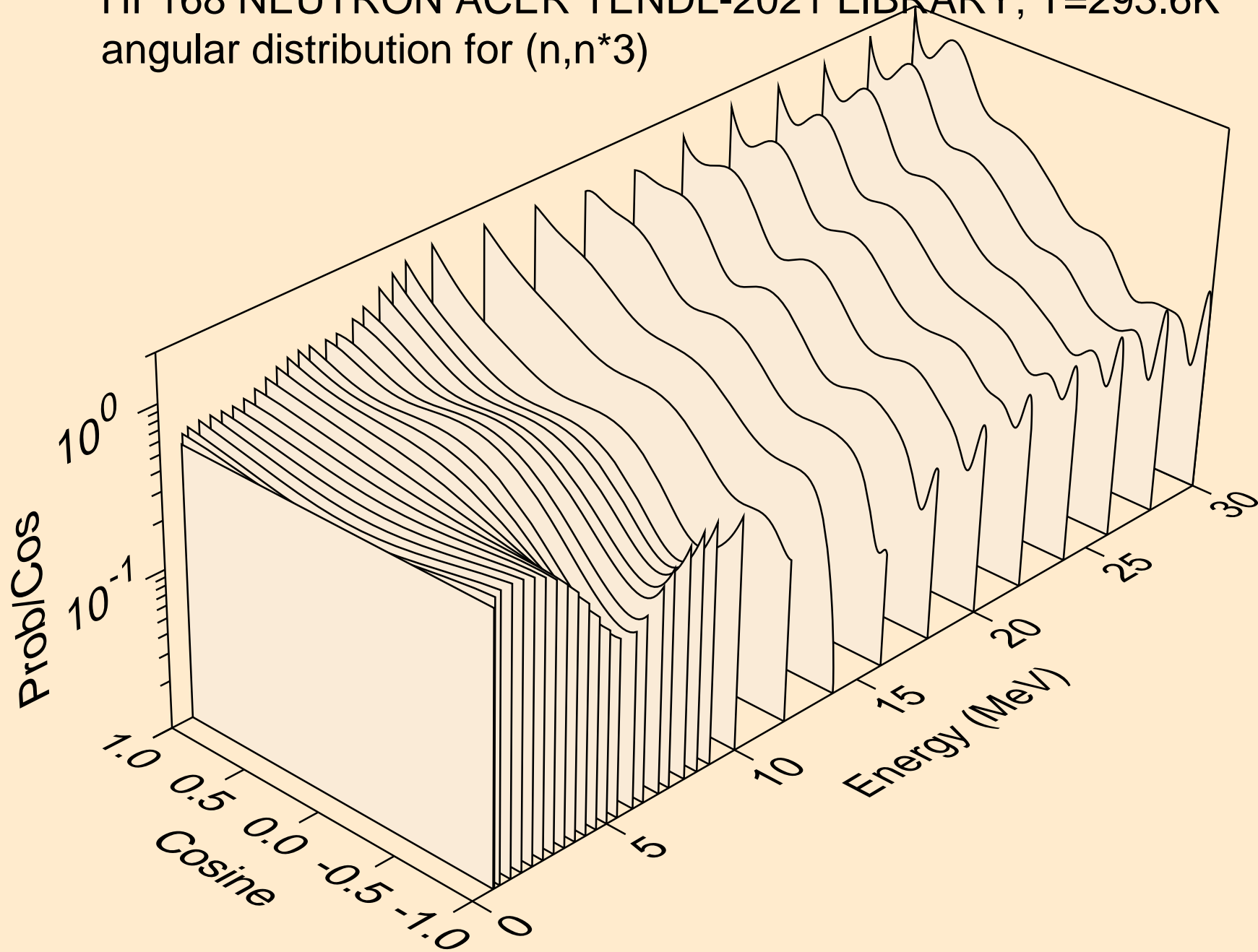

HF168 NEUTRON ACER TENDL-2021 LIBRARY; T=293.6K
angular distribution for (n,n*4)

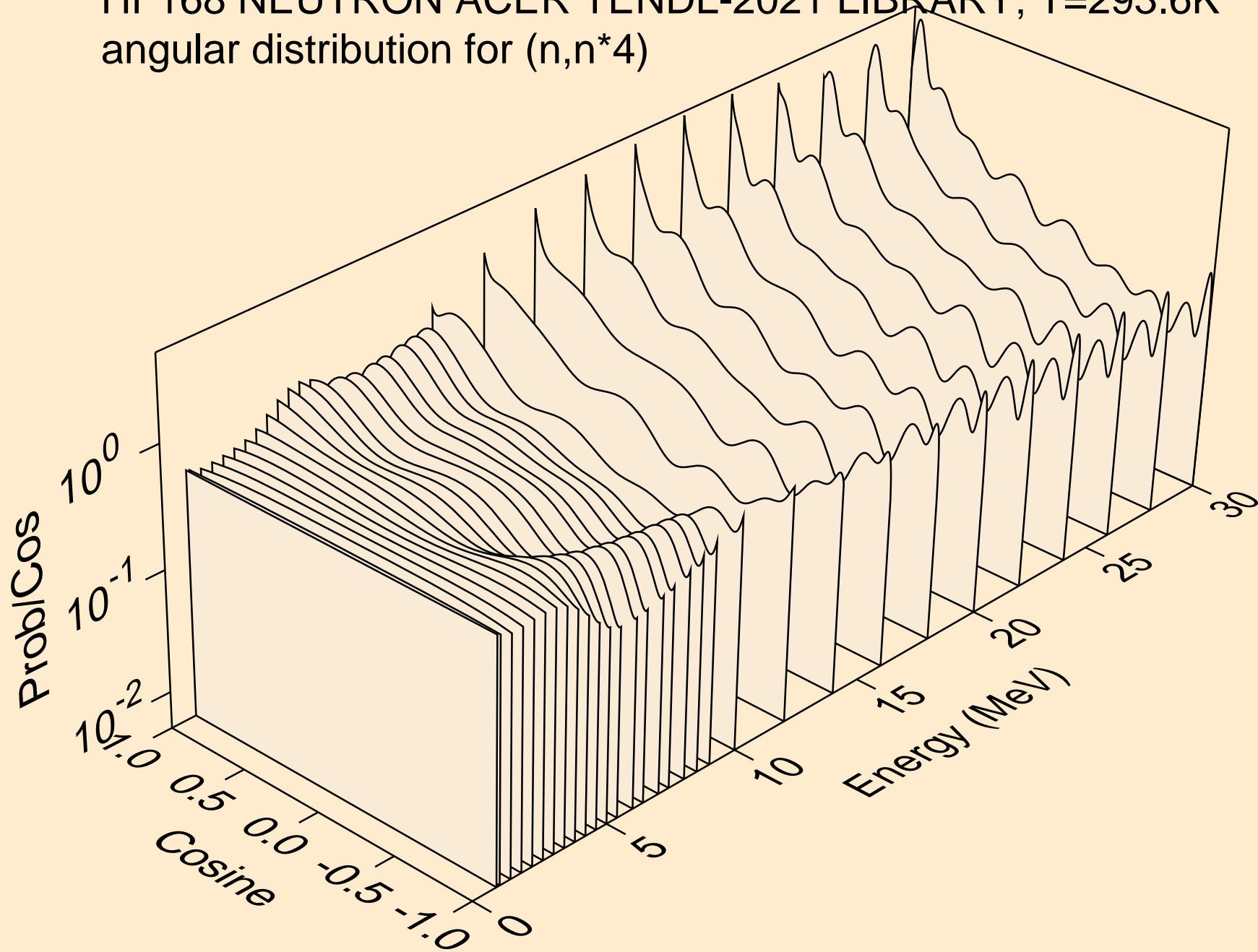

HF168 NEUTRON ACER TENDL-2021 LIBRARY; T=293.6K
angular distribution for (n,n*5)

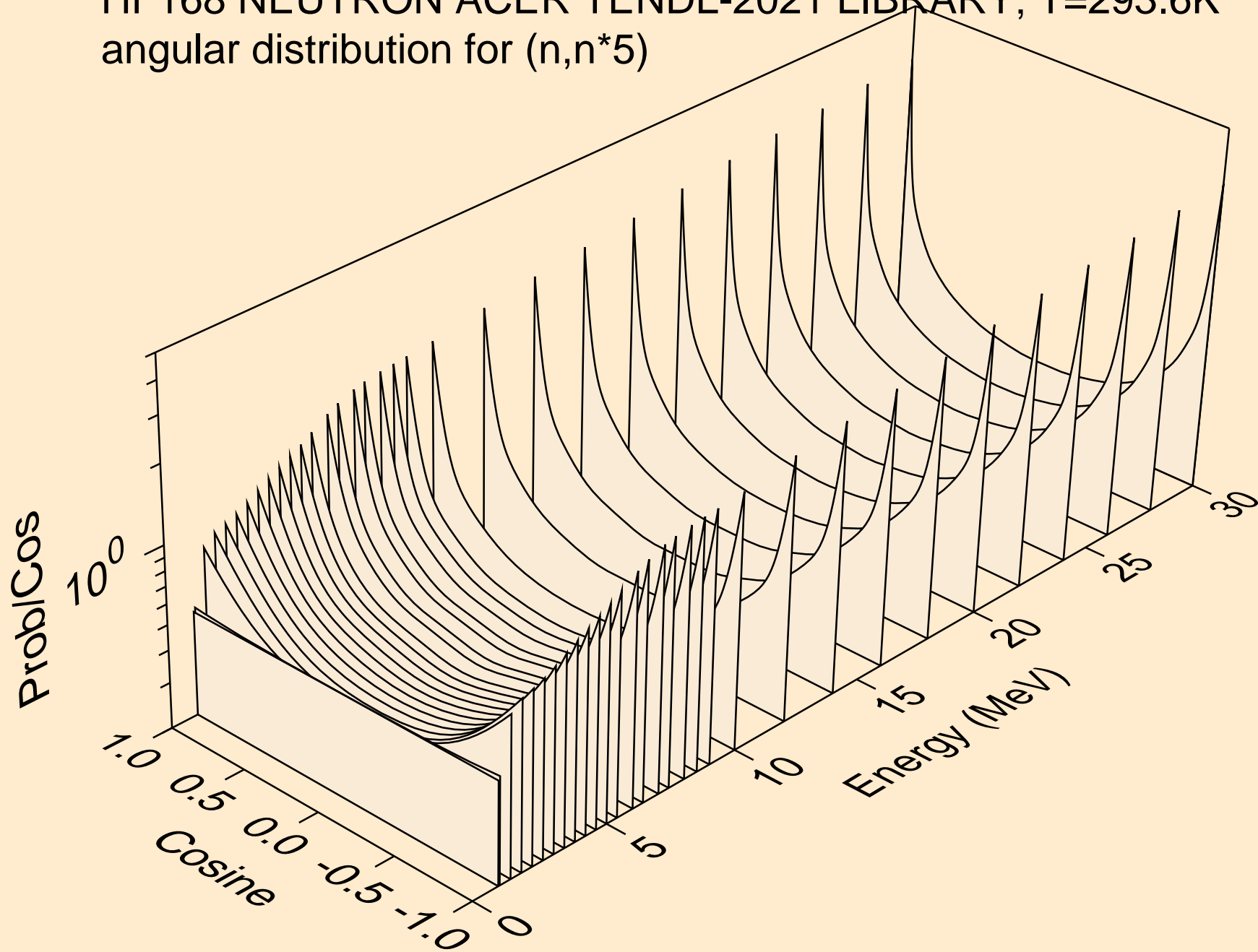

HF168 NEUTRON ACER TENDL-2021 LIBRARY; T=293.6K
angular distribution for (n,n*6)

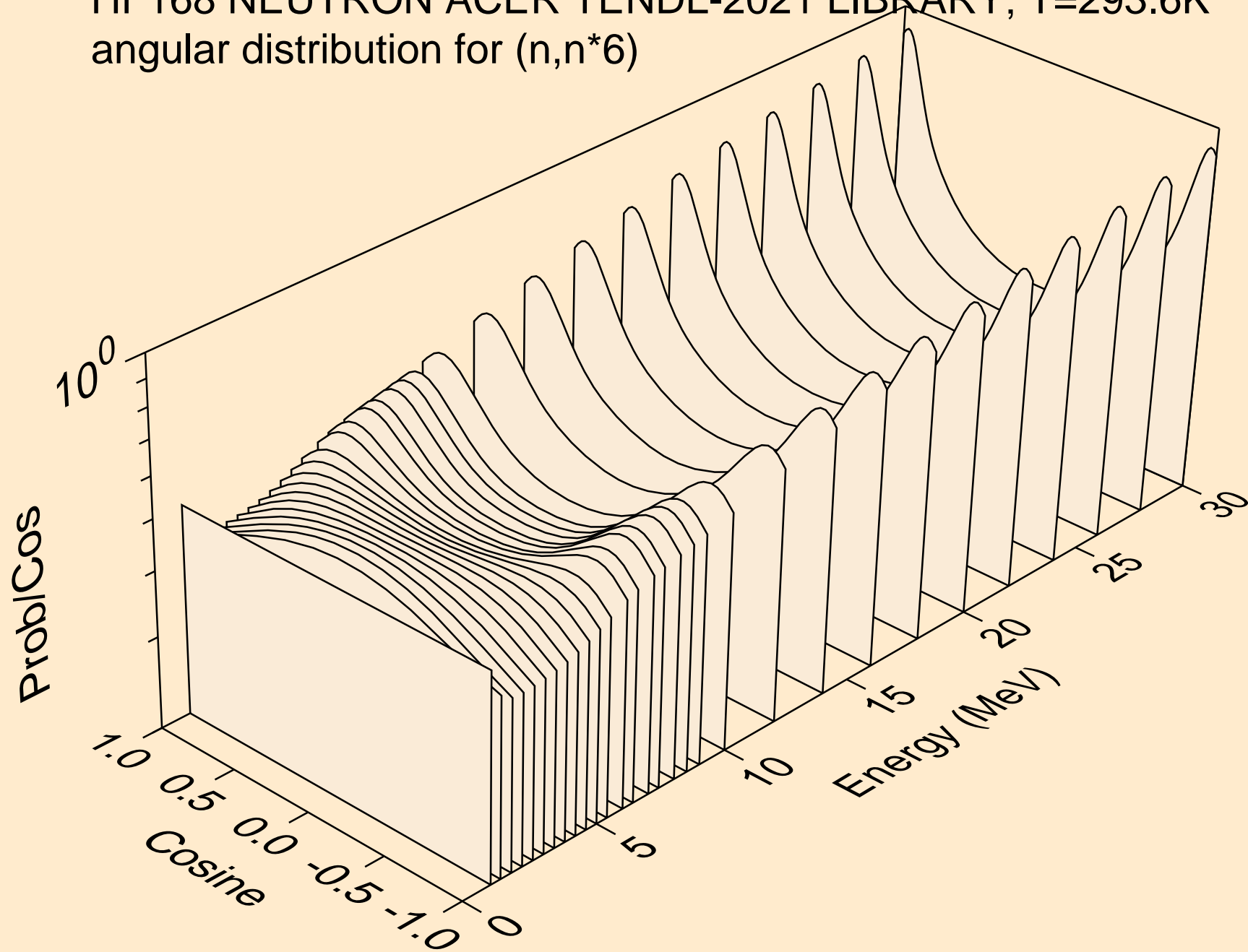

HF168 NEUTRON ACER TENDL-2021 LIBRARY; T=293.6K
angular distribution for (n,n*7)

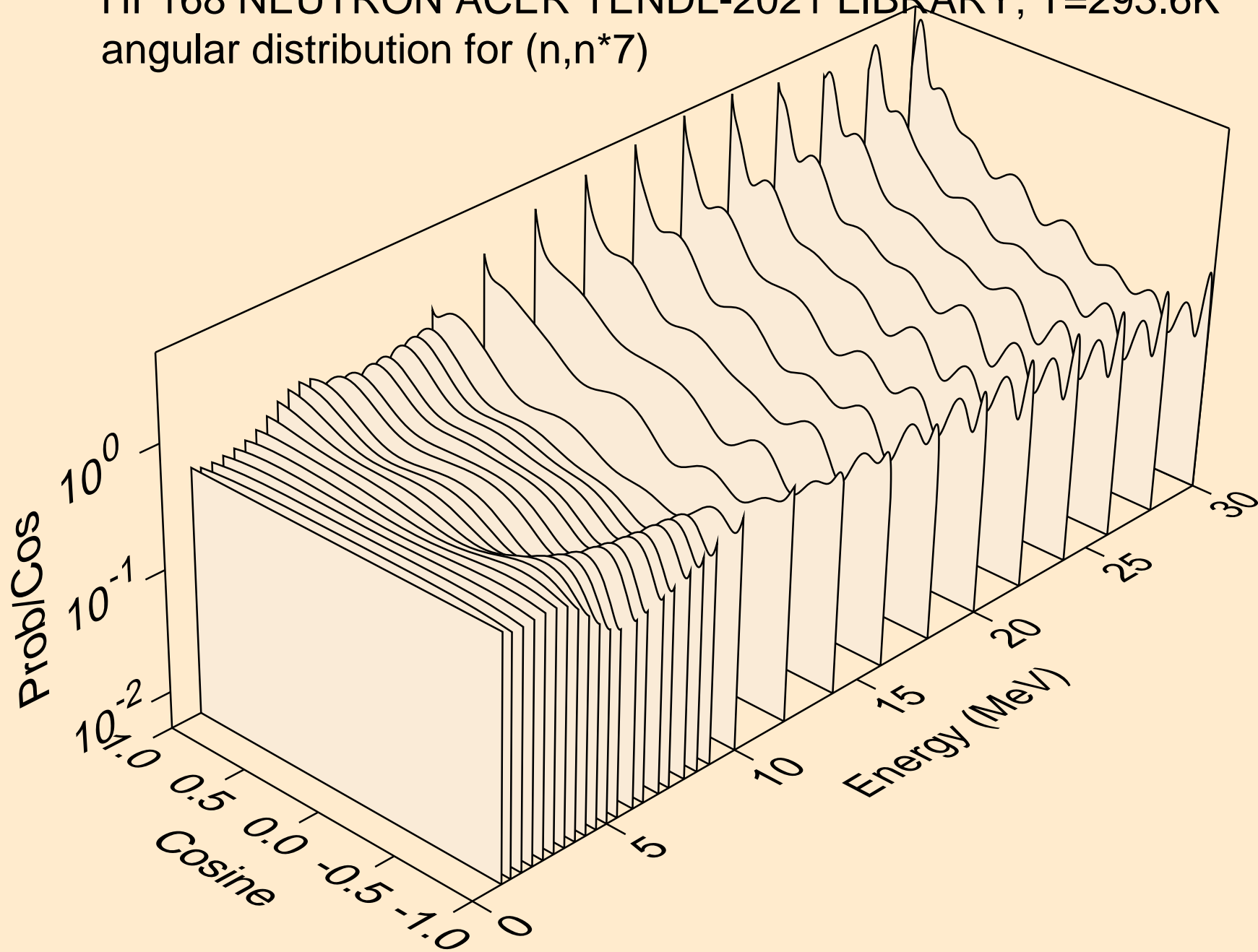

HF168 NEUTRON ACER TENDL-2021 LIBRARY; T=293.6K
angular distribution for (n,n*8)

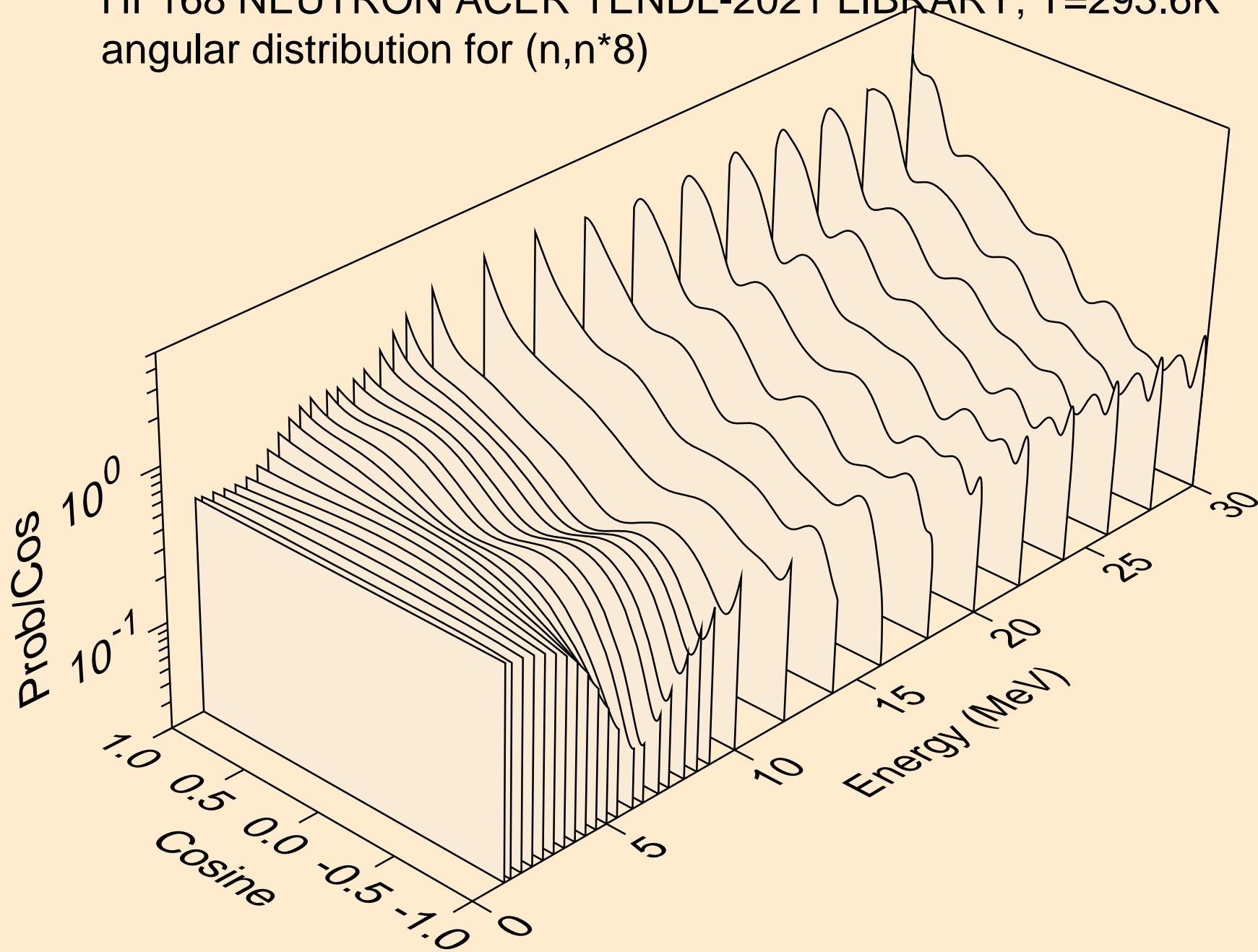

HF168 NEUTRON ACER TENDL-2021 LIBRARY; T=293.6K
angular distribution for (n,n*9)

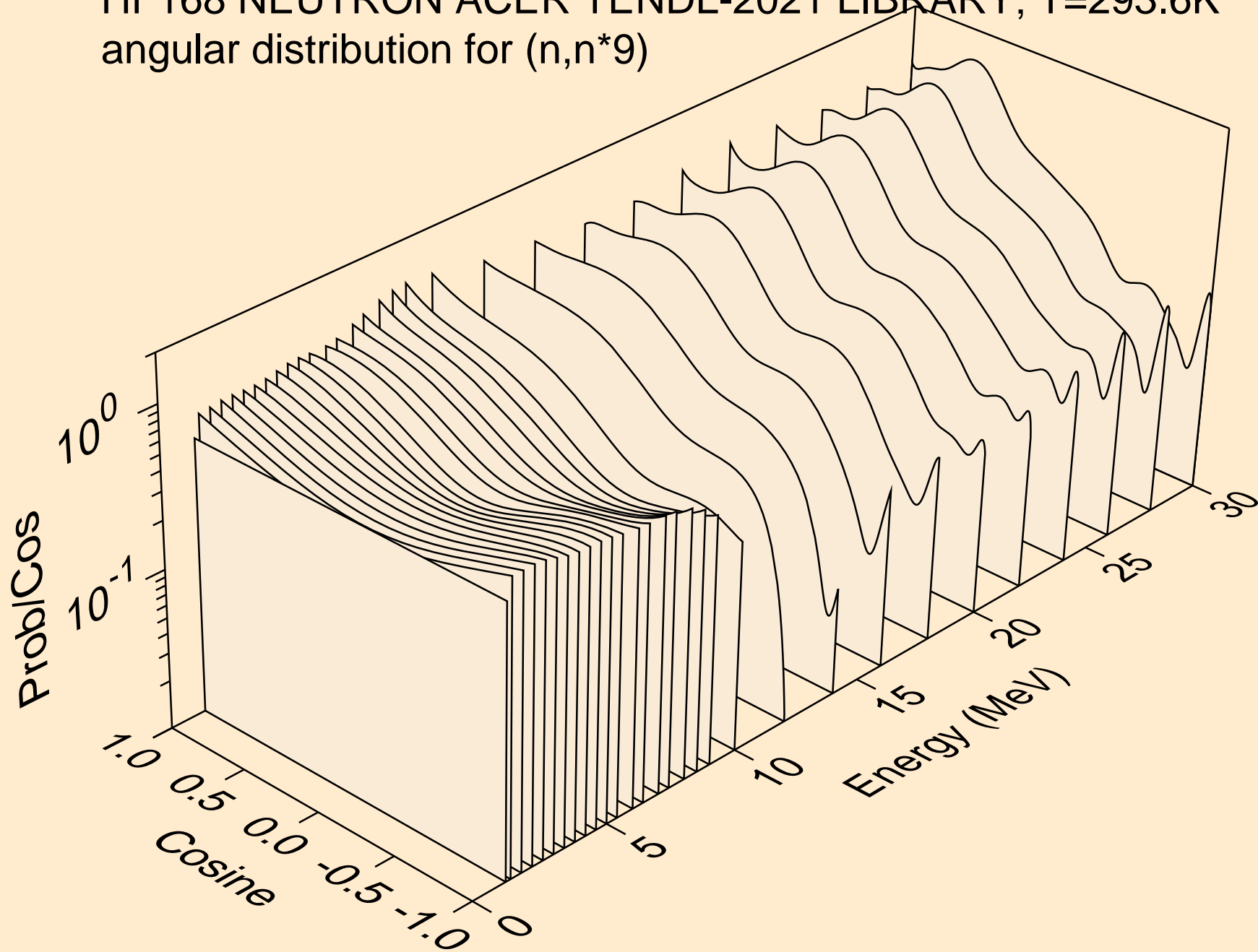

HF168 NEUTRON ACER TENDL-2021 LIBRARY; T=293.6K
angular distribution for (n,n*10)

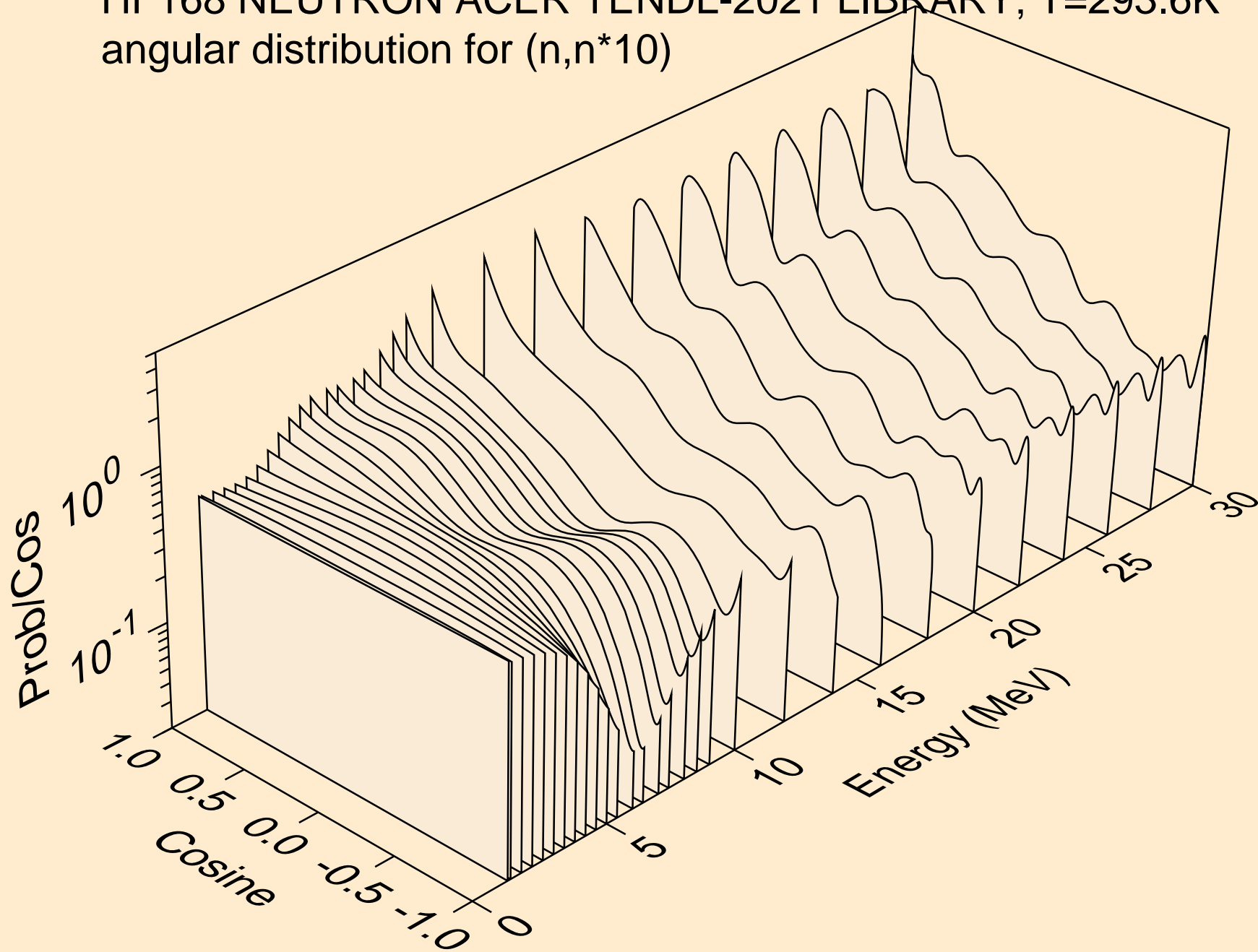

HF168 NEUTRON ACER TENDL-2021 LIBRARY; T=293.6K
angular distribution for (n,n*11)

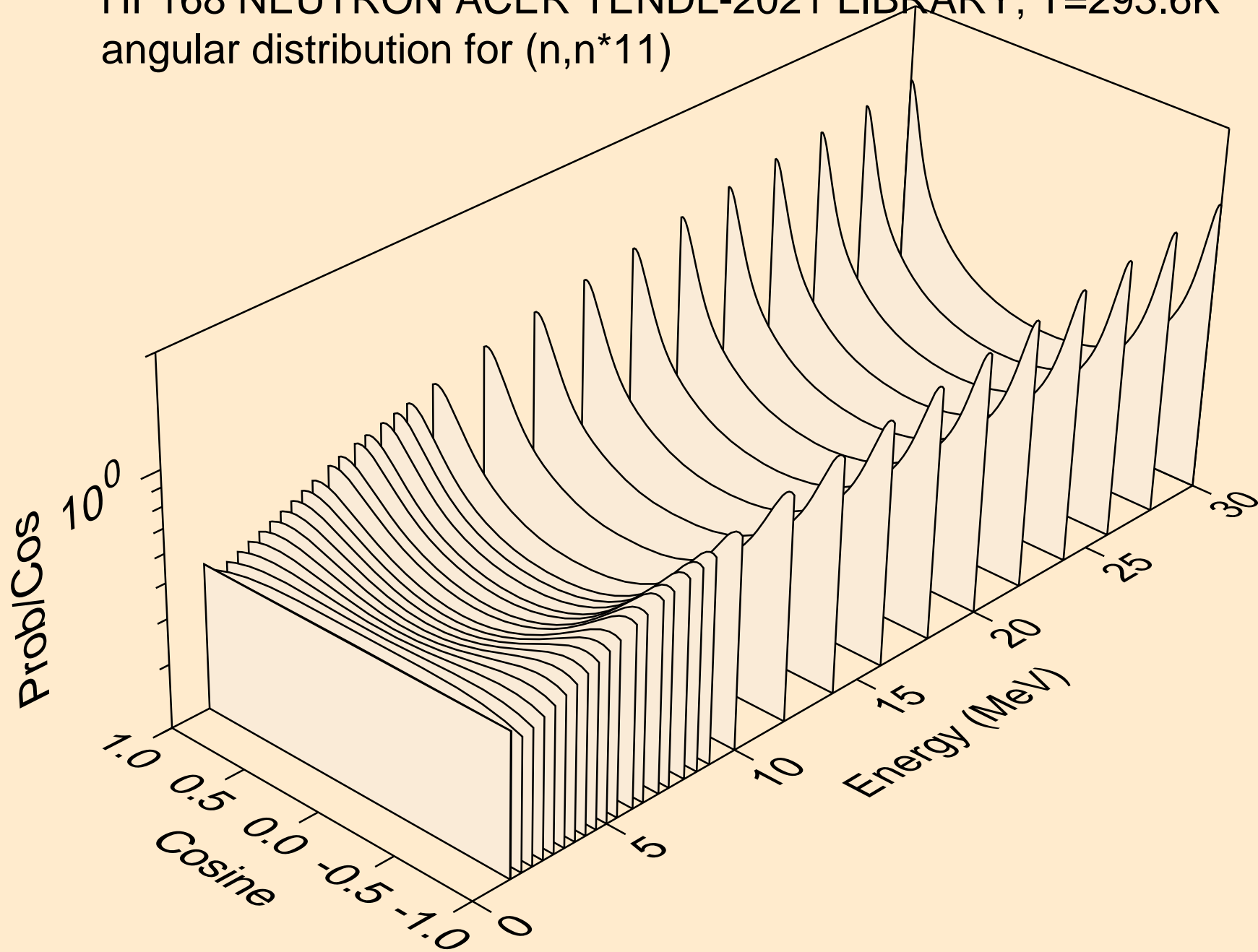

HF168 NEUTRON ACER TENDL-2021 LIBRARY; T=293.6K
angular distribution for (n,n*12)

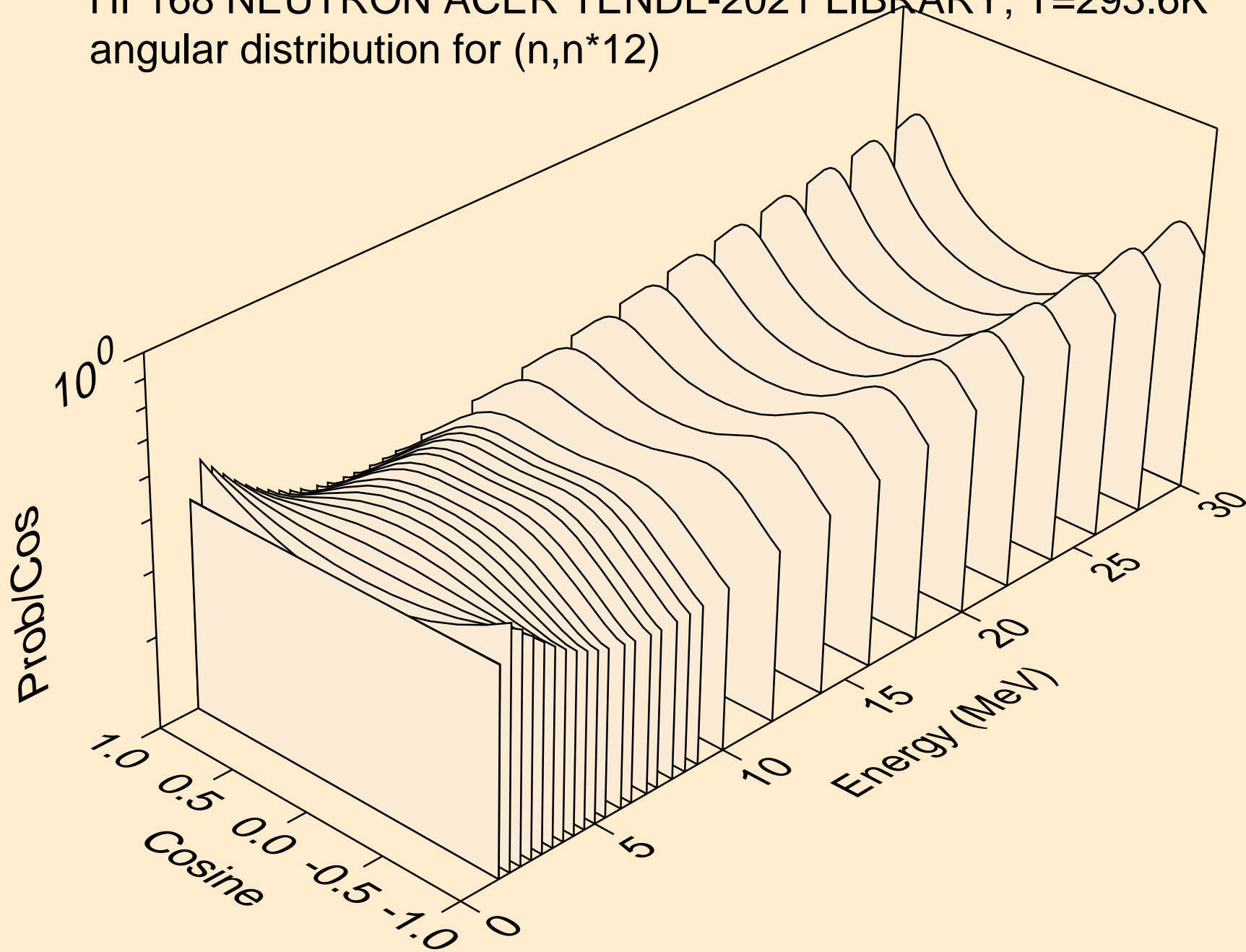

HF168 NEUTRON ACER TENDL-2021 LIBRARY; T=293.6K
angular distribution for (n,n*13)

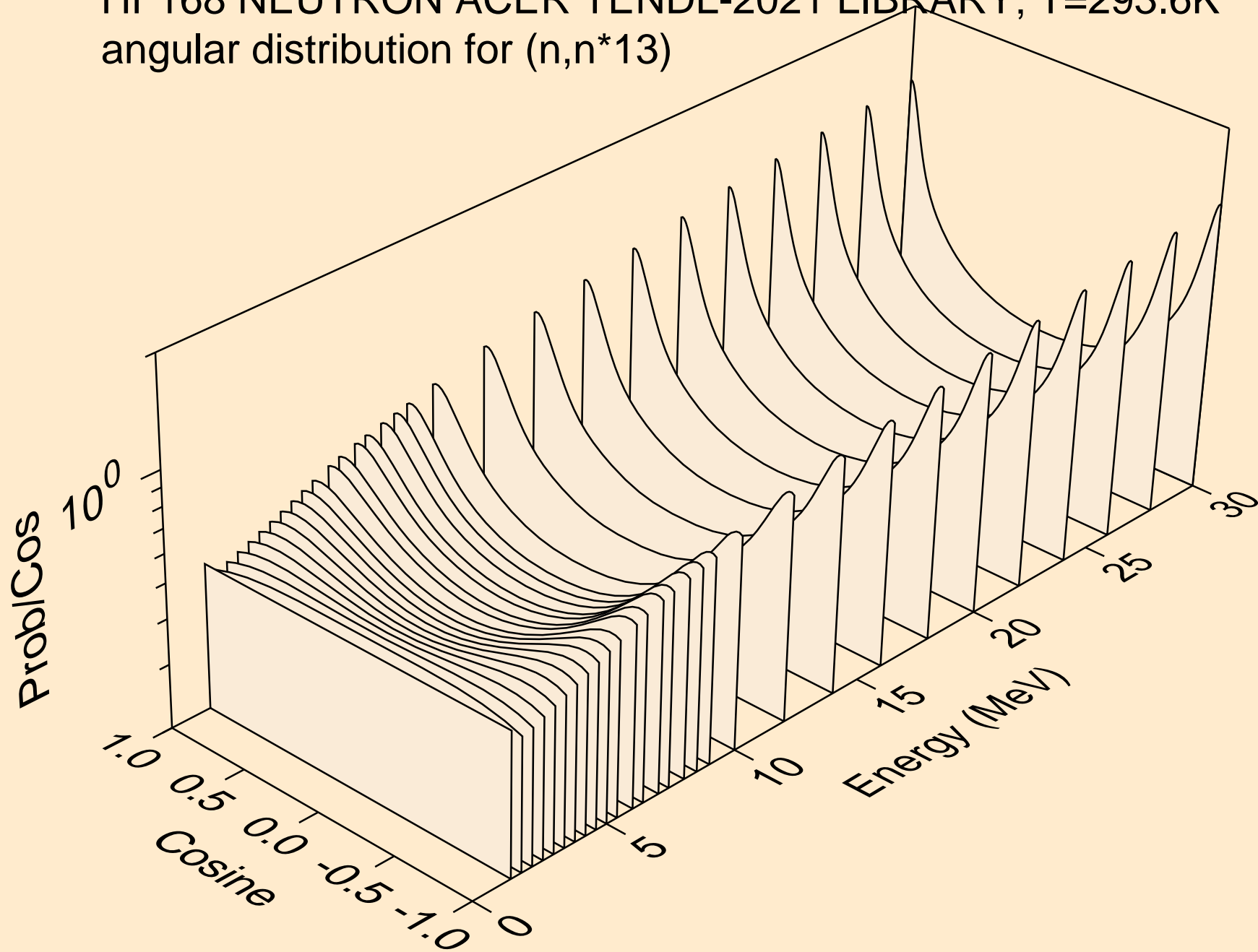

HF168 NEUTRON ACER TENDL-2021 LIBRARY; T=293.6K
angular distribution for (n,n*14)

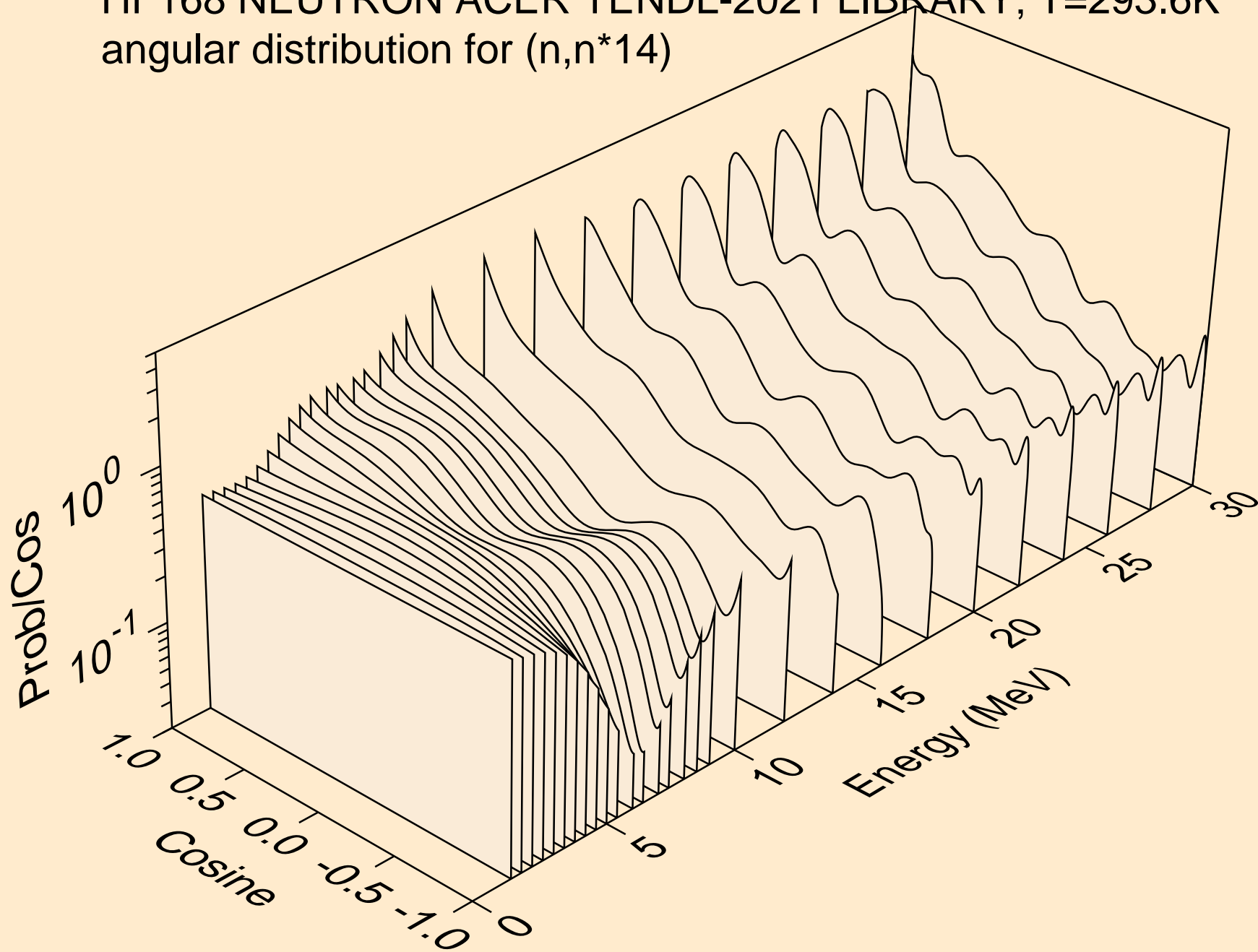

HF168 NEUTRON ACER TENDL-2021 LIBRARY; T=293.6K
angular distribution for (n,n*15)

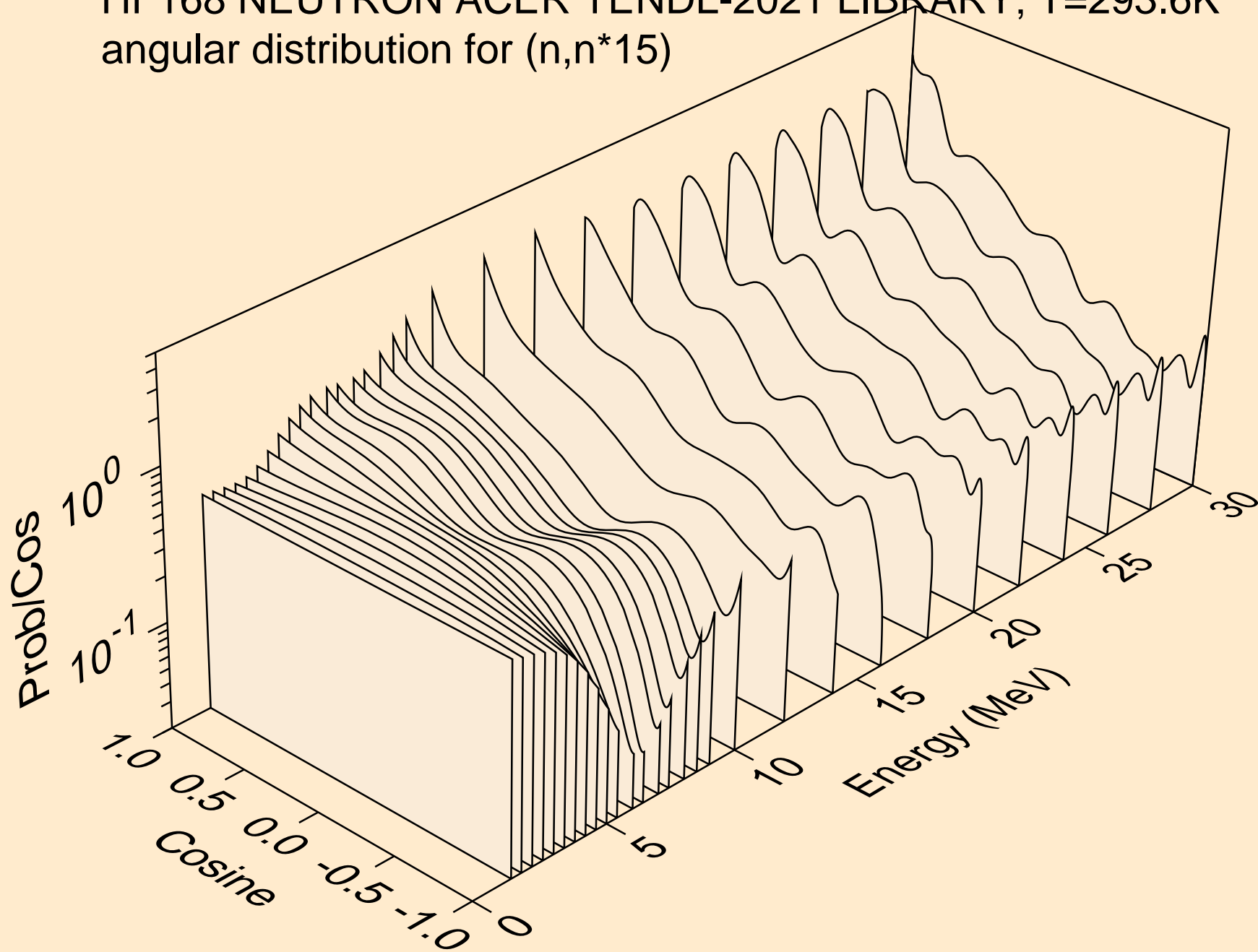

HF168 NEUTRON ACER TENDL-2021 LIBRARY; T=293.6K
angular distribution for (n,n*16)

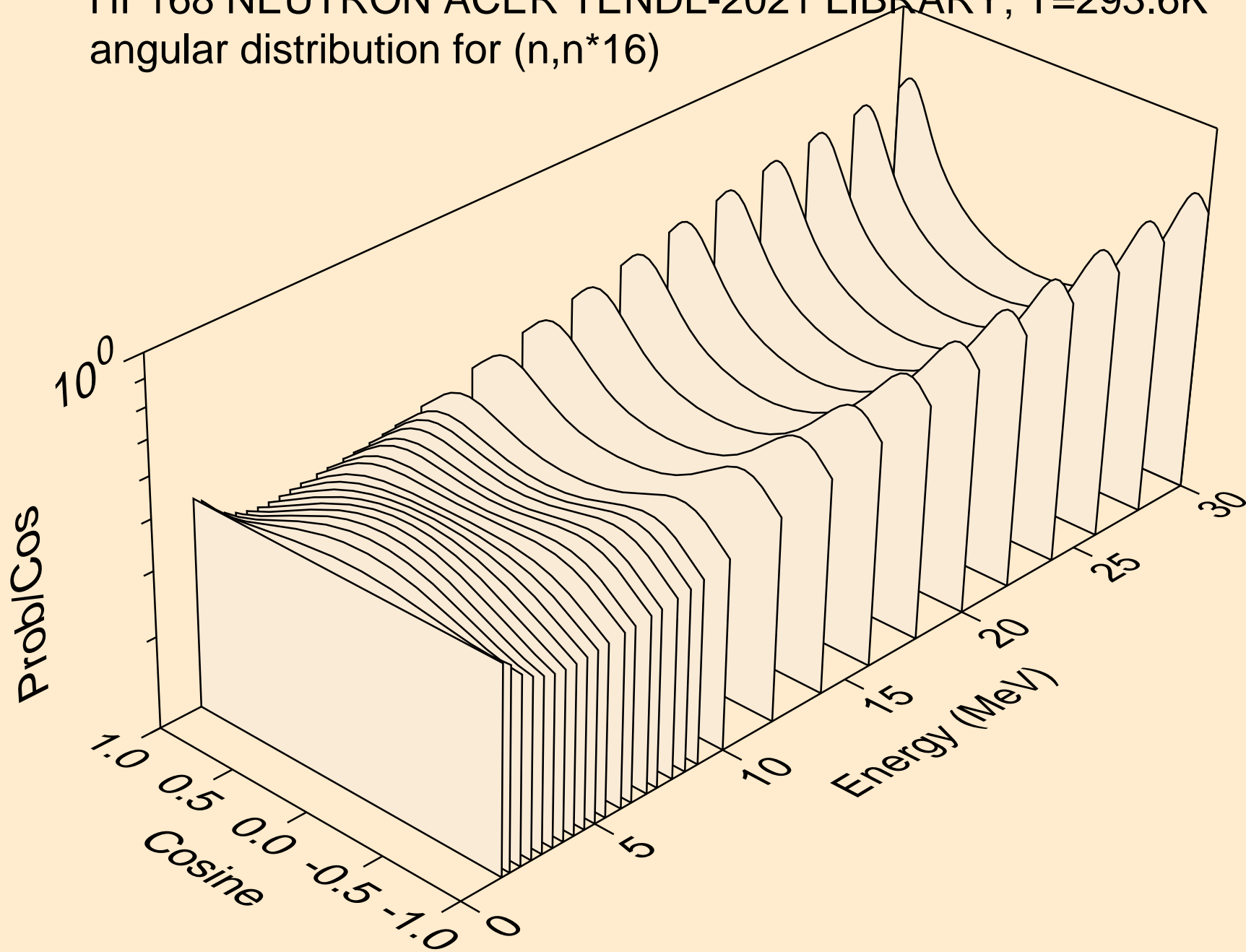

HF168 NEUTRON ACER TENDL-2021 LIBRARY; T=293.6K
angular distribution for (n,n*17)

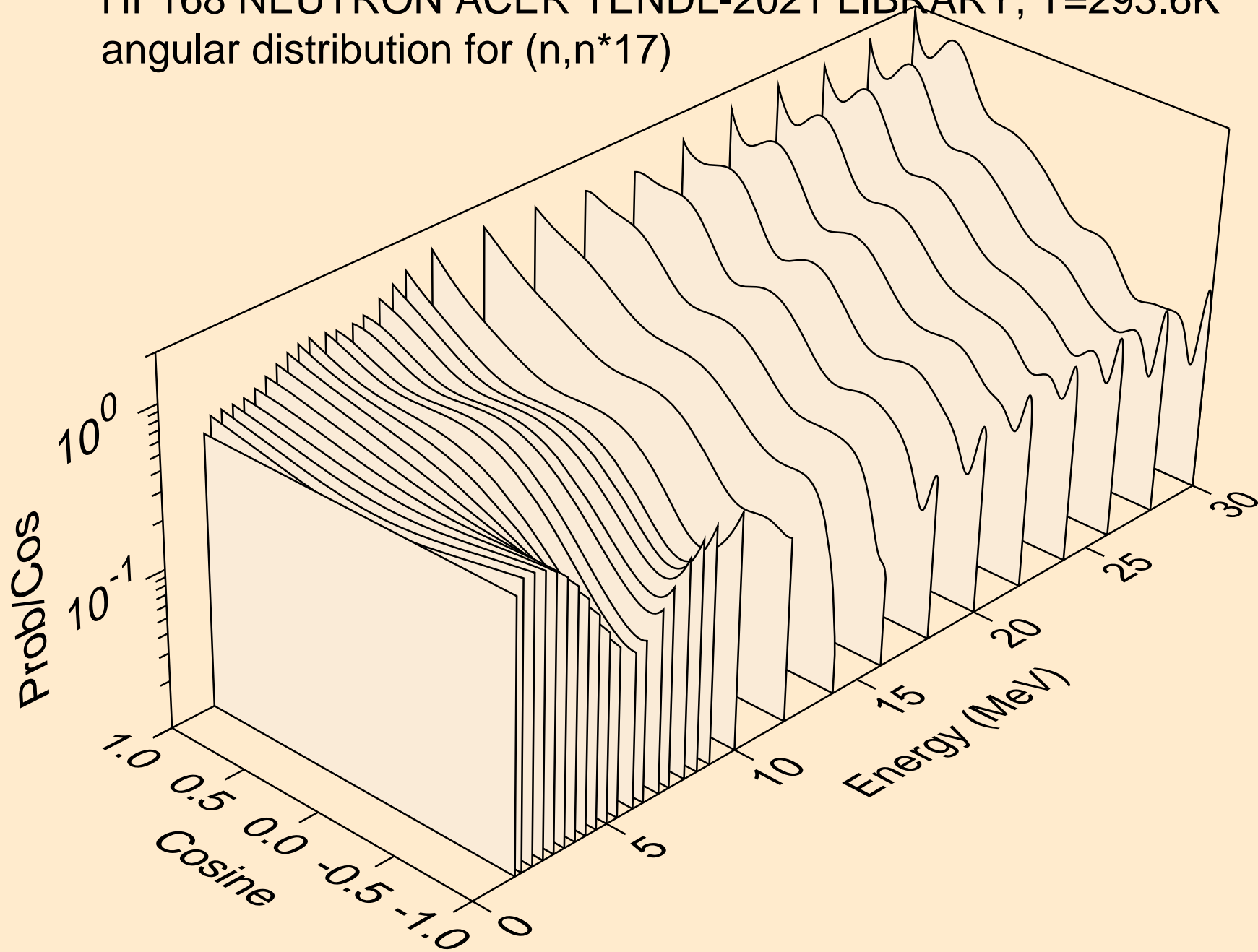

HF168 NEUTRON ACER TENDL-2021 LIBRARY; T=293.6K
angular distribution for (n,n*18)

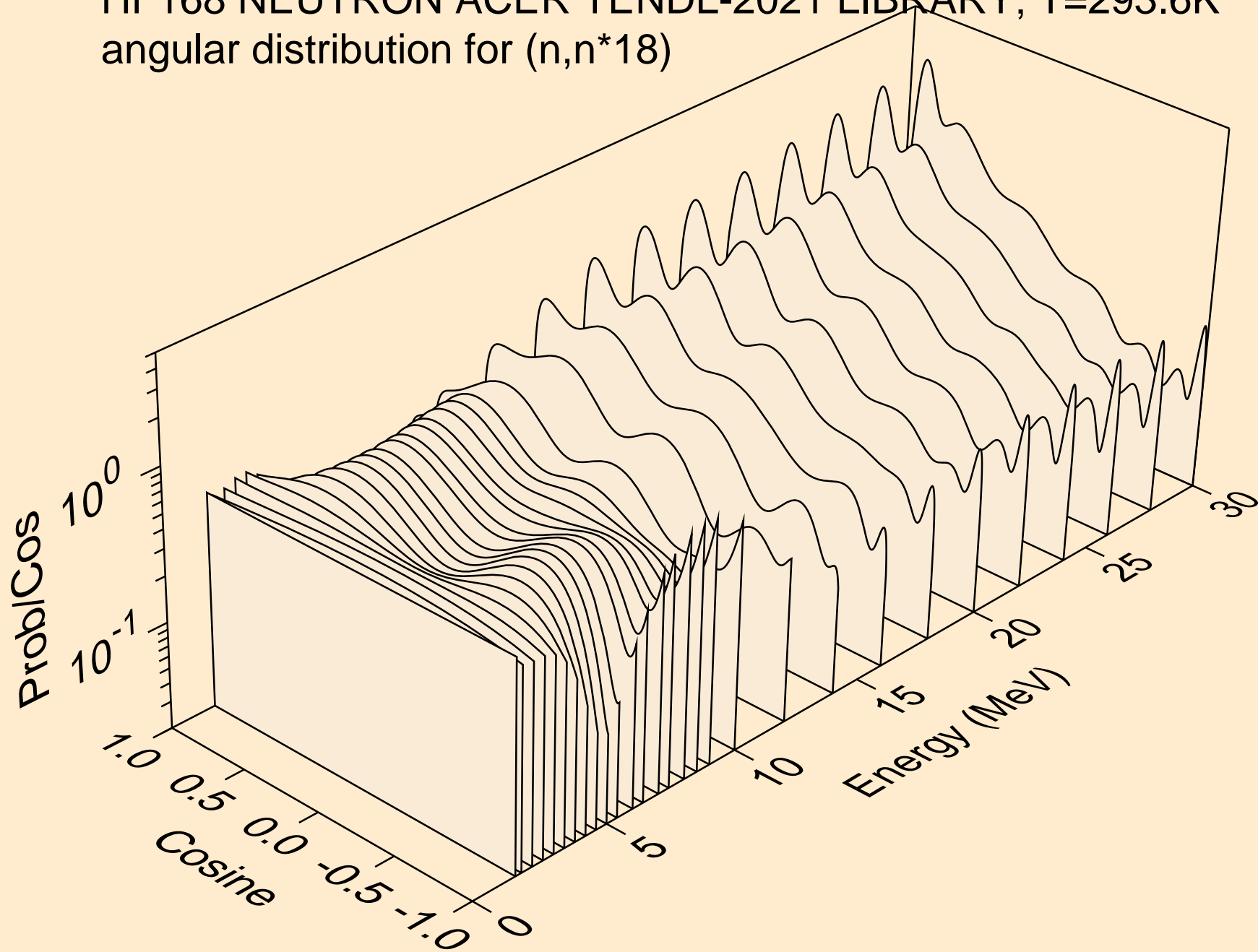

HF168 NEUTRON ACER TENDL-2021 LIBRARY; T=293.6K
angular distribution for (n,n*19)

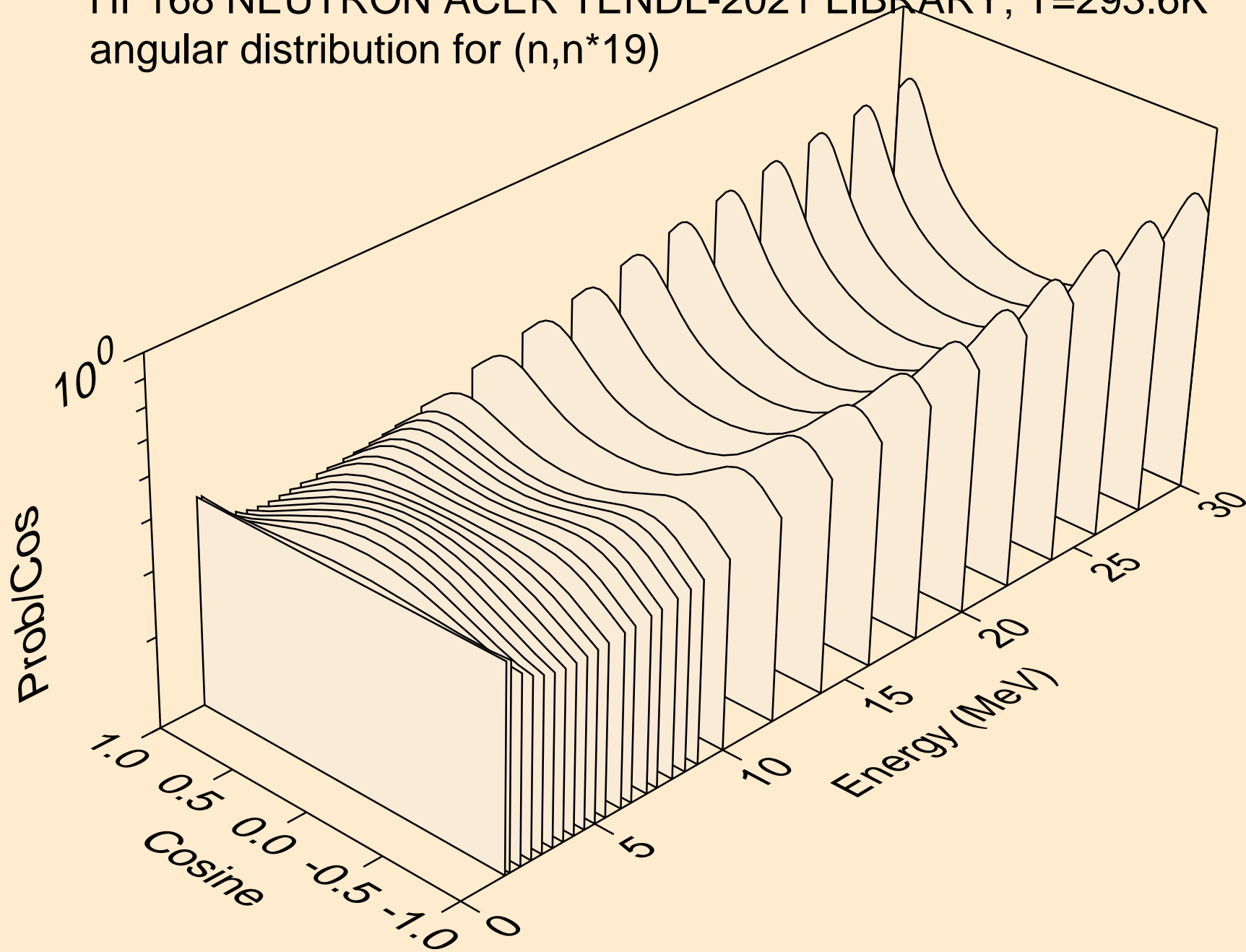

HF168 NEUTRON ACER TENDL-2021 LIBRARY; T=293.6K
angular distribution for (n,n*20)

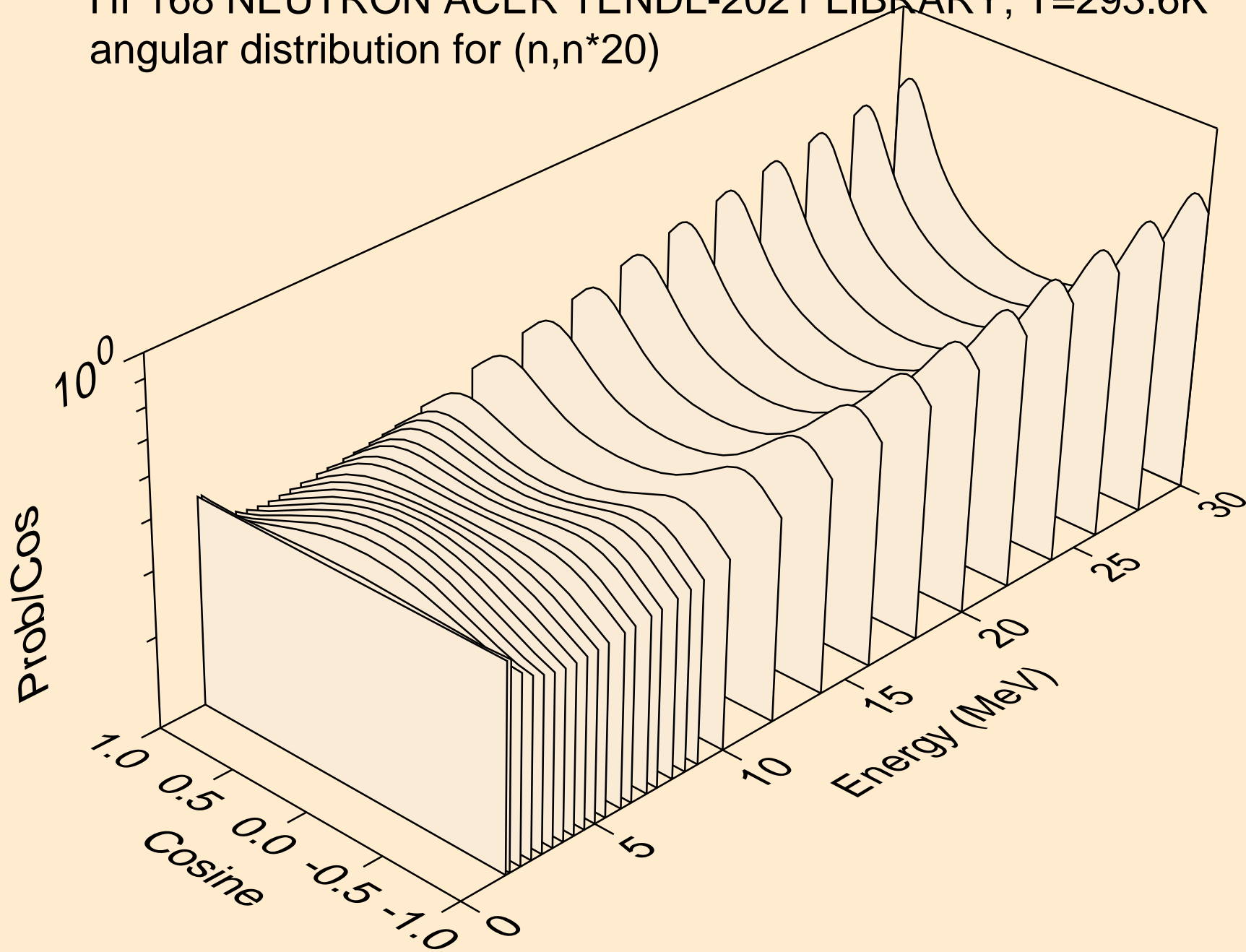

HF168 NEUTRON ACER TENDL-2021 LIBRARY; T=293.6K
angular distribution for (n,n*21)

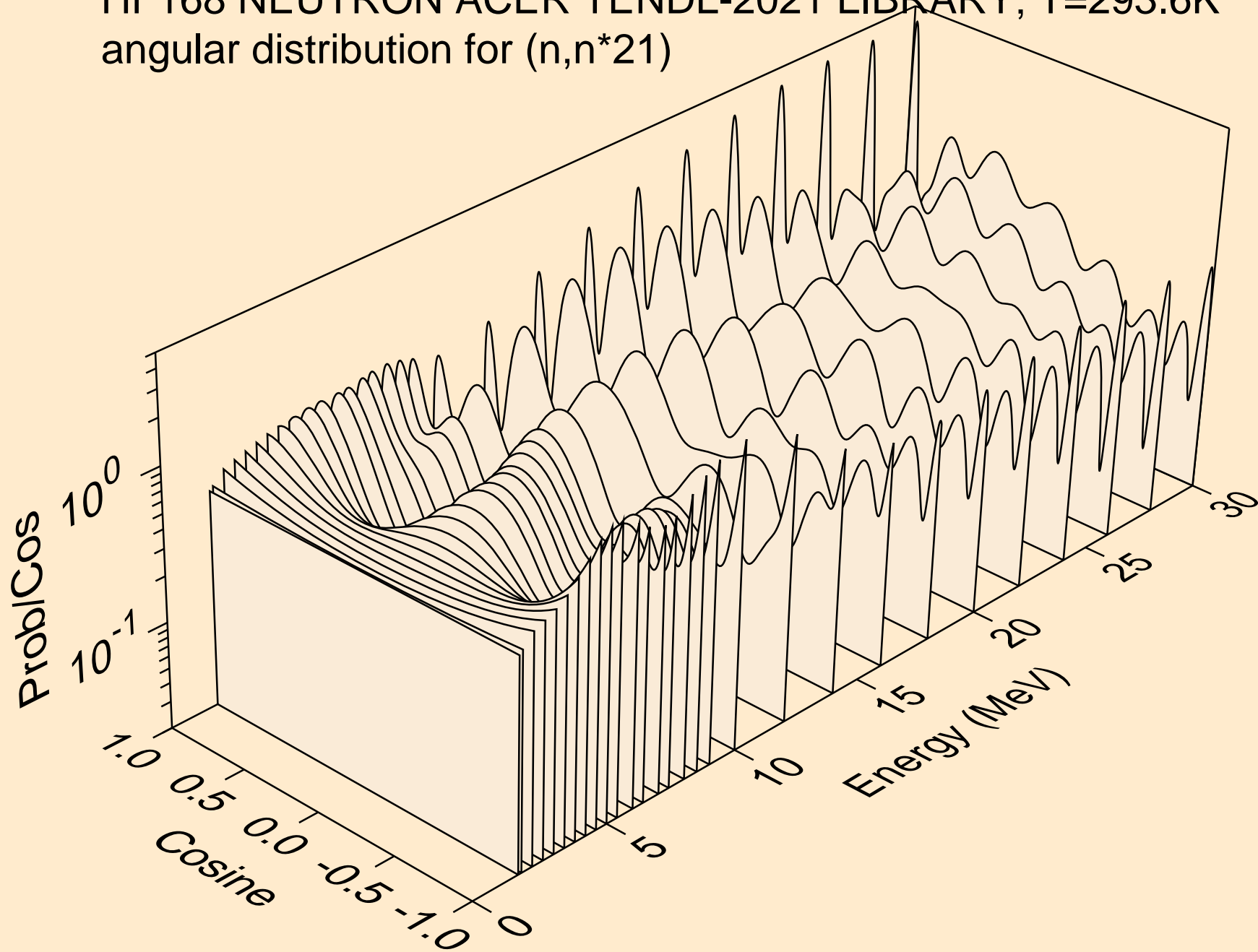

HF168 NEUTRON ACER TENDL-2021 LIBRARY; T=293.6K
angular distribution for (n,n*22)

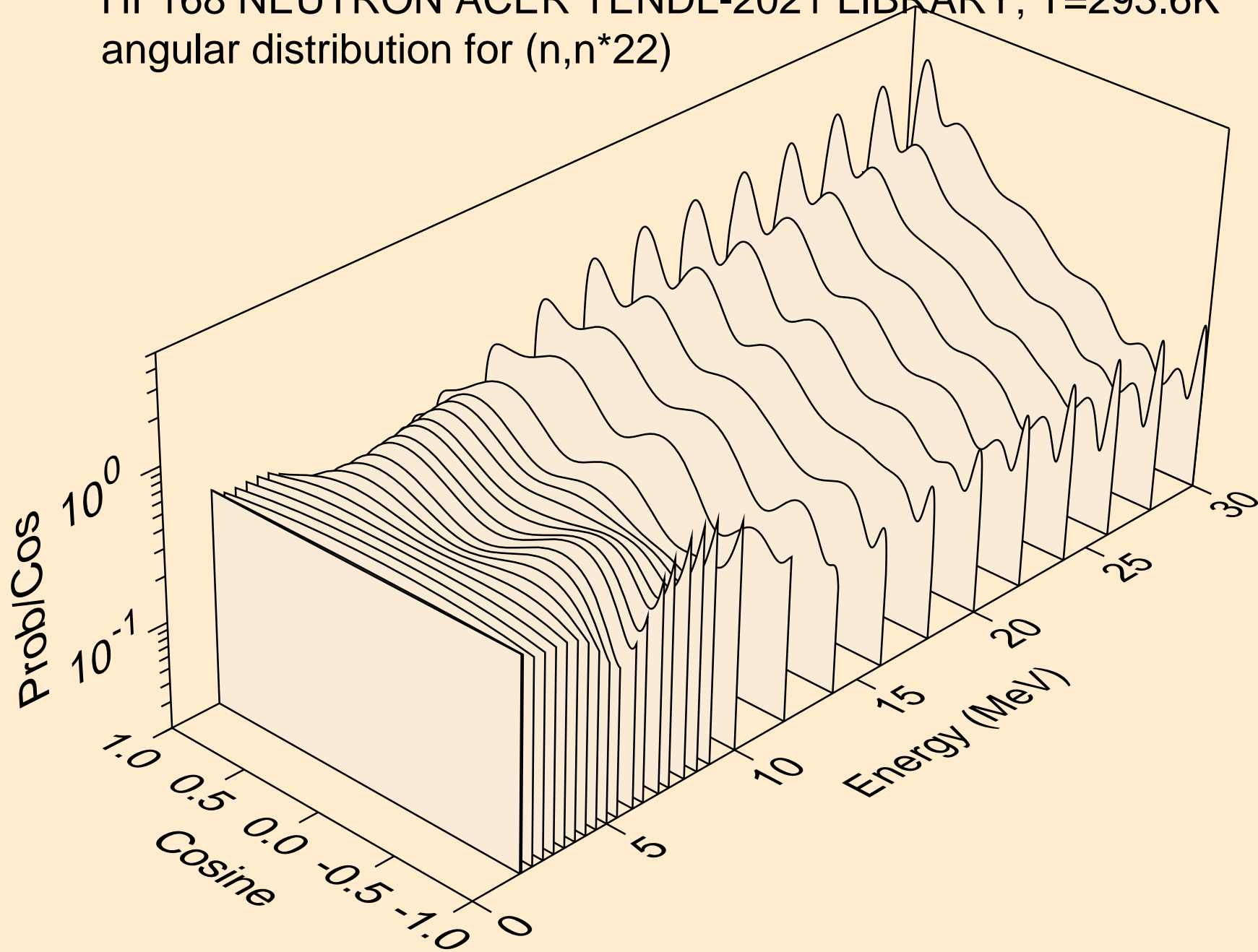

HF168 NEUTRON ACER TENDL-2021 LIBRARY; T=293.6K
angular distribution for (n,n*23)

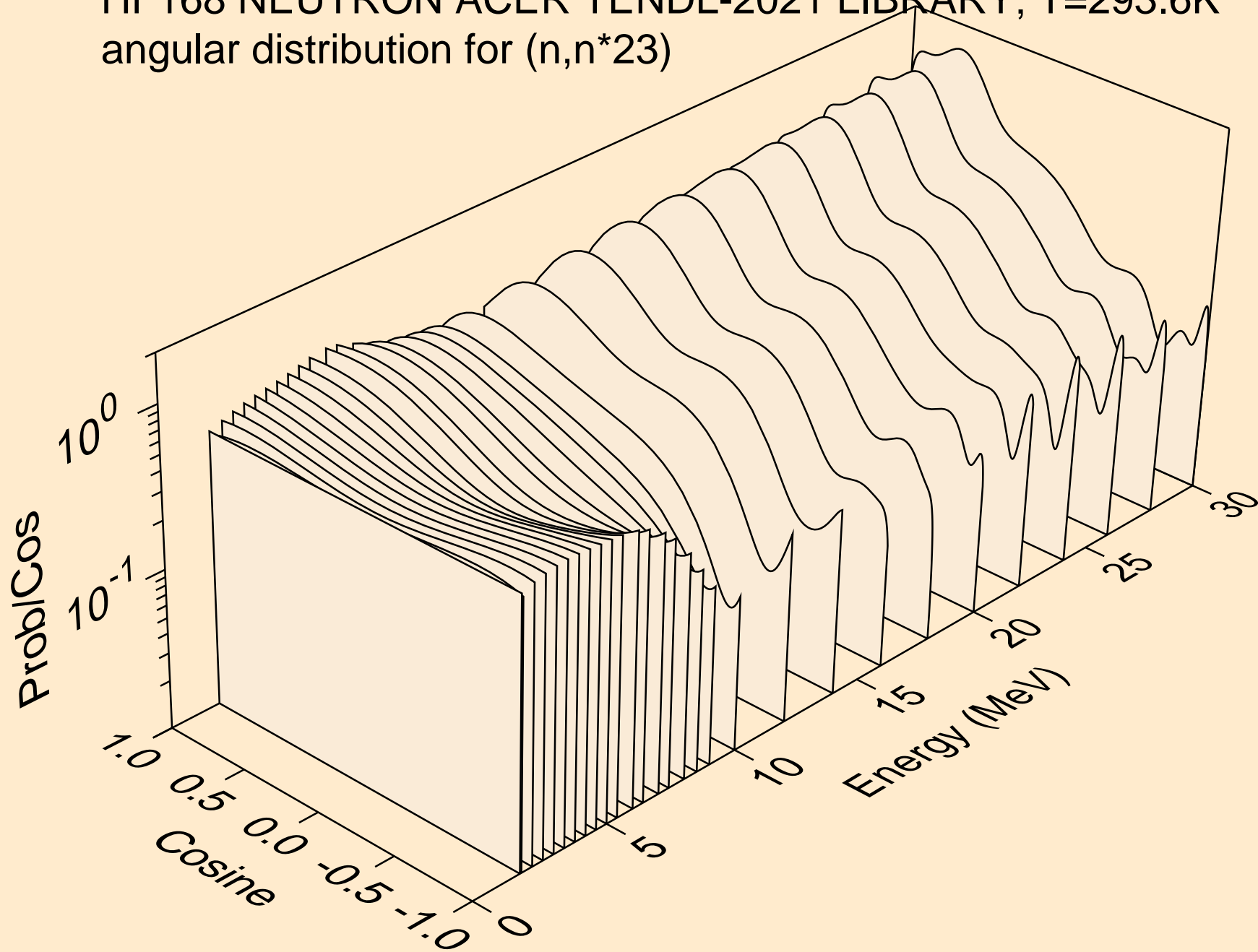

HF168 NEUTRON ACER TENDL-2021 LIBRARY; T=293.6K
angular distribution for (n,n*24)

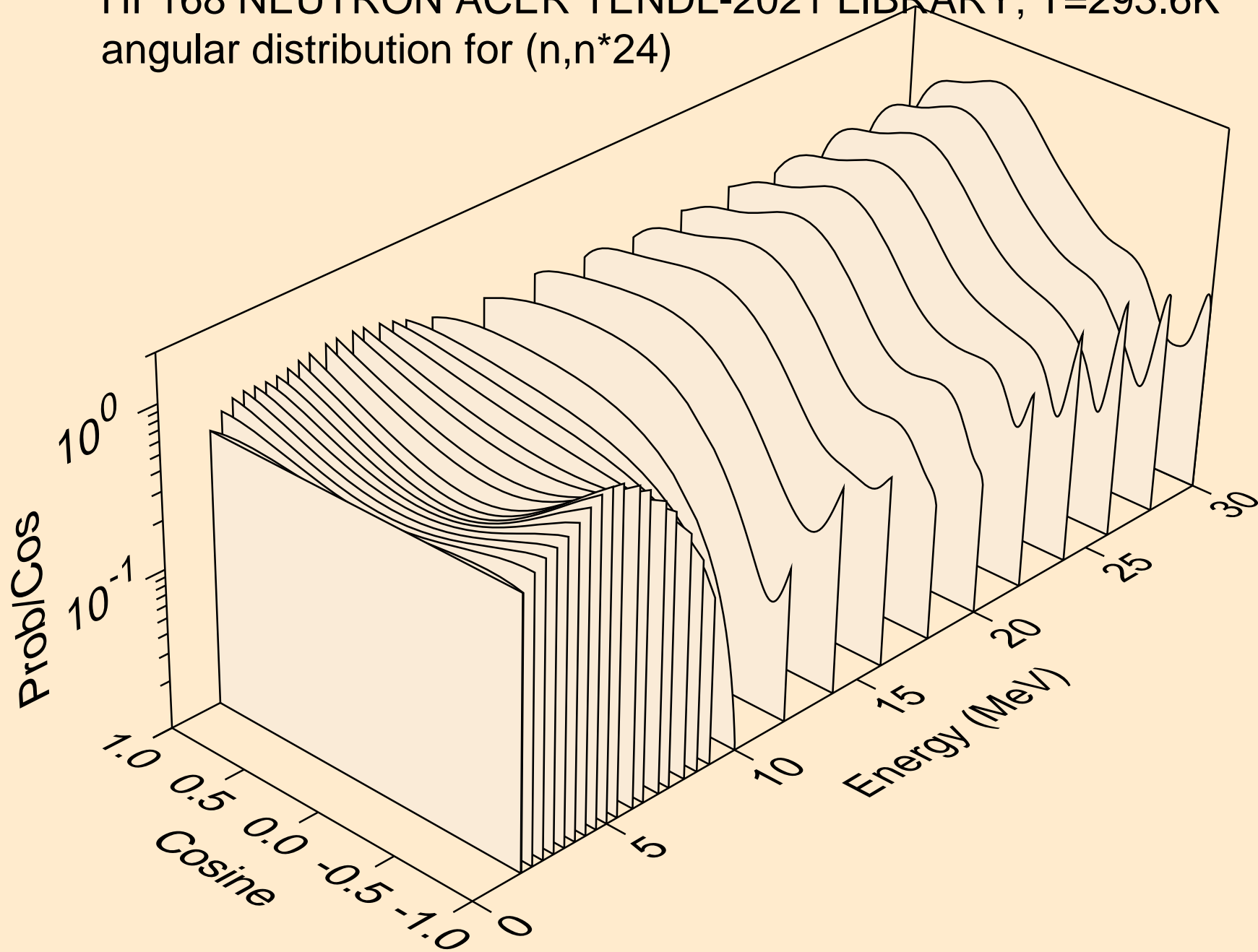

HF168 NEUTRON ACER TENDL-2021 LIBRARY; T=293.6K
angular distribution for (n,n*25)

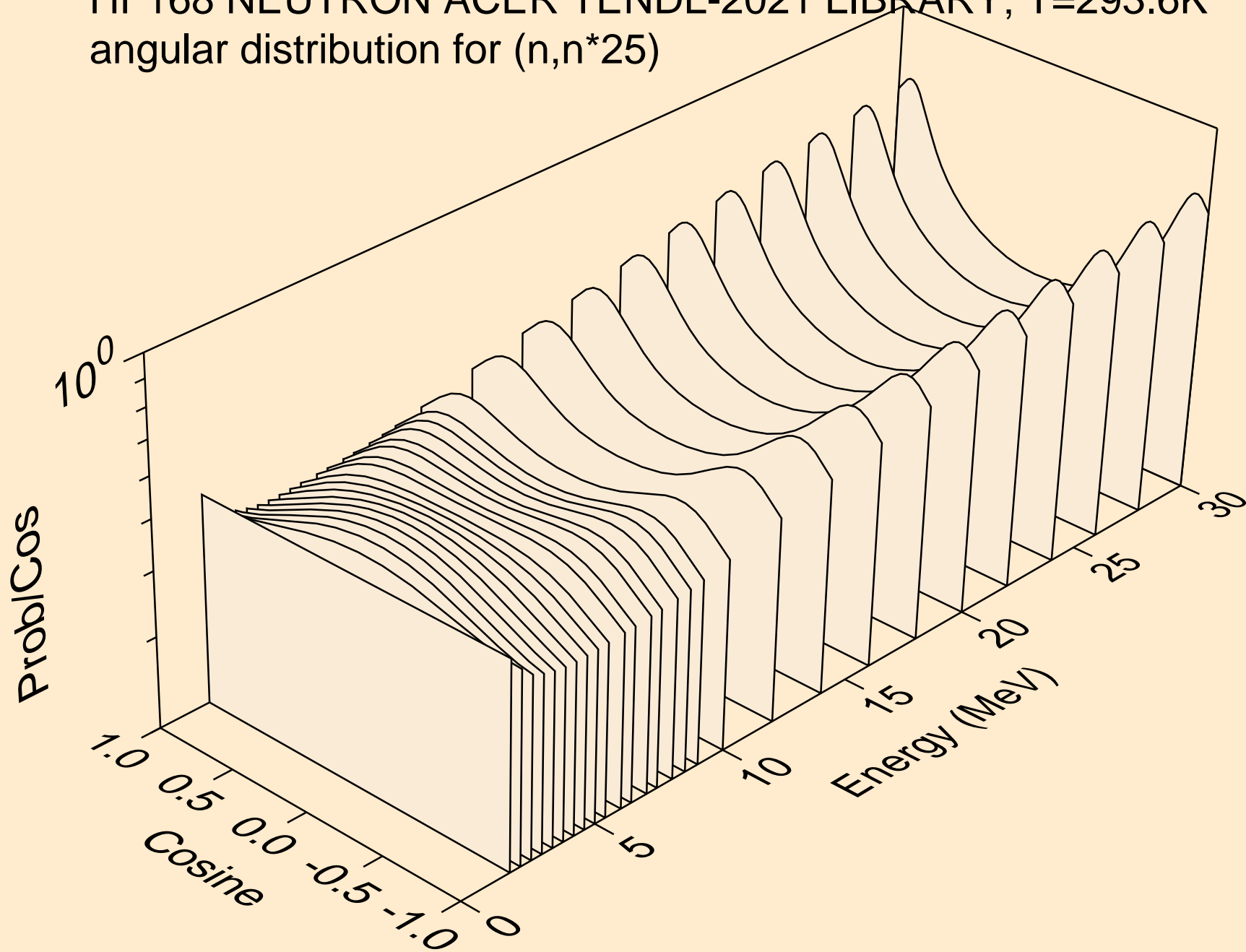

HF168 NEUTRON ACER TENDL-2021 LIBRARY; T=293.6K
angular distribution for (n,n*26)

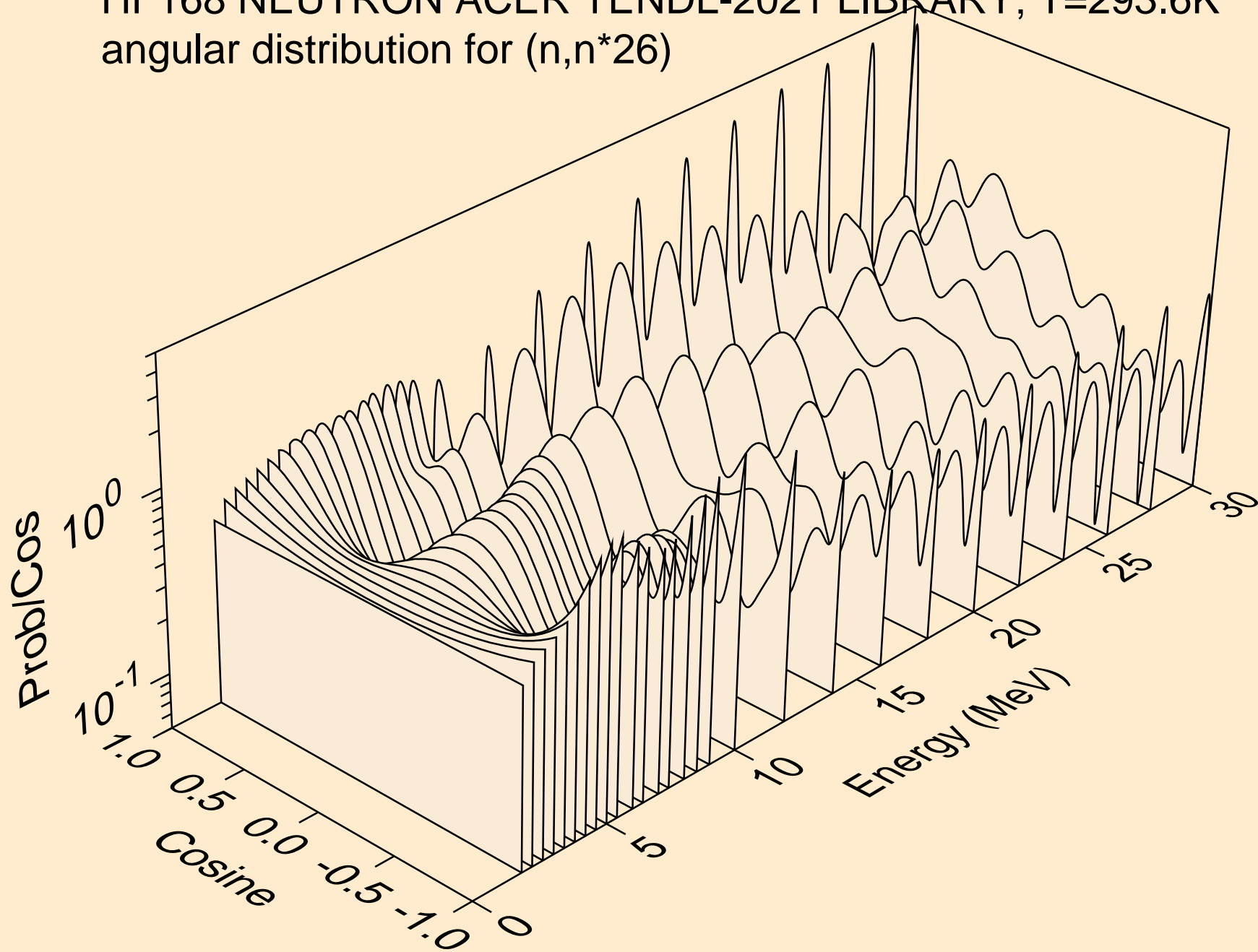

HF168 NEUTRON ACER TENDL-2021 LIBRARY; T=293.6K
angular distribution for (n,n*27)

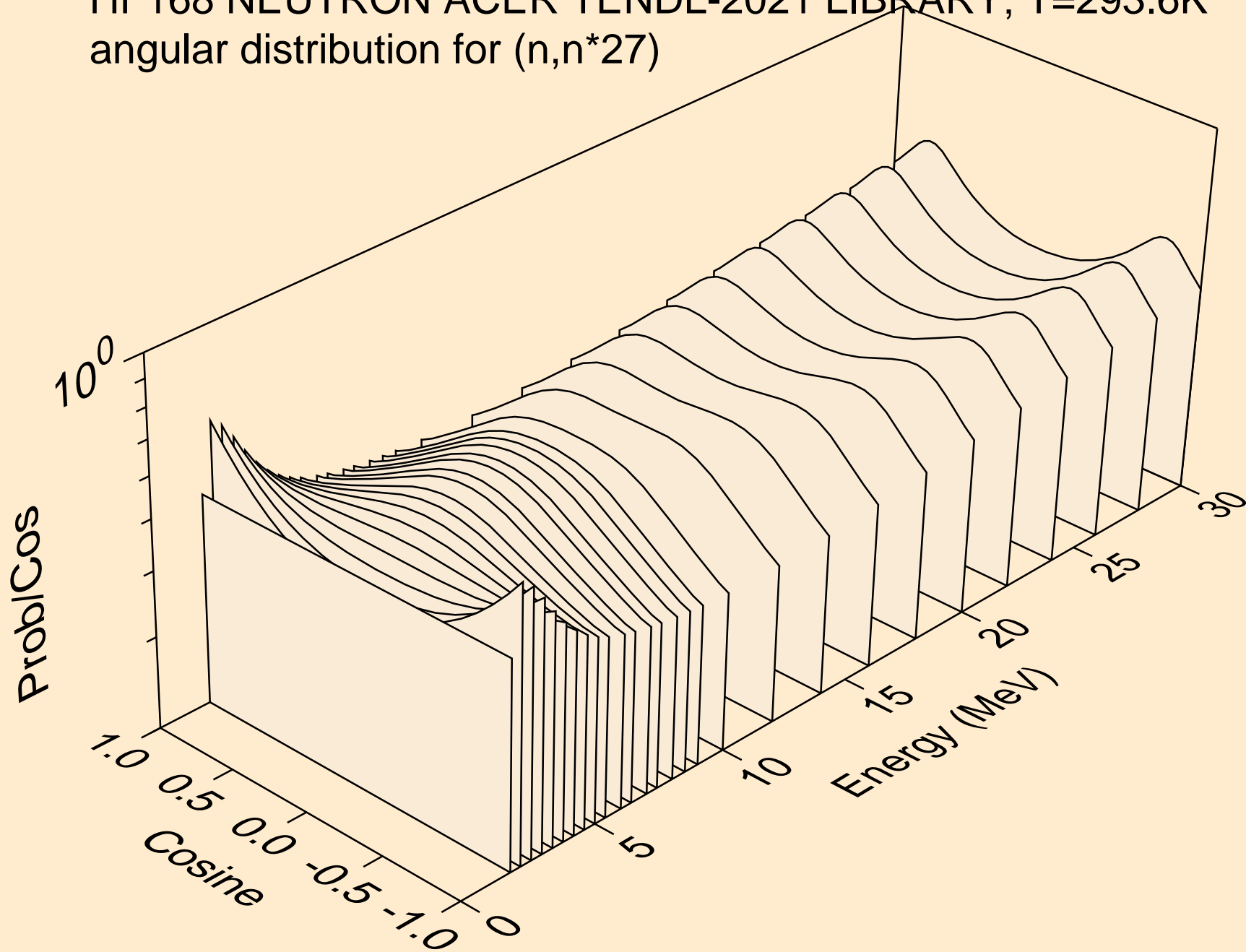

HF168 NEUTRON ACER TENDL-2021 LIBRARY; T=293.6K
angular distribution for (n,n*28)

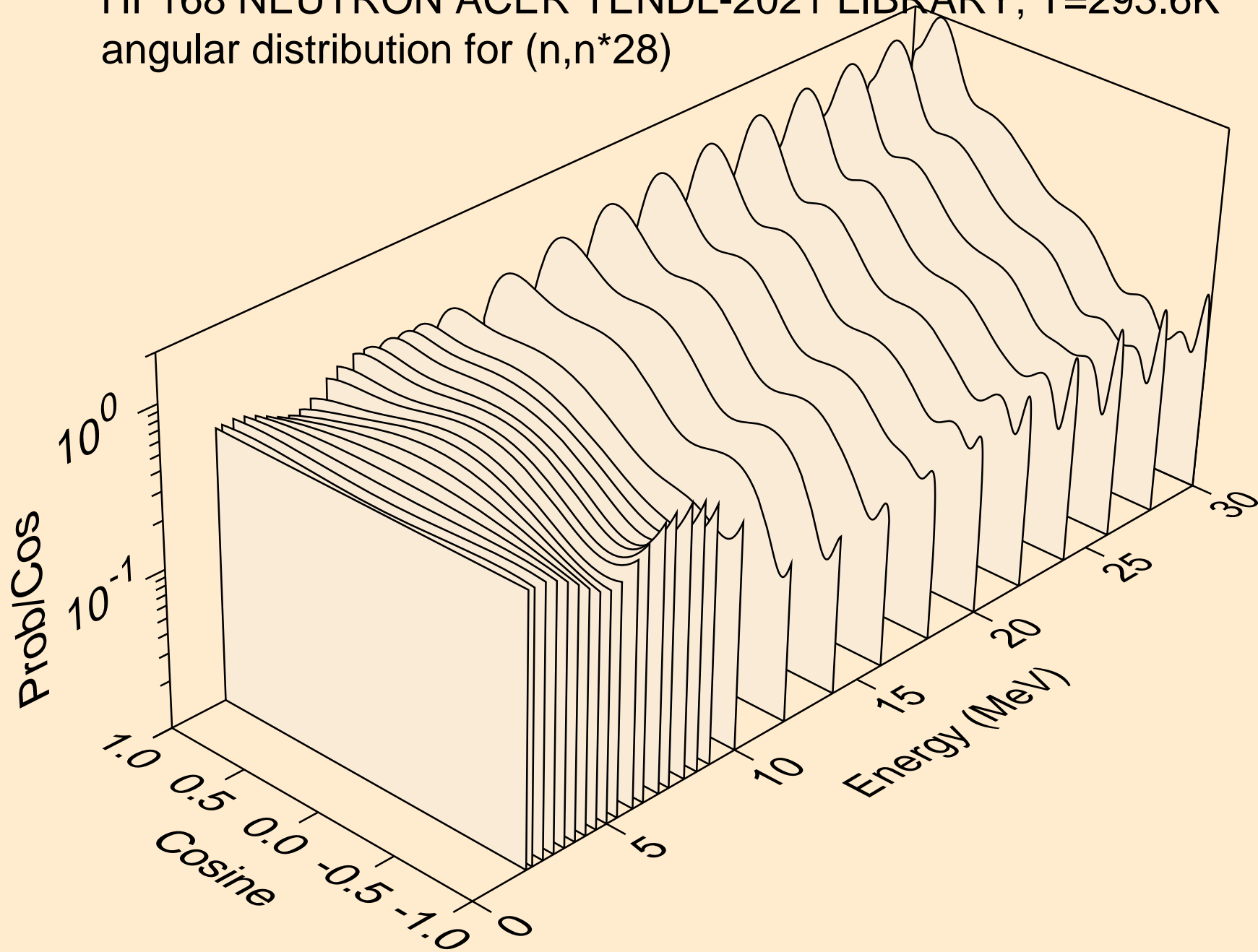

HF168 NEUTRON ACER TENDL-2021 LIBRARY; T=293.6K
angular distribution for (n,n*29)

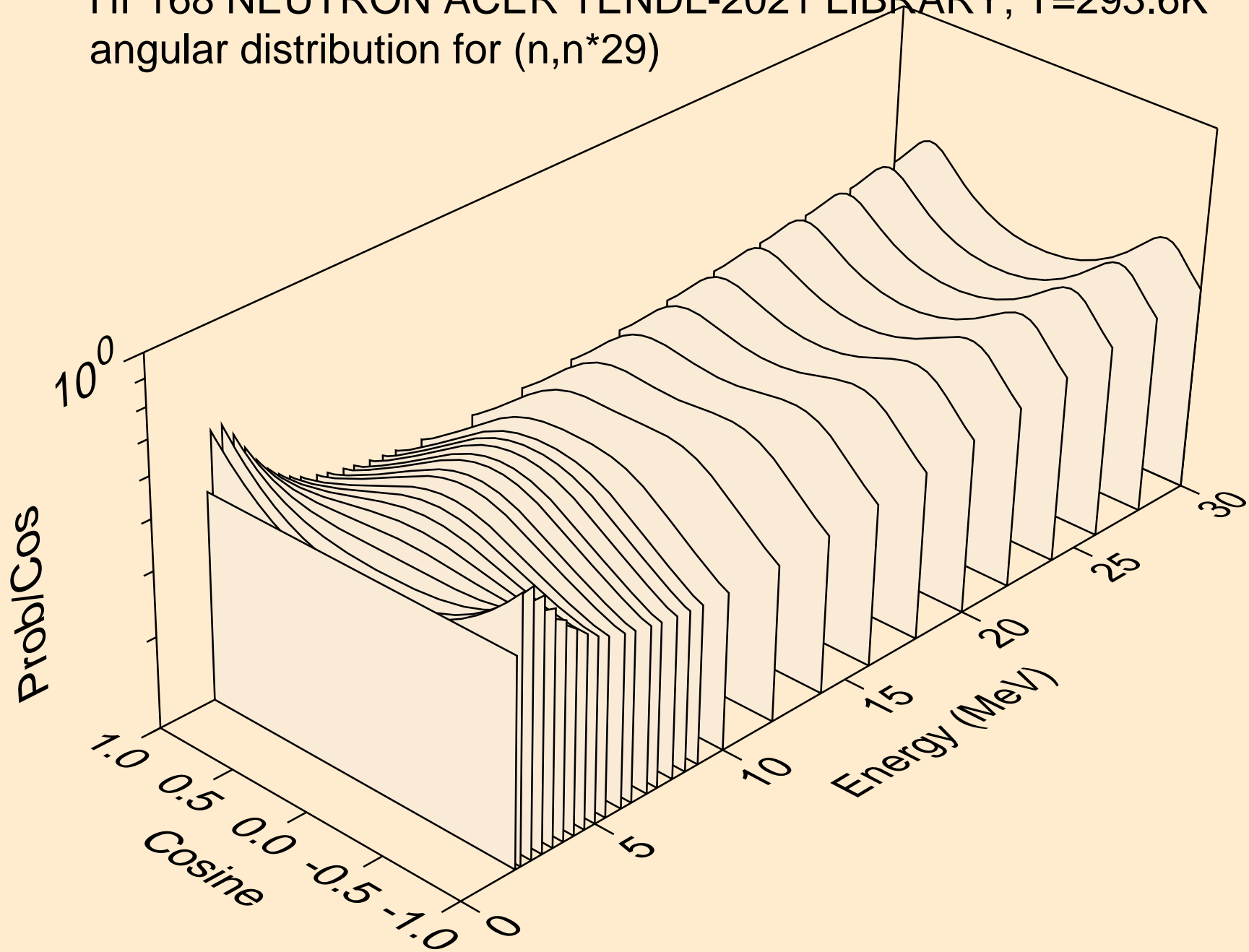

HF168 NEUTRON ACER TENDL-2021 LIBRARY; T=293.6K
angular distribution for (n,n*30)

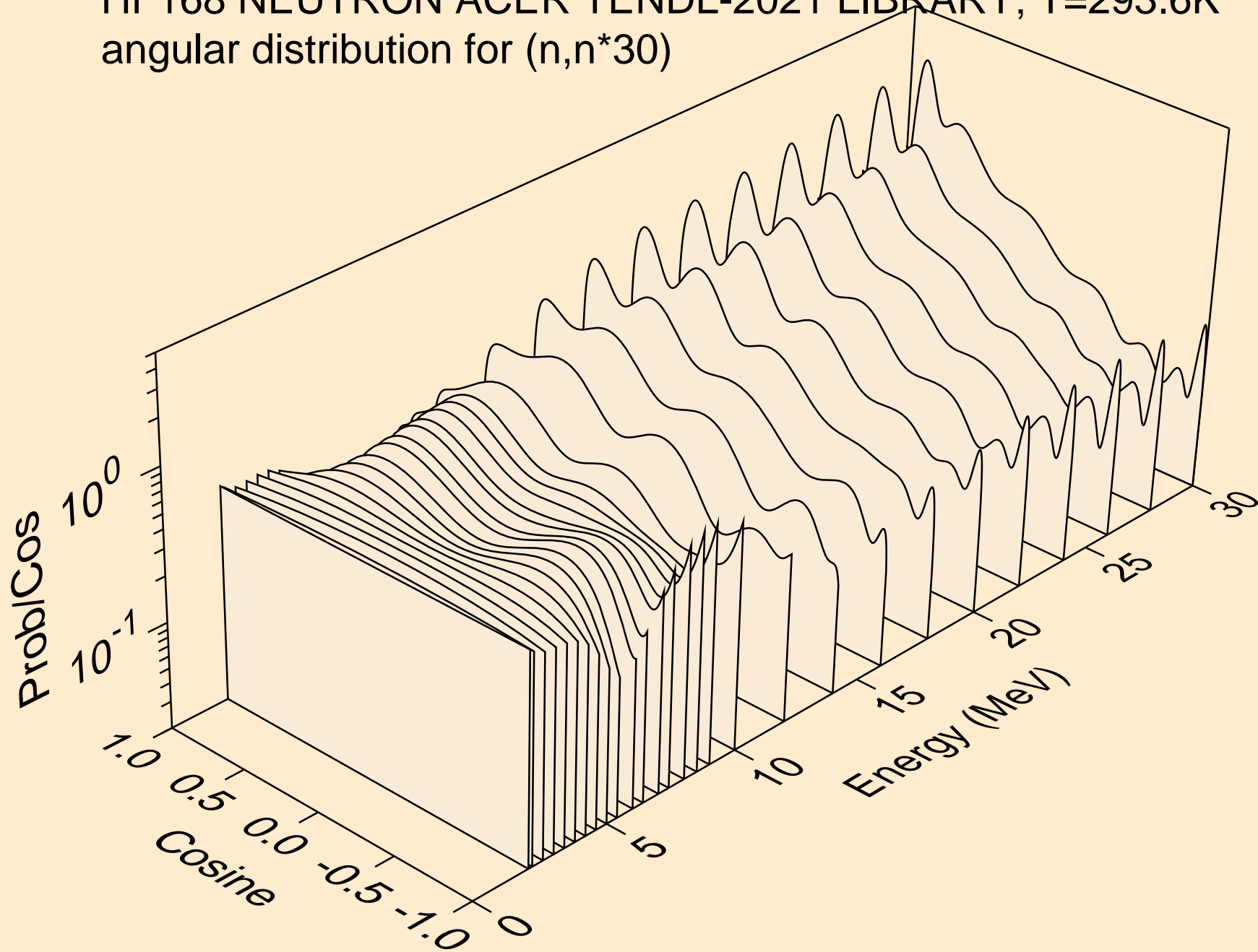

HF168 NEUTRON ACER TENDL-2021 LIBRARY; T=293.6K
Neutron emission for (n,x)

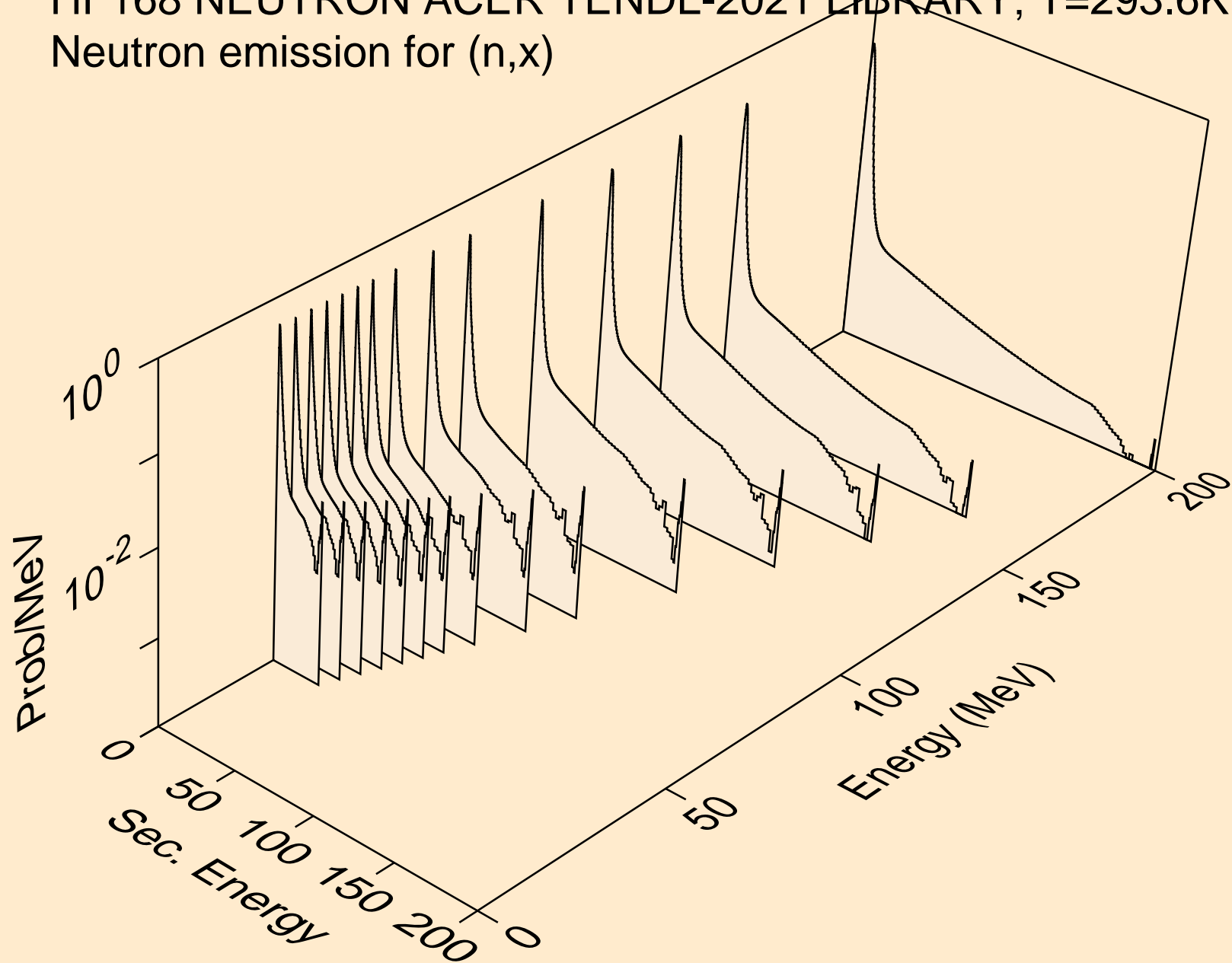

HF168 NEUTRON ACER TENDL-2021 LIBRARY; T=293.6K
Neutron emission for (n,2nd)

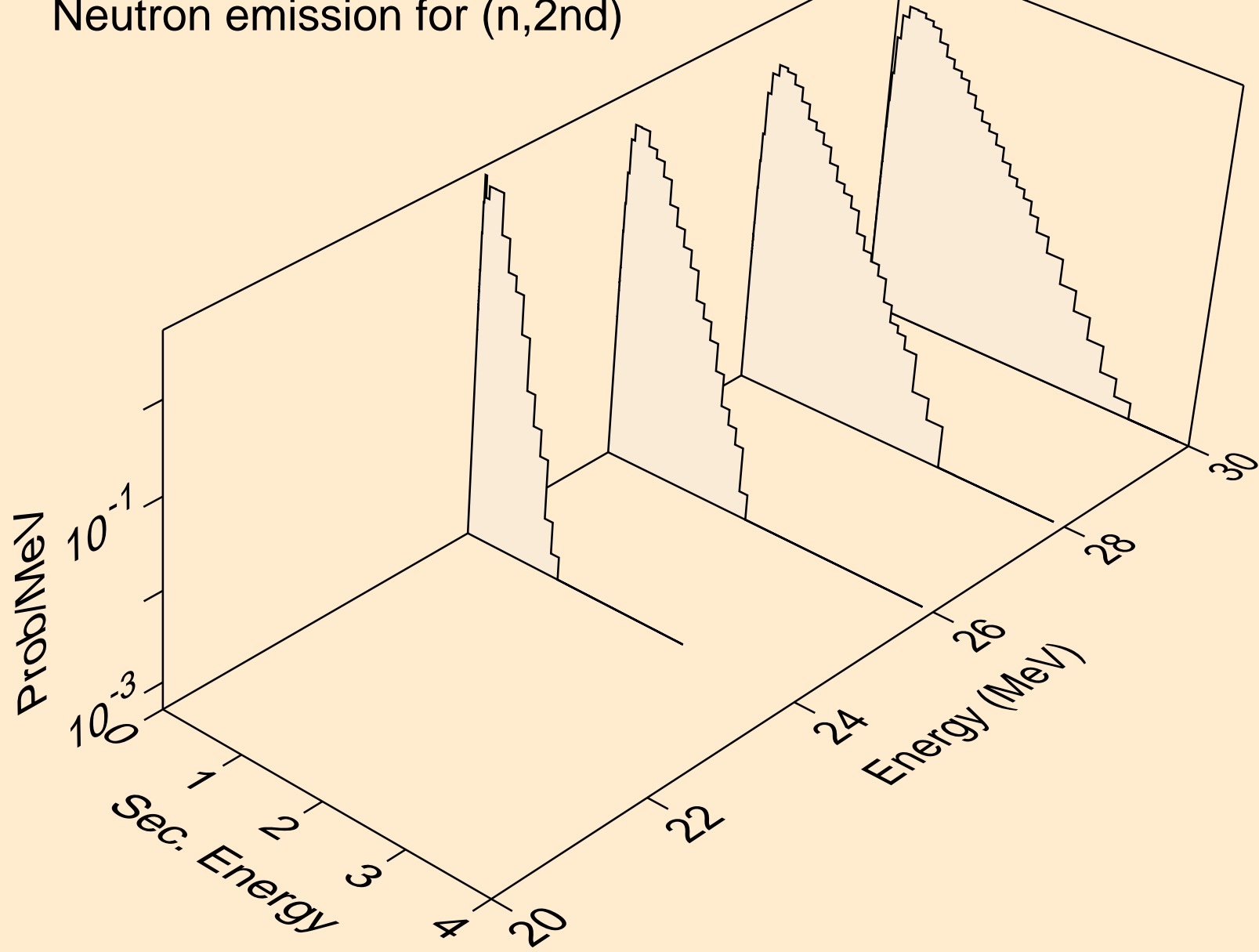

HF168 NEUTRON ACER TENDL-2021 LIBRARY; T=293.6K
Neutron emission for (n,2n)

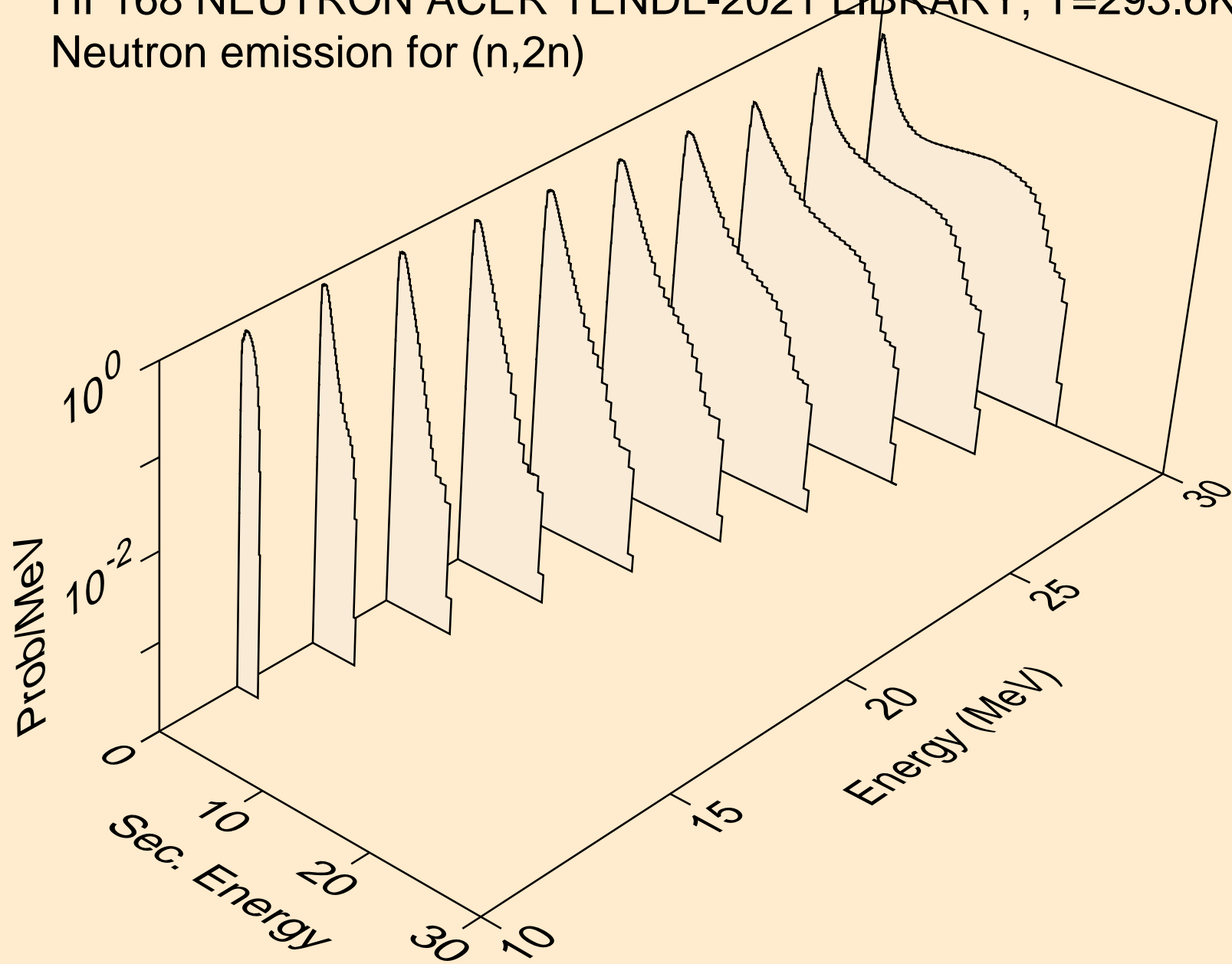

HF168 NEUTRON ACER TENDL-2021 LIBRARY; T=293.6K
Neutron emission for (n,3n)

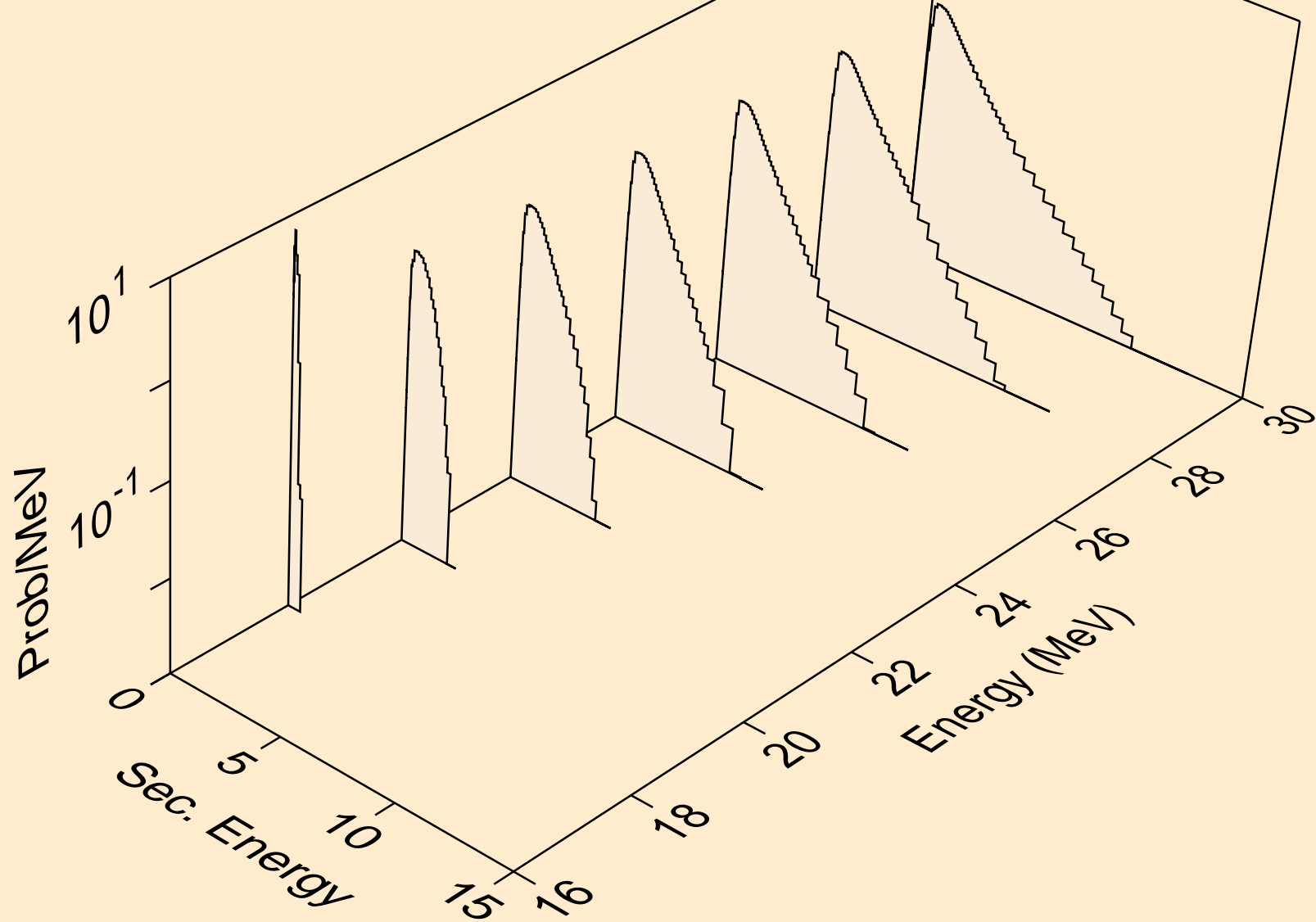

HF168 NEUTRON ACER TENDL-2021 LIBRARY; T=293.6K
Neutron emission for (n,n*)a

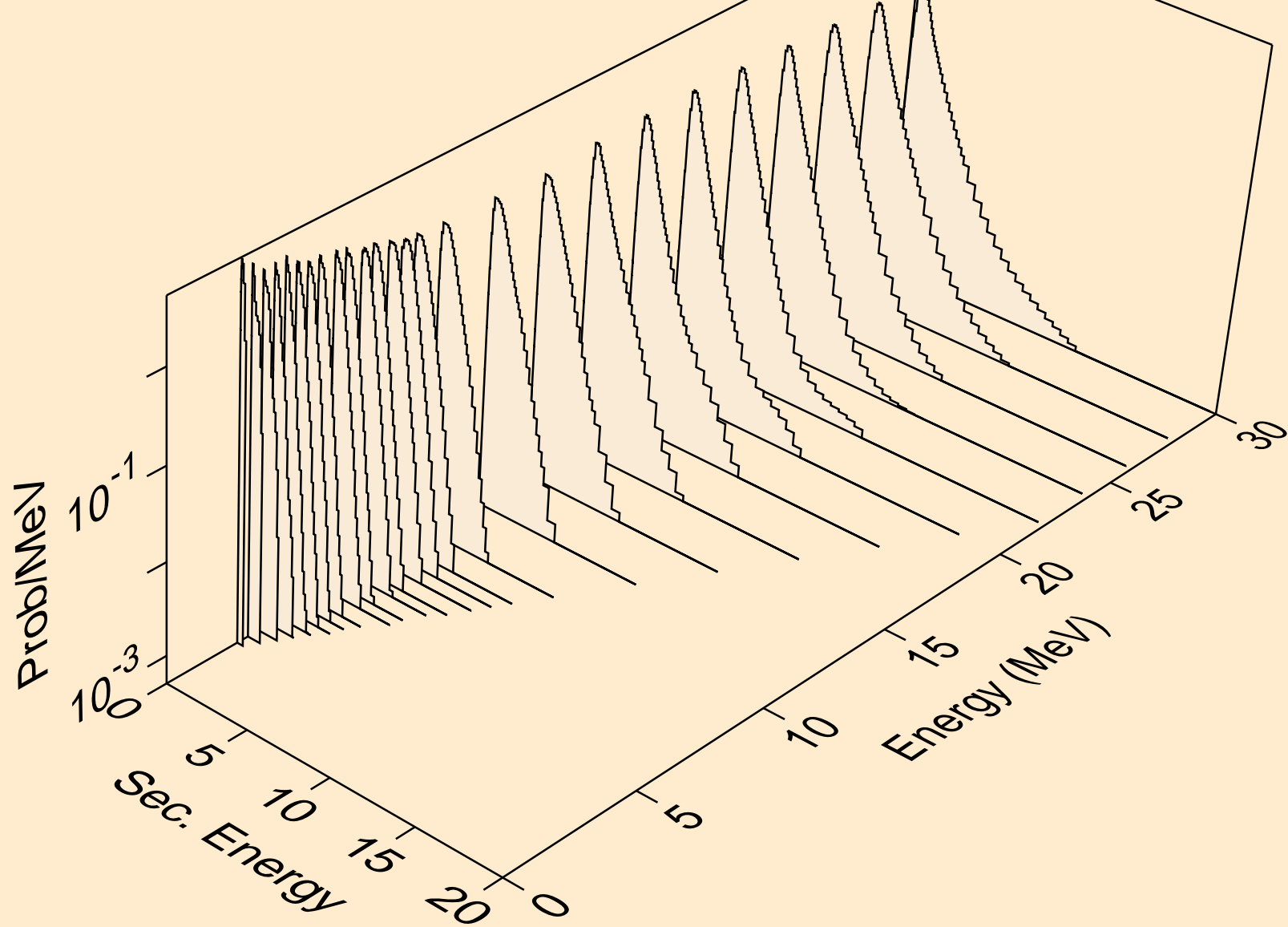

HF168 NEUTRON ACER TENDL-2021 LIBRARY; T=293.6K
Neutron emission for (n,2n)_a

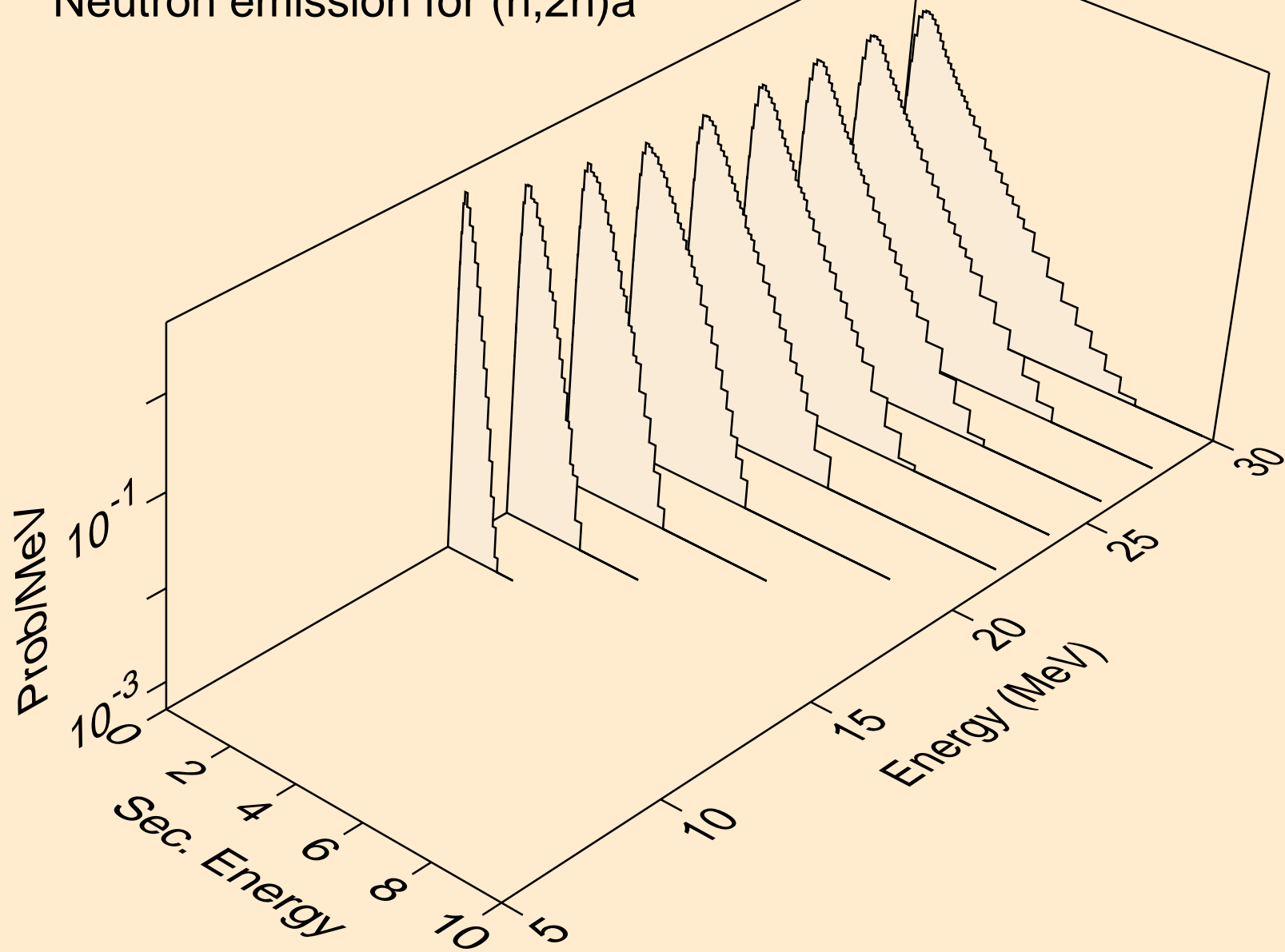

HF168 NEUTRON ACER TENDL-2021 LIBRARY; T=293.6K
Neutron emission for (n,3n)a

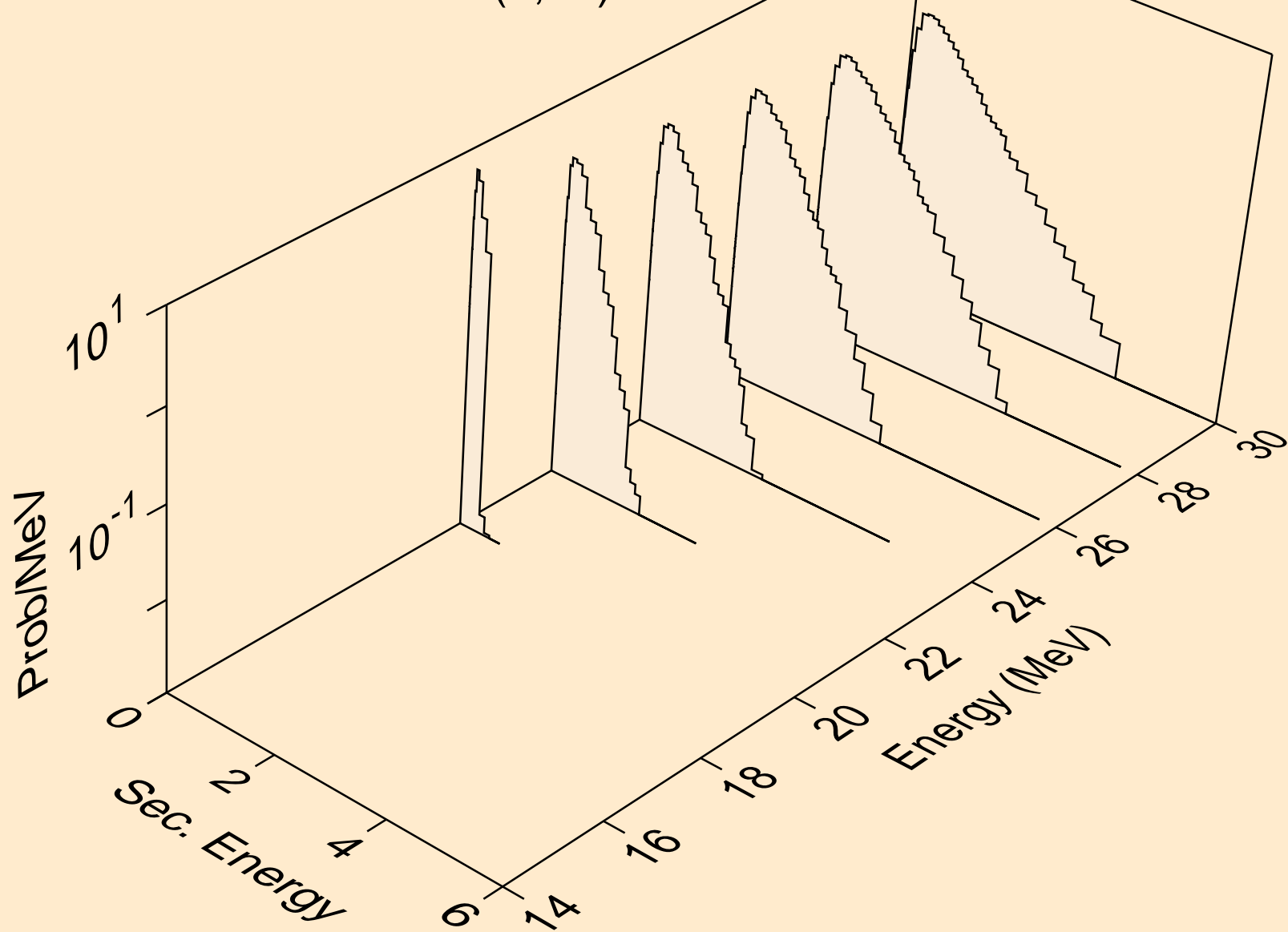

HF168 NEUTRON ACER TENDL-2021 LIBRARY; T=293.6K
Neutron emission for (n,n*)p

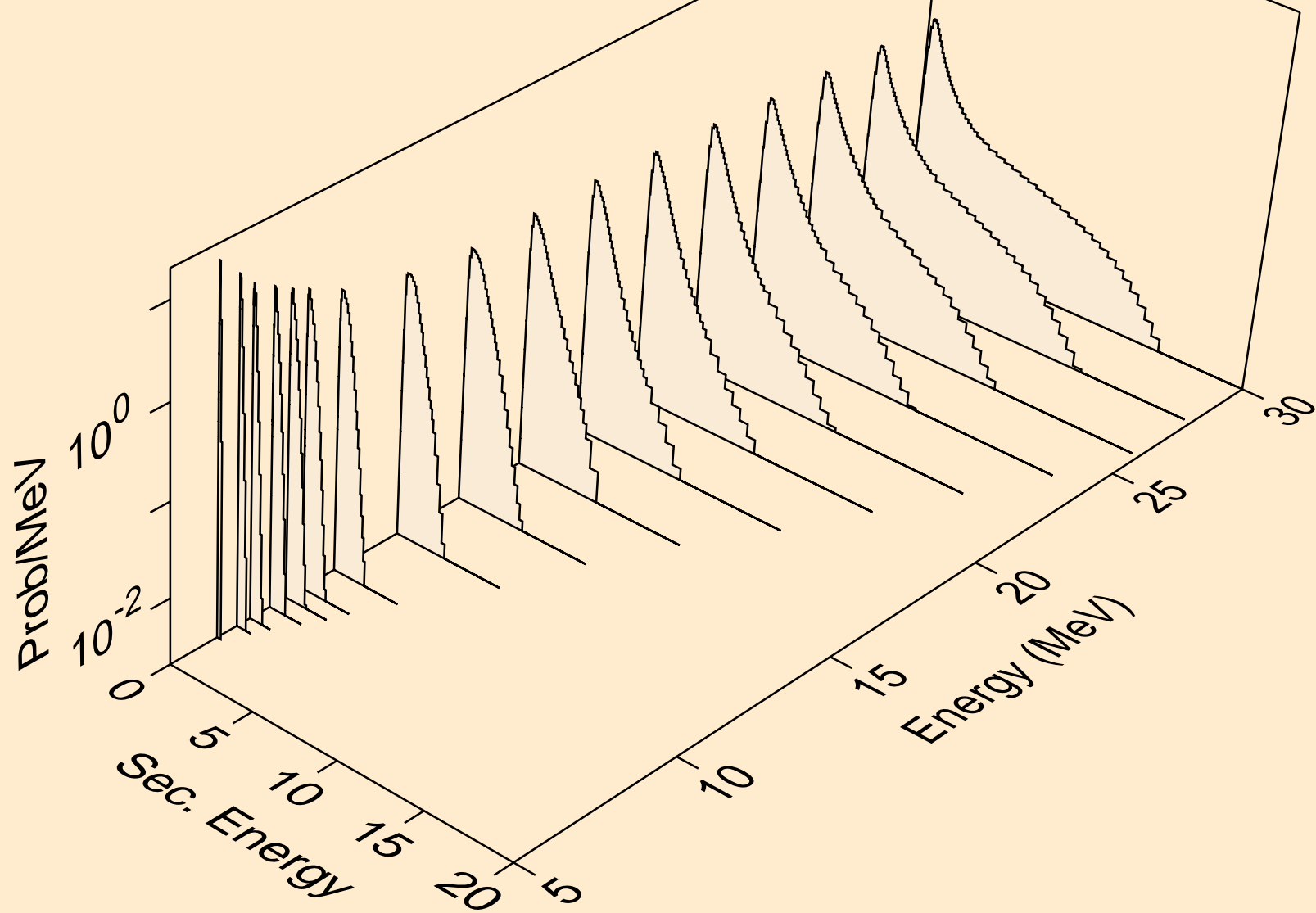

HF168 NEUTRON ACER TENDL-2021 LIBRARY; T=293.6K
Neutron emission for (n,n*)2a

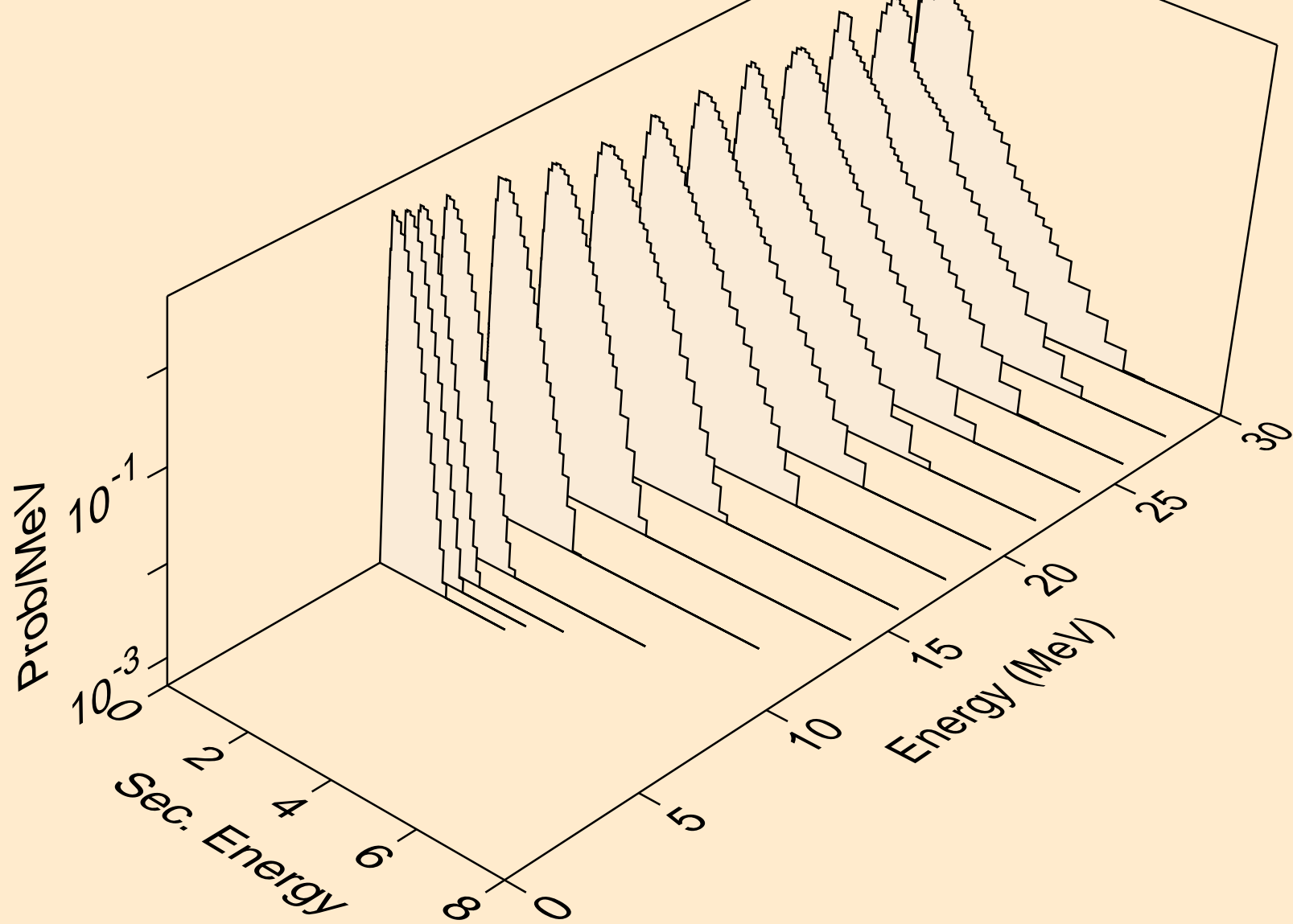

HF168 NEUTRON ACER TENDL-2021 LIBRARY; T=293.6K
Neutron emission for (n,2n)2a

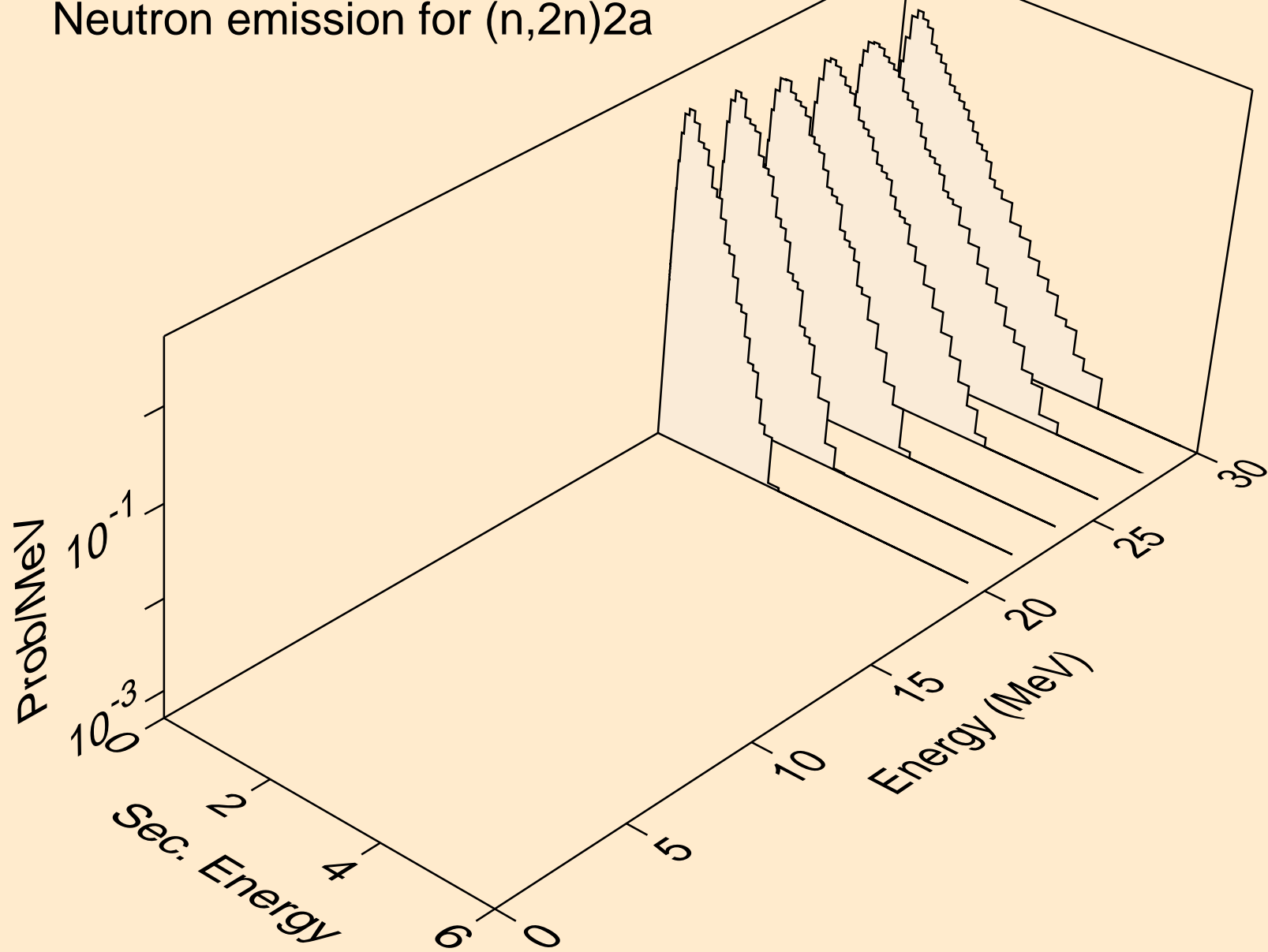

HF168 NEUTRON ACER TENDL-2021 LIBRARY; T=293.6K
Neutron emission for (n,n*)d

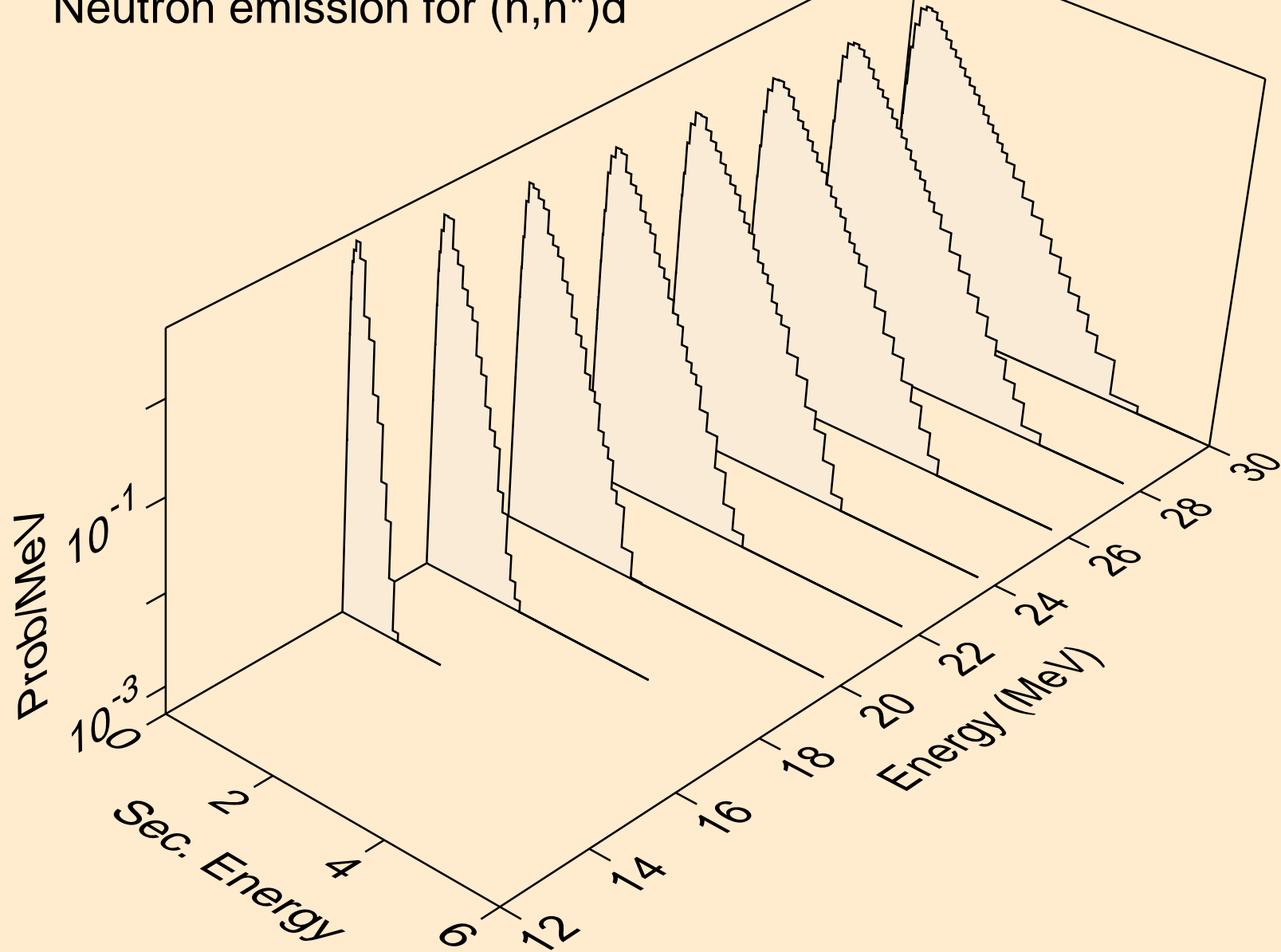

HF168 NEUTRON ACER TENDL-2021 LIBRARY; T=293.6K
Neutron emission for (n,n*)t

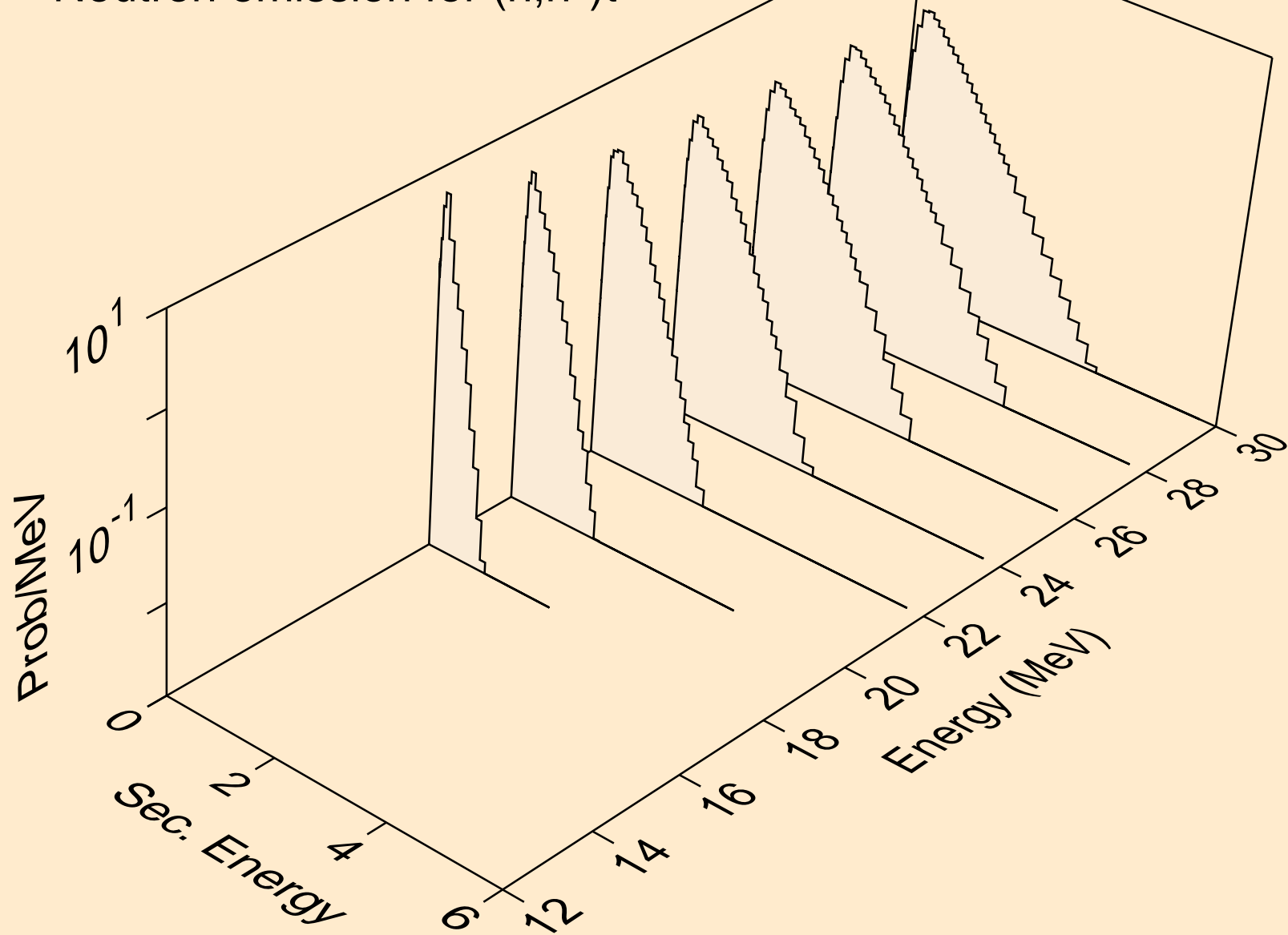

HF168 NEUTRON ACER TENDL-2021 LIBRARY; T=293.6K
Neutron emission for (n,n*)he3

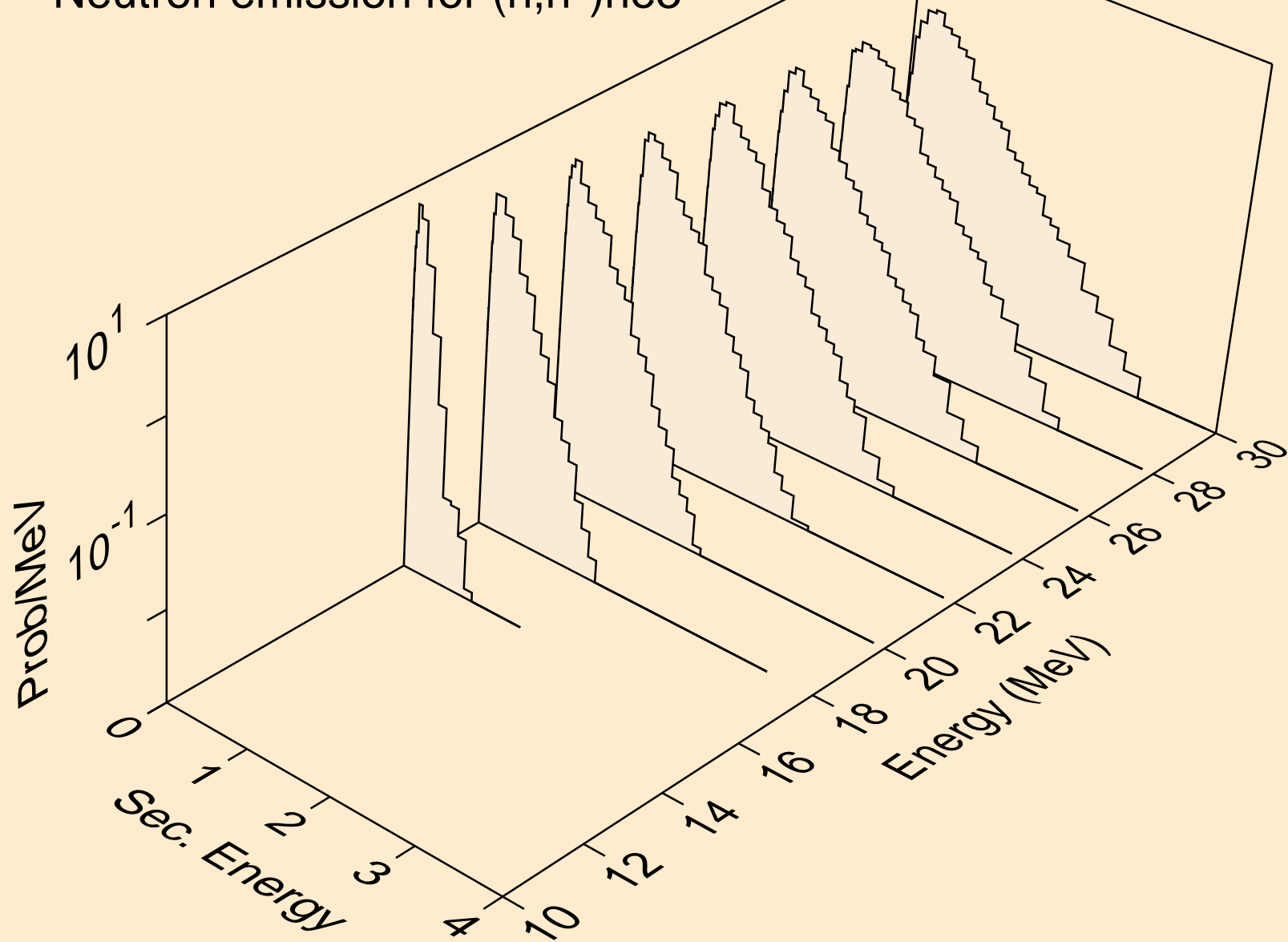

HF168 NEUTRON ACER TENDL-2021 LIBRARY; T=293.6K
Neutron emission for (n,4n)

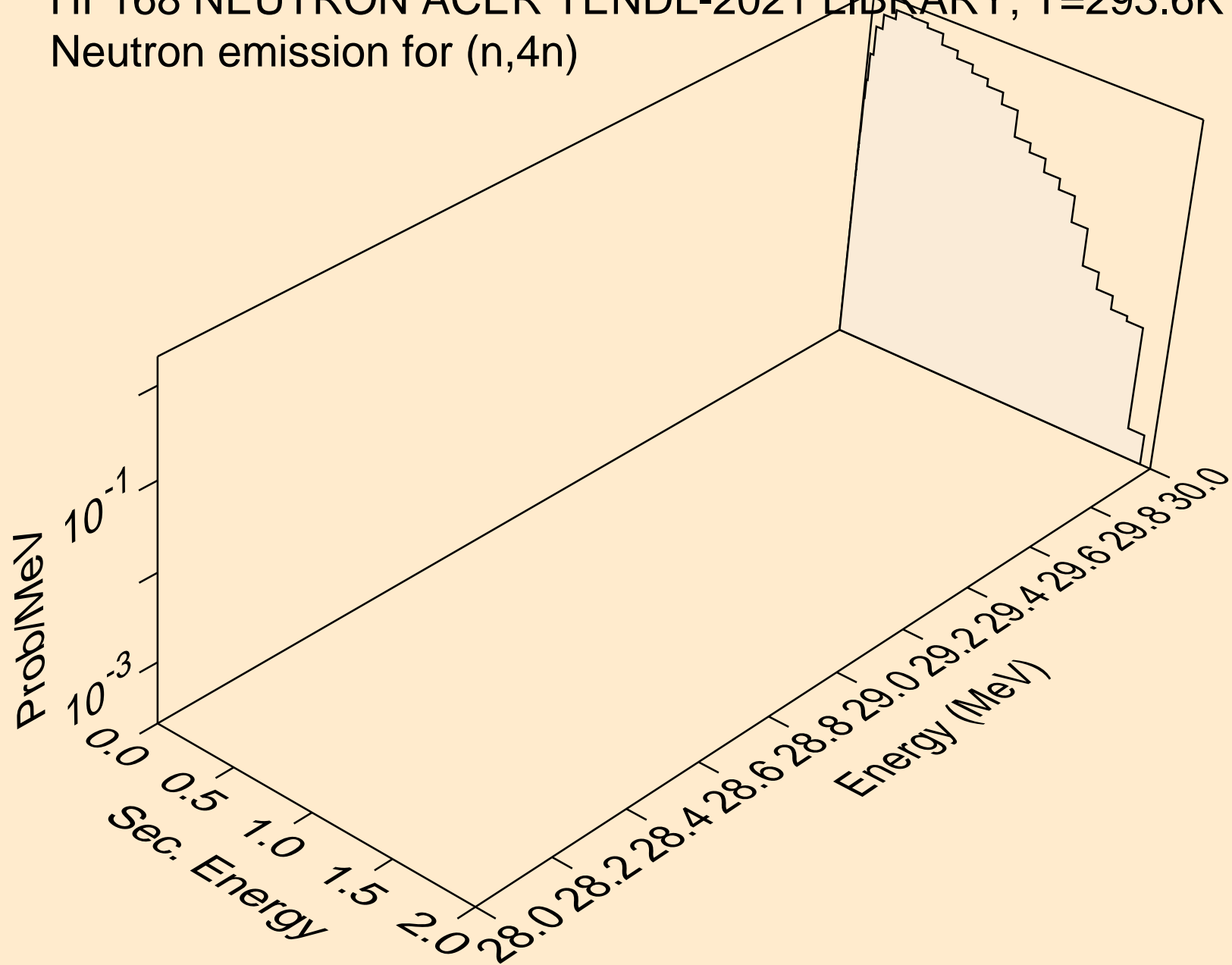

HF168 NEUTRON ACER TENDL-2021 LIBRARY; T=293.6K
Neutron emission for (n,2np)

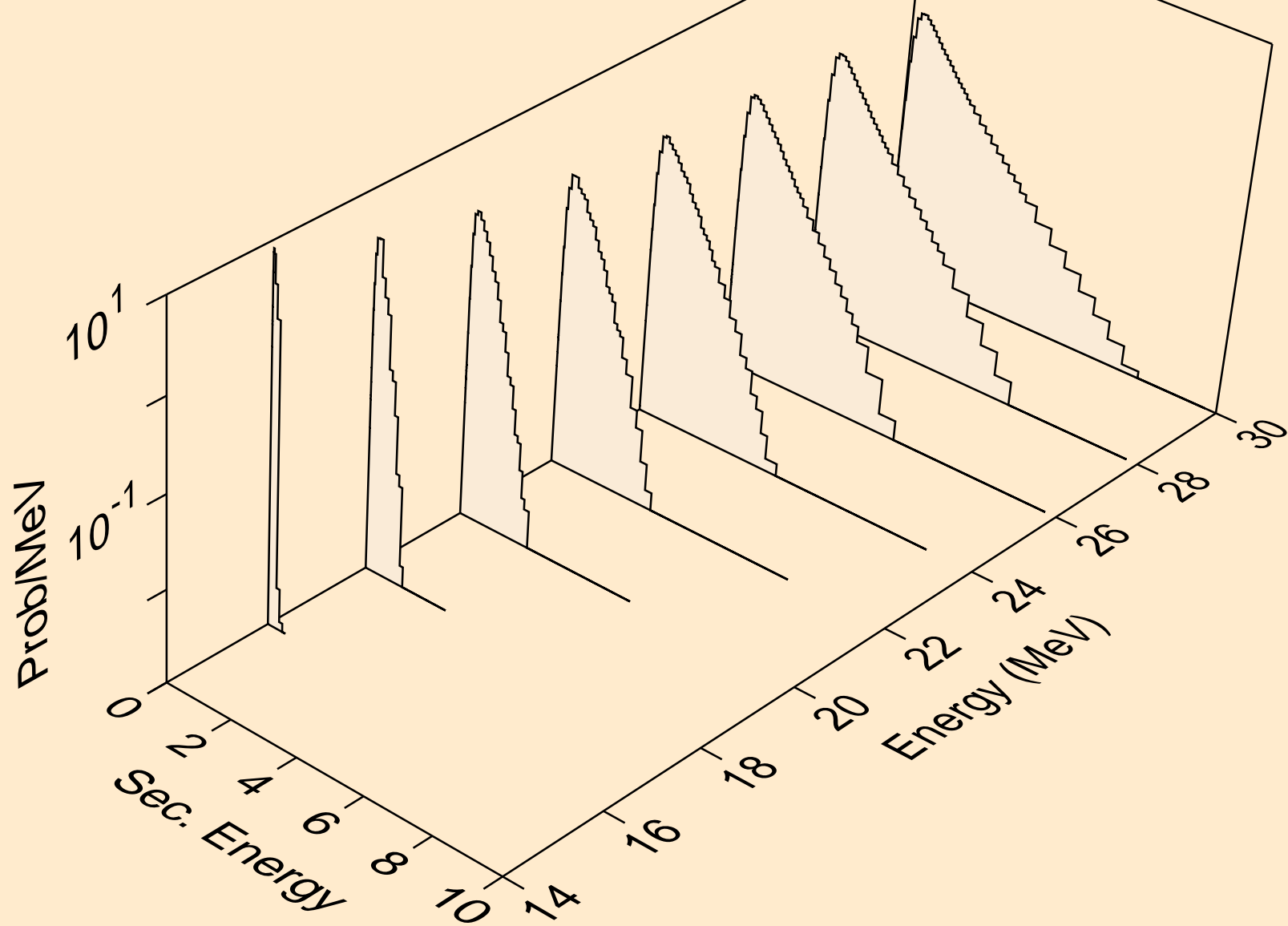

HF168 NEUTRON ACER TENDL-2021 LIBRARY; T=293.6K
Neutron emission for (n,3np)

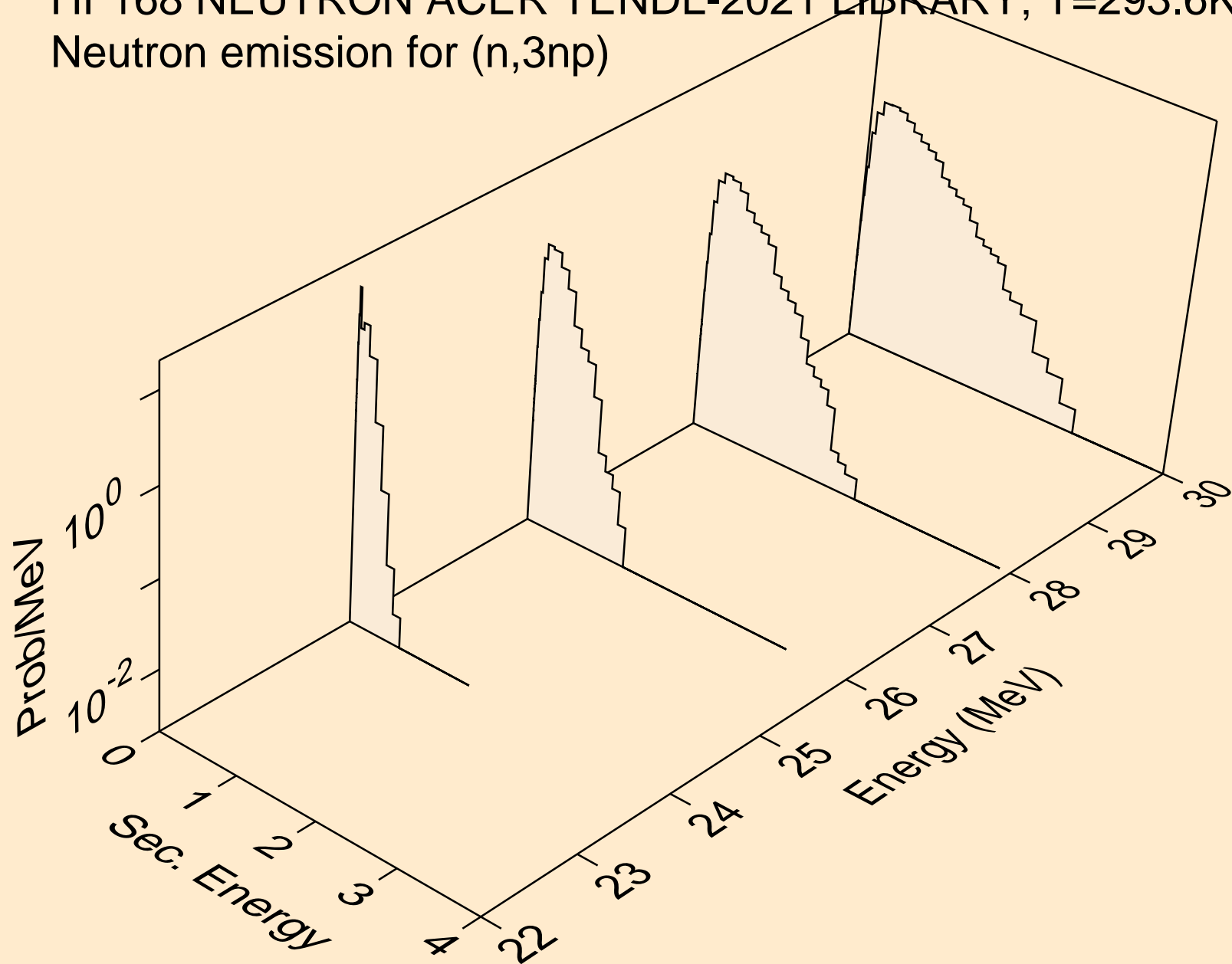

HF168 NEUTRON ACER TENDL-2021 LIBRARY; T=293.6K
Neutron emission for (n,2np)

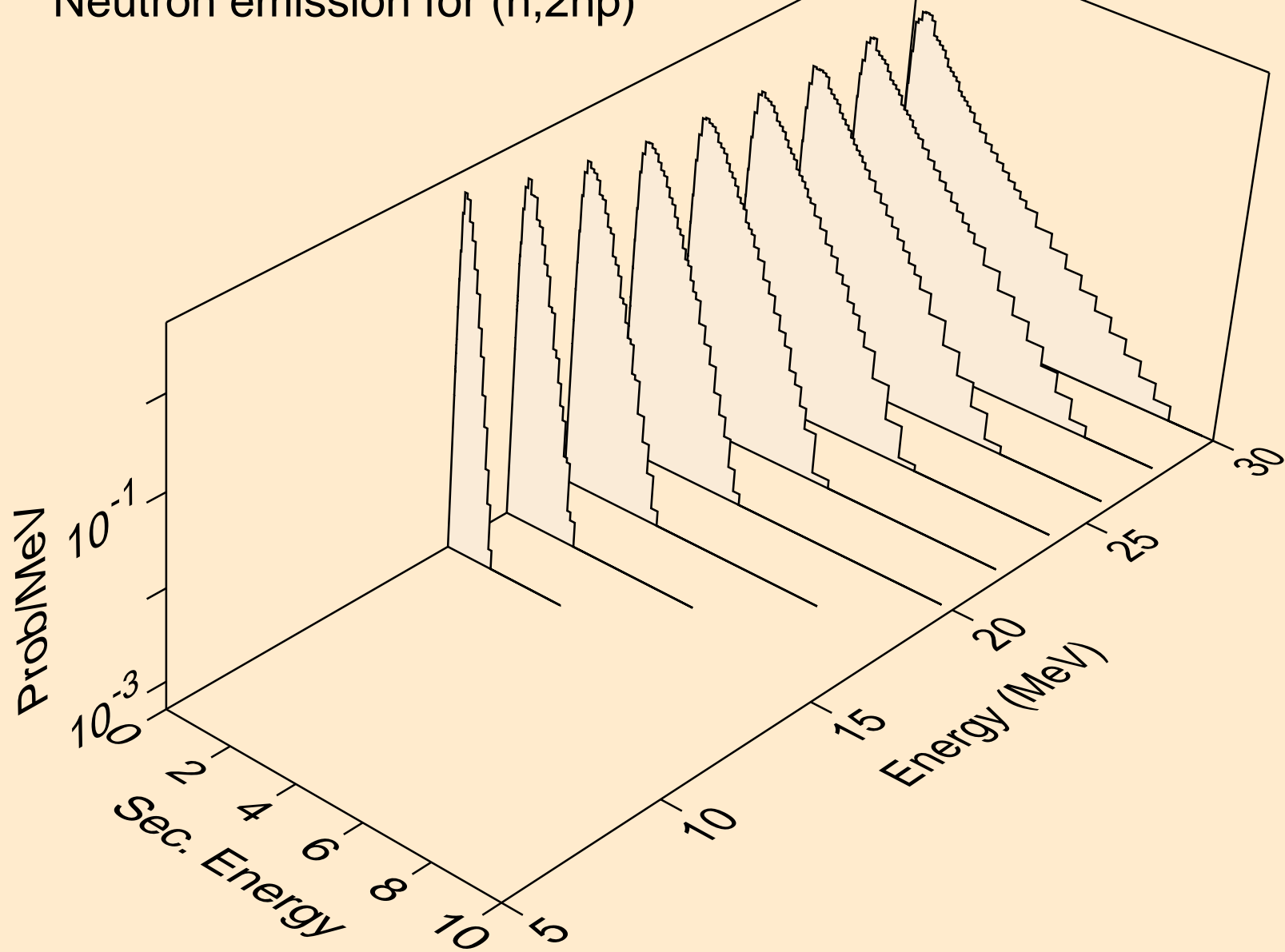

HF168 NEUTRON ACER TENDL-2021 LIBRARY; T=293.6K
Neutron emission for (n,npa)

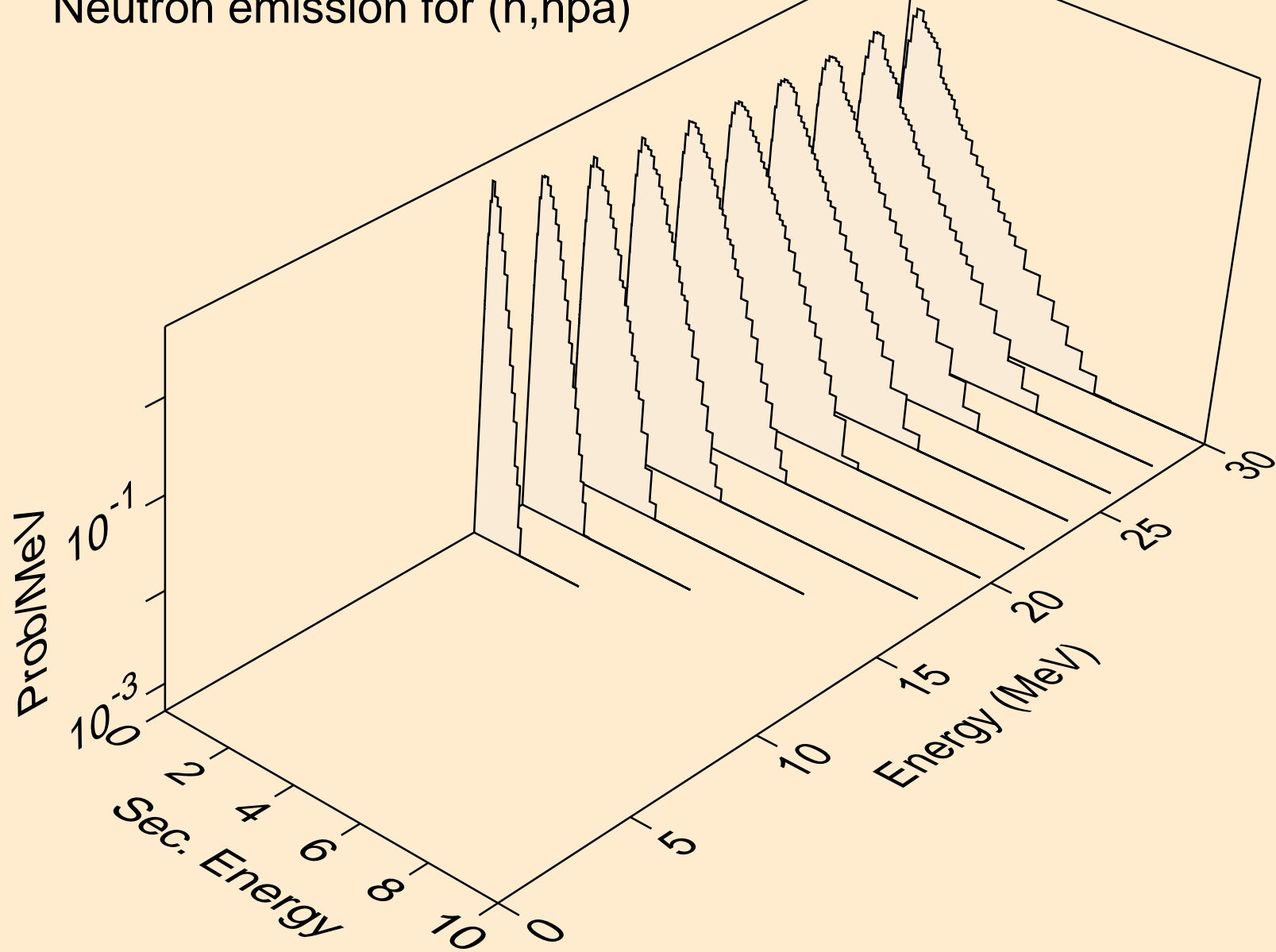

HF168 NEUTRON ACER TENDL-2021 LIBRARY; T=293.6K
Neutron emission for (n,n*c)

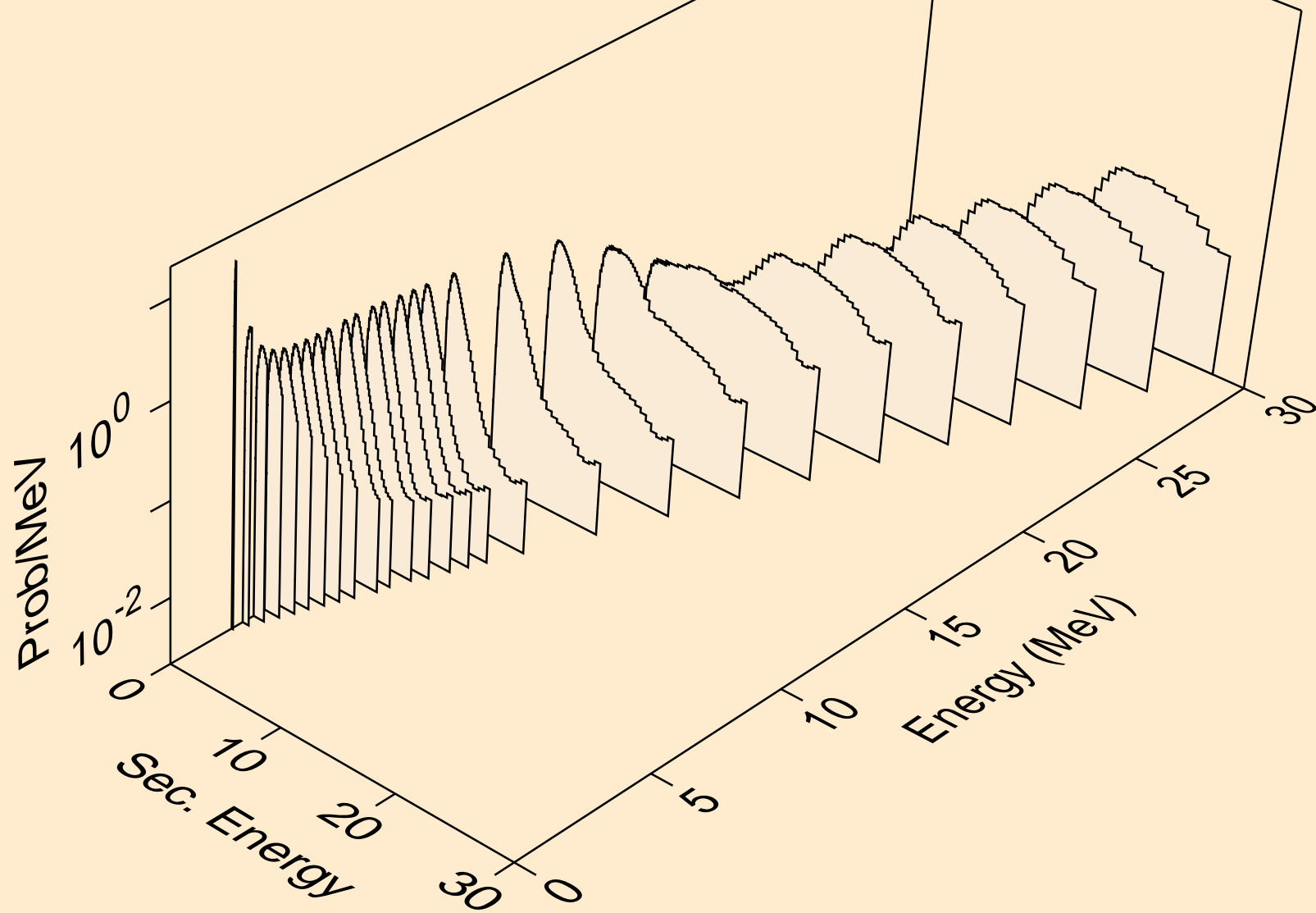

HF168 NEUTRON ACER TENDL-2021 LIBRARY; T=293.6K
Photon emission for (n,x)

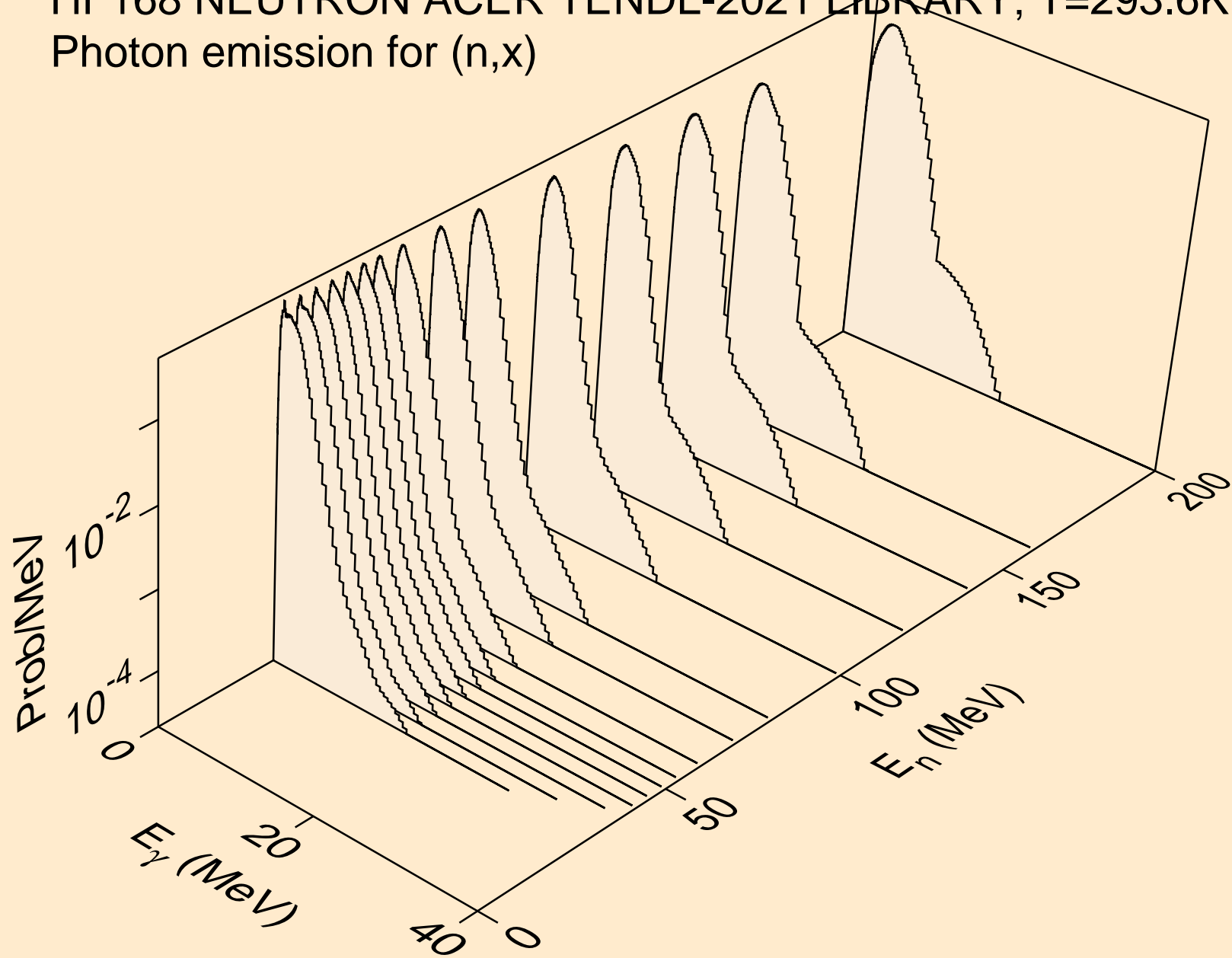

HF168 NEUTRON ACER TENDL-2021 LIBRARY; T=293.6K
Photon emission for (n,2nd)

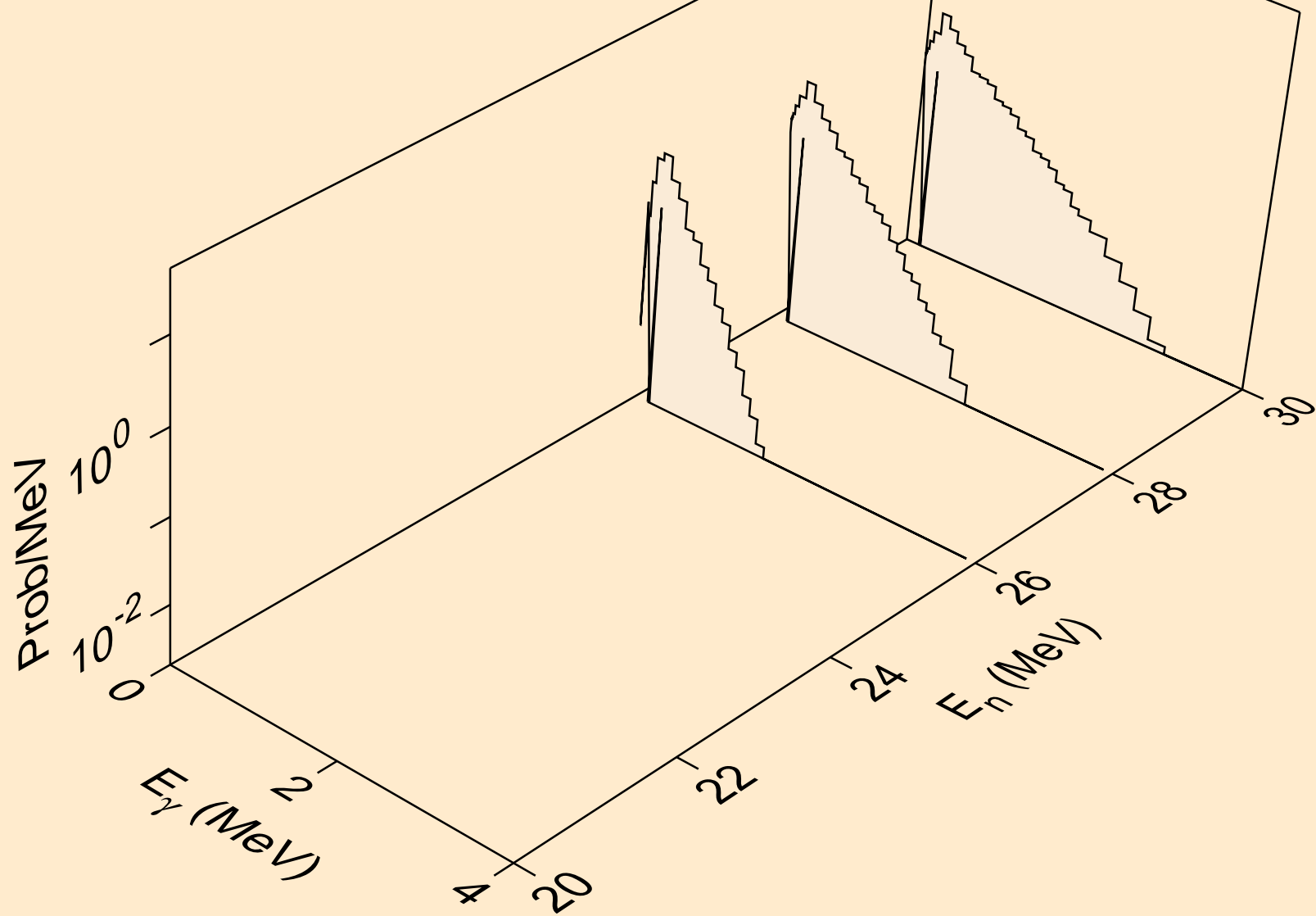

HF168 NEUTRON ACER TENDL-2021 LIBRARY; T=293.6K
Photon emission for (n,2n)

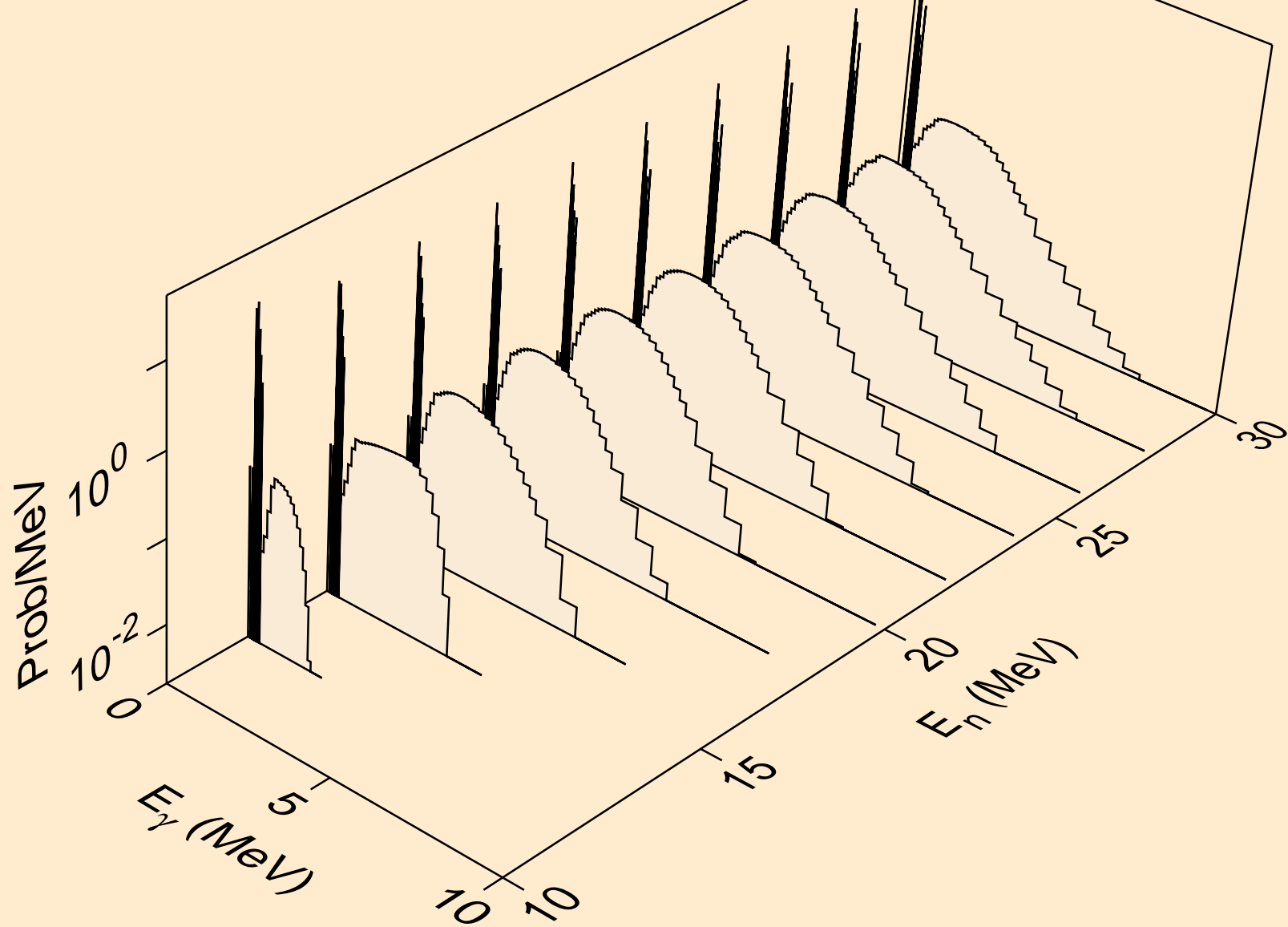

HF168 NEUTRON ACER TENDL-2021 LIBRARY; T=293.6K
Photon emission for (n,3n)

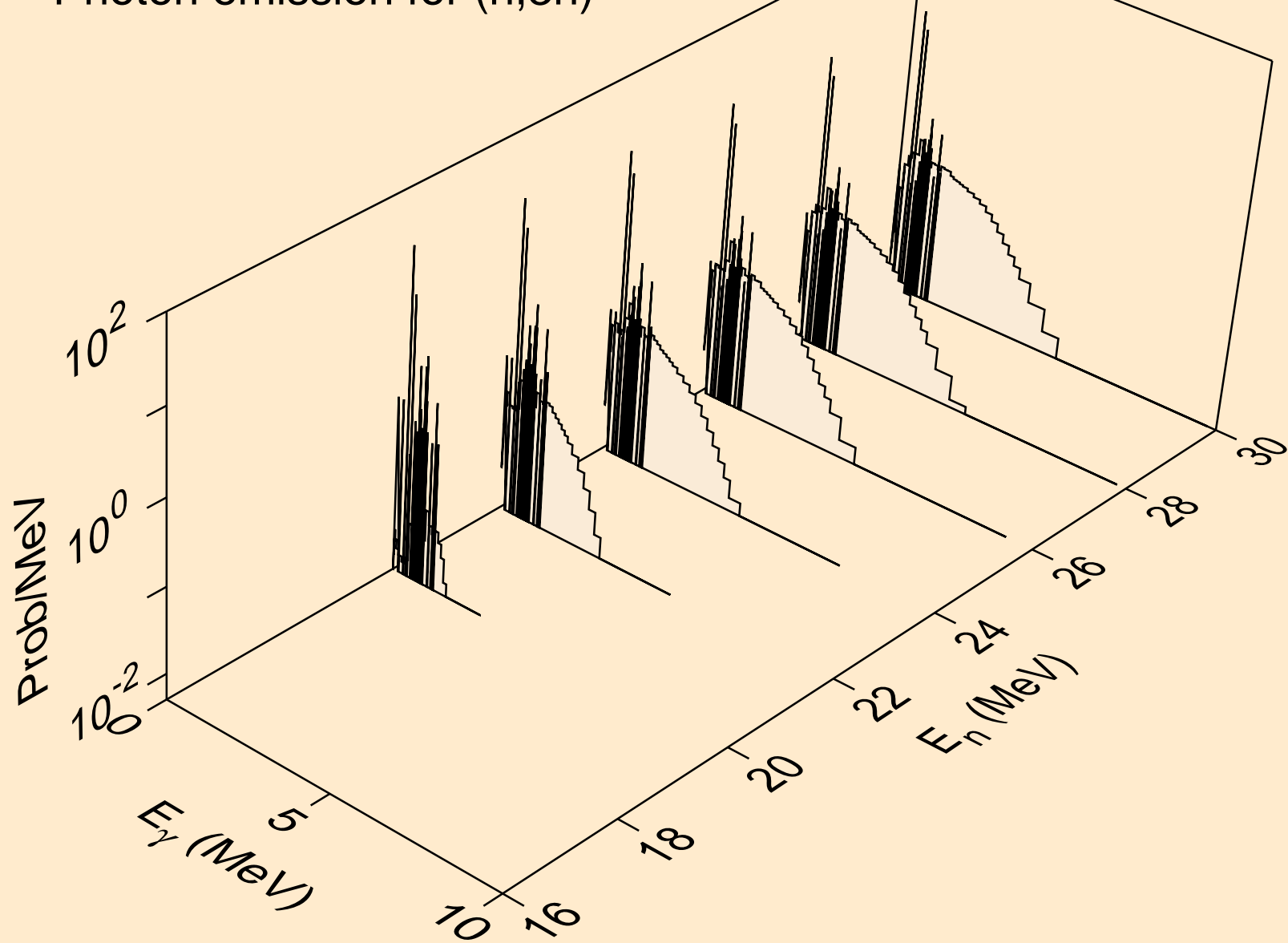

HF168 NEUTRON ACER TENDL-2021 LIBRARY; T=293.6K
Photon emission for (n,n*)a

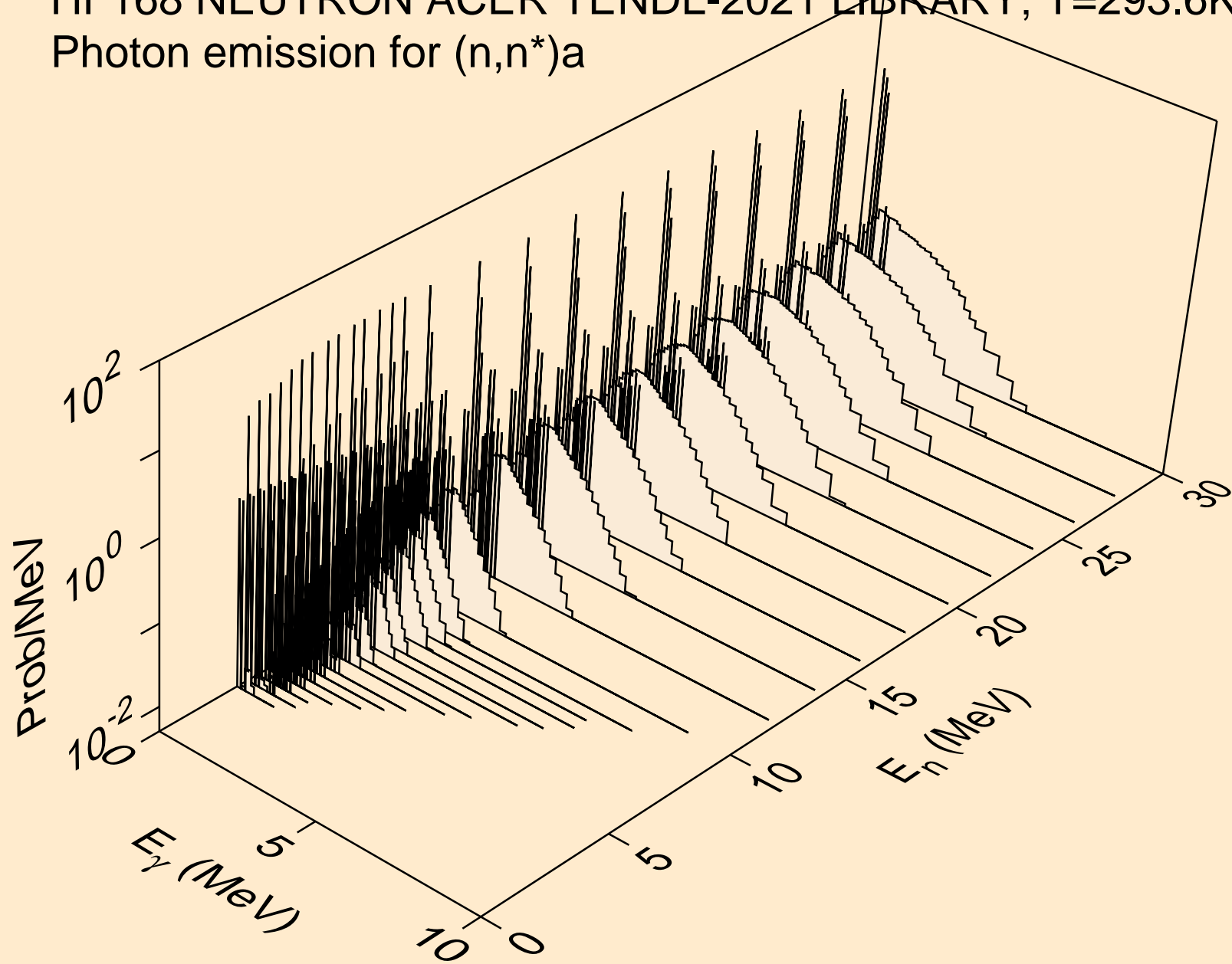

HF168 NEUTRON ACER TENDL-2021 LIBRARY; T=293.6K
Photon emission for (n,2n)a

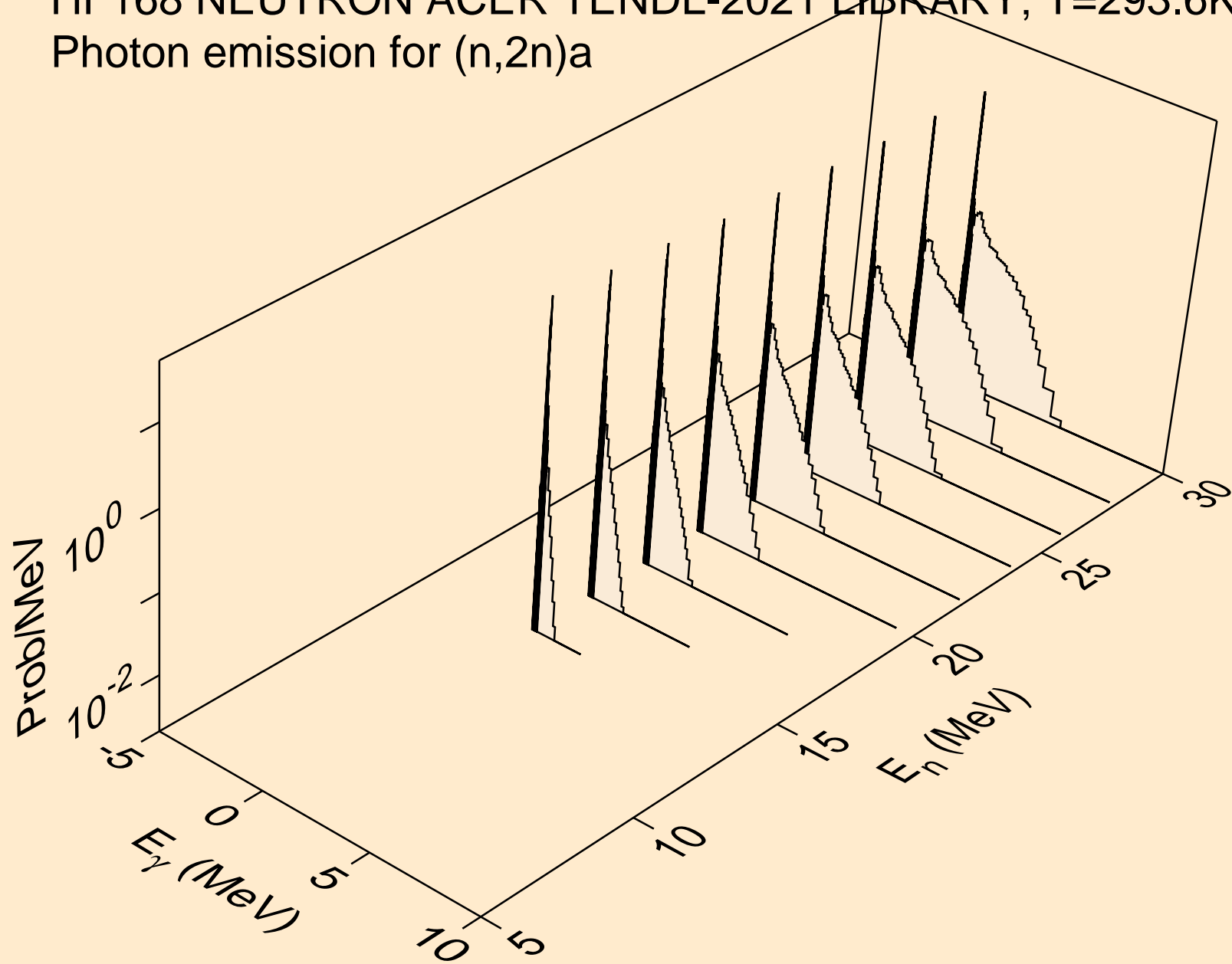

HF168 NEUTRON ACER TENDL-2021 LIBRARY; T=293.6K
Photon emission for (n,3n)a

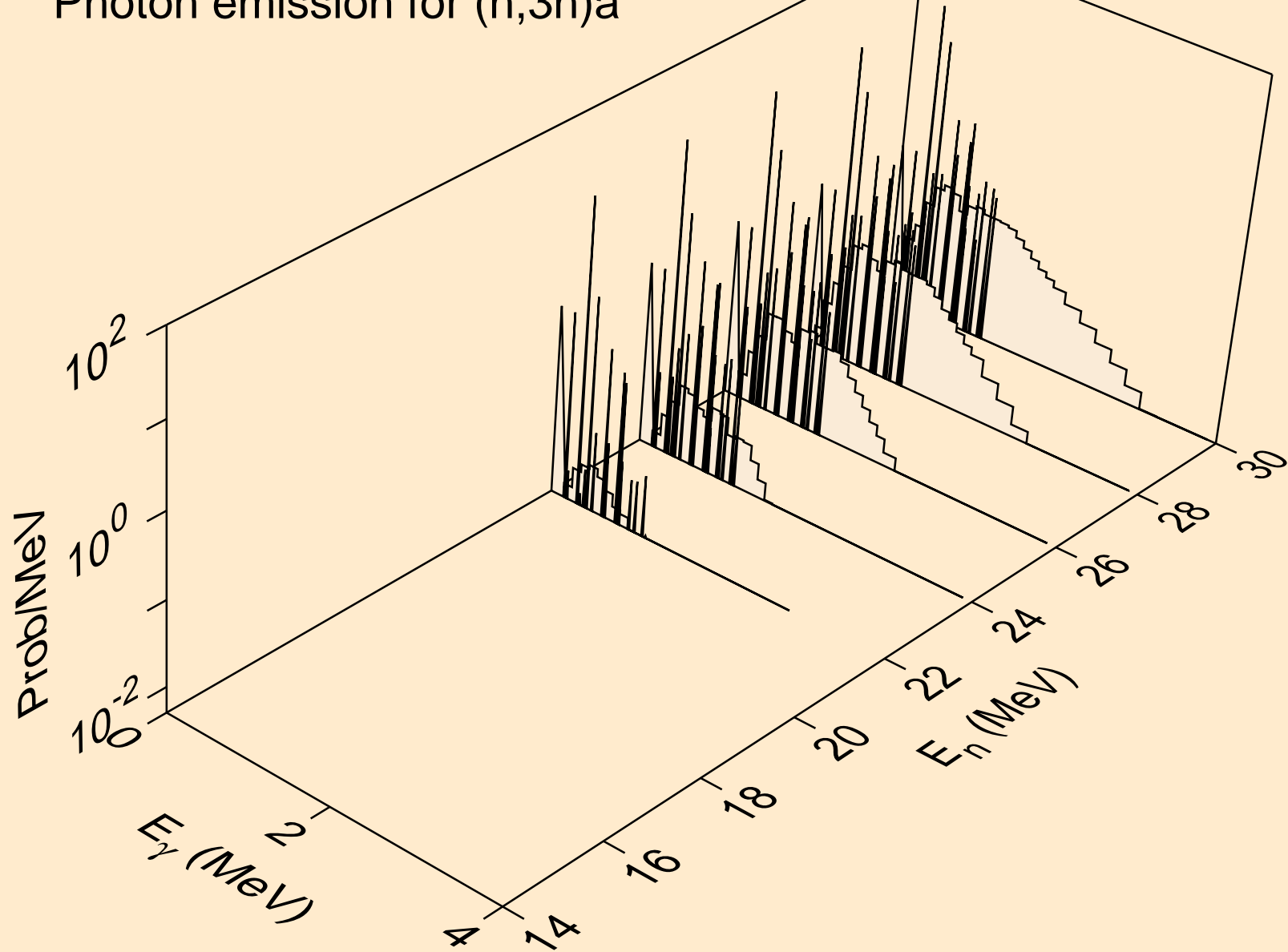

HF168 NEUTRON ACER TENDL-2021 LIBRARY; T=293.6K
Photon emission for (n,n*)p

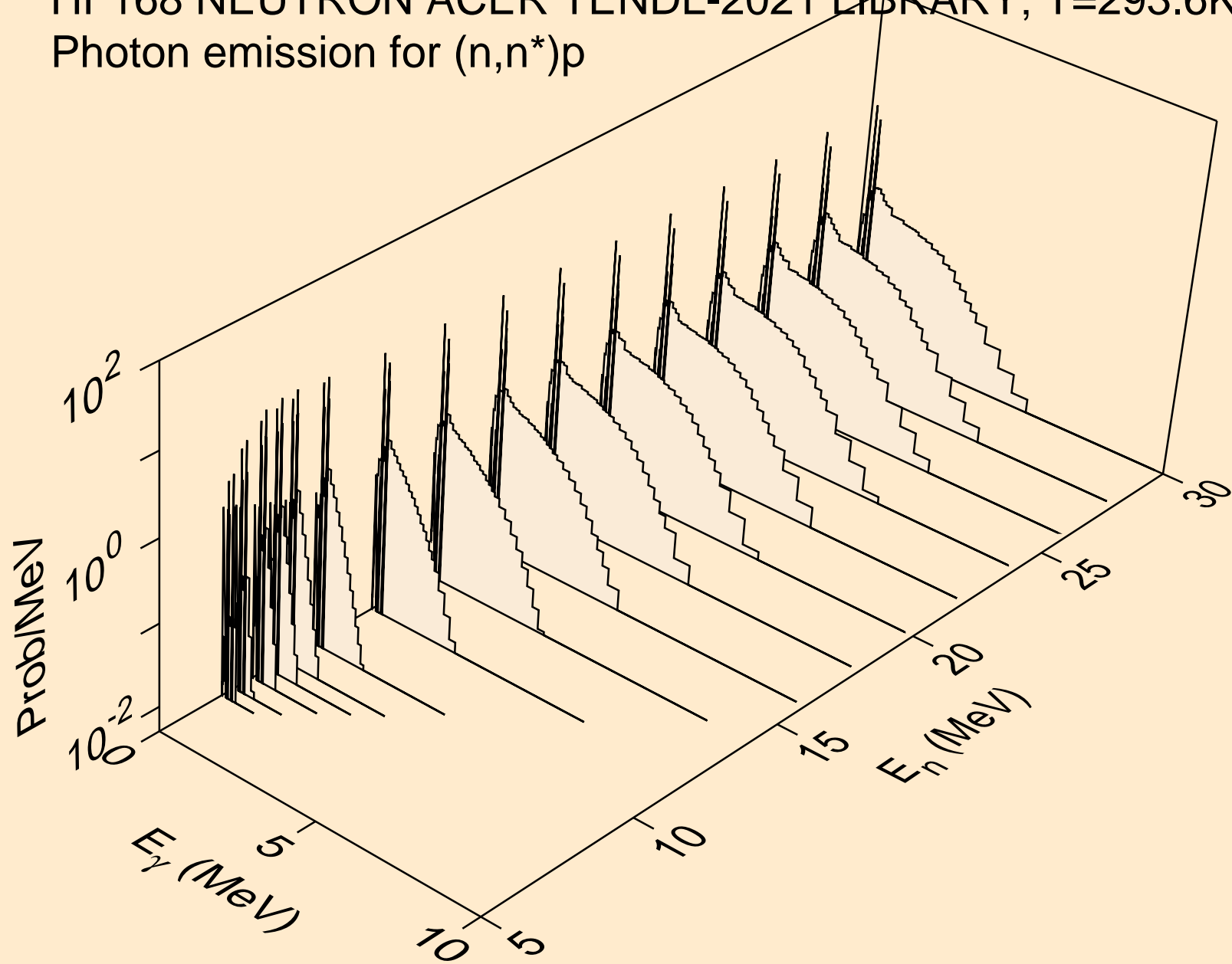

HF168 NEUTRON ACER TENDL-2021 LIBRARY; T=293.6K
Photon emission for (n,n*)2a

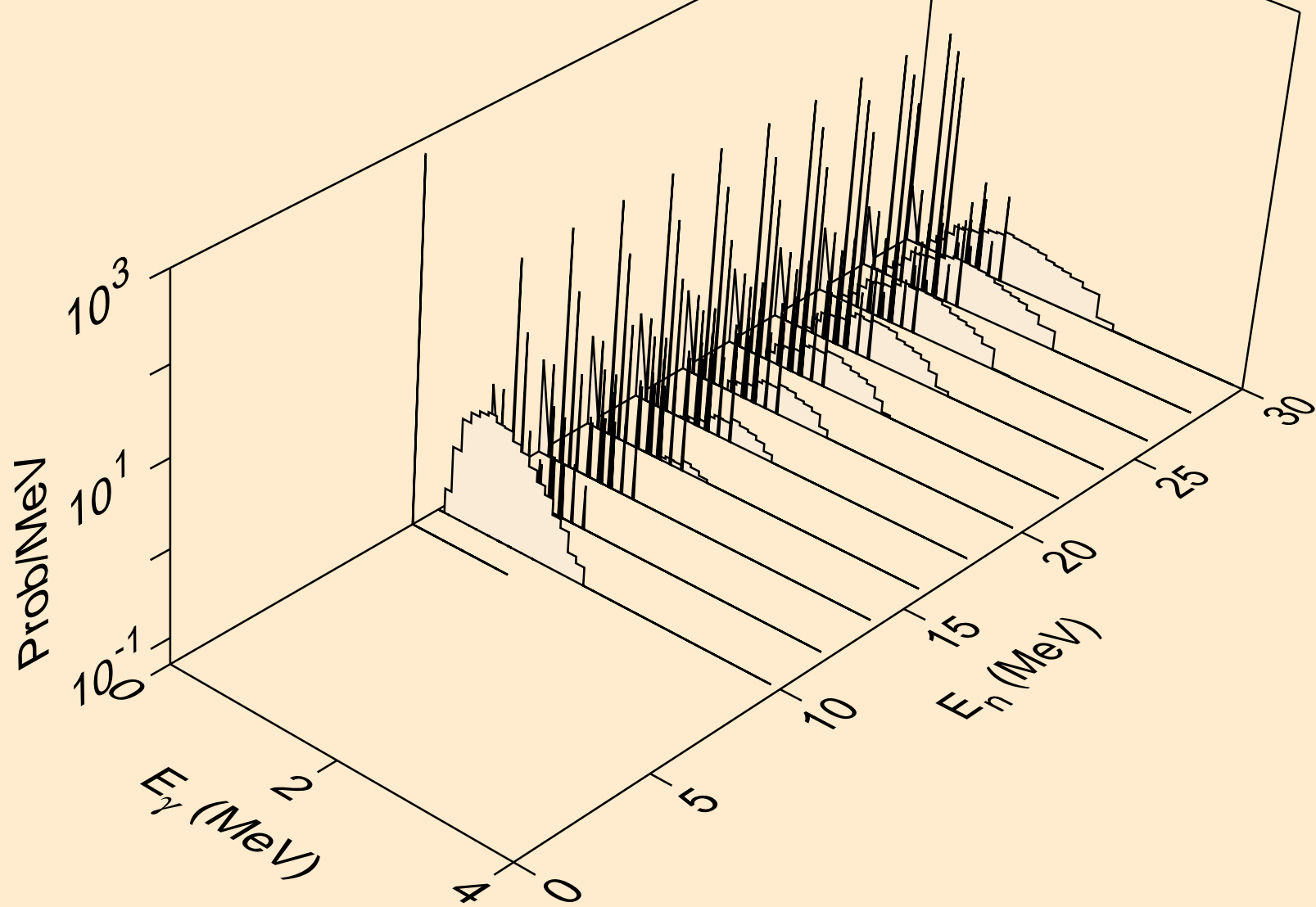

HF168 NEUTRON ACER TENDL-2021 LIBRARY; T=293.6K
Photon emission for (n,2n)2a

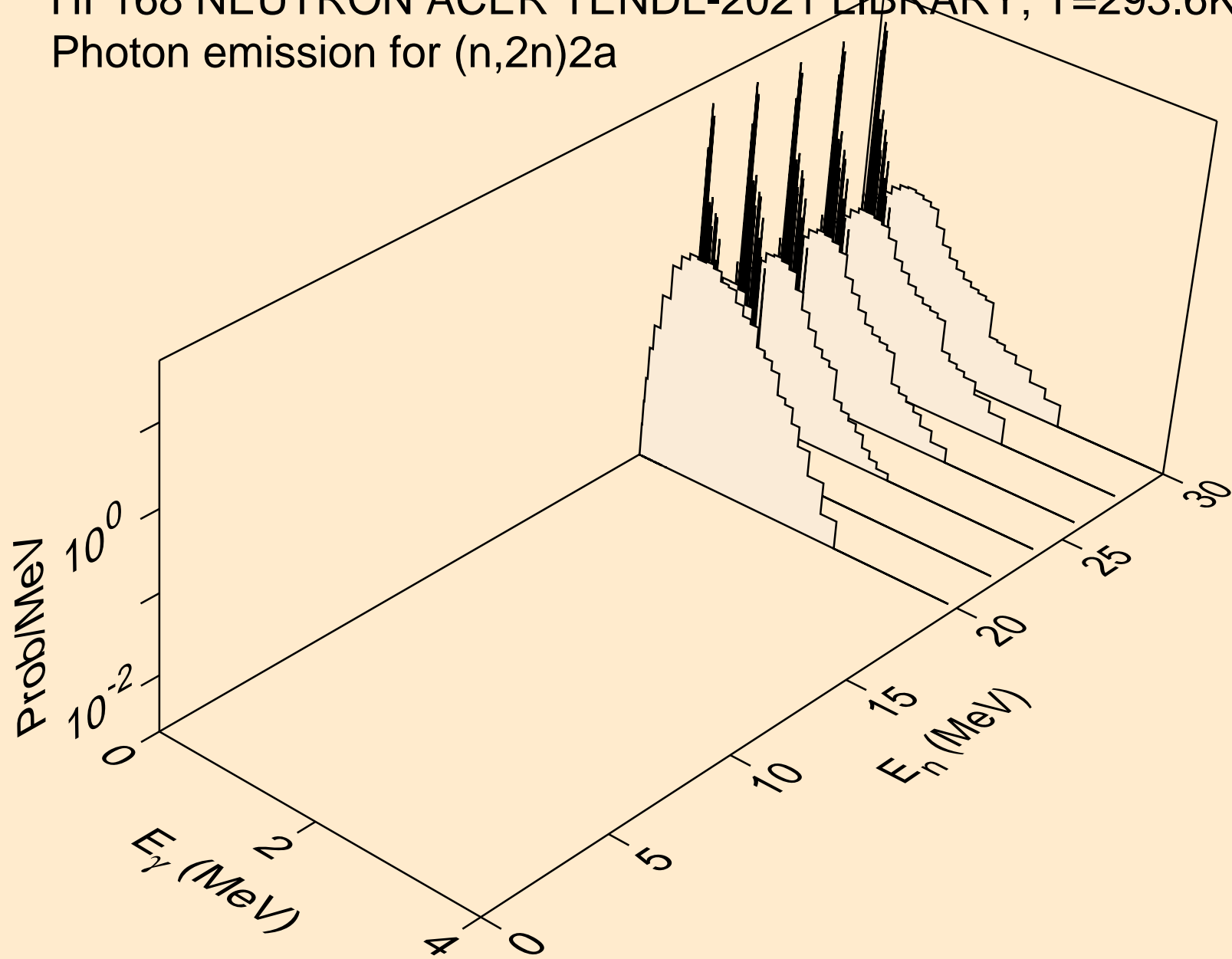

HF168 NEUTRON ACER TENDL-2021 LIBRARY; T=293.6K
Photon emission for (n,n*)d

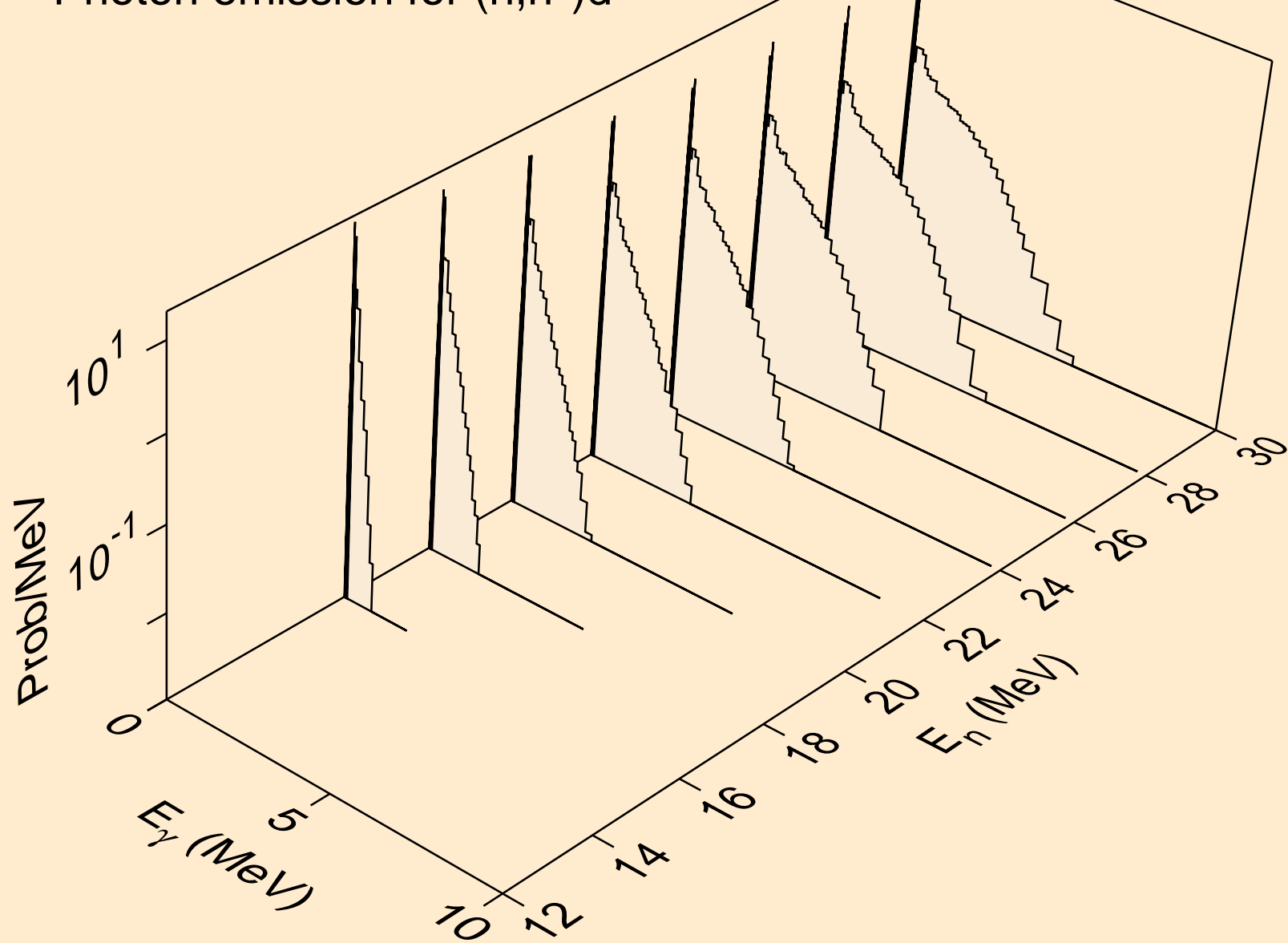

HF168 NEUTRON ACER TENDL-2021 LIBRARY; T=293.6K
Photon emission for (n,n*)t

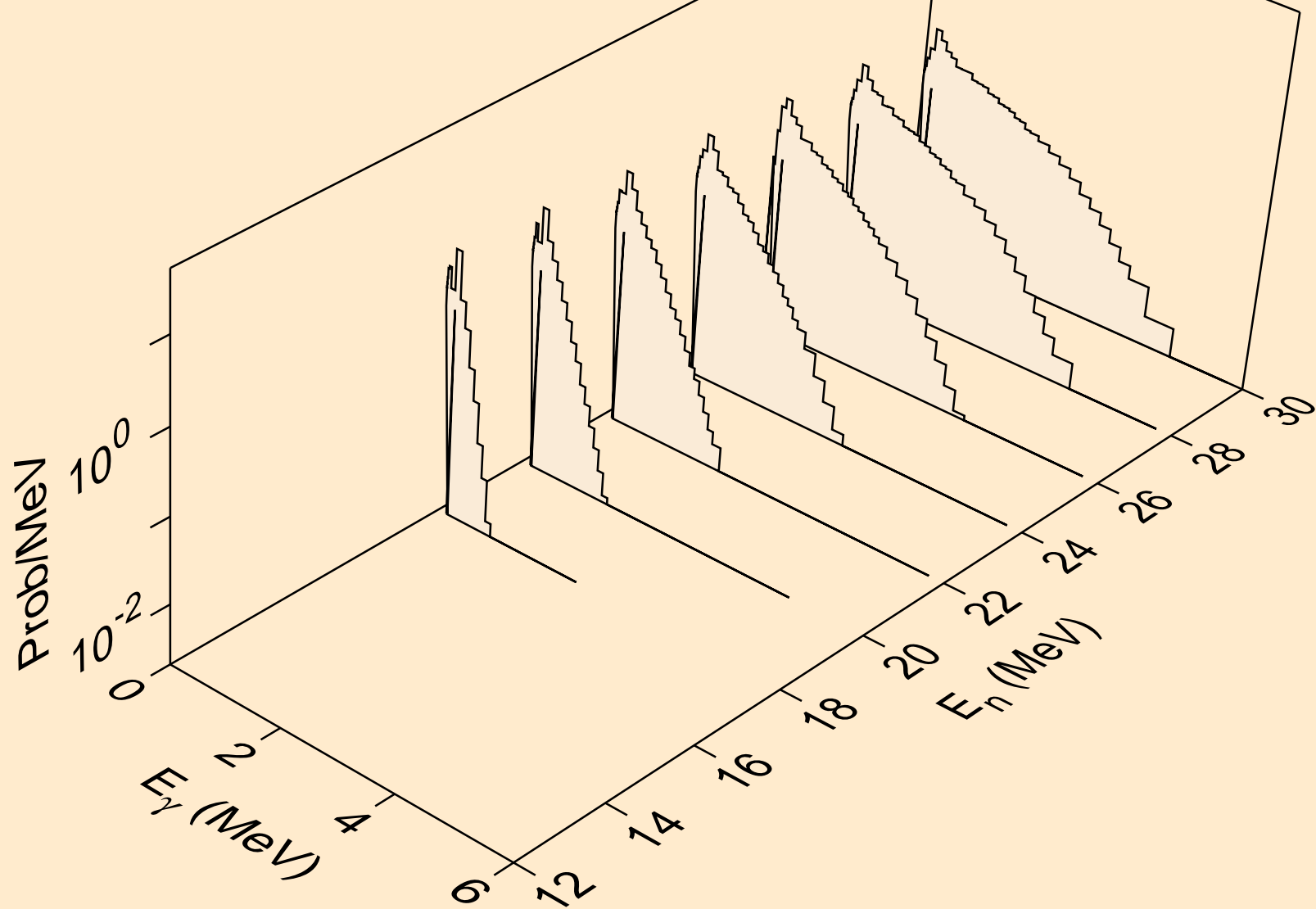

HF168 NEUTRON ACER TENDL-2021 LIBRARY; T=293.6K
Photon emission for (n,n*)he3

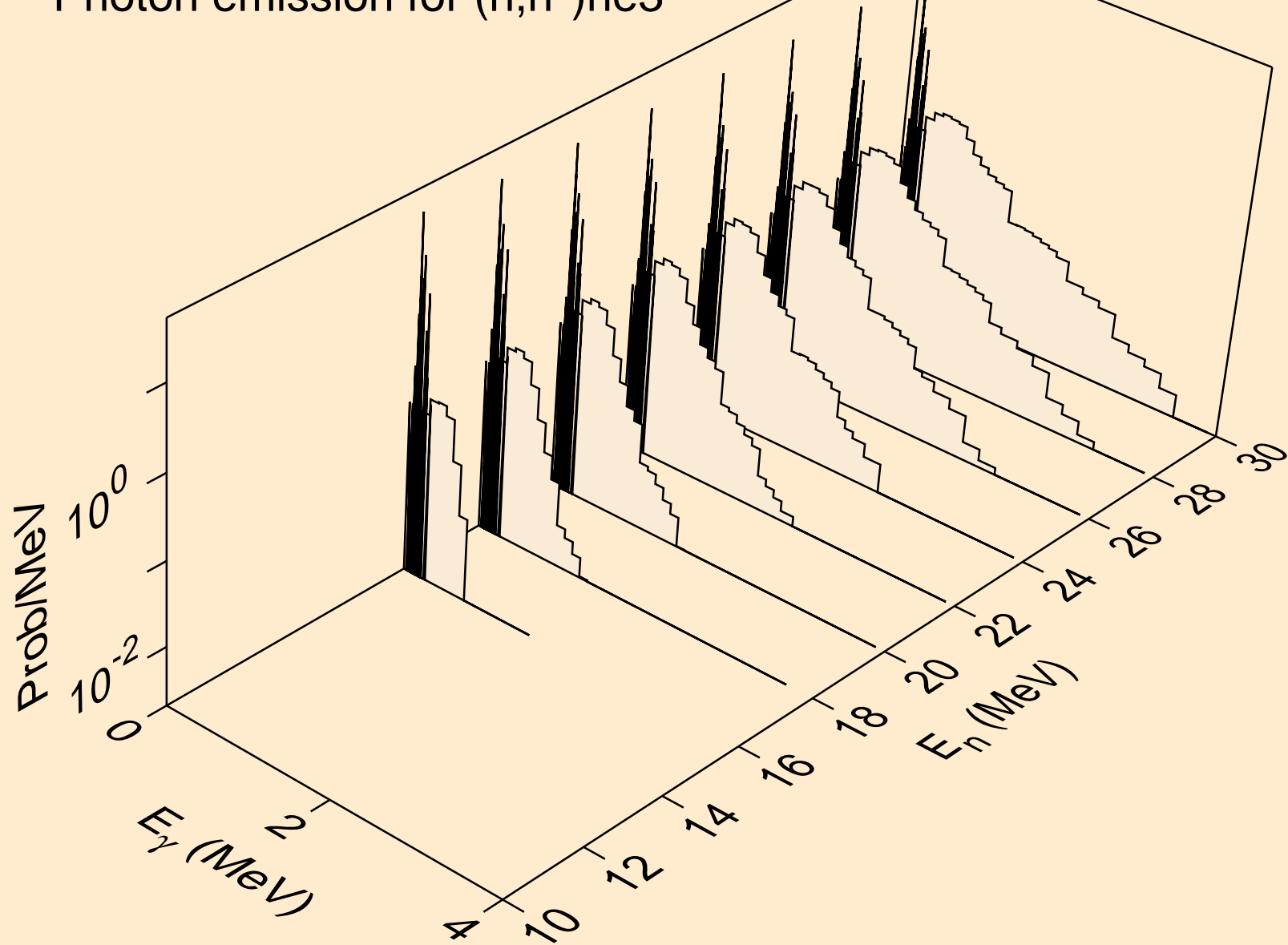

HF168 NEUTRON ACER TENDL-2021 LIBRARY; T=293.6K
Photon emission for (n,4n)

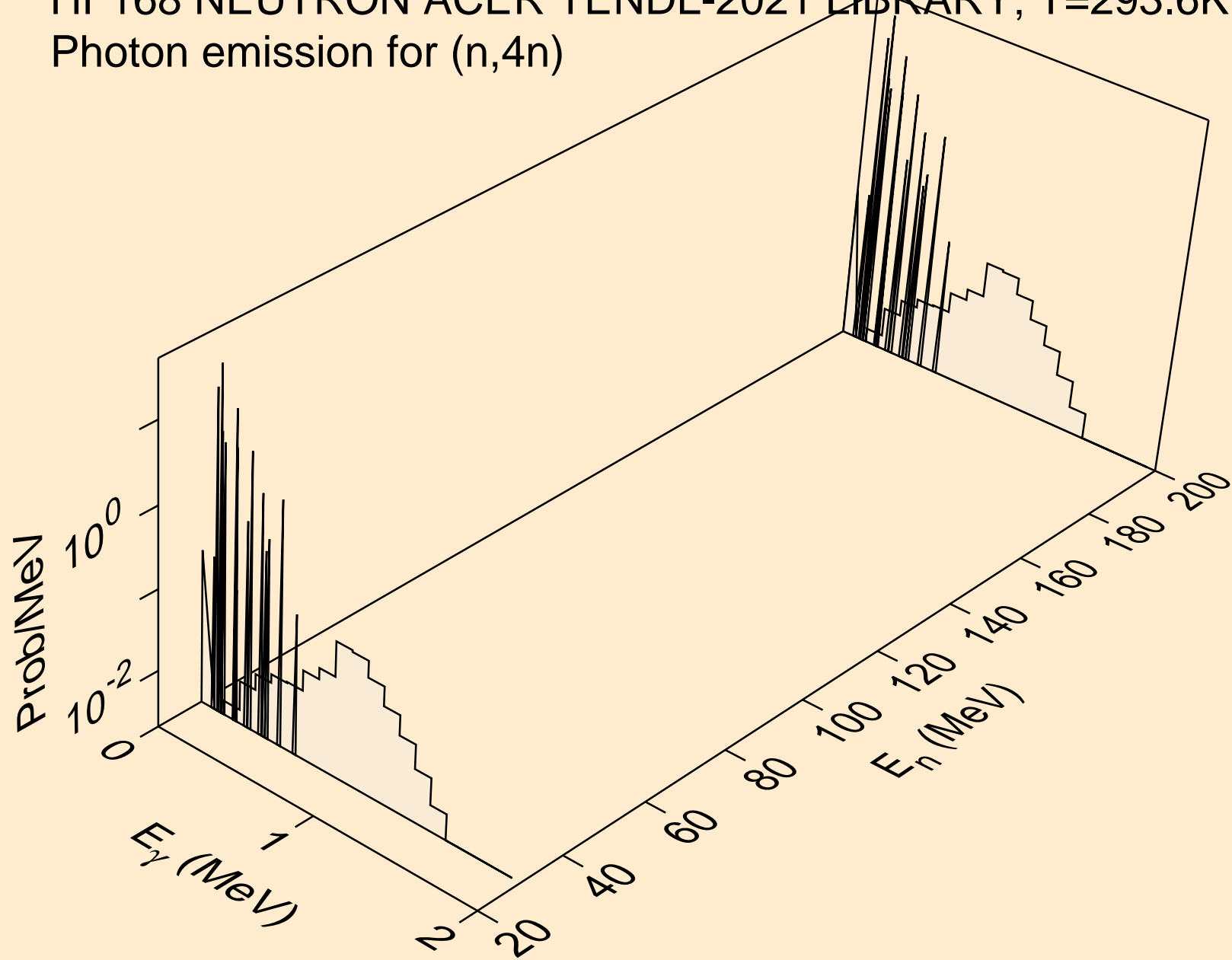

HF168 NEUTRON ACER TENDL-2021 LIBRARY; T=293.6K
Photon emission for (n,2np)

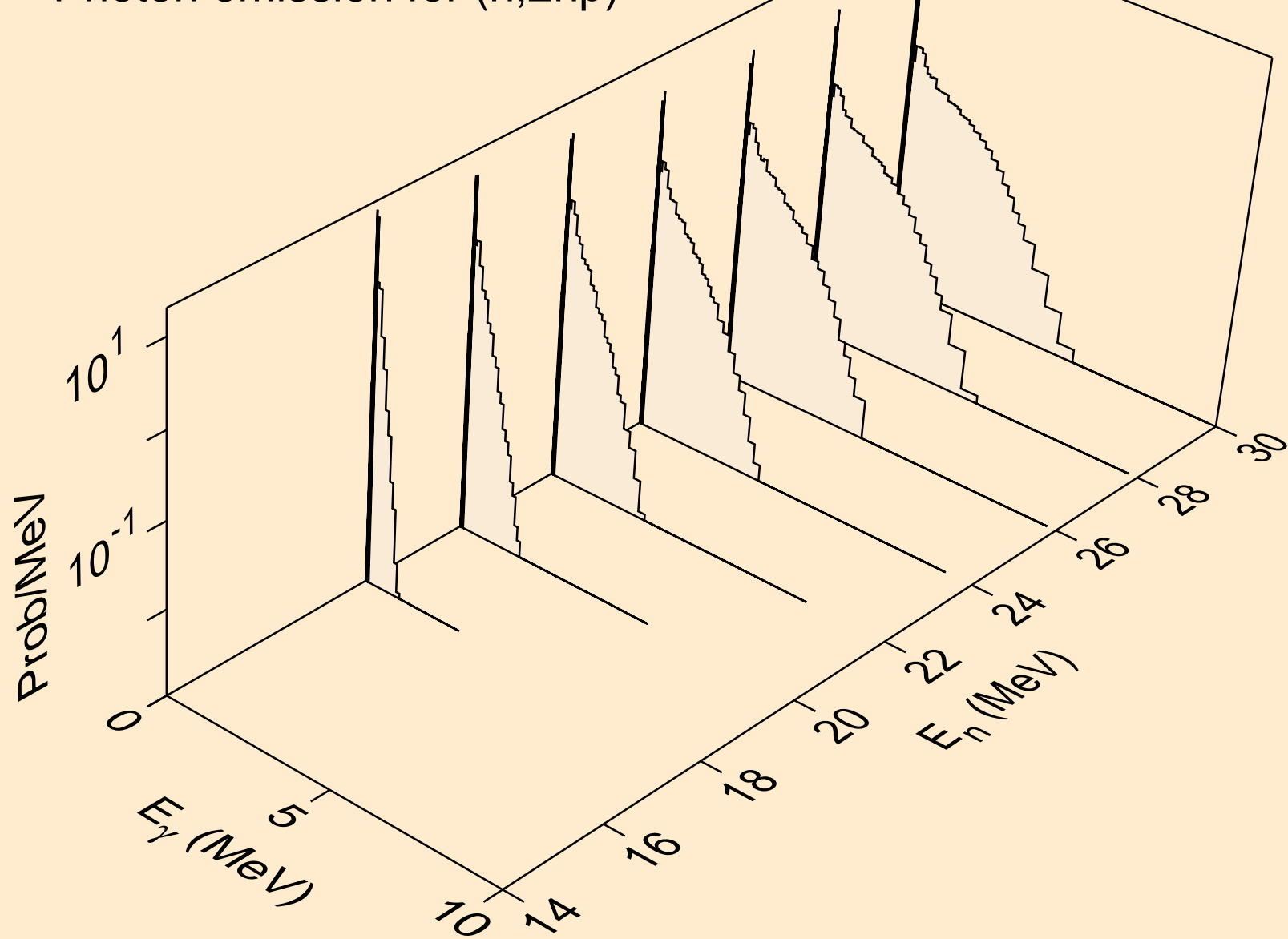

HF168 NEUTRON ACER TENDL-2021 LIBRARY; T=293.6K
Photon emission for (n,3np)

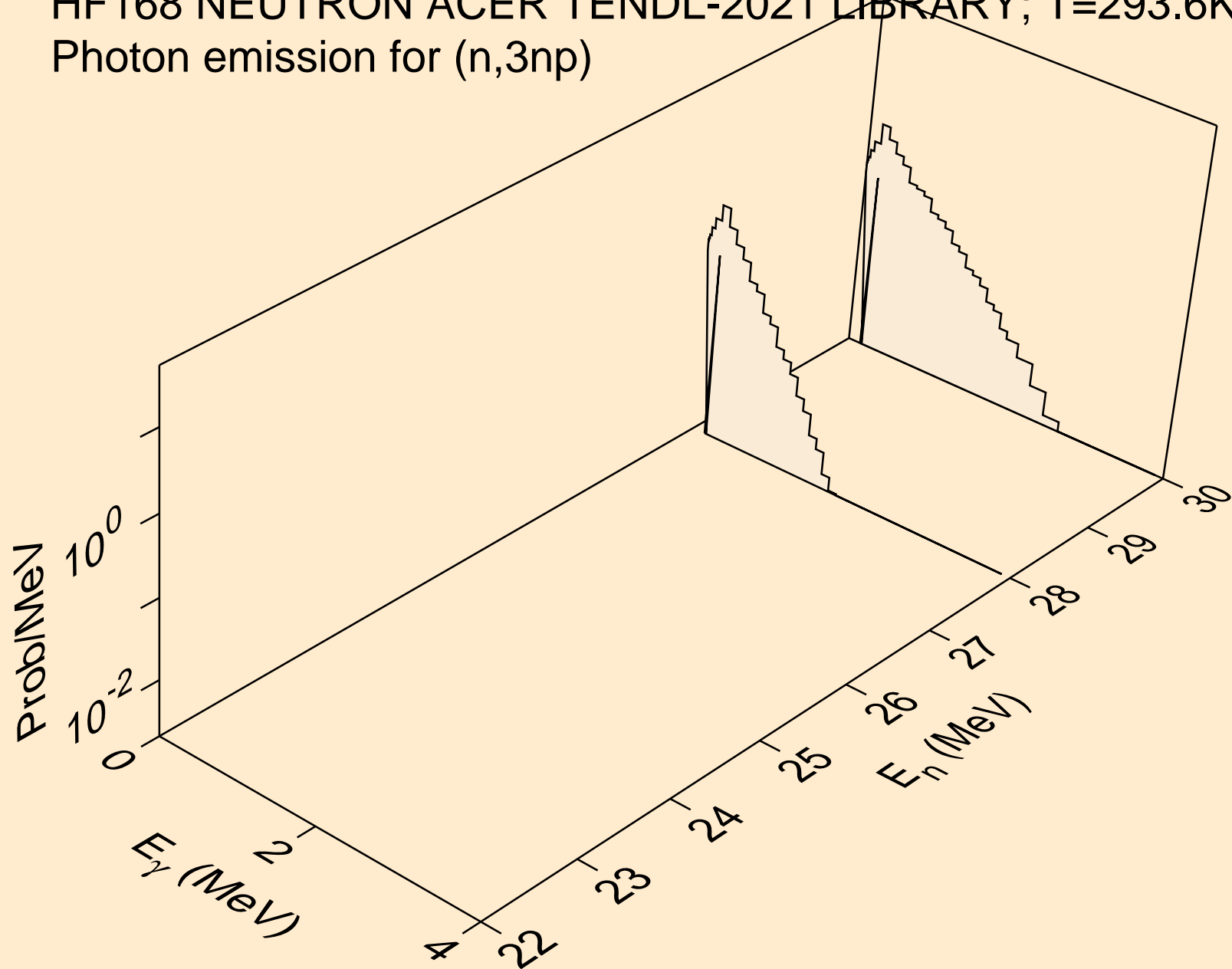

HF168 NEUTRON ACER TENDL-2021 LIBRARY; T=293.6K
Photon emission for (n,2np)

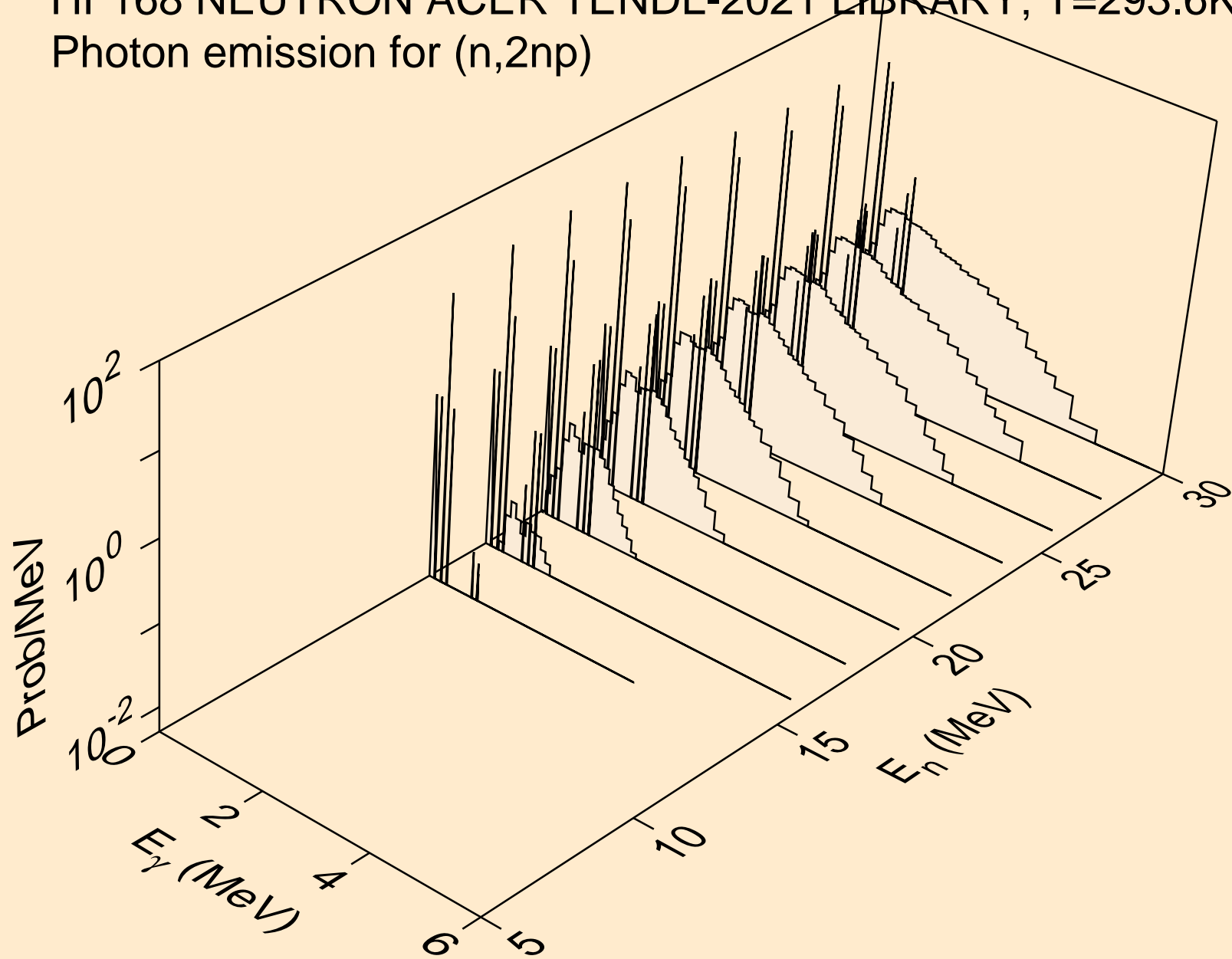

HF168 NEUTRON ACER TENDL-2021 LIBRARY; T=293.6K
Photon emission for (n,npa)

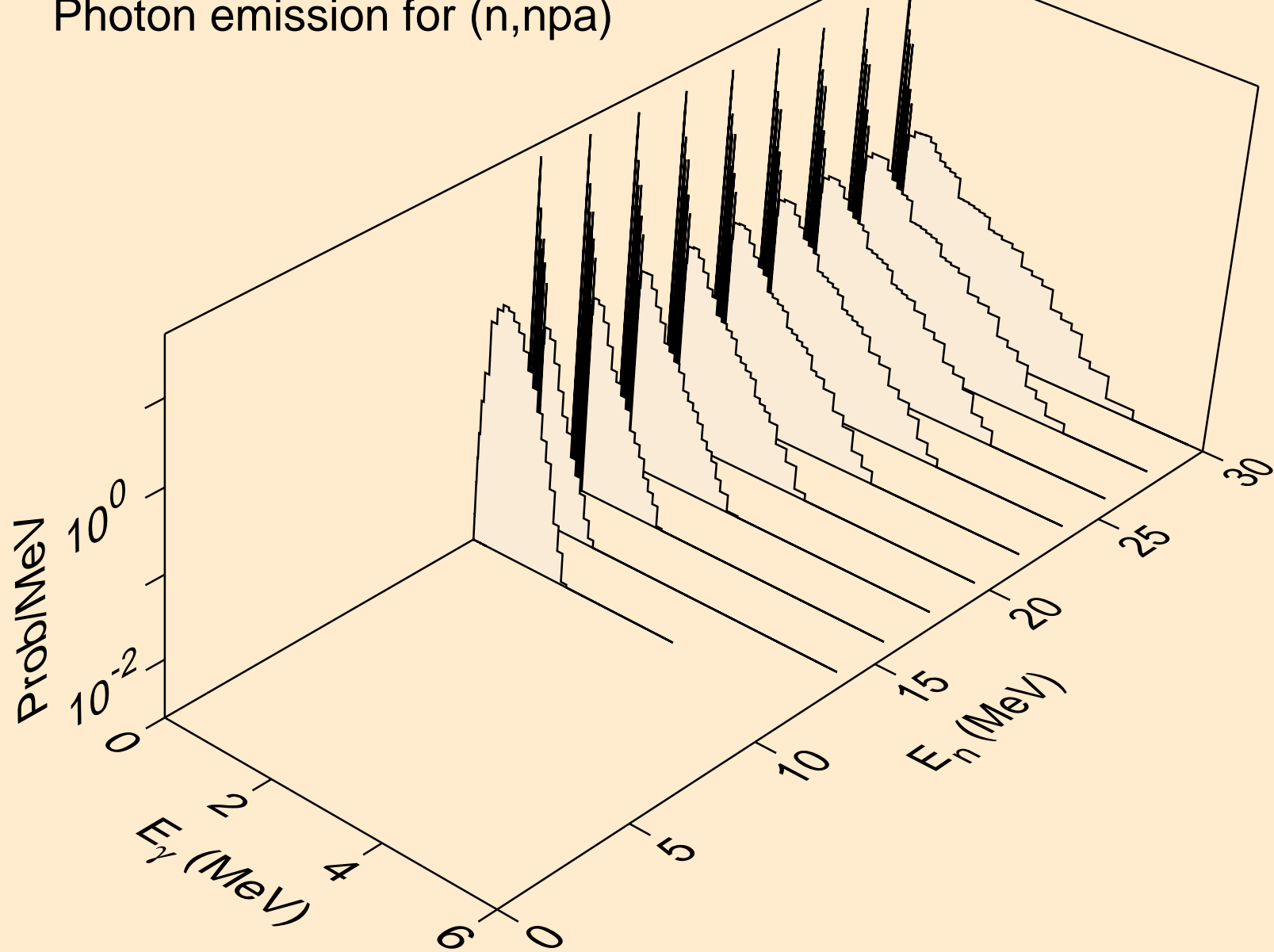

HF168 NEUTRON ACER TENDL-2021 LIBRARY; T=293.6K
Photon emission for (n,n*c)

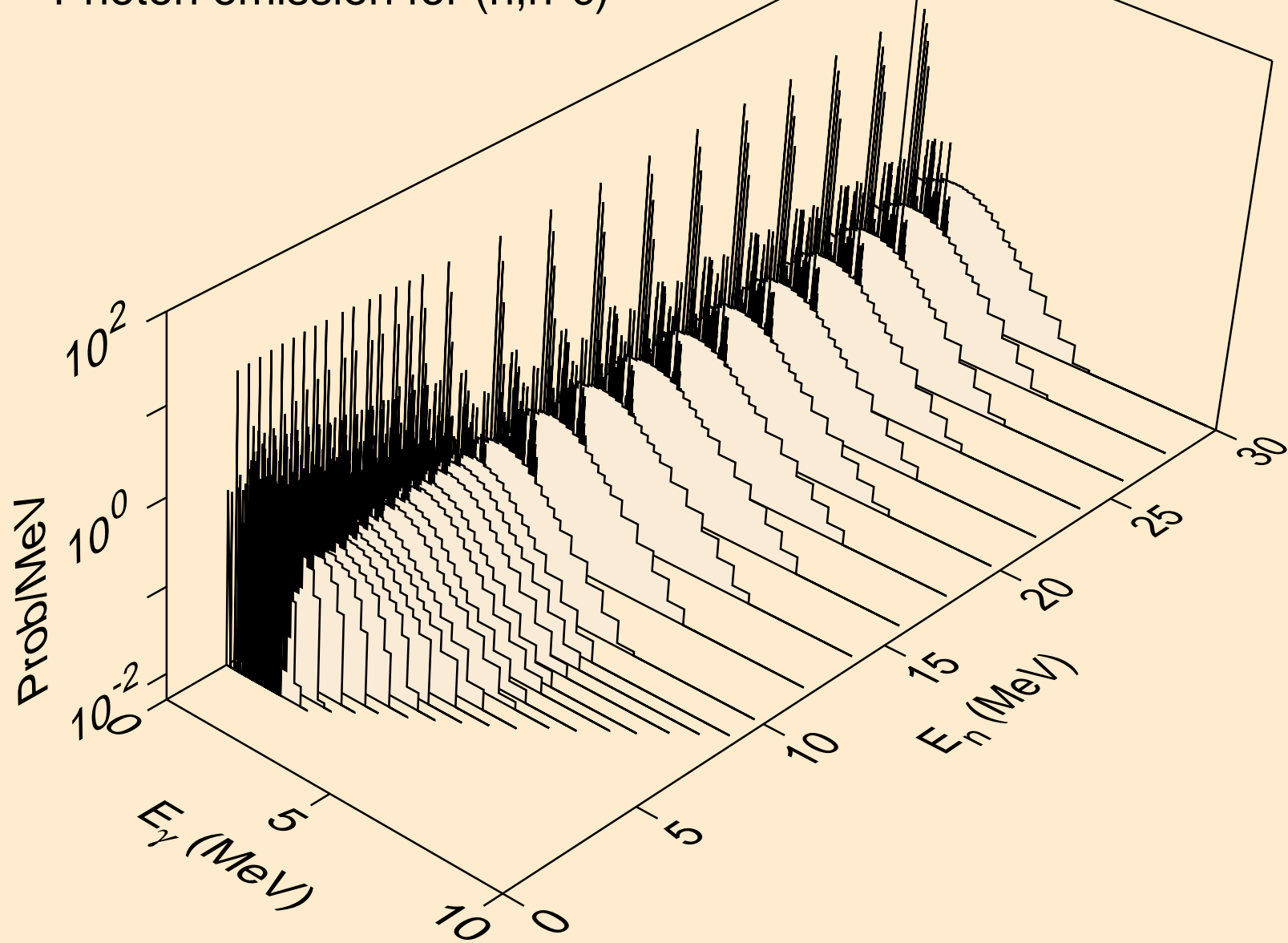

HF168 NEUTRON ACER TENDL-2021 LIBRARY; T=293.6K
Photon emission for (n,gma)

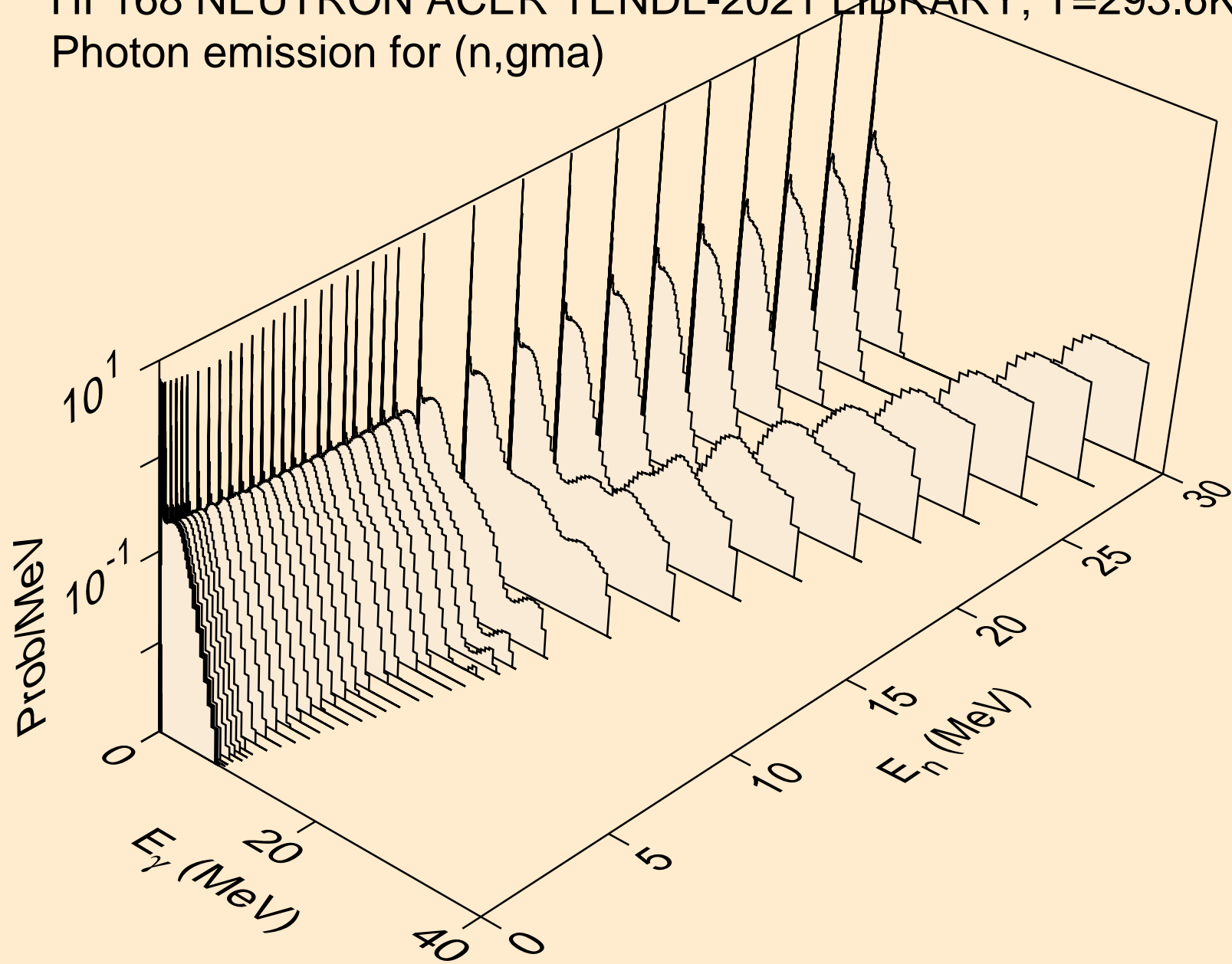

HF168 NEUTRON ACER TENDL-2021 LIBRARY; T=293.6K
Photon emission for (n,p)

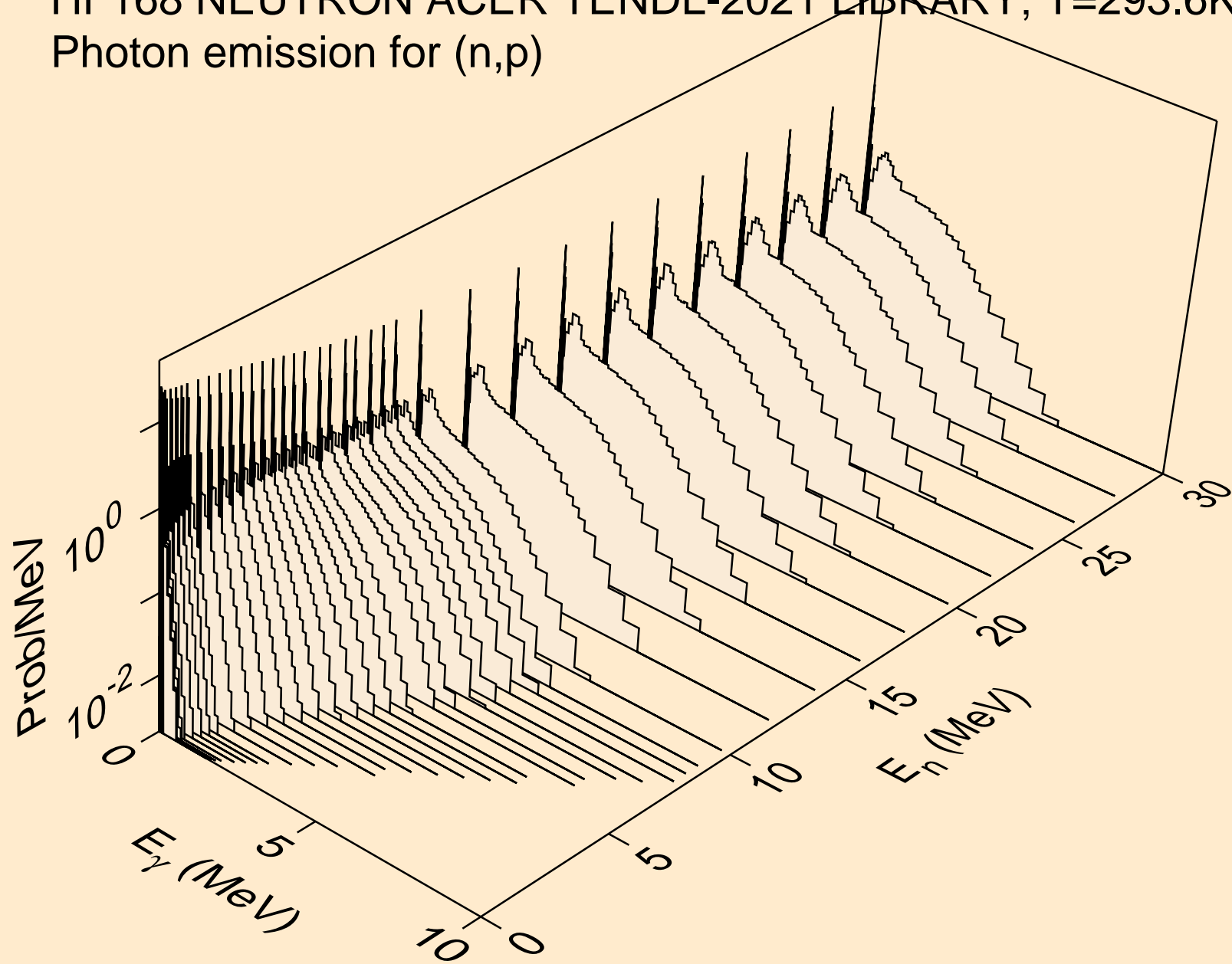

HF168 NEUTRON ACER TENDL-2021 LIBRARY; T=293.6K
Photon emission for (n,d)

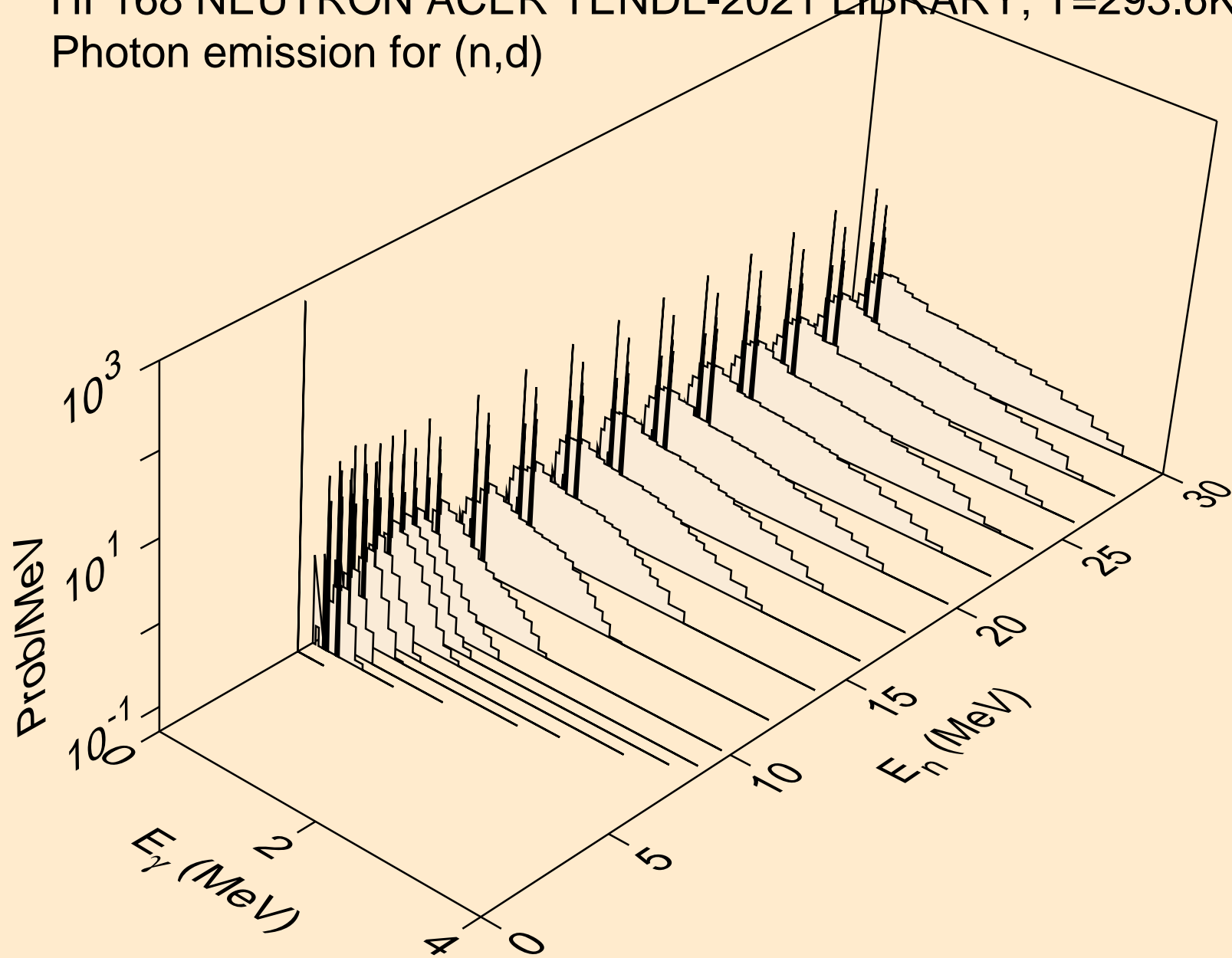

HF168 NEUTRON ACER TENDL-2021 LIBRARY; T=293.6K
Photon emission for (n,t)

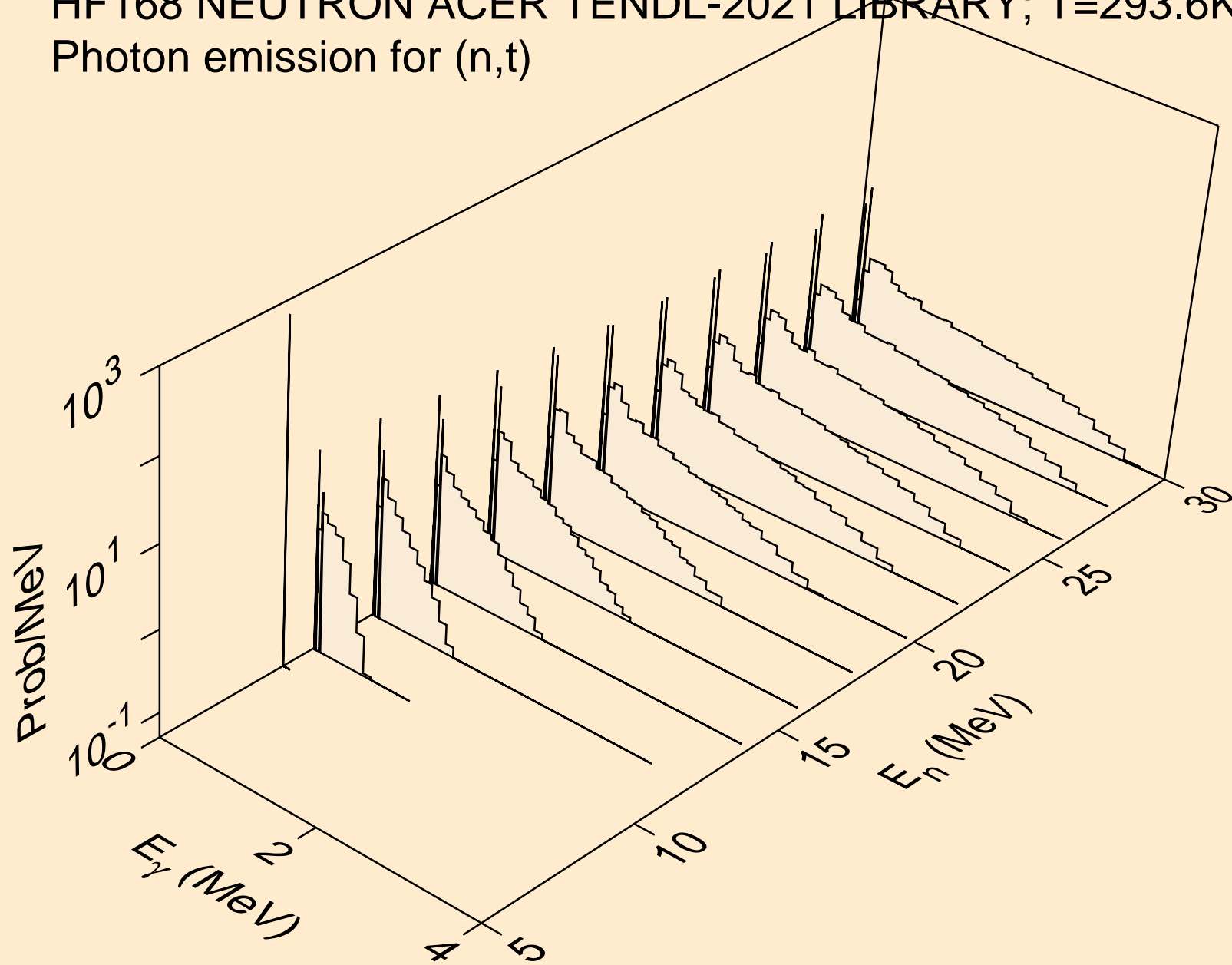

HF168 NEUTRON ACER TENDL-2021 LIBRARY; T=293.6K
Photon emission for (n,he3)

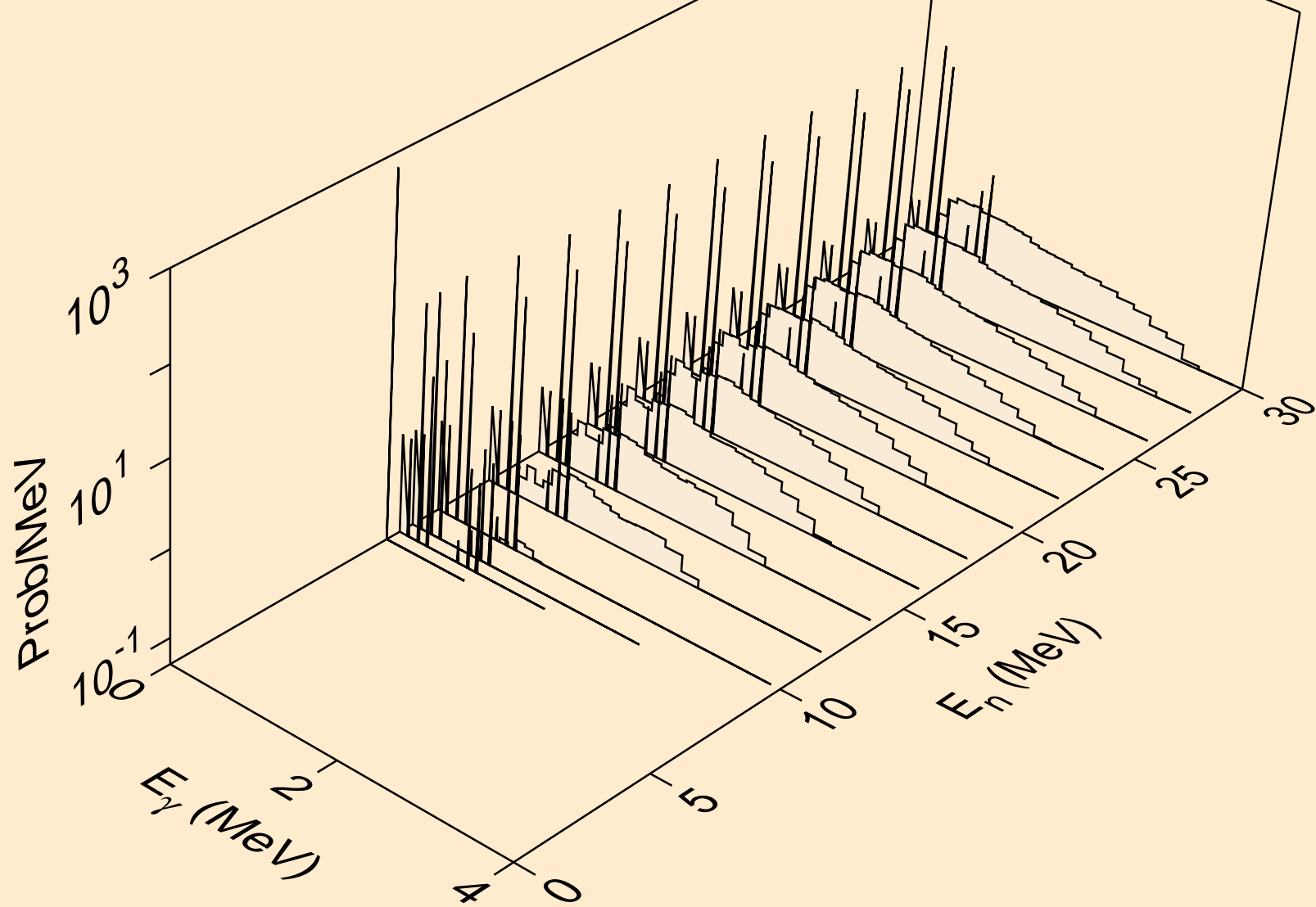

HF168 NEUTRON ACER TENDL-2021 LIBRARY; T=293.6K
Photon emission for (n,a)

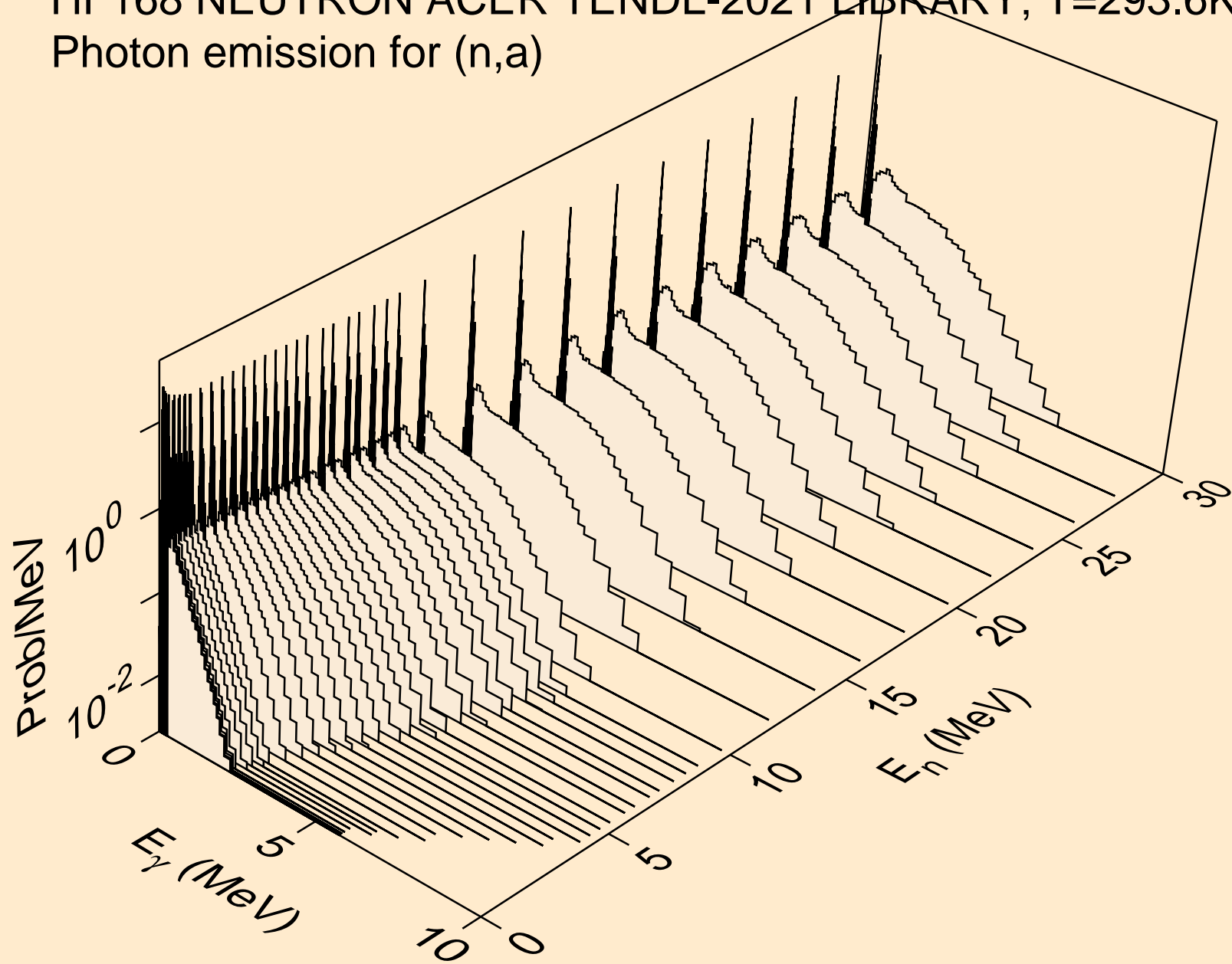

HF168 NEUTRON ACER TENDL-2021 LIBRARY; T=293.6K
Photon emission for (n,2a)

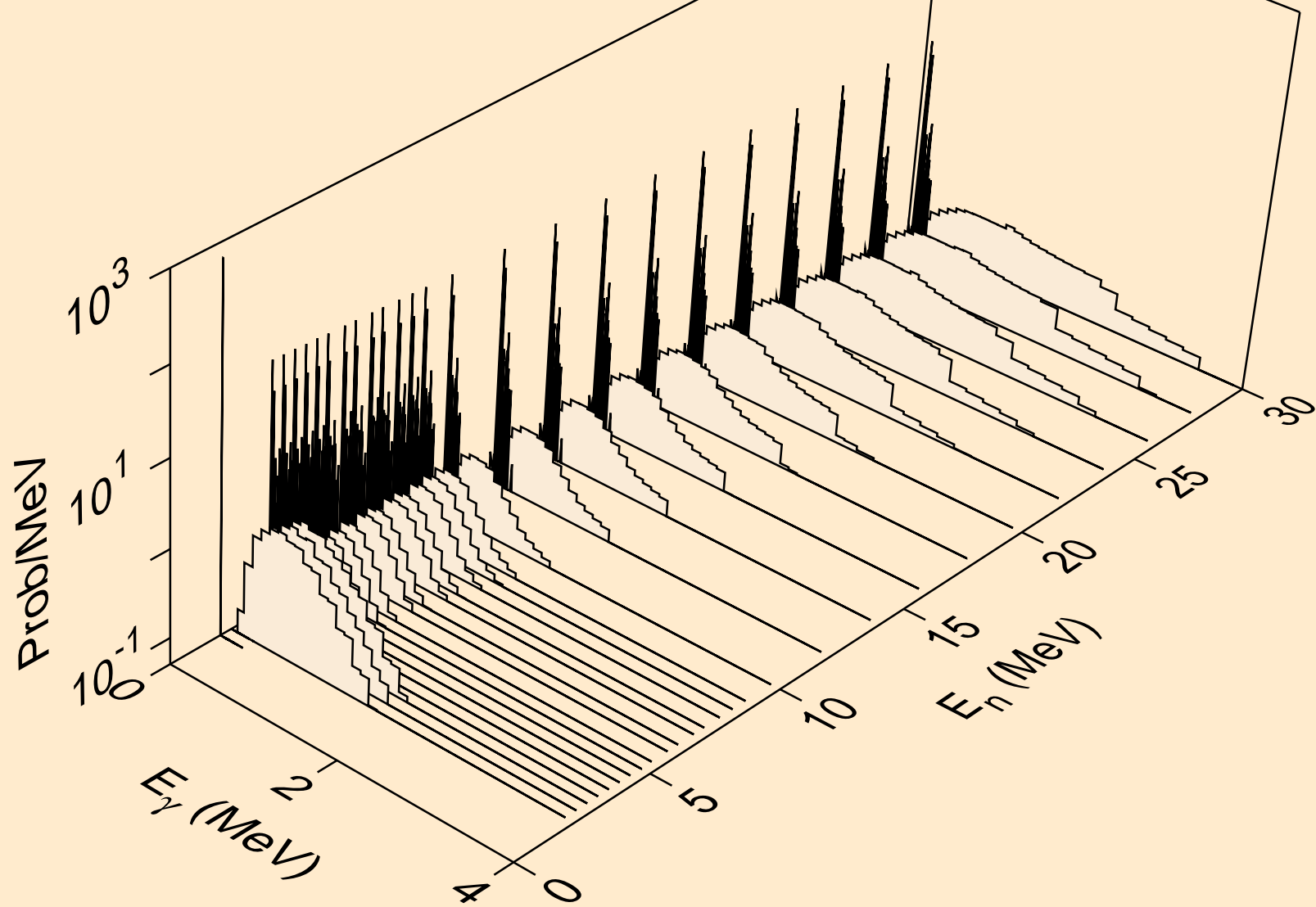

HF168 NEUTRON ACER TENDL-2021 LIBRARY; T=293.6K
Photon emission for (n,2p)

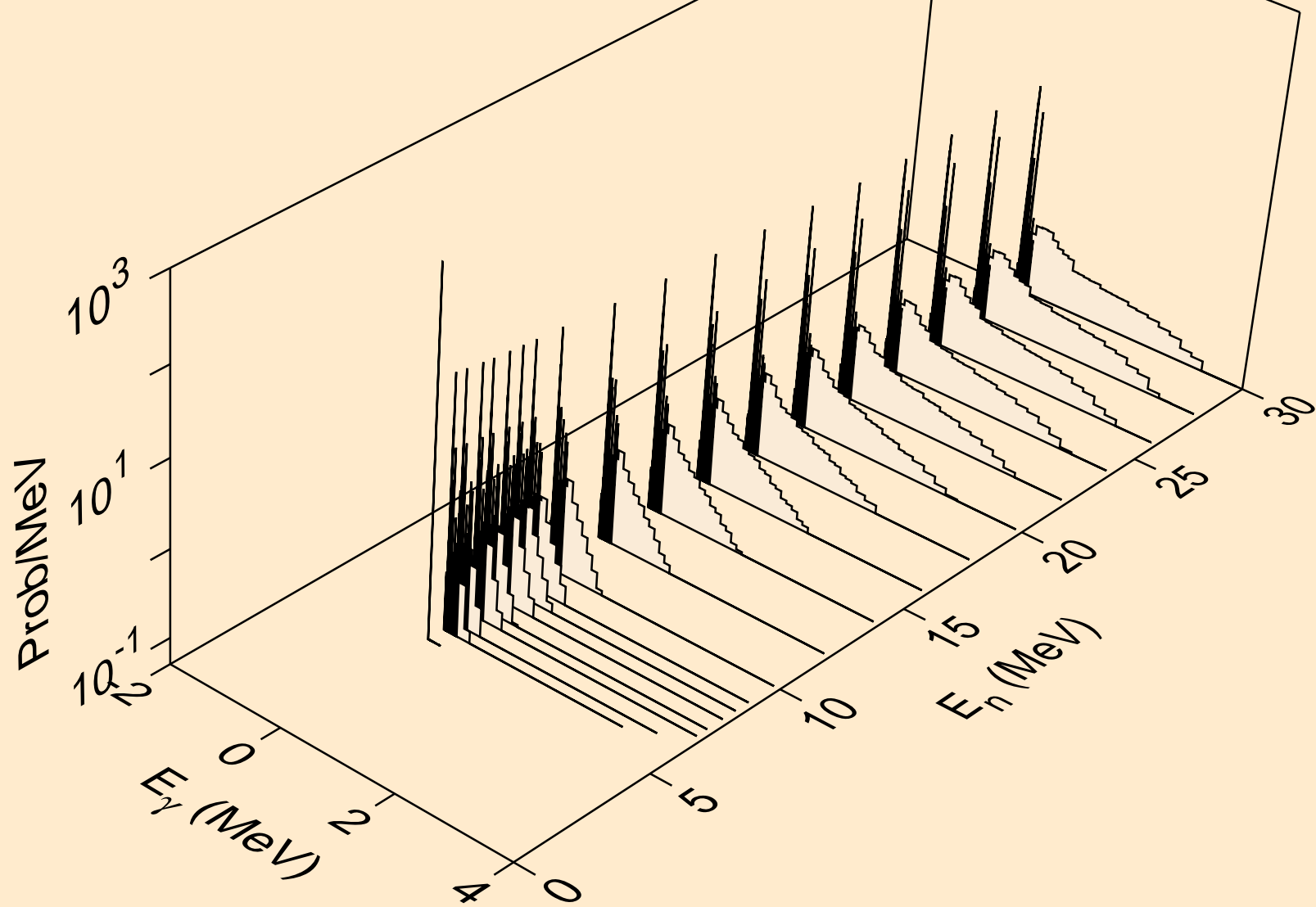

HF168 NEUTRON ACER TENDL-2021 LIBRARY; T=293.6K
Photon emission for (n,p)

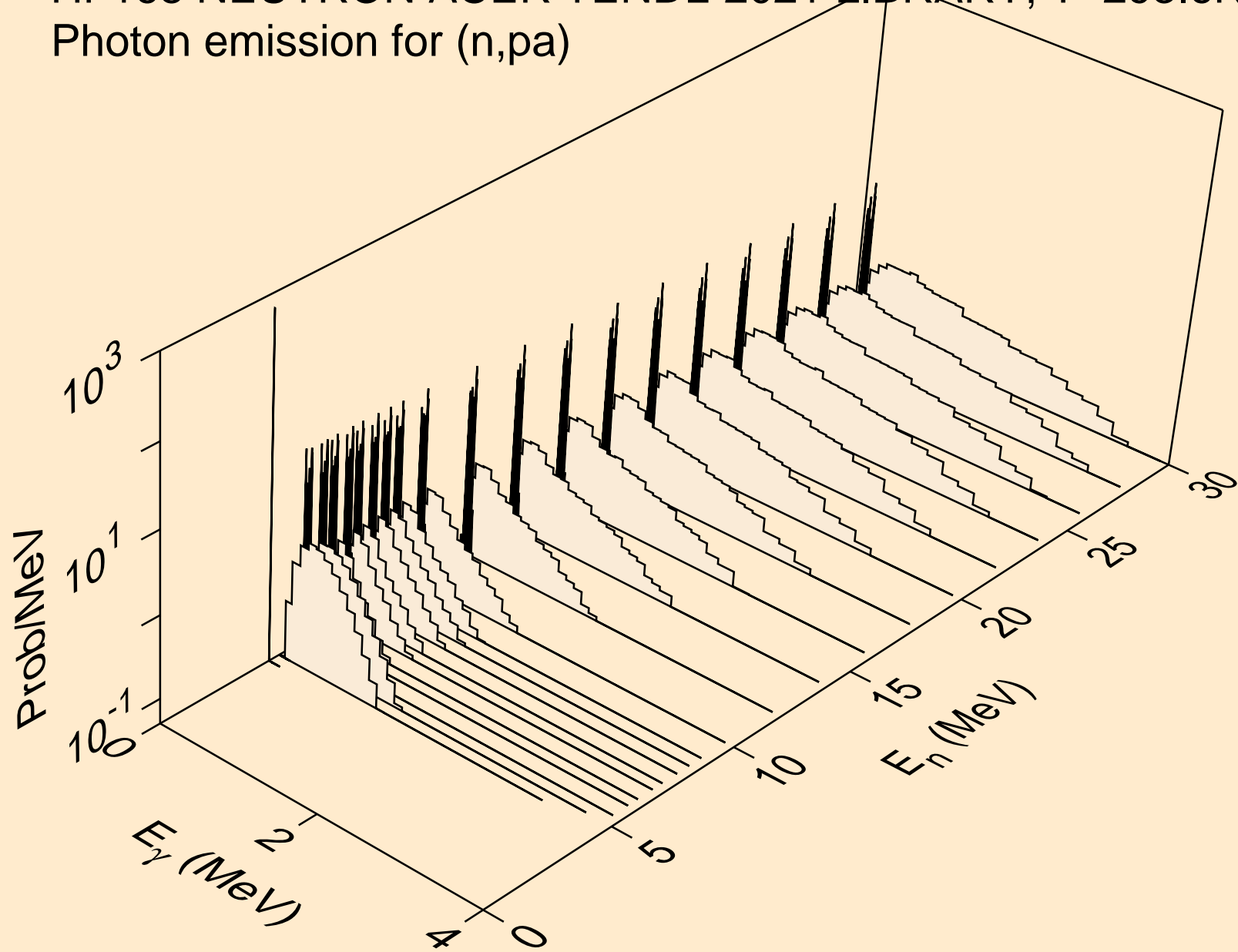

HF168 NEUTRON ACER TENDL-2021 LIBRARY; T=293.6K
Photon emission for (n,pd)

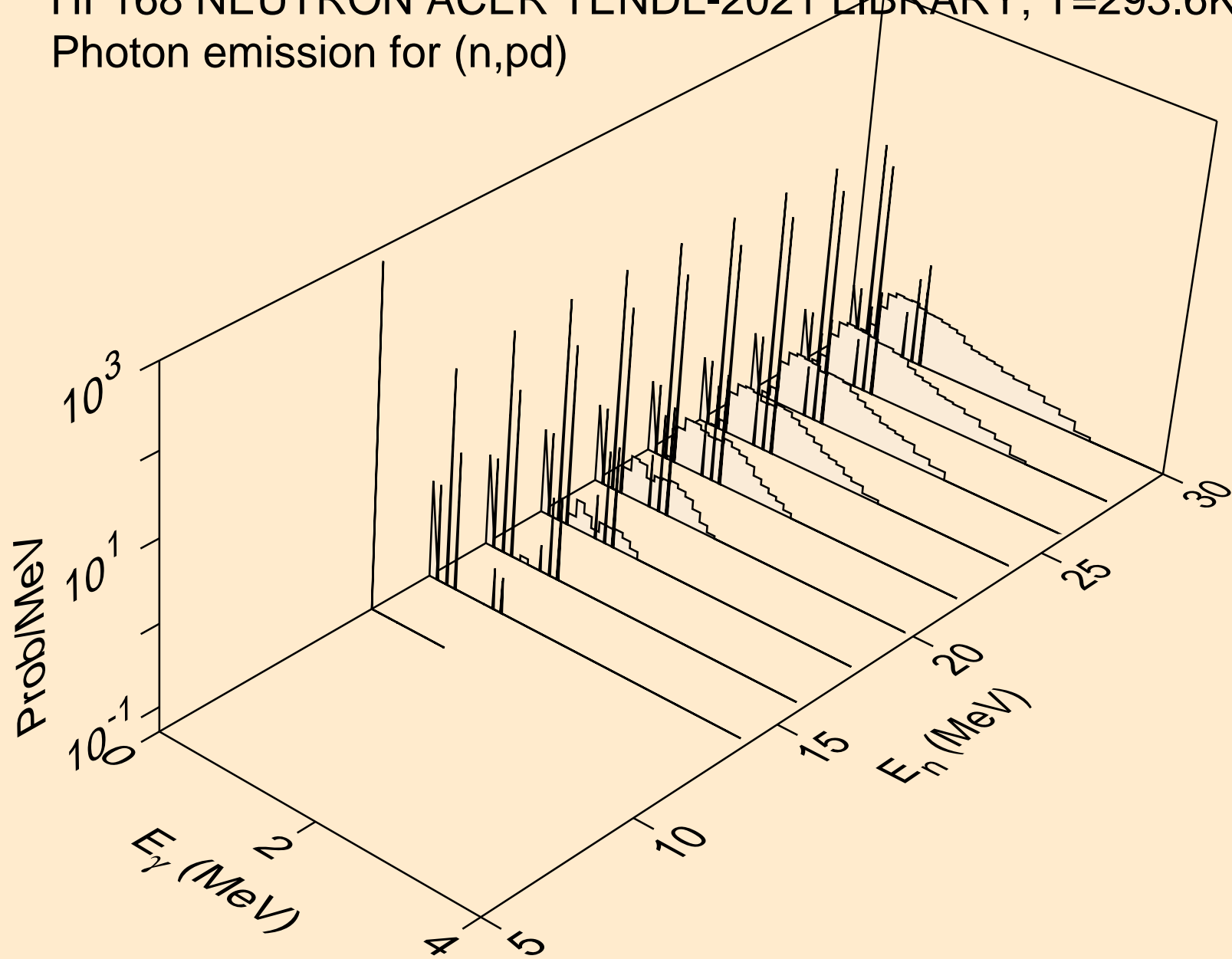

HF168 NEUTRON ACER TENDL-2021 LIBRARY; T=293.6K
Photon emission for (n,pt)

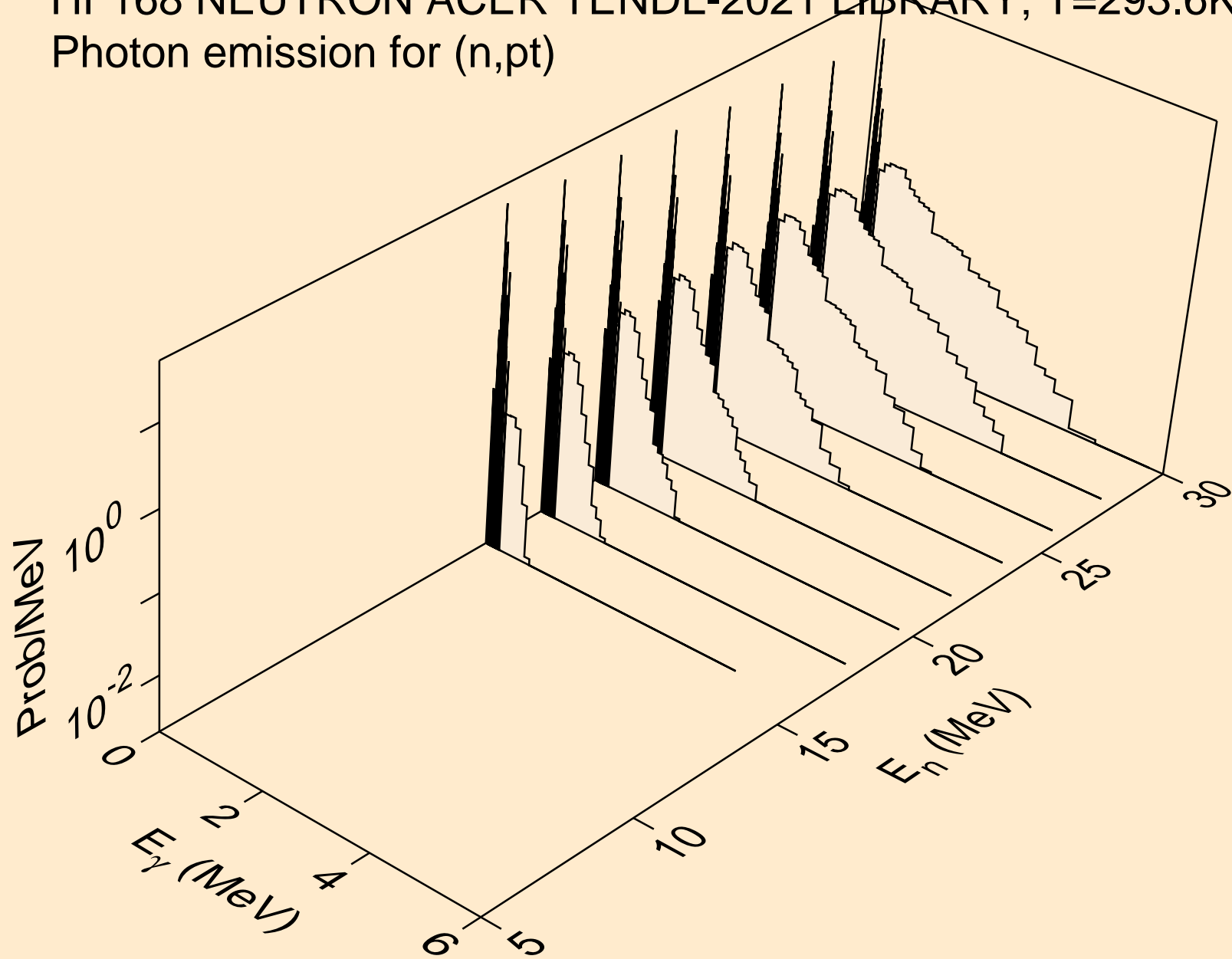

HF168 NEUTRON ACER TENDL-2021 LIBRARY; T=293.6K
Photon emission for (n,da)

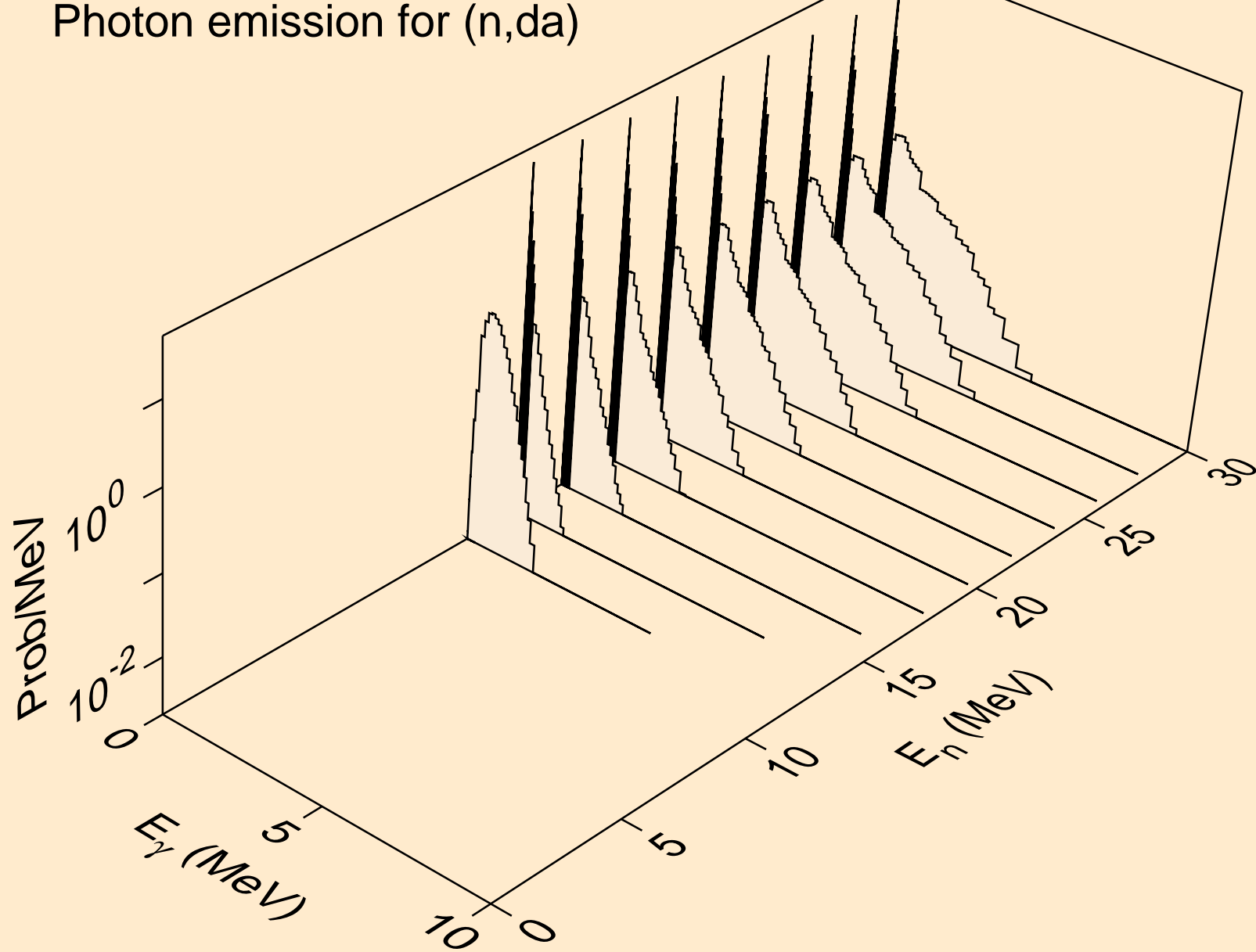

HF168 NEUTRON ACER TENDL-2021 LIBRARY; T=293.6K
thermal capture photon spectrum

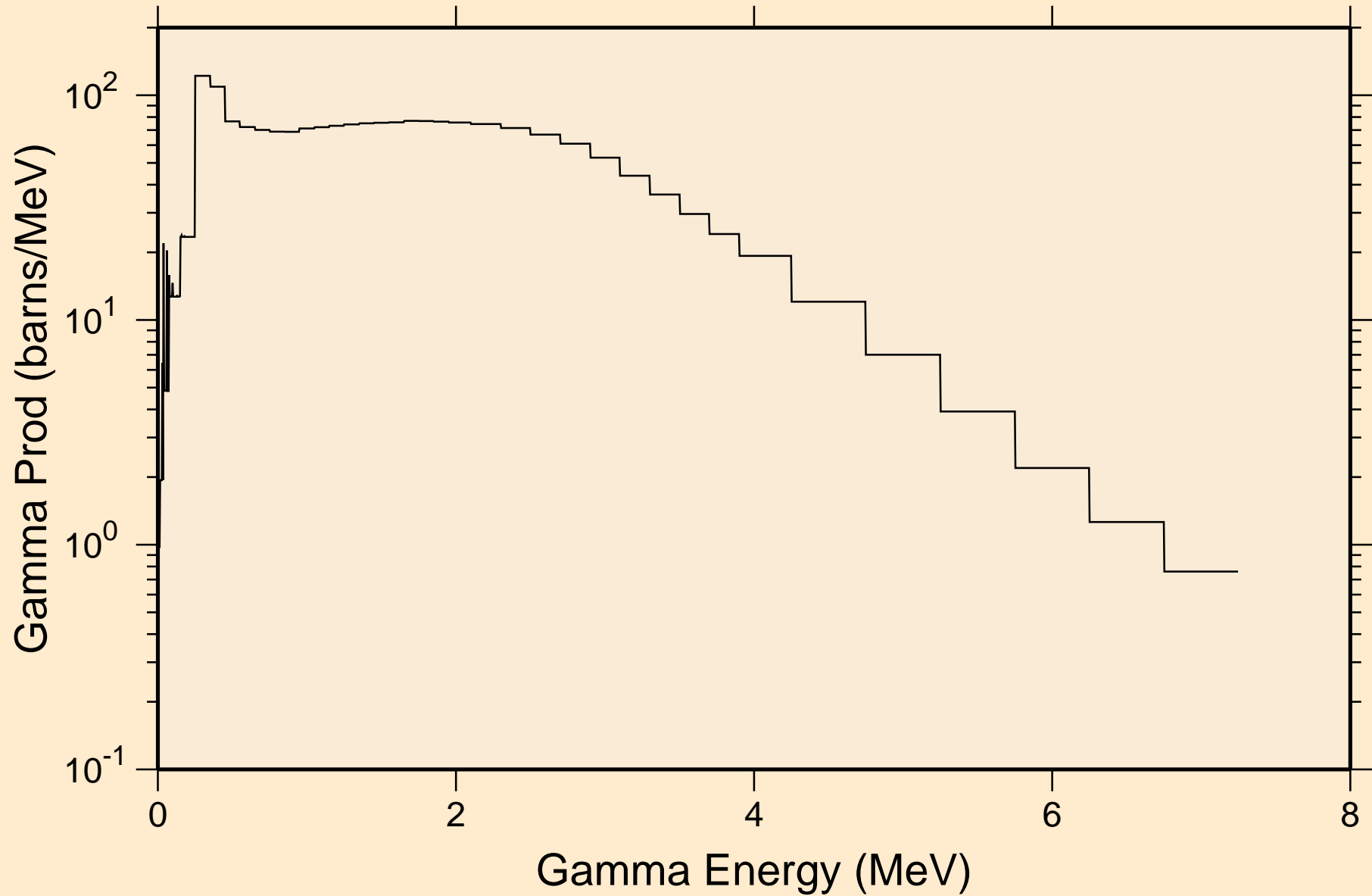

HF168 NEUTRON ACER TENDL-2021 LIBRARY; T=293.6K
14 MeV photon spectrum

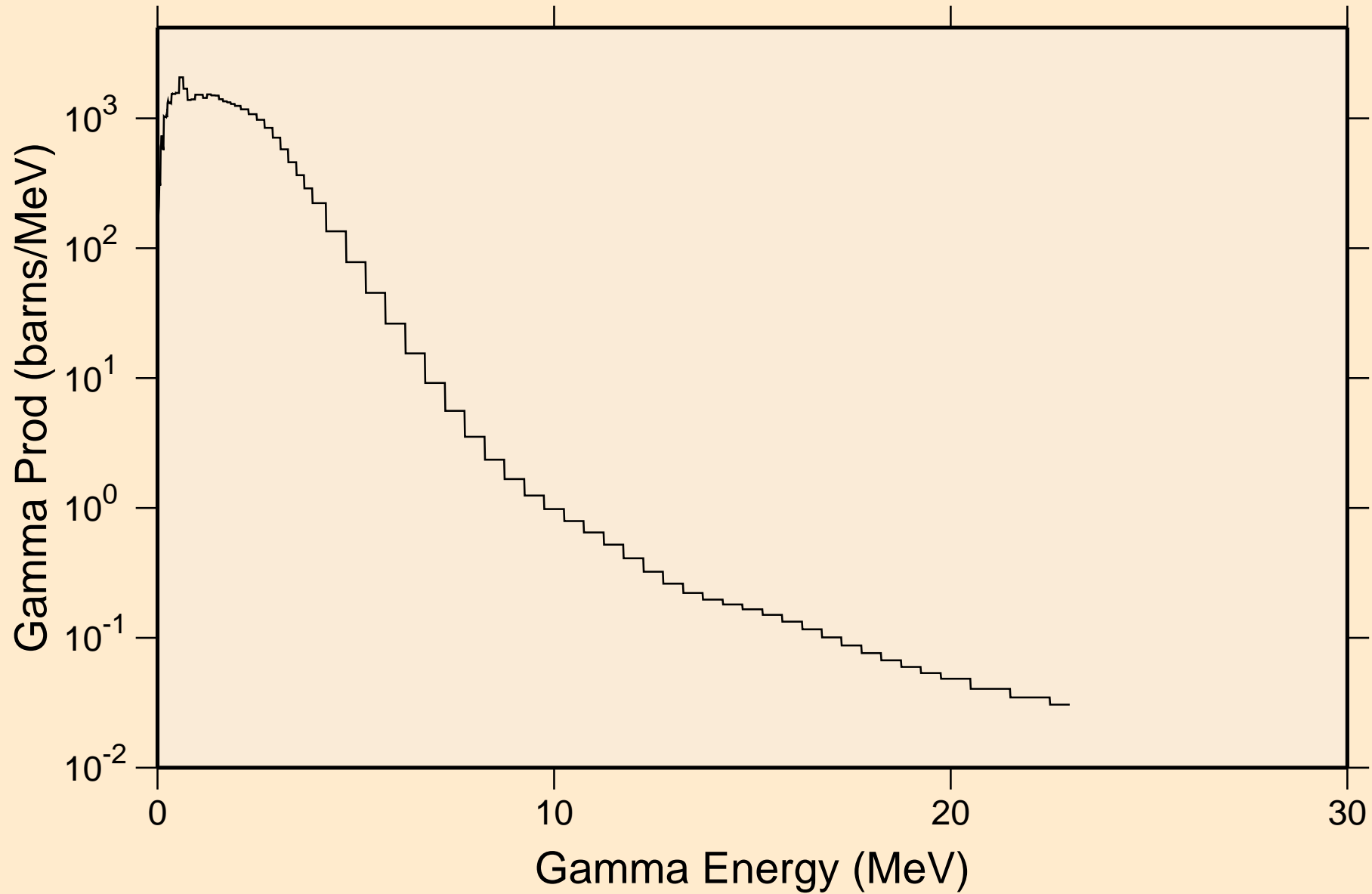

HF168 NEUTRON ACER TENDL-2021 LIBRARY; T=293.6K

Particle heating contributions

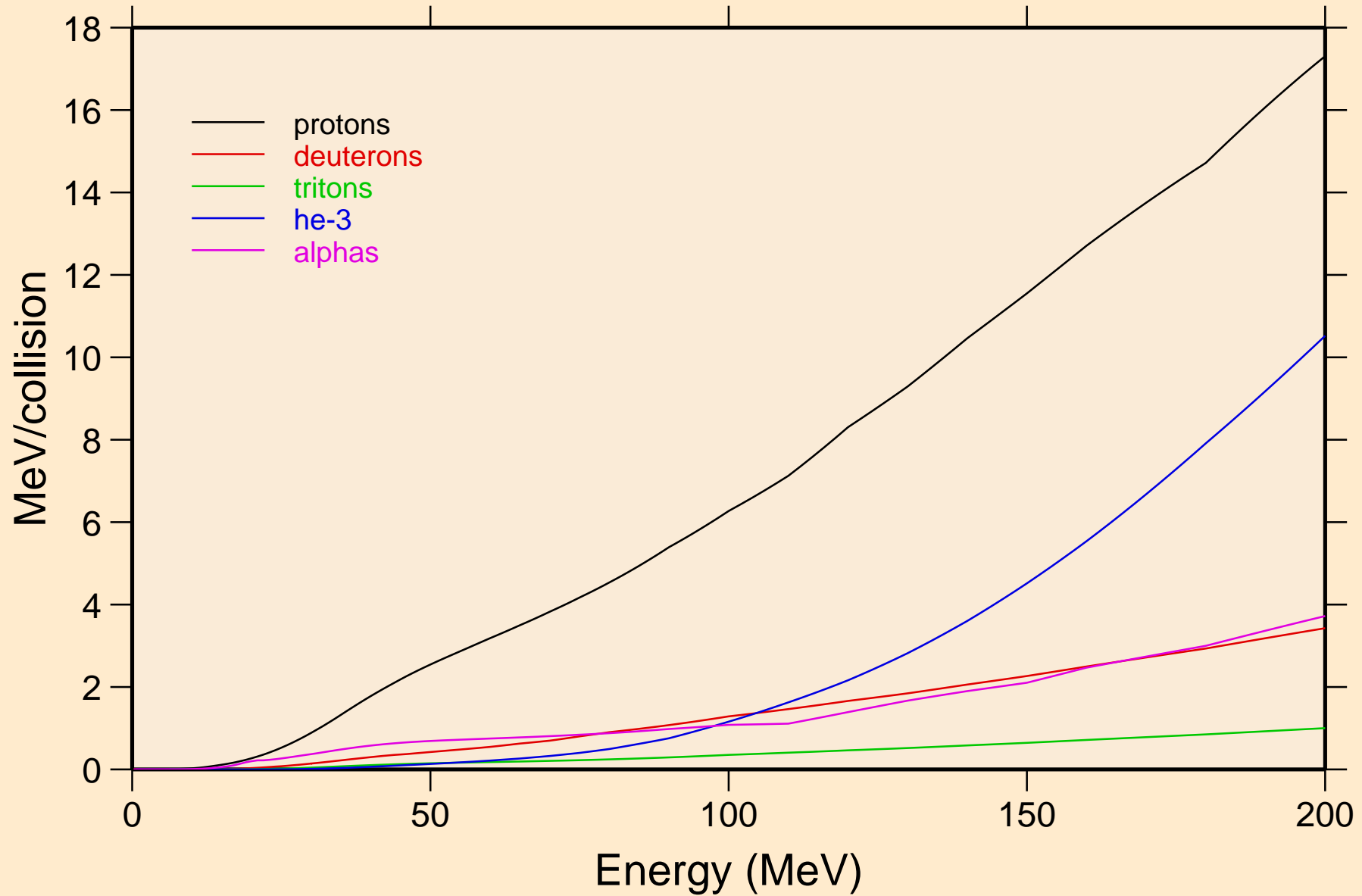

HF168 NEUTRON ACER TENDL-2021 LIBRARY; T=293.6K
Recoil Heating

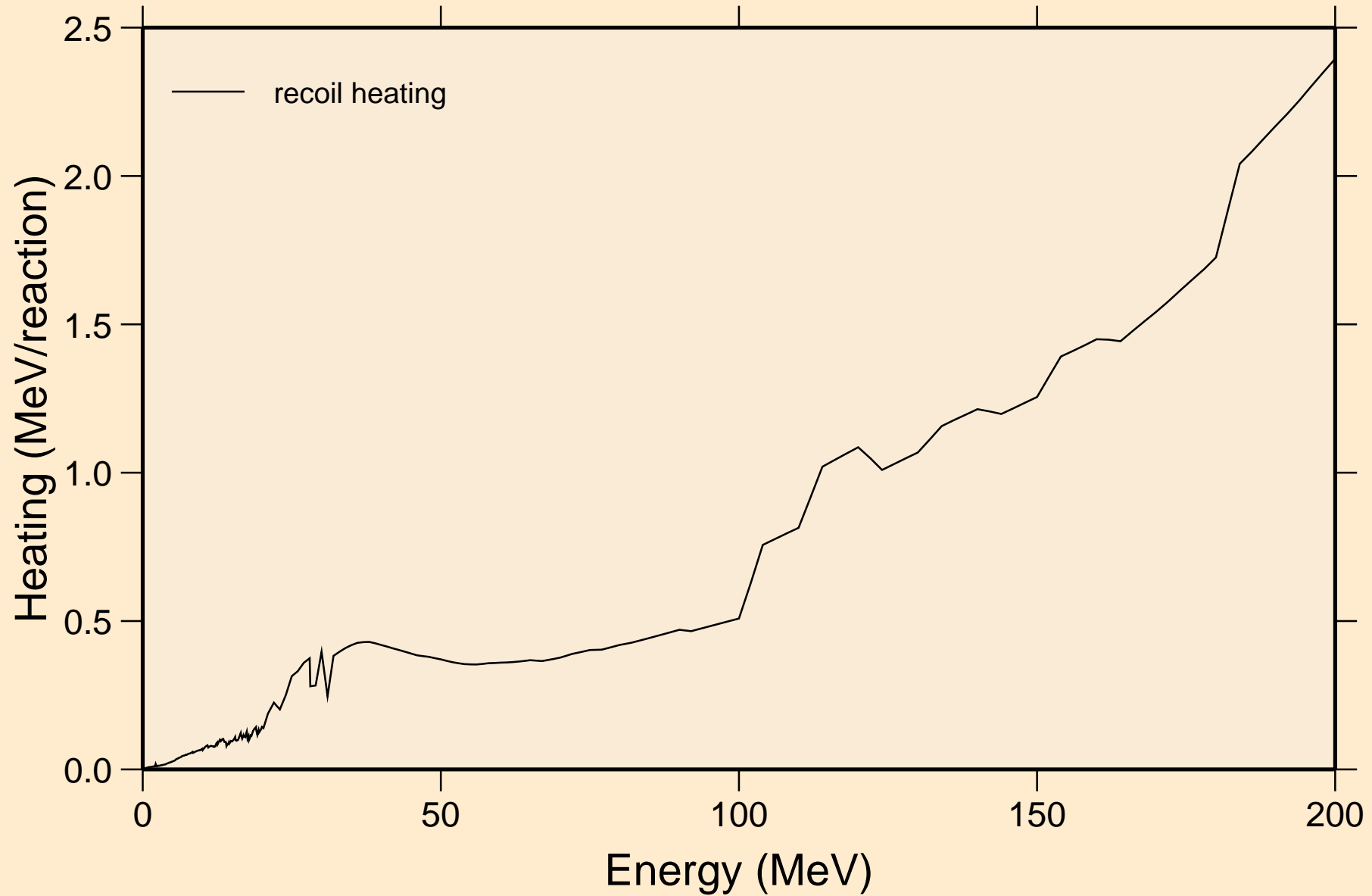

HF168 NEUTRON ACER TENDL-2021 LIBRARY; T=293.6K
Particle production cross sections

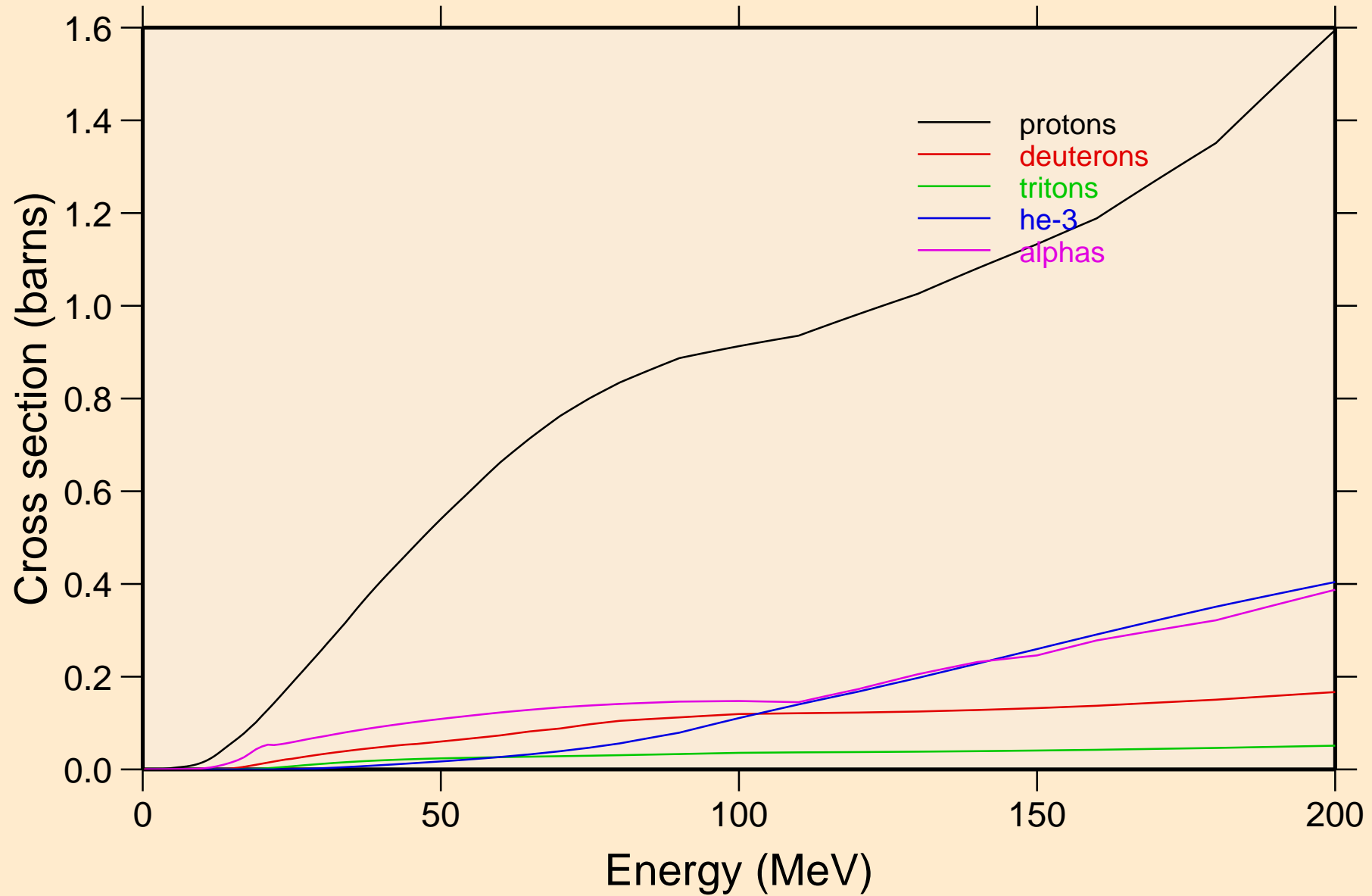

HF168 NEUTRON ACER TENDL-2021 LIBRARY; T=293.6K
protons from (n,x)

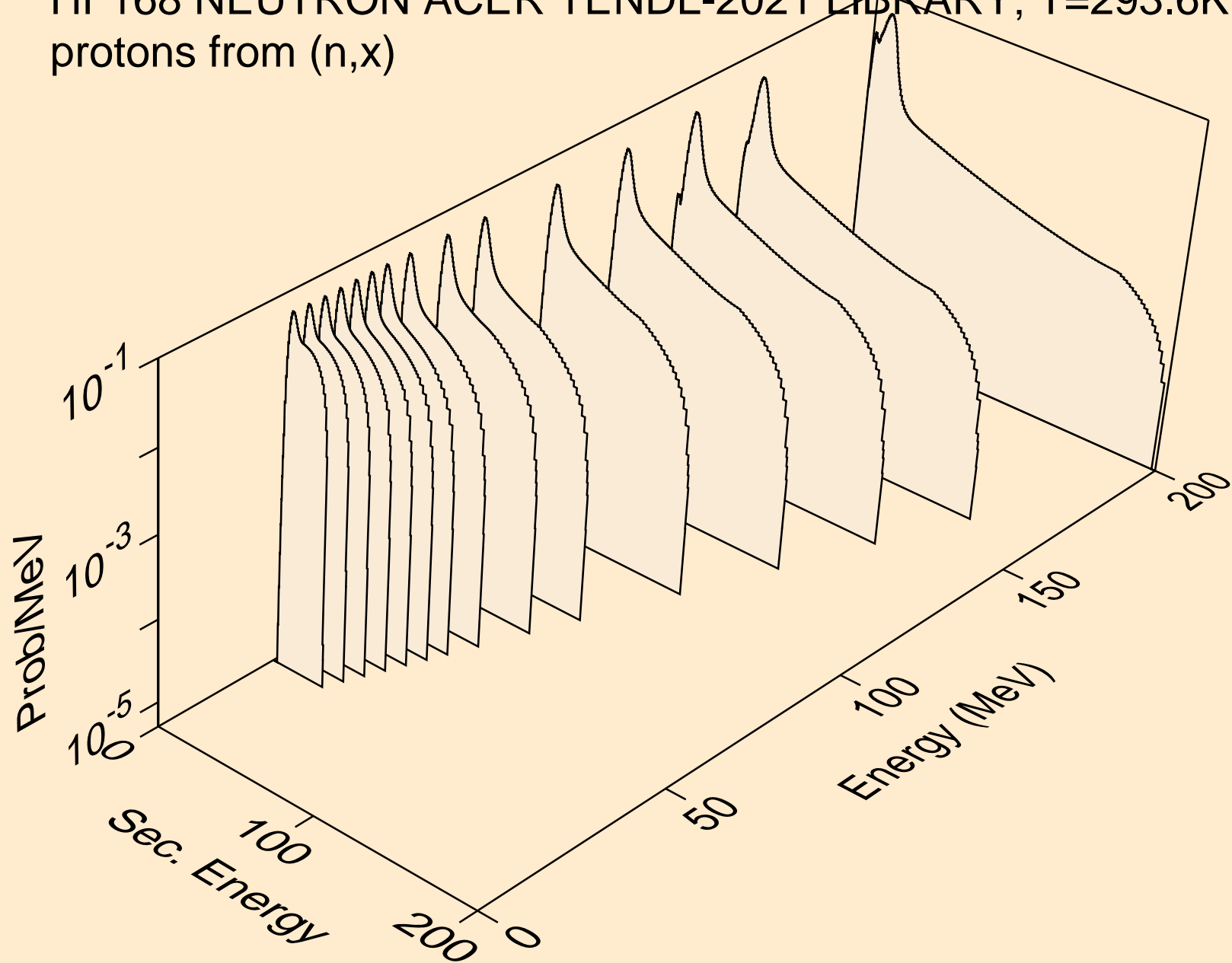

HF168 NEUTRON ACER TENDL-2021 LIBRARY; T=293.6K
protons from (n,n*)p

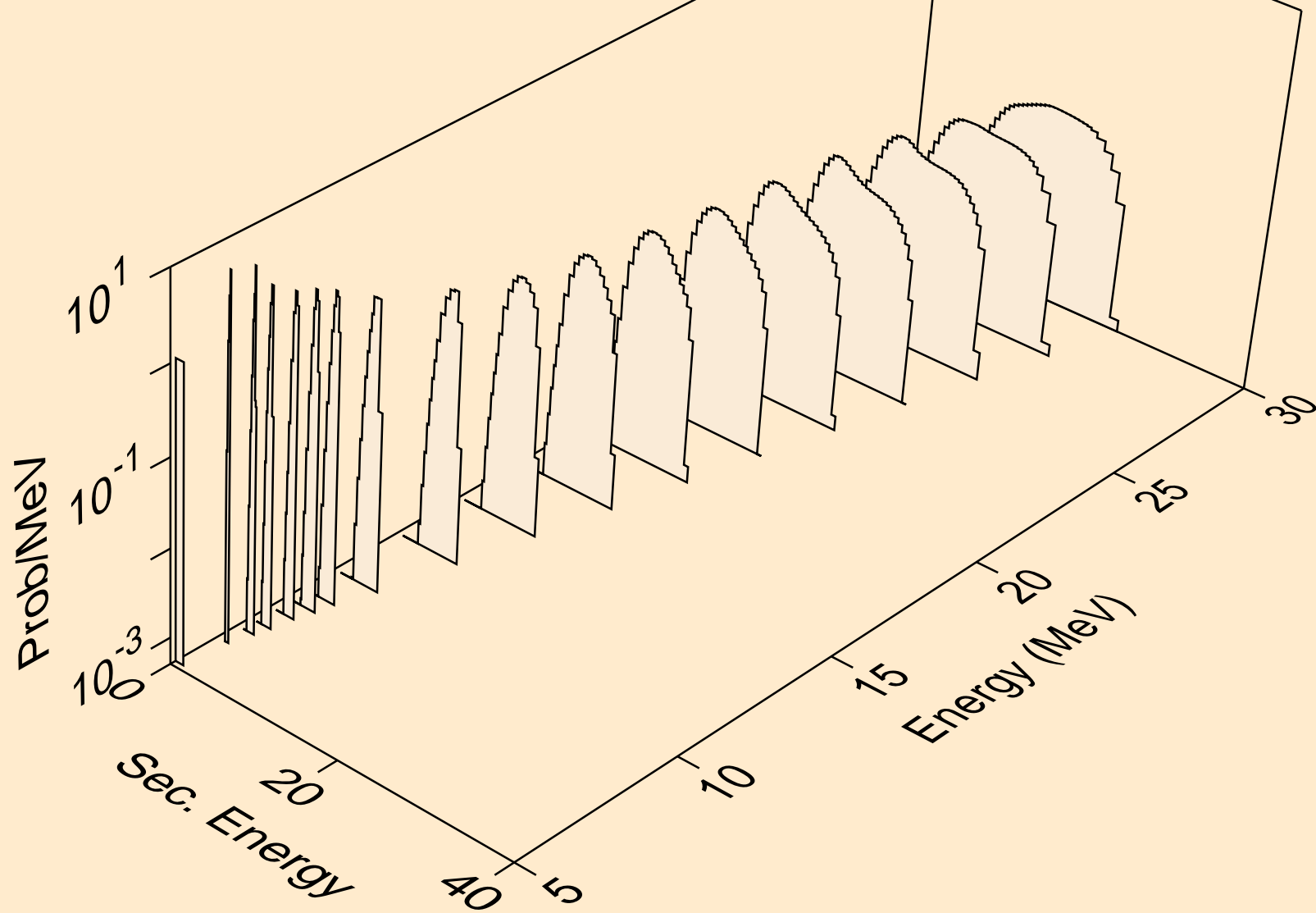

HF168 NEUTRON ACER TENDL-2021 LIBRARY; T=293.6K
protons from (n,2np)

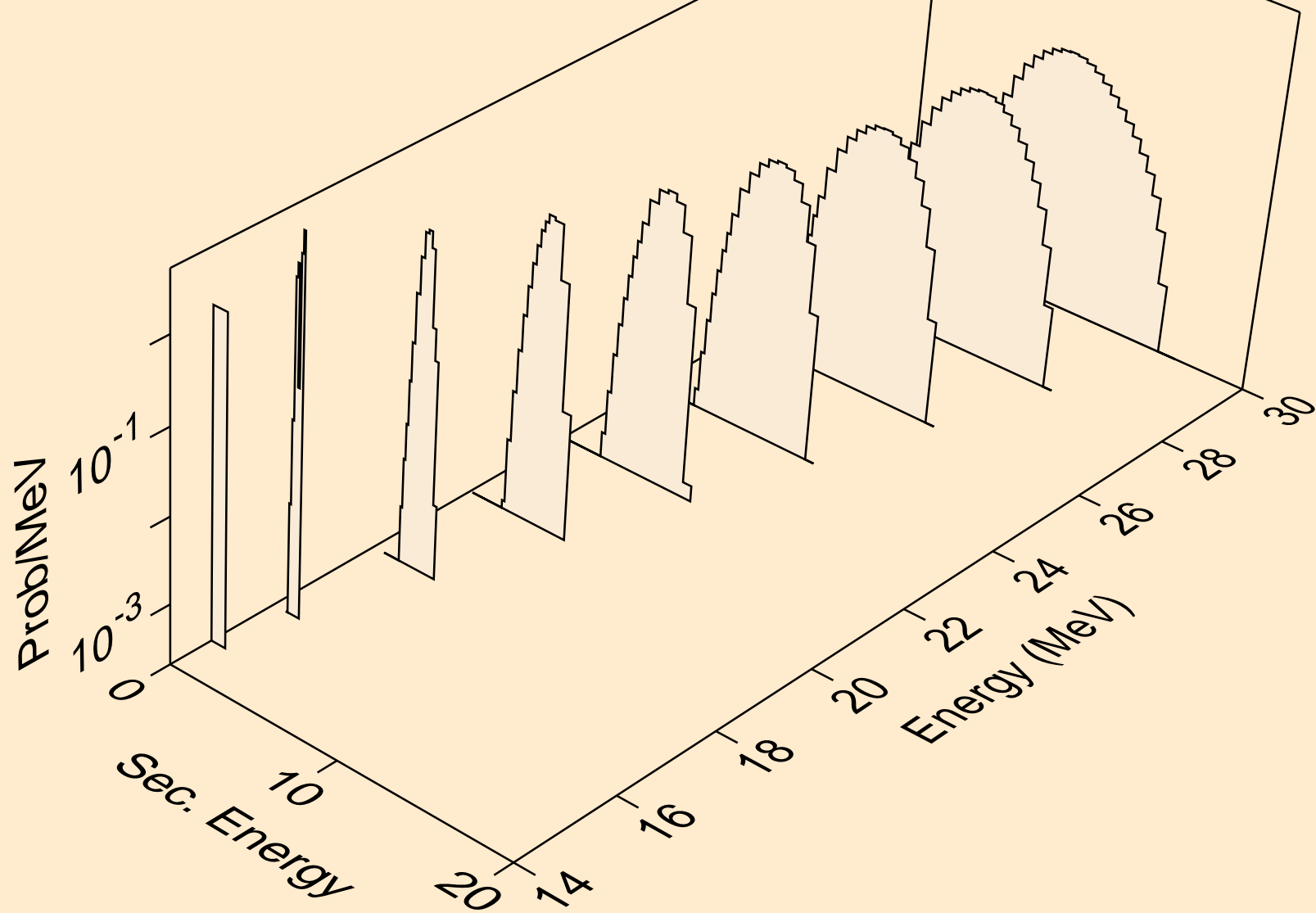

HF168 NEUTRON ACER TENDL-2021 LIBRARY; T=293.6K
protons from (n,3np)

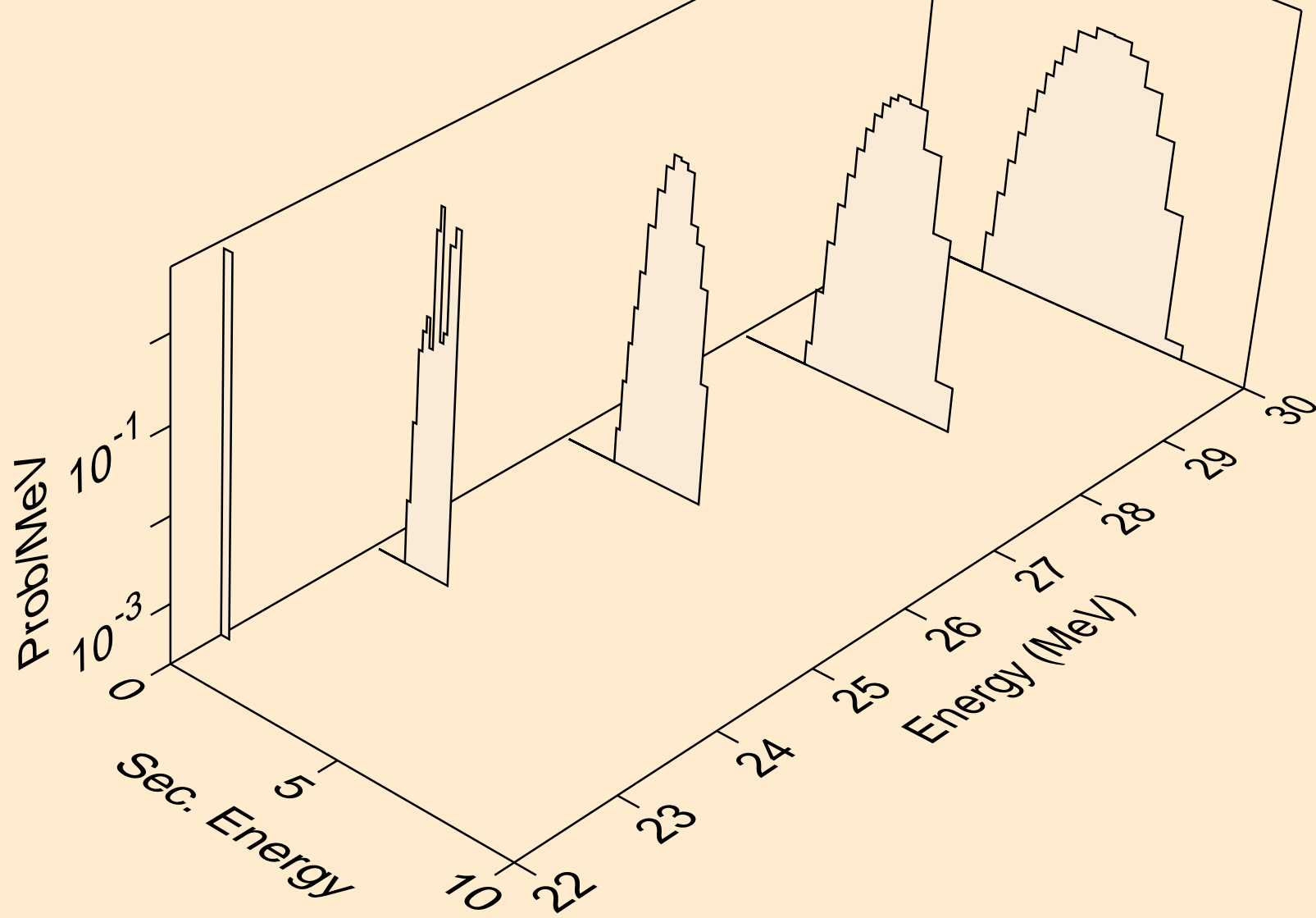

HF168 NEUTRON ACER TENDL-2021 LIBRARY; T=293.6K
protons from (n,2np)

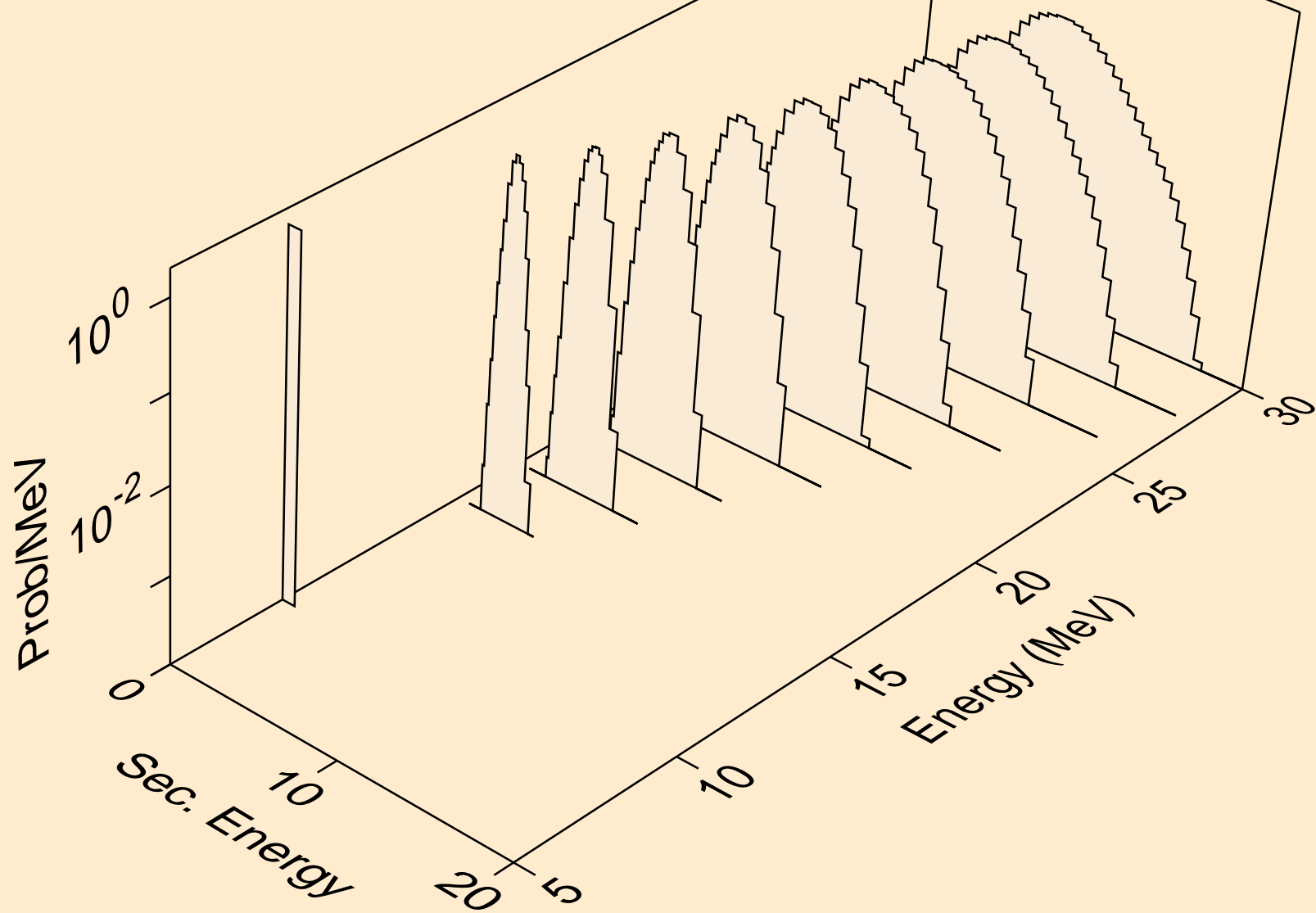

HF168 NEUTRON ACER TENDL-2021 LIBRARY; T=293.6K
protons from (n,npa)

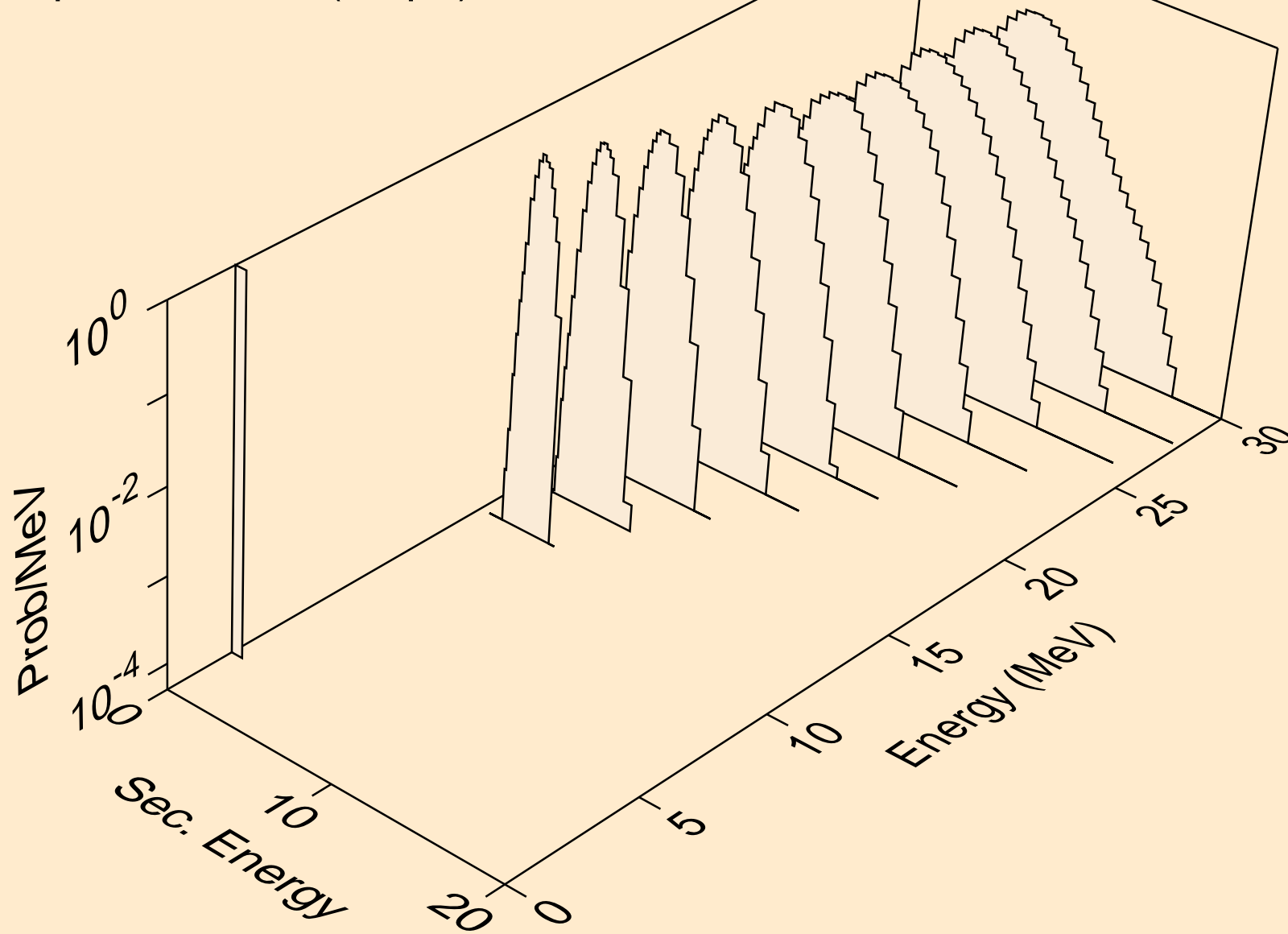

HF168 NEUTRON ACER TENDL-2021 LIBRARY; T=293.6K
protons from (n,p)

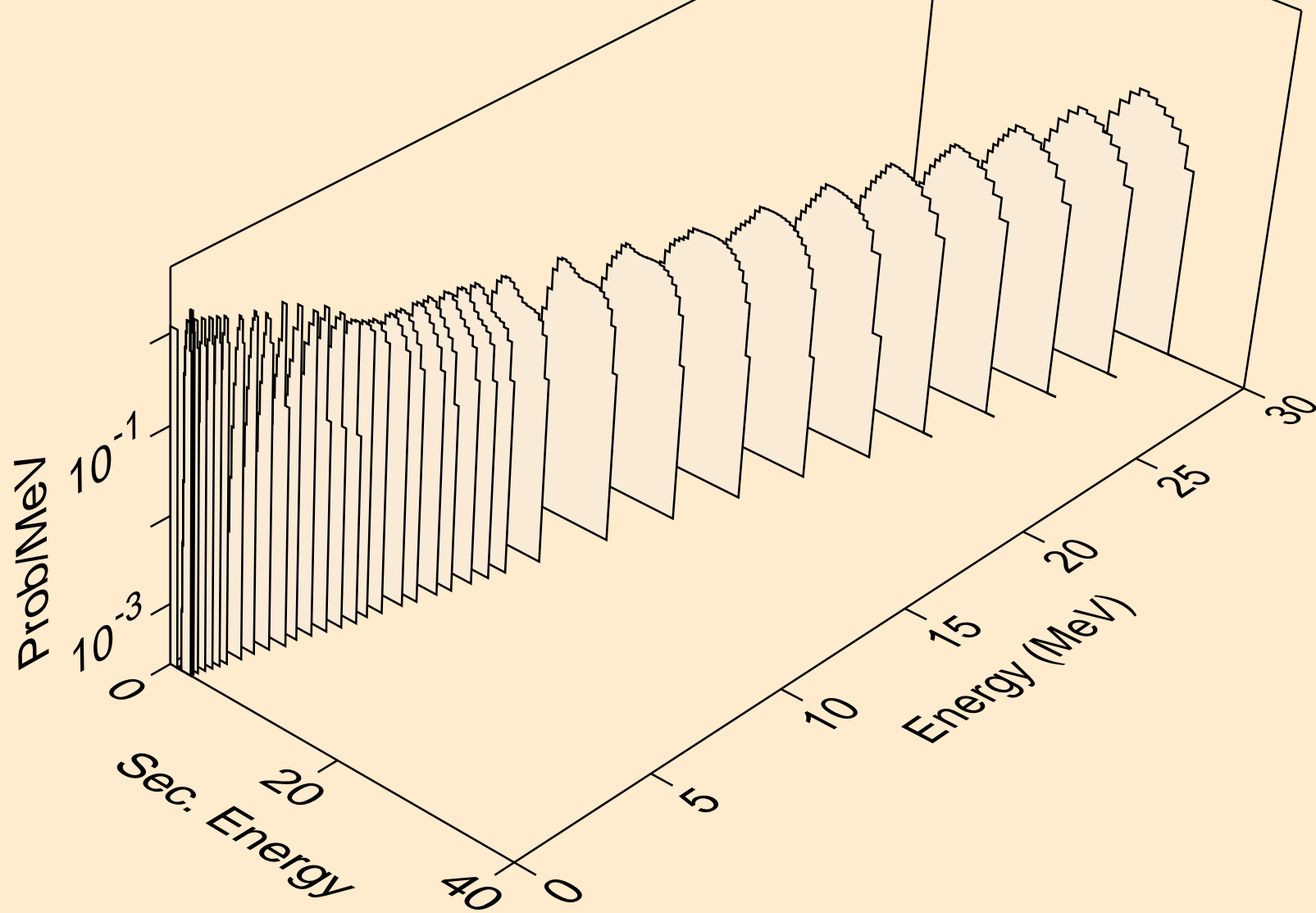

HF168 NEUTRON ACER TENDL-2021 LIBRARY; T=293.6K
protons from (n,2p)

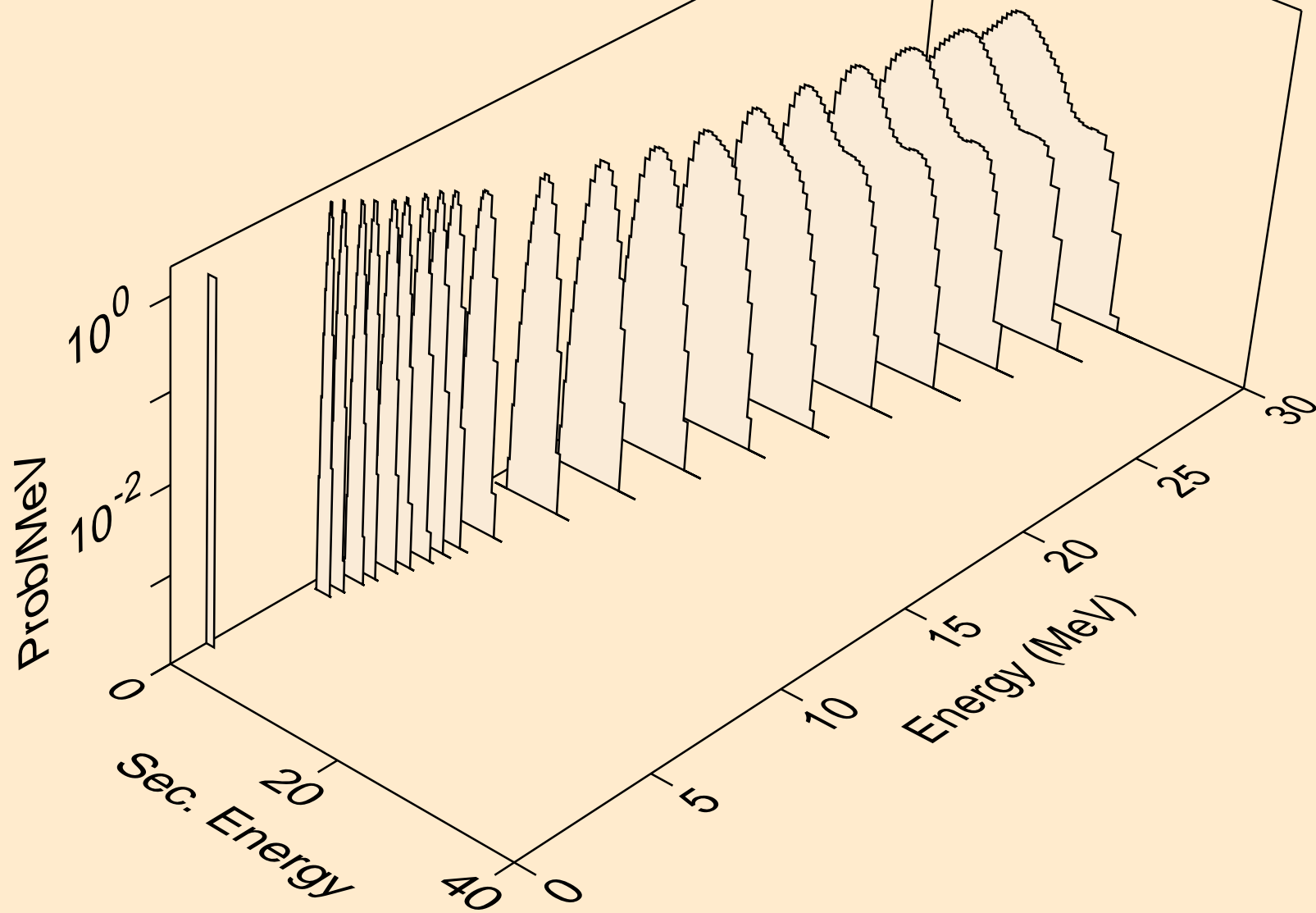

HF168 NEUTRON ACER TENDL-2021 LIBRARY; T=293.6K
protons from (n,p)

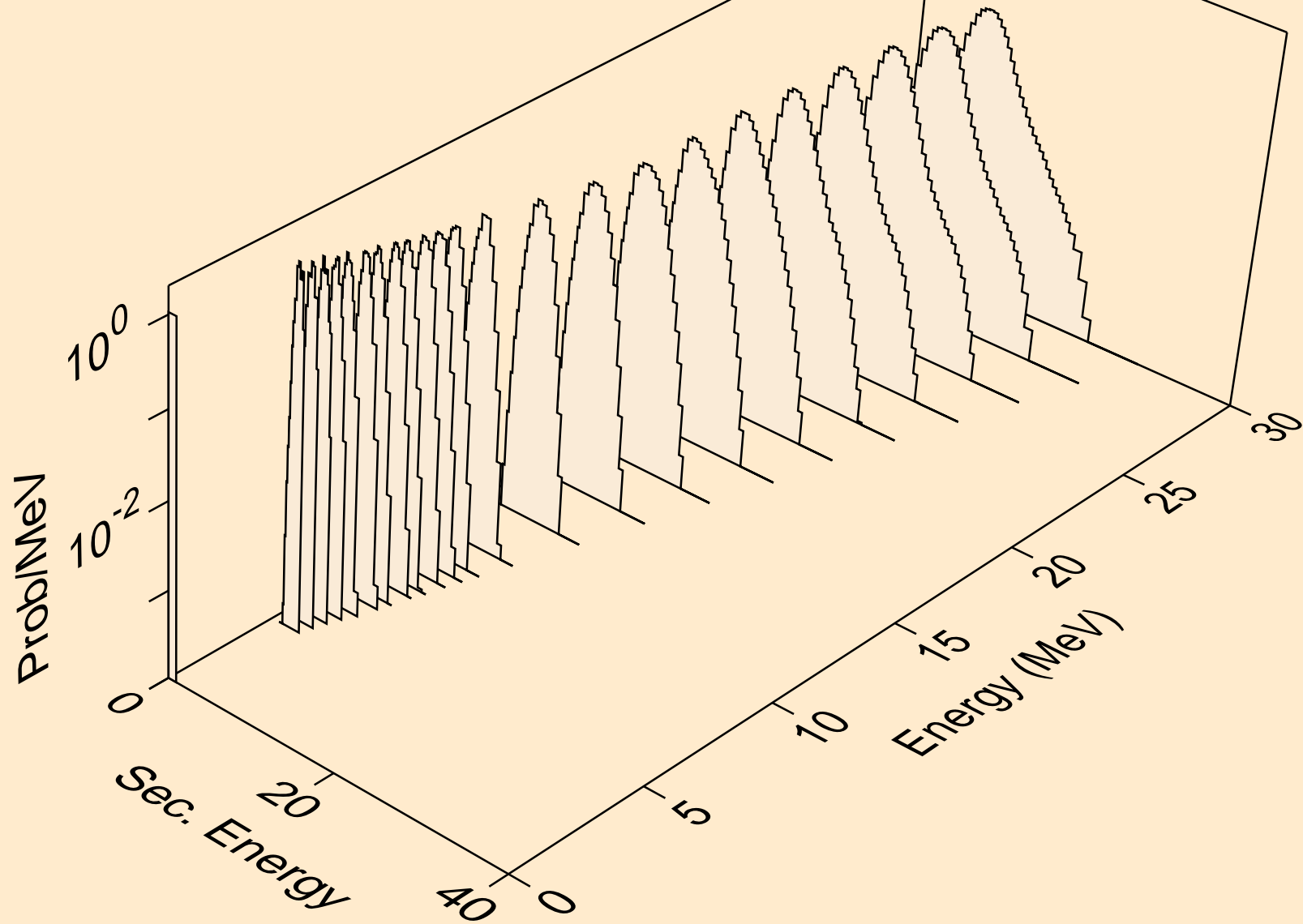

HF168 NEUTRON ACER TENDL-2021 LIBRARY; T=293.6K
protons from (n,pd)

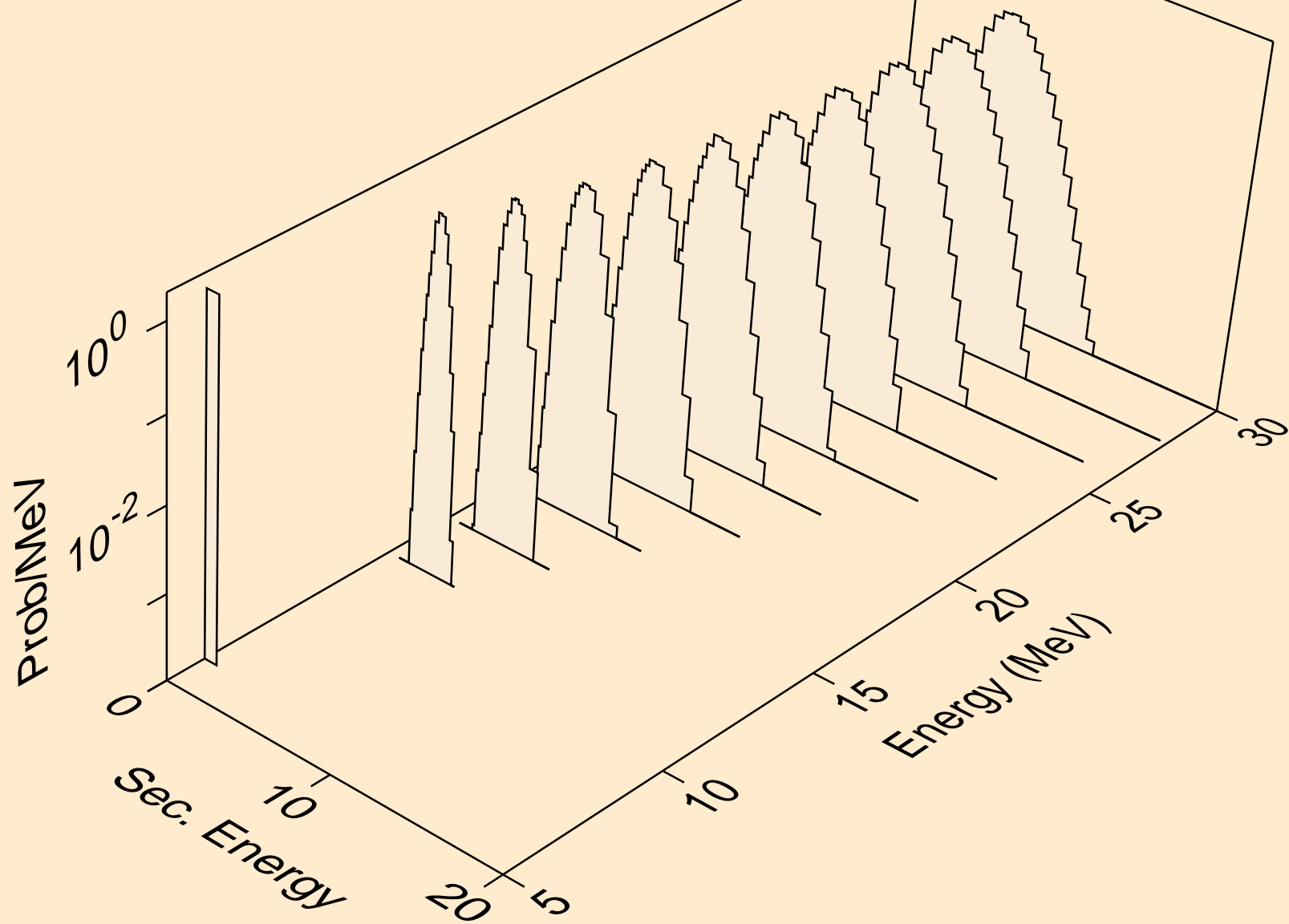

HF168 NEUTRON ACER TENDL-2021 LIBRARY; T=293.6K
protons from (n,pt)

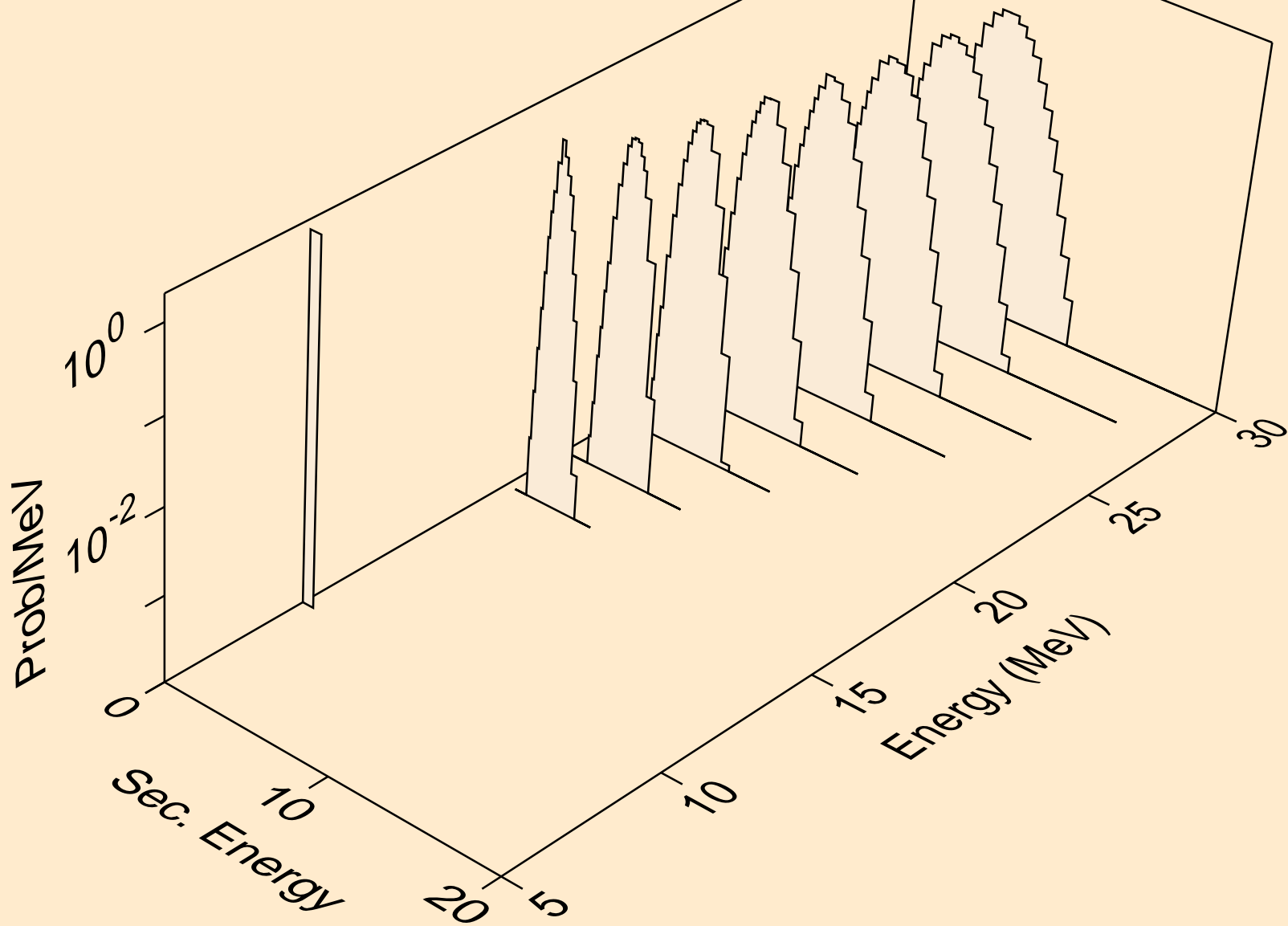

HF168 NEUTRON ACER TENDL-2021 LIBRARY; T=293.6K
deuterons from (n,x)

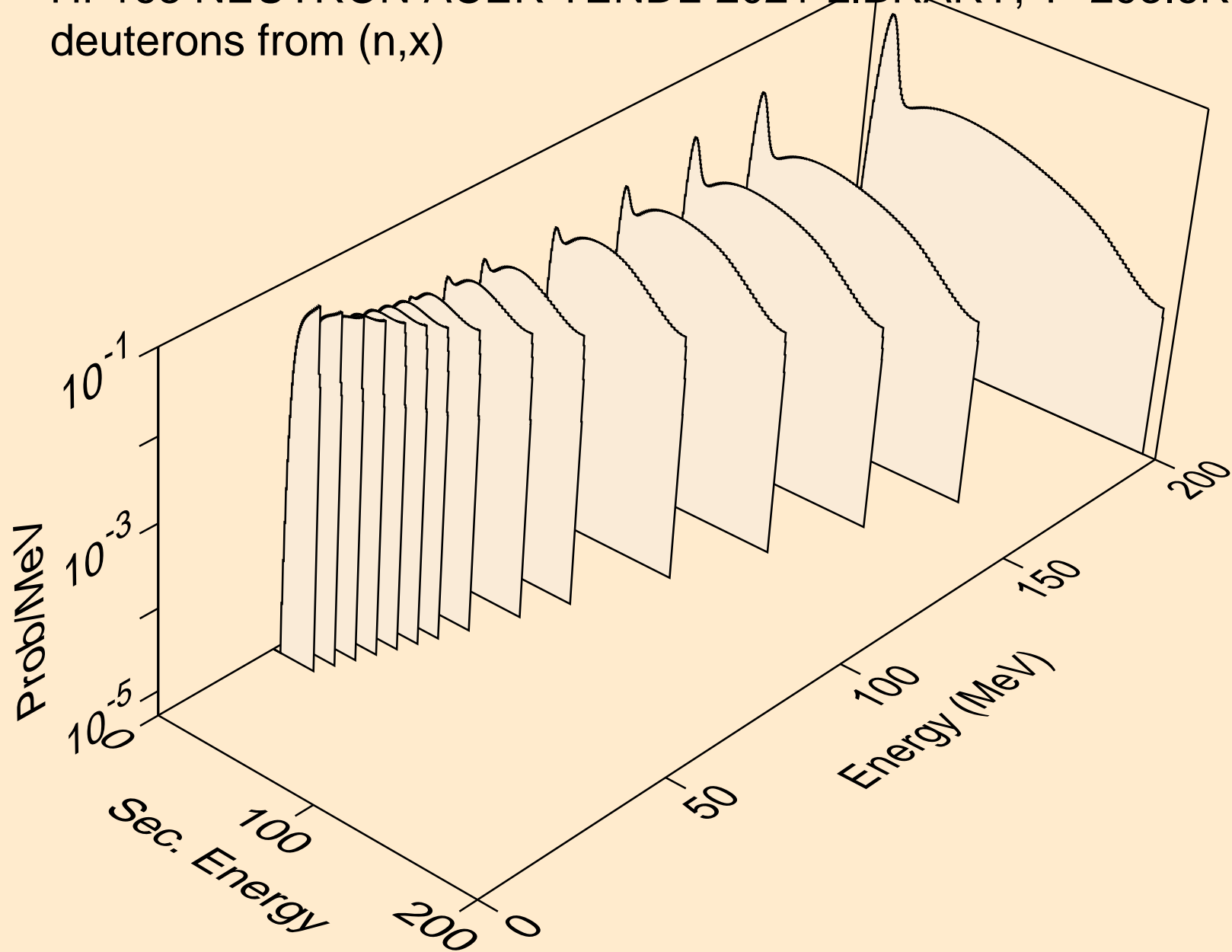

HF168 NEUTRON ACER TENDL-2021 LIBRARY; T=293.6K
deuterons from (n,2nd)

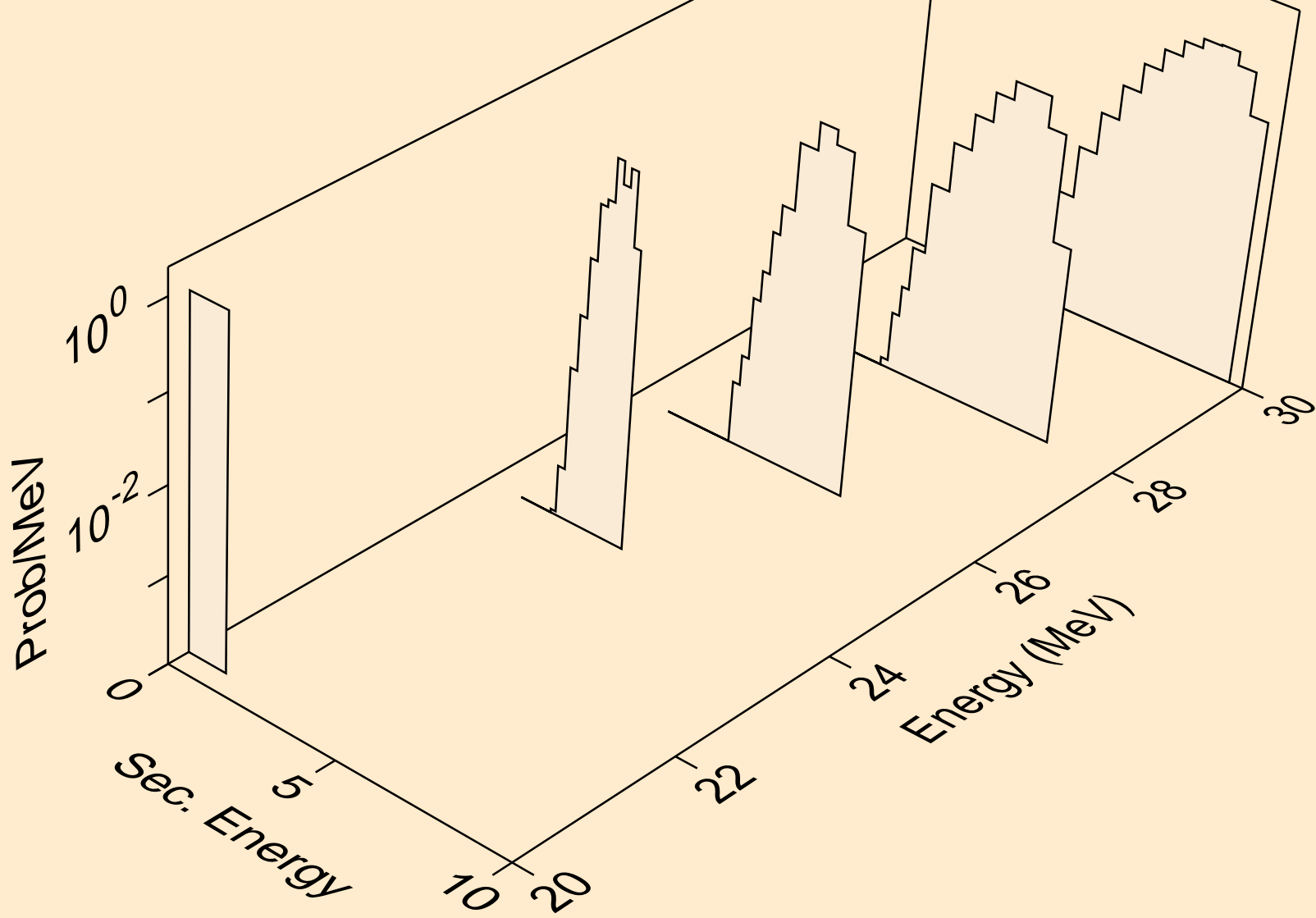

HF168 NEUTRON ACER TENDL-2021 LIBRARY; T=293.6K
deuterons from (n,n*)d

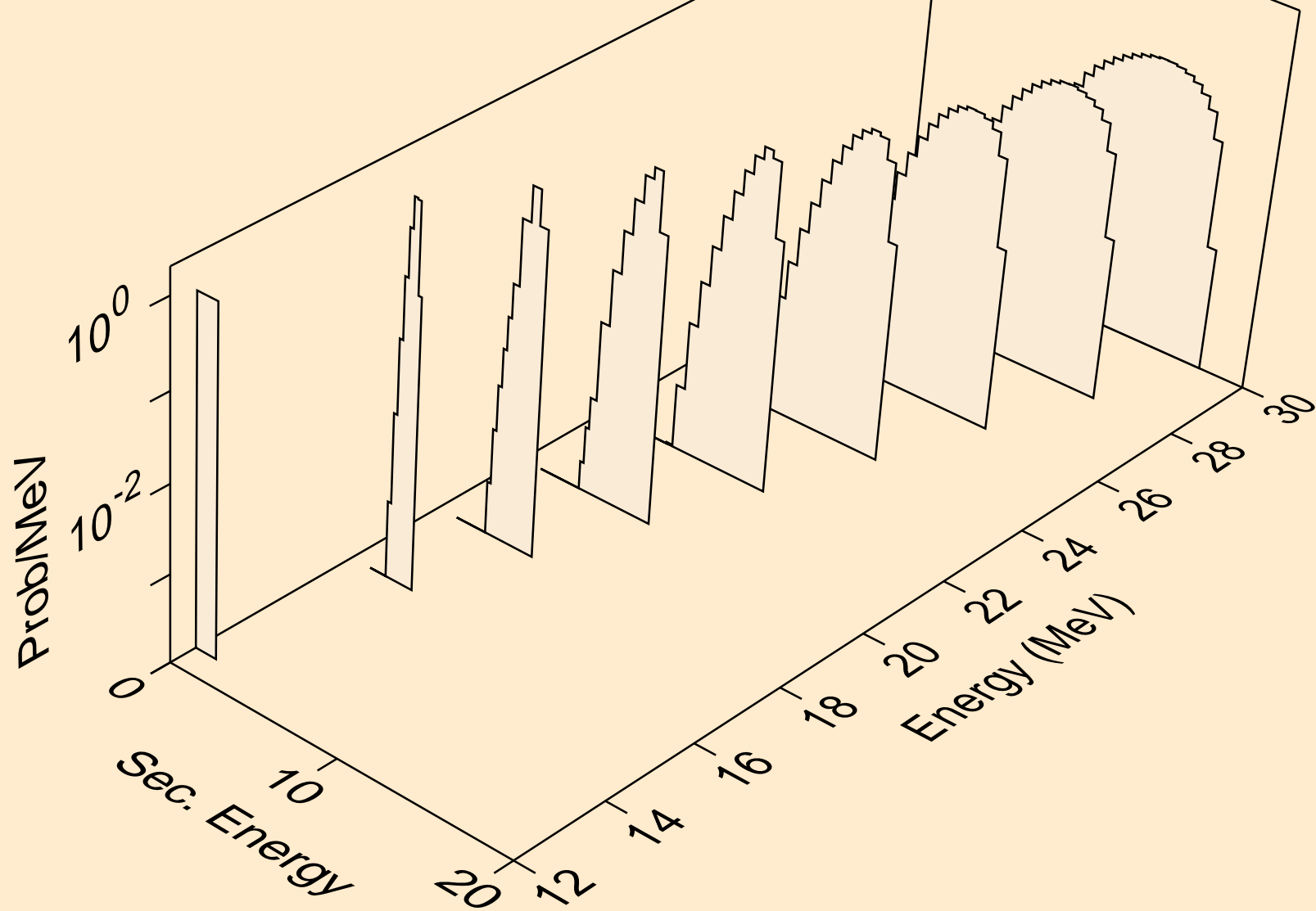

HF168 NEUTRON ACER TENDL-2021 LIBRARY; T=293.6K
deuterons from (n,d)

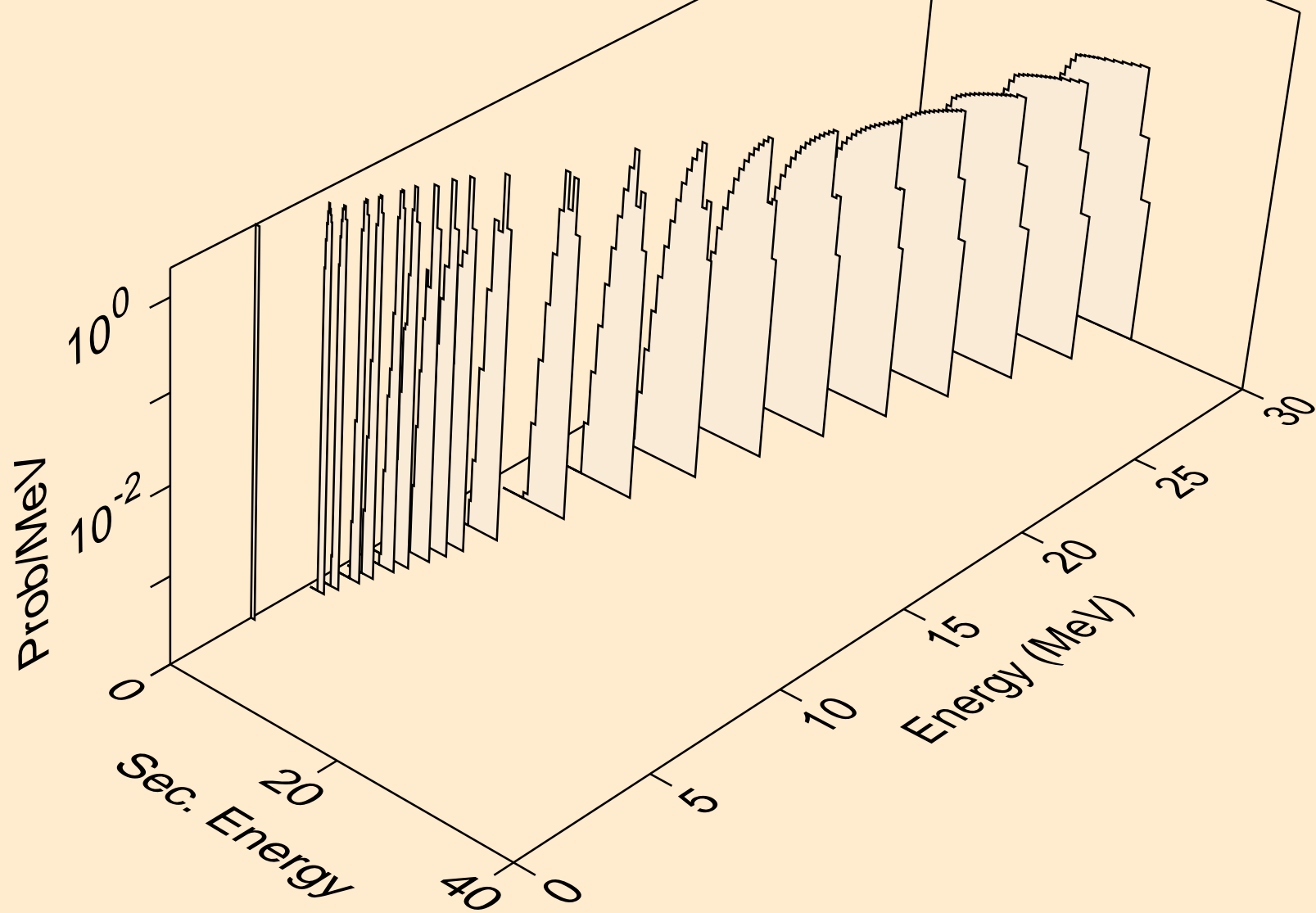

HF168 NEUTRON ACER TENDL-2021 LIBRARY; T=293.6K
deuterons from (n,pd)

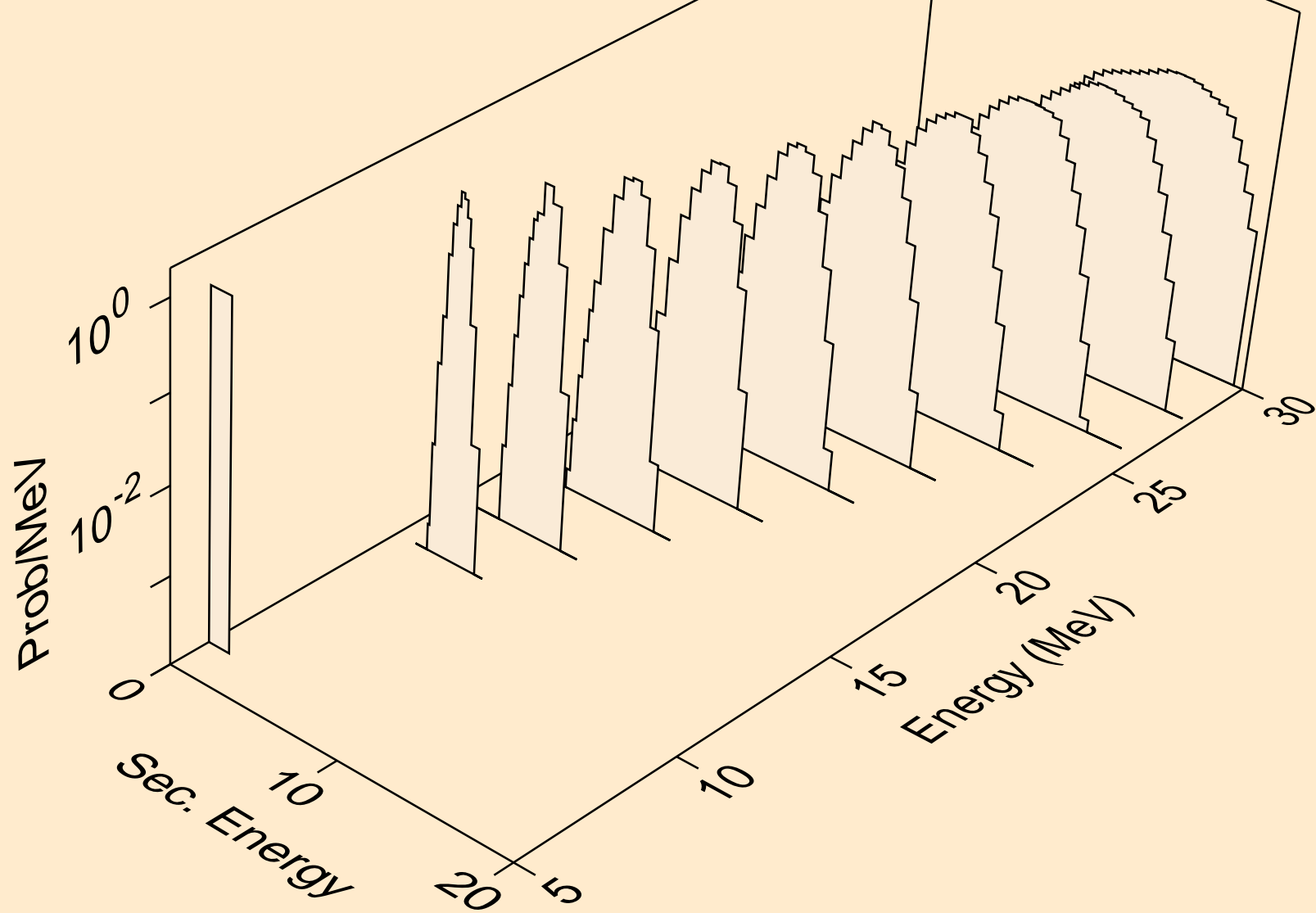

HF168 NEUTRON ACER TENDL-2021 LIBRARY; T=293.6K
deuterons from (n,da)

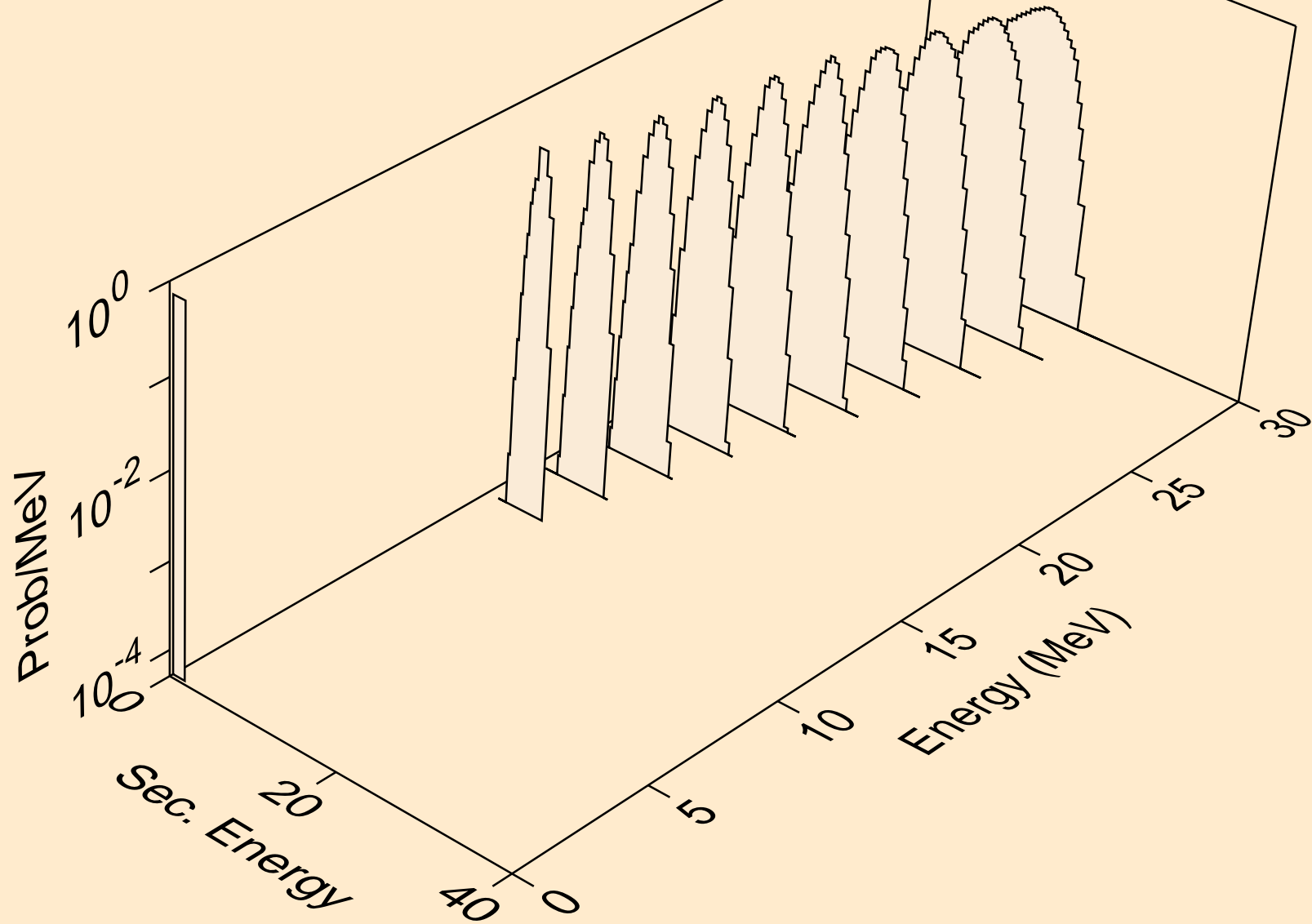

HF168 NEUTRON ACER TENDL-2021 LIBRARY; T=293.6K
tritons from (n,x)

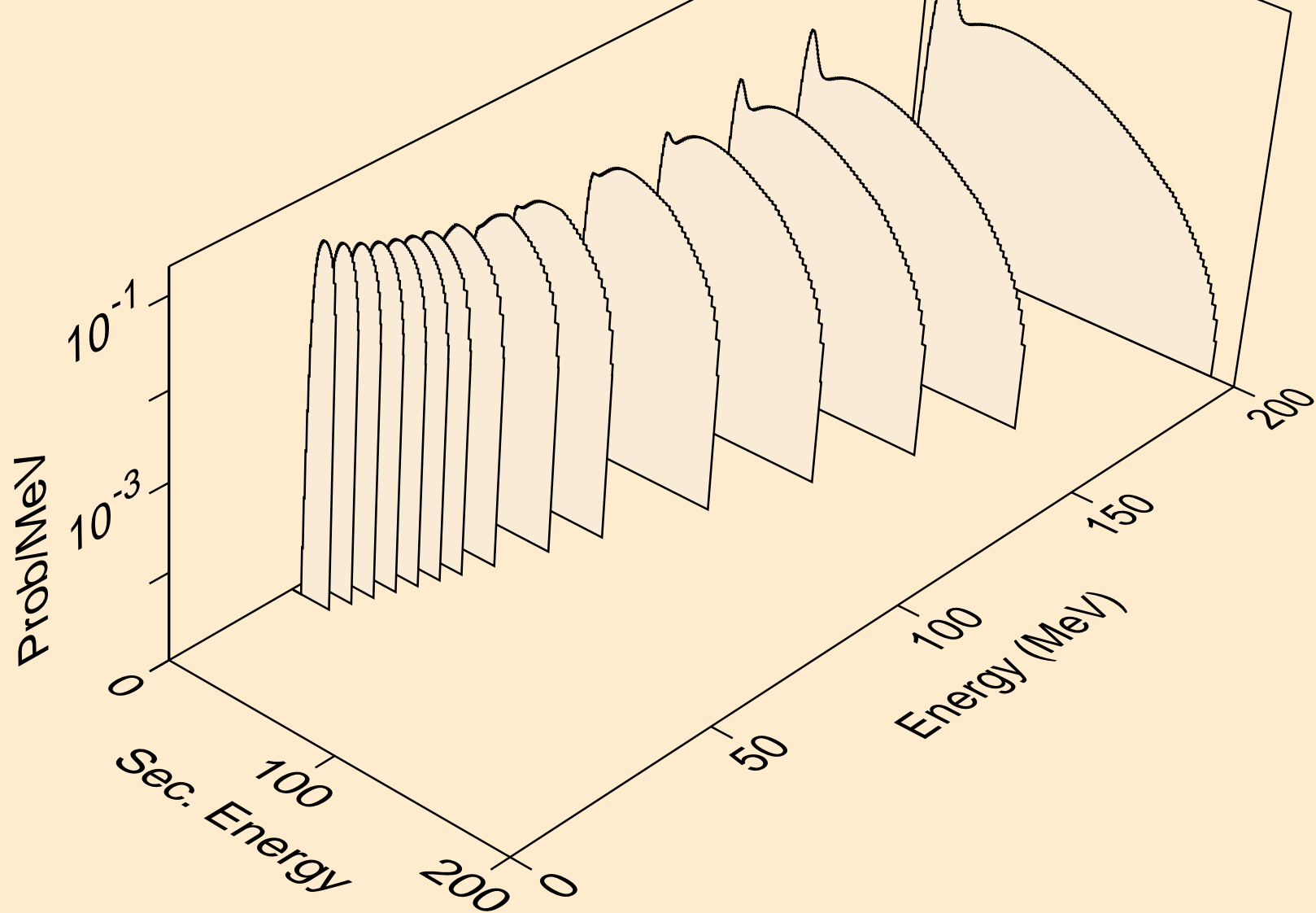

HF168 NEUTRON ACER TENDL-2021 LIBRARY; T=293.6K
tritons from (n,n*)t

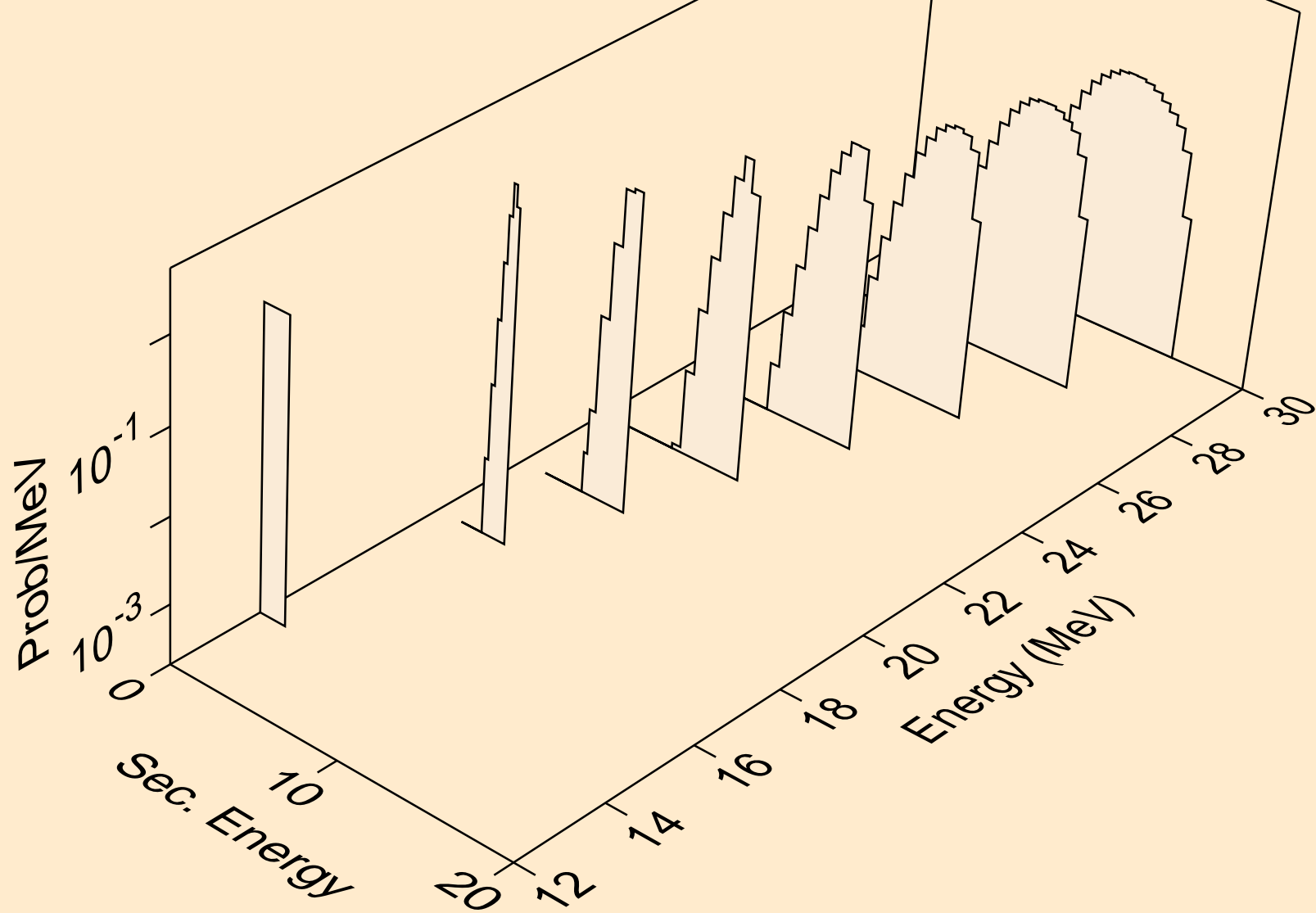

HF168 NEUTRON ACER TENDL-2021 LIBRARY; T=293.6K
tritons from (n,t)

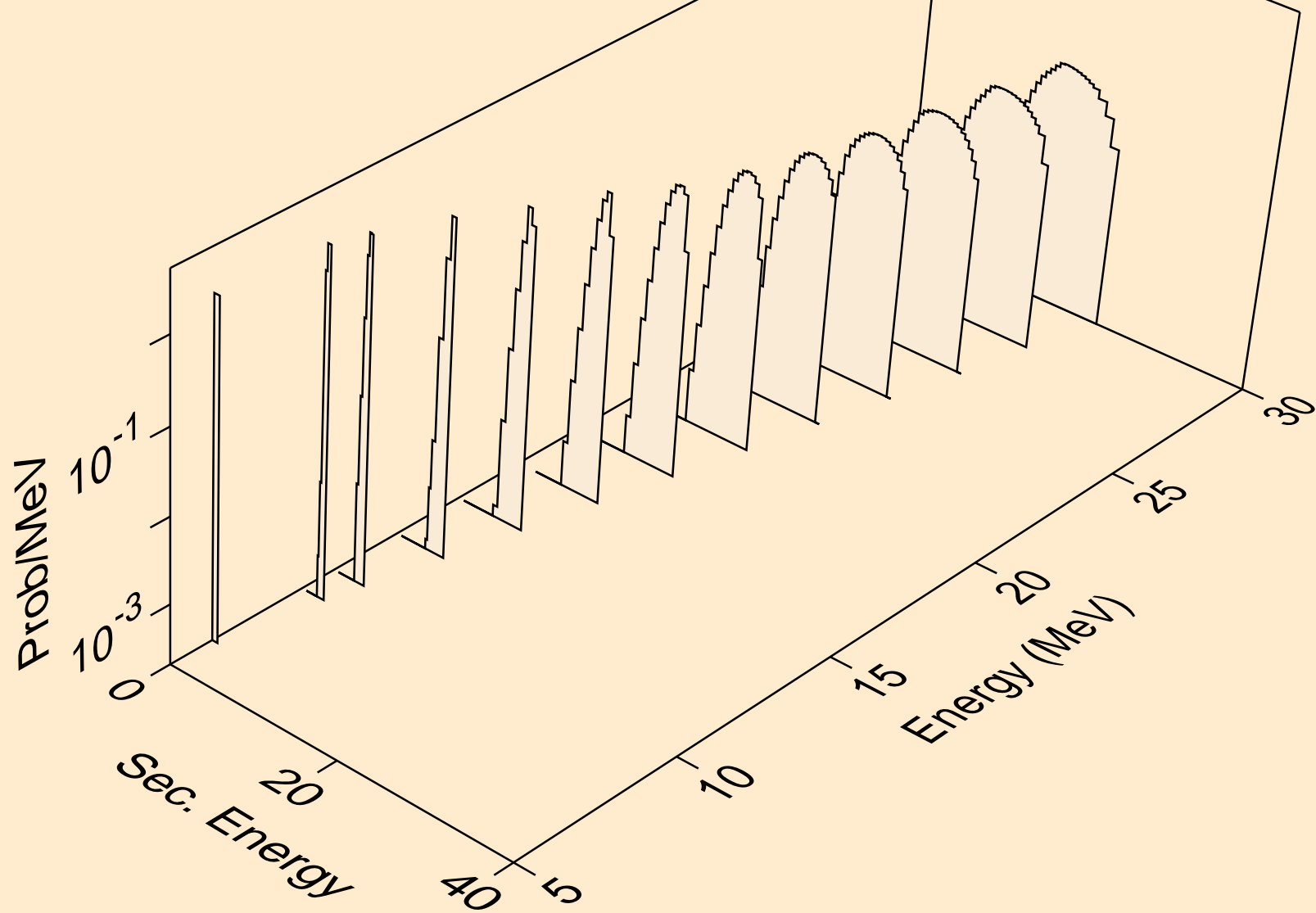

HF168 NEUTRON ACER TENDL-2021 LIBRARY; T=293.6K
tritons from (n,pt)

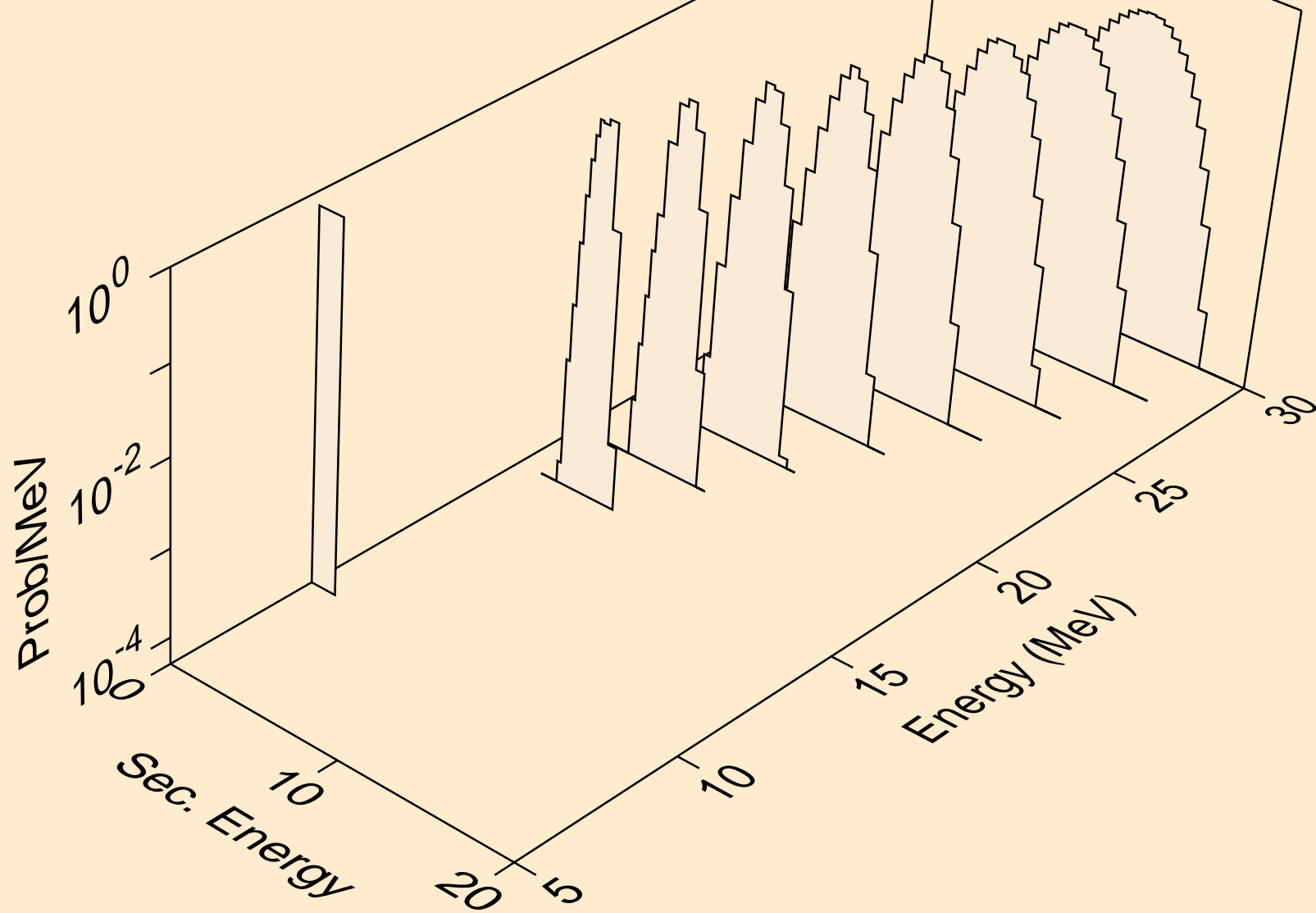

HF168 NEUTRON ACER TENDL-2021 LIBRARY; T=293.6K
he3s from (n,x)

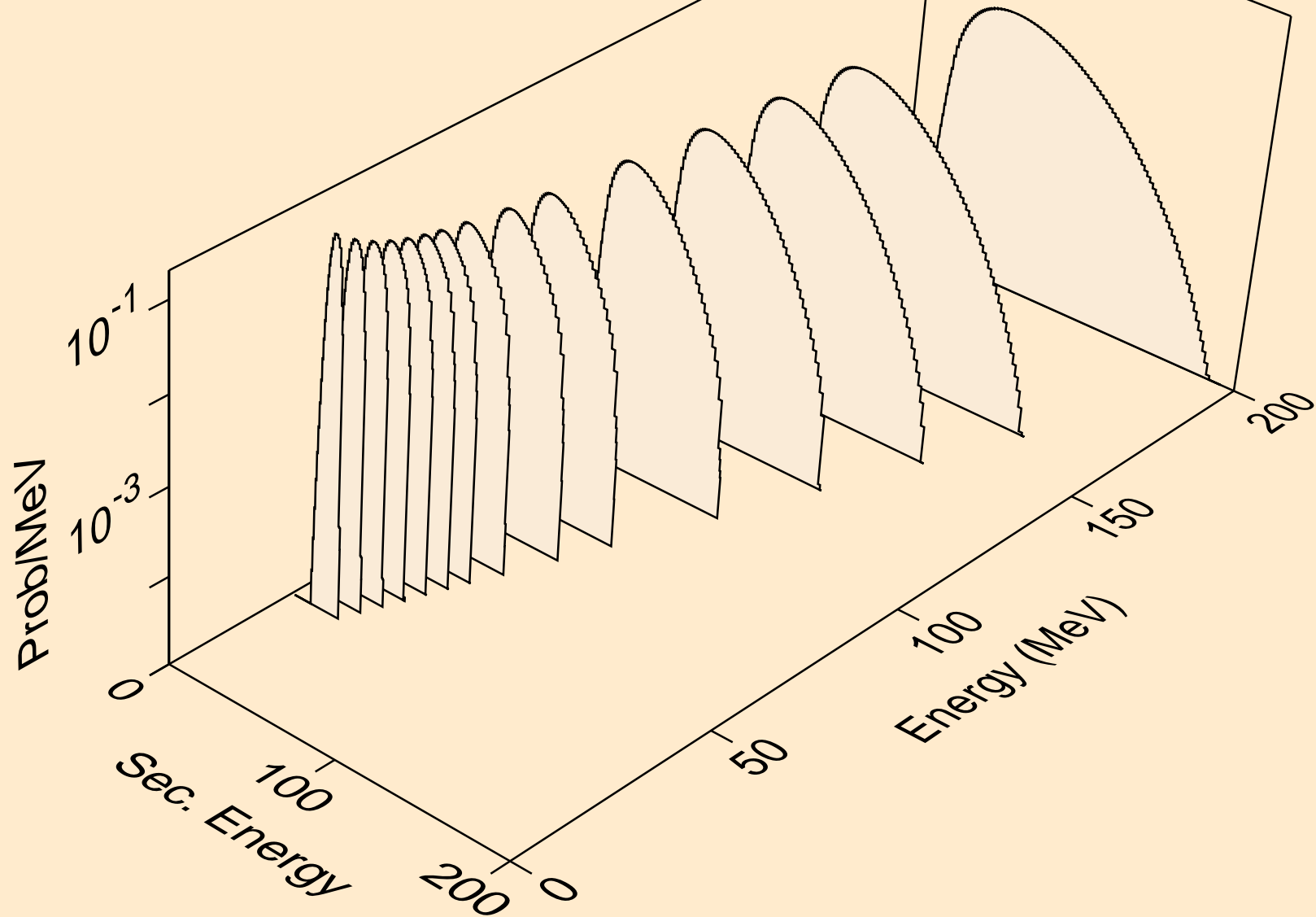

HF168 NEUTRON ACER TENDL-2021 LIBRARY; T=293.6K
he3s from (n,n*)he3

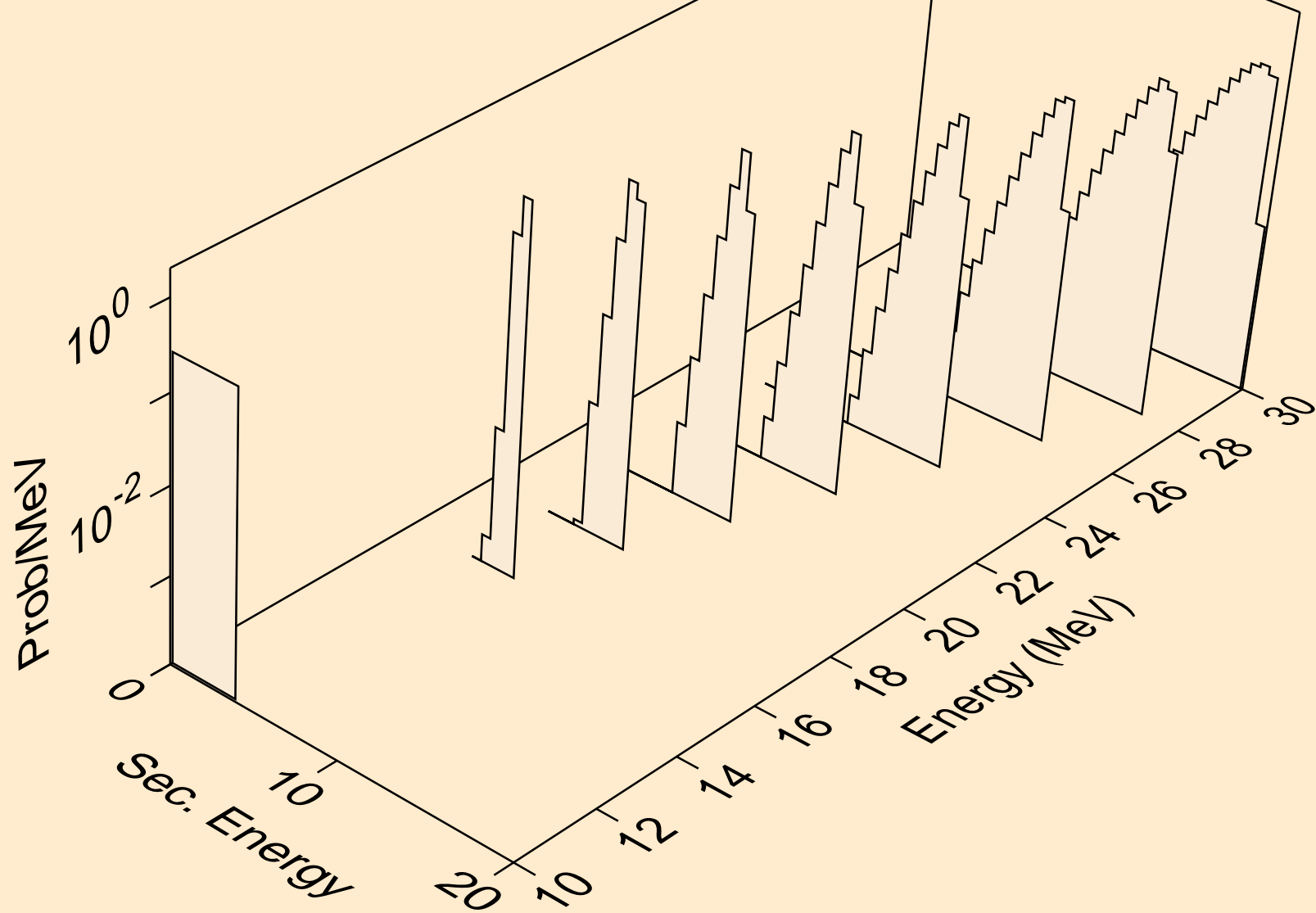

HF168 NEUTRON ACER TENDL-2021 LIBRARY; T=293.6K
he3s from (n,he3)

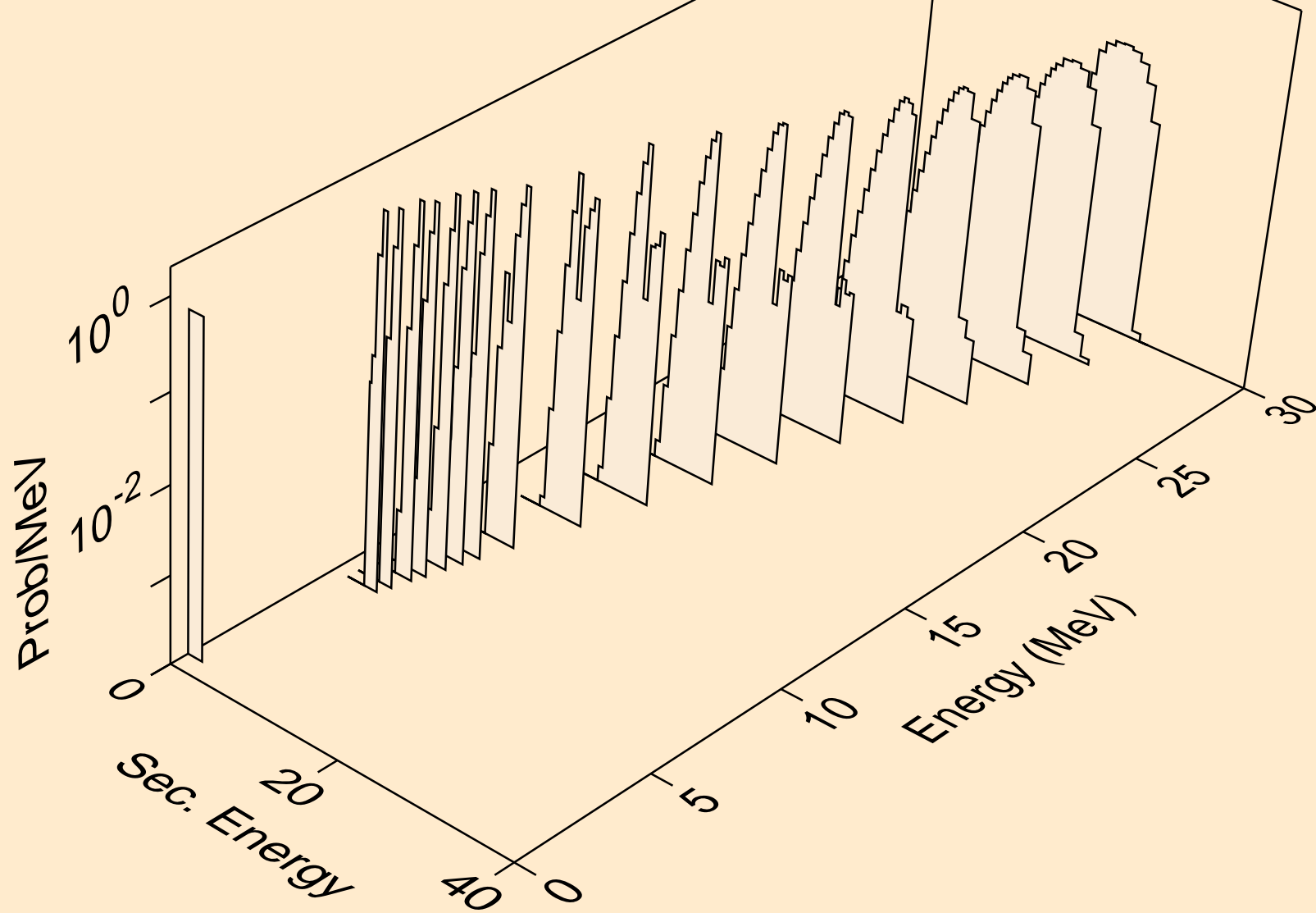

HF168 NEUTRON ACER TENDL-2021 LIBRARY; T=293.6K
alphas from (n,x)

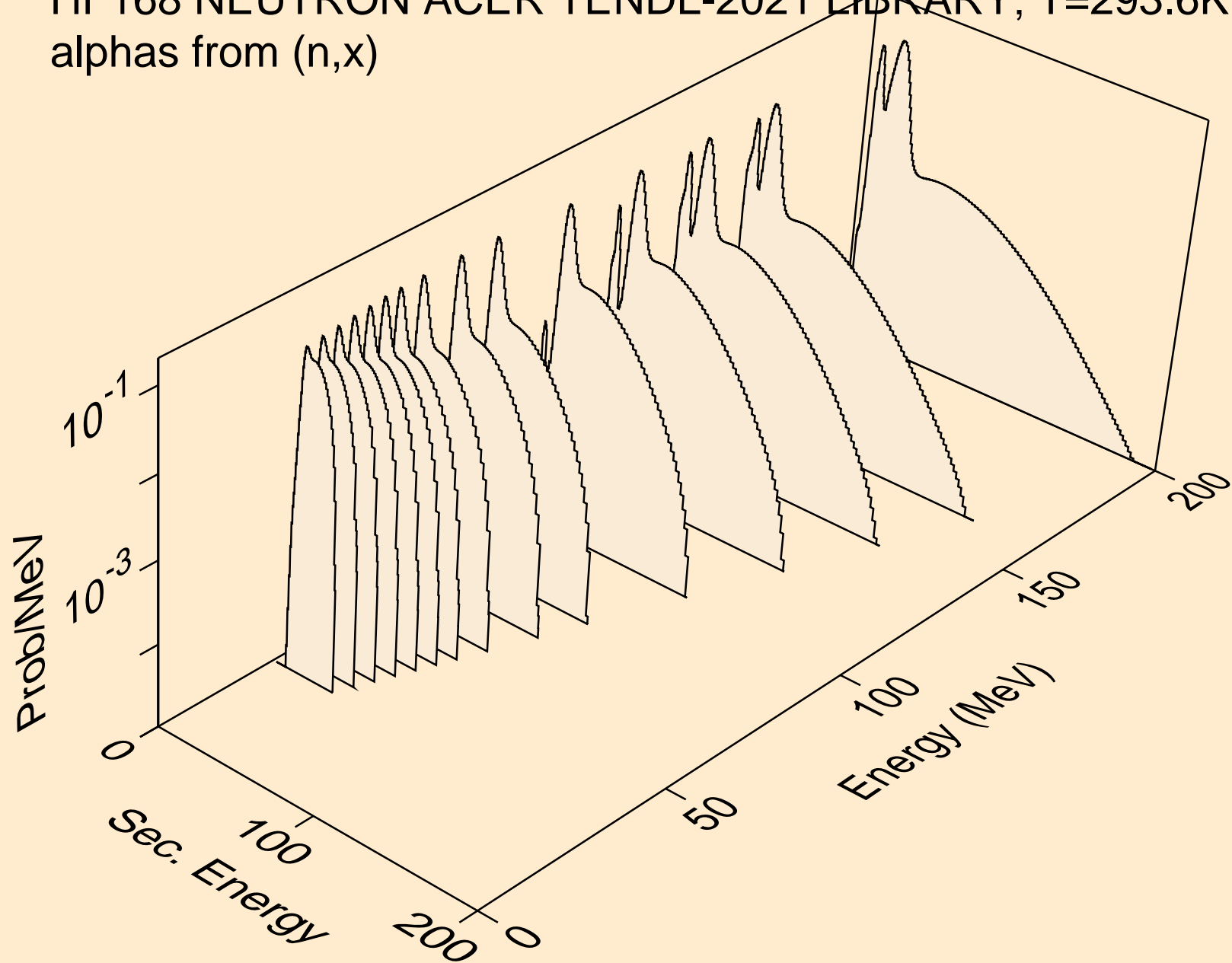

HF168 NEUTRON ACER TENDL-2021 LIBRARY; T=293.6K
alphas from (n,n*)a

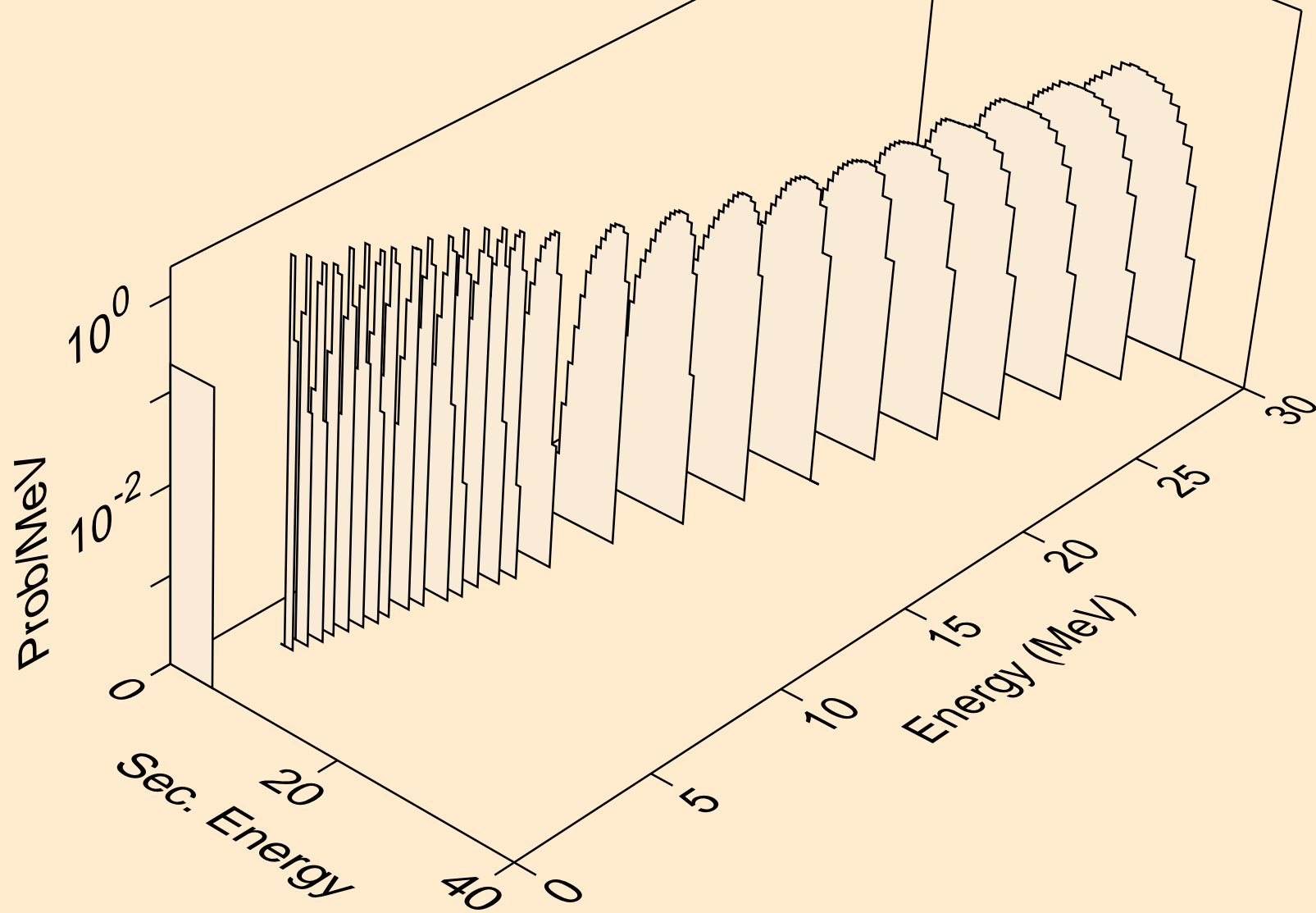

HF168 NEUTRON ACER TENDL-2021 LIBRARY; T=293.6K
alphas from (n,2n)a

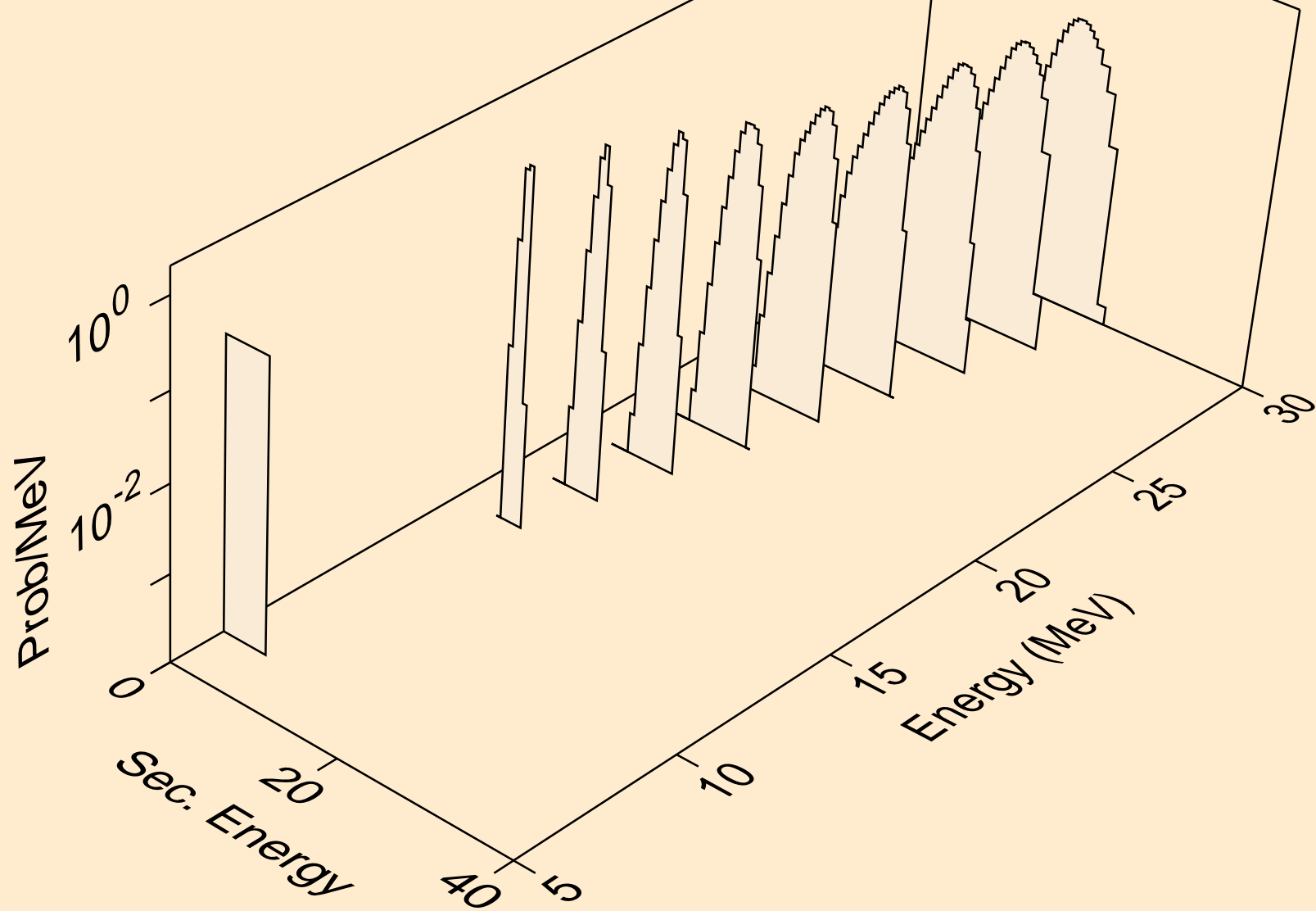

HF168 NEUTRON ACER TENDL-2021 LIBRARY; T=293.6K
alphas from (n,3n)a

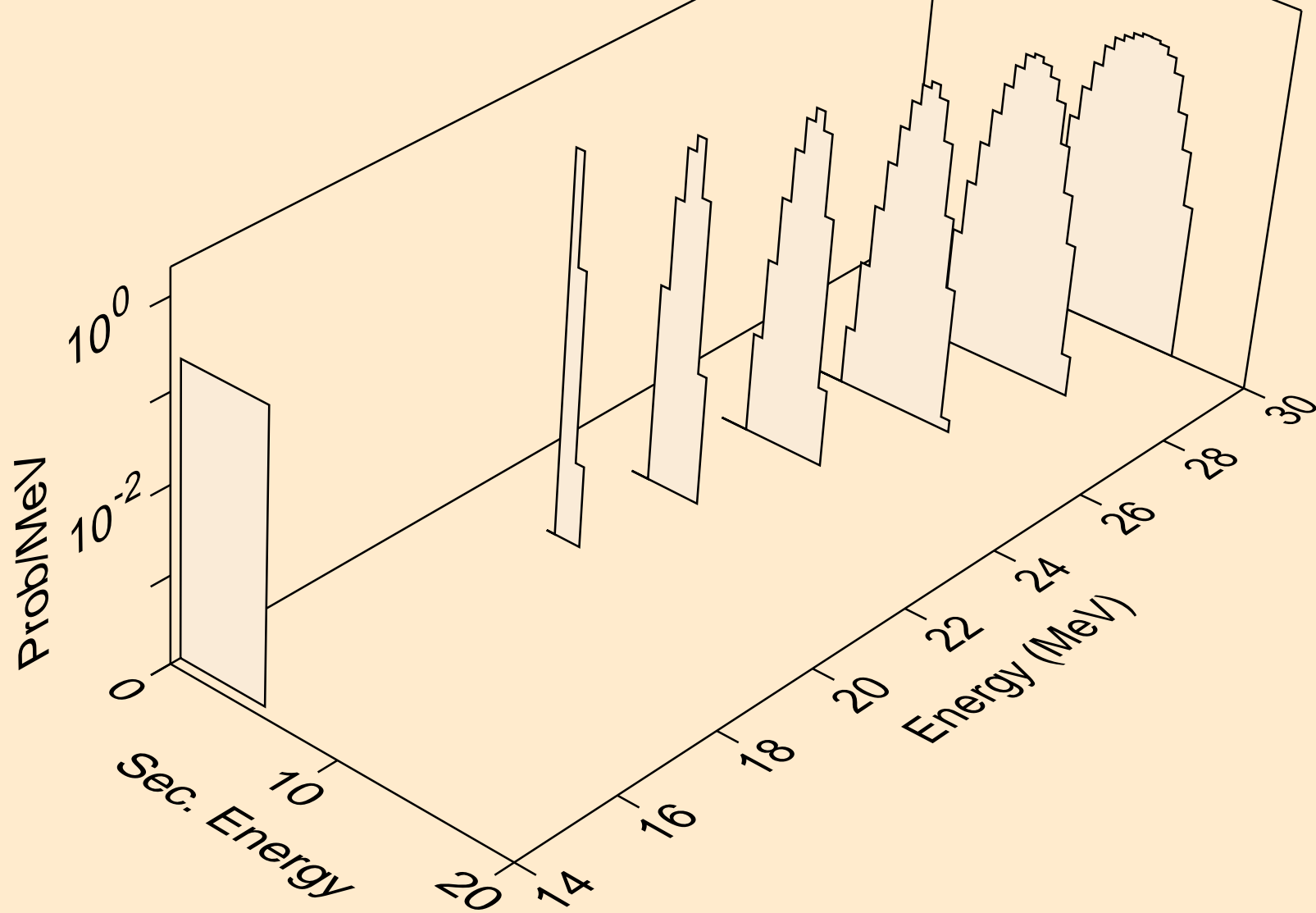

HF168 NEUTRON ACER TENDL-2021 LIBRARY; T=293.6K
alphas from (n,n*)2a

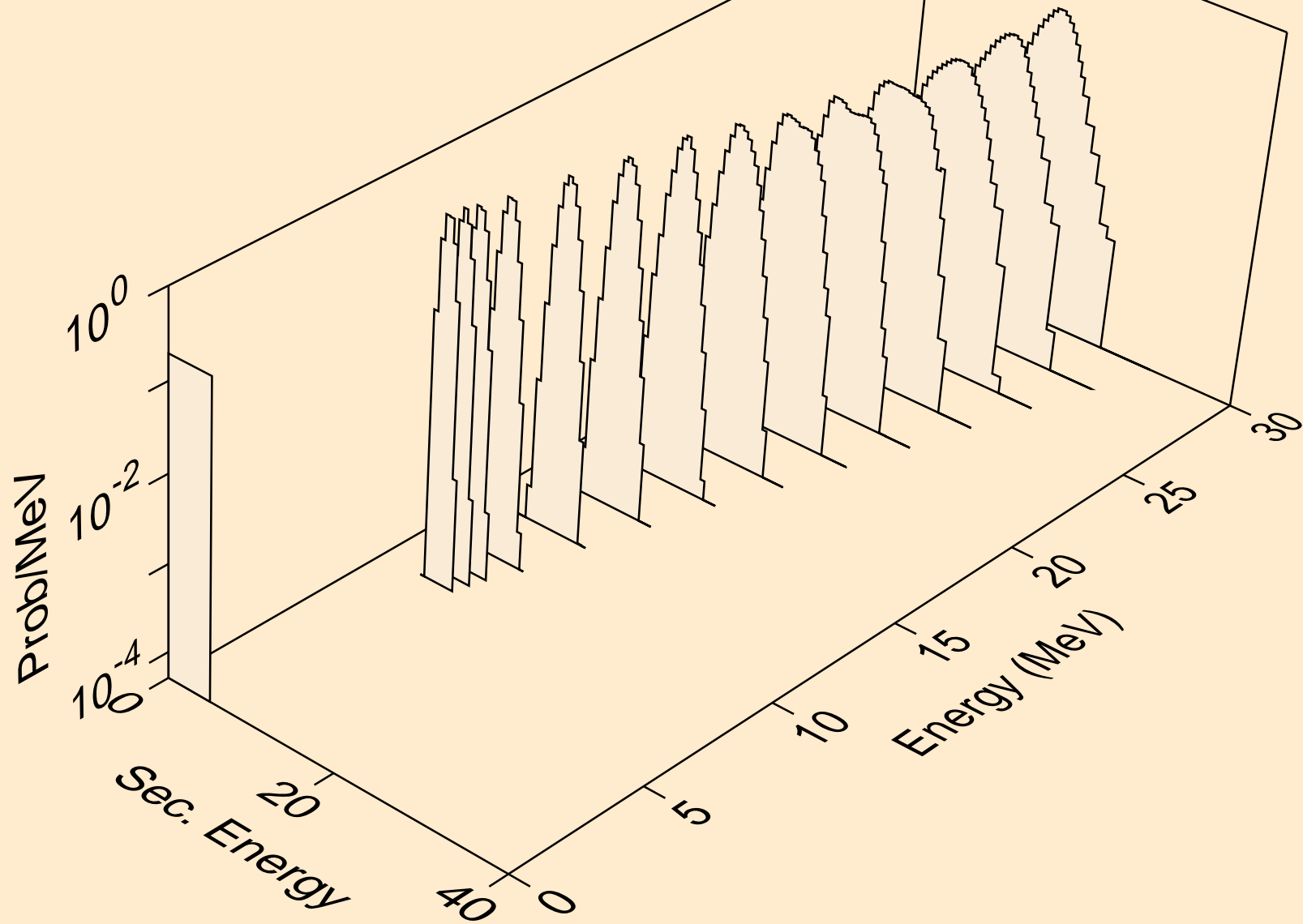

HF168 NEUTRON ACER TENDL-2021 LIBRARY; T=293.6K
alphas from (n,2n)2a

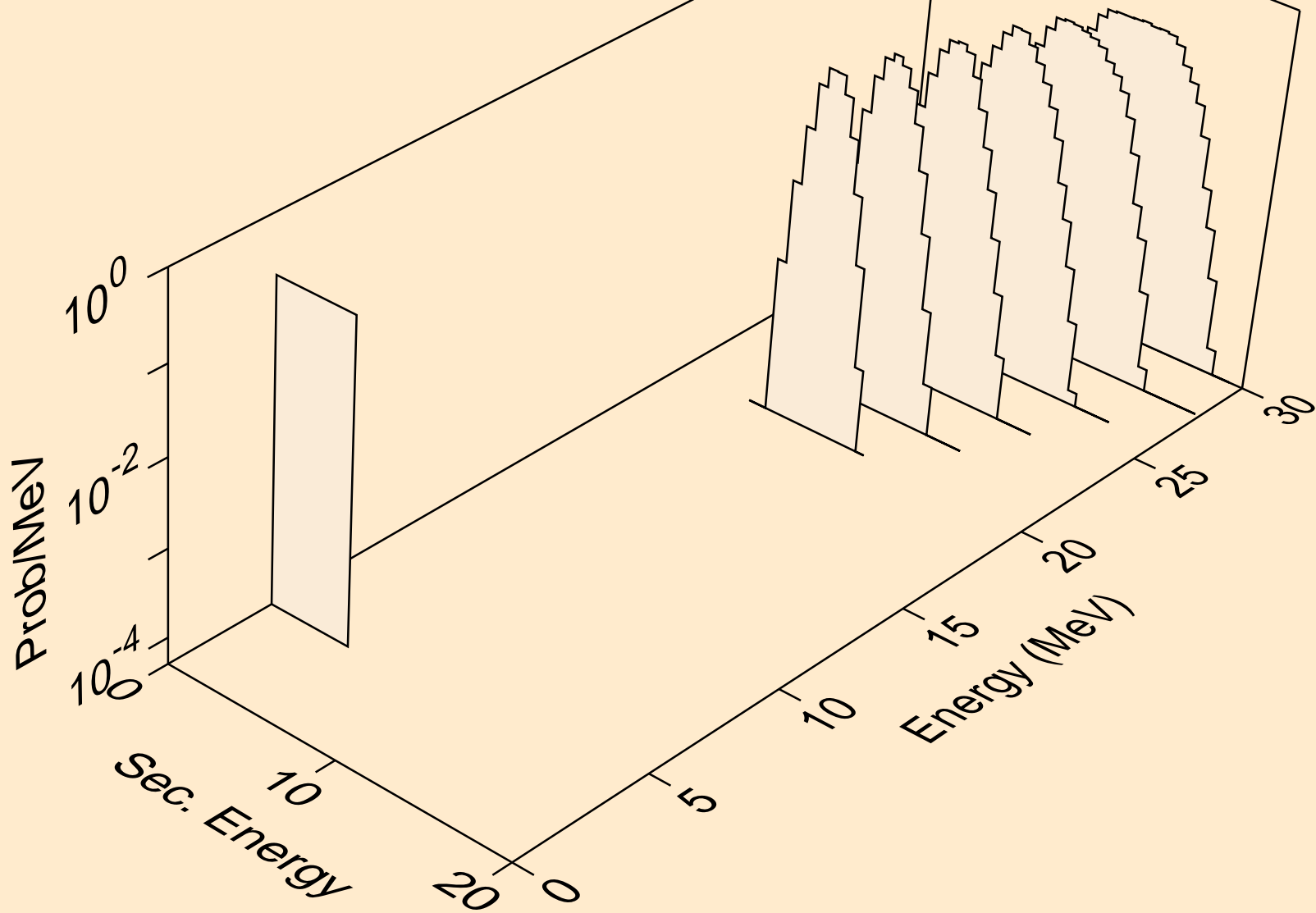

HF168 NEUTRON ACER TENDL-2021 LIBRARY; T=293.6K
alphas from (n,npa)

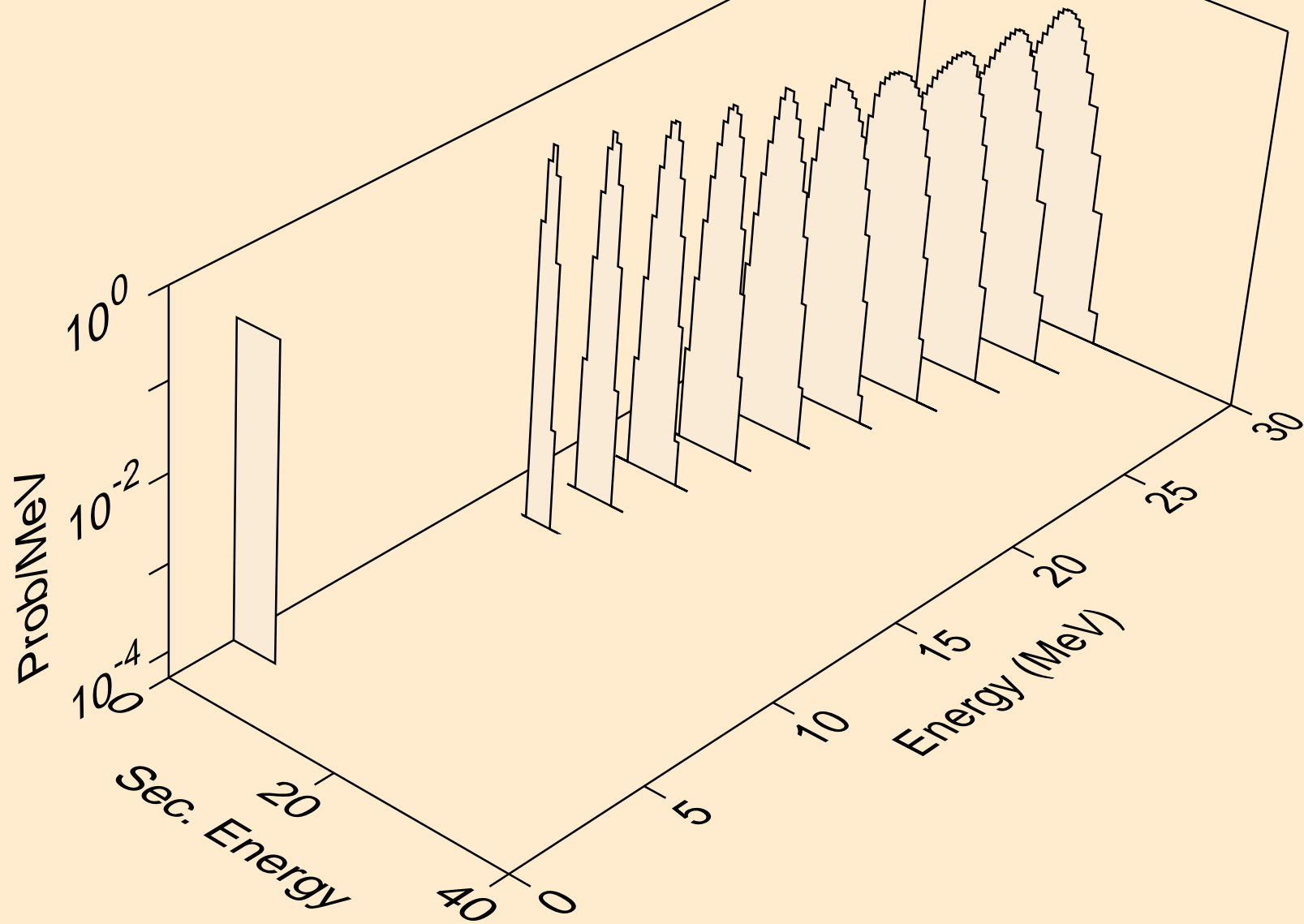

HF168 NEUTRON ACER TENDL-2021 LIBRARY; T=293.6K
alphas from (n,a)

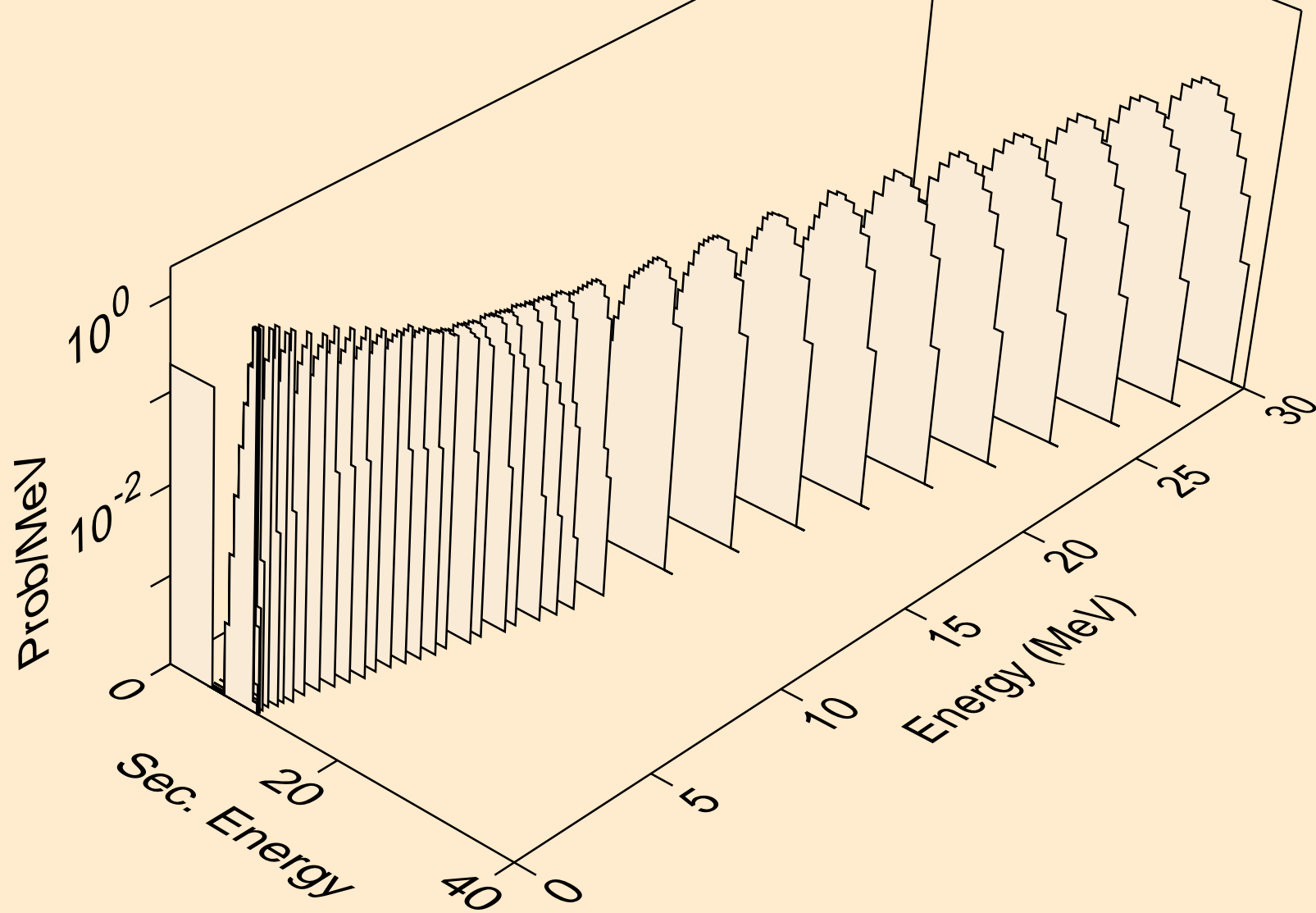

HF168 NEUTRON ACER TENDL-2021 LIBRARY; T=293.6K
alphas from (n,2a)

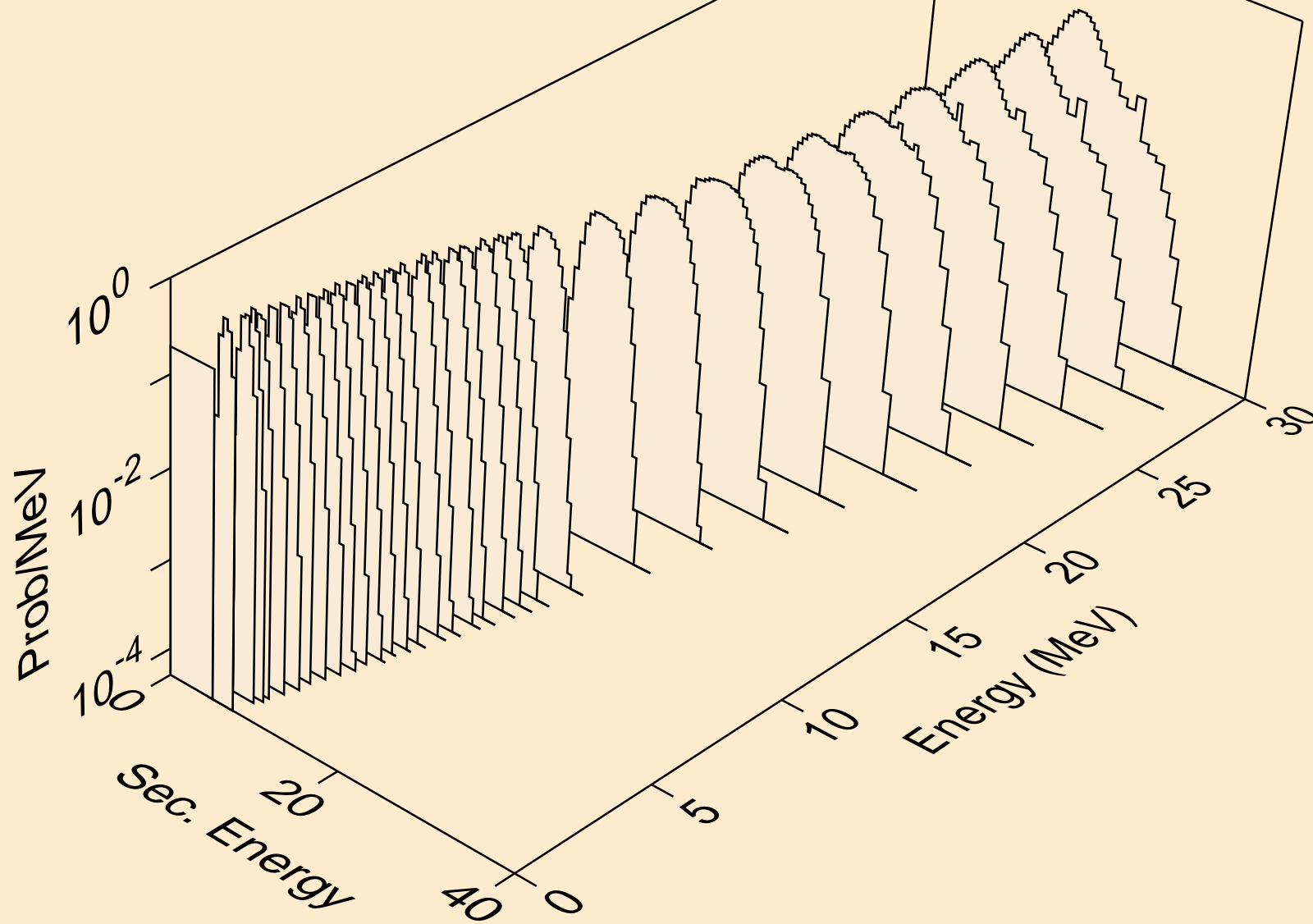

HF168 NEUTRON ACER TENDL-2021 LIBRARY; T=293.6K
alphas from (n,pa)

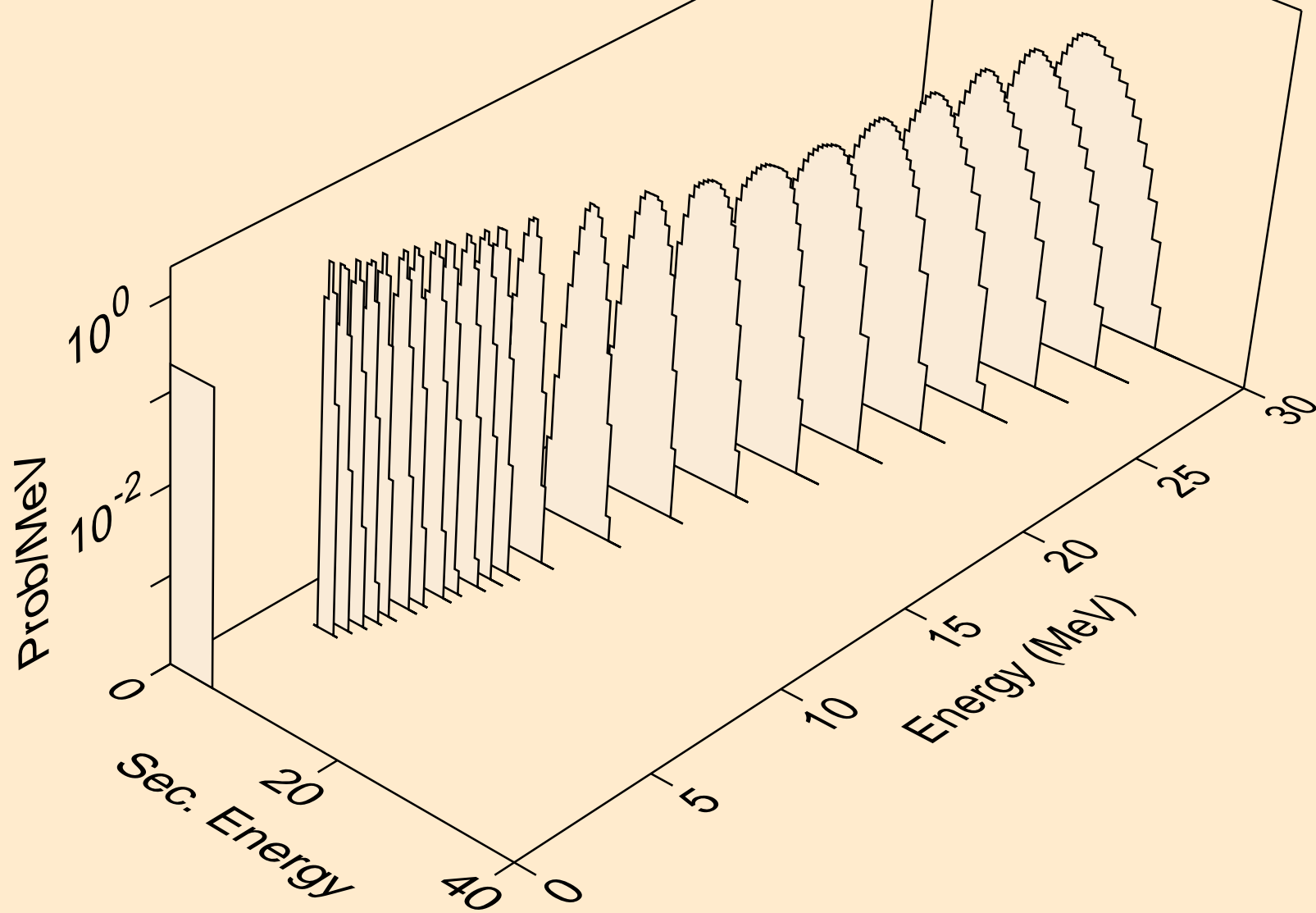

HF168 NEUTRON ACER TENDL-2021 LIBRARY; T=293.6K
alphas from (n,da)

