

# HF188 NEUTRON ACER TENDL-2021 LIBRARY; T=293.6K

## Principal cross sections

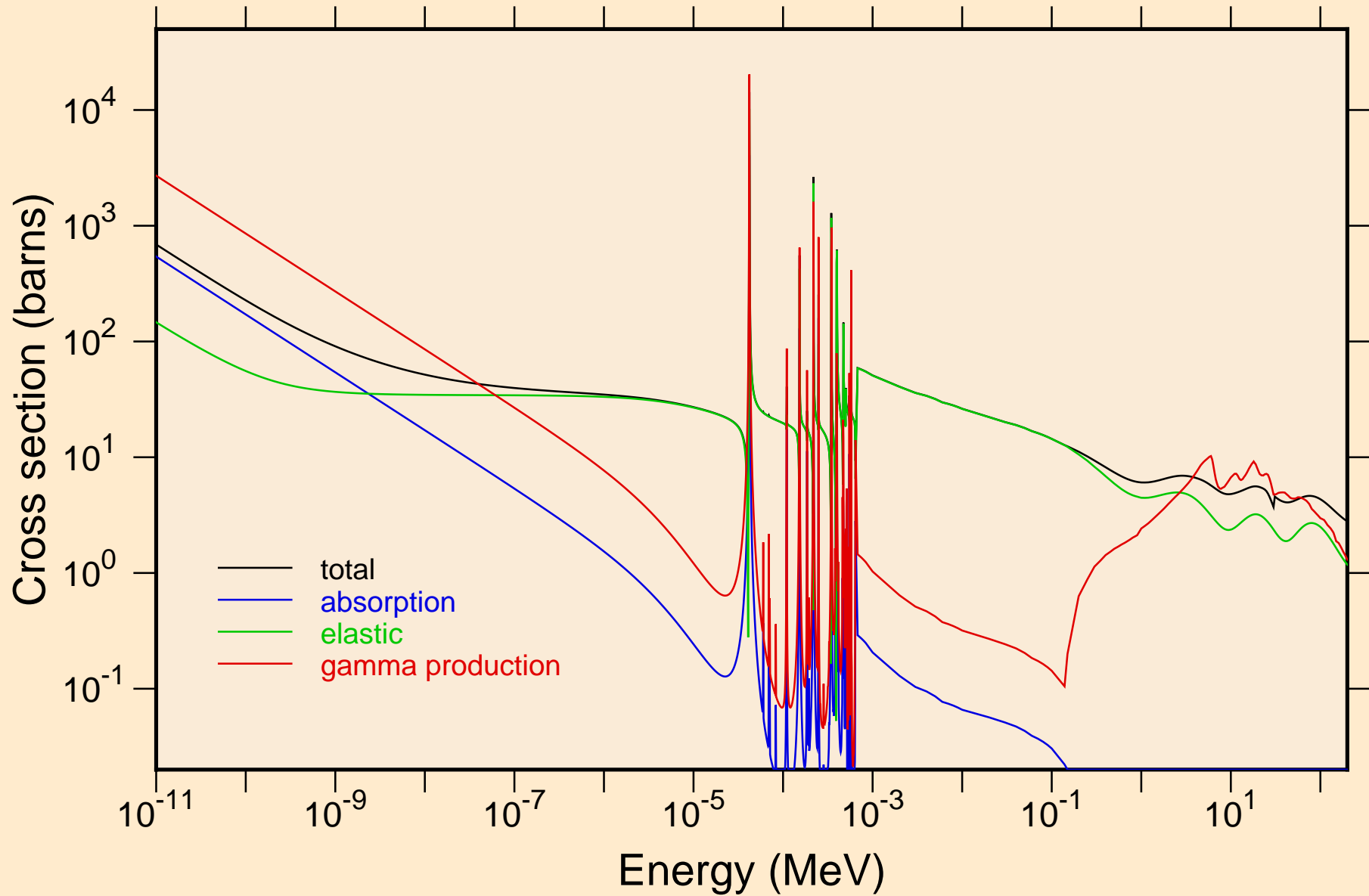

HF188 NEUTRON ACER TENDL-2021 LIBRARY; T=293.6K  
resonance total cross section

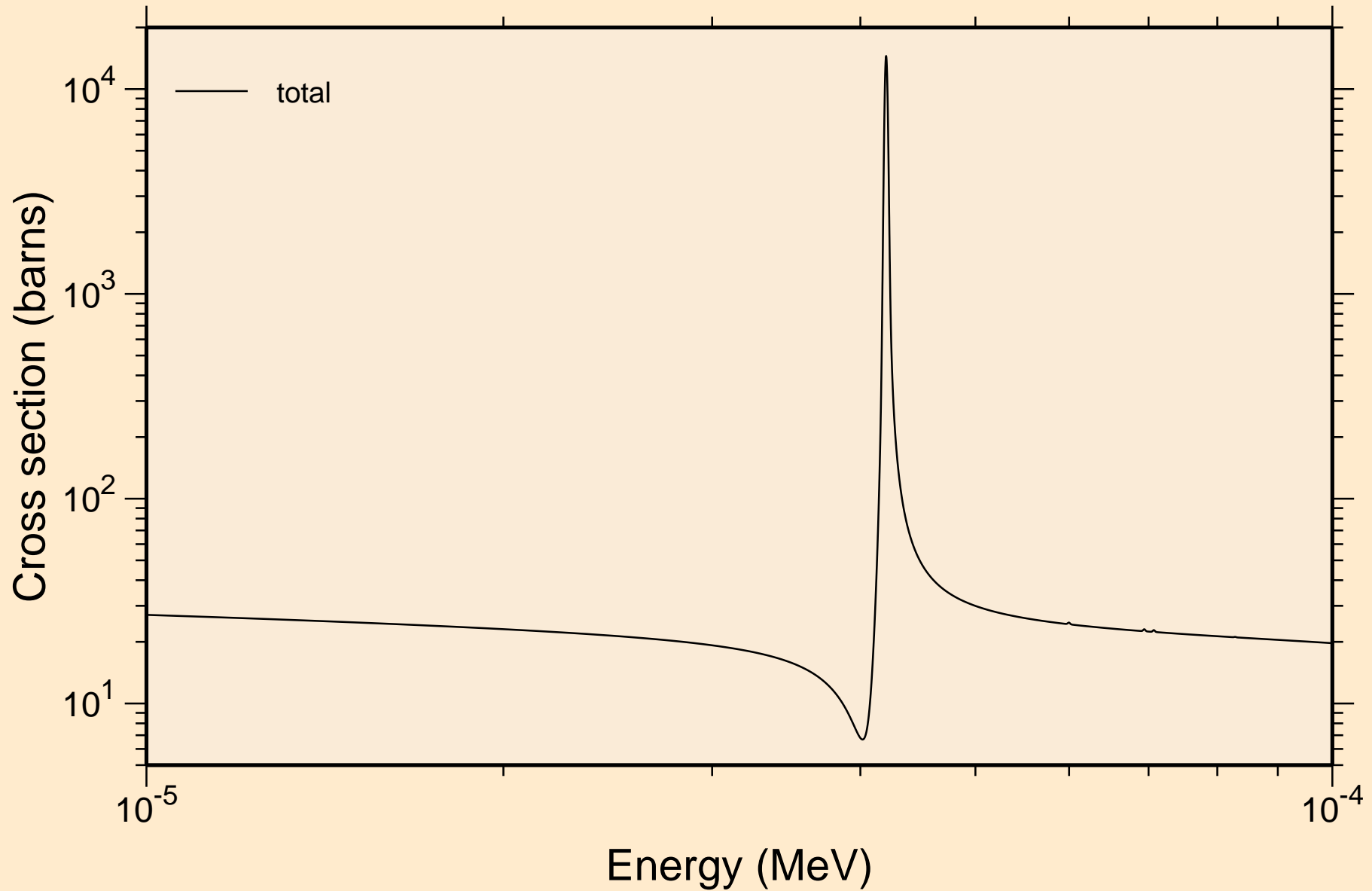

HF188 NEUTRON ACER TENDL-2021 LIBRARY; T=293.6K  
resonance total cross section

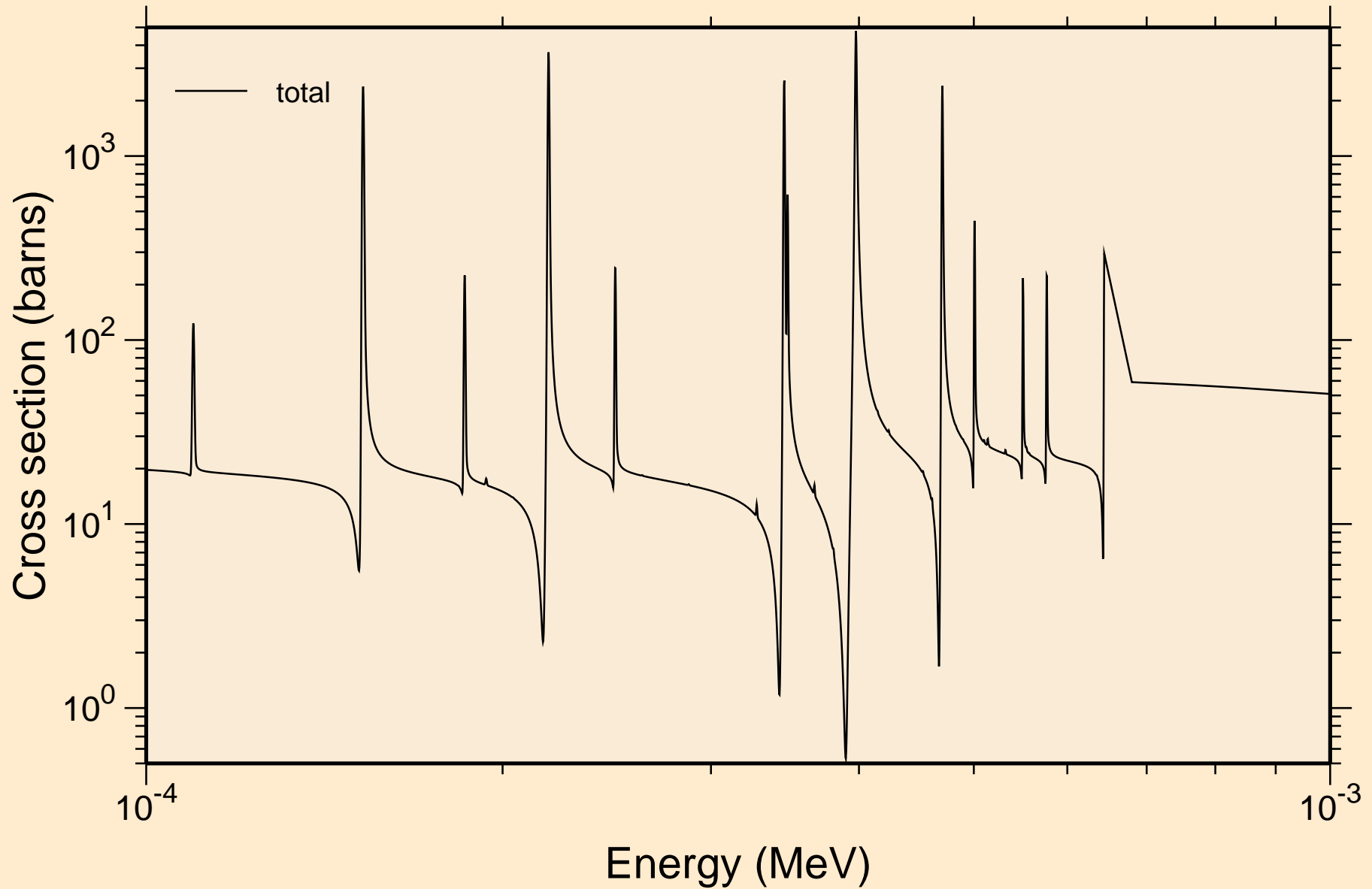

HF188 NEUTRON ACER TENDL-2021 LIBRARY; T=293.6K  
resonance total cross section

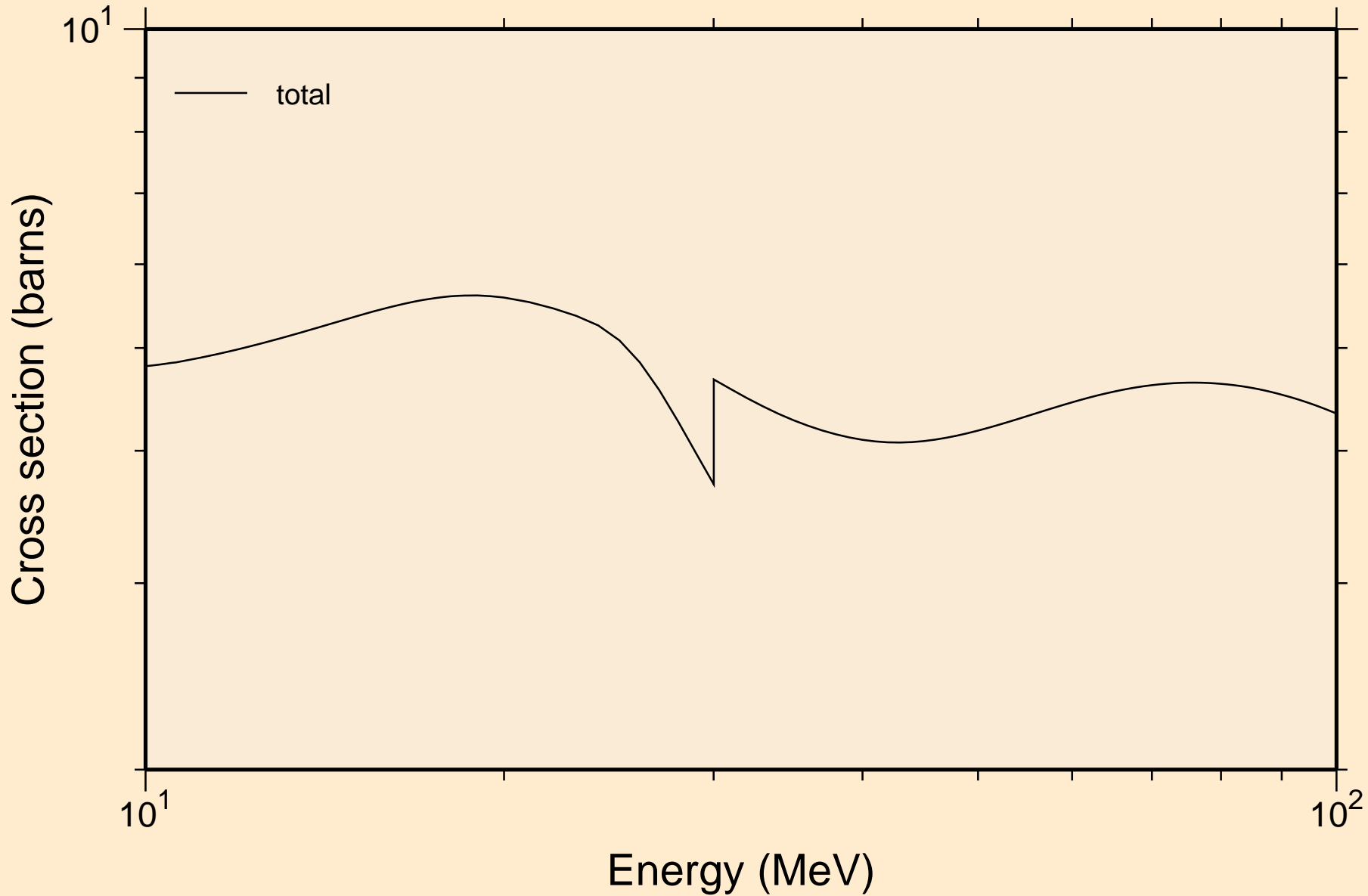

HF188 NEUTRON ACER TENDL-2021 LIBRARY; T=293.6K  
resonance absorption cross sections

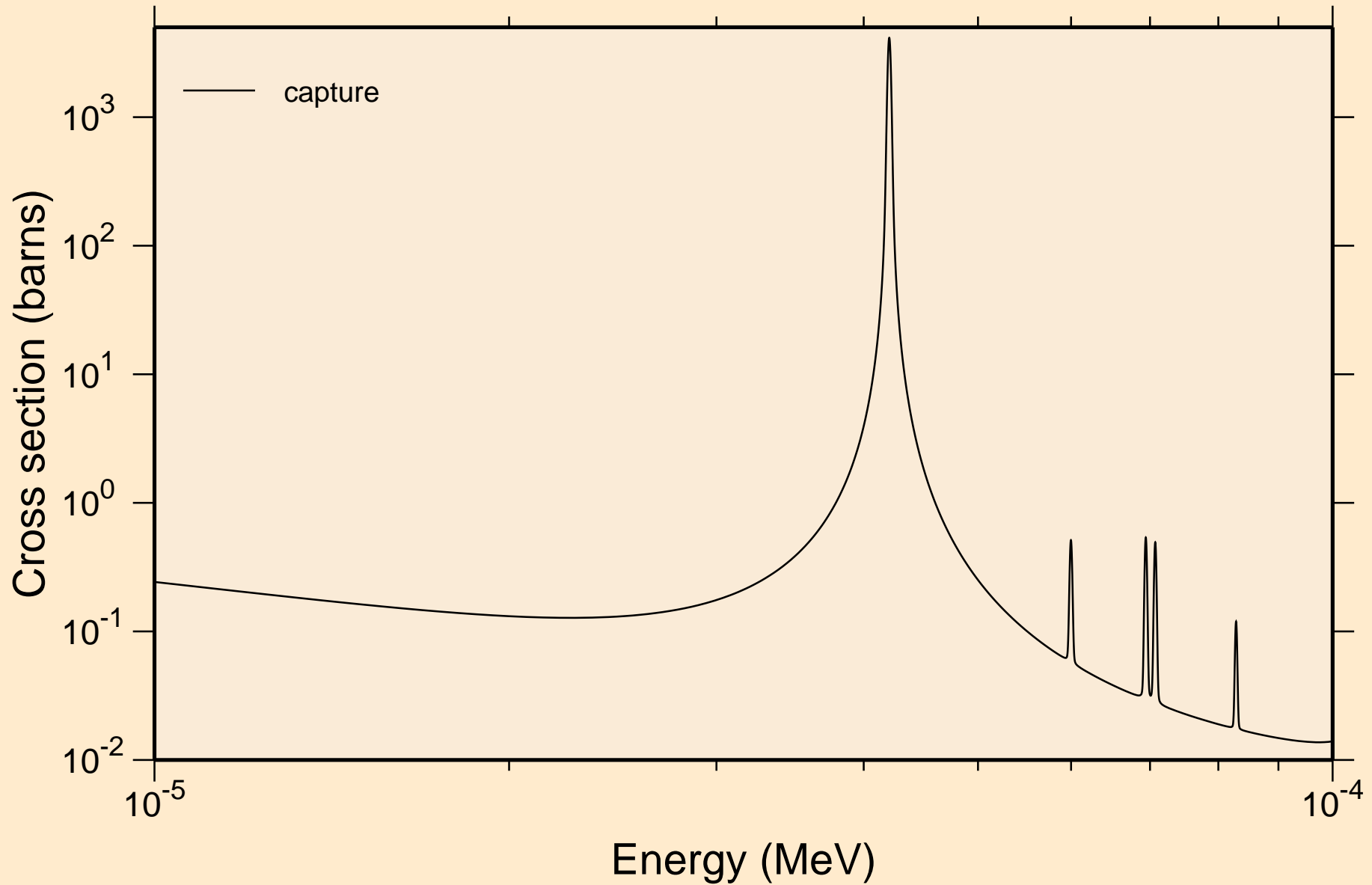

HF188 NEUTRON ACER TENDL-2021 LIBRARY; T=293.6K  
resonance absorption cross sections

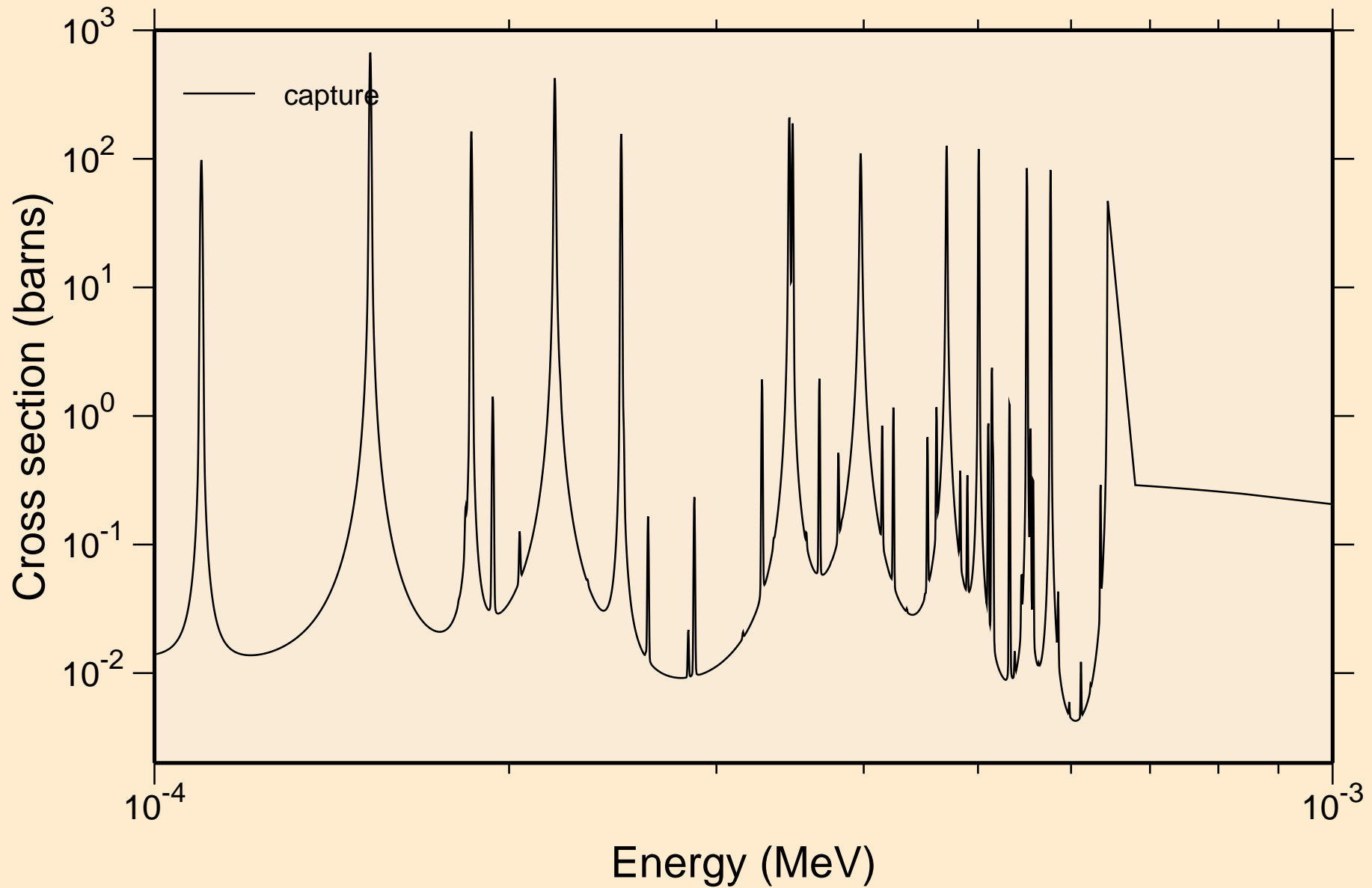

HF188 NEUTRON ACER TENDL-2021 LIBRARY; T=293.6K  
resonance absorption cross sections

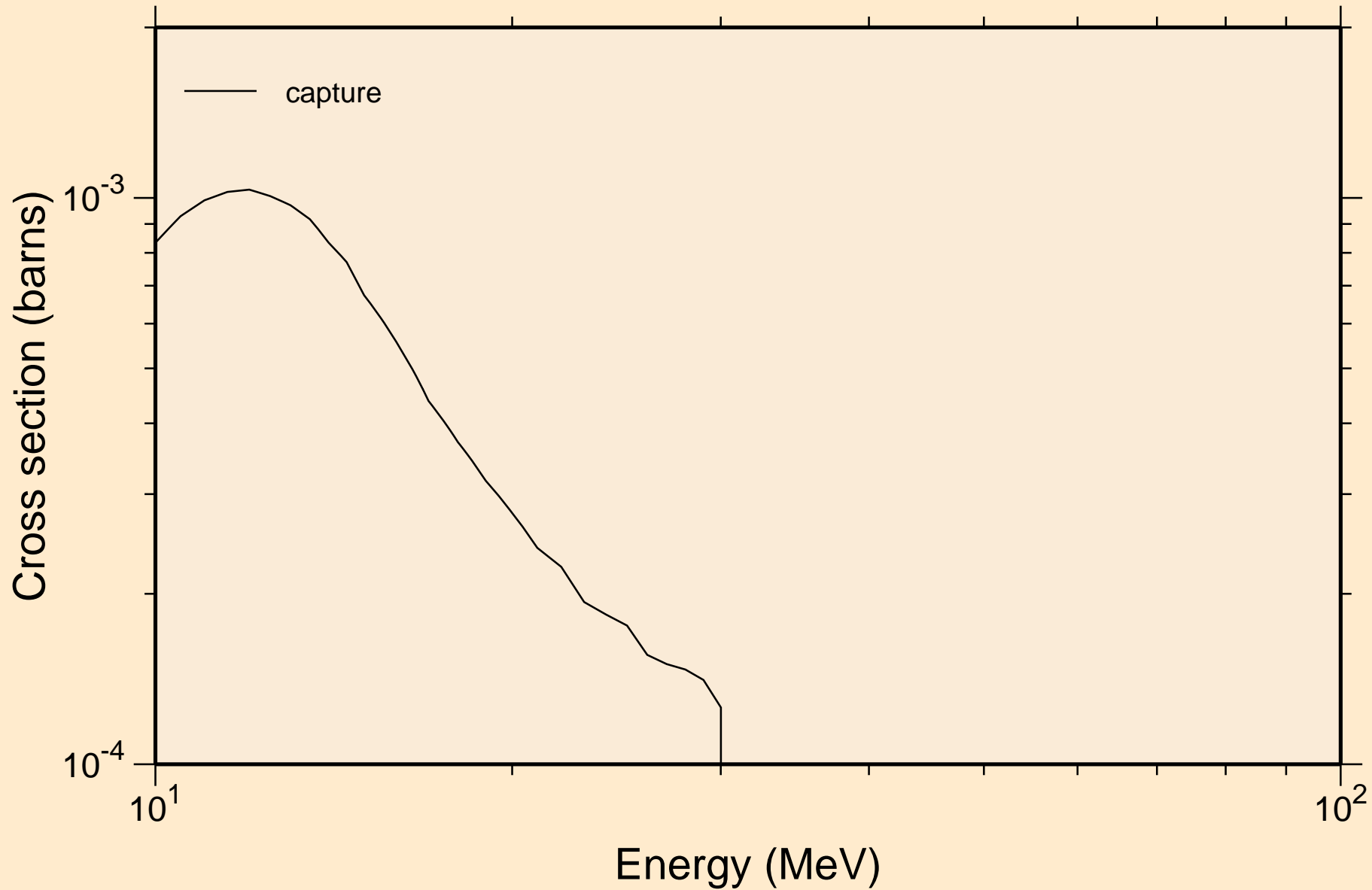

HF188 NEUTRON ACER TENDL-2021 LIBRARY; T=293.6K  
Heating

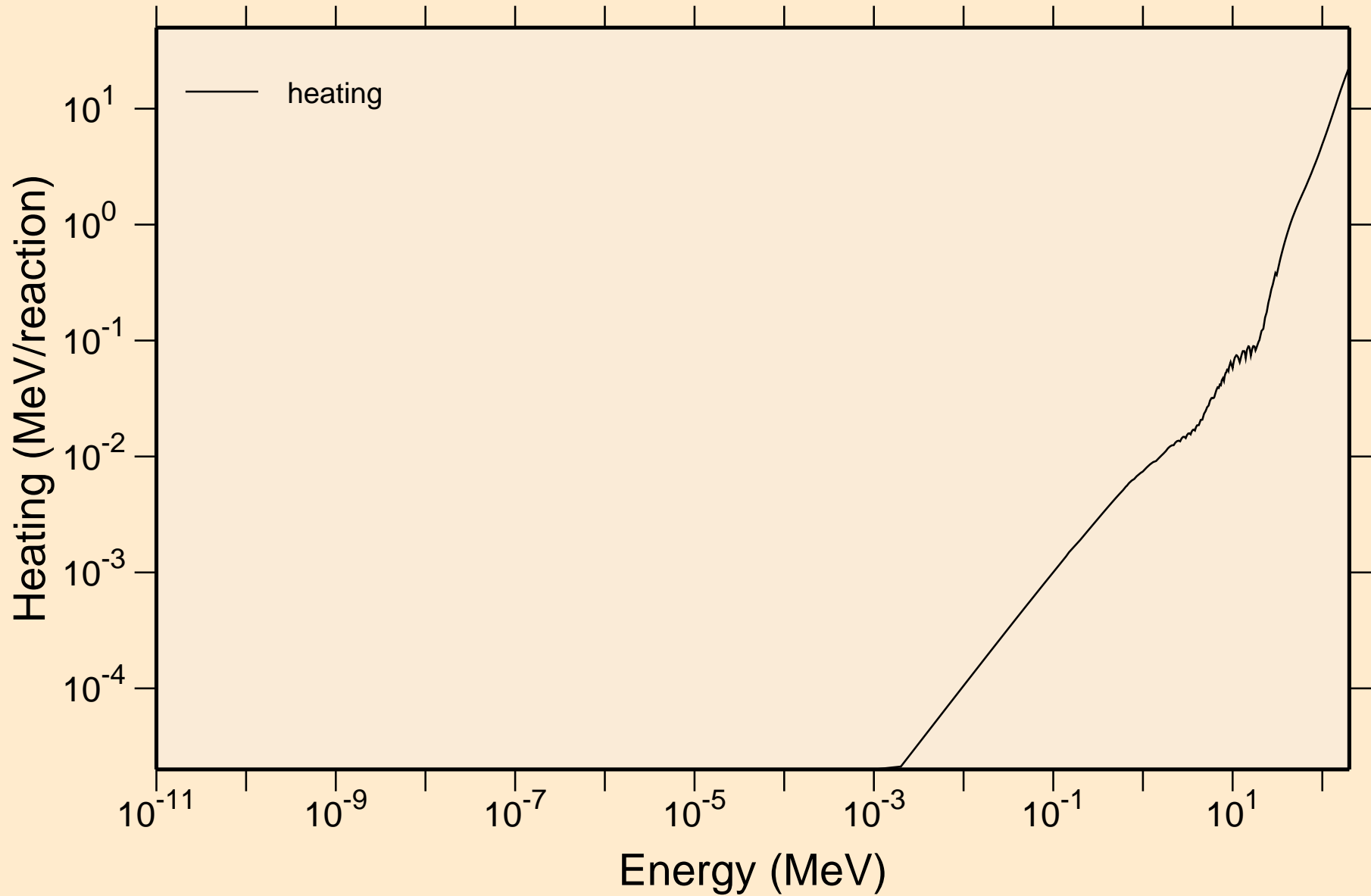



# HF188 NEUTRON ACER TENDL-2021 LIBRARY; T=293.6K

## Damage

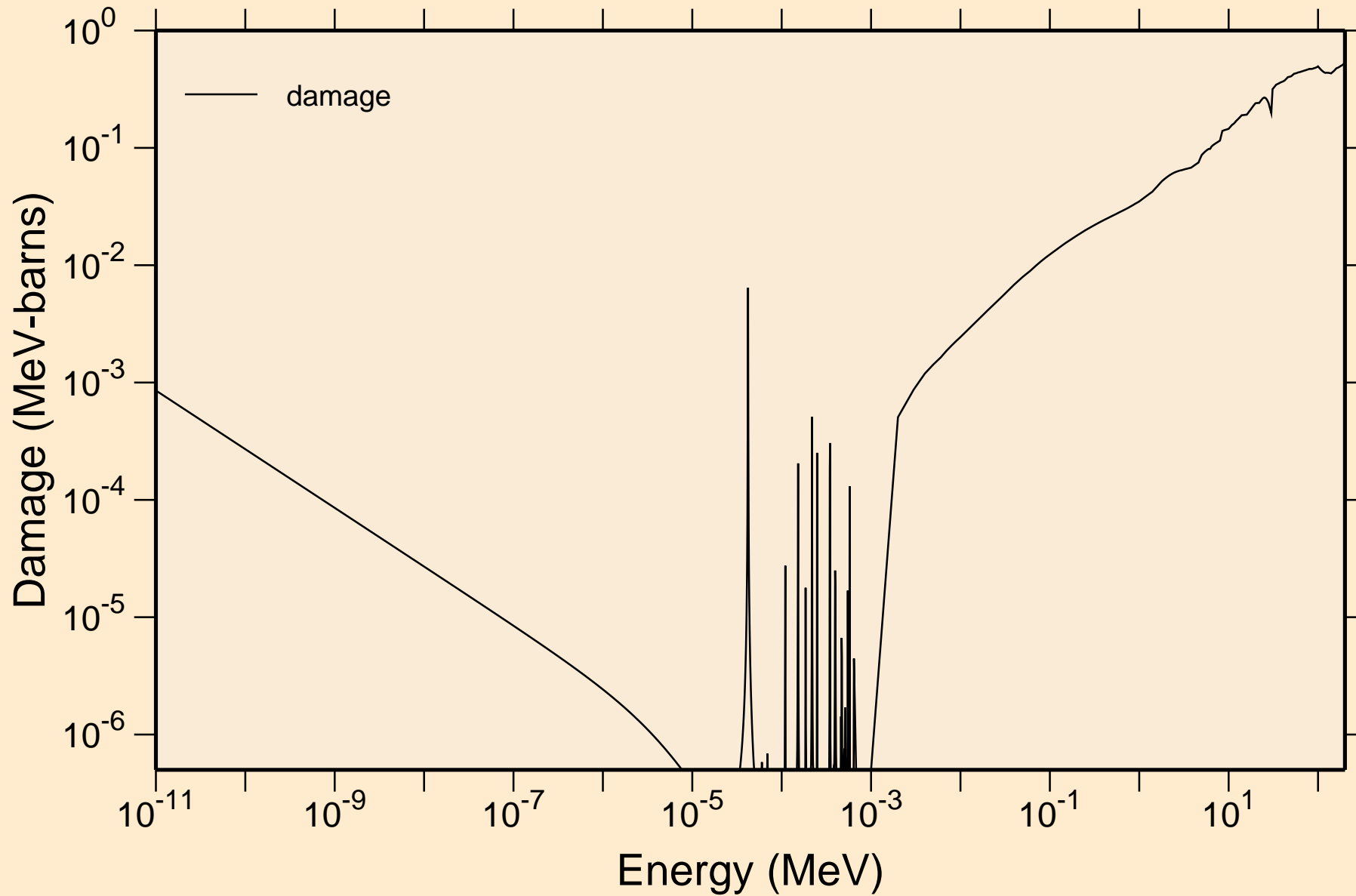

HF188 NEUTRON ACER TENDL-2021 LIBRARY; T=293.6K  
Non-threshold reactions

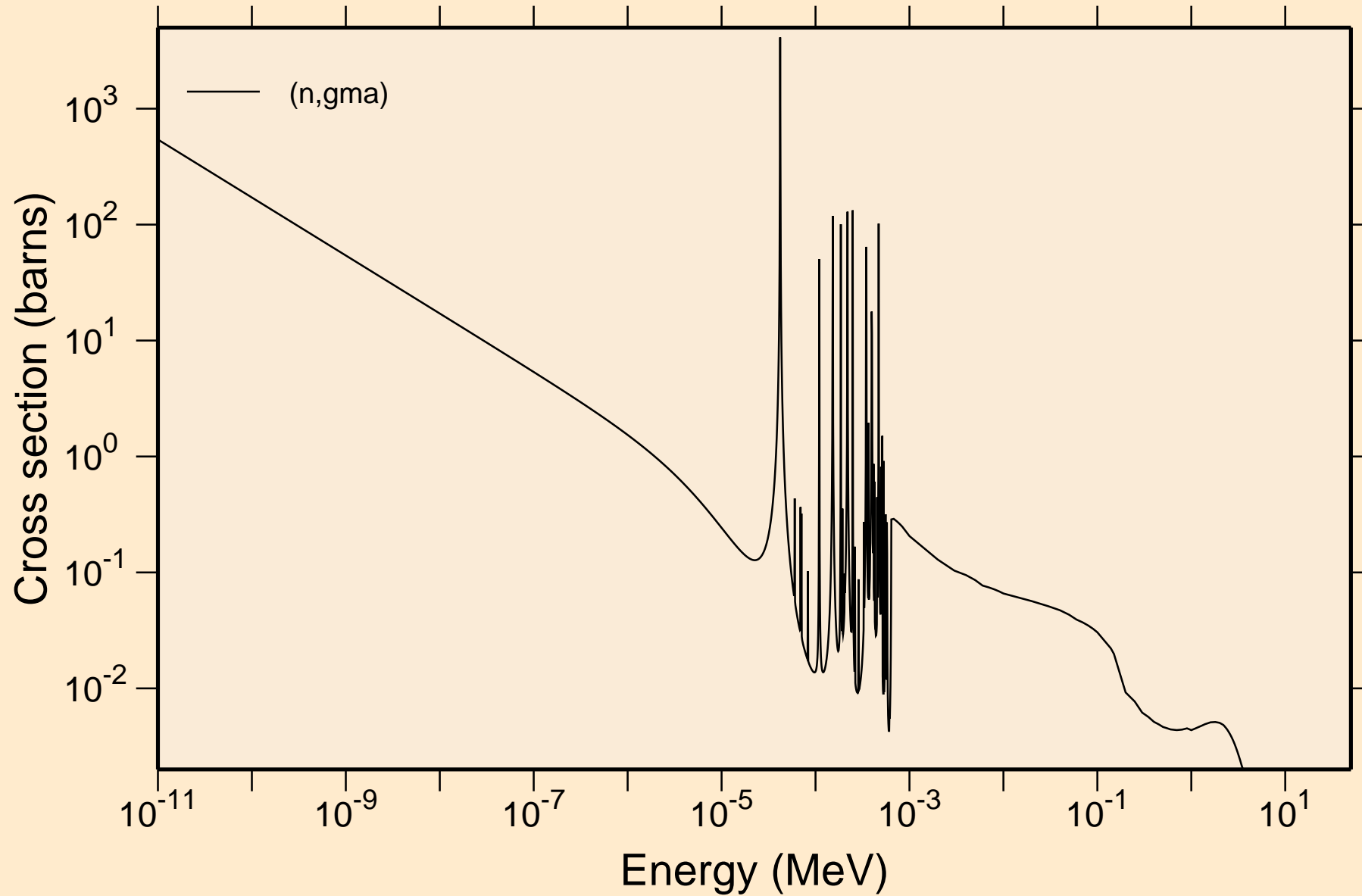

# HF188 NEUTRON ACER TENDL-2021 LIBRARY; T=293.6K

## Principal cross sections

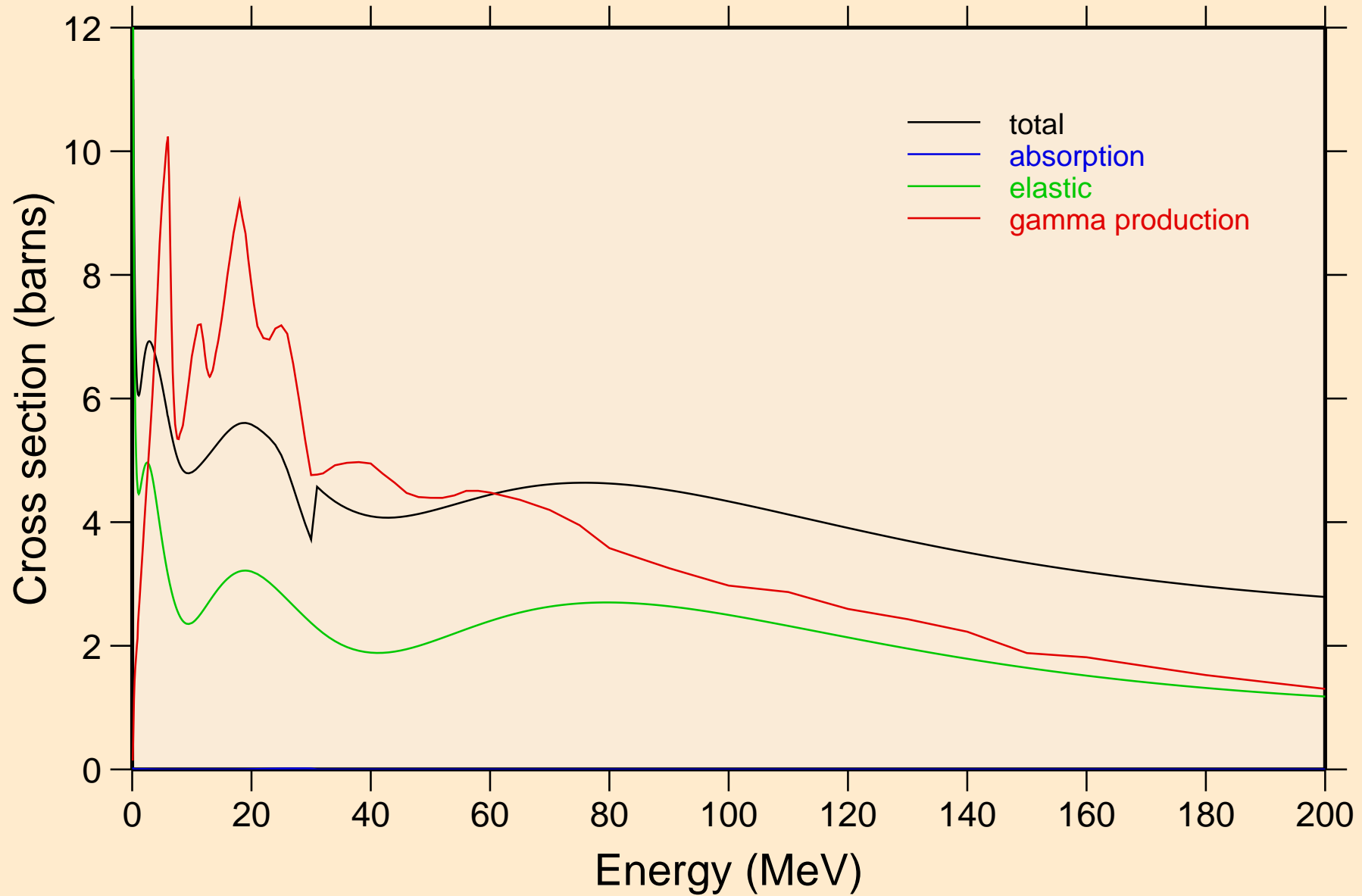

HF188 NEUTRON ACER TENDL-2021 LIBRARY; T=293.6K  
Heating

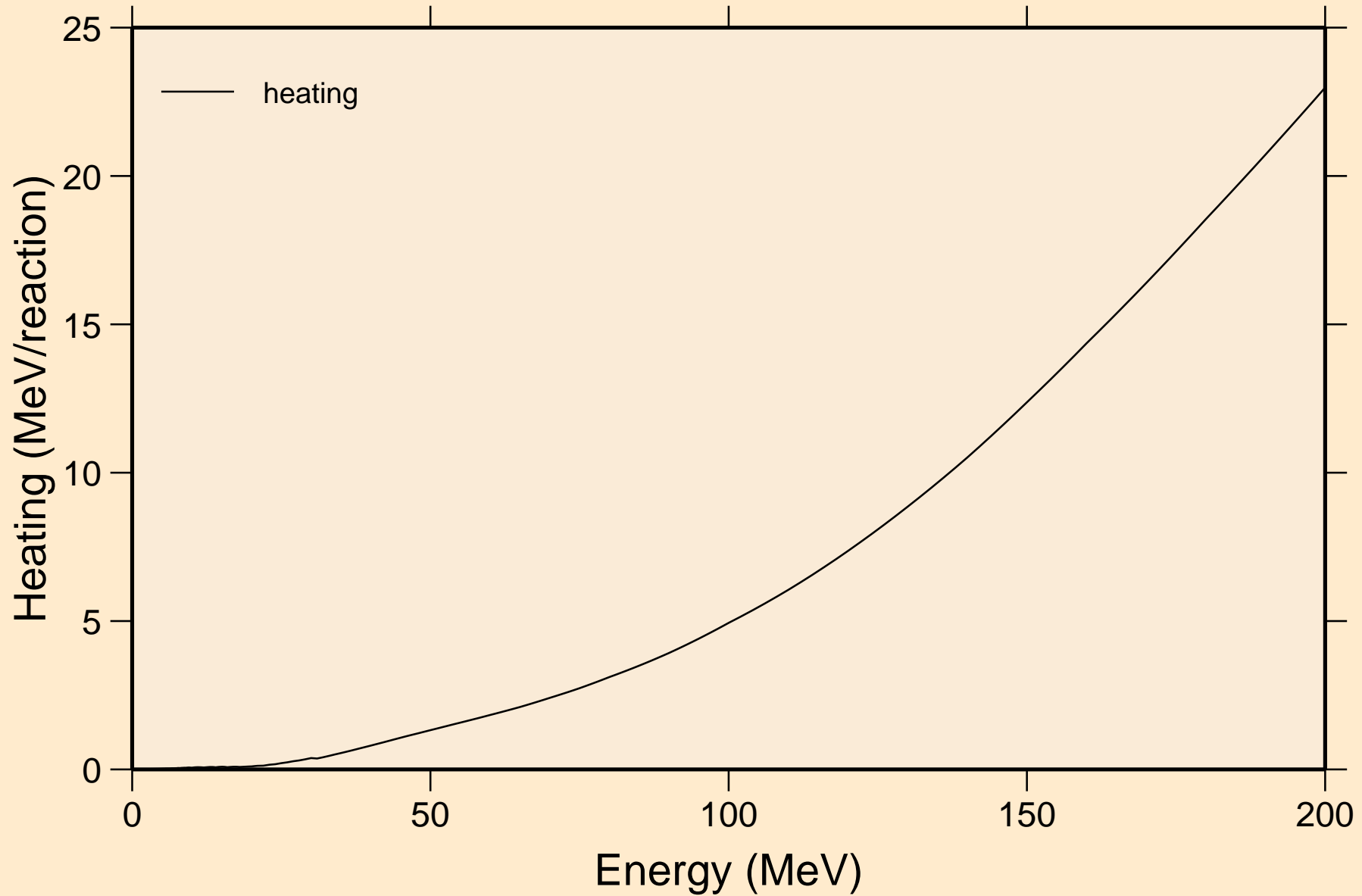

# HF188 NEUTRON ACER TENDL-2021 LIBRARY; T=293.6K

## Damage

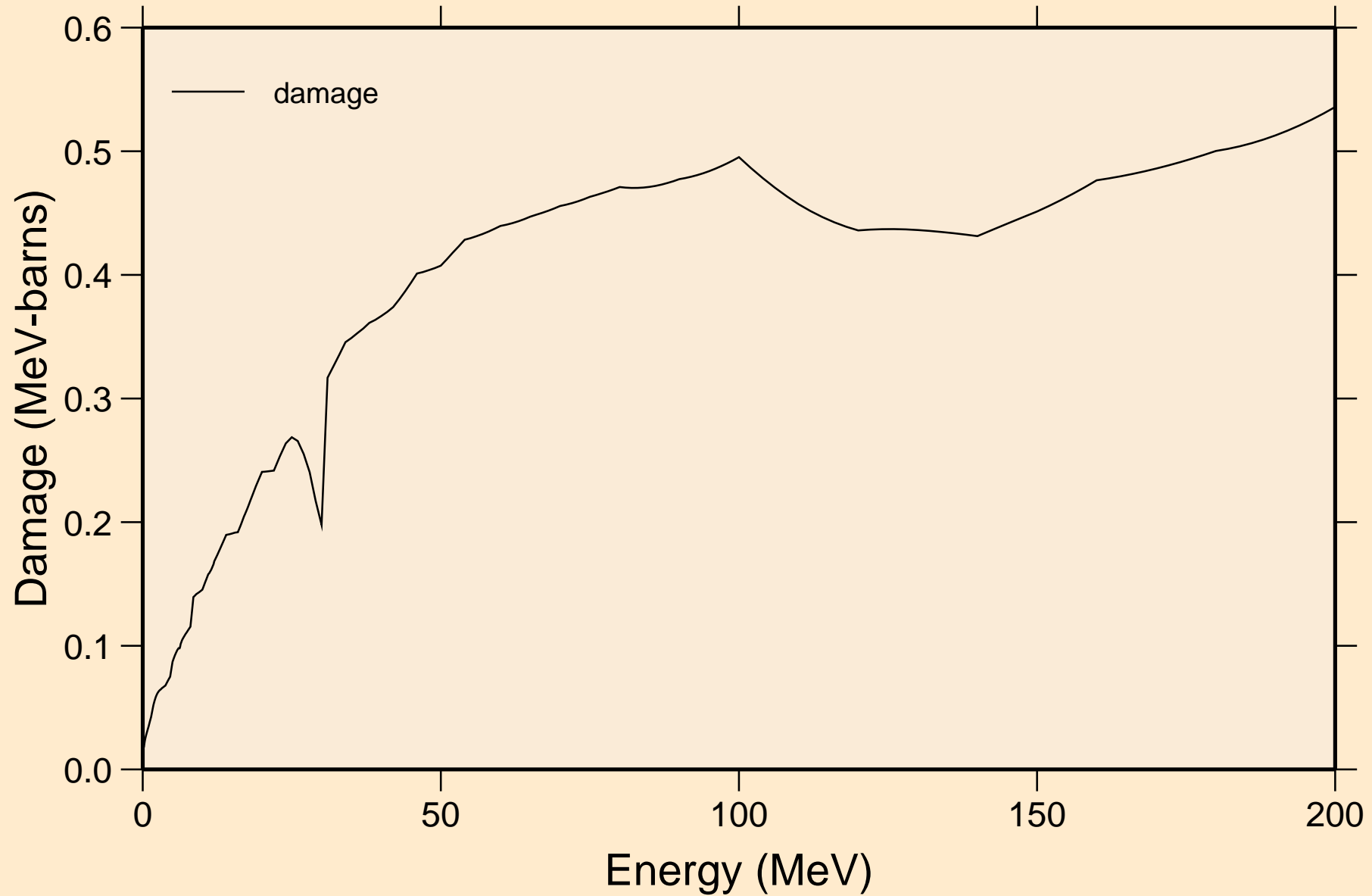

HF188 NEUTRON ACER TENDL-2021 LIBRARY; T=293.6K  
Non-threshold reactions

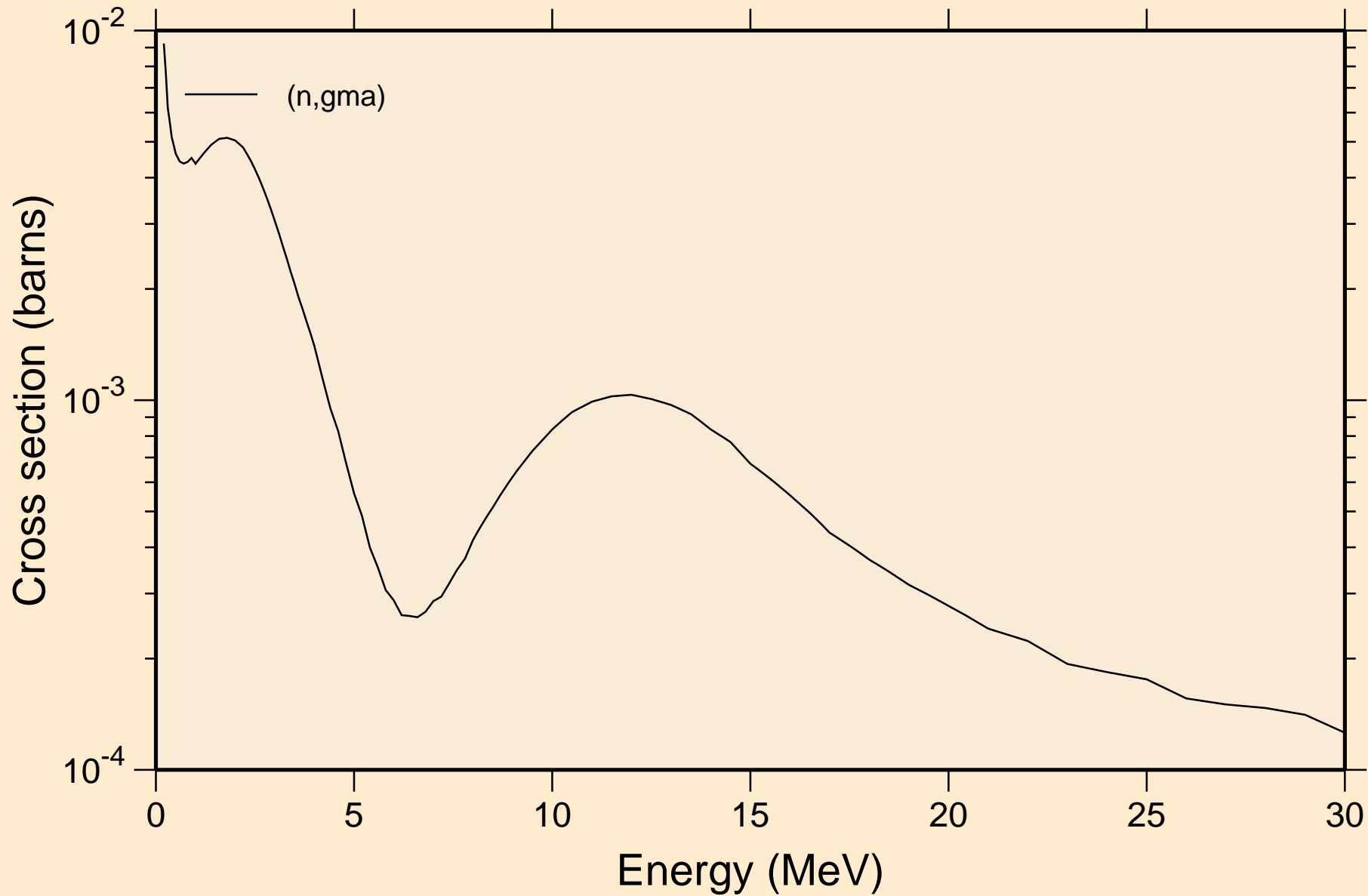

HF188 NEUTRON ACER TENDL-2021 LIBRARY; T=293.6K  
Inelastic levels

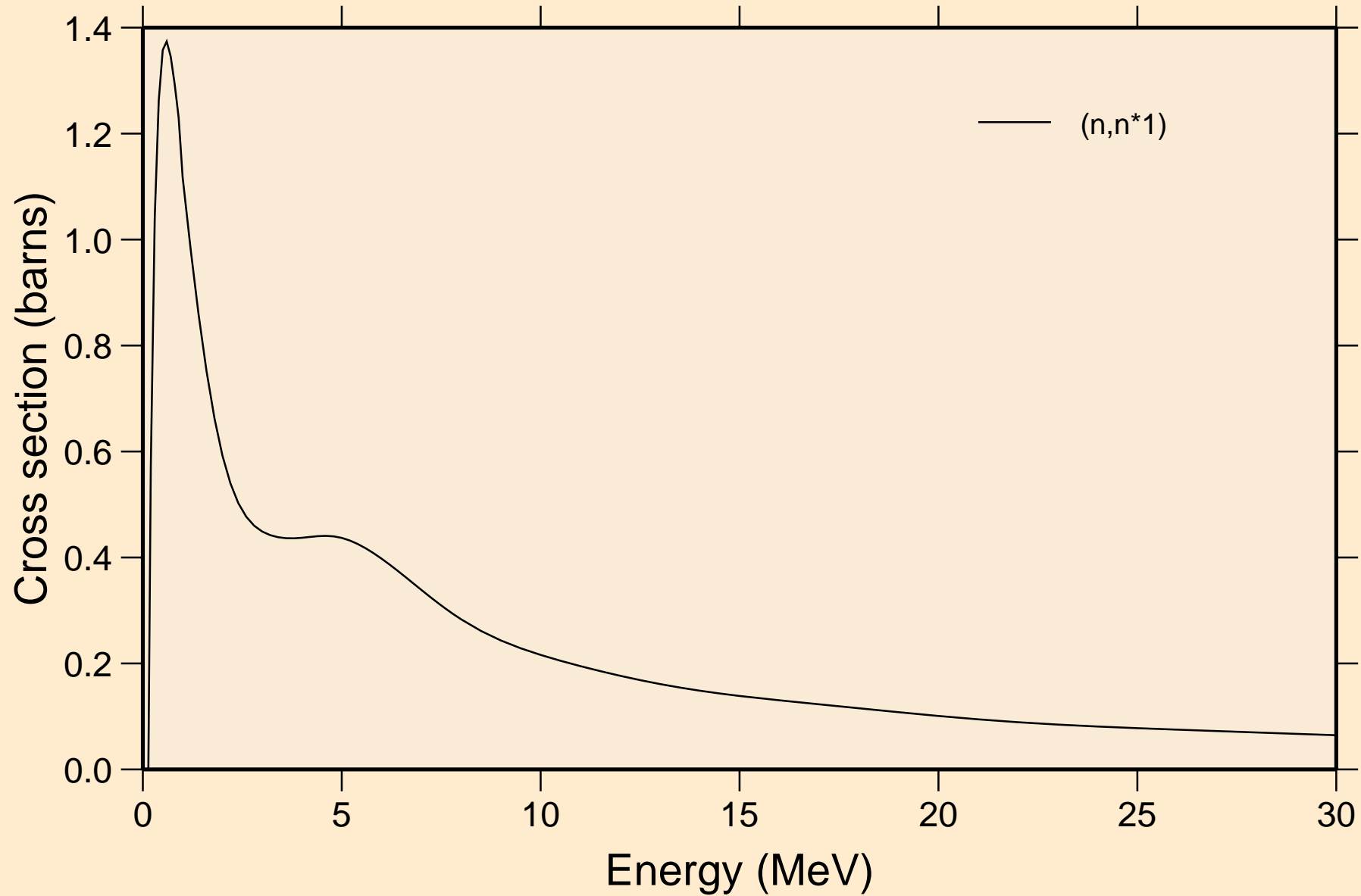

HF188 NEUTRON ACER TENDL-2021 LIBRARY; T=293.6K  
Threshold reactions

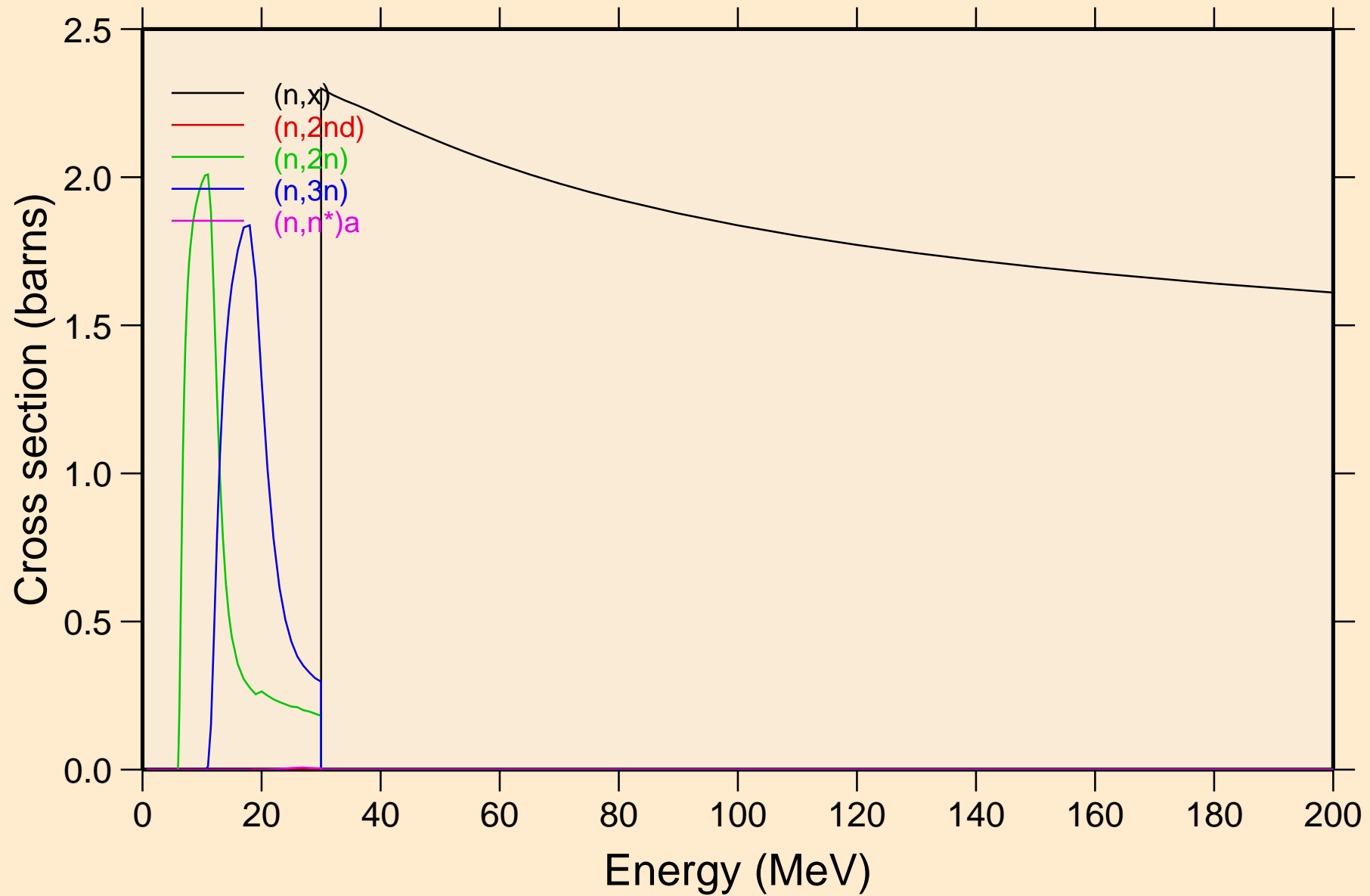



# HF188 NEUTRON ACER TENDL-2021 LIBRARY; T=293.6K

## Threshold reactions

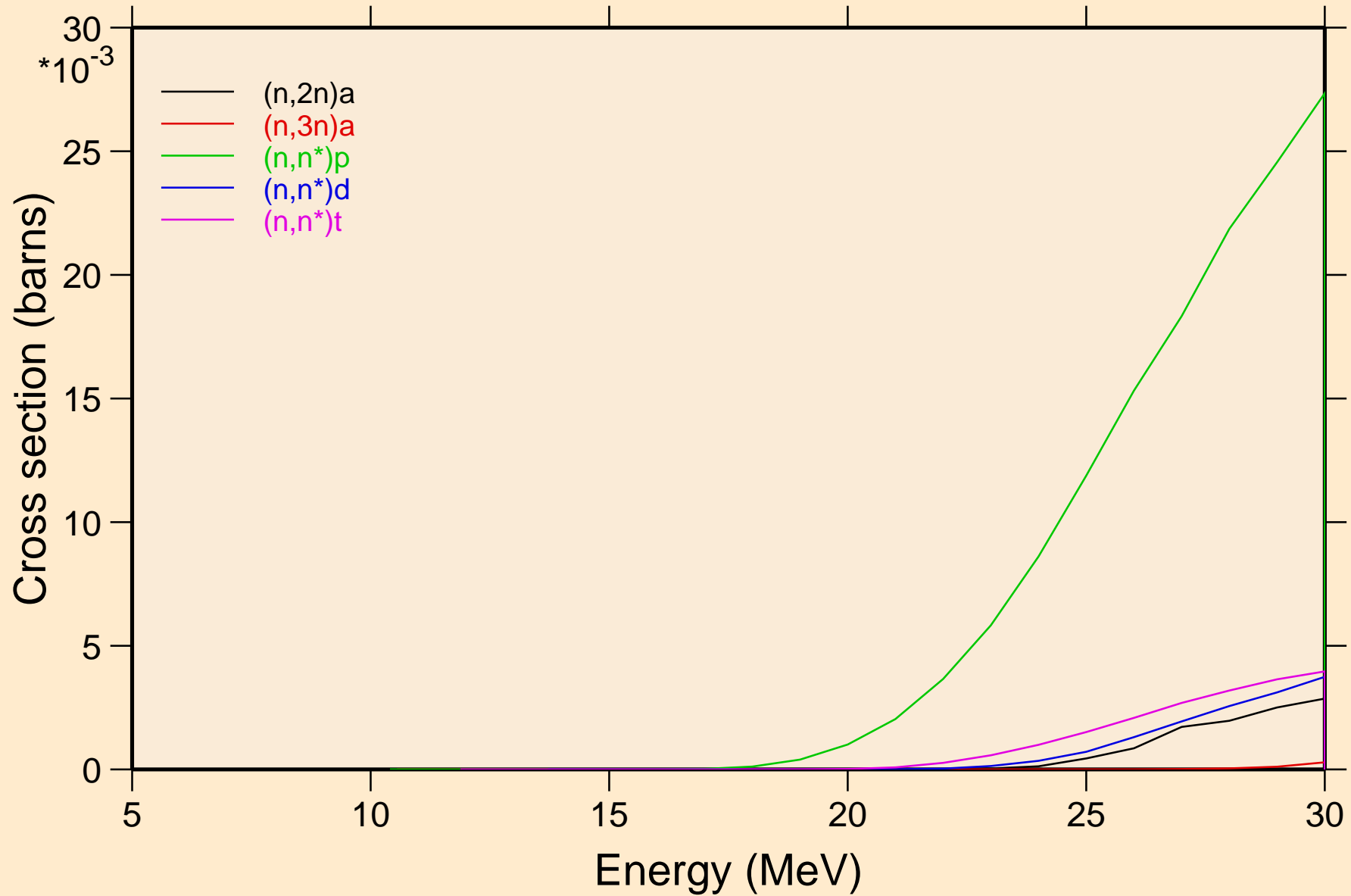

HF188 NEUTRON ACER TENDL-2021 LIBRARY; T=293.6K  
Threshold reactions

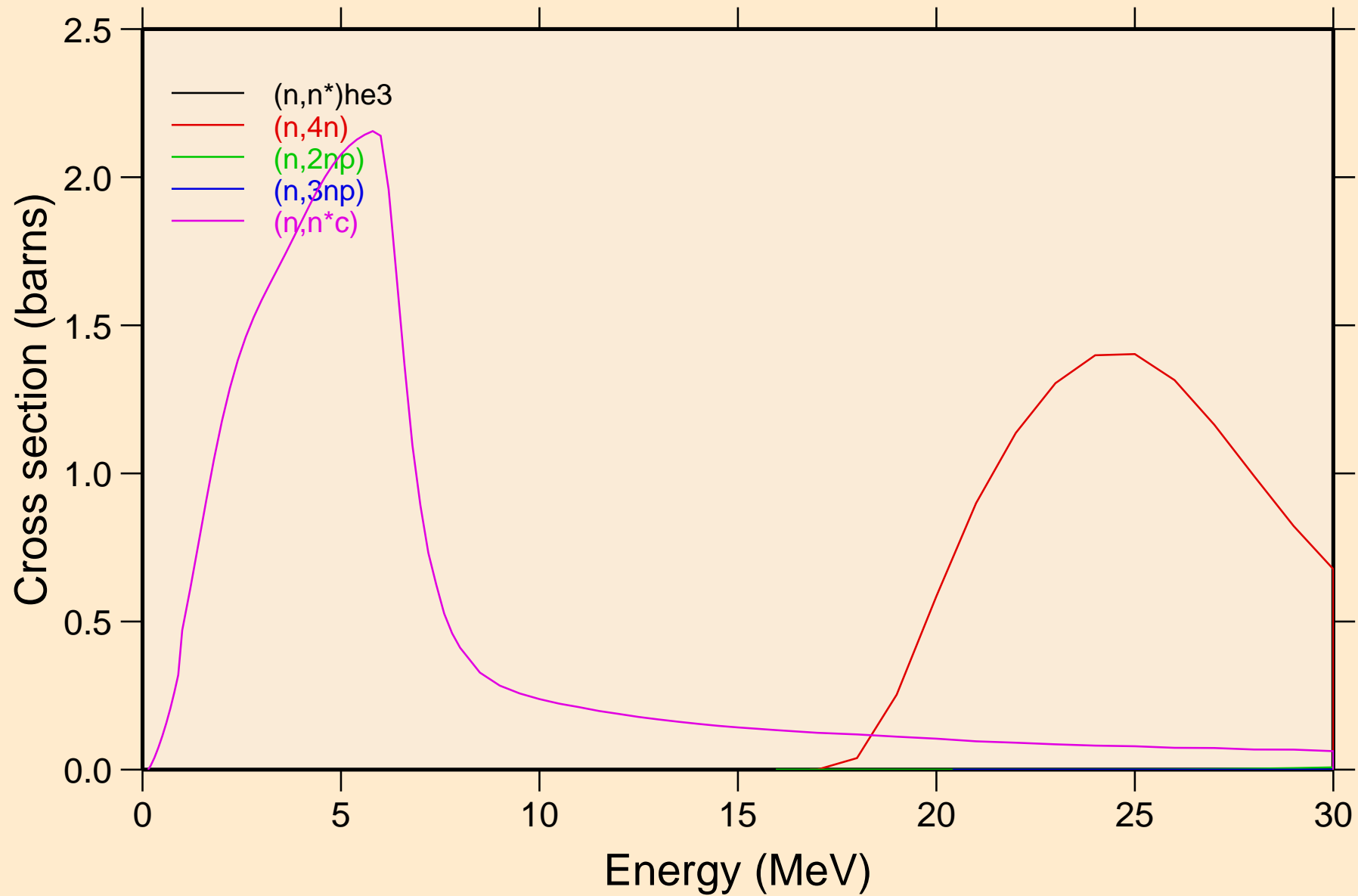

# HF188 NEUTRON ACER TENDL-2021 LIBRARY; T=293.6K

## Threshold reactions

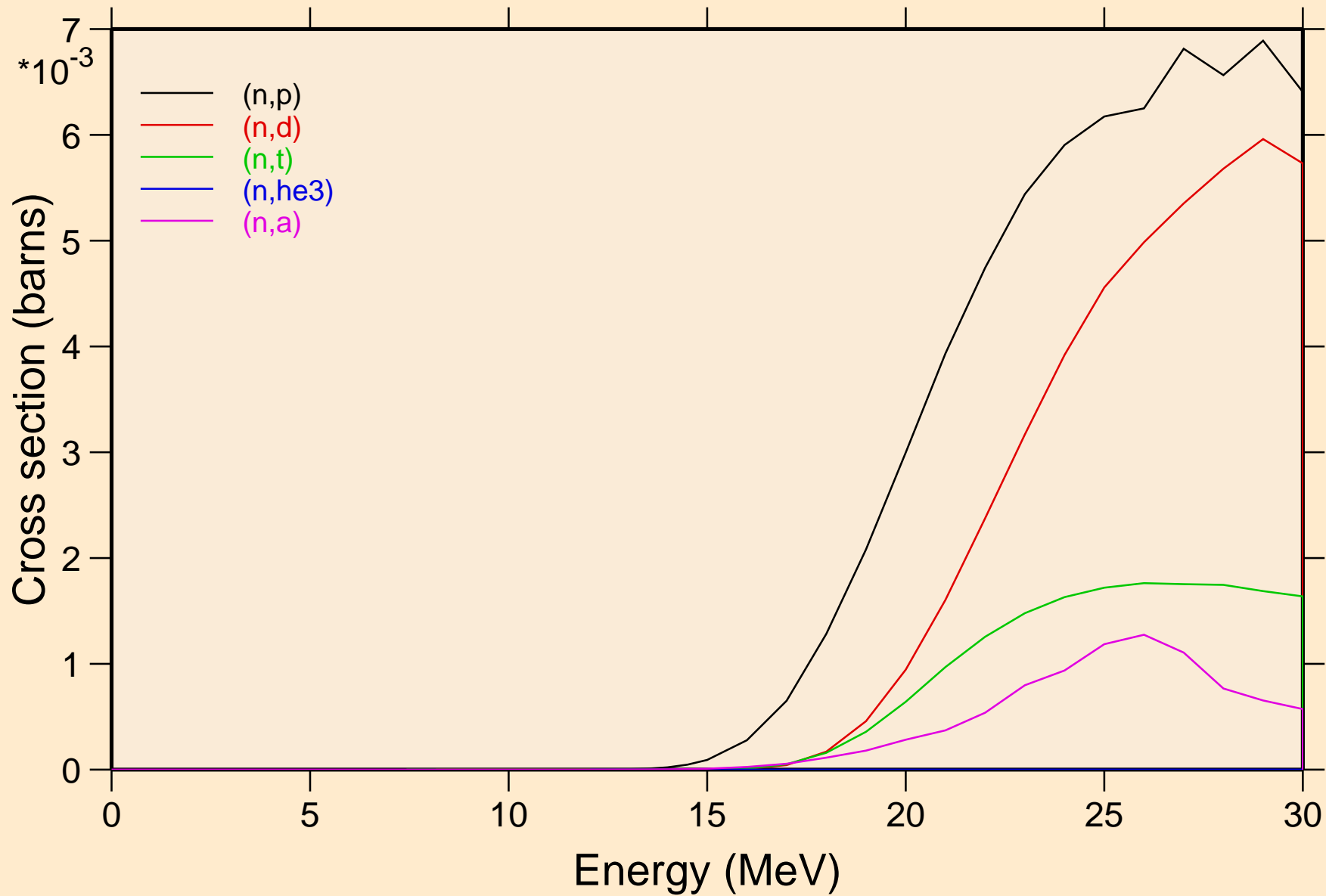

# HF188 NEUTRON ACER TENDL-2021 LIBRARY; T=293.6K

## Threshold reactions

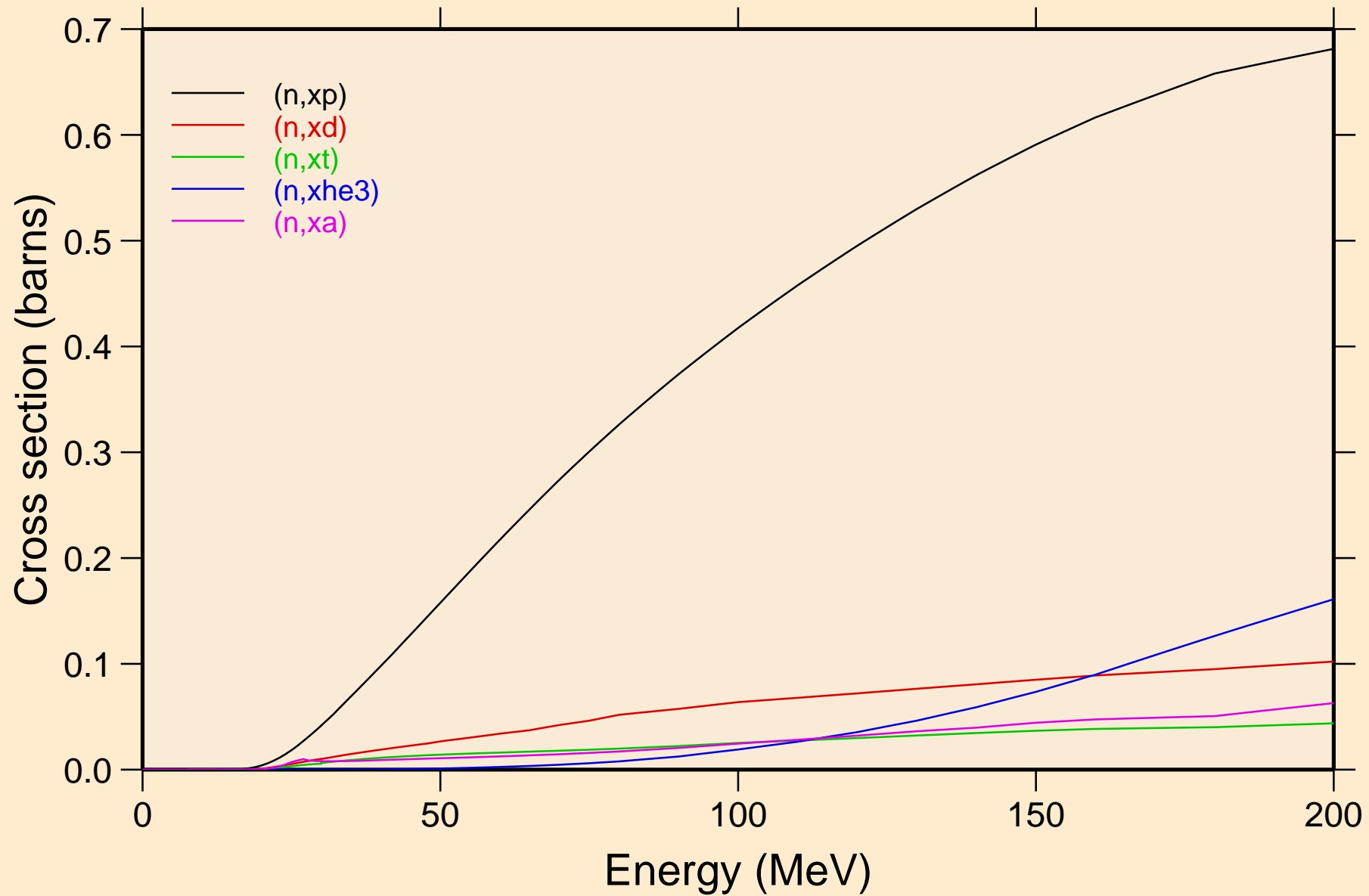

HF188 NEUTRON ACER TENDL-2021 LIBRARY; T=293.6K  
angular distribution for elastic

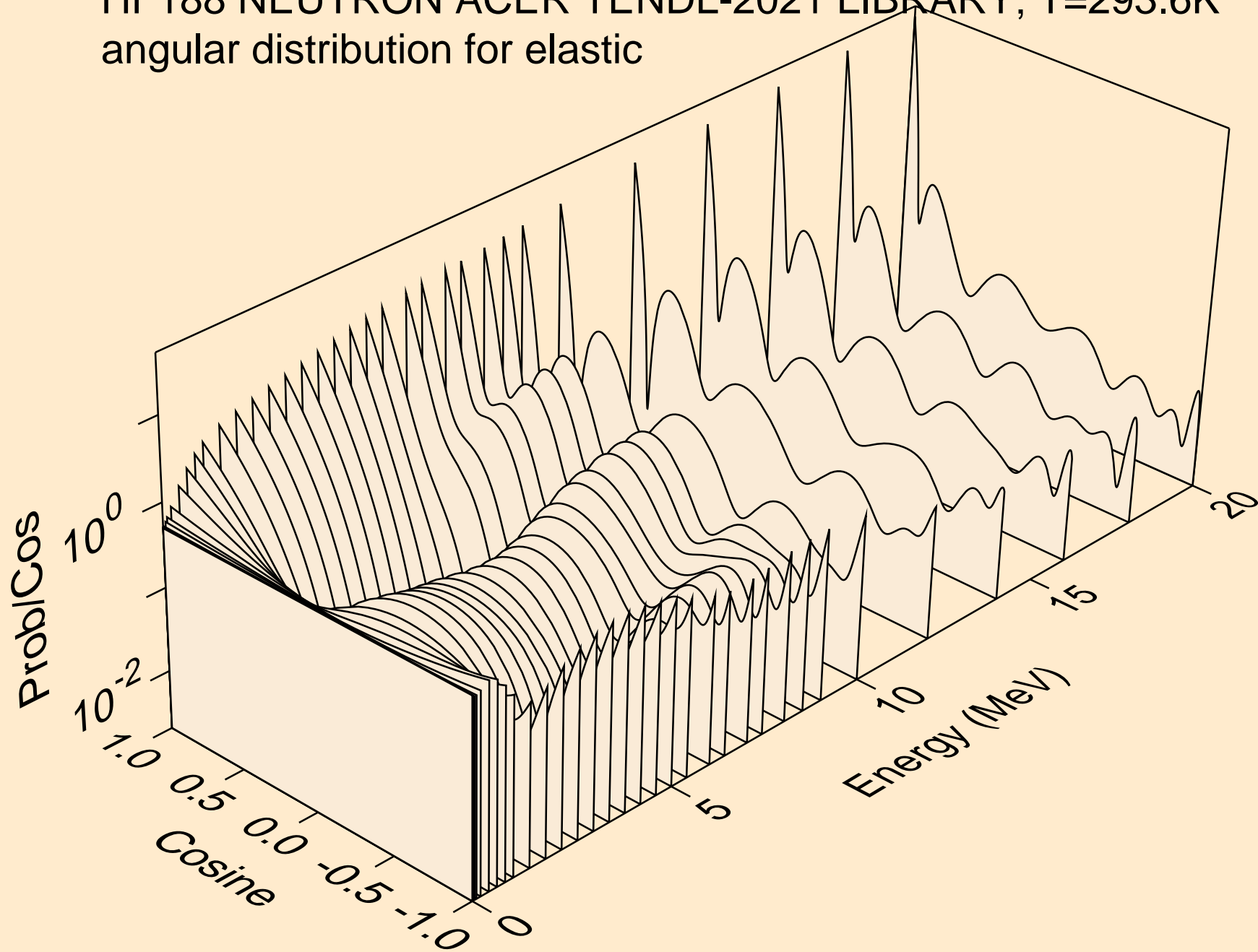

HF188 NEUTRON ACER TENDL-2021 LIBRARY; T=293.6K  
angular distribution for elastic

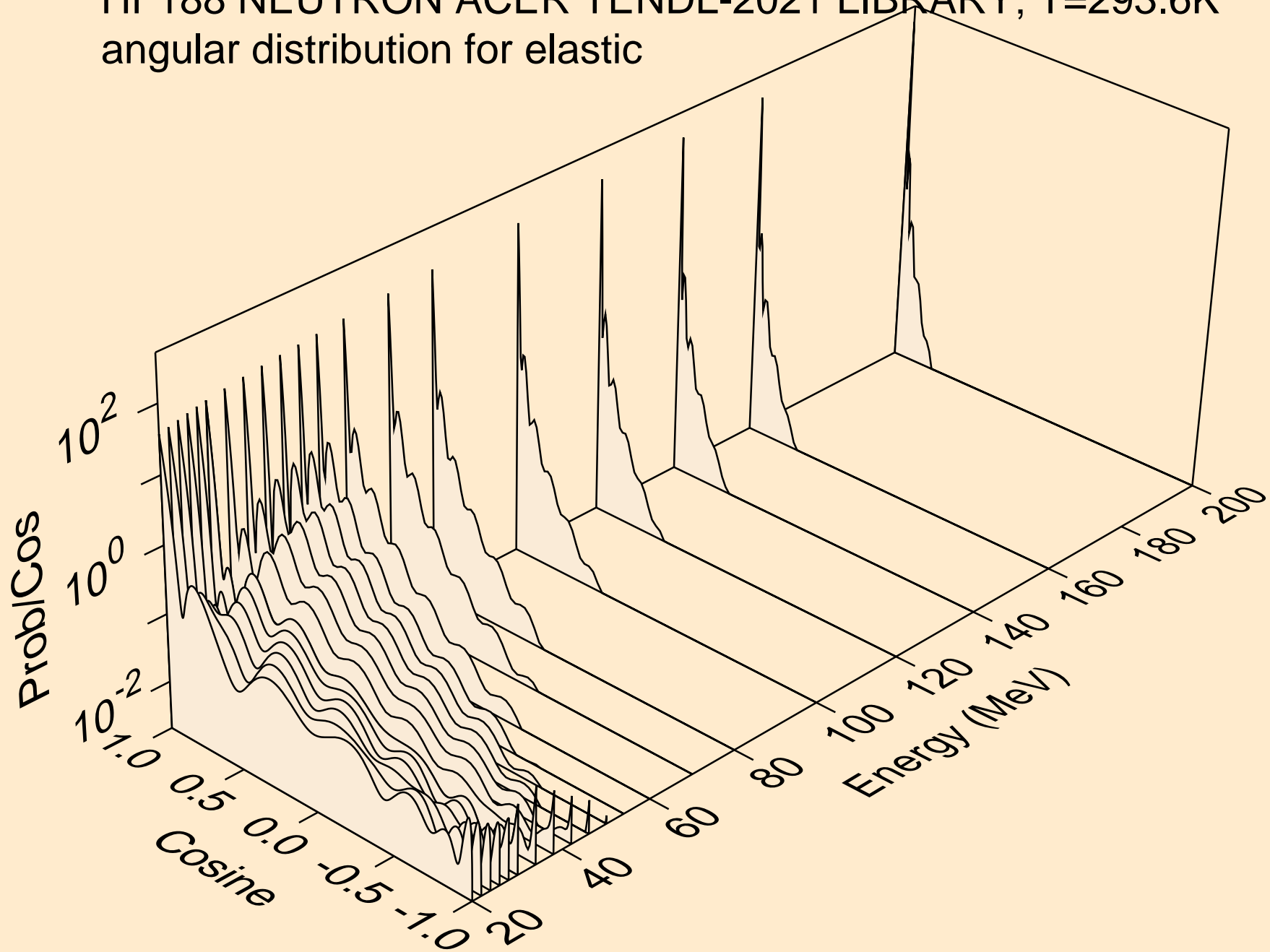

HF188 NEUTRON ACER TENDL-2021 LIBRARY; T=293.6K  
angular distribution for (n,n\*1)

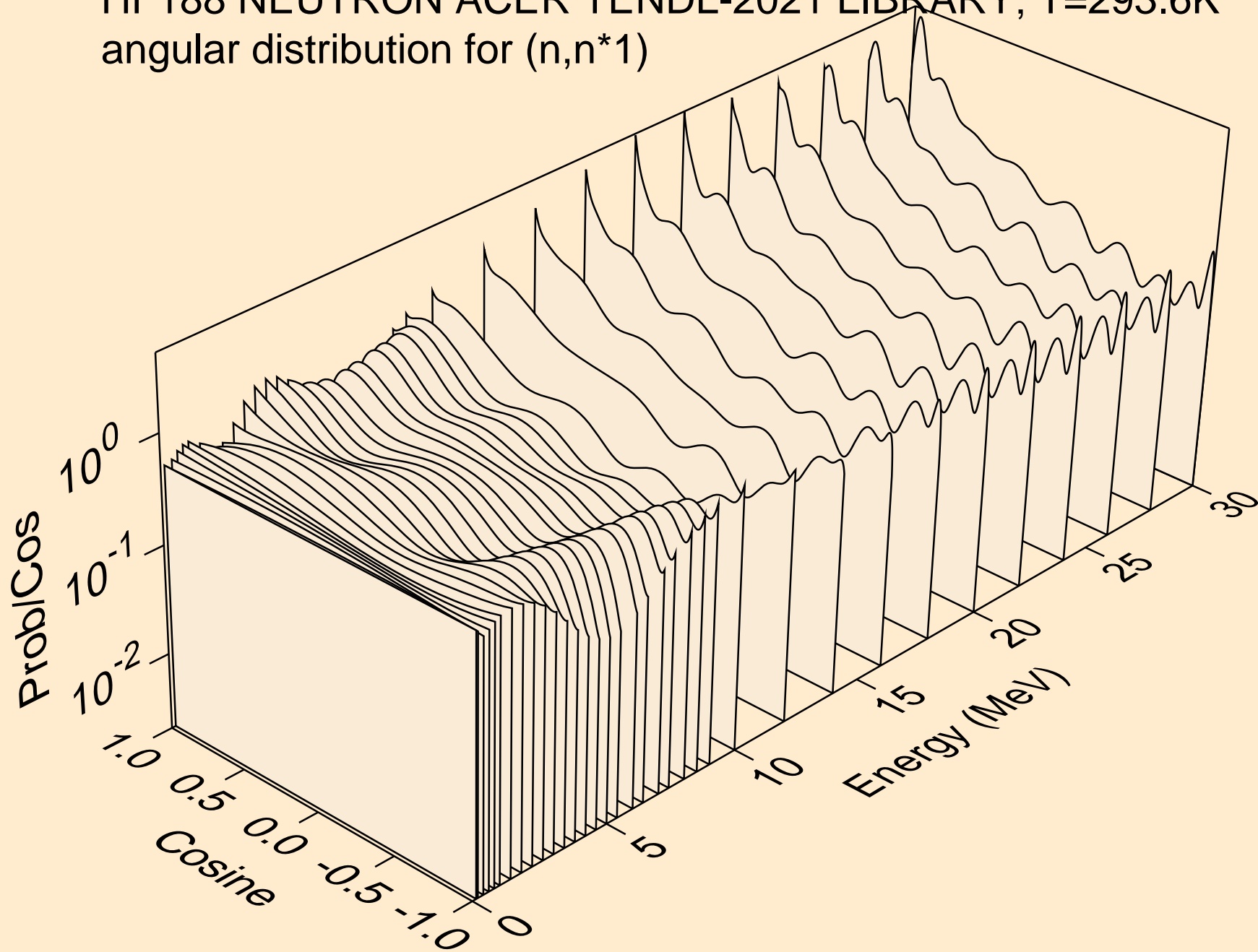

HF188 NEUTRON ACER TENDL-2021 LIBRARY; T=293.6K  
Neutron emission for (n,x)

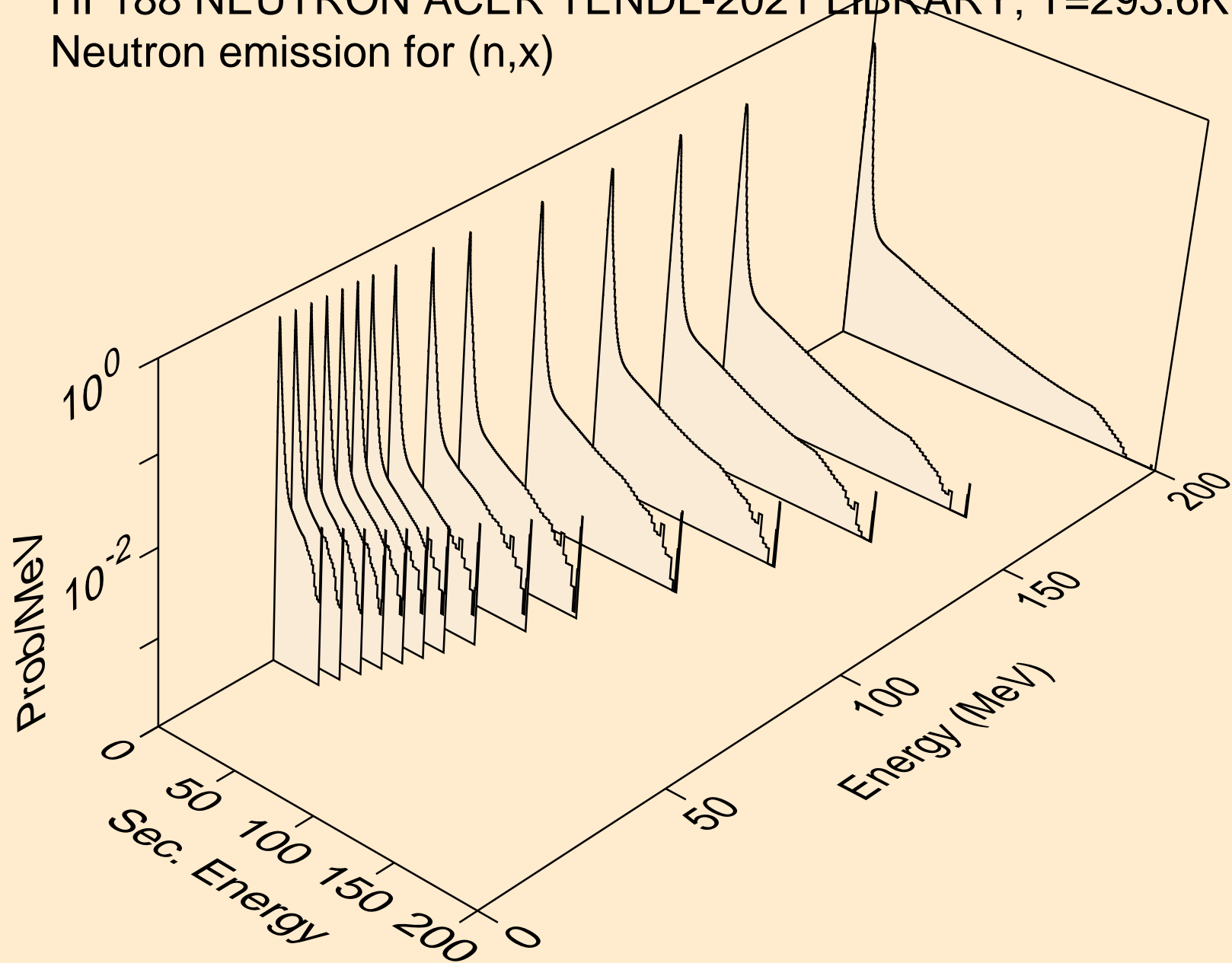



HF188 NEUTRON ACER TENDL-2021 LIBRARY; T=293.6K  
Neutron emission for (n,2nd)

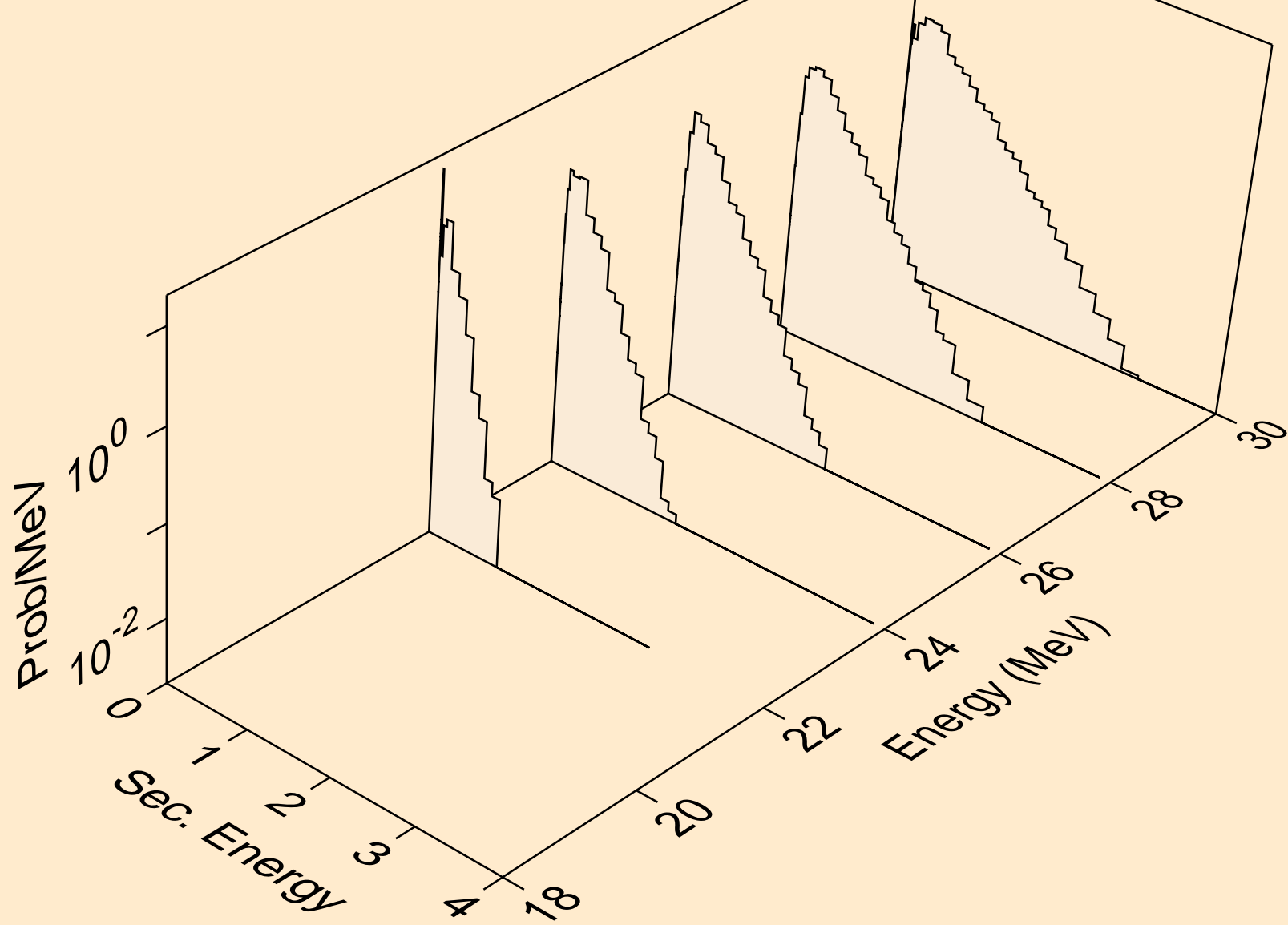

HF188 NEUTRON ACER TENDL-2021 LIBRARY; T=293.6K  
Neutron emission for (n,2n)

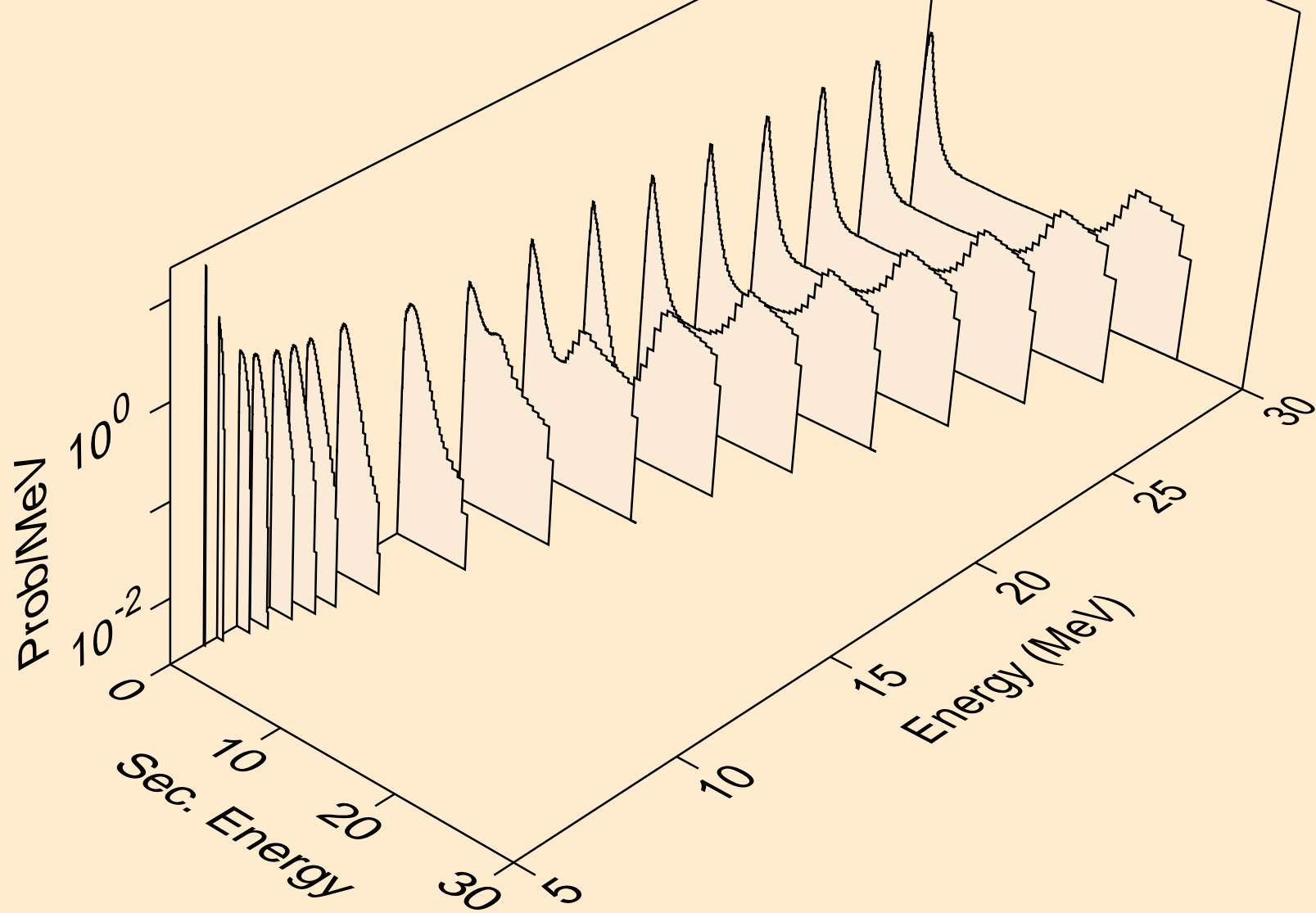

HF188 NEUTRON ACER TENDL-2021 LIBRARY; T=293.6K  
Neutron emission for (n,3n)

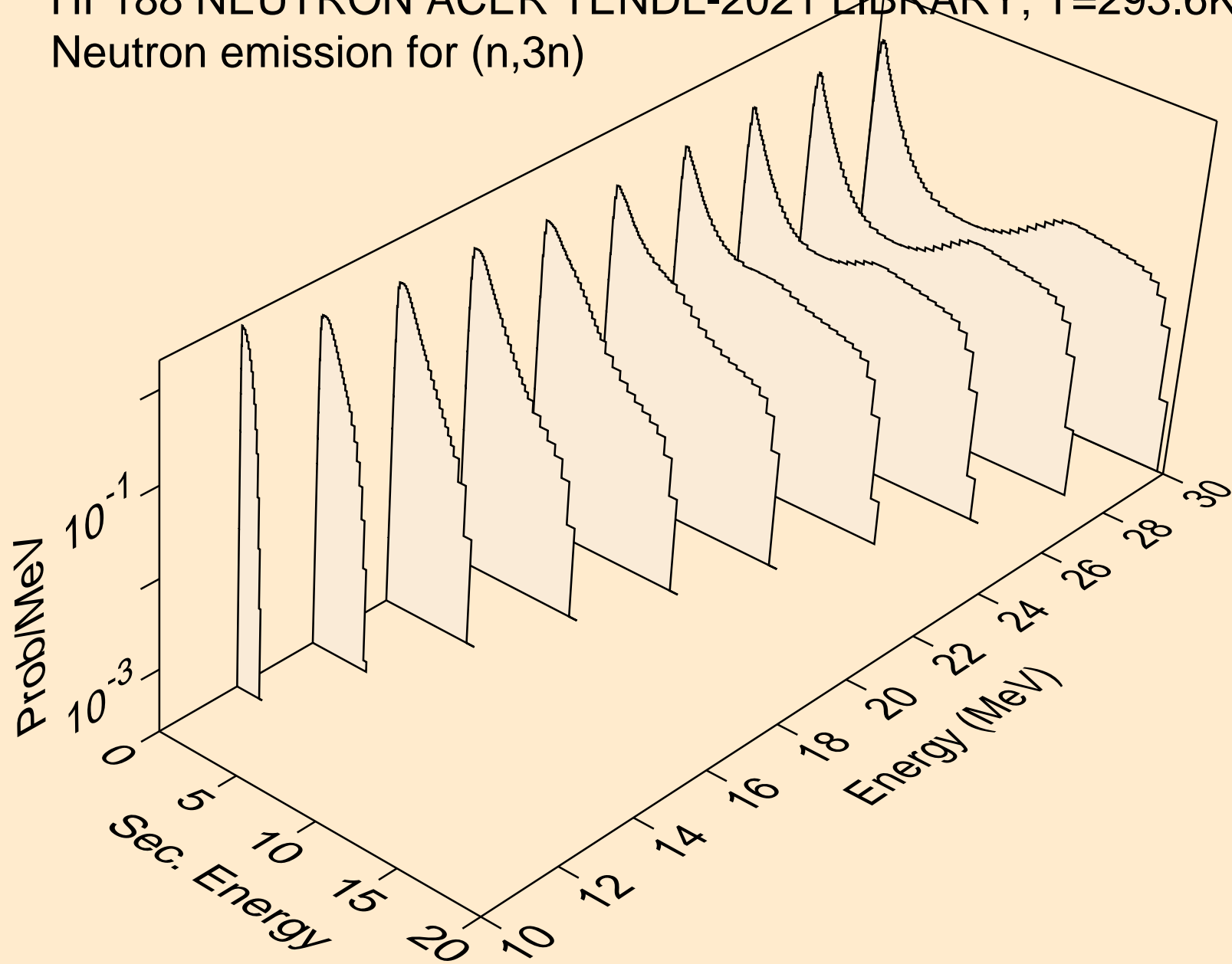

HF188 NEUTRON ACER TENDL-2021 LIBRARY; T=293.6K  
Neutron emission for (n,n\*)a

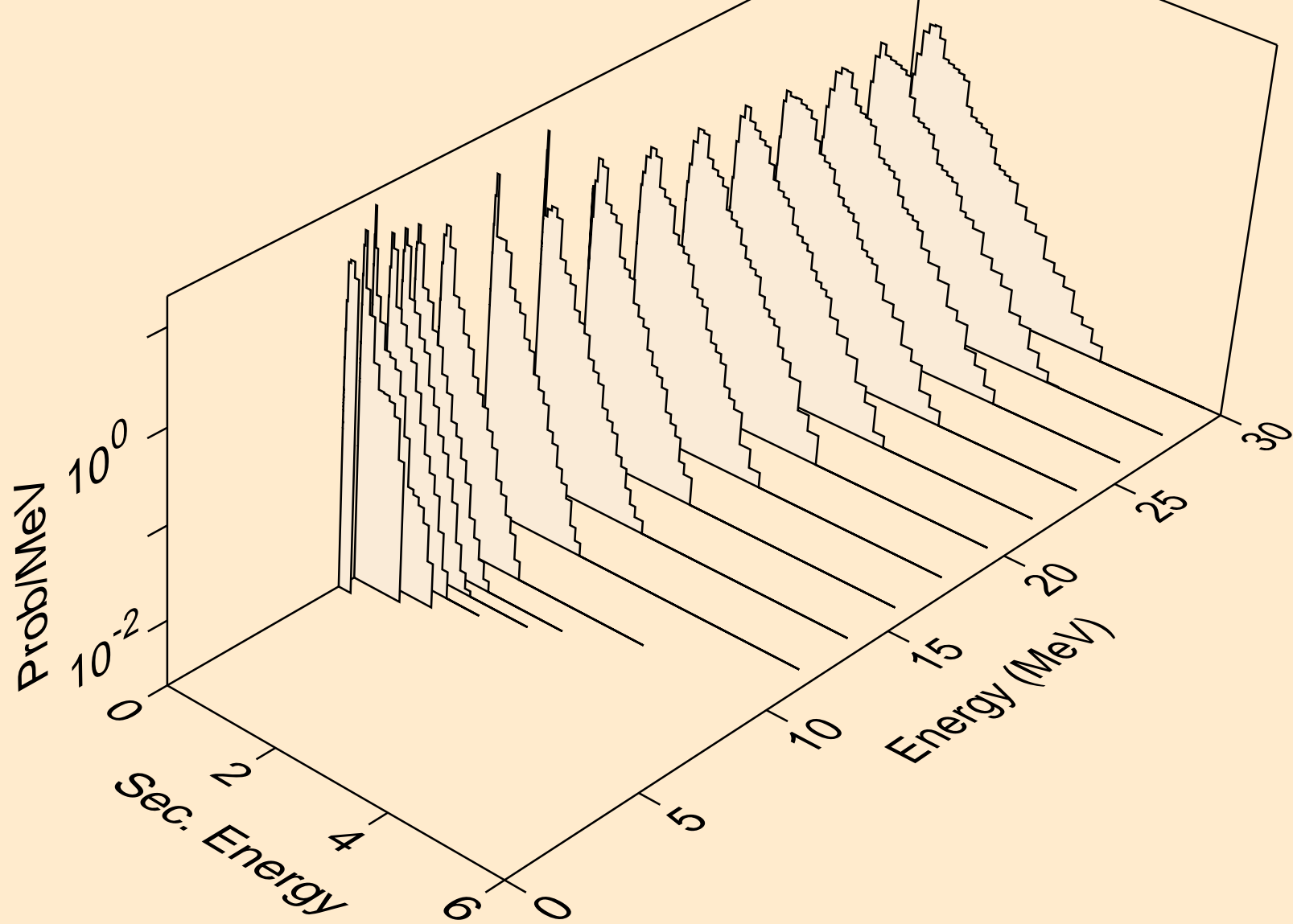

HF188 NEUTRON ACER TENDL-2021 LIBRARY; T=293.6K  
Neutron emission for (n,2n)<sub>a</sub>

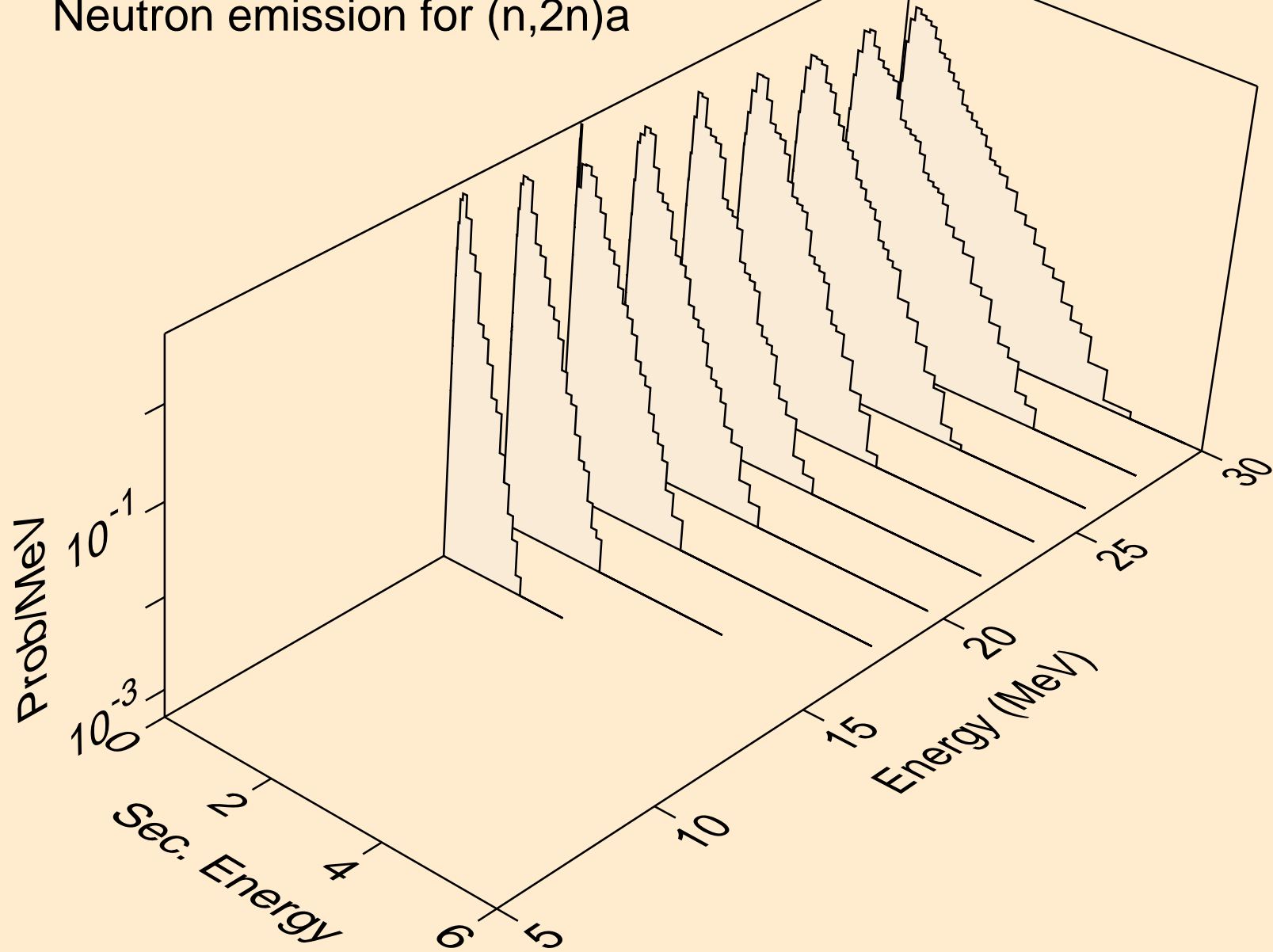

HF188 NEUTRON ACER TENDL-2021 LIBRARY; T=293.6K  
Neutron emission for (n,3n)a

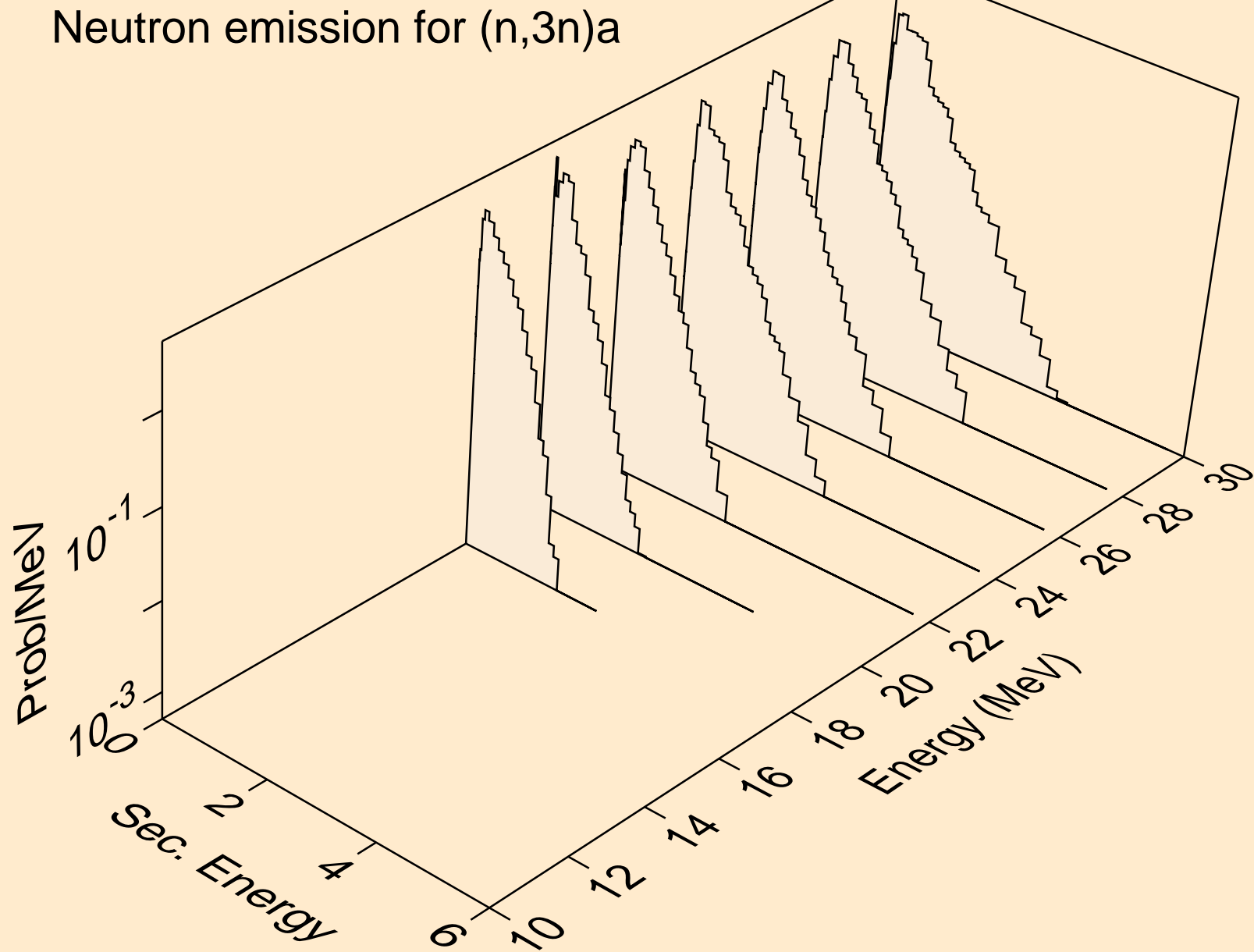

HF188 NEUTRON ACER TENDL-2021 LIBRARY; T=293.6K  
Neutron emission for (n,n\*)p

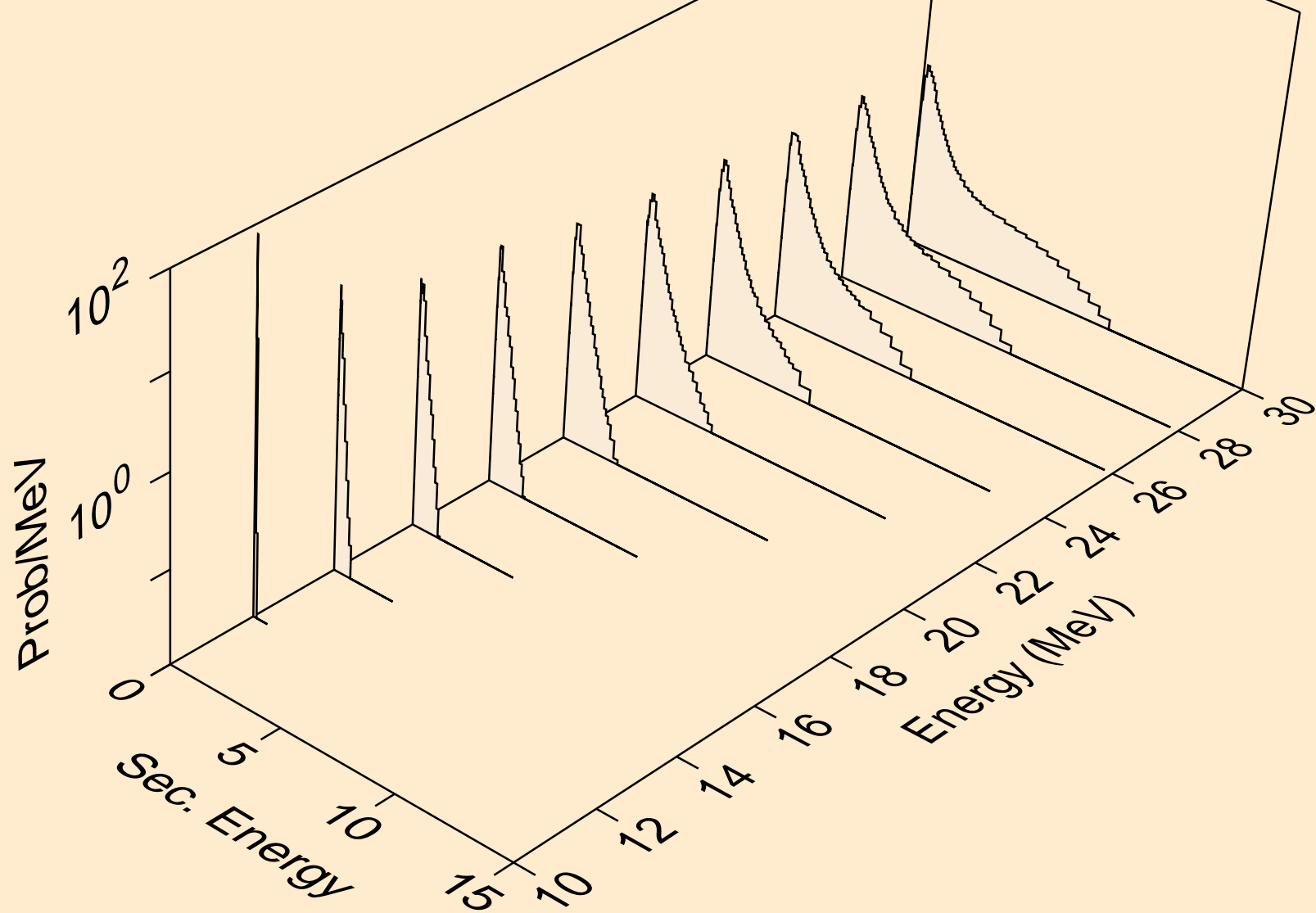

HF188 NEUTRON ACER TENDL-2021 LIBRARY; T=293.6K  
Neutron emission for (n,n\*)d

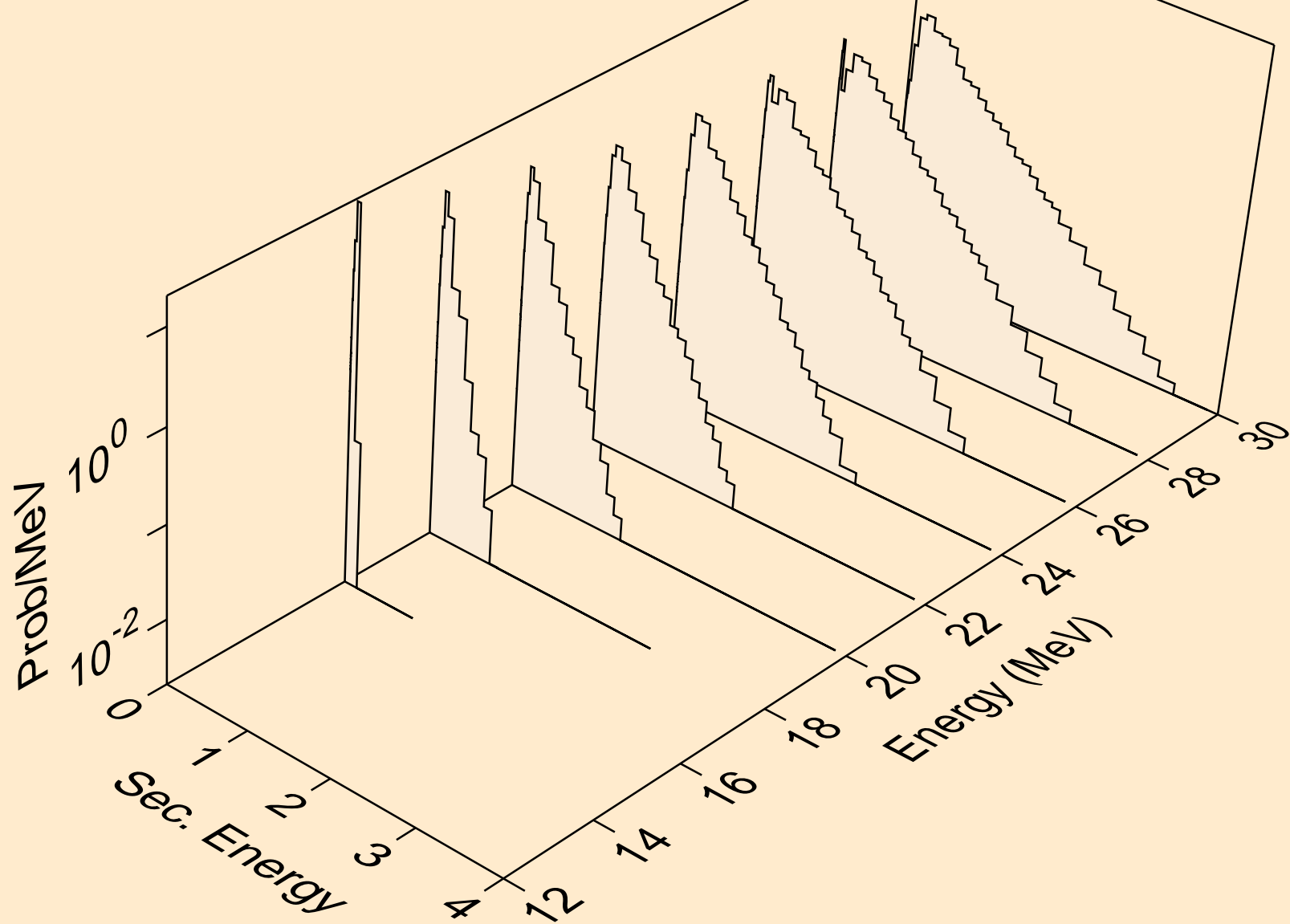



HF188 NEUTRON ACER TENDL-2021 LIBRARY; T=293.6K  
Neutron emission for (n,n\*)t

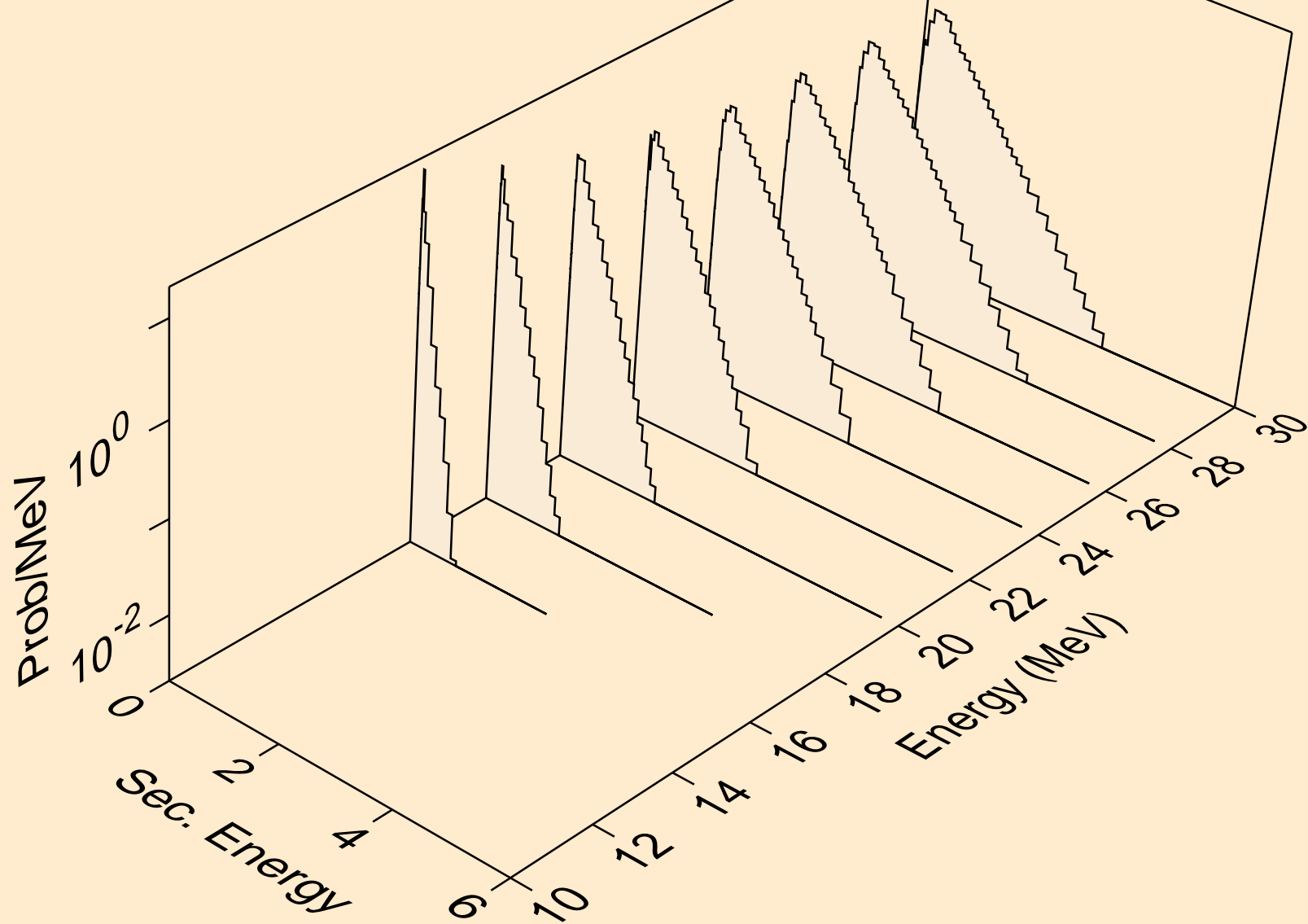

HF188 NEUTRON ACER TENDL-2021 LIBRARY; T=293.6K  
Neutron emission for (n,n\*)he3

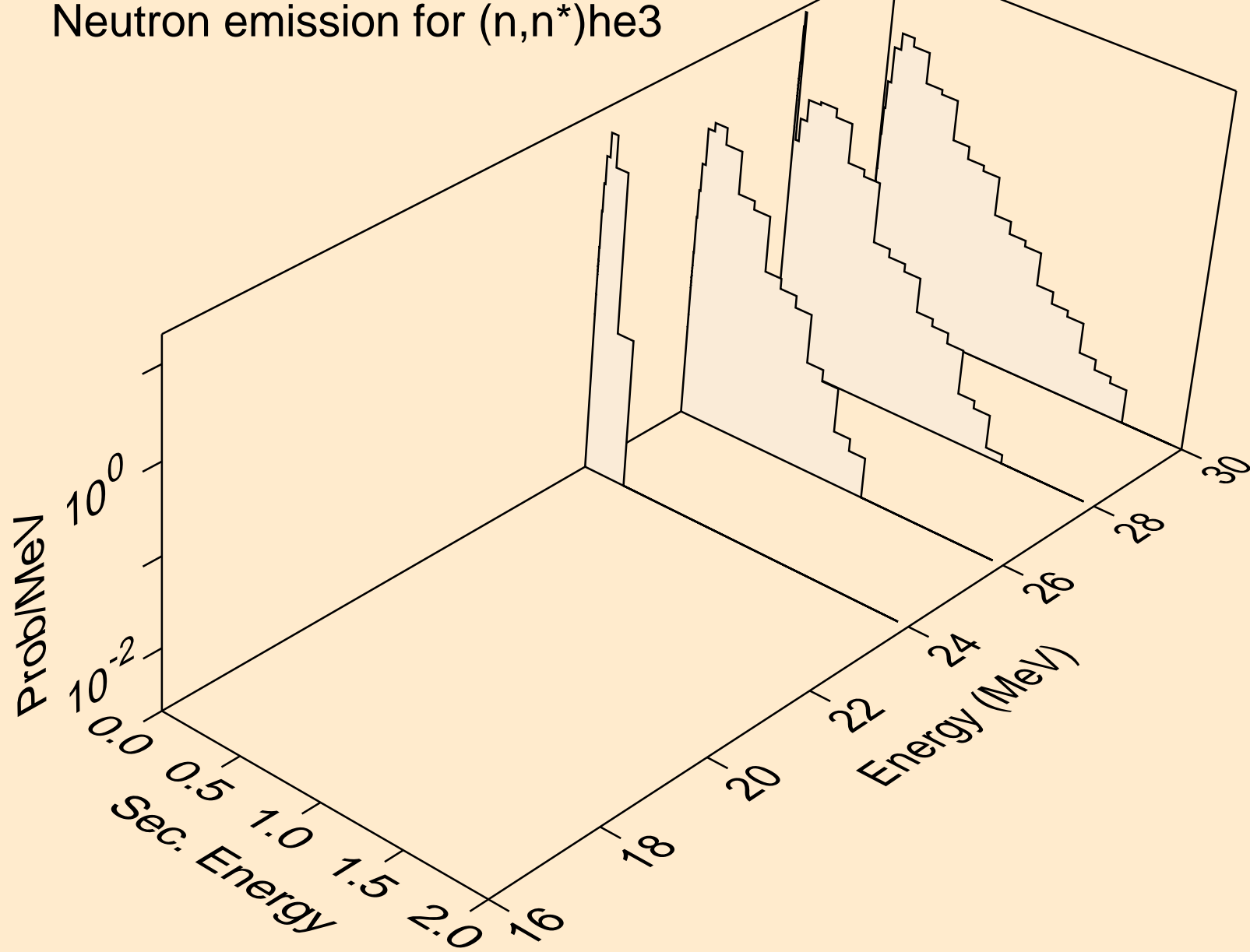

HF188 NEUTRON ACER TENDL-2021 LIBRARY; T=293.6K  
Neutron emission for (n,4n)

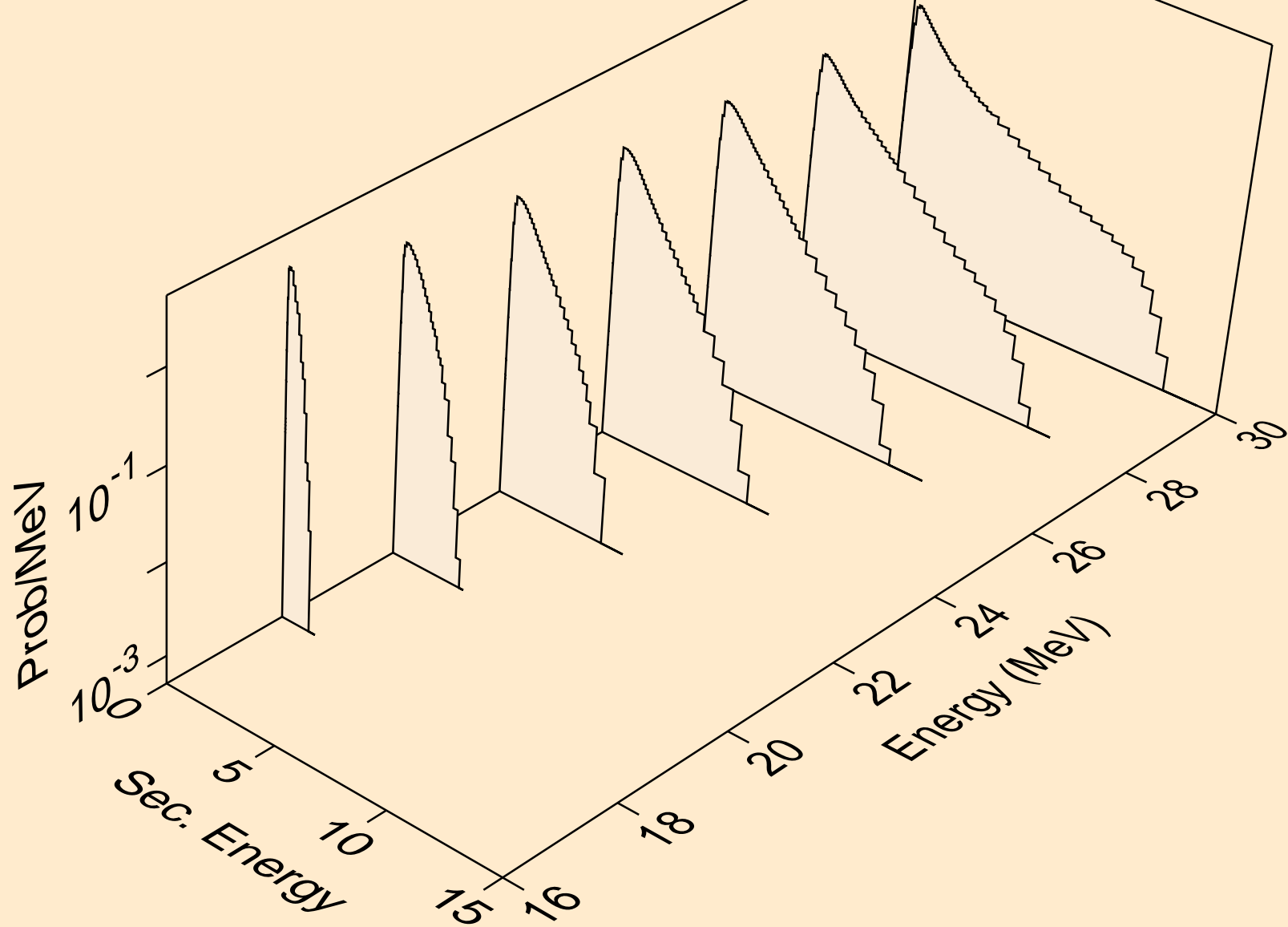

HF188 NEUTRON ACER TENDL-2021 LIBRARY; T=293.6K  
Neutron emission for (n,2np)

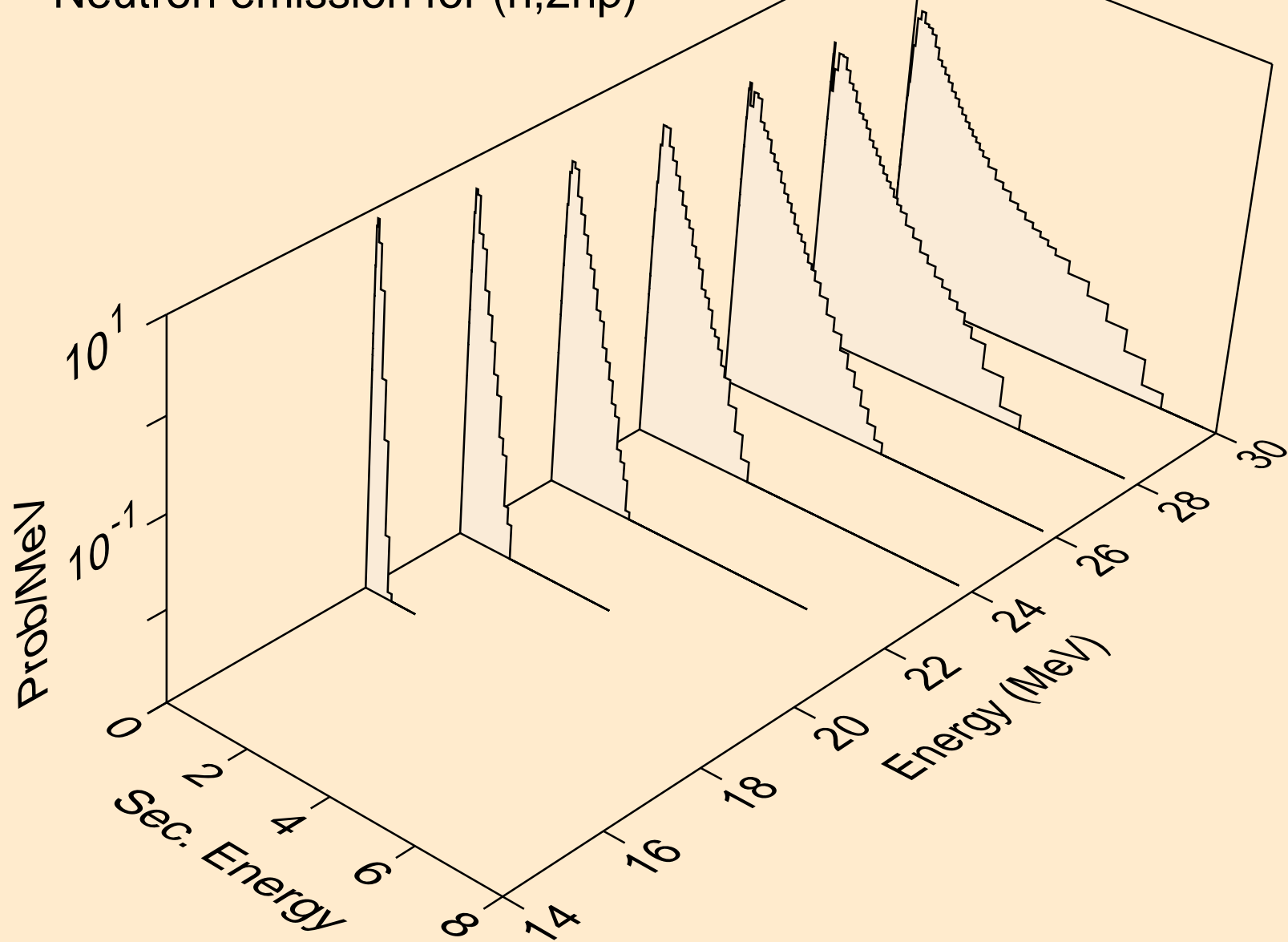

HF188 NEUTRON ACER TENDL-2021 LIBRARY; T=293.6K  
Neutron emission for (n,3np)

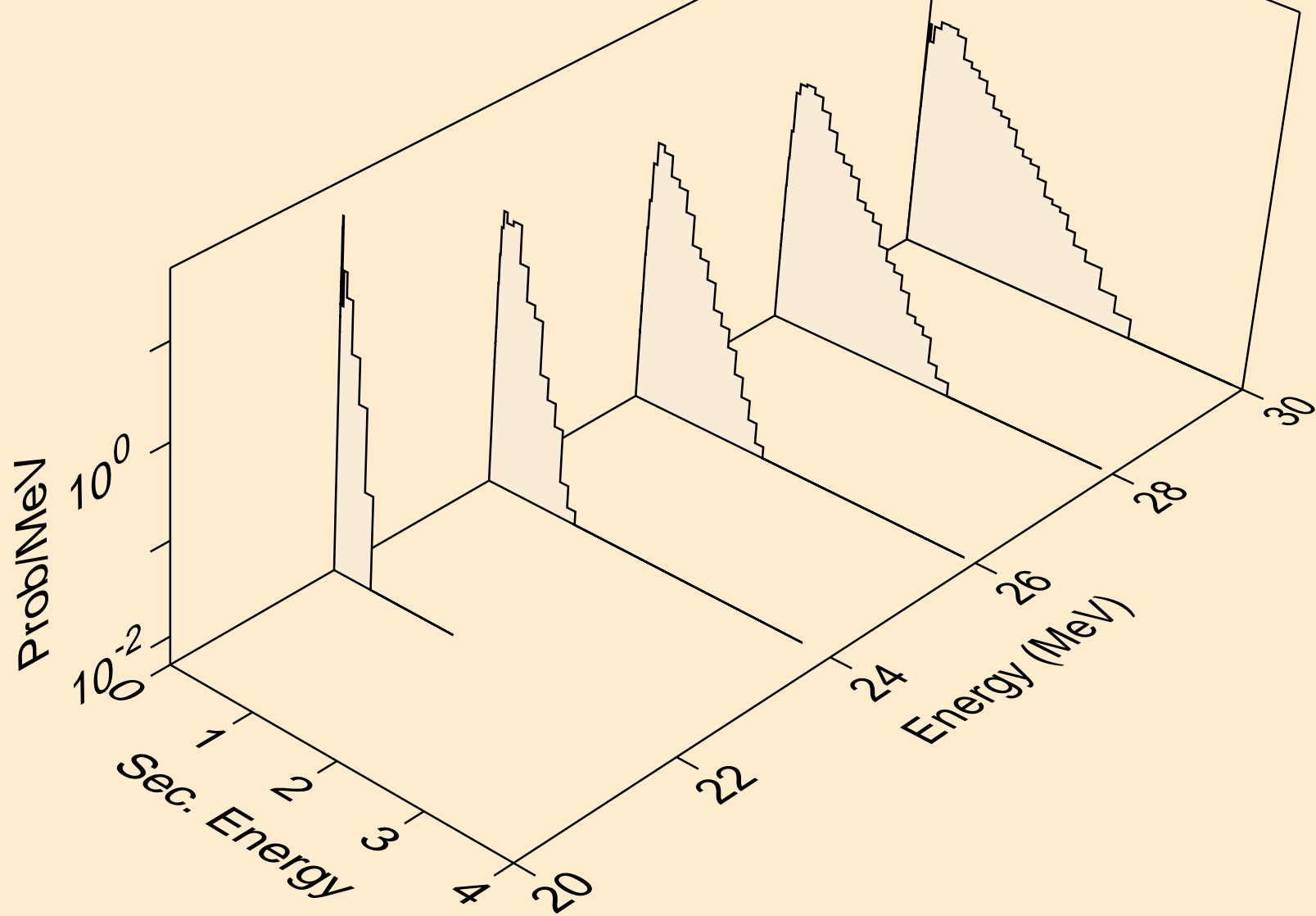

HF188 NEUTRON ACER TENDL-2021 LIBRARY; T=293.6K  
Neutron emission for (n,n\*c)

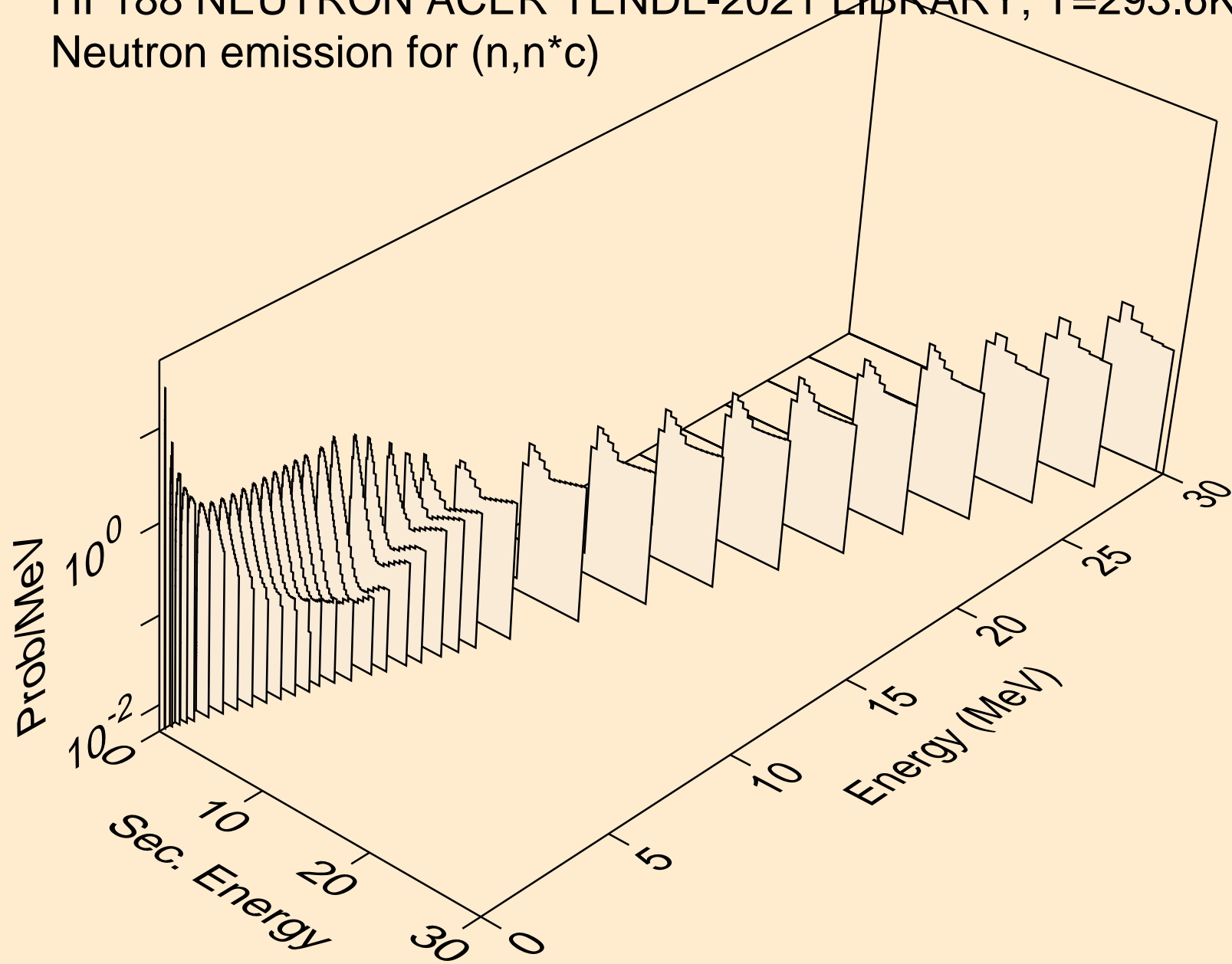

HF188 NEUTRON ACER TENDL-2021 LIBRARY; T=293.6K  
Photon emission for (n,x)

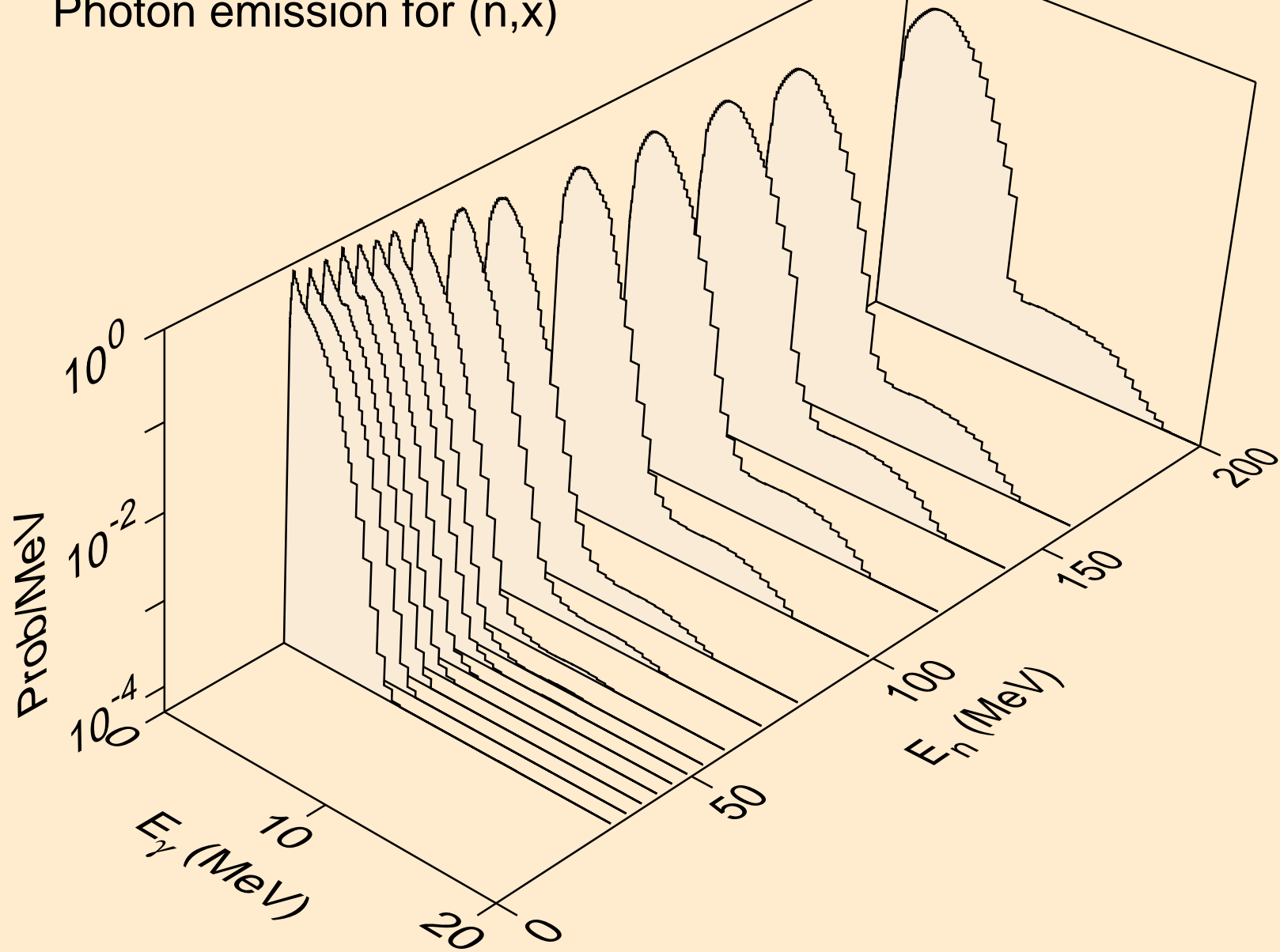

HF188 NEUTRON ACER TENDL-2021 LIBRARY; T=293.6K  
Photon emission for (n,2nd)

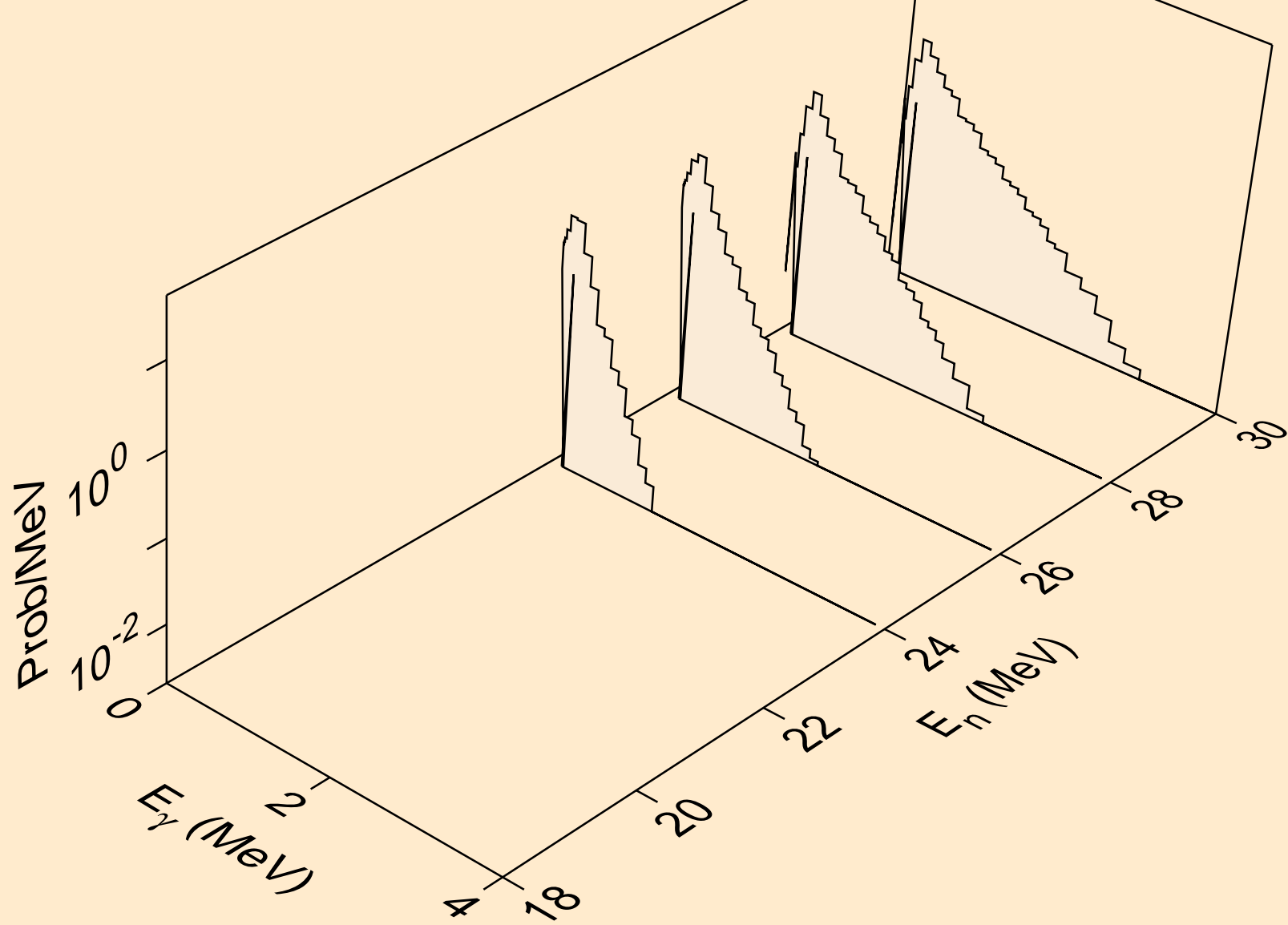



HF188 NEUTRON ACER TENDL-2021 LIBRARY; T=293.6K  
Photon emission for (n,2n)

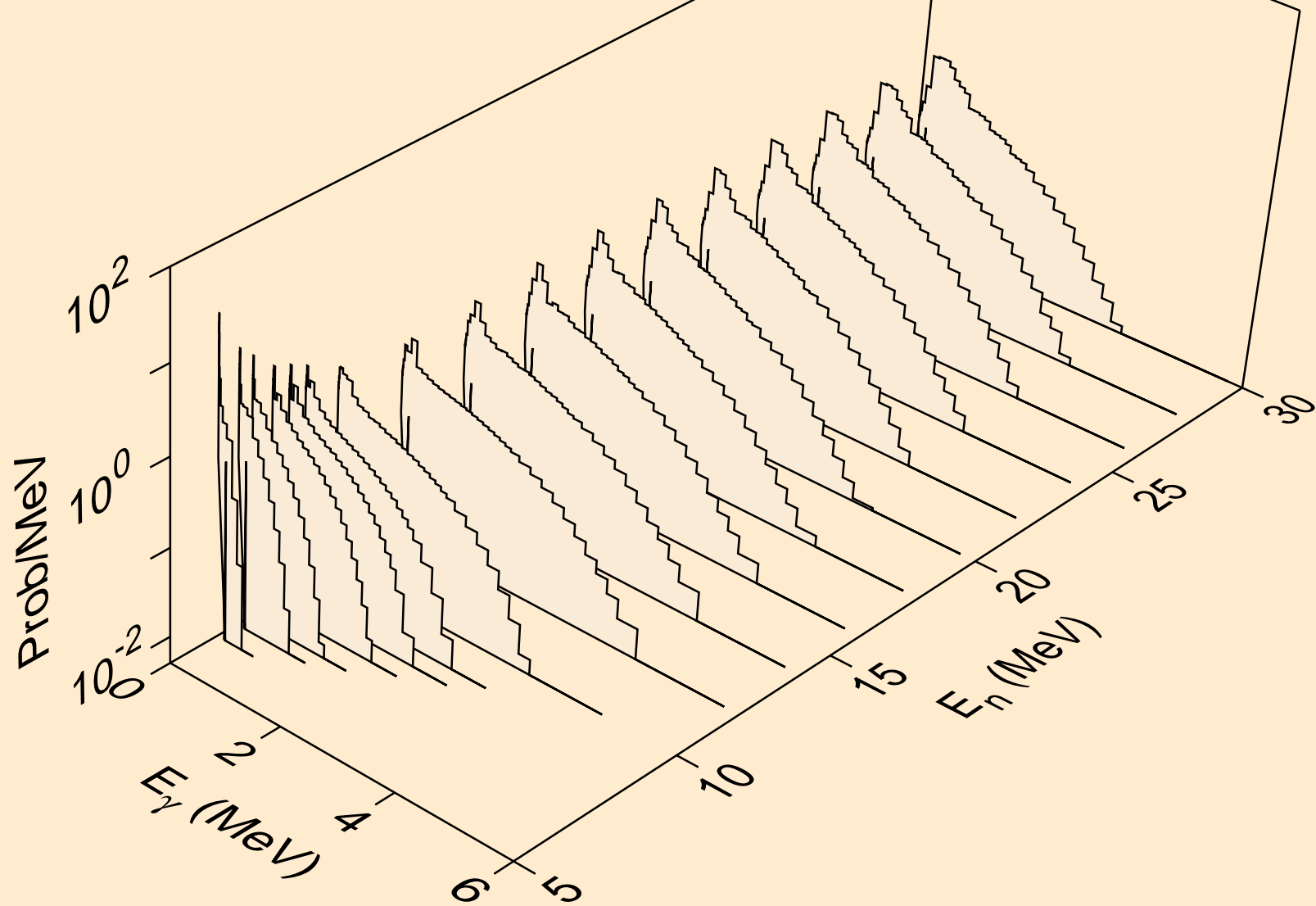

HF188 NEUTRON ACER TENDL-2021 LIBRARY; T=293.6K  
Photon emission for (n,3n)

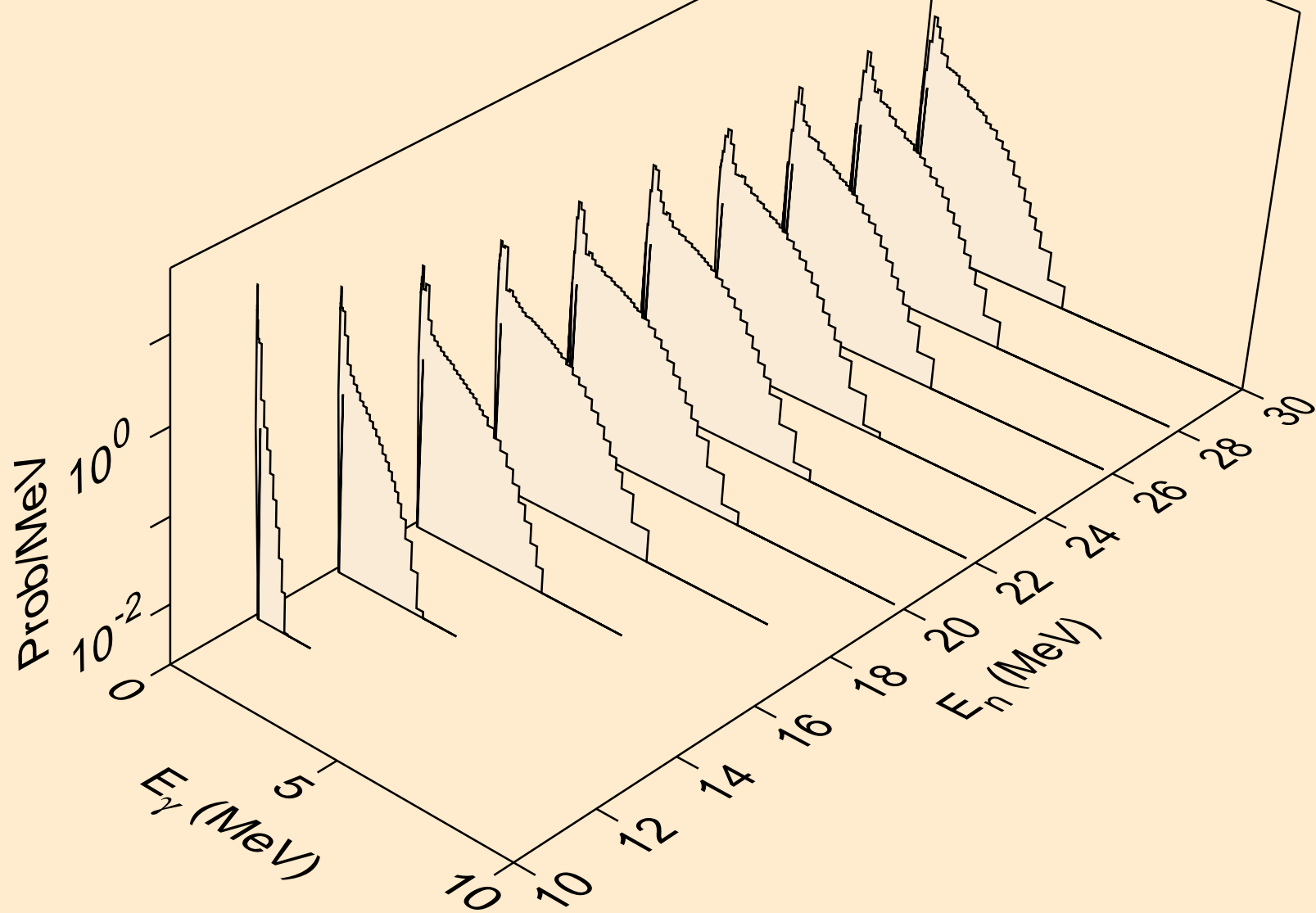

HF188 NEUTRON ACER TENDL-2021 LIBRARY; T=293.6K  
Photon emission for (n,n\*)a

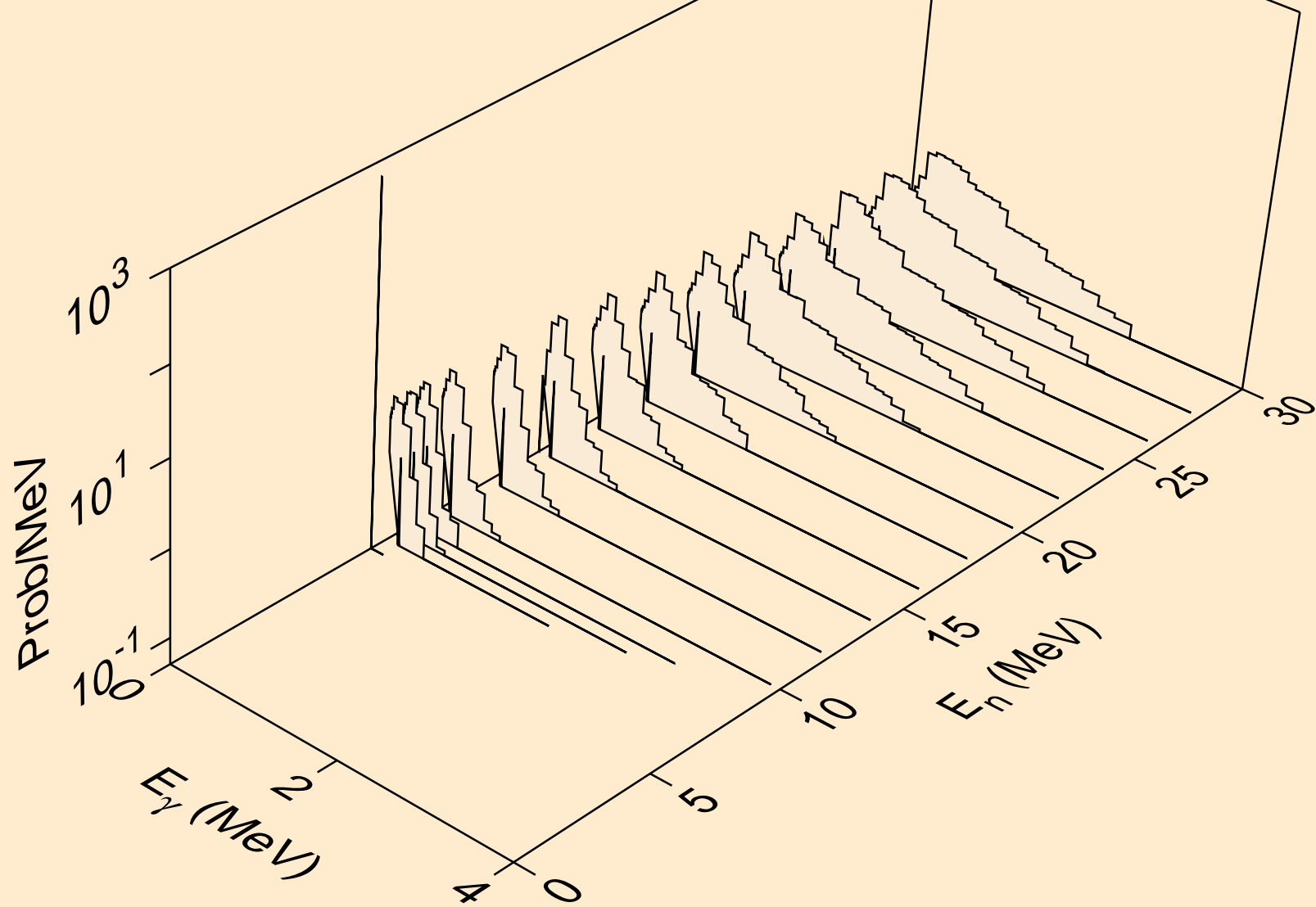

HF188 NEUTRON ACER TENDL-2021 LIBRARY; T=293.6K  
Photon emission for (n,2n)a

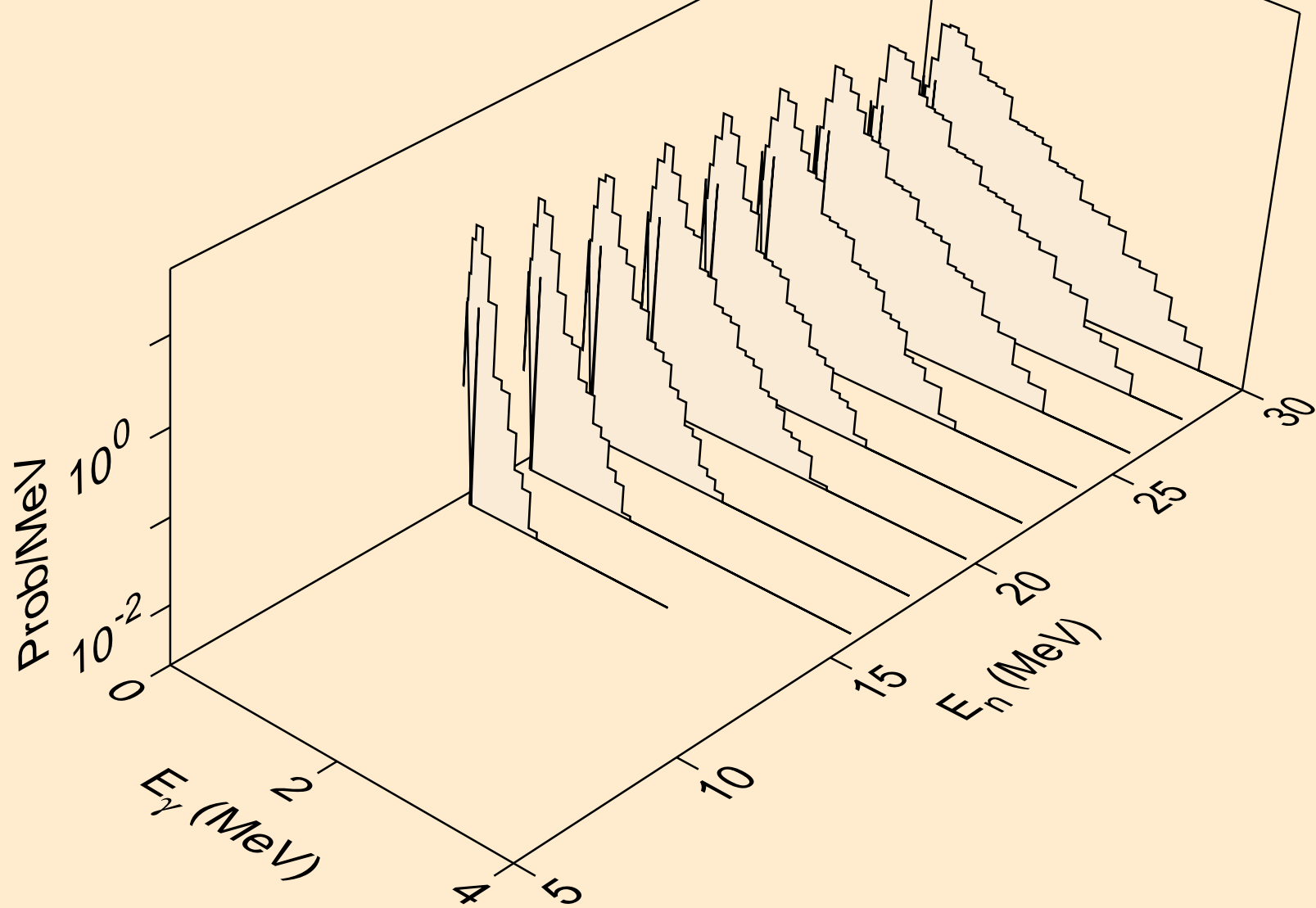

HF188 NEUTRON ACER TENDL-2021 LIBRARY; T=293.6K  
Photon emission for (n,3n)a

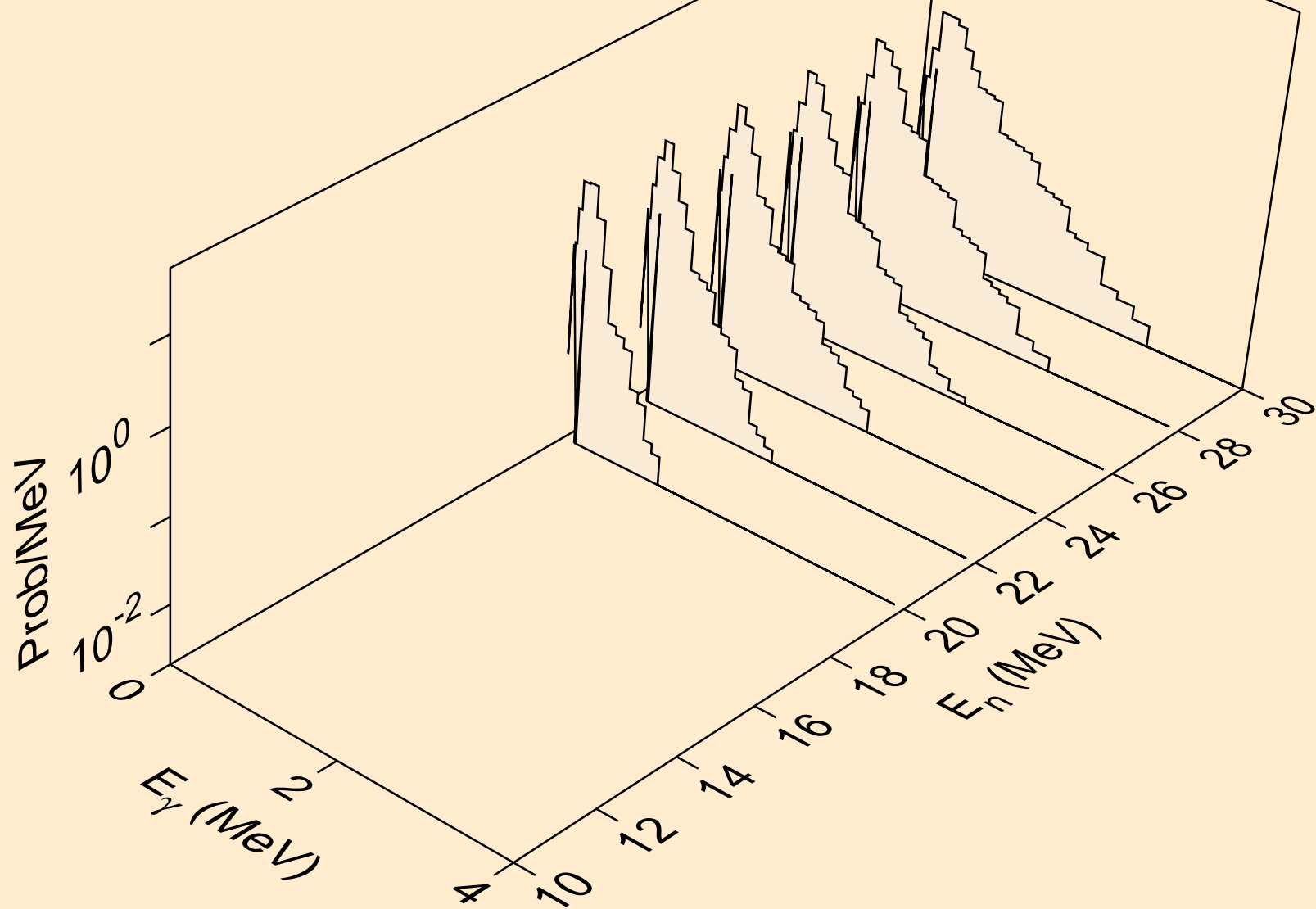

HF188 NEUTRON ACER TENDL-2021 LIBRARY; T=293.6K  
Photon emission for (n,n\*)p

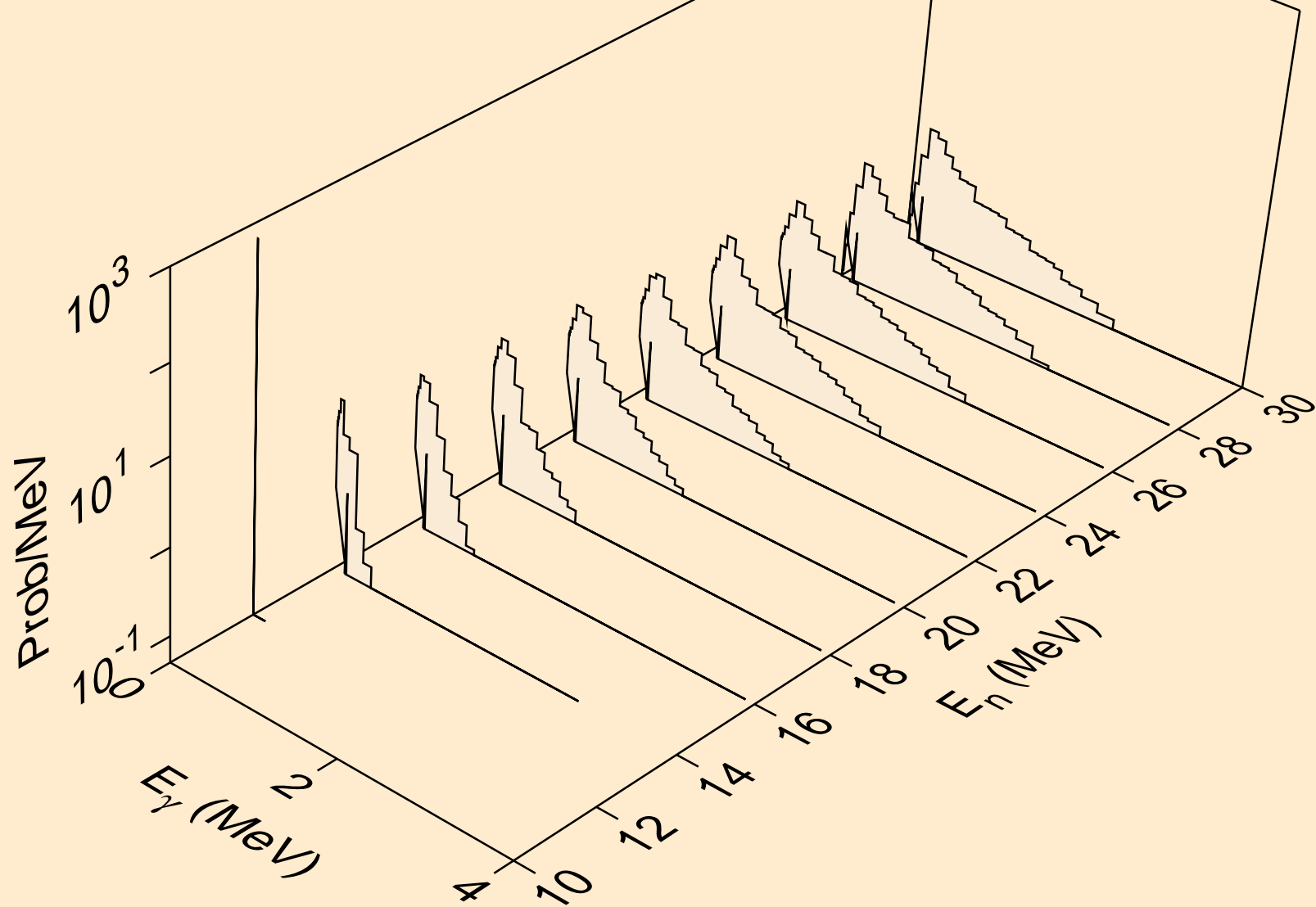

HF188 NEUTRON ACER TENDL-2021 LIBRARY; T=293.6K  
Photon emission for (n,n\*)d

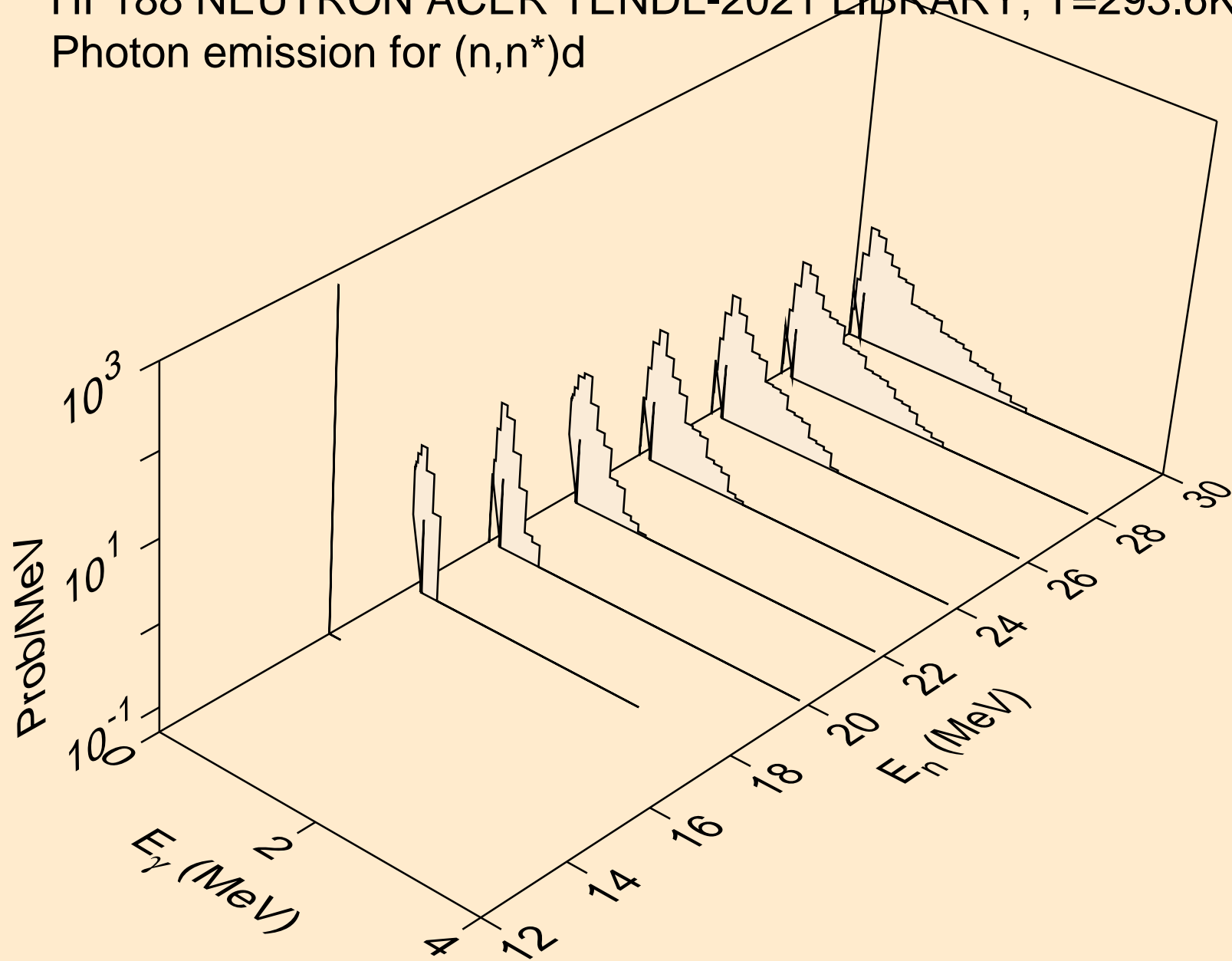

HF188 NEUTRON ACER TENDL-2021 LIBRARY; T=293.6K  
Photon emission for (n,n\*)t

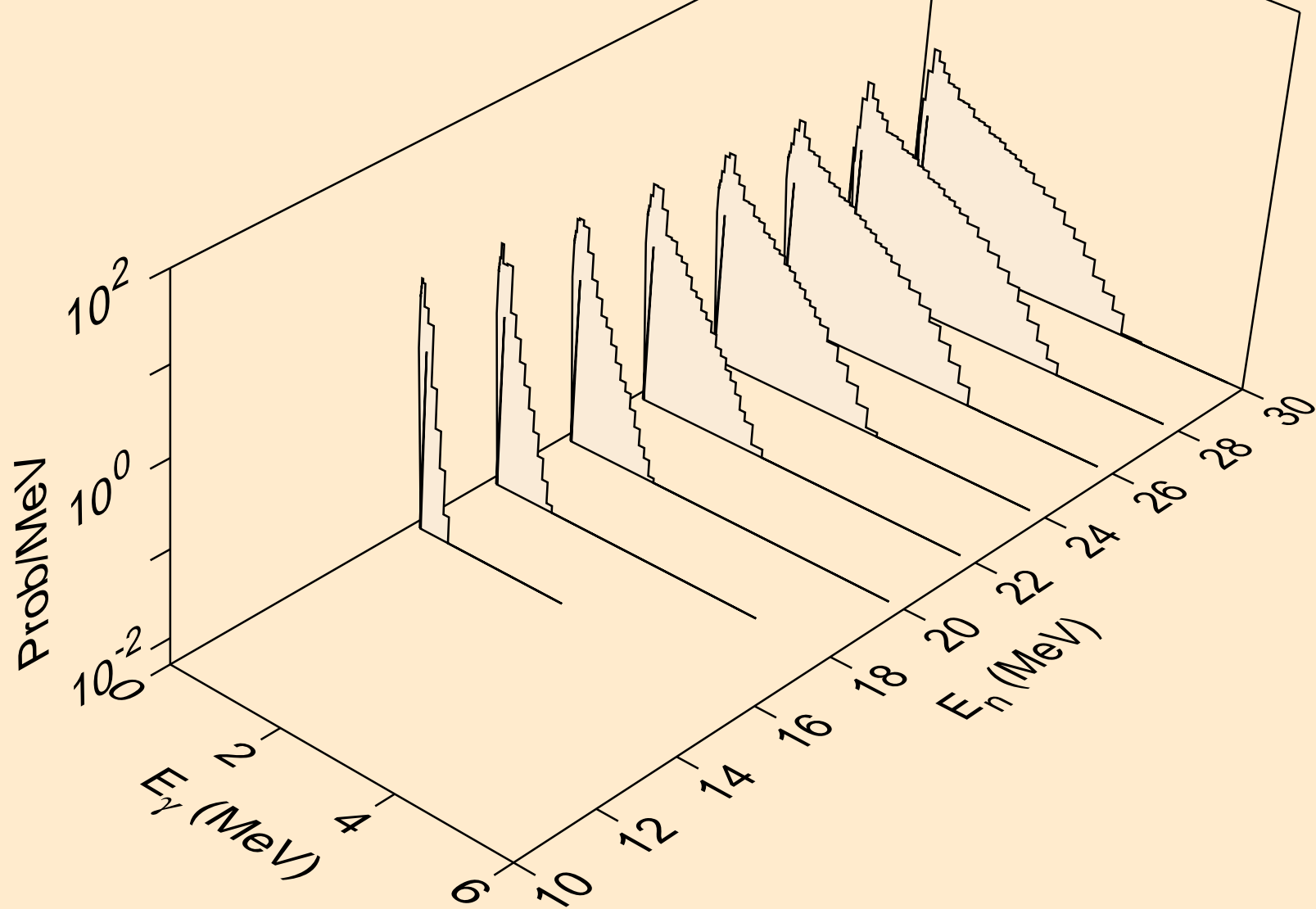



HF188 NEUTRON ACER TENDL-2021 LIBRARY; T=293.6K  
Photon emission for (n,n\*)he3

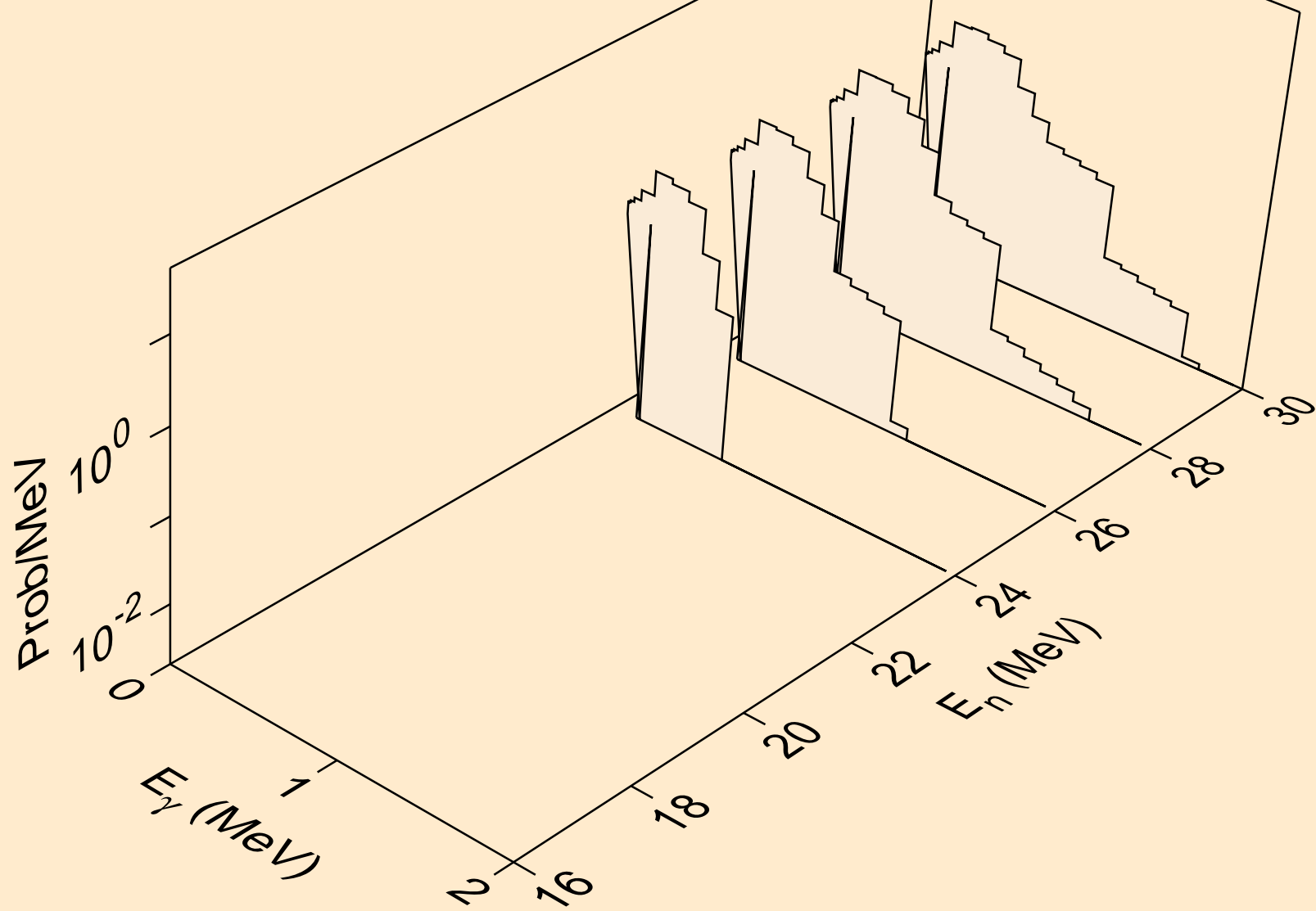

HF188 NEUTRON ACER TENDL-2021 LIBRARY; T=293.6K  
Photon emission for (n,4n)

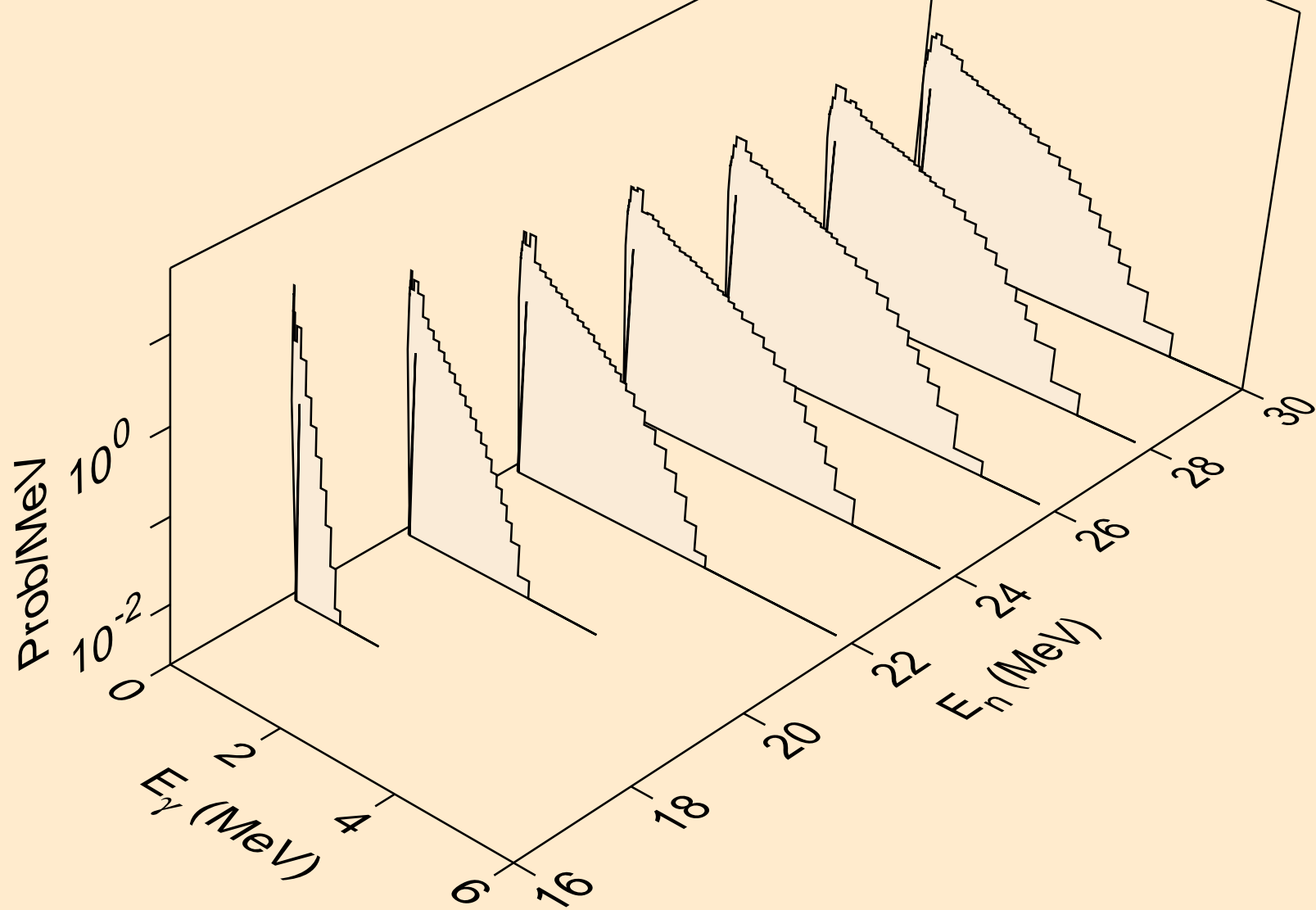

HF188 NEUTRON ACER TENDL-2021 LIBRARY; T=293.6K  
Photon emission for (n,2np)

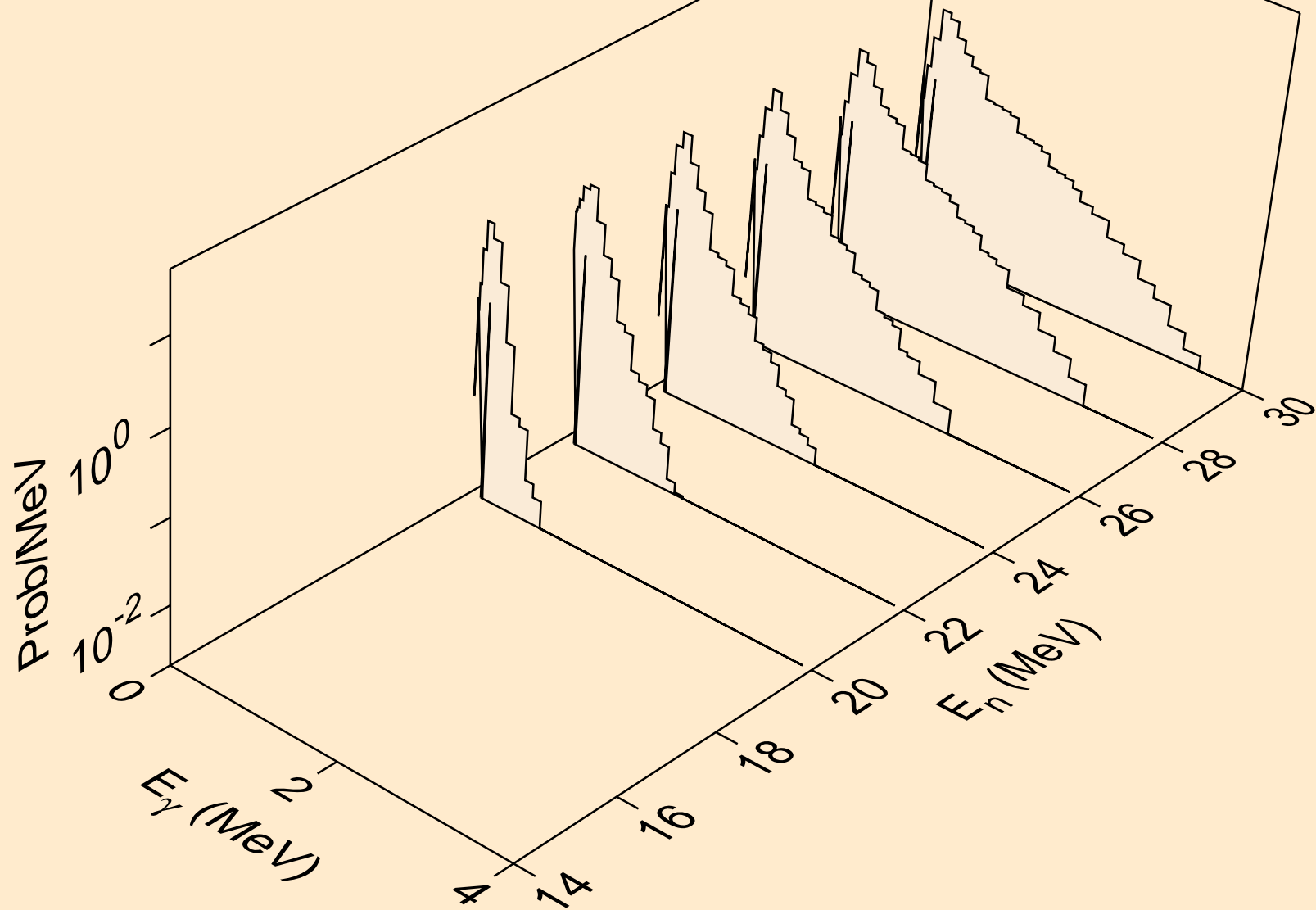

HF188 NEUTRON ACER TENDL-2021 LIBRARY; T=293.6K  
Photon emission for (n,3np)

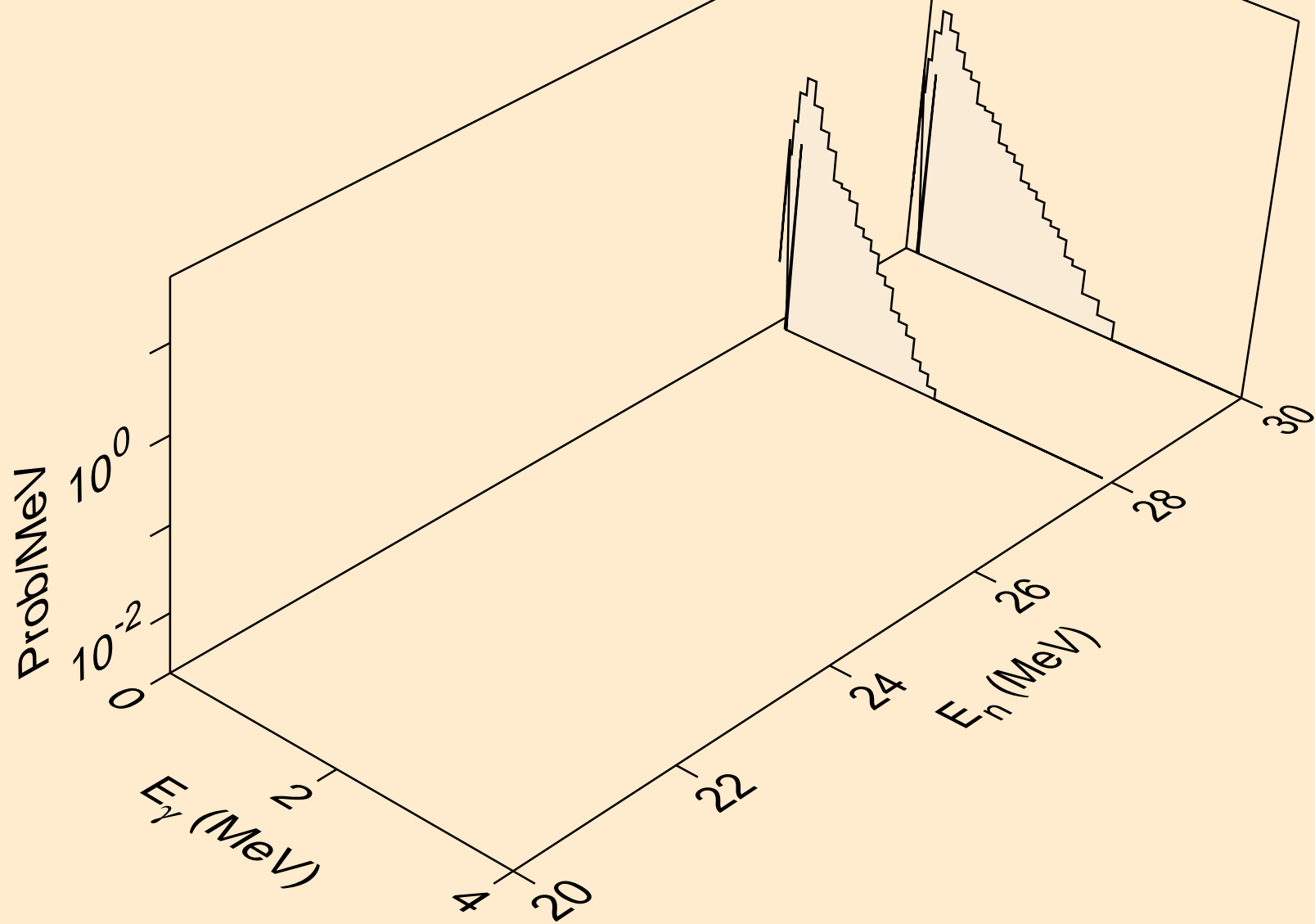

HF188 NEUTRON ACER TENDL-2021 LIBRARY; T=293.6K  
Photon emission for (n,n\*c)

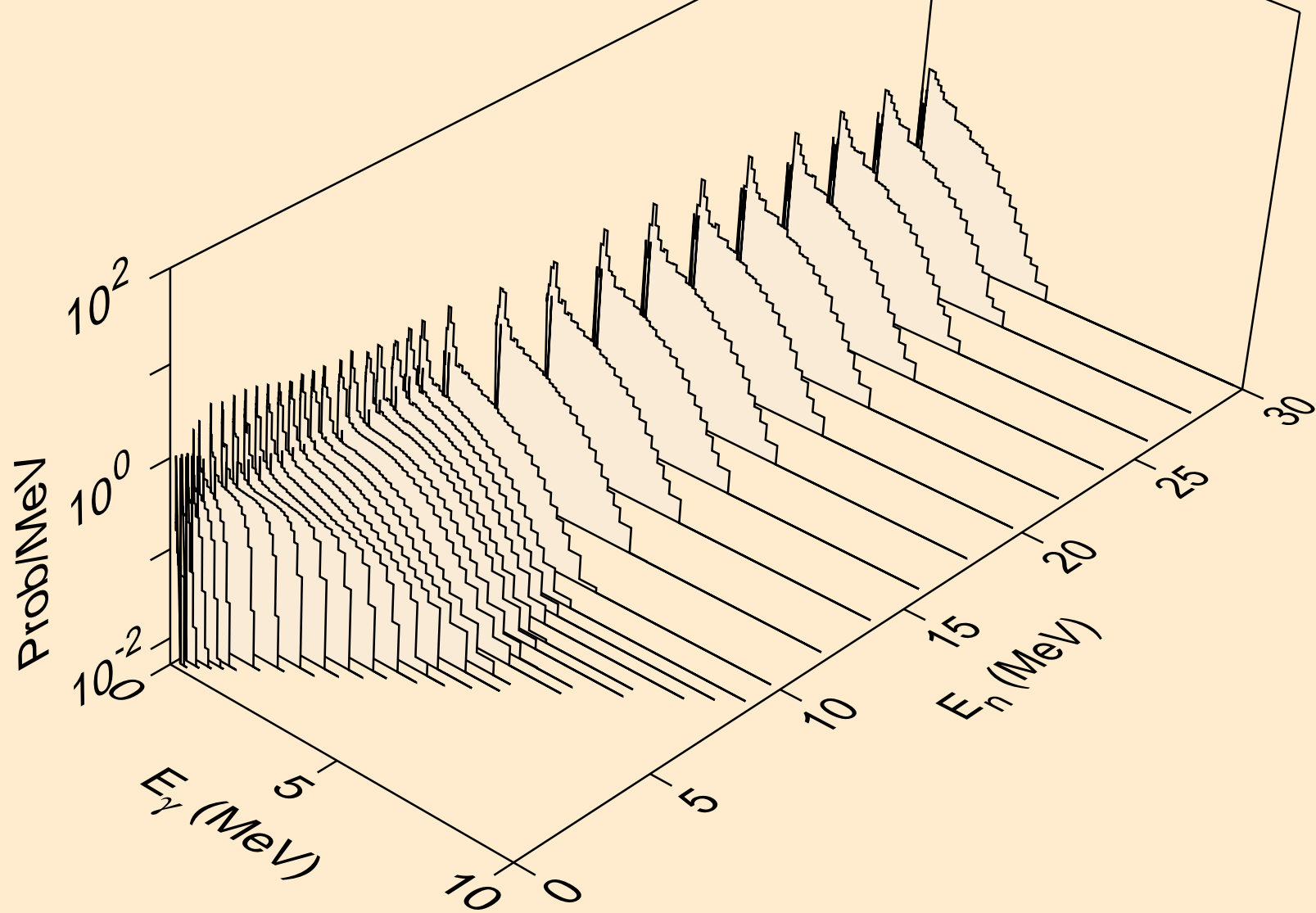

HF188 NEUTRON ACER TENDL-2021 LIBRARY; T=293.6K  
Photon emission for (n,gma)

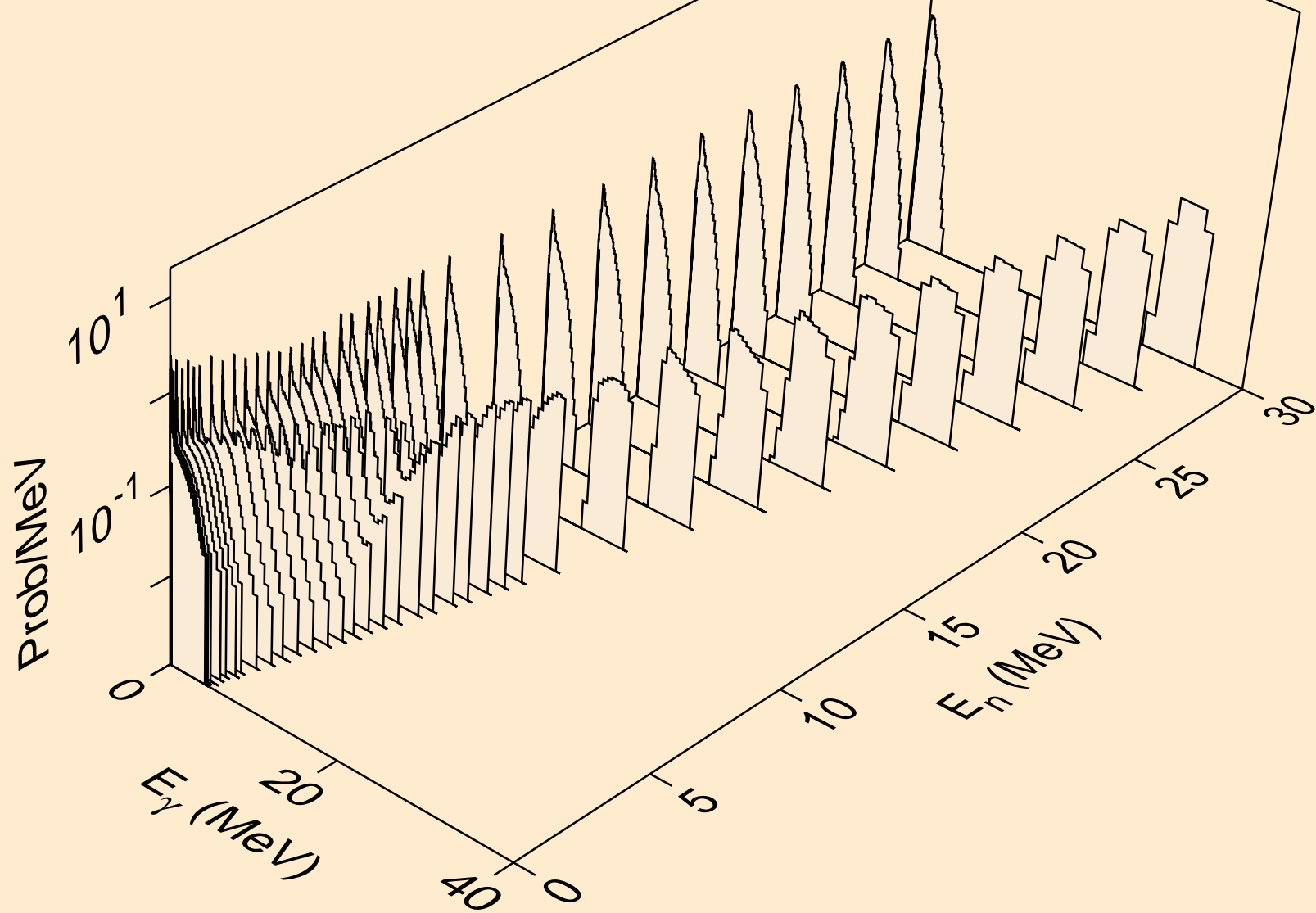

HF188 NEUTRON ACER TENDL-2021 LIBRARY; T=293.6K  
Photon emission for (n,p)

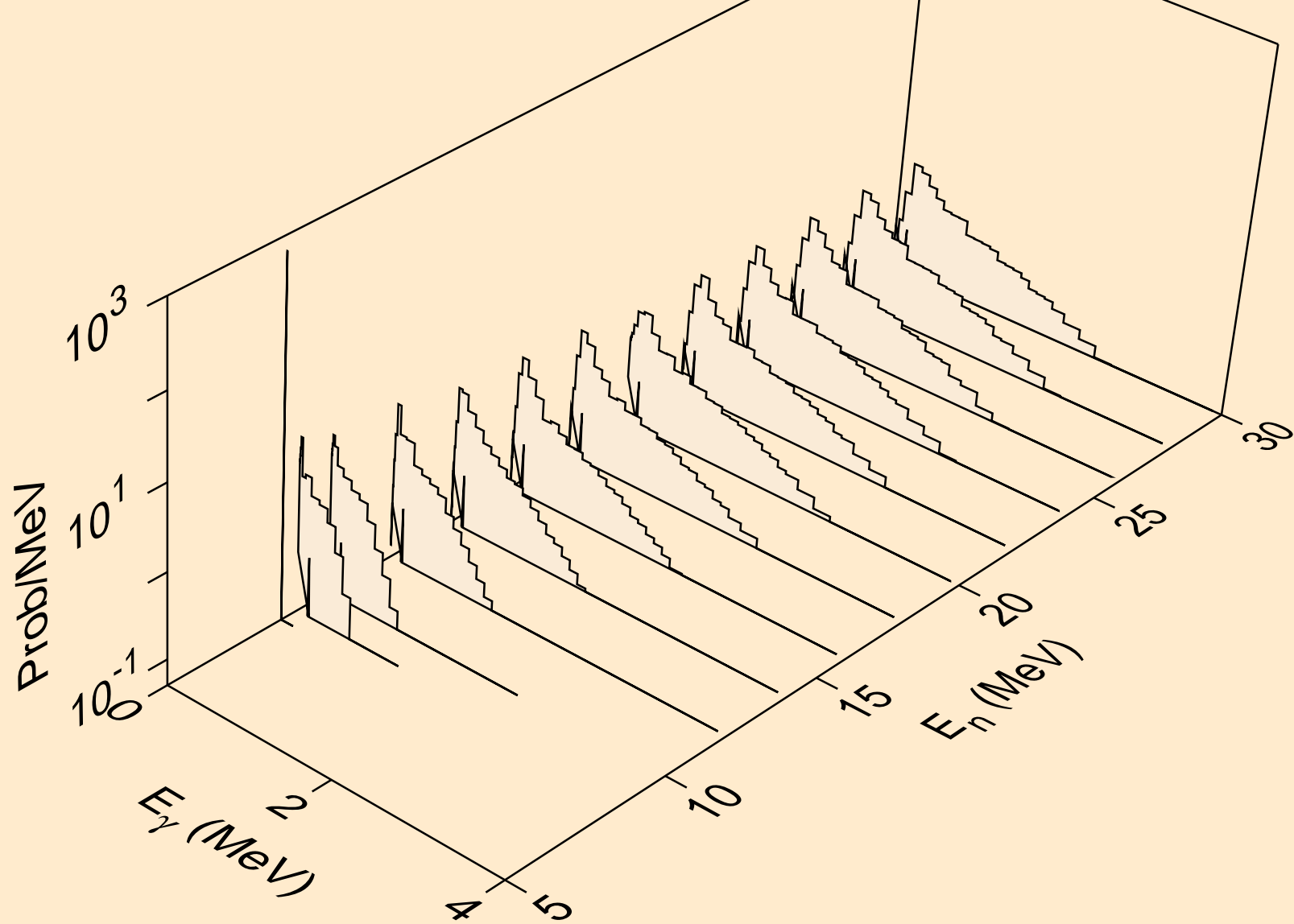

HF188 NEUTRON ACER TENDL-2021 LIBRARY; T=293.6K  
Photon emission for (n,d)

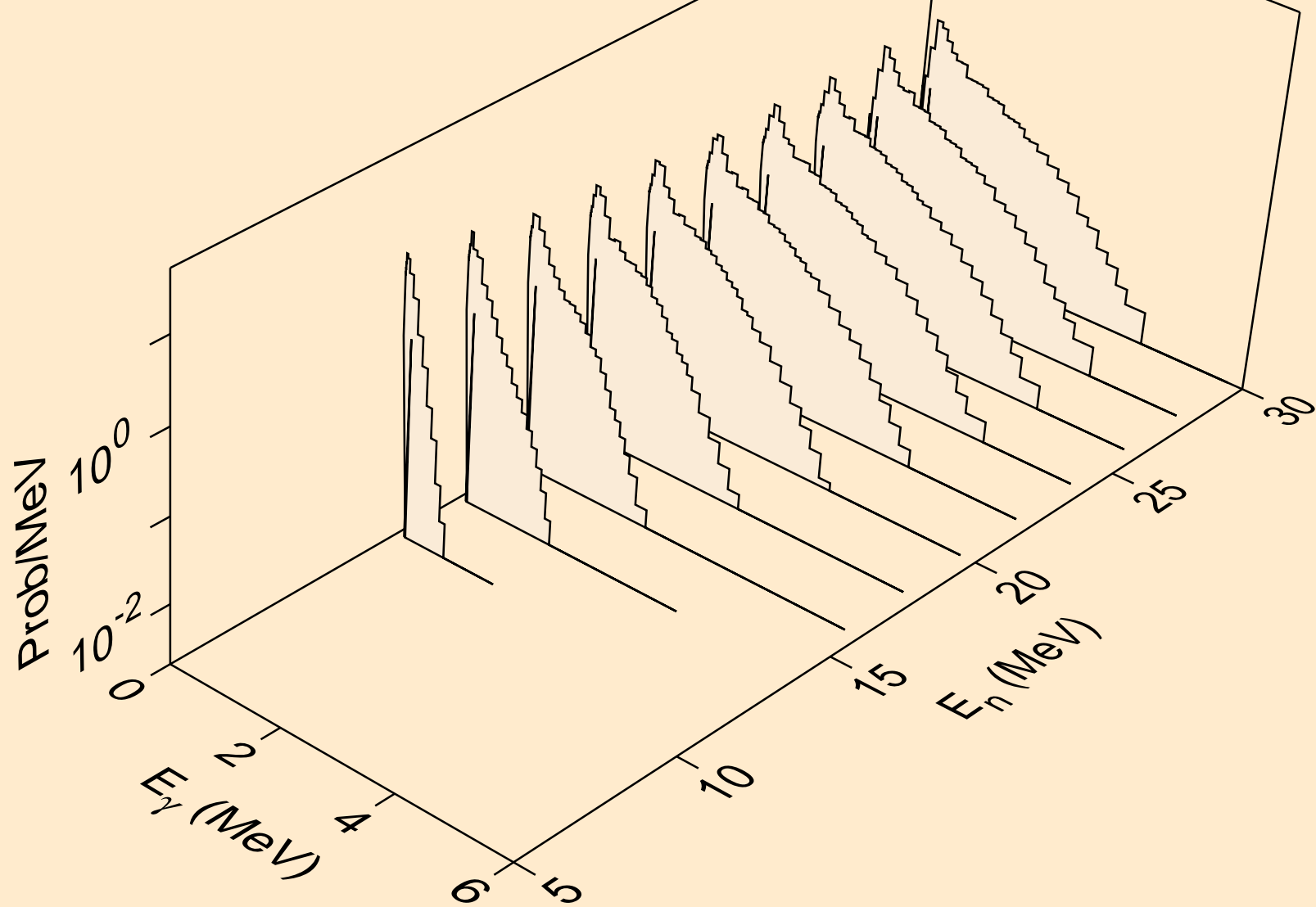



HF188 NEUTRON ACER TENDL-2021 LIBRARY; T=293.6K  
Photon emission for (n,t)

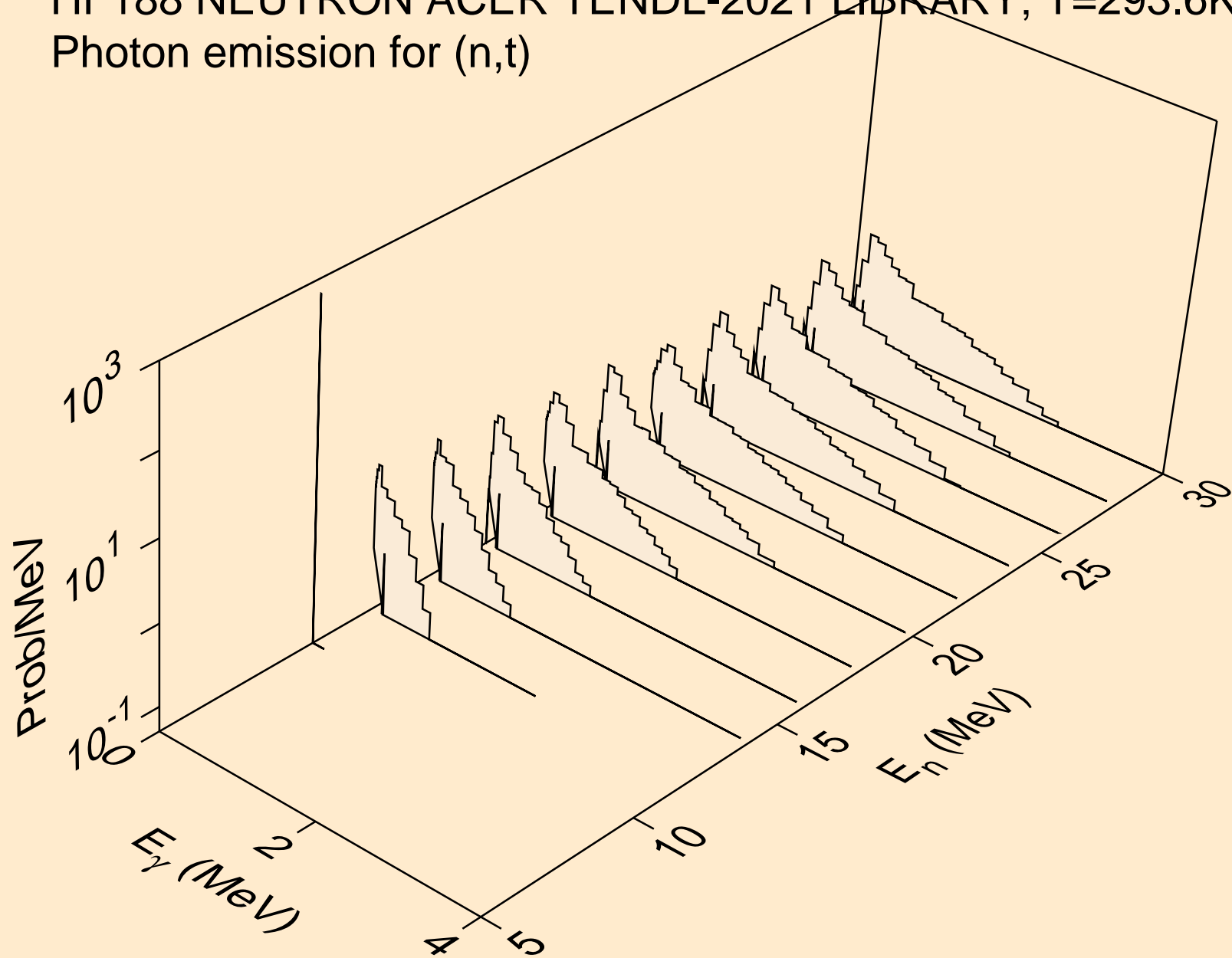

HF188 NEUTRON ACER TENDL-2021 LIBRARY; T=293.6K  
Photon emission for (n,he3)

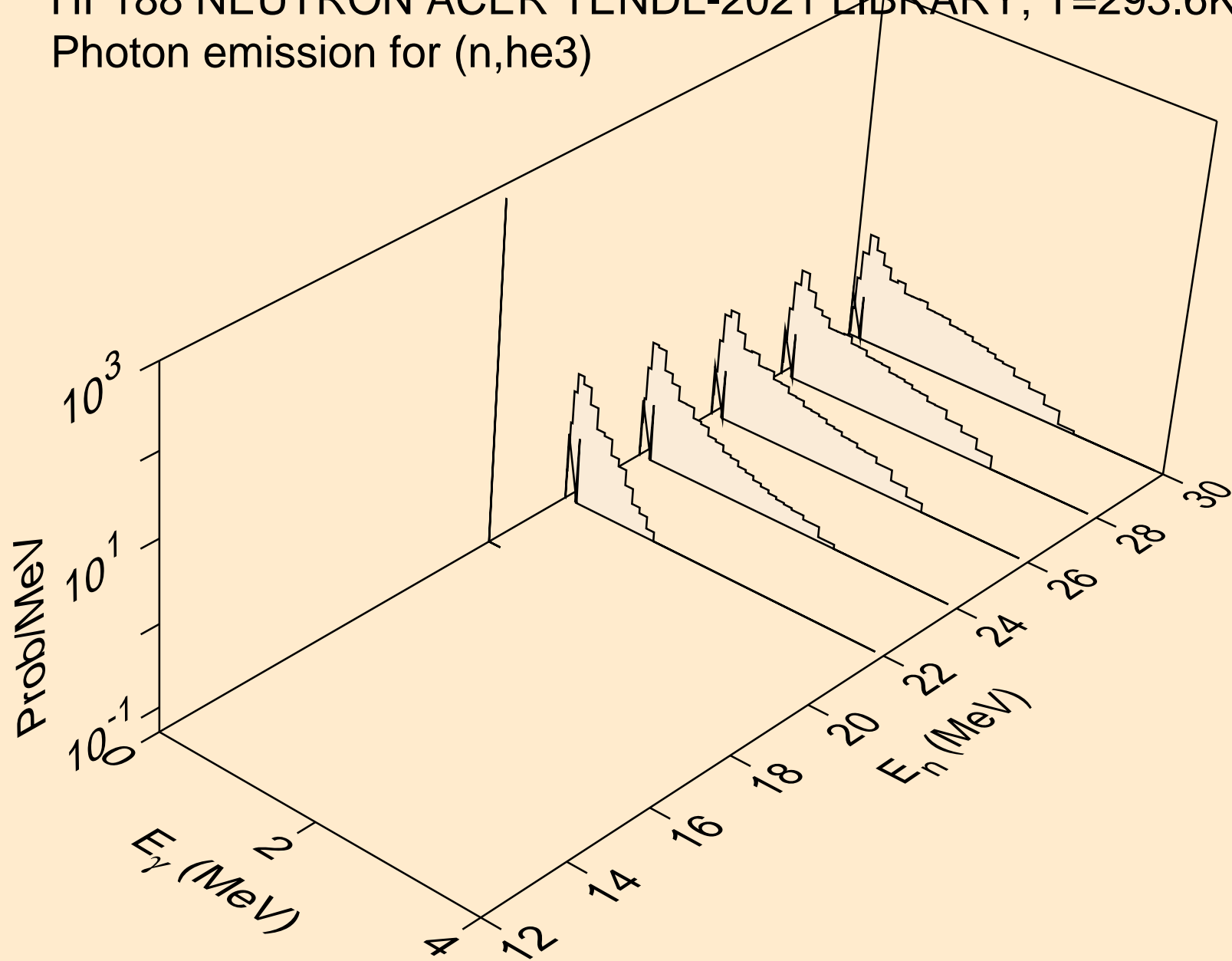

HF188 NEUTRON ACER TENDL-2021 LIBRARY; T=293.6K  
Photon emission for (n,a)

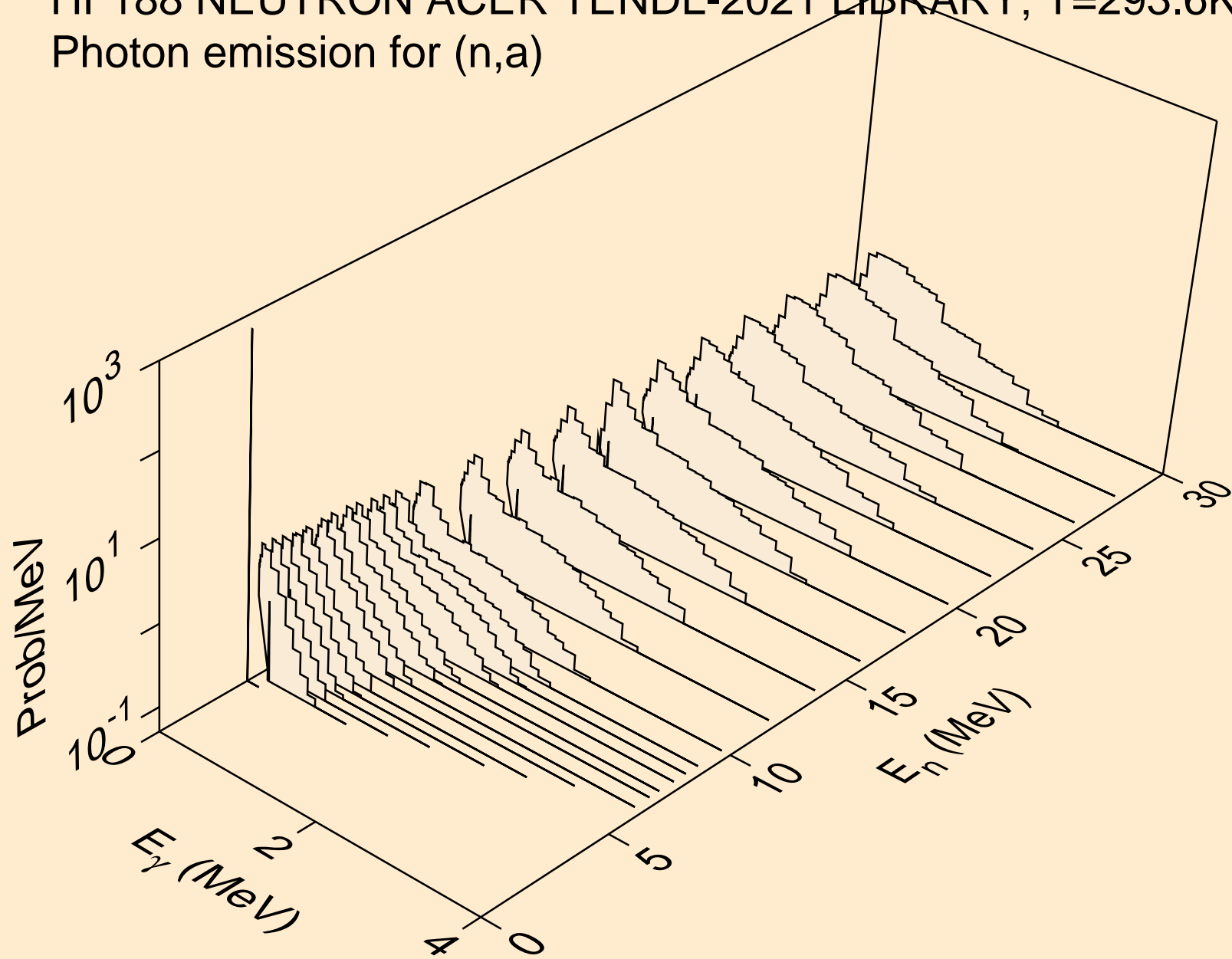

HF188 NEUTRON ACER TENDL-2021 LIBRARY; T=293.6K  
thermal capture photon spectrum

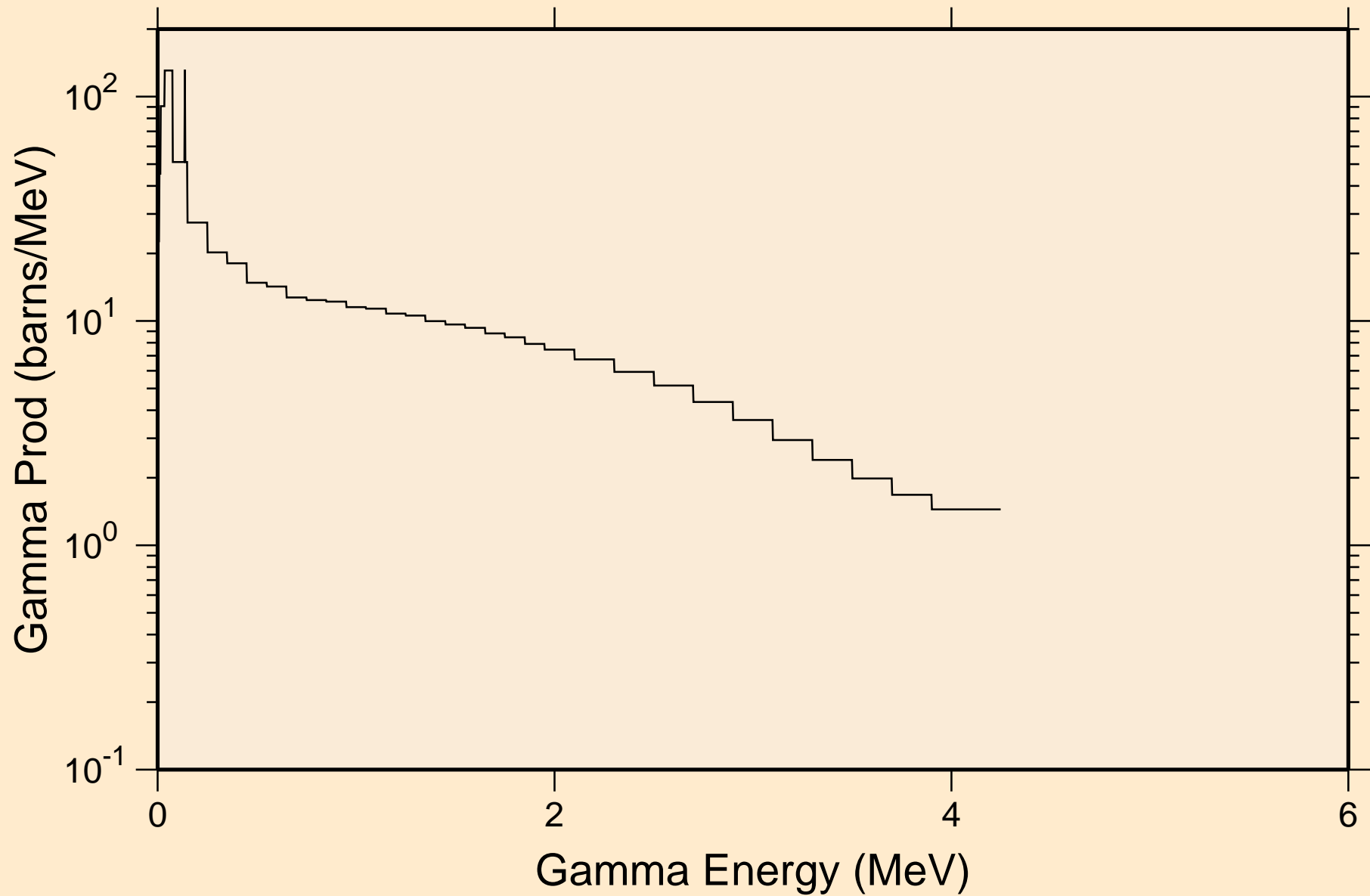

HF188 NEUTRON ACER TENDL-2021 LIBRARY; T=293.6K  
14 MeV photon spectrum

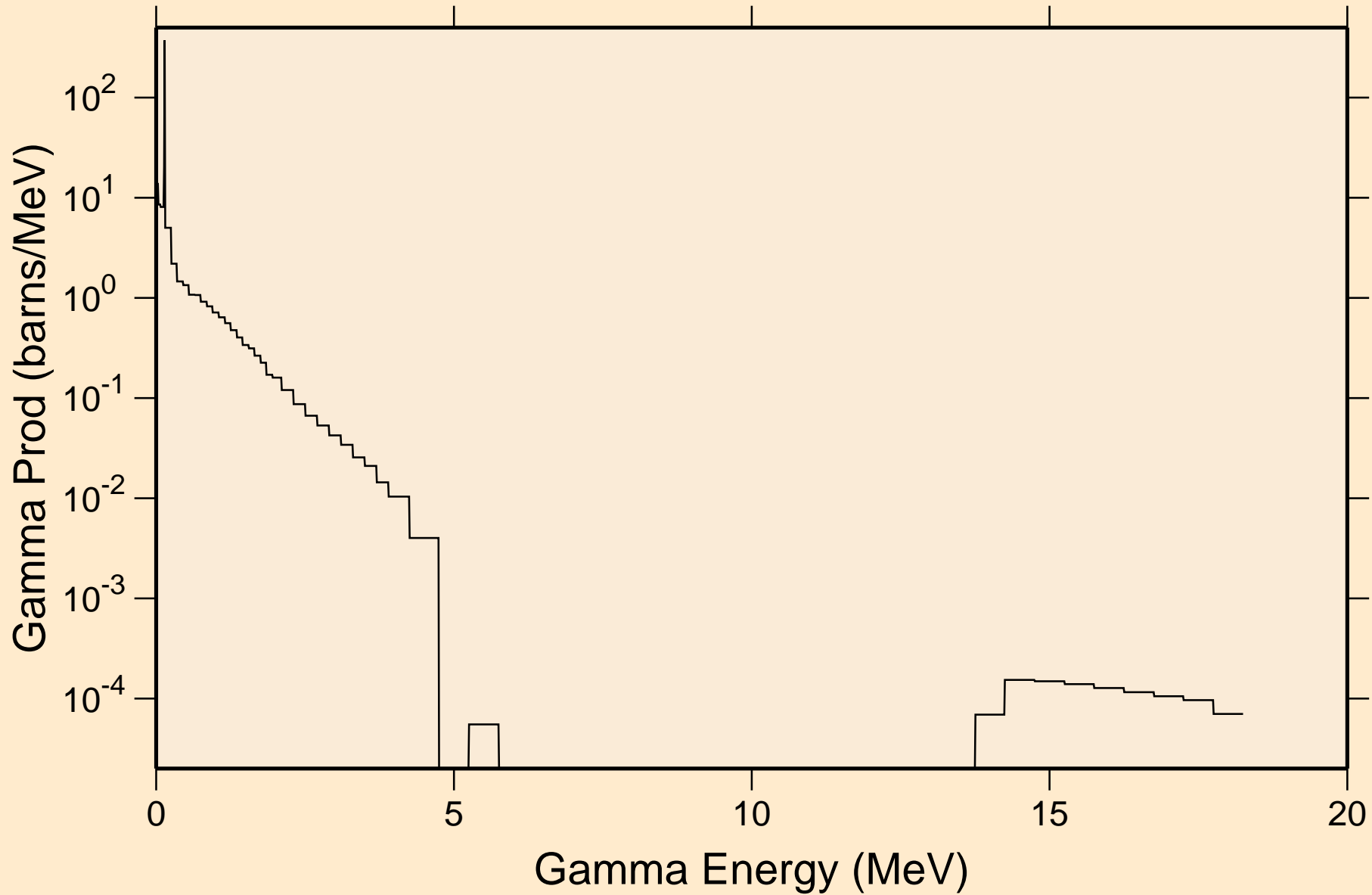

# HF188 NEUTRON ACER TENDL-2021 LIBRARY; T=293.6K

## Particle heating contributions

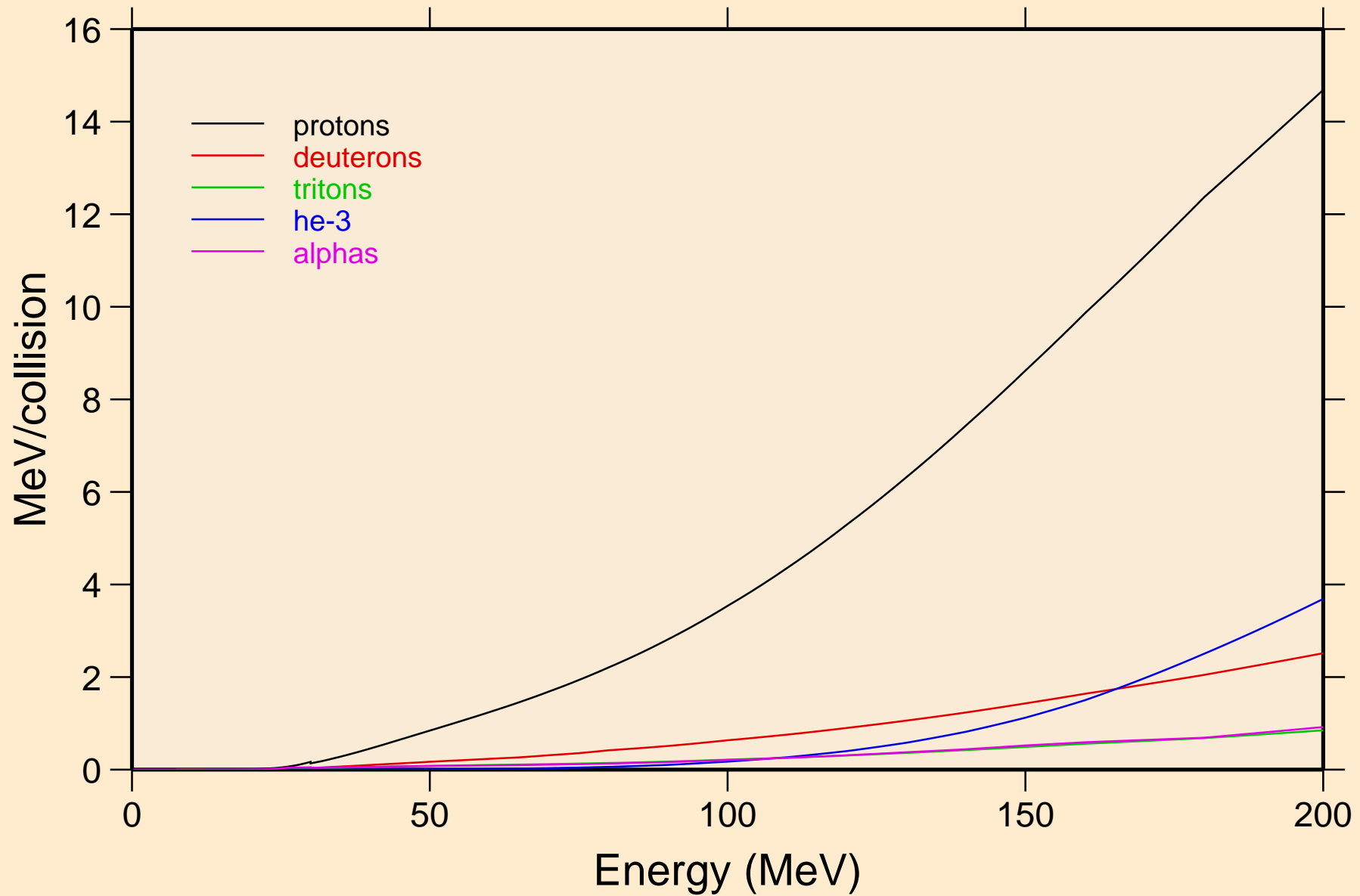

HF188 NEUTRON ACER TENDL-2021 LIBRARY; T=293.6K  
Recoil Heating

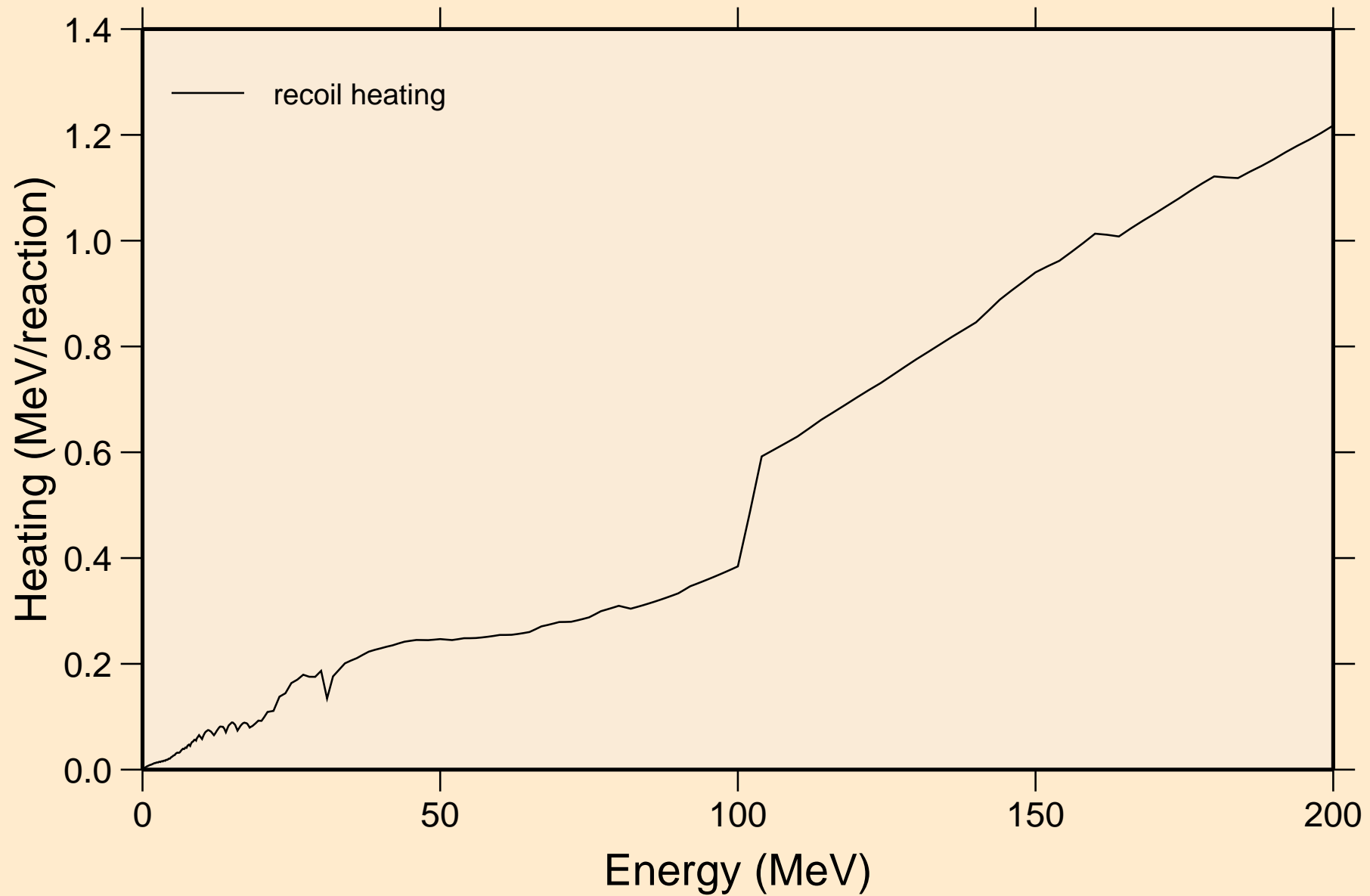

# HF188 NEUTRON ACER TENDL-2021 LIBRARY; T=293.6K

## Particle production cross sections

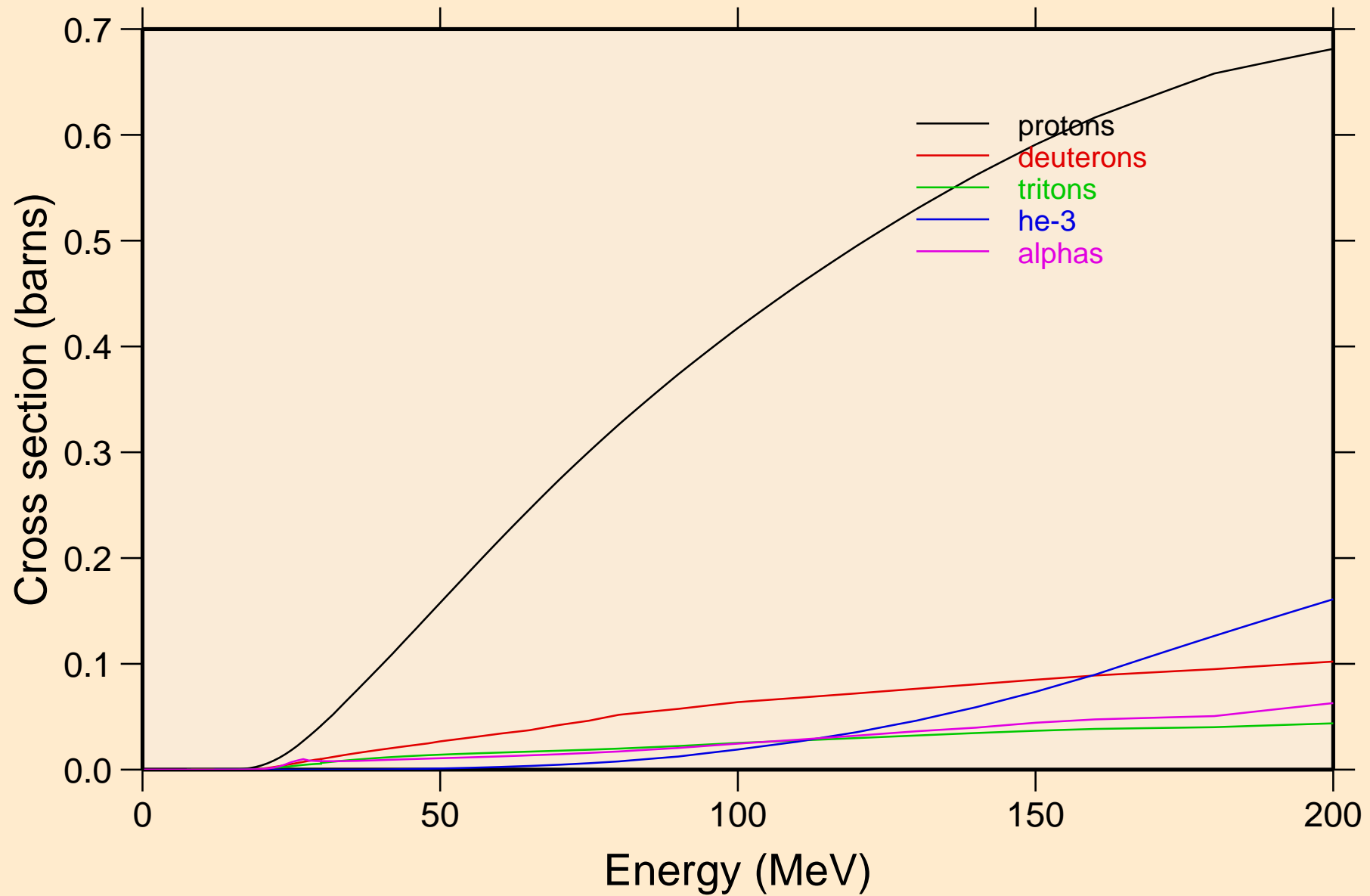



HF188 NEUTRON ACER TENDL-2021 LIBRARY; T=293.6K  
protons from (n,x)

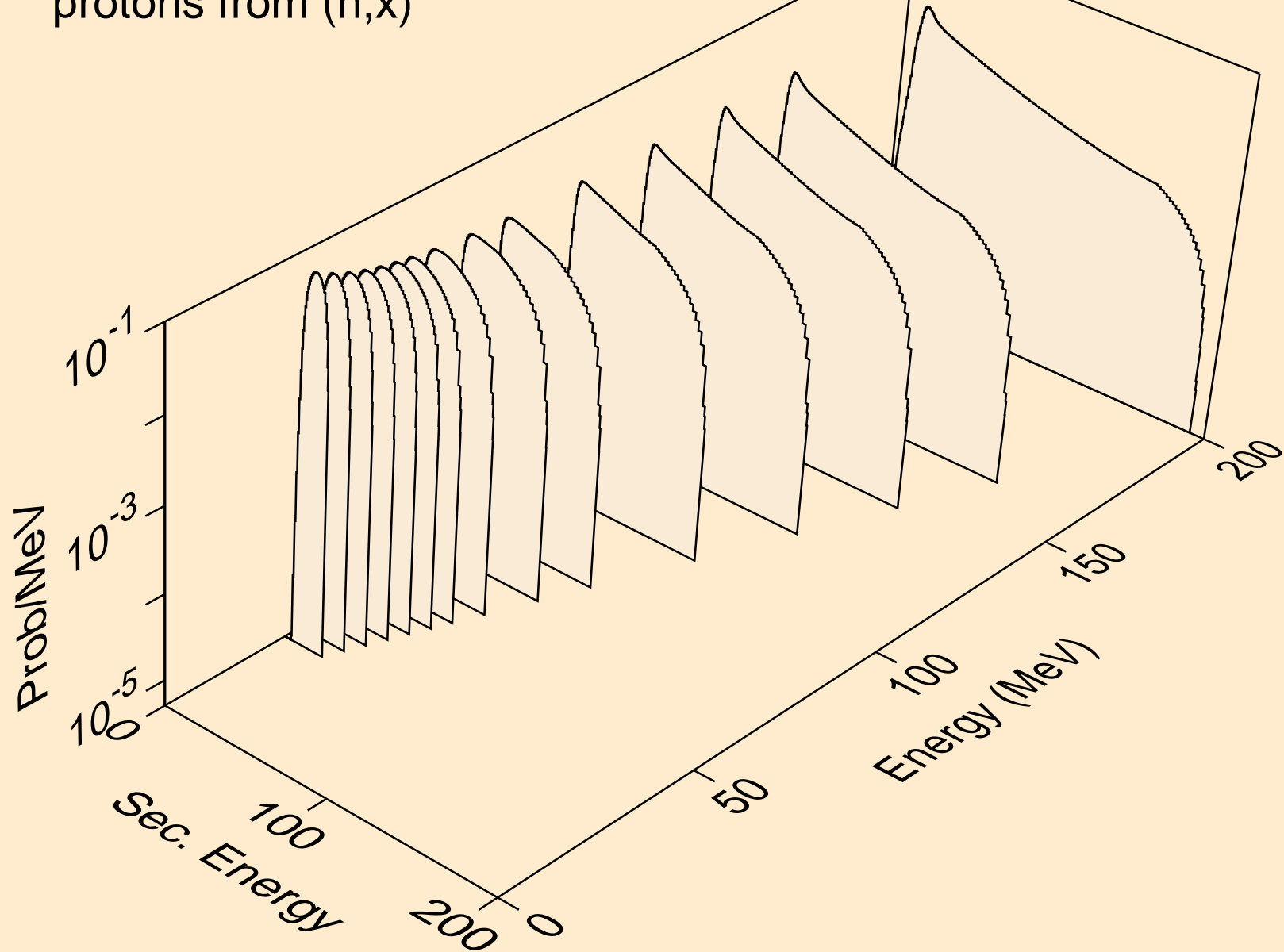

HF188 NEUTRON ACER TENDL-2021 LIBRARY; T=293.6K  
protons from (n,n\*)p

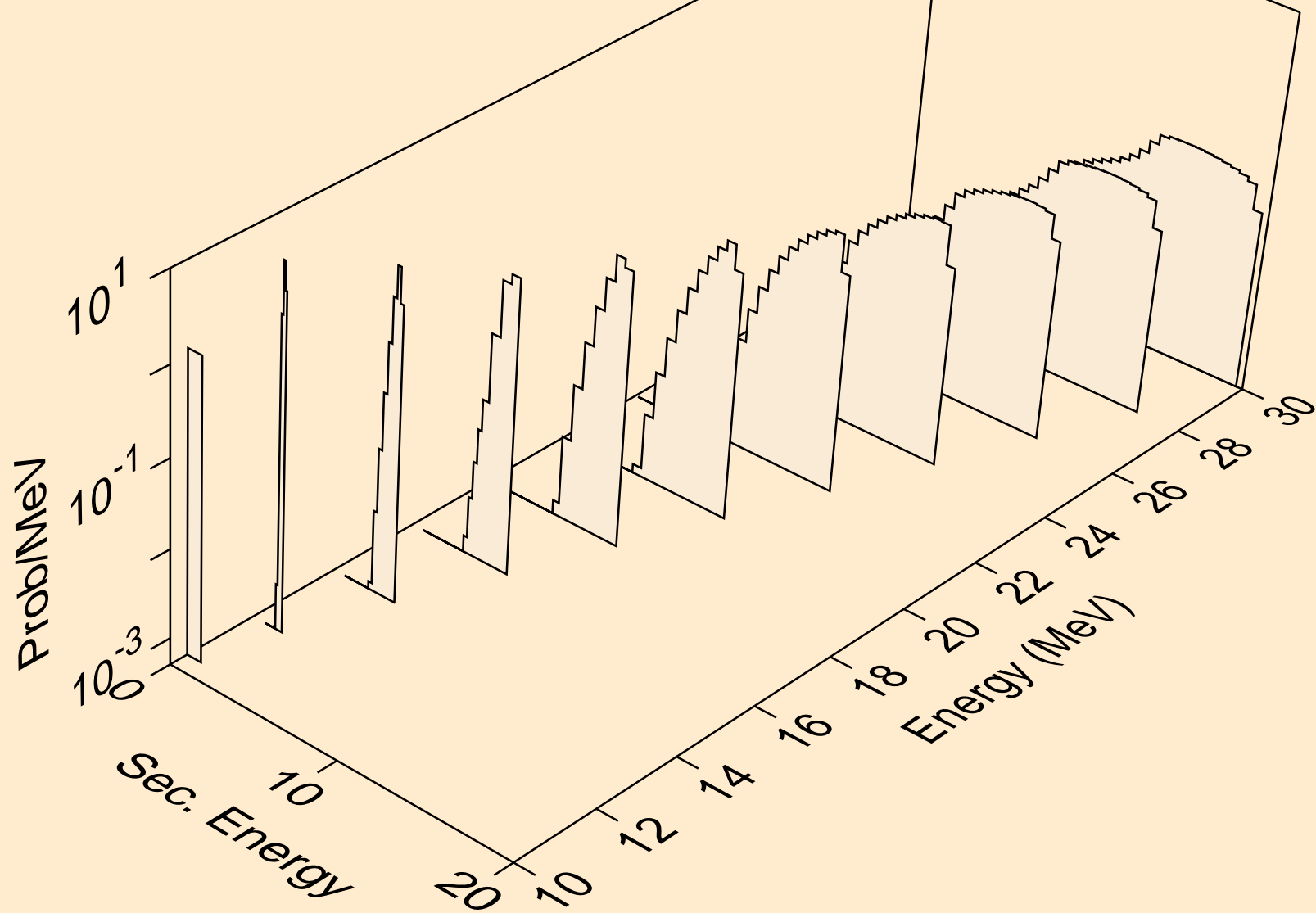

HF188 NEUTRON ACER TENDL-2021 LIBRARY; T=293.6K  
protons from (n,2np)

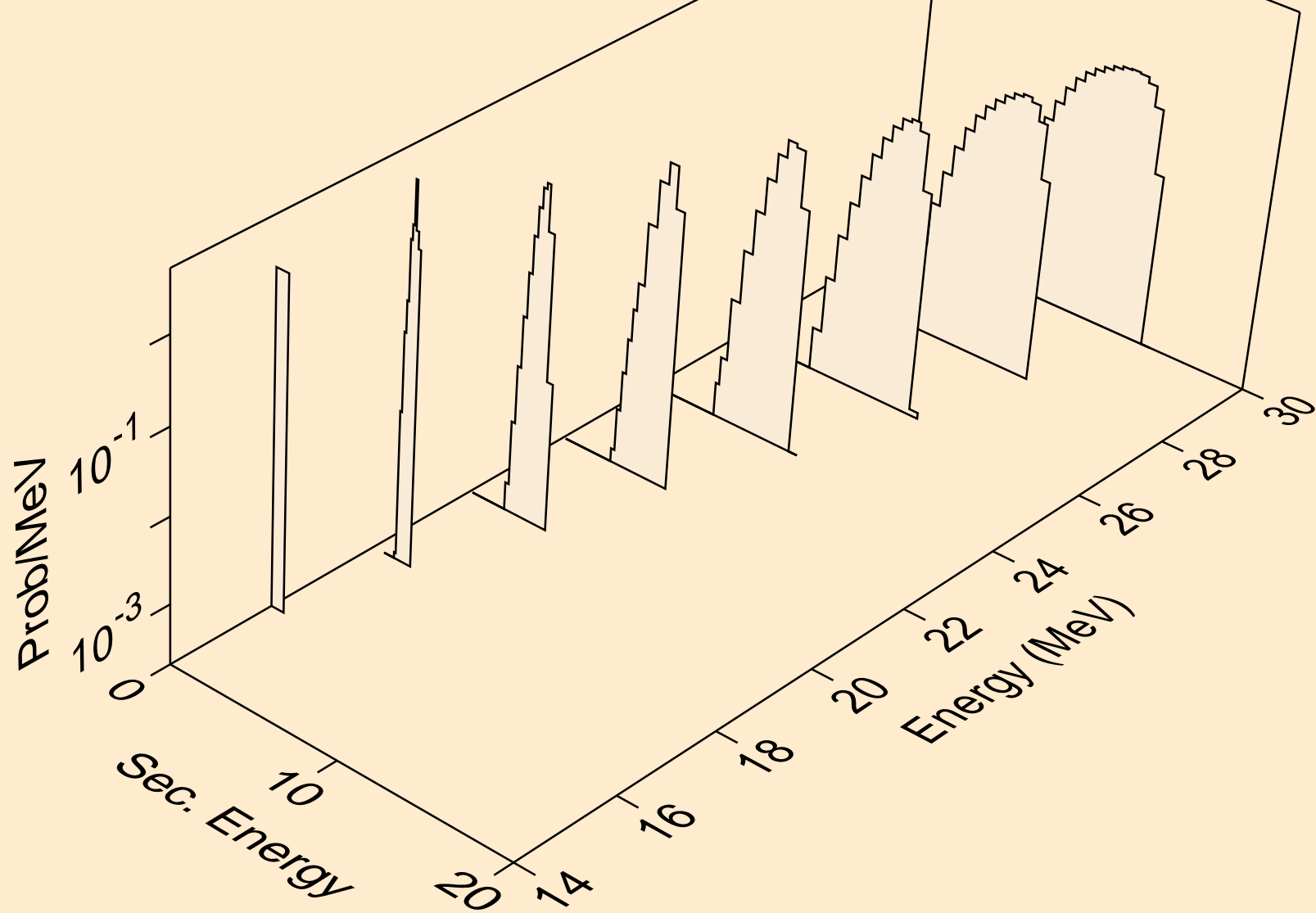

HF188 NEUTRON ACER TENDL-2021 LIBRARY; T=293.6K  
protons from (n,3np)

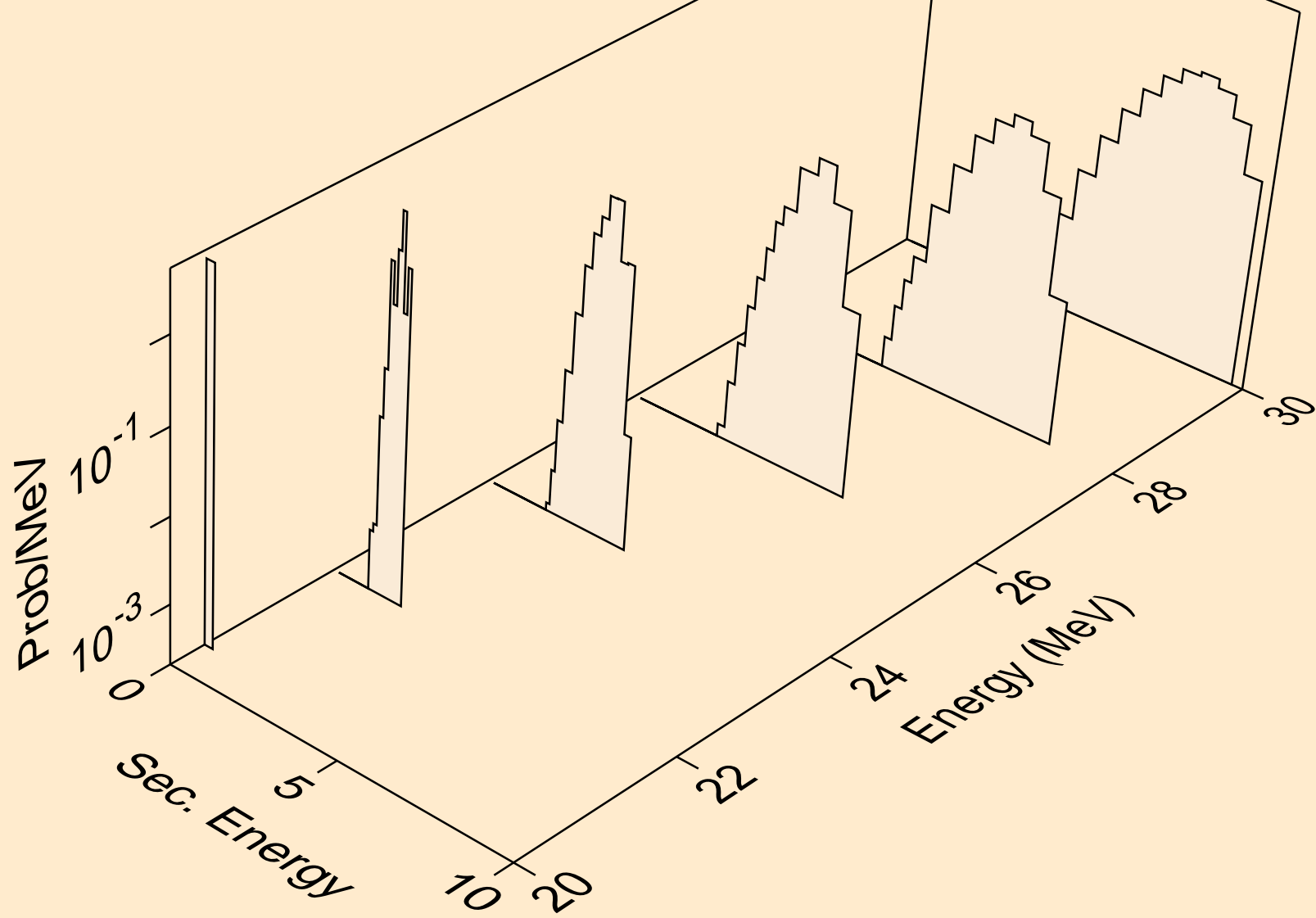

HF188 NEUTRON ACER TENDL-2021 LIBRARY; T=293.6K  
protons from (n,p)

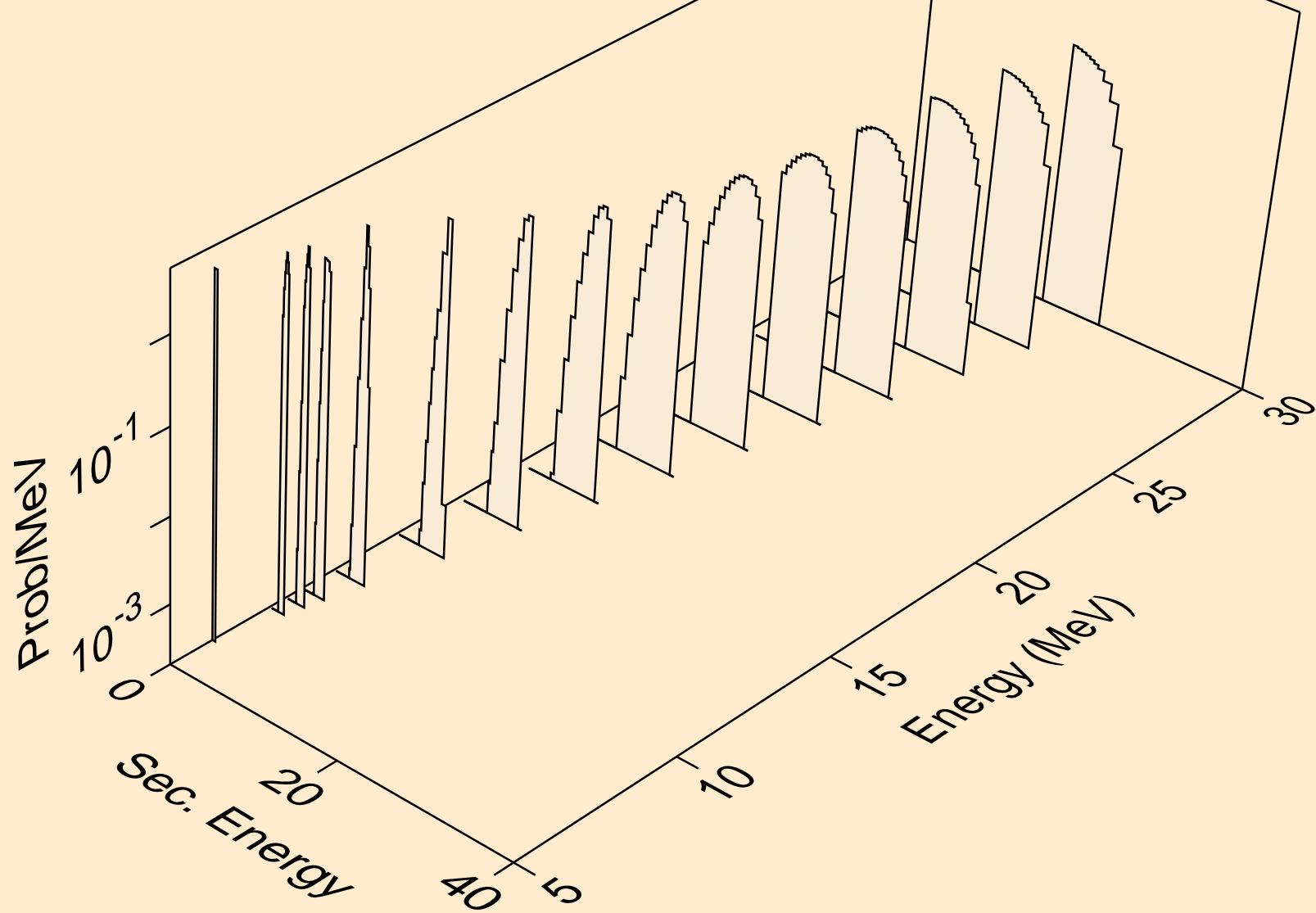

HF188 NEUTRON ACER TENDL-2021 LIBRARY; T=293.6K  
deuterons from (n,x)

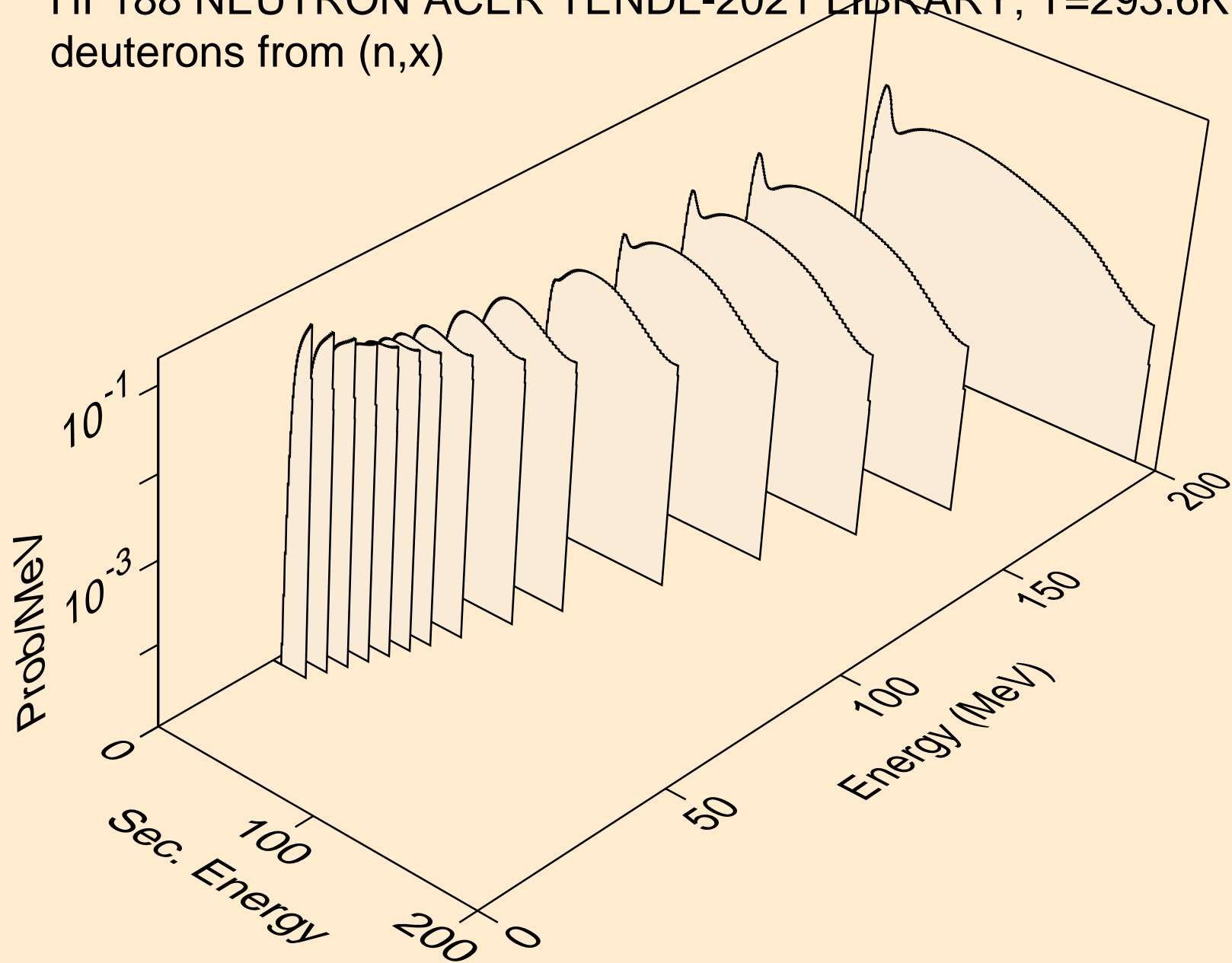

HF188 NEUTRON ACER TENDL-2021 LIBRARY; T=293.6K  
deuterons from (n,2nd)

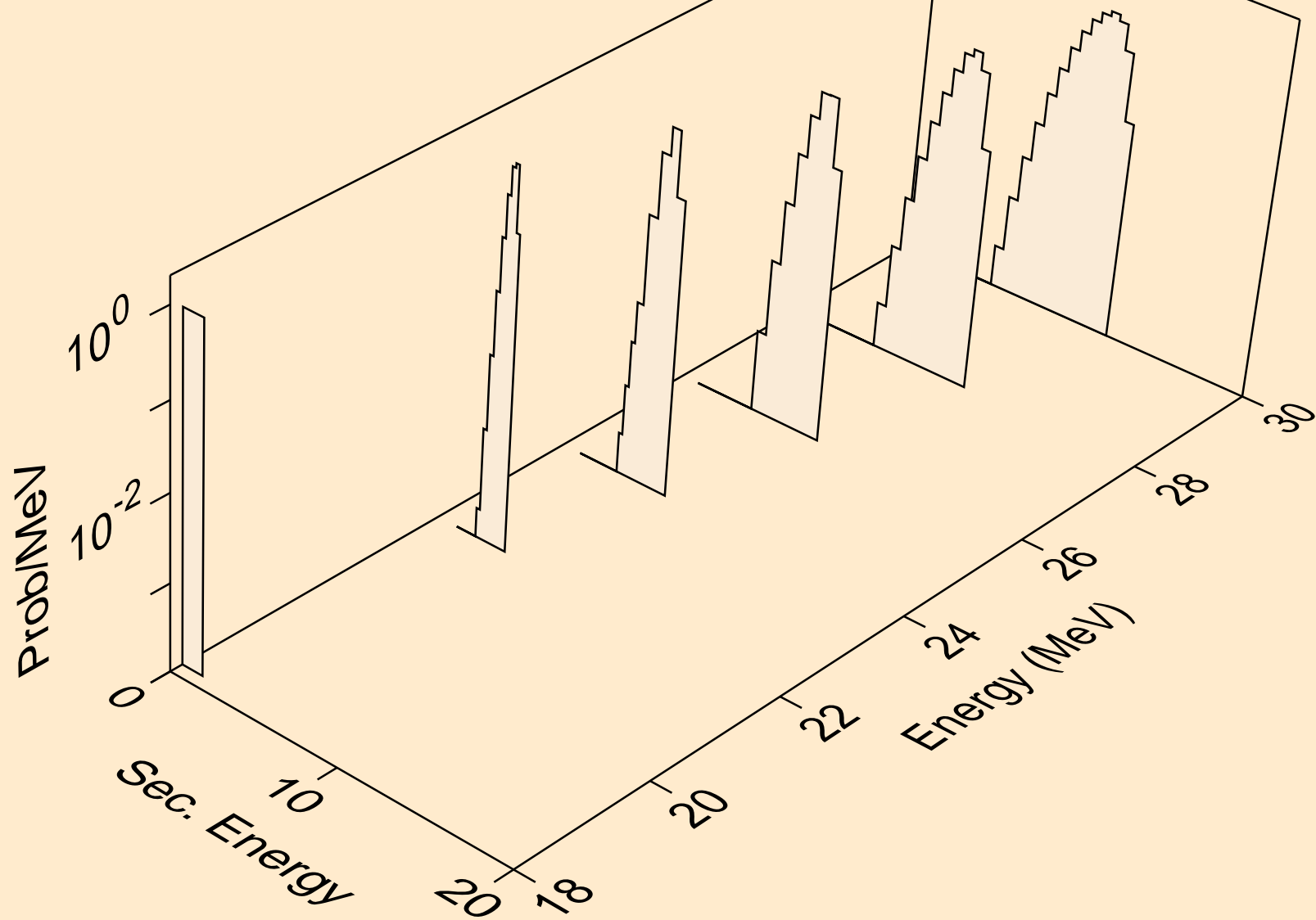

HF188 NEUTRON ACER TENDL-2021 LIBRARY; T=293.6K  
deuterons from (n,n\*)d

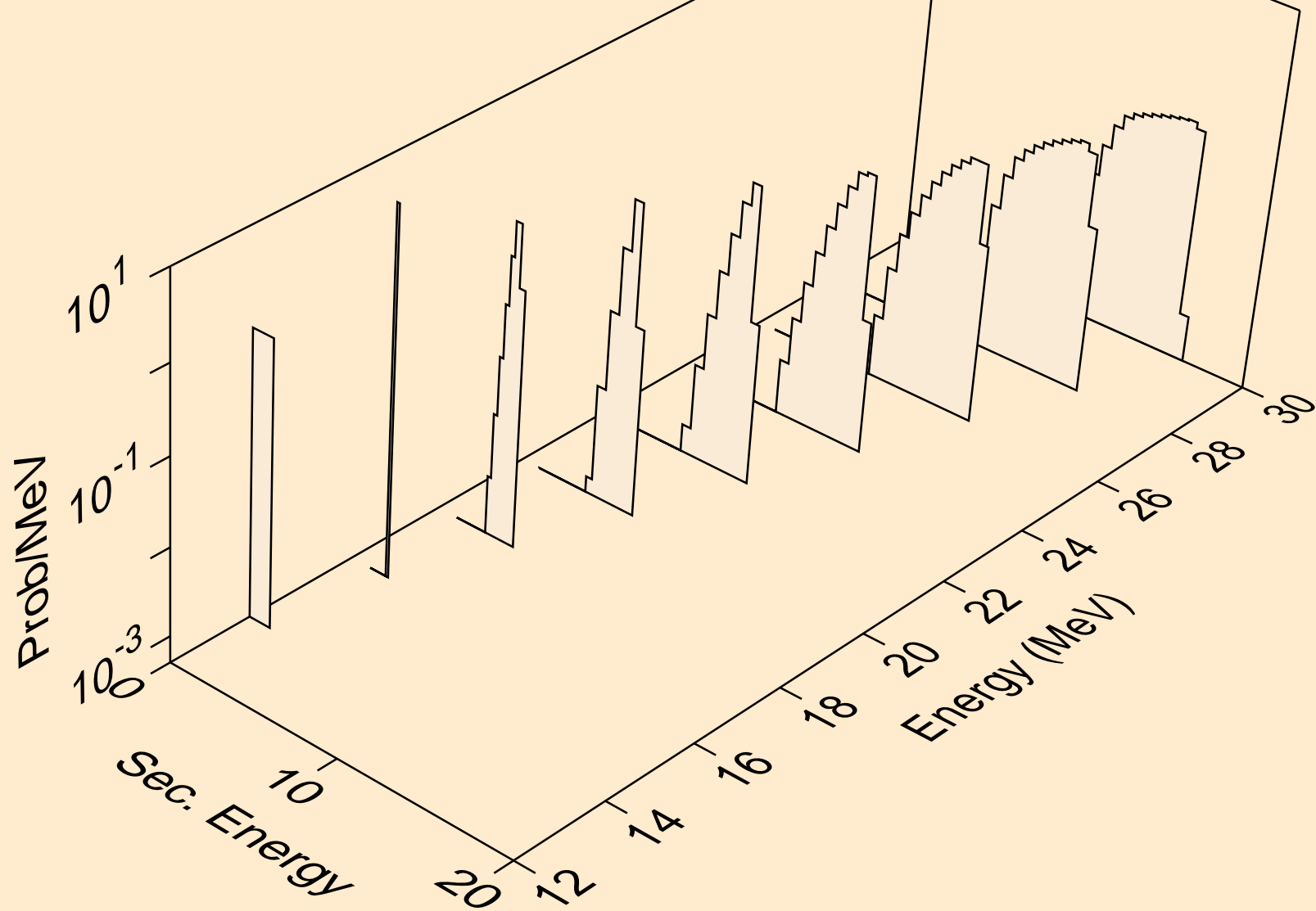



HF188 NEUTRON ACER TENDL-2021 LIBRARY; T=293.6K  
deuterons from (n,d)

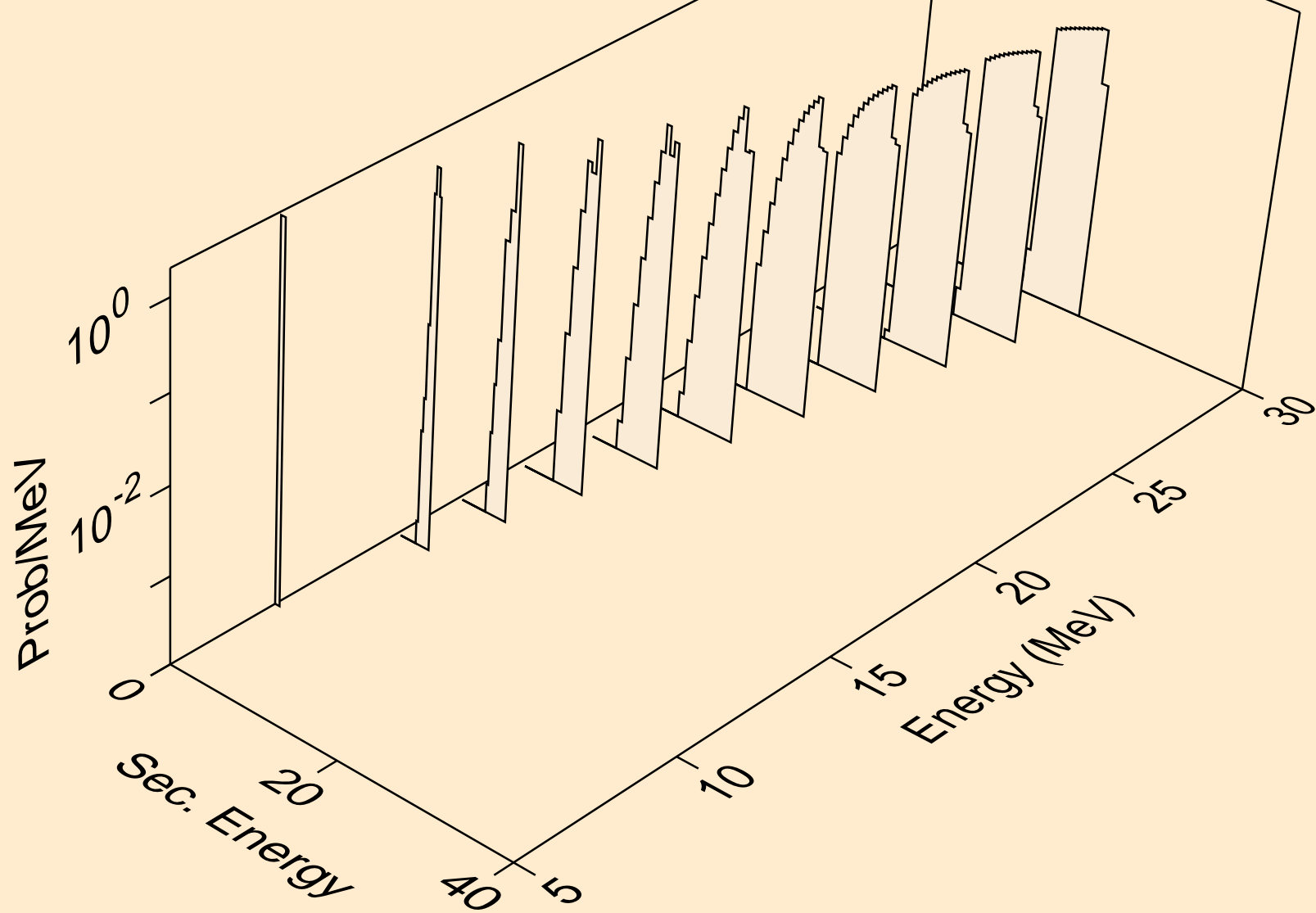

HF188 NEUTRON ACER TENDL-2021 LIBRARY; T=293.6K  
tritons from (n,x)

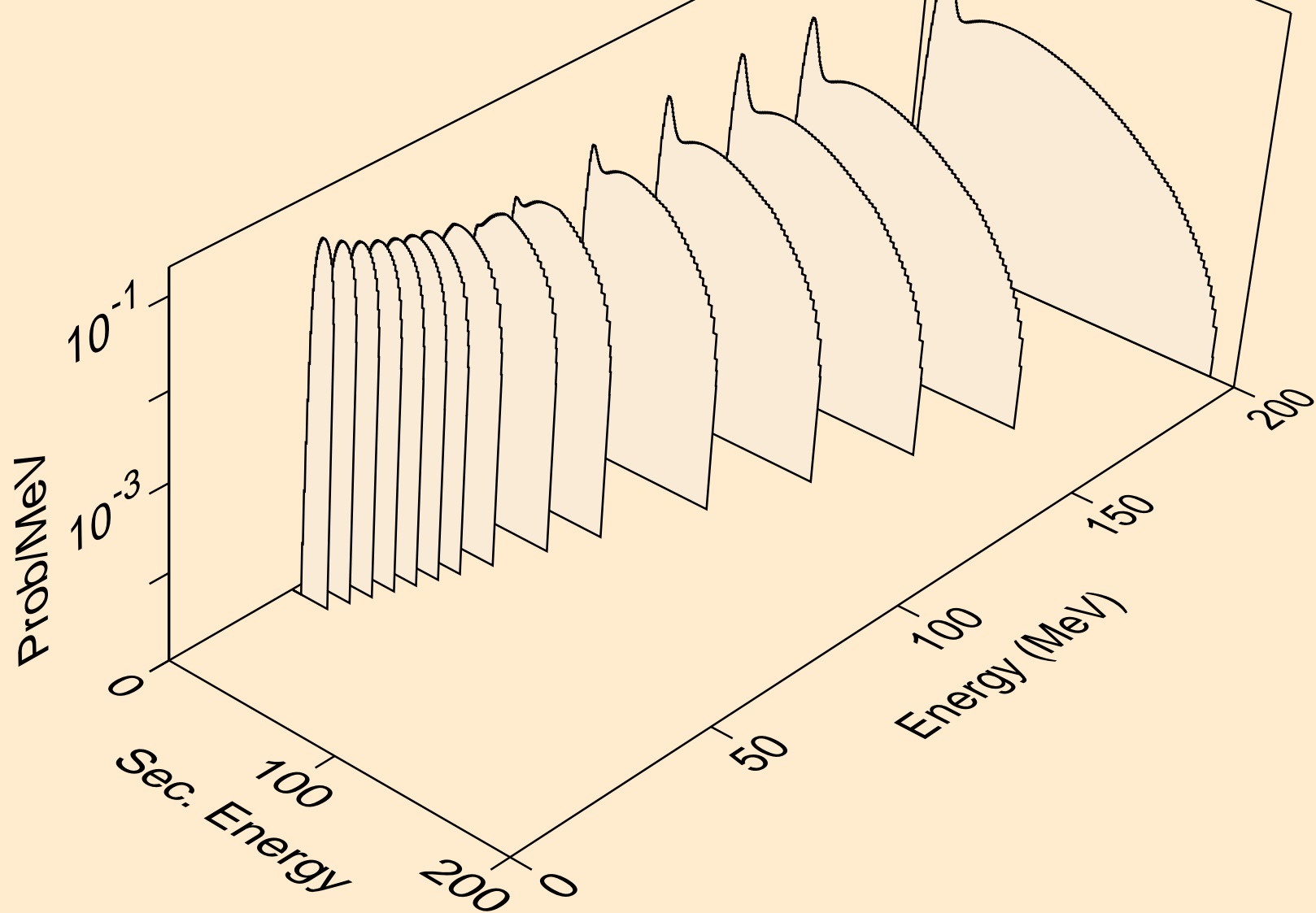

HF188 NEUTRON ACER TENDL-2021 LIBRARY; T=293.6K  
tritons from (n,n\*)t

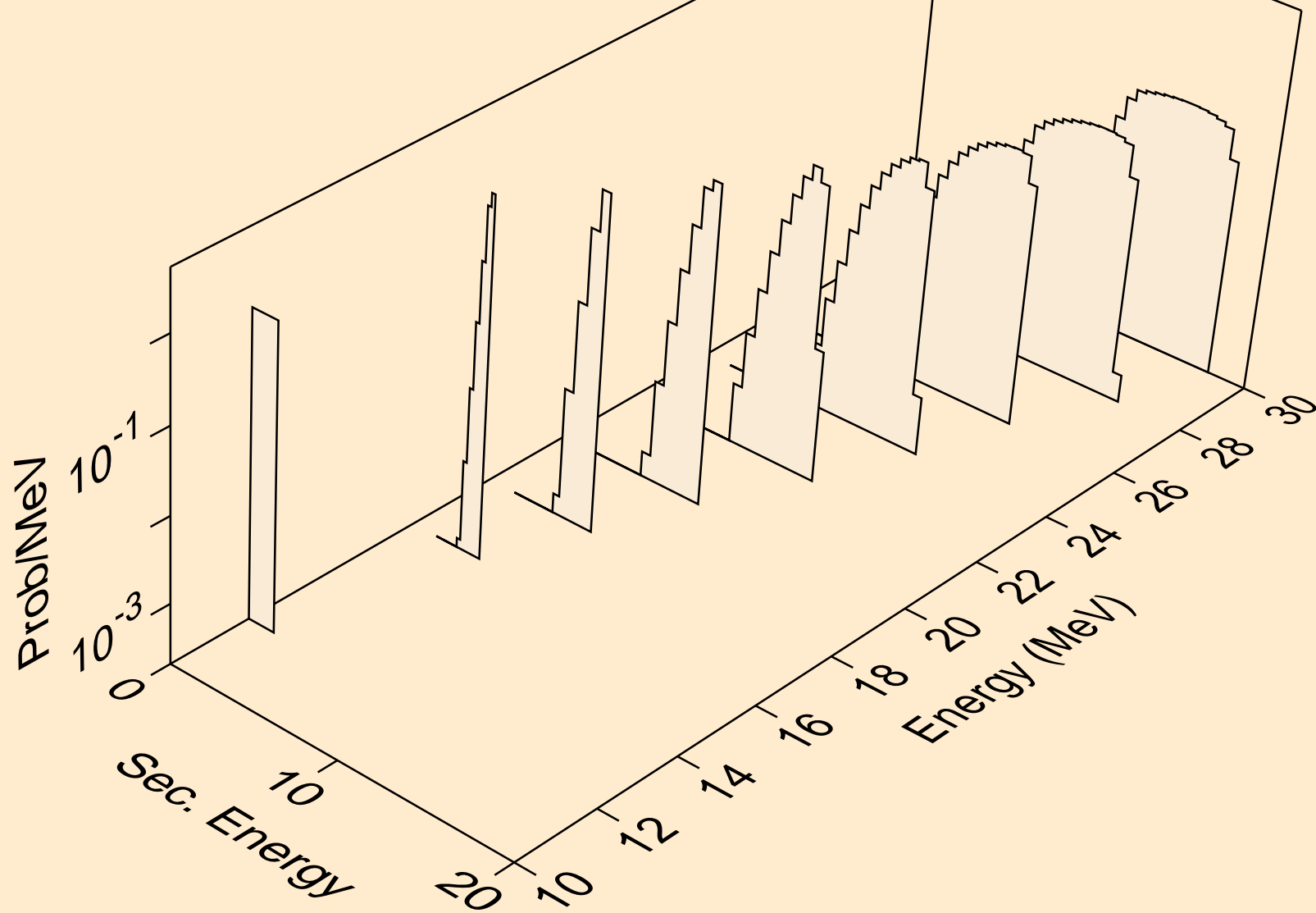

HF188 NEUTRON ACER TENDL-2021 LIBRARY; T=293.6K  
tritons from (n,t)

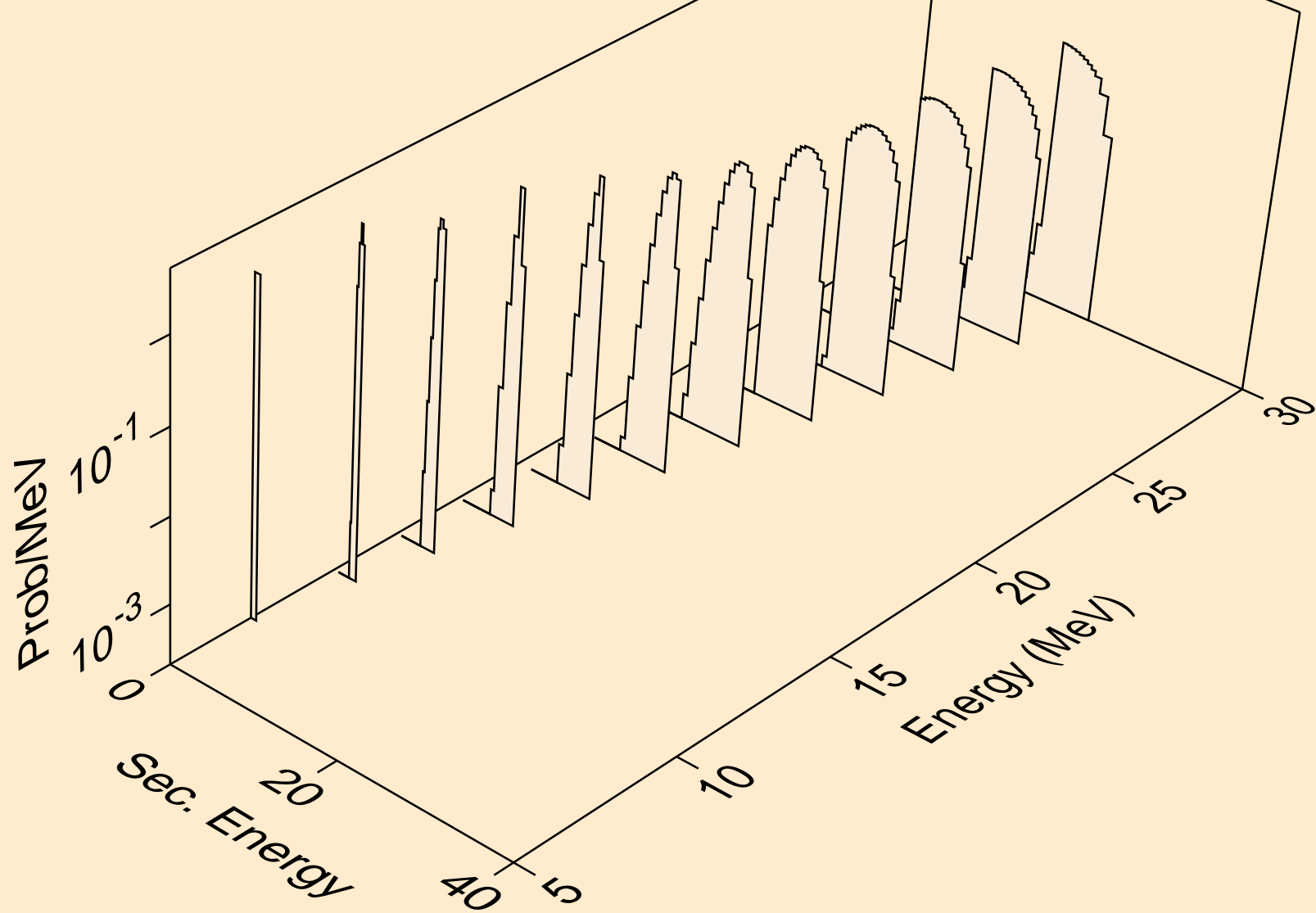

HF188 NEUTRON ACER TENDL-2021 LIBRARY; T=293.6K  
he3s from (n,x)

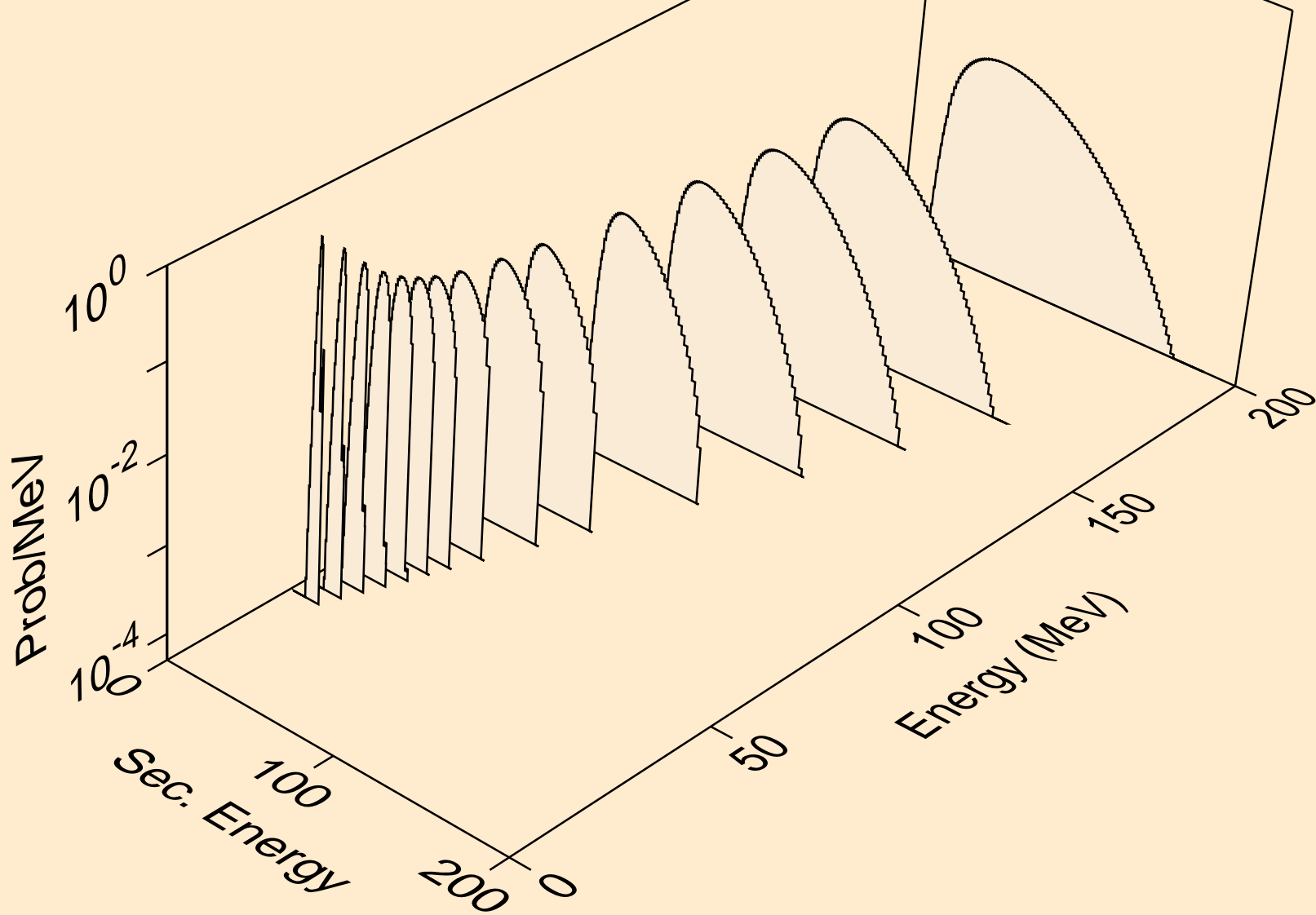

HF188 NEUTRON ACER TENDL-2021 LIBRARY; T=293.6K  
he3s from (n,n\*)he3

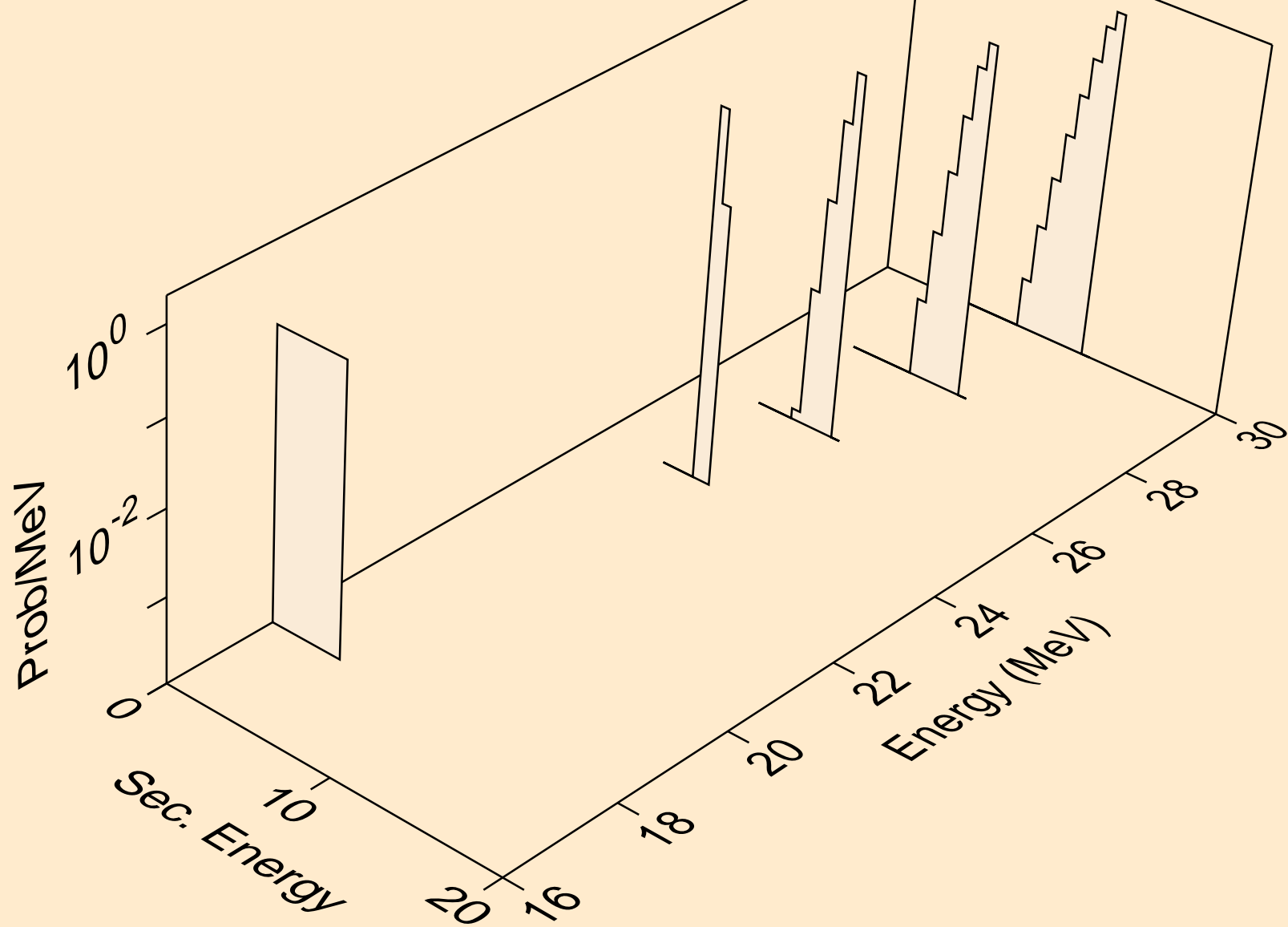

HF188 NEUTRON ACER TENDL-2021 LIBRARY; T=293.6K  
he3s from (n,he3)

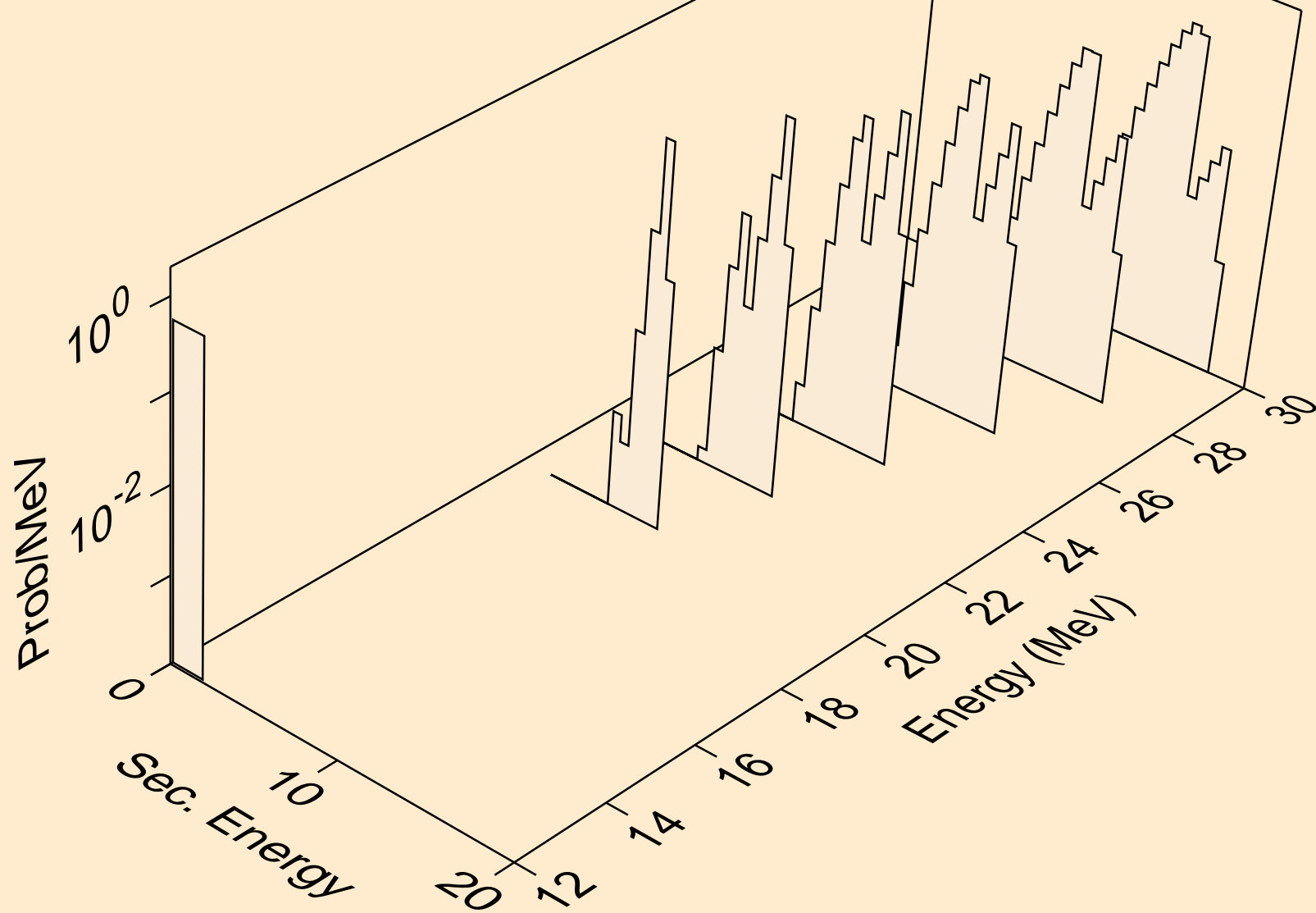

HF188 NEUTRON ACER TENDL-2021 LIBRARY; T=293.6K  
alphas from (n,x)

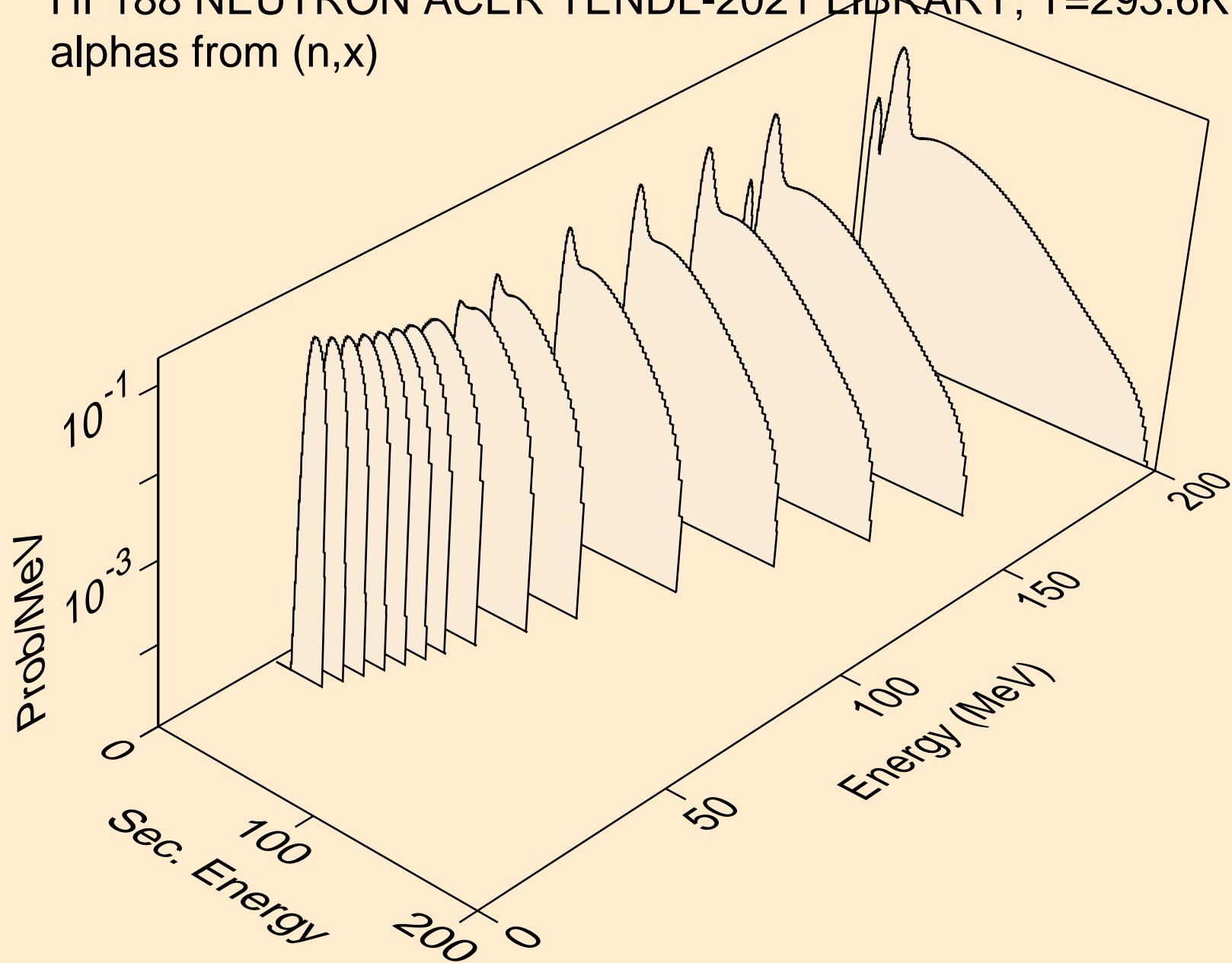



HF188 NEUTRON ACER TENDL-2021 LIBRARY; T=293.6K  
alphas from (n,n\*)a

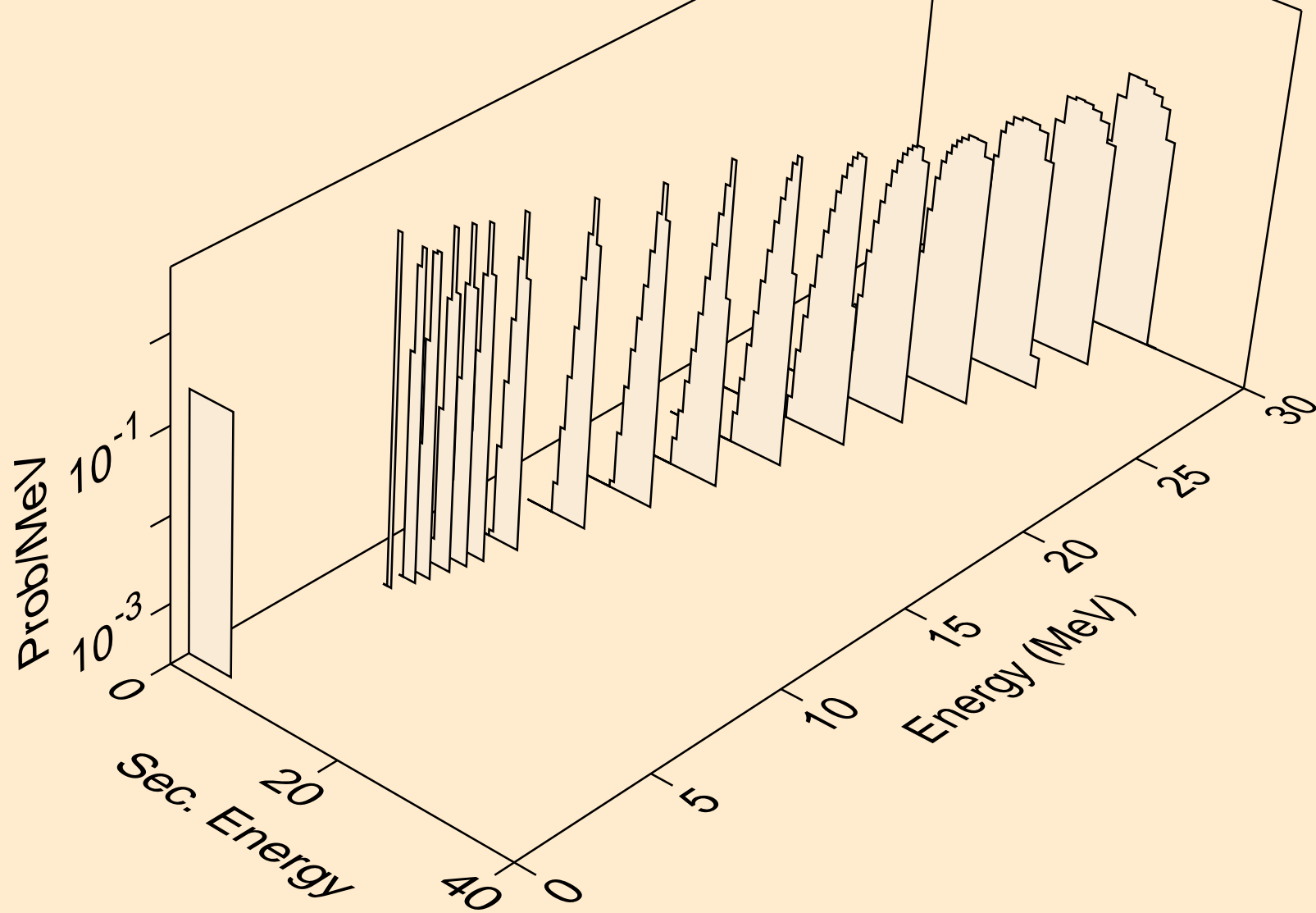

HF188 NEUTRON ACER TENDL-2021 LIBRARY; T=293.6K  
alphas from (n,2n)a

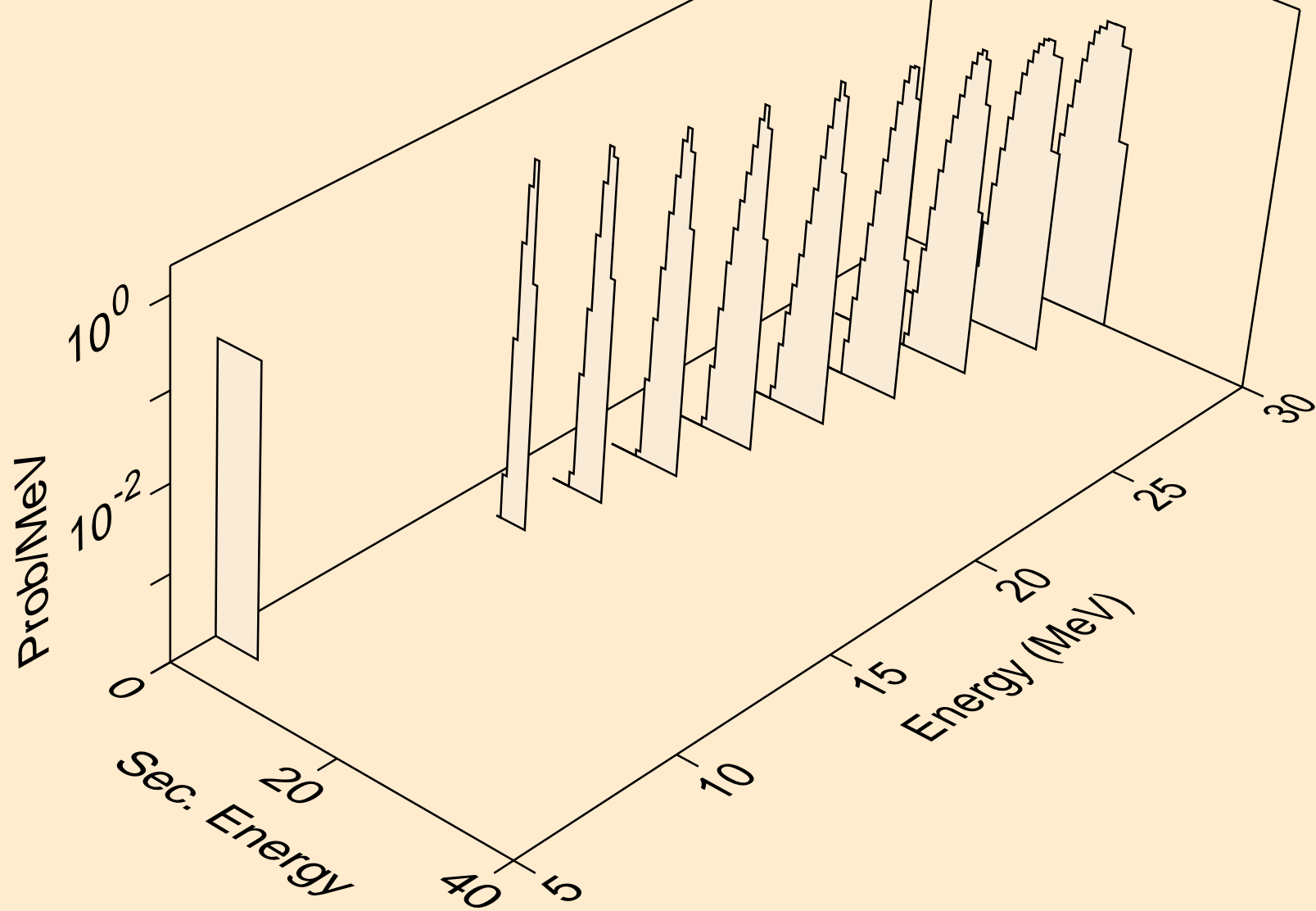

HF188 NEUTRON ACER TENDL-2021 LIBRARY; T=293.6K  
alphas from (n,3n)a

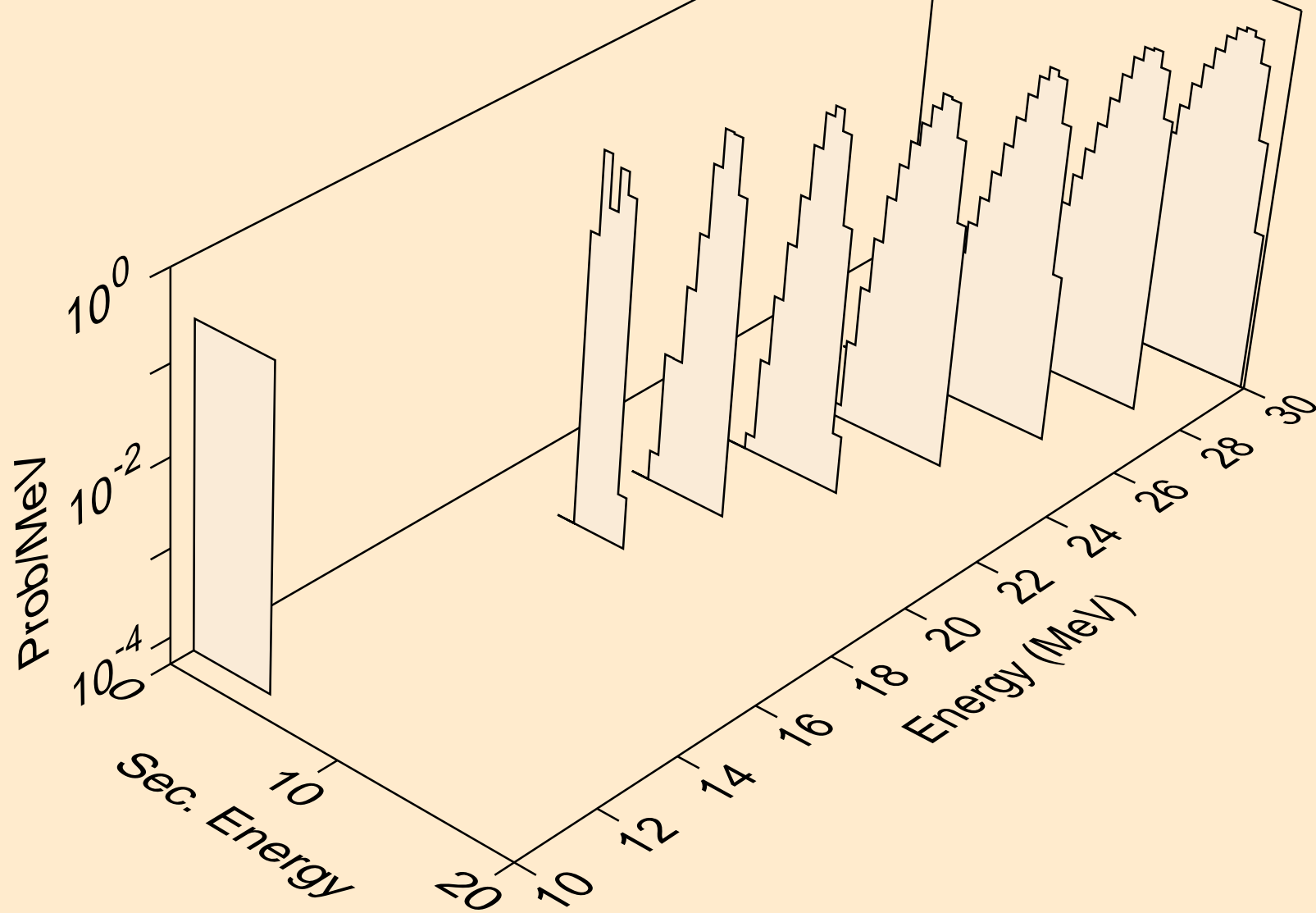

HF188 NEUTRON ACER TENDL-2021 LIBRARY; T=293.6K  
alphas from (n,a)

