

# HG179 NEUTRON ACER TENDL-2021 LIBRARY; T=293.6K

## Principal cross sections

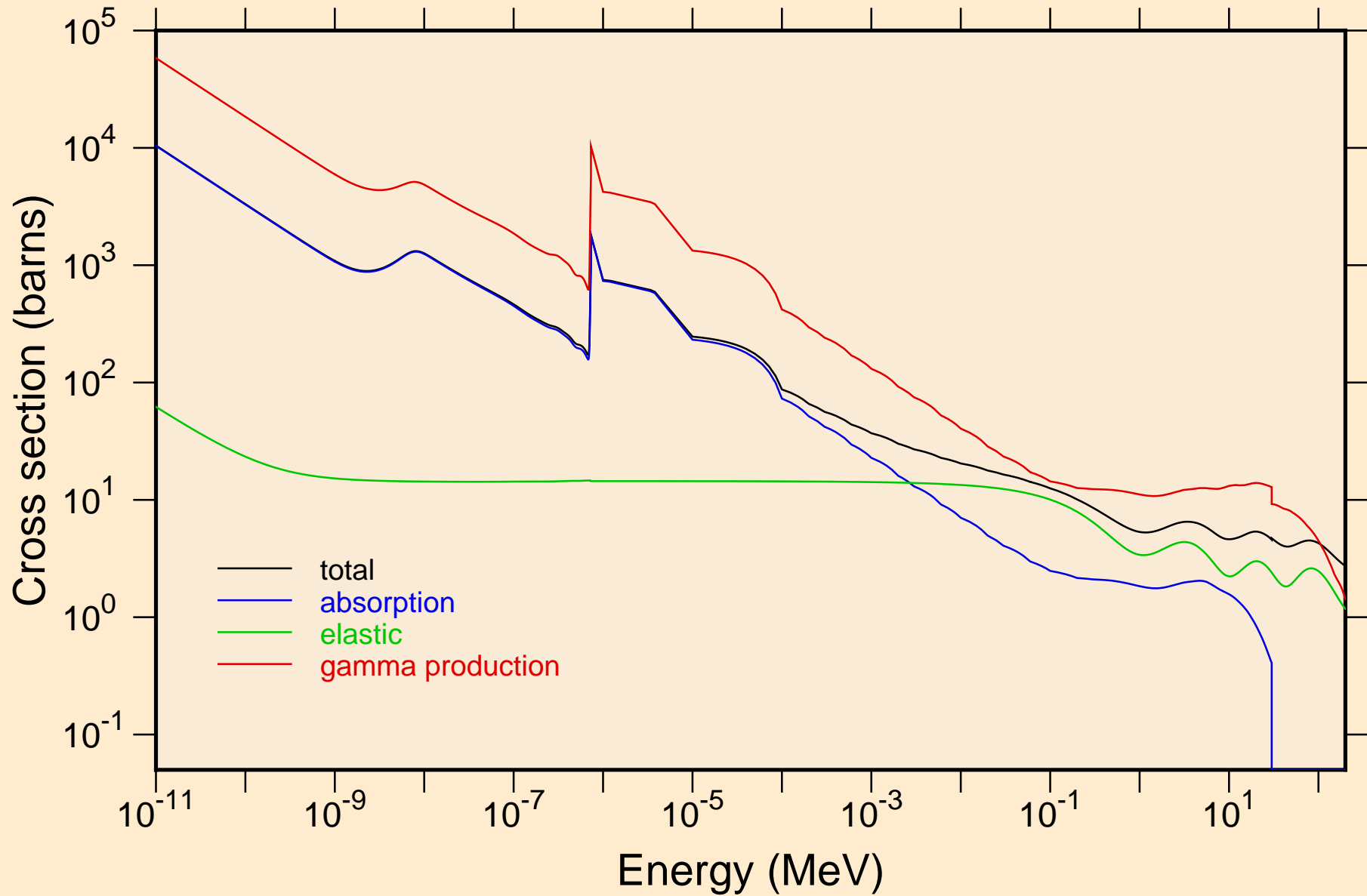

HG179 NEUTRON ACER TENDL-2021 LIBRARY; T=293.6K  
Heating

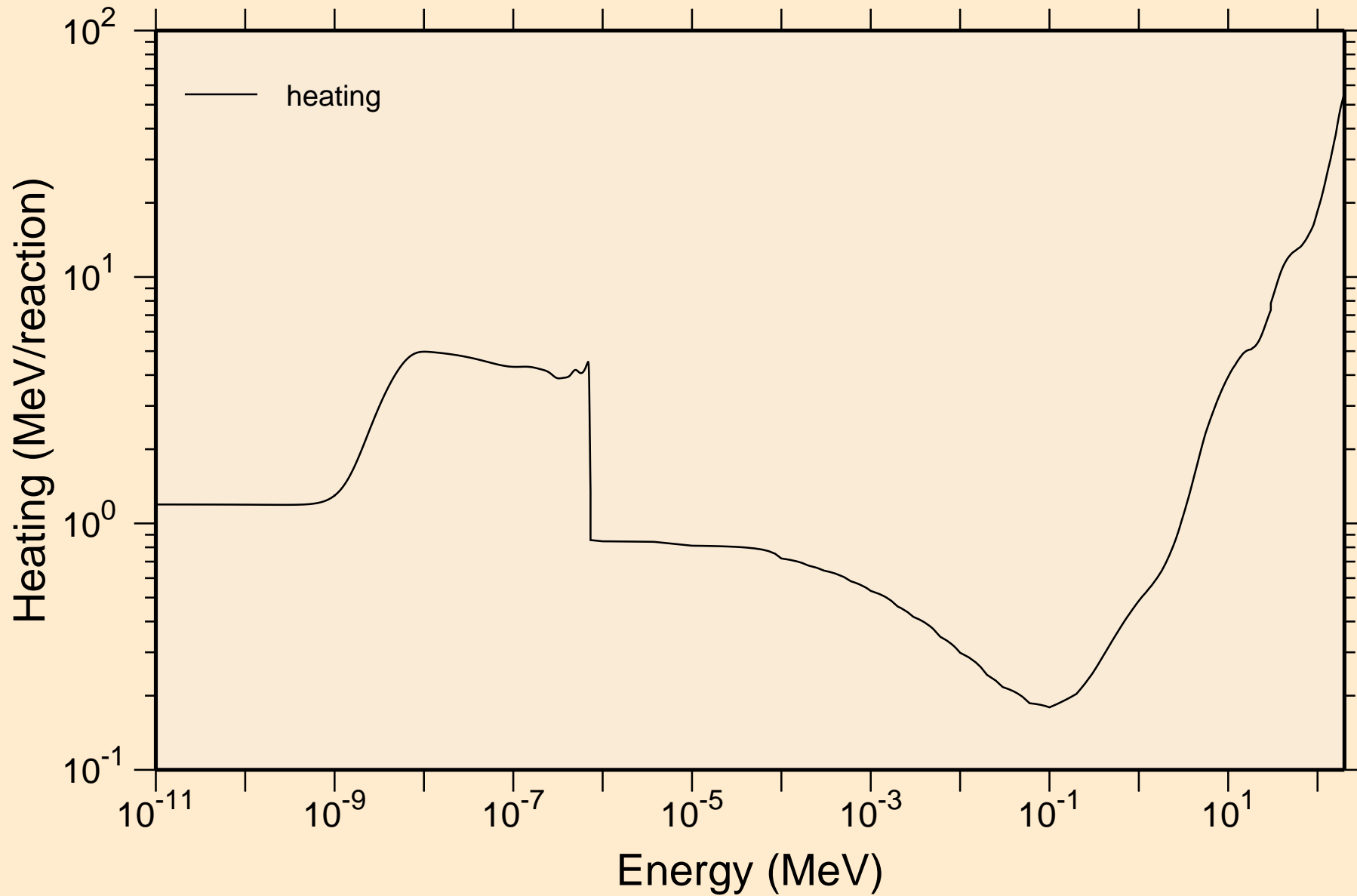

HG179 NEUTRON ACER TENDL-2021 LIBRARY; T=293.6K  
Damage

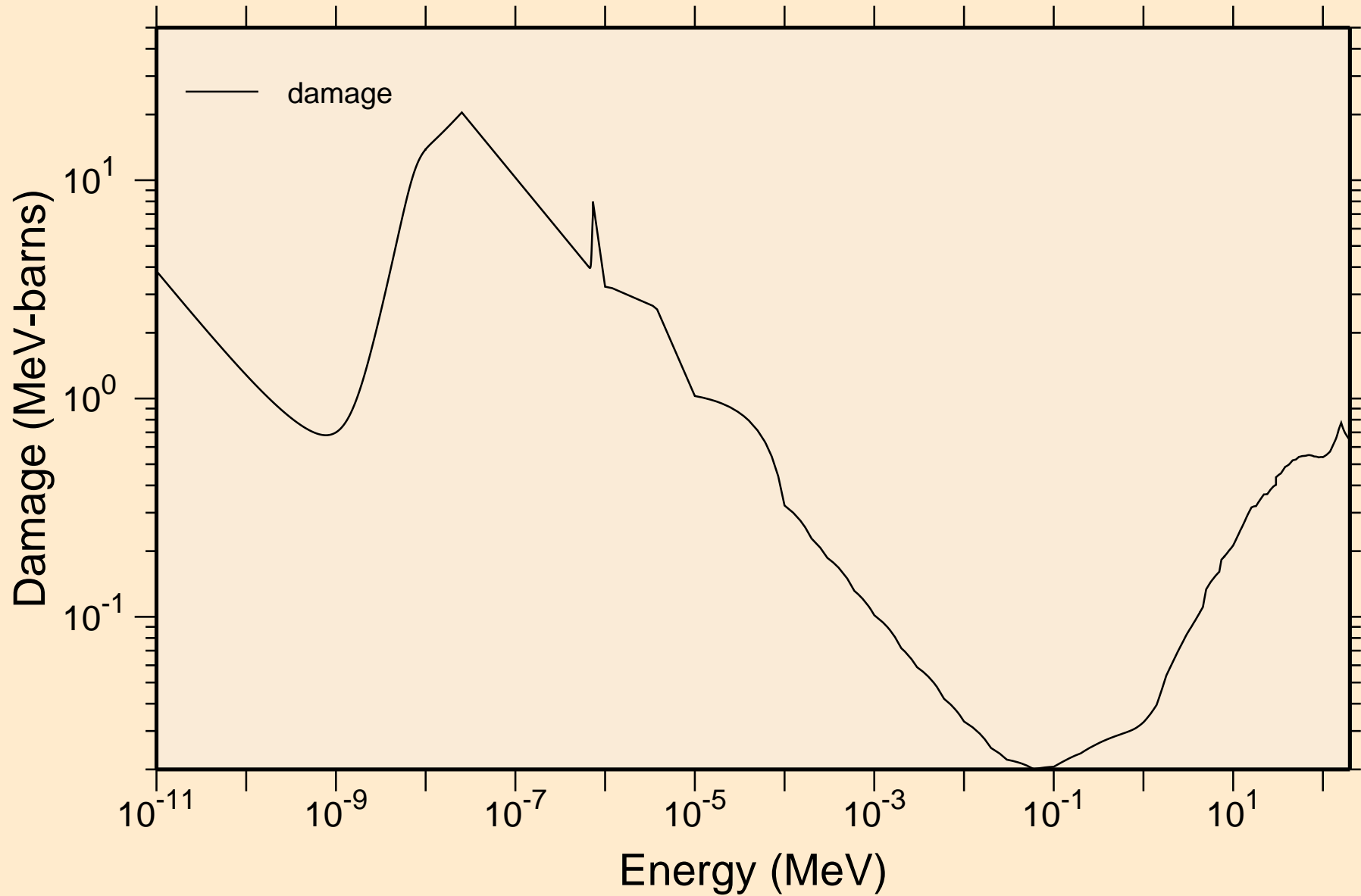

# HG179 NEUTRON ACER TENDL-2021 LIBRARY; T=293.6K

## Non-threshold reactions

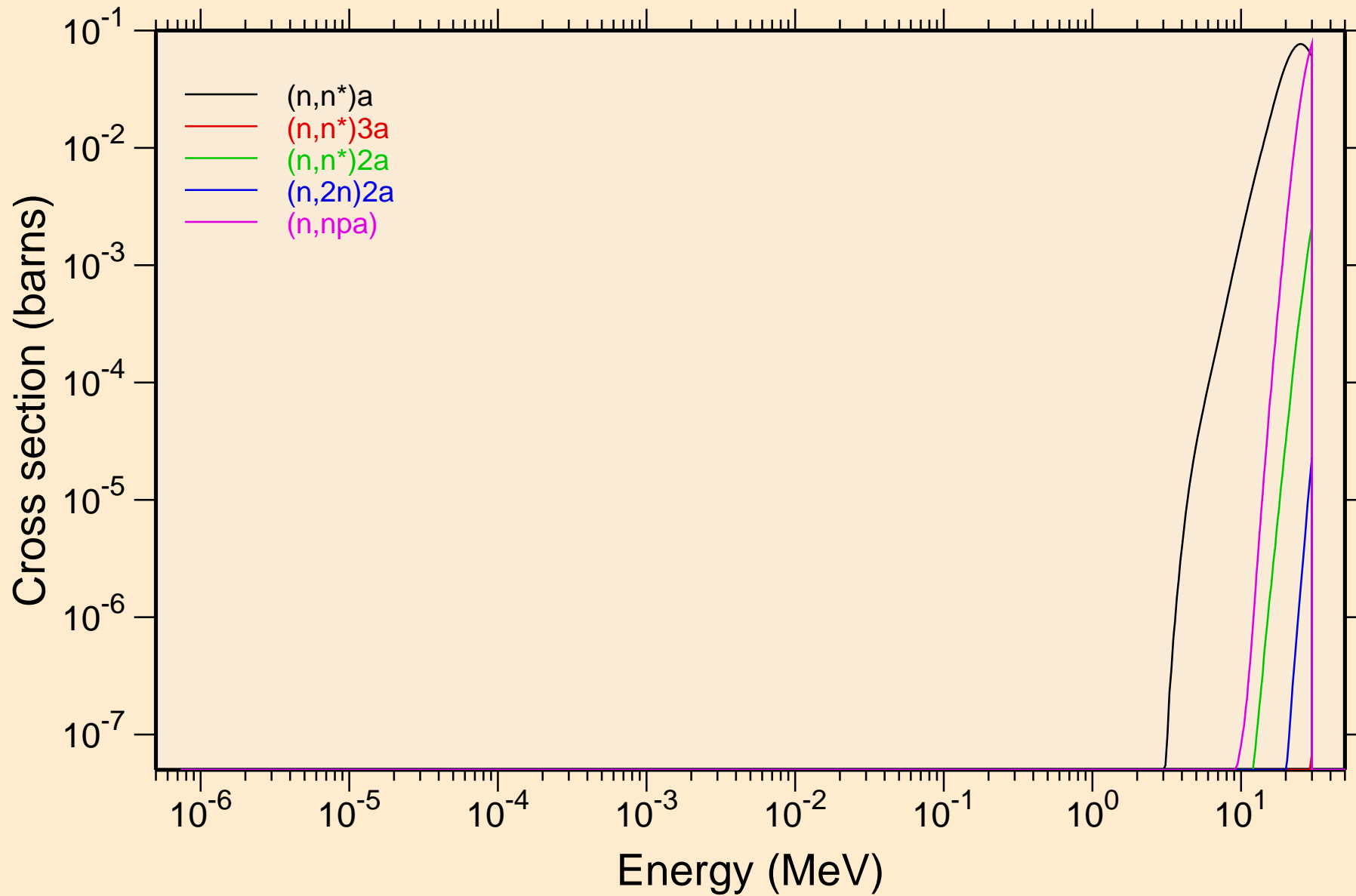

# HG179 NEUTRON ACER TENDL-2021 LIBRARY; T=293.6K

## Non-threshold reactions

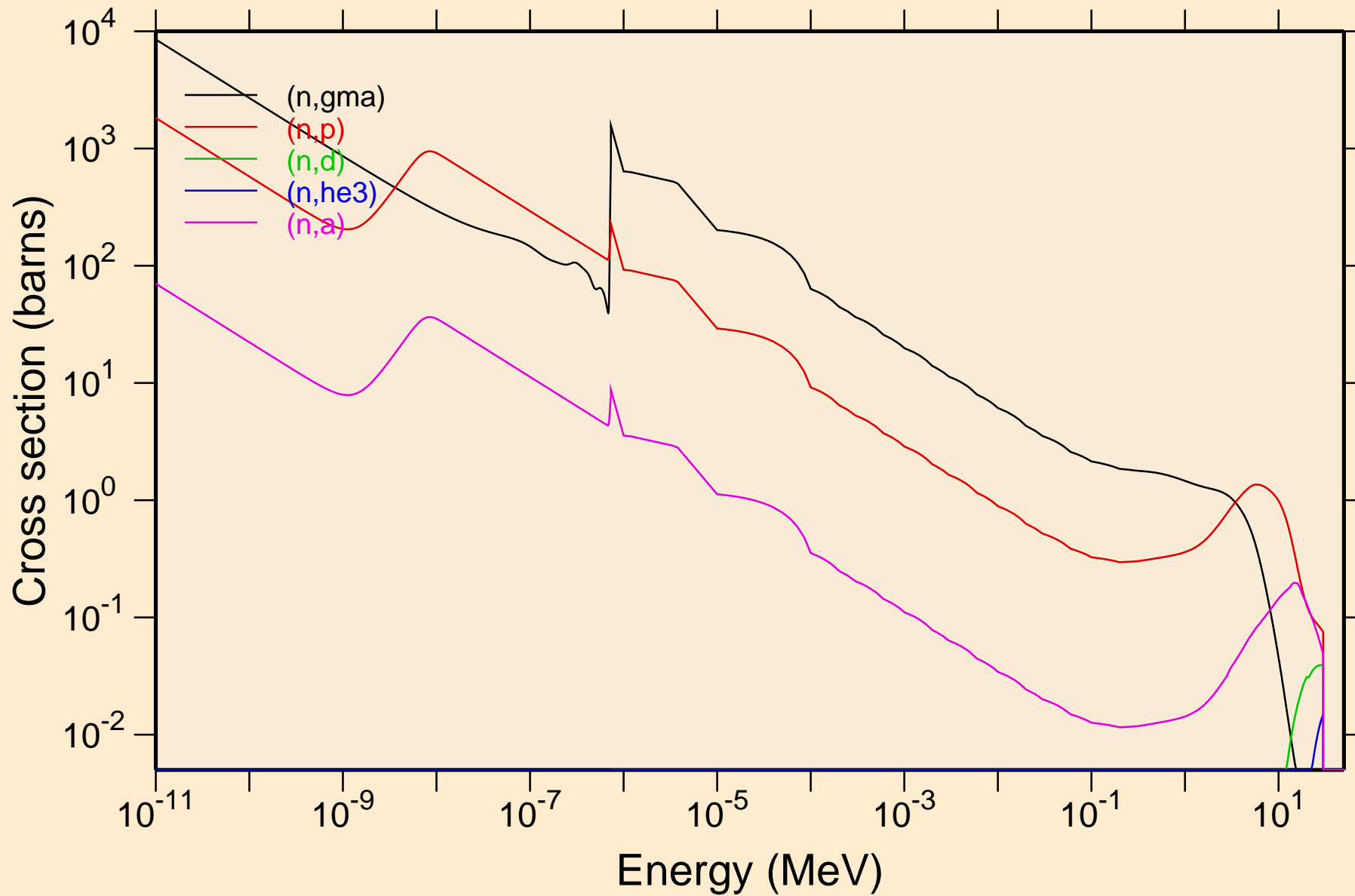

HG179 NEUTRON ACER TENDL-2021 LIBRARY; T=293.6K  
Non-threshold reactions

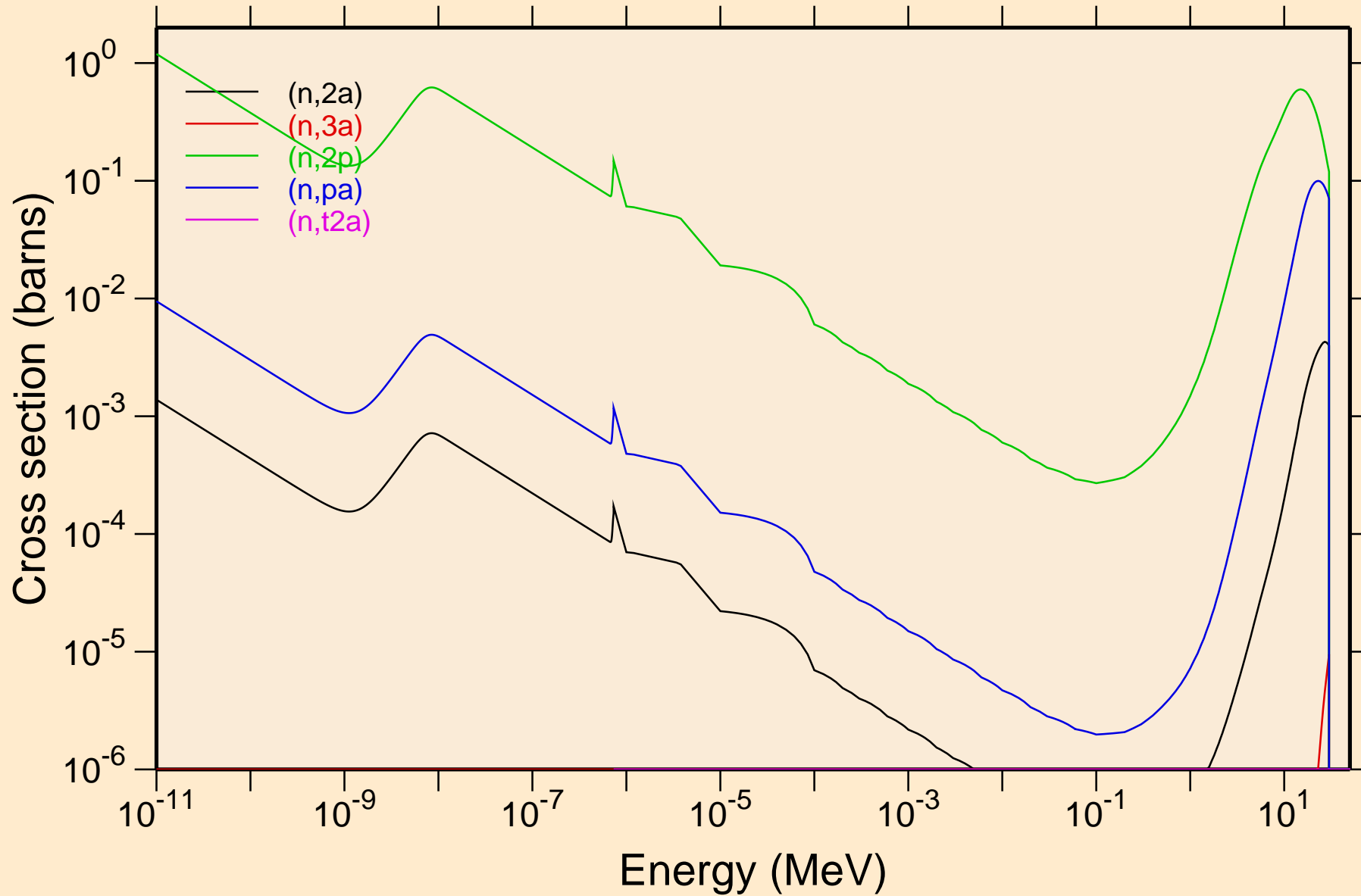

# HG179 NEUTRON ACER TENDL-2021 LIBRARY; T=293.6K

## Non-threshold reactions

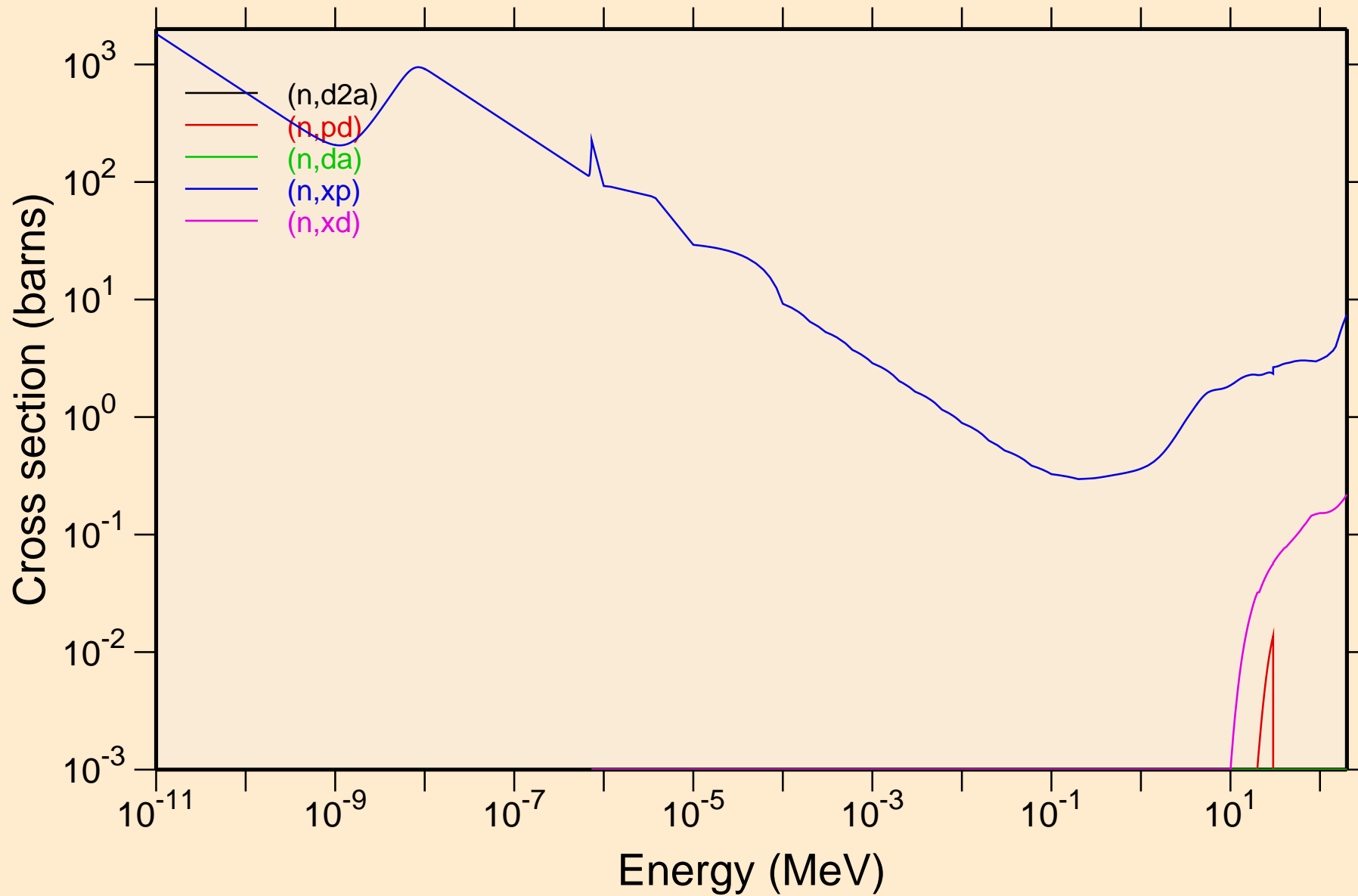

HG179 NEUTRON ACER TENDL-2021 LIBRARY; T=293.6K  
Non-threshold reactions

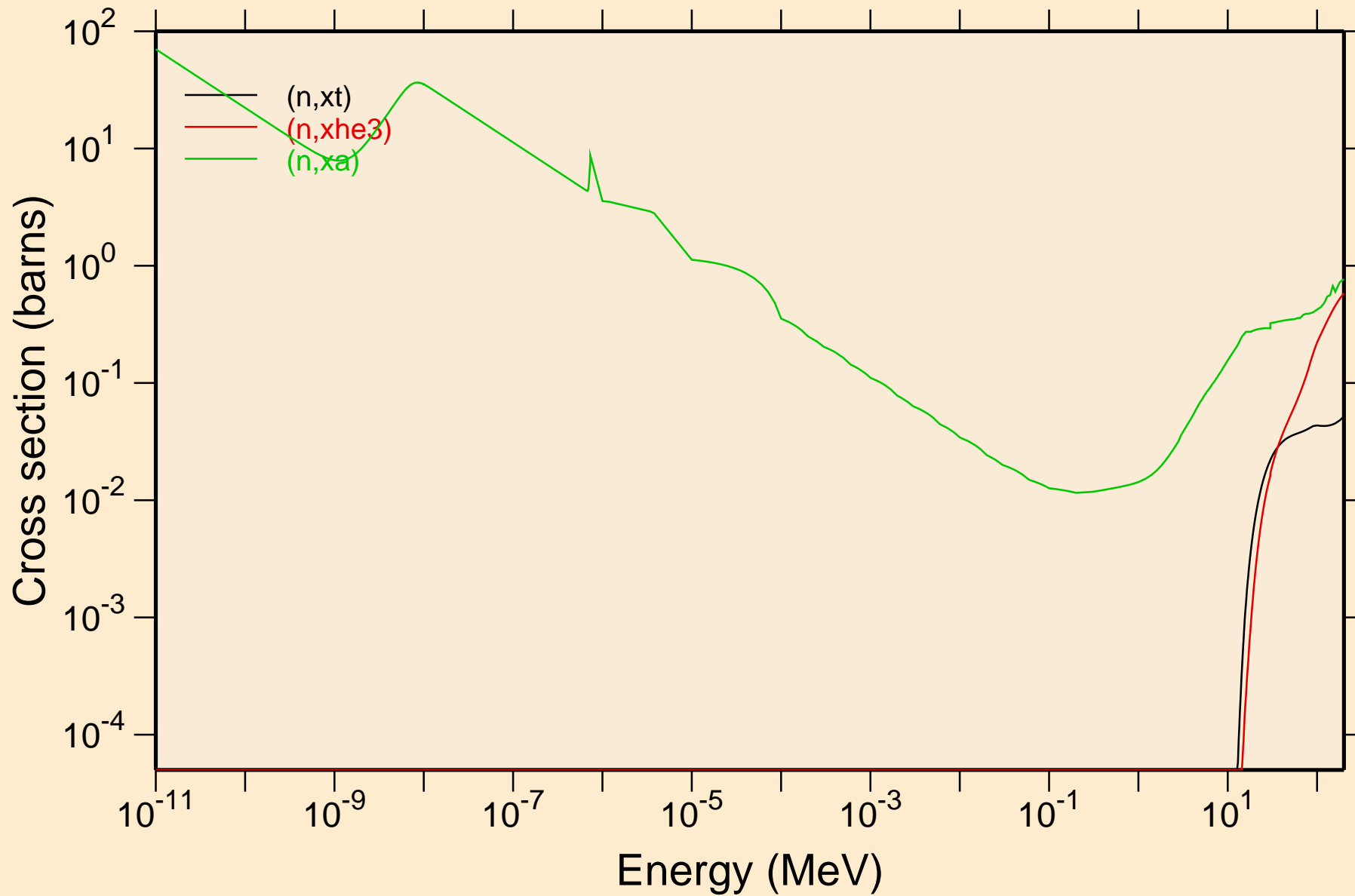



# HG179 NEUTRON ACER TENDL-2021 LIBRARY; T=293.6K

## Principal cross sections

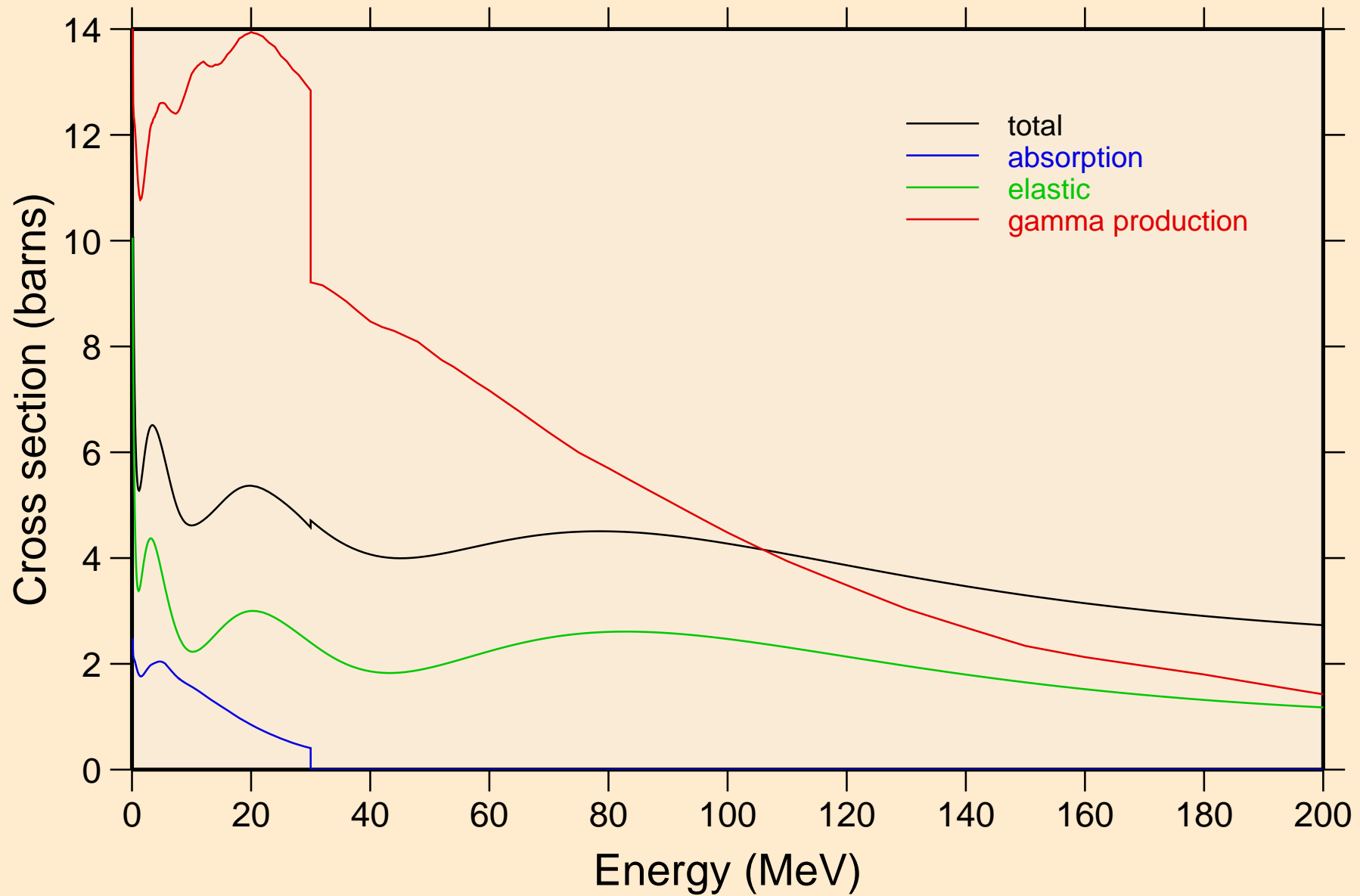

HG179 NEUTRON ACER TENDL-2021 LIBRARY; T=293.6K  
Heating

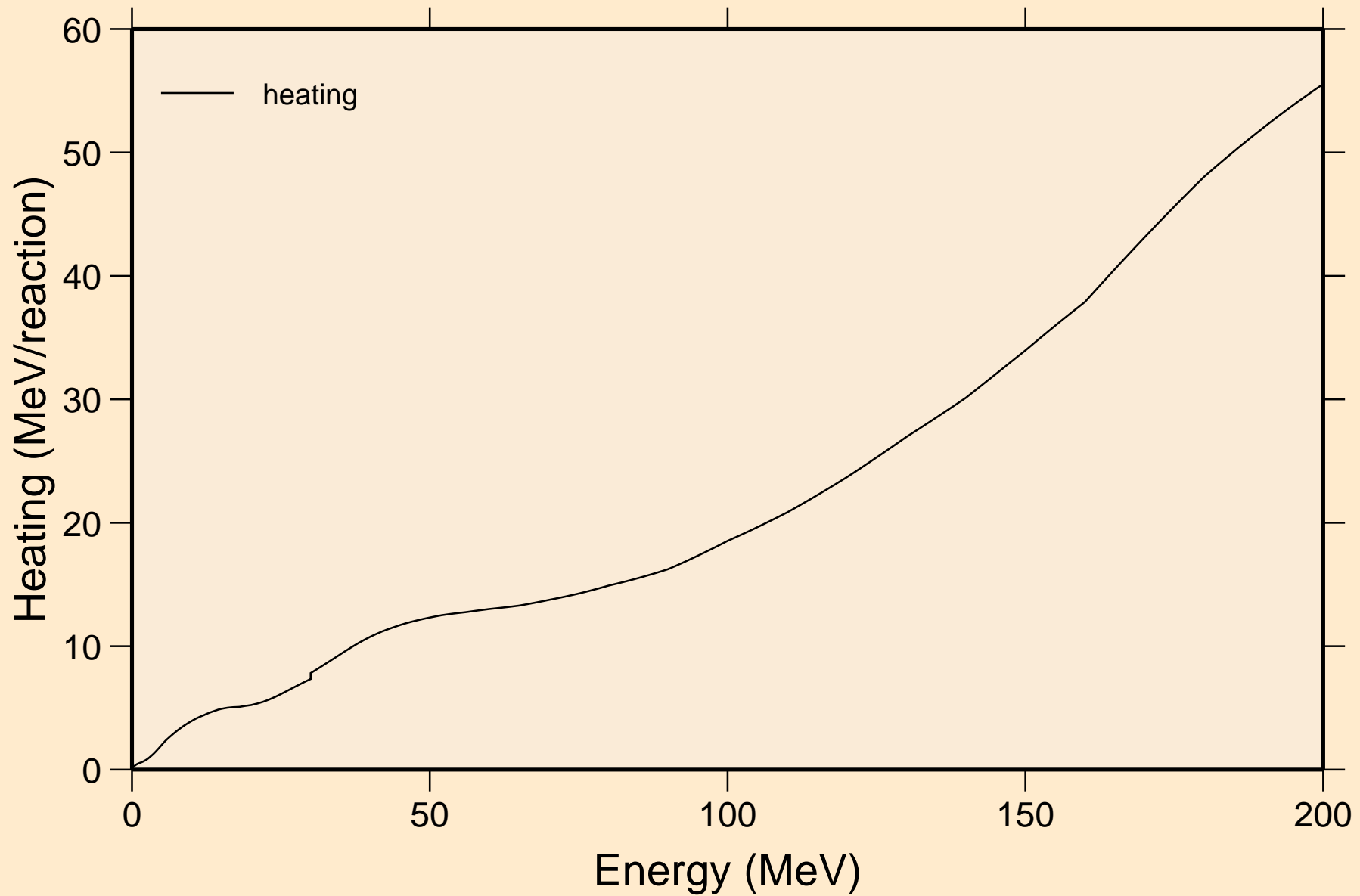

# HG179 NEUTRON ACER TENDL-2021 LIBRARY; T=293.6K

## Damage

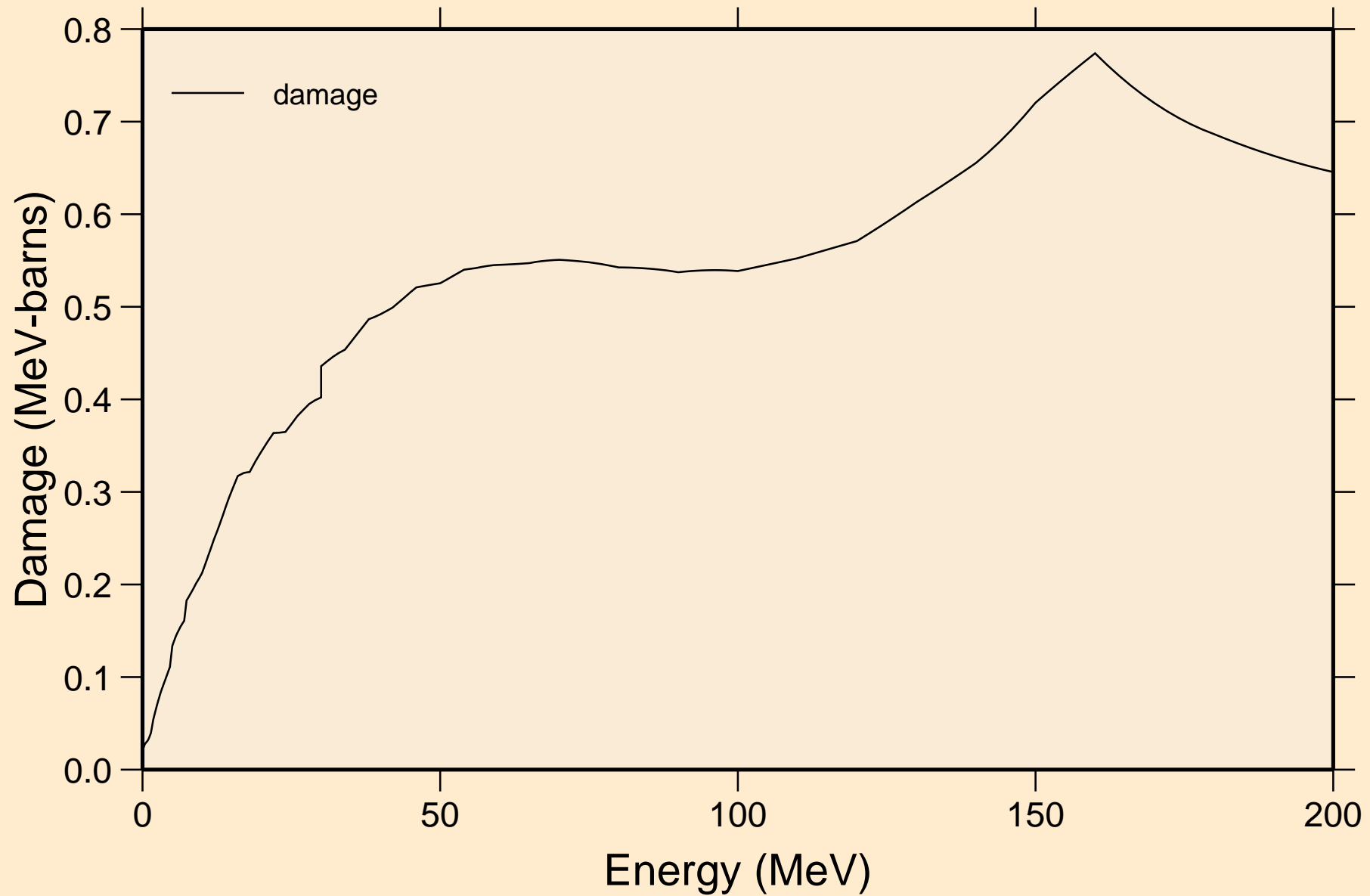

# HG179 NEUTRON ACER TENDL-2021 LIBRARY; T=293.6K

## Non-threshold reactions

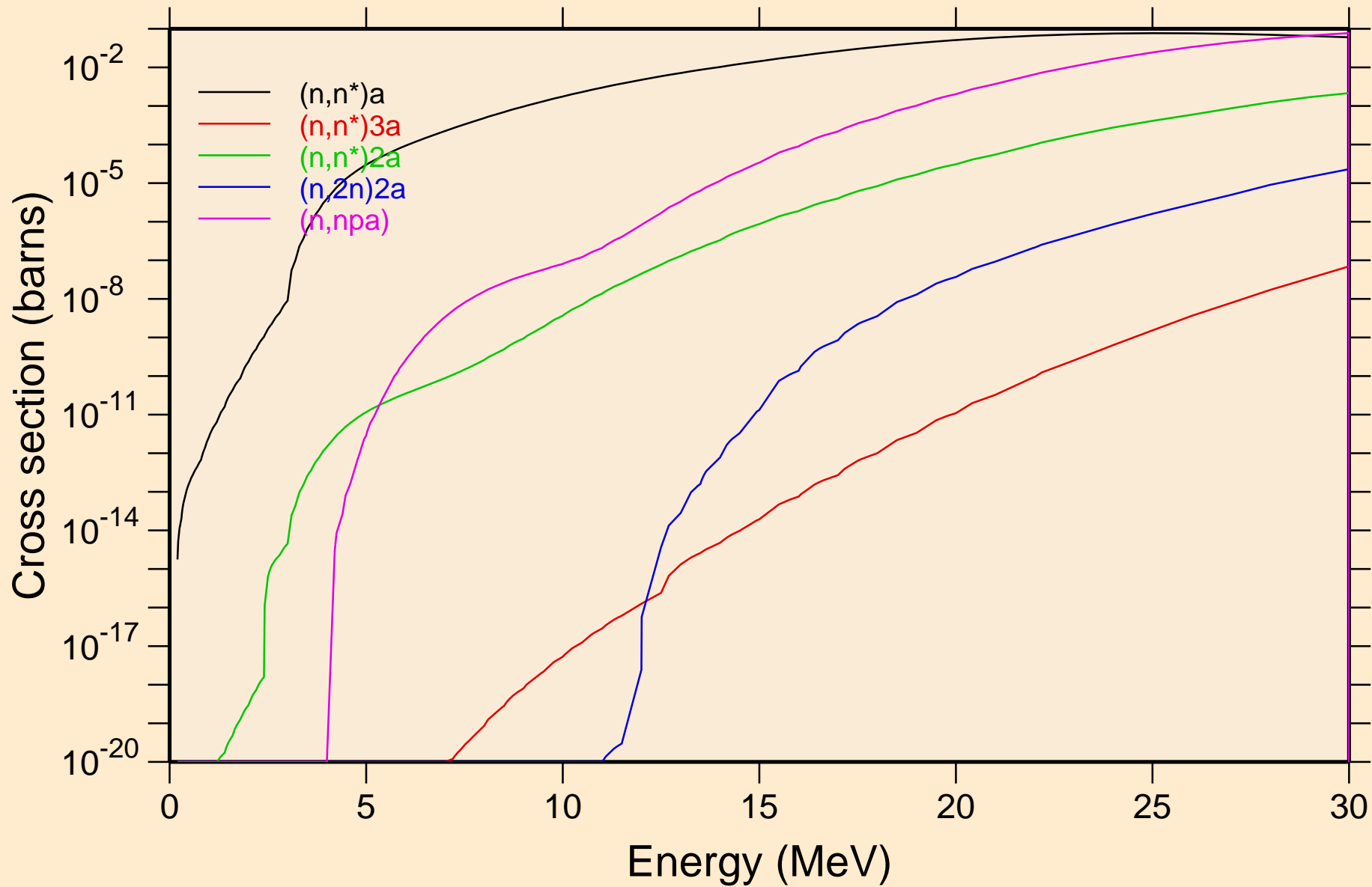

# HG179 NEUTRON ACER TENDL-2021 LIBRARY; T=293.6K

## Non-threshold reactions

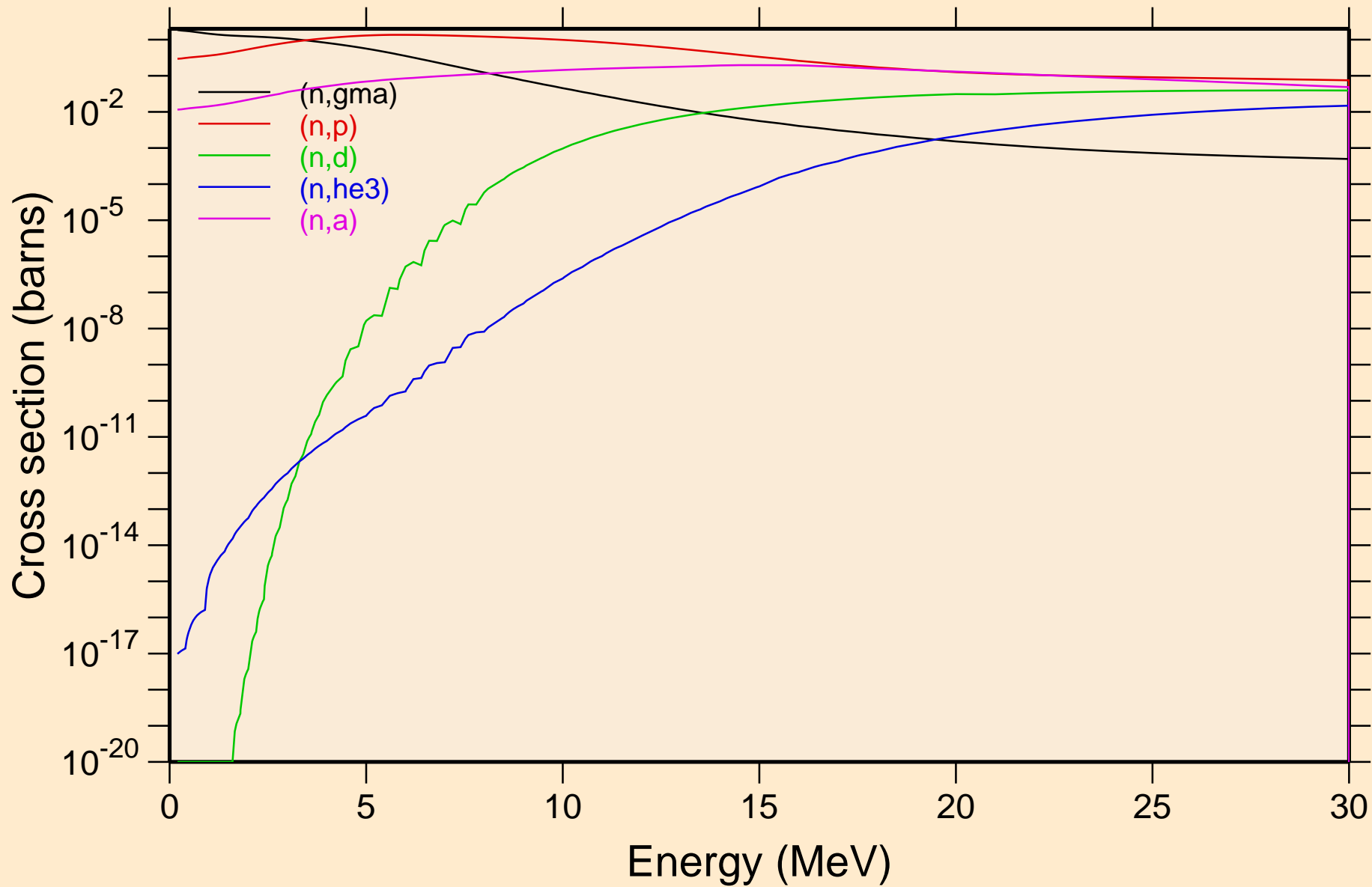

# HG179 NEUTRON ACER TENDL-2021 LIBRARY; T=293.6K

## Non-threshold reactions

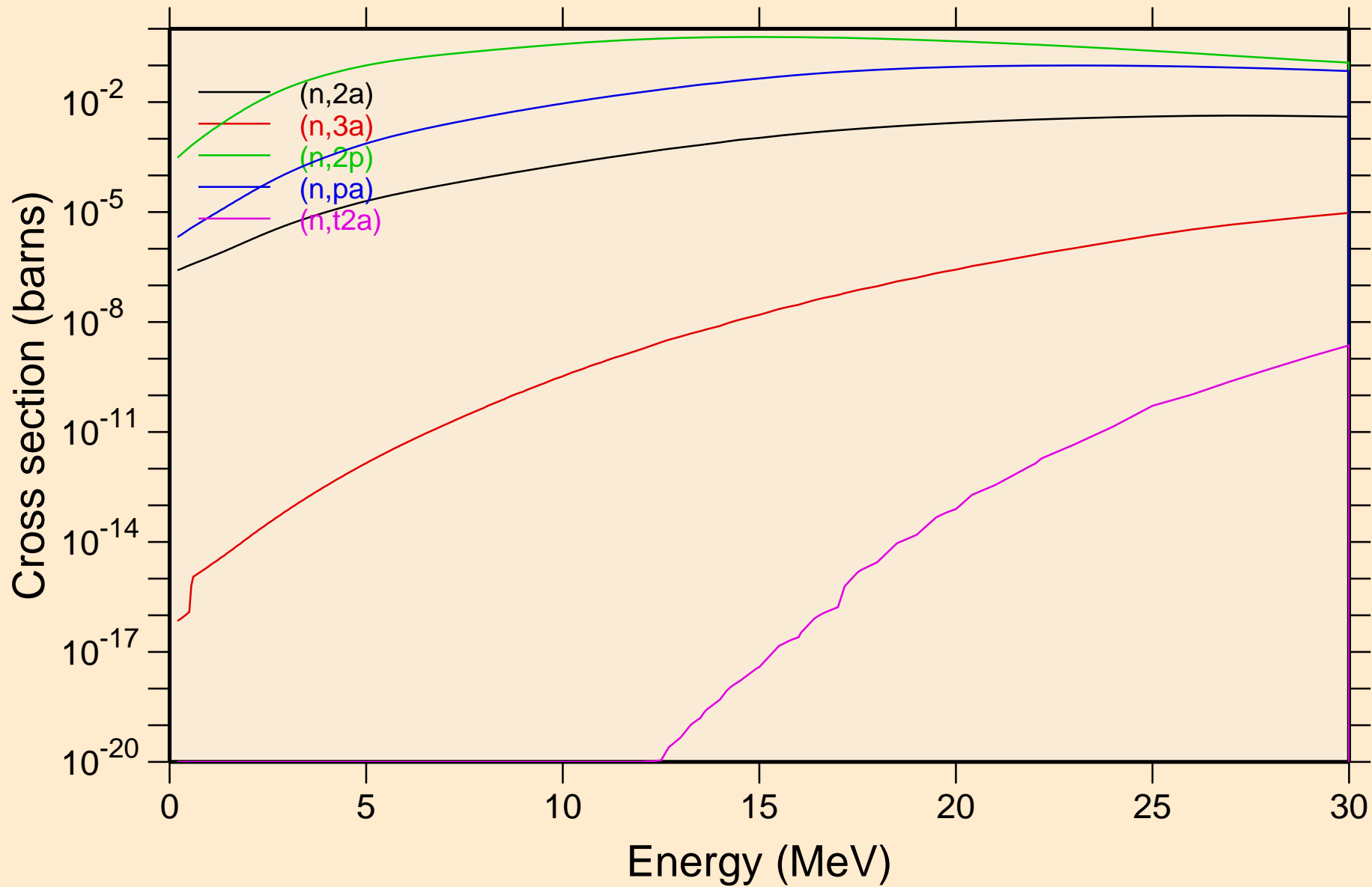

# HG179 NEUTRON ACER TENDL-2021 LIBRARY; T=293.6K

## Non-threshold reactions

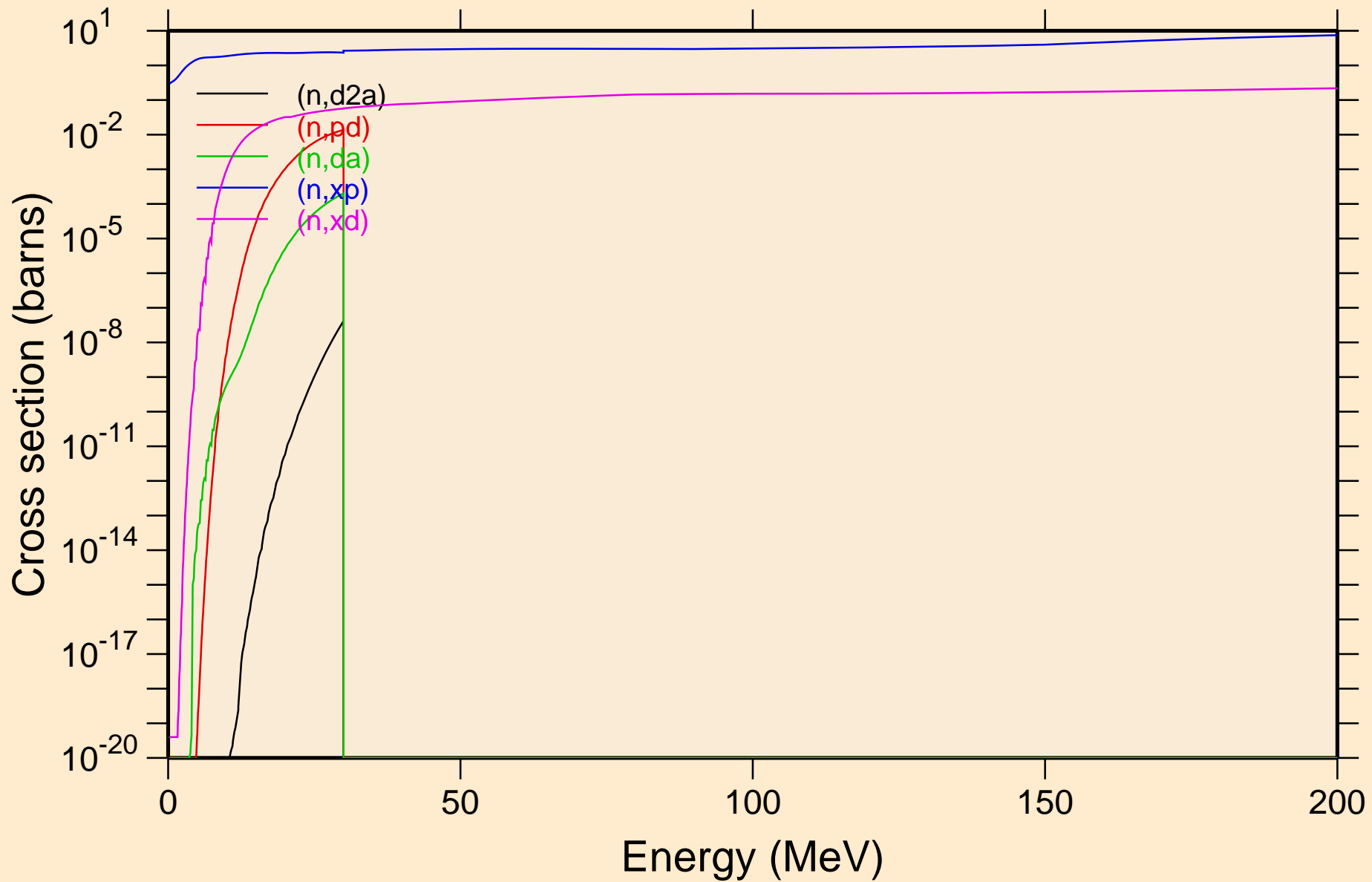

HG179 NEUTRON ACER TENDL-2021 LIBRARY; T=293.6K  
Non-threshold reactions

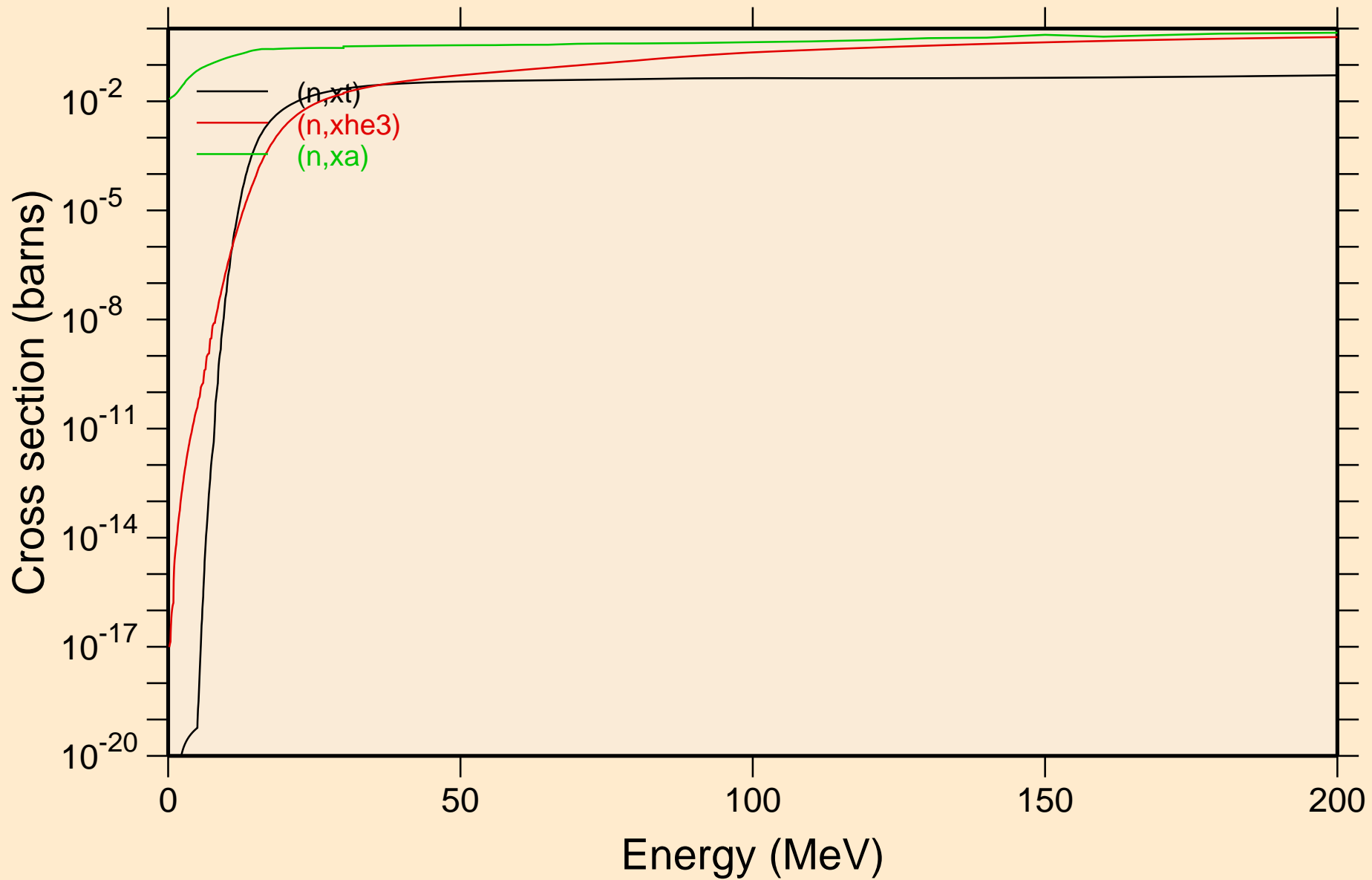



HG179 NEUTRON ACER TENDL-2021 LIBRARY; T=293.6K  
Inelastic levels

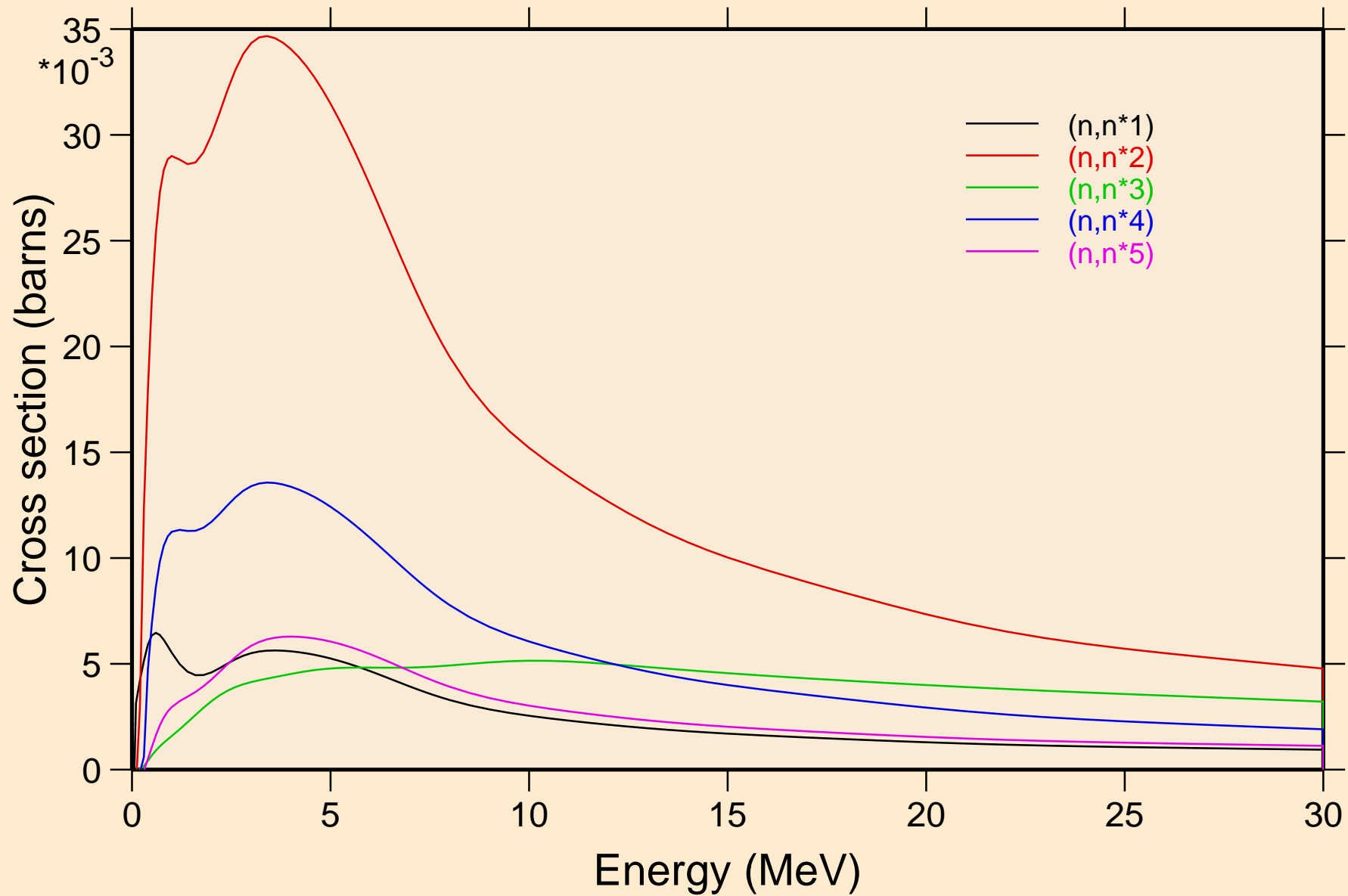

HG179 NEUTRON ACER TENDL-2021 LIBRARY; T=293.6K  
Inelastic levels

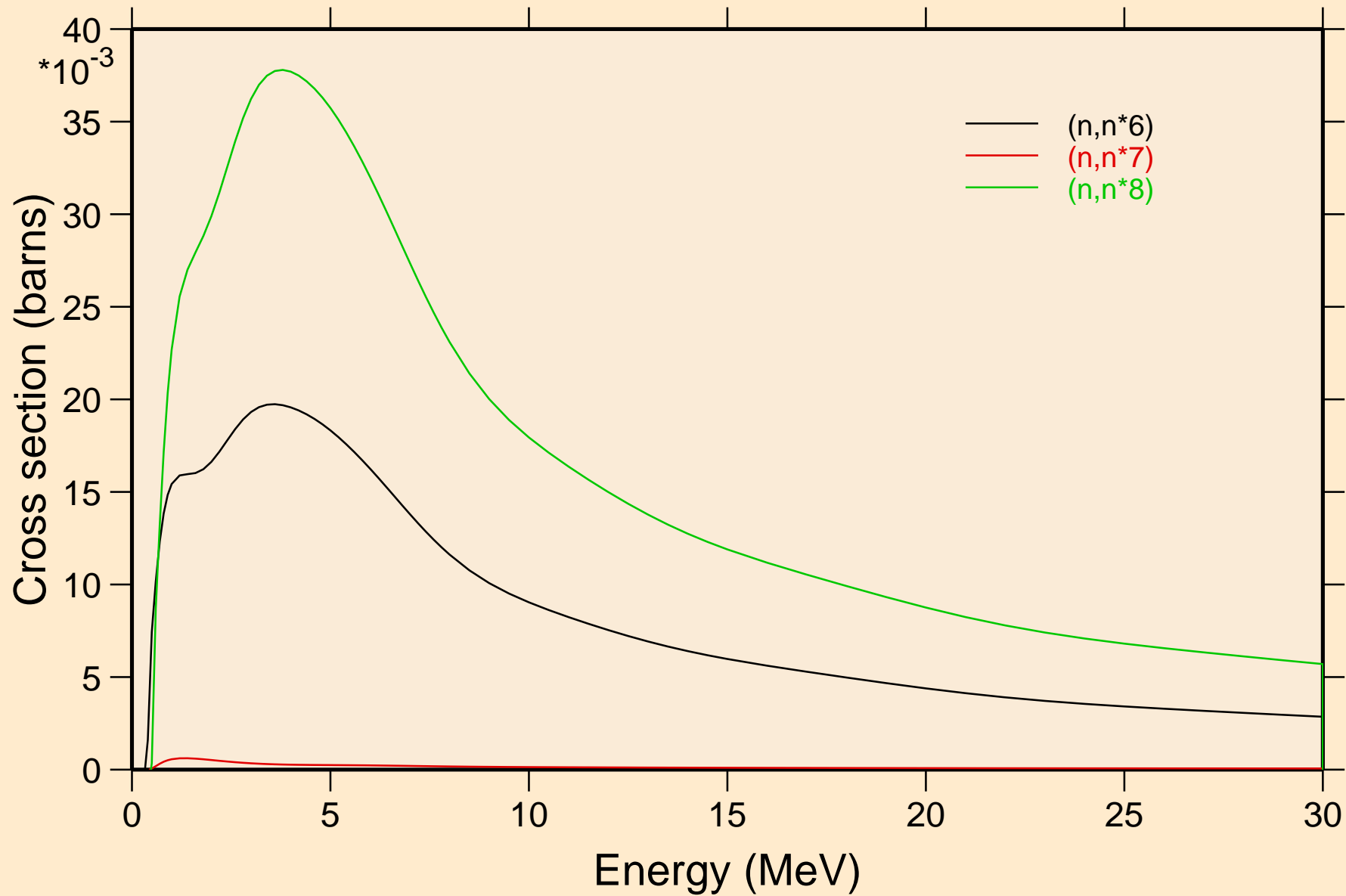

HG179 NEUTRON ACER TENDL-2021 LIBRARY; T=293.6K  
Threshold reactions

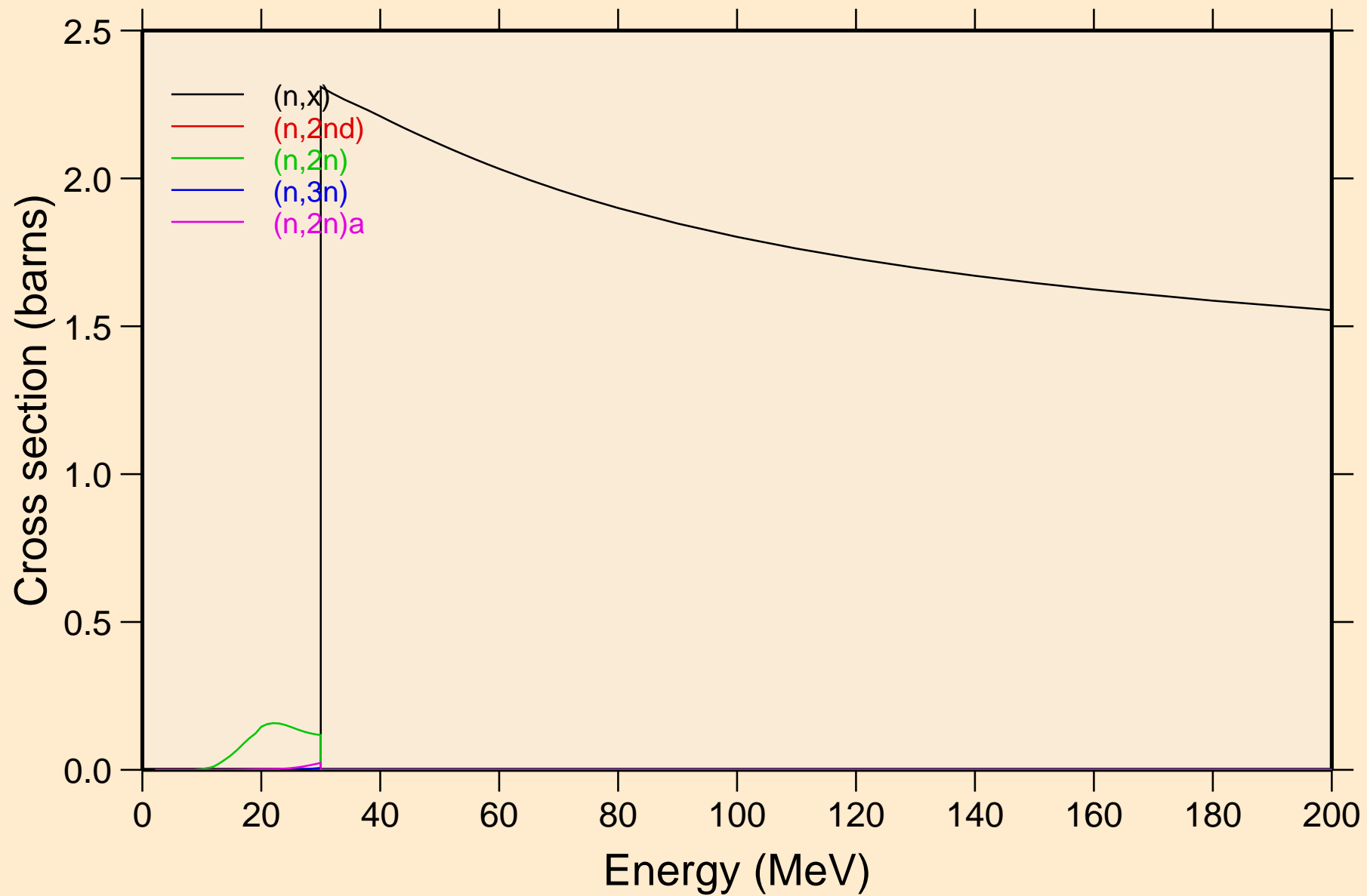

HG179 NEUTRON ACER TENDL-2021 LIBRARY; T=293.6K  
Threshold reactions

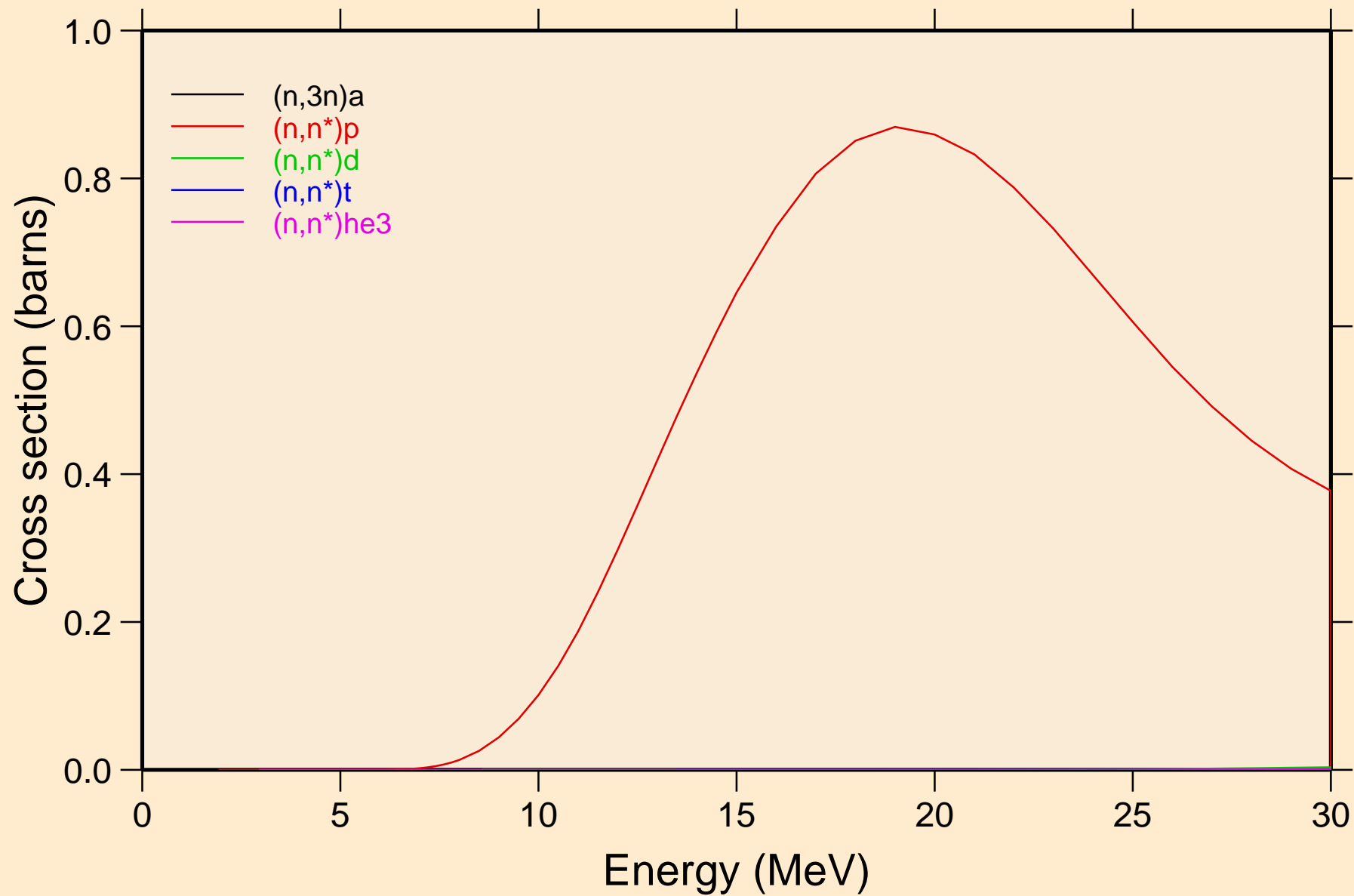

HG179 NEUTRON ACER TENDL-2021 LIBRARY; T=293.6K  
Threshold reactions

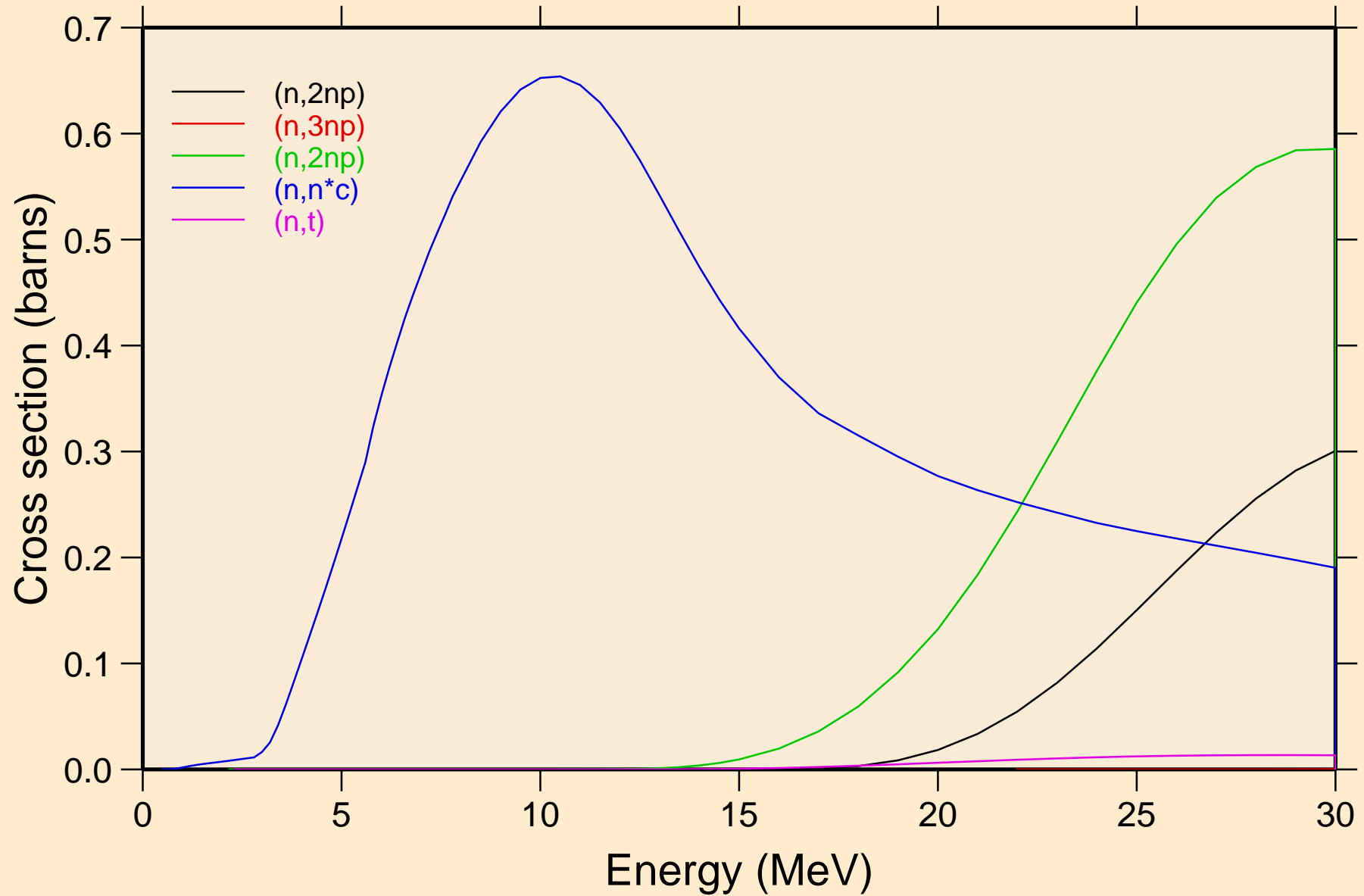

HG179 NEUTRON ACER TENDL-2021 LIBRARY; T=293.6K  
Threshold reactions

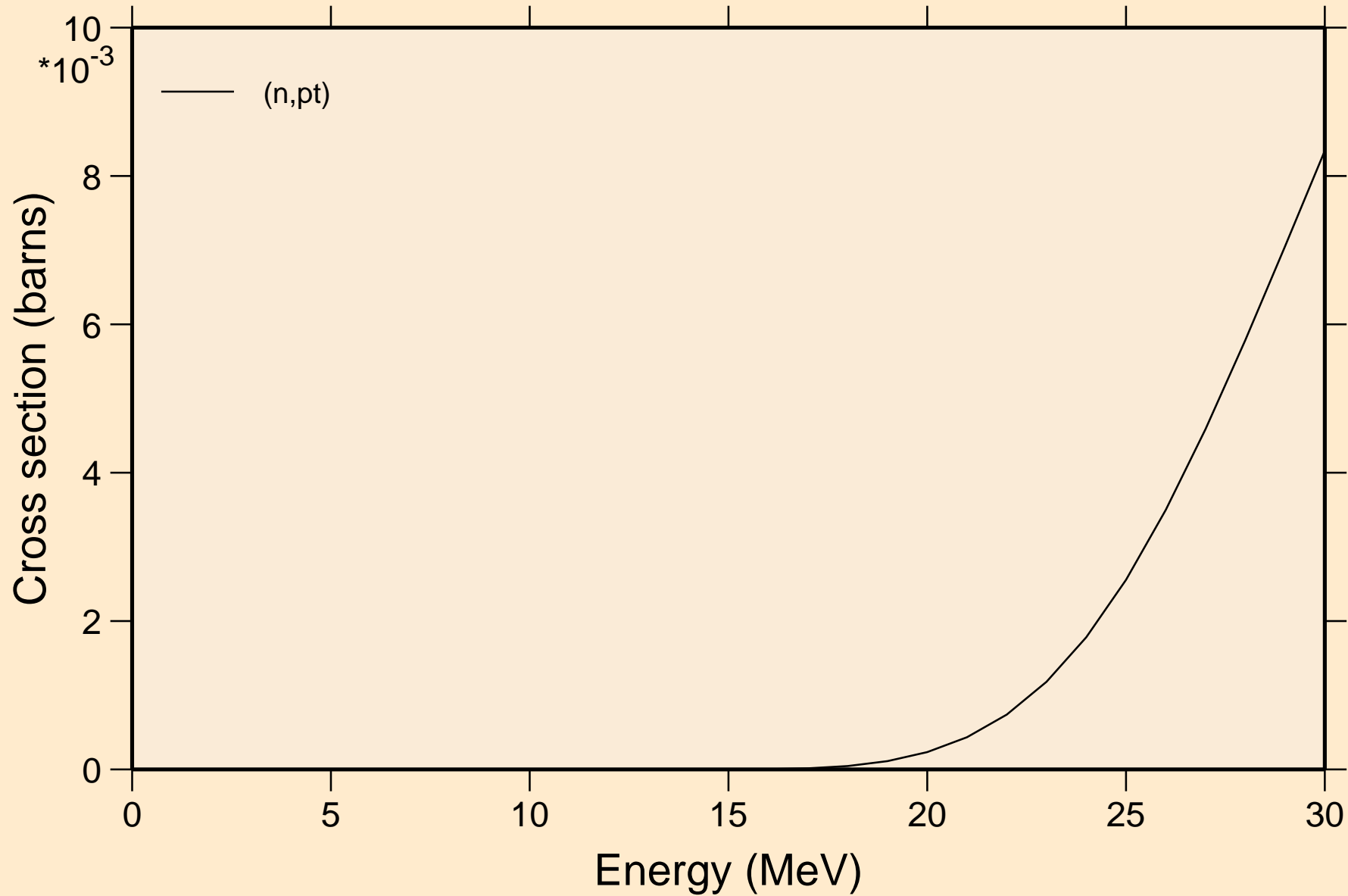

HG179 NEUTRON ACER TENDL-2021 LIBRARY; T=293.6K  
angular distribution for elastic

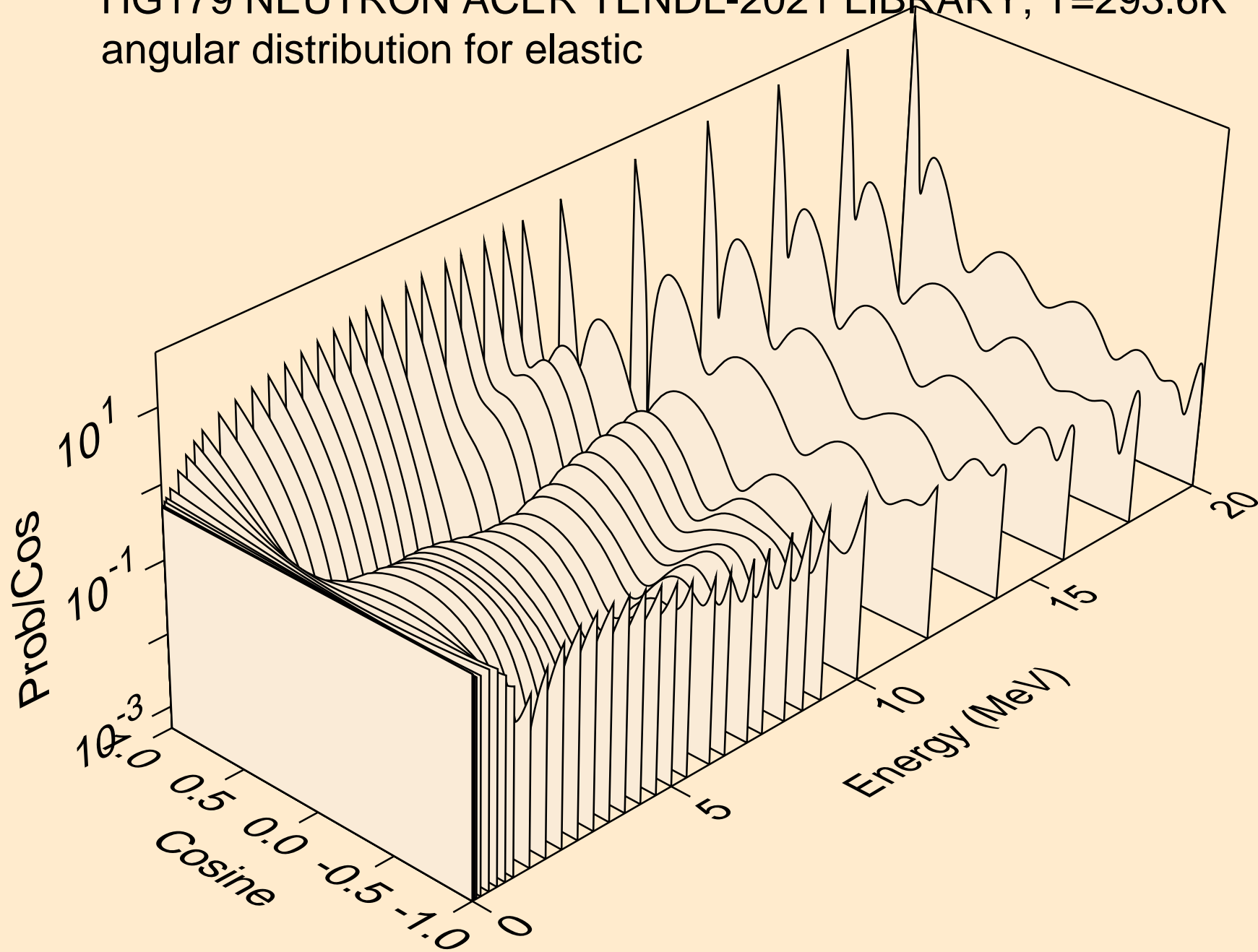

HG179 NEUTRON ACER TENDL-2021 LIBRARY; T=293.6K  
angular distribution for elastic

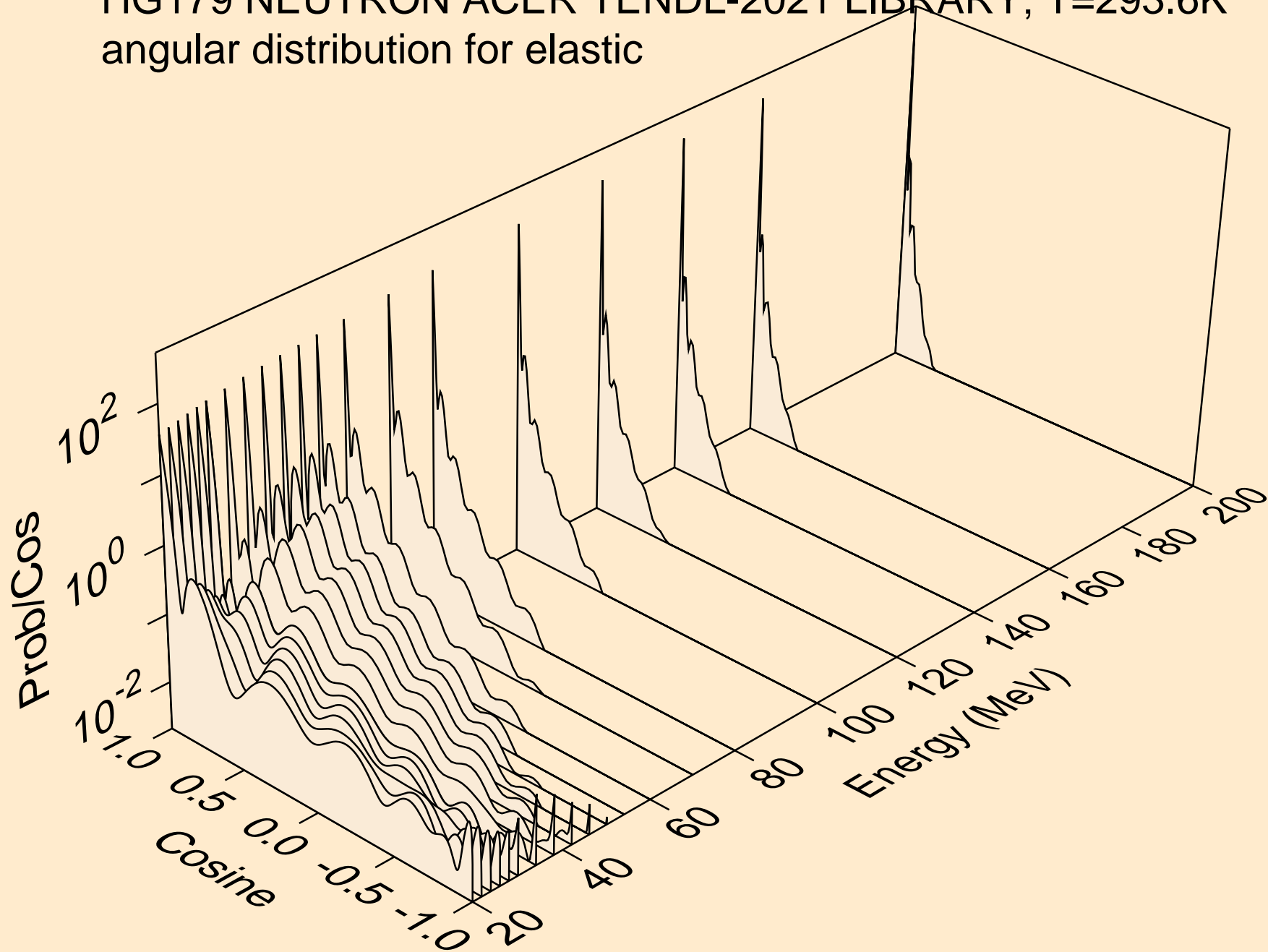



HG179 NEUTRON ACER TENDL-2021 LIBRARY; T=293.6K  
angular distribution for (n,n\*1)

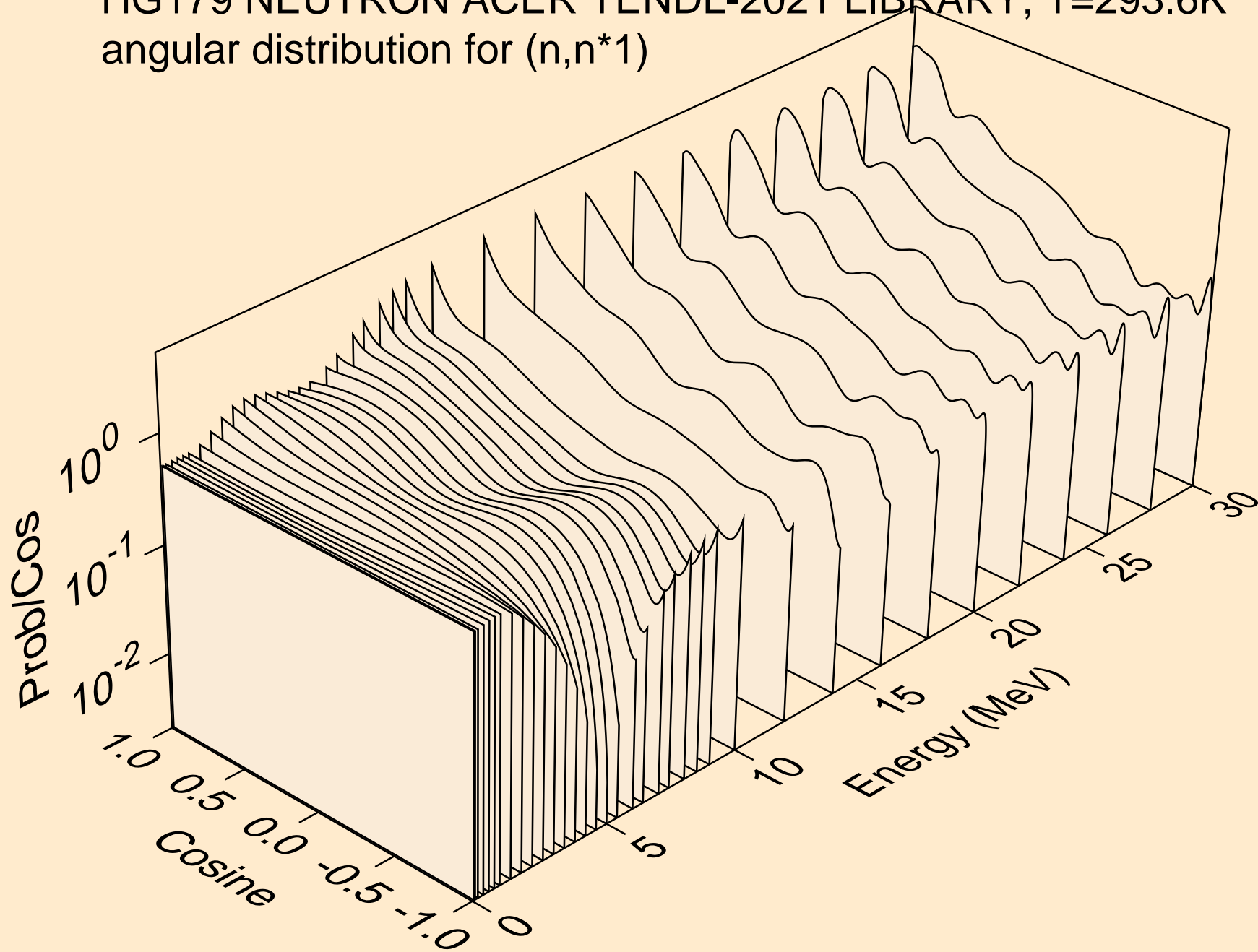

HG179 NEUTRON ACER TENDL-2021 LIBRARY; T=293.6K  
angular distribution for (n,n\*2)

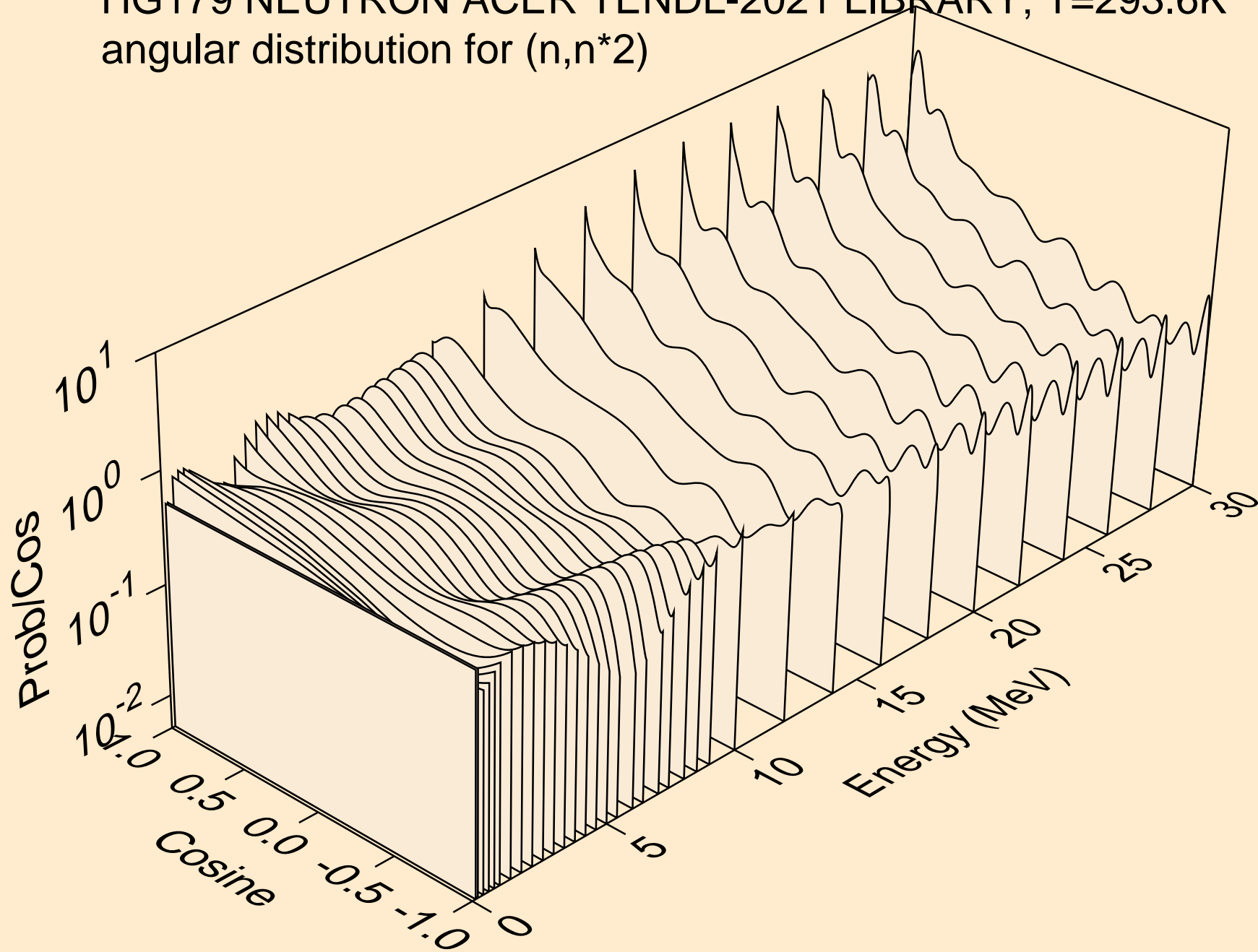

HG179 NEUTRON ACER TENDL-2021 LIBRARY; T=293.6K  
angular distribution for (n,n\*3)

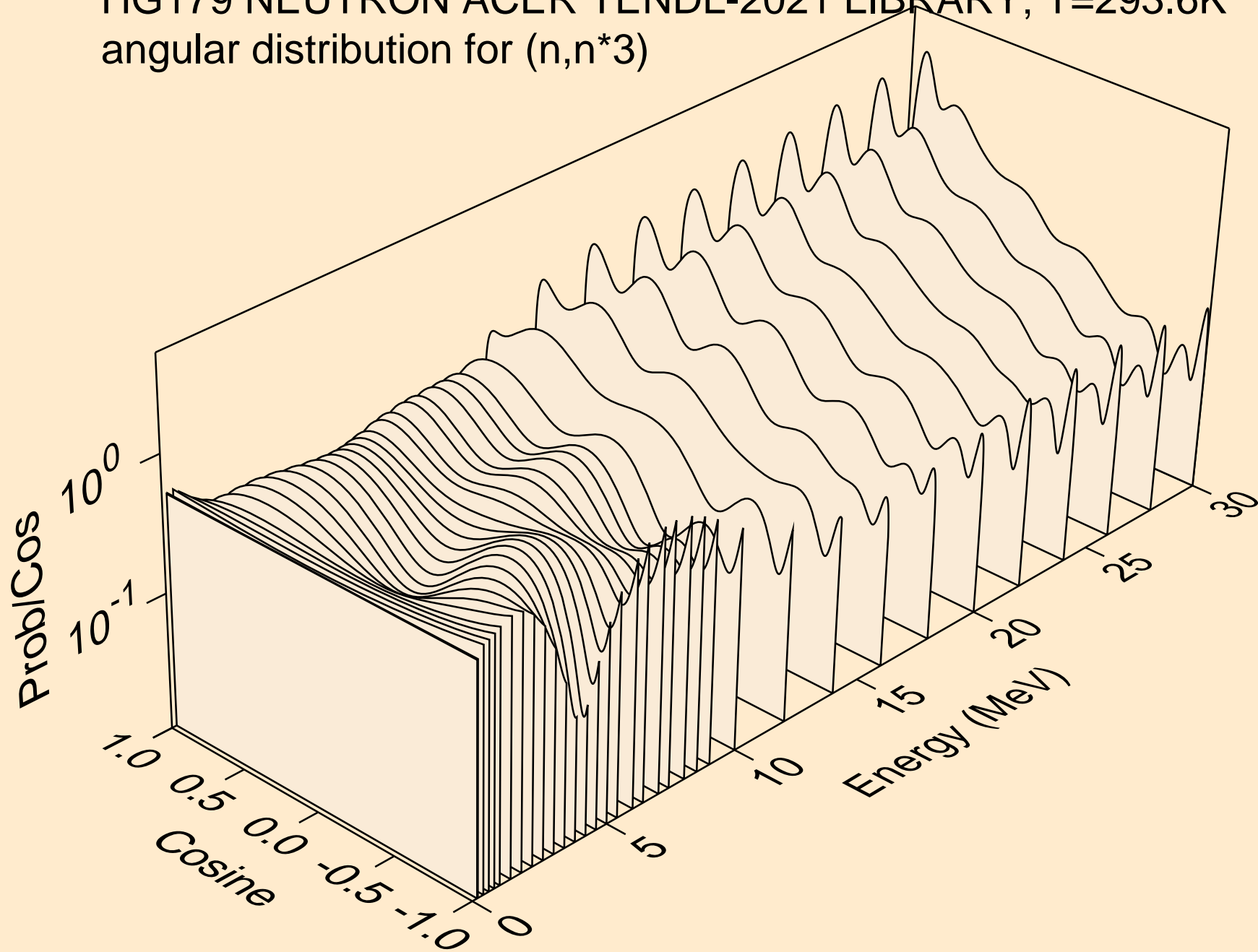

HG179 NEUTRON ACER TENDL-2021 LIBRARY; T=293.6K  
angular distribution for (n,n\*4)

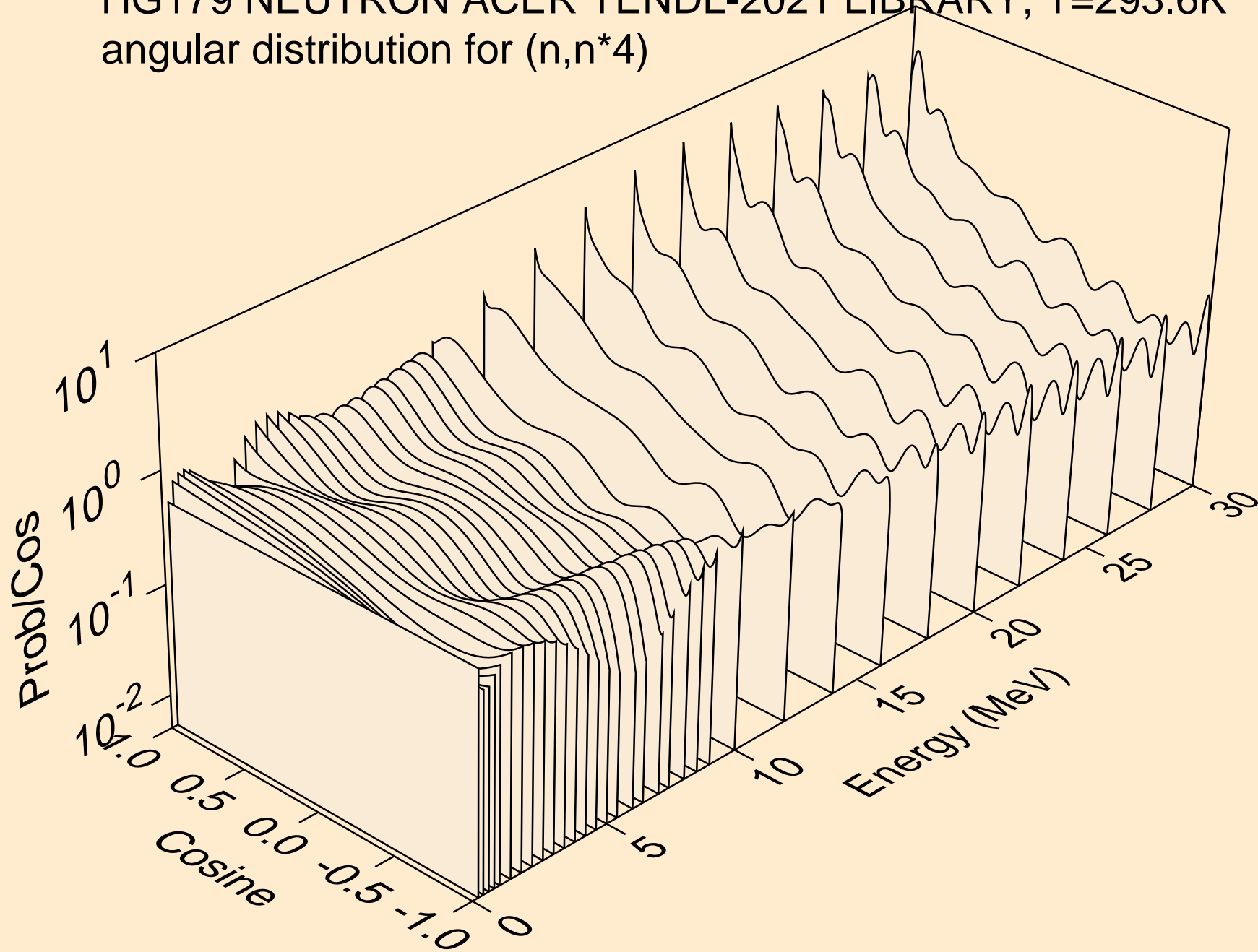

HG179 NEUTRON ACER TENDL-2021 LIBRARY; T=293.6K  
angular distribution for (n,n\*5)

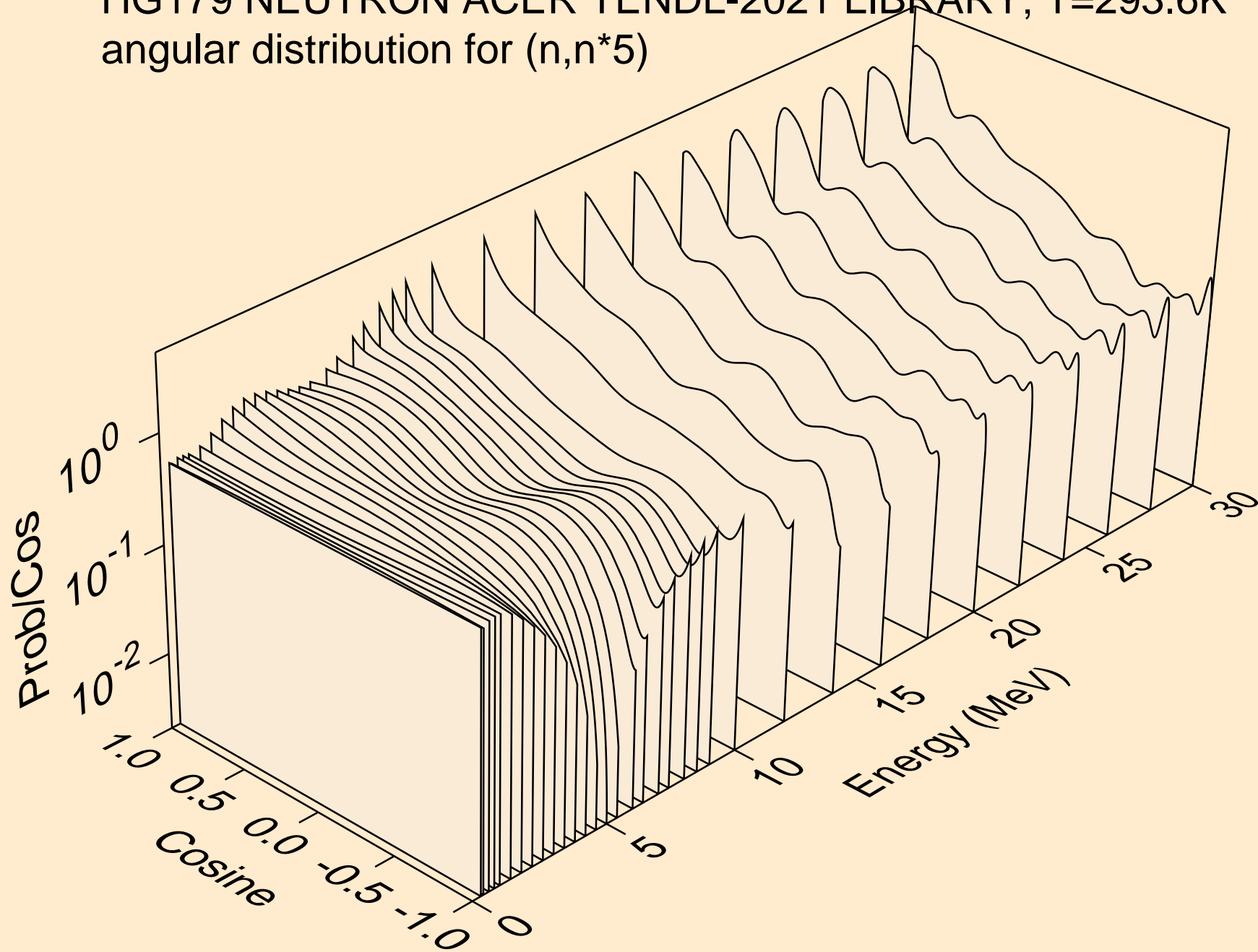

HG179 NEUTRON ACER TENDL-2021 LIBRARY; T=293.6K  
angular distribution for (n,n\*6)

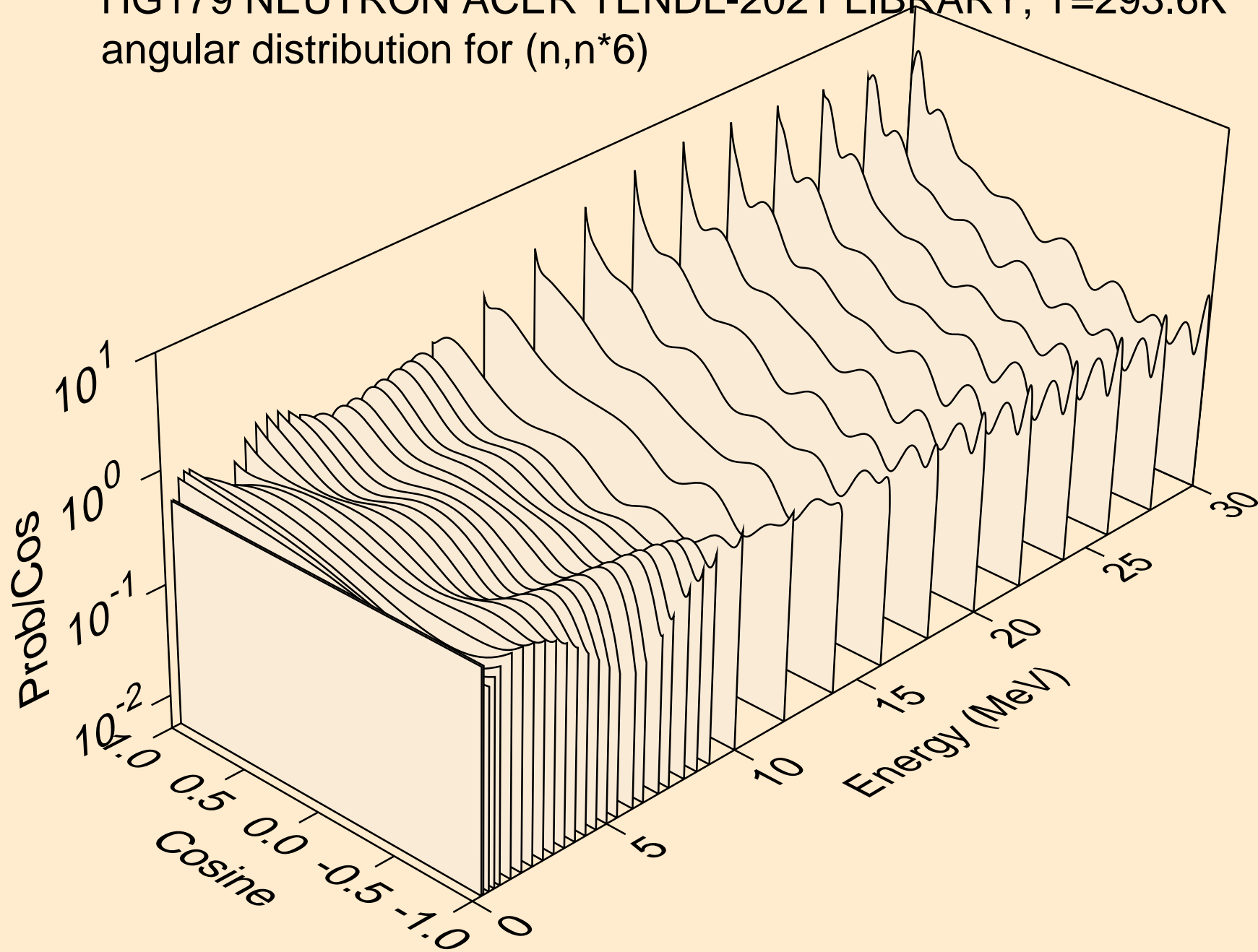

HG179 NEUTRON ACER TENDL-2021 LIBRARY; T=293.6K  
angular distribution for (n,n\*7)

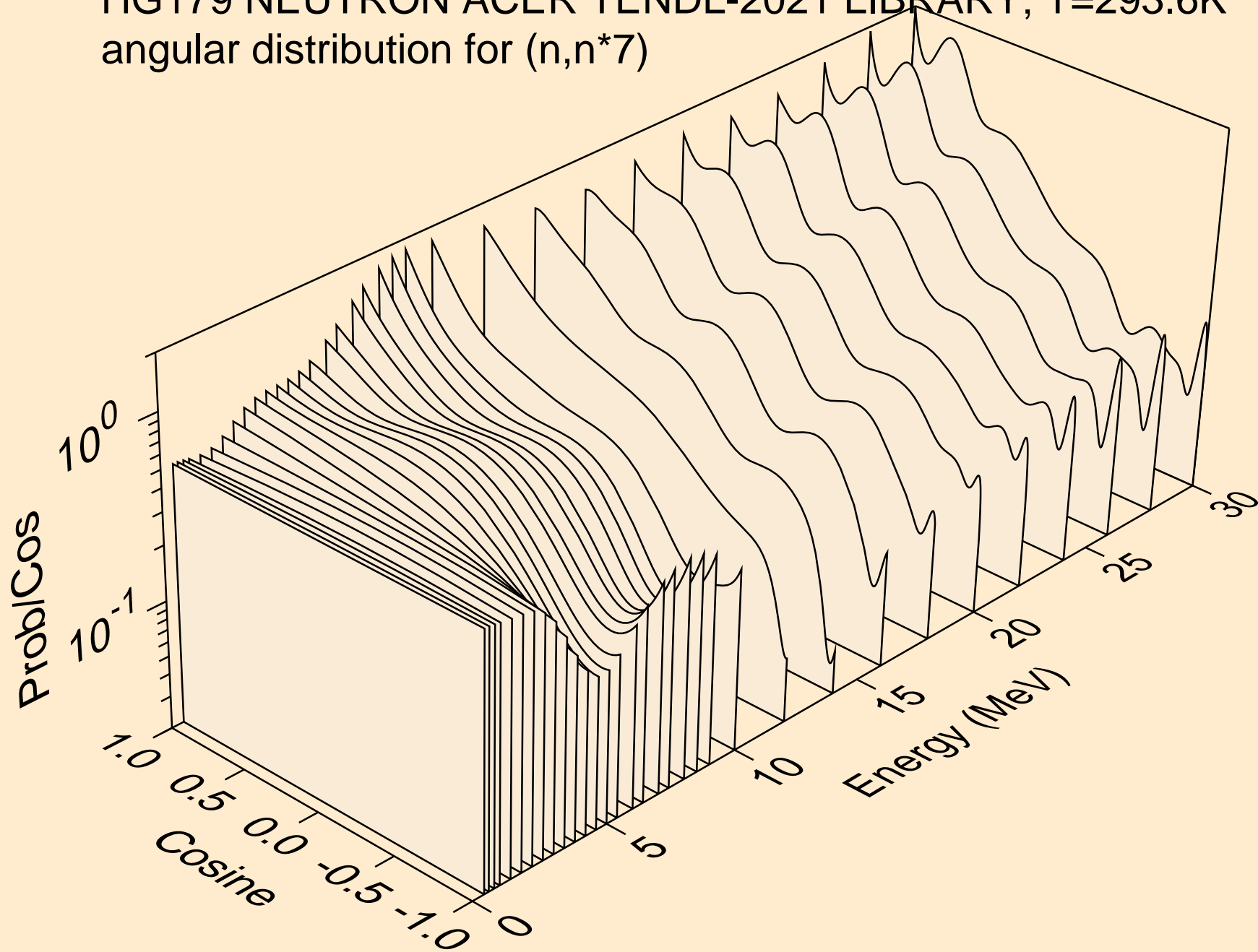

HG179 NEUTRON ACER TENDL-2021 LIBRARY; T=293.6K  
angular distribution for (n,n\*8)

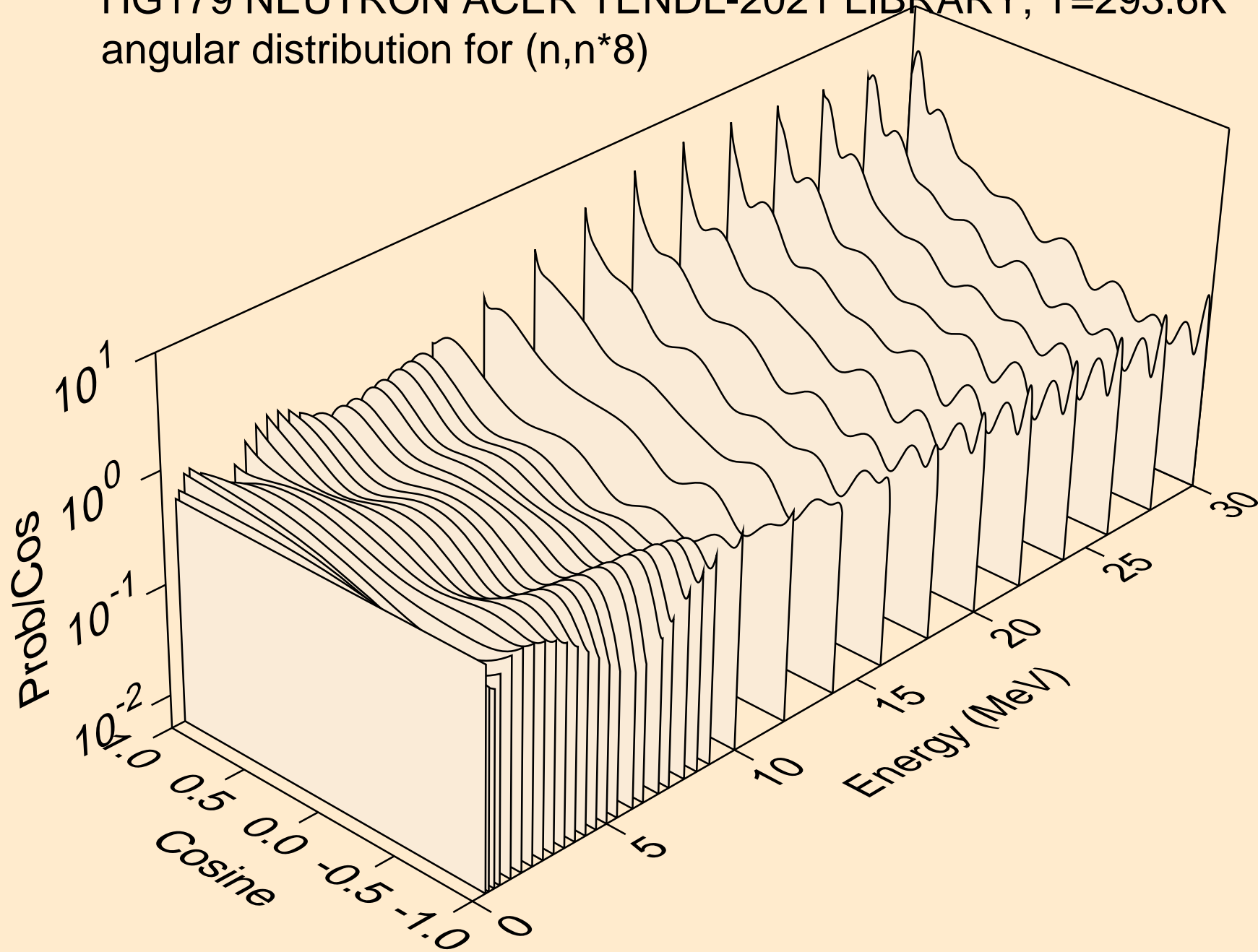



HG179 NEUTRON ACER TENDL-2021 LIBRARY; T=293.6K  
Neutron emission for (n,x)

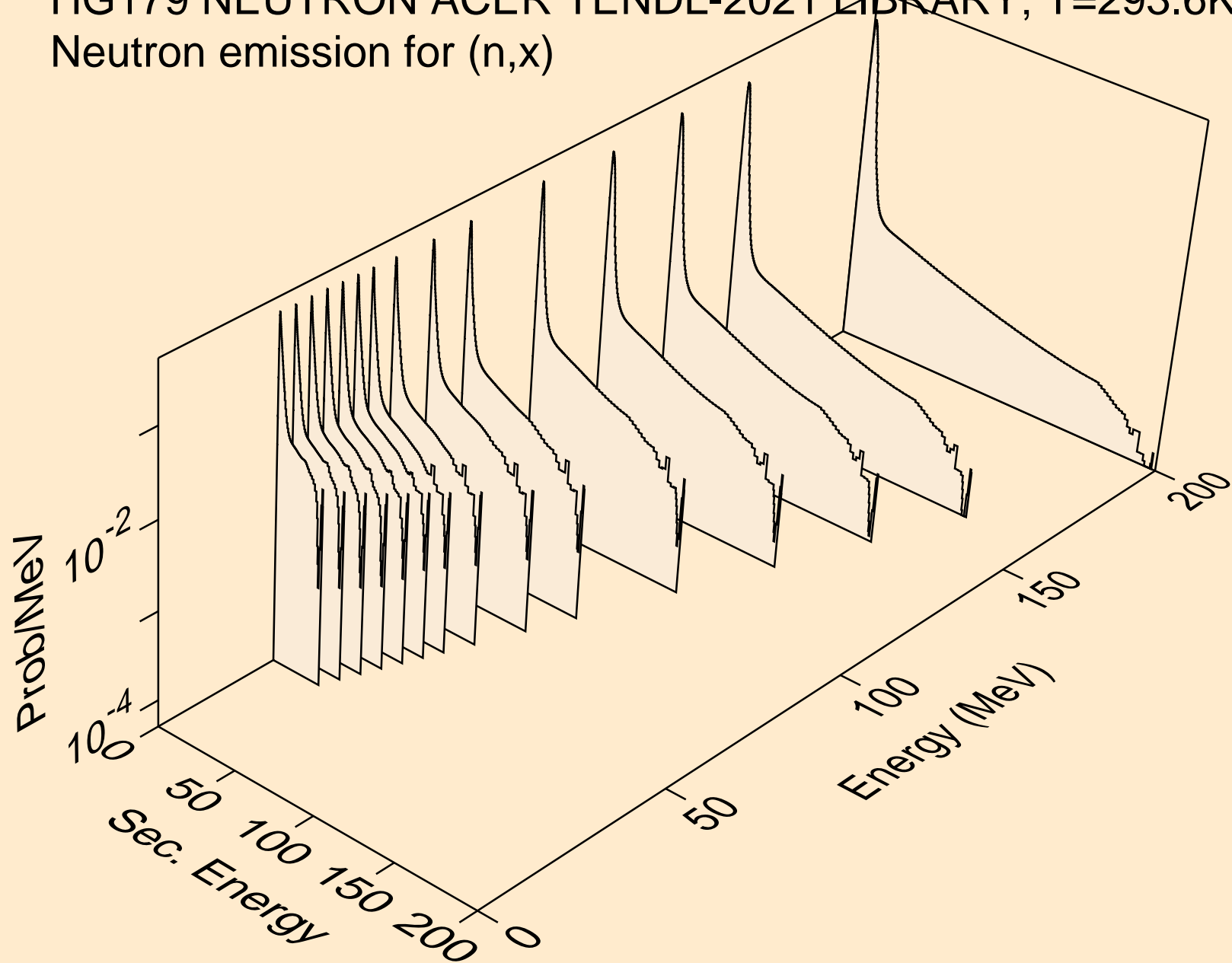

HG179 NEUTRON ACER TENDL-2021 LIBRARY; T=293.6K  
Neutron emission for (n,2nd)

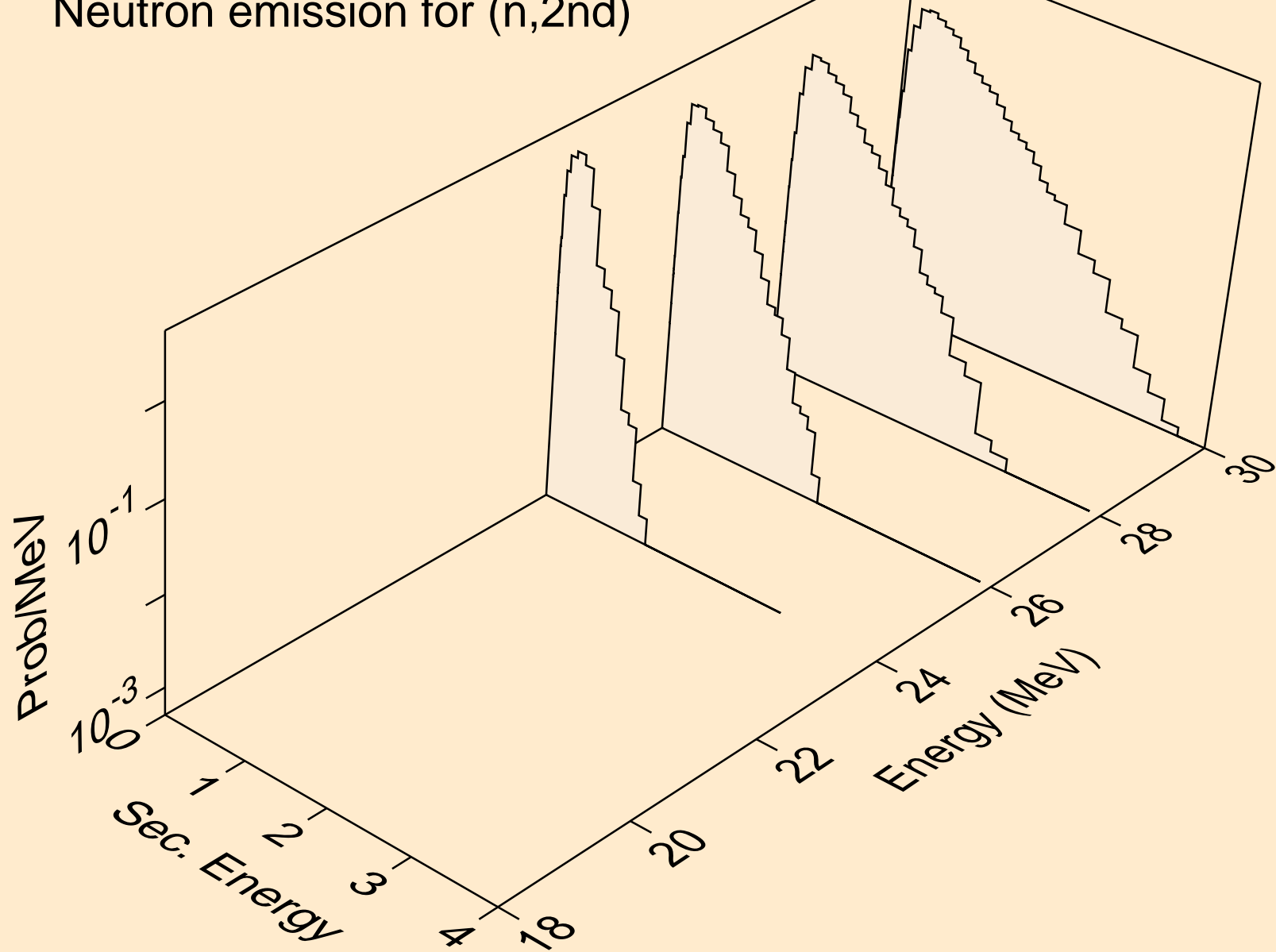

HG179 NEUTRON ACER TENDL-2021 LIBRARY; T=293.6K  
Neutron emission for (n,2n)

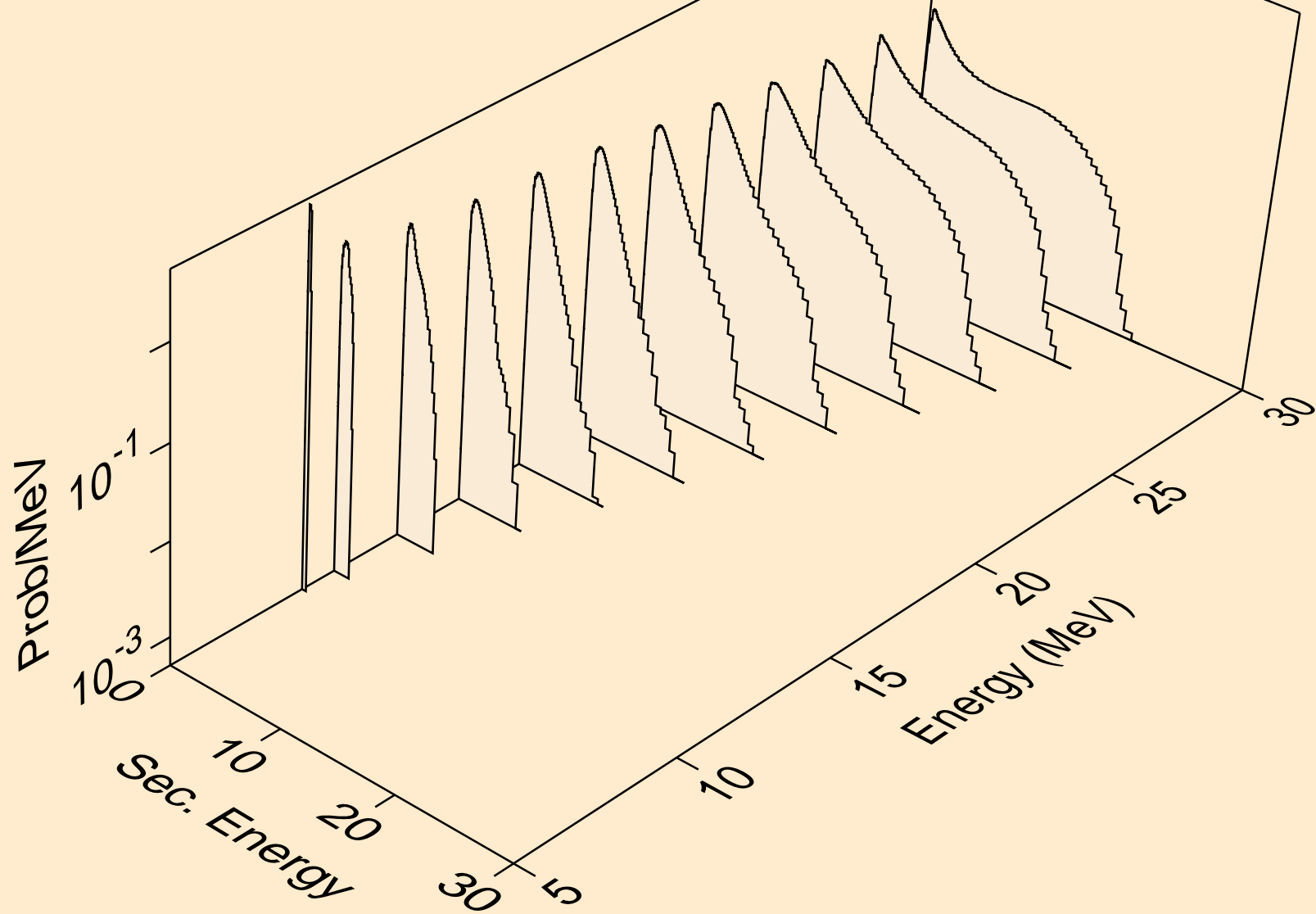

HG179 NEUTRON ACER TENDL-2021 LIBRARY; T=293.6K  
Neutron emission for (n,3n)

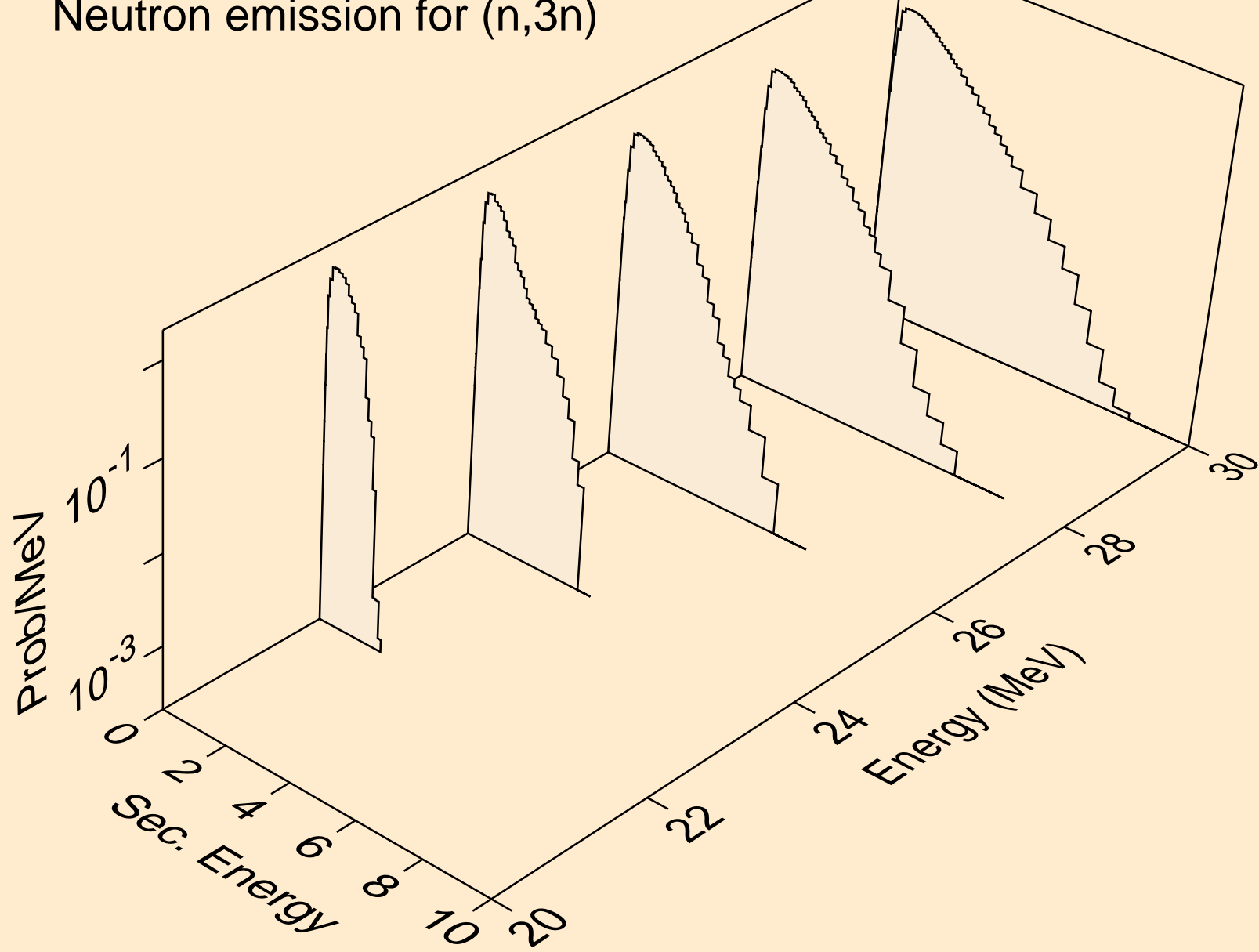

HG179 NEUTRON ACER TENDL-2021 LIBRARY; T=293.6K  
Neutron emission for (n,n\*)a

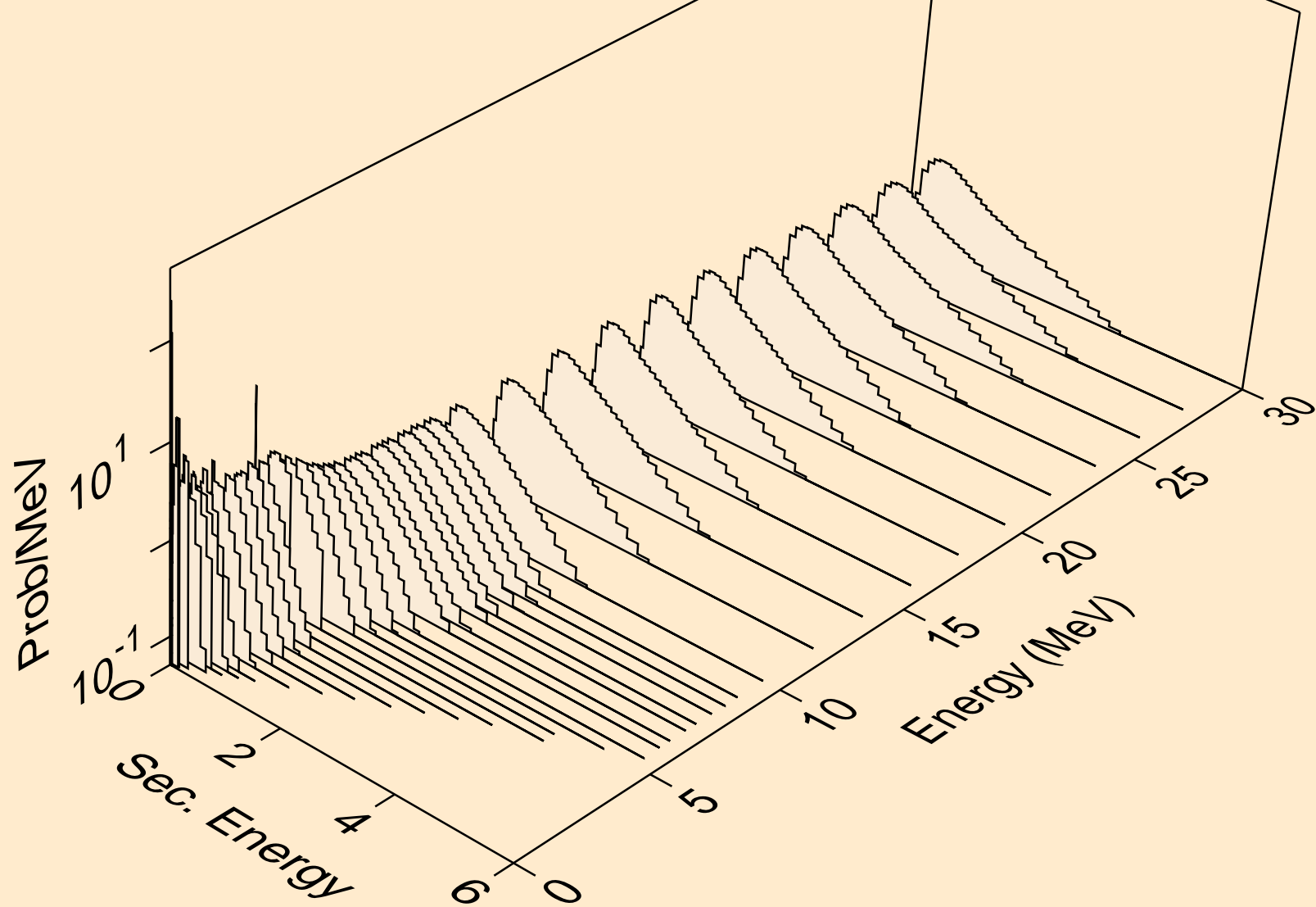

HG179 NEUTRON ACER TENDL-2021 LIBRARY; T=293.6K  
Neutron emission for (n,n\*)3a

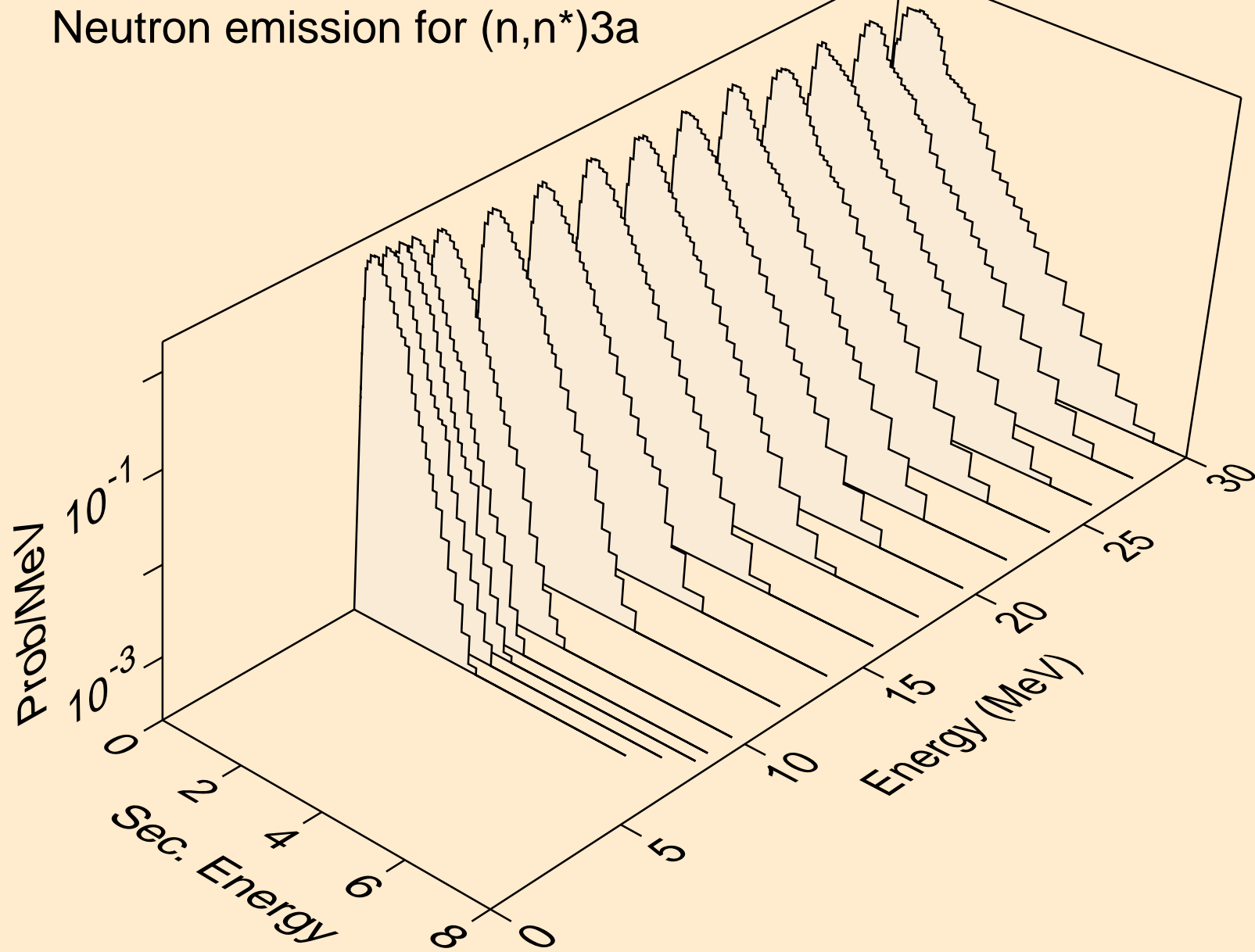

HG179 NEUTRON ACER TENDL-2021 LIBRARY; T=293.6K  
Neutron emission for (n,2n)a

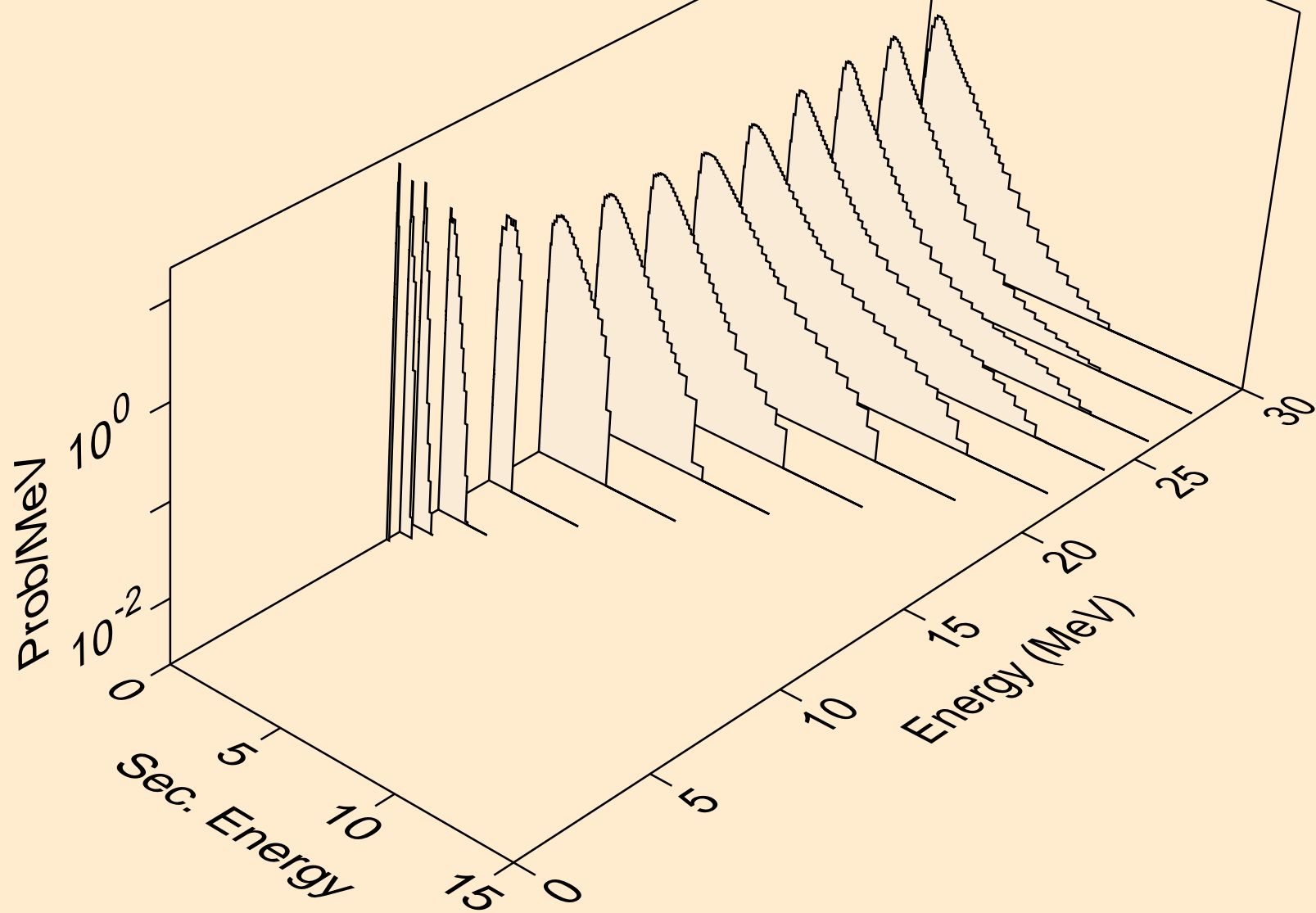

HG179 NEUTRON ACER TENDL-2021 LIBRARY; T=293.6K  
Neutron emission for (n,3n)a

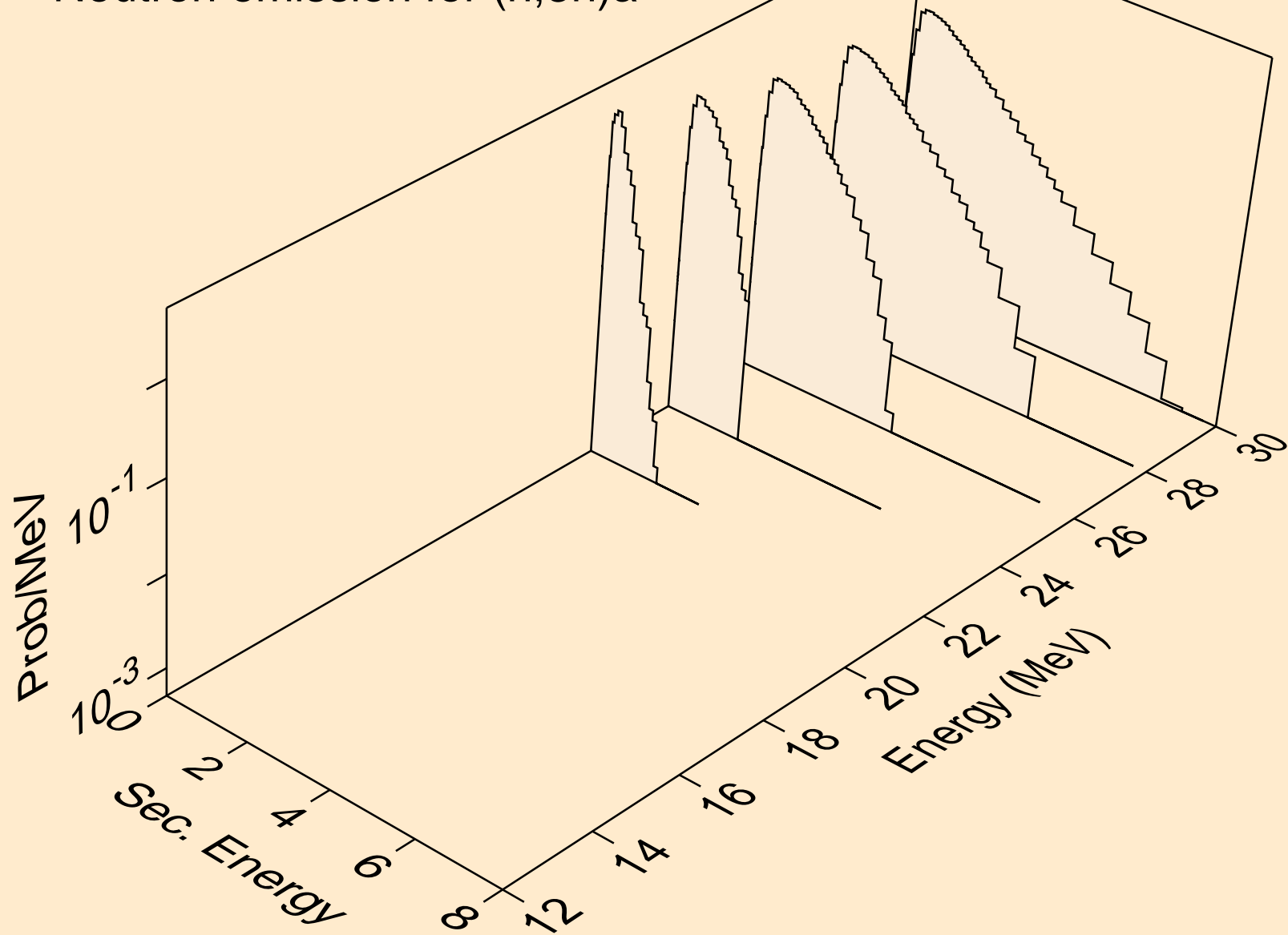



HG179 NEUTRON ACER TENDL-2021 LIBRARY; T=293.6K  
Neutron emission for (n,n\*)p

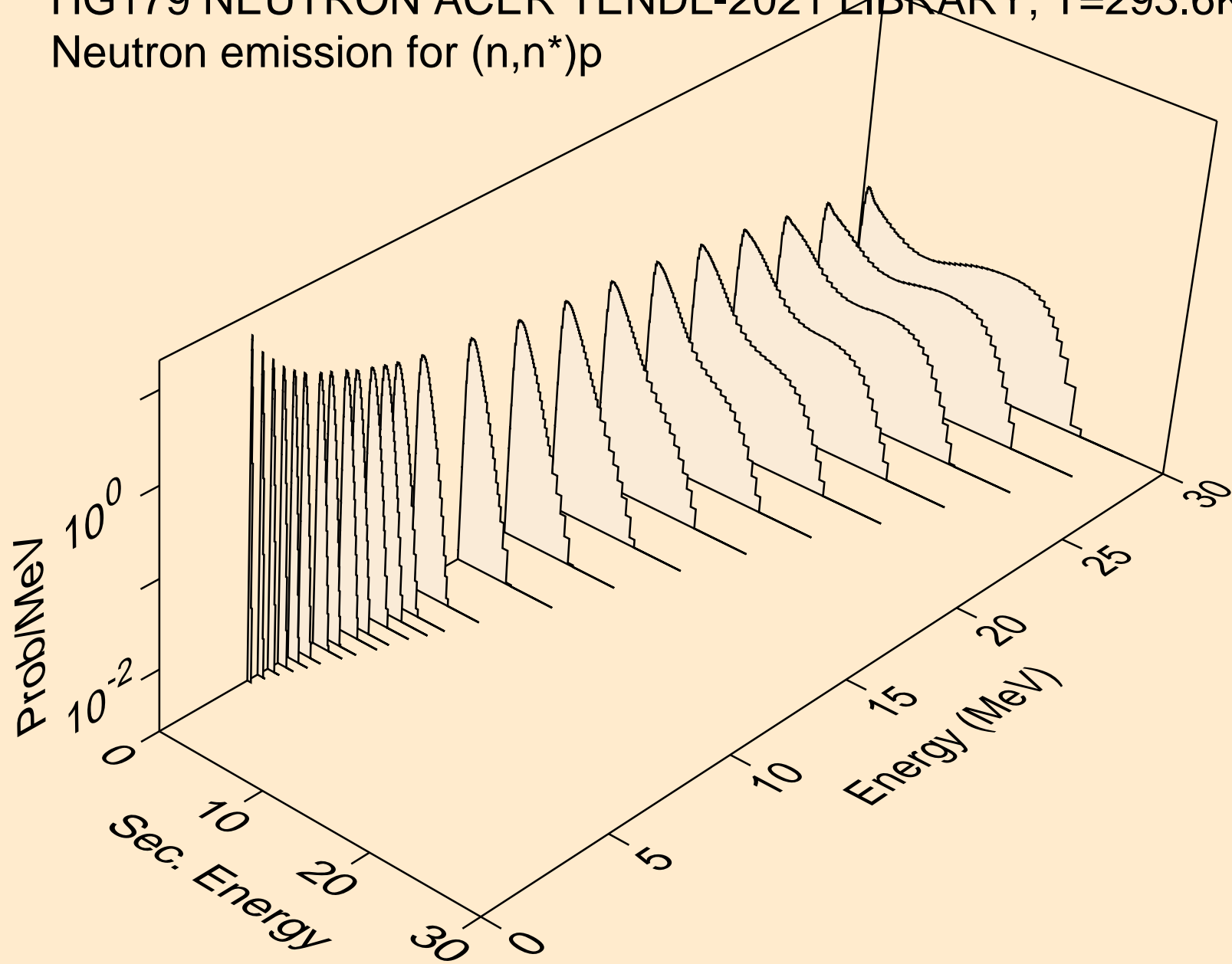

HG179 NEUTRON ACER TENDL-2021 LIBRARY; T=293.6K  
Neutron emission for (n,n\*)2a

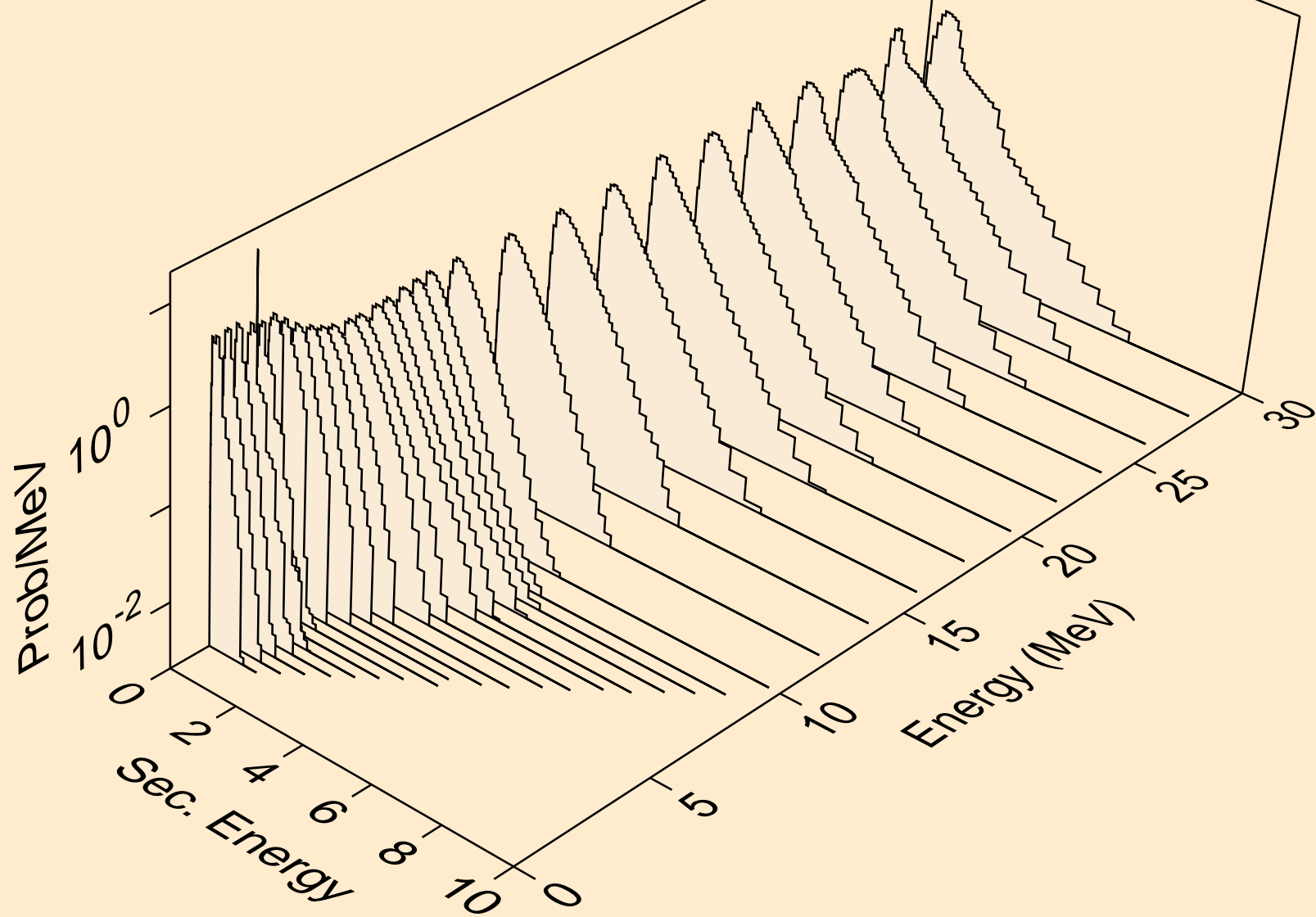

HG179 NEUTRON ACER TENDL-2021 LIBRARY; T=293.6K  
Neutron emission for (n,2n)2a

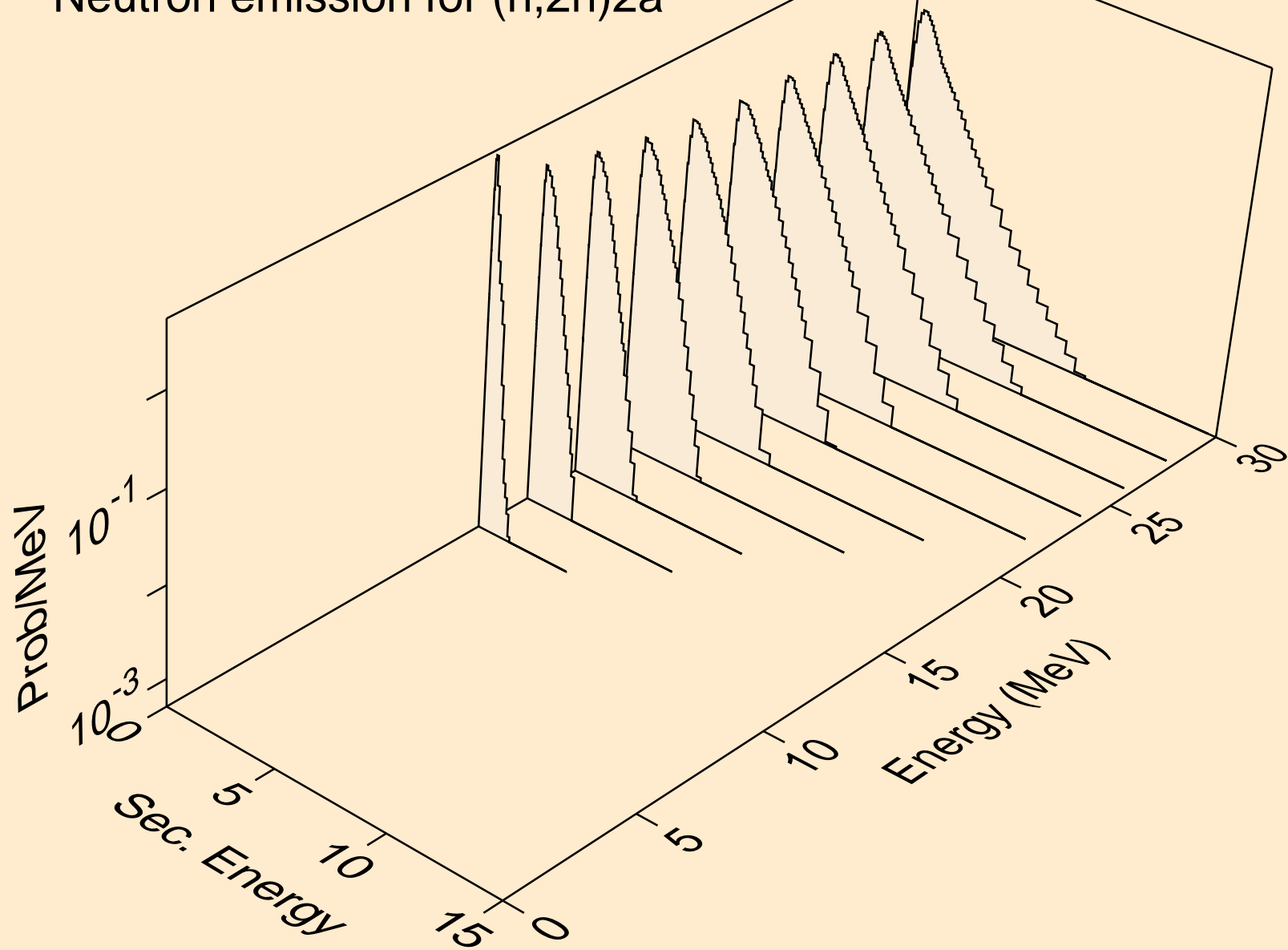

HG179 NEUTRON ACER TENDL-2021 LIBRARY; T=293.6K  
Neutron emission for (n,n\*)d

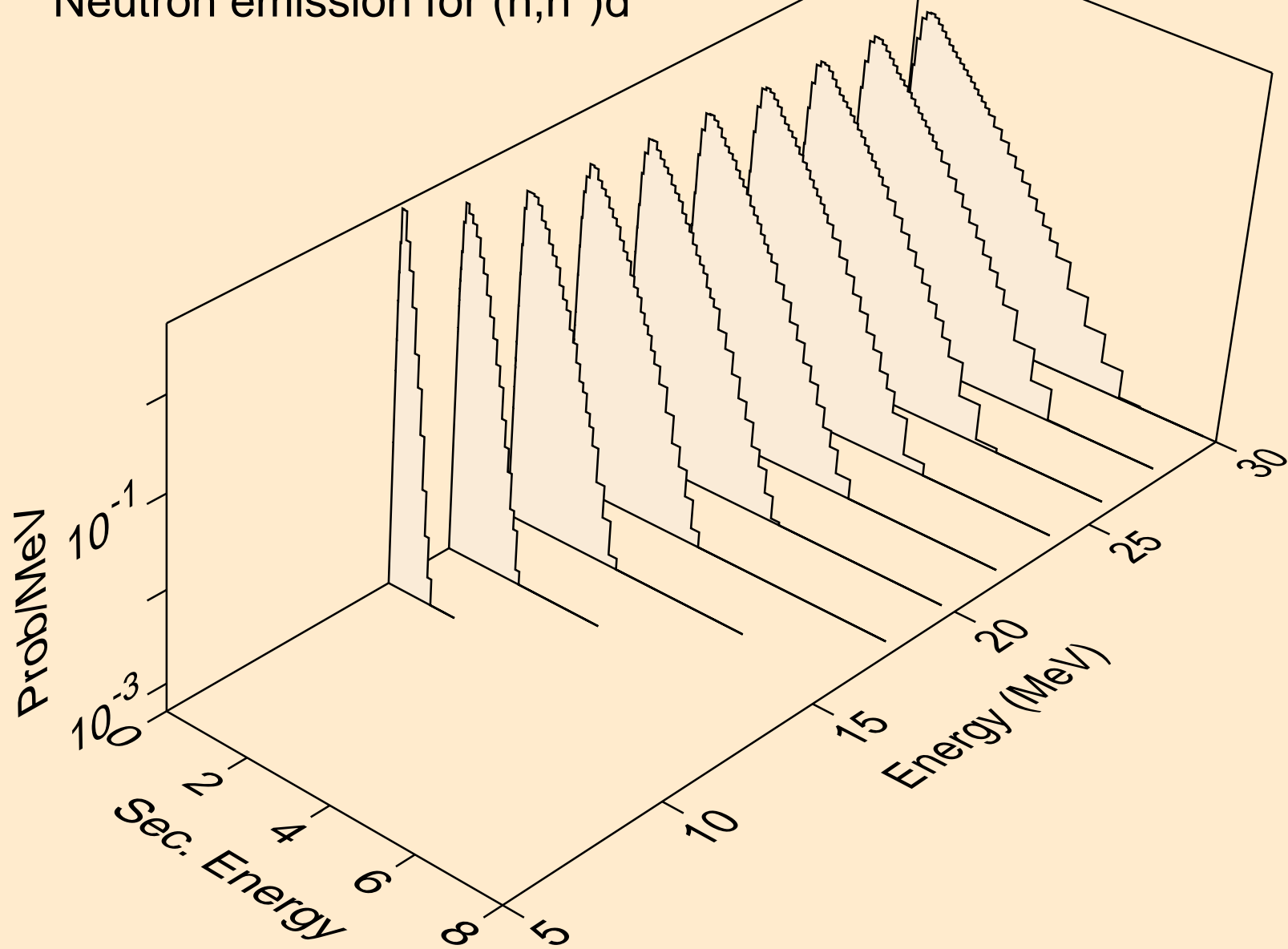

HG179 NEUTRON ACER TENDL-2021 LIBRARY; T=293.6K  
Neutron emission for (n,n\*)t

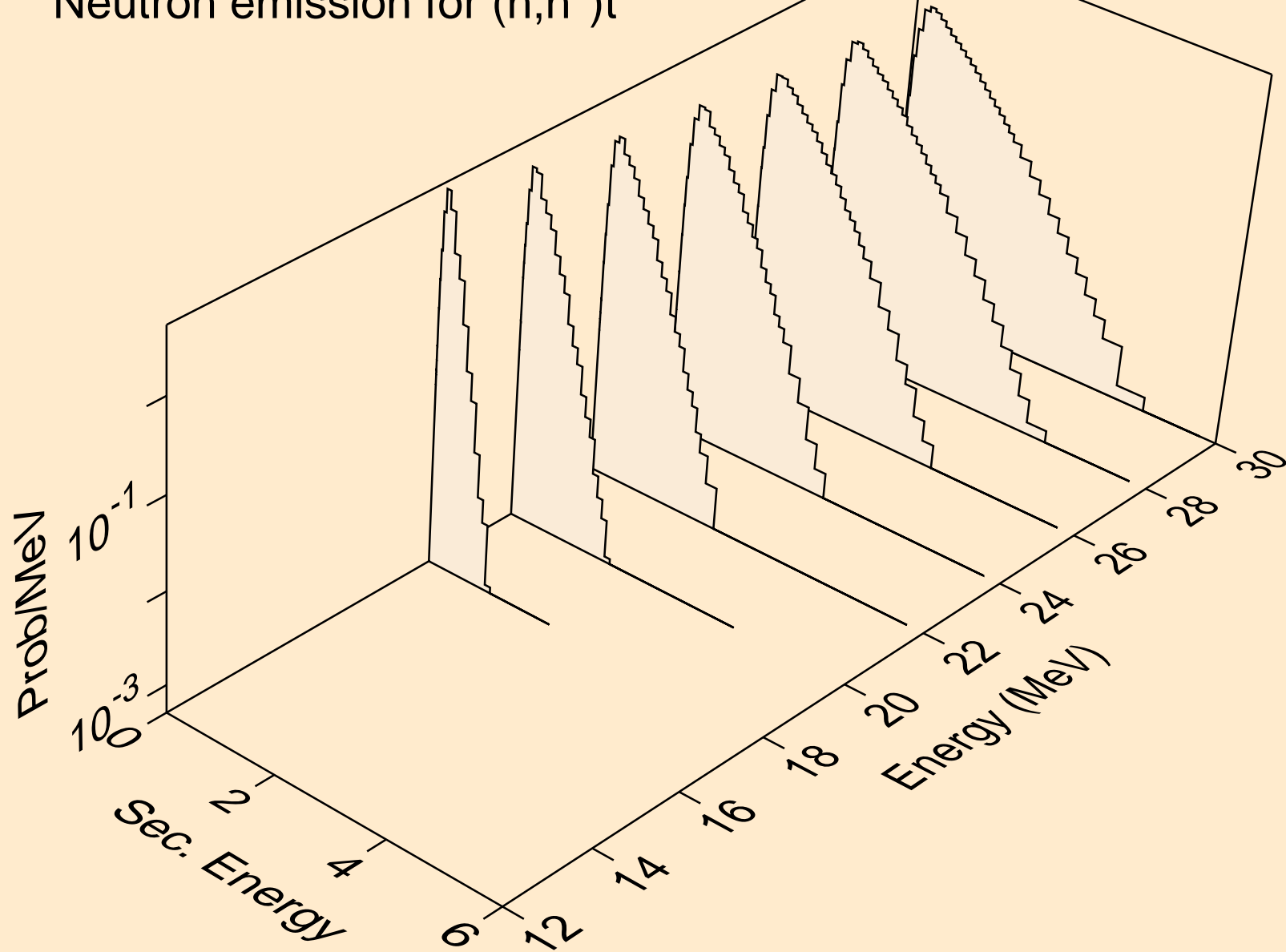

HG179 NEUTRON ACER TENDL-2021 LIBRARY; T=293.6K  
Neutron emission for (n,n\*)he3

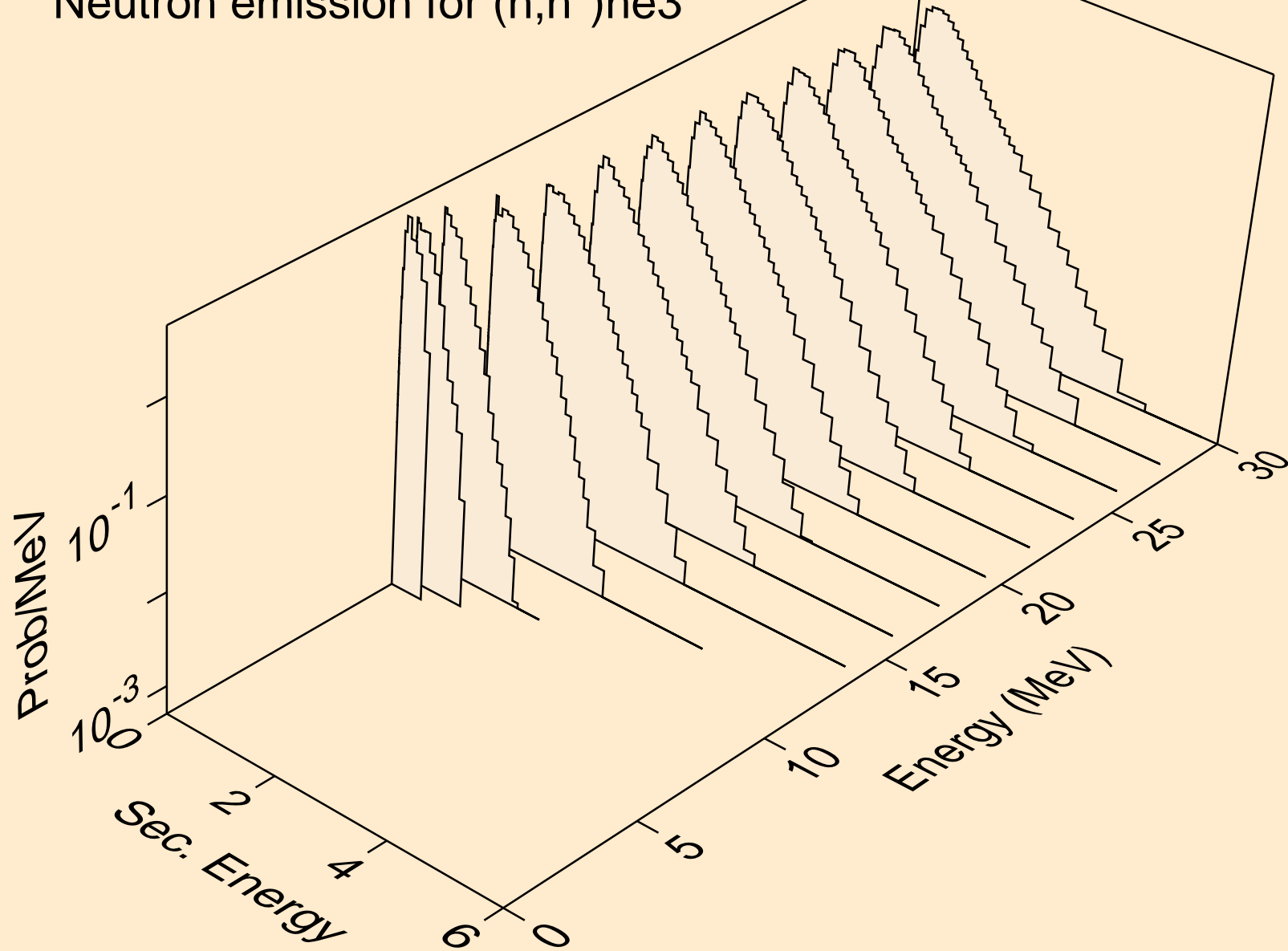

HG179 NEUTRON ACER TENDL-2021 LIBRARY; T=293.6K  
Neutron emission for (n,2np)

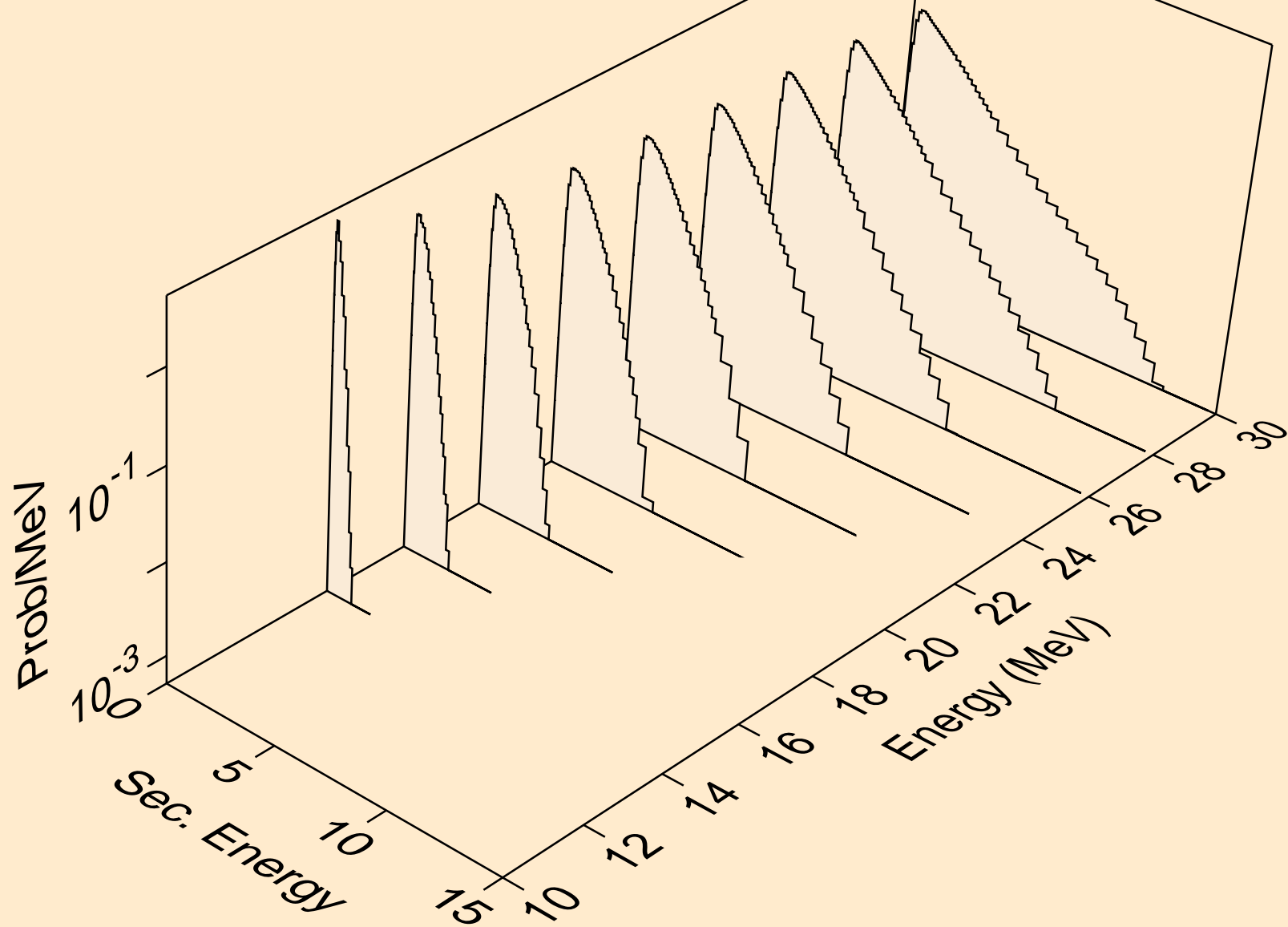

HG179 NEUTRON ACER TENDL-2021 LIBRARY; T=293.6K  
Neutron emission for (n,3np)

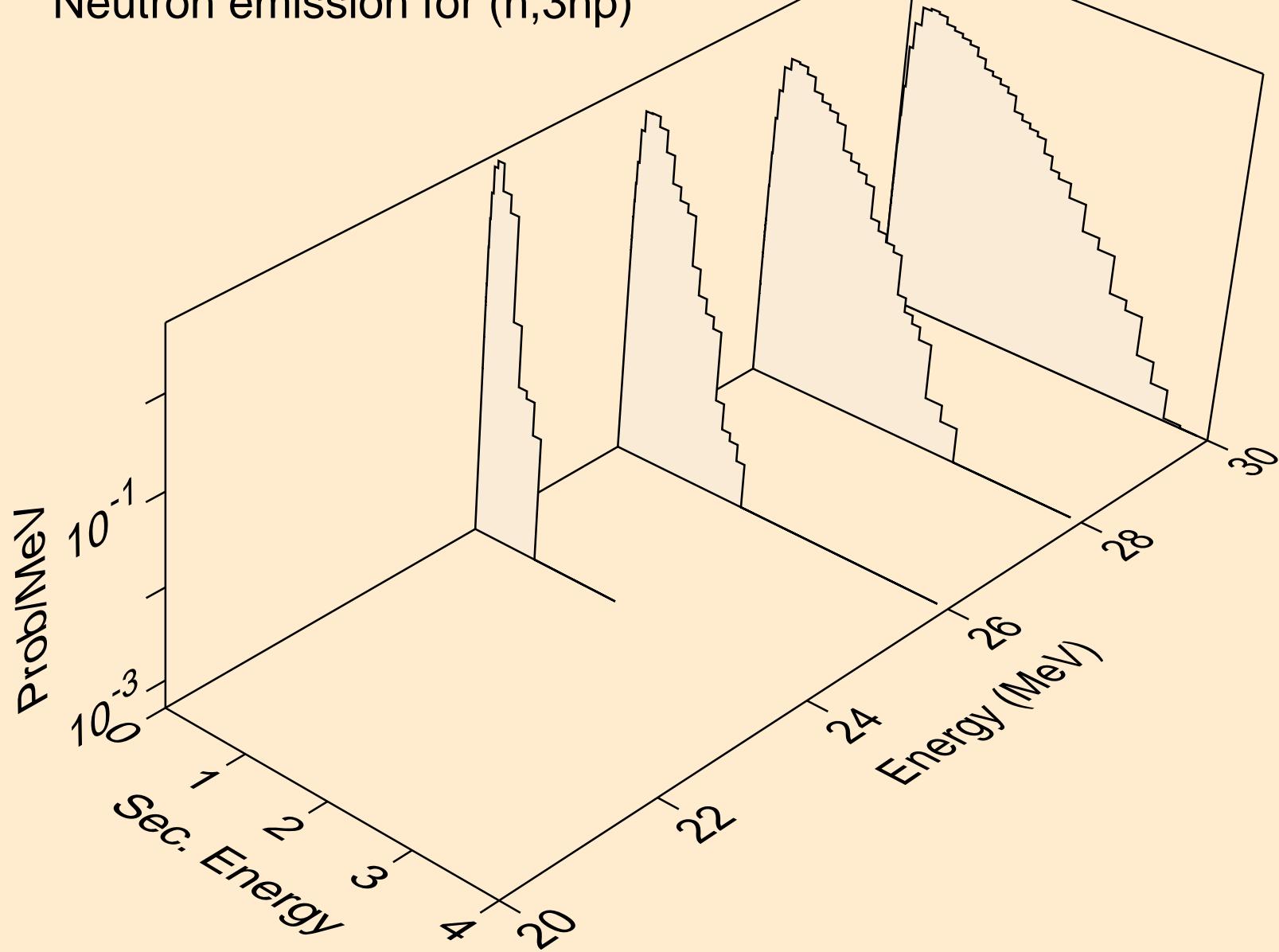



HG179 NEUTRON ACER TENDL-2021 LIBRARY; T=293.6K  
Neutron emission for (n,2np)

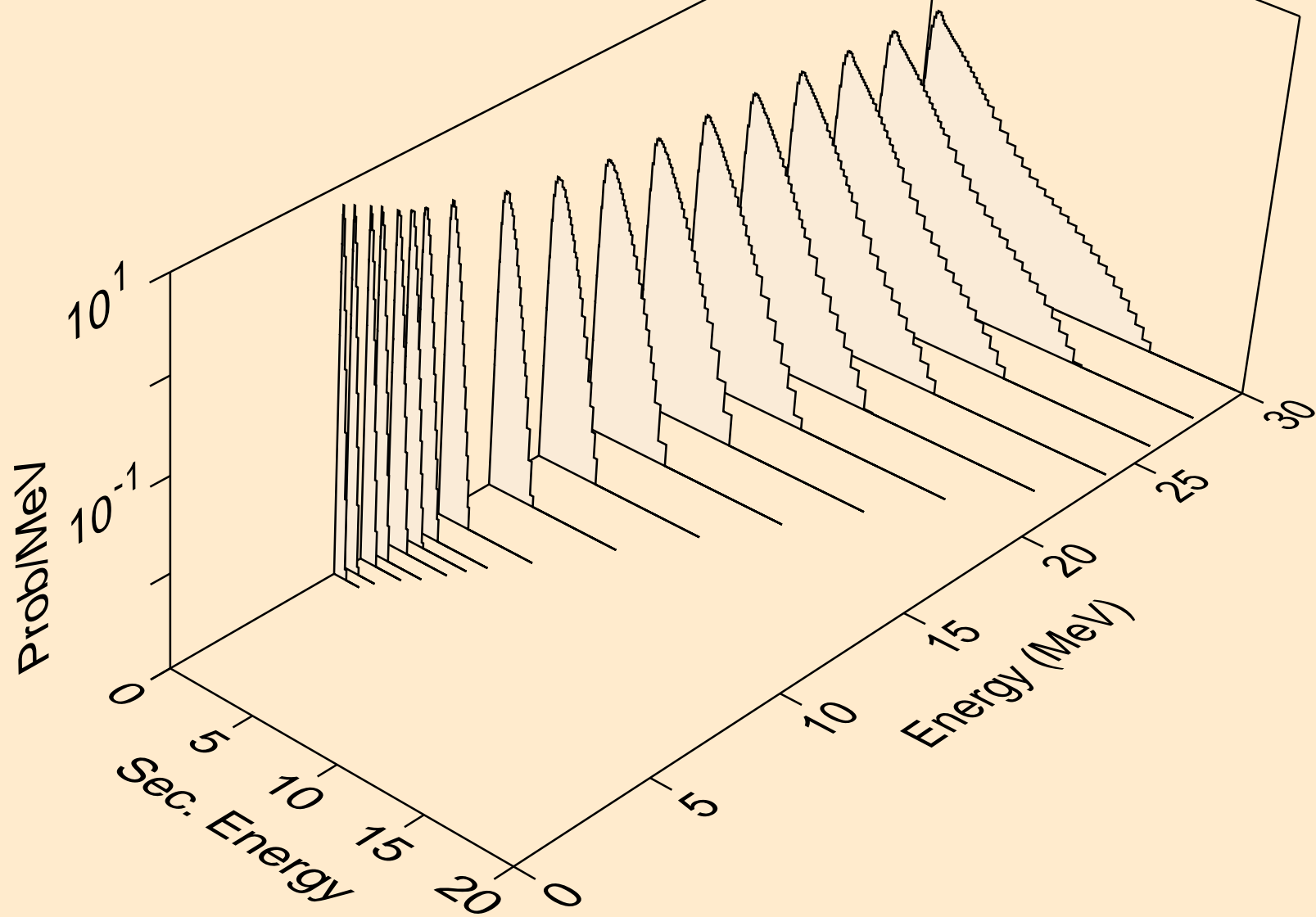

HG179 NEUTRON ACER TENDL-2021 LIBRARY; T=293.6K  
Neutron emission for (n,npa)

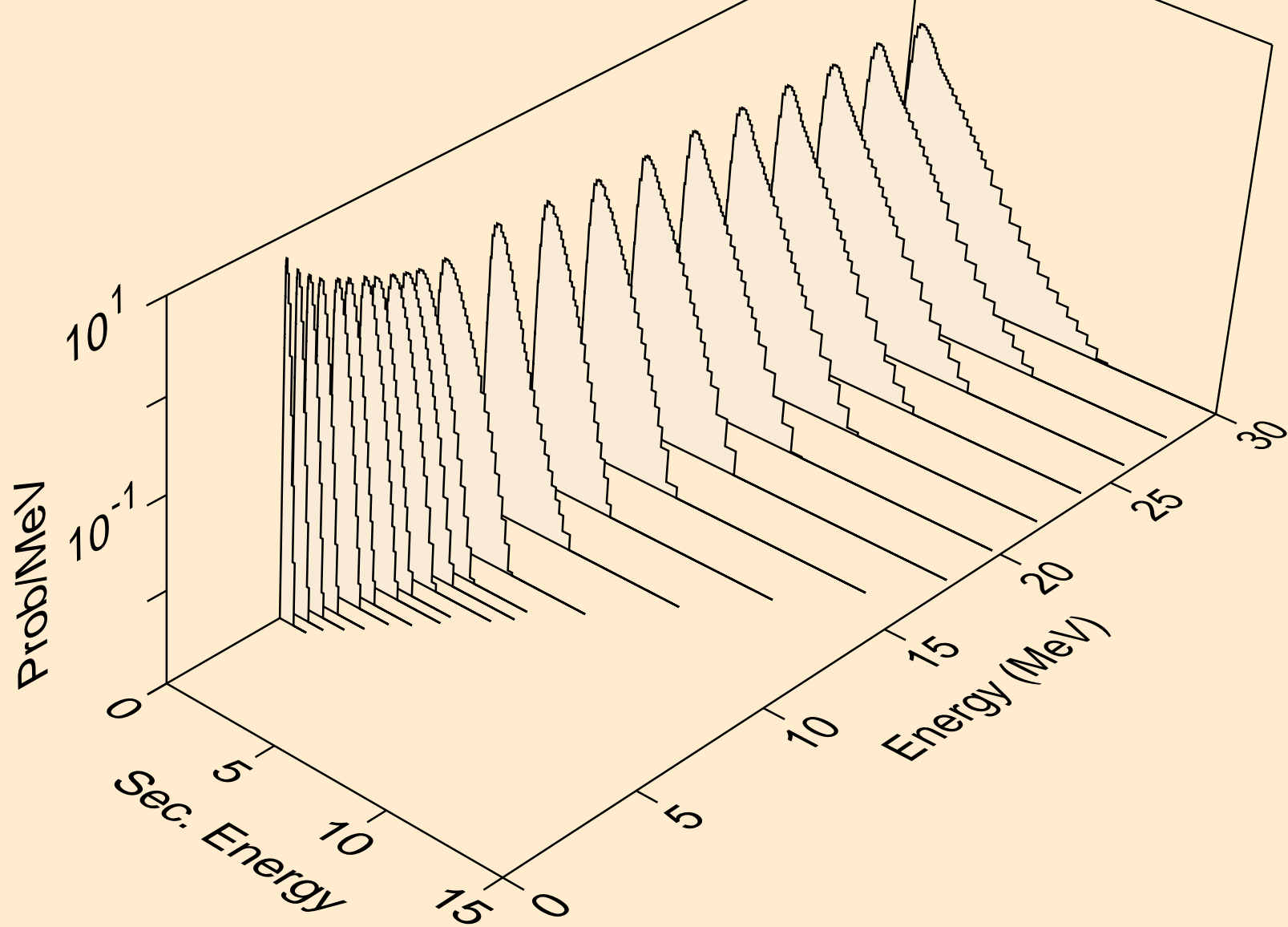

HG179 NEUTRON ACER TENDL-2021 LIBRARY; T=293.6K  
Neutron emission for (n,n\*c)

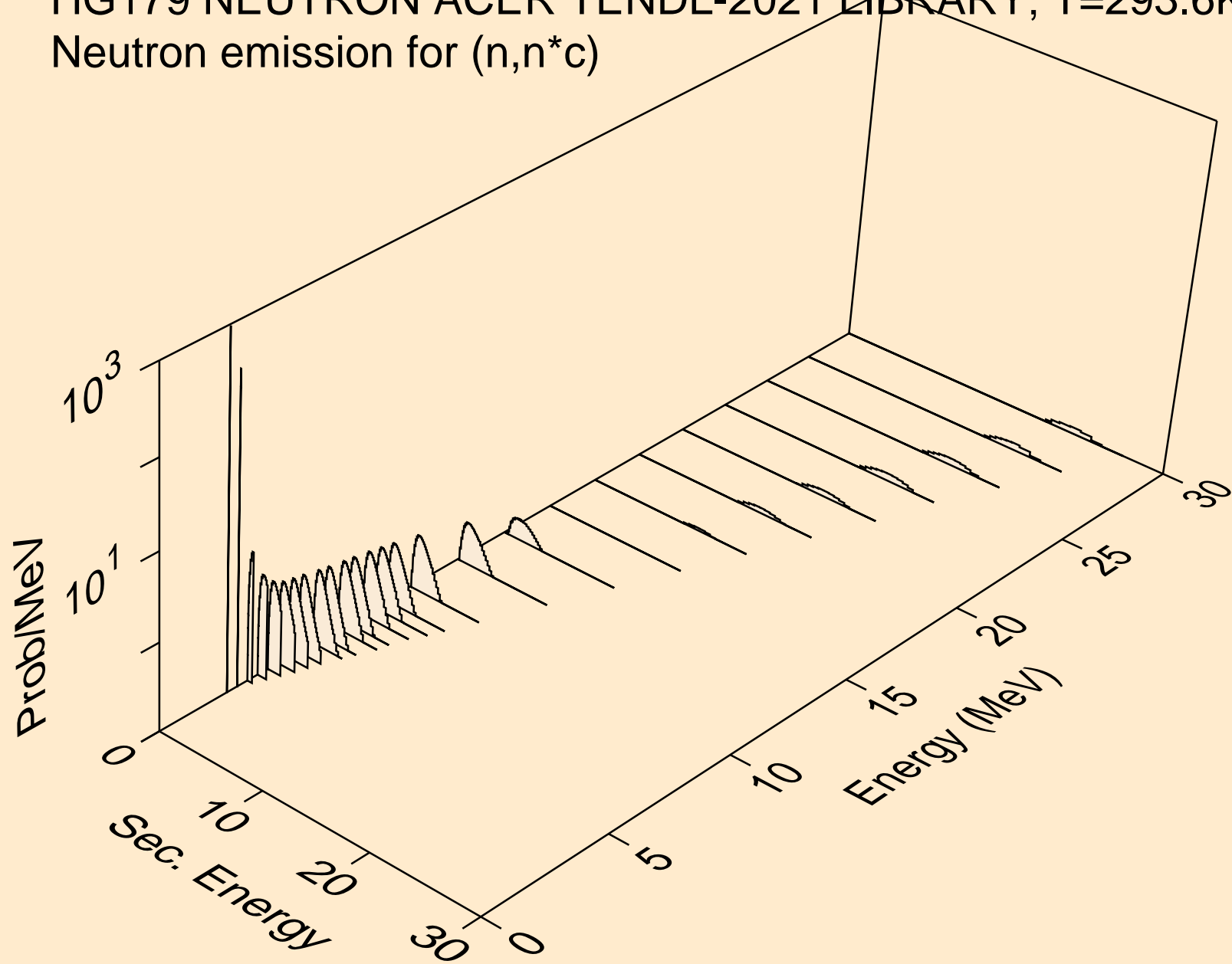

HG179 NEUTRON ACER TENDL-2021 LIBRARY; T=293.6K  
Photon emission for (n,x)

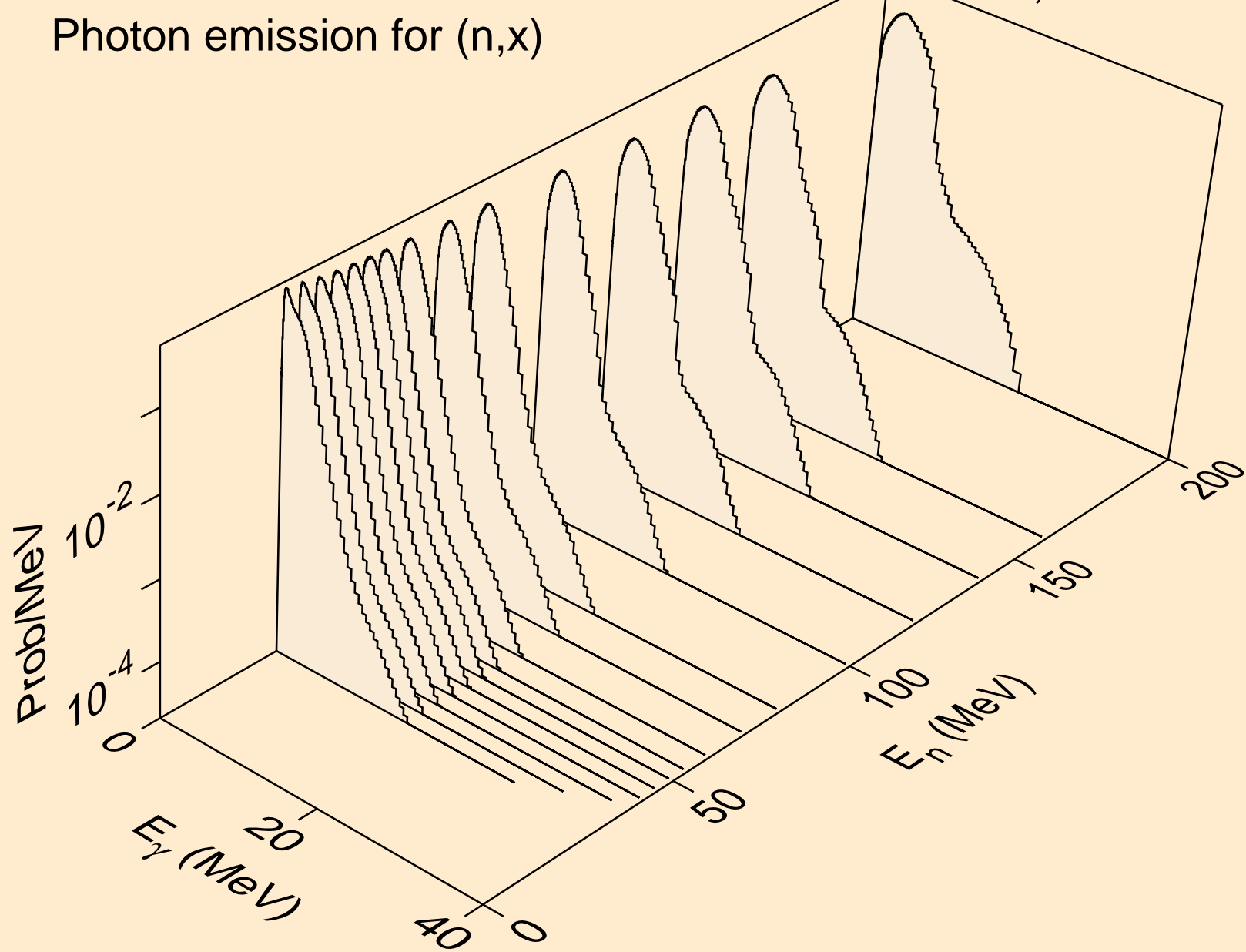

HG179 NEUTRON ACER TENDL-2021 LIBRARY; T=293.6K  
Photon emission for (n,2nd)

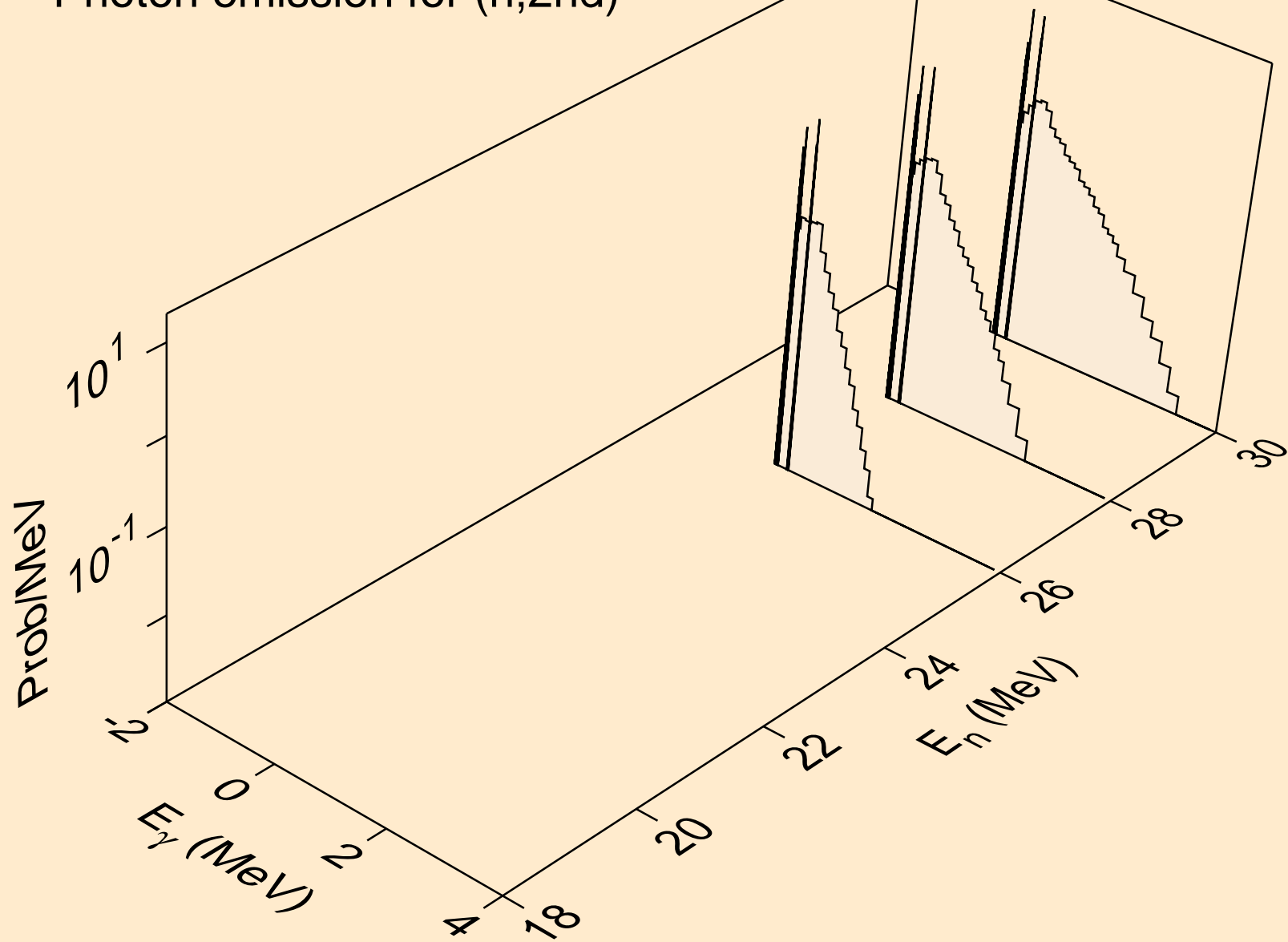

HG179 NEUTRON ACER TENDL-2021 LIBRARY; T=293.6K  
Photon emission for (n,2n)

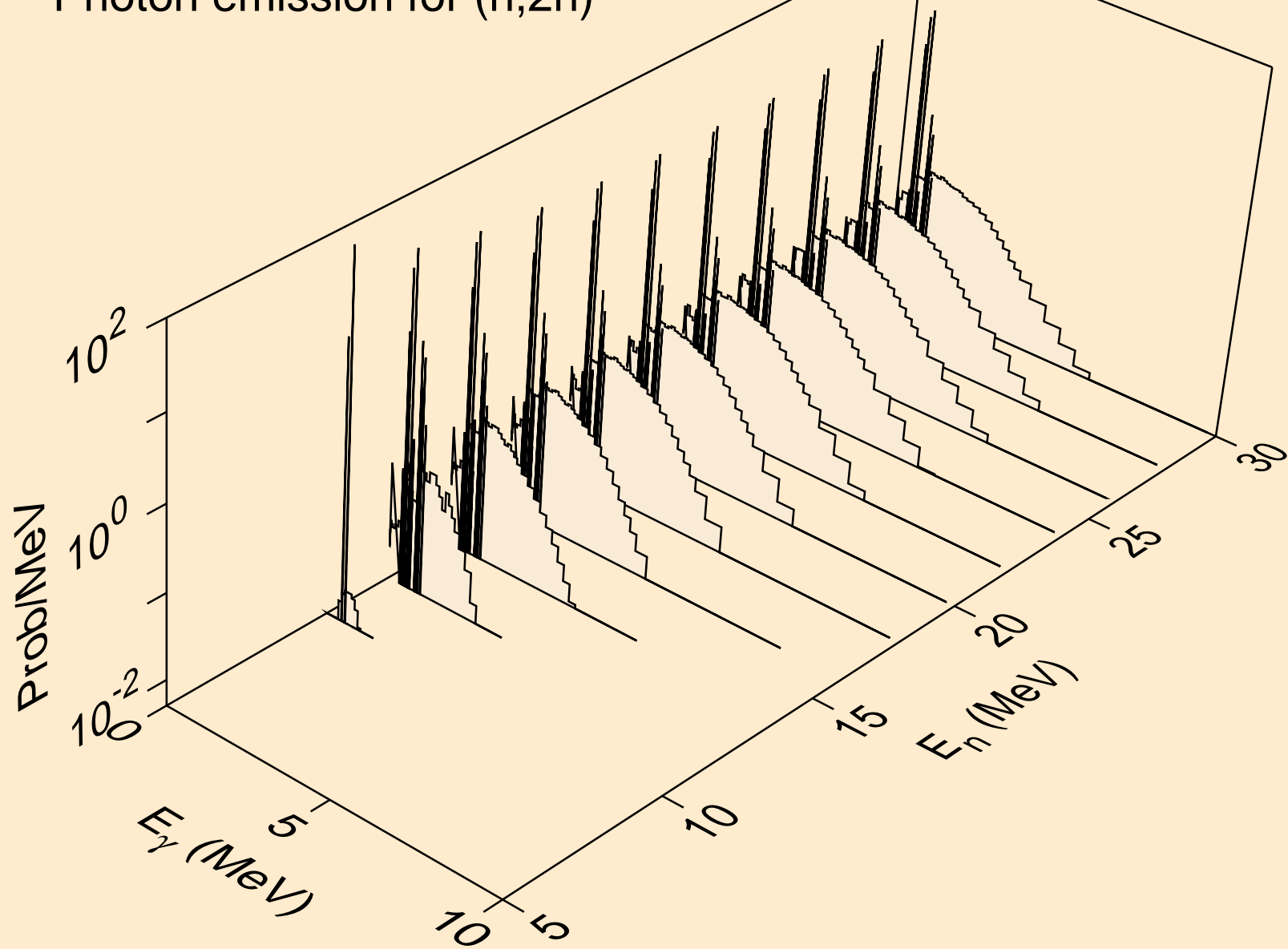

HG179 NEUTRON ACER TENDL-2021 LIBRARY; T=293.6K  
Photon emission for (n,3n)

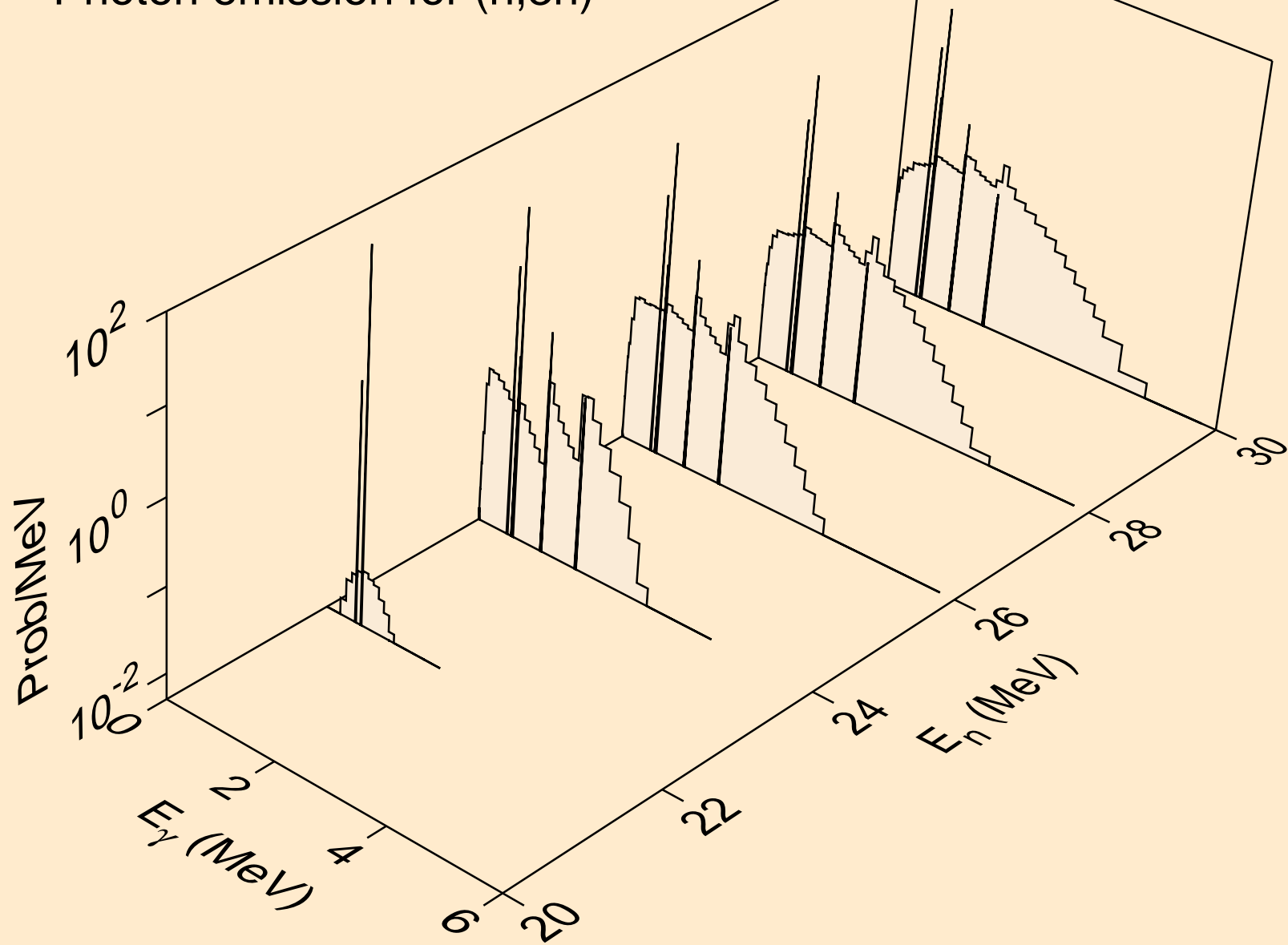

HG179 NEUTRON ACER TENDL-2021 LIBRARY; T=293.6K  
Photon emission for (n,n\*)a

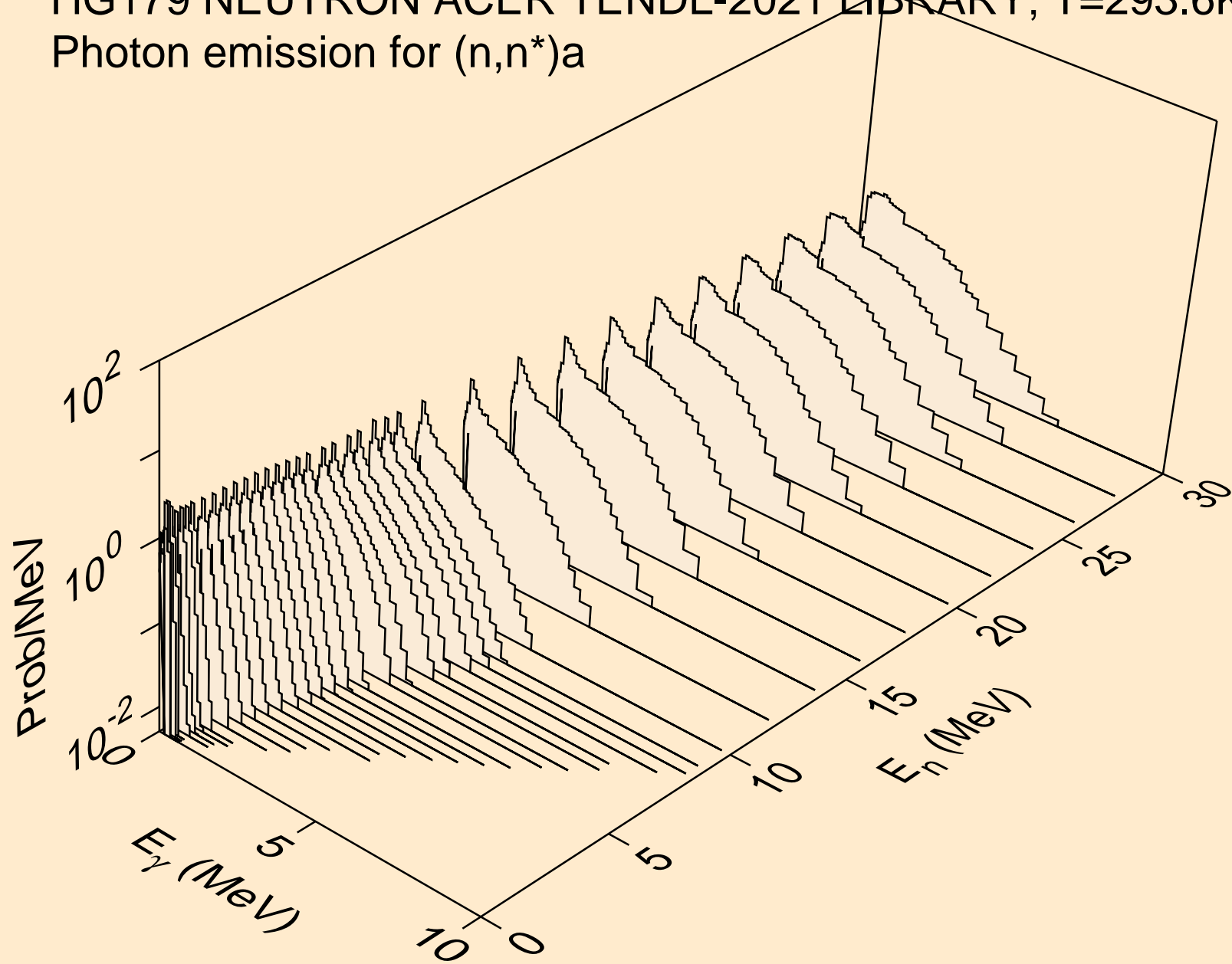



HG179 NEUTRON ACER TENDL-2021 LIBRARY; T=293.6K  
Photon emission for (n,n\*)3a

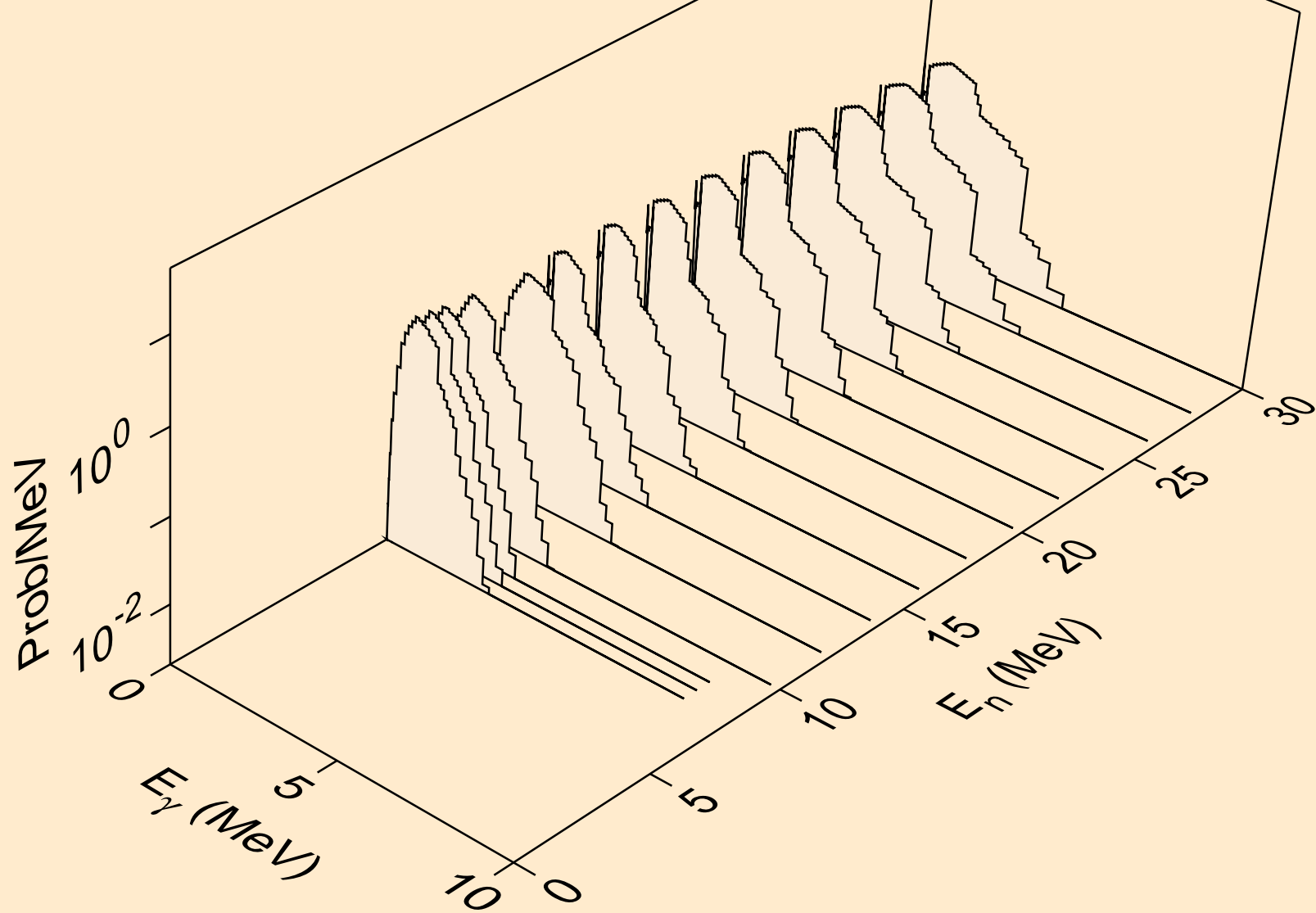

HG179 NEUTRON ACER TENDL-2021 LIBRARY; T=293.6K  
Photon emission for (n,2n)a

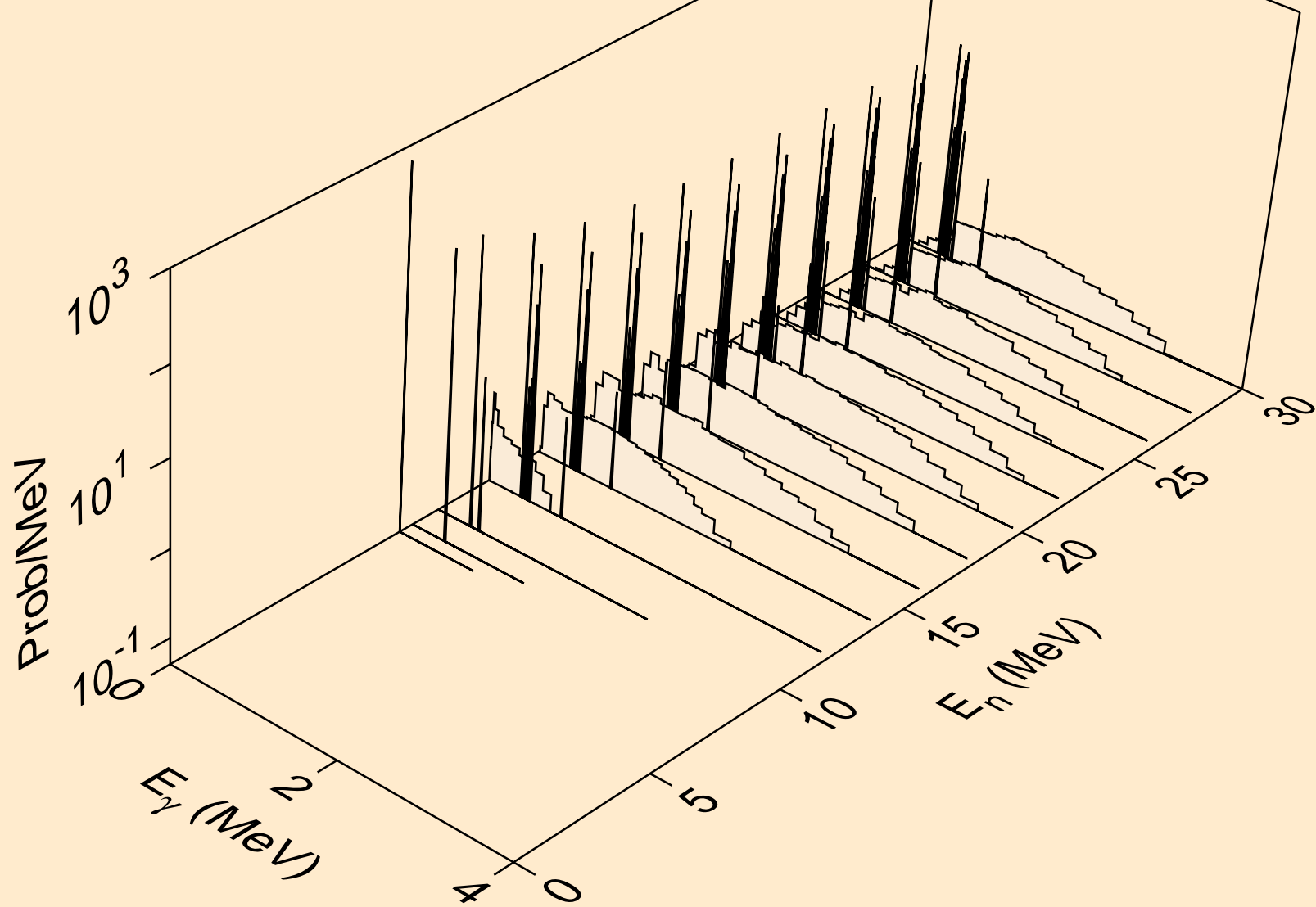

HG179 NEUTRON ACER TENDL-2021 LIBRARY; T=293.6K  
Photon emission for (n,3n)a

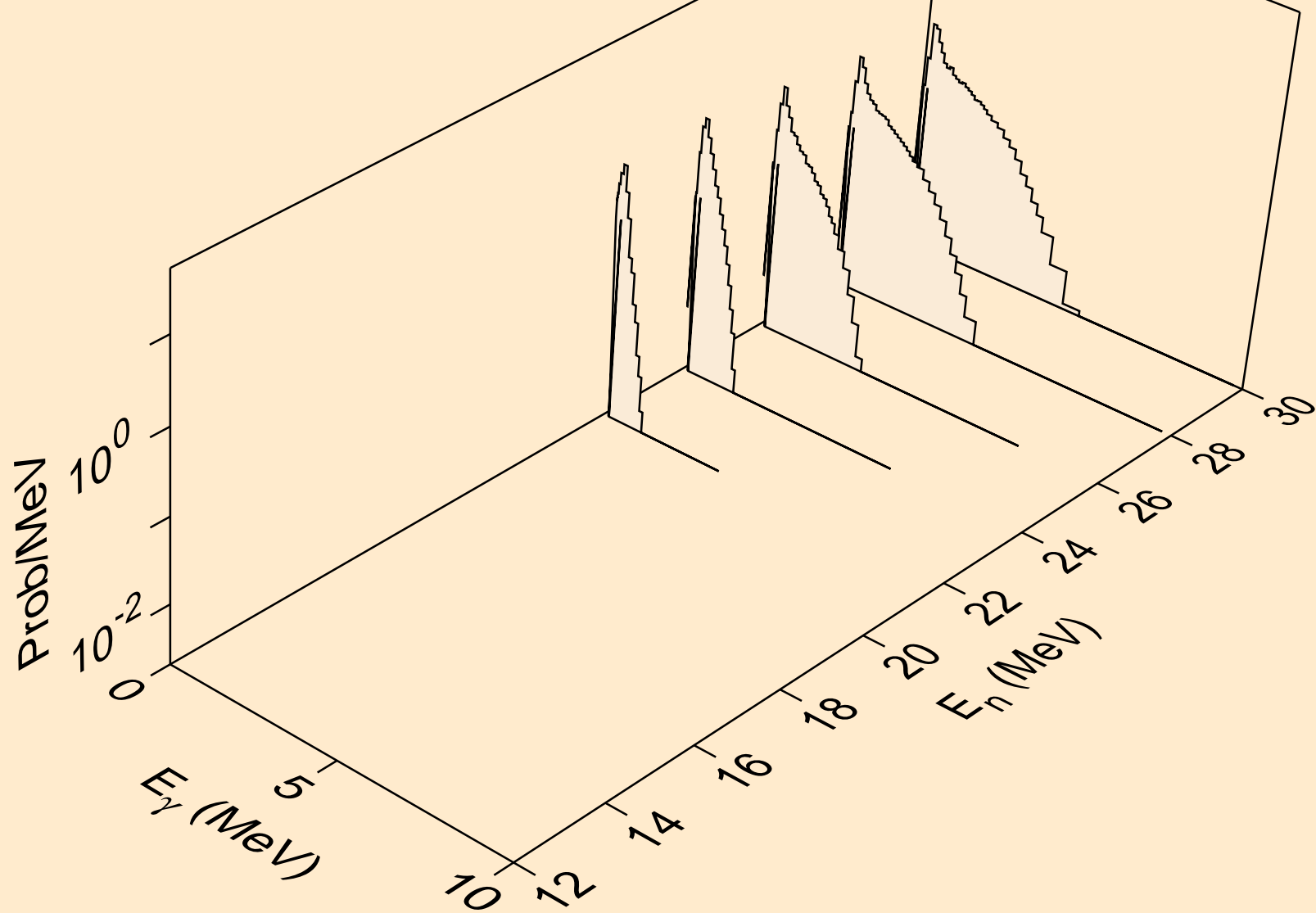

HG179 NEUTRON ACER TENDL-2021 LIBRARY; T=293.6K  
Photon emission for (n,n\*)p

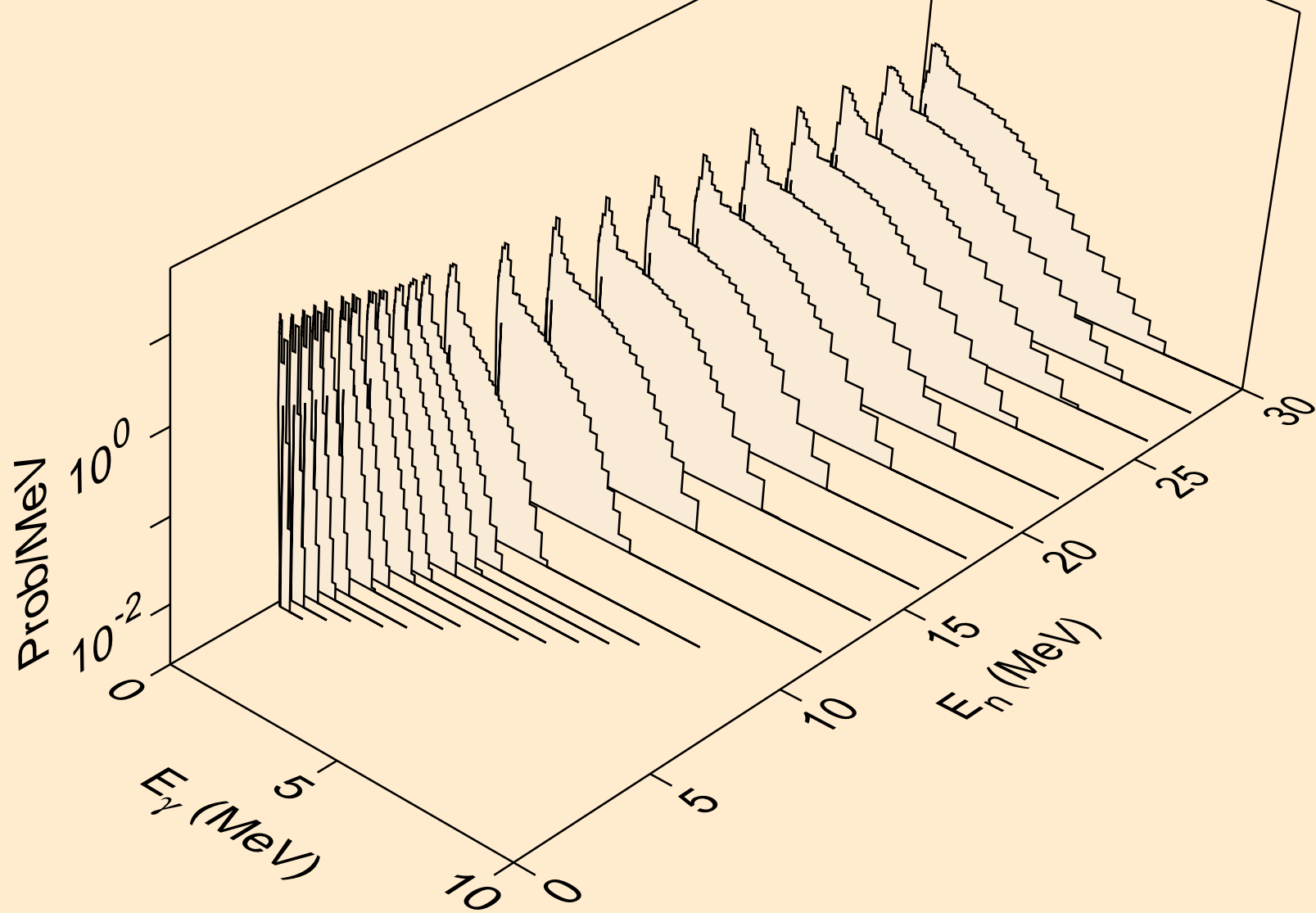

HG179 NEUTRON ACER TENDL-2021 LIBRARY; T=293.6K  
Photon emission for (n,n\*)2a

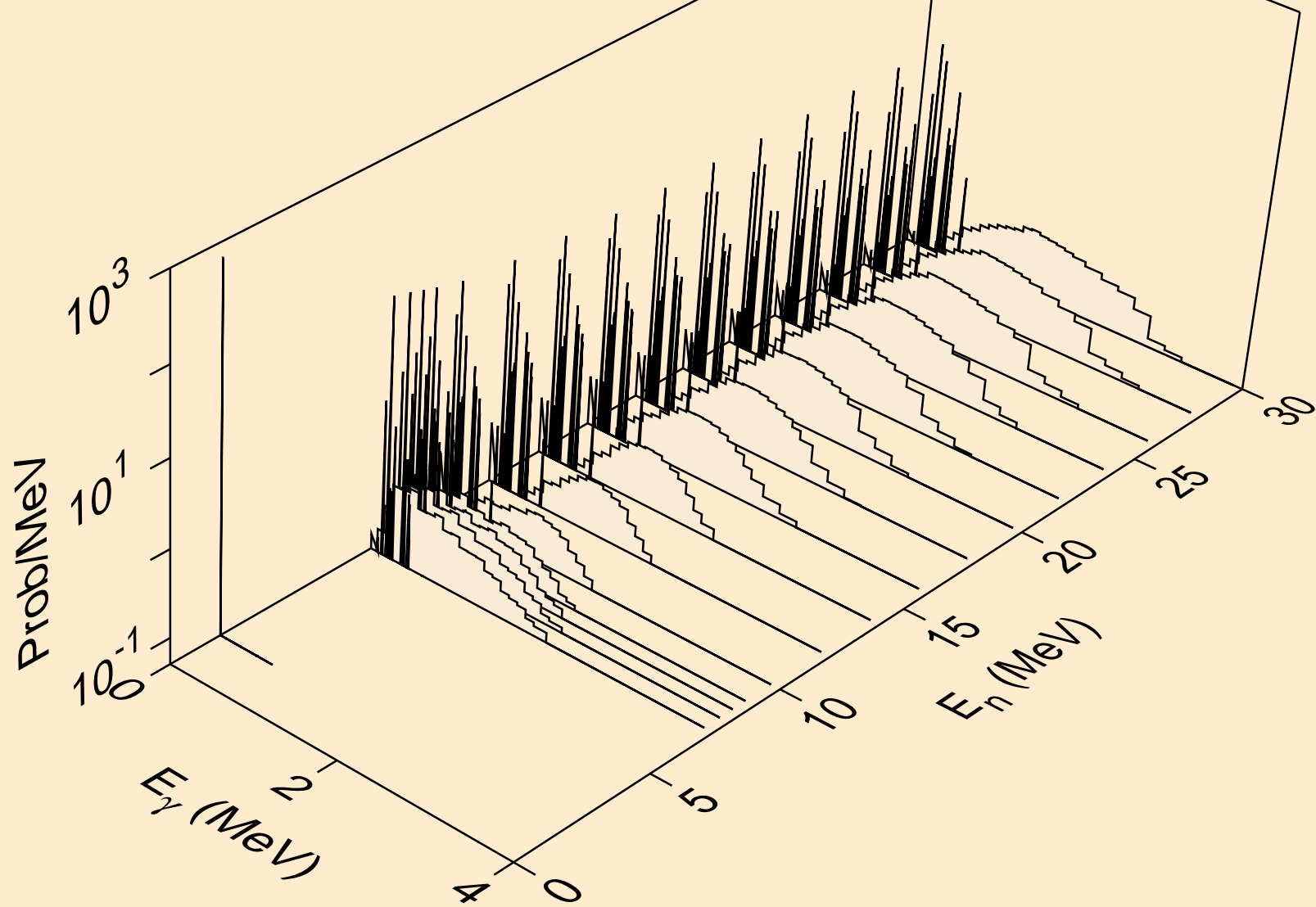

HG179 NEUTRON ACER TENDL-2021 LIBRARY; T=293.6K  
Photon emission for (n,2n)2a

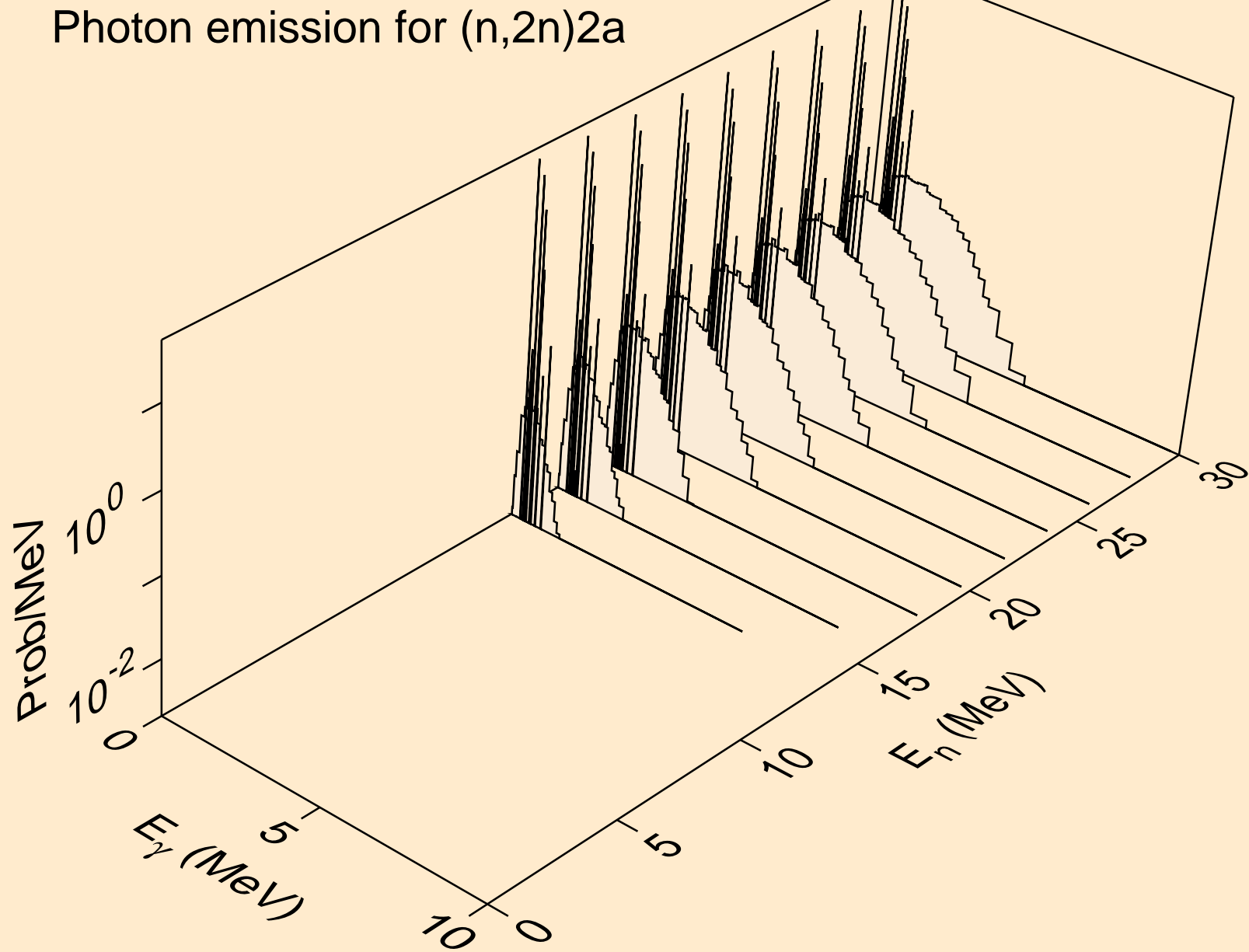

HG179 NEUTRON ACER TENDL-2021 LIBRARY; T=293.6K  
Photon emission for (n,n\*)d

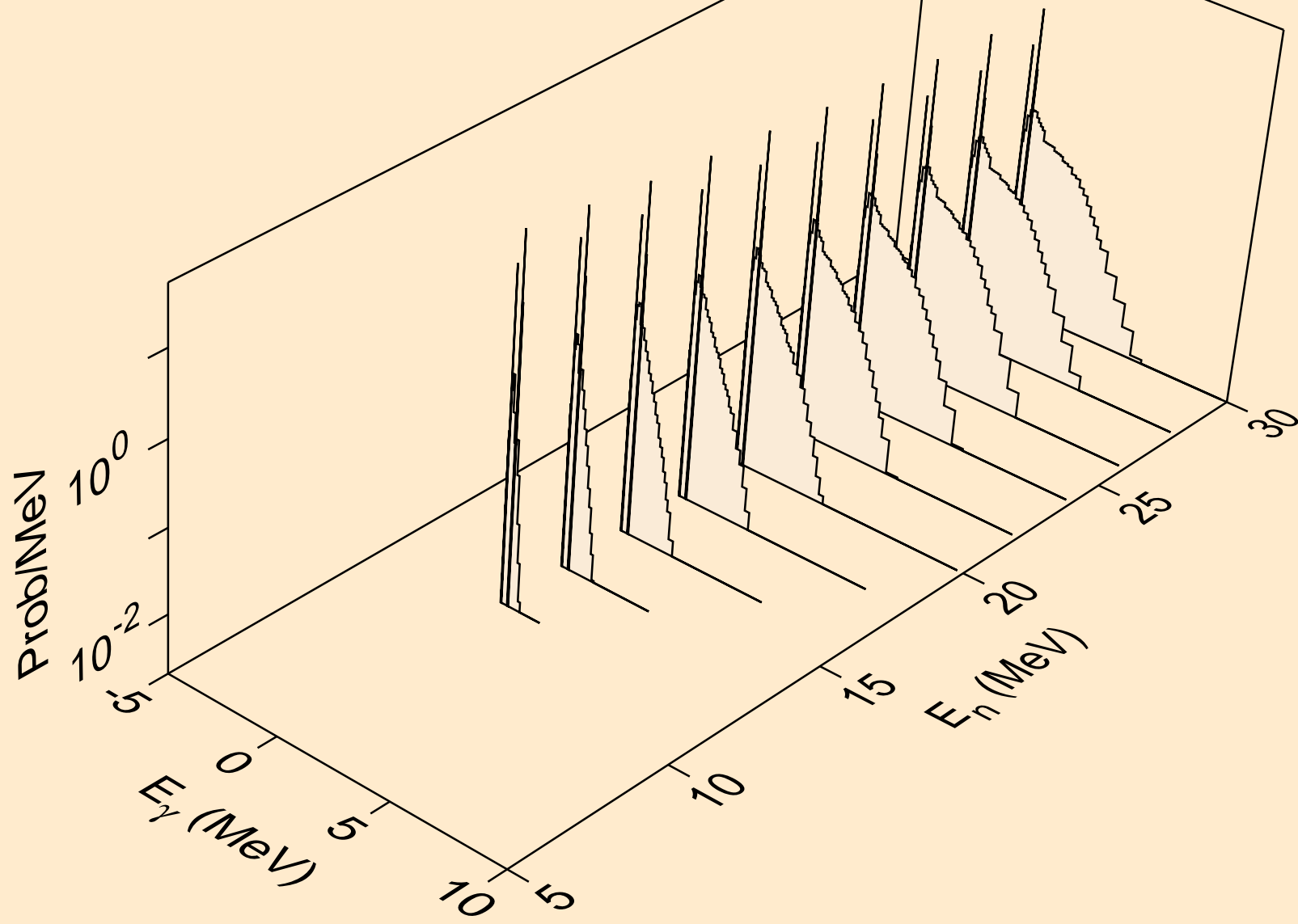

HG179 NEUTRON ACER TENDL-2021 LIBRARY; T=293.6K  
Photon emission for (n,n\*)t

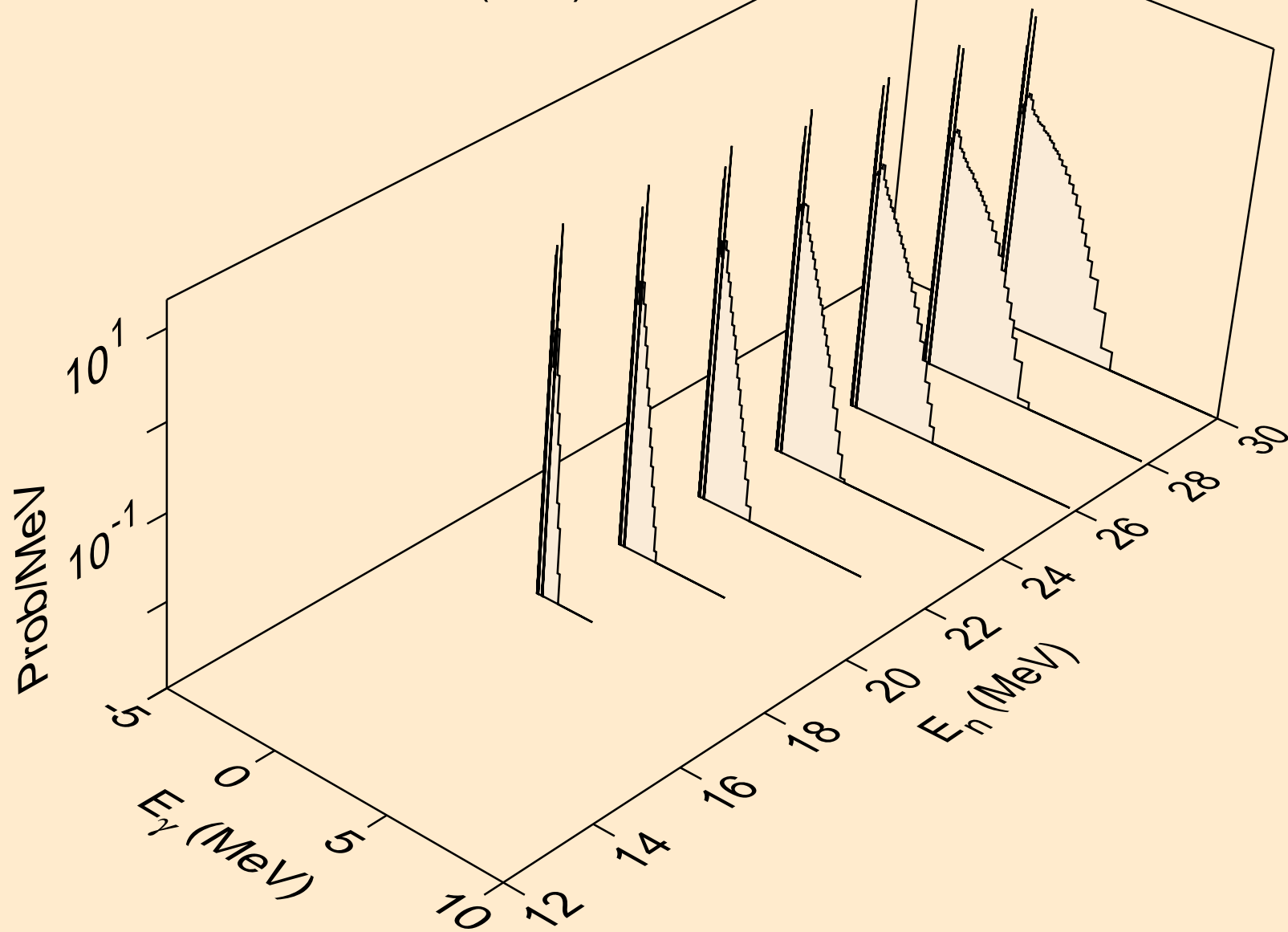



HG179 NEUTRON ACER TENDL-2021 LIBRARY; T=293.6K  
Photon emission for (n,n\*)he3

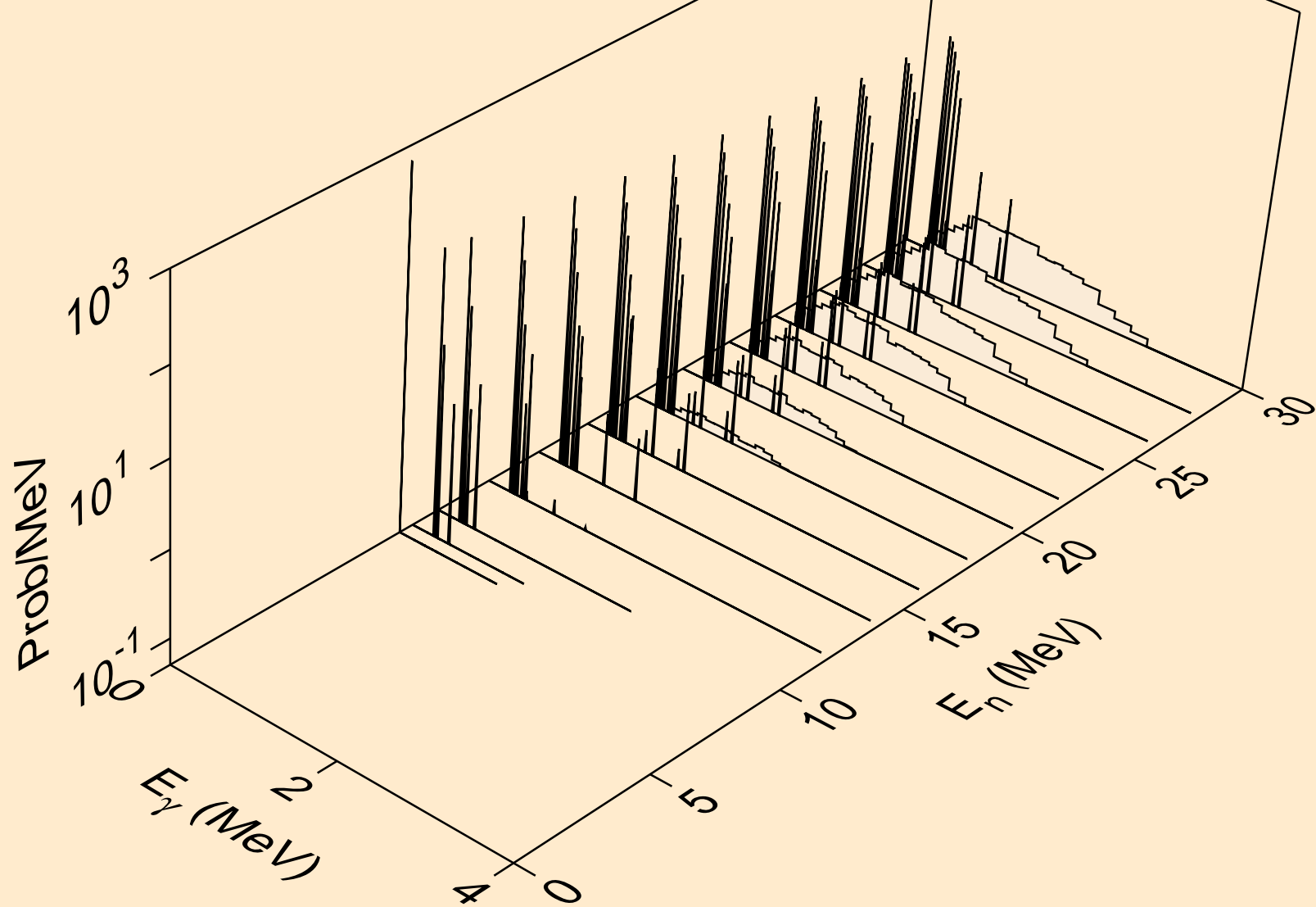

HG179 NEUTRON ACER TENDL-2021 LIBRARY; T=293.6K  
Photon emission for (n,2np)

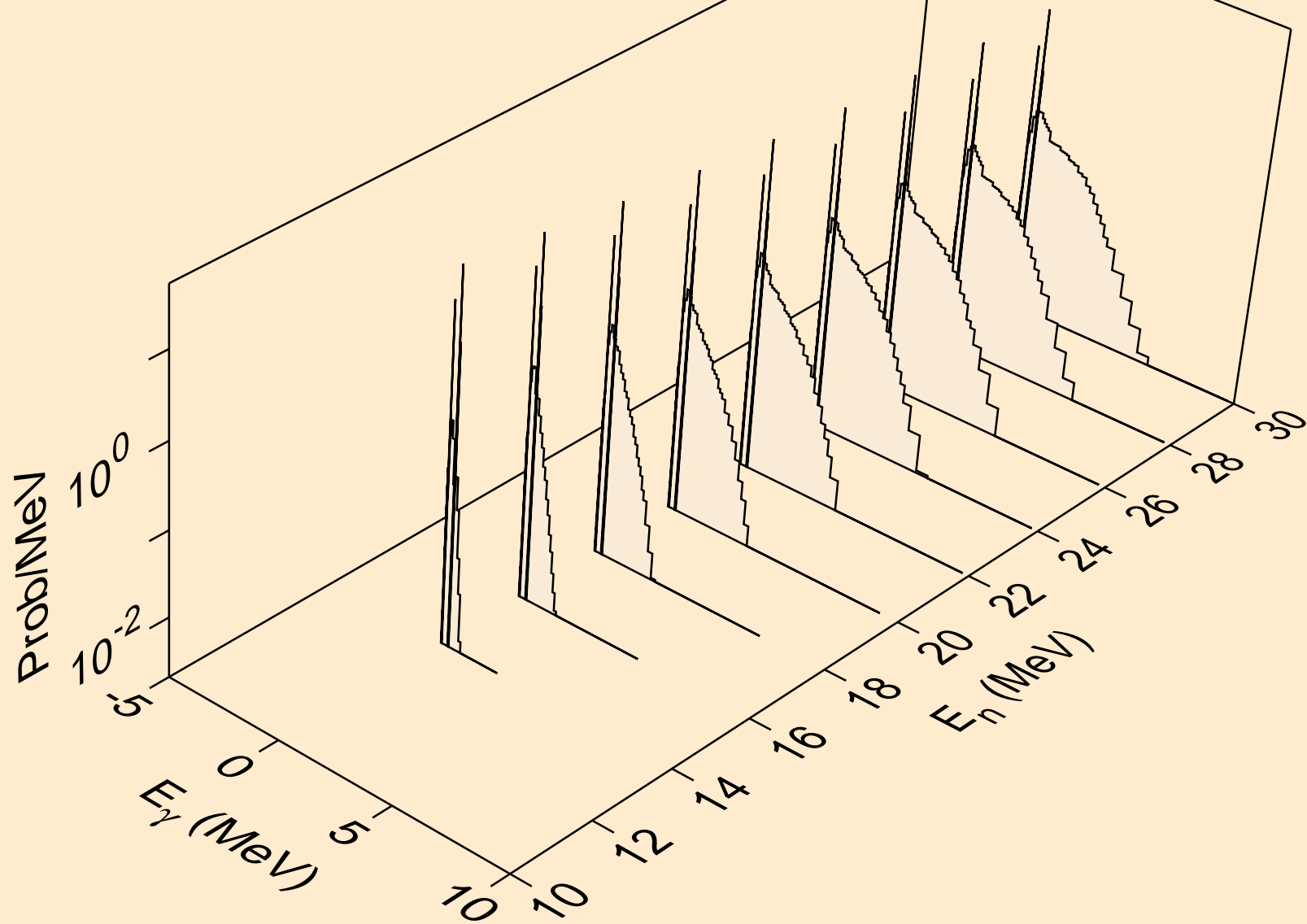

HG179 NEUTRON ACER TENDL-2021 LIBRARY; T=293.6K  
Photon emission for (n,3np)

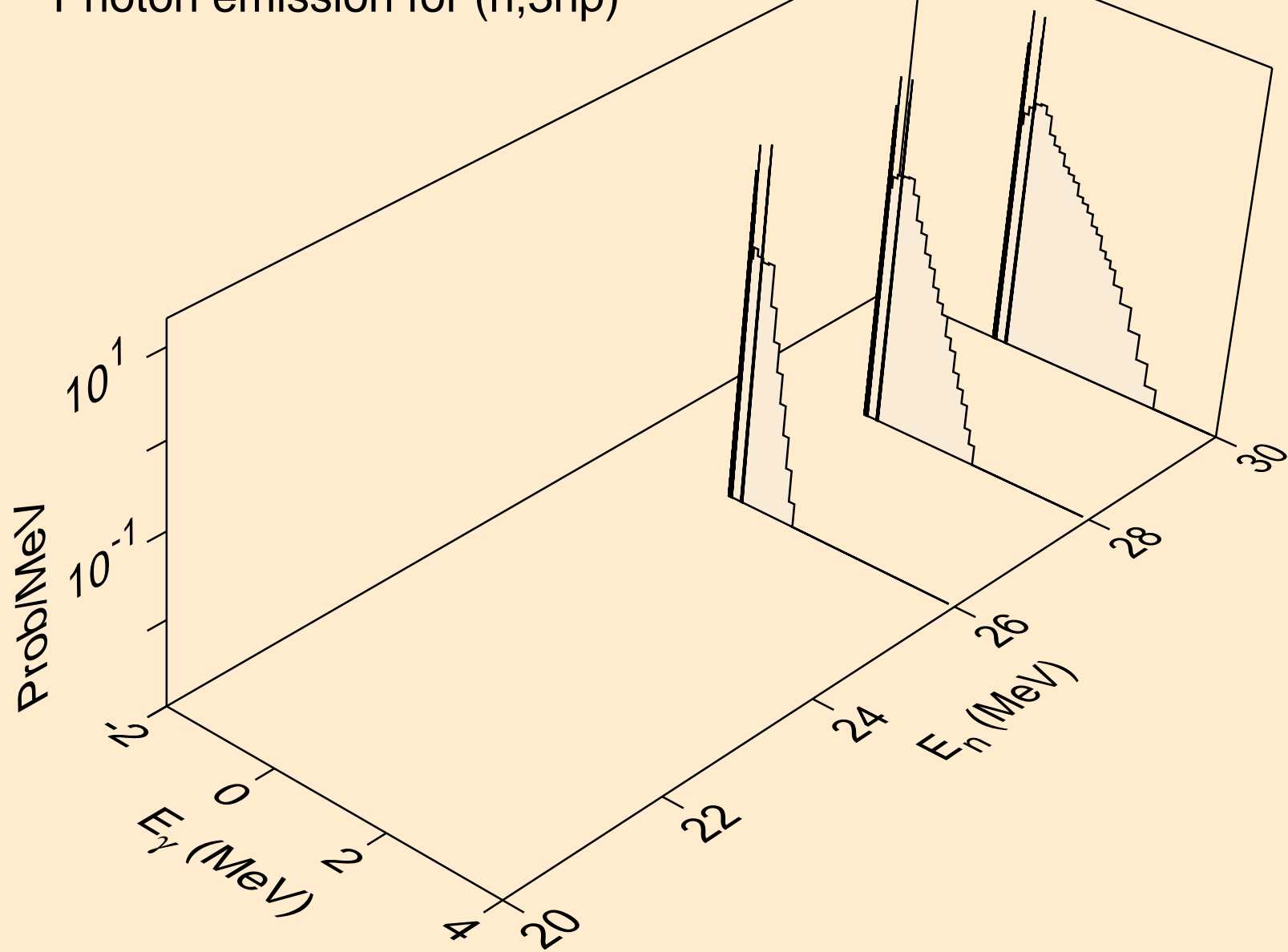

HG179 NEUTRON ACER TENDL-2021 LIBRARY; T=293.6K  
Photon emission for (n,2np)

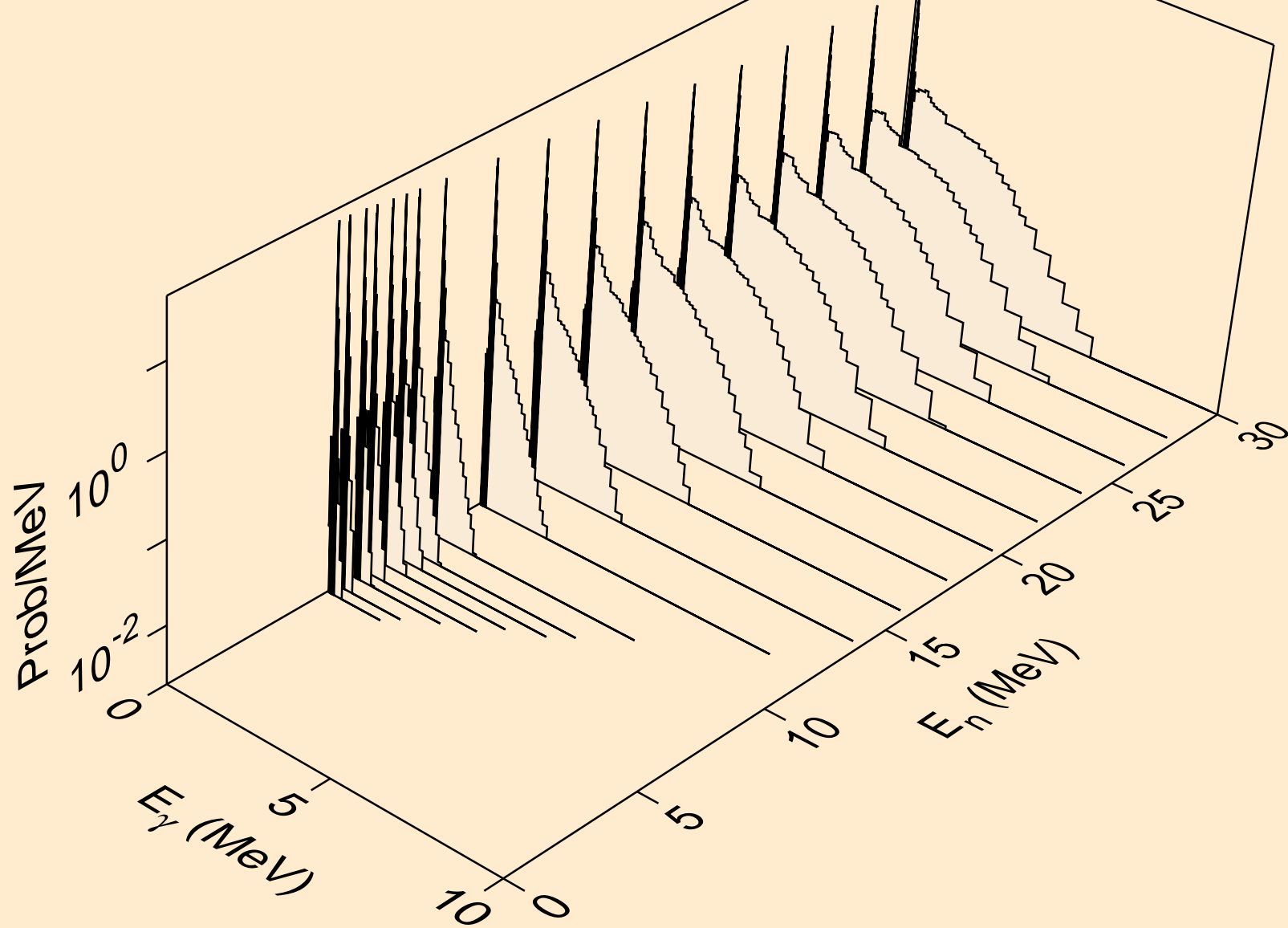

HG179 NEUTRON ACER TENDL-2021 LIBRARY; T=293.6K  
Photon emission for (n,npa)

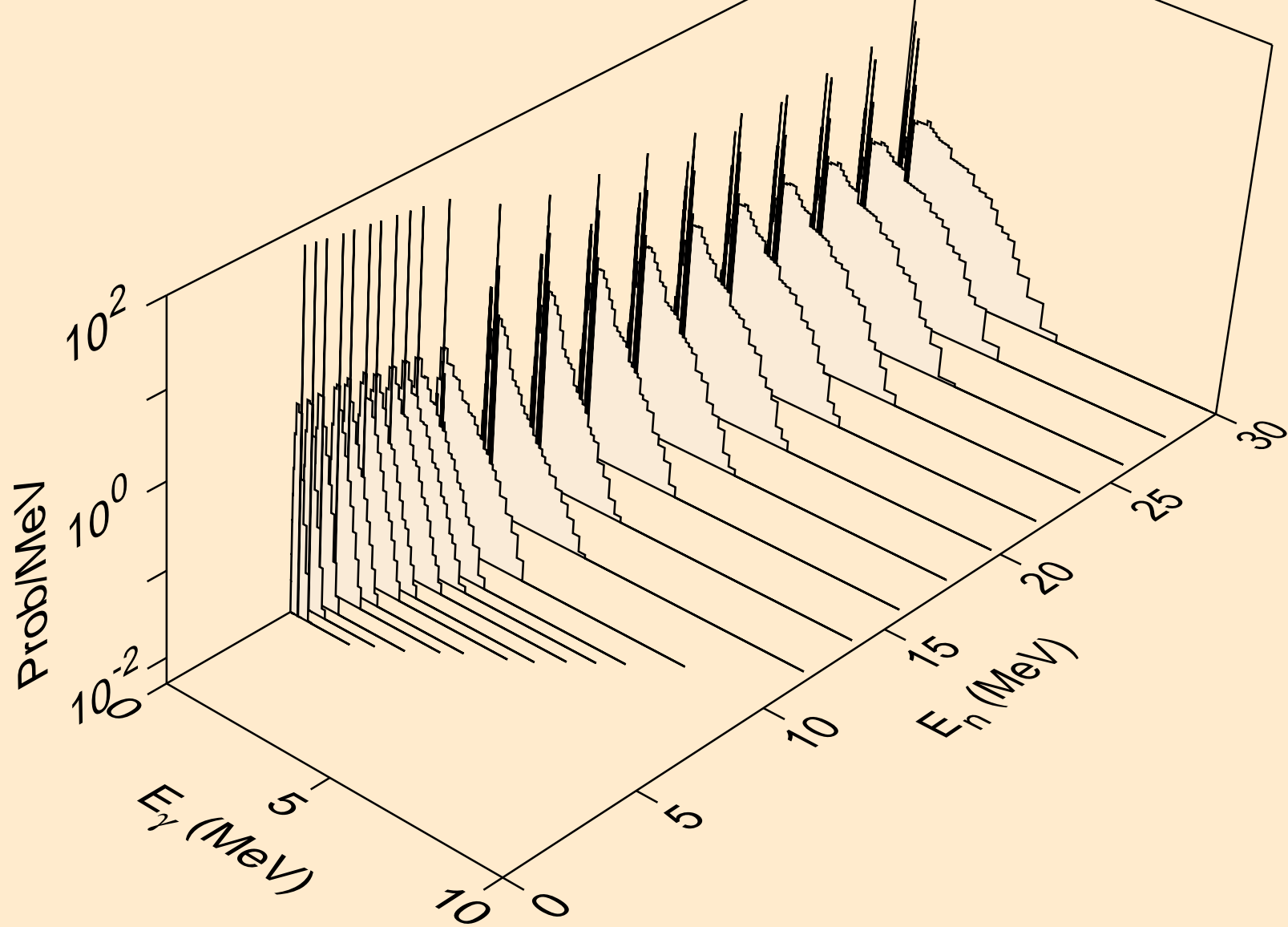

HG179 NEUTRON ACER TENDL-2021 LIBRARY; T=293.6K  
Photon emission for (n,n\*c)

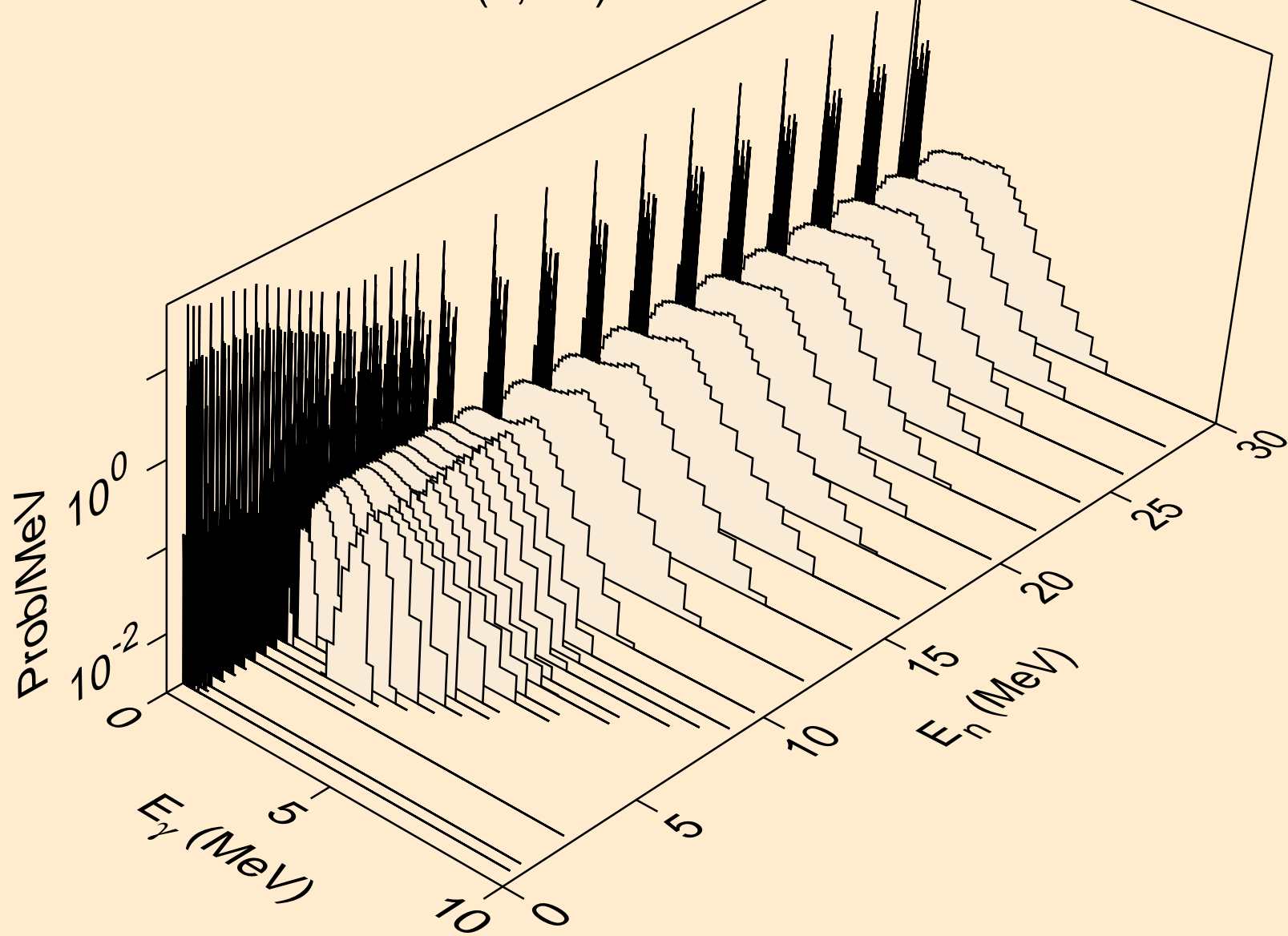

HG179 NEUTRON ACER TENDL-2021 LIBRARY; T=293.6K  
Photon emission for (n,gma)

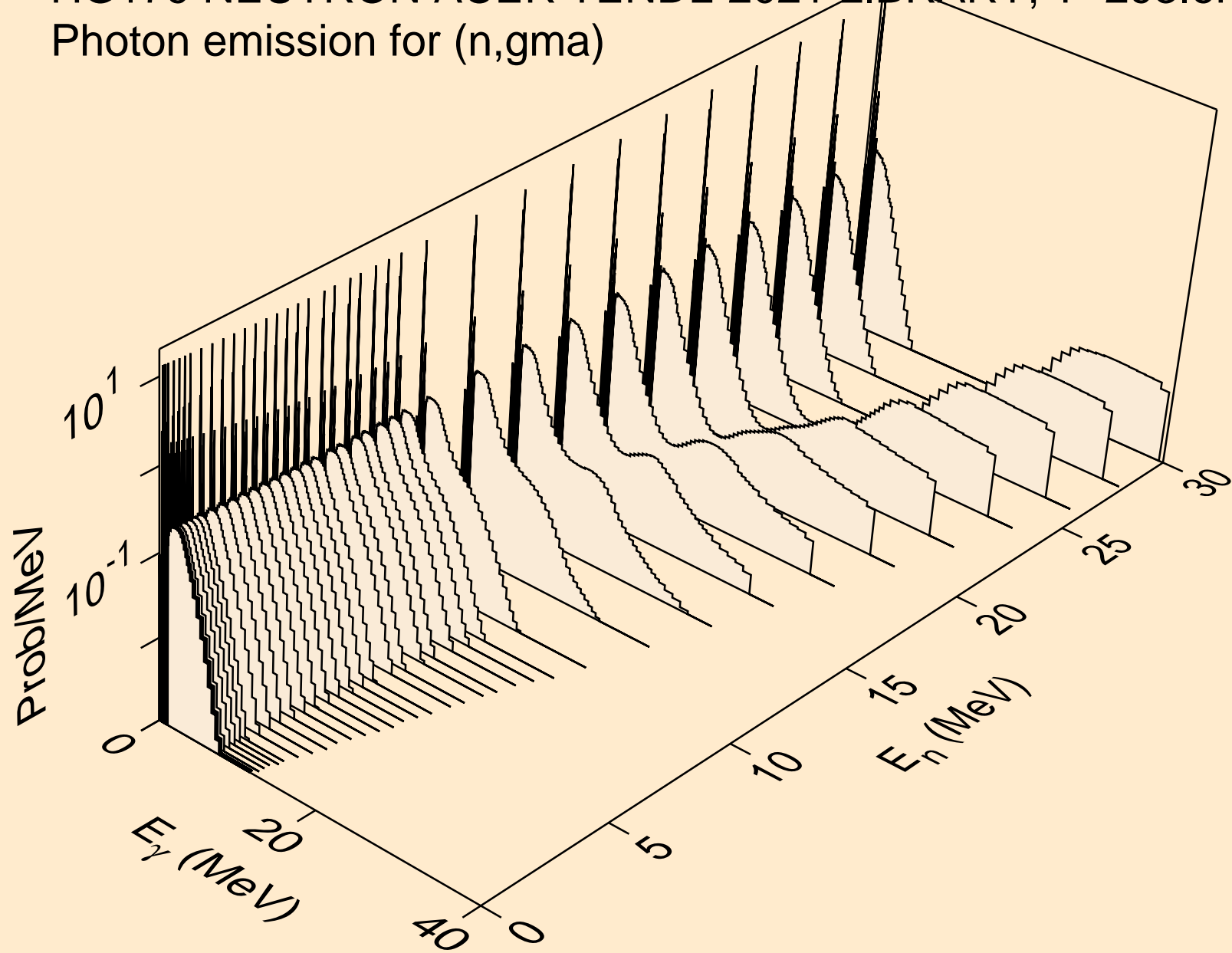

HG179 NEUTRON ACER TENDL-2021 LIBRARY; T=293.6K  
Photon emission for (n,p)

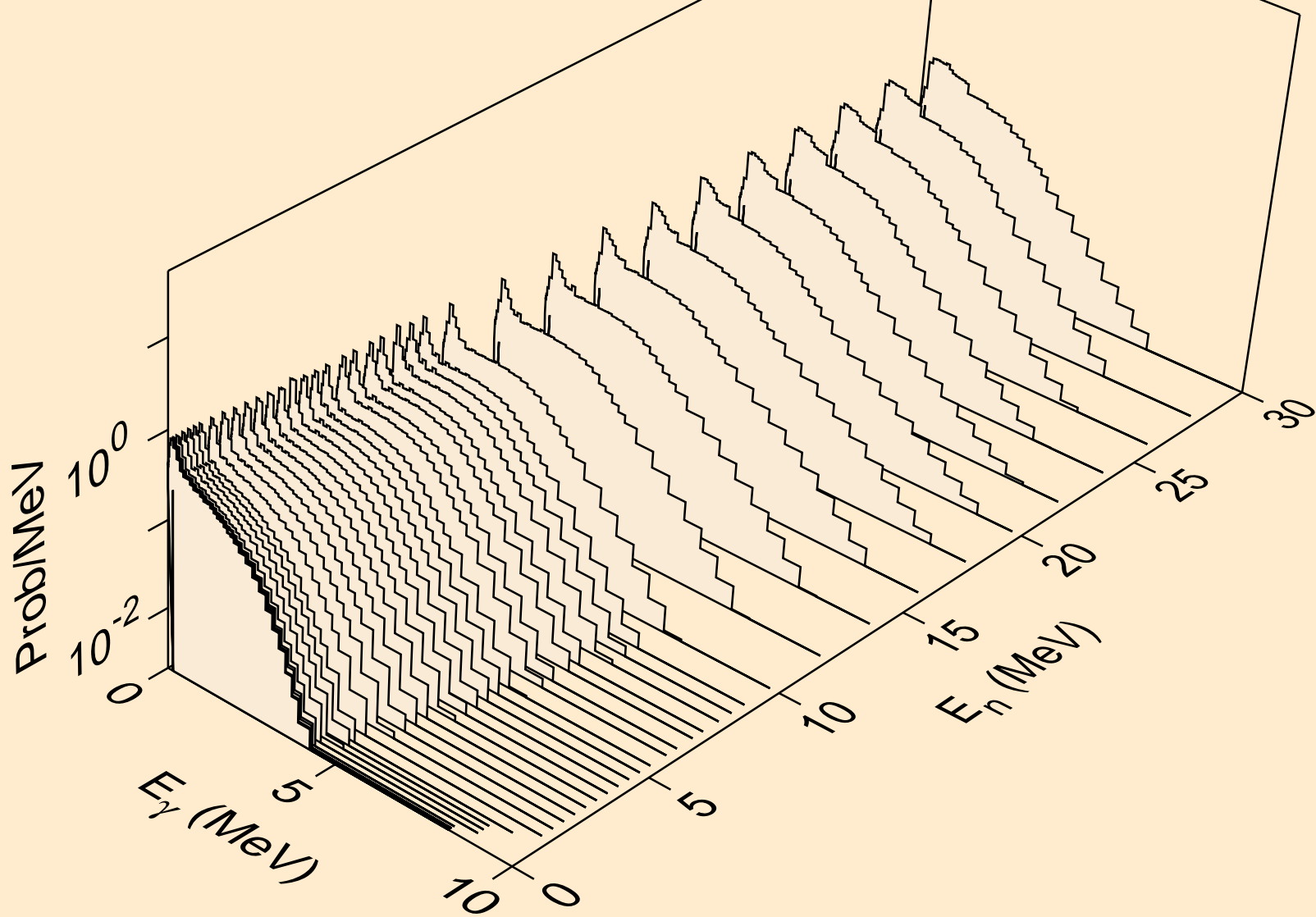



HG179 NEUTRON ACER TENDL-2021 LIBRARY; T=293.6K  
Photon emission for (n,d)

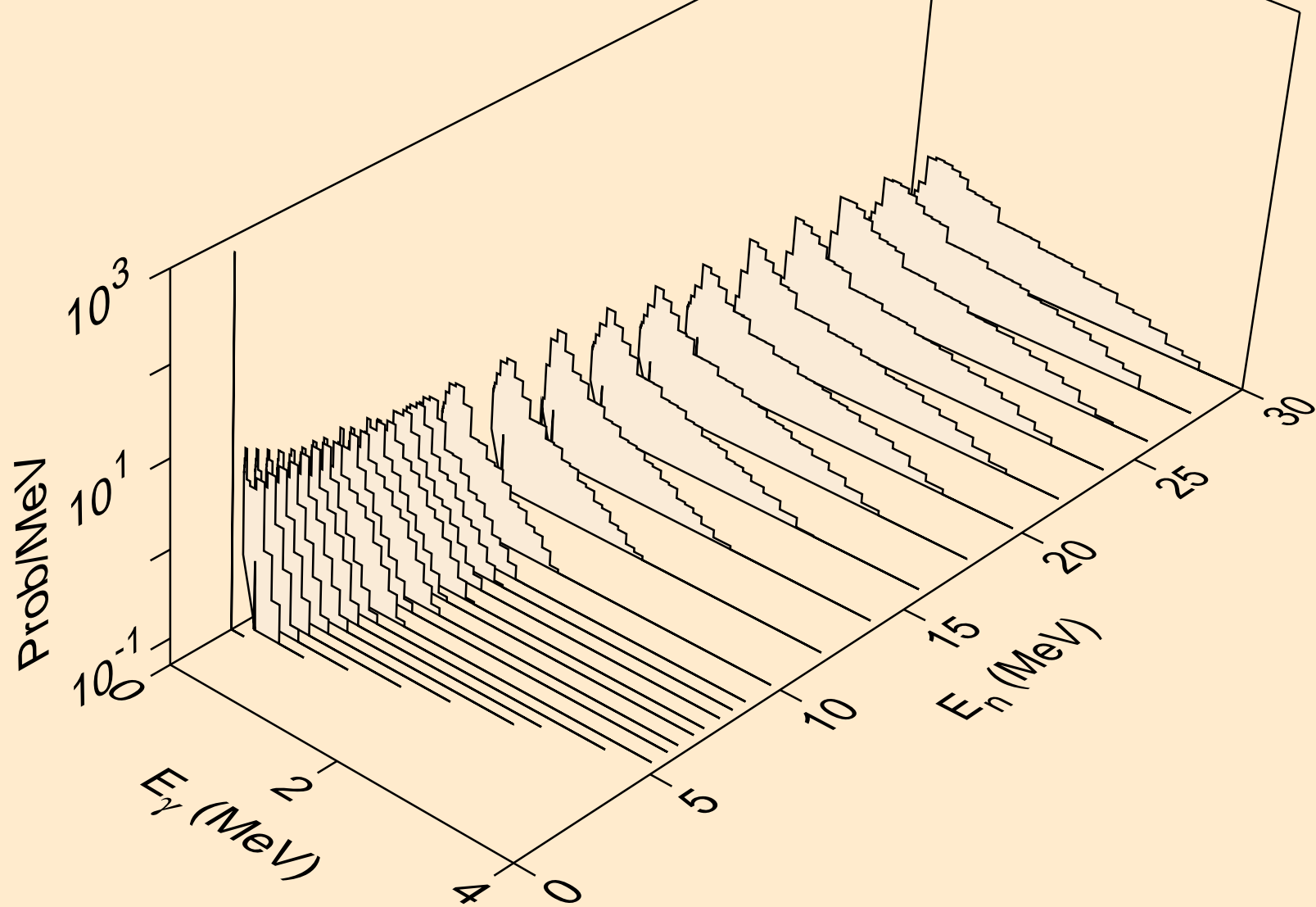

HG179 NEUTRON ACER TENDL-2021 LIBRARY; T=293.6K  
Photon emission for (n,t)

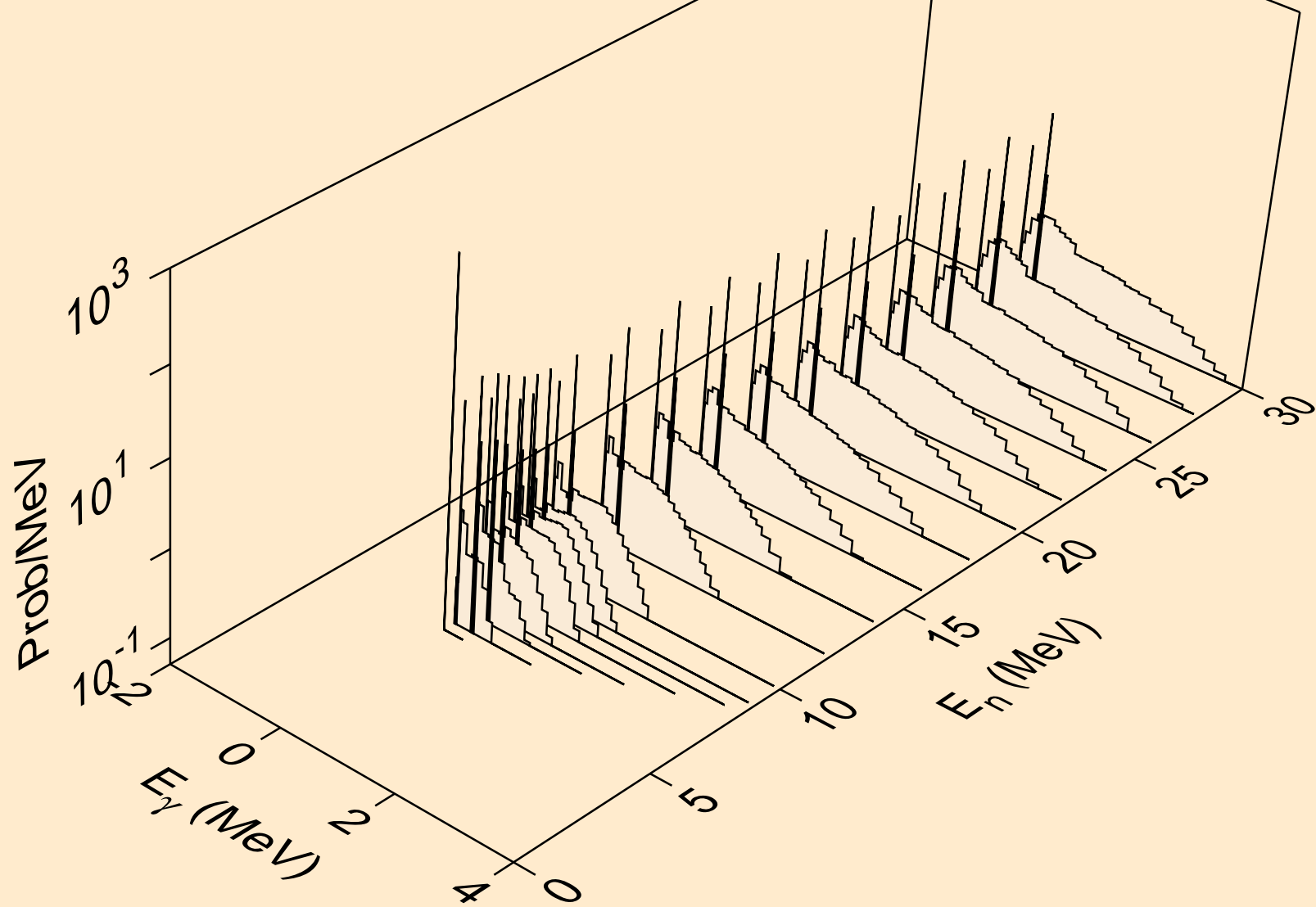

HG179 NEUTRON ACER TENDL-2021 LIBRARY; T=293.6K  
Photon emission for (n,he3)

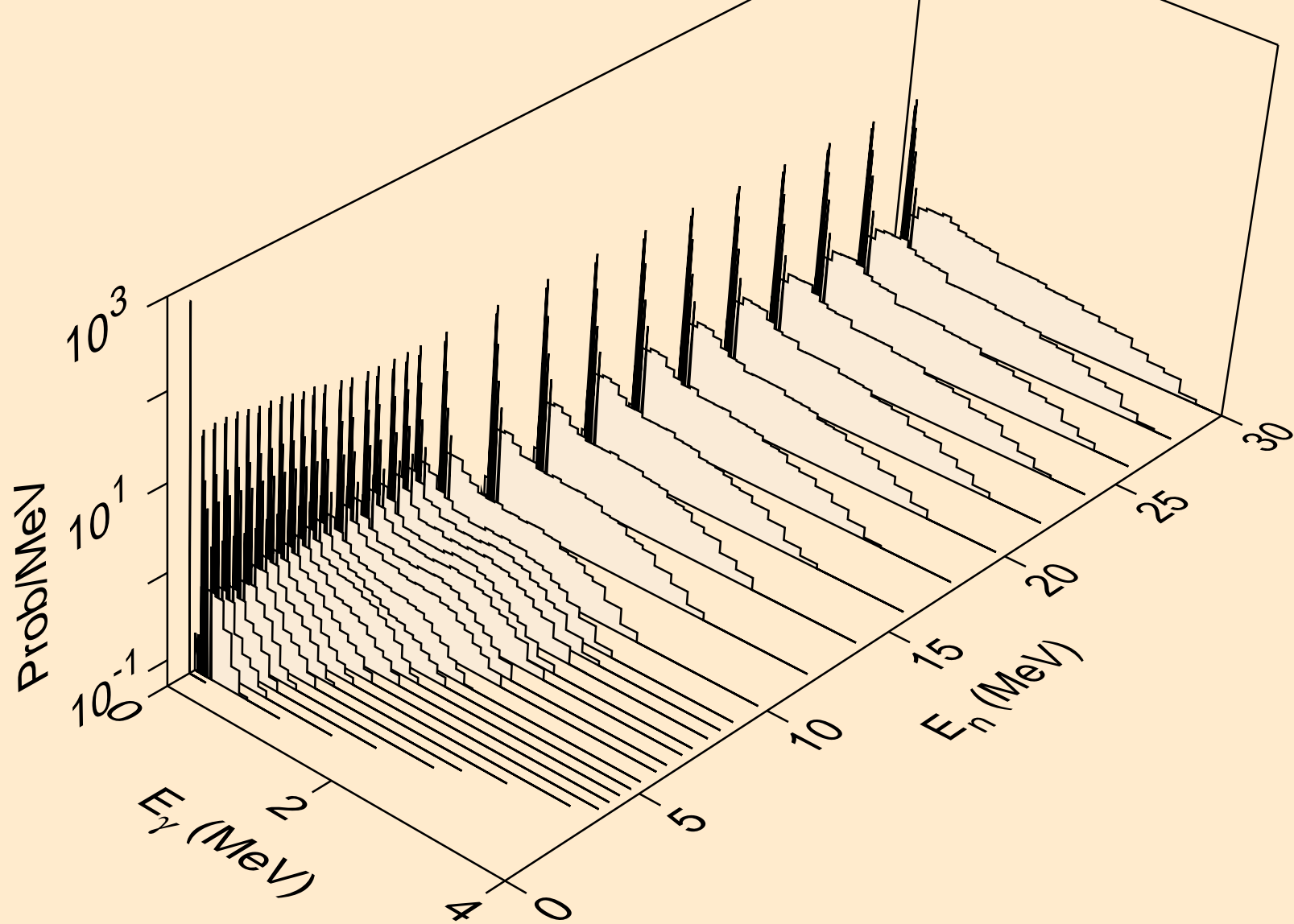

HG179 NEUTRON ACER TENDL-2021 LIBRARY; T=293.6K  
Photon emission for (n,a)

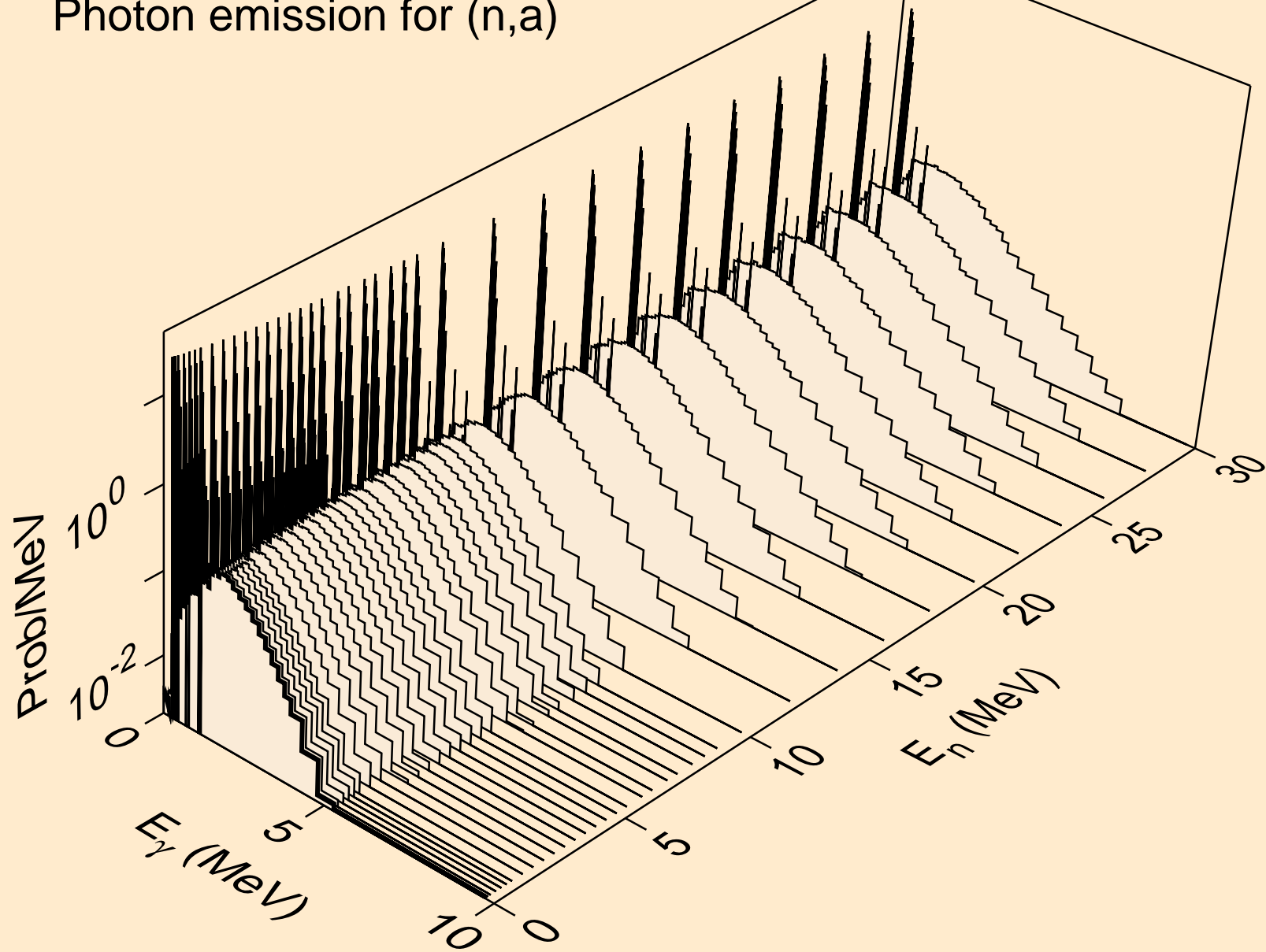

HG179 NEUTRON ACER TENDL-2021 LIBRARY; T=293.6K  
Photon emission for (n,2a)

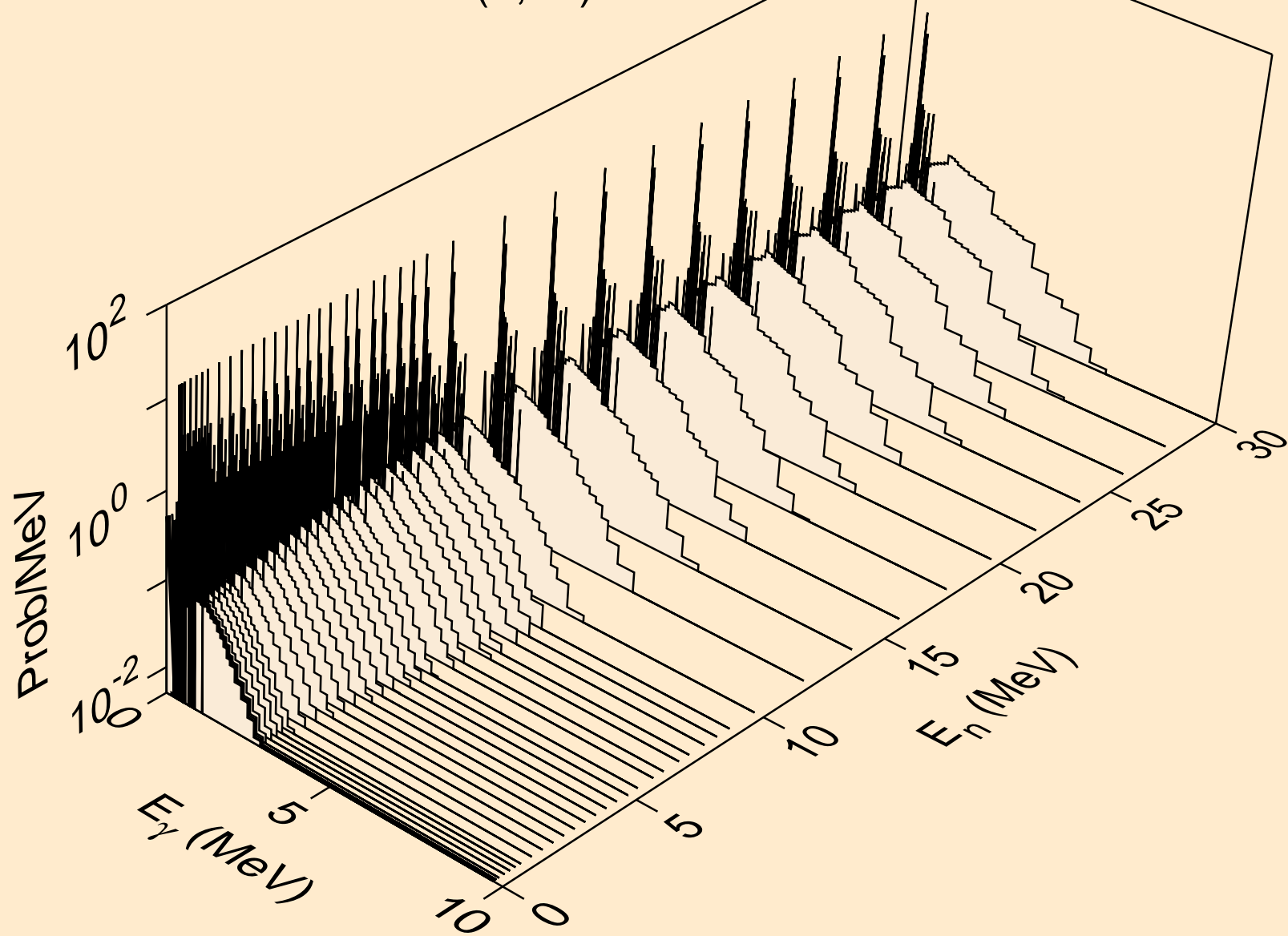

HG179 NEUTRON ACER TENDL-2021 LIBRARY; T=293.6K  
Photon emission for (n,3a)

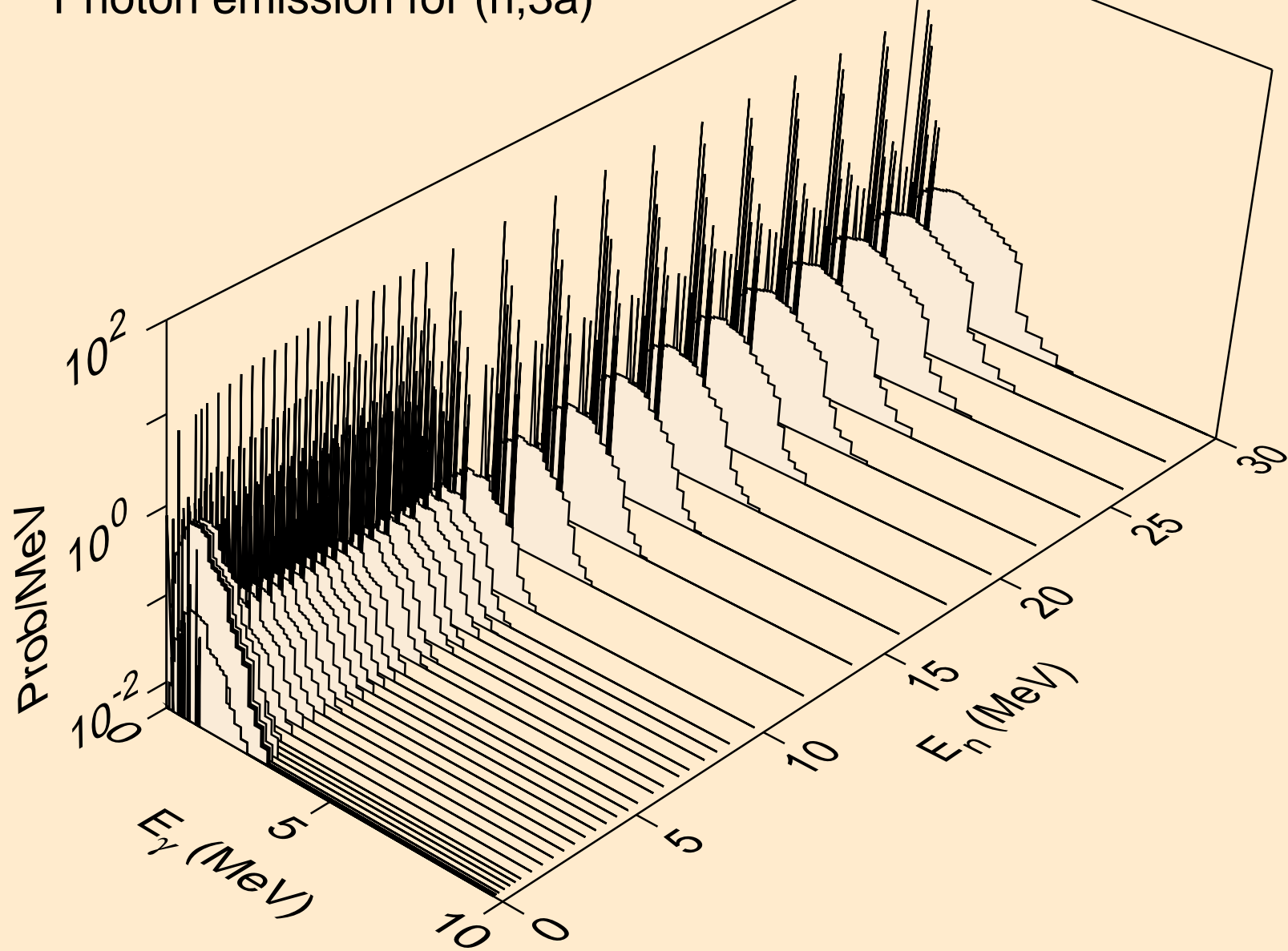

HG179 NEUTRON ACER TENDL-2021 LIBRARY; T=293.6K  
Photon emission for (n,2p)

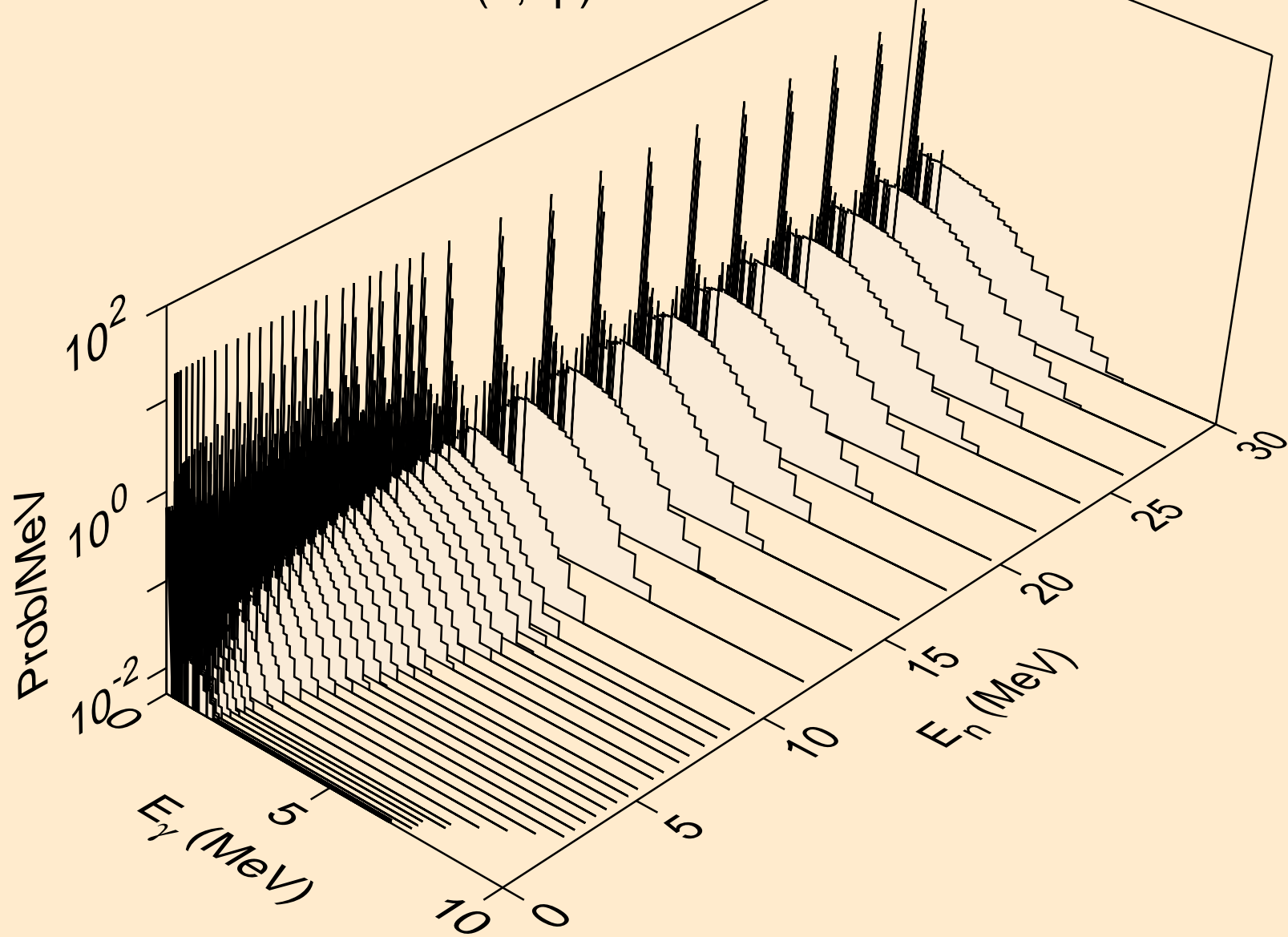

HG179 NEUTRON ACER TENDL-2021 LIBRARY; T=293.6K  
Photon emission for (n,p $\alpha$ )

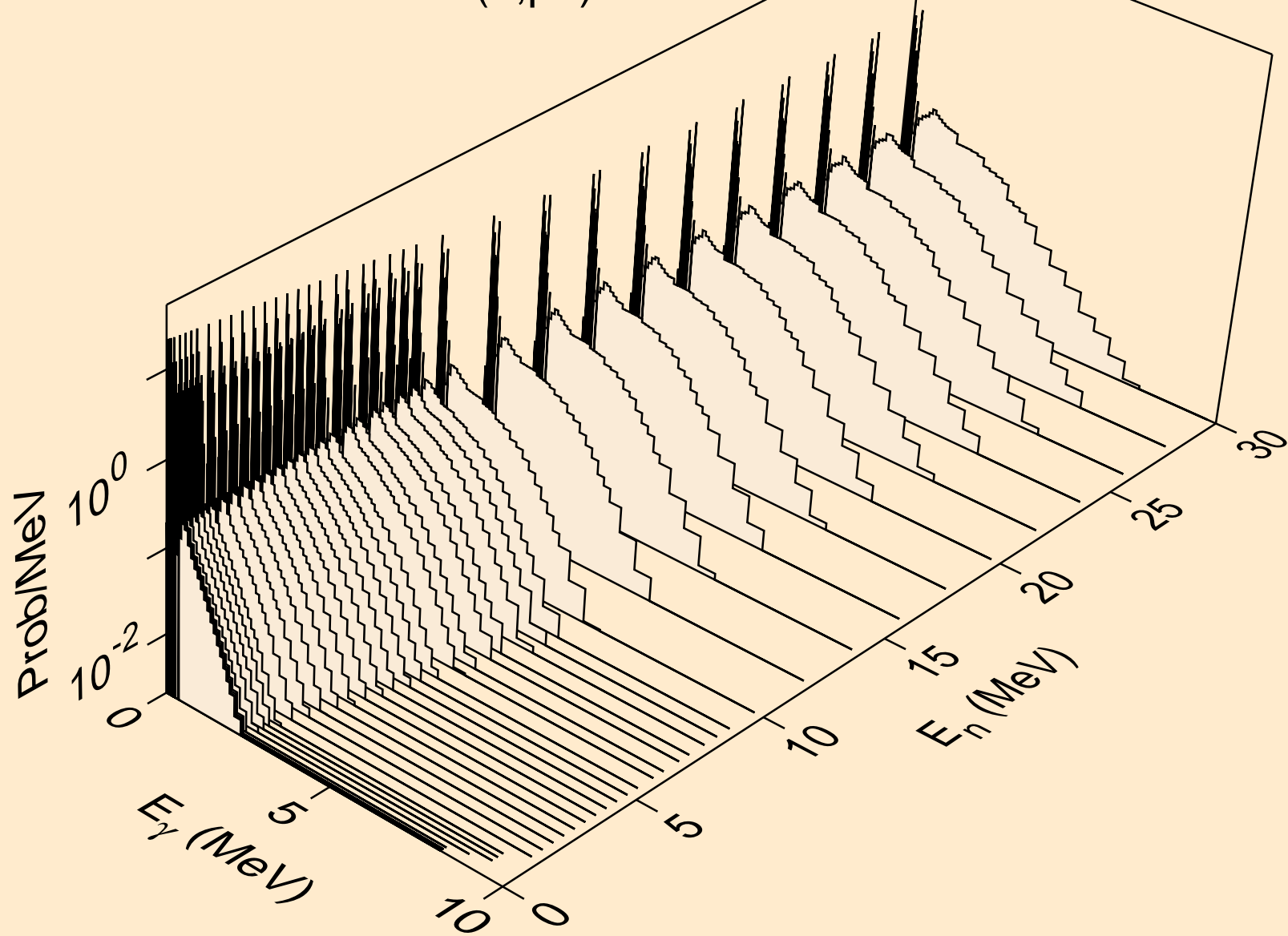



HG179 NEUTRON ACER TENDL-2021 LIBRARY; T=293.6K  
Photon emission for (n,t2a)

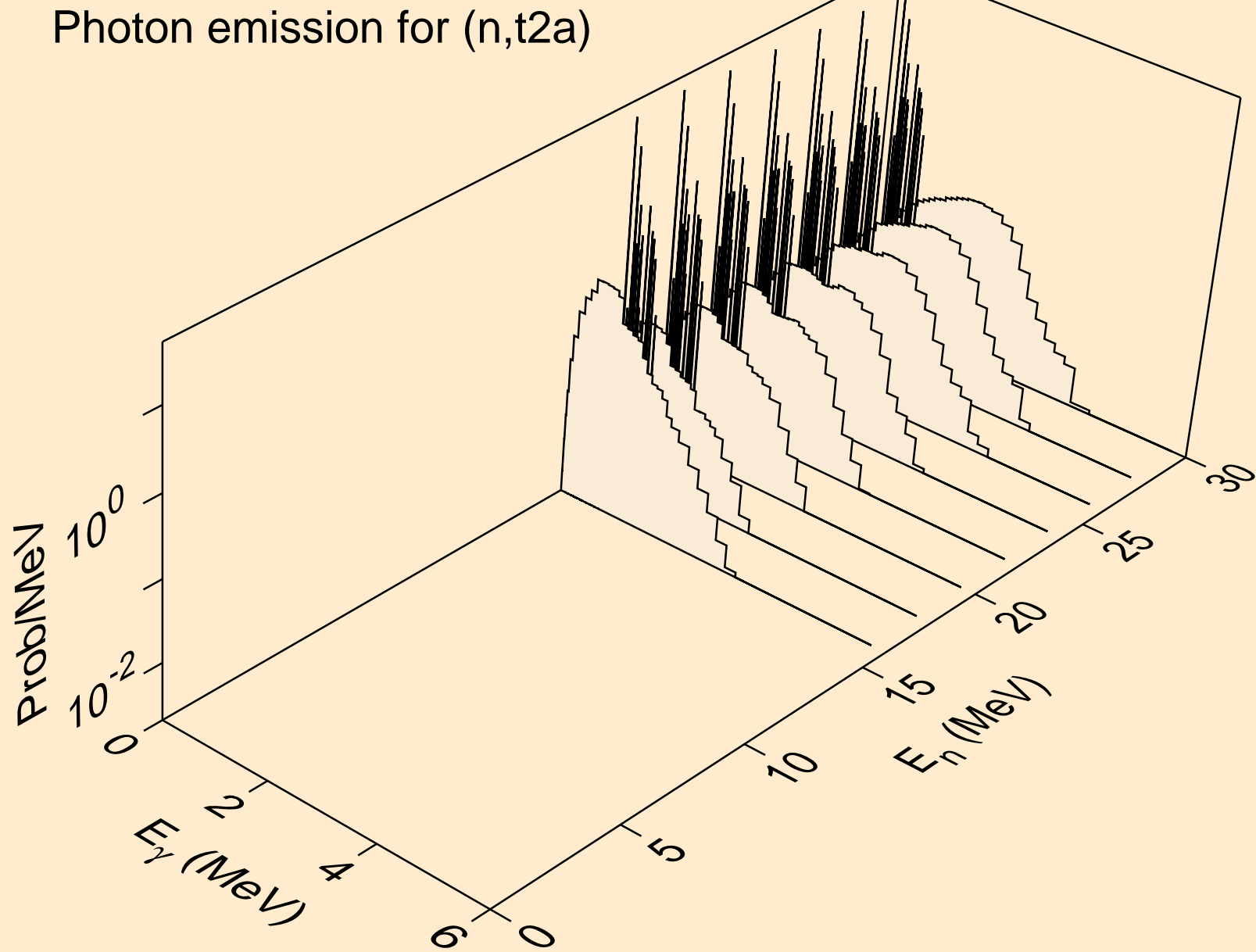

HG179 NEUTRON ACER TENDL-2021 LIBRARY; T=293.6K  
Photon emission for (n,d2a)

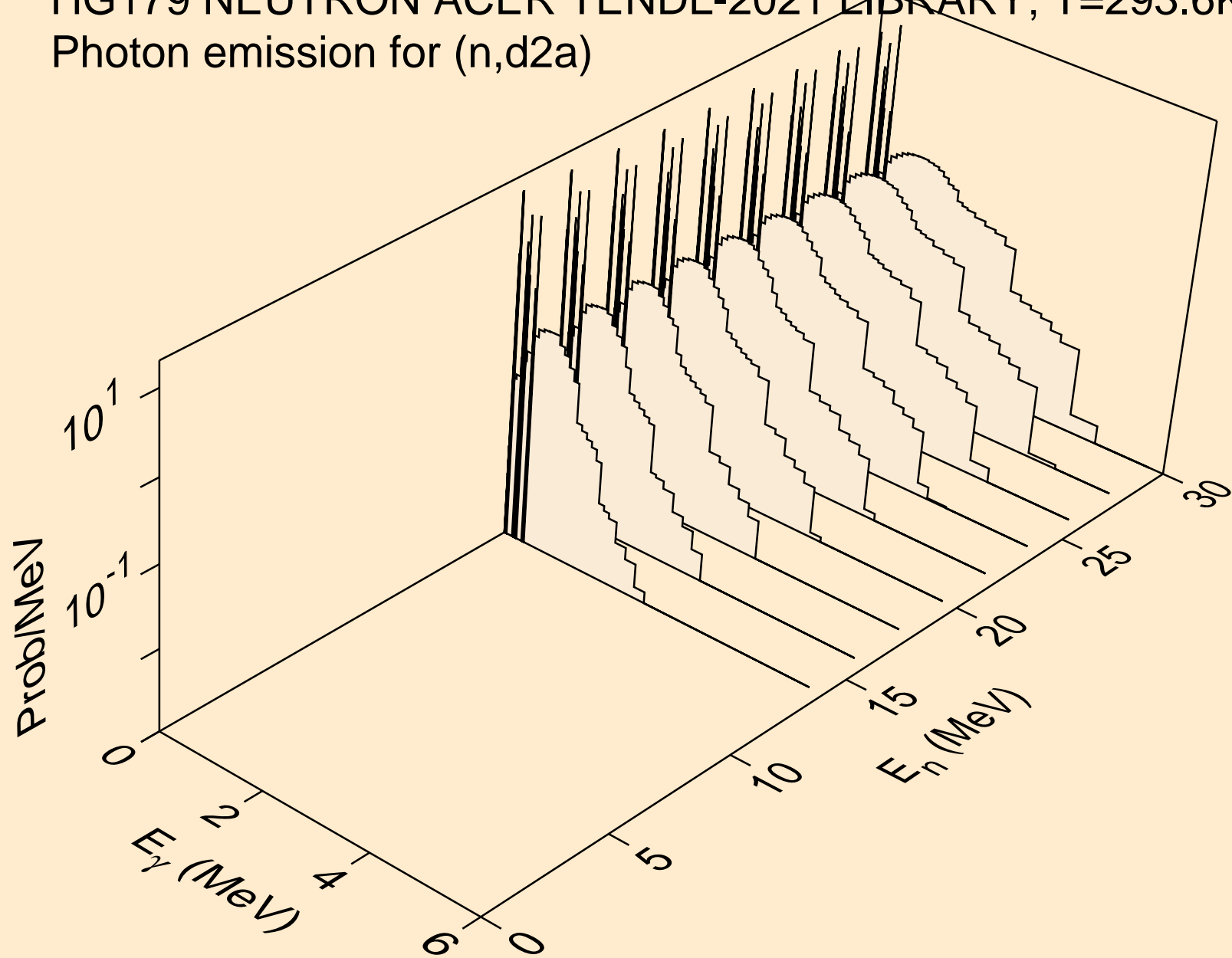

HG179 NEUTRON ACER TENDL-2021 LIBRARY; T=293.6K  
Photon emission for (n,pd)

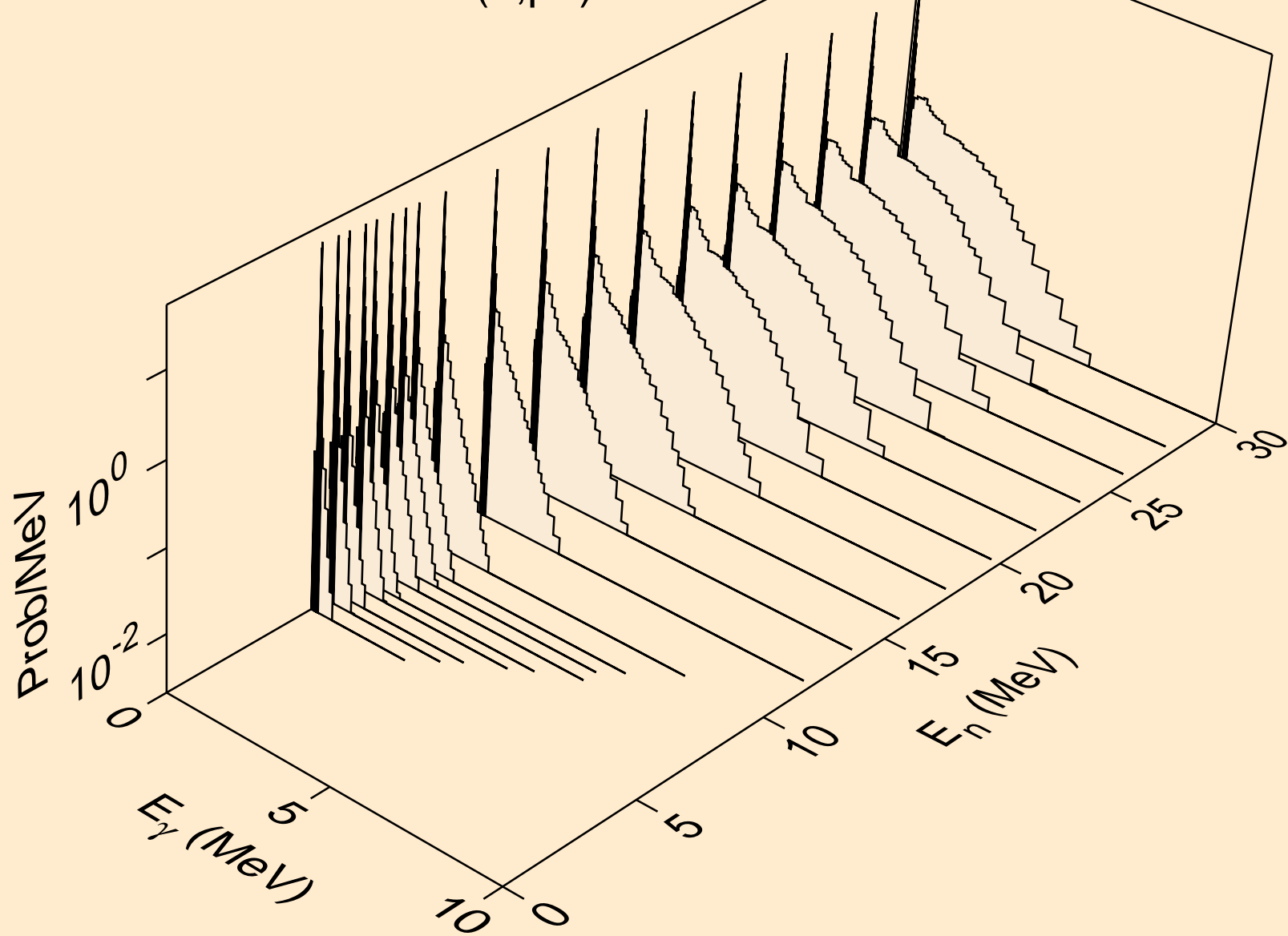

HG179 NEUTRON ACER TENDL-2021 LIBRARY; T=293.6K  
Photon emission for (n,pt)

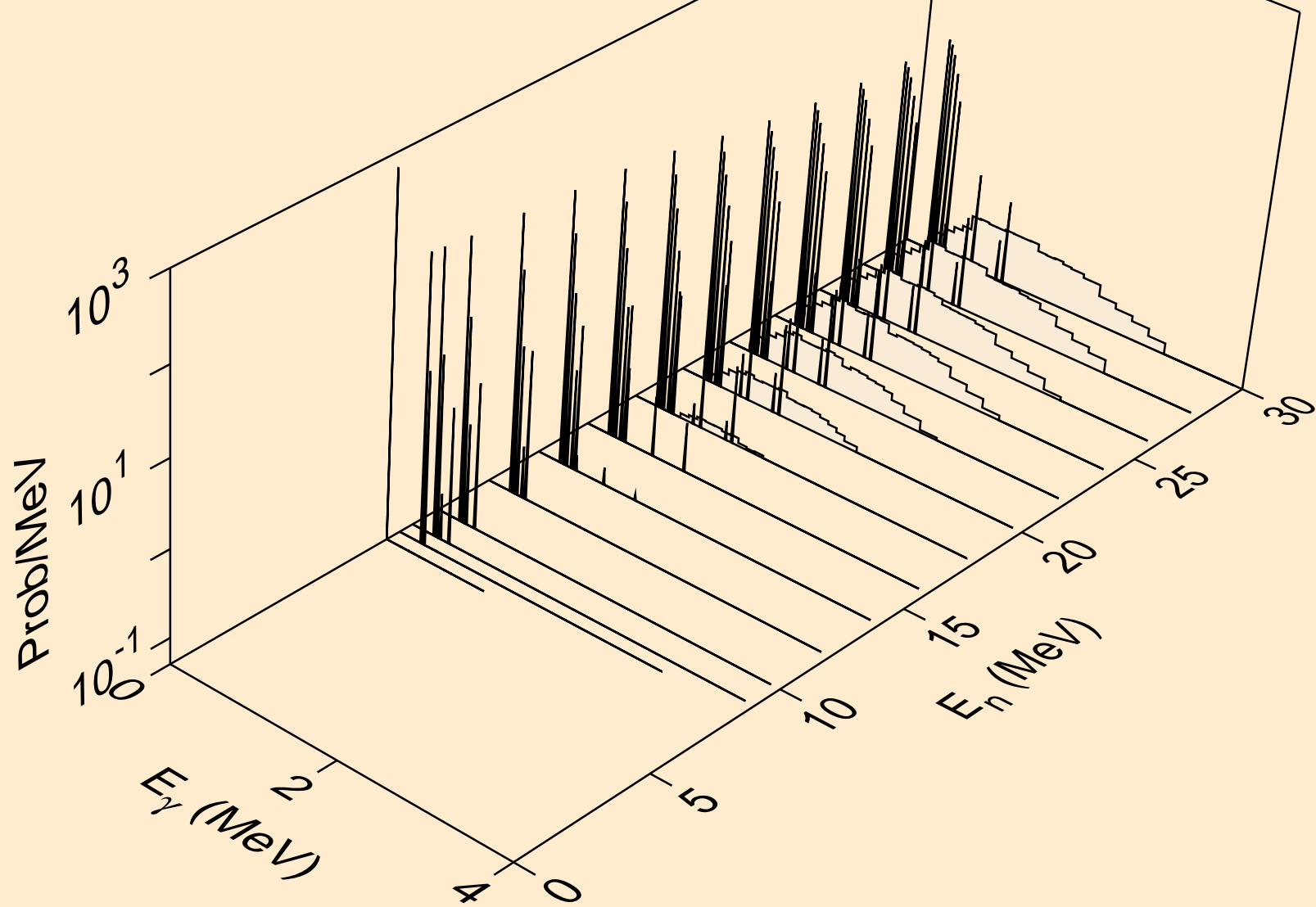

HG179 NEUTRON ACER TENDL-2021 LIBRARY; T=293.6K  
Photon emission for (n,da)

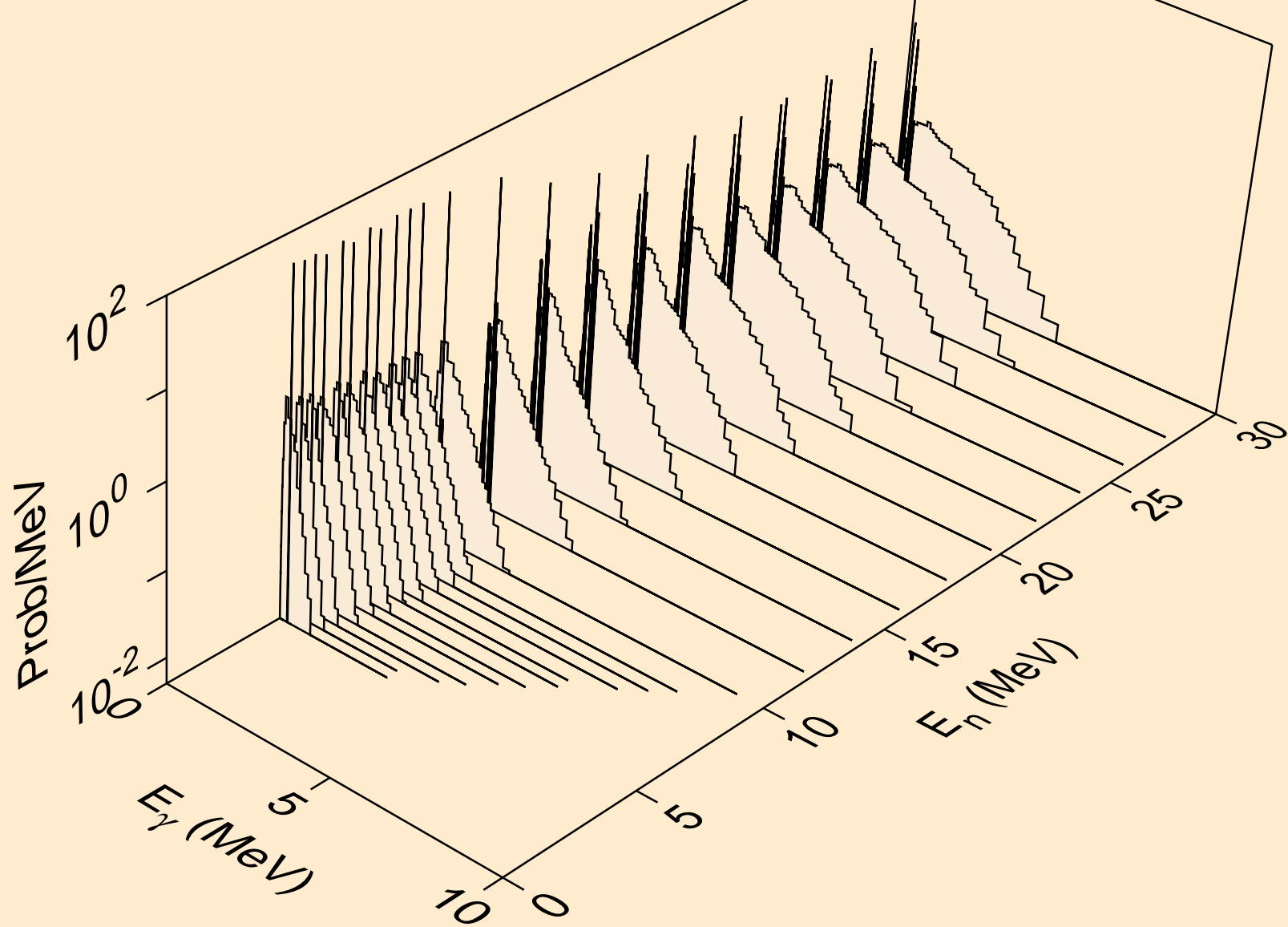

HG179 NEUTRON ACER TENDL-2021 LIBRARY; T=293.6K  
thermal capture photon spectrum

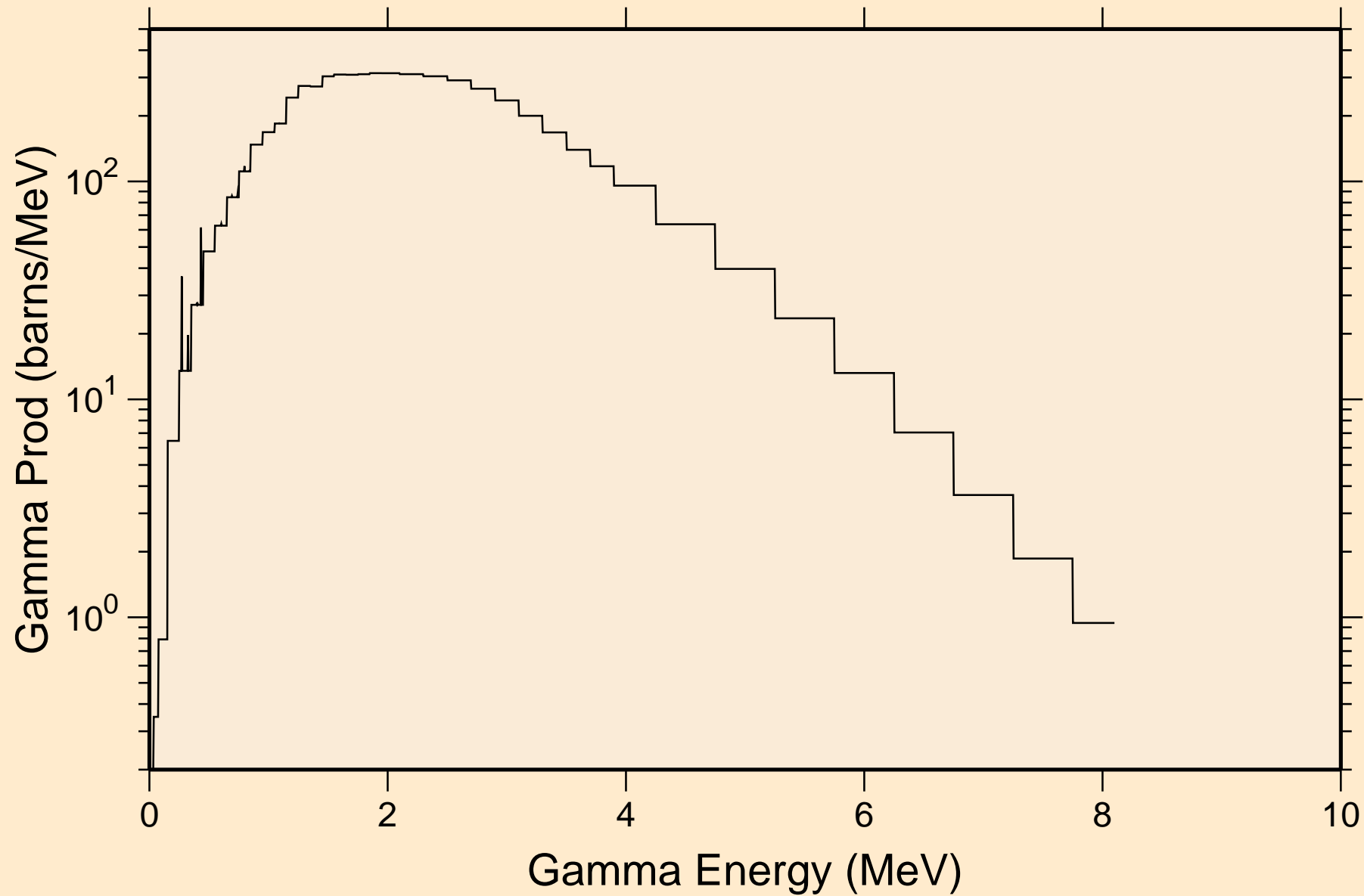

HG179 NEUTRON ACER TENDL-2021 LIBRARY; T=293.6K  
14 MeV photon spectrum

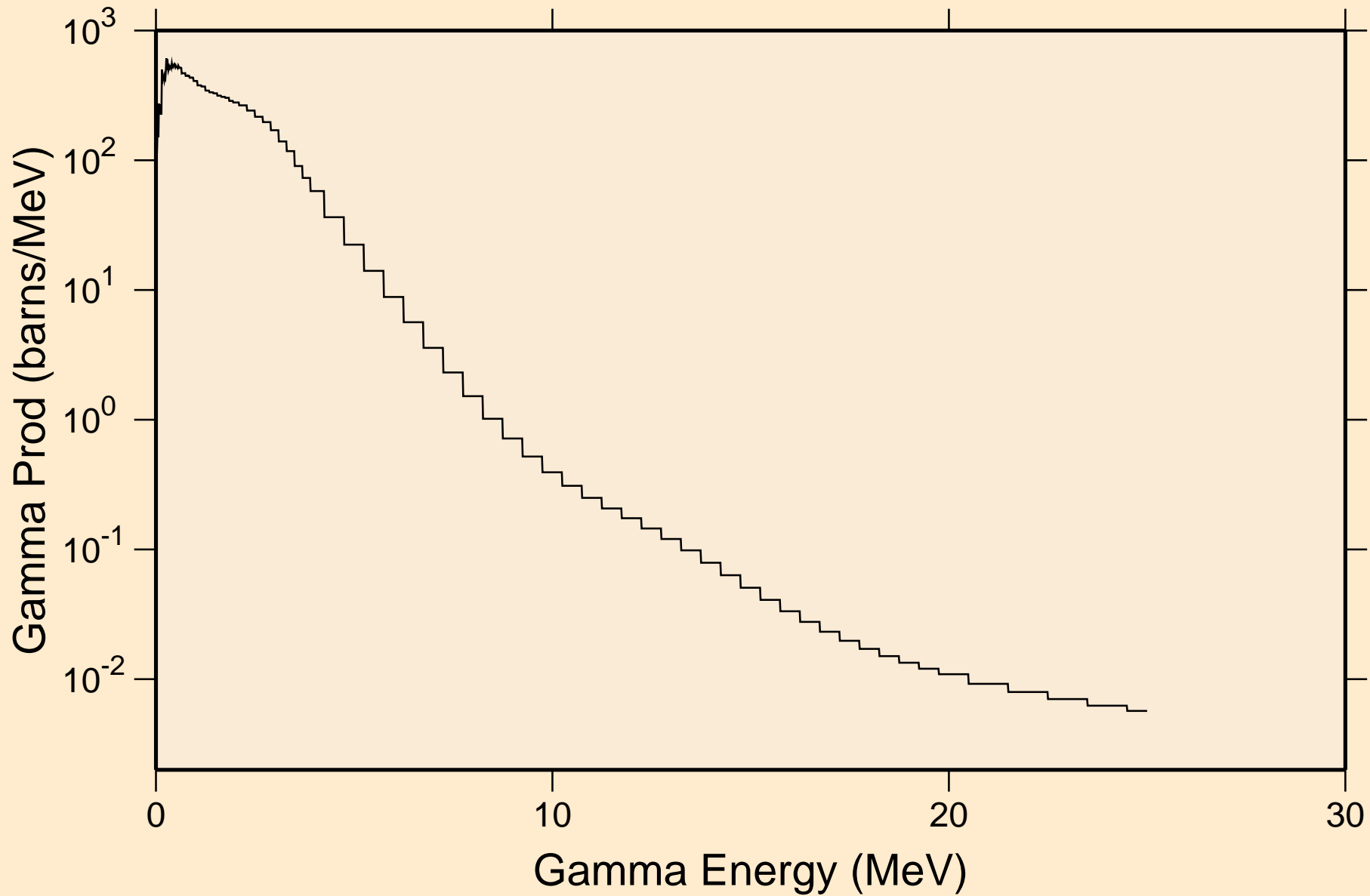

# HG179 NEUTRON ACER TENDL-2021 LIBRARY; T=293.6K

## Particle heating contributions

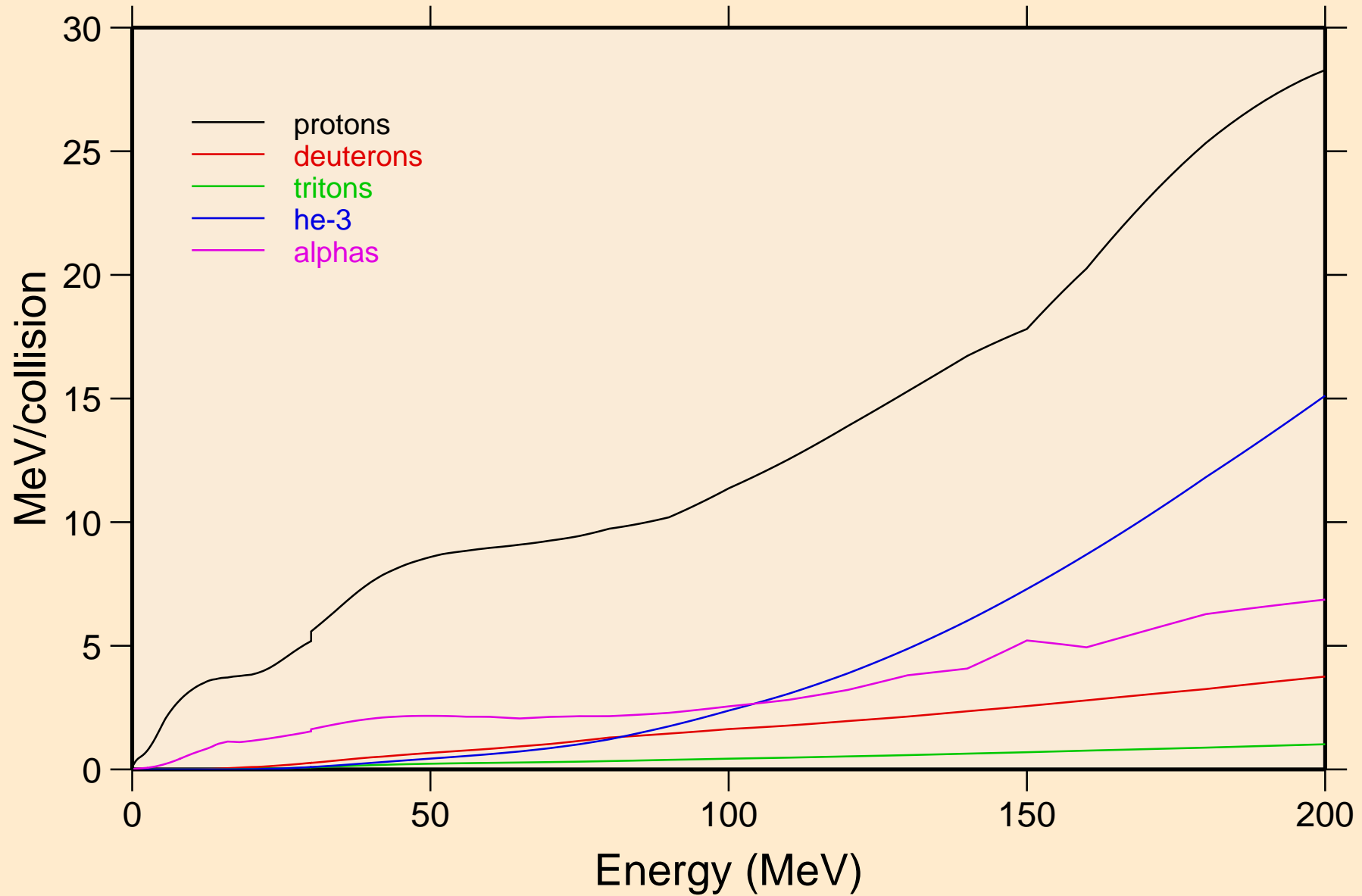



HG179 NEUTRON ACER TENDL-2021 LIBRARY; T=293.6K  
Recoil Heating

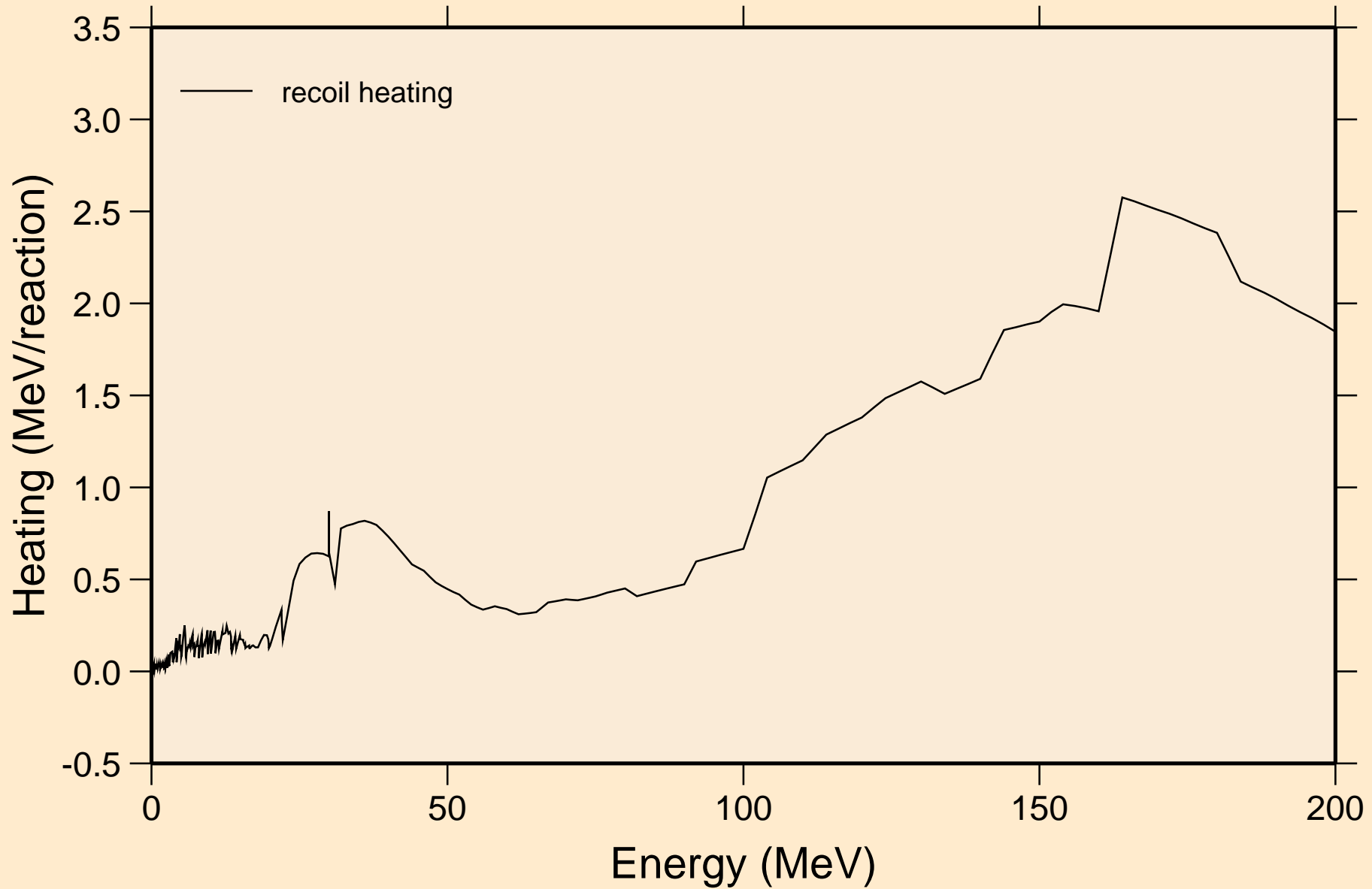

# HG179 NEUTRON ACER TENDL-2021 LIBRARY; T=293.6K

## Particle production cross sections

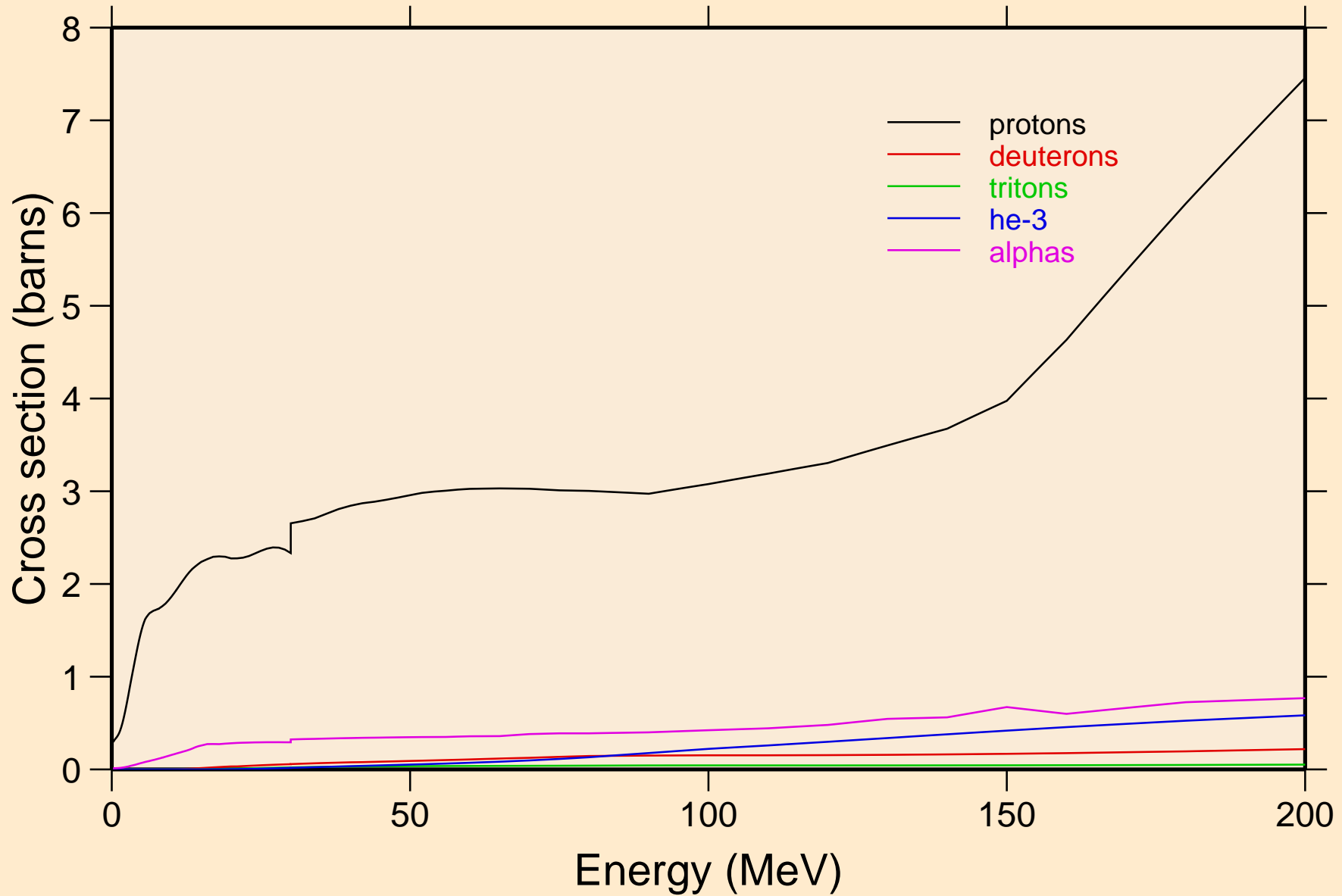

HG179 NEUTRON ACER TENDL-2021 LIBRARY; T=293.6K  
protons from (n,x)

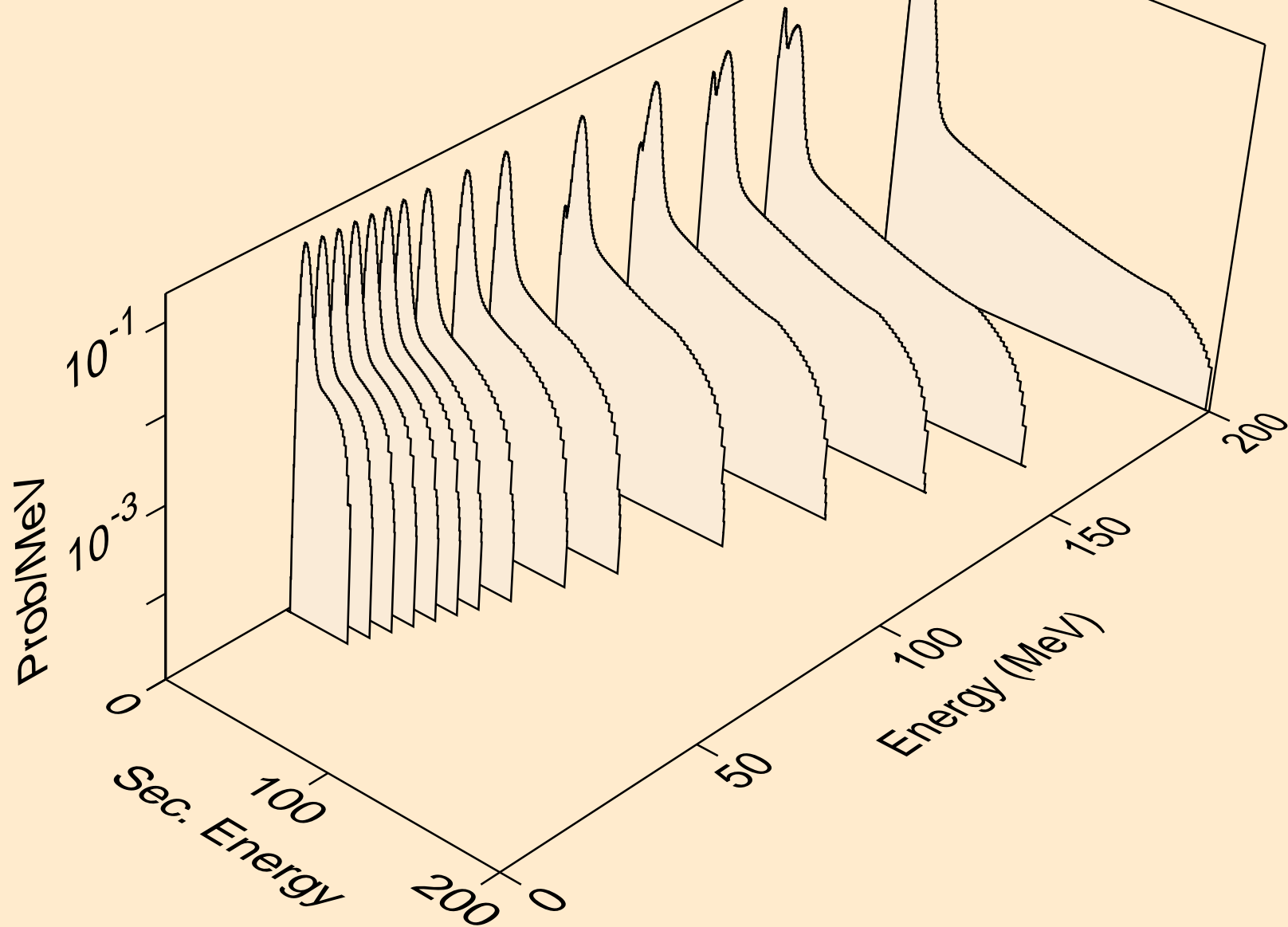

HG179 NEUTRON ACER TENDL-2021 LIBRARY; T=293.6K  
protons from (n,n\*)p

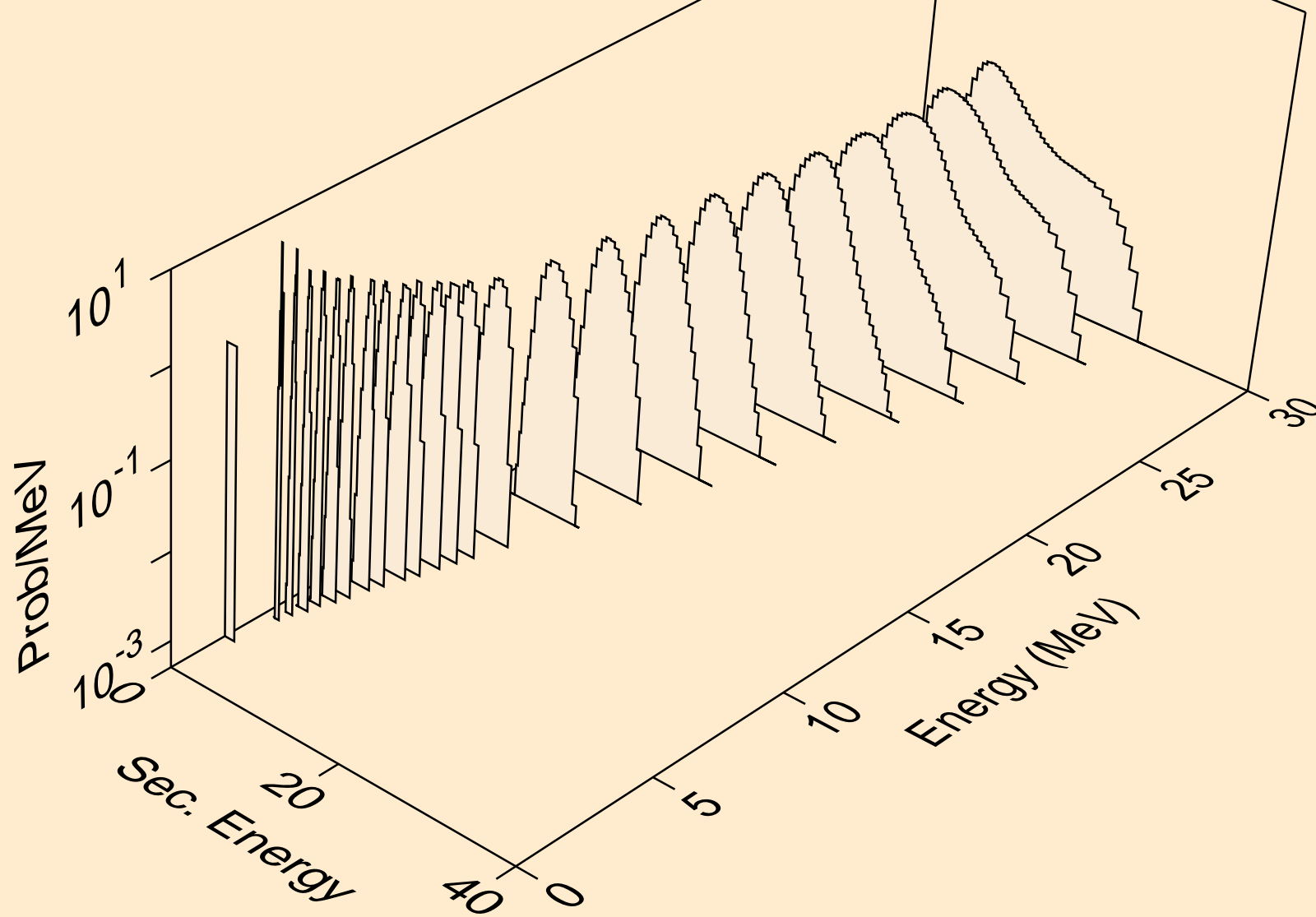

HG179 NEUTRON ACER TENDL-2021 LIBRARY; T=293.6K  
protons from (n,2np)

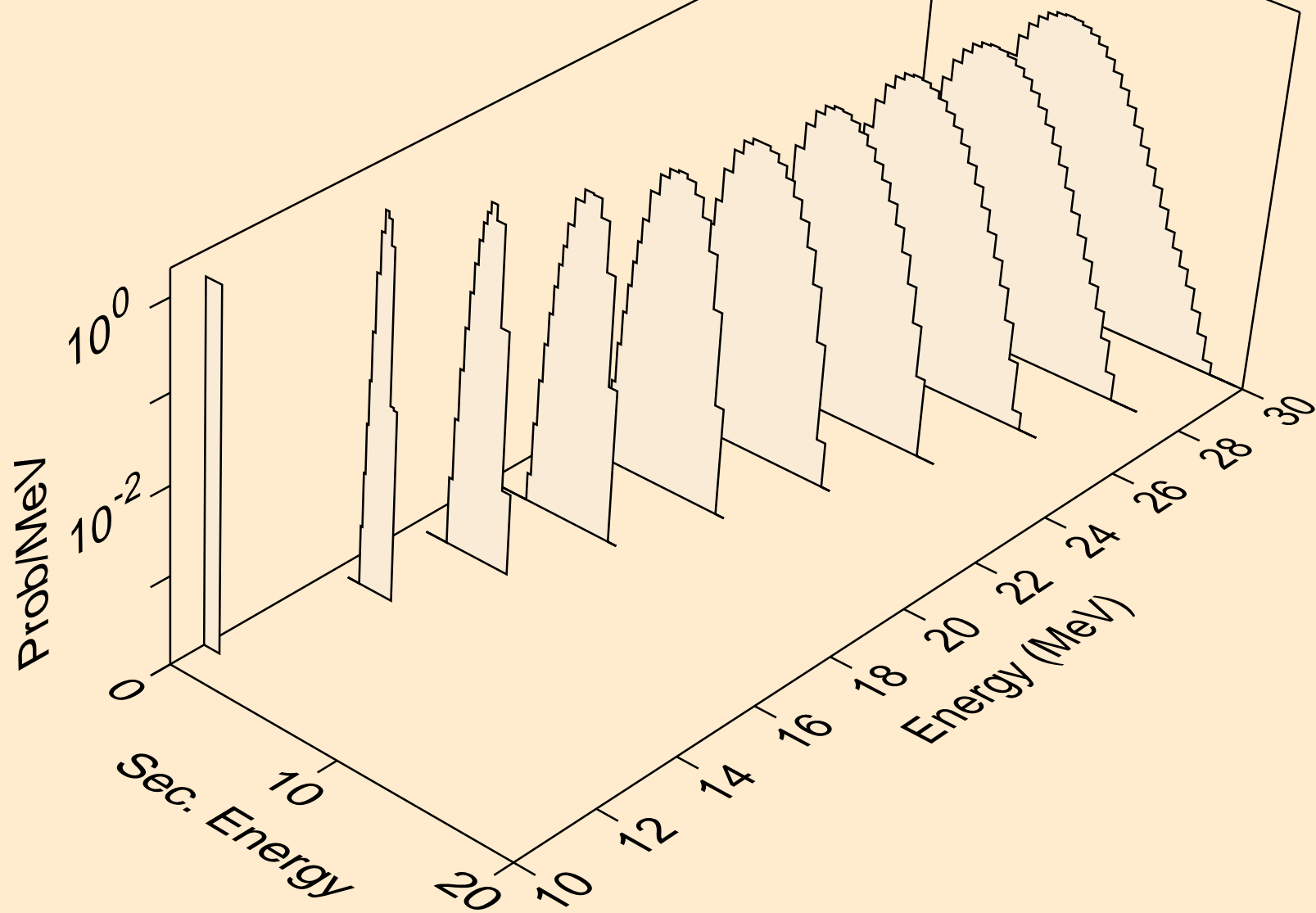

HG179 NEUTRON ACER TENDL-2021 LIBRARY; T=293.6K  
protons from (n,3np)

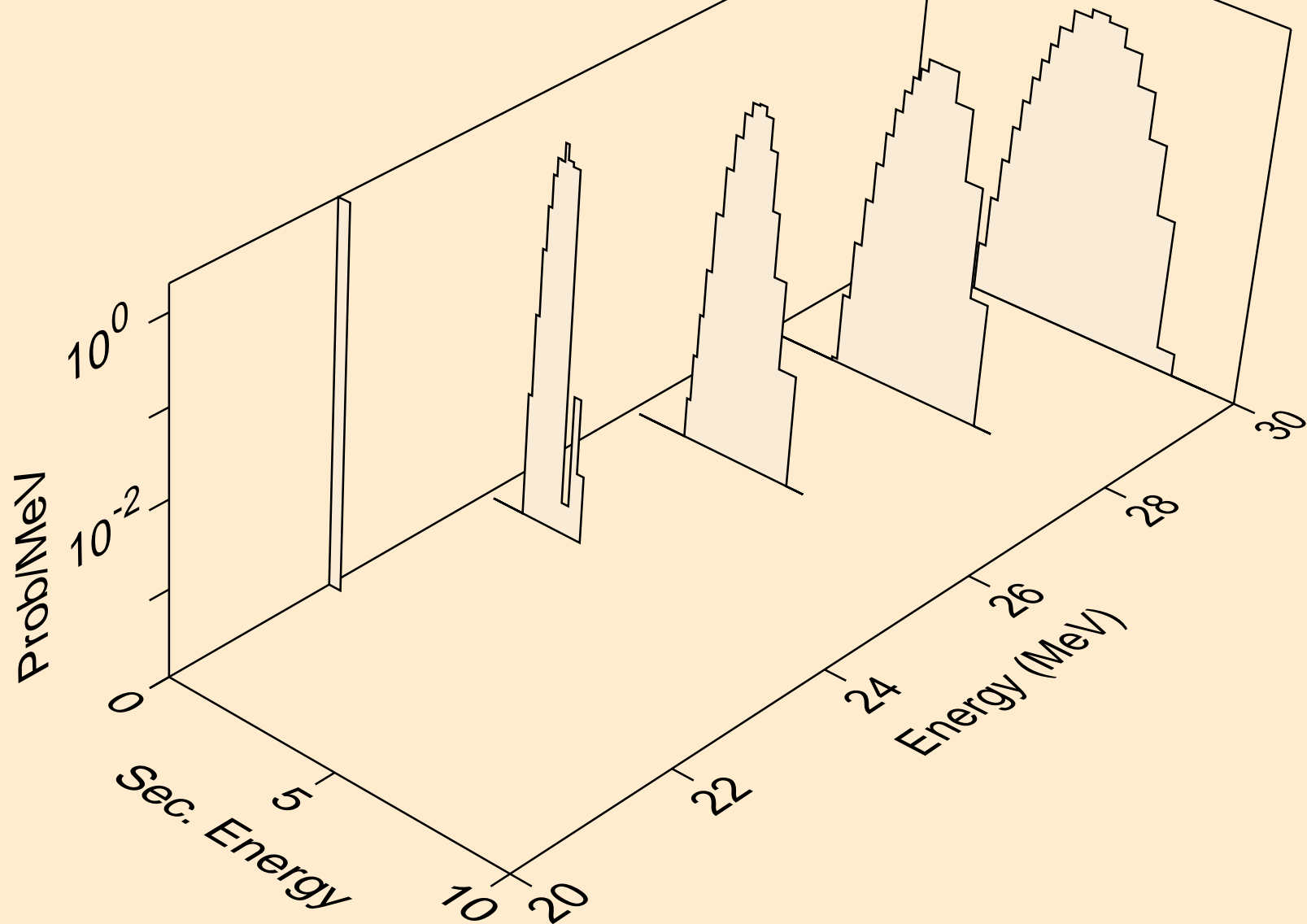

HG179 NEUTRON ACER TENDL-2021 LIBRARY; T=293.6K  
protons from (n,2np)

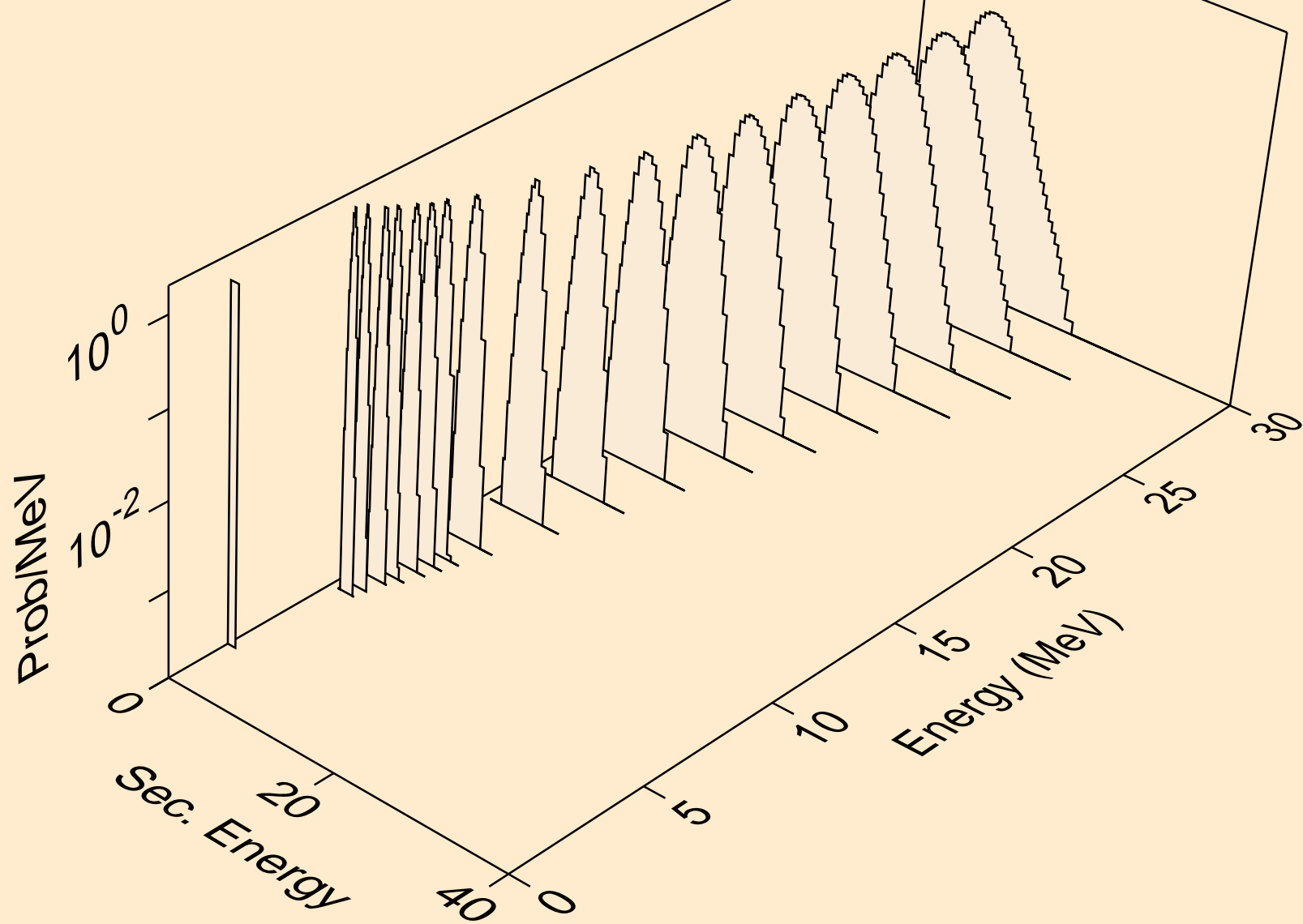

HG179 NEUTRON ACER TENDL-2021 LIBRARY; T=293.6K  
protons from (n,npa)

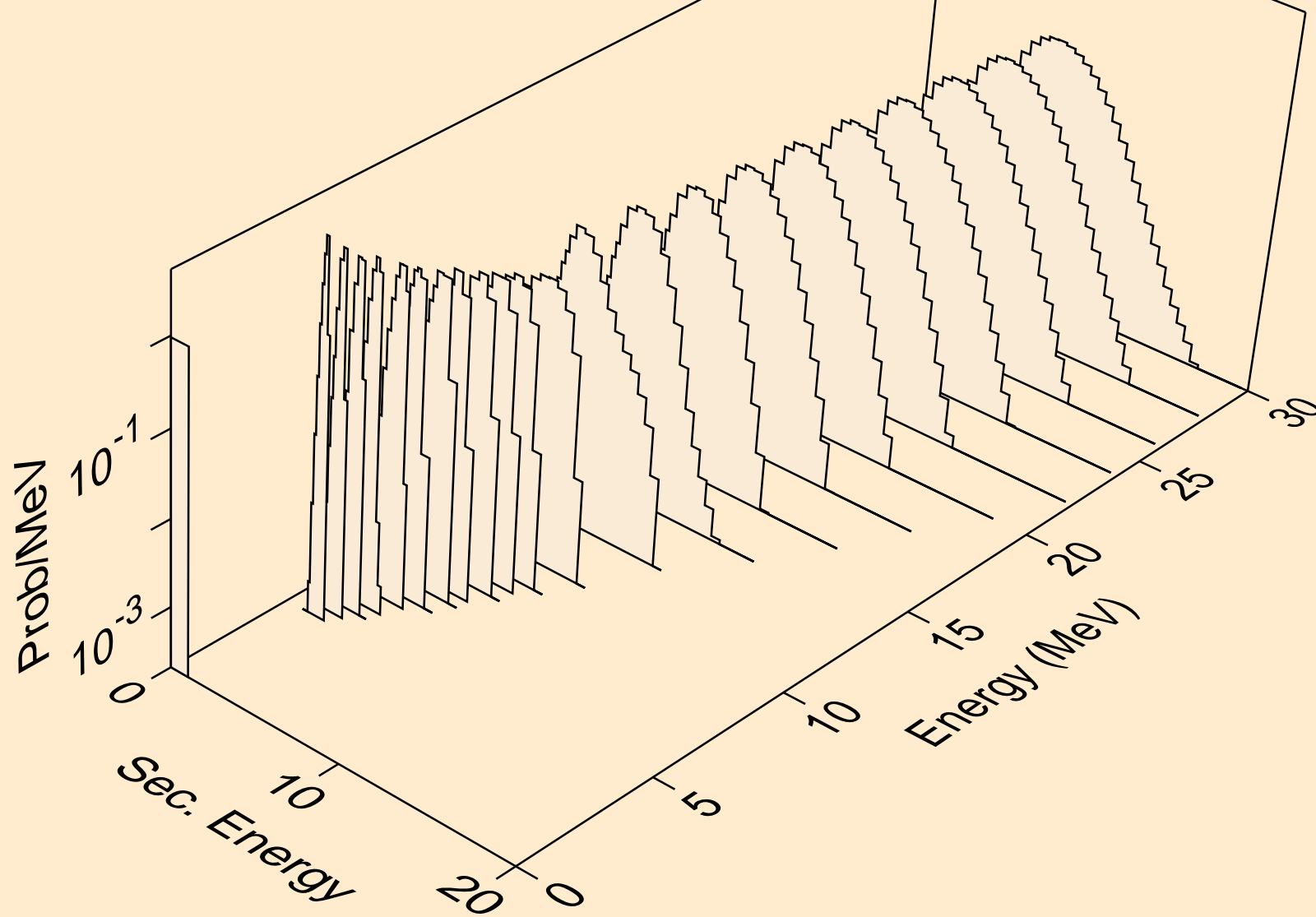



HG179 NEUTRON ACER TENDL-2021 LIBRARY; T=293.6K  
protons from (n,p)

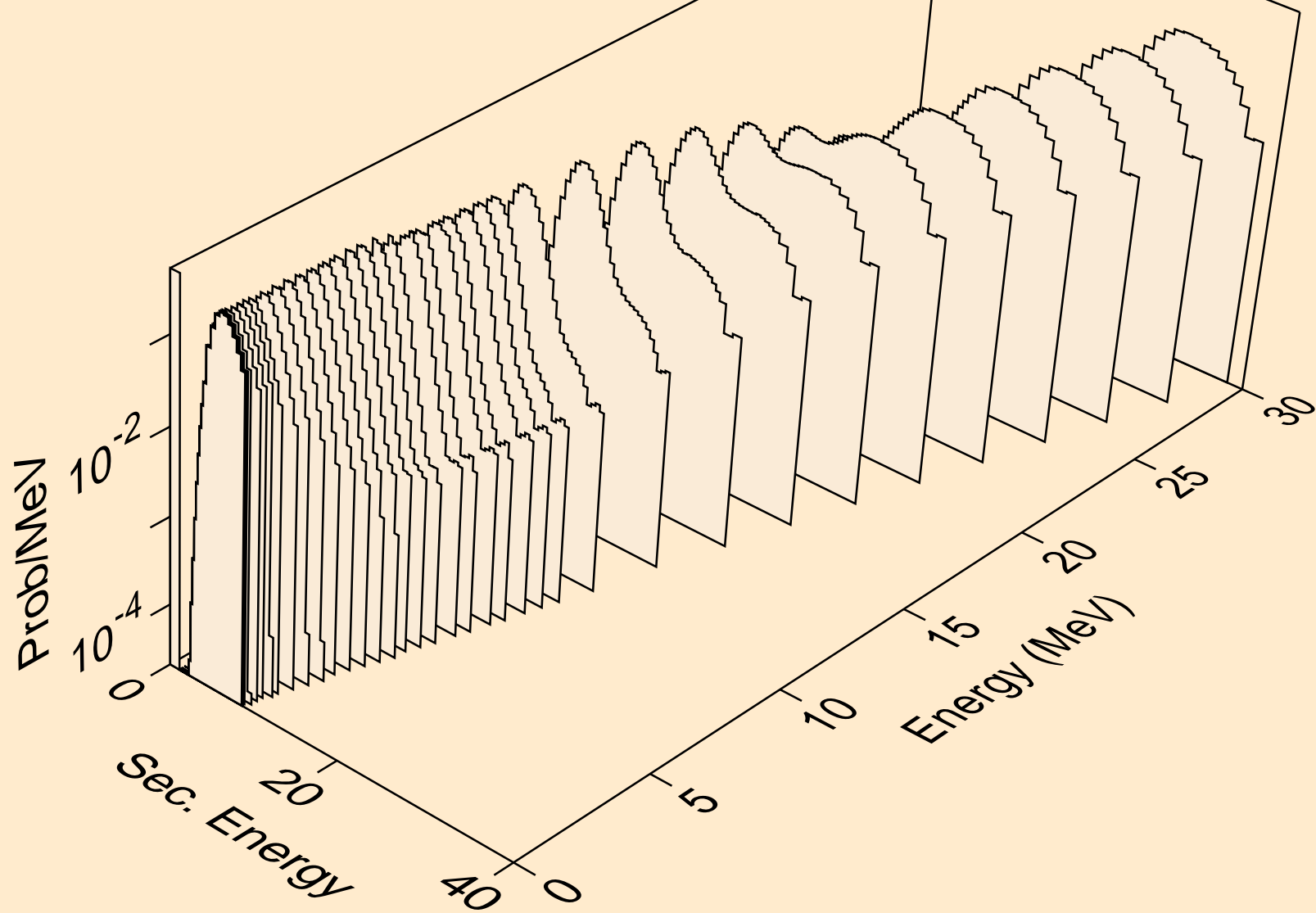

HG179 NEUTRON ACER TENDL-2021 LIBRARY; T=293.6K  
protons from (n,2p)

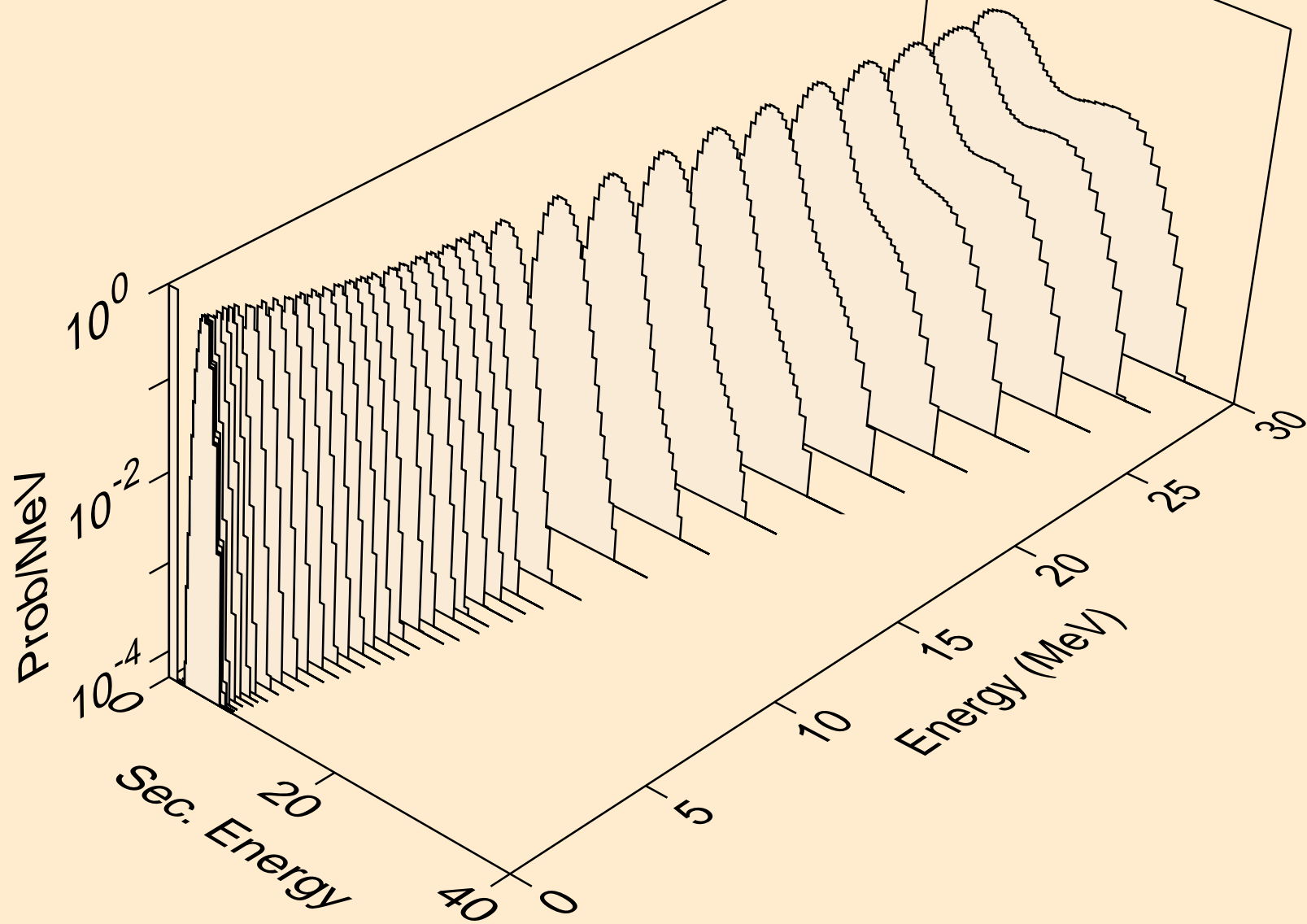

HG179 NEUTRON ACER TENDL-2021 LIBRARY; T=293.6K  
protons from (n,p)

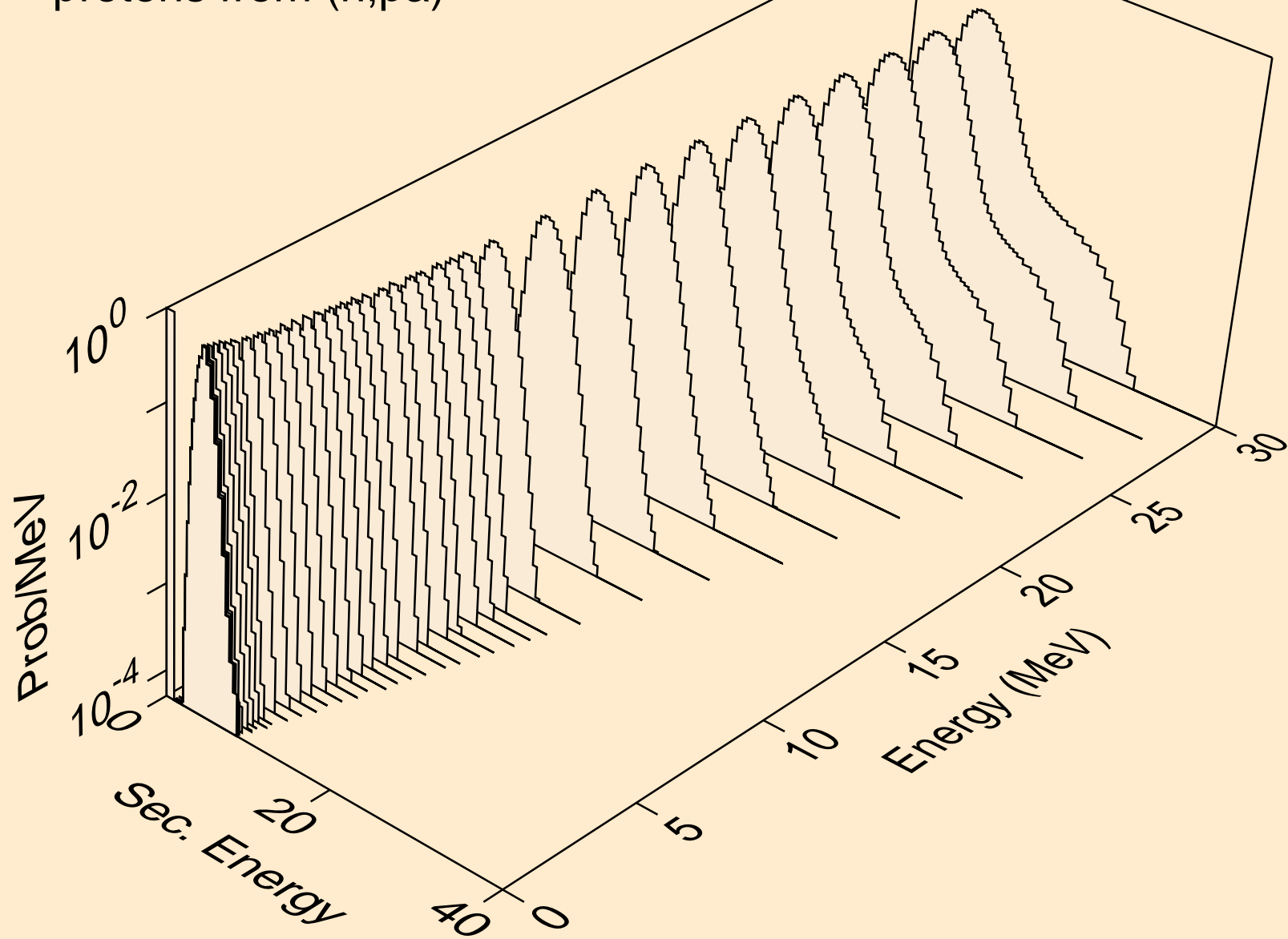

HG179 NEUTRON ACER TENDL-2021 LIBRARY; T=293.6K  
protons from (n,pd)

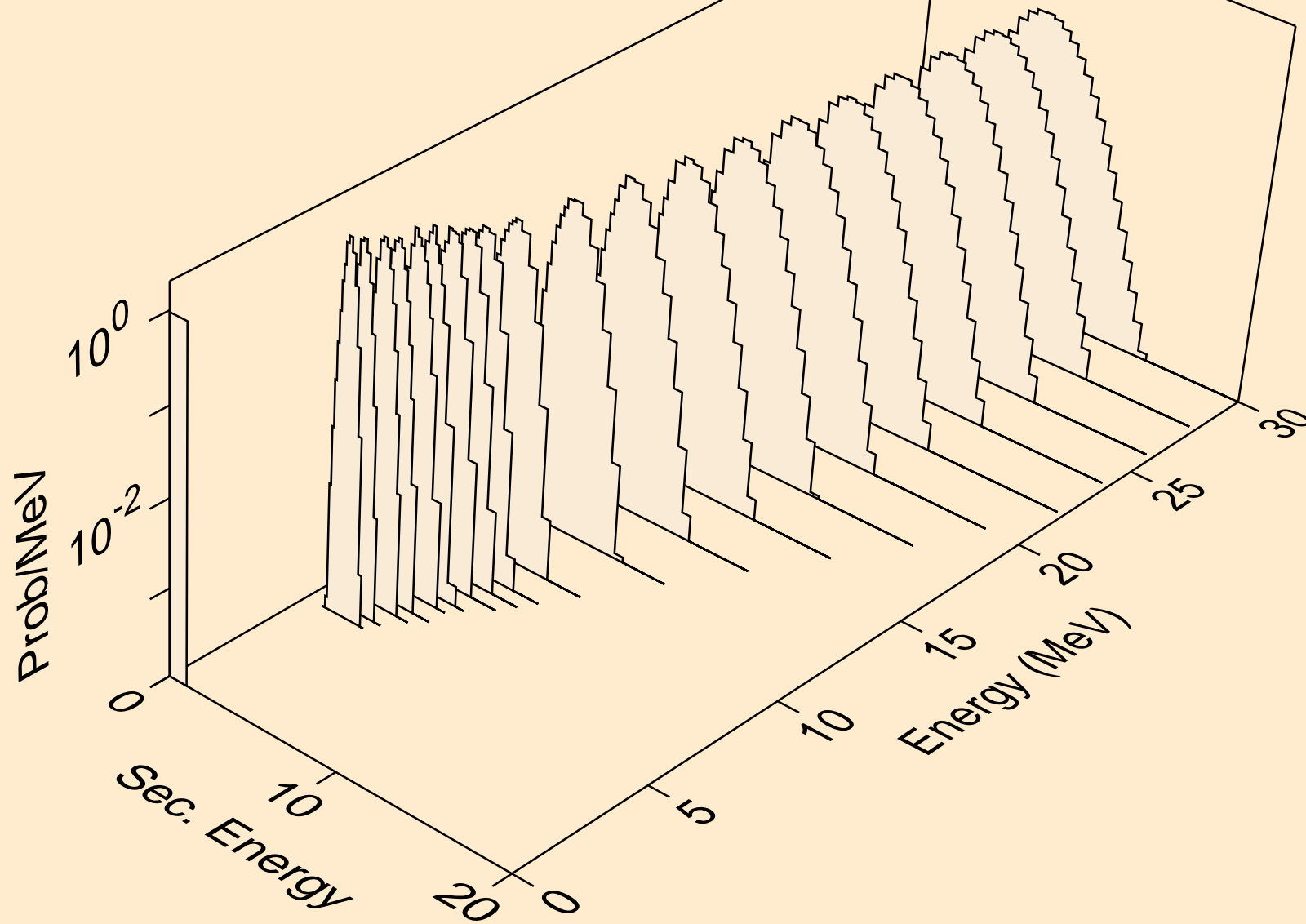

HG179 NEUTRON ACER TENDL-2021 LIBRARY; T=293.6K  
protons from (n,pt)

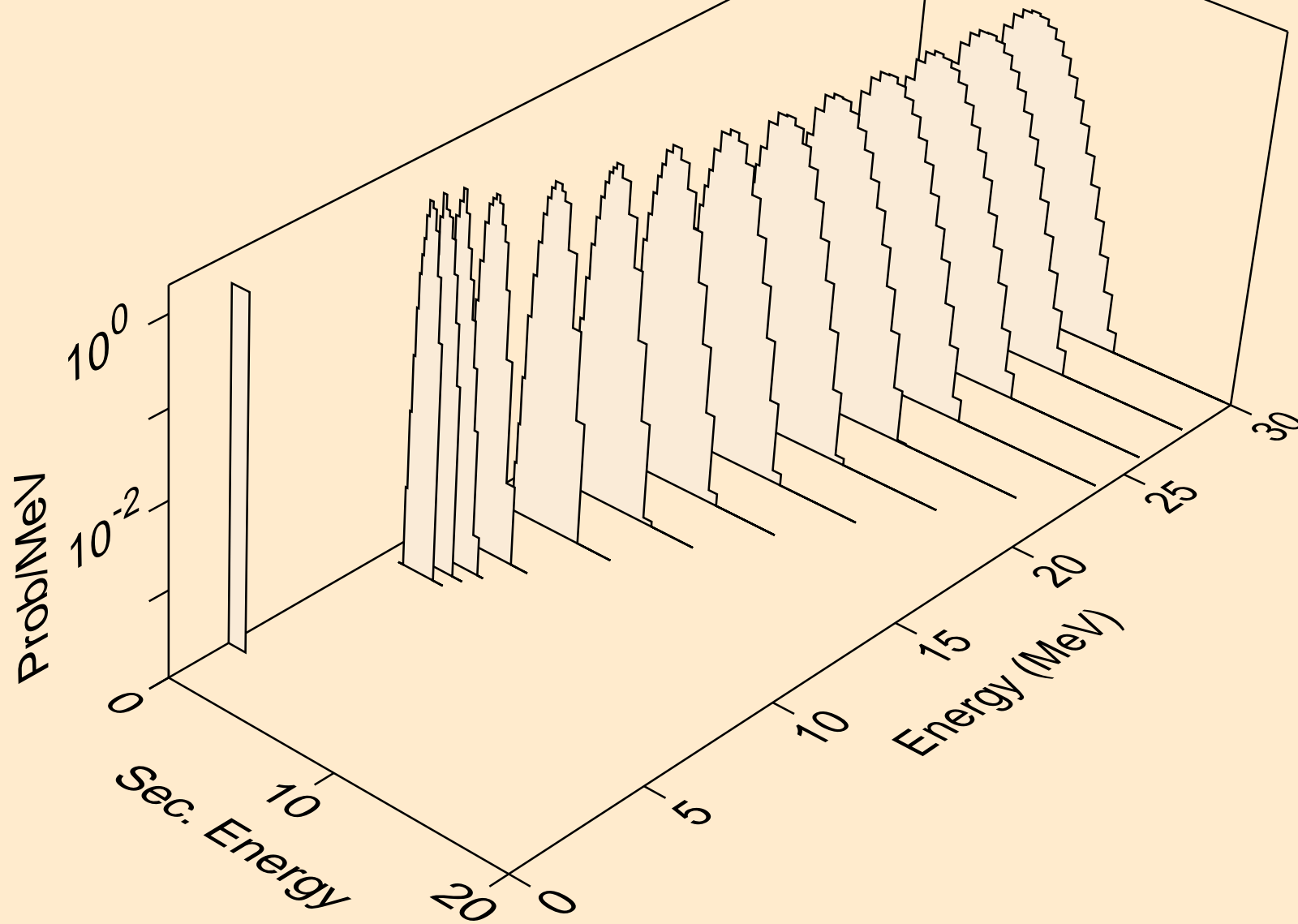

HG179 NEUTRON ACER TENDL-2021 LIBRARY; T=293.6K  
deuterons from (n,x)

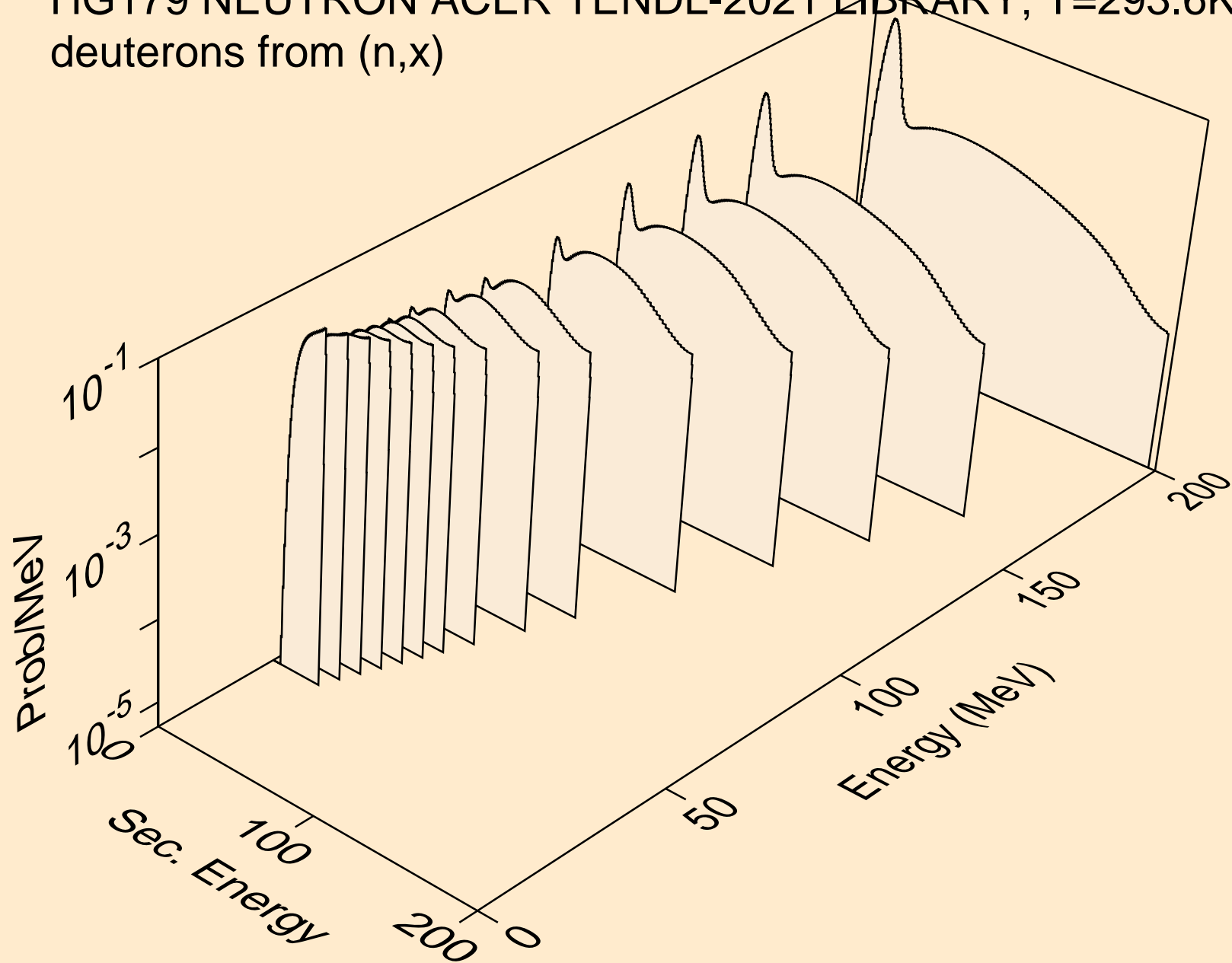

HG179 NEUTRON ACER TENDL-2021 LIBRARY; T=293.6K  
deuterons from (n,2nd)

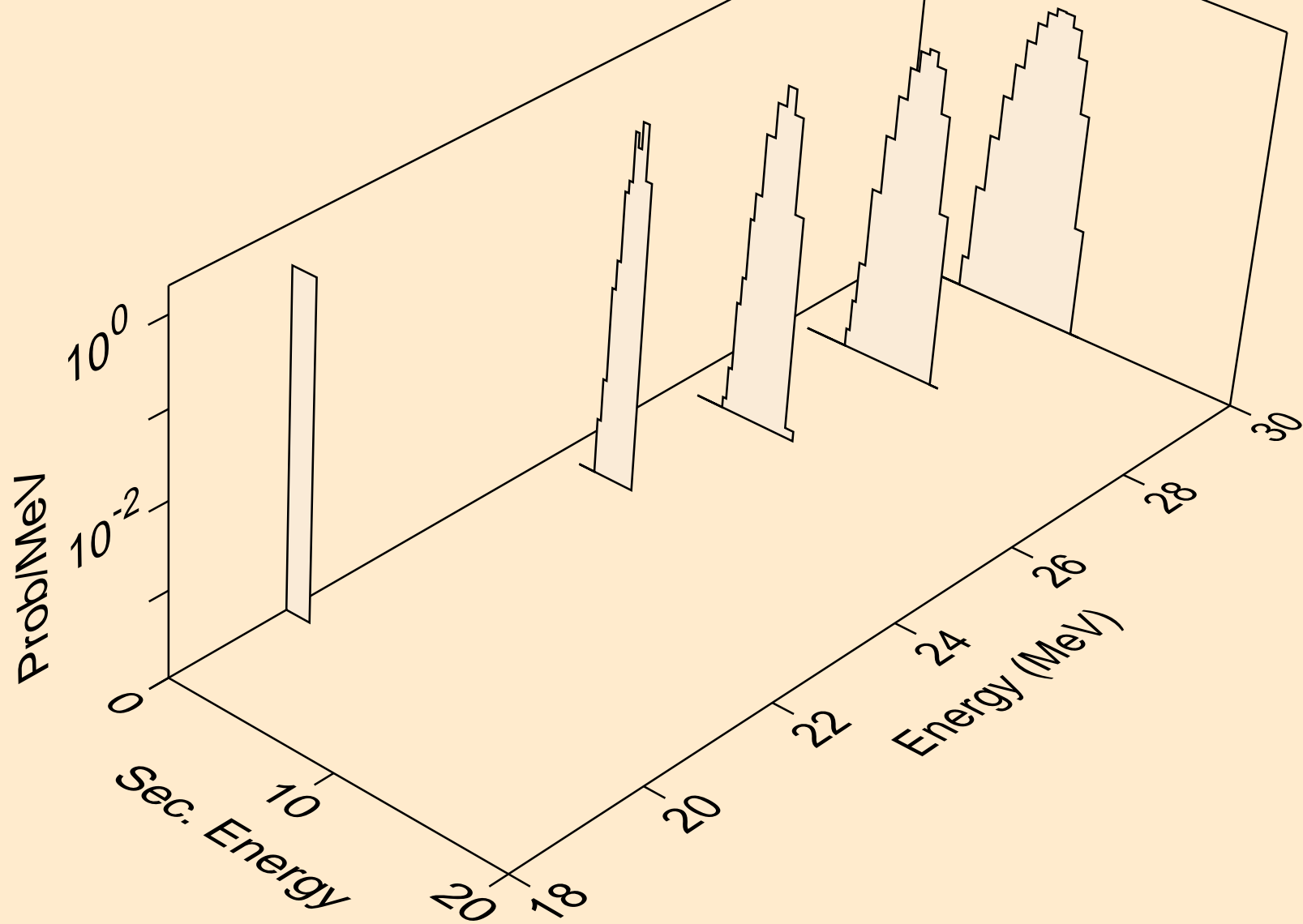

HG179 NEUTRON ACER TENDL-2021 LIBRARY; T=293.6K  
deuterons from (n,n\*)d

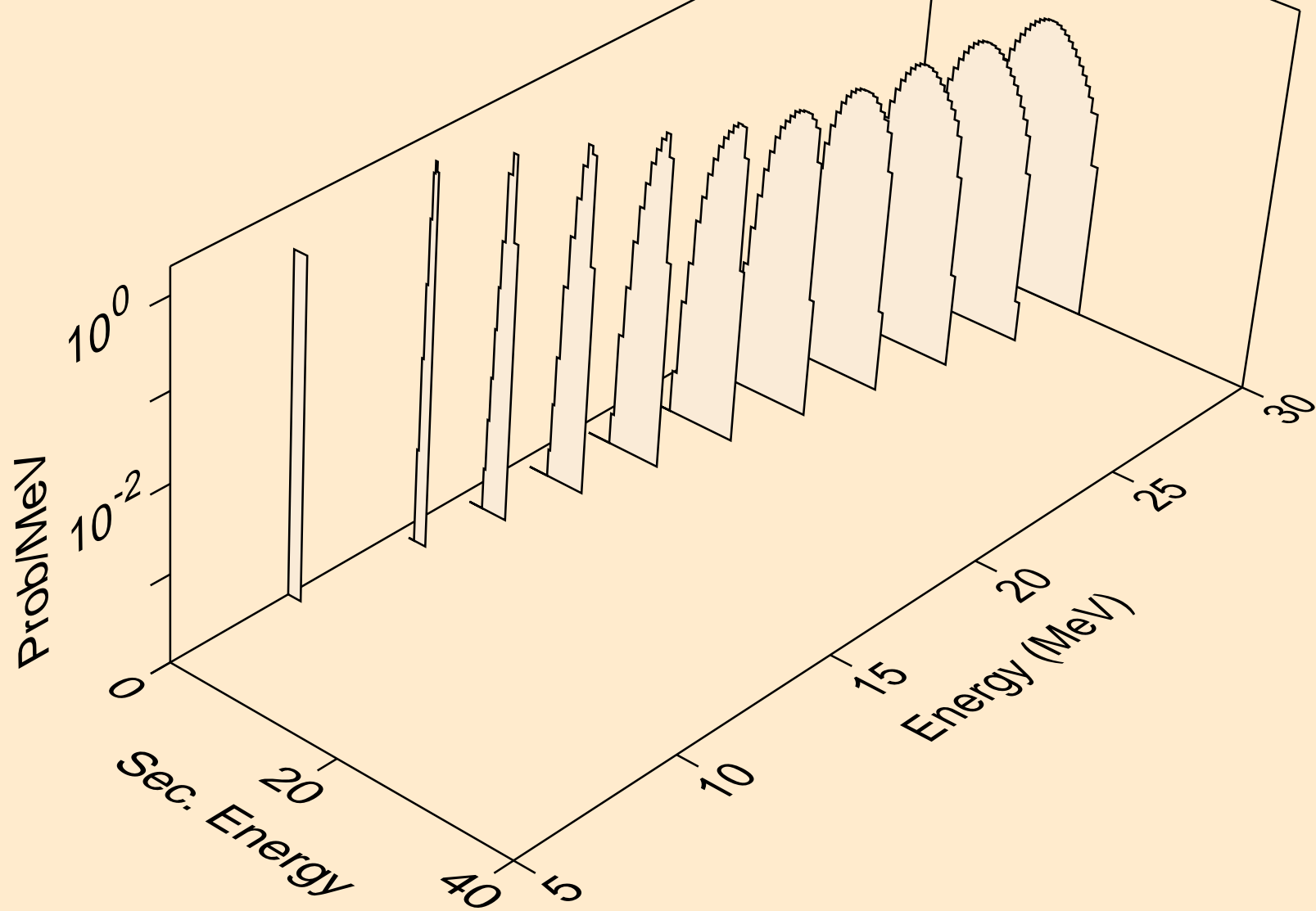



HG179 NEUTRON ACER TENDL-2021 LIBRARY; T=293.6K  
deuterons from (n,d)

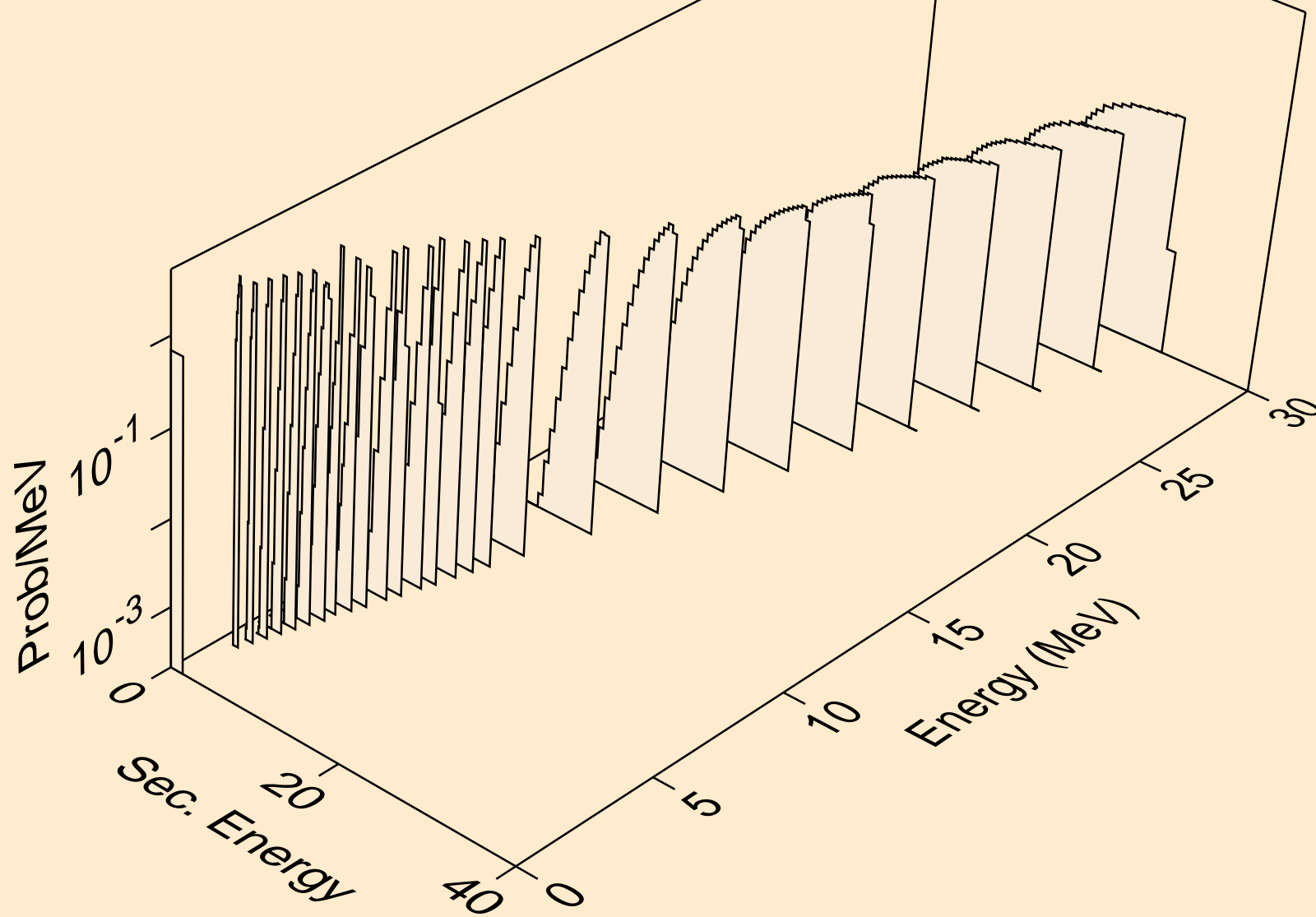

HG179 NEUTRON ACER TENDL-2021 LIBRARY; T=293.6K  
deuterons from (n,d2a)

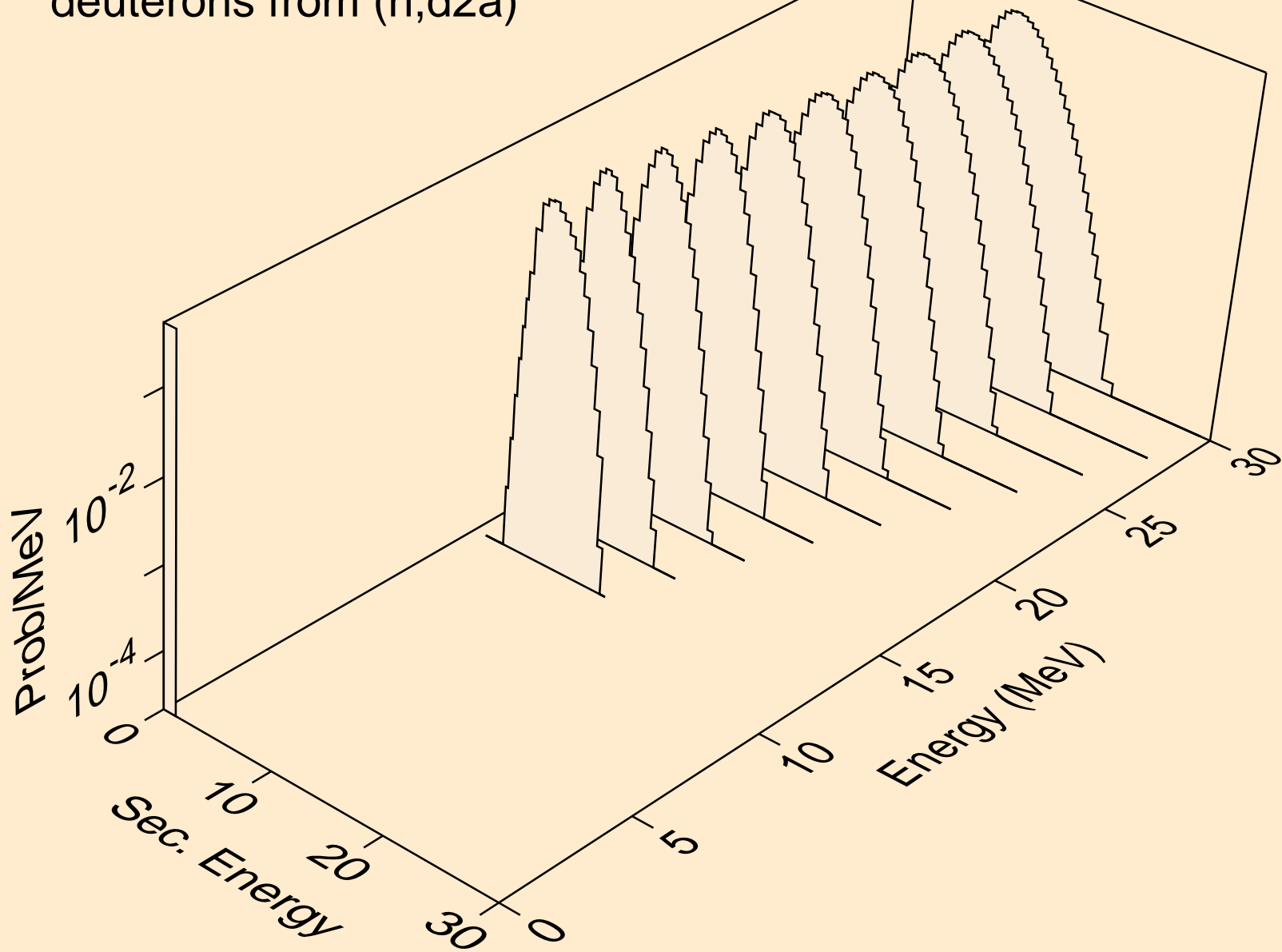

HG179 NEUTRON ACER TENDL-2021 LIBRARY; T=293.6K  
deuterons from (n,pd)

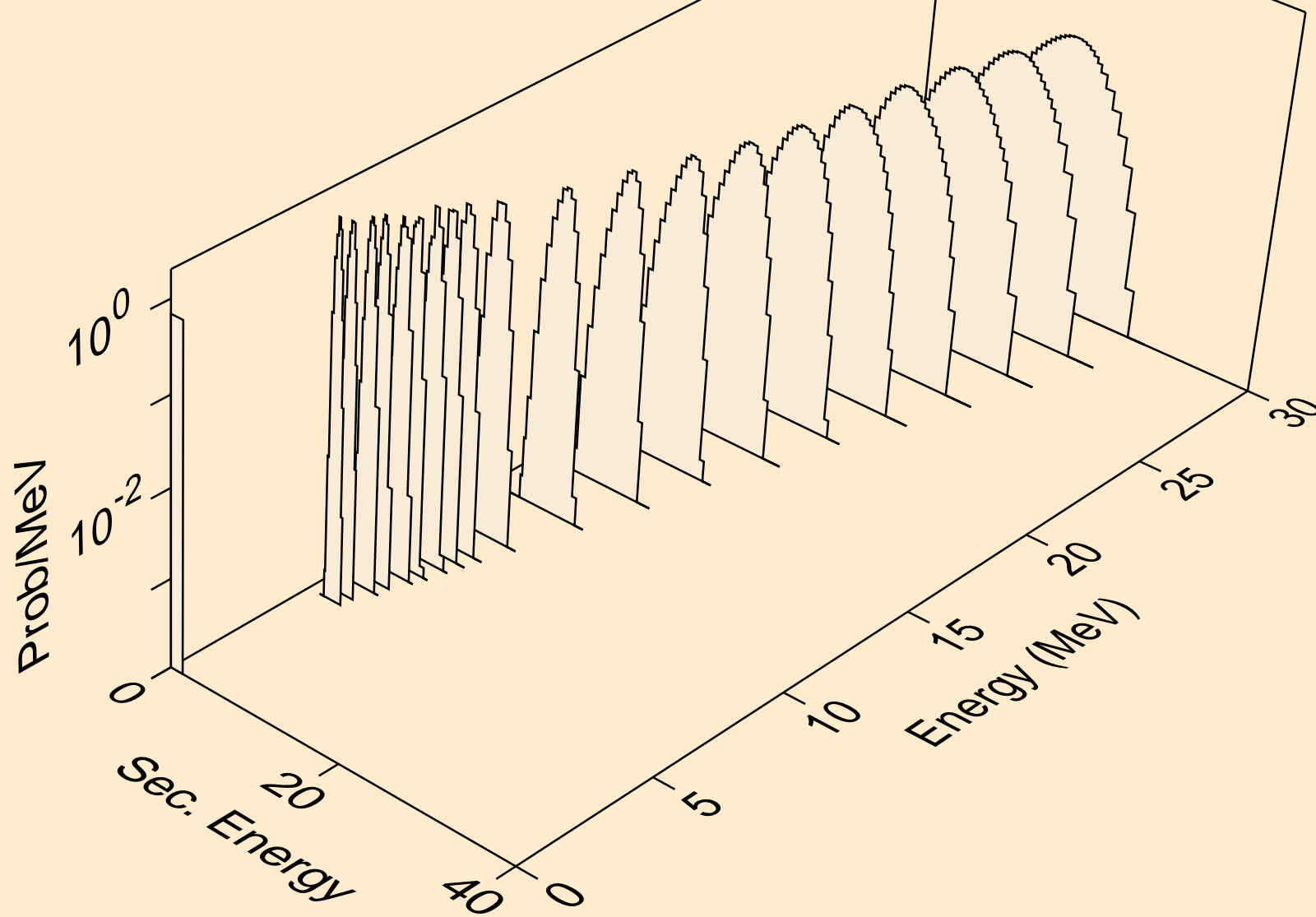

HG179 NEUTRON ACER TENDL-2021 LIBRARY; T=293.6K  
deuterons from (n,da)

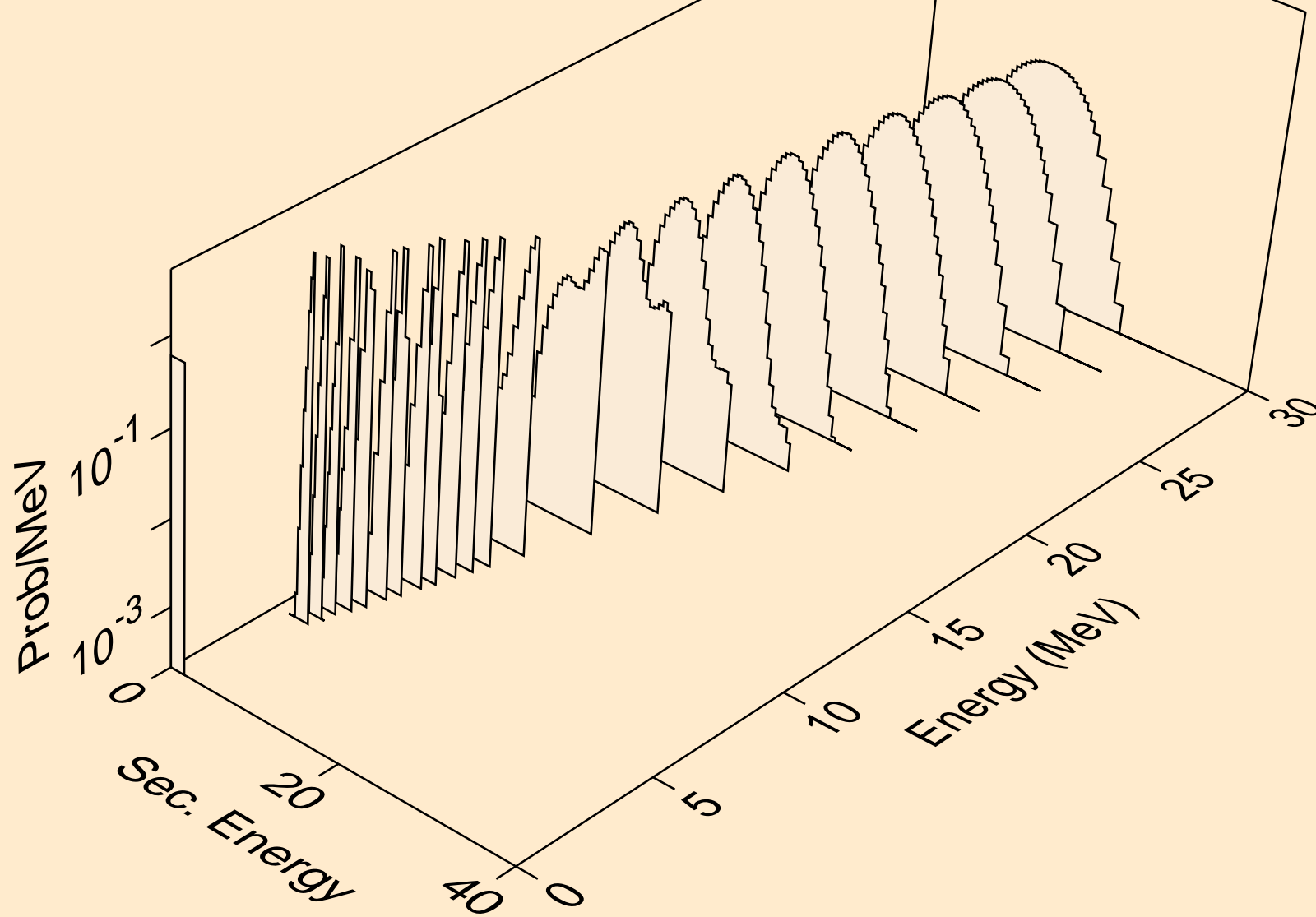

HG179 NEUTRON ACER TENDL-2021 LIBRARY; T=293.6K  
tritons from (n,x)

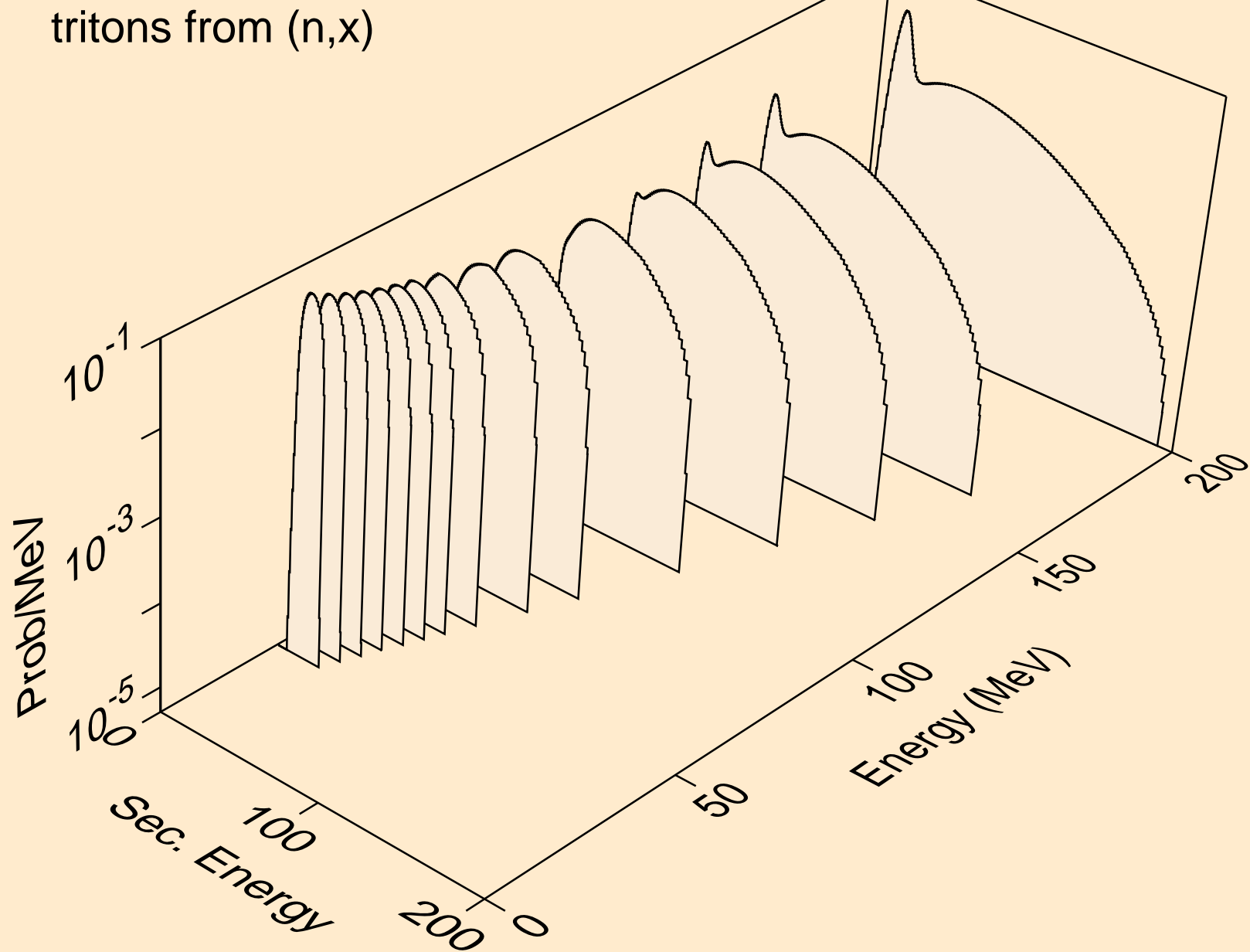

HG179 NEUTRON ACER TENDL-2021 LIBRARY; T=293.6K  
tritons from (n,n\*)t

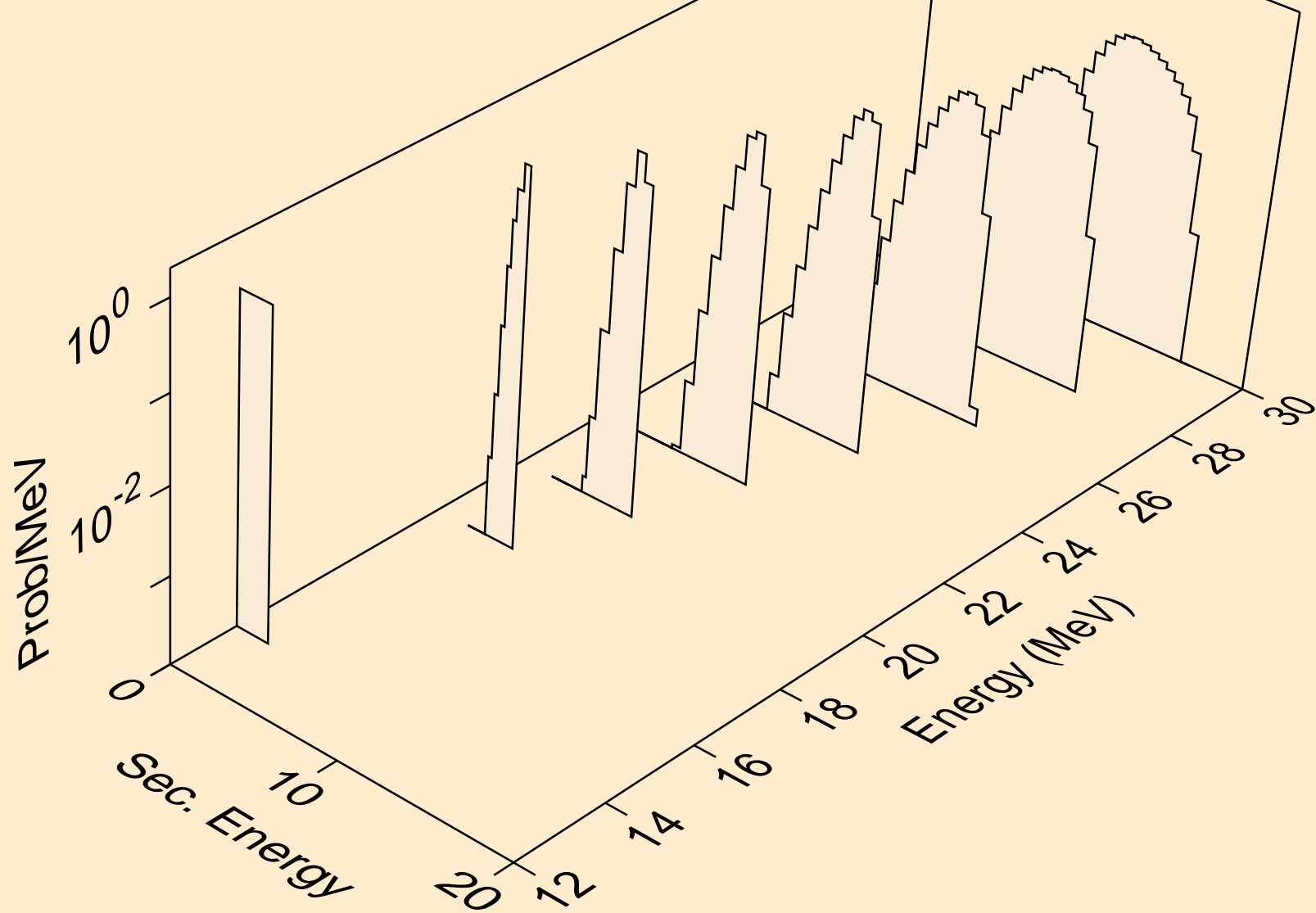

HG179 NEUTRON ACER TENDL-2021 LIBRARY; T=293.6K  
tritons from (n,t)

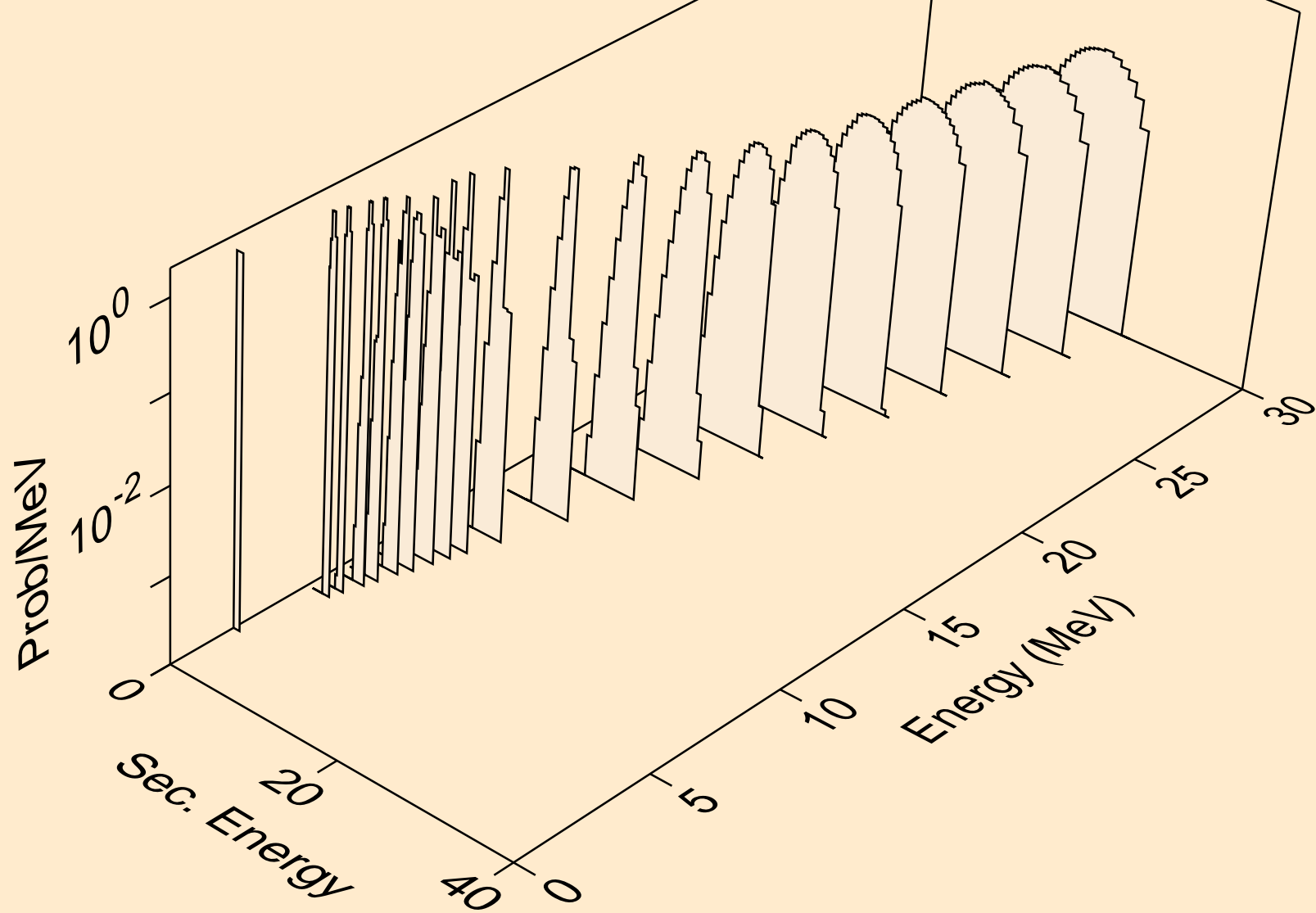

HG179 NEUTRON ACER TENDL-2021 LIBRARY; T=293.6K  
tritons from (n,t2a)

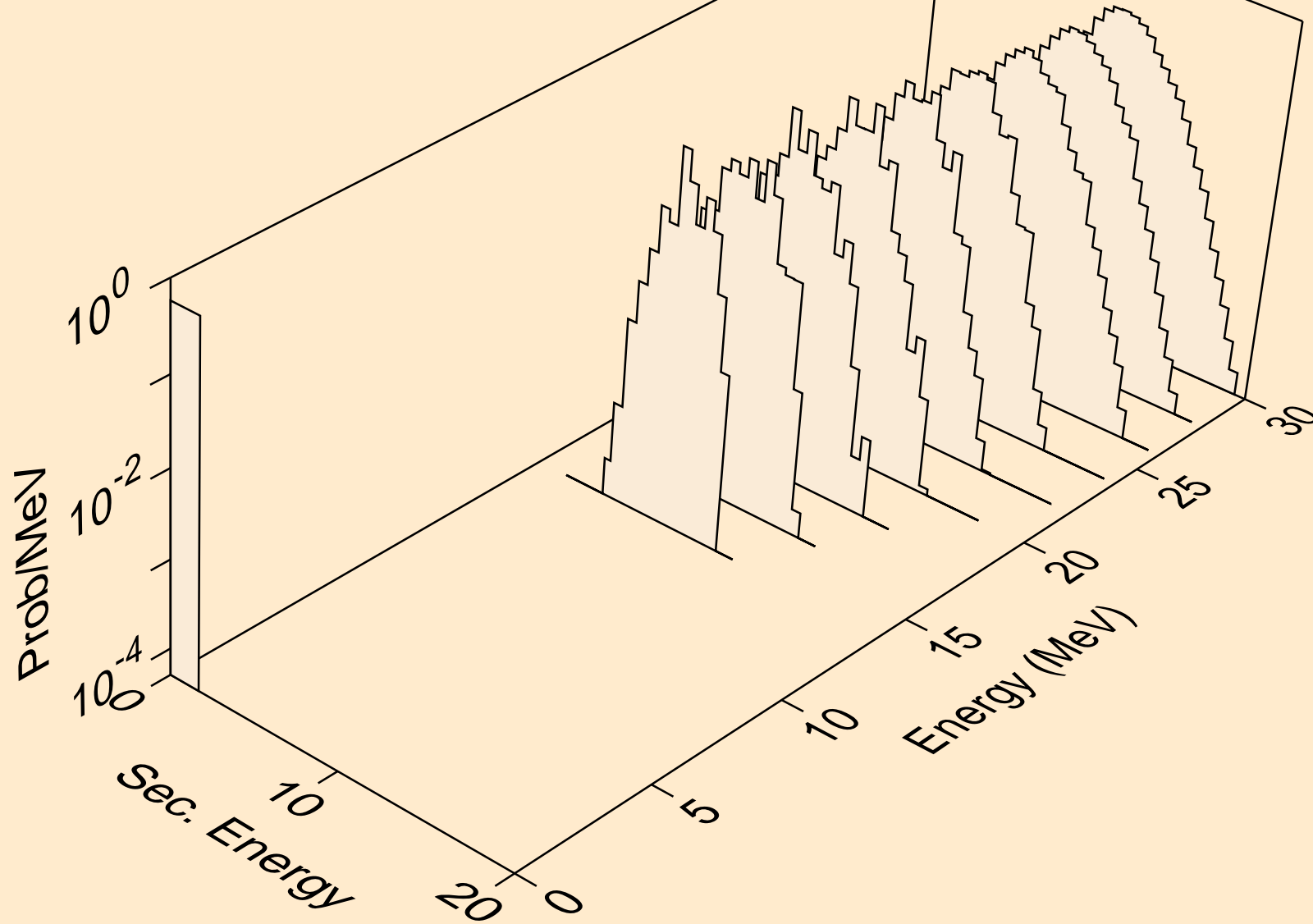



HG179 NEUTRON ACER TENDL-2021 LIBRARY; T=293.6K  
tritons from (n,pt)

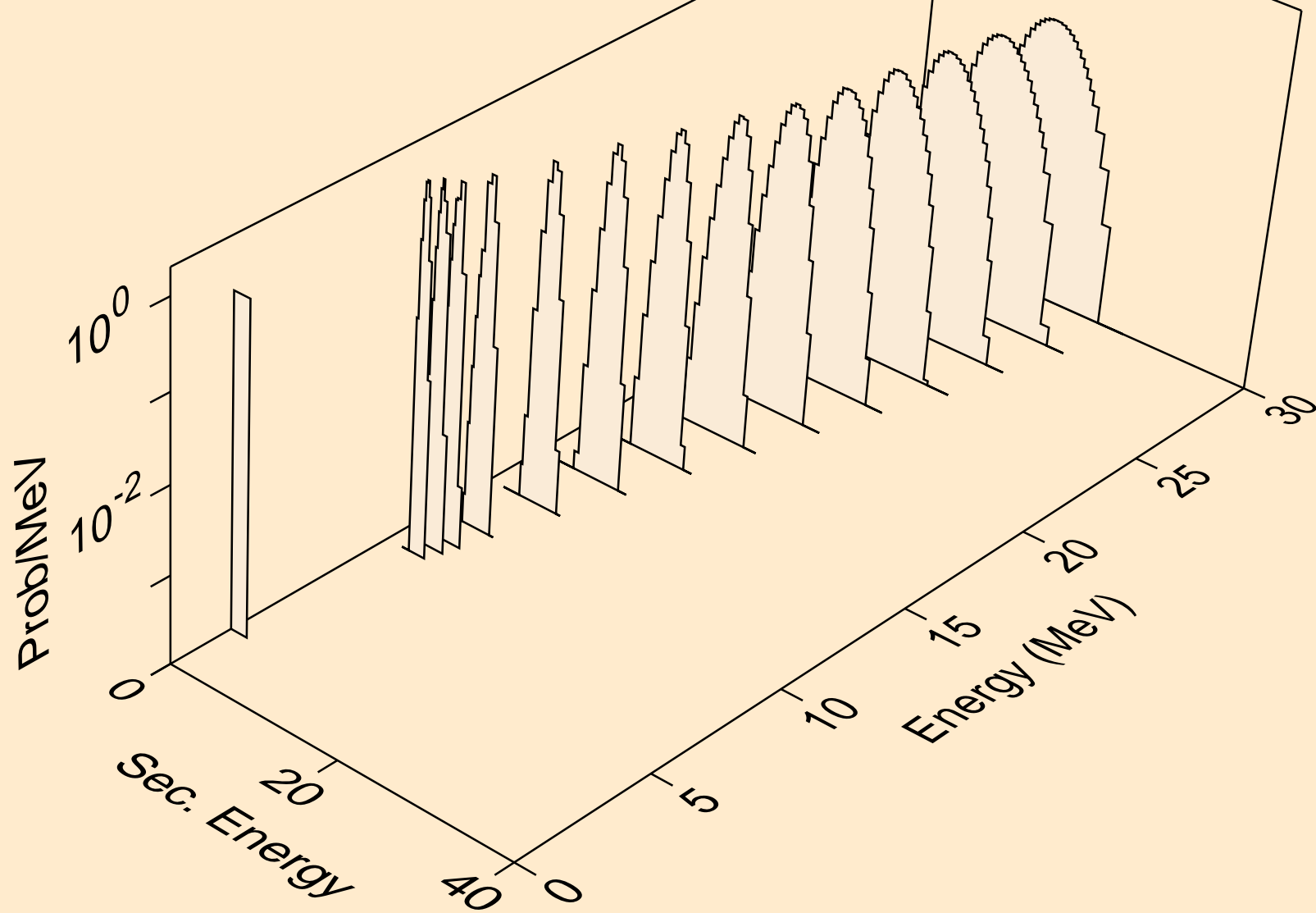

HG179 NEUTRON ACER TENDL-2021 LIBRARY; T=293.6K  
he3s from (n,x)

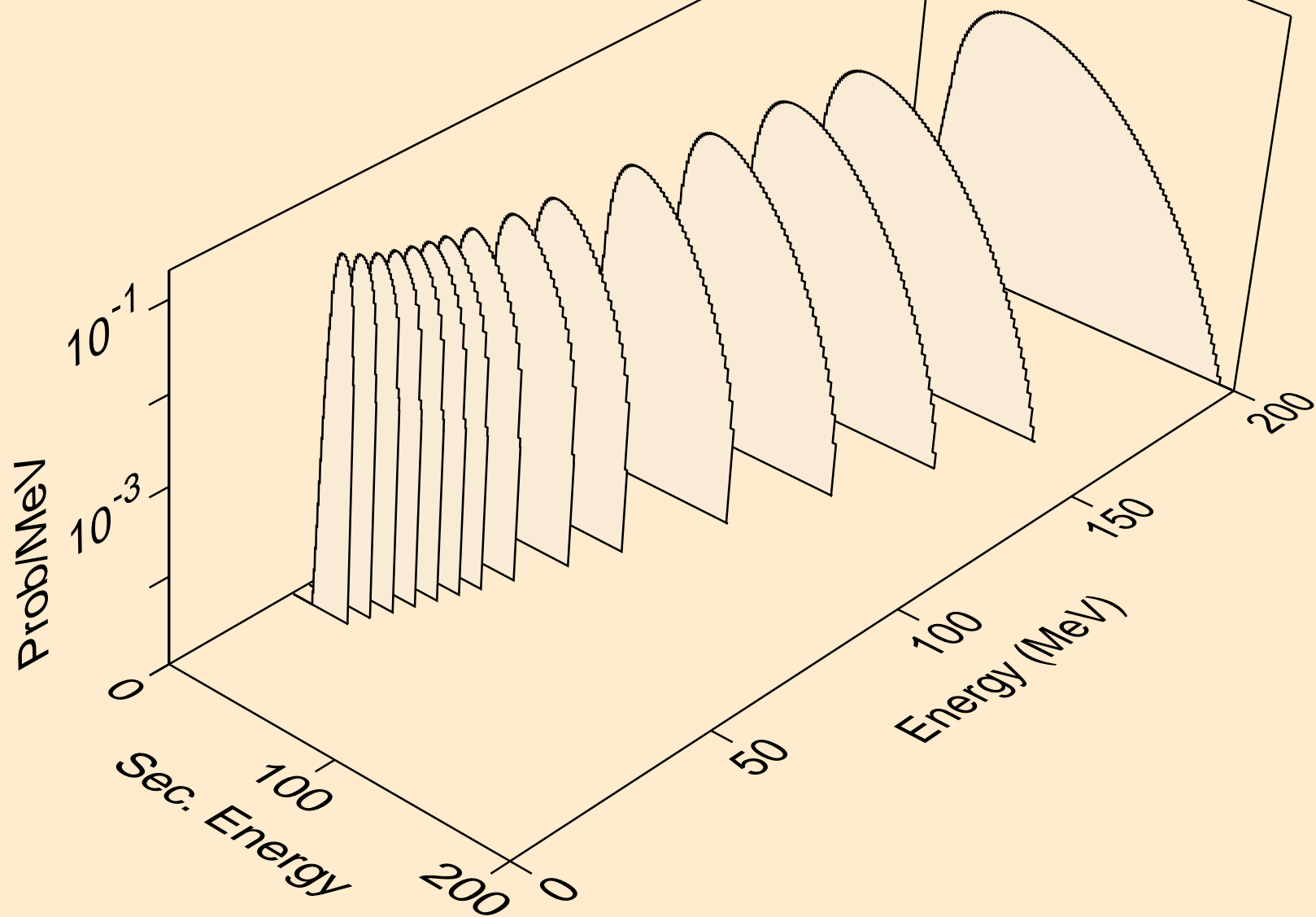

HG179 NEUTRON ACER TENDL-2021 LIBRARY; T=293.6K  
he3s from (n,n\*)he3

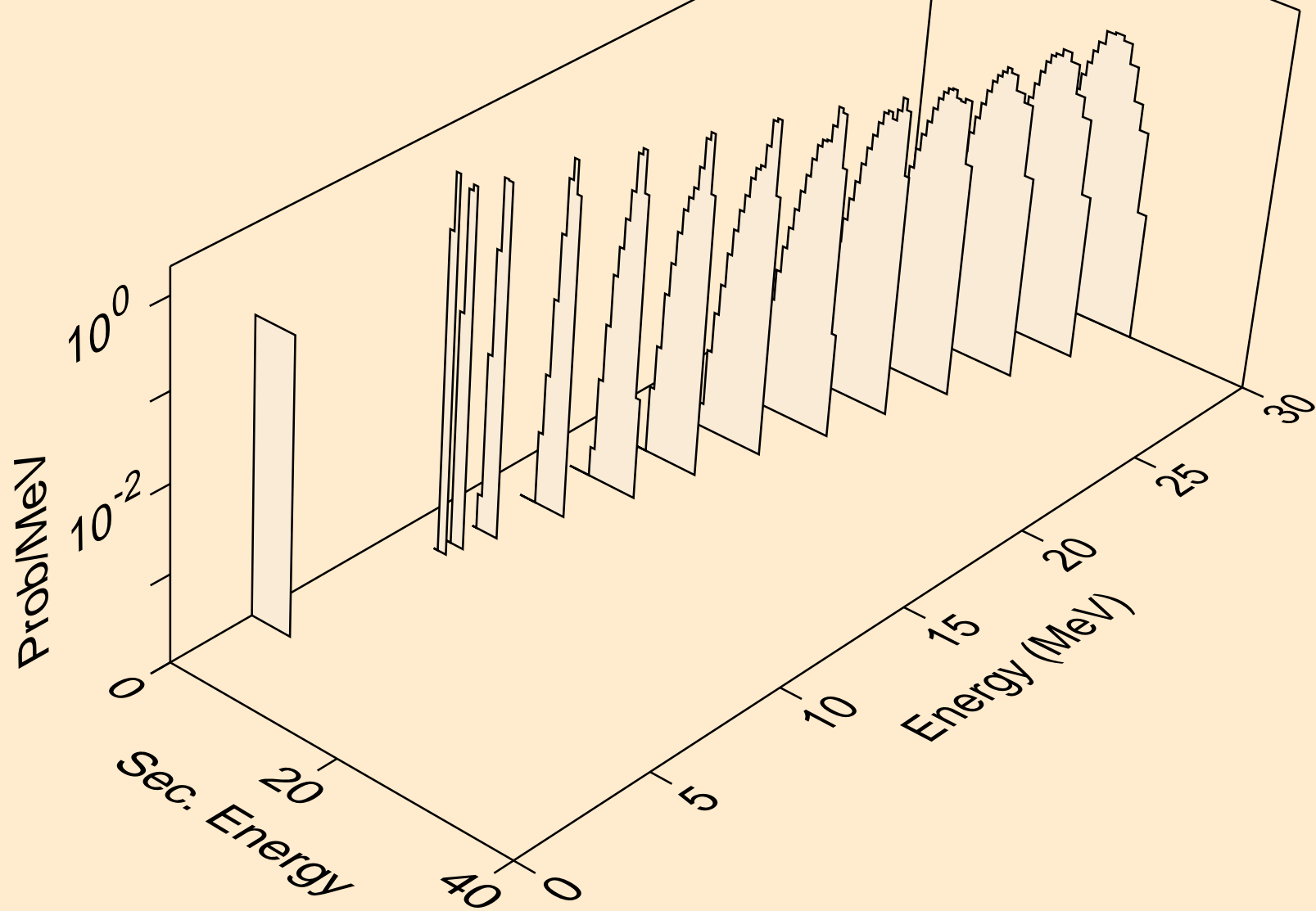

HG179 NEUTRON ACER TENDL-2021 LIBRARY; T=293.6K  
he3s from (n,he3)

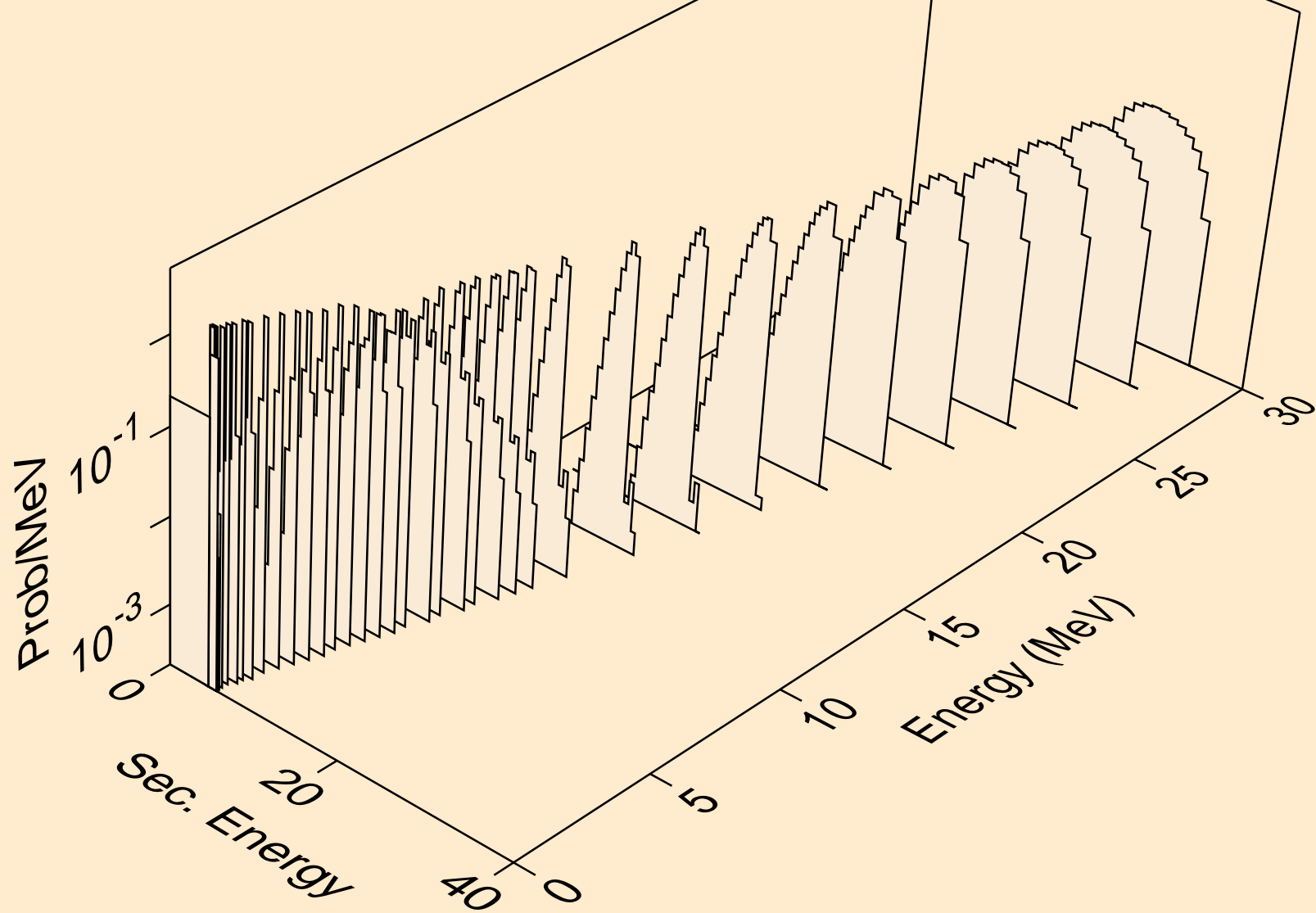

HG179 NEUTRON ACER TENDL-2021 LIBRARY; T=293.6K  
alphas from (n,x)

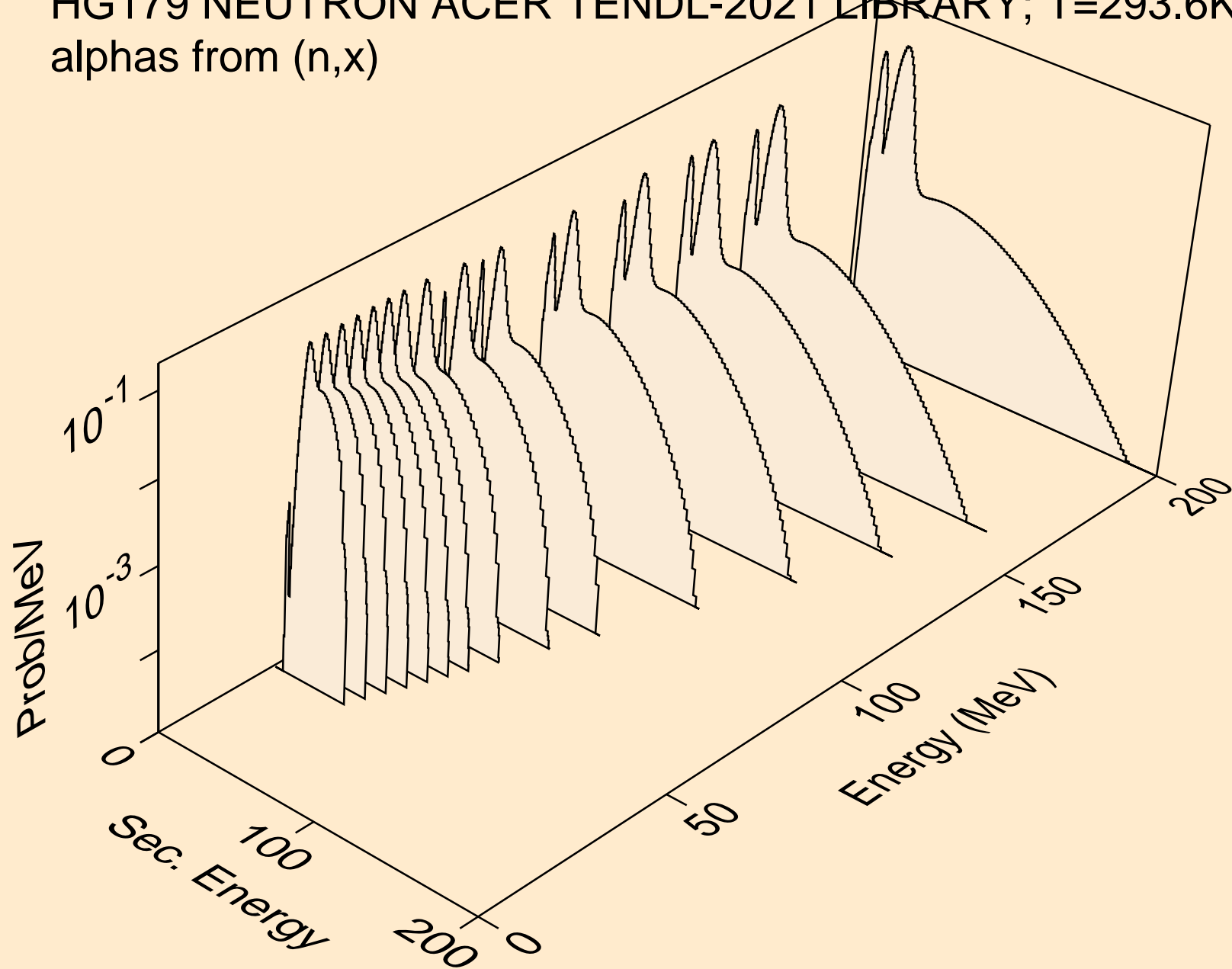

HG179 NEUTRON ACER TENDL-2021 LIBRARY; T=293.6K  
alphas from (n,n\*)a

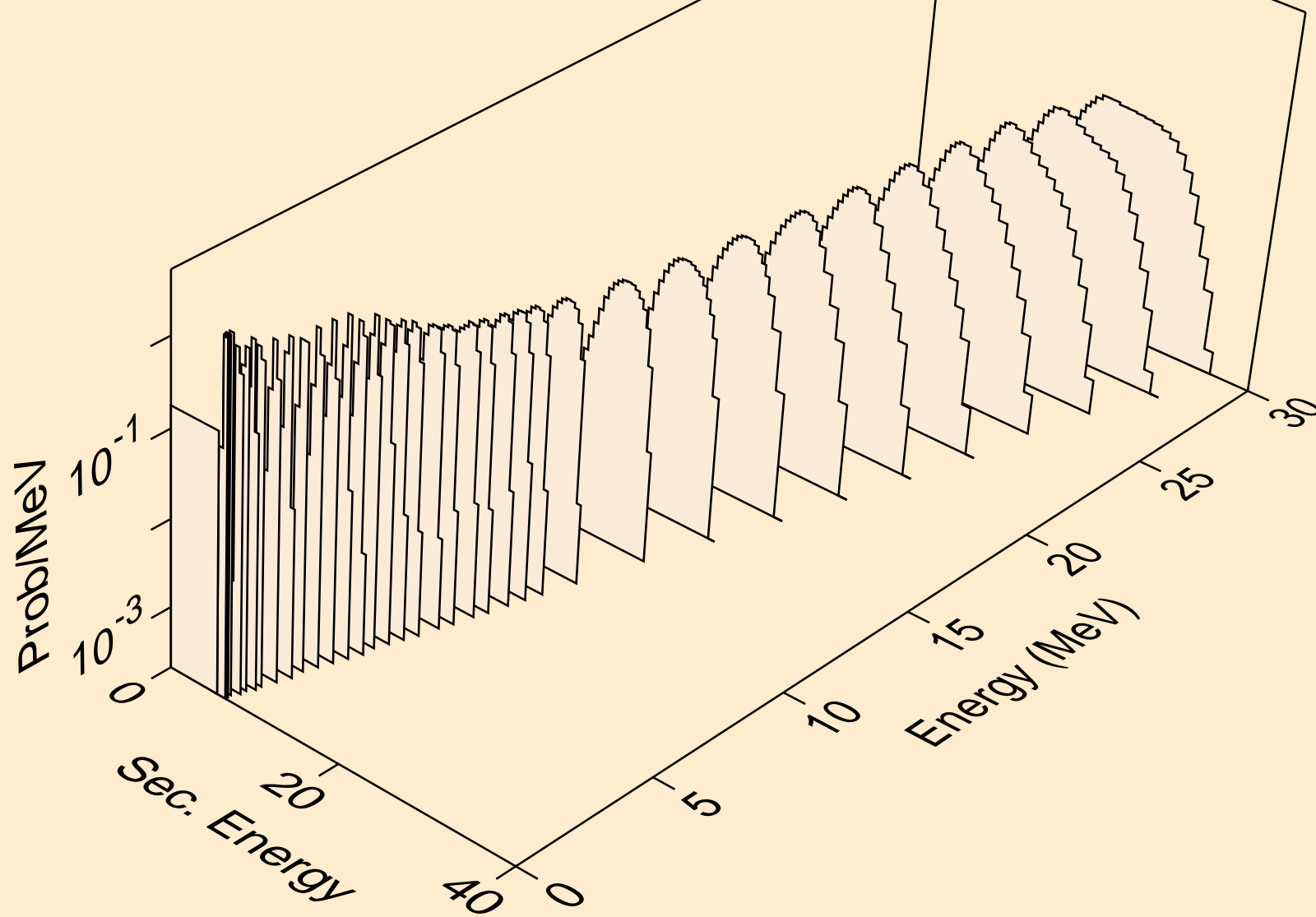

HG179 NEUTRON ACER TENDL-2021 LIBRARY; T=293.6K  
alphas from (n,n\*)3a

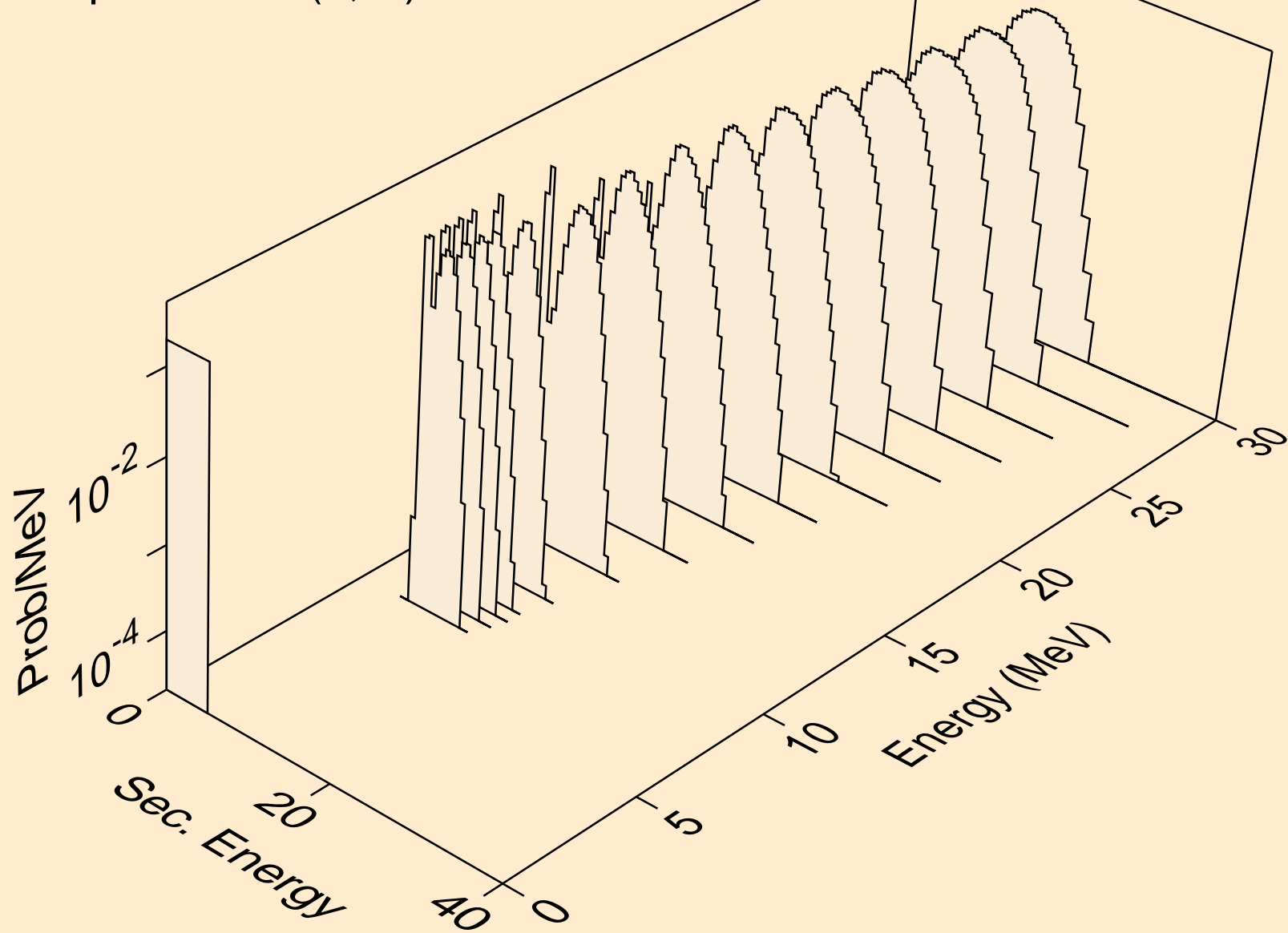

HG179 NEUTRON ACER TENDL-2021 LIBRARY; T=293.6K  
alphas from (n,2n)a

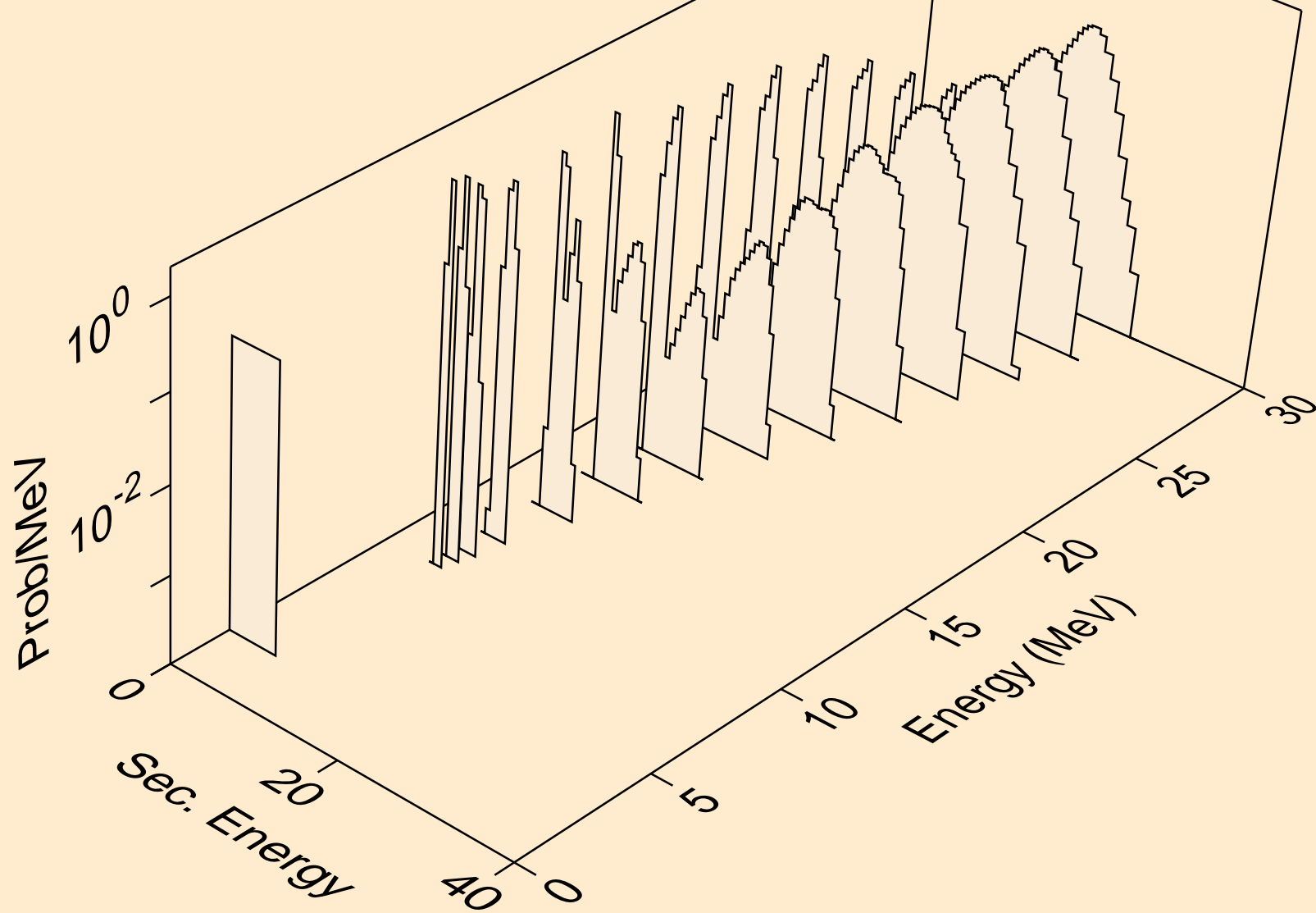



HG179 NEUTRON ACER TENDL-2021 LIBRARY; T=293.6K  
alphas from (n,3n)a

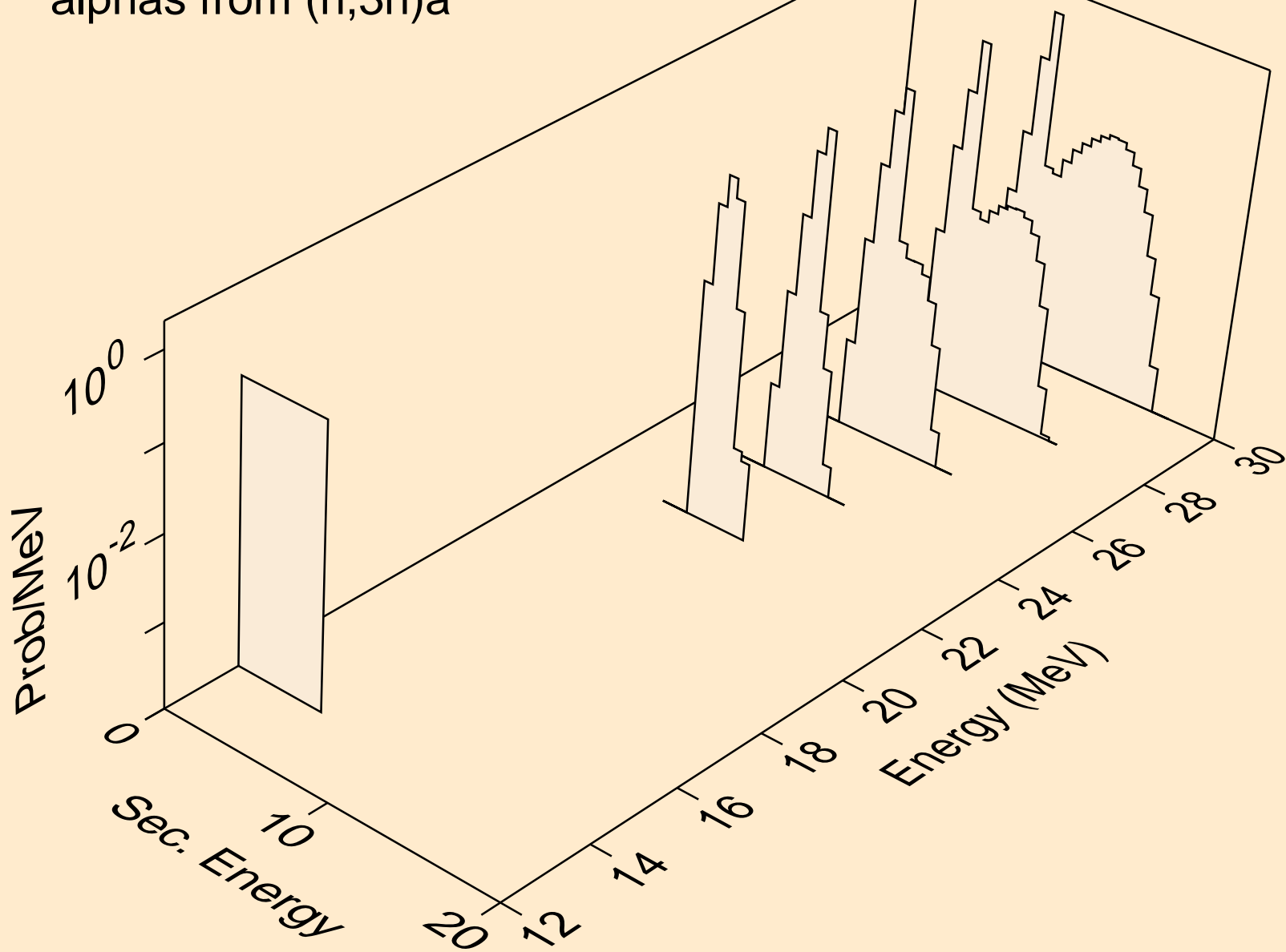

HG179 NEUTRON ACER TENDL-2021 LIBRARY; T=293.6K  
alphas from (n,n\*)2a

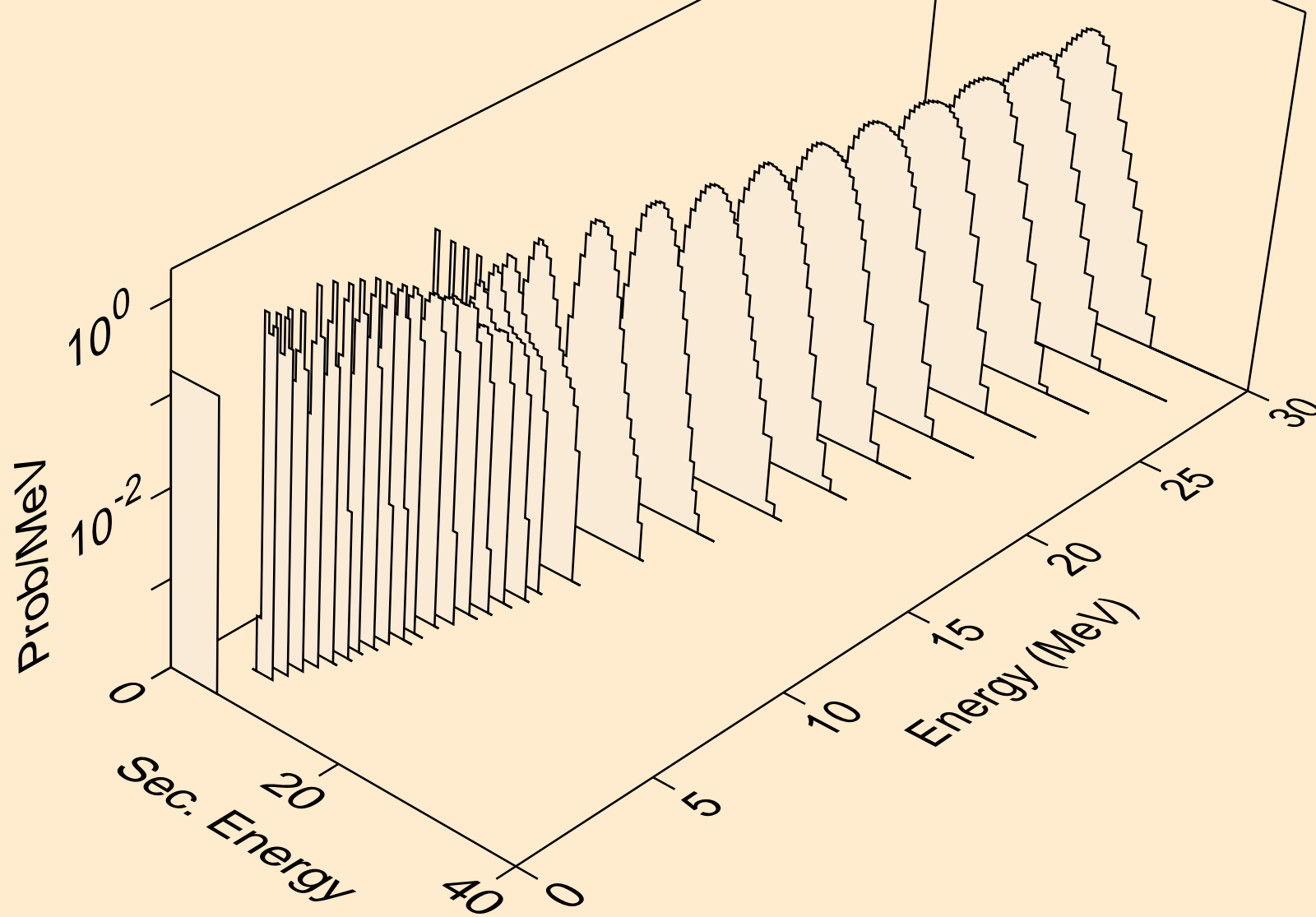

HG179 NEUTRON ACER TENDL-2021 LIBRARY; T=293.6K  
alphas from (n,2n)2a

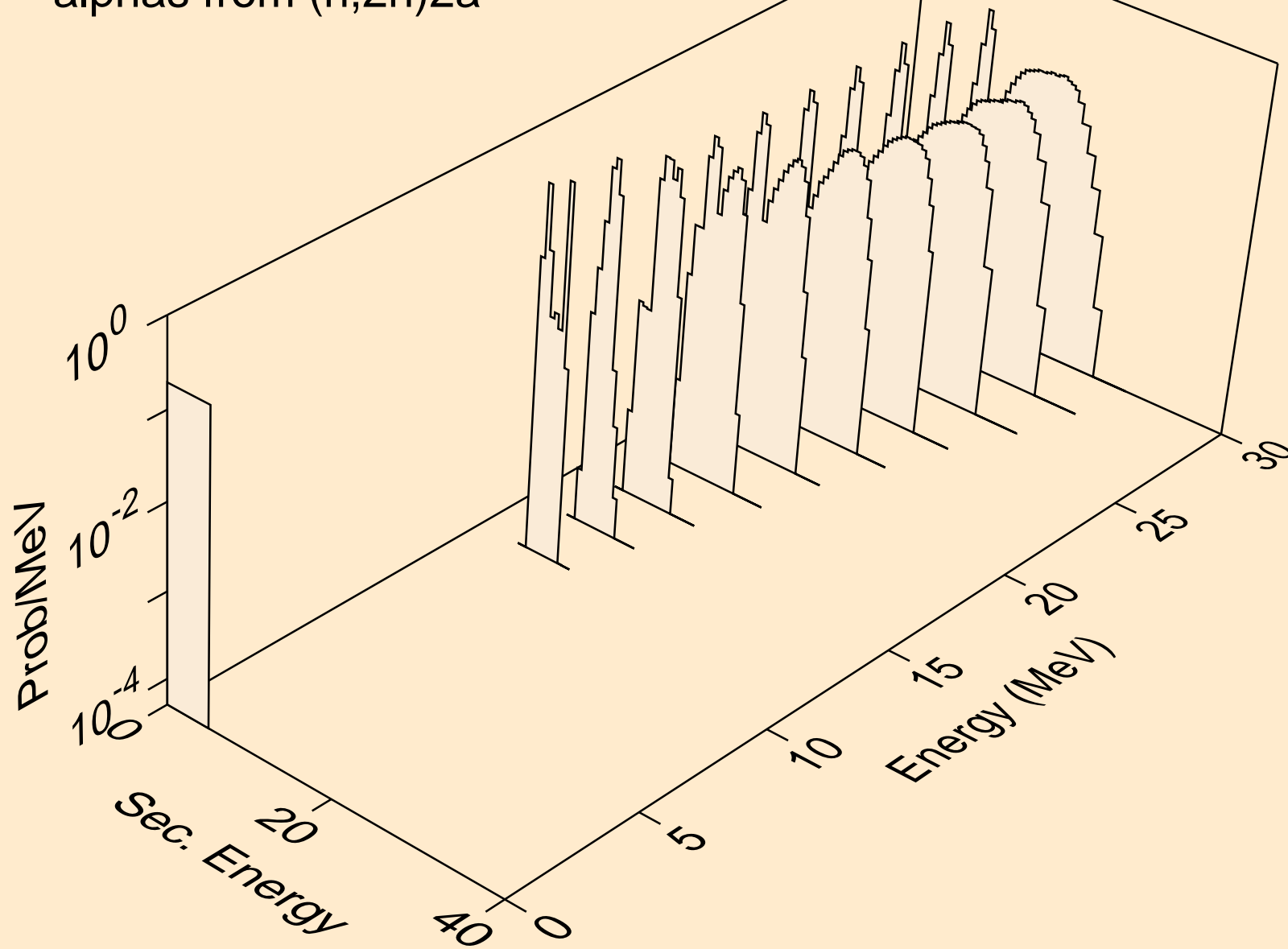

HG179 NEUTRON ACER TENDL-2021 LIBRARY; T=293.6K  
alphas from (n,npa)

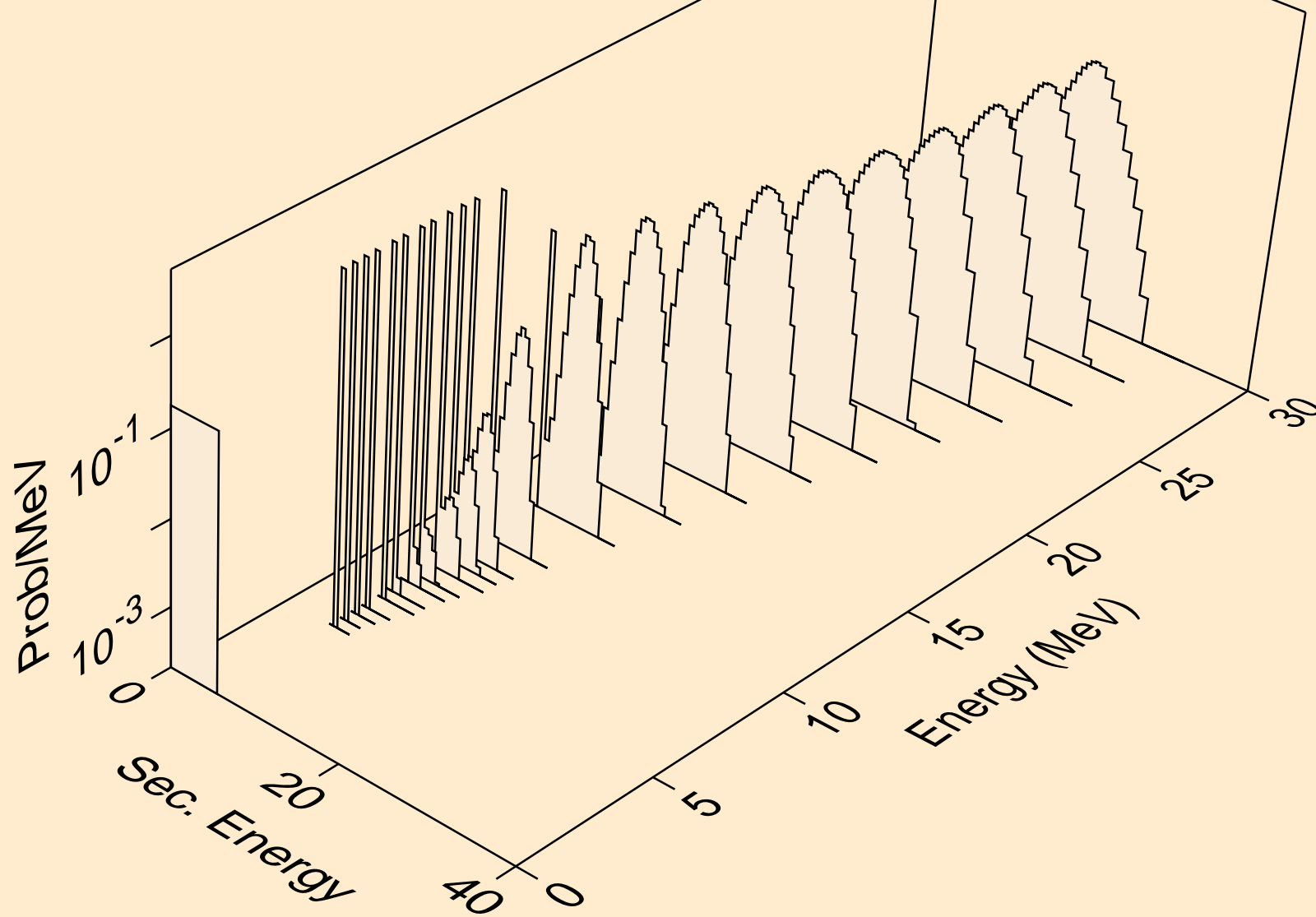

HG179 NEUTRON ACER TENDL-2021 LIBRARY; T=293.6K  
alphas from (n,a)

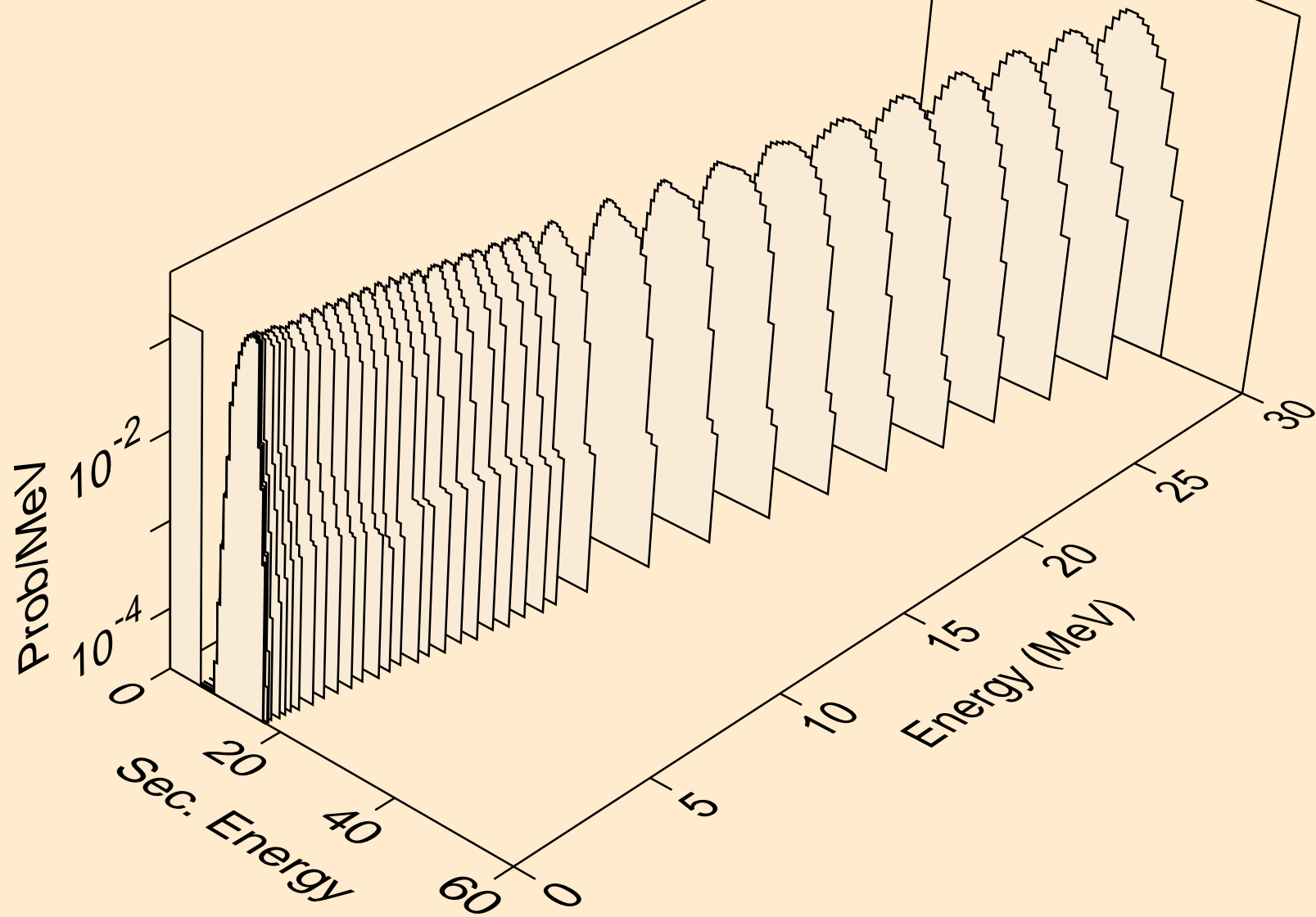

HG179 NEUTRON ACER TENDL-2021 LIBRARY; T=293.6K  
alphas from (n,2a)

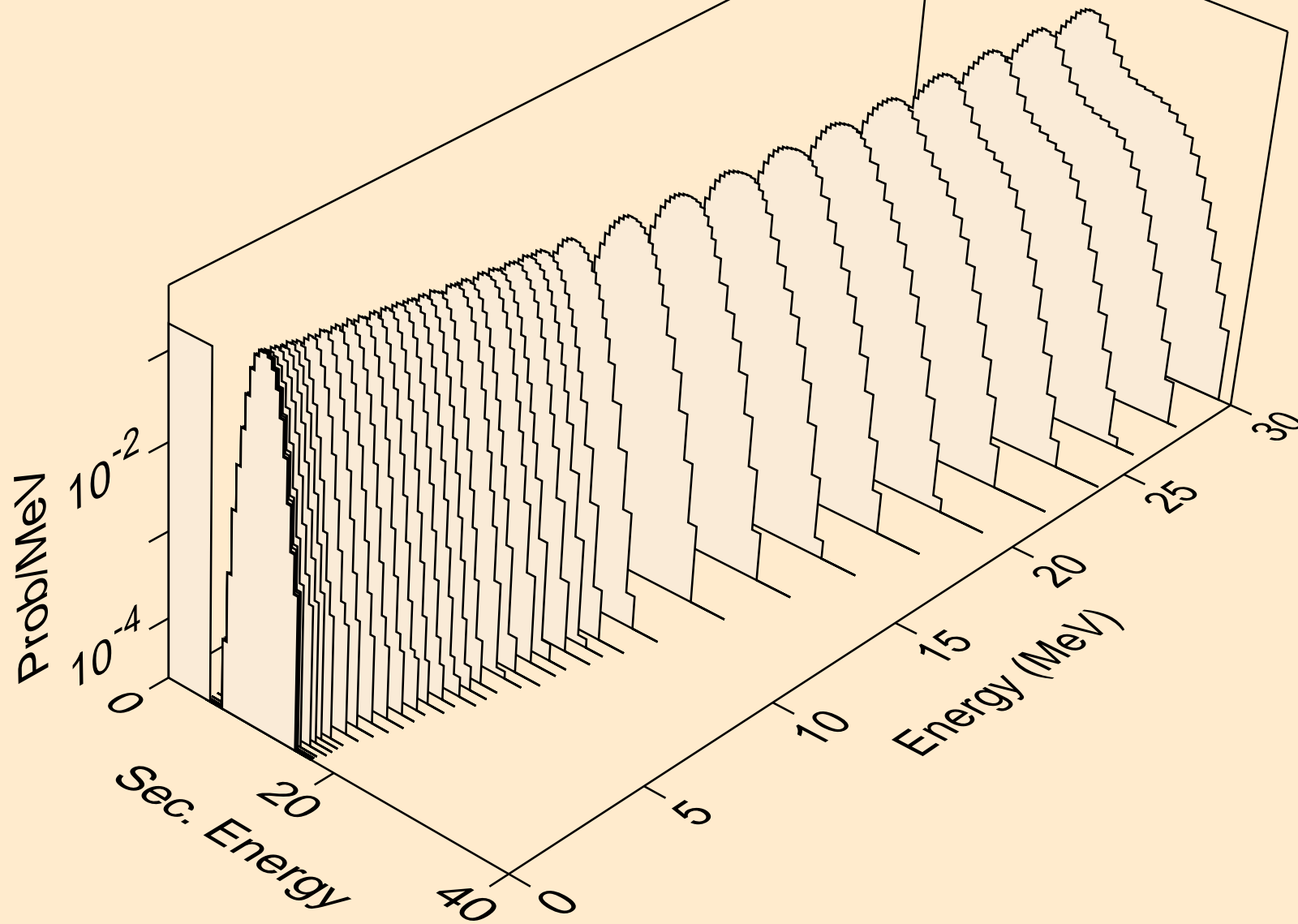

HG179 NEUTRON ACER TENDL-2021 LIBRARY; T=293.6K  
alphas from (n,3a)

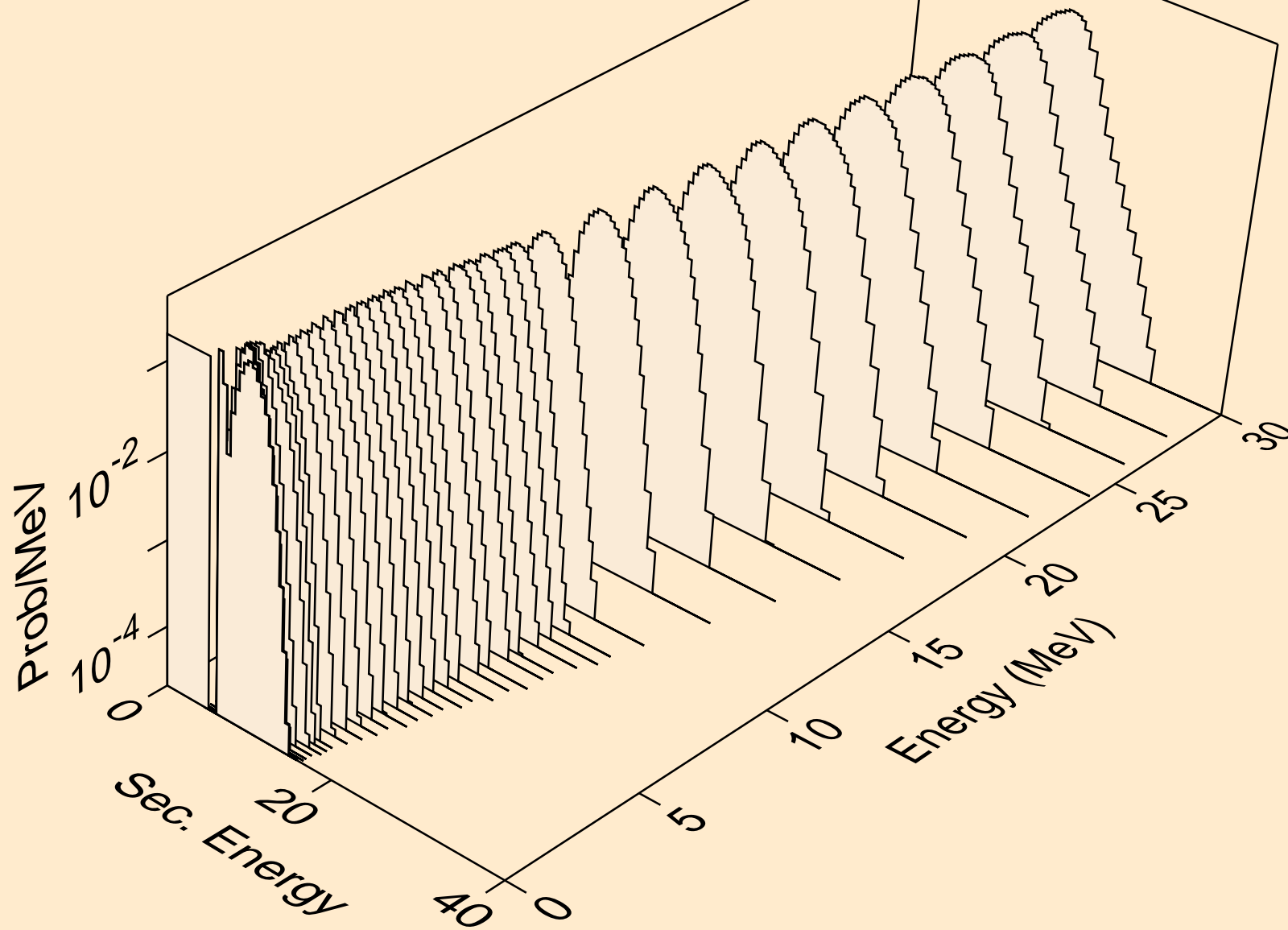

HG179 NEUTRON ACER TENDL-2021 LIBRARY; T=293.6K  
alphas from (n,pa)

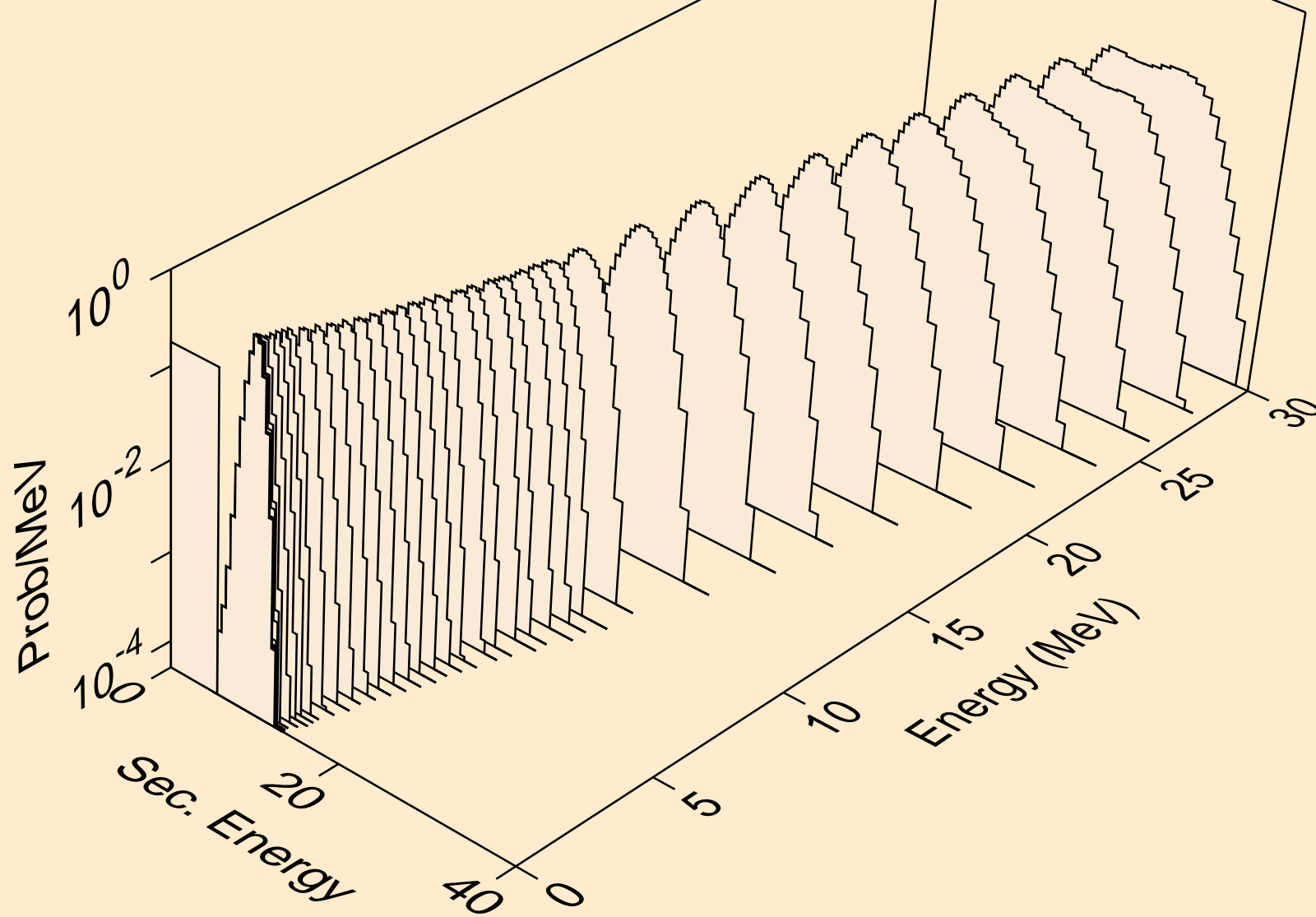



HG179 NEUTRON ACER TENDL-2021 LIBRARY; T=293.6K  
alphas from (n,t2a)

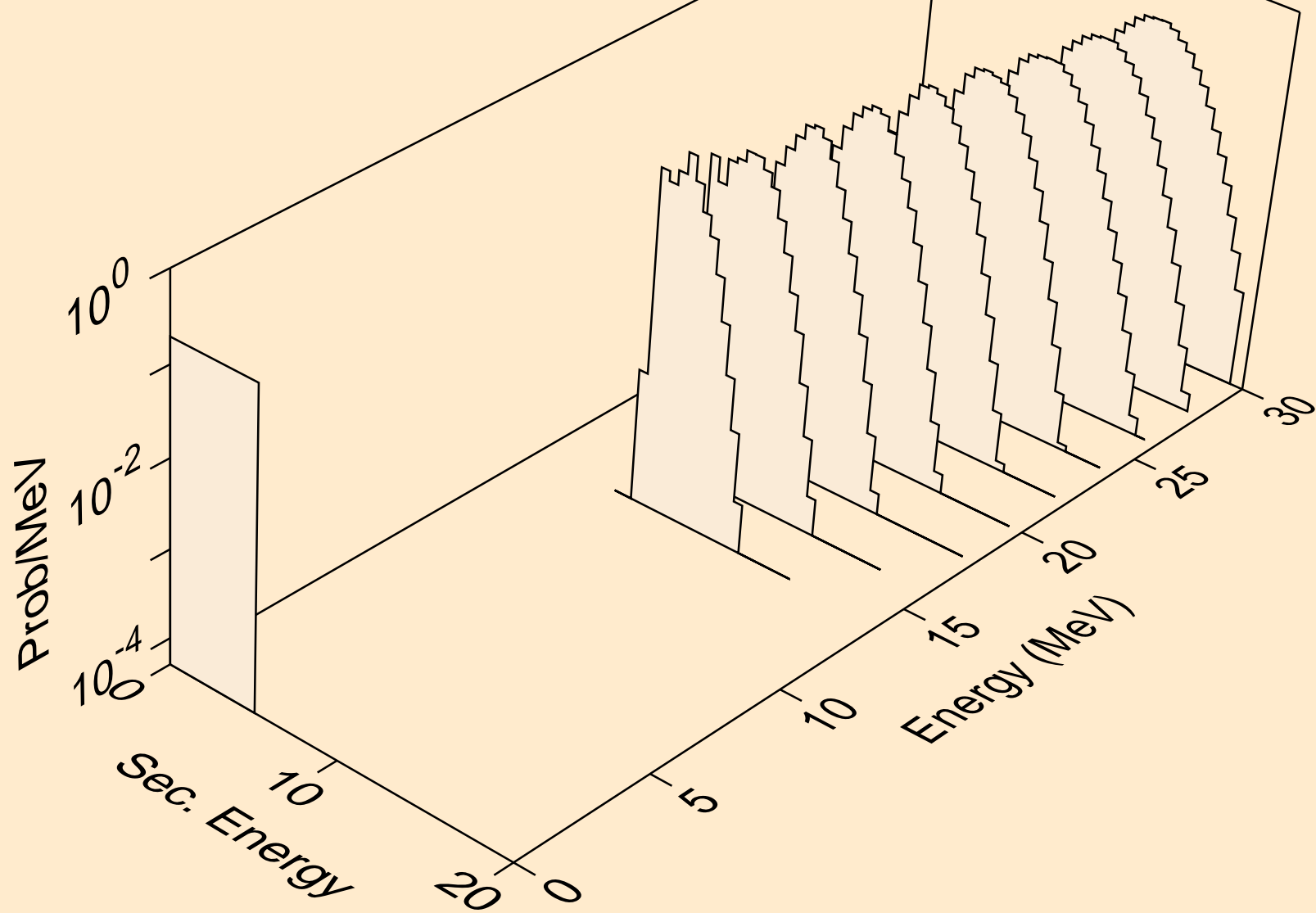

HG179 NEUTRON ACER TENDL-2021 LIBRARY; T=293.6K  
alphas from (n,d2a)

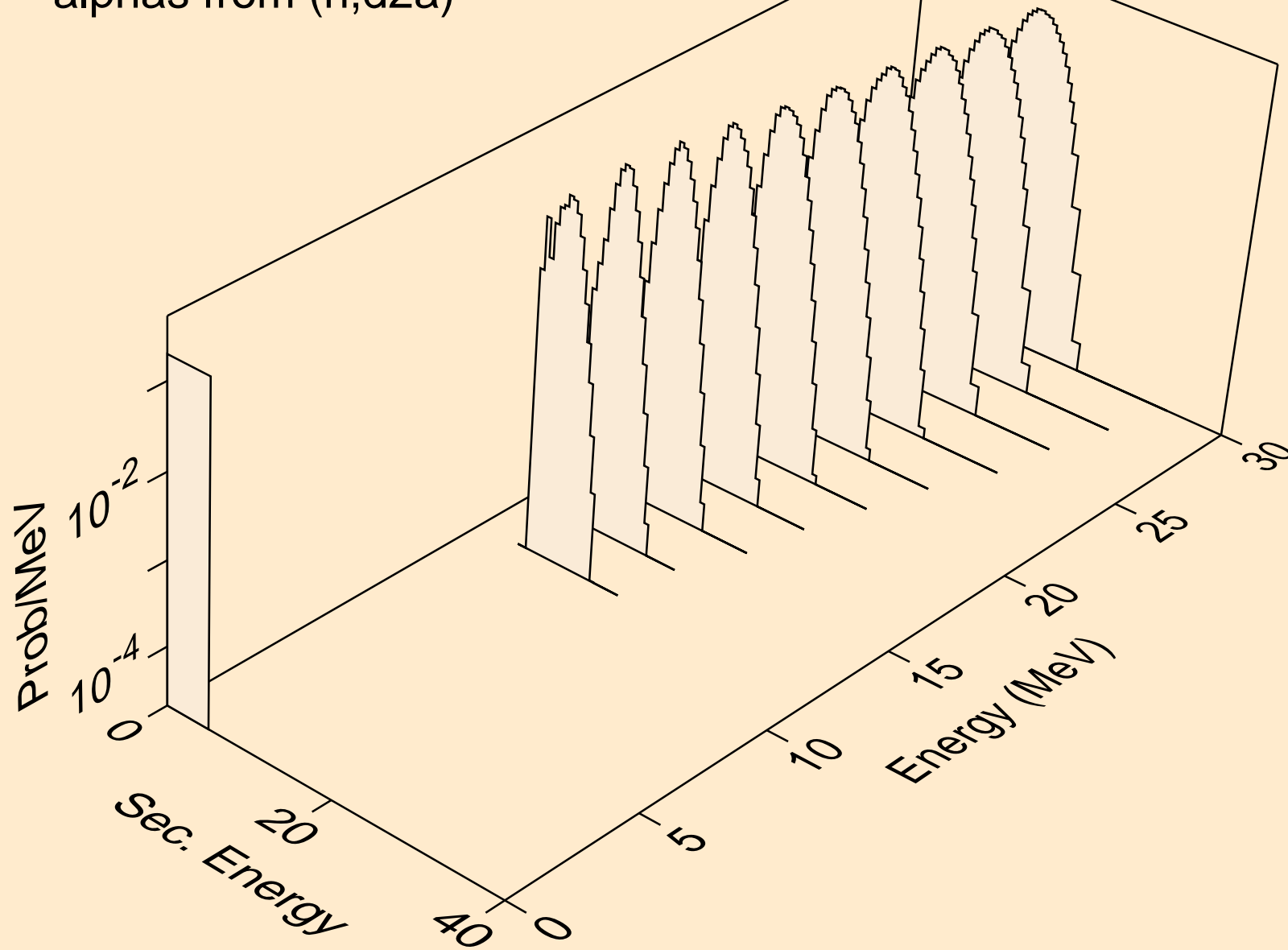

HG179 NEUTRON ACER TENDL-2021 LIBRARY; T=293.6K  
alphas from (n,da)

