

# HG183 NEUTRON ACER TENDL-2021 LIBRARY; T=293.6K

## Principal cross sections

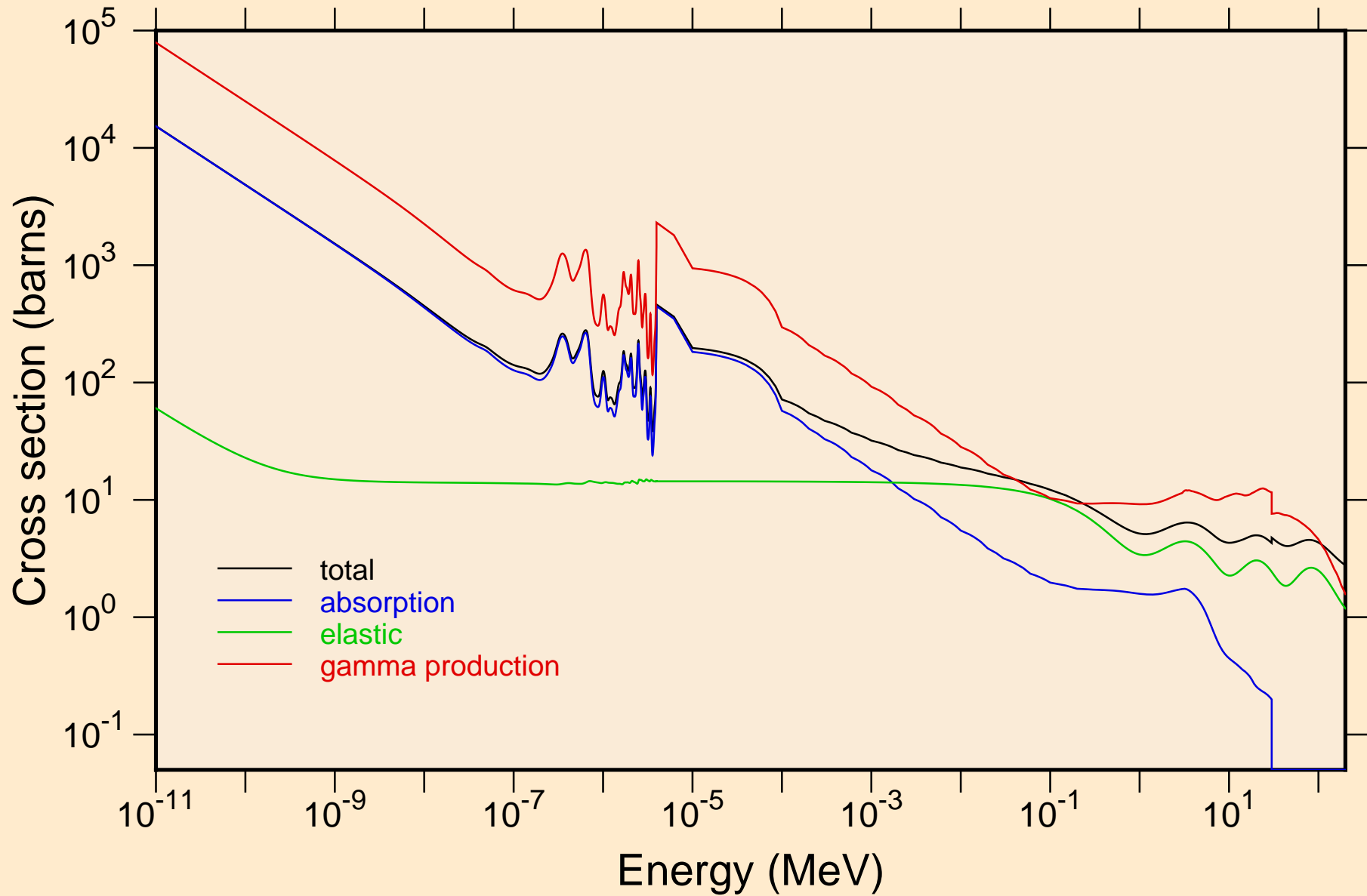

HG183 NEUTRON ACER TENDL-2021 LIBRARY; T=293.6K  
resonance total cross section

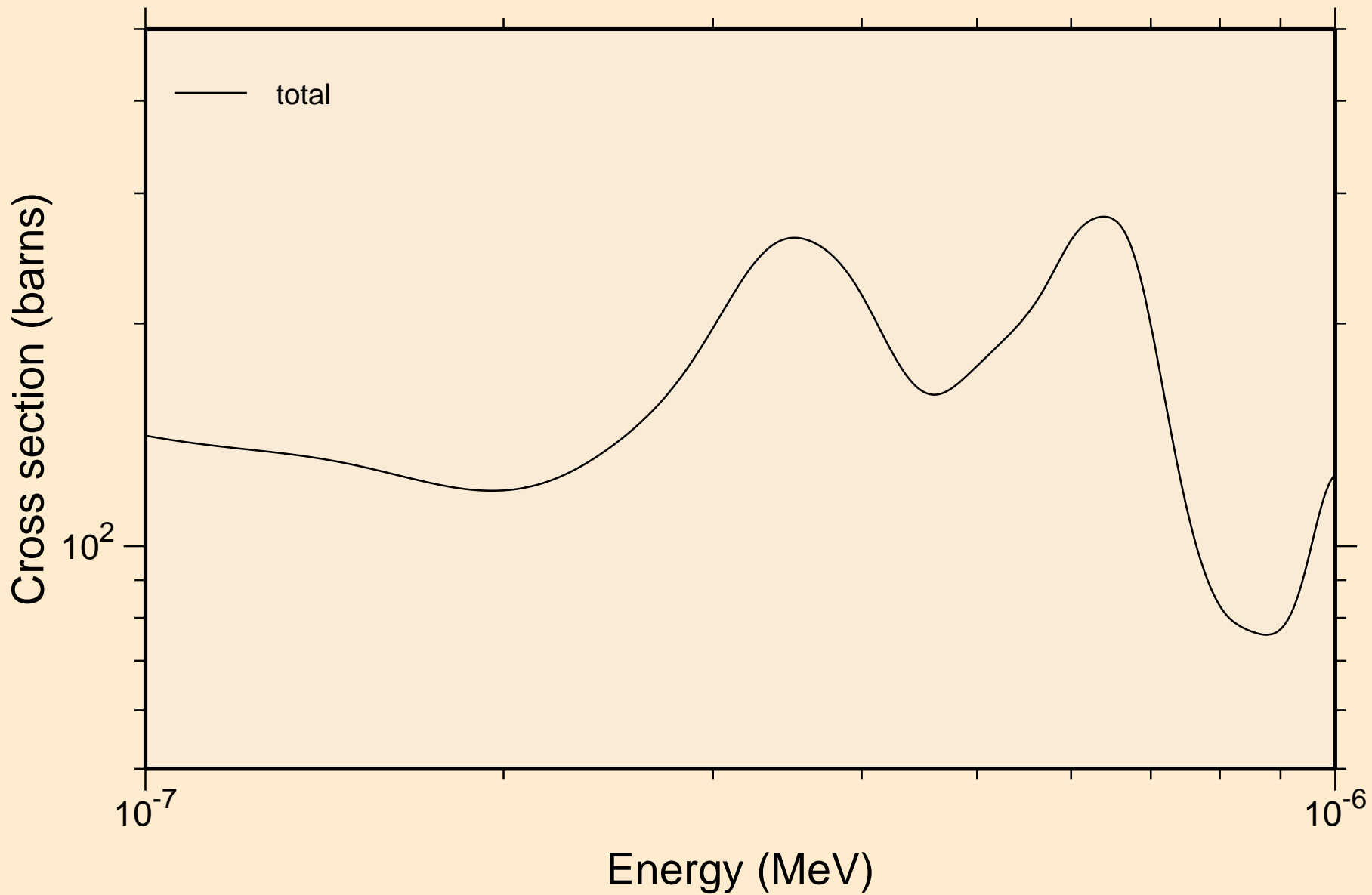

HG183 NEUTRON ACER TENDL-2021 LIBRARY; T=293.6K  
resonance total cross section

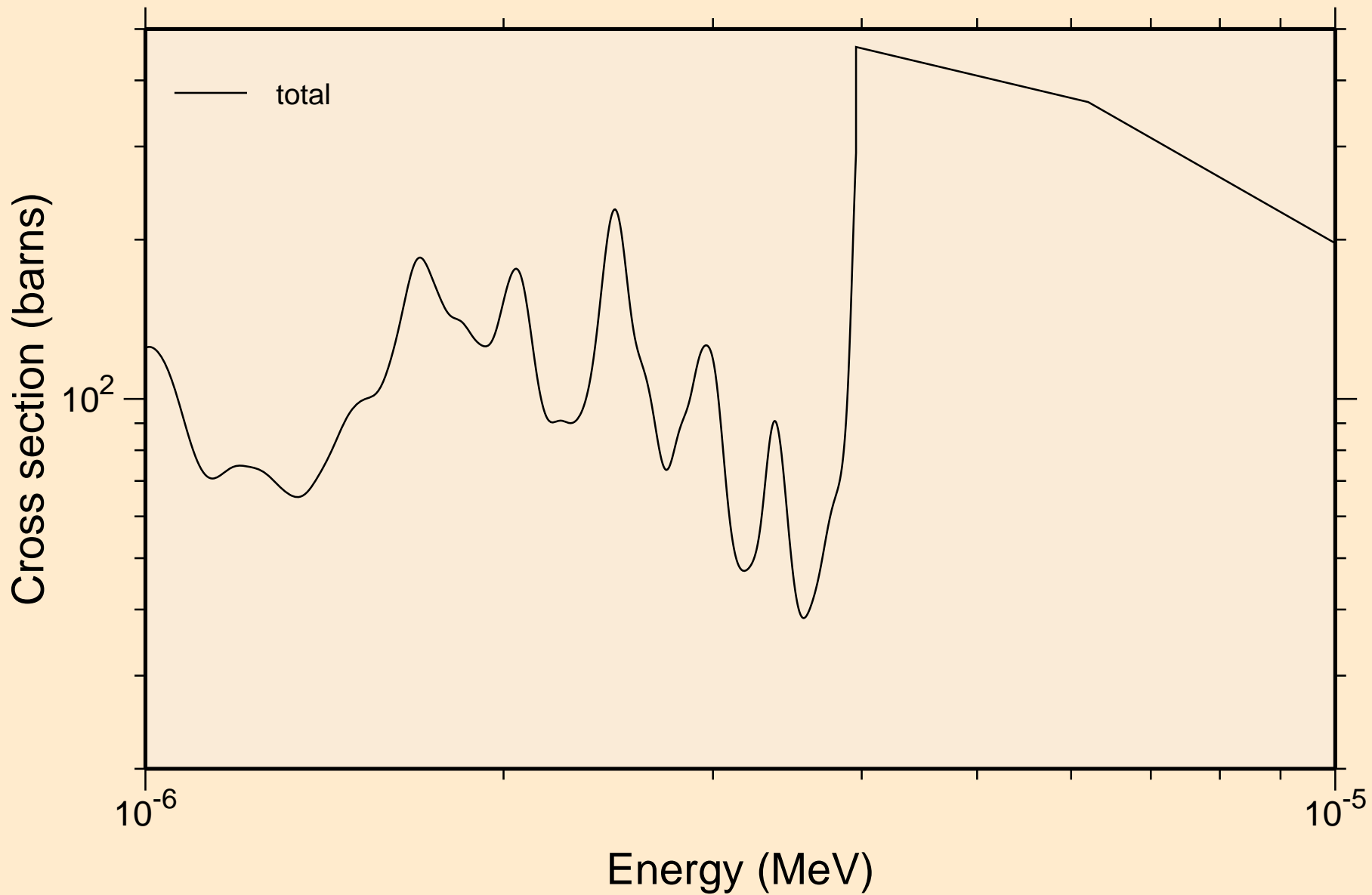

HG183 NEUTRON ACER TENDL-2021 LIBRARY; T=293.6K  
resonance total cross section

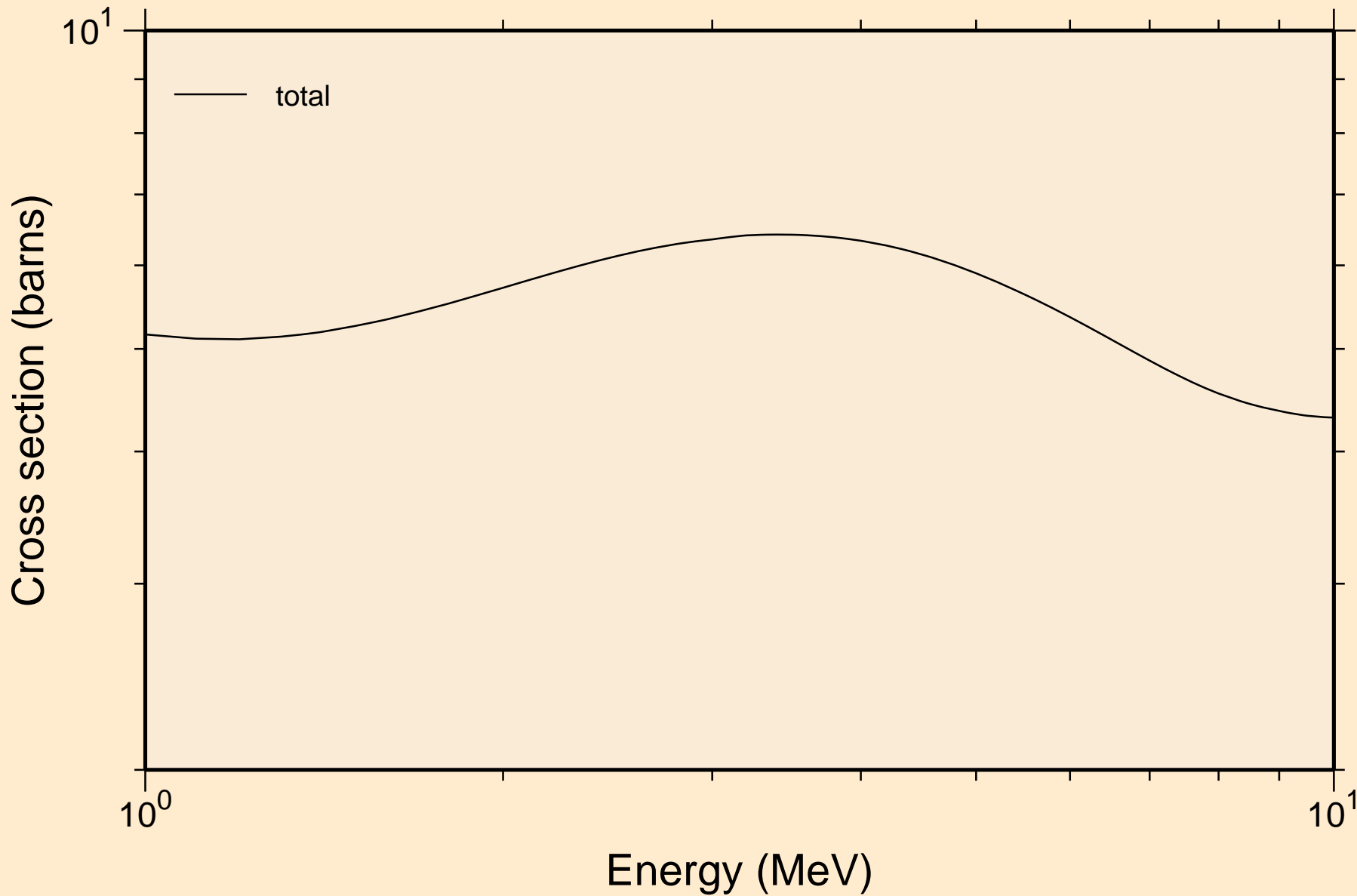

HG183 NEUTRON ACER TENDL-2021 LIBRARY; T=293.6K  
resonance absorption cross sections

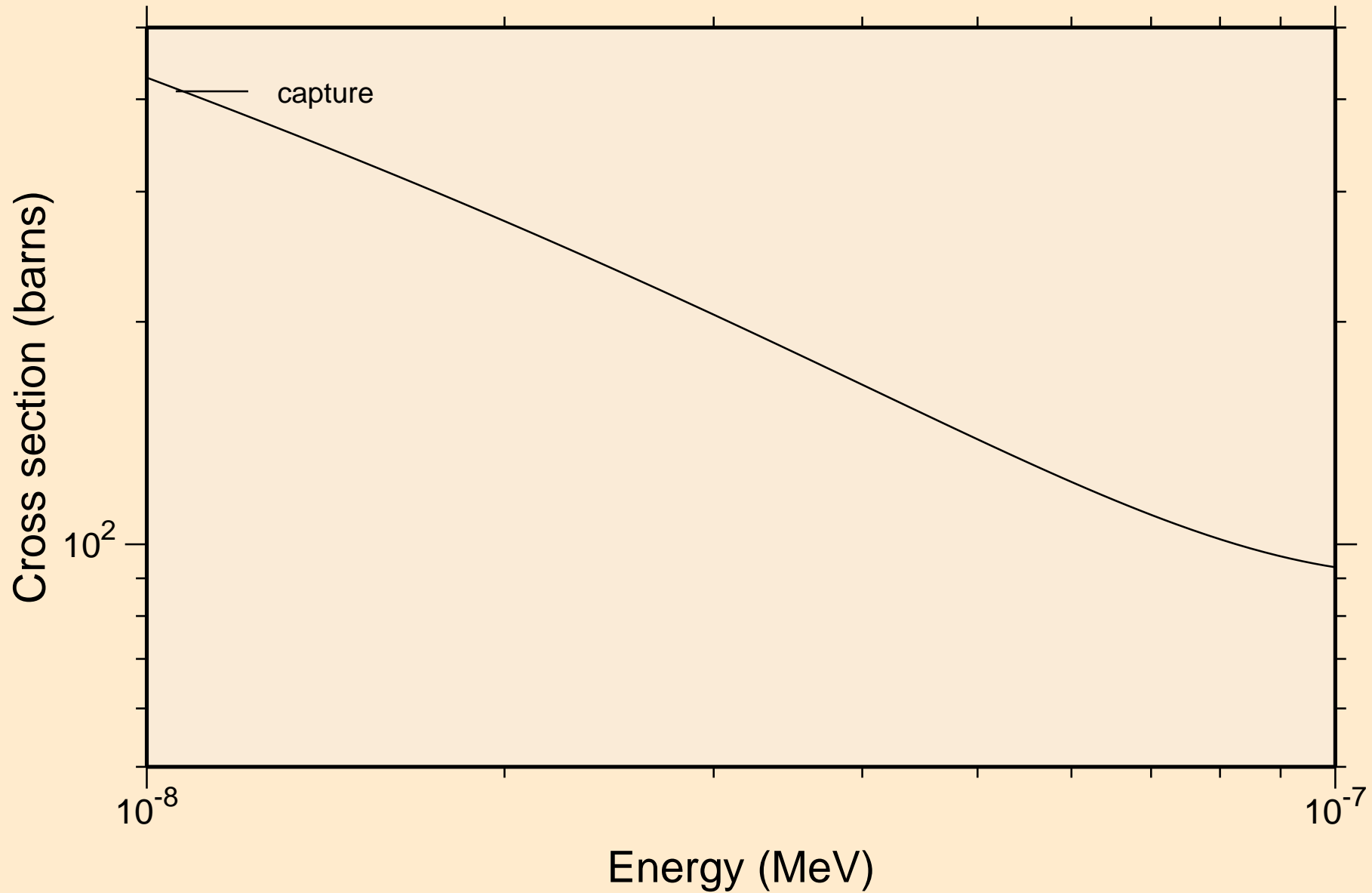

HG183 NEUTRON ACER TENDL-2021 LIBRARY; T=293.6K  
resonance absorption cross sections

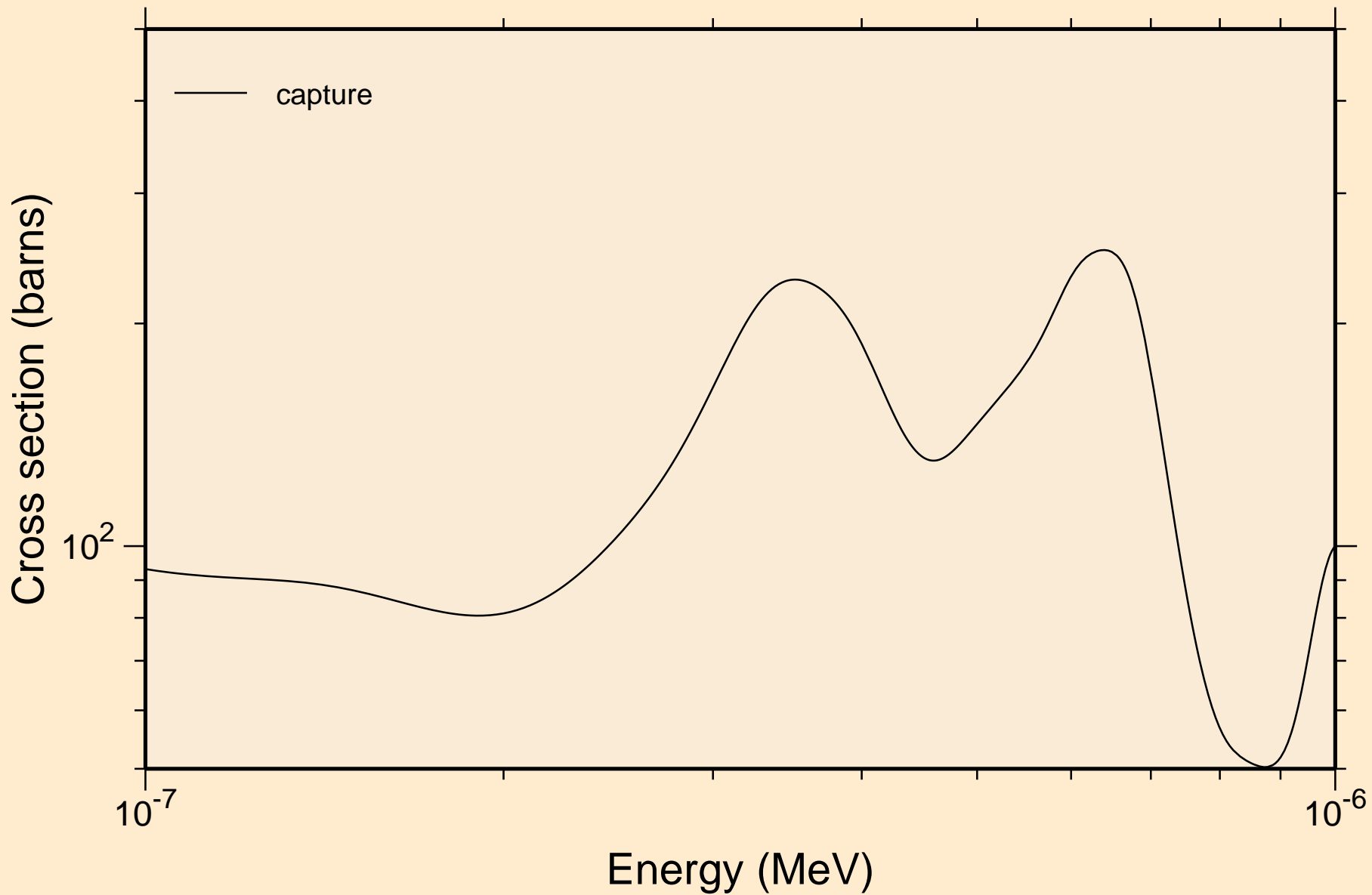

HG183 NEUTRON ACER TENDL-2021 LIBRARY; T=293.6K  
resonance absorption cross sections

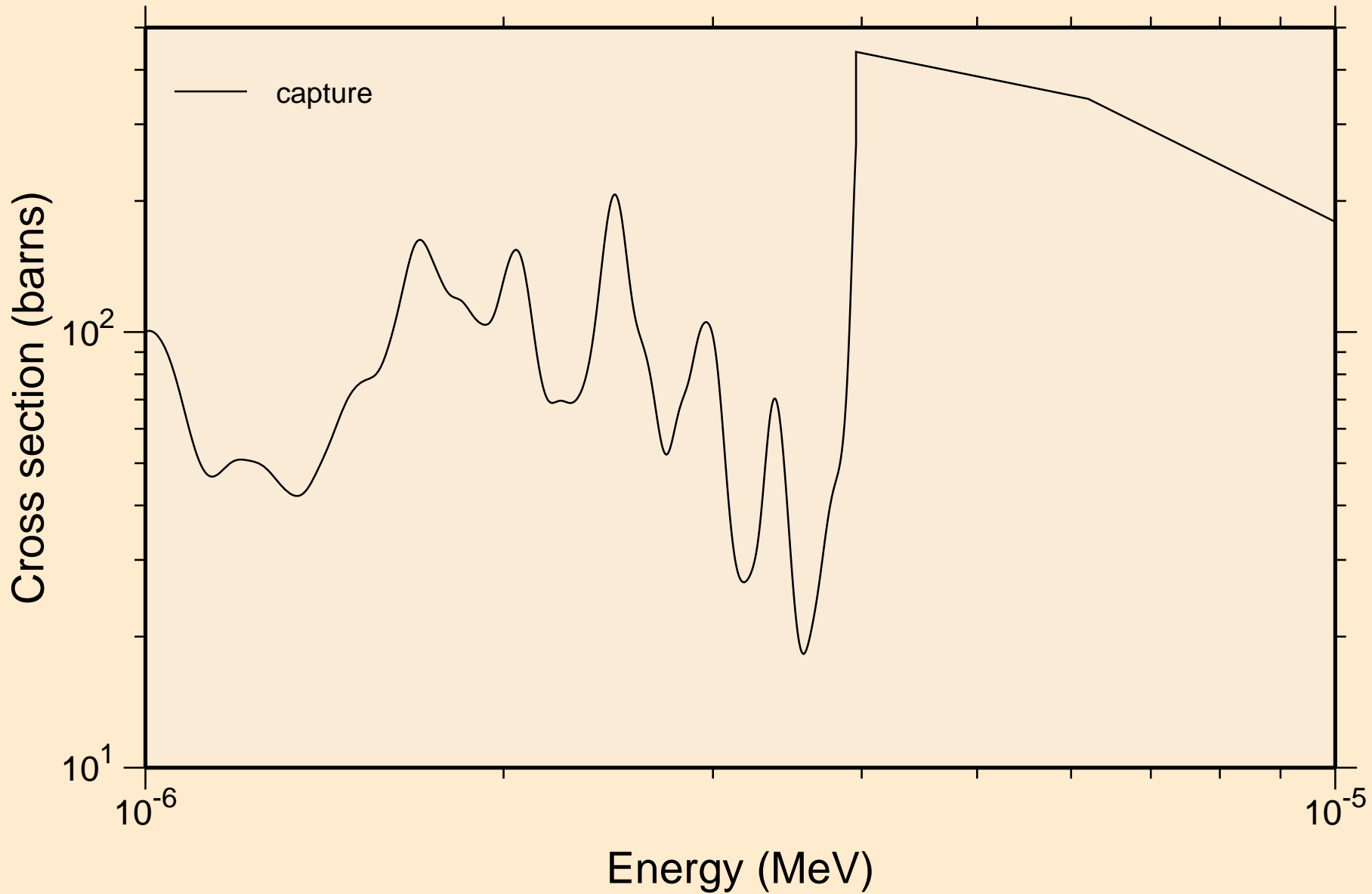

HG183 NEUTRON ACER TENDL-2021 LIBRARY; T=293.6K  
resonance absorption cross sections

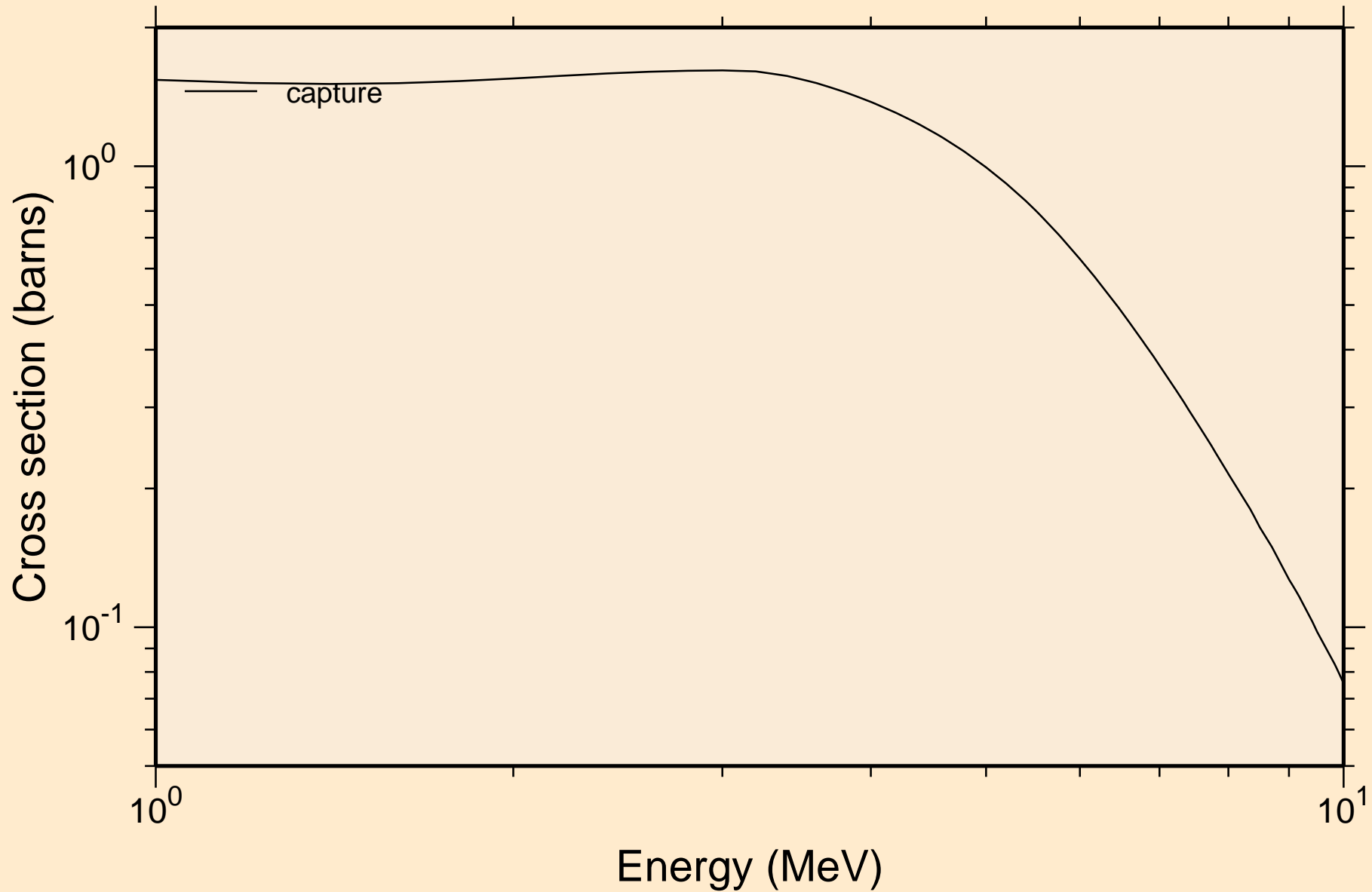



HG183 NEUTRON ACER TENDL-2021 LIBRARY; T=293.6K  
Heating

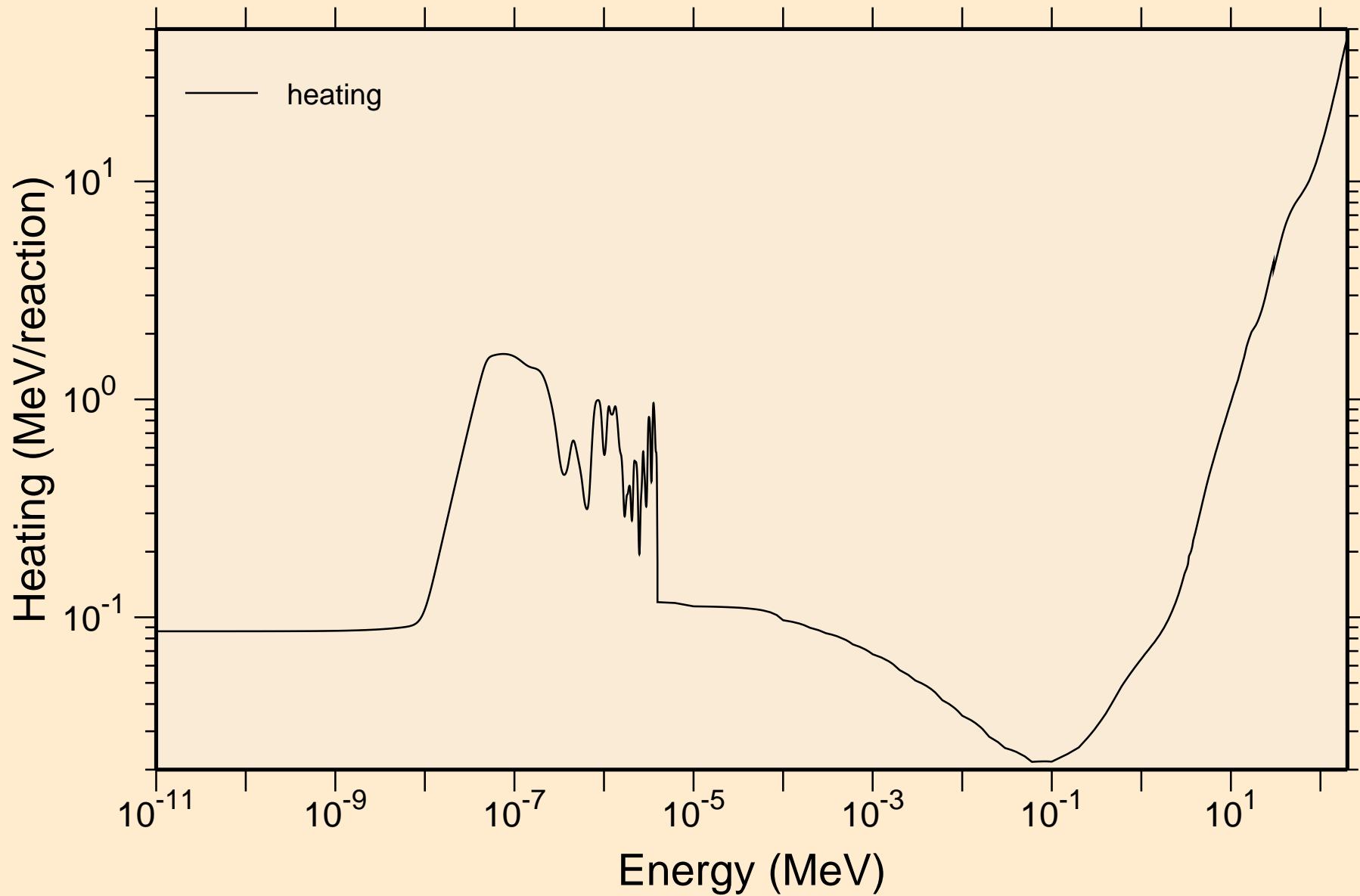

# HG183 NEUTRON ACER TENDL-2021 LIBRARY; T=293.6K

## Damage

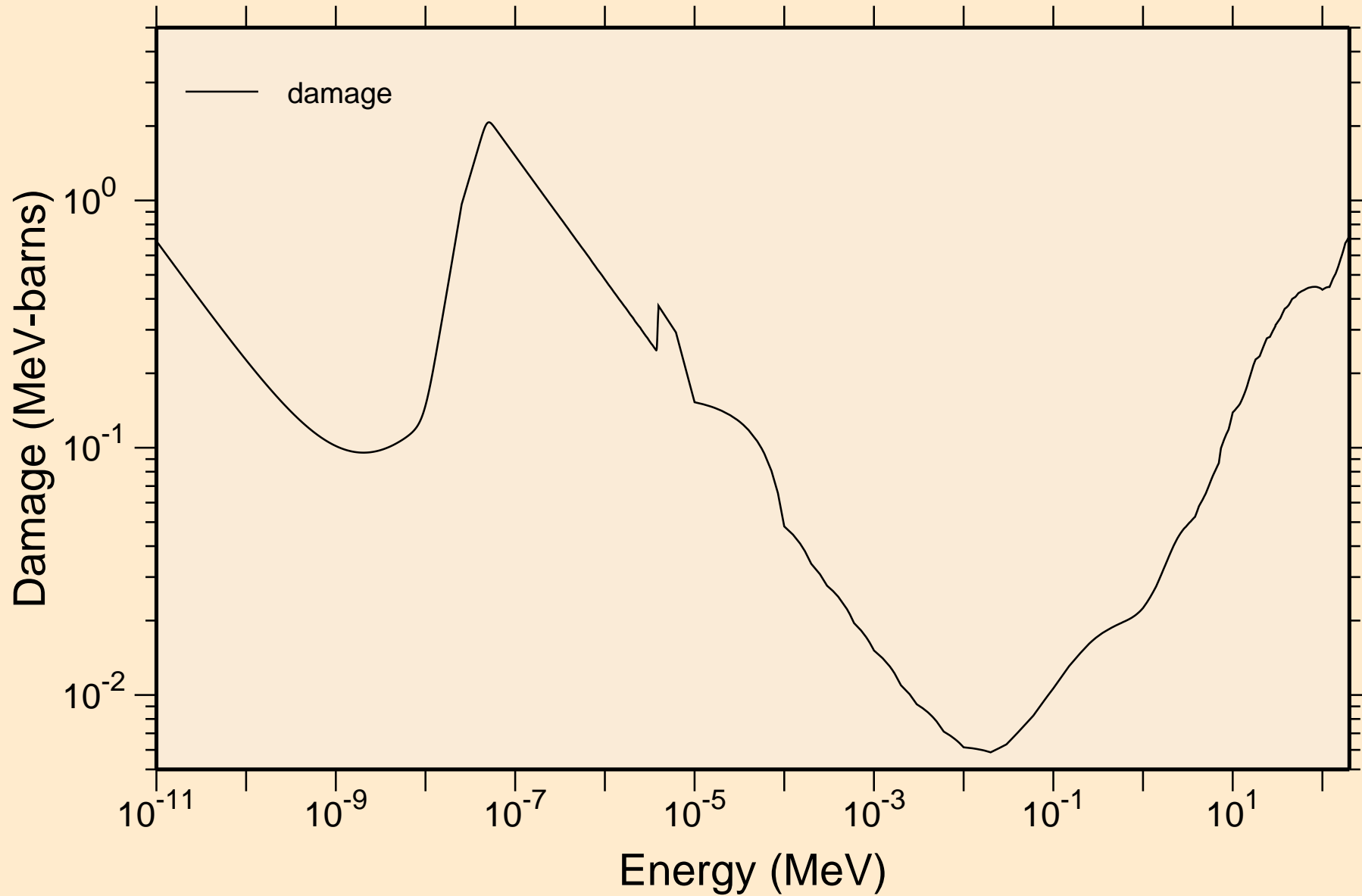

# HG183 NEUTRON ACER TENDL-2021 LIBRARY; T=293.6K

## Non-threshold reactions

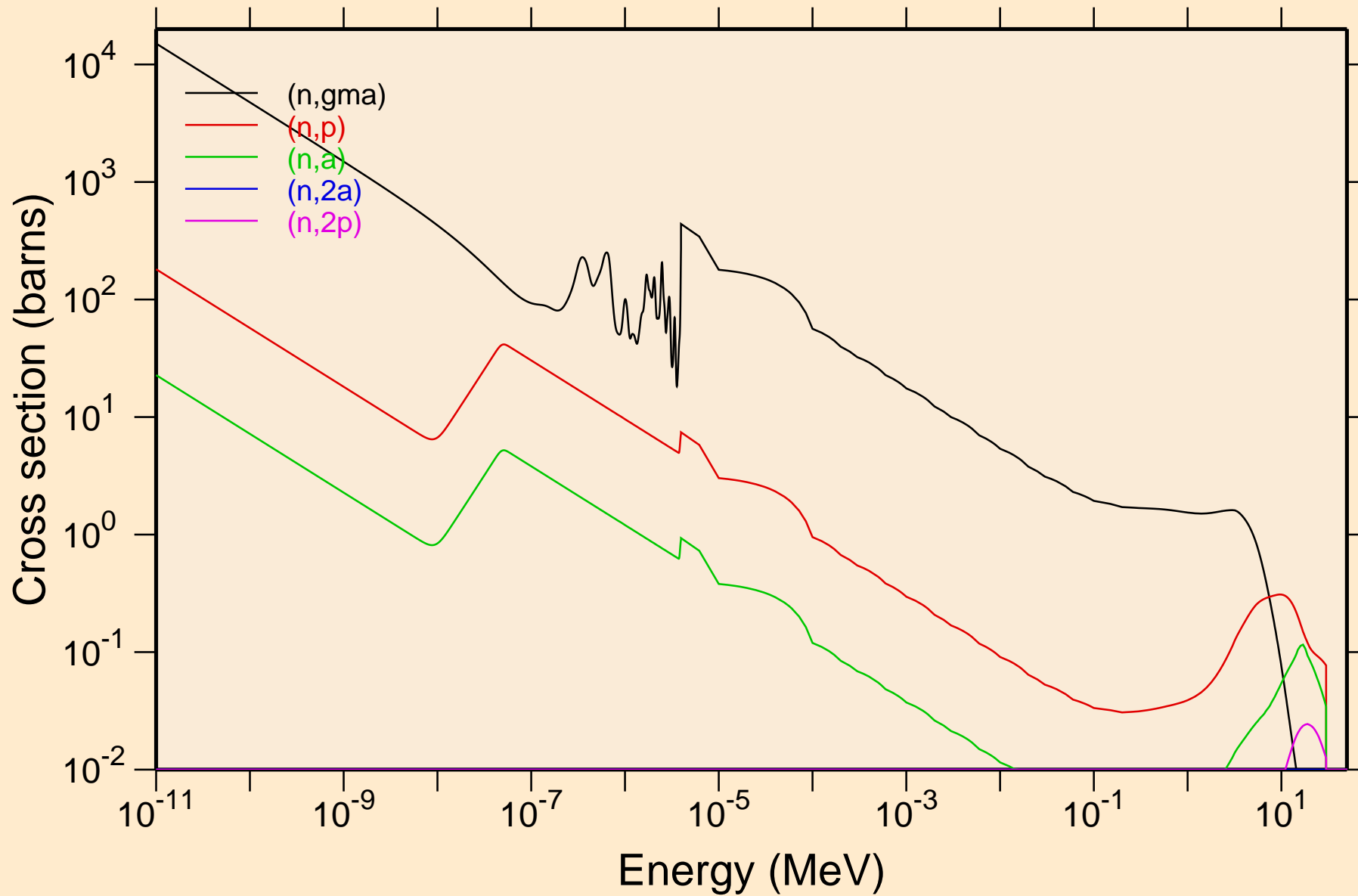

HG183 NEUTRON ACER TENDL-2021 LIBRARY; T=293.6K  
Non-threshold reactions

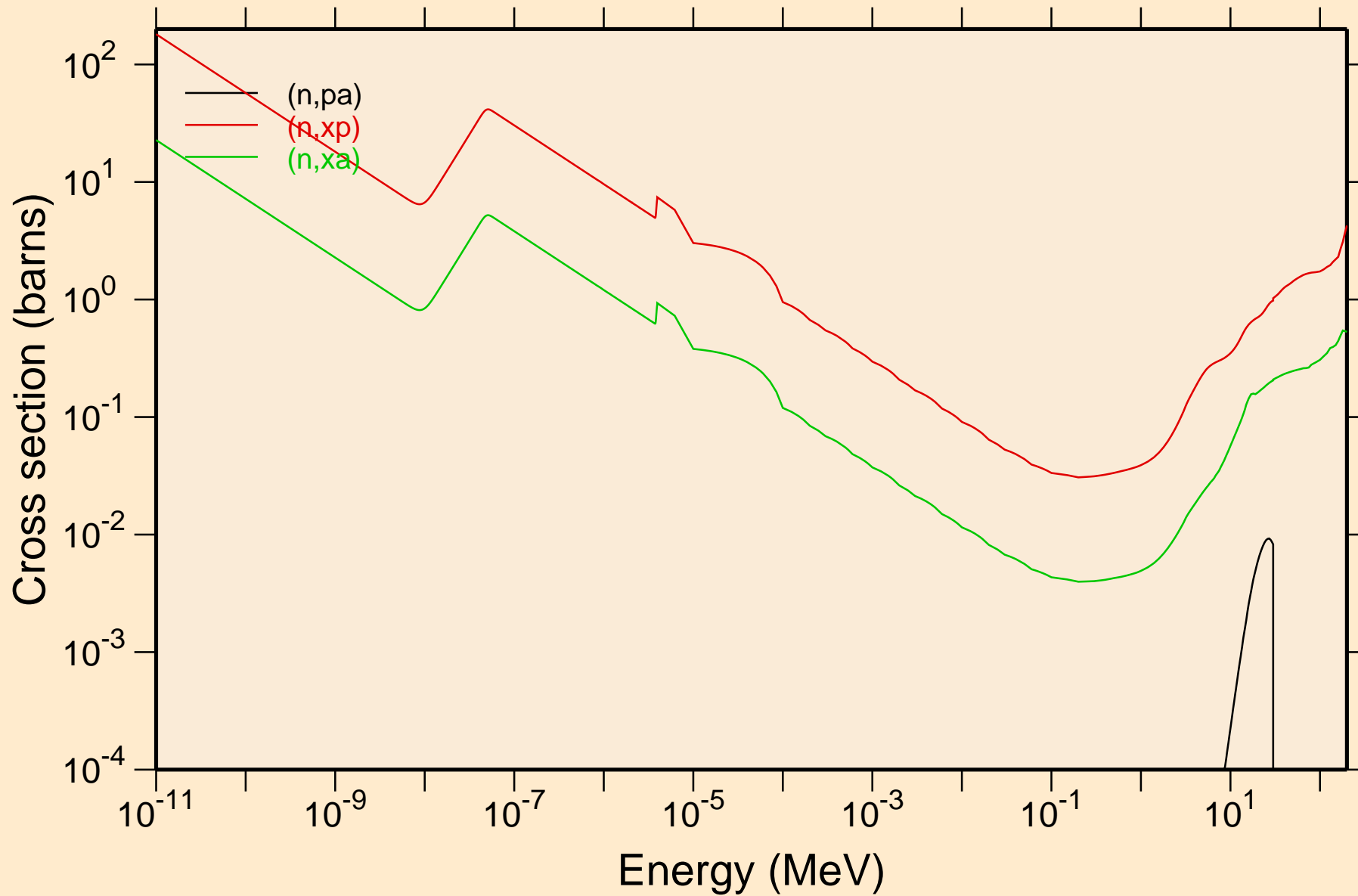

# HG183 NEUTRON ACER TENDL-2021 LIBRARY; T=293.6K

## Principal cross sections

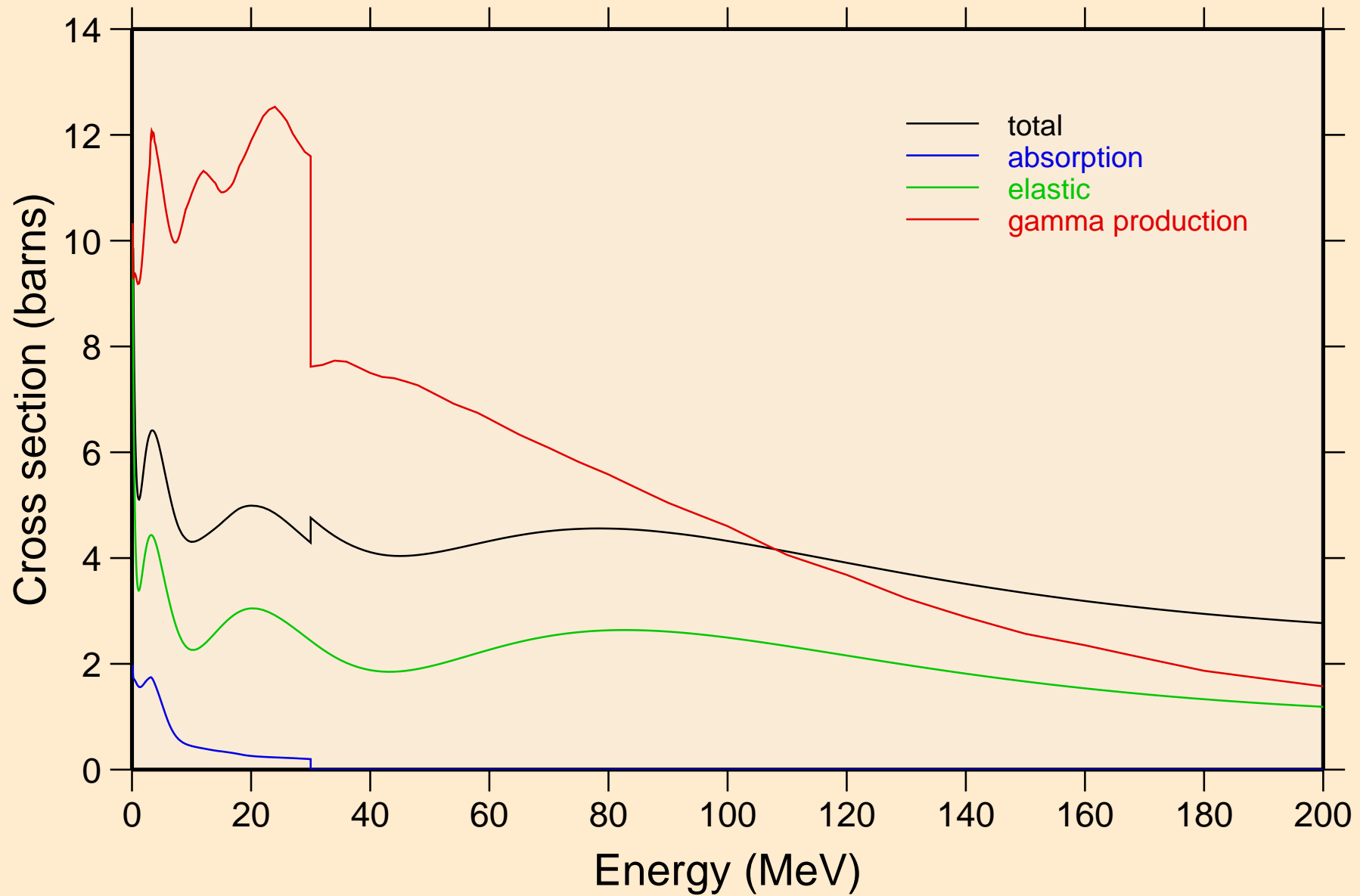

HG183 NEUTRON ACER TENDL-2021 LIBRARY; T=293.6K  
Heating

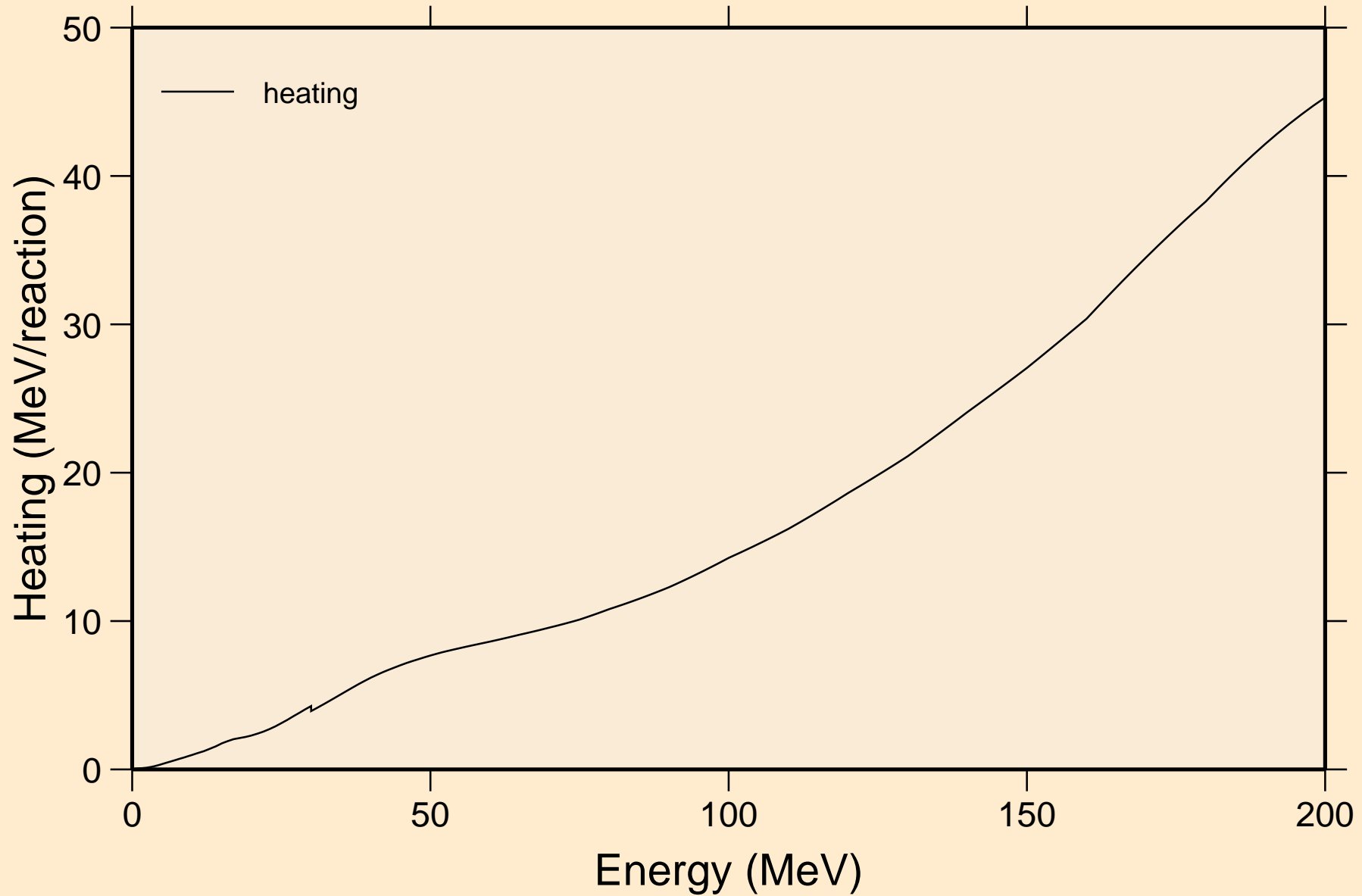

# HG183 NEUTRON ACER TENDL-2021 LIBRARY; T=293.6K

## Damage

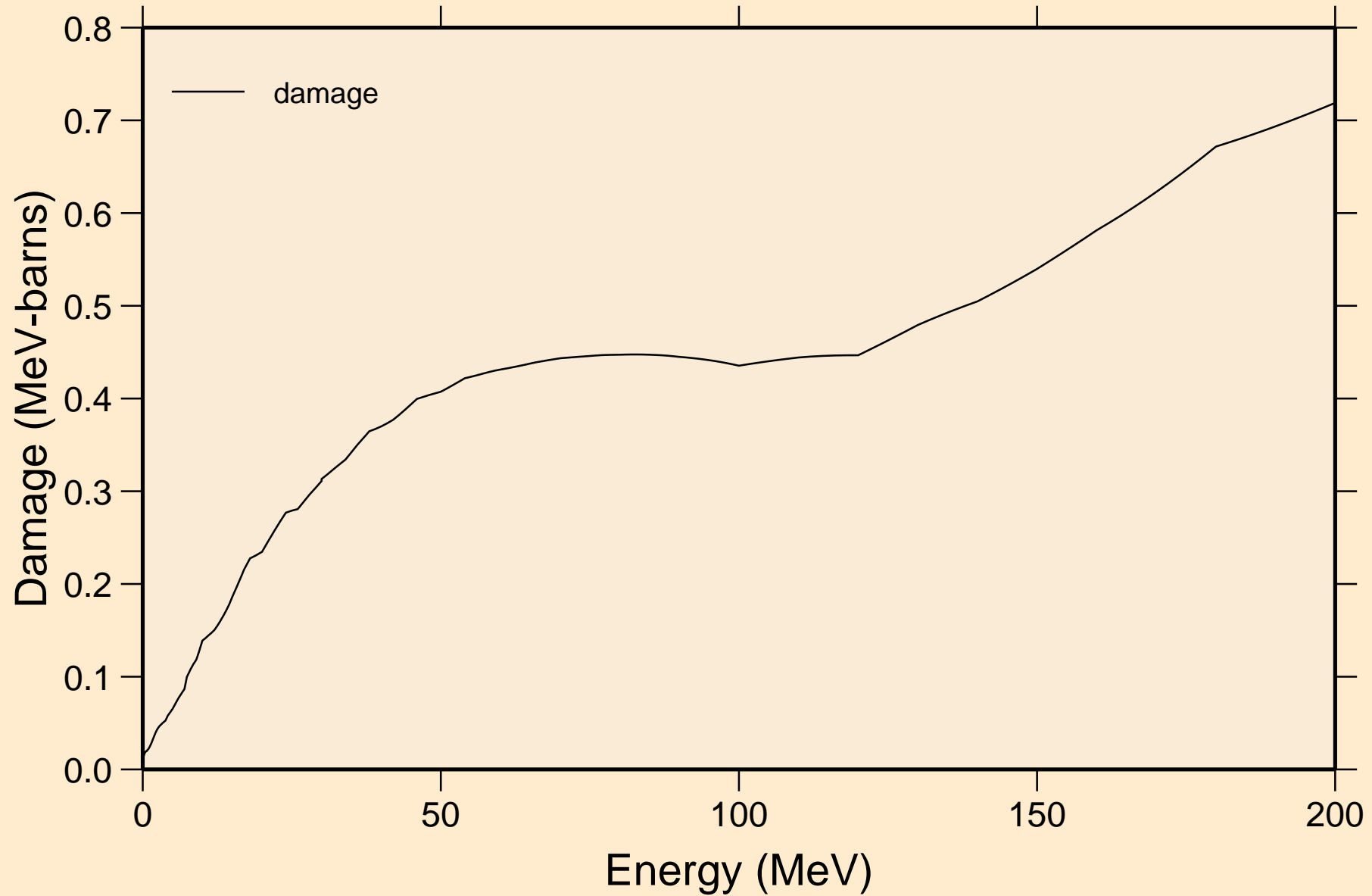

# HG183 NEUTRON ACER TENDL-2021 LIBRARY; T=293.6K

## Non-threshold reactions

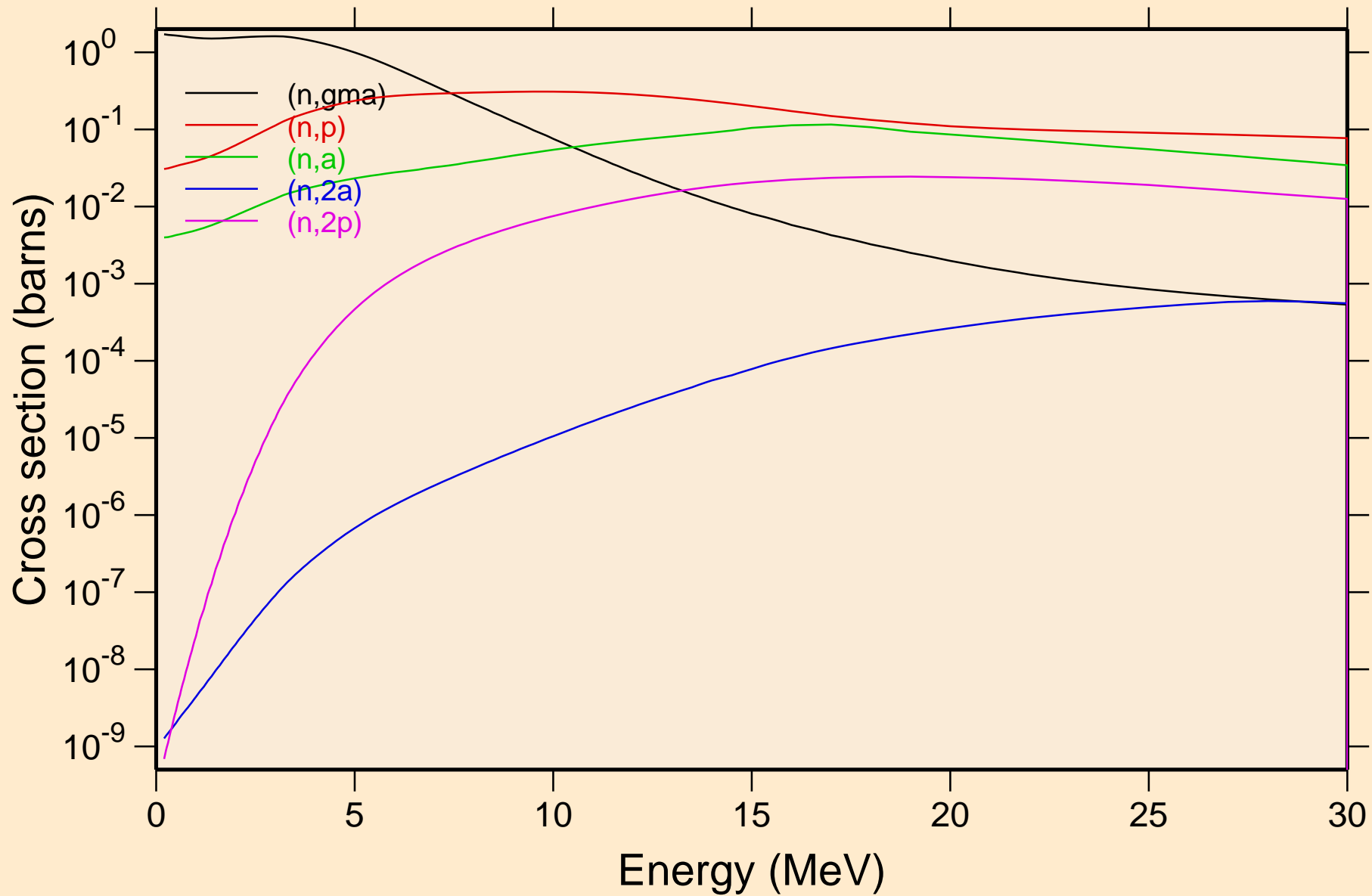



# HG183 NEUTRON ACER TENDL-2021 LIBRARY; T=293.6K

## Non-threshold reactions

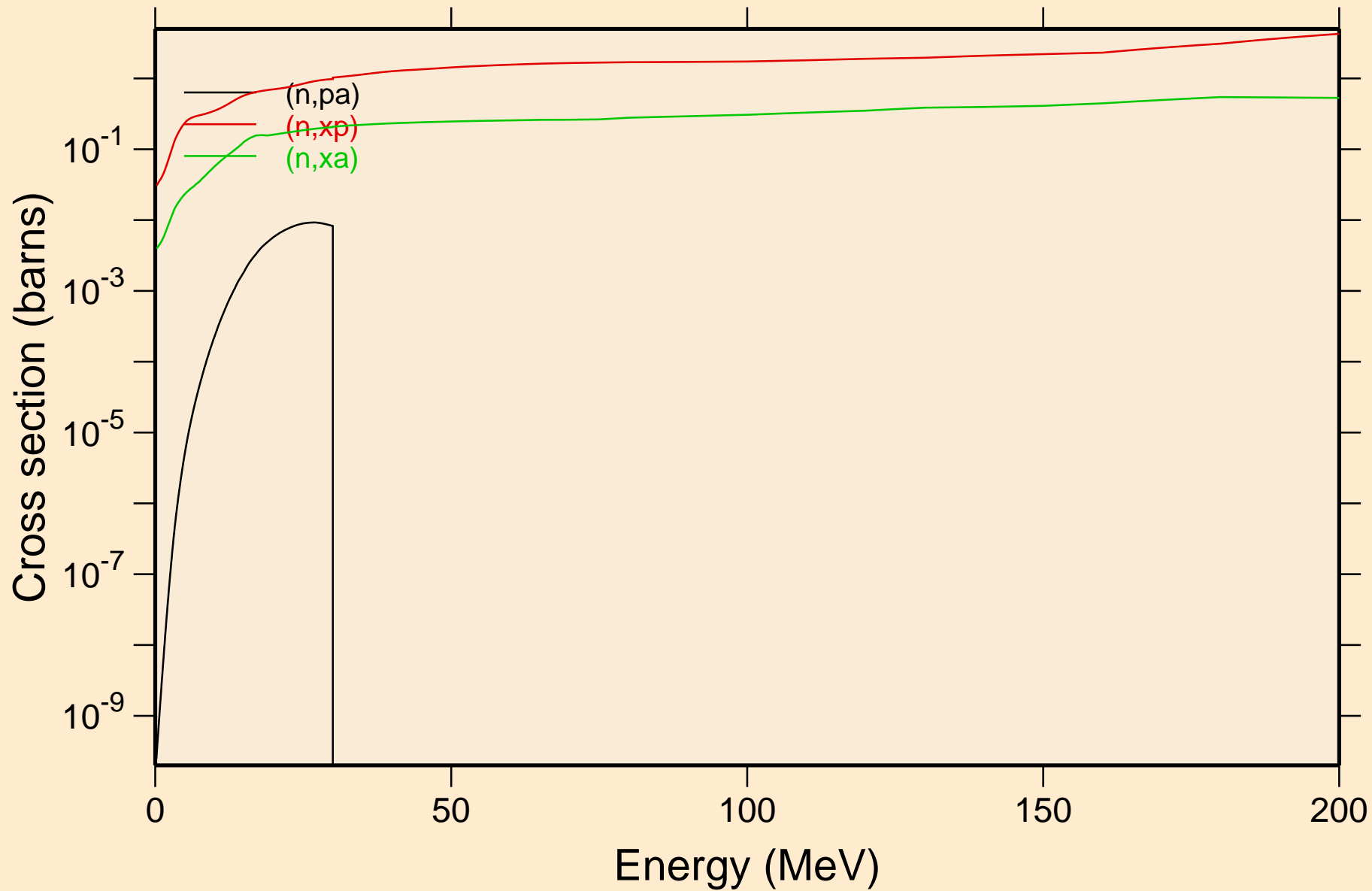

HG183 NEUTRON ACER TENDL-2021 LIBRARY; T=293.6K  
Inelastic levels

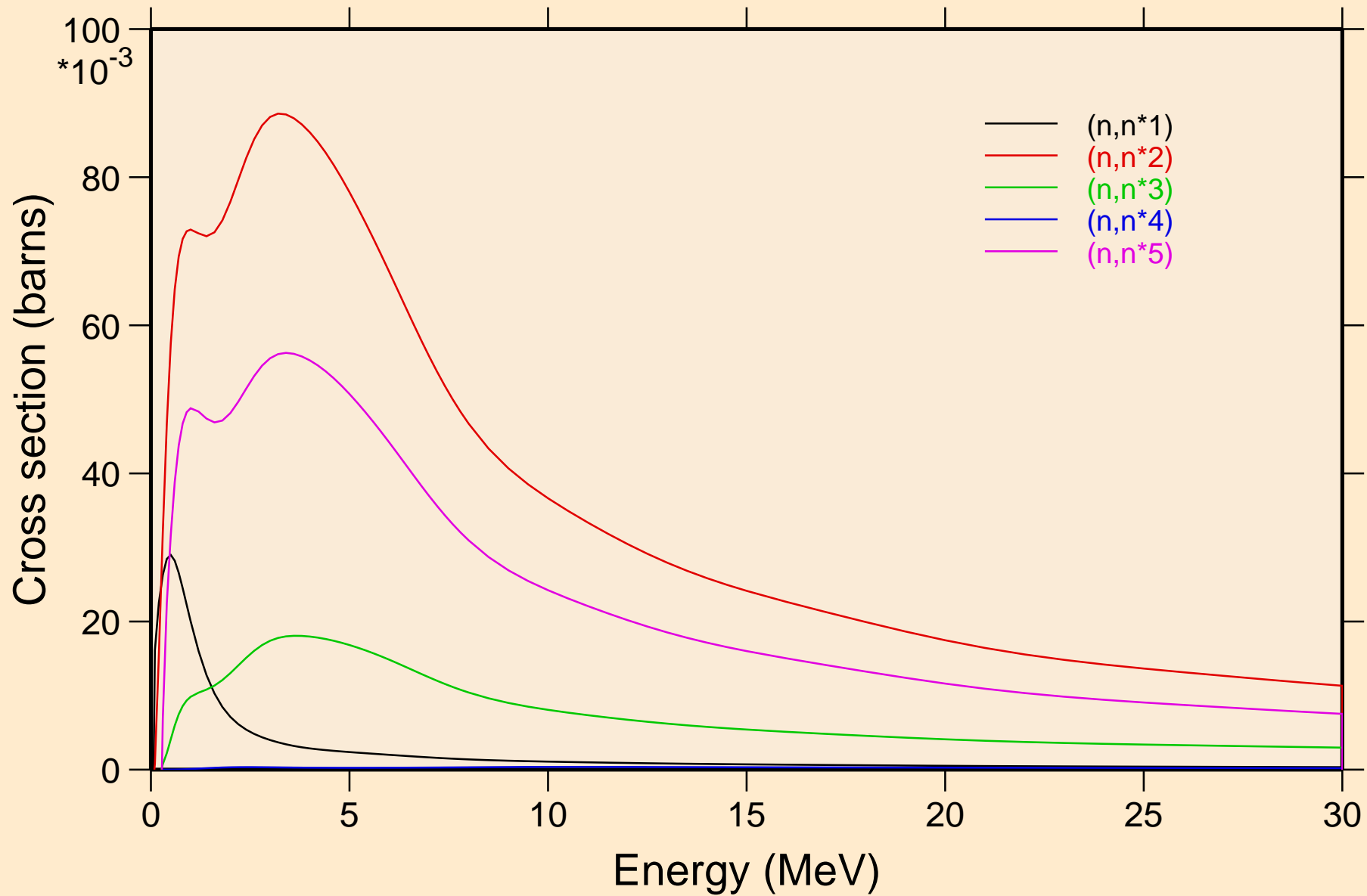

HG183 NEUTRON ACER TENDL-2021 LIBRARY; T=293.6K  
Inelastic levels

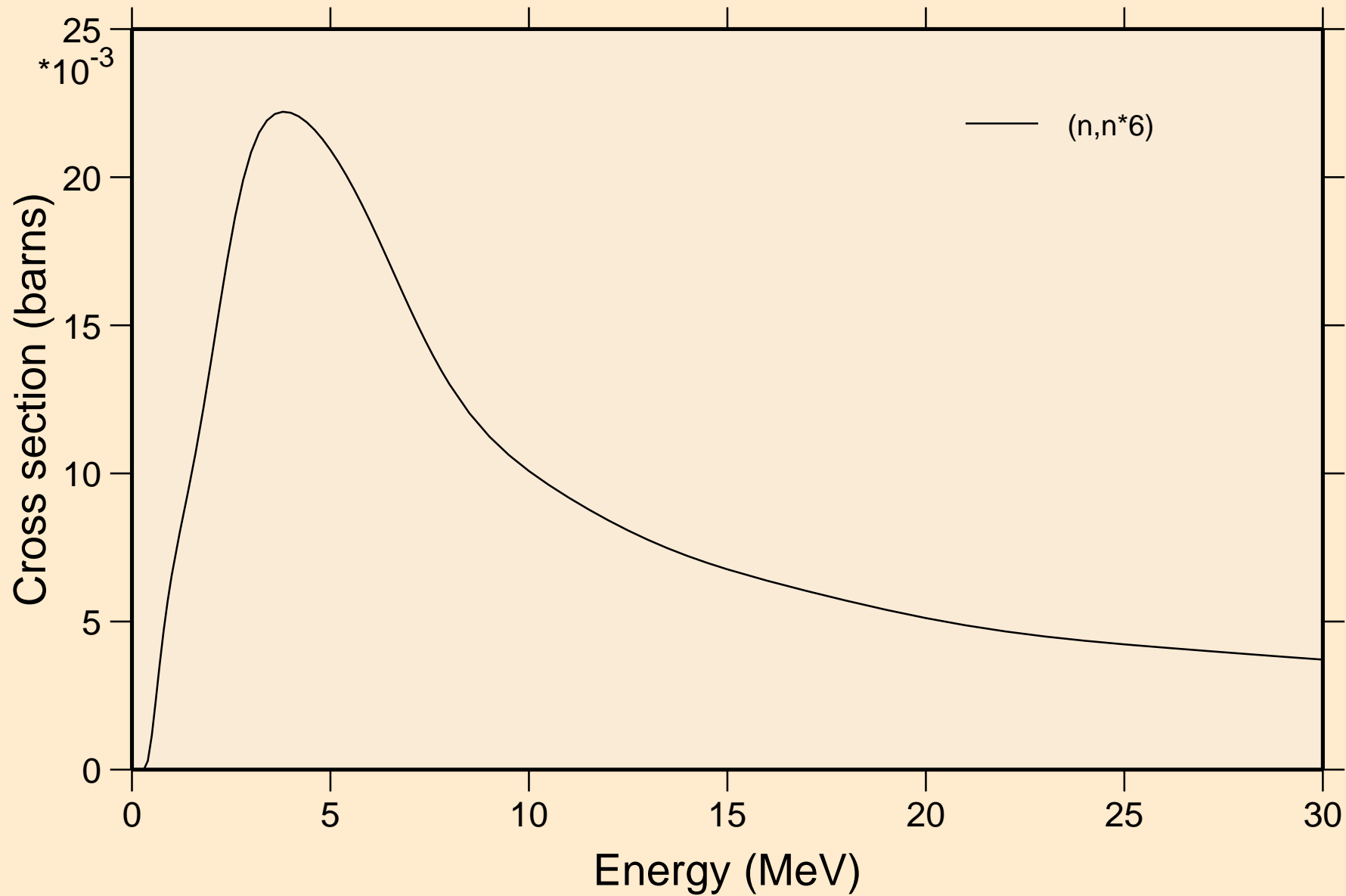

# HG183 NEUTRON ACER TENDL-2021 LIBRARY; T=293.6K

## Threshold reactions

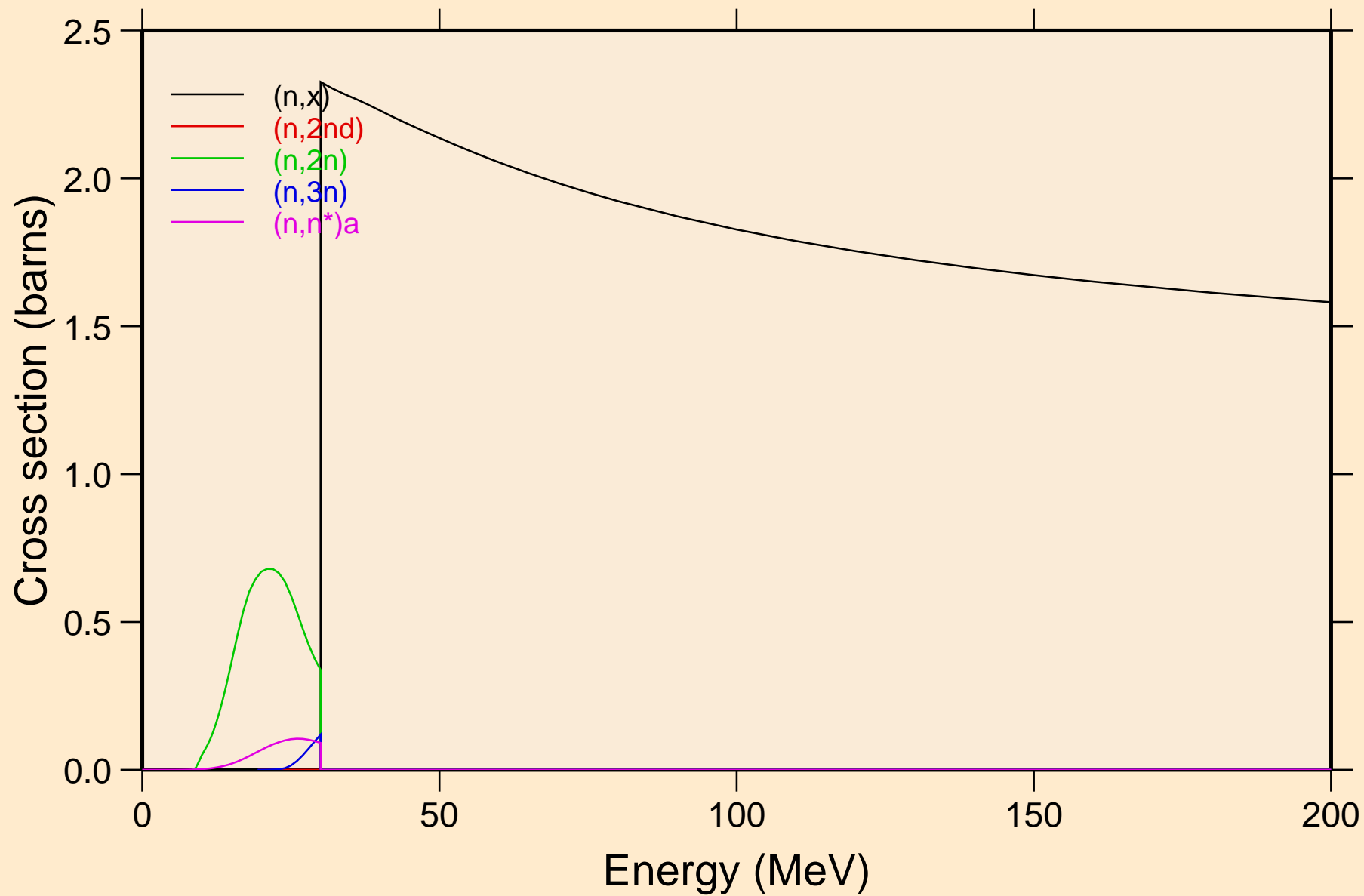

# HG183 NEUTRON ACER TENDL-2021 LIBRARY; T=293.6K

## Threshold reactions

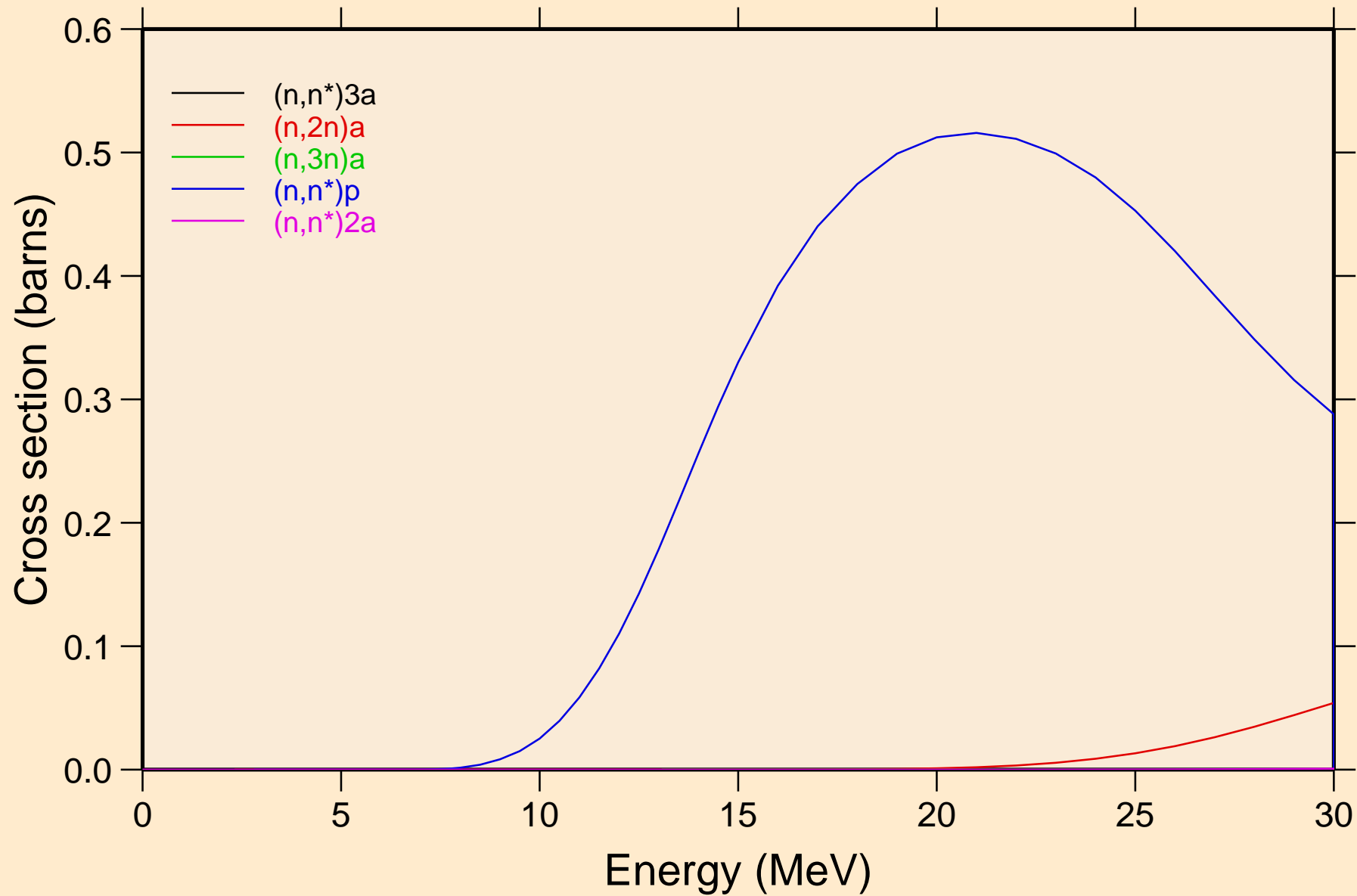

# HG183 NEUTRON ACER TENDL-2021 LIBRARY; T=293.6K

## Threshold reactions

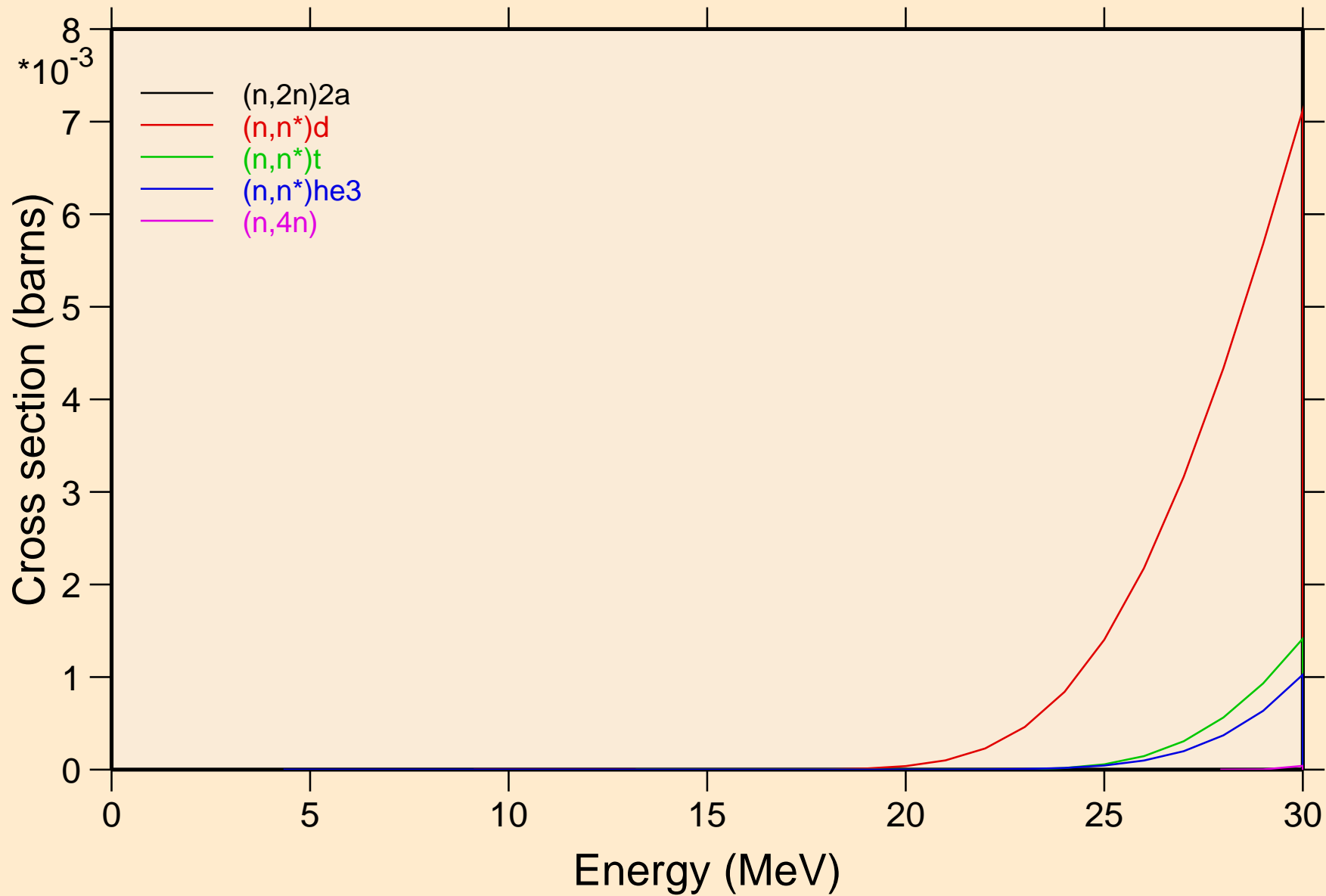

# HG183 NEUTRON ACER TENDL-2021 LIBRARY; T=293.6K

## Threshold reactions

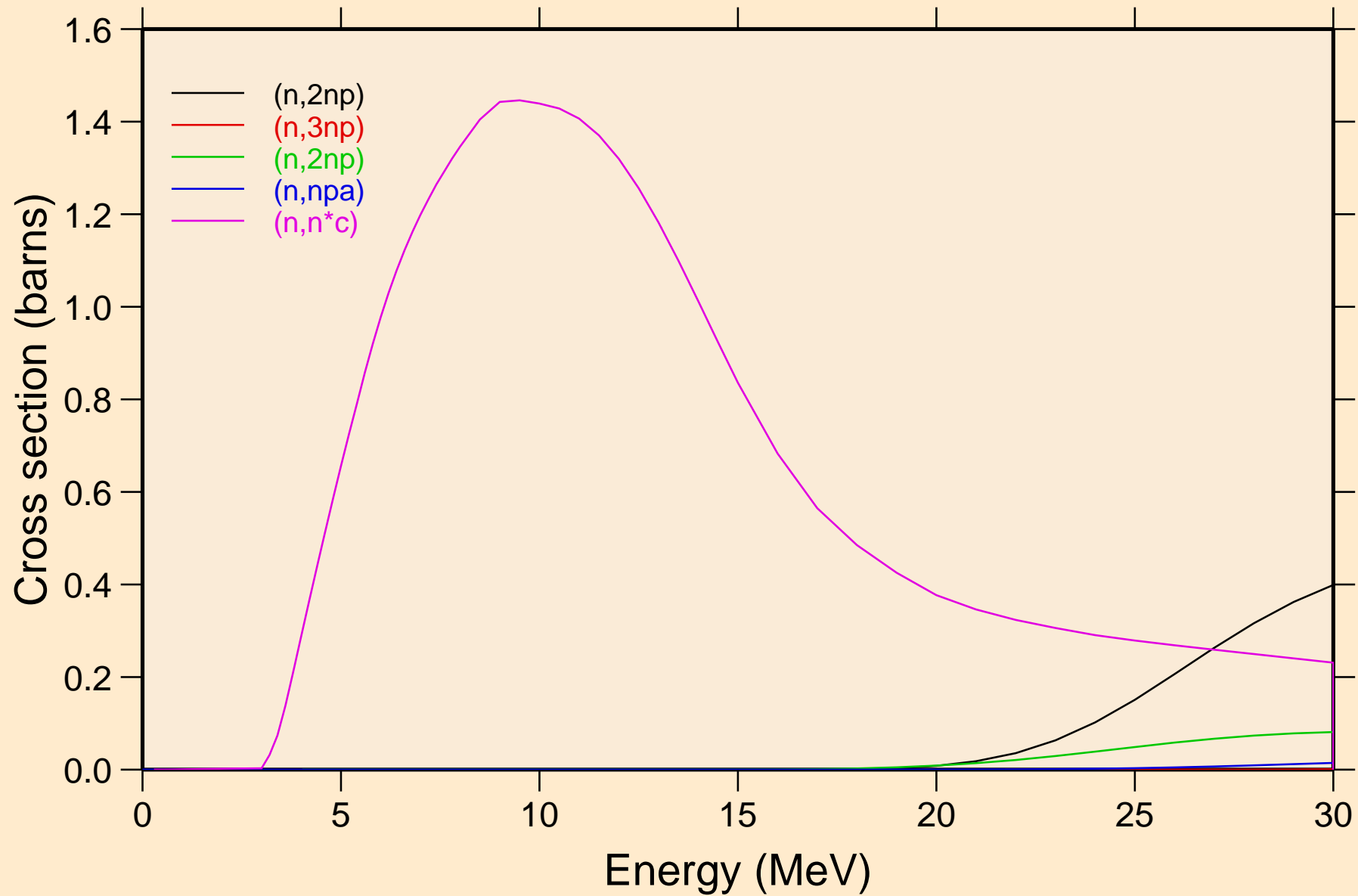

# HG183 NEUTRON ACER TENDL-2021 LIBRARY; T=293.6K

## Threshold reactions

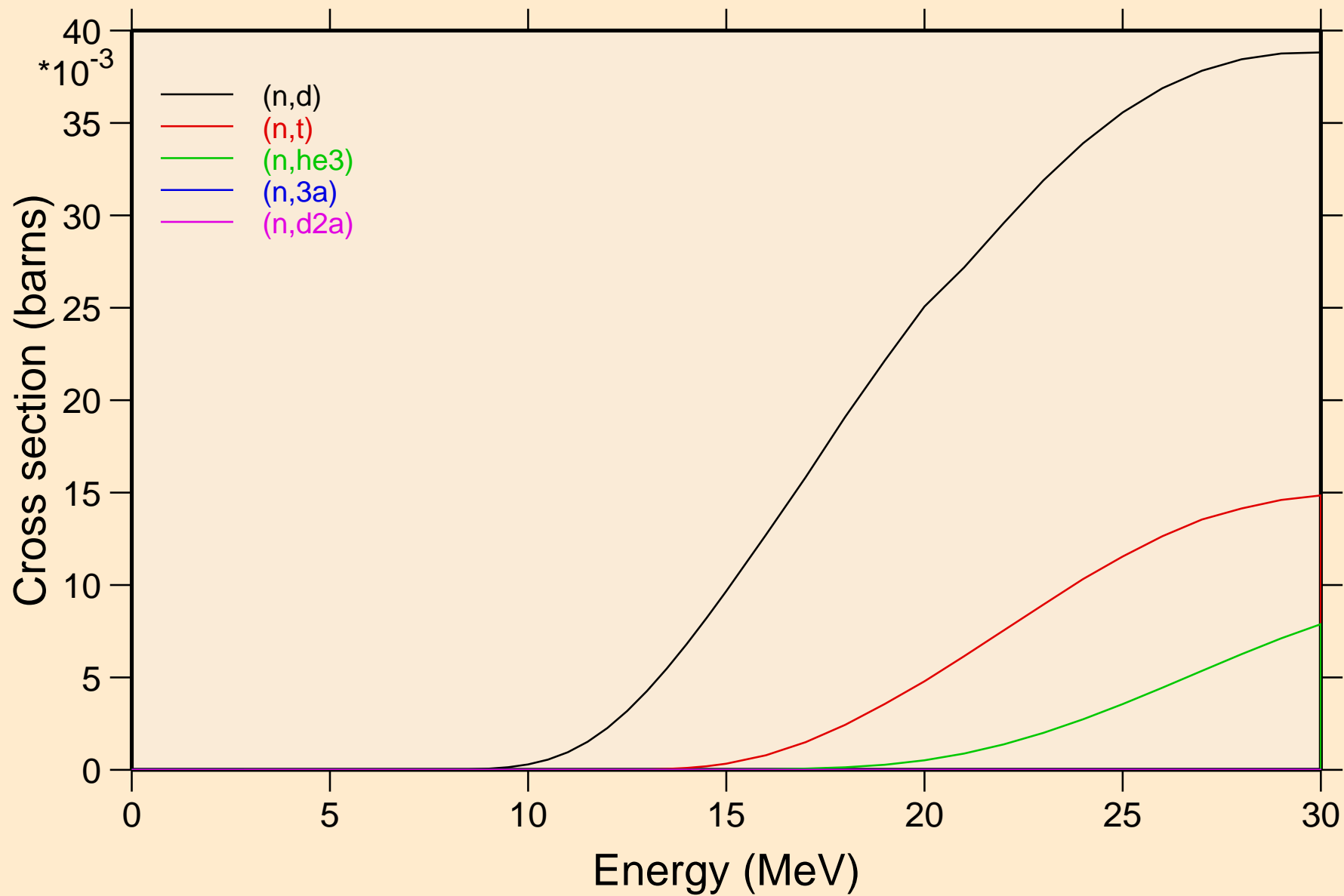



HG183 NEUTRON ACER TENDL-2021 LIBRARY; T=293.6K  
Threshold reactions

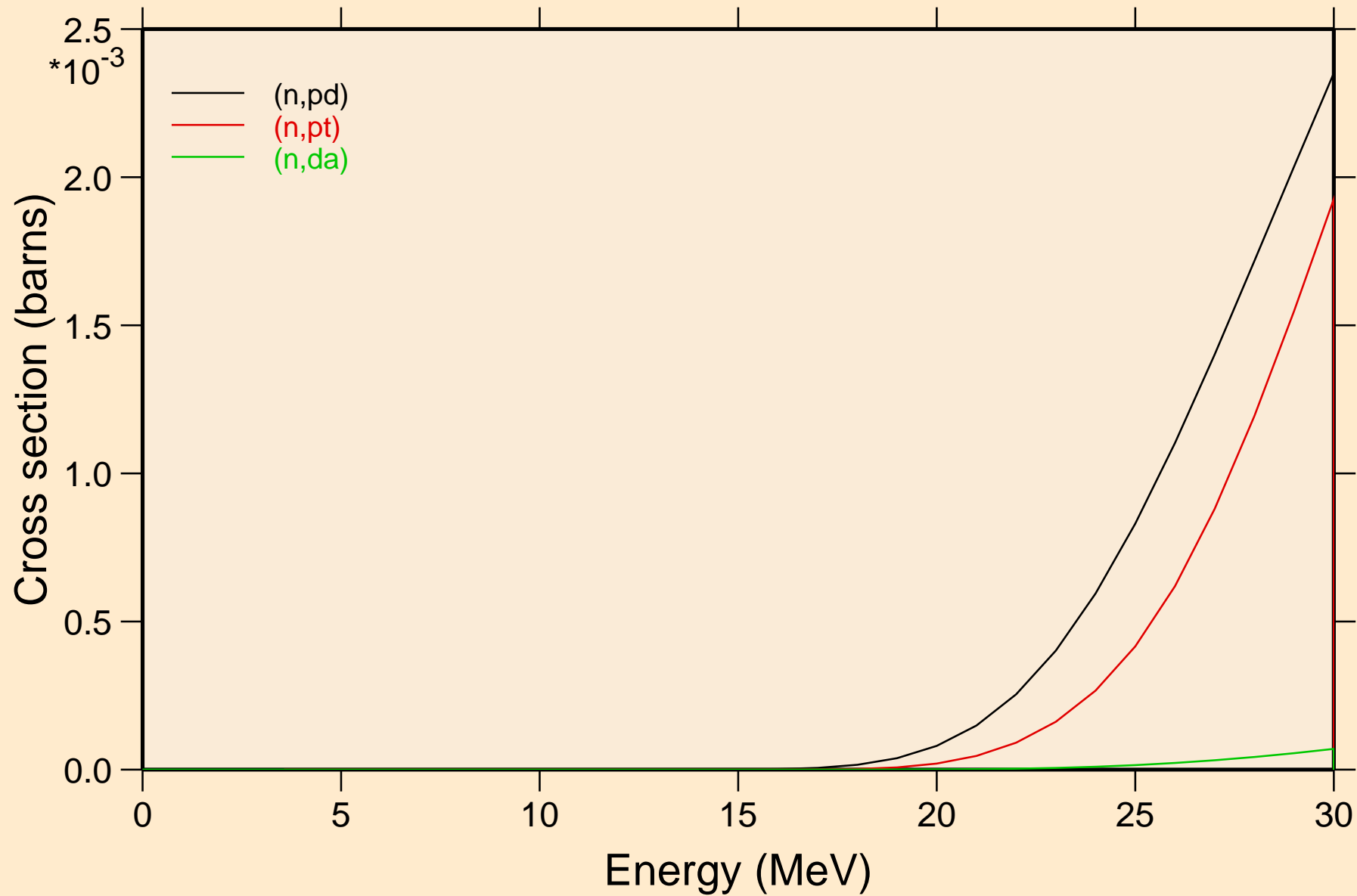

HG183 NEUTRON ACER TENDL-2021 LIBRARY; T=293.6K  
Threshold reactions

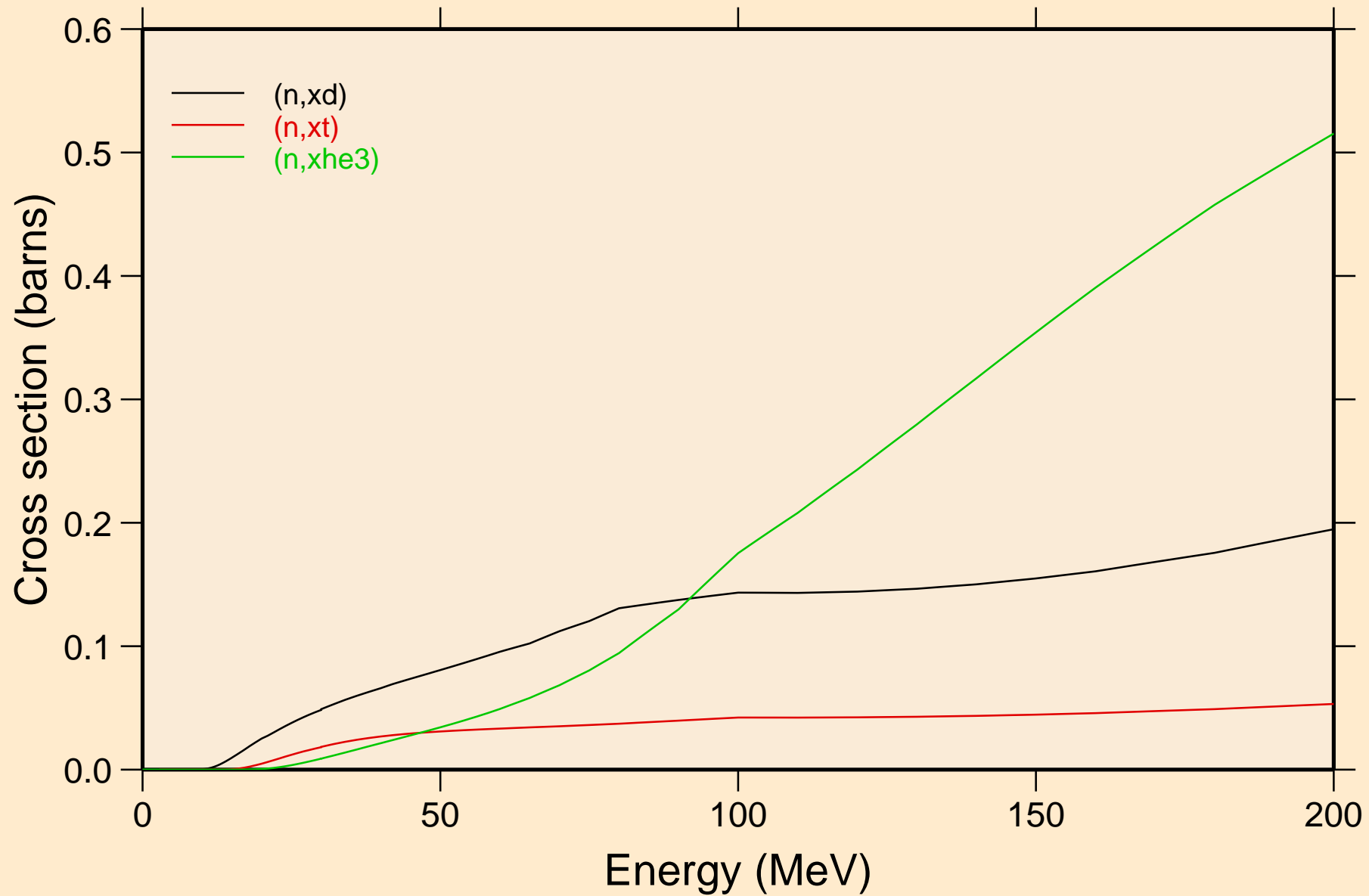

HG183 NEUTRON ACER TENDL-2021 LIBRARY; T=293.6K  
angular distribution for elastic

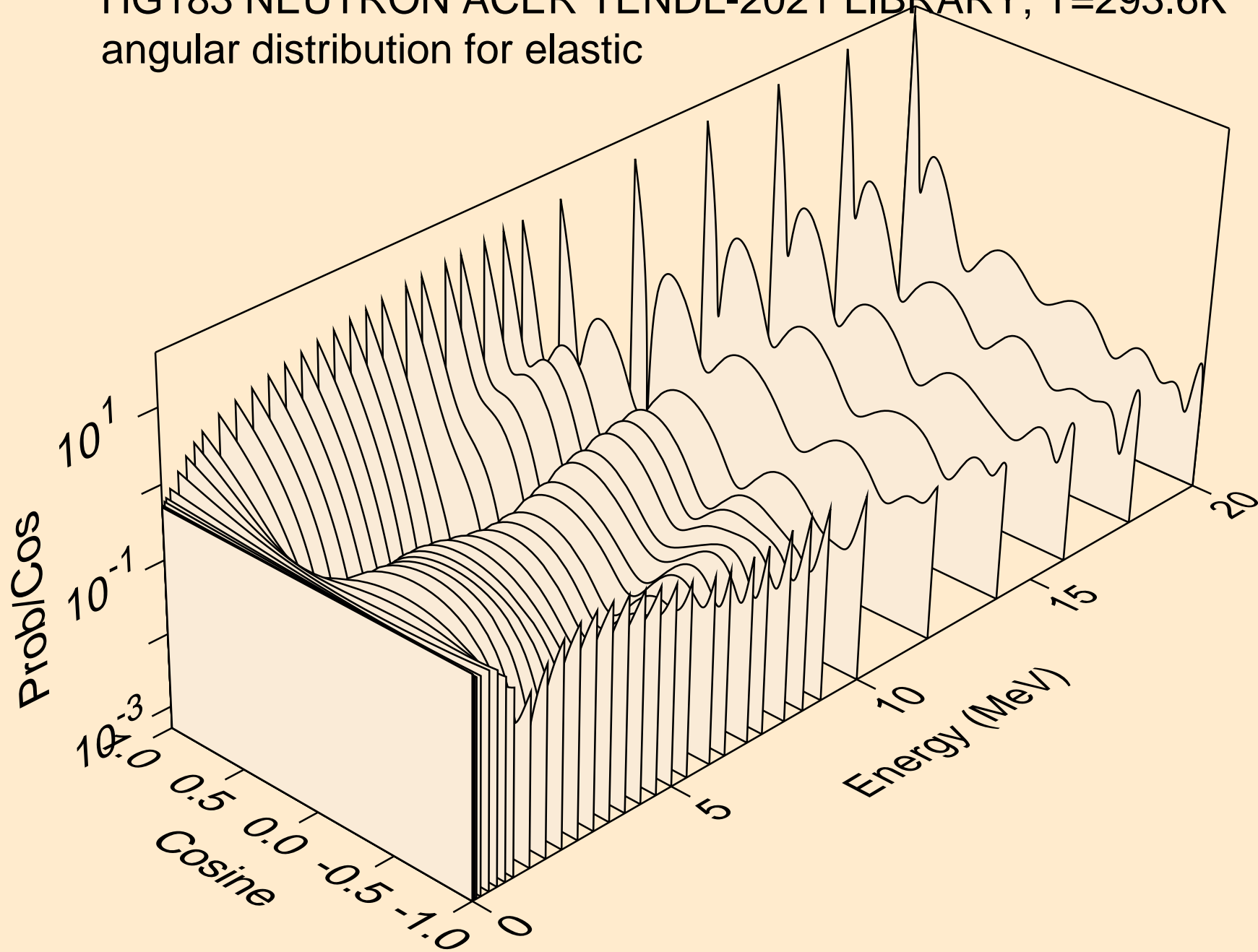

HG183 NEUTRON ACER TENDL-2021 LIBRARY; T=293.6K  
angular distribution for elastic

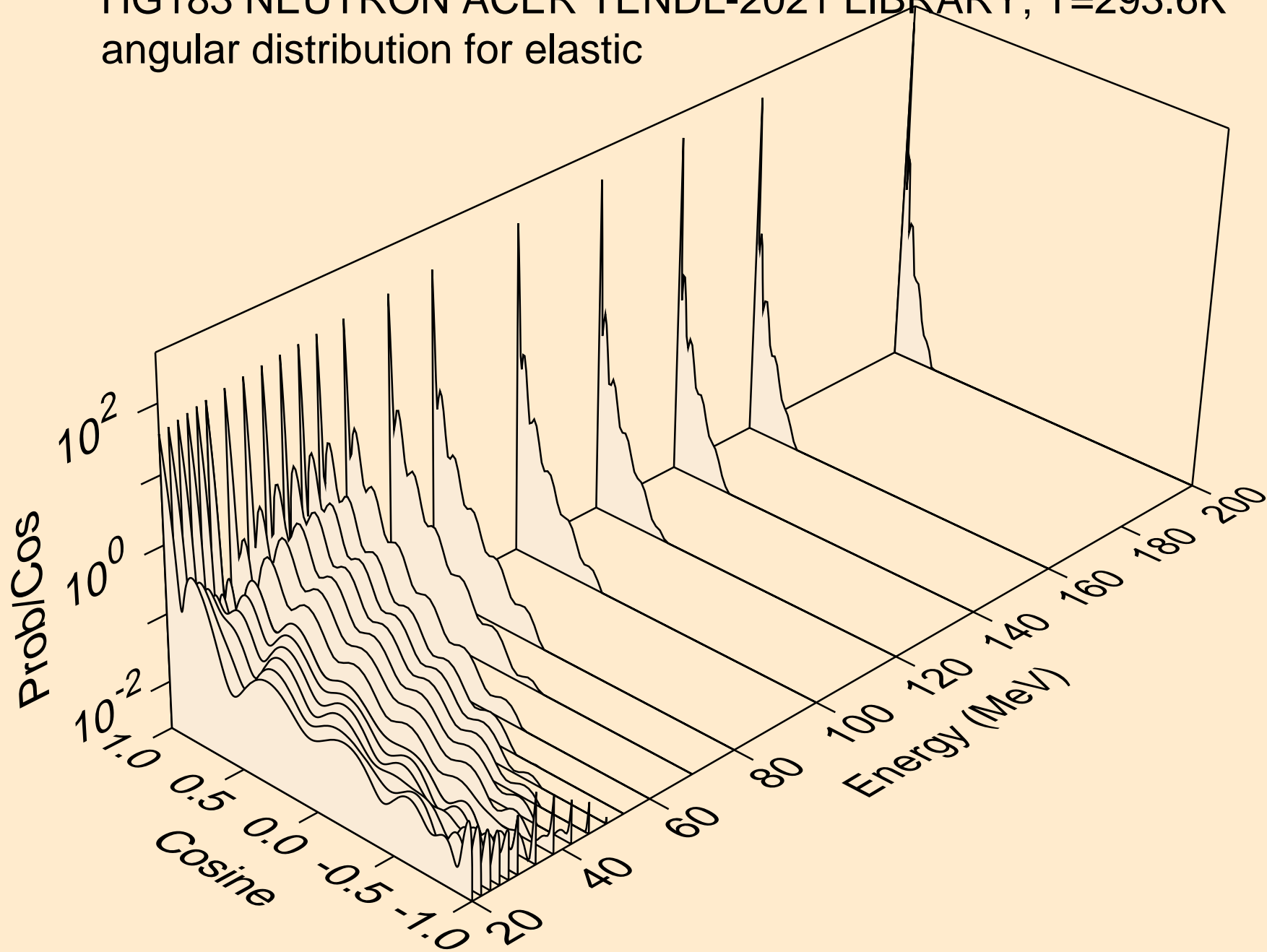

HG183 NEUTRON ACER TENDL-2021 LIBRARY; T=293.6K  
angular distribution for (n,n\*1)

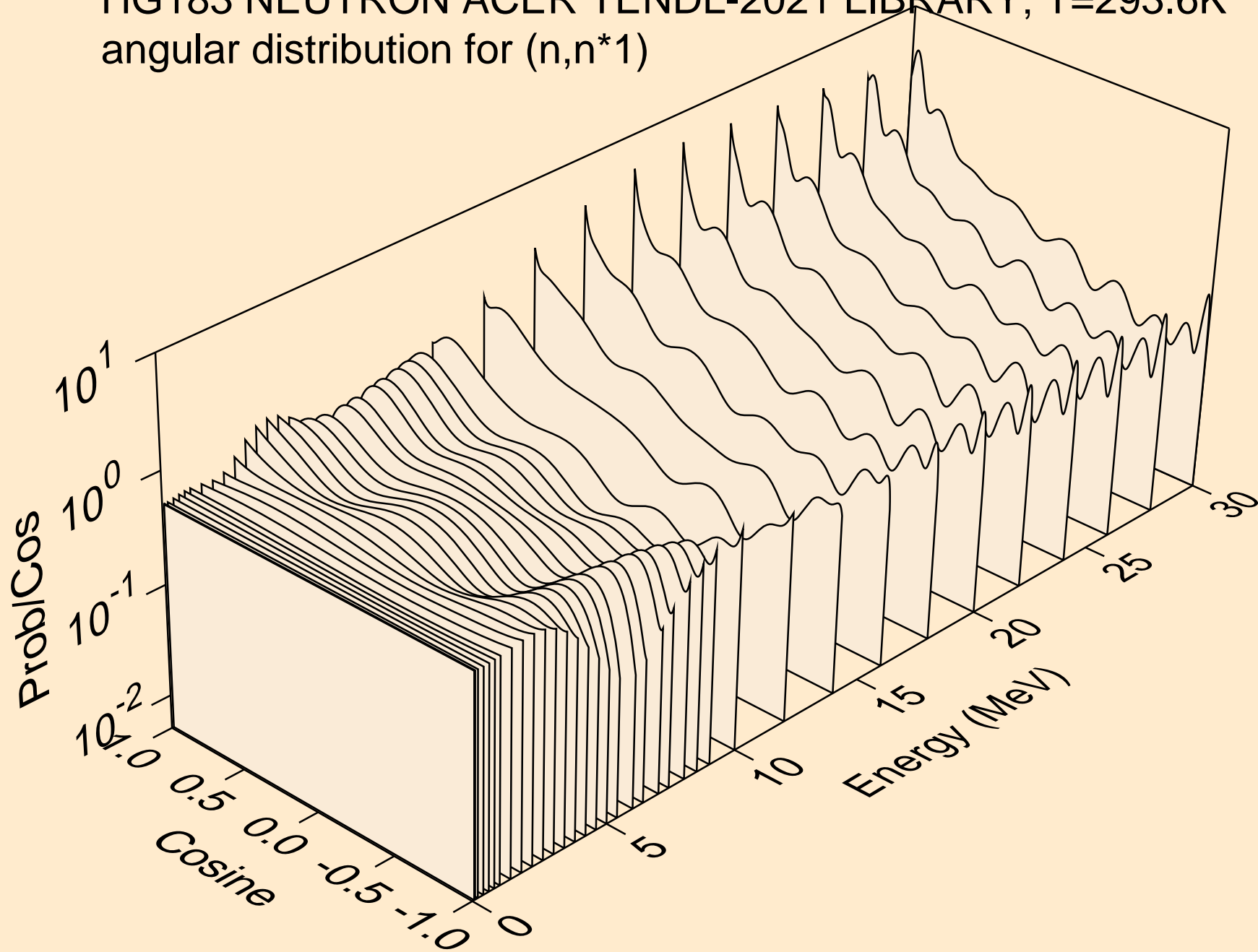

HG183 NEUTRON ACER TENDL-2021 LIBRARY; T=293.6K  
angular distribution for (n,n\*2)

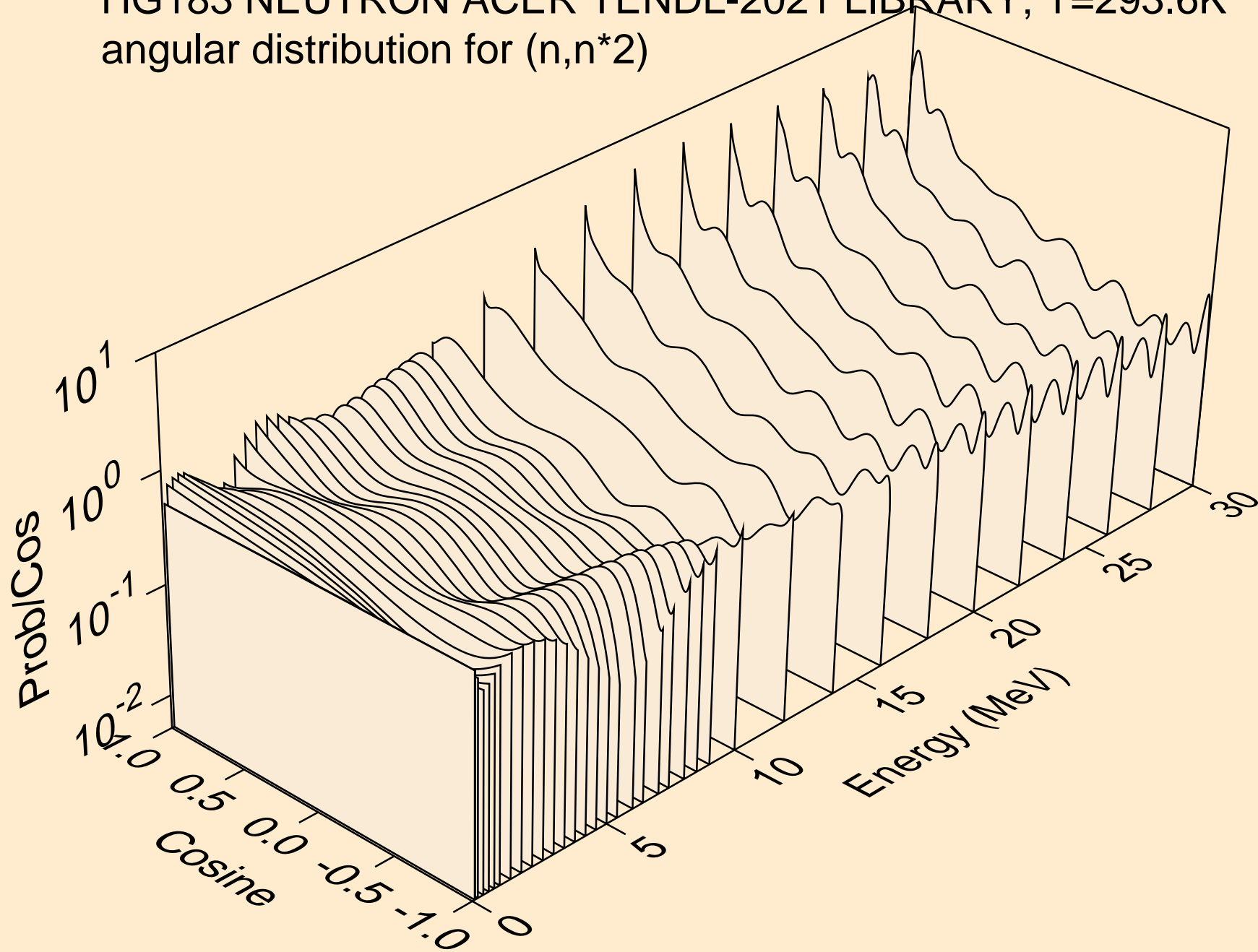

HG183 NEUTRON ACER TENDL-2021 LIBRARY; T=293.6K  
angular distribution for (n,n\*3)

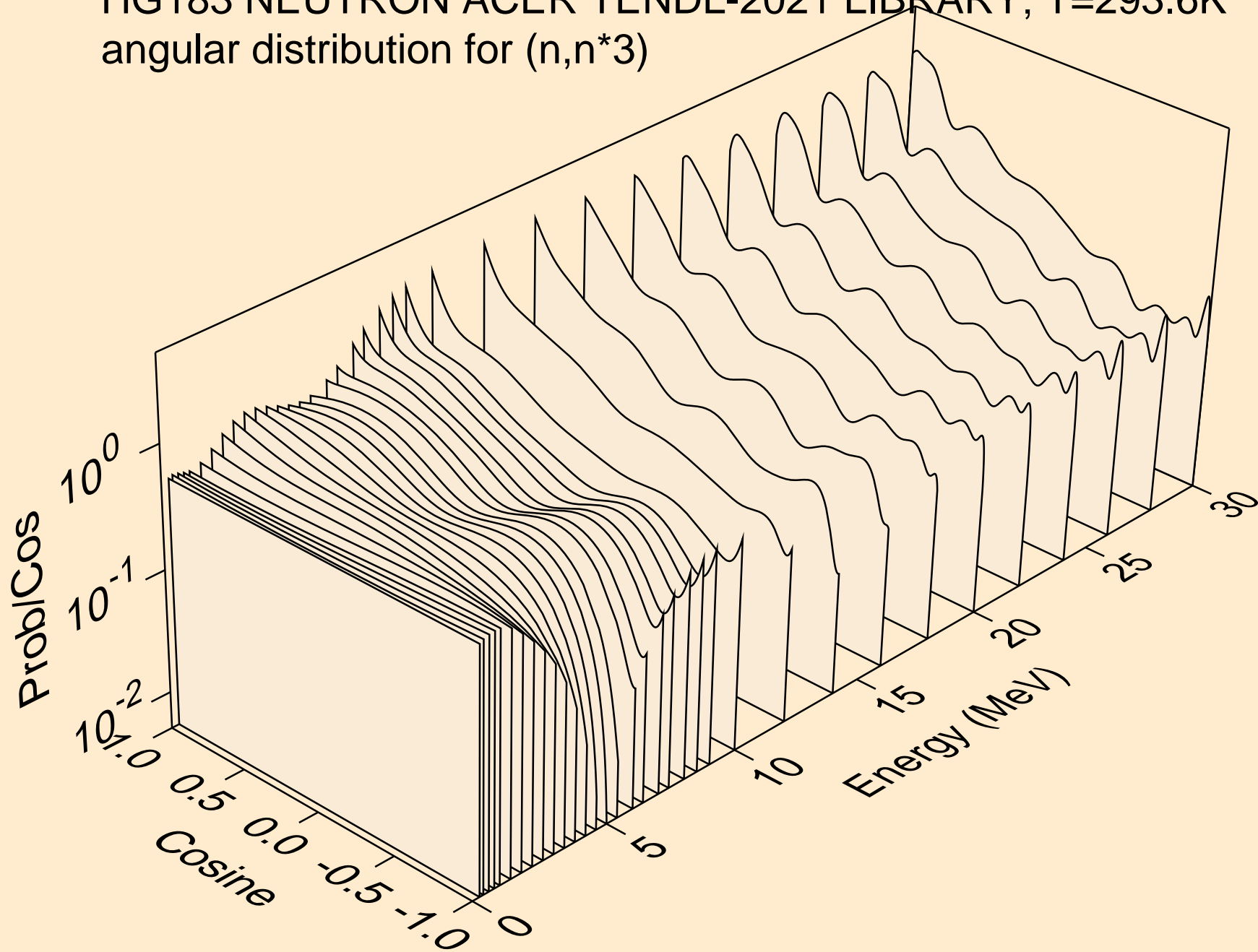

HG183 NEUTRON ACER TENDL-2021 LIBRARY; T=293.6K  
angular distribution for (n,n\*4)

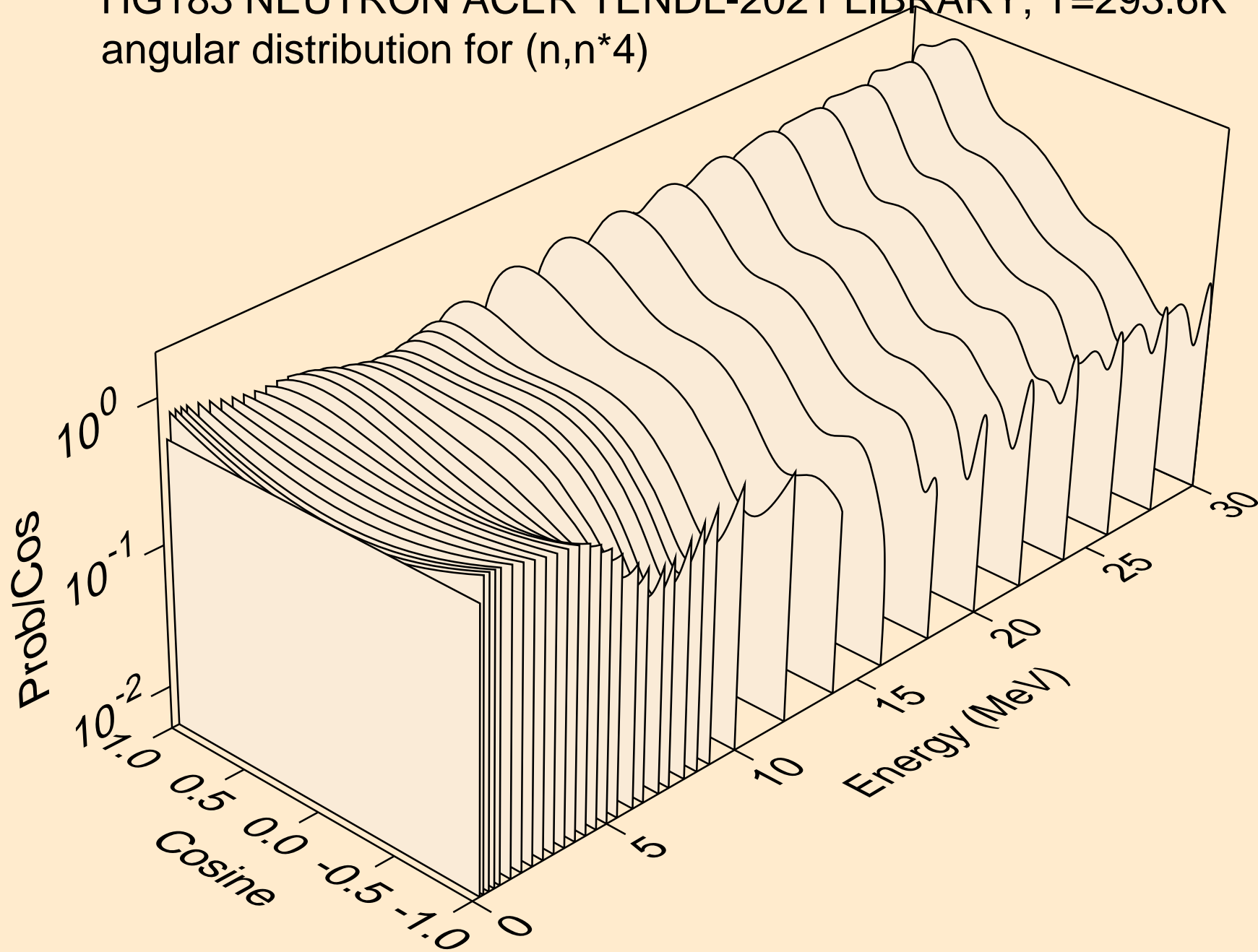



HG183 NEUTRON ACER TENDL-2021 LIBRARY; T=293.6K  
angular distribution for (n,n\*5)

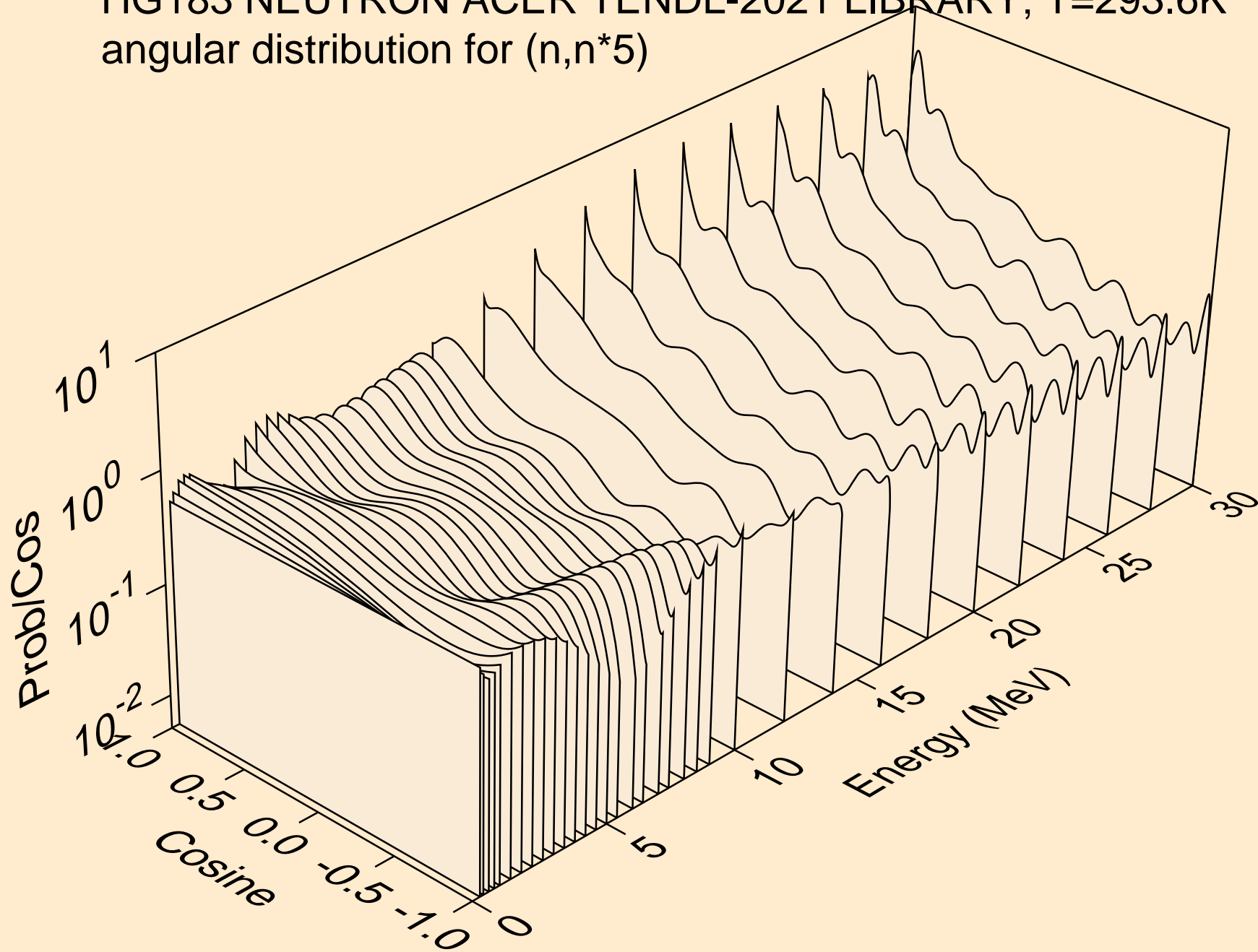

HG183 NEUTRON ACER TENDL-2021 LIBRARY; T=293.6K  
angular distribution for (n,n\*6)

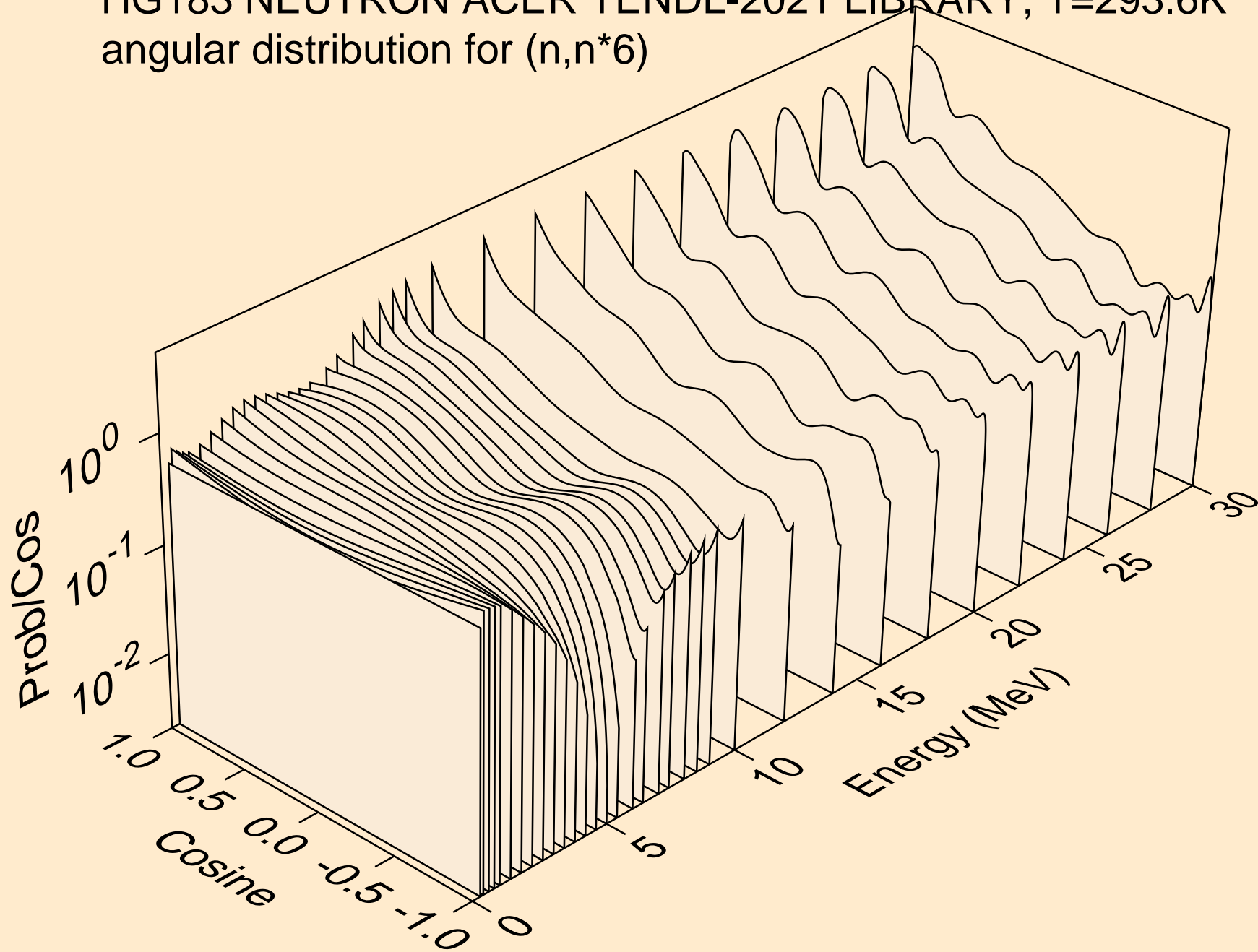

HG183 NEUTRON ACER TENDL-2021 LIBRARY; T=293.6K  
Neutron emission for (n,x)

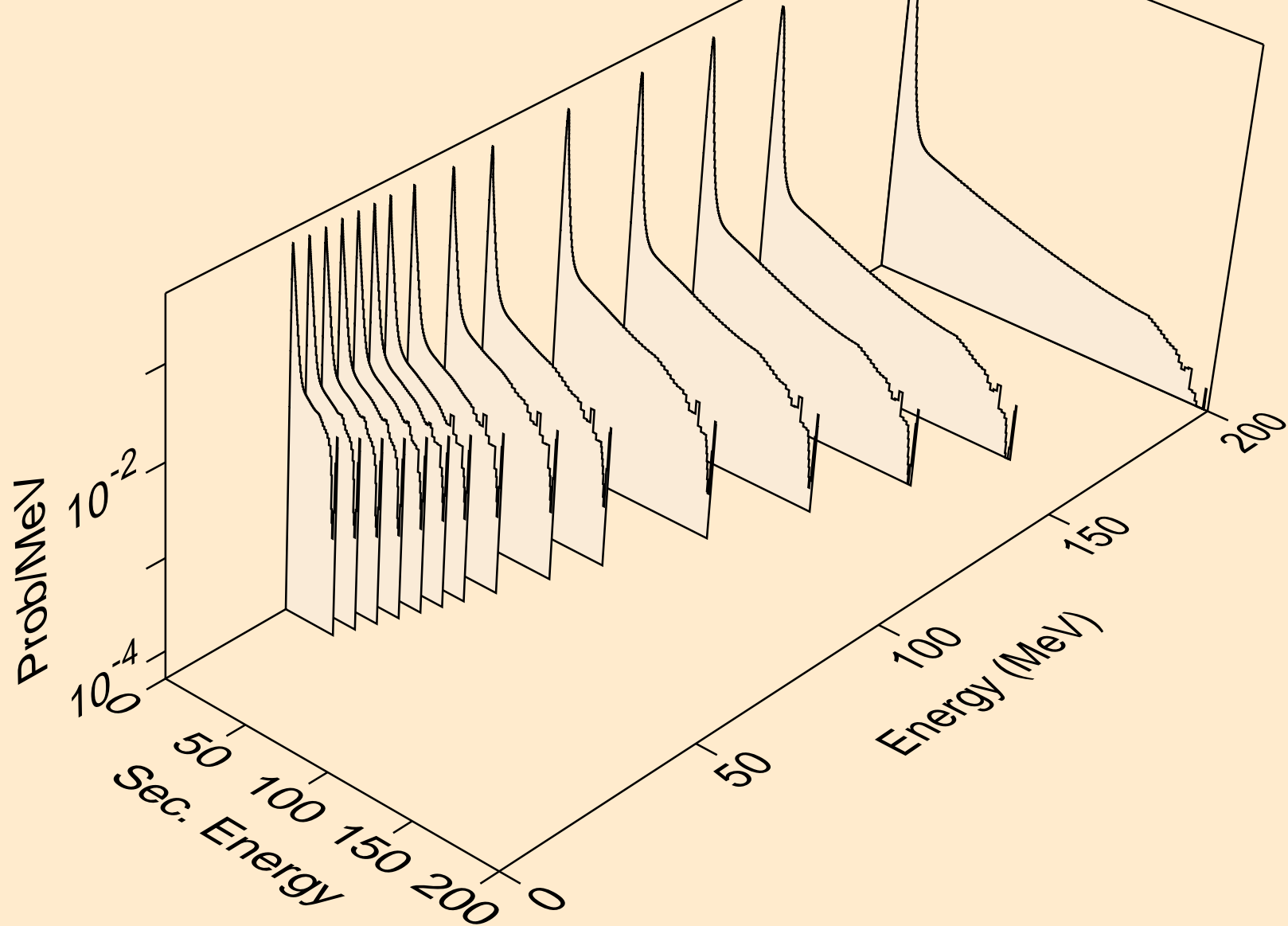

HG183 NEUTRON ACER TENDL-2021 LIBRARY; T=293.6K  
Neutron emission for (n,2nd)

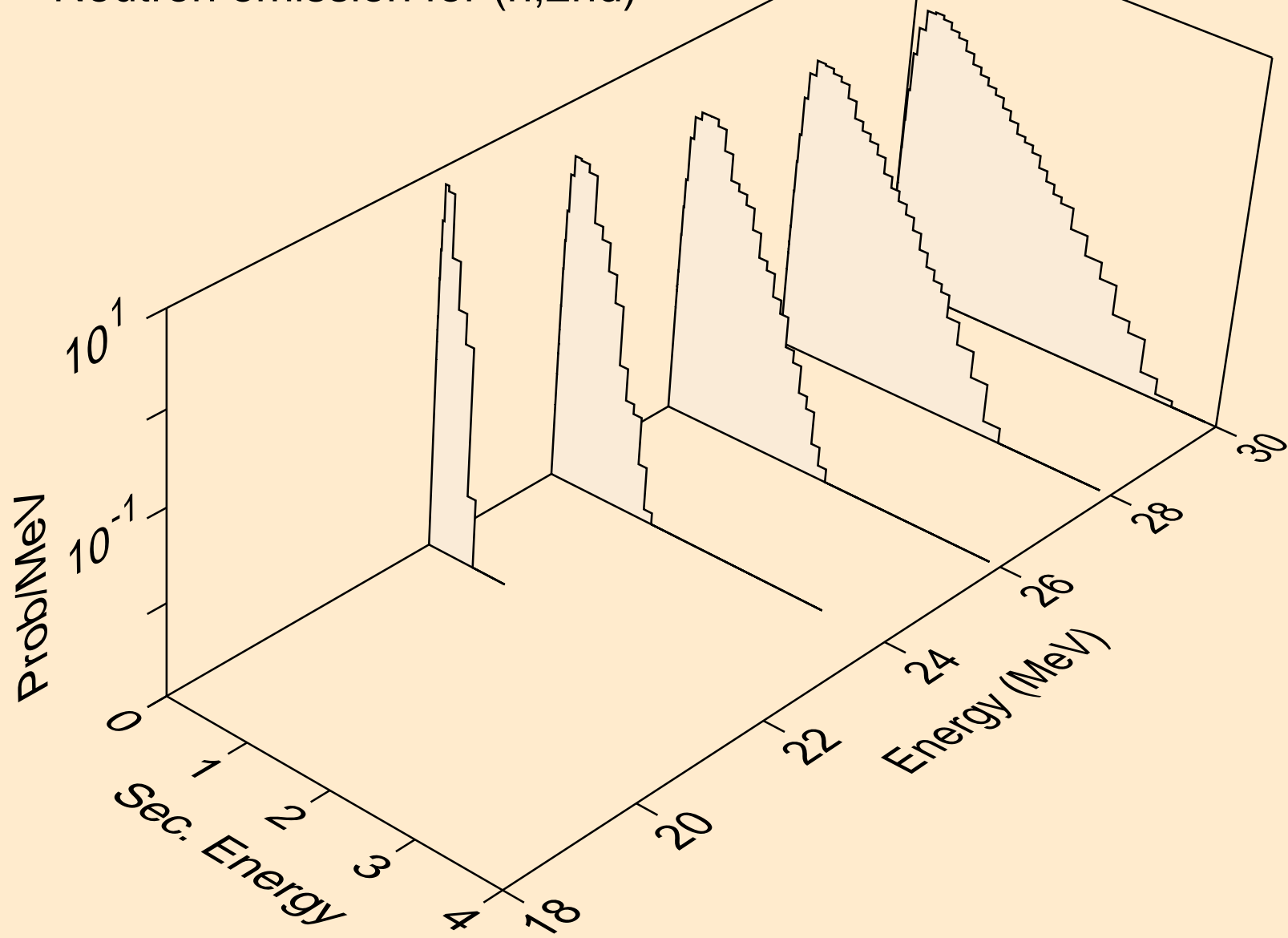

HG183 NEUTRON ACER TENDL-2021 LIBRARY; T=293.6K  
Neutron emission for (n,2n)

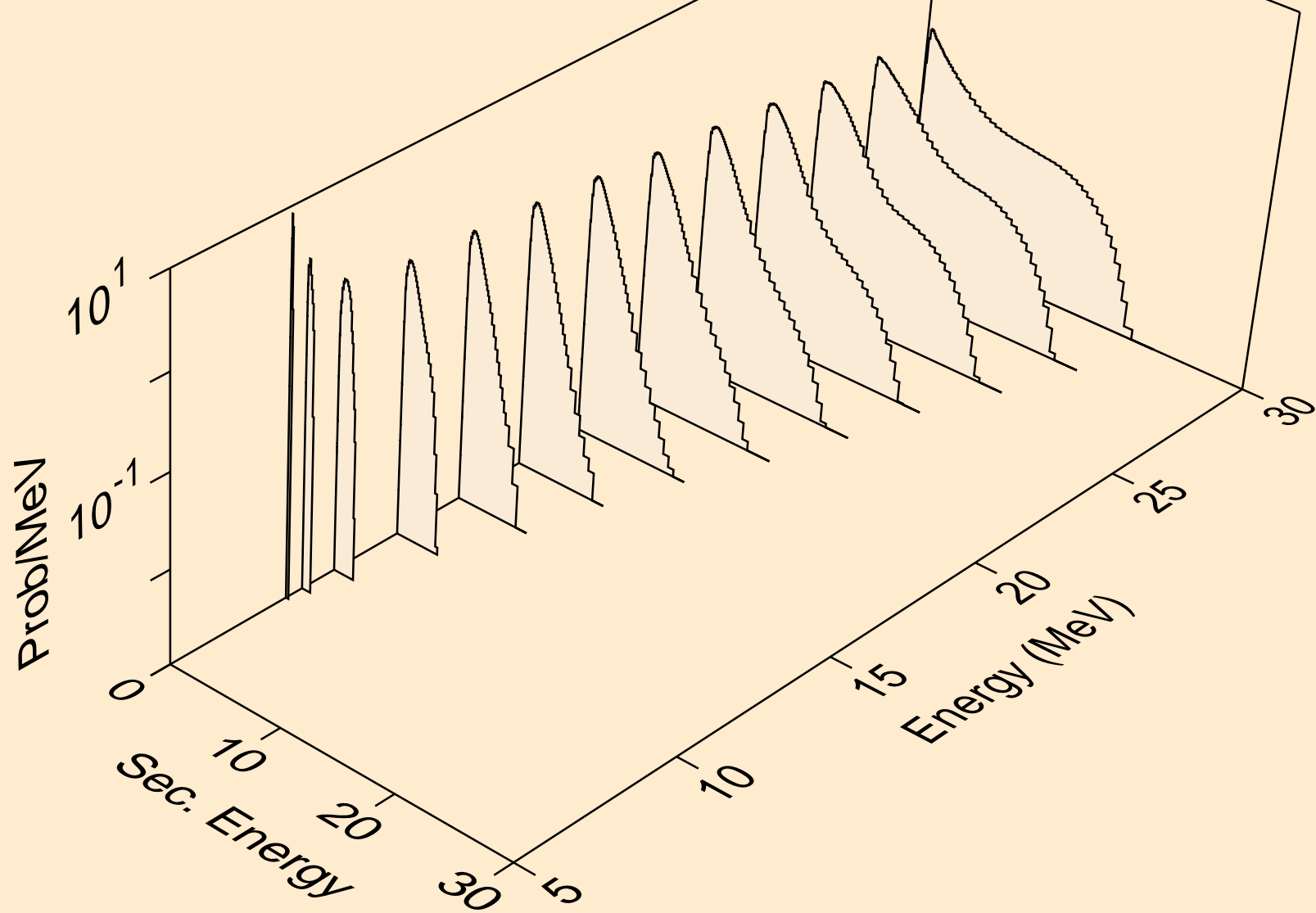

HG183 NEUTRON ACER TENDL-2021 LIBRARY; T=293.6K  
Neutron emission for (n,3n)

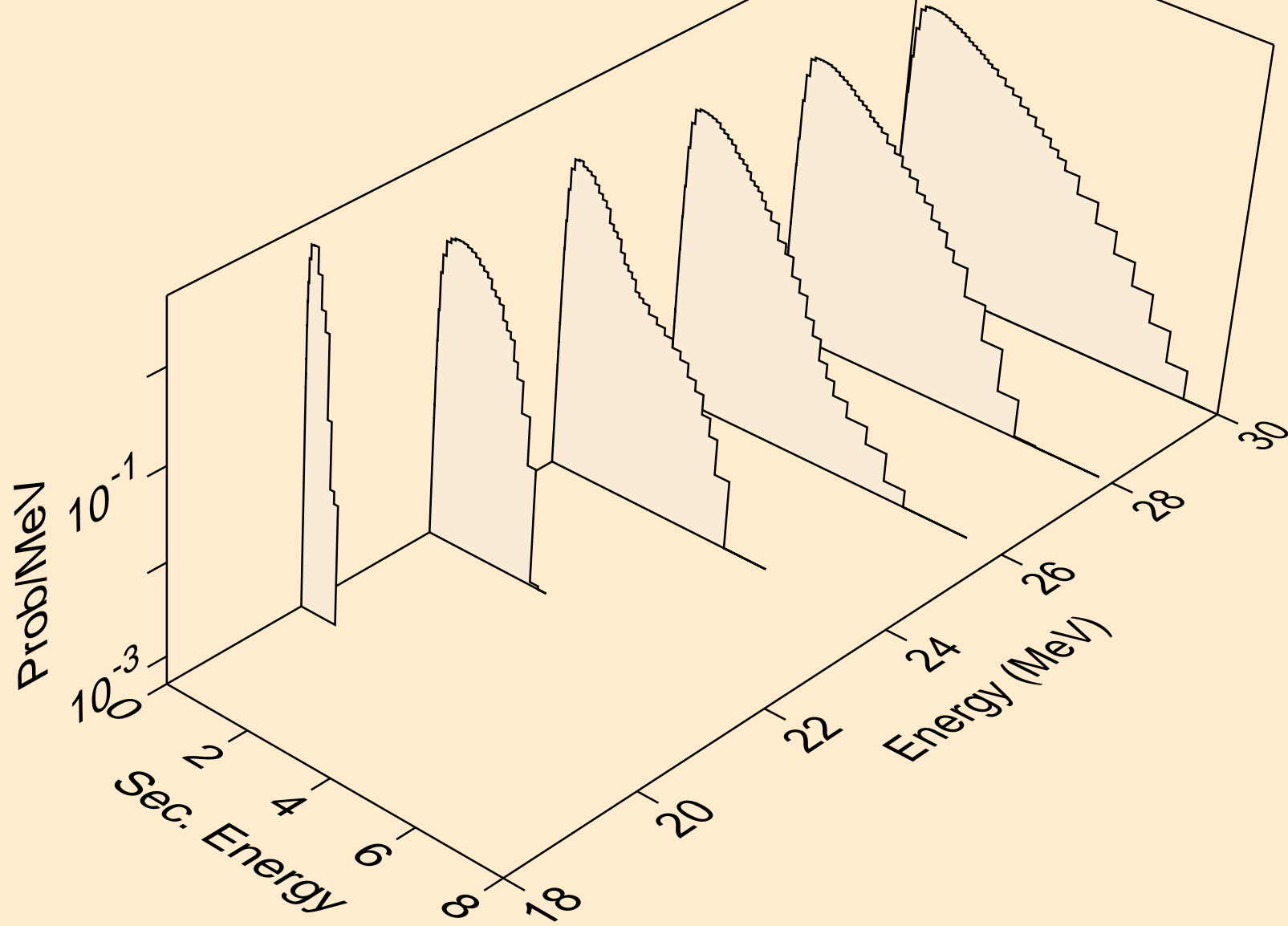

HG183 NEUTRON ACER TENDL-2021 LIBRARY; T=293.6K  
Neutron emission for (n,n\*)a

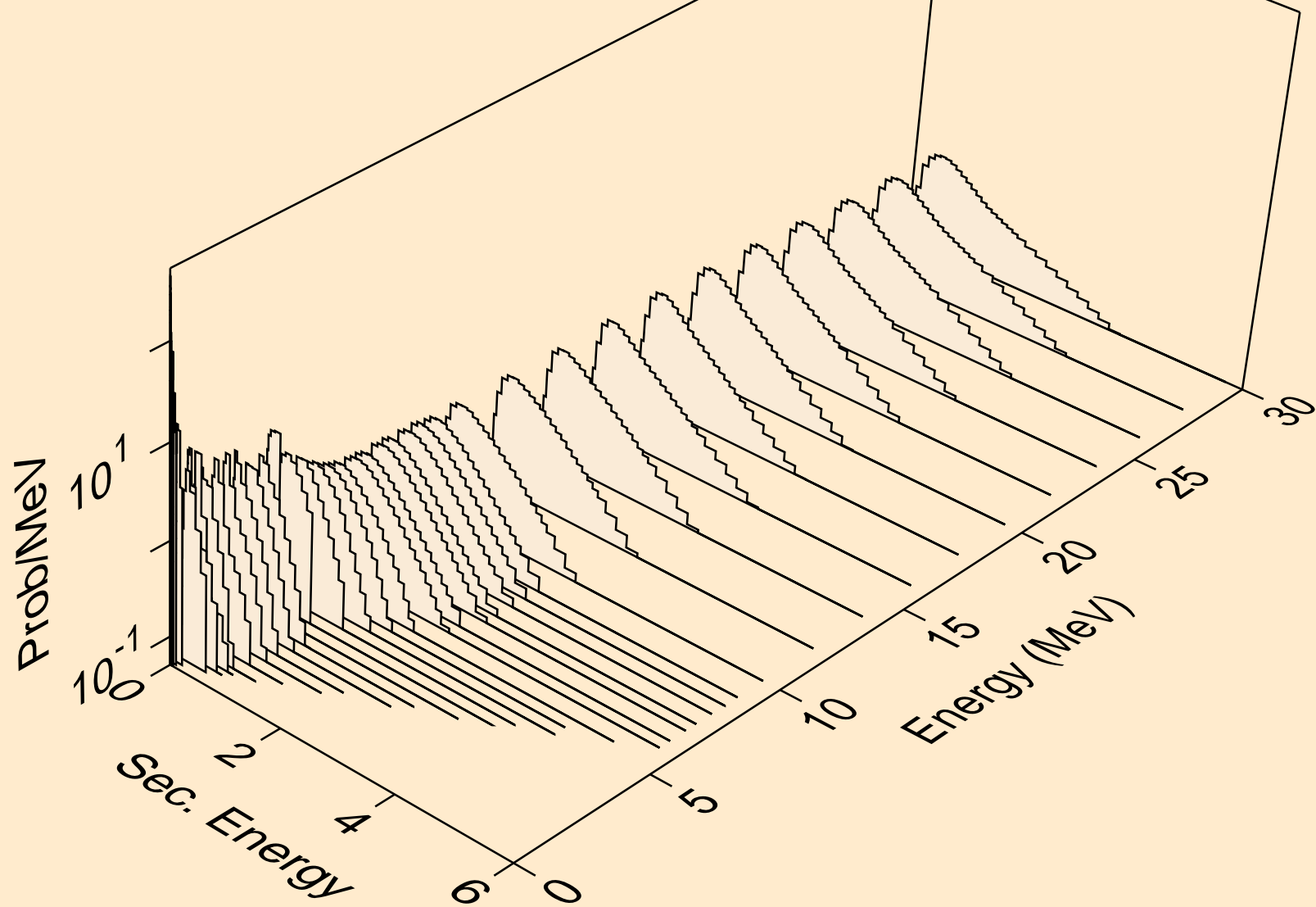

HG183 NEUTRON ACER TENDL-2021 LIBRARY; T=293.6K  
Neutron emission for (n,n\*)3a

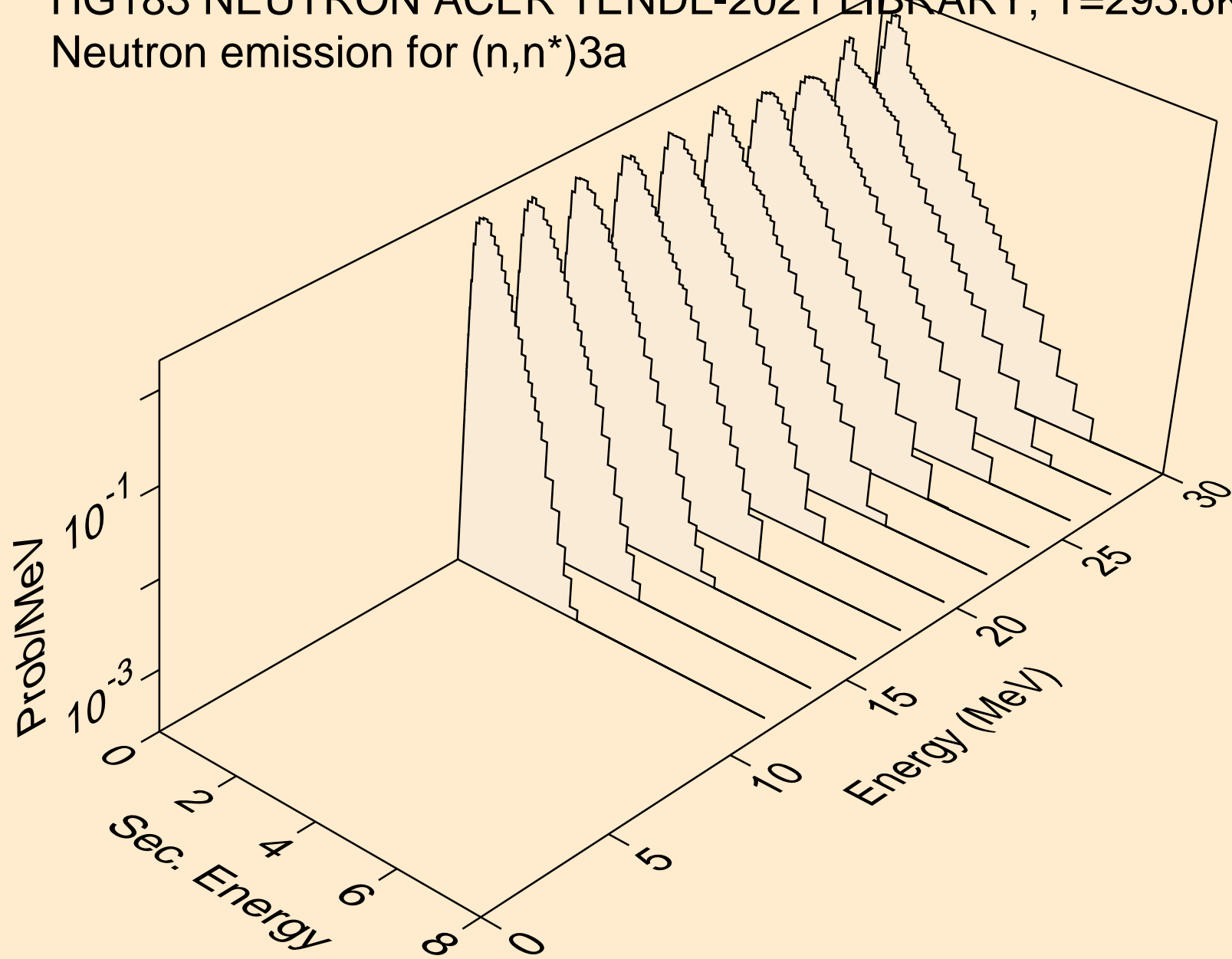



HG183 NEUTRON ACER TENDL-2021 LIBRARY; T=293.6K  
Neutron emission for (n,2n)a

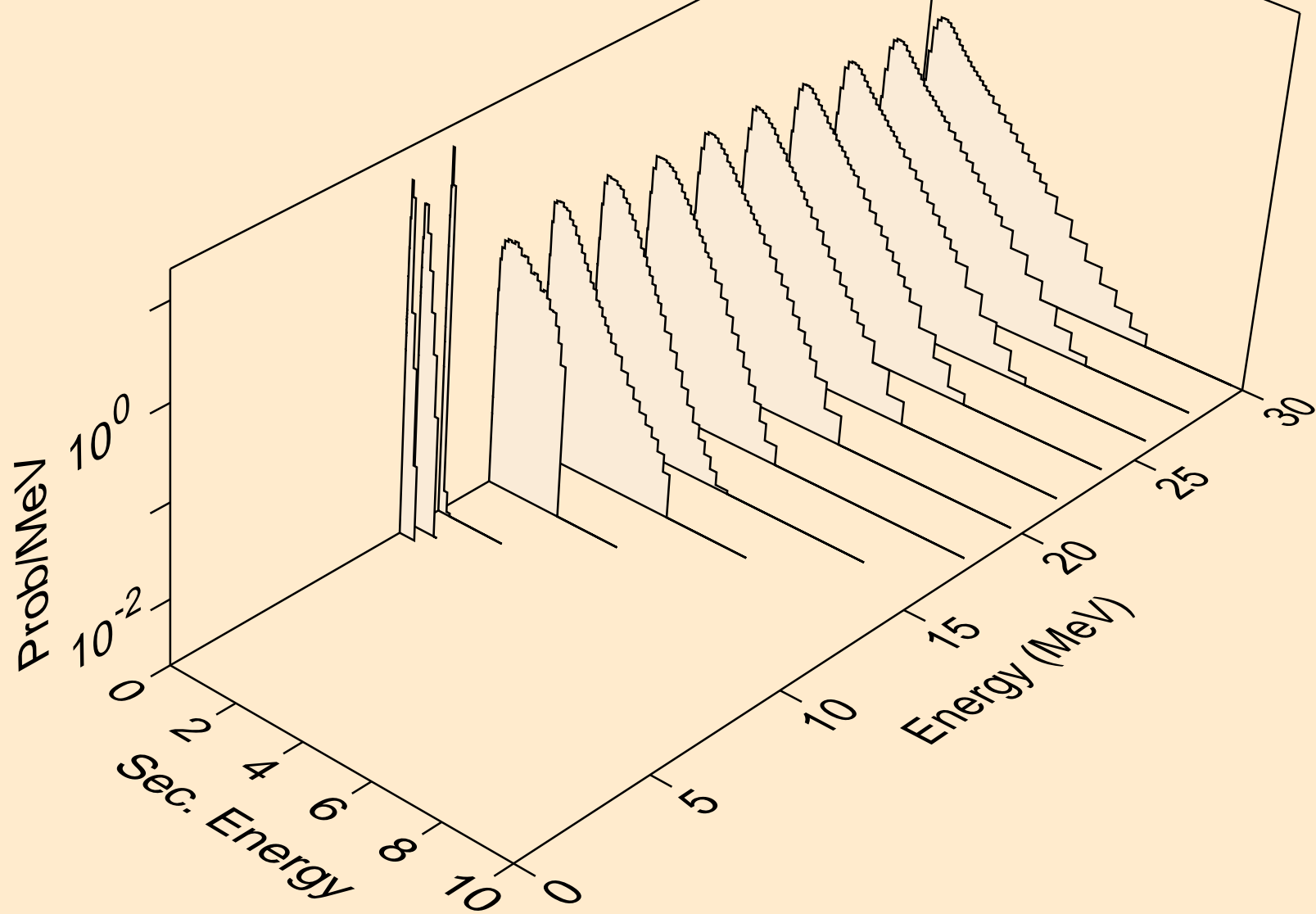

HG183 NEUTRON ACER TENDL-2021 LIBRARY; T=293.6K  
Neutron emission for (n,3n)a

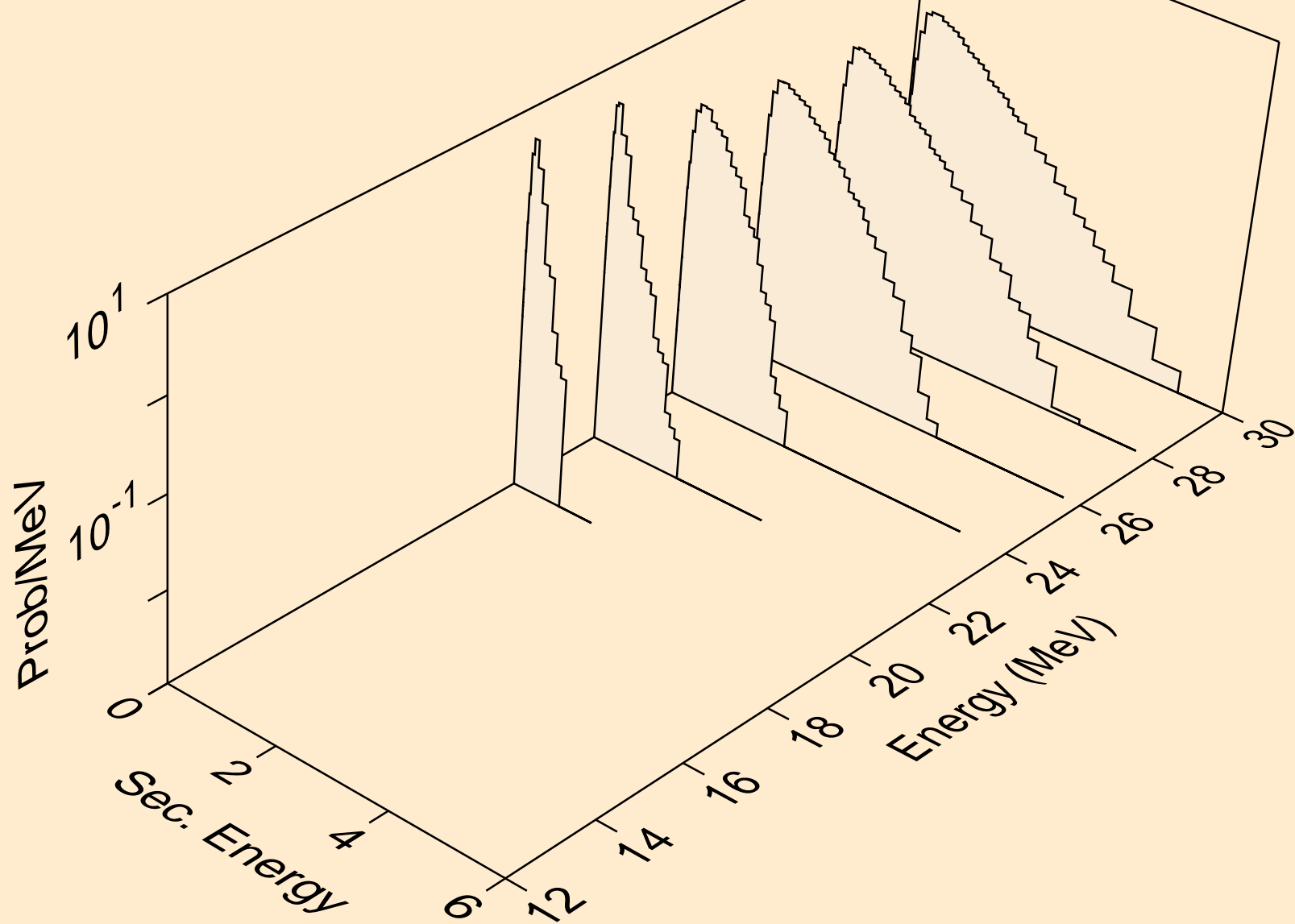

HG183 NEUTRON ACER TENDL-2021 LIBRARY; T=293.6K  
Neutron emission for (n,n\*)p

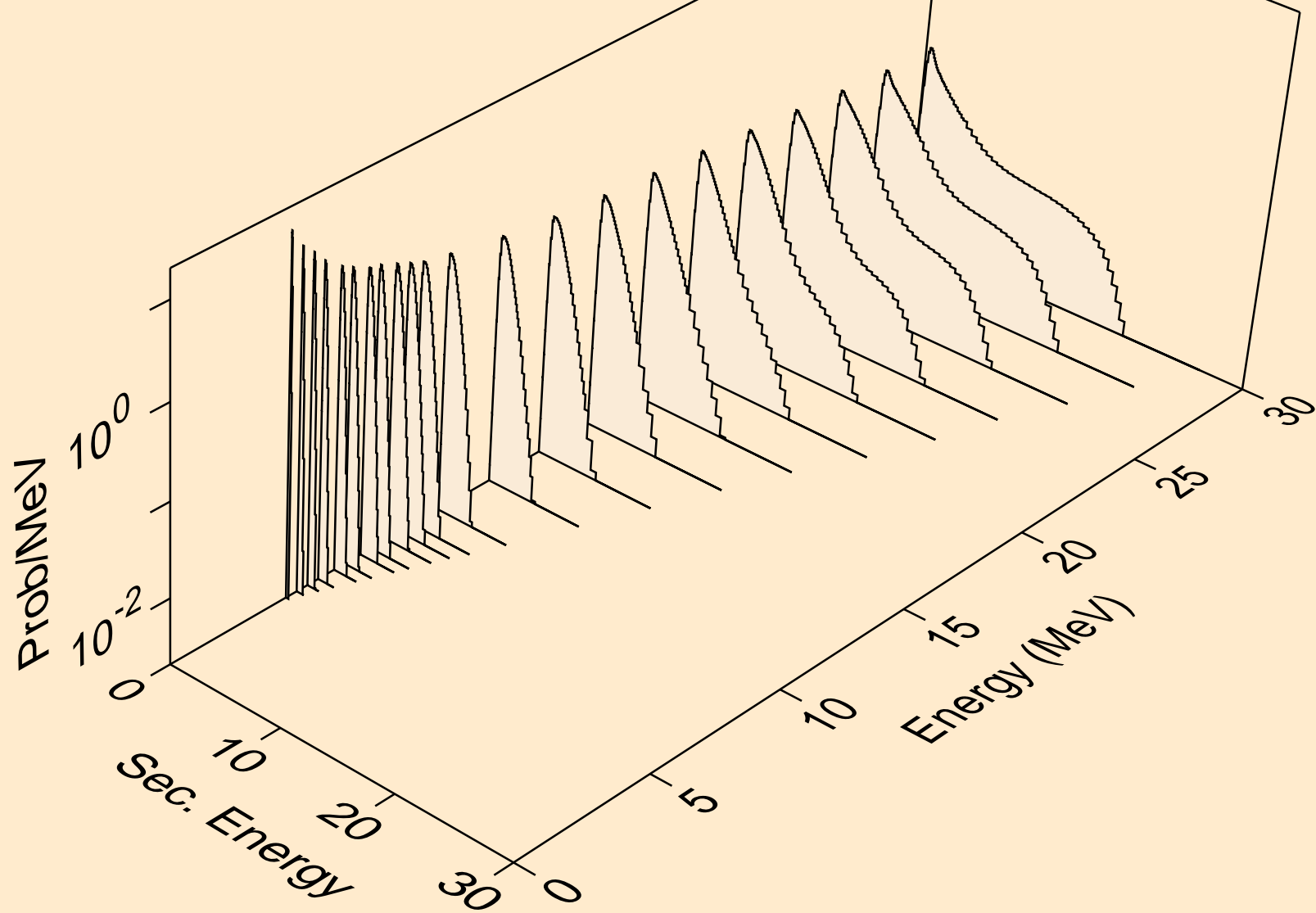

HG183 NEUTRON ACER TENDL-2021 LIBRARY; T=293.6K  
Neutron emission for (n,n\*)2a

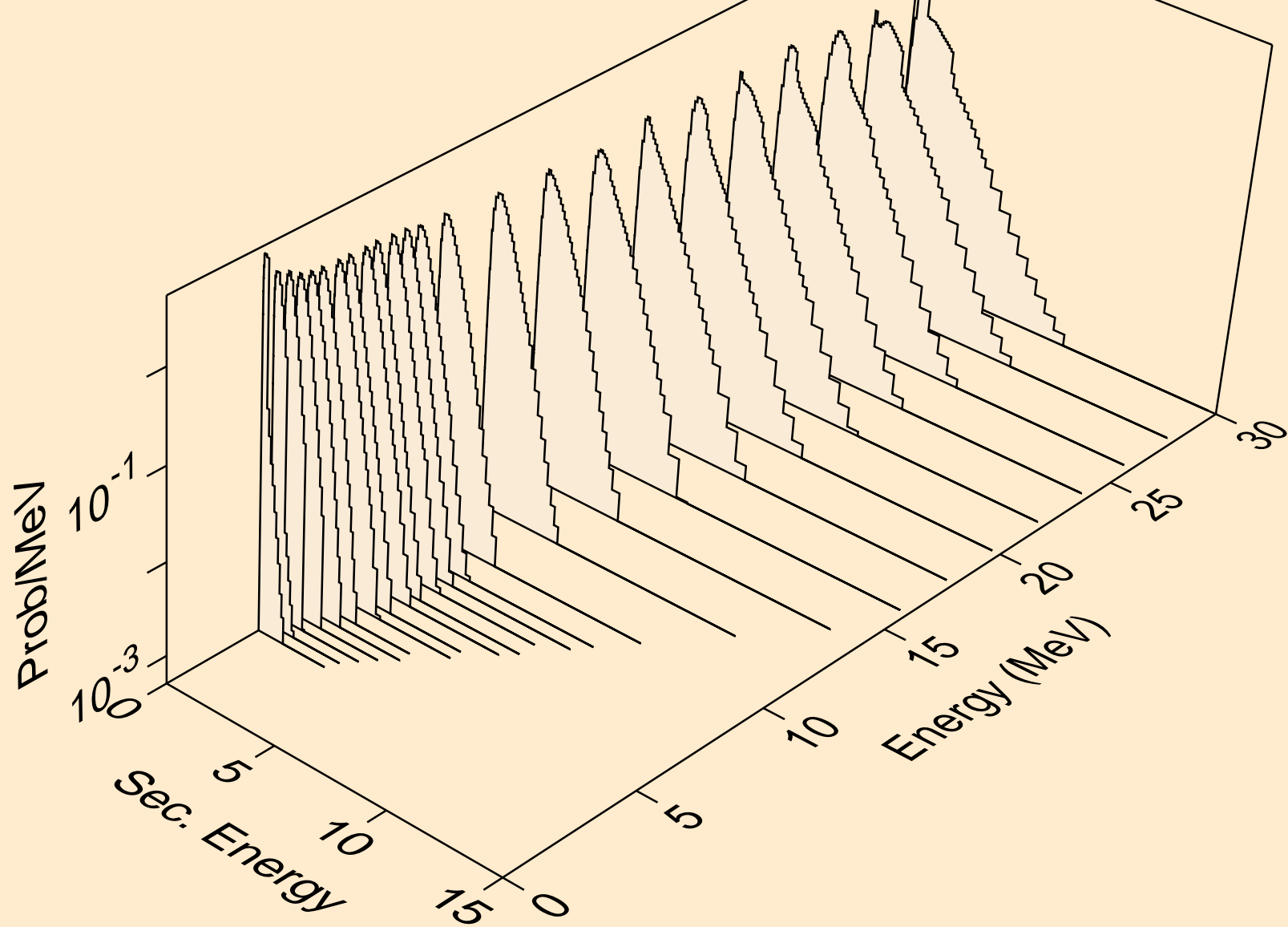

HG183 NEUTRON ACER TENDL-2021 LIBRARY; T=293.6K  
Neutron emission for (n,2n)2a

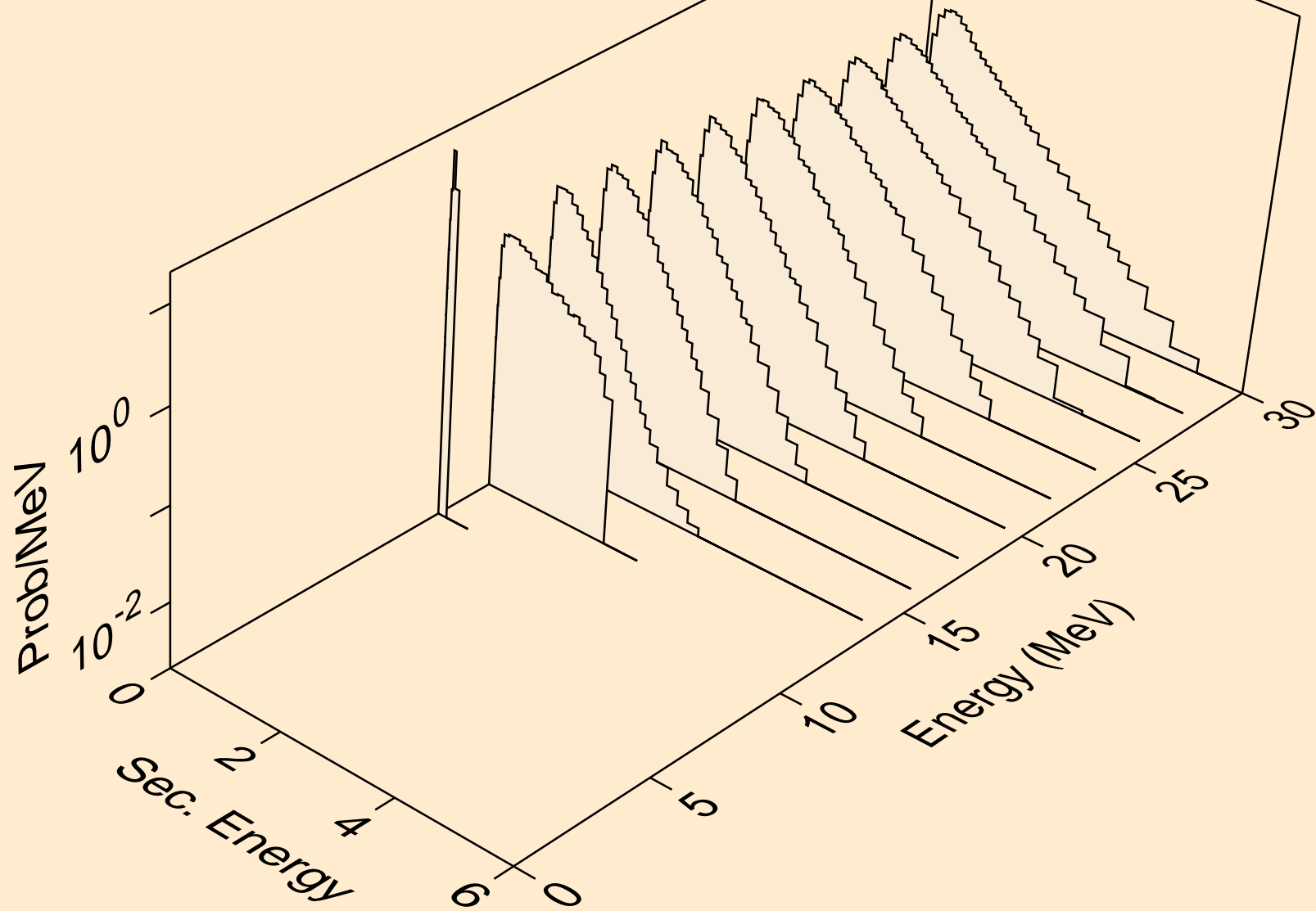

HG183 NEUTRON ACER TENDL-2021 LIBRARY; T=293.6K  
Neutron emission for (n,n\*)d

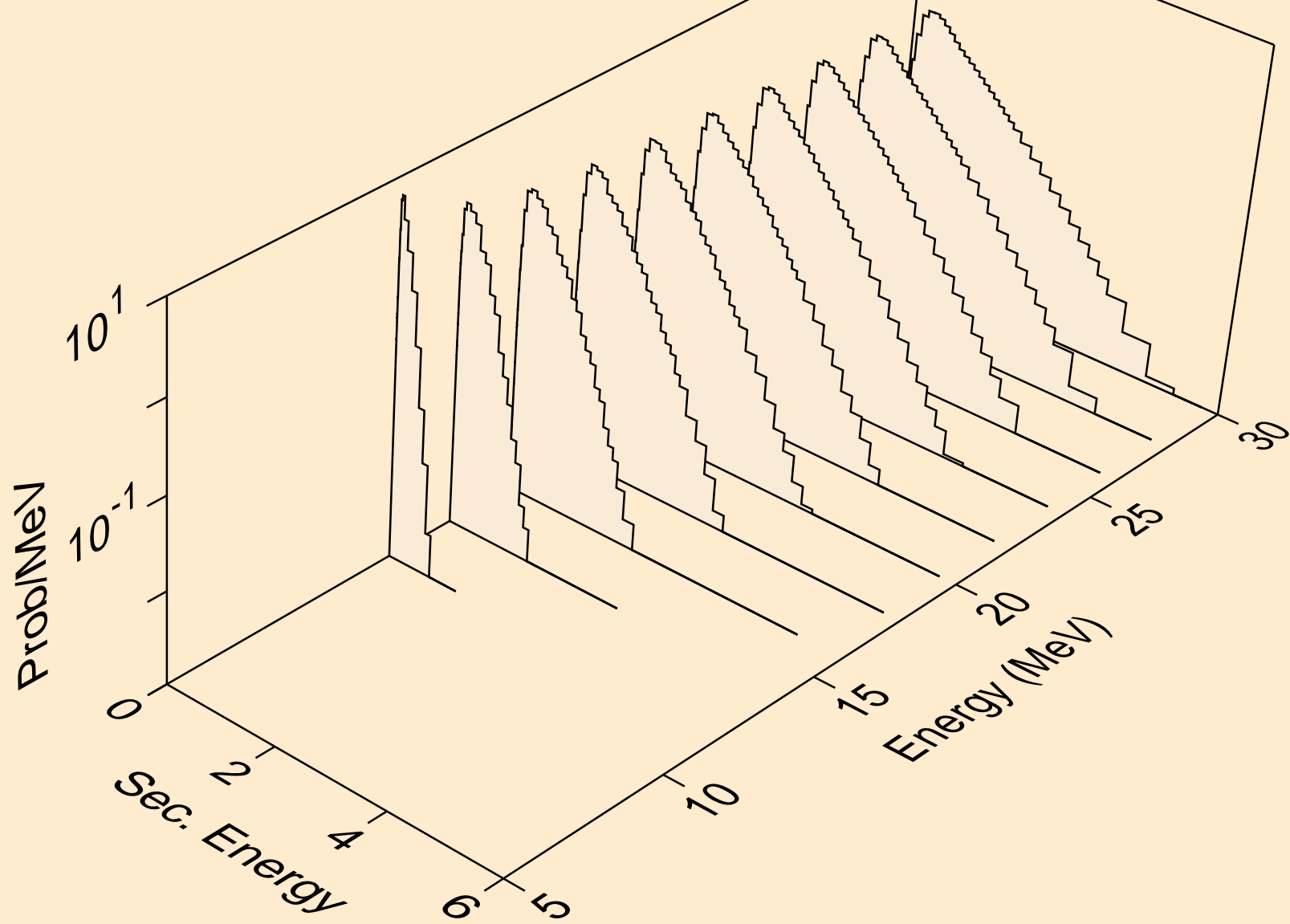

HG183 NEUTRON ACER TENDL-2021 LIBRARY; T=293.6K  
Neutron emission for (n,n\*)t

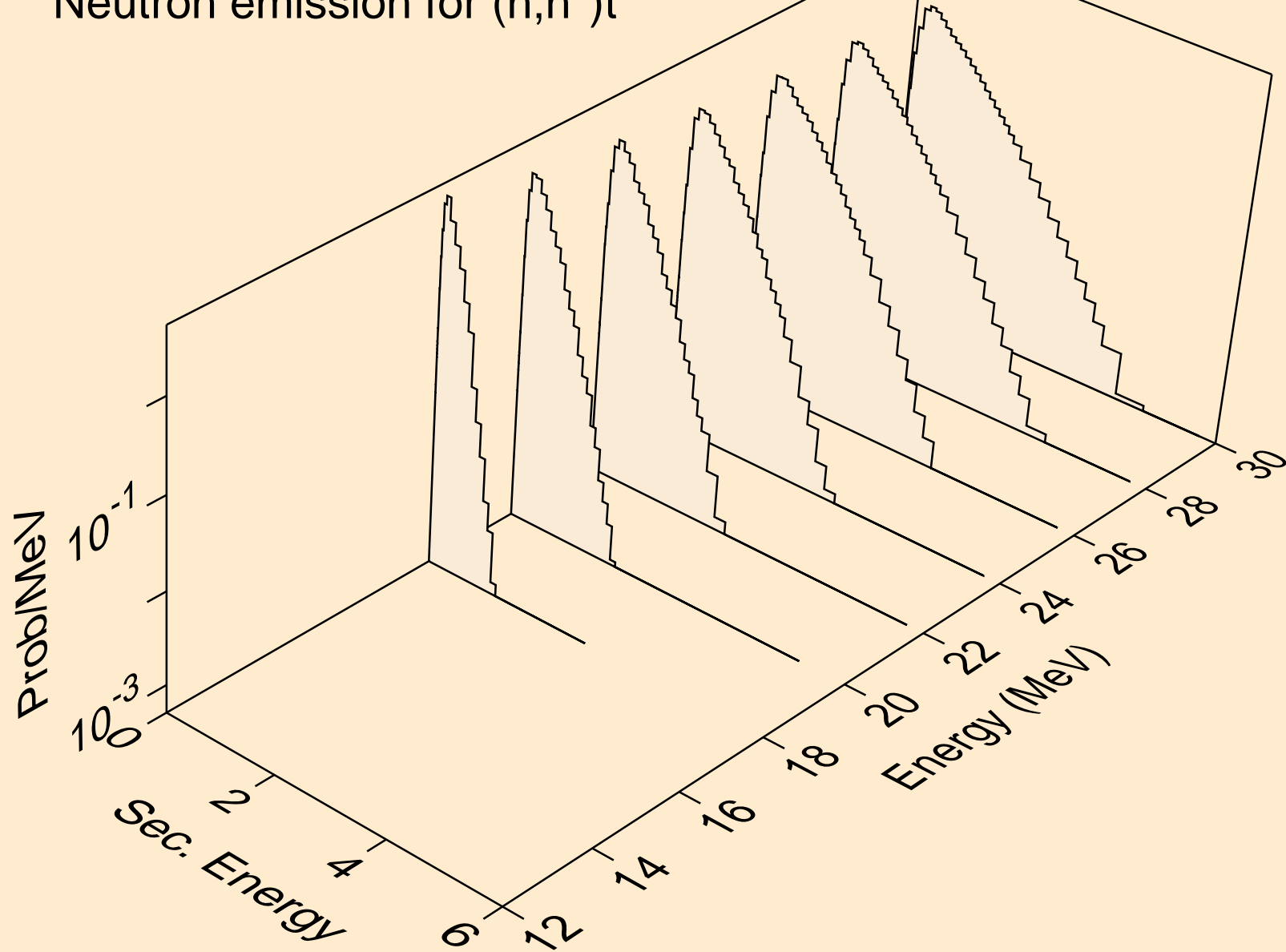

HG183 NEUTRON ACER TENDL-2021 LIBRARY; T=293.6K  
Neutron emission for (n,n\*)he3

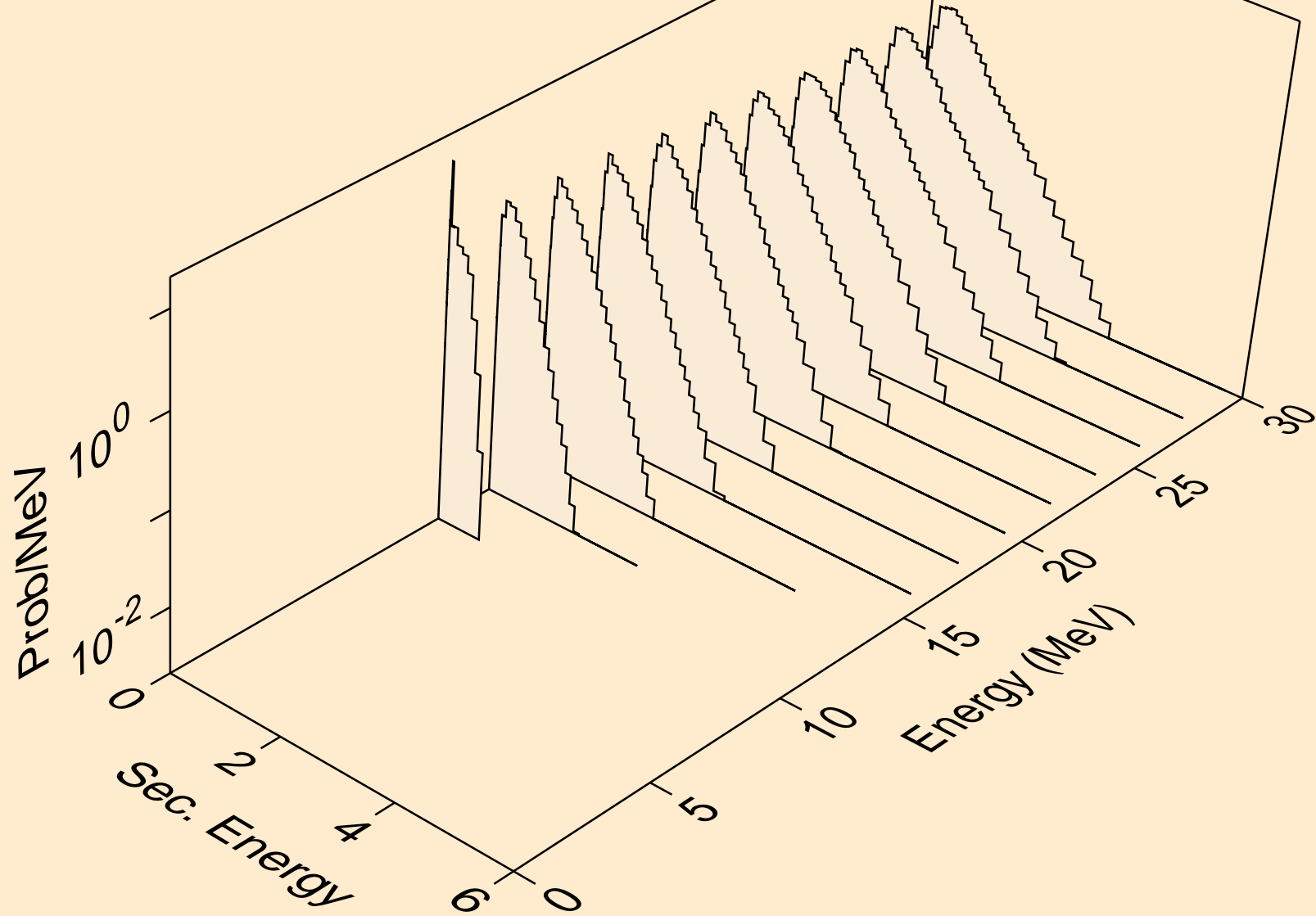



HG183 NEUTRON ACER TENDL-2021 LIBRARY; T=293.6K  
Neutron emission for (n,4n)

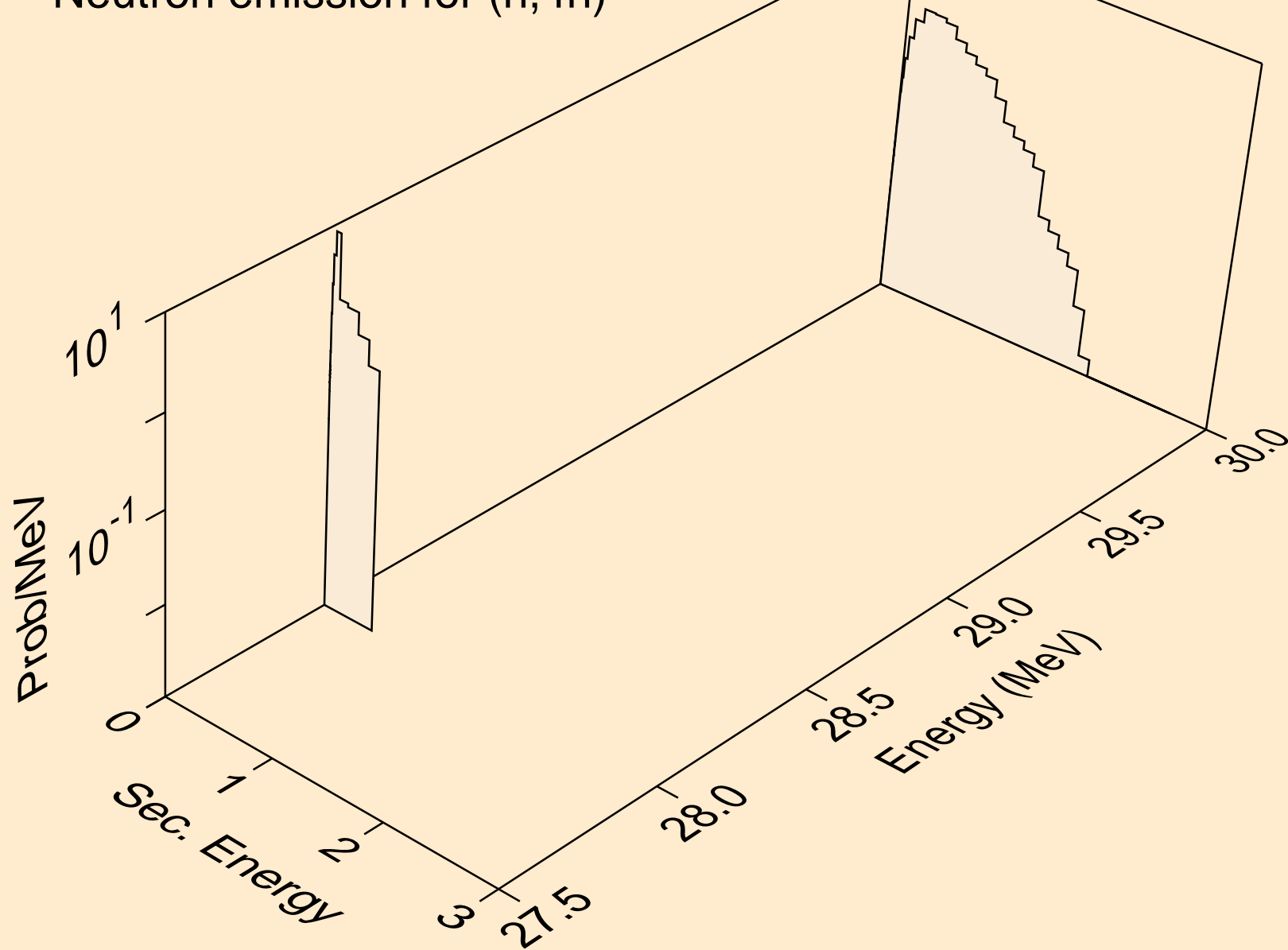

HG183 NEUTRON ACER TENDL-2021 LIBRARY; T=293.6K  
Neutron emission for (n,2np)

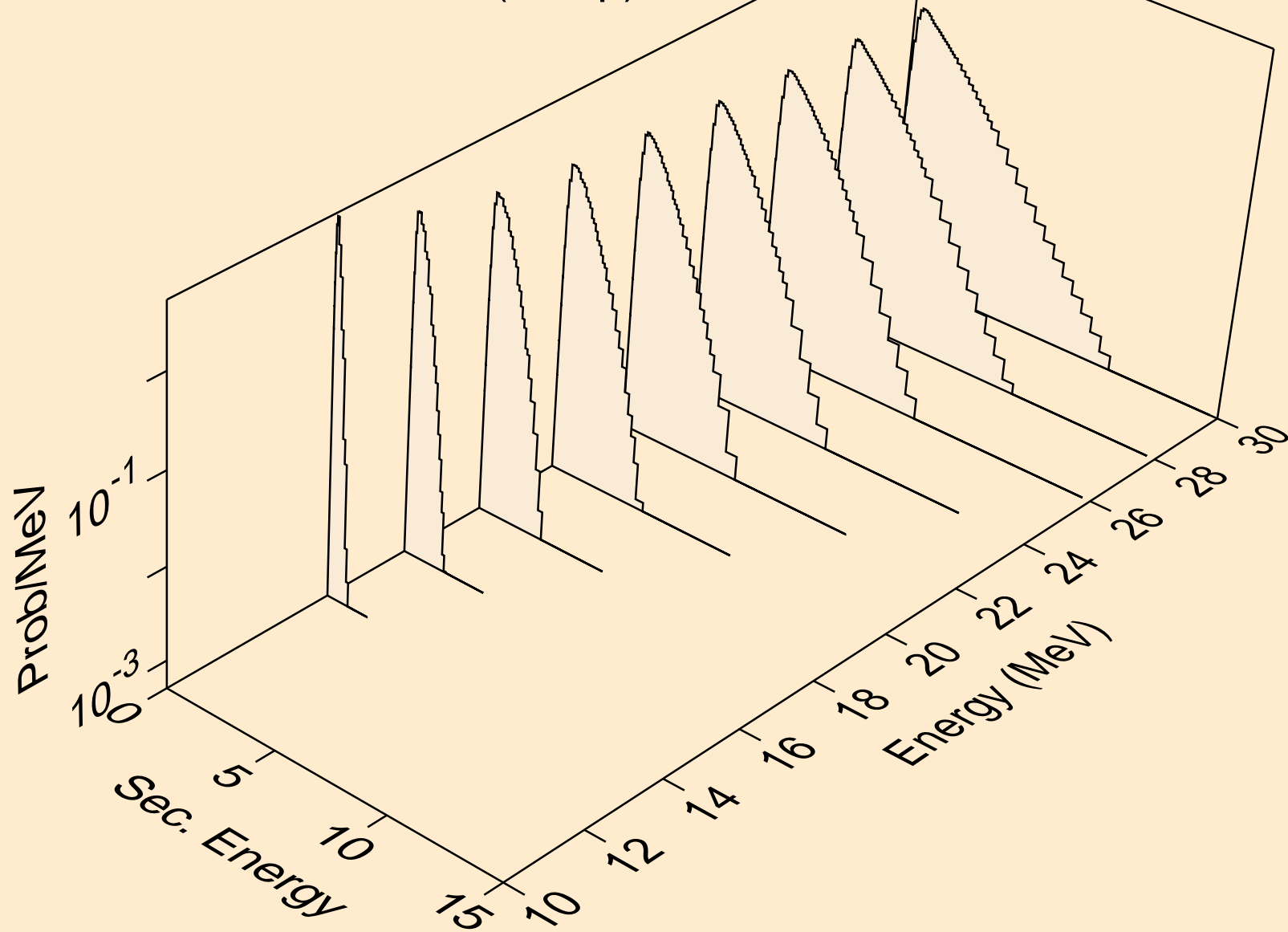

HG183 NEUTRON ACER TENDL-2021 LIBRARY; T=293.6K  
Neutron emission for (n,3np)

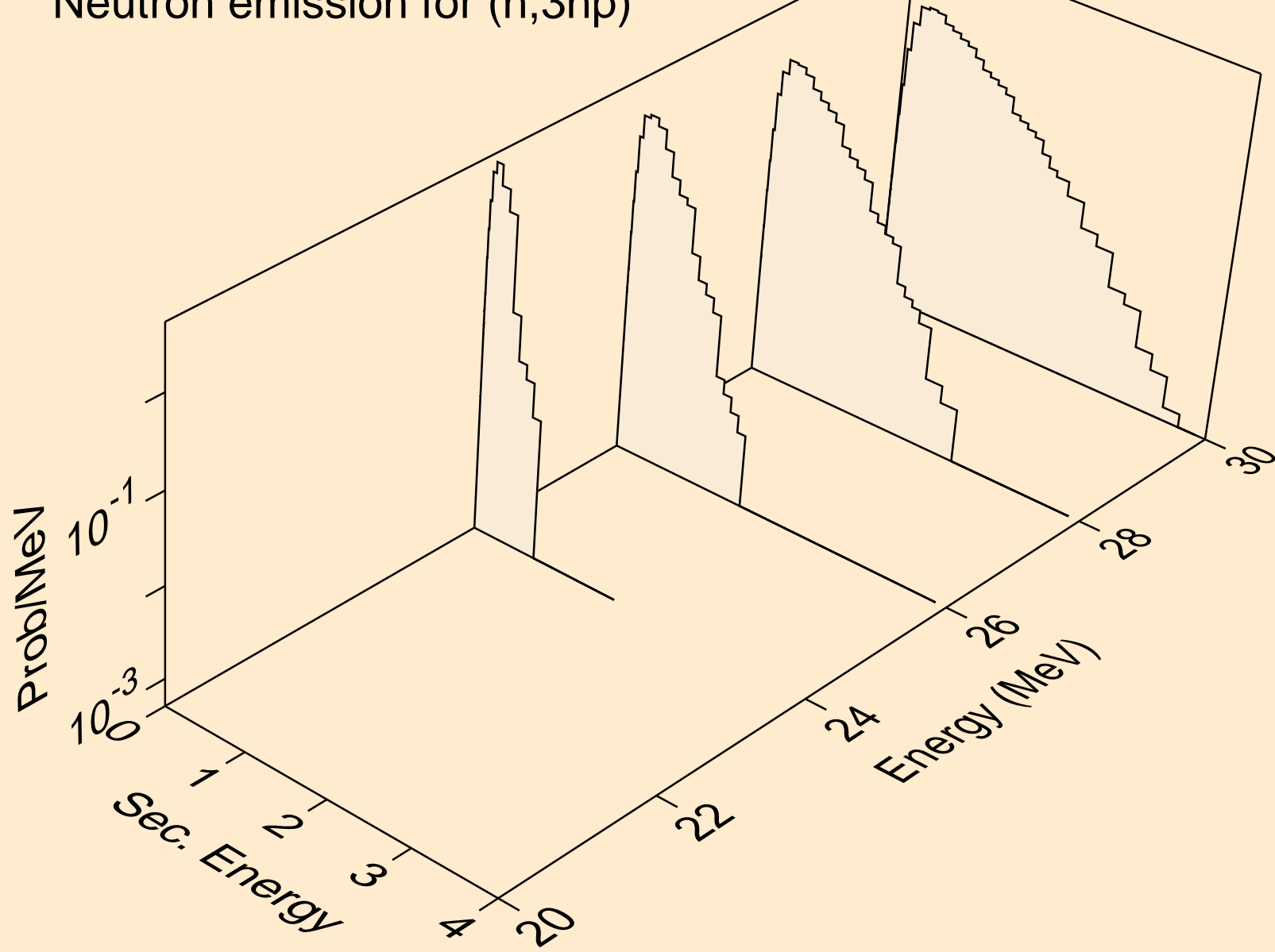

HG183 NEUTRON ACER TENDL-2021 LIBRARY; T=293.6K  
Neutron emission for (n,2np)

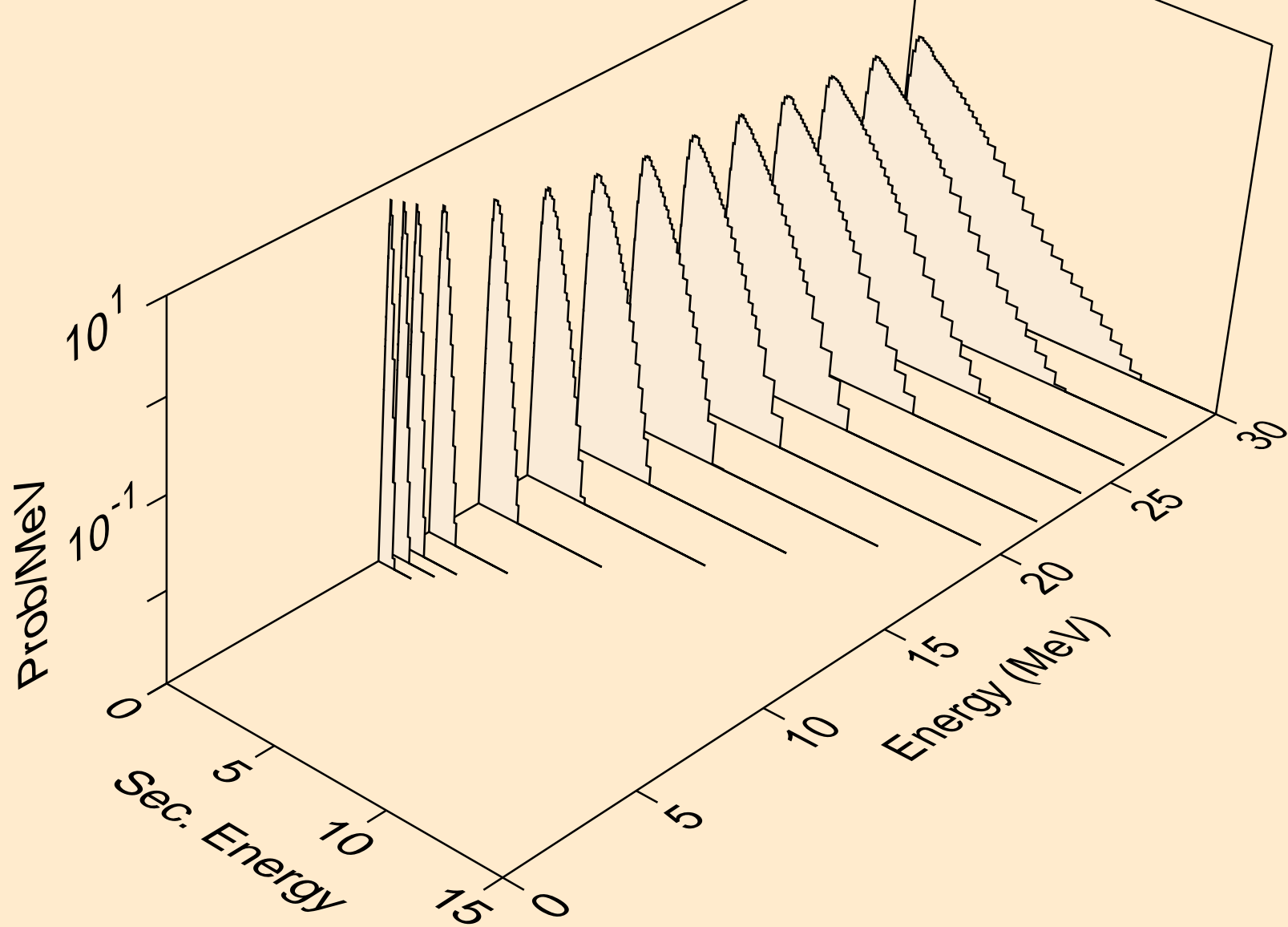

HG183 NEUTRON ACER TENDL-2021 LIBRARY; T=293.6K  
Neutron emission for (n,npa)

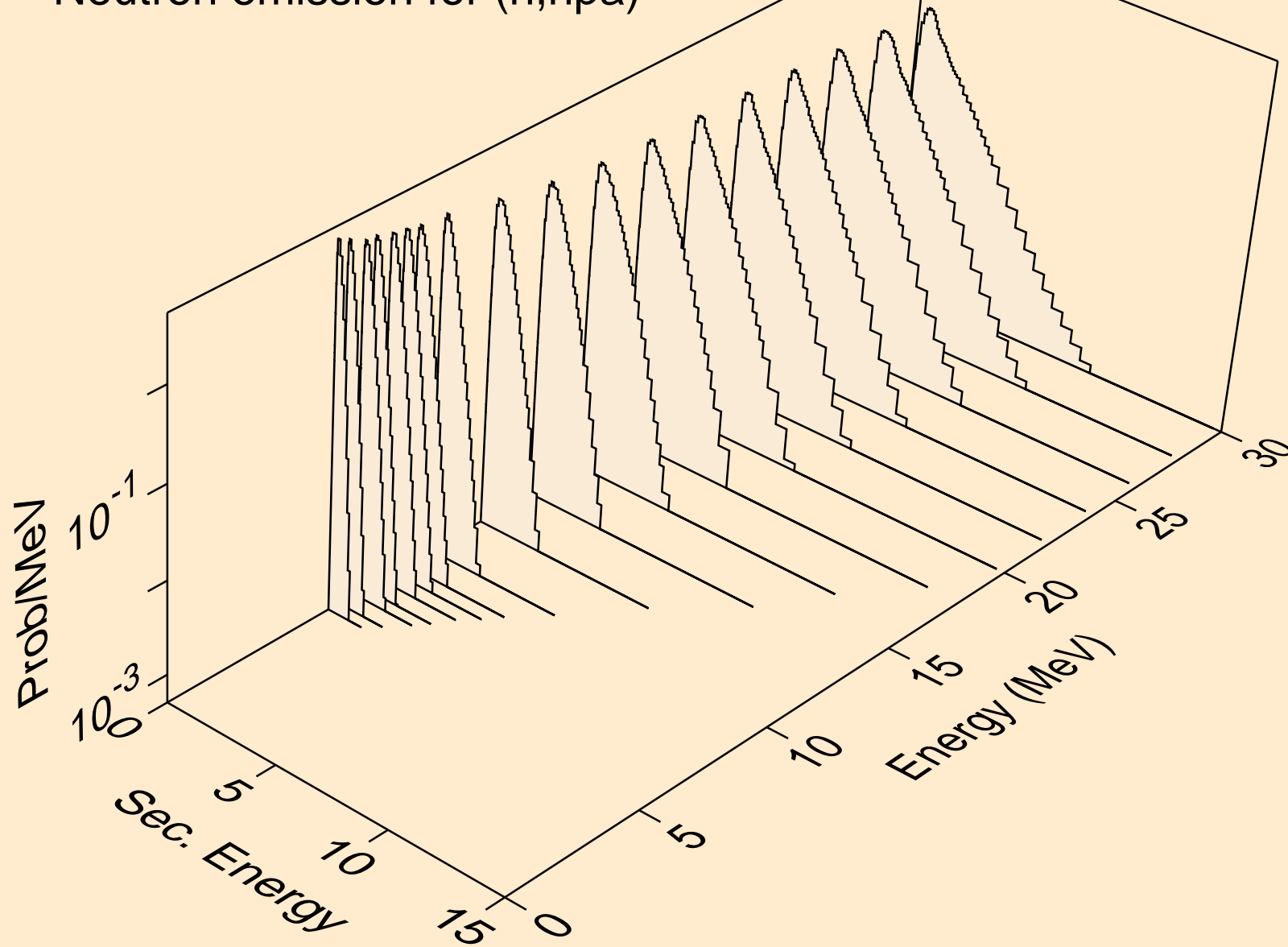

HG183 NEUTRON ACER TENDL-2021 LIBRARY; T=293.6K  
Neutron emission for (n,n\*c)

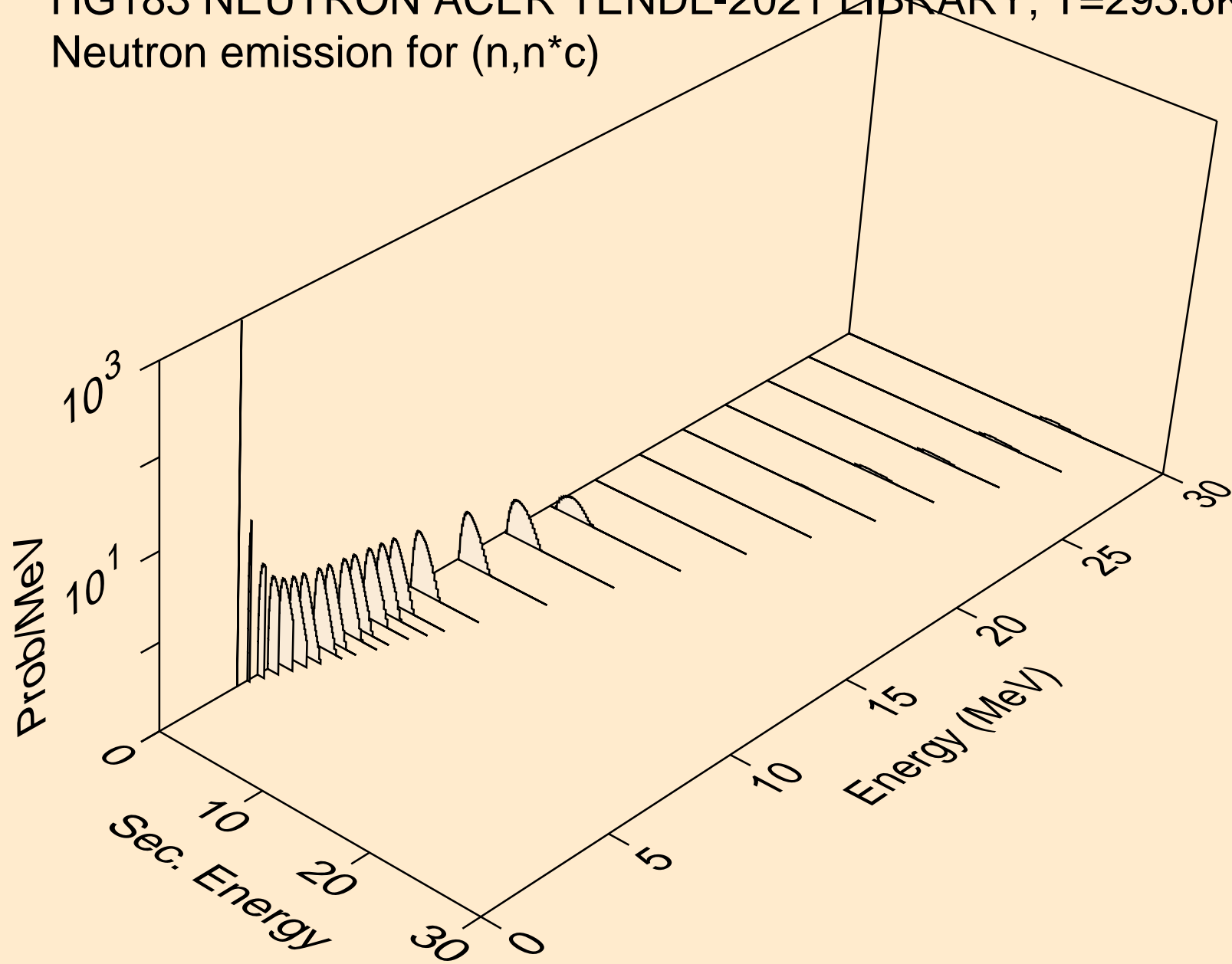

HG183 NEUTRON ACER TENDL-2021 LIBRARY; T=293.6K  
Photon emission for (n,x)

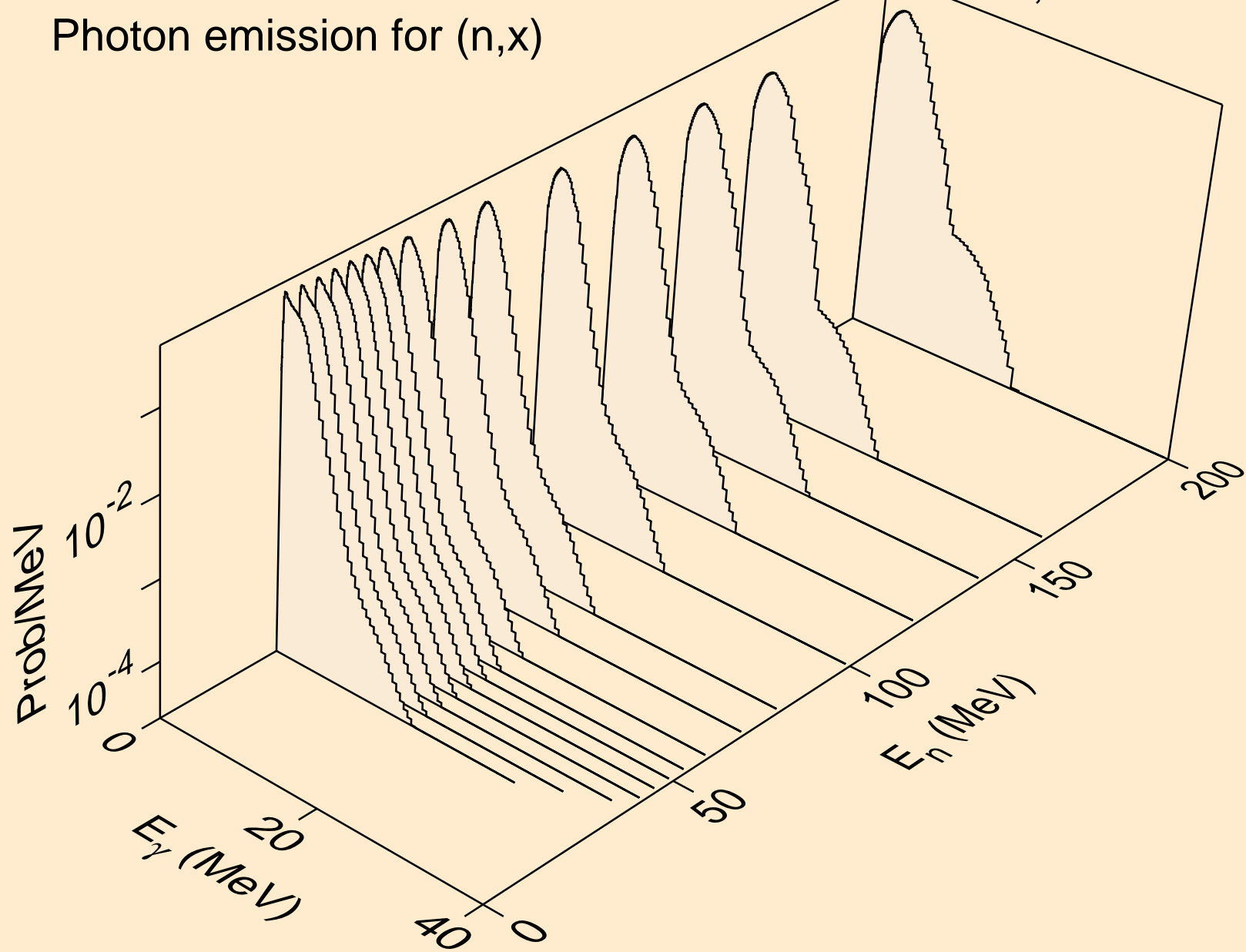

HG183 NEUTRON ACER TENDL-2021 LIBRARY; T=293.6K  
Photon emission for (n,2nd)

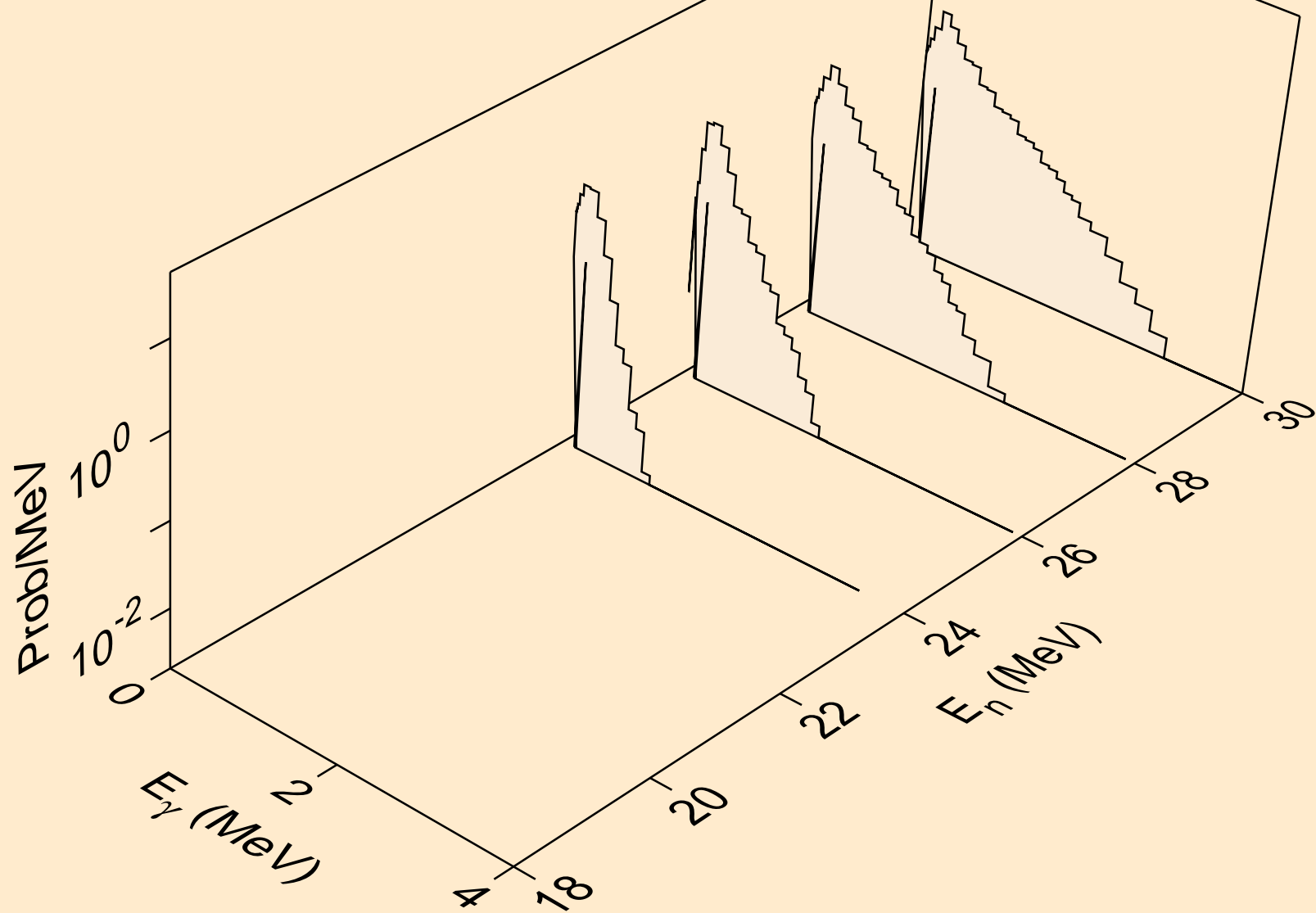



HG183 NEUTRON ACER TENDL-2021 LIBRARY; T=293.6K  
Photon emission for (n,2n)

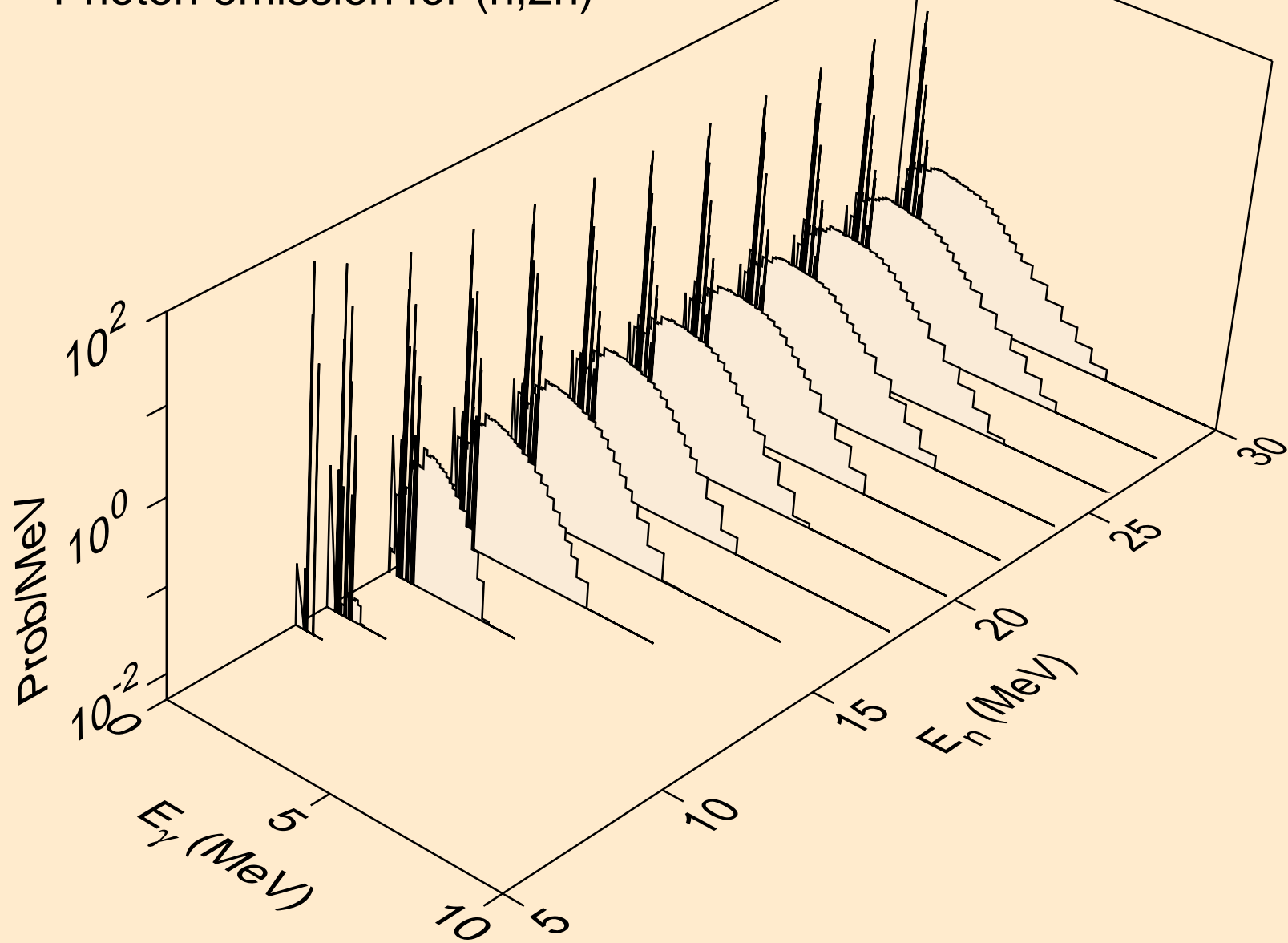

HG183 NEUTRON ACER TENDL-2021 LIBRARY; T=293.6K  
Photon emission for (n,3n)

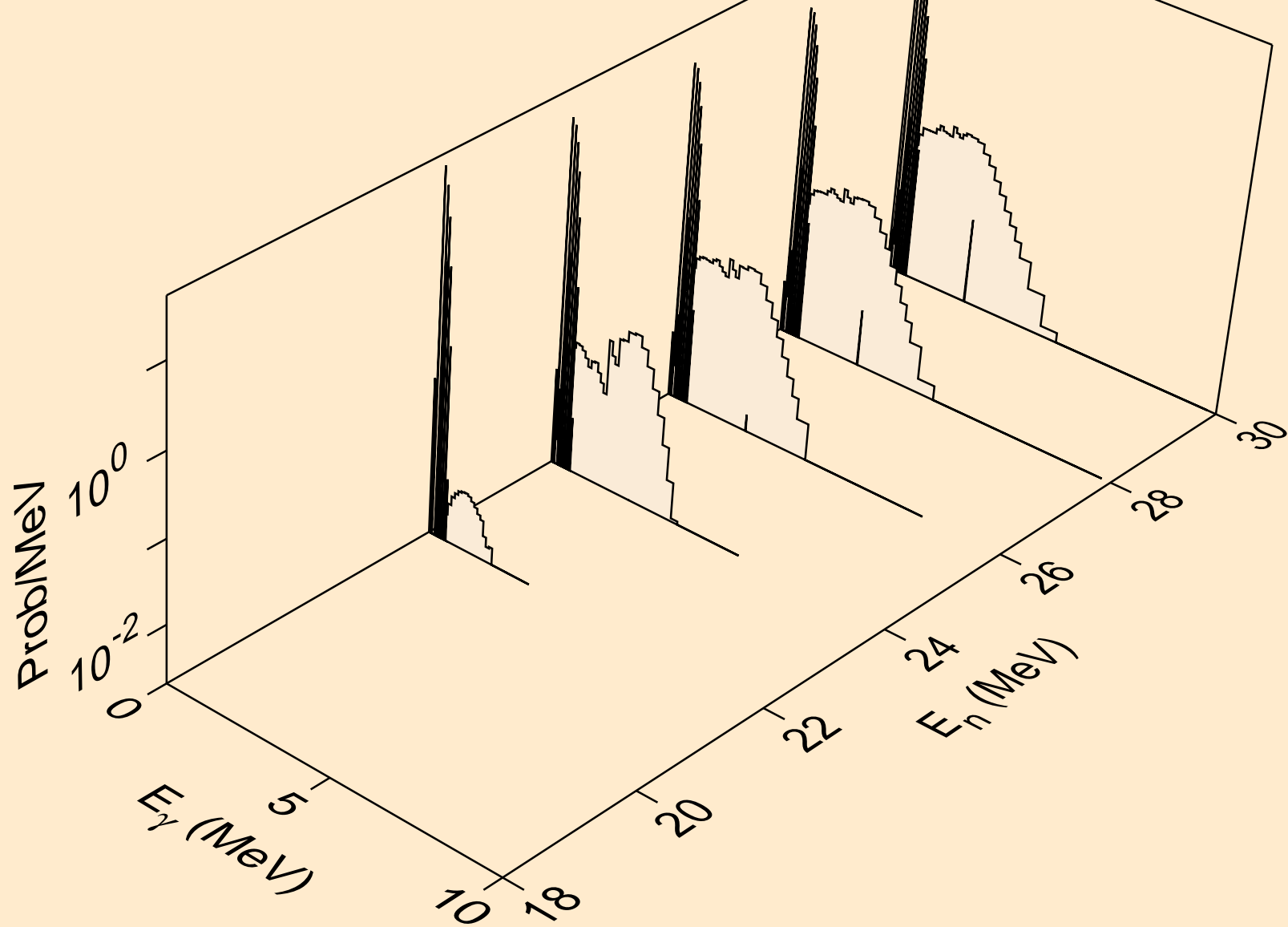

HG183 NEUTRON ACER TENDL-2021 LIBRARY; T=293.6K  
Photon emission for (n,n\*)a

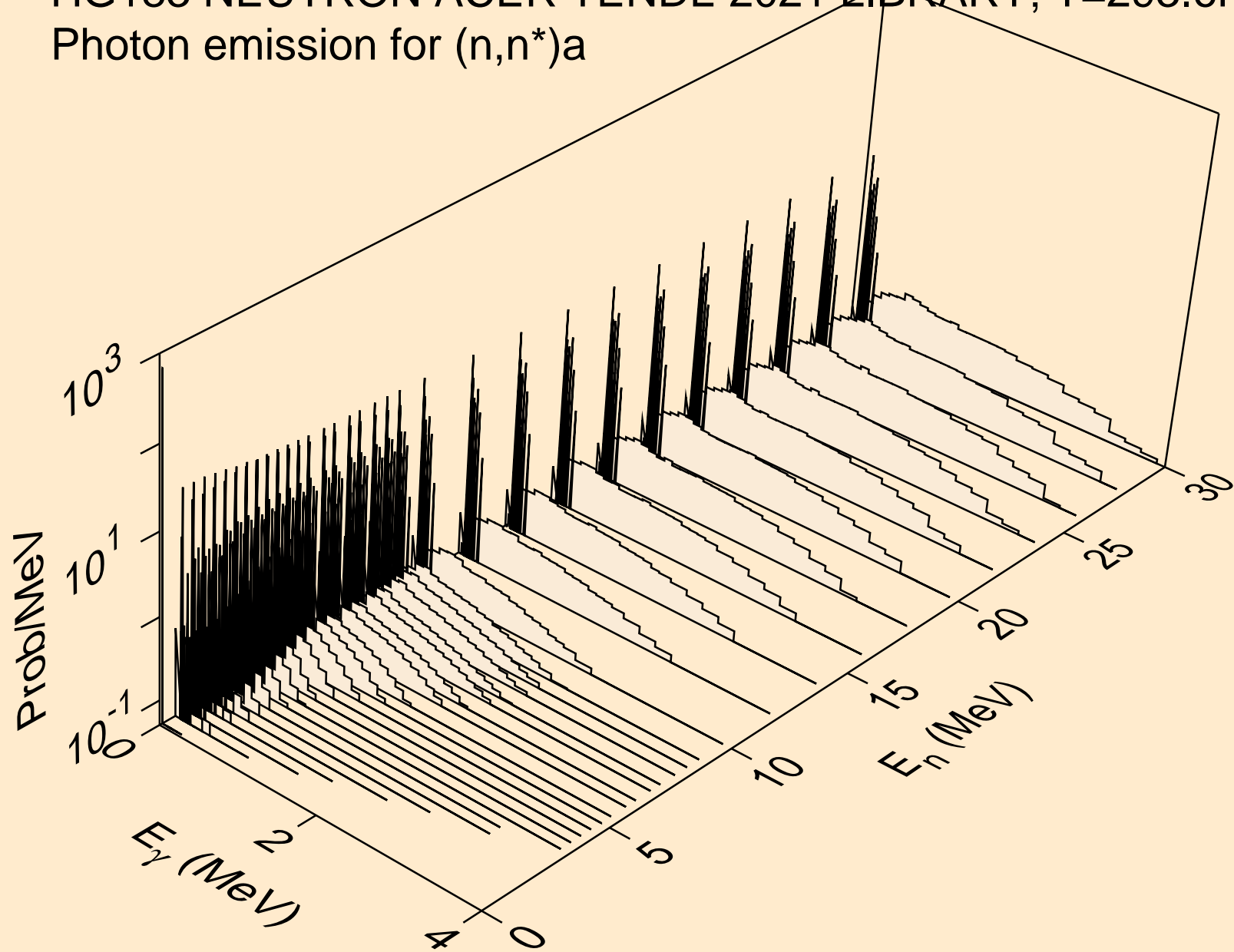

HG183 NEUTRON ACER TENDL-2021 LIBRARY; T=293.6K  
Photon emission for (n,n\*)3a

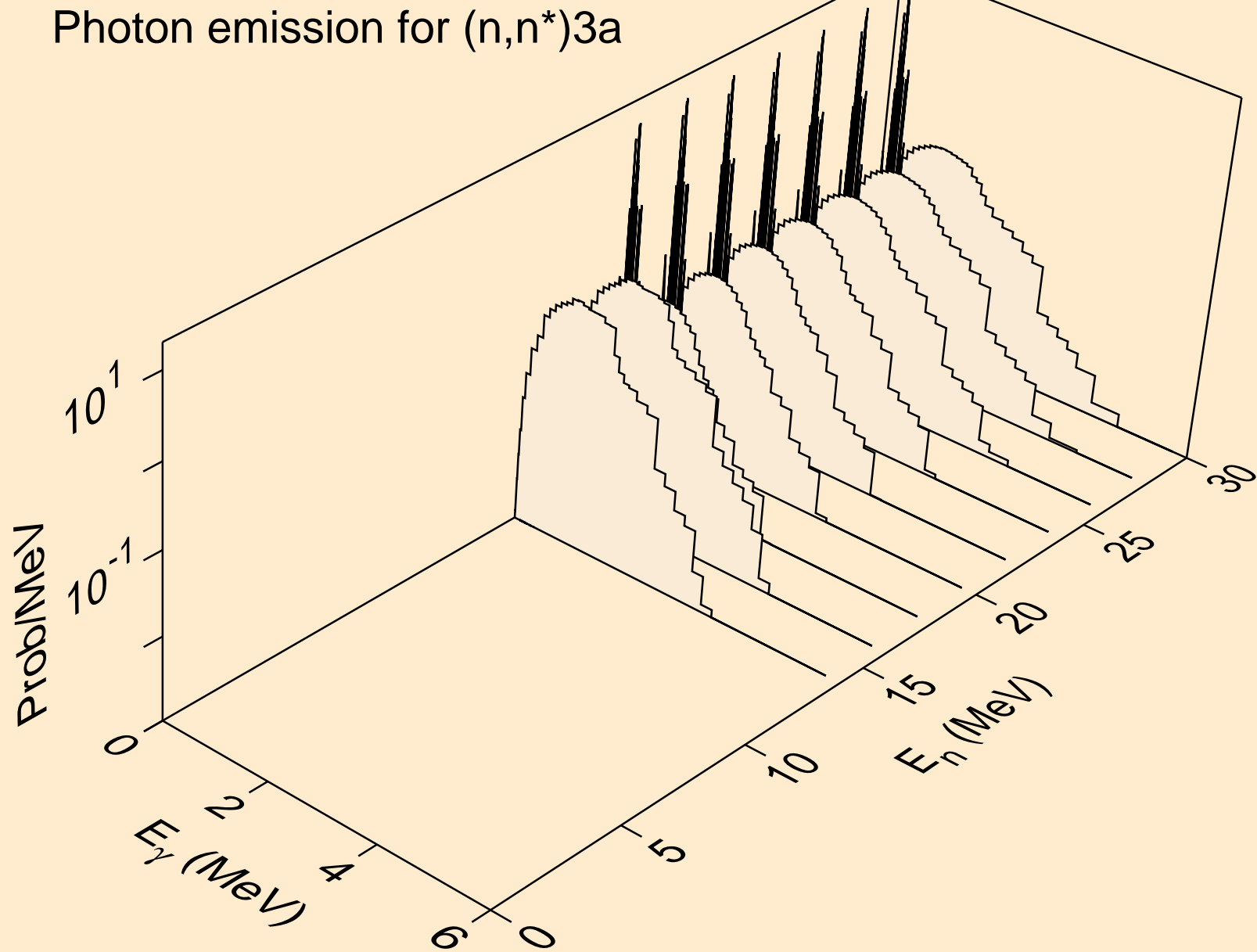

HG183 NEUTRON ACER TENDL-2021 LIBRARY; T=293.6K  
Photon emission for (n,2n)a

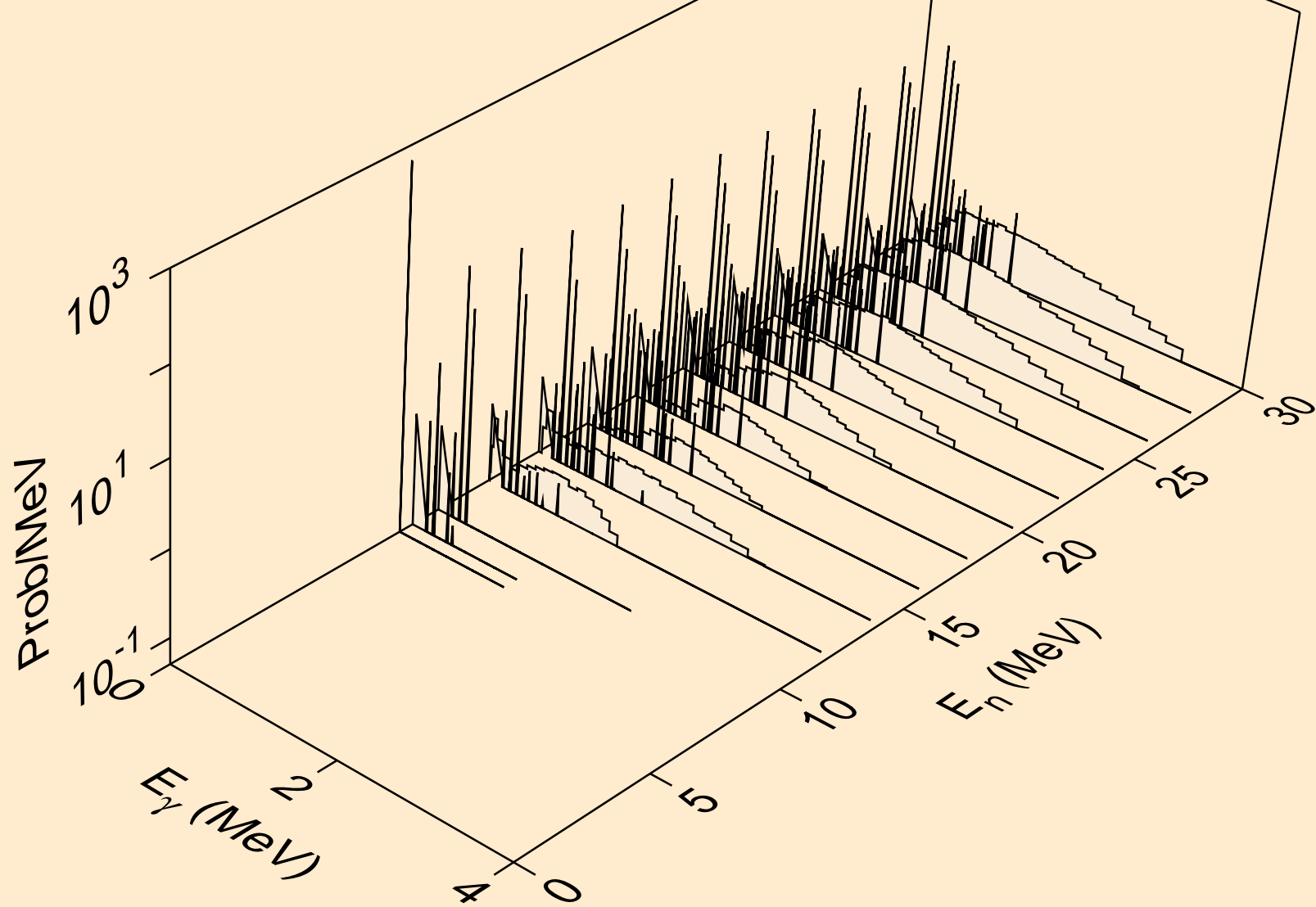

HG183 NEUTRON ACER TENDL-2021 LIBRARY; T=293.6K  
Photon emission for (n,3n)a

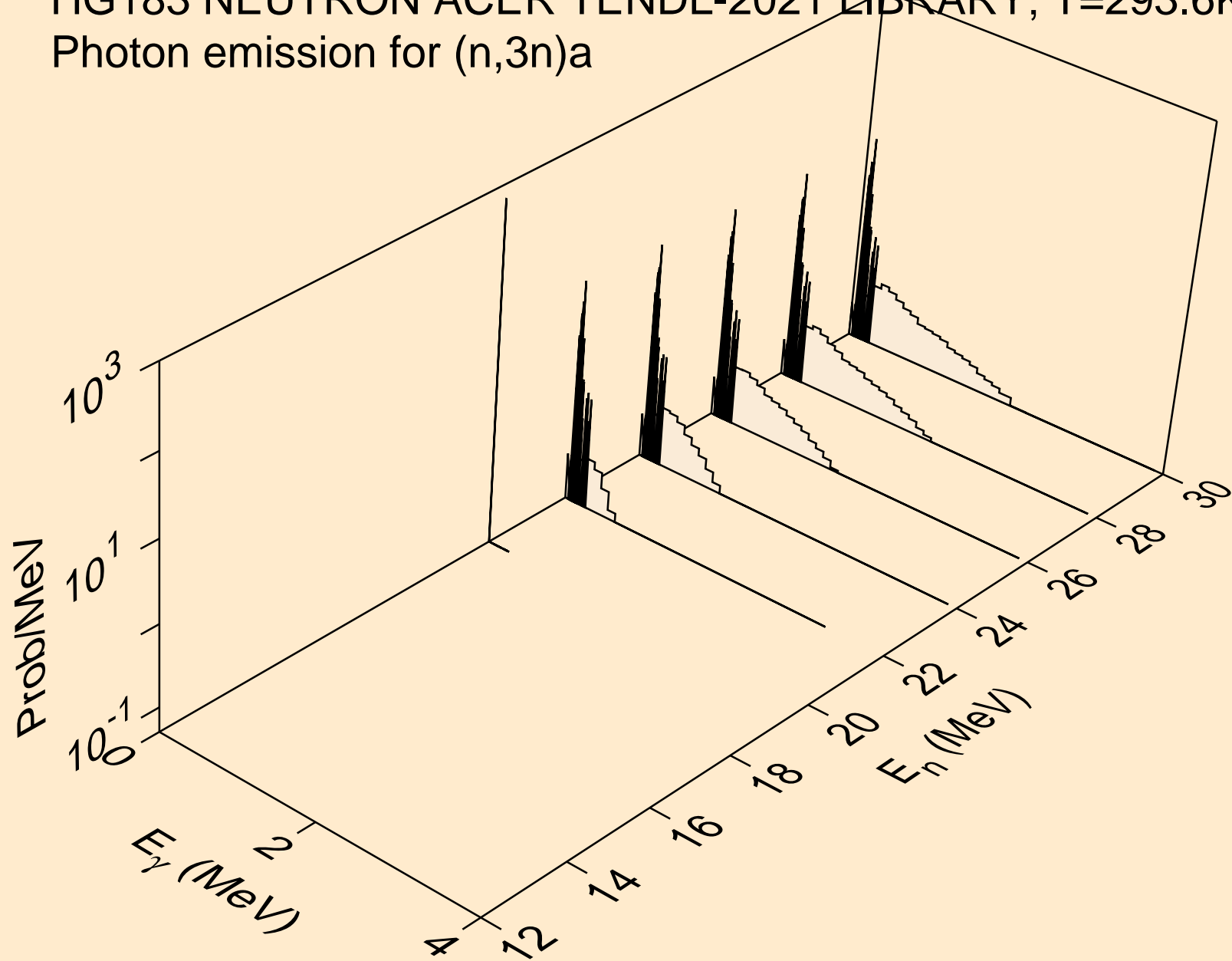

HG183 NEUTRON ACER TENDL-2021 LIBRARY; T=293.6K  
Photon emission for (n,n\*)p

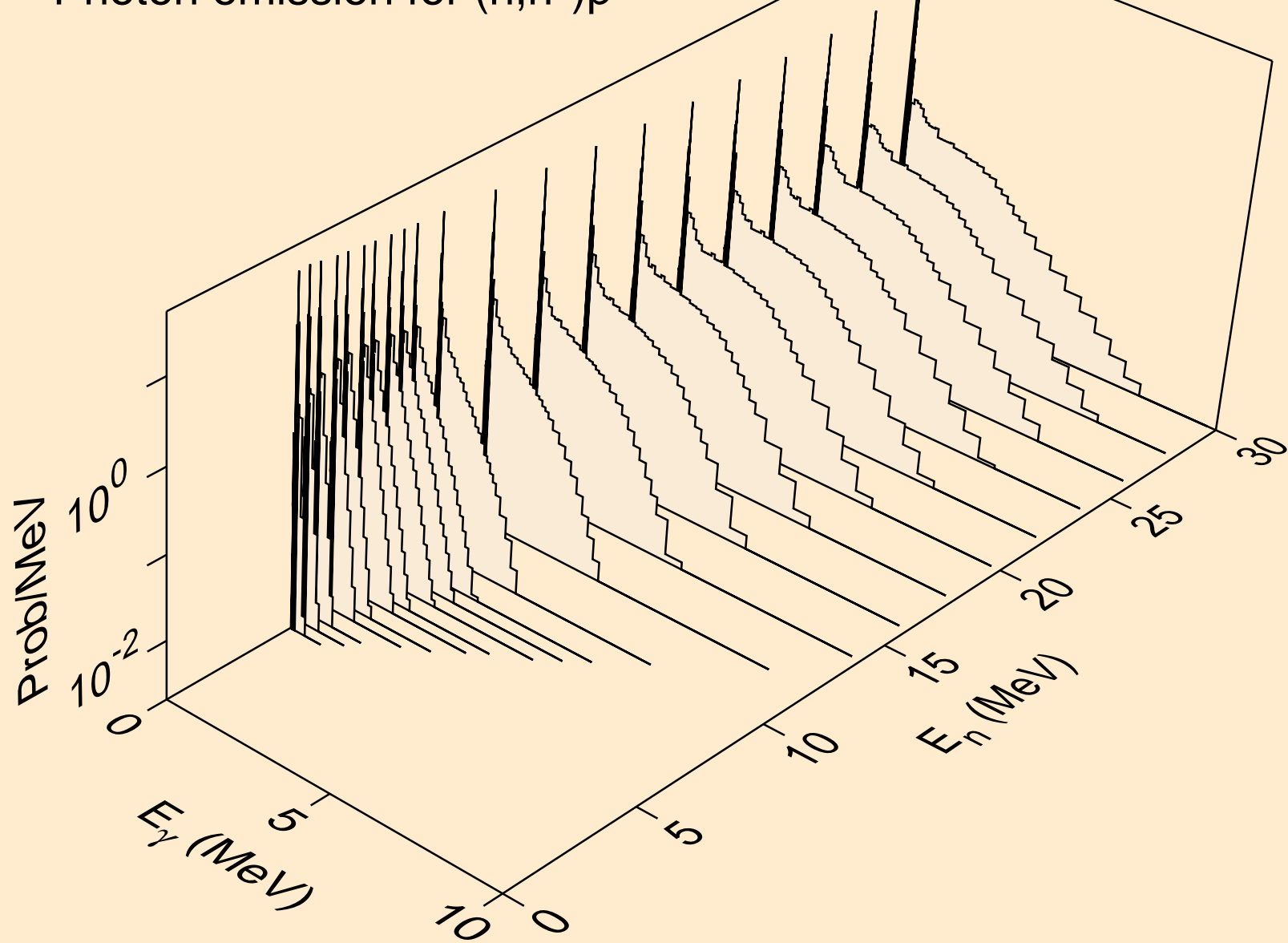

HG183 NEUTRON ACER TENDL-2021 LIBRARY; T=293.6K  
Photon emission for (n,n\*)2a

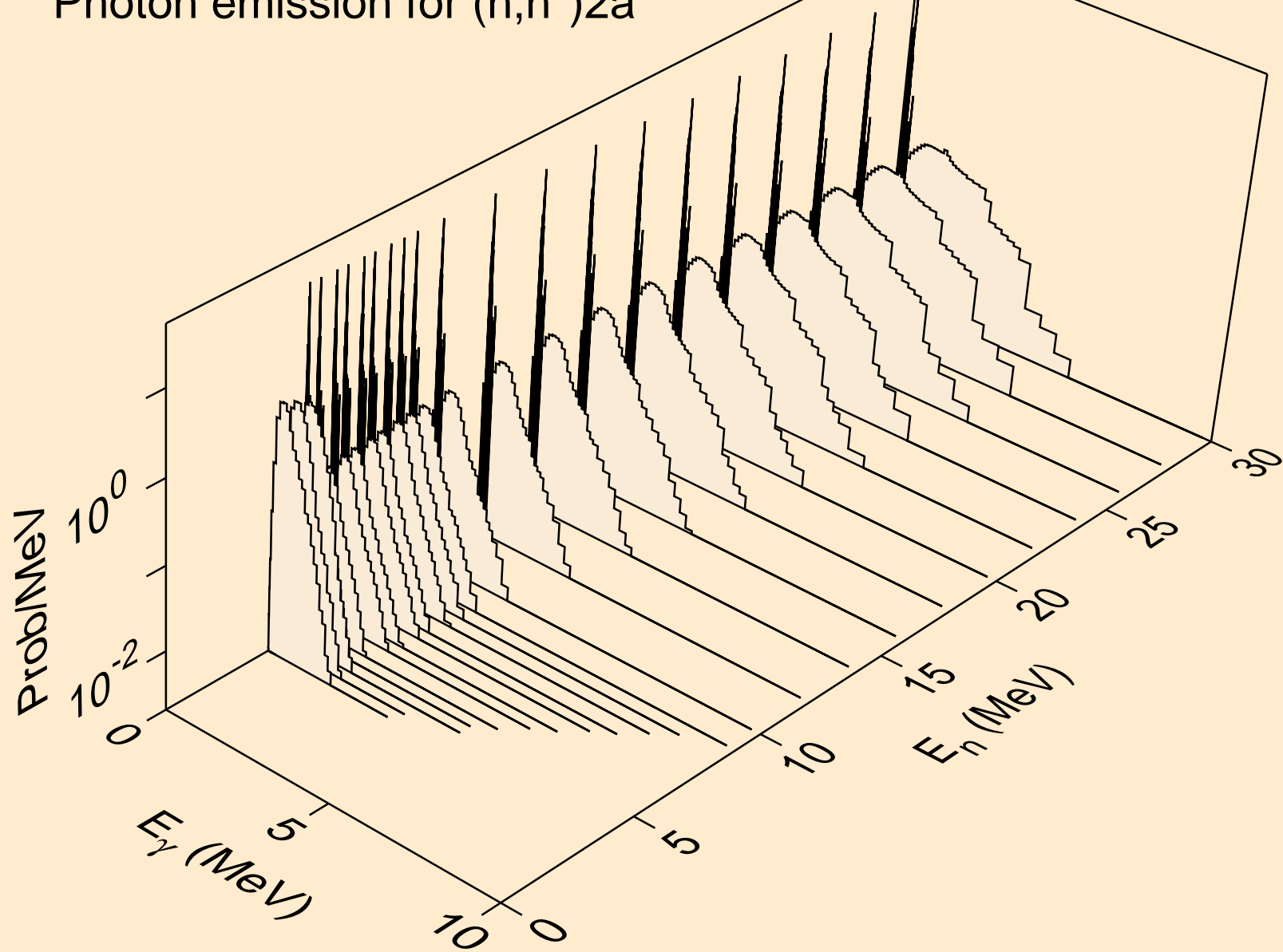



HG183 NEUTRON ACER TENDL-2021 LIBRARY; T=293.6K  
Photon emission for (n,2n)2a

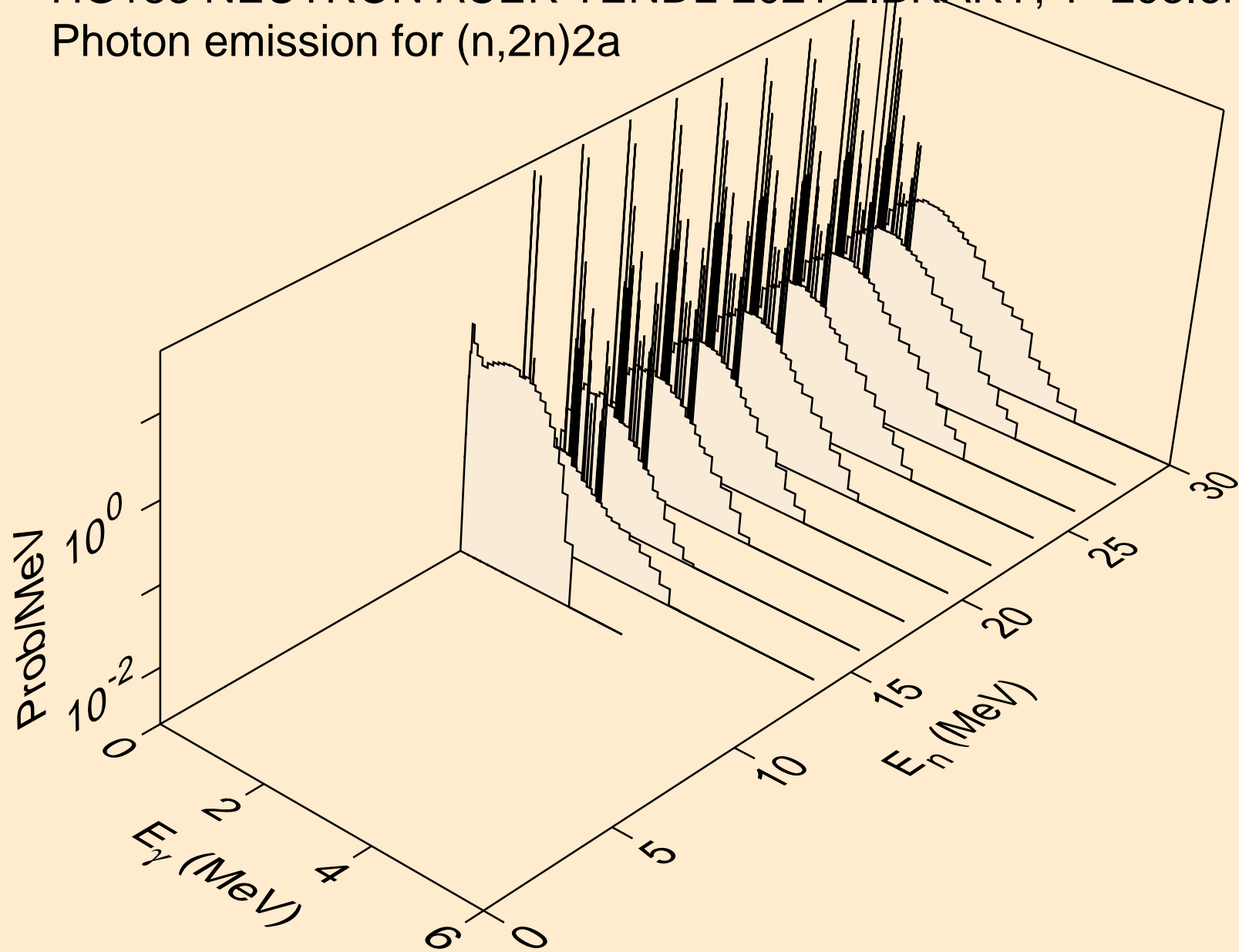

HG183 NEUTRON ACER TENDL-2021 LIBRARY; T=293.6K  
Photon emission for (n,n\*)d

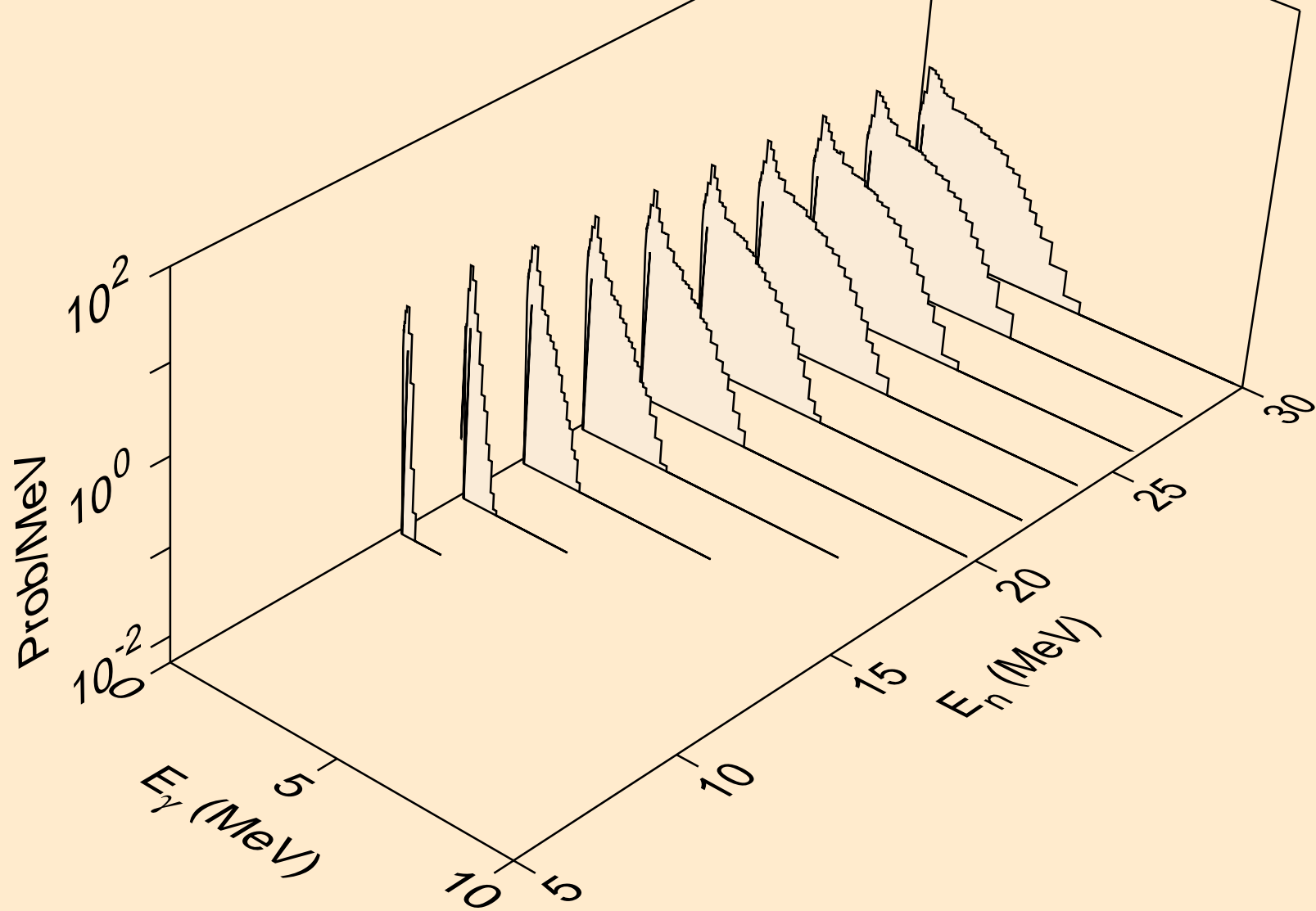

HG183 NEUTRON ACER TENDL-2021 LIBRARY; T=293.6K  
Photon emission for (n,n\*)t

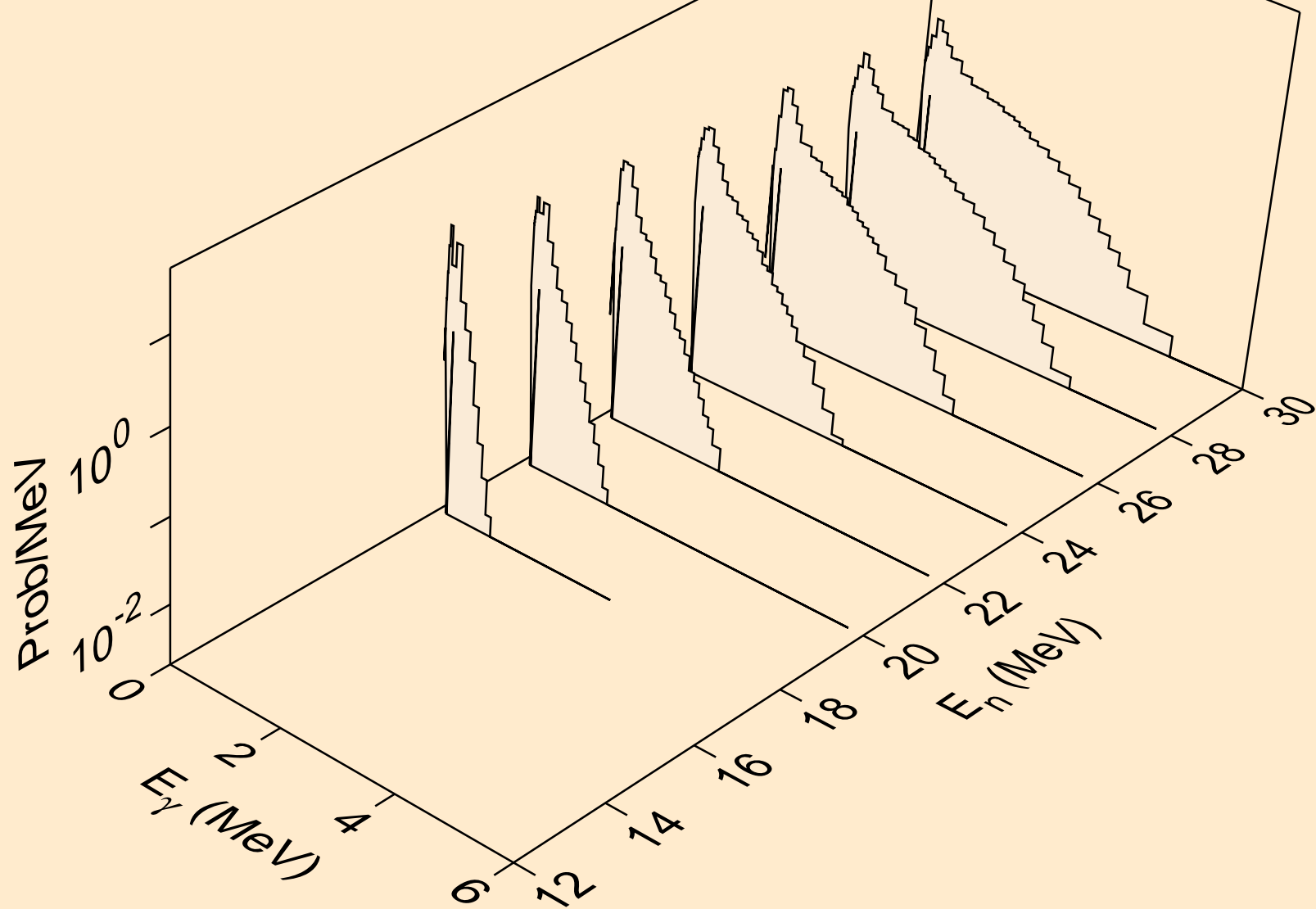

HG183 NEUTRON ACER TENDL-2021 LIBRARY; T=293.6K  
Photon emission for (n,n\*)he3

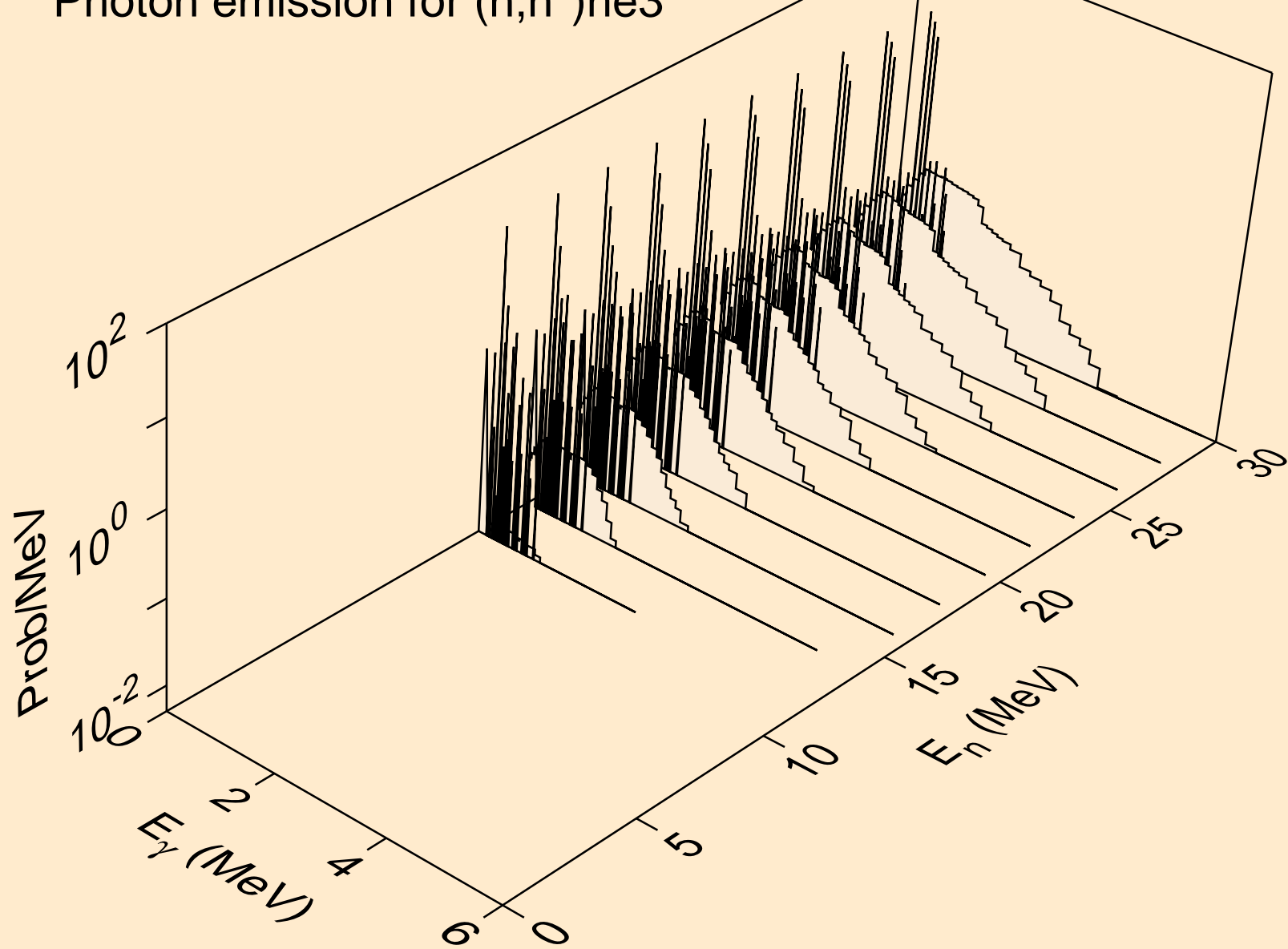

HG183 NEUTRON ACER TENDL-2021 LIBRARY; T=293.6K  
Photon emission for (n,4n)

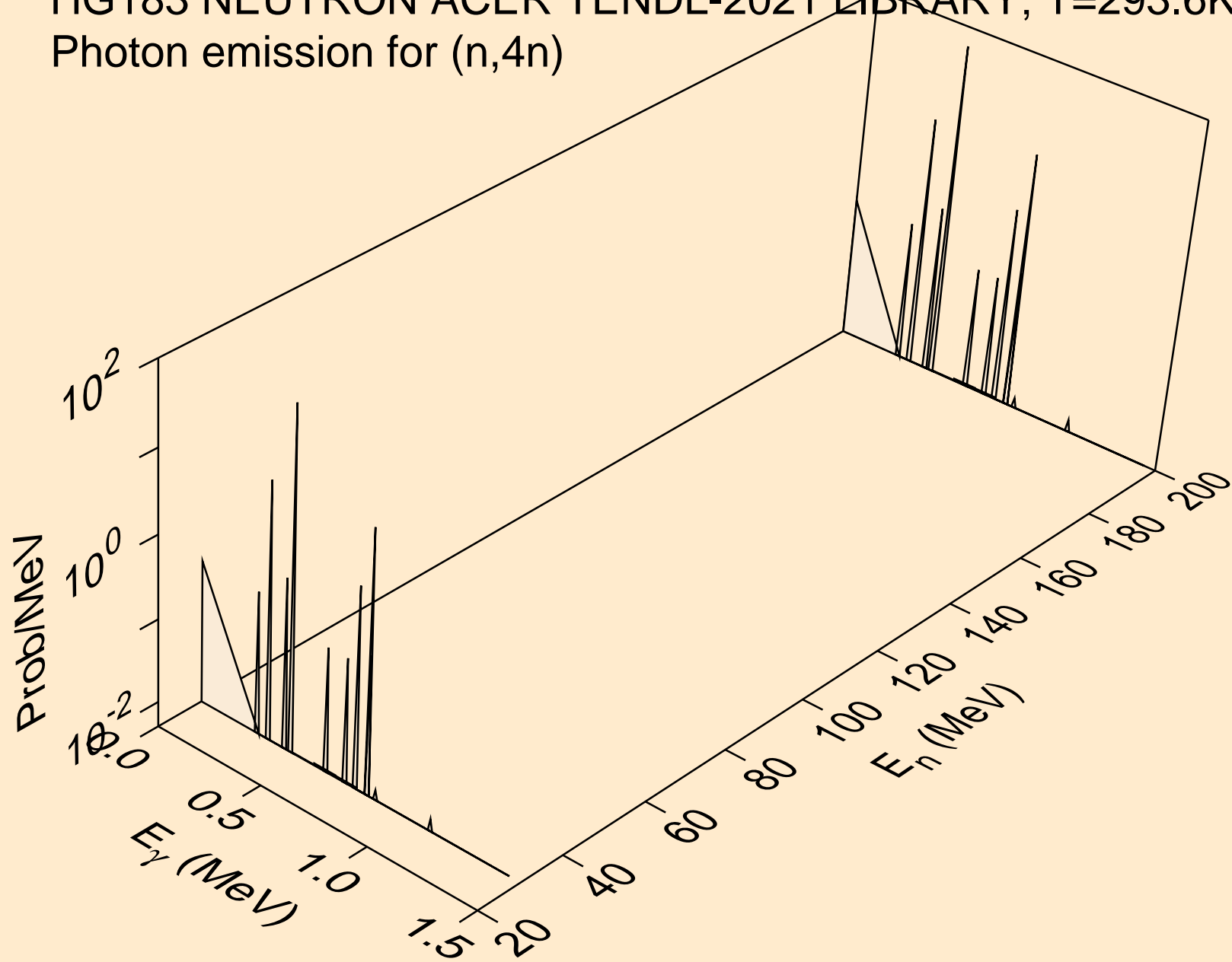

HG183 NEUTRON ACER TENDL-2021 LIBRARY; T=293.6K  
Photon emission for (n,2np)

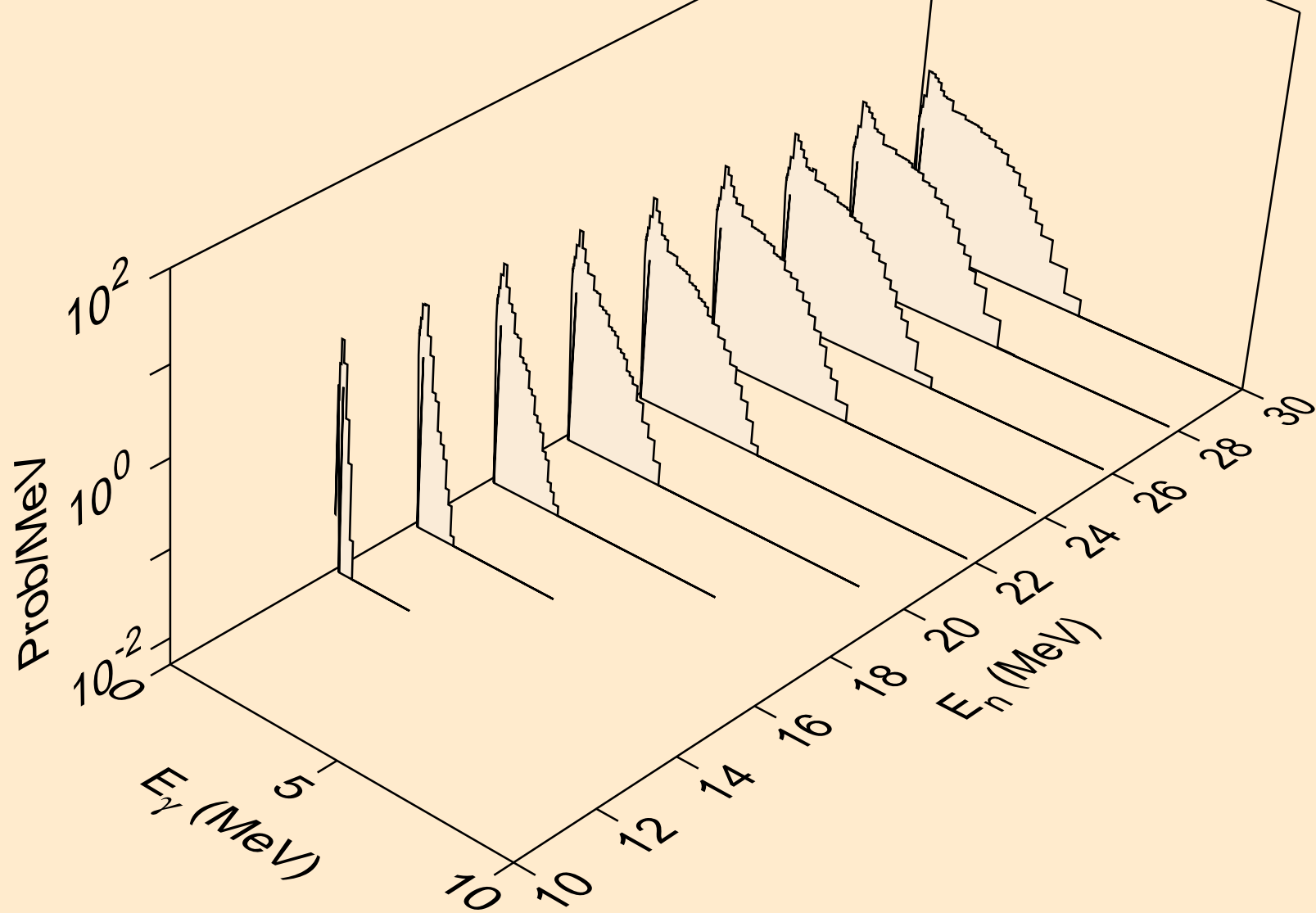

HG183 NEUTRON ACER TENDL-2021 LIBRARY; T=293.6K  
Photon emission for (n,3np)

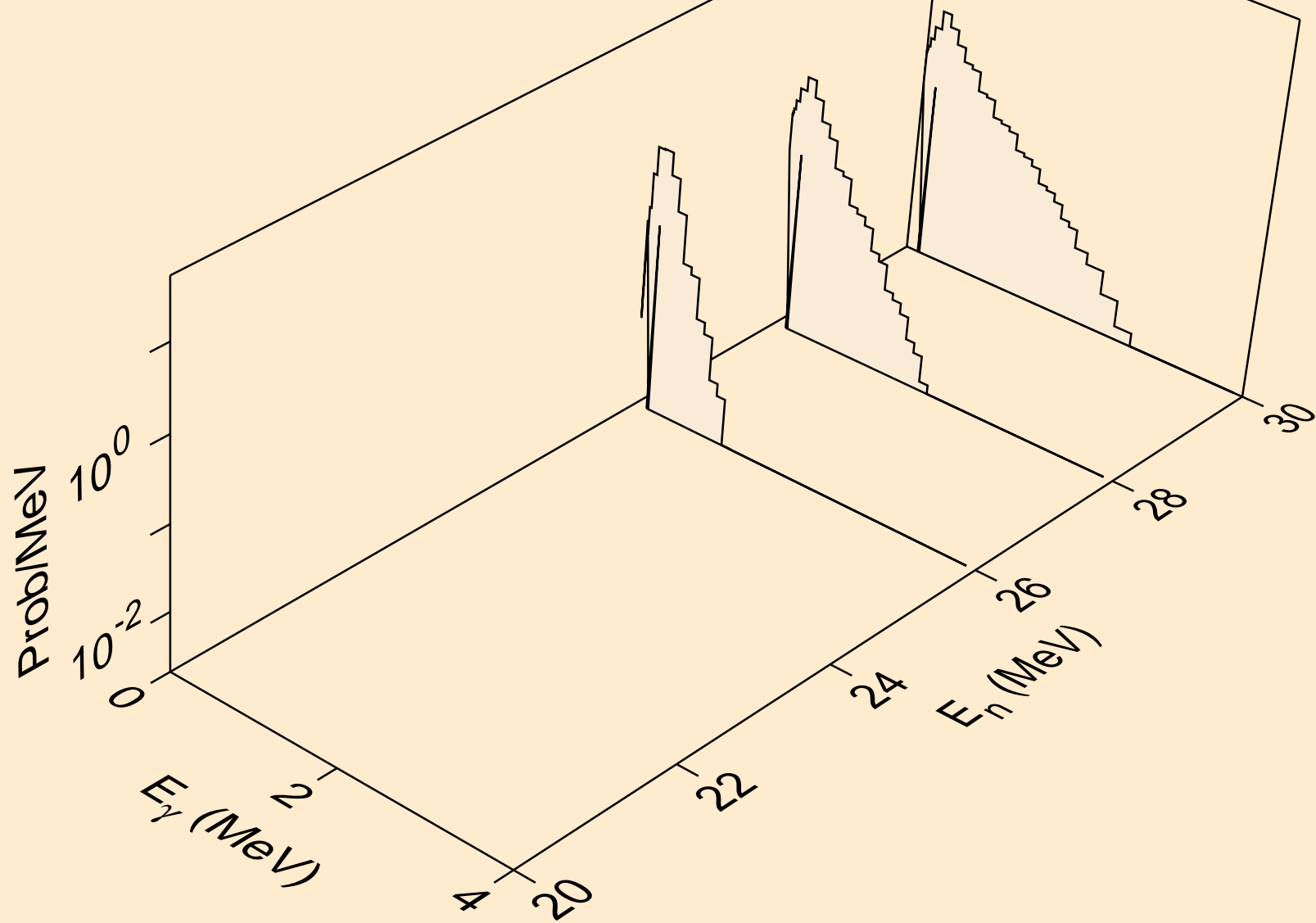

HG183 NEUTRON ACER TENDL-2021 LIBRARY; T=293.6K  
Photon emission for (n,2np)

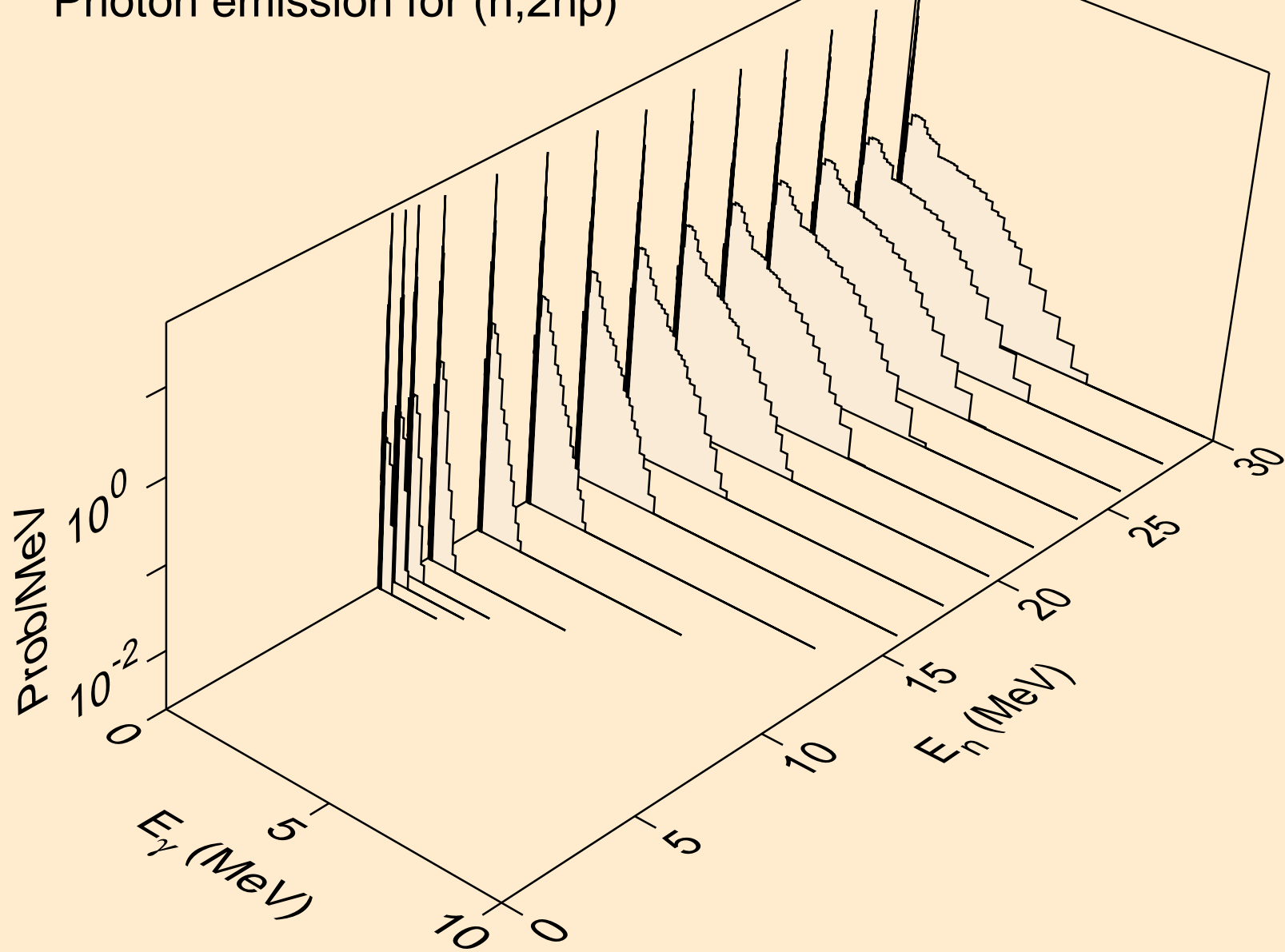



HG183 NEUTRON ACER TENDL-2021 LIBRARY; T=293.6K  
Photon emission for (n,npa)

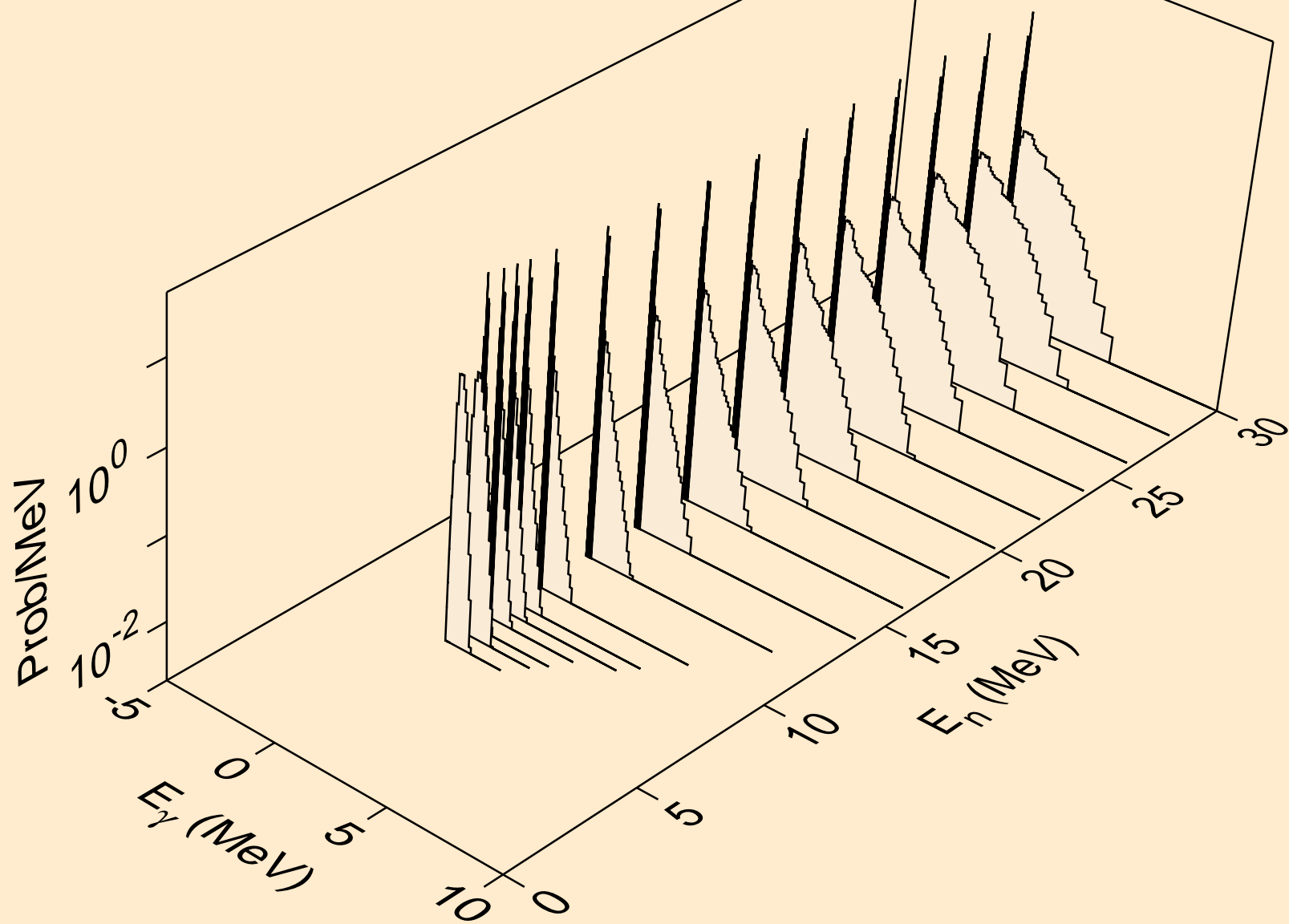

HG183 NEUTRON ACER TENDL-2021 LIBRARY; T=293.6K  
Photon emission for (n,n\*c)

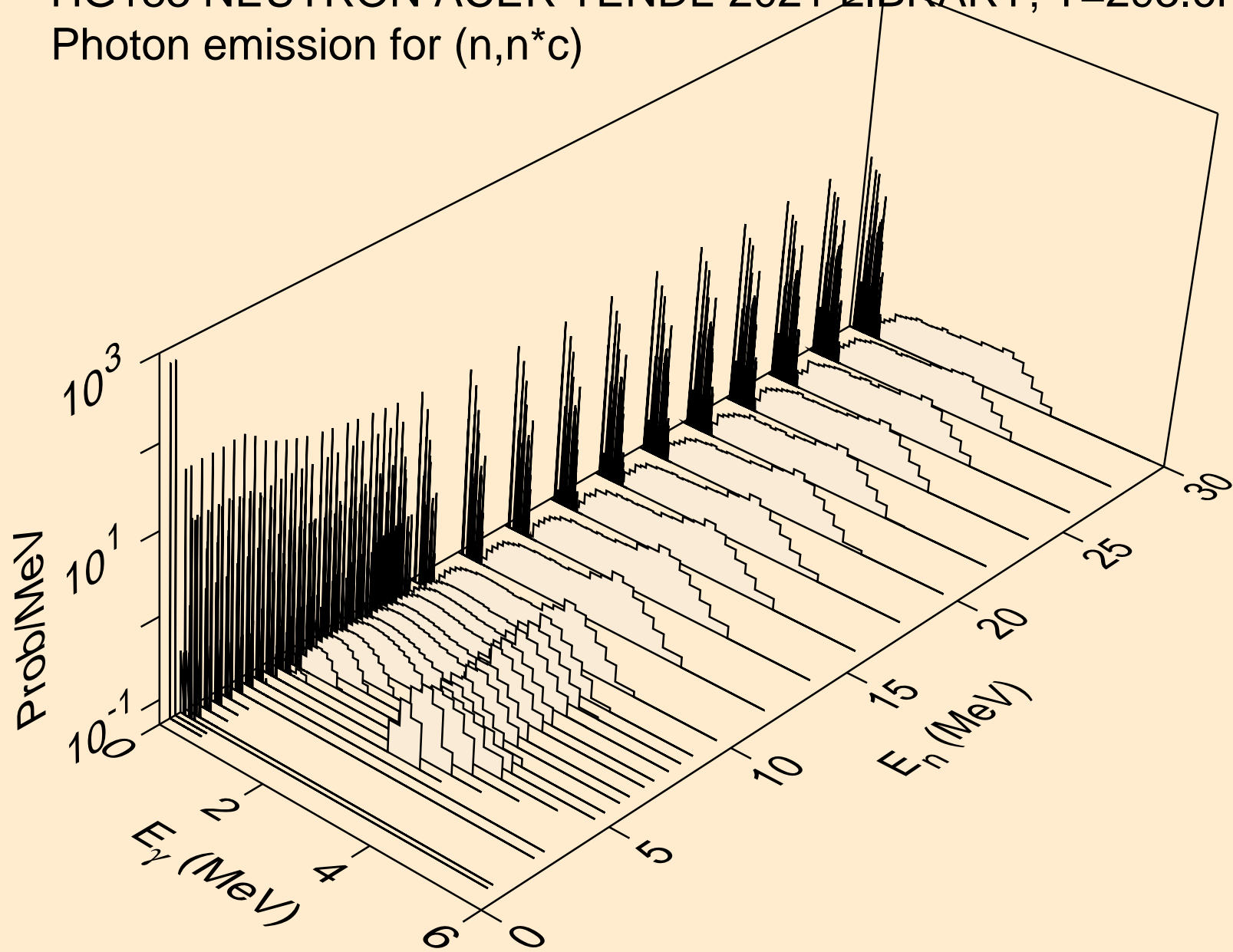

HG183 NEUTRON ACER TENDL-2021 LIBRARY; T=293.6K  
Photon emission for (n,gma)

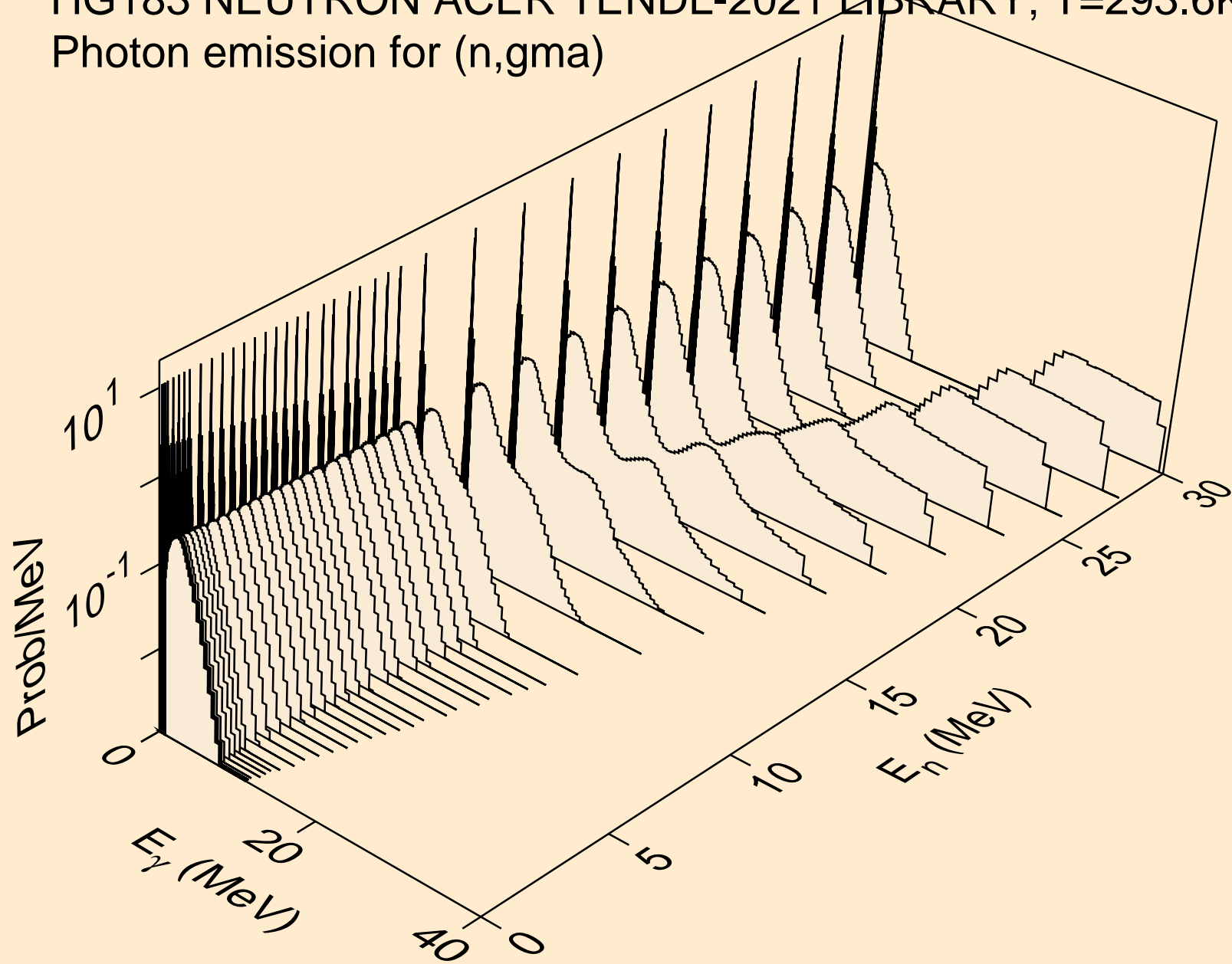

HG183 NEUTRON ACER TENDL-2021 LIBRARY; T=293.6K  
Photon emission for (n,p)

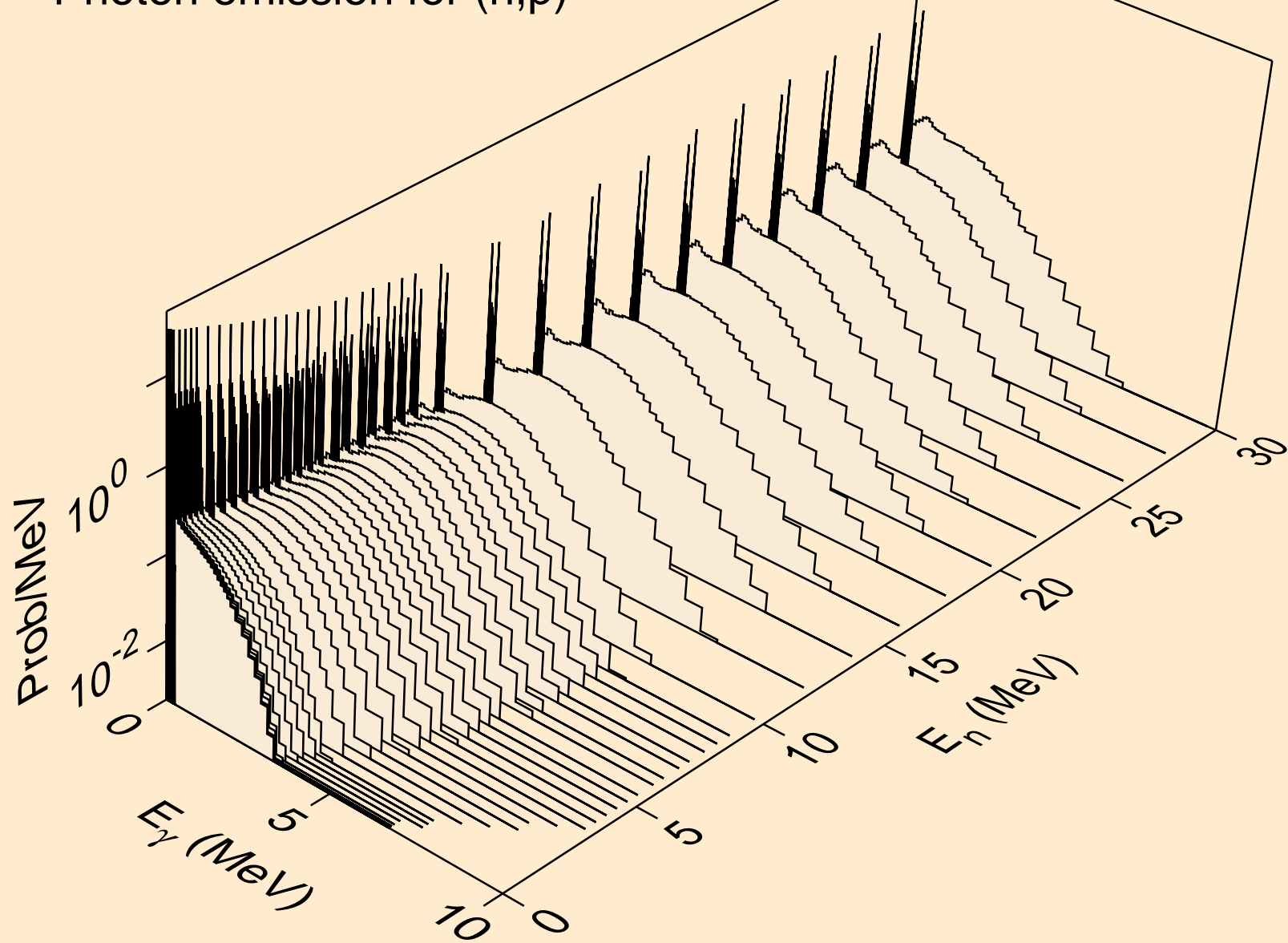

HG183 NEUTRON ACER TENDL-2021 LIBRARY; T=293.6K  
Photon emission for (n,d)

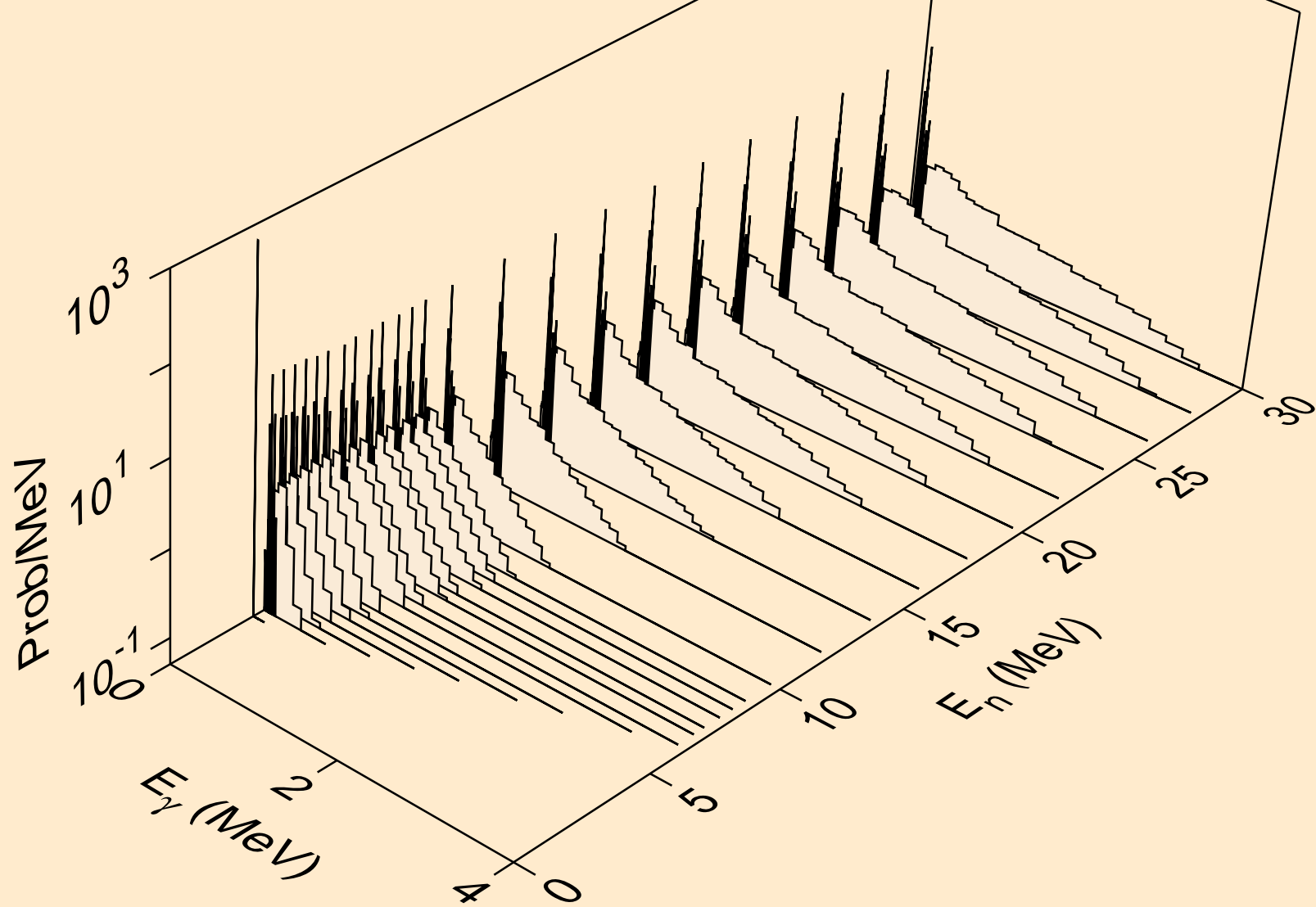

HG183 NEUTRON ACER TENDL-2021 LIBRARY; T=293.6K  
Photon emission for (n,t)

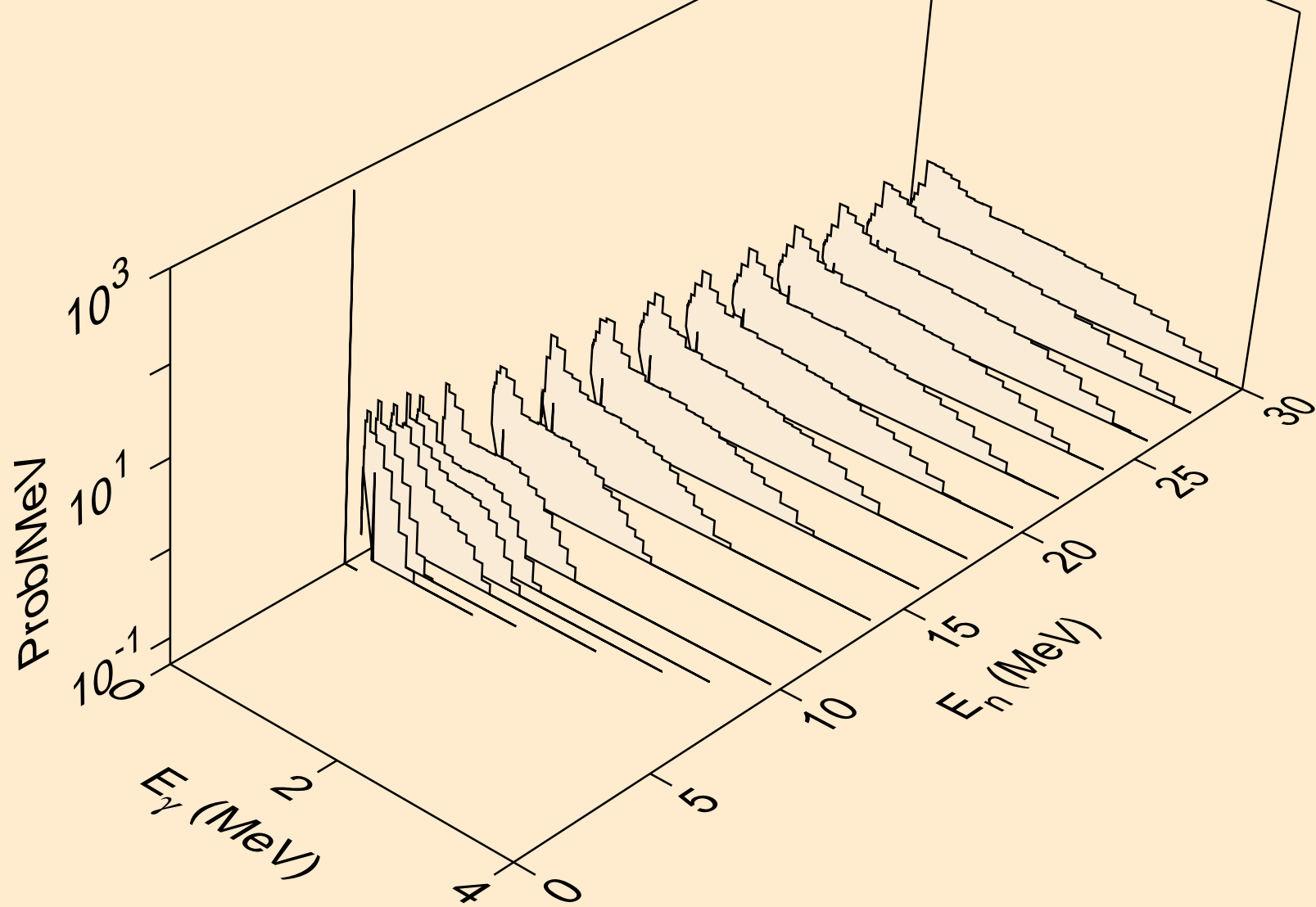

HG183 NEUTRON ACER TENDL-2021 LIBRARY; T=293.6K  
Photon emission for (n,he3)

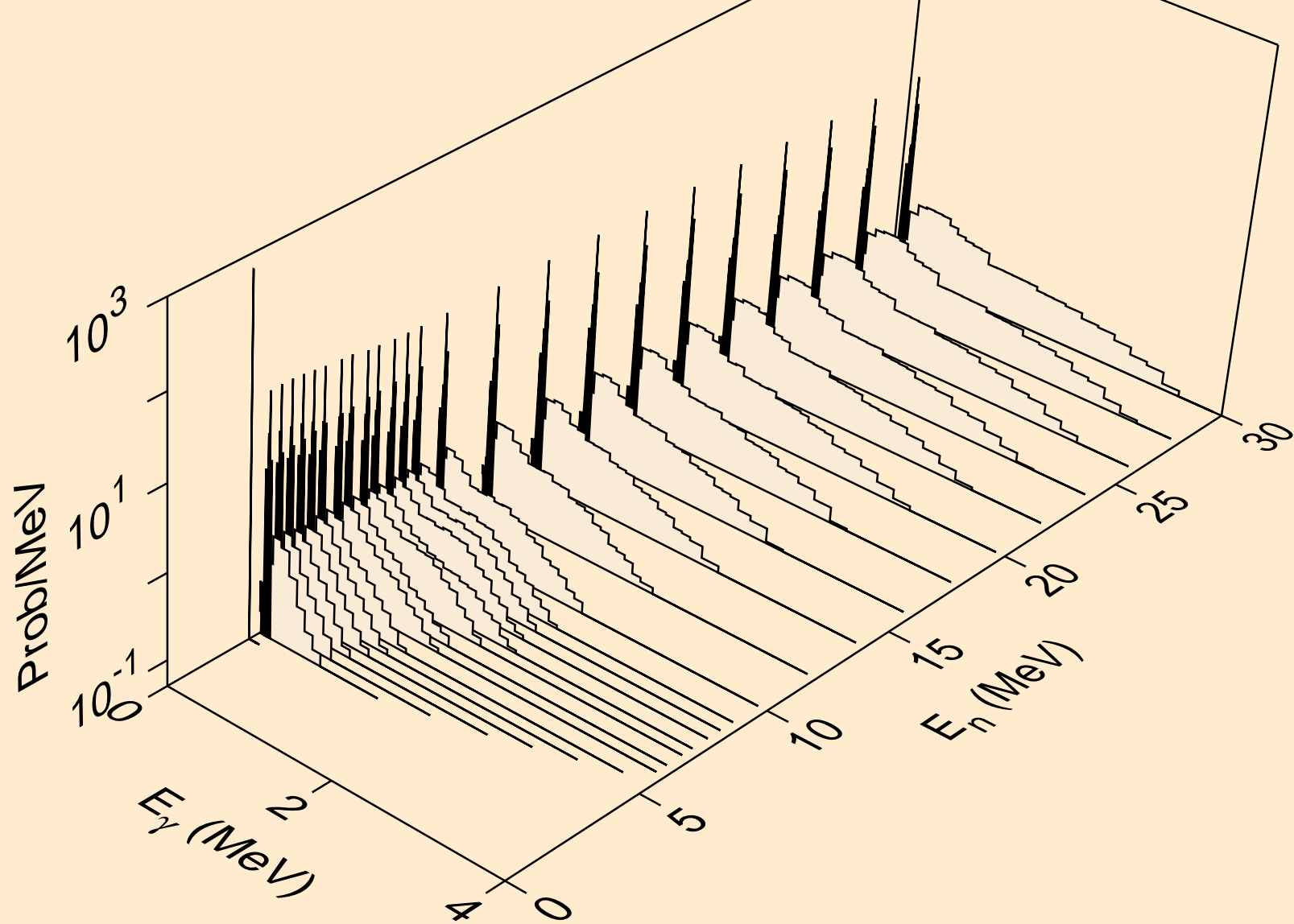

HG183 NEUTRON ACER TENDL-2021 LIBRARY; T=293.6K  
Photon emission for (n,a)

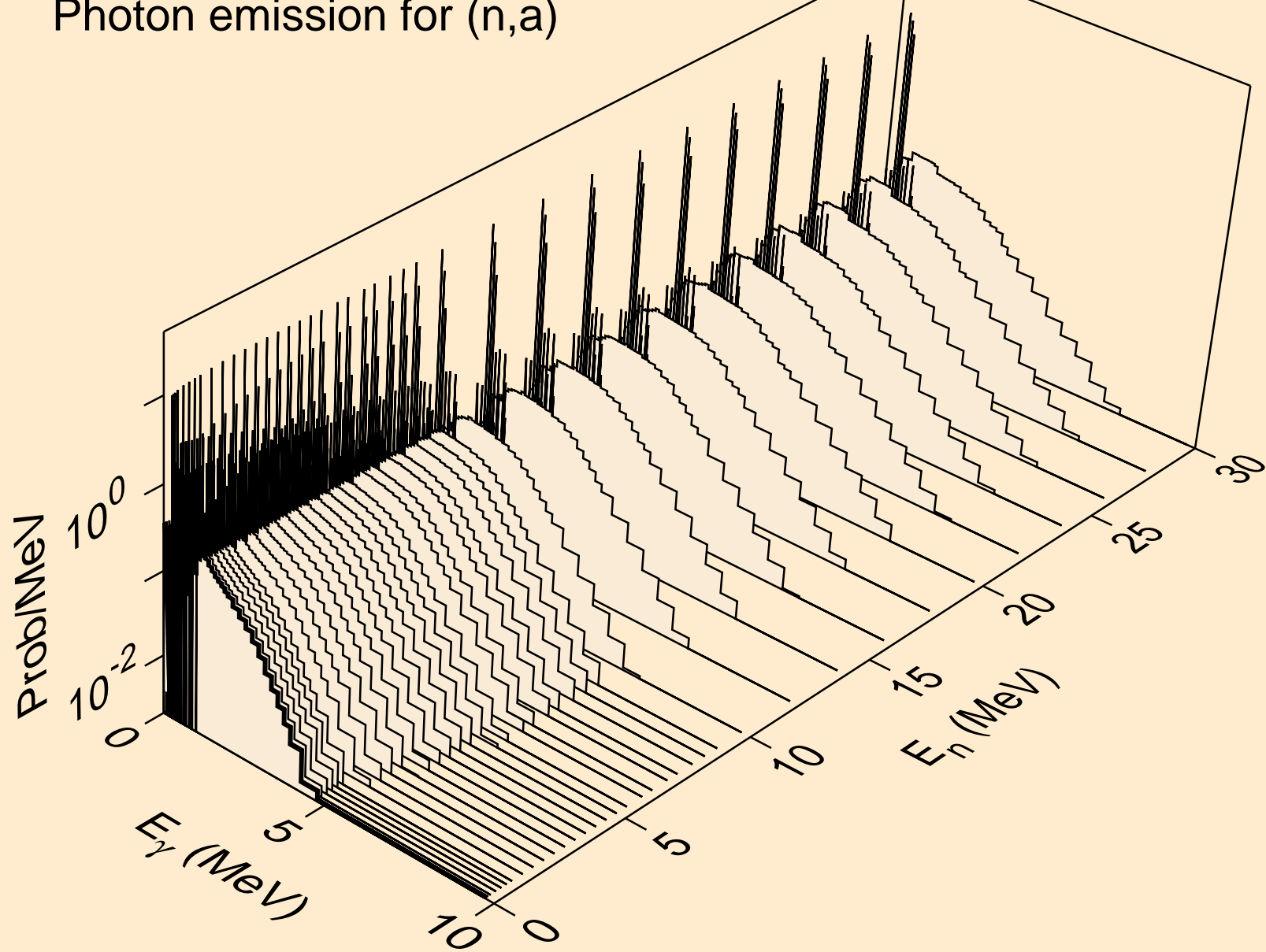



HG183 NEUTRON ACER TENDL-2021 LIBRARY; T=293.6K  
Photon emission for (n,2a)

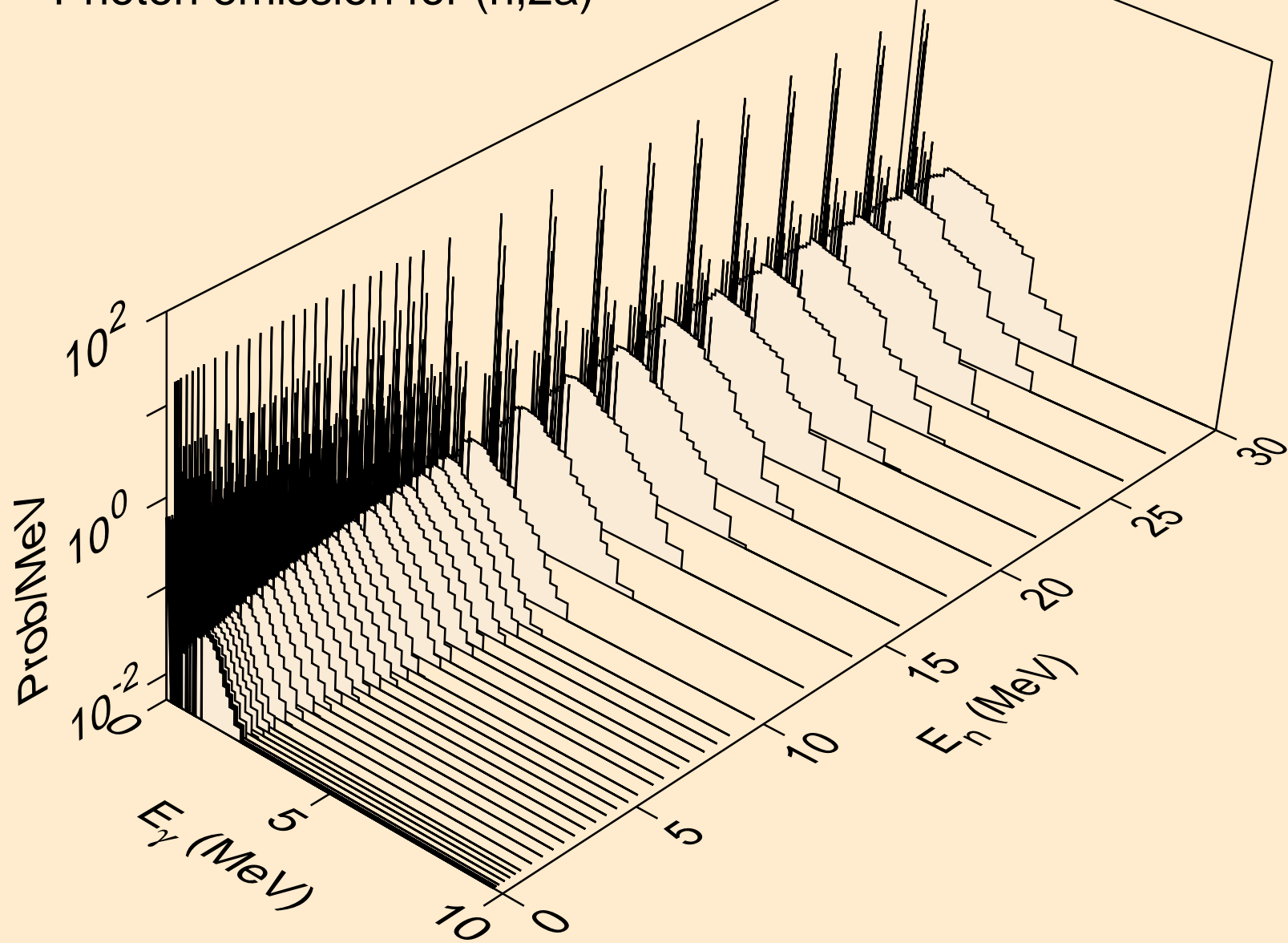

HG183 NEUTRON ACER TENDL-2021 LIBRARY; T=293.6K  
Photon emission for (n,3a)

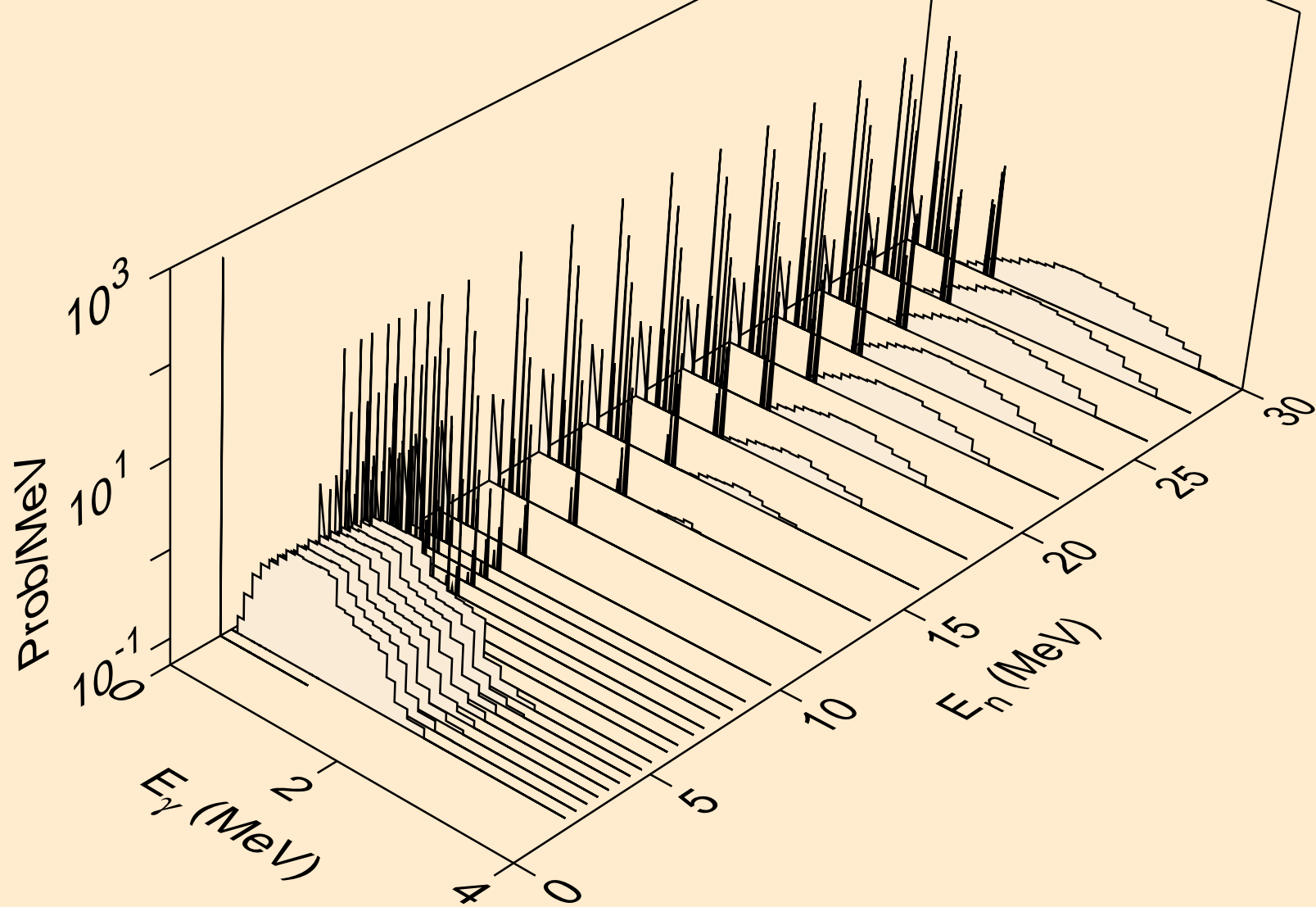

HG183 NEUTRON ACER TENDL-2021 LIBRARY; T=293.6K  
Photon emission for (n,2p)

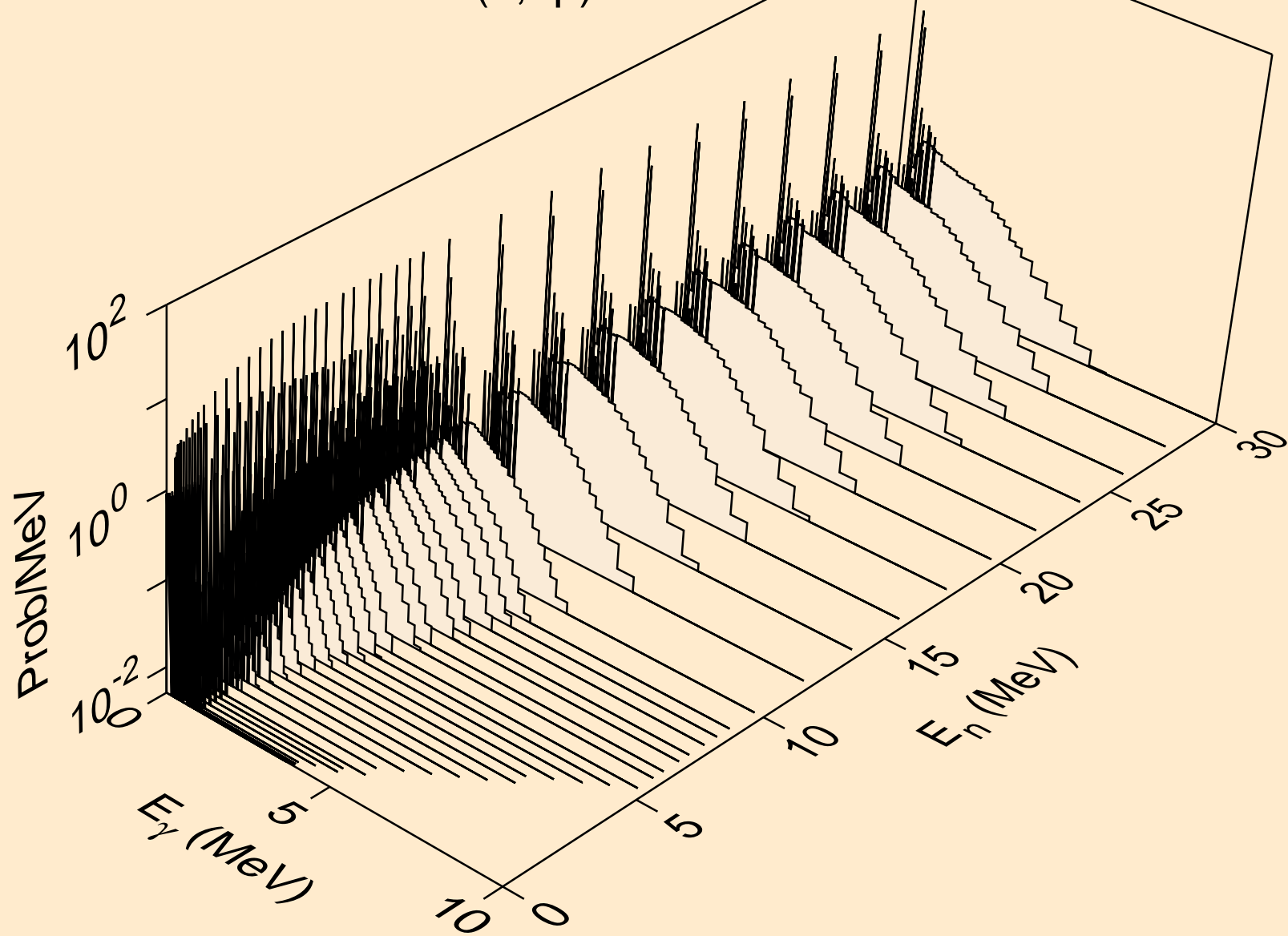

HG183 NEUTRON ACER TENDL-2021 LIBRARY; T=293.6K  
Photon emission for (n,p)

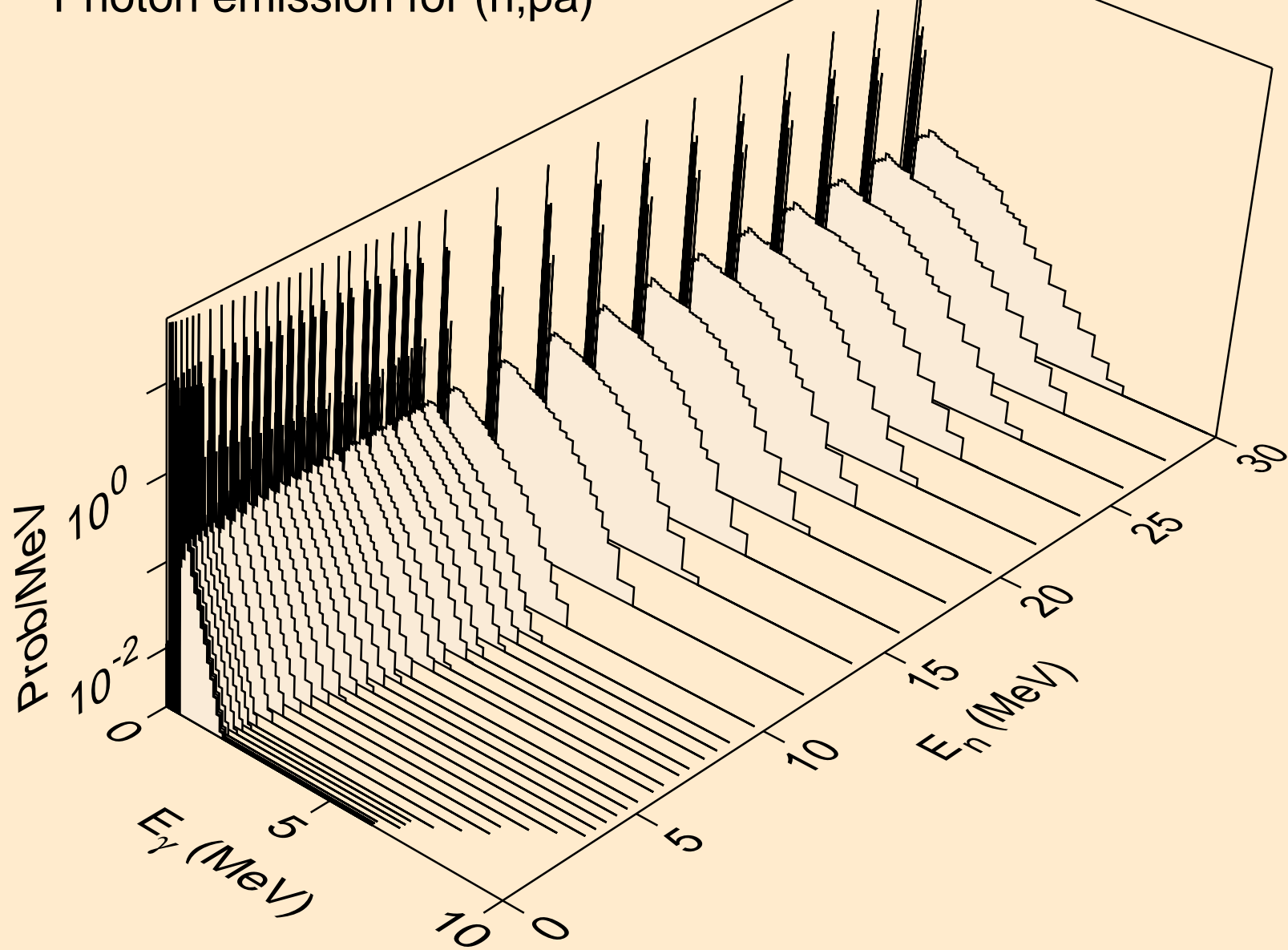

HG183 NEUTRON ACER TENDL-2021 LIBRARY; T=293.6K  
Photon emission for (n,d2a)

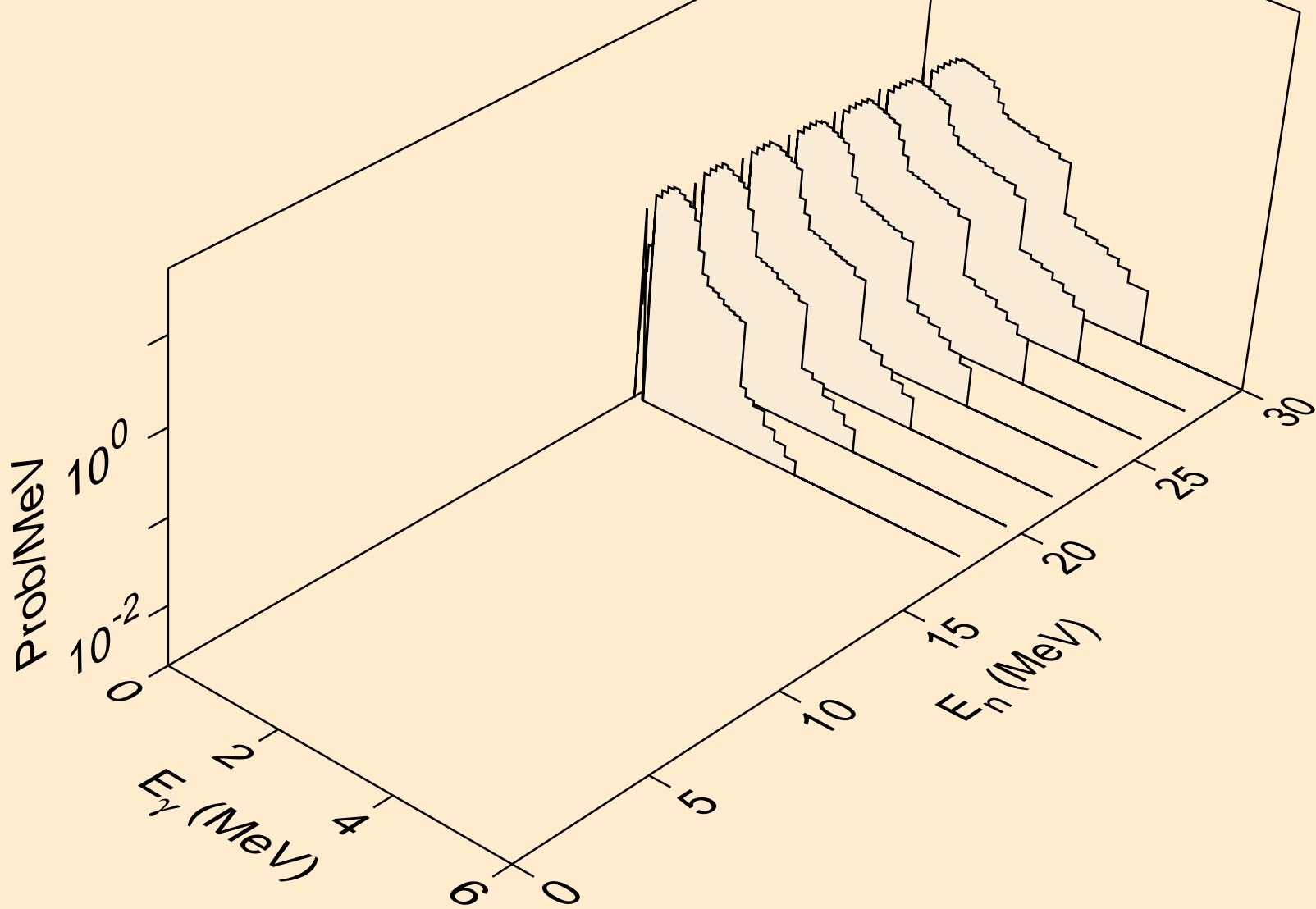

HG183 NEUTRON ACER TENDL-2021 LIBRARY; T=293.6K  
Photon emission for (n,pd)

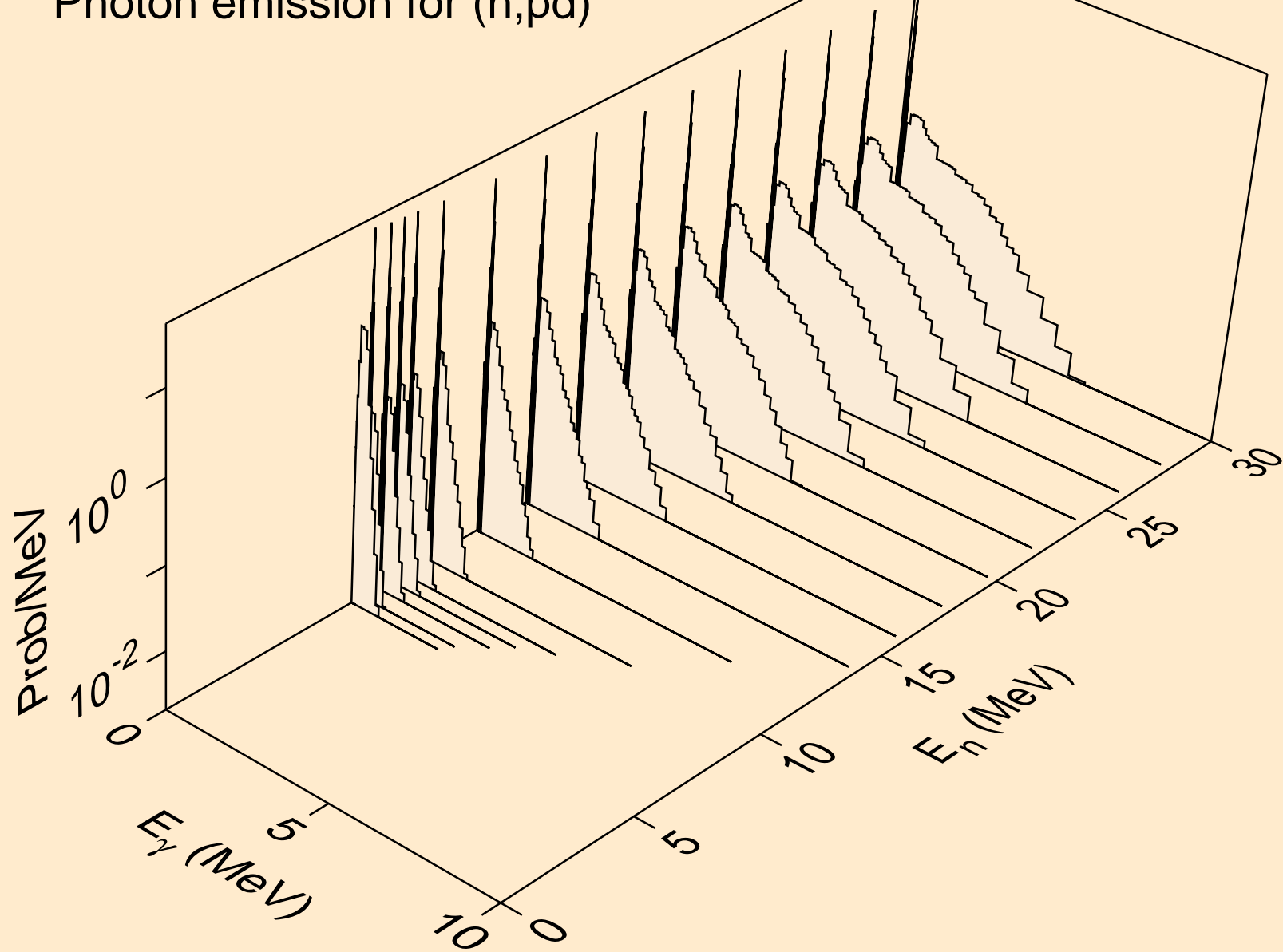

HG183 NEUTRON ACER TENDL-2021 LIBRARY; T=293.6K  
Photon emission for (n,pt)

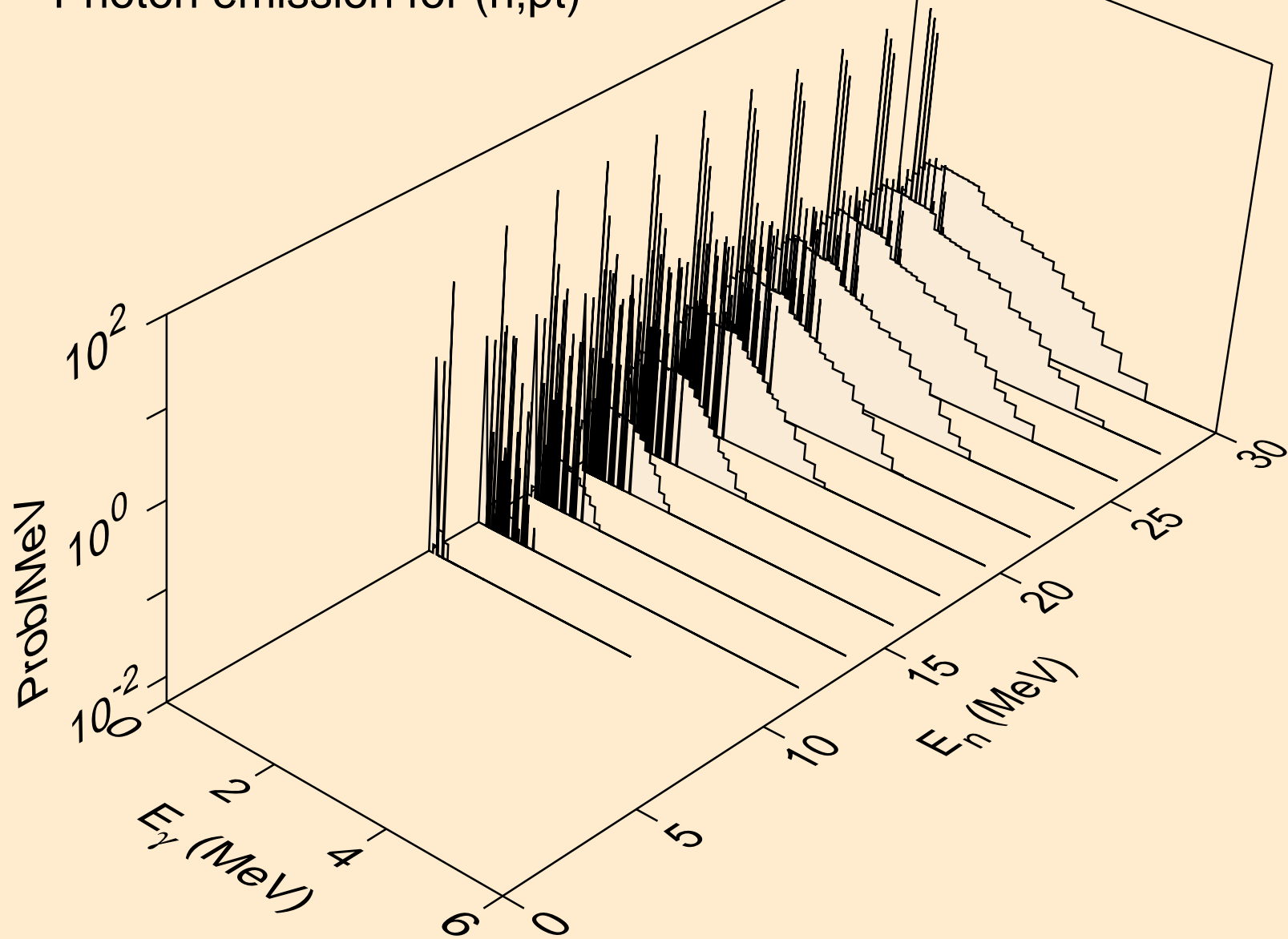

HG183 NEUTRON ACER TENDL-2021 LIBRARY; T=293.6K  
Photon emission for (n,da)

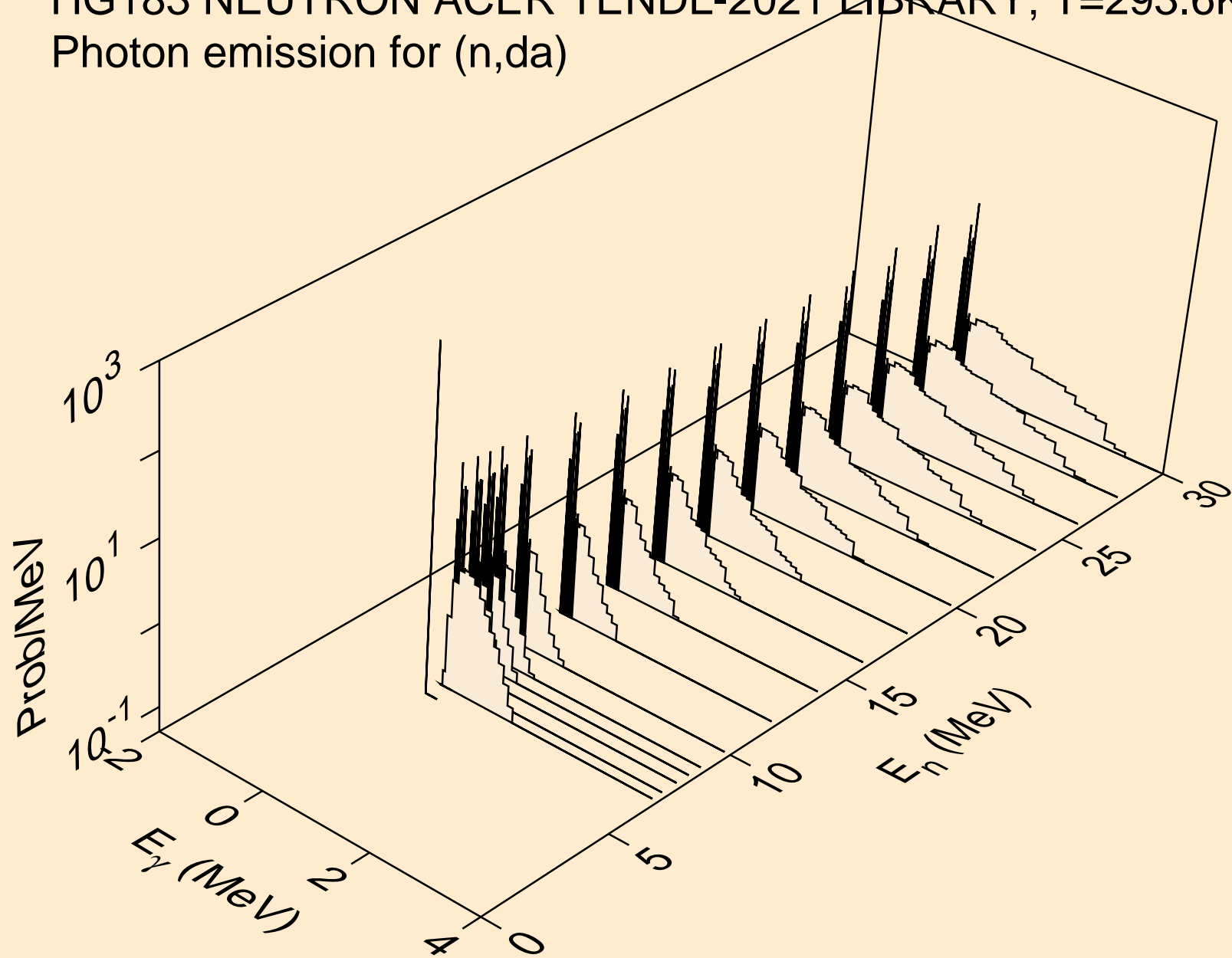



HG183 NEUTRON ACER TENDL-2021 LIBRARY; T=293.6K  
thermal capture photon spectrum

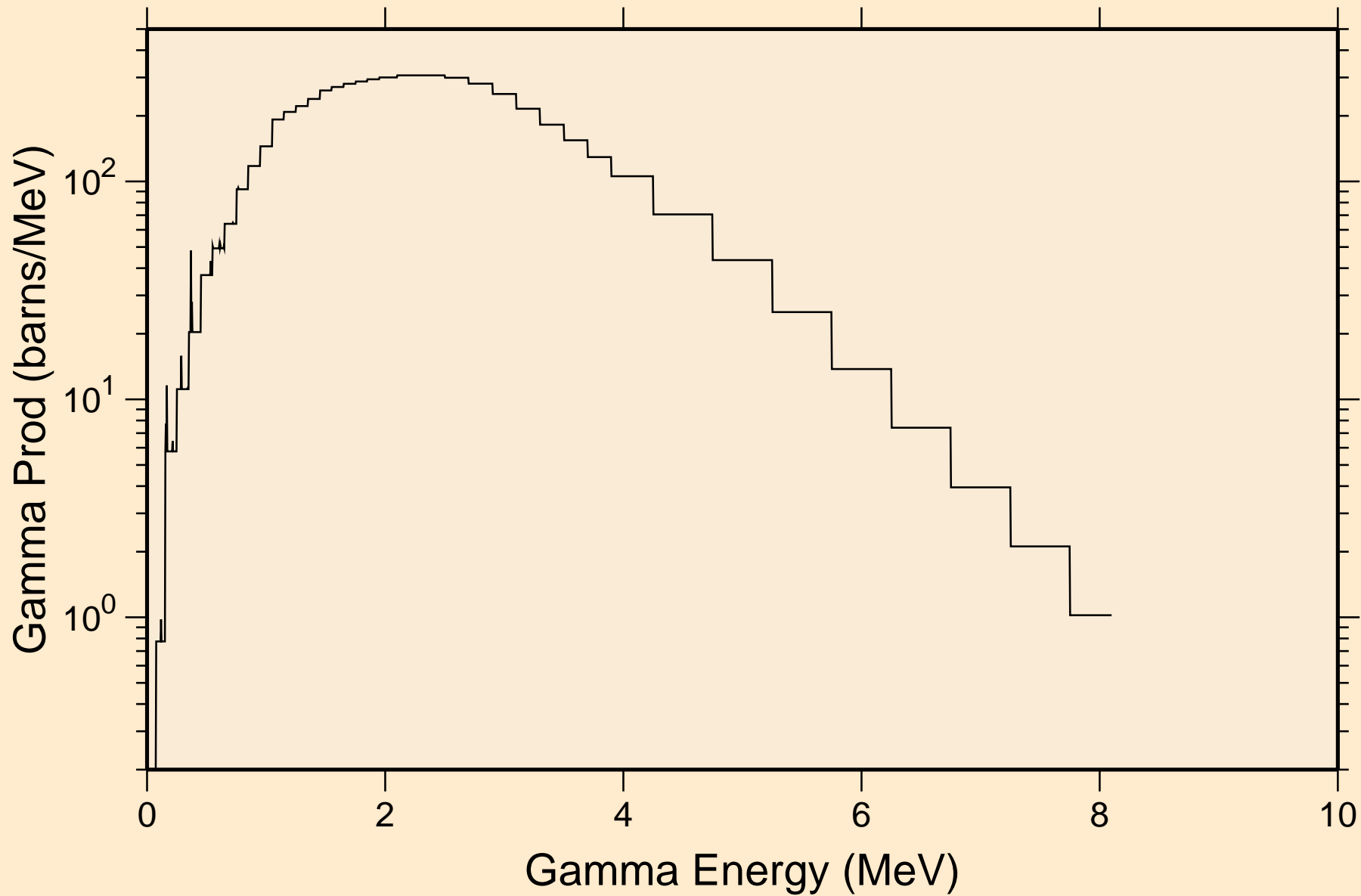

HG183 NEUTRON ACER TENDL-2021 LIBRARY; T=293.6K  
14 MeV photon spectrum

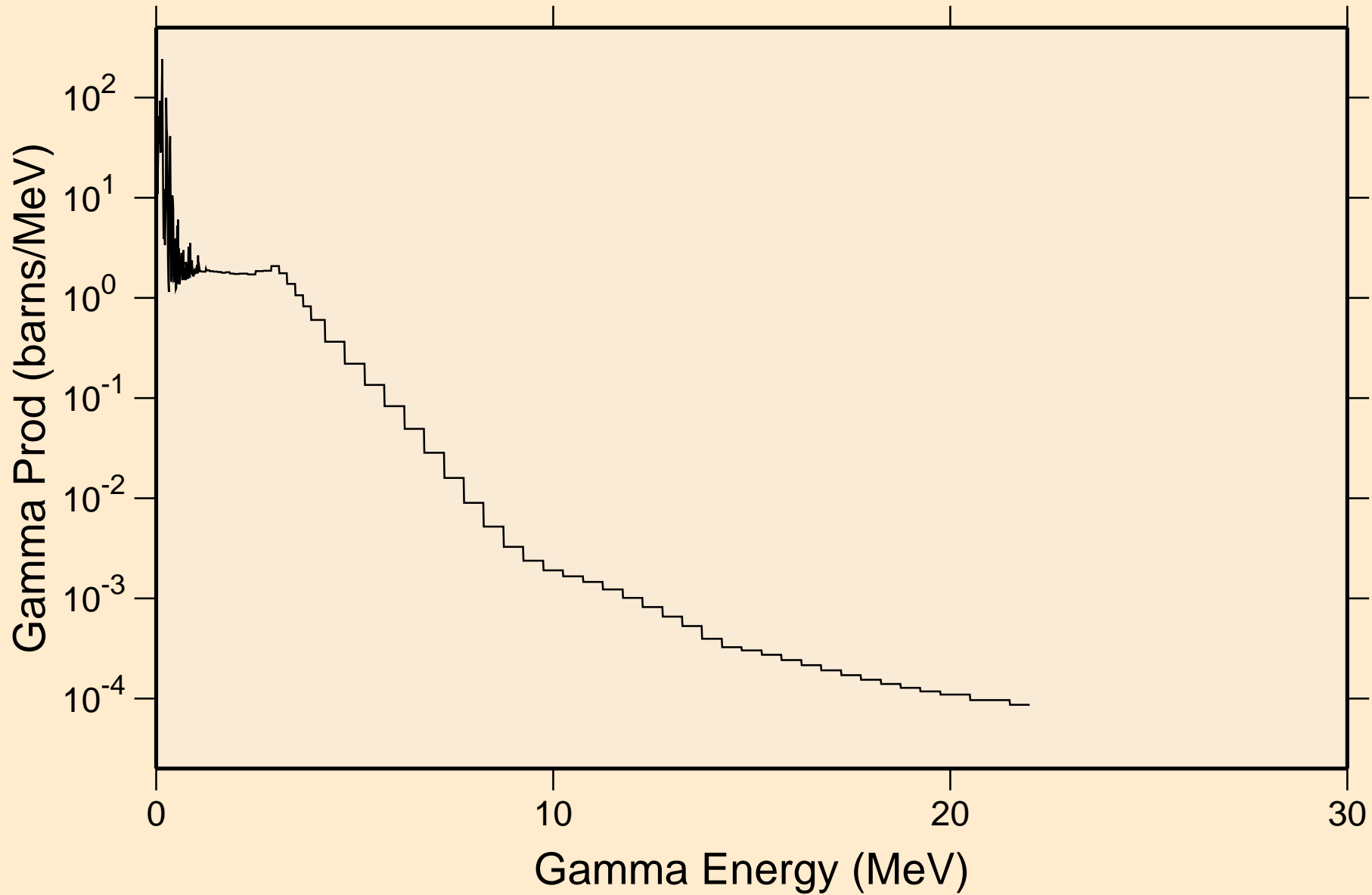

# HG183 NEUTRON ACER TENDL-2021 LIBRARY; T=293.6K

## Particle heating contributions

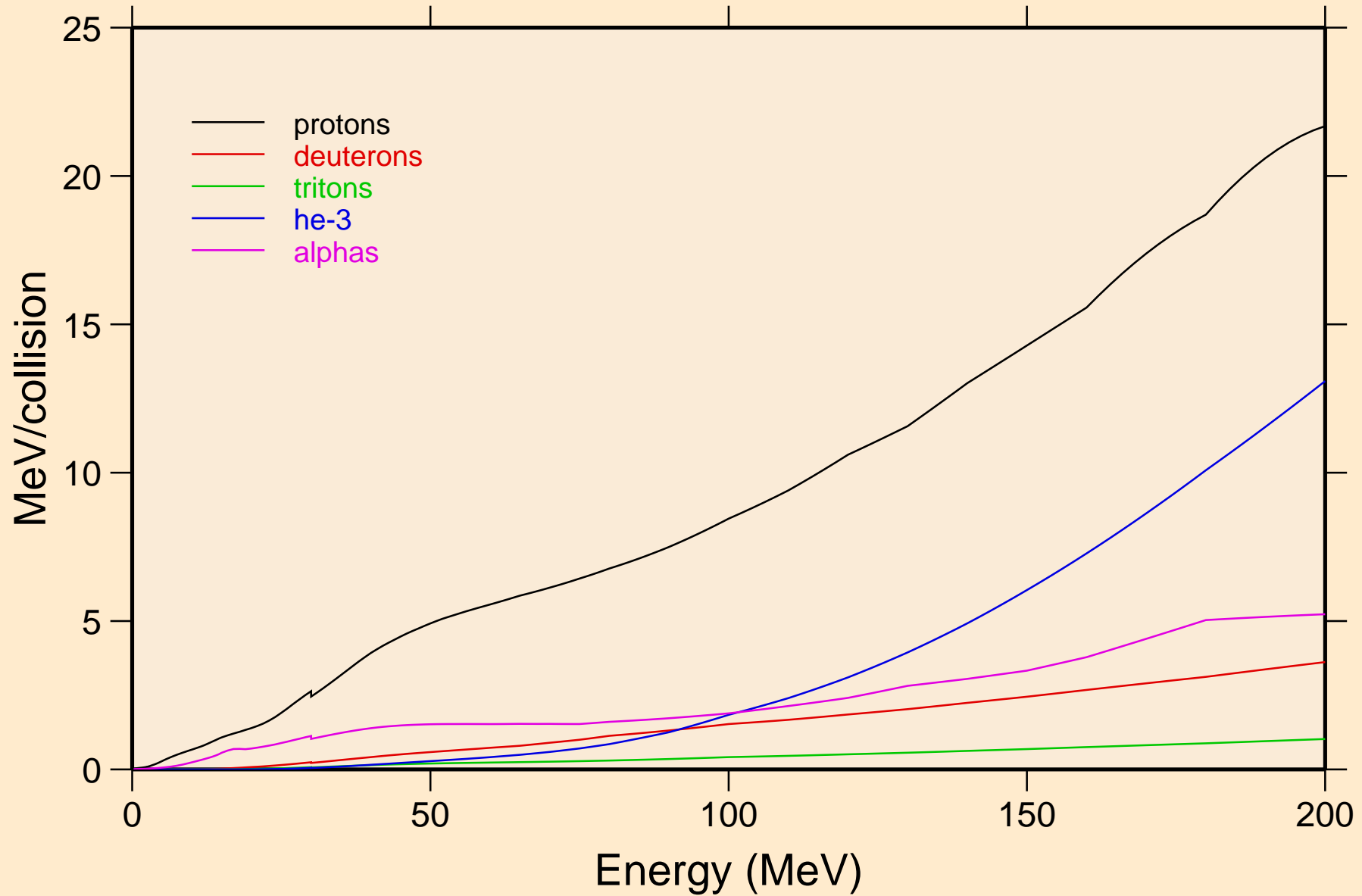

HG183 NEUTRON ACER TENDL-2021 LIBRARY; T=293.6K  
Recoil Heating

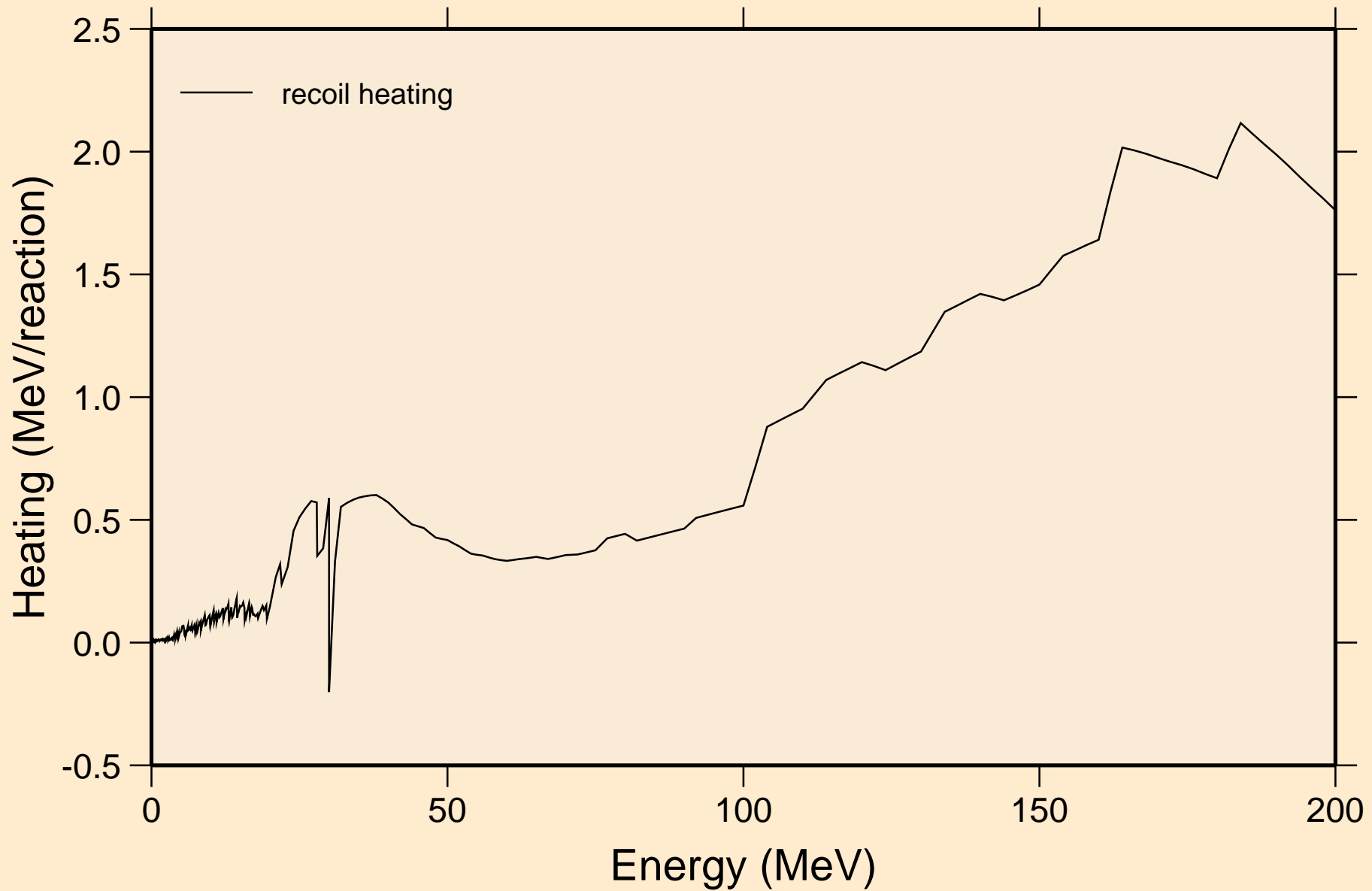

# HG183 NEUTRON ACER TENDL-2021 LIBRARY; T=293.6K

## Particle production cross sections

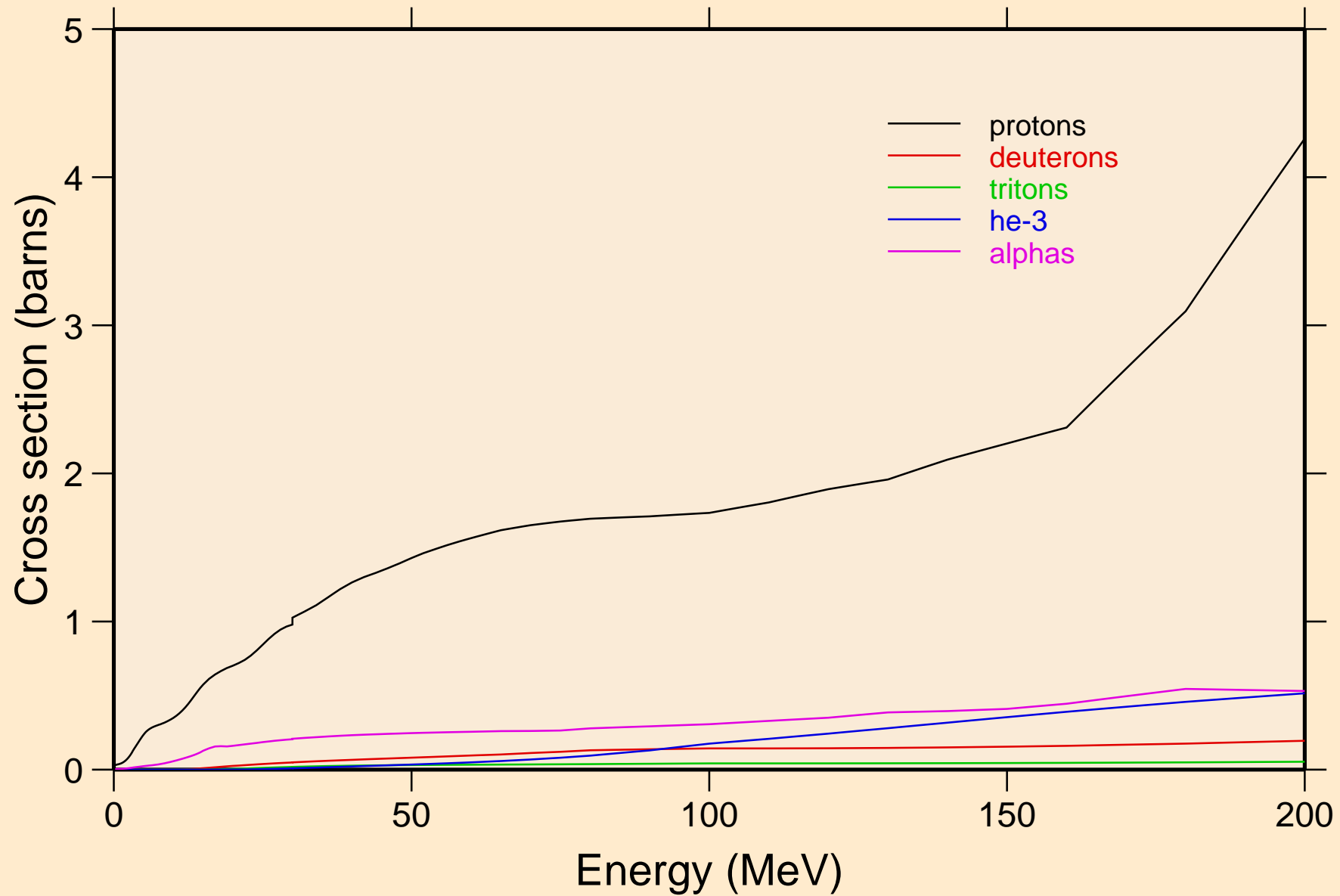

HG183 NEUTRON ACER TENDL-2021 LIBRARY; T=293.6K  
protons from (n,x)

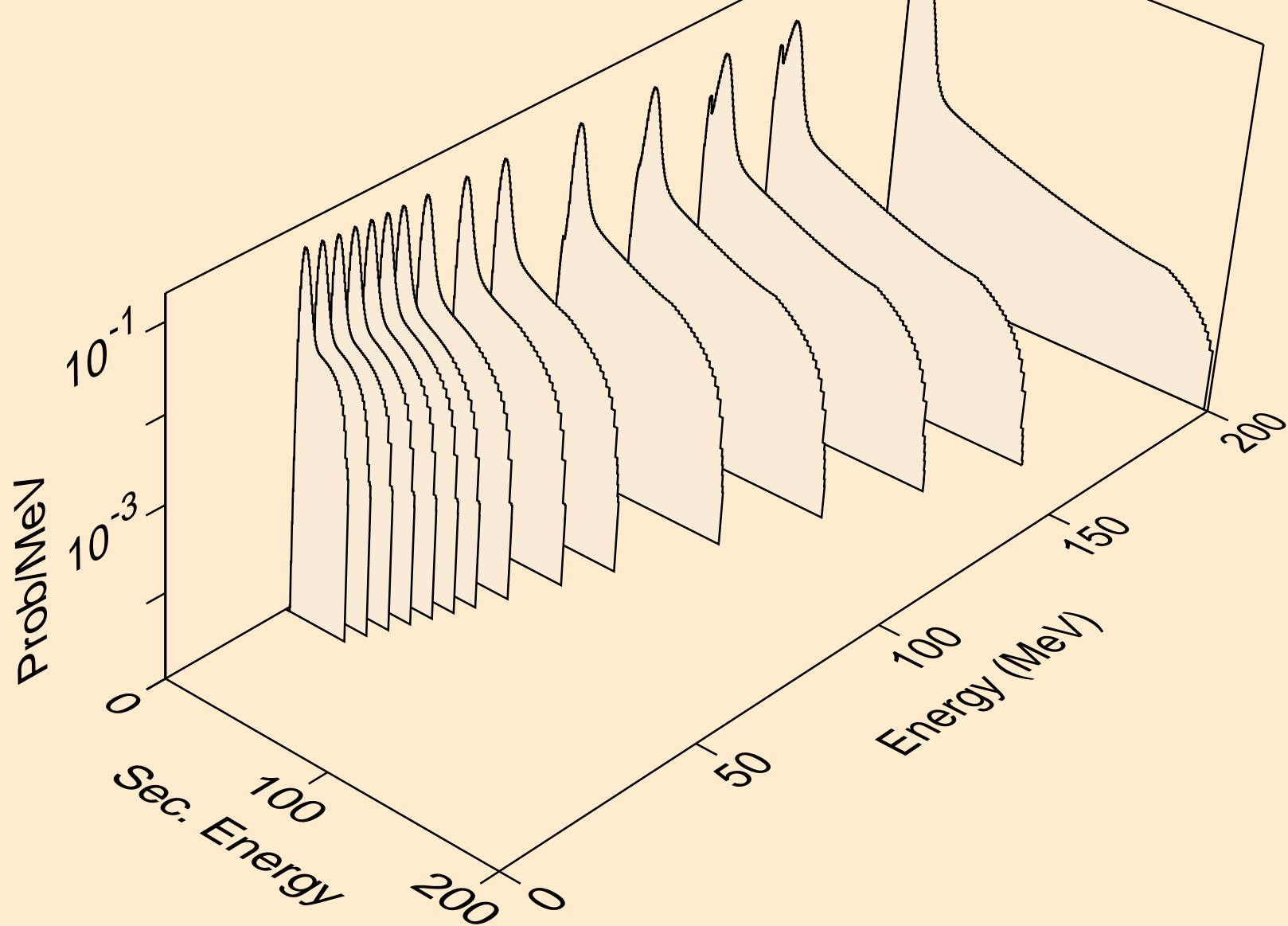

HG183 NEUTRON ACER TENDL-2021 LIBRARY; T=293.6K  
protons from (n,n\*)p

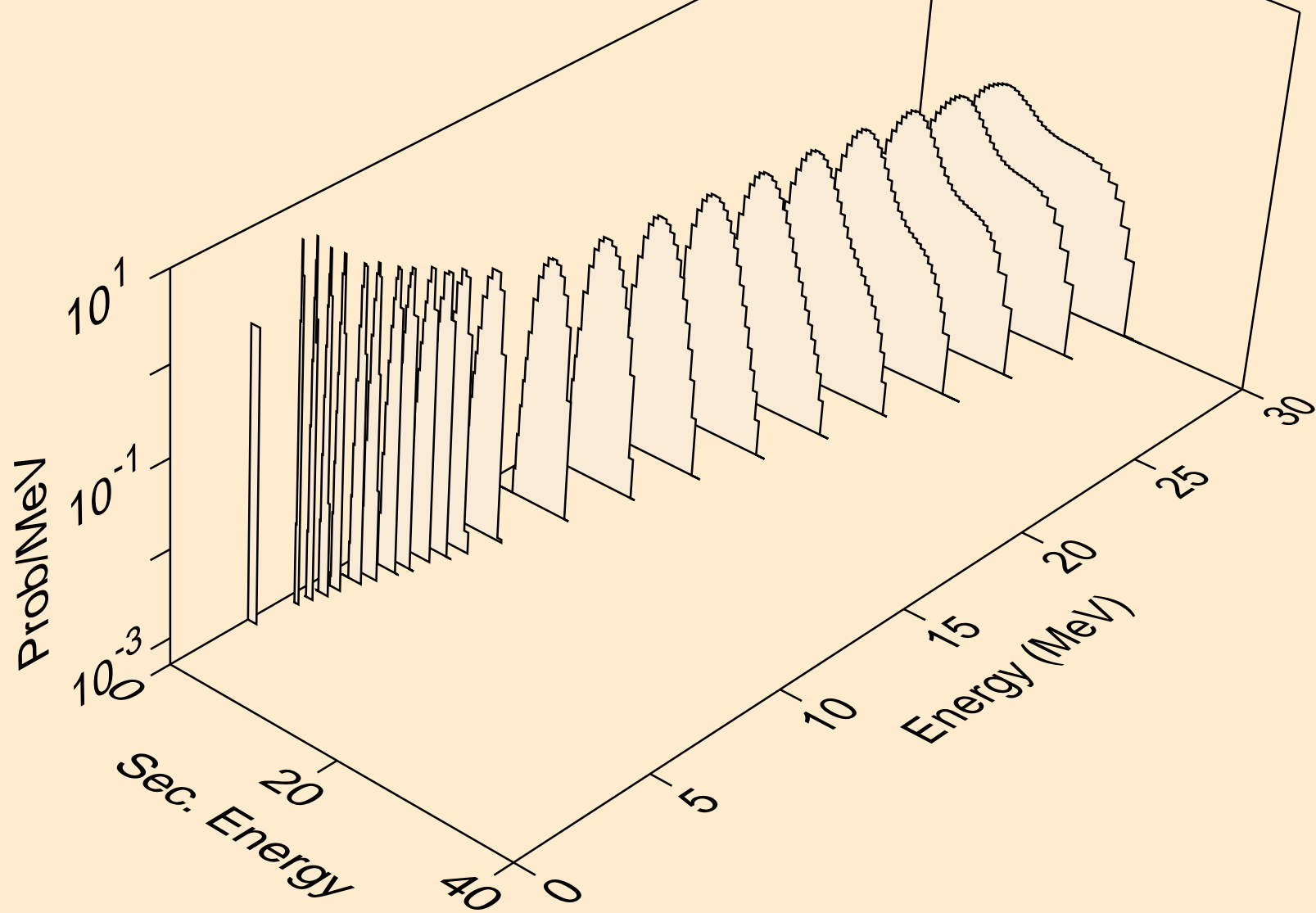

HG183 NEUTRON ACER TENDL-2021 LIBRARY; T=293.6K  
protons from (n,2np)

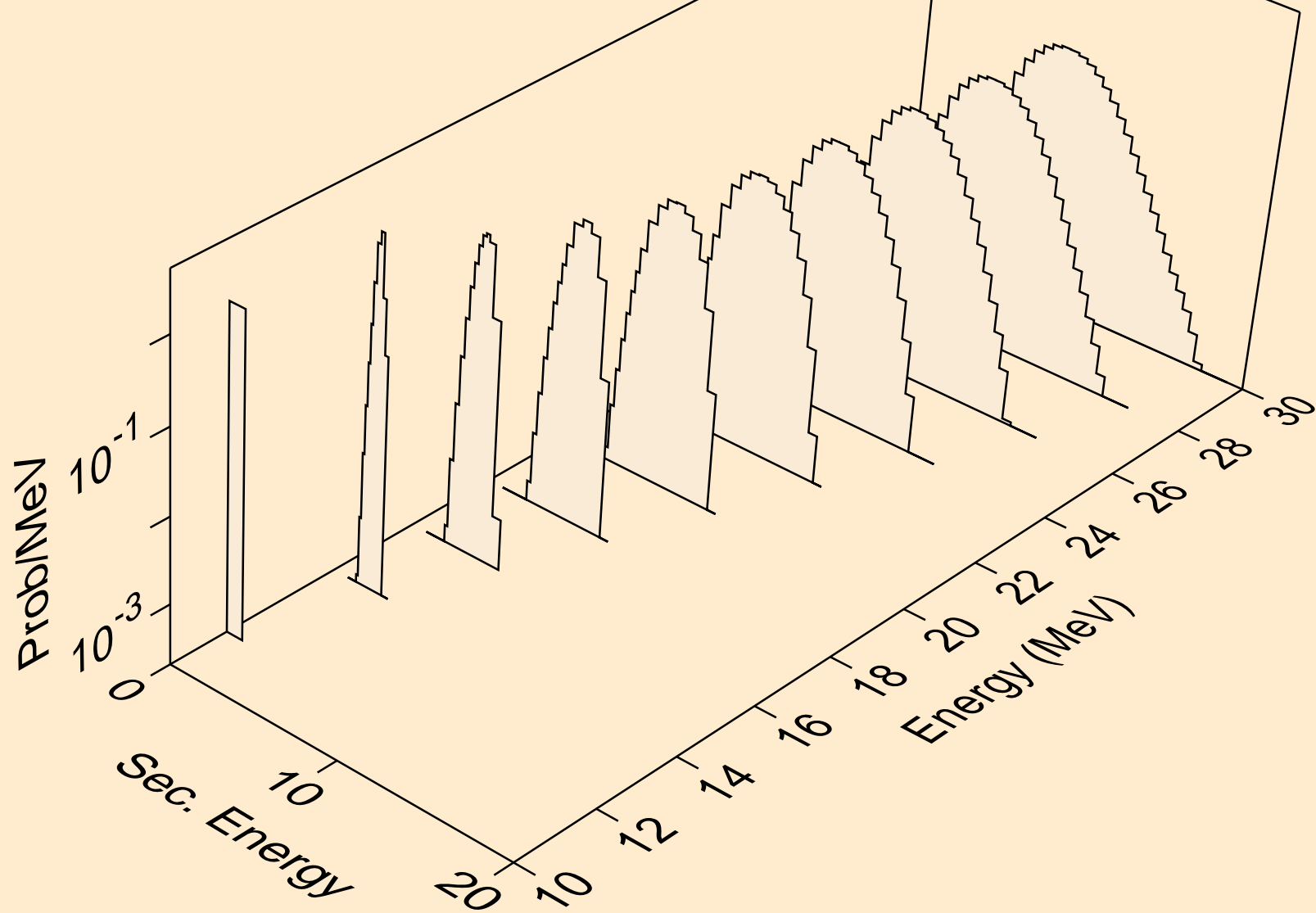



HG183 NEUTRON ACER TENDL-2021 LIBRARY; T=293.6K  
protons from (n,3np)

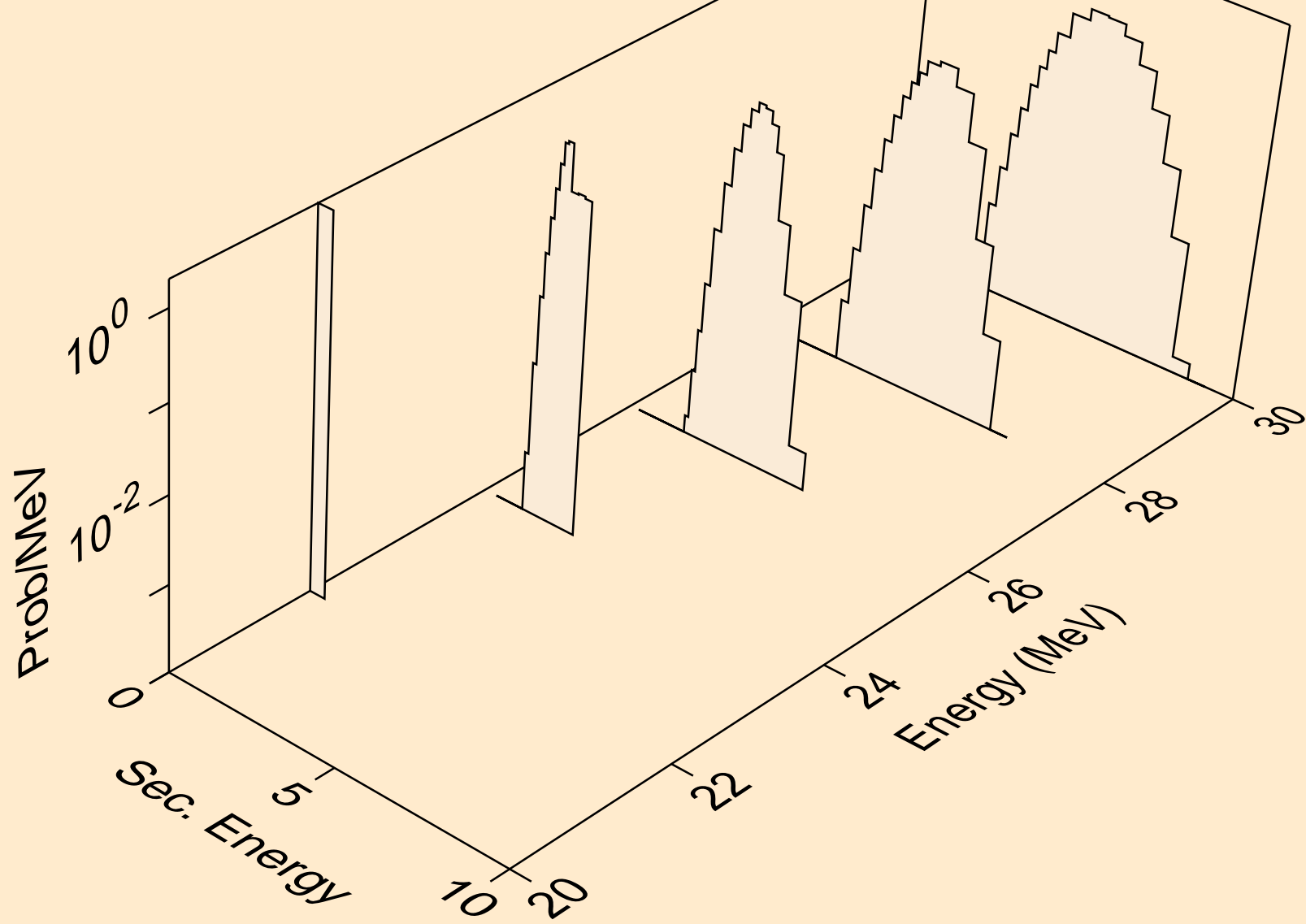

HG183 NEUTRON ACER TENDL-2021 LIBRARY; T=293.6K  
protons from (n,2np)

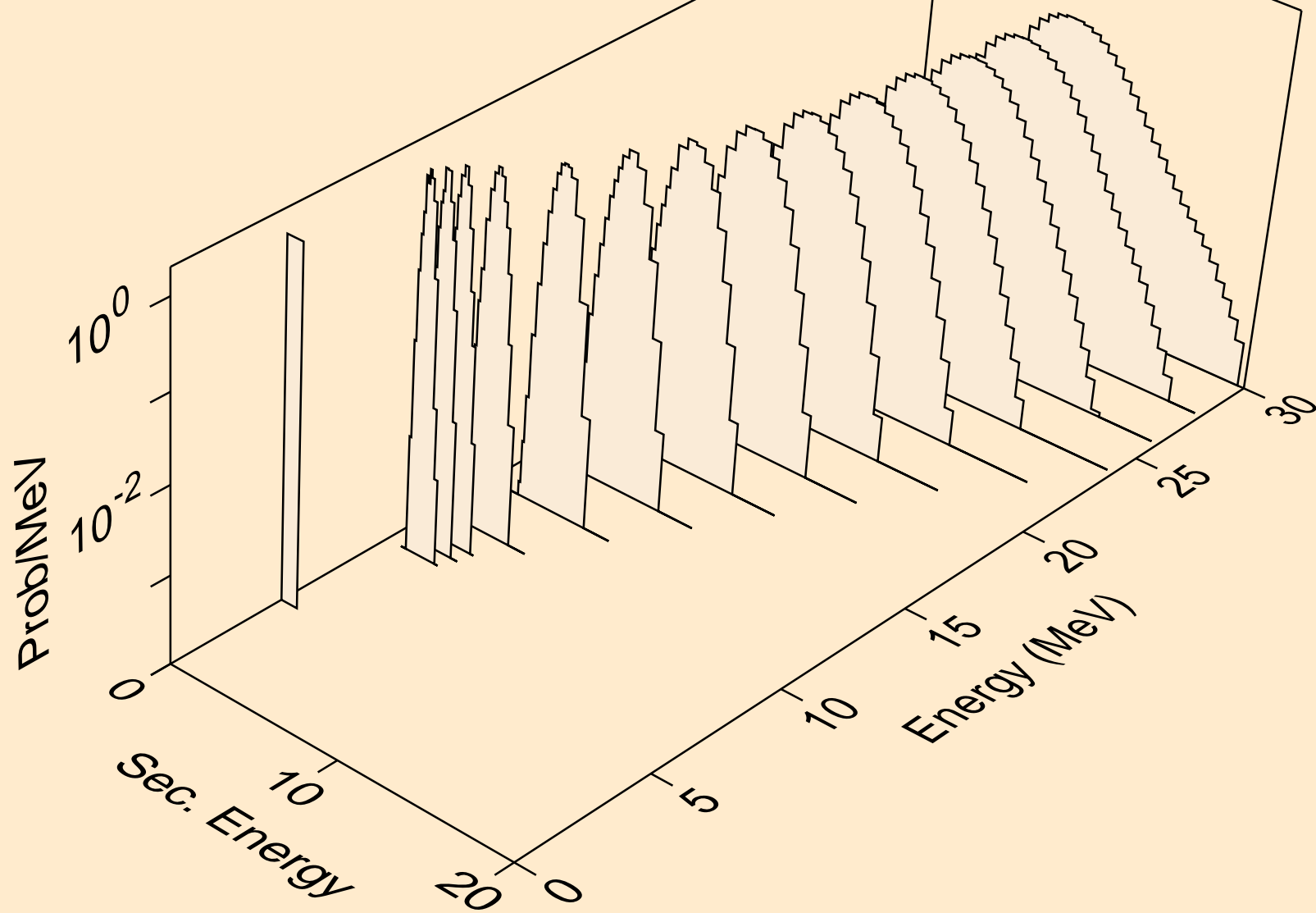

HG183 NEUTRON ACER TENDL-2021 LIBRARY; T=293.6K  
protons from (n,npa)

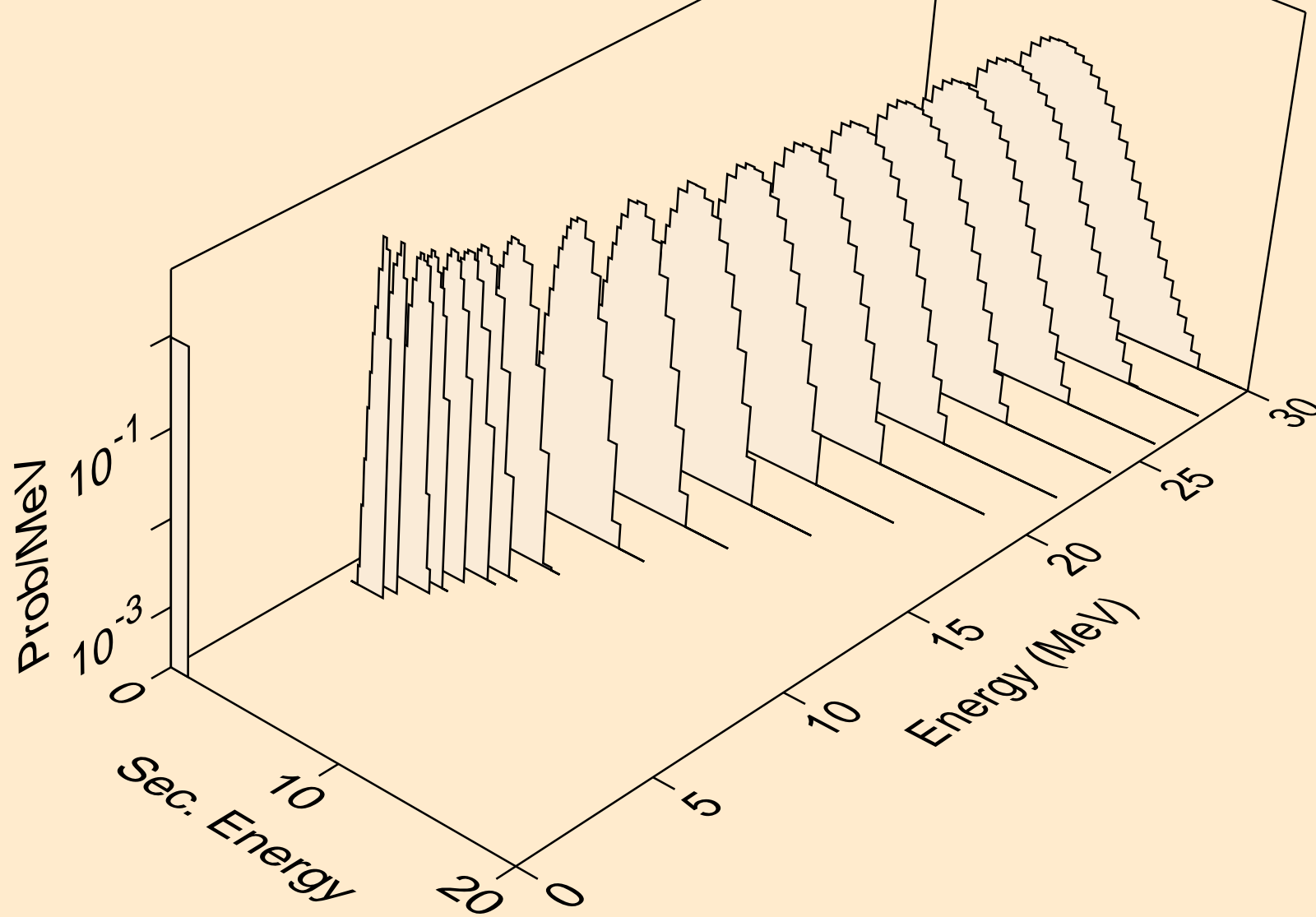

HG183 NEUTRON ACER TENDL-2021 LIBRARY; T=293.6K  
protons from (n,p)

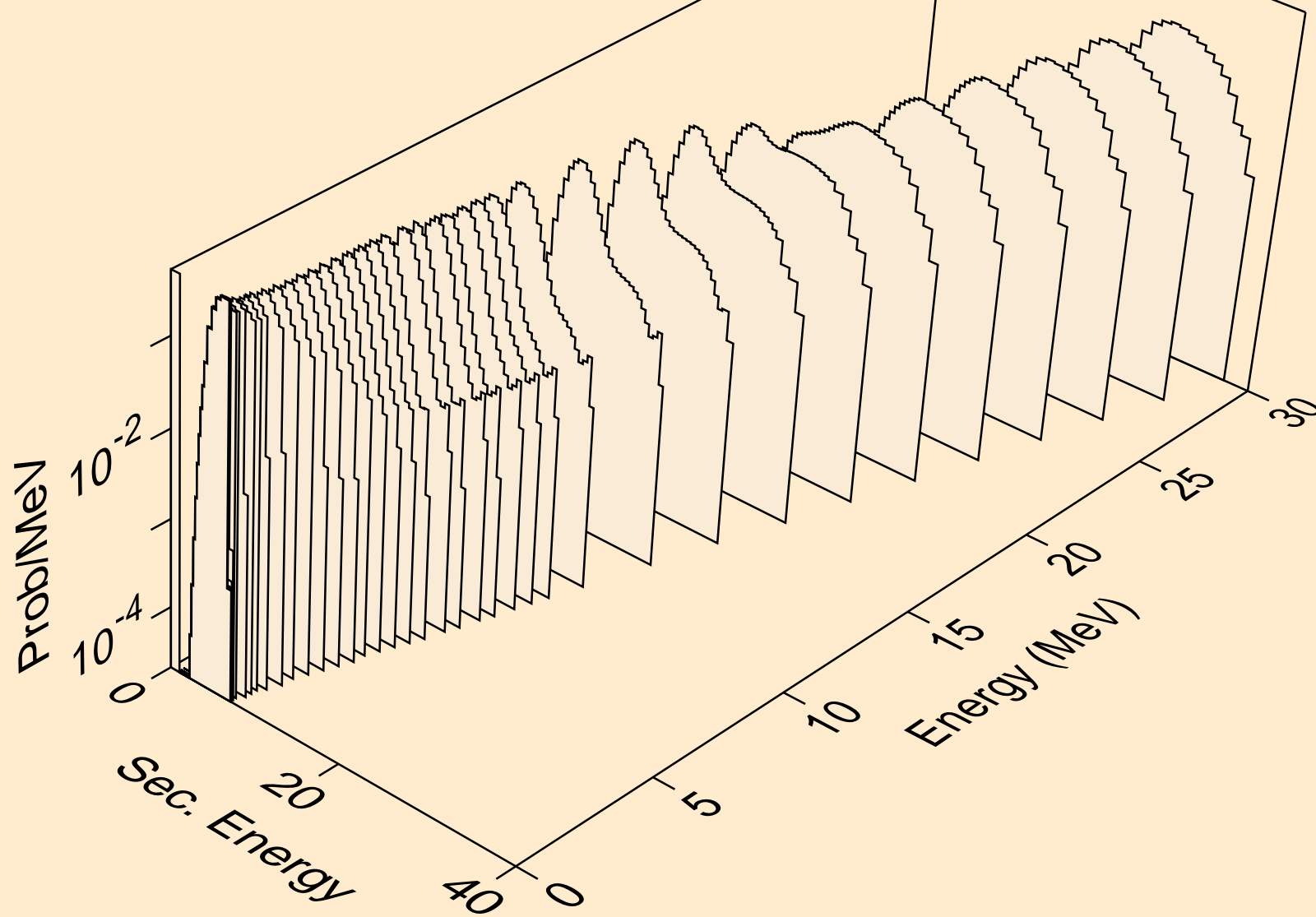

HG183 NEUTRON ACER TENDL-2021 LIBRARY; T=293.6K  
protons from (n,2p)

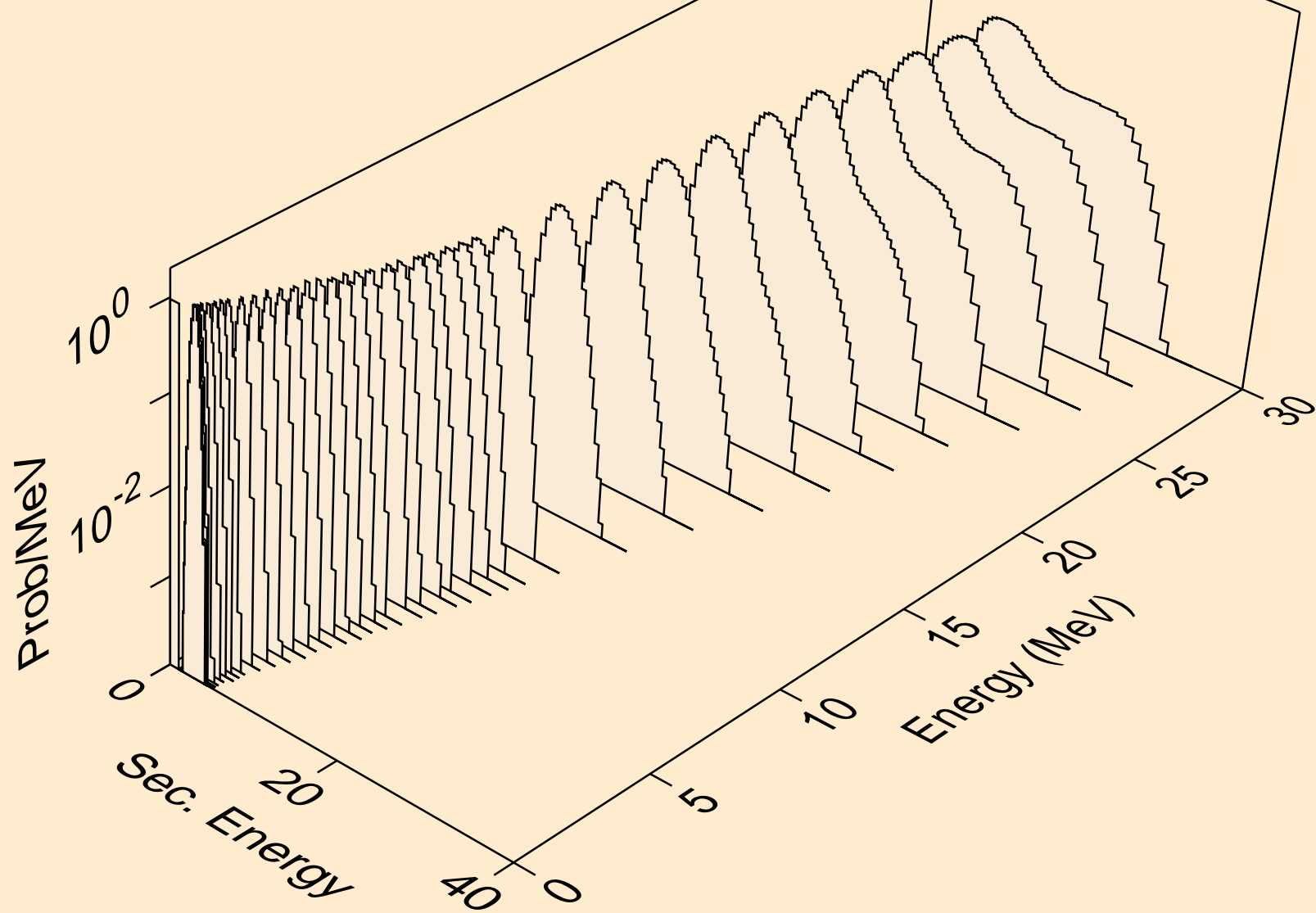

HG183 NEUTRON ACER TENDL-2021 LIBRARY; T=293.6K  
protons from (n,p)

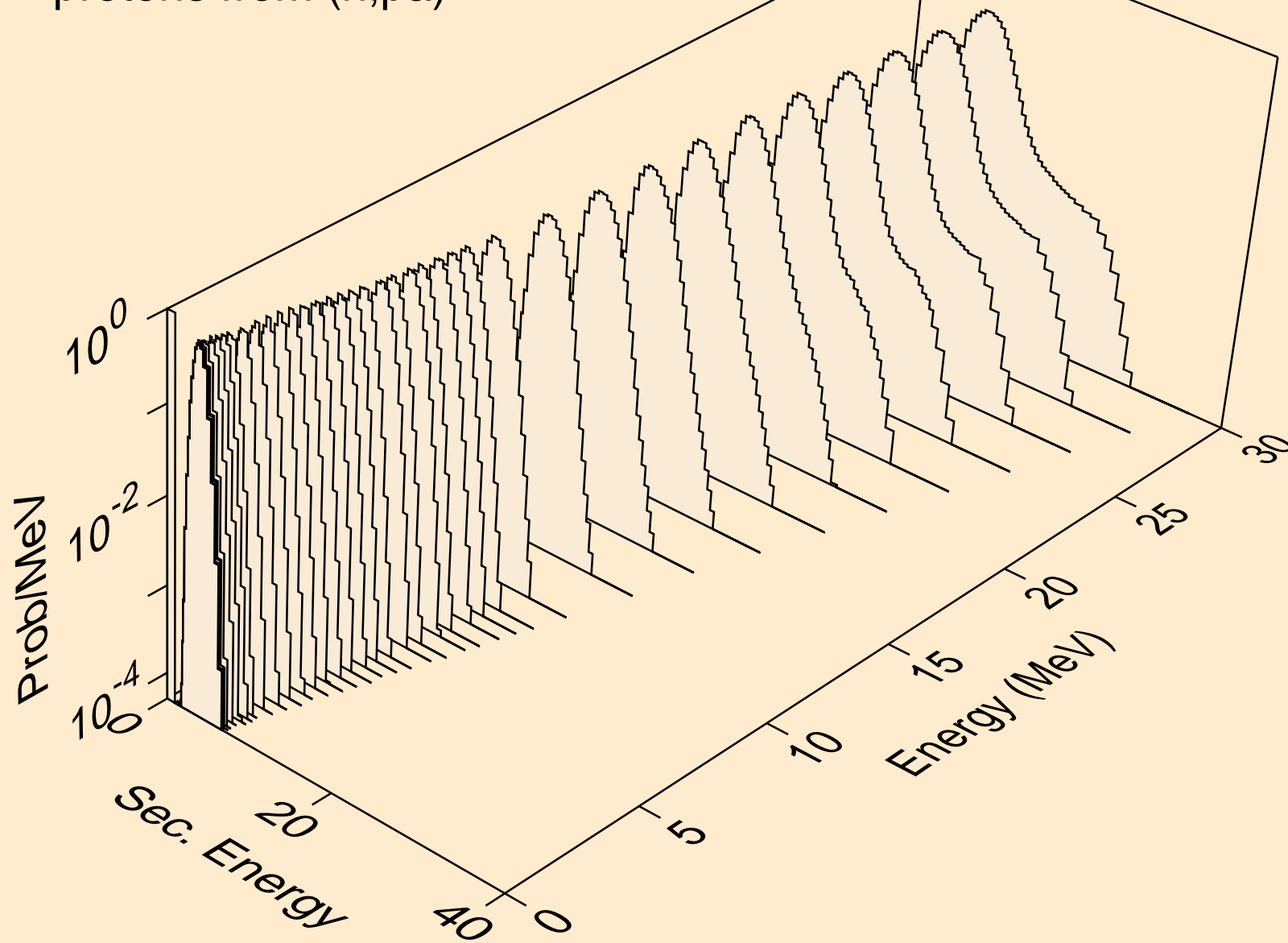

HG183 NEUTRON ACER TENDL-2021 LIBRARY; T=293.6K  
protons from (n,pd)

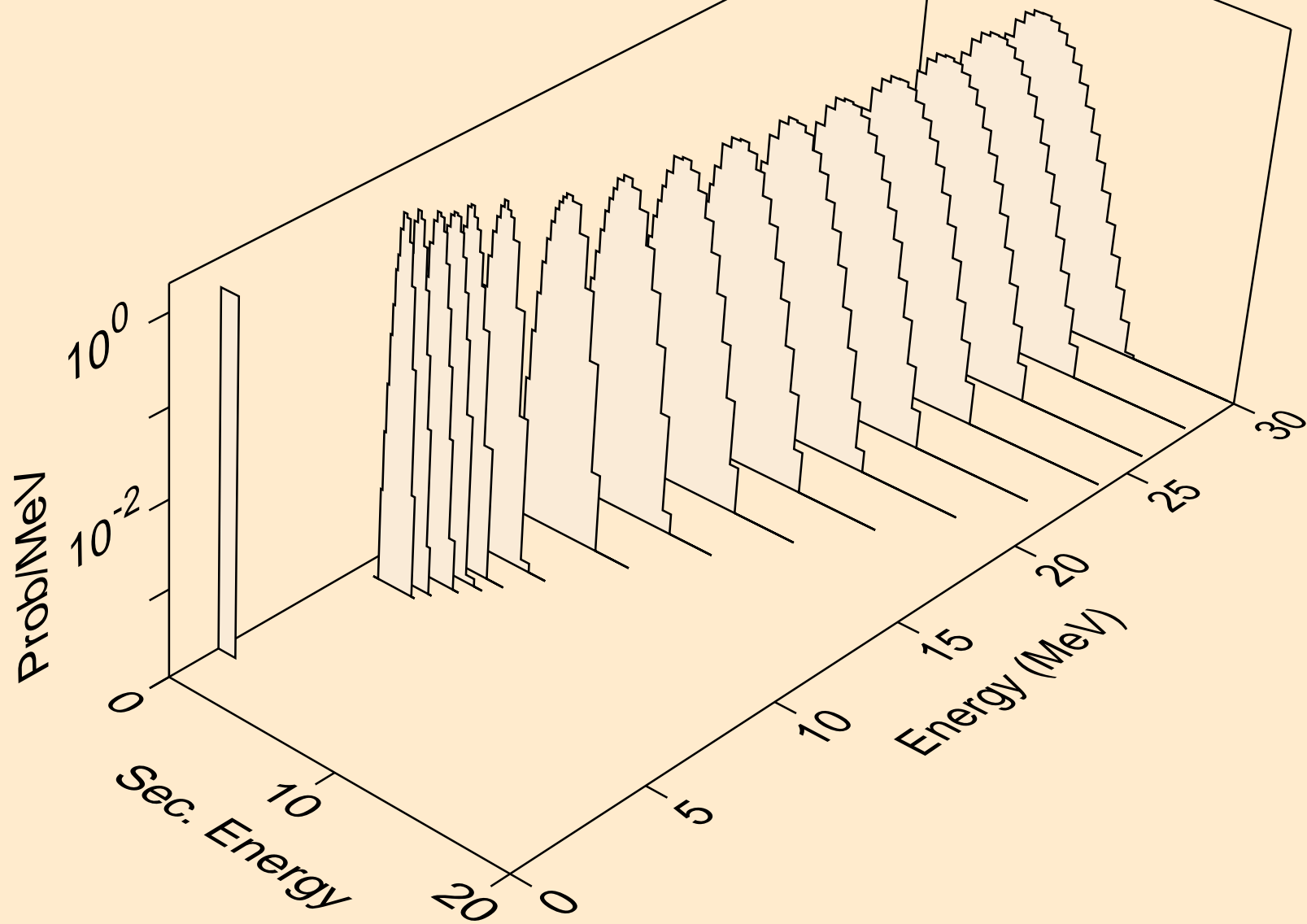

HG183 NEUTRON ACER TENDL-2021 LIBRARY; T=293.6K  
protons from (n,pt)

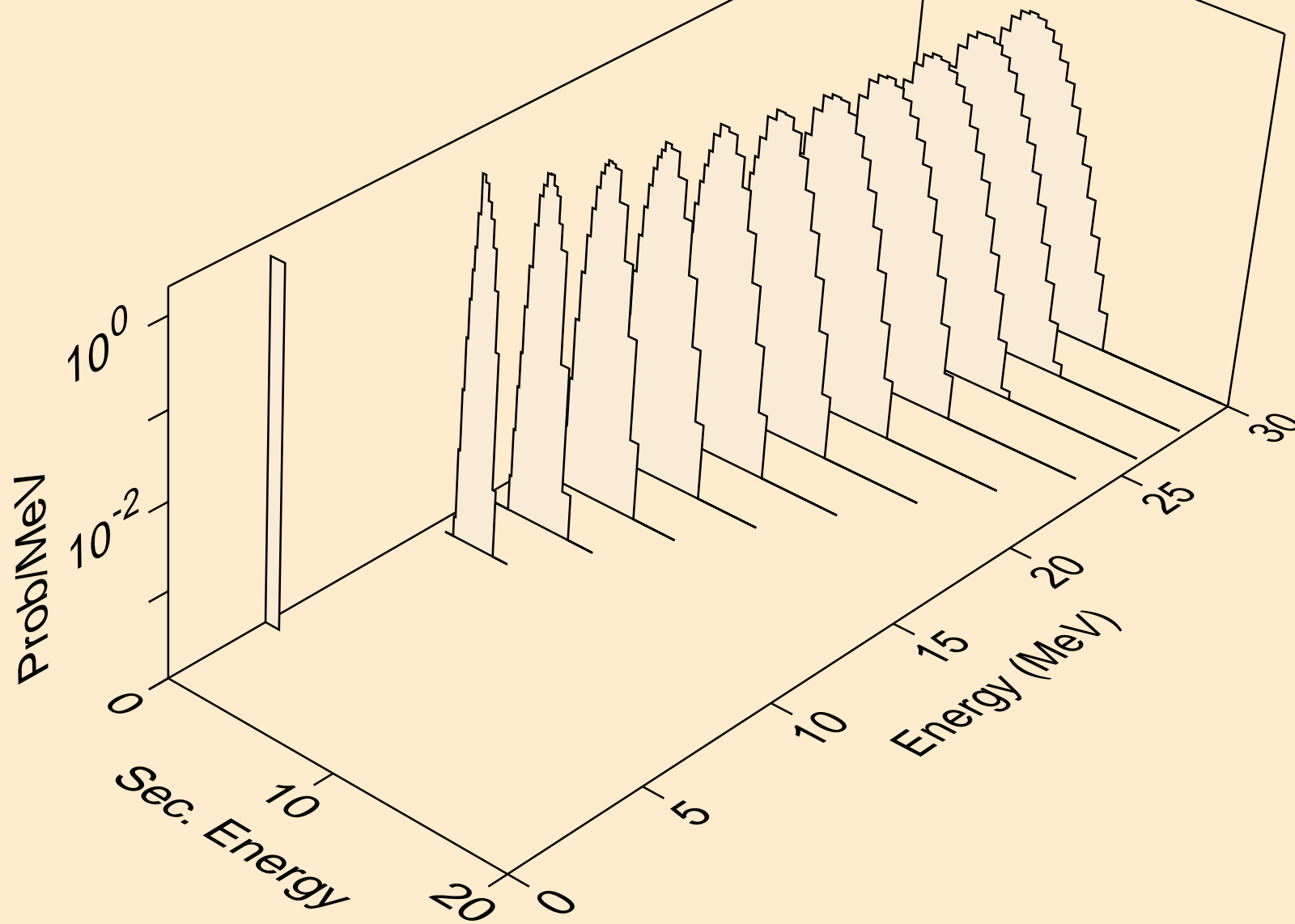



HG183 NEUTRON ACER TENDL-2021 LIBRARY; T=293.6K  
deuterons from (n,x)

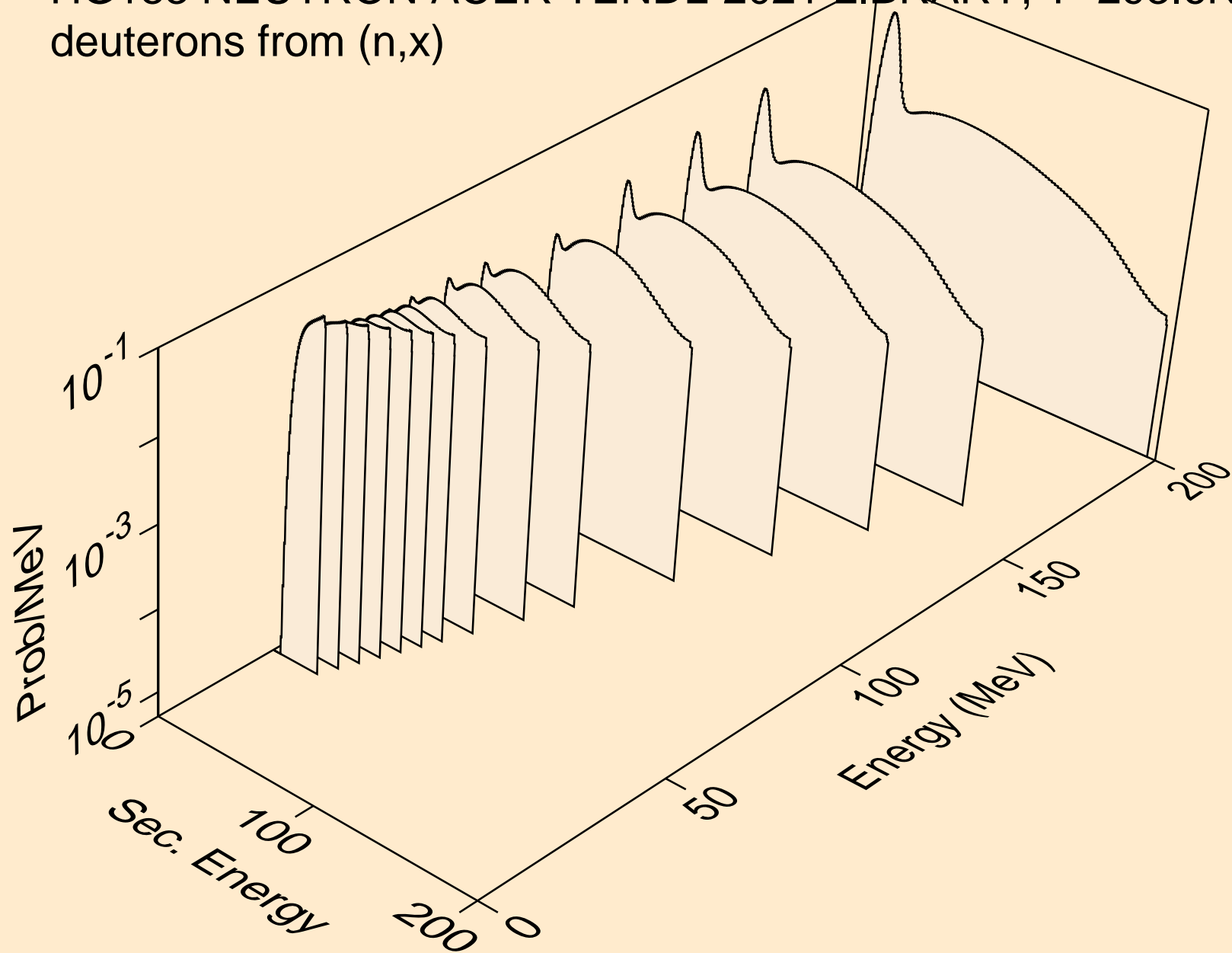

HG183 NEUTRON ACER TENDL-2021 LIBRARY; T=293.6K  
deuterons from (n,2nd)

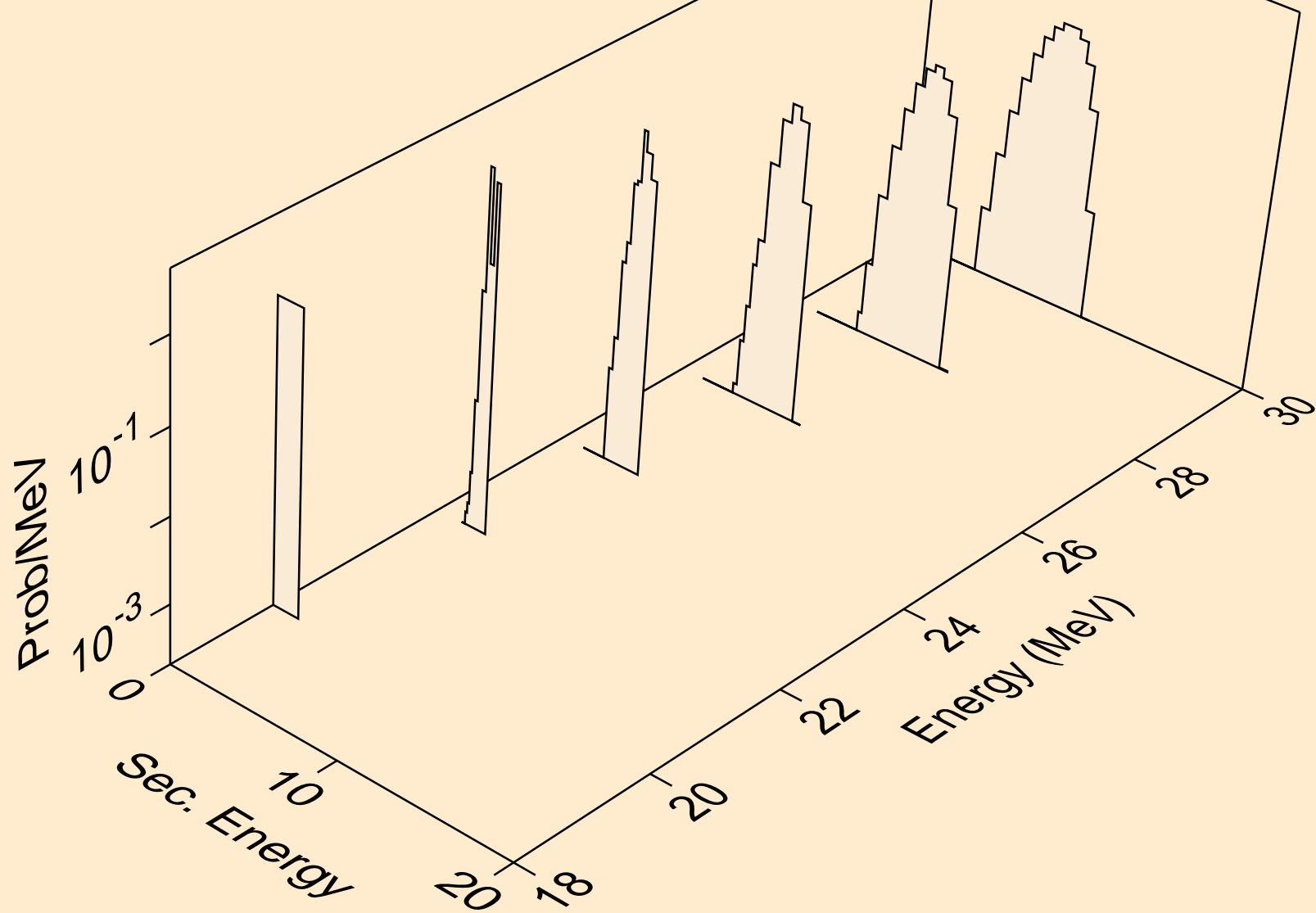

HG183 NEUTRON ACER TENDL-2021 LIBRARY; T=293.6K  
deuterons from (n,n\*)d

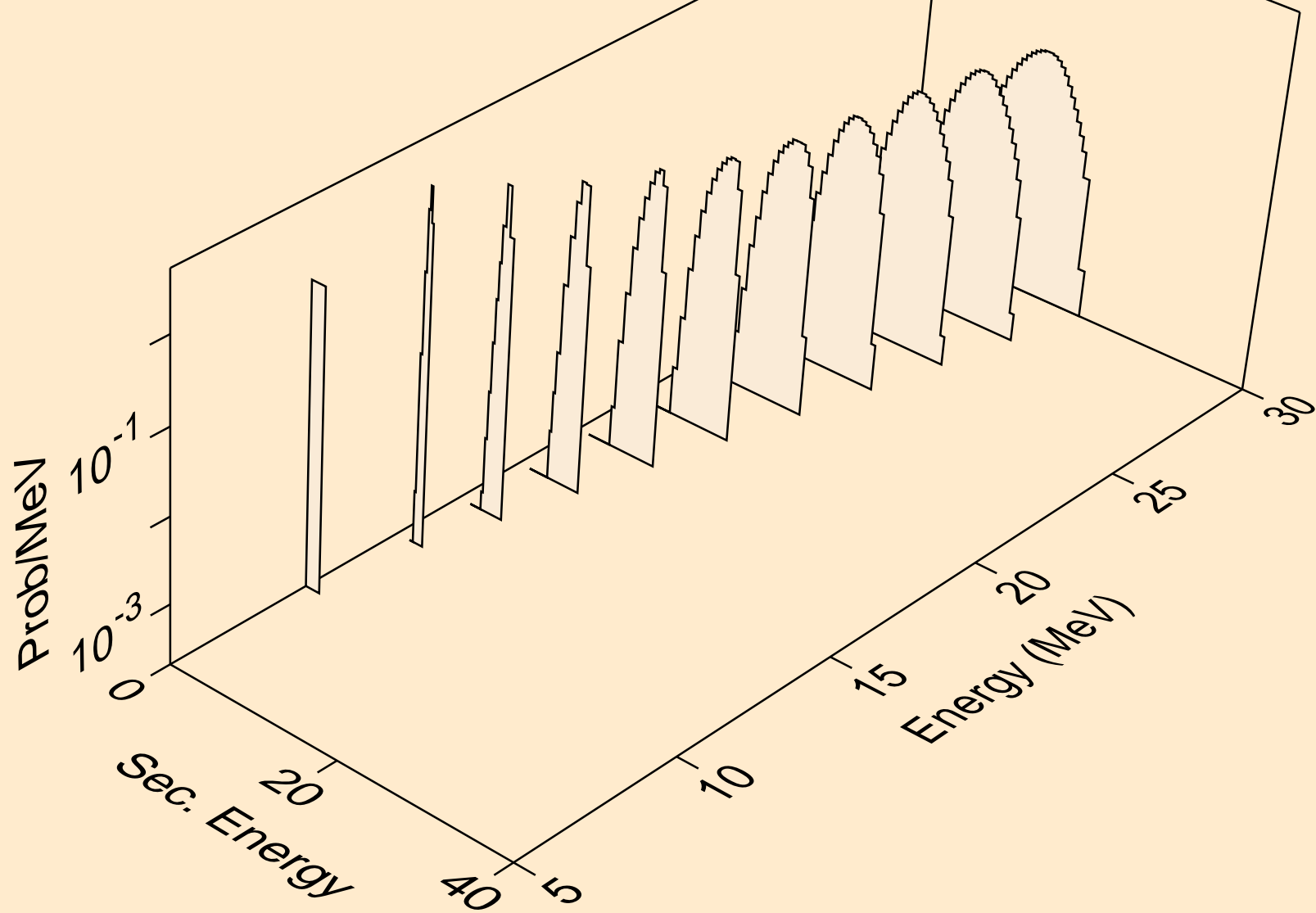

HG183 NEUTRON ACER TENDL-2021 LIBRARY; T=293.6K  
deuterons from (n,d)

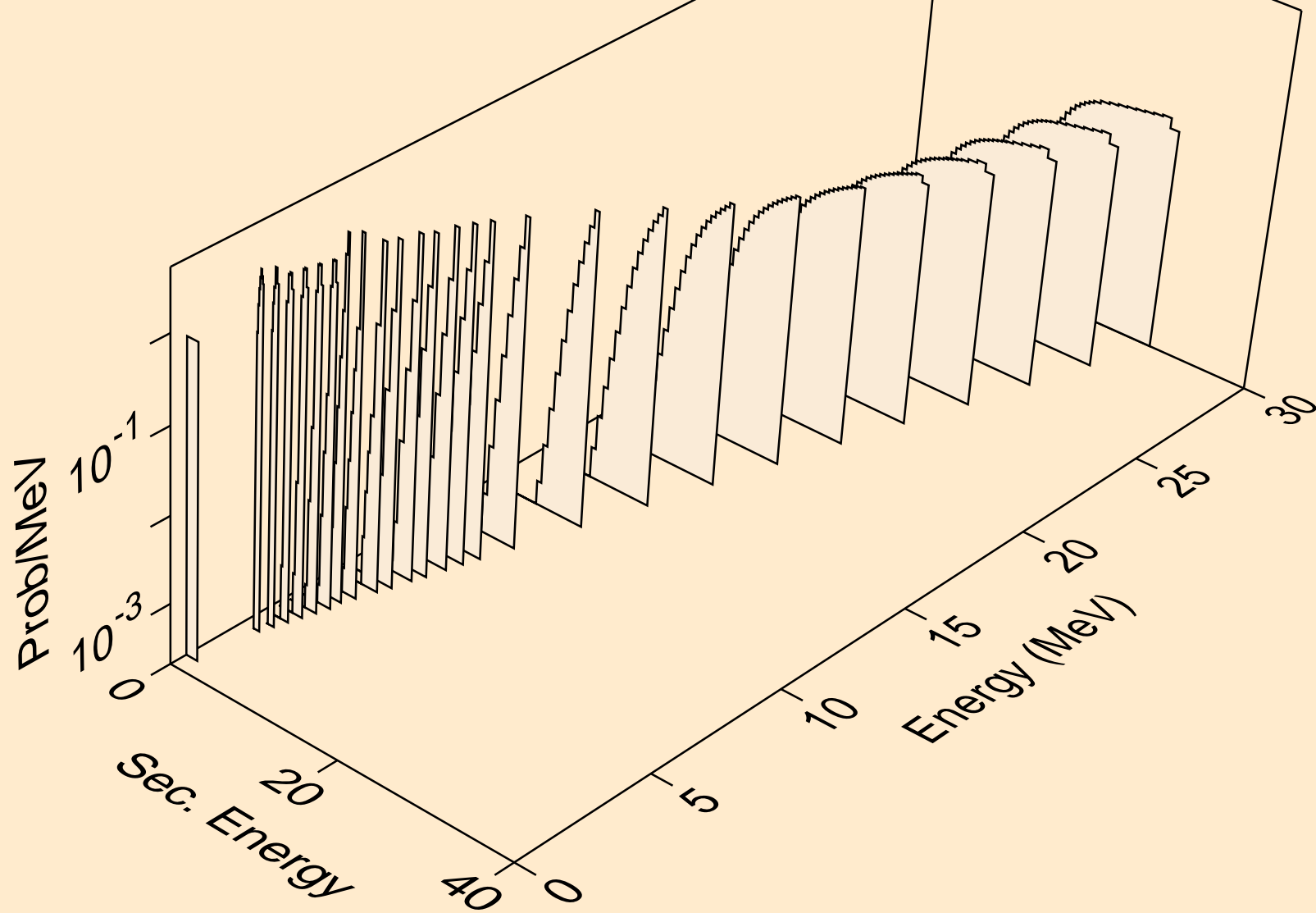

HG183 NEUTRON ACER TENDL-2021 LIBRARY; T=293.6K  
deuterons from (n,d2a)

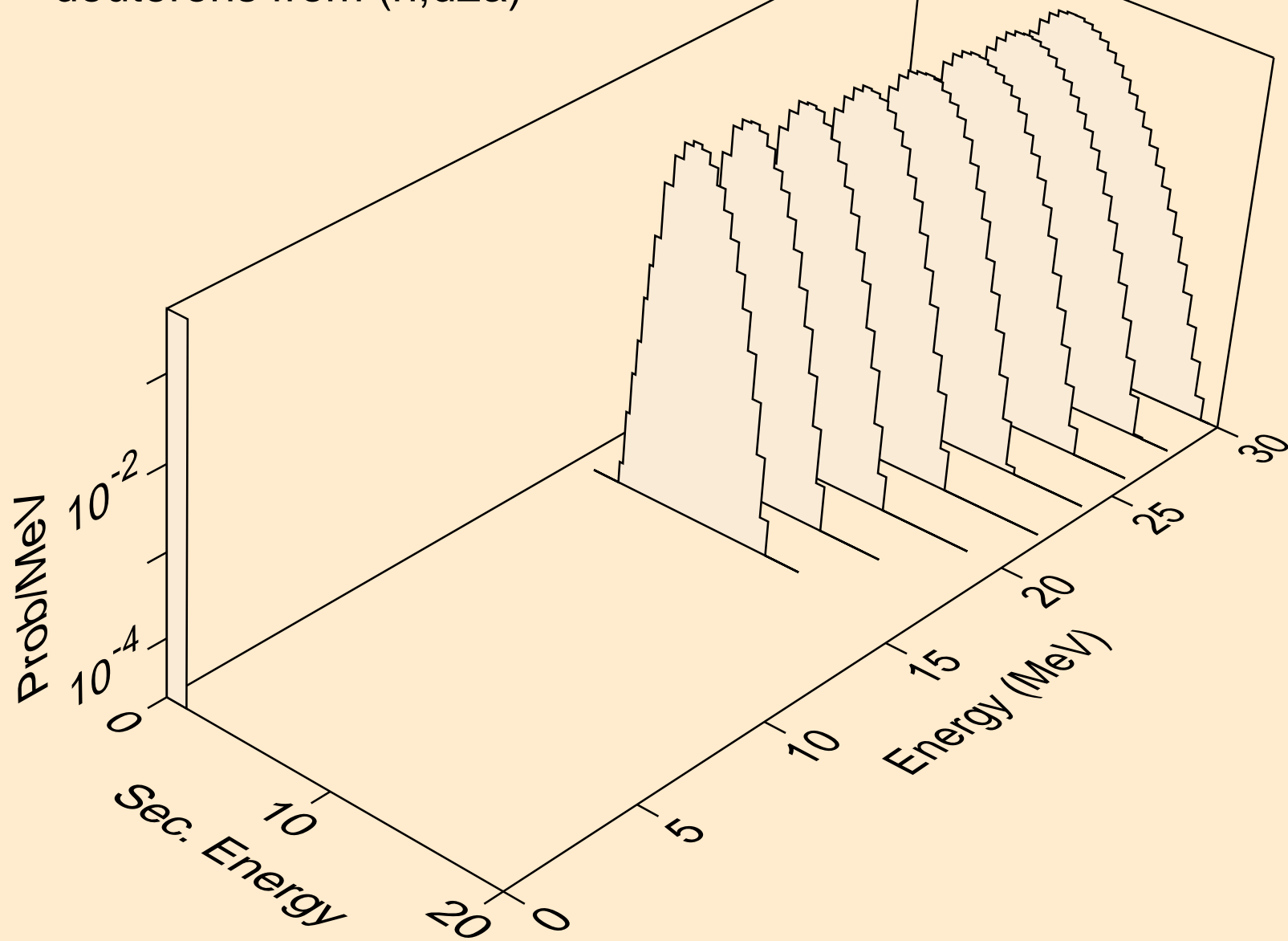

HG183 NEUTRON ACER TENDL-2021 LIBRARY; T=293.6K  
deuterons from (n,pd)

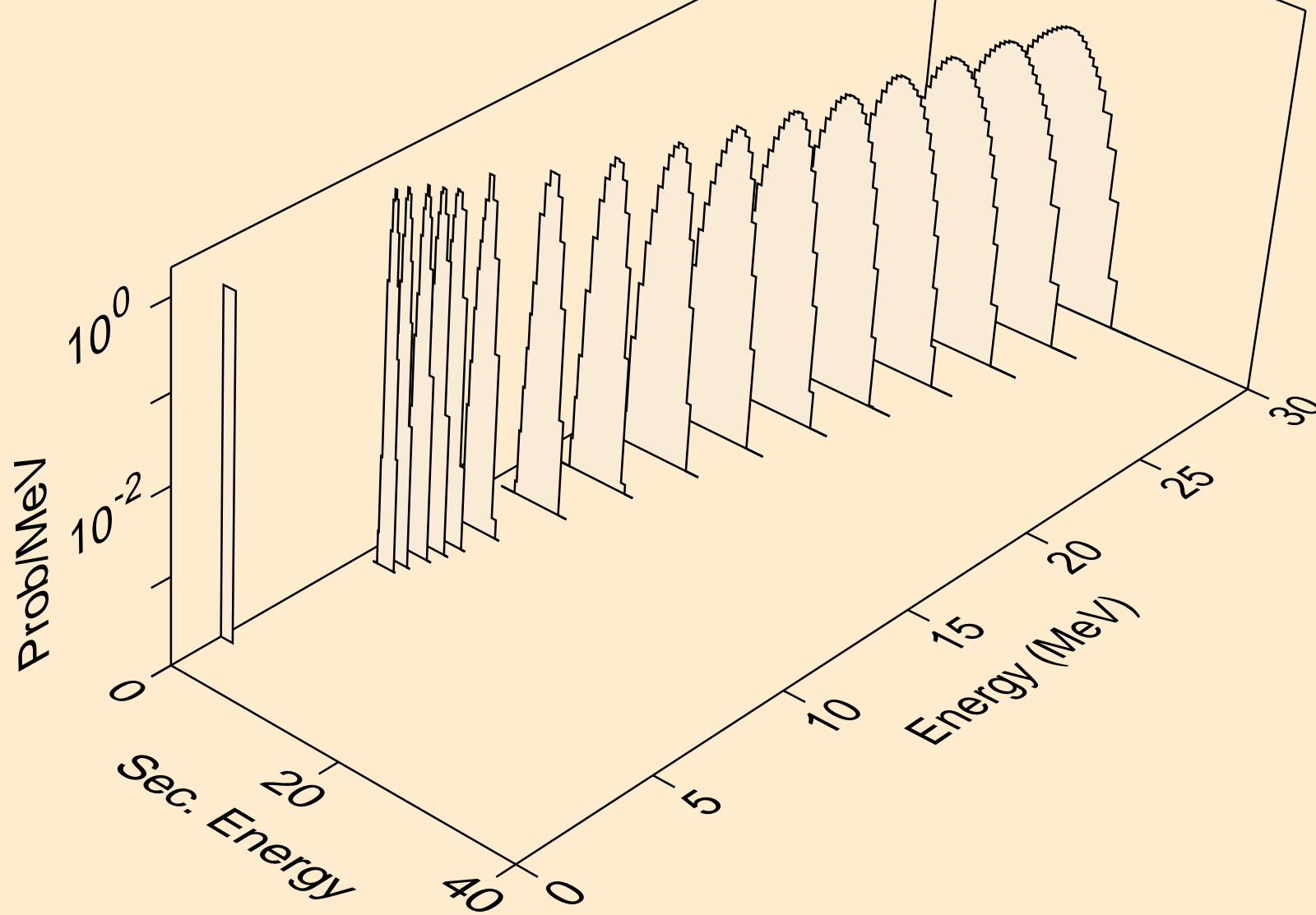

HG183 NEUTRON ACER TENDL-2021 LIBRARY; T=293.6K  
deuterons from (n,da)

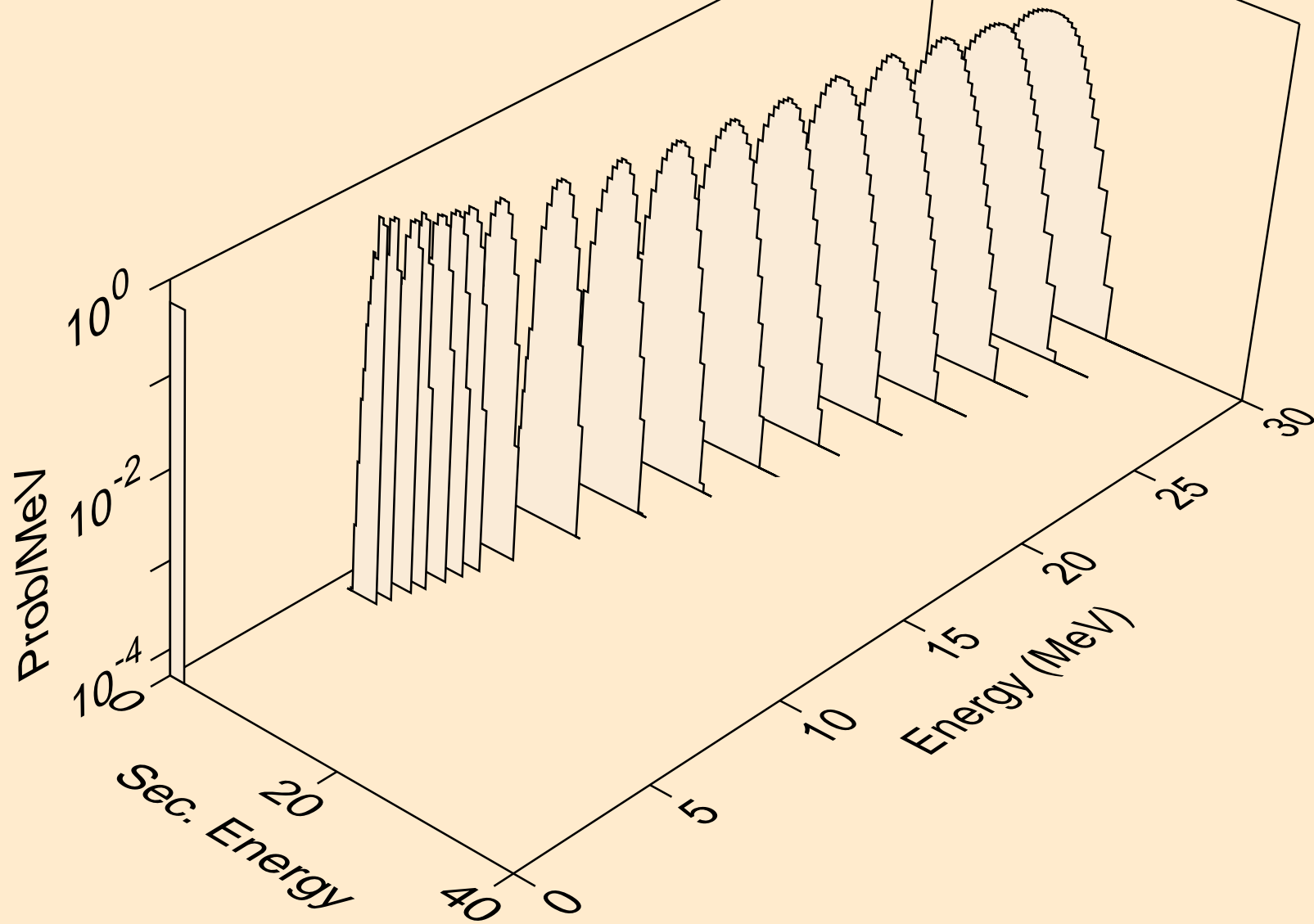

HG183 NEUTRON ACER TENDL-2021 LIBRARY; T=293.6K  
tritons from (n,x)

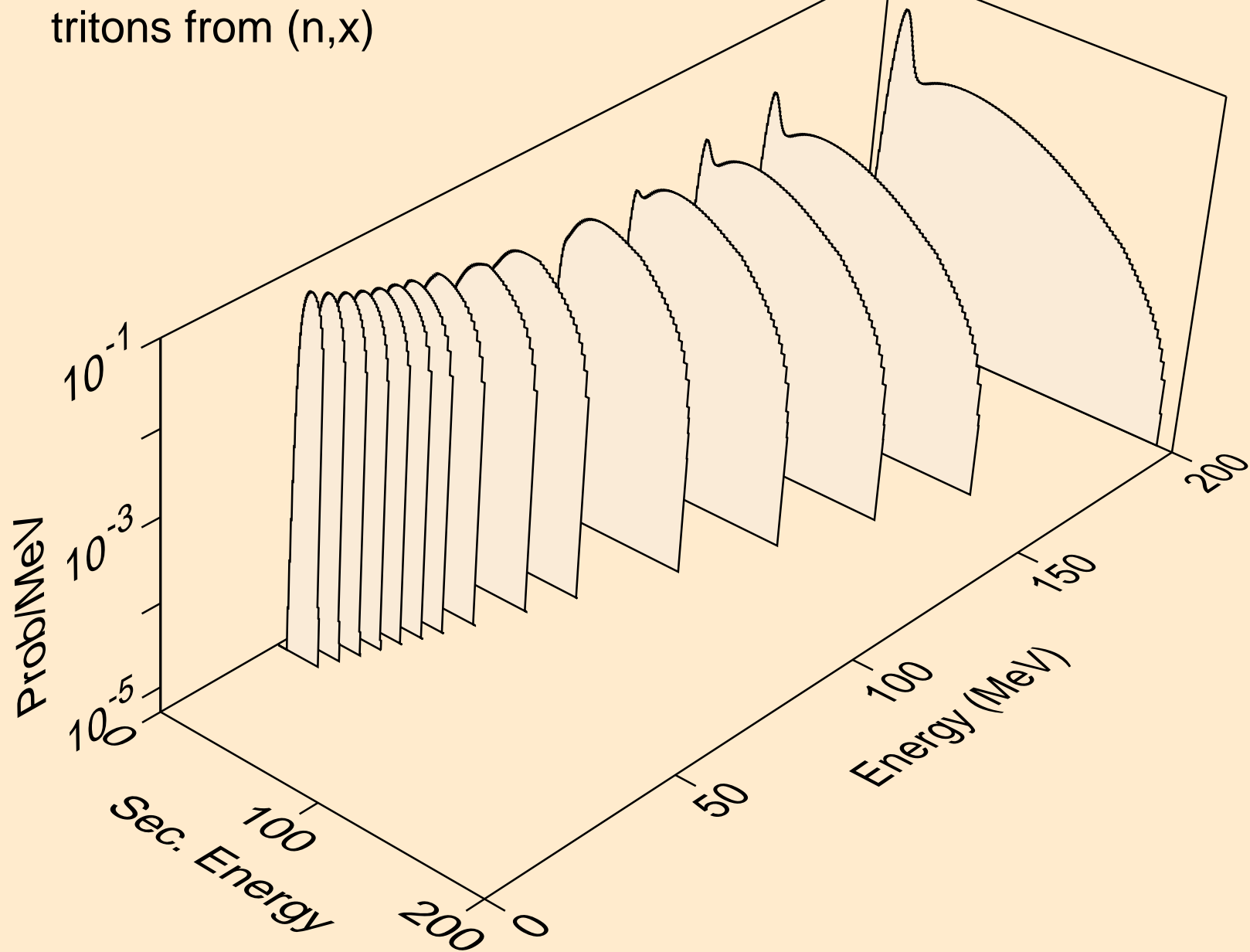



HG183 NEUTRON ACER TENDL-2021 LIBRARY; T=293.6K  
tritons from (n,n\*)t

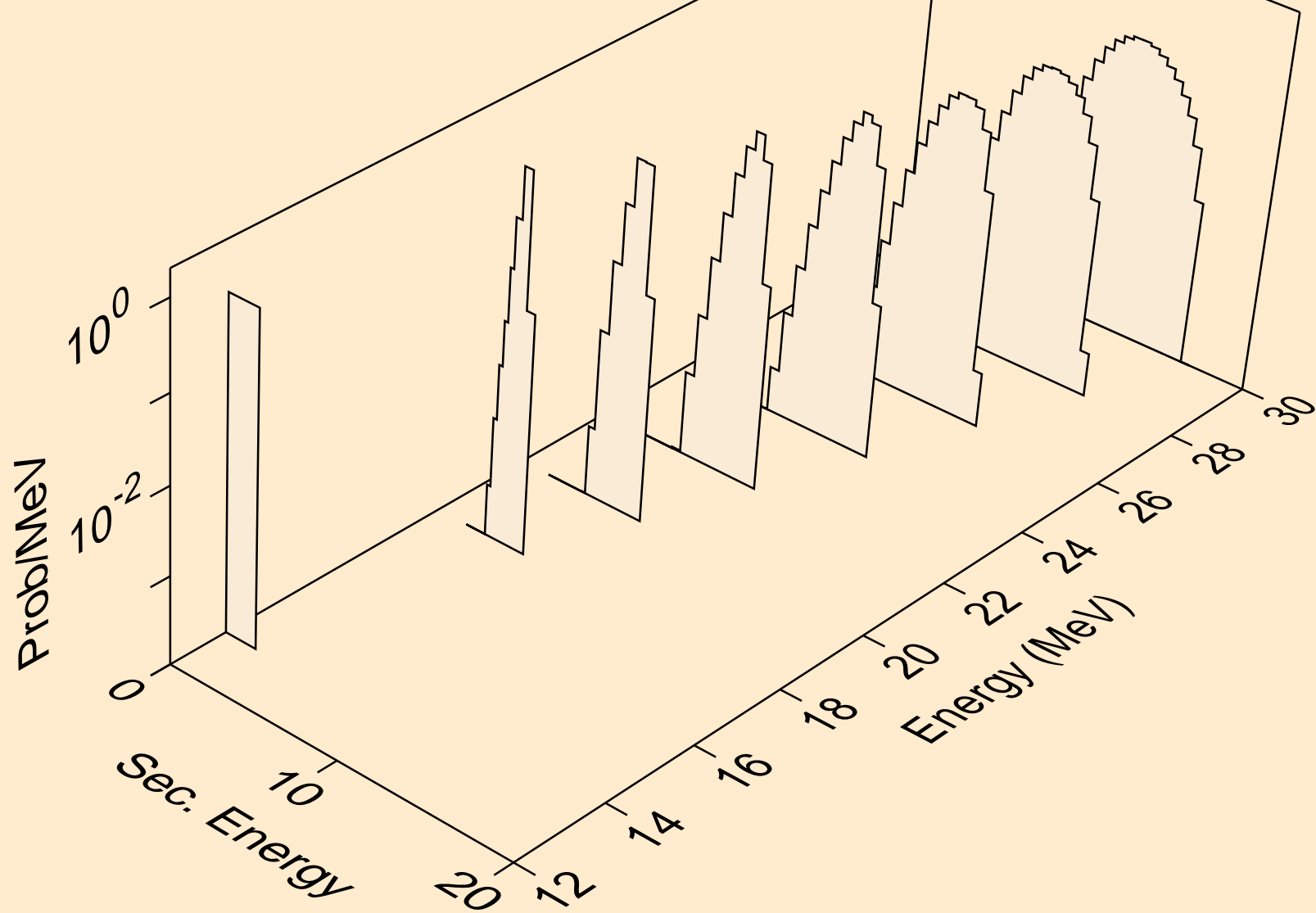

HG183 NEUTRON ACER TENDL-2021 LIBRARY; T=293.6K  
tritons from (n,t)

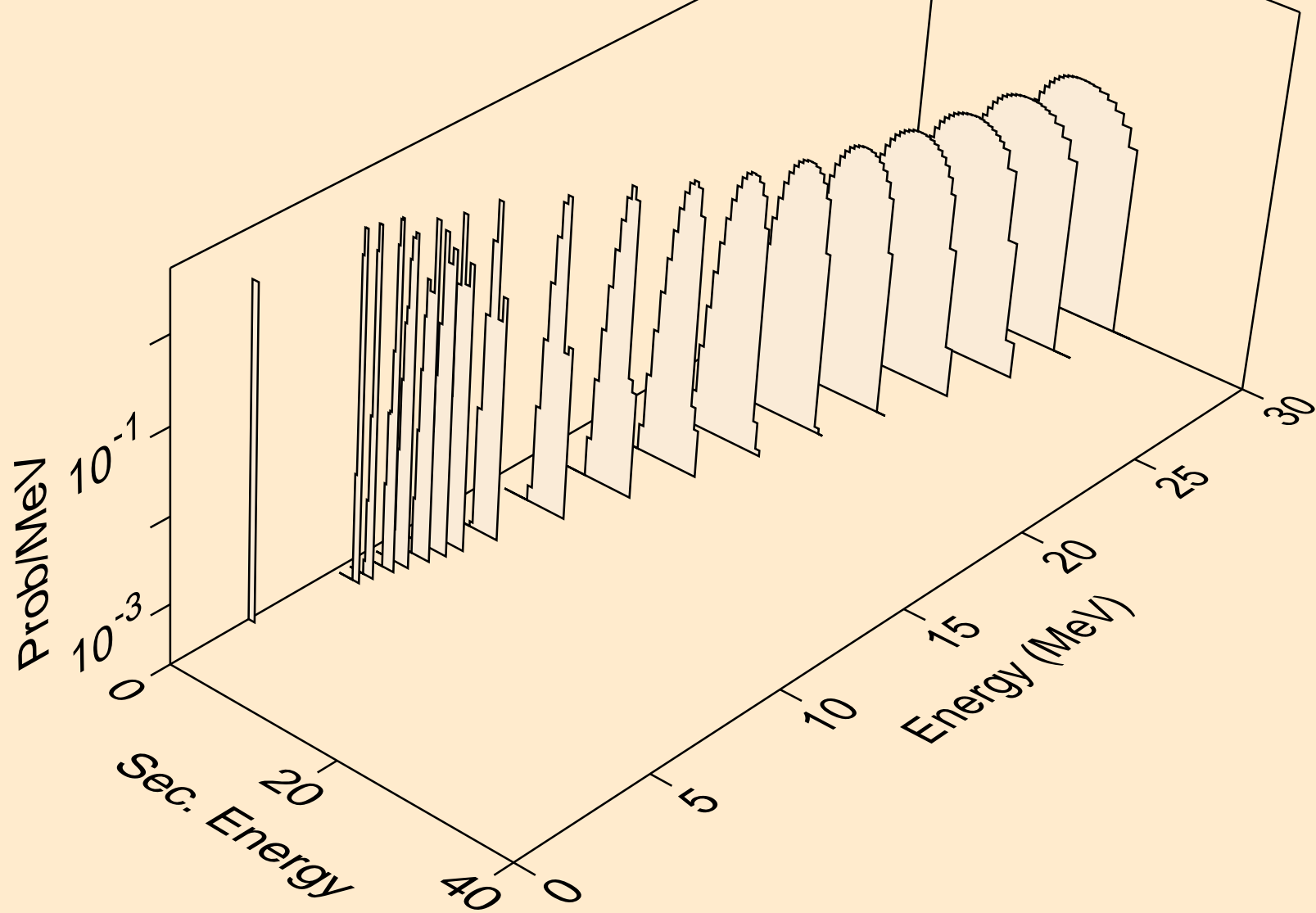

HG183 NEUTRON ACER TENDL-2021 LIBRARY; T=293.6K  
tritons from (n,pt)

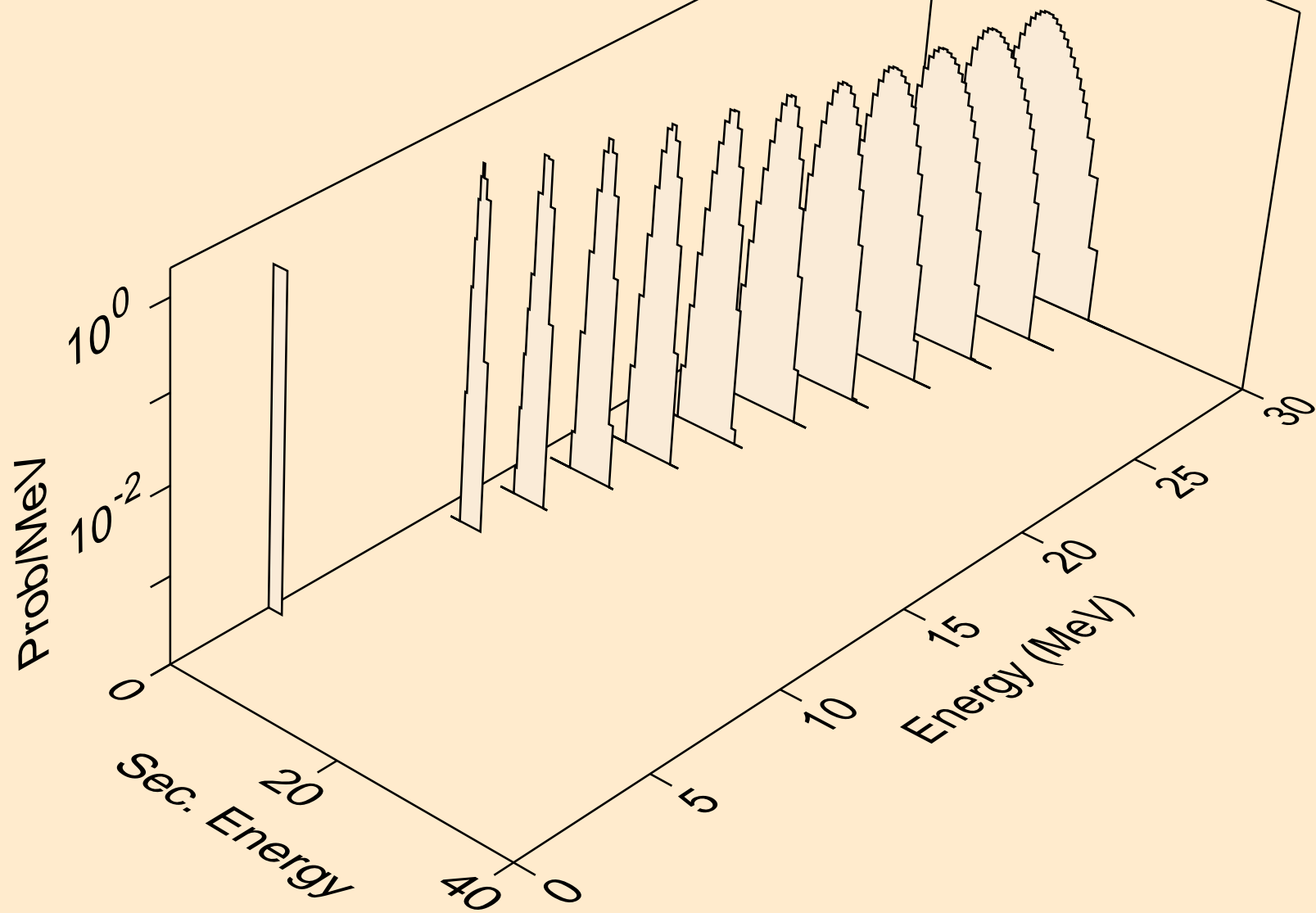

HG183 NEUTRON ACER TENDL-2021 LIBRARY; T=293.6K  
he3s from (n,x)

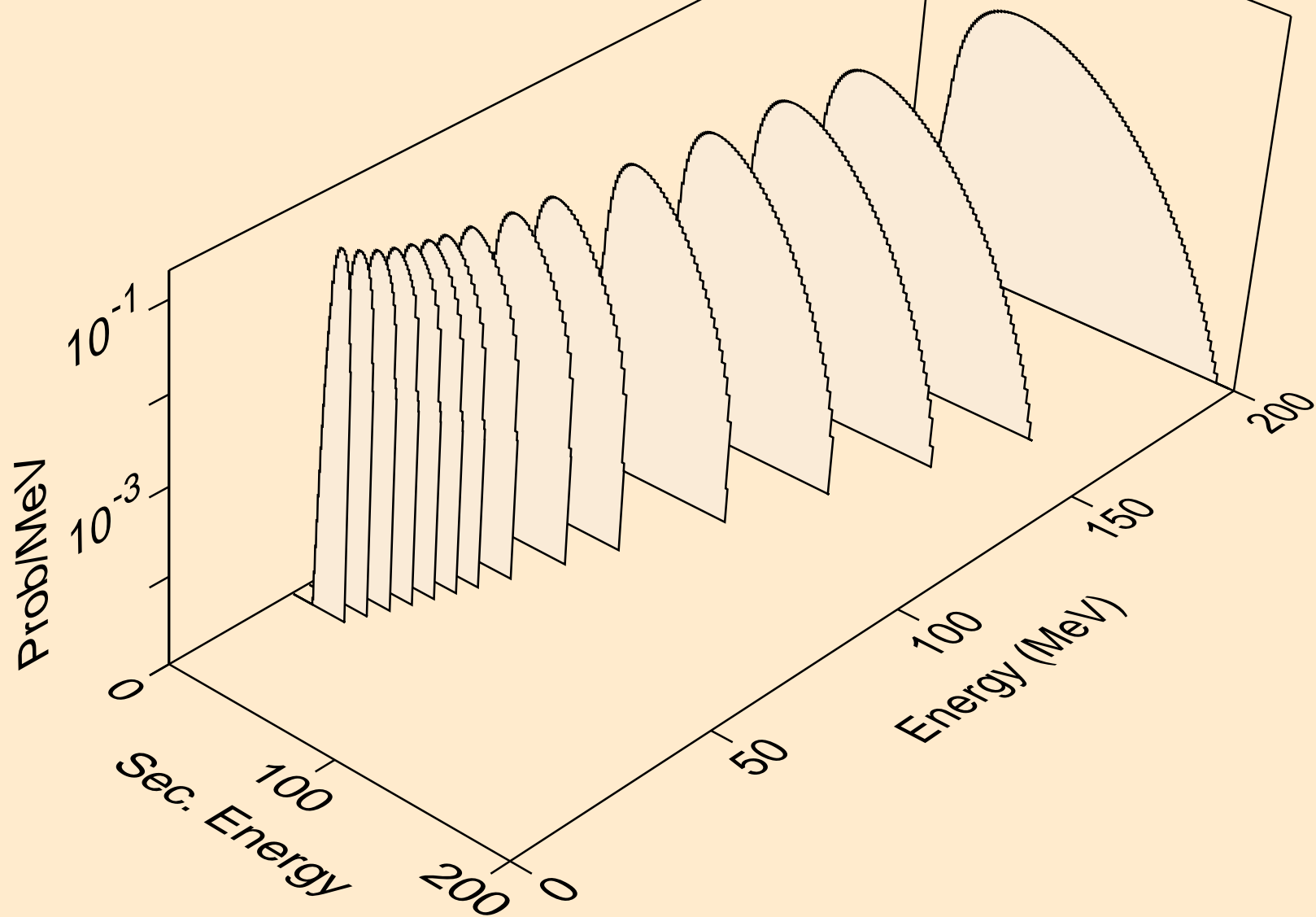

HG183 NEUTRON ACER TENDL-2021 LIBRARY; T=293.6K  
he3s from (n,n\*)he3

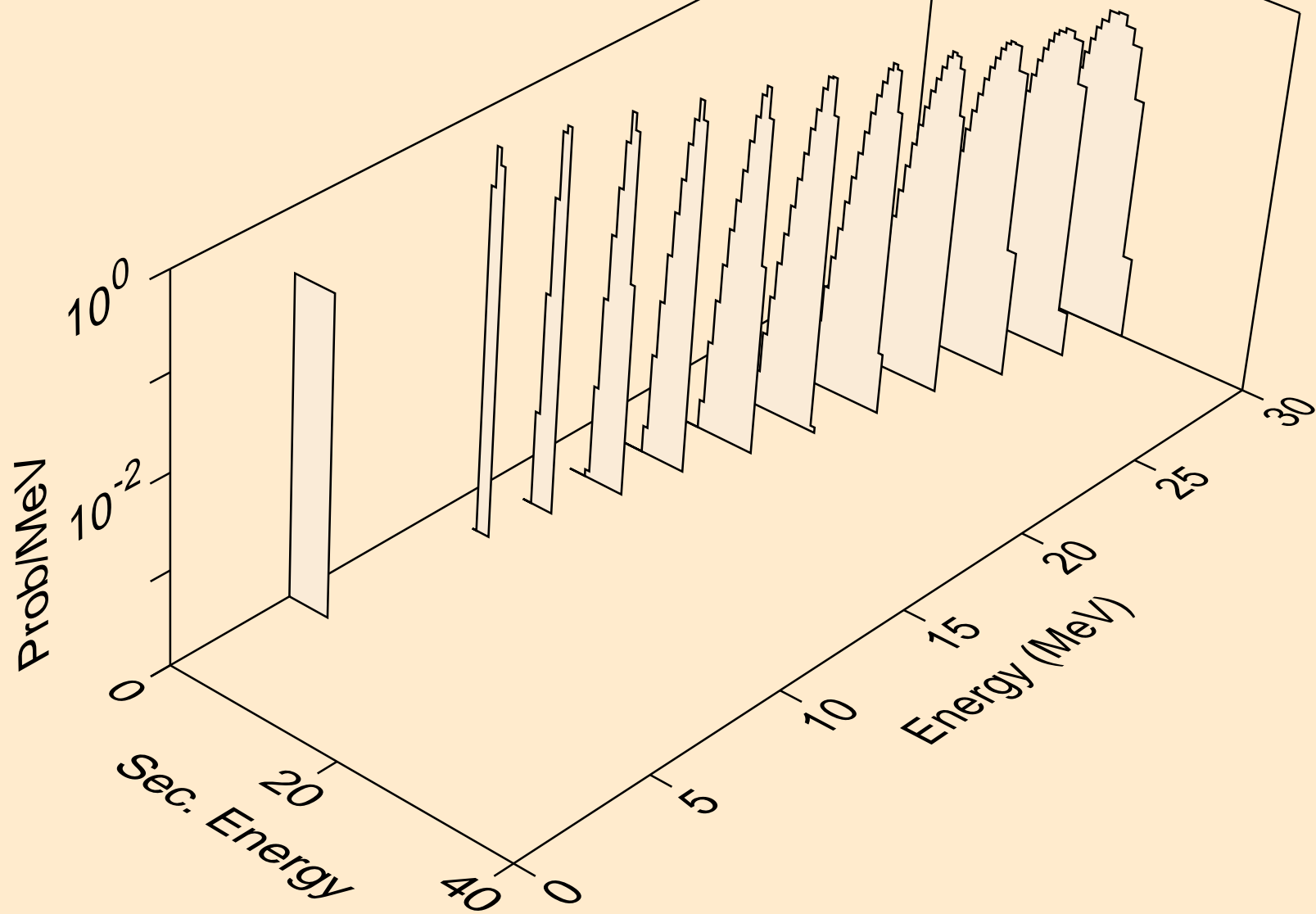

HG183 NEUTRON ACER TENDL-2021 LIBRARY; T=293.6K  
he3s from (n,he3)

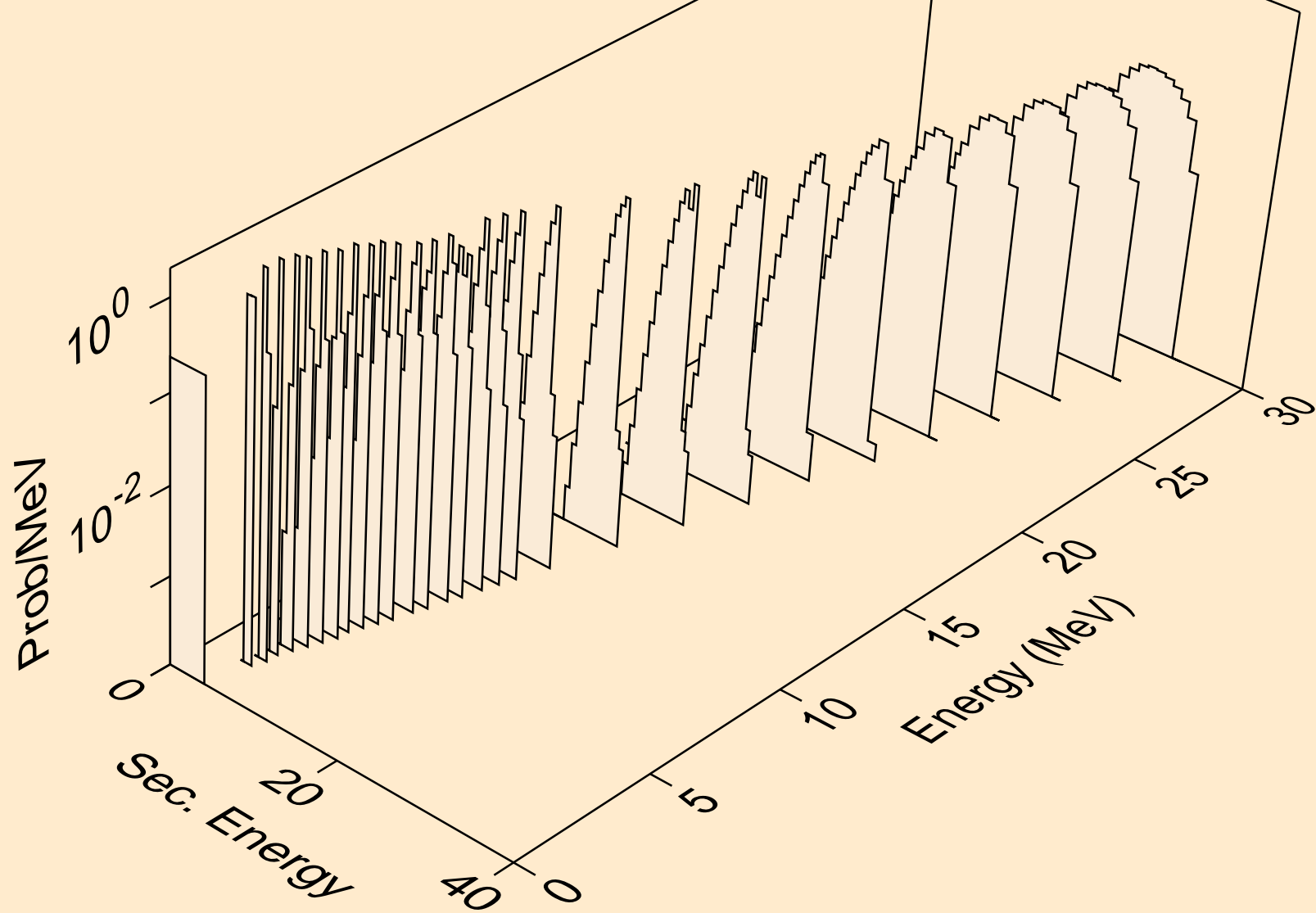

HG183 NEUTRON ACER TENDL-2021 LIBRARY; T=293.6K  
alphas from (n,x)

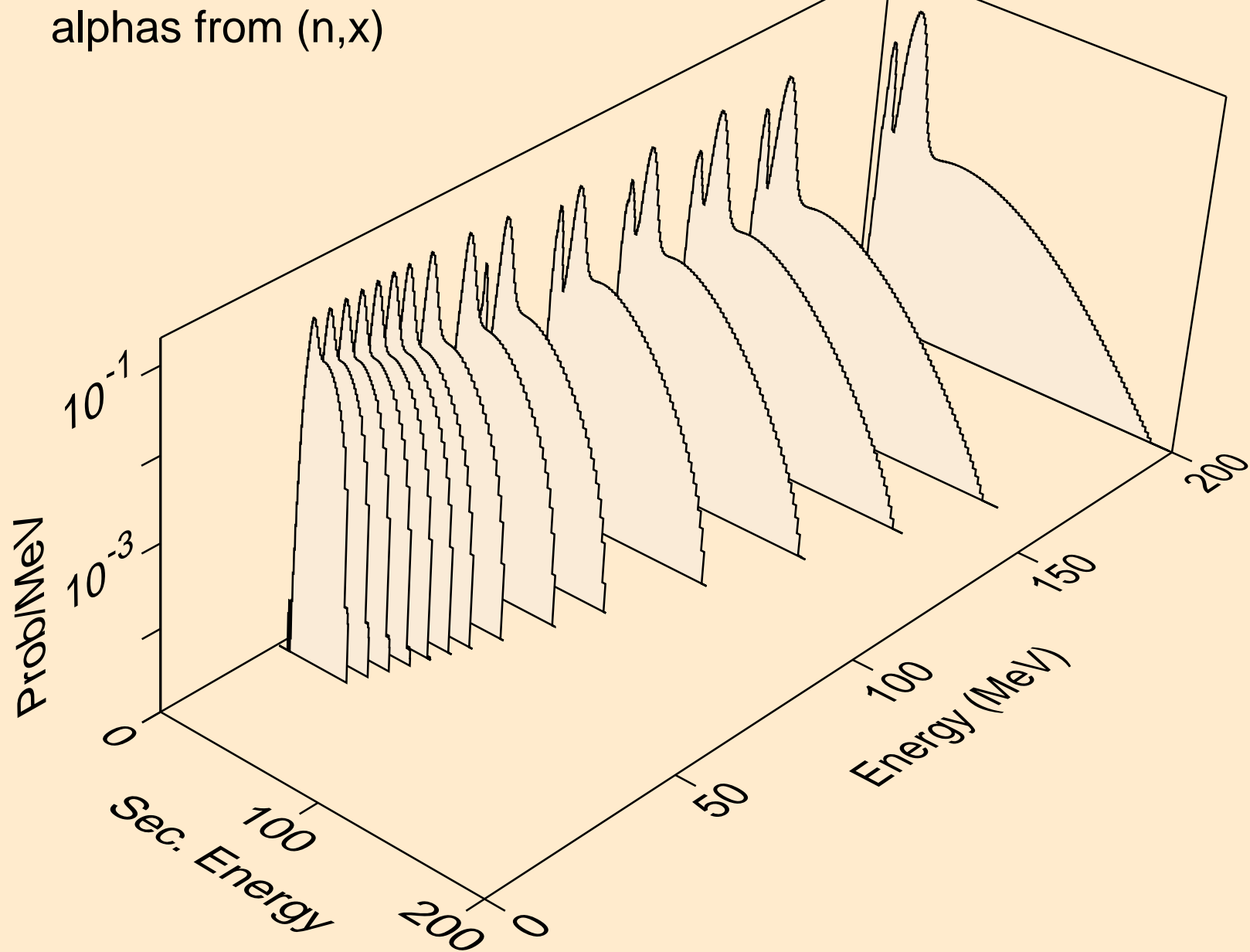

HG183 NEUTRON ACER TENDL-2021 LIBRARY; T=293.6K  
alphas from (n,n\*)a

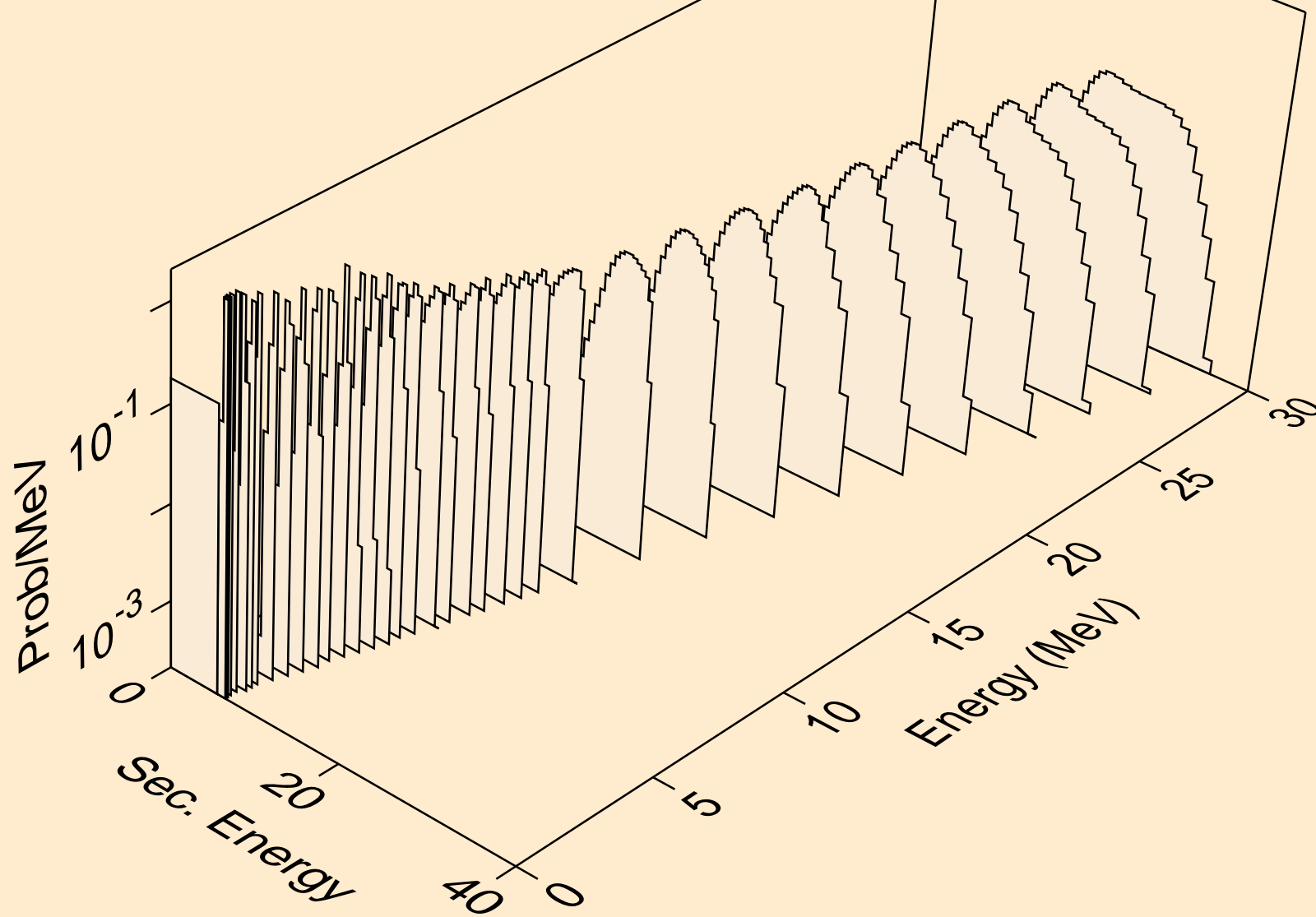



HG183 NEUTRON ACER TENDL-2021 LIBRARY; T=293.6K  
alphas from (n,n\*)3a

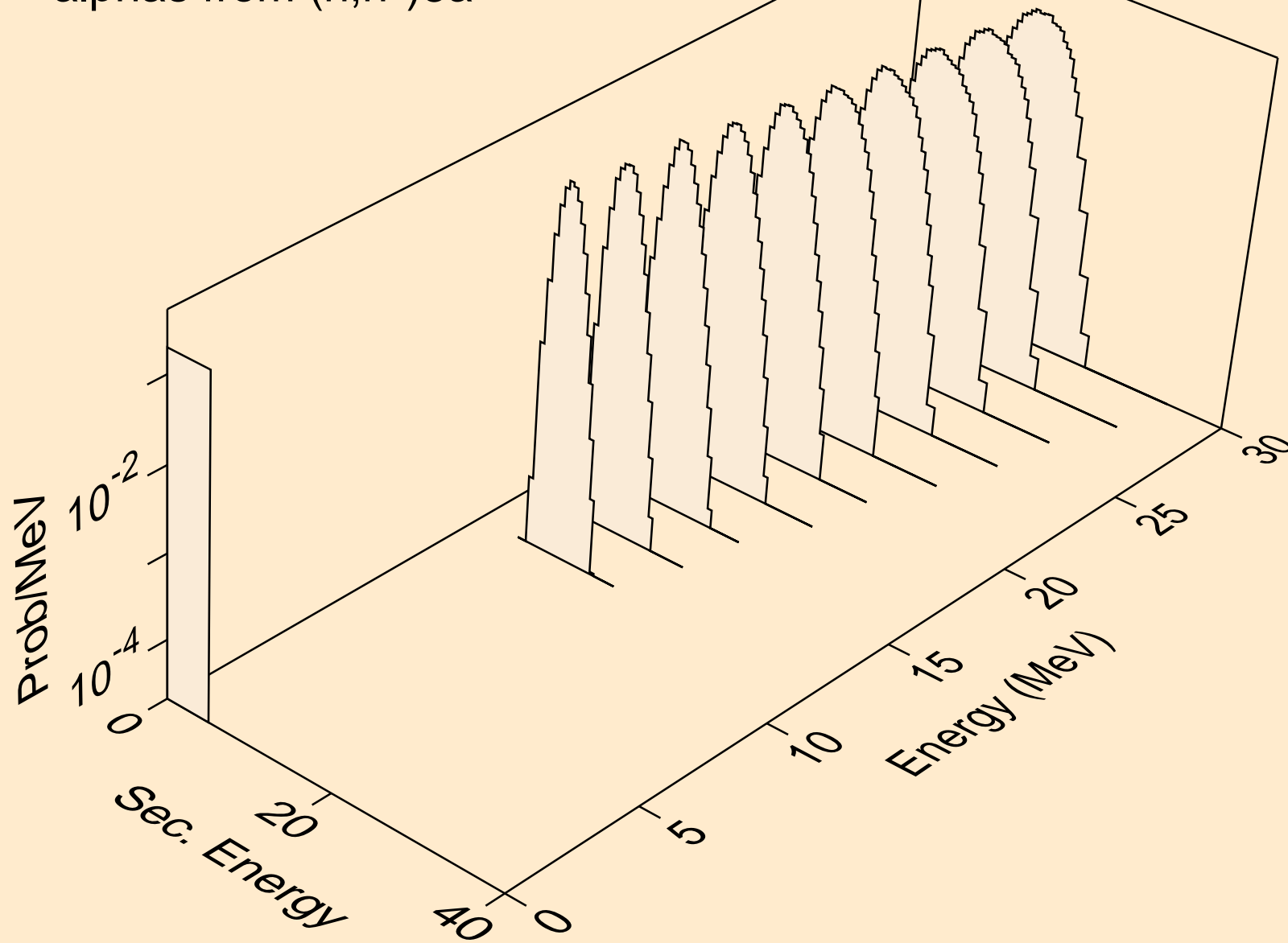

HG183 NEUTRON ACER TENDL-2021 LIBRARY; T=293.6K  
alphas from (n,2n)a

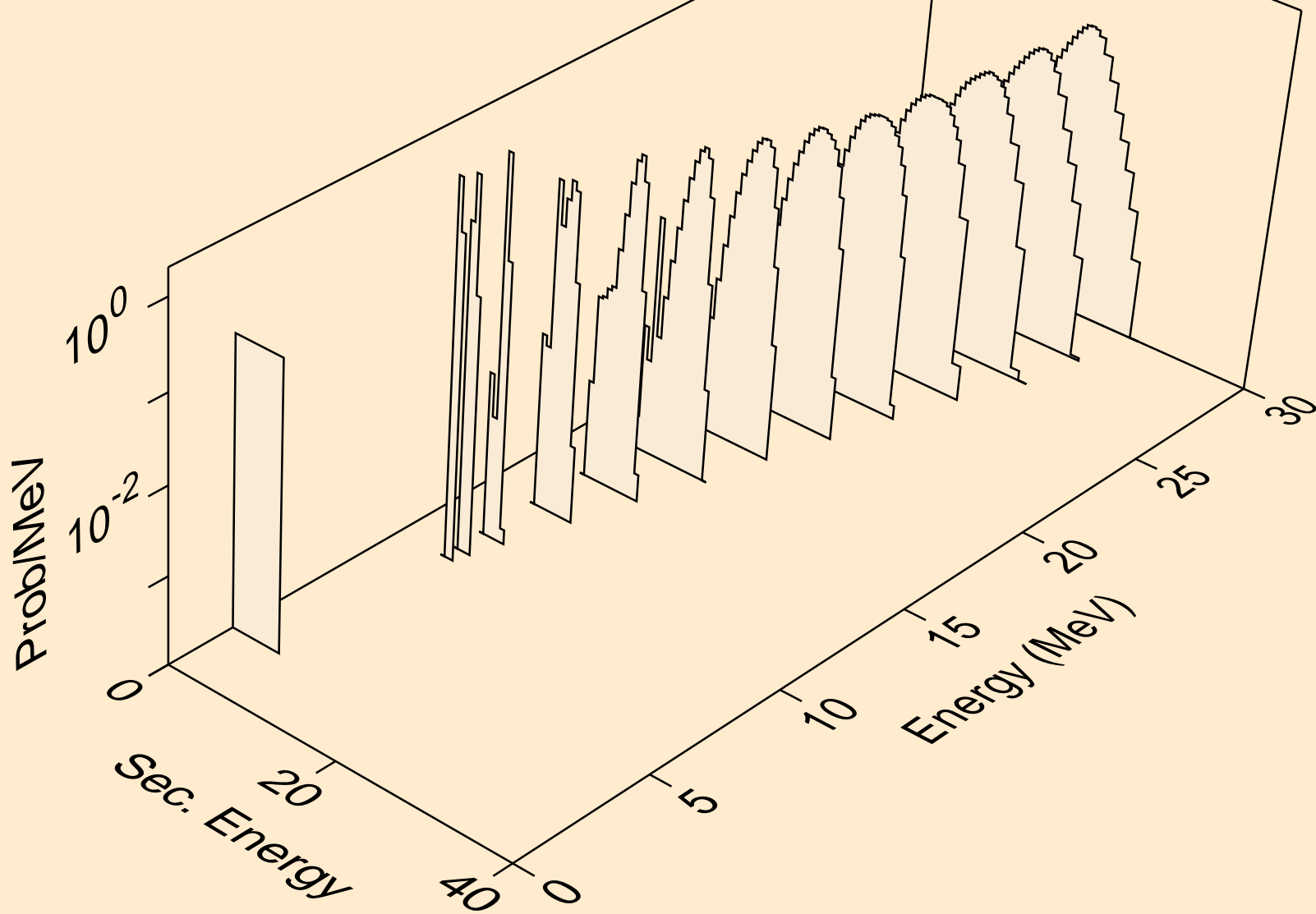

HG183 NEUTRON ACER TENDL-2021 LIBRARY; T=293.6K  
alphas from (n,3n)a

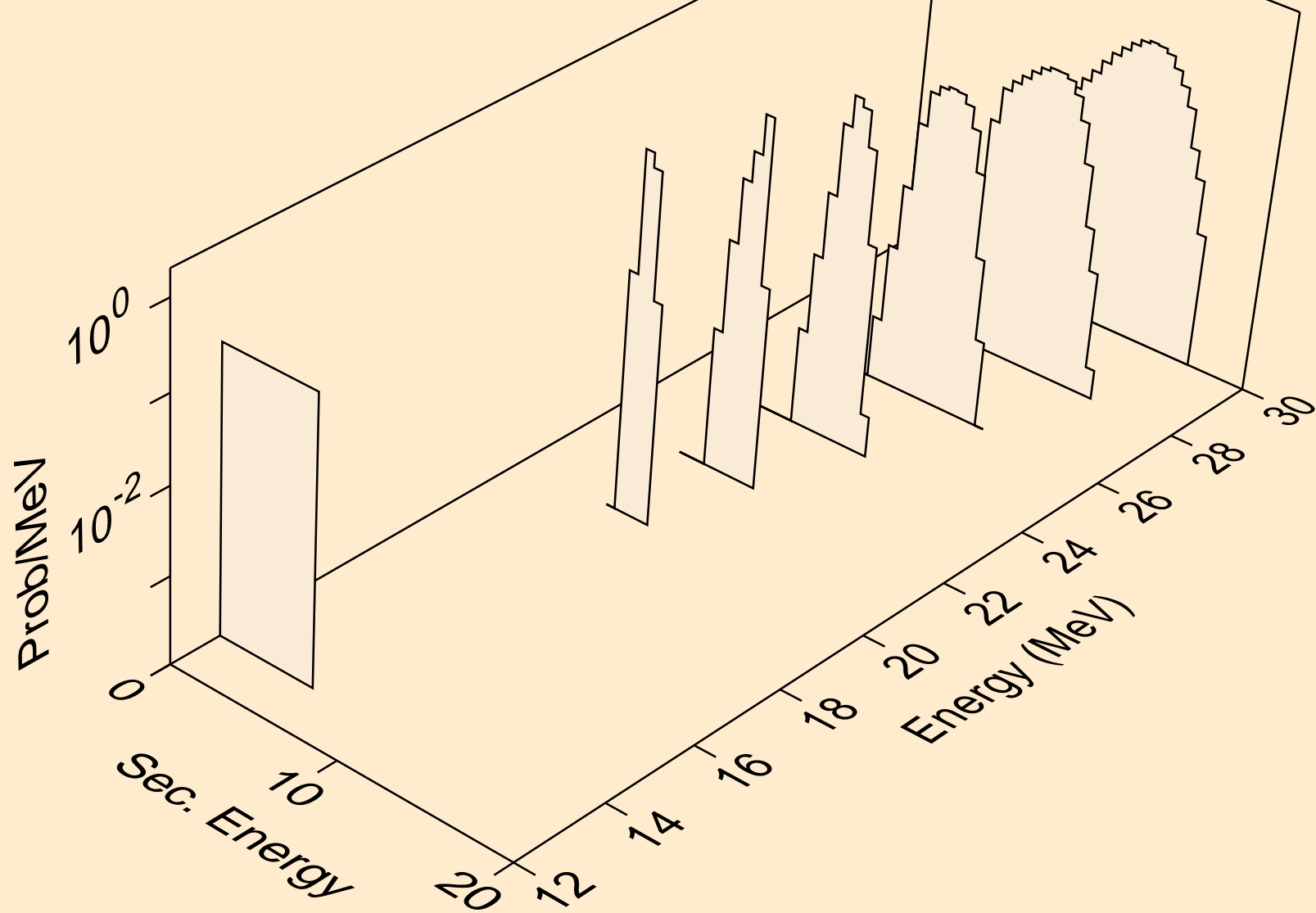

HG183 NEUTRON ACER TENDL-2021 LIBRARY; T=293.6K  
alphas from (n,n\*)2a

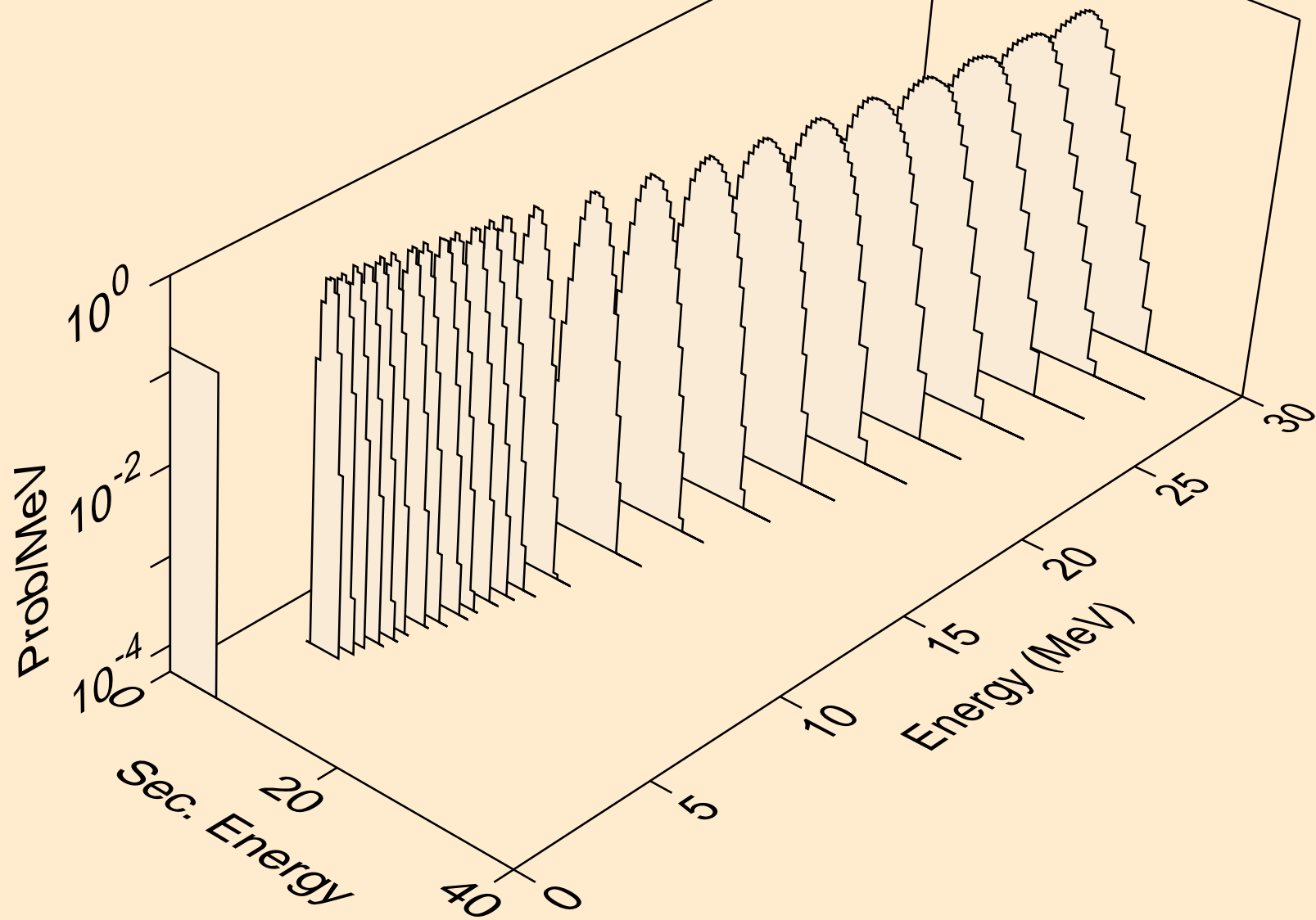

HG183 NEUTRON ACER TENDL-2021 LIBRARY; T=293.6K  
alphas from (n,2n)2a

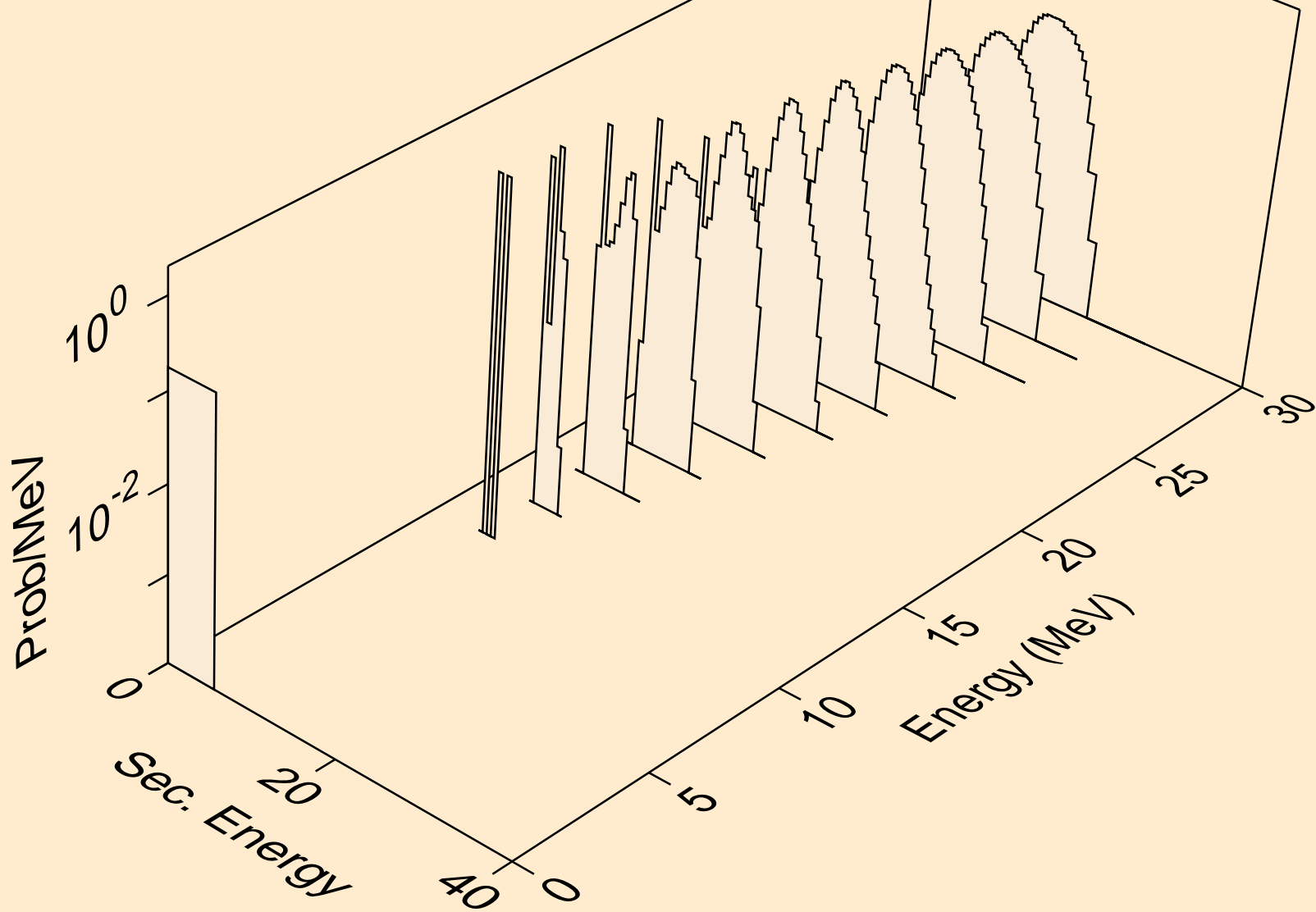

HG183 NEUTRON ACER TENDL-2021 LIBRARY; T=293.6K  
alphas from (n,npa)

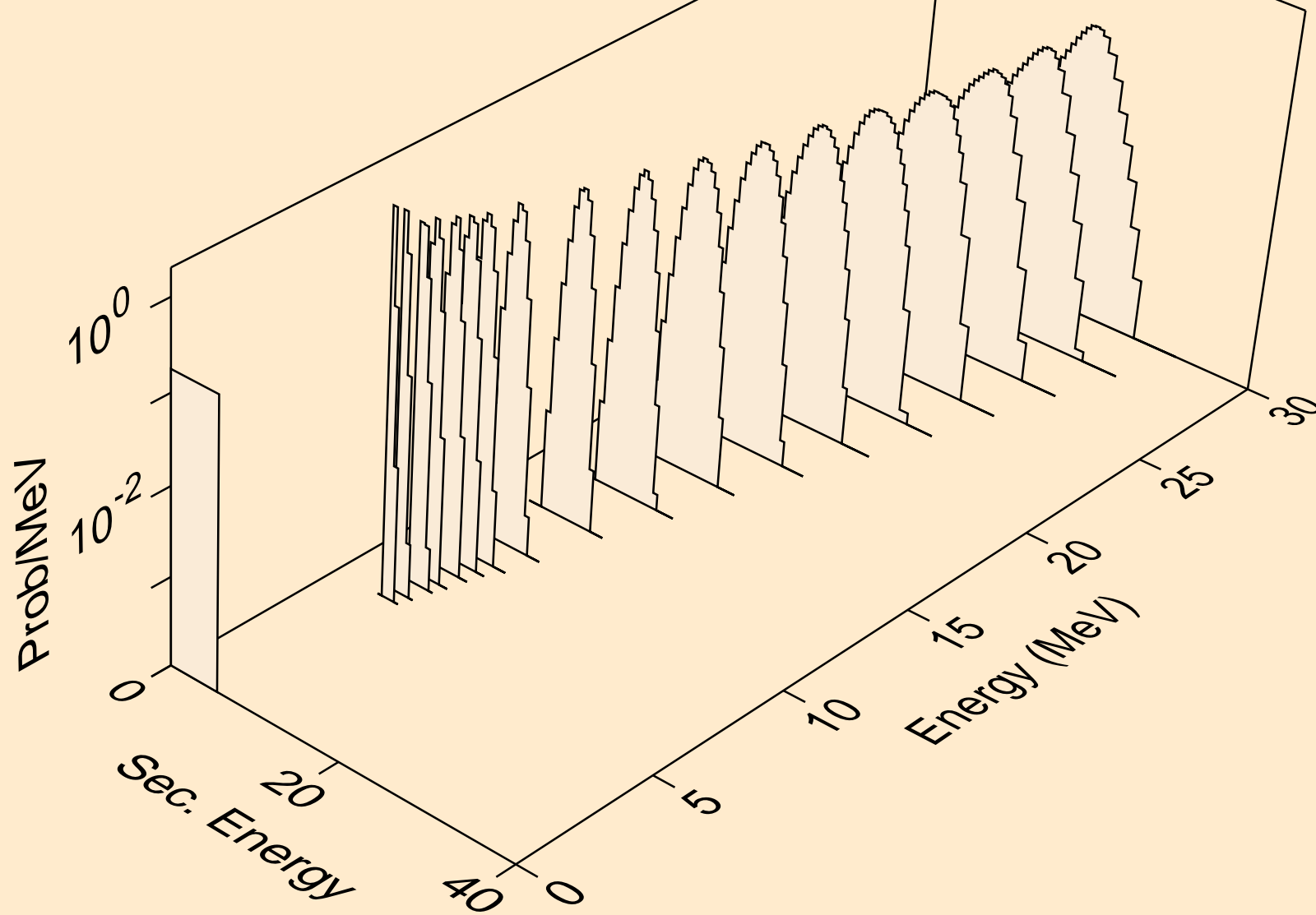

HG183 NEUTRON ACER TENDL-2021 LIBRARY; T=293.6K  
alphas from (n,a)

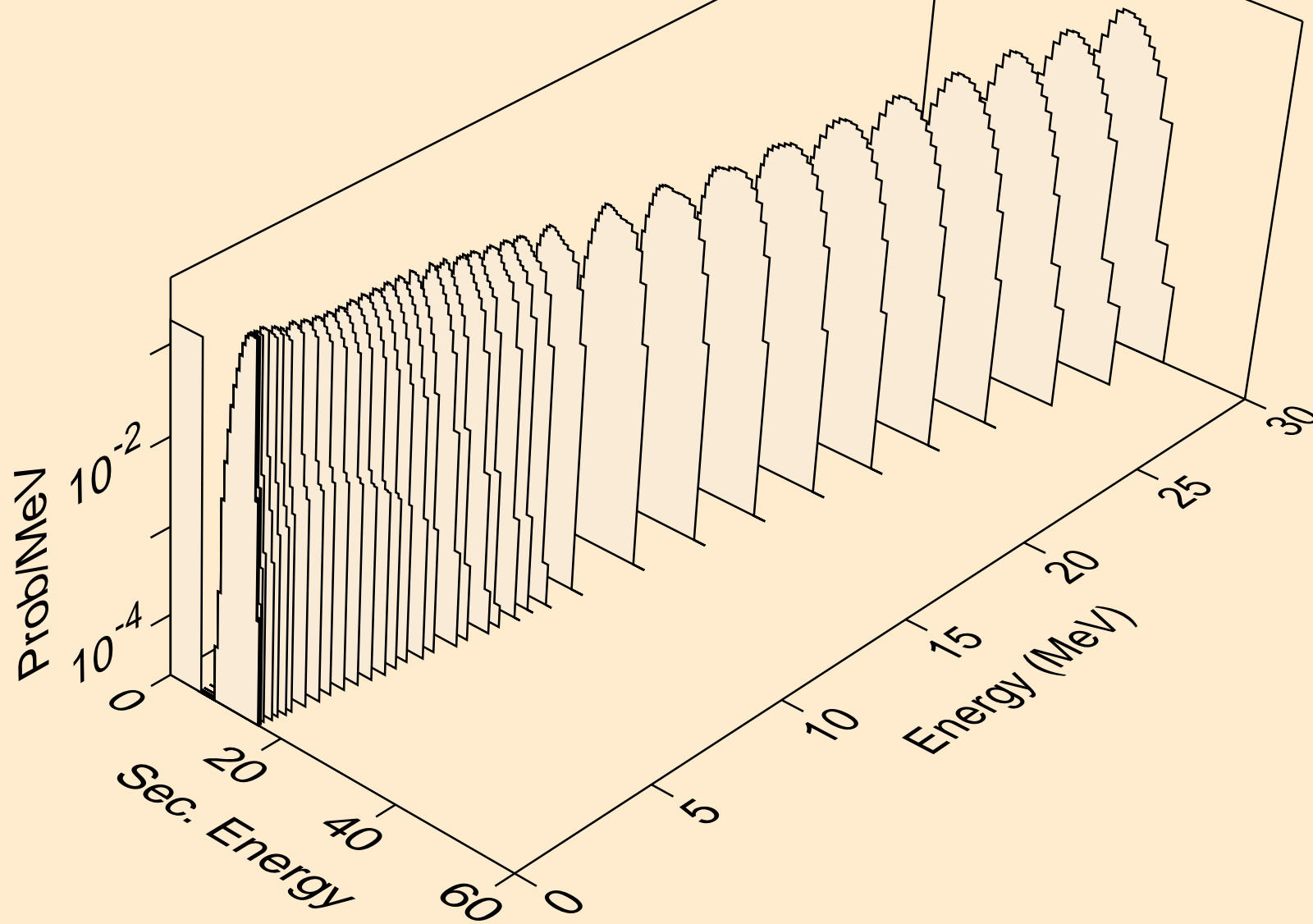

HG183 NEUTRON ACER TENDL-2021 LIBRARY; T=293.6K  
alphas from (n,2a)

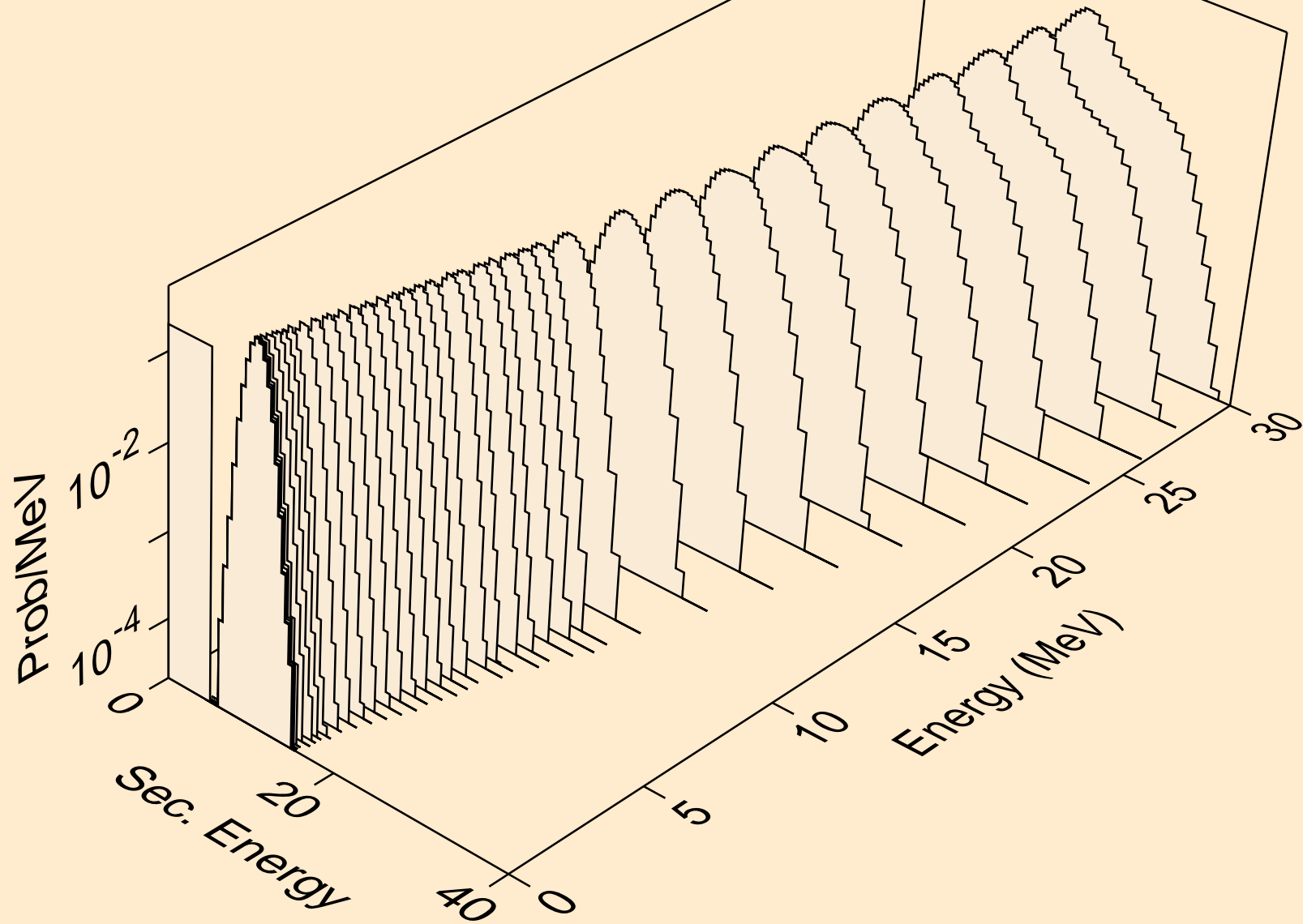



HG183 NEUTRON ACER TENDL-2021 LIBRARY; T=293.6K  
alphas from (n,3a)

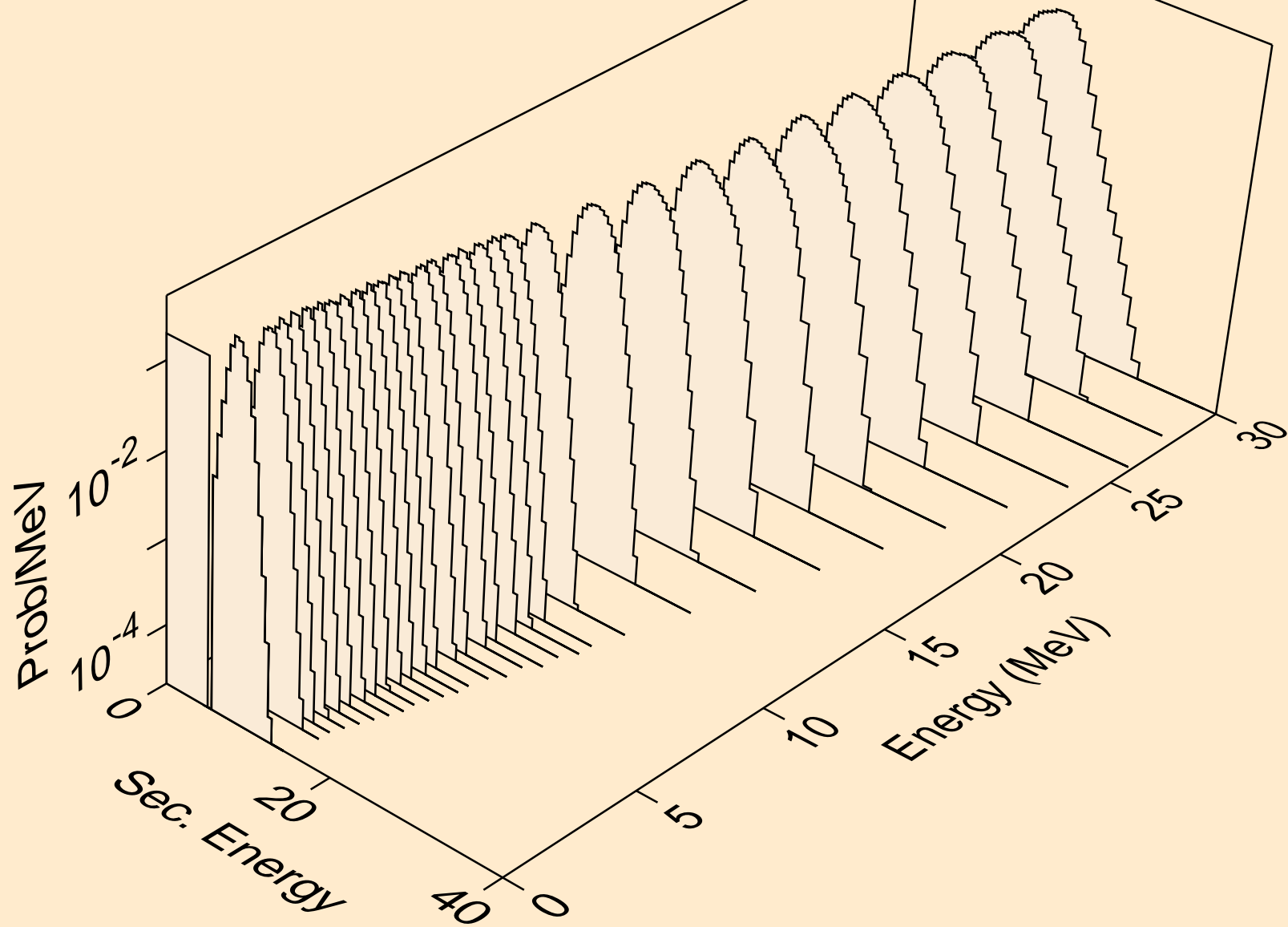

HG183 NEUTRON ACER TENDL-2021 LIBRARY; T=293.6K  
alphas from (n,pa)

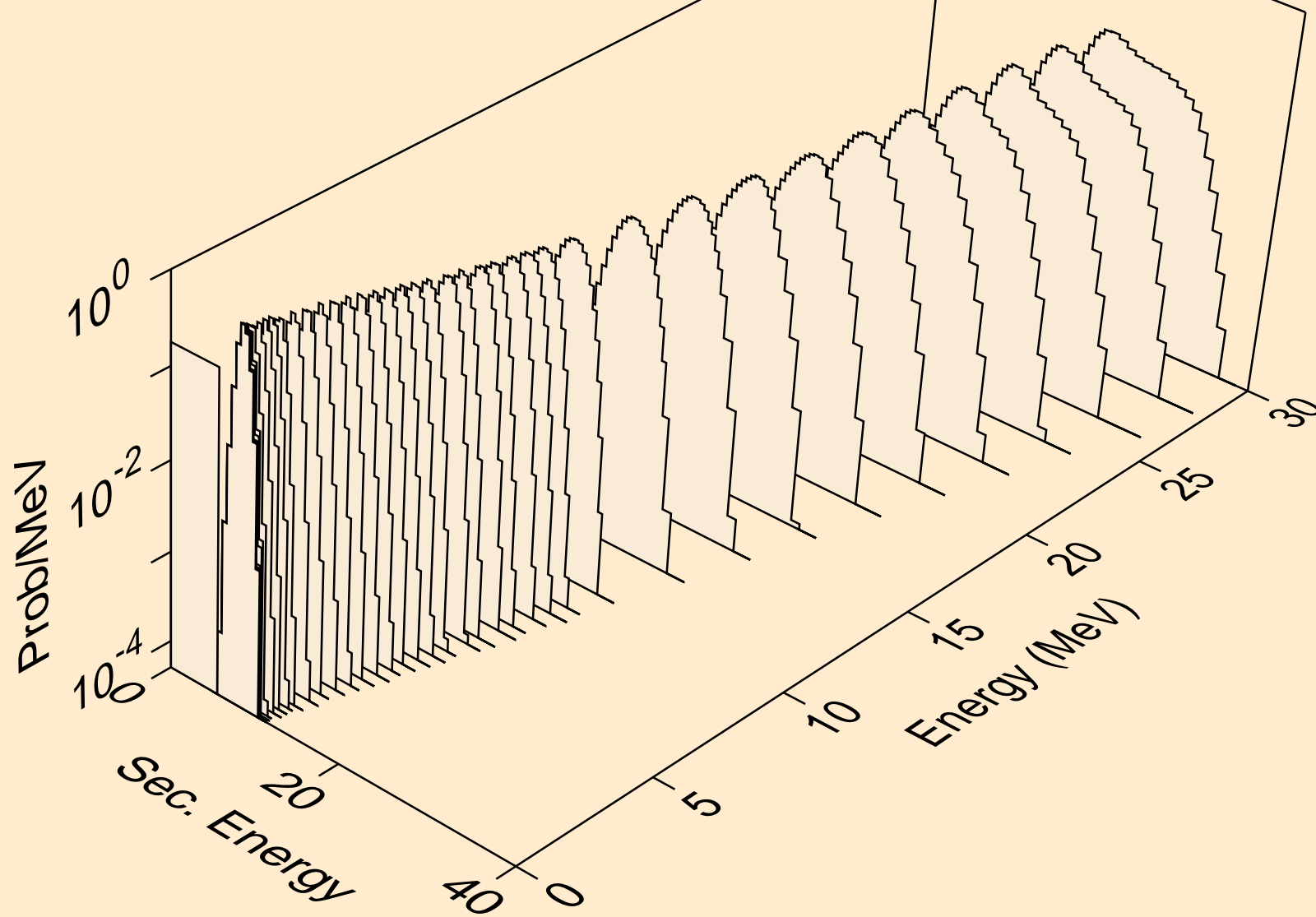

HG183 NEUTRON ACER TENDL-2021 LIBRARY; T=293.6K  
alphas from (n,d2a)

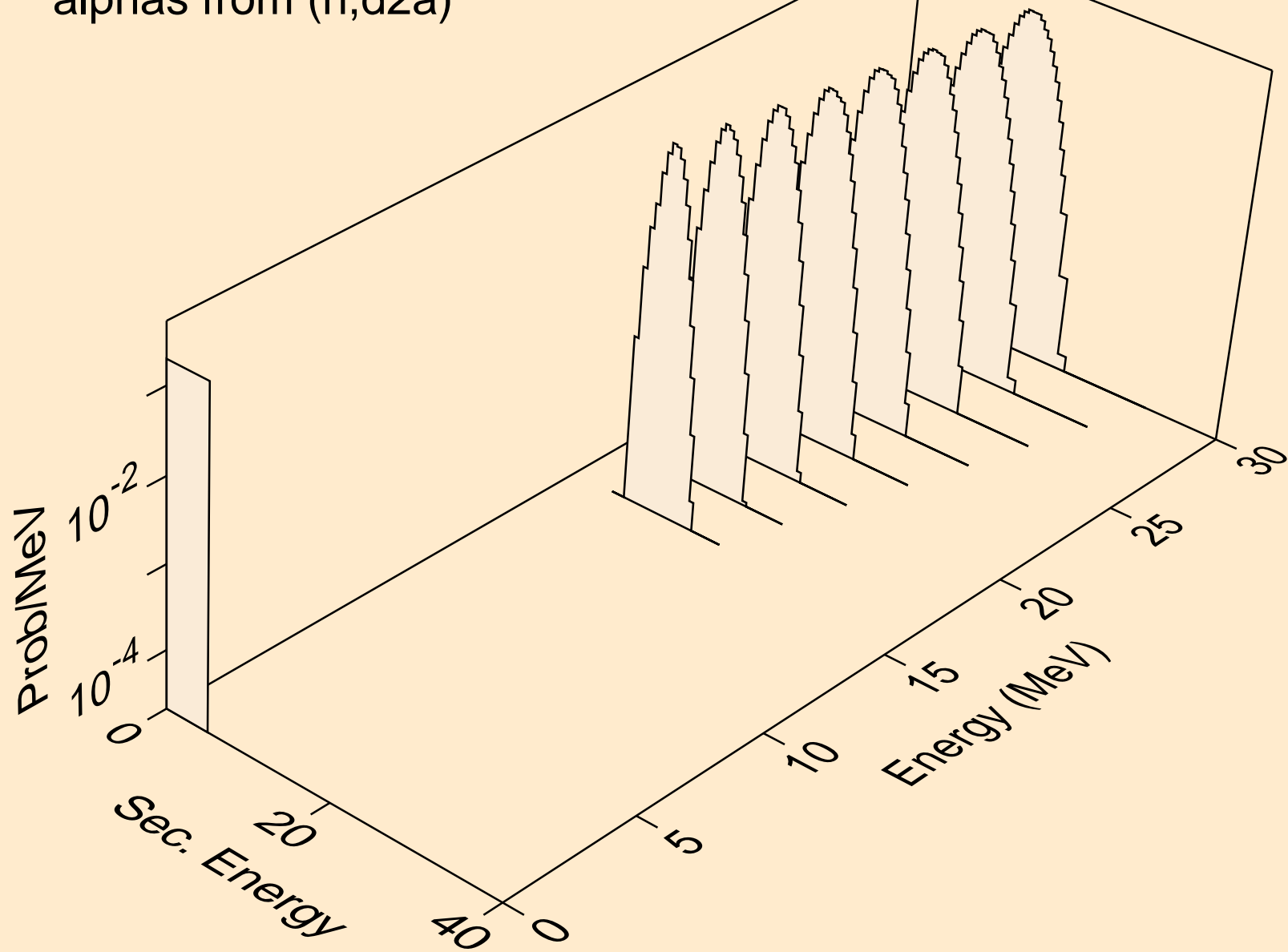

HG183 NEUTRON ACER TENDL-2021 LIBRARY; T=293.6K  
alphas from (n,da)

