

HG201 NEUTRON ACER TENDL-2021 LIBRARY; T=293.6K

Principal cross sections

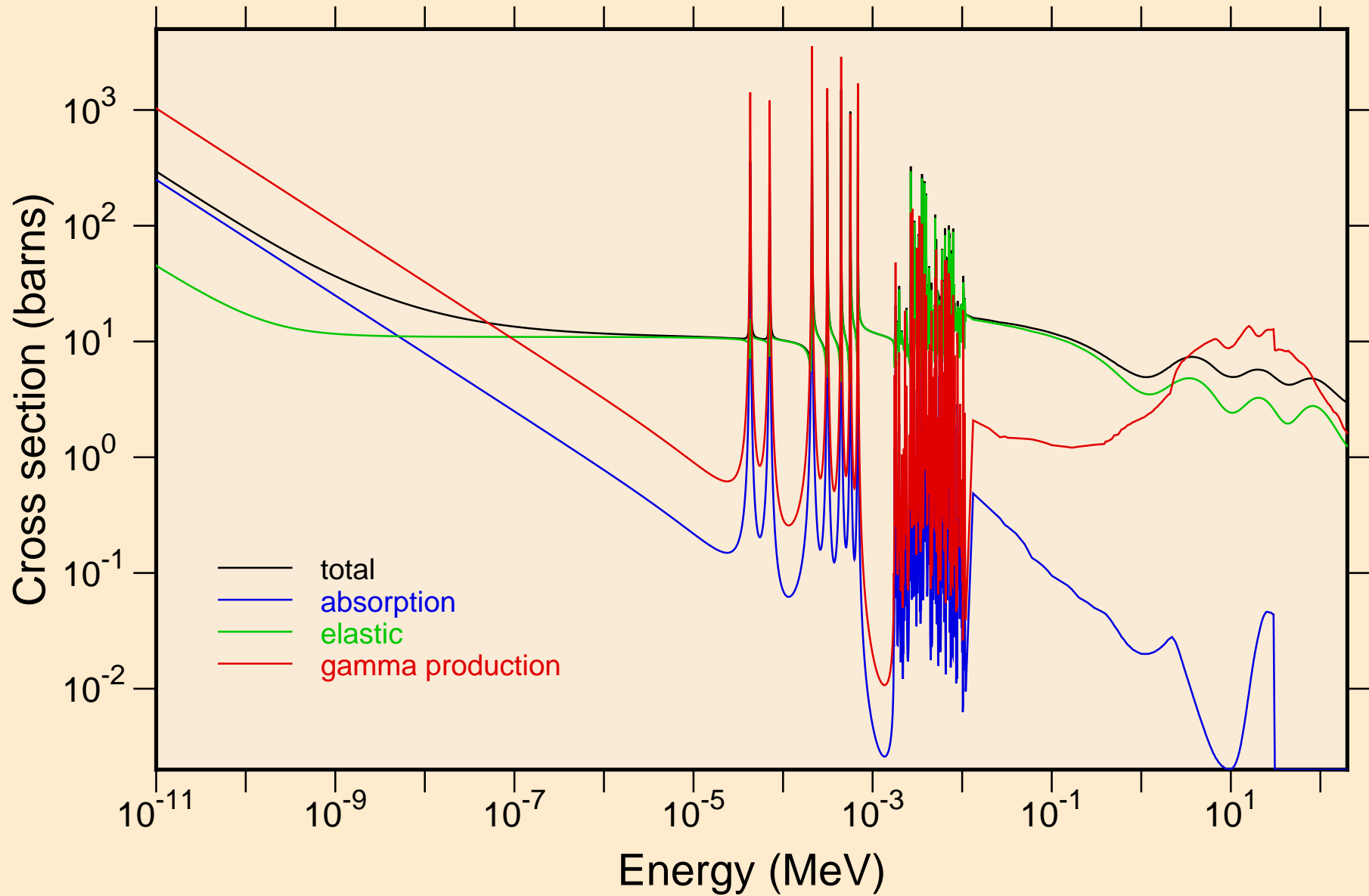

HG201 NEUTRON ACER TENDL-2021 LIBRARY; T=293.6K
resonance total cross section

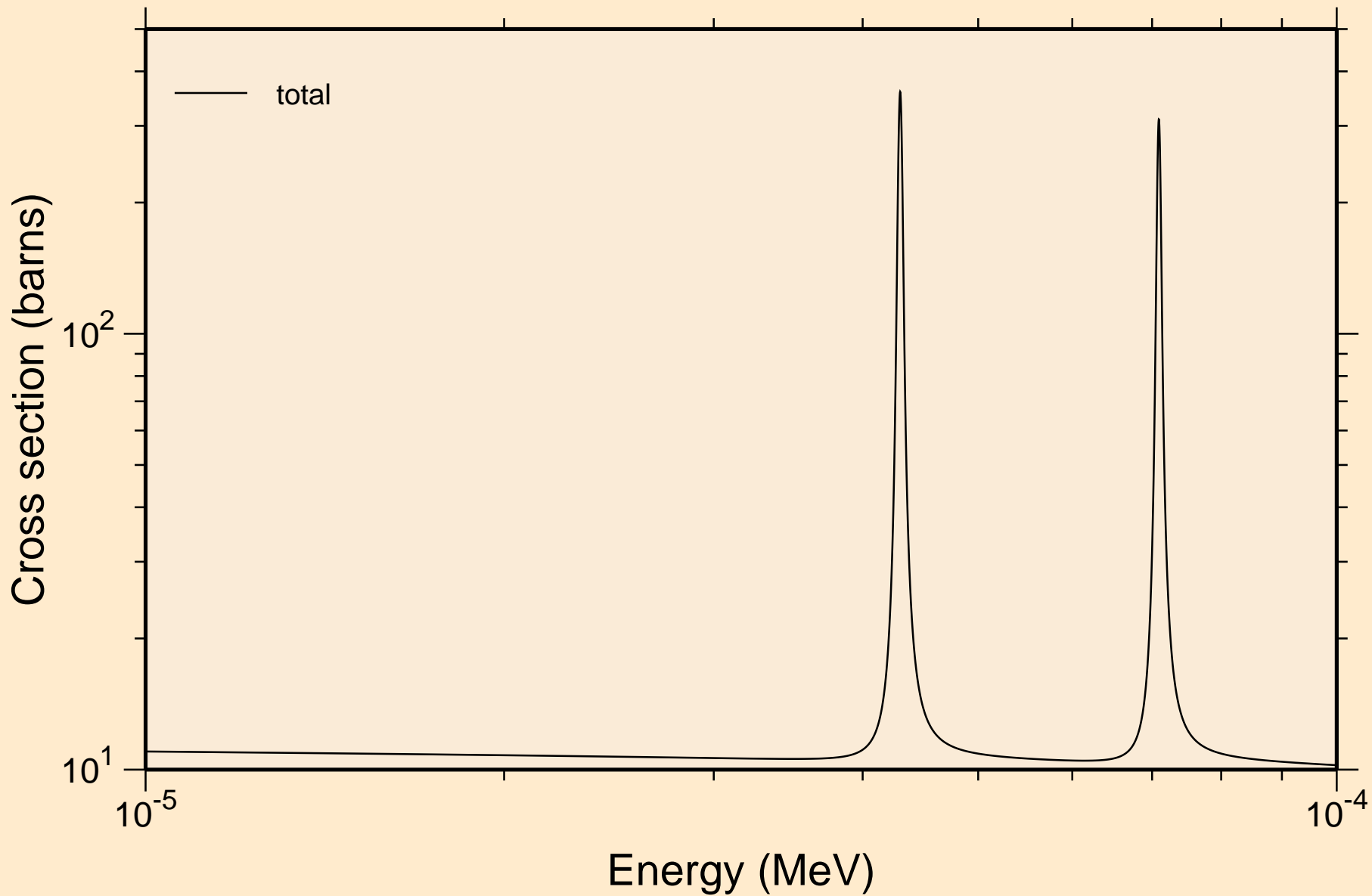

HG201 NEUTRON ACER TENDL-2021 LIBRARY; T=293.6K
resonance total cross section

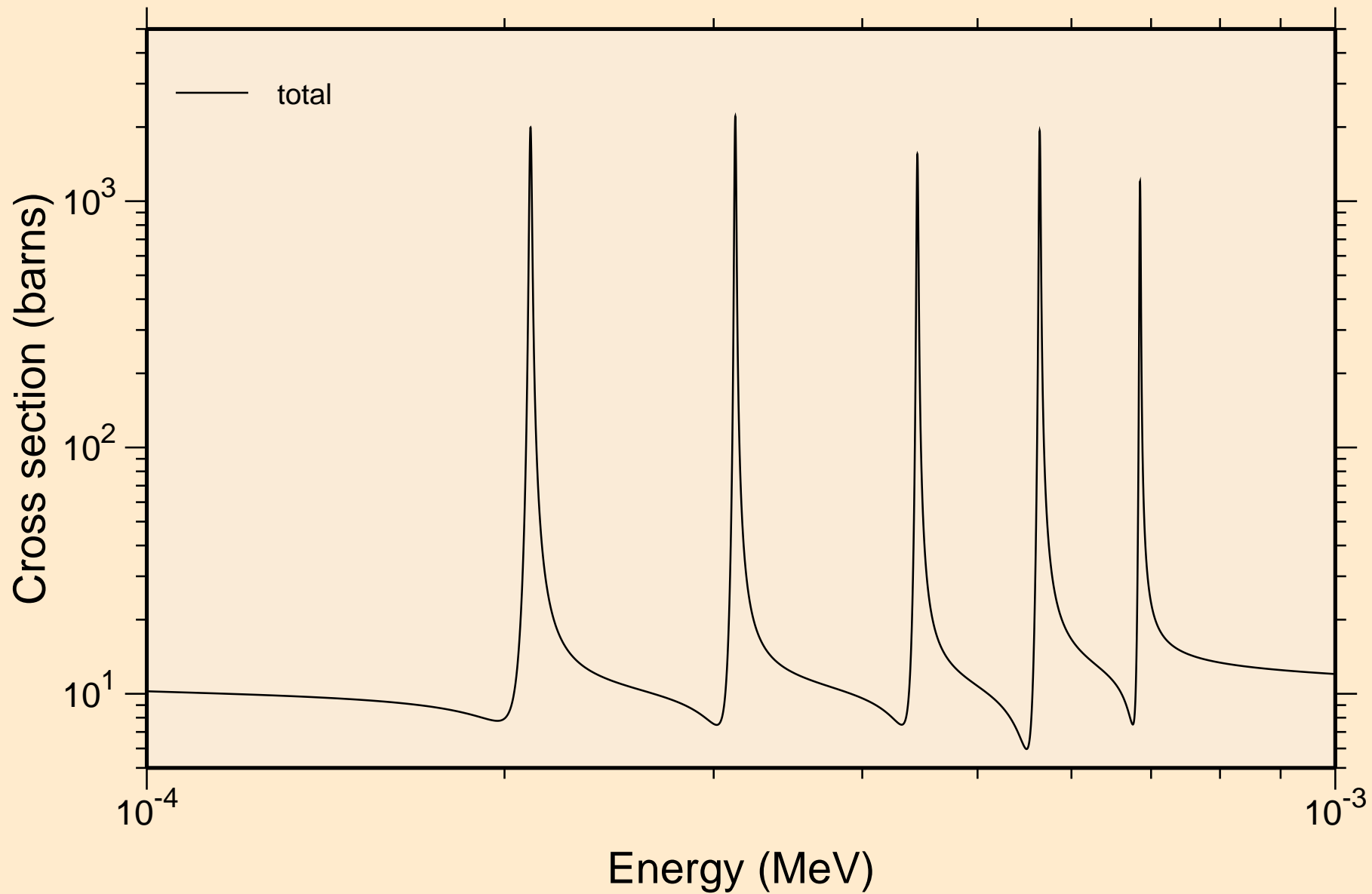

HG201 NEUTRON ACER TENDL-2021 LIBRARY; T=293.6K
resonance total cross section

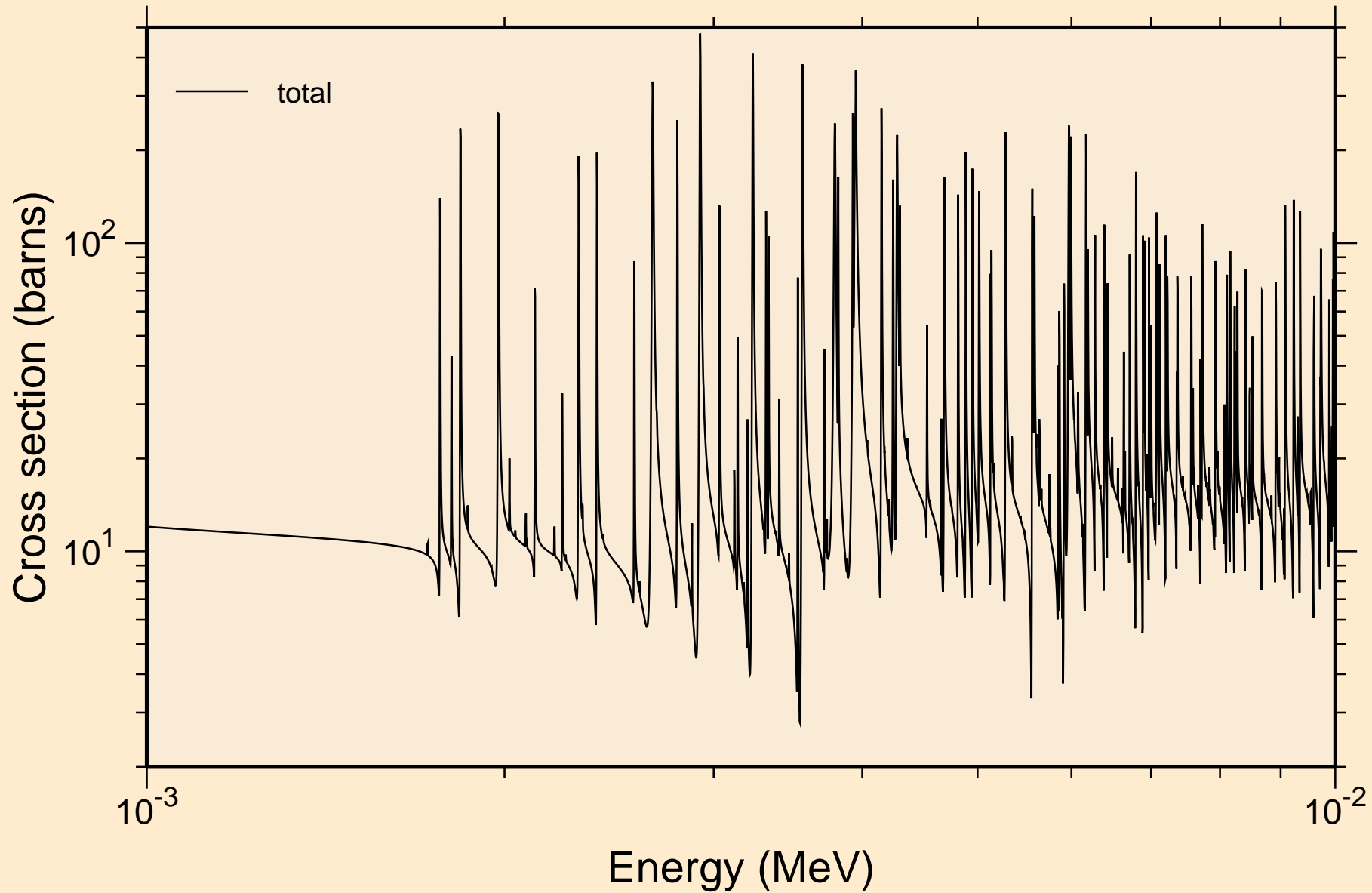

HG201 NEUTRON ACER TENDL-2021 LIBRARY; T=293.6K
resonance total cross section

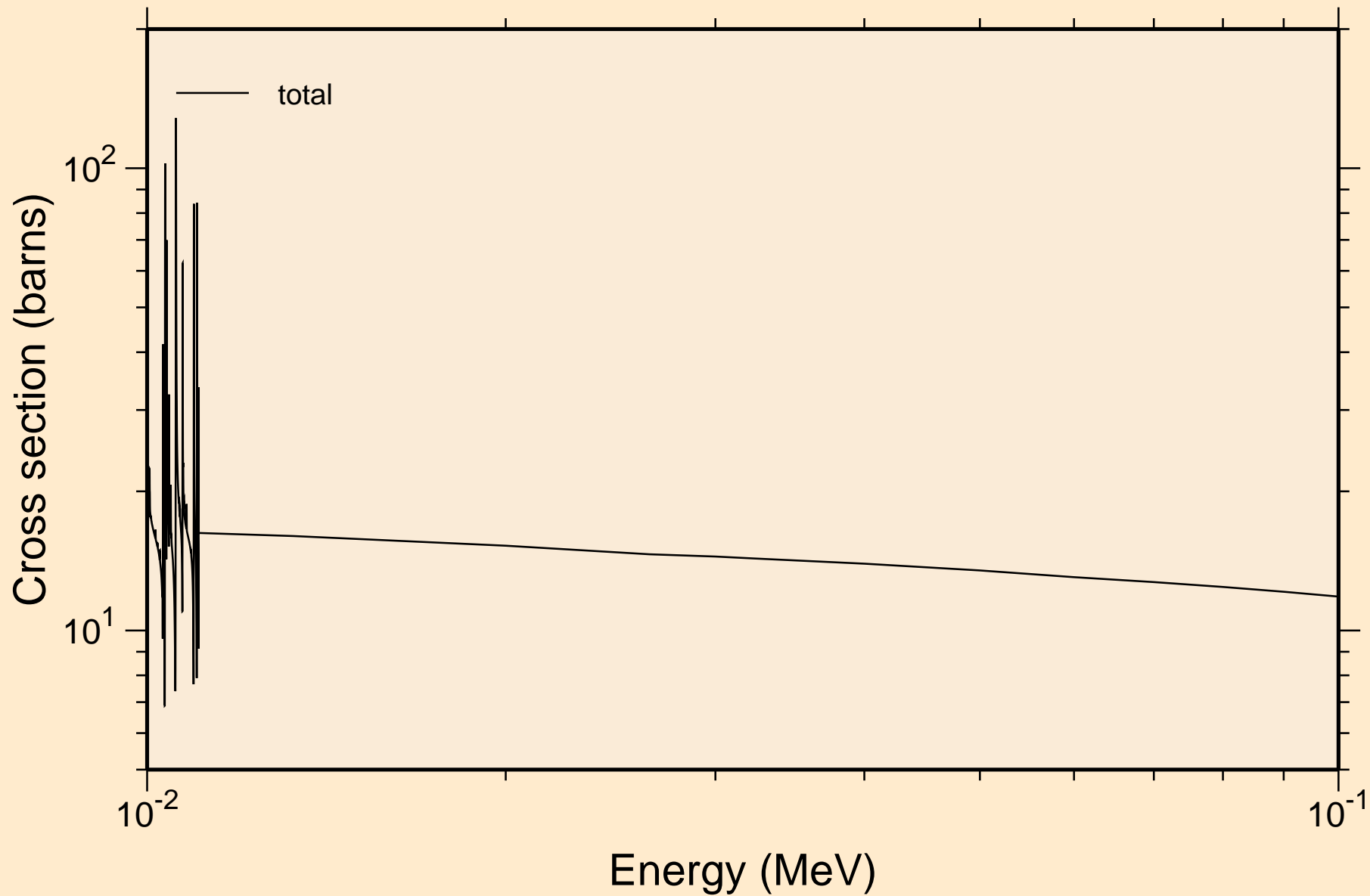

HG201 NEUTRON ACER TENDL-2021 LIBRARY; T=293.6K
resonance total cross section

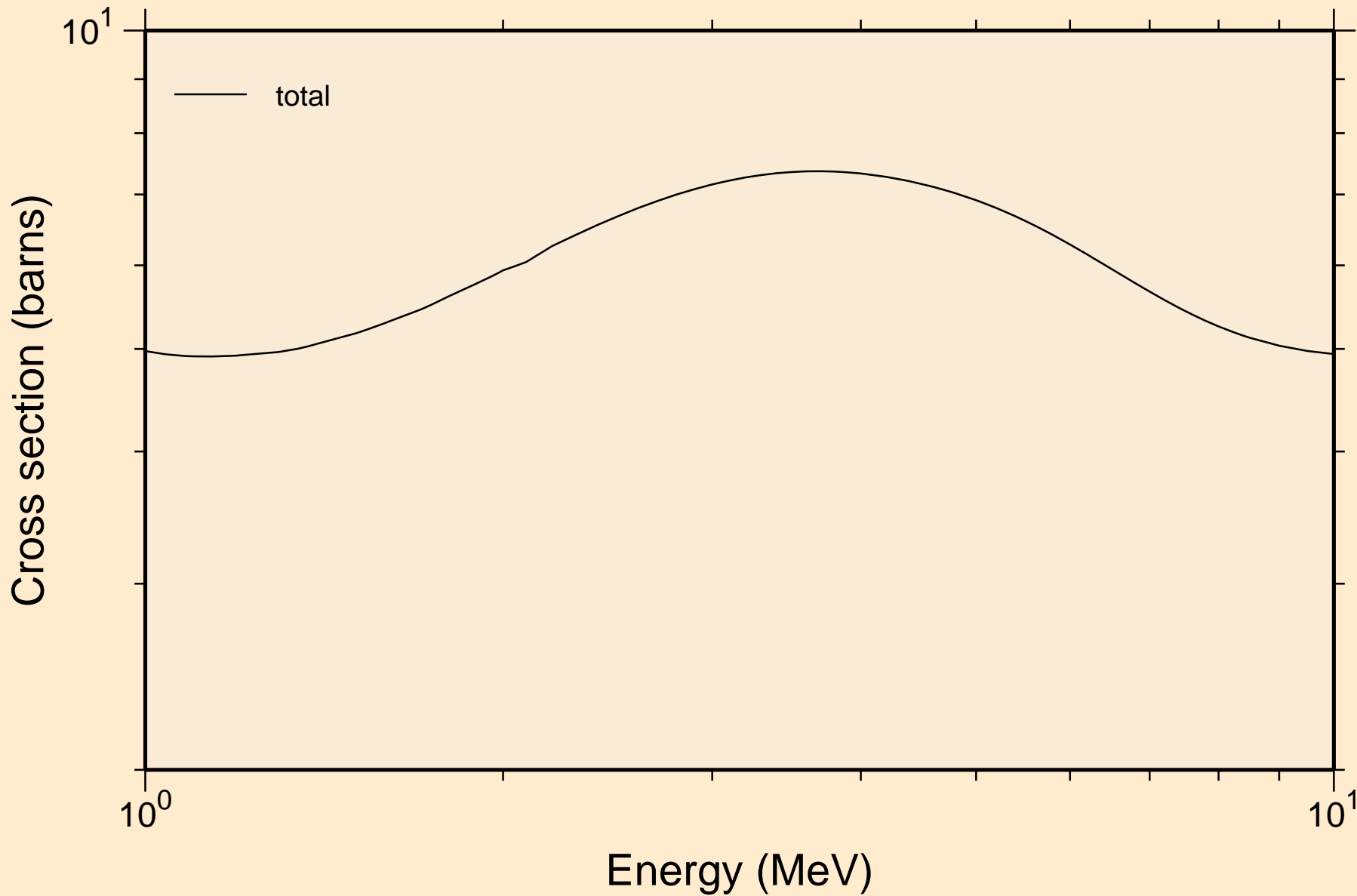

HG201 NEUTRON ACER TENDL-2021 LIBRARY; T=293.6K
resonance absorption cross sections

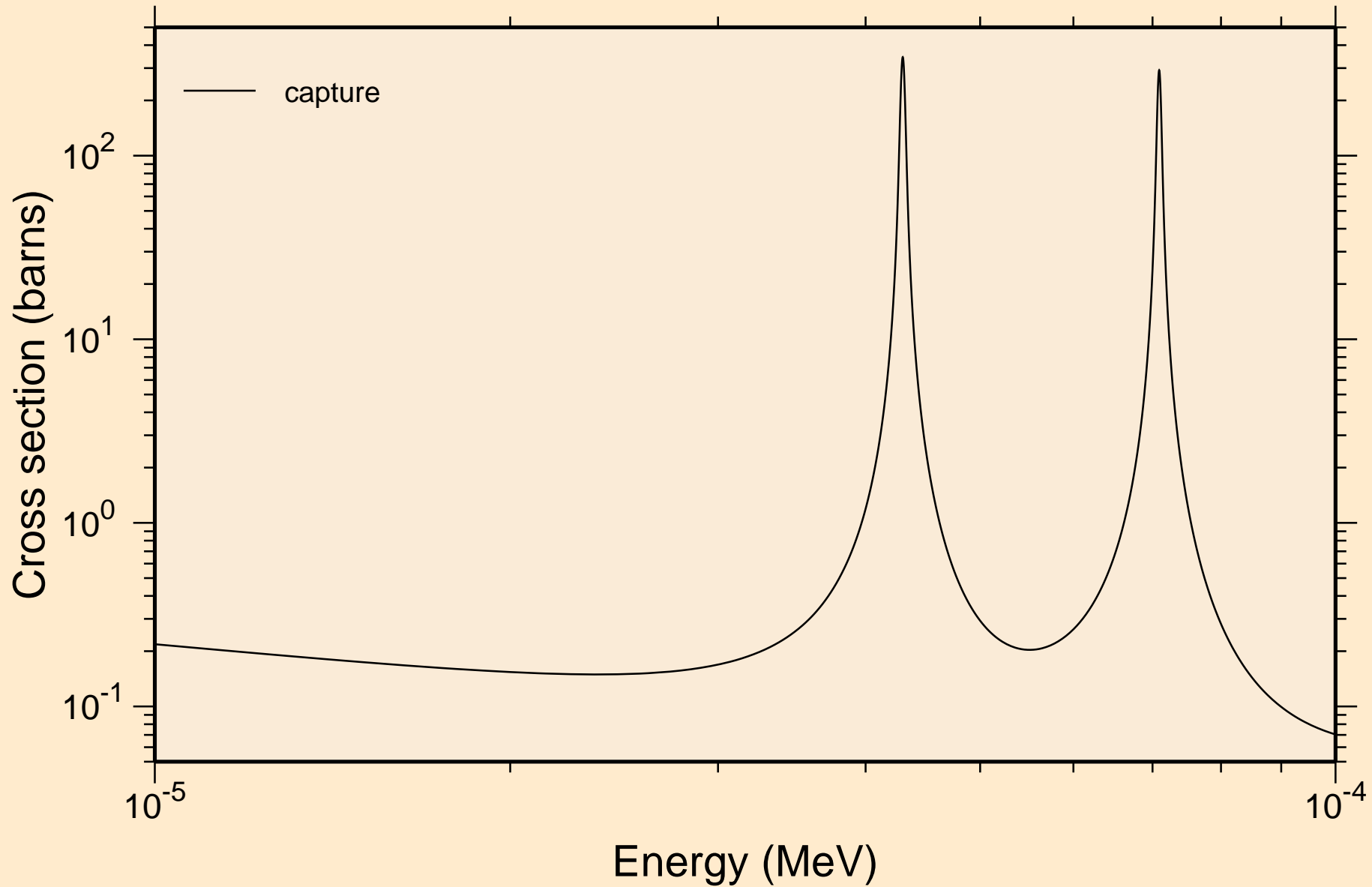

HG201 NEUTRON ACER TENDL-2021 LIBRARY; T=293.6K
resonance absorption cross sections

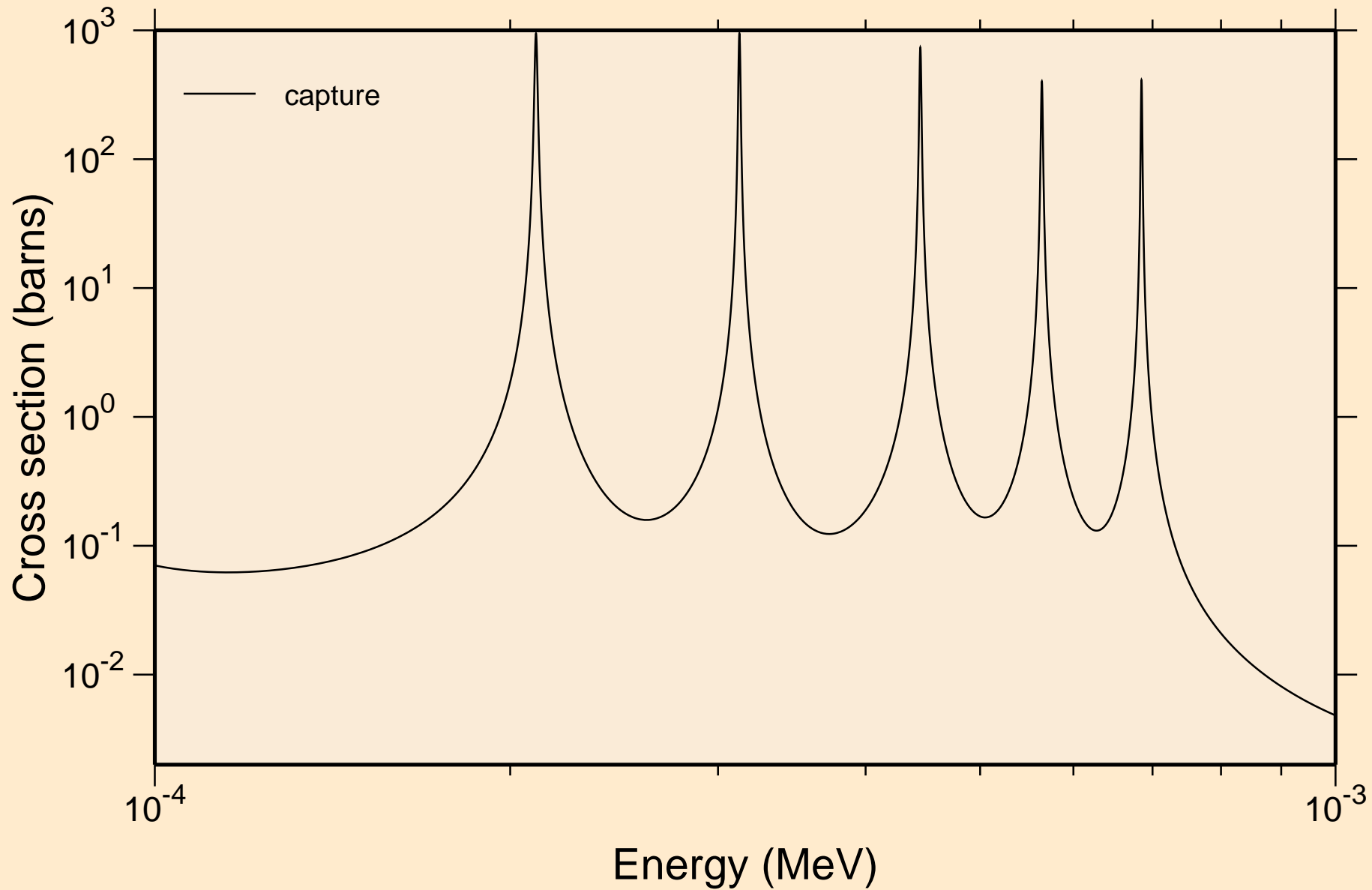

HG201 NEUTRON ACER TENDL-2021 LIBRARY; T=293.6K
resonance absorption cross sections

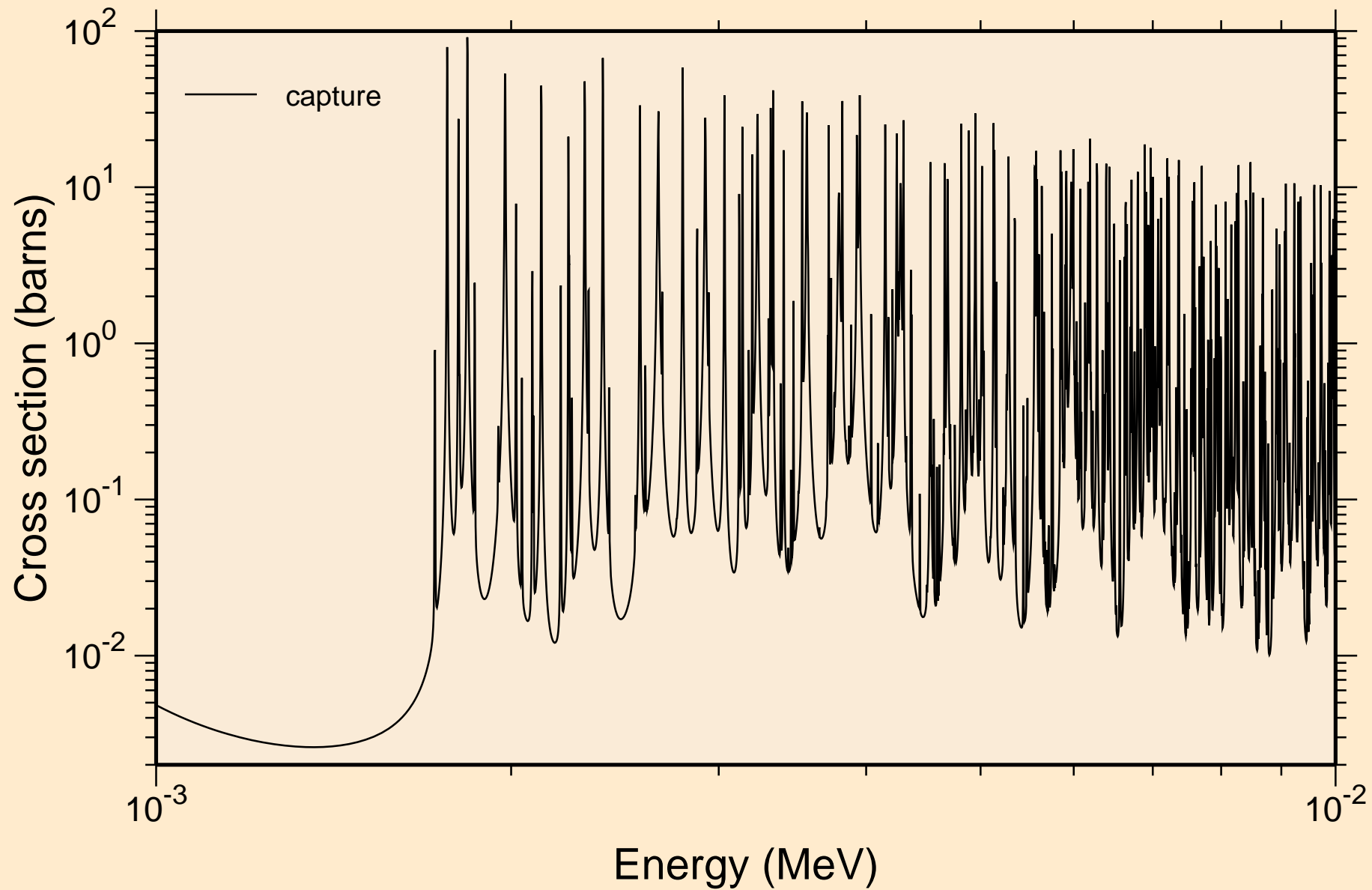

HG201 NEUTRON ACER TENDL-2021 LIBRARY; T=293.6K
resonance absorption cross sections

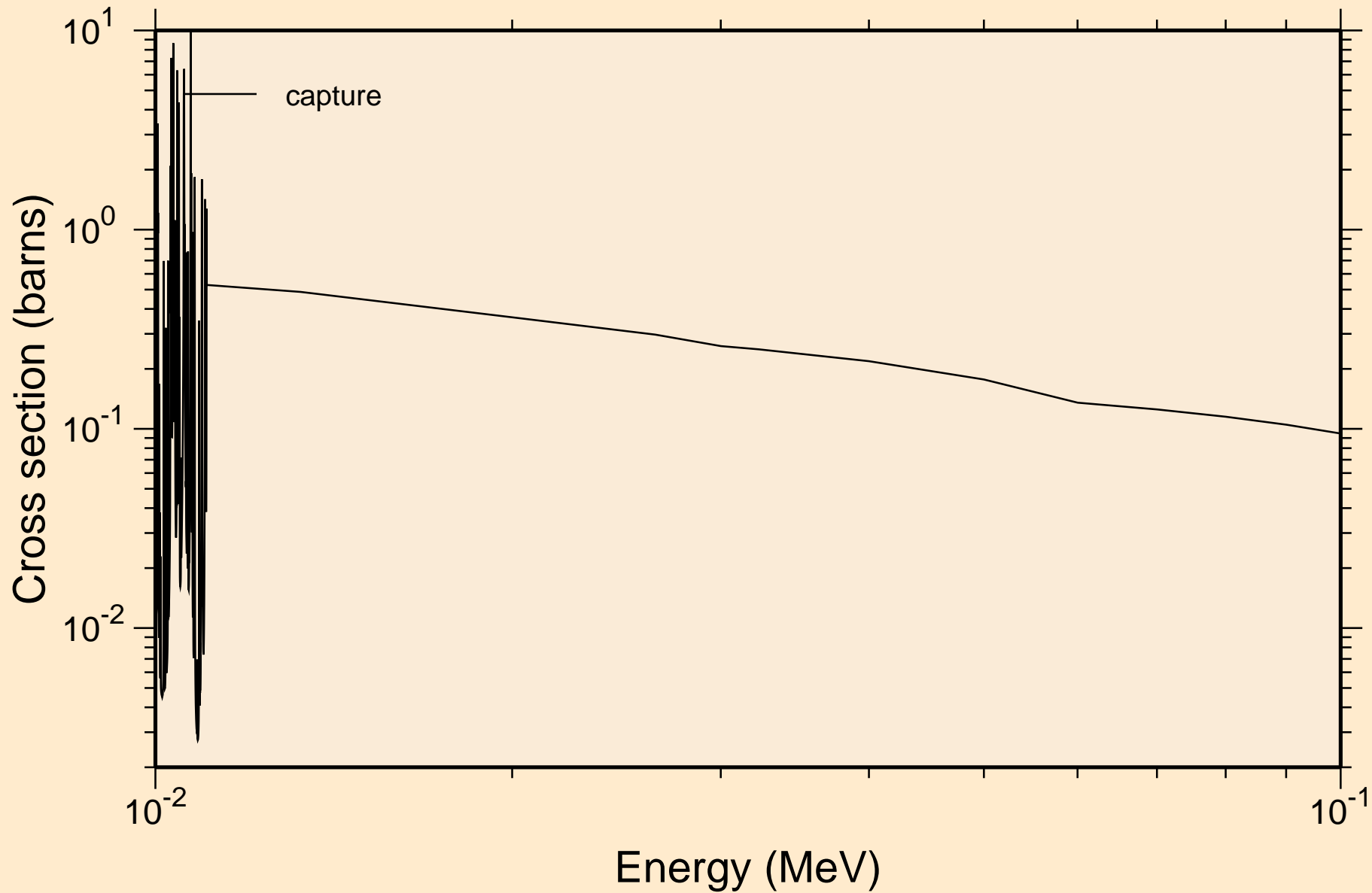

HG201 NEUTRON ACER TENDL-2021 LIBRARY; T=293.6K
resonance absorption cross sections

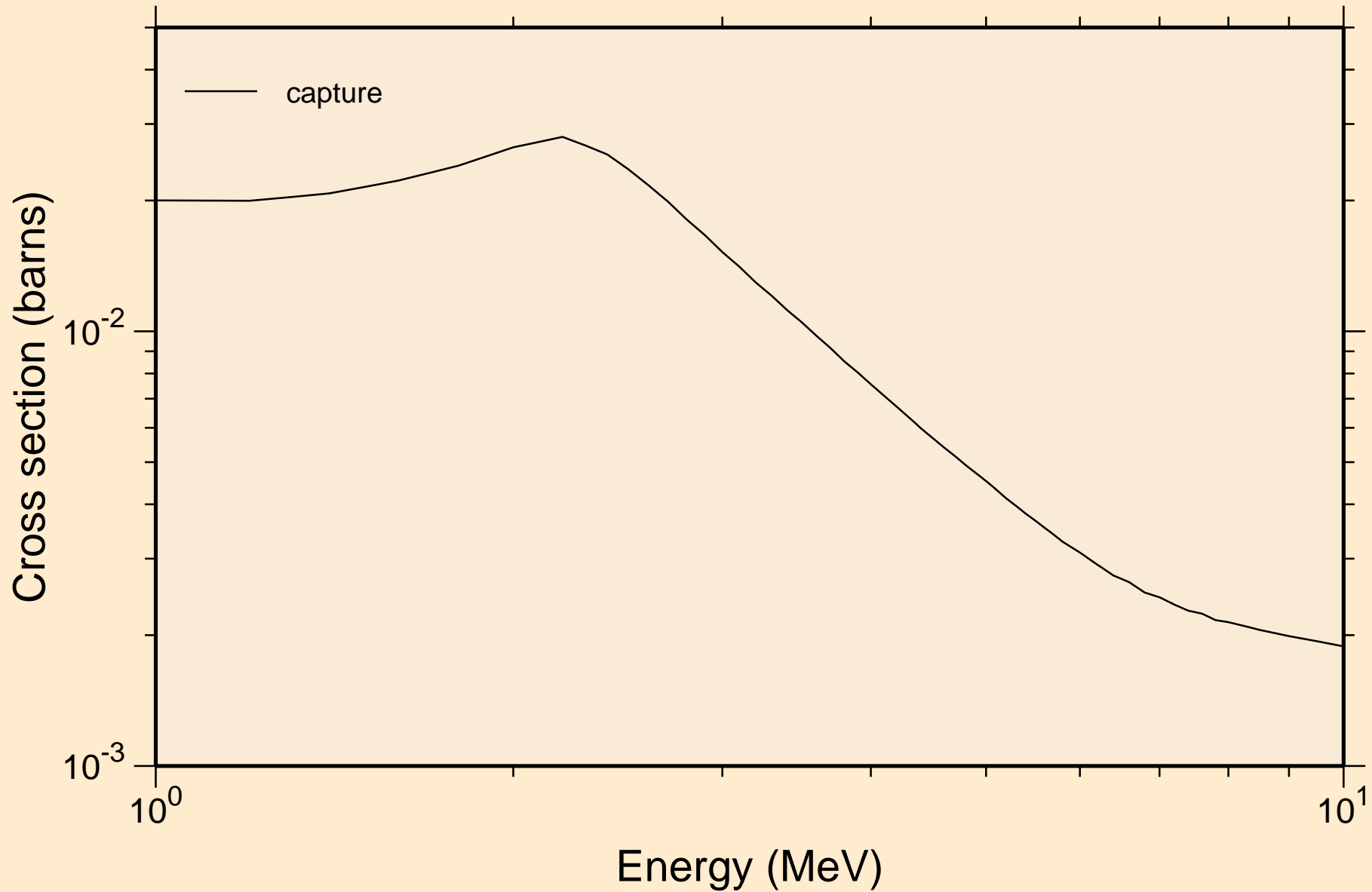

HG201 NEUTRON ACER TENDL-2021 LIBRARY; T=293.6K
Heating

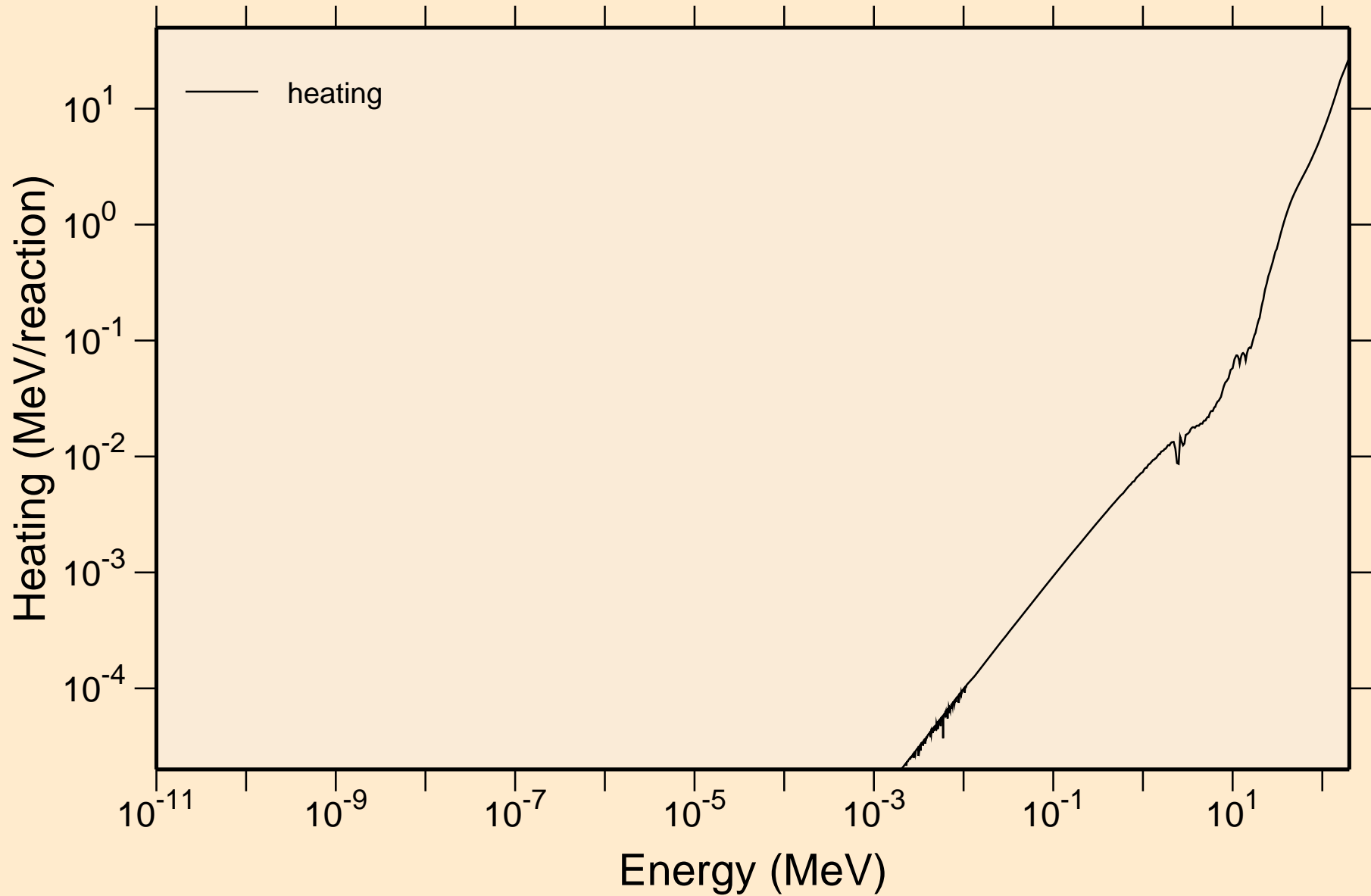

HG201 NEUTRON ACER TENDL-2021 LIBRARY; T=293.6K

Damage

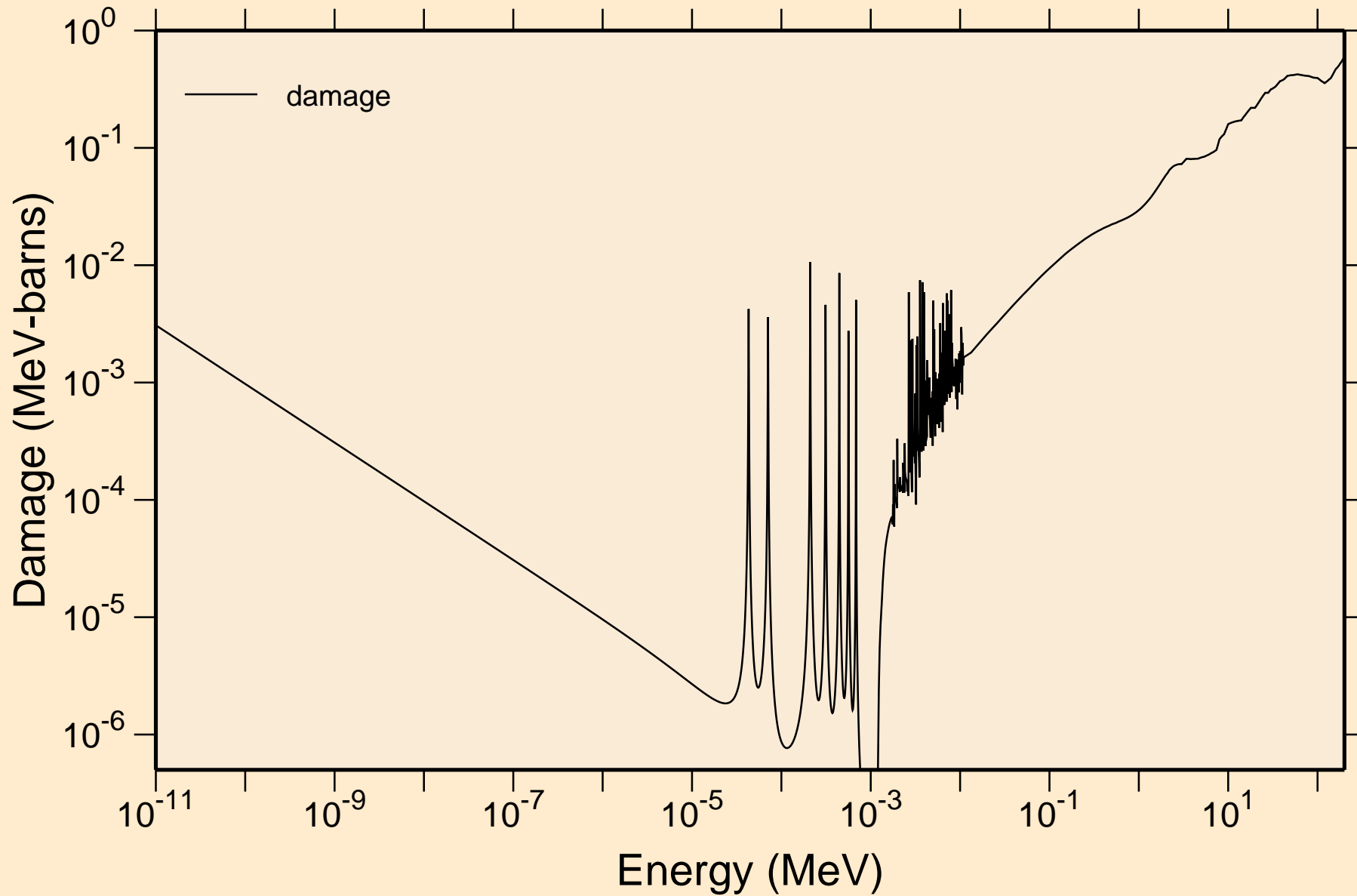

HG201 NEUTRON ACER TENDL-2021 LIBRARY; T=293.6K
Non-threshold reactions

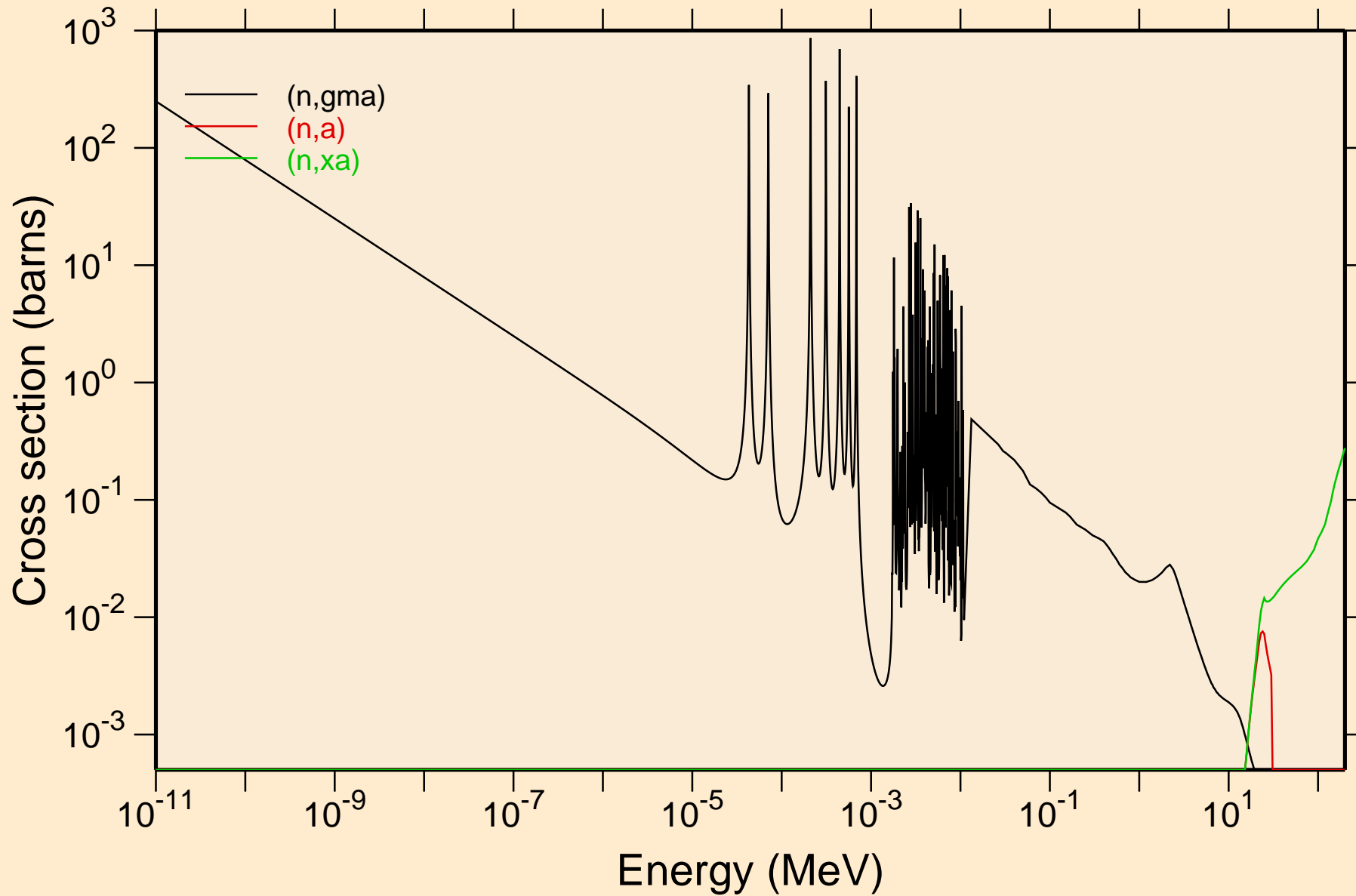

HG201 NEUTRON ACER TENDL-2021 LIBRARY; T=293.6K
Principal cross sections

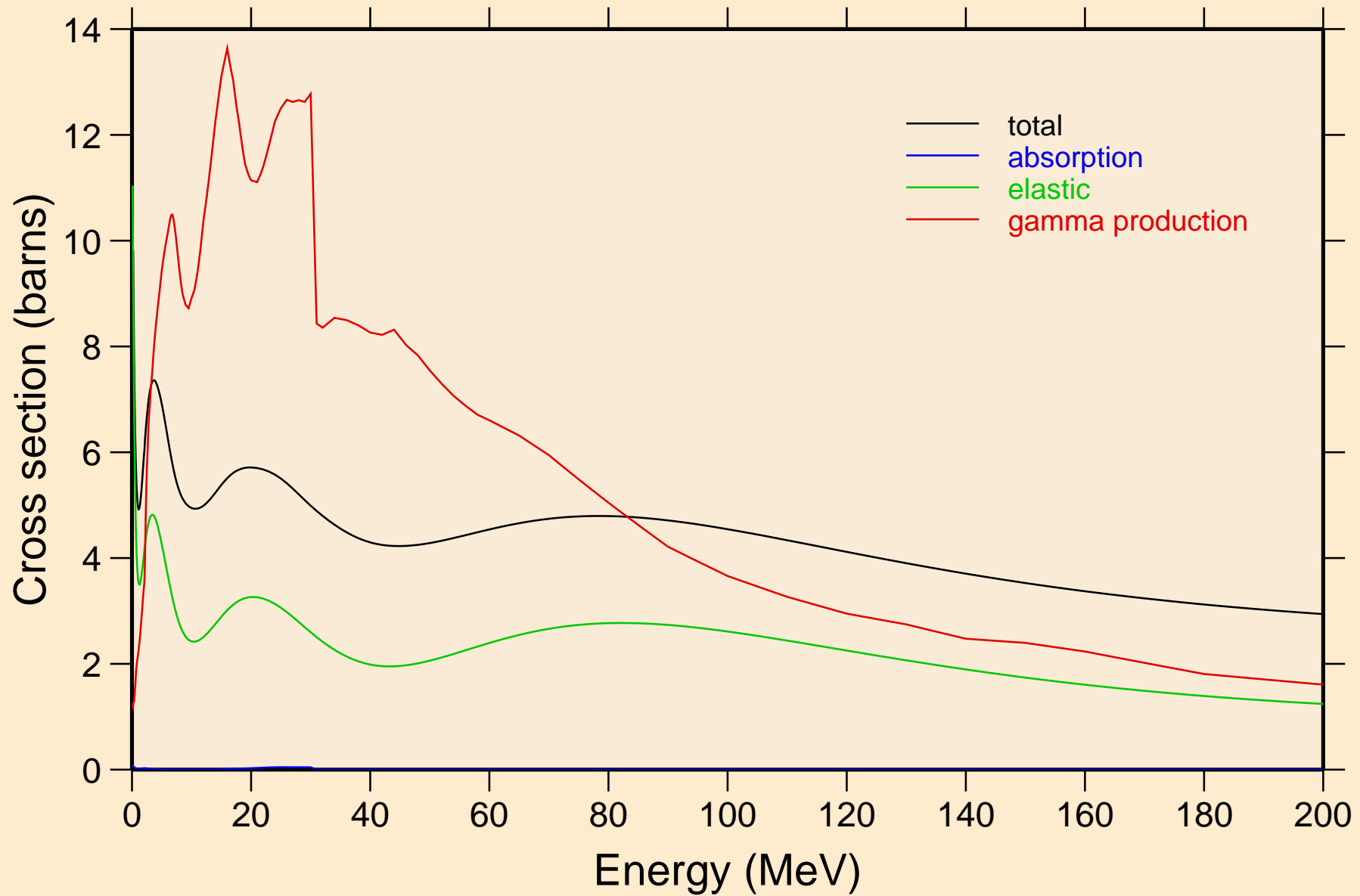

HG201 NEUTRON ACER TENDL-2021 LIBRARY; T=293.6K
Heating

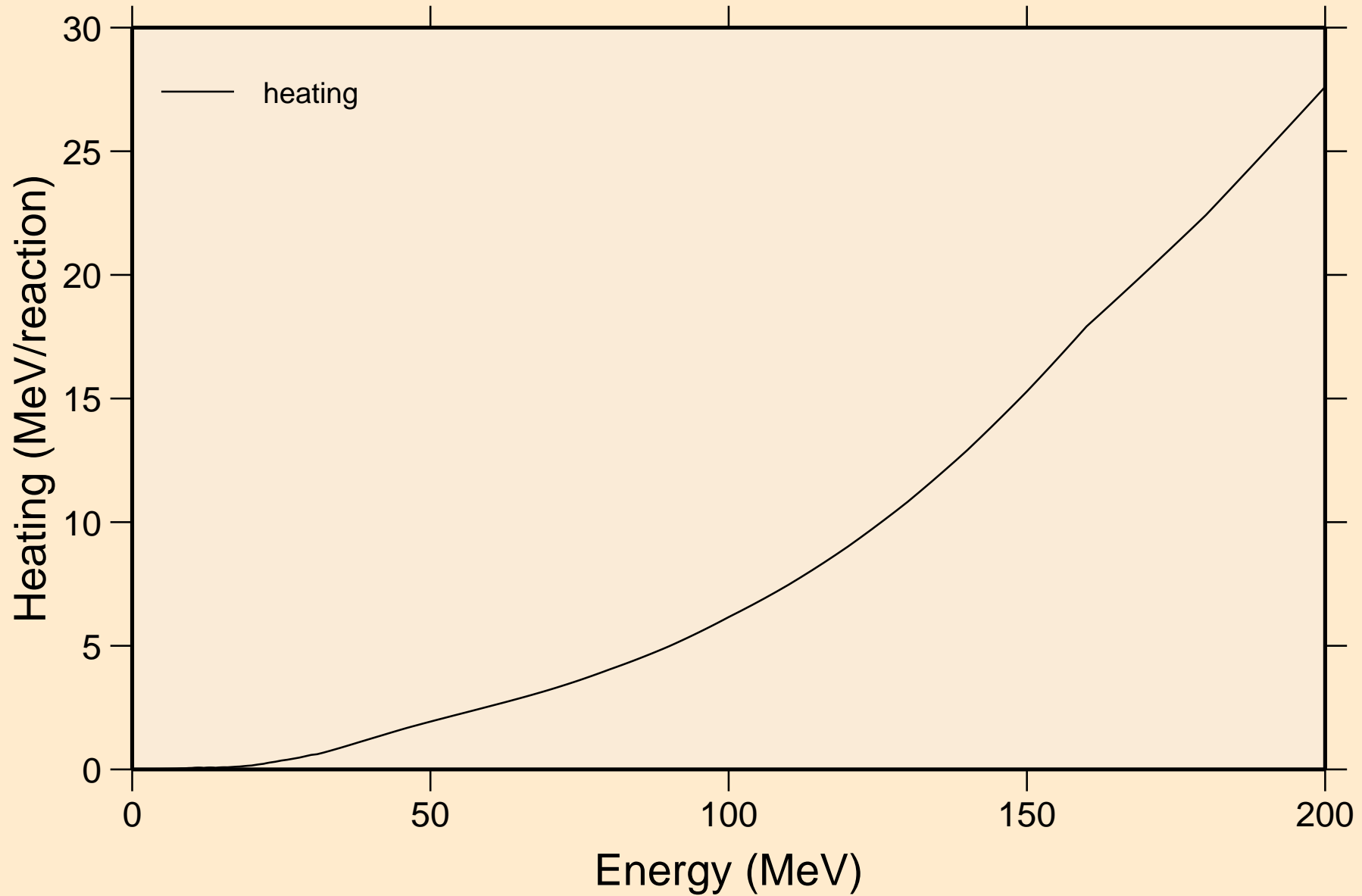

HG201 NEUTRON ACER TENDL-2021 LIBRARY; T=293.6K
Damage

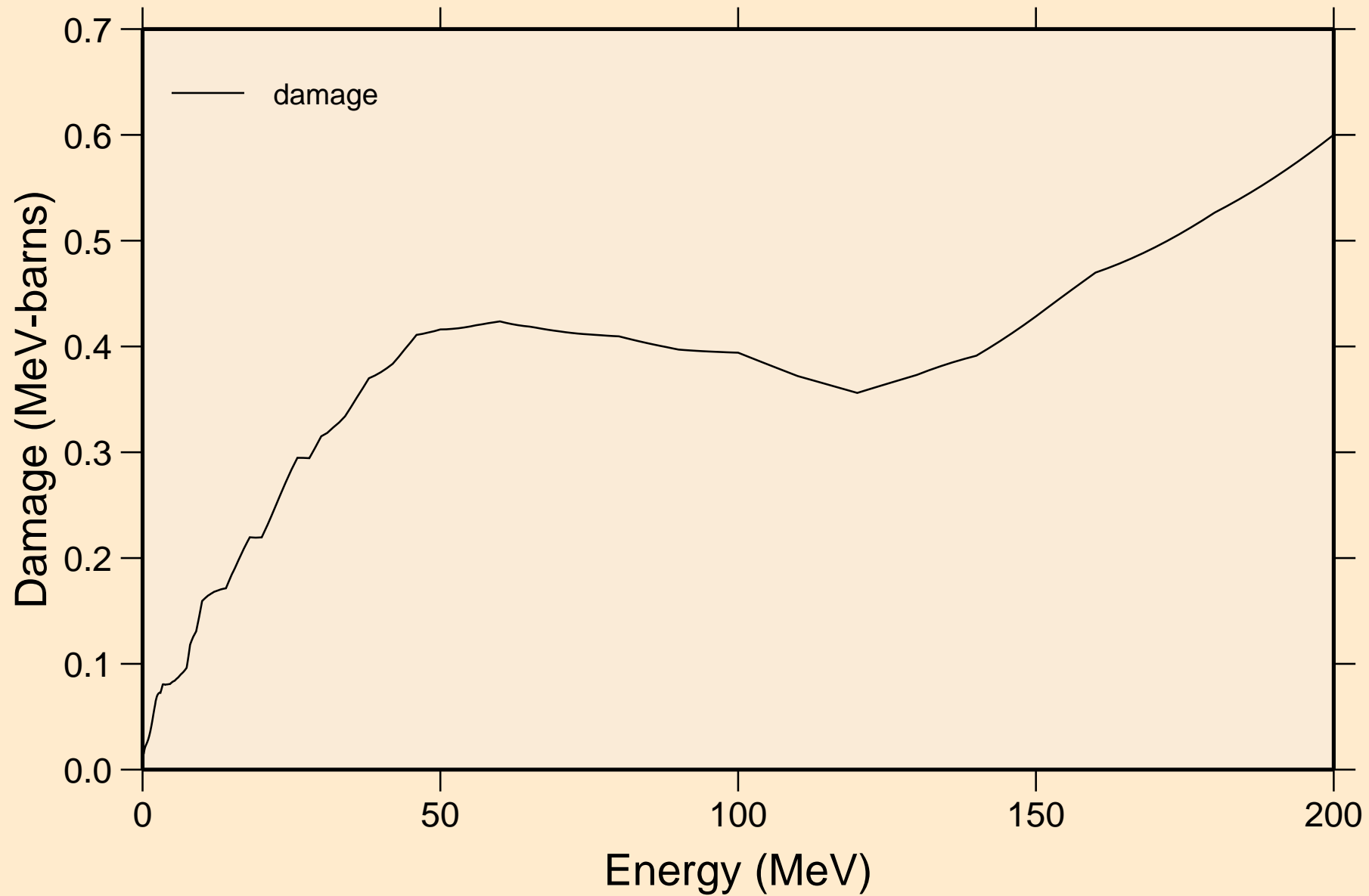

HG201 NEUTRON ACER TENDL-2021 LIBRARY; T=293.6K
Non-threshold reactions

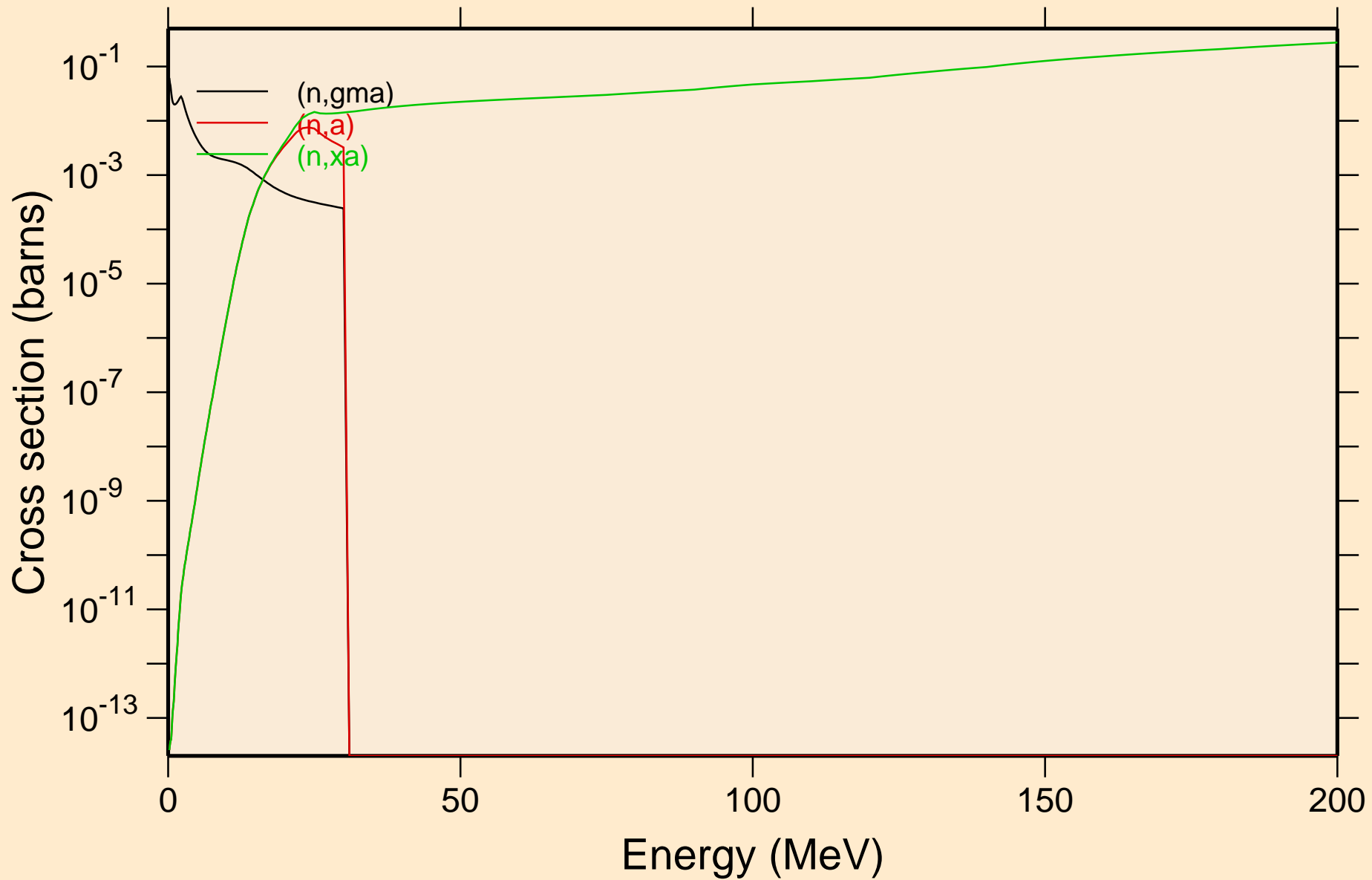

HG201 NEUTRON ACER TENDL-2021 LIBRARY; T=293.6K
Inelastic levels

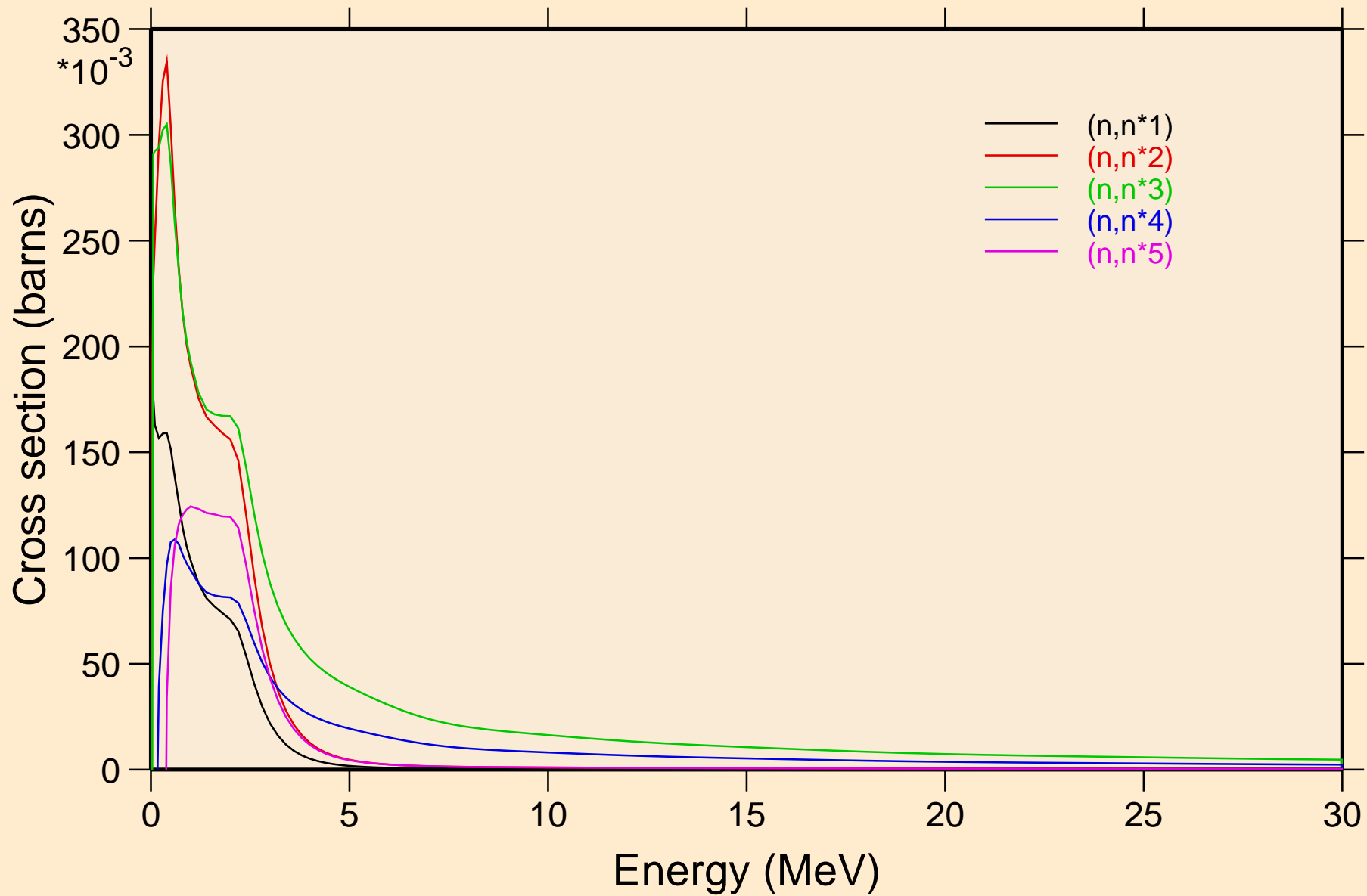

HG201 NEUTRON ACER TENDL-2021 LIBRARY; T=293.6K
Inelastic levels

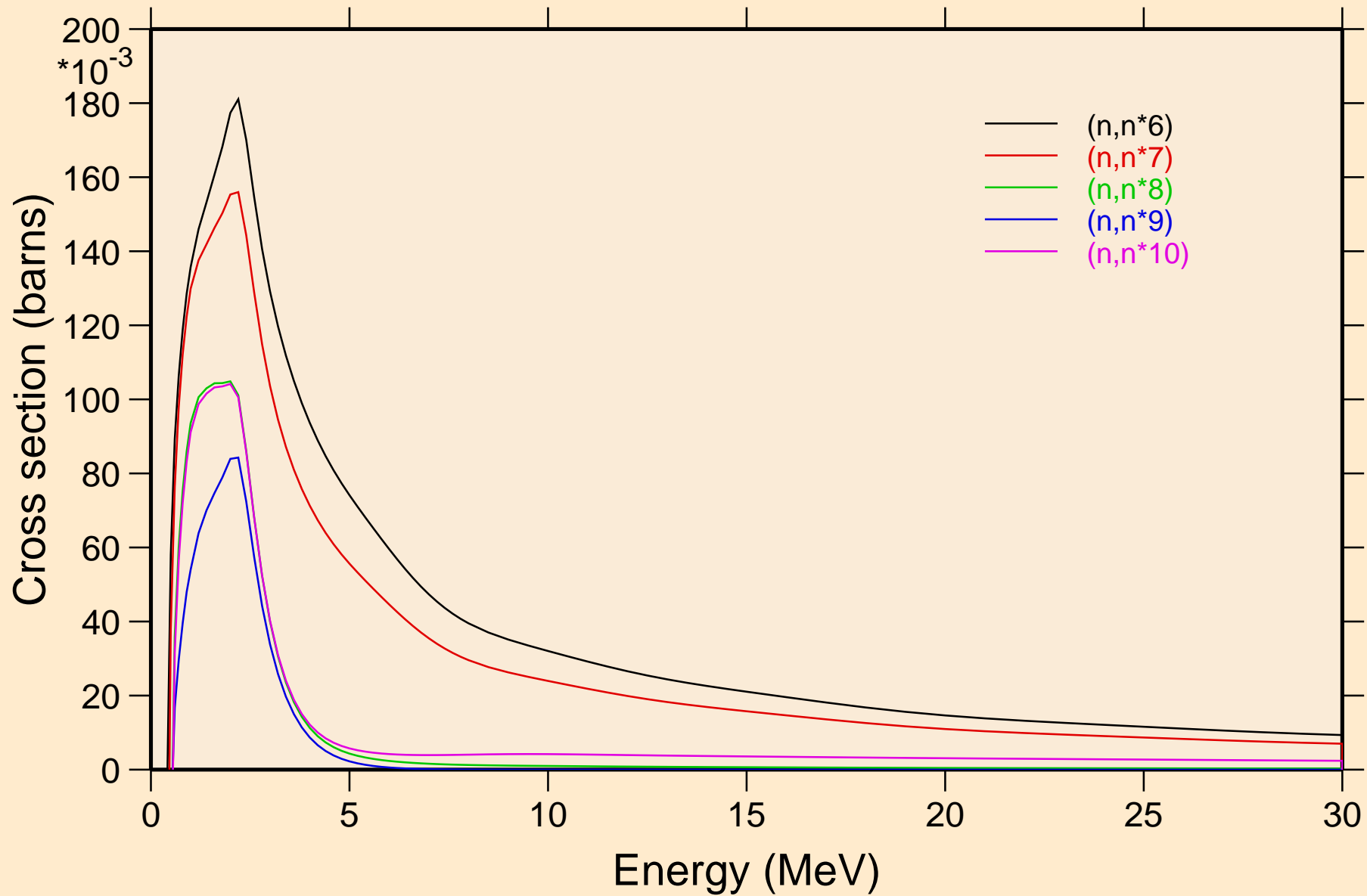

HG201 NEUTRON ACER TENDL-2021 LIBRARY; T=293.6K
Inelastic levels

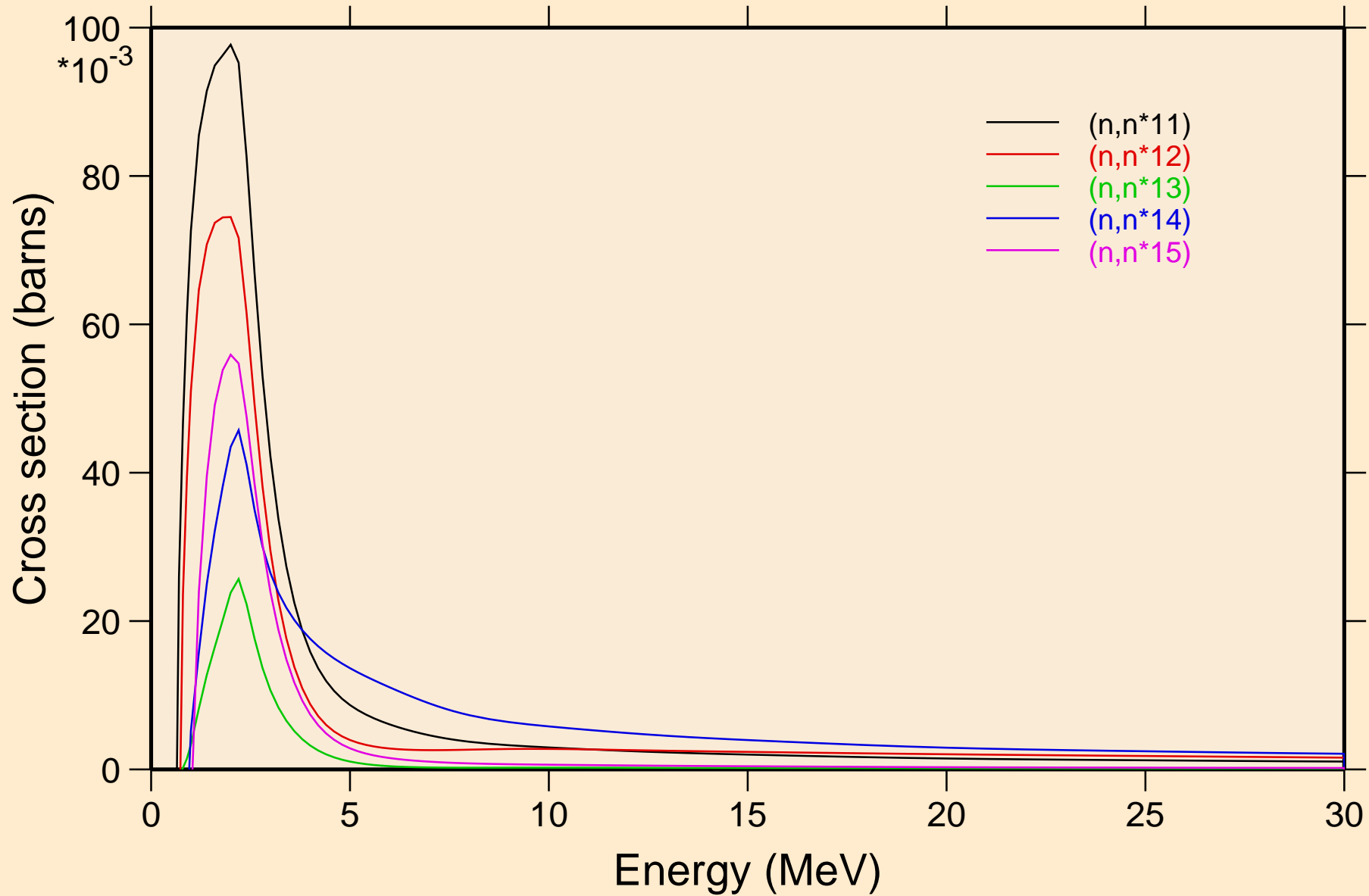

HG201 NEUTRON ACER TENDL-2021 LIBRARY; T=293.6K
Inelastic levels

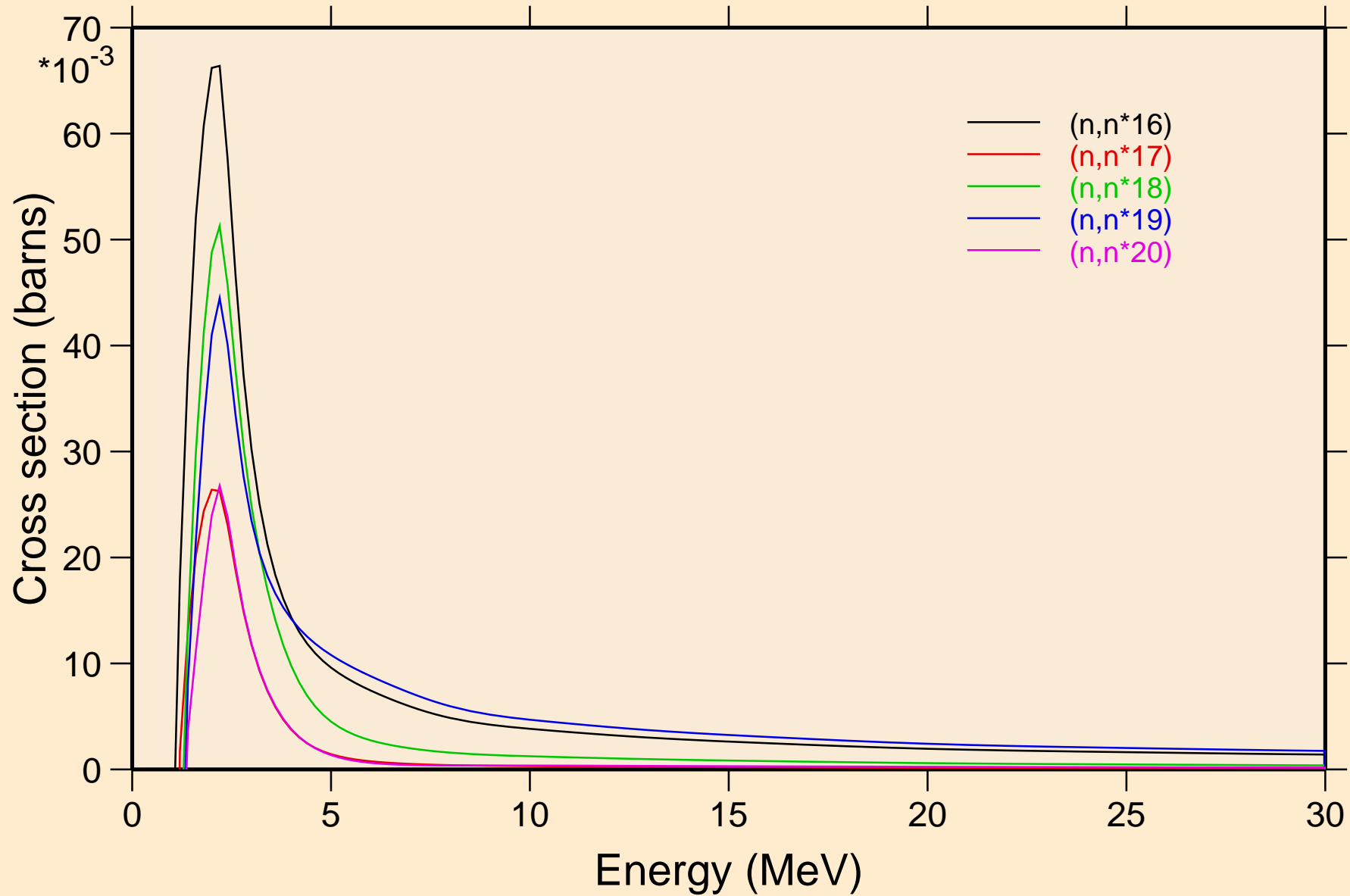

HG201 NEUTRON ACER TENDL-2021 LIBRARY; T=293.6K
Inelastic levels

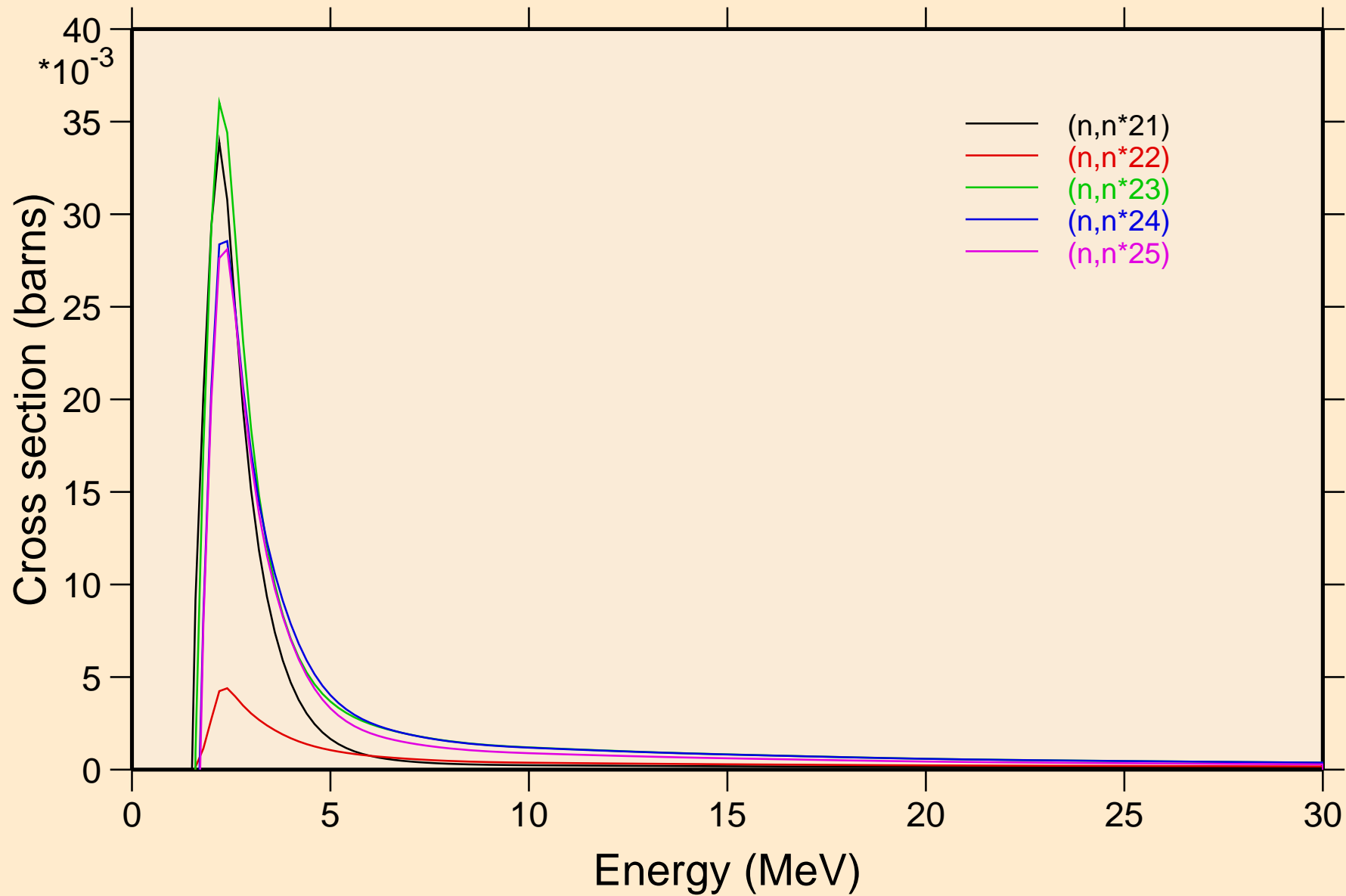

HG201 NEUTRON ACER TENDL-2021 LIBRARY; T=293.6K
Inelastic levels

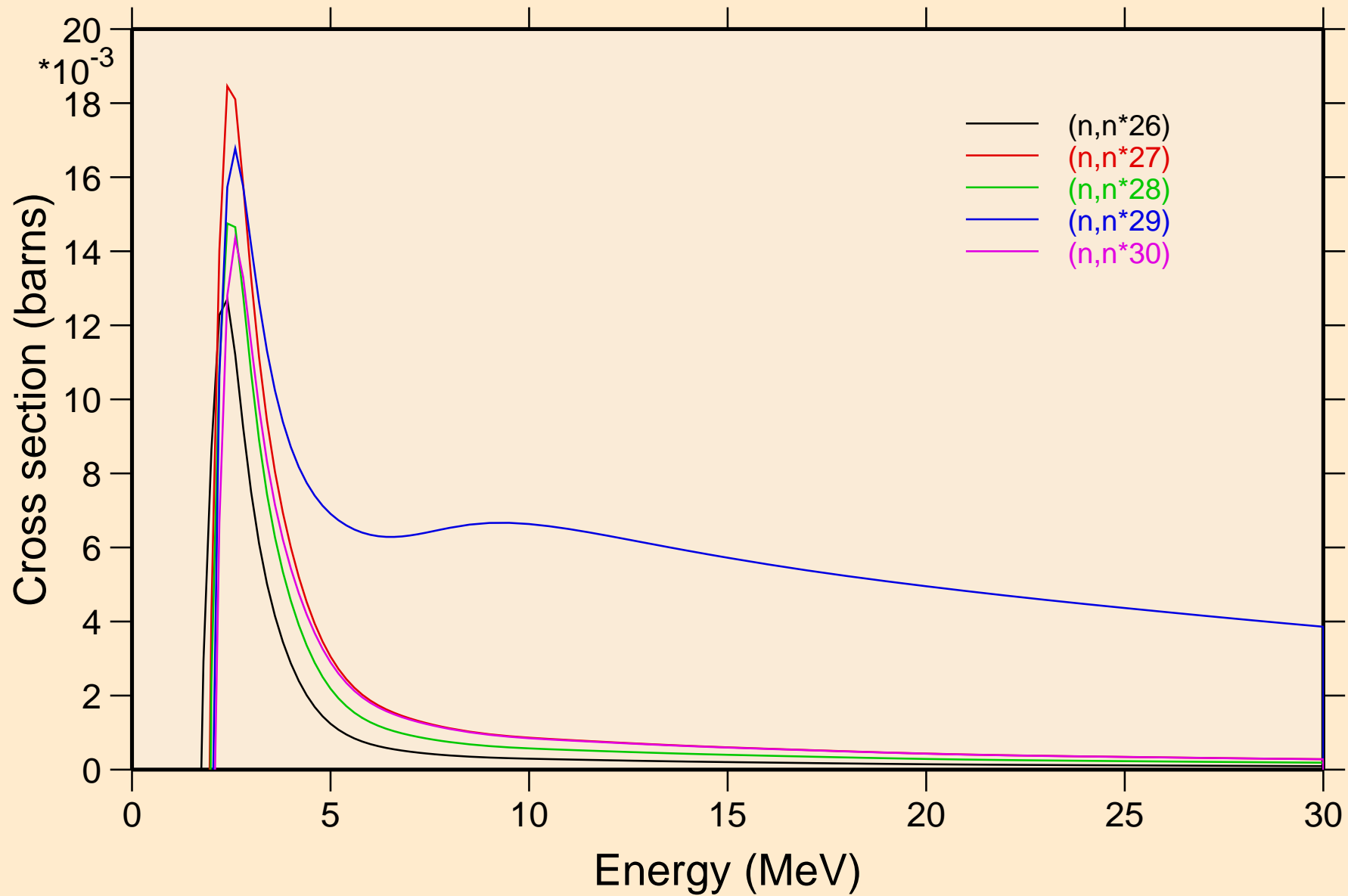

HG201 NEUTRON ACER TENDL-2021 LIBRARY; T=293.6K
Threshold reactions

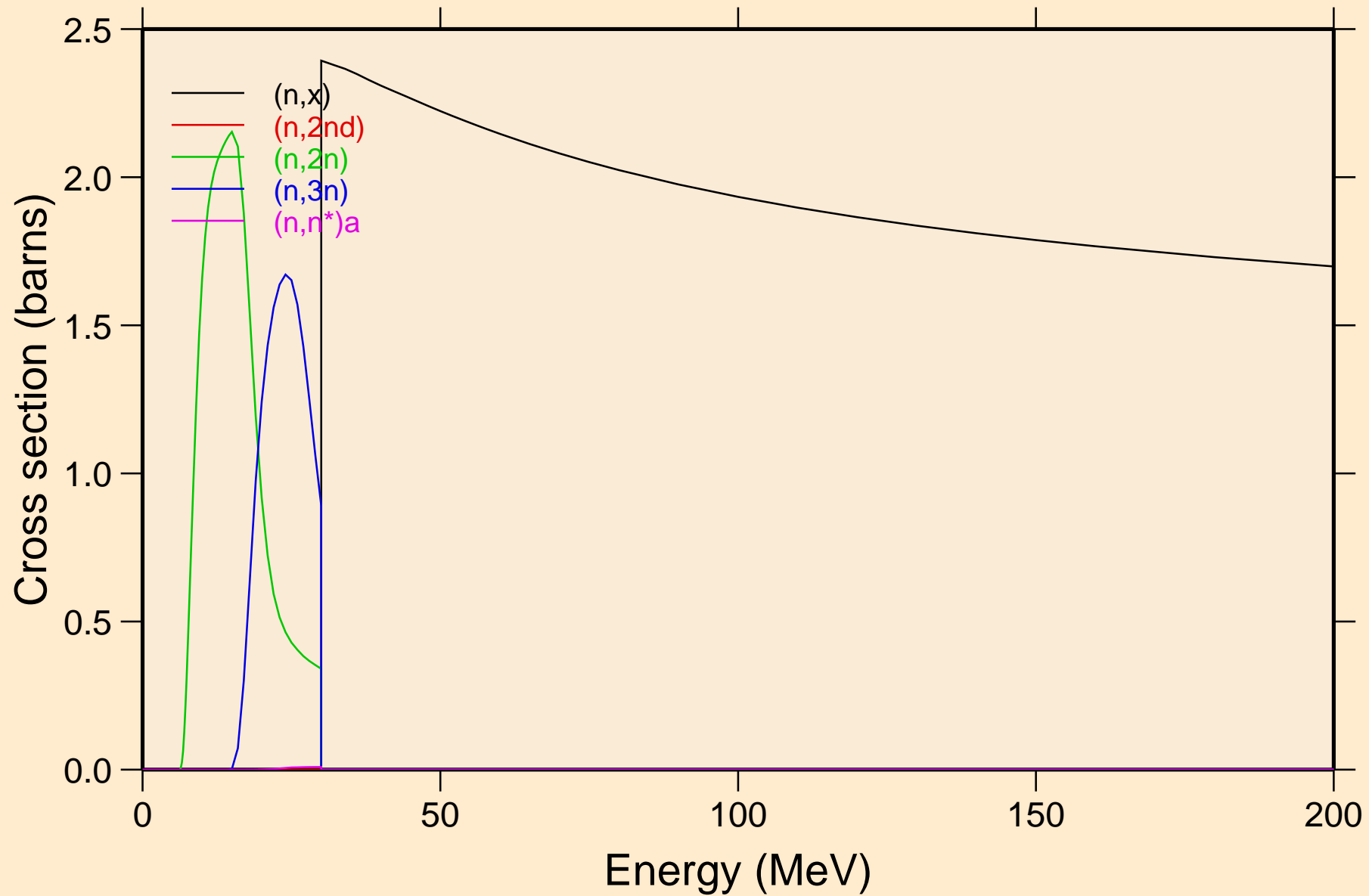

HG201 NEUTRON ACER TENDL-2021 LIBRARY; T=293.6K
Threshold reactions

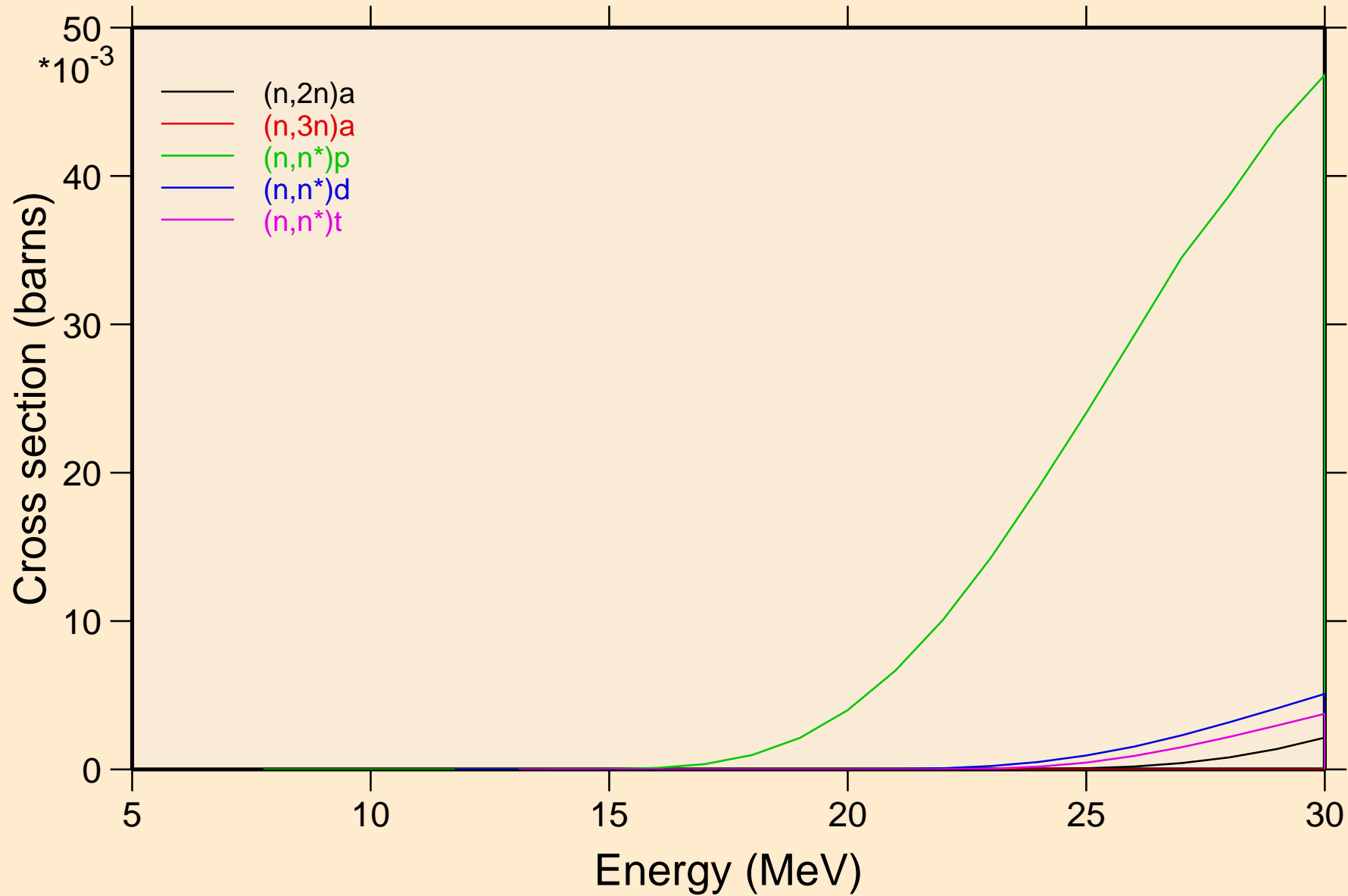

HG201 NEUTRON ACER TENDL-2021 LIBRARY; T=293.6K
Threshold reactions

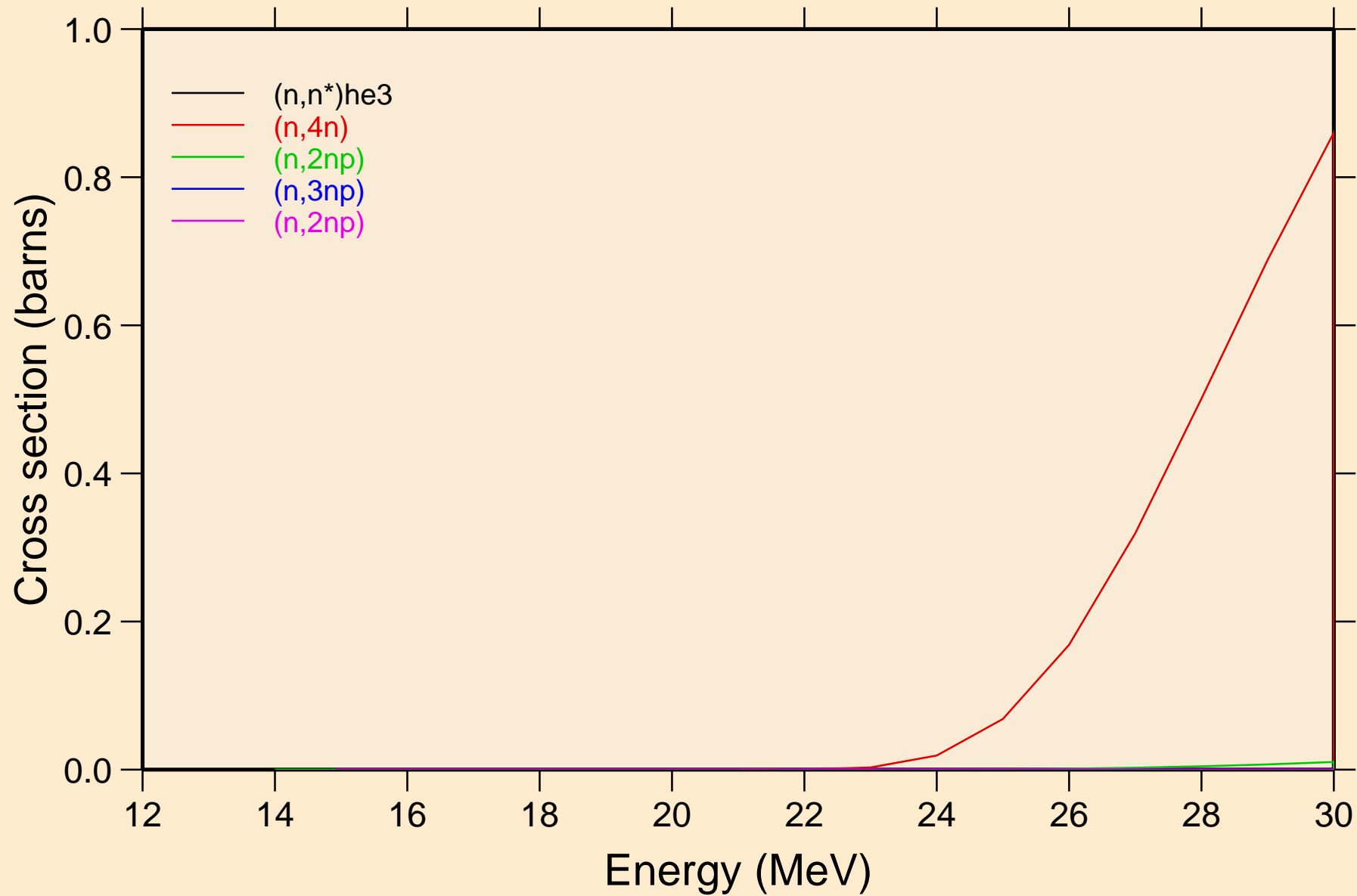

HG201 NEUTRON ACER TENDL-2021 LIBRARY; T=293.6K
Threshold reactions

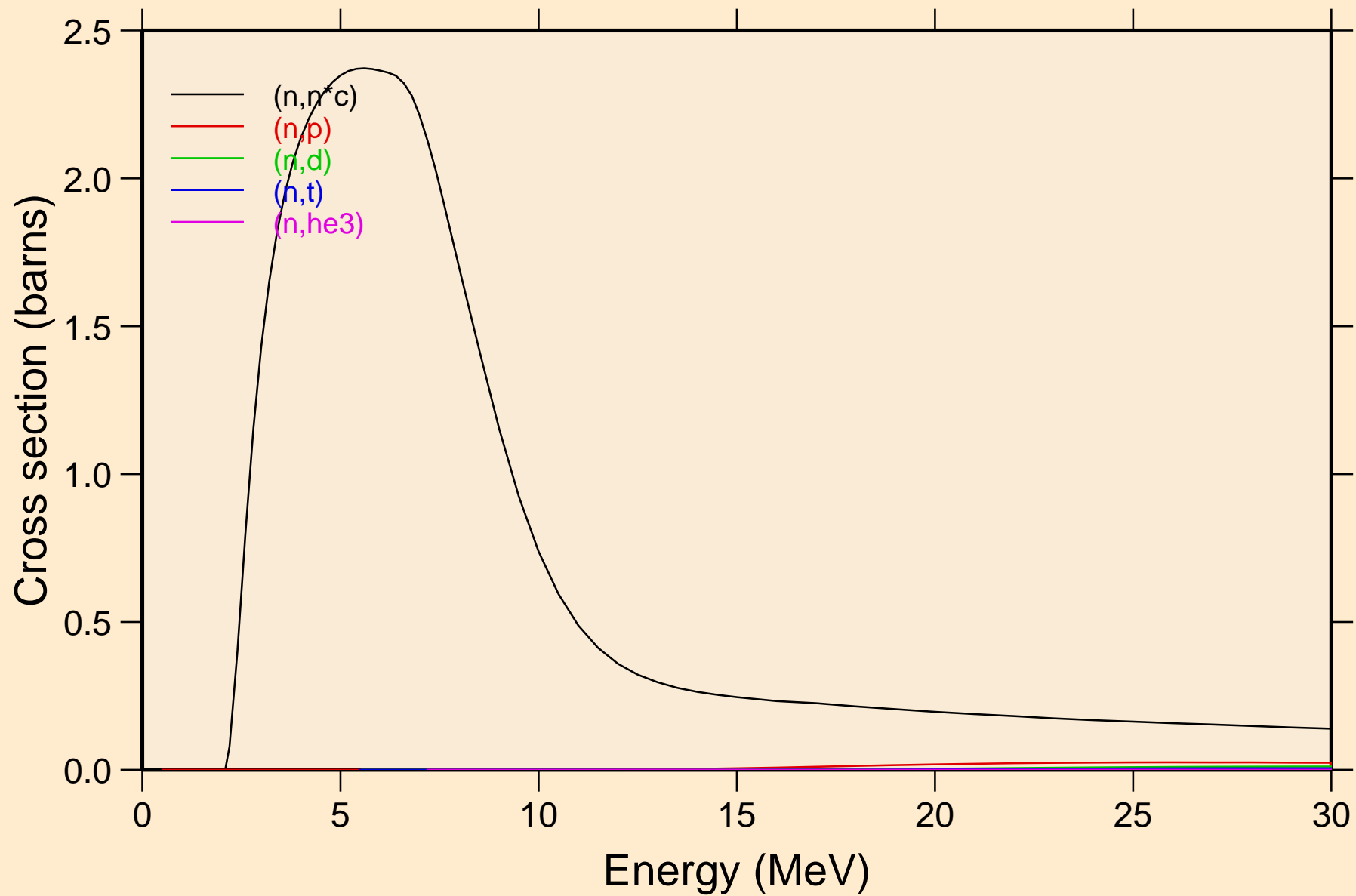

HG201 NEUTRON ACER TENDL-2021 LIBRARY; T=293.6K
Threshold reactions

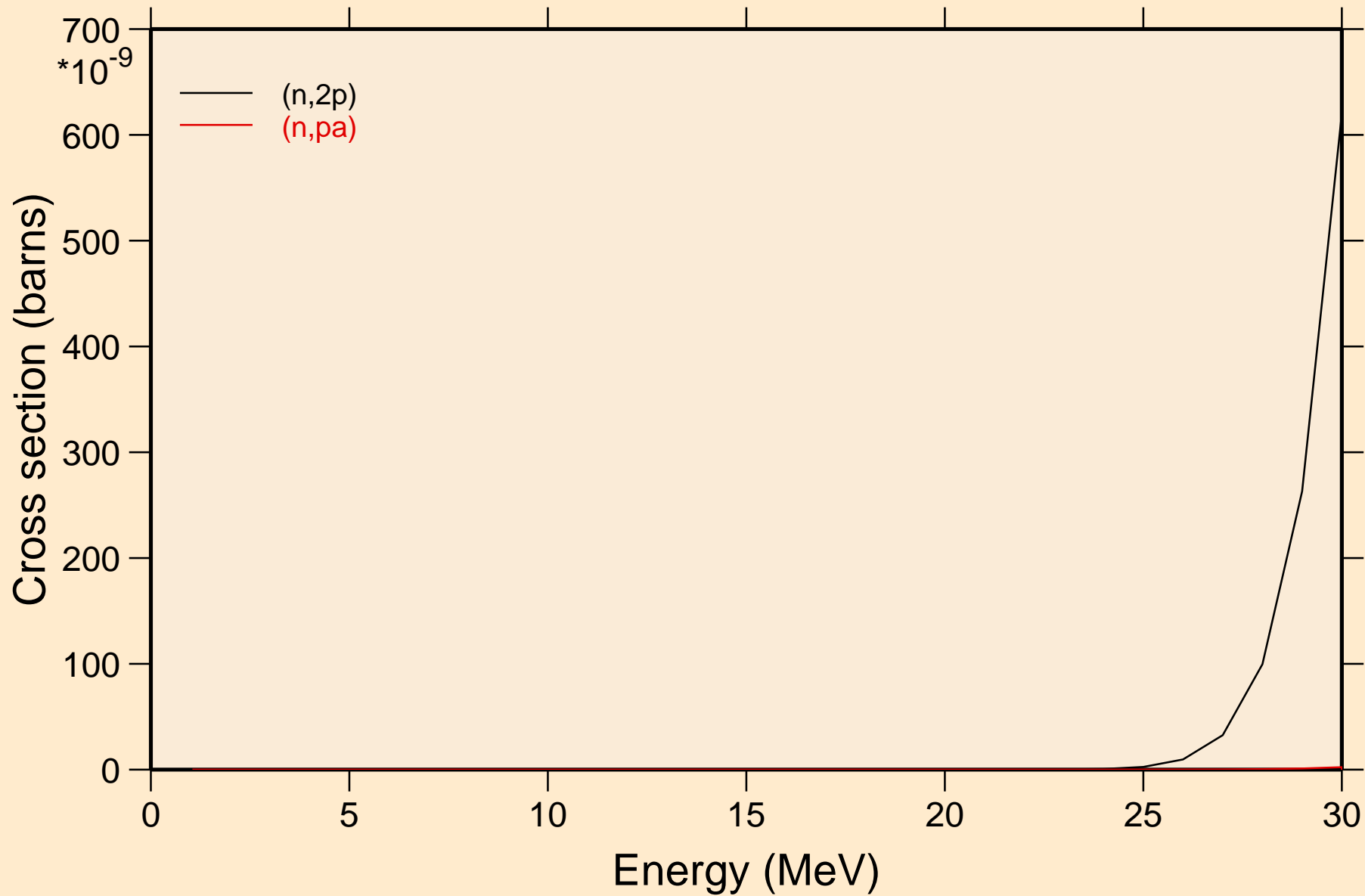

HG201 NEUTRON ACER TENDL-2021 LIBRARY; T=293.6K
Threshold reactions

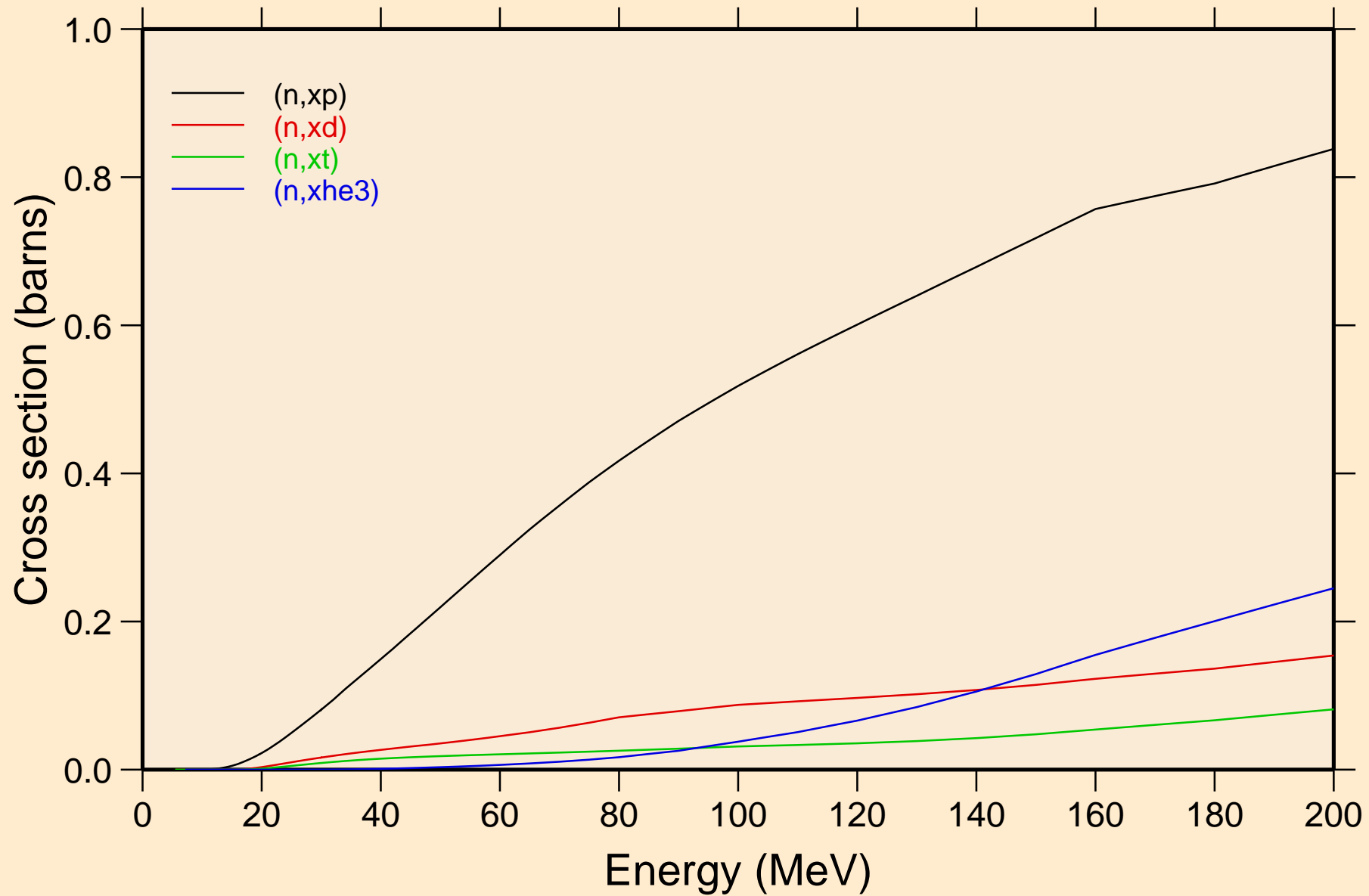

HG201 NEUTRON ACER TENDL-2021 LIBRARY; T=293.6K
angular distribution for elastic

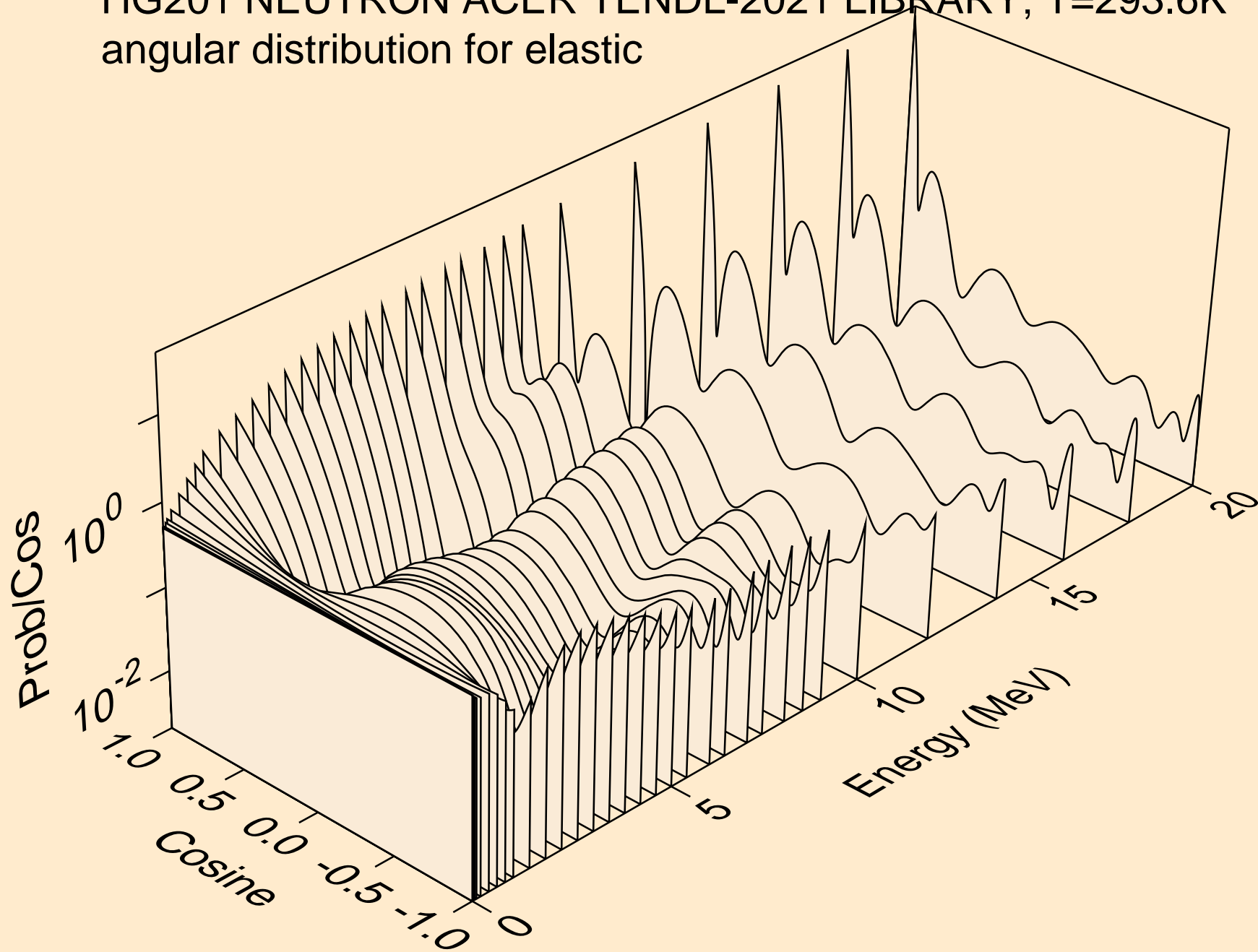

HG201 NEUTRON ACER TENDL-2021 LIBRARY; T=293.6K
angular distribution for elastic

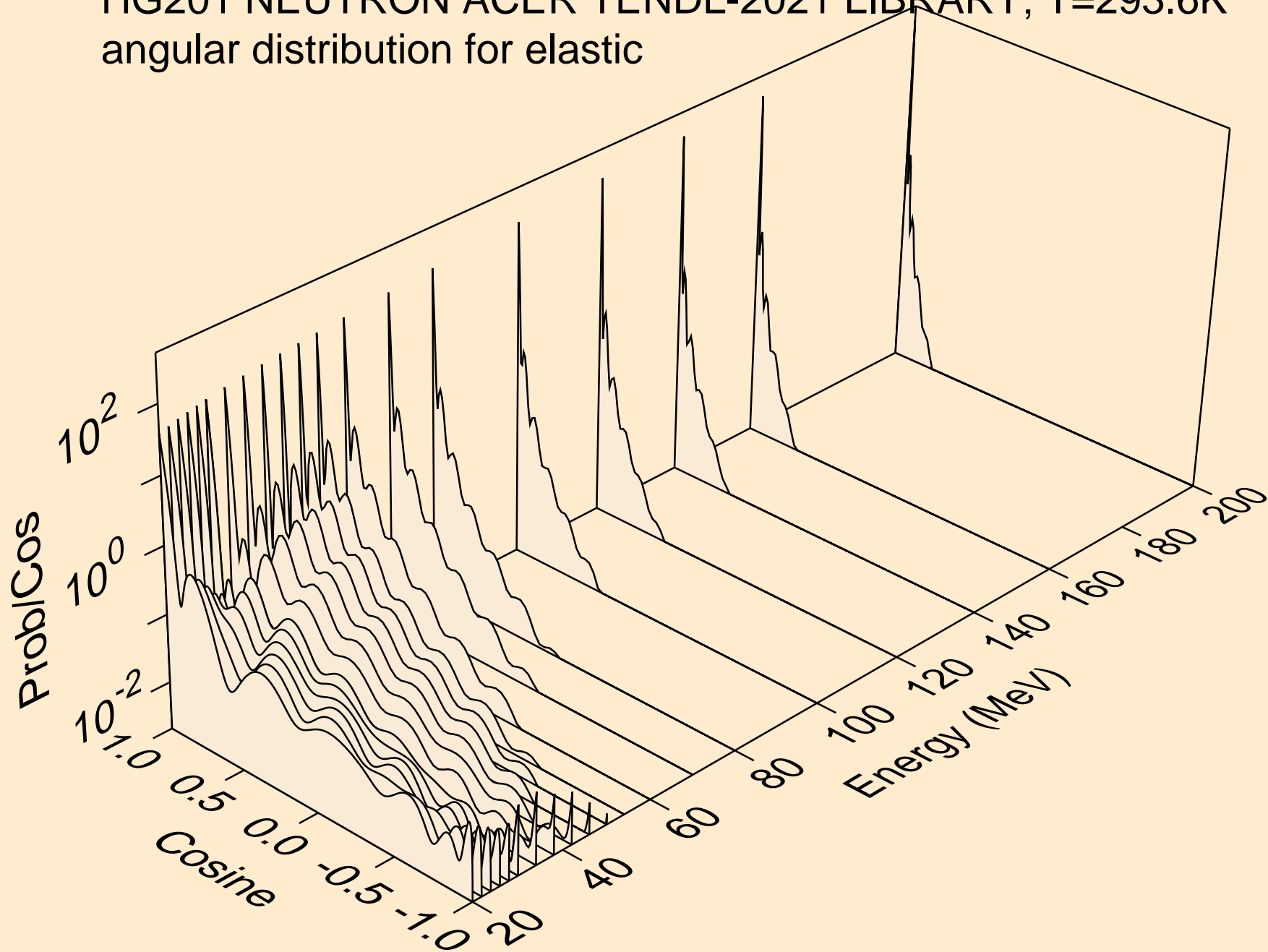

HG201 NEUTRON ACER TENDL-2021 LIBRARY; T=293.6K
angular distribution for (n,n*1)

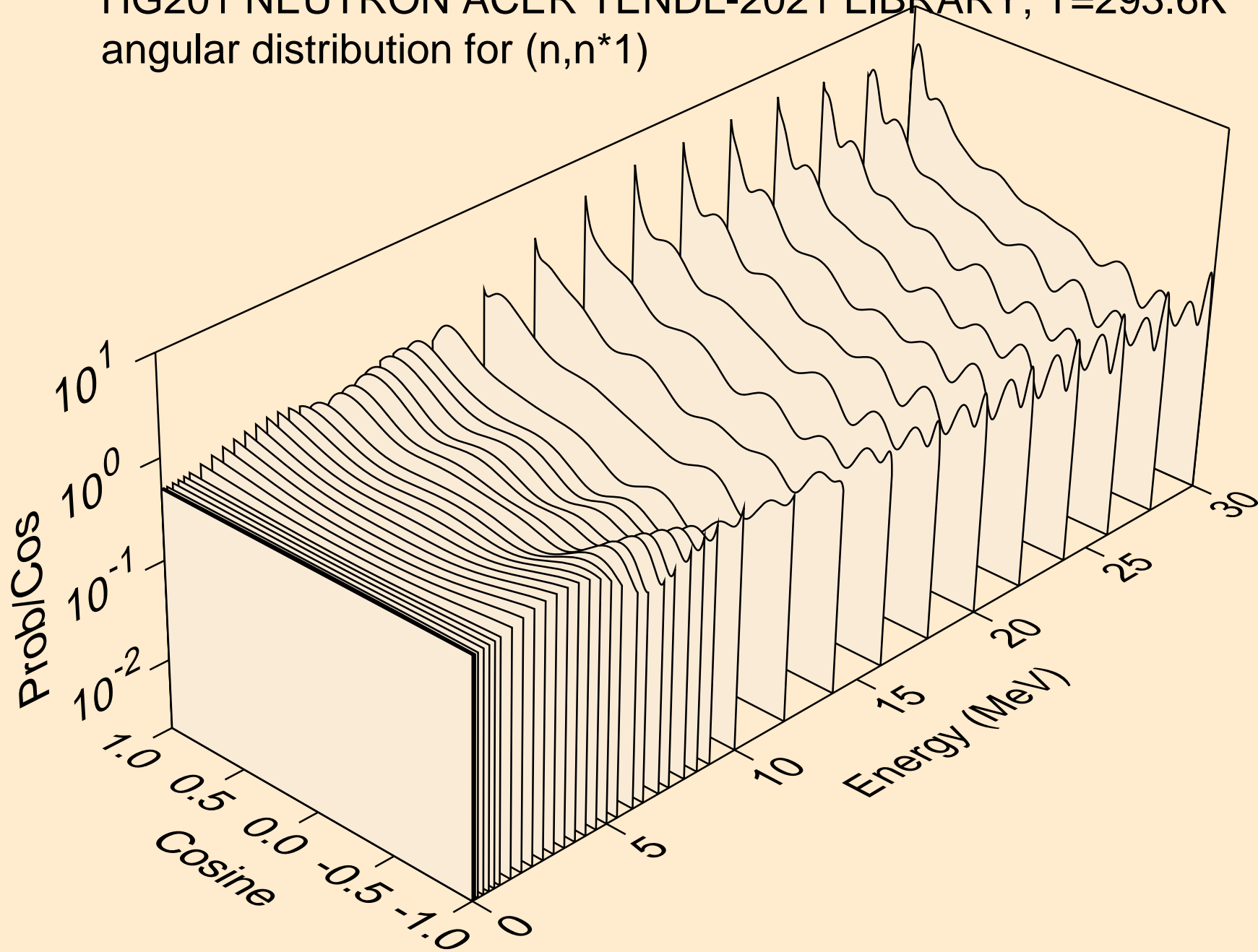

HG201 NEUTRON ACER TENDL-2021 LIBRARY; T=293.6K
angular distribution for (n,n*2)

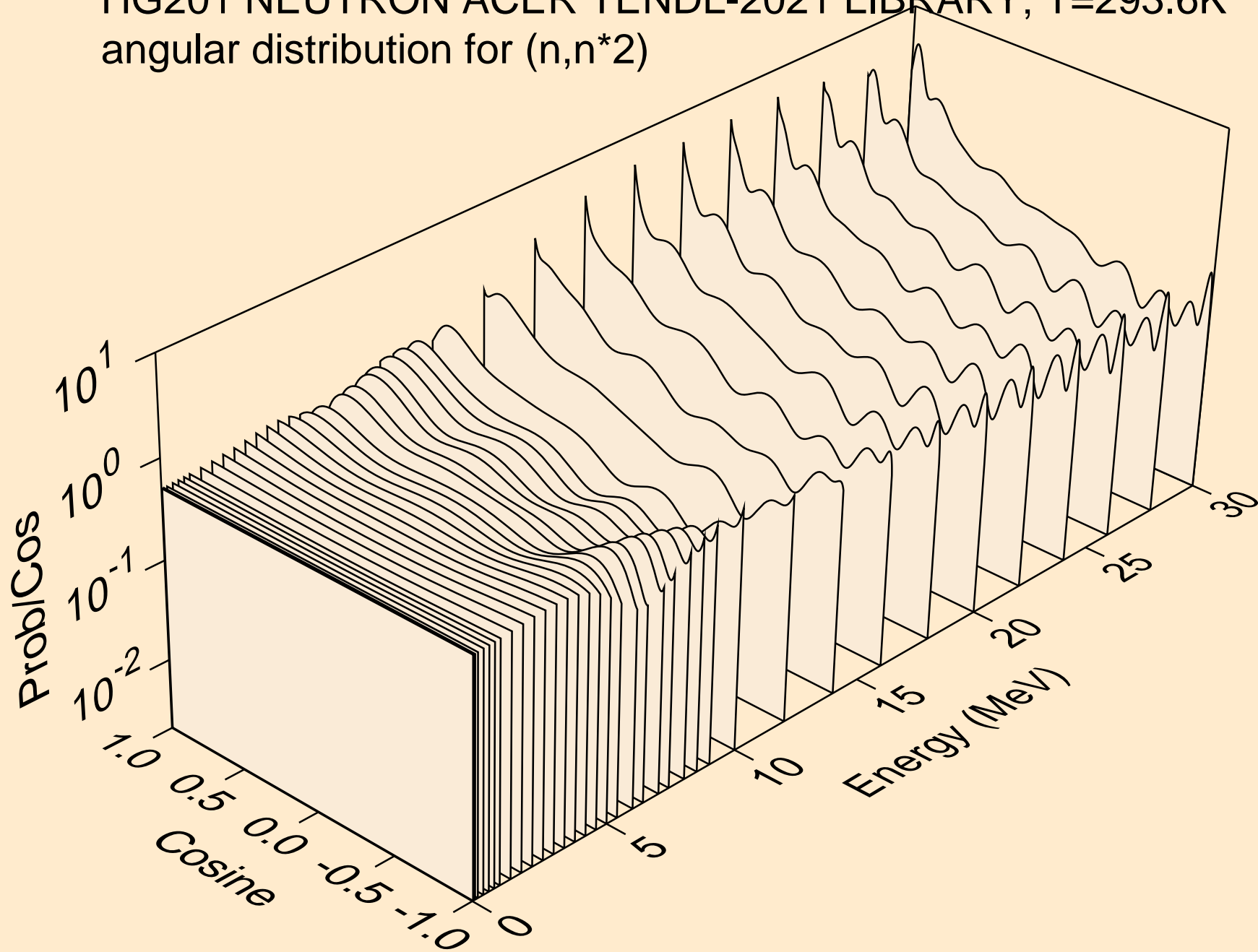

HG201 NEUTRON ACER TENDL-2021 LIBRARY; T=293.6K
angular distribution for (n,n*3)

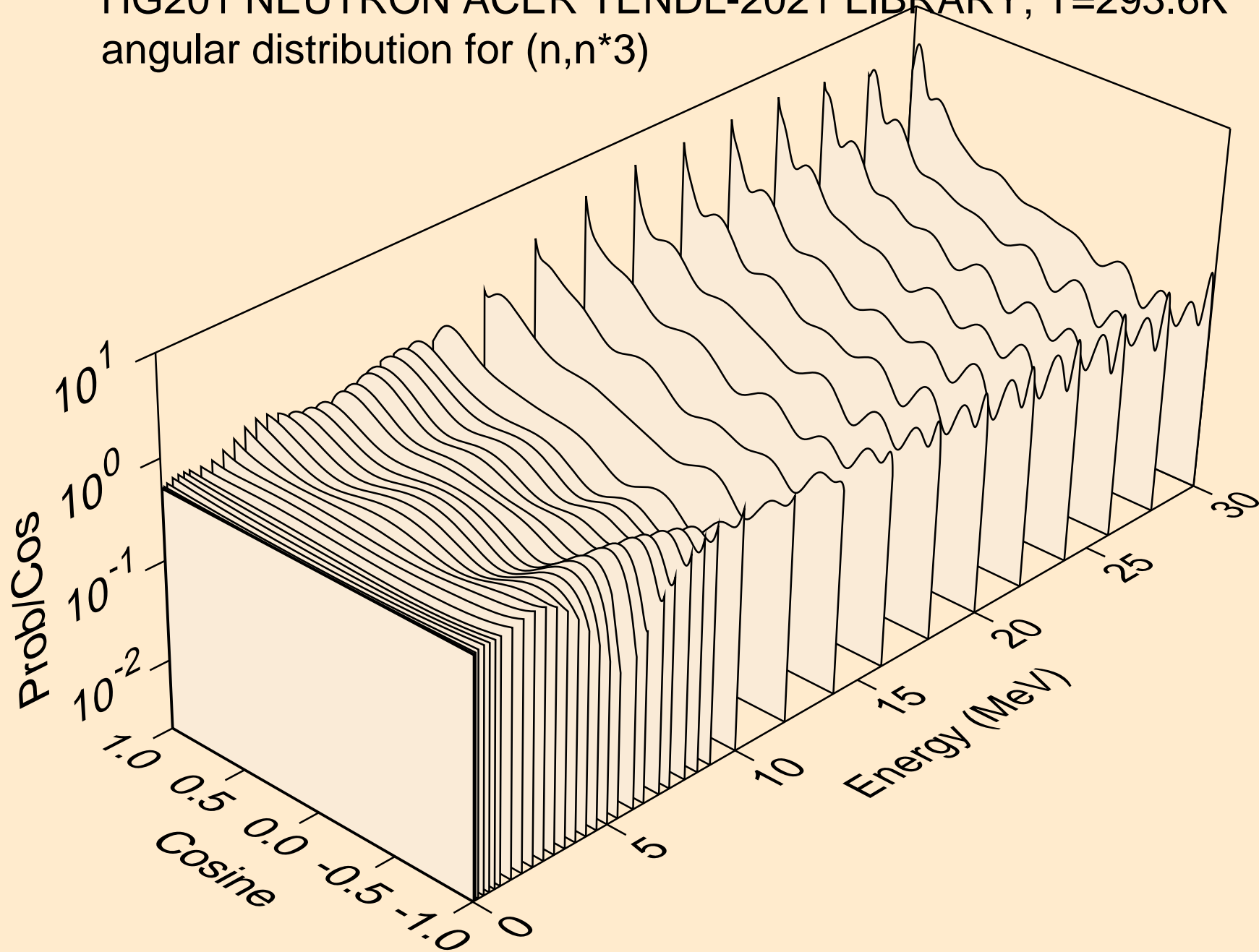

HG201 NEUTRON ACER TENDL-2021 LIBRARY; T=293.6K
angular distribution for (n,n*4)

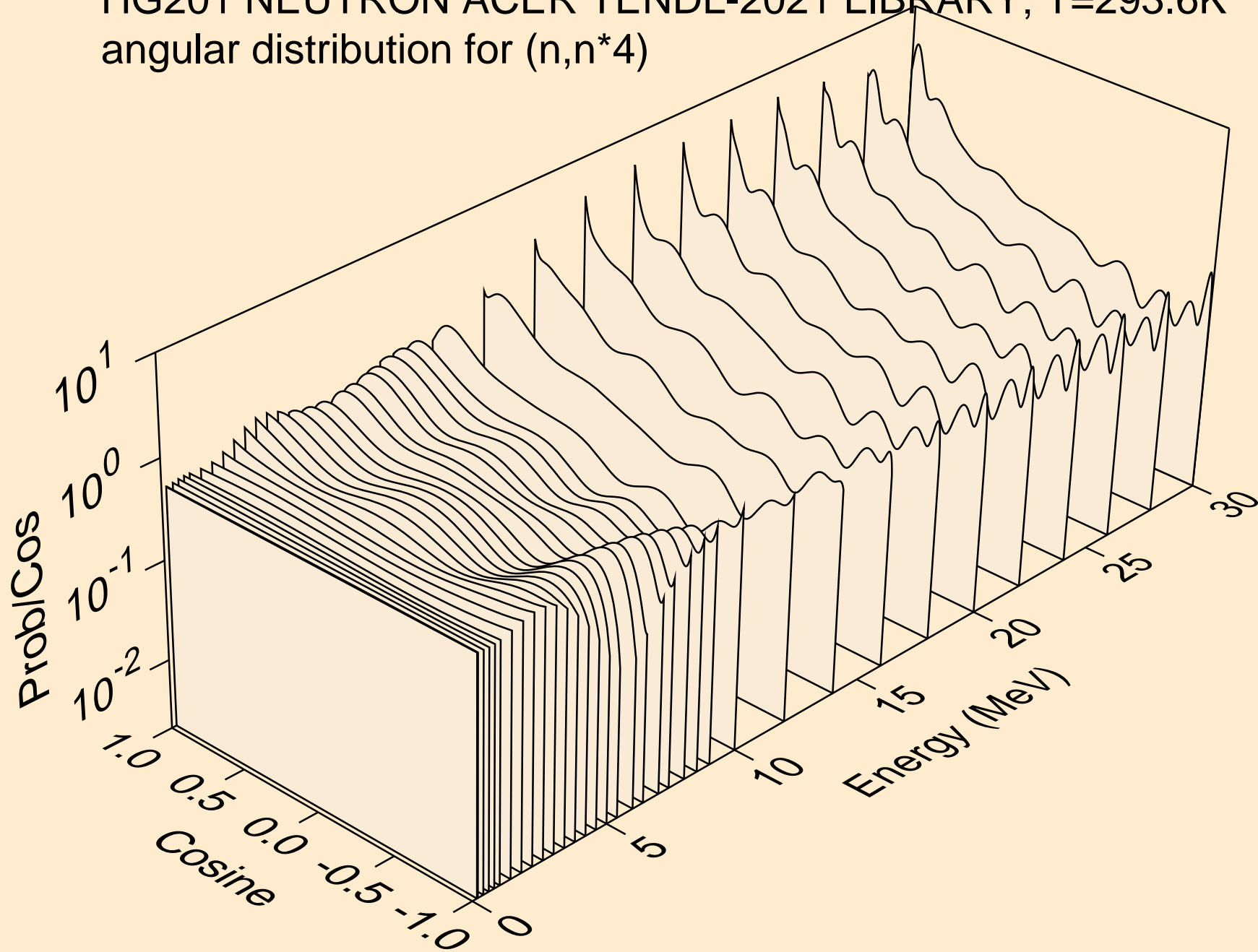

HG201 NEUTRON ACER TENDL-2021 LIBRARY; T=293.6K
angular distribution for (n,n*5)

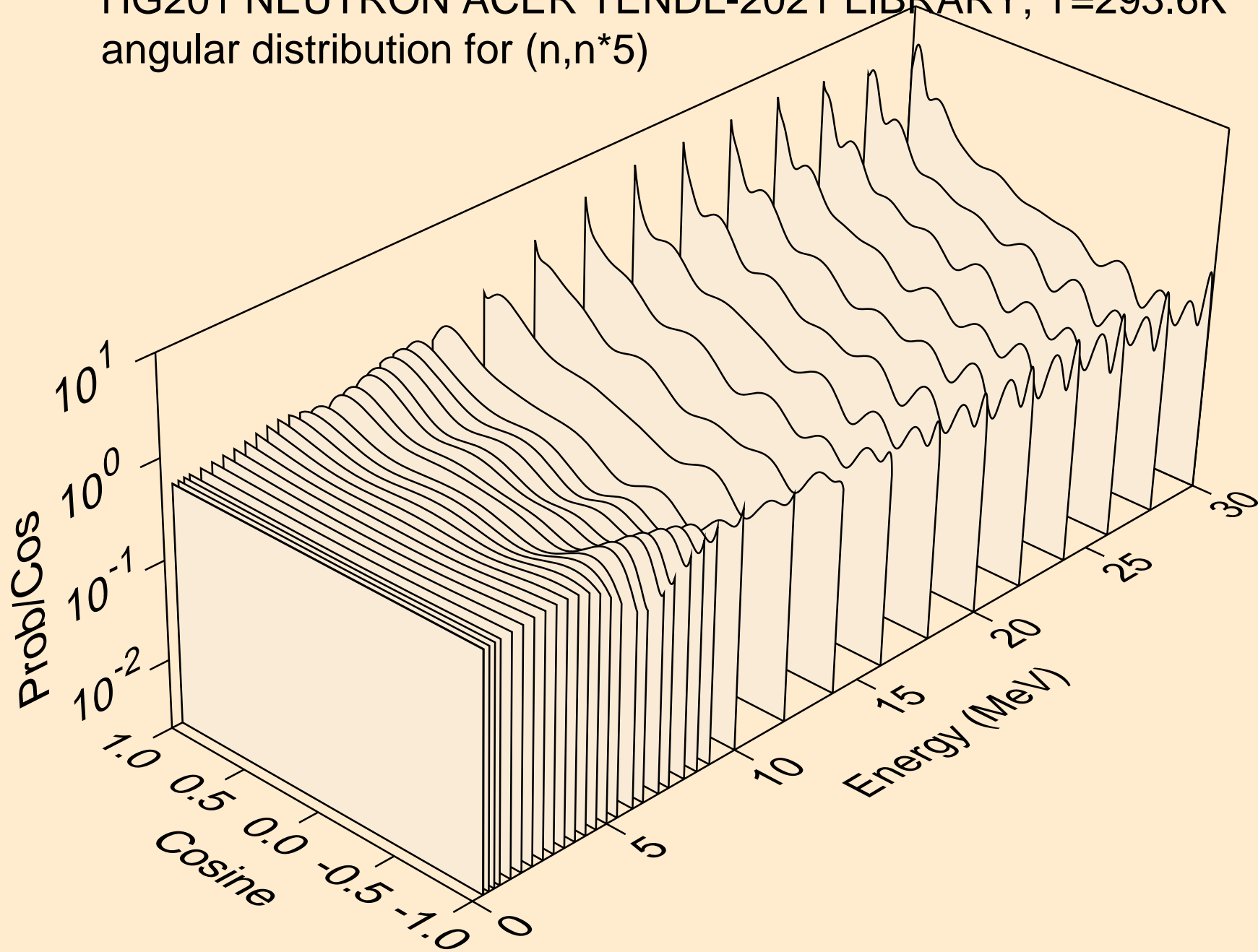

HG201 NEUTRON ACER TENDL-2021 LIBRARY; T=293.6K
angular distribution for (n,n*6)

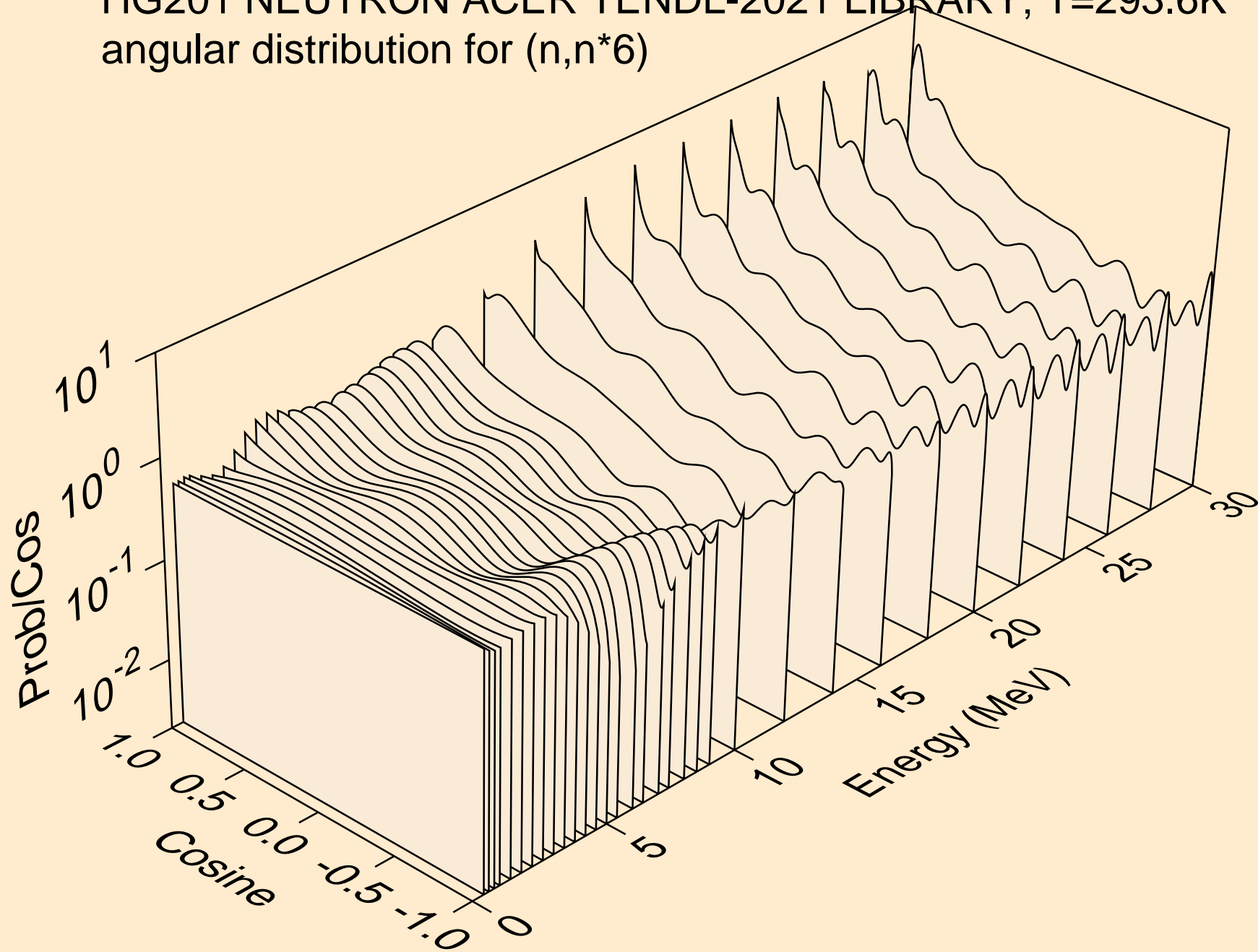

HG201 NEUTRON ACER TENDL-2021 LIBRARY; T=293.6K
angular distribution for (n,n*7)

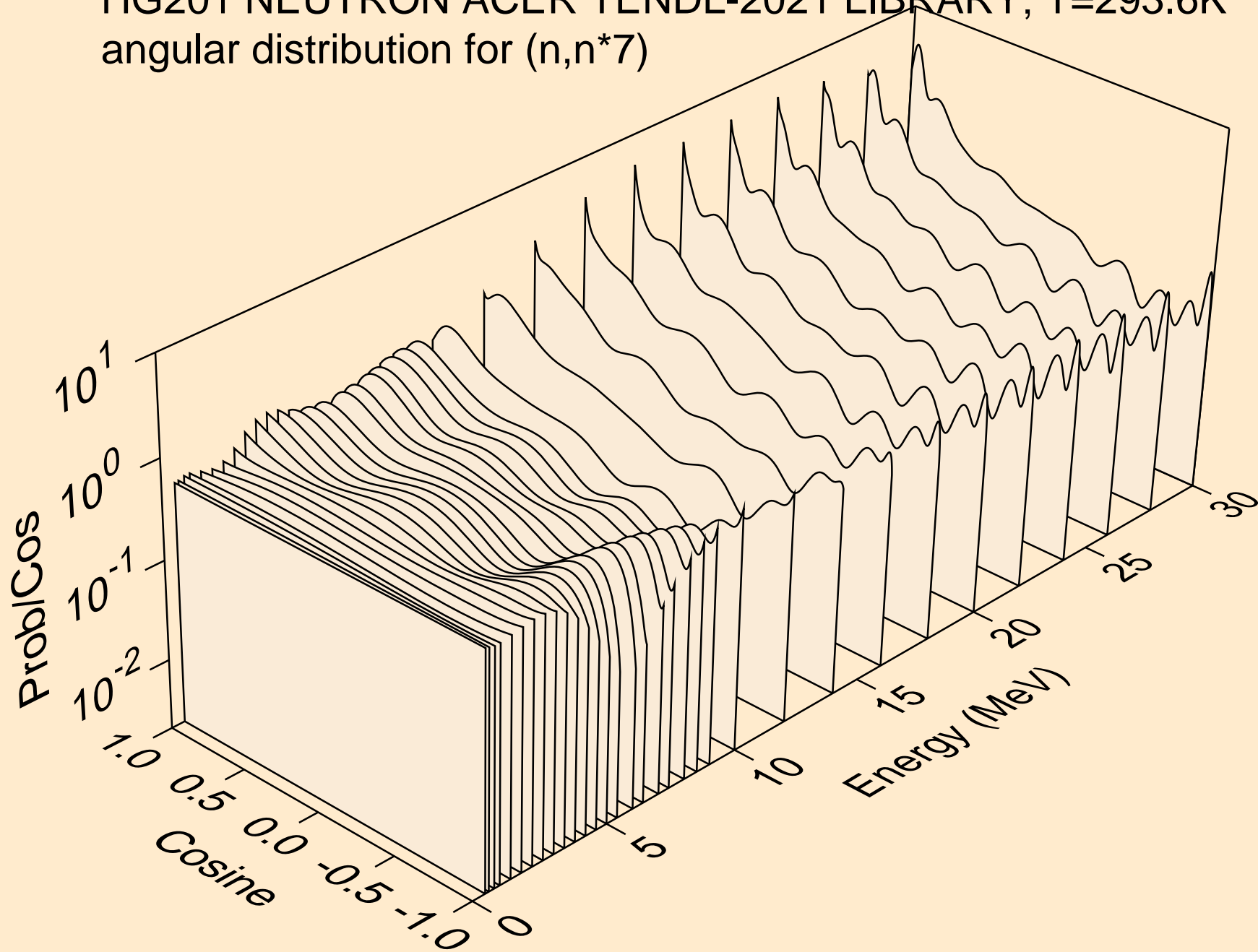

HG201 NEUTRON ACER TENDL-2021 LIBRARY; T=293.6K
angular distribution for (n,n*8)

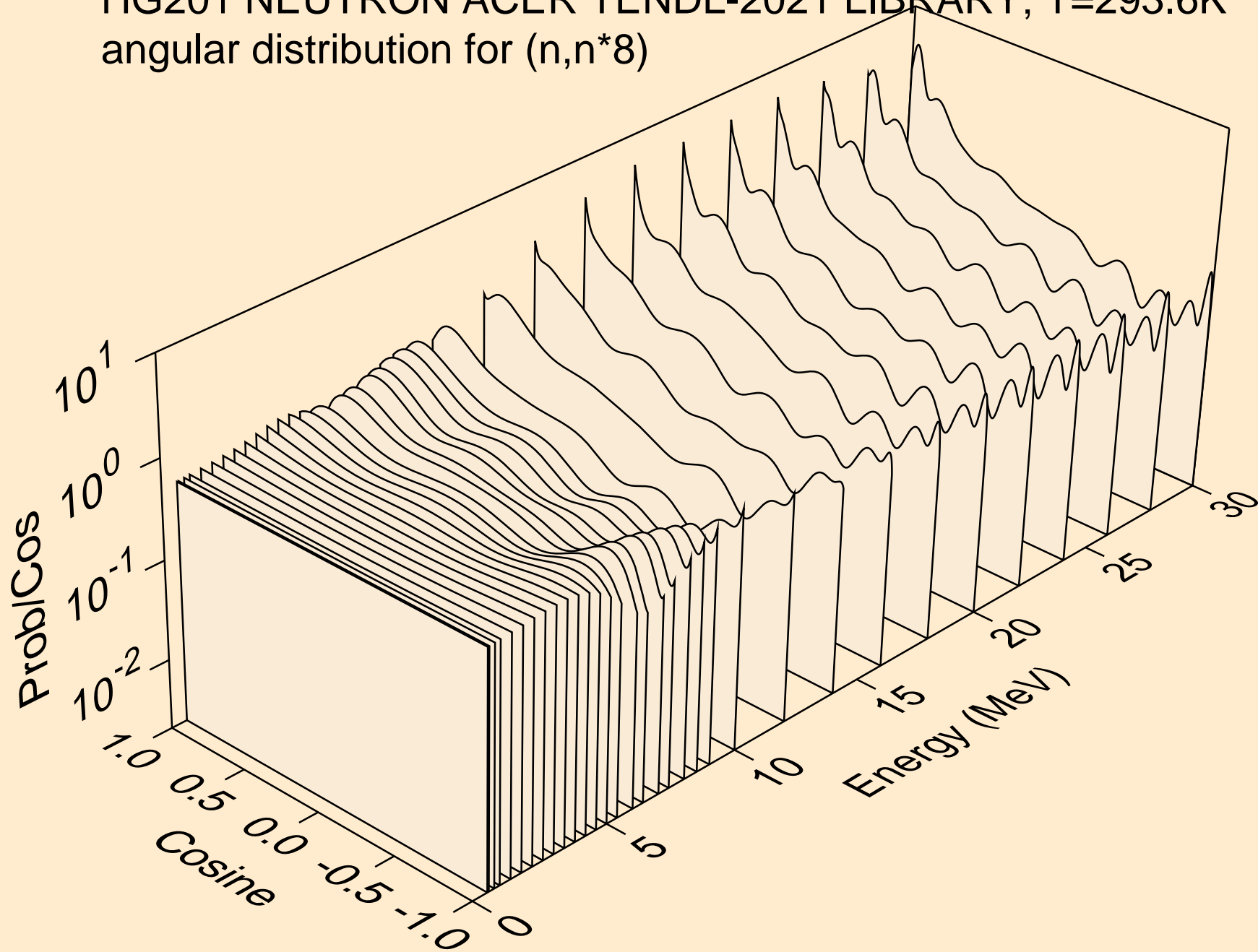

HG201 NEUTRON ACER TENDL-2021 LIBRARY; T=293.6K
angular distribution for (n,n*9)

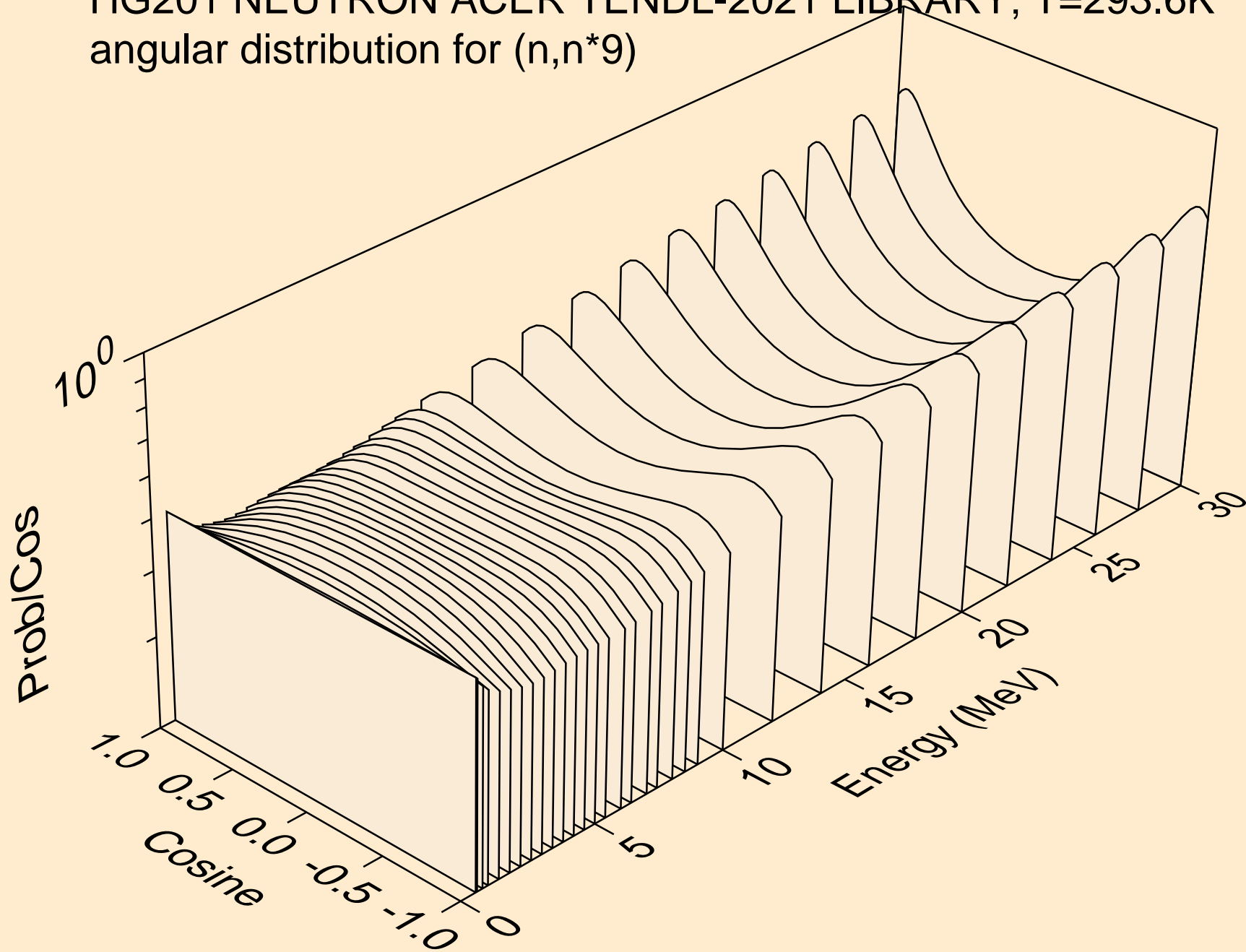

HG201 NEUTRON ACER TENDL-2021 LIBRARY; T=293.6K
angular distribution for (n,n*10)

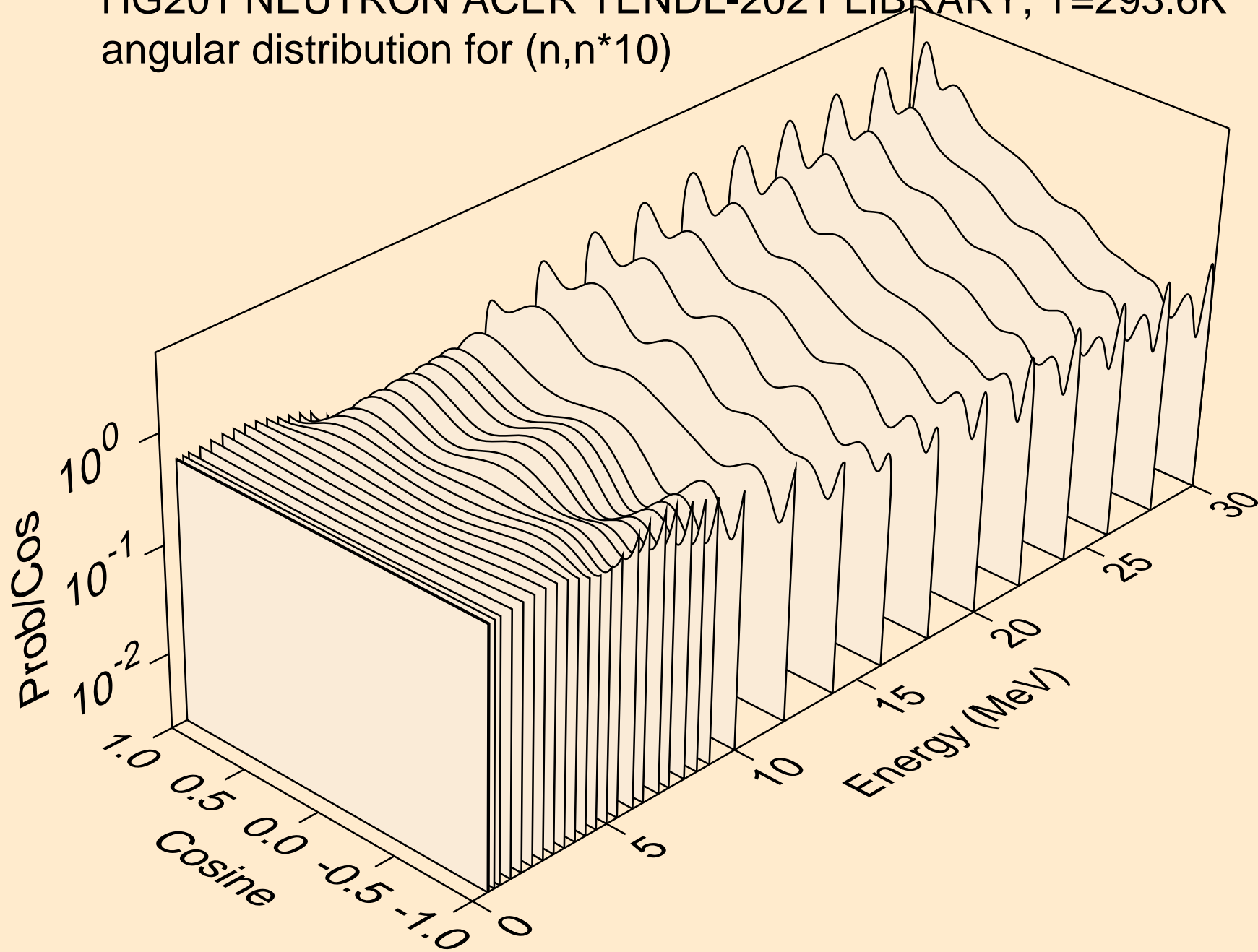

HG201 NEUTRON ACER TENDL-2021 LIBRARY; T=293.6K
angular distribution for (n,n*11)

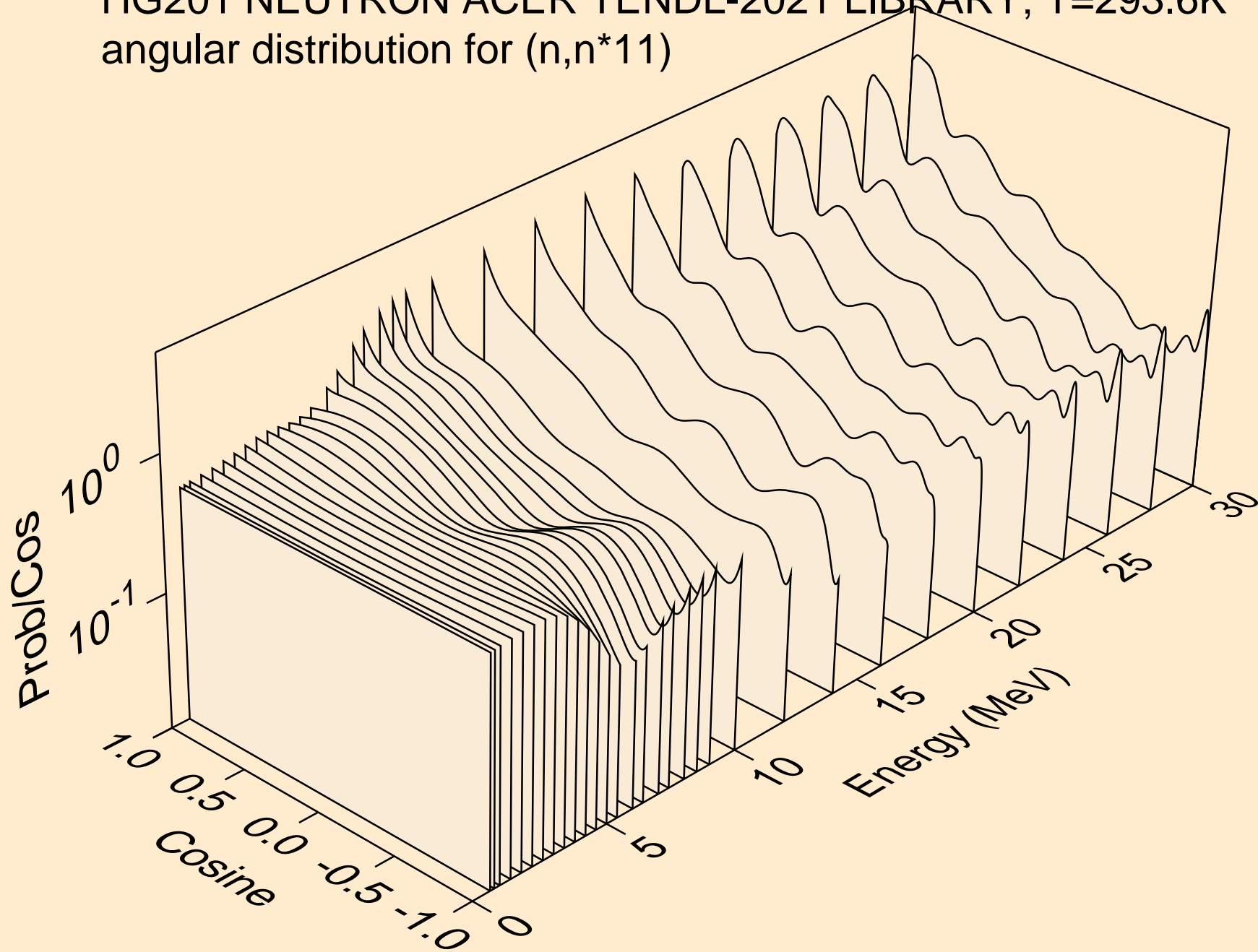

HG201 NEUTRON ACER TENDL-2021 LIBRARY; T=293.6K
angular distribution for (n,n*12)

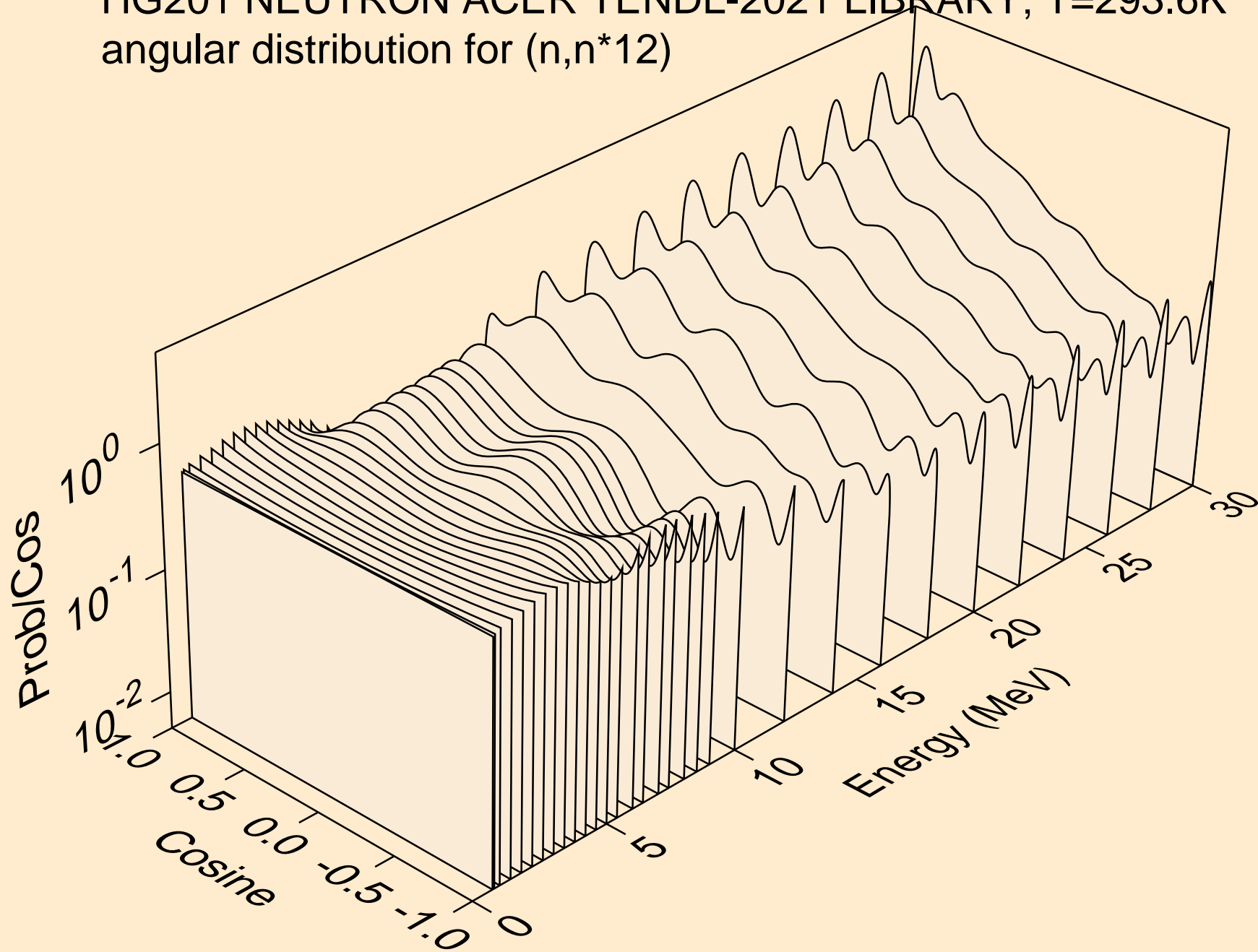

HG201 NEUTRON ACER TENDL-2021 LIBRARY; T=293.6K
angular distribution for (n,n*13)

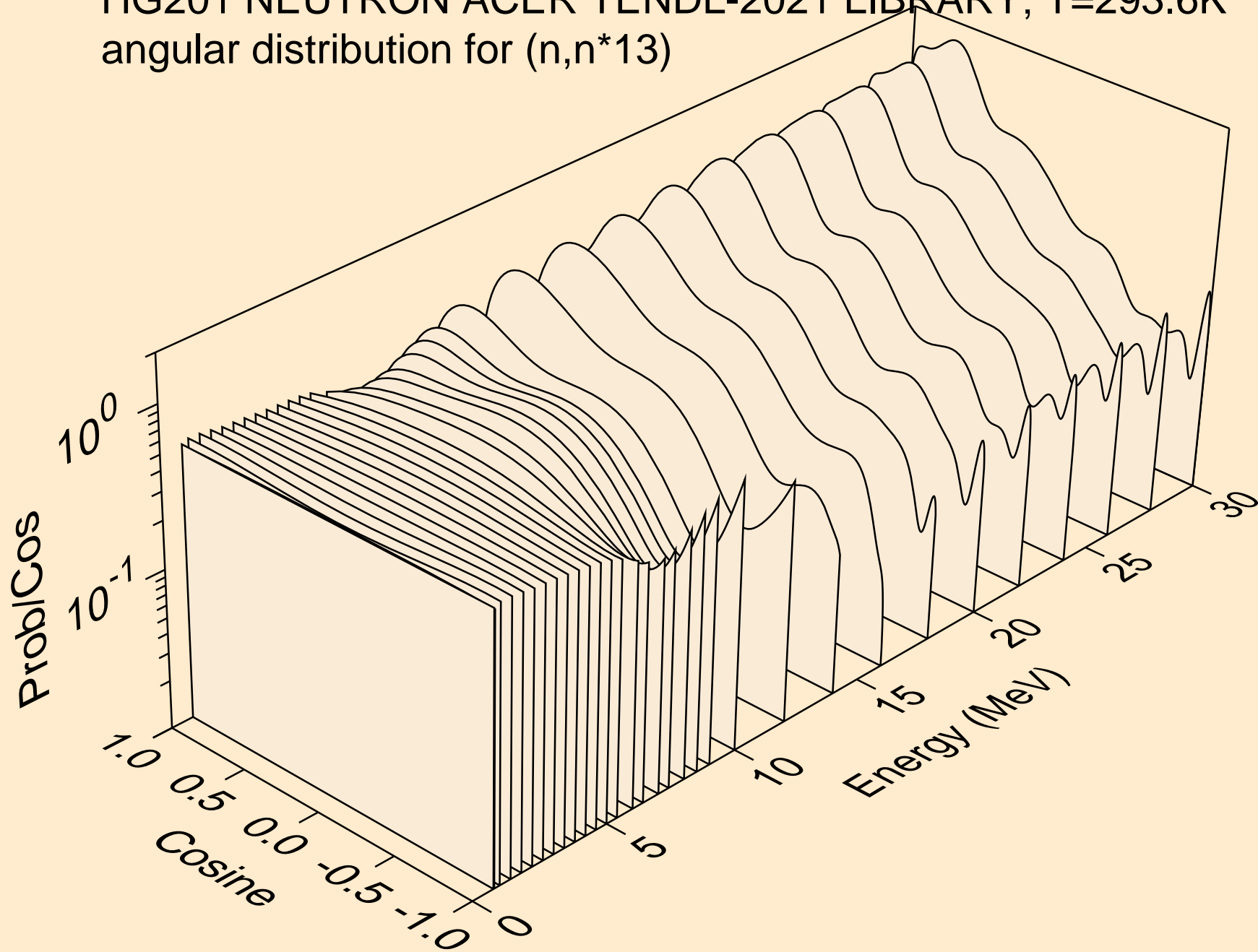

HG201 NEUTRON ACER TENDL-2021 LIBRARY; T=293.6K
angular distribution for (n,n*14)

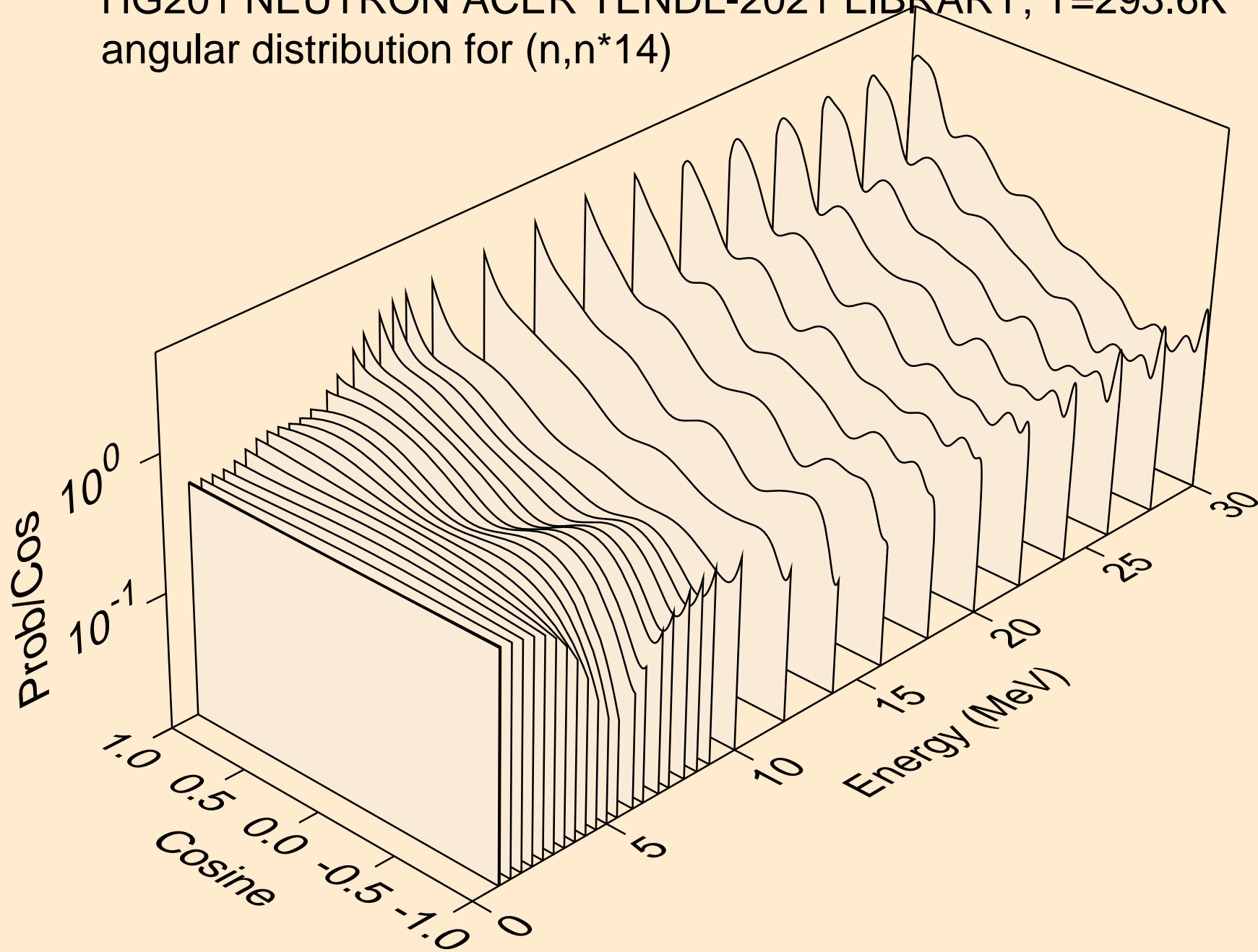

HG201 NEUTRON ACER TENDL-2021 LIBRARY; T=293.6K
angular distribution for (n,n*15)

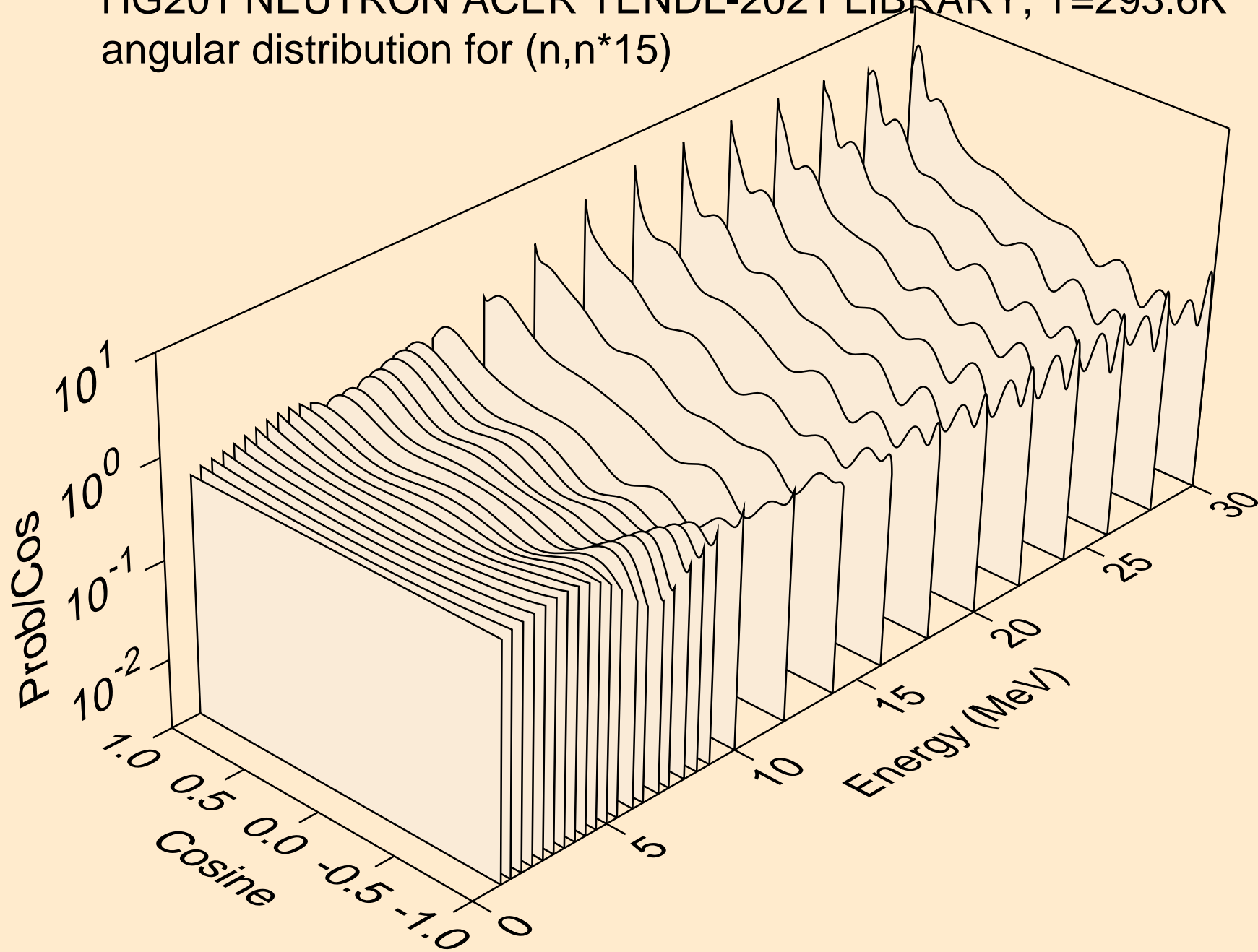

HG201 NEUTRON ACER TENDL-2021 LIBRARY; T=293.6K
angular distribution for (n,n*16)

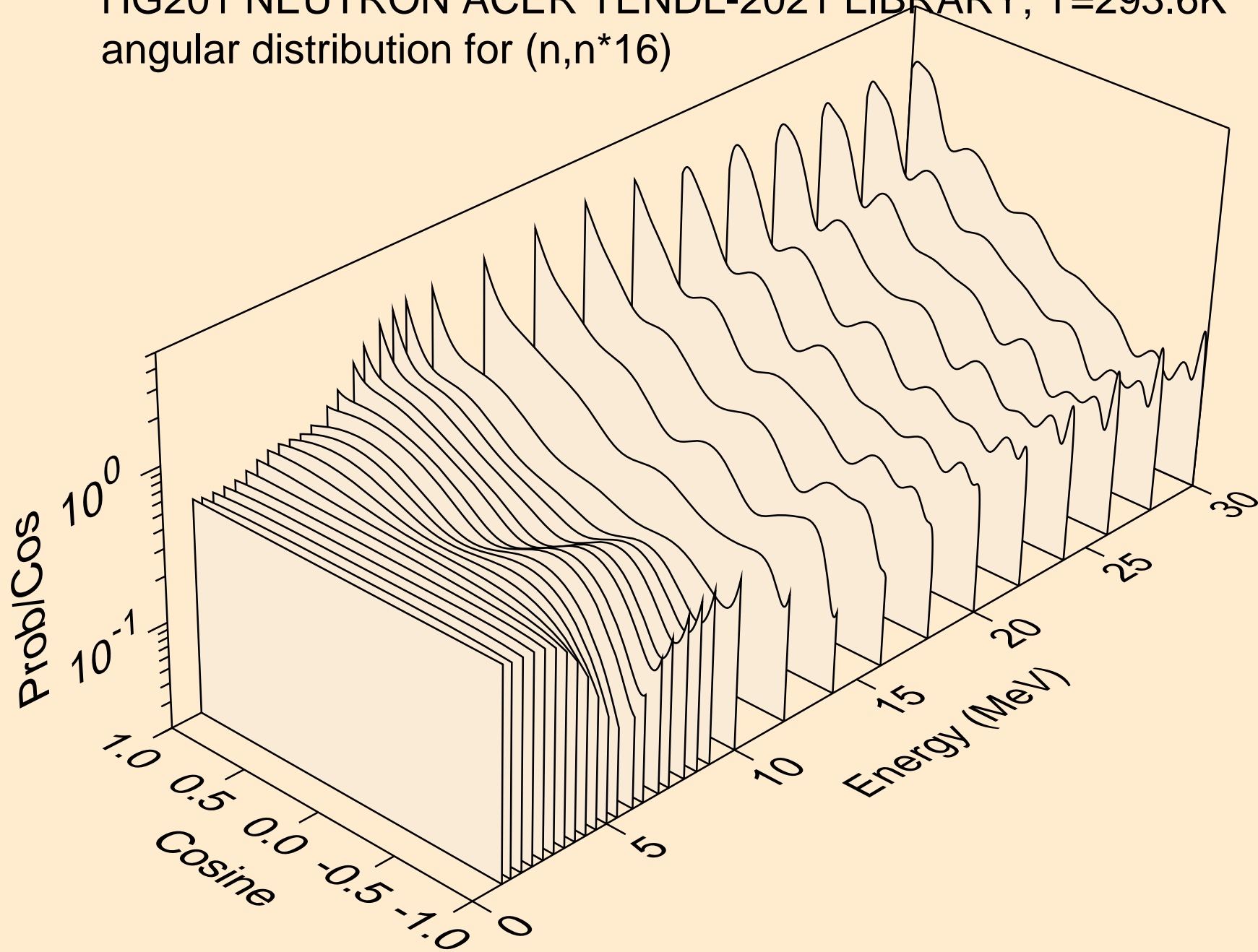

HG201 NEUTRON ACER TENDL-2021 LIBRARY; T=293.6K
angular distribution for (n,n*17)

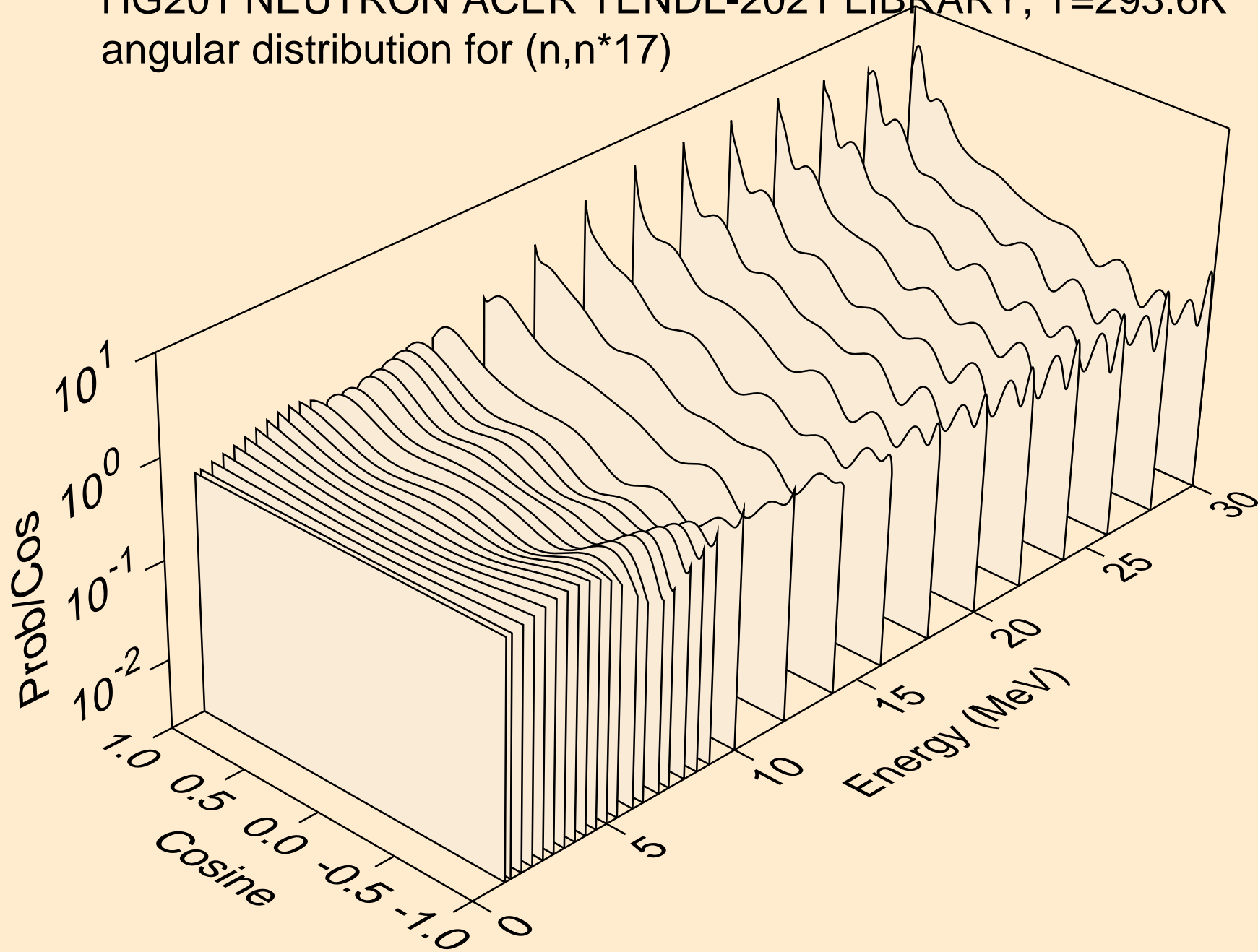

HG201 NEUTRON ACER TENDL-2021 LIBRARY; T=293.6K
angular distribution for (n,n*18)

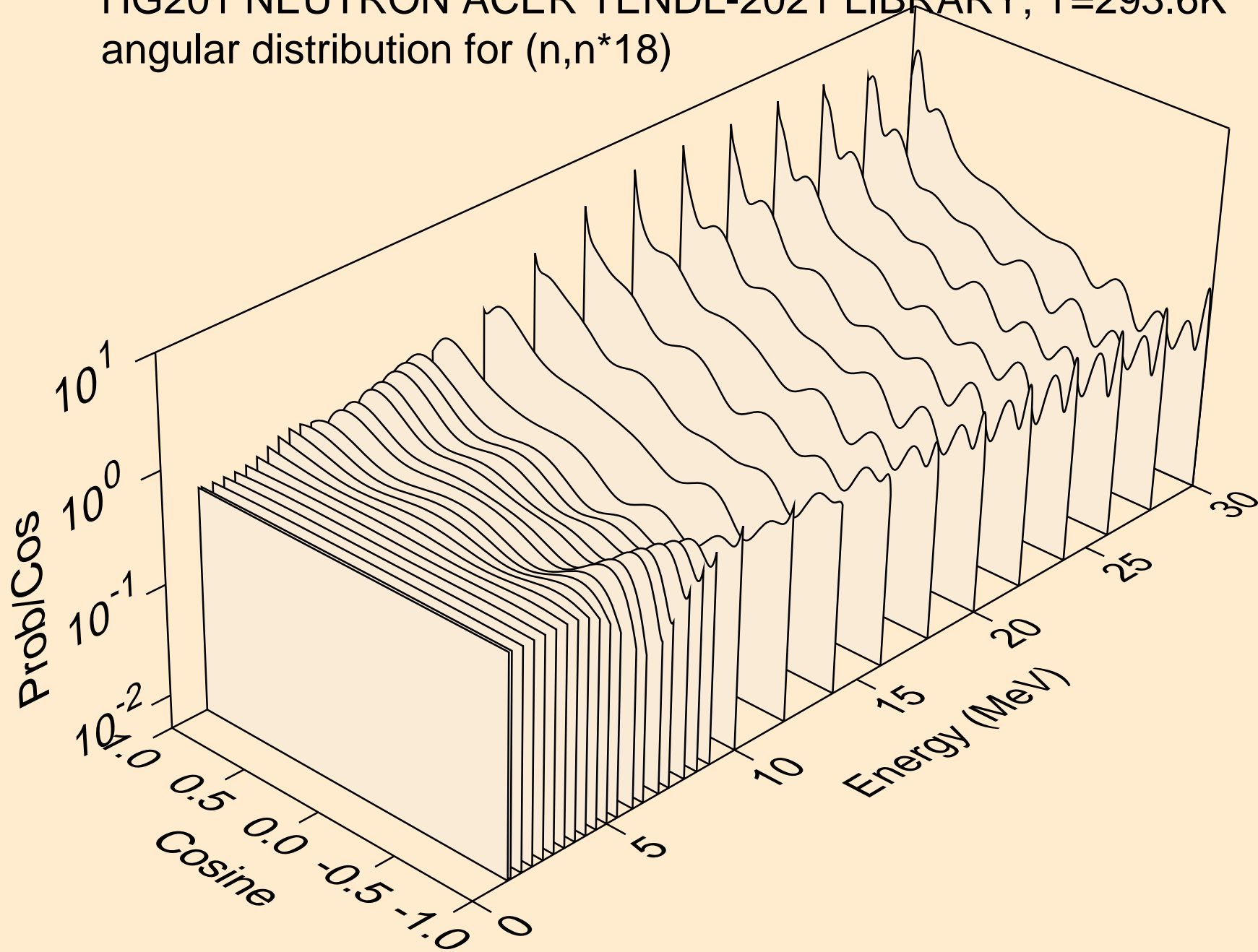

HG201 NEUTRON ACER TENDL-2021 LIBRARY; T=293.6K
angular distribution for (n,n*19)

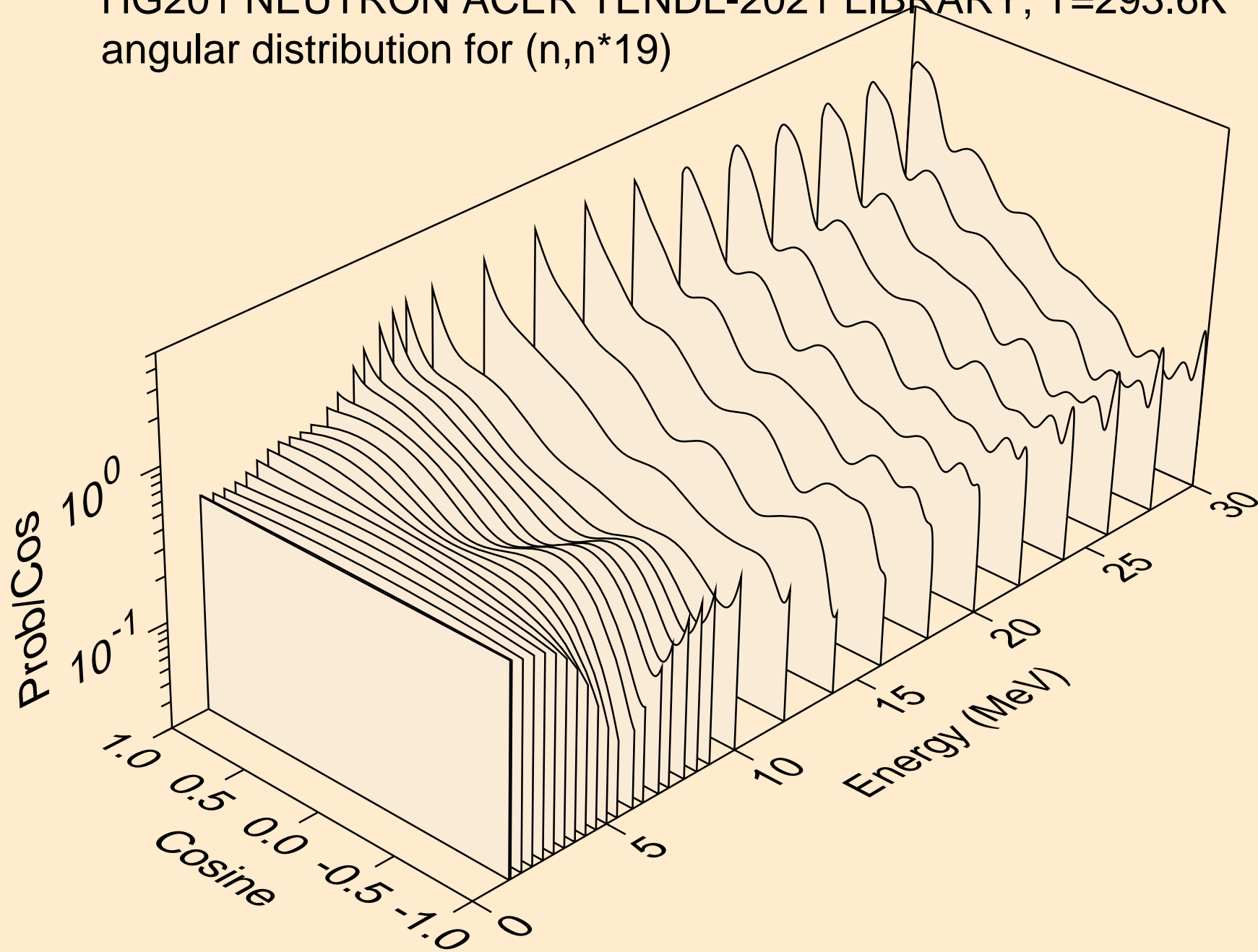

HG201 NEUTRON ACER TENDL-2021 LIBRARY; T=293.6K
angular distribution for (n,n*20)

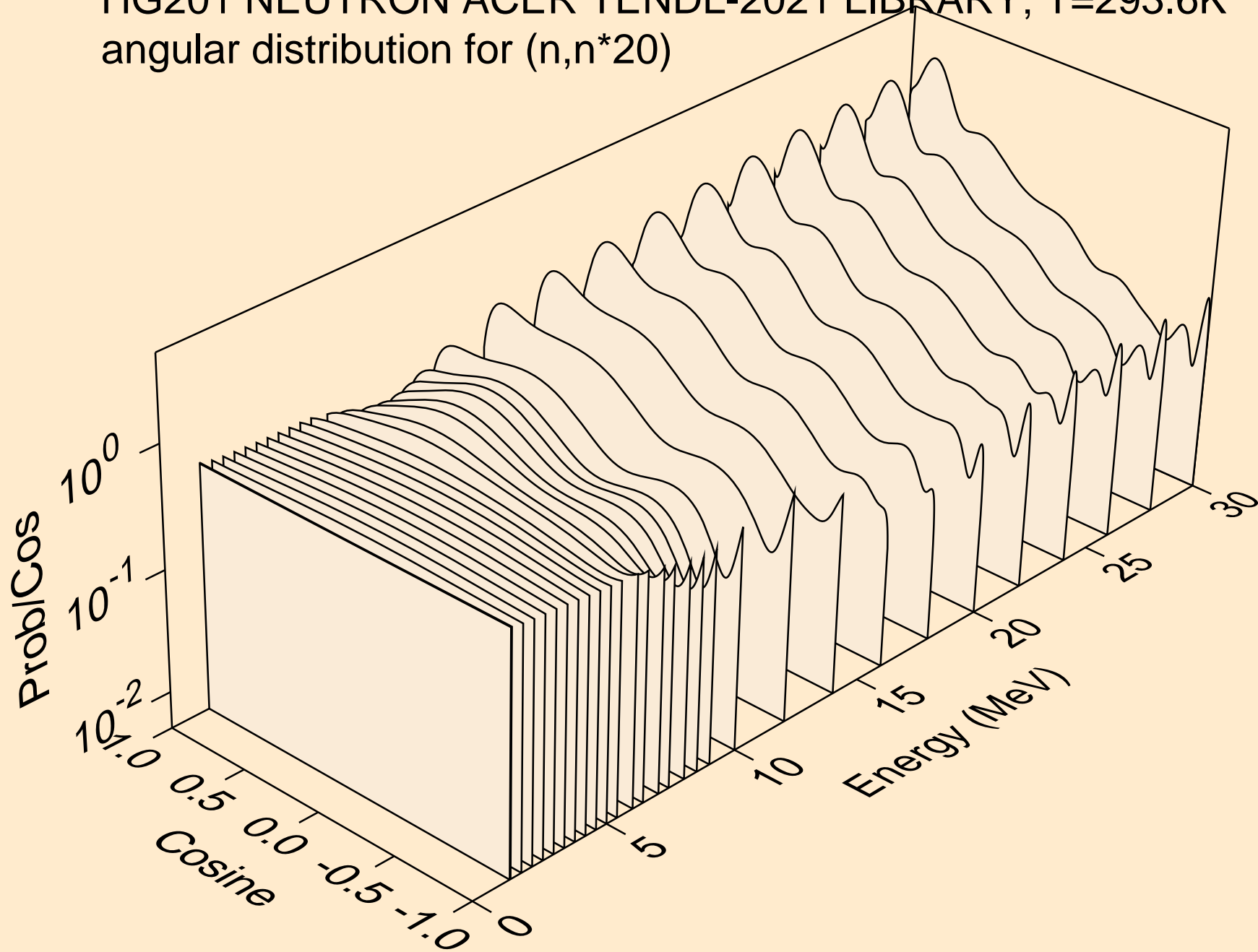

HG201 NEUTRON ACER TENDL-2021 LIBRARY; T=293.6K
angular distribution for (n,n*21)

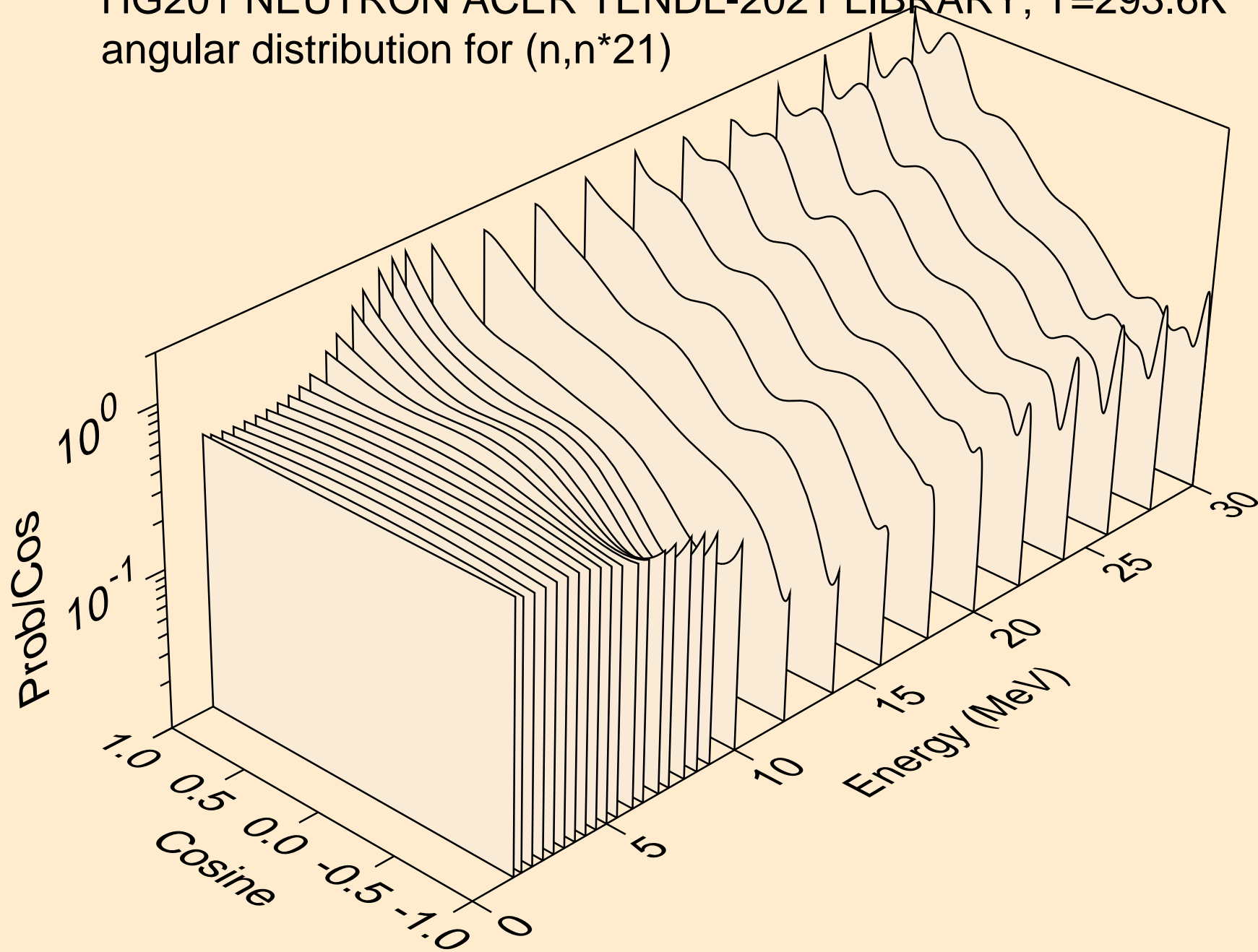

HG201 NEUTRON ACER TENDL-2021 LIBRARY; T=293.6K
angular distribution for (n,n*22)

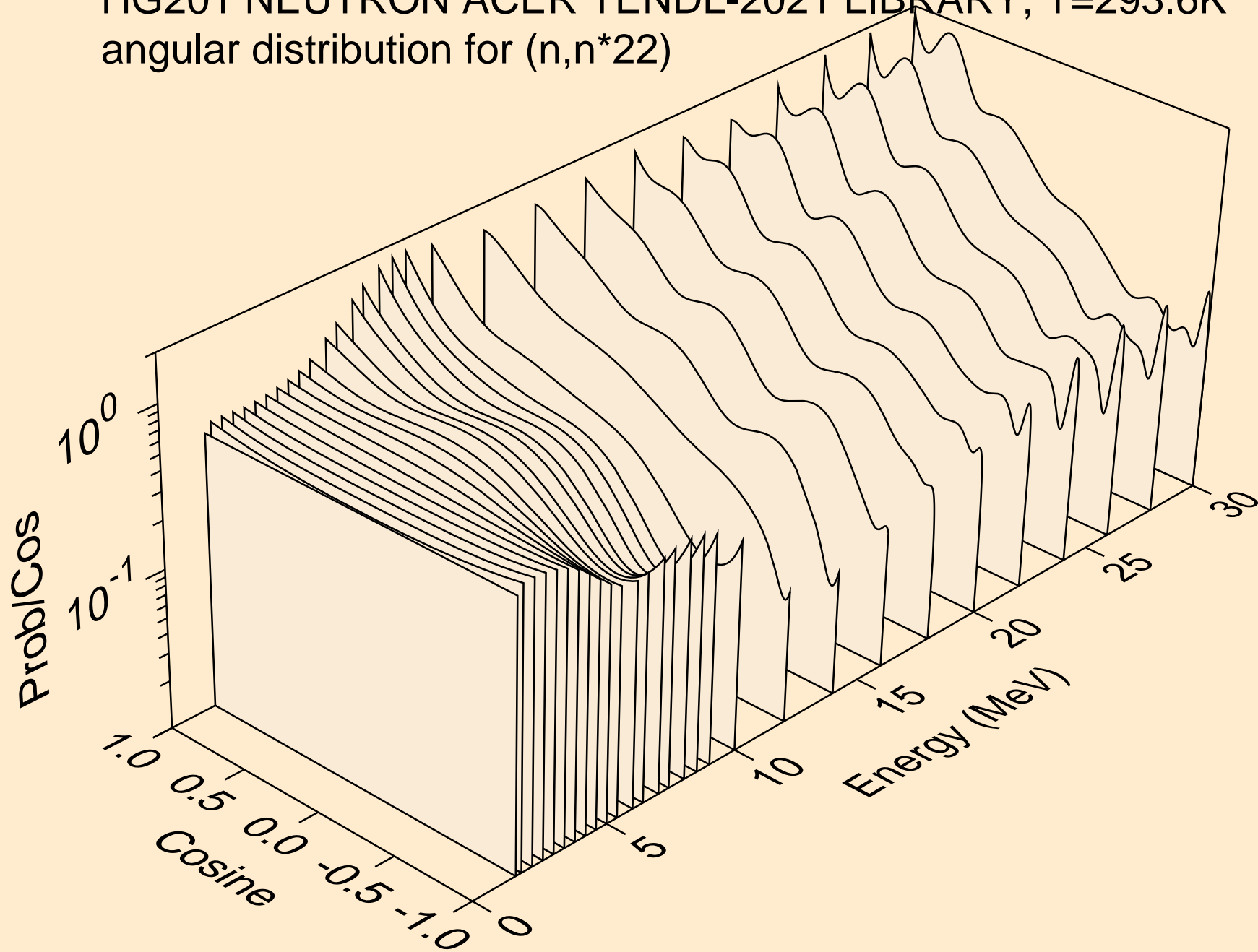

HG201 NEUTRON ACER TENDL-2021 LIBRARY; T=293.6K
angular distribution for (n,n*23)

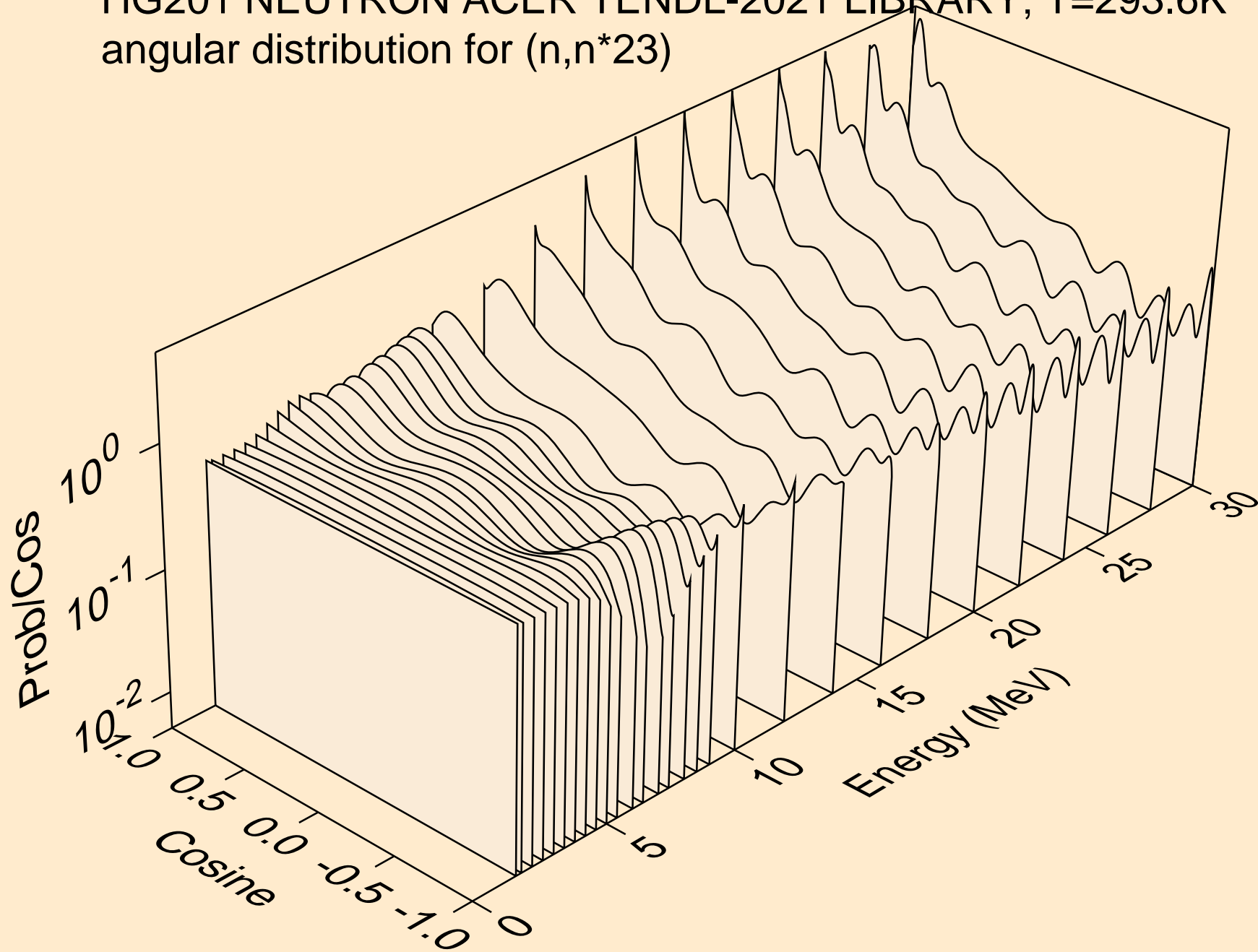

HG201 NEUTRON ACER TENDL-2021 LIBRARY; T=293.6K
angular distribution for (n,n*24)

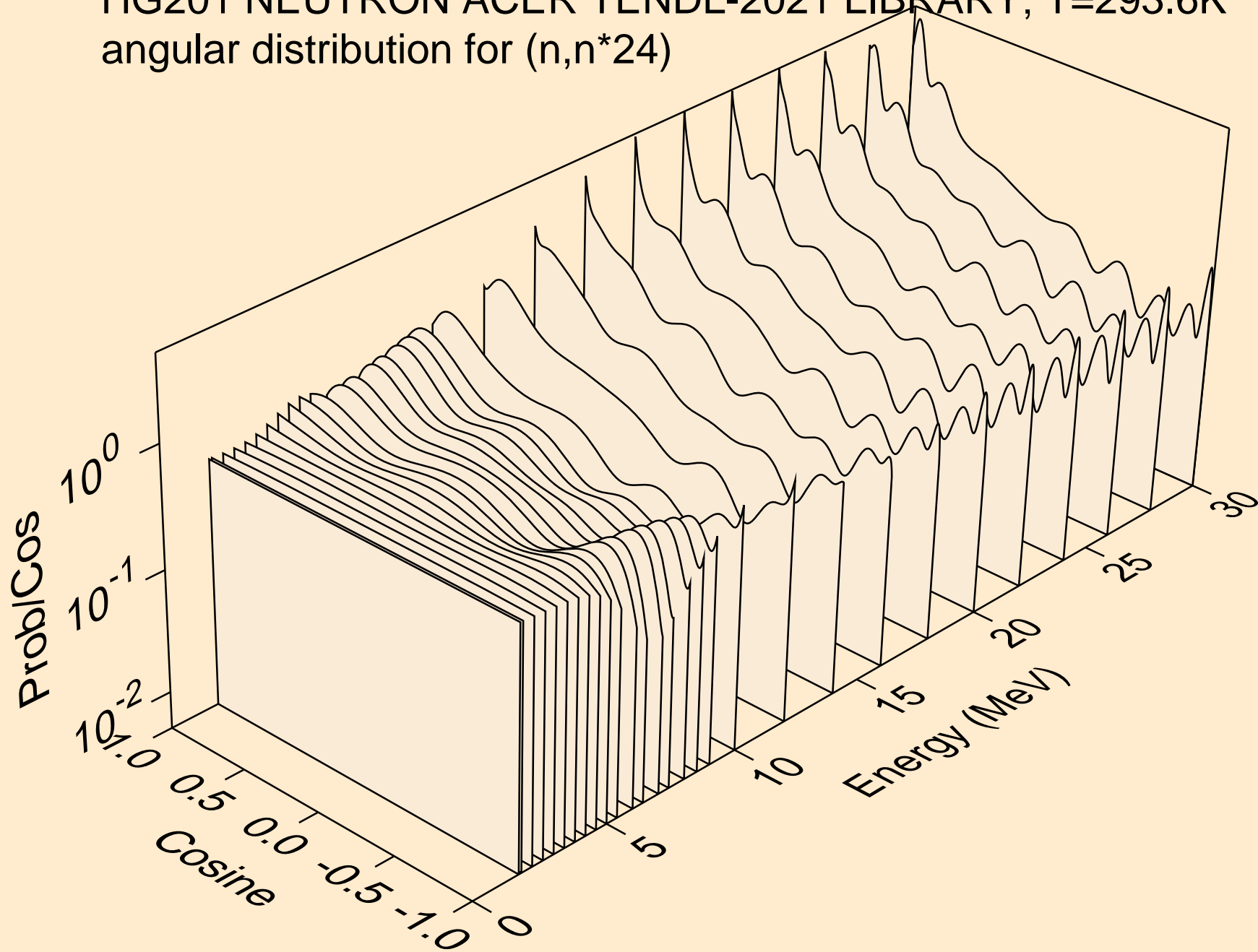

HG201 NEUTRON ACER TENDL-2021 LIBRARY; T=293.6K
angular distribution for (n,n*25)

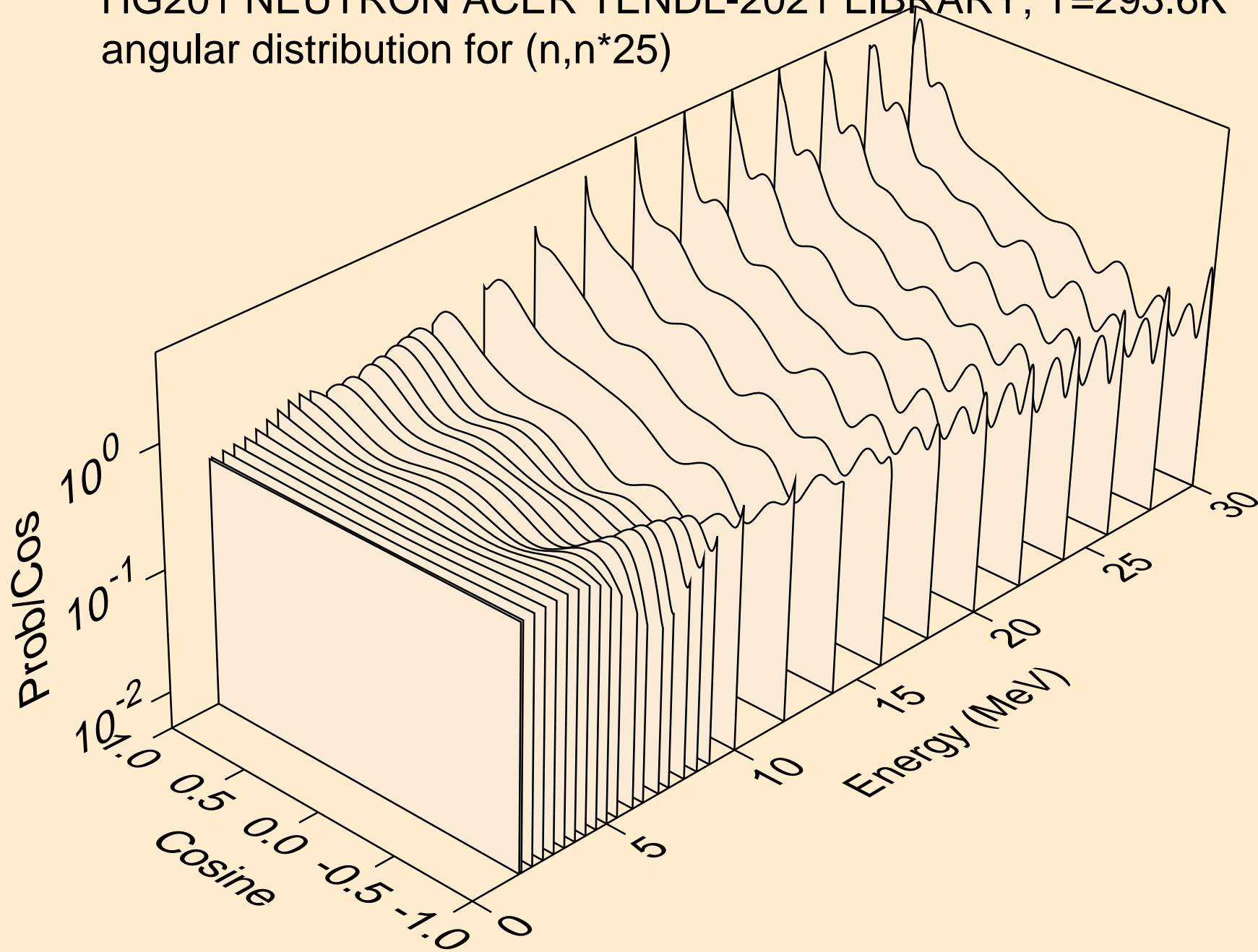

HG201 NEUTRON ACER TENDL-2021 LIBRARY; T=293.6K
angular distribution for (n,n*26)

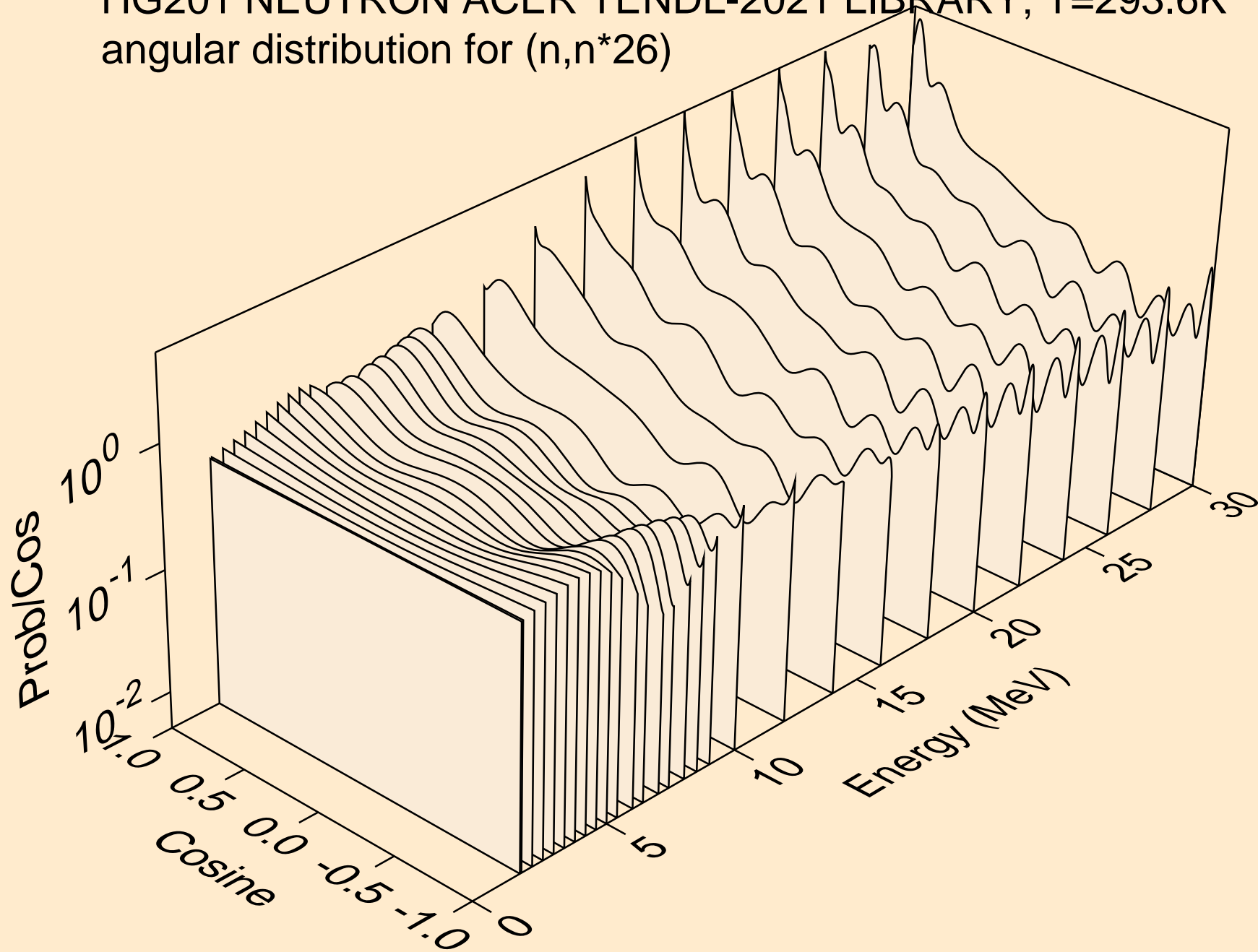

HG201 NEUTRON ACER TENDL-2021 LIBRARY; T=293.6K
angular distribution for (n,n*27)

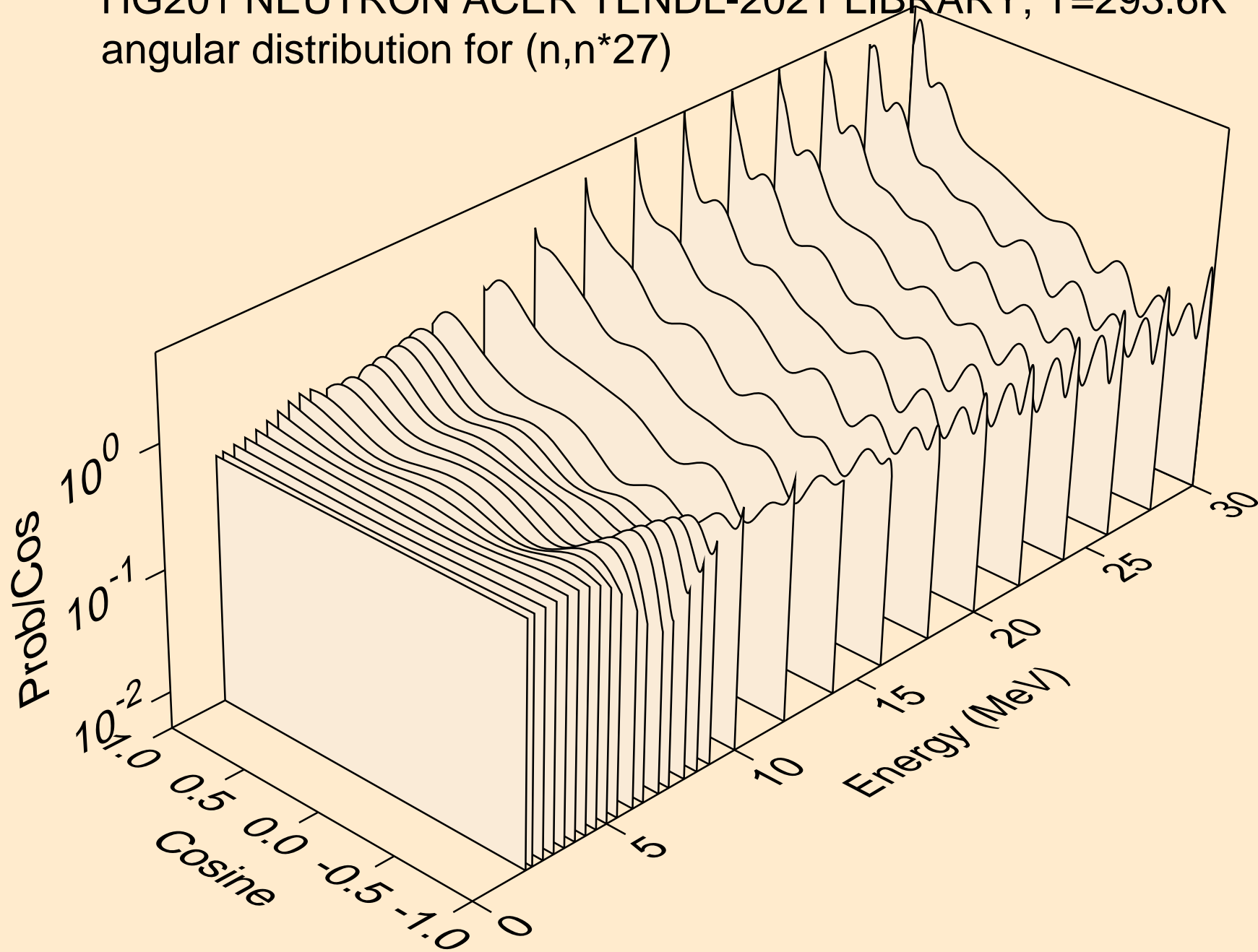

HG201 NEUTRON ACER TENDL-2021 LIBRARY; T=293.6K
angular distribution for (n,n*28)

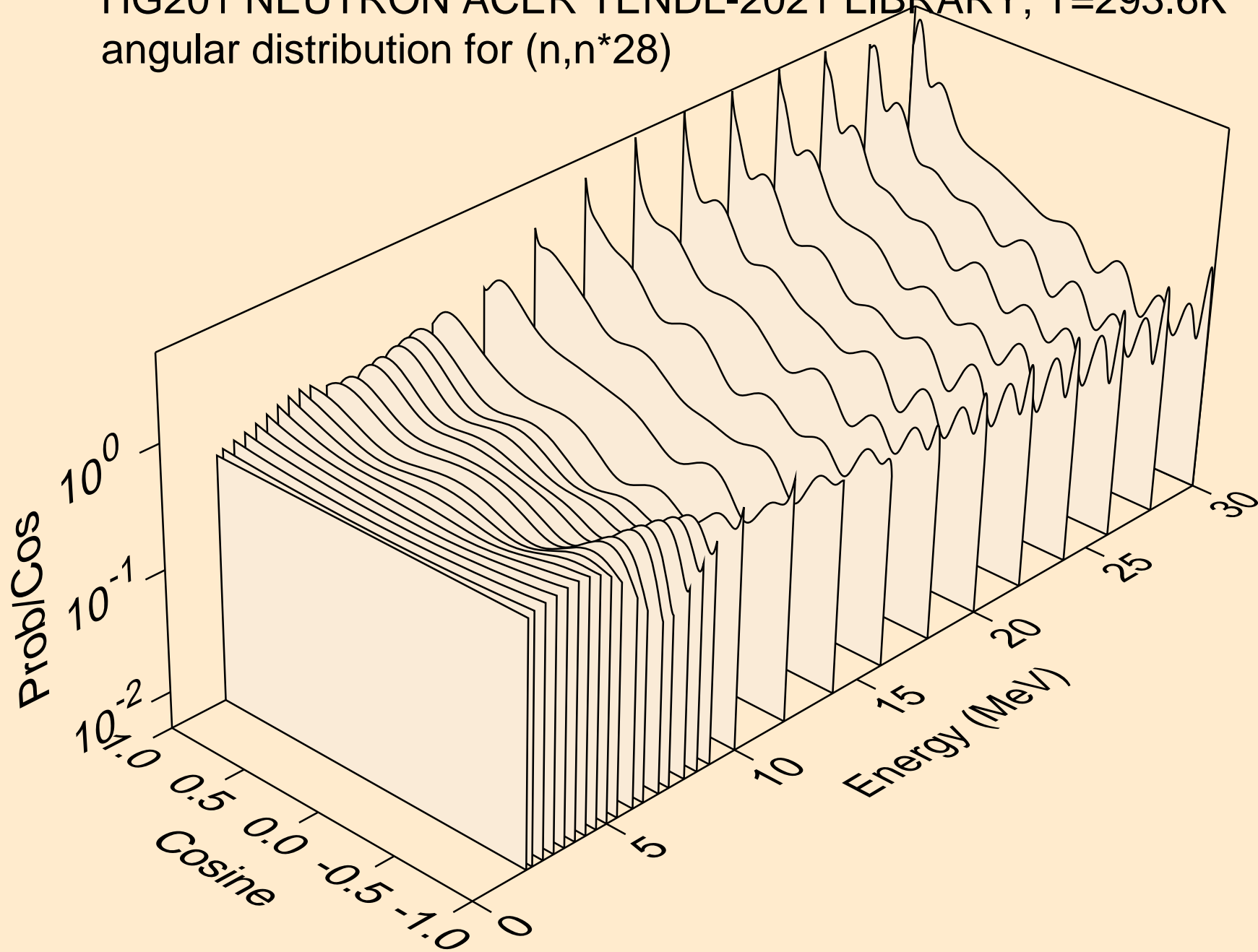

HG201 NEUTRON ACER TENDL-2021 LIBRARY; T=293.6K
angular distribution for (n,n*29)

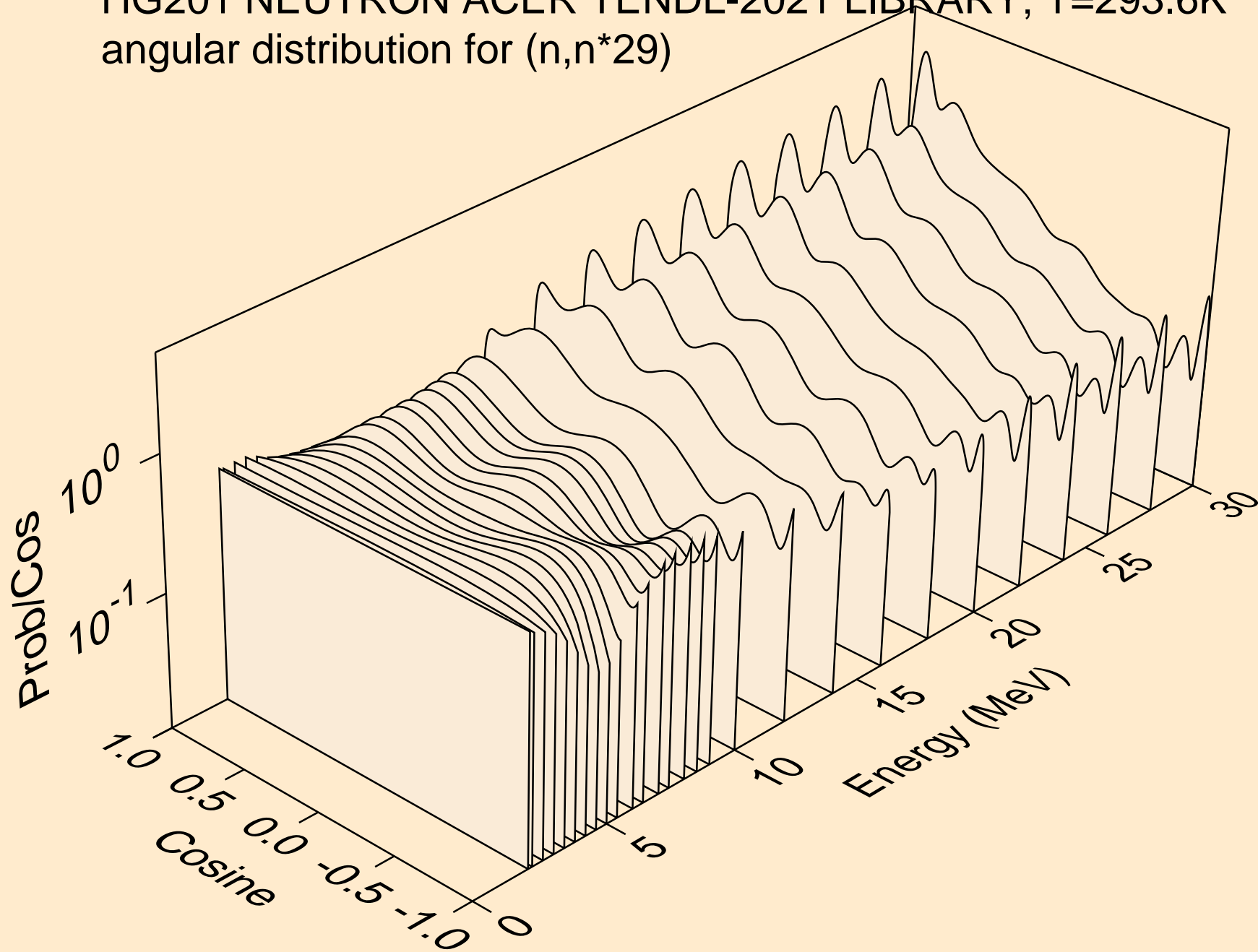

HG201 NEUTRON ACER TENDL-2021 LIBRARY; T=293.6K
angular distribution for (n,n*30)

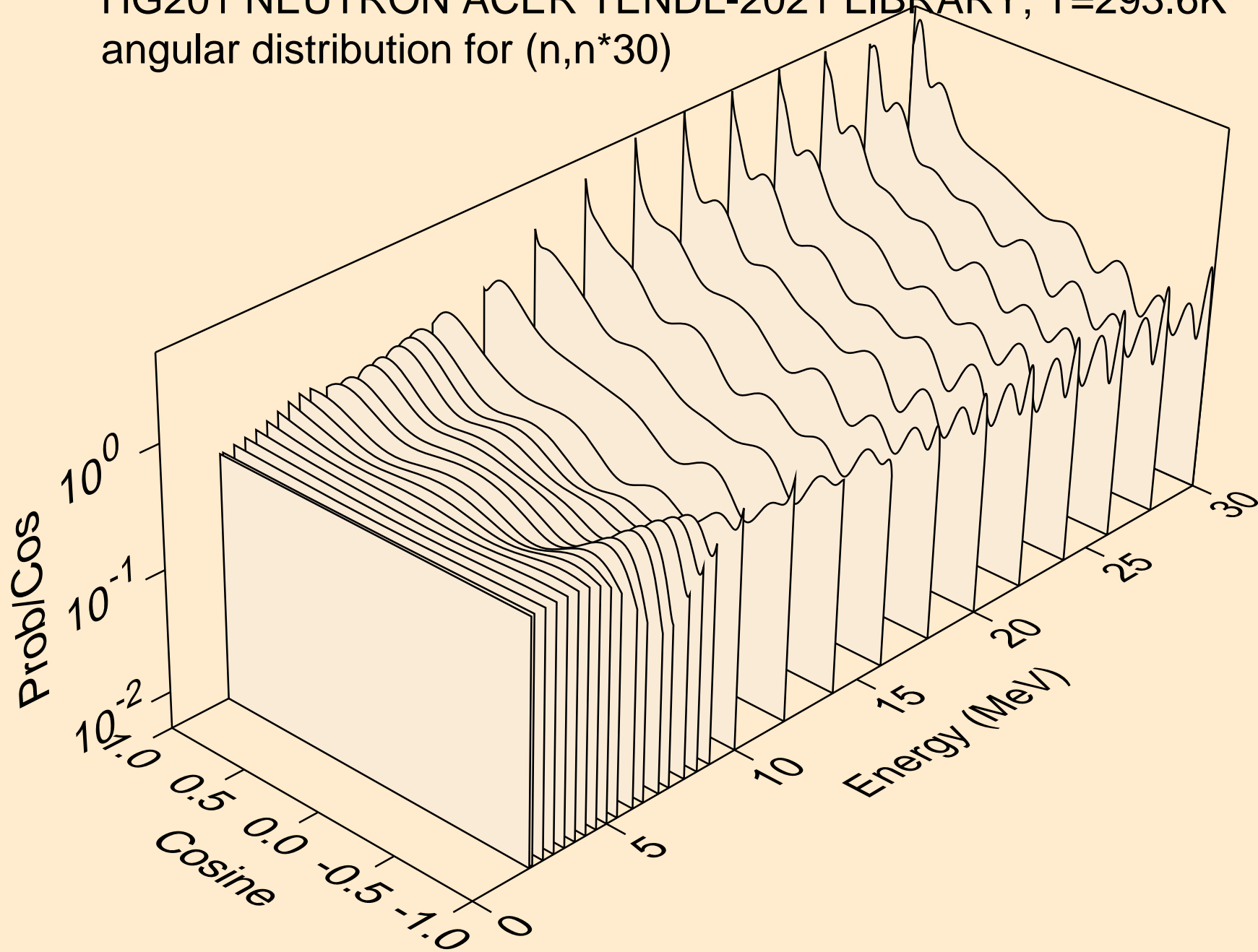

HG201 NEUTRON ACER TENDL-2021 LIBRARY; T=293.6K
Neutron emission for (n,x)

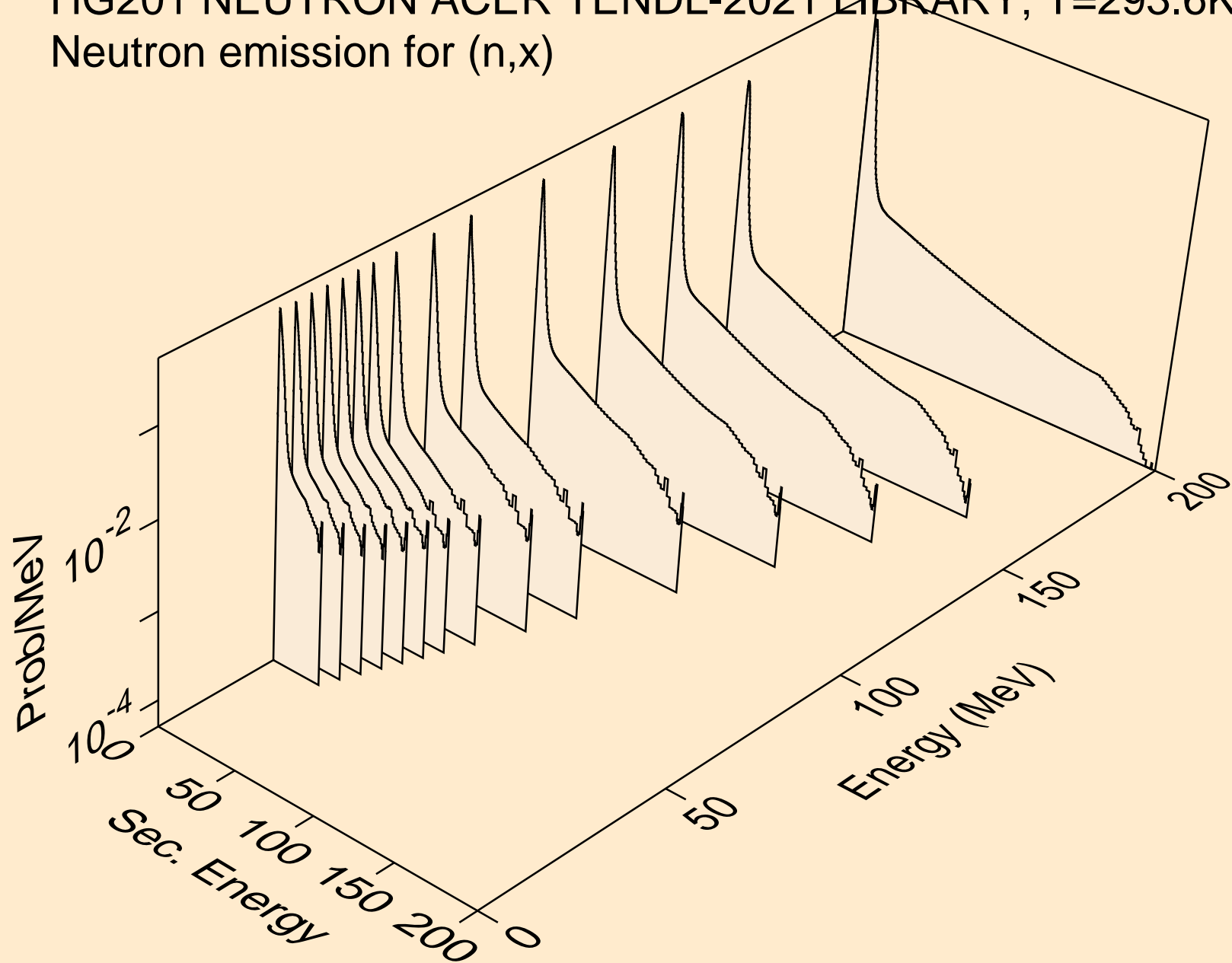

HG201 NEUTRON ACER TENDL-2021 LIBRARY; T=293.6K
Neutron emission for (n,2nd)

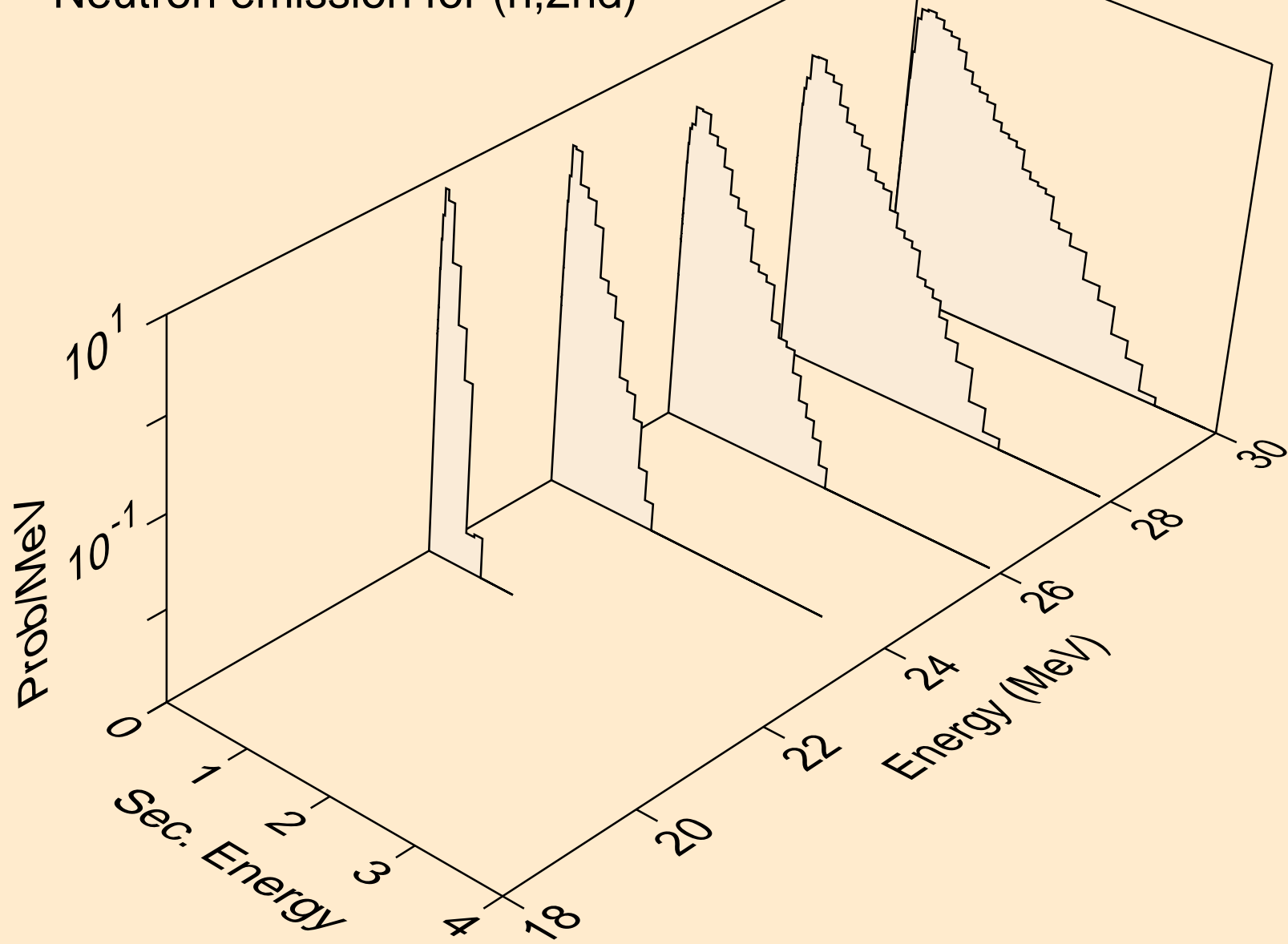

HG201 NEUTRON ACER TENDL-2021 LIBRARY; T=293.6K
Neutron emission for (n,2n)

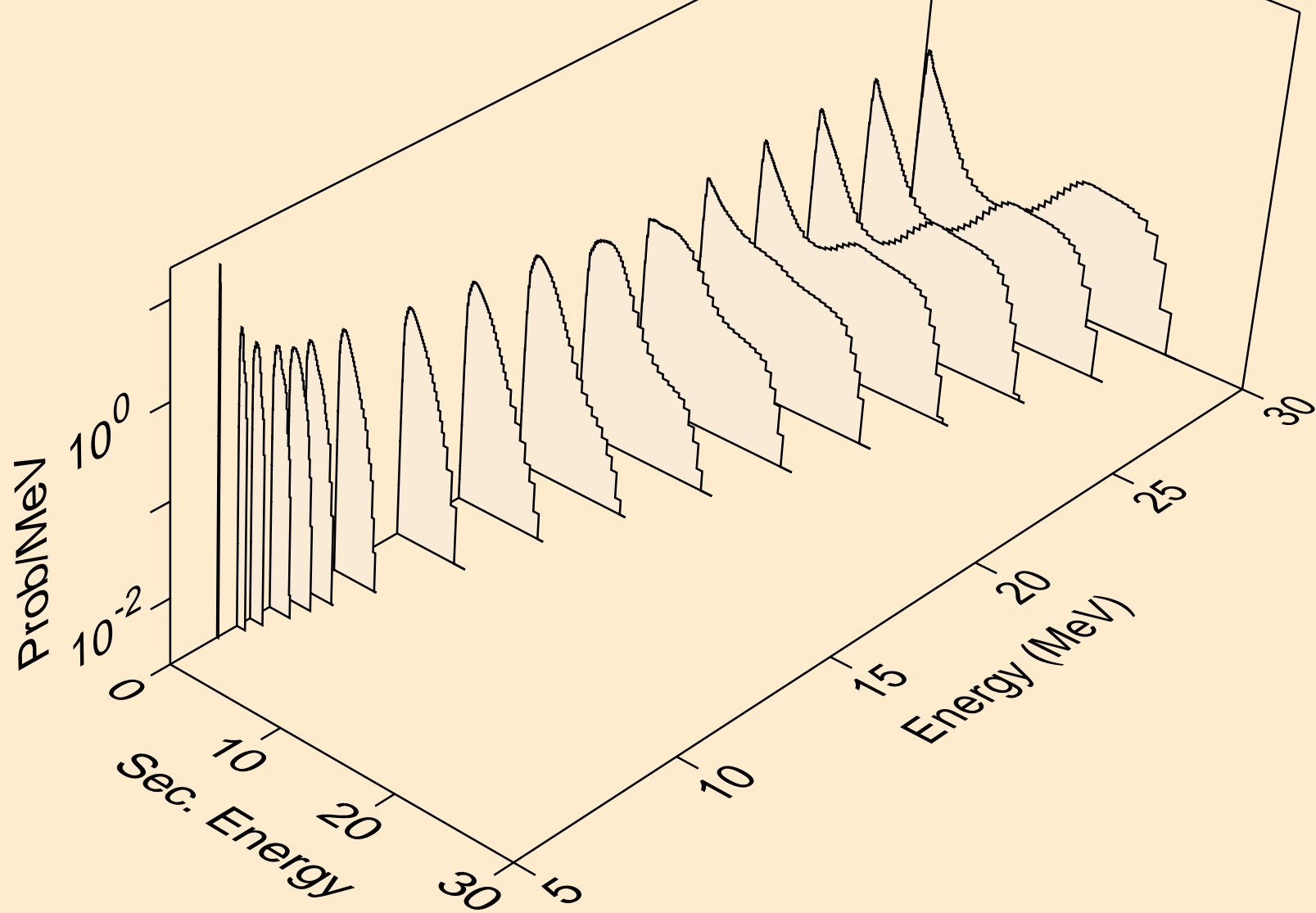

HG201 NEUTRON ACER TENDL-2021 LIBRARY; T=293.6K
Neutron emission for (n,3n)

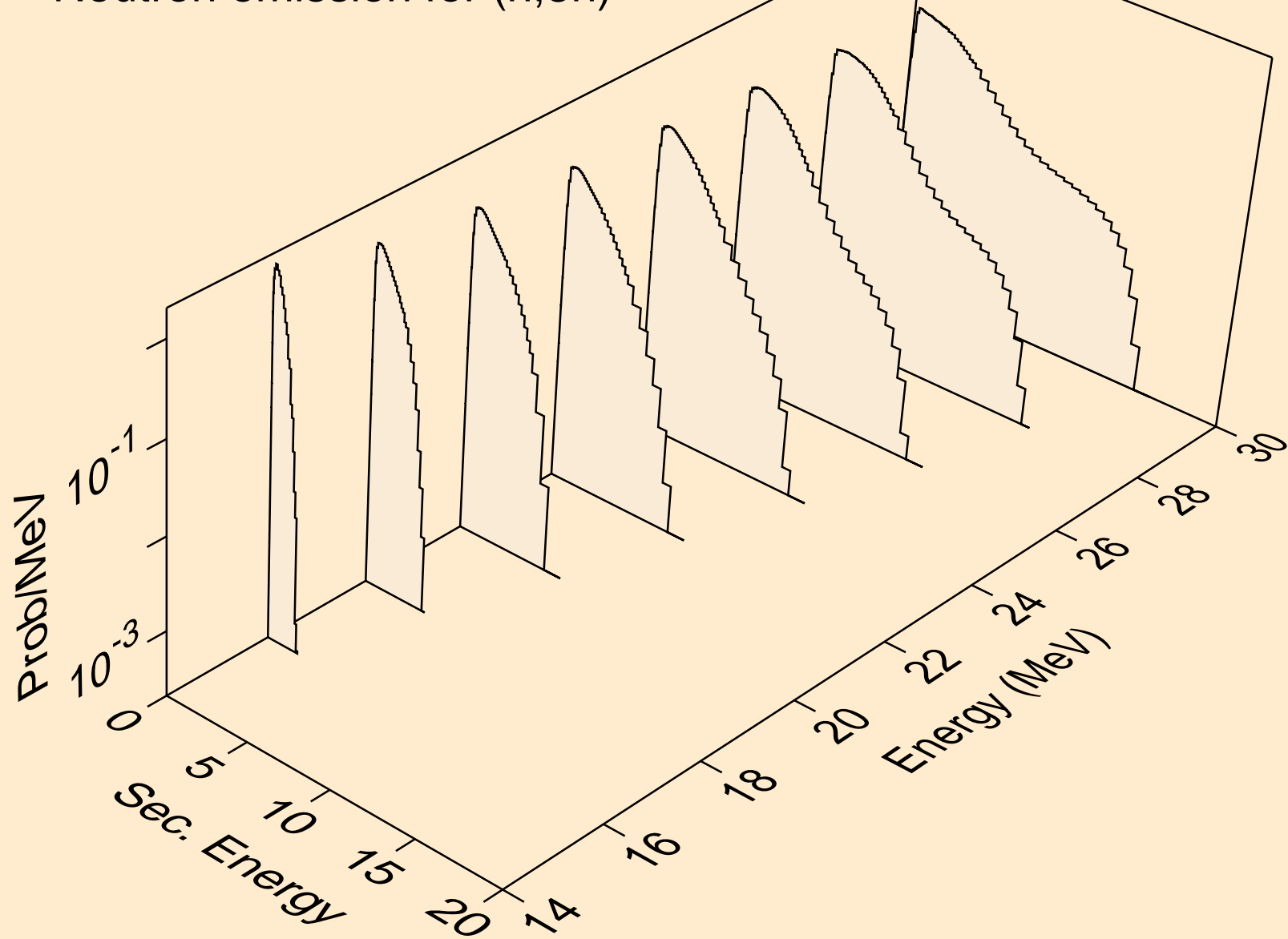

HG201 NEUTRON ACER TENDL-2021 LIBRARY; T=293.6K
Neutron emission for (n,n*)a

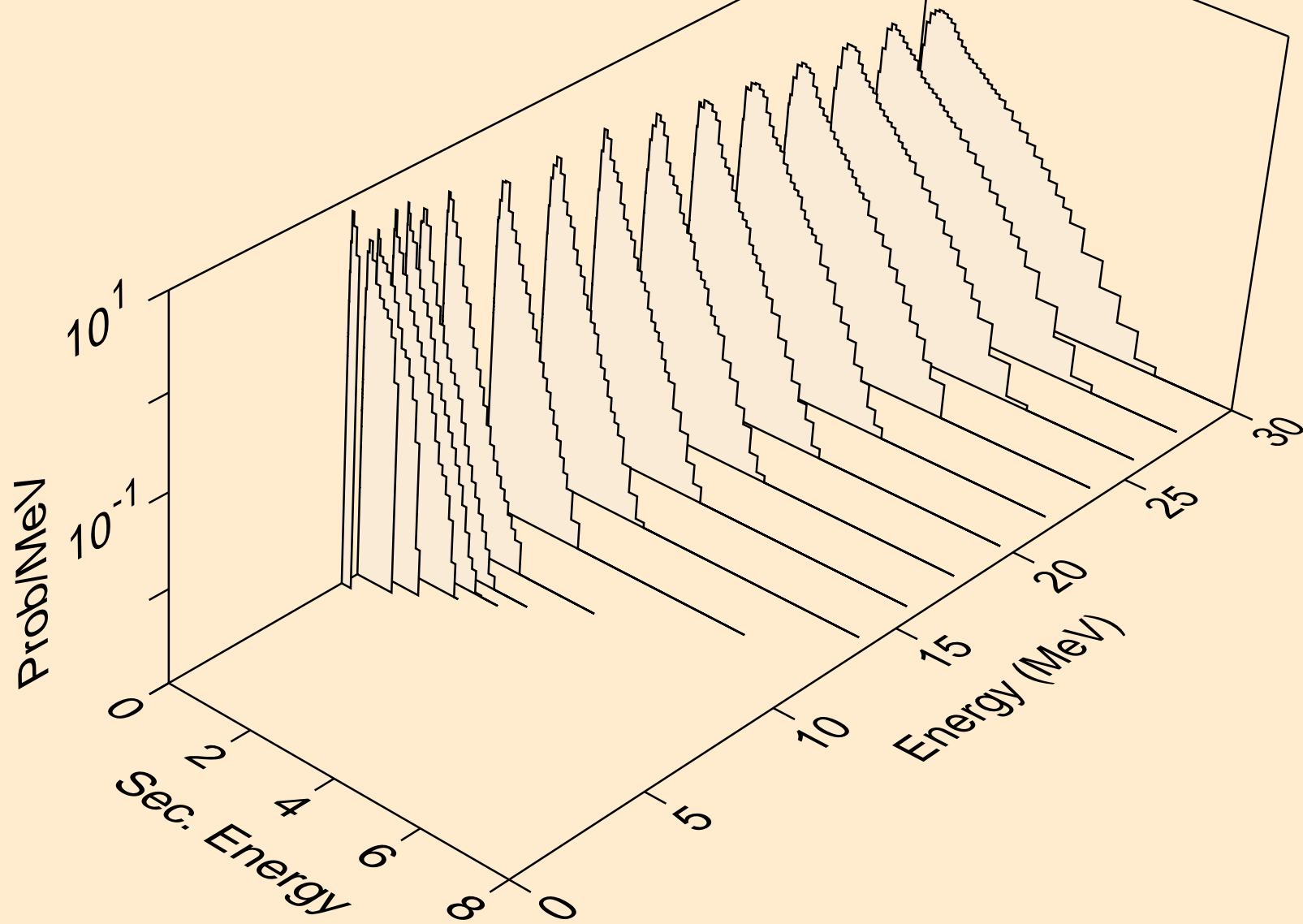

HG201 NEUTRON ACER TENDL-2021 LIBRARY; T=293.6K
Neutron emission for (n,2n)_a

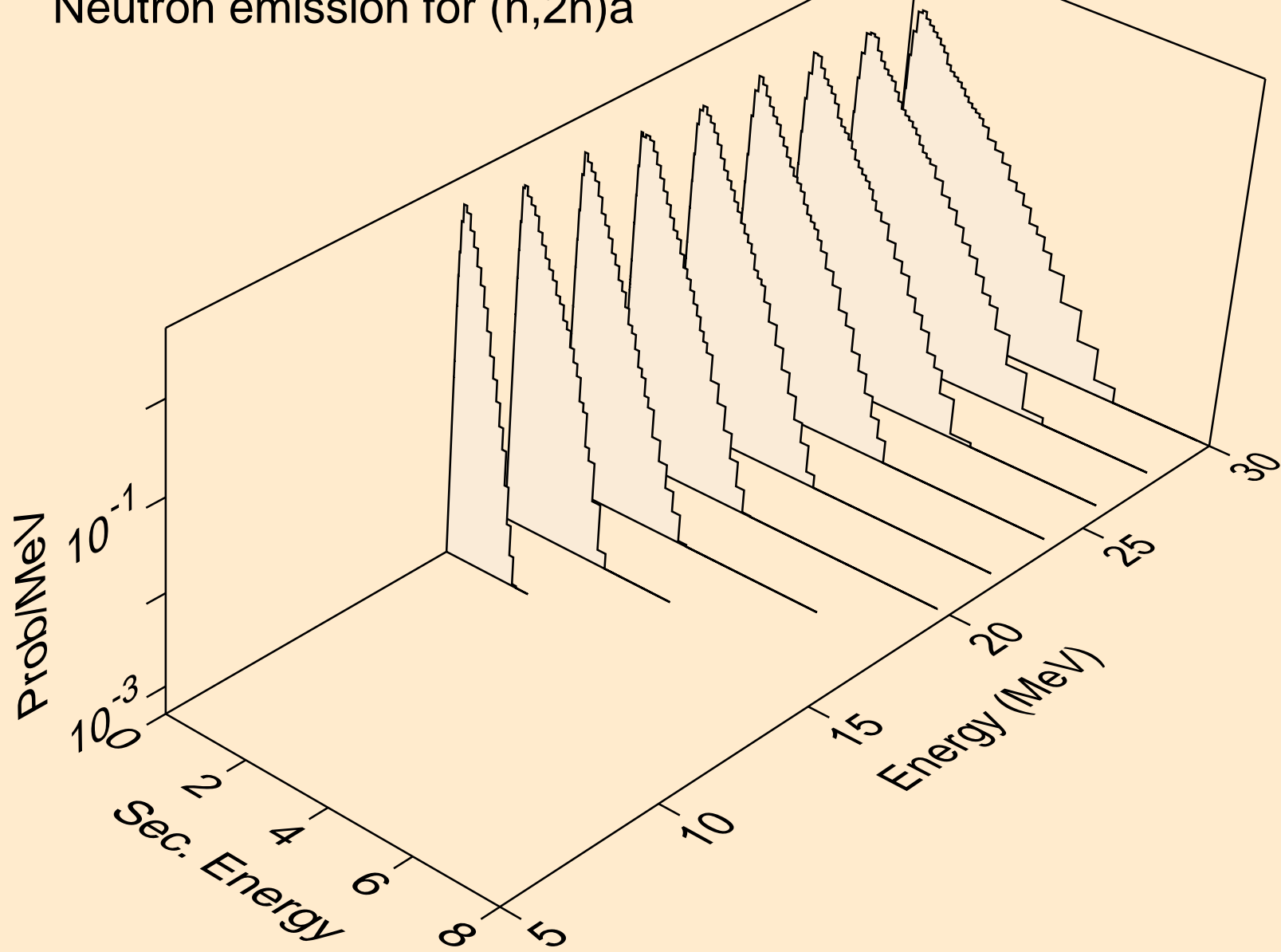

HG201 NEUTRON ACER TENDL-2021 LIBRARY; T=293.6K
Neutron emission for (n,3n)a

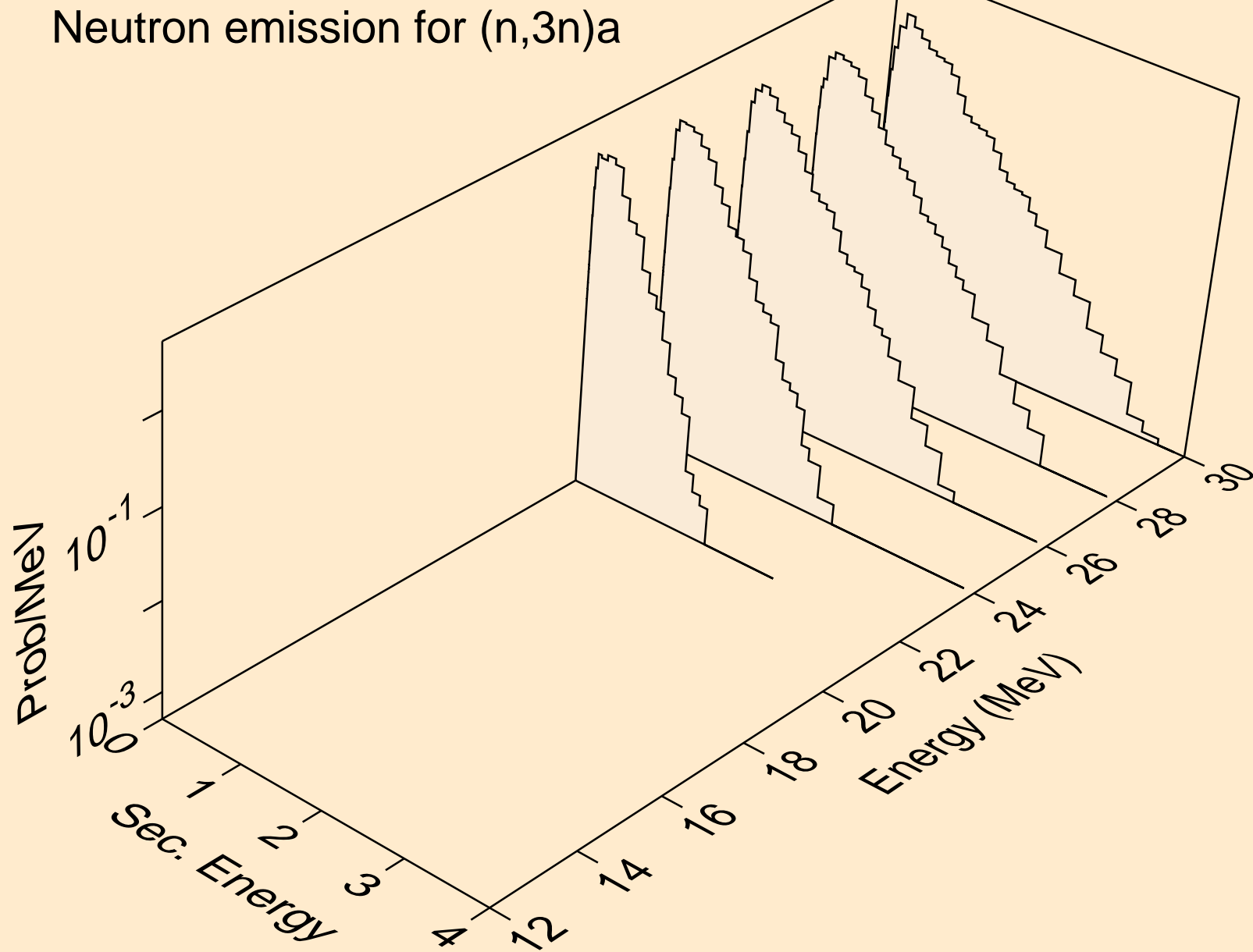

HG201 NEUTRON ACER TENDL-2021 LIBRARY; T=293.6K
Neutron emission for (n,n*)p

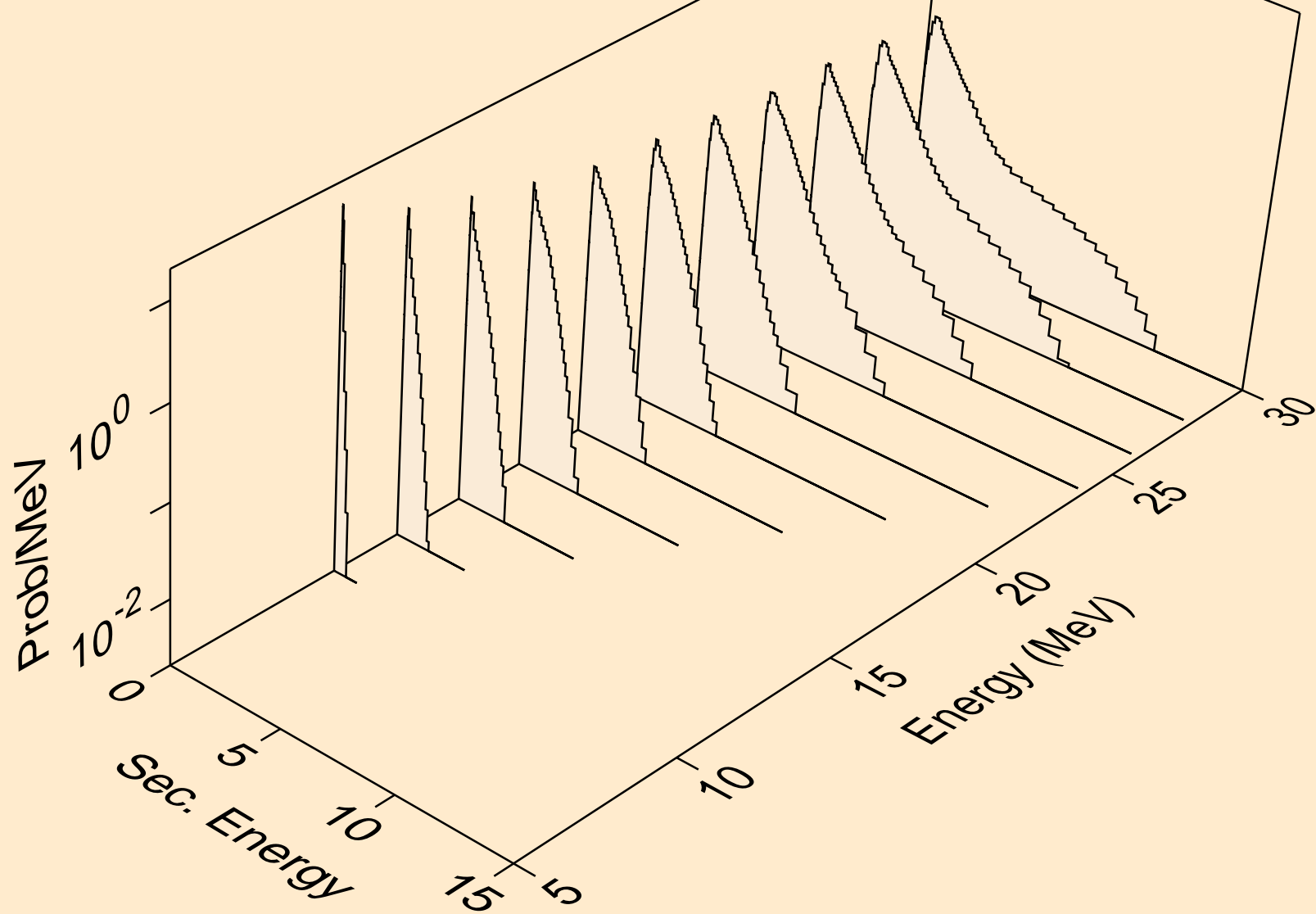

HG201 NEUTRON ACER TENDL-2021 LIBRARY; T=293.6K
Neutron emission for (n,n*)d

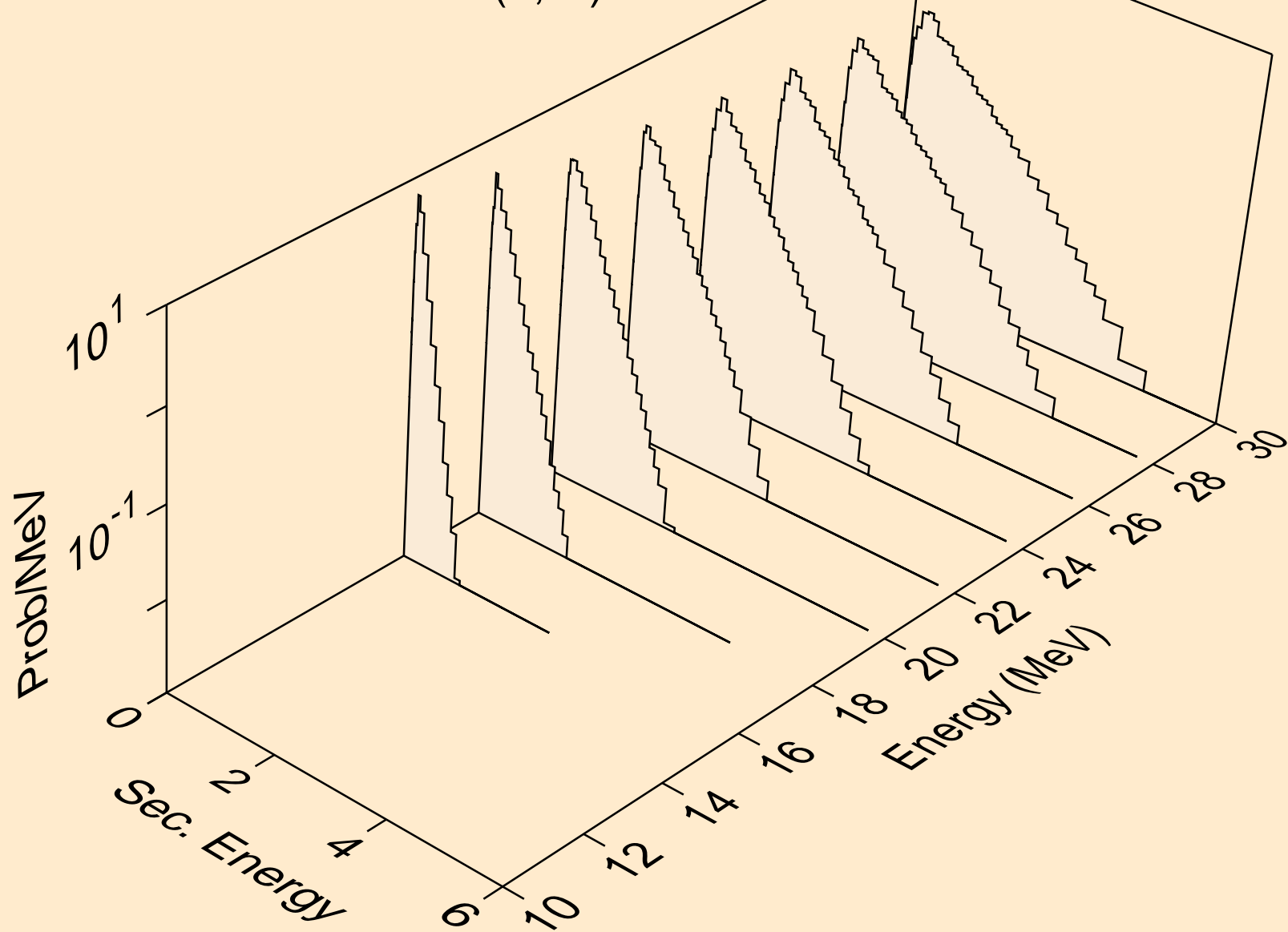

HG201 NEUTRON ACER TENDL-2021 LIBRARY; T=293.6K
Neutron emission for (n,n*)t

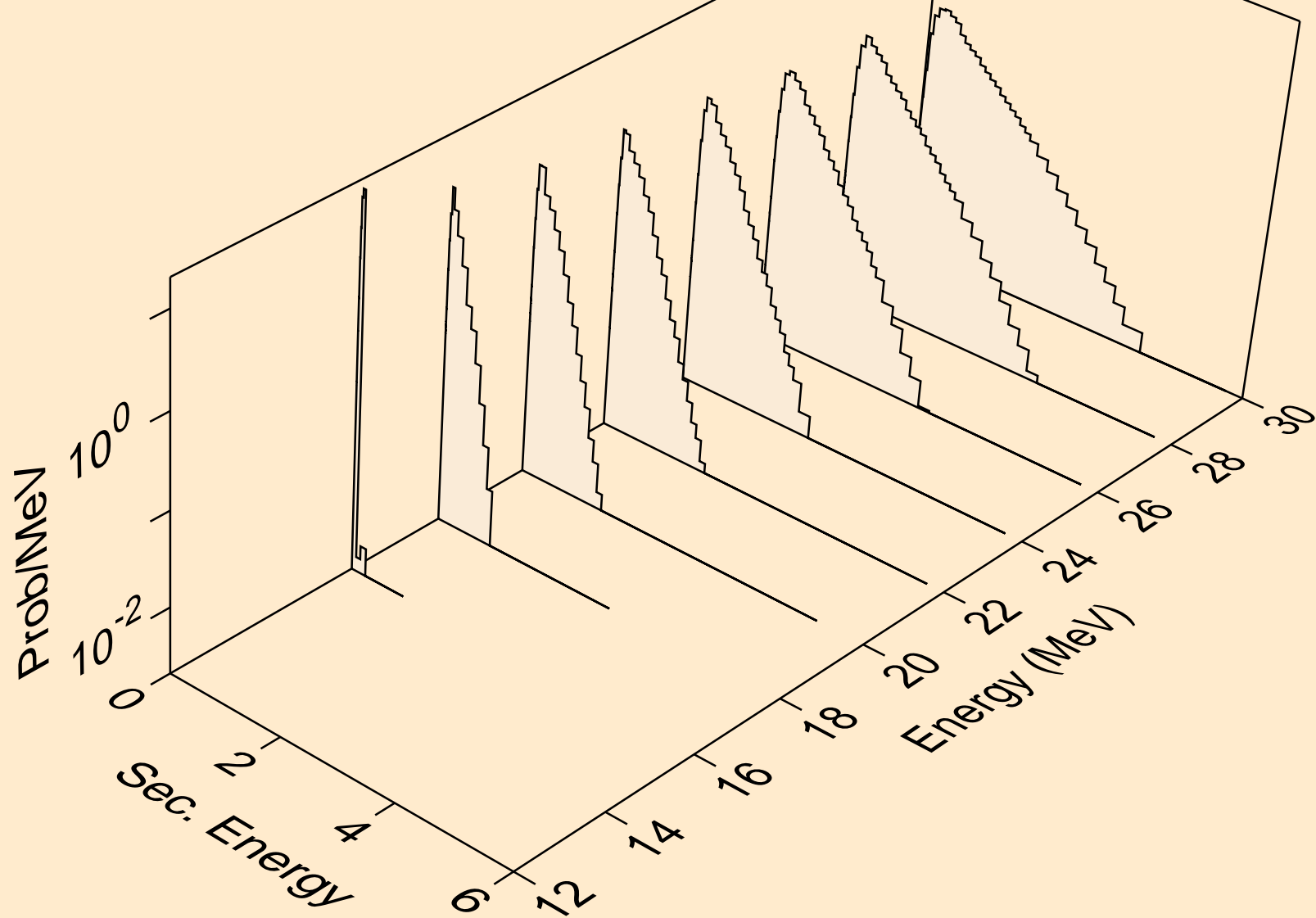

HG201 NEUTRON ACER TENDL-2021 LIBRARY; T=293.6K
Neutron emission for (n,n*)he3

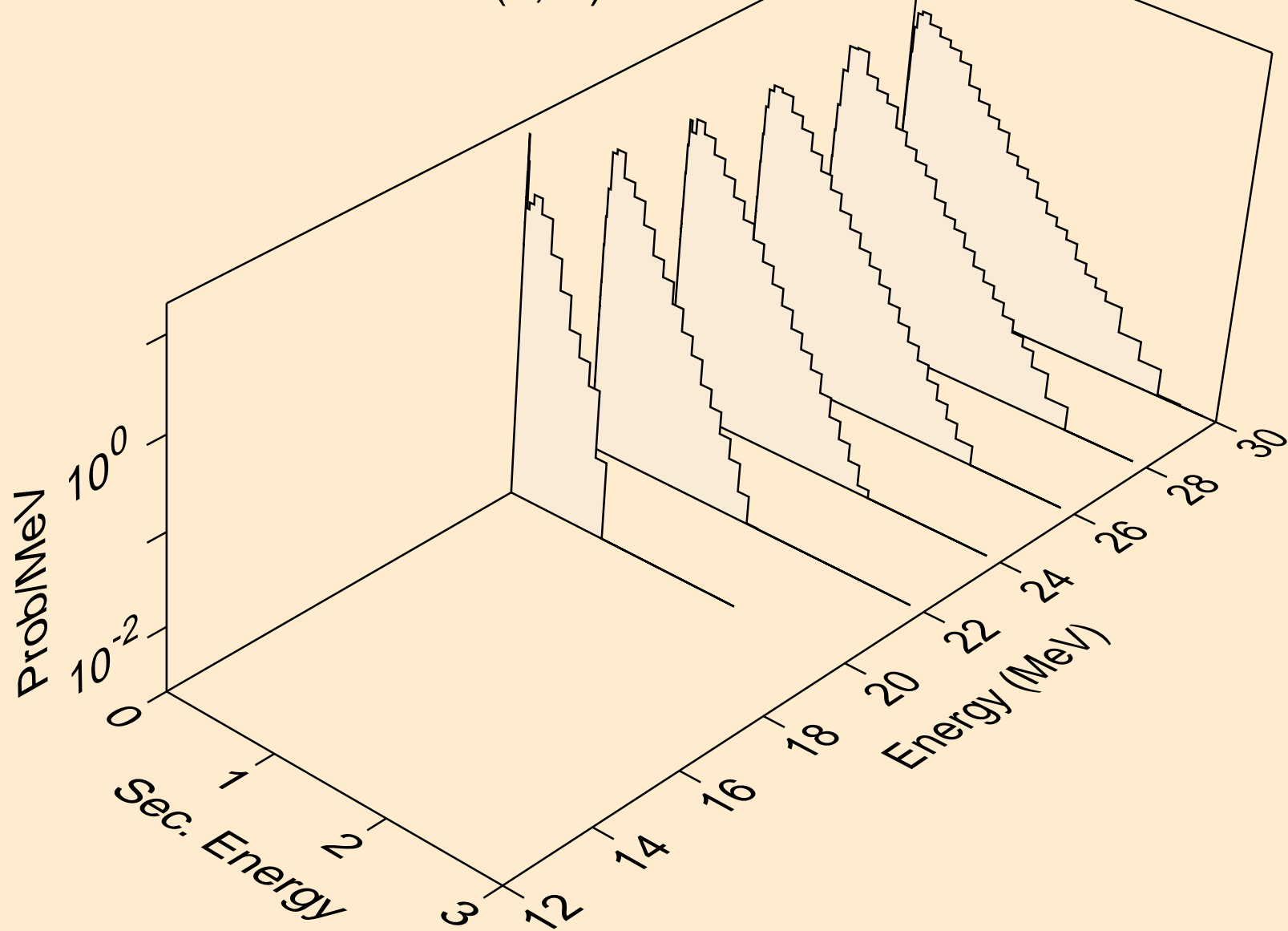

HG201 NEUTRON ACER TENDL-2021 LIBRARY; T=293.6K
Neutron emission for (n,4n)

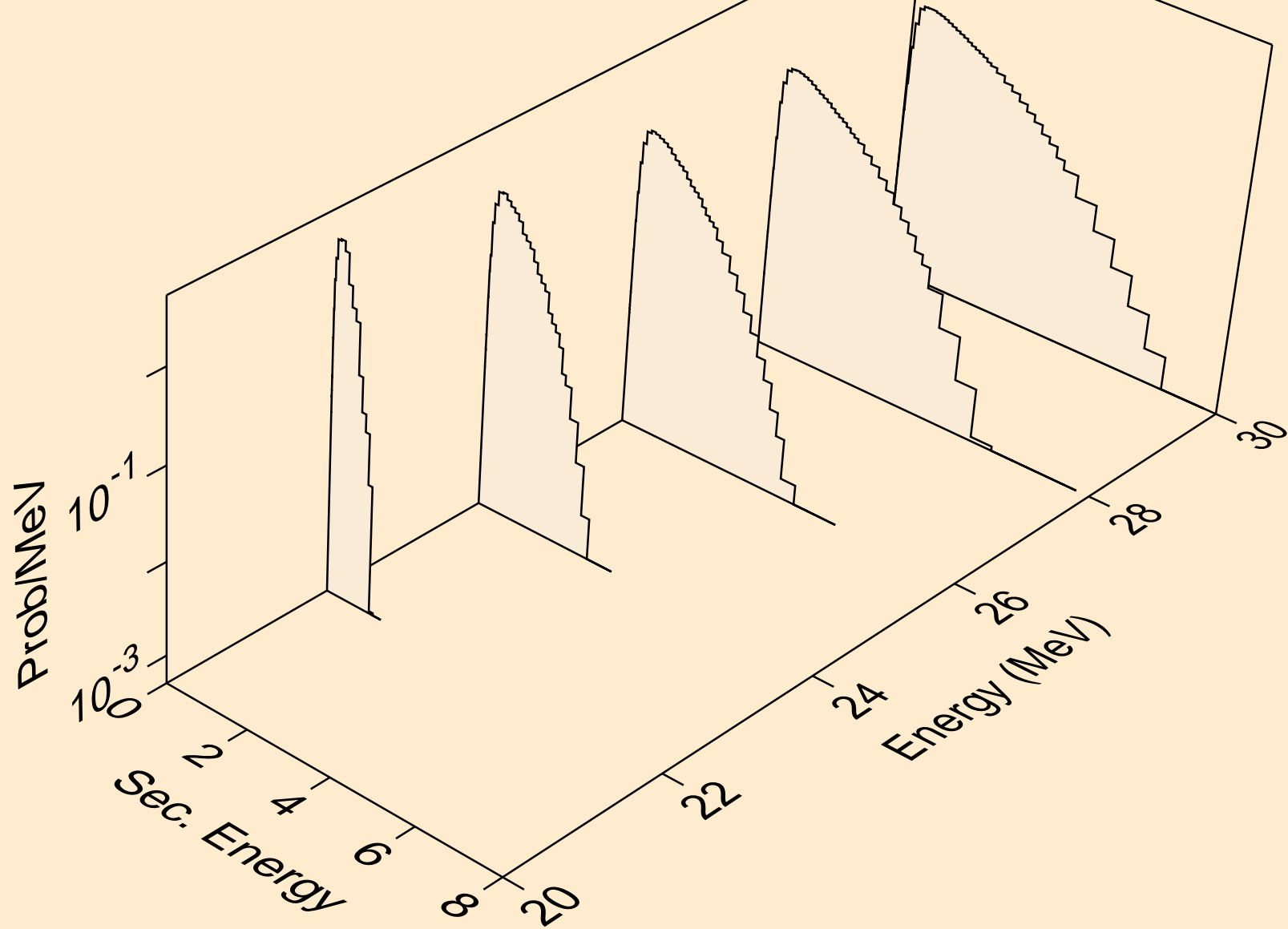

HG201 NEUTRON ACER TENDL-2021 LIBRARY; T=293.6K
Neutron emission for (n,2np)

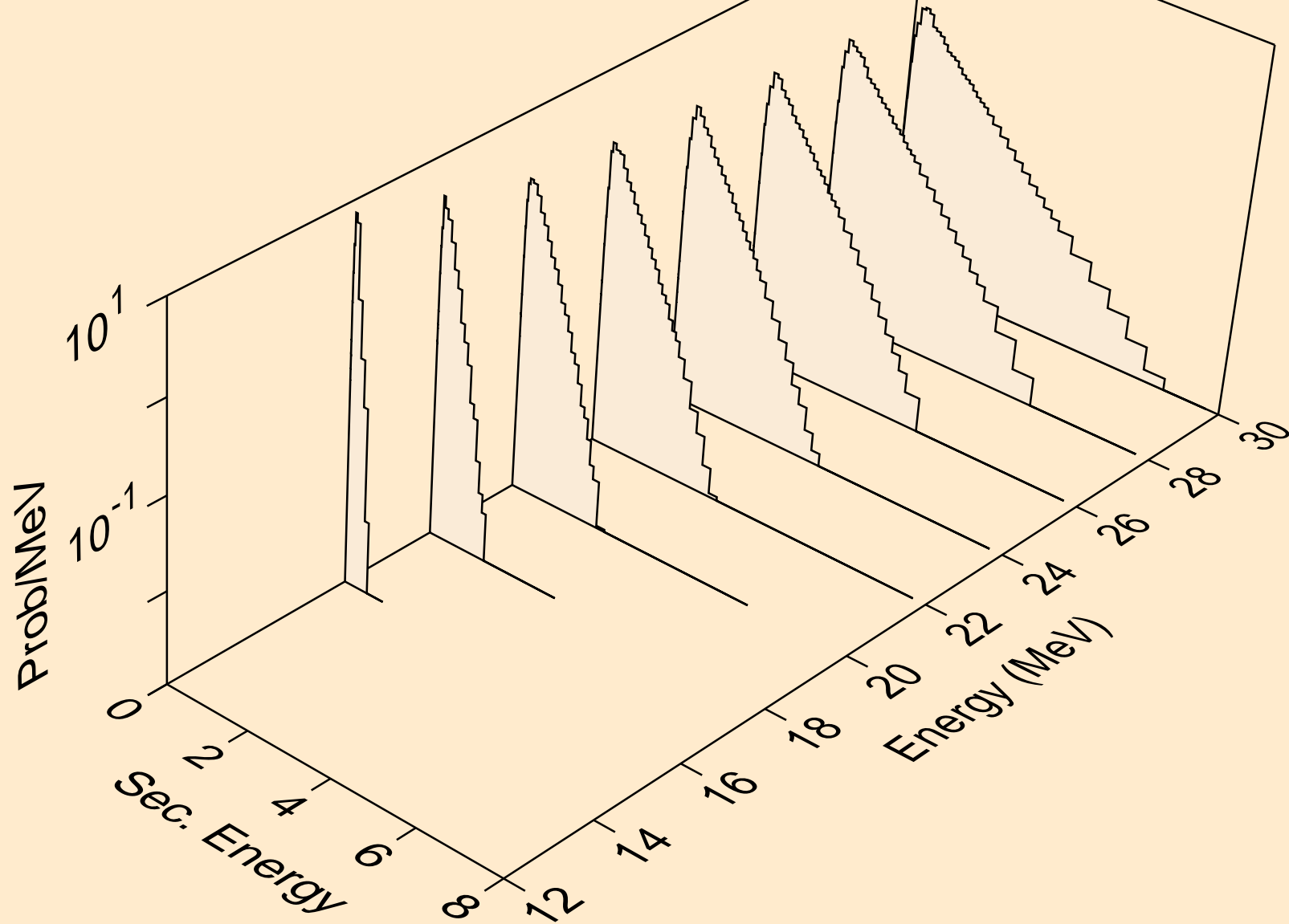

HG201 NEUTRON ACER TENDL-2021 LIBRARY; T=293.6K
Neutron emission for (n,3np)

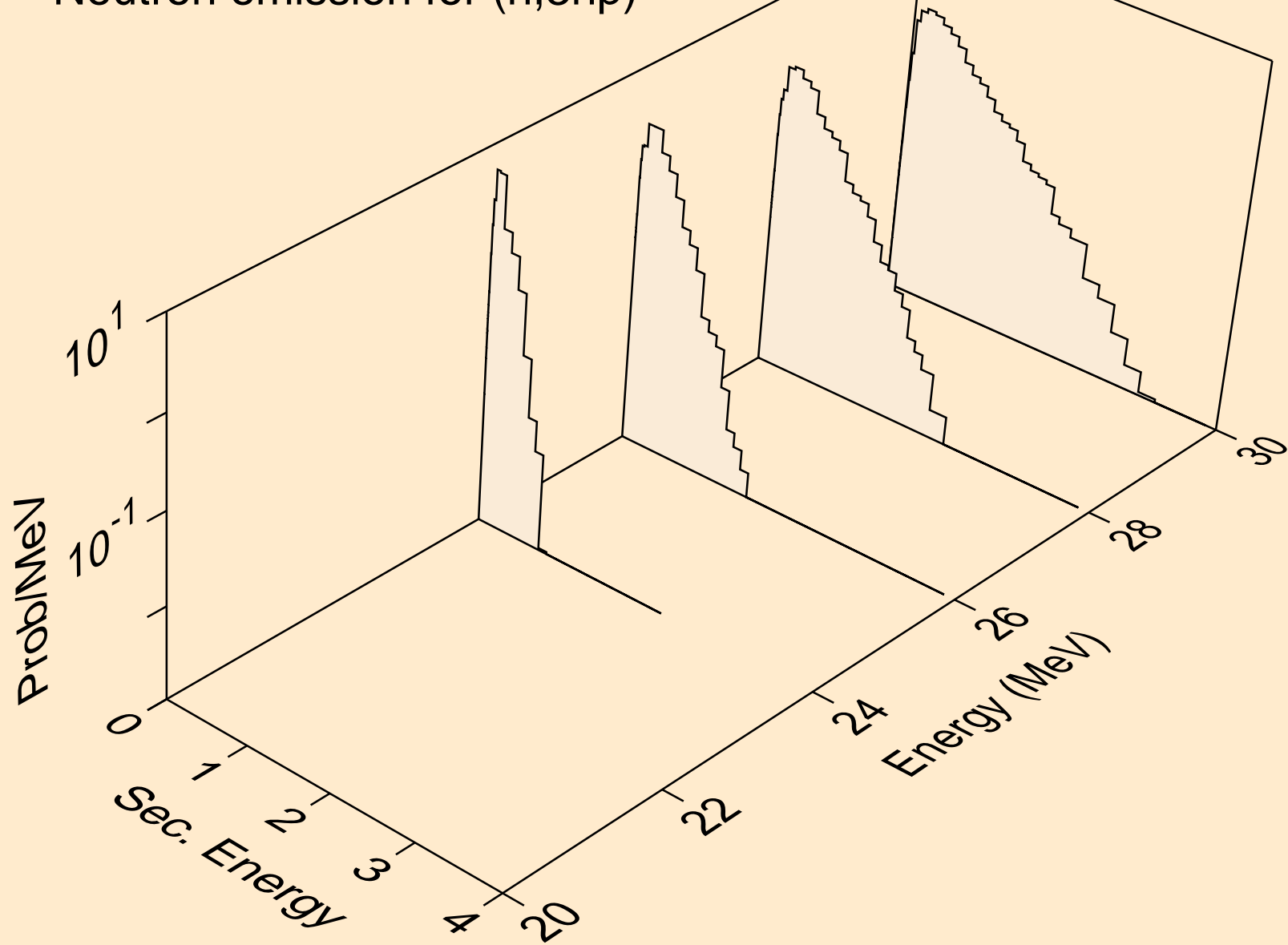

HG201 NEUTRON ACER TENDL-2021 LIBRARY; T=293.6K
Neutron emission for (n,2np)

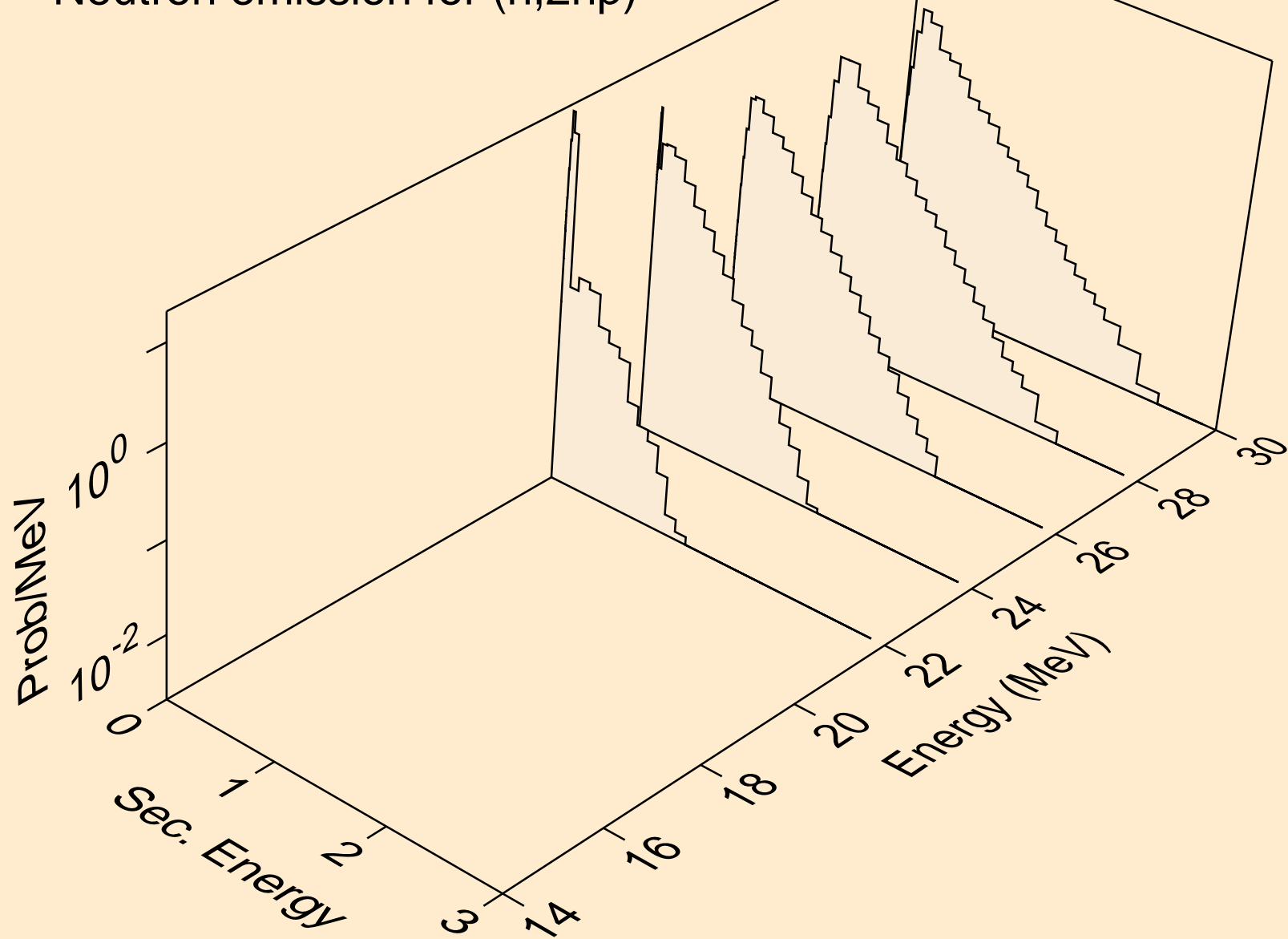

HG201 NEUTRON ACER TENDL-2021 LIBRARY; T=293.6K
Neutron emission for (n,n*c)

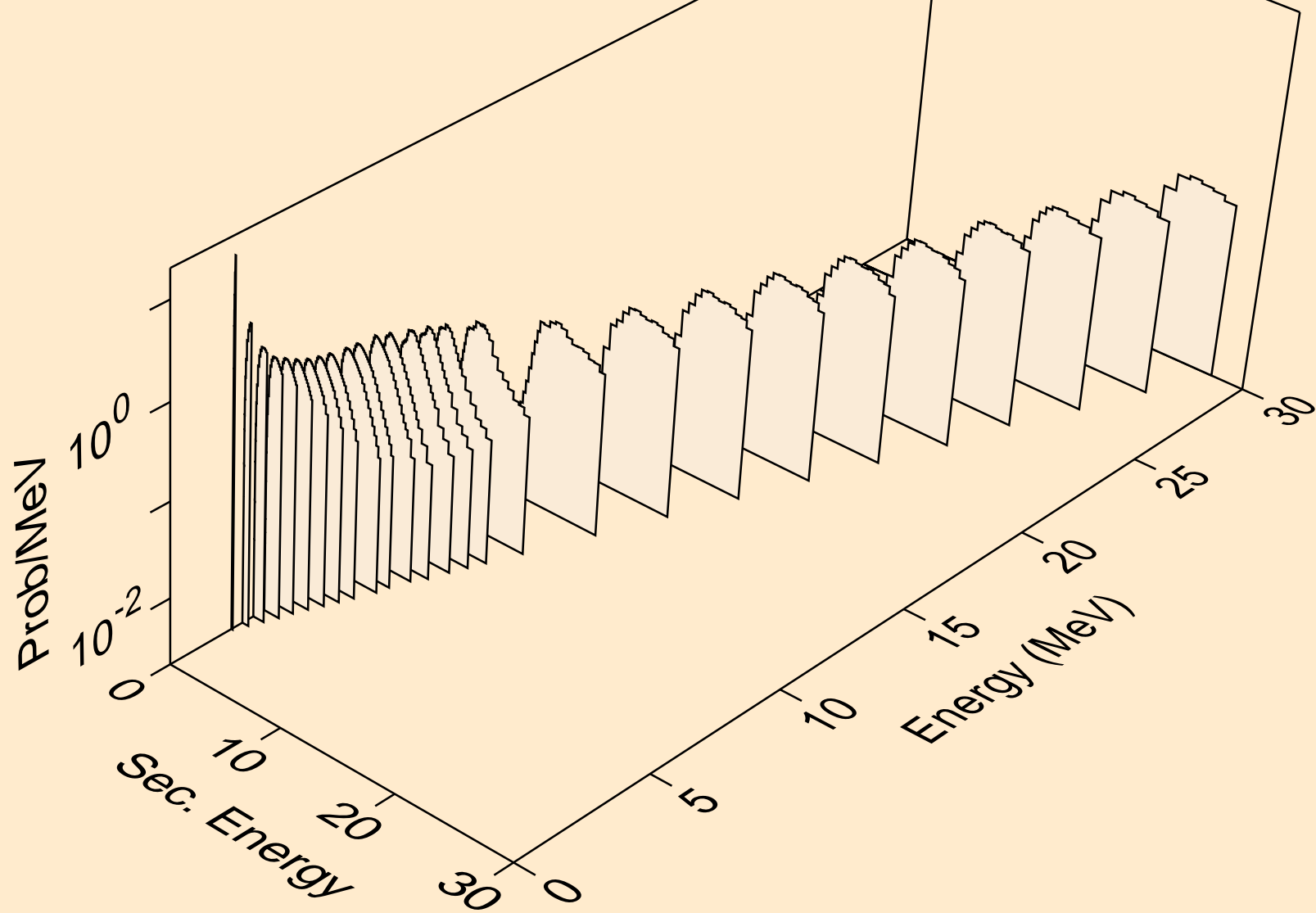

HG201 NEUTRON ACER TENDL-2021 LIBRARY; T=293.6K
Photon emission for (n,x)

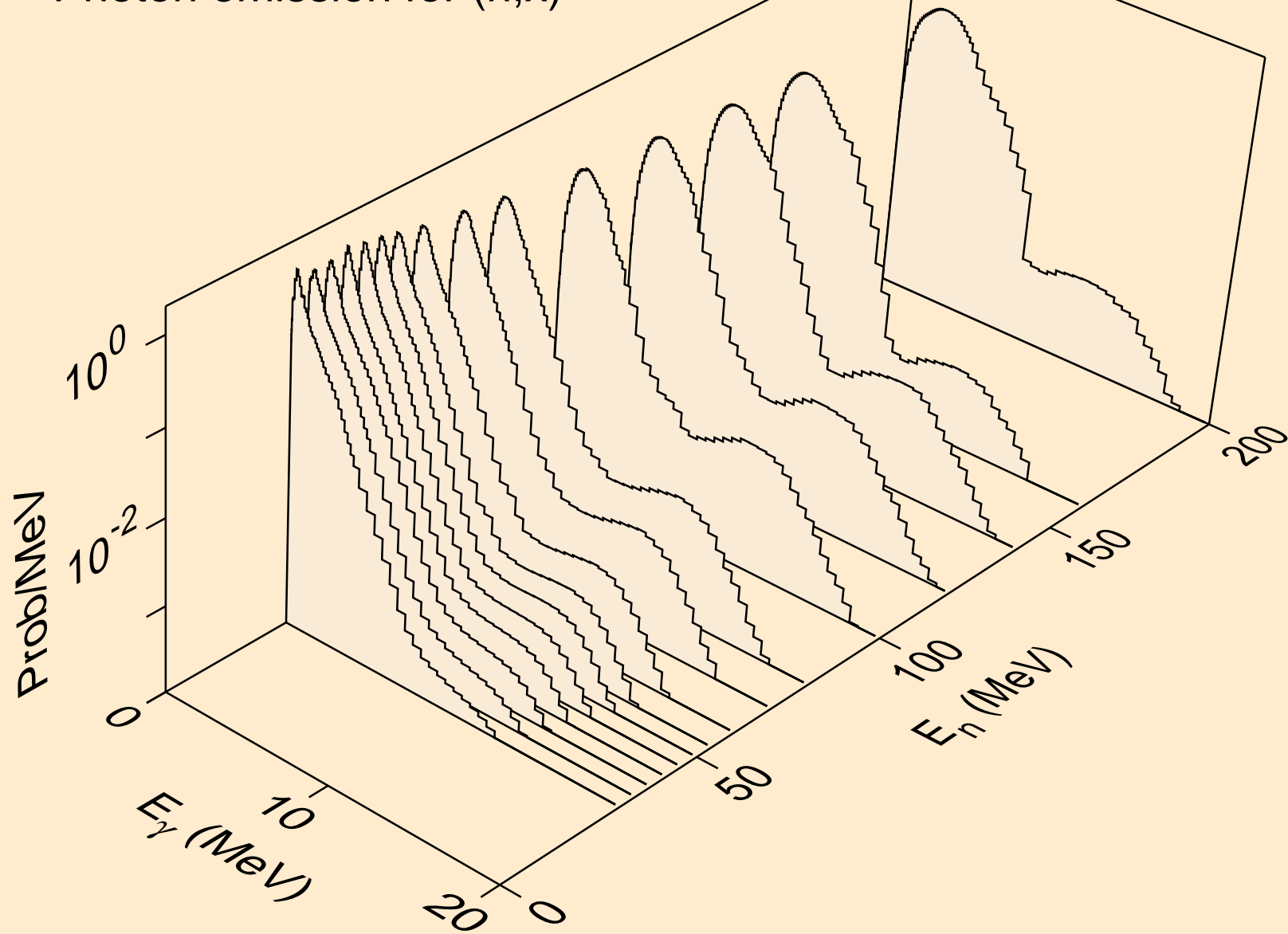

HG201 NEUTRON ACER TENDL-2021 LIBRARY; T=293.6K
Photon emission for (n,2nd)

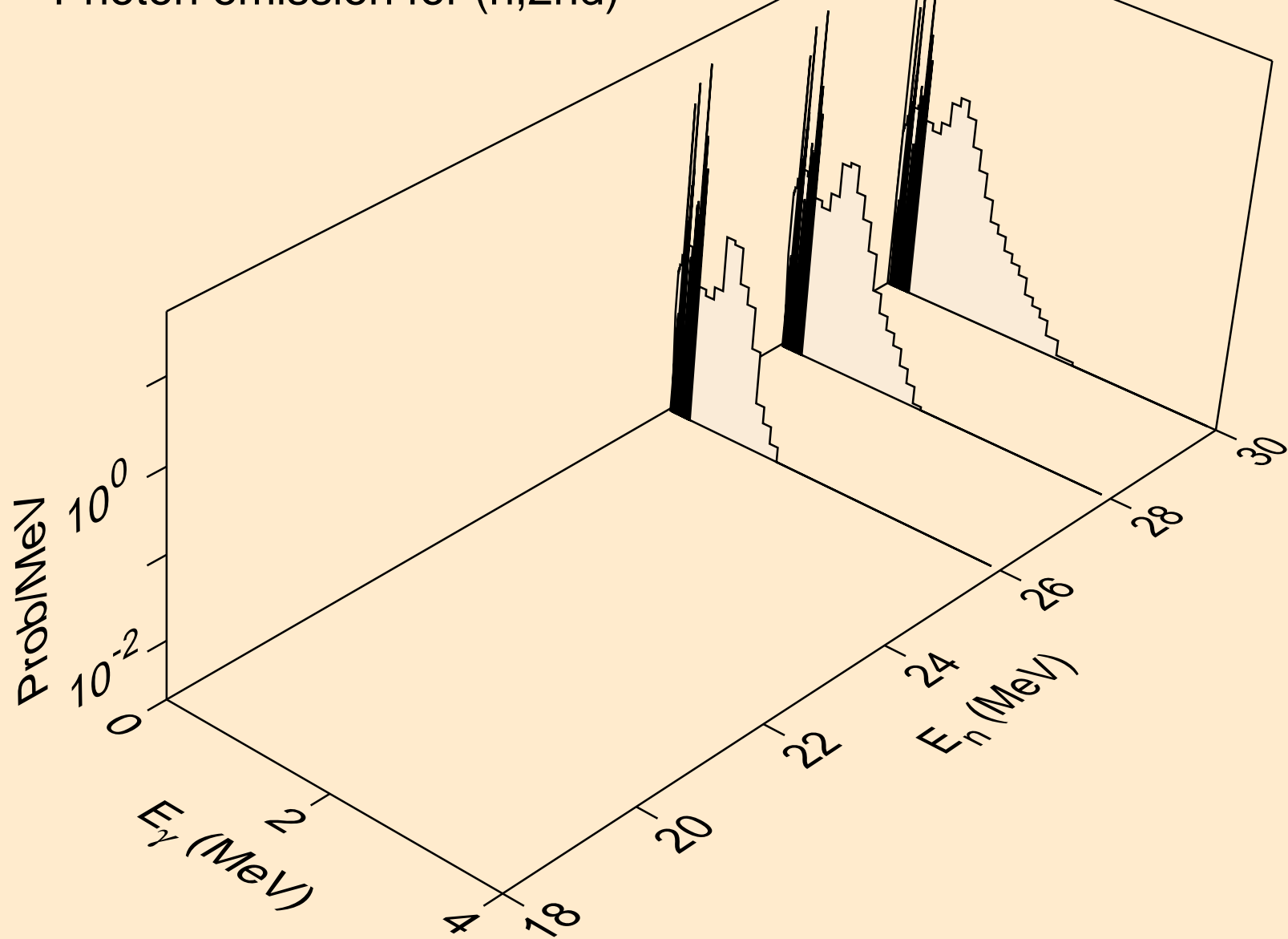

HG201 NEUTRON ACER TENDL-2021 LIBRARY; T=293.6K
Photon emission for (n,2n)

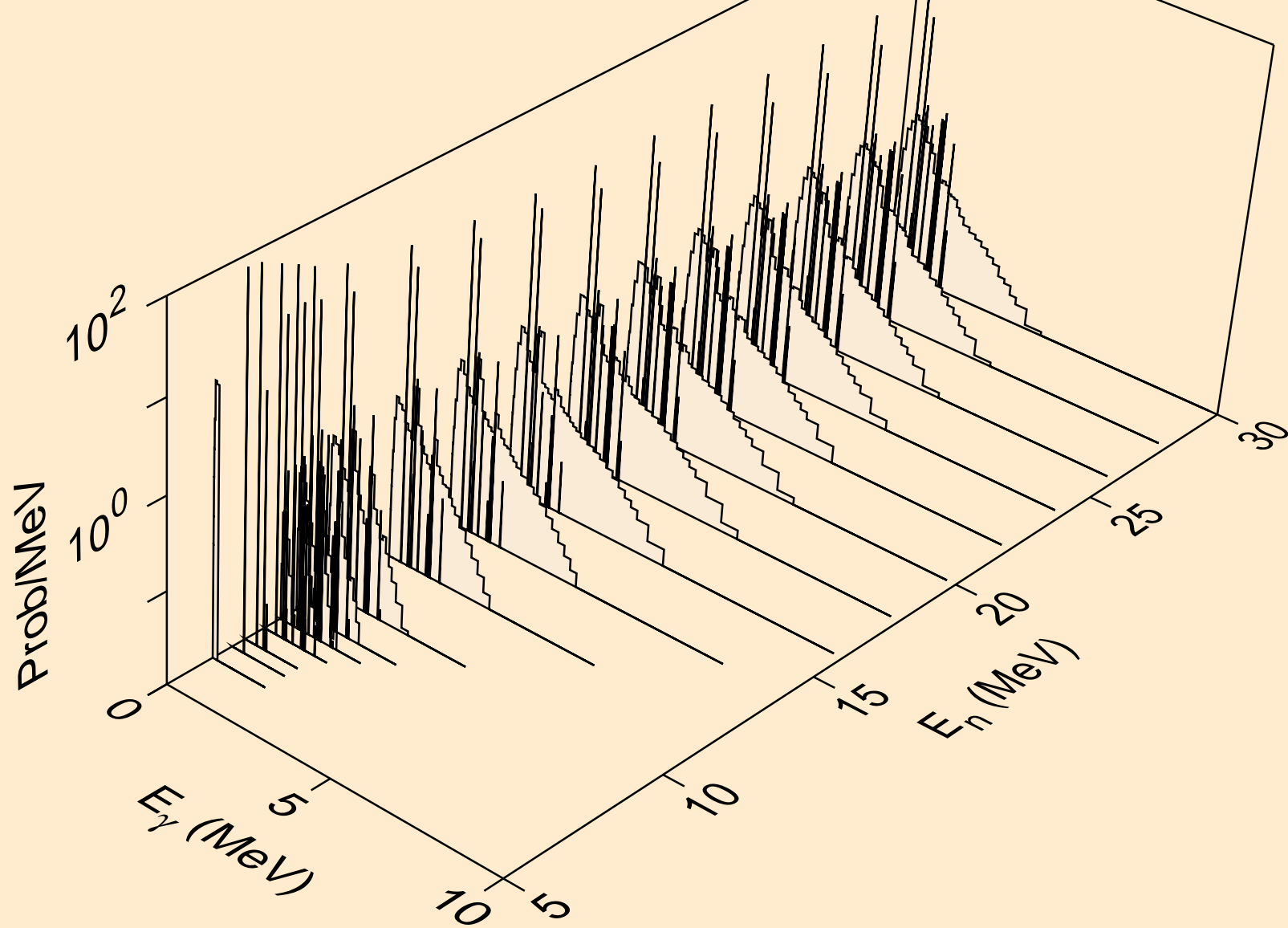

HG201 NEUTRON ACER TENDL-2021 LIBRARY; T=293.6K
Photon emission for (n,3n)

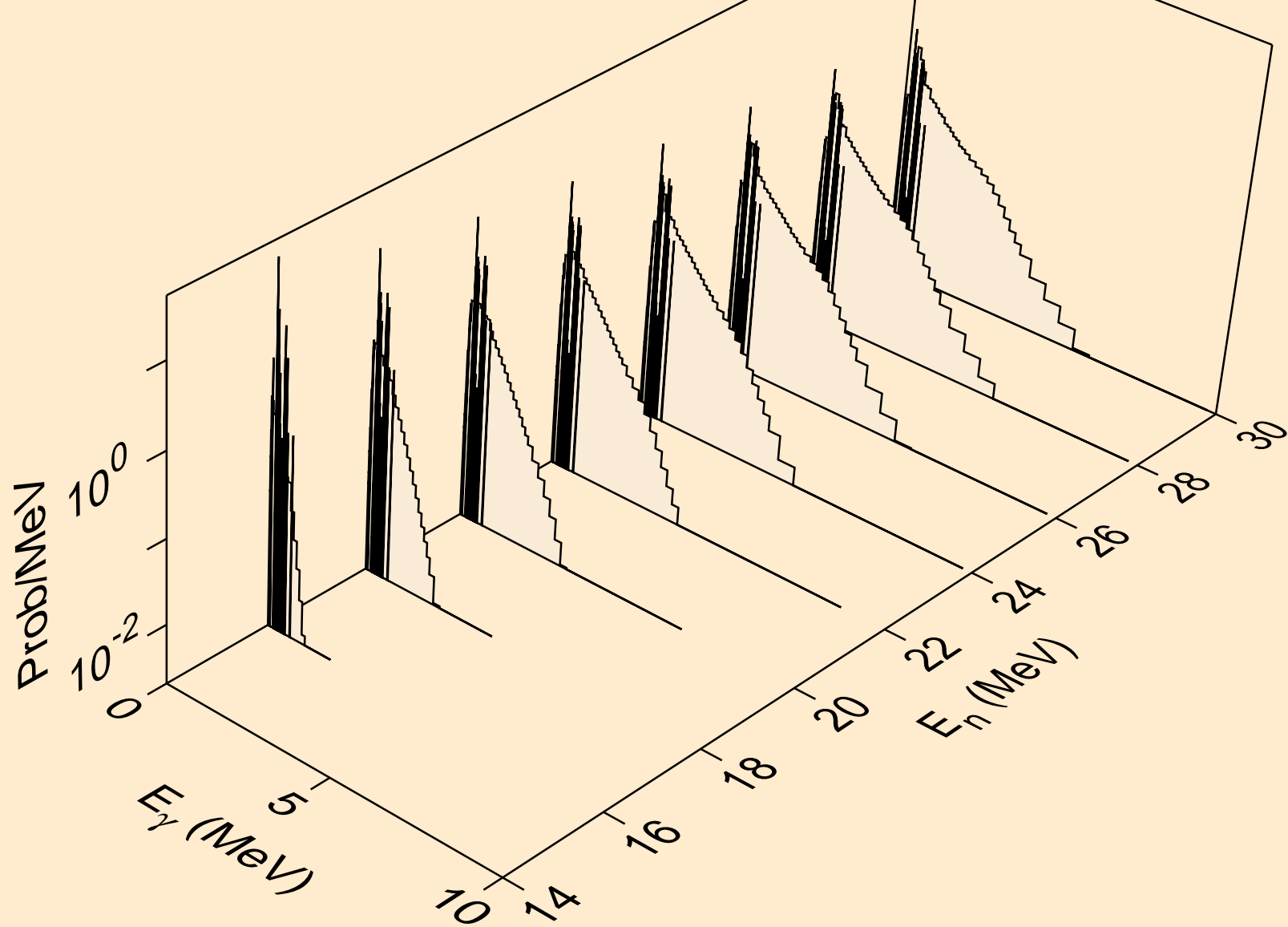

HG201 NEUTRON ACER TENDL-2021 LIBRARY; T=293.6K
Photon emission for (n,n*)a

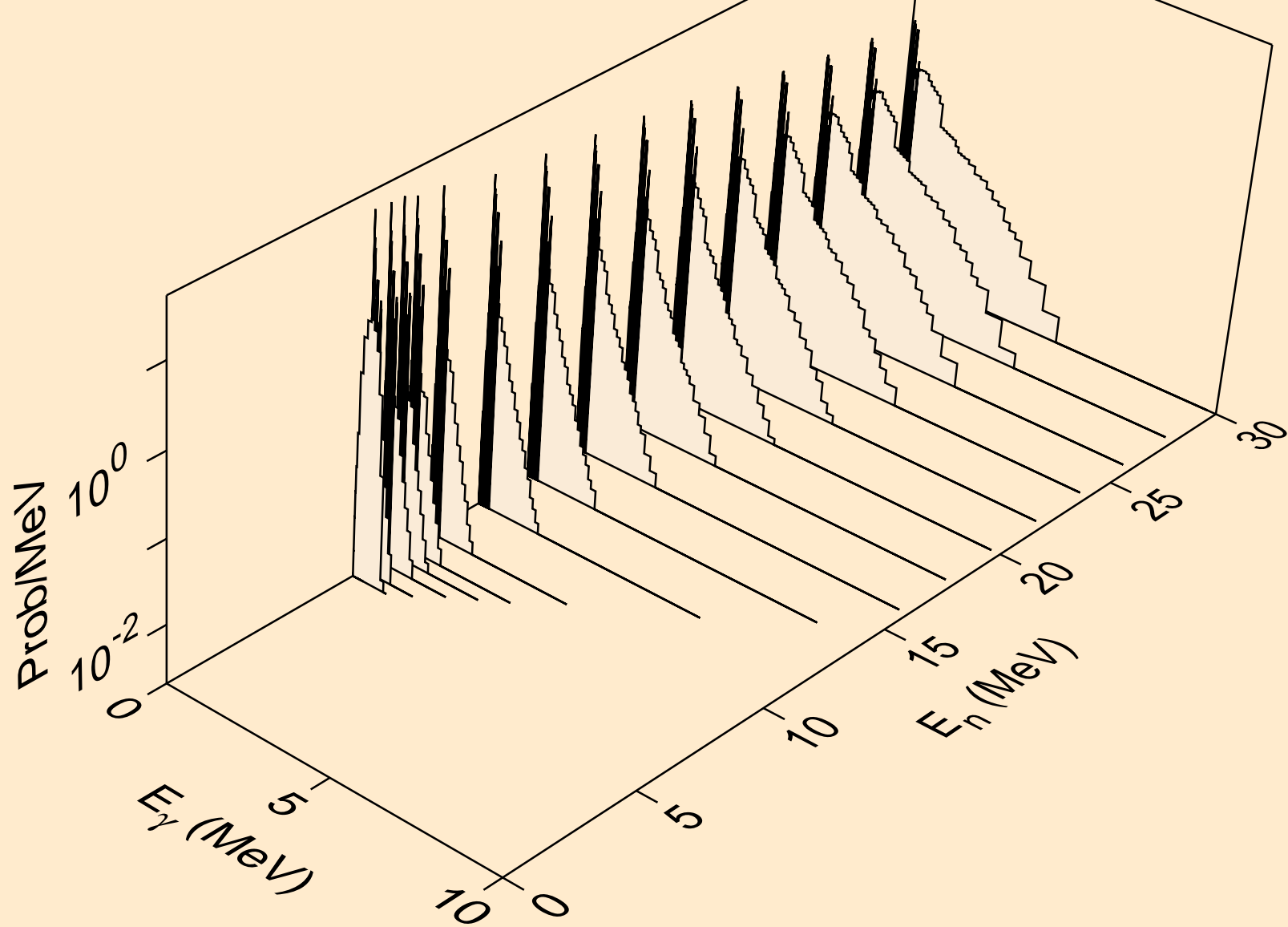

HG201 NEUTRON ACER TENDL-2021 LIBRARY; T=293.6K
Photon emission for (n,2n)a

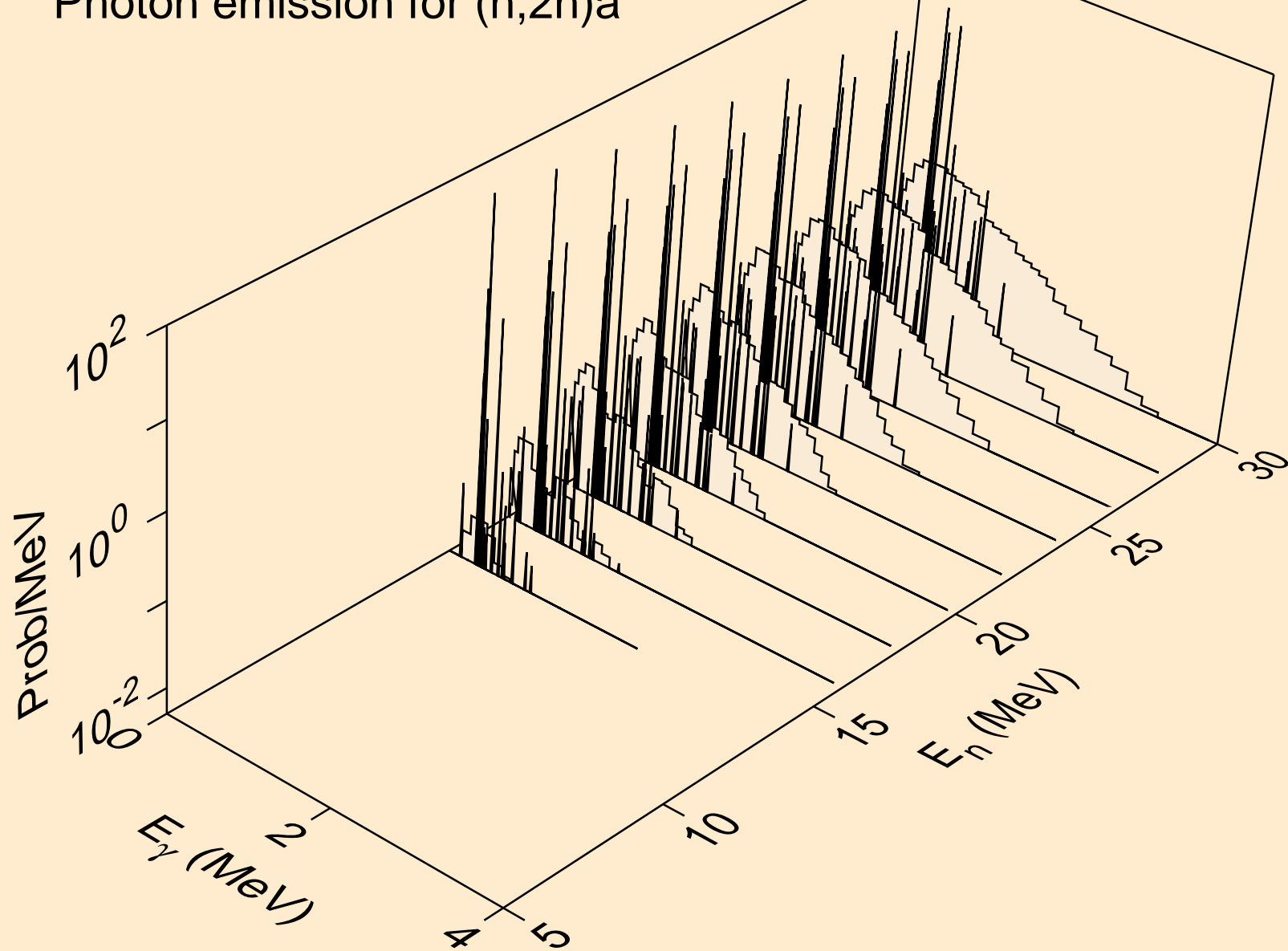

HG201 NEUTRON ACER TENDL-2021 LIBRARY; T=293.6K
Photon emission for (n,3n)a

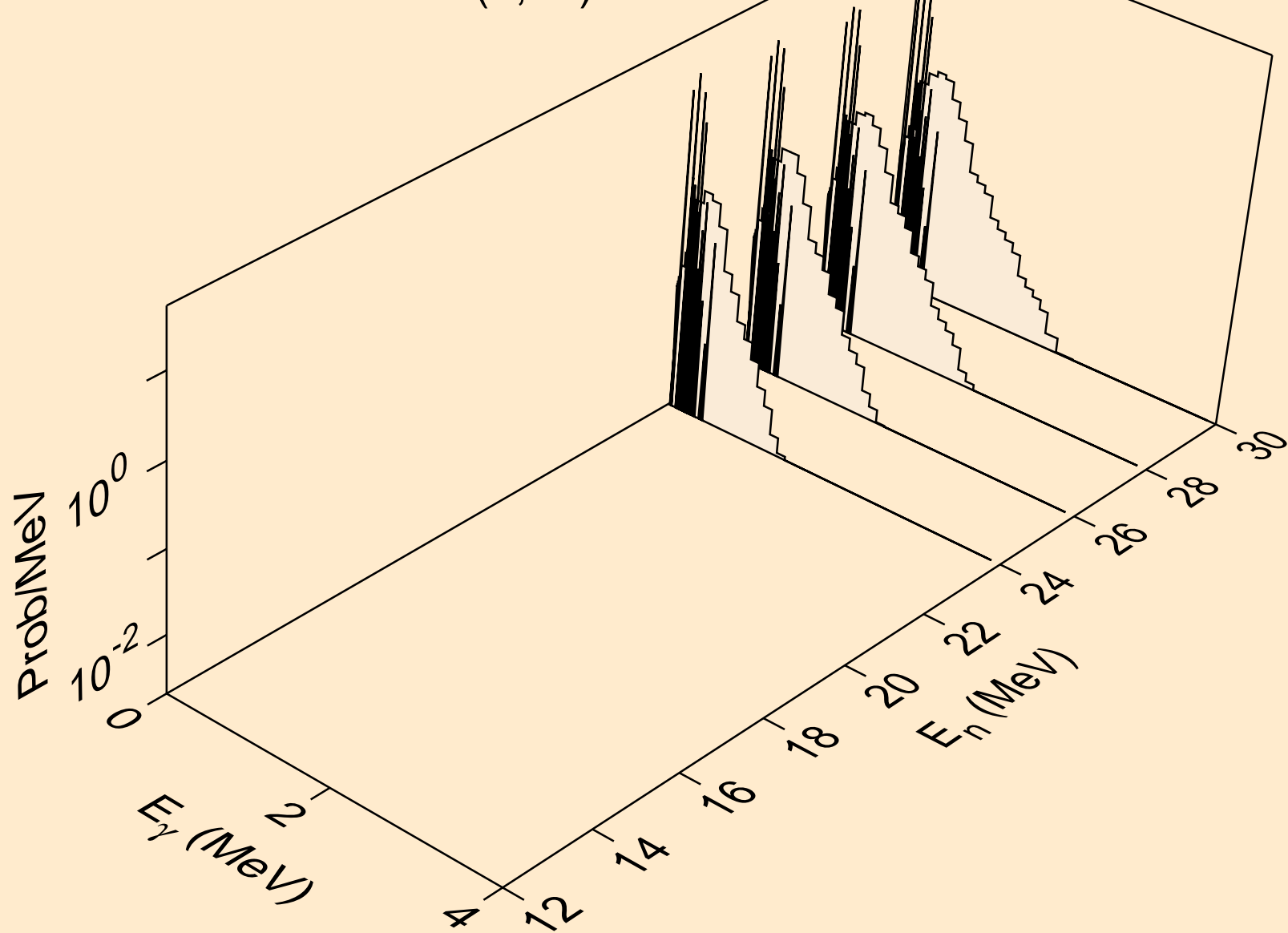

HG201 NEUTRON ACER TENDL-2021 LIBRARY; T=293.6K
Photon emission for (n,n*)p

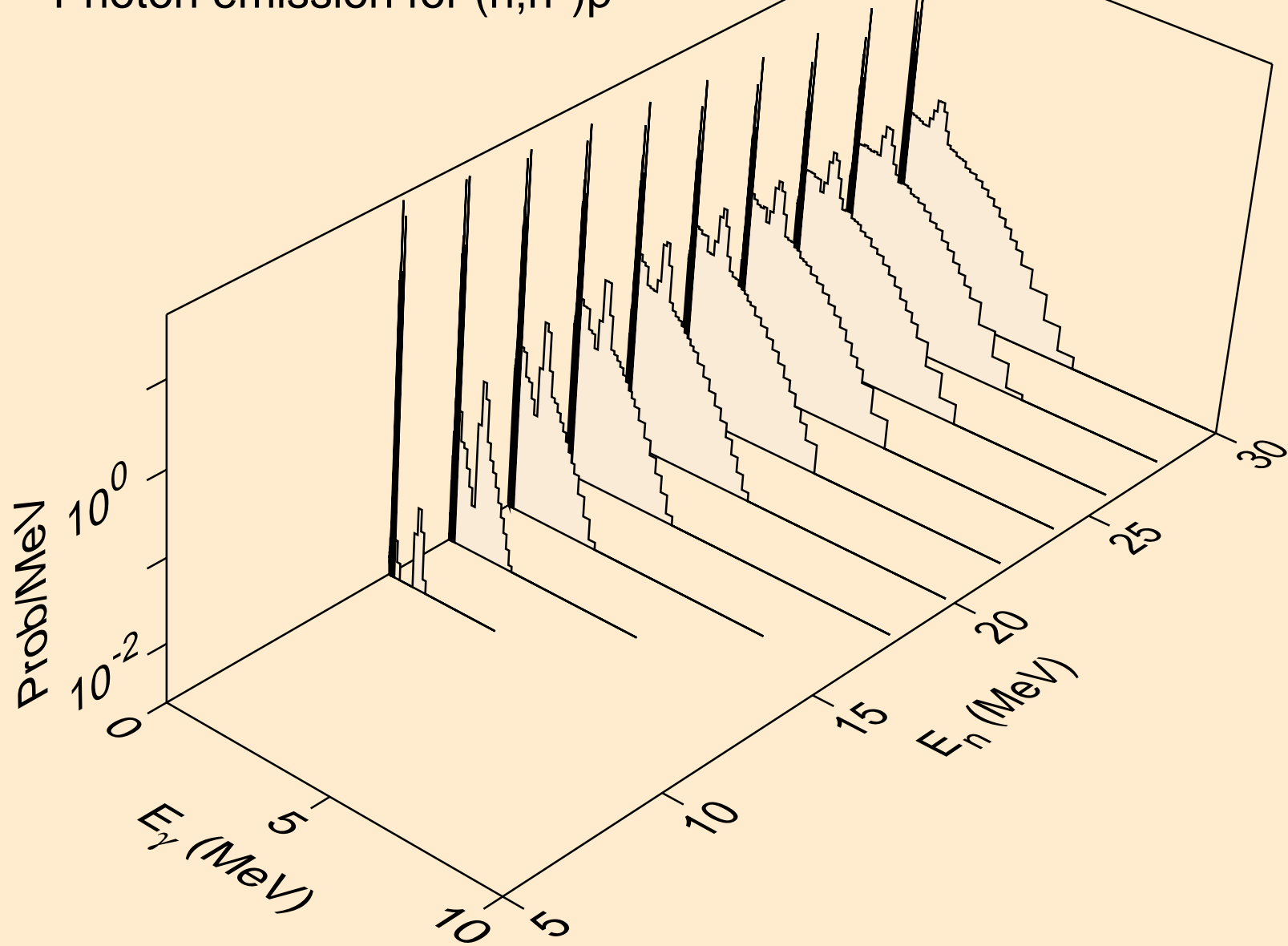

HG201 NEUTRON ACER TENDL-2021 LIBRARY; T=293.6K
Photon emission for (n,n*)d

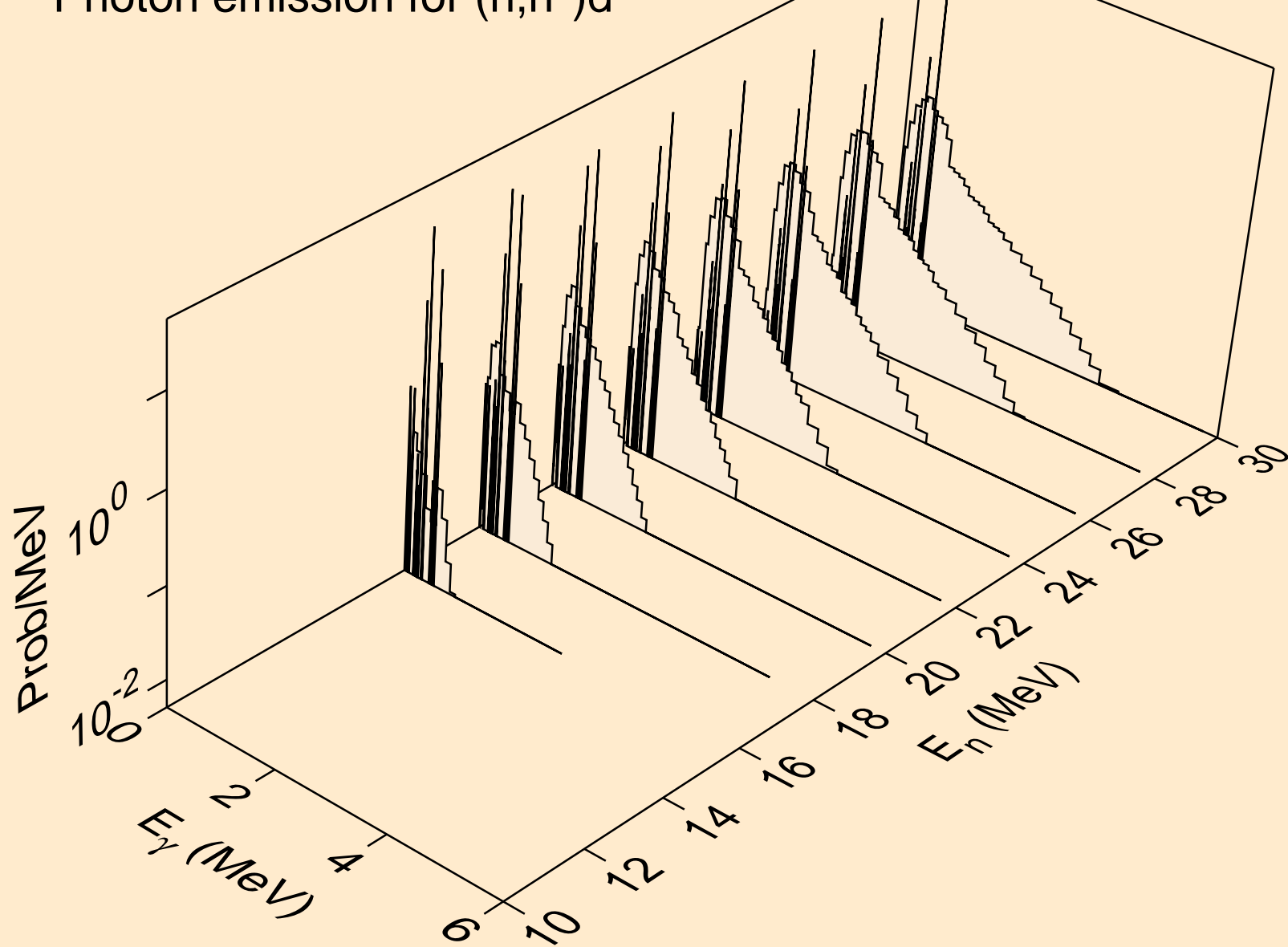

HG201 NEUTRON ACER TENDL-2021 LIBRARY; T=293.6K
Photon emission for (n,n*)t

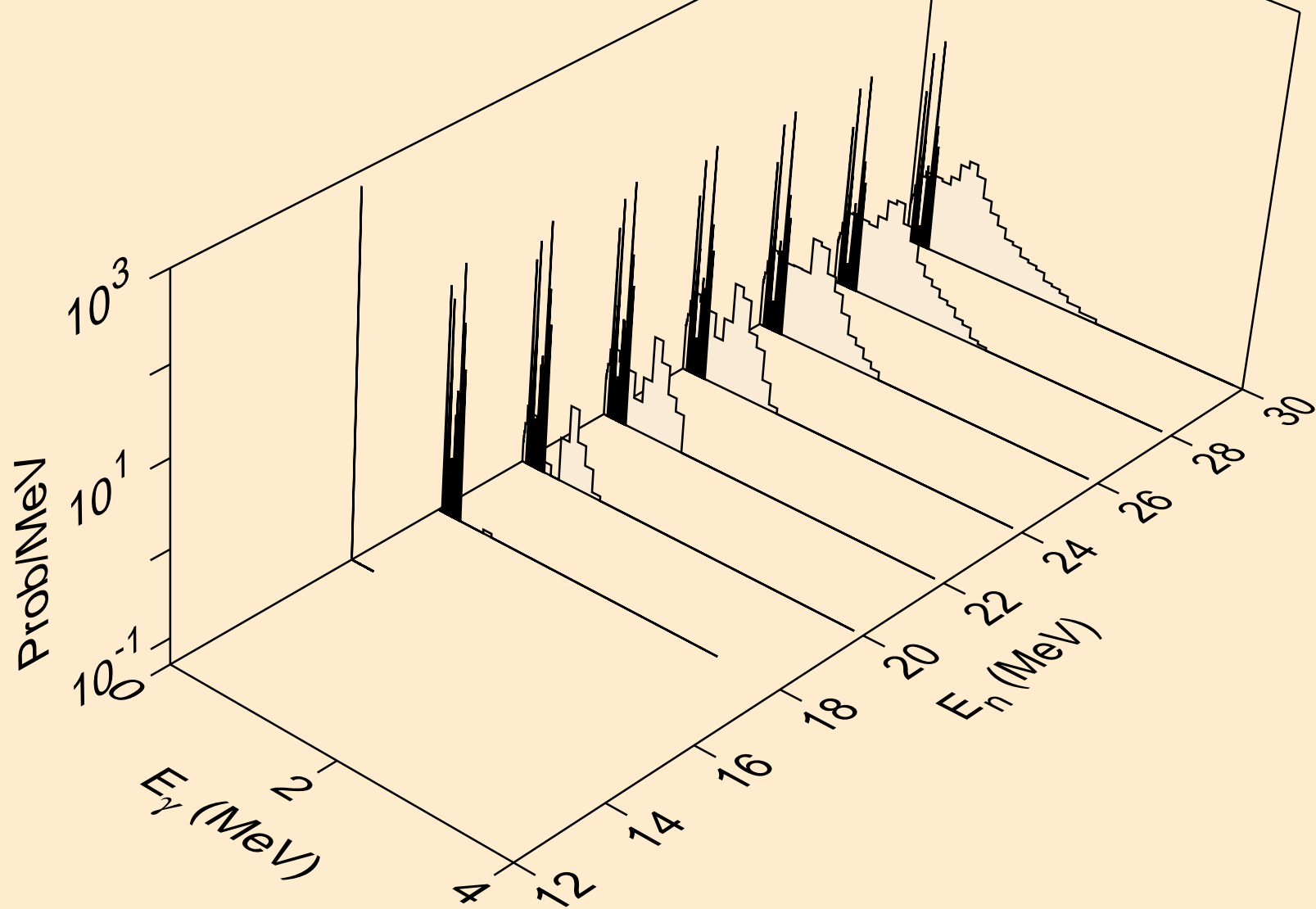

HG201 NEUTRON ACER TENDL-2021 LIBRARY; T=293.6K
Photon emission for (n,n*)he3

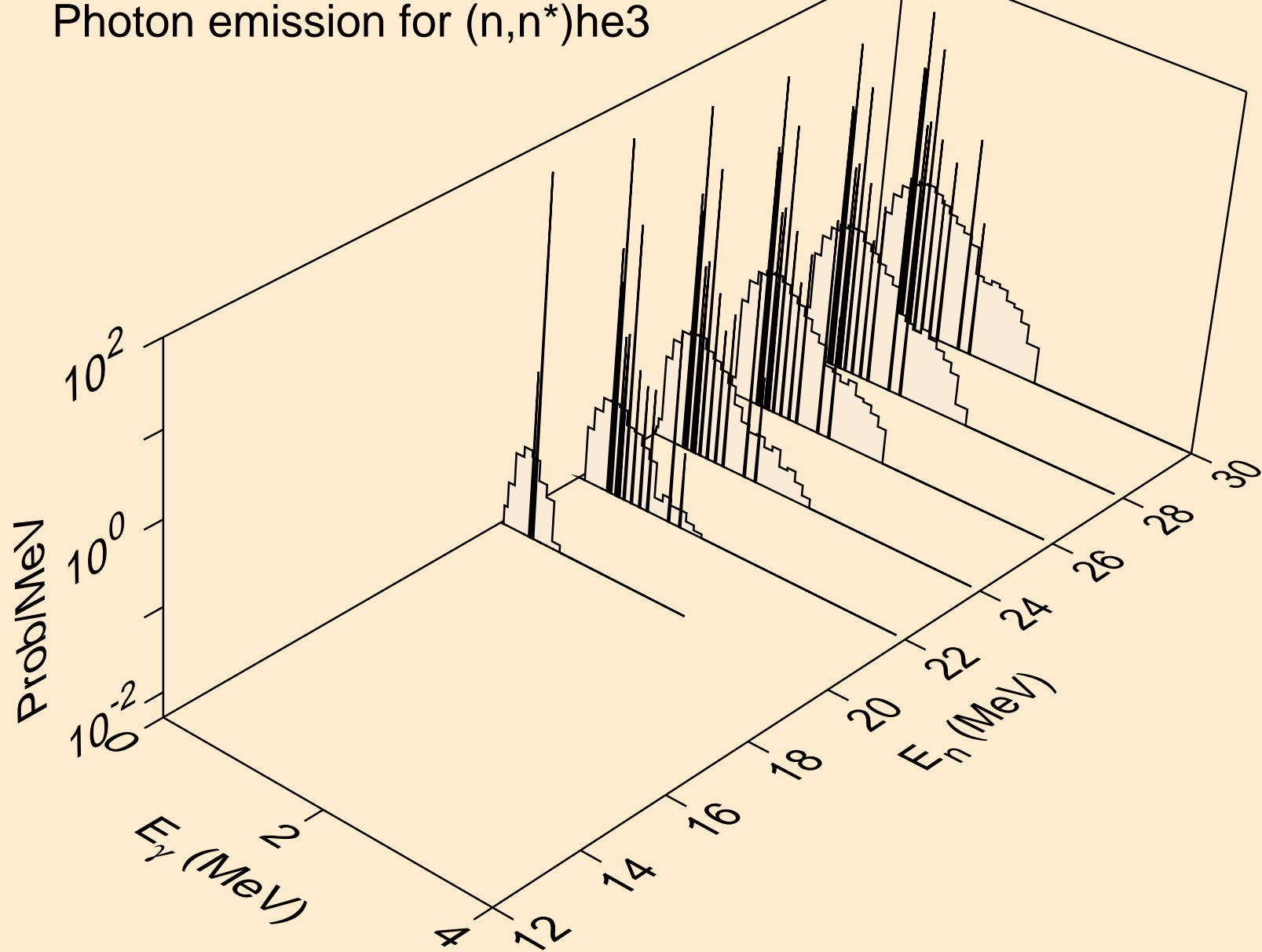

HG201 NEUTRON ACER TENDL-2021 LIBRARY; T=293.6K
Photon emission for (n,4n)

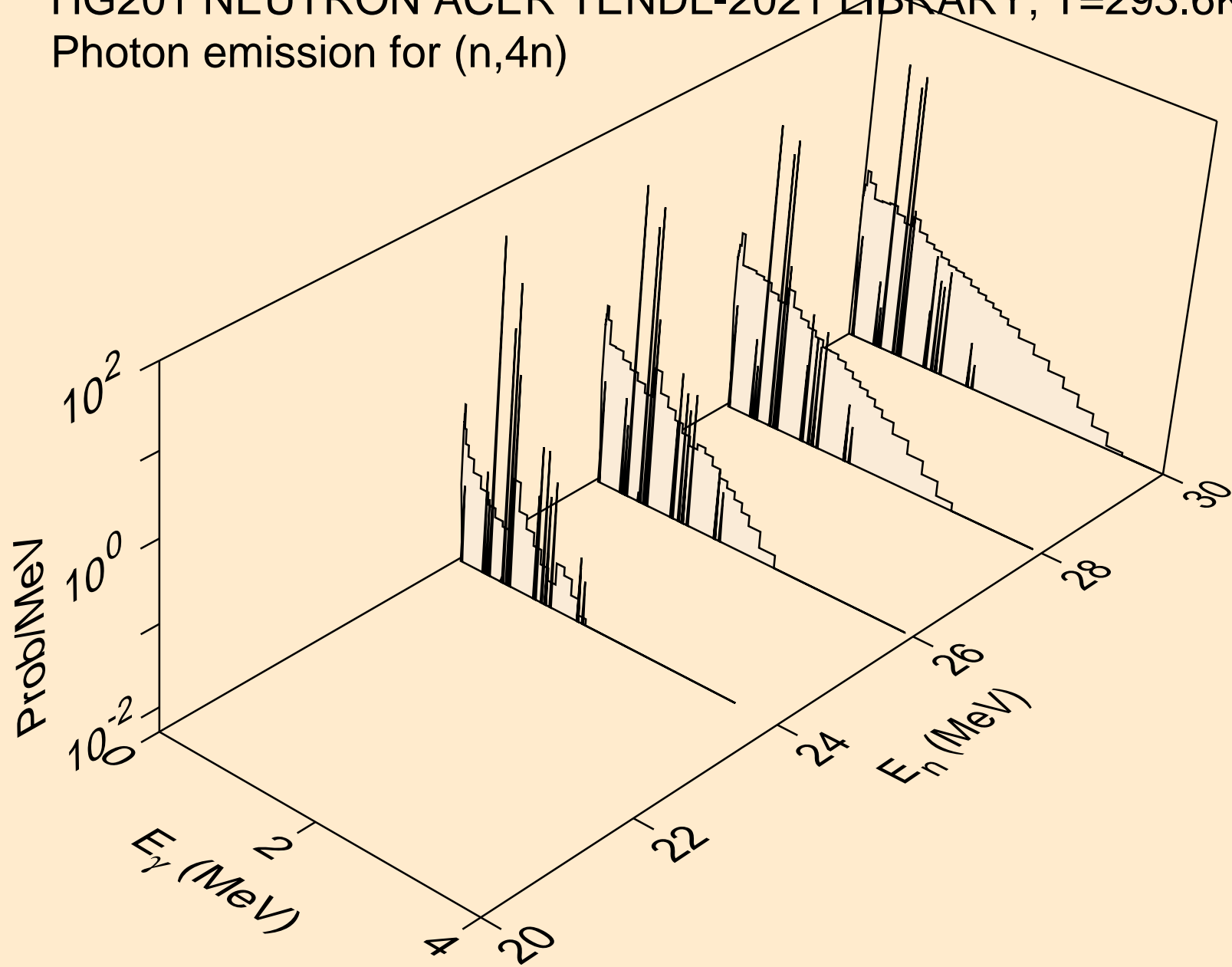

HG201 NEUTRON ACER TENDL-2021 LIBRARY; T=293.6K
Photon emission for (n,2np)

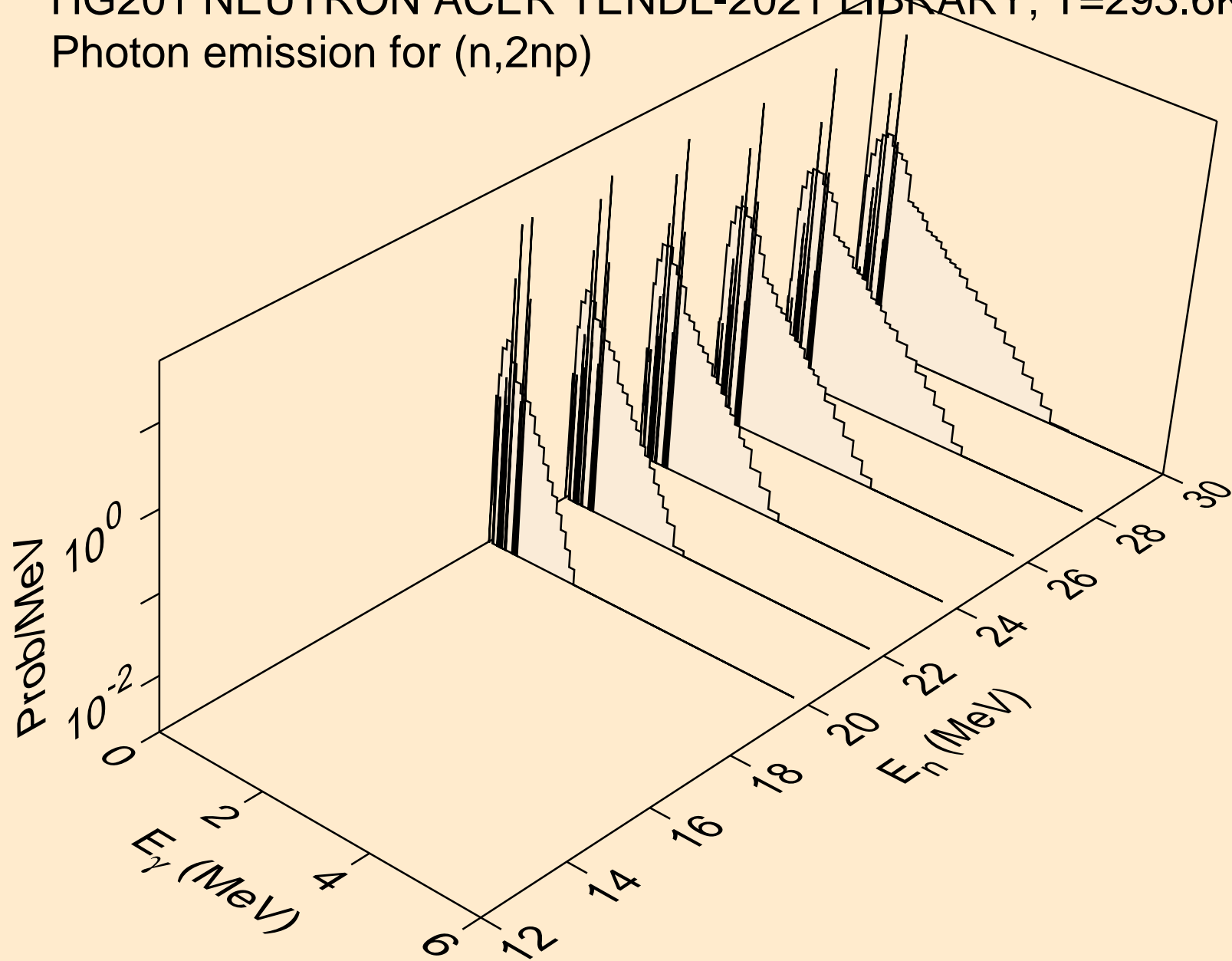

HG201 NEUTRON ACER TENDL-2021 LIBRARY; T=293.6K
Photon emission for (n,3np)

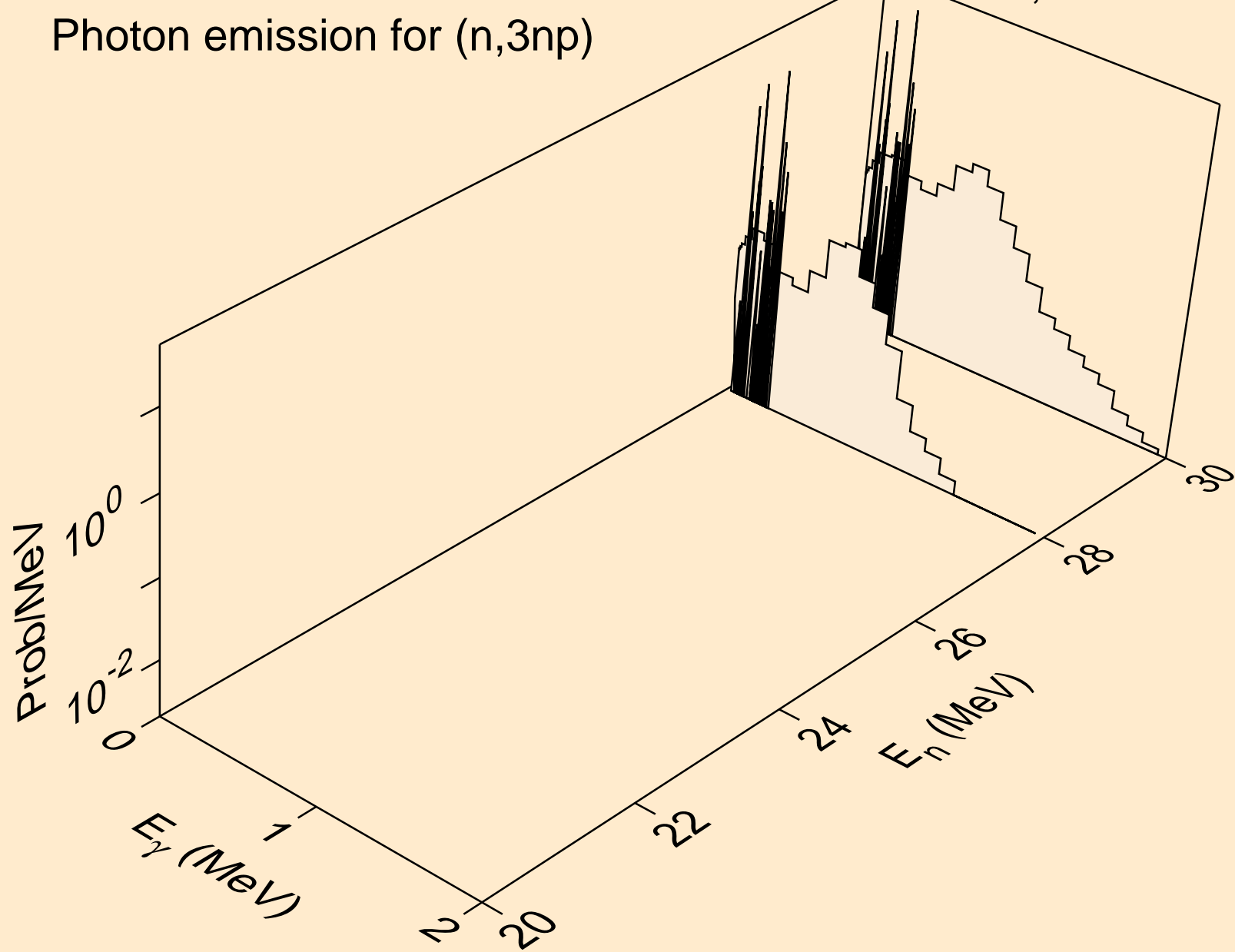

HG201 NEUTRON ACER TENDL-2021 LIBRARY; T=293.6K
Photon emission for (n,2np)

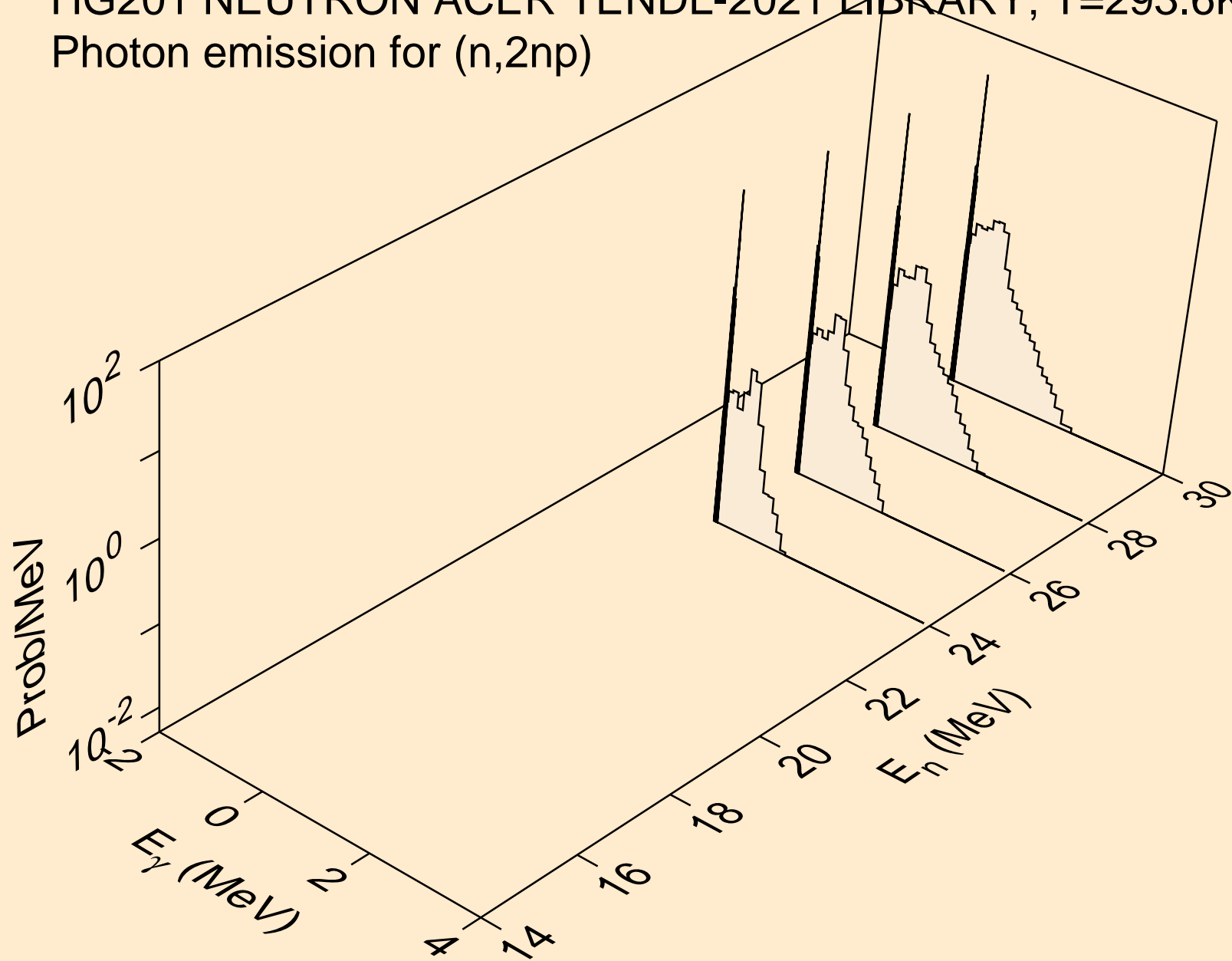

HG201 NEUTRON ACER TENDL-2021 LIBRARY; T=293.6K
Photon emission for (n,n*c)

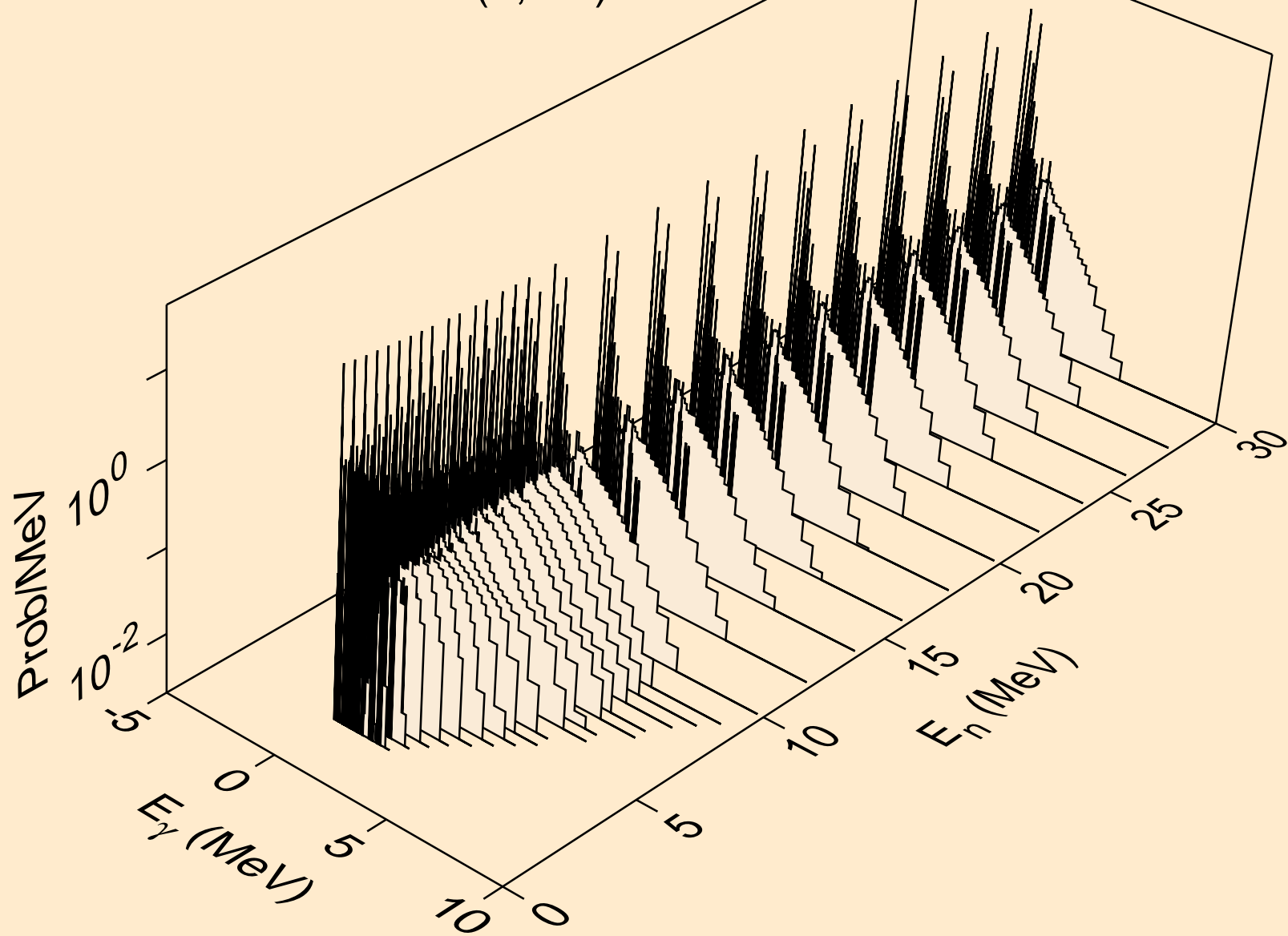

HG201 NEUTRON ACER TENDL-2021 LIBRARY; T=293.6K
Photon emission for (n,gma)

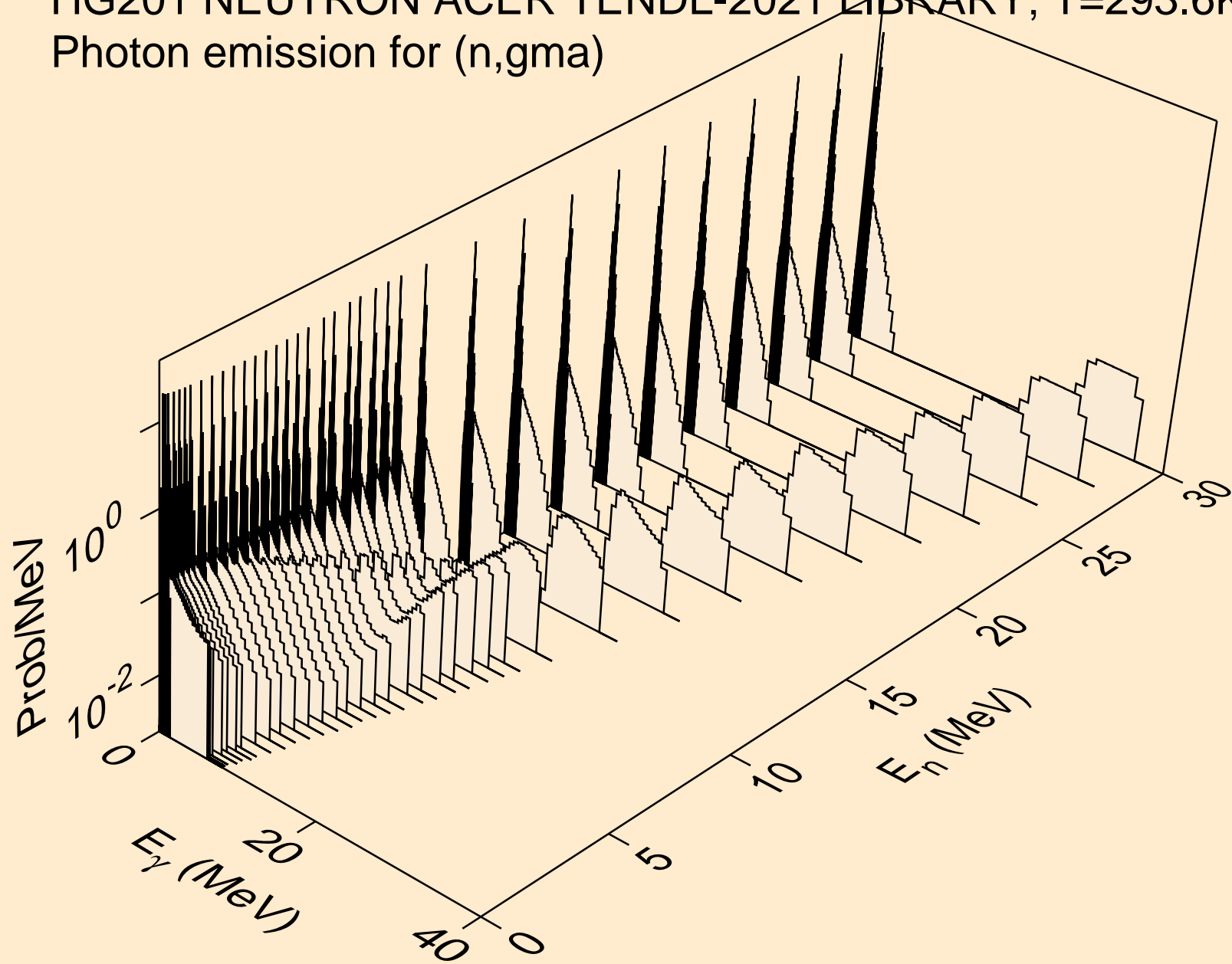

HG201 NEUTRON ACER TENDL-2021 LIBRARY; T=293.6K
Photon emission for (n,p)

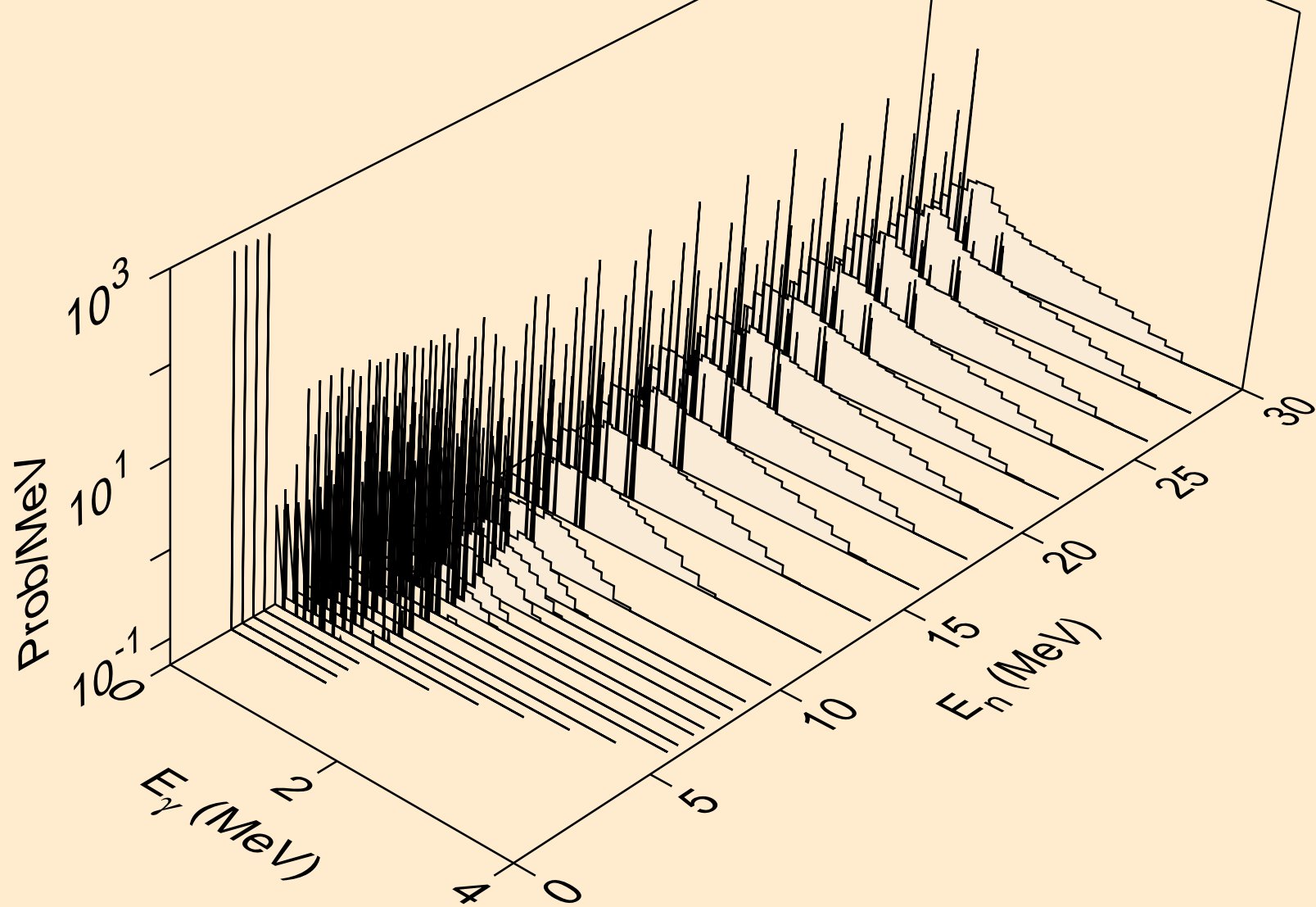

HG201 NEUTRON ACER TENDL-2021 LIBRARY; T=293.6K
Photon emission for (n,d)

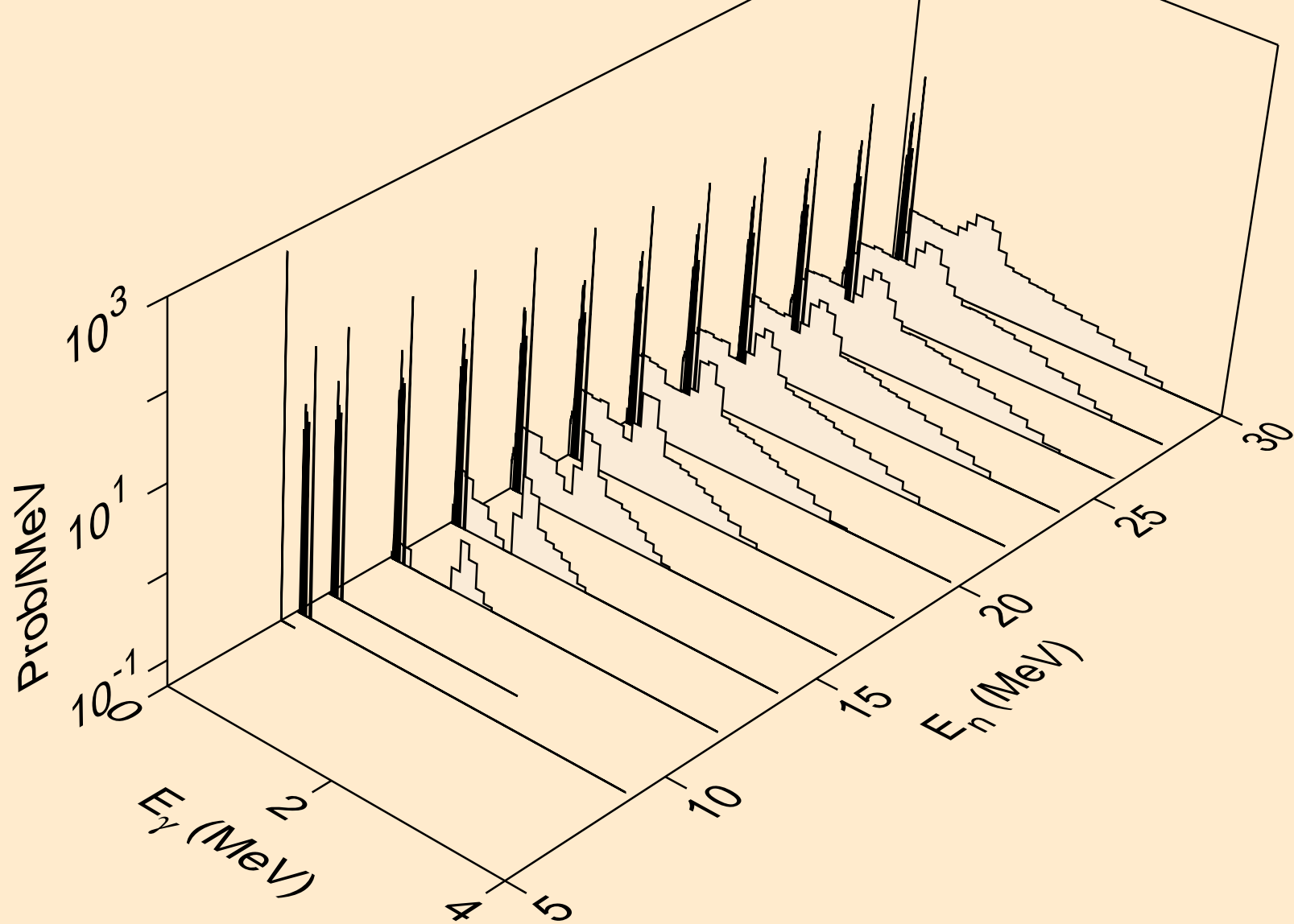

HG201 NEUTRON ACER TENDL-2021 LIBRARY; T=293.6K
Photon emission for (n,t)

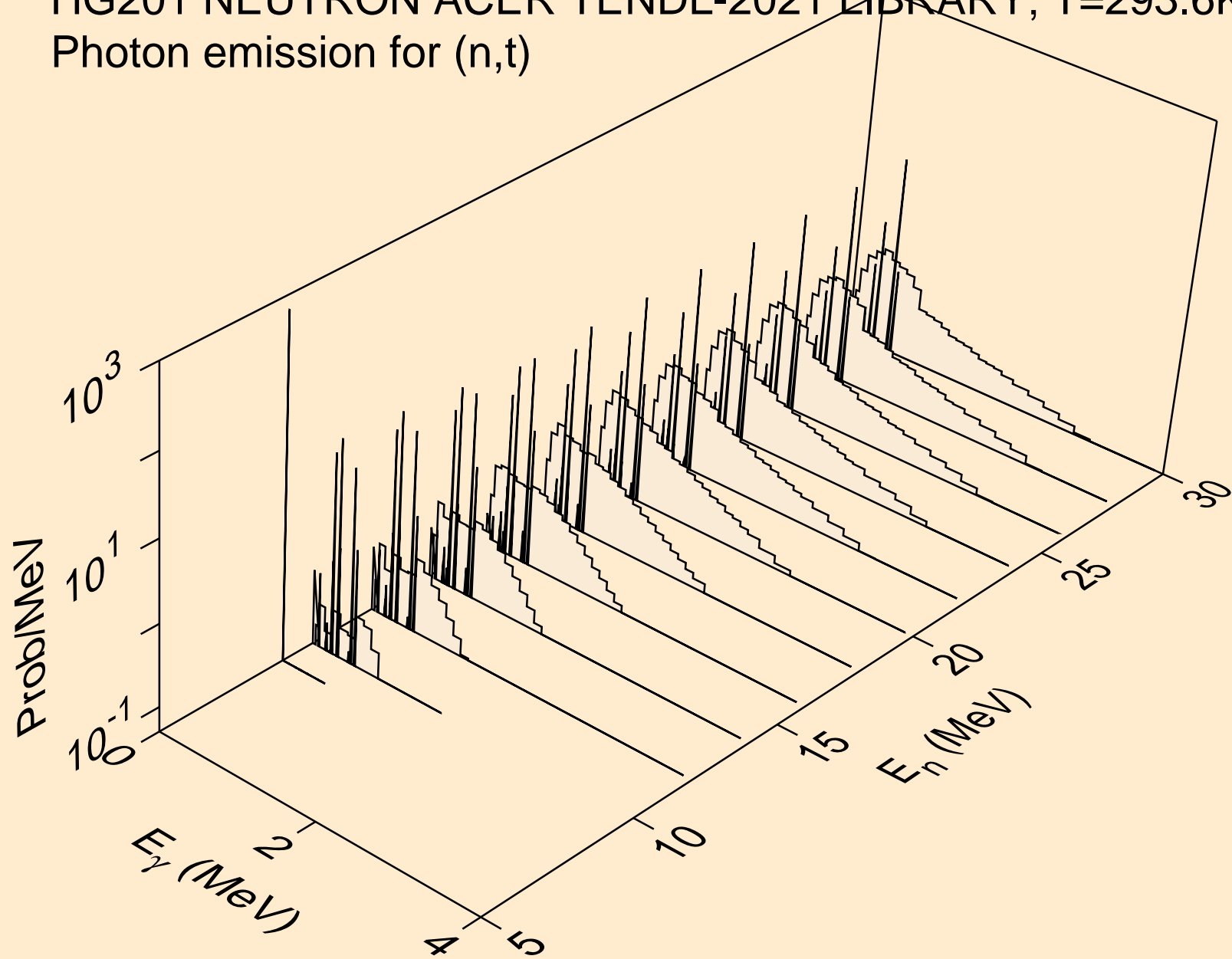

HG201 NEUTRON ACER TENDL-2021 LIBRARY; T=293.6K
Photon emission for (n,he3)

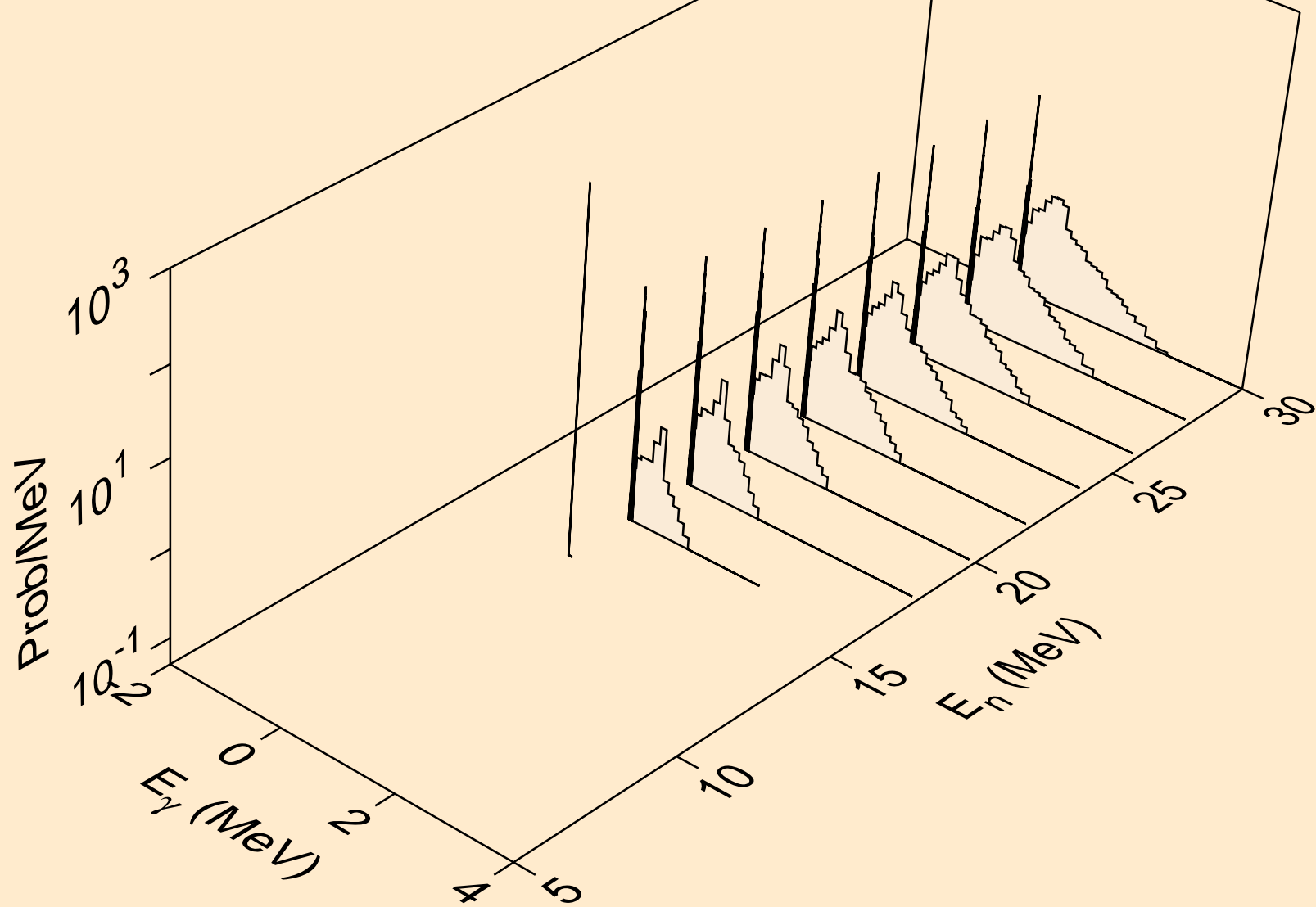

HG201 NEUTRON ACER TENDL-2021 LIBRARY; T=293.6K
Photon emission for (n,a)

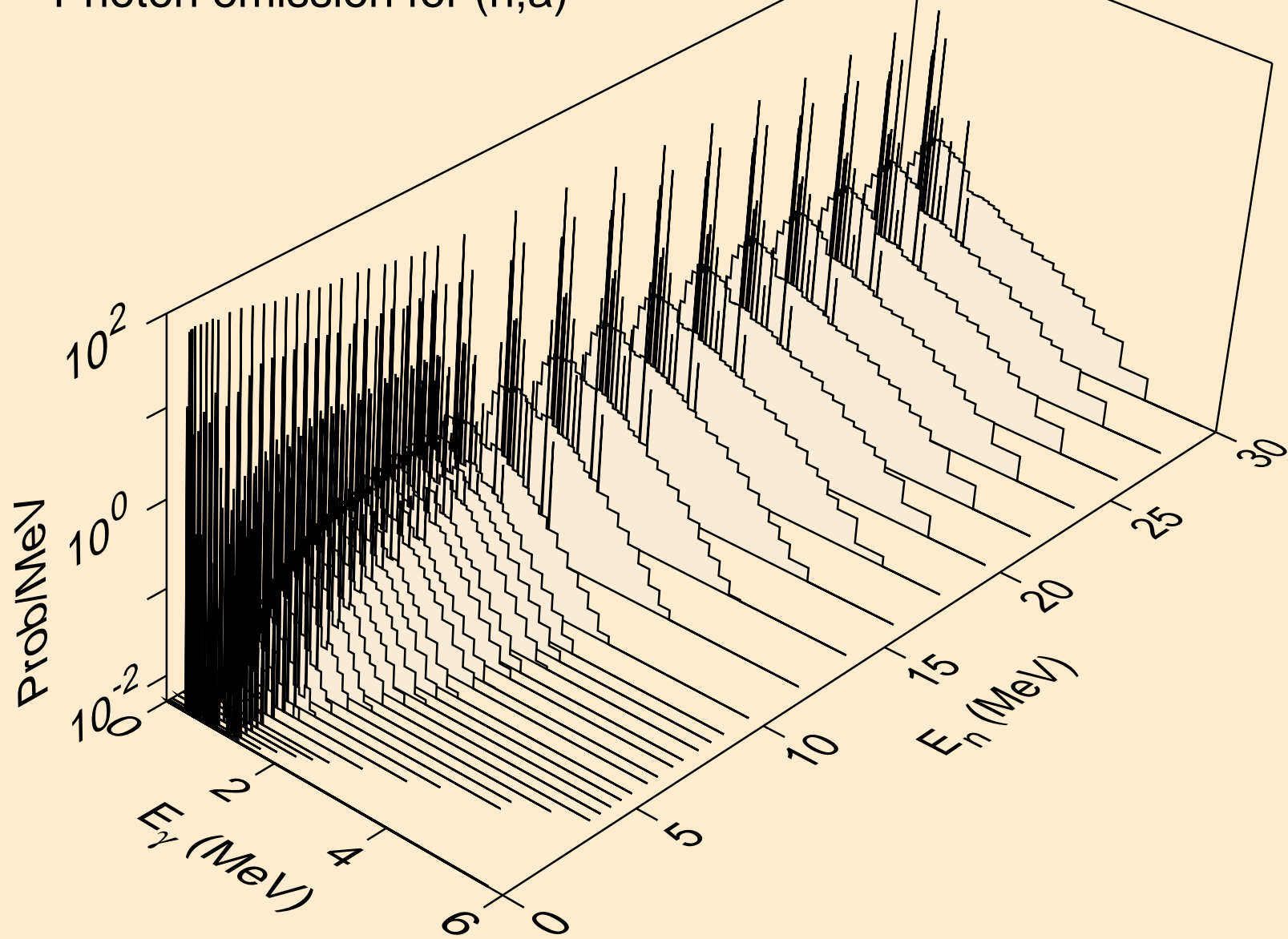

HG201 NEUTRON ACER TENDL-2021 LIBRARY; T=293.6K
Photon emission for (n,2p)

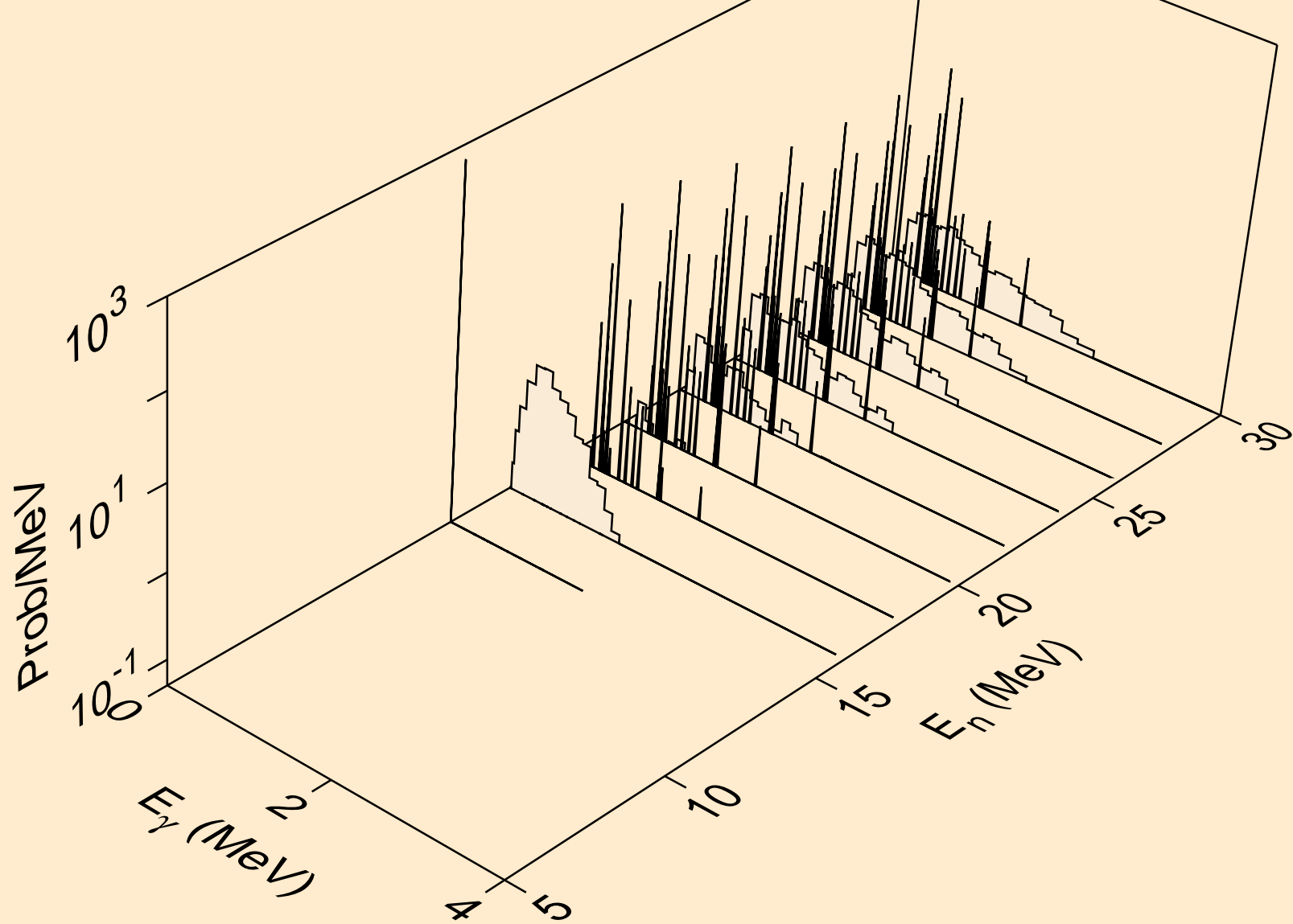

HG201 NEUTRON ACER TENDL-2021 LIBRARY; T=293.6K
Photon emission for (n,p α)

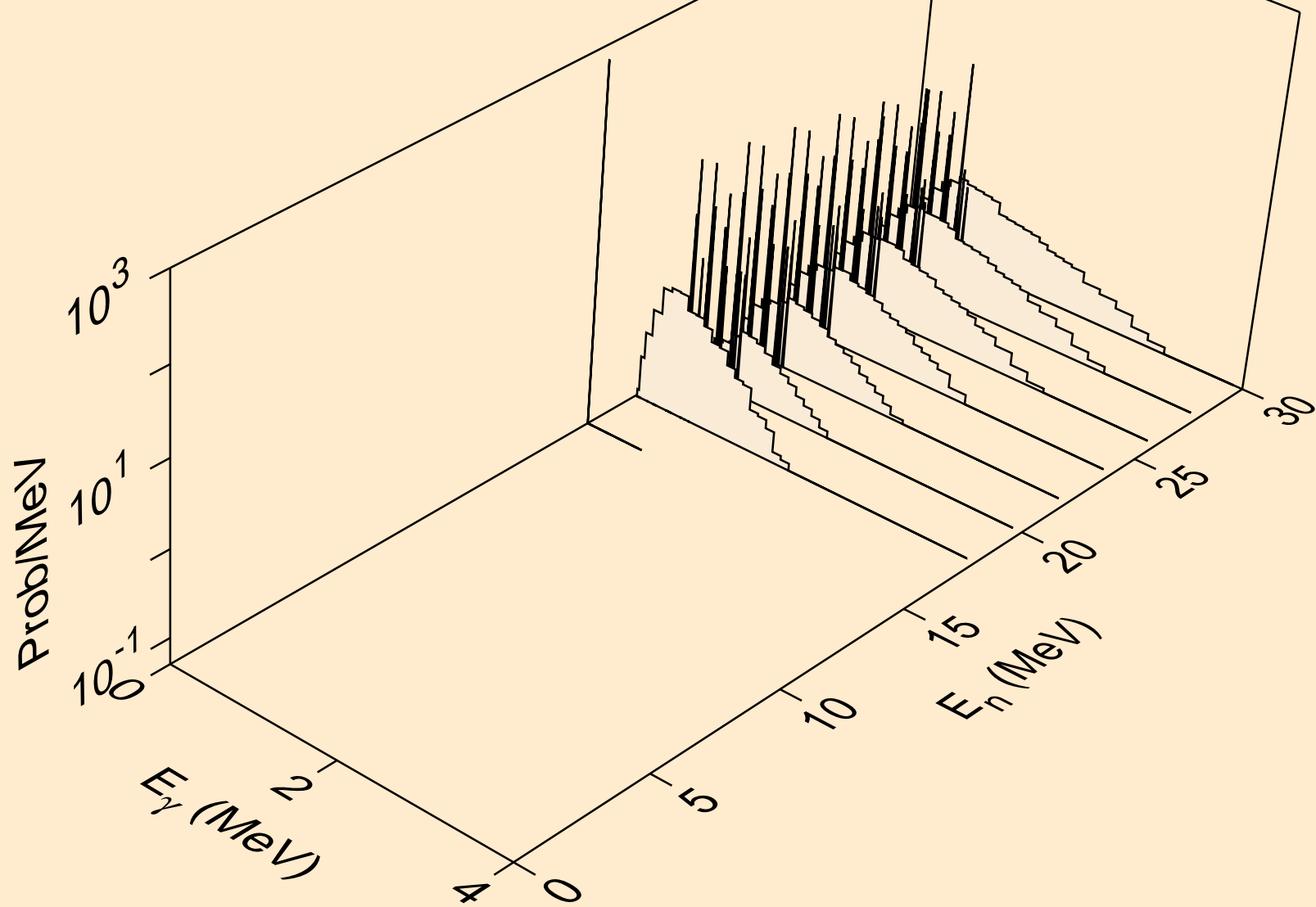

HG201 NEUTRON ACER TENDL-2021 LIBRARY; T=293.6K
thermal capture photon spectrum

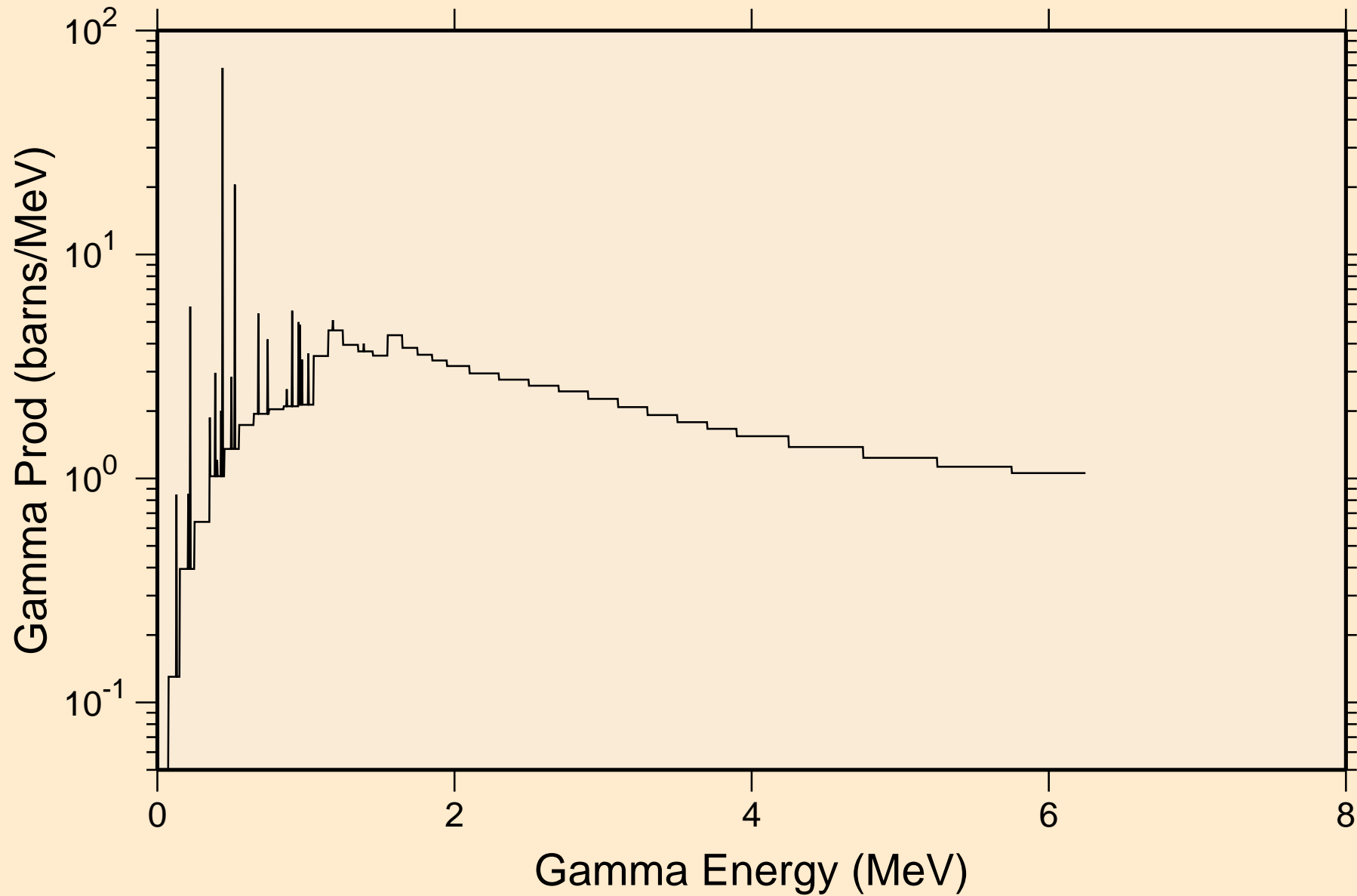

HG201 NEUTRON ACER TENDL-2021 LIBRARY; T=293.6K
14 MeV photon spectrum

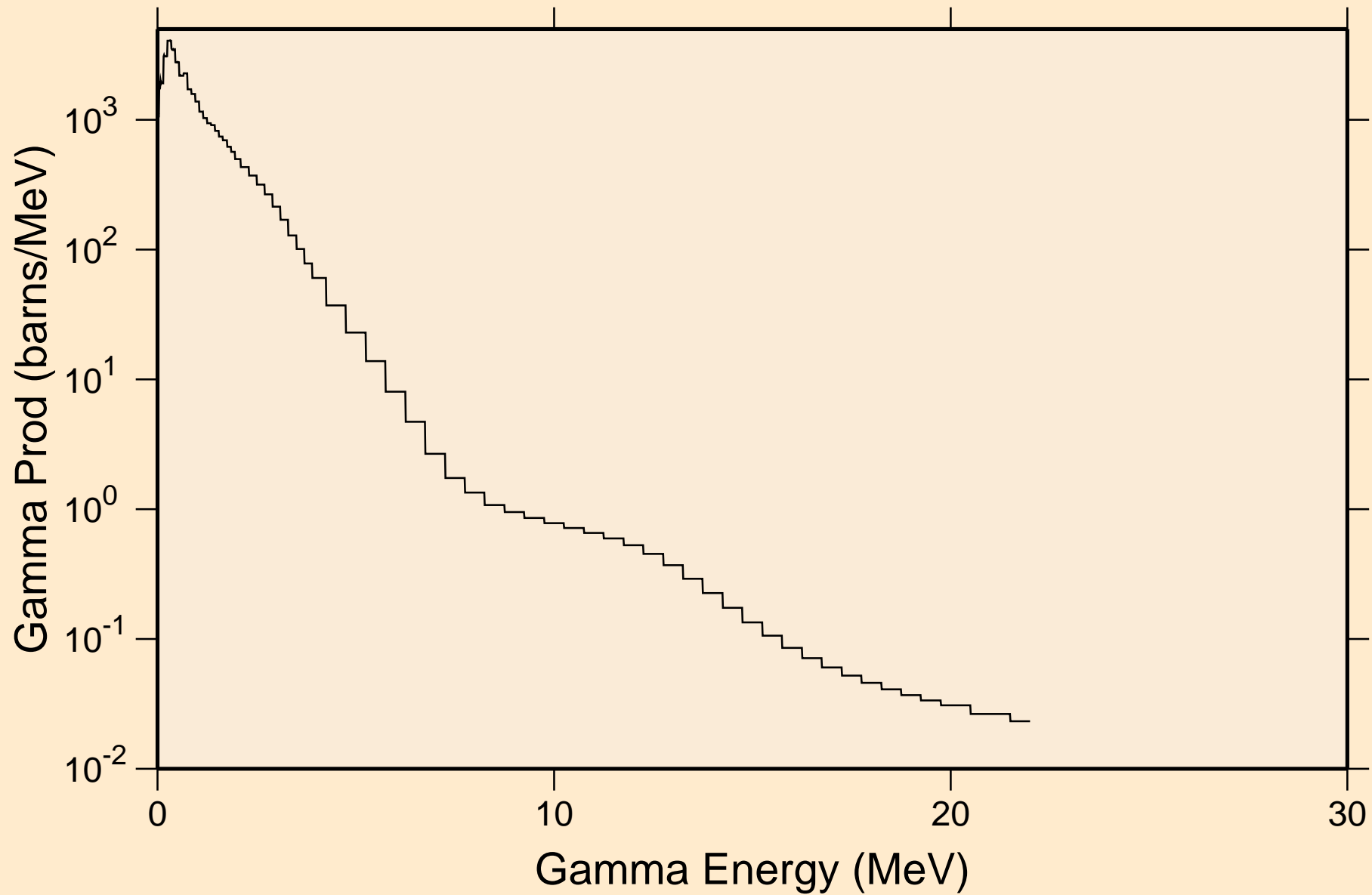

HG201 NEUTRON ACER TENDL-2021 LIBRARY; T=293.6K
Particle heating contributions

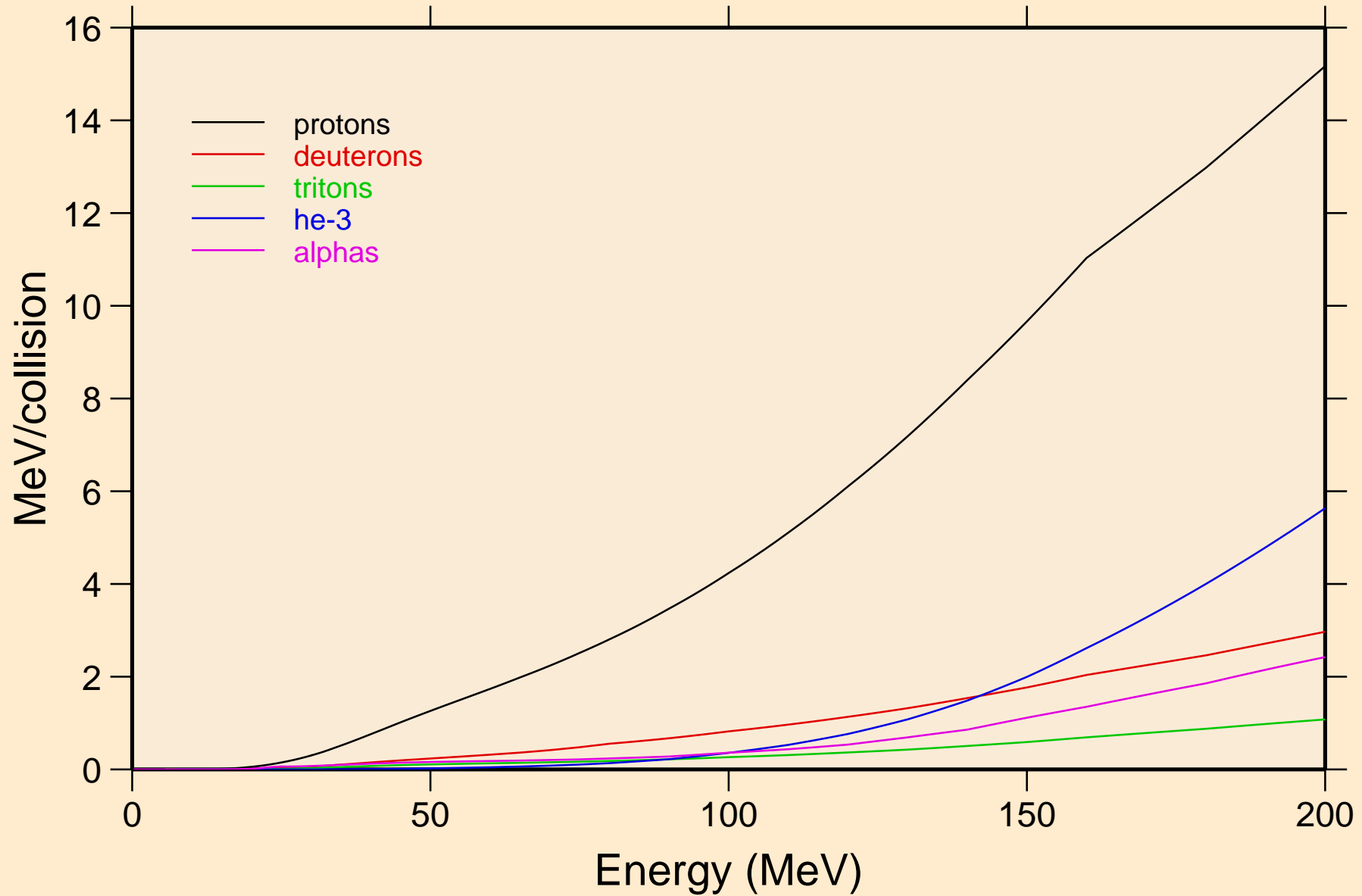

HG201 NEUTRON ACER TENDL-2021 LIBRARY; T=293.6K
Recoil Heating

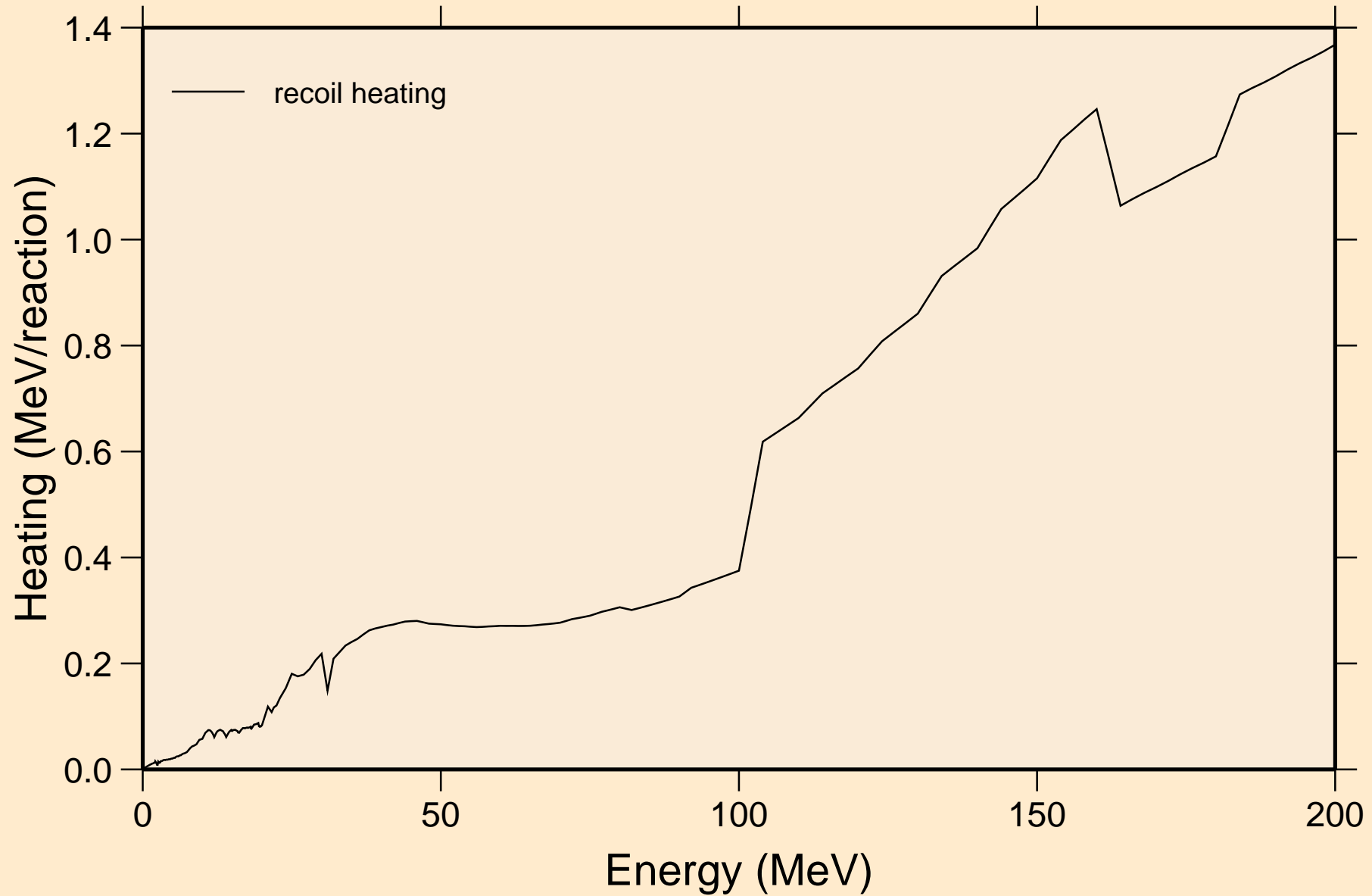

HG201 NEUTRON ACER TENDL-2021 LIBRARY; T=293.6K
Particle production cross sections

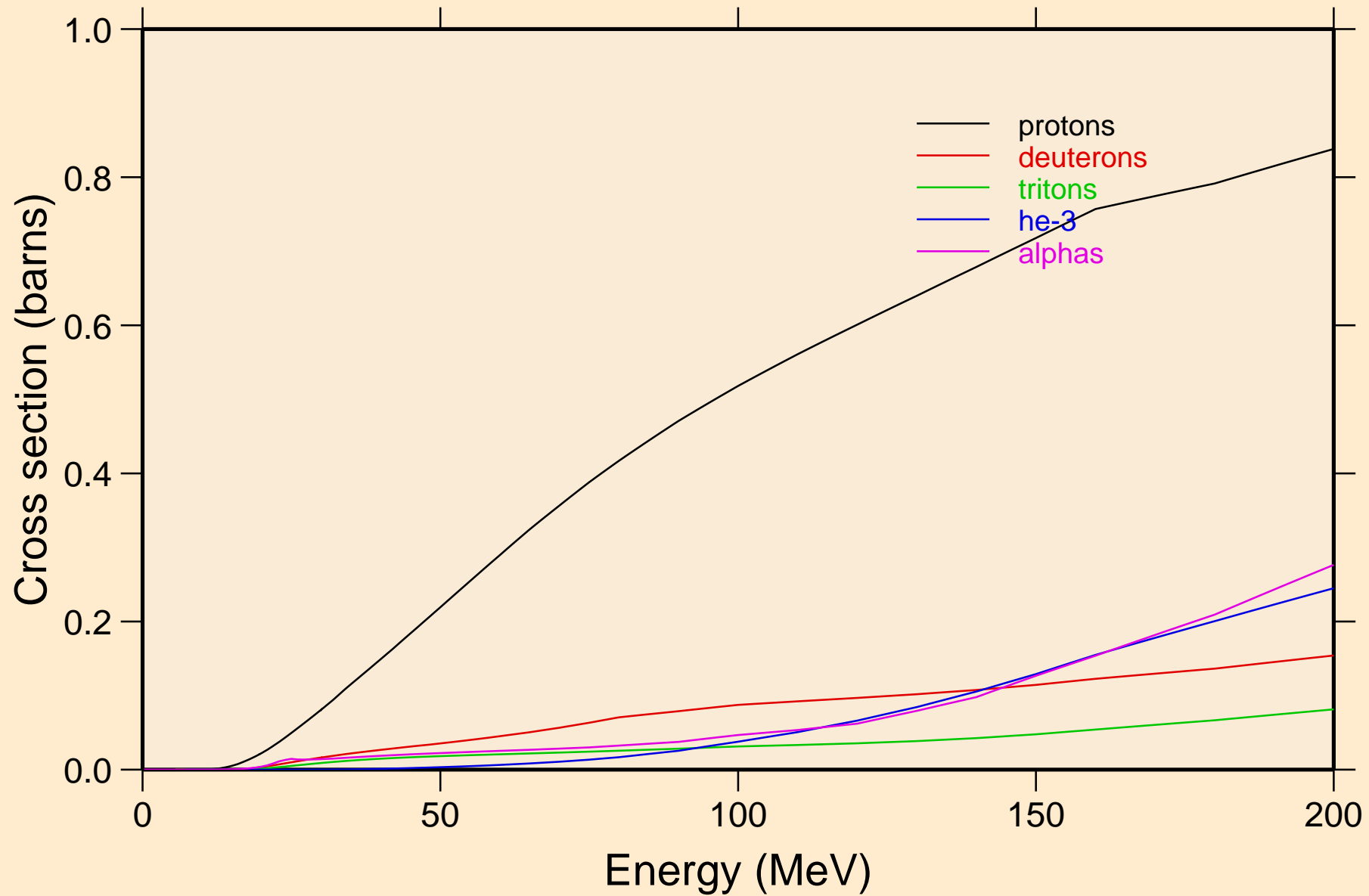

HG201 NEUTRON ACER TENDL-2021 LIBRARY; T=293.6K
protons from (n,x)

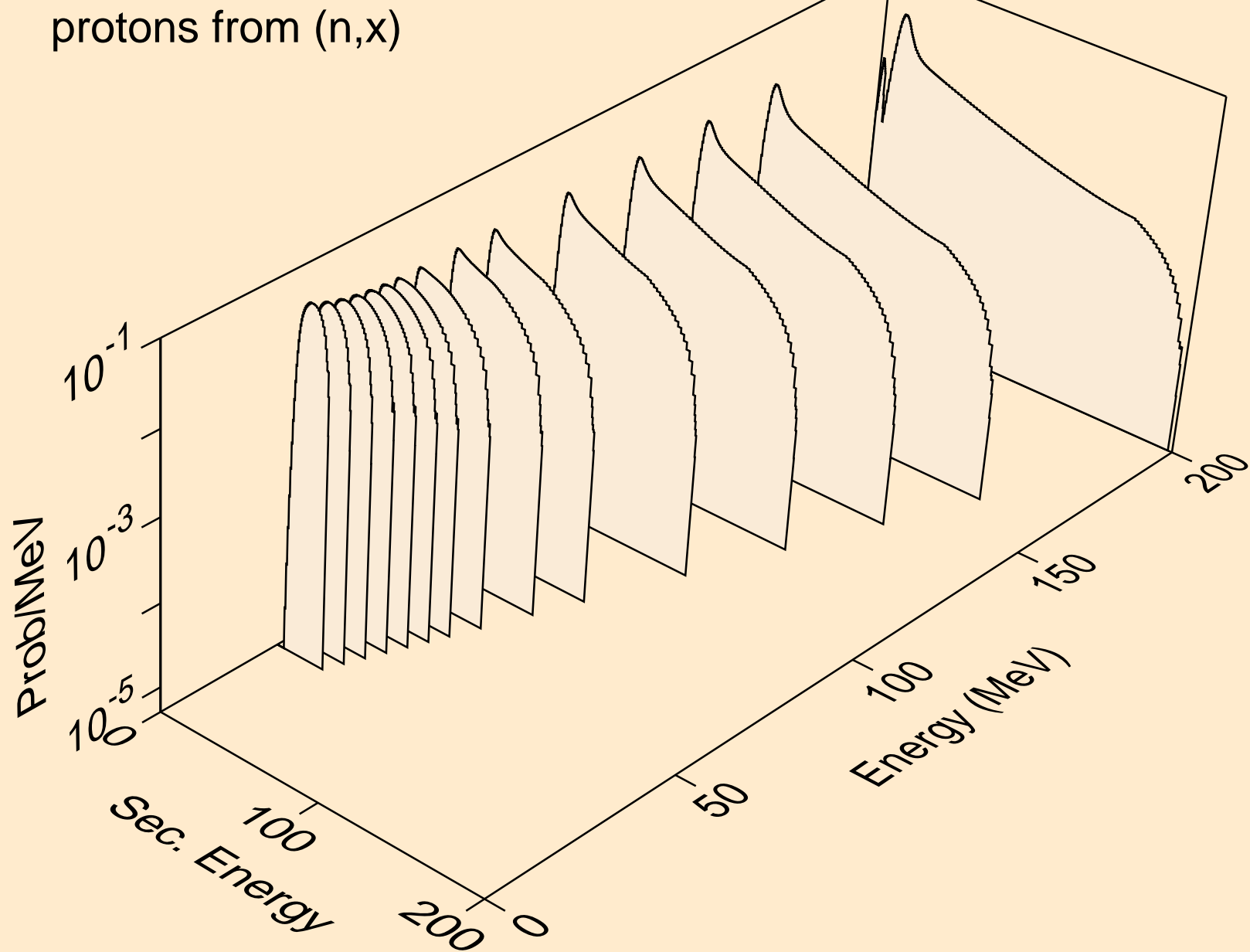

HG201 NEUTRON ACER TENDL-2021 LIBRARY; T=293.6K
protons from (n,n*)p

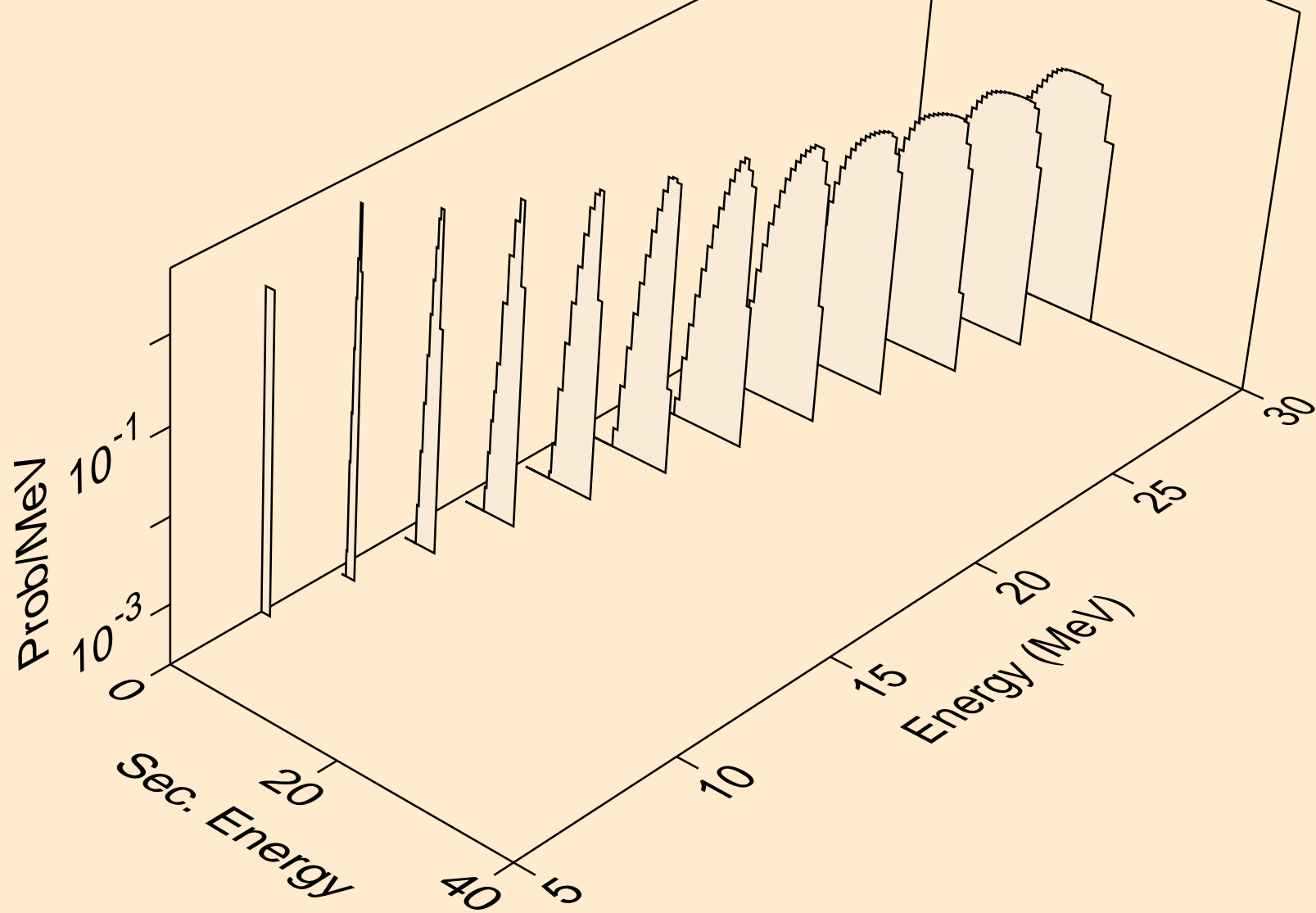

HG201 NEUTRON ACER TENDL-2021 LIBRARY; T=293.6K
protons from (n,2np)

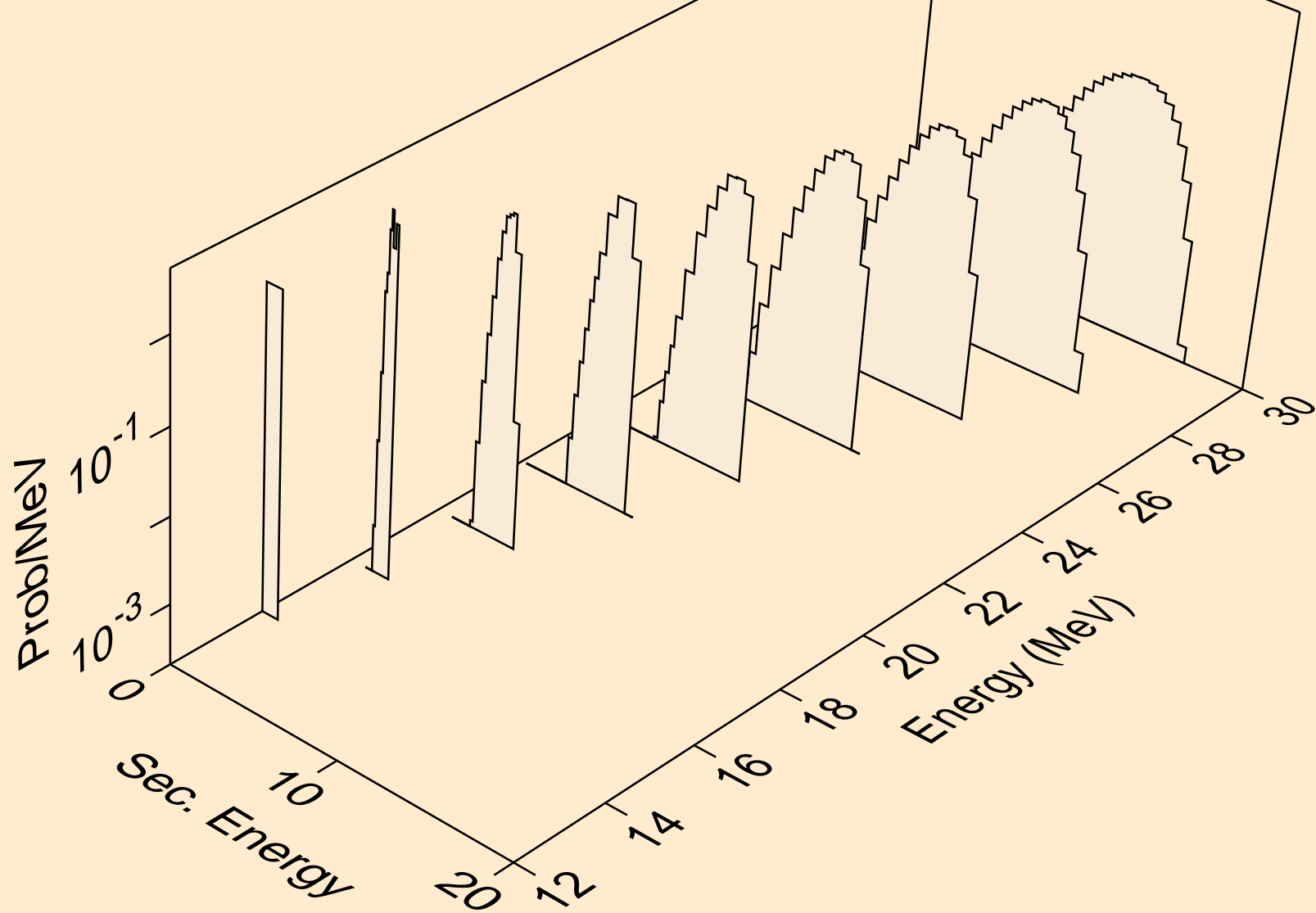

HG201 NEUTRON ACER TENDL-2021 LIBRARY; T=293.6K
protons from (n,3np)

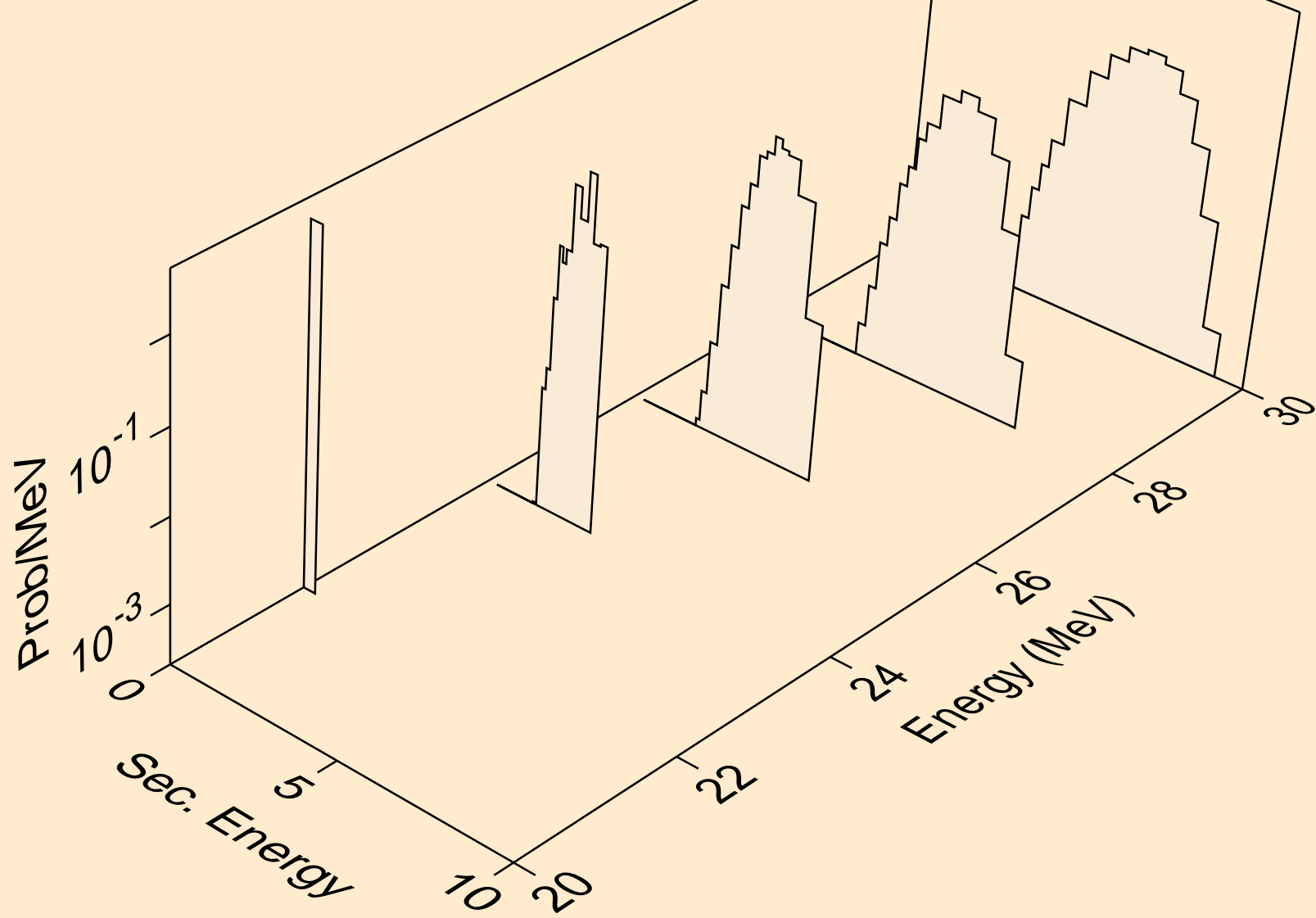

HG201 NEUTRON ACER TENDL-2021 LIBRARY; T=293.6K
protons from (n,2np)

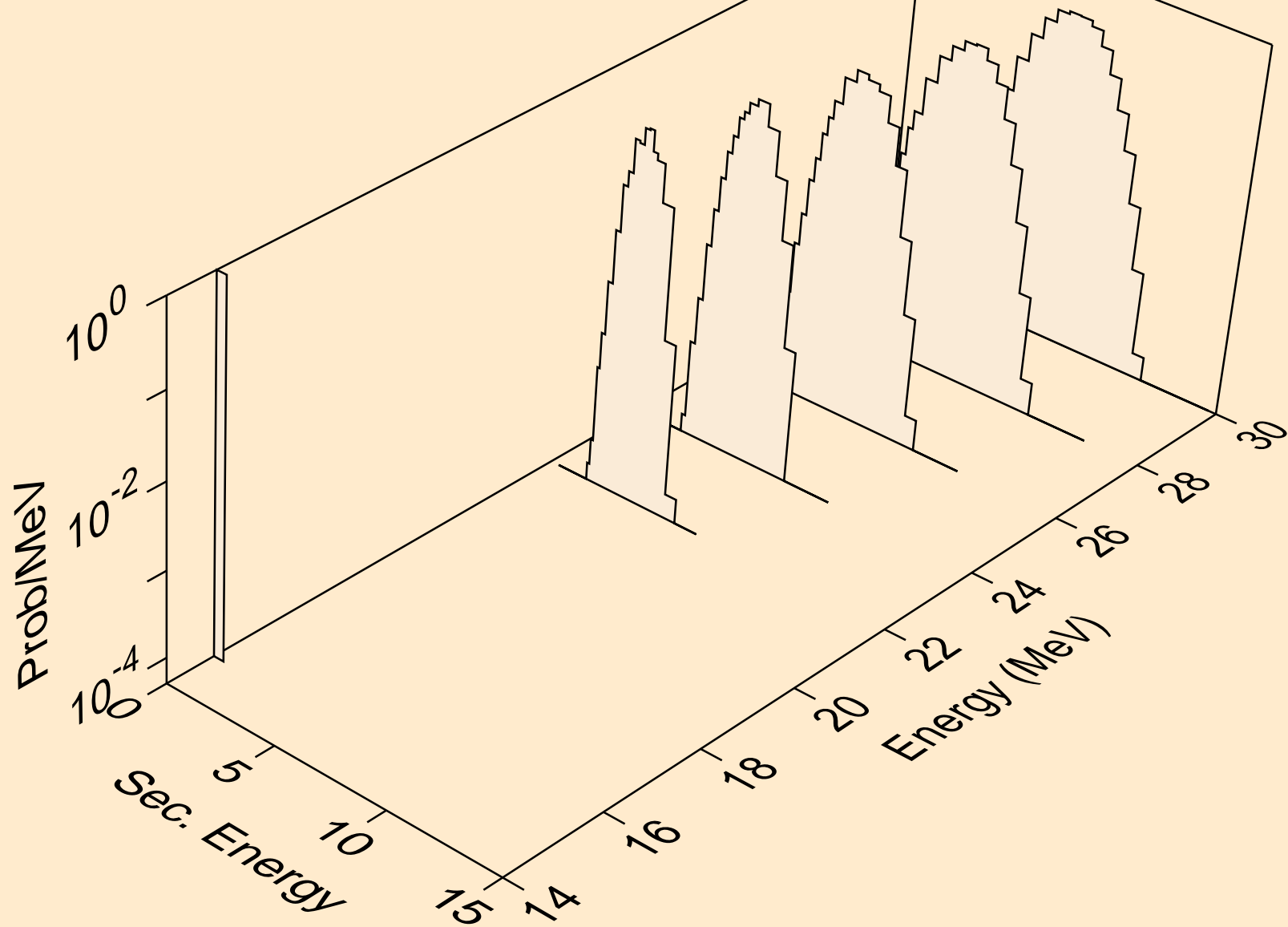

HG201 NEUTRON ACER TENDL-2021 LIBRARY; T=293.6K
protons from (n,p)

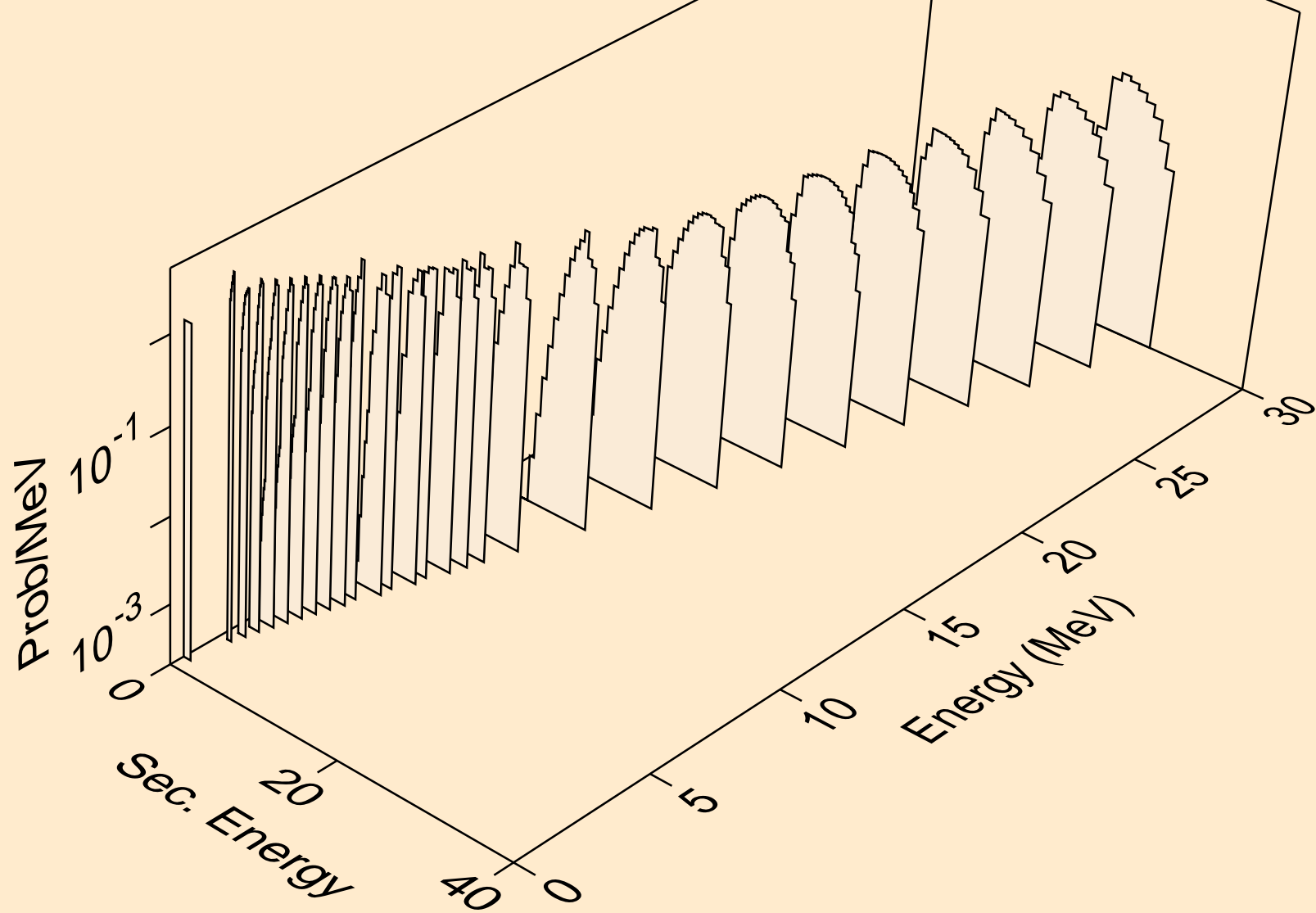

HG201 NEUTRON ACER TENDL-2021 LIBRARY; T=293.6K
protons from (n,2p)

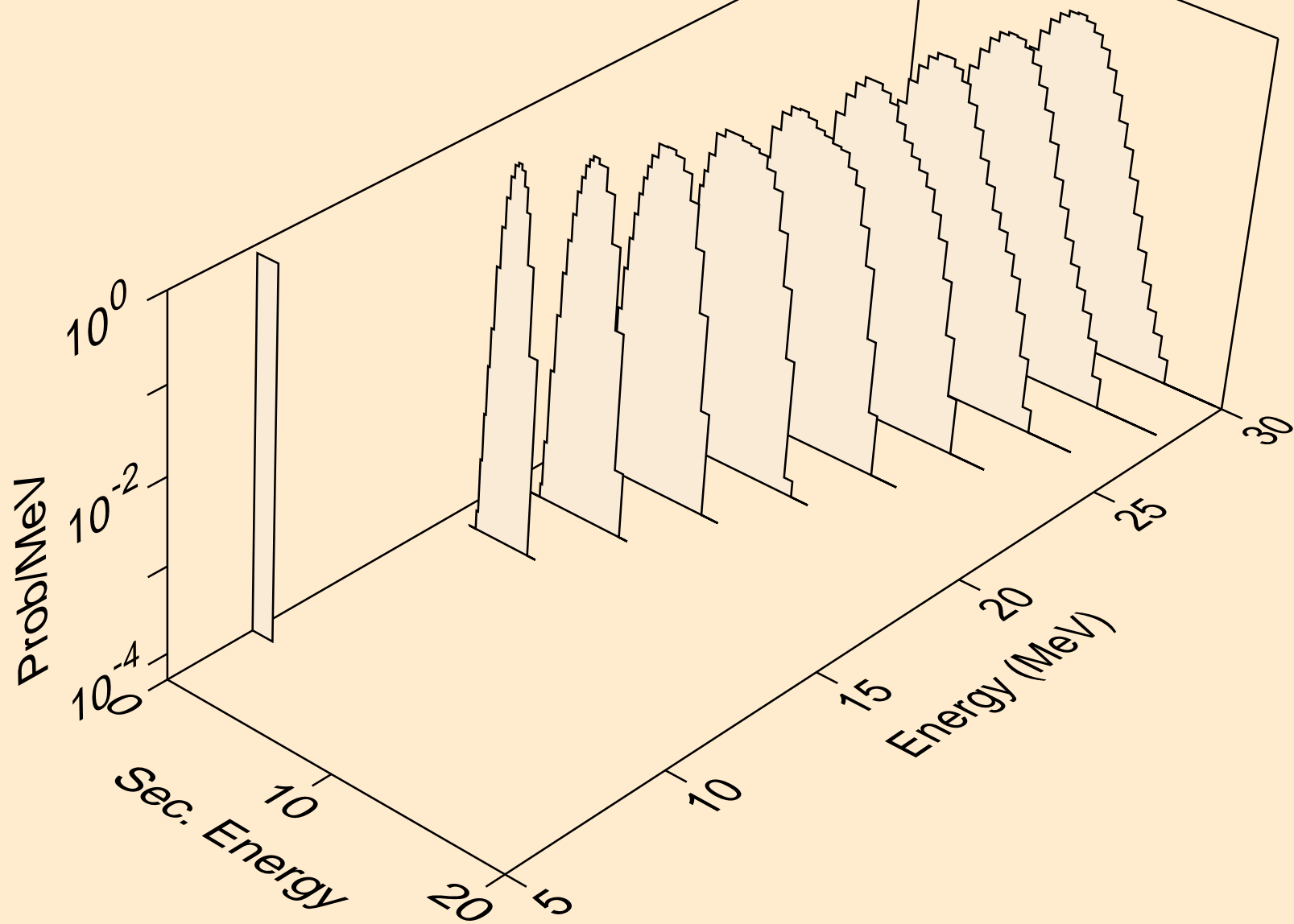

HG201 NEUTRON ACER TENDL-2021 LIBRARY; T=293.6K
protons from (n,p)

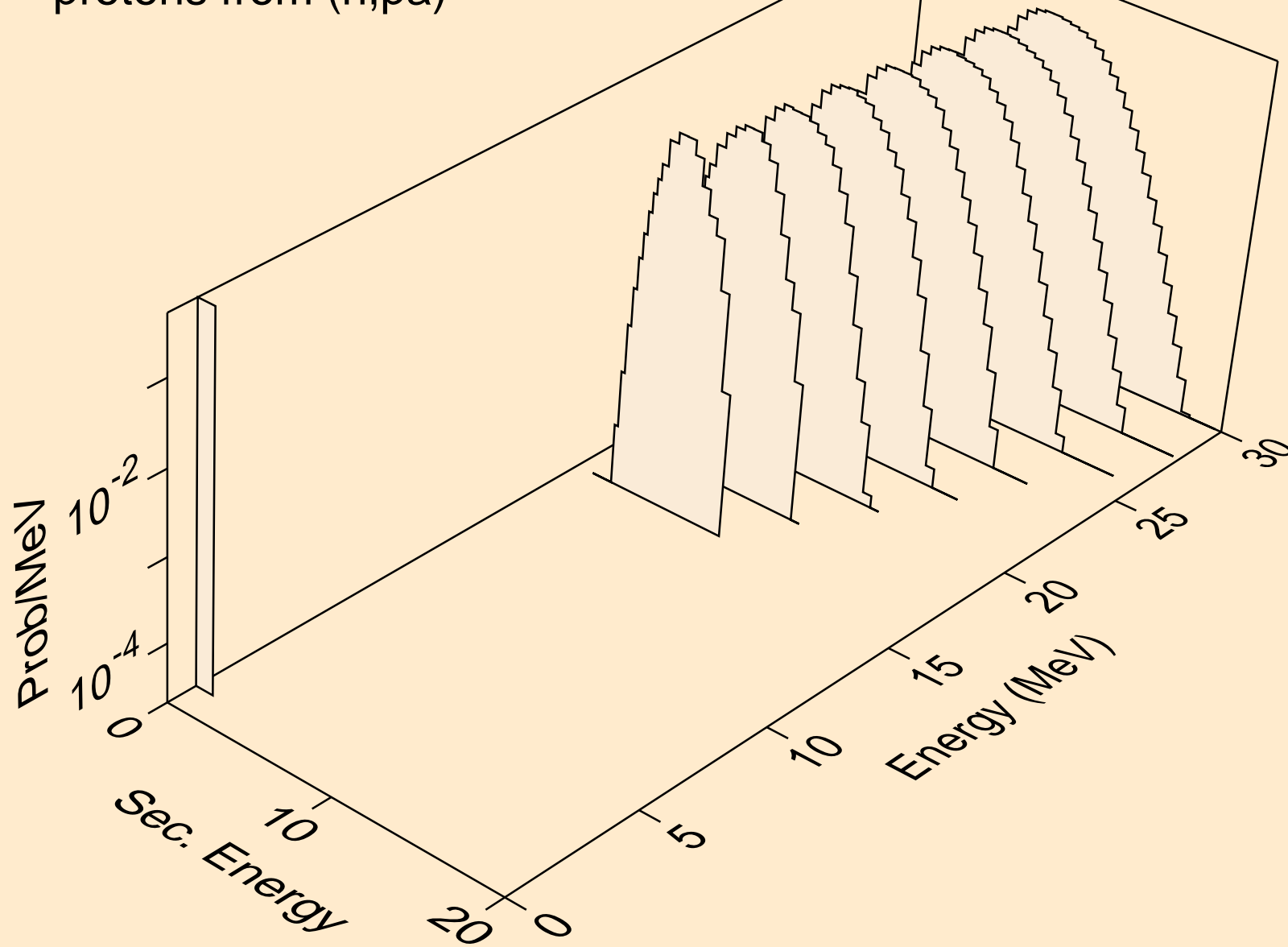

HG201 NEUTRON ACER TENDL-2021 LIBRARY; T=293.6K
deuterons from (n,x)

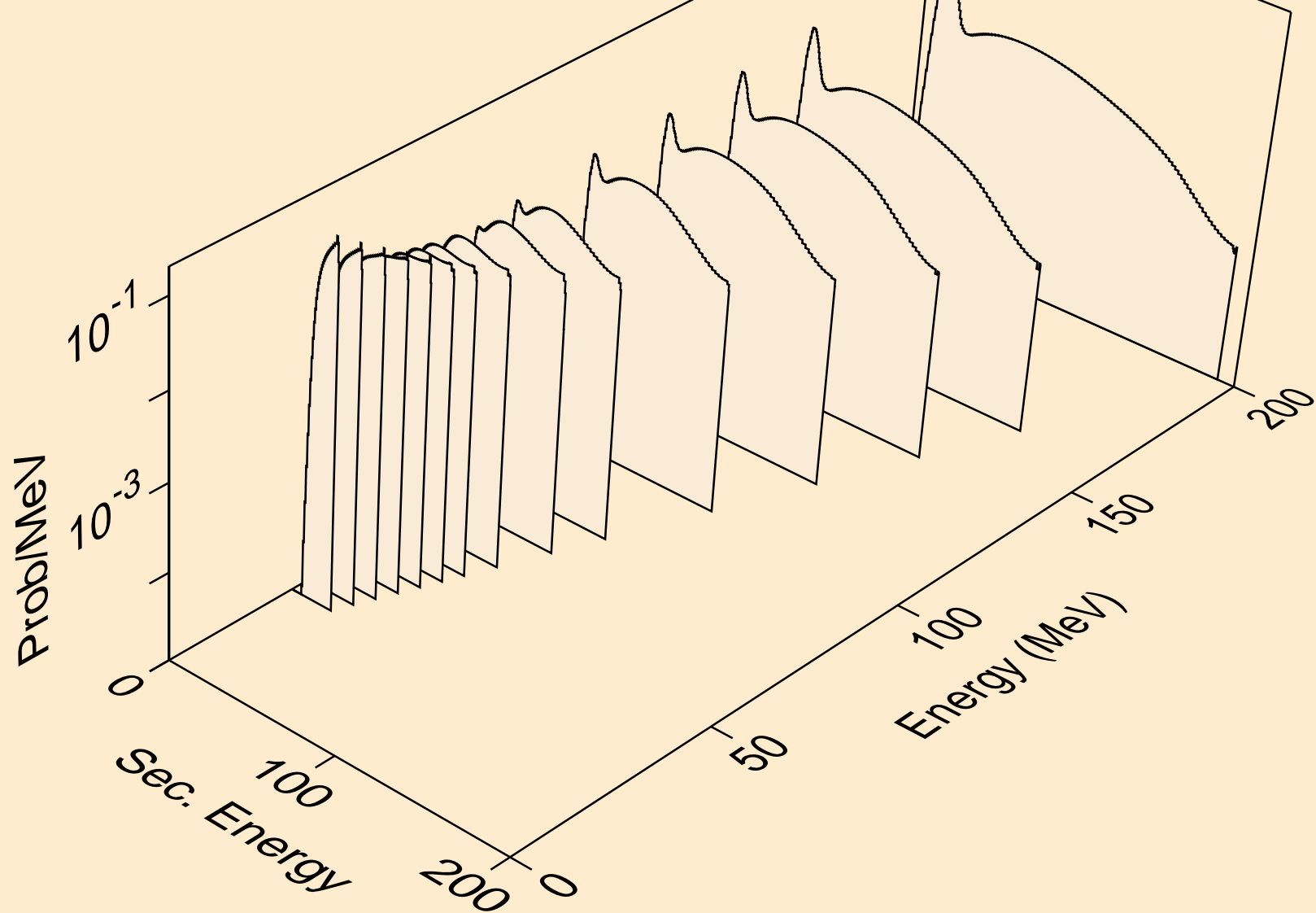

HG201 NEUTRON ACER TENDL-2021 LIBRARY; T=293.6K
deuterons from (n,2nd)

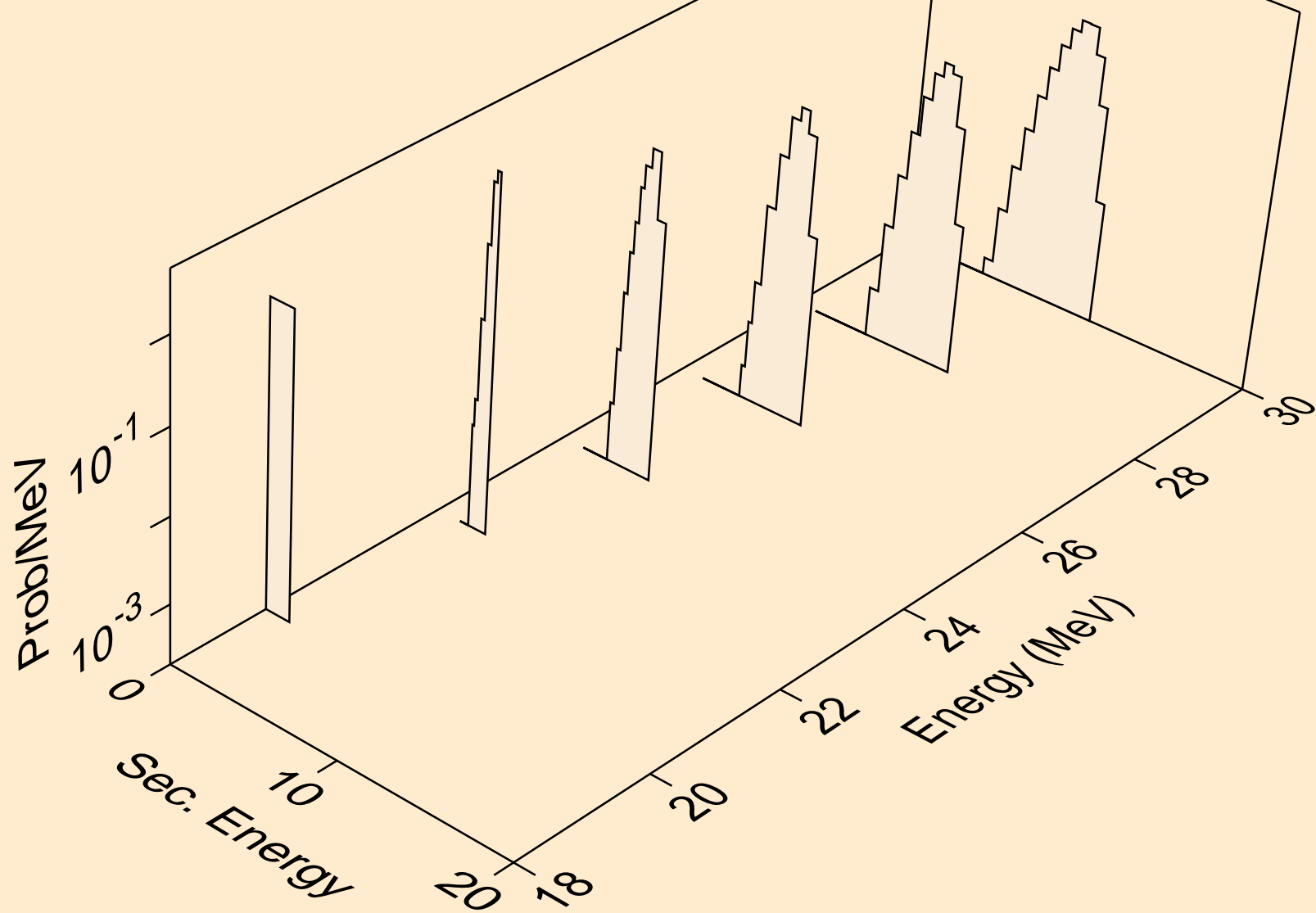

HG201 NEUTRON ACER TENDL-2021 LIBRARY; T=293.6K
deuterons from (n,n*)d

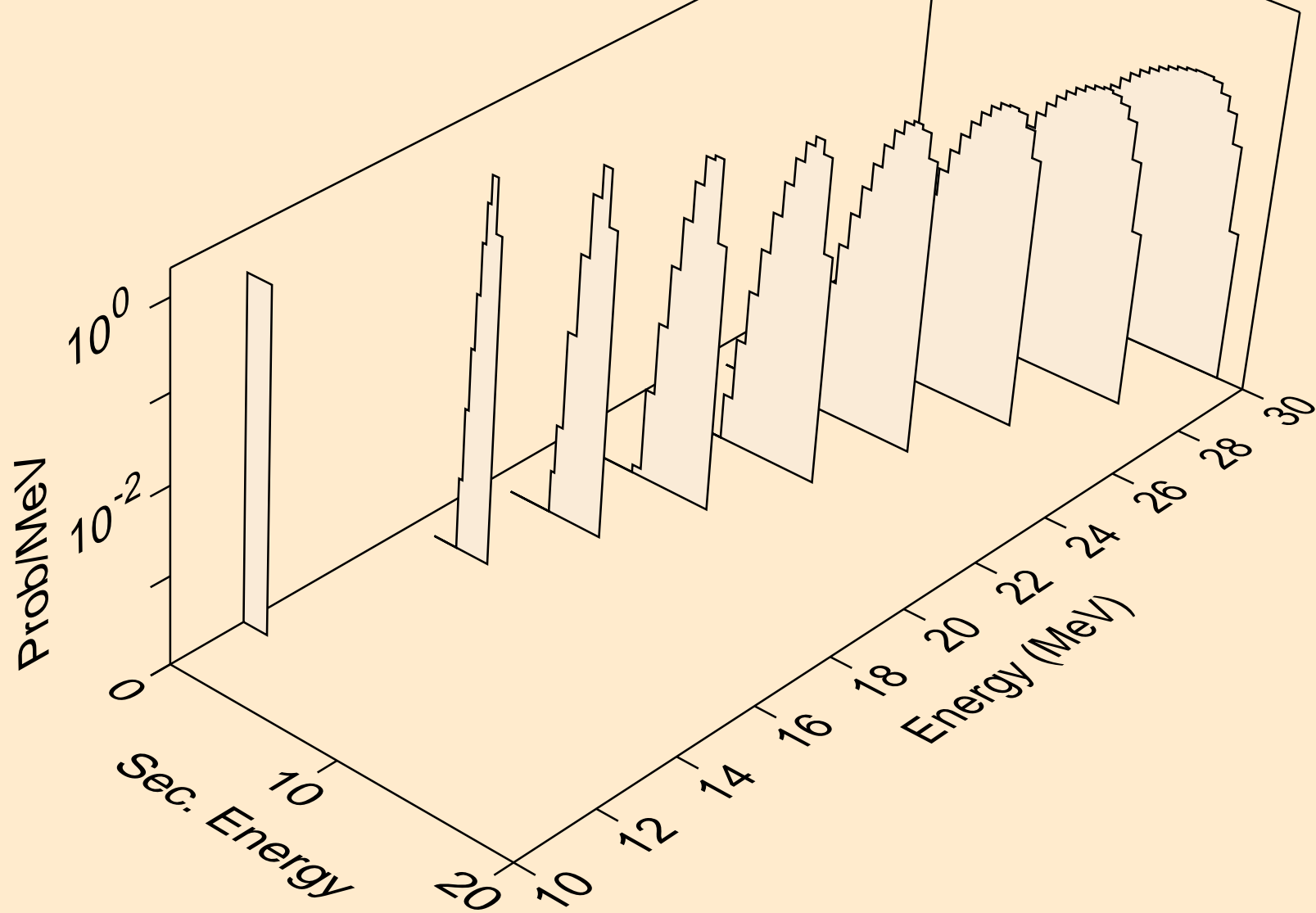

HG201 NEUTRON ACER TENDL-2021 LIBRARY; T=293.6K
deuterons from (n,d)

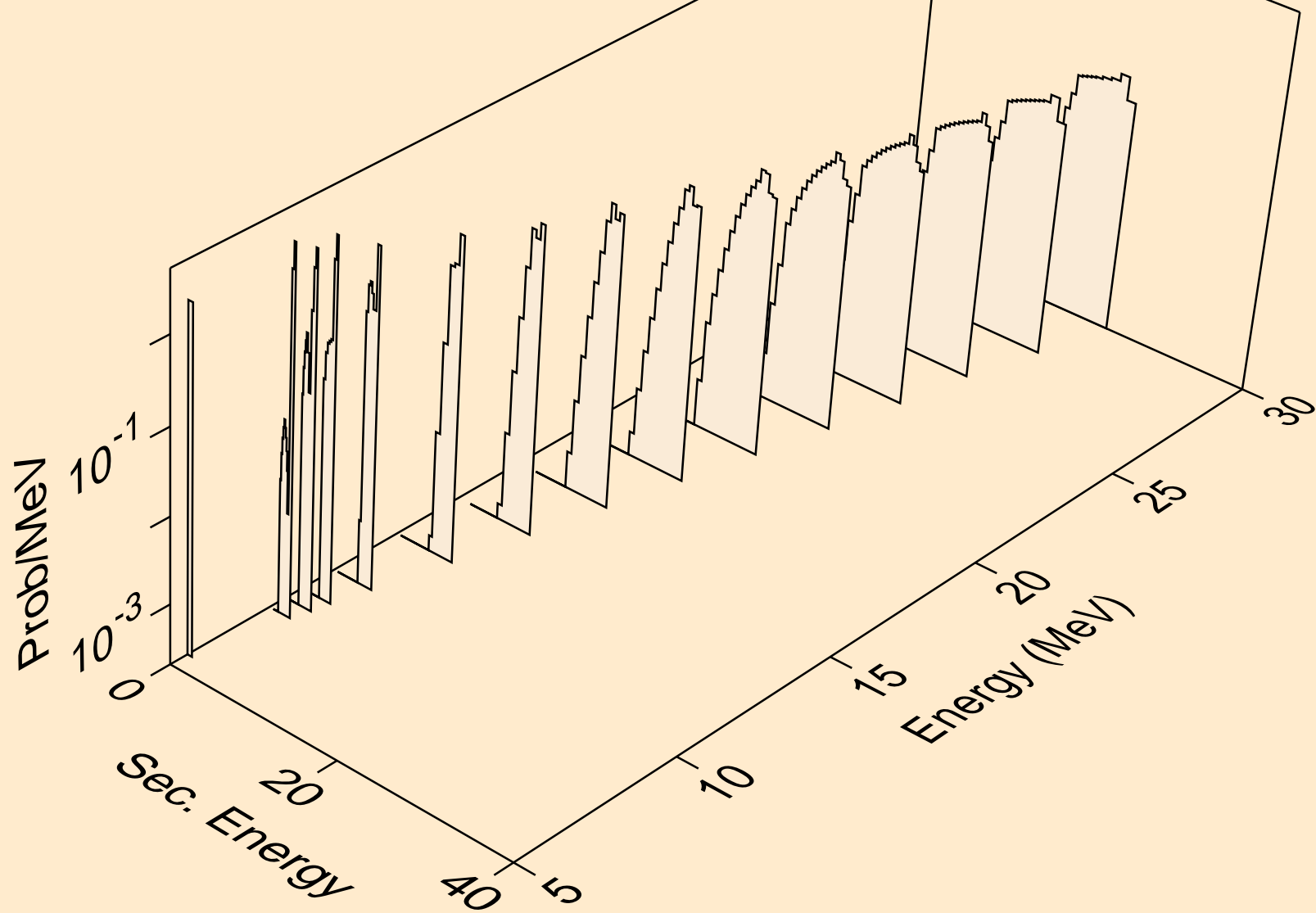

HG201 NEUTRON ACER TENDL-2021 LIBRARY; T=293.6K
tritons from (n,x)

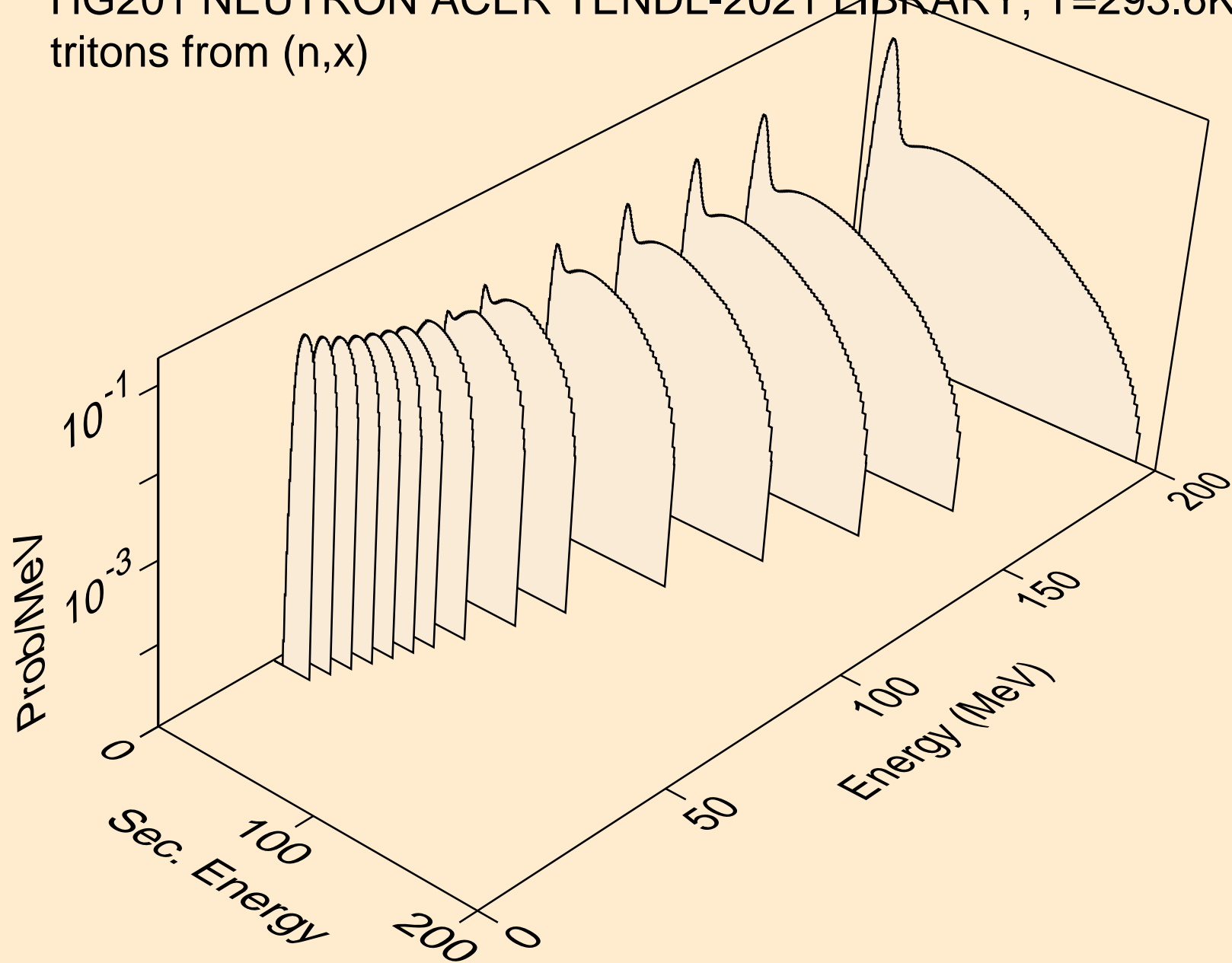

HG201 NEUTRON ACER TENDL-2021 LIBRARY; T=293.6K
tritons from (n,n*)t

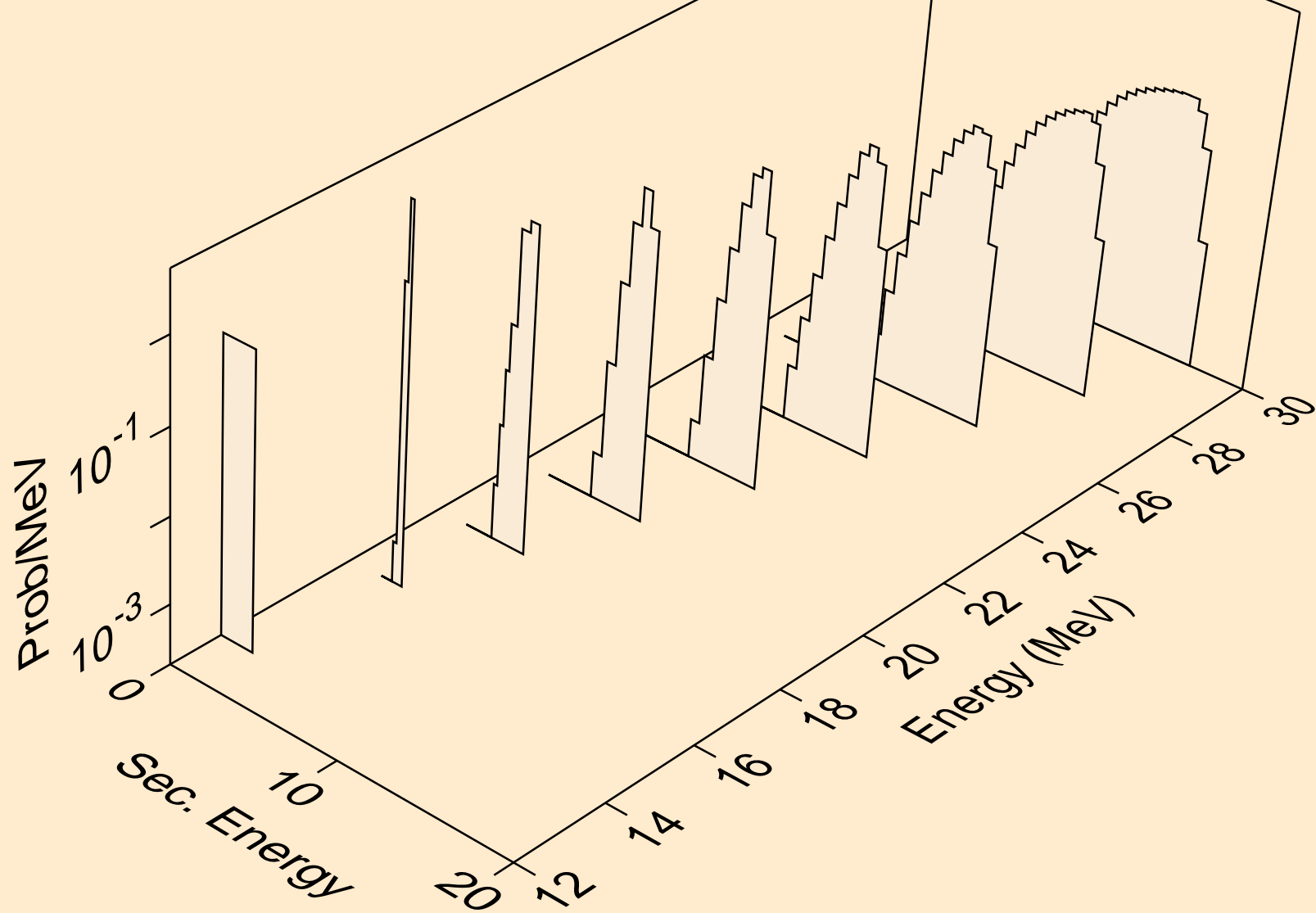

HG201 NEUTRON ACER TENDL-2021 LIBRARY; T=293.6K
tritons from (n,t)

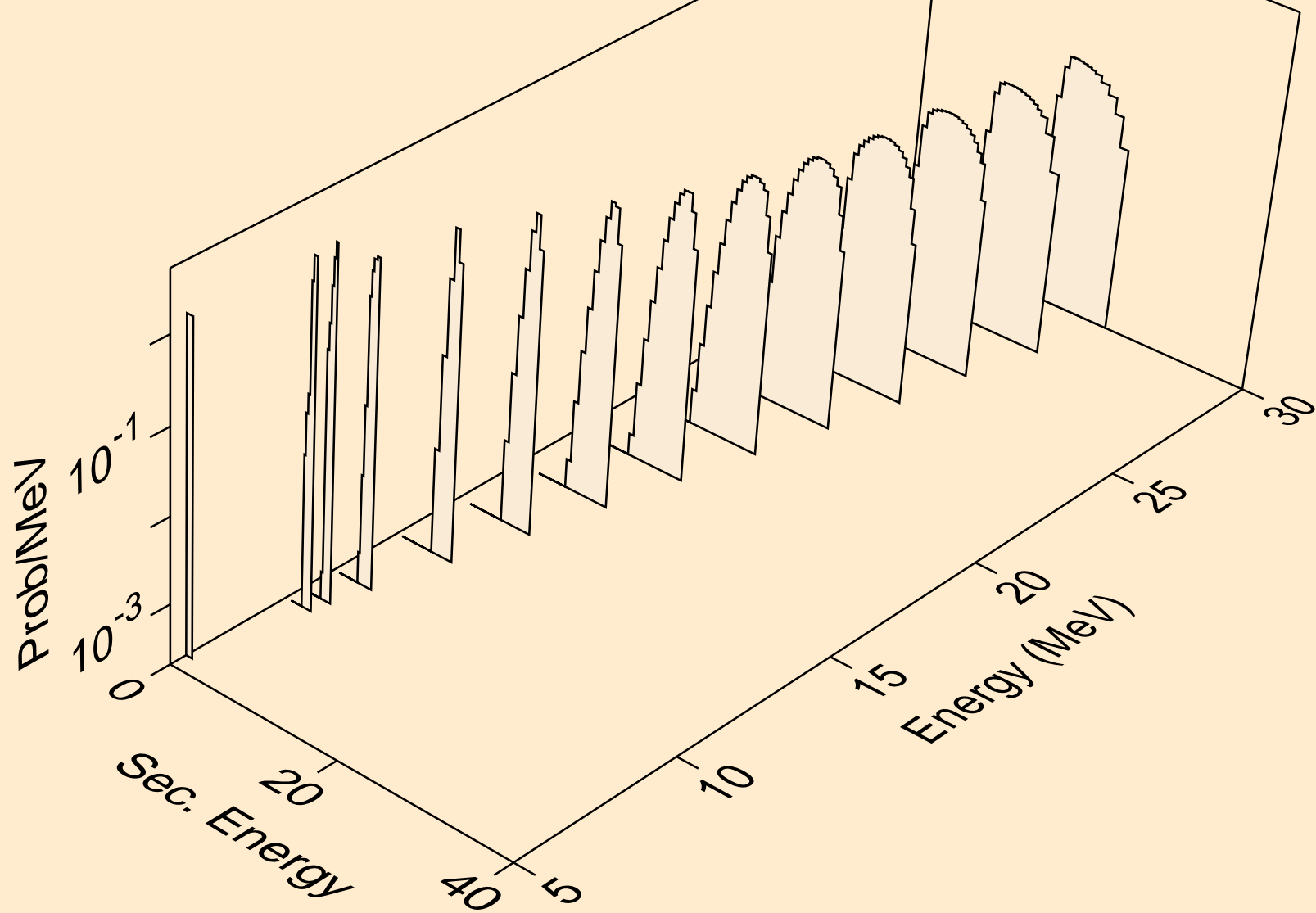

HG201 NEUTRON ACER TENDL-2021 LIBRARY; T=293.6K
he3s from (n,x)

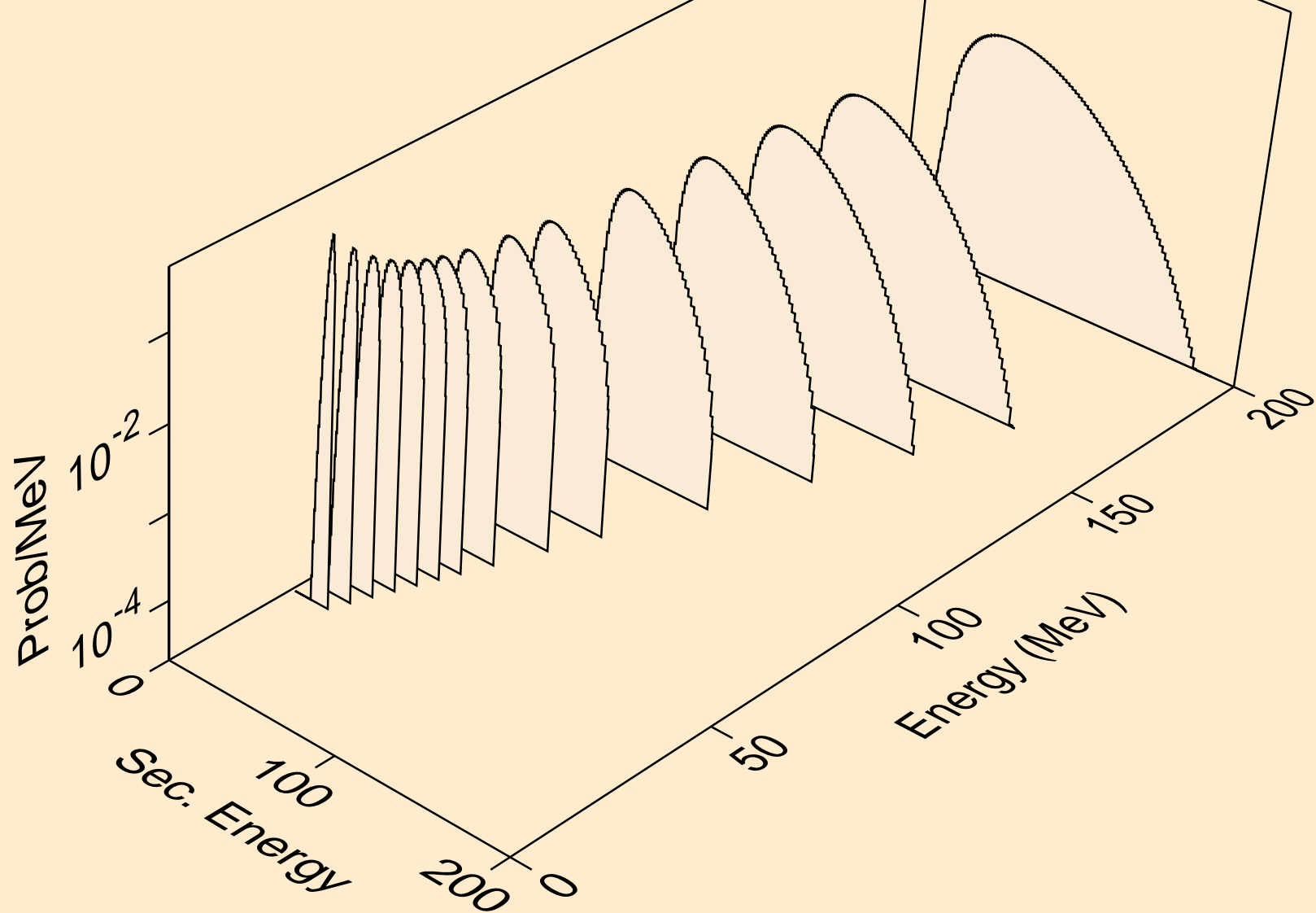

HG201 NEUTRON ACER TENDL-2021 LIBRARY; T=293.6K
he3s from (n,n*)he3

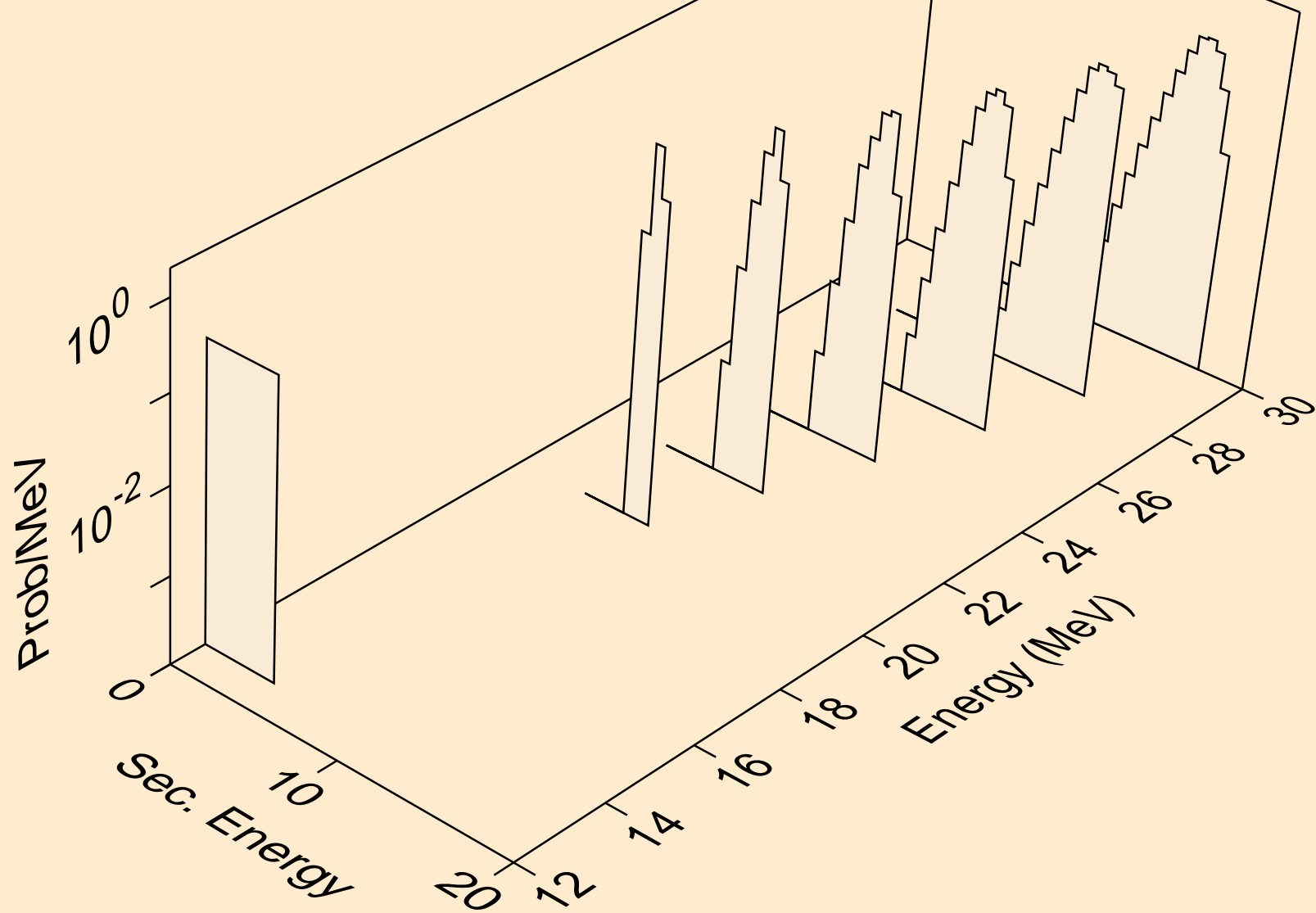

HG201 NEUTRON ACER TENDL-2021 LIBRARY; T=293.6K
he3s from (n,he3)

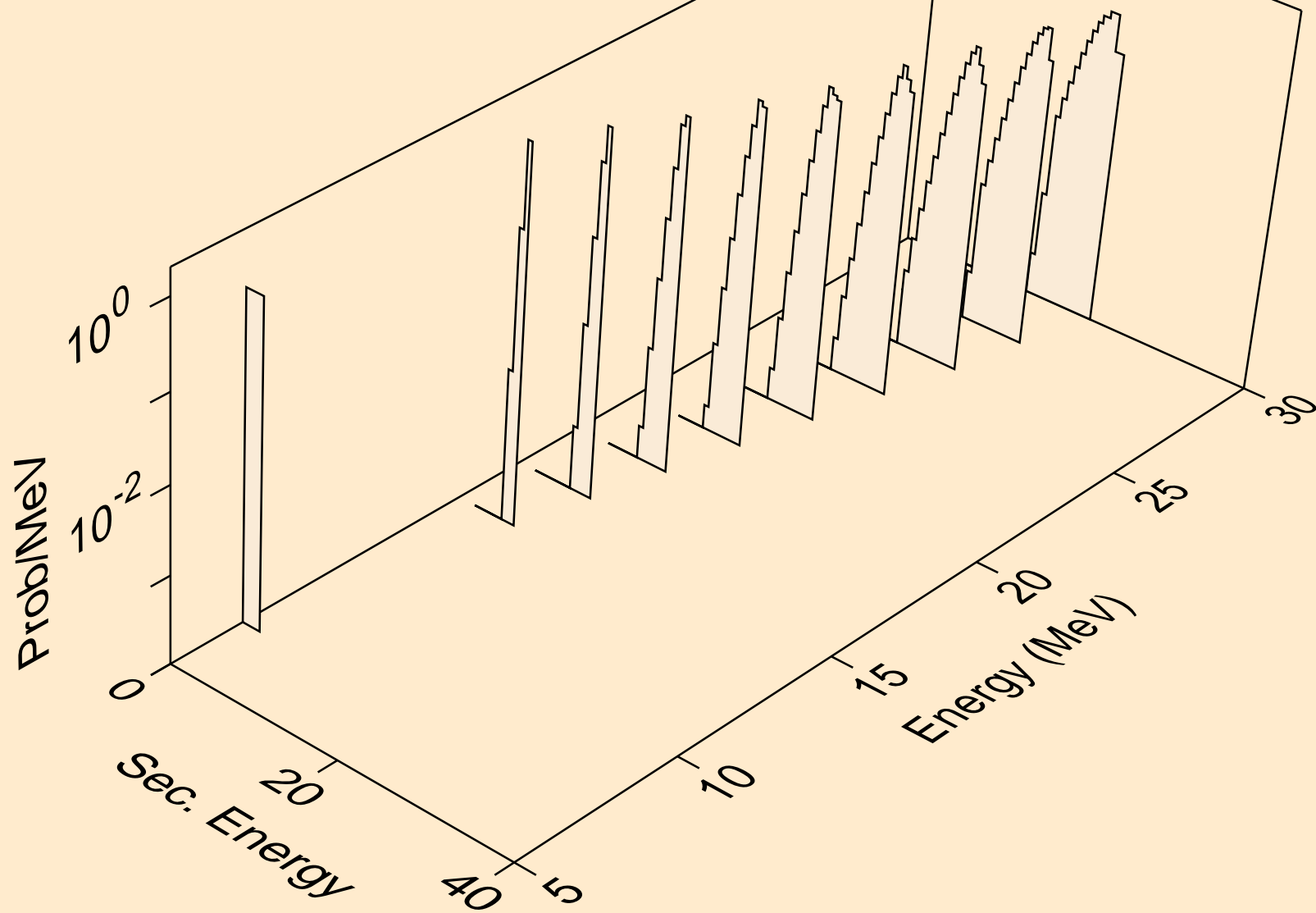

HG201 NEUTRON ACER TENDL-2021 LIBRARY; T=293.6K
alphas from (n,x)

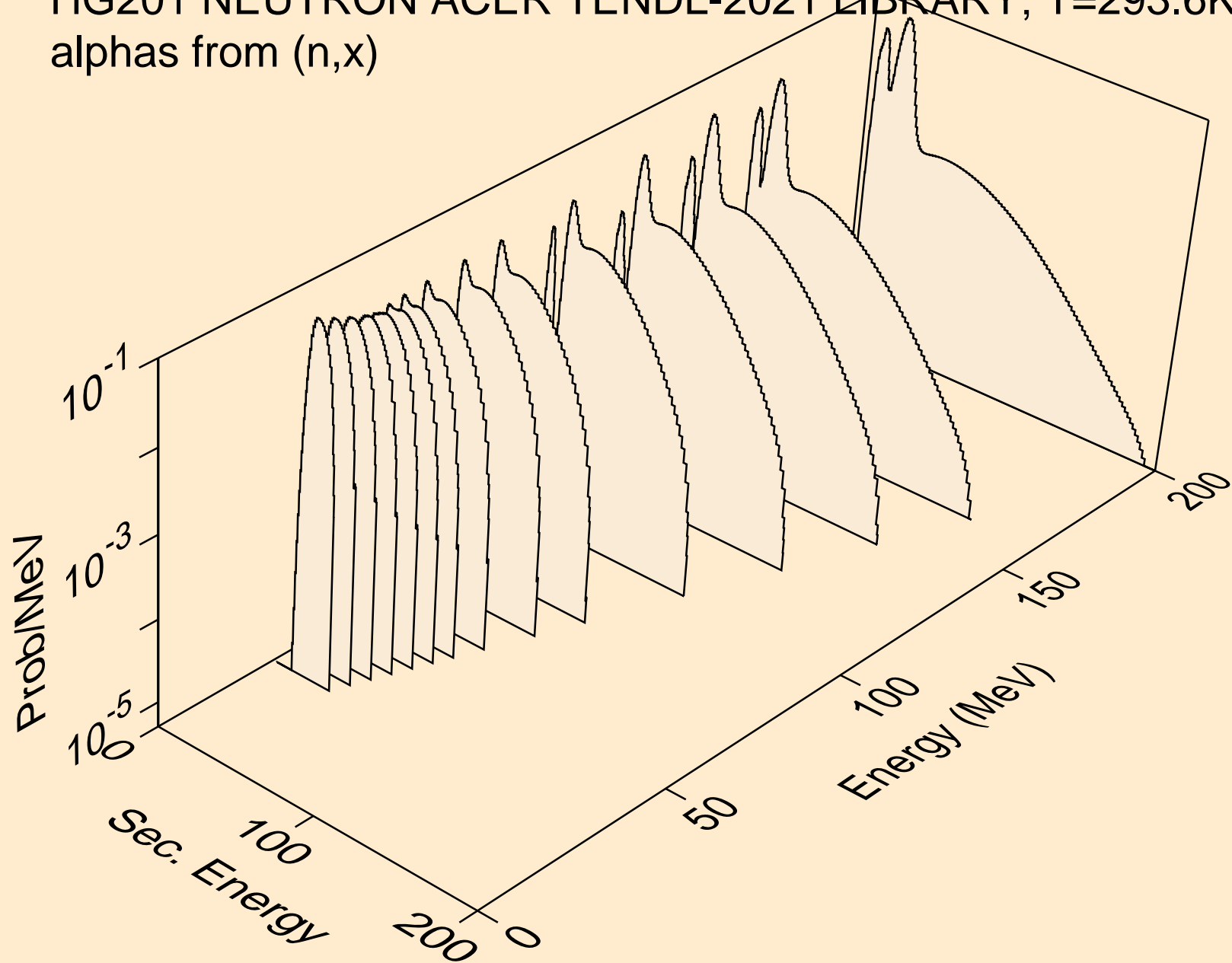

HG201 NEUTRON ACER TENDL-2021 LIBRARY; T=293.6K
alphas from (n,n*)a

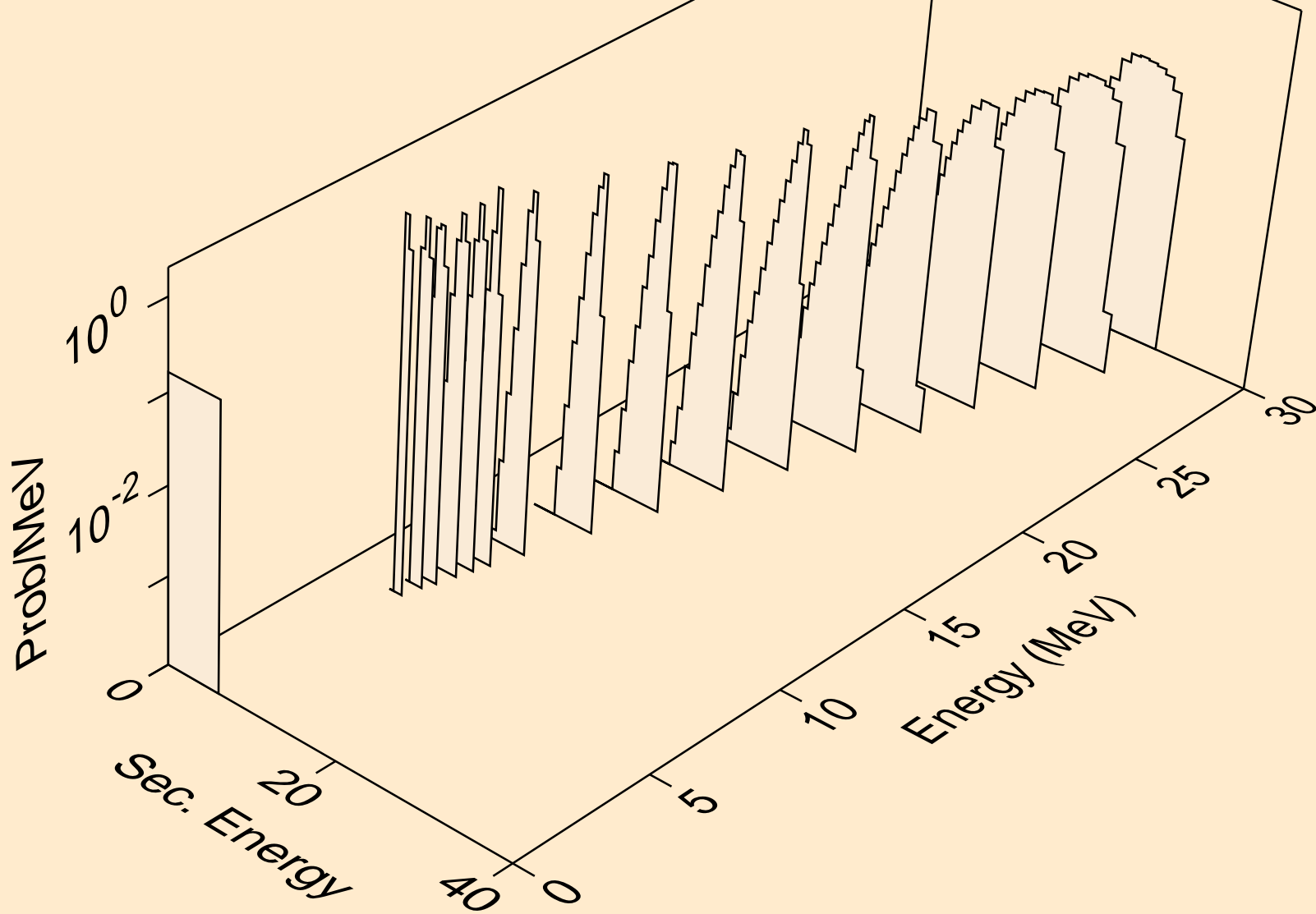

HG201 NEUTRON ACER TENDL-2021 LIBRARY; T=293.6K
alphas from (n,2n)a

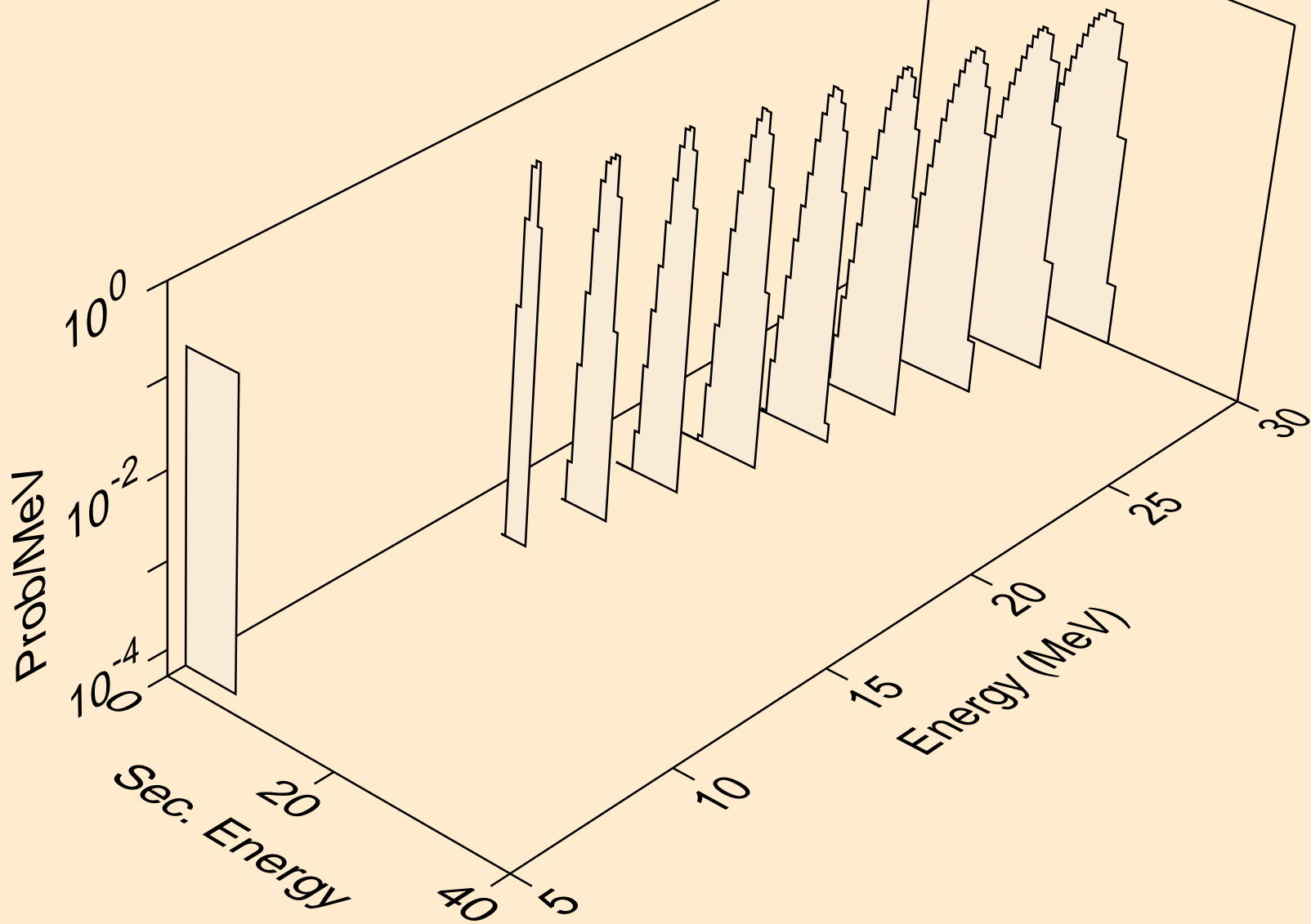

HG201 NEUTRON ACER TENDL-2021 LIBRARY; T=293.6K
alphas from (n,3n)a

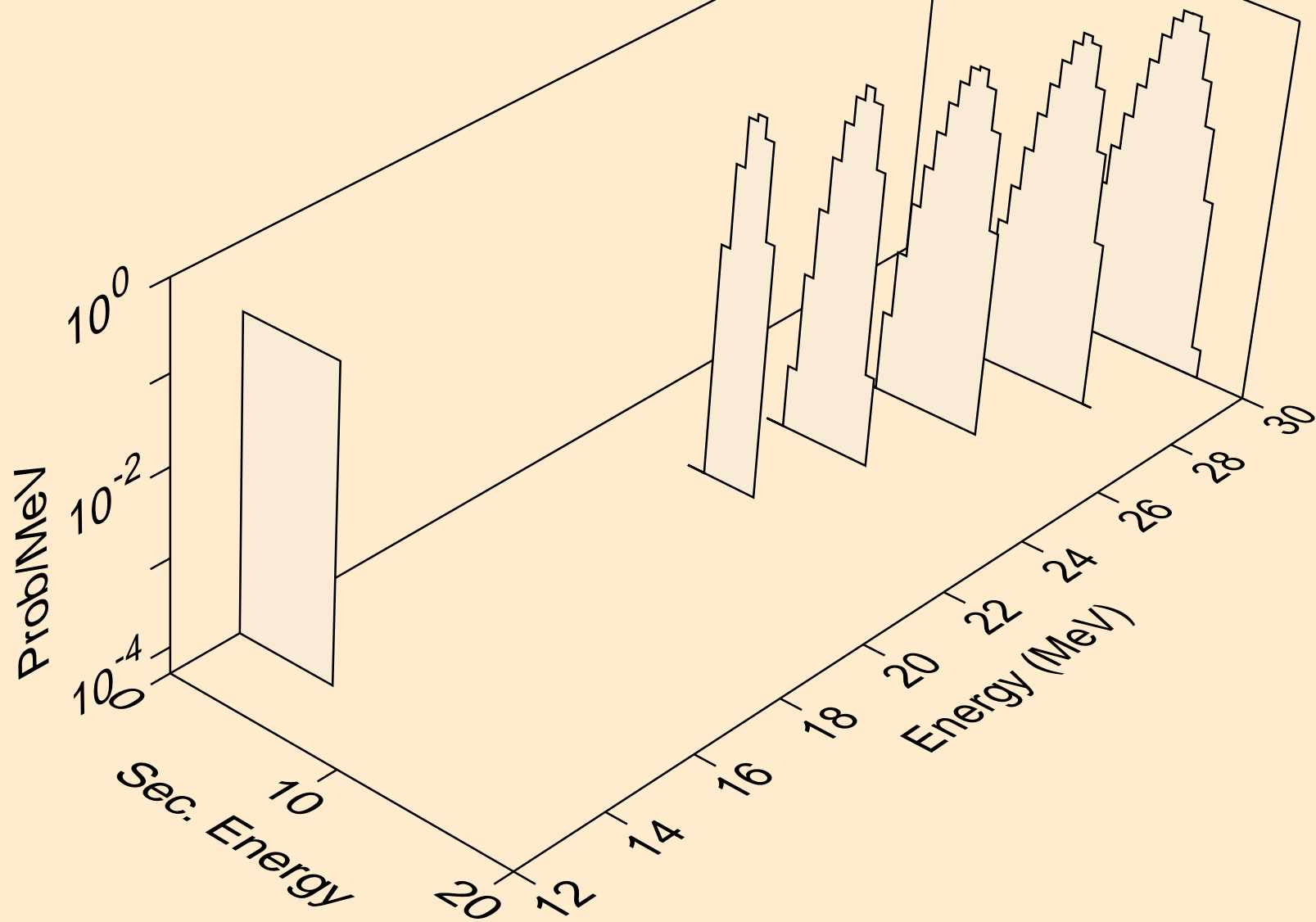

HG201 NEUTRON ACER TENDL-2021 LIBRARY; T=293.6K
alphas from (n,a)

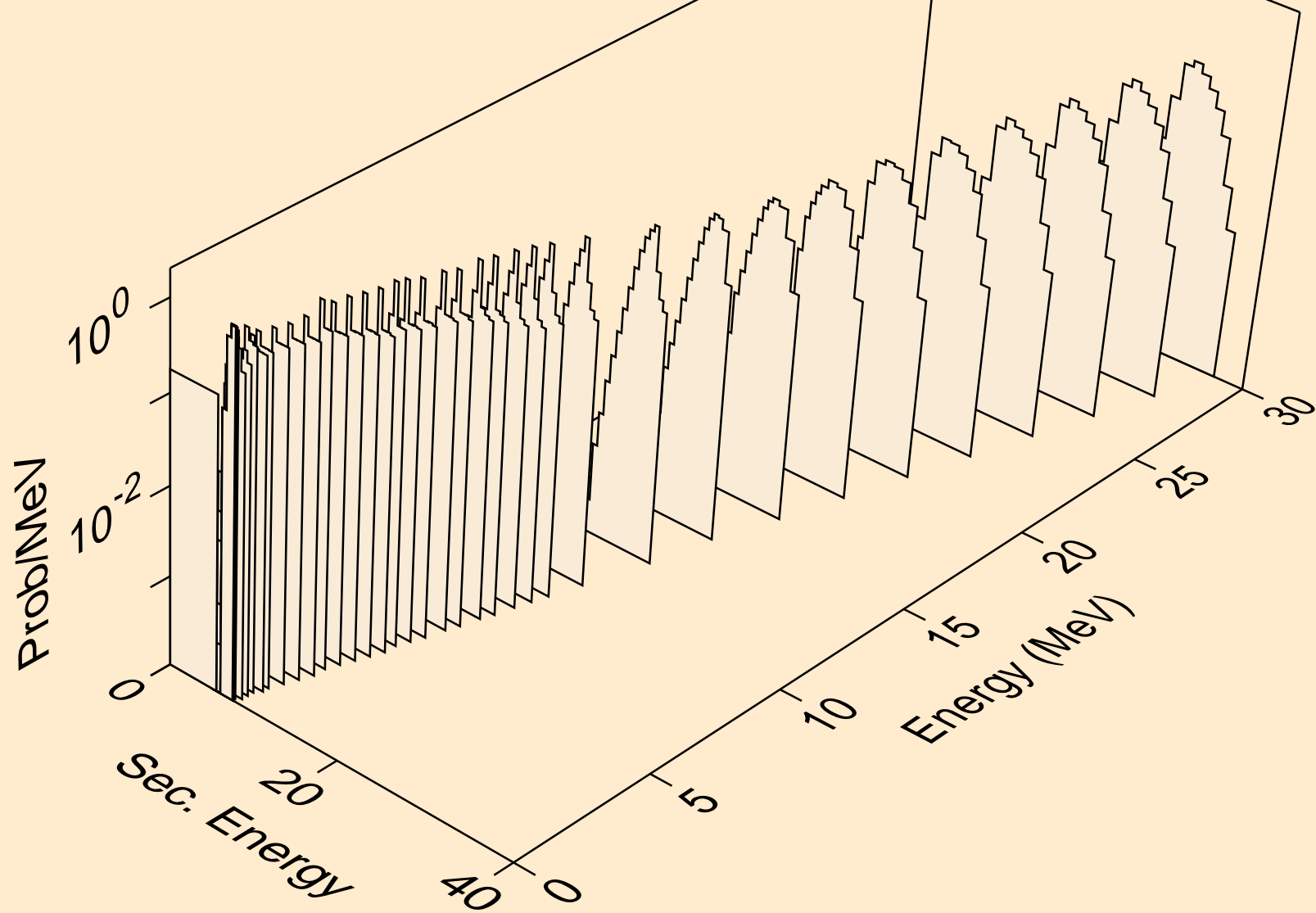

HG201 NEUTRON ACER TENDL-2021 LIBRARY; T=293.6K
alphas from (n,pa)

