

HG207 NEUTRON ACER TENDL-2021 LIBRARY; T=293.6K

Principal cross sections

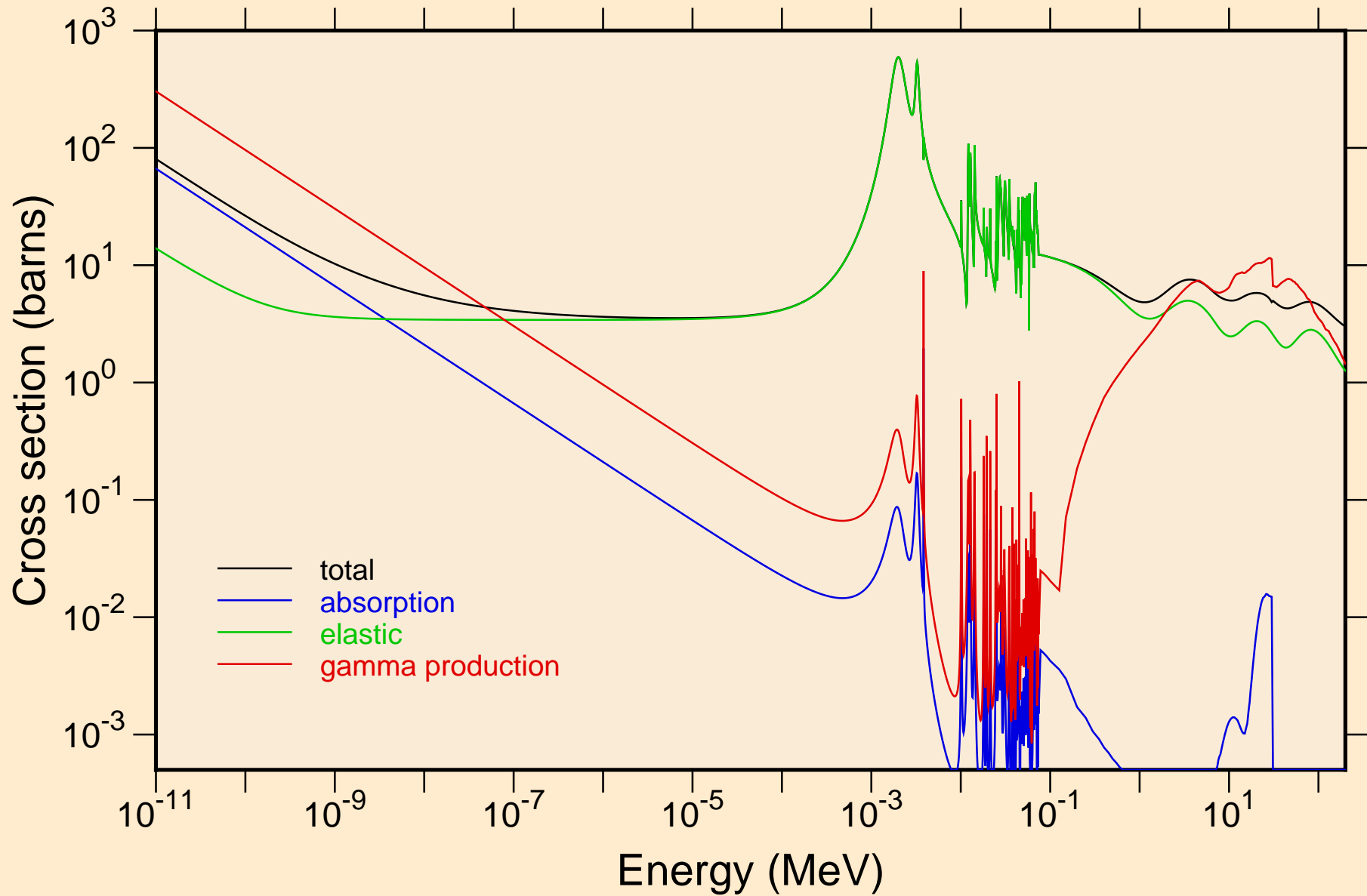

HG207 NEUTRON ACER TENDL-2021 LIBRARY; T=293.6K
resonance total cross section

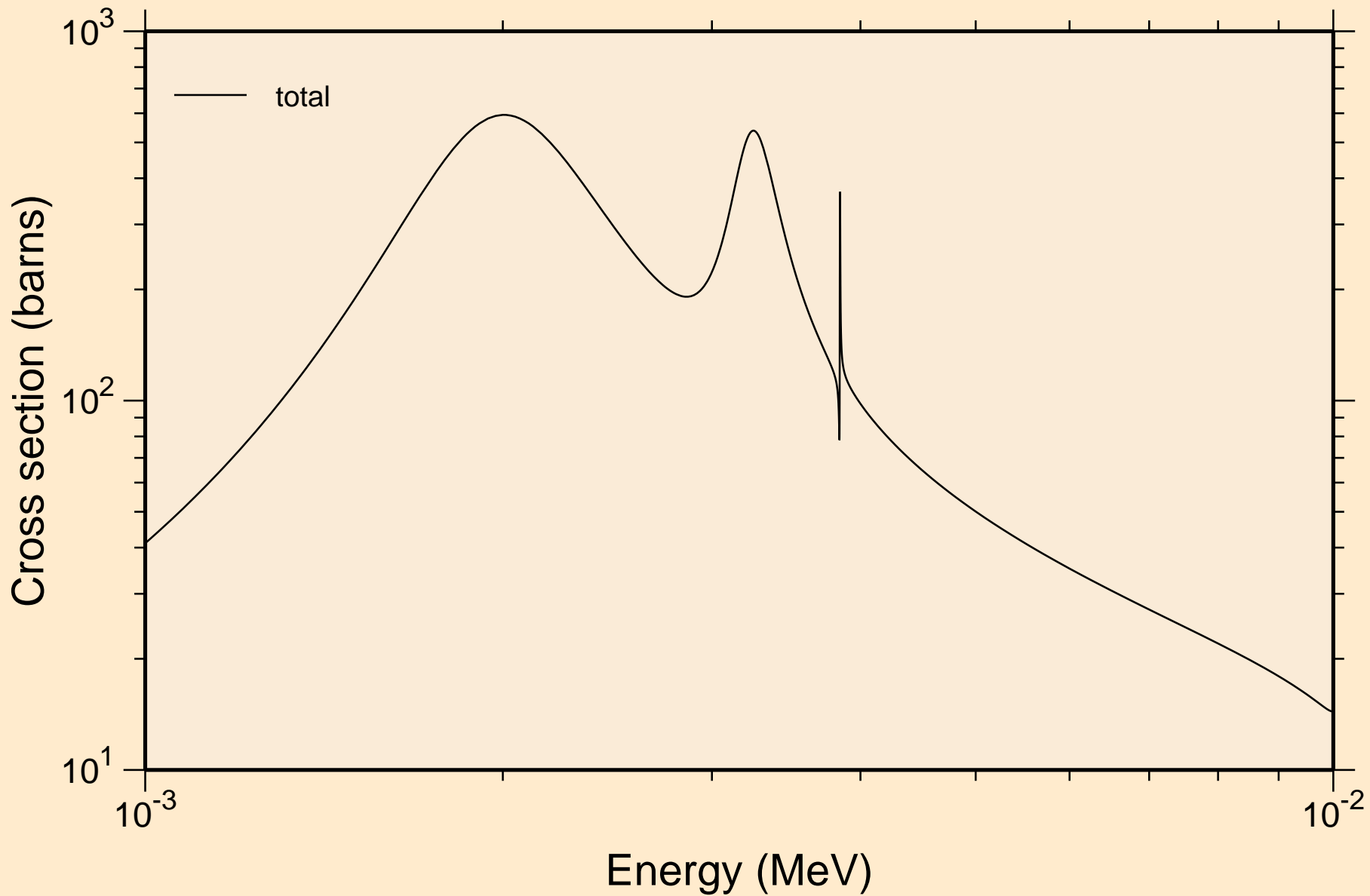

HG207 NEUTRON ACER TENDL-2021 LIBRARY; T=293.6K
resonance total cross section

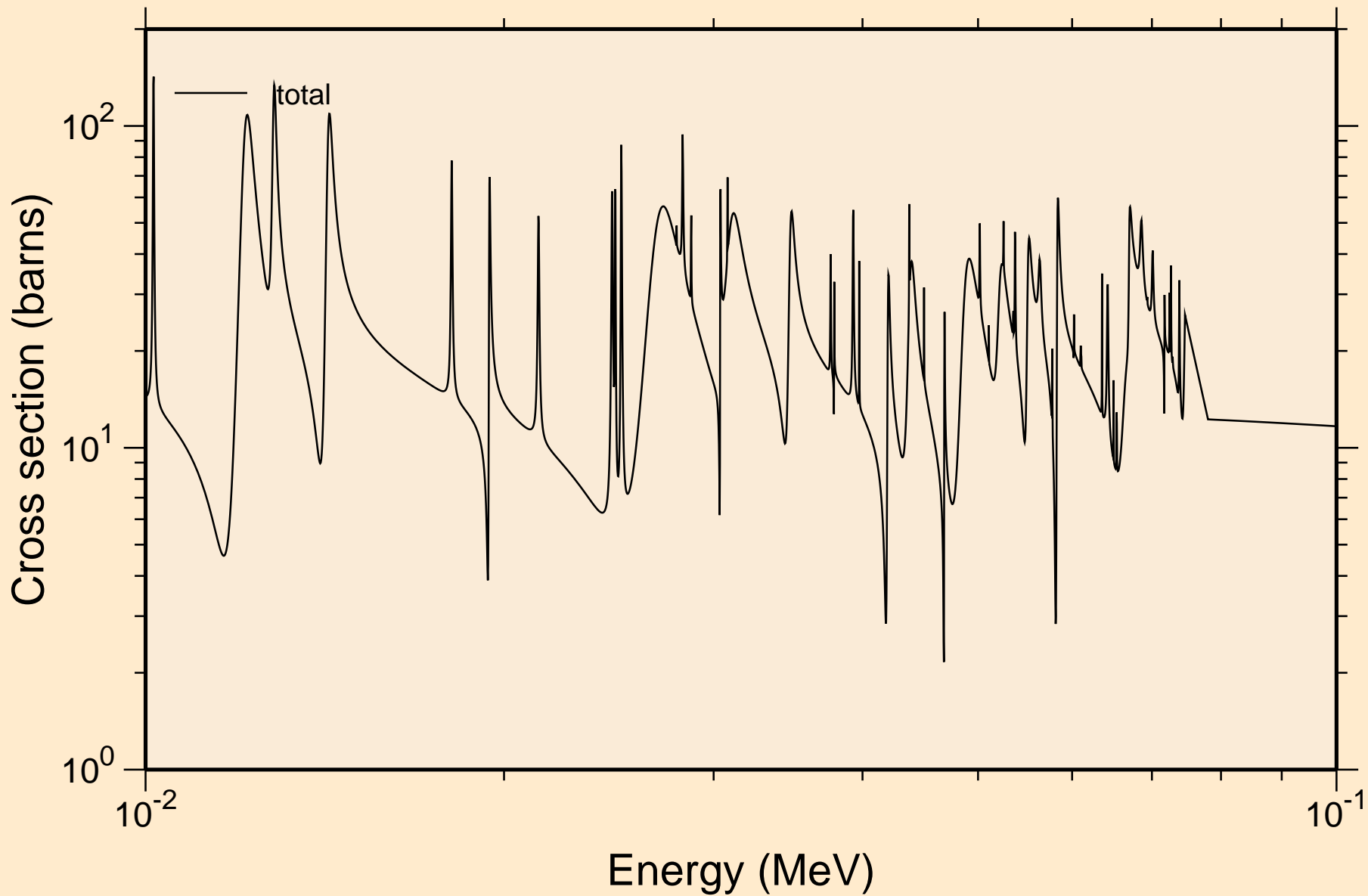

HG207 NEUTRON ACER TENDL-2021 LIBRARY; T=293.6K
resonance total cross section

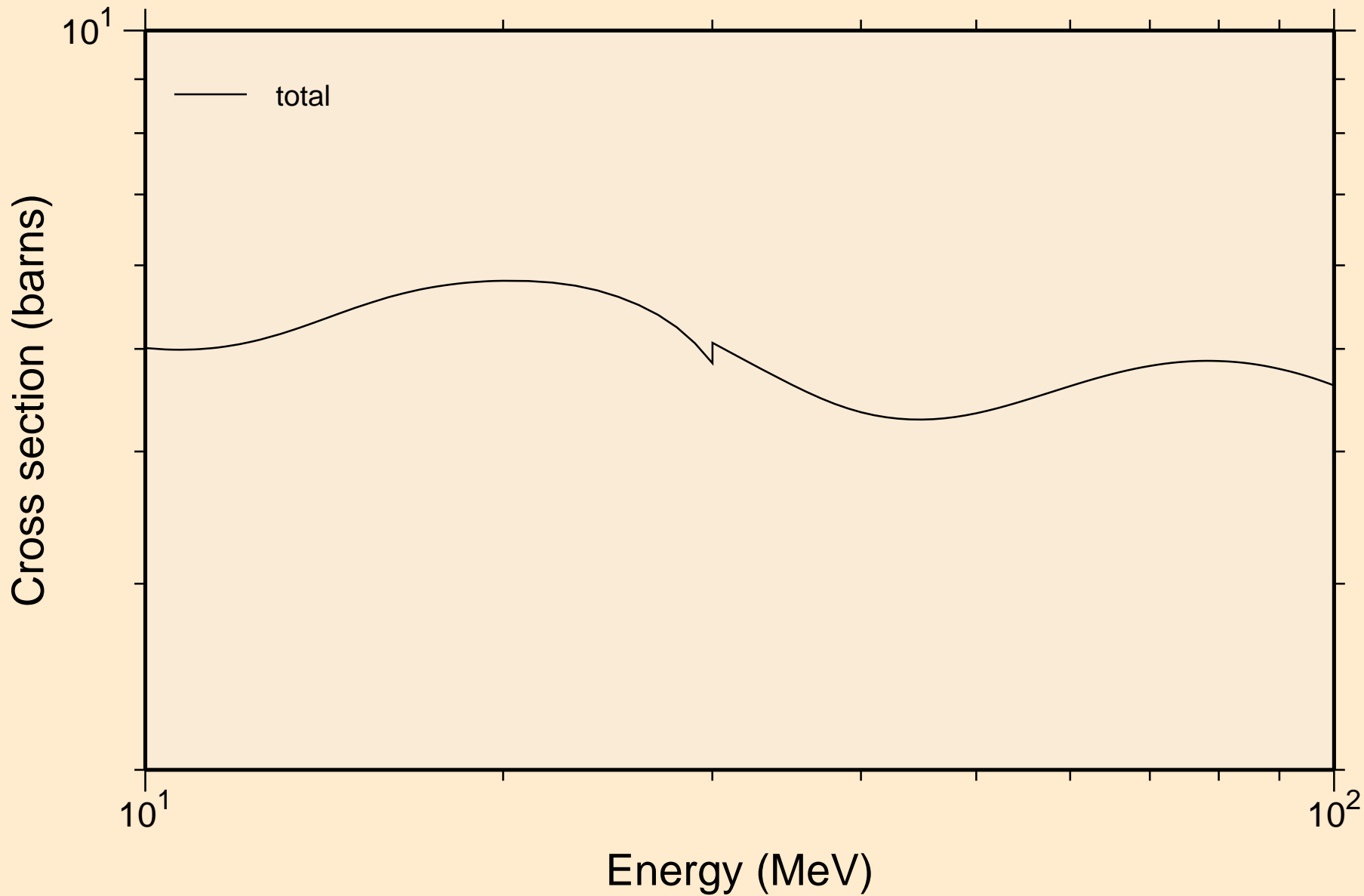

HG207 NEUTRON ACER TENDL-2021 LIBRARY; T=293.6K
resonance absorption cross sections

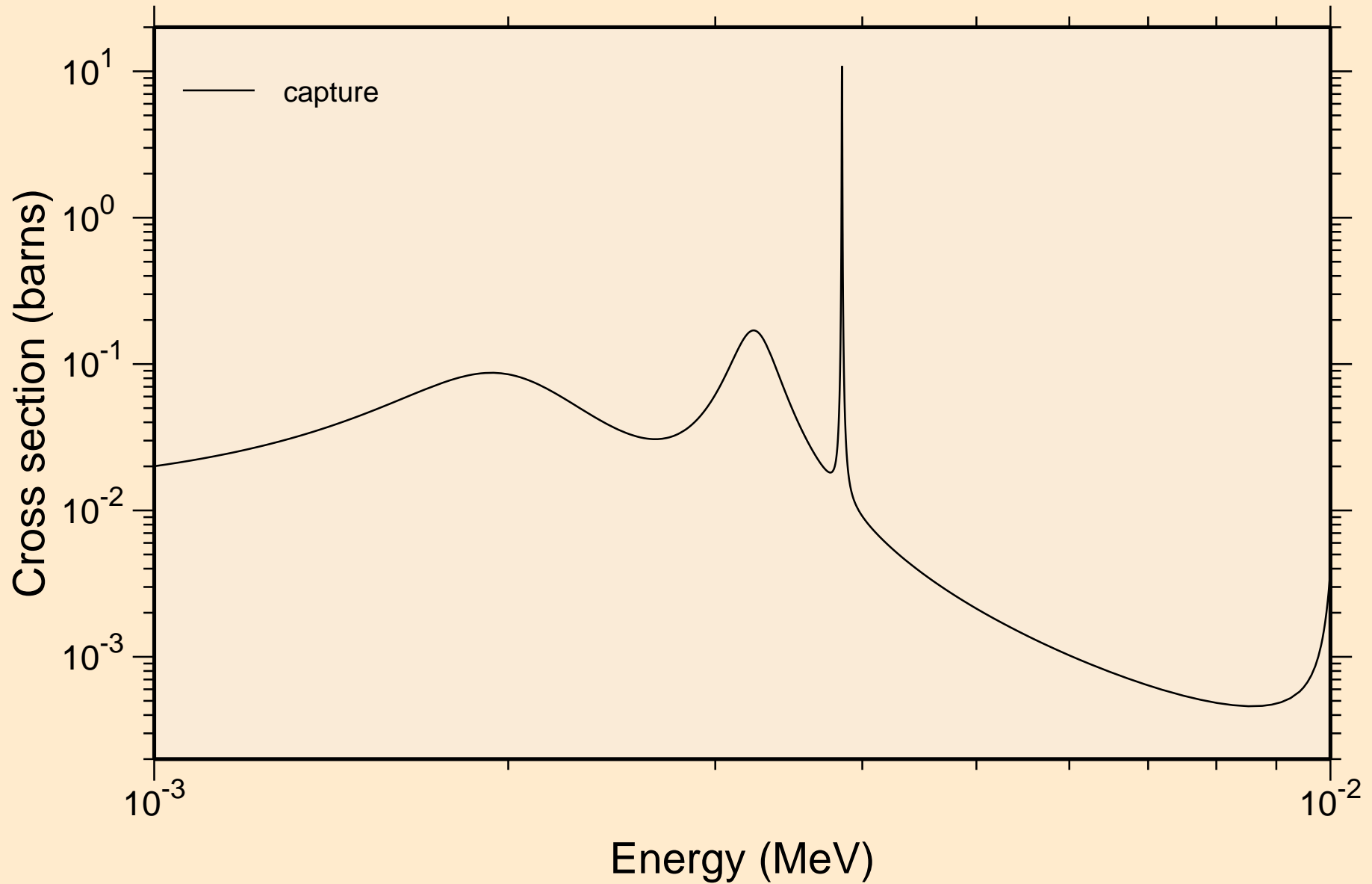

HG207 NEUTRON ACER TENDL-2021 LIBRARY; T=293.6K
resonance absorption cross sections

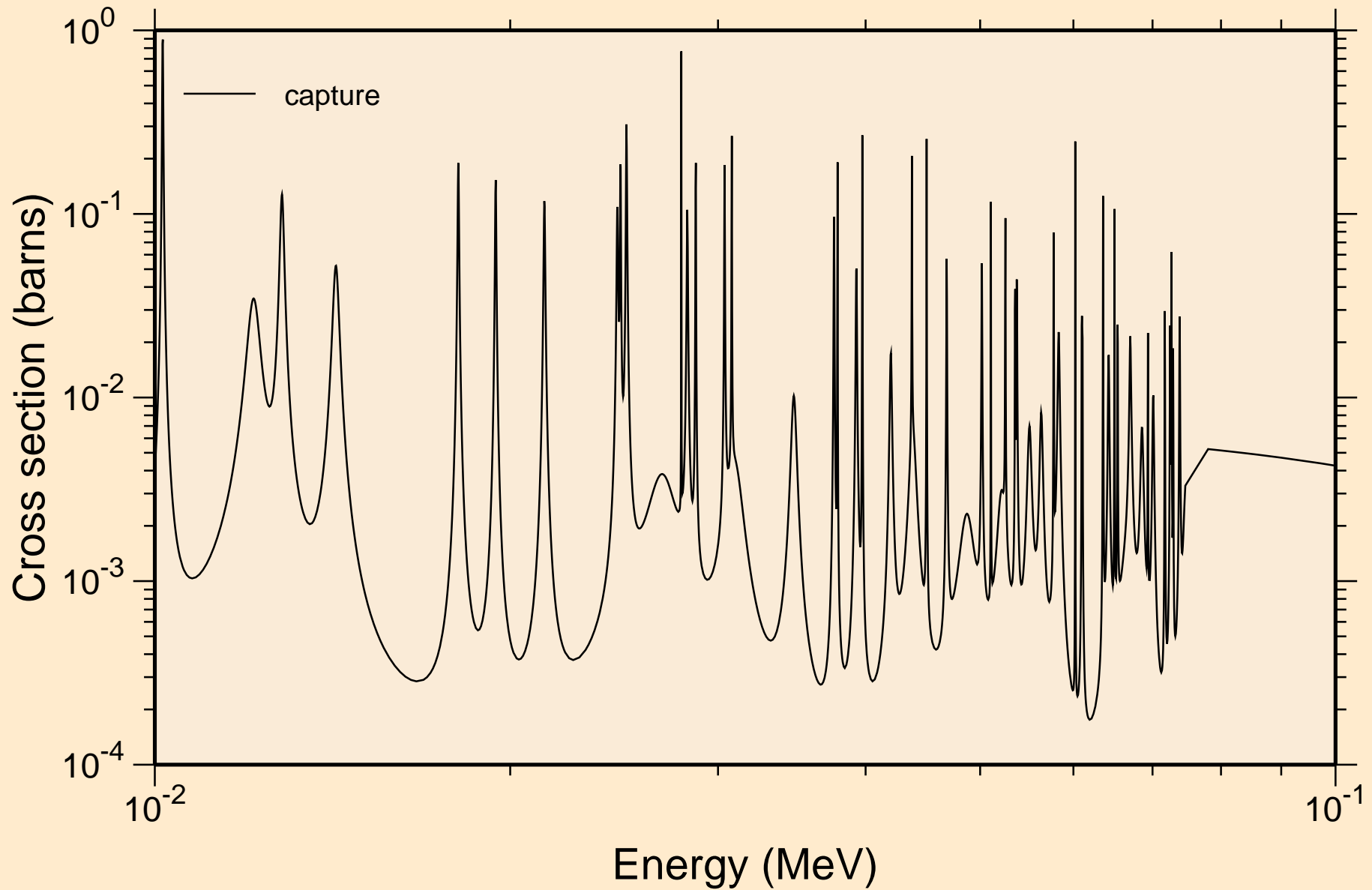

HG207 NEUTRON ACER TENDL-2021 LIBRARY; T=293.6K
resonance absorption cross sections

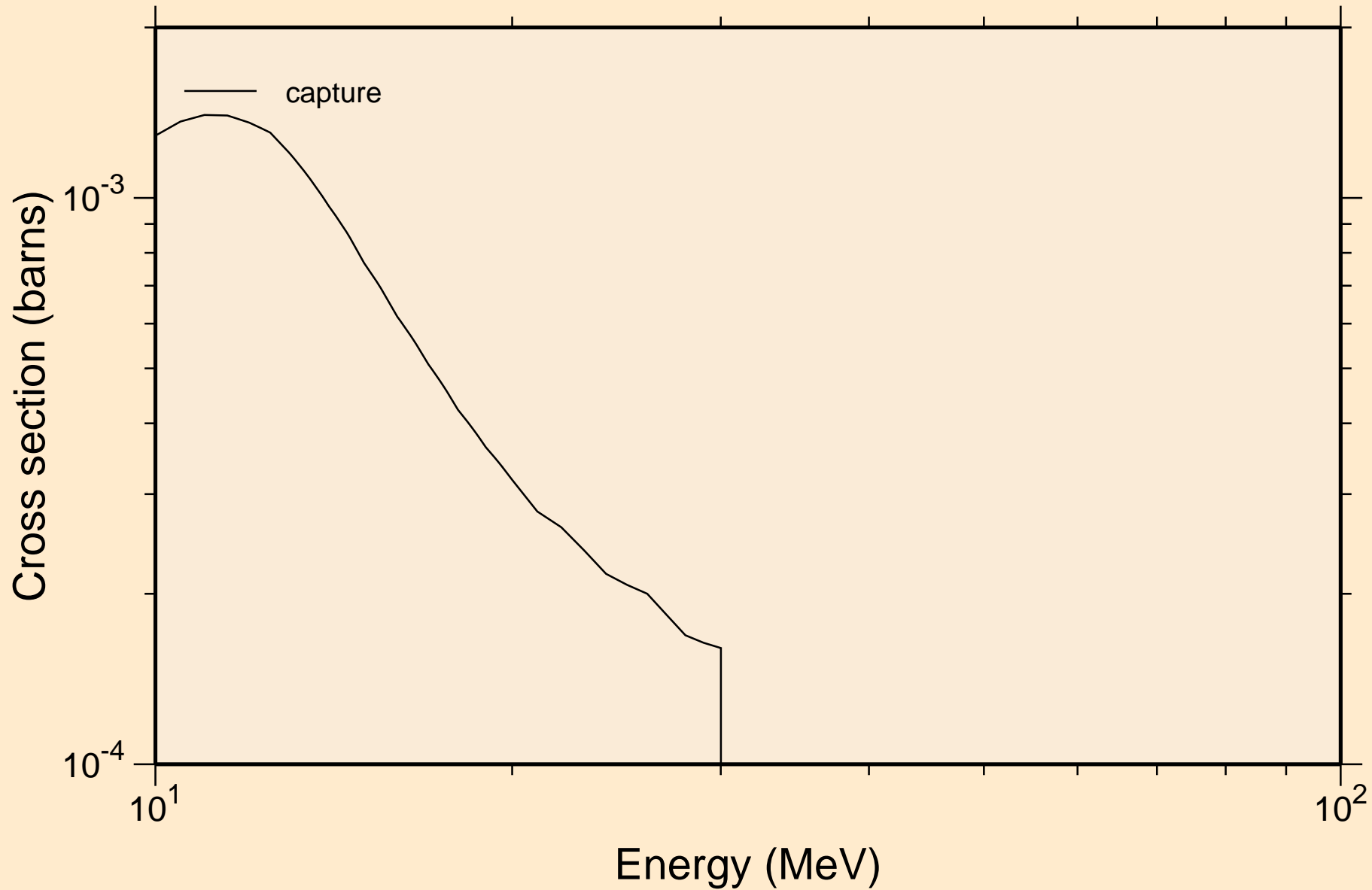

HG207 NEUTRON ACER TENDL-2021 LIBRARY; T=293.6K
Heating

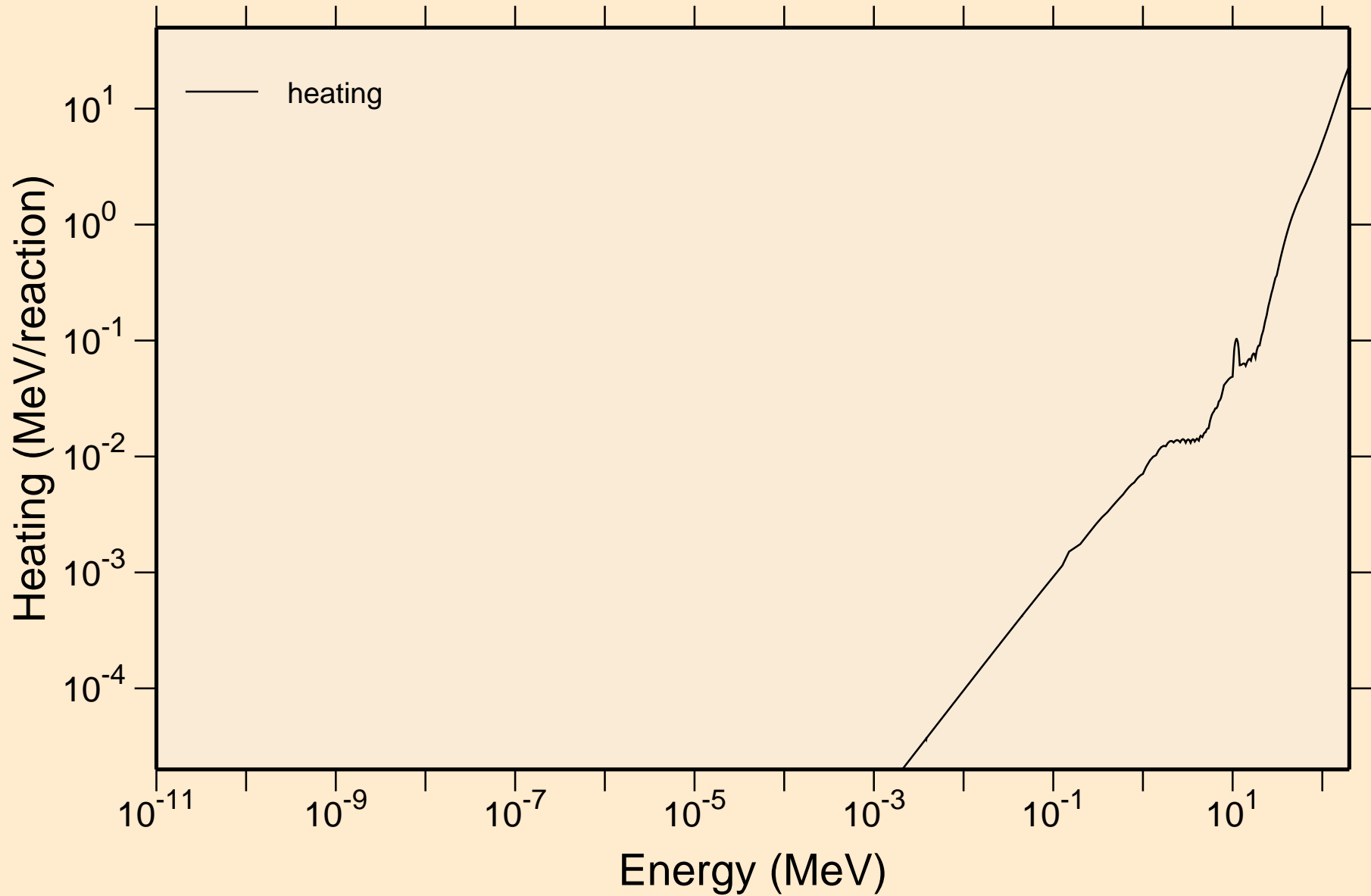

HG207 NEUTRON ACER TENDL-2021 LIBRARY; T=293.6K
Damage

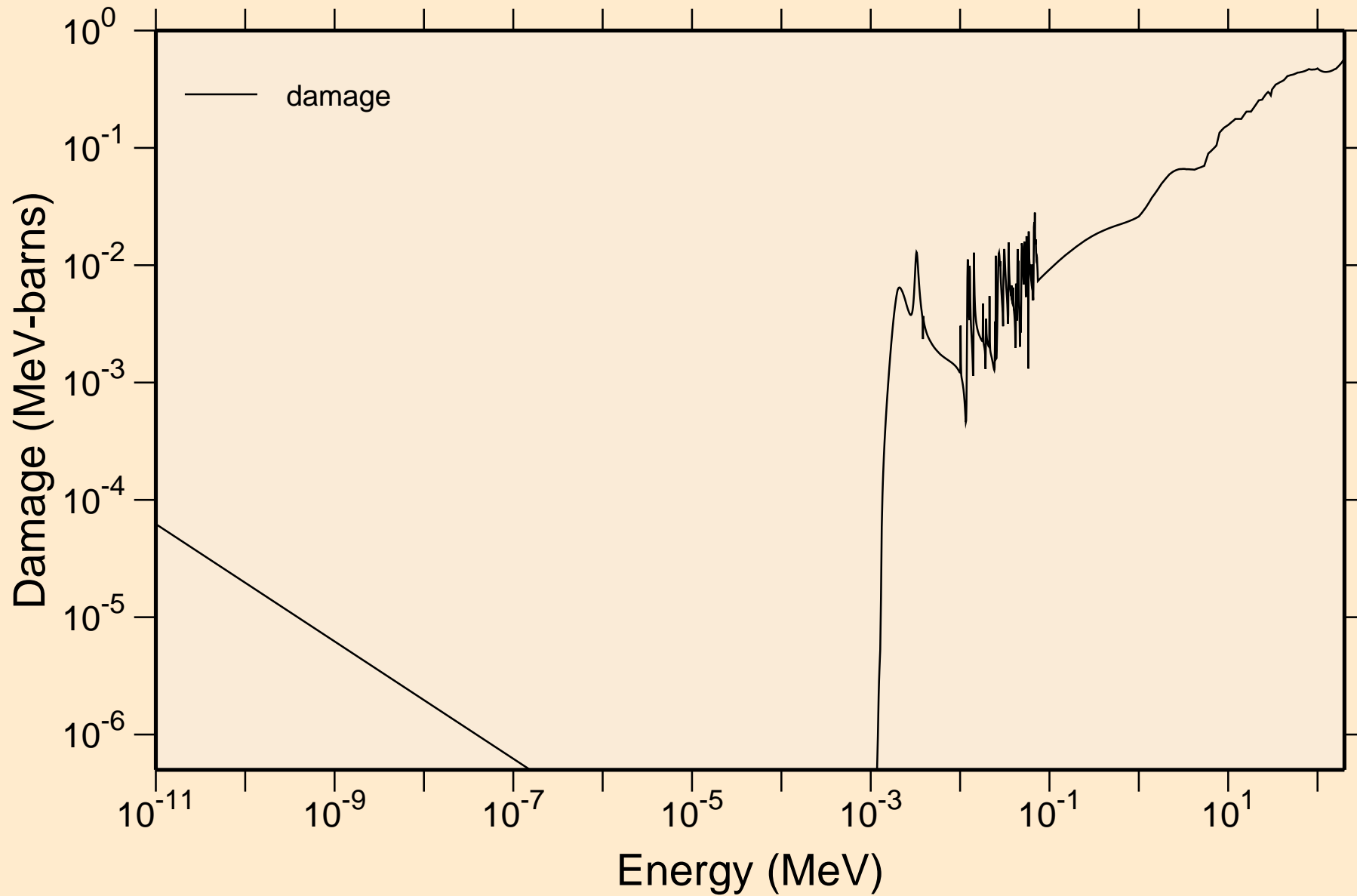

HG207 NEUTRON ACER TENDL-2021 LIBRARY; T=293.6K

Non-threshold reactions

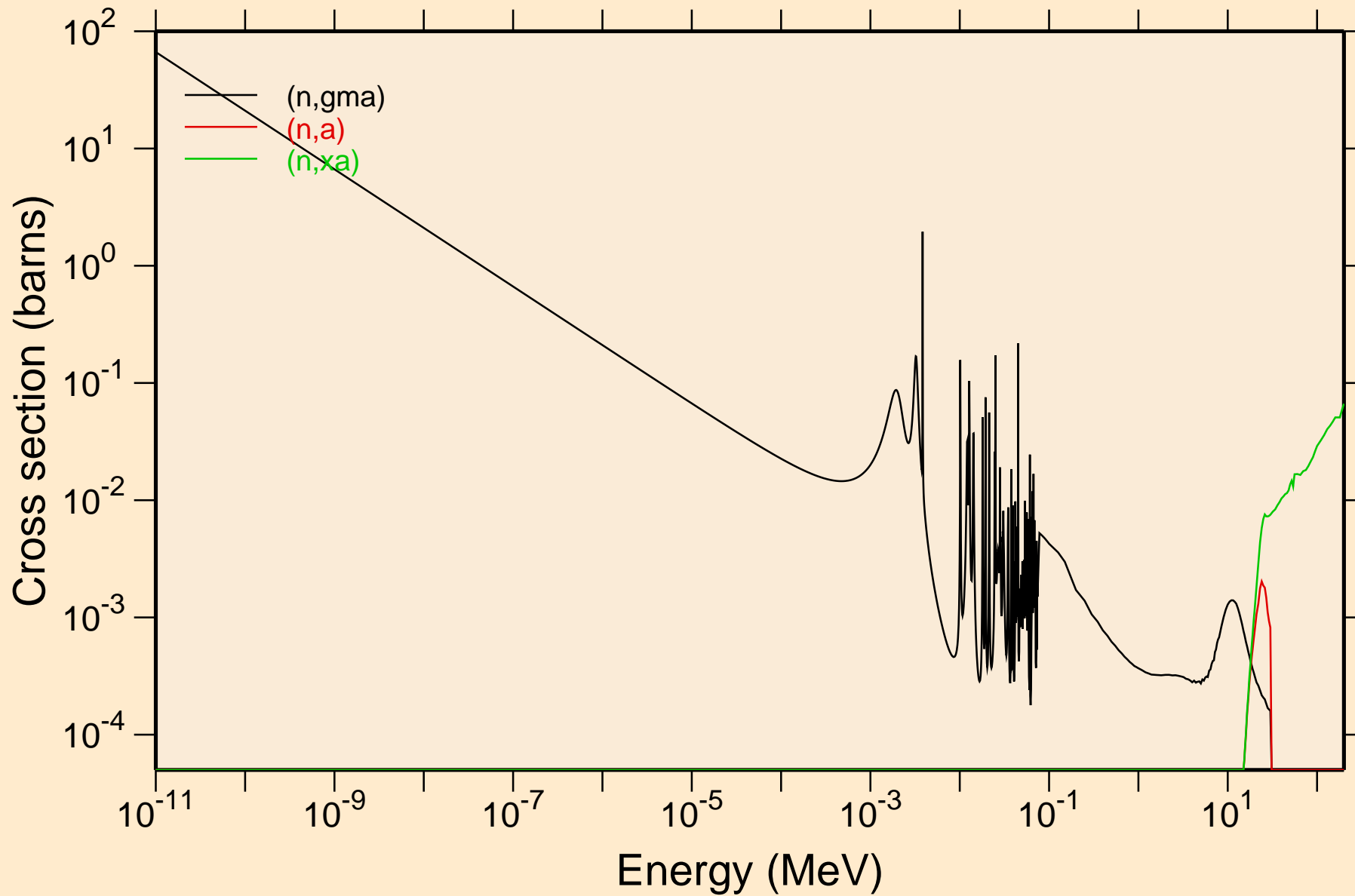

HG207 NEUTRON ACER TENDL-2021 LIBRARY; T=293.6K

Principal cross sections

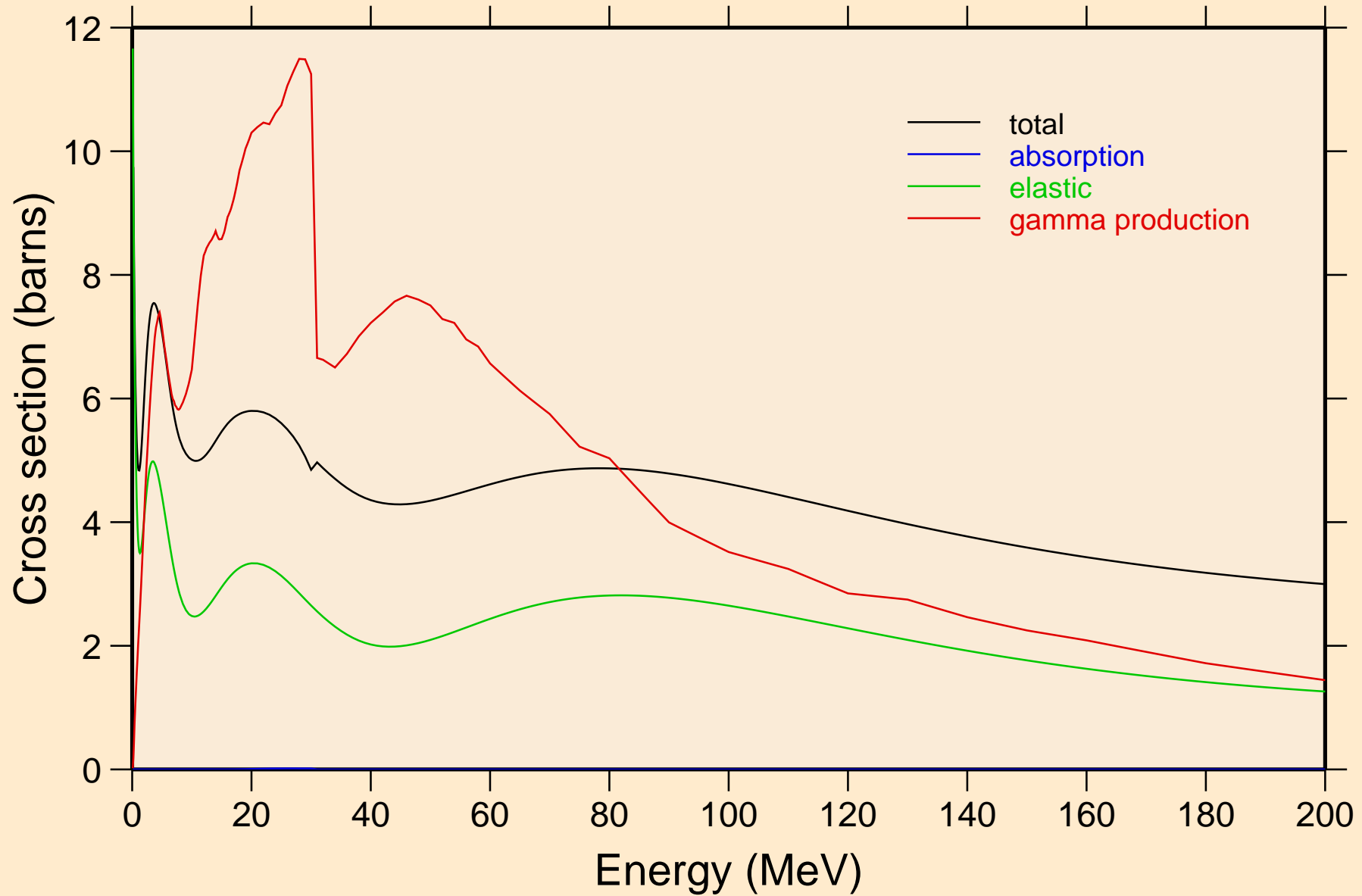

HG207 NEUTRON ACER TENDL-2021 LIBRARY; T=293.6K
Heating

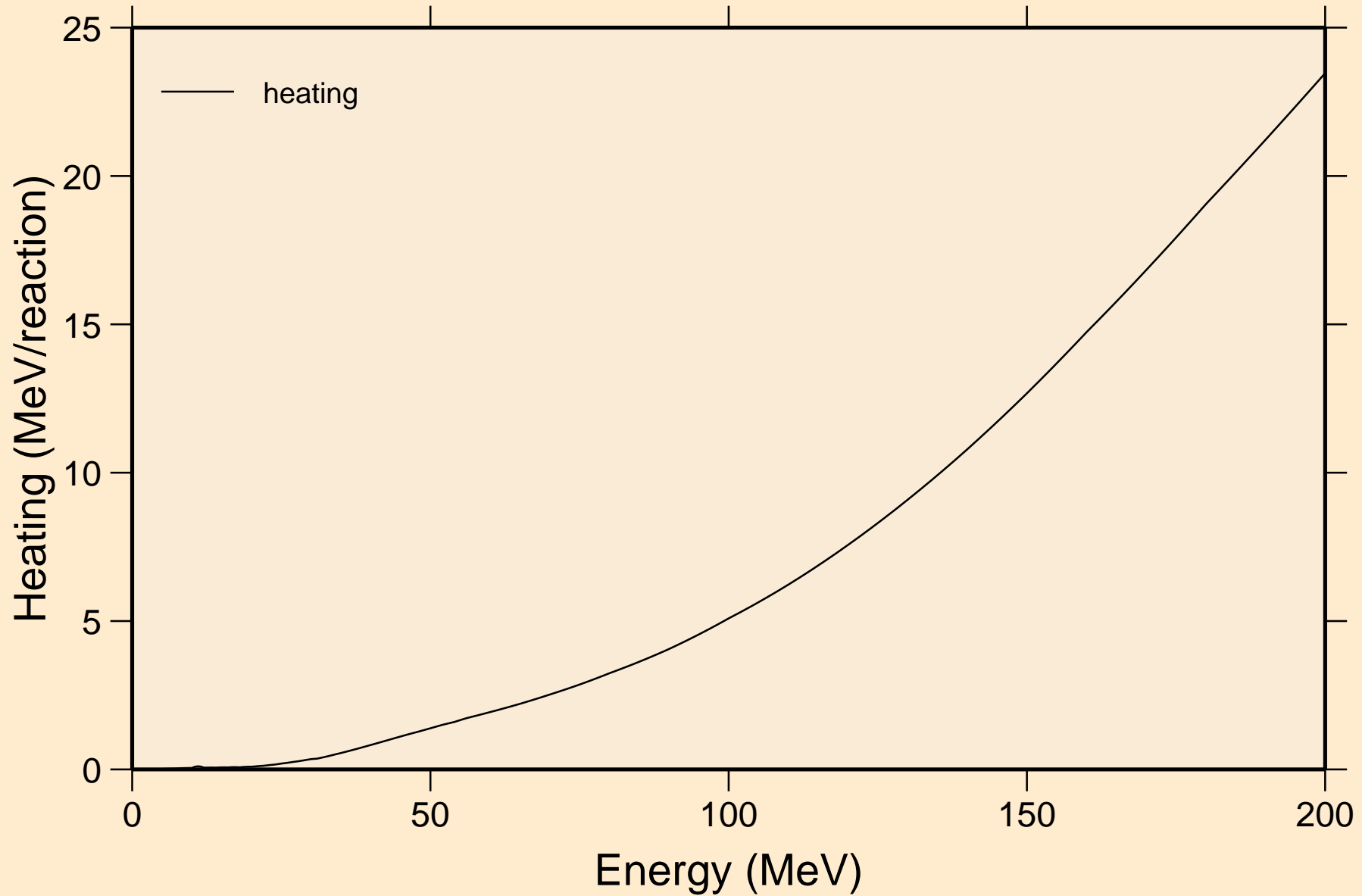

HG207 NEUTRON ACER TENDL-2021 LIBRARY; T=293.6K
Damage

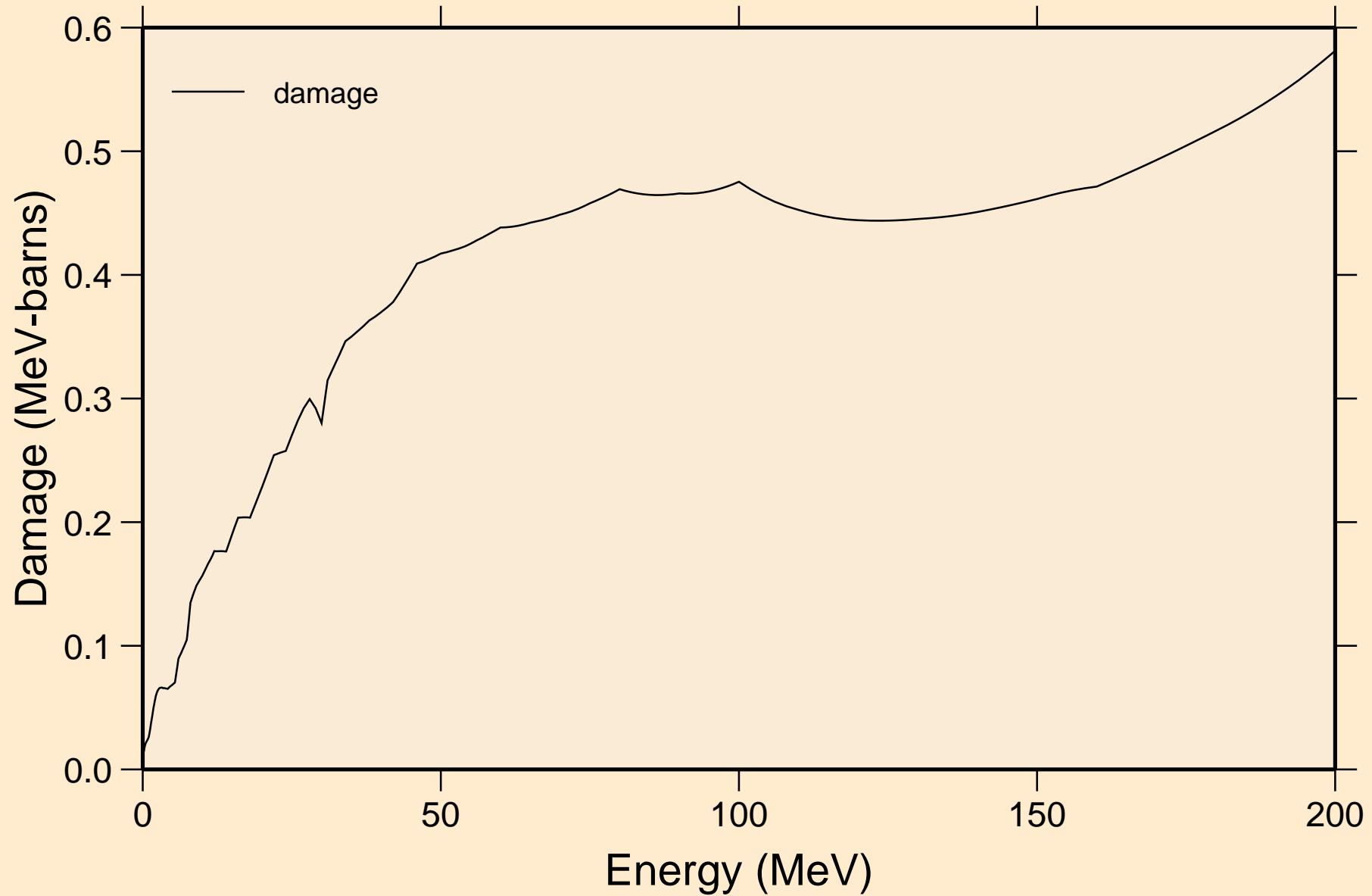

HG207 NEUTRON ACER TENDL-2021 LIBRARY; T=293.6K
Non-threshold reactions

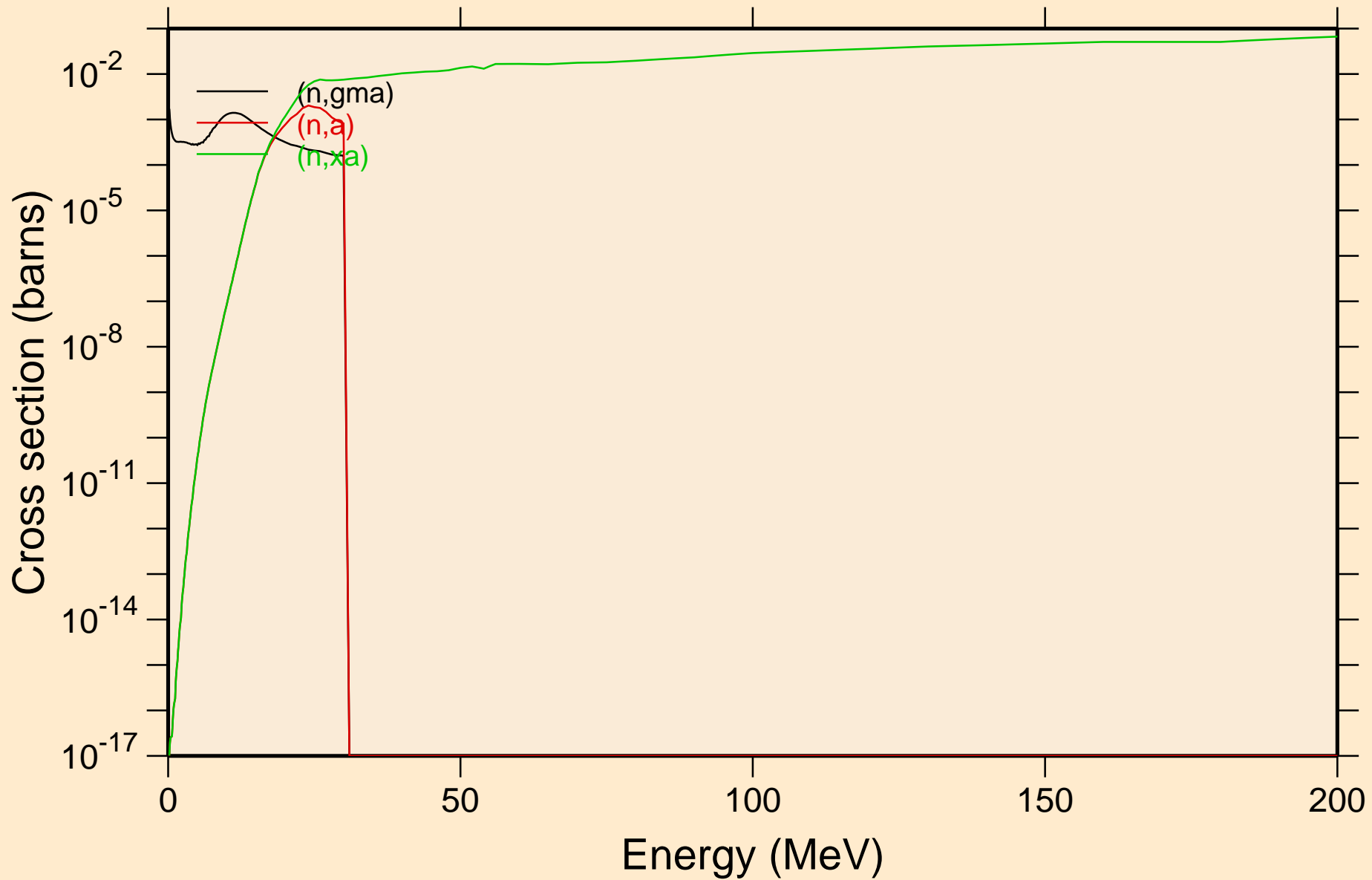

HG207 NEUTRON ACER TENDL-2021 LIBRARY; T=293.6K
Inelastic levels

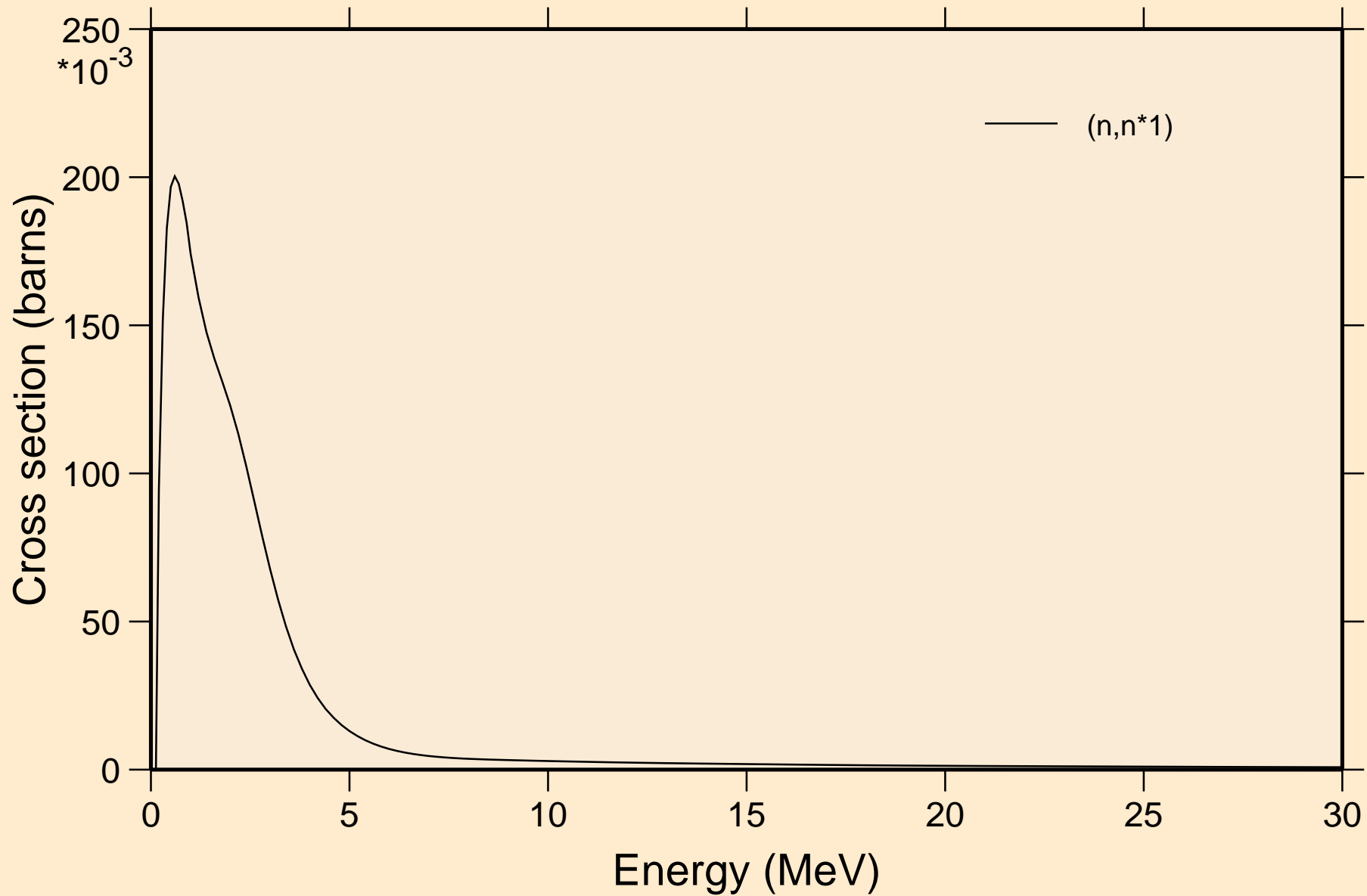

HG207 NEUTRON ACER TENDL-2021 LIBRARY; T=293.6K
Threshold reactions

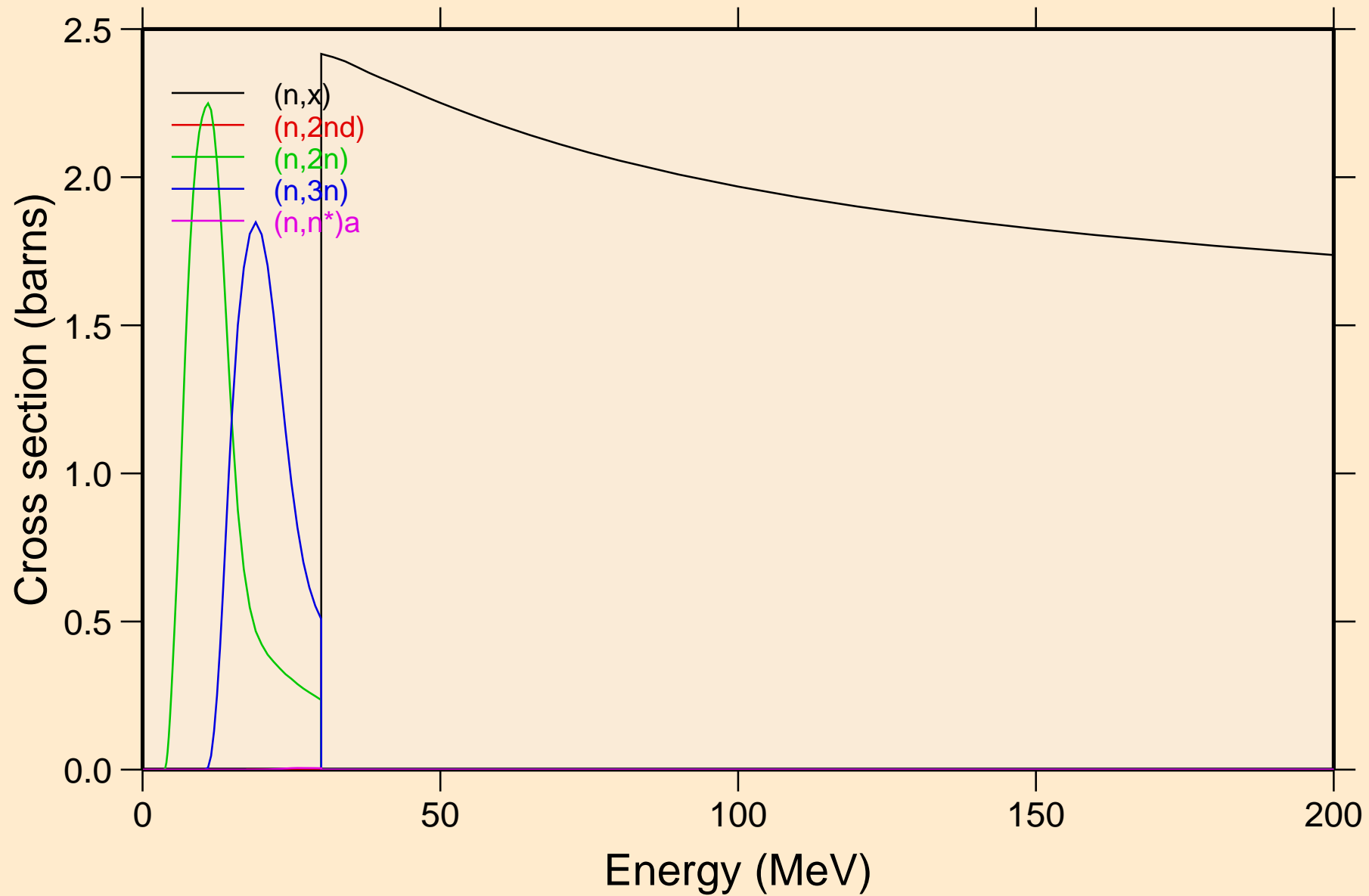

HG207 NEUTRON ACER TENDL-2021 LIBRARY; T=293.6K
Threshold reactions

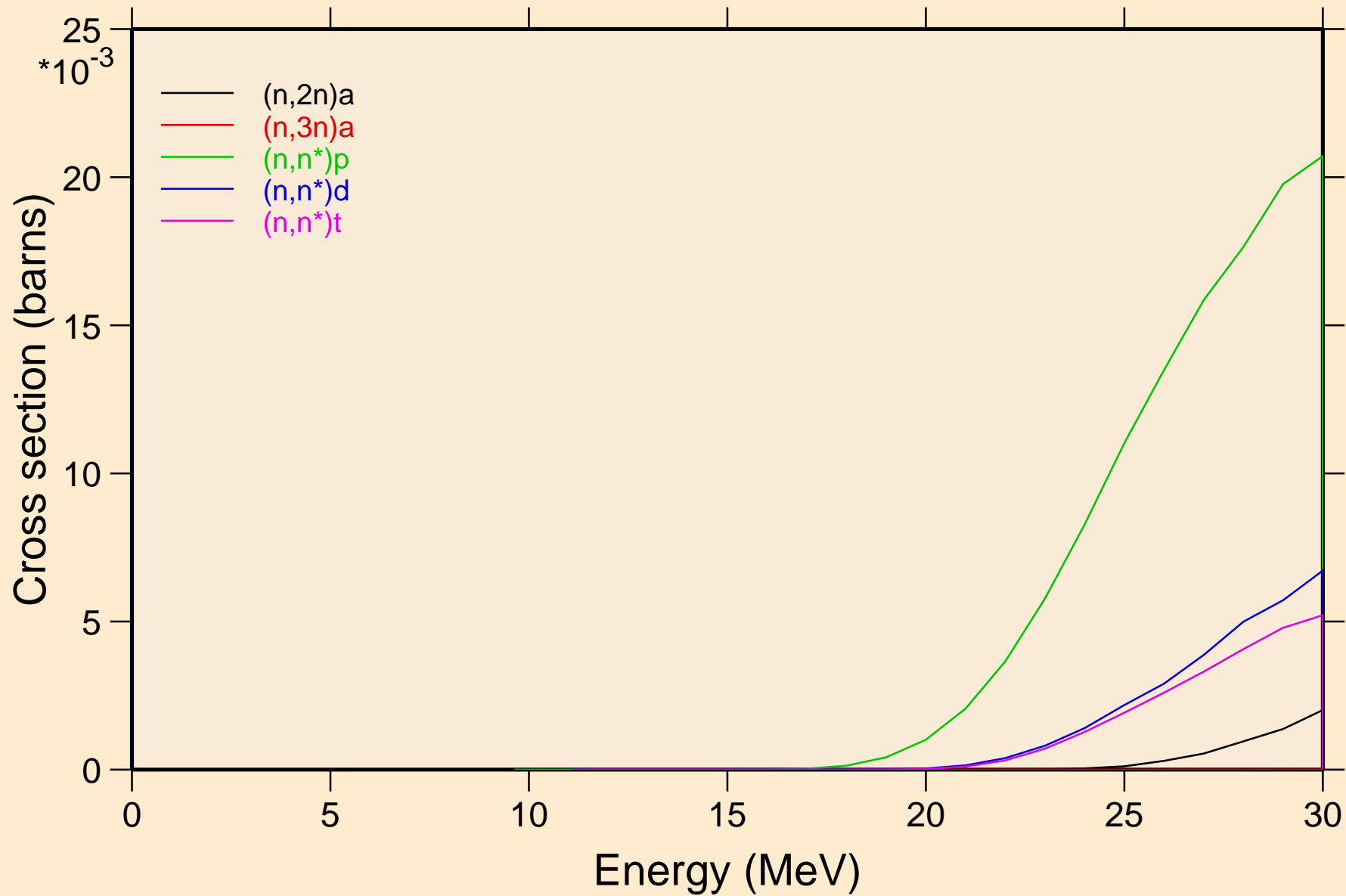

HG207 NEUTRON ACER TENDL-2021 LIBRARY; T=293.6K
Threshold reactions

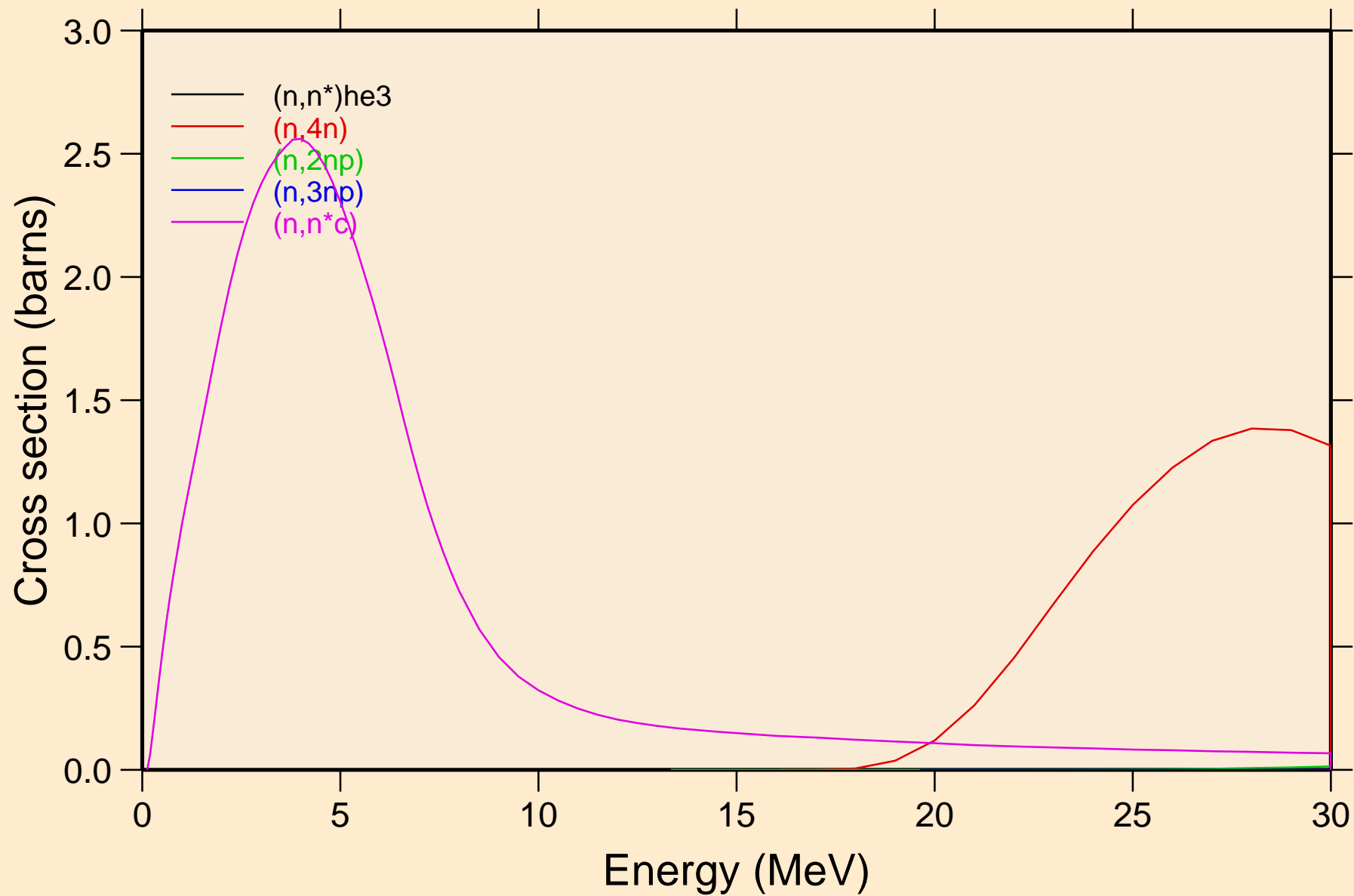

HG207 NEUTRON ACER TENDL-2021 LIBRARY; T=293.6K
Threshold reactions

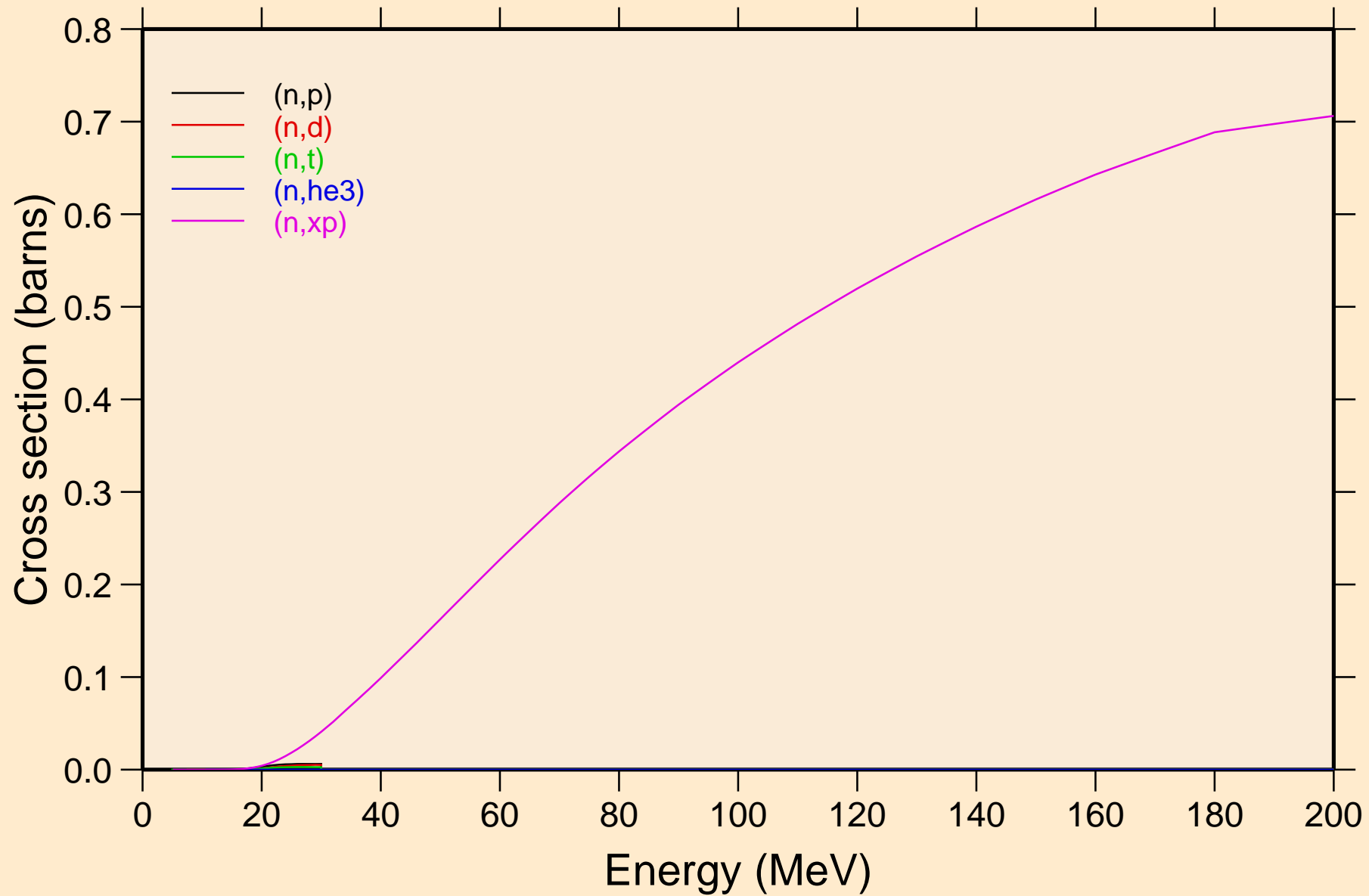

HG207 NEUTRON ACER TENDL-2021 LIBRARY; T=293.6K

Threshold reactions

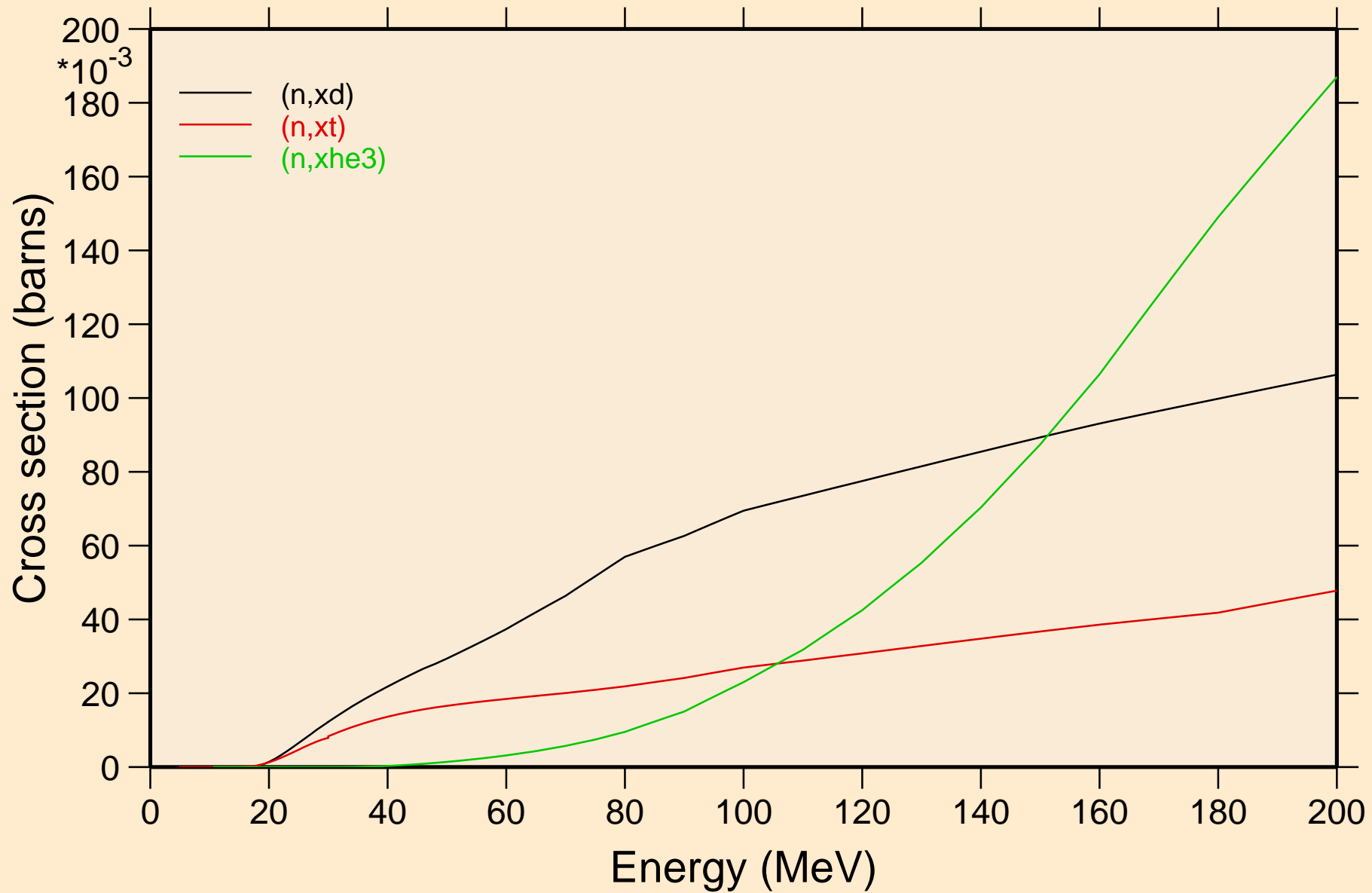

HG207 NEUTRON ACER TENDL-2021 LIBRARY; T=293.6K
angular distribution for elastic

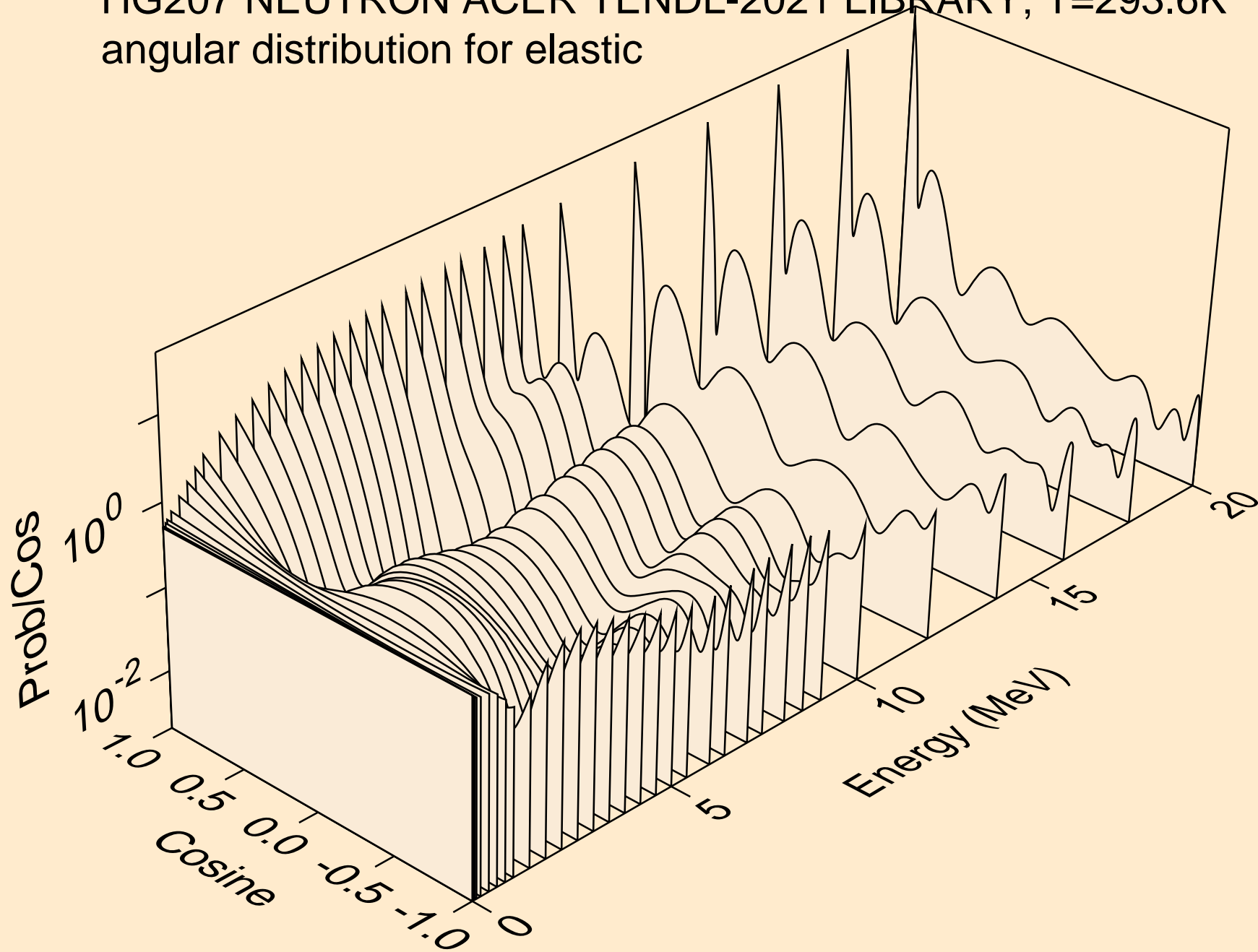

HG207 NEUTRON ACER TENDL-2021 LIBRARY; T=293.6K
angular distribution for elastic

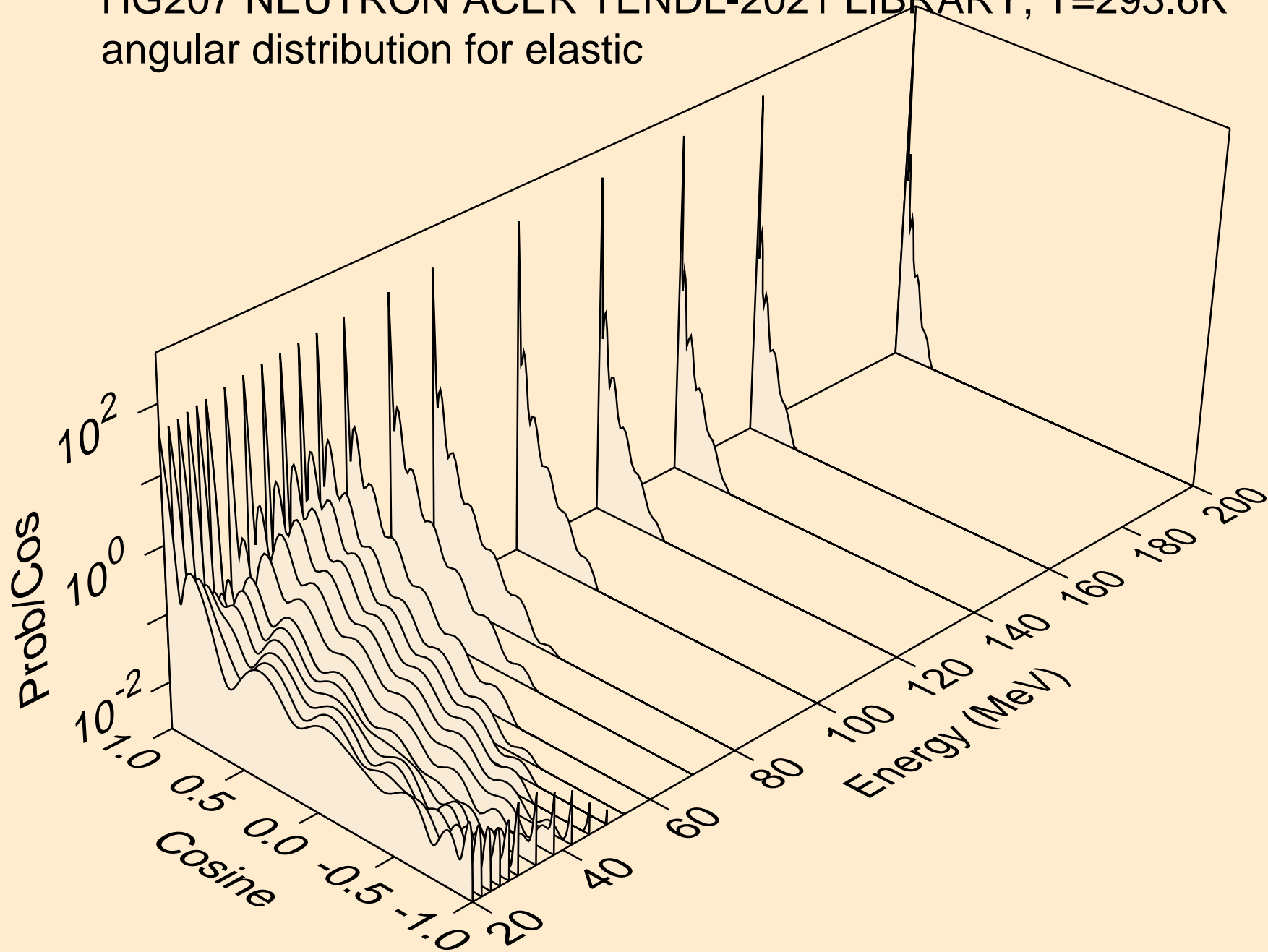

HG207 NEUTRON ACER TENDL-2021 LIBRARY; T=293.6K
angular distribution for (n,n*1)

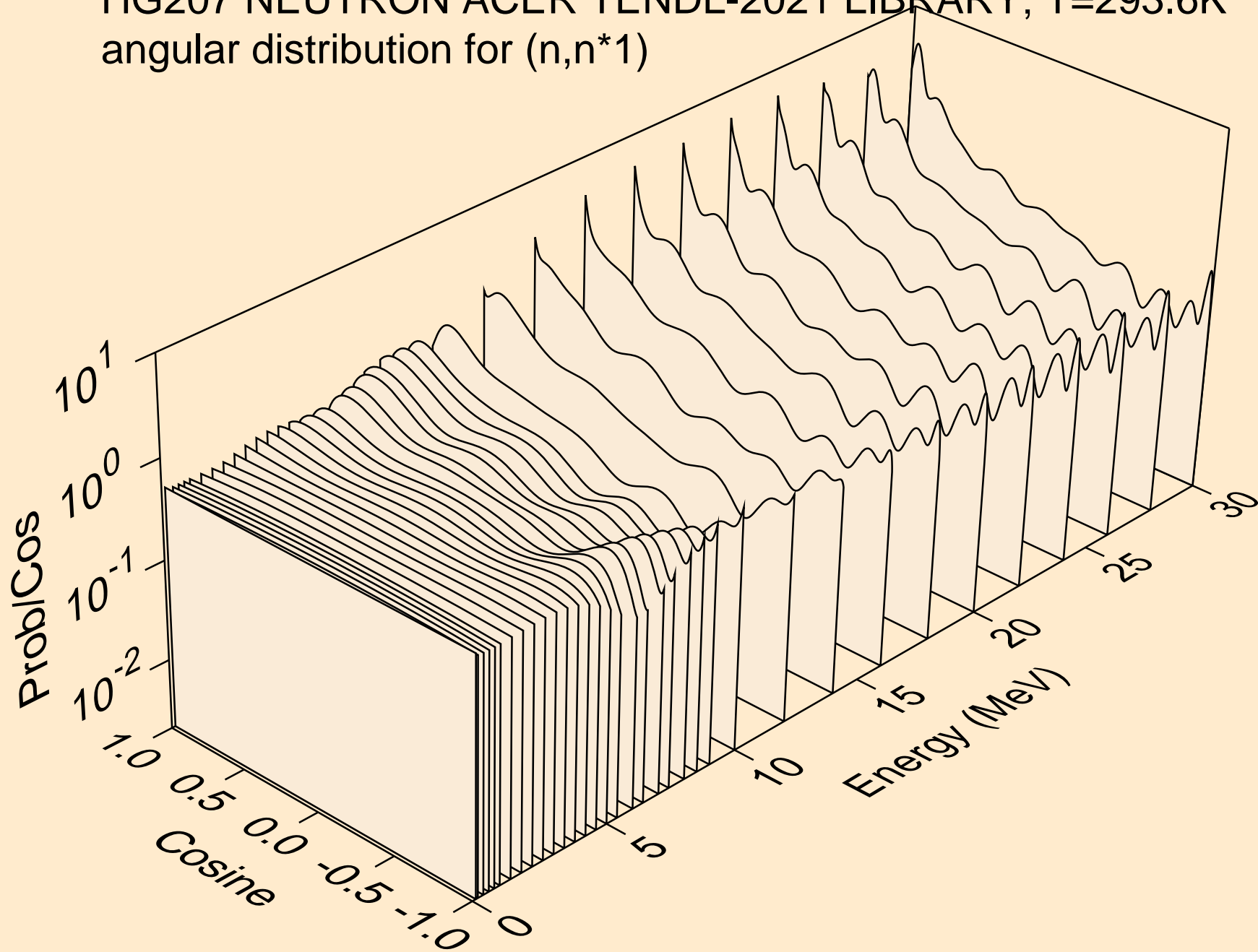

HG207 NEUTRON ACER TENDL-2021 LIBRARY; T=293.6K
Neutron emission for (n,x)

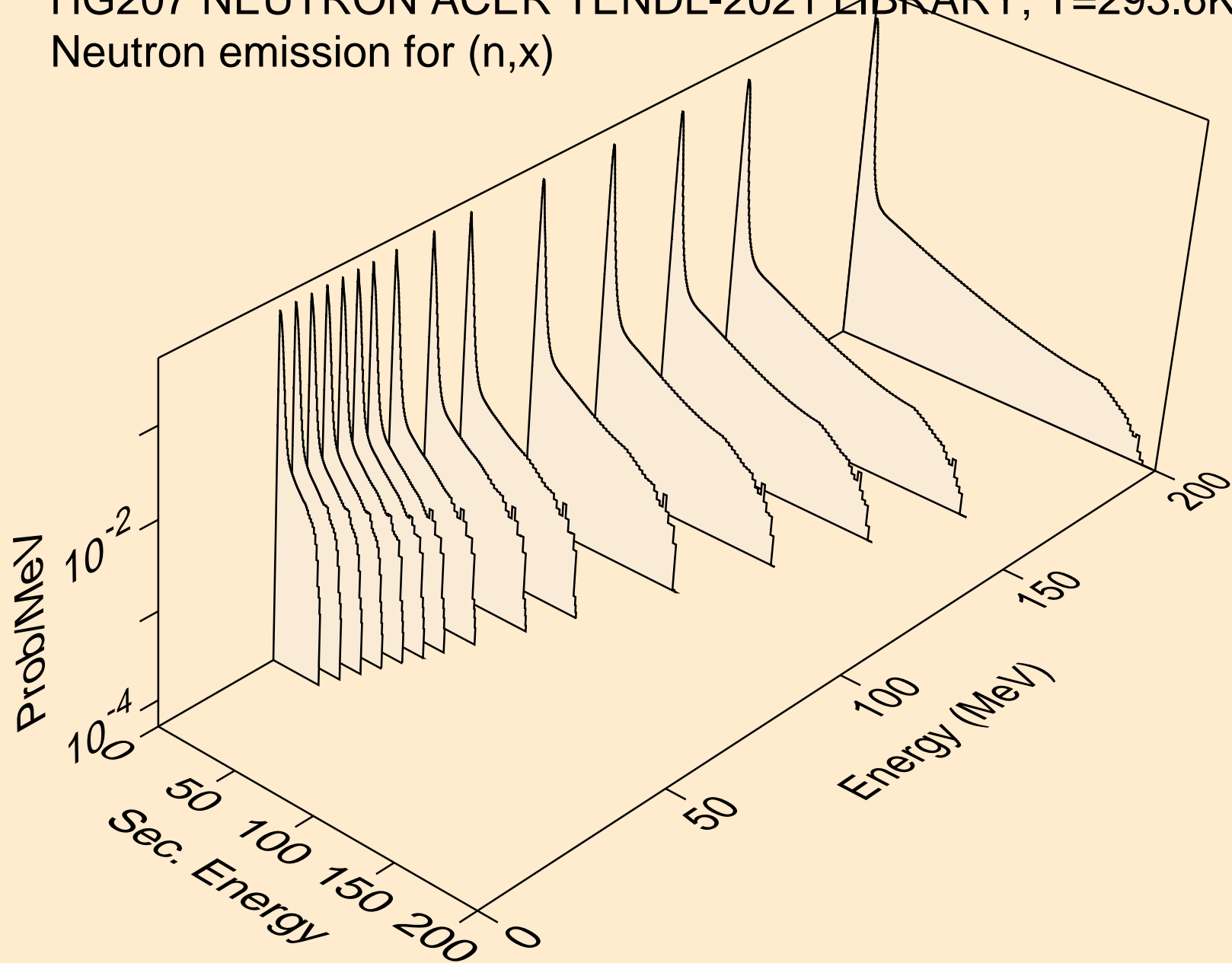

HG207 NEUTRON ACER TENDL-2021 LIBRARY; T=293.6K
Neutron emission for (n,2nd)

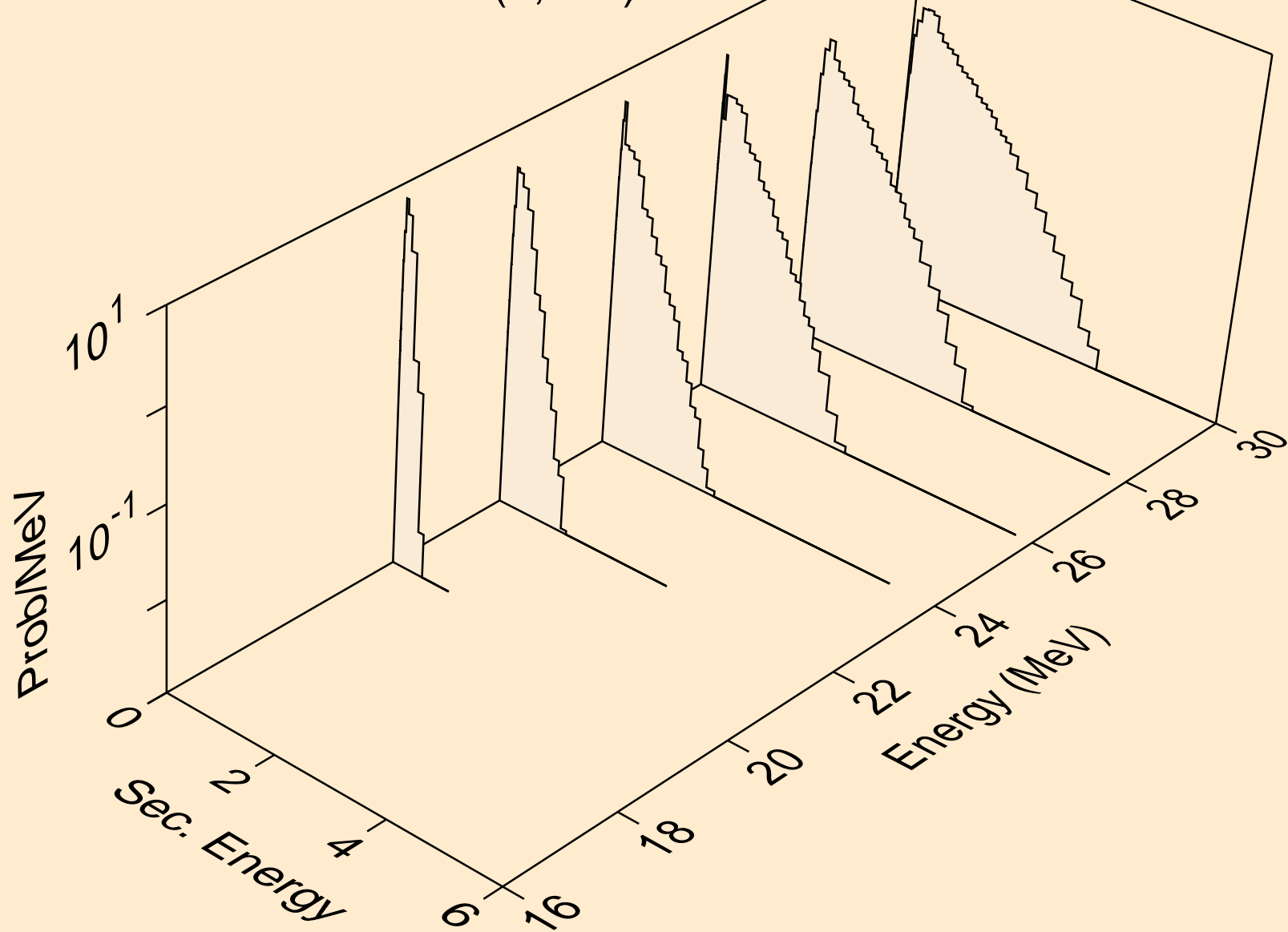

HG207 NEUTRON ACER TENDL-2021 LIBRARY; T=293.6K
Neutron emission for (n,2n)

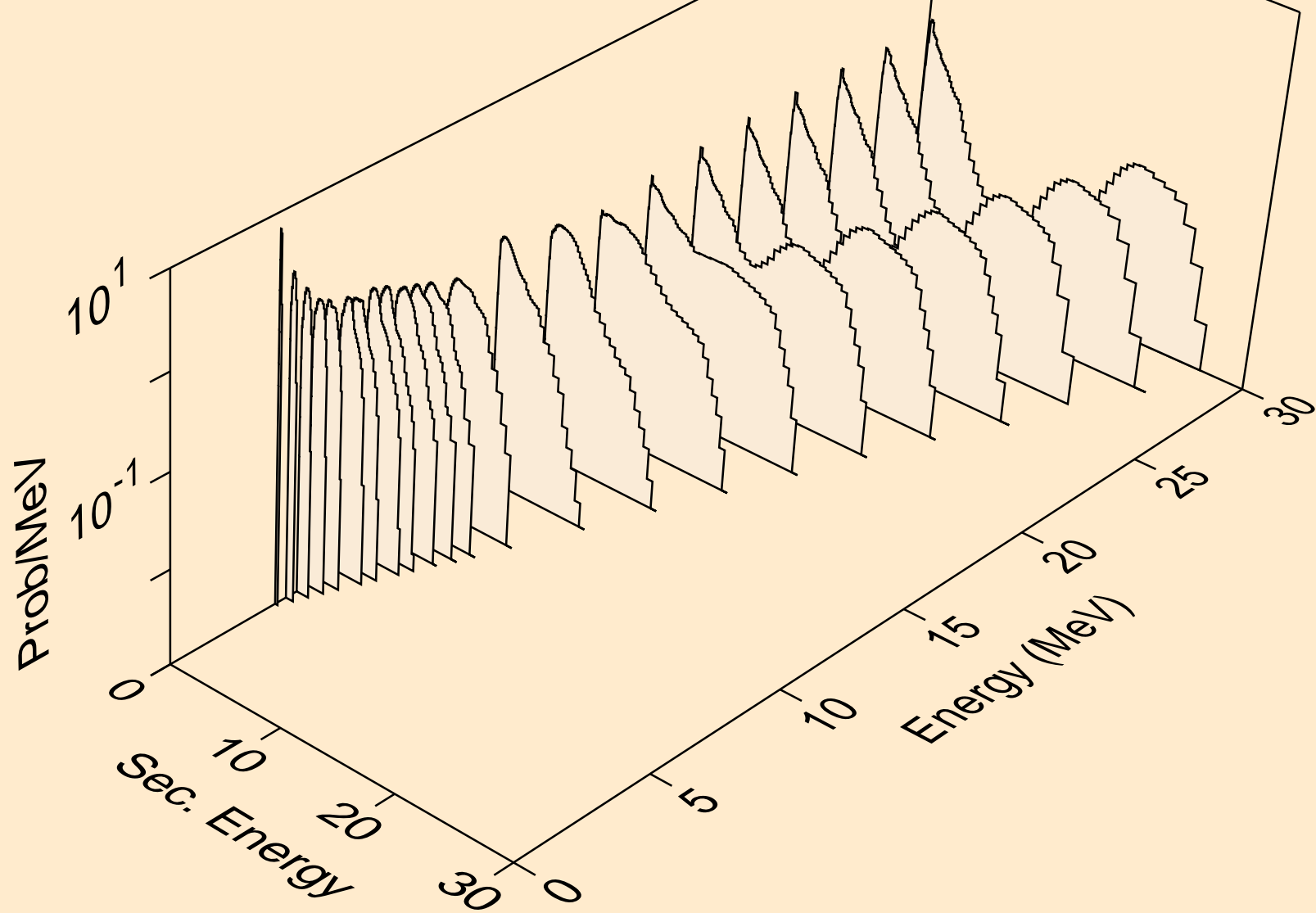

HG207 NEUTRON ACER TENDL-2021 LIBRARY; T=293.6K
Neutron emission for (n,3n)

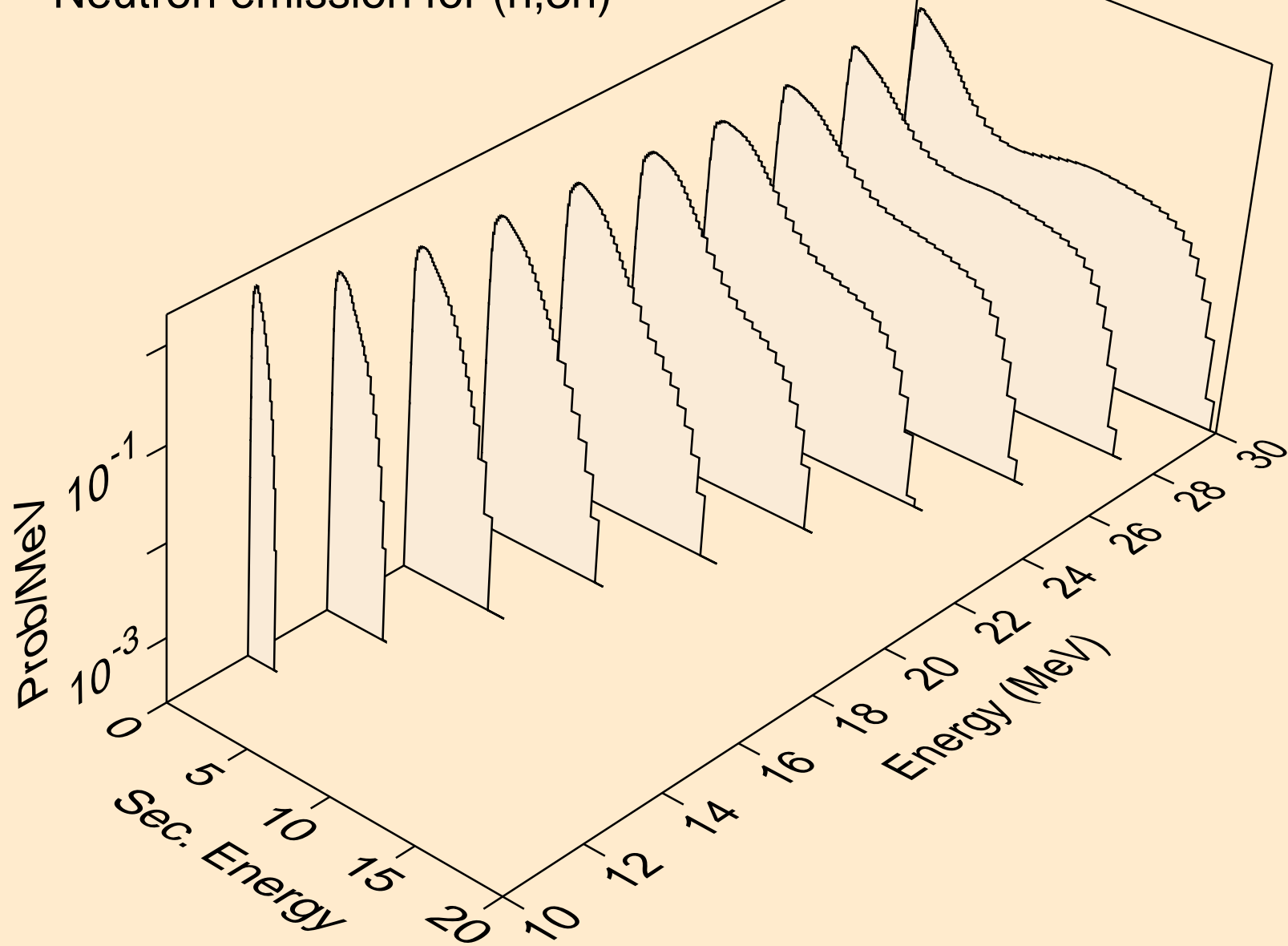

HG207 NEUTRON ACER TENDL-2021 LIBRARY; T=293.6K
Neutron emission for (n,n*)a

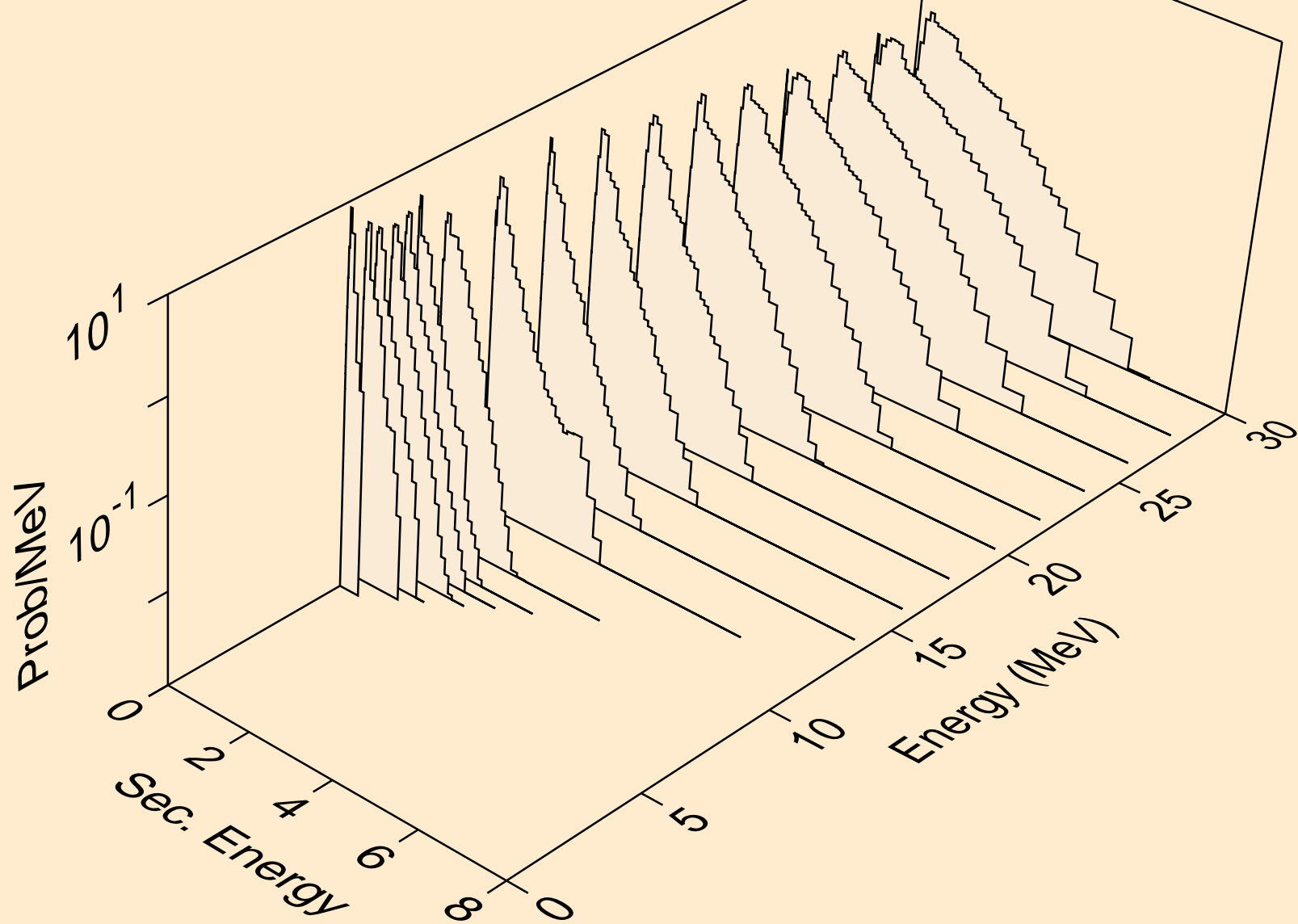

HG207 NEUTRON ACER TENDL-2021 LIBRARY; T=293.6K
Neutron emission for (n,2n)a

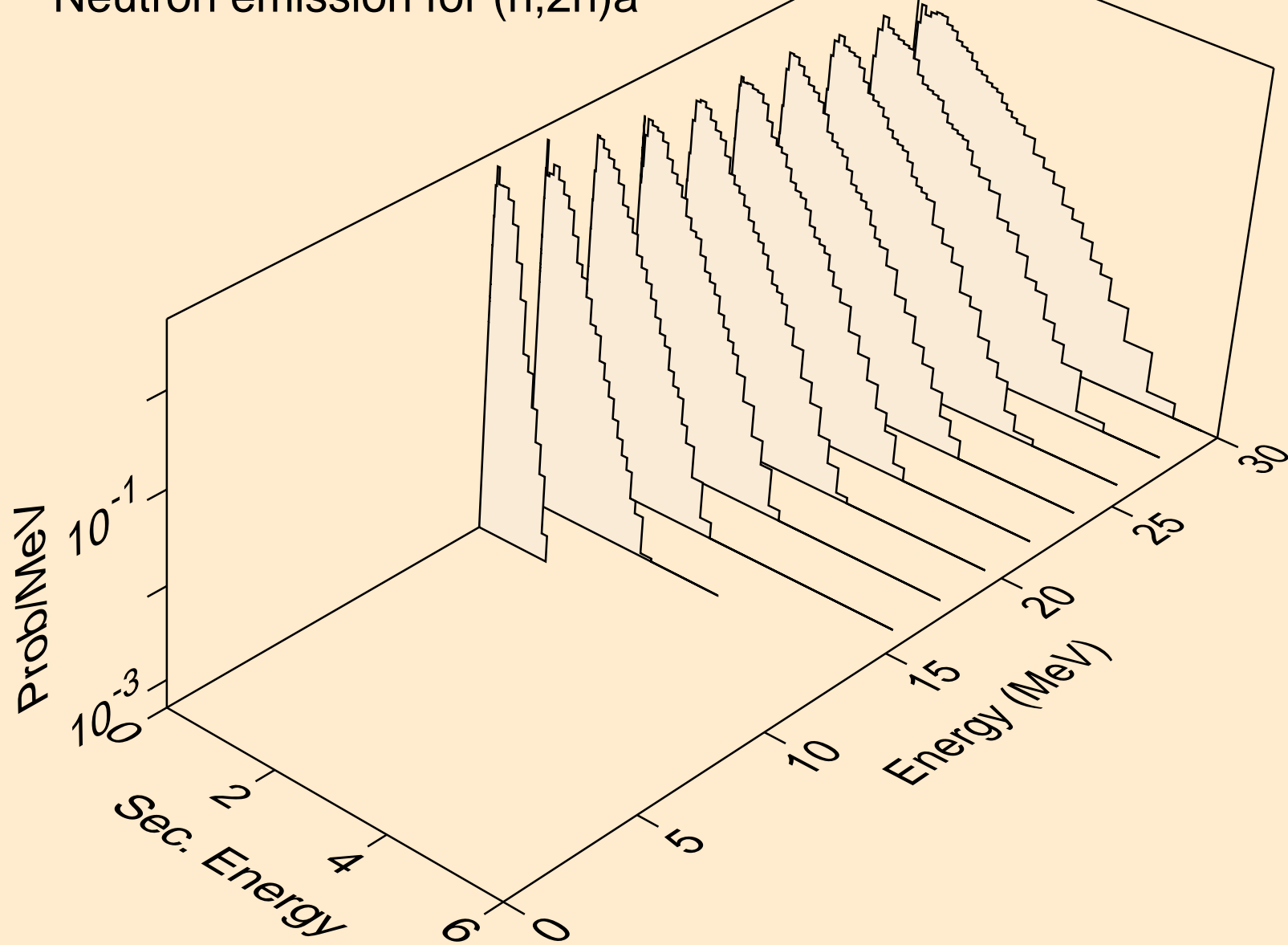

HG207 NEUTRON ACER TENDL-2021 LIBRARY; T=293.6K
Neutron emission for (n,3n)a

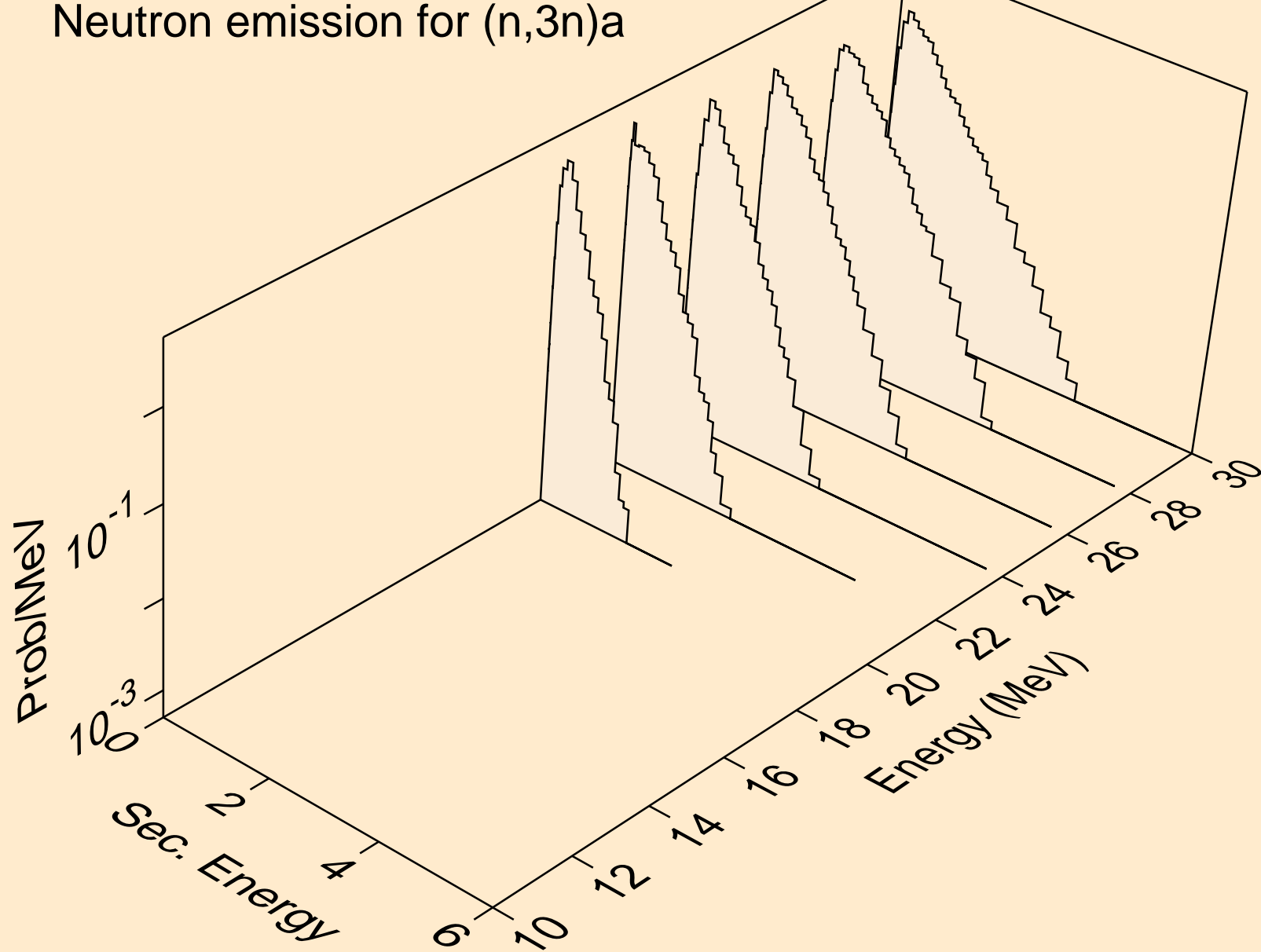

HG207 NEUTRON ACER TENDL-2021 LIBRARY; T=293.6K
Neutron emission for (n,n*)p

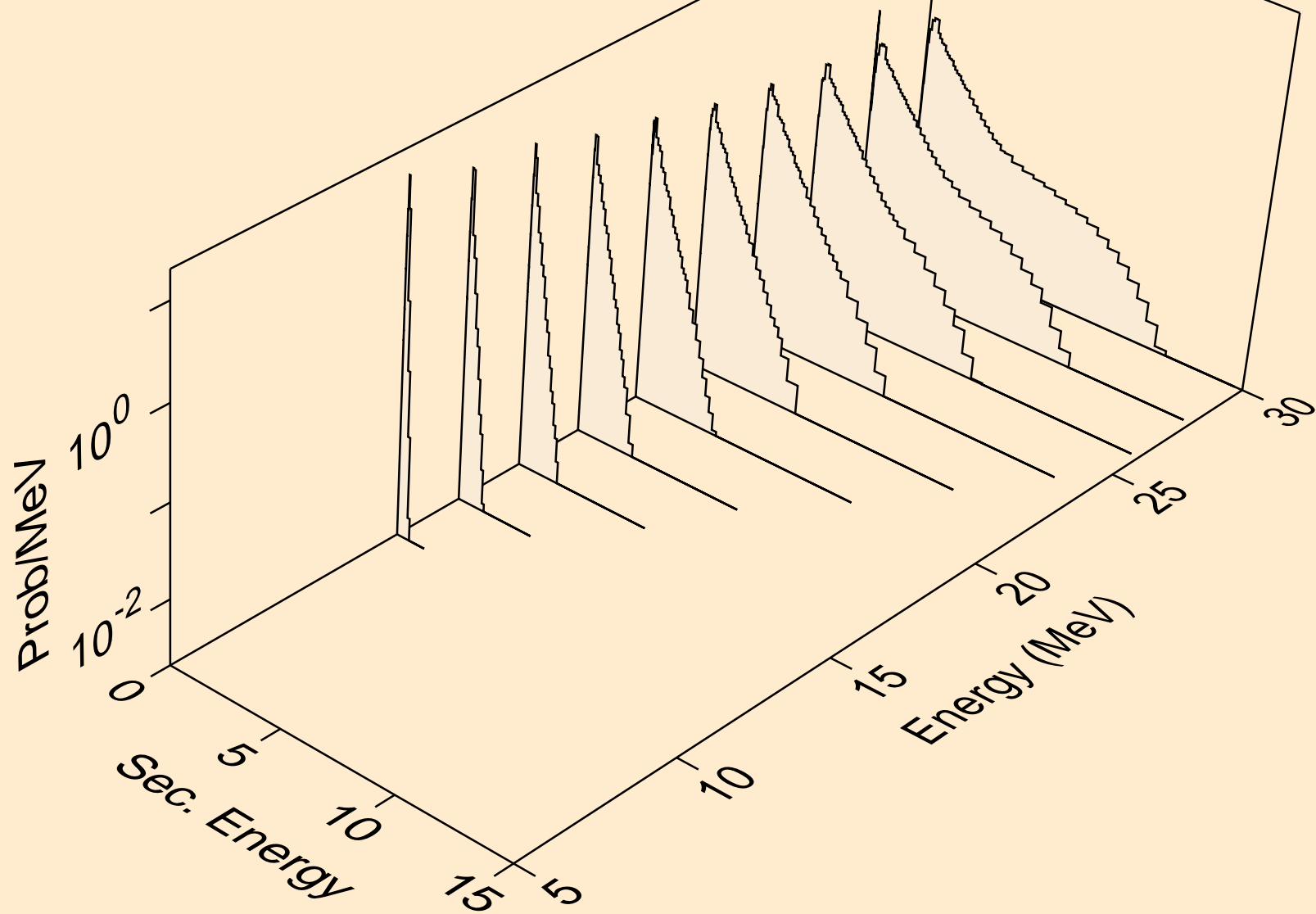

HG207 NEUTRON ACER TENDL-2021 LIBRARY; T=293.6K
Neutron emission for (n,n*)d

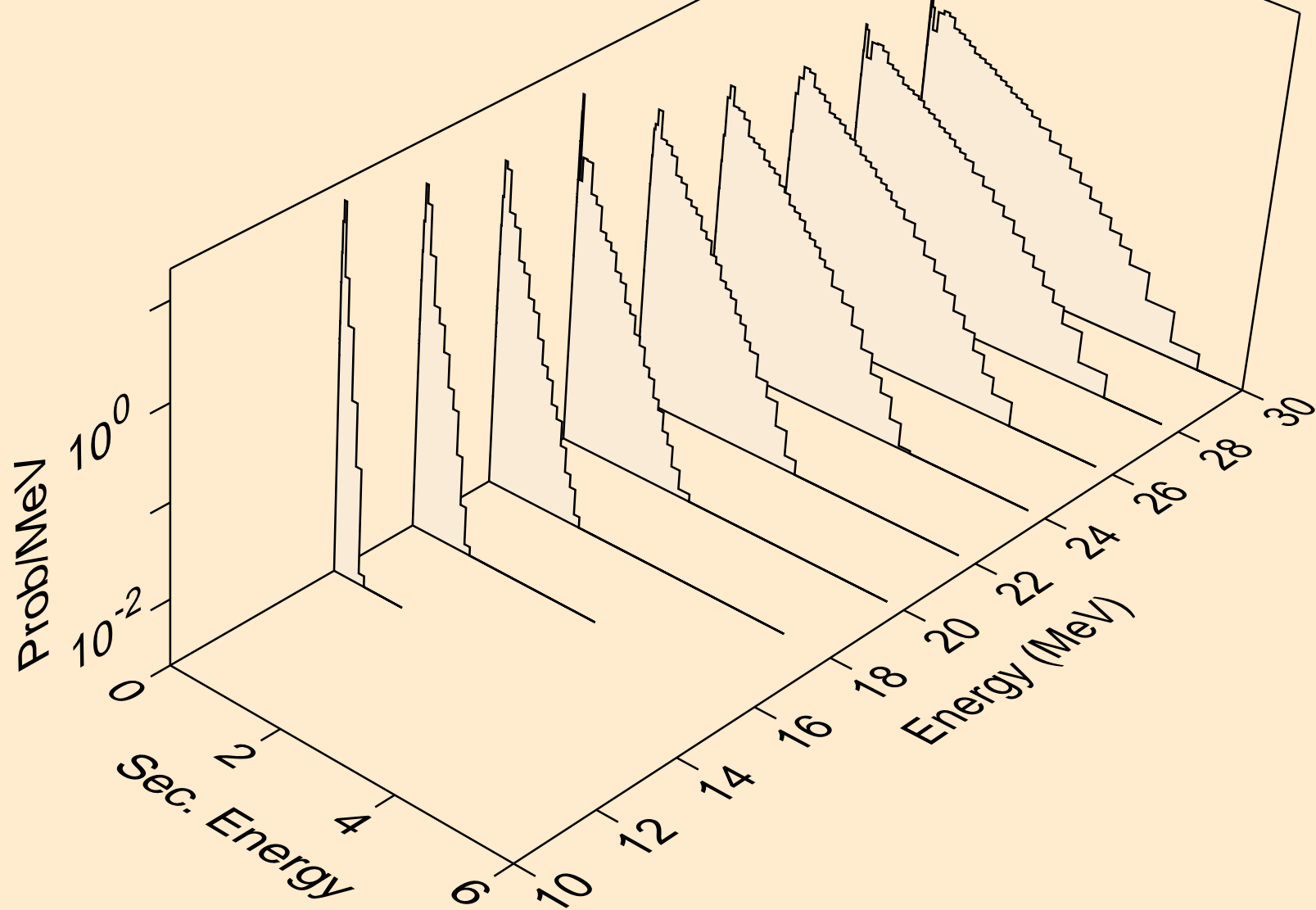

HG207 NEUTRON ACER TENDL-2021 LIBRARY; T=293.6K
Neutron emission for (n,n*)t

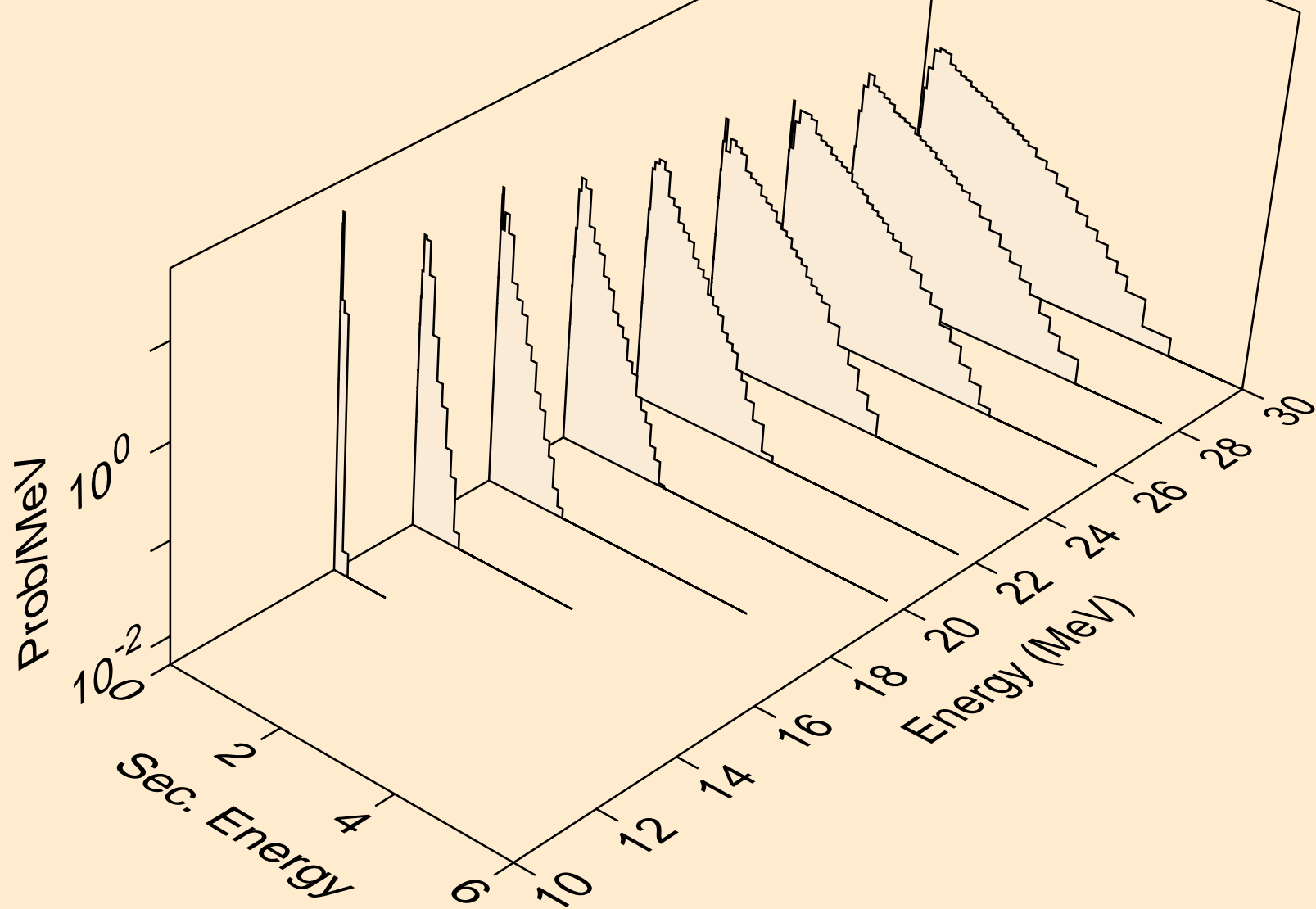

HG207 NEUTRON ACER TENDL-2021 LIBRARY; T=293.6K
Neutron emission for (n,n*)he3

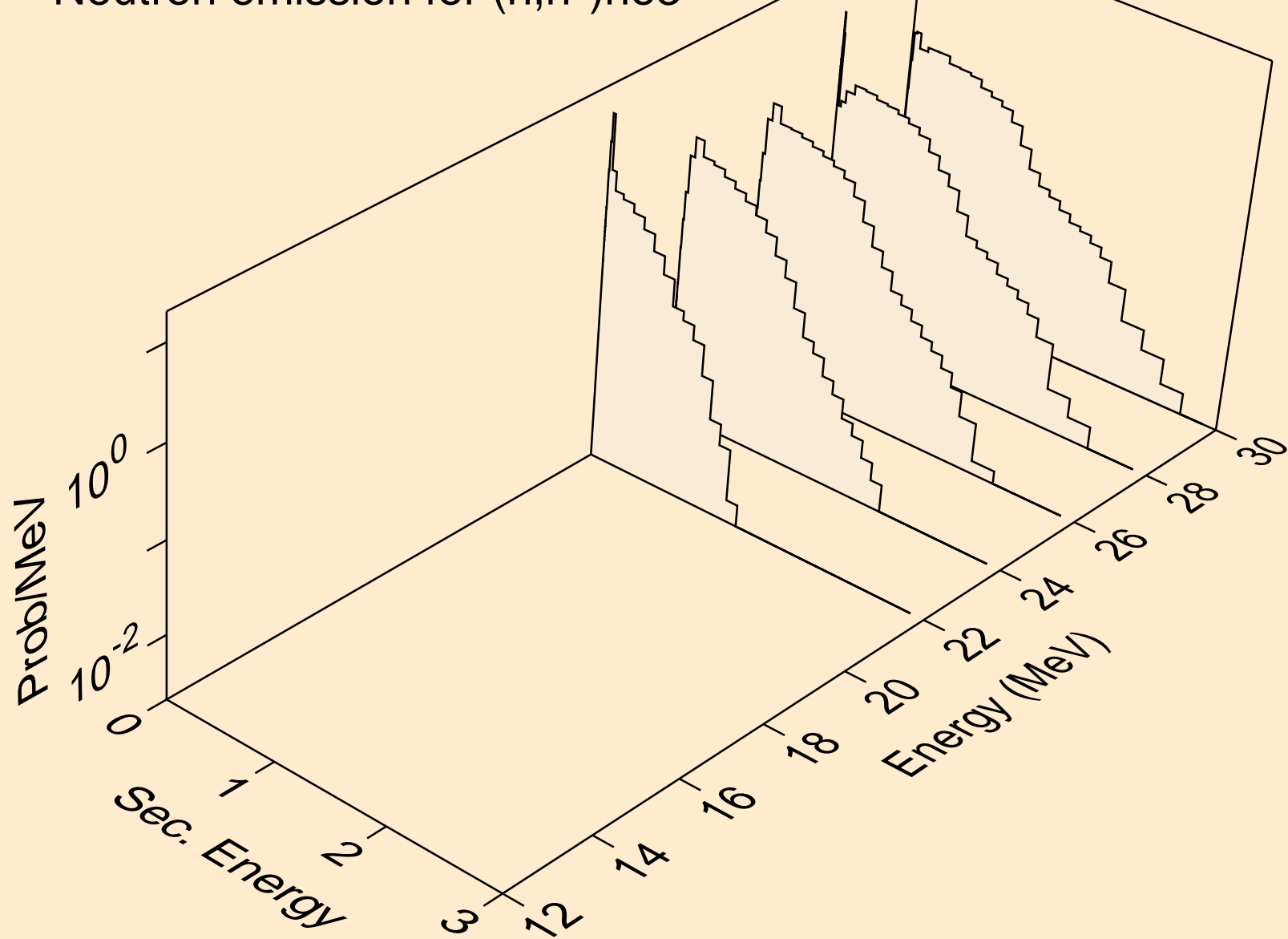

HG207 NEUTRON ACER TENDL-2021 LIBRARY; T=293.6K
Neutron emission for (n,4n)

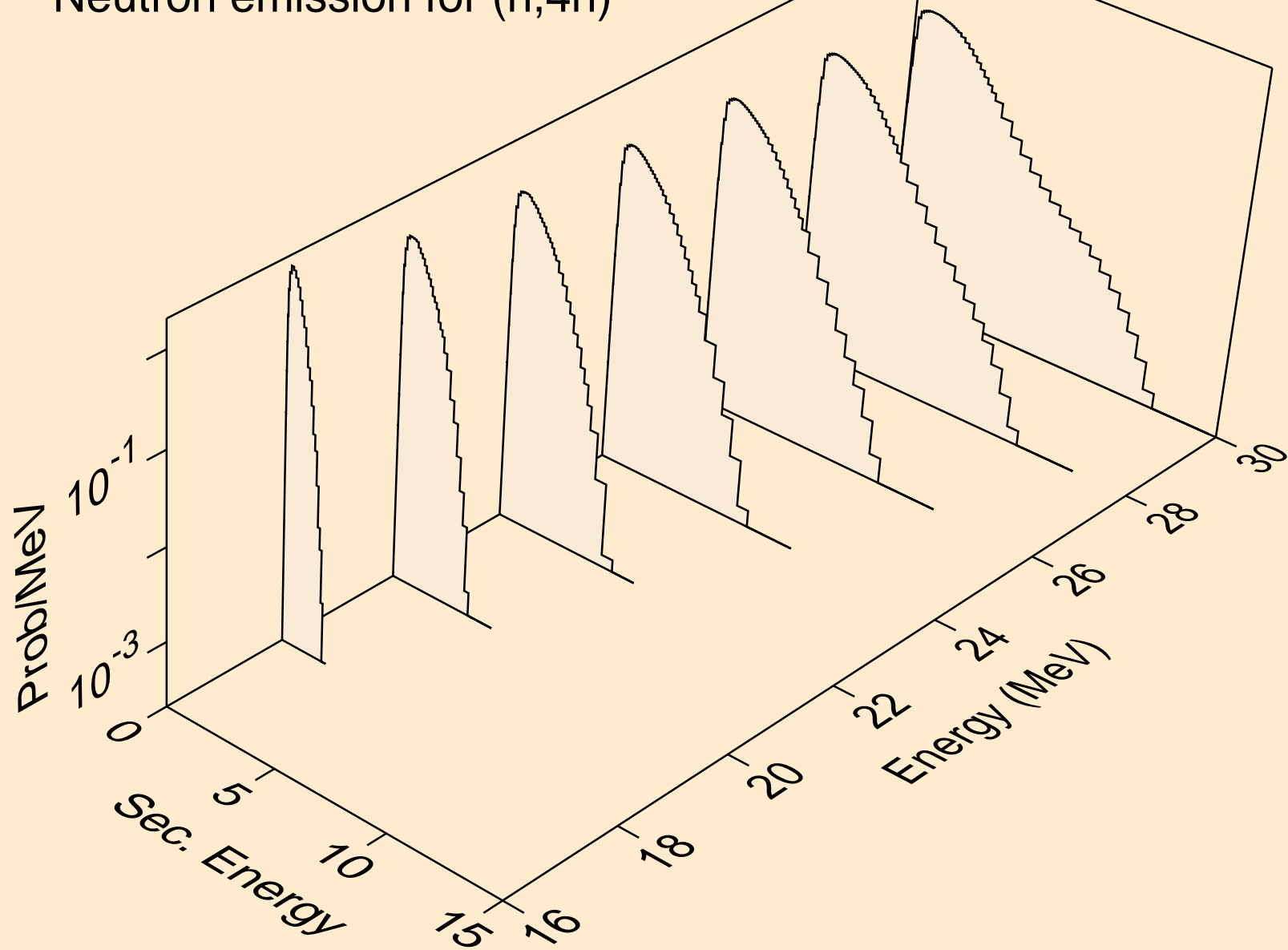

HG207 NEUTRON ACER TENDL-2021 LIBRARY; T=293.6K
Neutron emission for (n,2np)

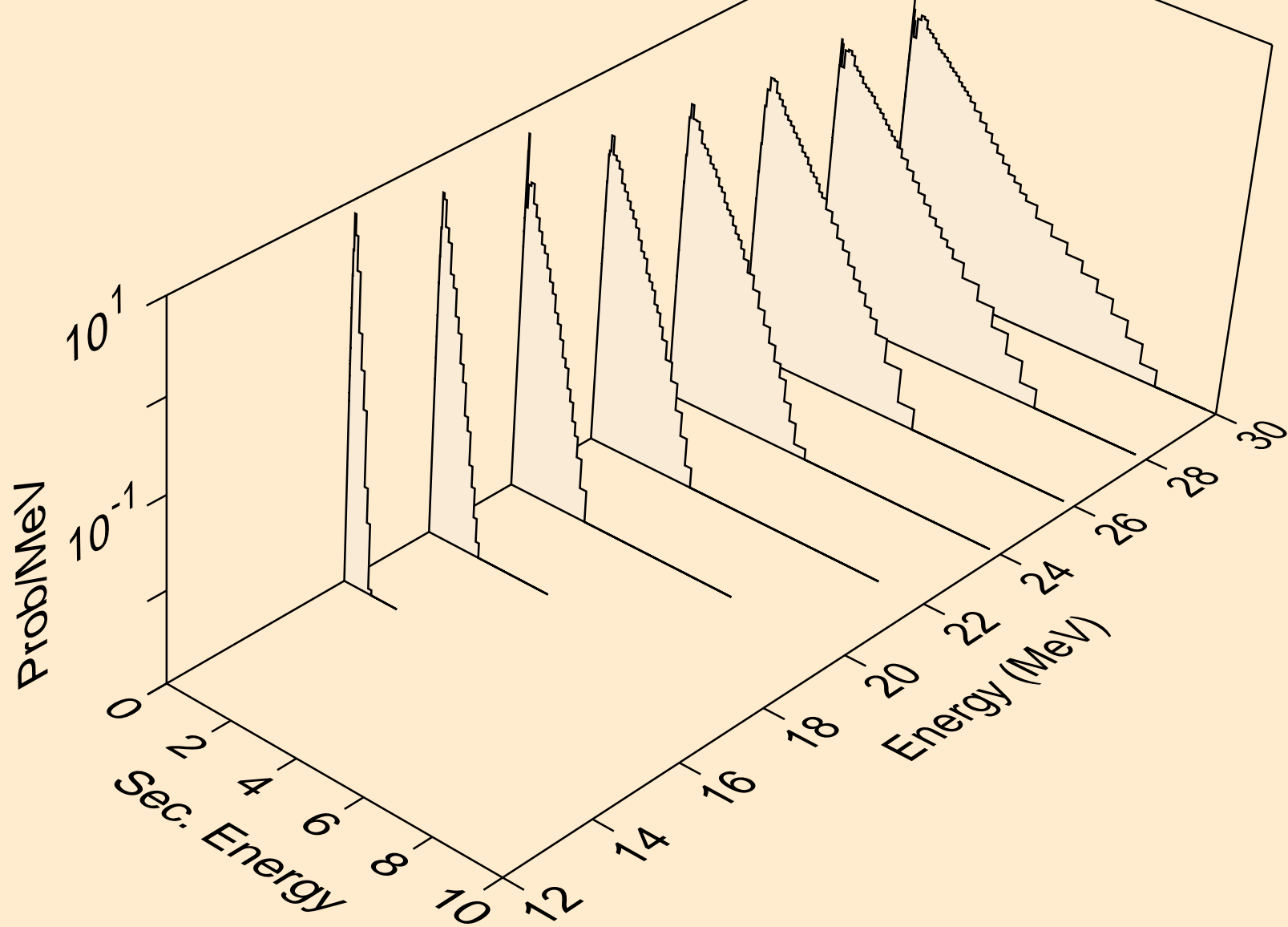

HG207 NEUTRON ACER TENDL-2021 LIBRARY; T=293.6K
Neutron emission for (n,3np)

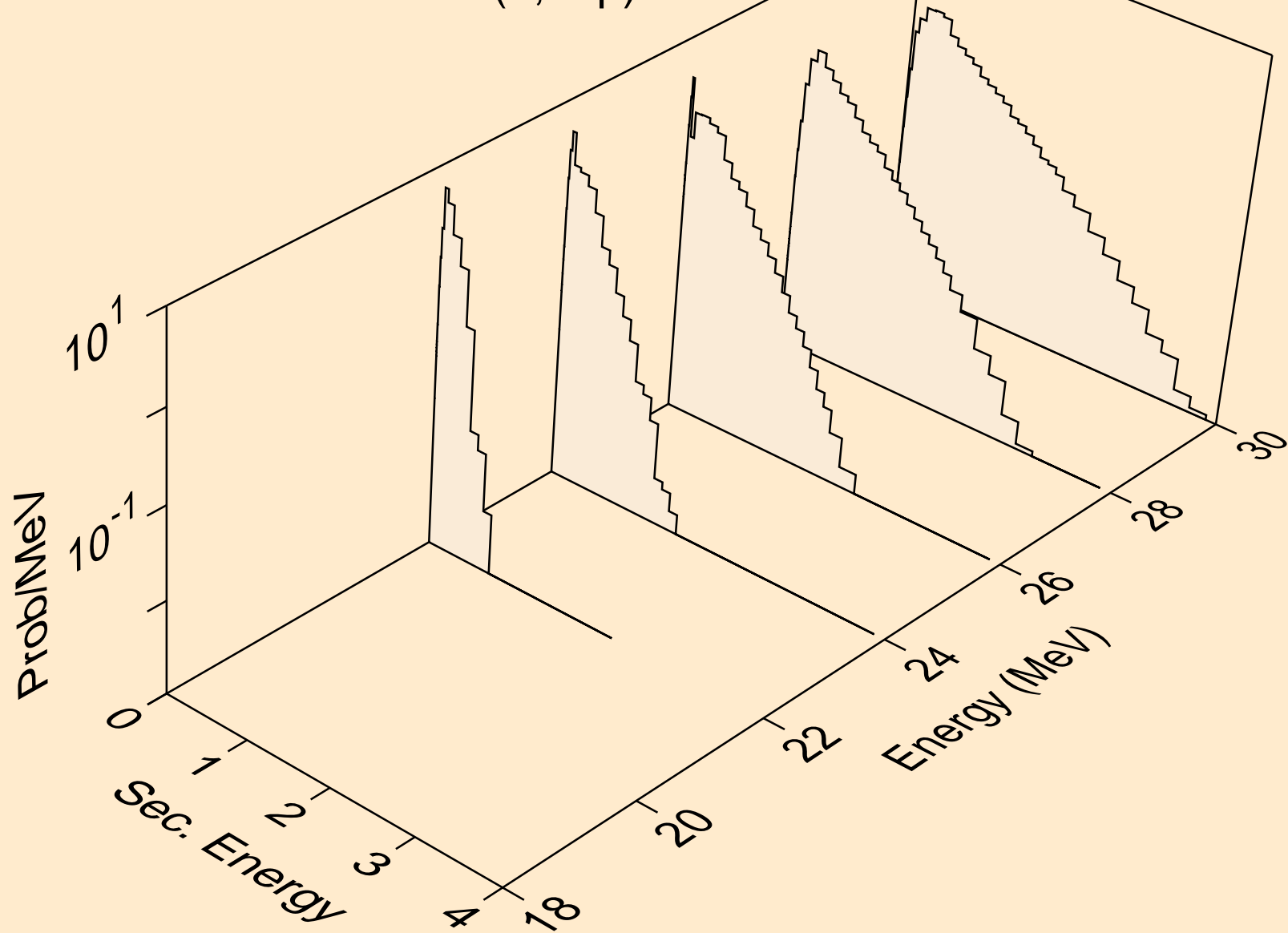

HG207 NEUTRON ACER TENDL-2021 LIBRARY; T=293.6K
Neutron emission for (n,n*c)

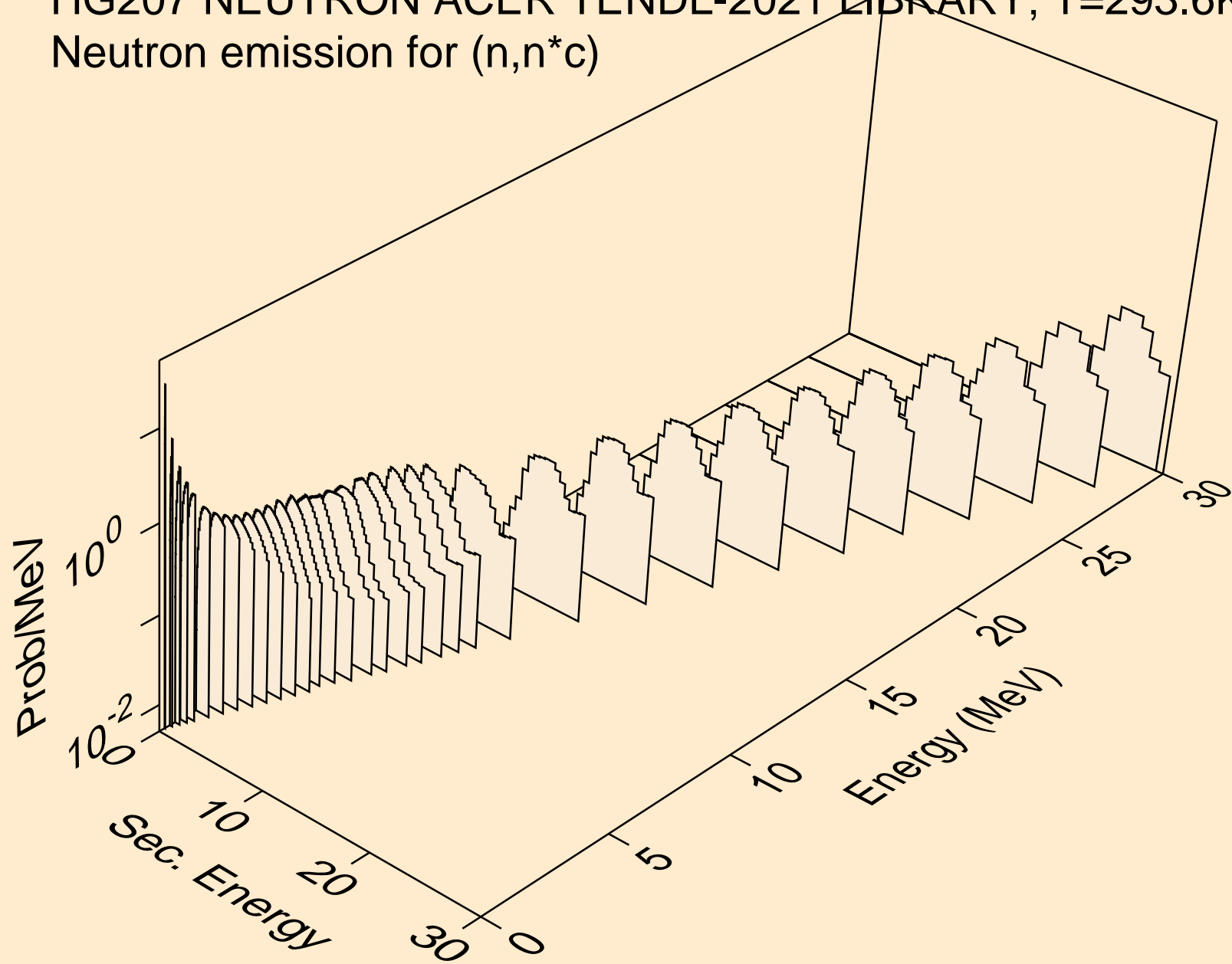

HG207 NEUTRON ACER TENDL-2021 LIBRARY; T=293.6K
Photon emission for (n,x)

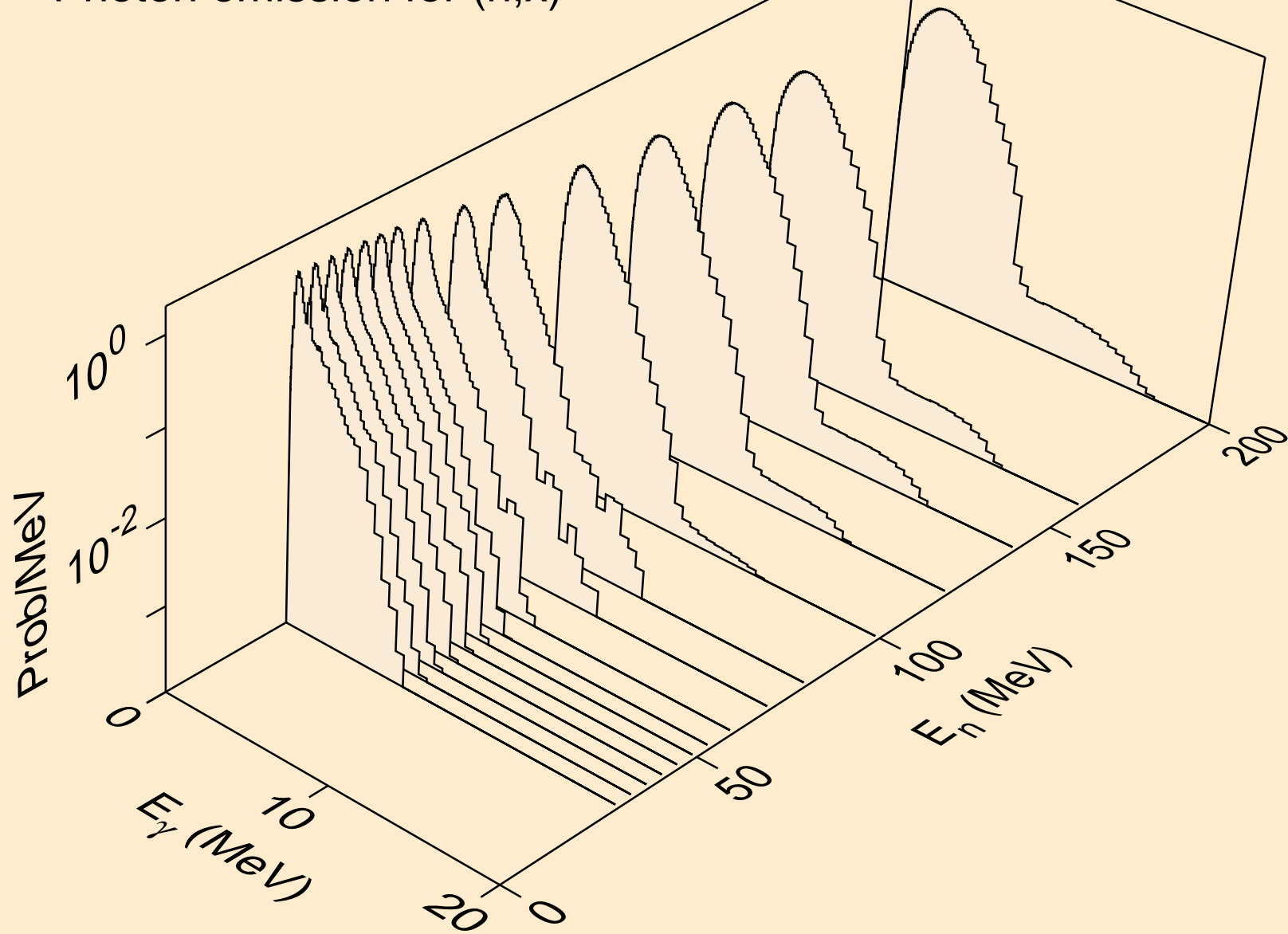

HG207 NEUTRON ACER TENDL-2021 LIBRARY; T=293.6K
Photon emission for (n,2nd)

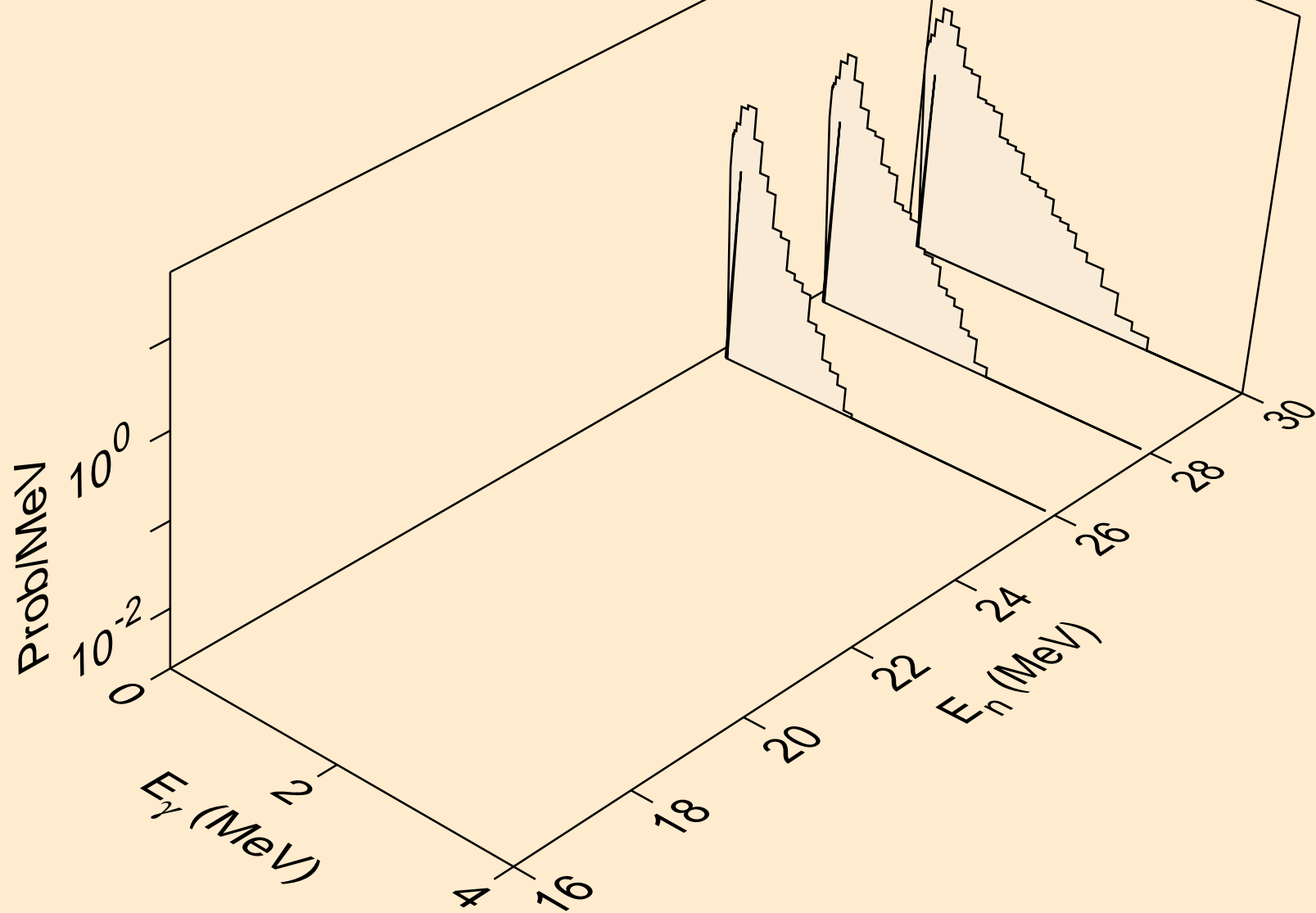

HG207 NEUTRON ACER TENDL-2021 LIBRARY; T=293.6K
Photon emission for (n,2n)

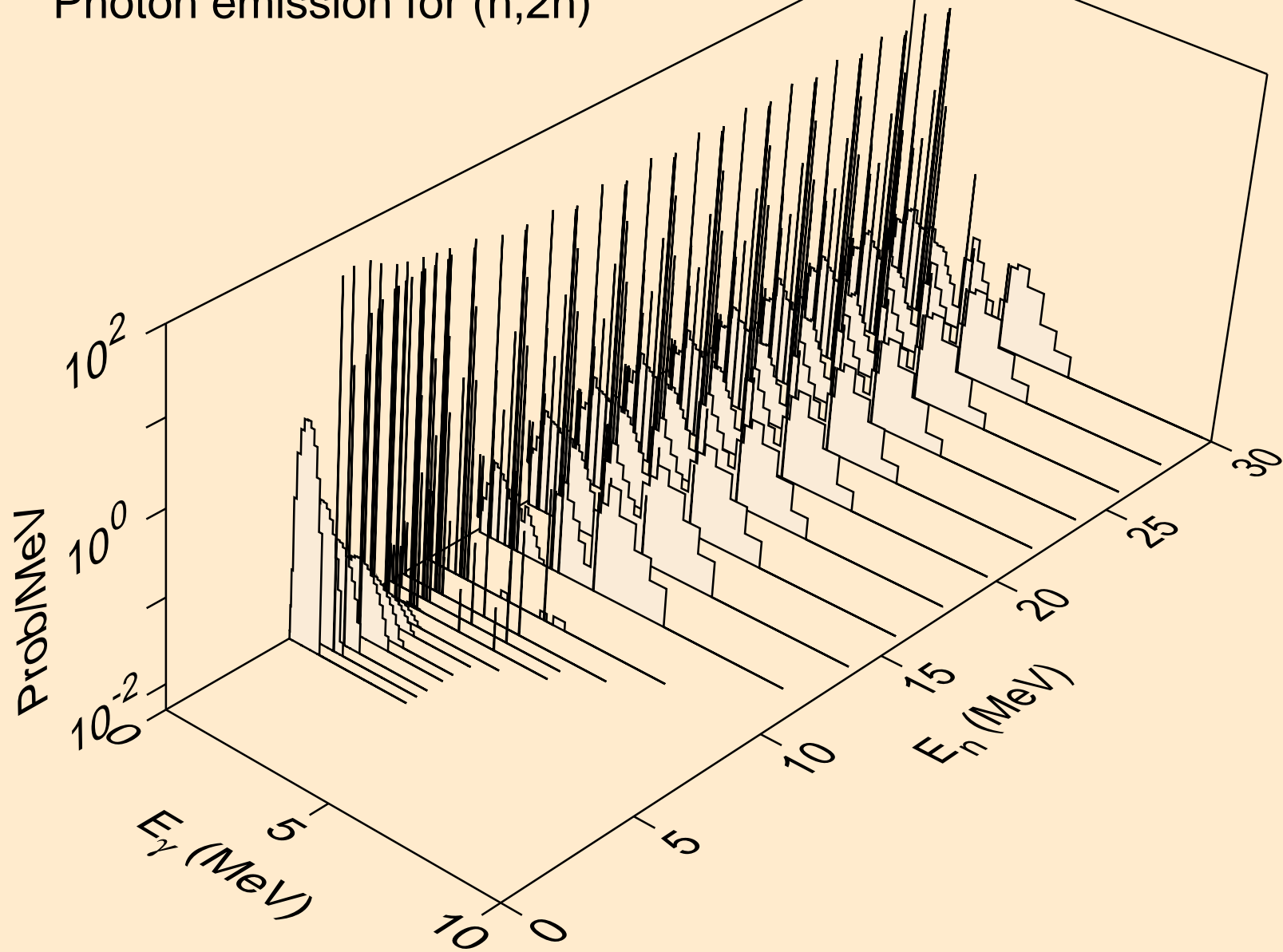

HG207 NEUTRON ACER TENDL-2021 LIBRARY; T=293.6K
Photon emission for (n,3n)

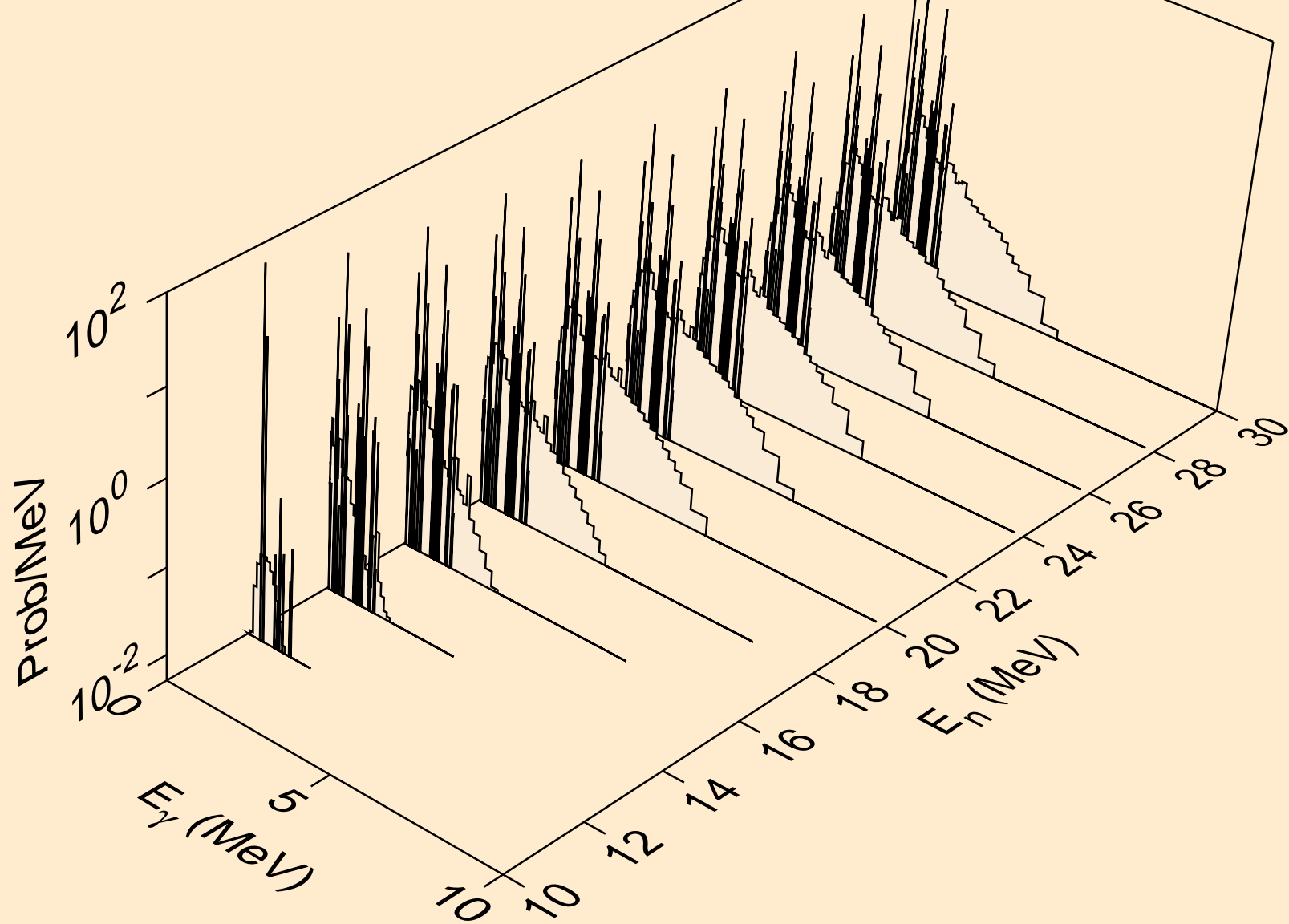

HG207 NEUTRON ACER TENDL-2021 LIBRARY; T=293.6K
Photon emission for (n,n*)a

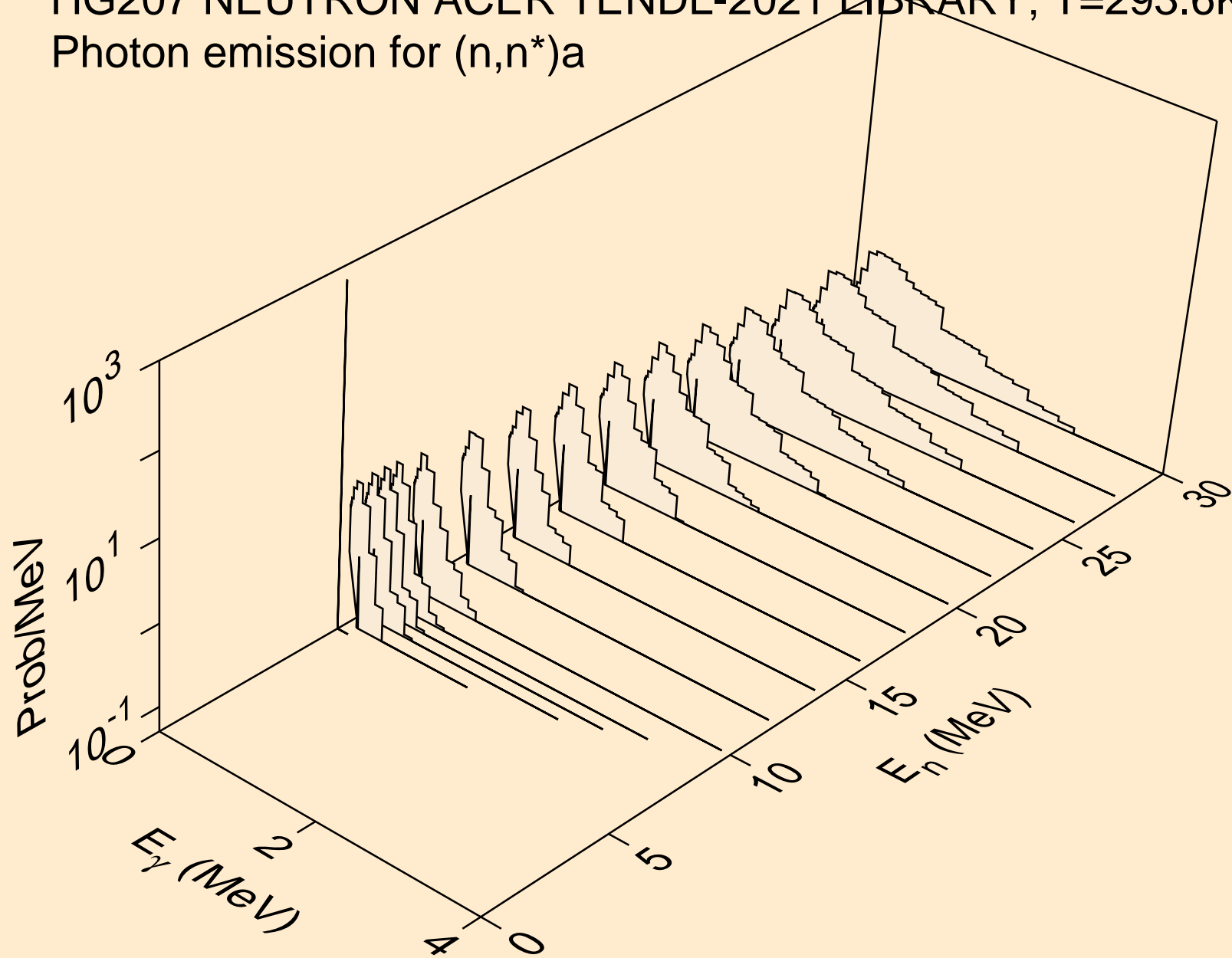

HG207 NEUTRON ACER TENDL-2021 LIBRARY; T=293.6K
Photon emission for (n,2n)a

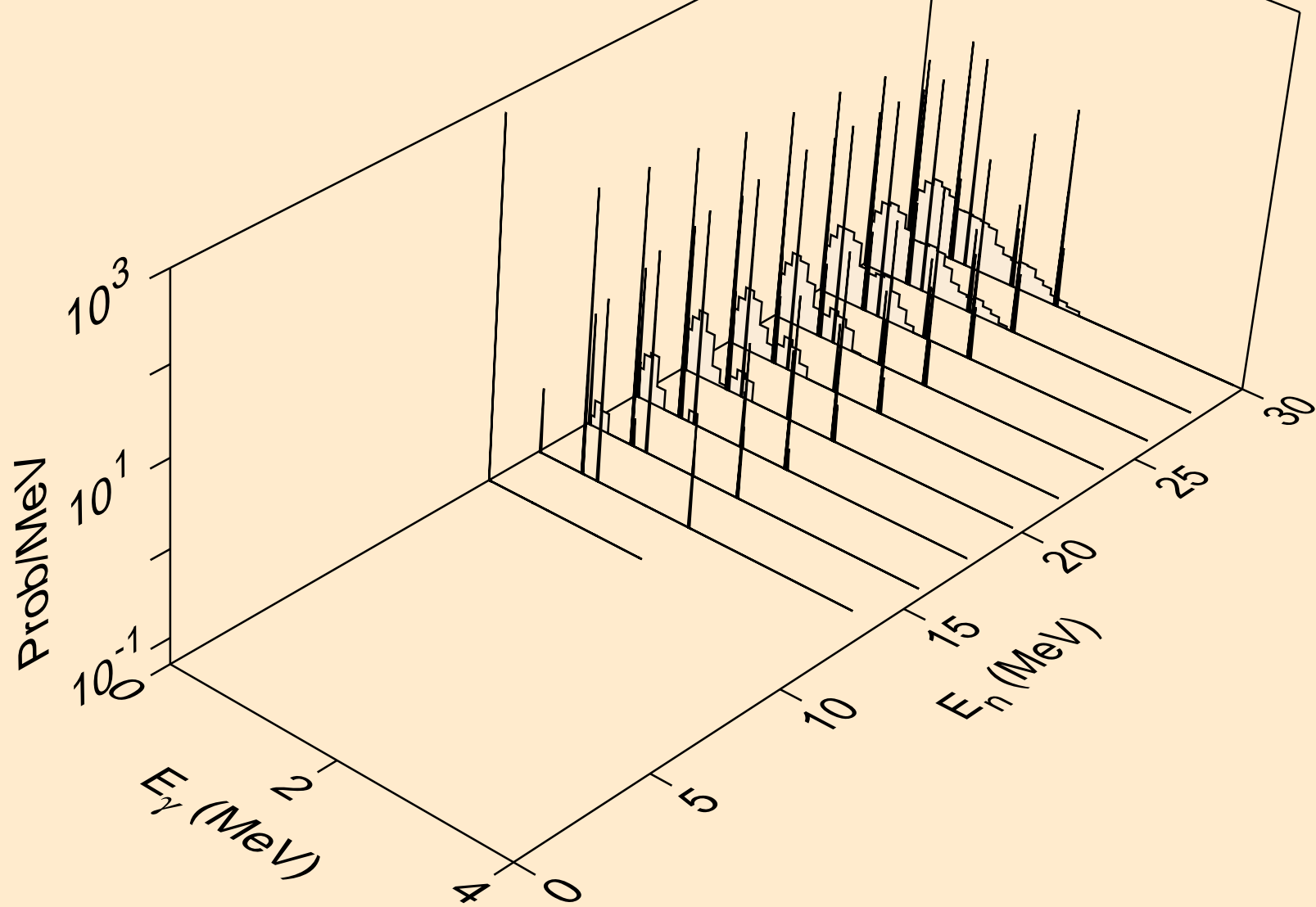

HG207 NEUTRON ACER TENDL-2021 LIBRARY; T=293.6K
Photon emission for (n,3n)a

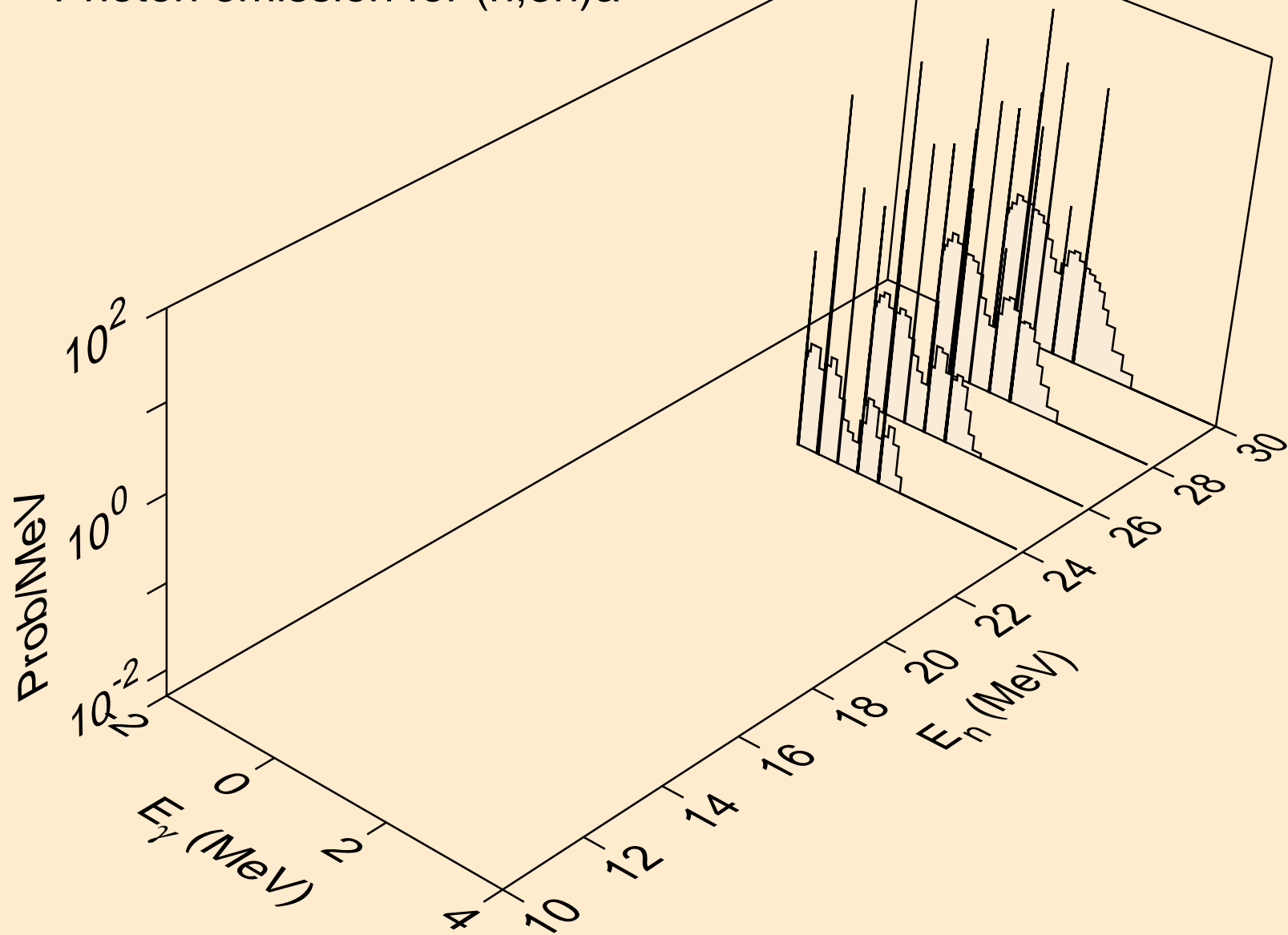

HG207 NEUTRON ACER TENDL-2021 LIBRARY; T=293.6K
Photon emission for (n,n*)p

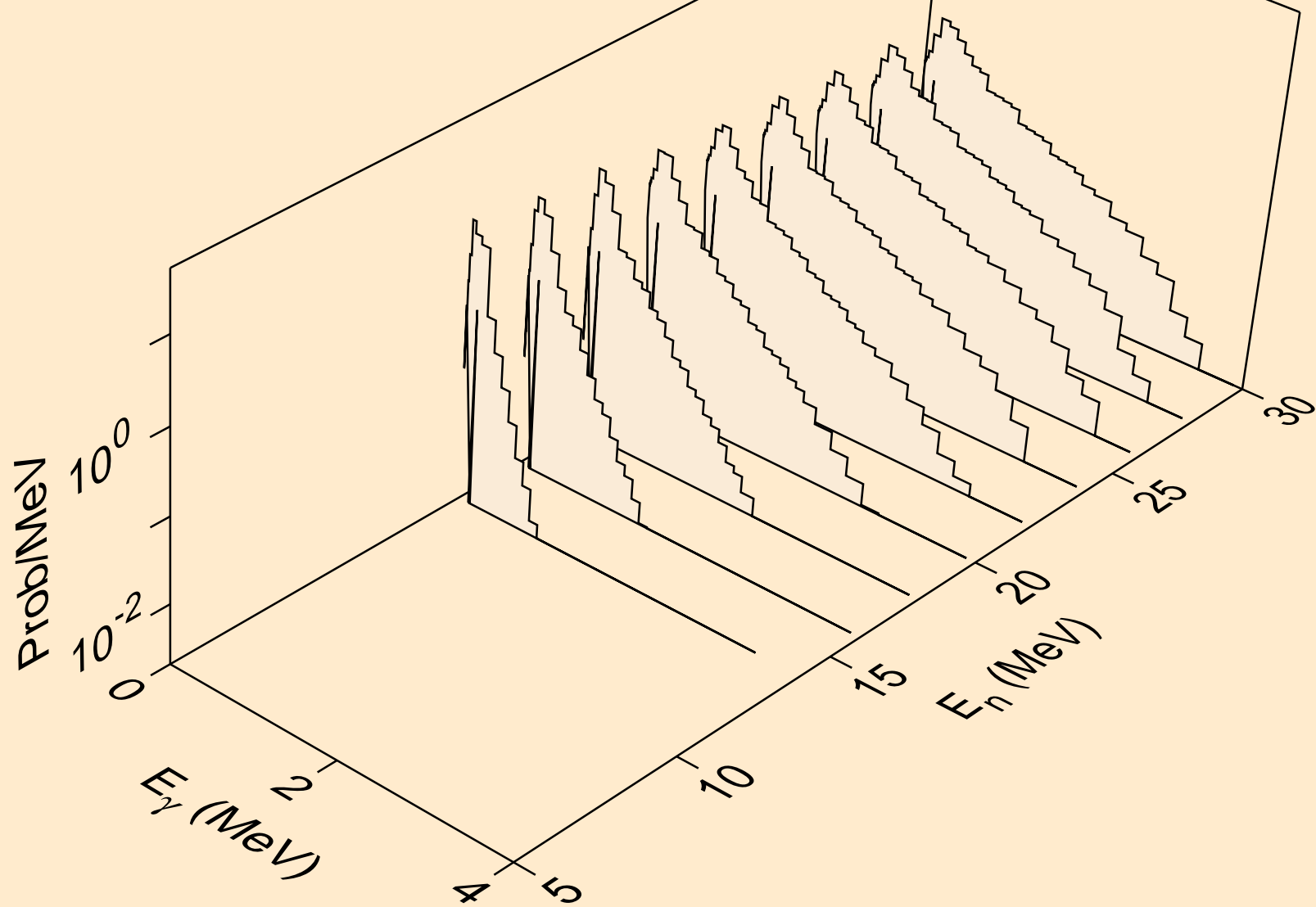

HG207 NEUTRON ACER TENDL-2021 LIBRARY; T=293.6K
Photon emission for (n,n*)d

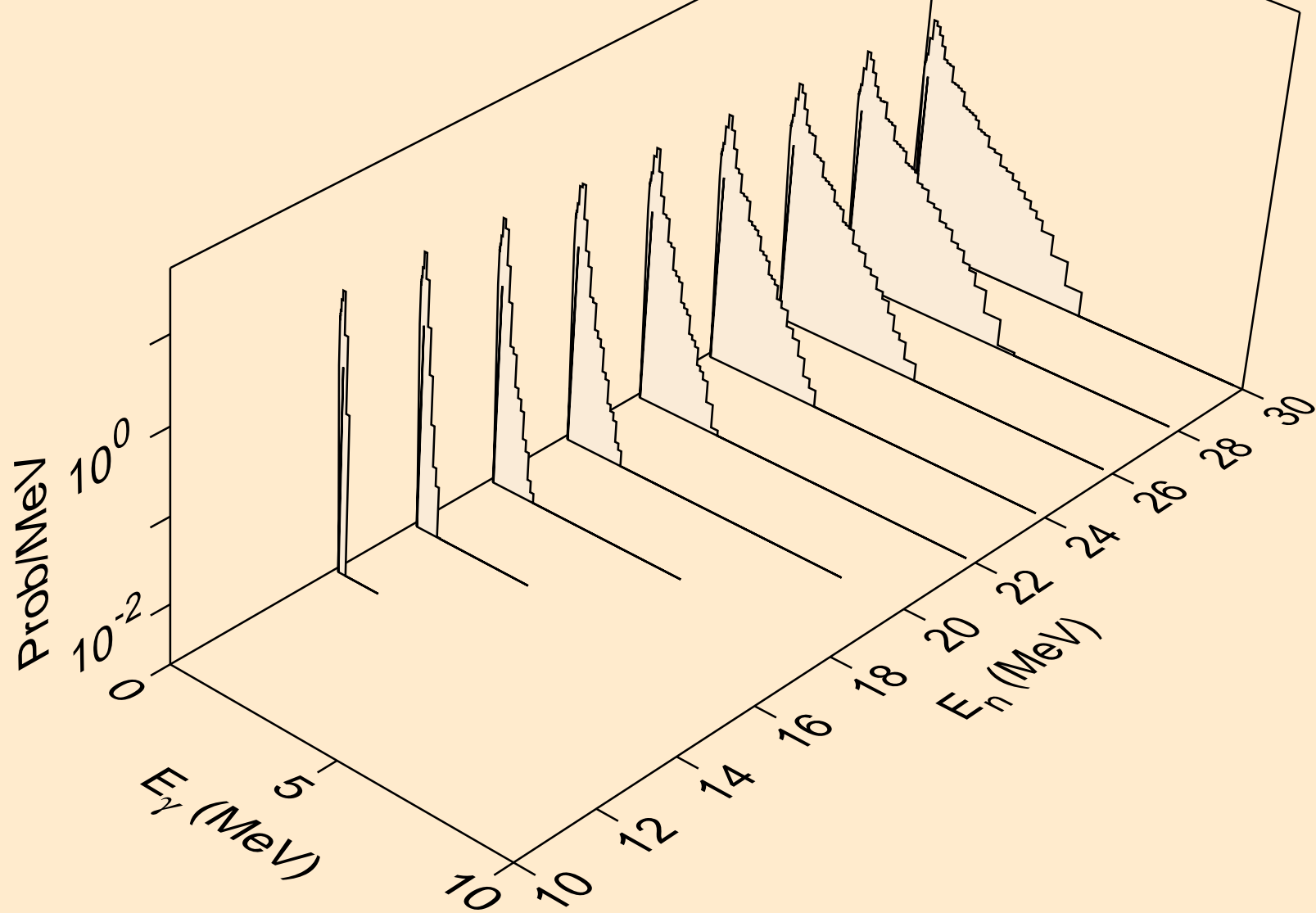

HG207 NEUTRON ACER TENDL-2021 LIBRARY; T=293.6K
Photon emission for (n,n*)t

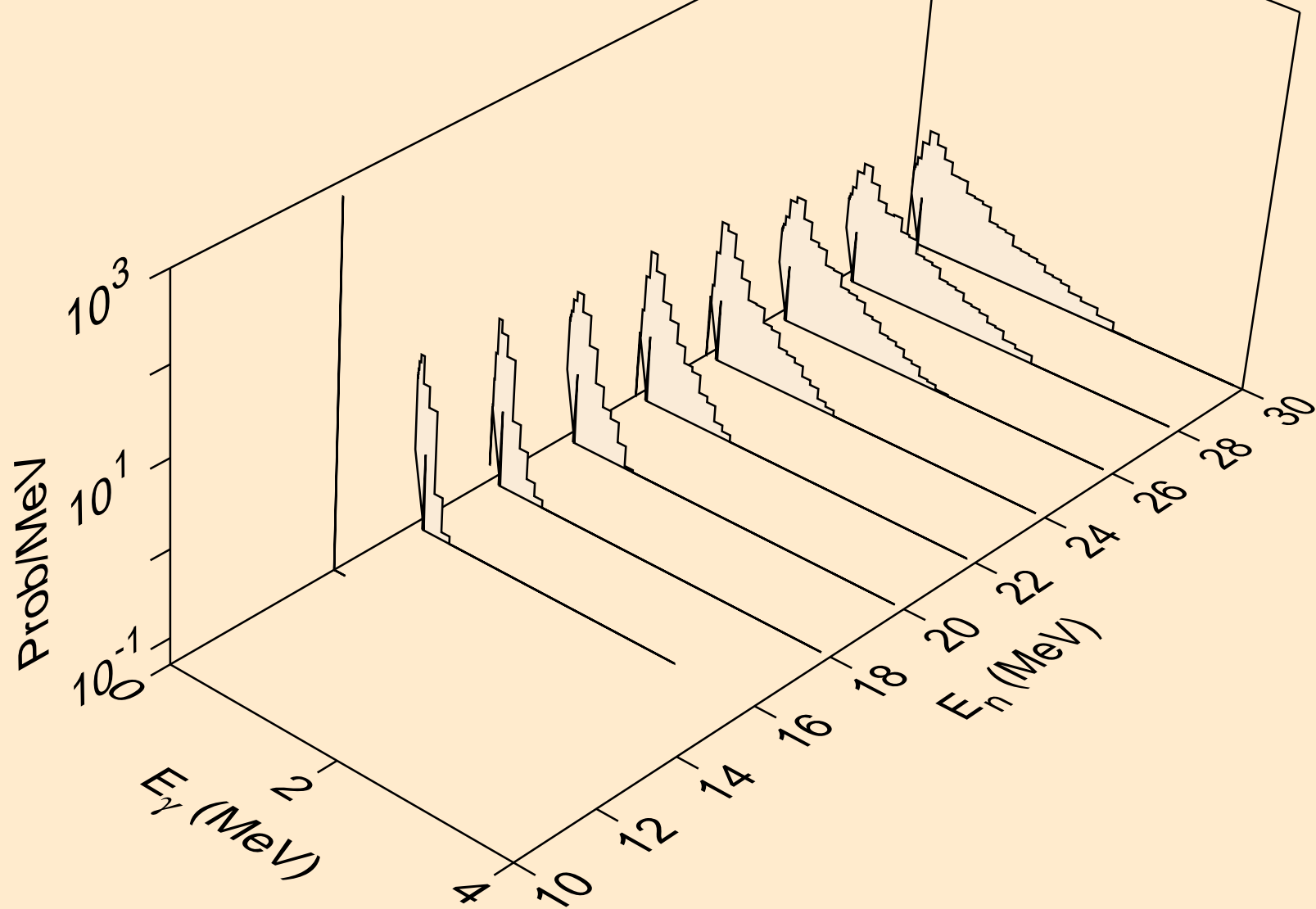

HG207 NEUTRON ACER TENDL-2021 LIBRARY; T=293.6K
Photon emission for (n,n*)he3

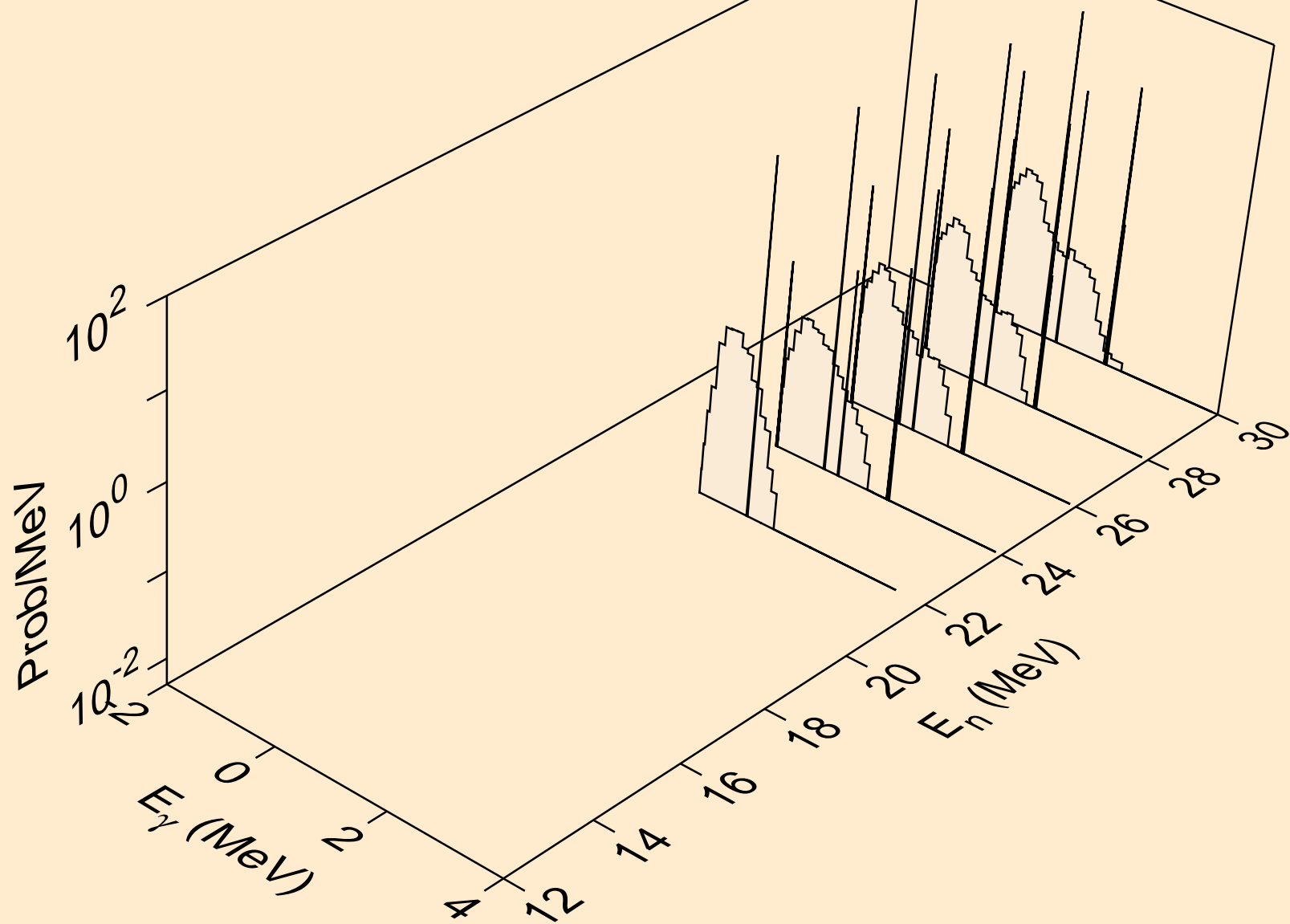

HG207 NEUTRON ACER TENDL-2021 LIBRARY; T=293.6K
Photon emission for (n,4n)

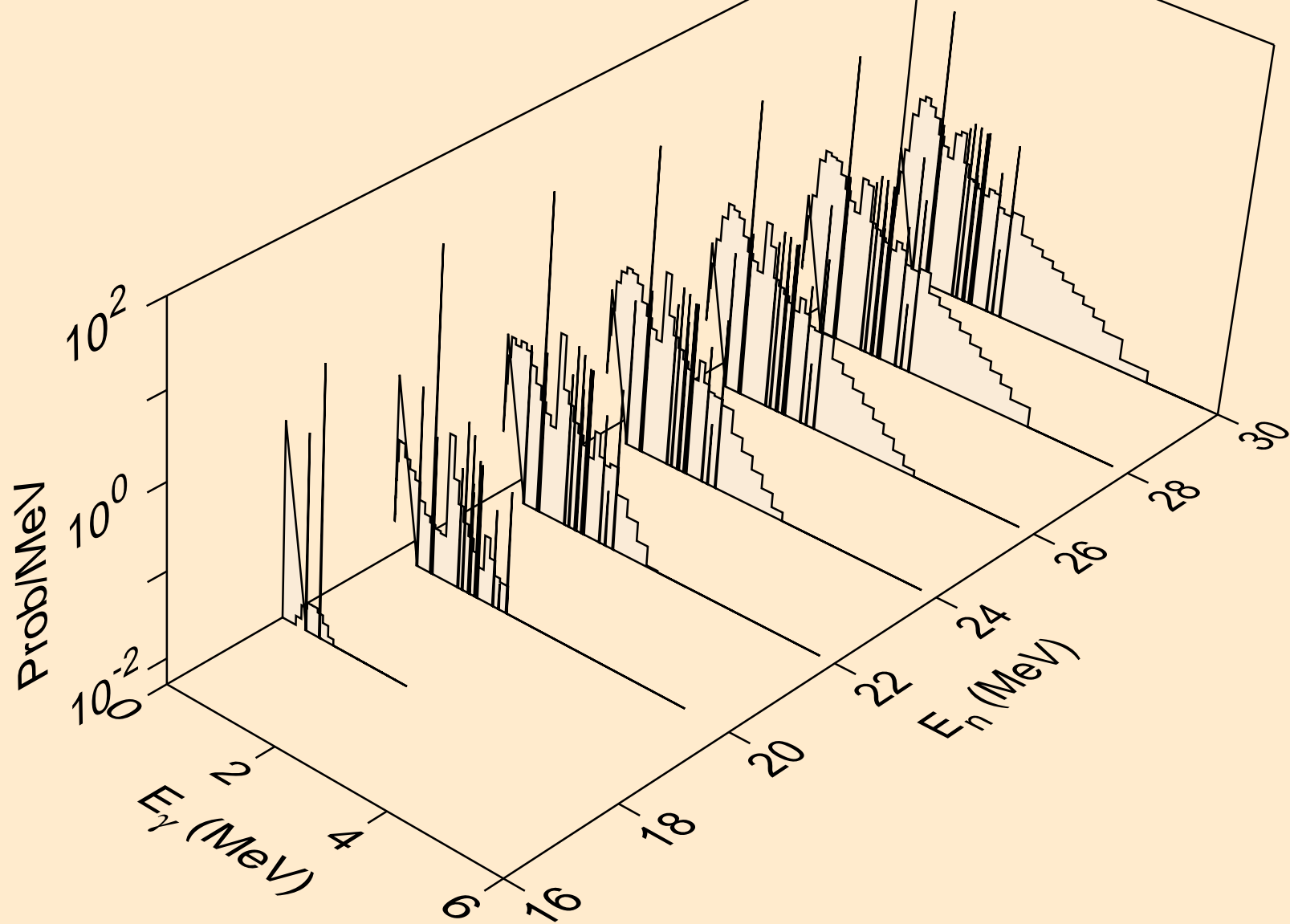

HG207 NEUTRON ACER TENDL-2021 LIBRARY; T=293.6K
Photon emission for (n,2np)

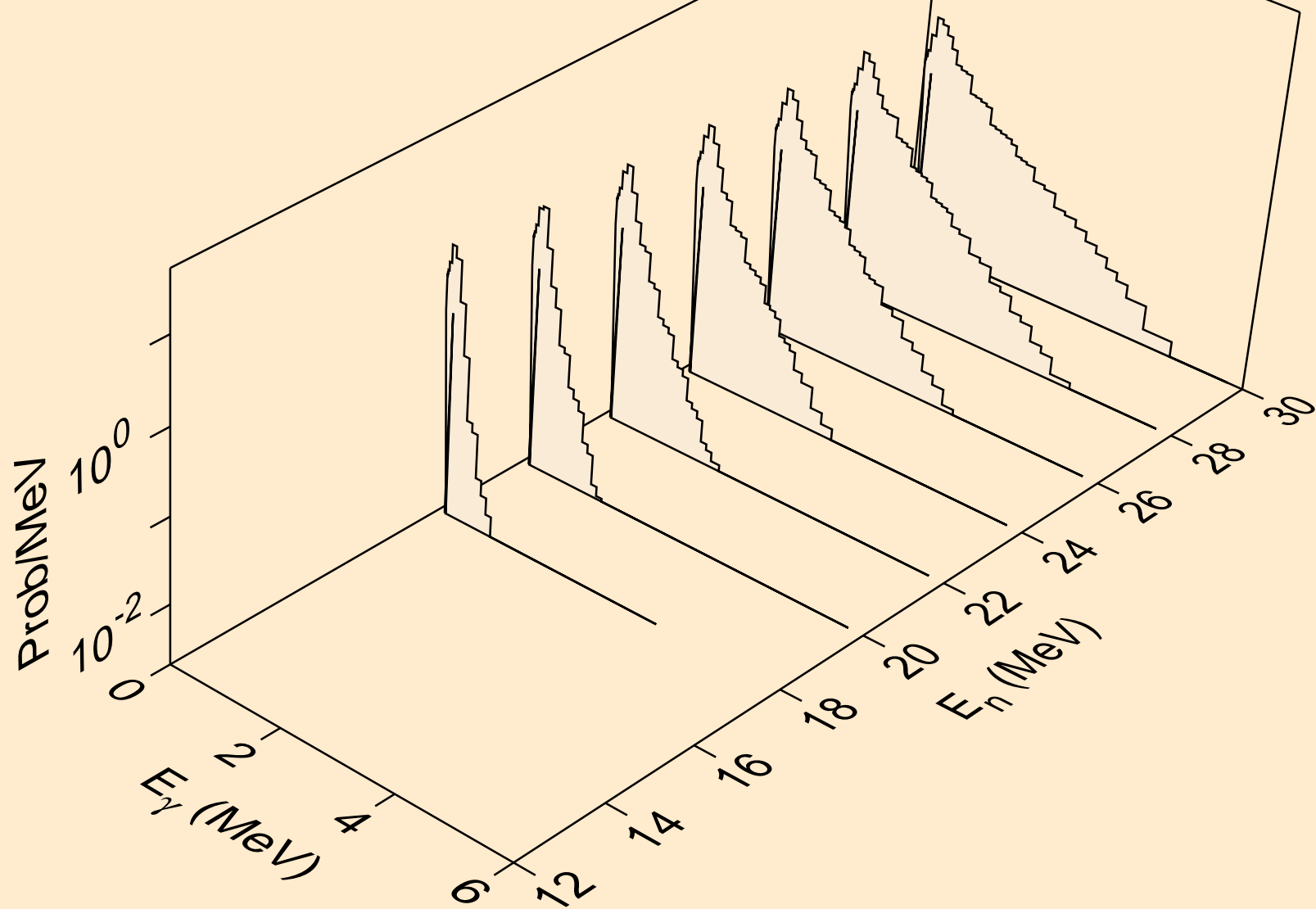

HG207 NEUTRON ACER TENDL-2021 LIBRARY; T=293.6K
Photon emission for (n,3np)

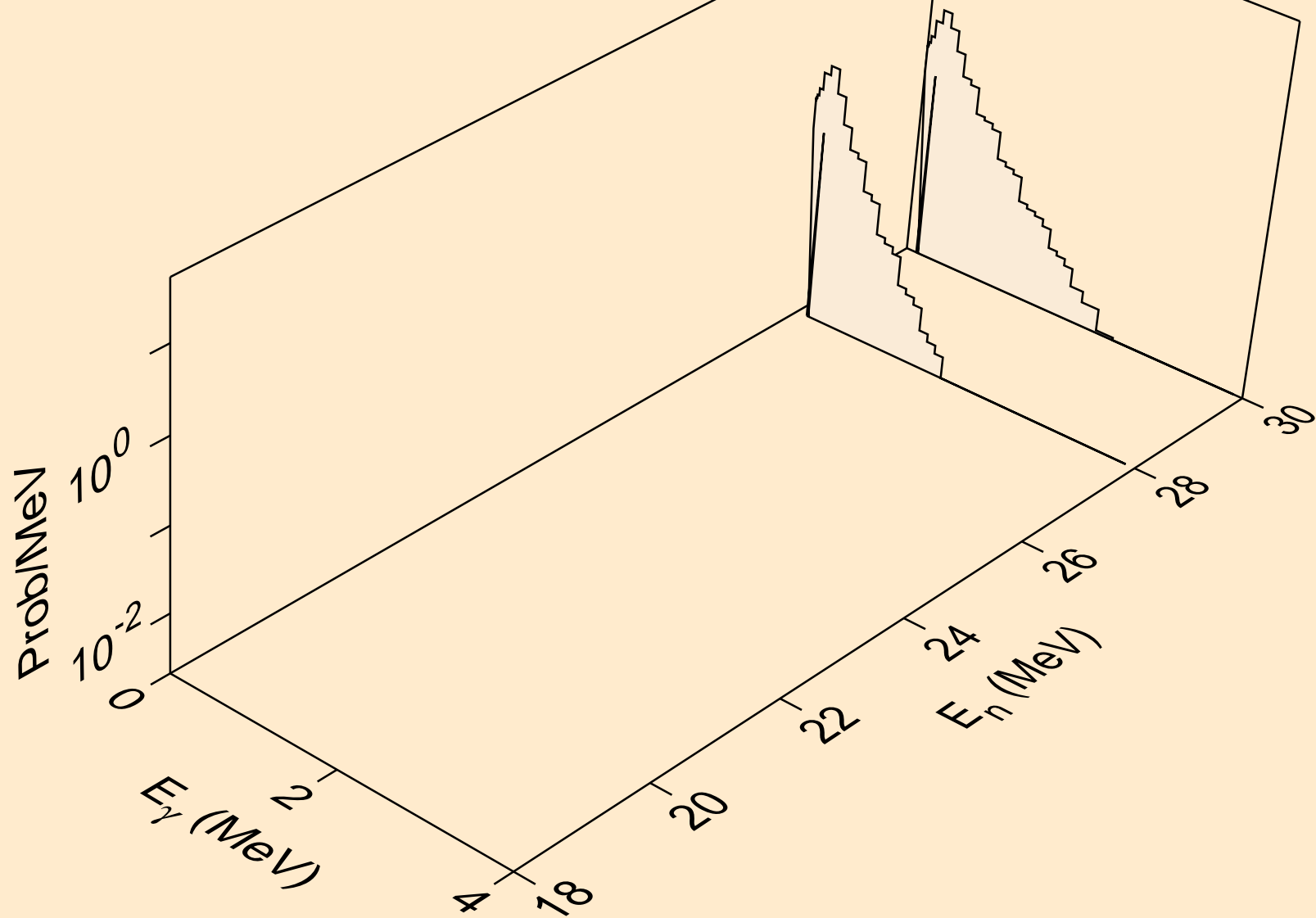

HG207 NEUTRON ACER TENDL-2021 LIBRARY; T=293.6K
Photon emission for (n,n*c)

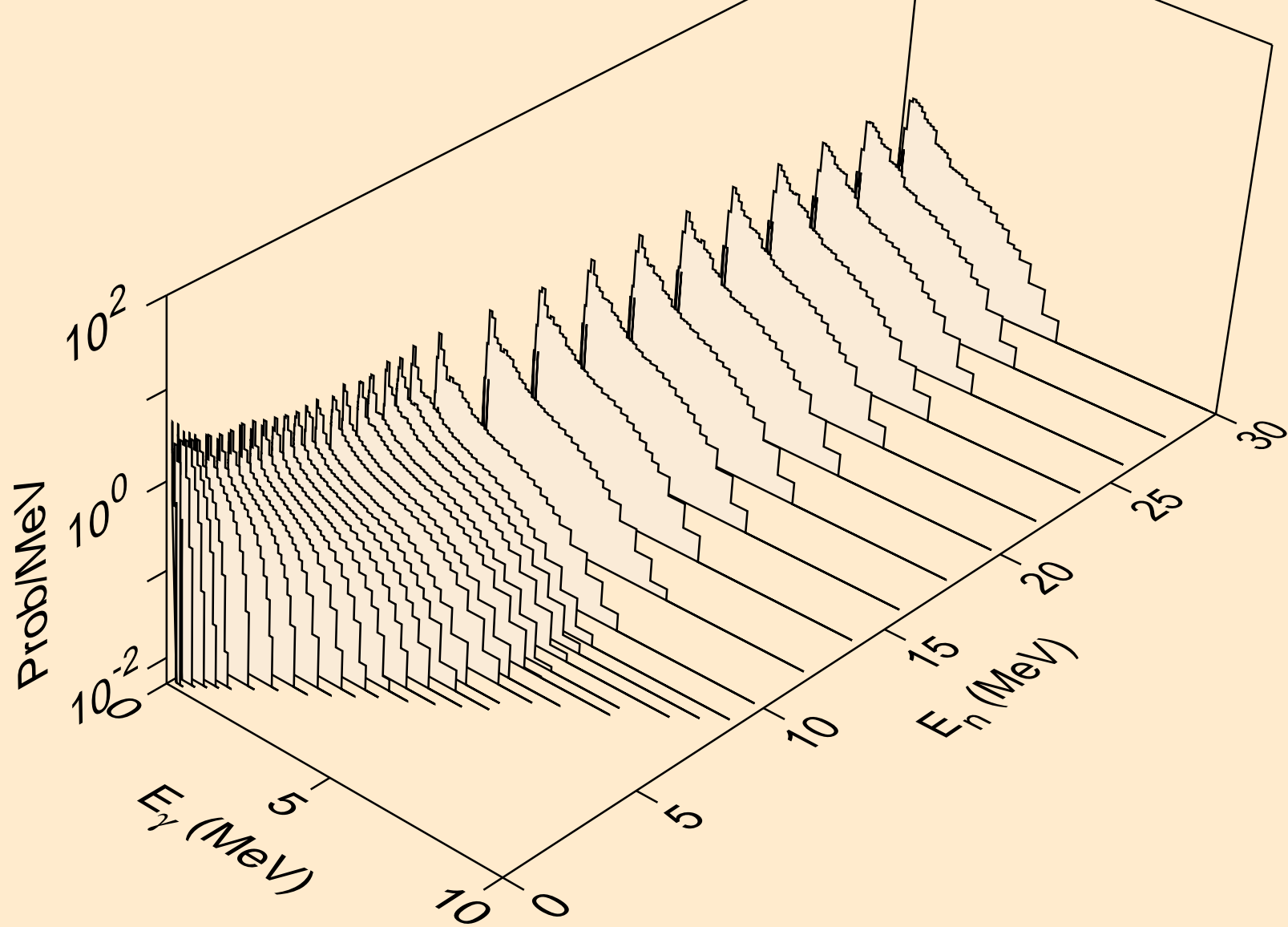

HG207 NEUTRON ACER TENDL-2021 LIBRARY; T=293.6K
Photon emission for (n,gma)

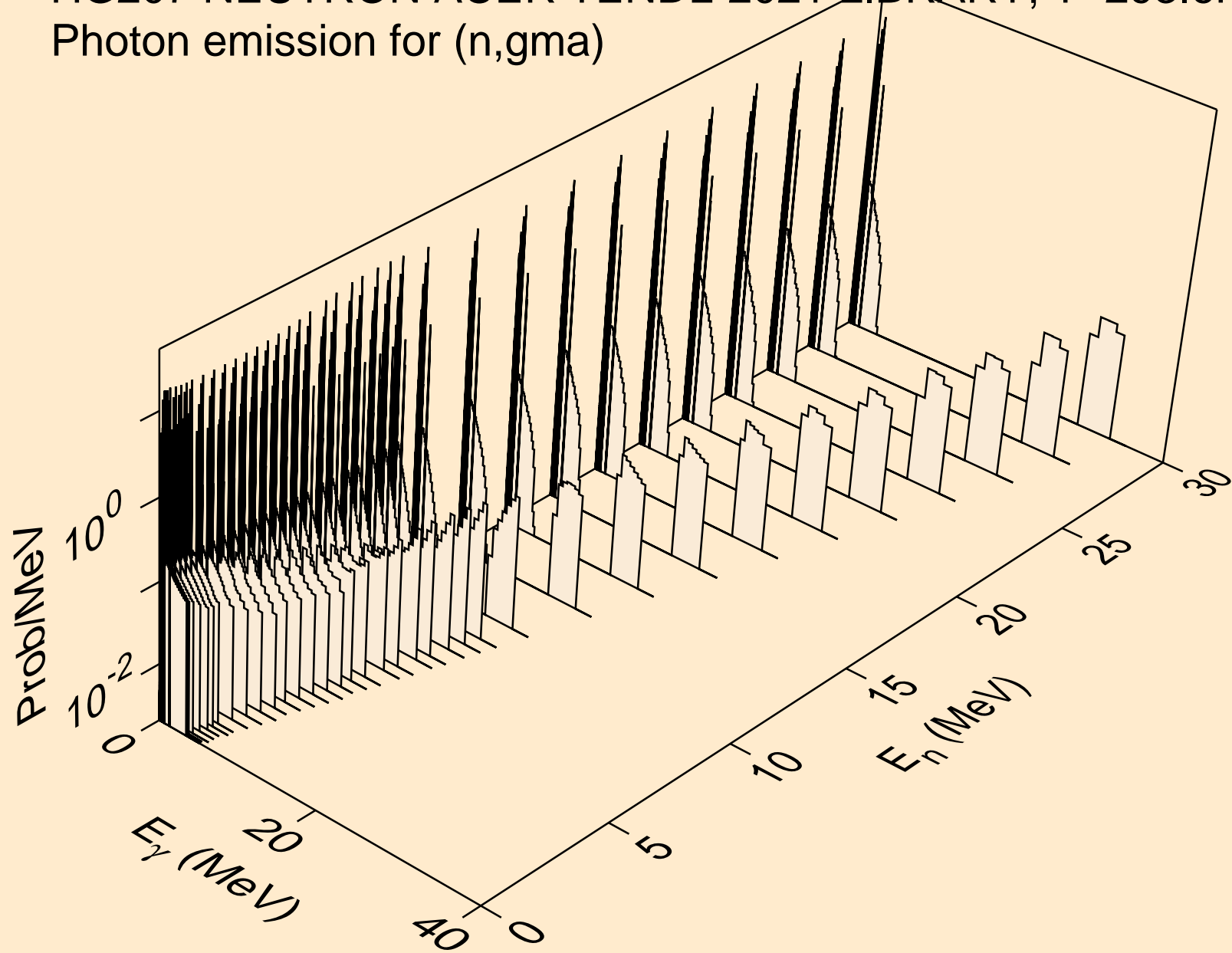

HG207 NEUTRON ACER TENDL-2021 LIBRARY; T=293.6K
Photon emission for (n,p)

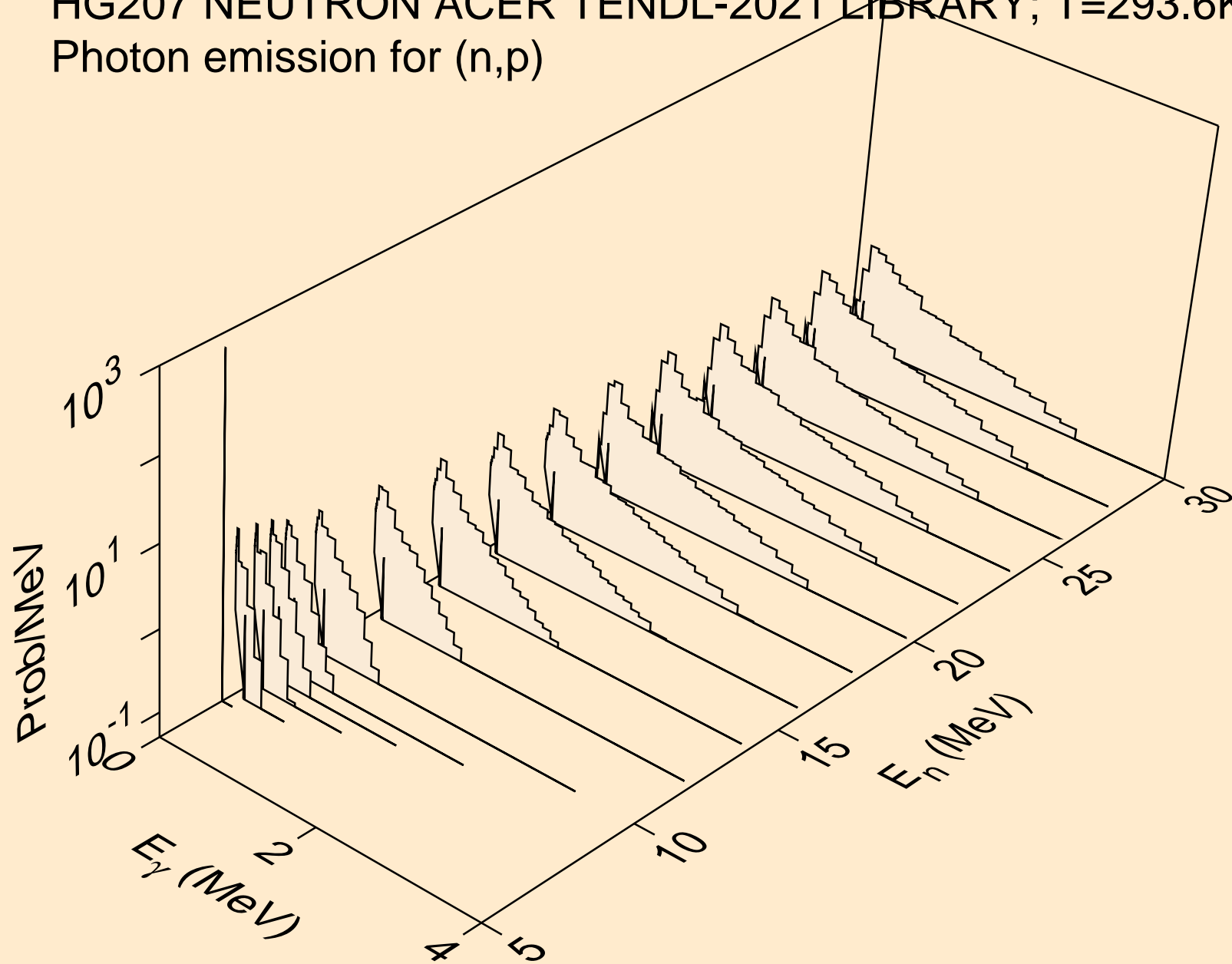

HG207 NEUTRON ACER TENDL-2021 LIBRARY; T=293.6K
Photon emission for (n,d)

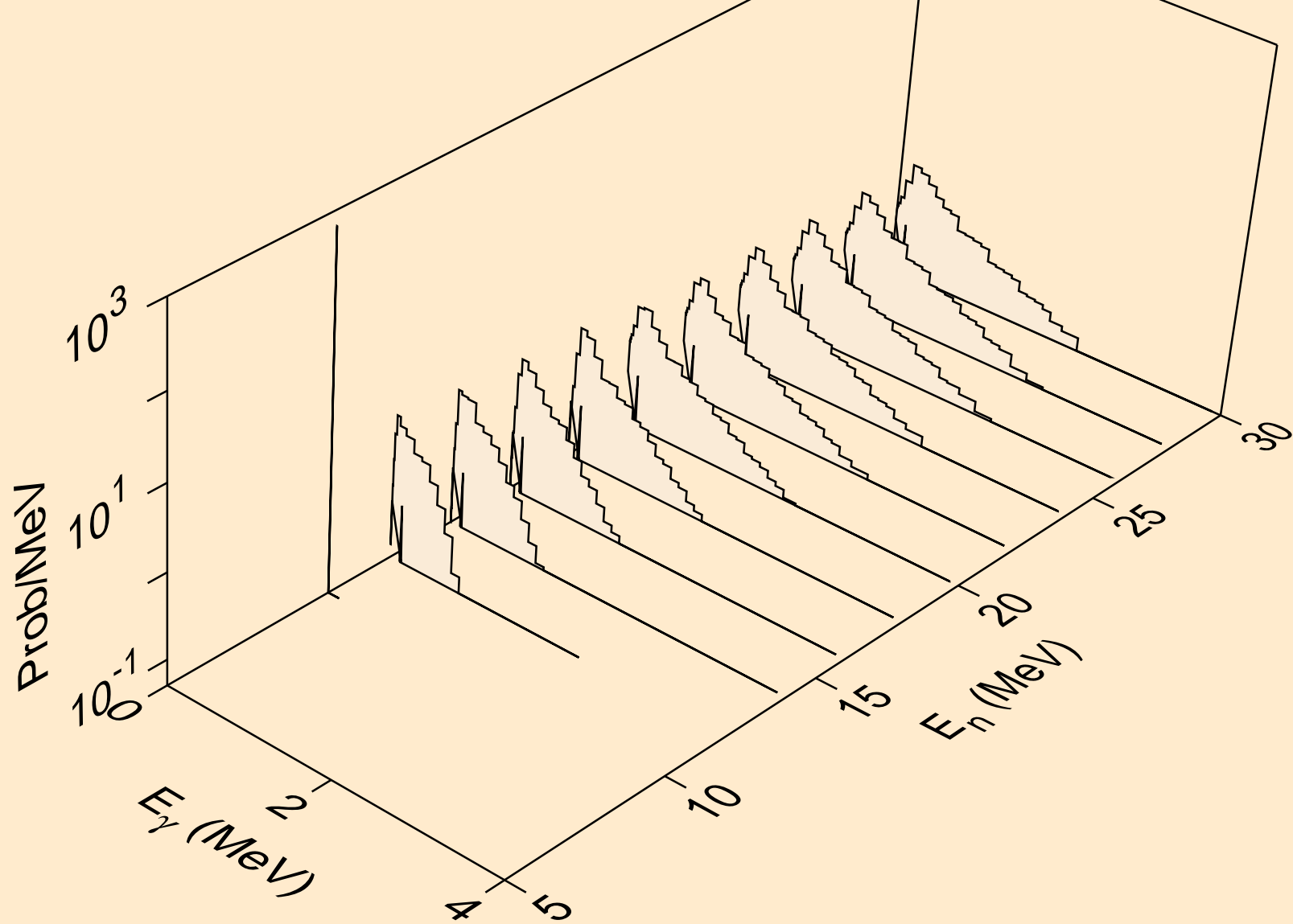

HG207 NEUTRON ACER TENDL-2021 LIBRARY; T=293.6K
Photon emission for (n,t)

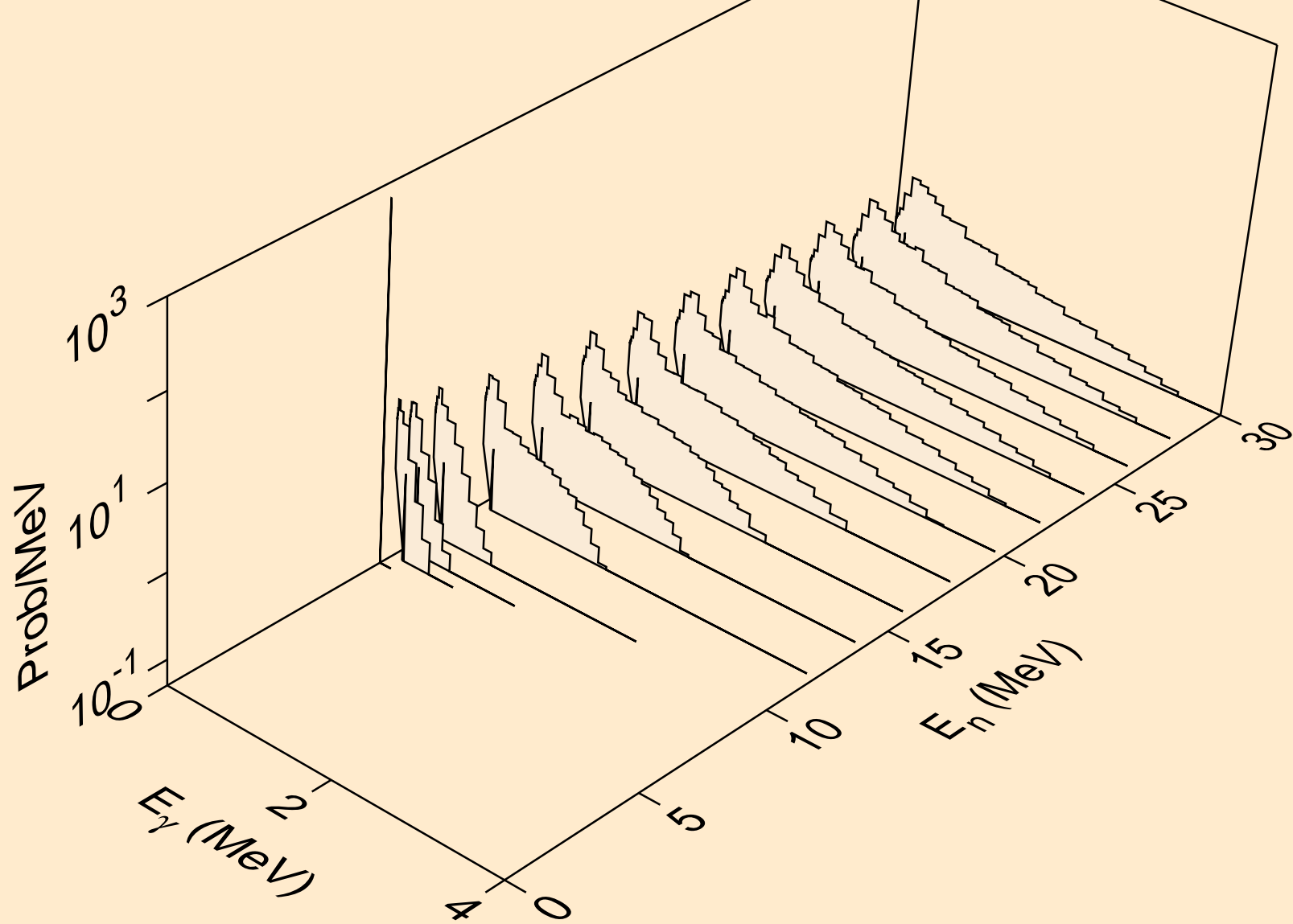

HG207 NEUTRON ACER TENDL-2021 LIBRARY; T=293.6K
Photon emission for (n,he3)

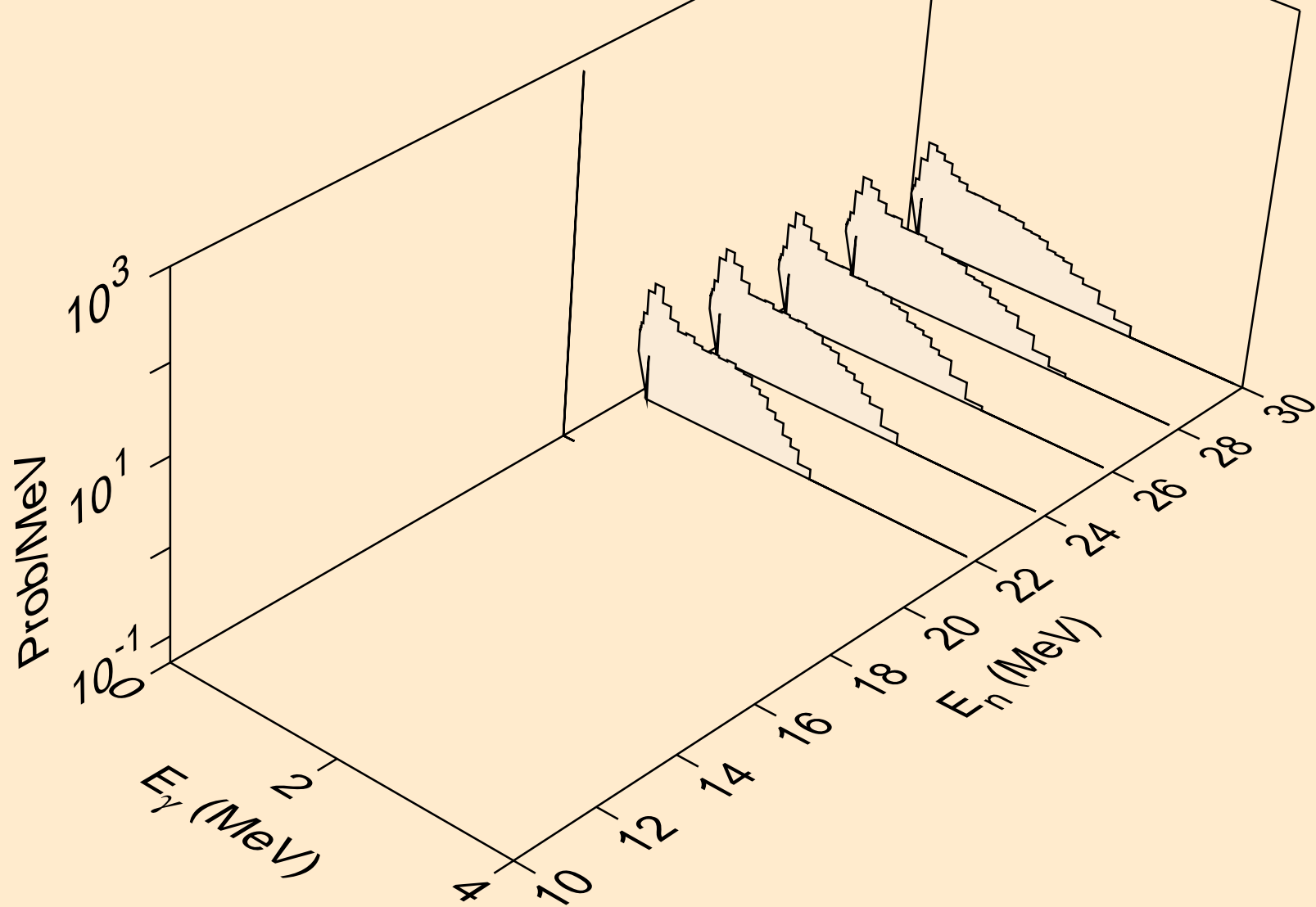

HG207 NEUTRON ACER TENDL-2021 LIBRARY; T=293.6K
Photon emission for (n,a)

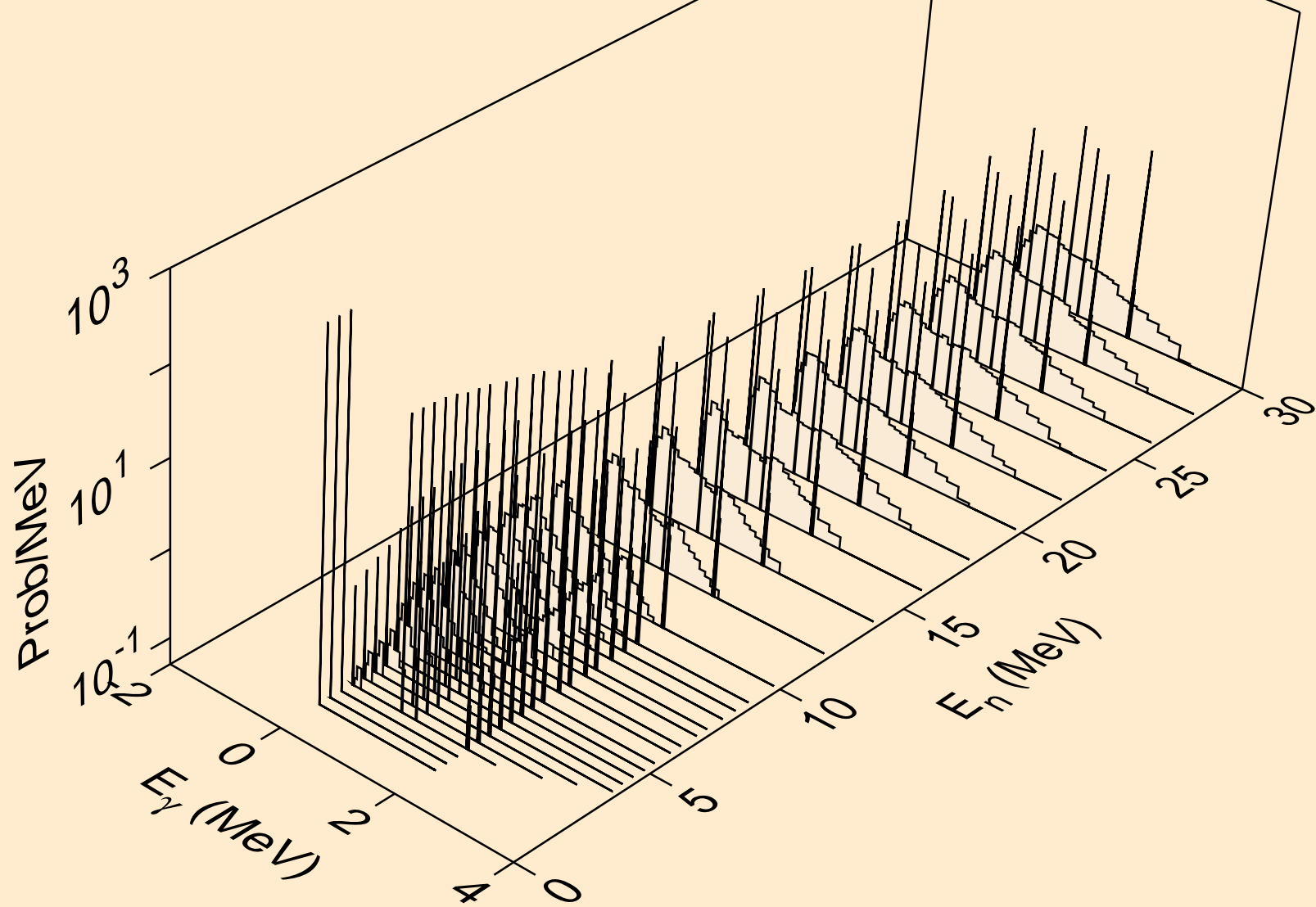

HG207 NEUTRON ACER TENDL-2021 LIBRARY; T=293.6K
thermal capture photon spectrum

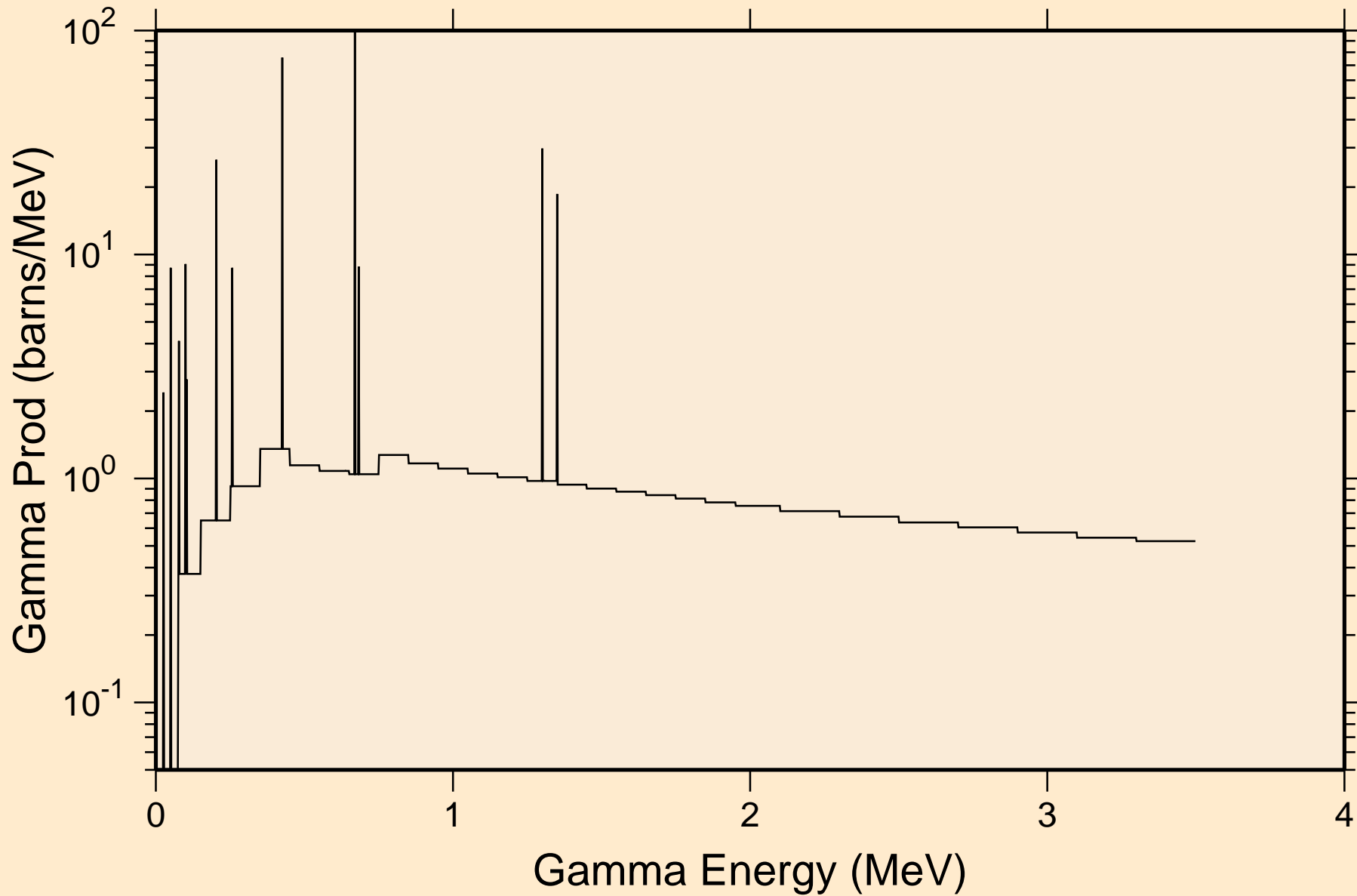

HG207 NEUTRON ACER TENDL-2021 LIBRARY; T=293.6K
14 MeV photon spectrum

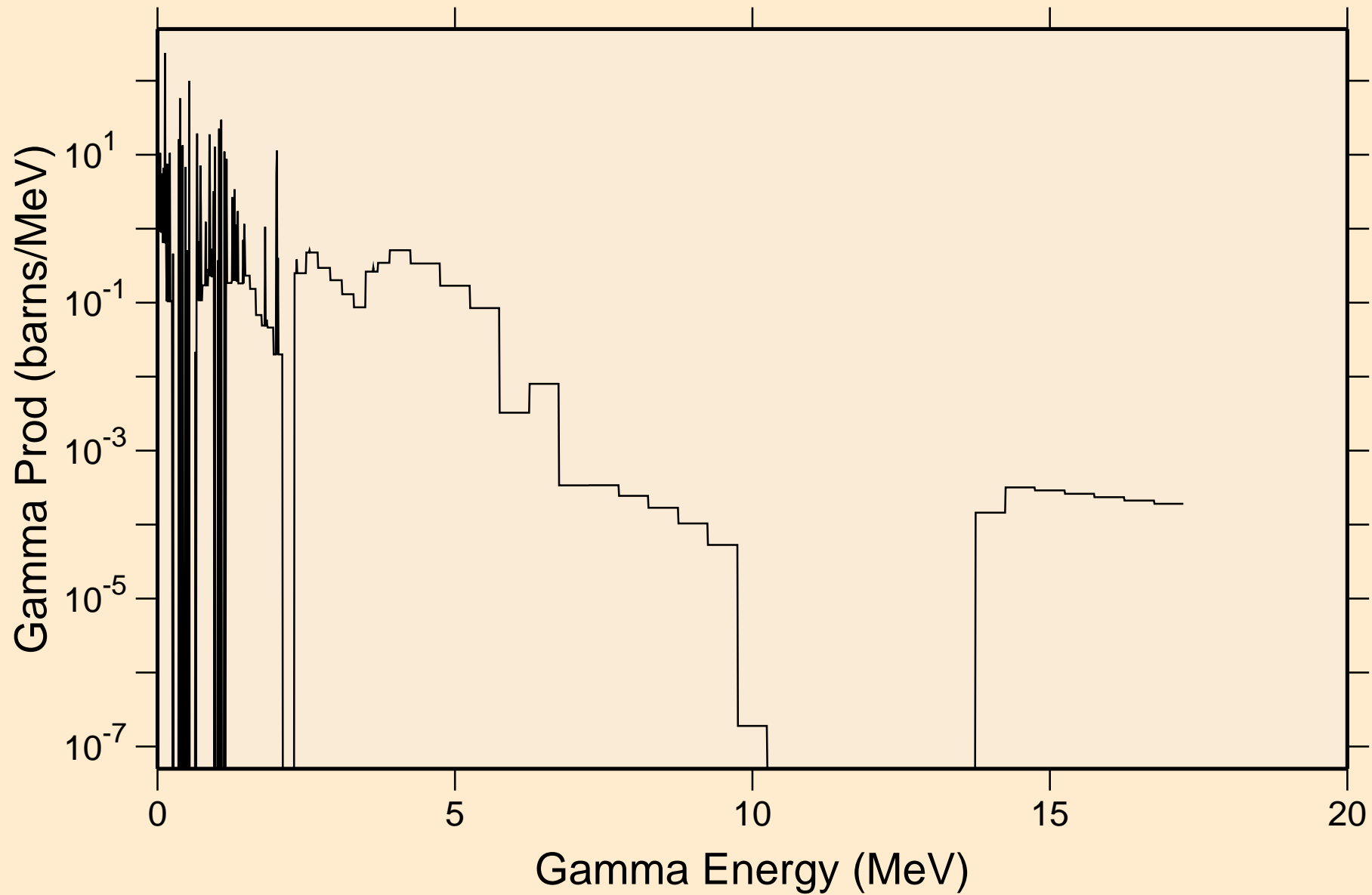

HG207 NEUTRON ACER TENDL-2021 LIBRARY; T=293.6K

Particle heating contributions

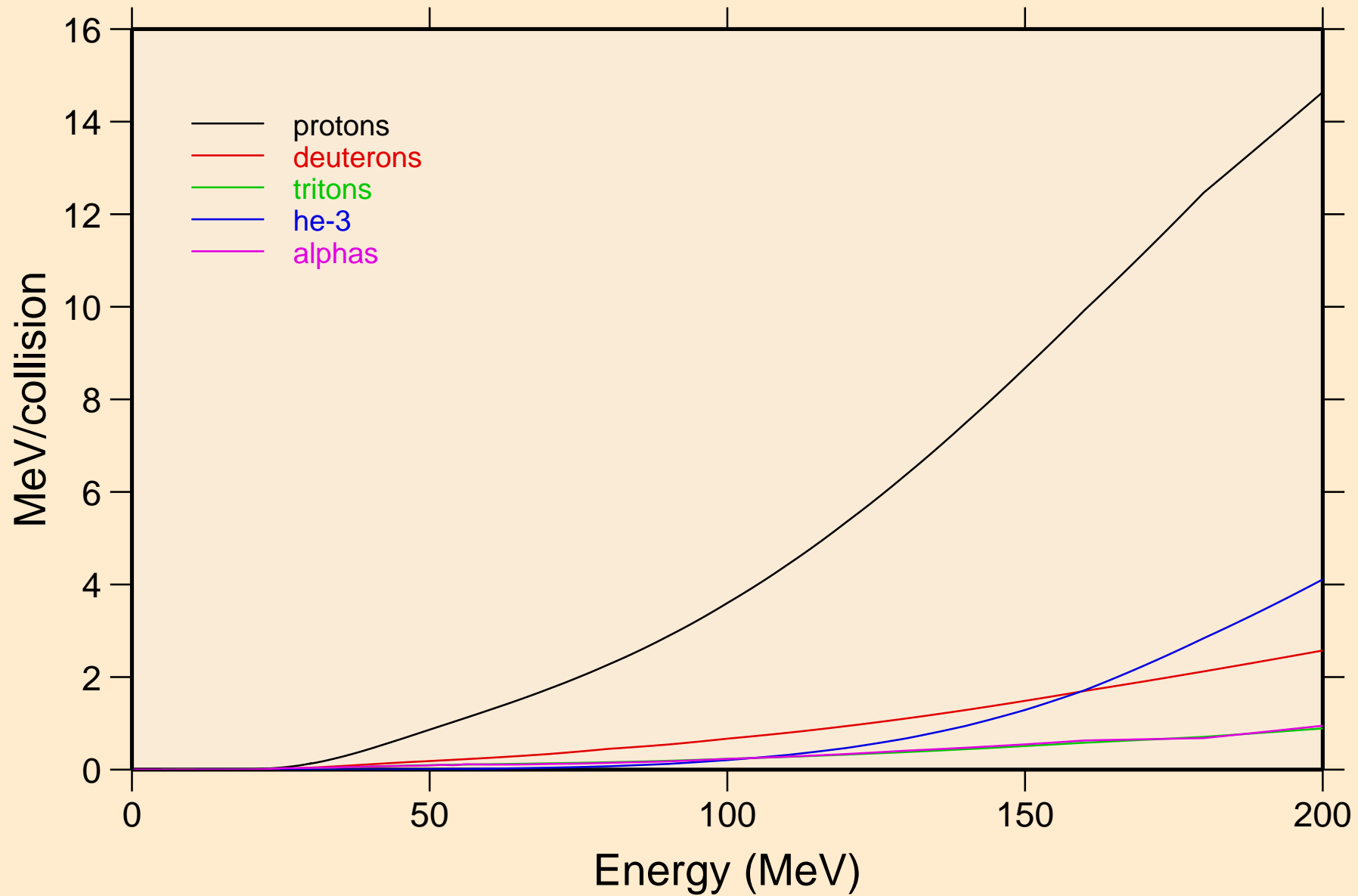

HG207 NEUTRON ACER TENDL-2021 LIBRARY; T=293.6K
Recoil Heating

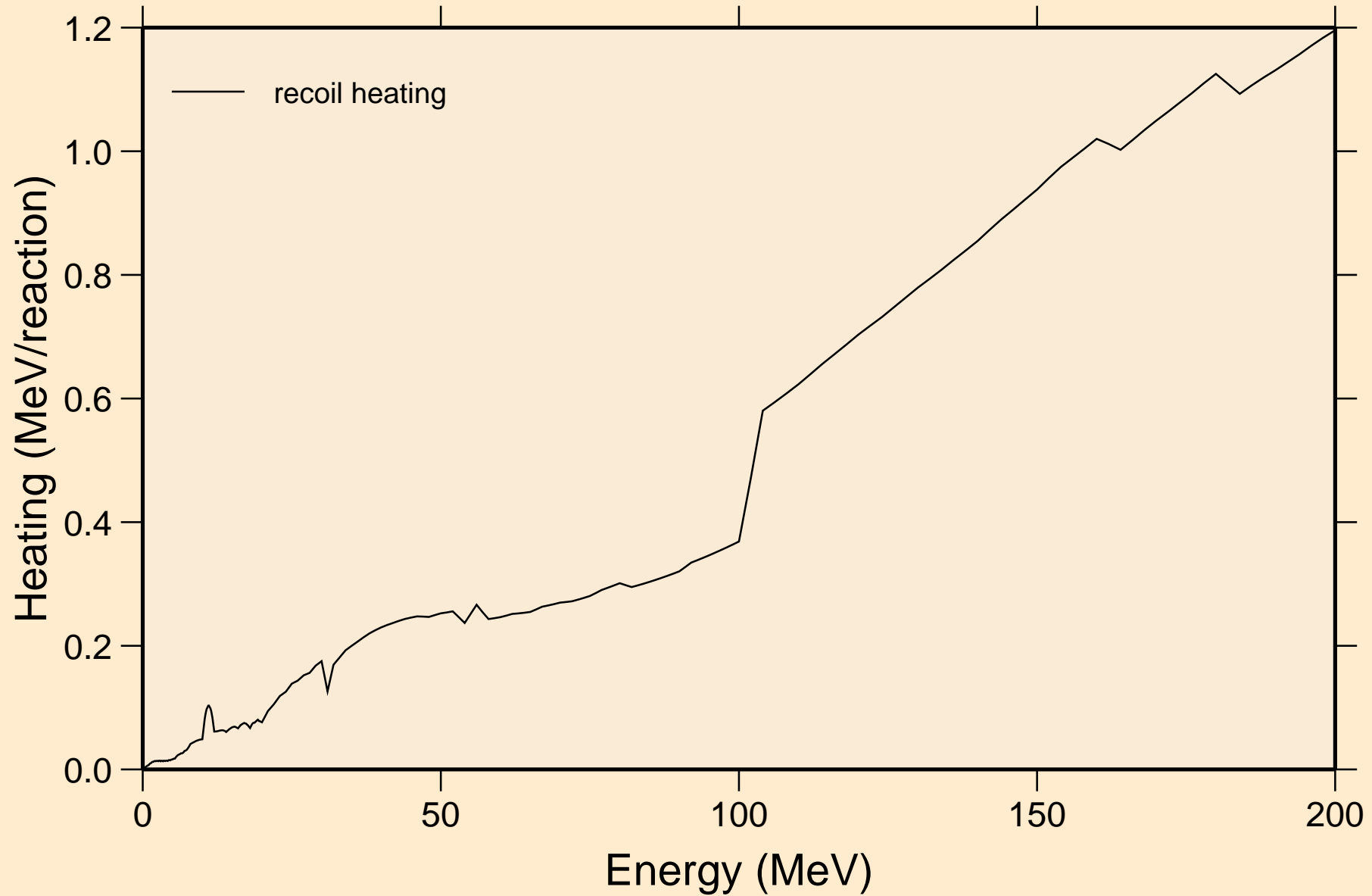

HG207 NEUTRON ACER TENDL-2021 LIBRARY; T=293.6K
Particle production cross sections

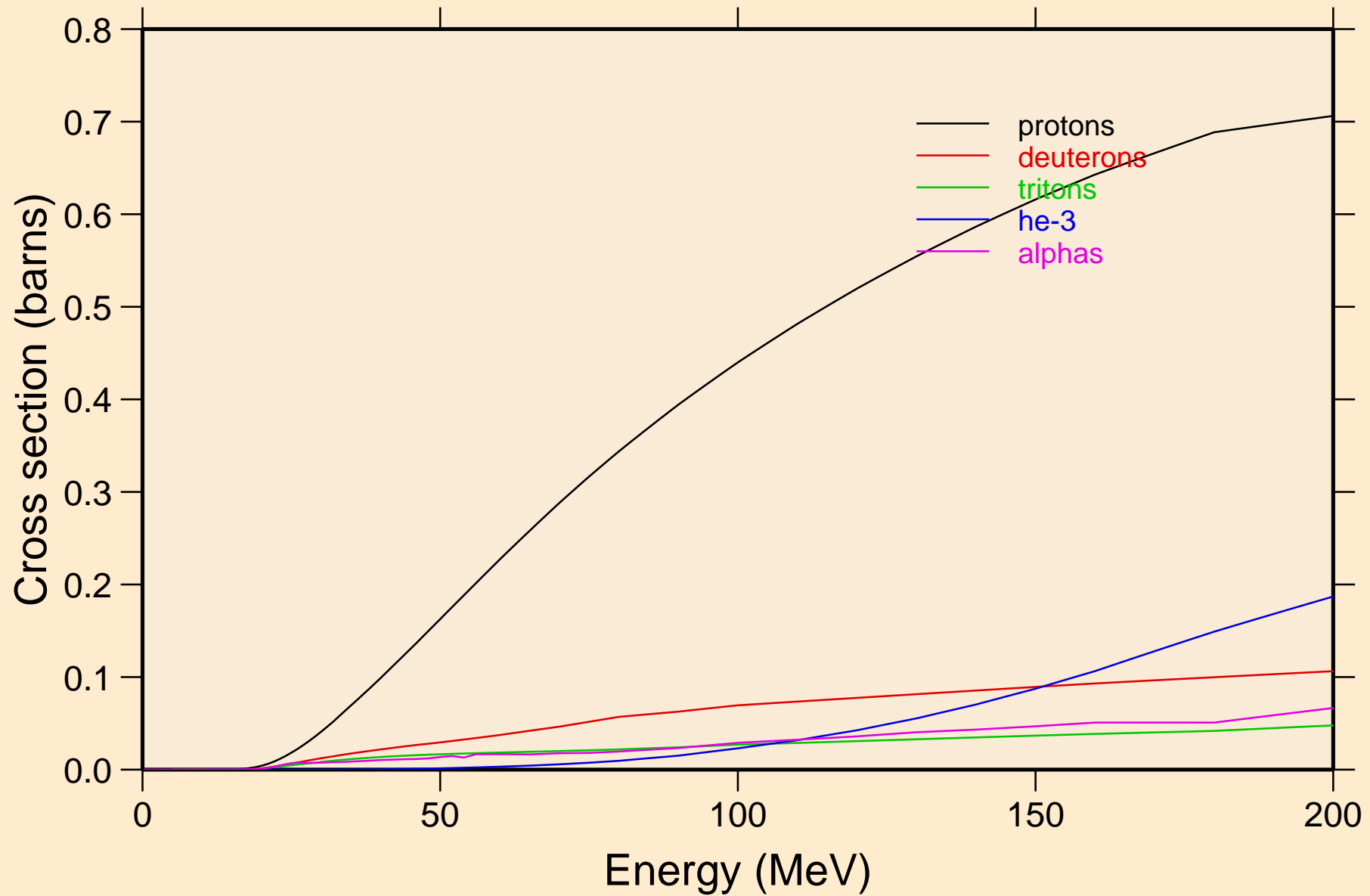

HG207 NEUTRON ACER TENDL-2021 LIBRARY; T=293.6K
protons from (n,x)

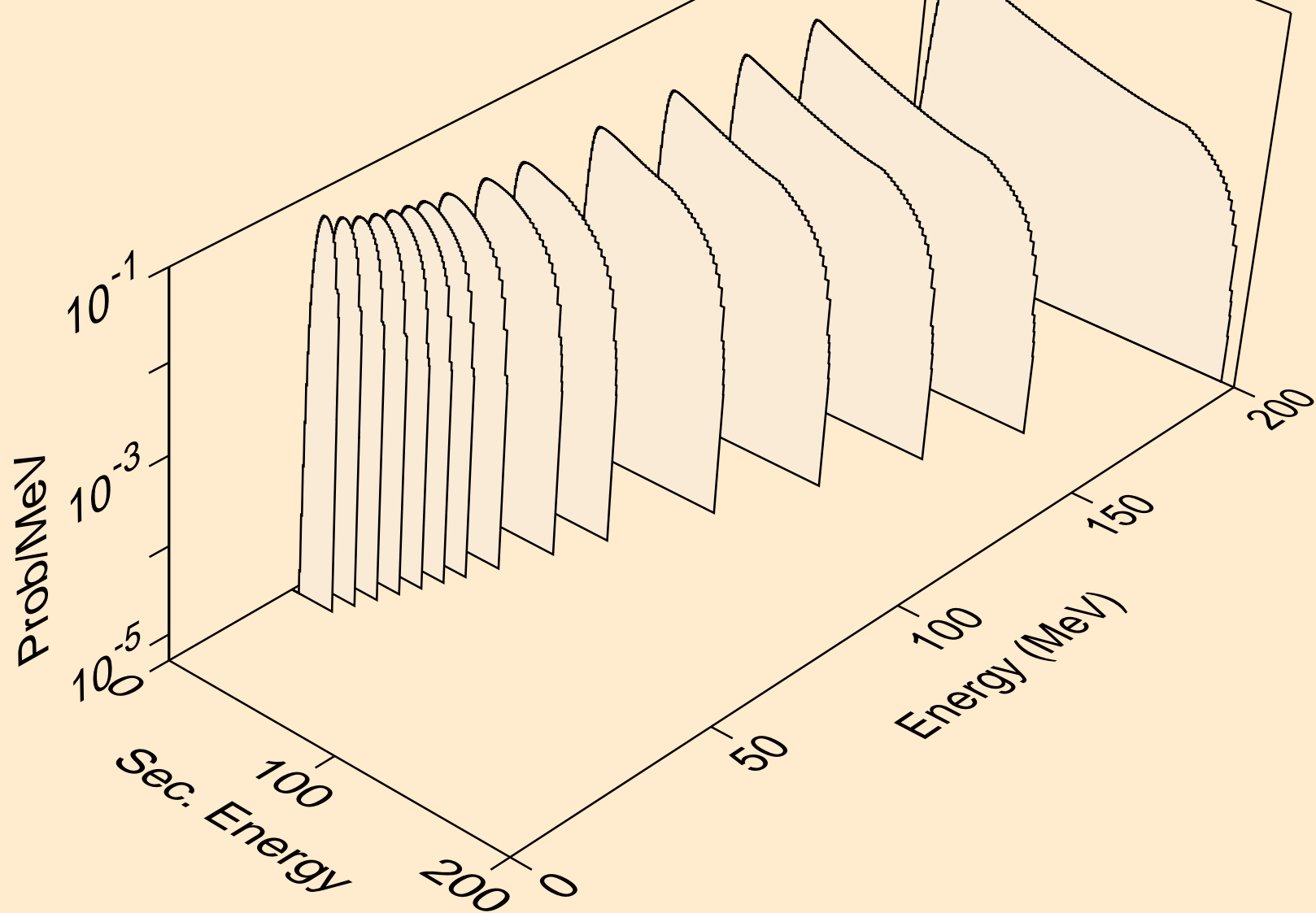

HG207 NEUTRON ACER TENDL-2021 LIBRARY; T=293.6K
protons from (n,n*)p

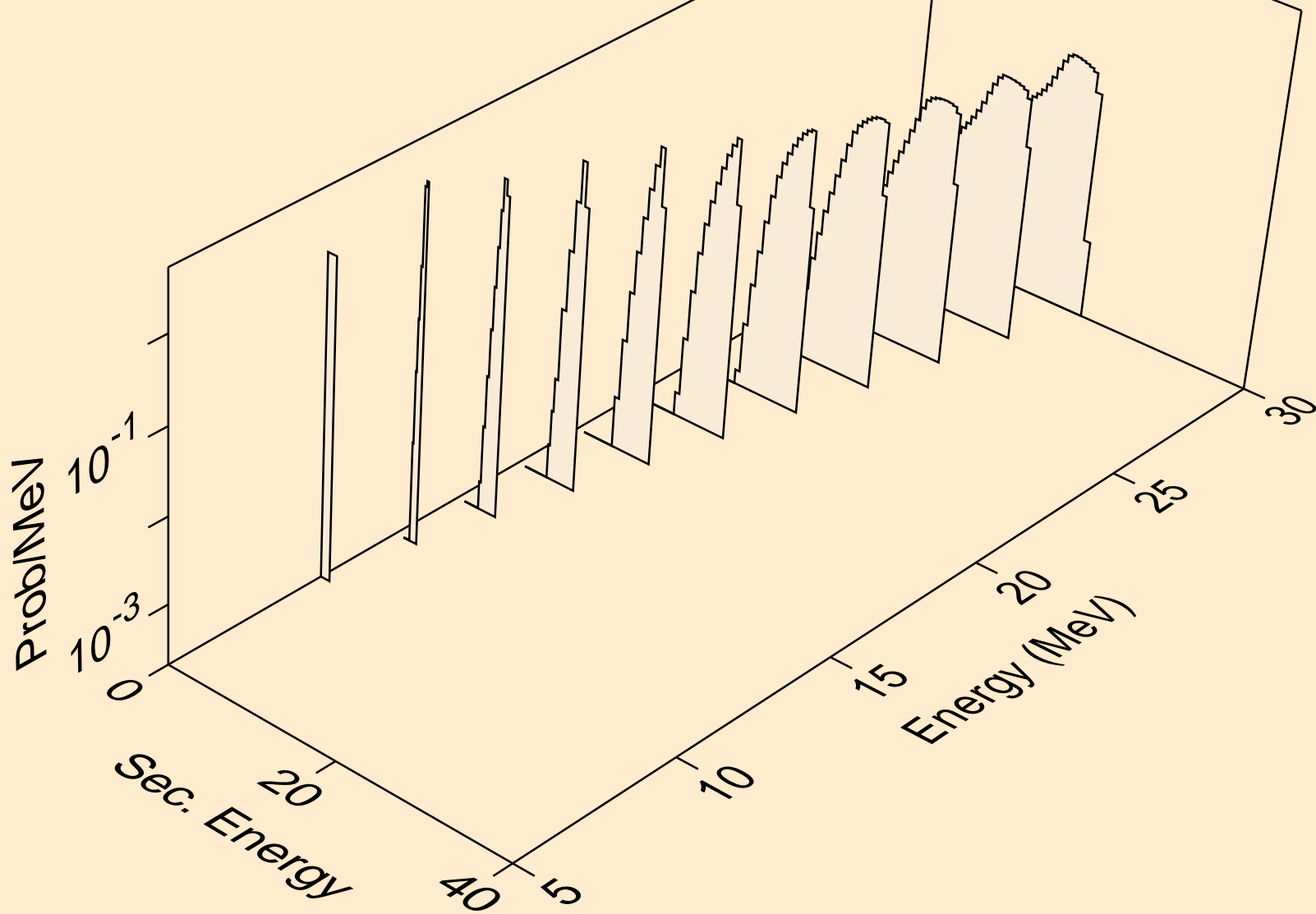

HG207 NEUTRON ACER TENDL-2021 LIBRARY; T=293.6K
protons from (n,2np)

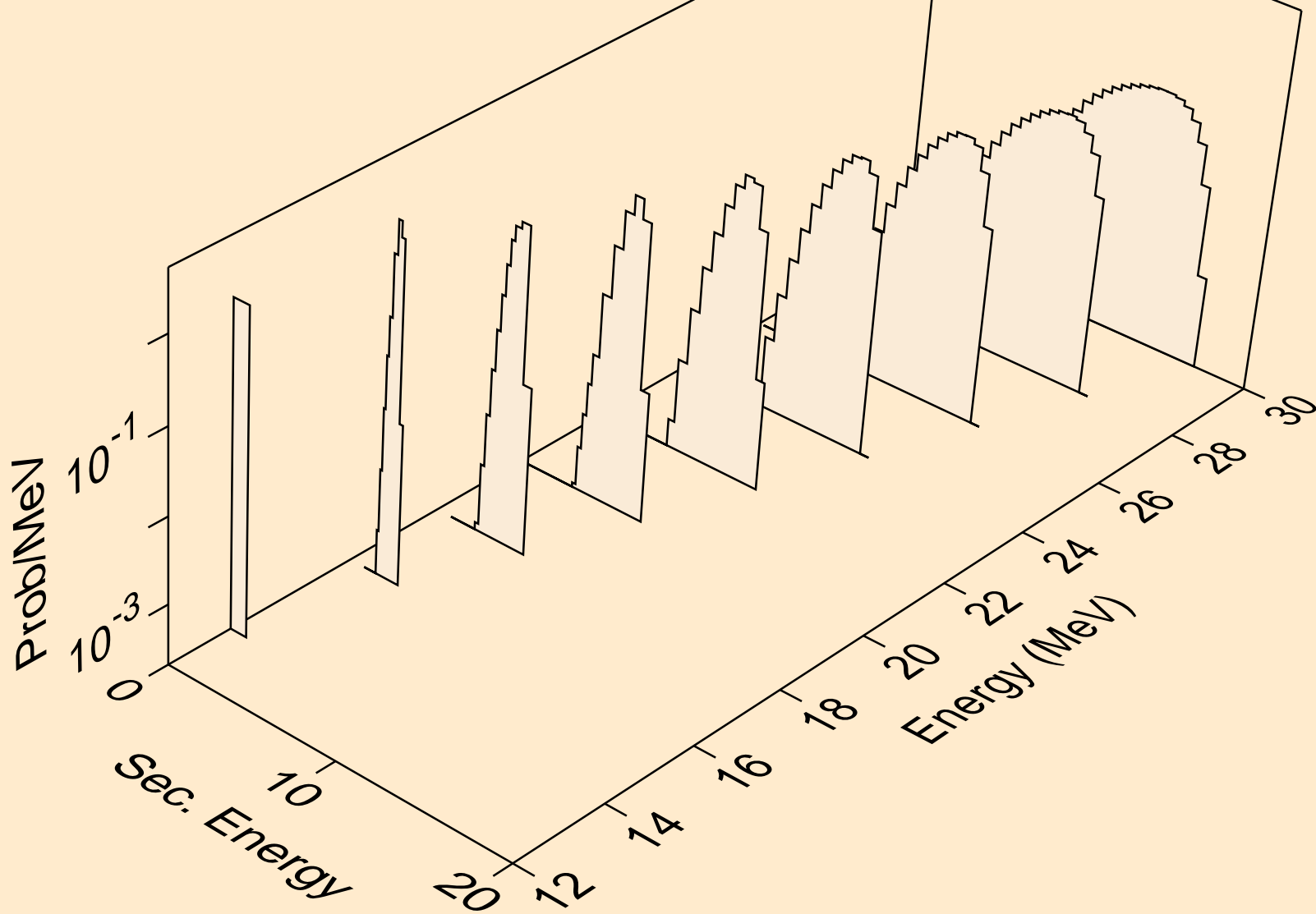

HG207 NEUTRON ACER TENDL-2021 LIBRARY; T=293.6K
protons from (n,3np)

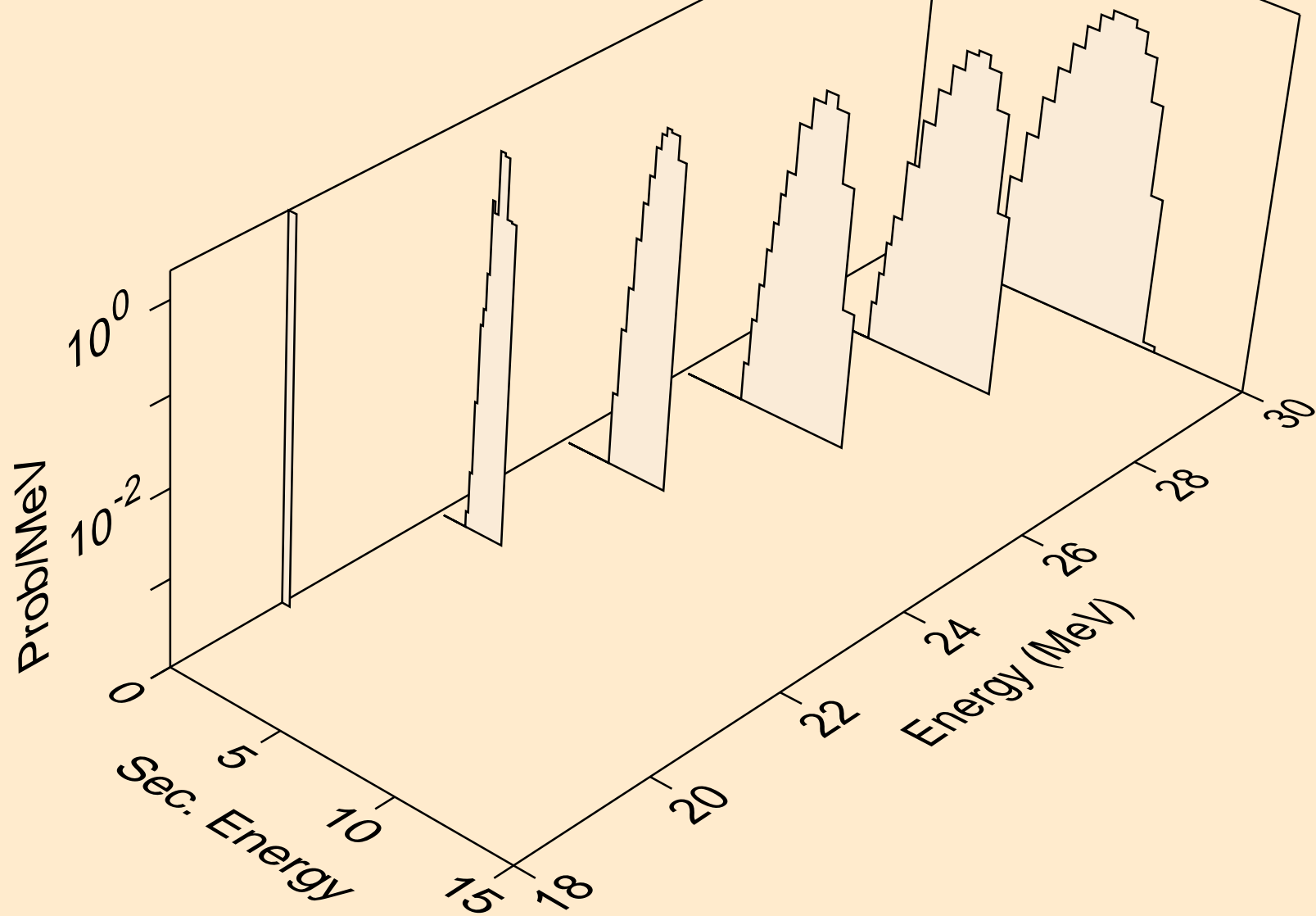

HG207 NEUTRON ACER TENDL-2021 LIBRARY; T=293.6K
protons from (n,p)

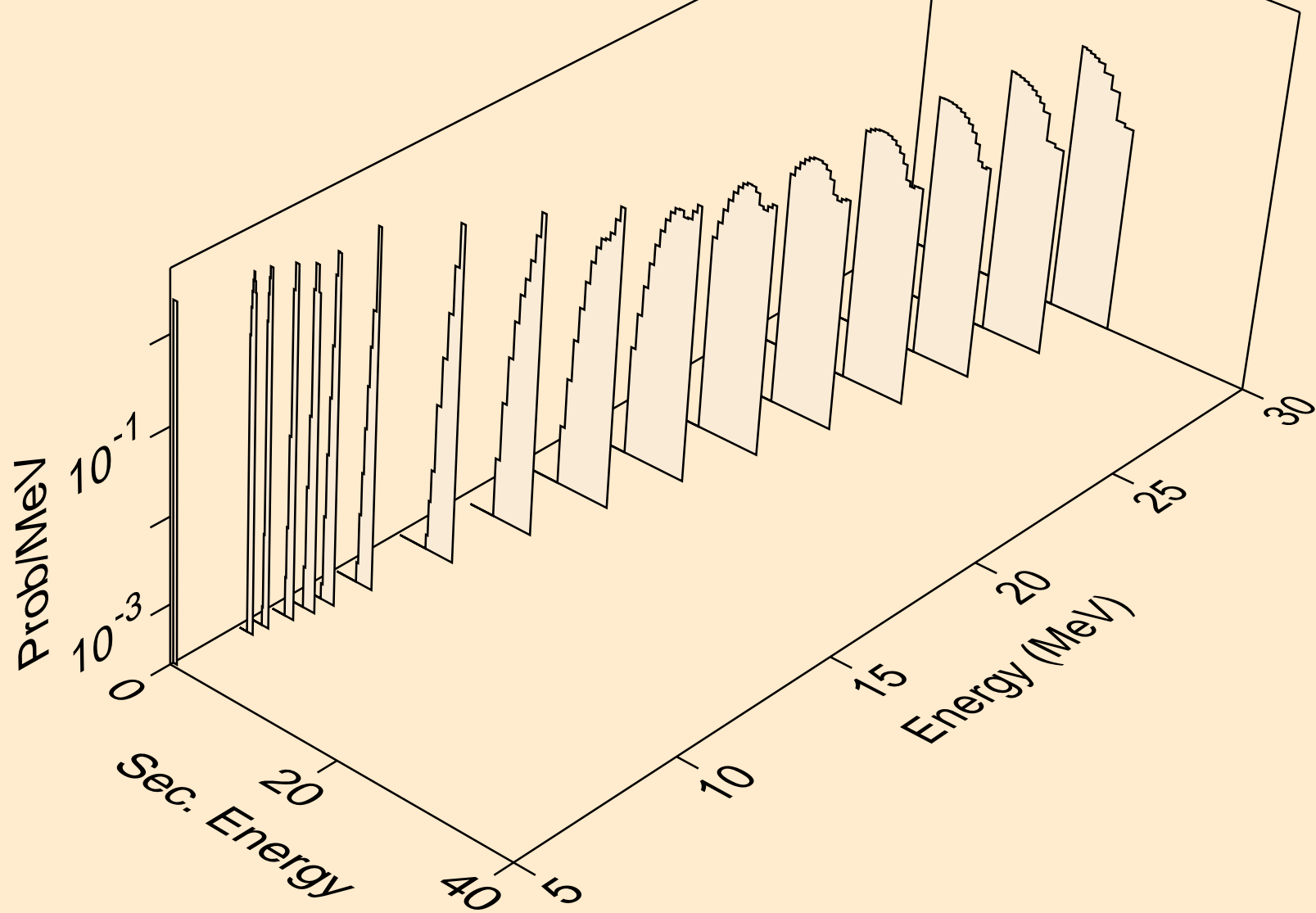

HG207 NEUTRON ACER TENDL-2021 LIBRARY; T=293.6K
deuterons from (n,x)

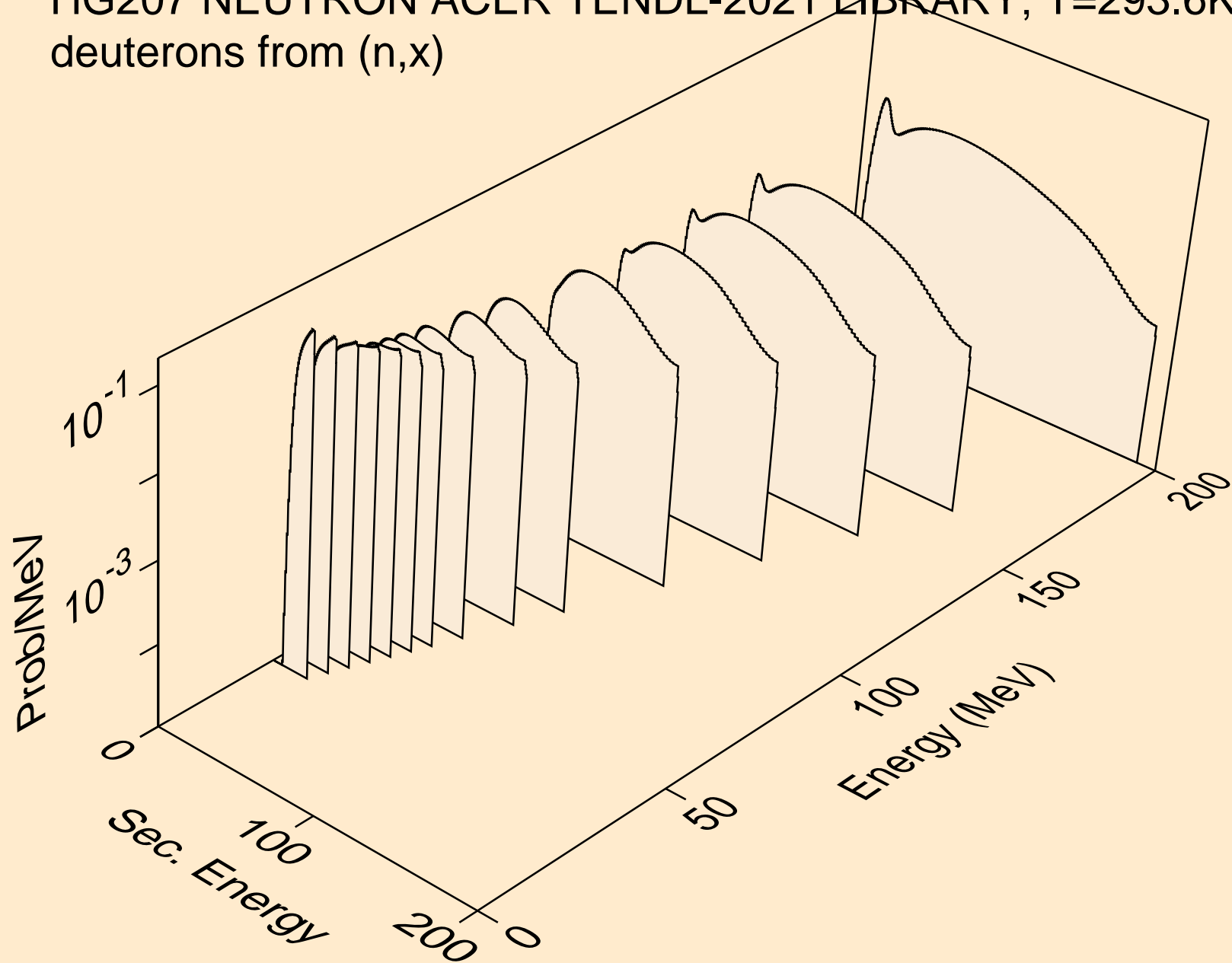

HG207 NEUTRON ACER TENDL-2021 LIBRARY; T=293.6K
deuterons from (n,2nd)

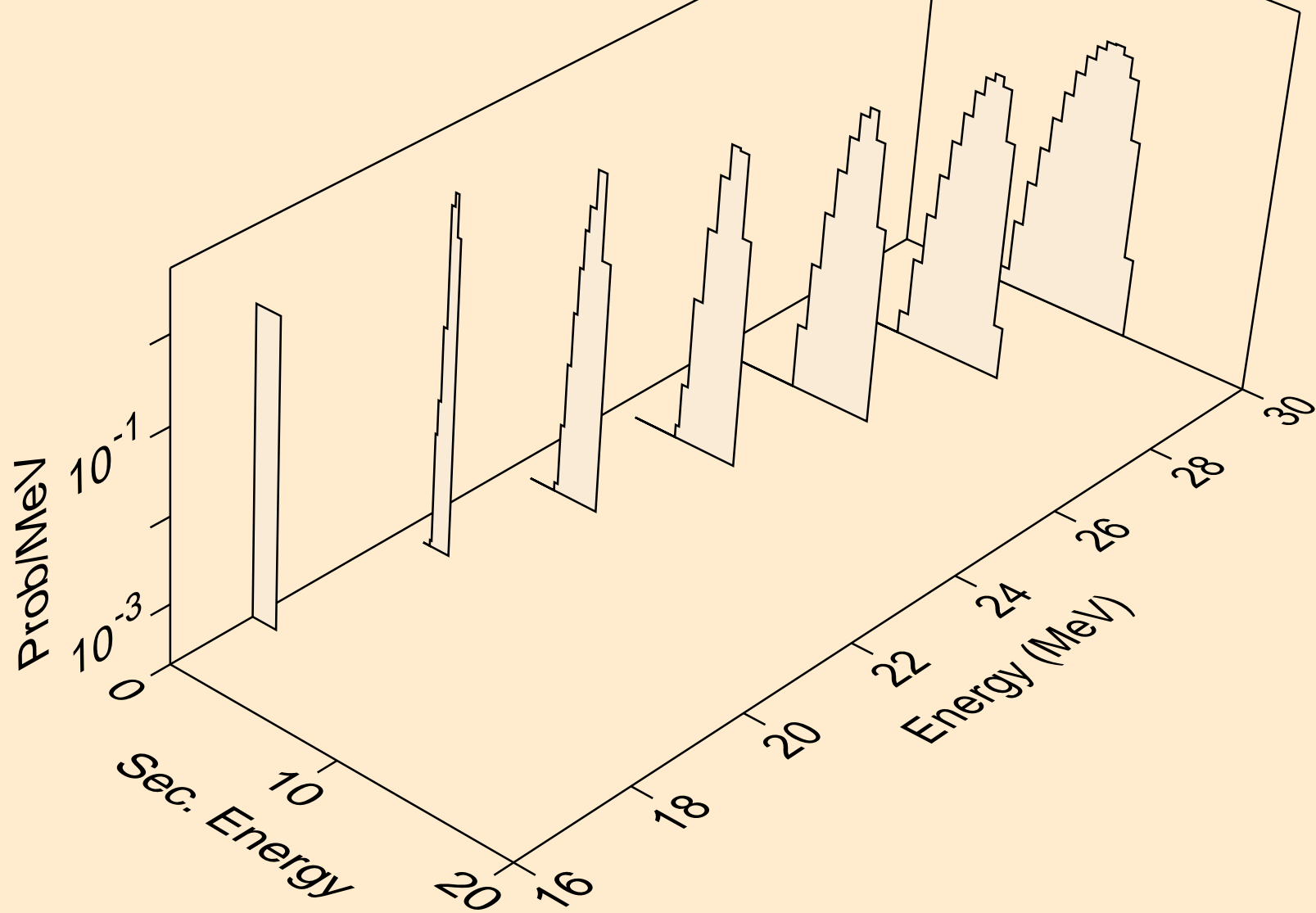

HG207 NEUTRON ACER TENDL-2021 LIBRARY; T=293.6K
deuterons from (n,n*)d

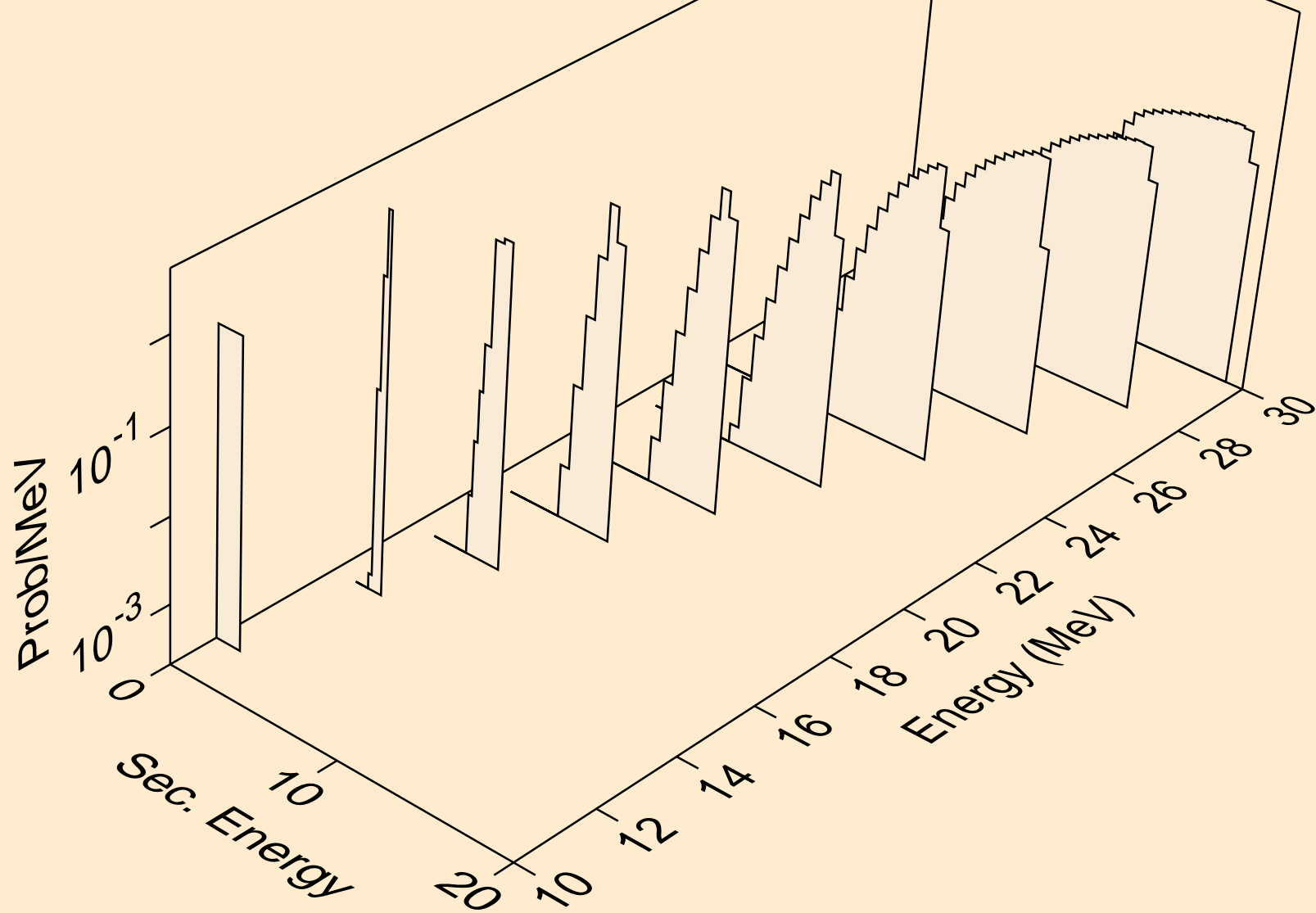

HG207 NEUTRON ACER TENDL-2021 LIBRARY; T=293.6K
deuterons from (n,d)

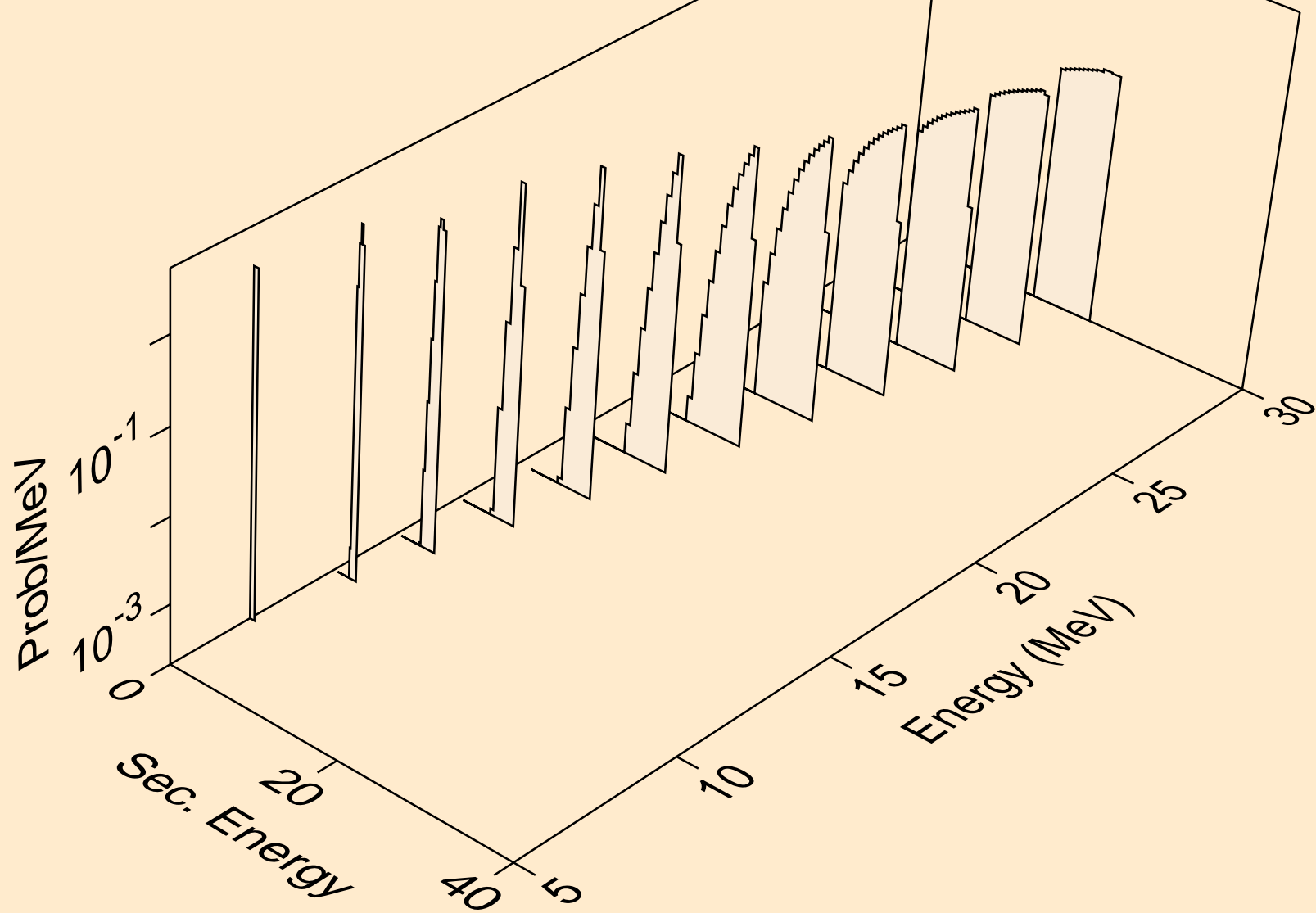

HG207 NEUTRON ACER TENDL-2021 LIBRARY; T=293.6K
tritons from (n,x)

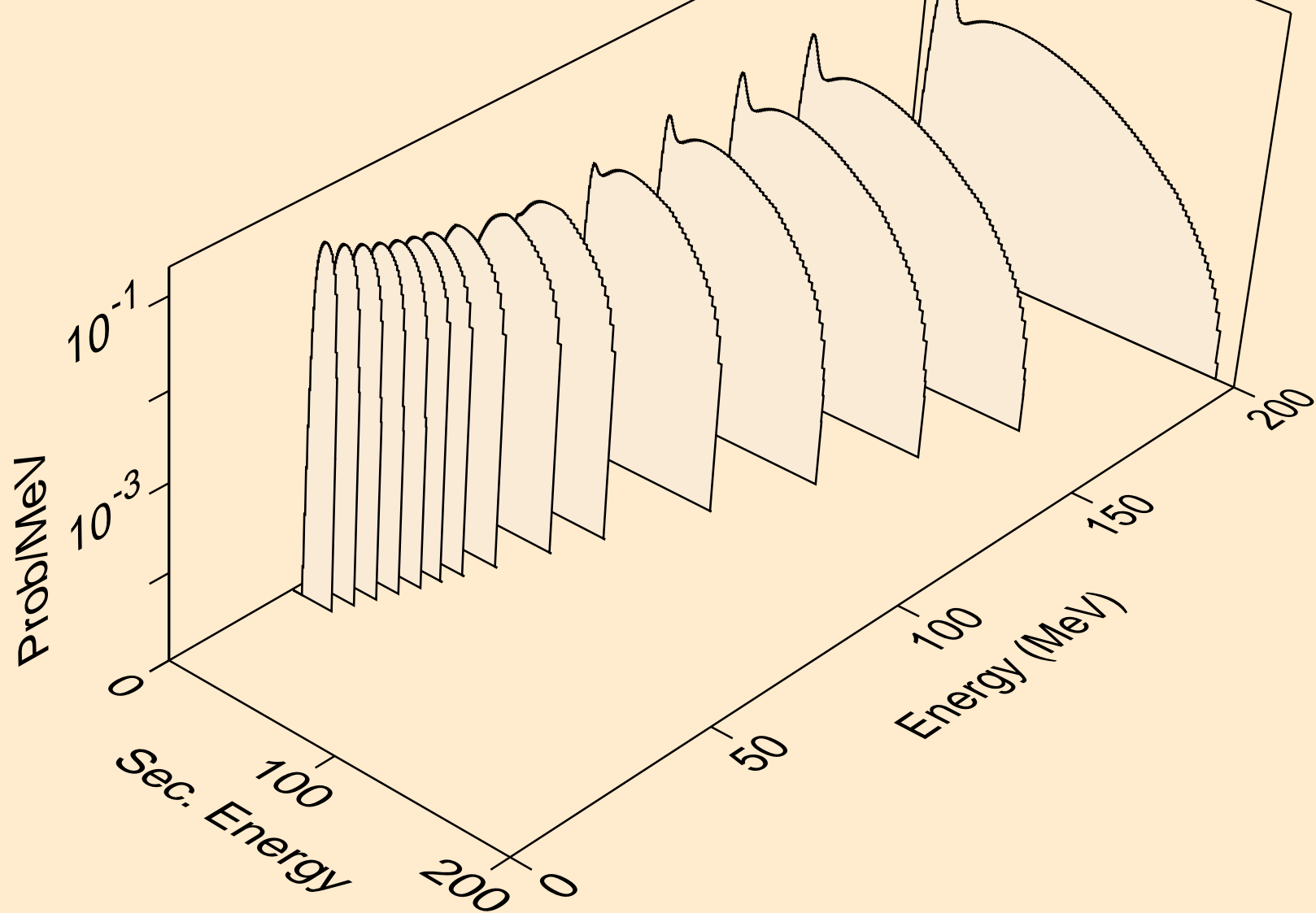

HG207 NEUTRON ACER TENDL-2021 LIBRARY; T=293.6K
tritons from (n,n*)t

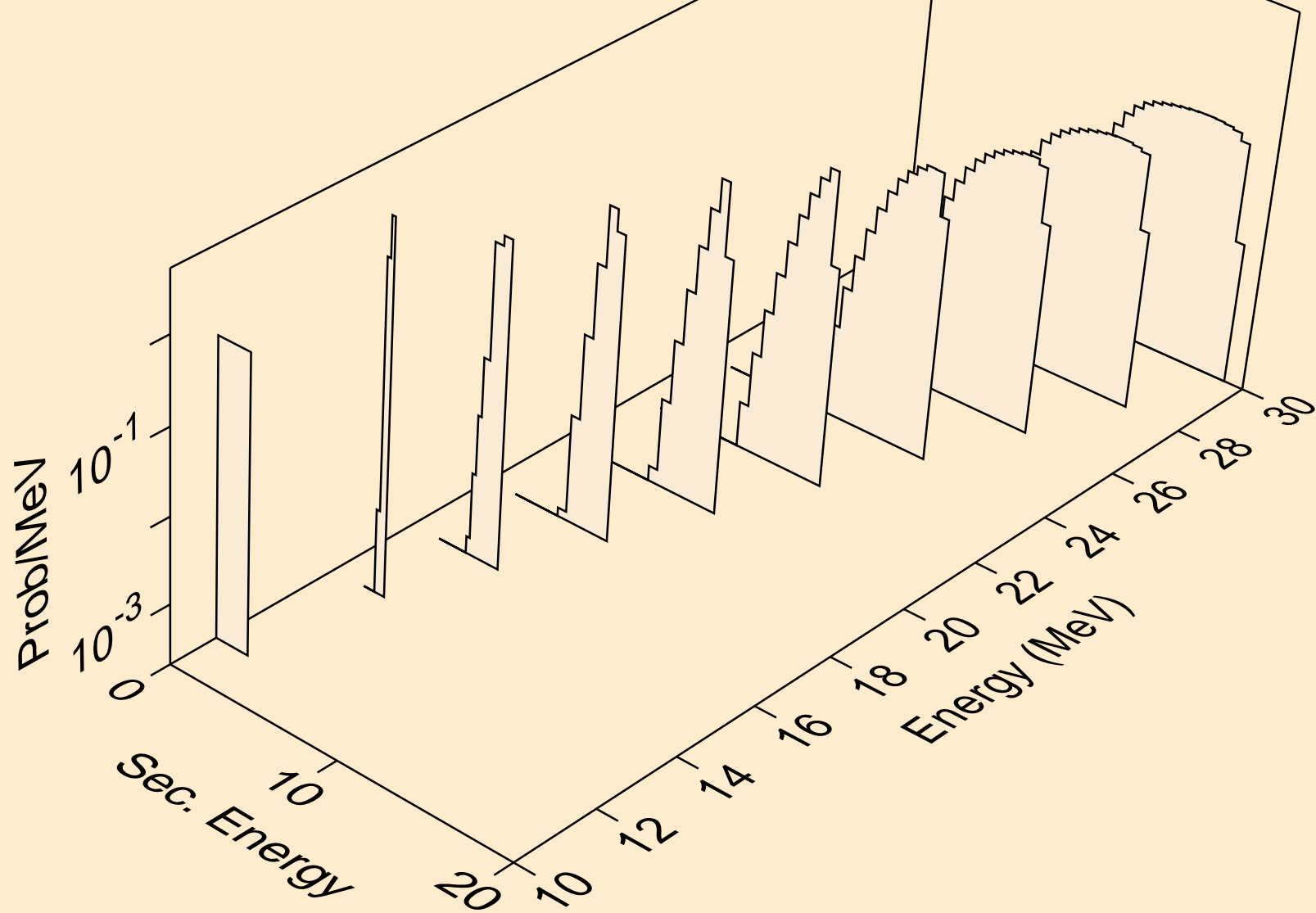

HG207 NEUTRON ACER TENDL-2021 LIBRARY; T=293.6K
tritons from (n,t)

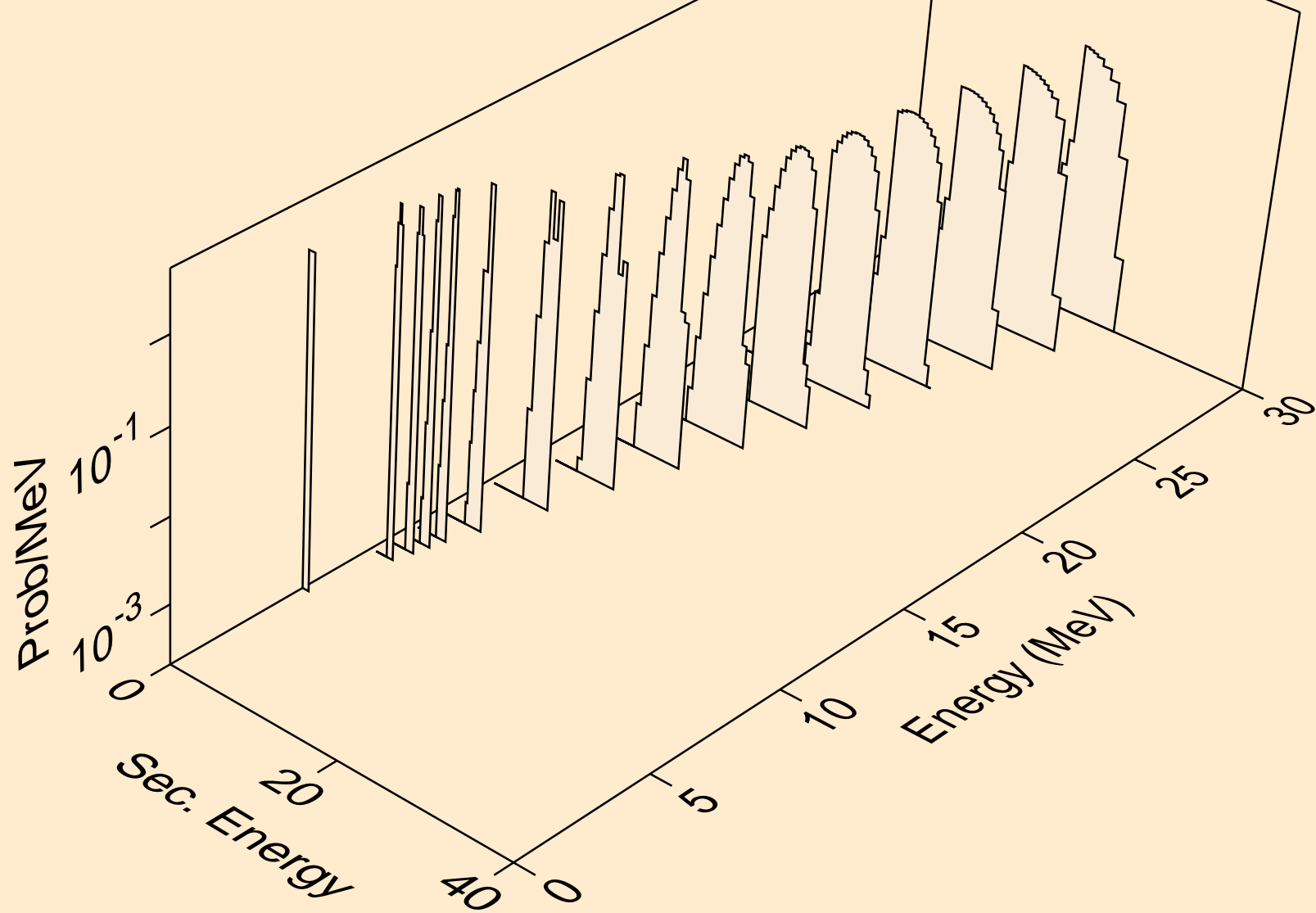

HG207 NEUTRON ACER TENDL-2021 LIBRARY; T=293.6K
he3s from (n,x)

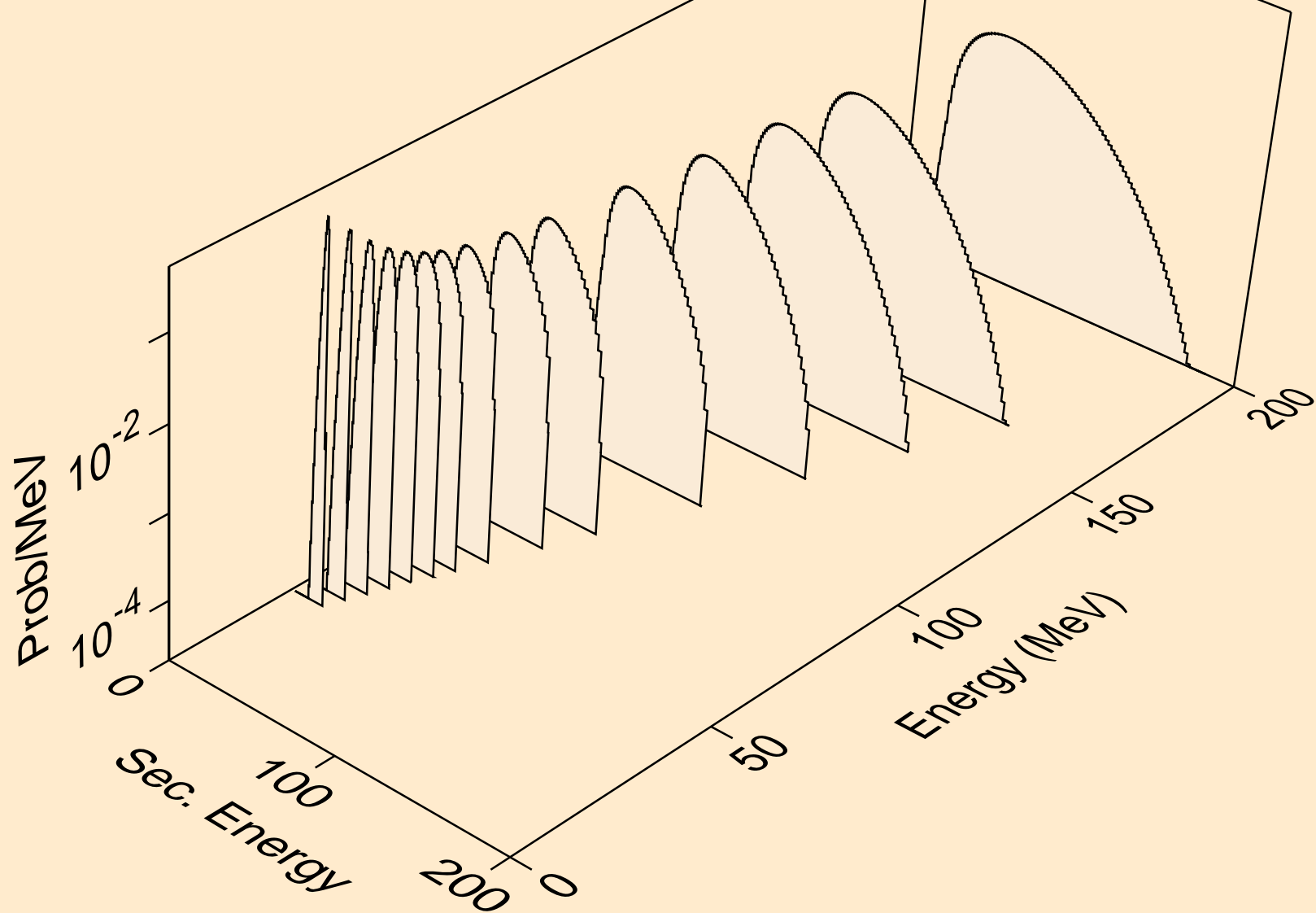

HG207 NEUTRON ACER TENDL-2021 LIBRARY; T=293.6K
he3s from (n,n*)he3

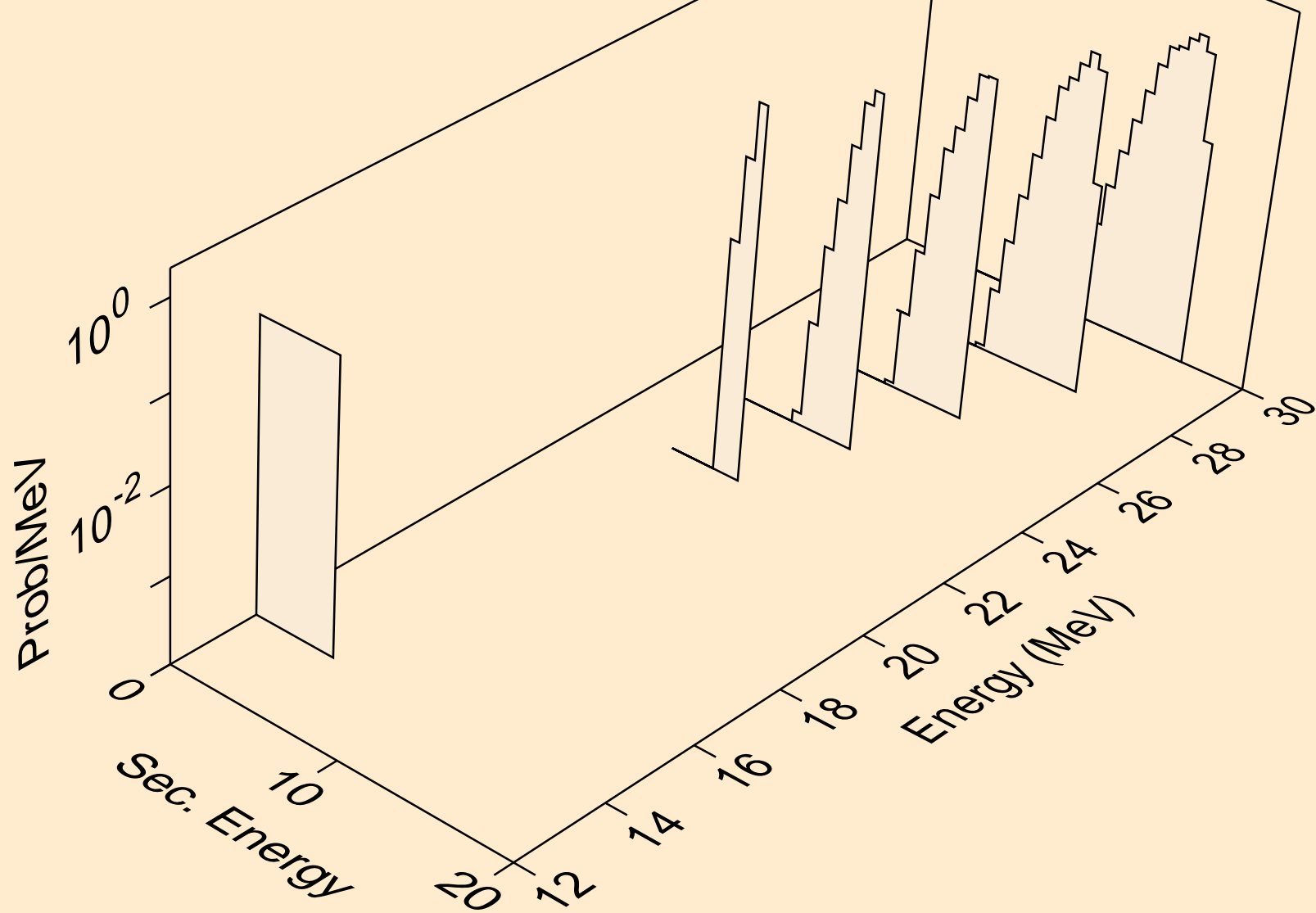

HG207 NEUTRON ACER TENDL-2021 LIBRARY; T=293.6K
he3s from (n,he3)

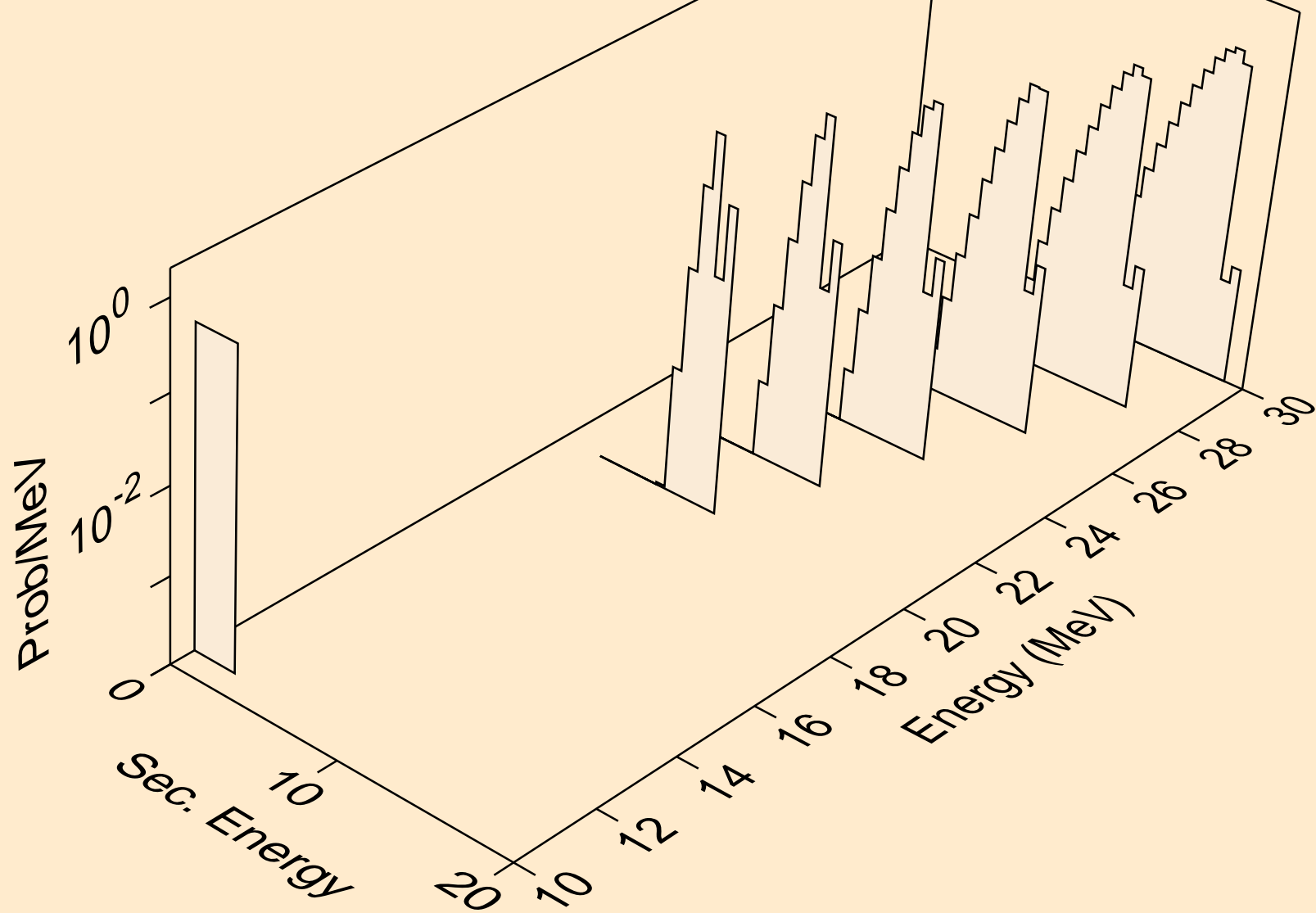

HG207 NEUTRON ACER TENDL-2021 LIBRARY; T=293.6K
alphas from (n,x)

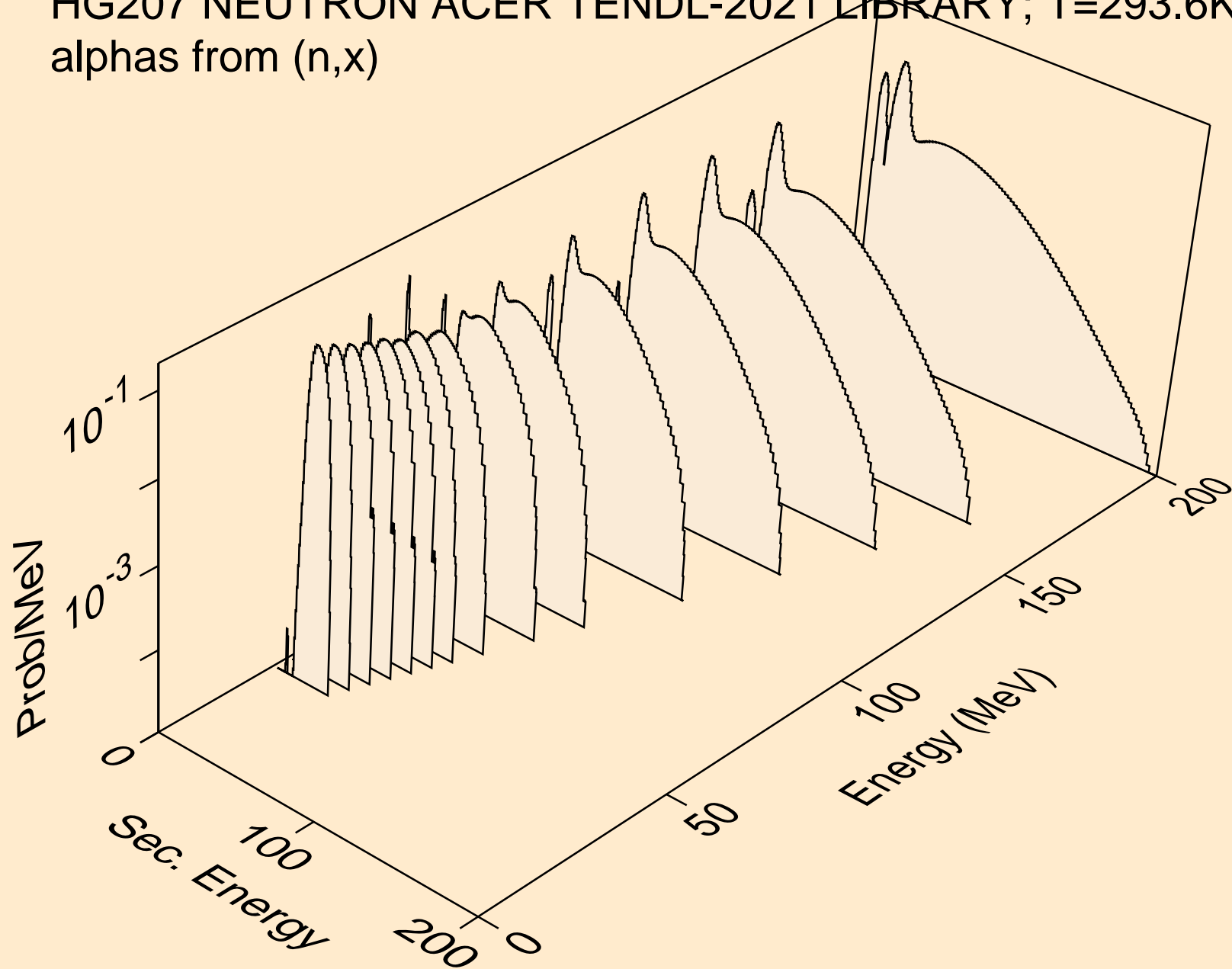

HG207 NEUTRON ACER TENDL-2021 LIBRARY; T=293.6K
alphas from (n,n*)a

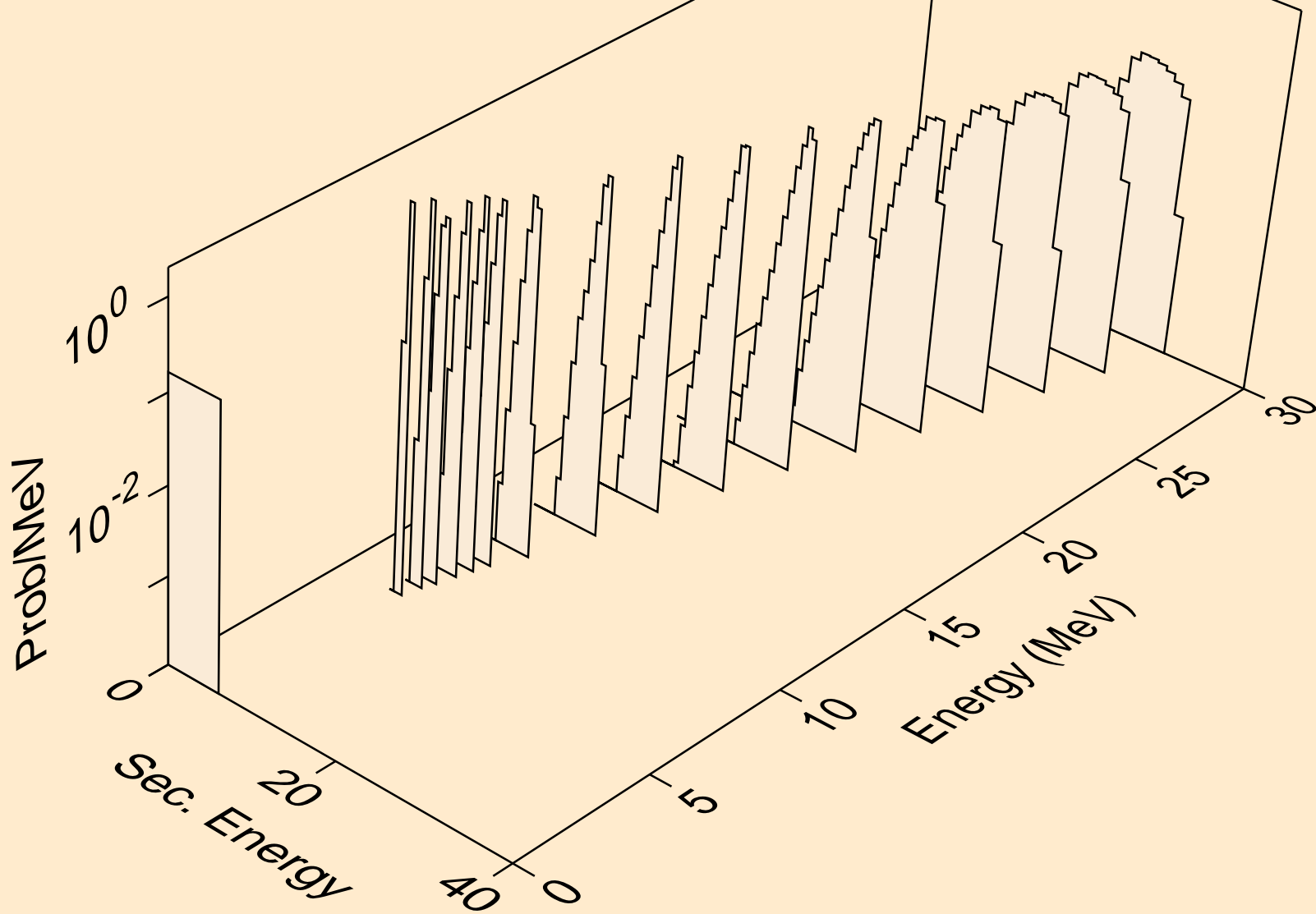

HG207 NEUTRON ACER TENDL-2021 LIBRARY; T=293.6K
alphas from (n,2n)a

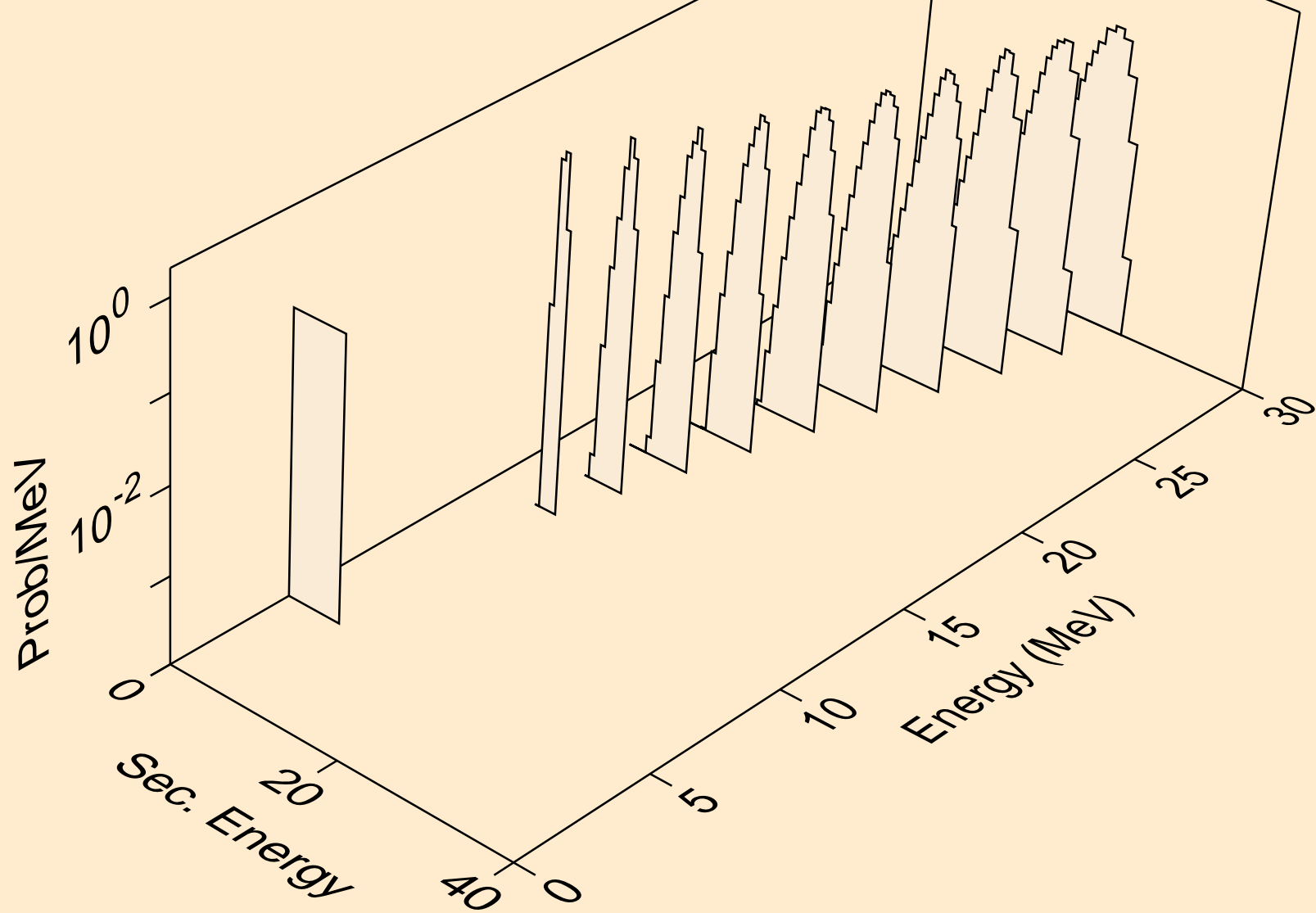

HG207 NEUTRON ACER TENDL-2021 LIBRARY; T=293.6K
alphas from (n,3n)a

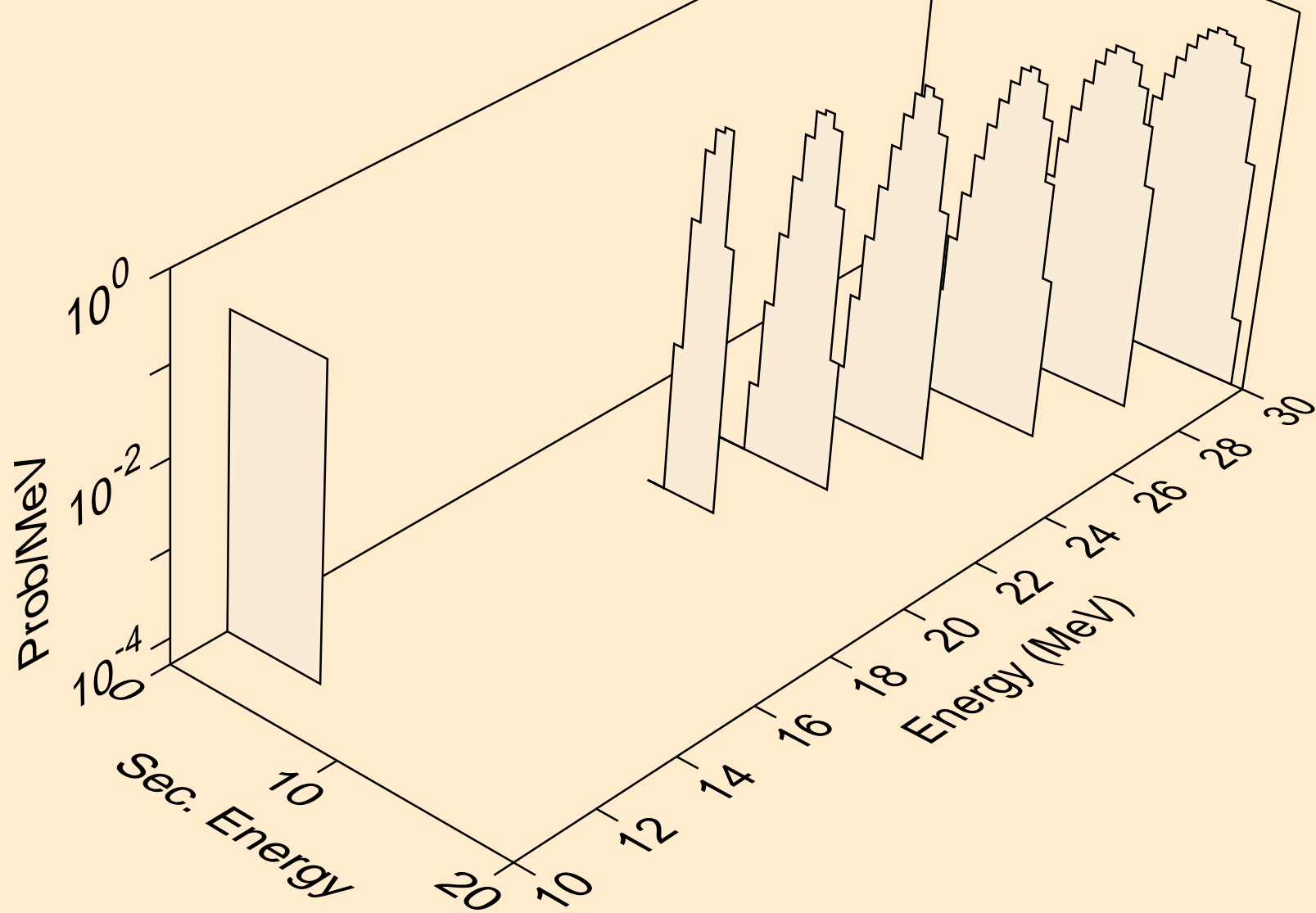

HG207 NEUTRON ACER TENDL-2021 LIBRARY; T=293.6K
alphas from (n,a)

