

HO146 NEUTRON ACER TENDL-2021 LIBRARY; T=293.6K

Principal cross sections

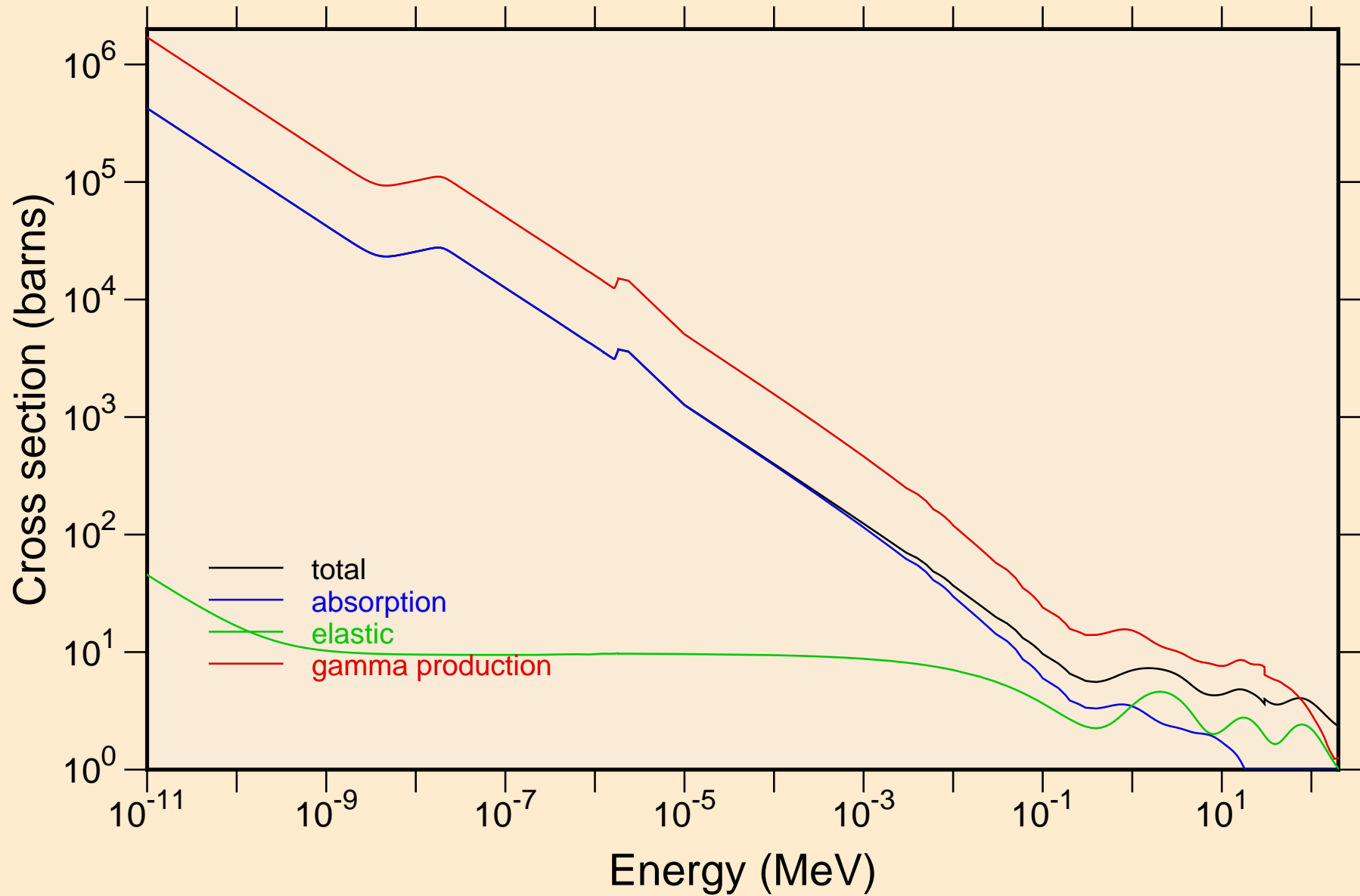

HO146 NEUTRON ACER TENDL-2021 LIBRARY; T=293.6K
Heating

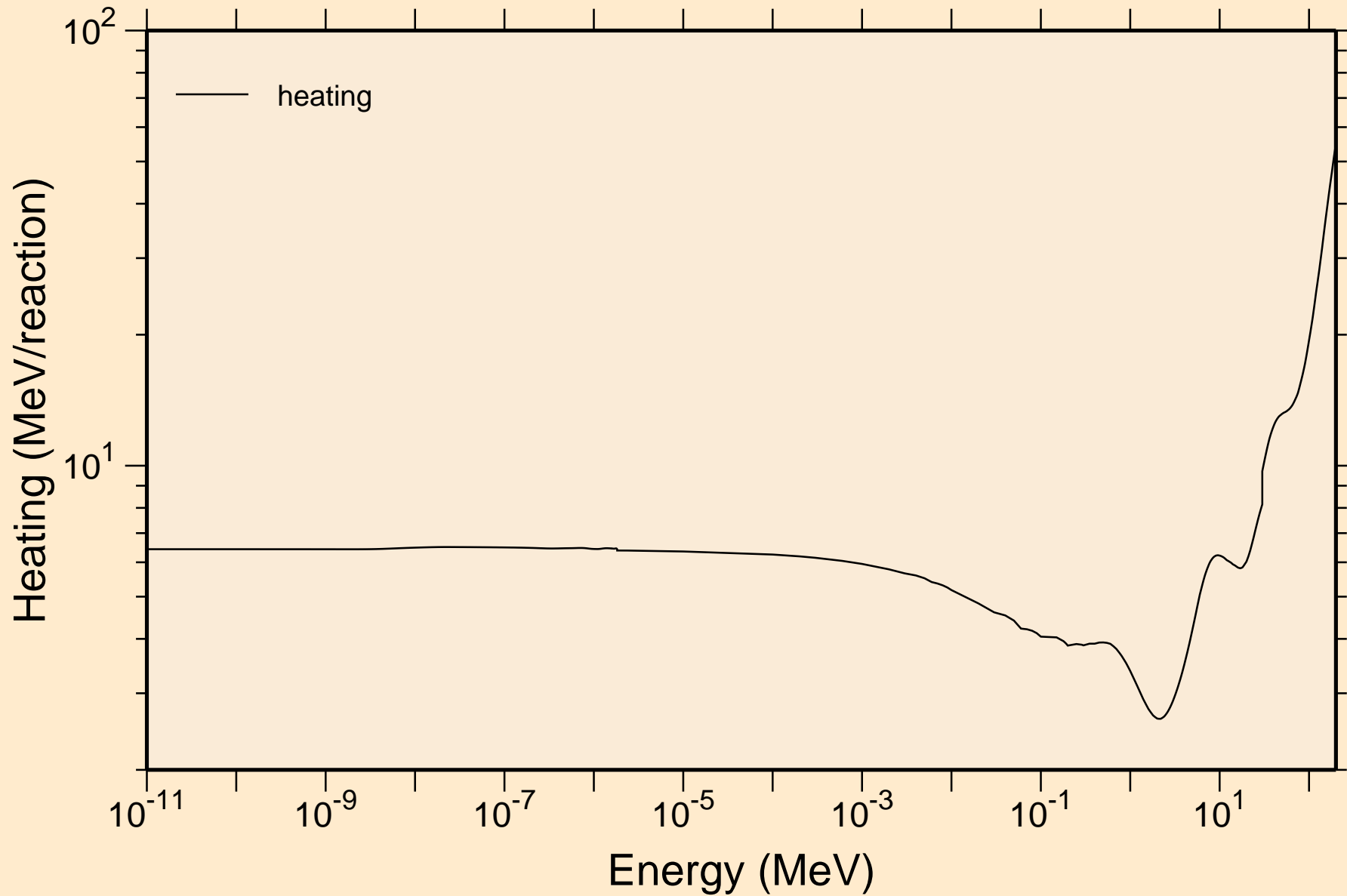

HO146 NEUTRON ACER TENDL-2021 LIBRARY; T=293.6K
Damage

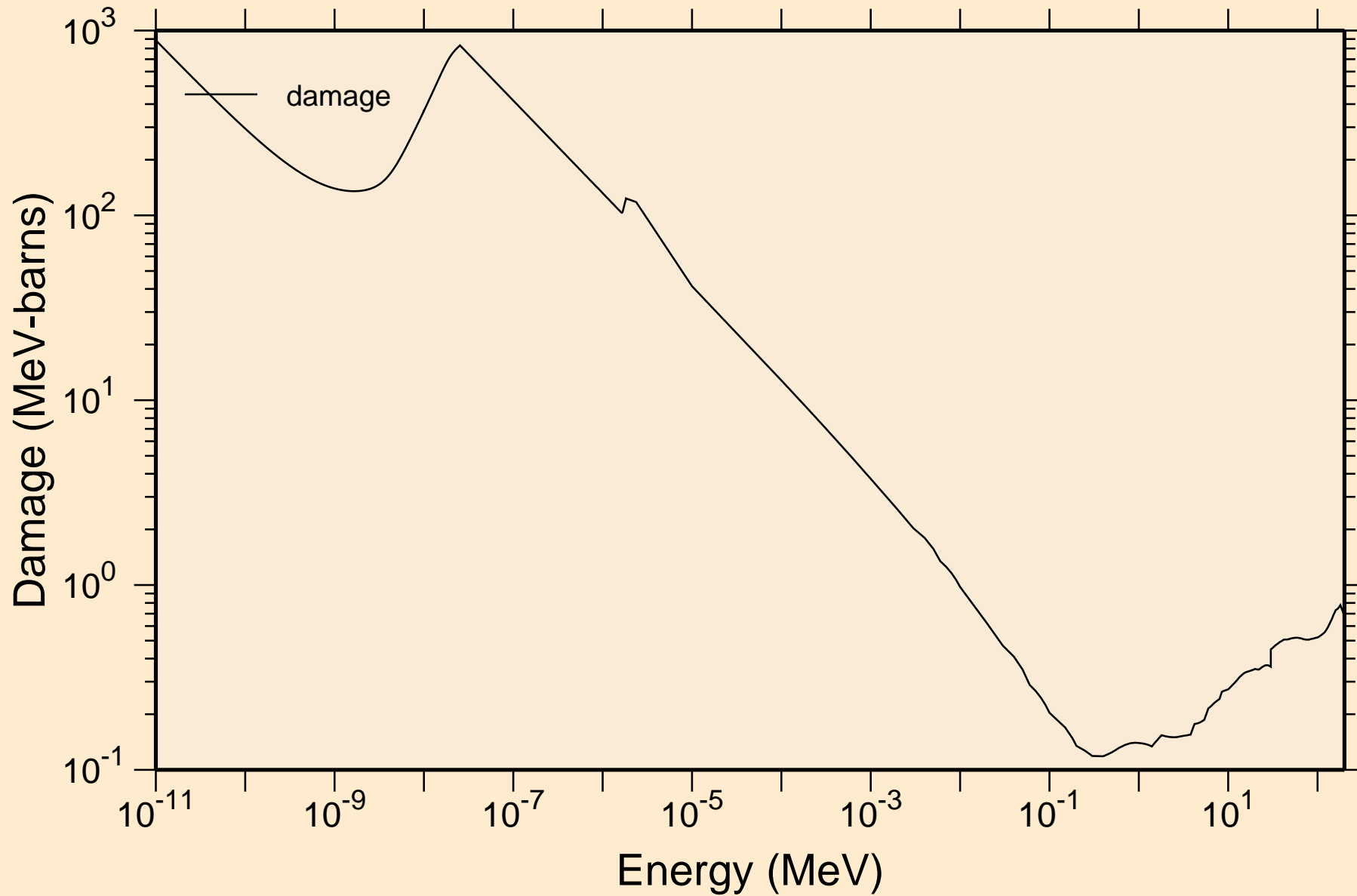

HO146 NEUTRON ACER TENDL-2021 LIBRARY; T=293.6K
Non-threshold reactions

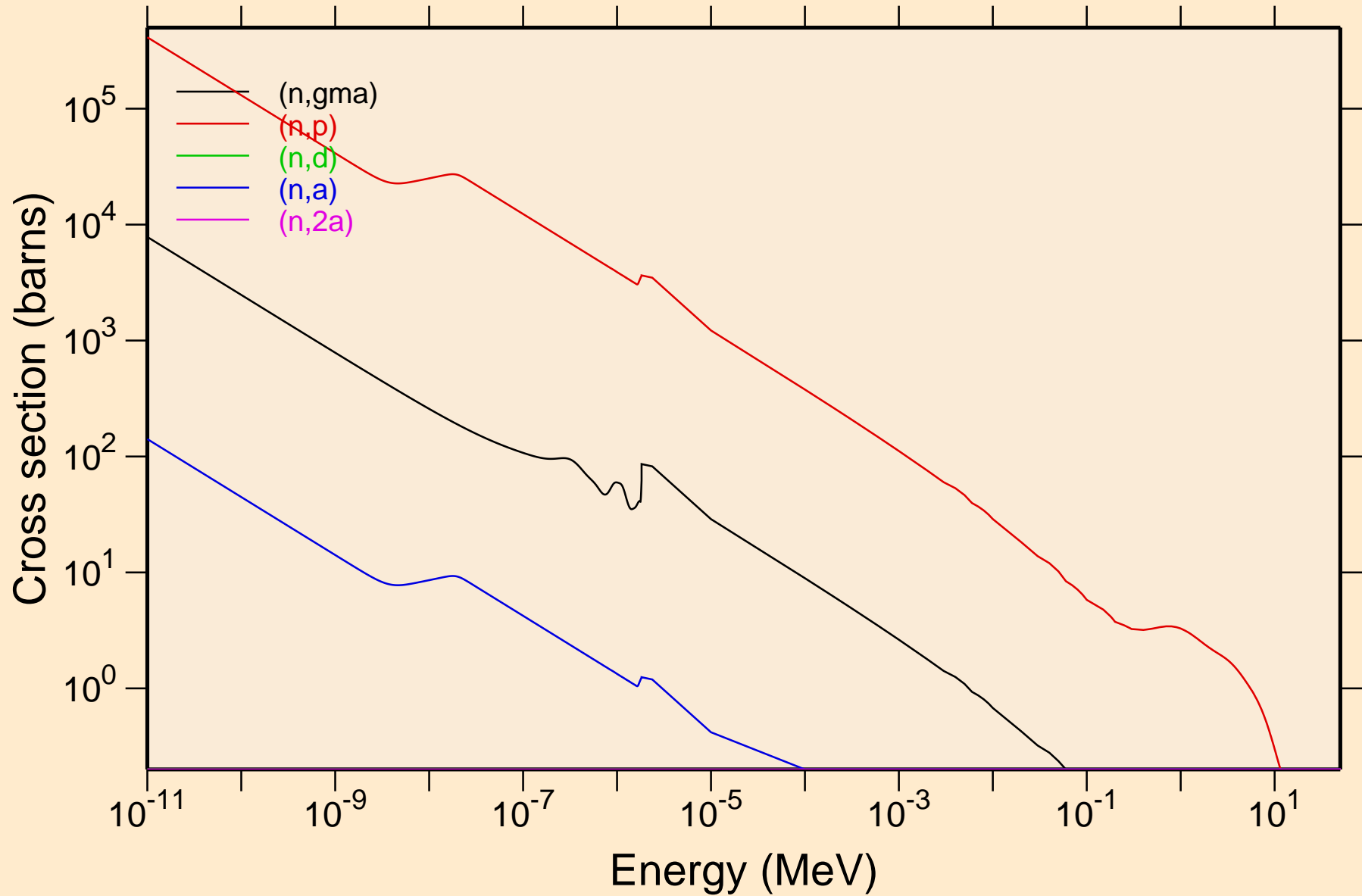

HO146 NEUTRON ACER TENDL-2021 LIBRARY; T=293.6K

Non-threshold reactions

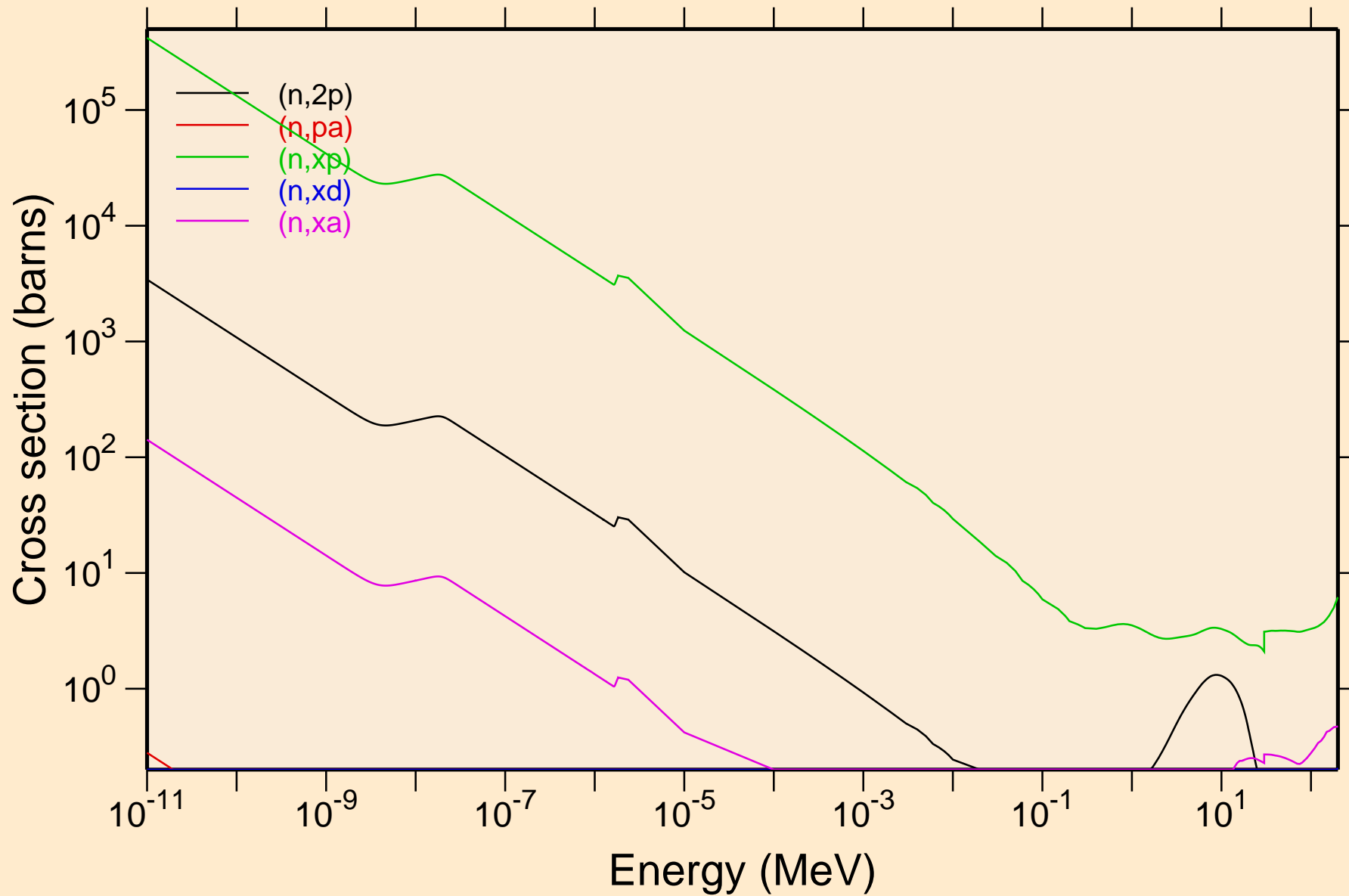

HO146 NEUTRON ACER TENDL-2021 LIBRARY; T=293.6K

Principal cross sections

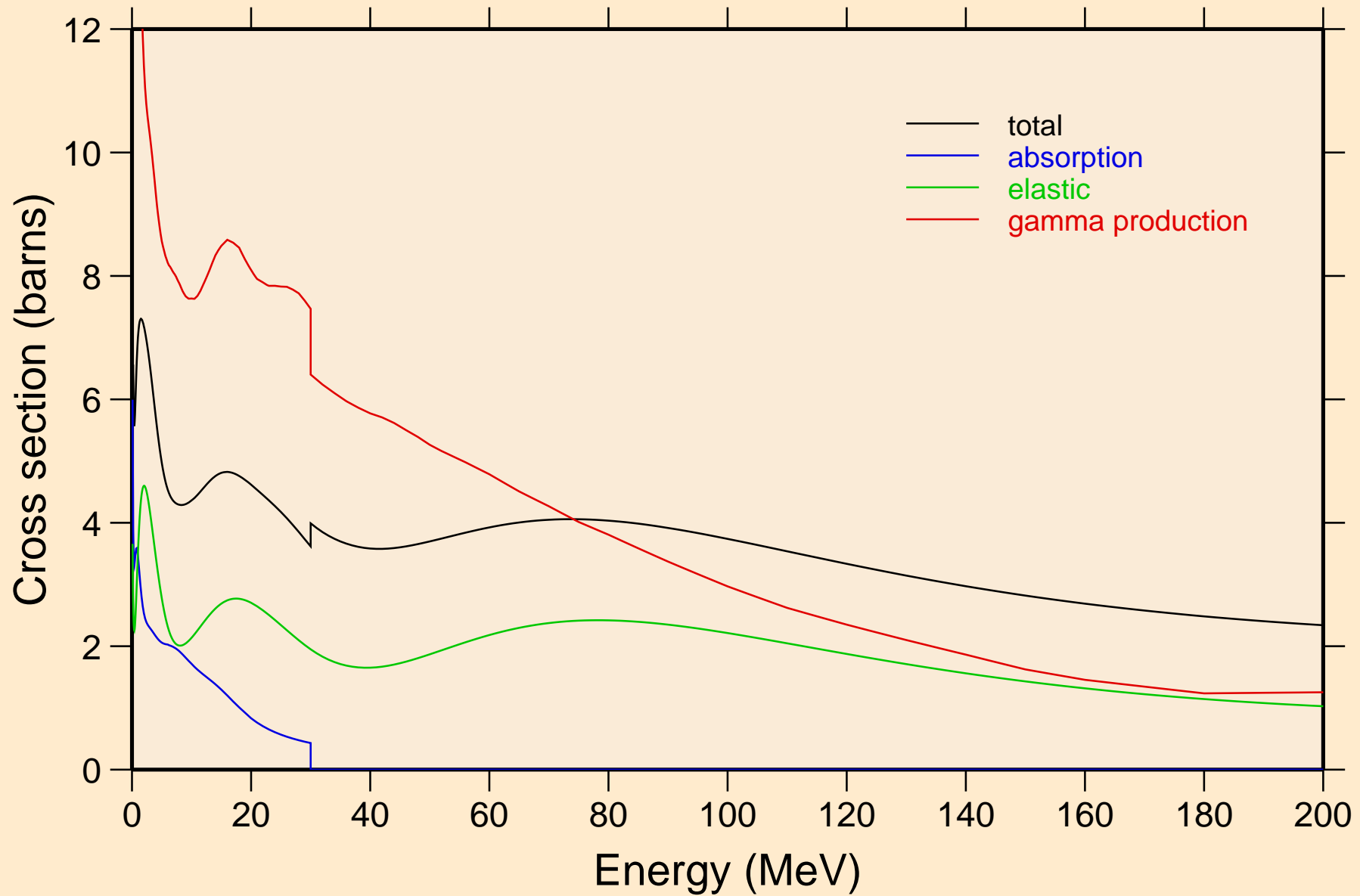

HO146 NEUTRON ACER TENDL-2021 LIBRARY; T=293.6K
Heating

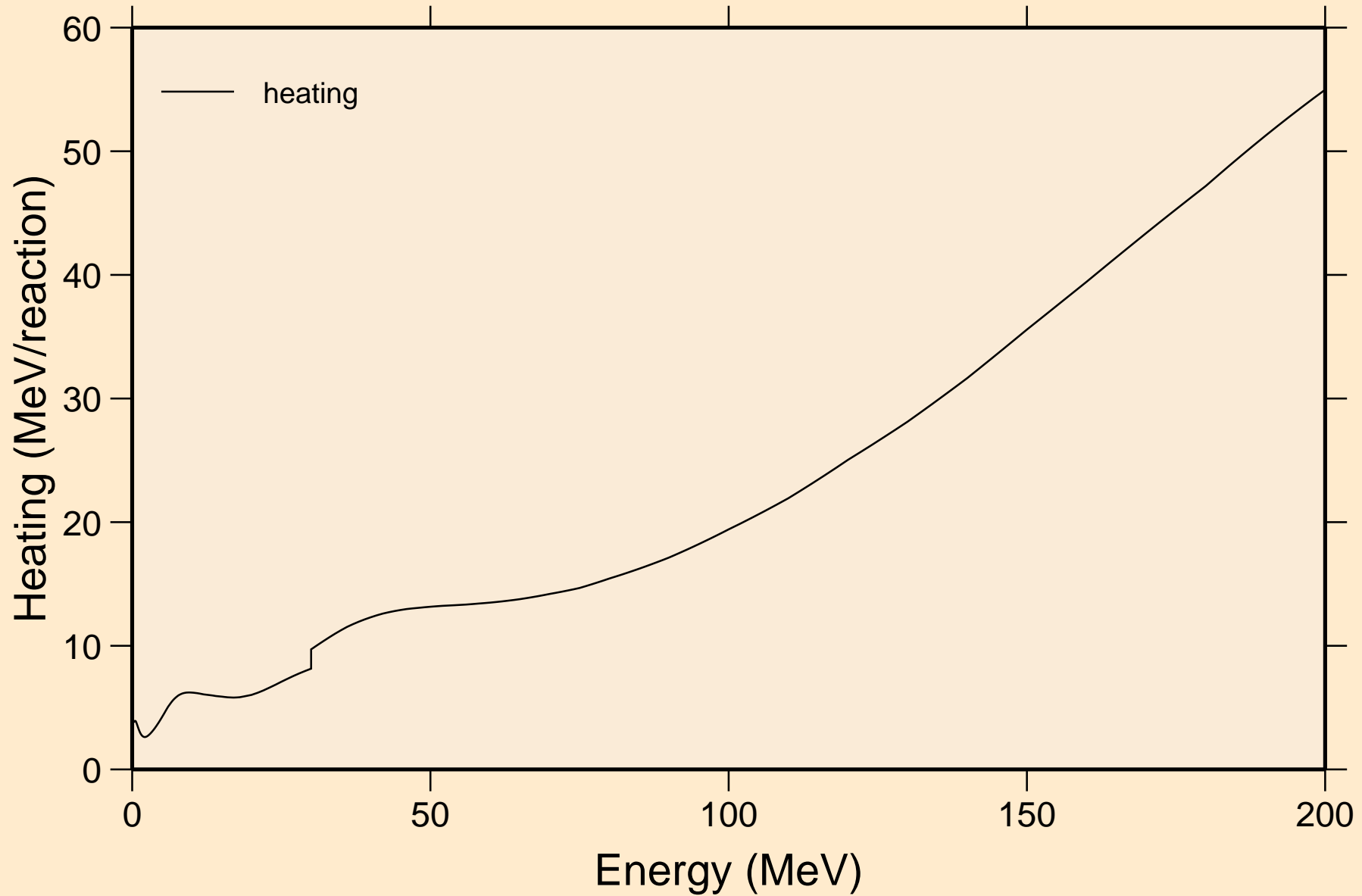

HO146 NEUTRON ACER TENDL-2021 LIBRARY; T=293.6K

Damage

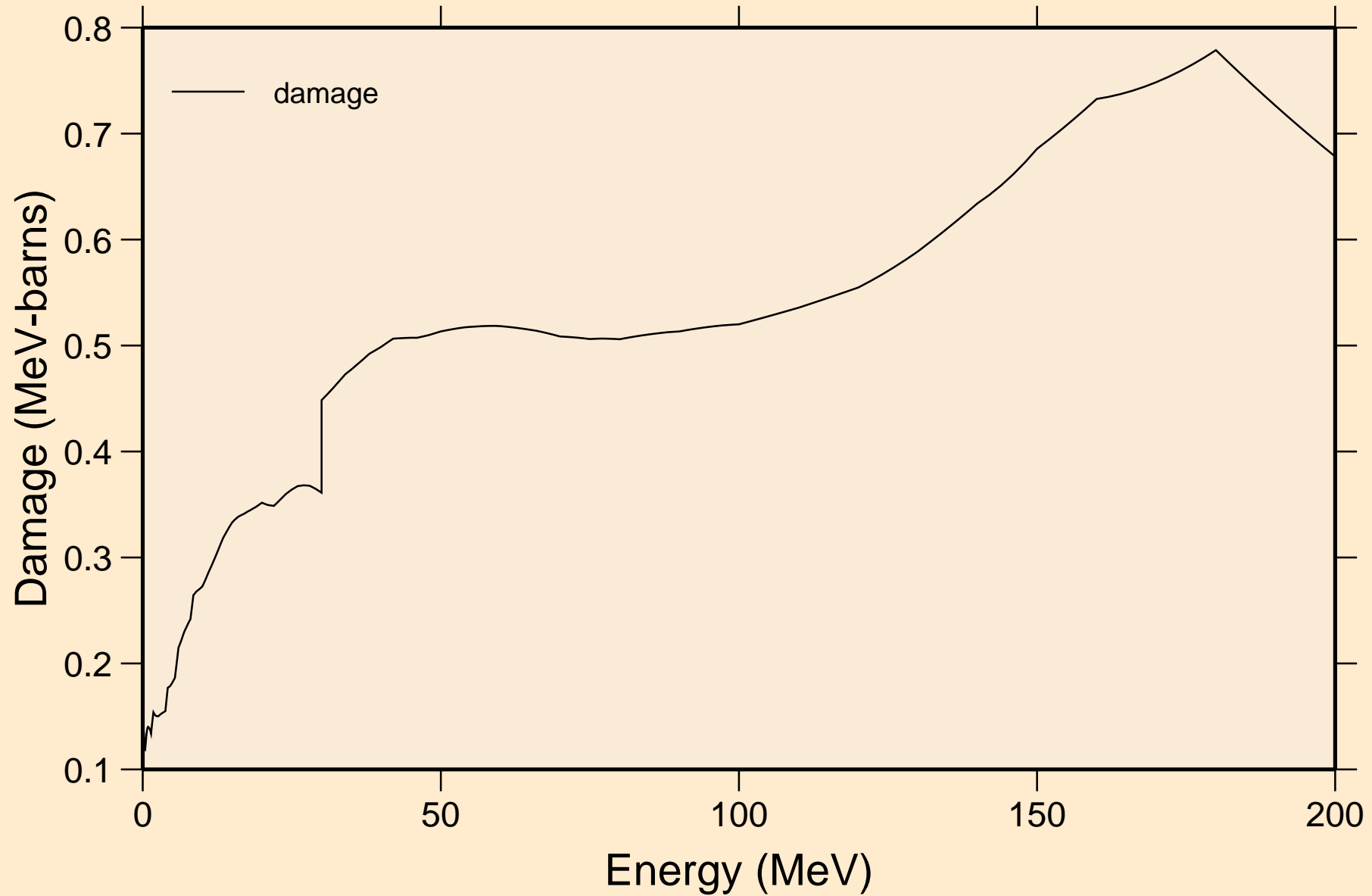

HO146 NEUTRON ACER TENDL-2021 LIBRARY; T=293.6K
Non-threshold reactions

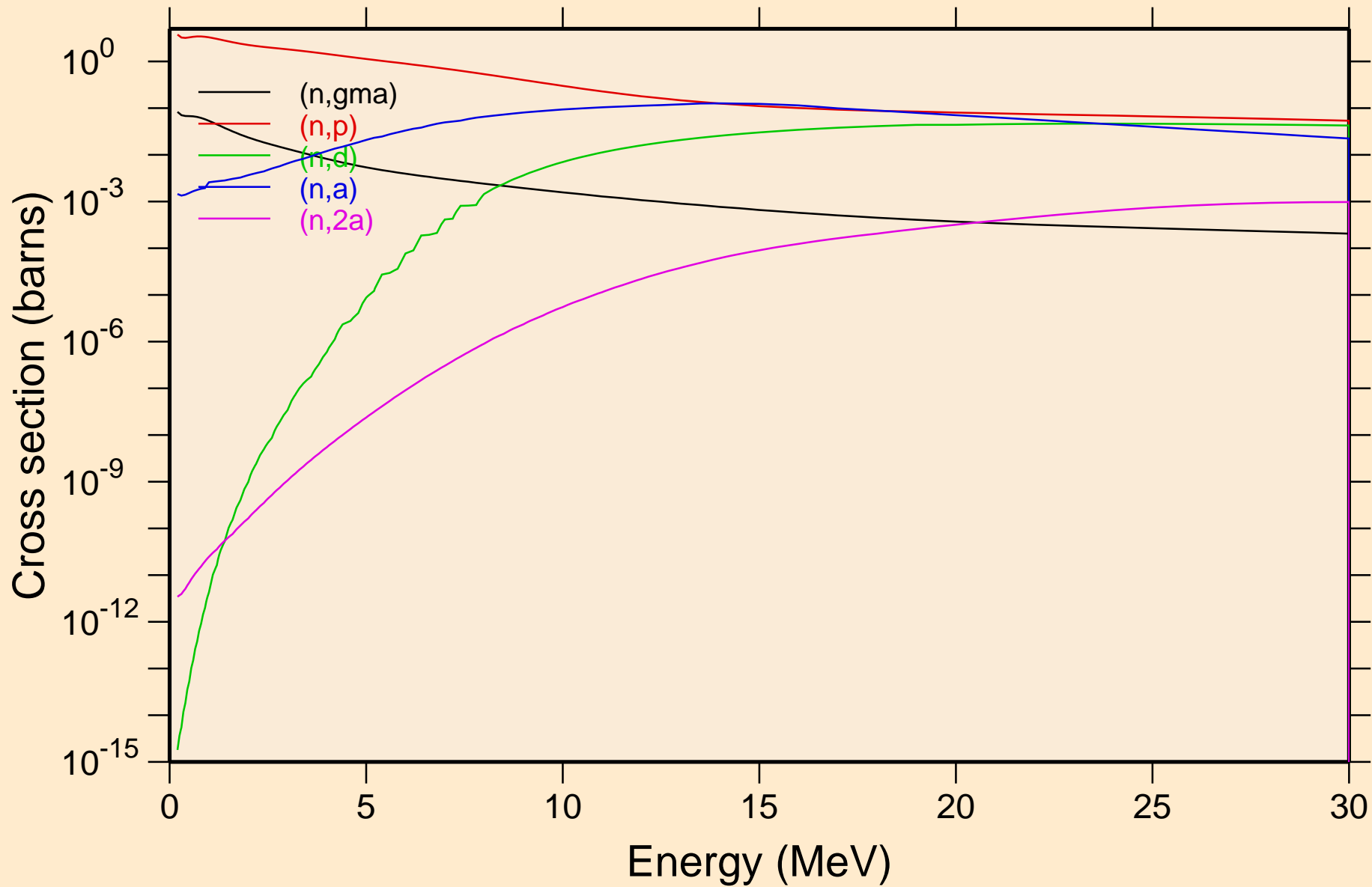

HO146 NEUTRON ACER TENDL-2021 LIBRARY; T=293.6K
Non-threshold reactions

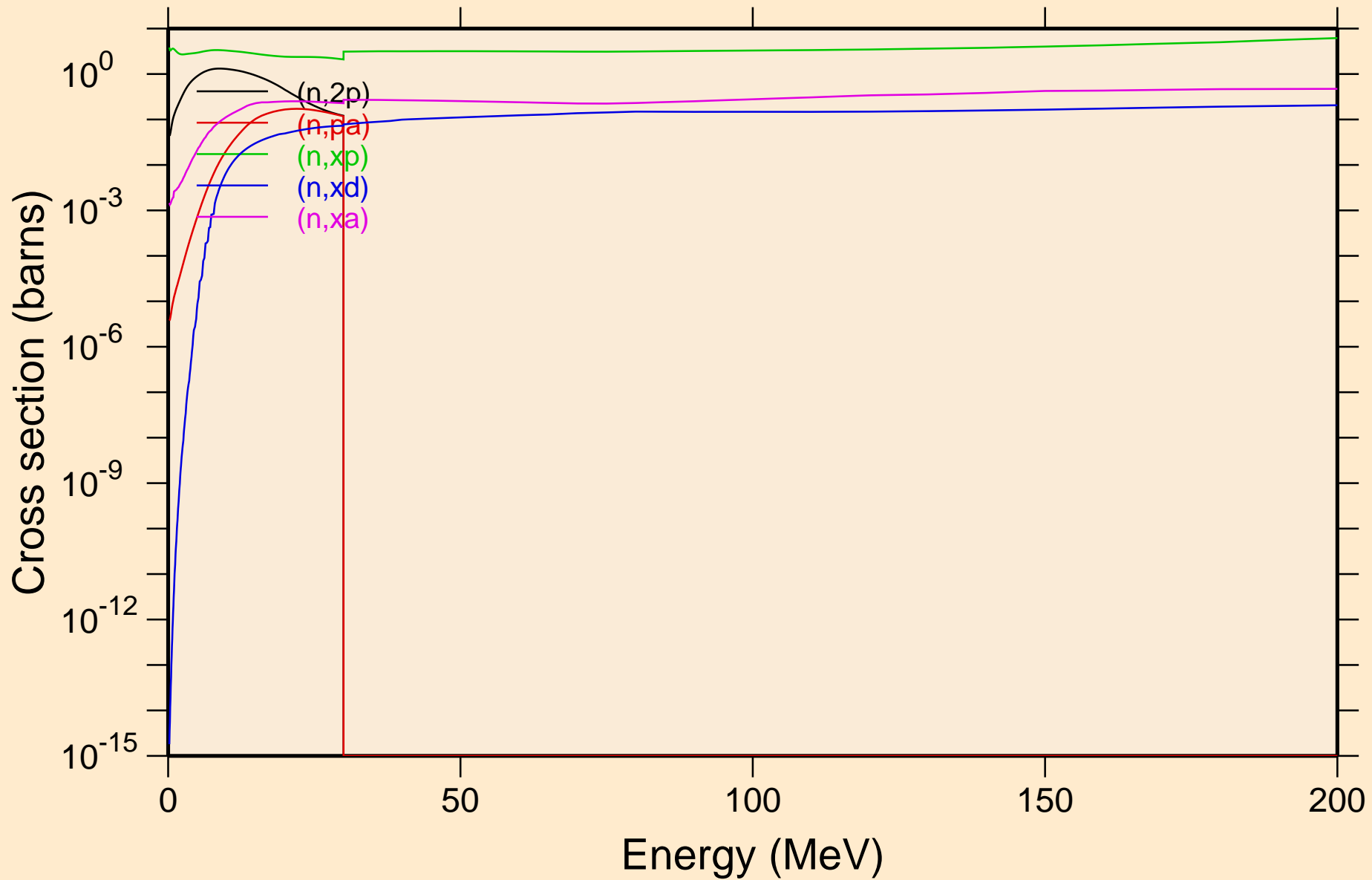

HO146 NEUTRON ACER TENDL-2021 LIBRARY; T=293.6K
Inelastic levels

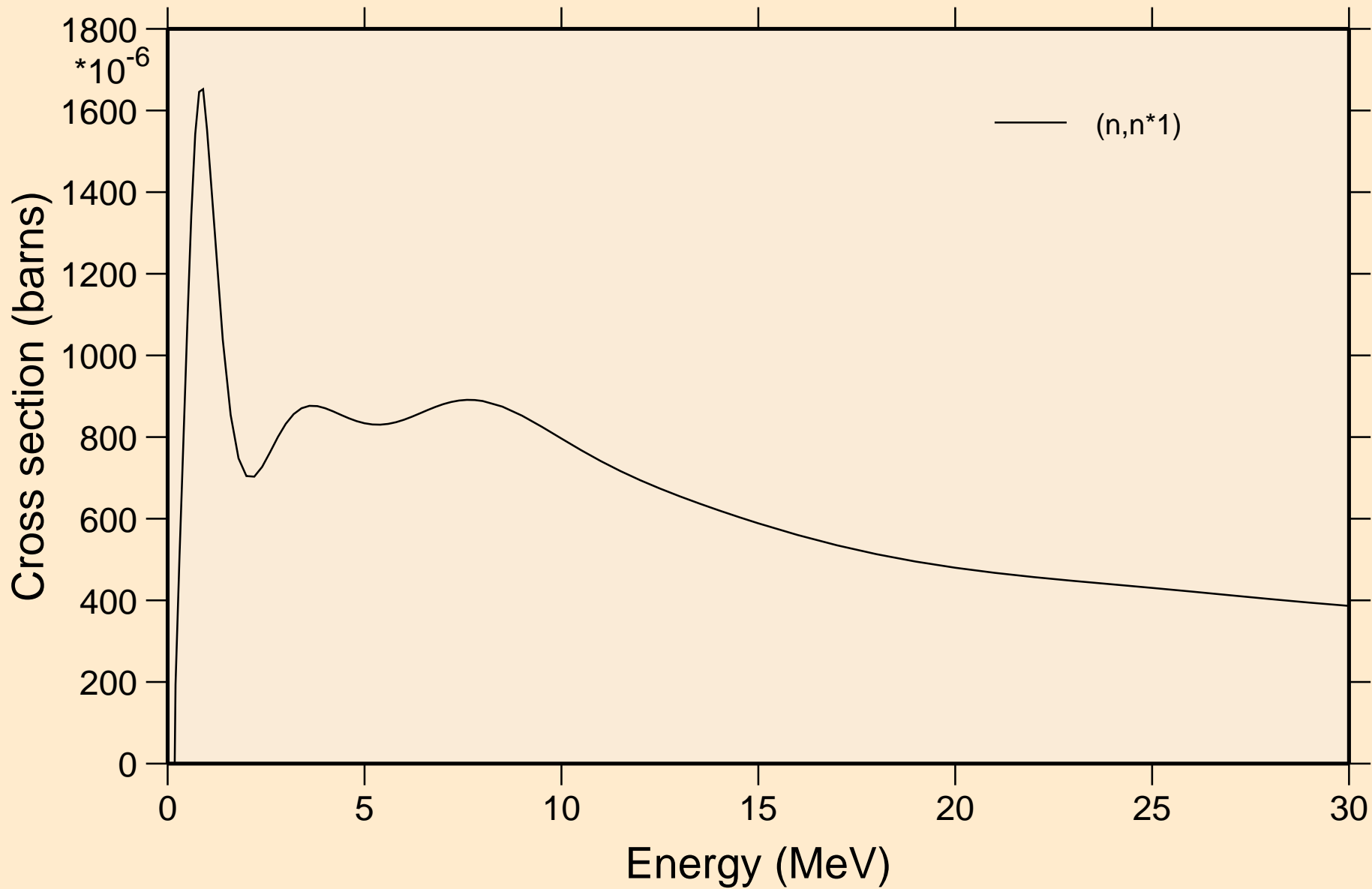

HO146 NEUTRON ACER TENDL-2021 LIBRARY; T=293.6K

Threshold reactions

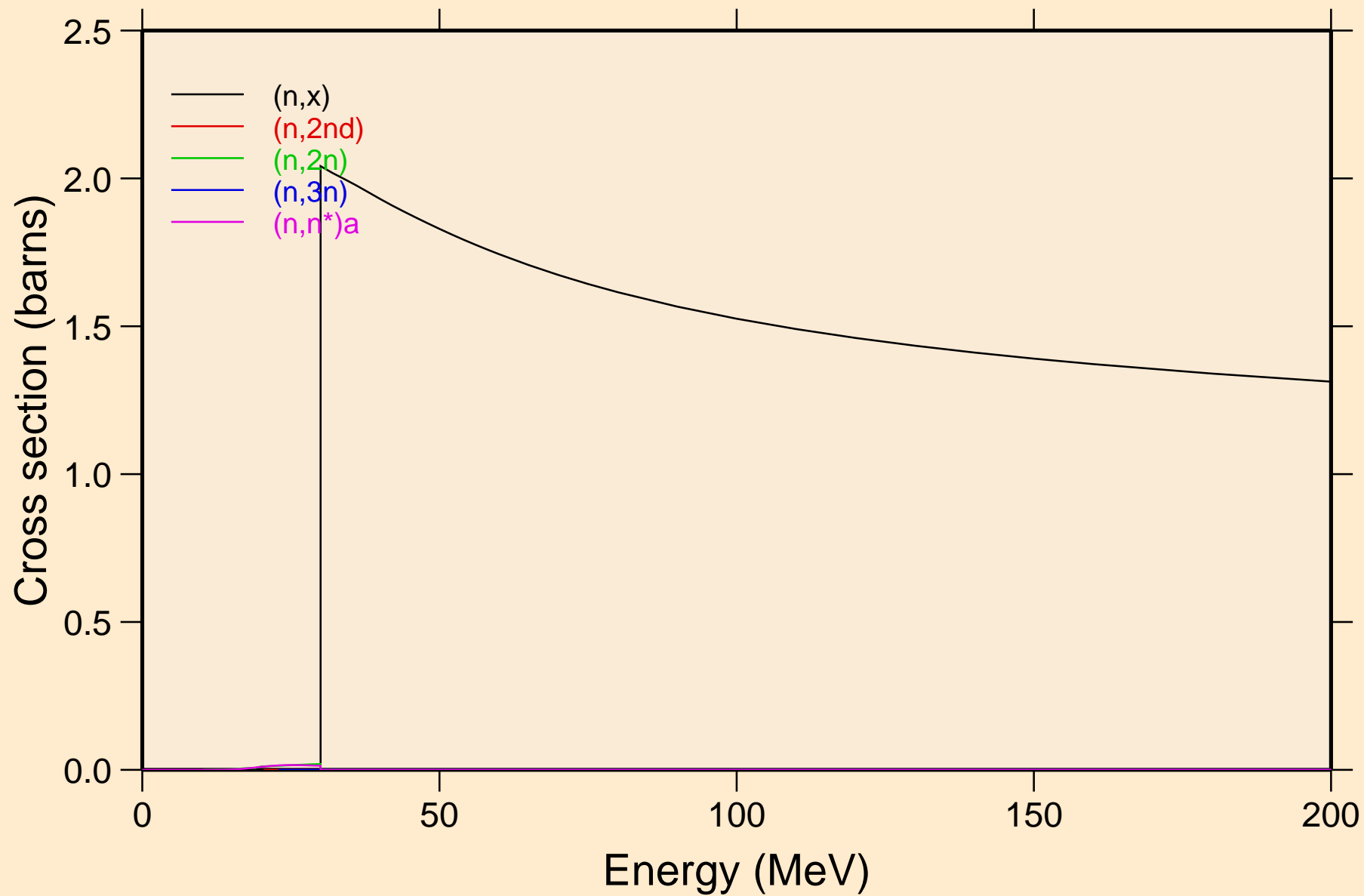

HO146 NEUTRON ACER TENDL-2021 LIBRARY; T=293.6K
Threshold reactions

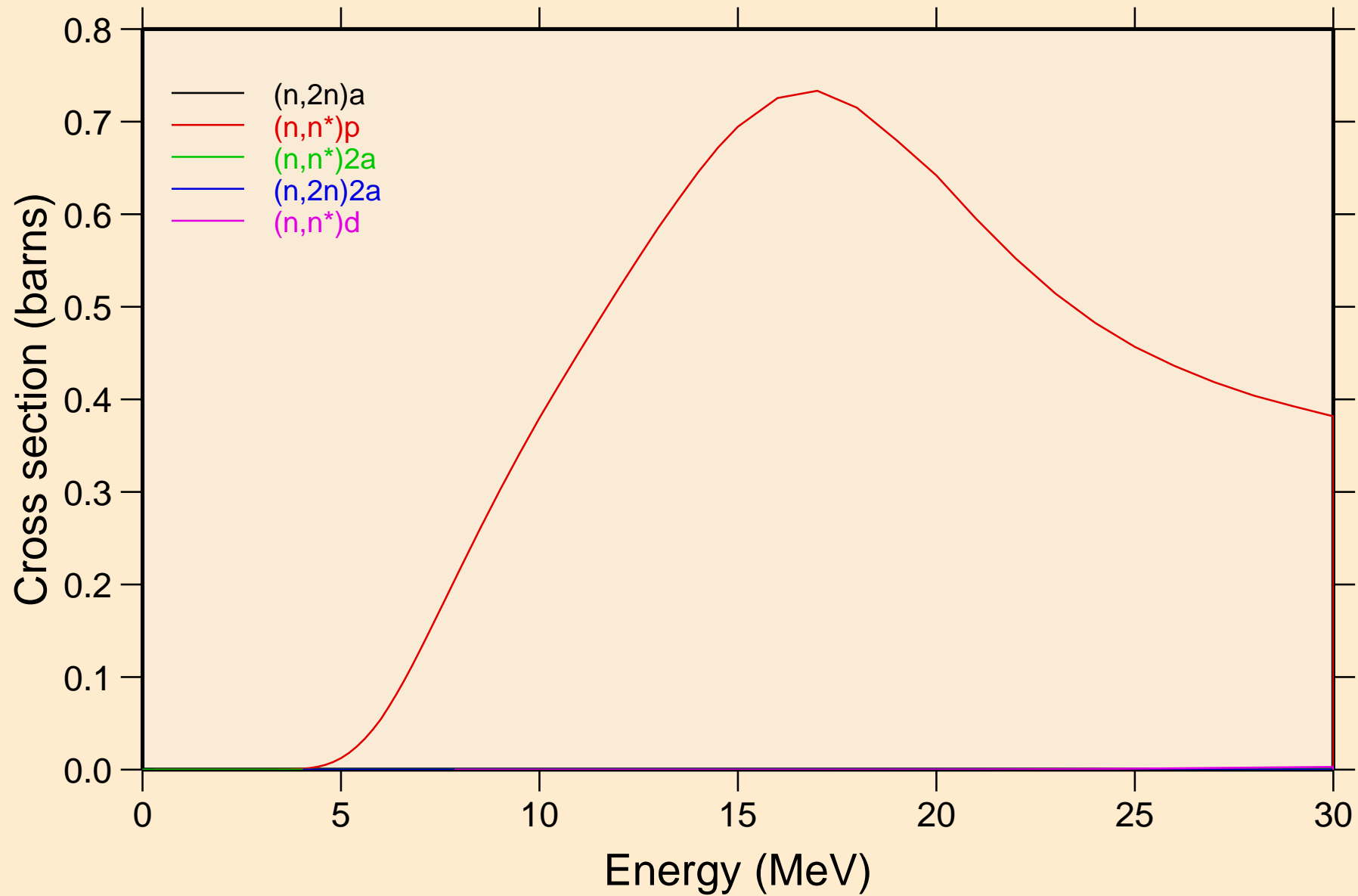

HO146 NEUTRON ACER TENDL-2021 LIBRARY; T=293.6K
Threshold reactions

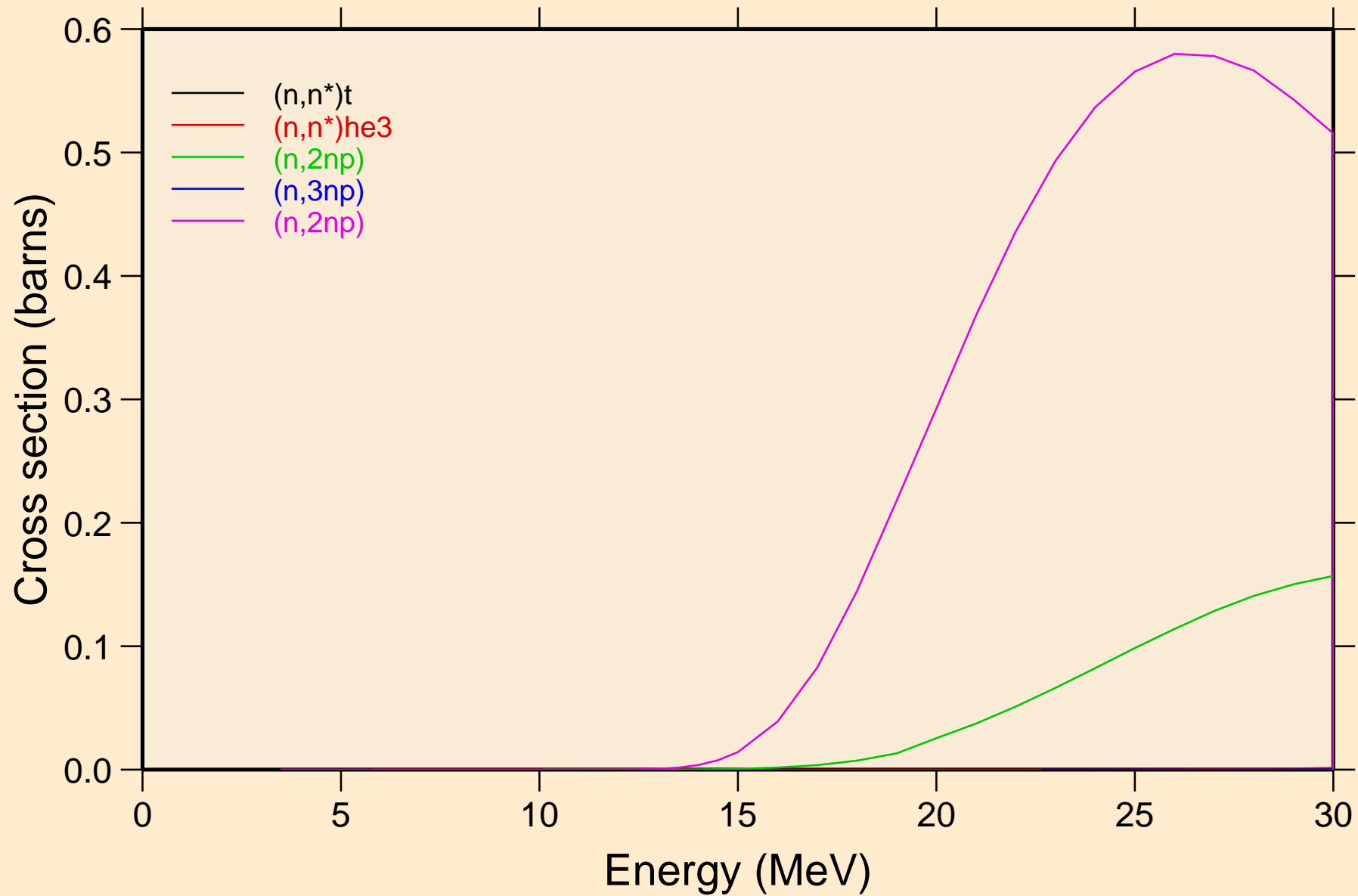

HO146 NEUTRON ACER TENDL-2021 LIBRARY; T=293.6K

Threshold reactions

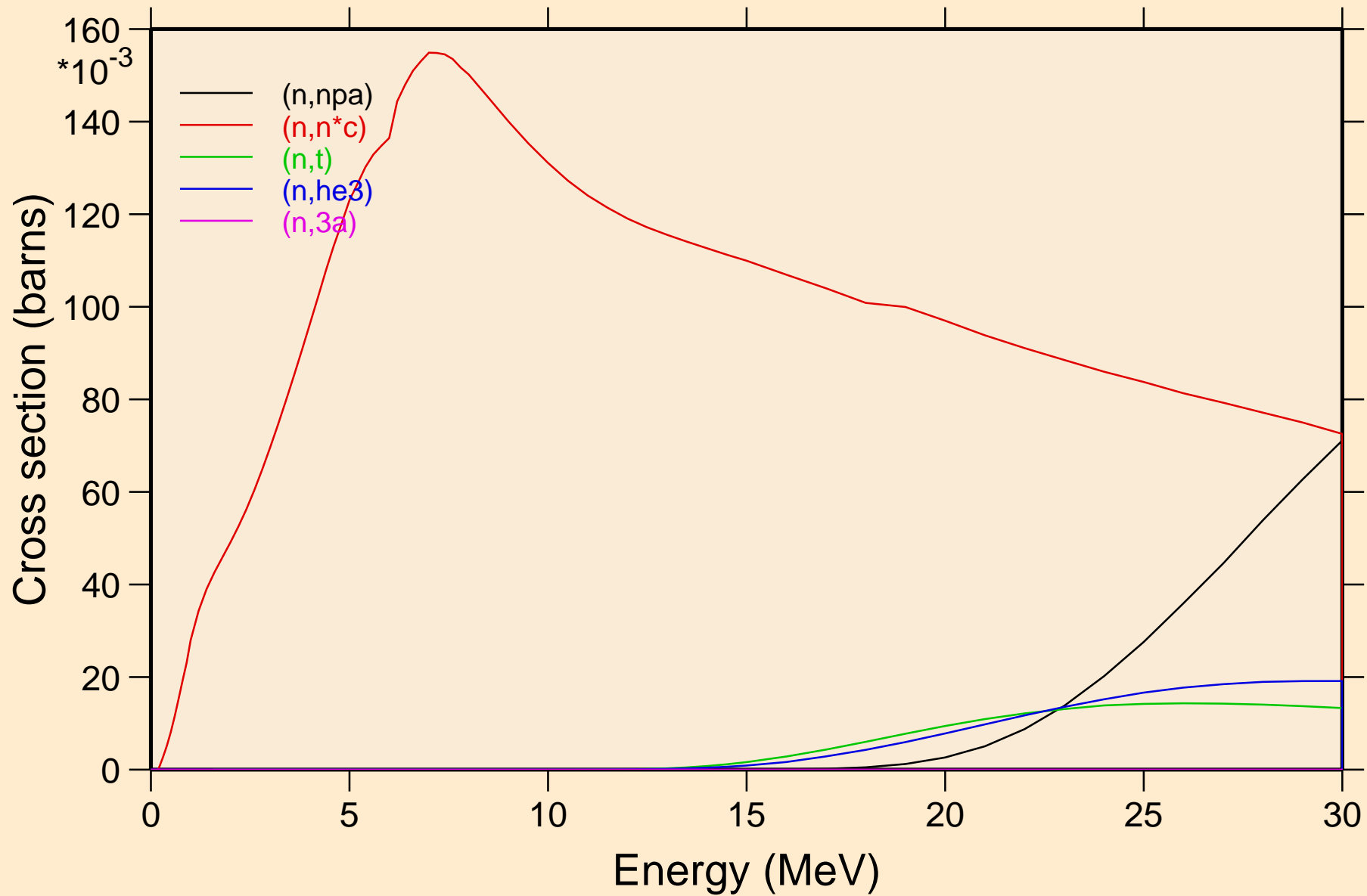

HO146 NEUTRON ACER TENDL-2021 LIBRARY; T=293.6K

Threshold reactions

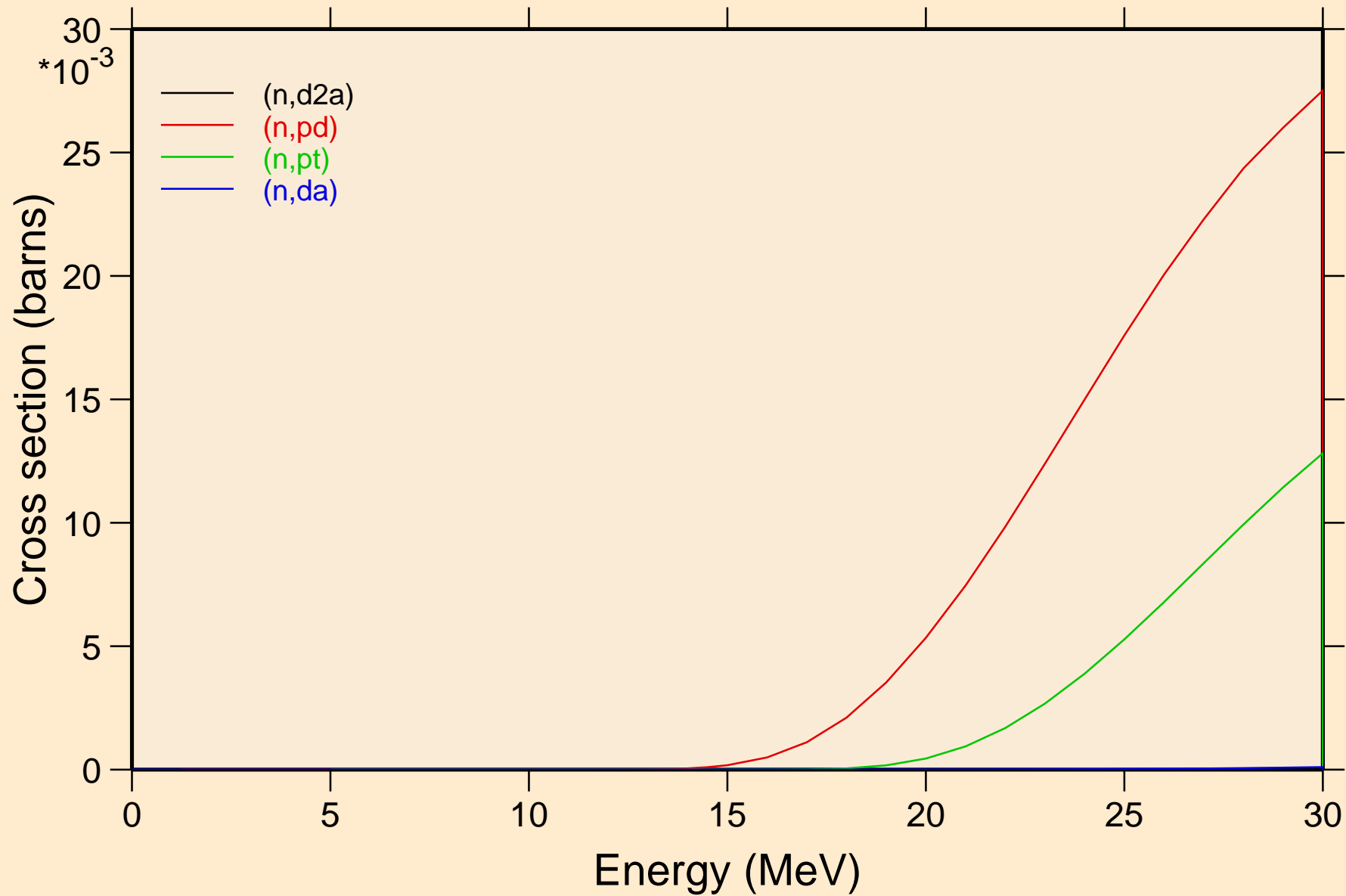

HO146 NEUTRON ACER TENDL-2021 LIBRARY; T=293.6K
Threshold reactions

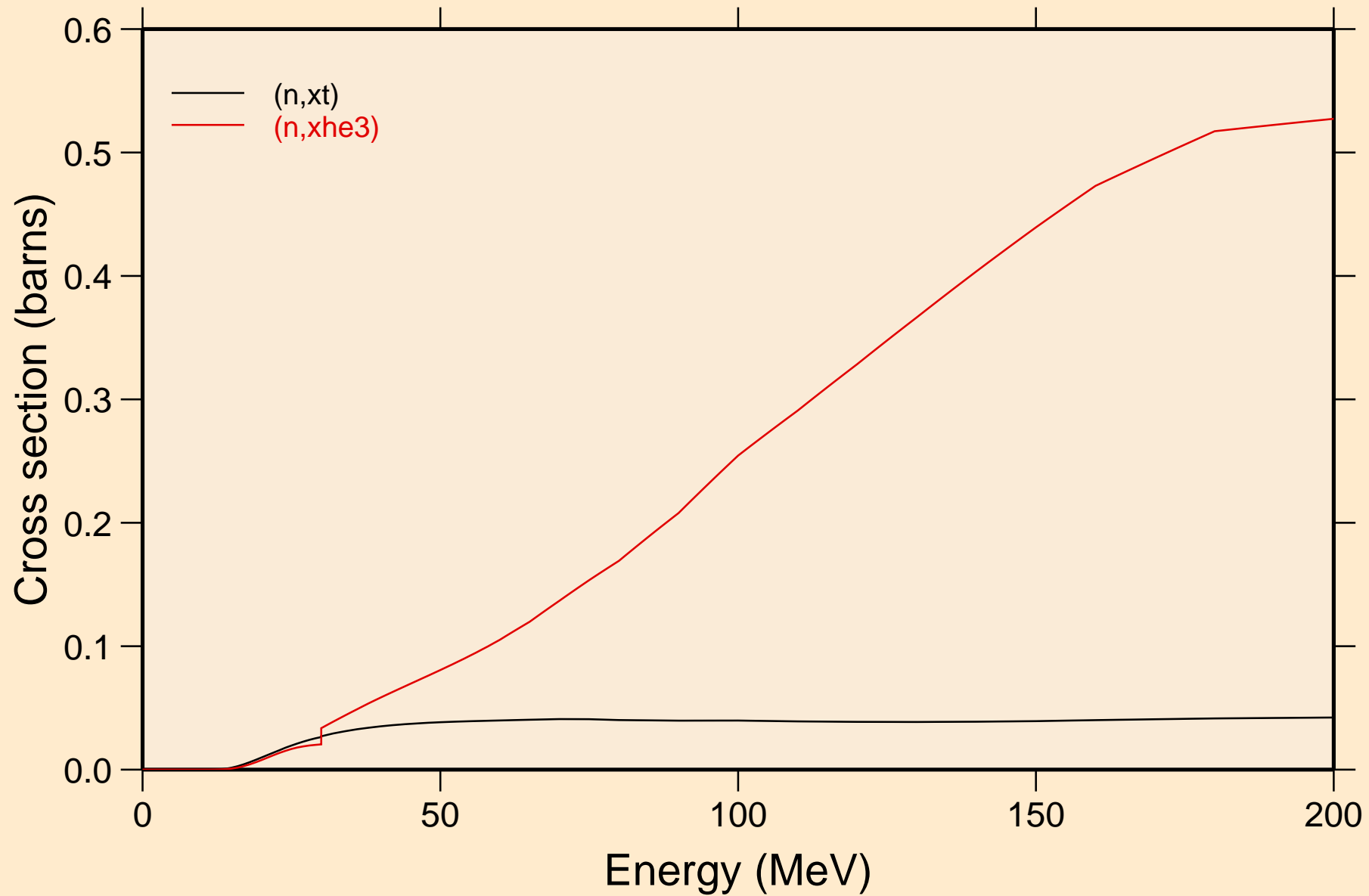

HO146 NEUTRON ACER TENDL-2021 LIBRARY; T=293.6K
angular distribution for elastic

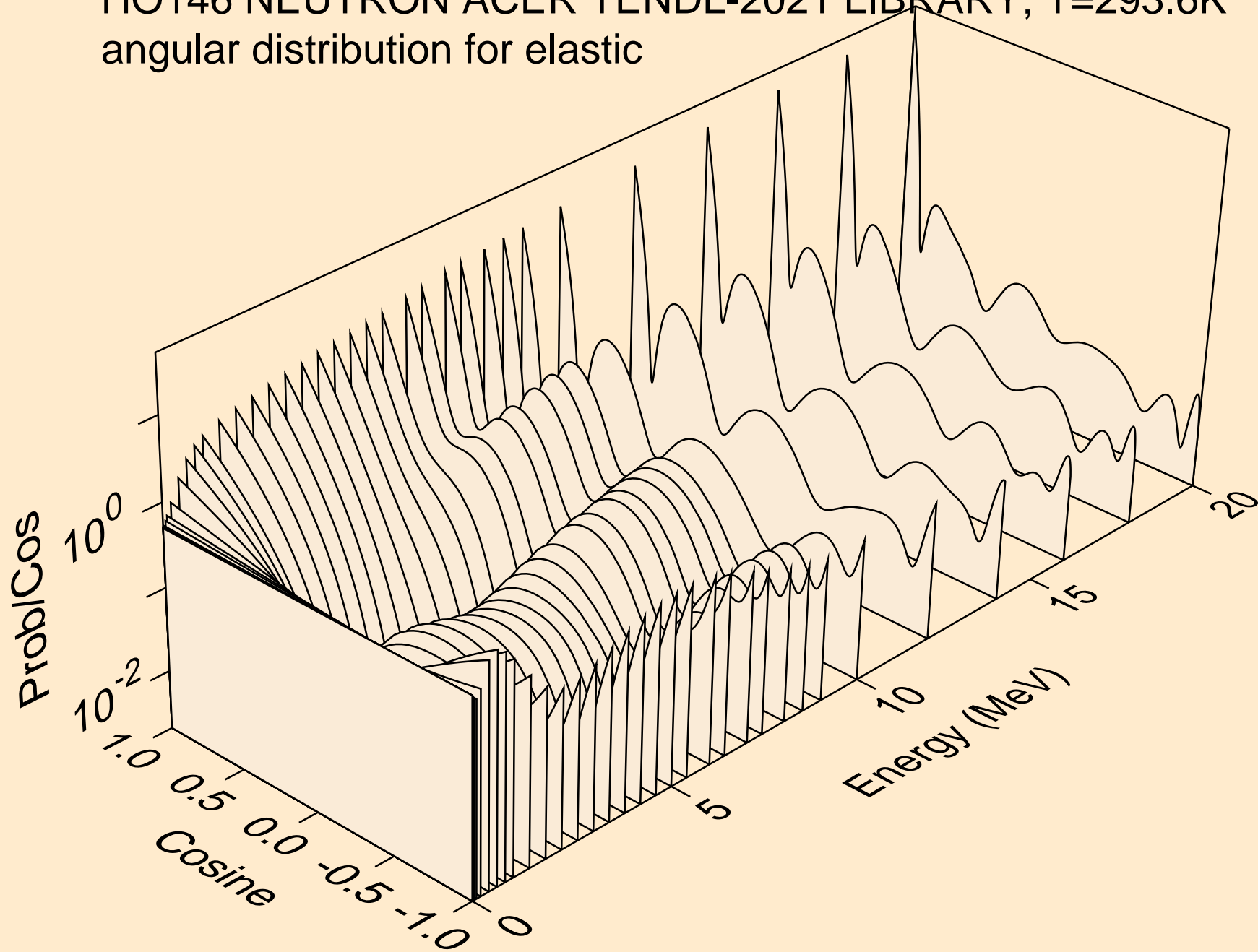

HO146 NEUTRON ACER TENDL-2021 LIBRARY; T=293.6K
angular distribution for elastic

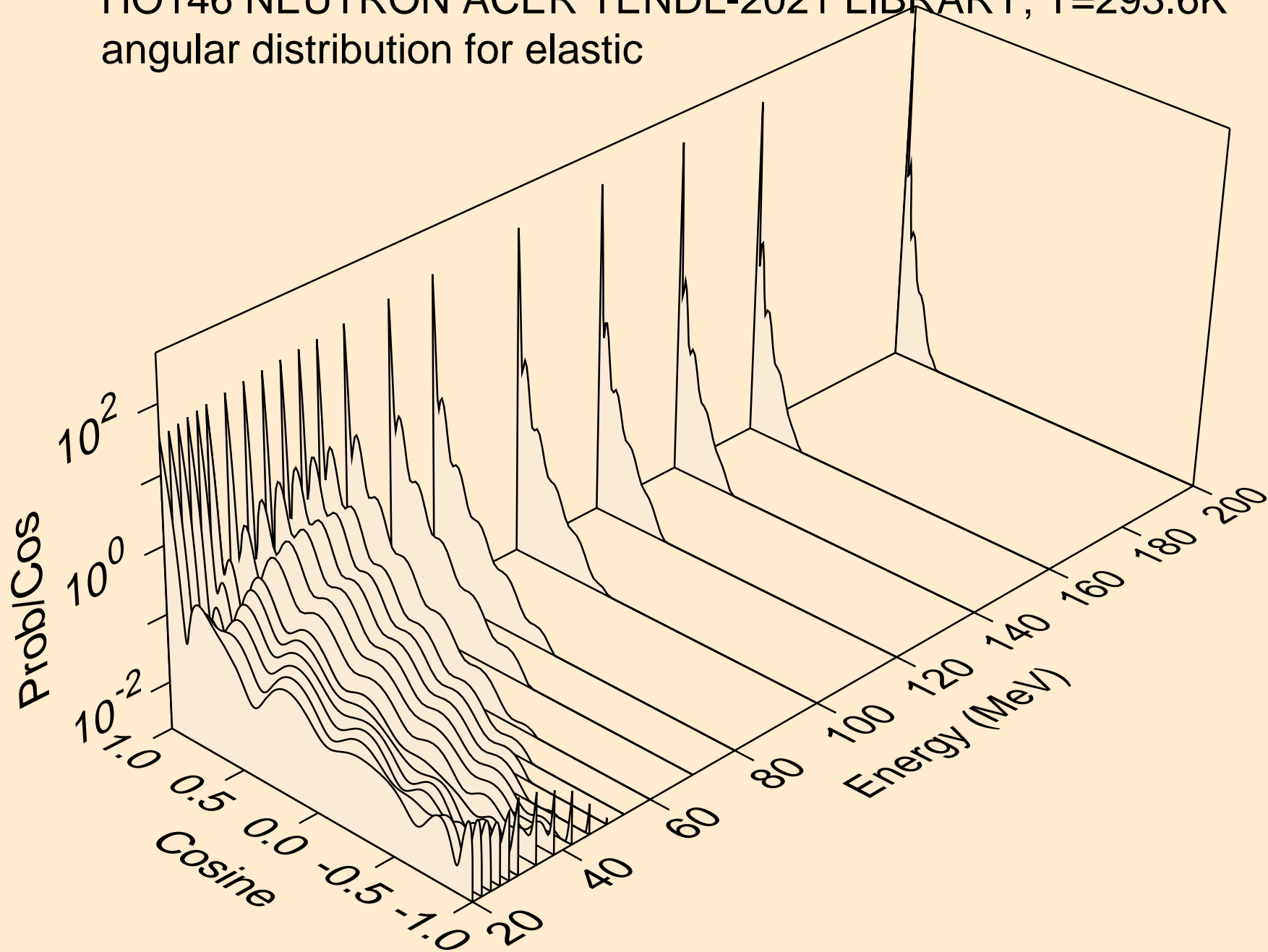

HO146 NEUTRON ACER TENDL-2021 LIBRARY; T=293.6K
angular distribution for (n,n*1)

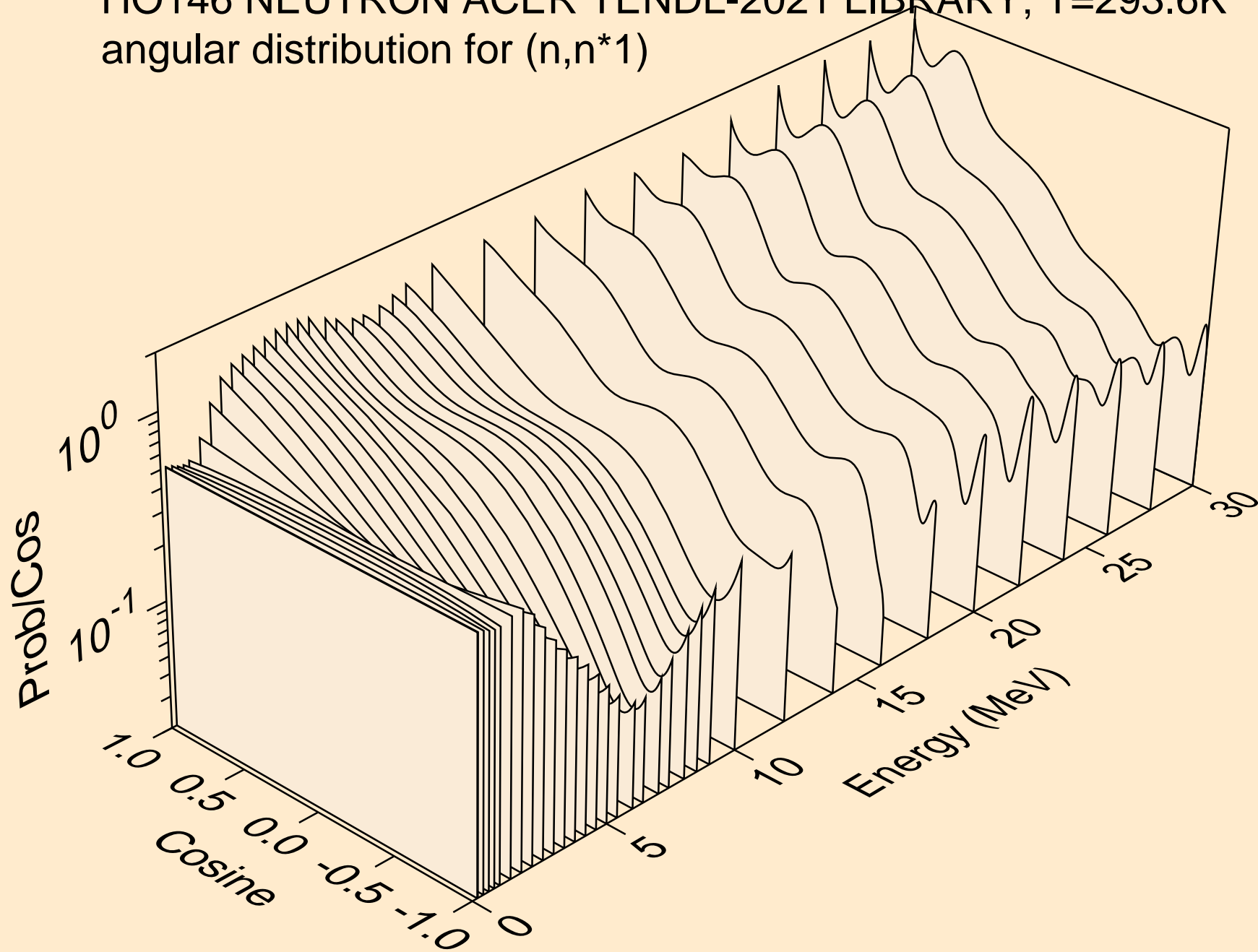

HO146 NEUTRON ACER TENDL-2021 LIBRARY; T=293.6K
Neutron emission for (n,x)

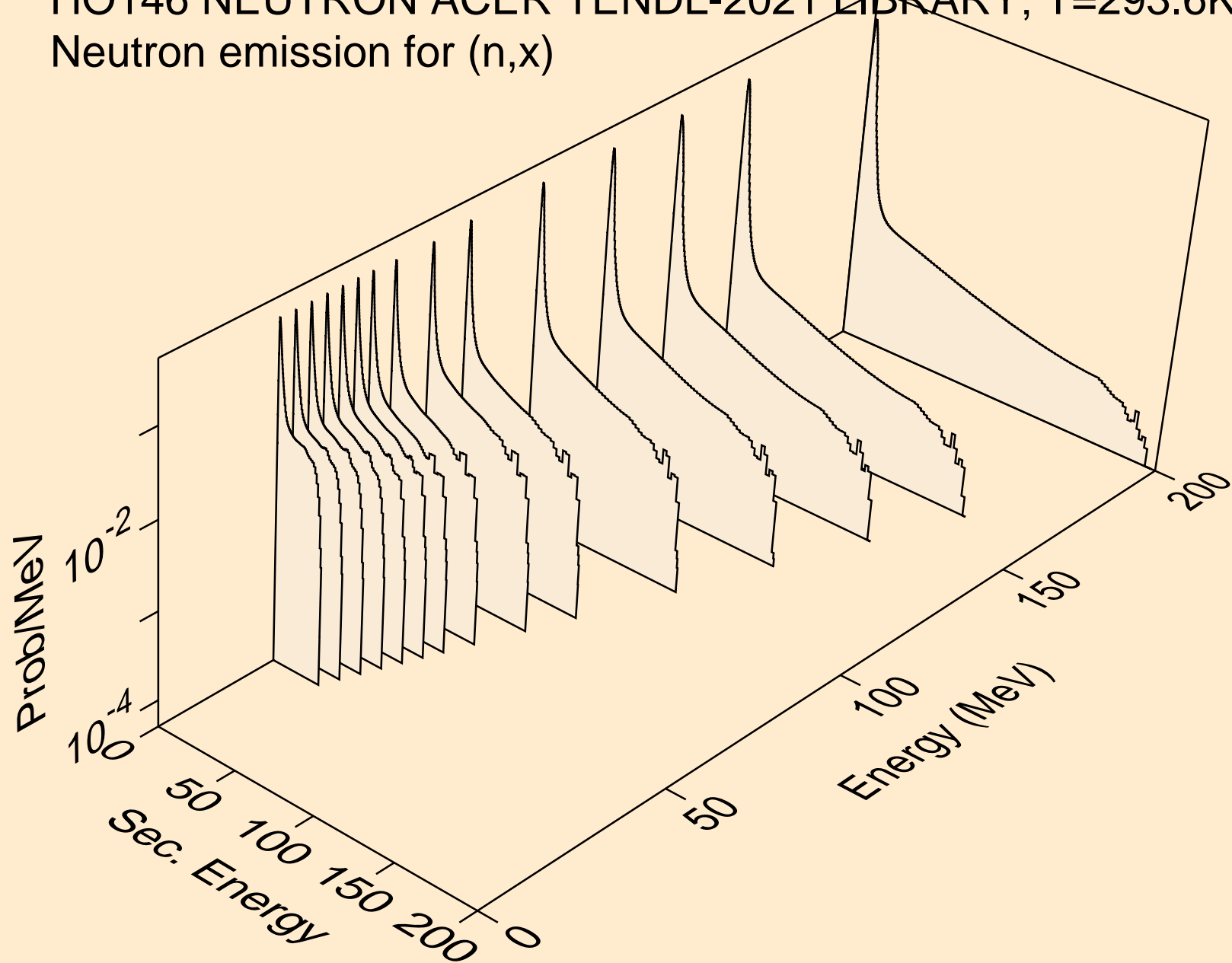

HO146 NEUTRON ACER TENDL-2021 LIBRARY; T=293.6K
Neutron emission for (n,2nd)

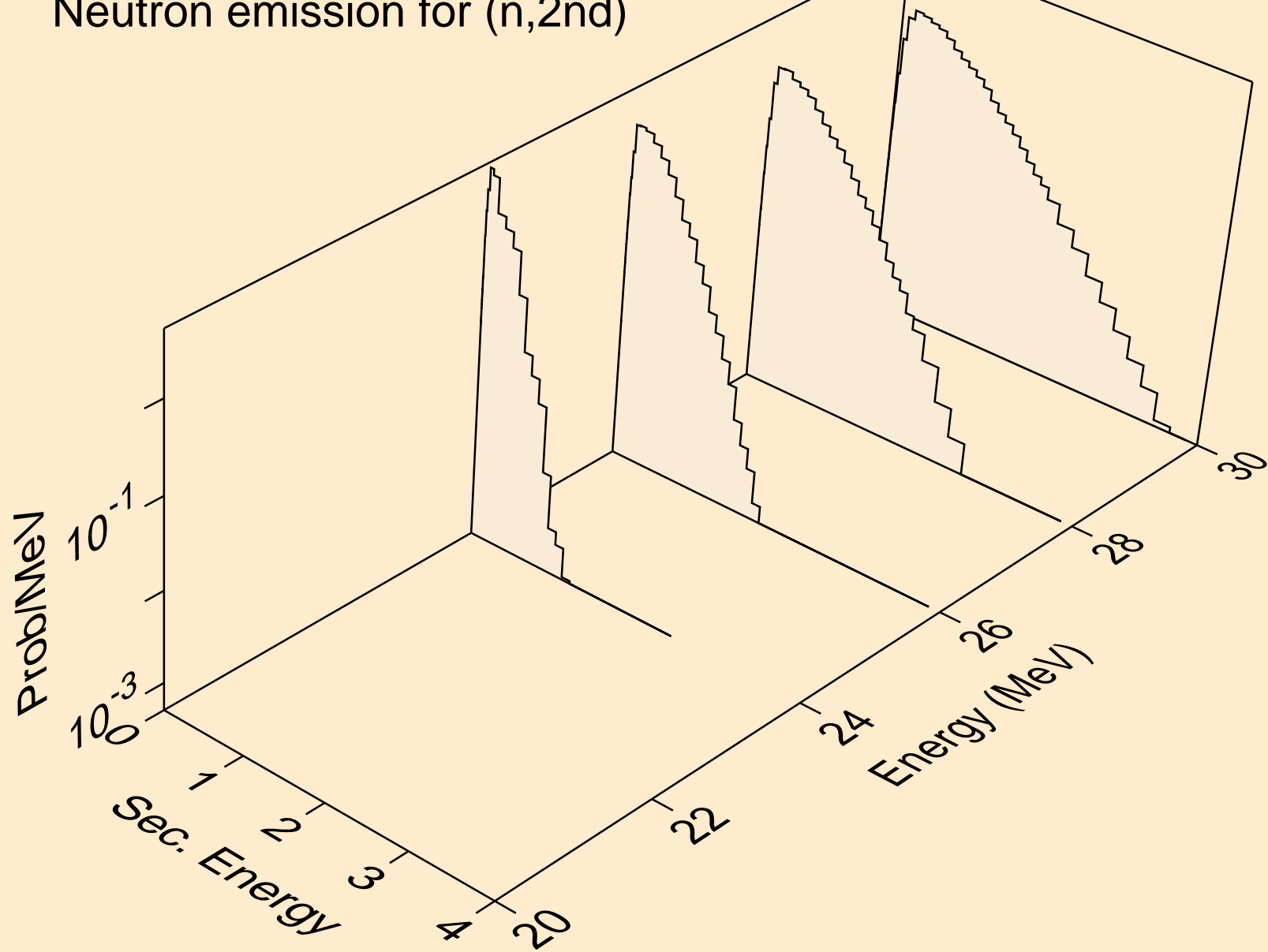

HO146 NEUTRON ACER TENDL-2021 LIBRARY; T=293.6K
Neutron emission for (n,2n)

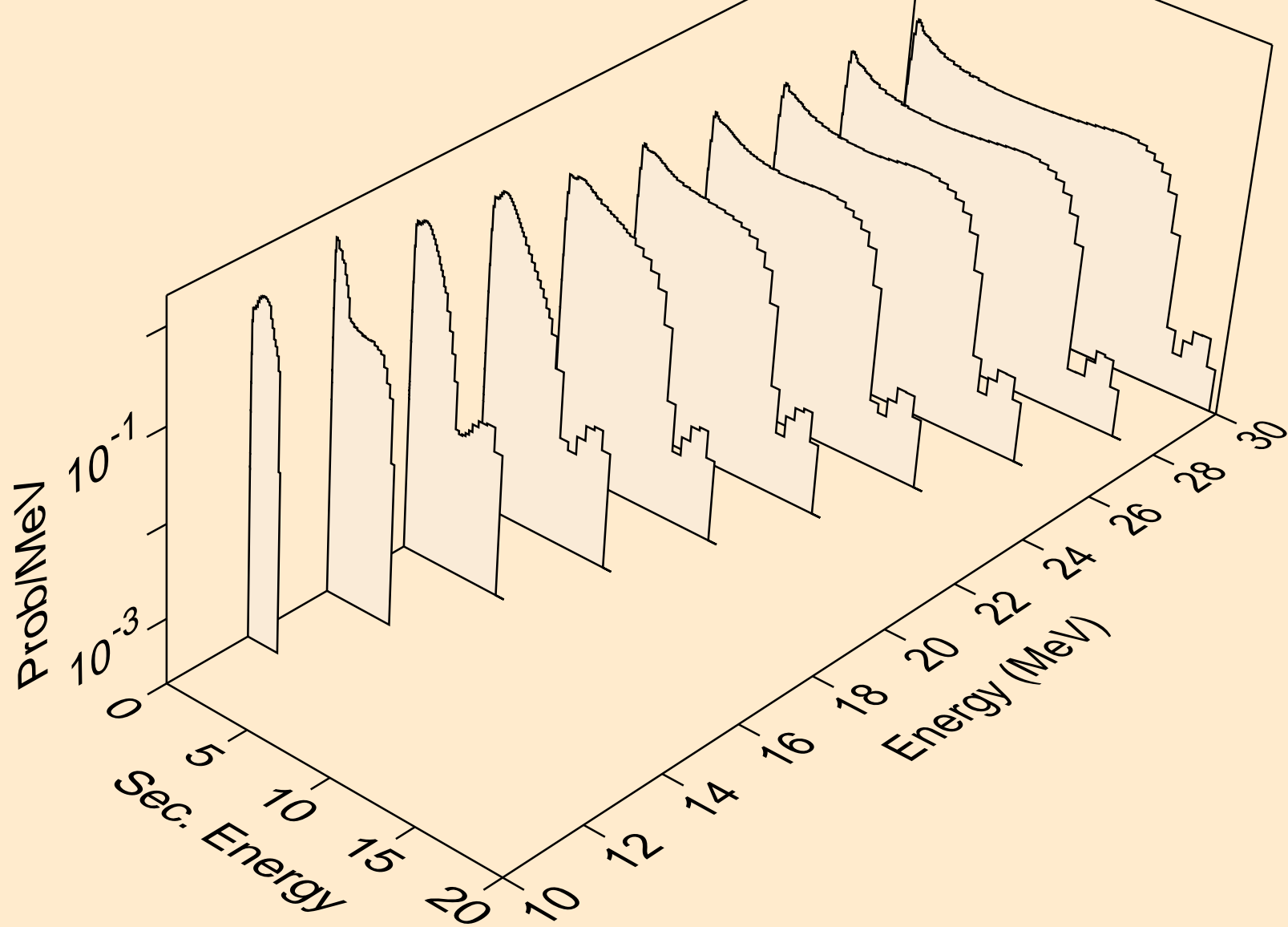

HO146 NEUTRON ACER TENDL-2021 LIBRARY; T=293.6K
Neutron emission for (n,3n)

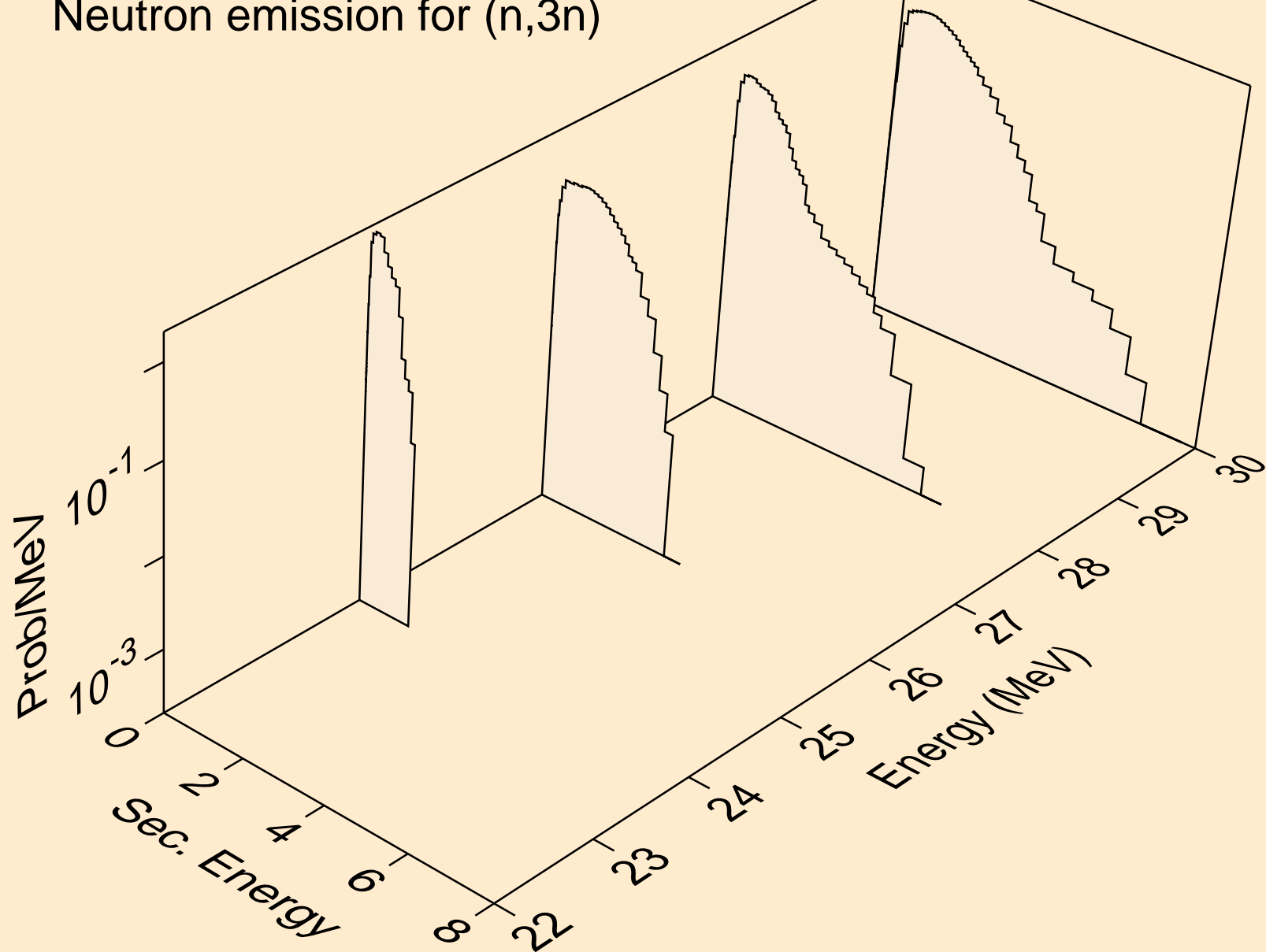

HO146 NEUTRON ACER TENDL-2021 LIBRARY; T=293.6K
Neutron emission for (n,n*)a

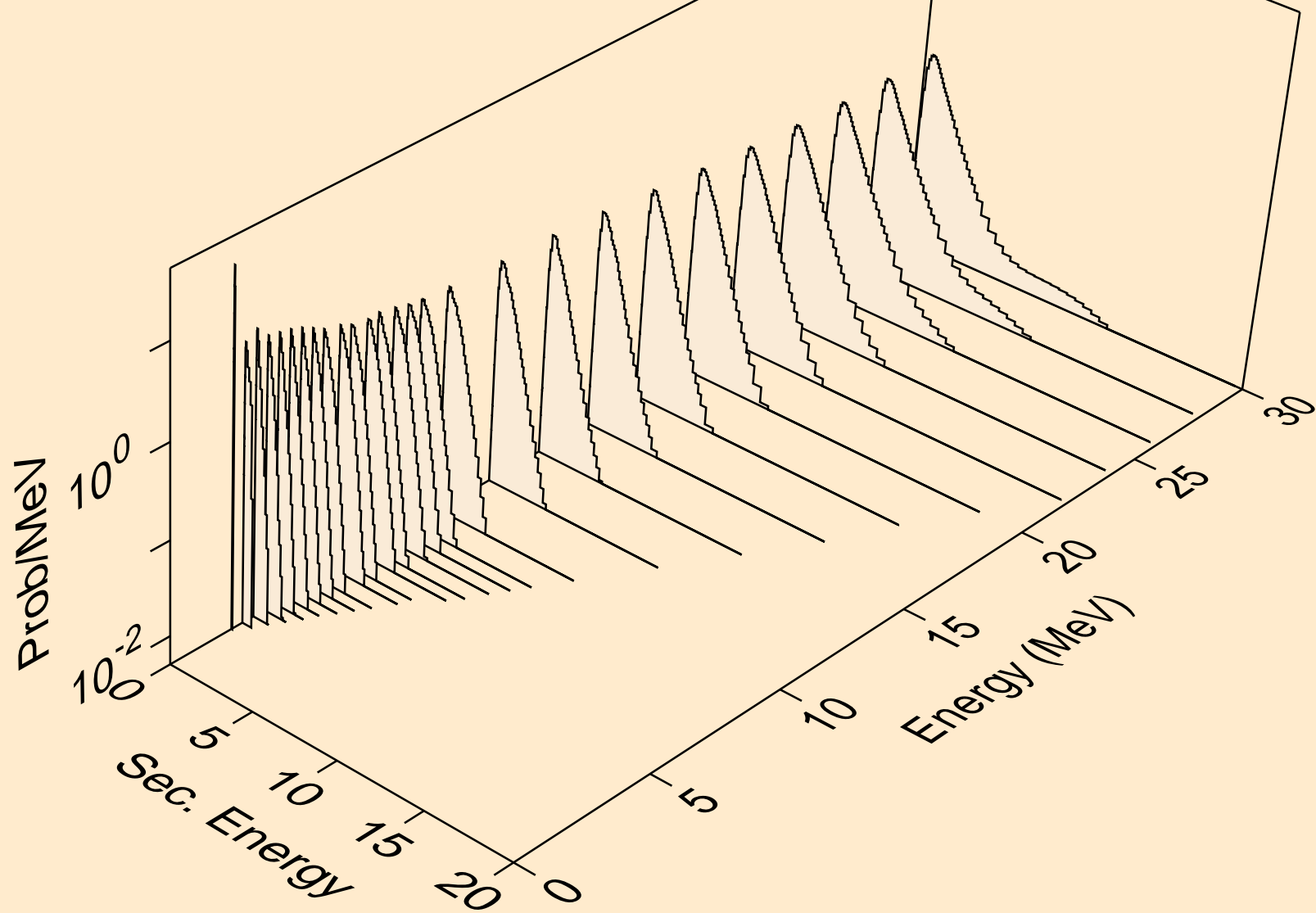

HO146 NEUTRON ACER TENDL-2021 LIBRARY; T=293.6K
Neutron emission for (n,2n)_a

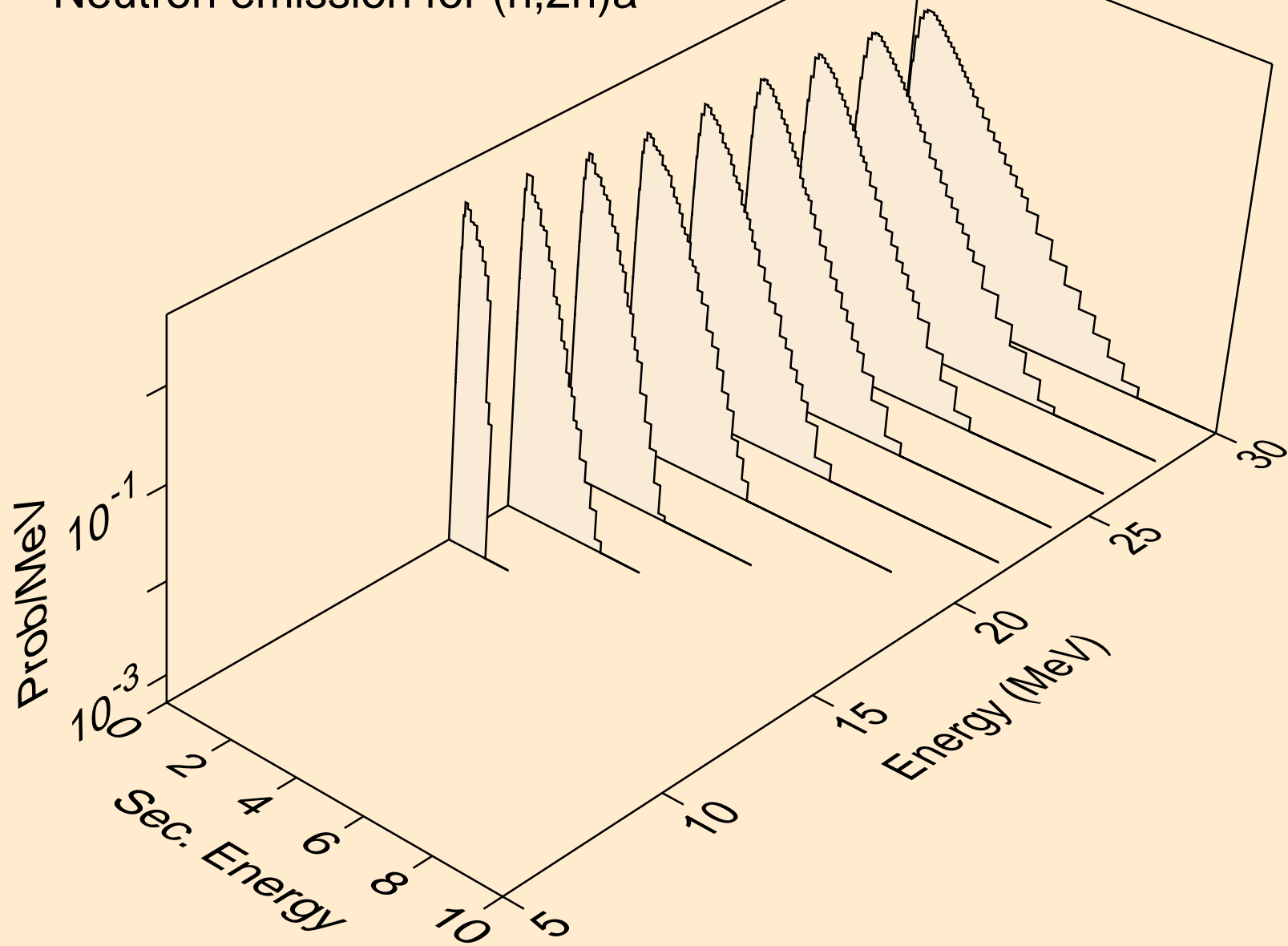

HO146 NEUTRON ACER TENDL-2021 LIBRARY; T=293.6K
Neutron emission for (n,n*)p

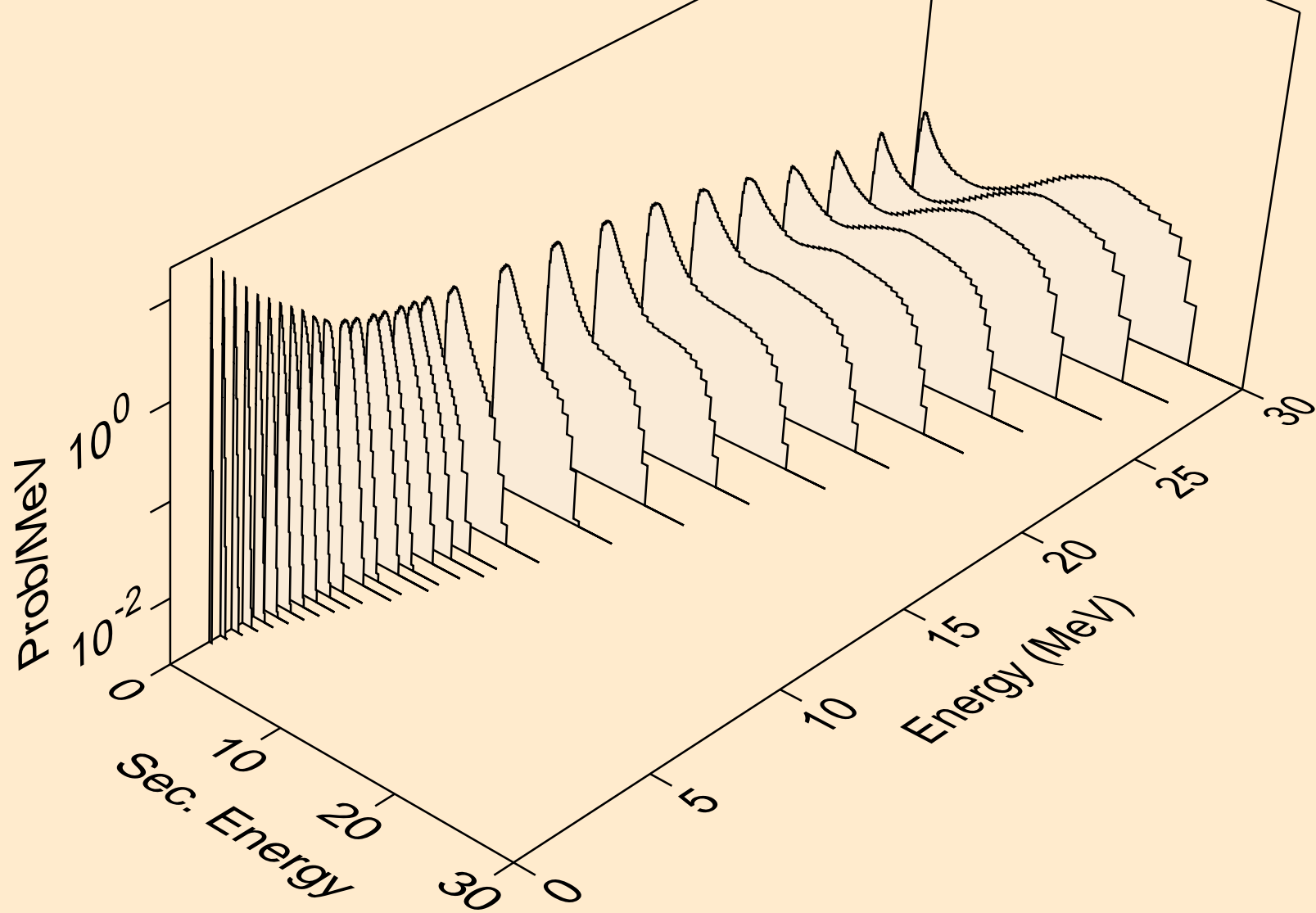

HO146 NEUTRON ACER TENDL-2021 LIBRARY; T=293.6K
Neutron emission for (n,n*)2a

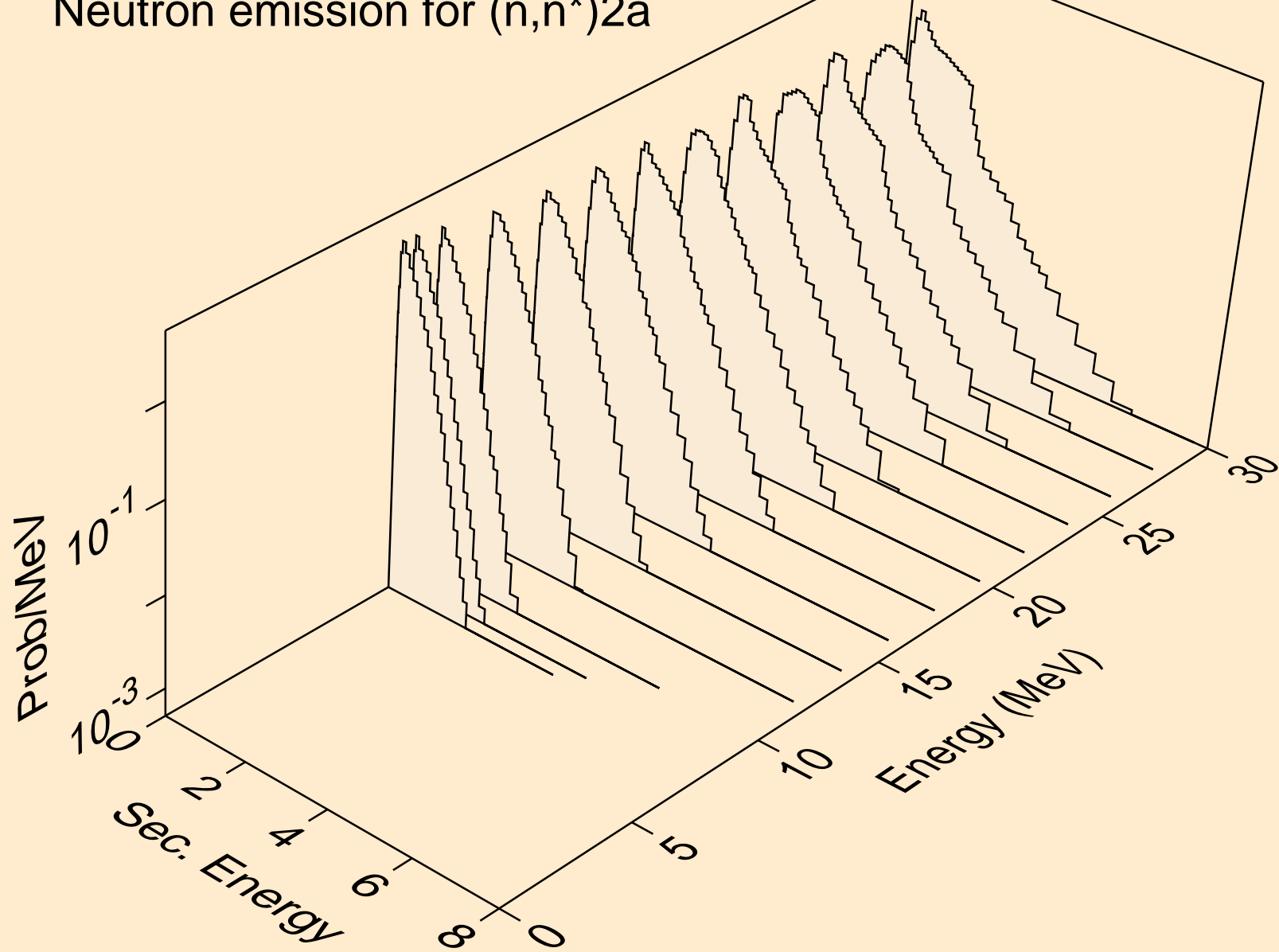

HO146 NEUTRON ACER TENDL-2021 LIBRARY; T=293.6K
Neutron emission for (n,2n)2a

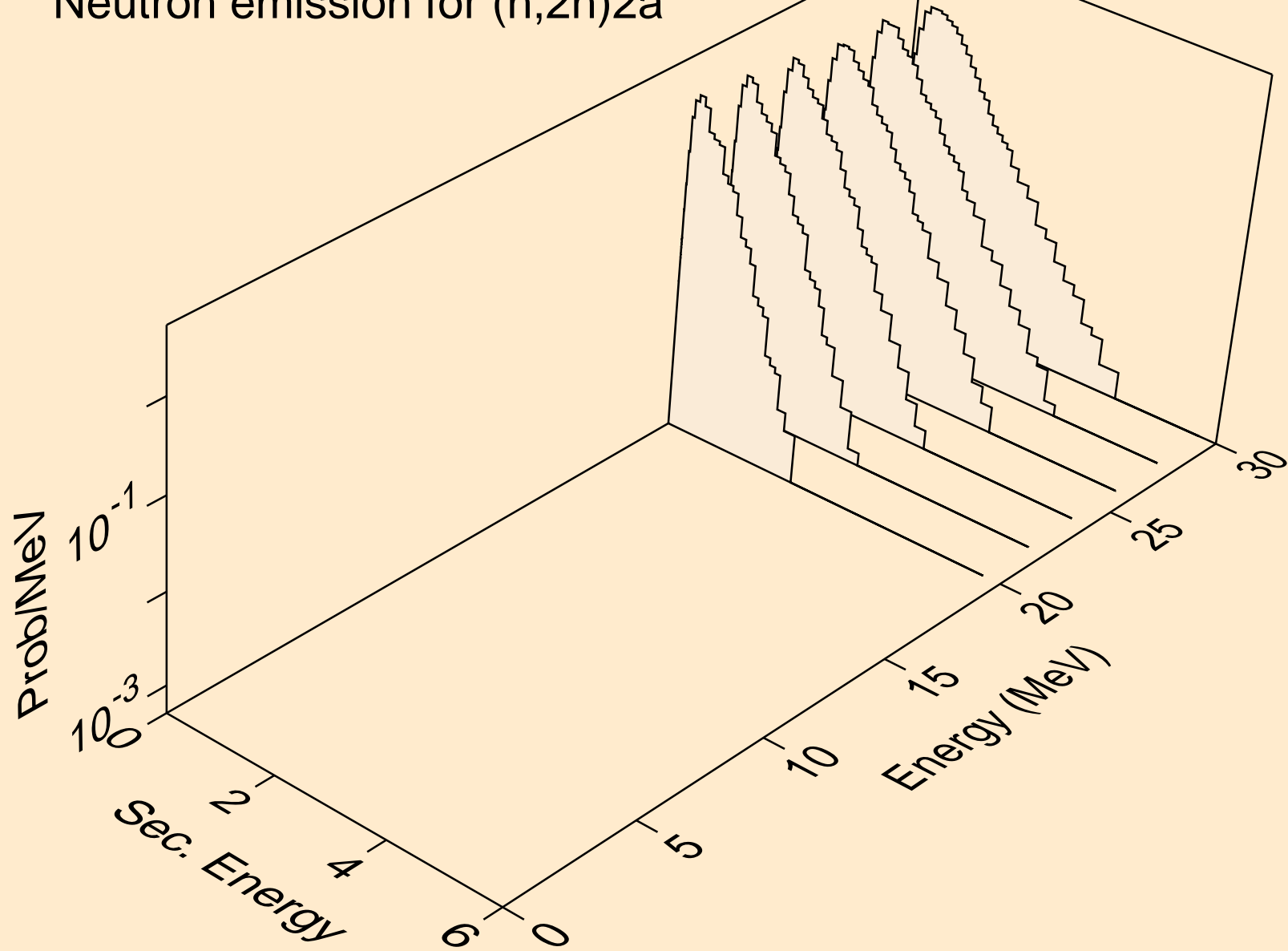

HO146 NEUTRON ACER TENDL-2021 LIBRARY; T=293.6K
Neutron emission for (n,n*)d

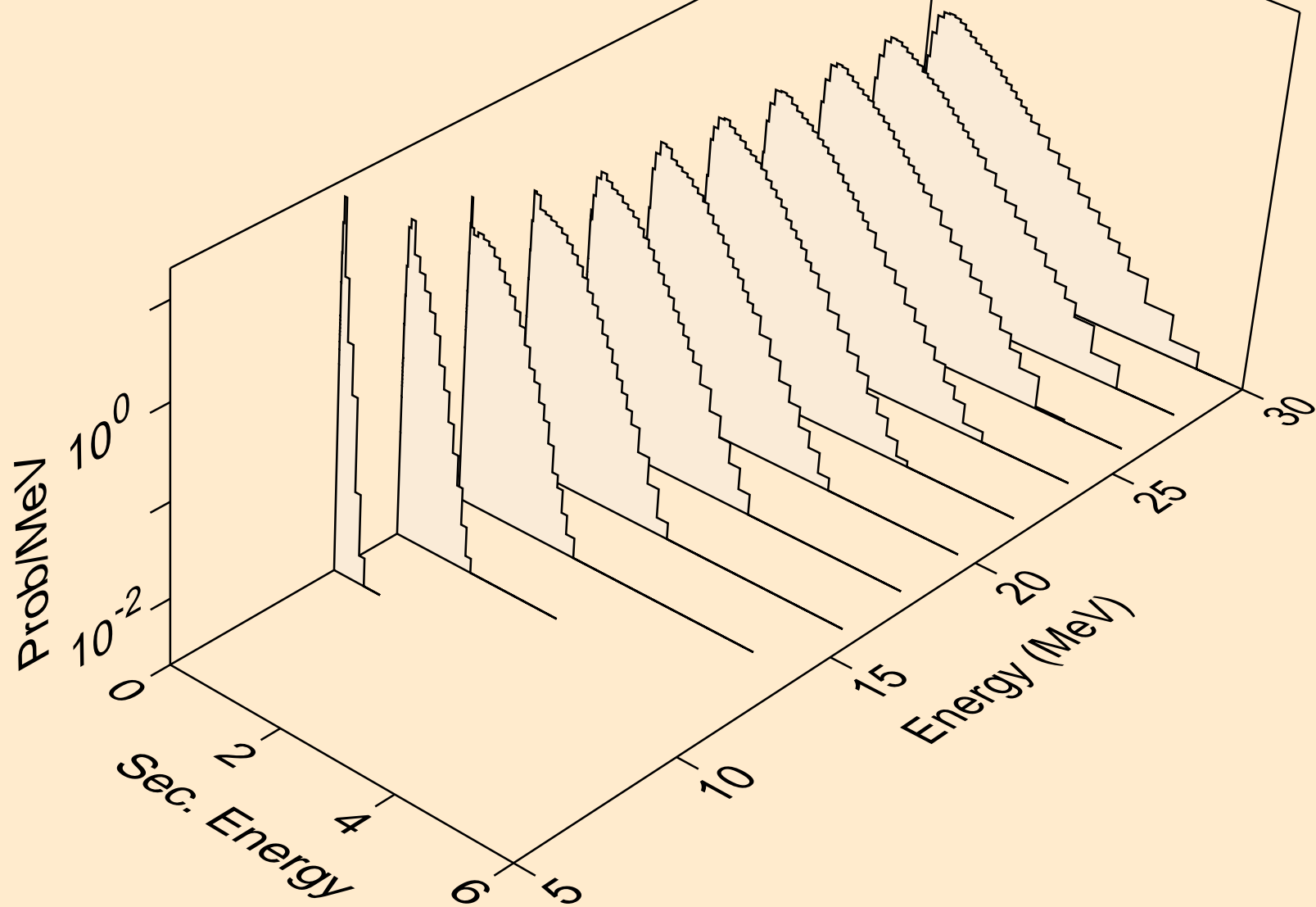

HO146 NEUTRON ACER TENDL-2021 LIBRARY; T=293.6K
Neutron emission for (n,n*)t

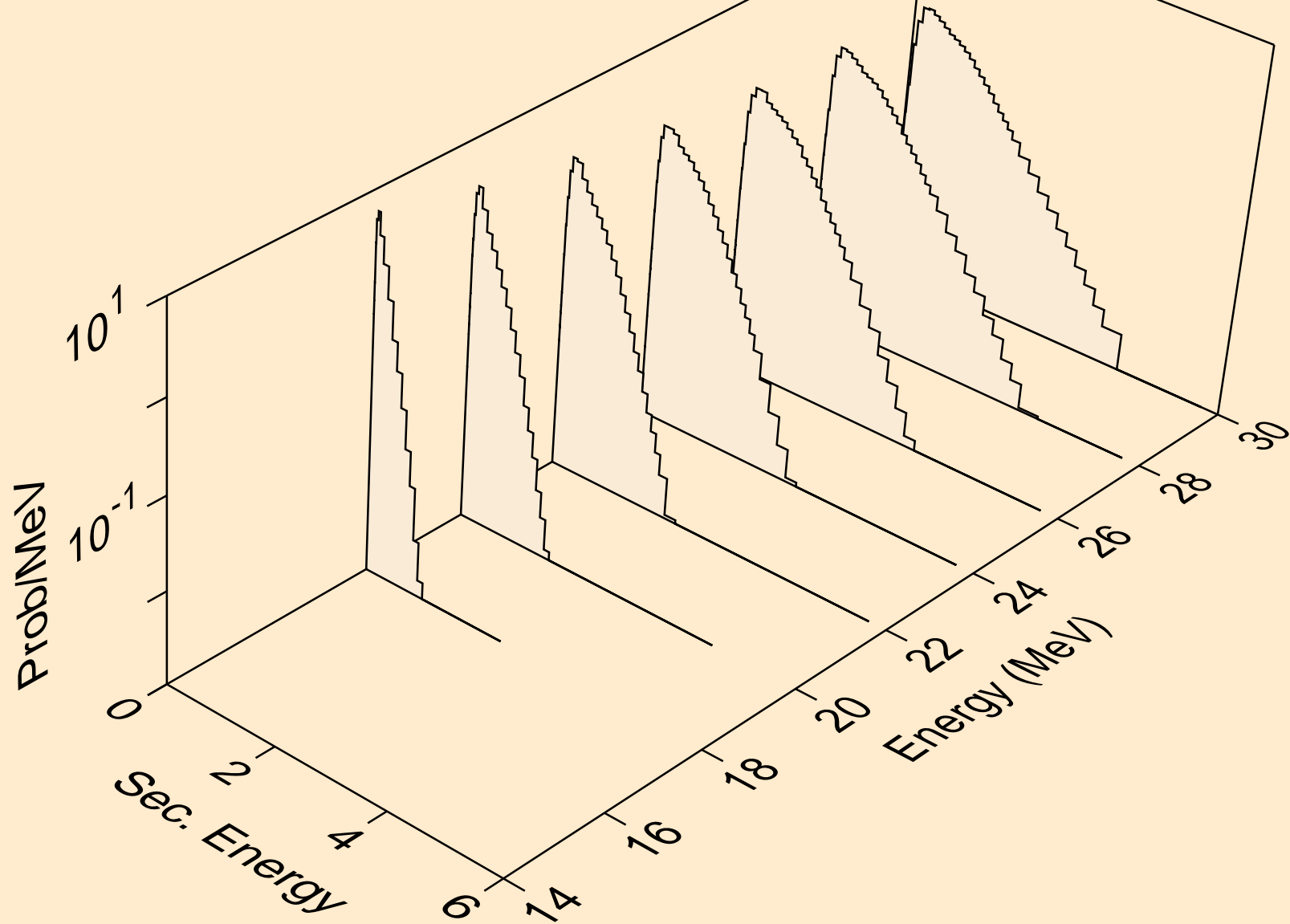

HO146 NEUTRON ACER TENDL-2021 LIBRARY; T=293.6K
Neutron emission for (n,n*)he3

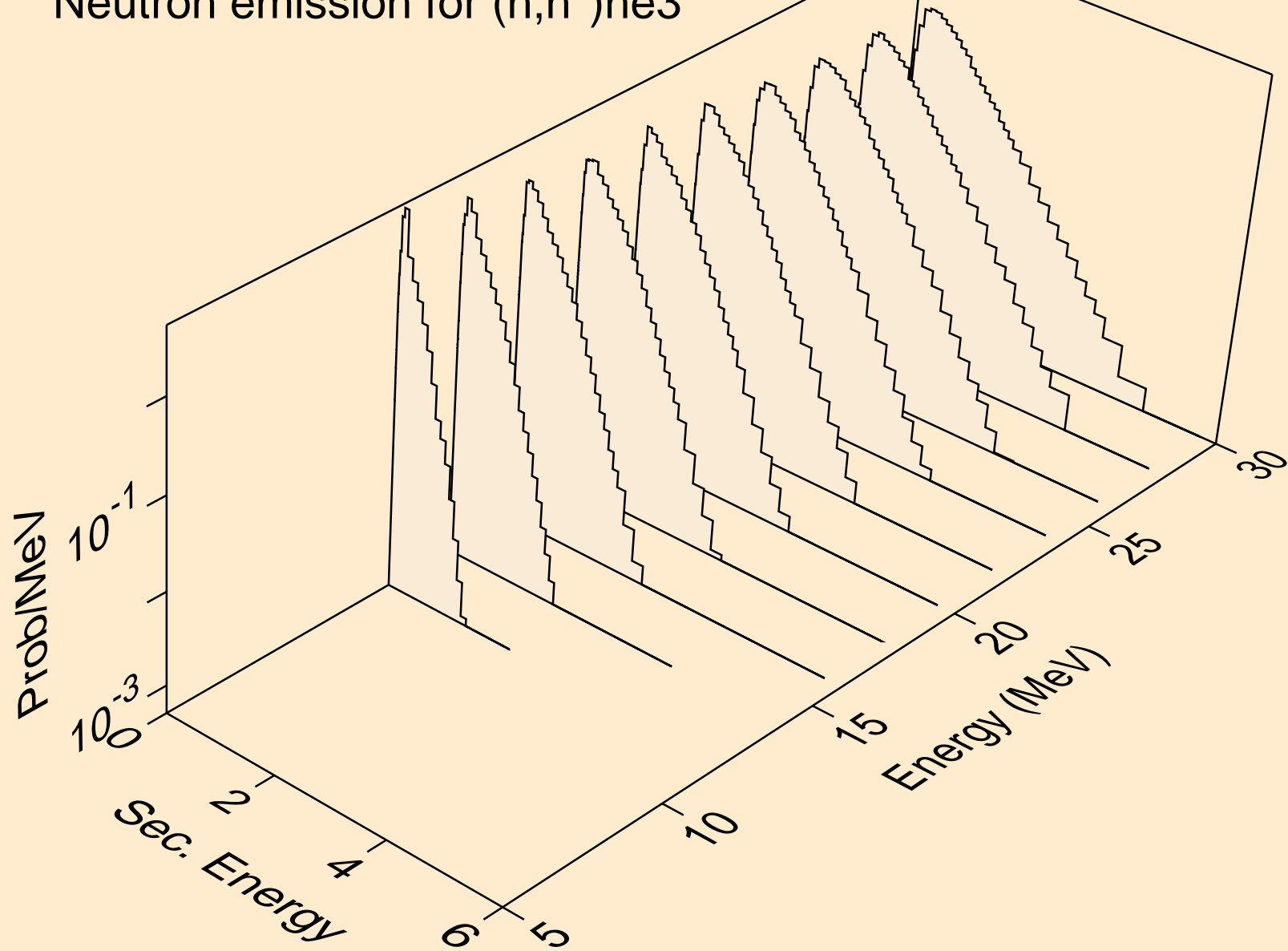

HO146 NEUTRON ACER TENDL-2021 LIBRARY; T=293.6K
Neutron emission for (n,2np)

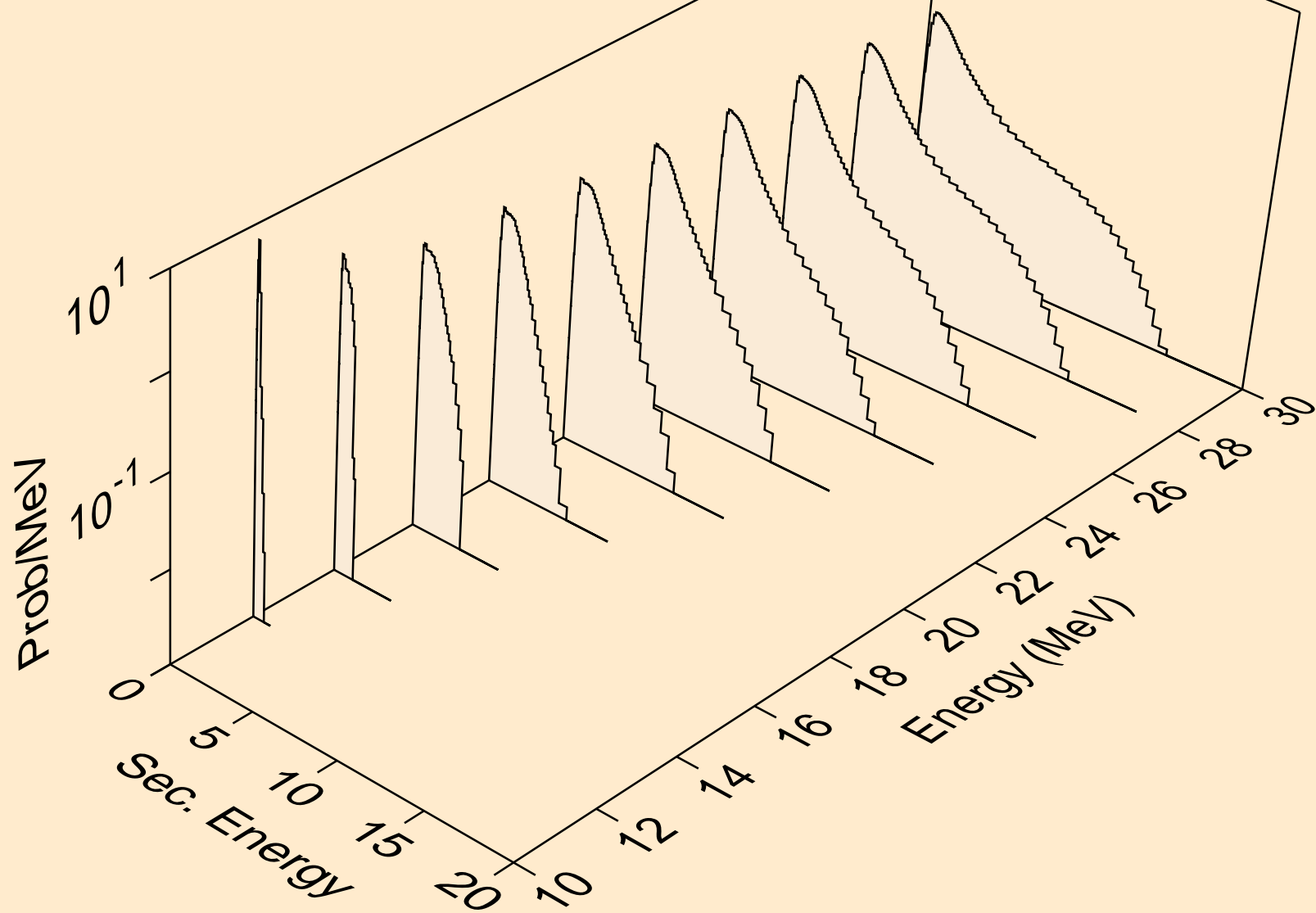

HO146 NEUTRON ACER TENDL-2021 LIBRARY; T=293.6K
Neutron emission for (n,3np)

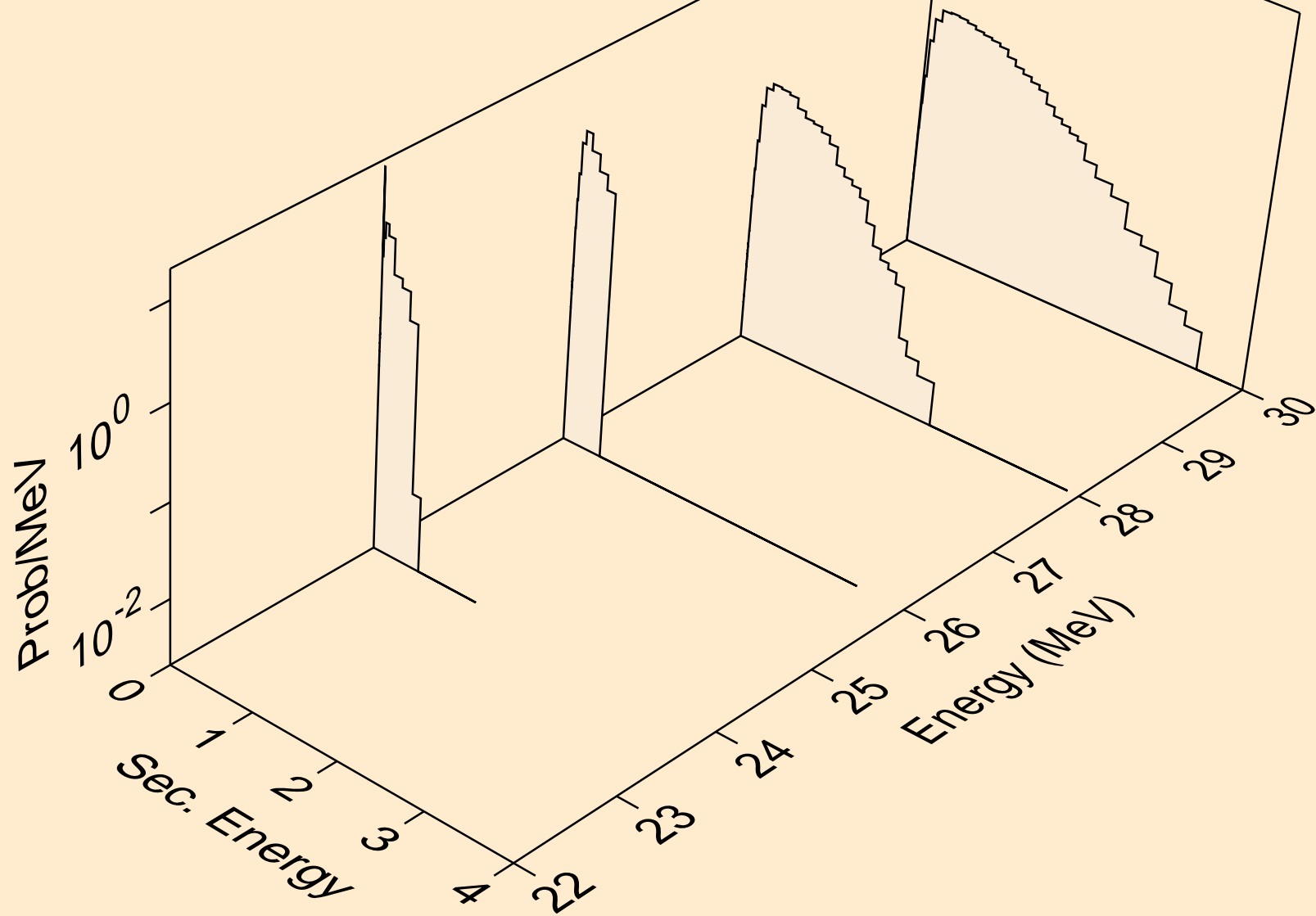

HO146 NEUTRON ACER TENDL-2021 LIBRARY; T=293.6K
Neutron emission for (n,2np)

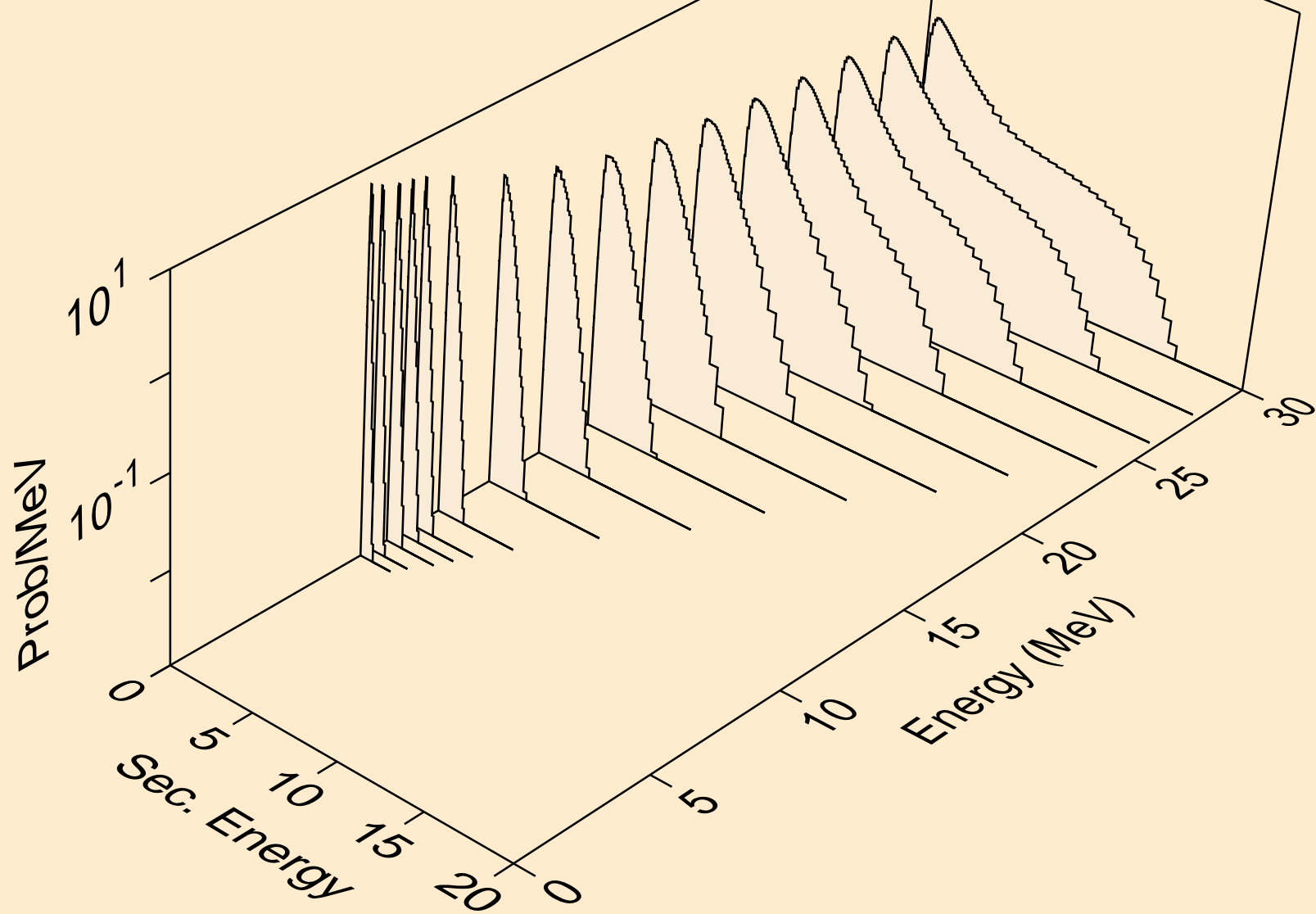

HO146 NEUTRON ACER TENDL-2021 LIBRARY; T=293.6K
Neutron emission for (n,npa)

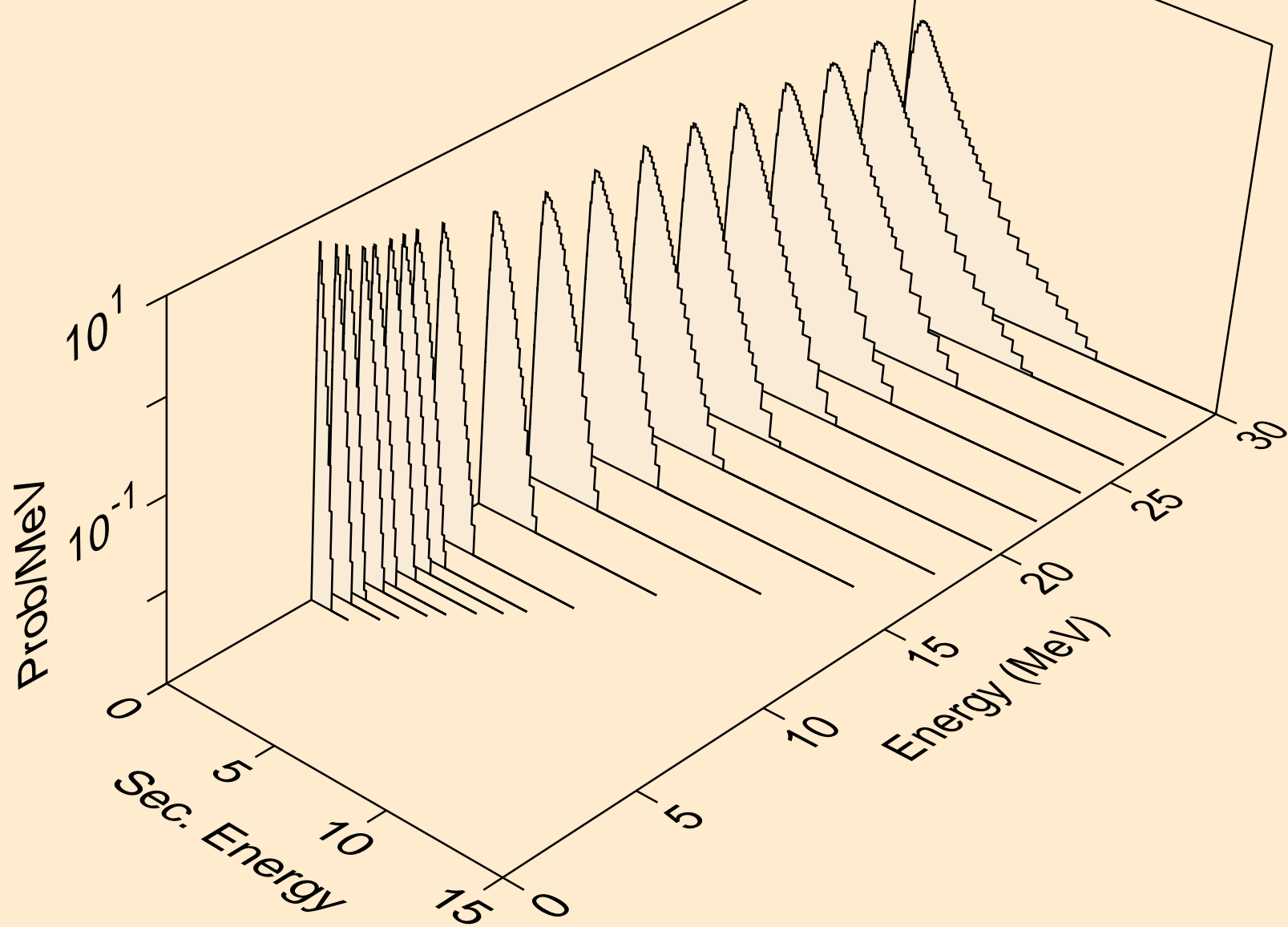

HO146 NEUTRON ACER TENDL-2021 LIBRARY; T=293.6K
Neutron emission for (n,n*c)

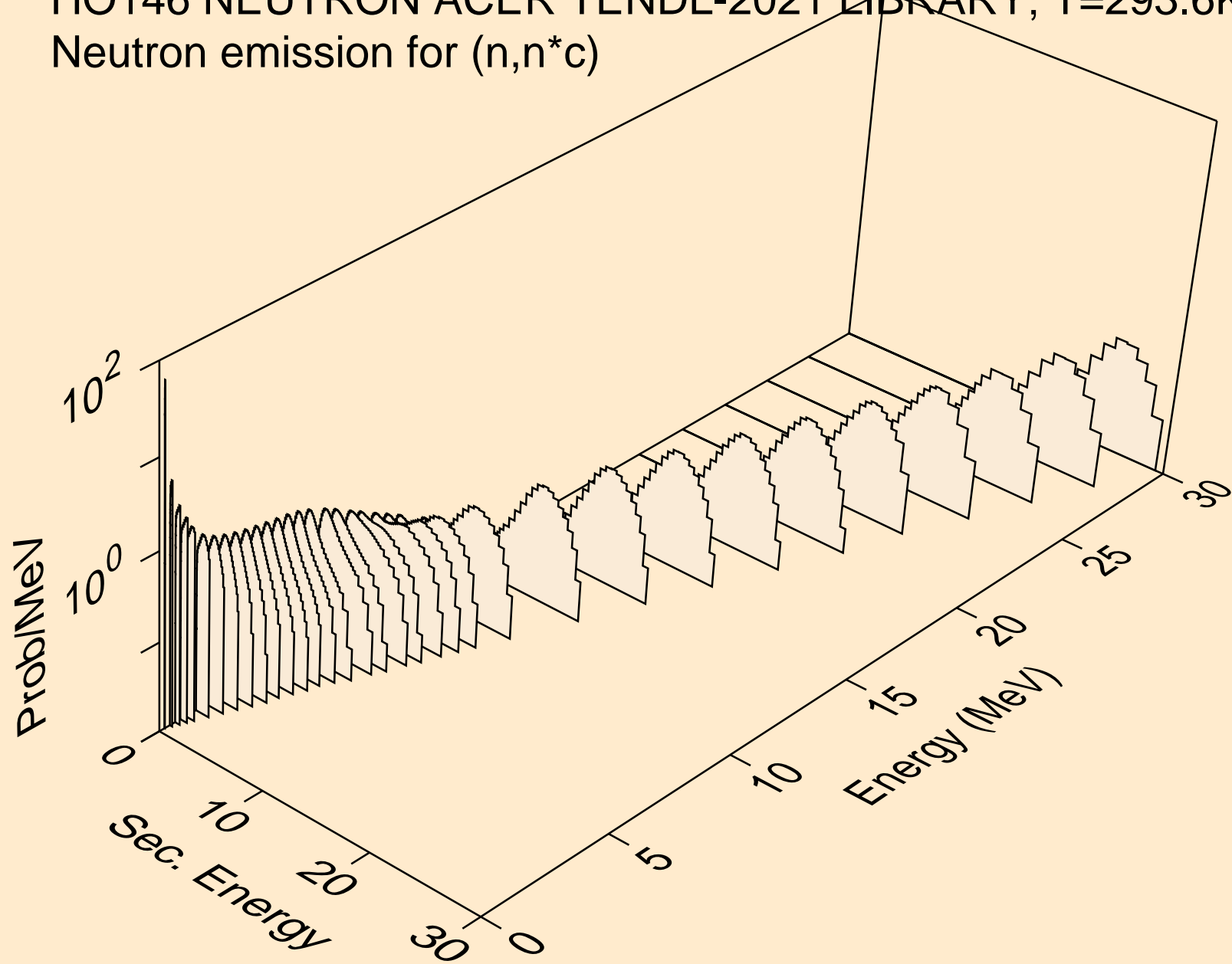

HO146 NEUTRON ACER TENDL-2021 LIBRARY; T=293.6K
Photon emission for (n,x)

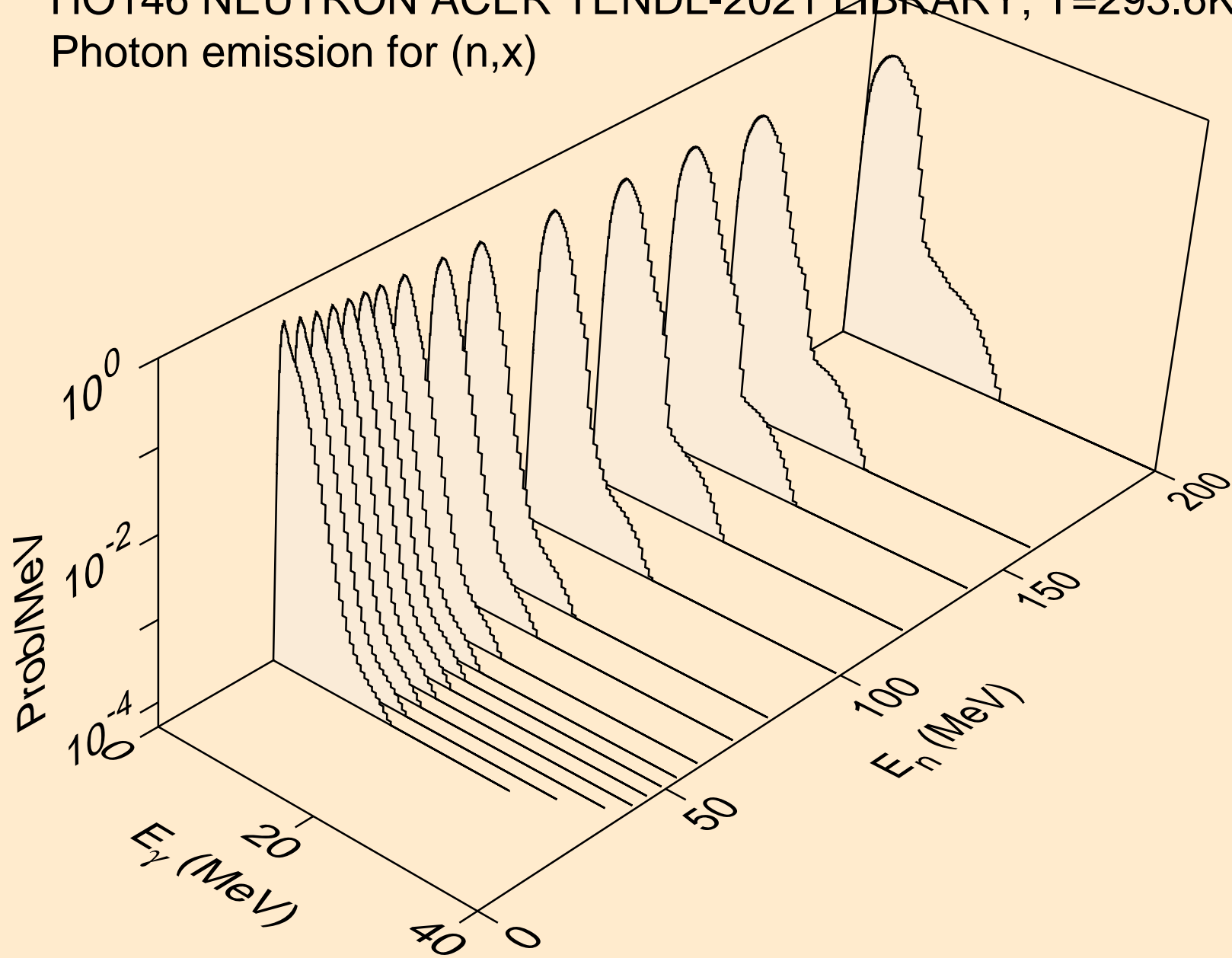

HO146 NEUTRON ACER TENDL-2021 LIBRARY; T=293.6K
Photon emission for (n,2nd)

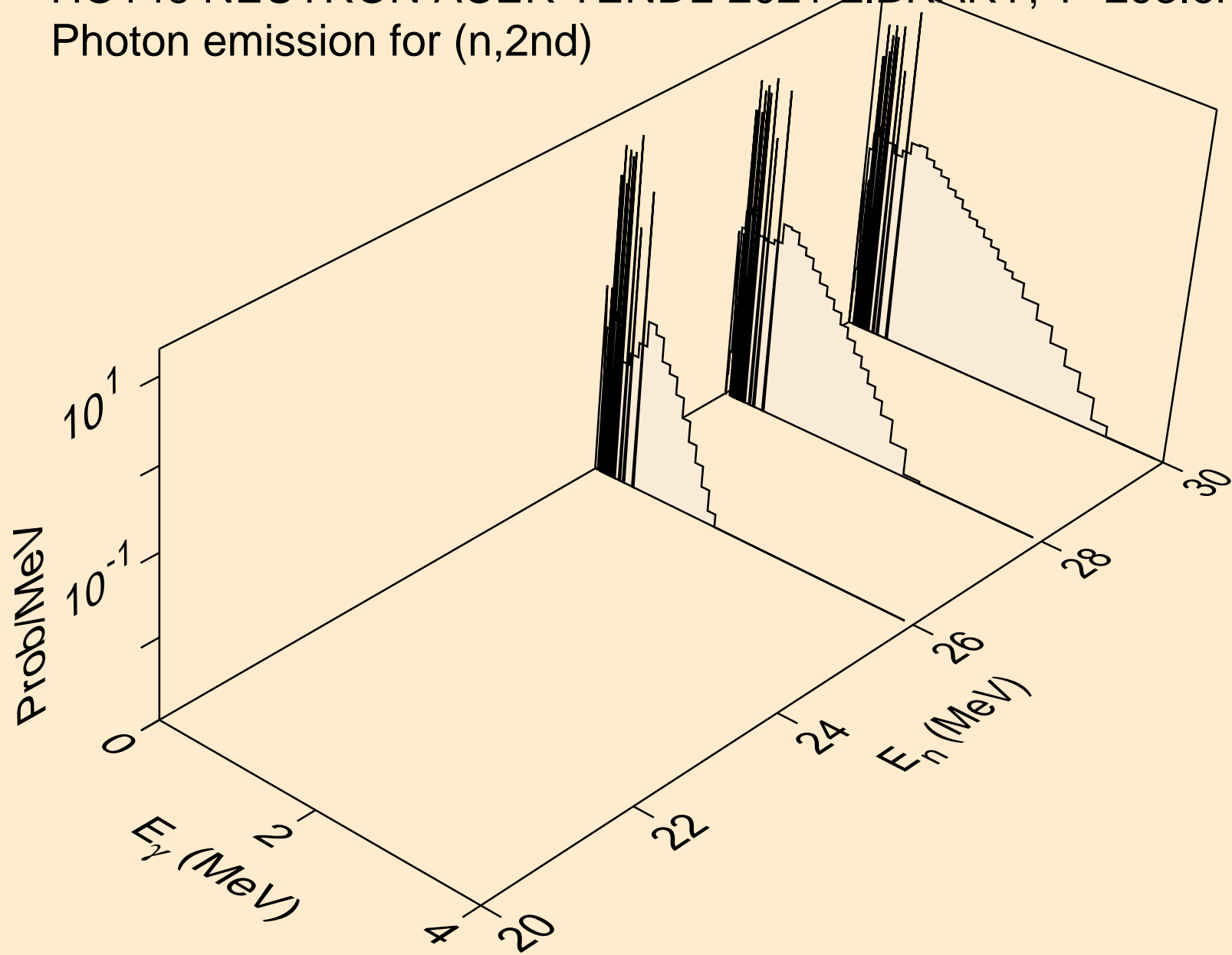

HO146 NEUTRON ACER TENDL-2021 LIBRARY; T=293.6K
Photon emission for (n,2n)

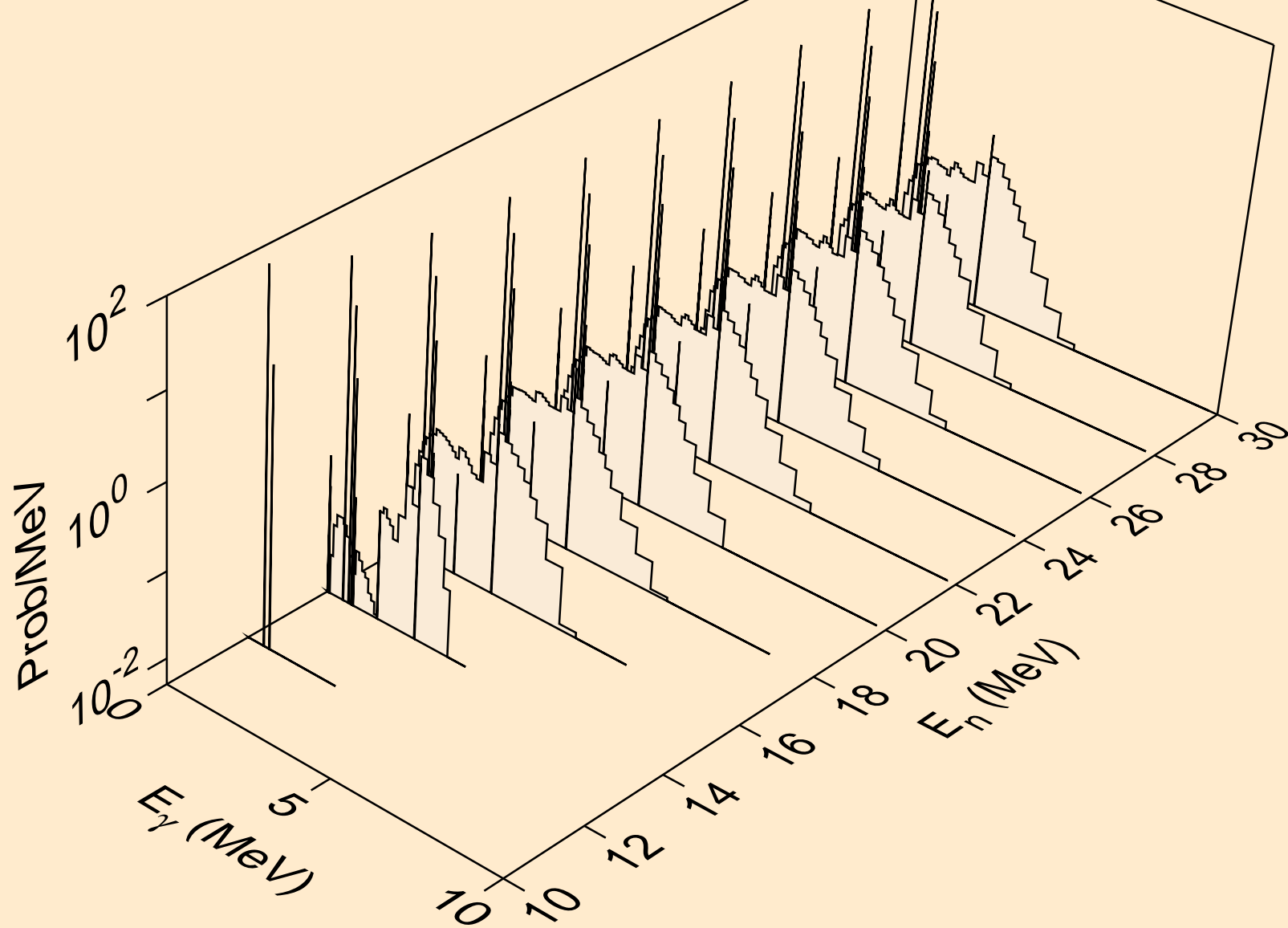

HO146 NEUTRON ACER TENDL-2021 LIBRARY; T=293.6K
Photon emission for (n,3n)

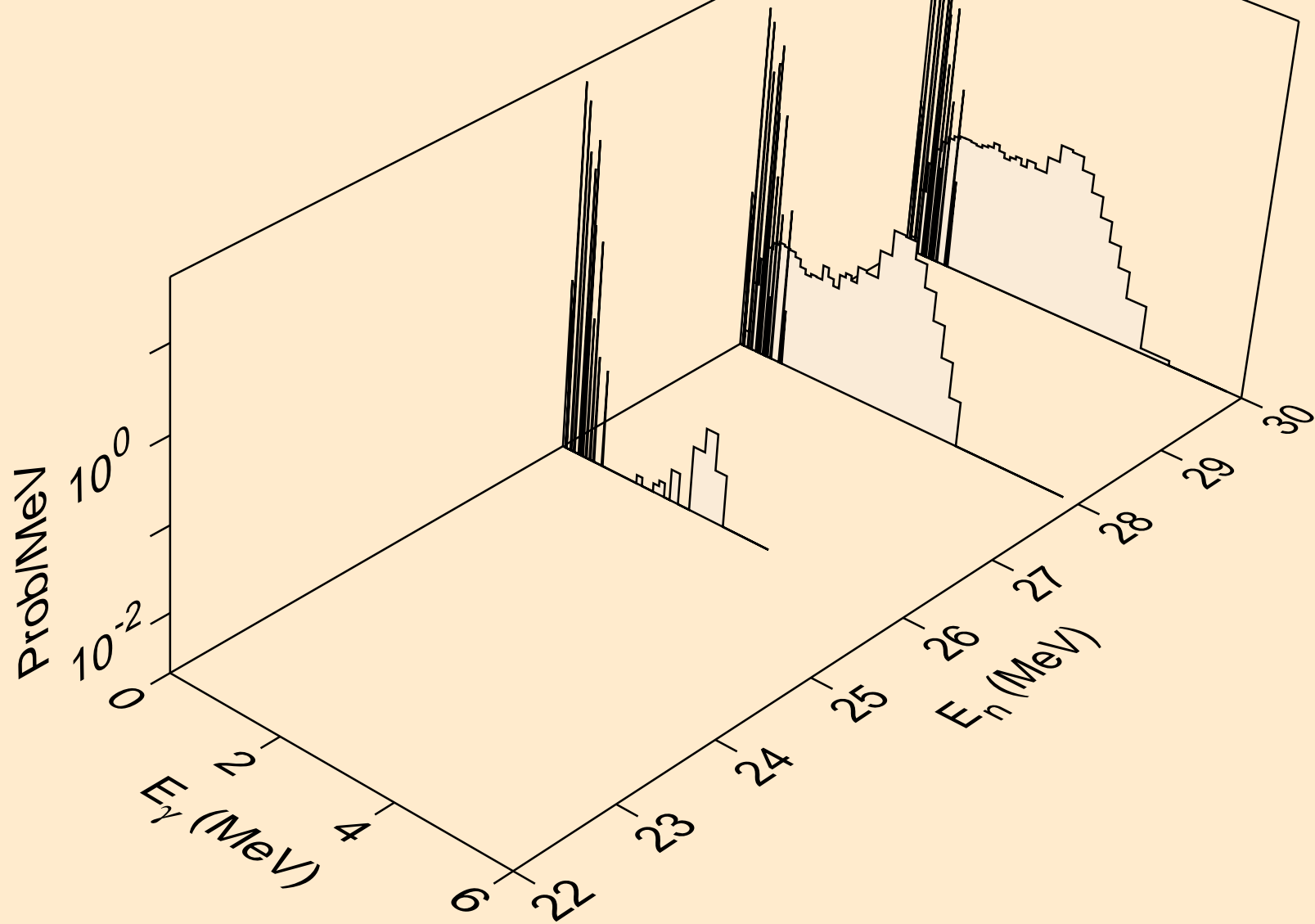

HO146 NEUTRON ACER TENDL-2021 LIBRARY; T=293.6K
Photon emission for (n,n*)a

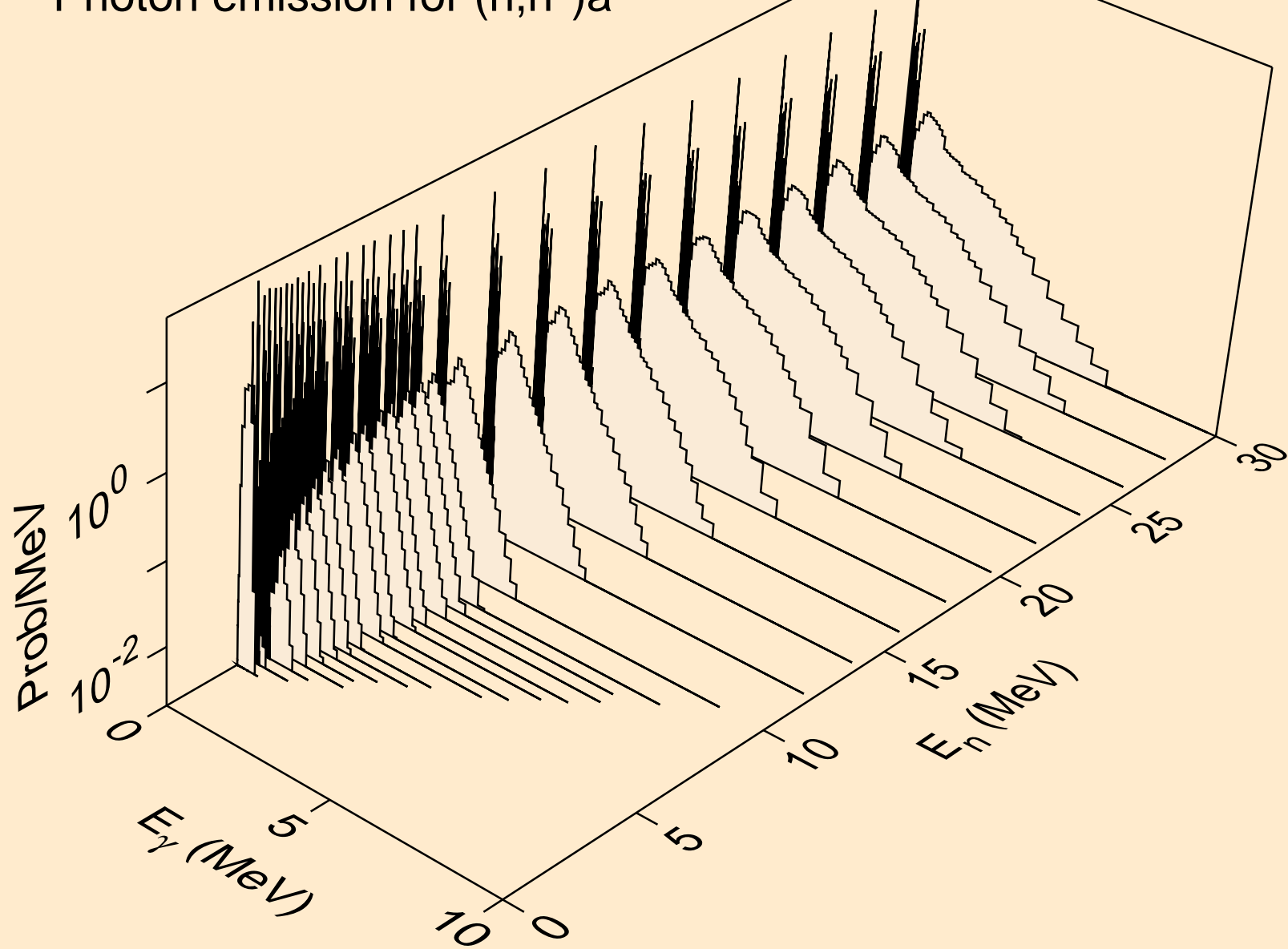

HO146 NEUTRON ACER TENDL-2021 LIBRARY; T=293.6K
Photon emission for (n,2n)a

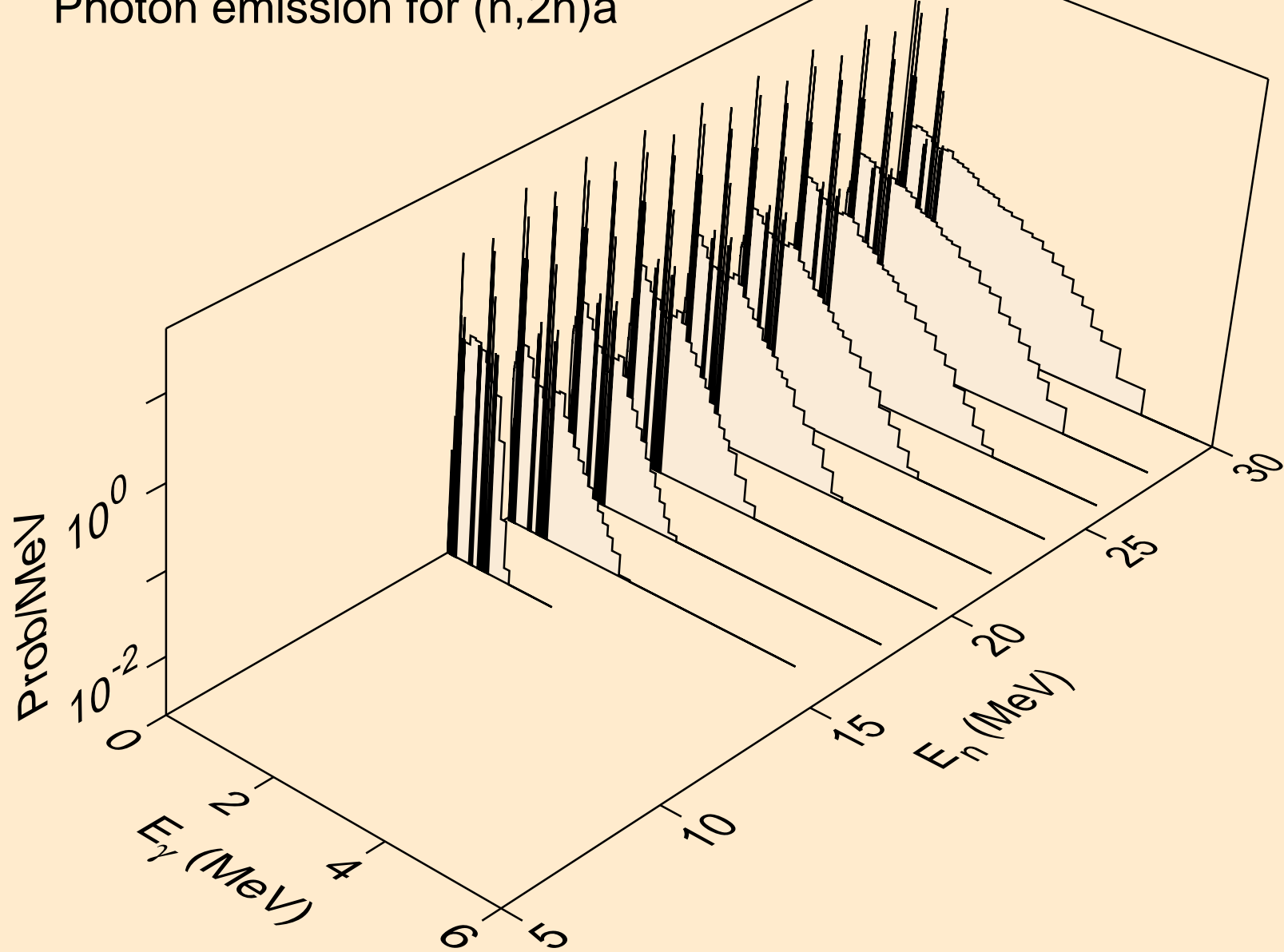

HO146 NEUTRON ACER TENDL-2021 LIBRARY; T=293.6K
Photon emission for (n,n*)p

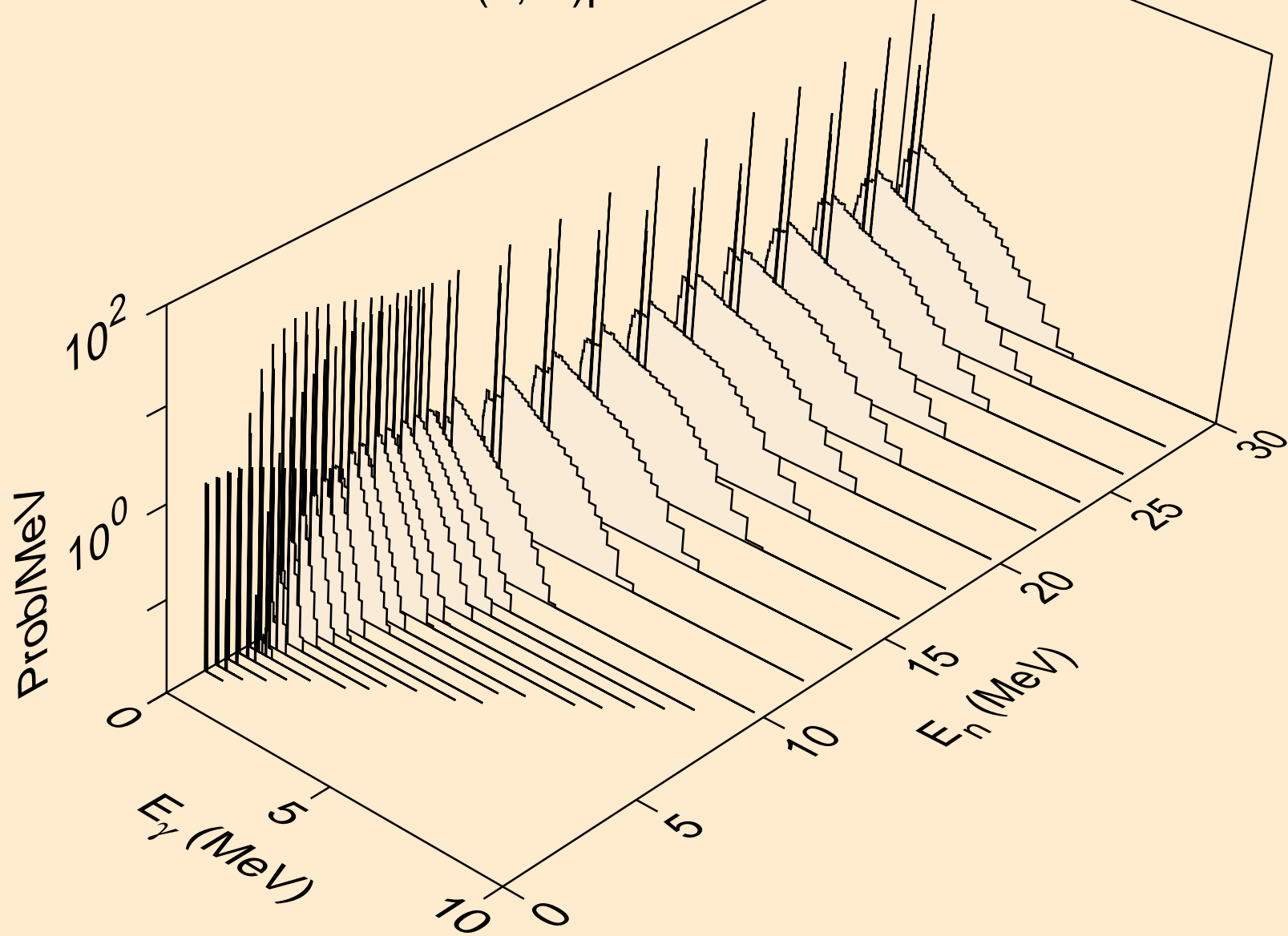

HO146 NEUTRON ACER TENDL-2021 LIBRARY; T=293.6K
Photon emission for (n,n*)2a

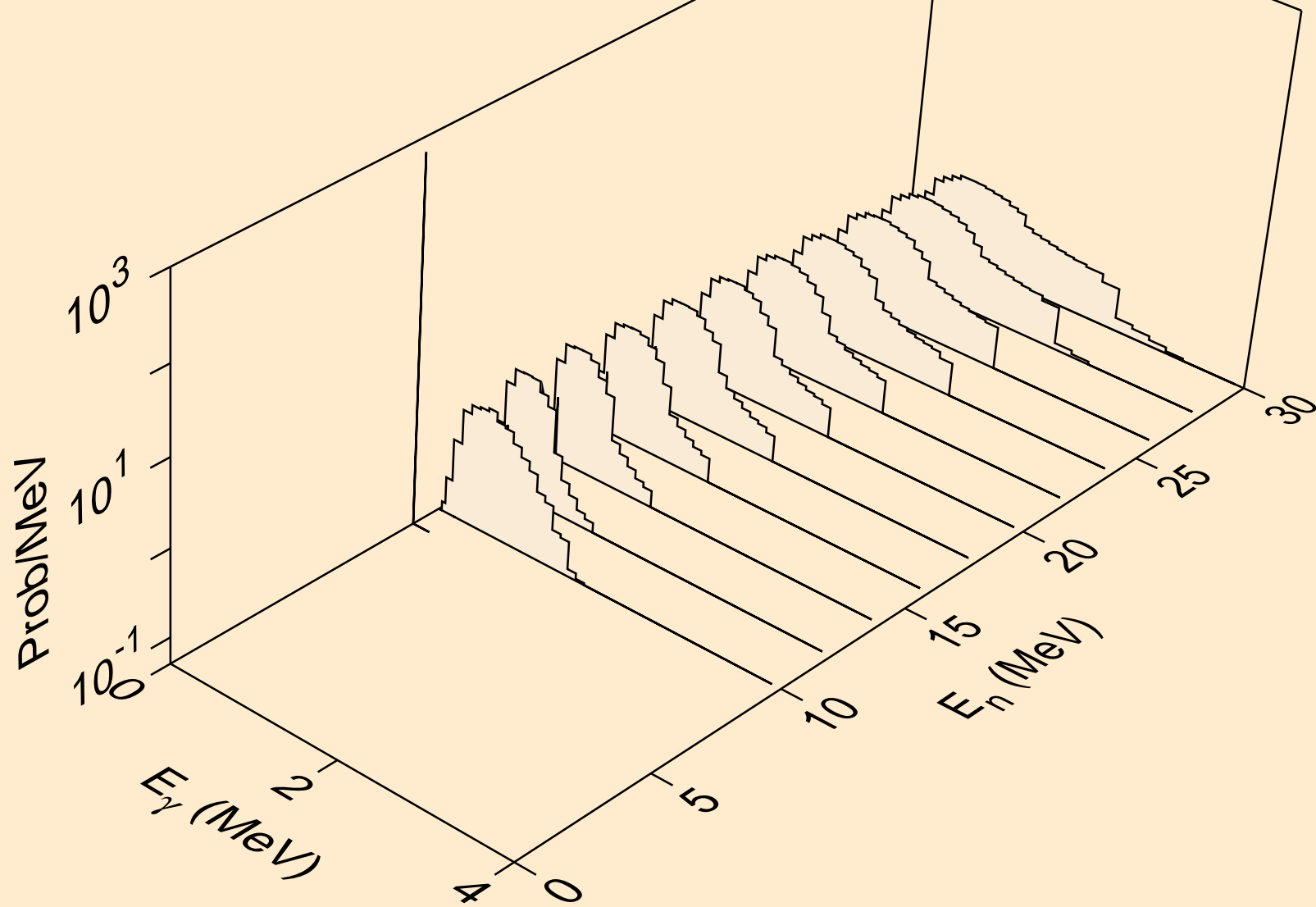

HO146 NEUTRON ACER TENDL-2021 LIBRARY; T=293.6K
Photon emission for (n,2n)2a

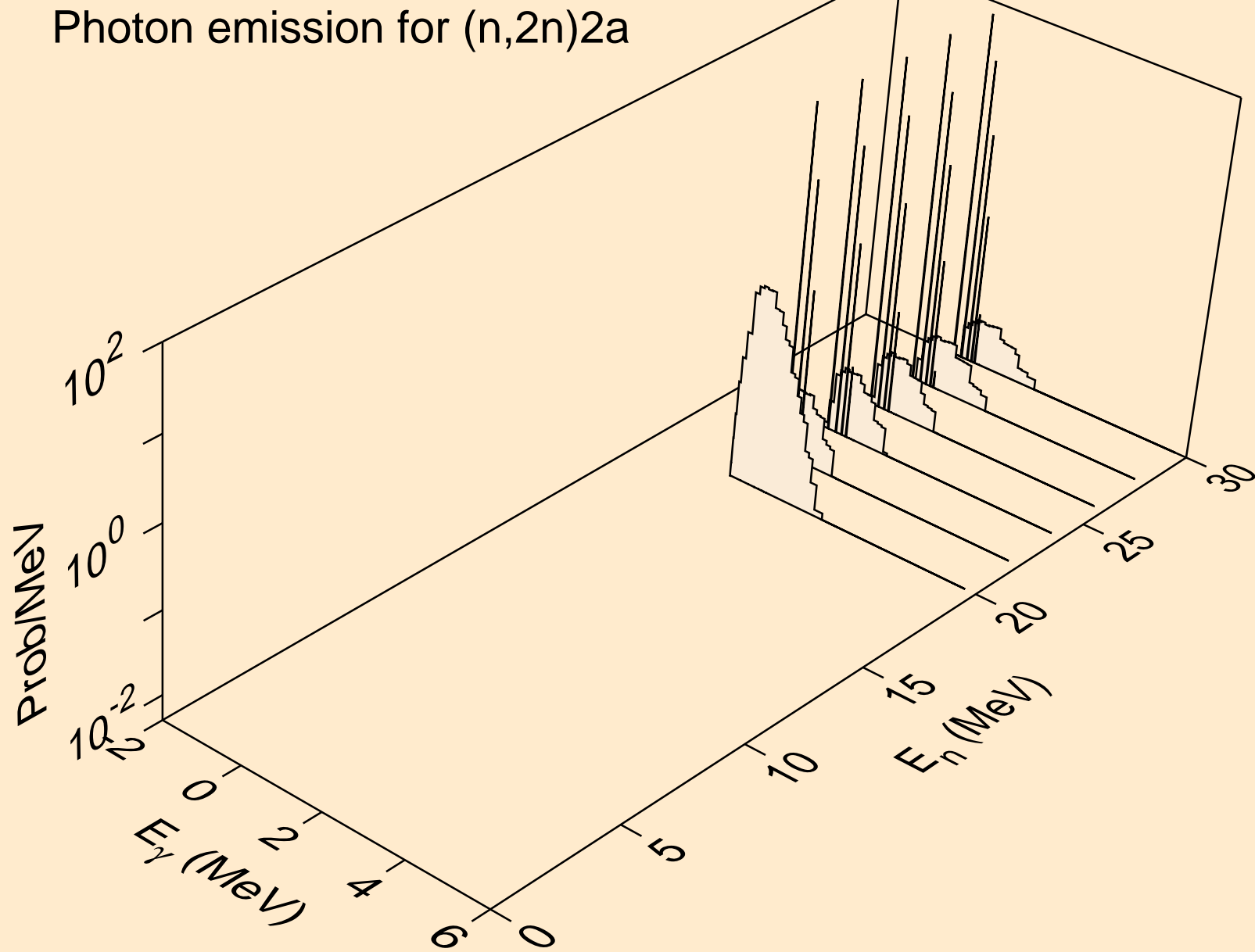

HO146 NEUTRON ACER TENDL-2021 LIBRARY; T=293.6K
Photon emission for (n,n*)d

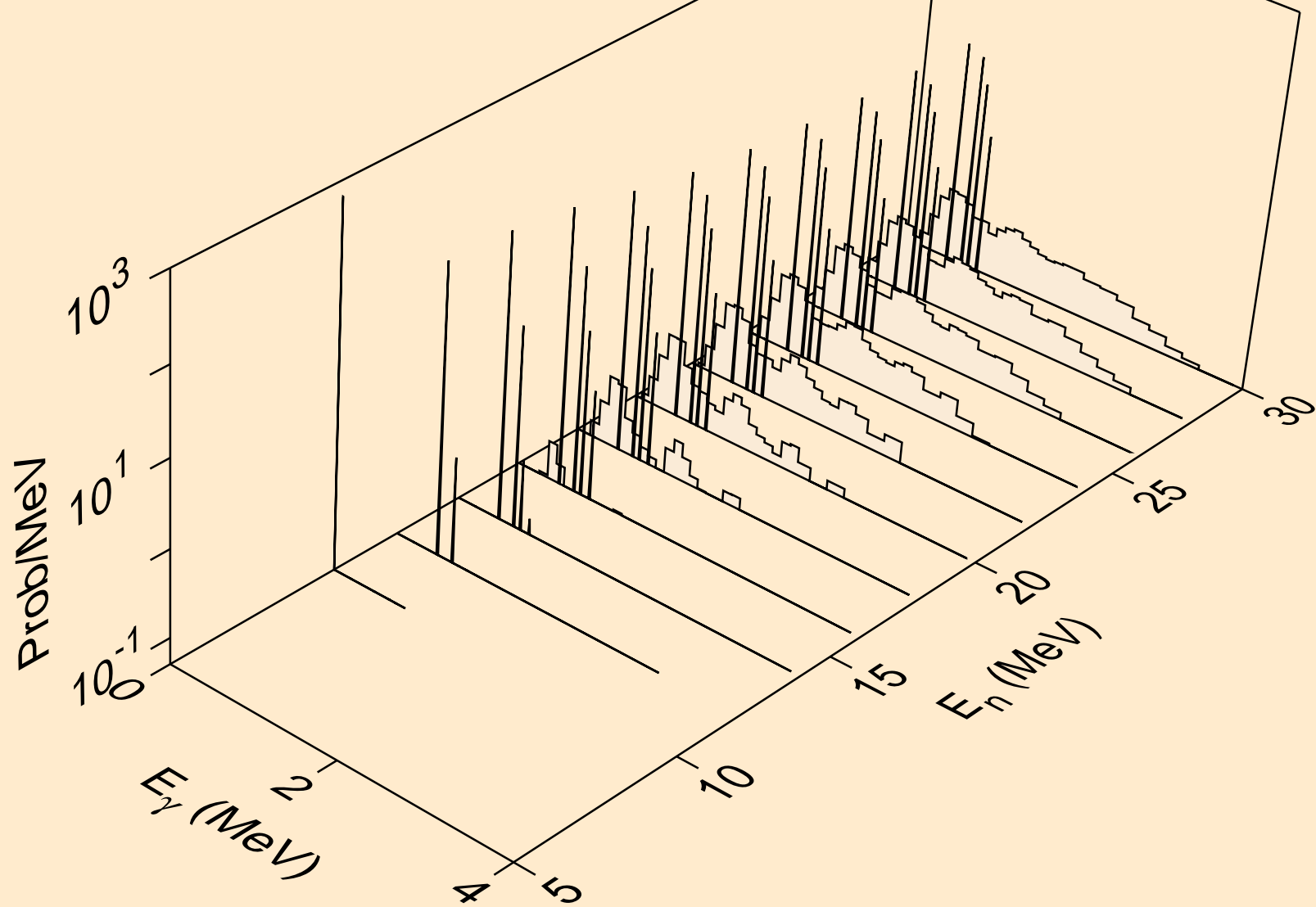

HO146 NEUTRON ACER TENDL-2021 LIBRARY; T=293.6K
Photon emission for (n,n*)t

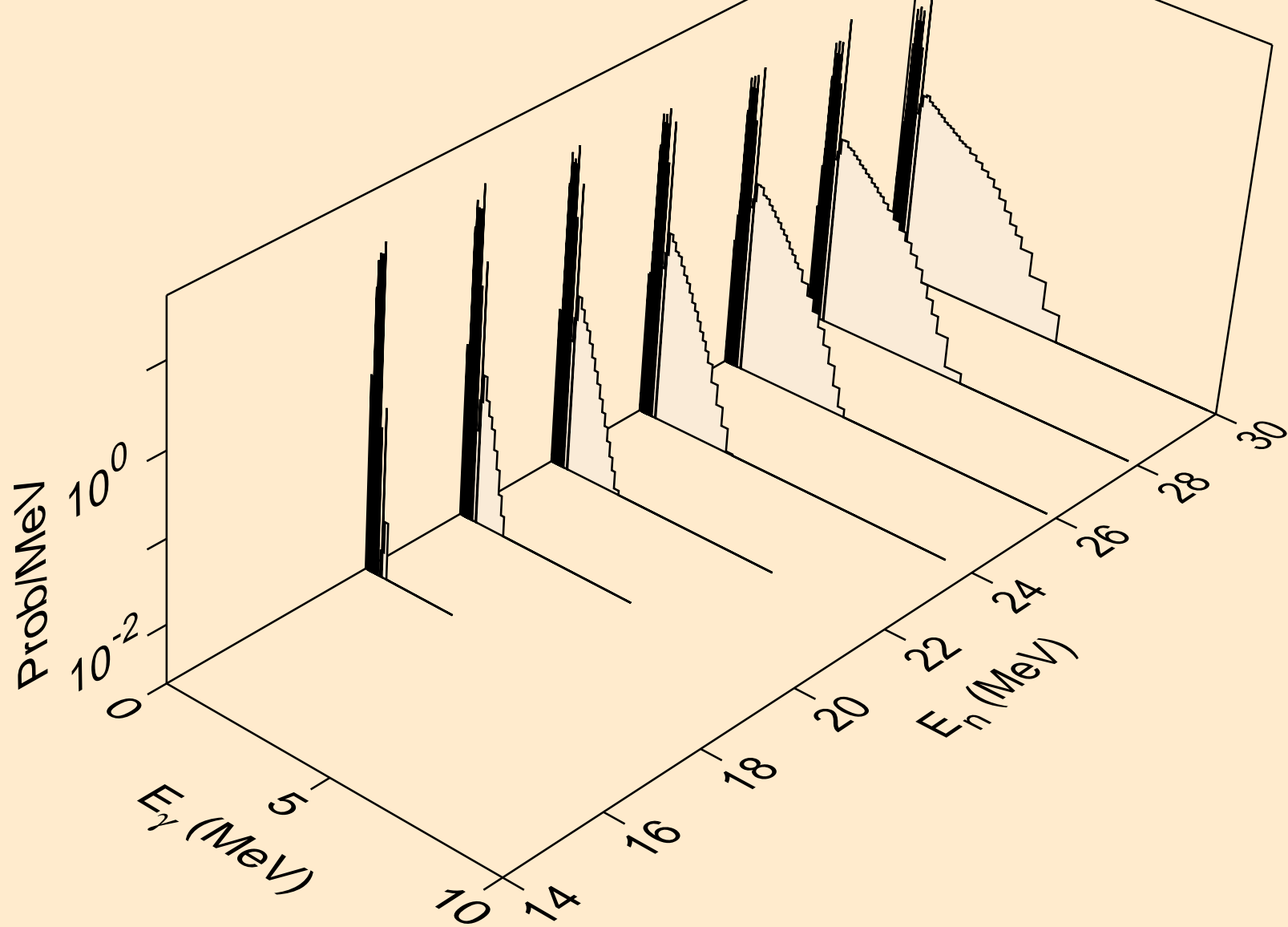

HO146 NEUTRON ACER TENDL-2021 LIBRARY; T=293.6K
Photon emission for (n,n*)he3

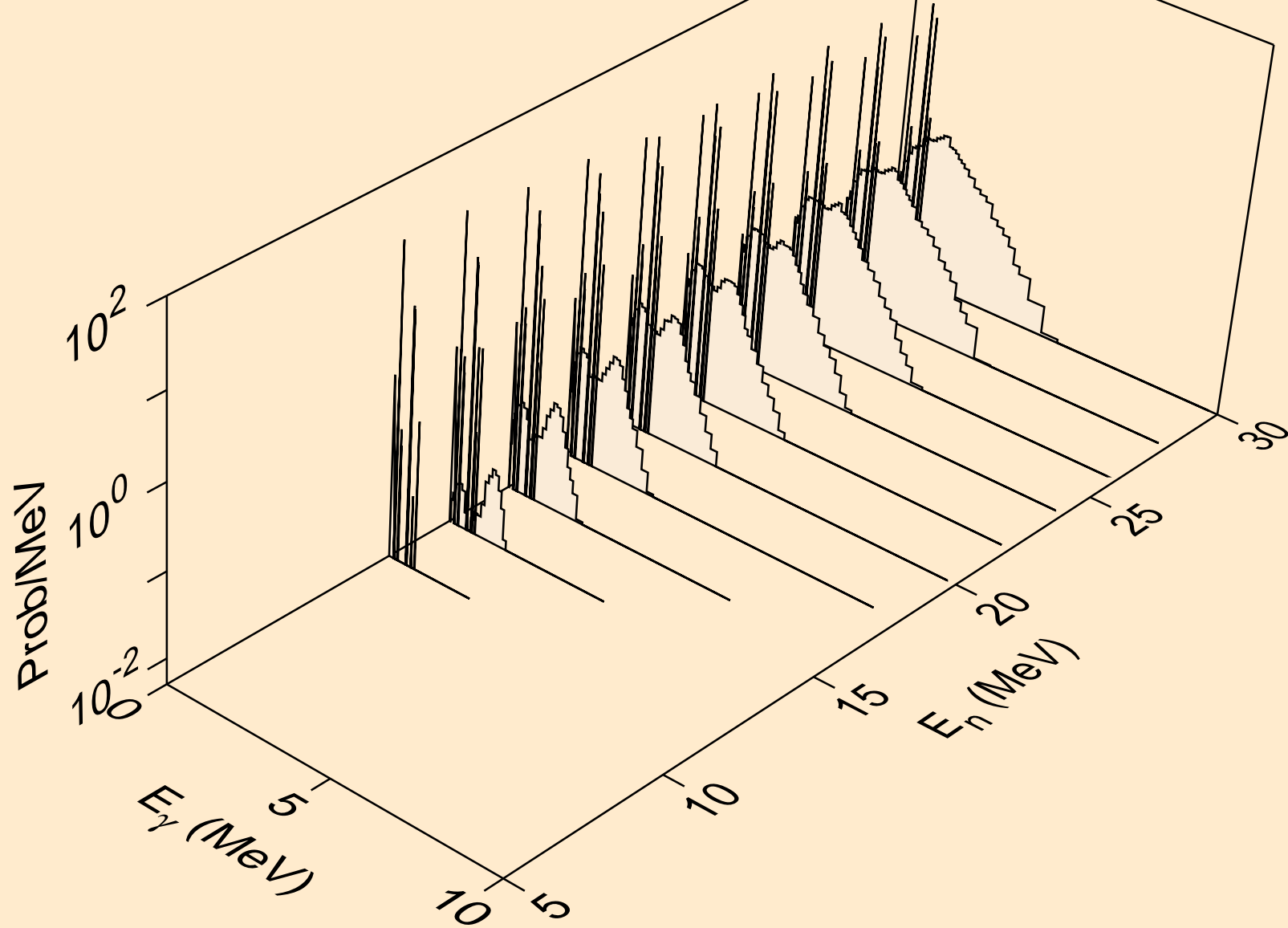

HO146 NEUTRON ACER TENDL-2021 LIBRARY; T=293.6K
Photon emission for (n,2np)

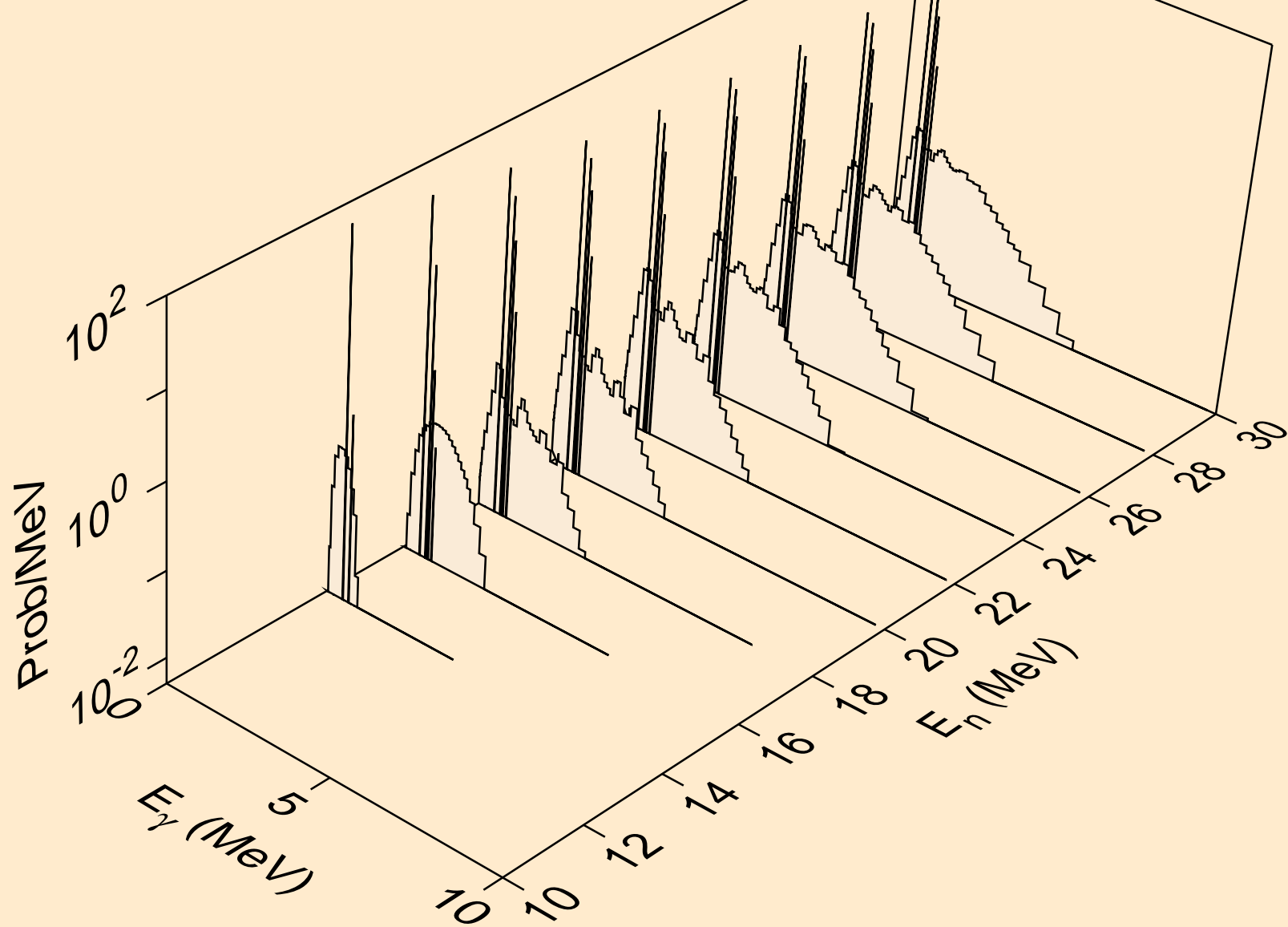

HO146 NEUTRON ACER TENDL-2021 LIBRARY; T=293.6K
Photon emission for (n,3np)

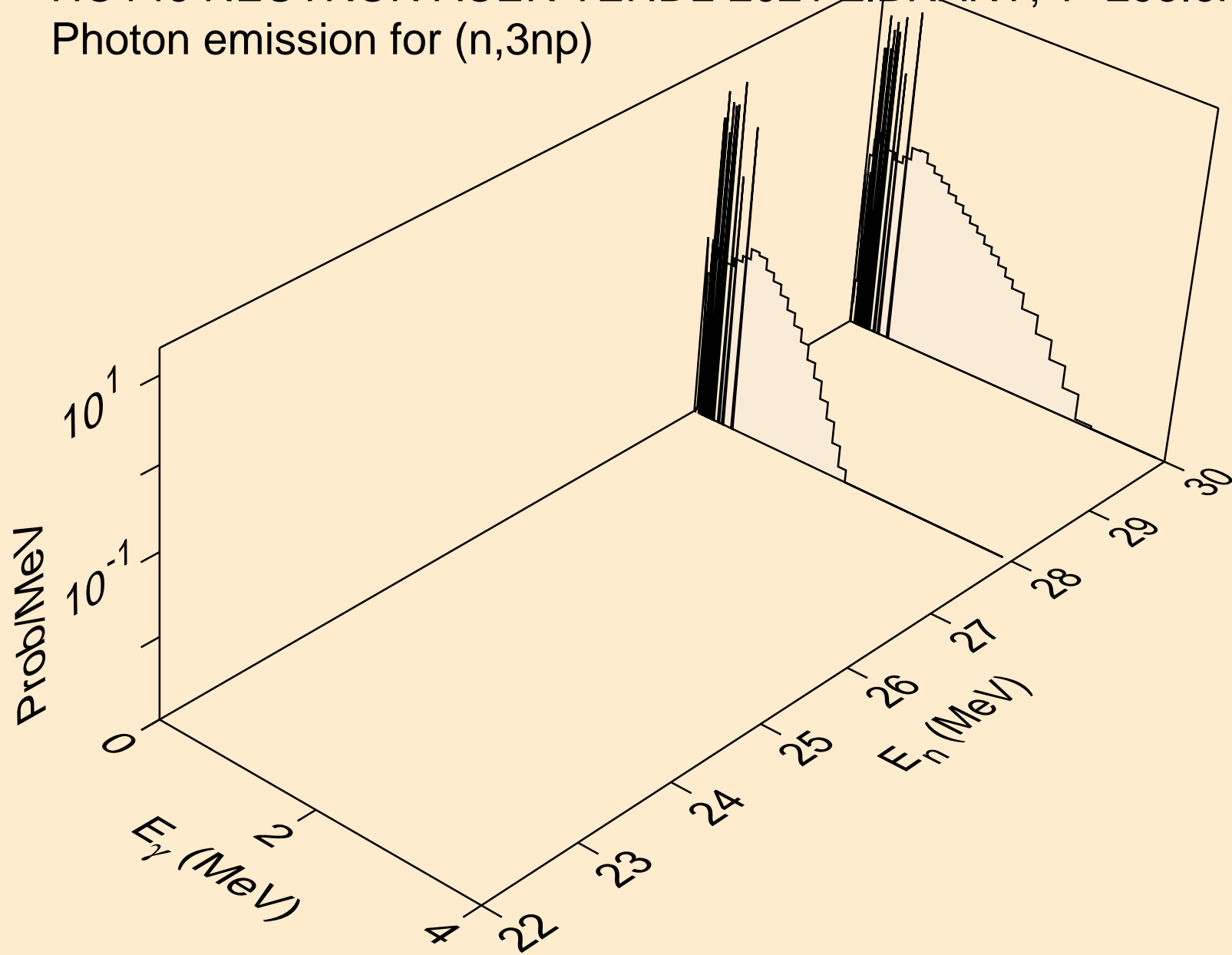

HO146 NEUTRON ACER TENDL-2021 LIBRARY; T=293.6K
Photon emission for (n,2np)

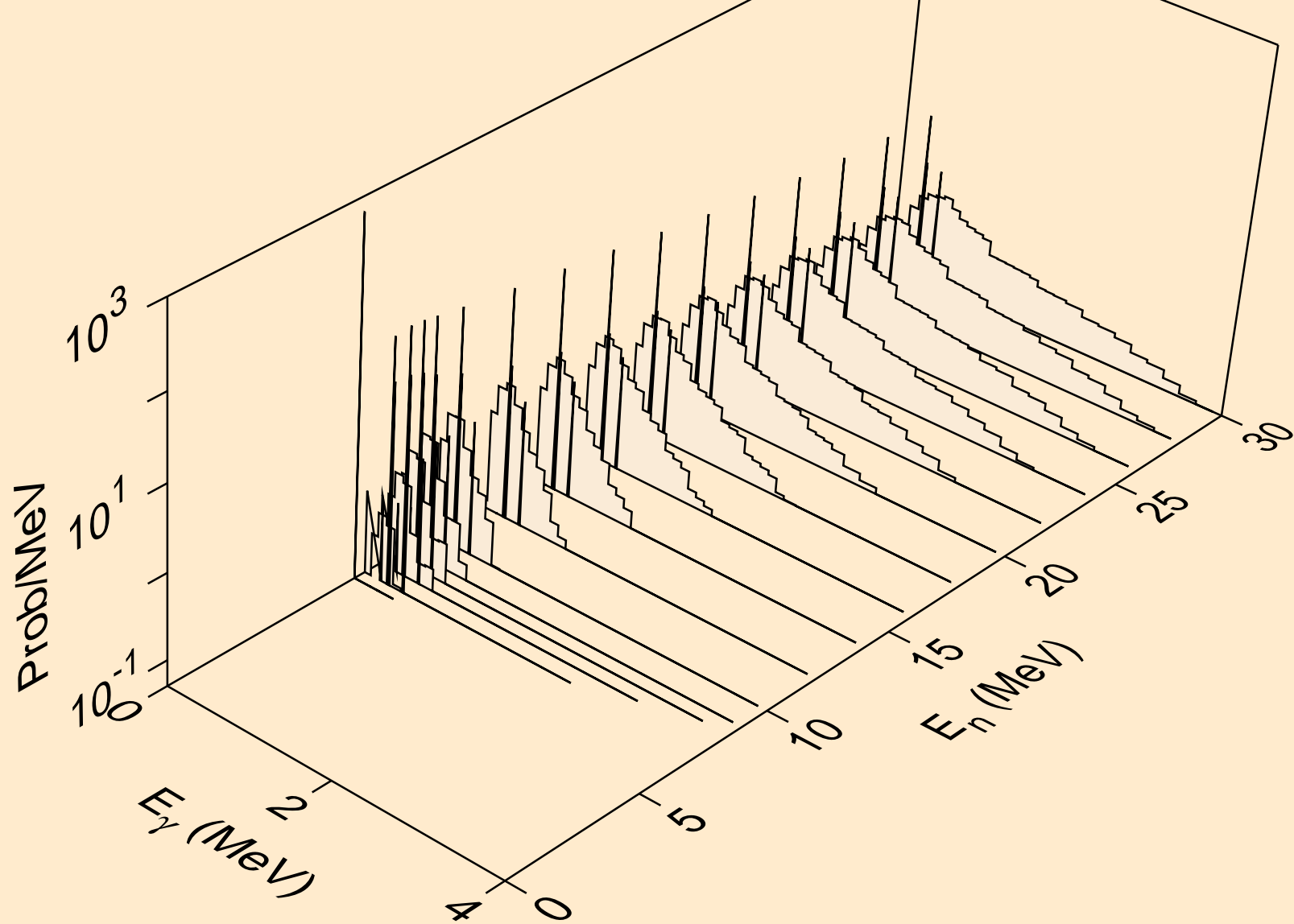

HO146 NEUTRON ACER TENDL-2021 LIBRARY; T=293.6K
Photon emission for (n,npa)

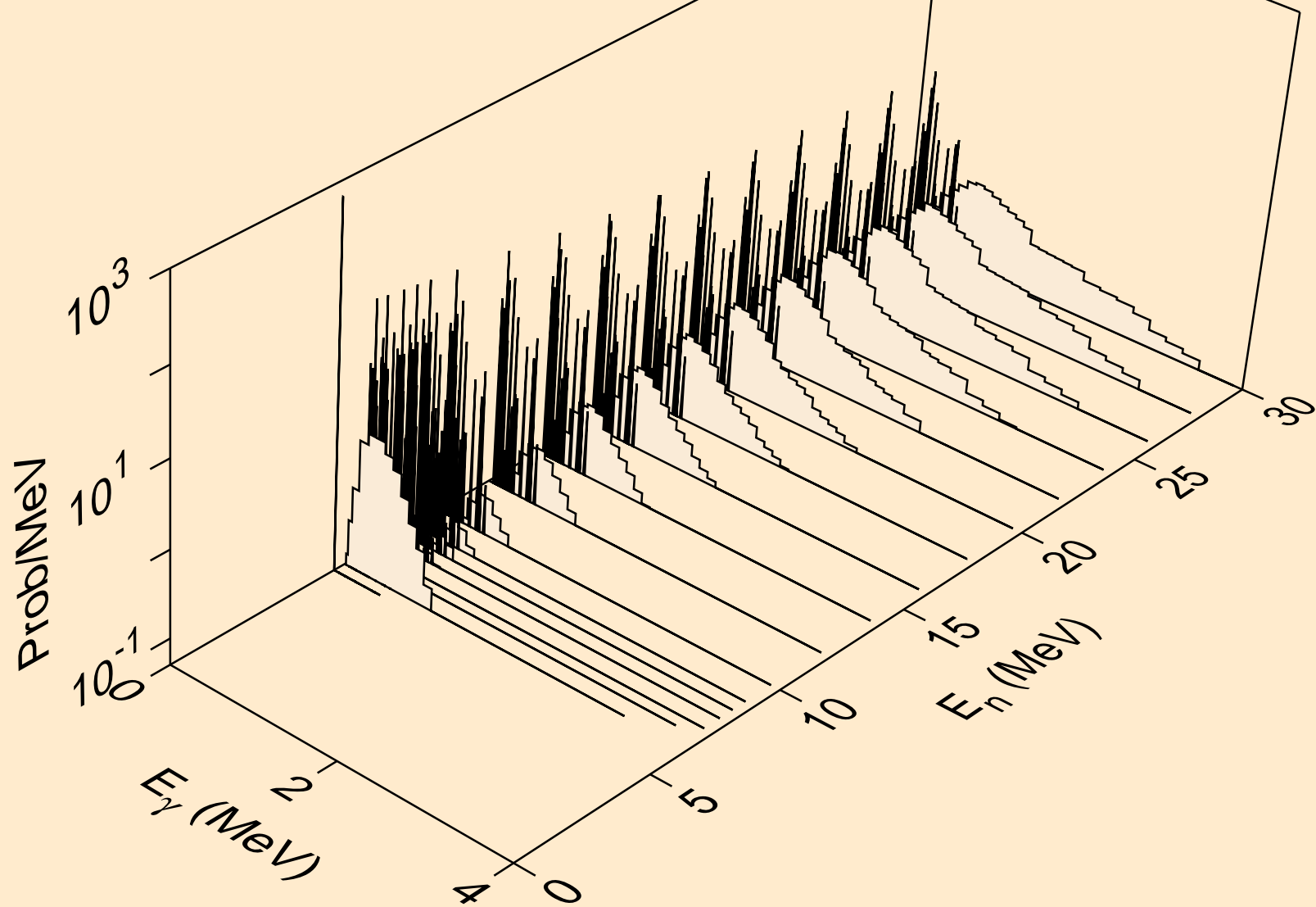

HO146 NEUTRON ACER TENDL-2021 LIBRARY; T=293.6K
Photon emission for (n,n*c)

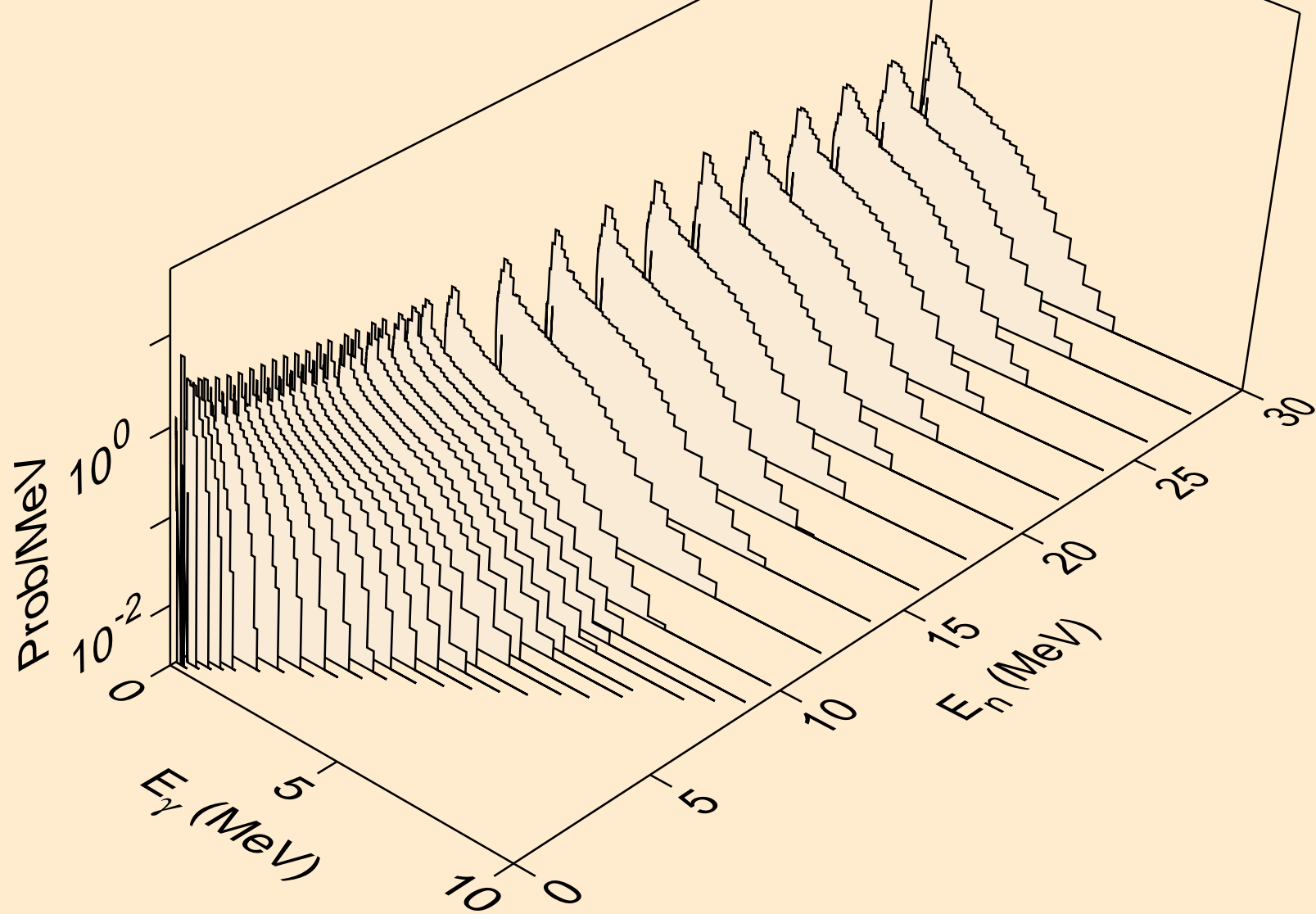

HO146 NEUTRON ACER TENDL-2021 LIBRARY; T=293.6K
Photon emission for (n,gma)

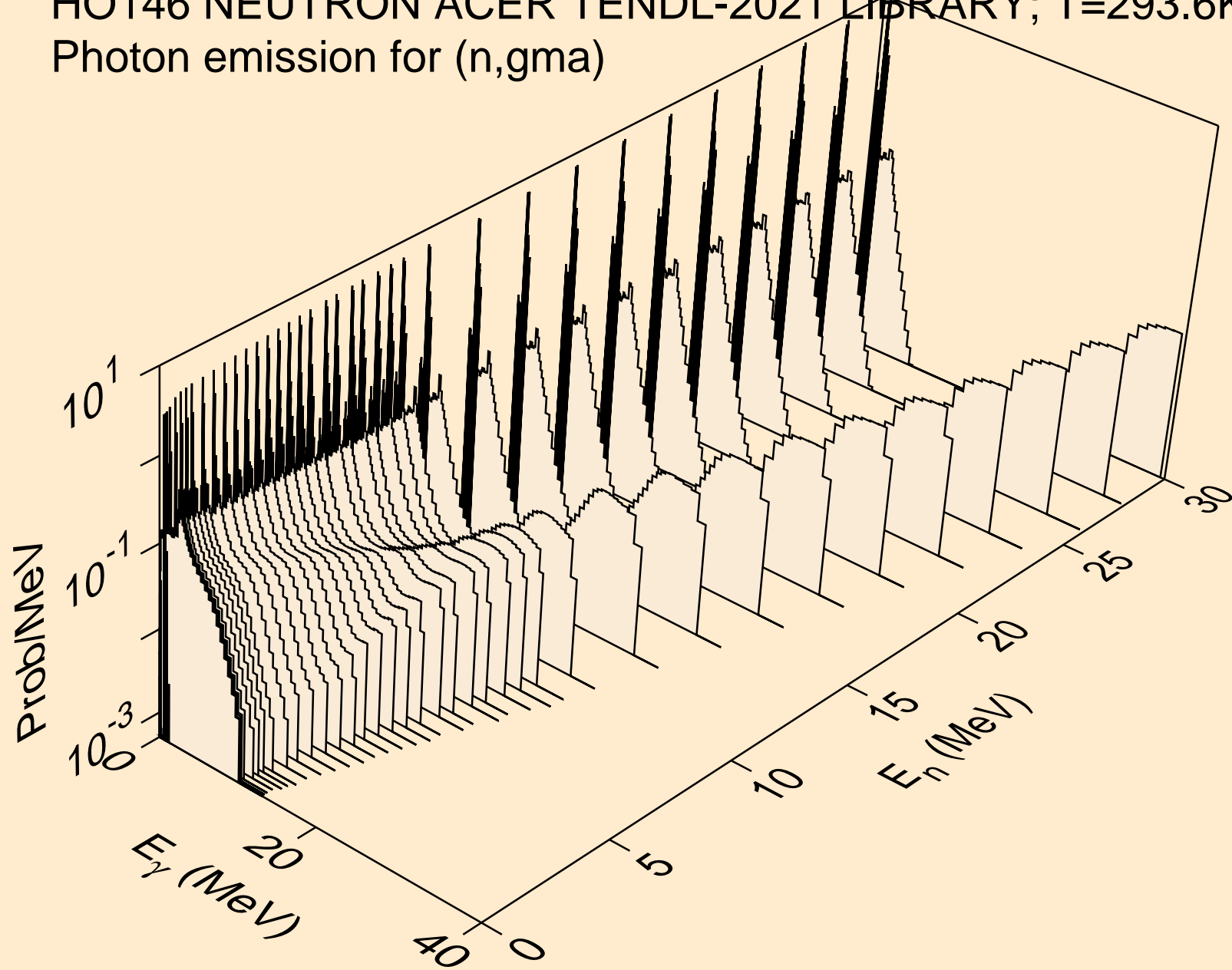

HO146 NEUTRON ACER TENDL-2021 LIBRARY; T=293.6K
Photon emission for (n,p)

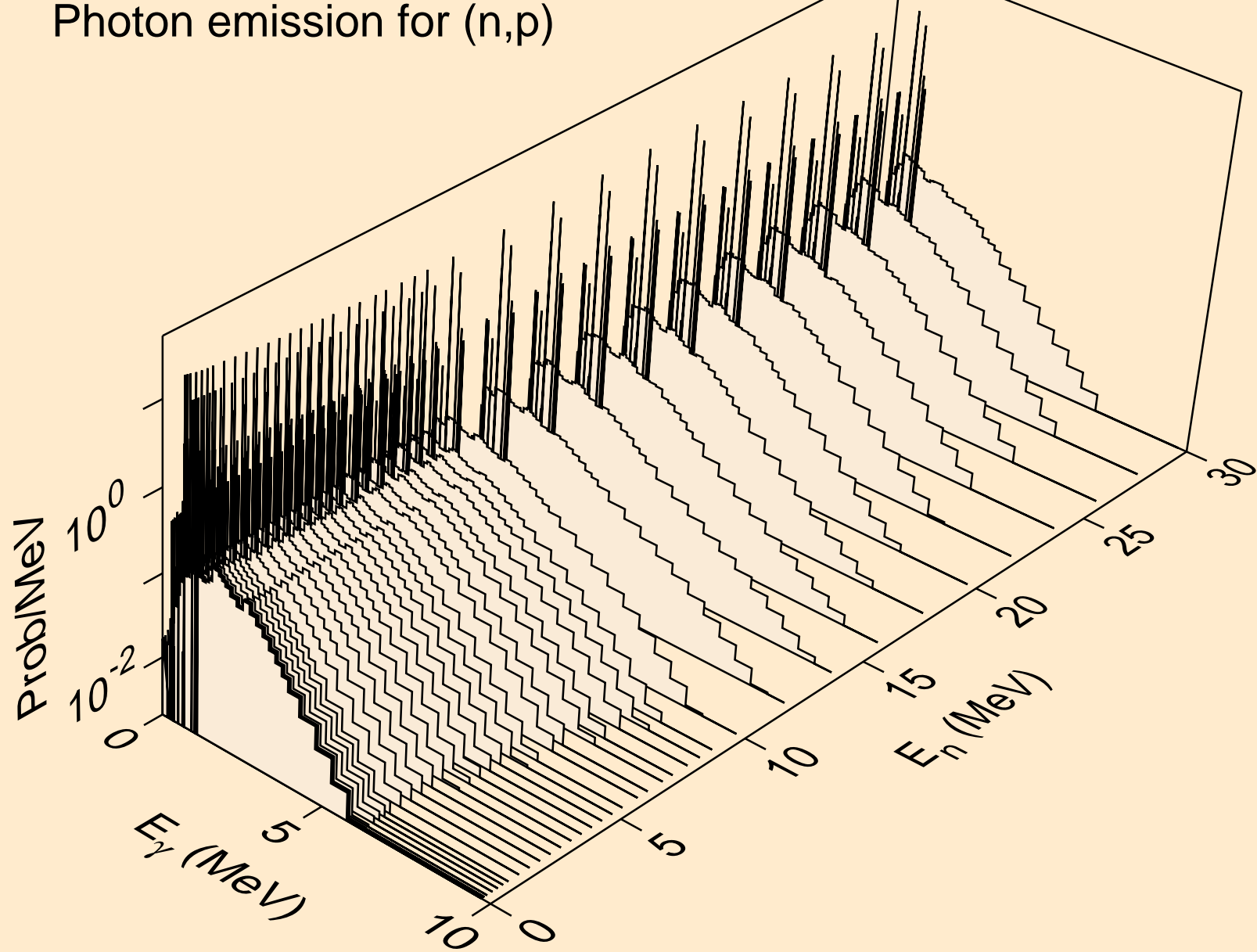

HO146 NEUTRON ACER TENDL-2021 LIBRARY; T=293.6K
Photon emission for (n,d)

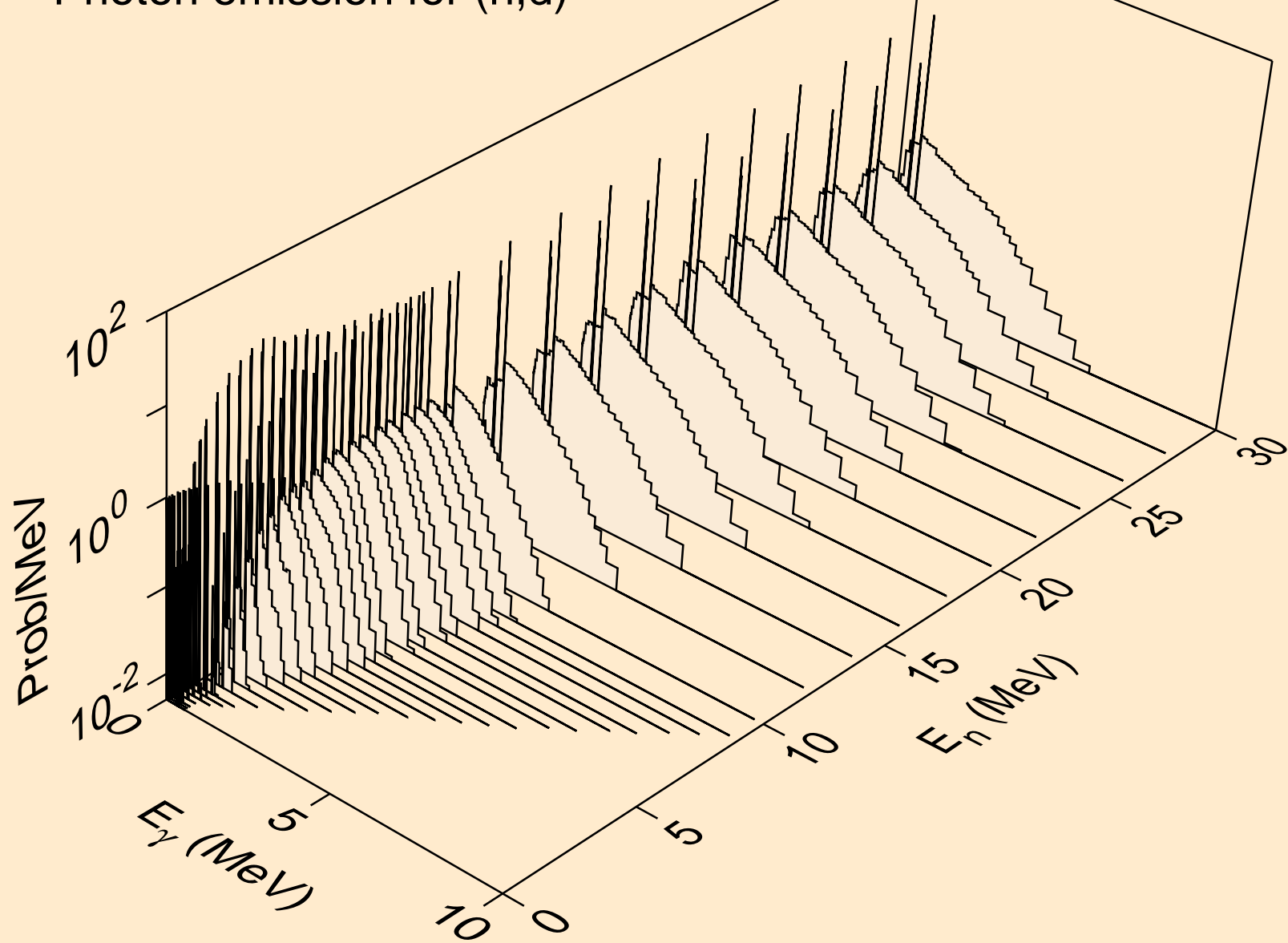

HO146 NEUTRON ACER TENDL-2021 LIBRARY; T=293.6K
Photon emission for (n,t)

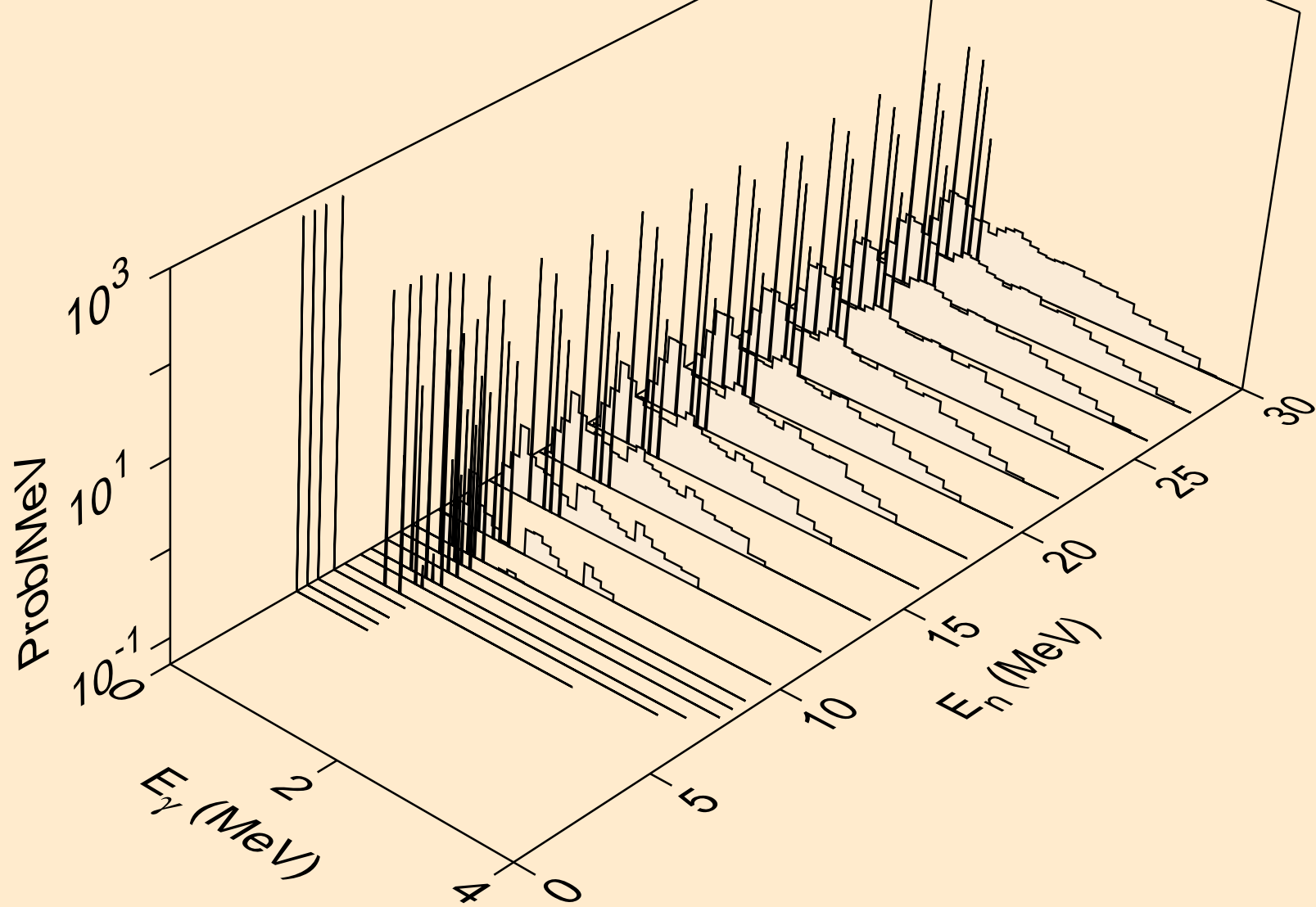

HO146 NEUTRON ACER TENDL-2021 LIBRARY; T=293.6K
Photon emission for (n,he3)

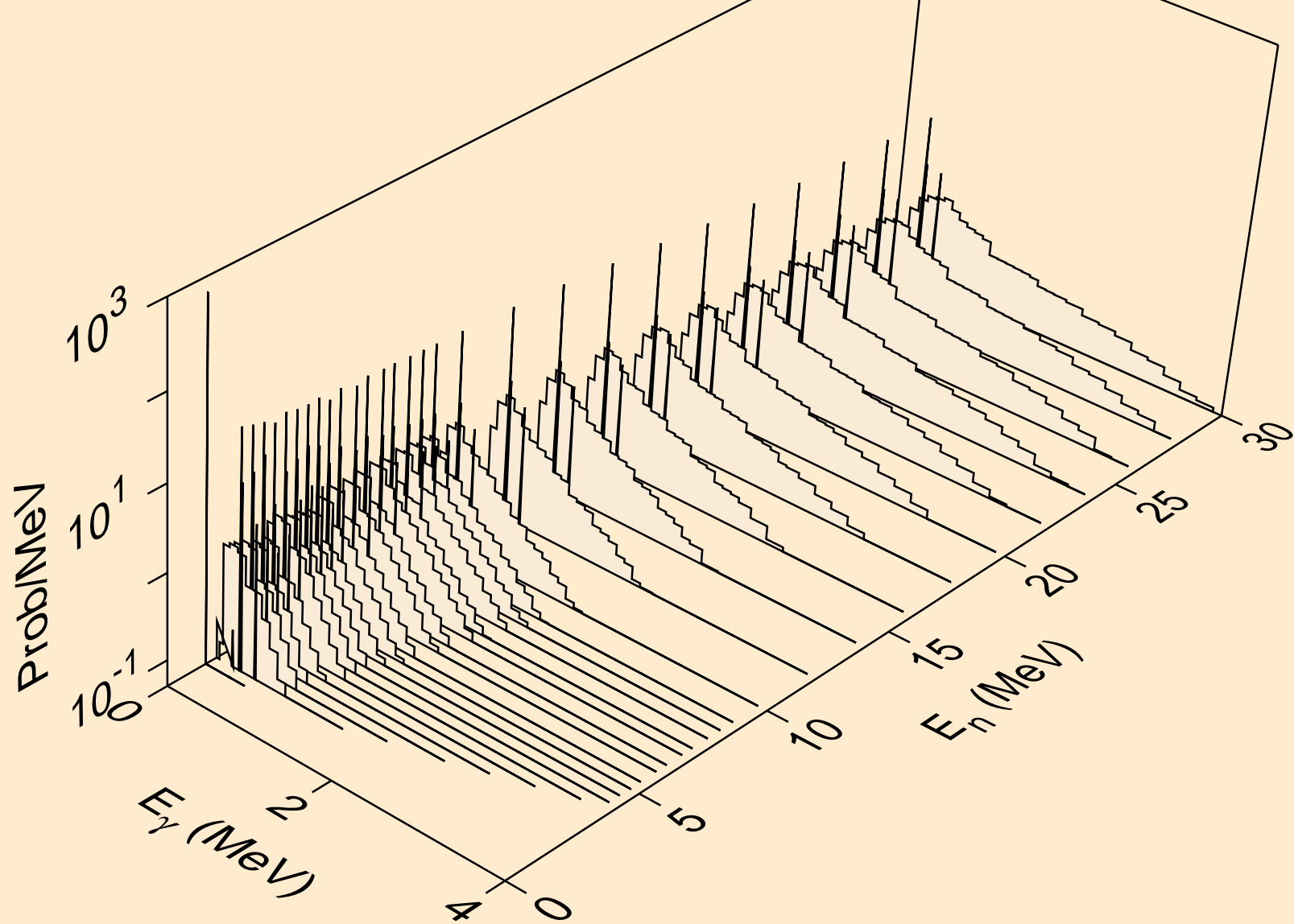

HO146 NEUTRON ACER TENDL-2021 LIBRARY; T=293.6K
Photon emission for (n,a)

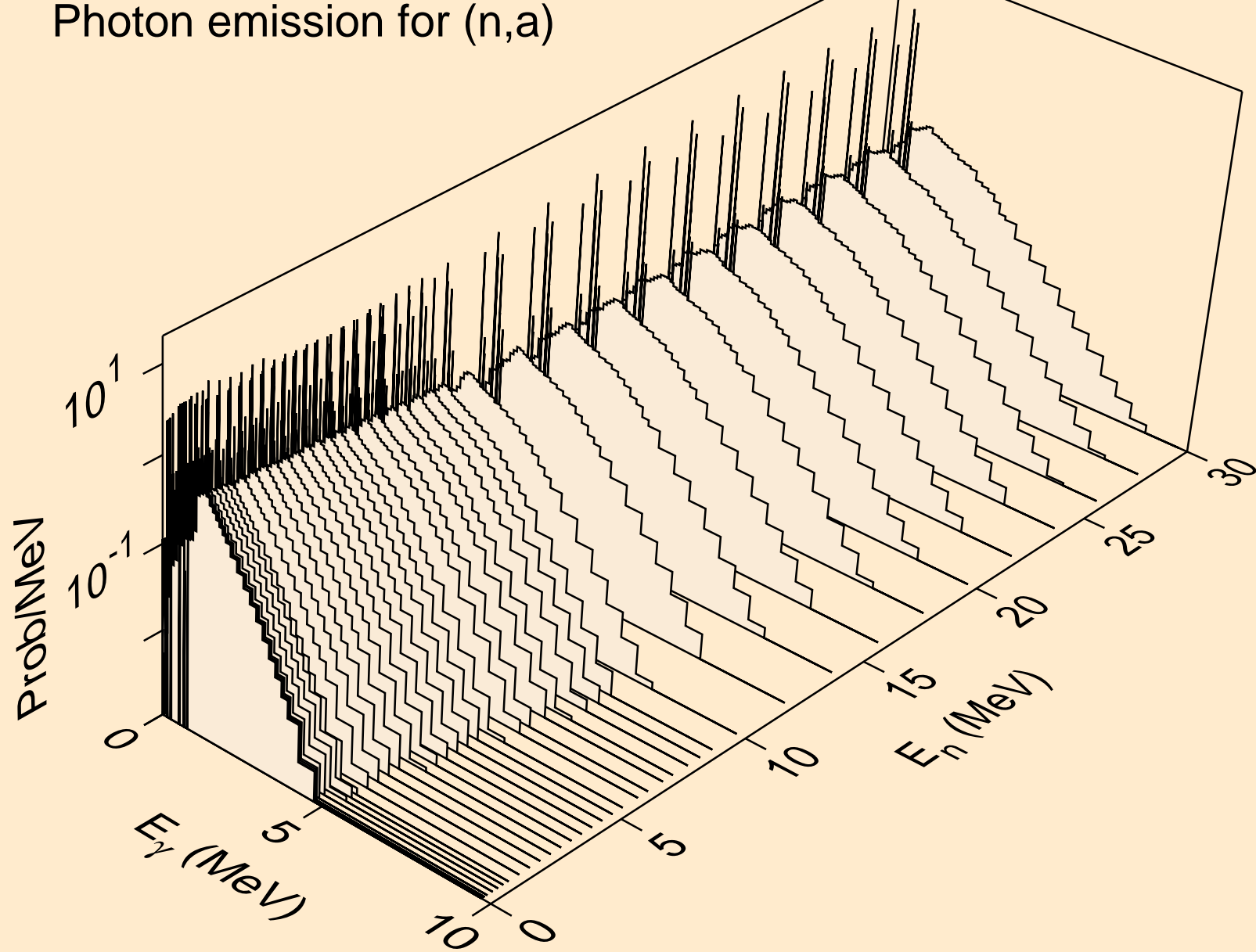

HO146 NEUTRON ACER TENDL-2021 LIBRARY; T=293.6K
Photon emission for (n,2a)

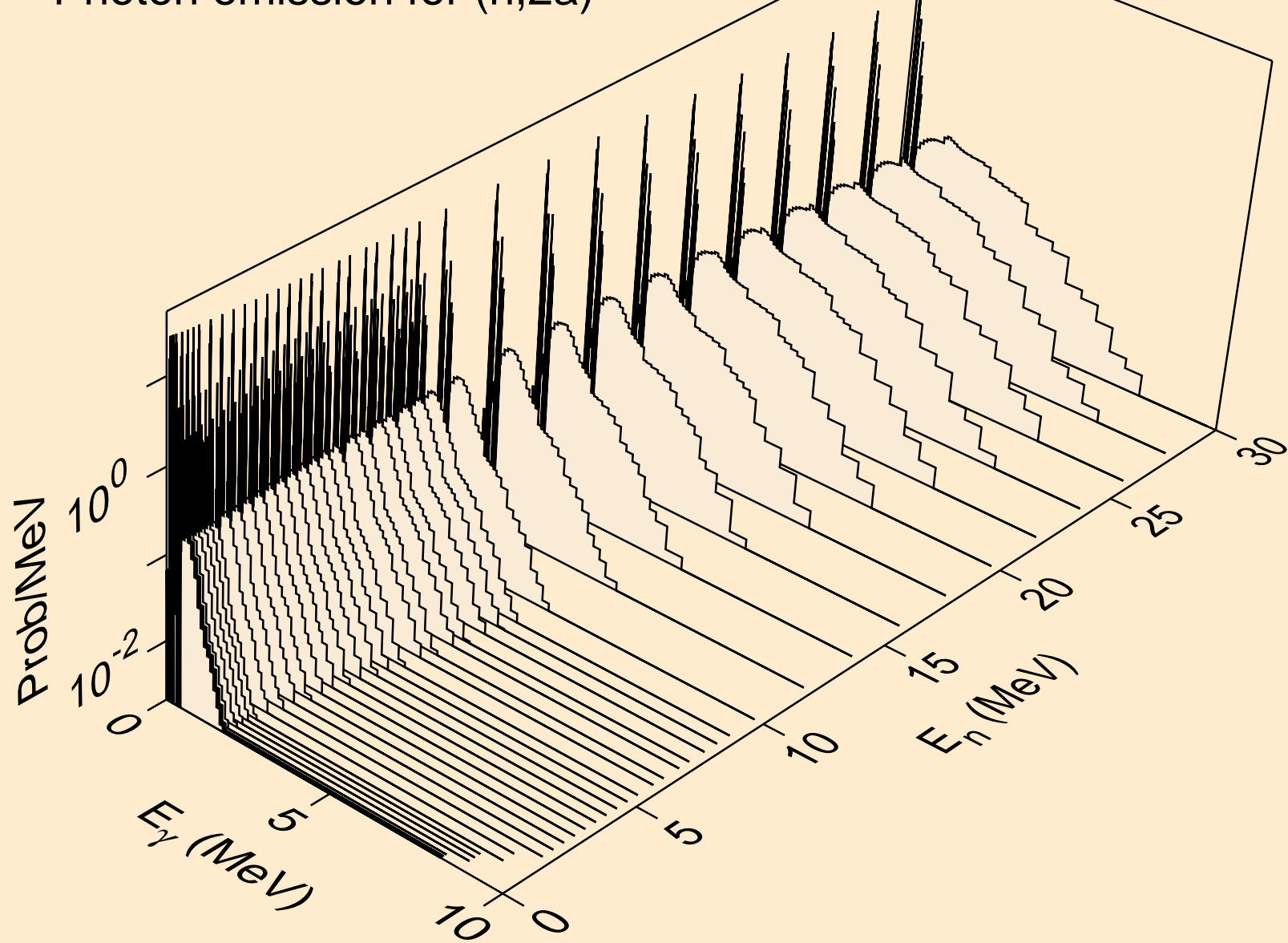

HO146 NEUTRON ACER TENDL-2021 LIBRARY; T=293.6K
Photon emission for (n,3a)

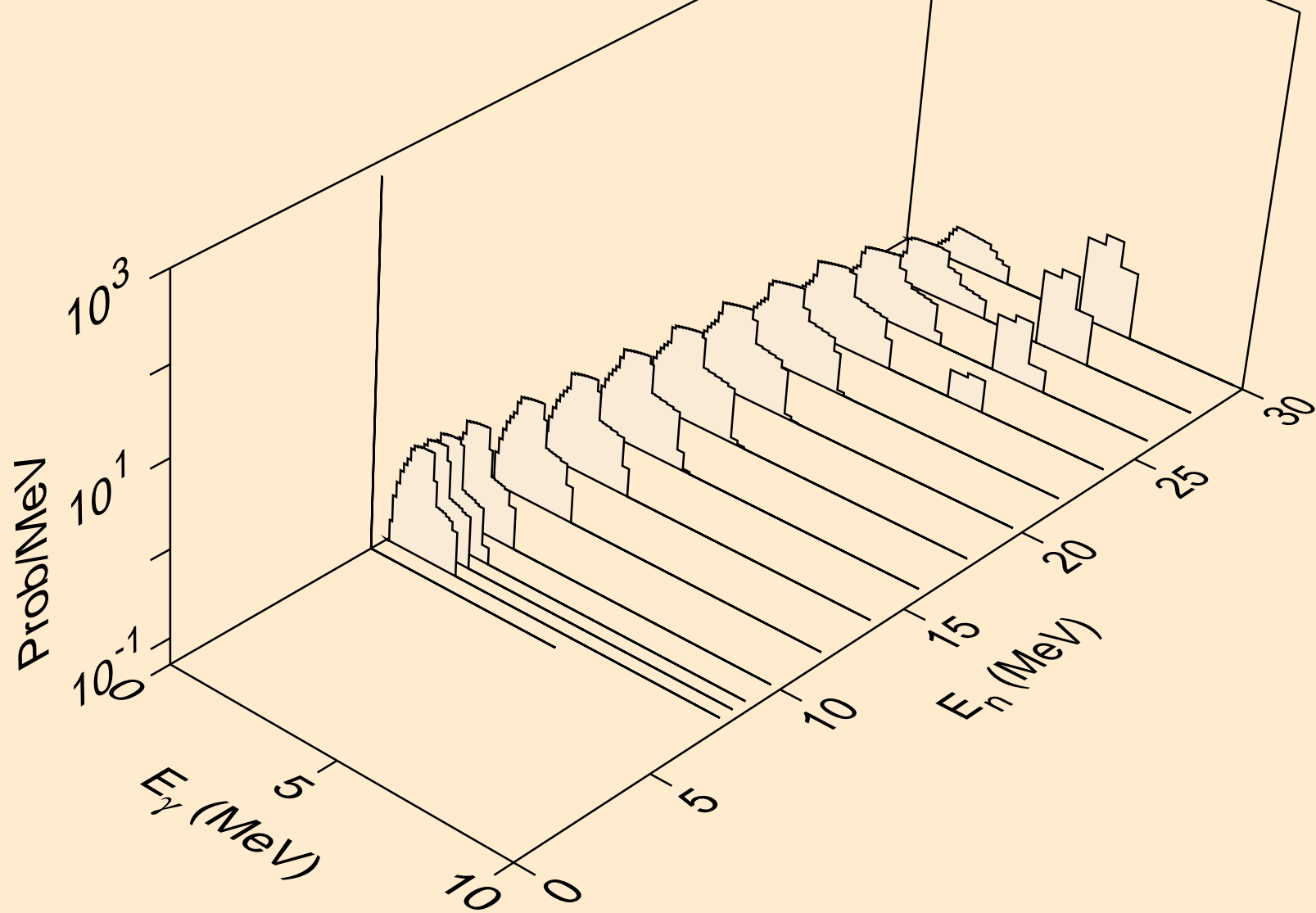

HO146 NEUTRON ACER TENDL-2021 LIBRARY; T=293.6K
Photon emission for (n,2p)

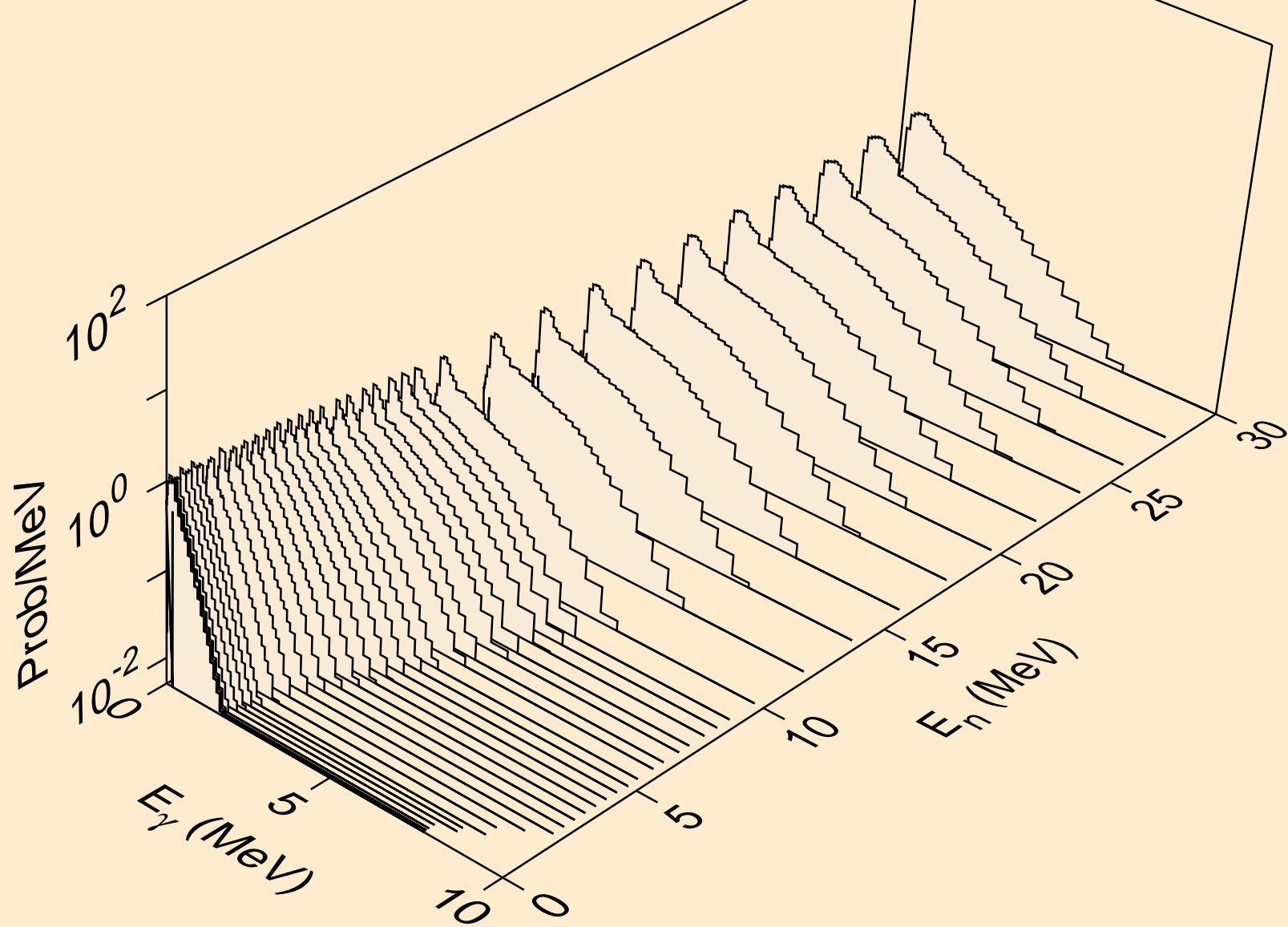

HO146 NEUTRON ACER TENDL-2021 LIBRARY; T=293.6K
Photon emission for (n,p α)

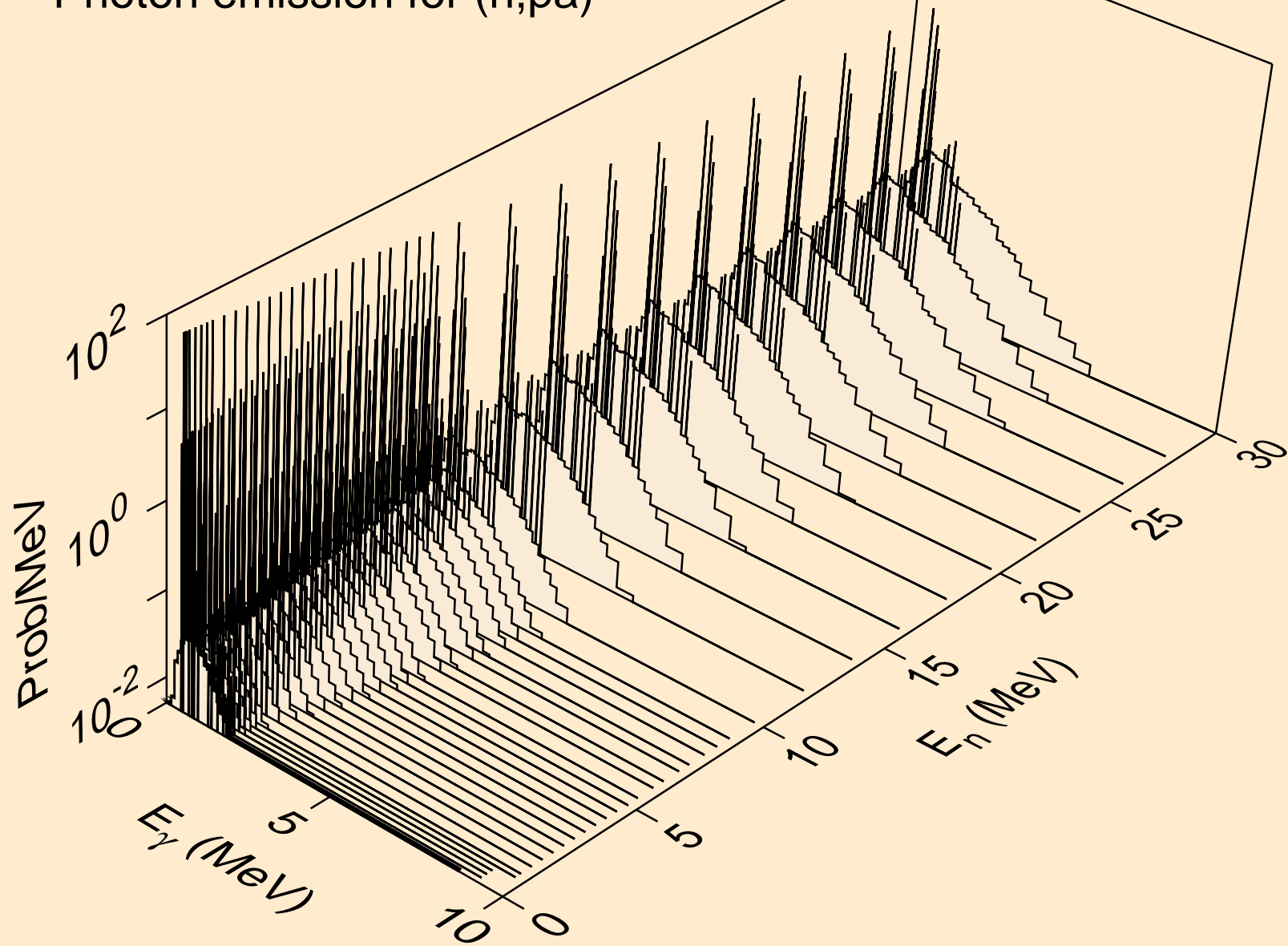

HO146 NEUTRON ACER TENDL-2021 LIBRARY; T=293.6K
Photon emission for (n,d2a)

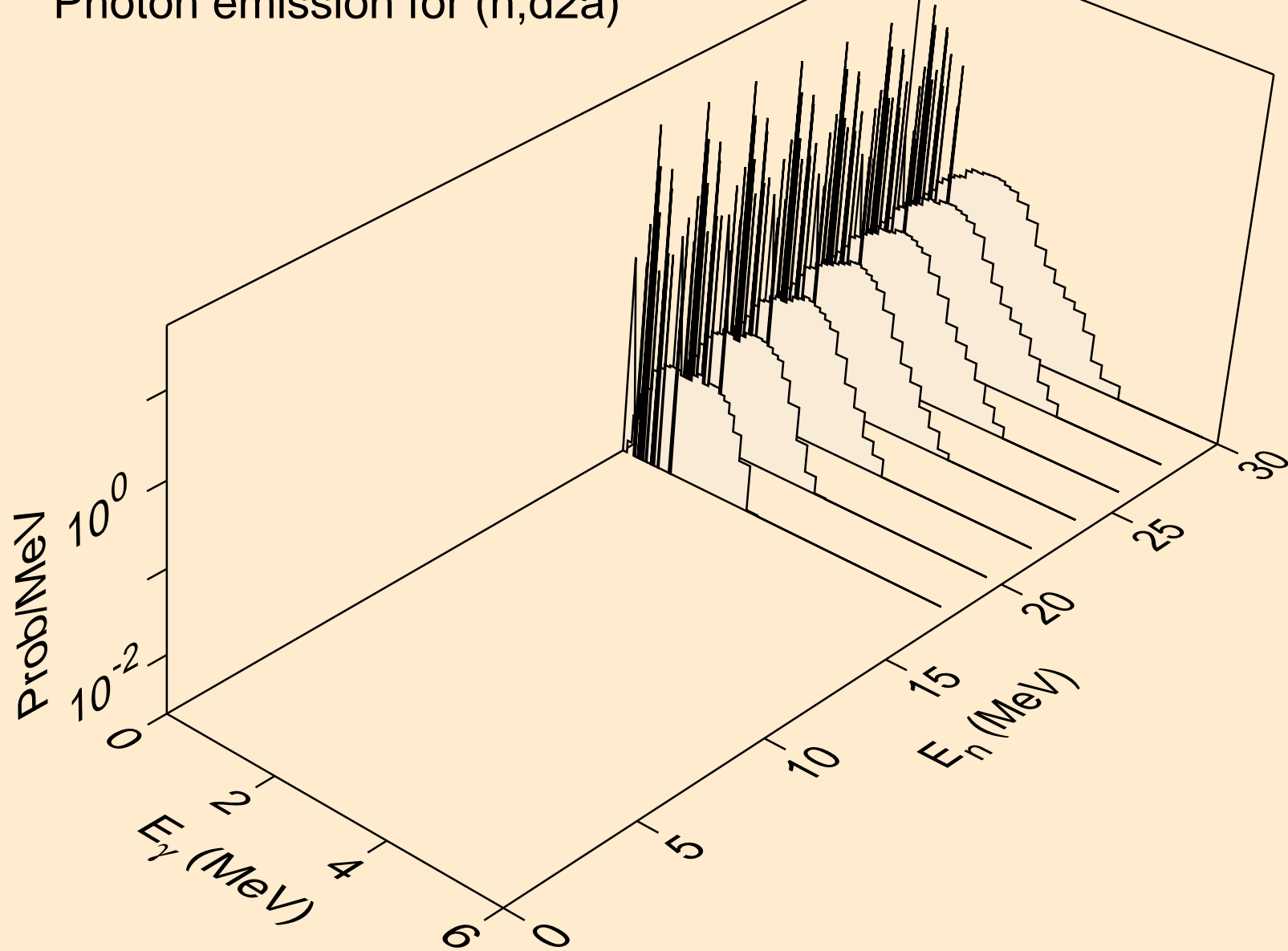

HO146 NEUTRON ACER TENDL-2021 LIBRARY; T=293.6K
Photon emission for (n,pd)

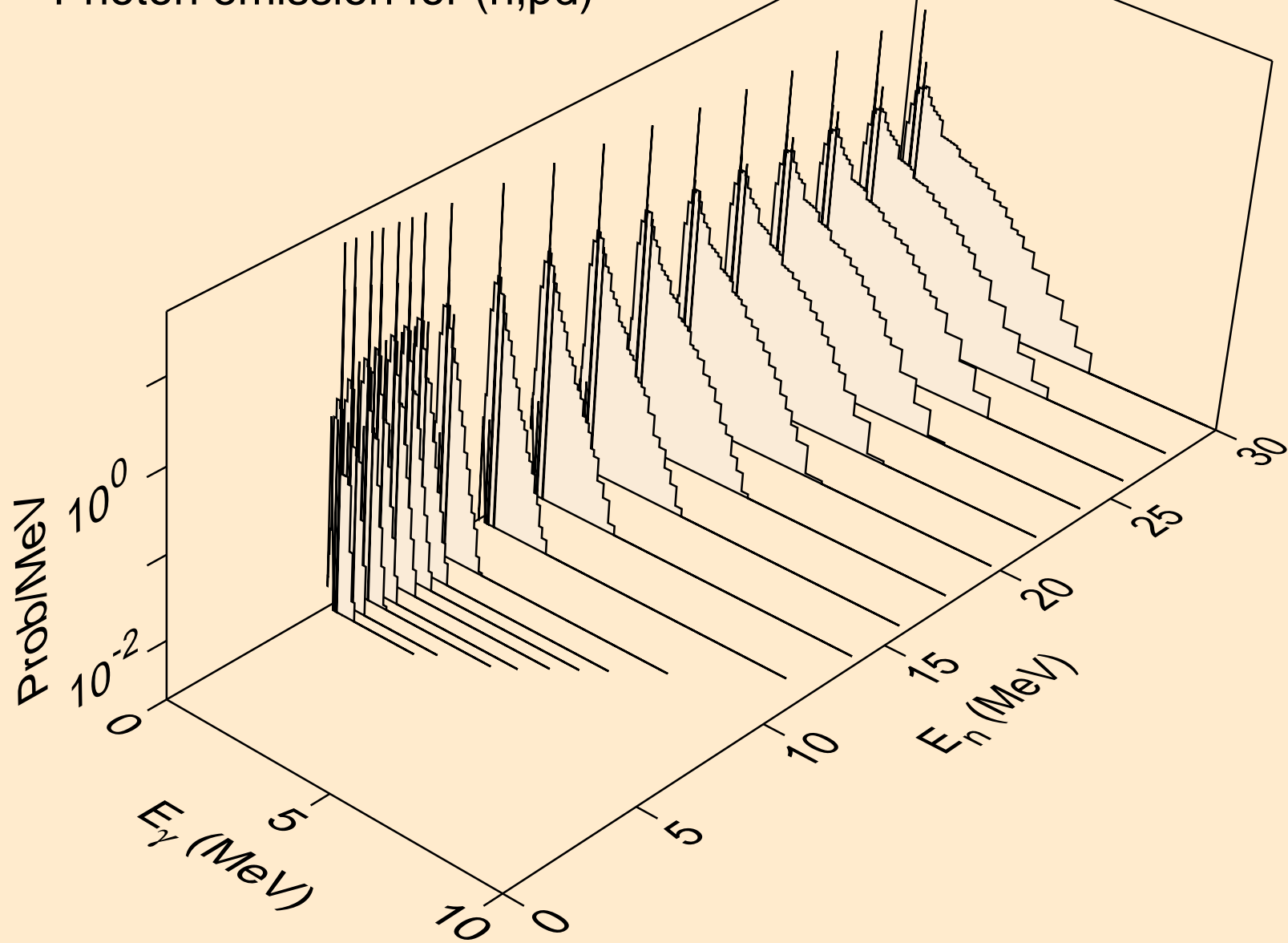

HO146 NEUTRON ACER TENDL-2021 LIBRARY; T=293.6K
Photon emission for (n,pt)

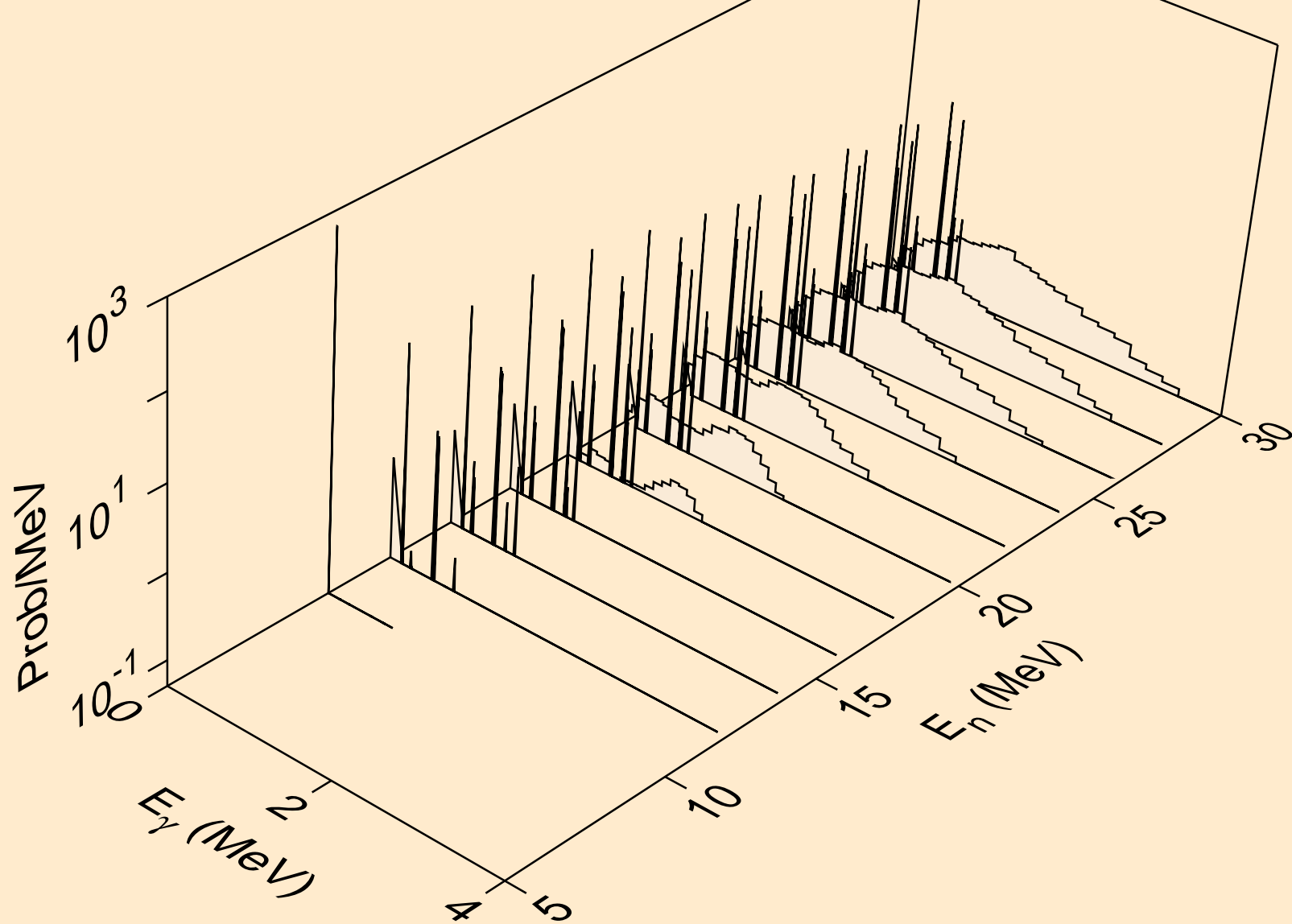

HO146 NEUTRON ACER TENDL-2021 LIBRARY; T=293.6K
Photon emission for (n,da)

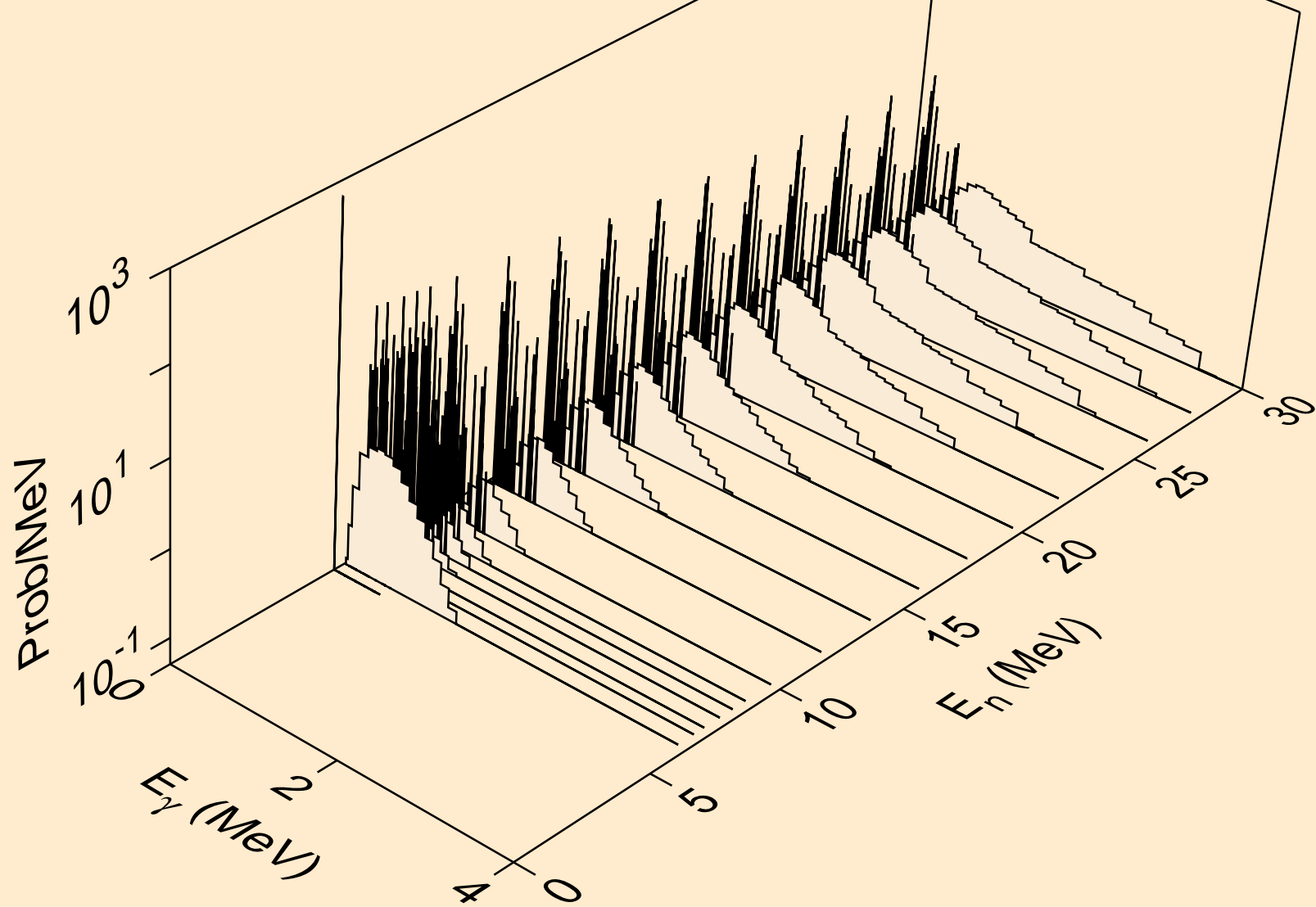

HO146 NEUTRON ACER TENDL-2021 LIBRARY; T=293.6K
thermal capture photon spectrum

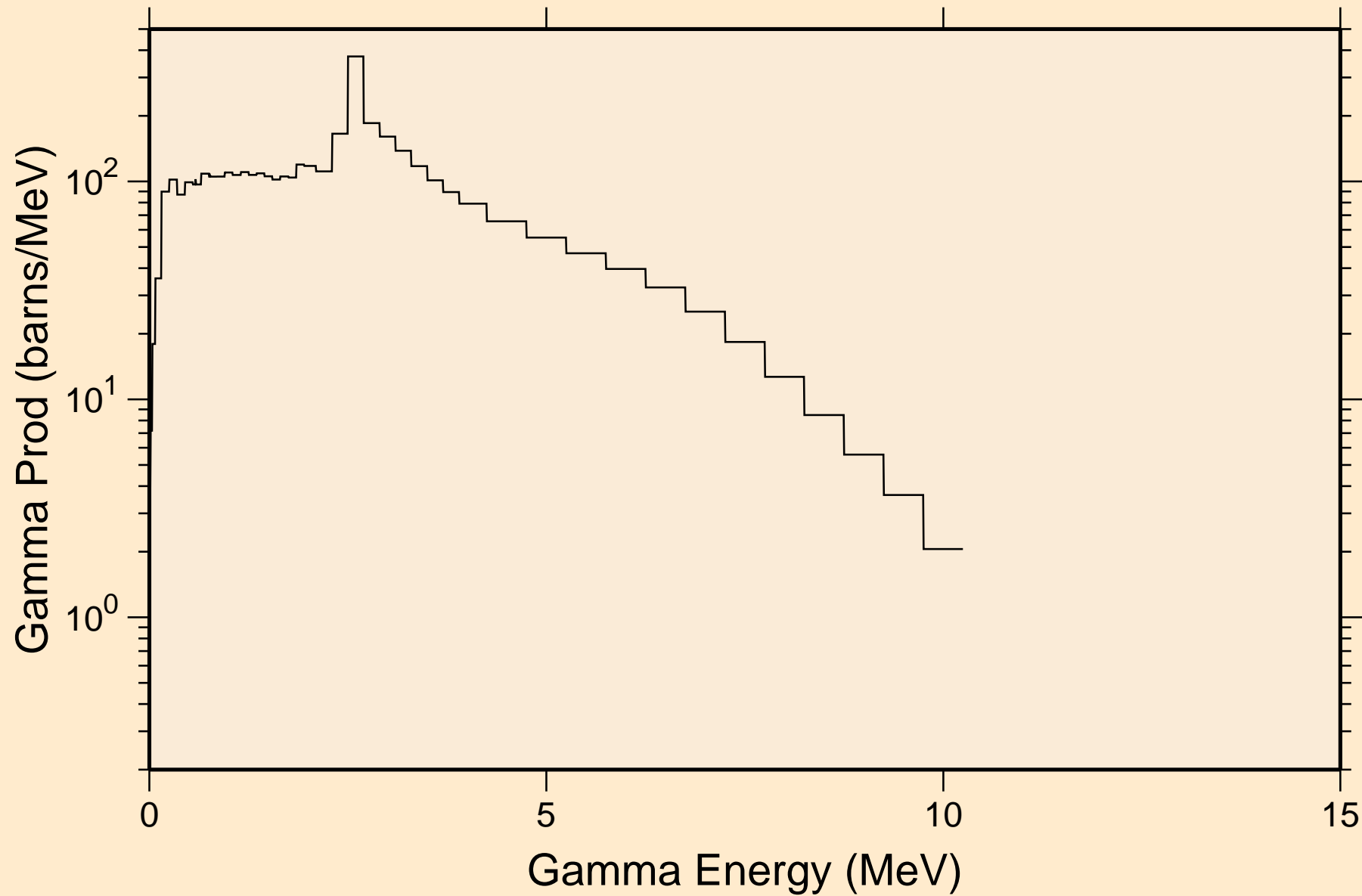

HO146 NEUTRON ACER TENDL-2021 LIBRARY; T=293.6K
14 MeV photon spectrum

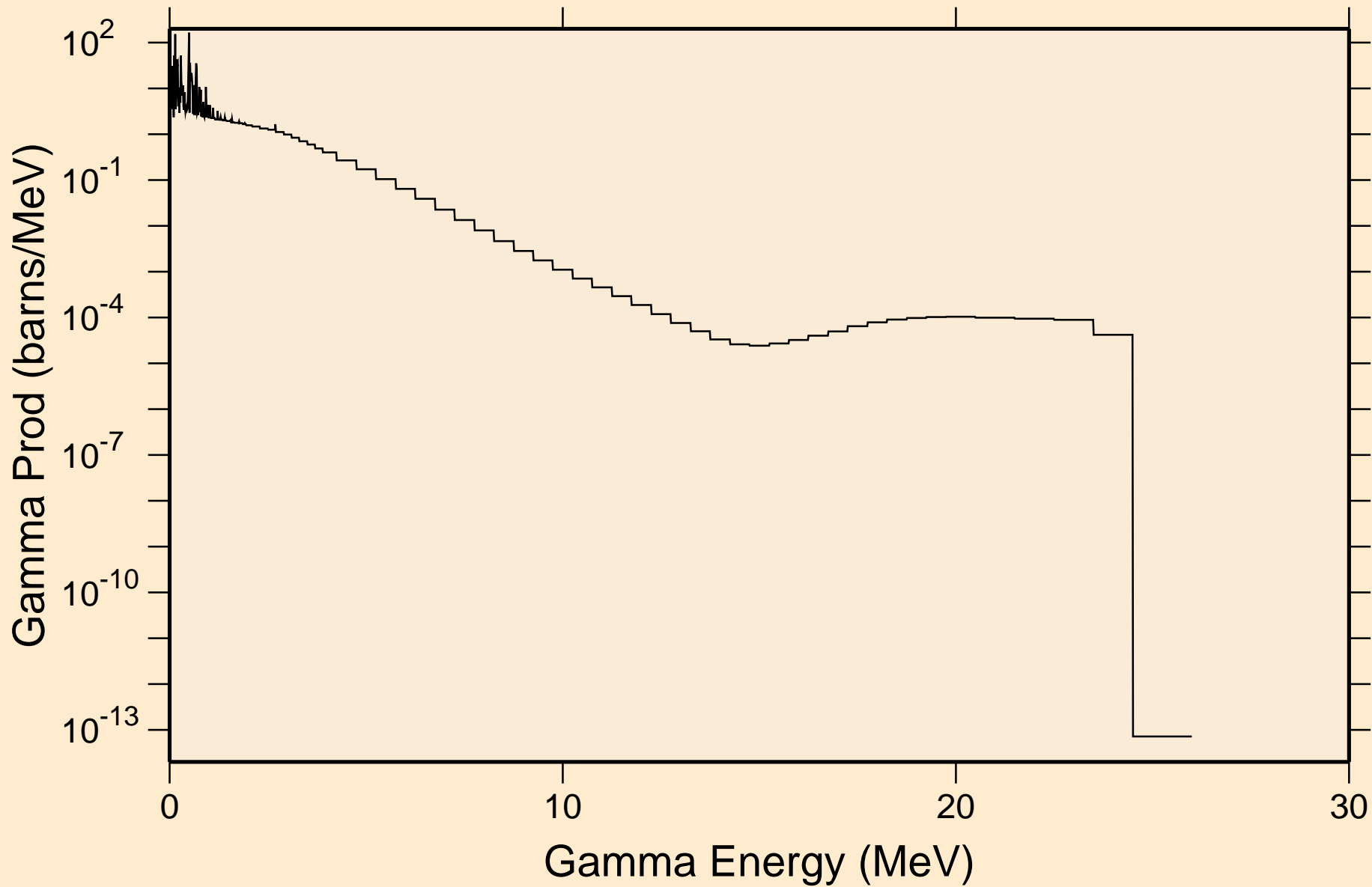

HO146 NEUTRON ACER TENDL-2021 LIBRARY; T=293.6K

Particle heating contributions

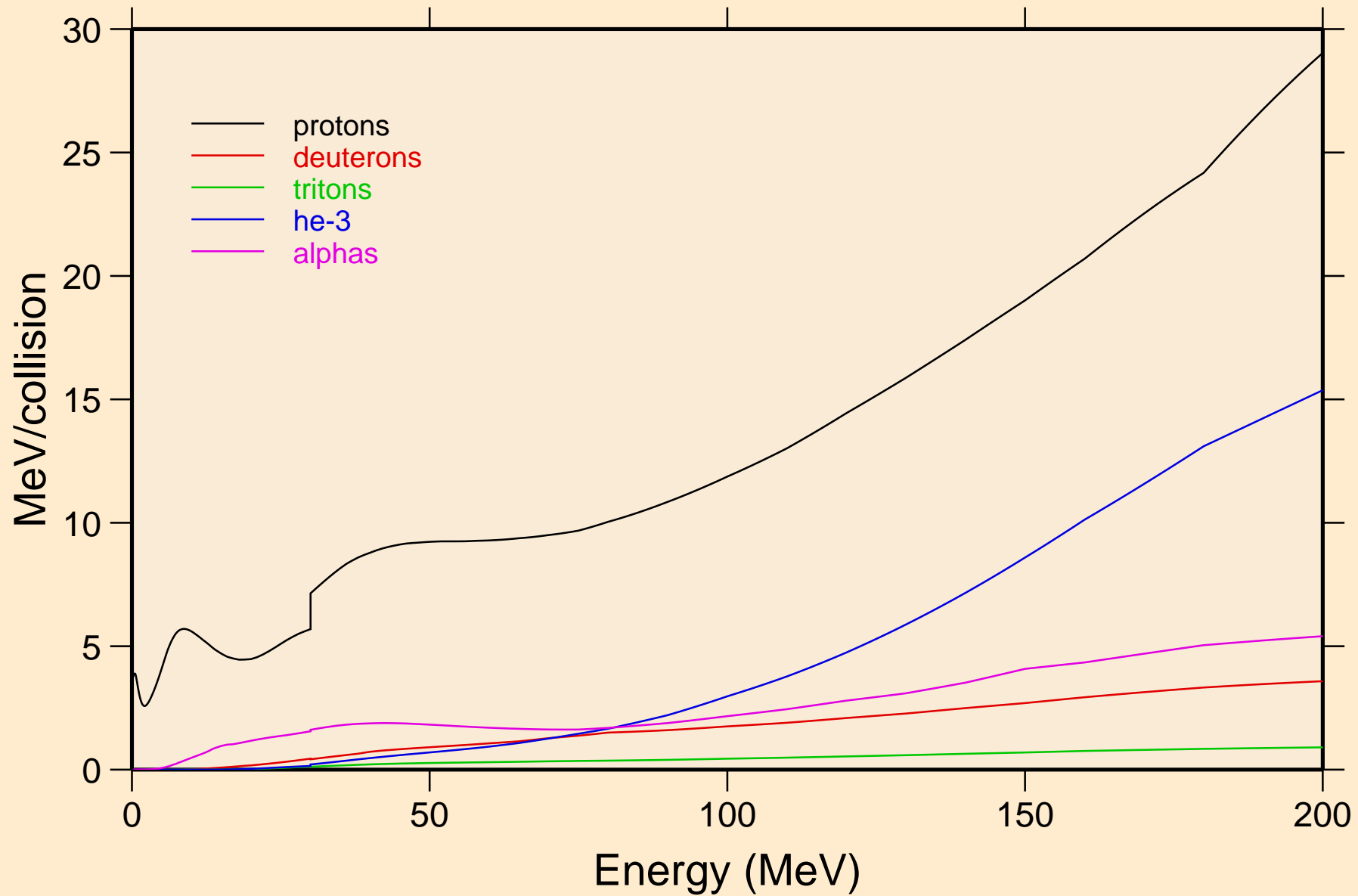

HO146 NEUTRON ACER TENDL-2021 LIBRARY; T=293.6K
Recoil Heating

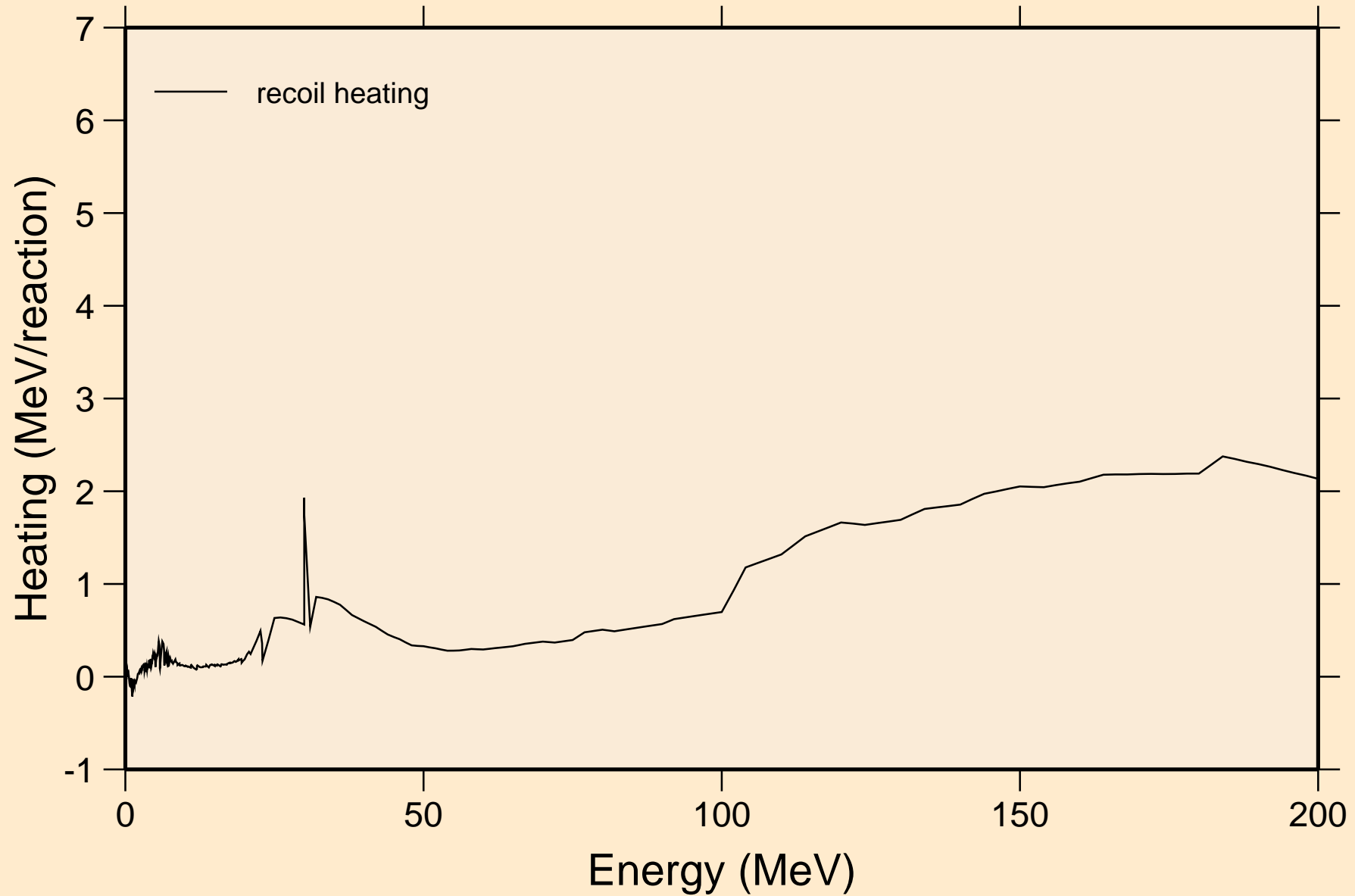

HO146 NEUTRON ACER TENDL-2021 LIBRARY; T=293.6K

Particle production cross sections

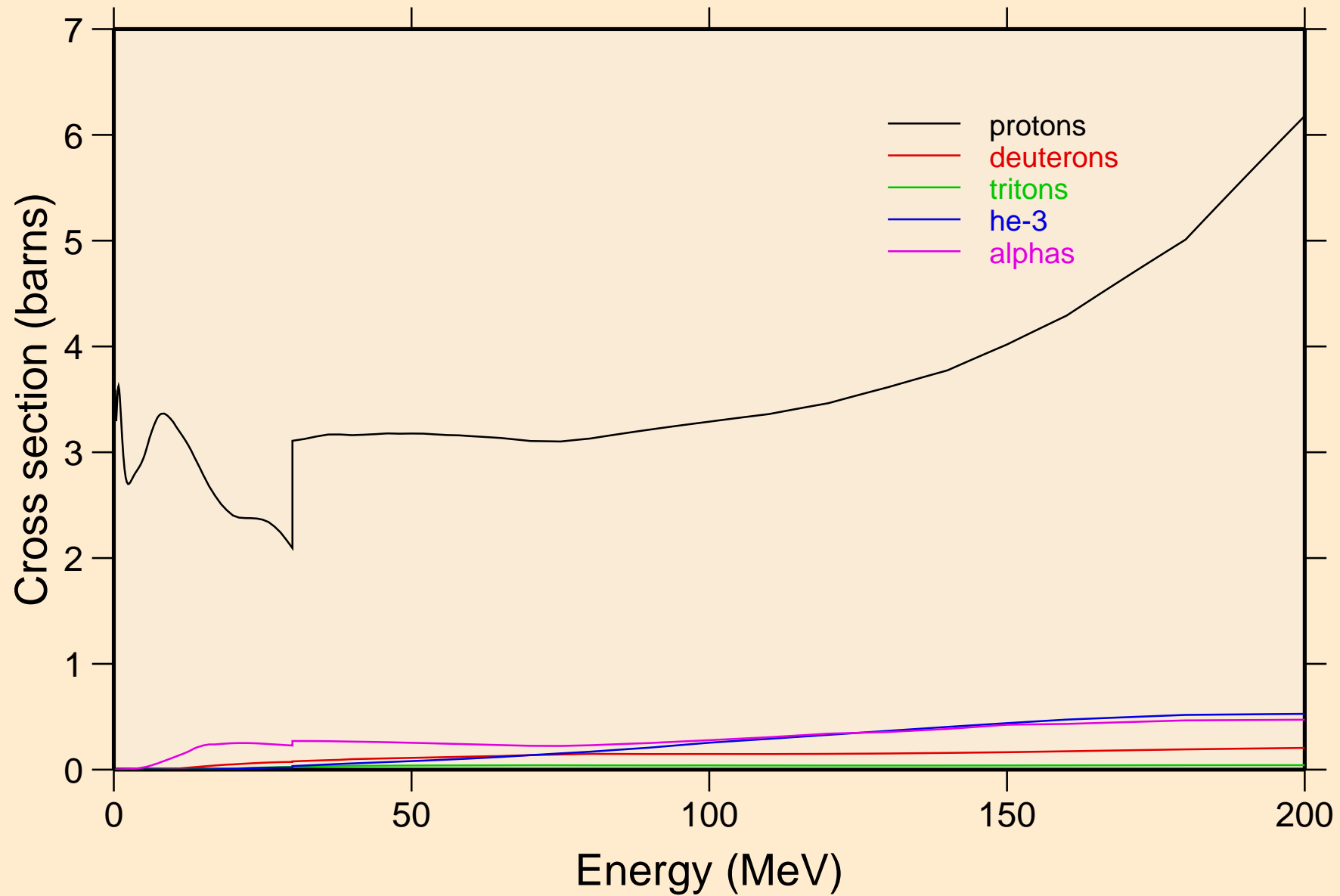

HO146 NEUTRON ACER TENDL-2021 LIBRARY; T=293.6K
protons from (n,x)

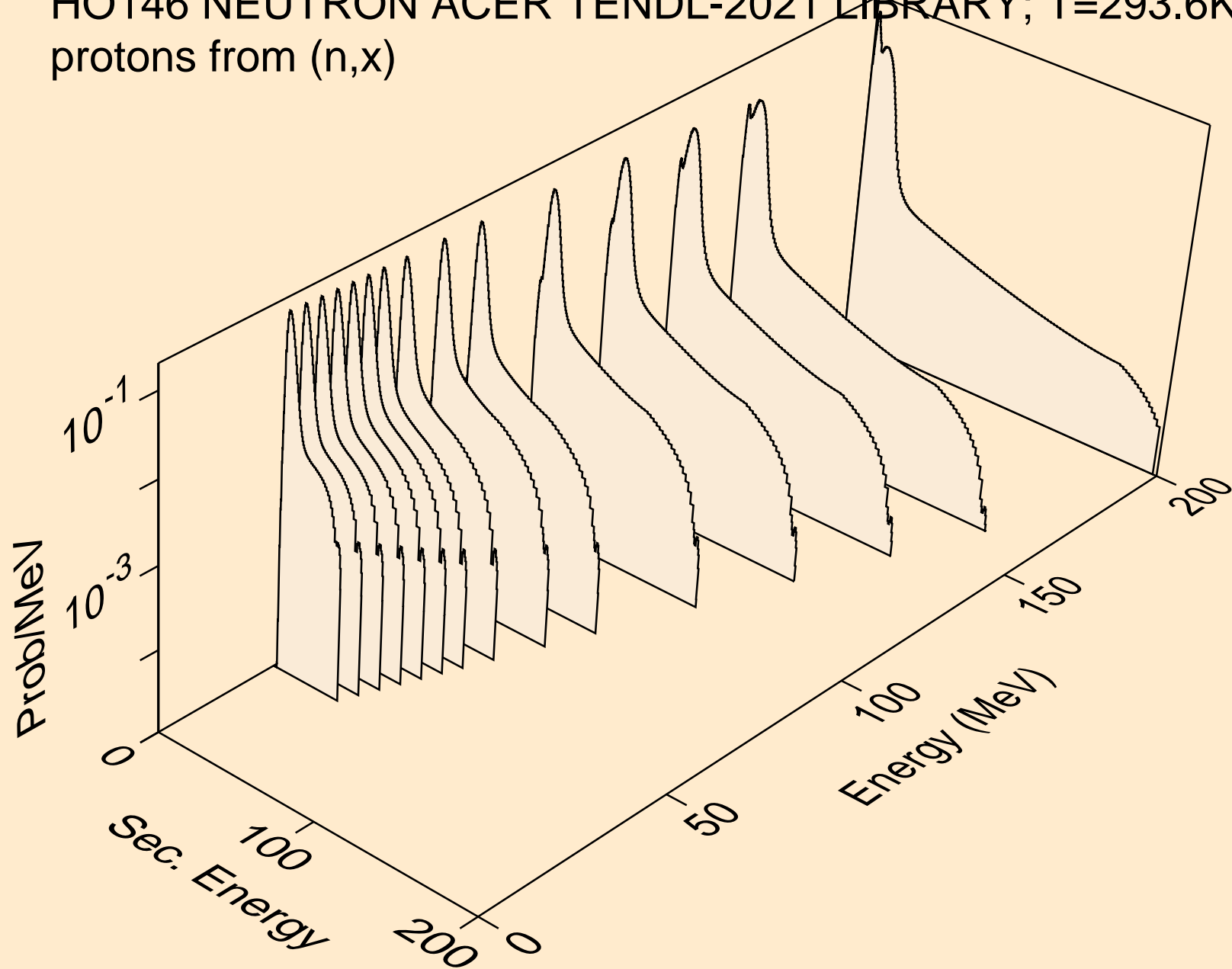

HO146 NEUTRON ACER TENDL-2021 LIBRARY; T=293.6K
protons from (n,n*)p

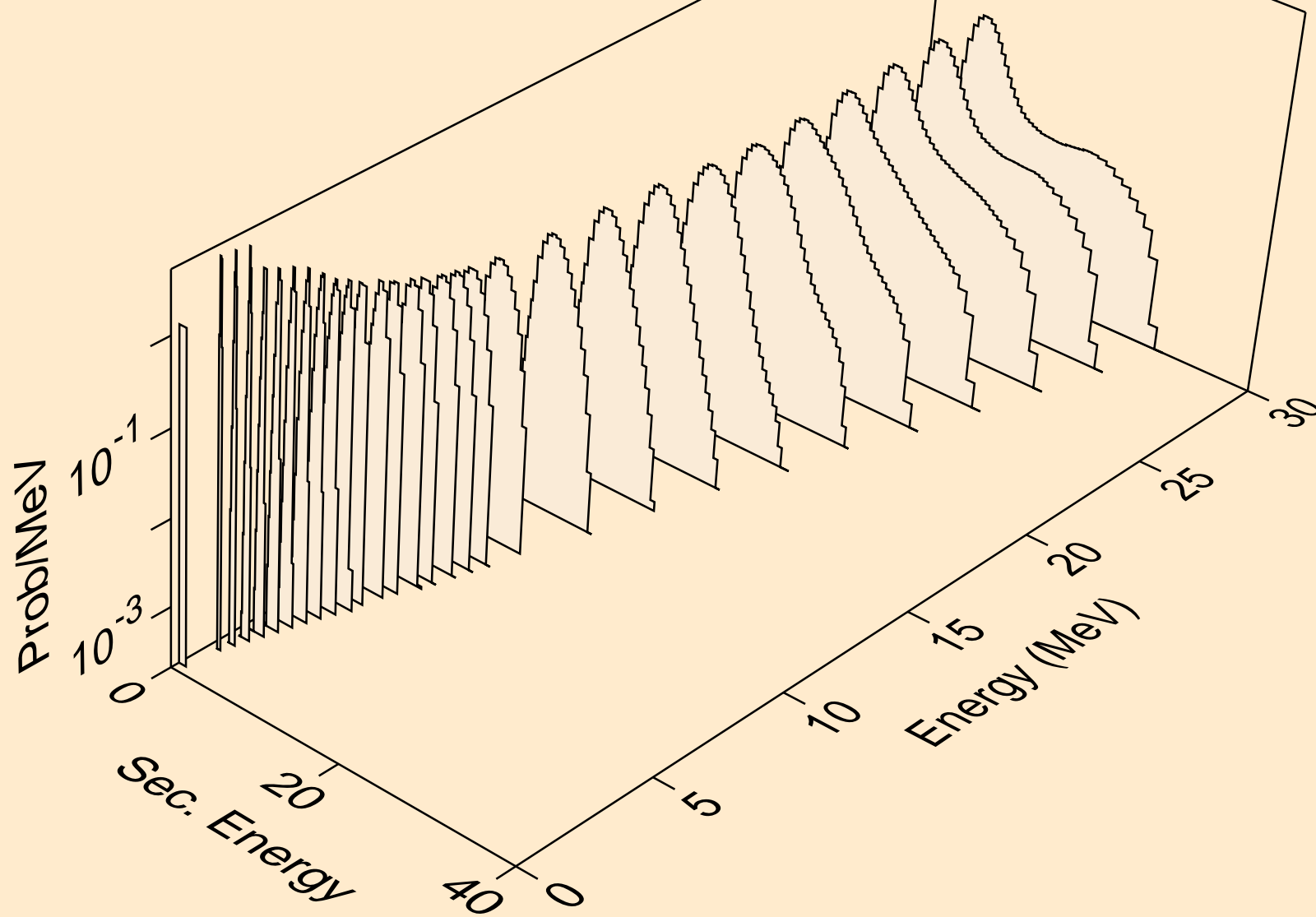

HO146 NEUTRON ACER TENDL-2021 LIBRARY; T=293.6K
protons from (n,2np)

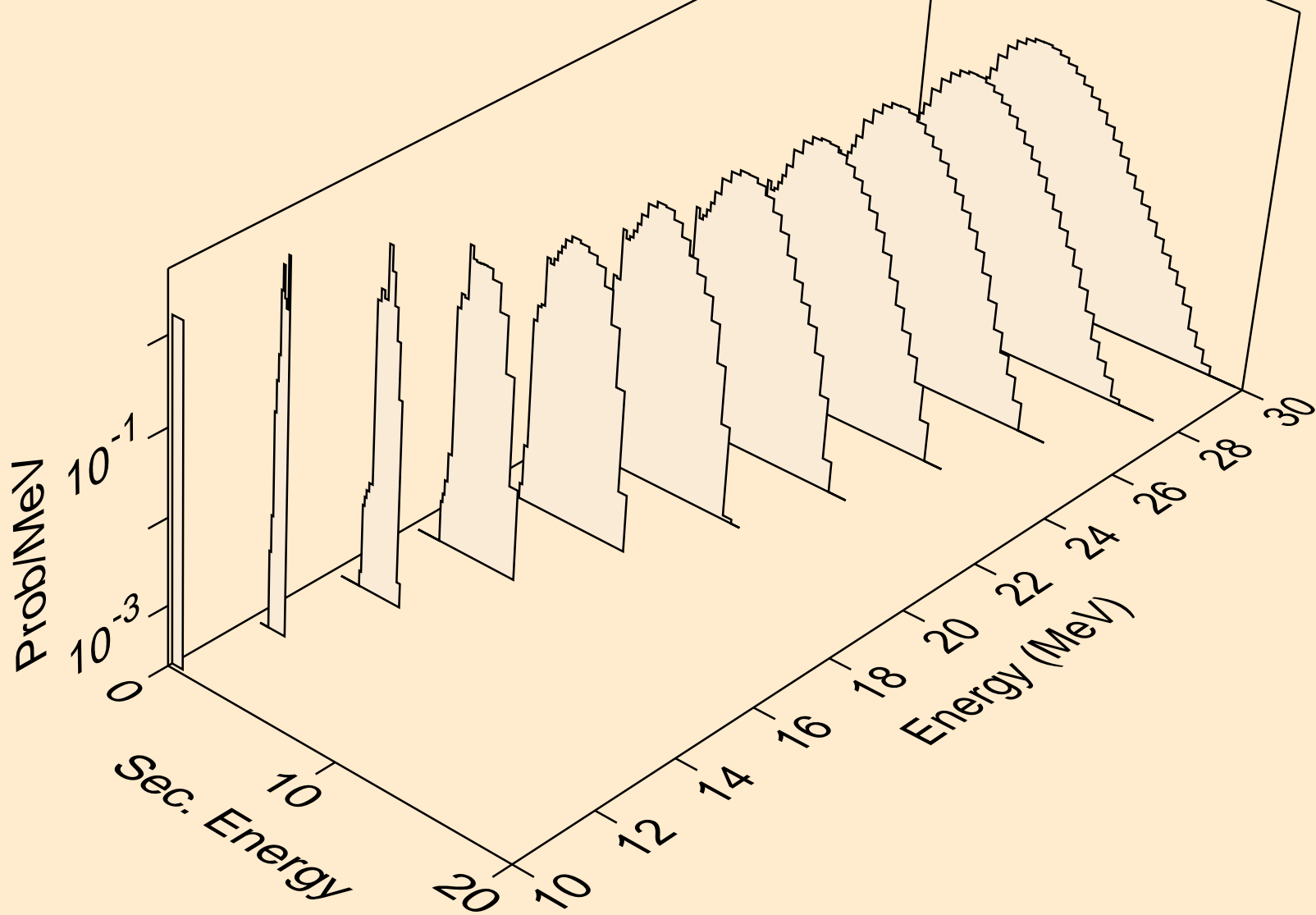

HO146 NEUTRON ACER TENDL-2021 LIBRARY; T=293.6K
protons from (n,3np)

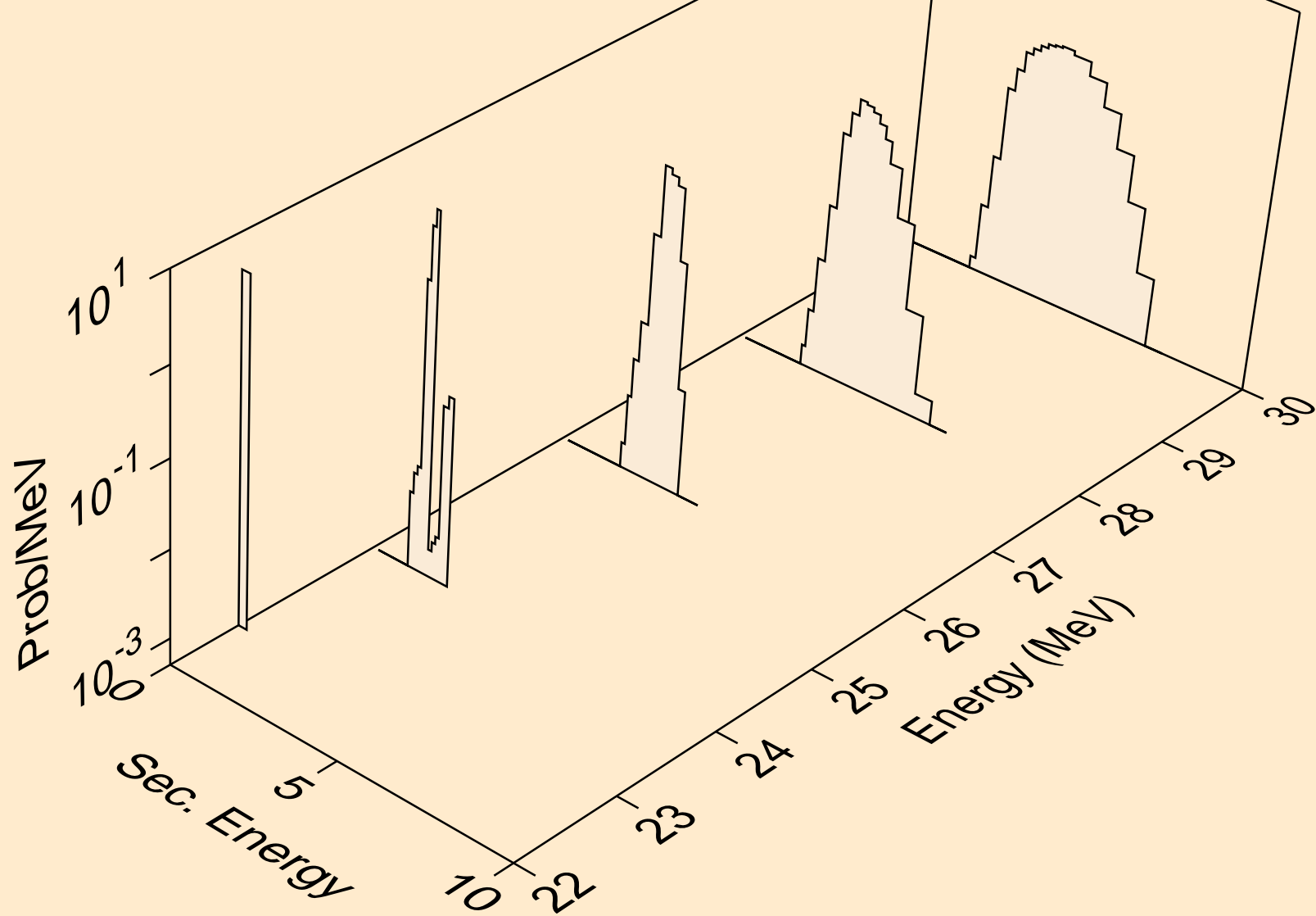

HO146 NEUTRON ACER TENDL-2021 LIBRARY; T=293.6K
protons from (n,2np)

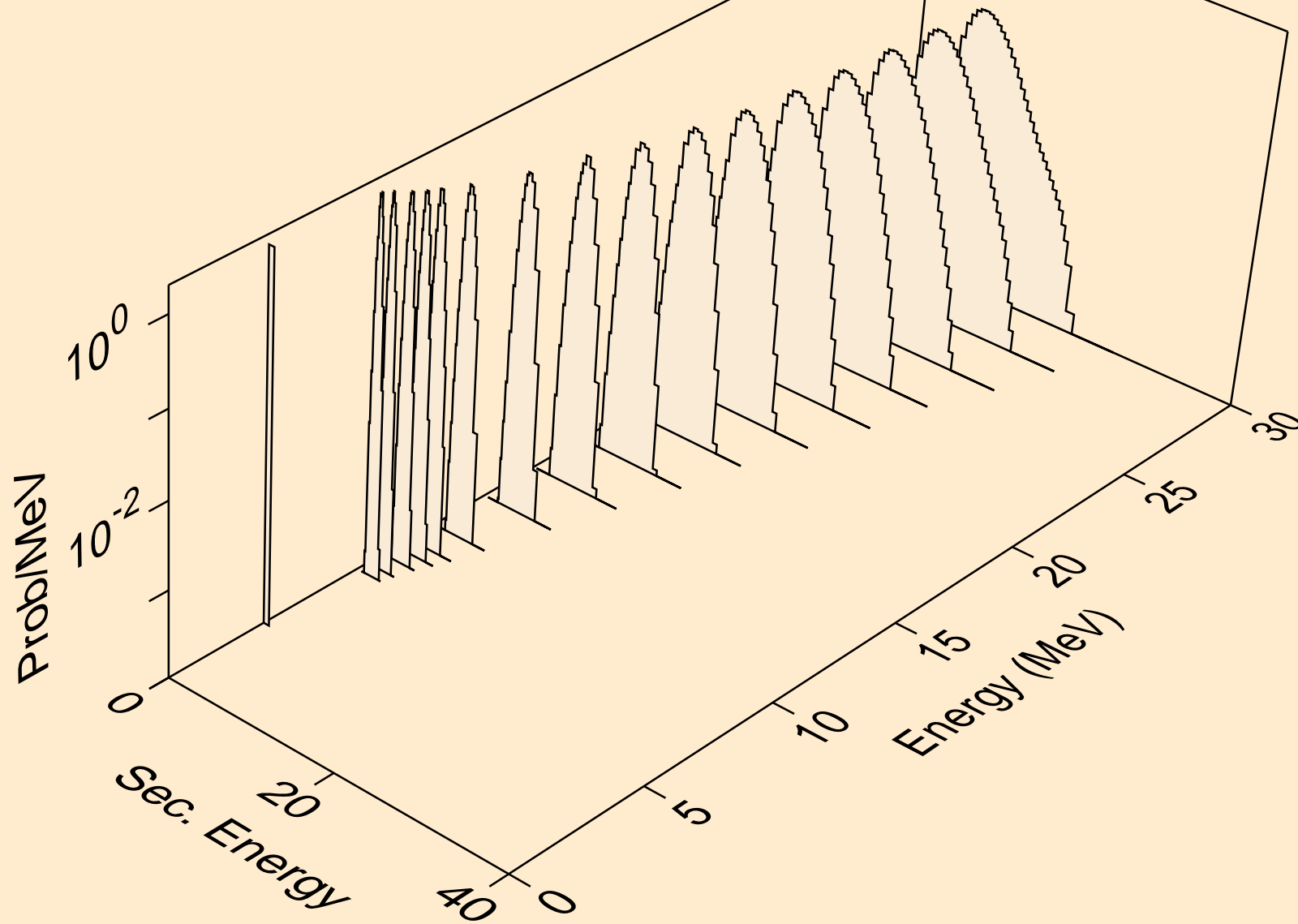

HO146 NEUTRON ACER TENDL-2021 LIBRARY; T=293.6K
protons from (n,npa)

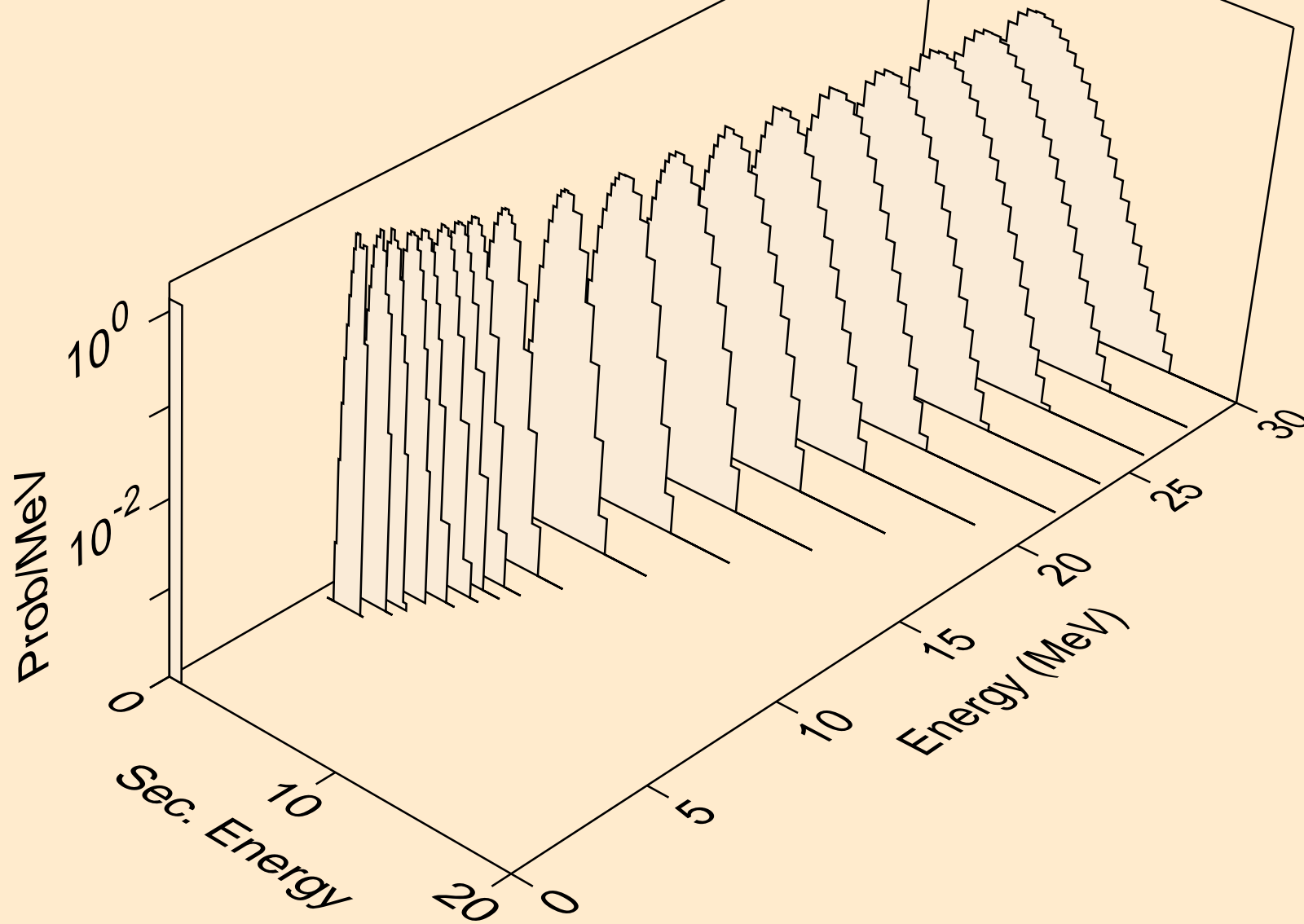

HO146 NEUTRON ACER TENDL-2021 LIBRARY; T=293.6K
protons from (n,p)

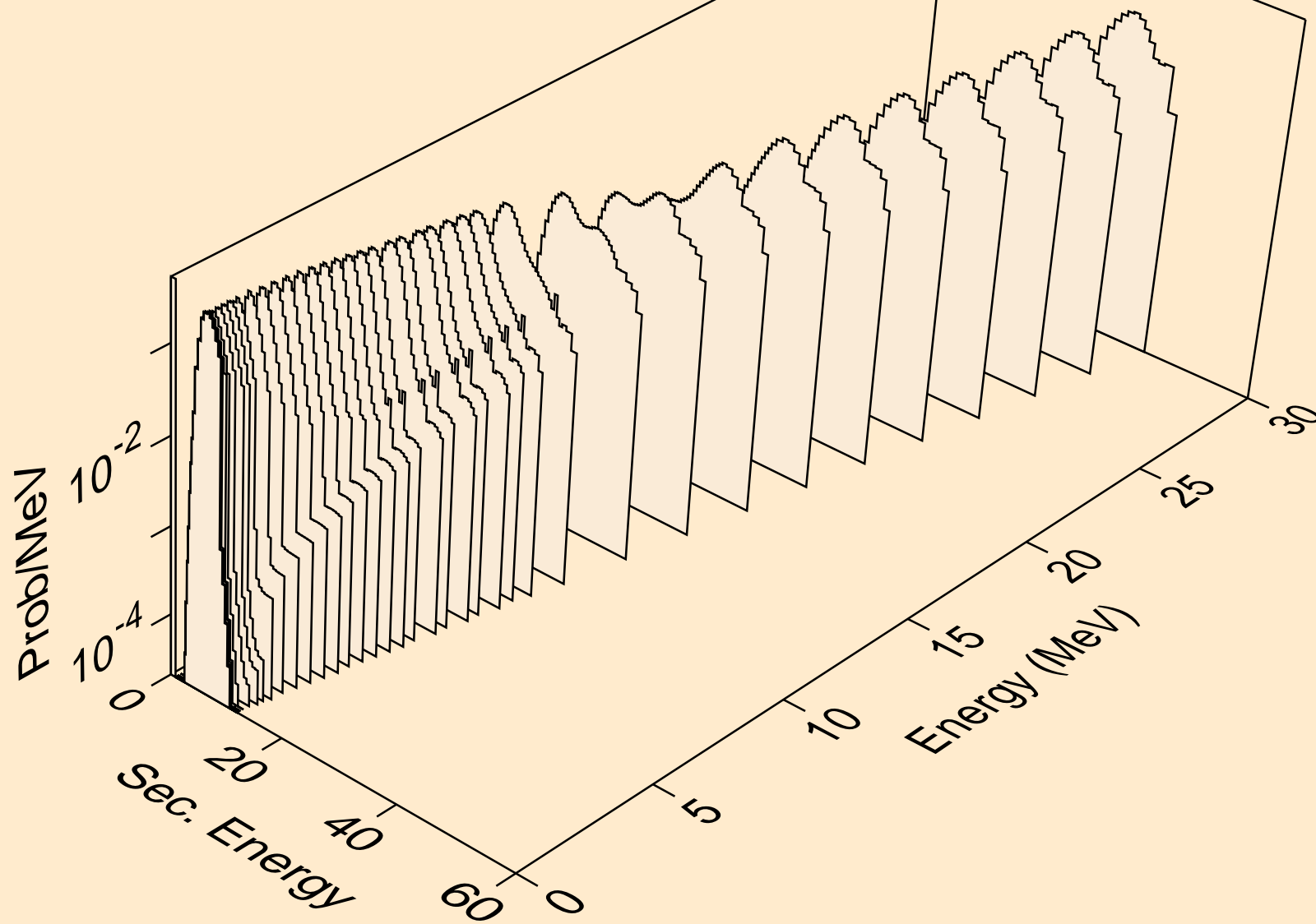

HO146 NEUTRON ACER TENDL-2021 LIBRARY; T=293.6K
protons from (n,2p)

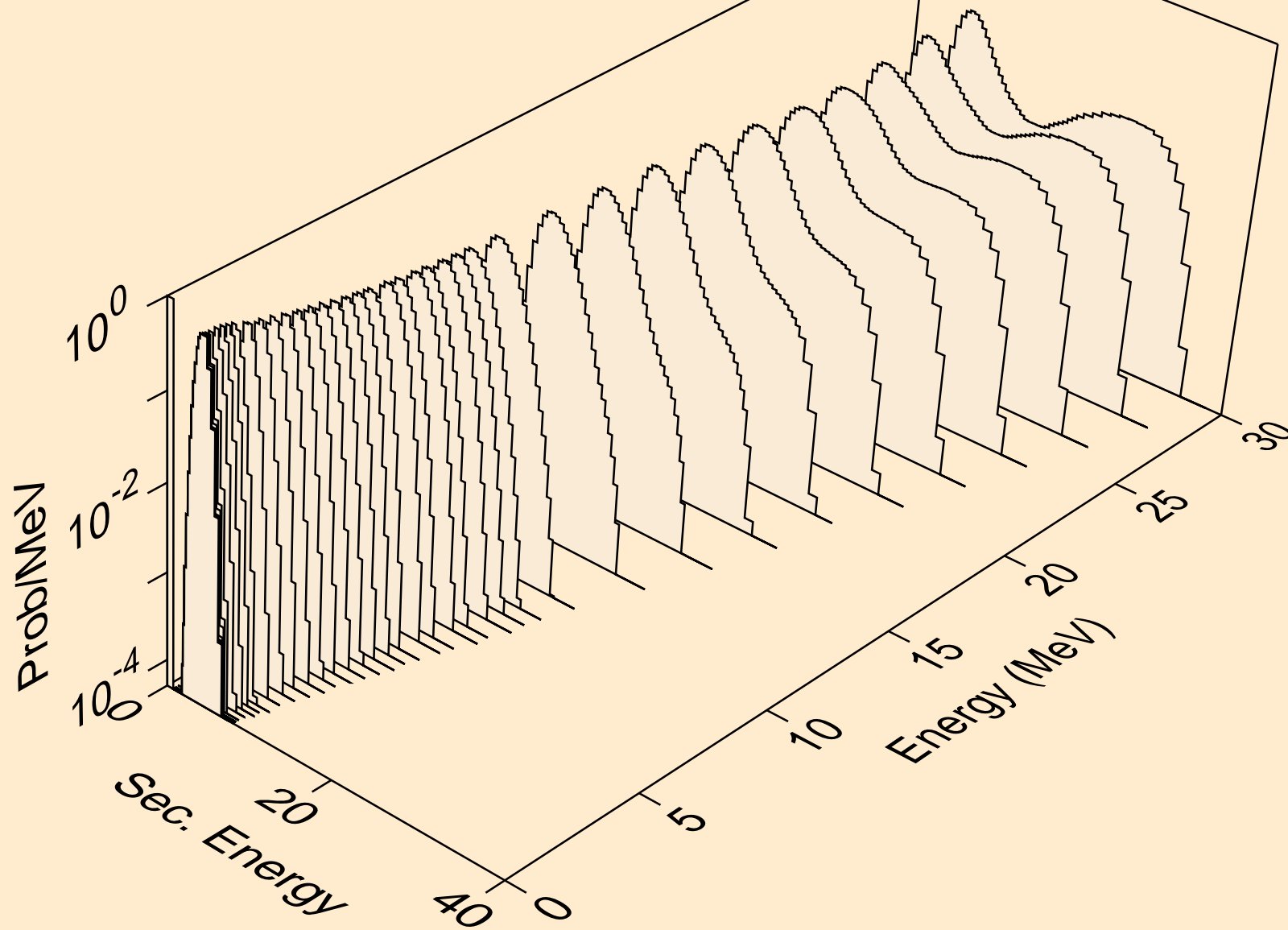

HO146 NEUTRON ACER TENDL-2021 LIBRARY; T=293.6K
protons from (n,p)

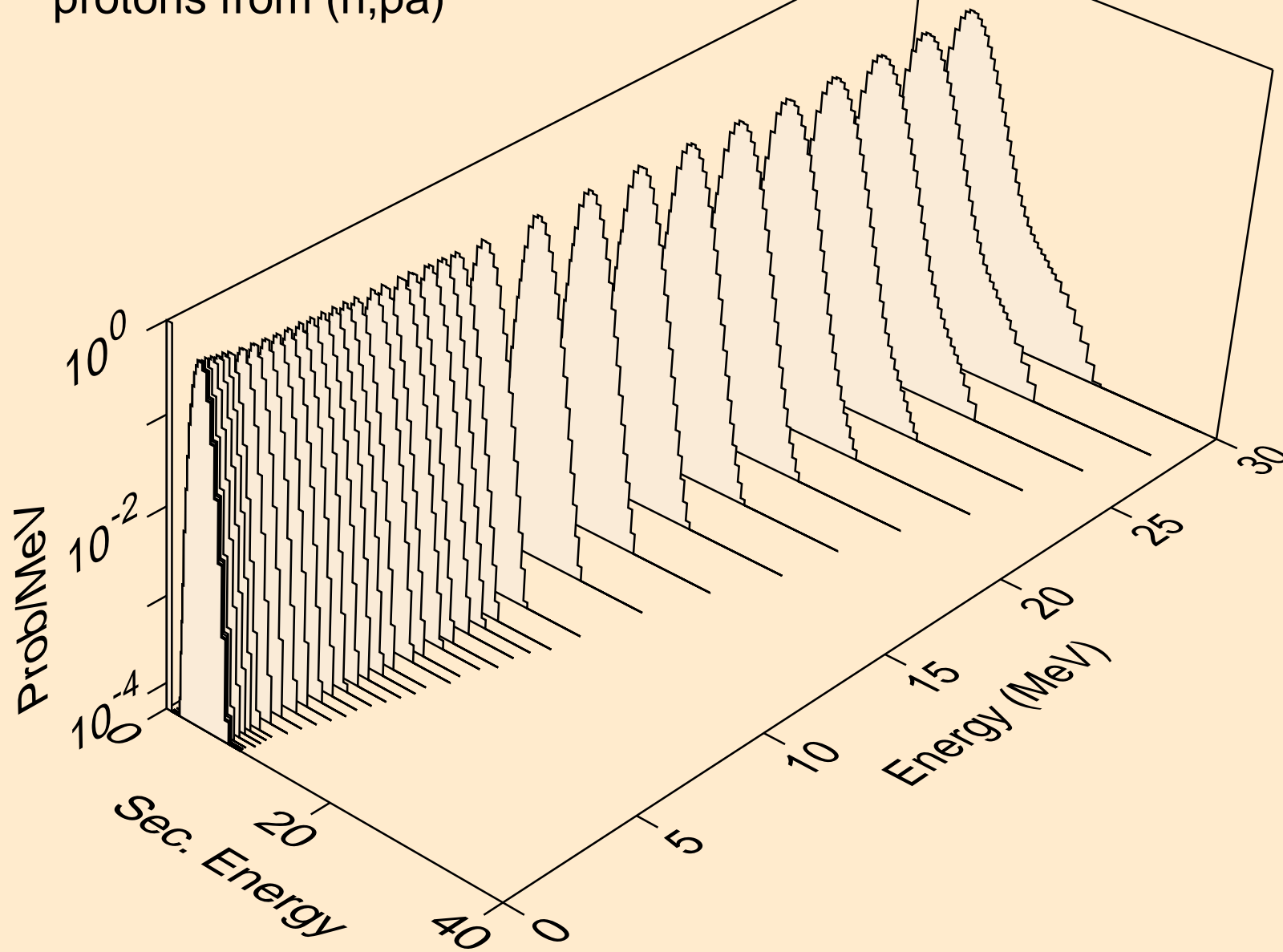

HO146 NEUTRON ACER TENDL-2021 LIBRARY; T=293.6K
protons from (n,pd)

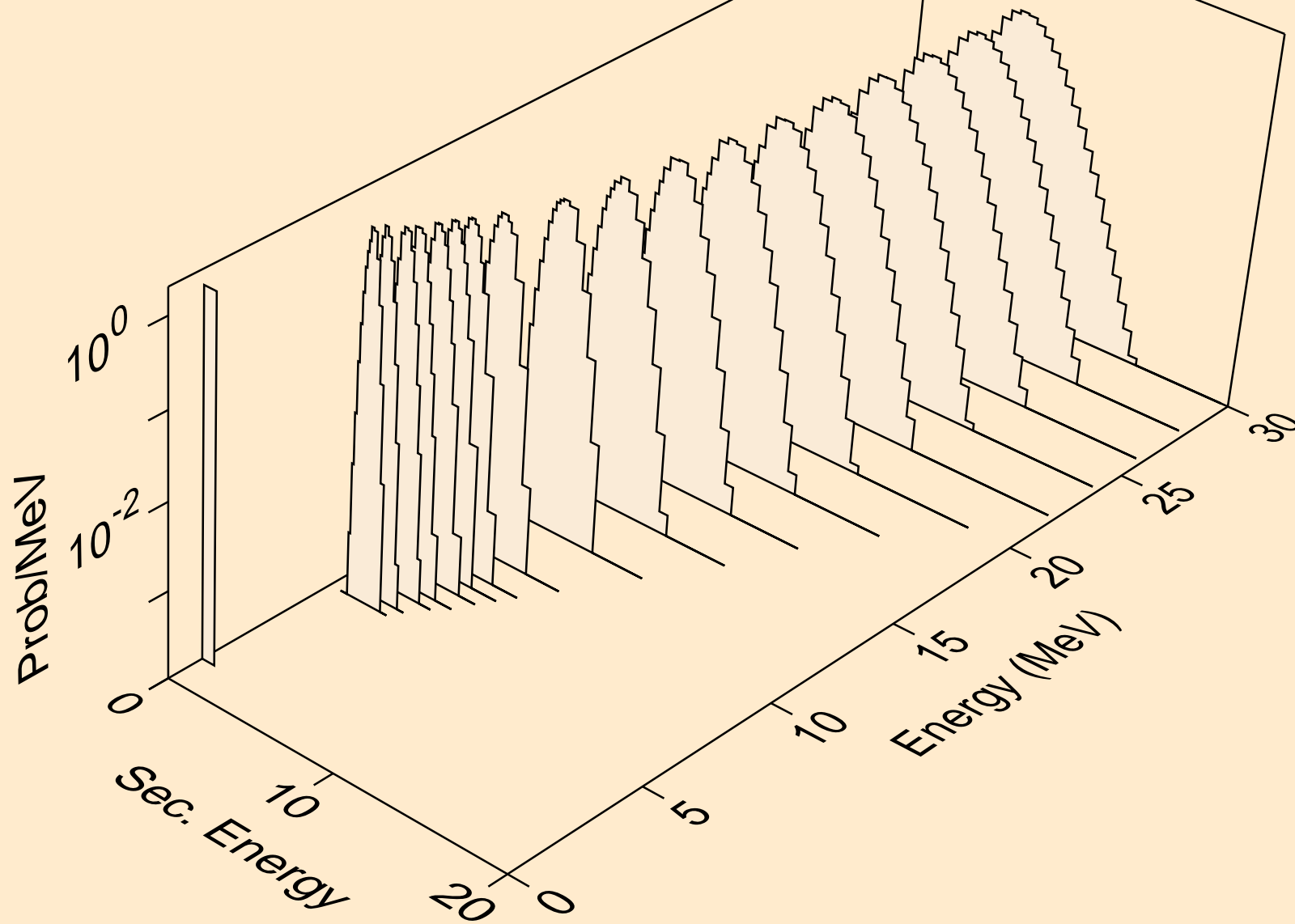

HO146 NEUTRON ACER TENDL-2021 LIBRARY; T=293.6K
protons from (n,pt)

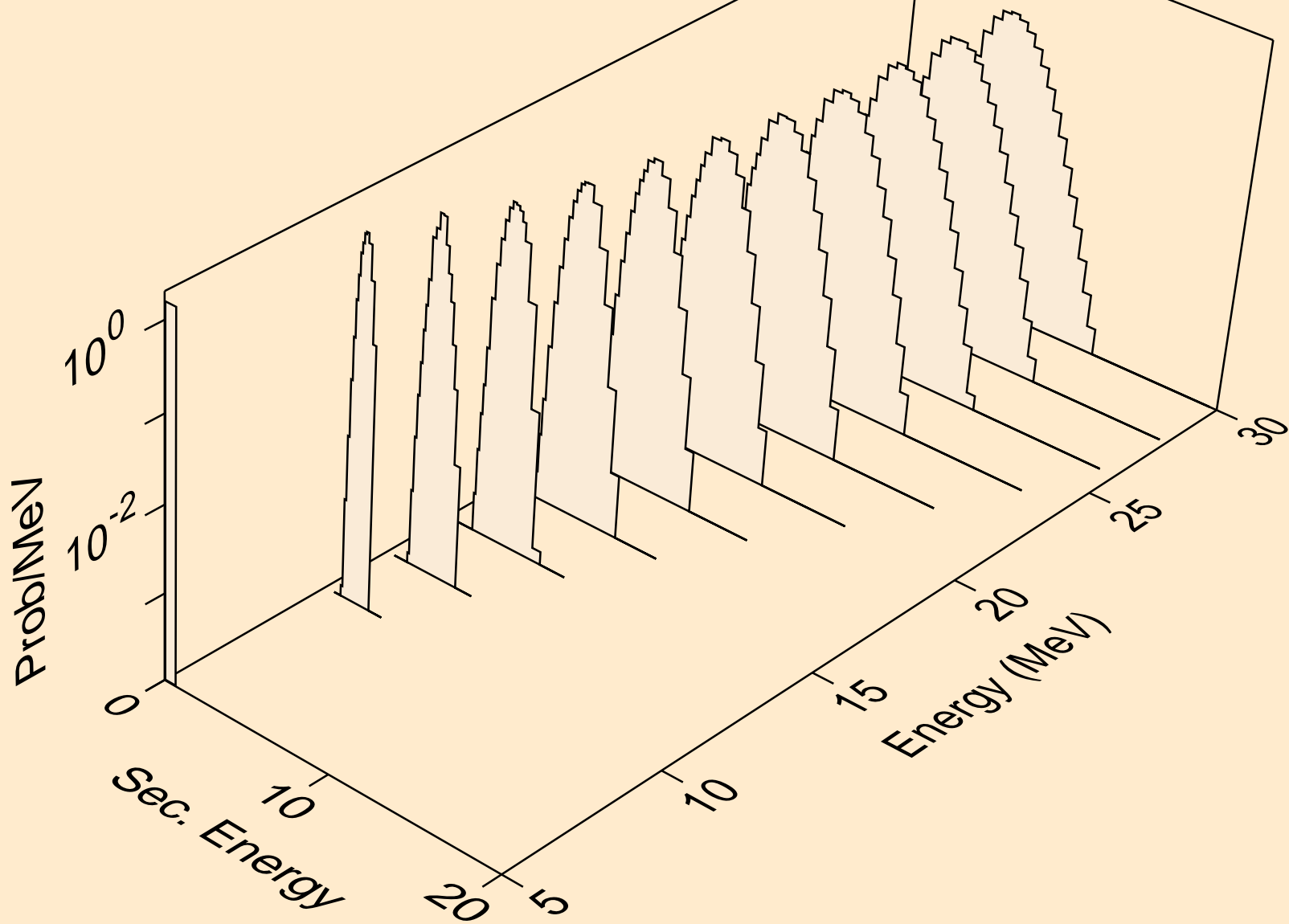

HO146 NEUTRON ACER TENDL-2021 LIBRARY; T=293.6K
deuterons from (n,x)

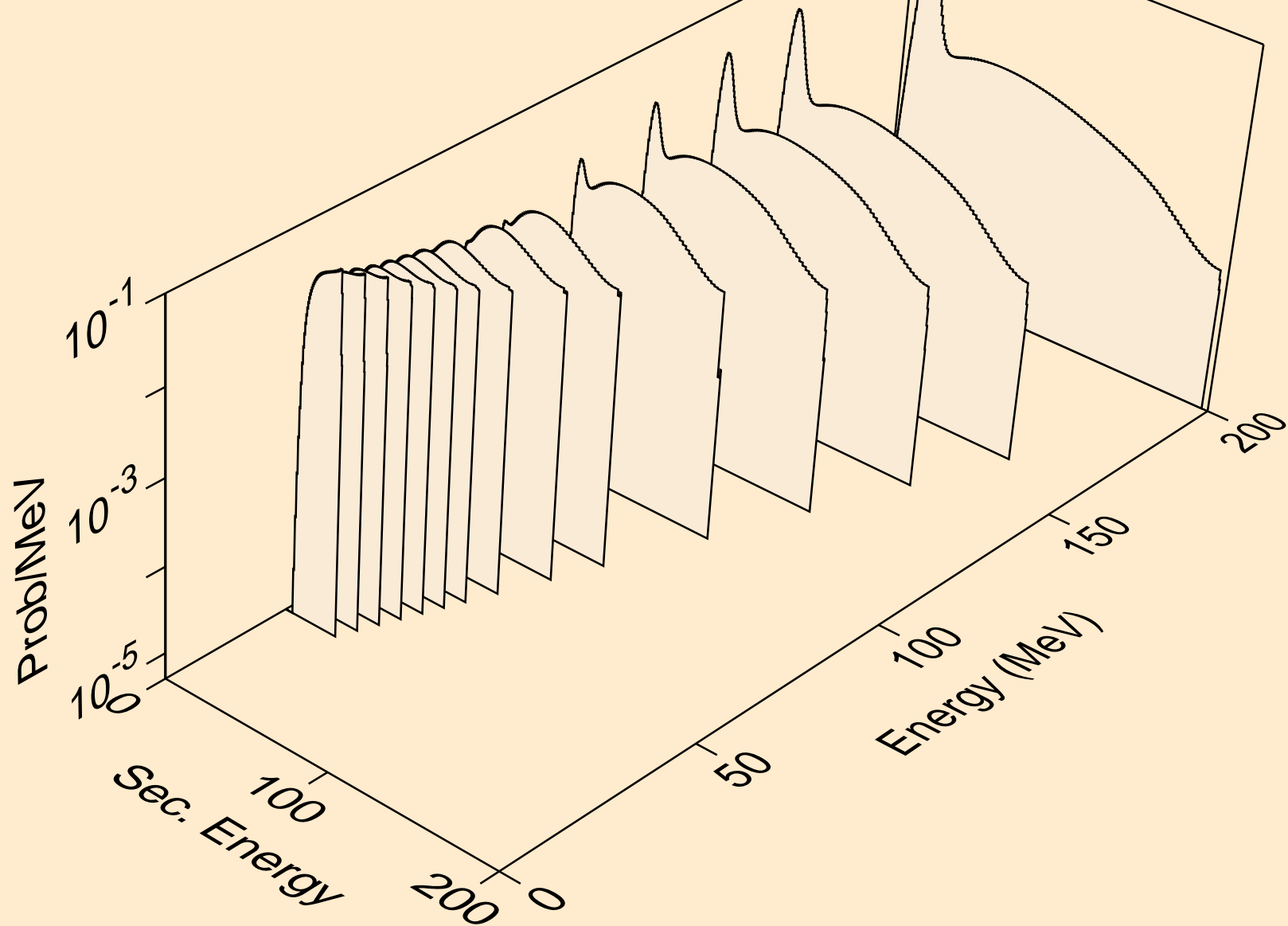

HO146 NEUTRON ACER TENDL-2021 LIBRARY; T=293.6K
deuterons from (n,2nd)

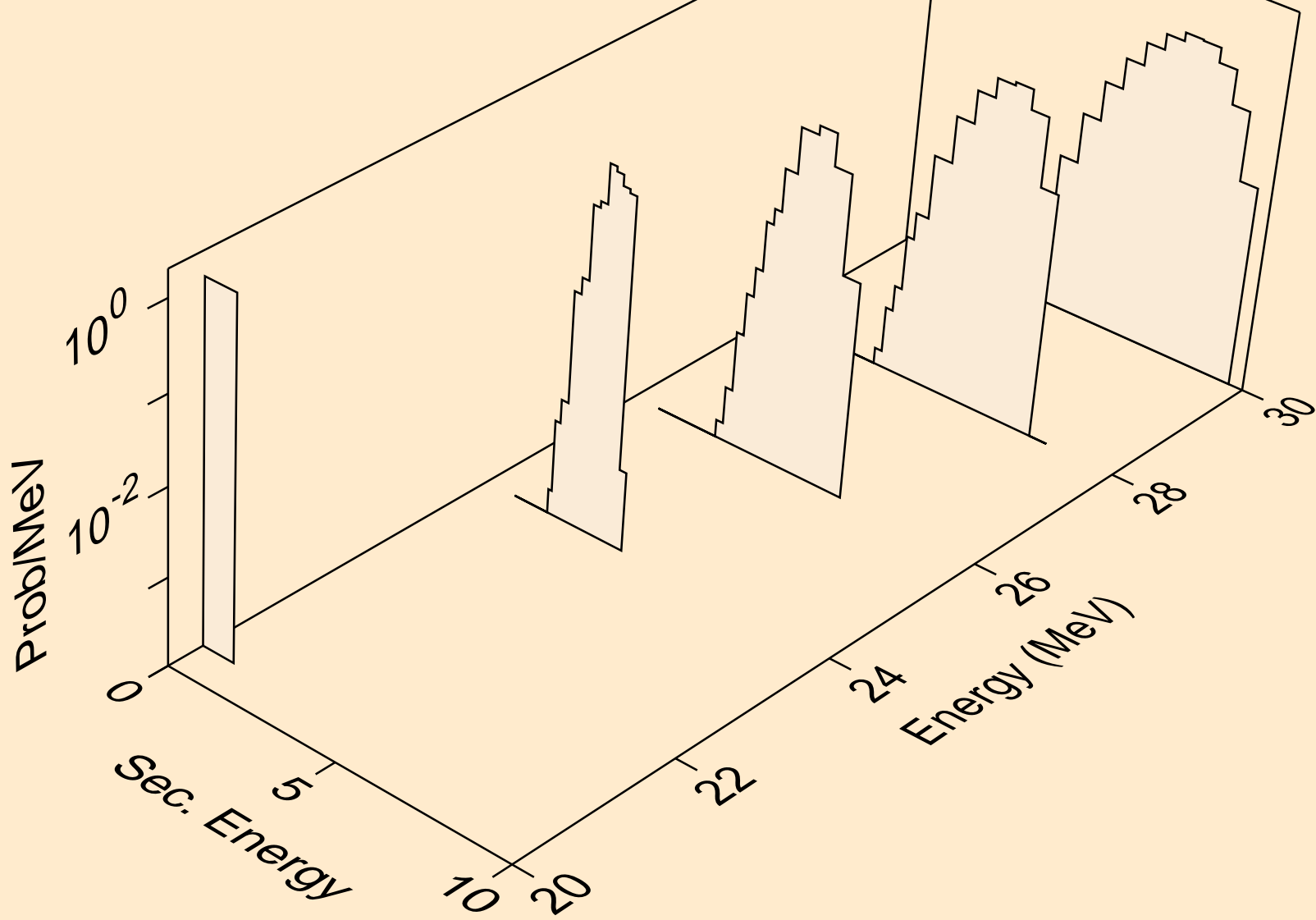

HO146 NEUTRON ACER TENDL-2021 LIBRARY; T=293.6K
deuterons from (n,n*)d

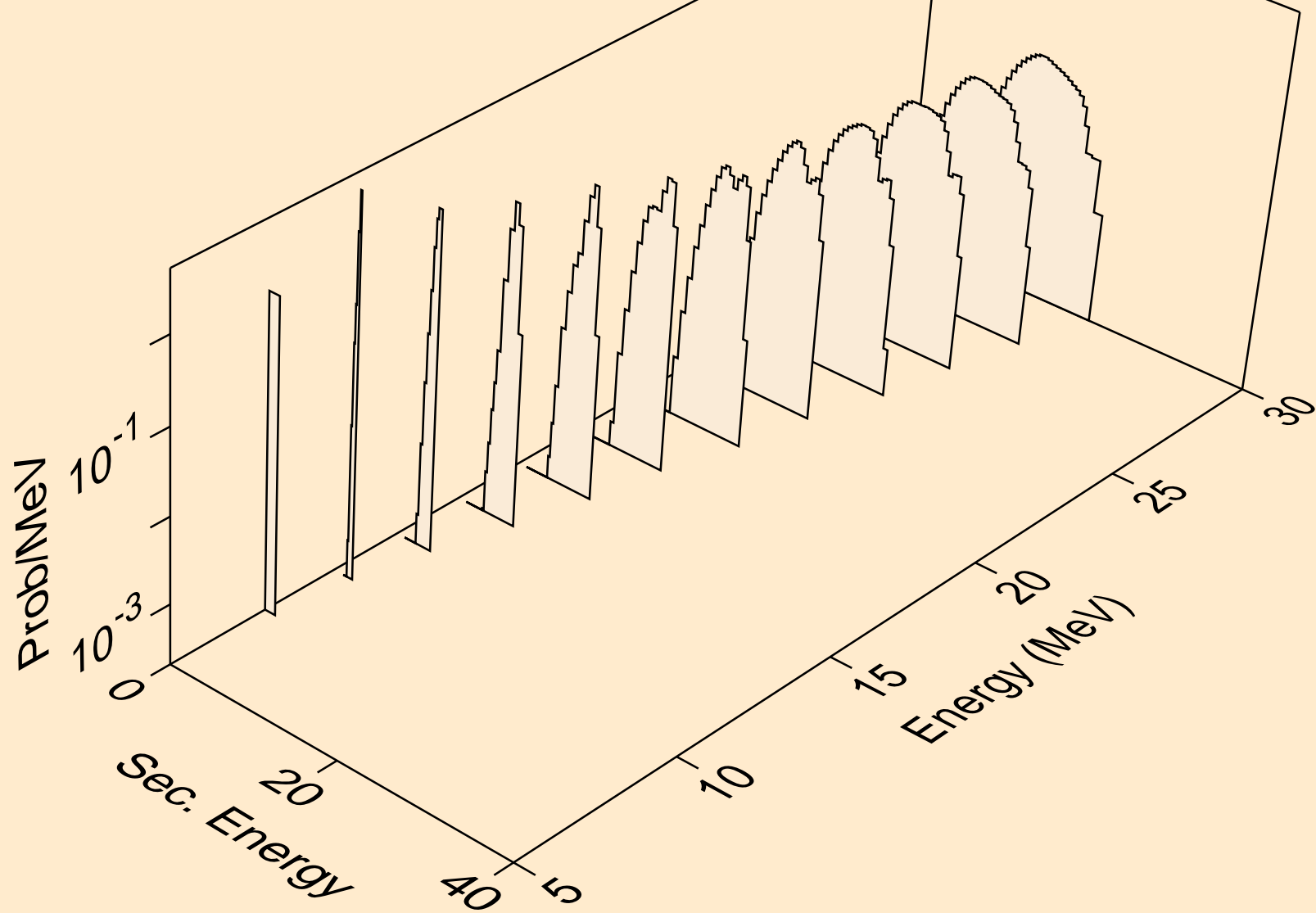

HO146 NEUTRON ACER TENDL-2021 LIBRARY; T=293.6K
deuterons from (n,d)

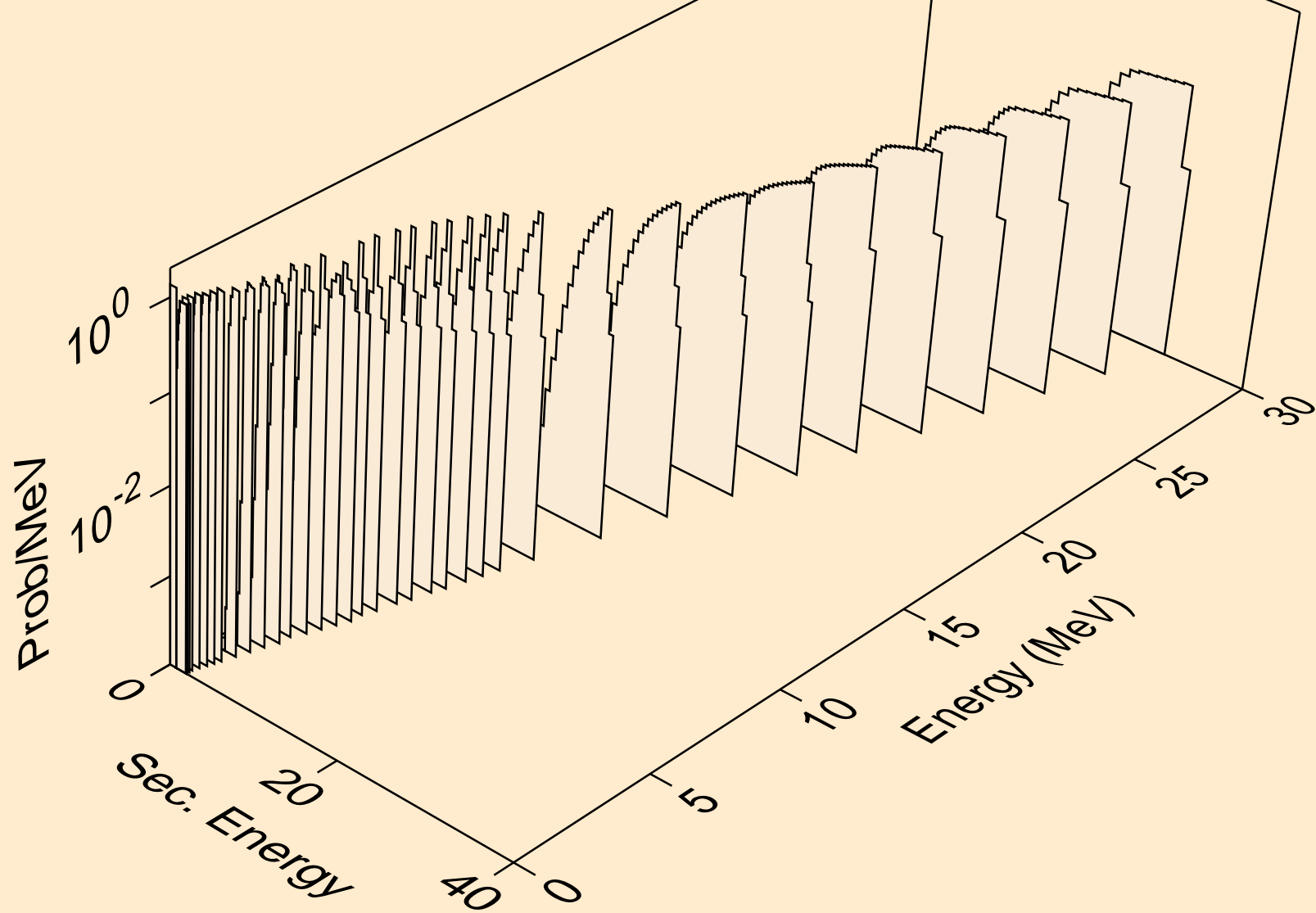

HO146 NEUTRON ACER TENDL-2021 LIBRARY; T=293.6K
deuterons from (n,d2a)

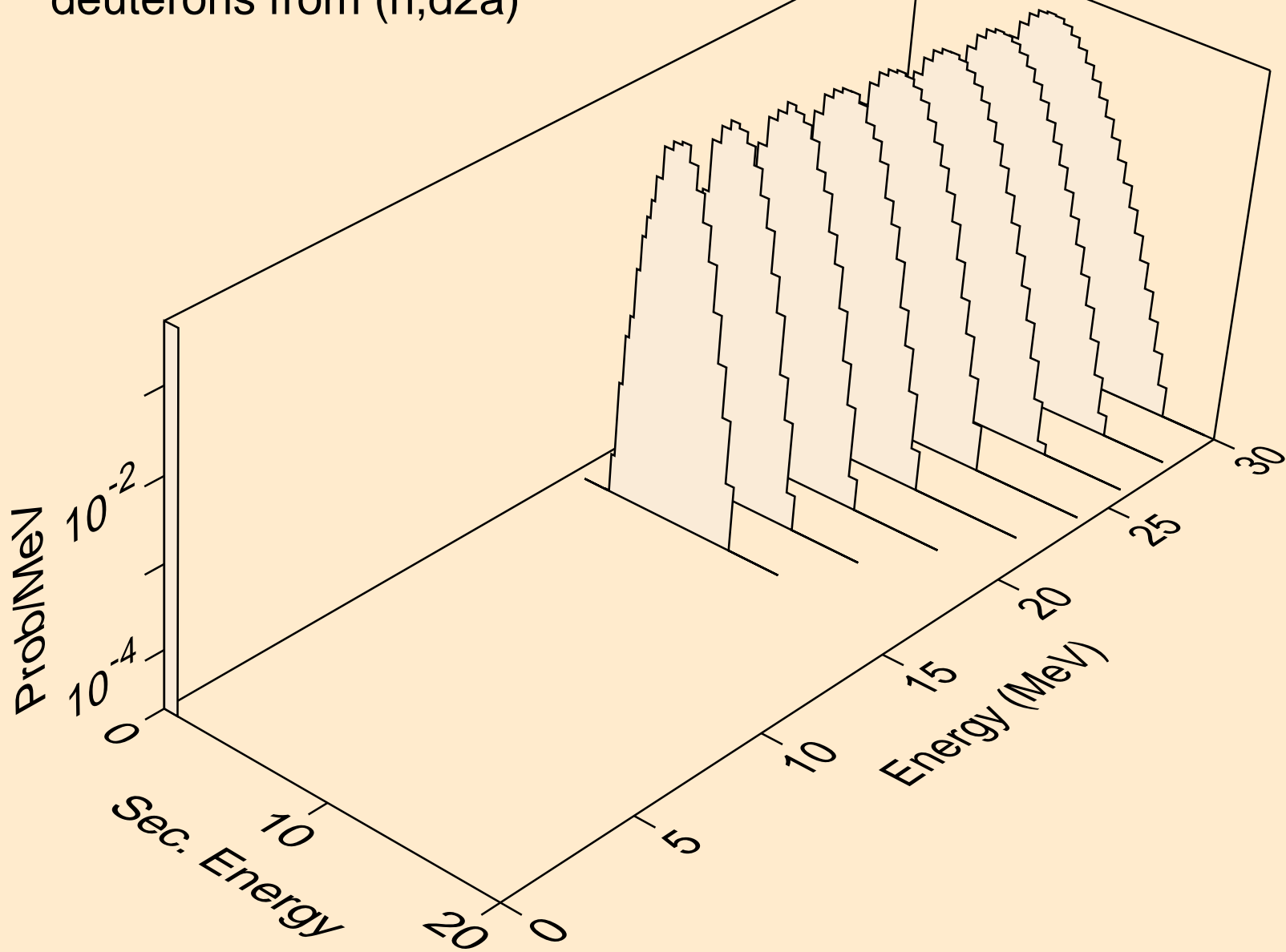

HO146 NEUTRON ACER TENDL-2021 LIBRARY; T=293.6K
deuterons from (n,pd)

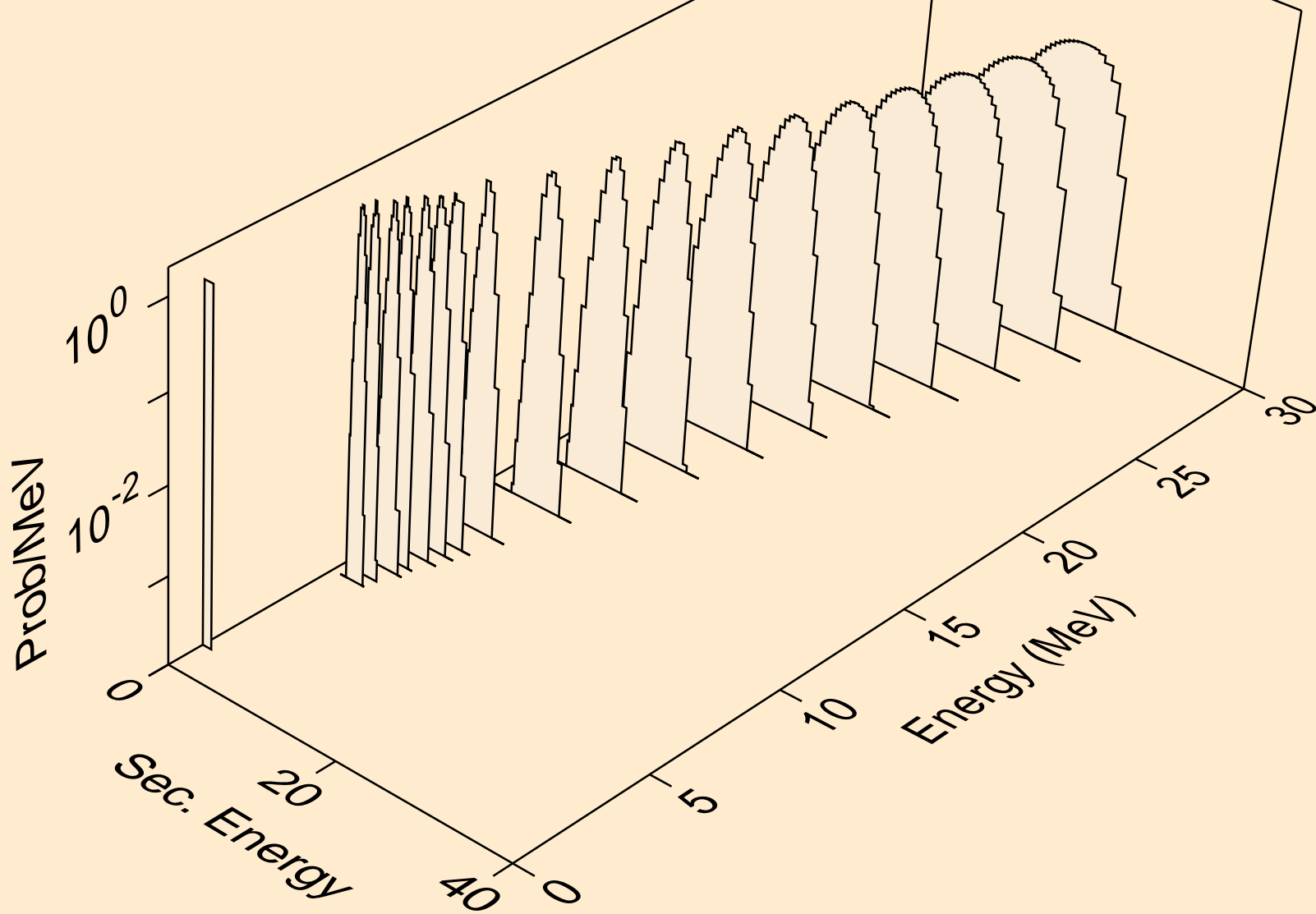

HO146 NEUTRON ACER TENDL-2021 LIBRARY; T=293.6K
deuterons from (n,da)

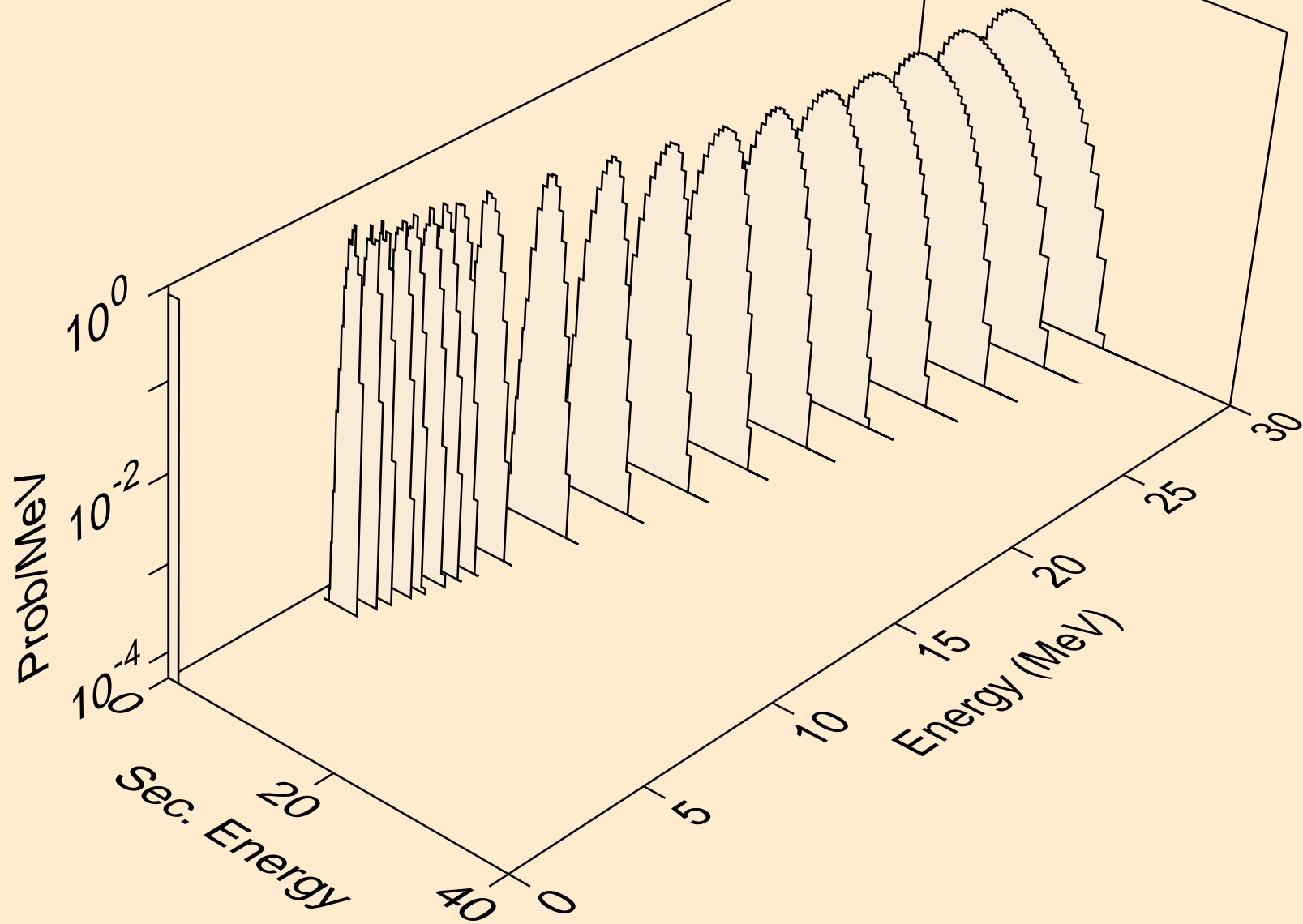

HO146 NEUTRON ACER TENDL-2021 LIBRARY; T=293.6K
tritons from (n,x)

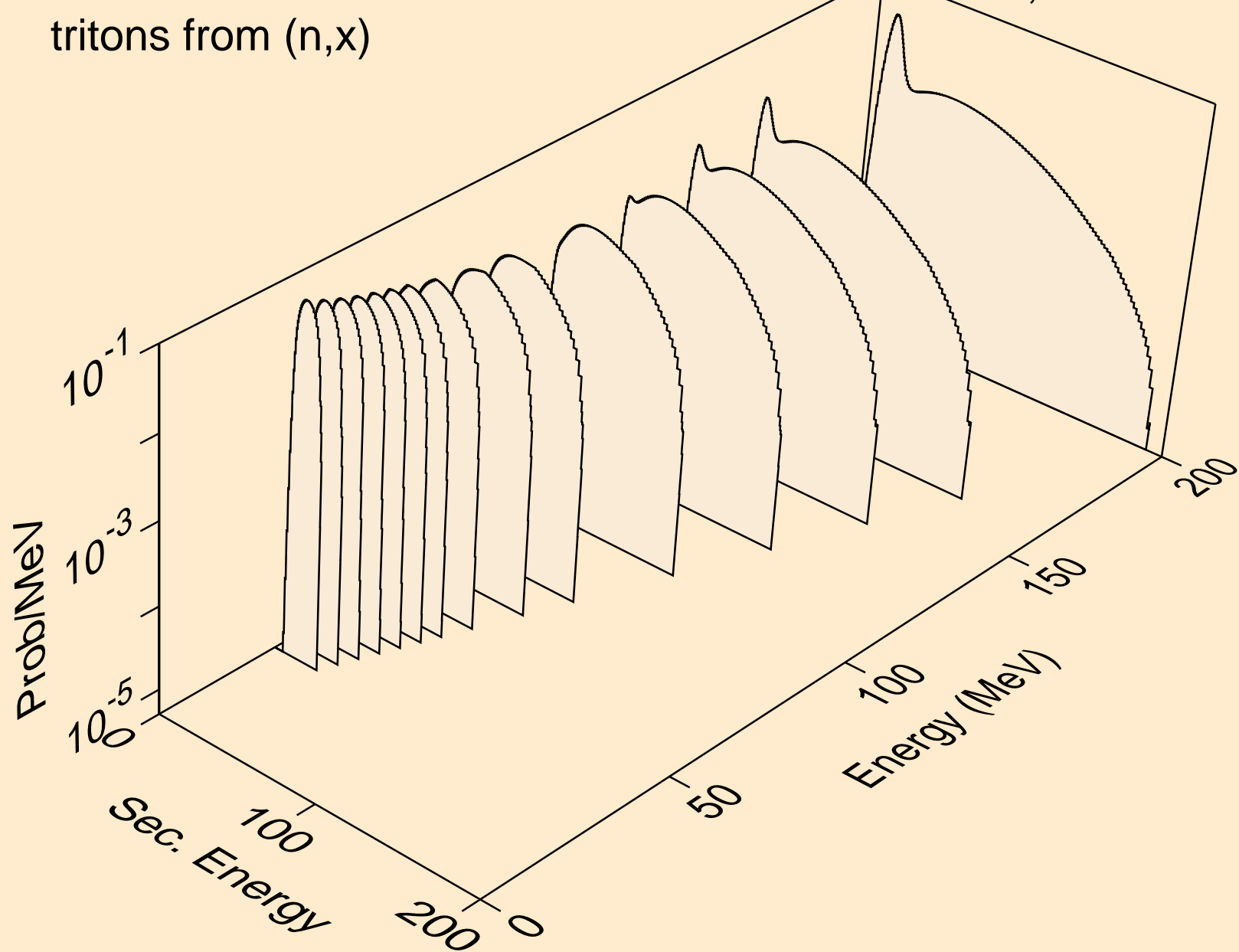

HO146 NEUTRON ACER TENDL-2021 LIBRARY; T=293.6K
tritons from (n,n*)t

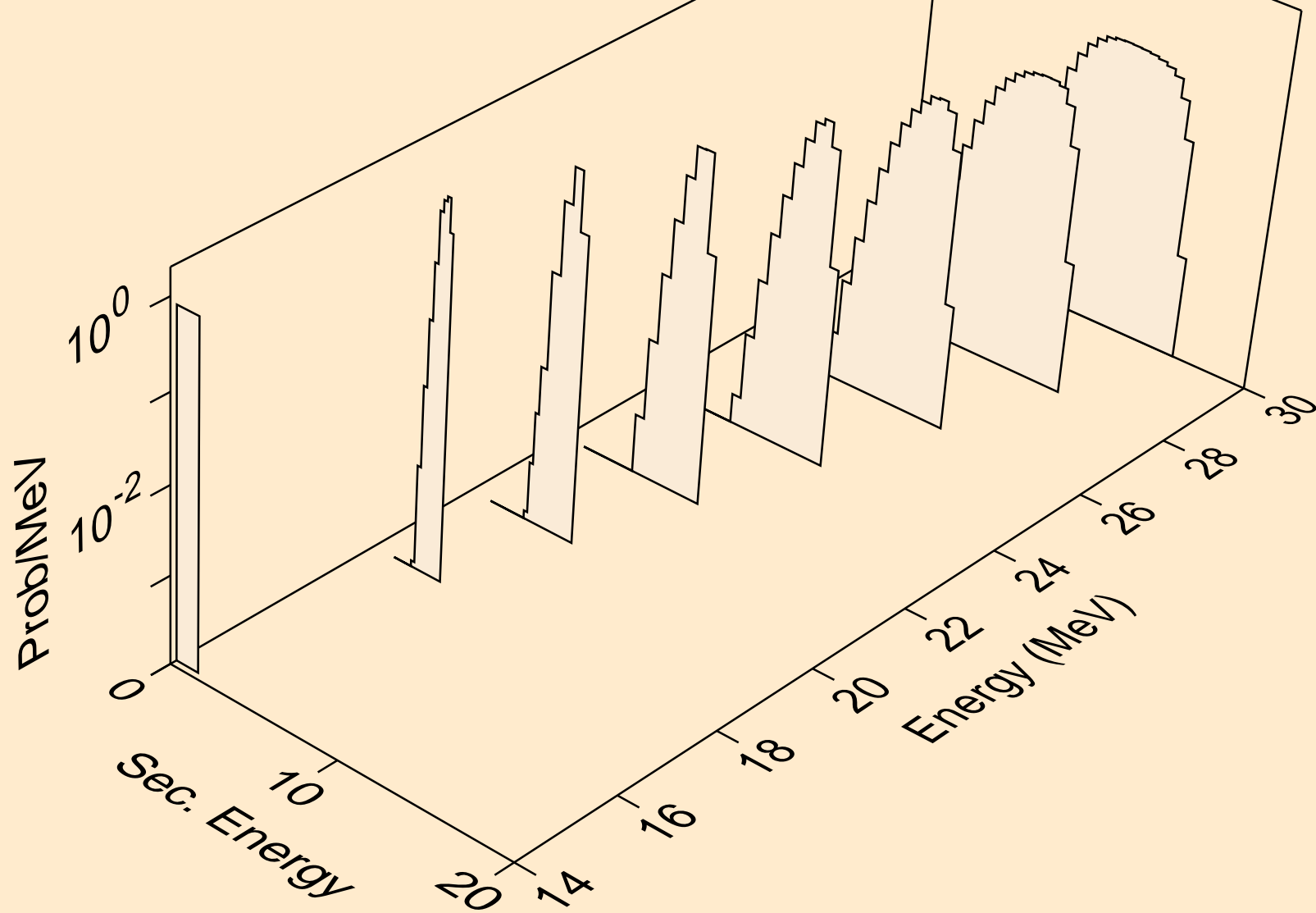

HO146 NEUTRON ACER TENDL-2021 LIBRARY; T=293.6K
tritons from (n,t)

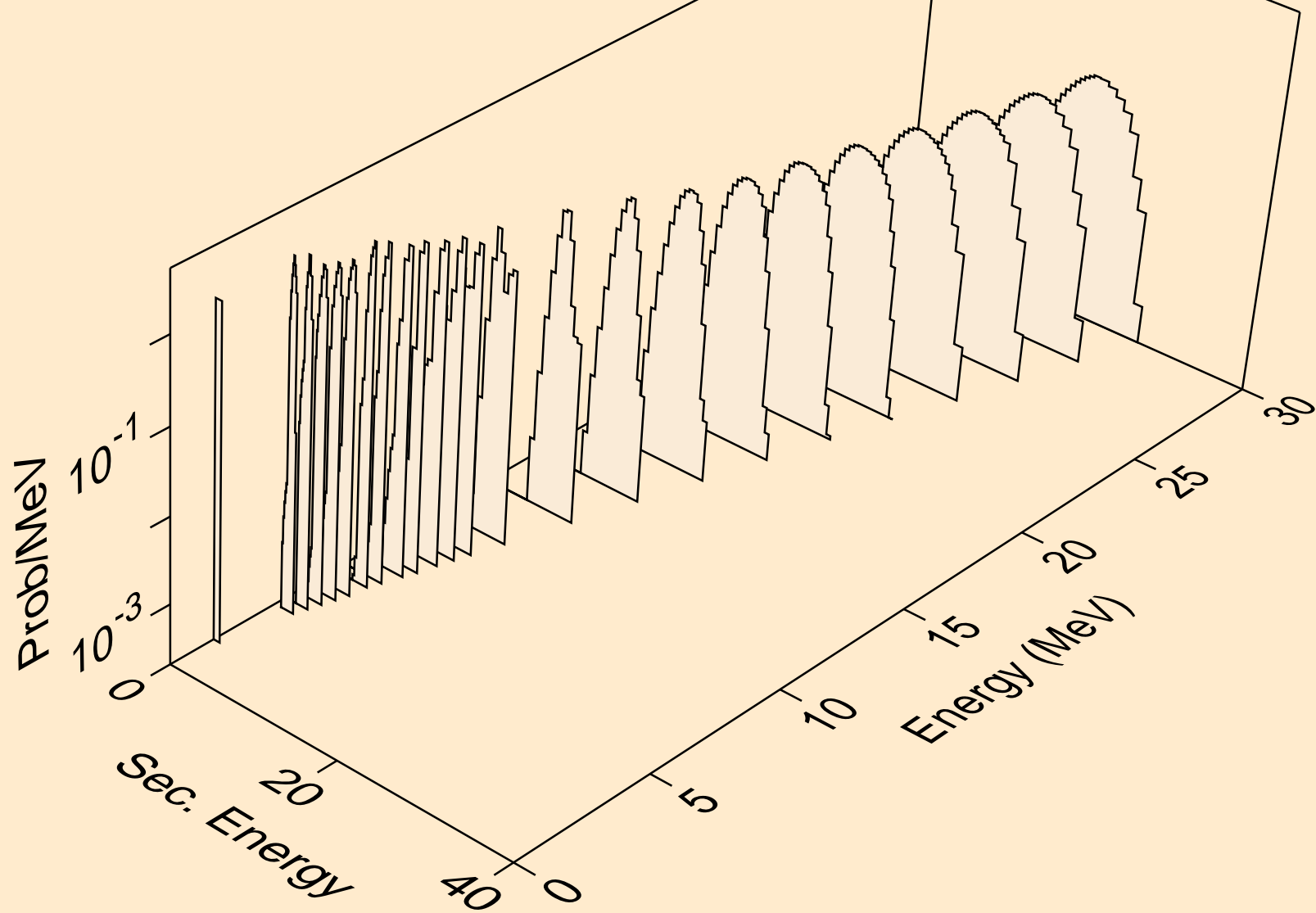

HO146 NEUTRON ACER TENDL-2021 LIBRARY; T=293.6K
tritons from (n,pt)

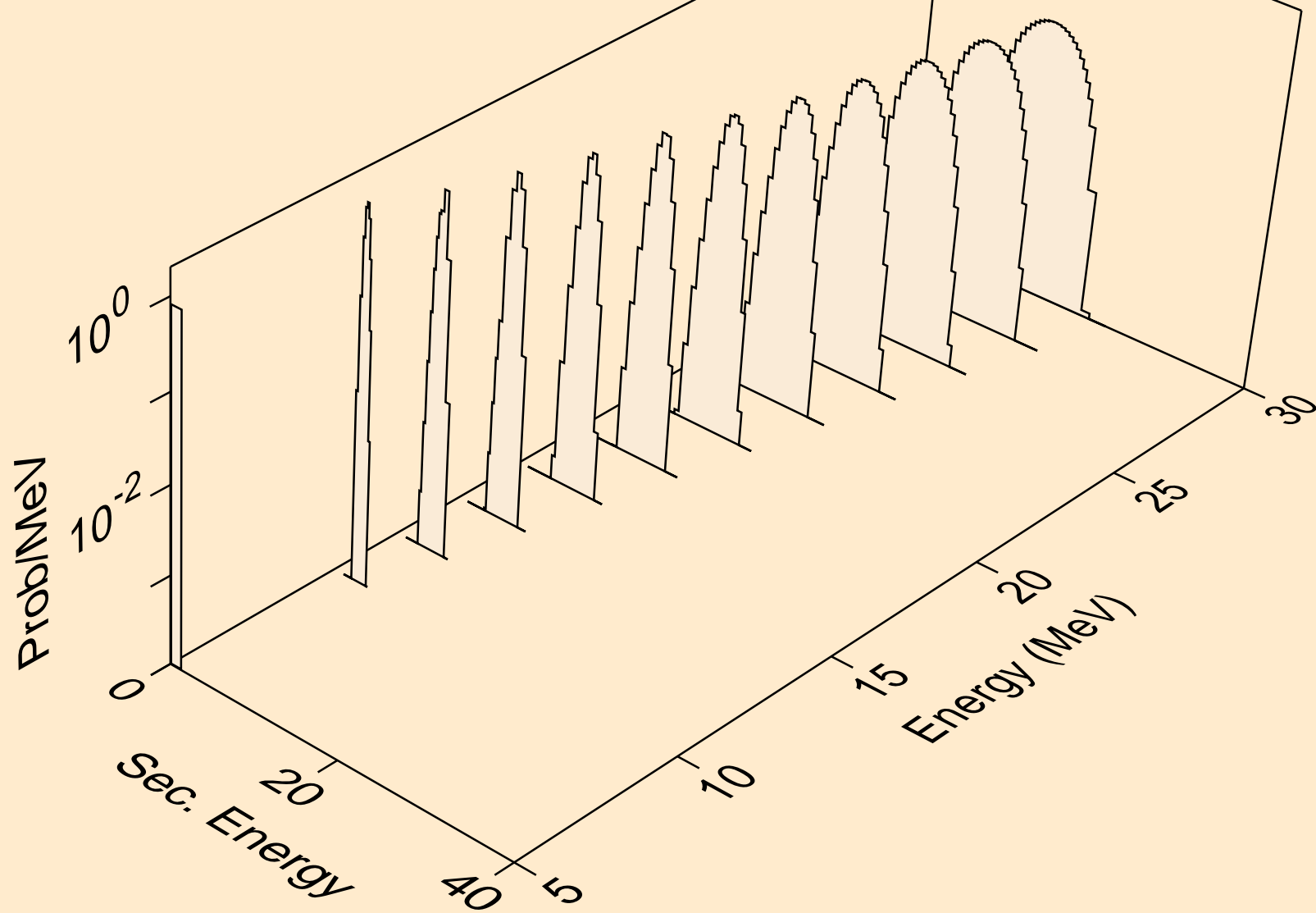

HO146 NEUTRON ACER TENDL-2021 LIBRARY; T=293.6K
he3s from (n,x)

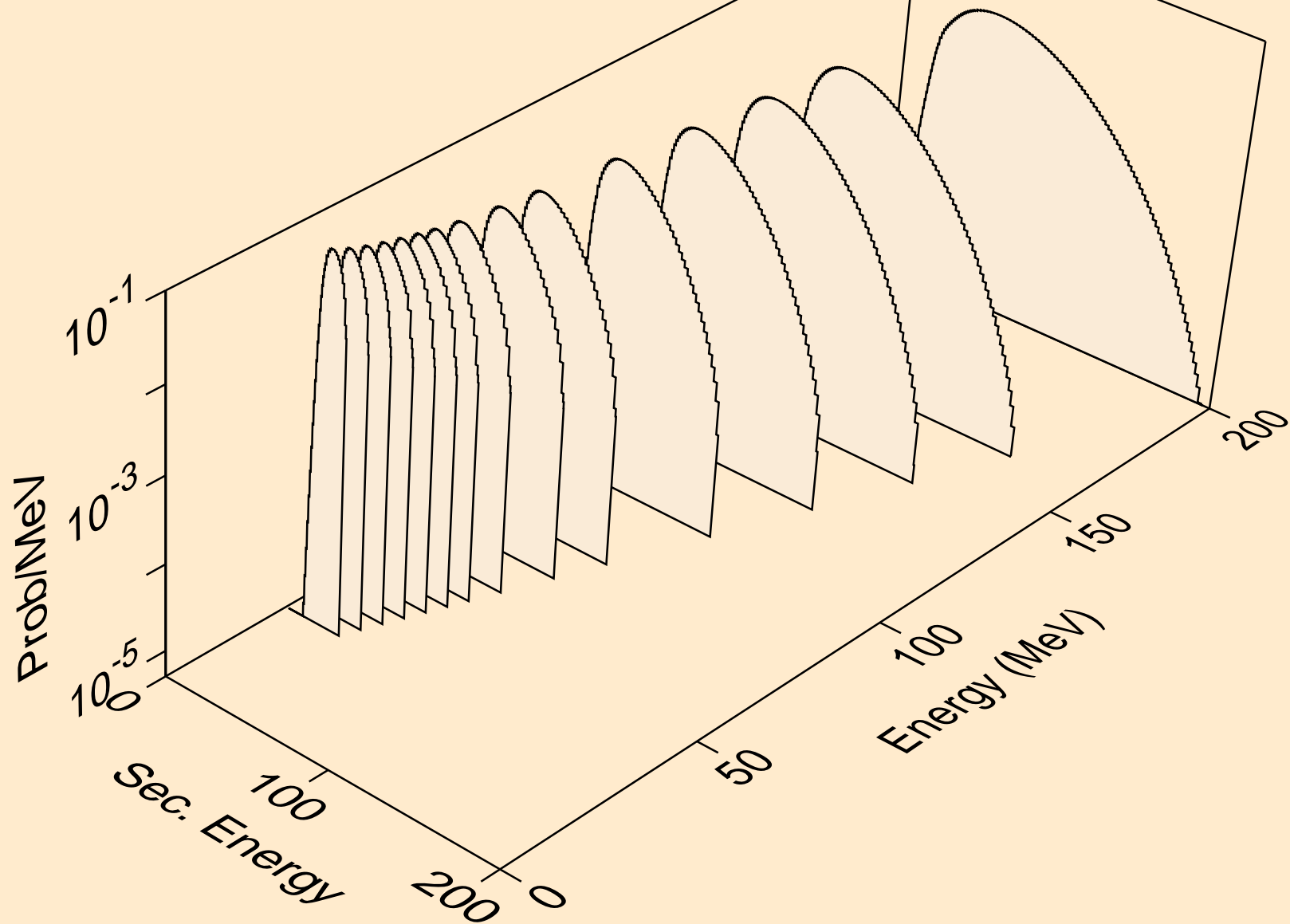

HO146 NEUTRON ACER TENDL-2021 LIBRARY; T=293.6K
he3s from (n,n*)he3

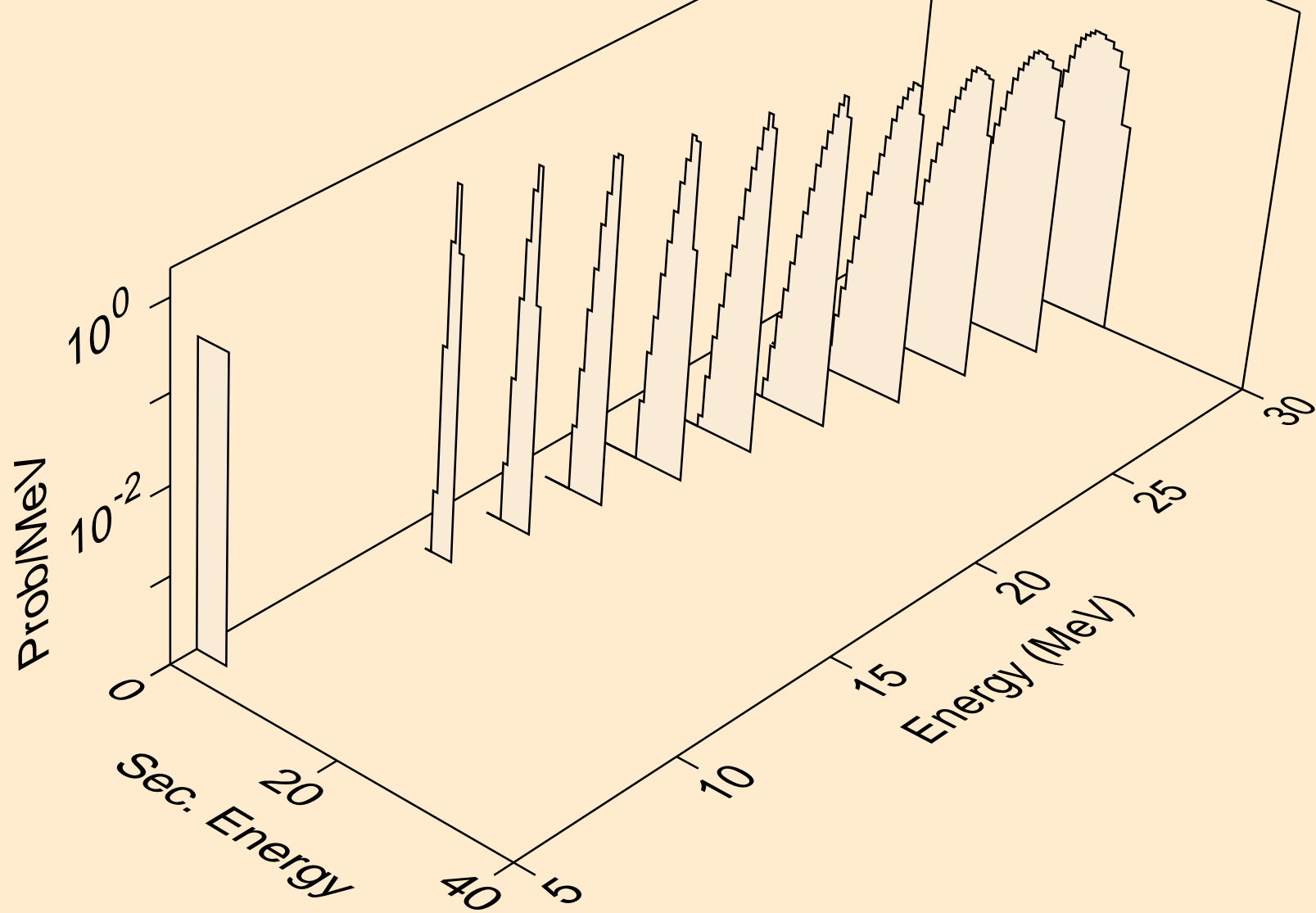

HO146 NEUTRON ACER TENDL-2021 LIBRARY; T=293.6K
he3s from (n,he3)

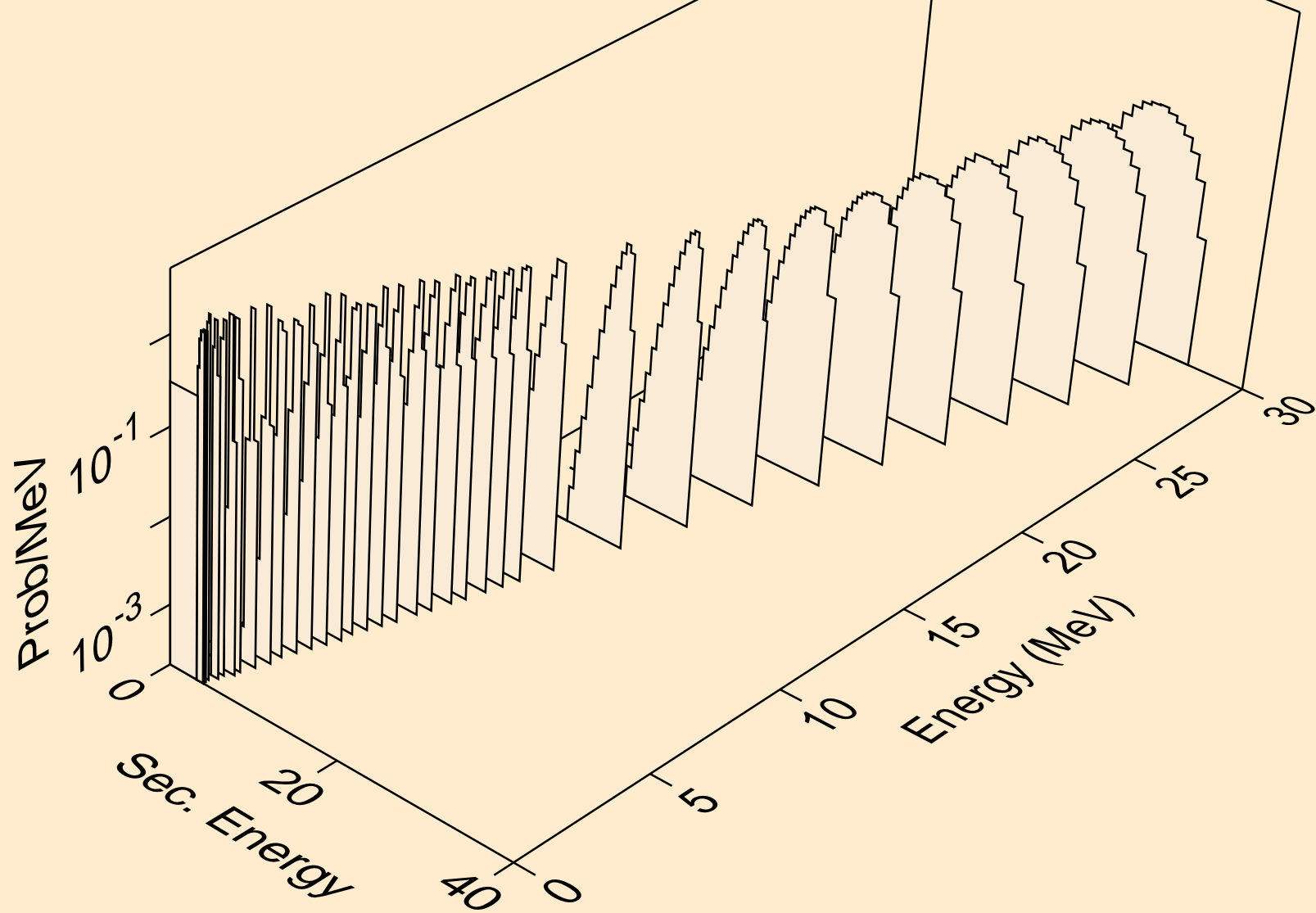

HO146 NEUTRON ACER TENDL-2021 LIBRARY; T=293.6K
alphas from (n,x)

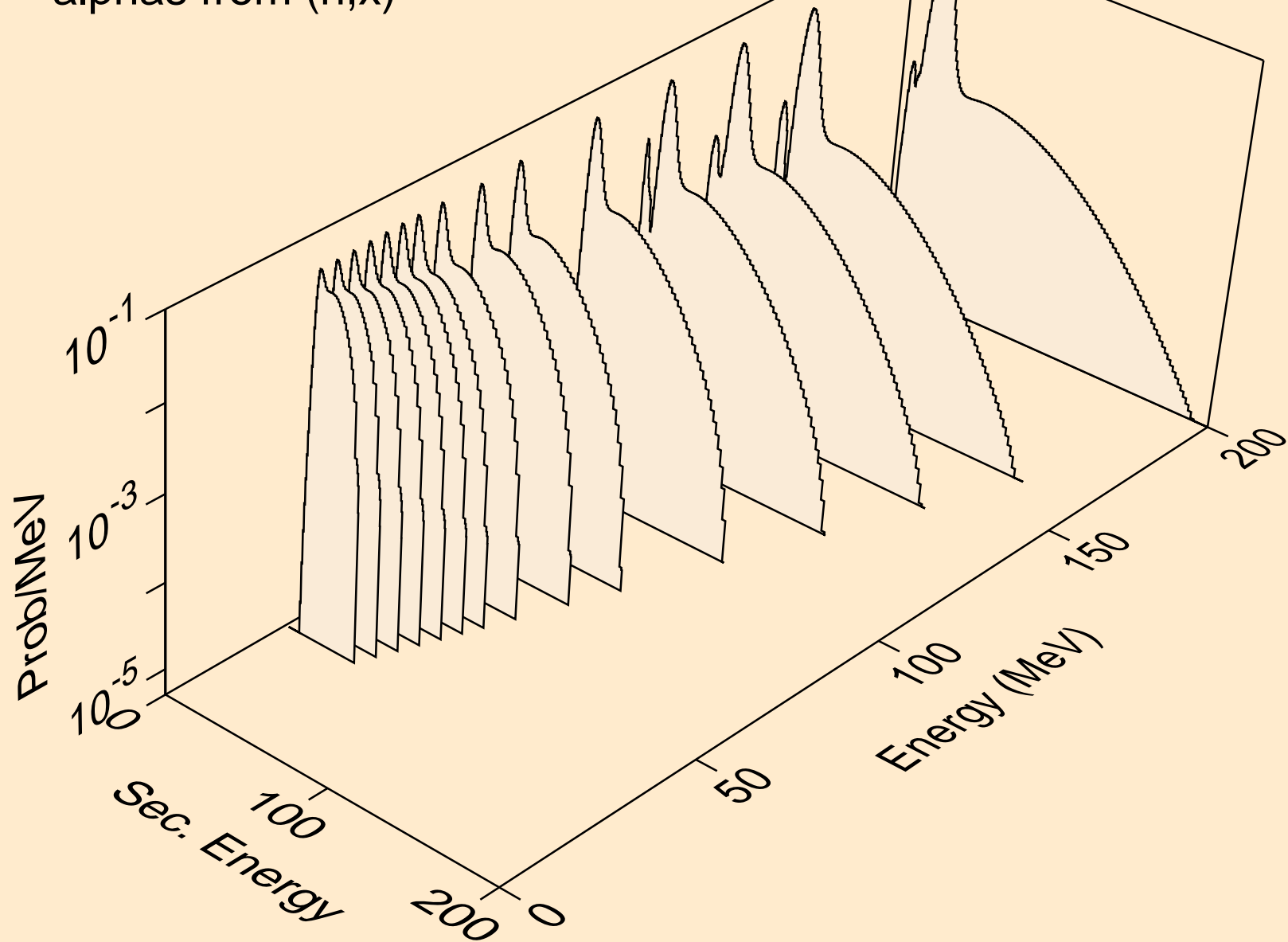

HO146 NEUTRON ACER TENDL-2021 LIBRARY; T=293.6K
alphas from (n,n*)a

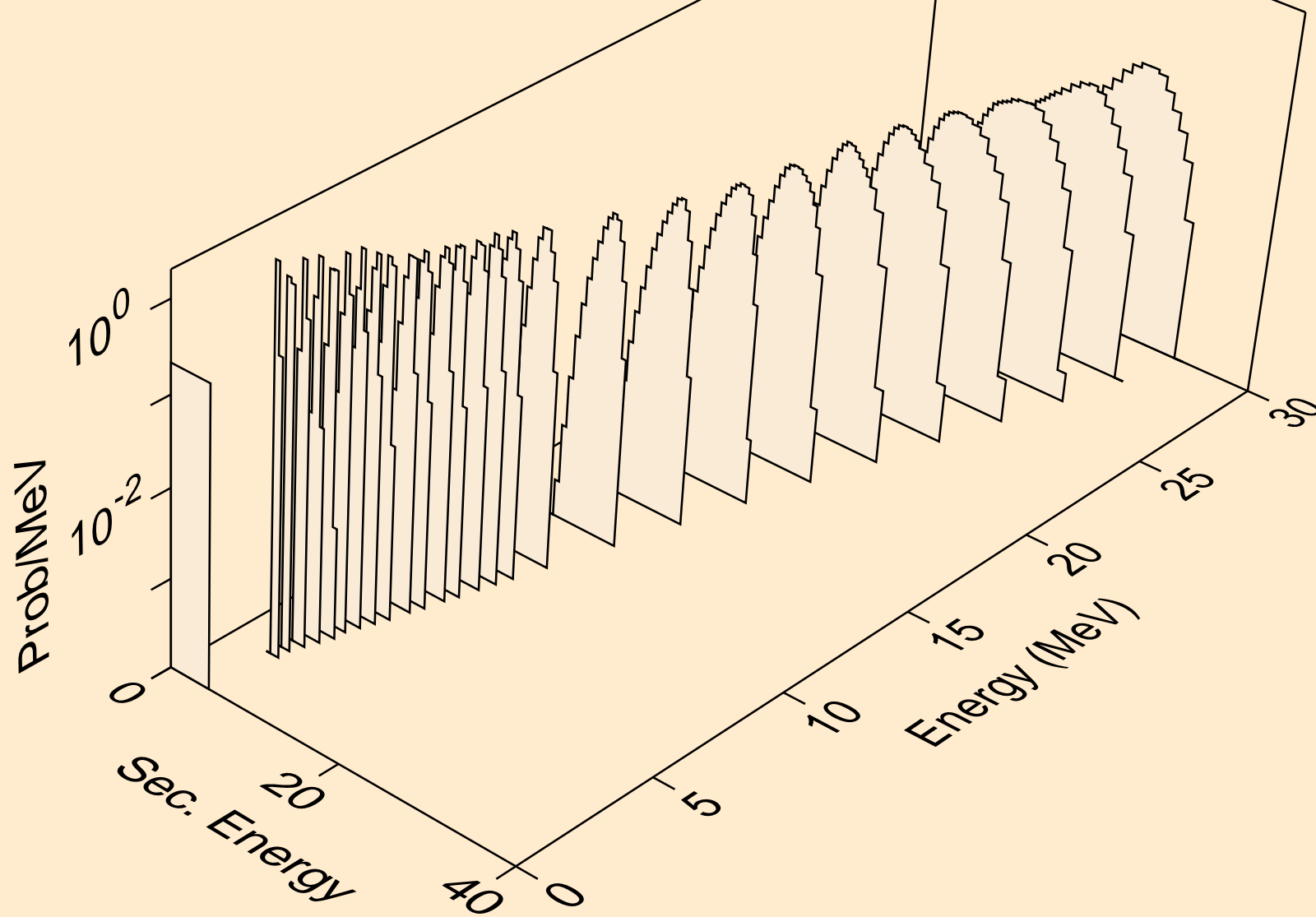

HO146 NEUTRON ACER TENDL-2021 LIBRARY; T=293.6K
alphas from (n,2n)a

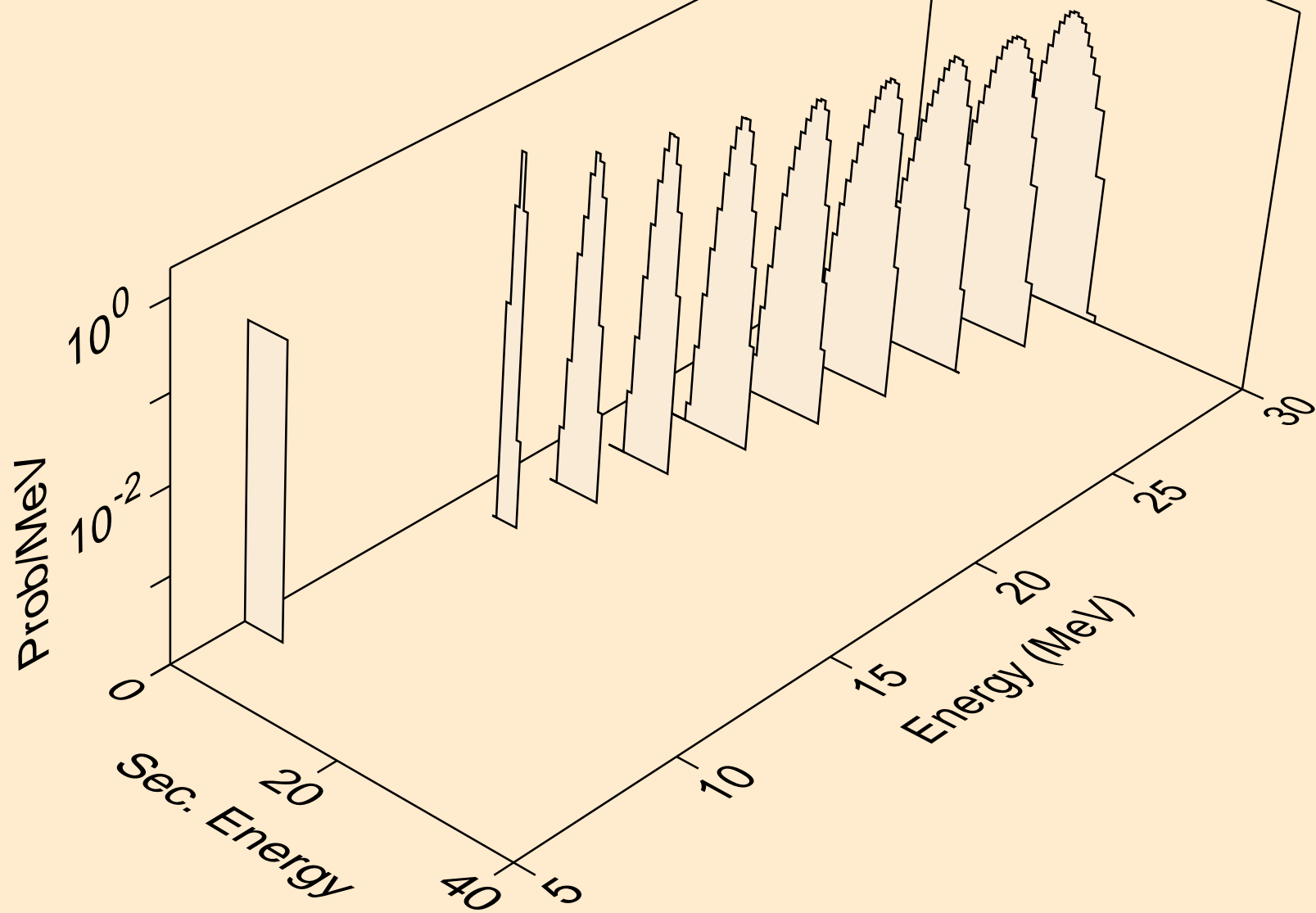

HO146 NEUTRON ACER TENDL-2021 LIBRARY; T=293.6K
alphas from (n,n*)2a

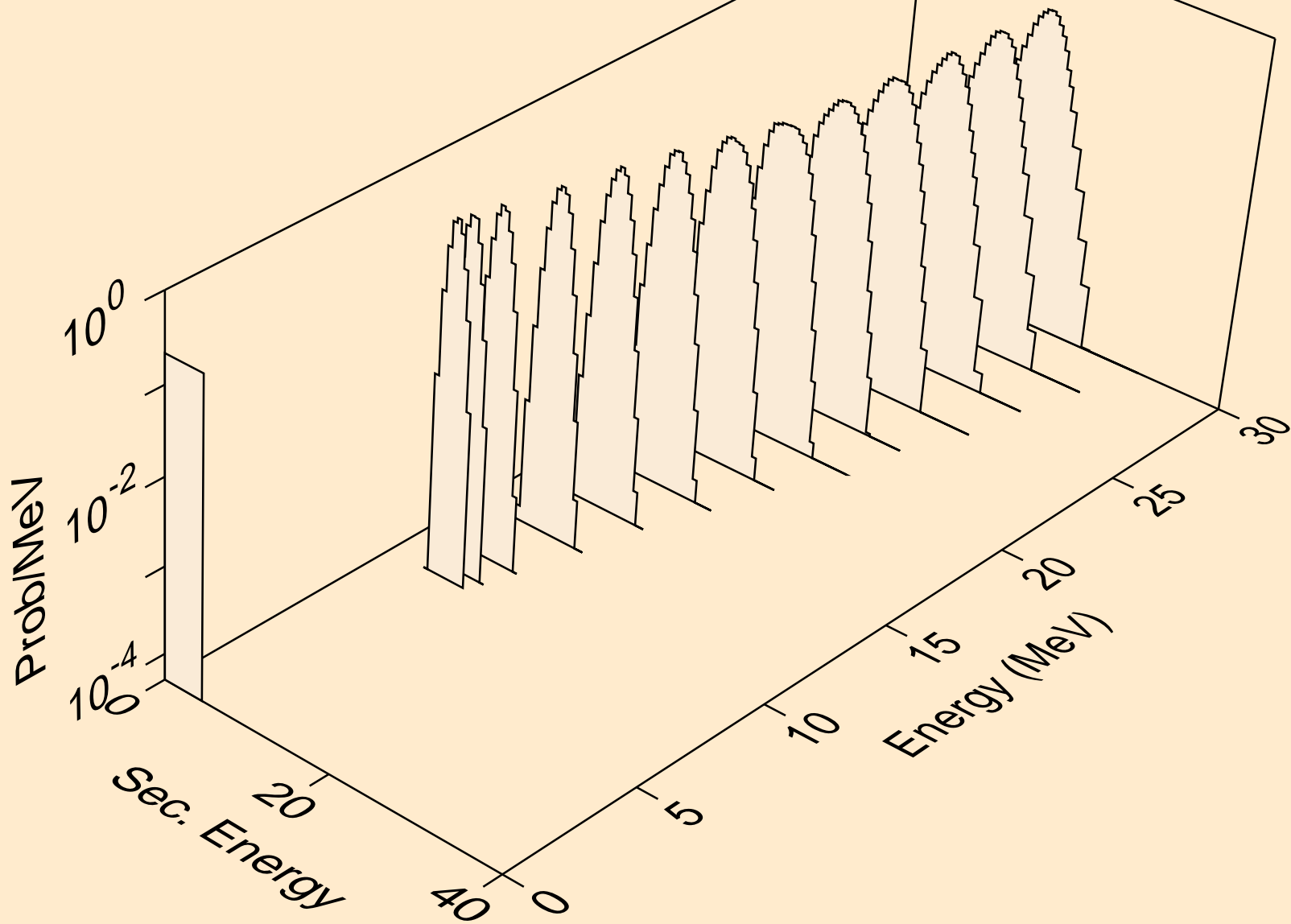

HO146 NEUTRON ACER TENDL-2021 LIBRARY; T=293.6K
alphas from (n,2n)2a

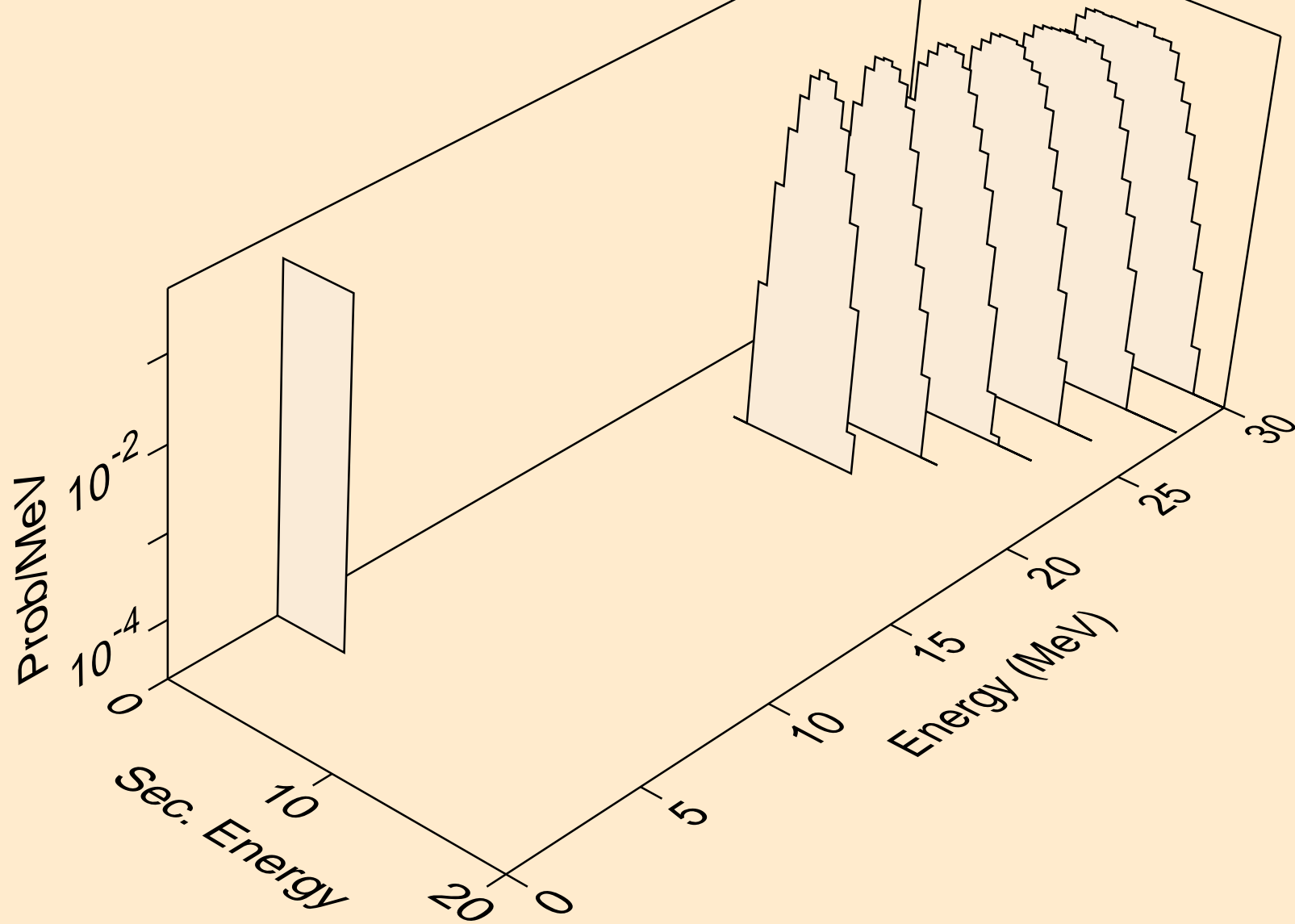

HO146 NEUTRON ACER TENDL-2021 LIBRARY; T=293.6K
alphas from (n,npa)

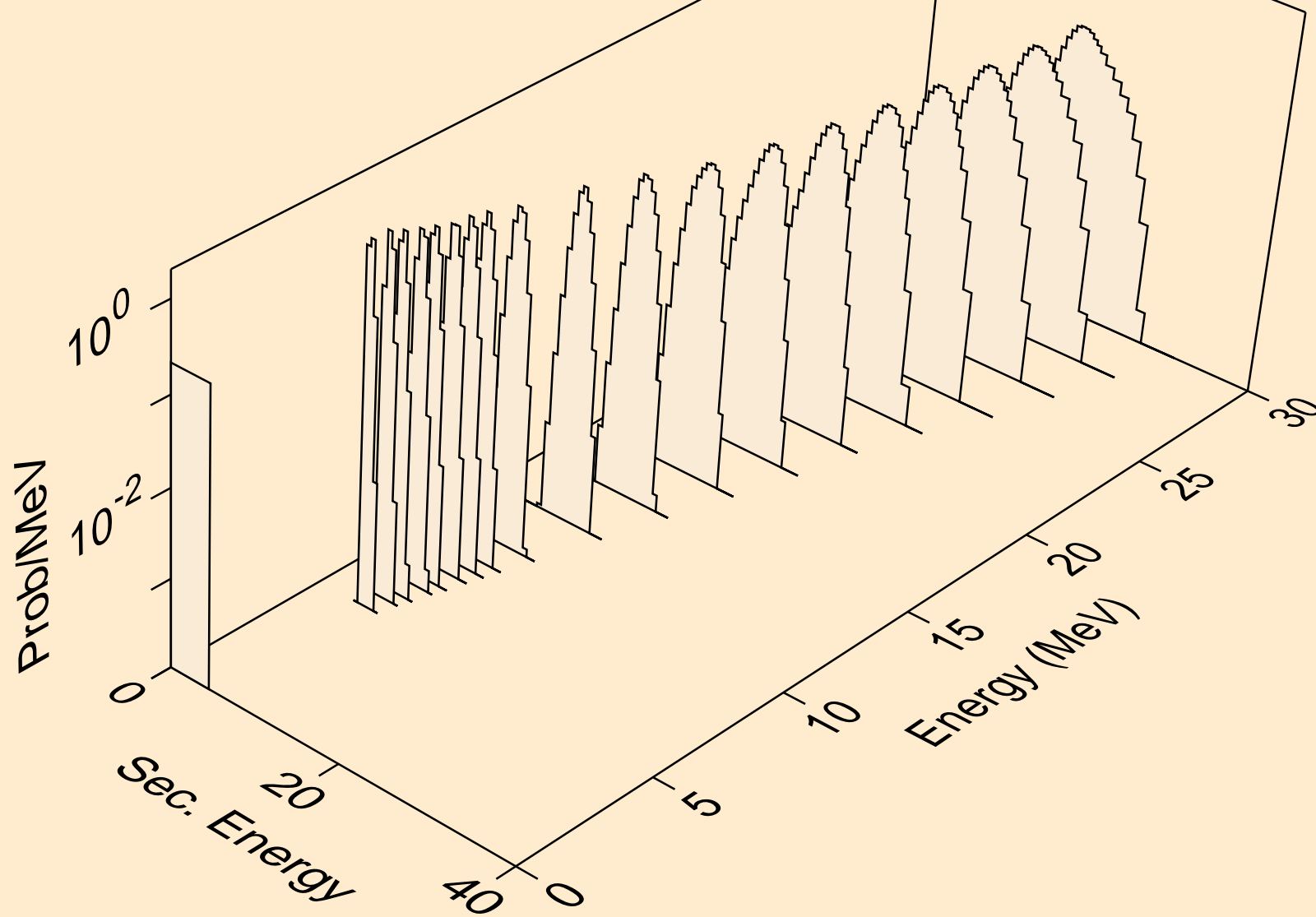

HO146 NEUTRON ACER TENDL-2021 LIBRARY; T=293.6K
alphas from (n,a)

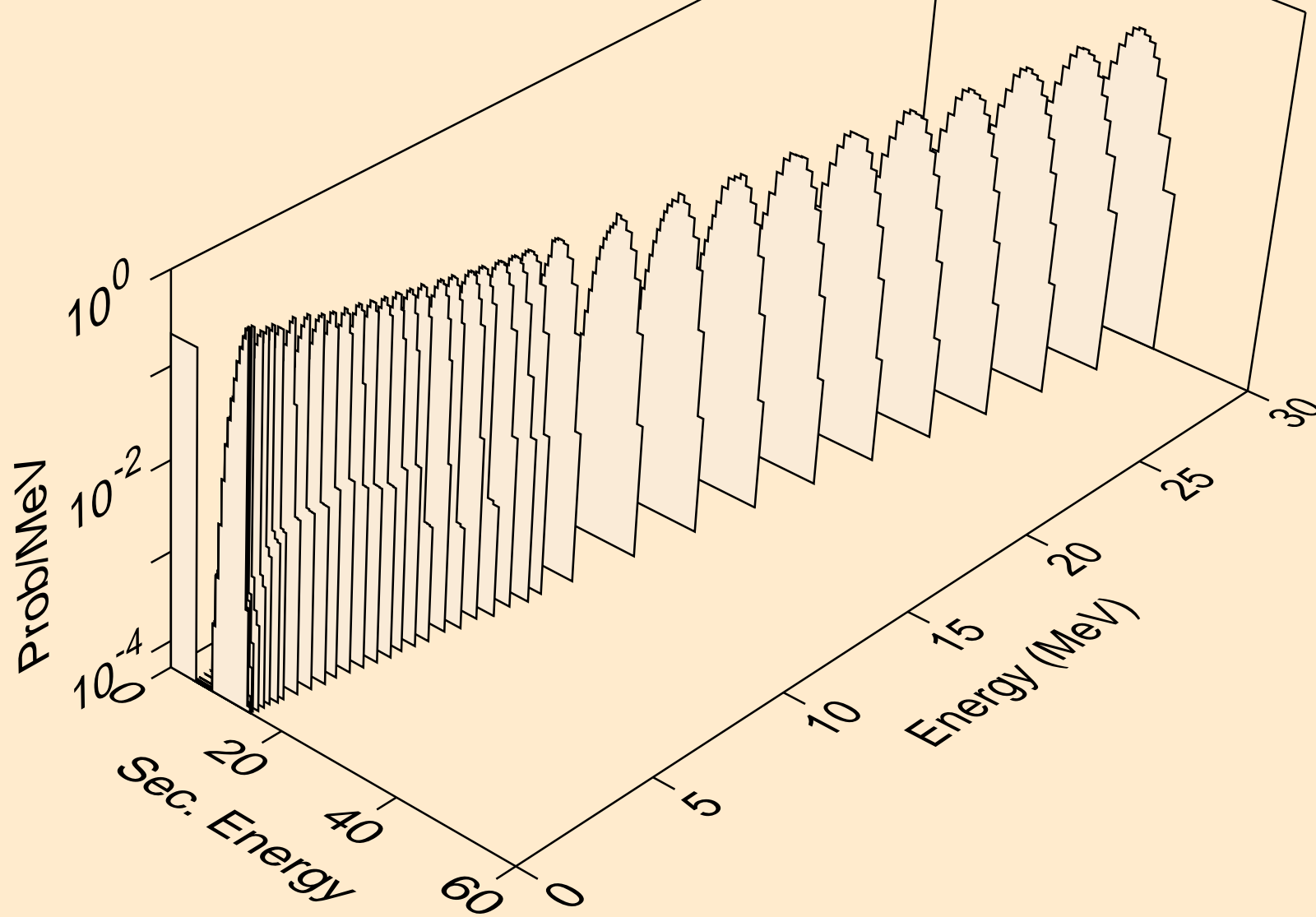

HO146 NEUTRON ACER TENDL-2021 LIBRARY; T=293.6K
alphas from (n,2a)

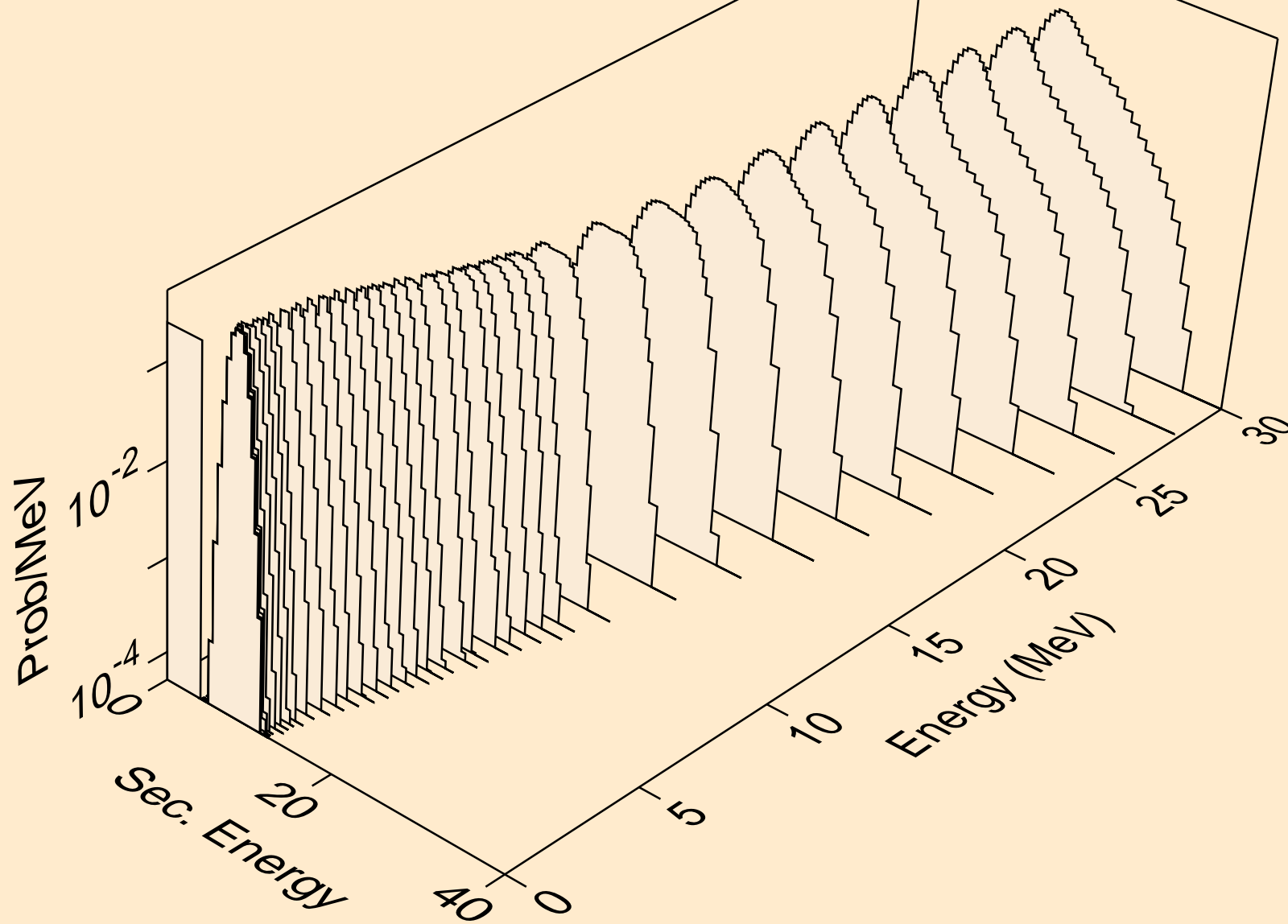

HO146 NEUTRON ACER TENDL-2021 LIBRARY; T=293.6K
alphas from (n,3a)

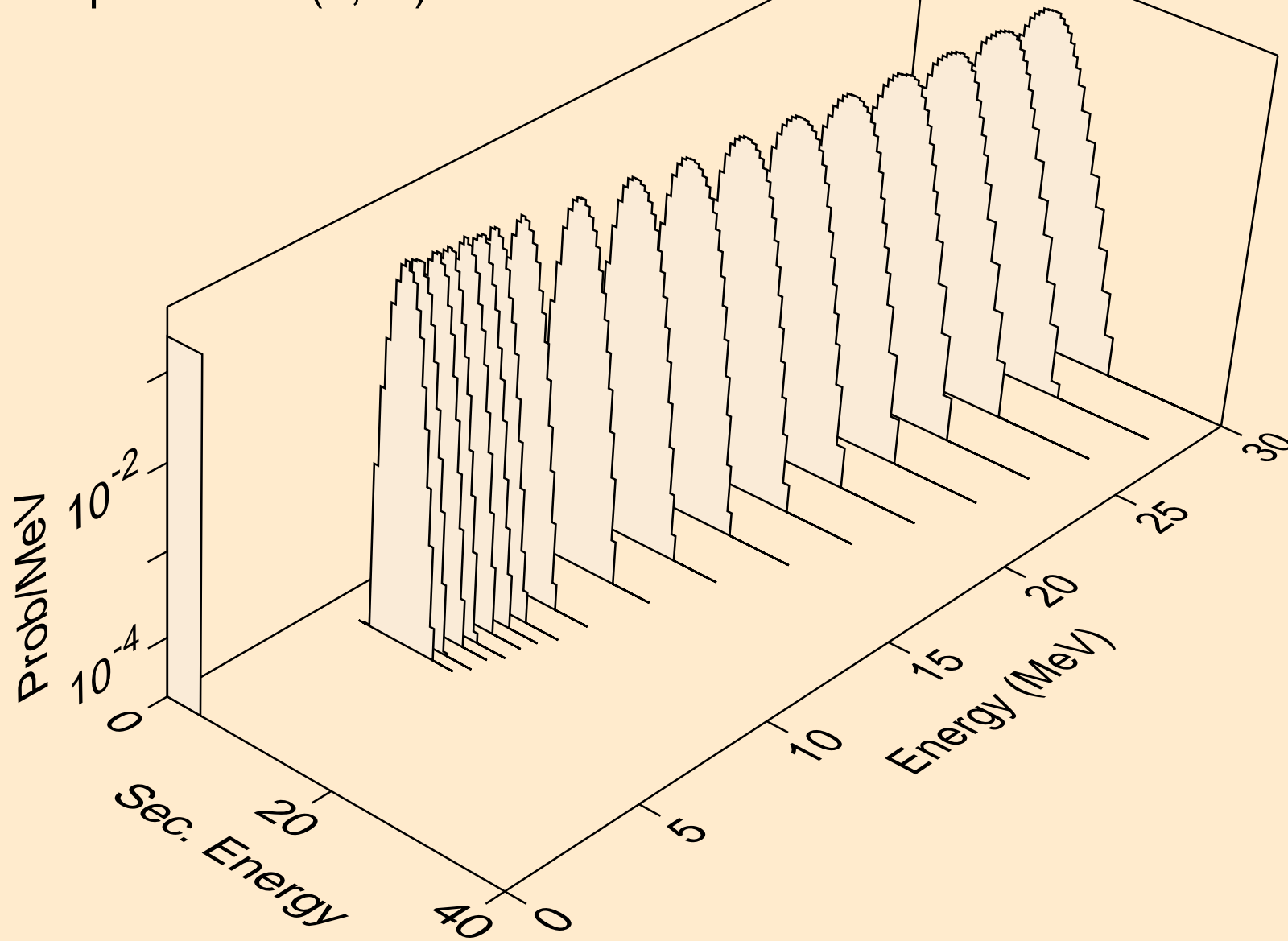

HO146 NEUTRON ACER TENDL-2021 LIBRARY; T=293.6K
alphas from (n,pa)

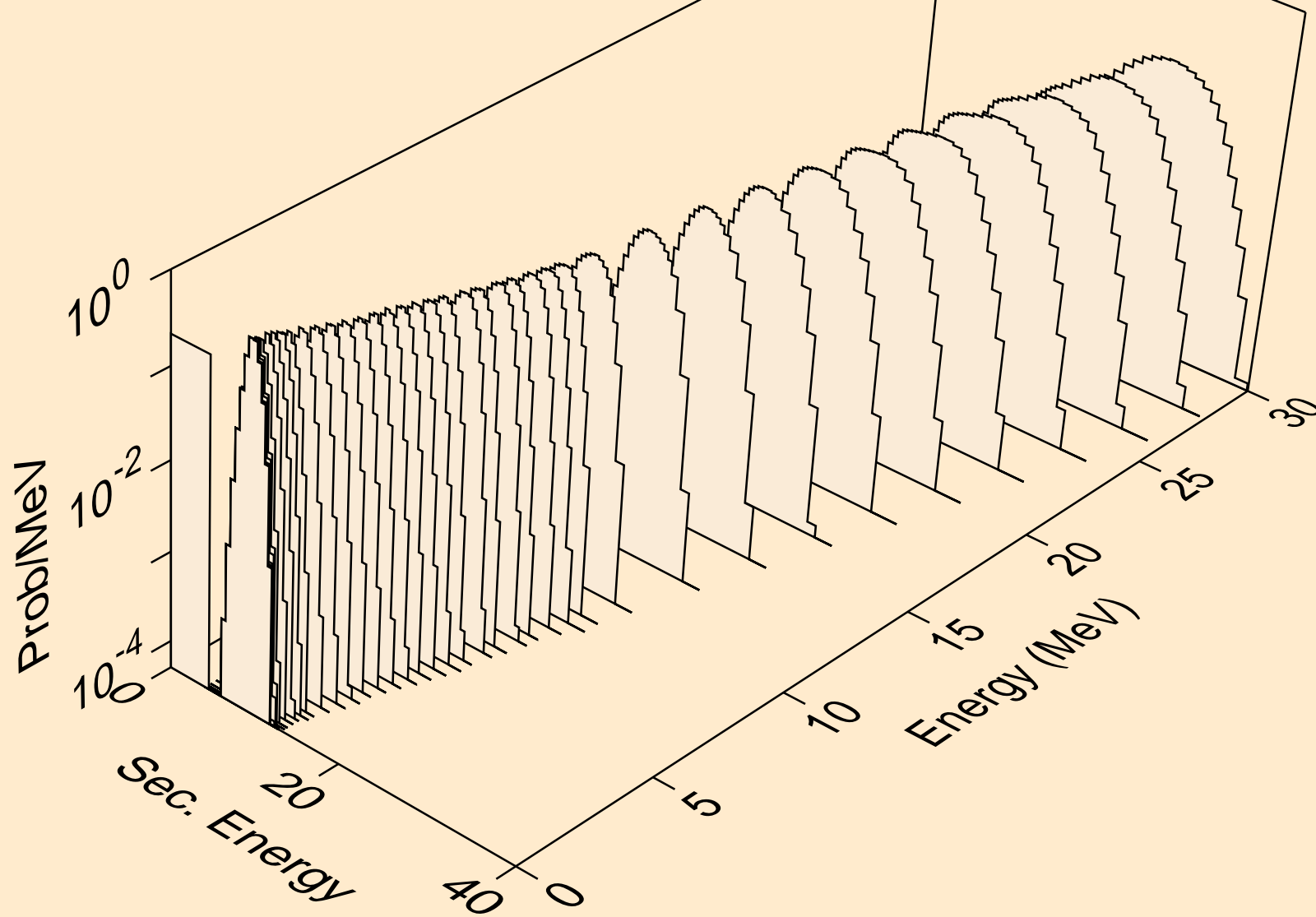

HO146 NEUTRON ACER TENDL-2021 LIBRARY; T=293.6K
alphas from (n,d2a)

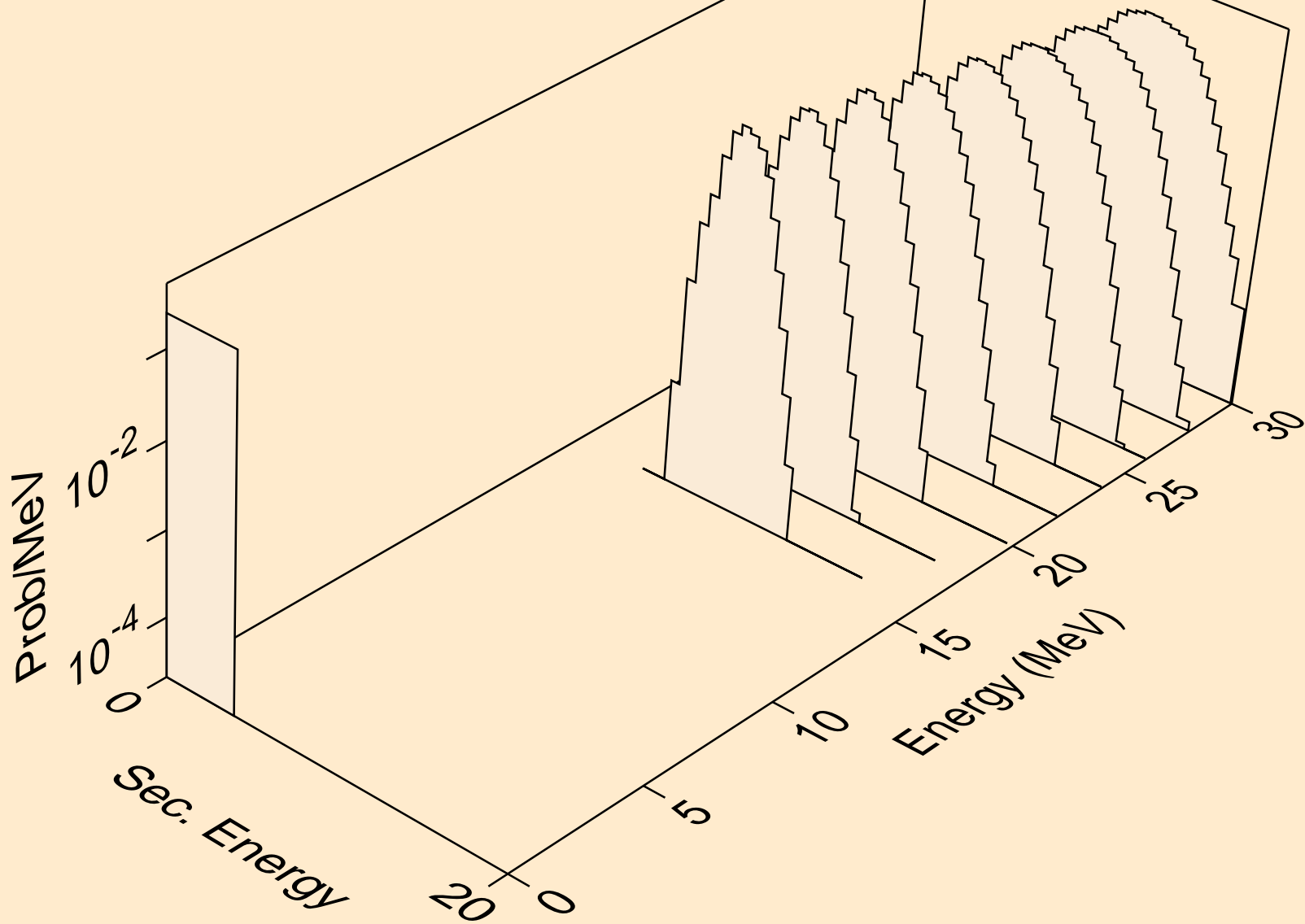

HO146 NEUTRON ACER TENDL-2021 LIBRARY; T=293.6K
alphas from (n,da)

