

# HO150 NEUTRON ACER TENDL-2021 LIBRARY; T=293.6K

## Principal cross sections

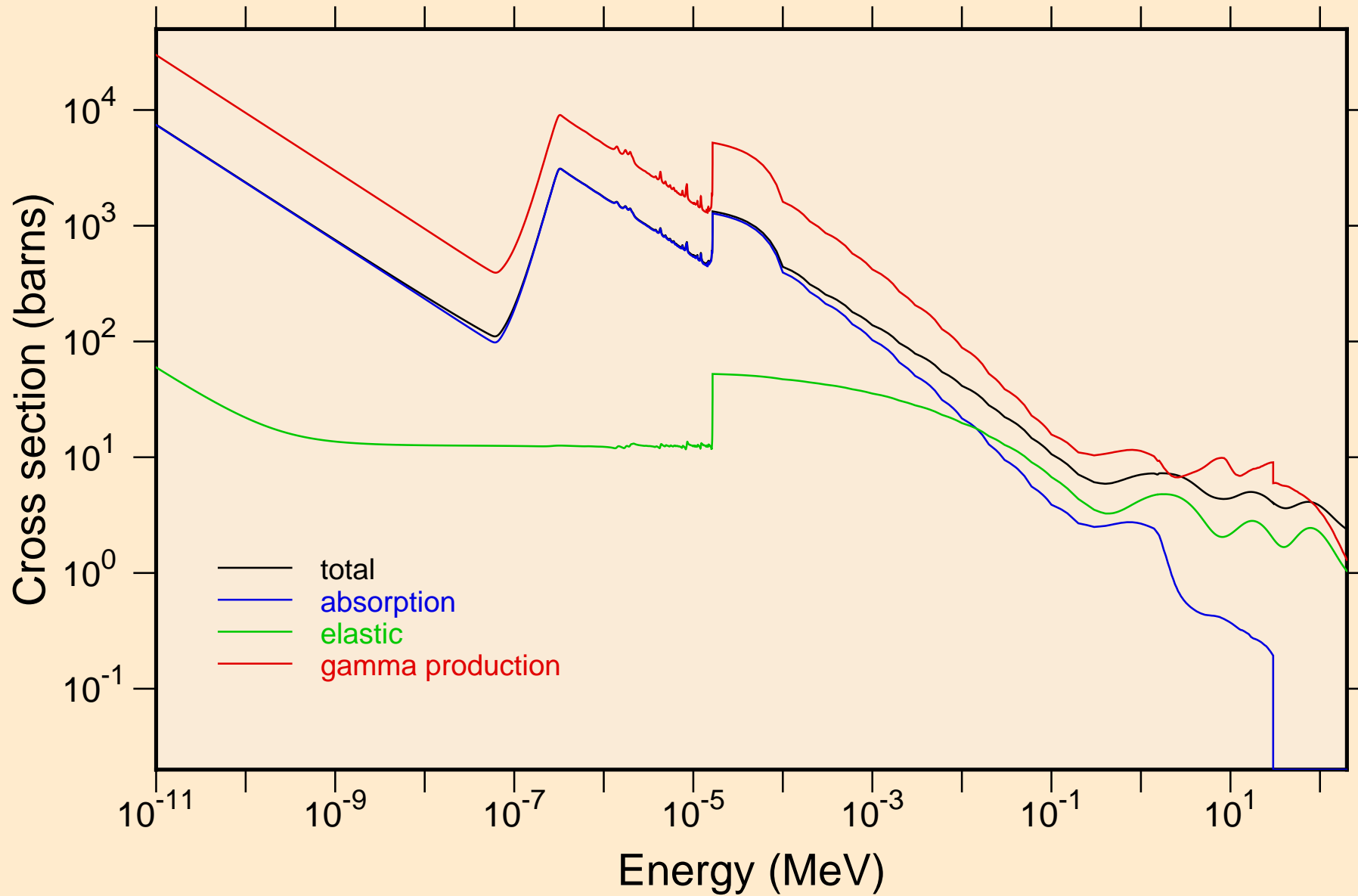

HO150 NEUTRON ACER TENDL-2021 LIBRARY; T=293.6K  
resonance total cross section

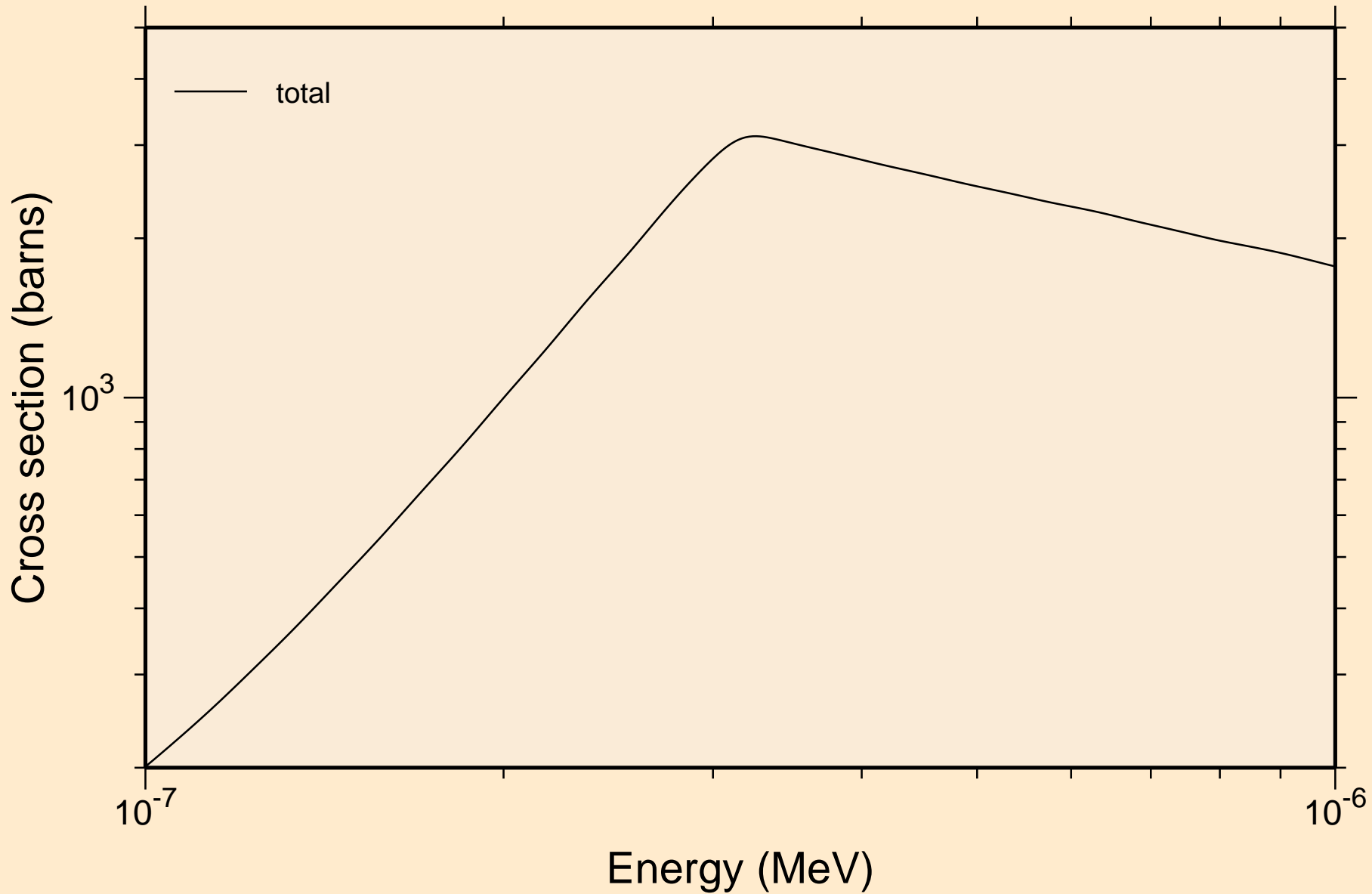

HO150 NEUTRON ACER TENDL-2021 LIBRARY; T=293.6K  
resonance total cross section

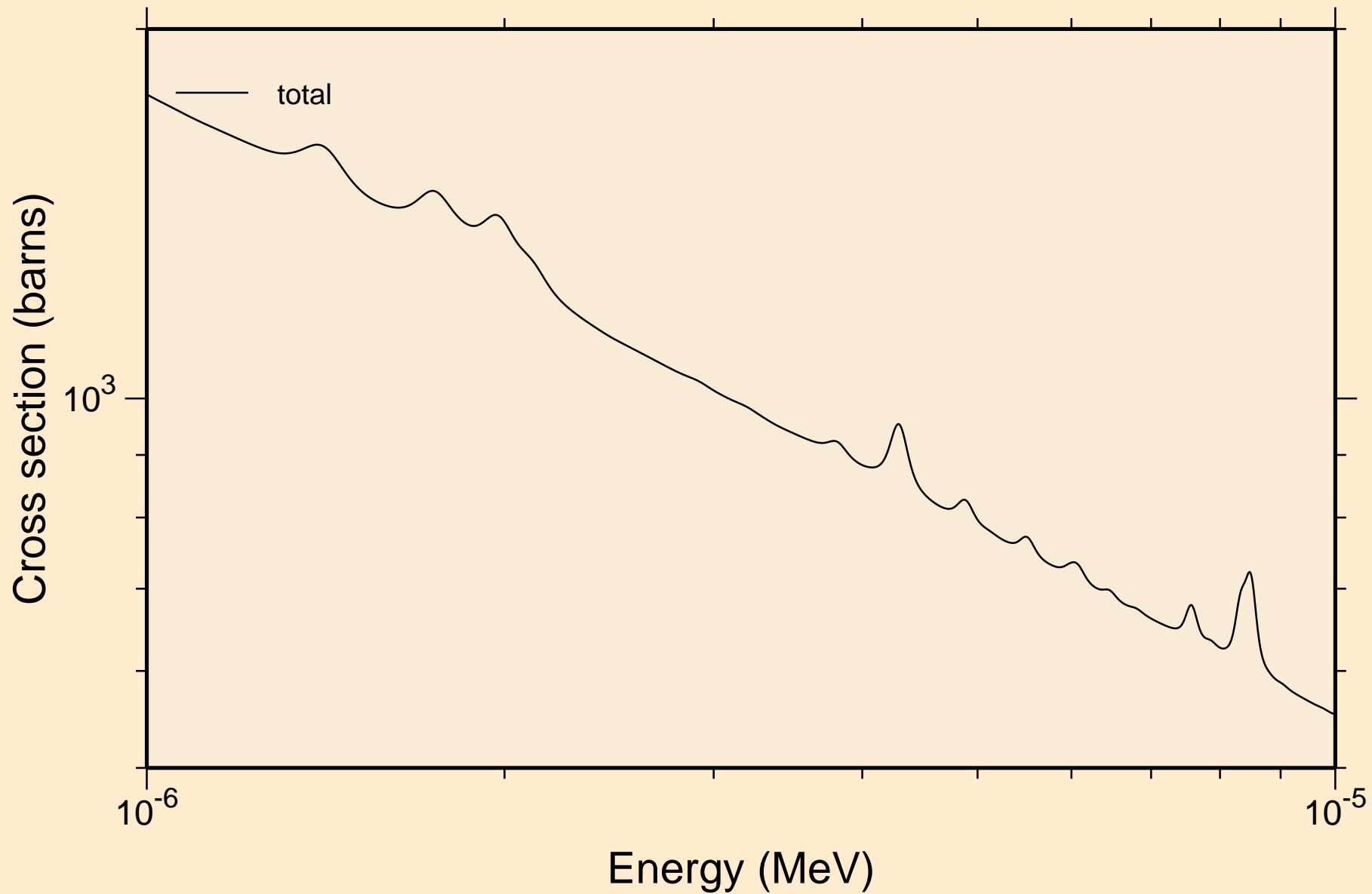

HO150 NEUTRON ACER TENDL-2021 LIBRARY; T=293.6K  
resonance total cross section

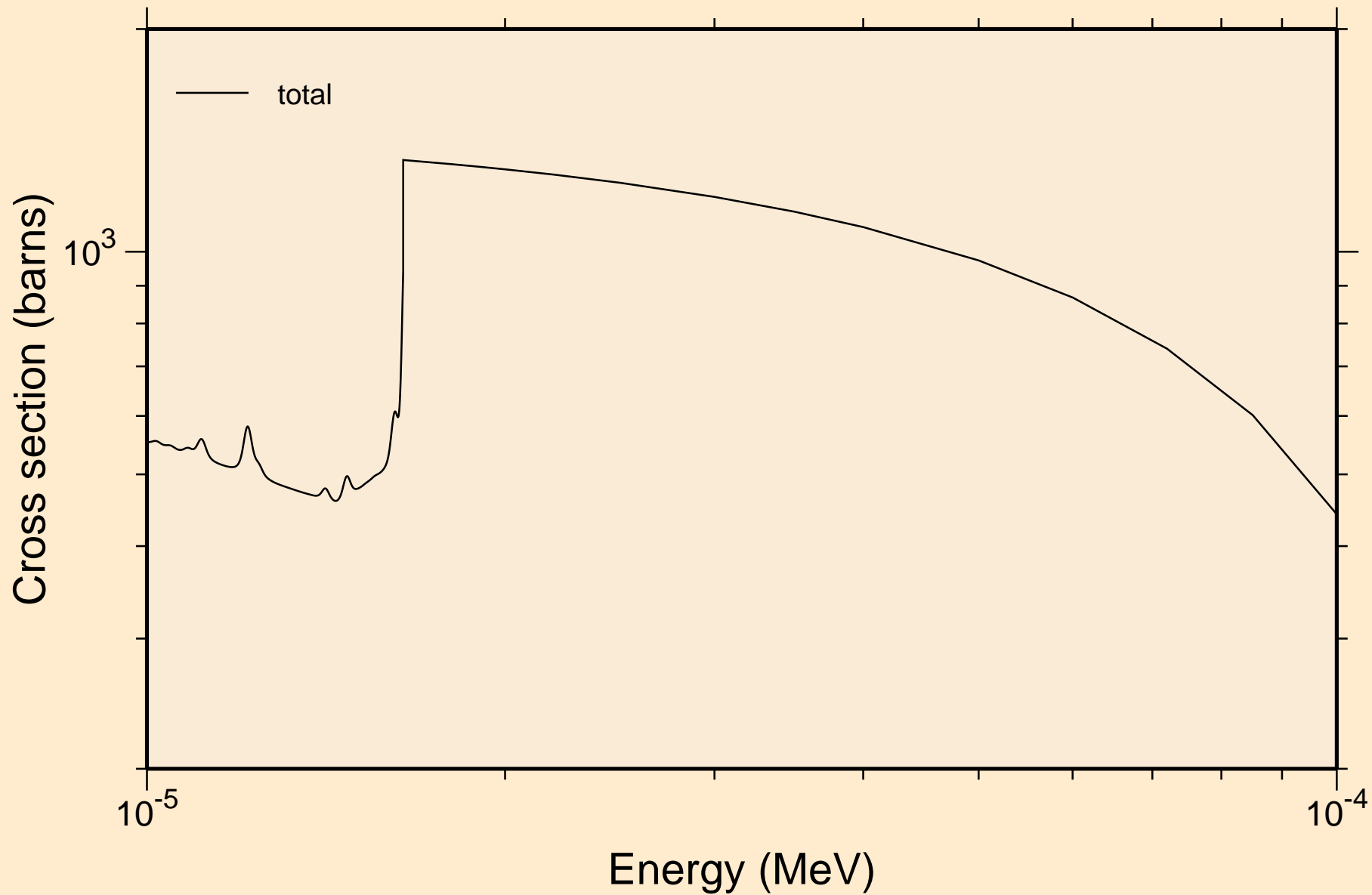

HO150 NEUTRON ACER TENDL-2021 LIBRARY; T=293.6K  
resonance total cross section

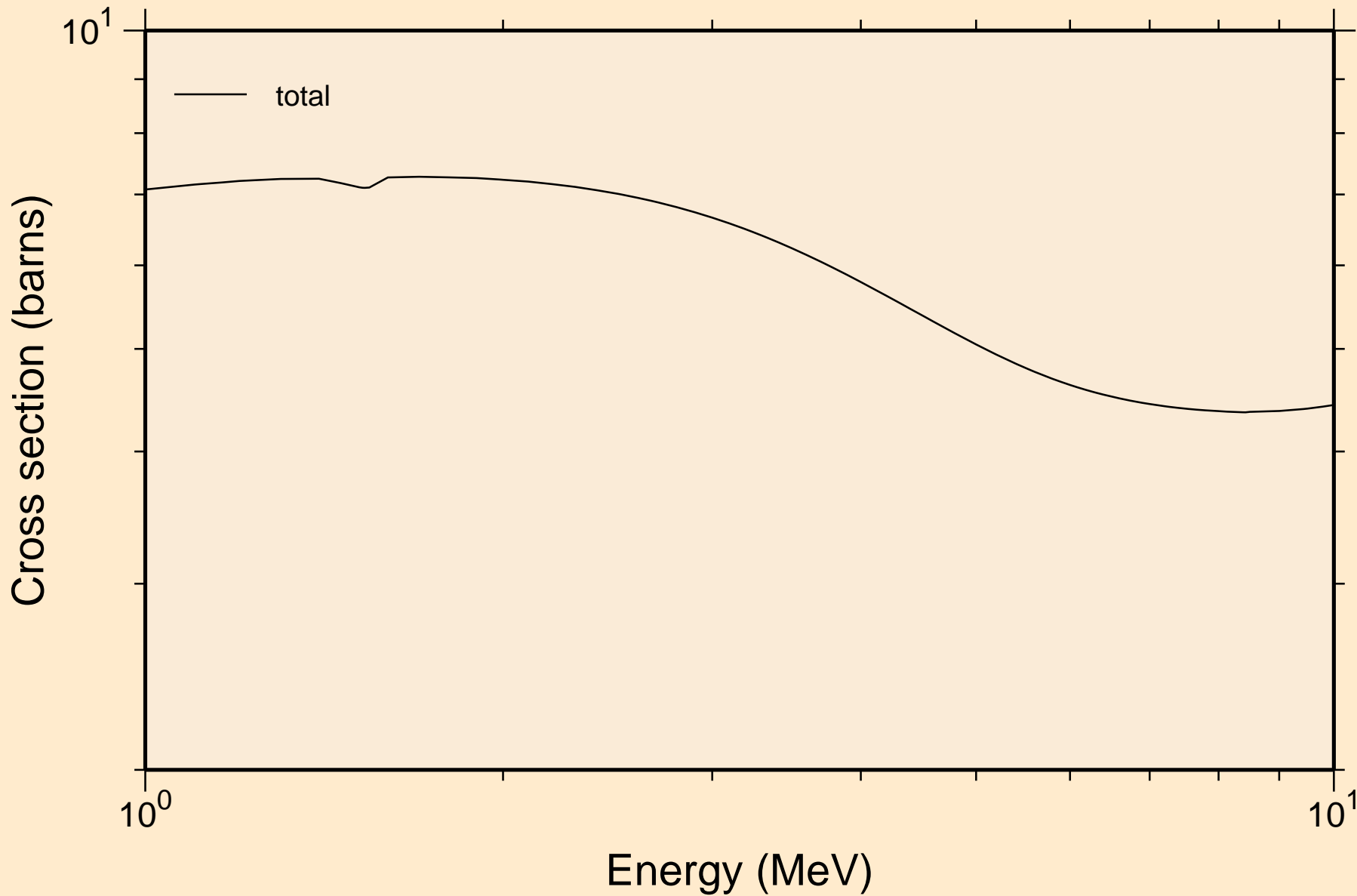

HO150 NEUTRON ACER TENDL-2021 LIBRARY; T=293.6K  
resonance absorption cross sections

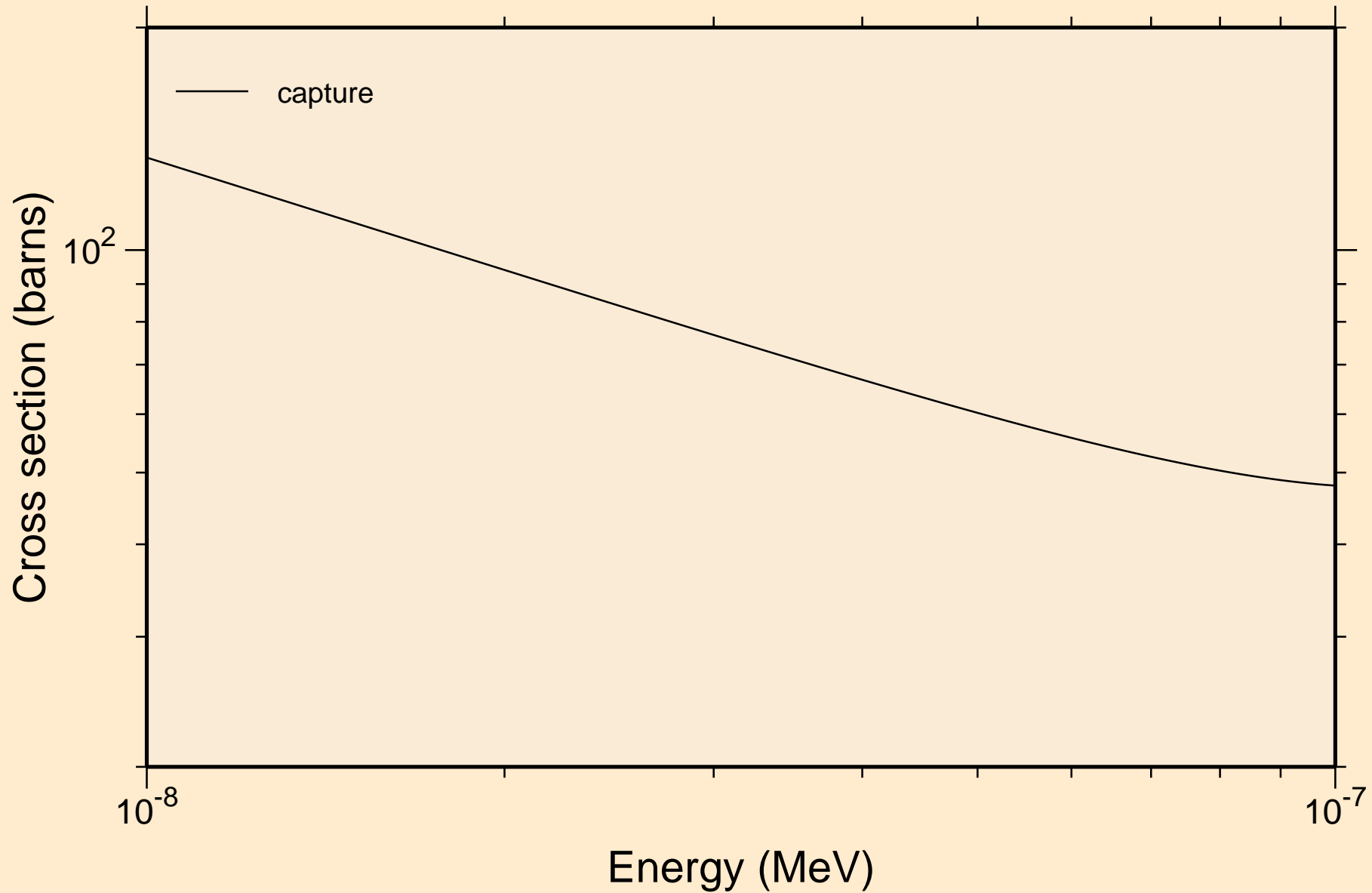

HO150 NEUTRON ACER TENDL-2021 LIBRARY; T=293.6K  
resonance absorption cross sections

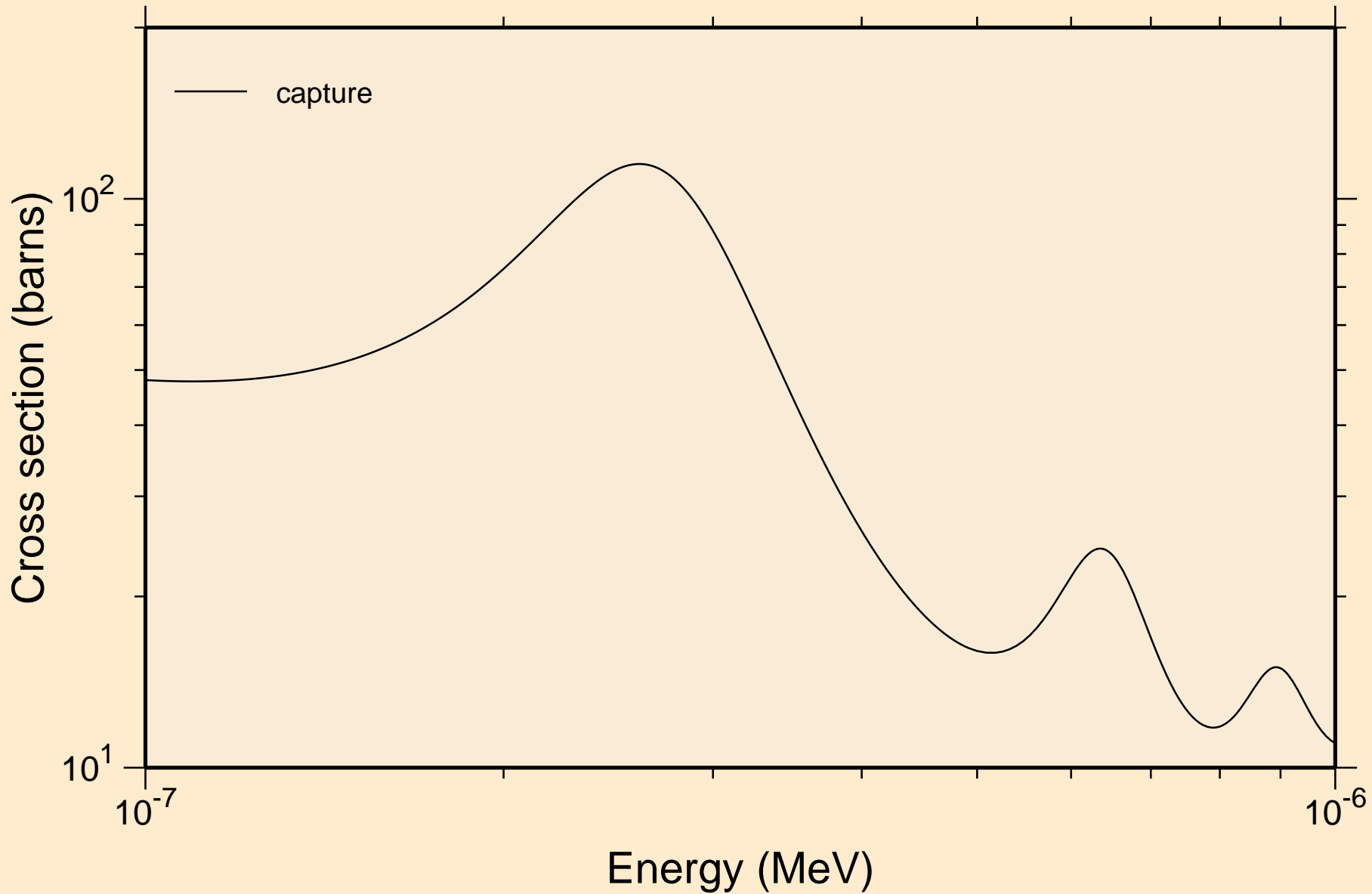

HO150 NEUTRON ACER TENDL-2021 LIBRARY; T=293.6K  
resonance absorption cross sections

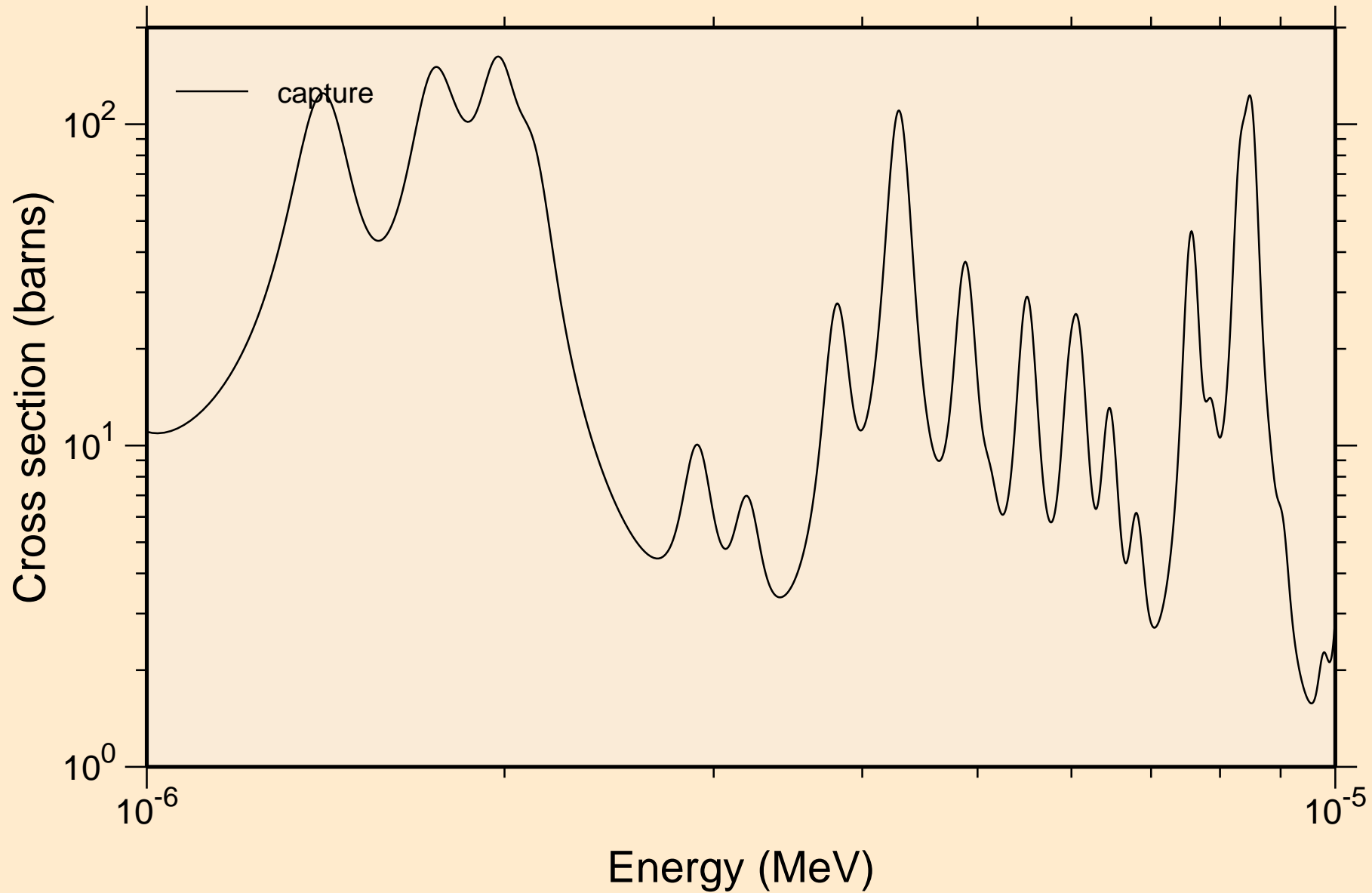



HO150 NEUTRON ACER TENDL-2021 LIBRARY; T=293.6K  
resonance absorption cross sections

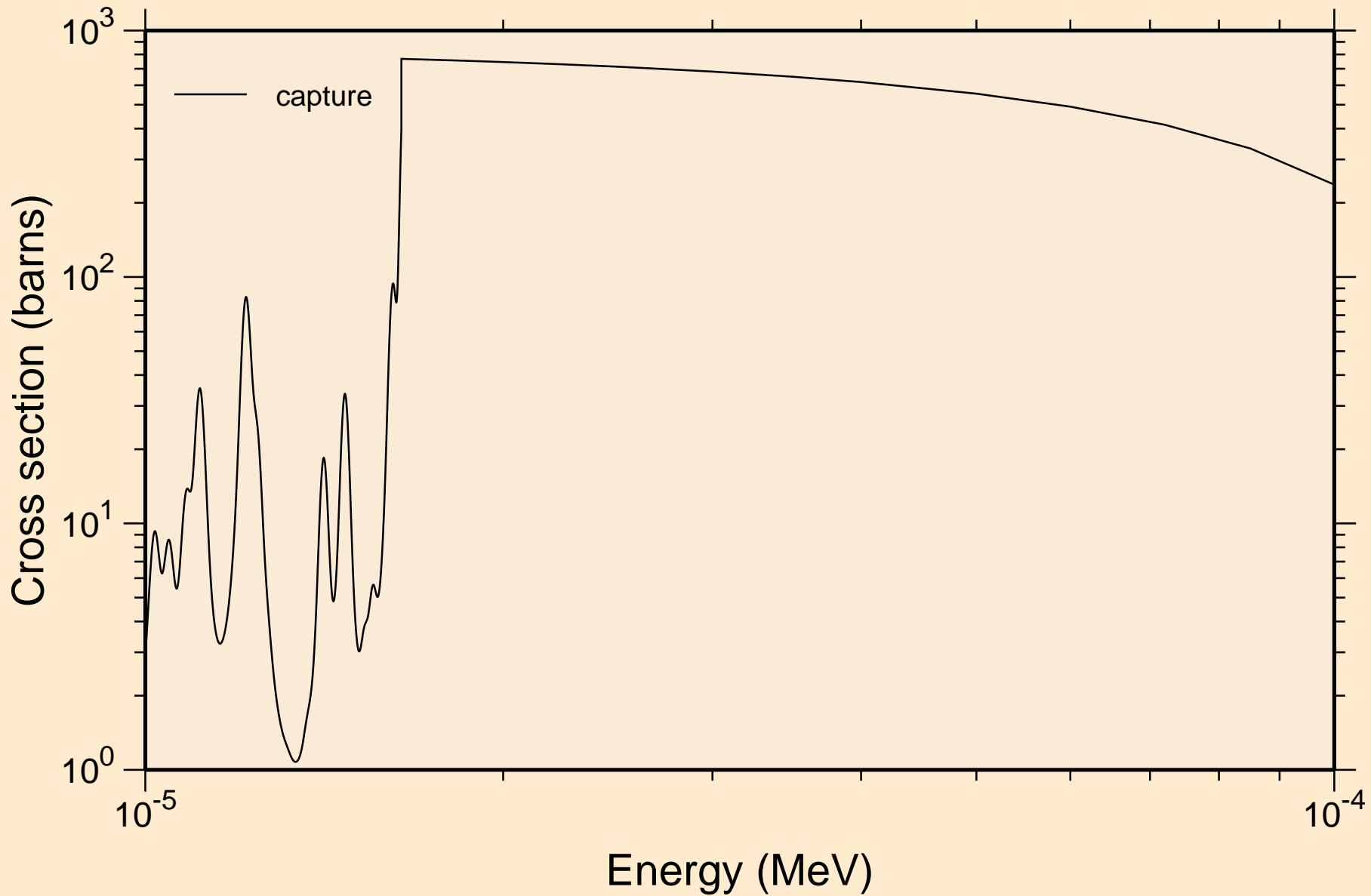

HO150 NEUTRON ACER TENDL-2021 LIBRARY; T=293.6K  
resonance absorption cross sections

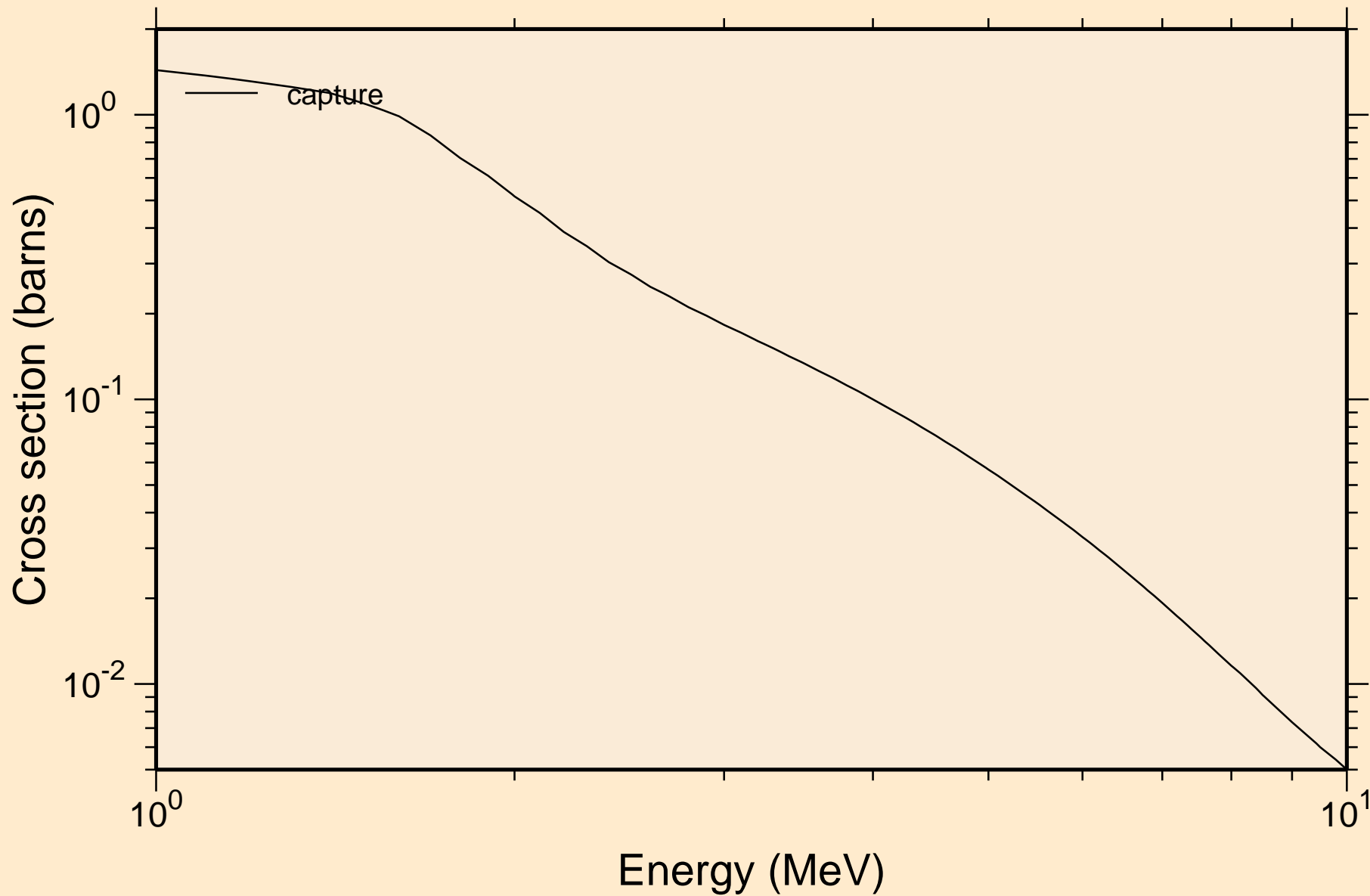

HO150 NEUTRON ACER TENDL-2021 LIBRARY; T=293.6K  
Heating

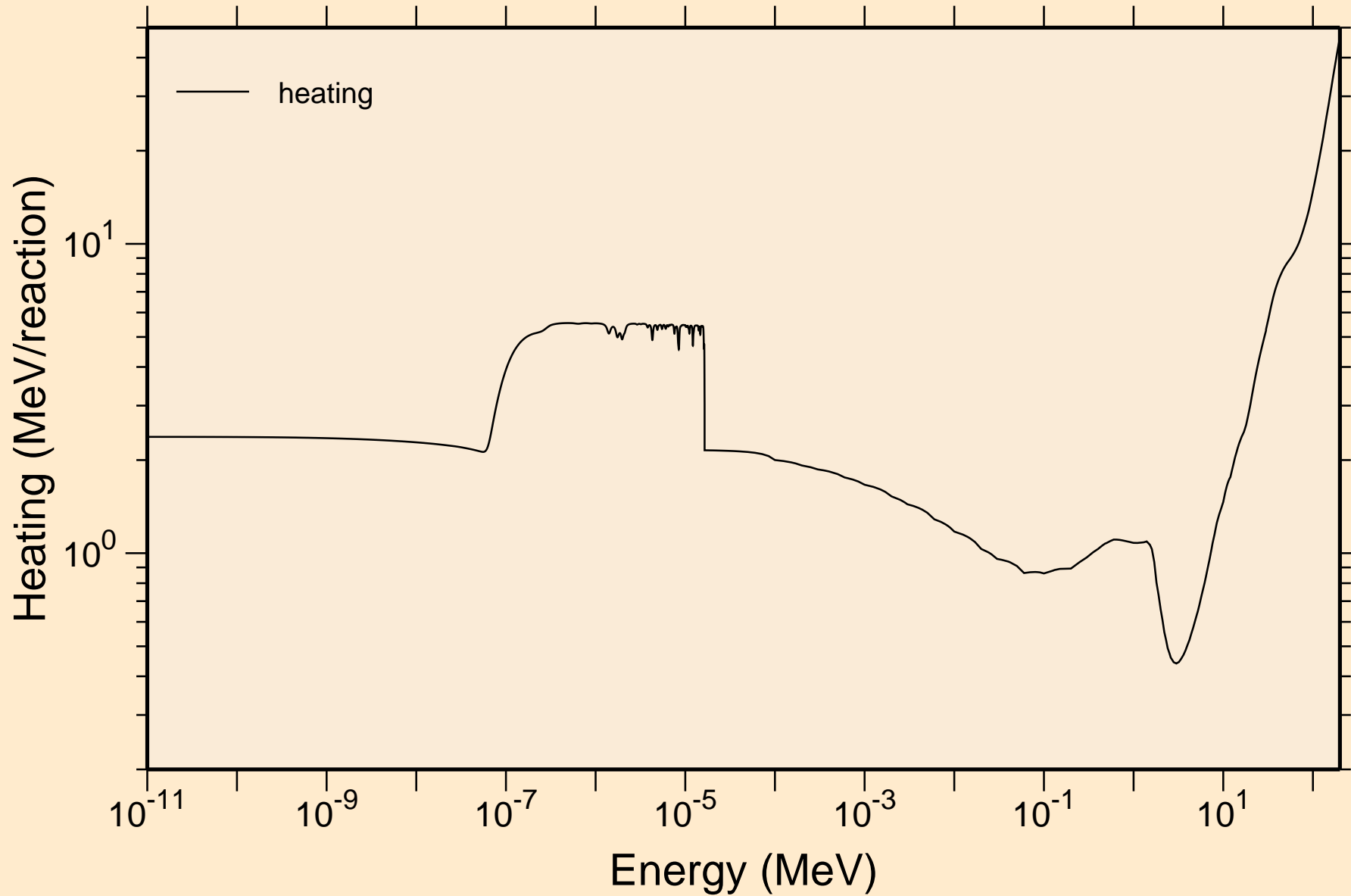

HO150 NEUTRON ACER TENDL-2021 LIBRARY; T=293.6K  
Damage

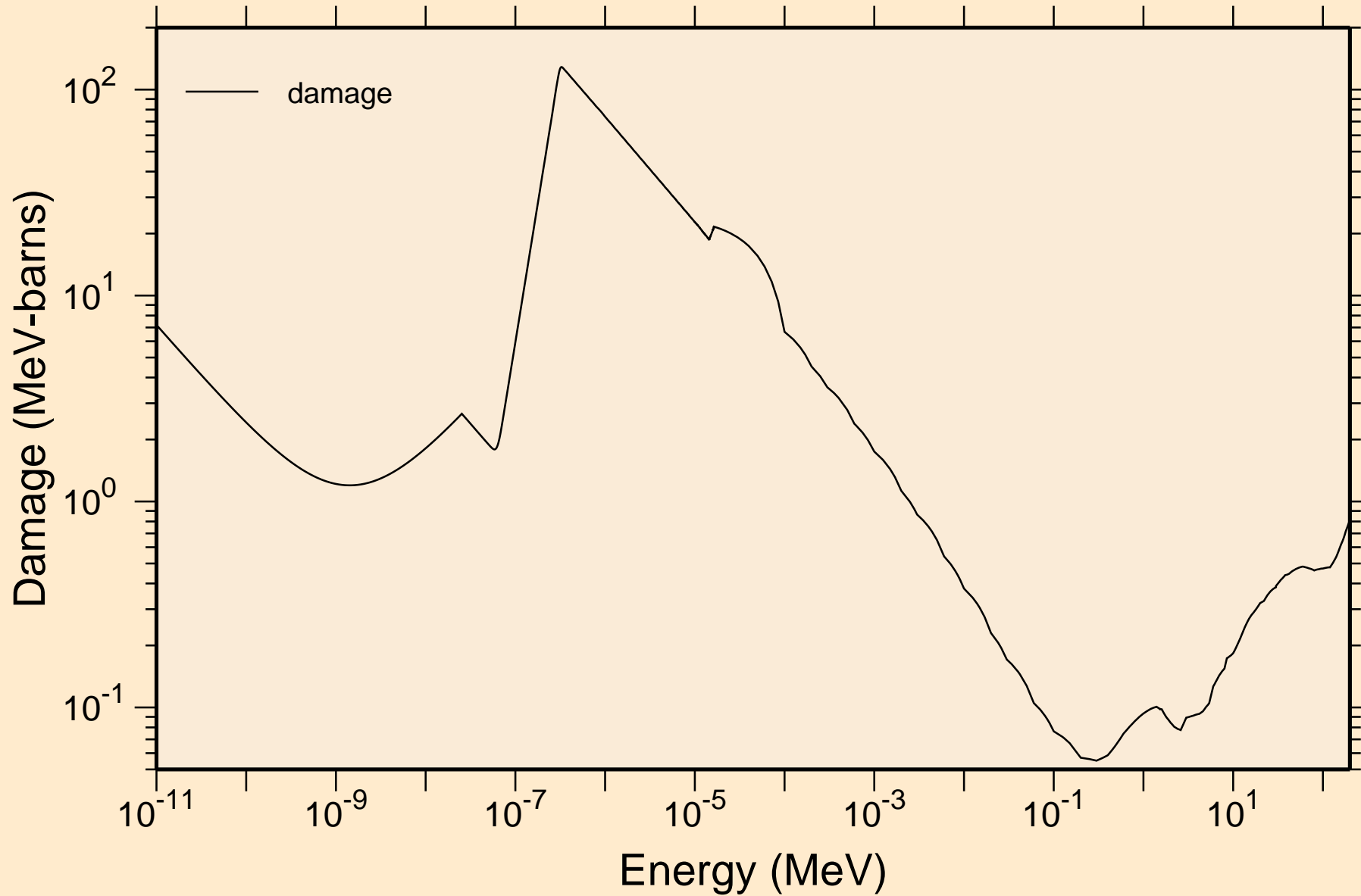

HO150 NEUTRON ACER TENDL-2021 LIBRARY; T=293.6K  
Non-threshold reactions

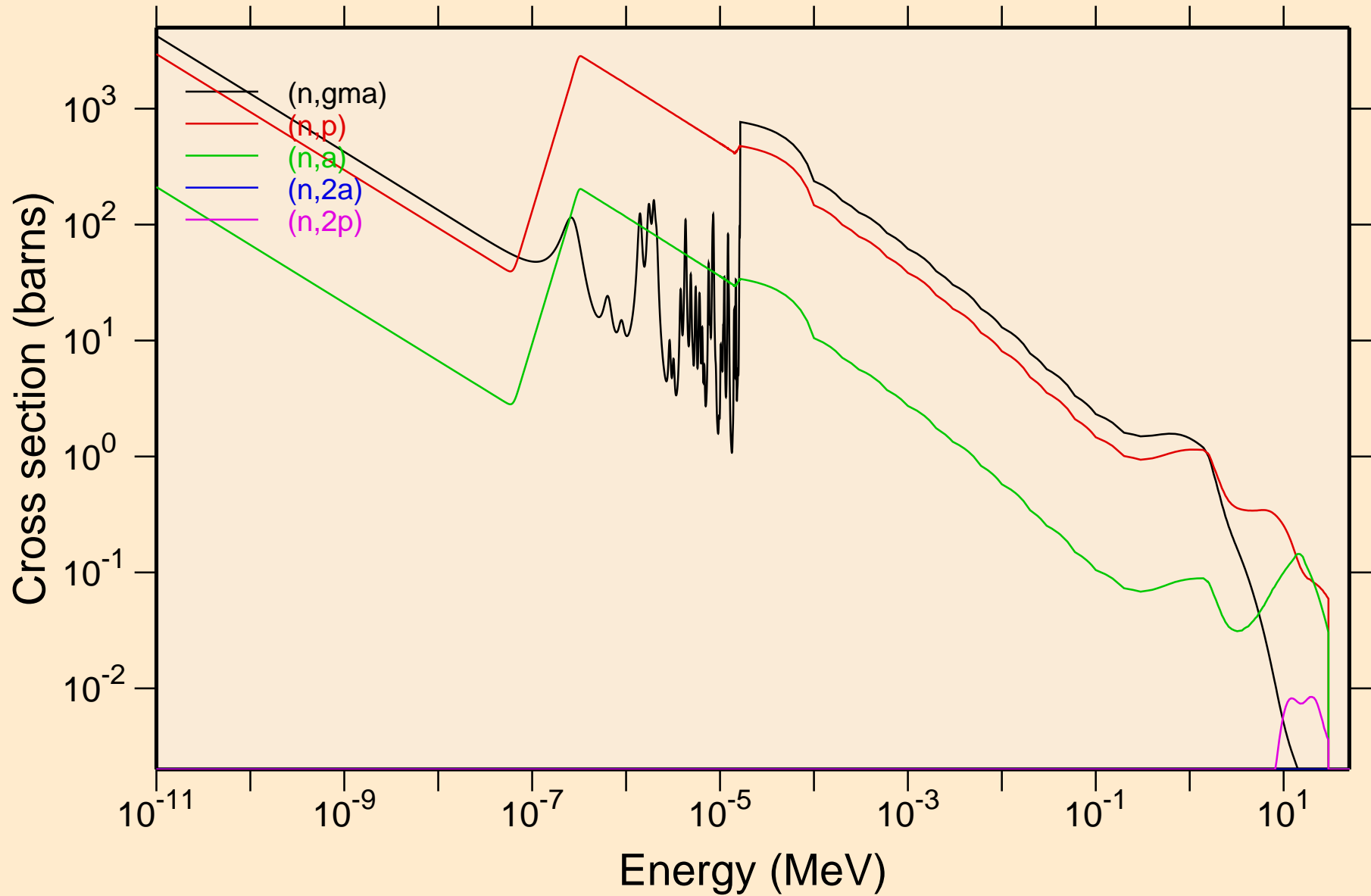

HO150 NEUTRON ACER TENDL-2021 LIBRARY; T=293.6K  
Non-threshold reactions

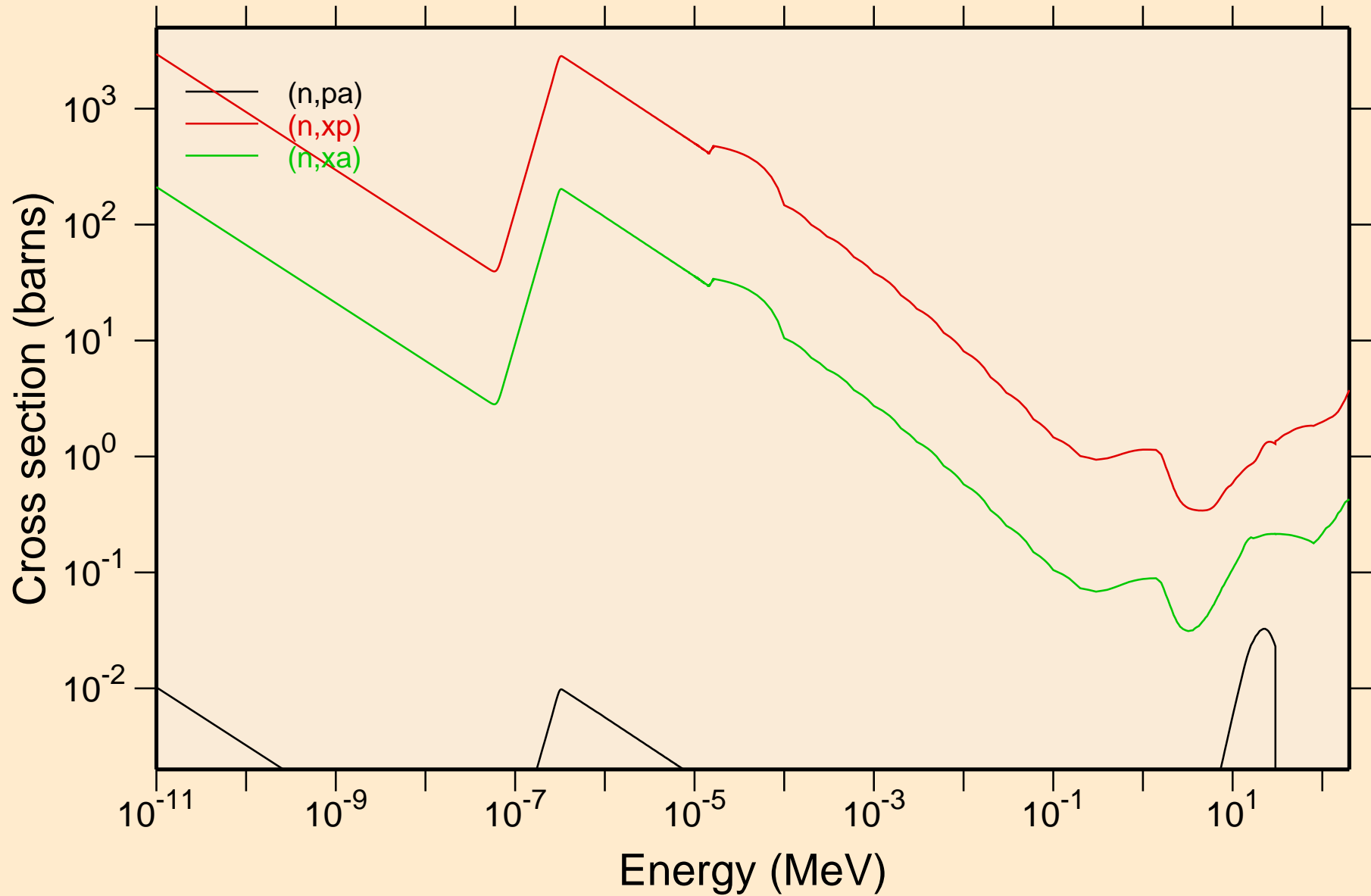

HO150 NEUTRON ACER TENDL-2021 LIBRARY; T=293.6K  
Principal cross sections

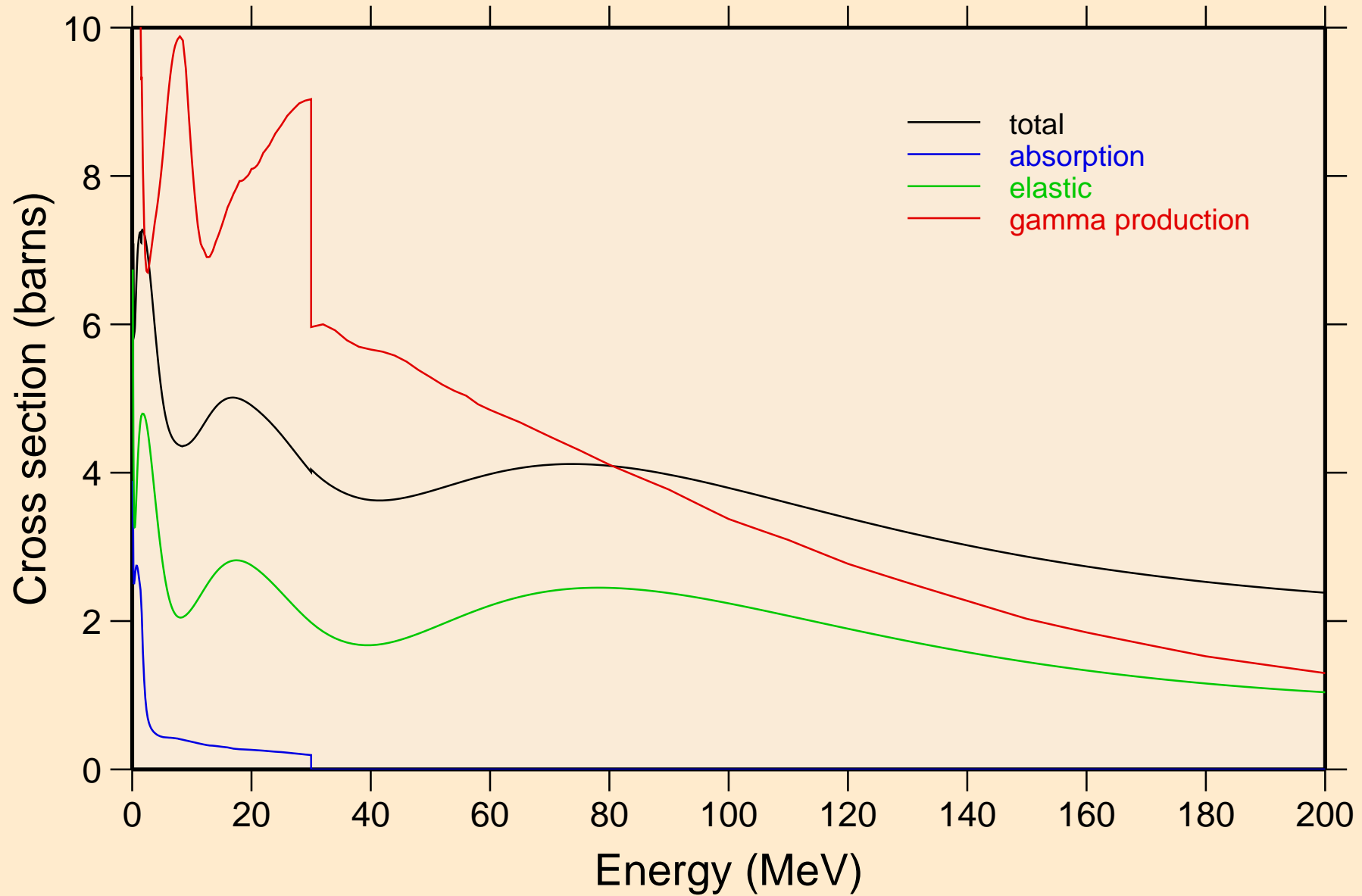

HO150 NEUTRON ACER TENDL-2021 LIBRARY; T=293.6K  
Heating

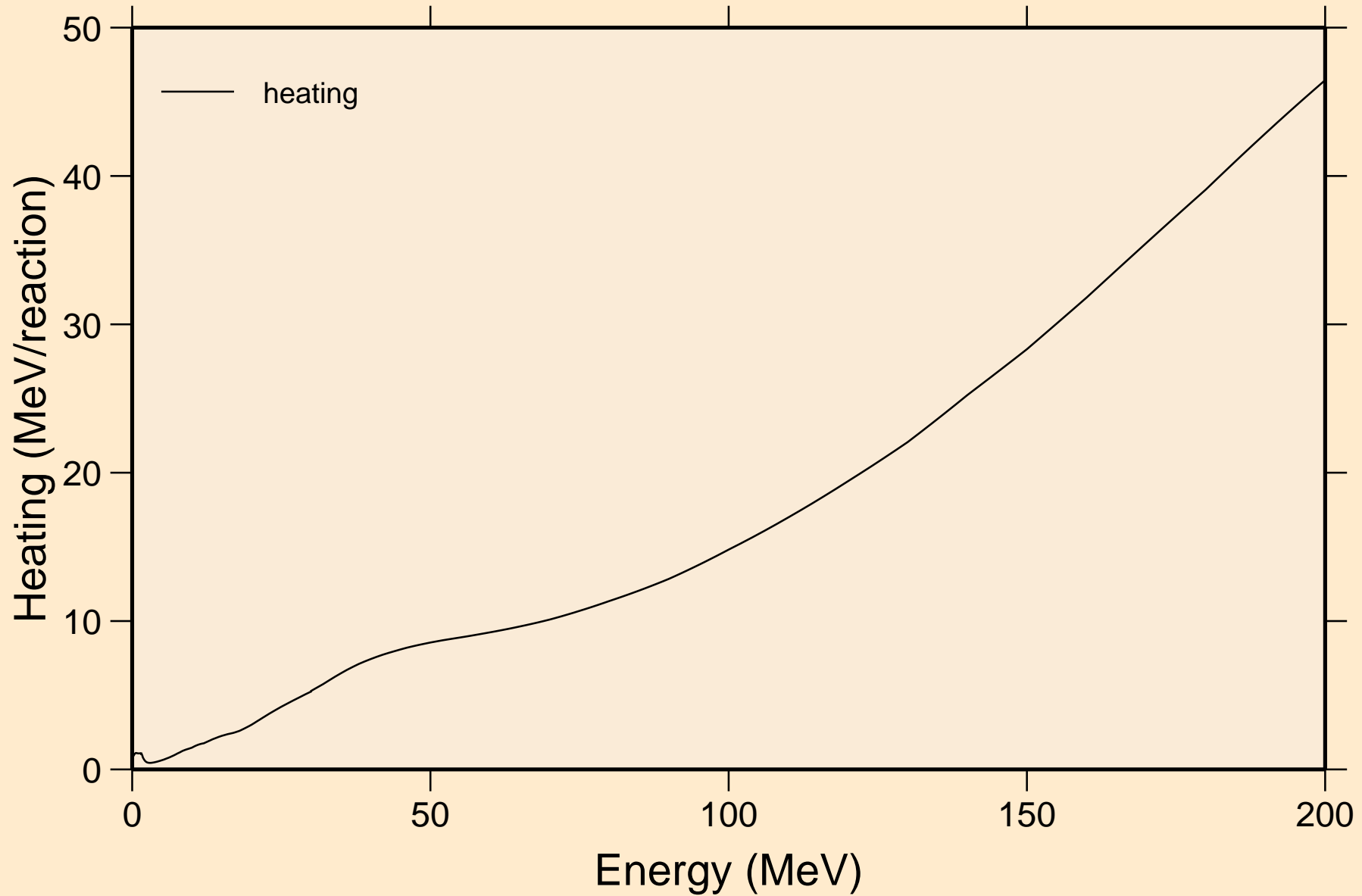



HO150 NEUTRON ACER TENDL-2021 LIBRARY; T=293.6K  
Damage

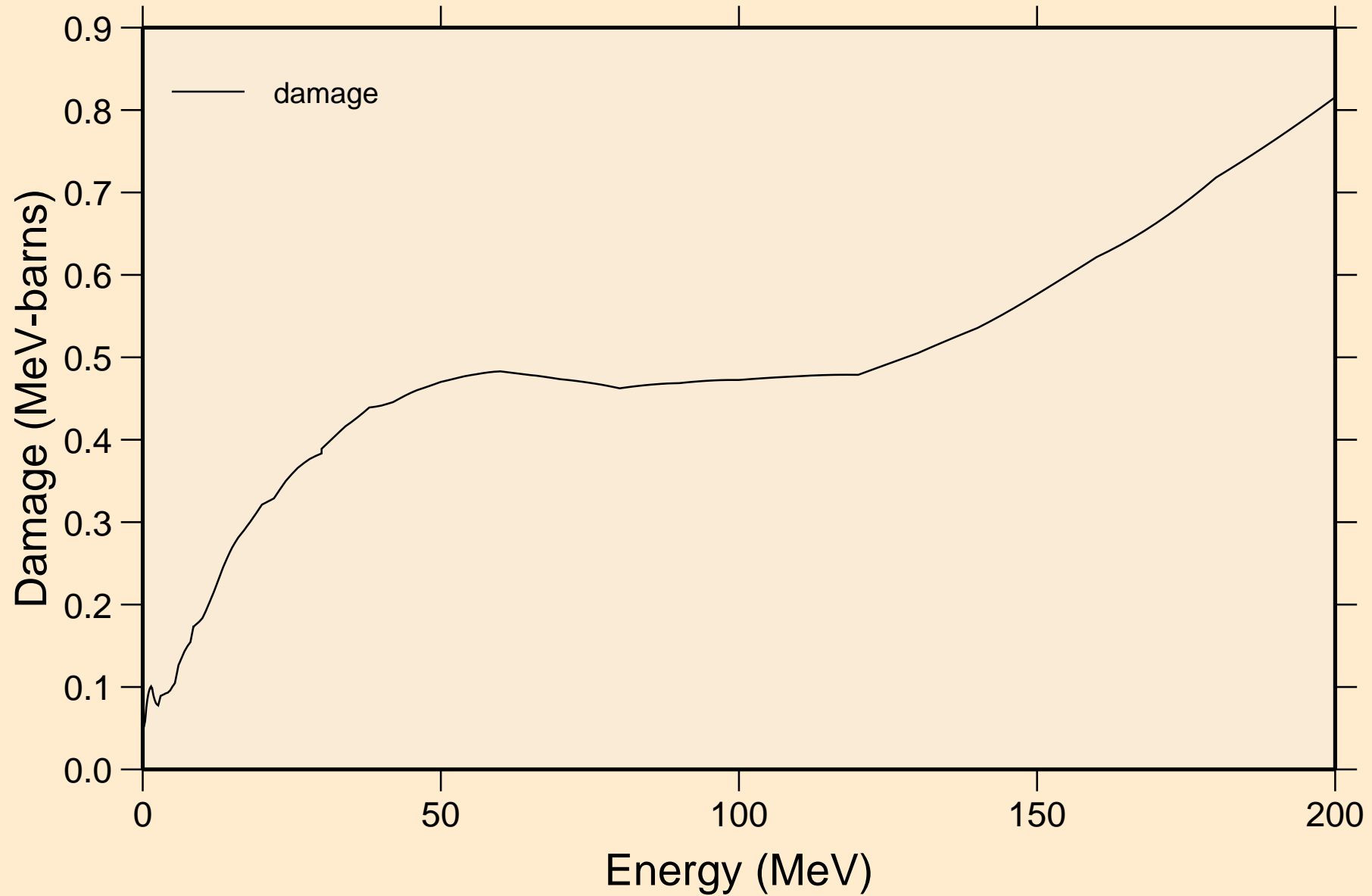

HO150 NEUTRON ACER TENDL-2021 LIBRARY; T=293.6K  
Non-threshold reactions

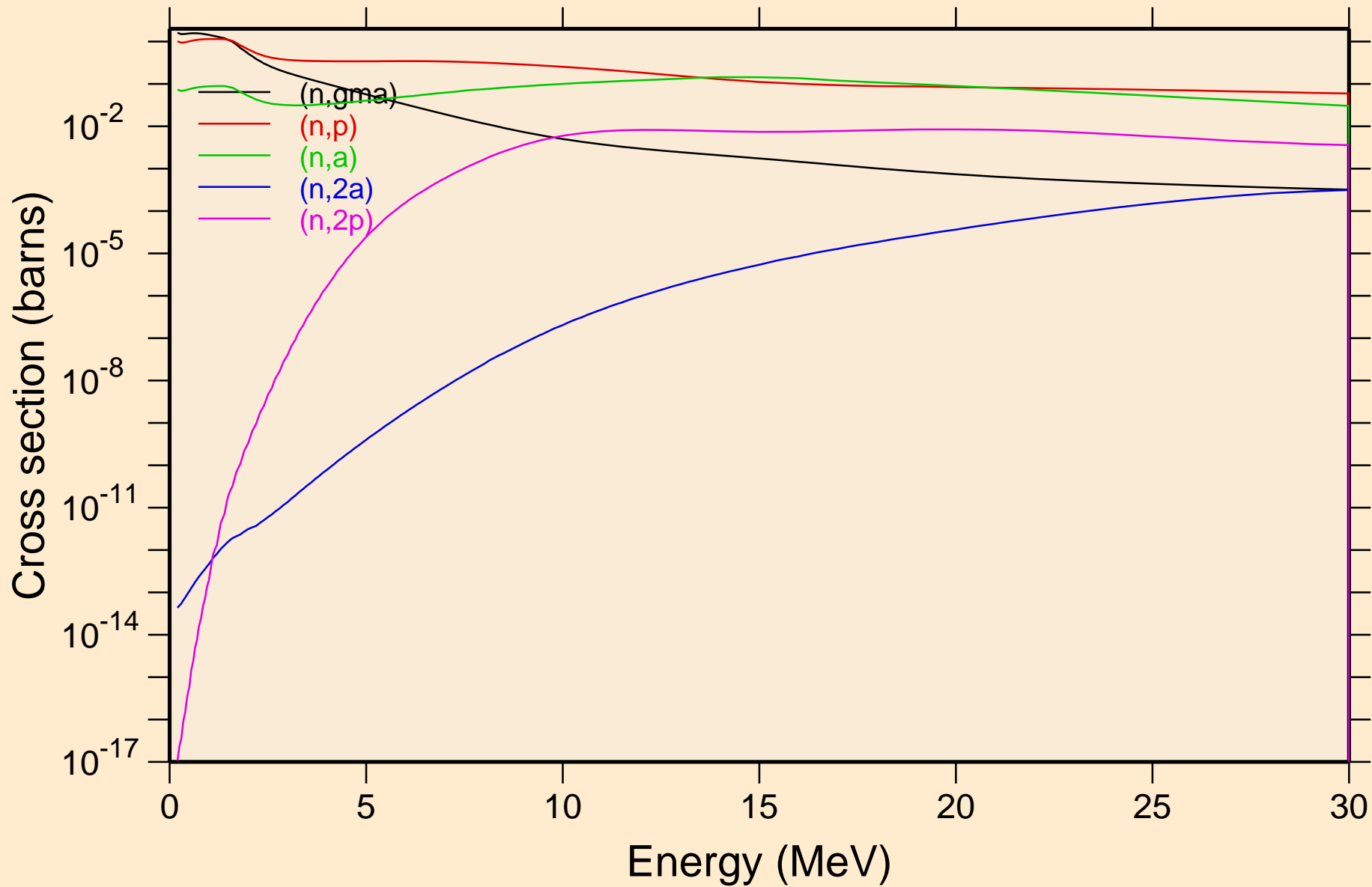

HO150 NEUTRON ACER TENDL-2021 LIBRARY; T=293.6K  
Non-threshold reactions

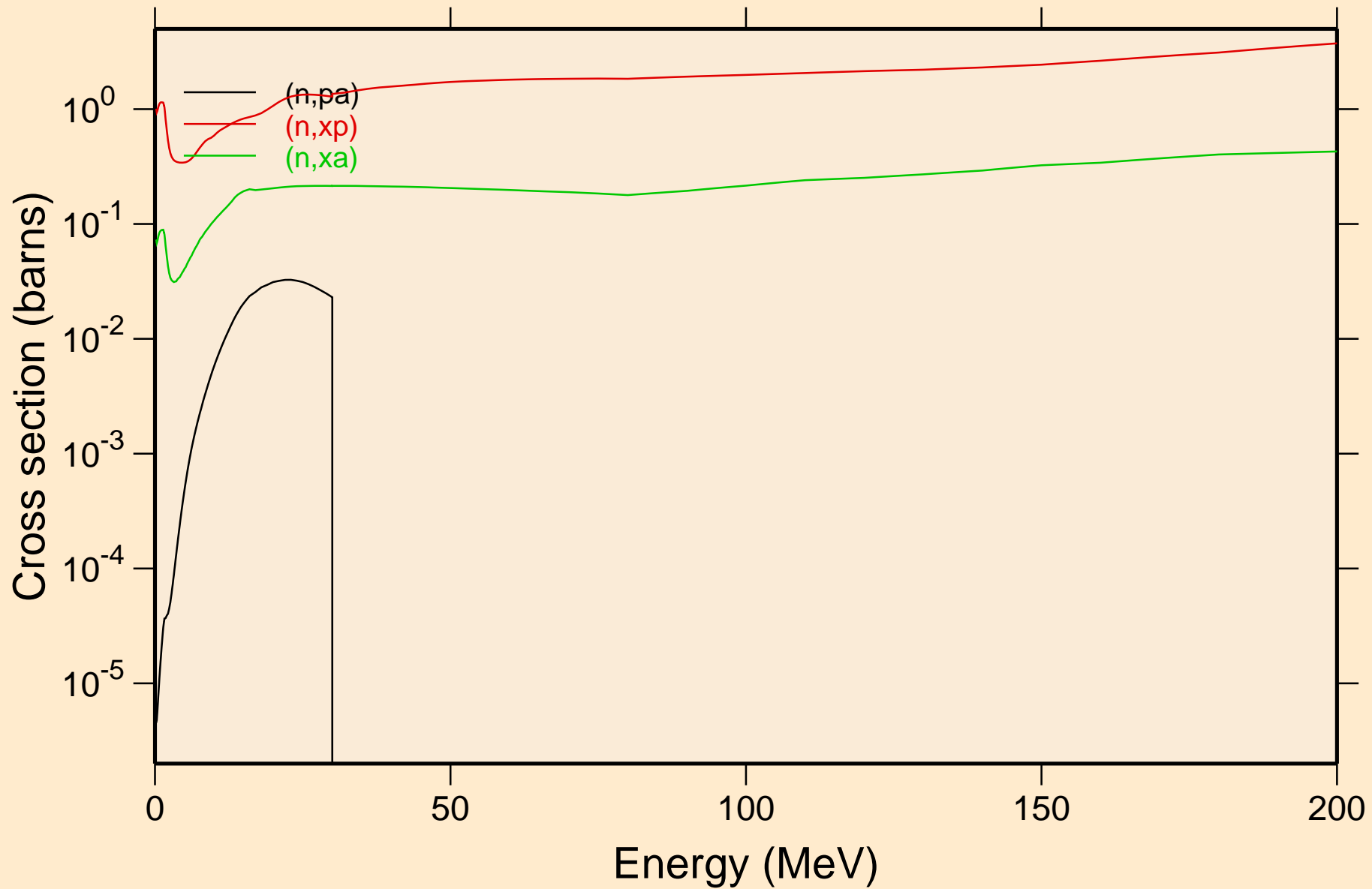

HO150 NEUTRON ACER TENDL-2021 LIBRARY; T=293.6K  
Inelastic levels

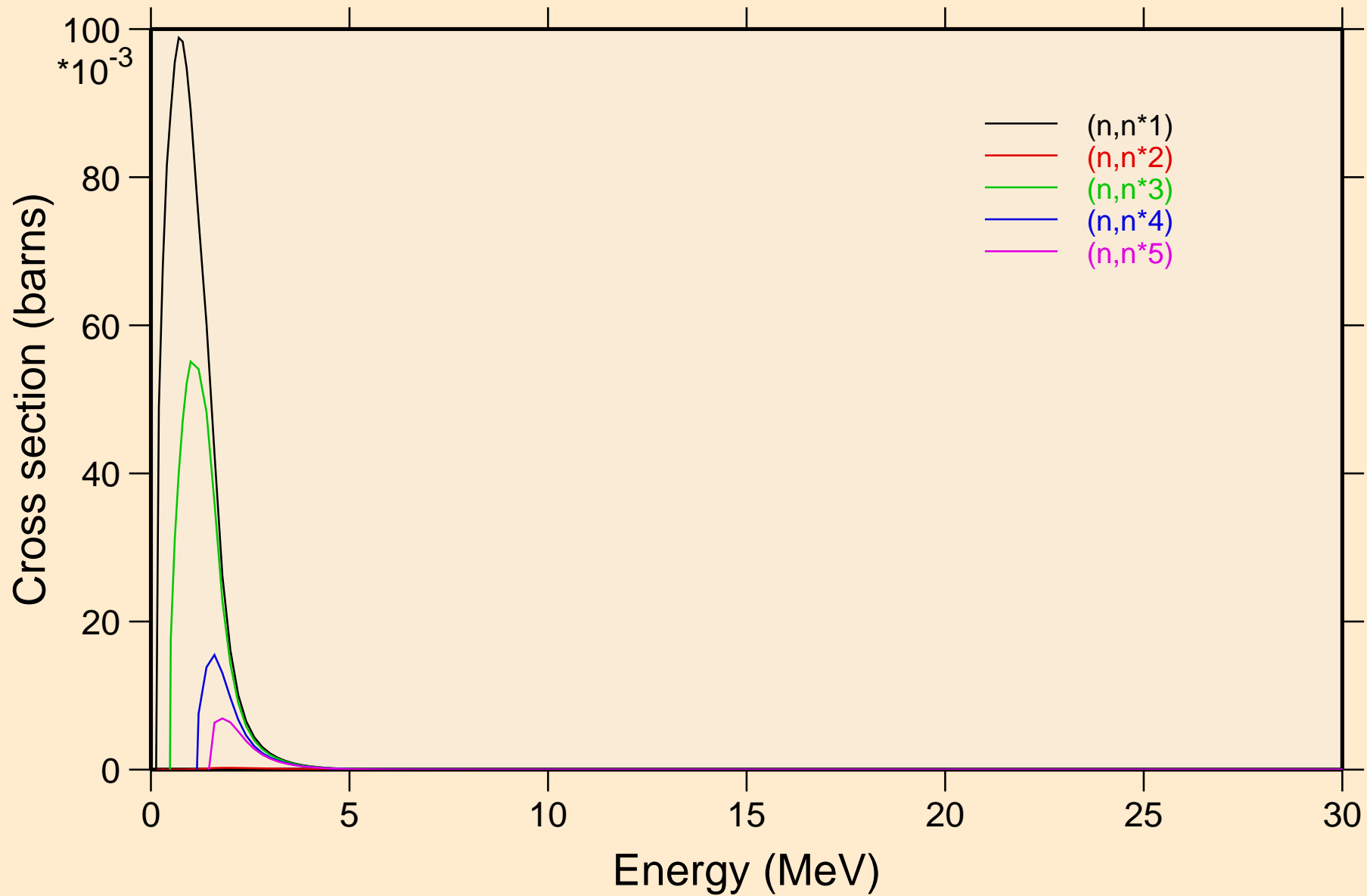

HO150 NEUTRON ACER TENDL-2021 LIBRARY; T=293.6K  
Inelastic levels

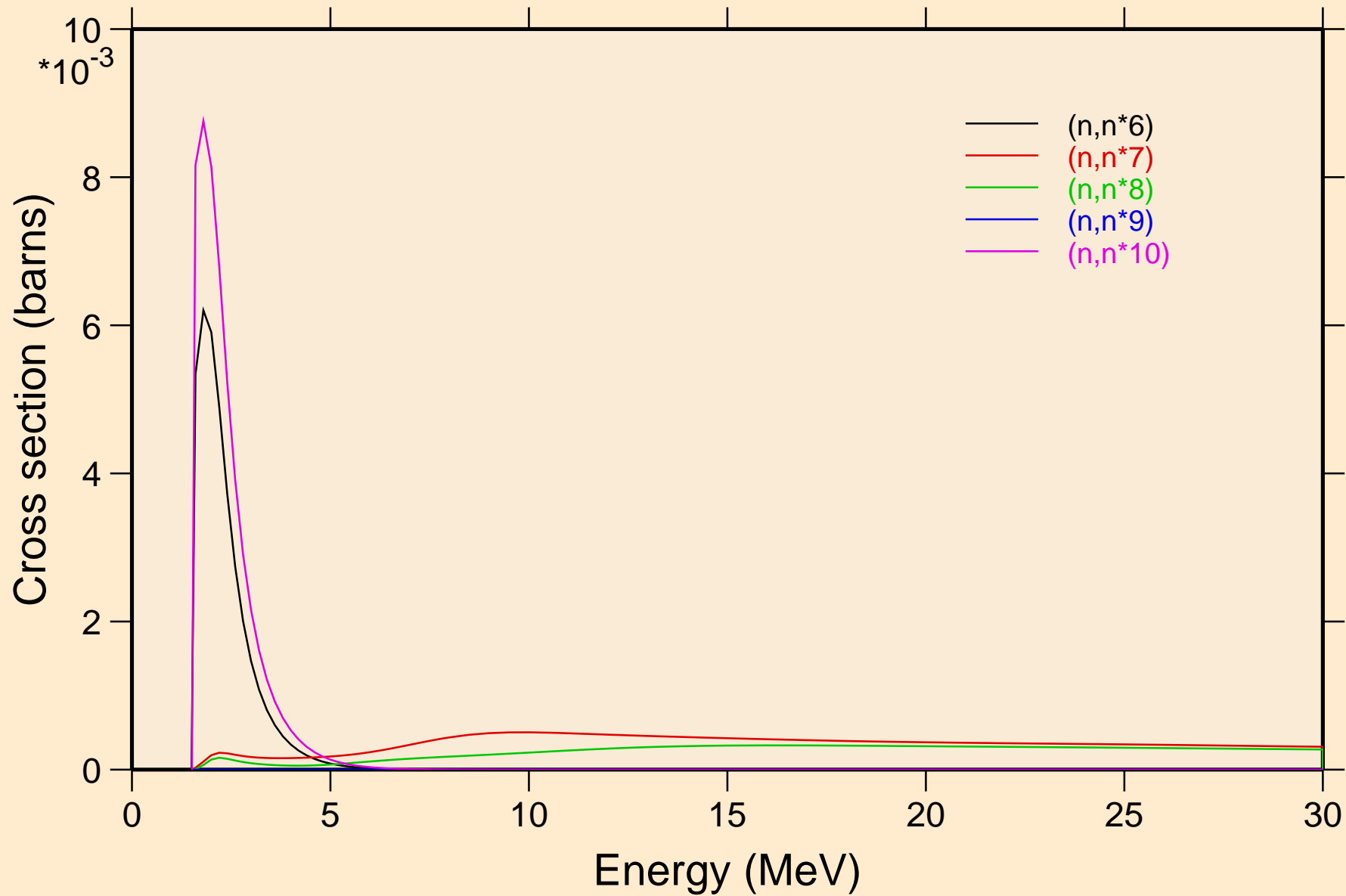

HO150 NEUTRON ACER TENDL-2021 LIBRARY; T=293.6K  
Inelastic levels

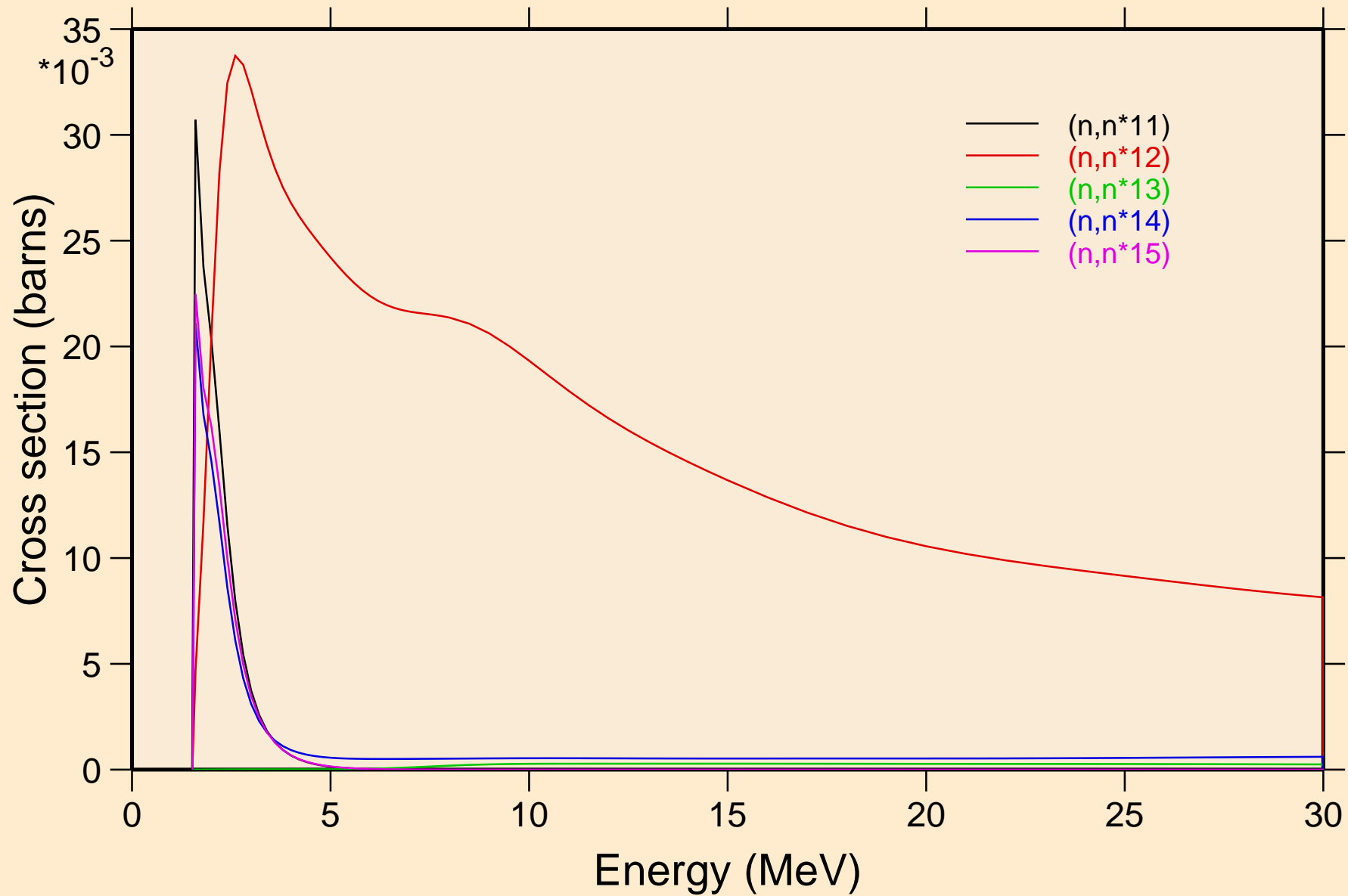

HO150 NEUTRON ACER TENDL-2021 LIBRARY; T=293.6K  
Inelastic levels

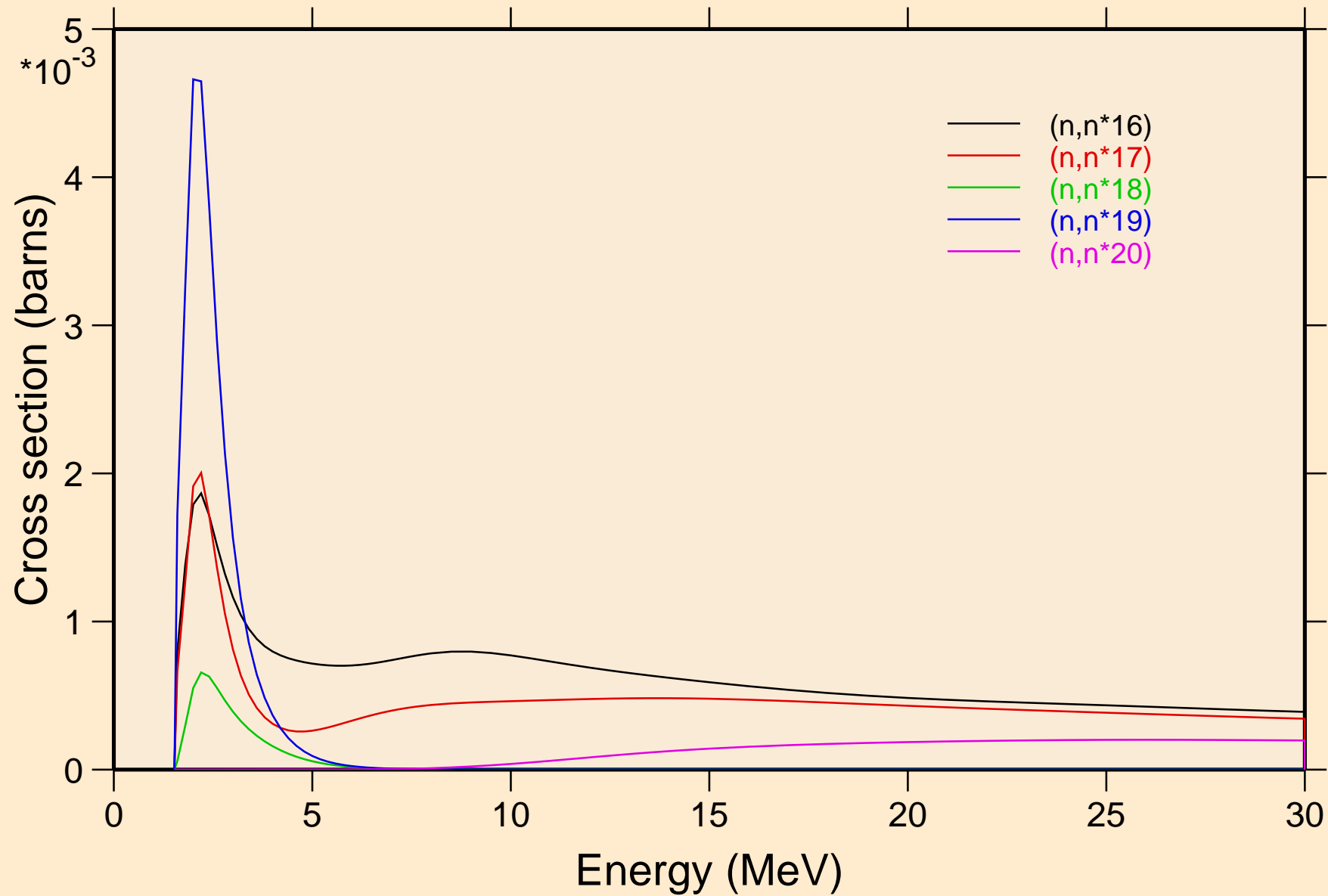

HO150 NEUTRON ACER TENDL-2021 LIBRARY; T=293.6K  
Inelastic levels

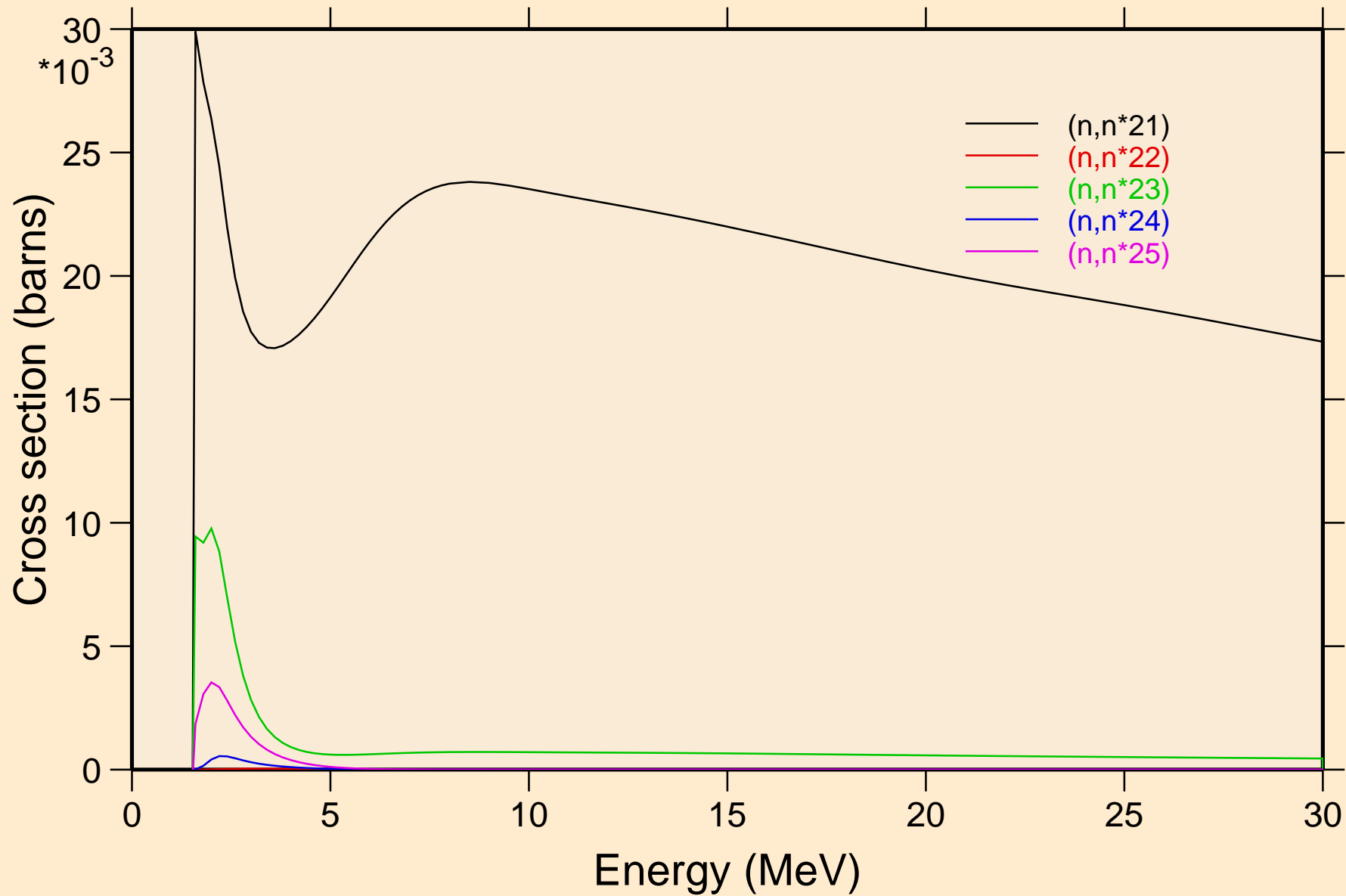



HO150 NEUTRON ACER TENDL-2021 LIBRARY; T=293.6K  
Inelastic levels

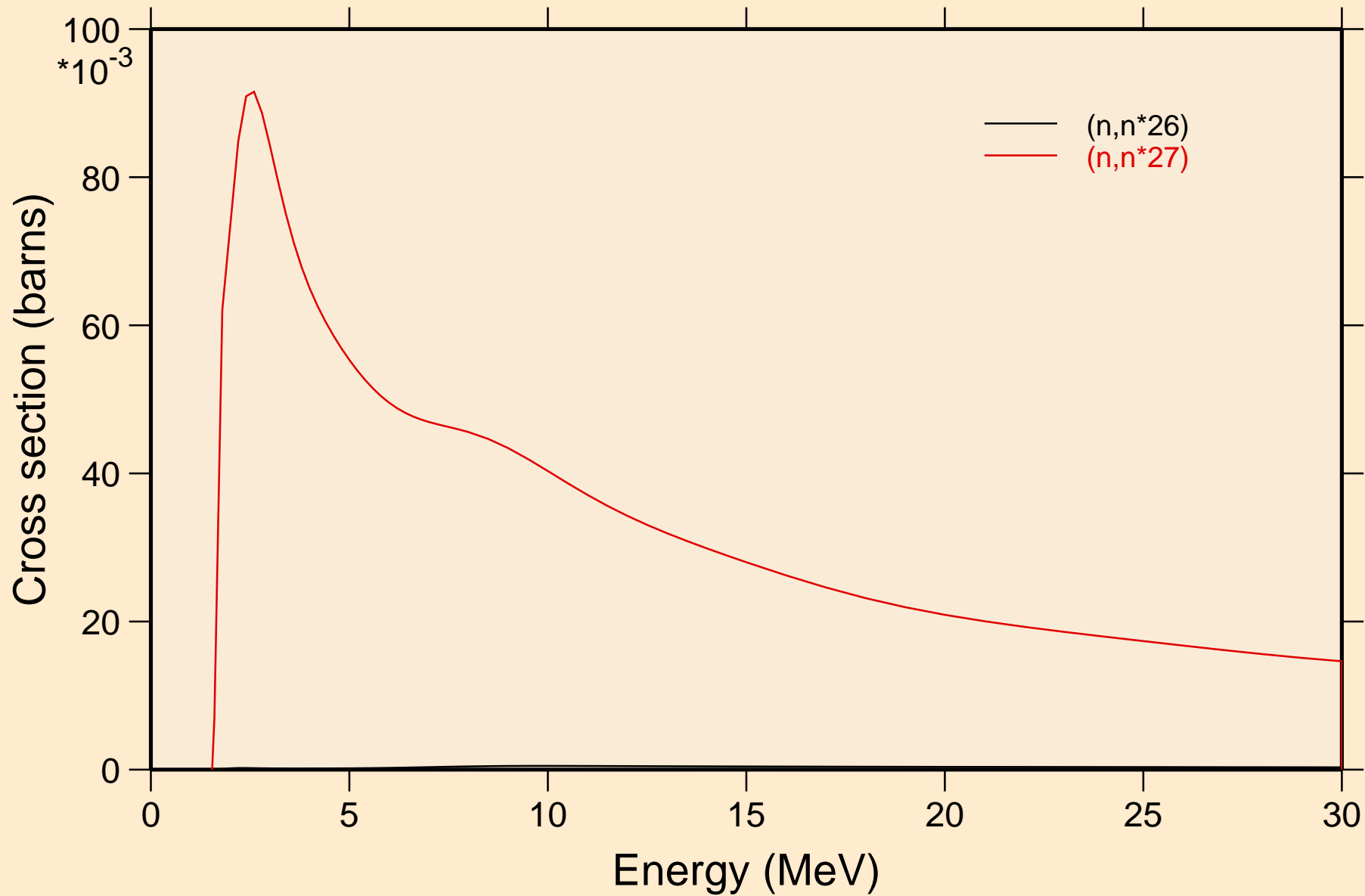

# HO150 NEUTRON ACER TENDL-2021 LIBRARY; T=293.6K

## Threshold reactions

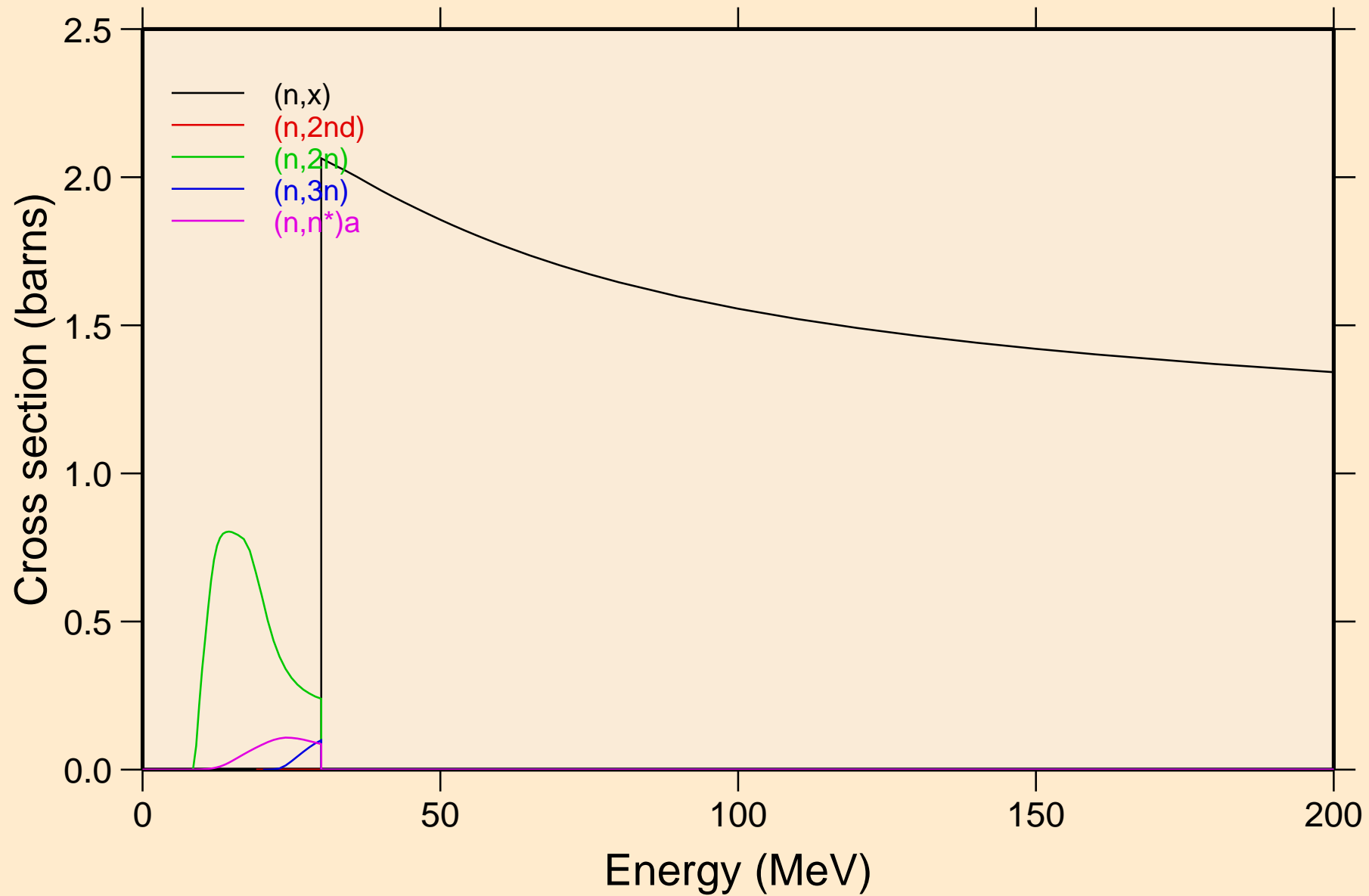

# HO150 NEUTRON ACER TENDL-2021 LIBRARY; T=293.6K

## Threshold reactions

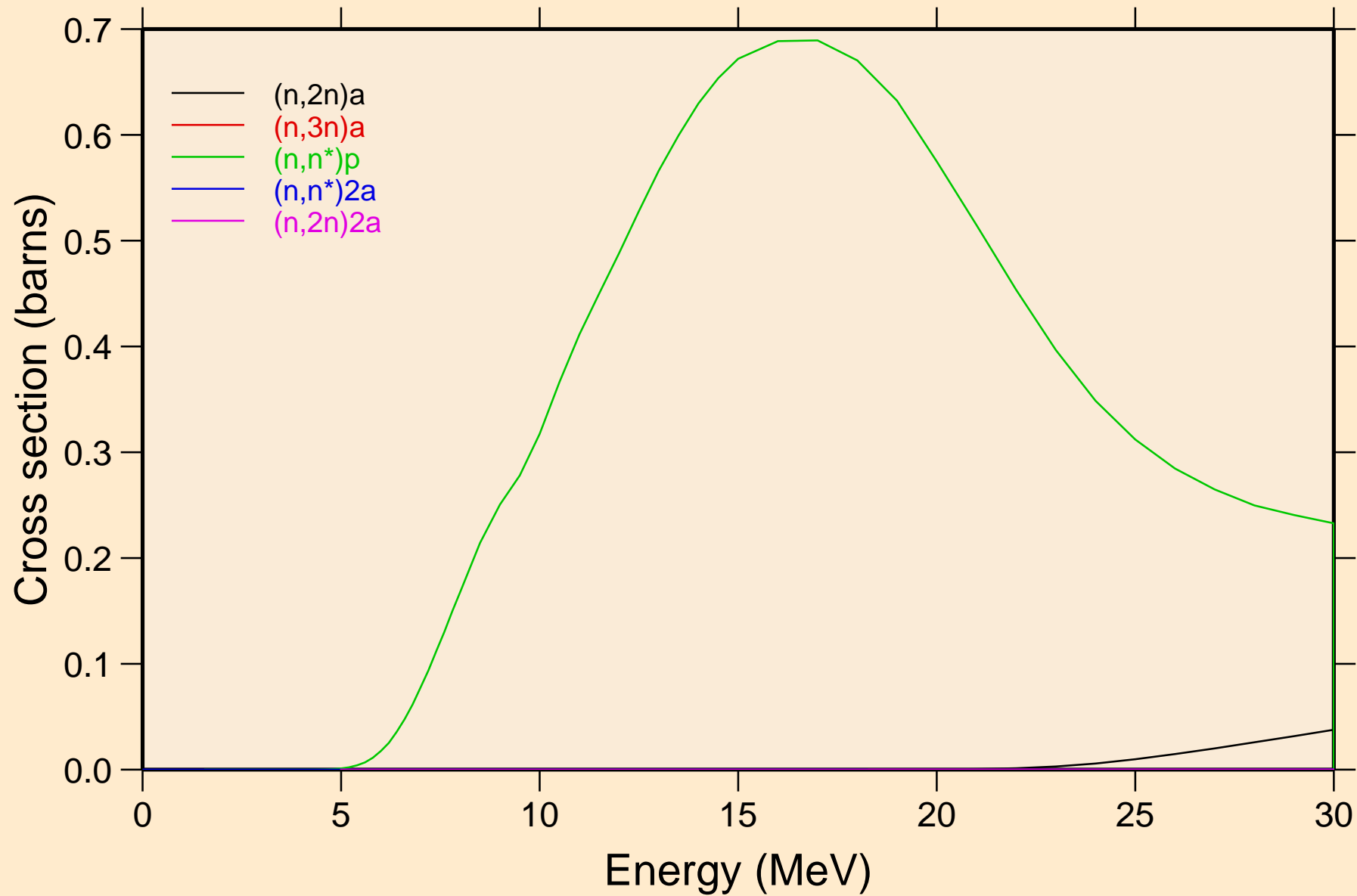

HO150 NEUTRON ACER TENDL-2021 LIBRARY; T=293.6K  
Threshold reactions

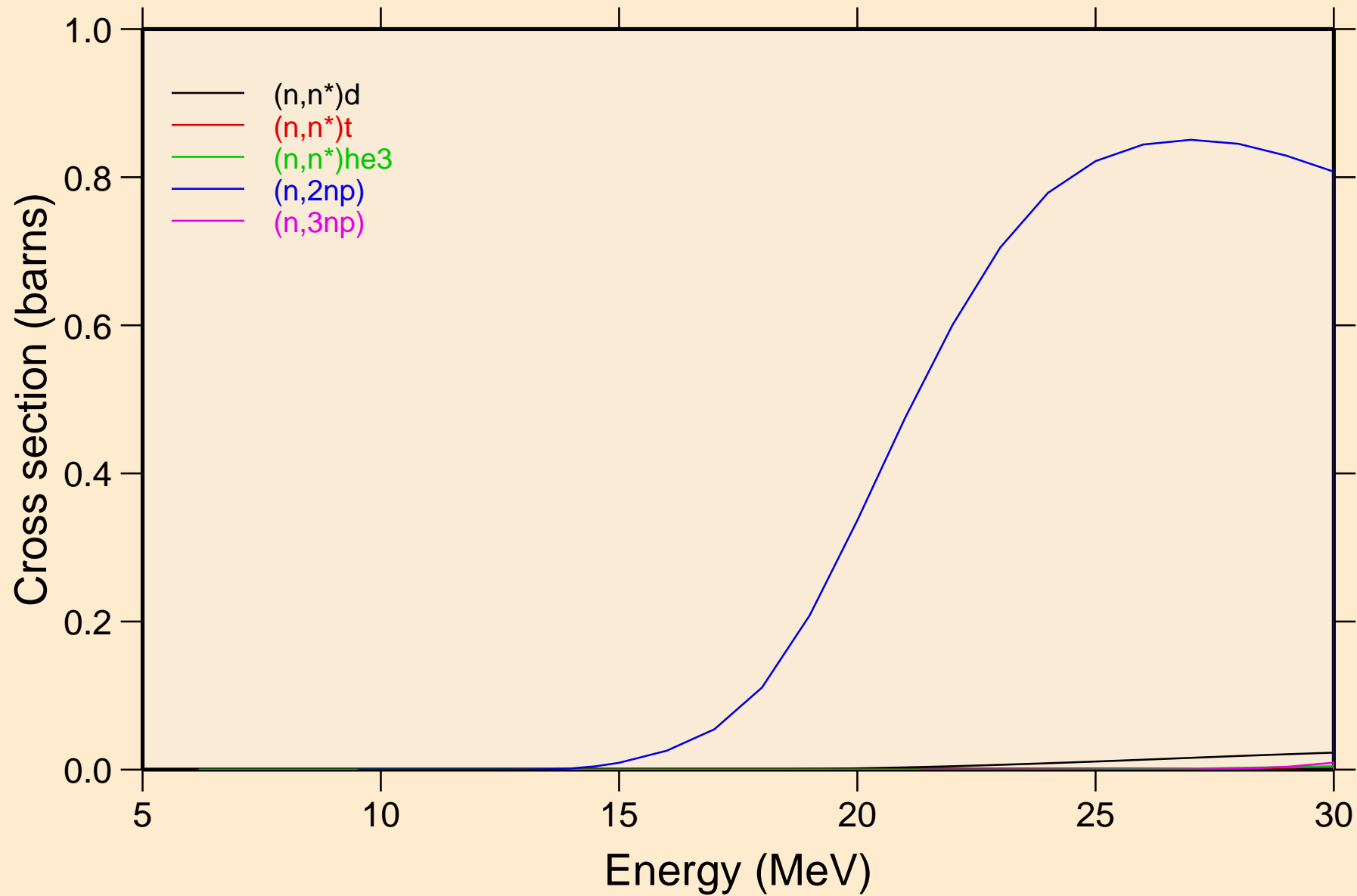

# HO150 NEUTRON ACER TENDL-2021 LIBRARY; T=293.6K

## Threshold reactions

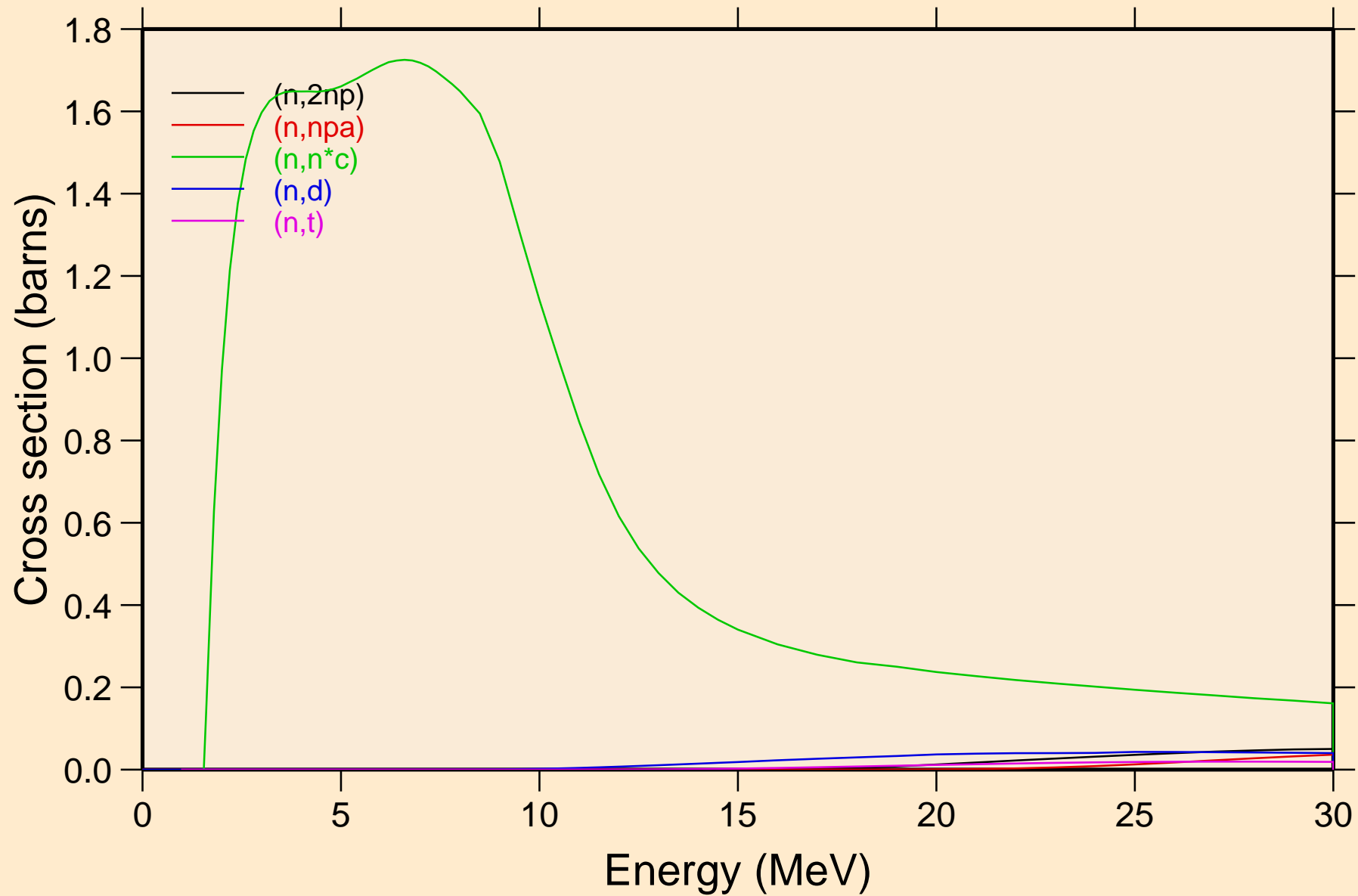

HO150 NEUTRON ACER TENDL-2021 LIBRARY; T=293.6K  
Threshold reactions

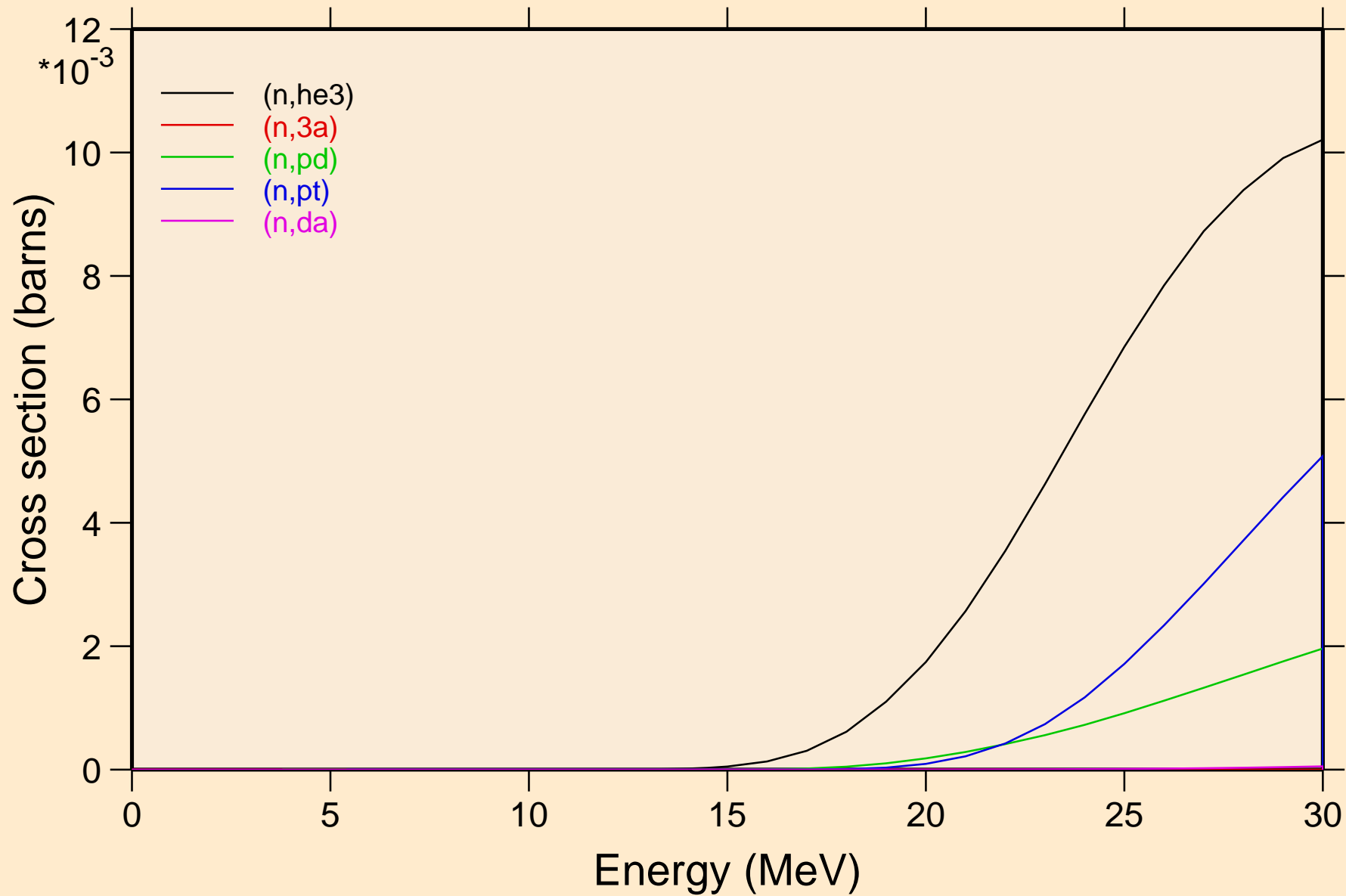

# HO150 NEUTRON ACER TENDL-2021 LIBRARY; T=293.6K

## Threshold reactions

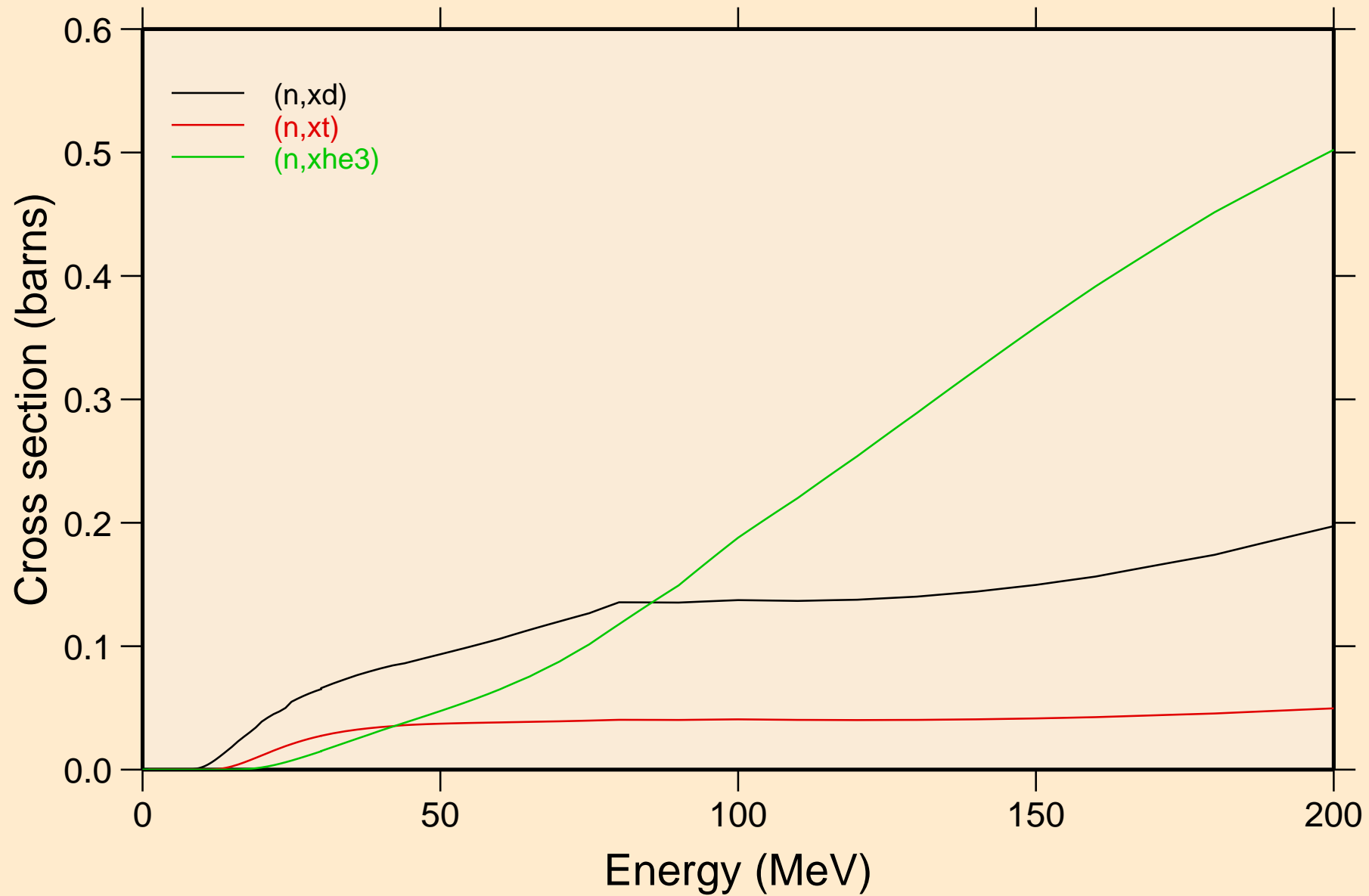

HO150 NEUTRON ACER TENDL-2021 LIBRARY; T=293.6K  
angular distribution for elastic

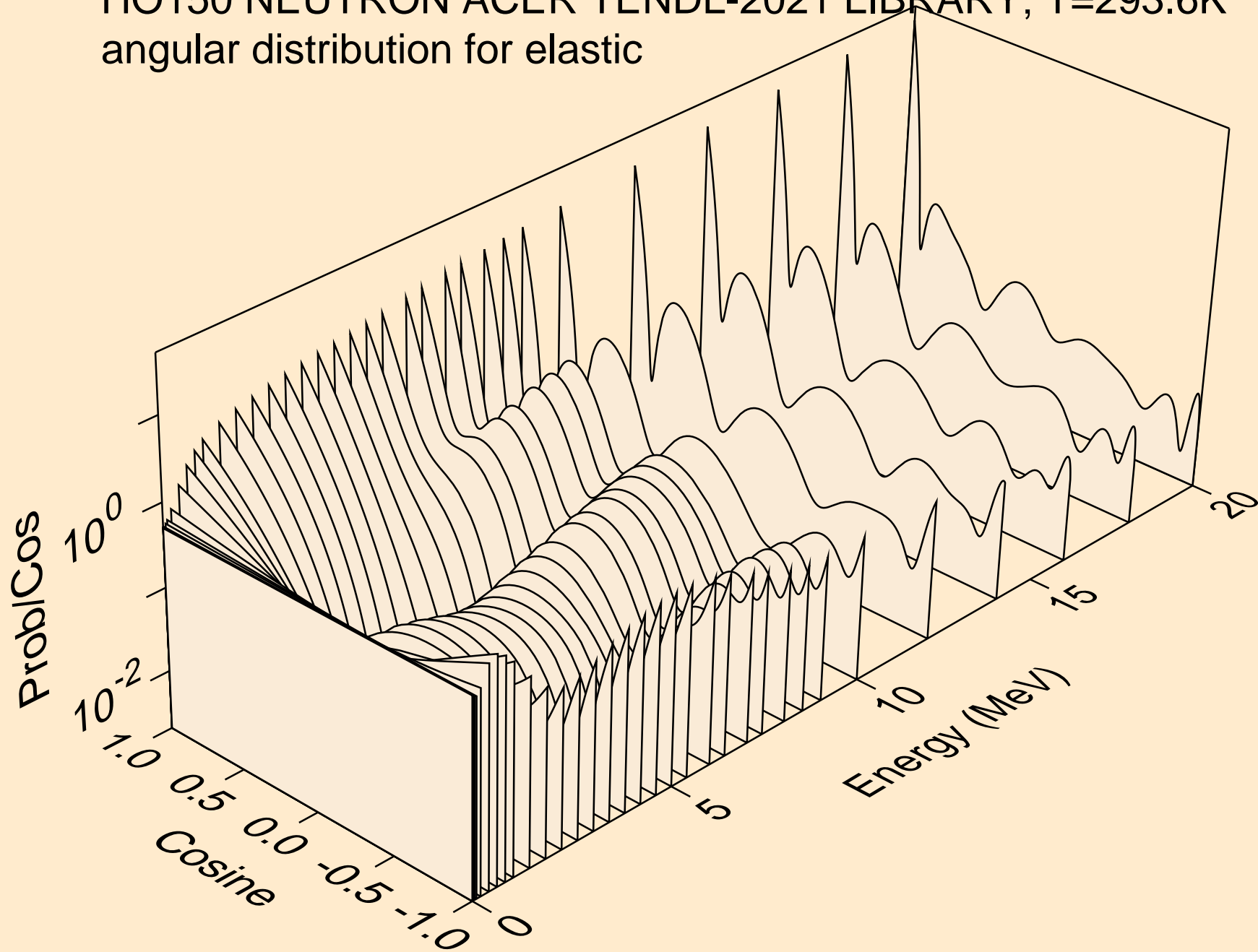



HO150 NEUTRON ACER TENDL-2021 LIBRARY; T=293.6K  
angular distribution for elastic

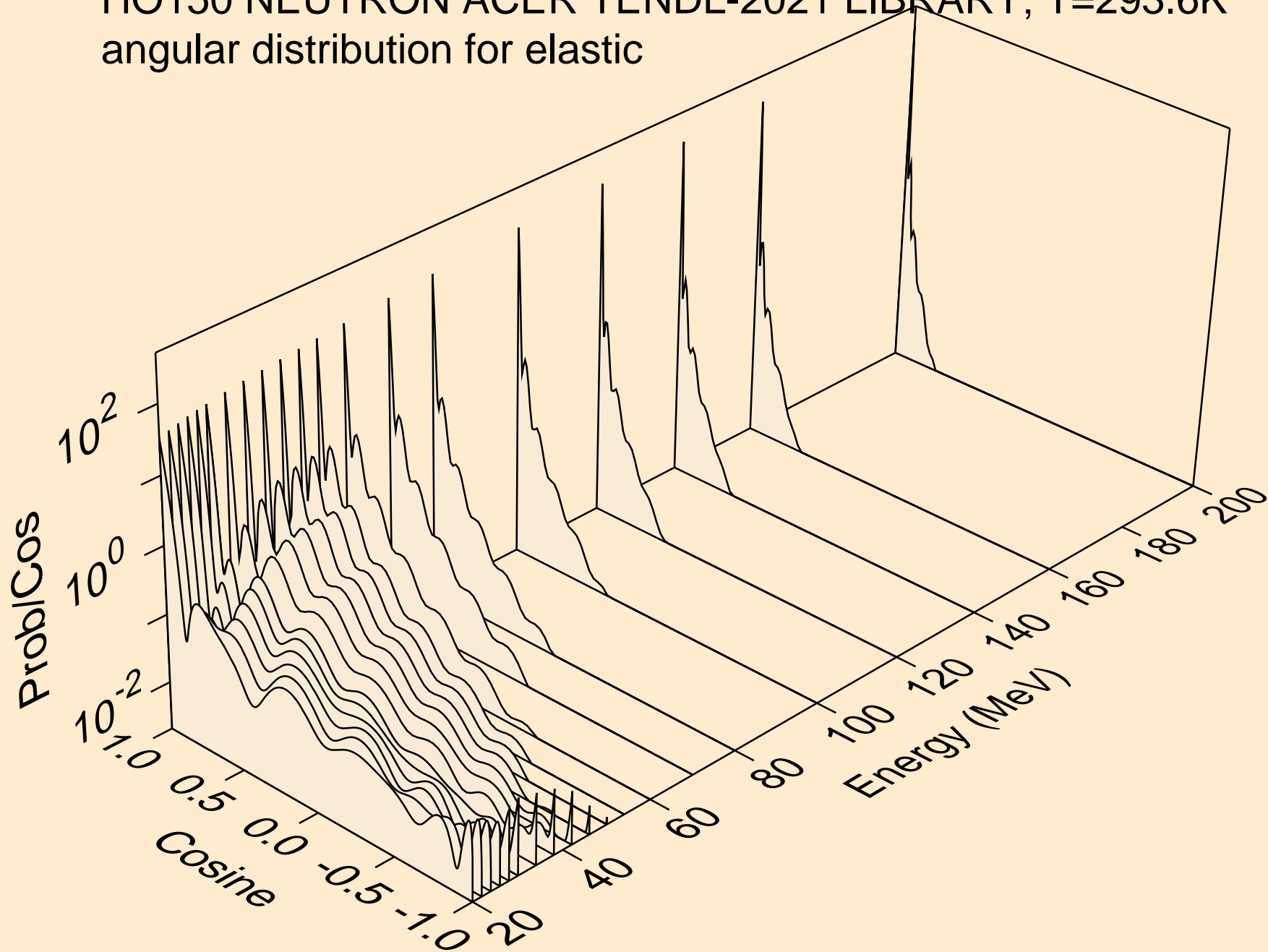

HO150 NEUTRON ACER TENDL-2021 LIBRARY; T=293.6K  
angular distribution for (n,n\*1)

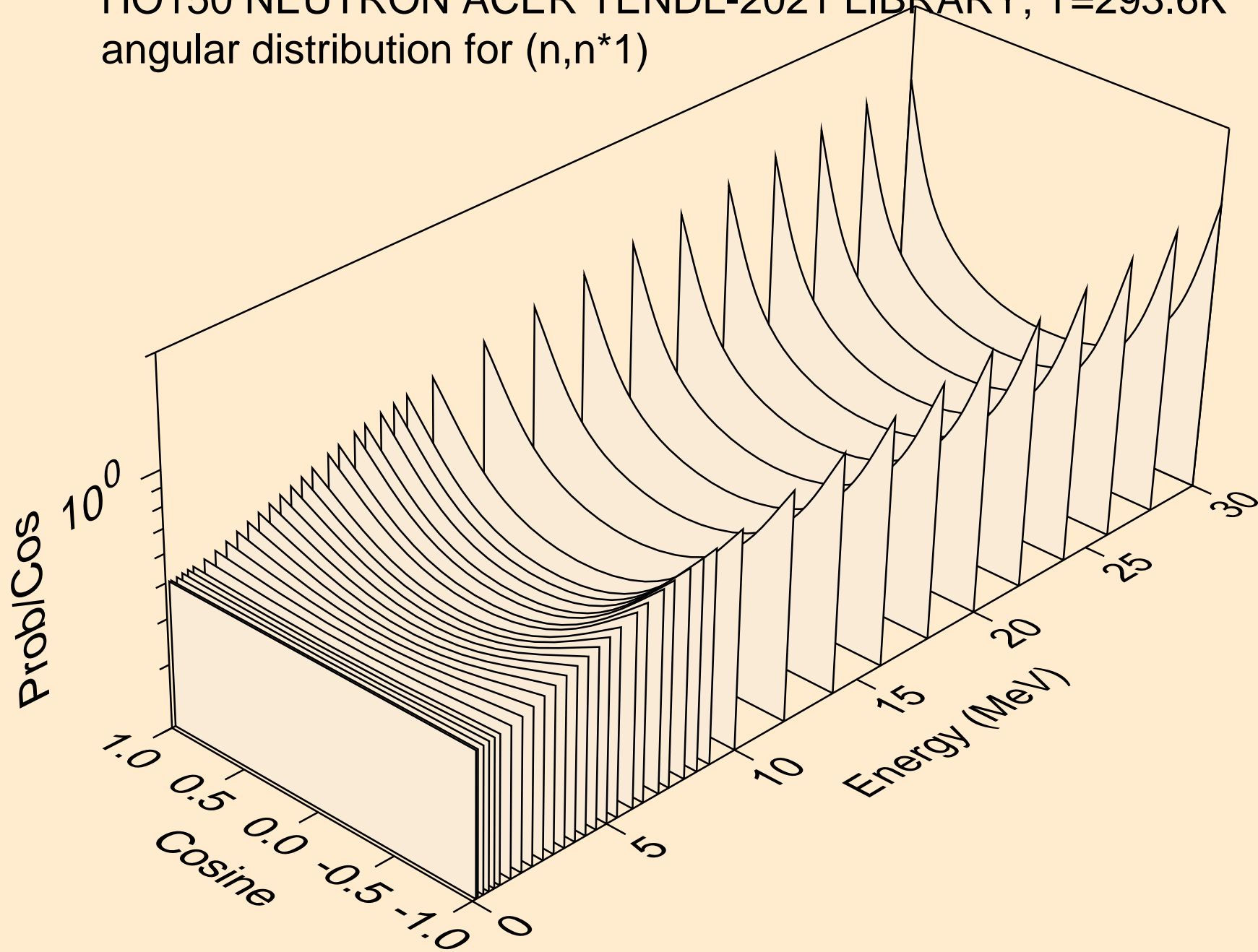

HO150 NEUTRON ACER TENDL-2021 LIBRARY; T=293.6K  
angular distribution for (n,n\*2)

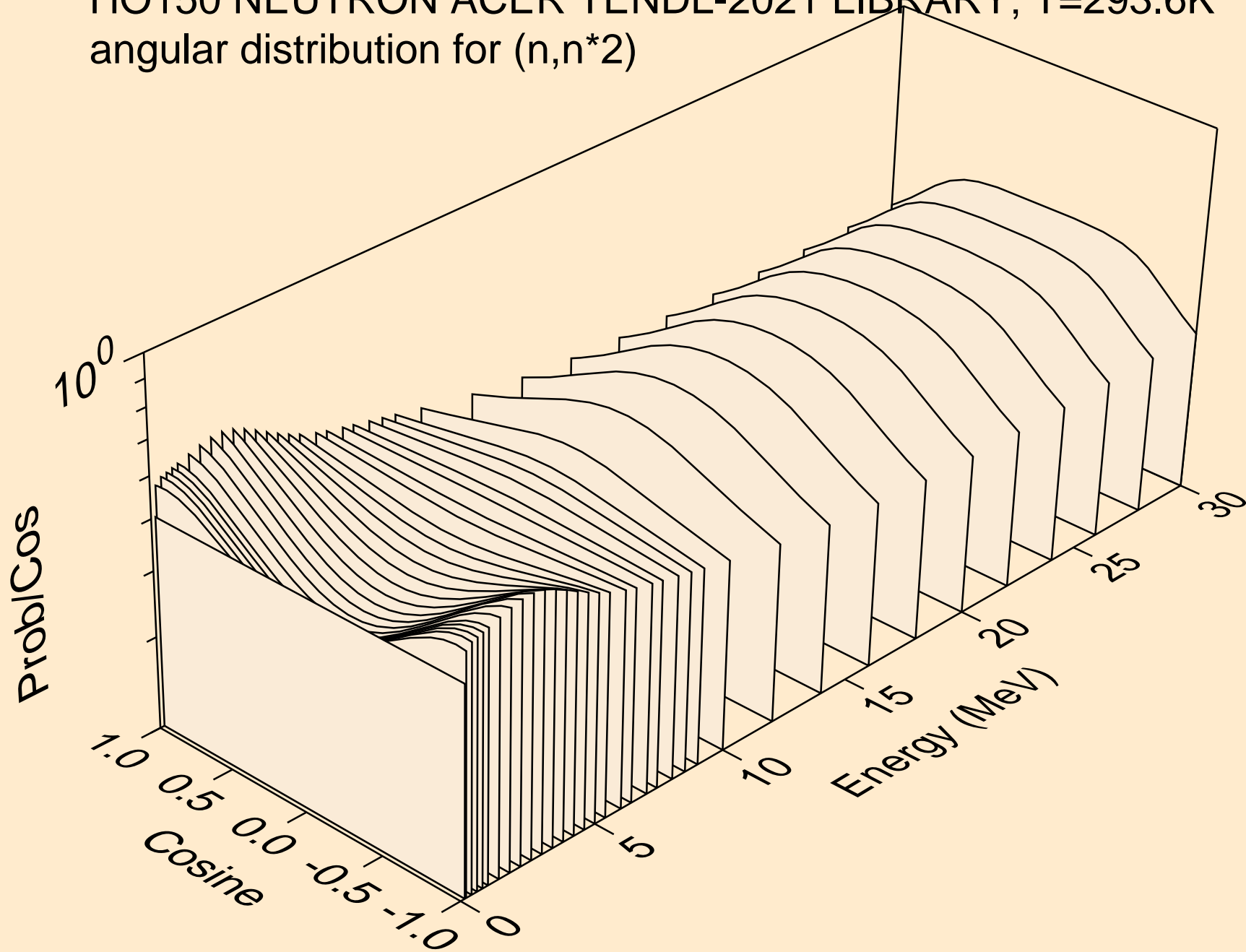

HO150 NEUTRON ACER TENDL-2021 LIBRARY; T=293.6K  
angular distribution for (n,n\*3)

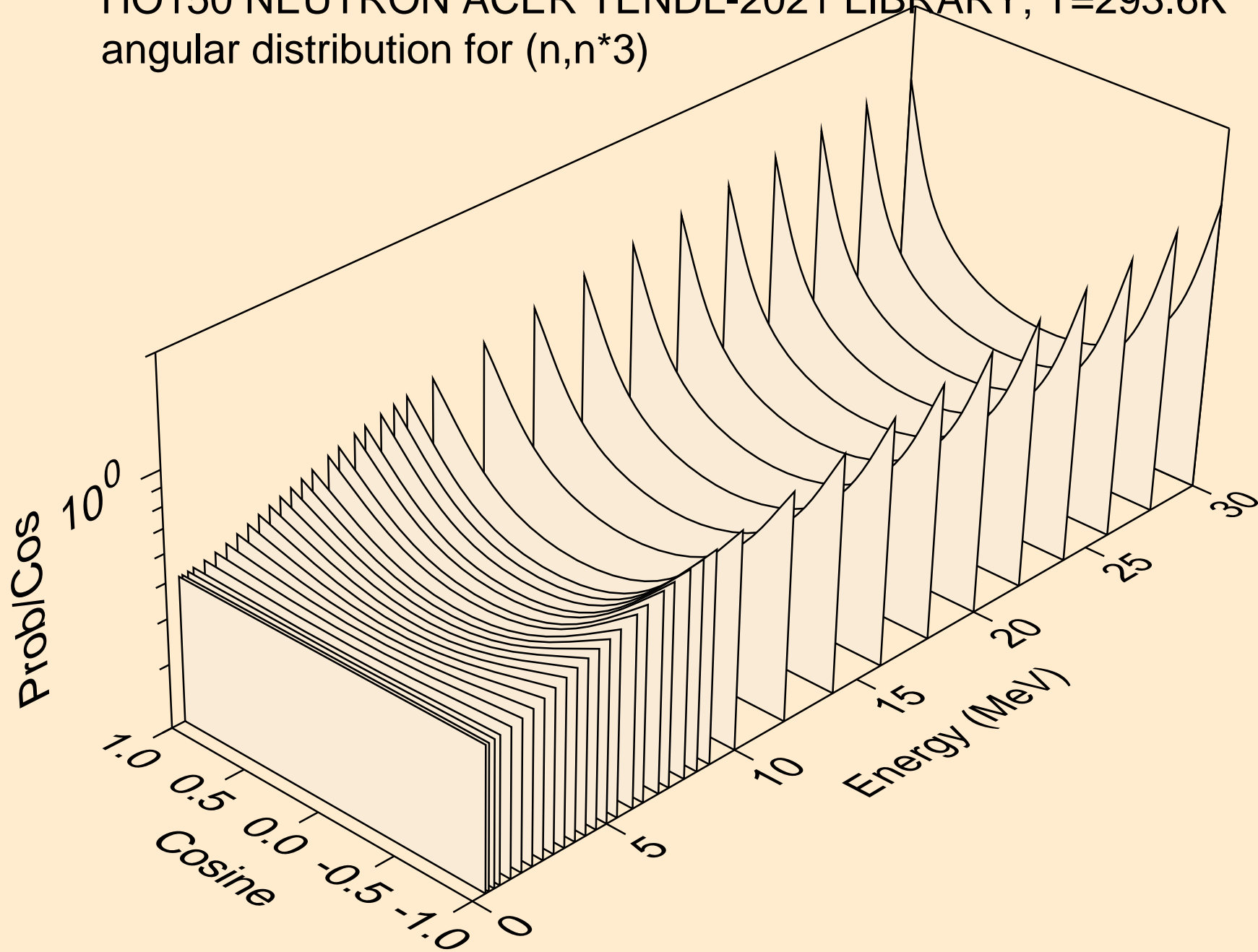

HO150 NEUTRON ACER TENDL-2021 LIBRARY; T=293.6K  
angular distribution for (n,n\*4)

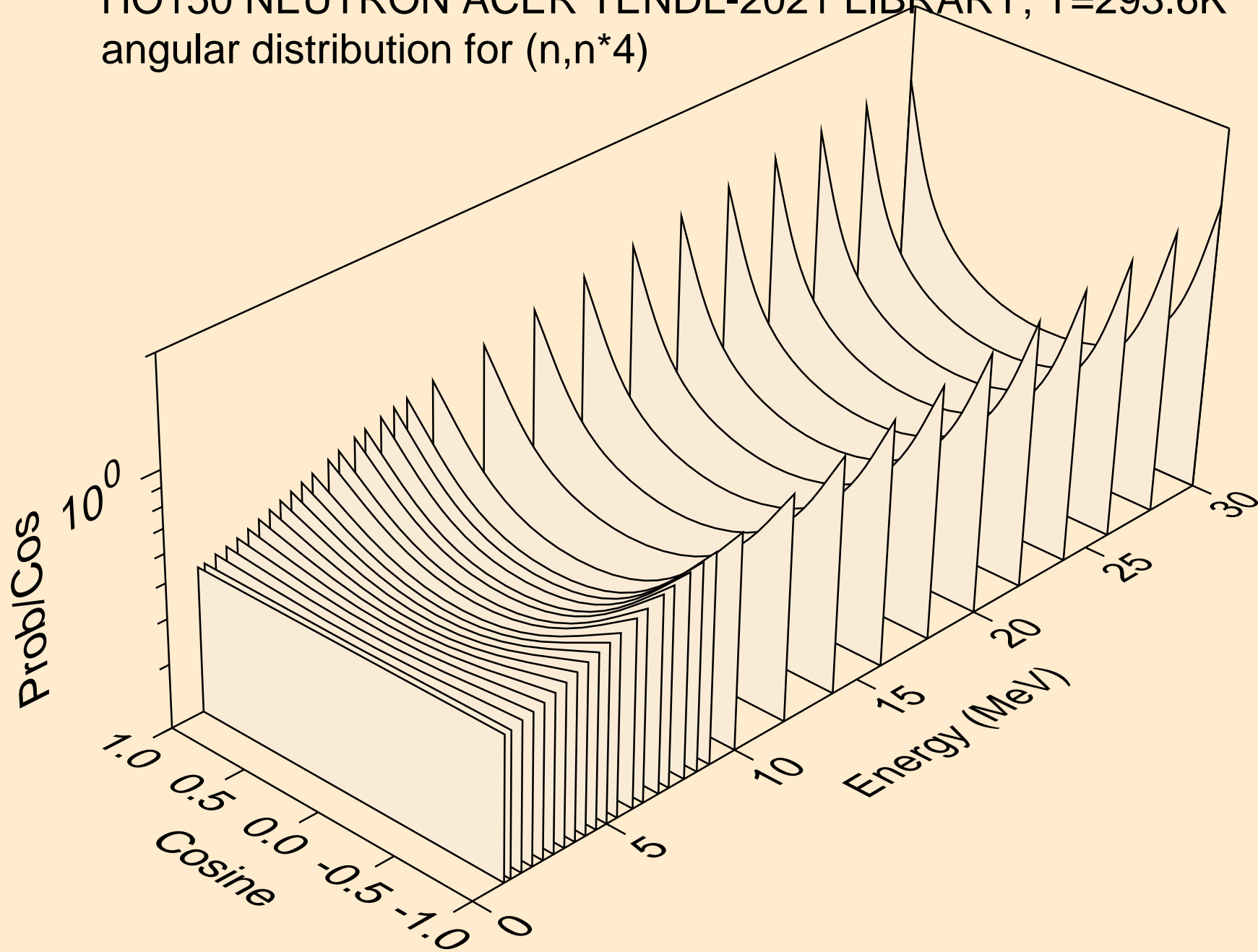

HO150 NEUTRON ACER TENDL-2021 LIBRARY; T=293.6K  
angular distribution for (n,n\*5)

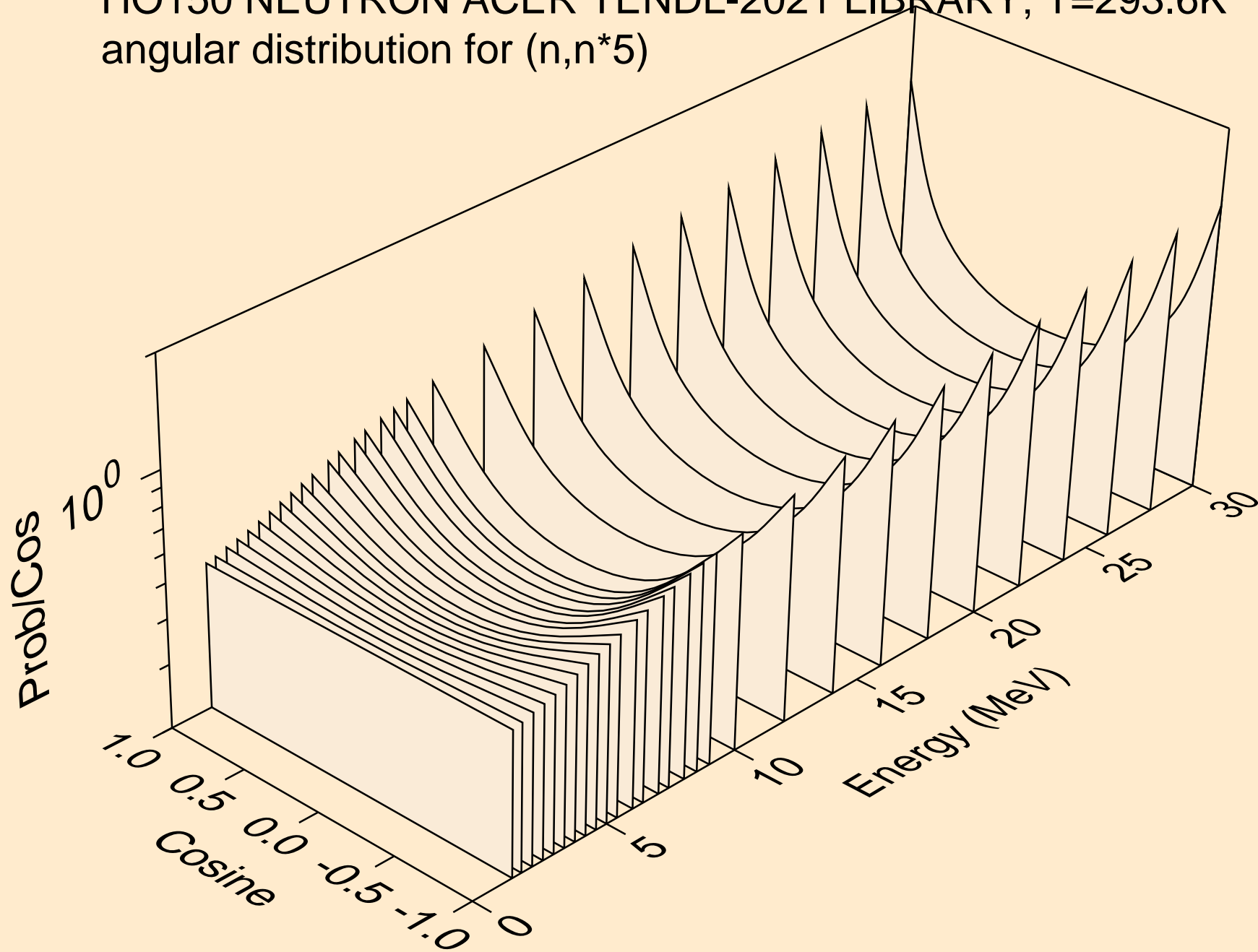

HO150 NEUTRON ACER TENDL-2021 LIBRARY; T=293.6K  
angular distribution for (n,n\*6)

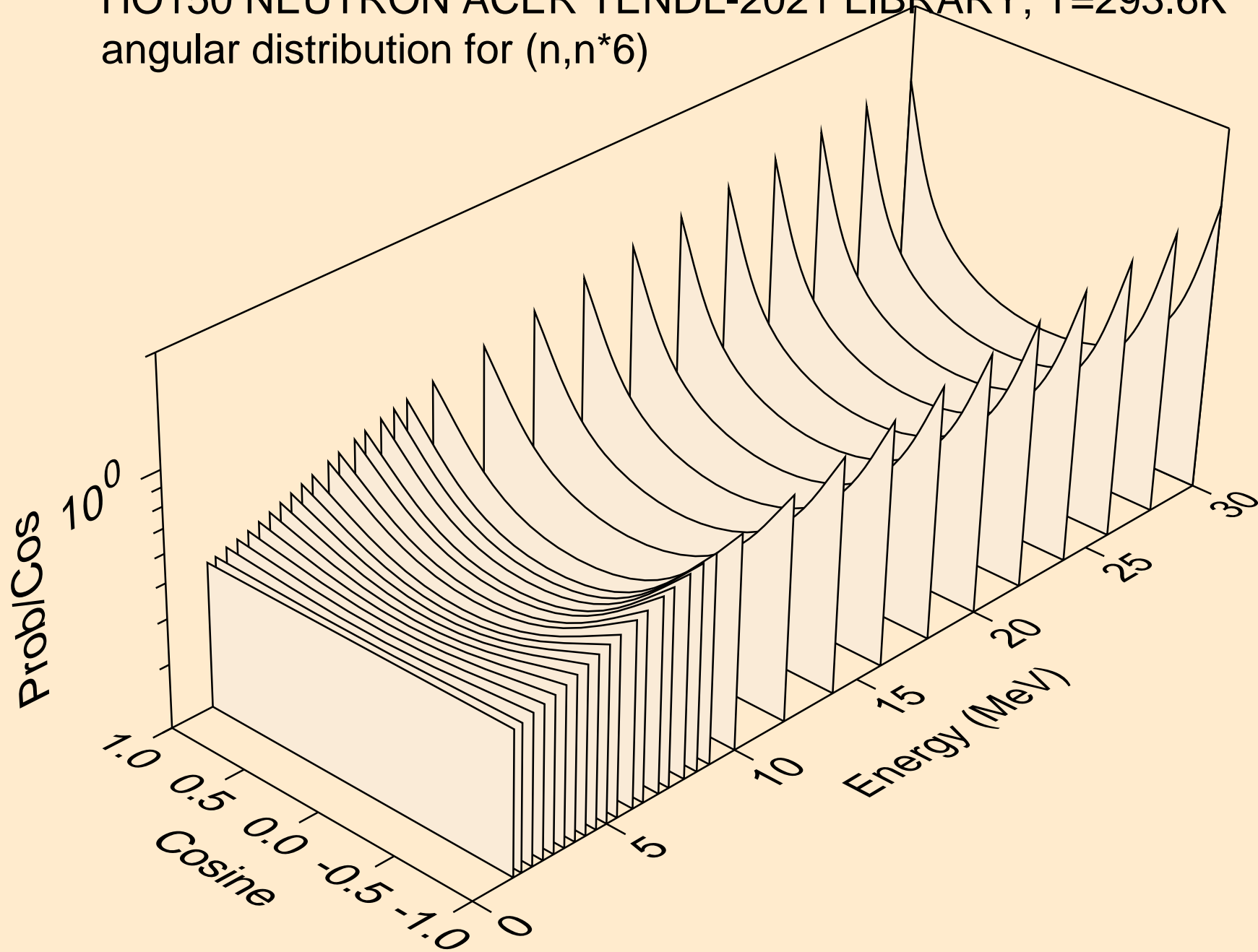

HO150 NEUTRON ACER TENDL-2021 LIBRARY; T=293.6K  
angular distribution for (n,n\*7)

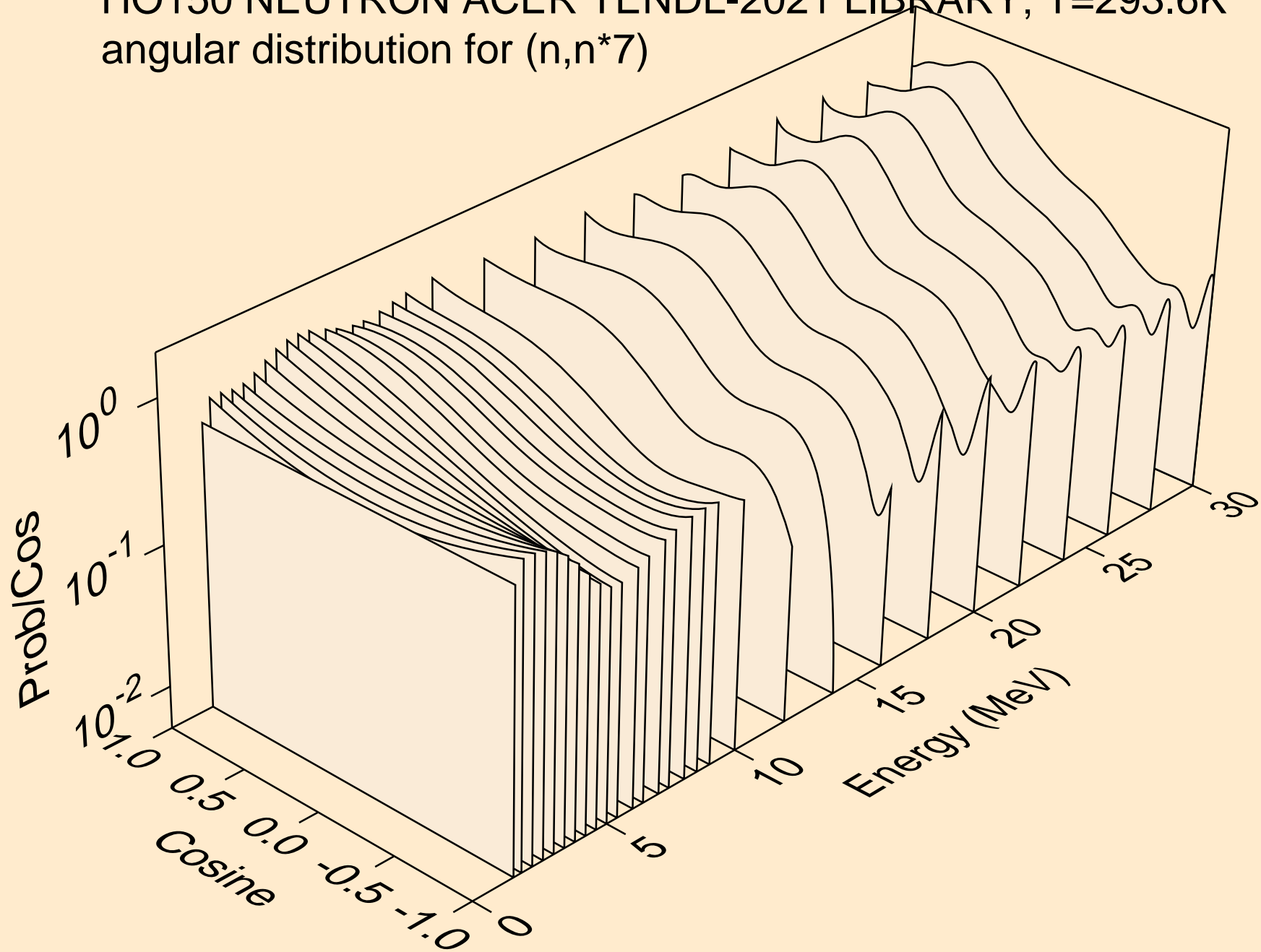



HO150 NEUTRON ACER TENDL-2021 LIBRARY; T=293.6K  
angular distribution for (n,n\*8)

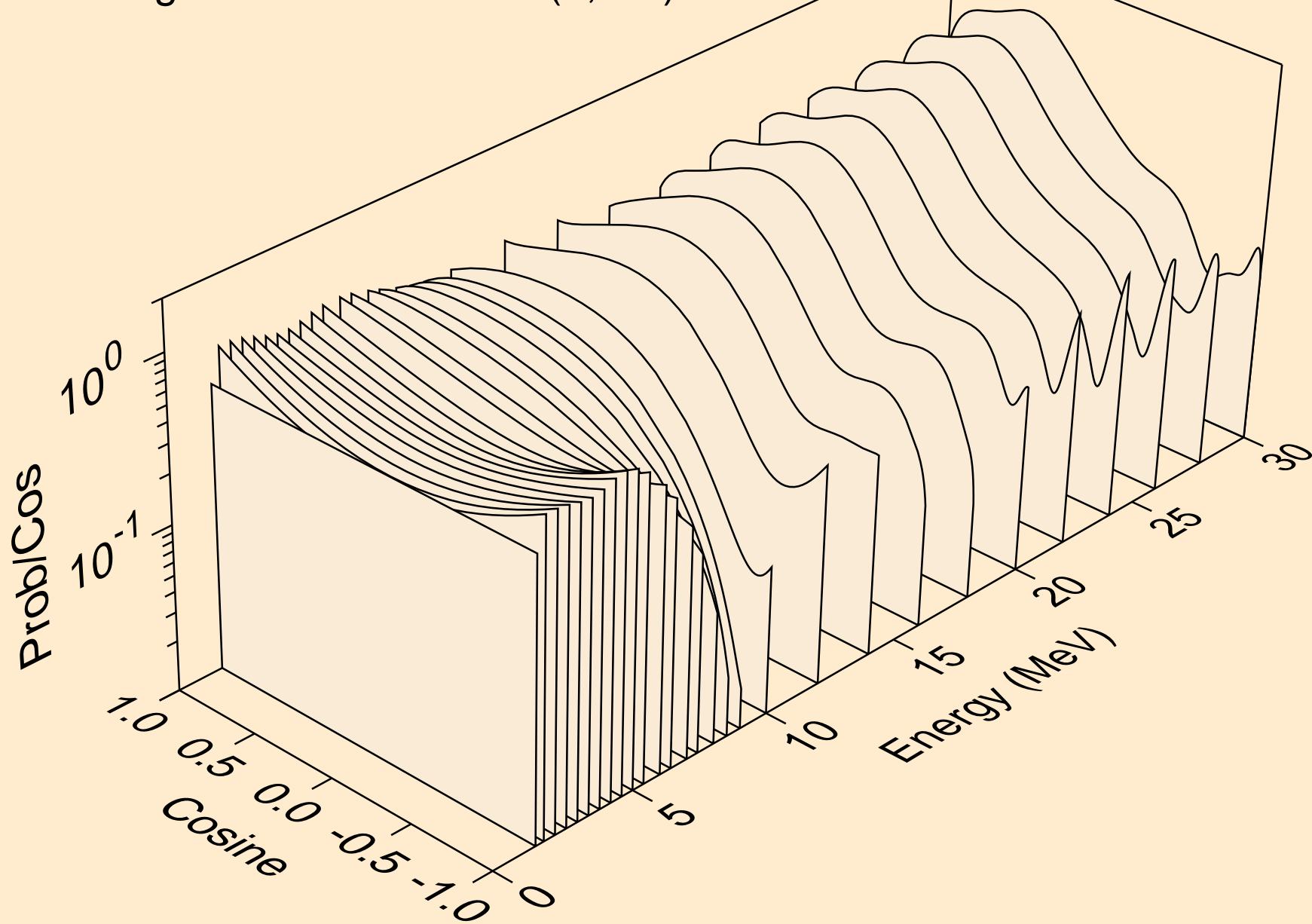

HO150 NEUTRON ACER TENDL-2021 LIBRARY; T=293.6K  
angular distribution for (n,n\*9)

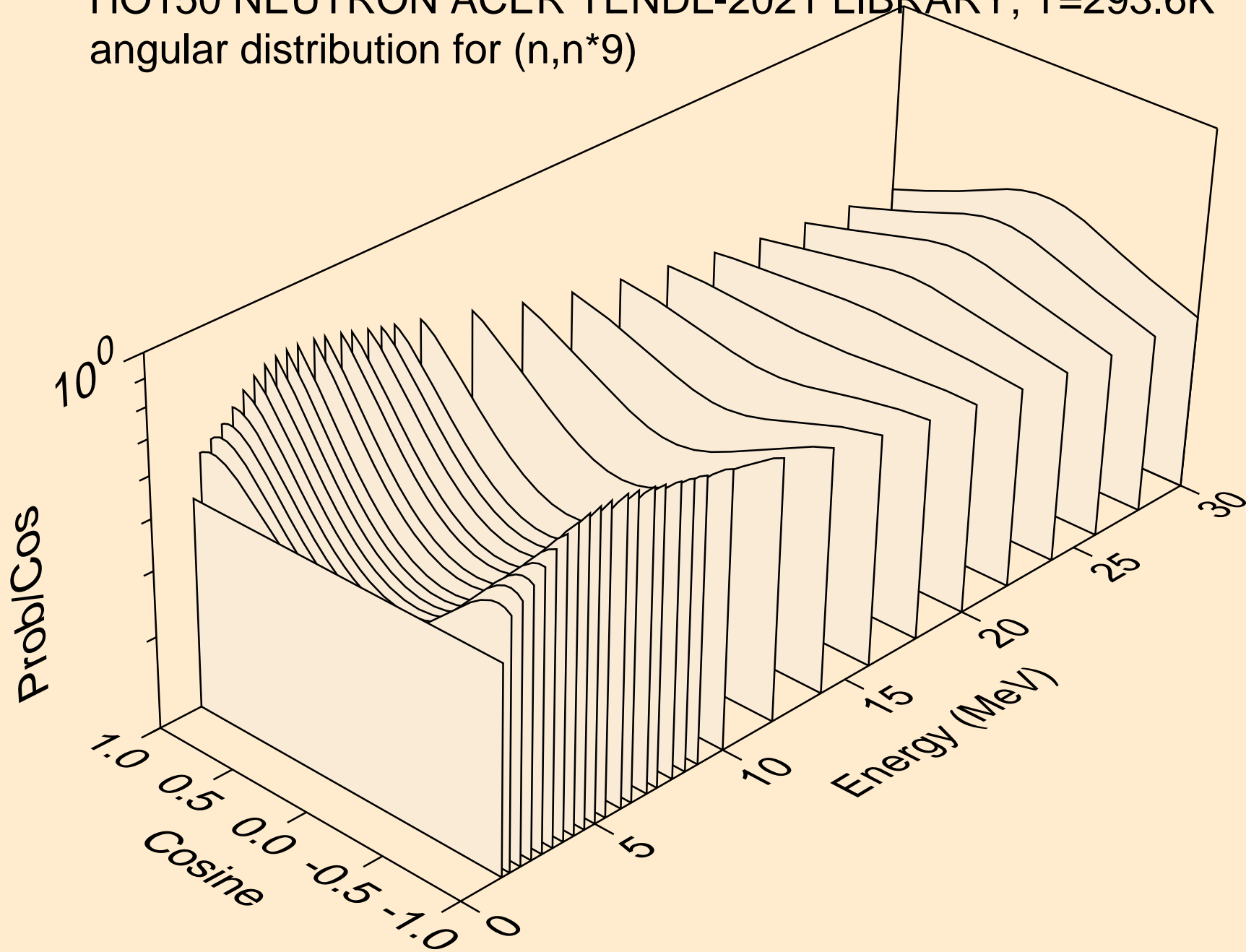

HO150 NEUTRON ACER TENDL-2021 LIBRARY; T=293.6K  
angular distribution for (n,n\*10)

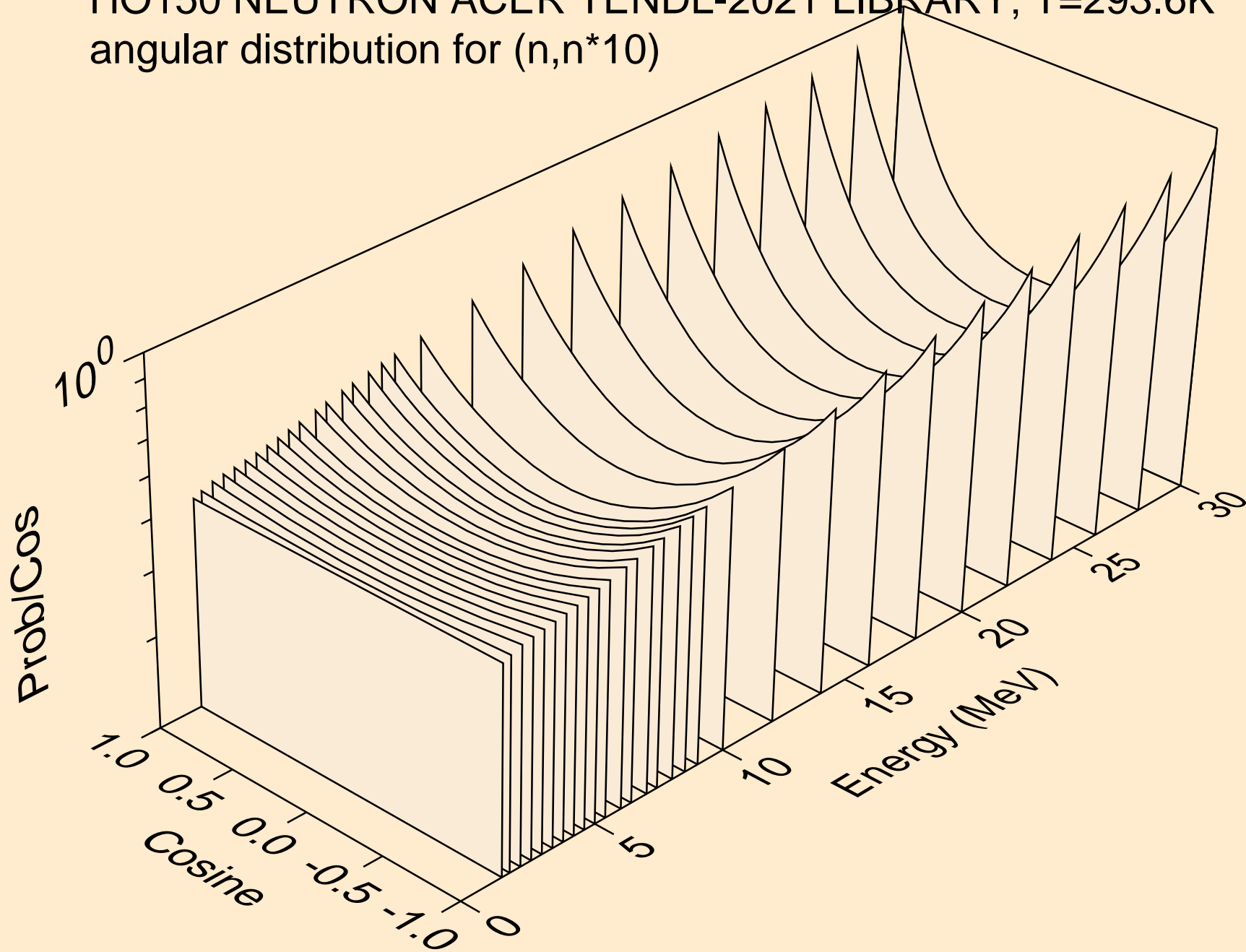

HO150 NEUTRON ACER TENDL-2021 LIBRARY; T=293.6K  
angular distribution for (n,n\*11)

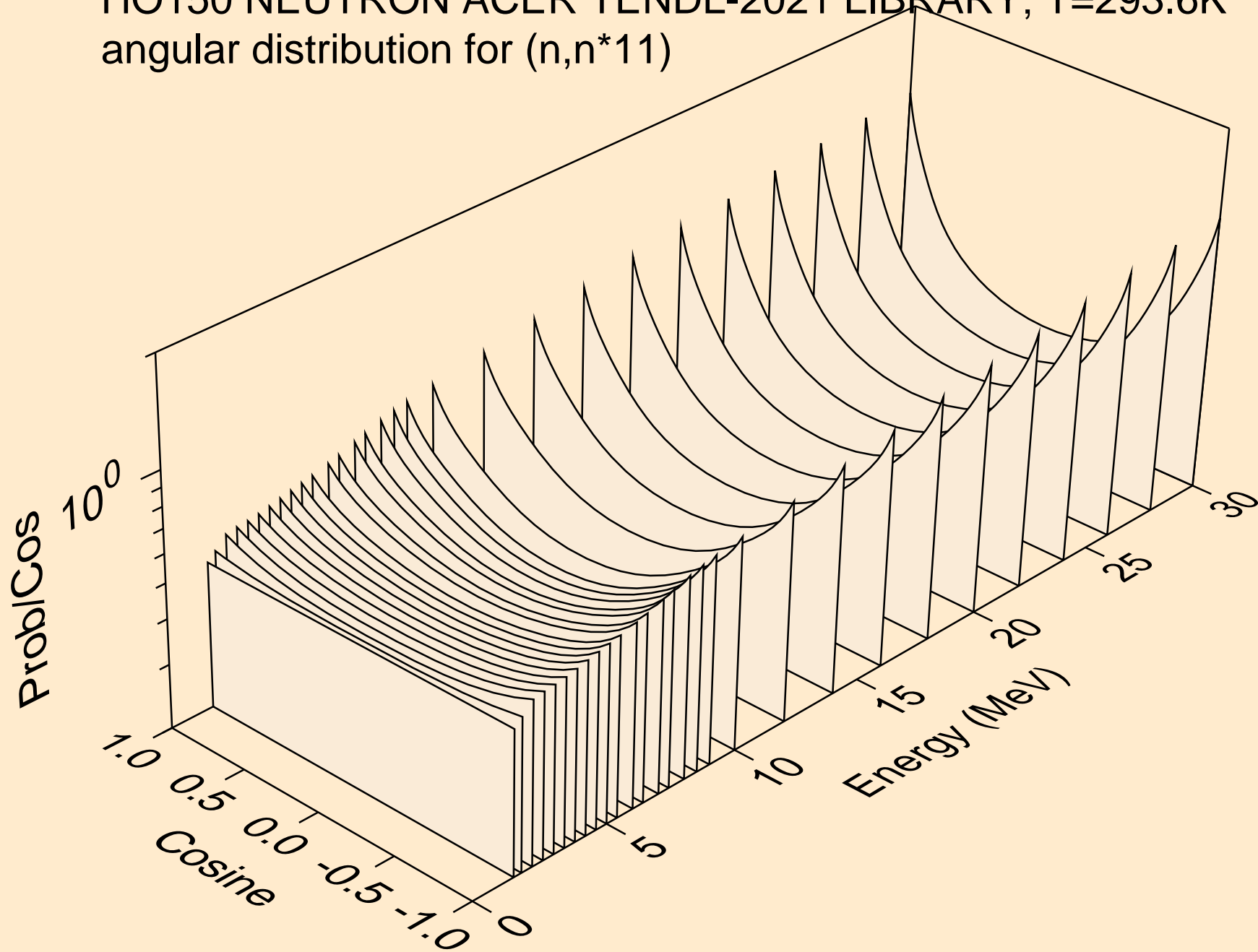

HO150 NEUTRON ACER TENDL-2021 LIBRARY; T=293.6K  
angular distribution for (n,n\*12)

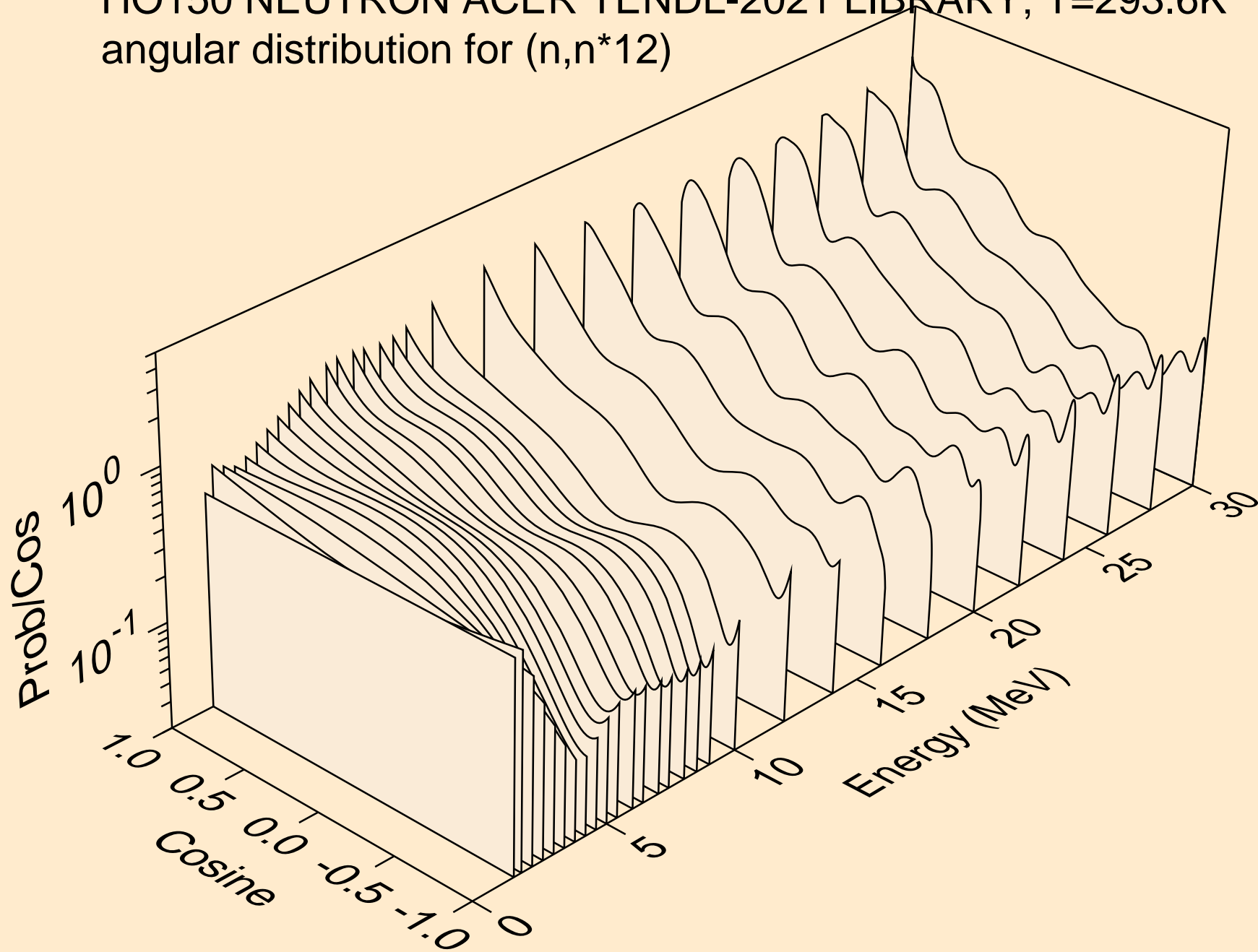

HO150 NEUTRON ACER TENDL-2021 LIBRARY; T=293.6K  
angular distribution for (n,n\*13)

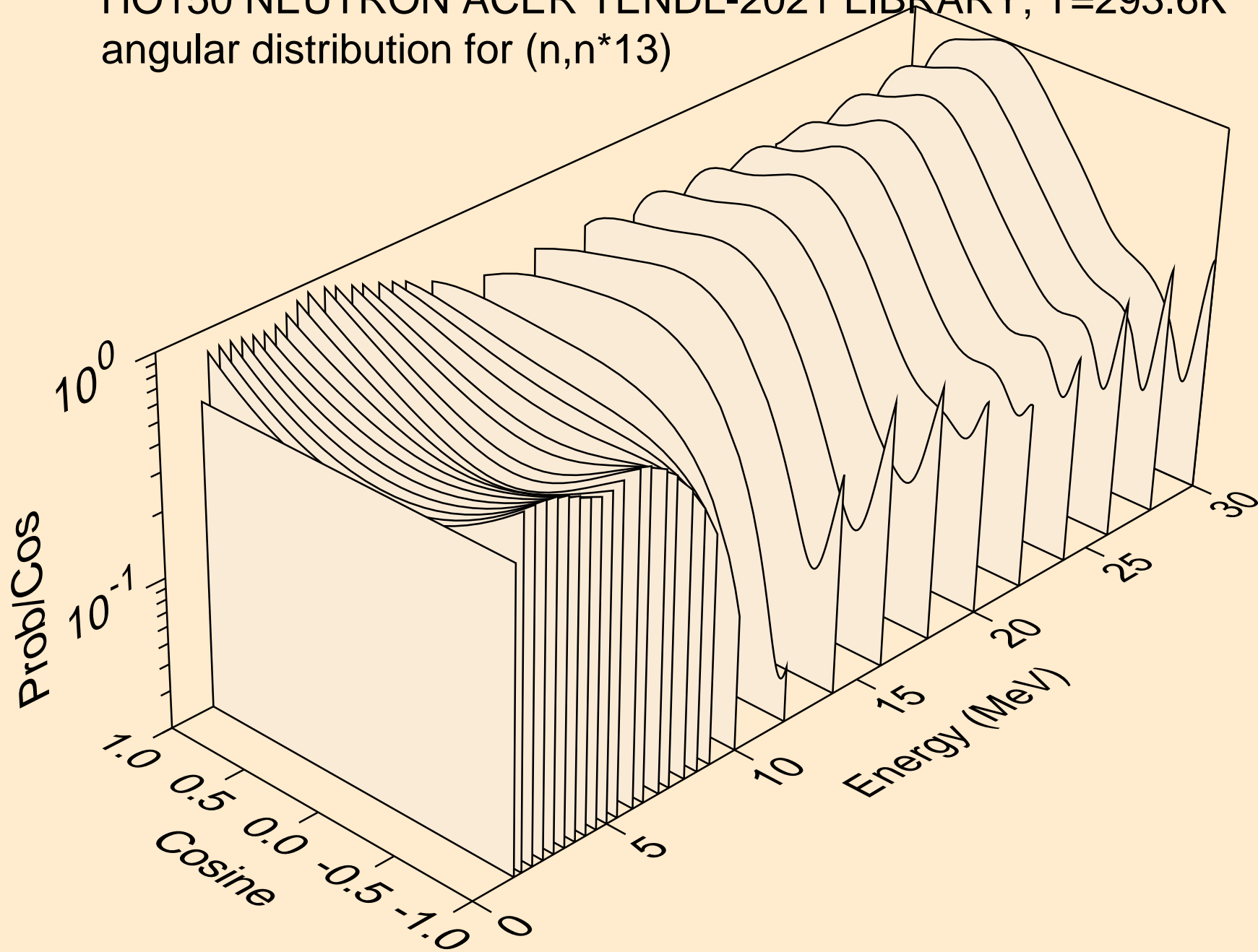

HO150 NEUTRON ACER TENDL-2021 LIBRARY; T=293.6K  
angular distribution for (n,n\*14)

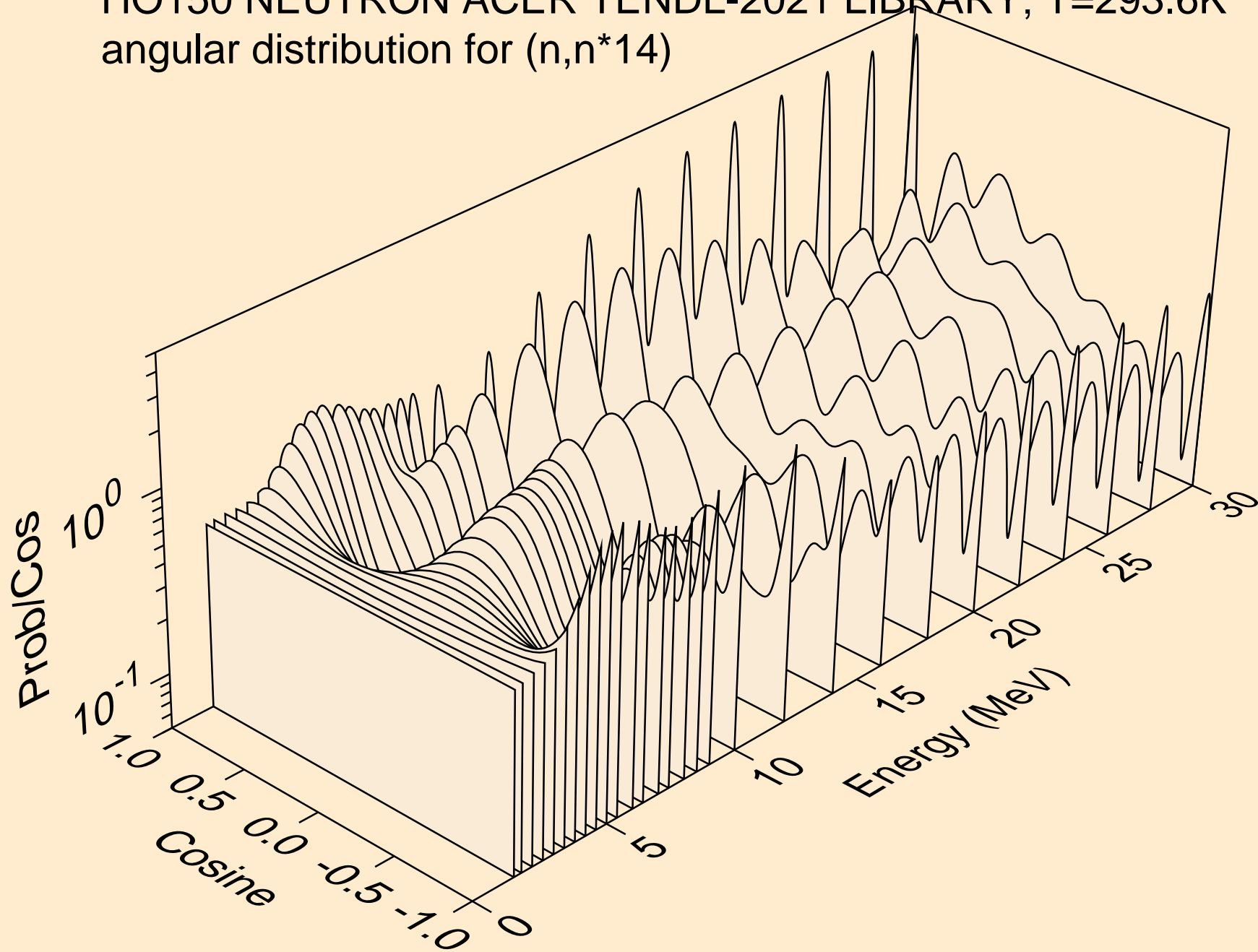

HO150 NEUTRON ACER TENDL-2021 LIBRARY; T=293.6K  
angular distribution for (n,n\*15)

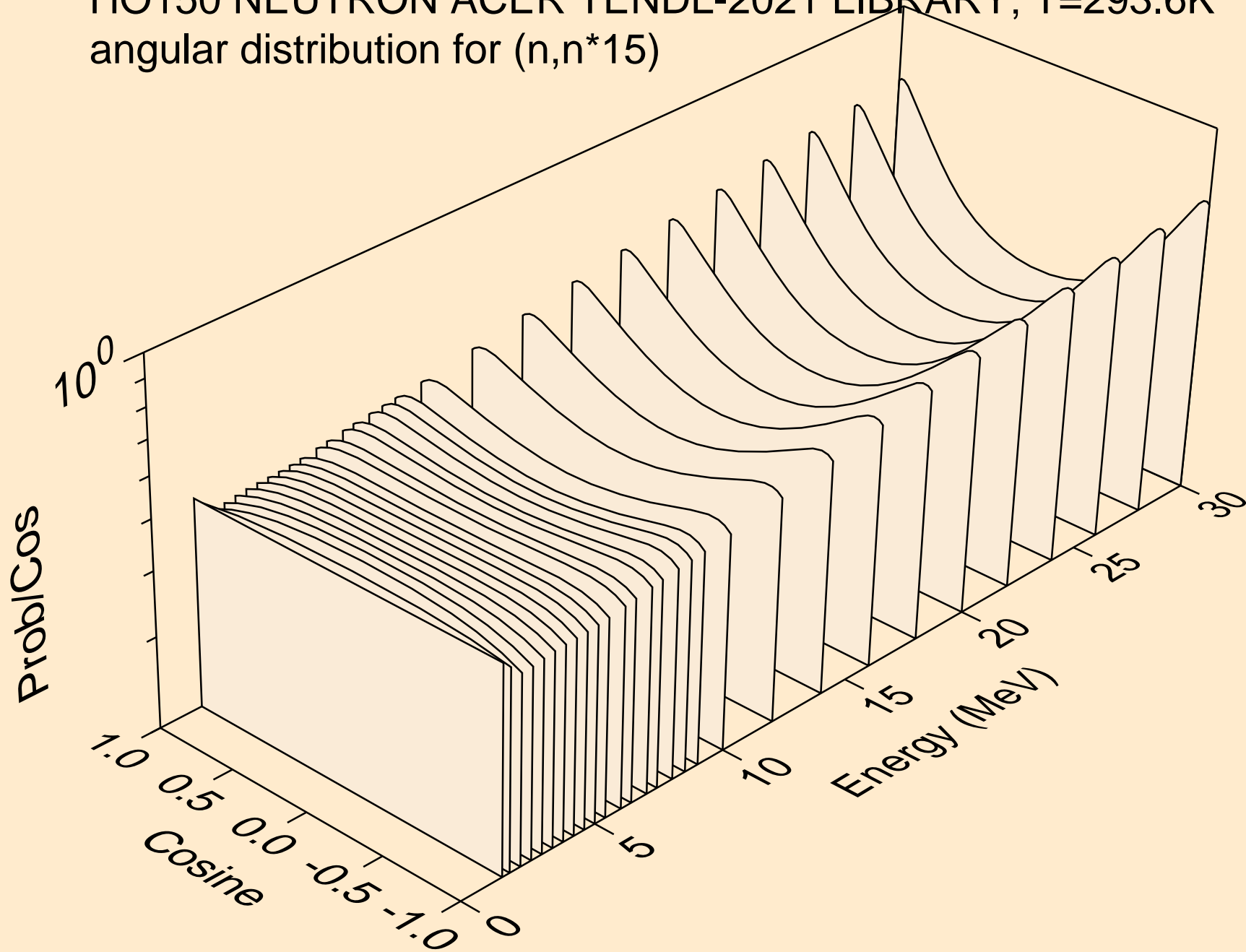



HO150 NEUTRON ACER TENDL-2021 LIBRARY; T=293.6K  
angular distribution for (n,n\*16)

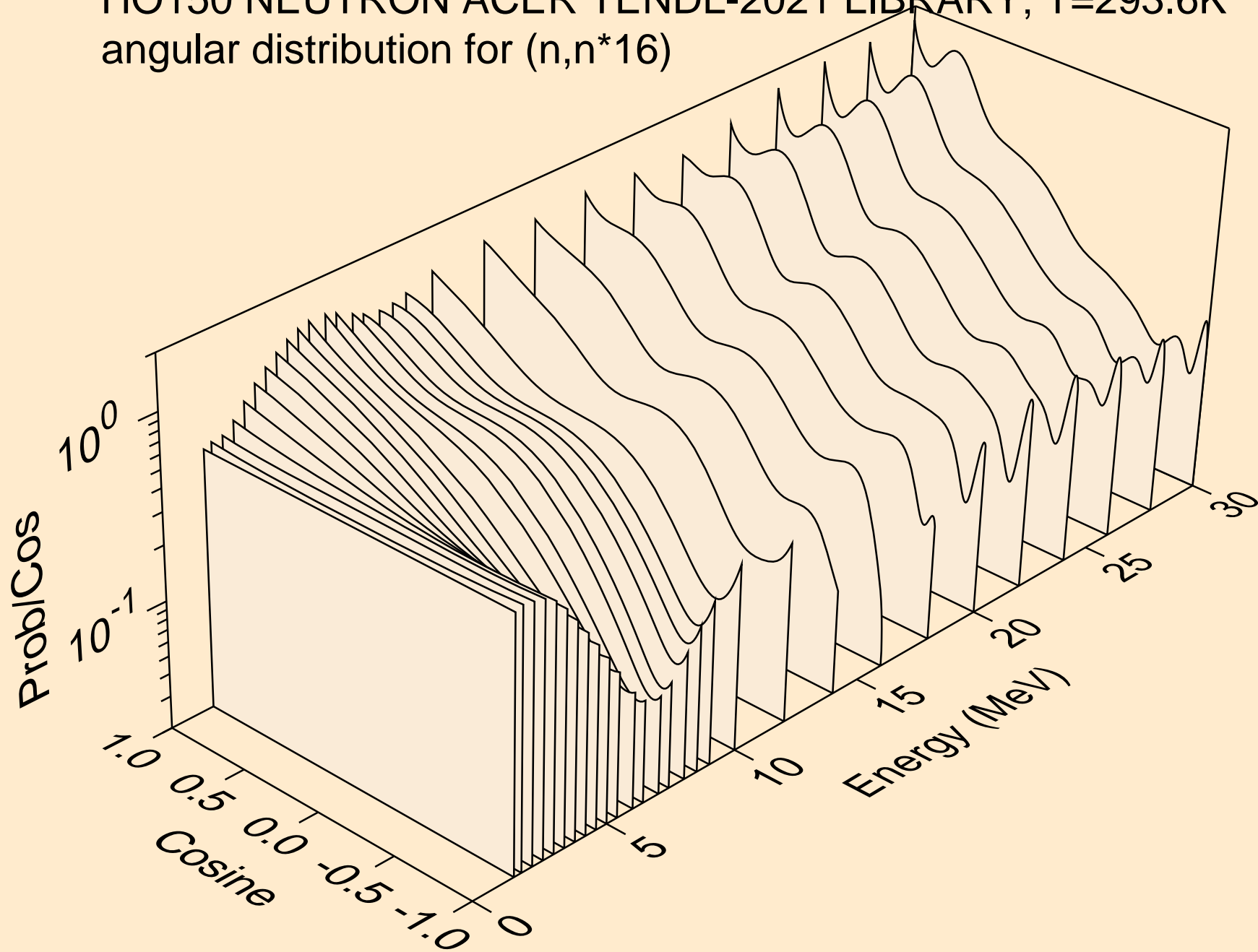

HO150 NEUTRON ACER TENDL-2021 LIBRARY; T=293.6K  
angular distribution for (n,n\*17)

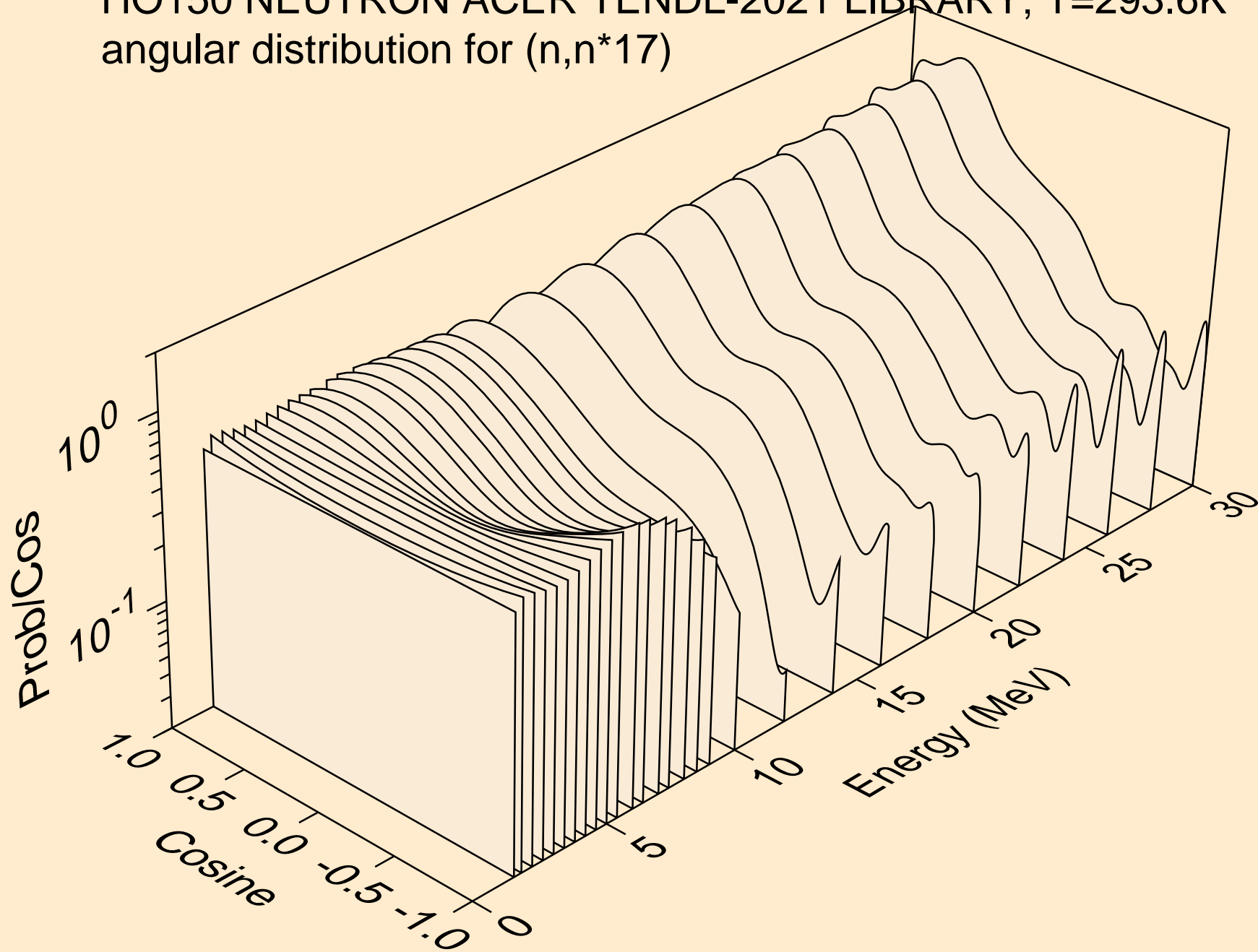

HO150 NEUTRON ACER TENDL-2021 LIBRARY; T=293.6K  
angular distribution for (n,n\*18)

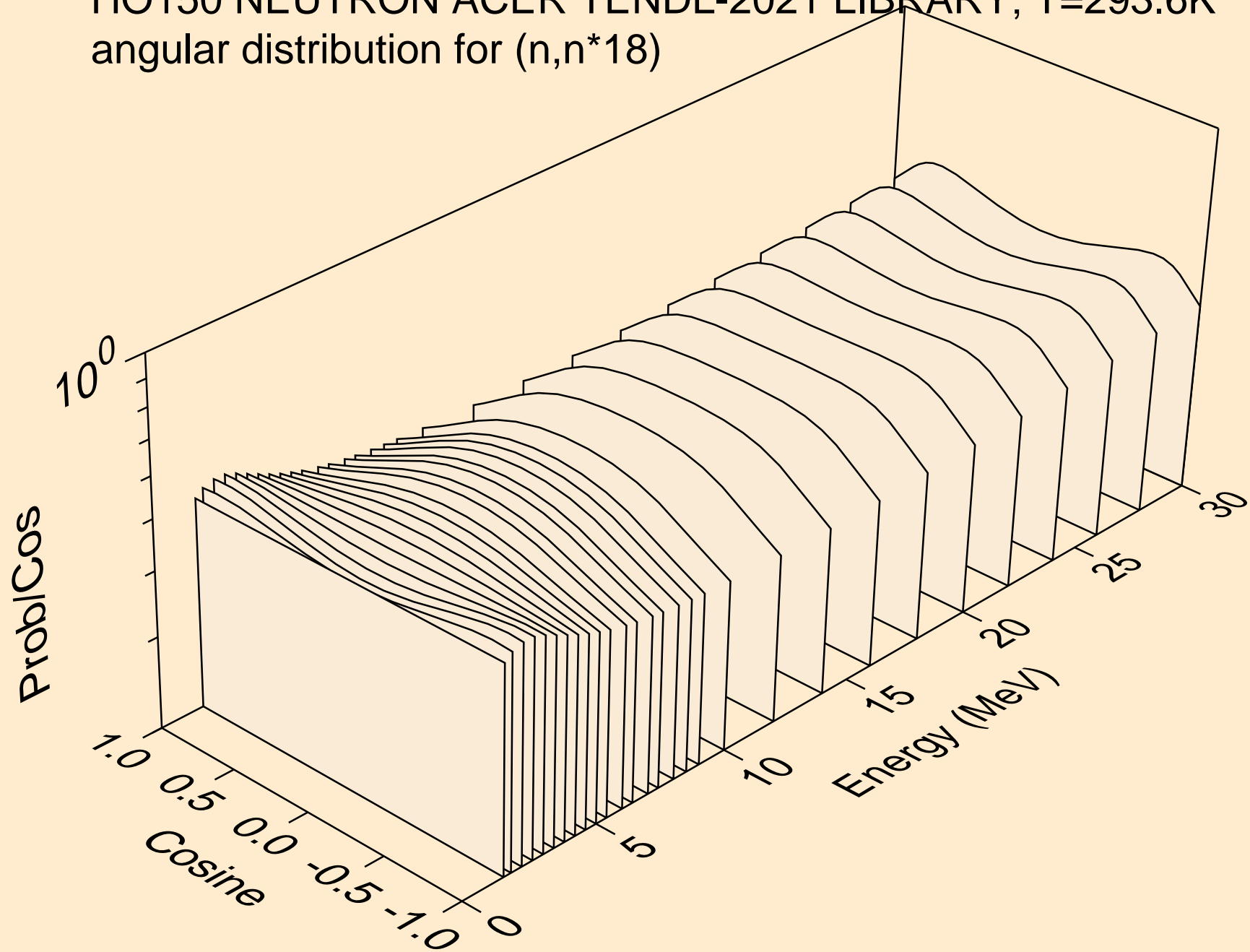

HO150 NEUTRON ACER TENDL-2021 LIBRARY; T=293.6K  
angular distribution for (n,n\*19)

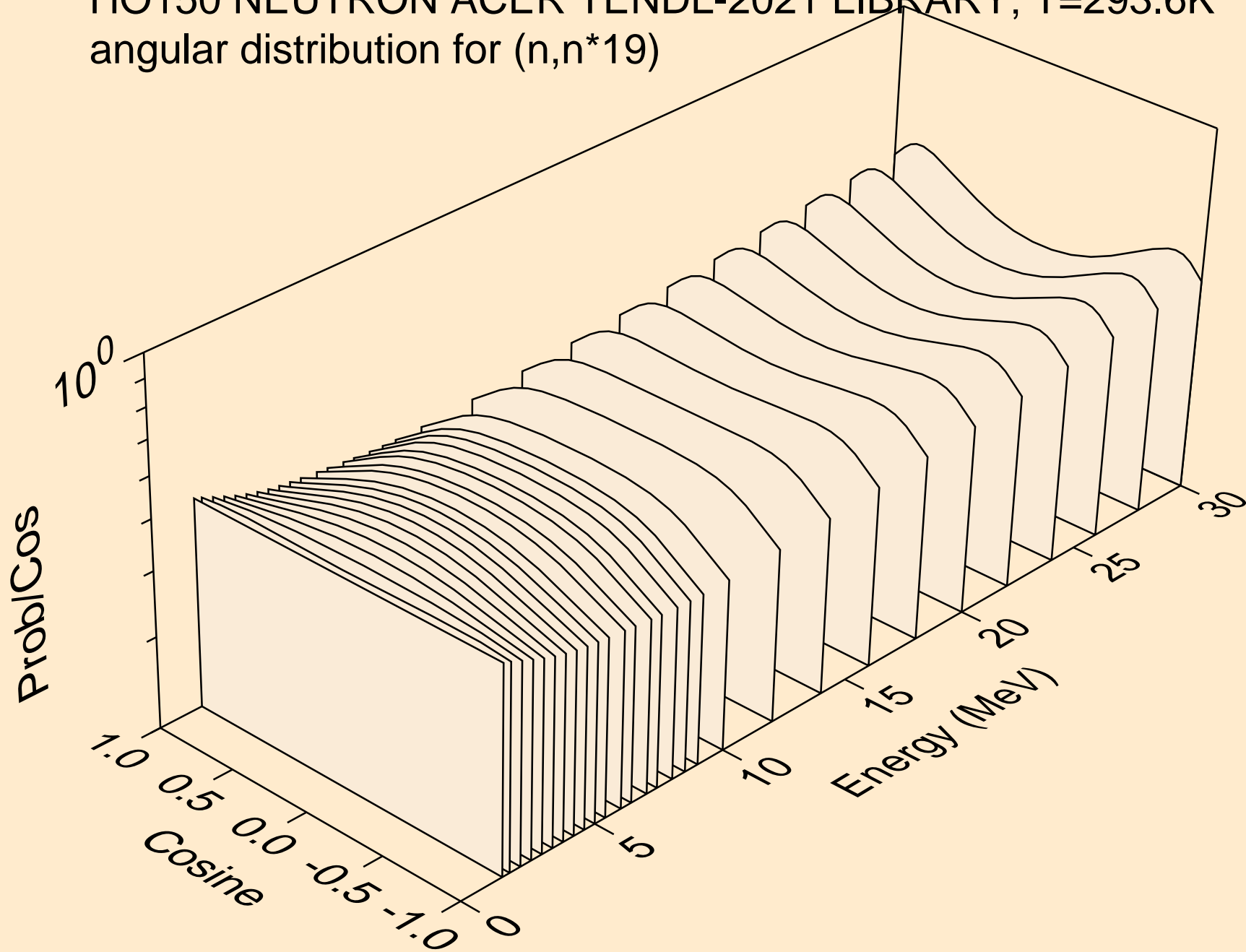

HO150 NEUTRON ACER TENDL-2021 LIBRARY; T=293.6K  
angular distribution for (n,n\*20)

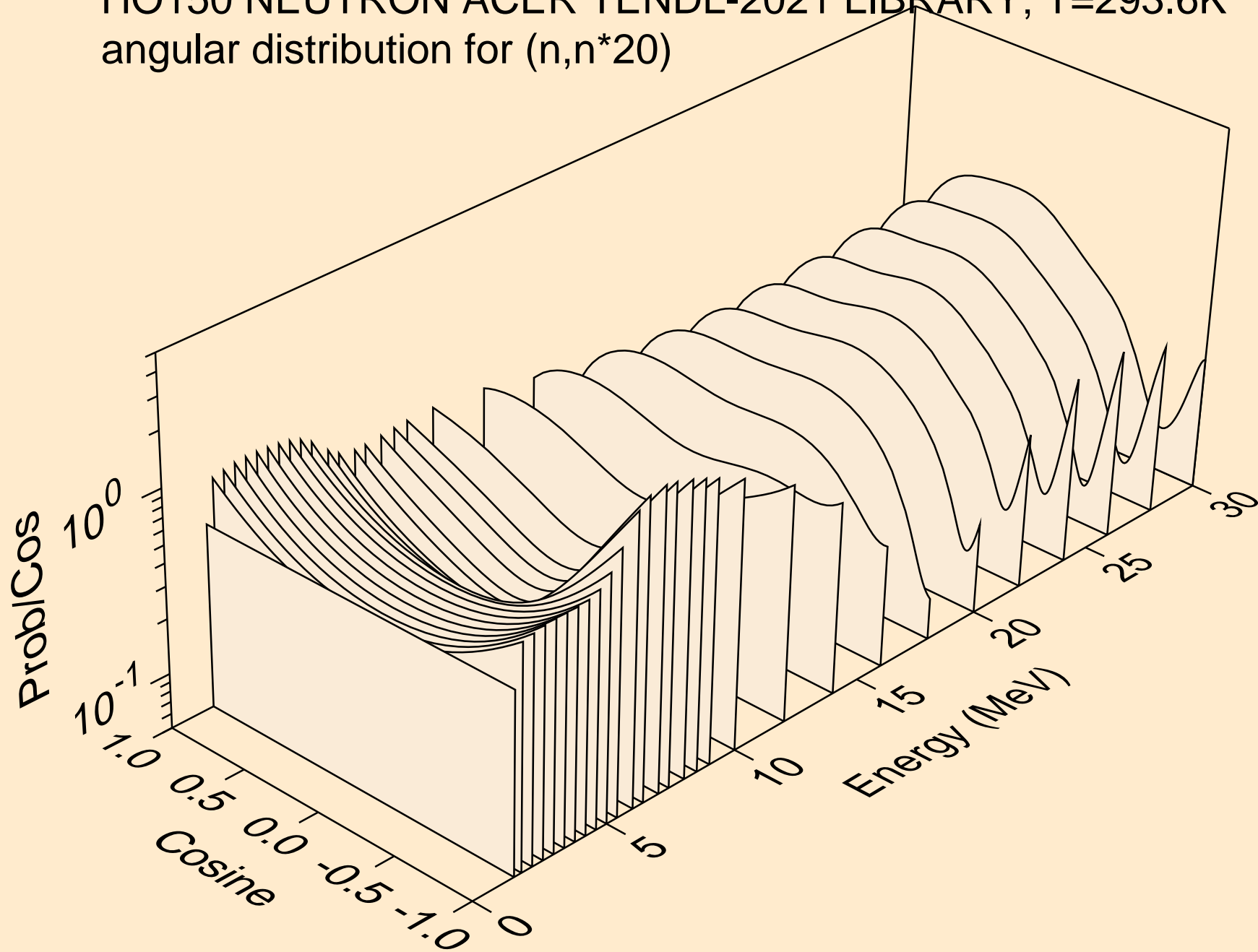

HO150 NEUTRON ACER TENDL-2021 LIBRARY; T=293.6K  
angular distribution for (n,n\*21)

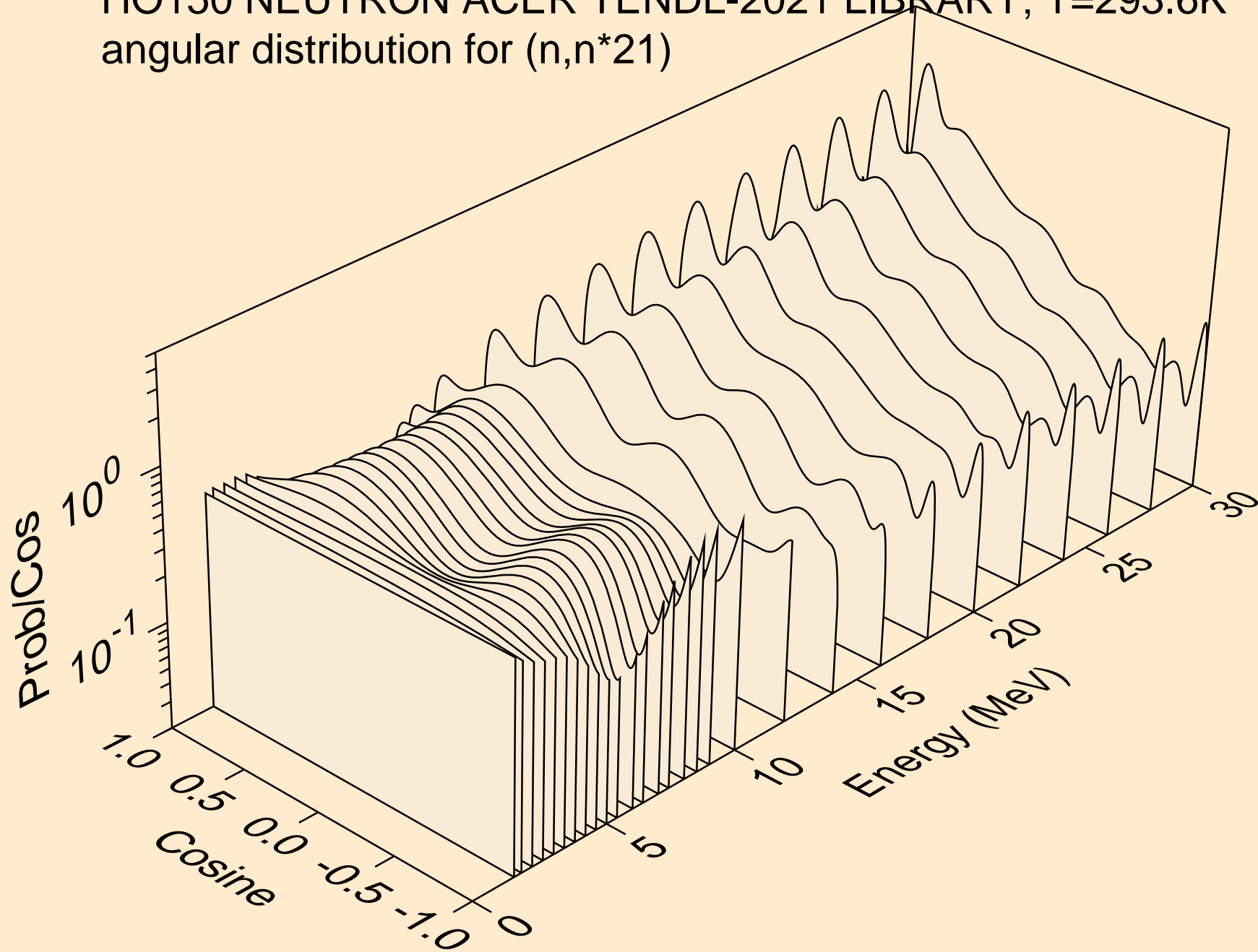

HO150 NEUTRON ACER TENDL-2021 LIBRARY; T=293.6K  
angular distribution for (n,n\*22)

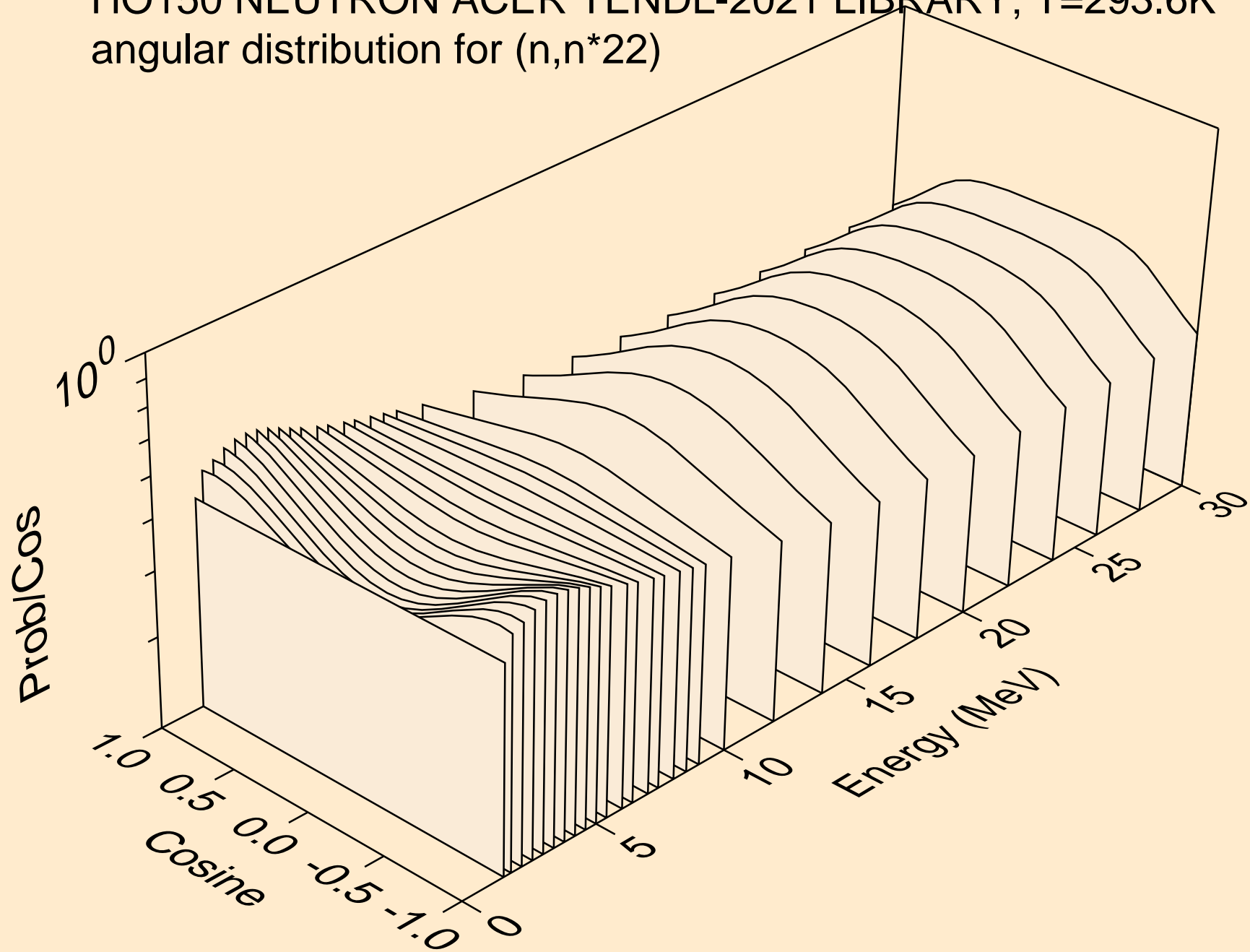

HO150 NEUTRON ACER TENDL-2021 LIBRARY; T=293.6K  
angular distribution for (n,n\*23)

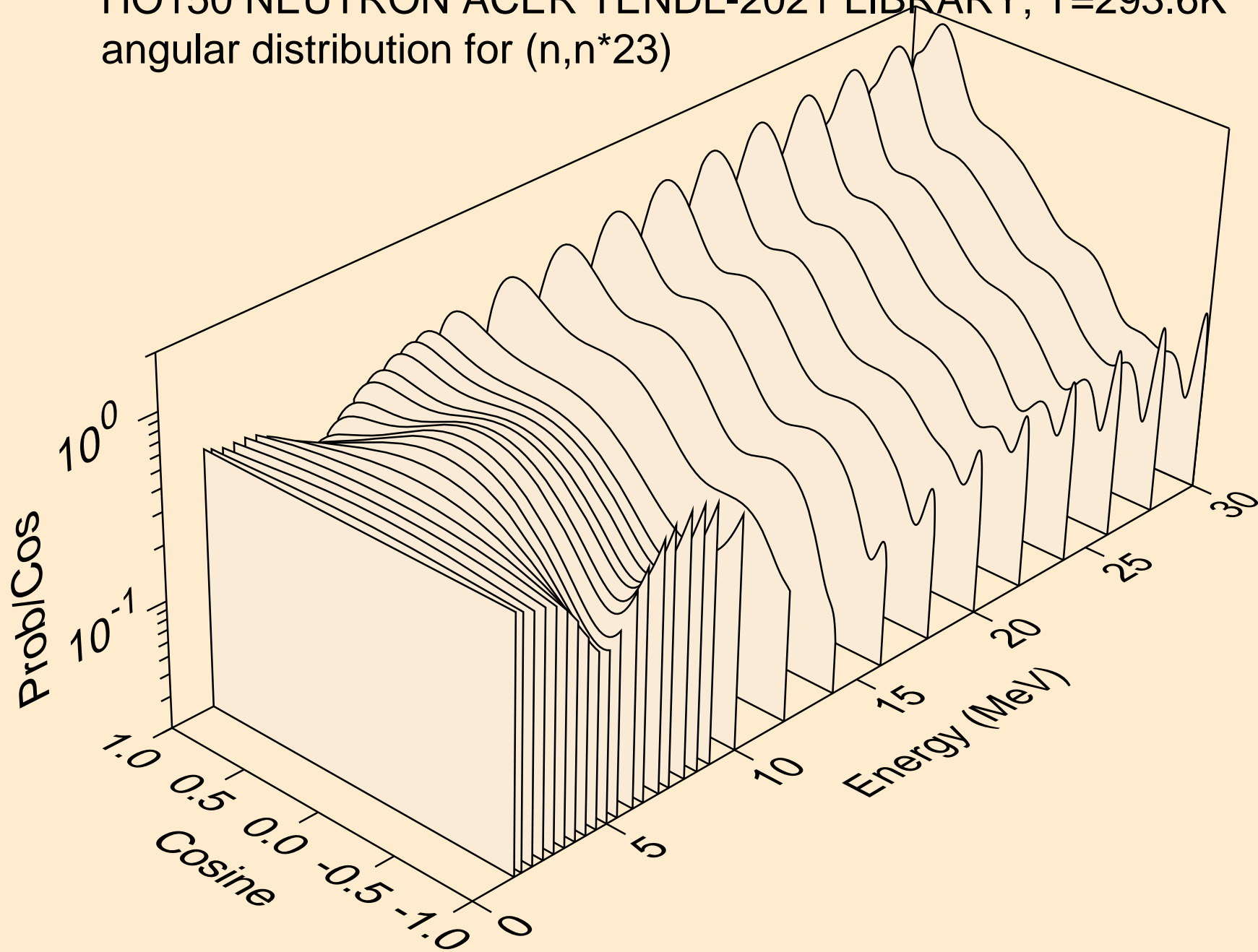



HO150 NEUTRON ACER TENDL-2021 LIBRARY; T=293.6K  
angular distribution for (n,n\*24)

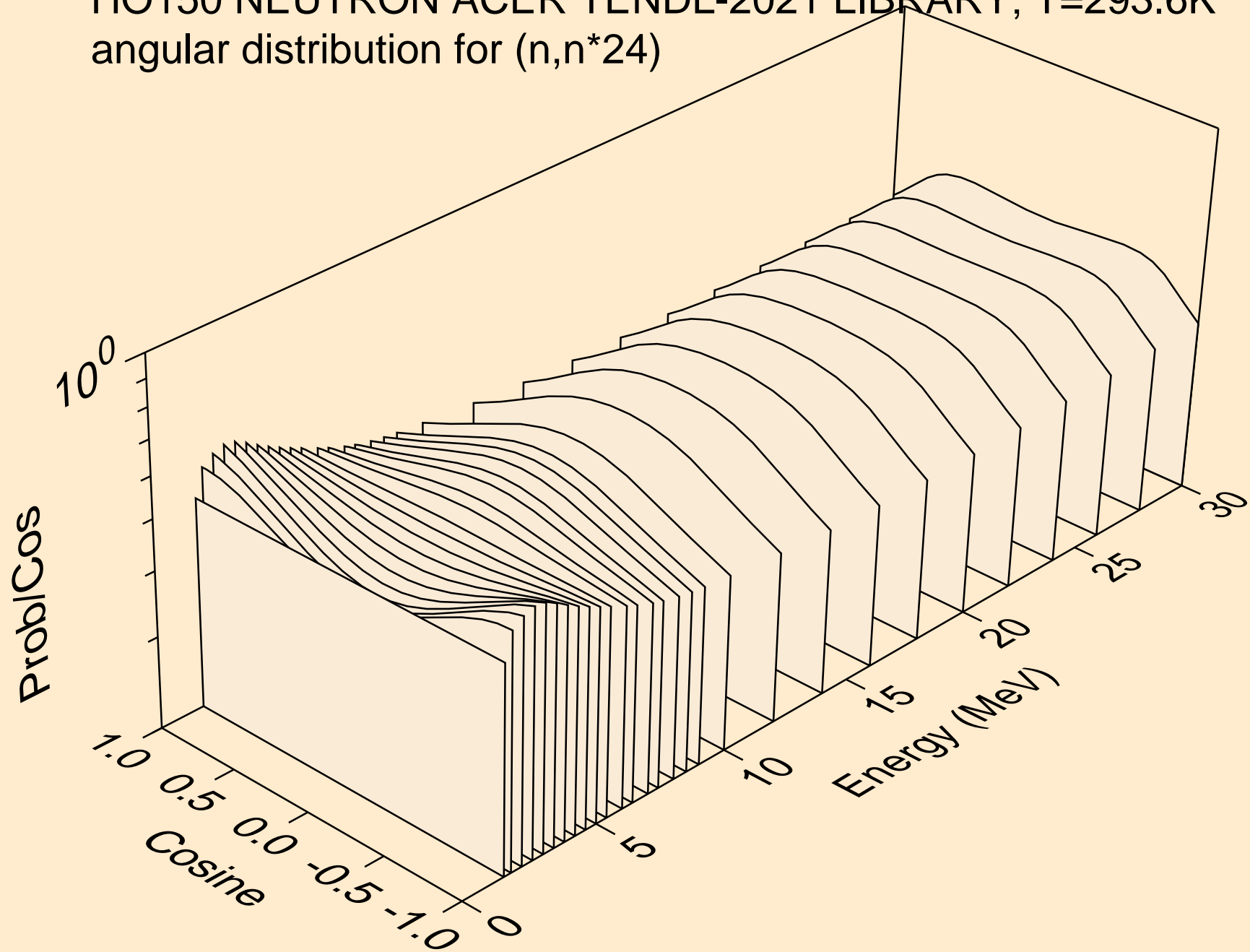

HO150 NEUTRON ACER TENDL-2021 LIBRARY; T=293.6K  
angular distribution for (n,n\*25)

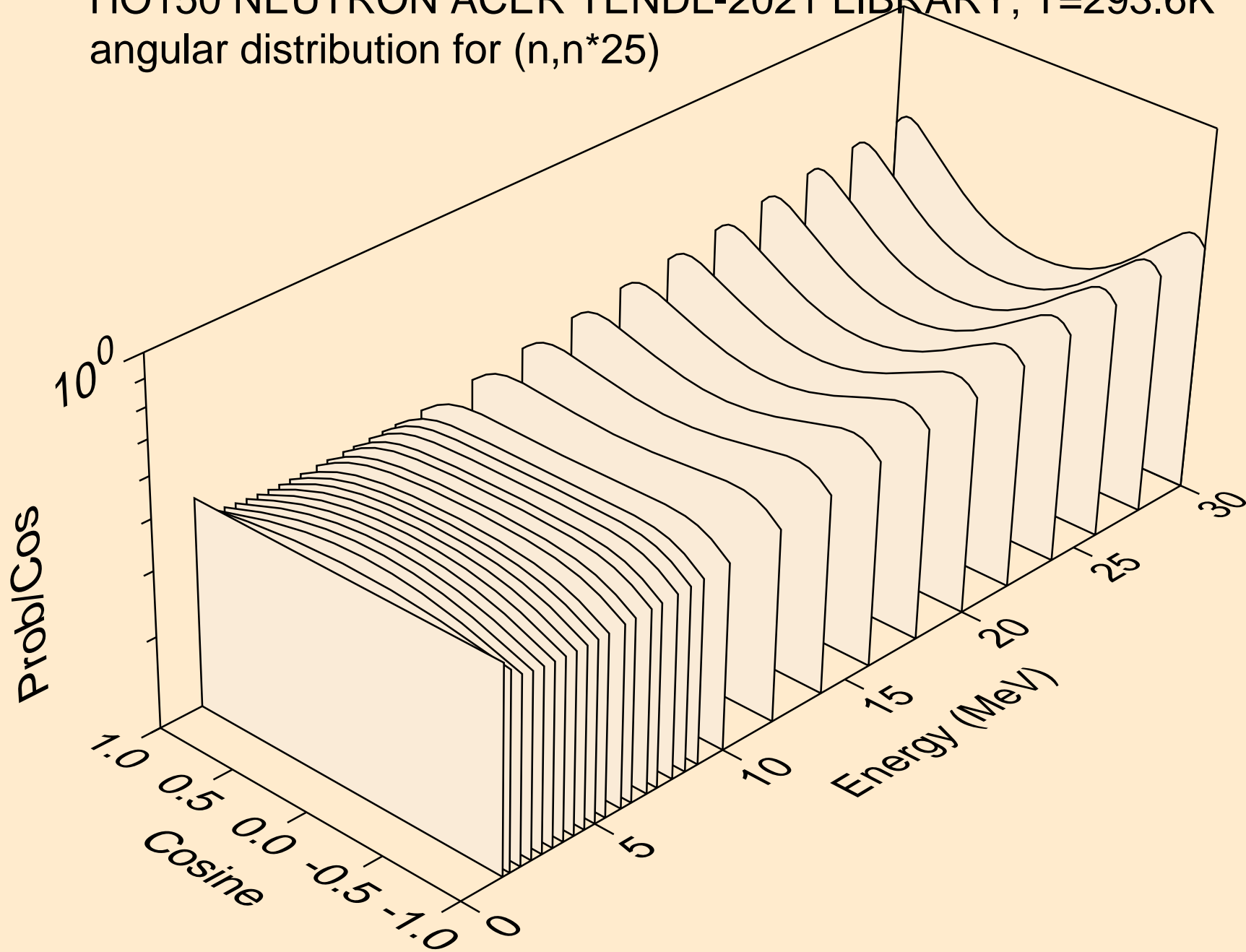

HO150 NEUTRON ACER TENDL-2021 LIBRARY; T=293.6K  
angular distribution for (n,n\*26)

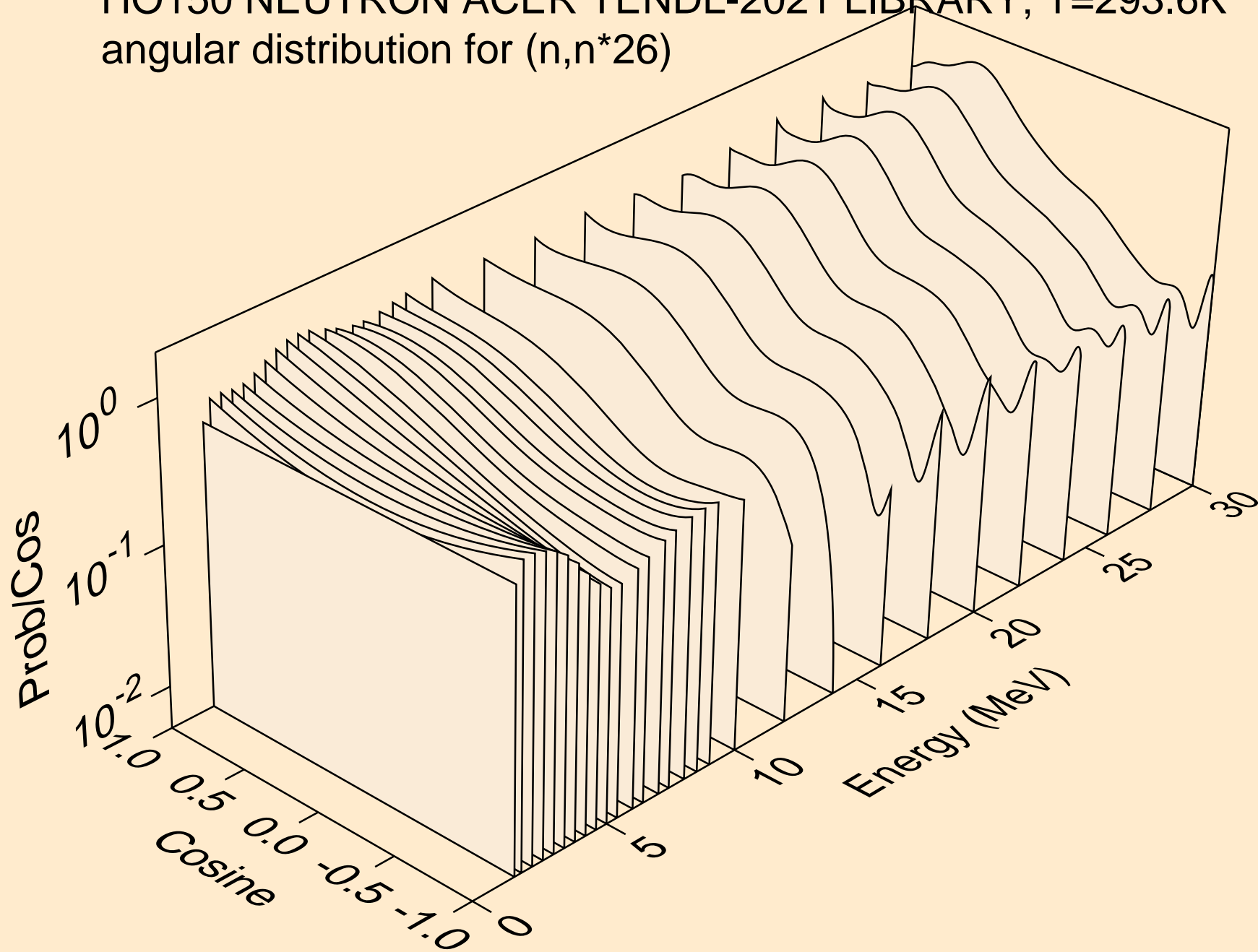

HO150 NEUTRON ACER TENDL-2021 LIBRARY; T=293.6K  
angular distribution for (n,n\*27)

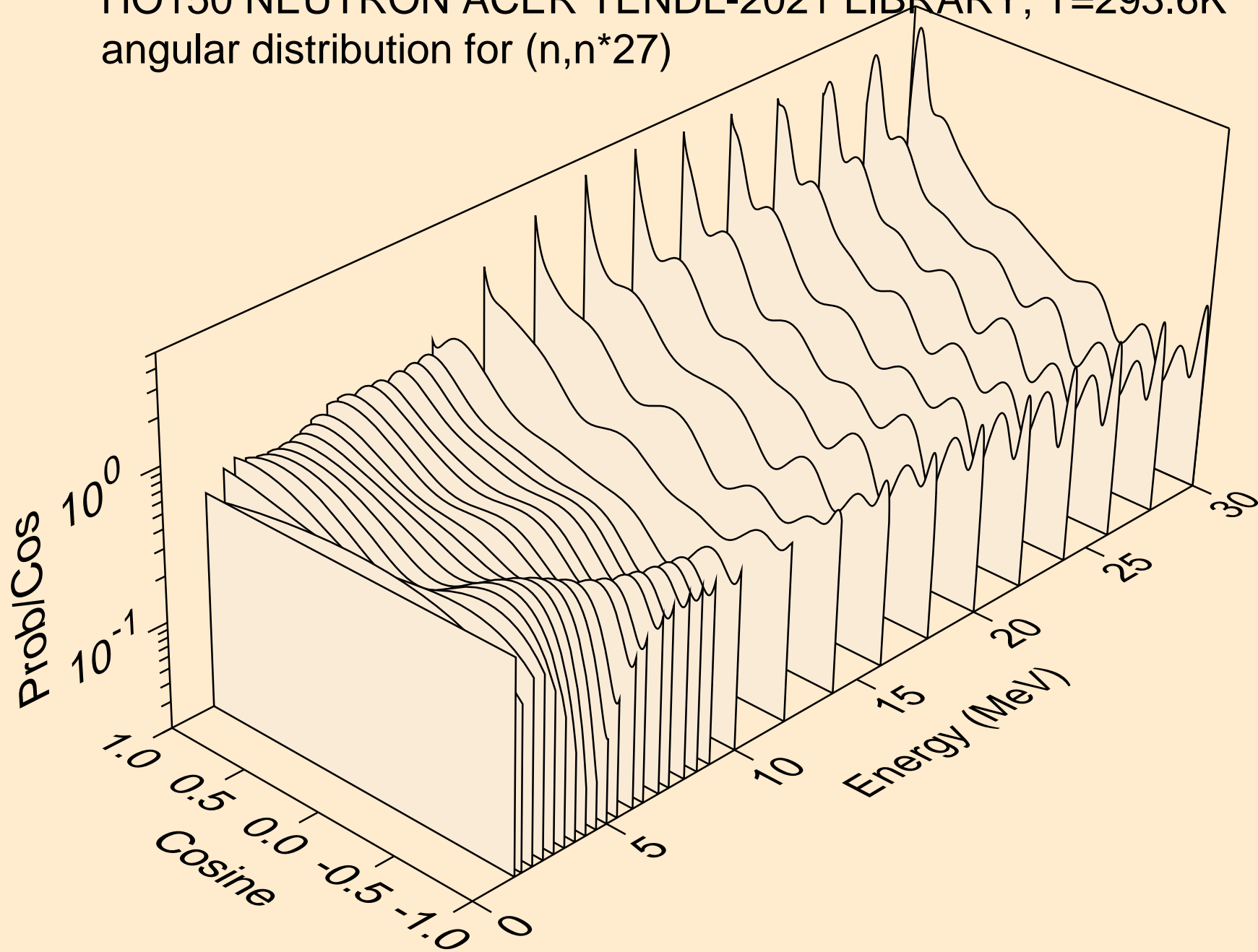

HO150 NEUTRON ACER TENDL-2021 LIBRARY; T=293.6K  
Neutron emission for (n,x)

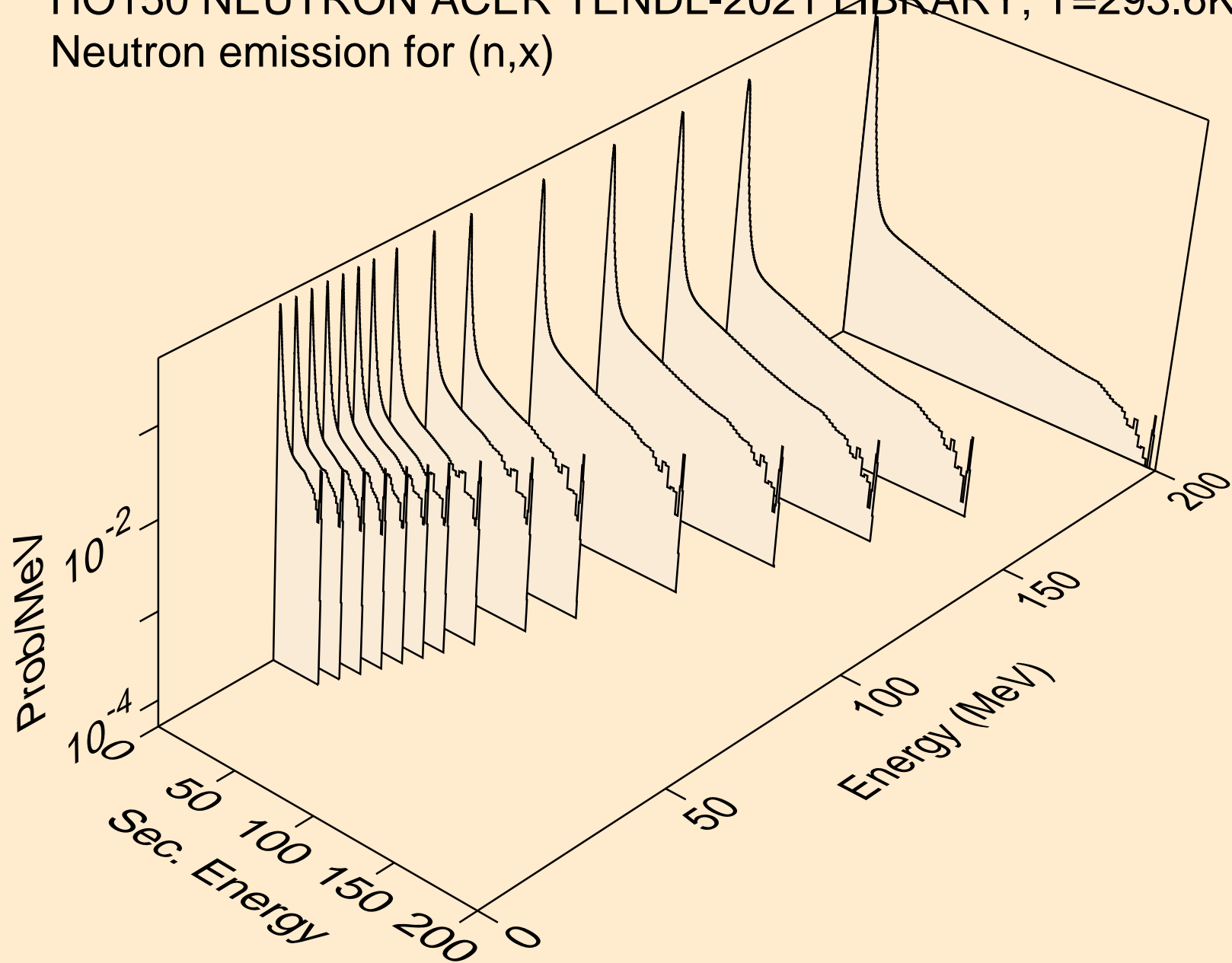

HO150 NEUTRON ACER TENDL-2021 LIBRARY; T=293.6K  
Neutron emission for (n,2nd)

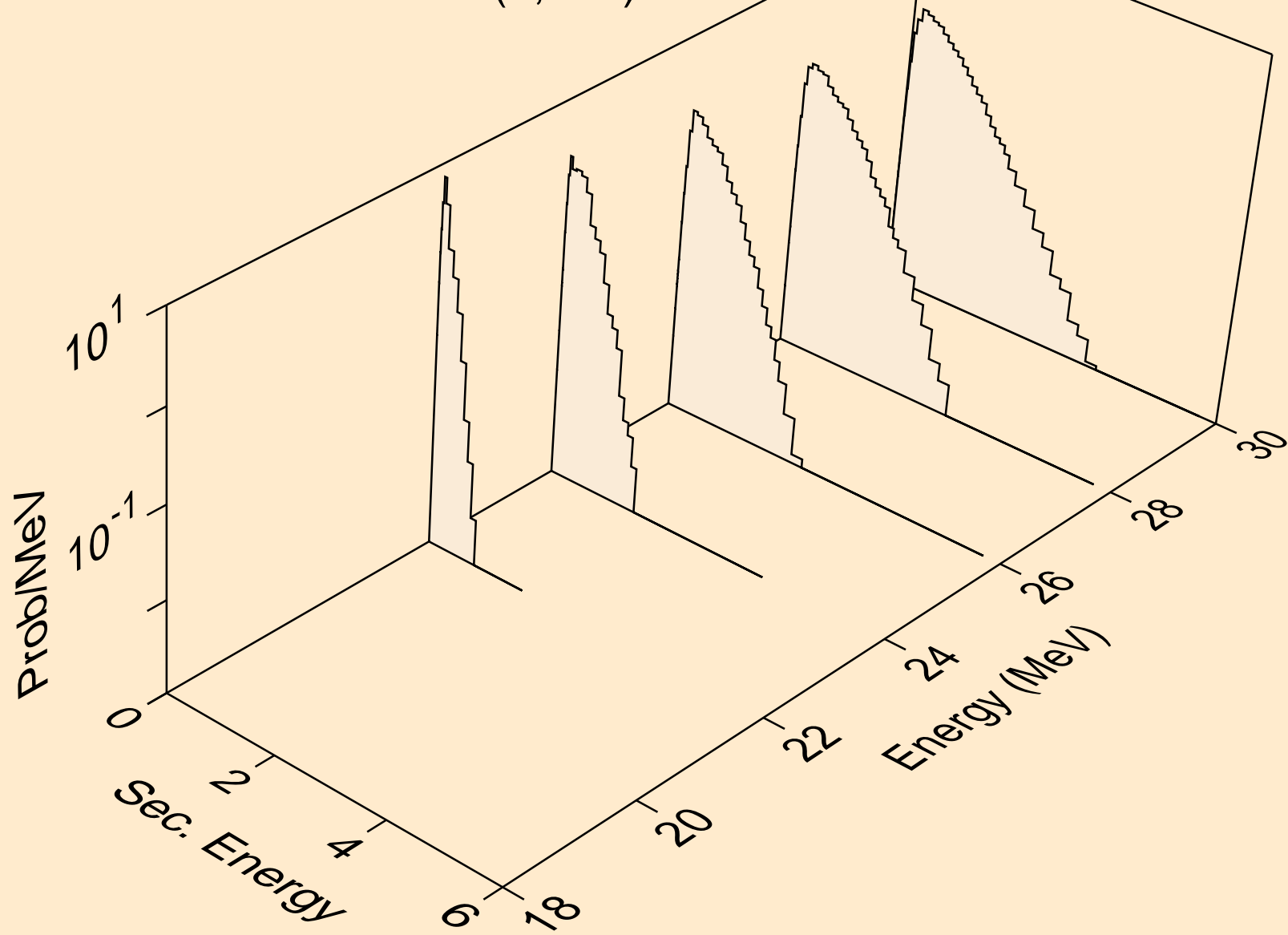

HO150 NEUTRON ACER TENDL-2021 LIBRARY; T=293.6K  
Neutron emission for (n,2n)

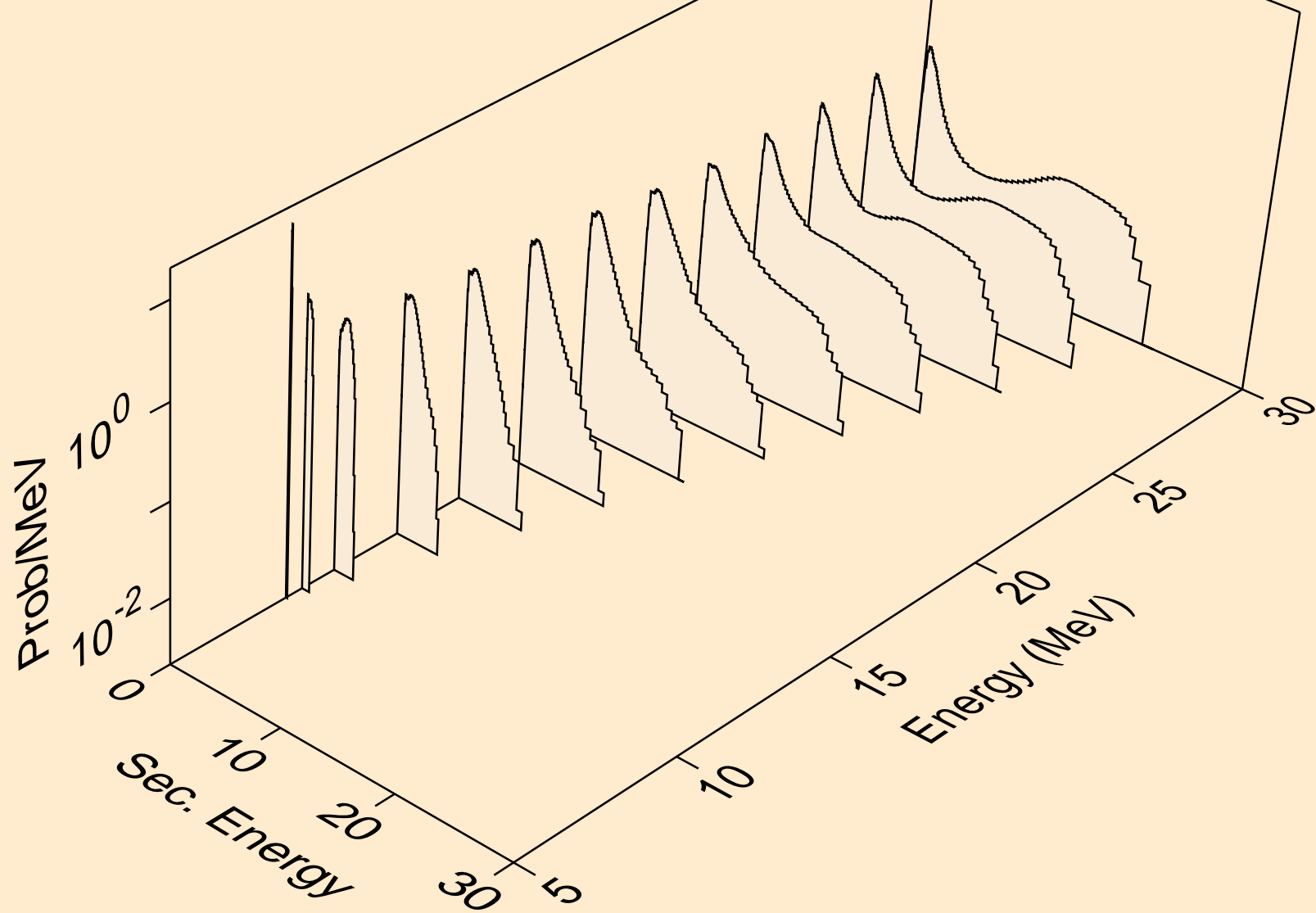

HO150 NEUTRON ACER TENDL-2021 LIBRARY; T=293.6K  
Neutron emission for (n,3n)

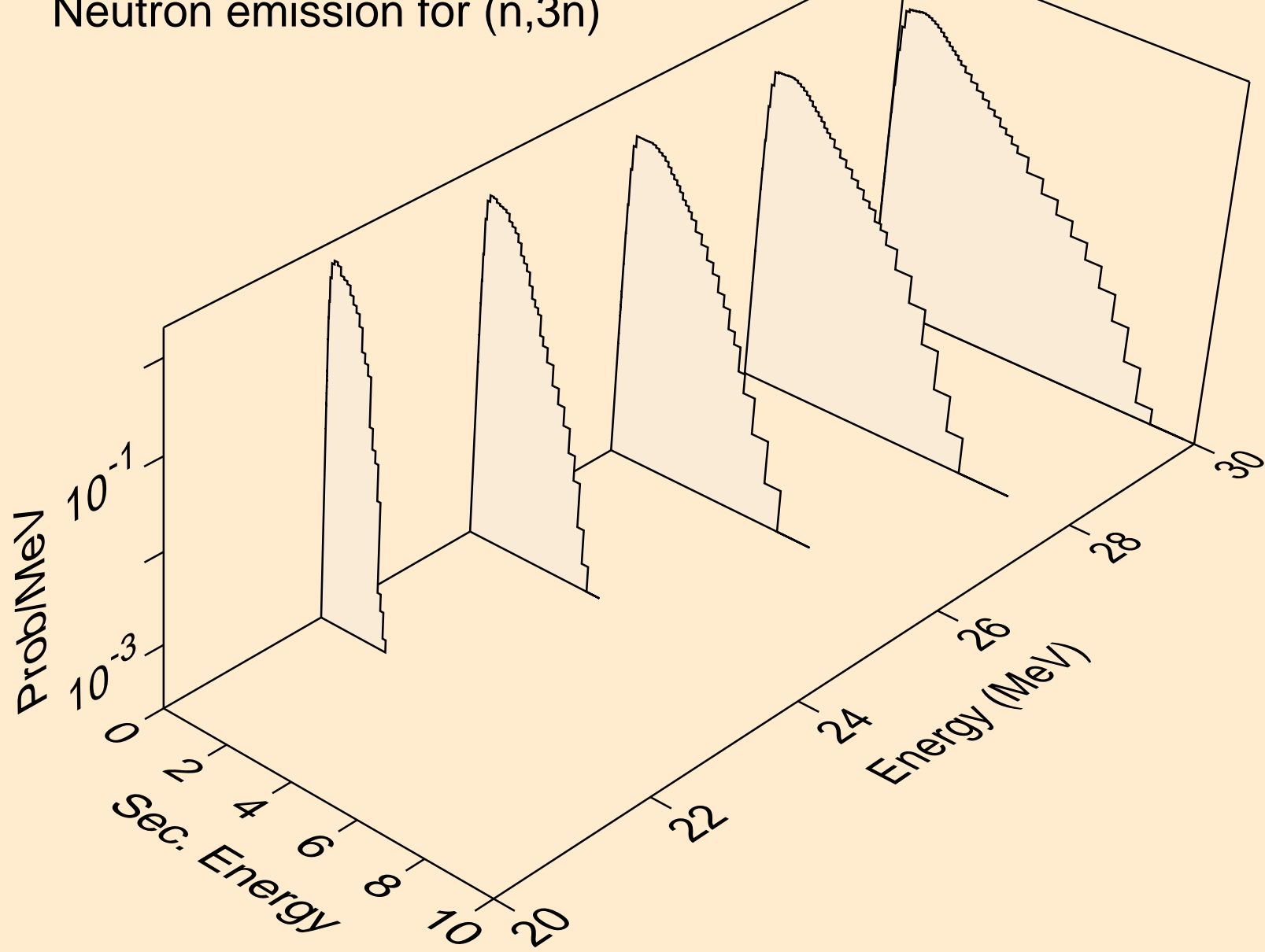



HO150 NEUTRON ACER TENDL-2021 LIBRARY; T=293.6K  
Neutron emission for (n,n\*)a

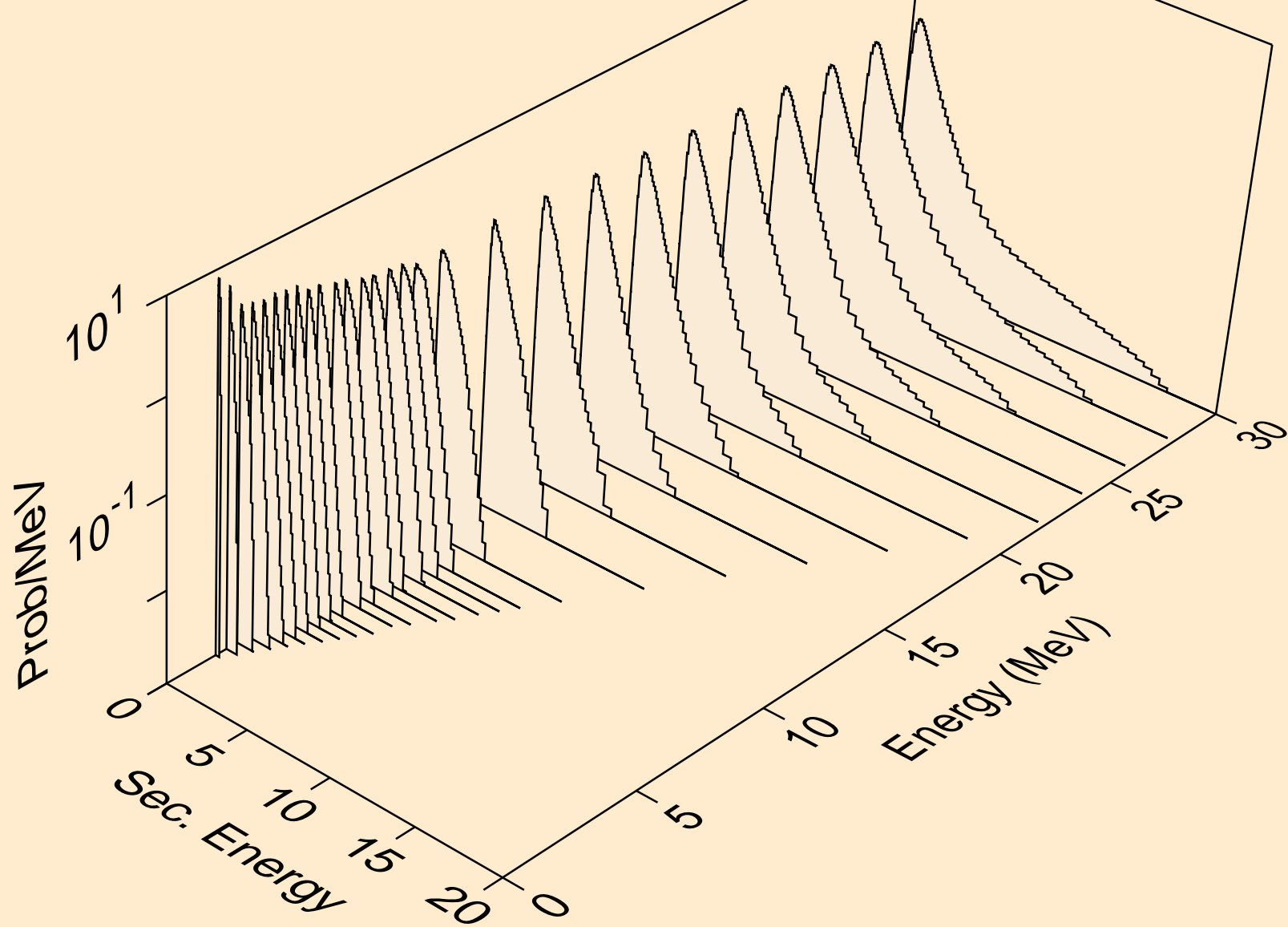

HO150 NEUTRON ACER TENDL-2021 LIBRARY; T=293.6K  
Neutron emission for (n,2n)<sub>a</sub>

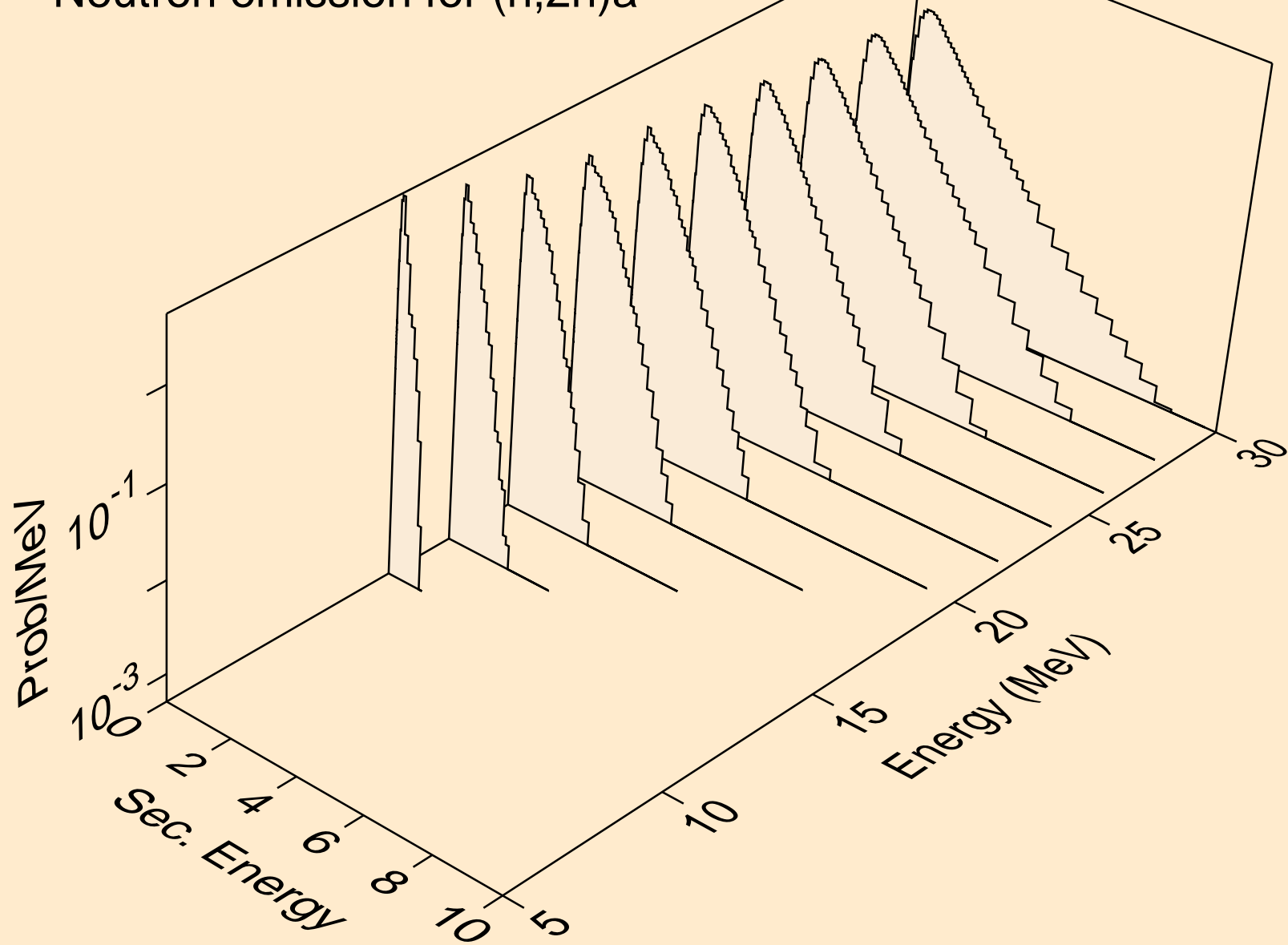

HO150 NEUTRON ACER TENDL-2021 LIBRARY; T=293.6K  
Neutron emission for (n,3n)a

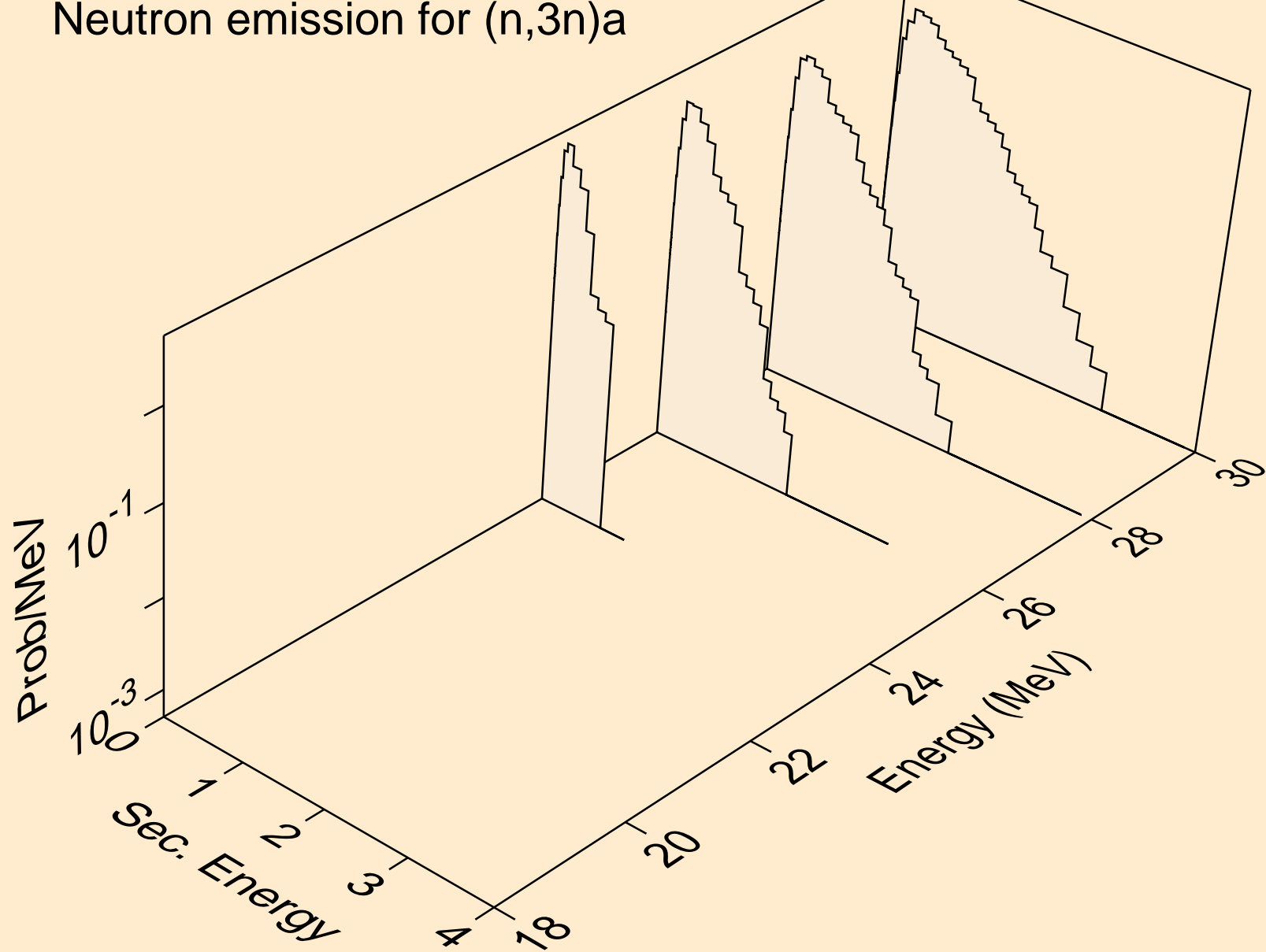

HO150 NEUTRON ACER TENDL-2021 LIBRARY; T=293.6K  
Neutron emission for (n,n\*)p

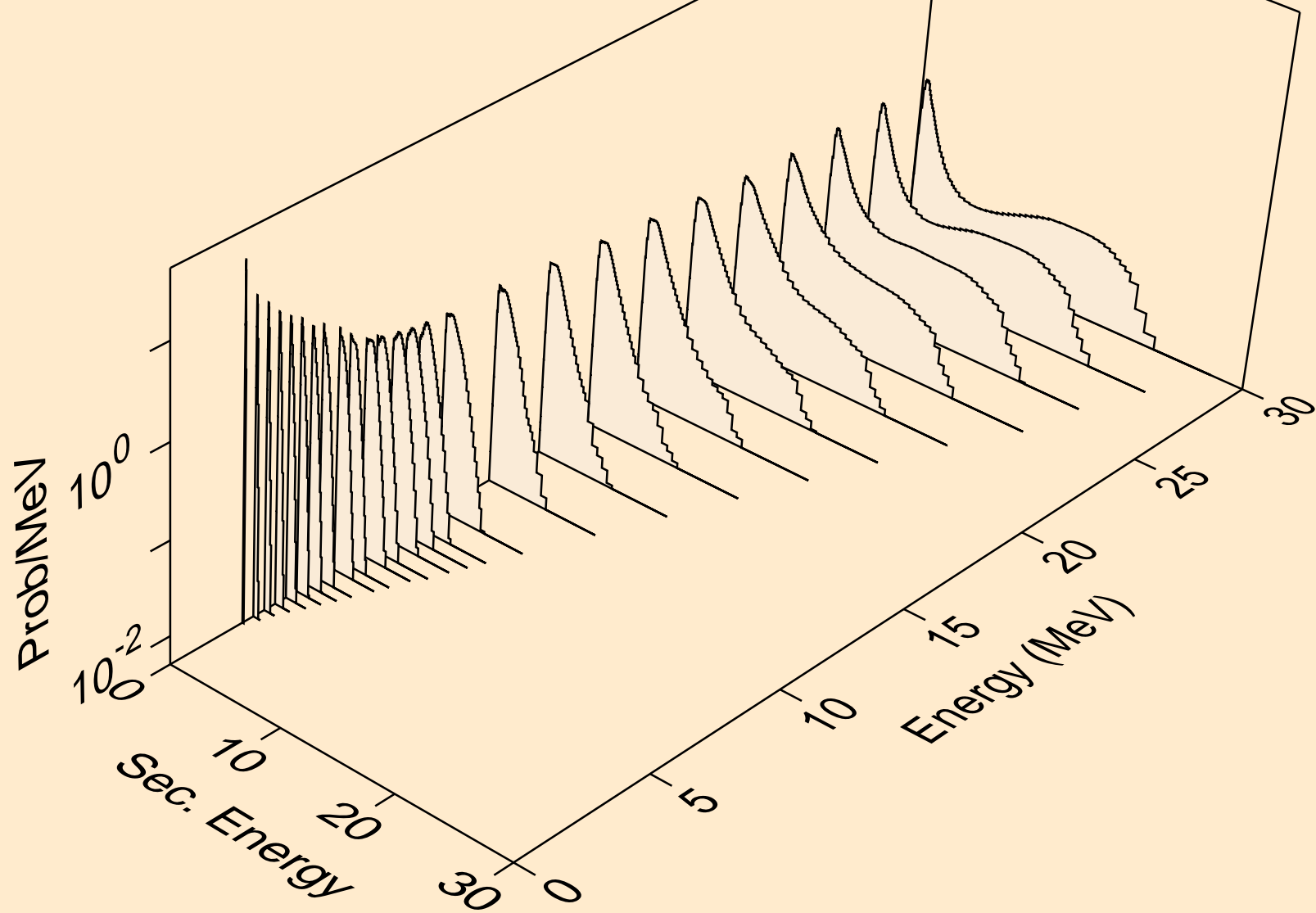

HO150 NEUTRON ACER TENDL-2021 LIBRARY; T=293.6K  
Neutron emission for (n,n\*)2a

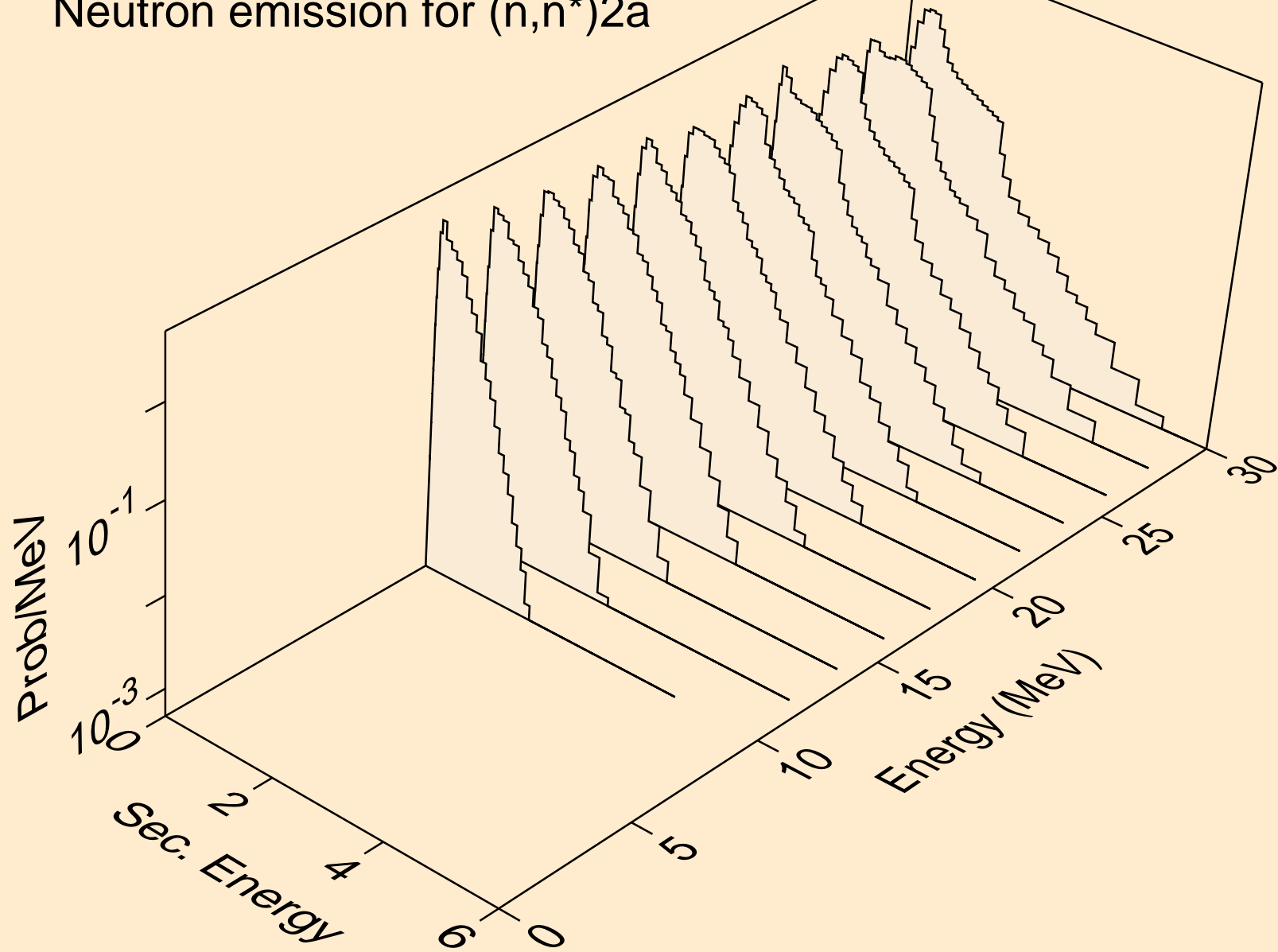

HO150 NEUTRON ACER TENDL-2021 LIBRARY; T=293.6K  
Neutron emission for (n,2n)2a

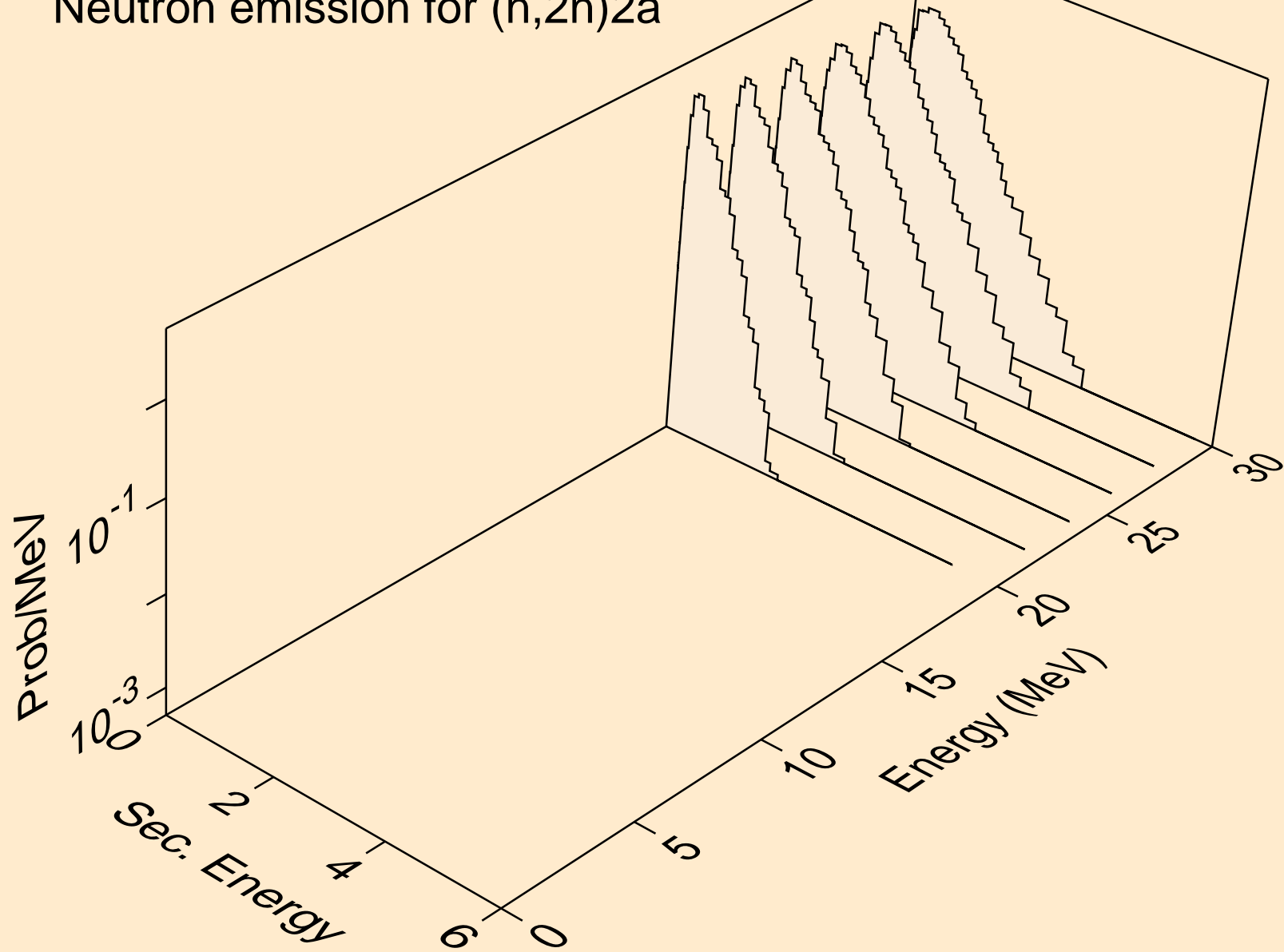

HO150 NEUTRON ACER TENDL-2021 LIBRARY; T=293.6K  
Neutron emission for (n,n\*)d

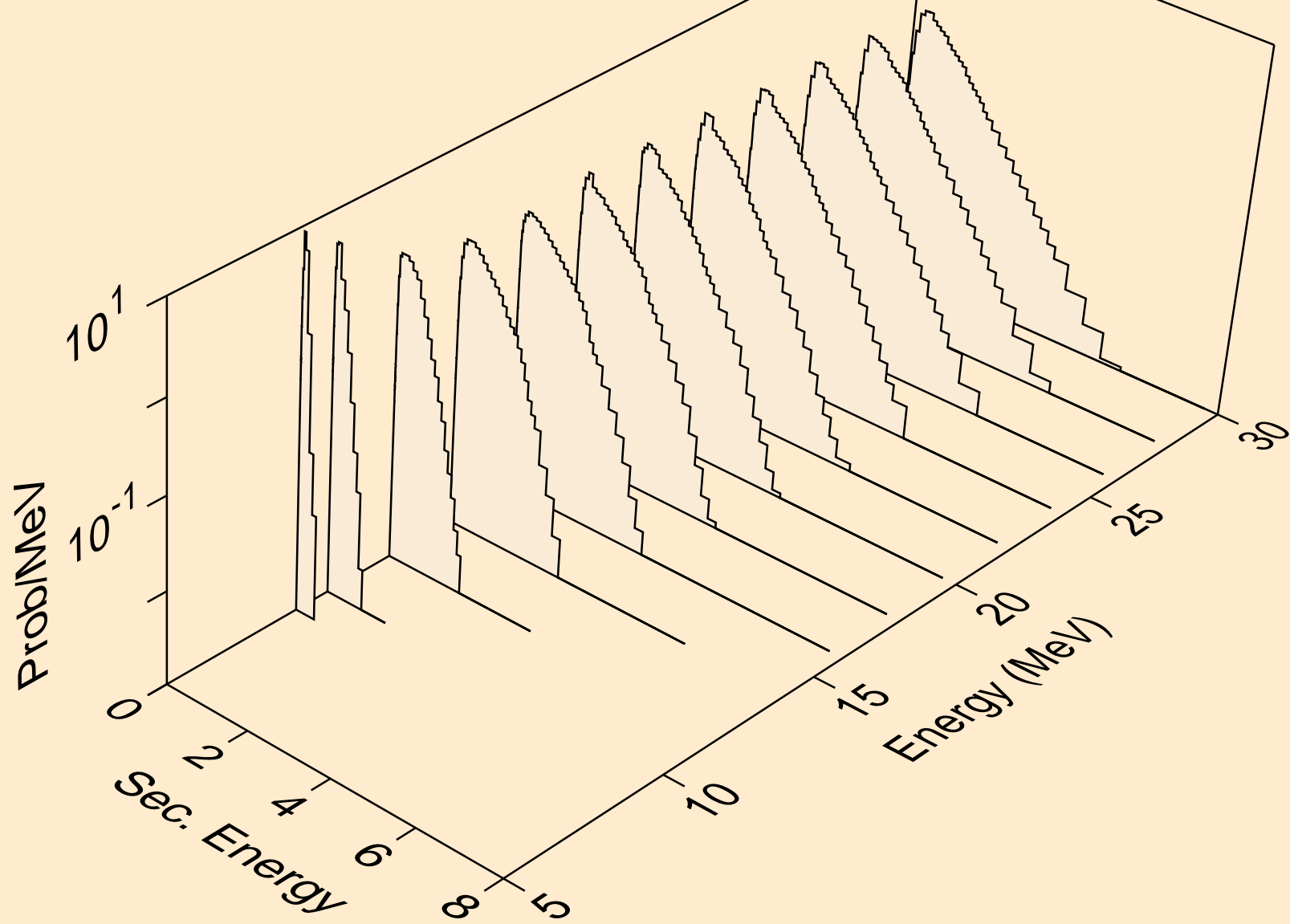

HO150 NEUTRON ACER TENDL-2021 LIBRARY; T=293.6K  
Neutron emission for (n,n\*)t

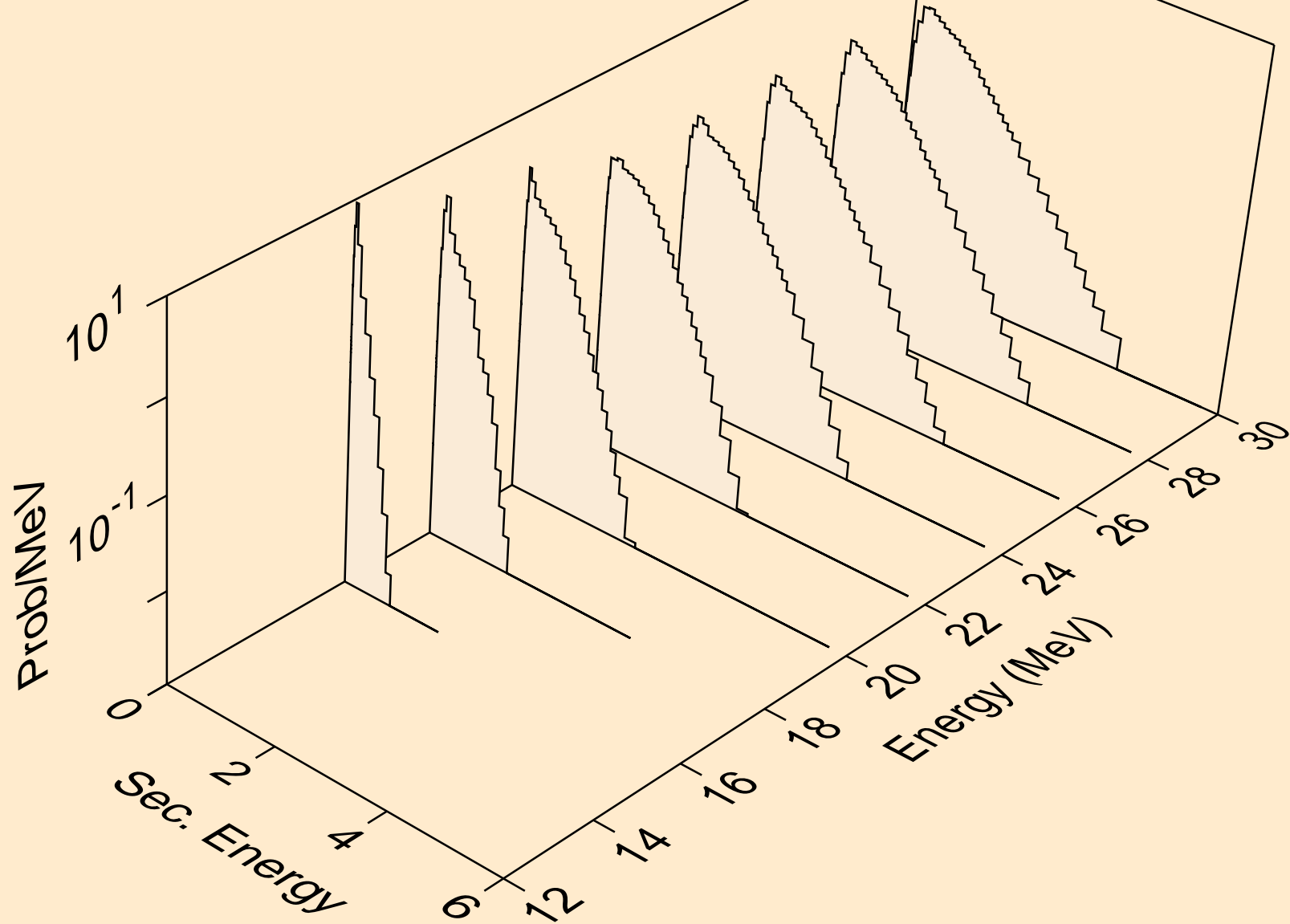



HO150 NEUTRON ACER TENDL-2021 LIBRARY; T=293.6K  
Neutron emission for (n,n\*)he3

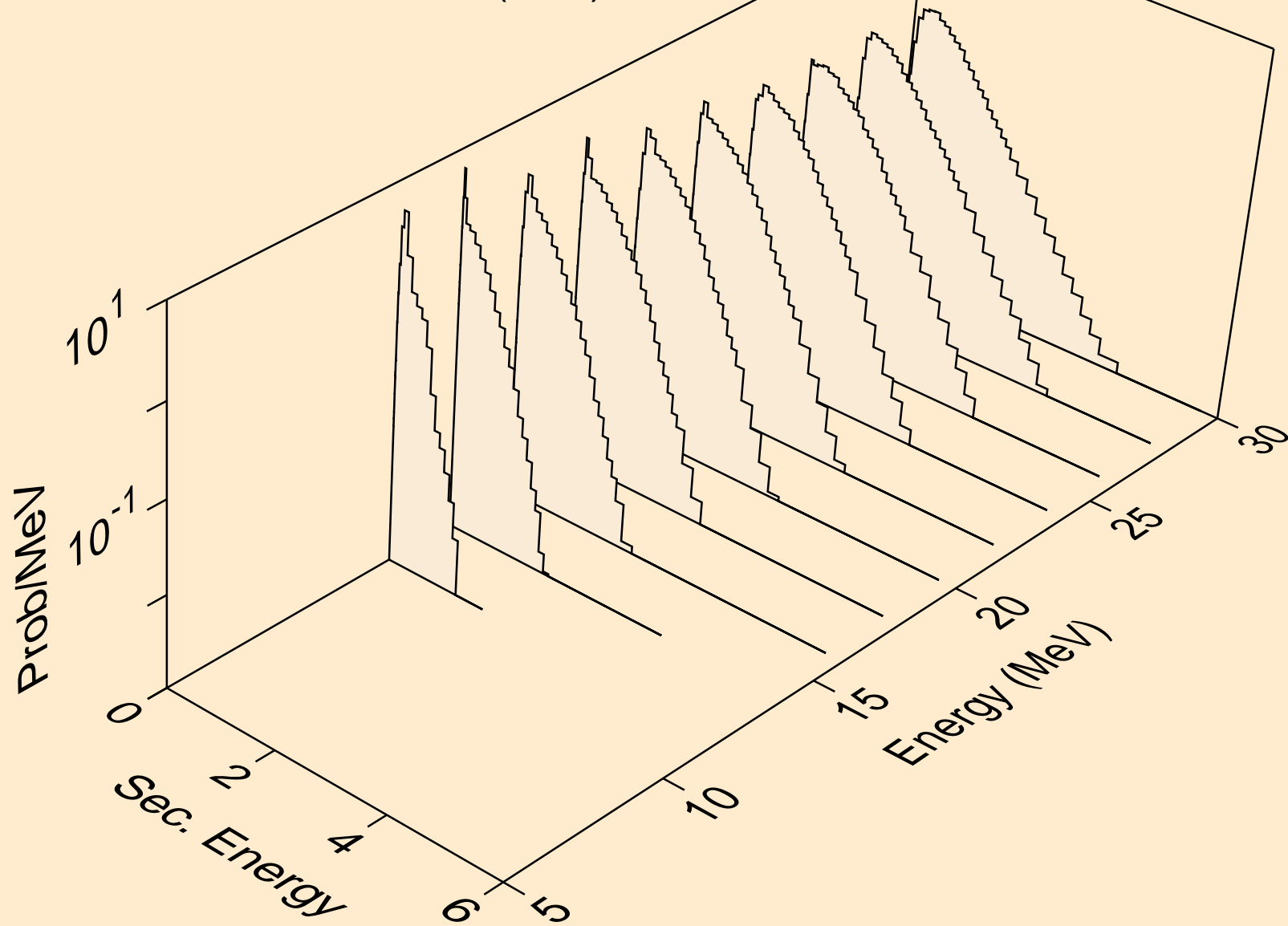

HO150 NEUTRON ACER TENDL-2021 LIBRARY; T=293.6K  
Neutron emission for (n,2np)

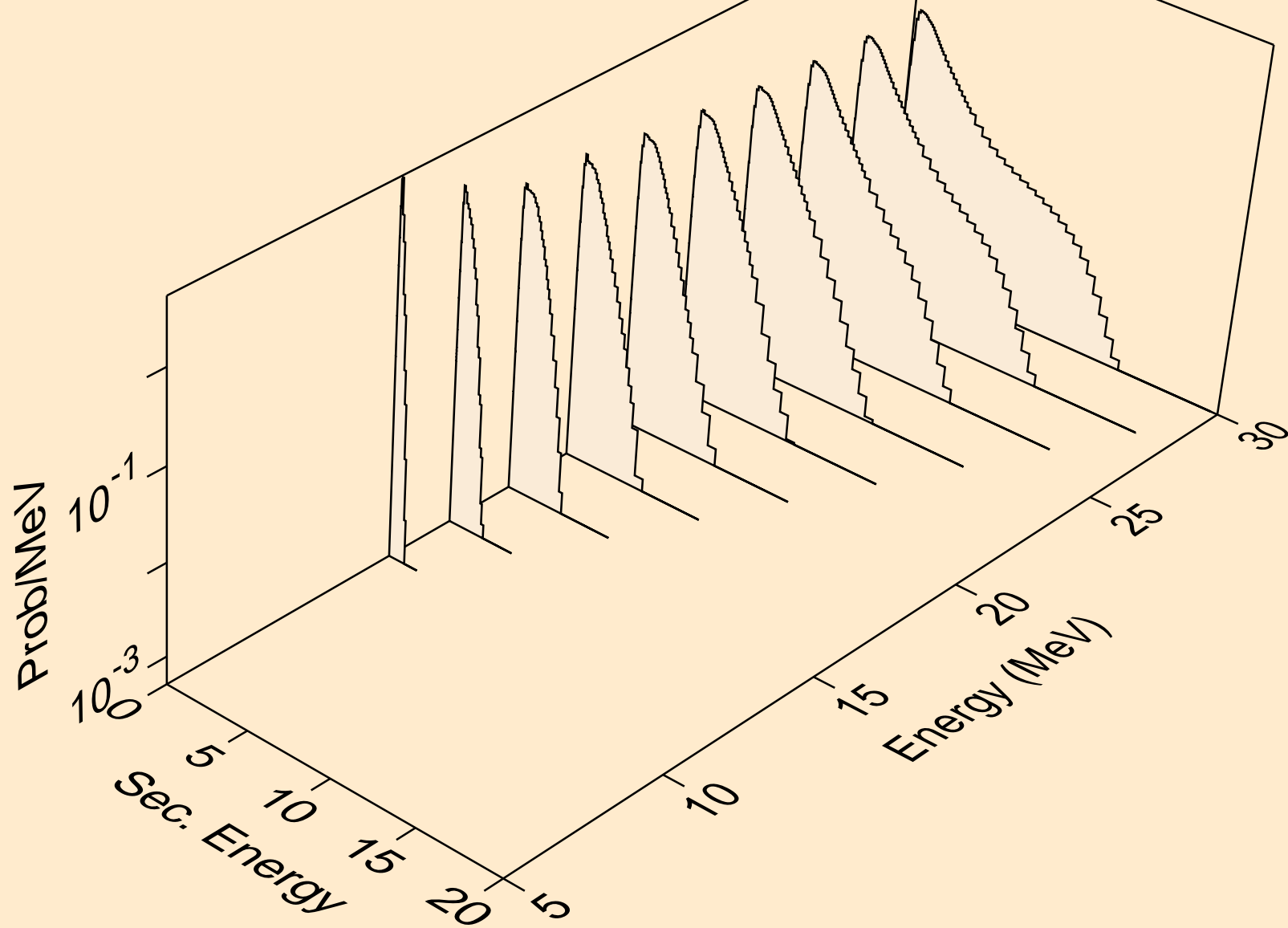

HO150 NEUTRON ACER TENDL-2021 LIBRARY; T=293.6K  
Neutron emission for (n,3np)

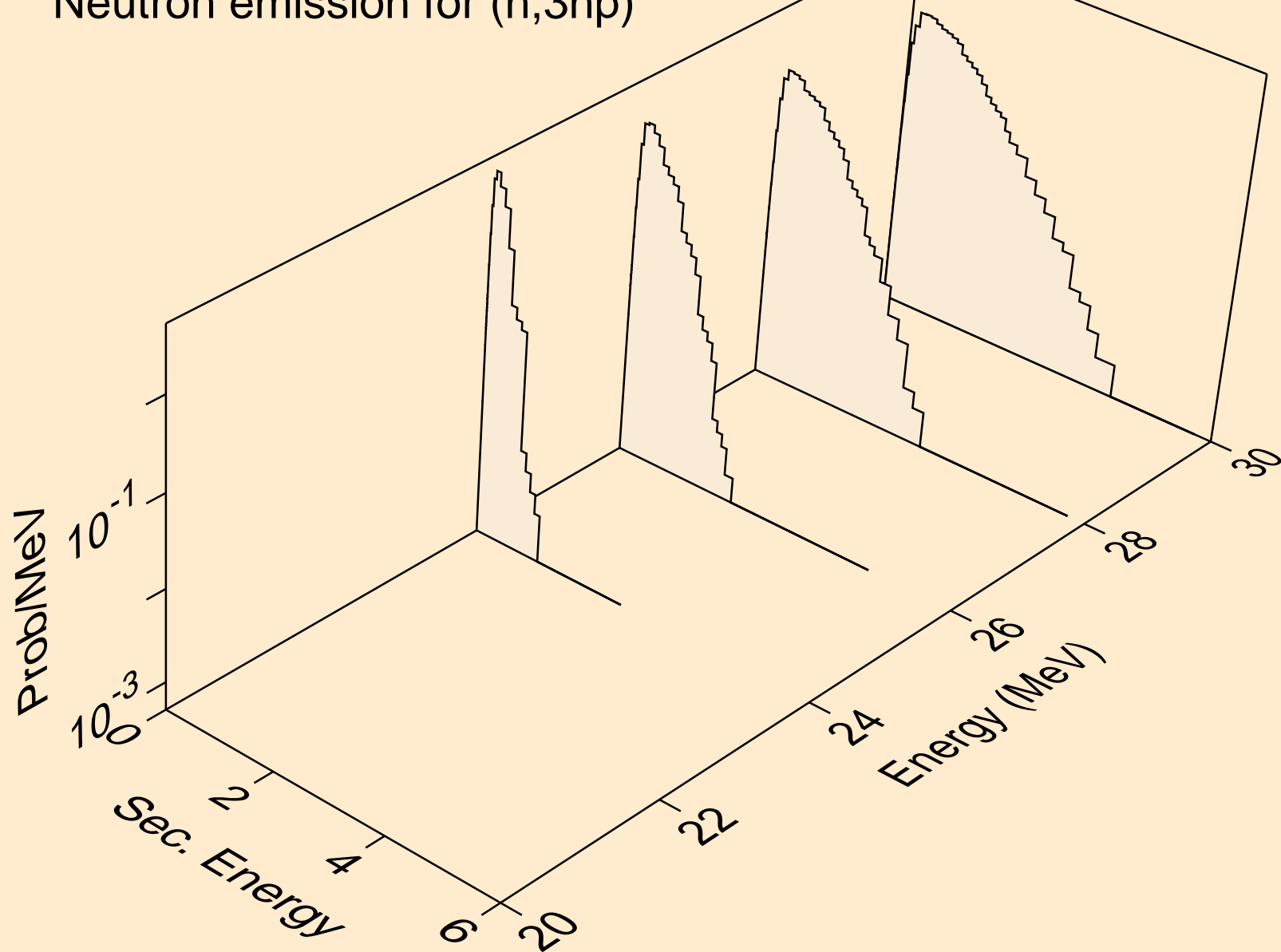

HO150 NEUTRON ACER TENDL-2021 LIBRARY; T=293.6K  
Neutron emission for (n,2np)

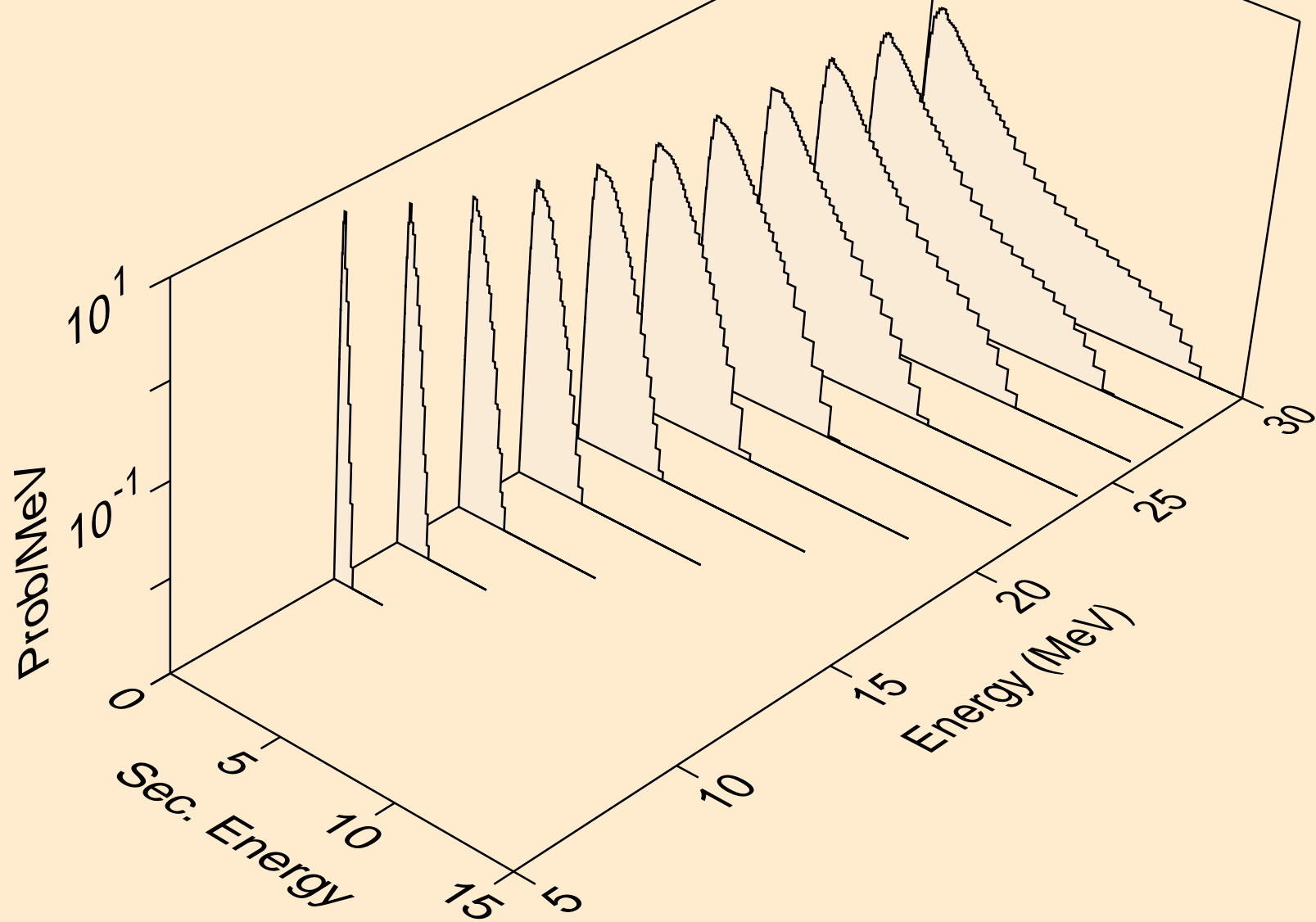

HO150 NEUTRON ACER TENDL-2021 LIBRARY; T=293.6K  
Neutron emission for (n,npa)

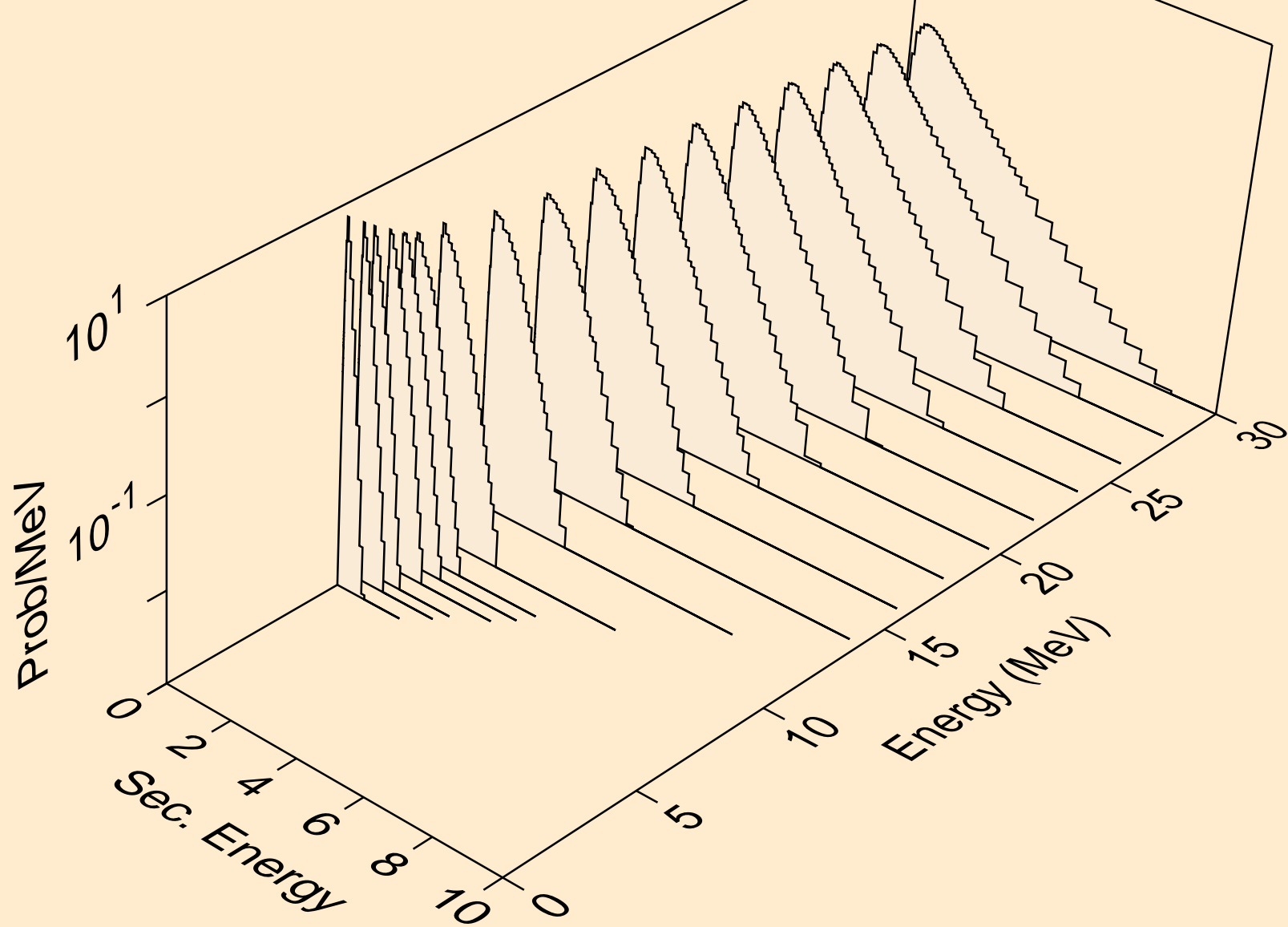

HO150 NEUTRON ACER TENDL-2021 LIBRARY; T=293.6K  
Neutron emission for (n,n\*c)

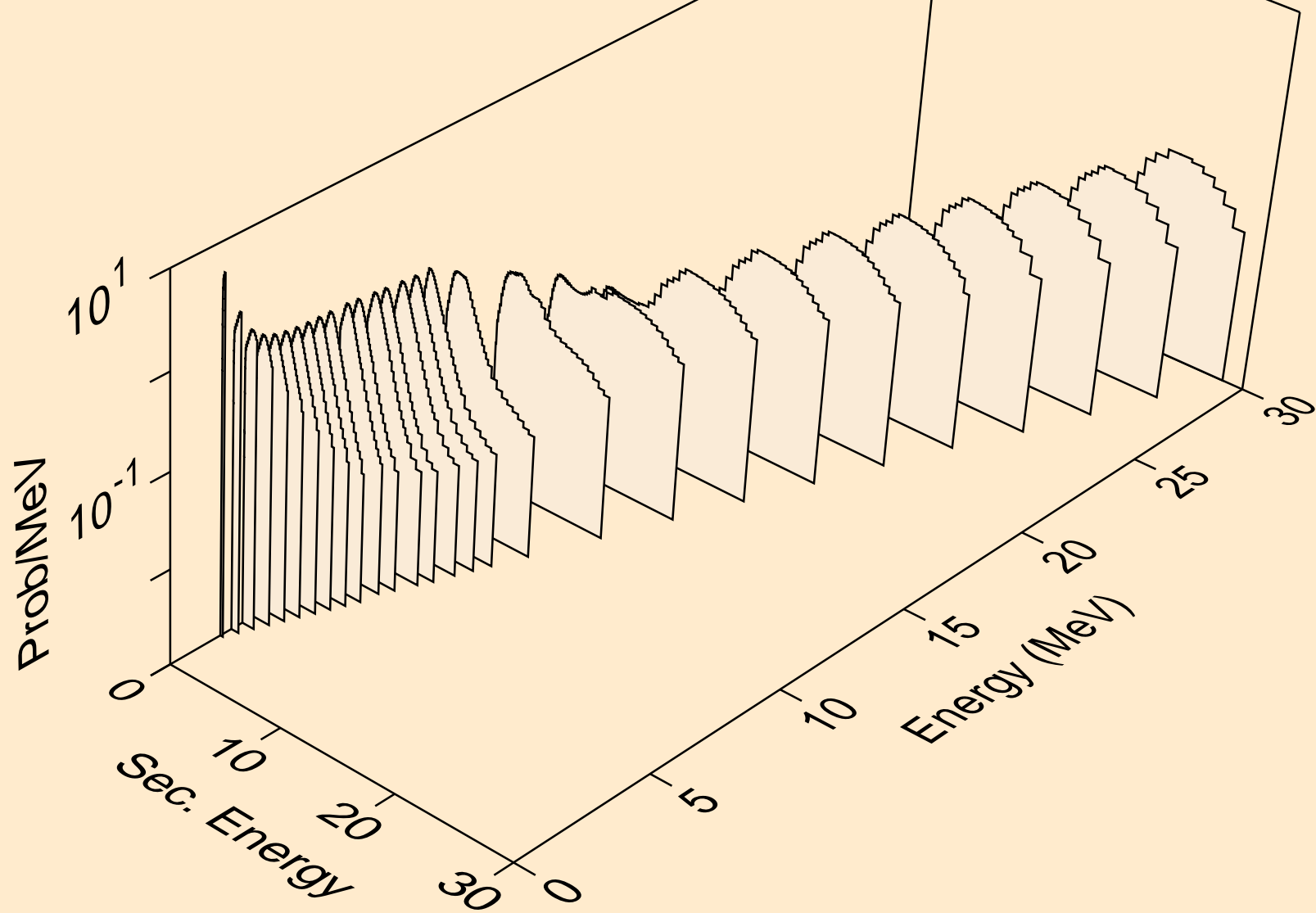

HO150 NEUTRON ACER TENDL-2021 LIBRARY; T=293.6K  
Photon emission for (n,x)

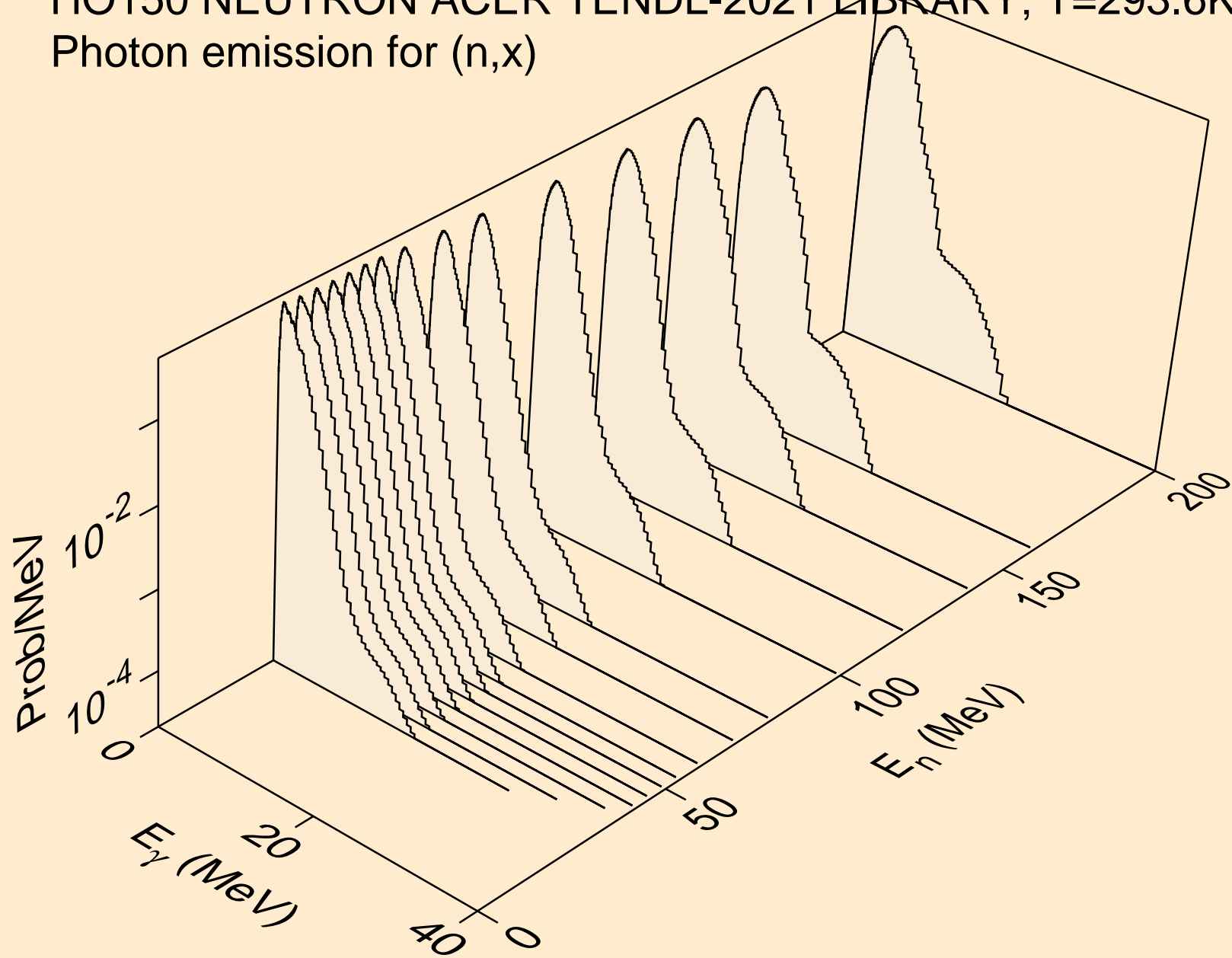

HO150 NEUTRON ACER TENDL-2021 LIBRARY; T=293.6K  
Photon emission for (n,2nd)

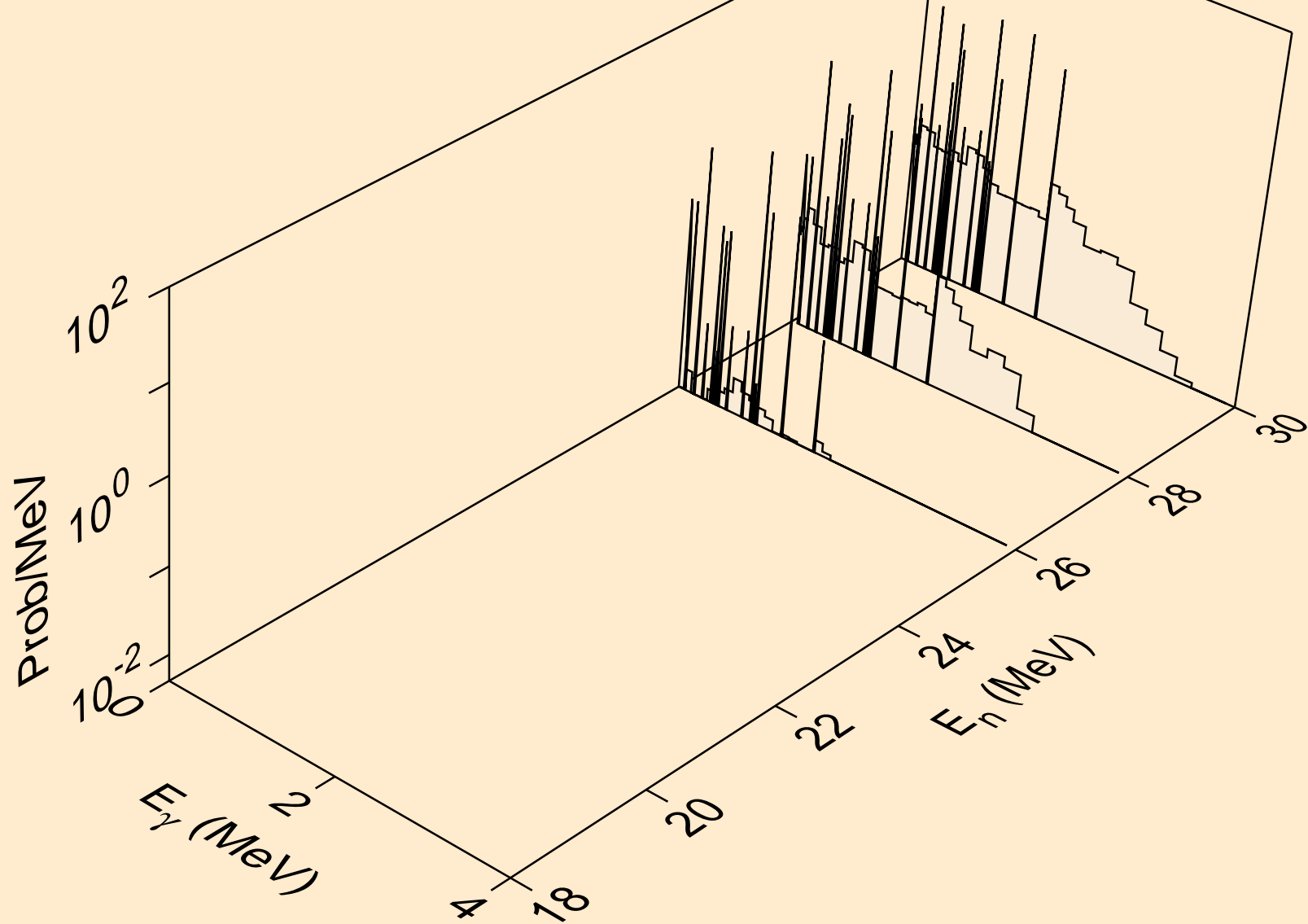



HO150 NEUTRON ACER TENDL-2021 LIBRARY; T=293.6K  
Photon emission for (n,2n)

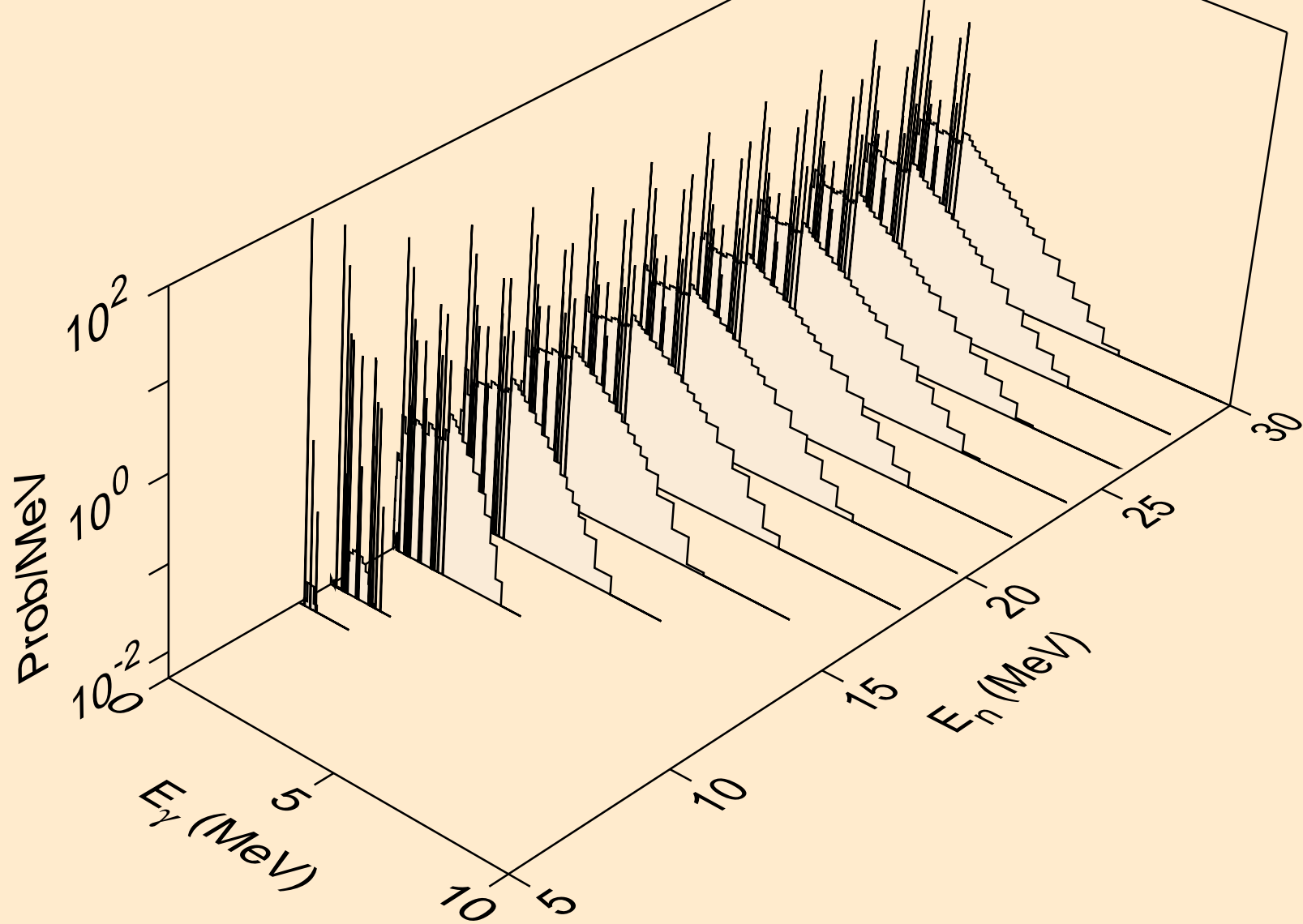

HO150 NEUTRON ACER TENDL-2021 LIBRARY; T=293.6K  
Photon emission for (n,3n)

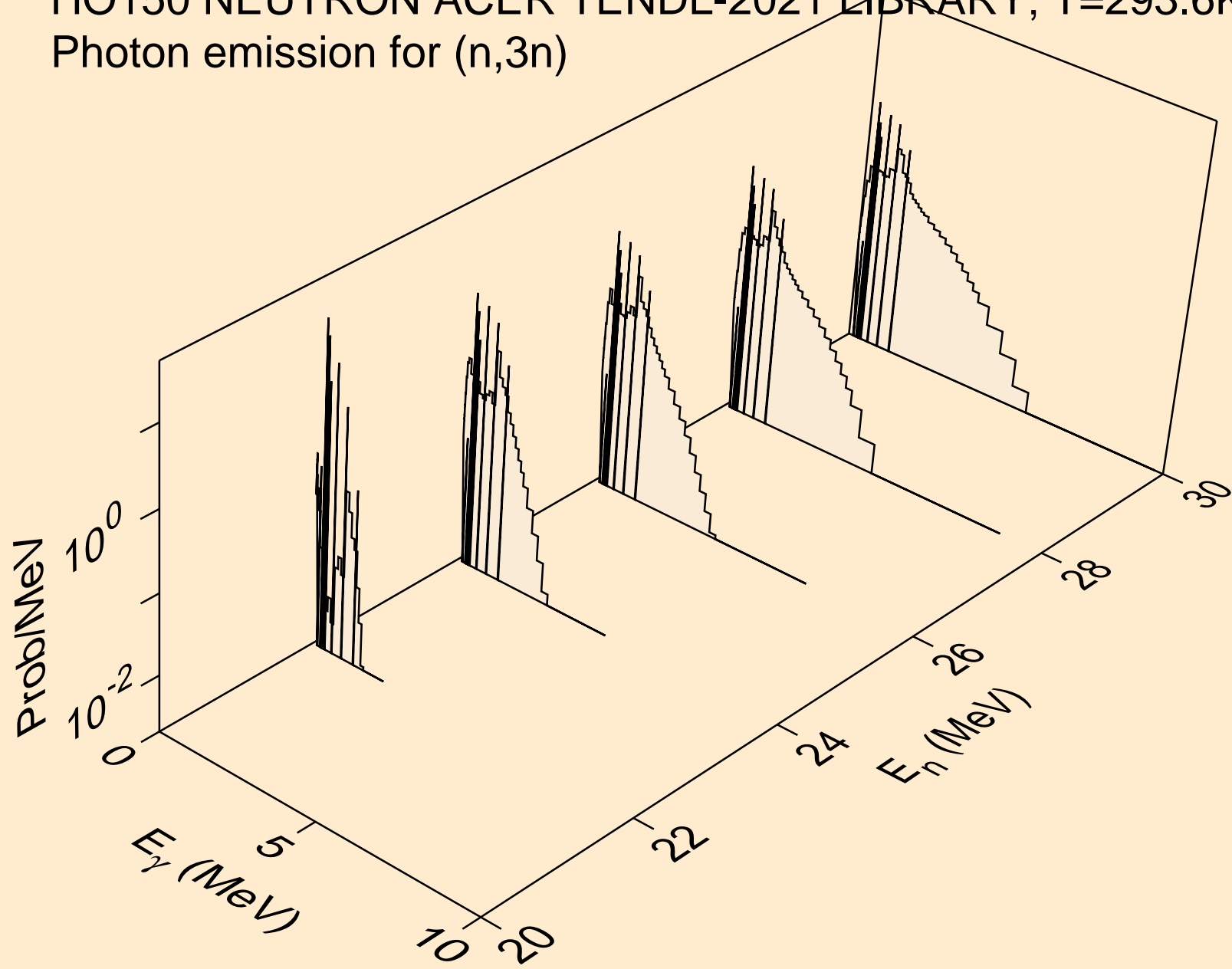

HO150 NEUTRON ACER TENDL-2021 LIBRARY; T=293.6K  
Photon emission for (n,n\*)a

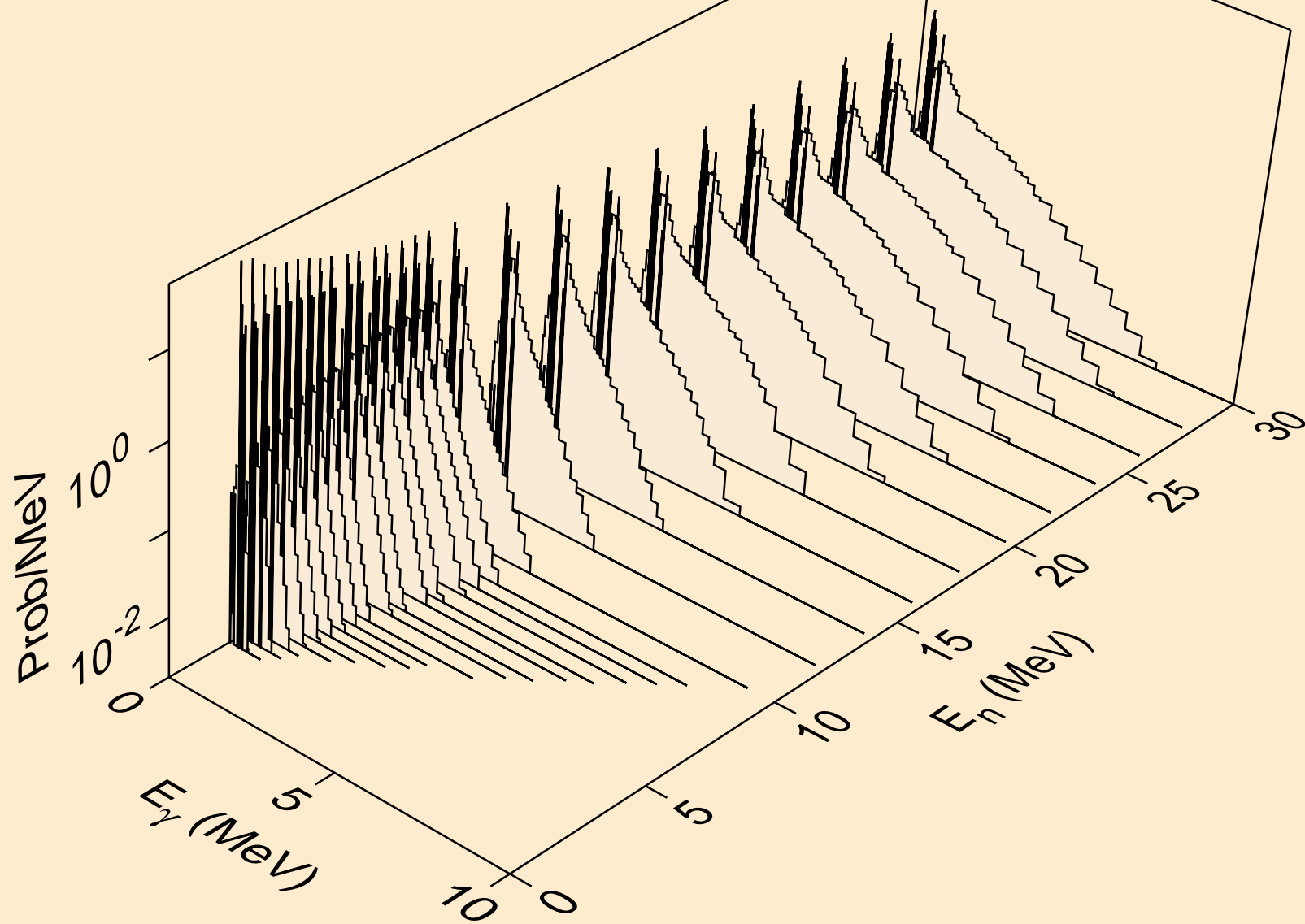

HO150 NEUTRON ACER TENDL-2021 LIBRARY; T=293.6K  
Photon emission for (n,2n)a

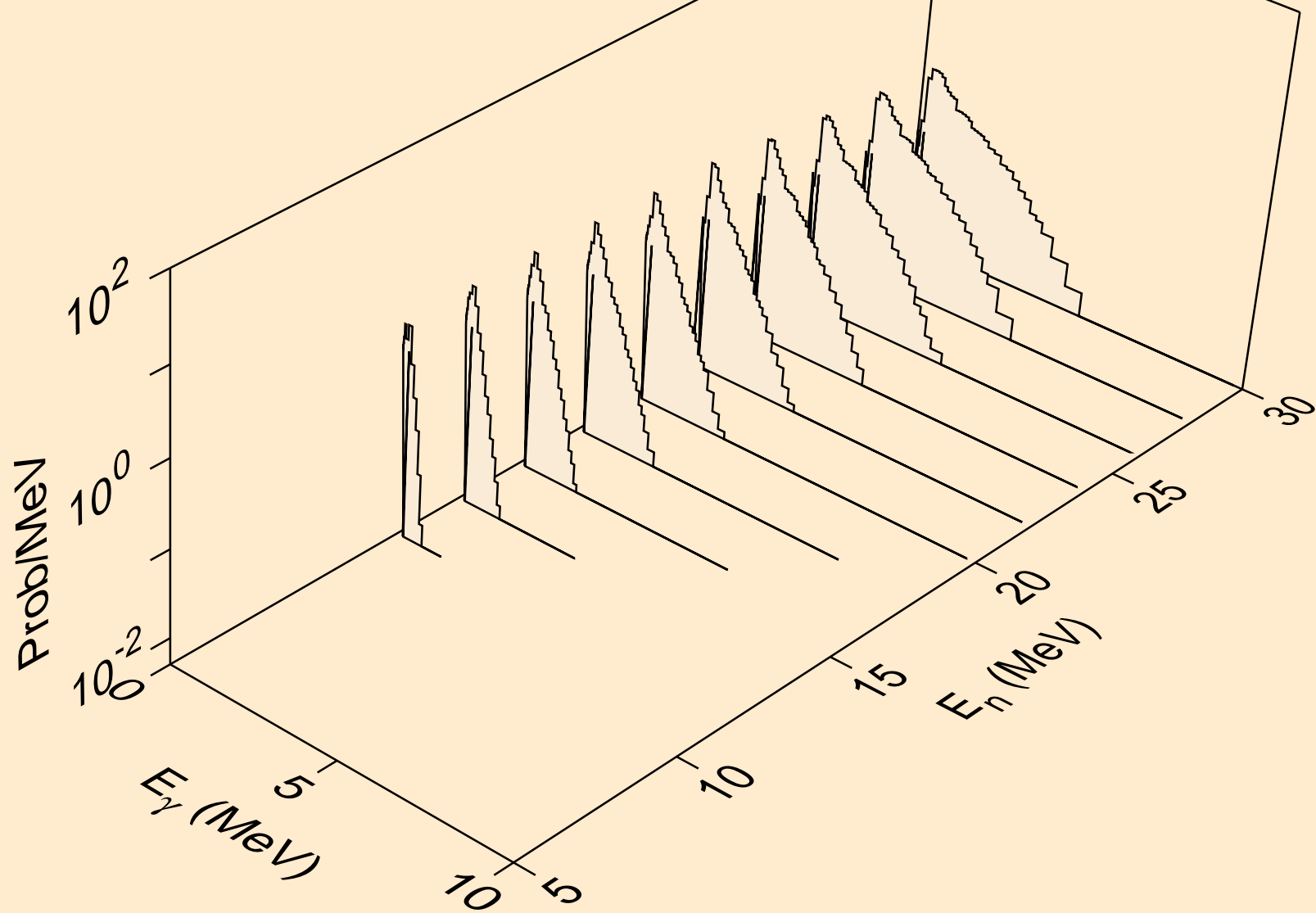

HO150 NEUTRON ACER TENDL-2021 LIBRARY; T=293.6K  
Photon emission for (n,3n)a

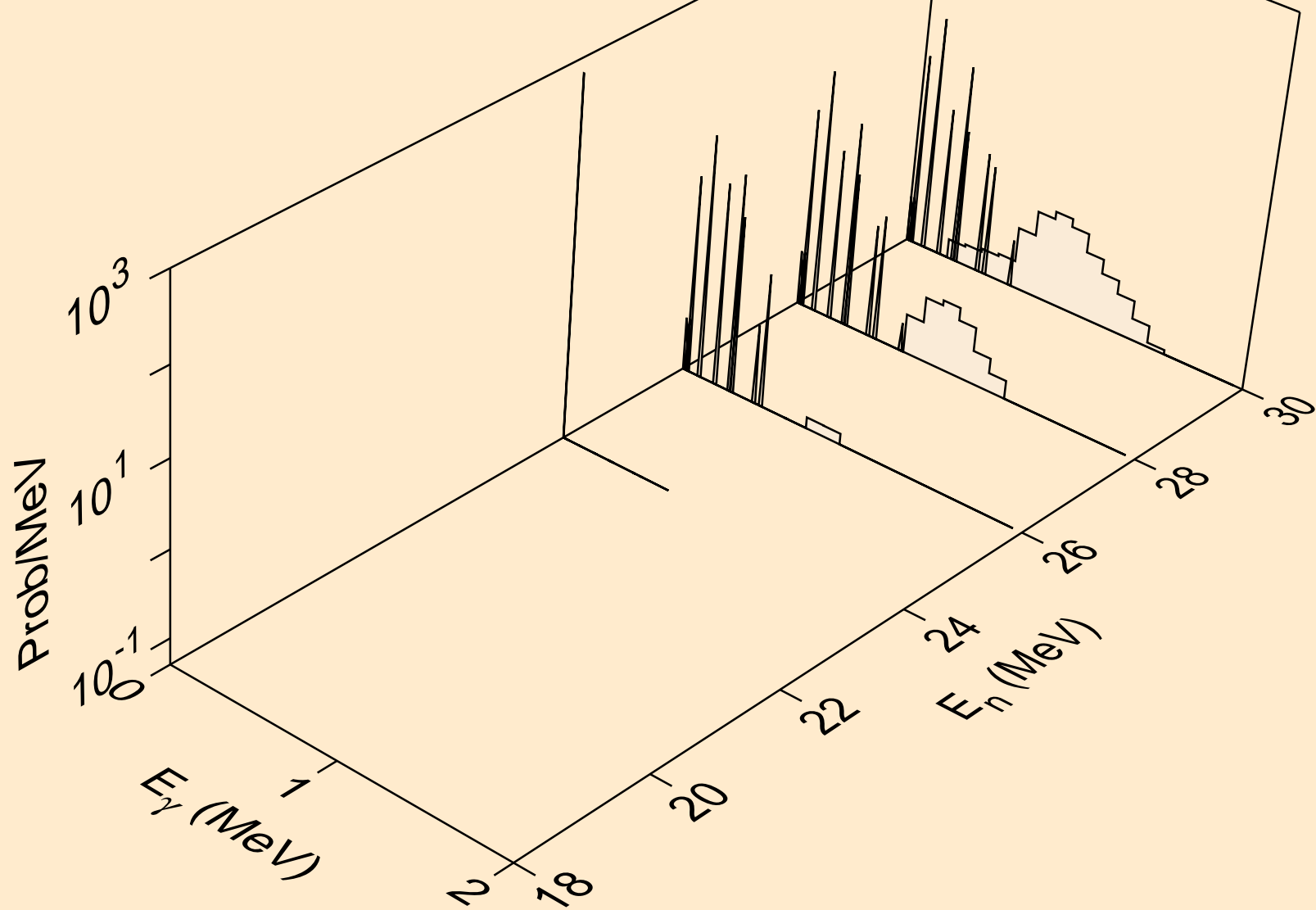

HO150 NEUTRON ACER TENDL-2021 LIBRARY; T=293.6K  
Photon emission for (n,n\*)p

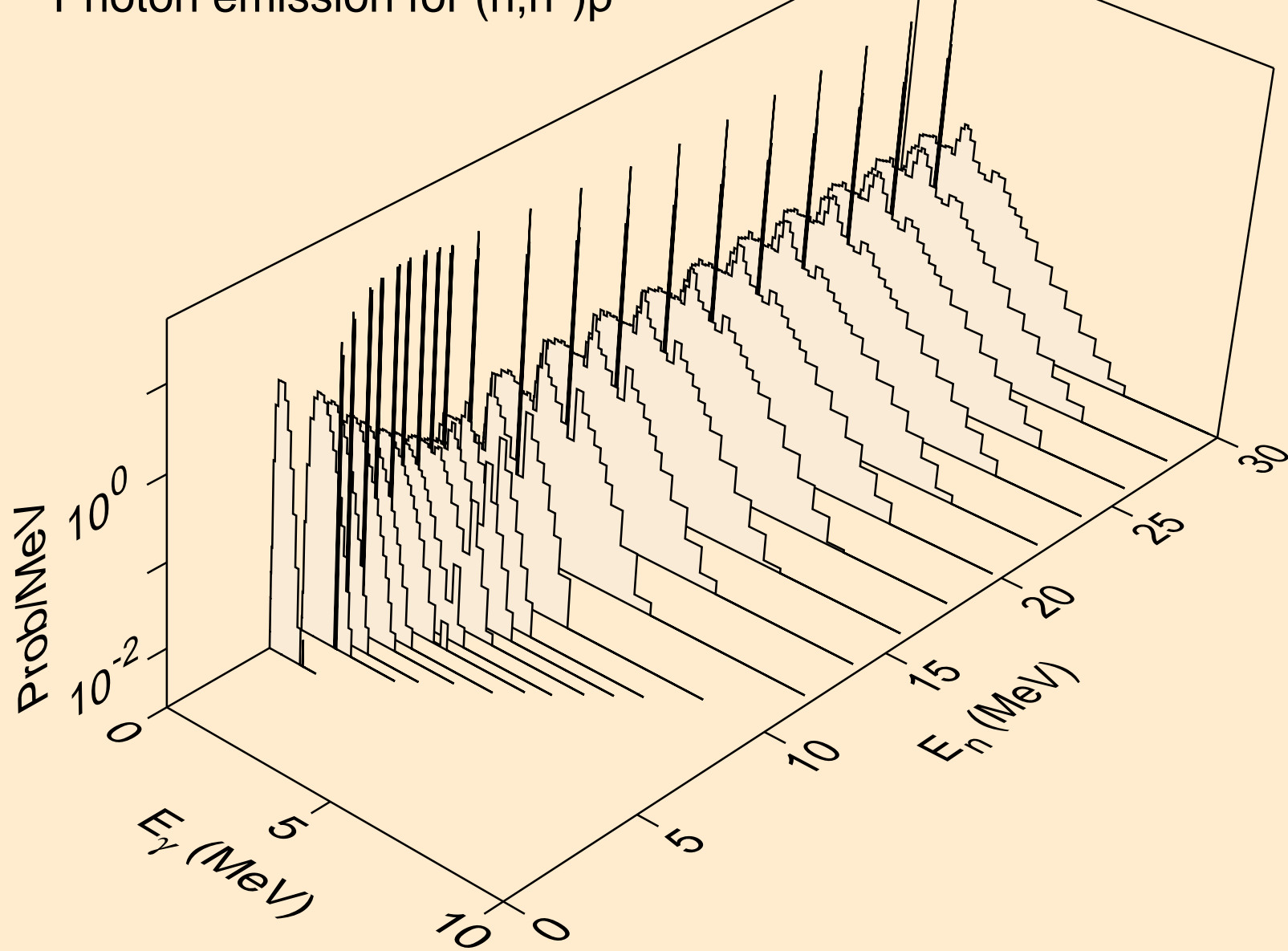

HO150 NEUTRON ACER TENDL-2021 LIBRARY; T=293.6K  
Photon emission for (n,n\*)2a

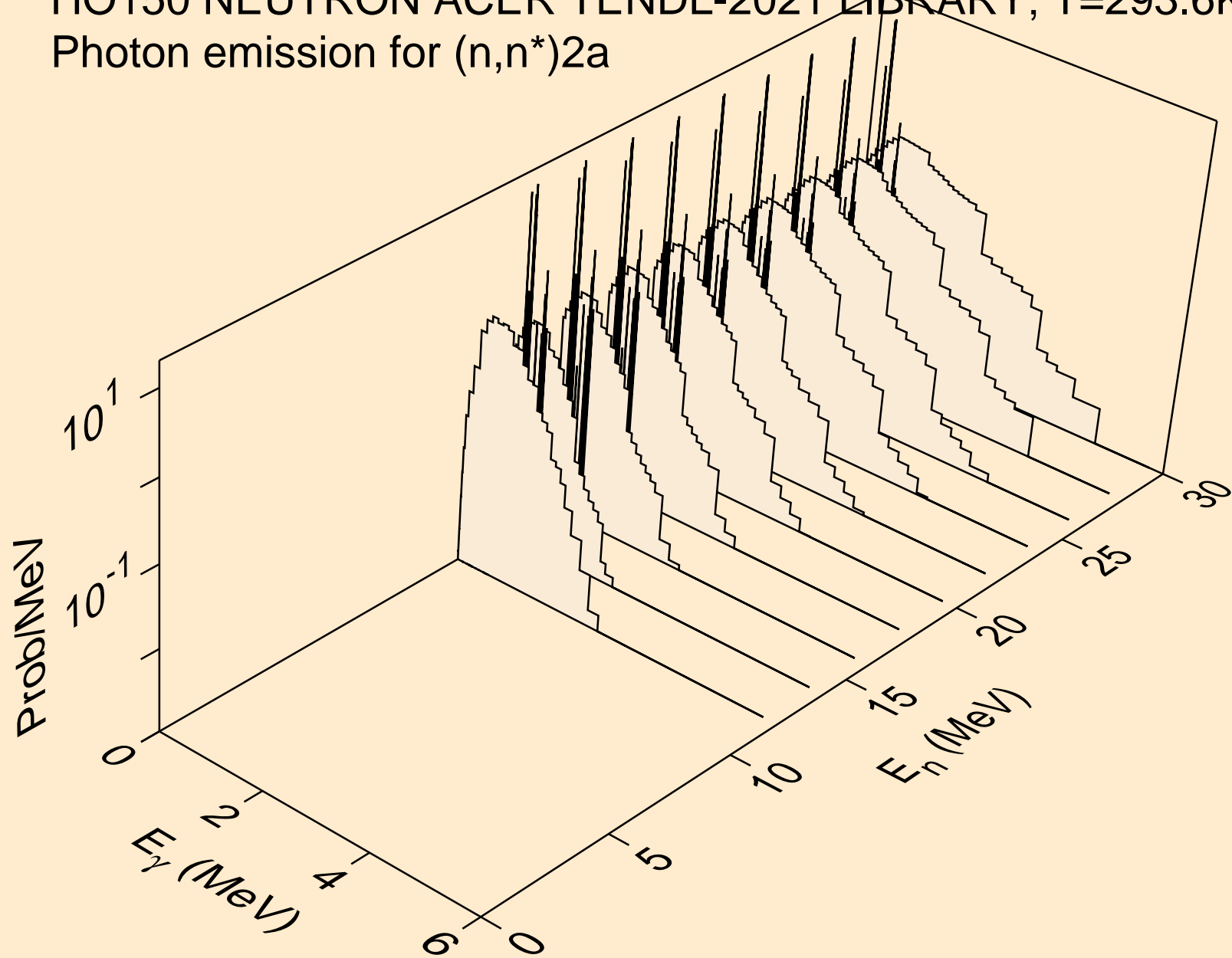

HO150 NEUTRON ACER TENDL-2021 LIBRARY; T=293.6K  
Photon emission for (n,2n)2a

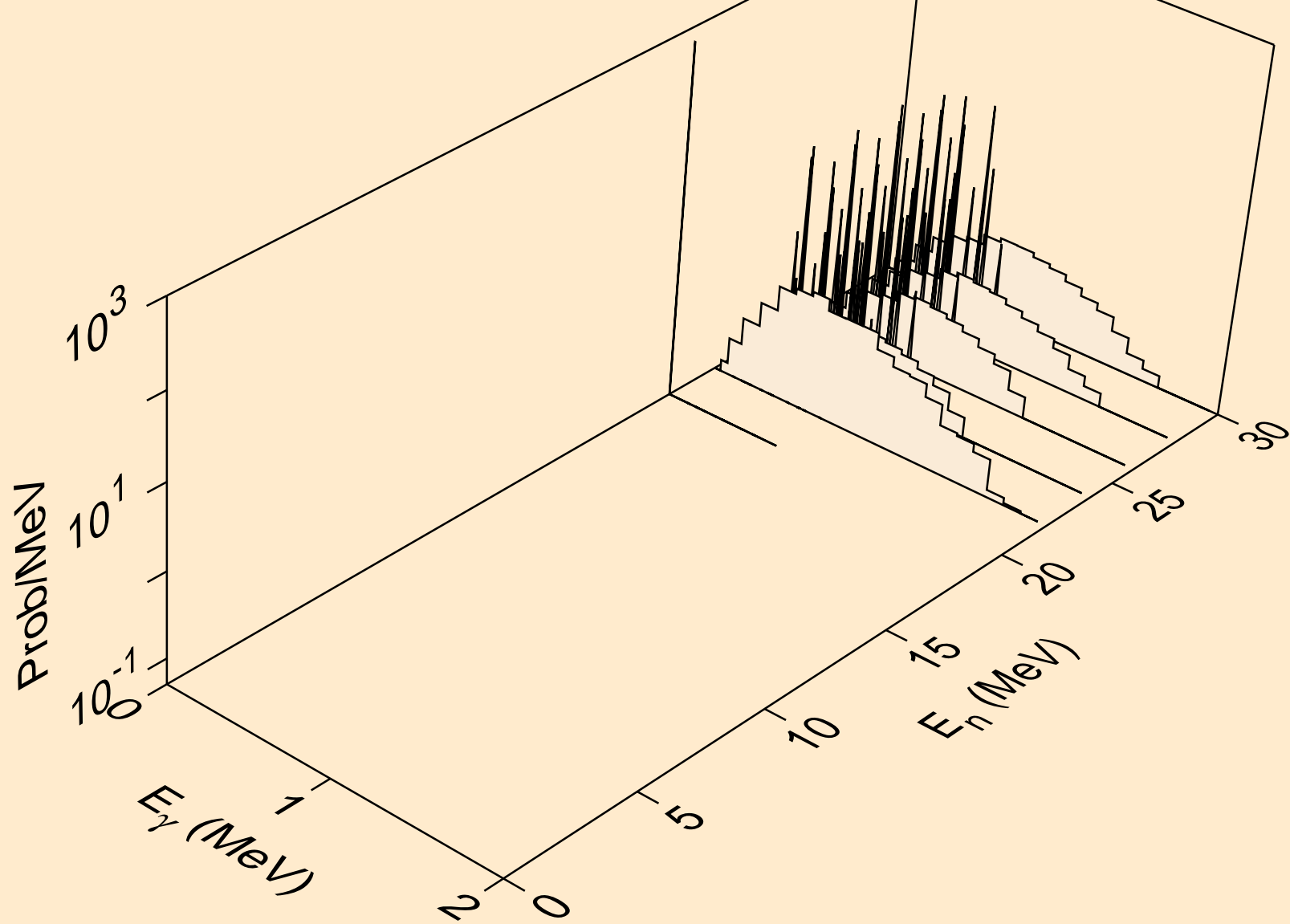



HO150 NEUTRON ACER TENDL-2021 LIBRARY; T=293.6K  
Photon emission for (n,n\*)d

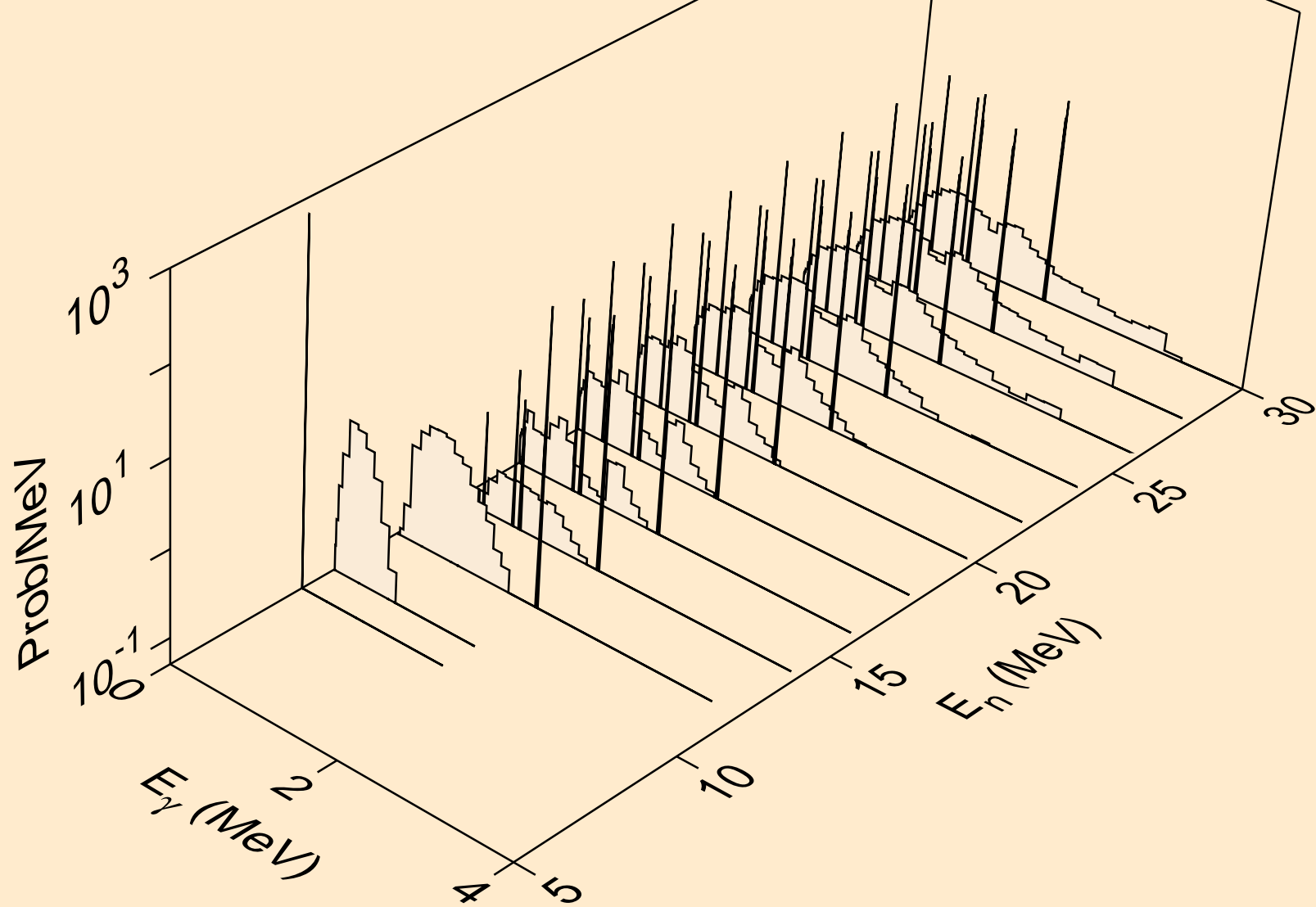

HO150 NEUTRON ACER TENDL-2021 LIBRARY; T=293.6K  
Photon emission for (n,n\*)t

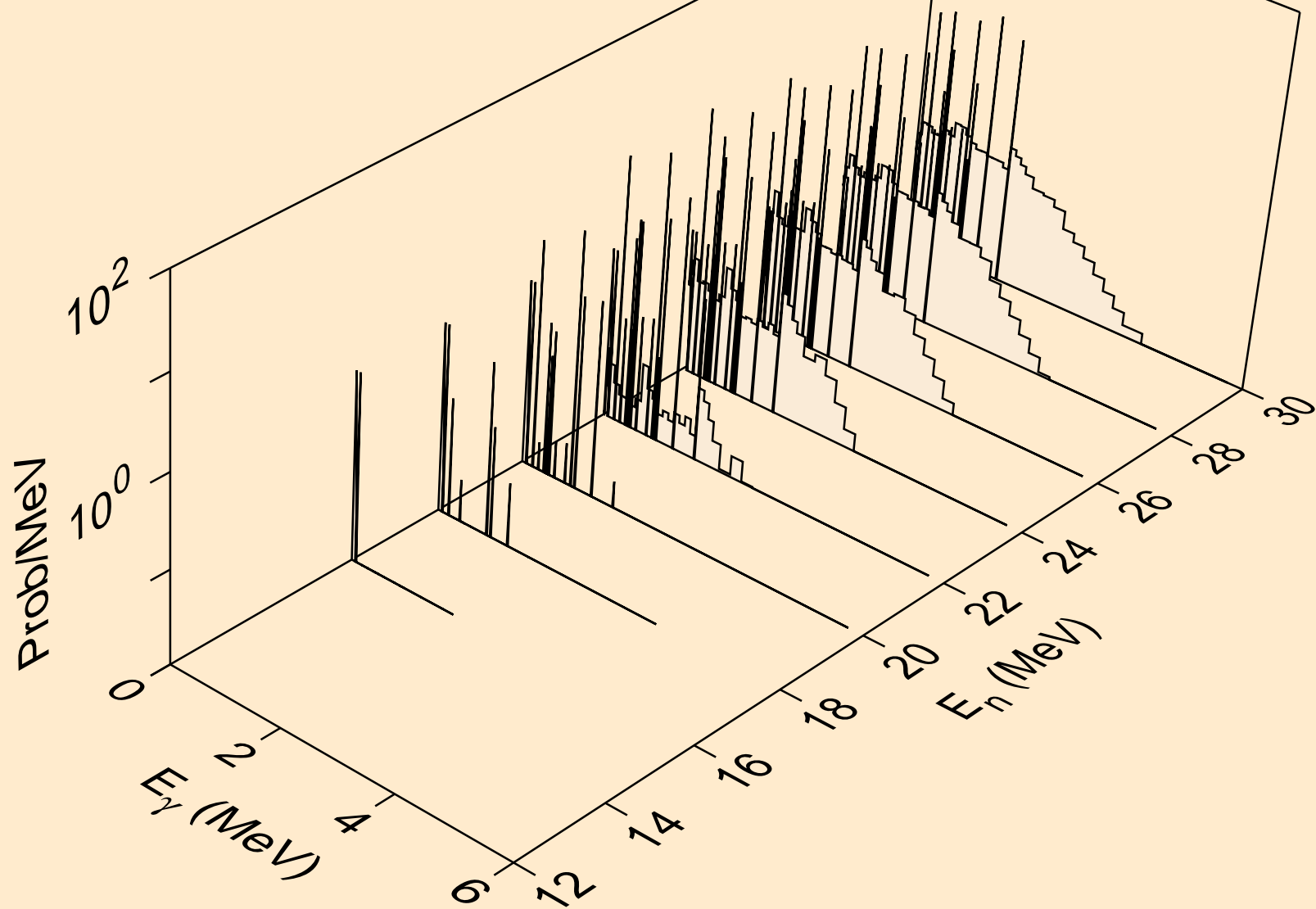

HO150 NEUTRON ACER TENDL-2021 LIBRARY; T=293.6K  
Photon emission for (n,n\*)he3

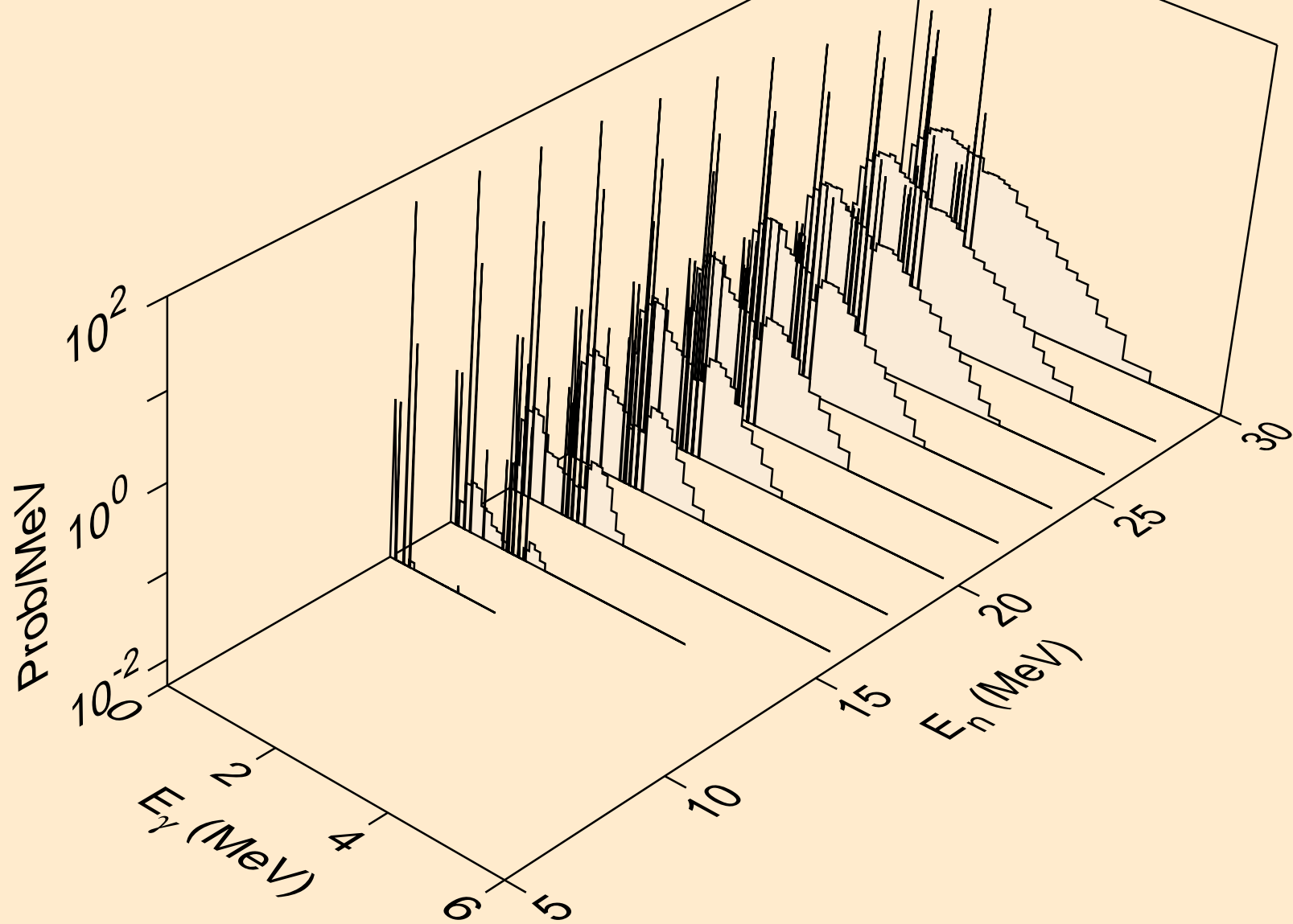

HO150 NEUTRON ACER TENDL-2021 LIBRARY; T=293.6K  
Photon emission for (n,2np)

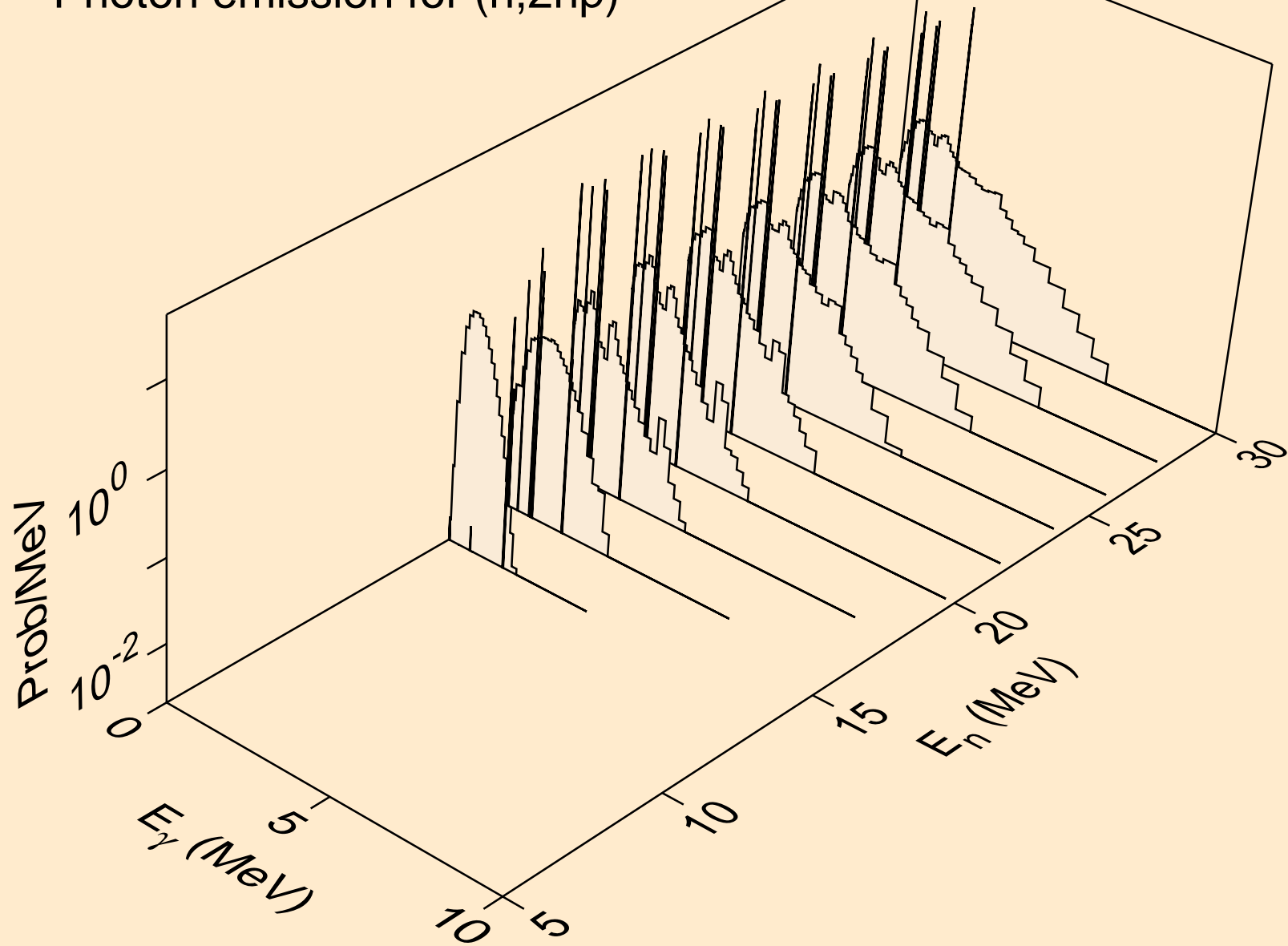

HO150 NEUTRON ACER TENDL-2021 LIBRARY; T=293.6K  
Photon emission for (n,3np)

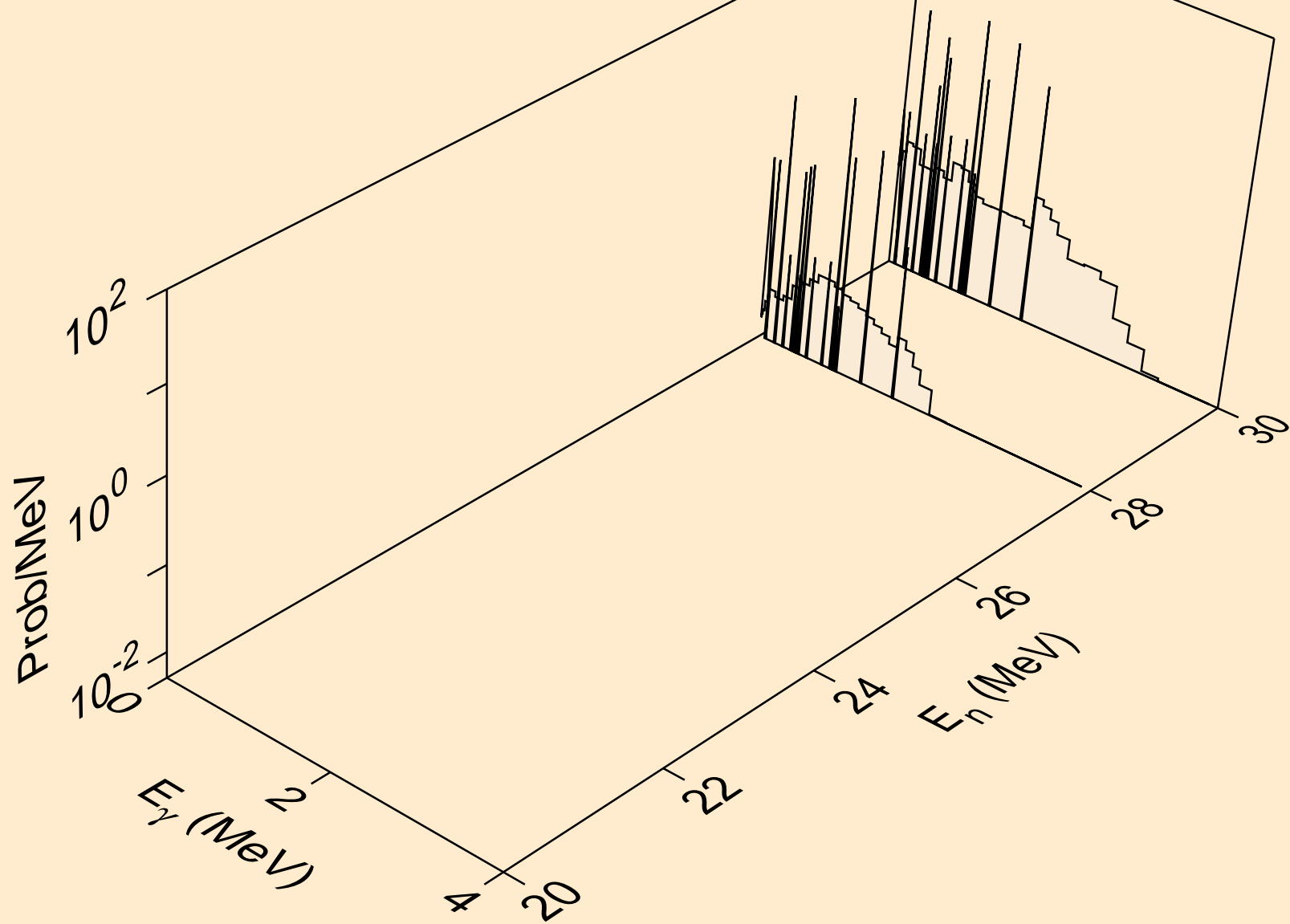

HO150 NEUTRON ACER TENDL-2021 LIBRARY; T=293.6K  
Photon emission for (n,2np)

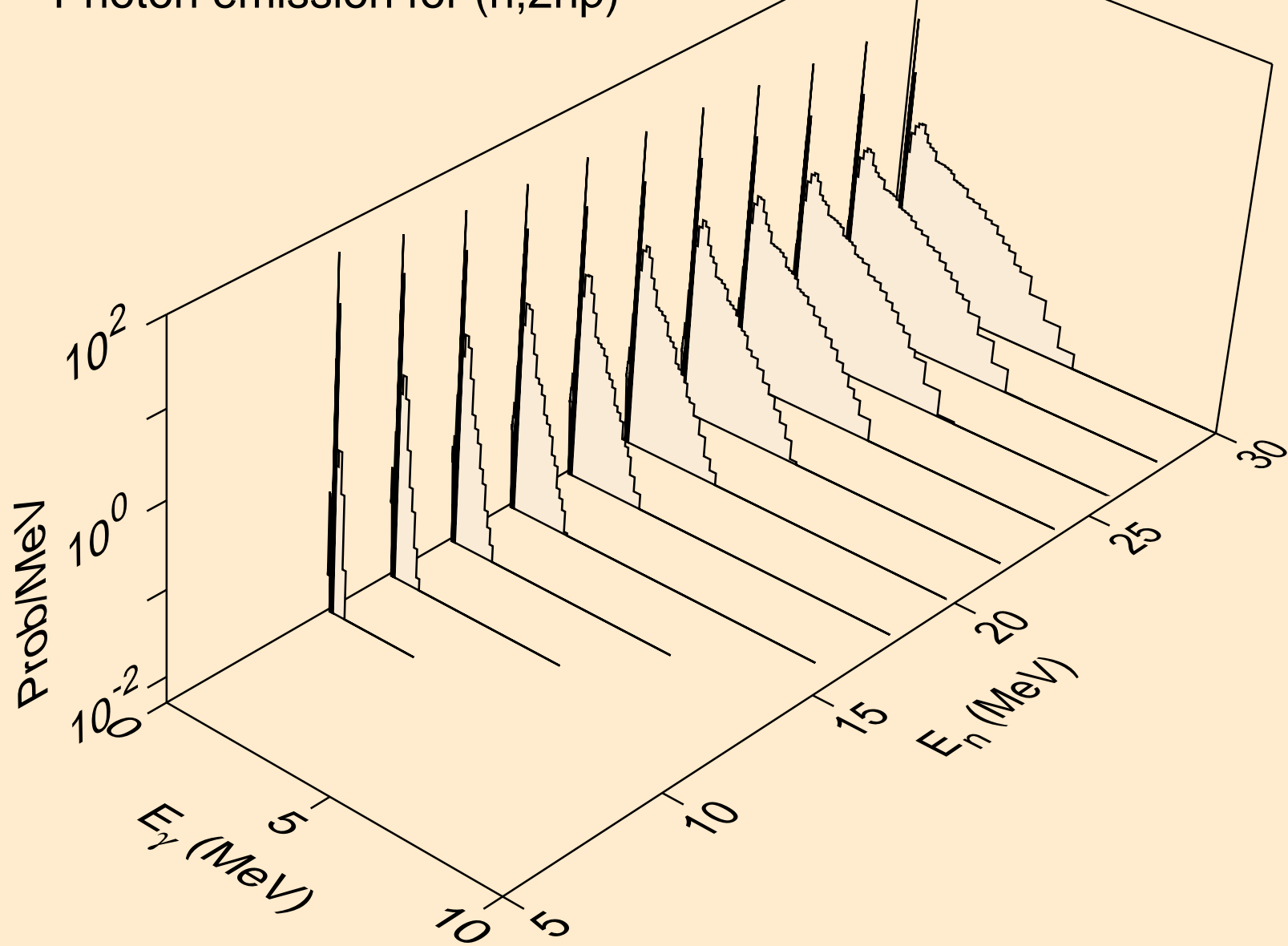

HO150 NEUTRON ACER TENDL-2021 LIBRARY; T=293.6K  
Photon emission for (n,npa)

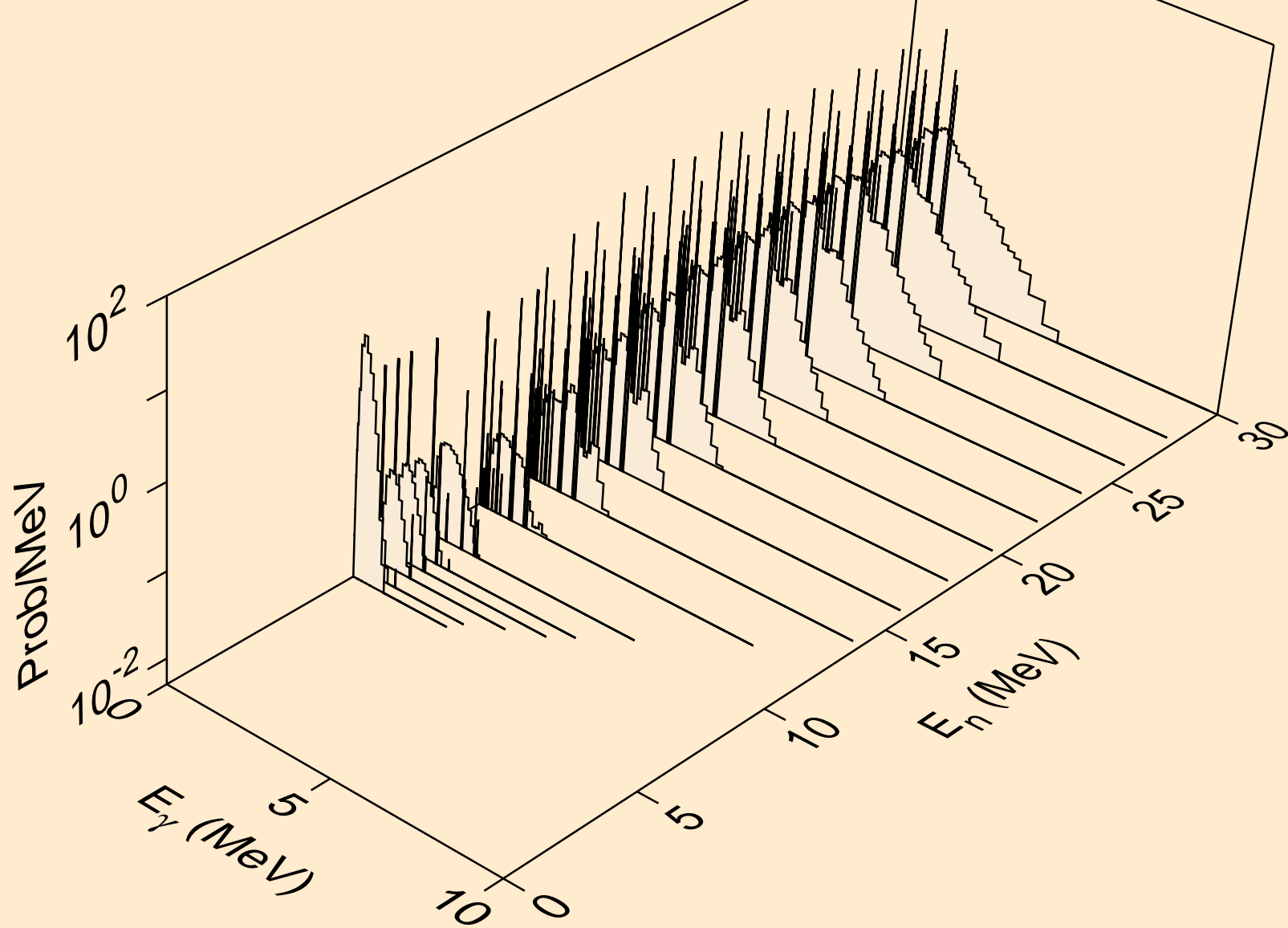

HO150 NEUTRON ACER TENDL-2021 LIBRARY; T=293.6K  
Photon emission for (n,n\*c)

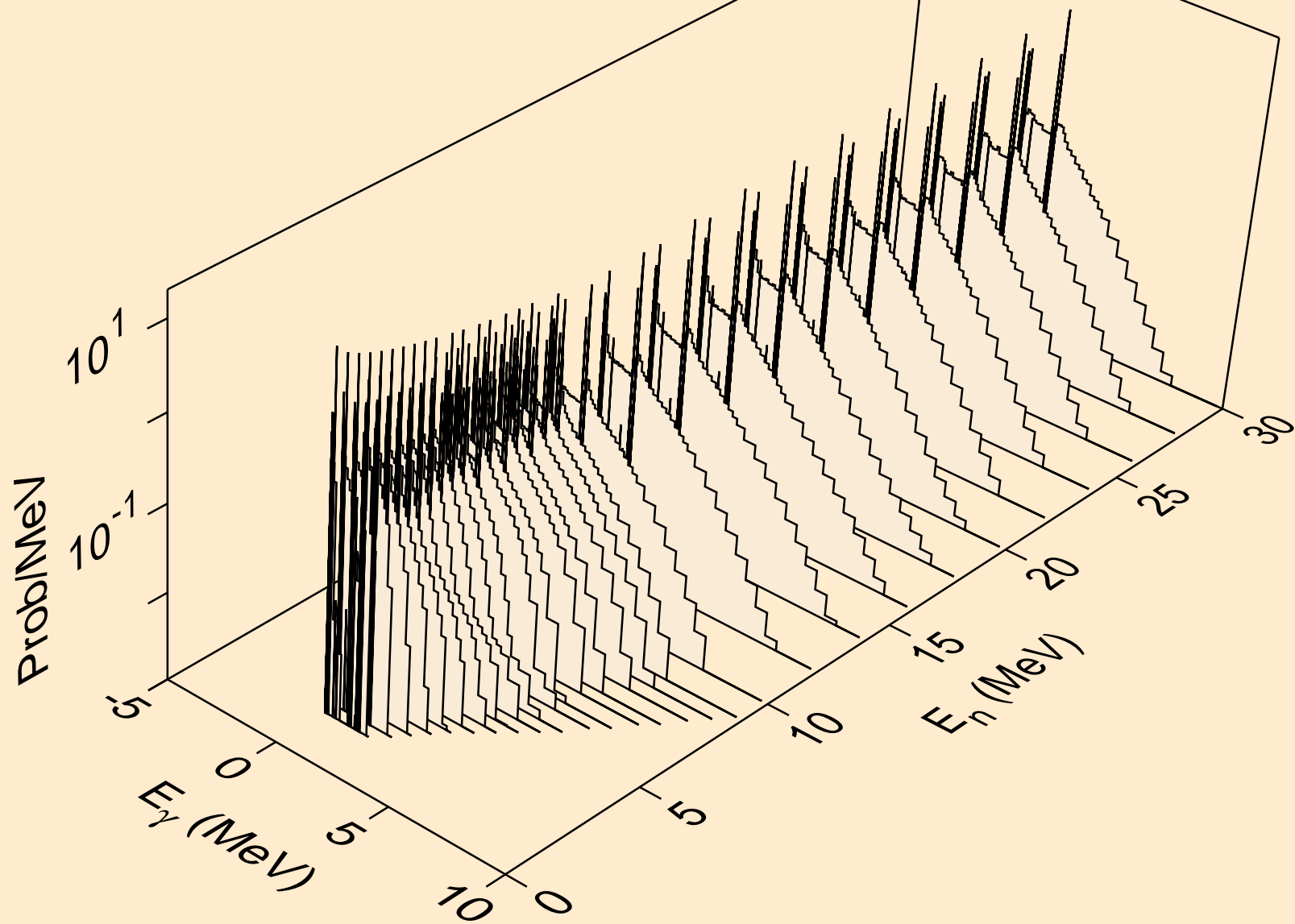



HO150 NEUTRON ACER TENDL-2021 LIBRARY; T=293.6K  
Photon emission for (n,gma)

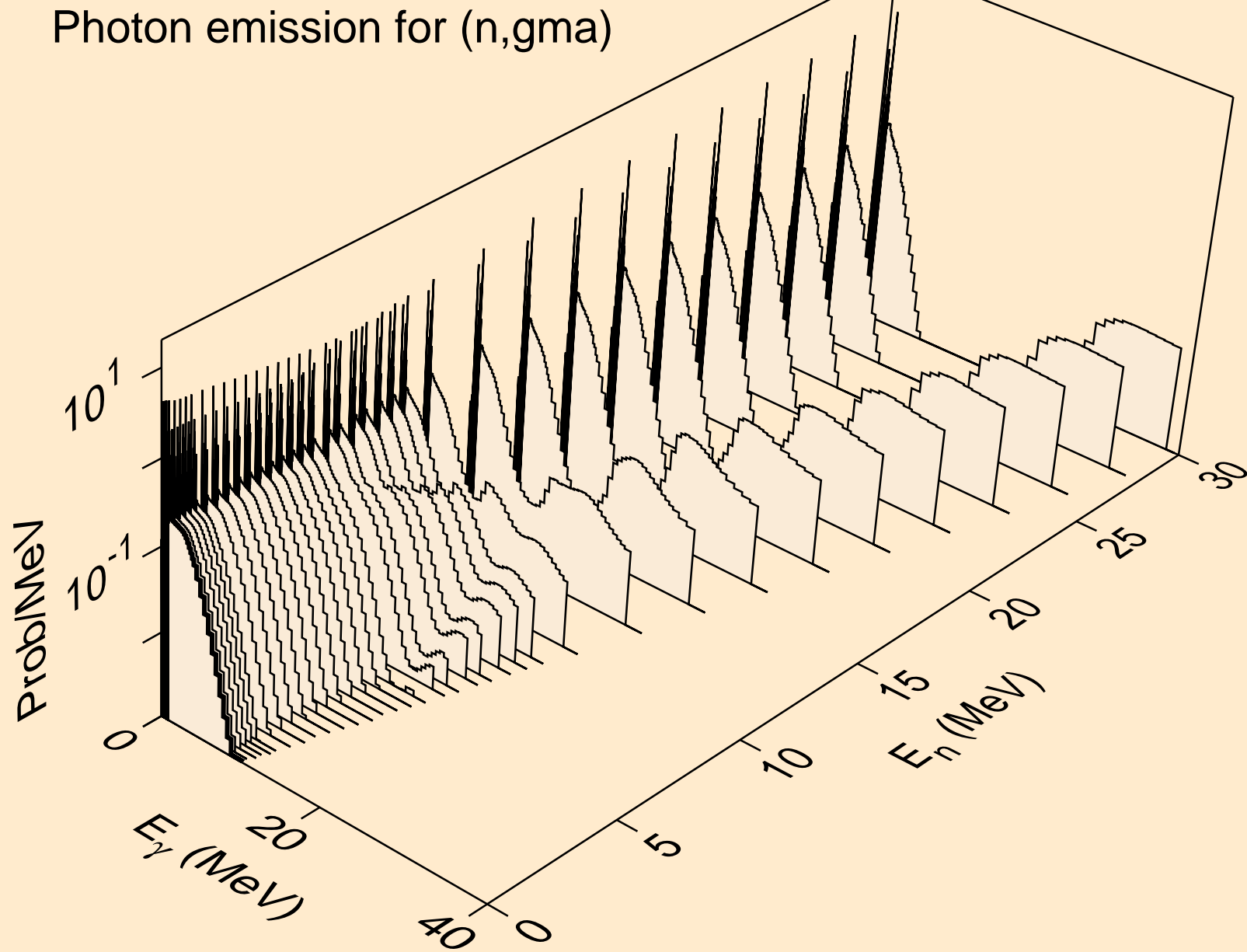

HO150 NEUTRON ACER TENDL-2021 LIBRARY; T=293.6K  
Photon emission for (n,p)

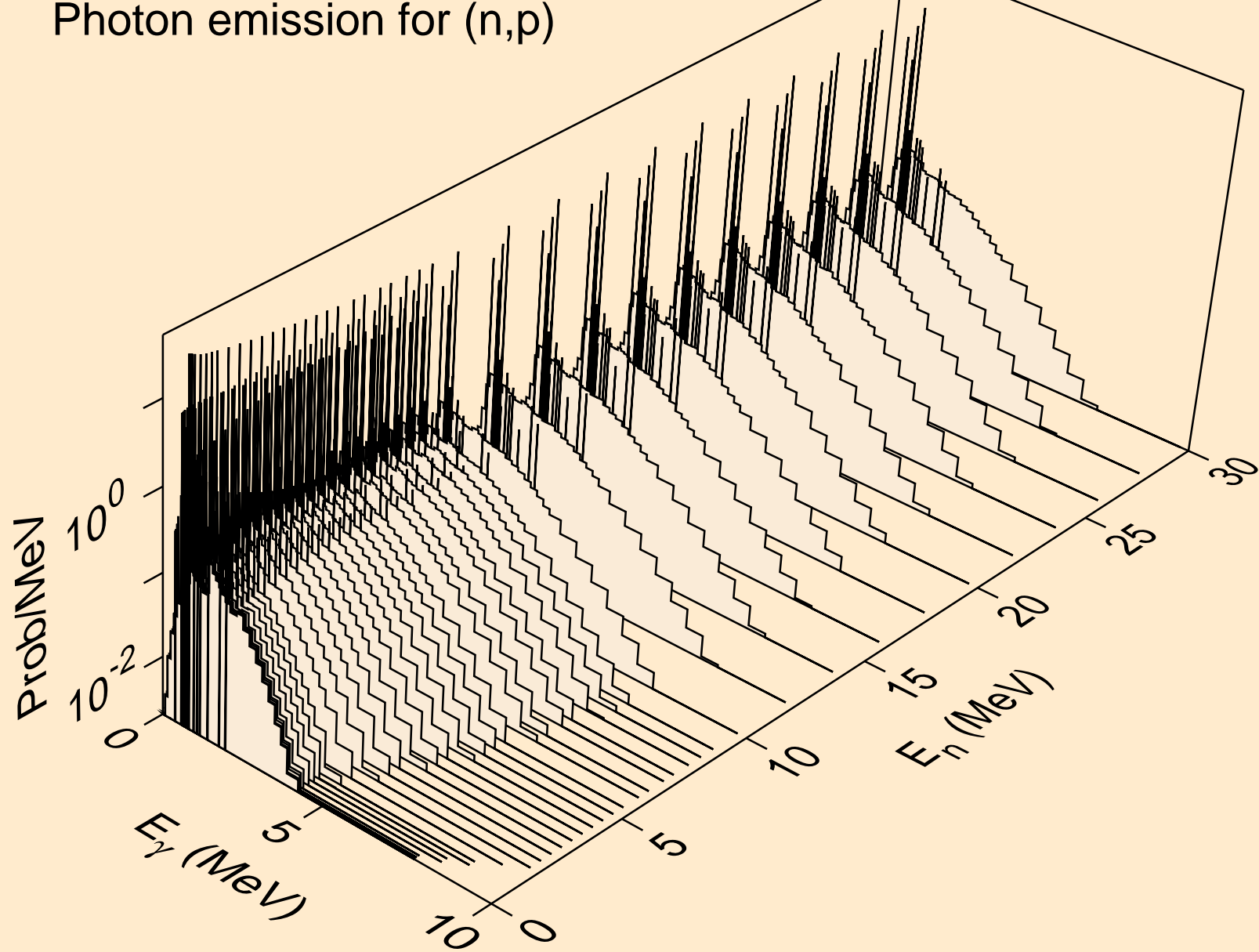

HO150 NEUTRON ACER TENDL-2021 LIBRARY; T=293.6K  
Photon emission for (n,d)

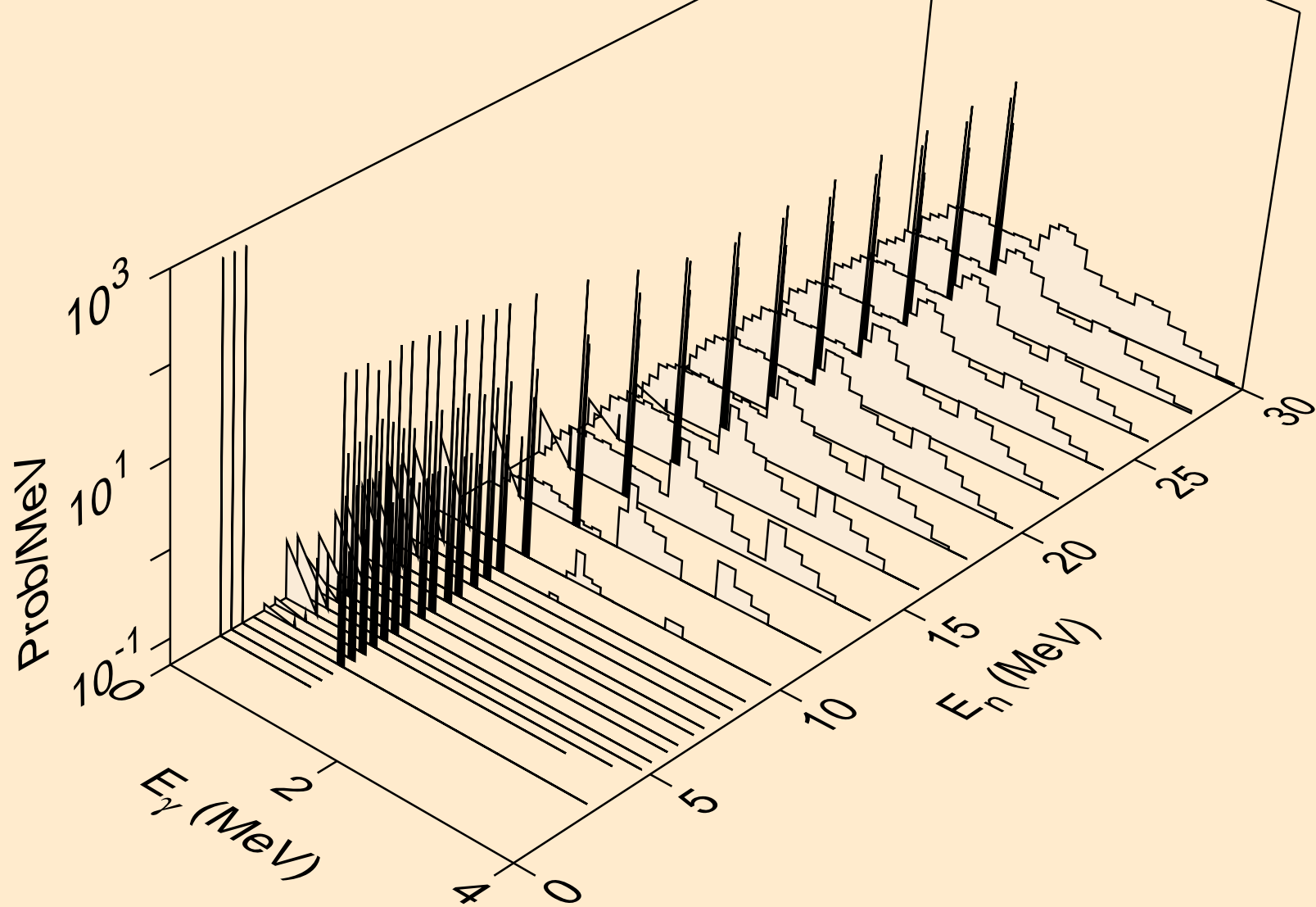

HO150 NEUTRON ACER TENDL-2021 LIBRARY; T=293.6K  
Photon emission for (n,t)

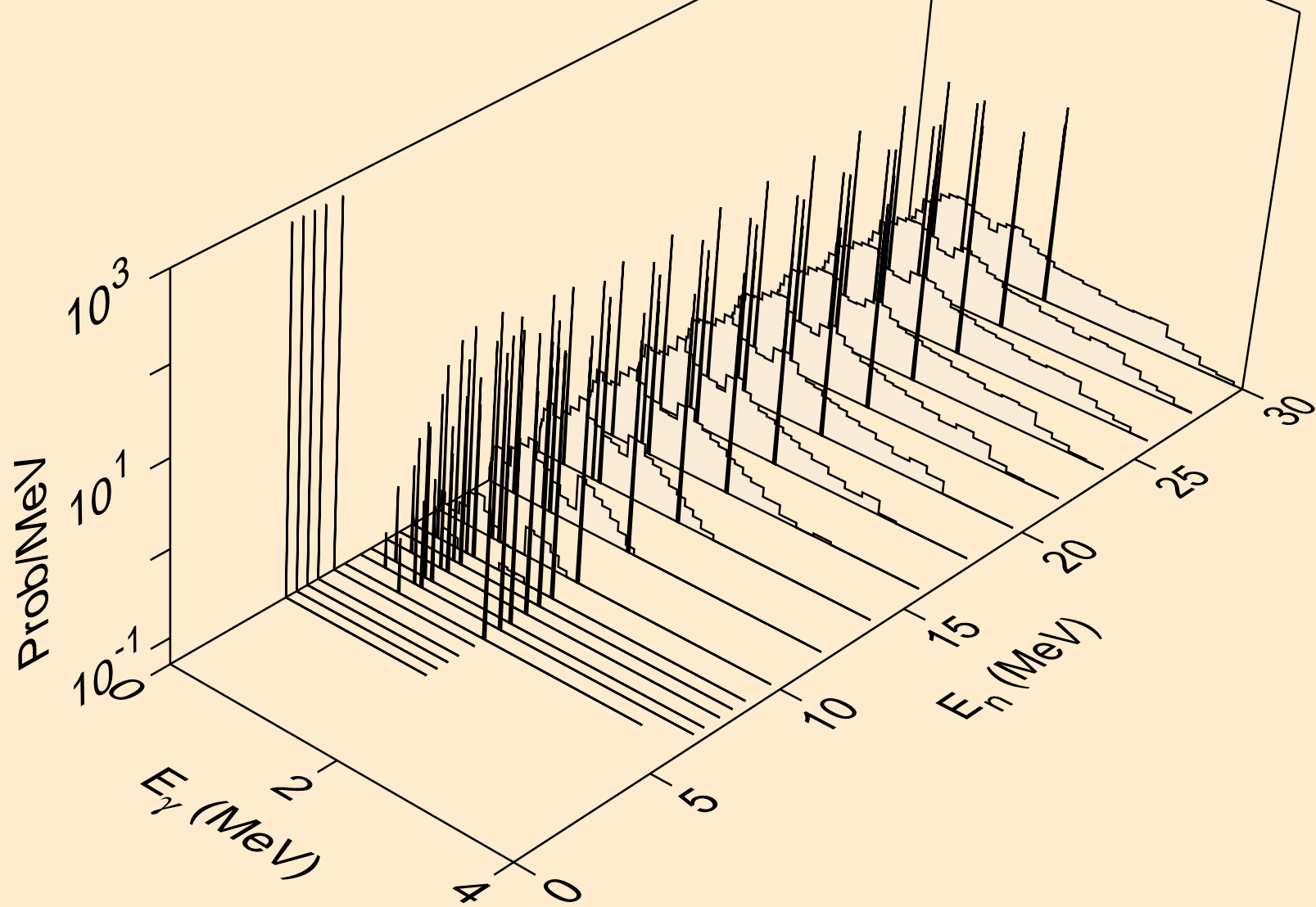

HO150 NEUTRON ACER TENDL-2021 LIBRARY; T=293.6K  
Photon emission for (n,he3)

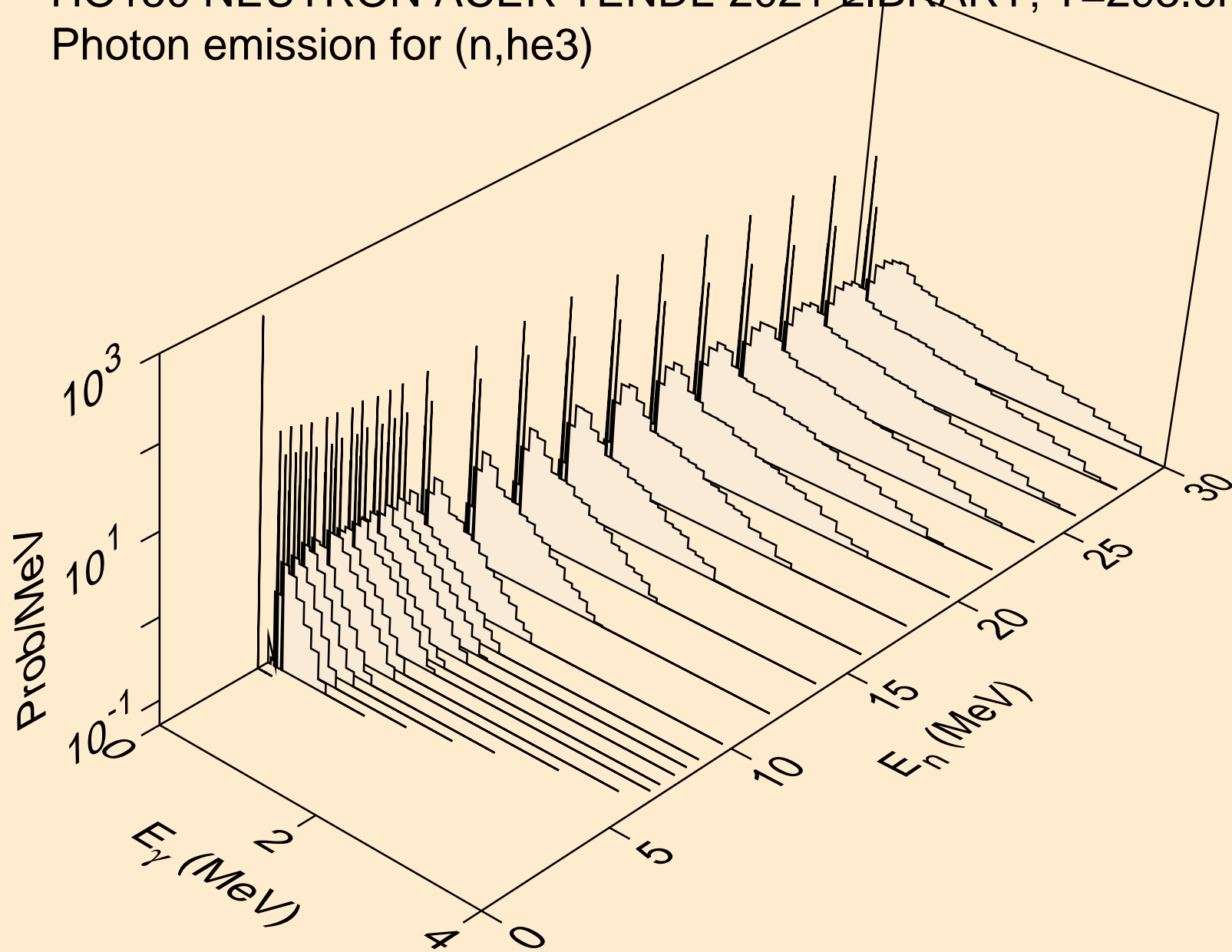

HO150 NEUTRON ACER TENDL-2021 LIBRARY; T=293.6K  
Photon emission for (n,a)

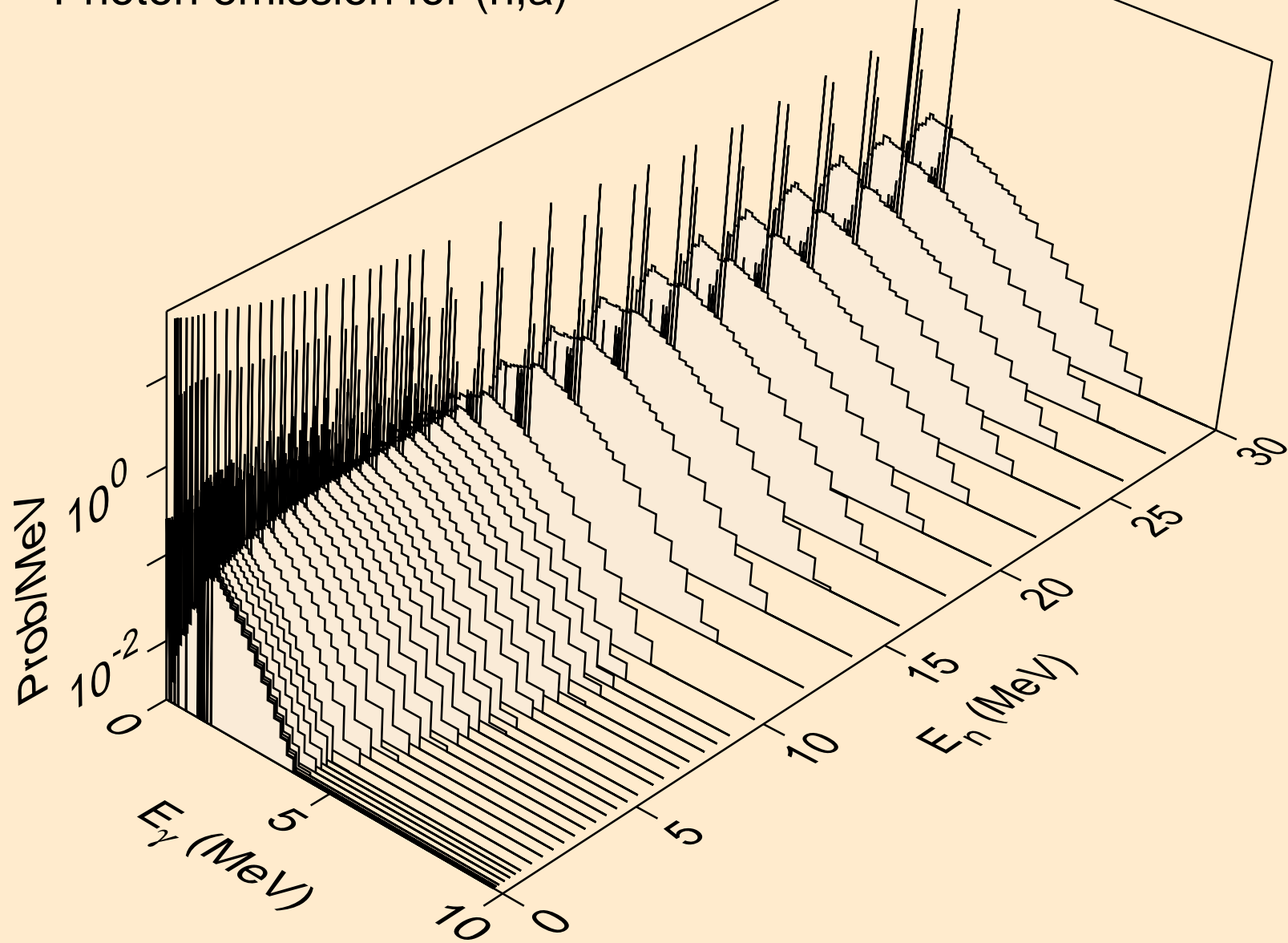

HO150 NEUTRON ACER TENDL-2021 LIBRARY; T=293.6K  
Photon emission for (n,2a)

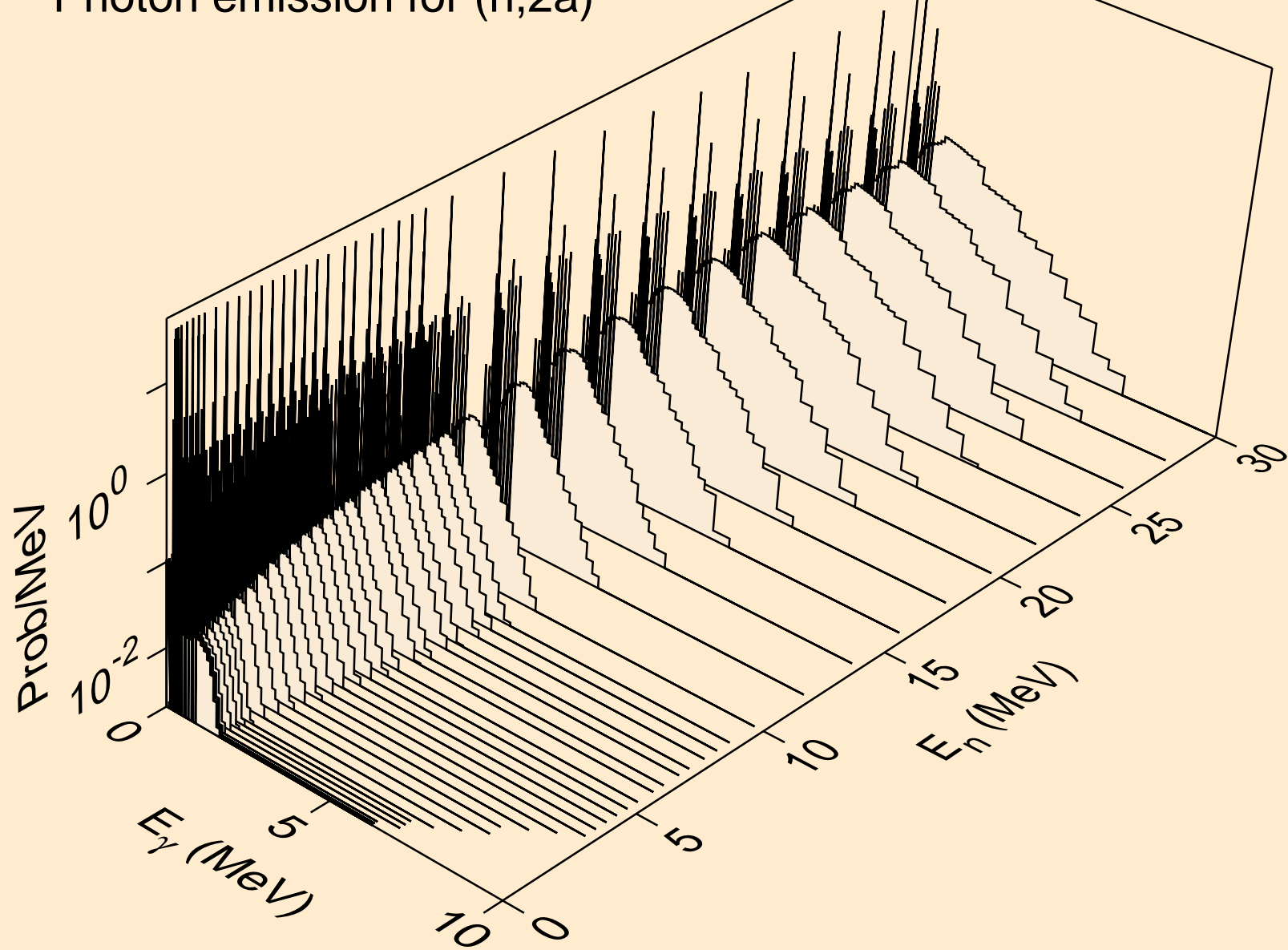

HO150 NEUTRON ACER TENDL-2021 LIBRARY; T=293.6K  
Photon emission for (n,3a)

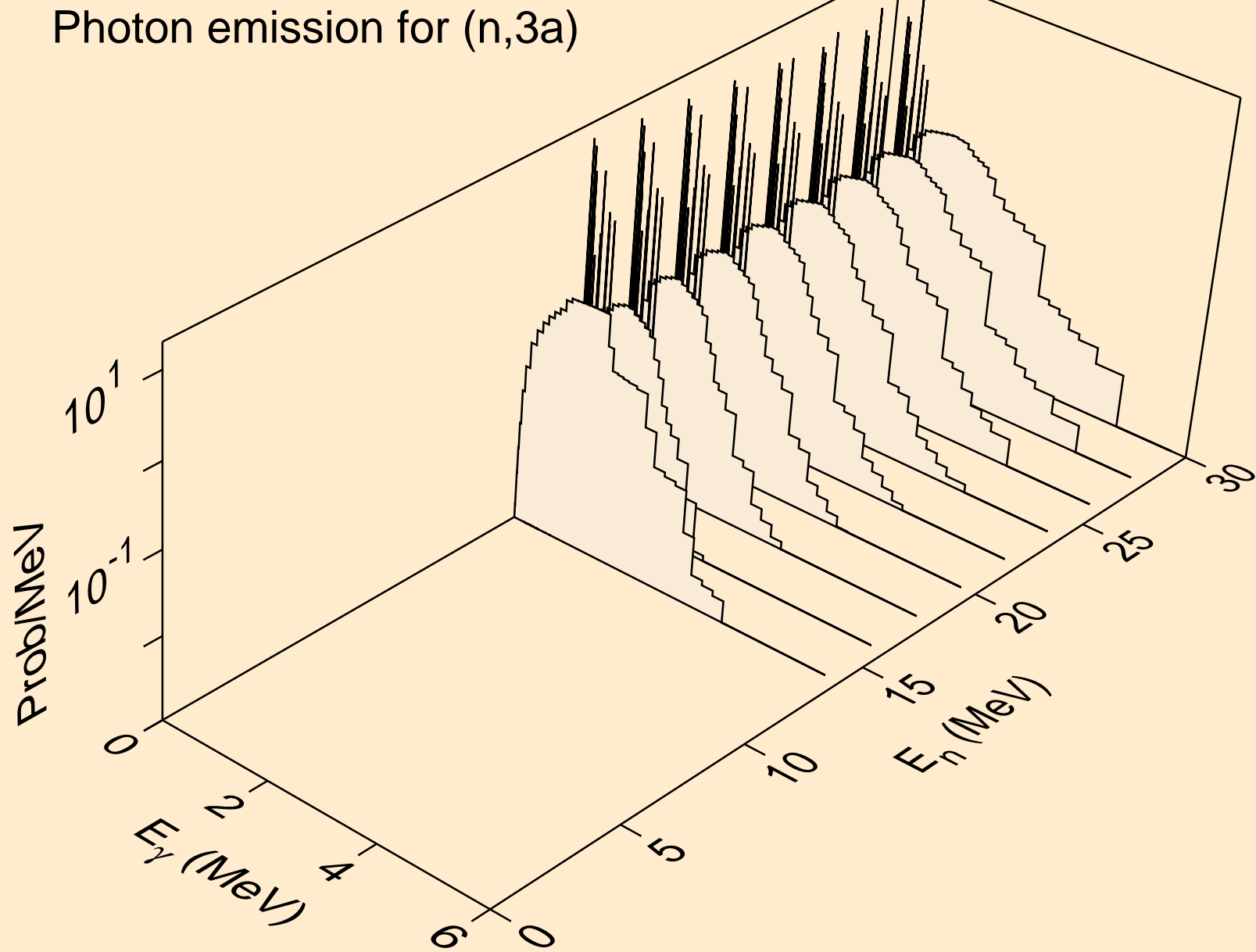



HO150 NEUTRON ACER TENDL-2021 LIBRARY; T=293.6K  
Photon emission for (n,2p)

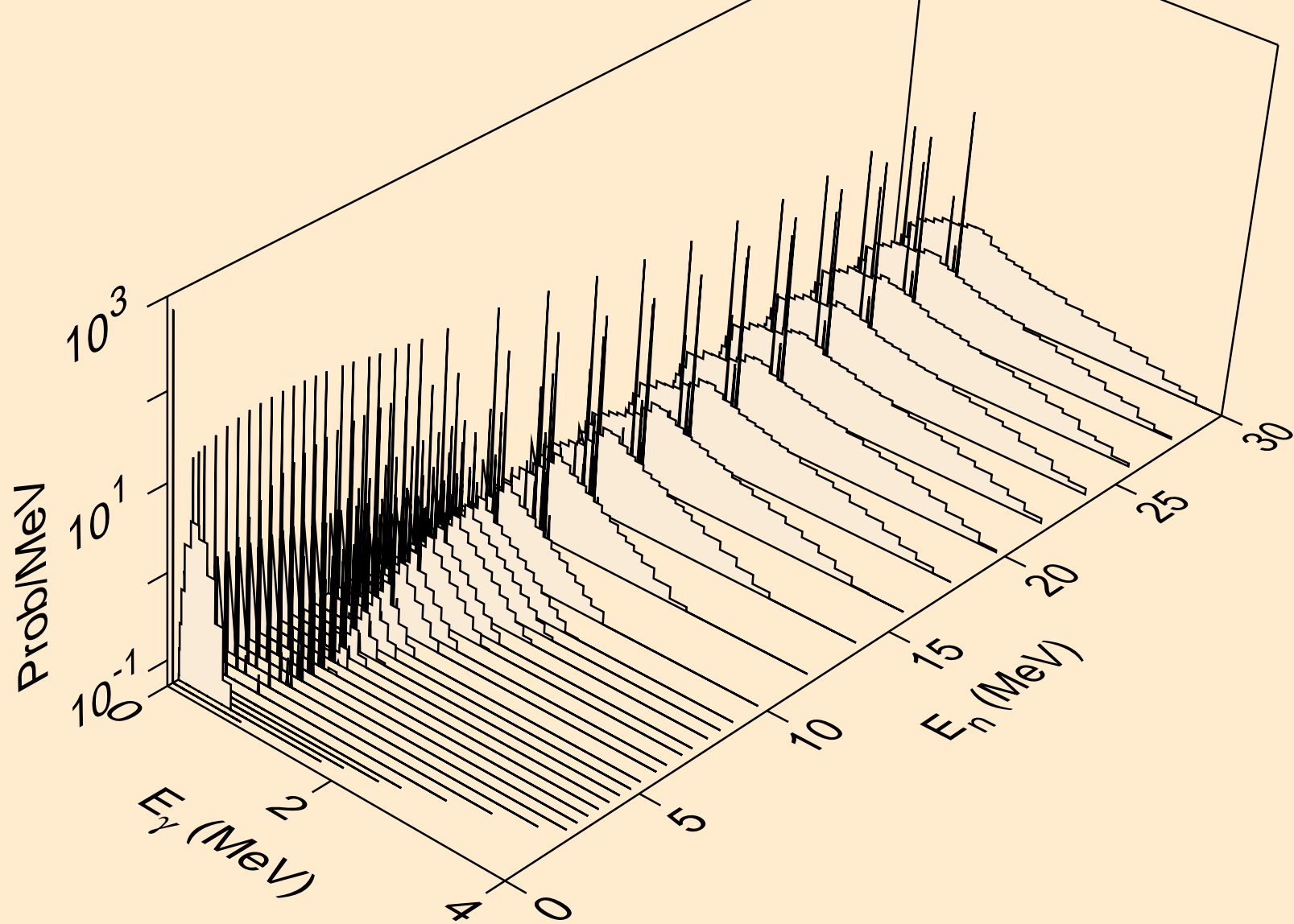

HO150 NEUTRON ACER TENDL-2021 LIBRARY; T=293.6K  
Photon emission for (n,p $\alpha$ )

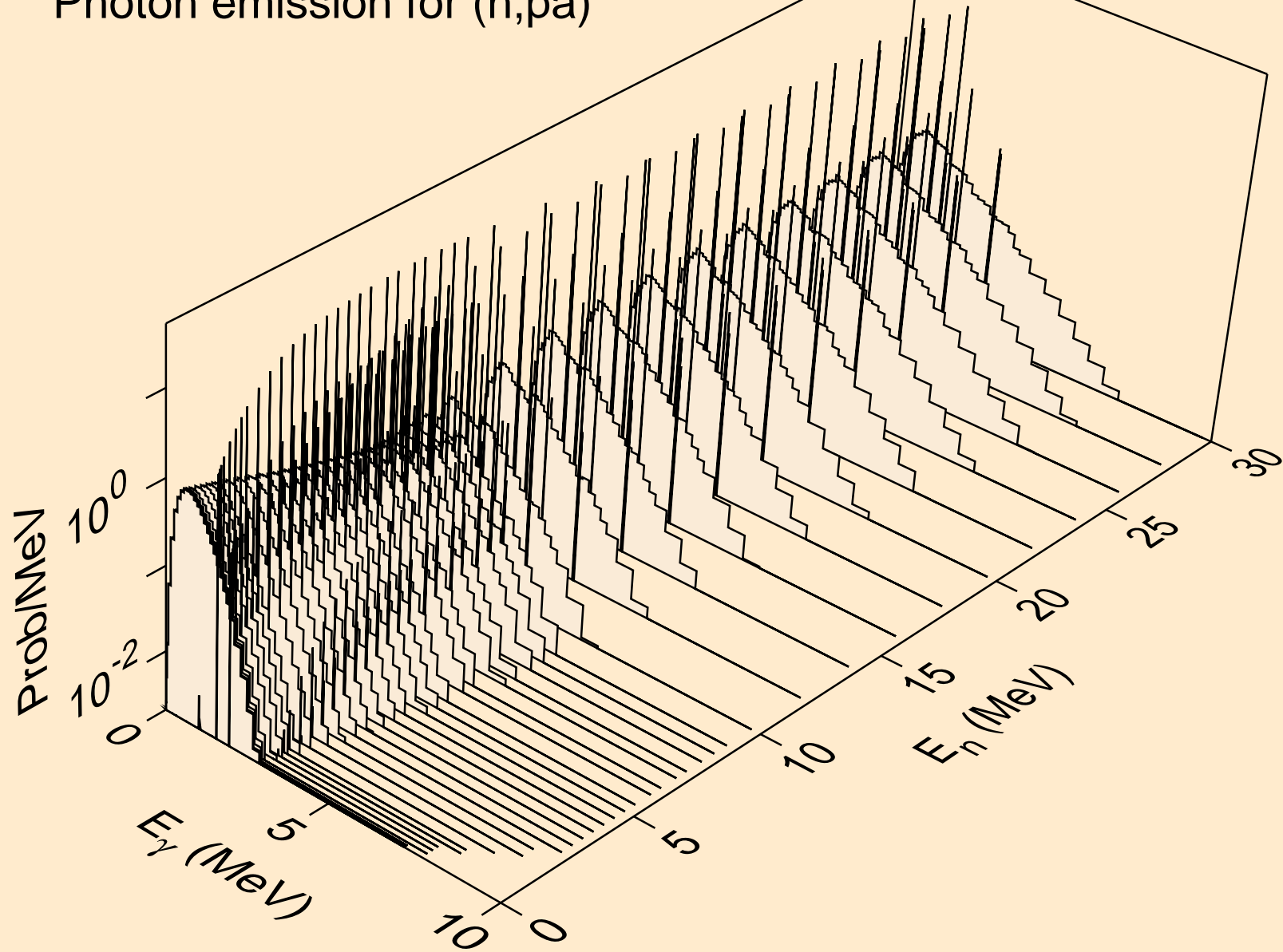

HO150 NEUTRON ACER TENDL-2021 LIBRARY; T=293.6K  
Photon emission for (n,pd)

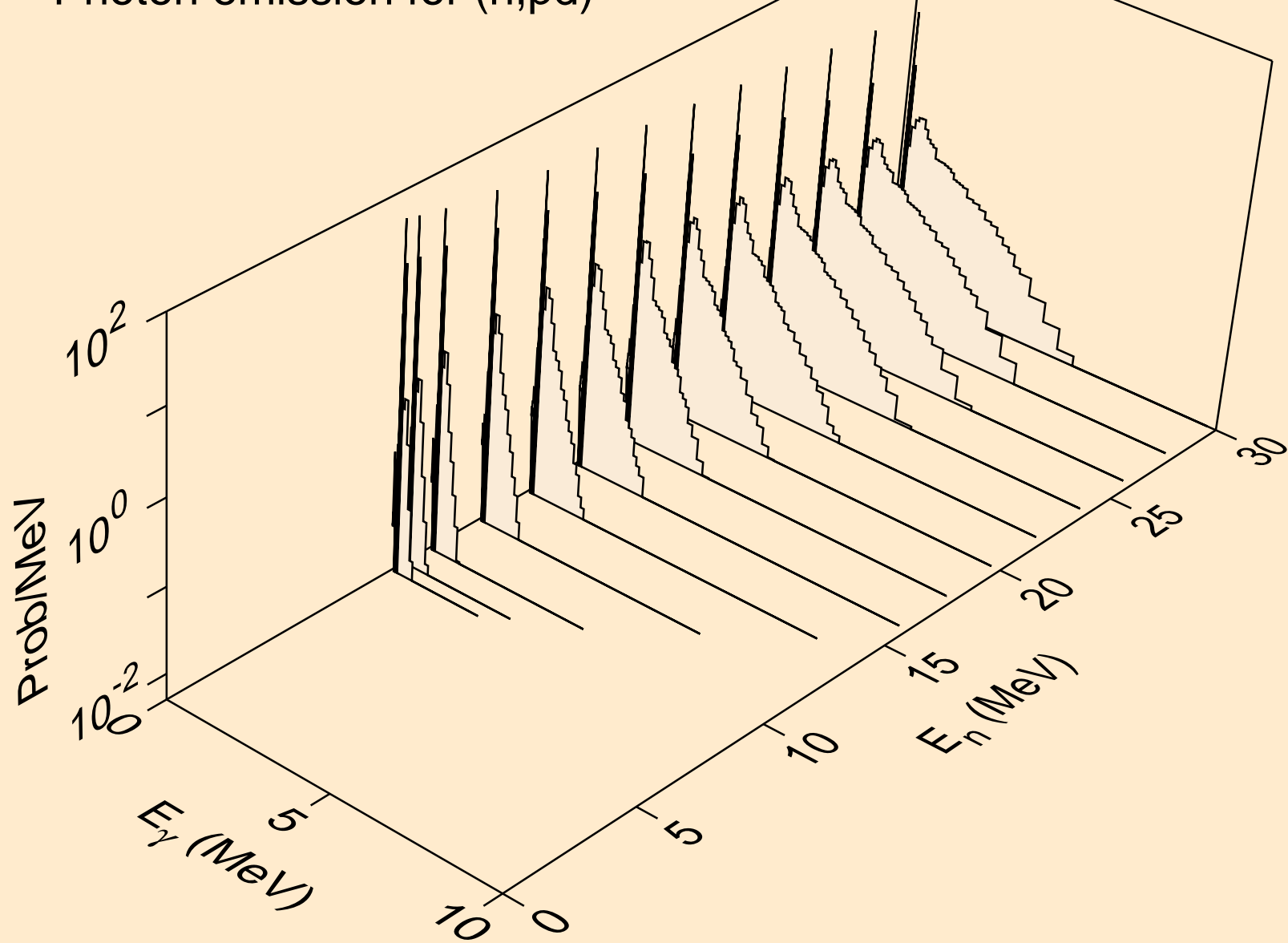

HO150 NEUTRON ACER TENDL-2021 LIBRARY; T=293.6K  
Photon emission for (n,pt)

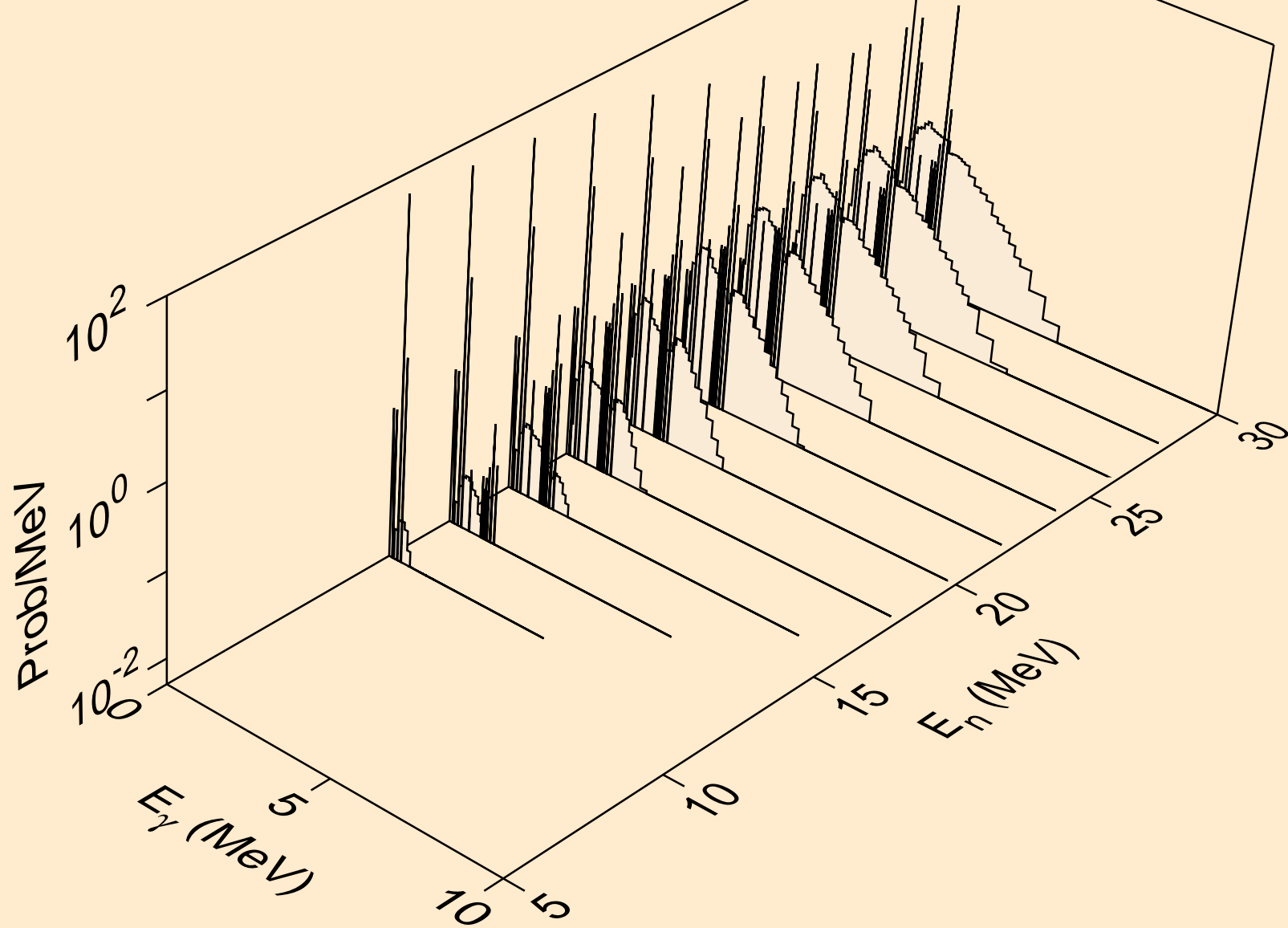

HO150 NEUTRON ACER TENDL-2021 LIBRARY; T=293.6K  
Photon emission for (n,da)

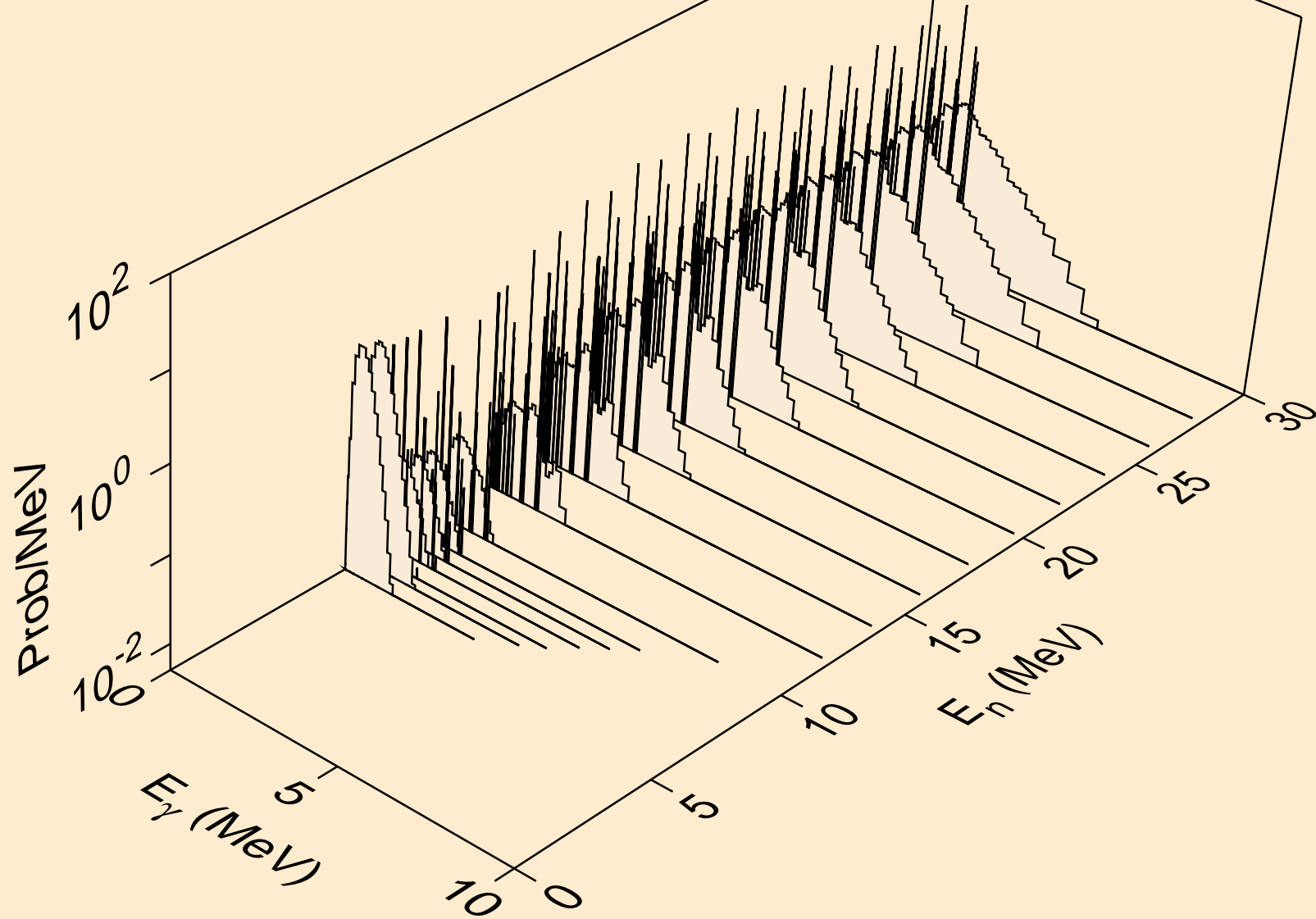

HO150 NEUTRON ACER TENDL-2021 LIBRARY; T=293.6K  
thermal capture photon spectrum

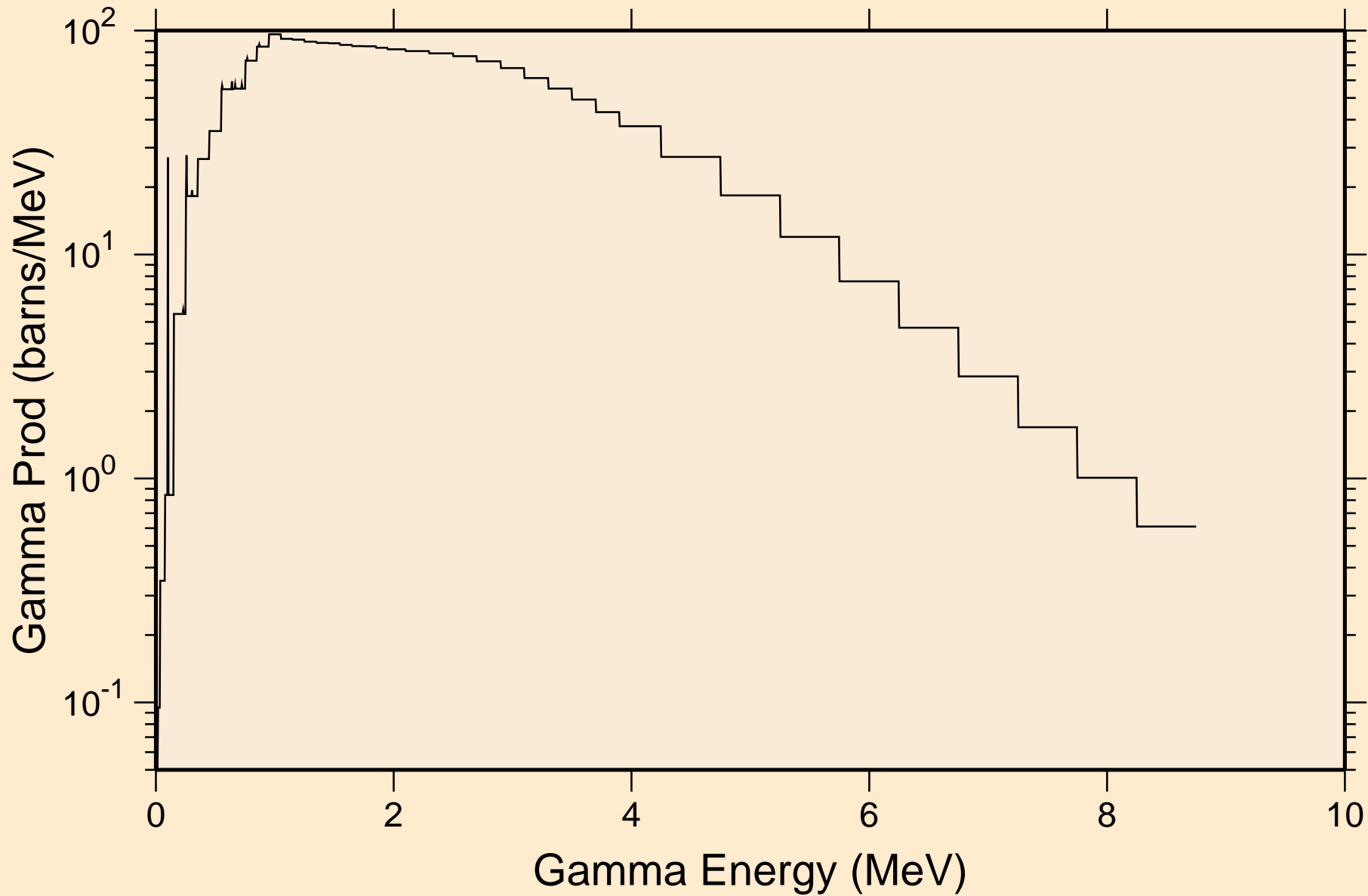

HO150 NEUTRON ACER TENDL-2021 LIBRARY; T=293.6K  
14 MeV photon spectrum

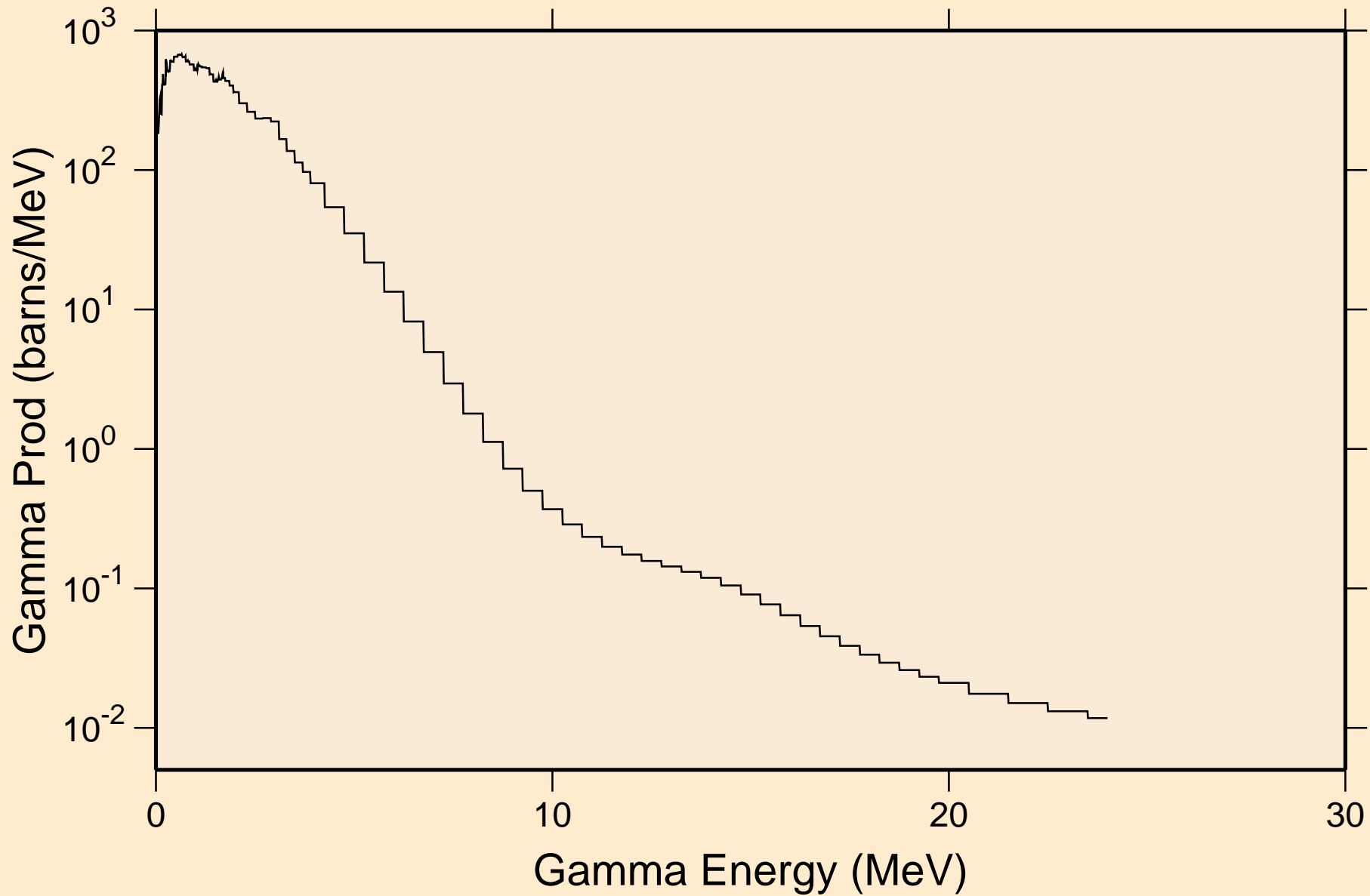

# HO150 NEUTRON ACER TENDL-2021 LIBRARY; T=293.6K

## Particle heating contributions

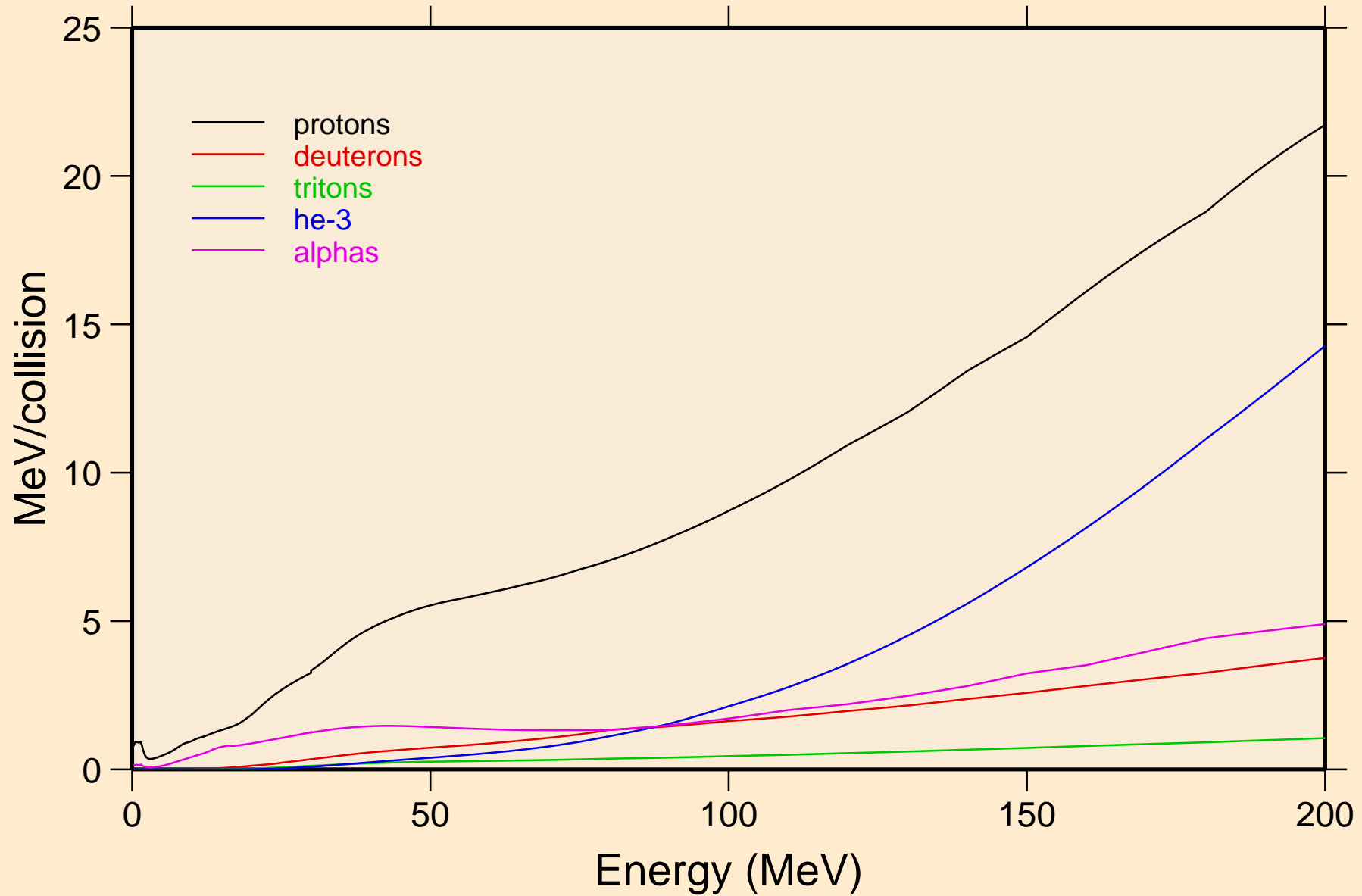



HO150 NEUTRON ACER TENDL-2021 LIBRARY; T=293.6K  
Recoil Heating

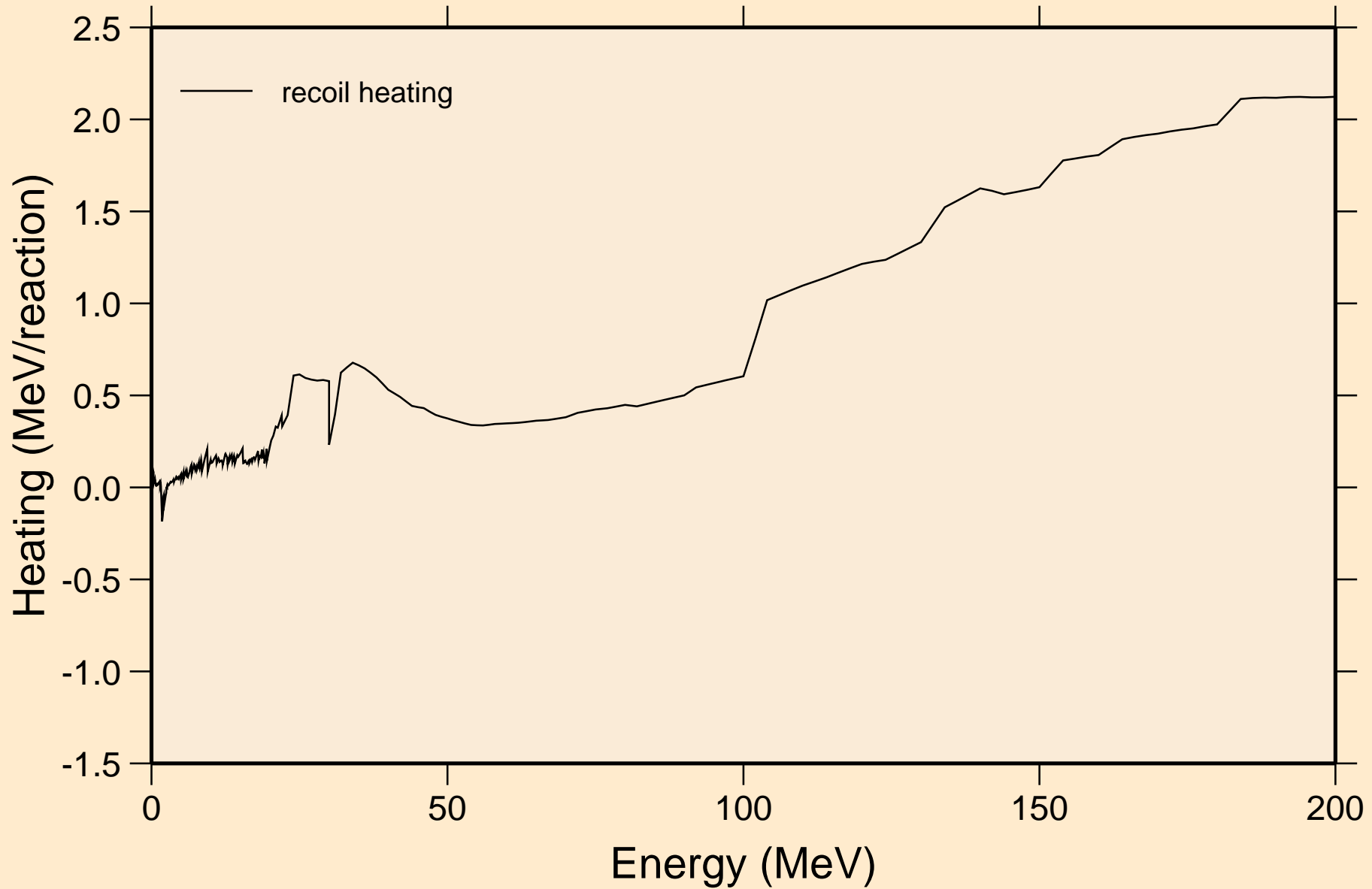

# HO150 NEUTRON ACER TENDL-2021 LIBRARY; T=293.6K

## Particle production cross sections

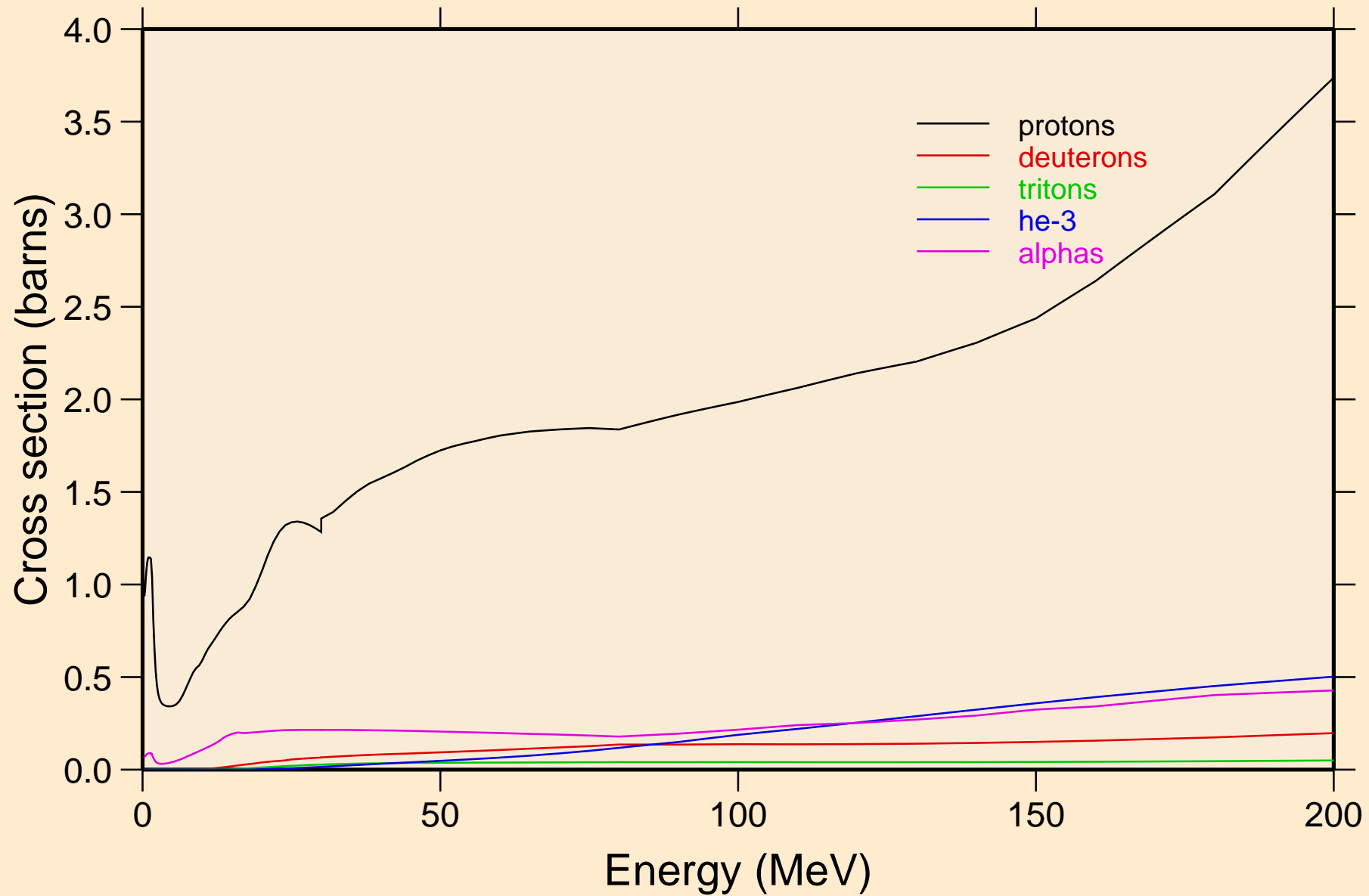

HO150 NEUTRON ACER TENDL-2021 LIBRARY; T=293.6K  
protons from (n,x)

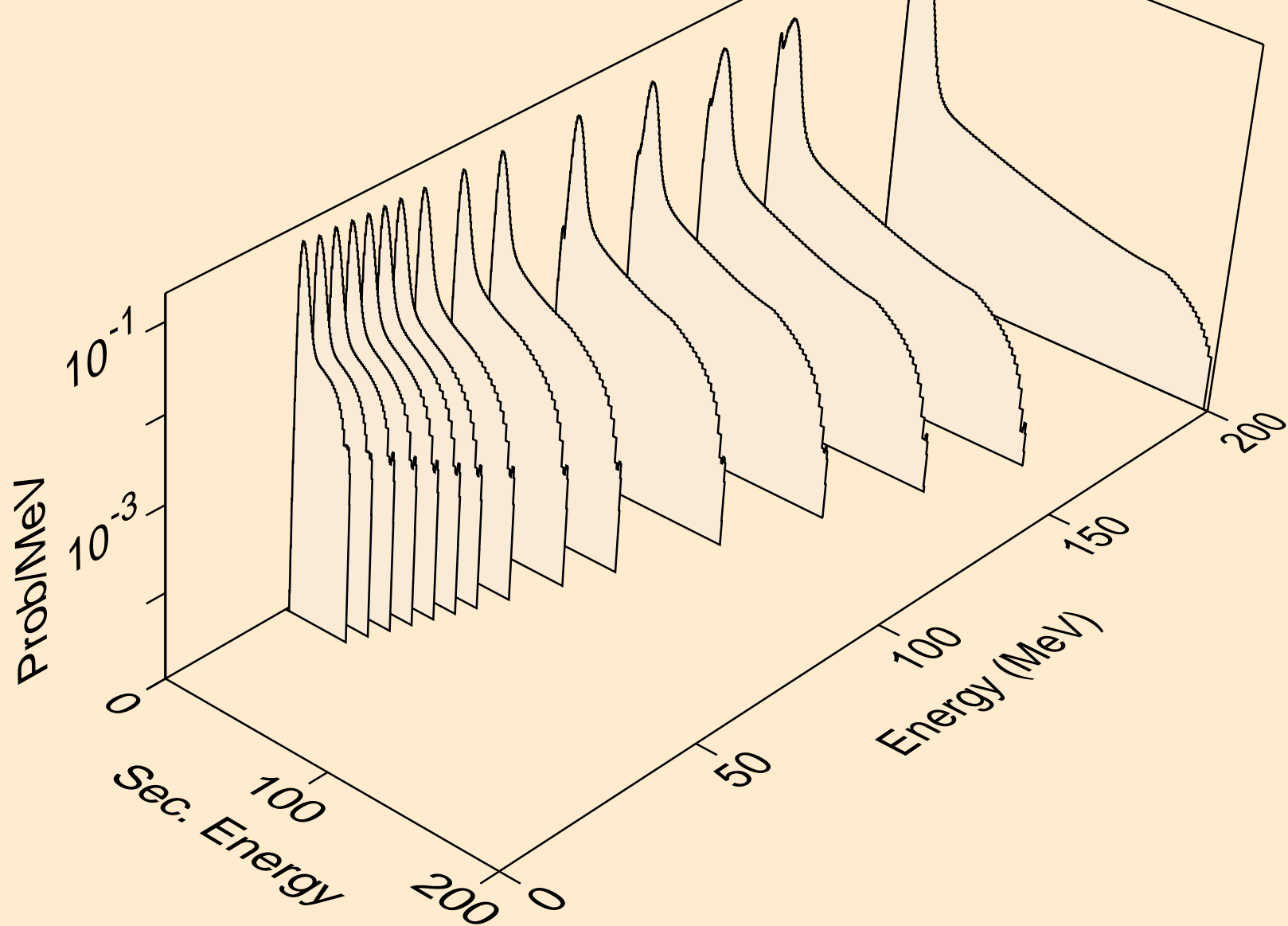

HO150 NEUTRON ACER TENDL-2021 LIBRARY; T=293.6K  
protons from (n,n\*)p

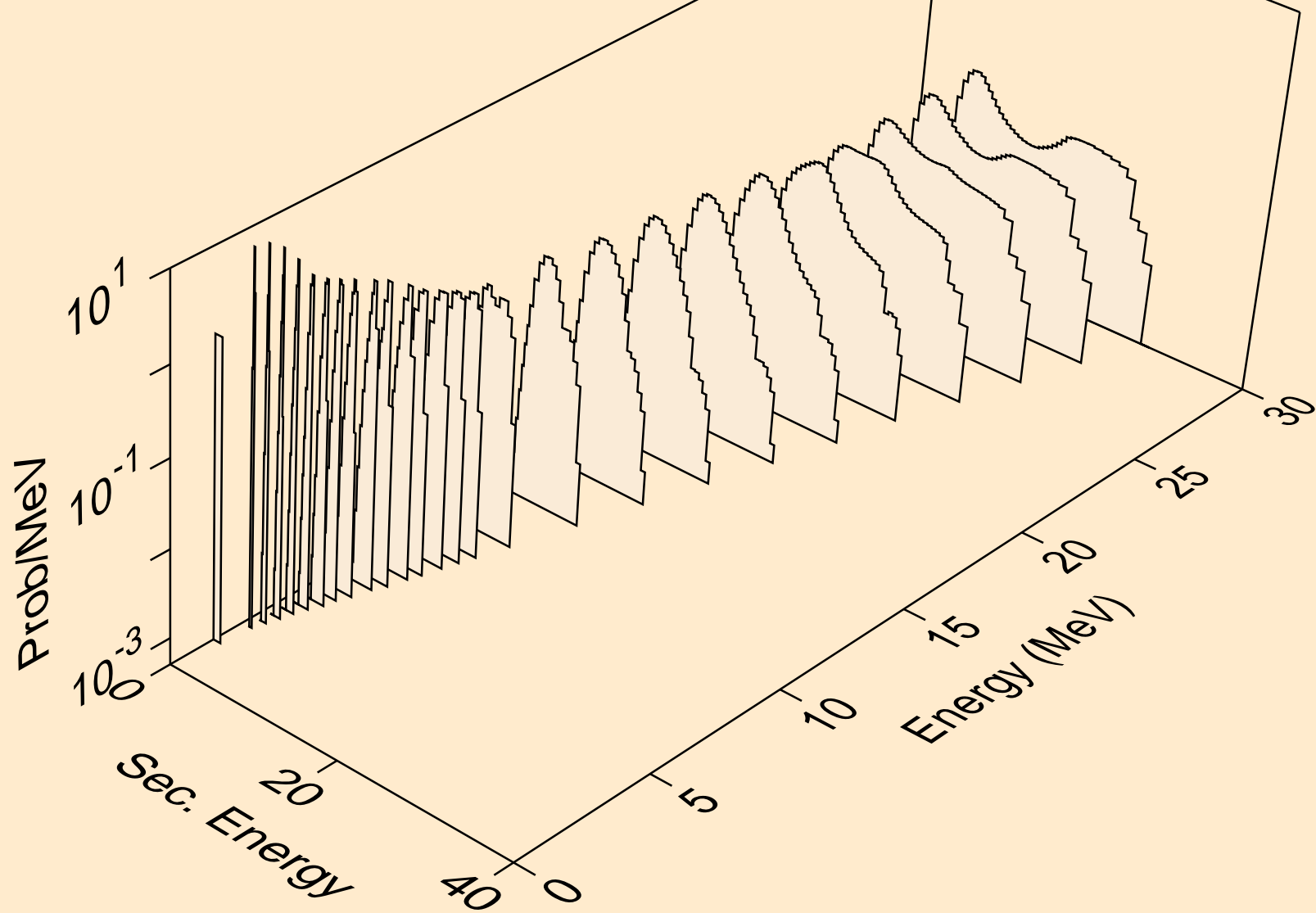

HO150 NEUTRON ACER TENDL-2021 LIBRARY; T=293.6K  
protons from (n,2np)

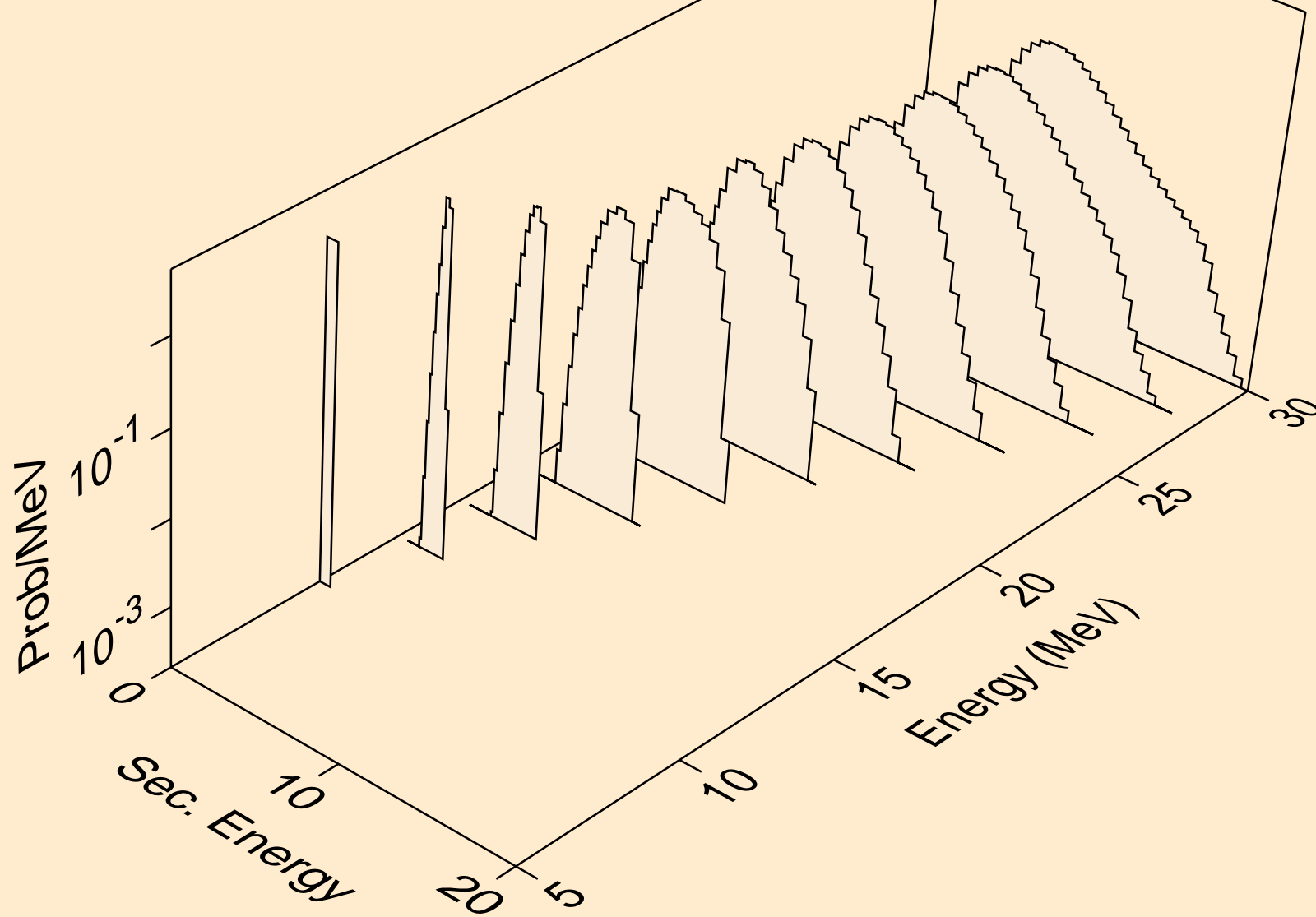

HO150 NEUTRON ACER TENDL-2021 LIBRARY; T=293.6K  
protons from (n,3np)

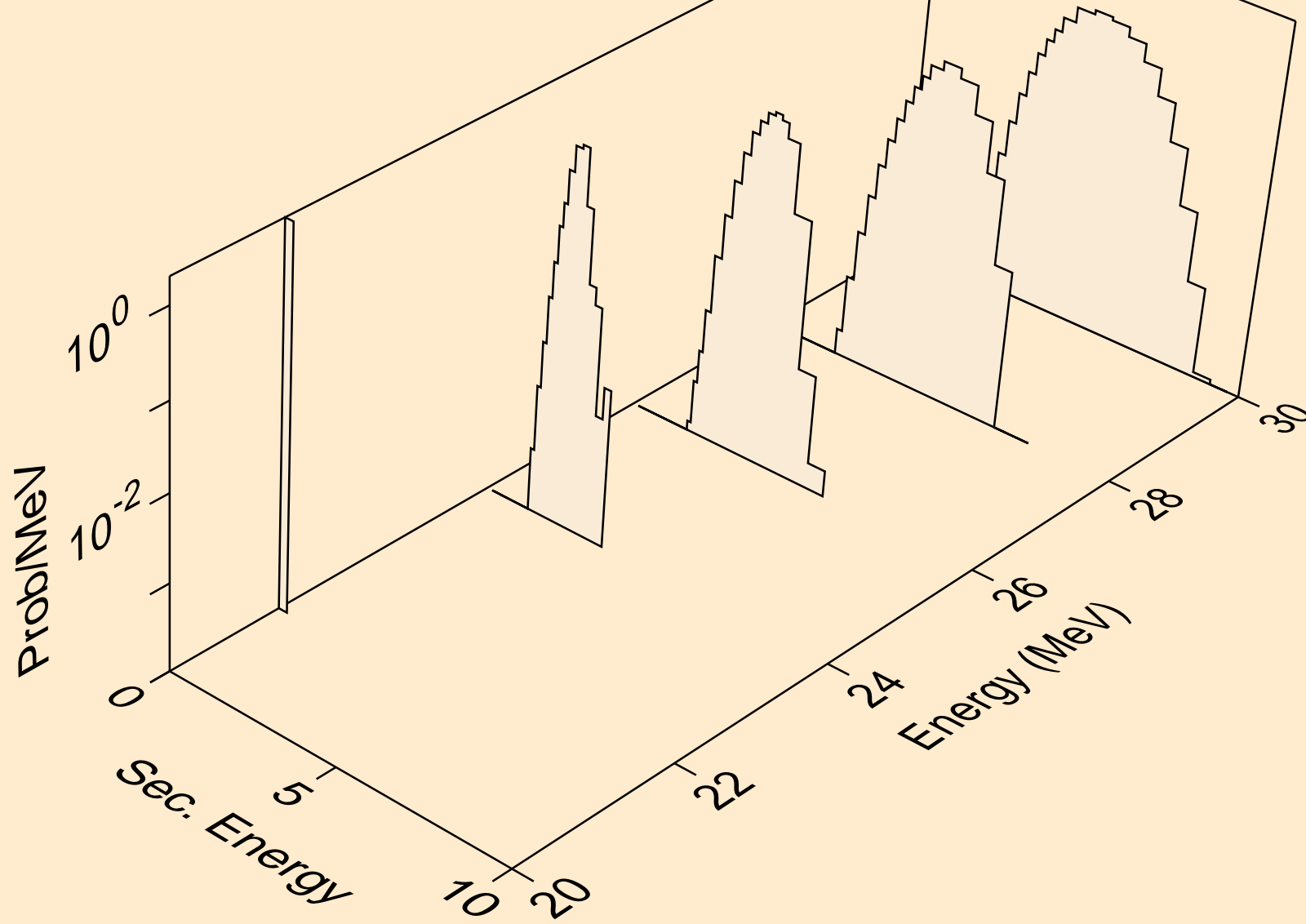

HO150 NEUTRON ACER TENDL-2021 LIBRARY; T=293.6K  
protons from (n,2np)

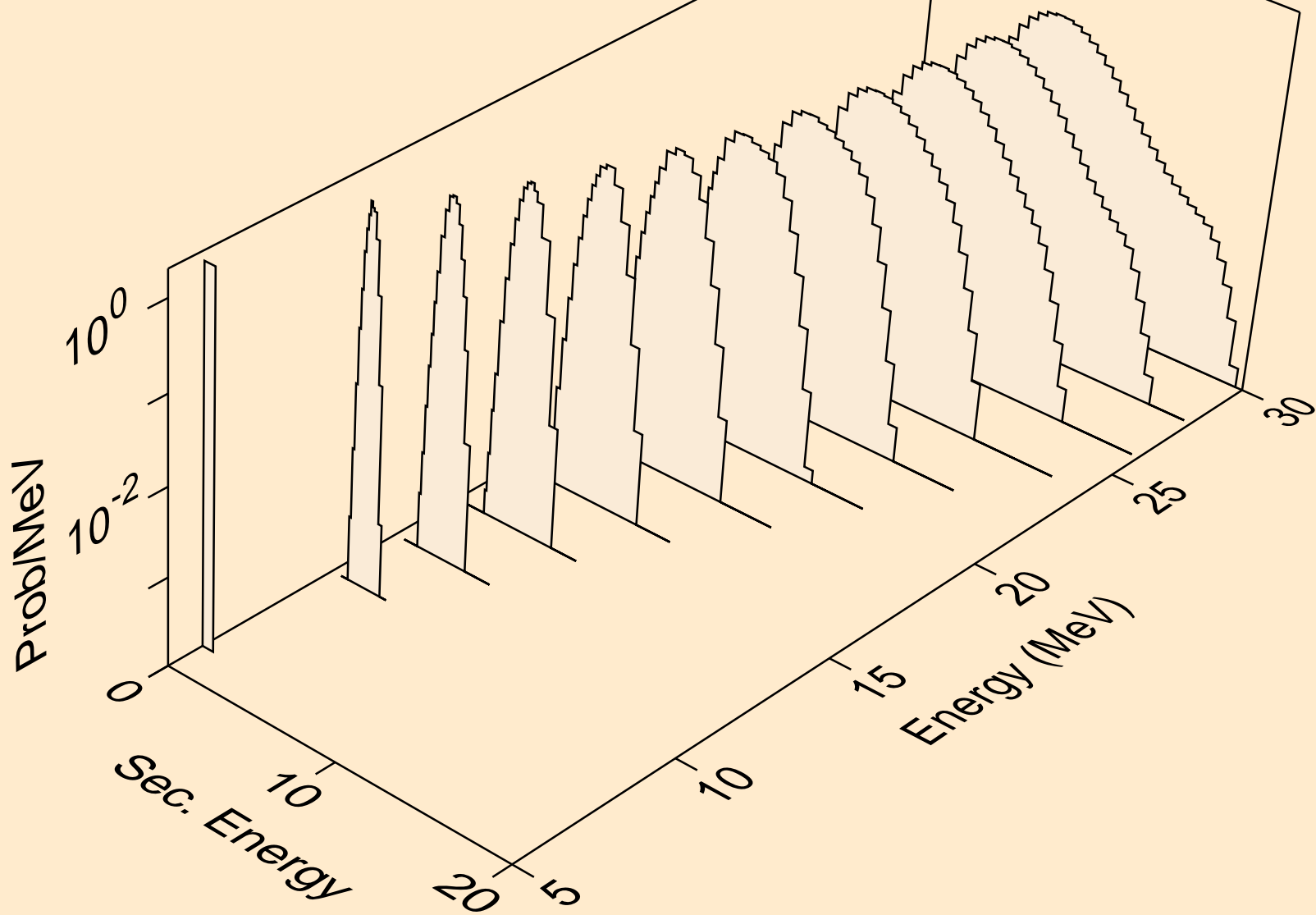

HO150 NEUTRON ACER TENDL-2021 LIBRARY; T=293.6K  
protons from (n,npa)

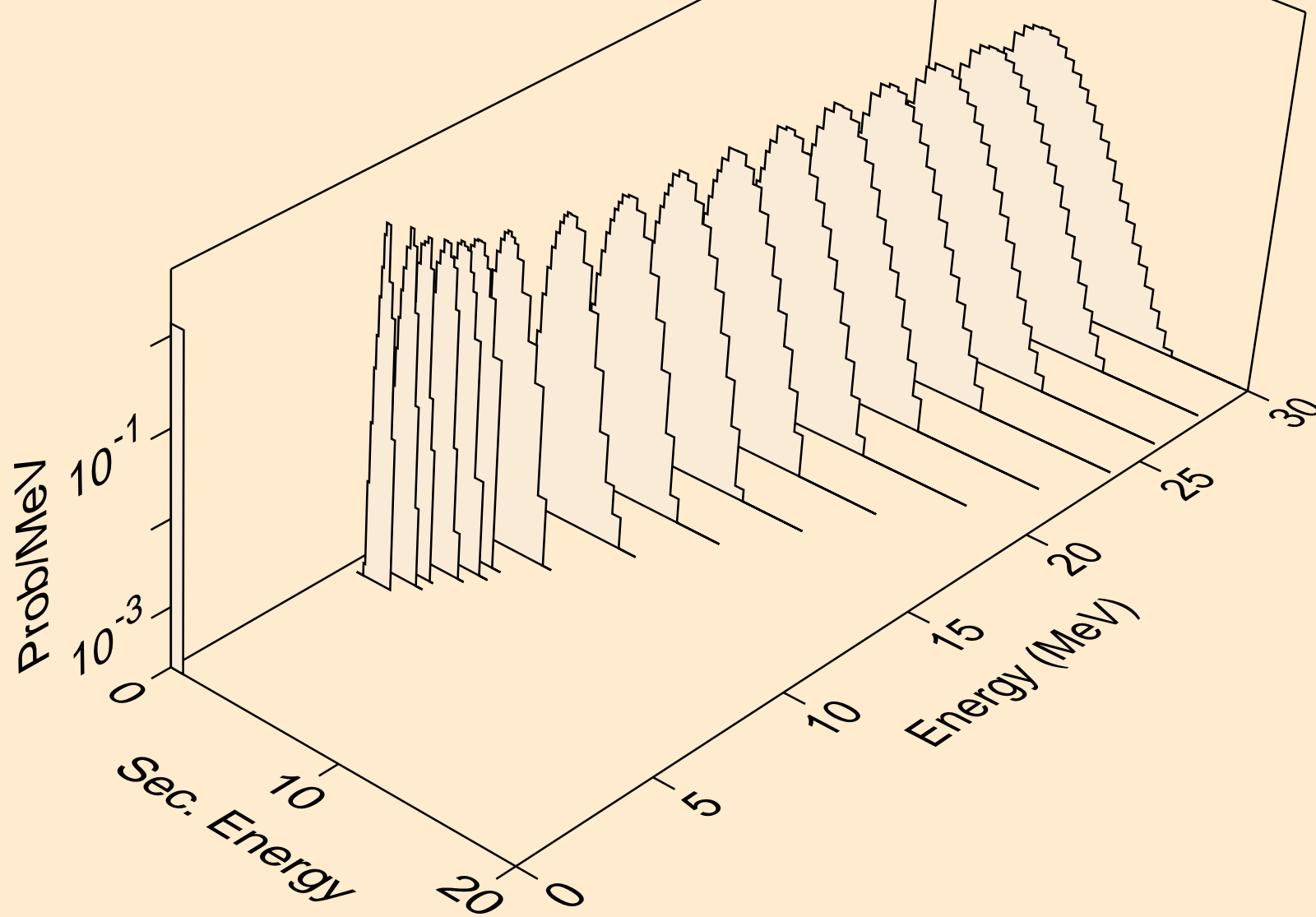



HO150 NEUTRON ACER TENDL-2021 LIBRARY; T=293.6K  
protons from (n,p)

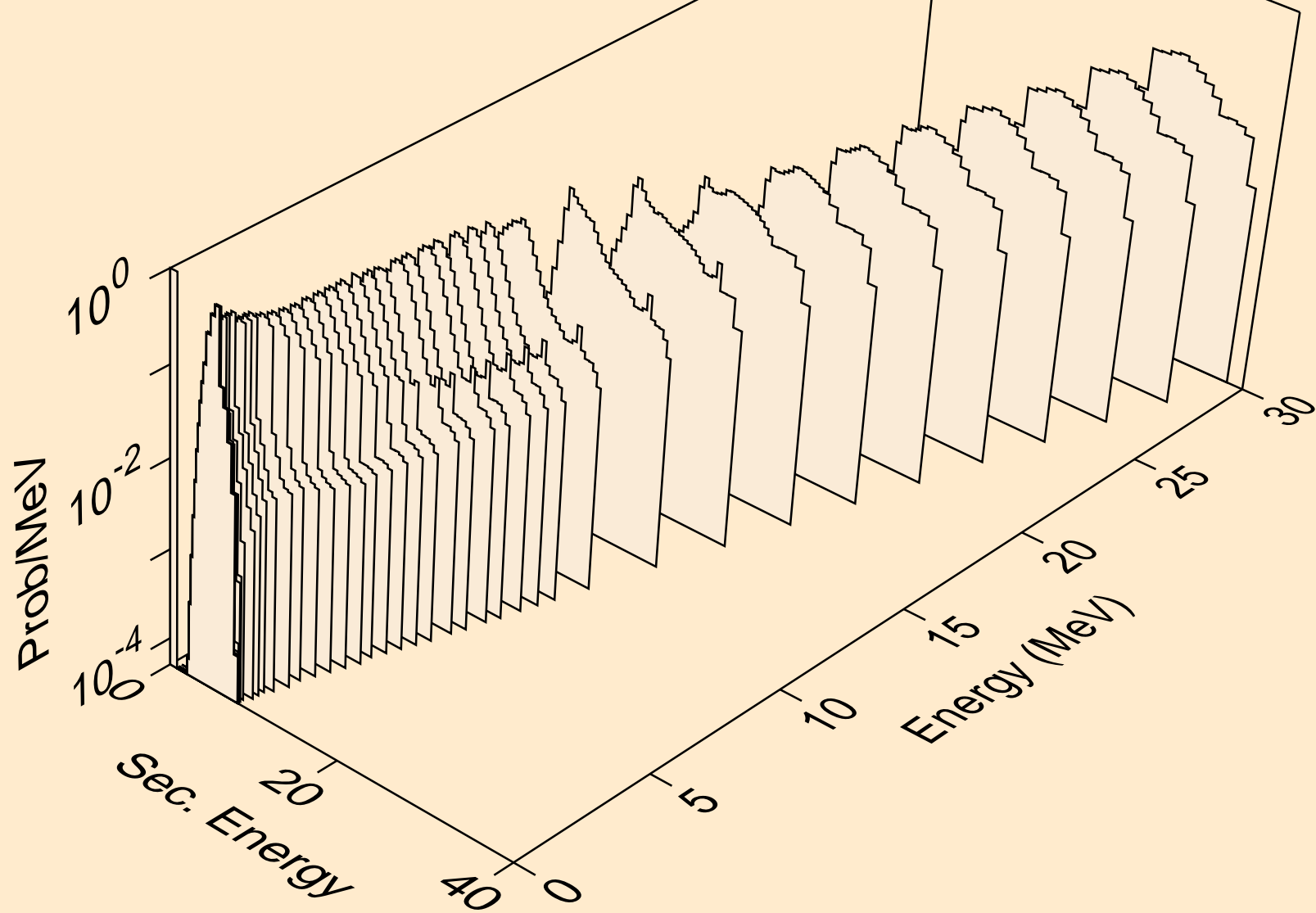

HO150 NEUTRON ACER TENDL-2021 LIBRARY; T=293.6K  
protons from (n,2p)

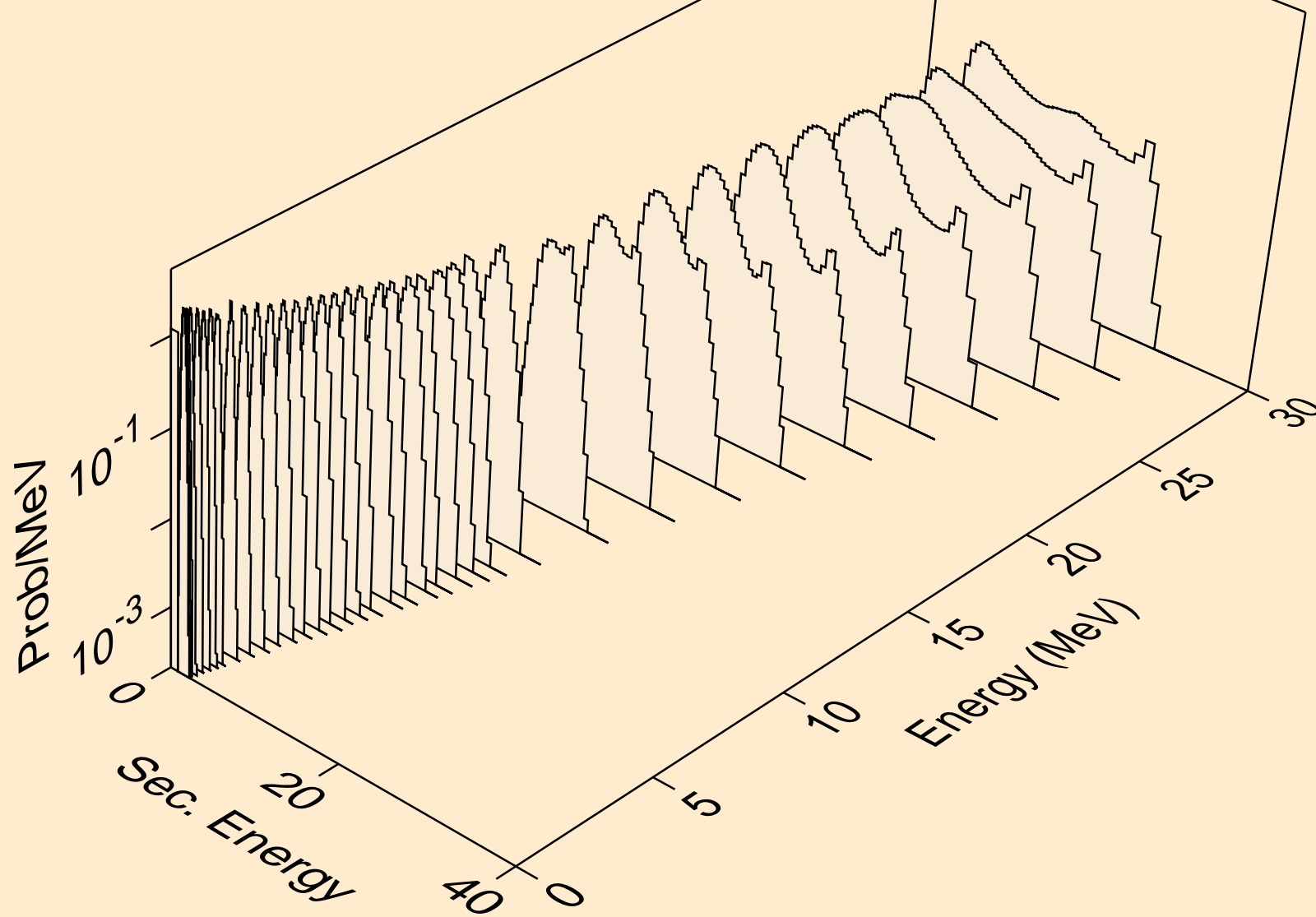

HO150 NEUTRON ACER TENDL-2021 LIBRARY; T=293.6K  
protons from (n,p)

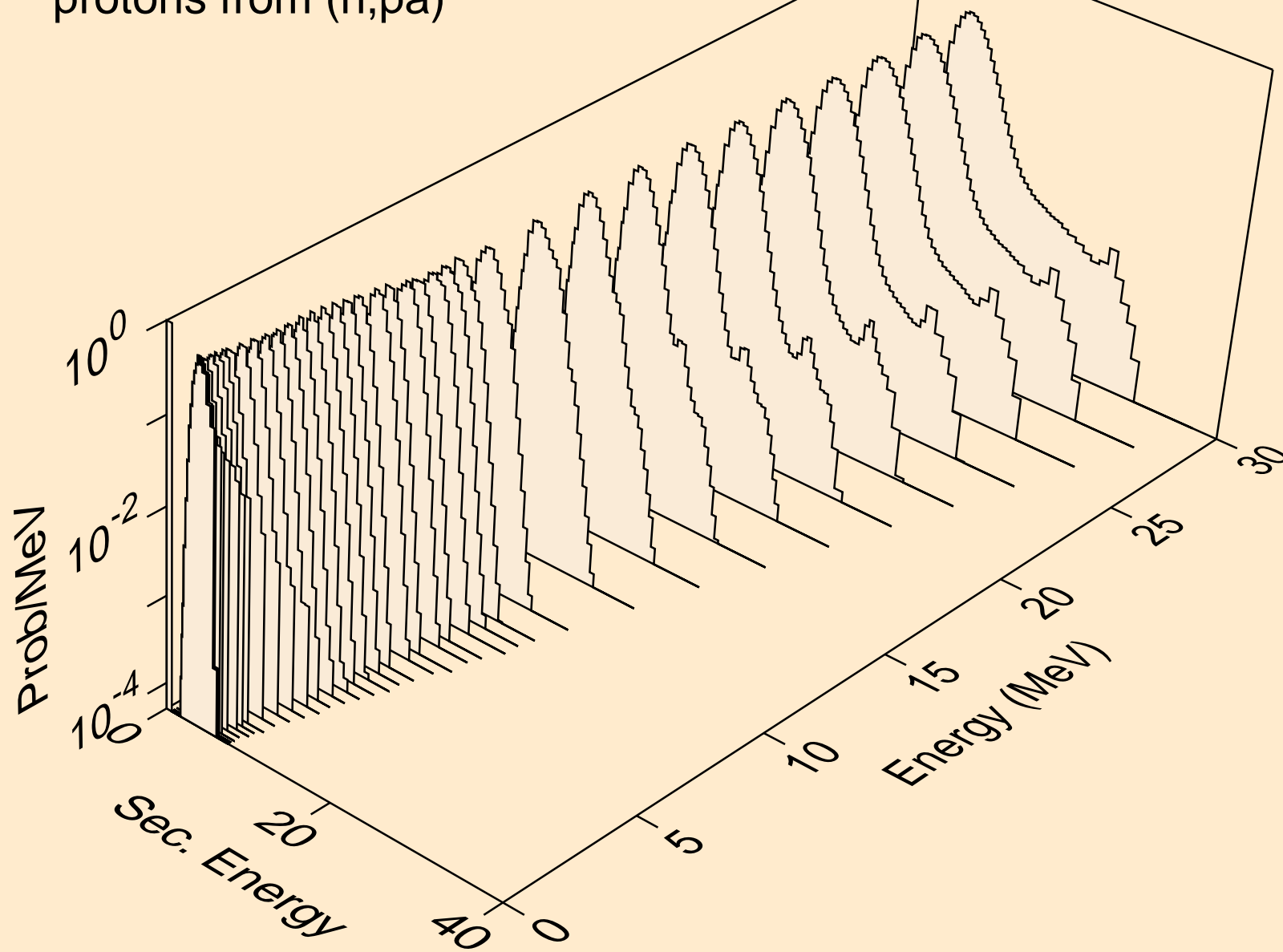

HO150 NEUTRON ACER TENDL-2021 LIBRARY; T=293.6K  
protons from (n,pd)

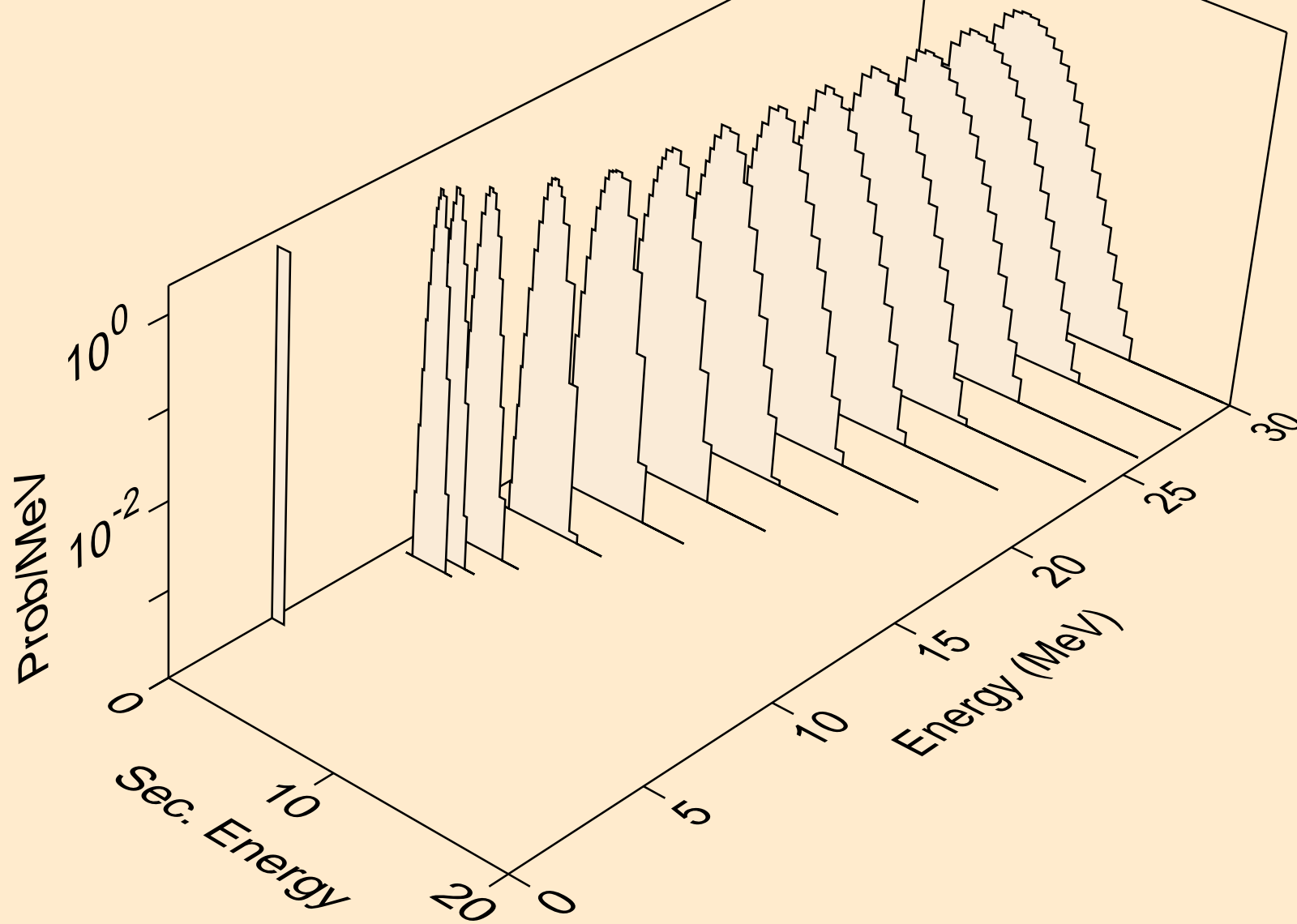

HO150 NEUTRON ACER TENDL-2021 LIBRARY; T=293.6K  
protons from (n,pt)

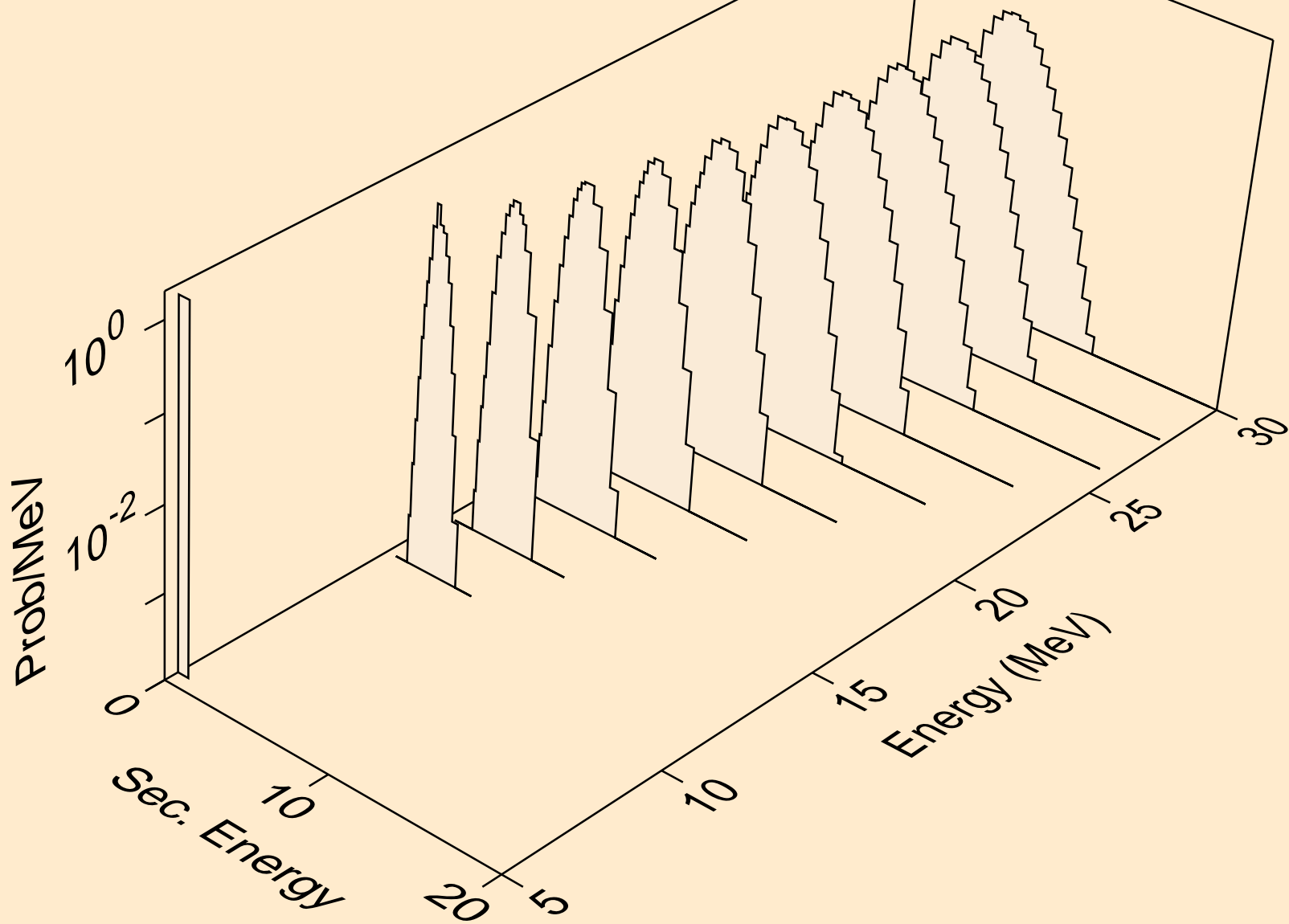

HO150 NEUTRON ACER TENDL-2021 LIBRARY; T=293.6K  
deuterons from (n,x)

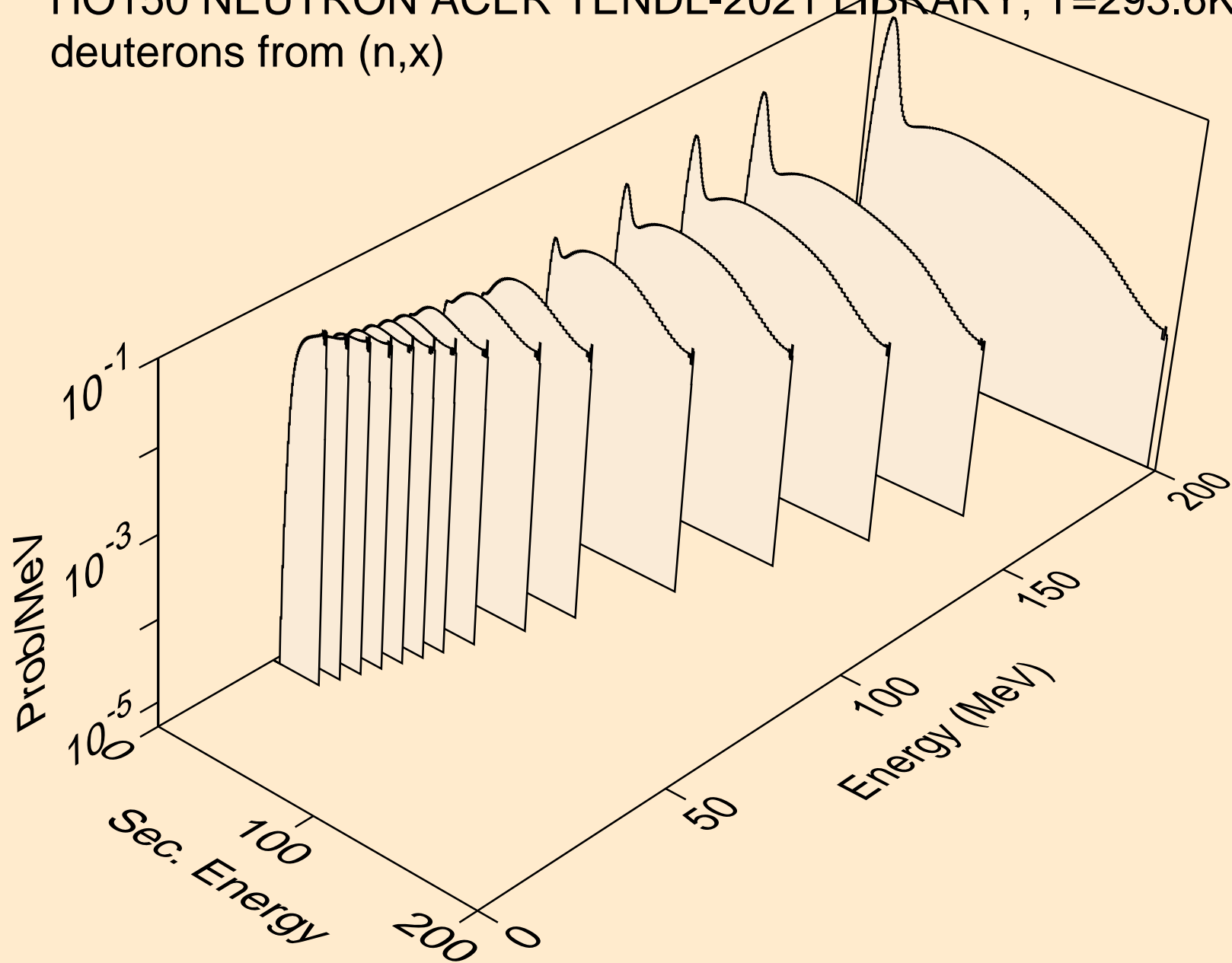

HO150 NEUTRON ACER TENDL-2021 LIBRARY; T=293.6K  
deuterons from (n,2nd)

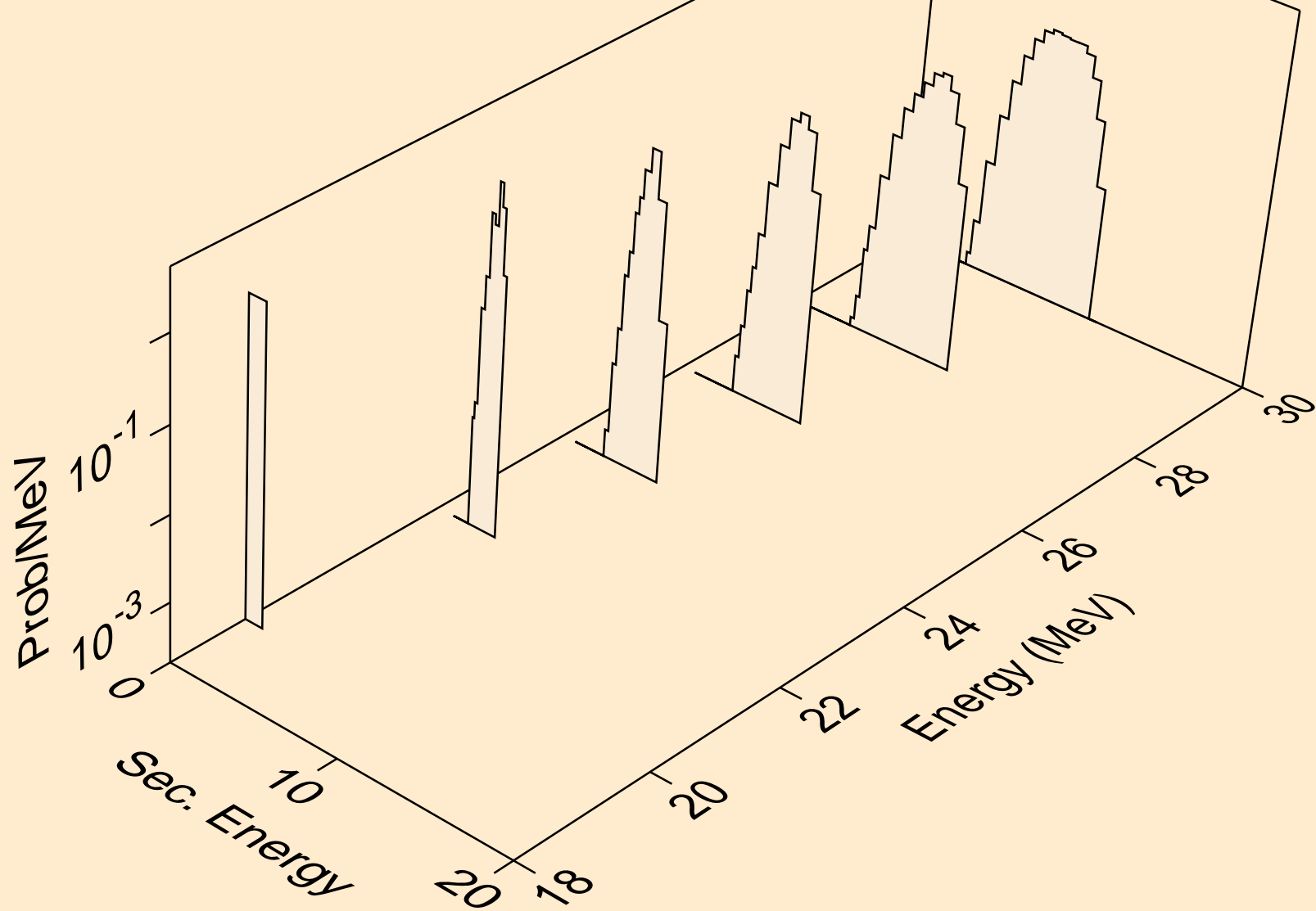

HO150 NEUTRON ACER TENDL-2021 LIBRARY; T=293.6K  
deuterons from (n,n\*)d

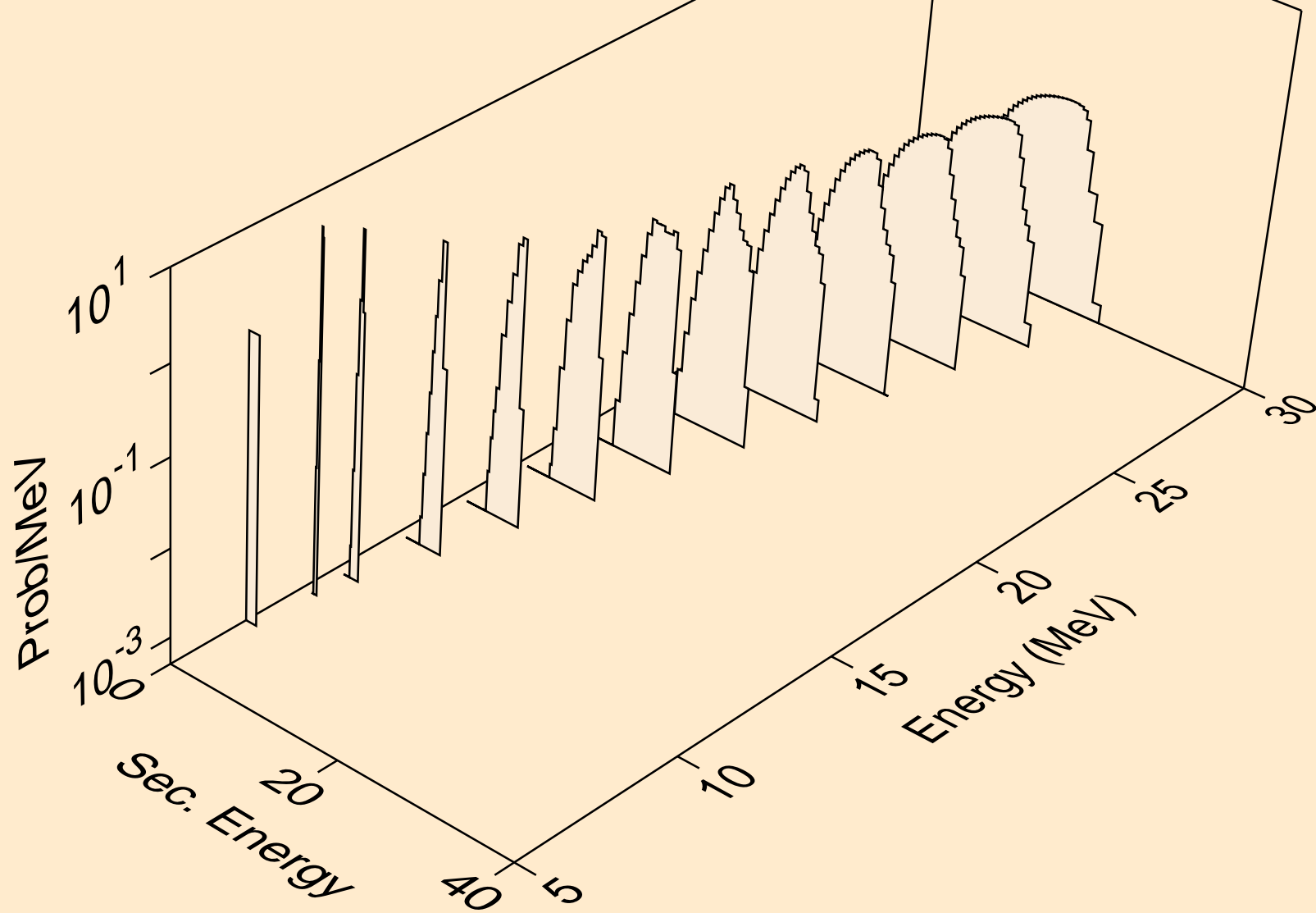



HO150 NEUTRON ACER TENDL-2021 LIBRARY; T=293.6K  
deuterons from (n,d)

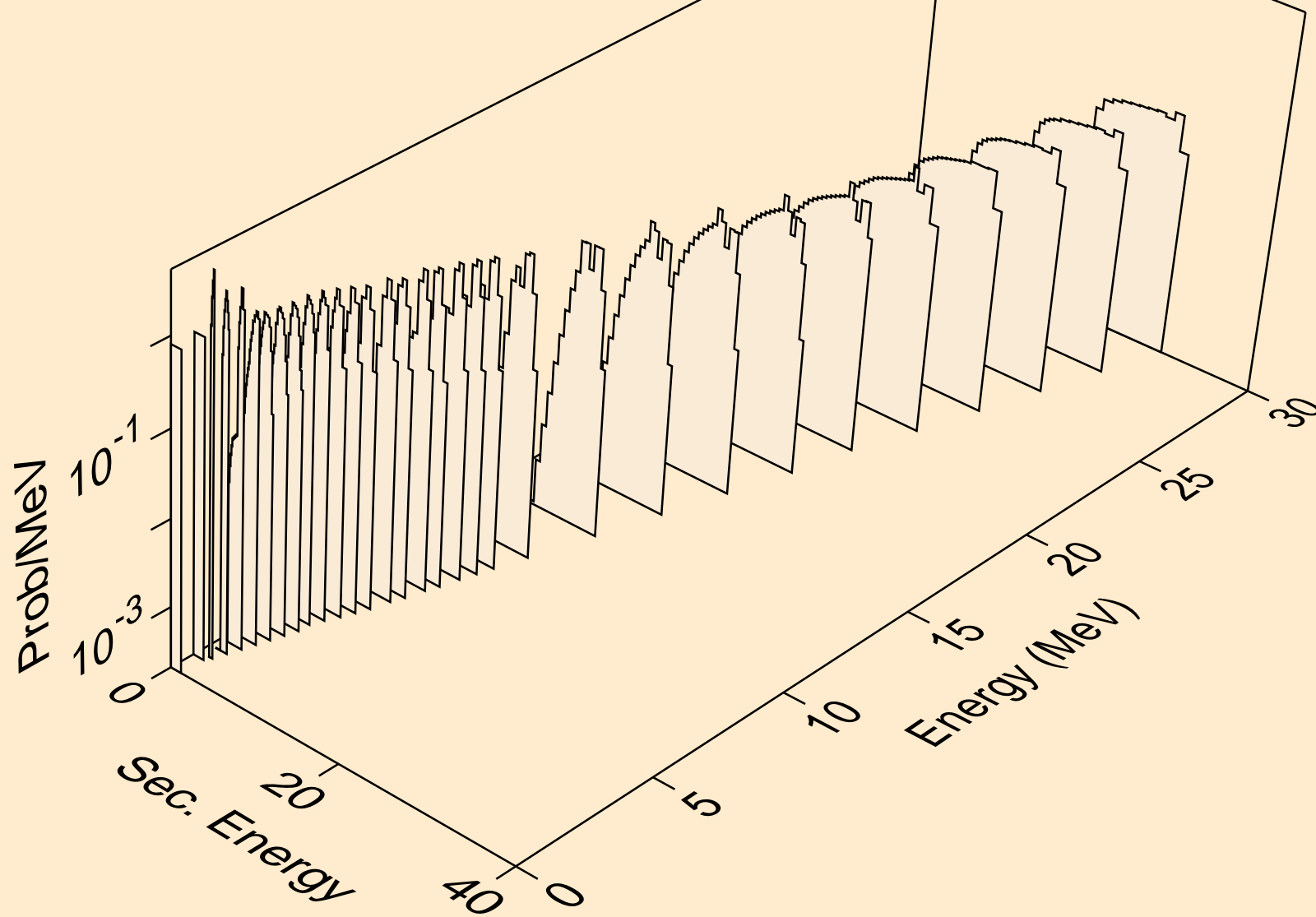

HO150 NEUTRON ACER TENDL-2021 LIBRARY; T=293.6K  
deuterons from (n,pd)

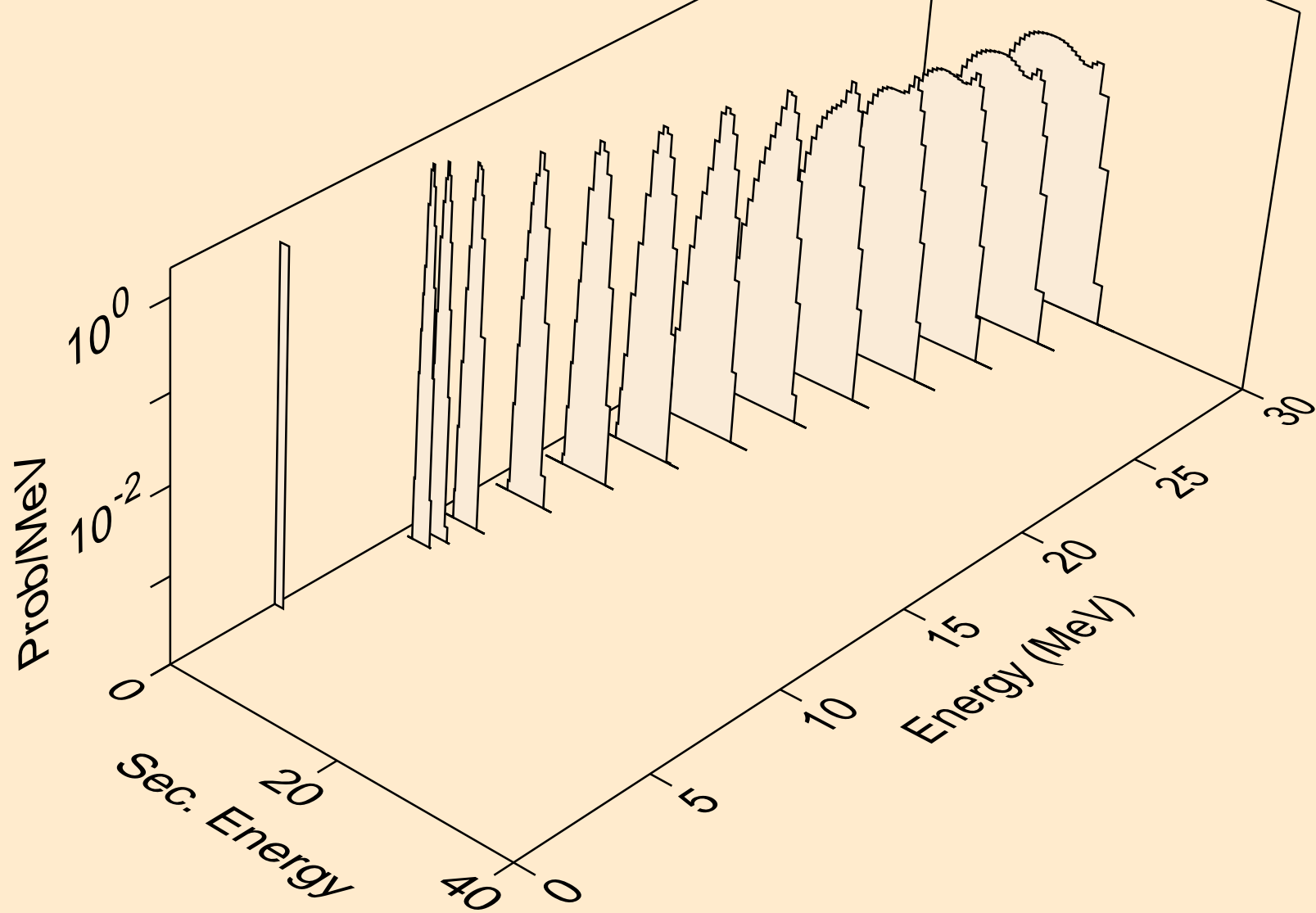

HO150 NEUTRON ACER TENDL-2021 LIBRARY; T=293.6K  
deuterons from (n,da)

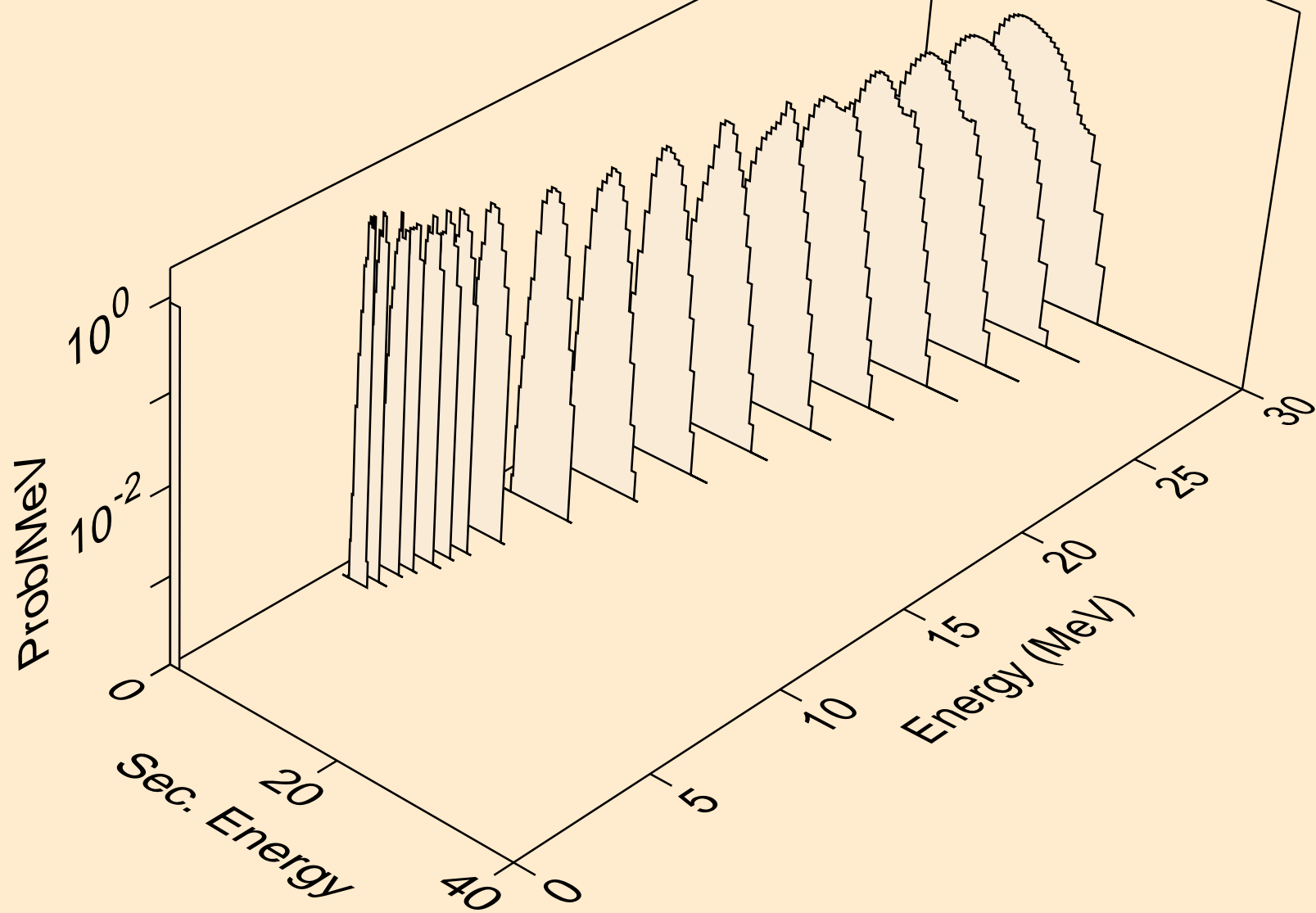

HO150 NEUTRON ACER TENDL-2021 LIBRARY; T=293.6K  
tritons from (n,x)

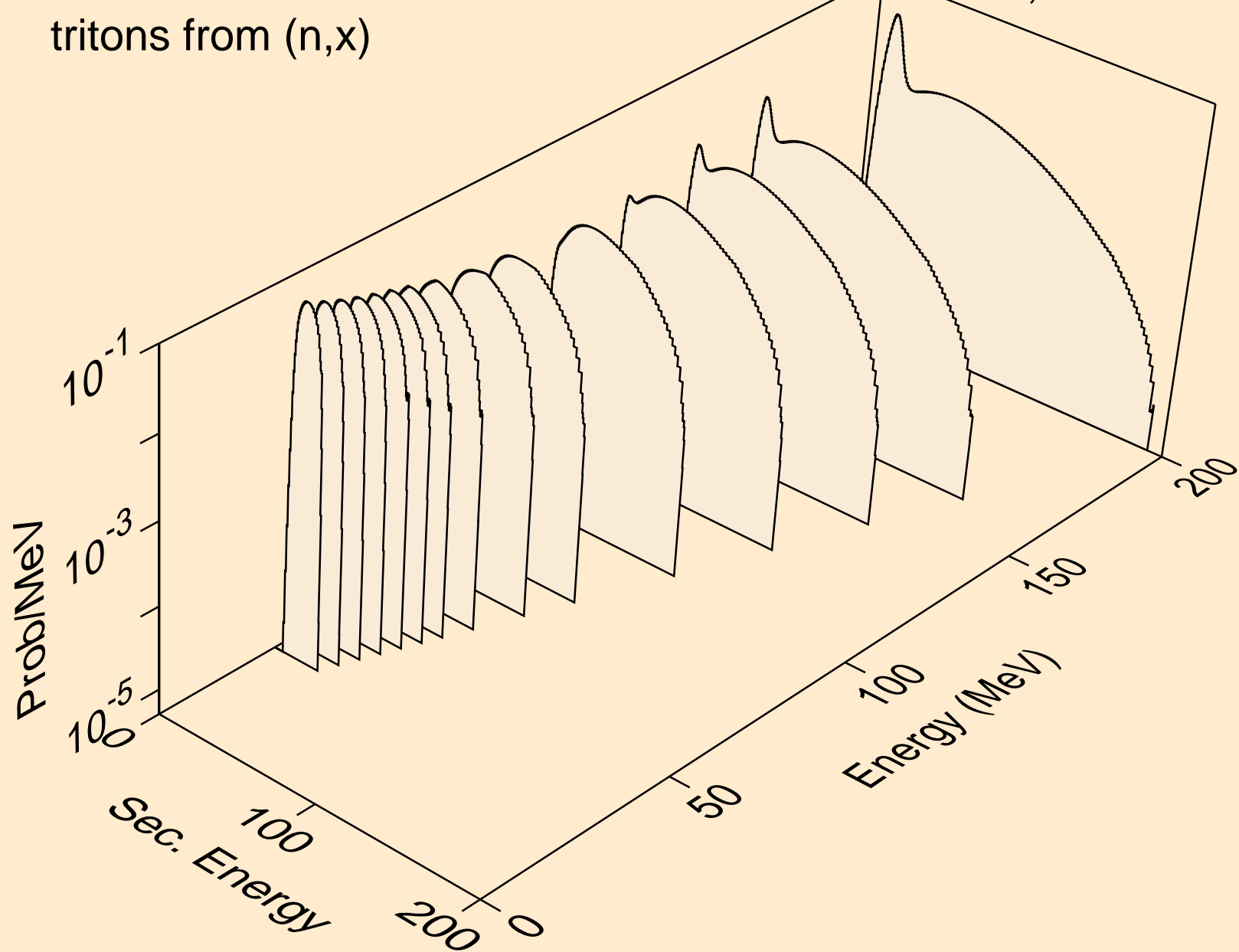

HO150 NEUTRON ACER TENDL-2021 LIBRARY; T=293.6K  
tritons from (n,n\*)t

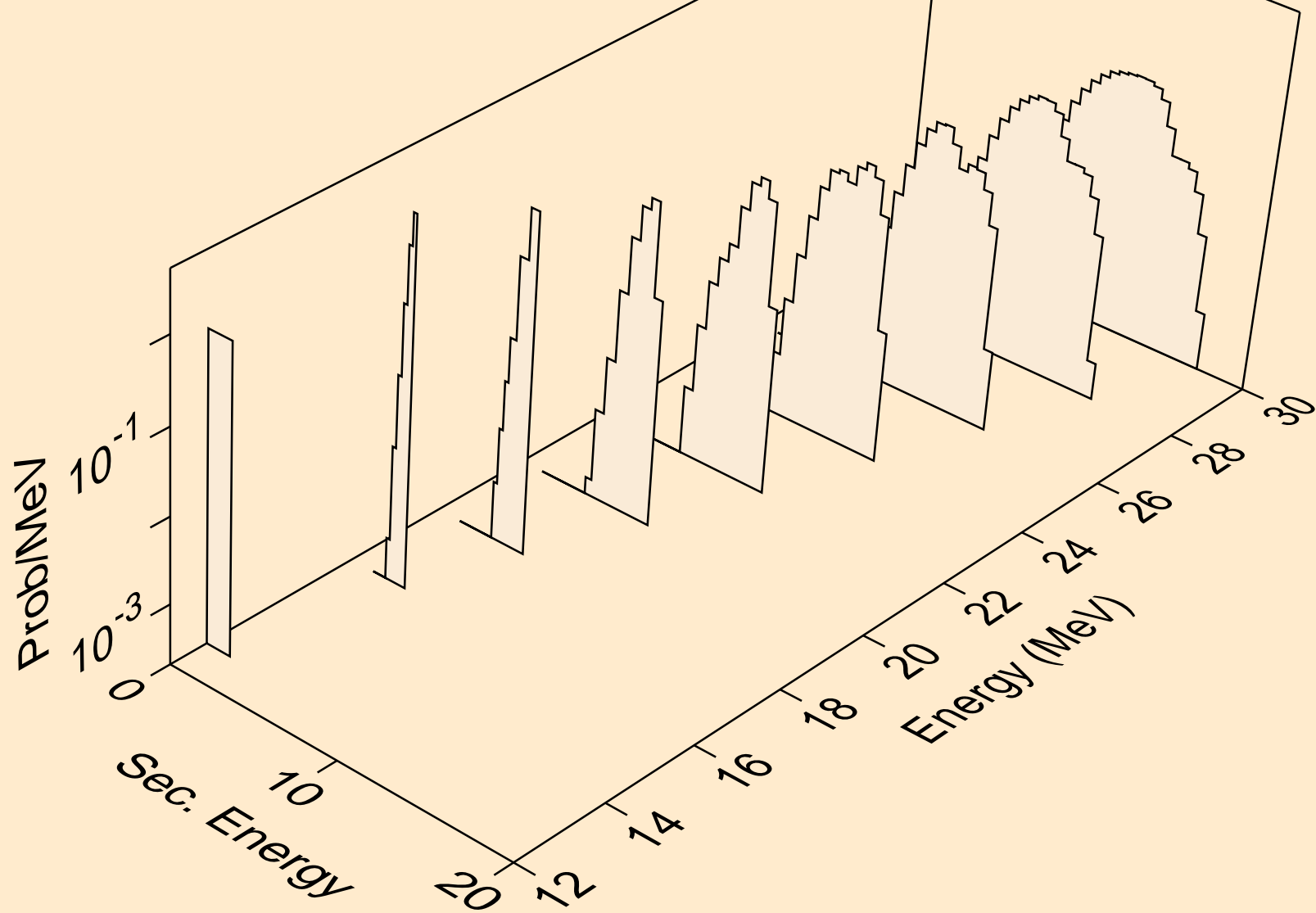

HO150 NEUTRON ACER TENDL-2021 LIBRARY; T=293.6K  
tritons from (n,t)

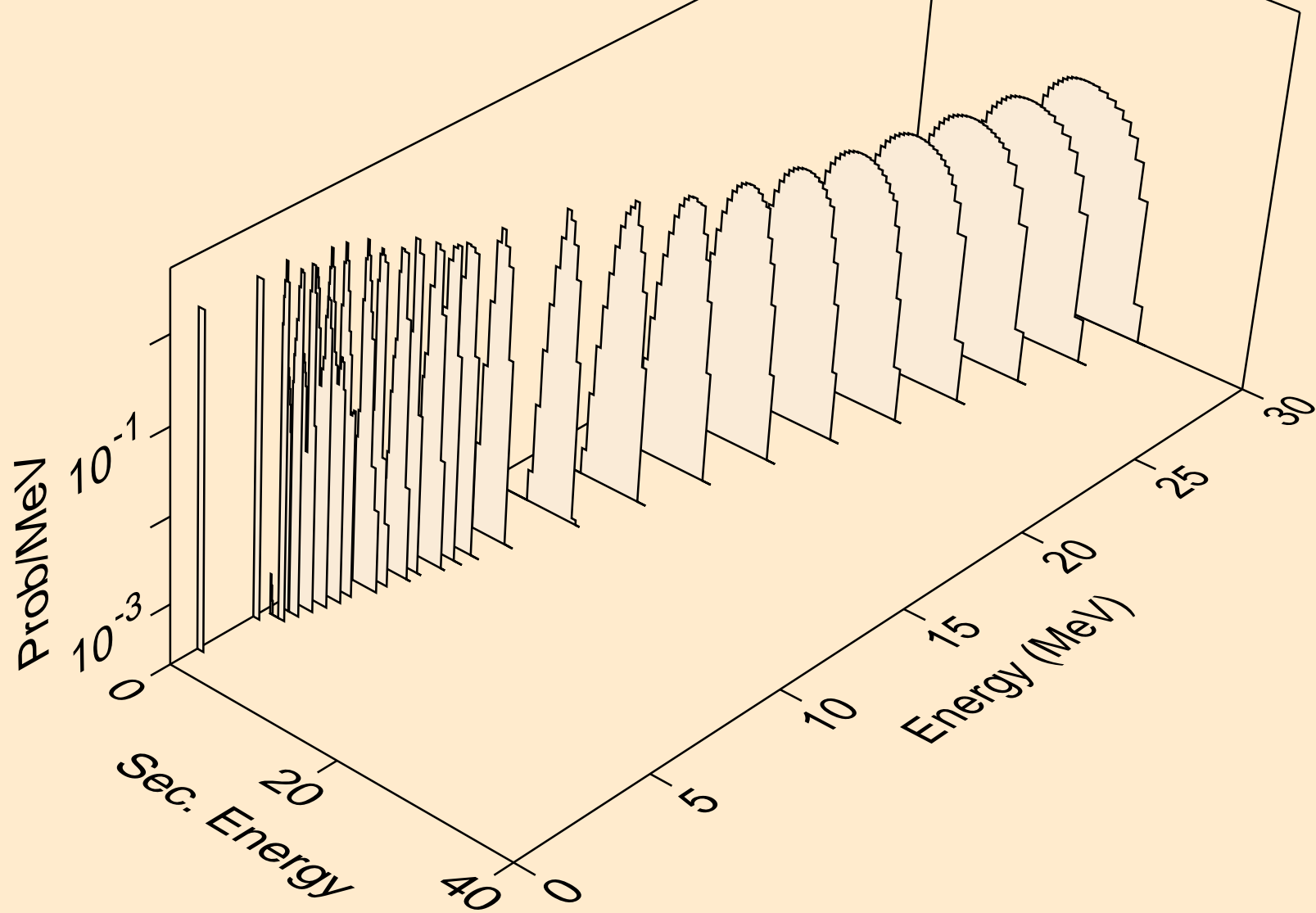

HO150 NEUTRON ACER TENDL-2021 LIBRARY; T=293.6K  
tritons from (n,pt)

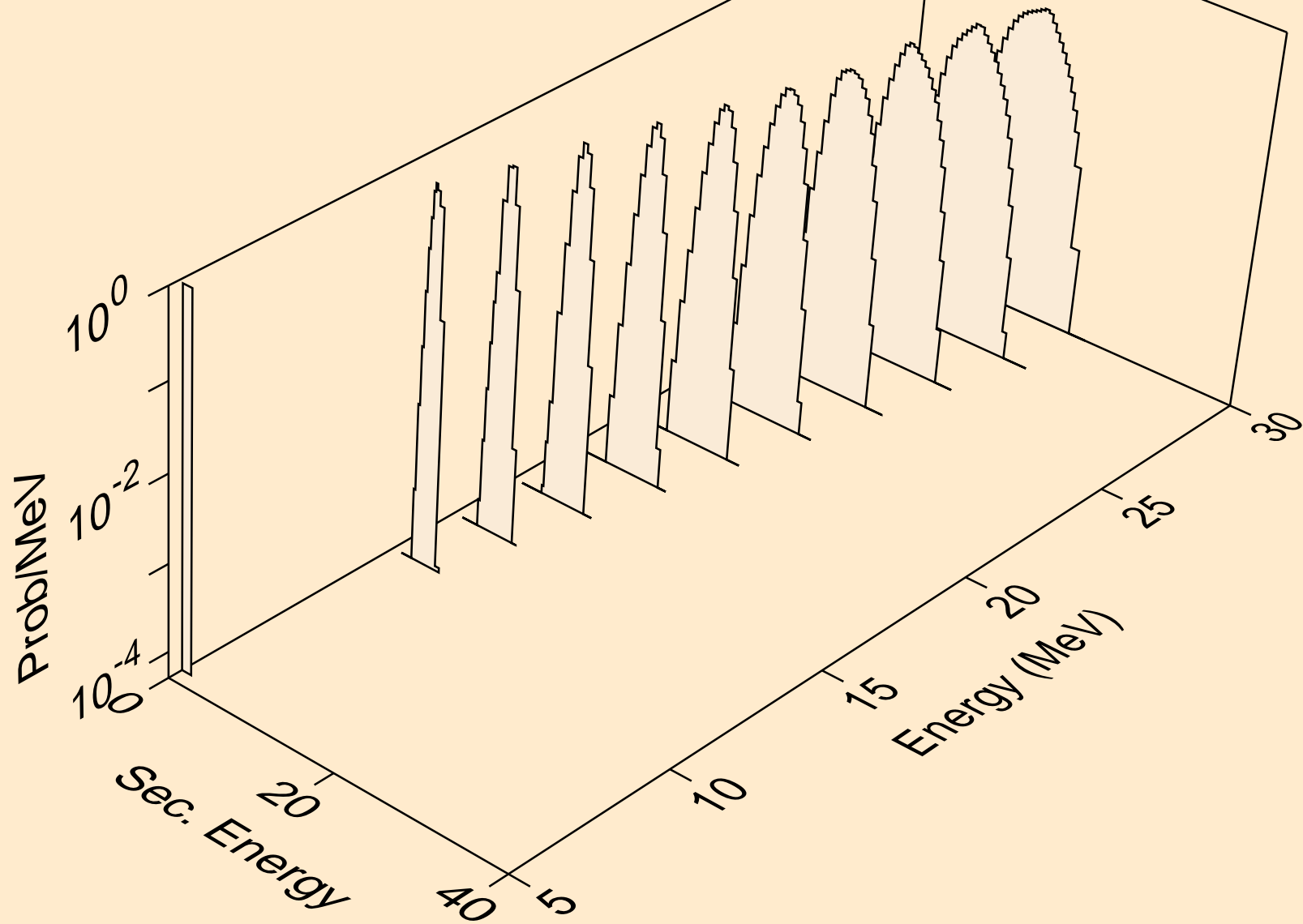

HO150 NEUTRON ACER TENDL-2021 LIBRARY; T=293.6K  
he3s from (n,x)

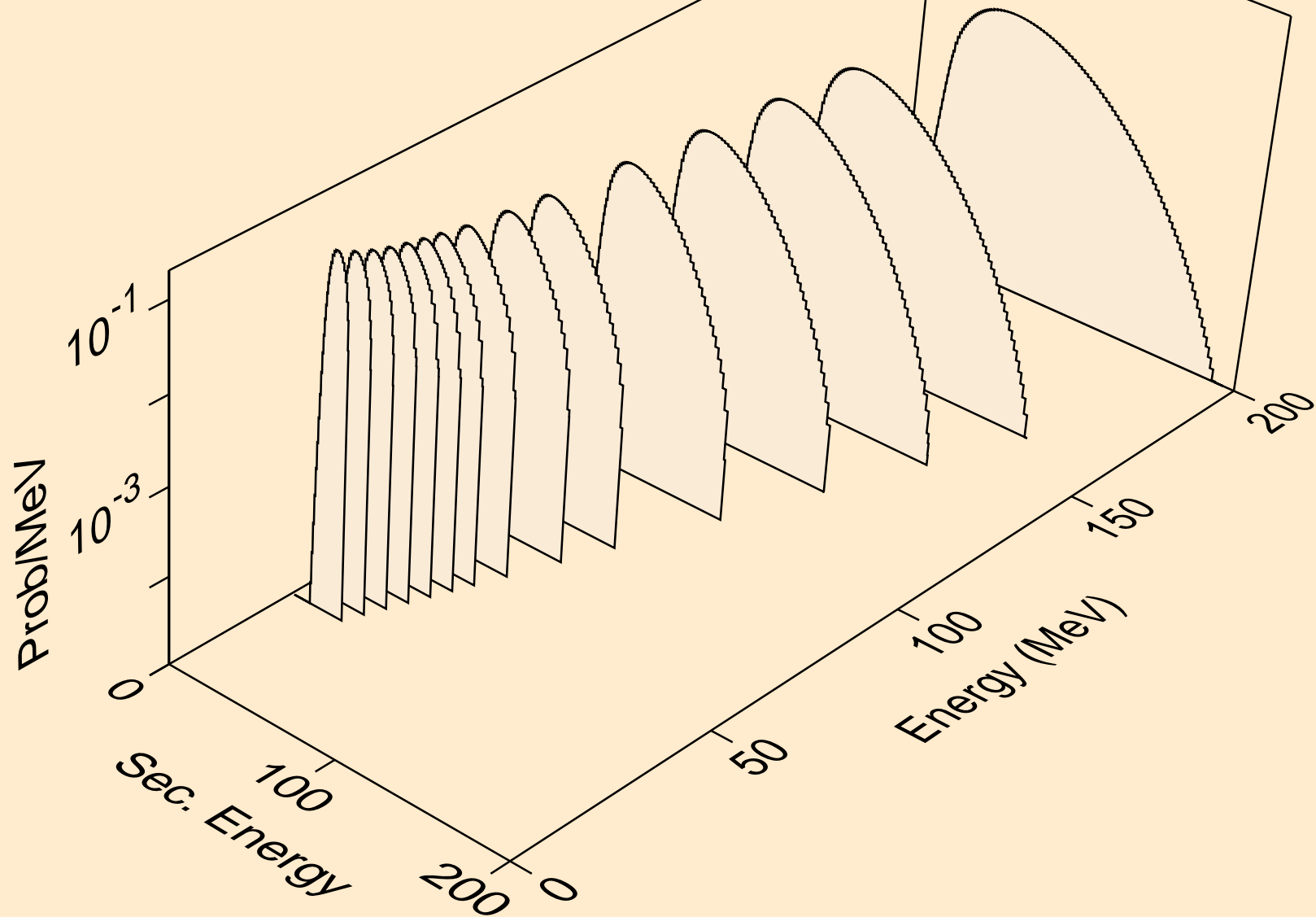



HO150 NEUTRON ACER TENDL-2021 LIBRARY; T=293.6K  
he3s from (n,n\*)he3

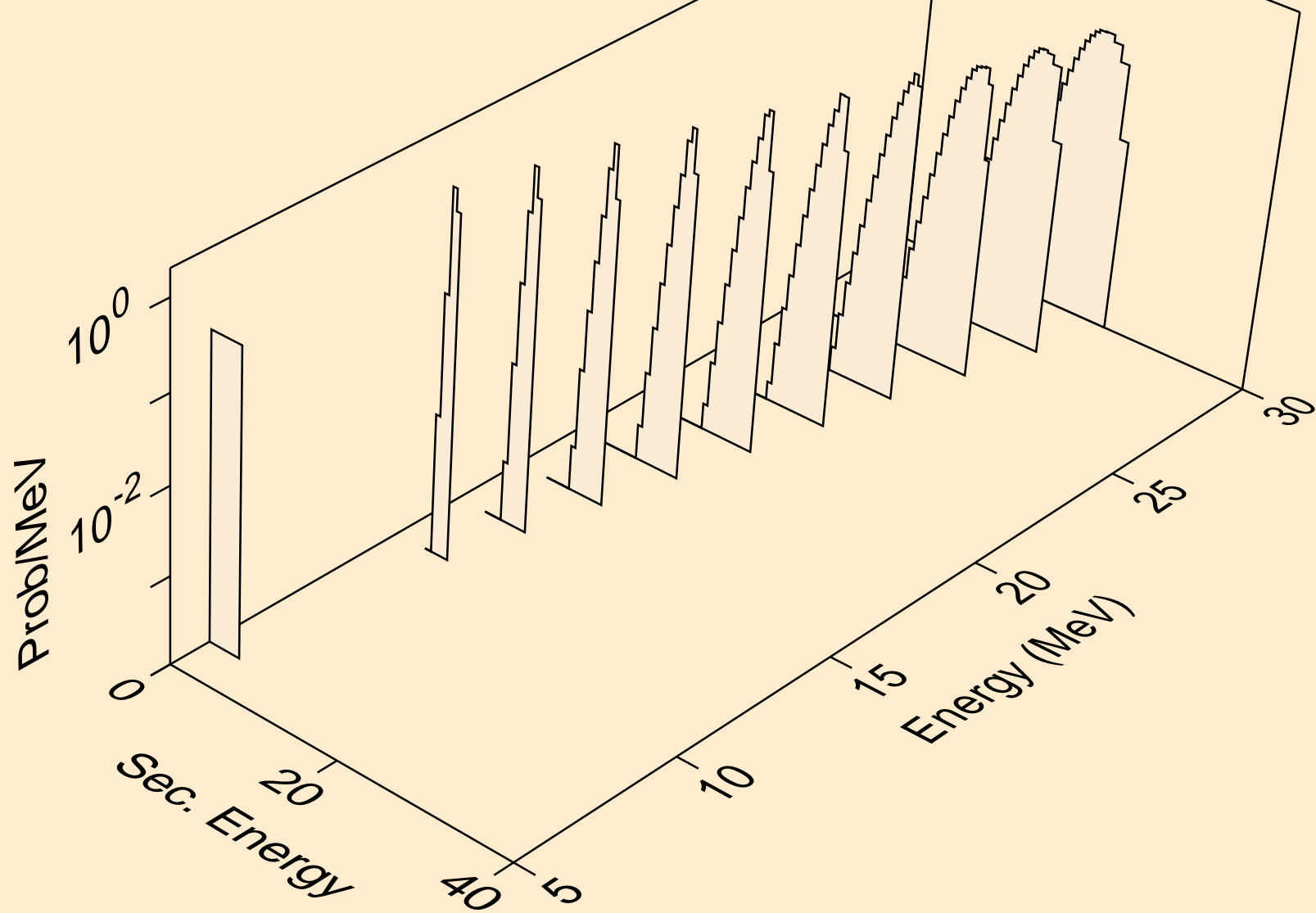

HO150 NEUTRON ACER TENDL-2021 LIBRARY; T=293.6K  
he3s from (n,he3)

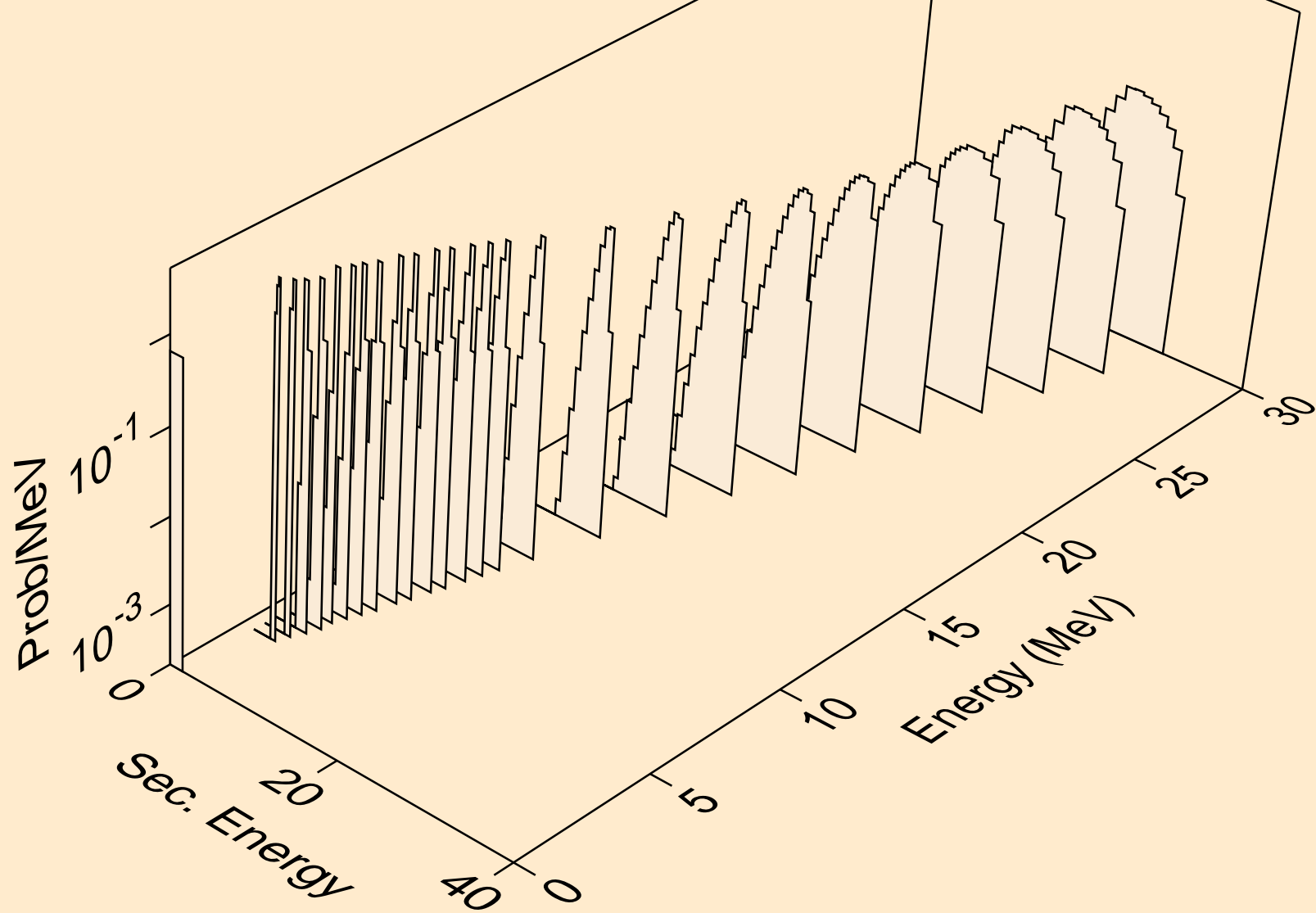

HO150 NEUTRON ACER TENDL-2021 LIBRARY; T=293.6K  
alphas from (n,x)

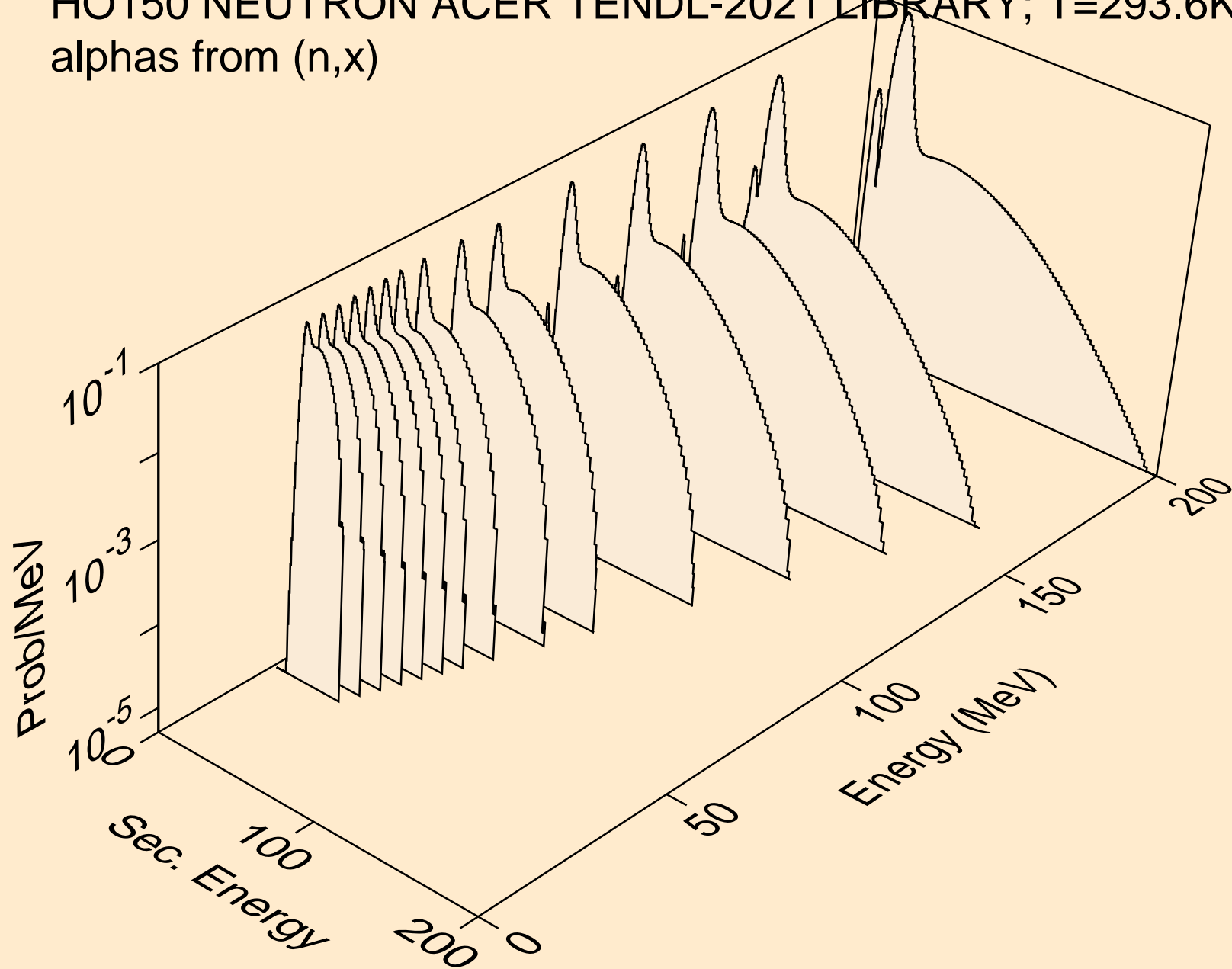

HO150 NEUTRON ACER TENDL-2021 LIBRARY; T=293.6K  
alphas from (n,n\*)a

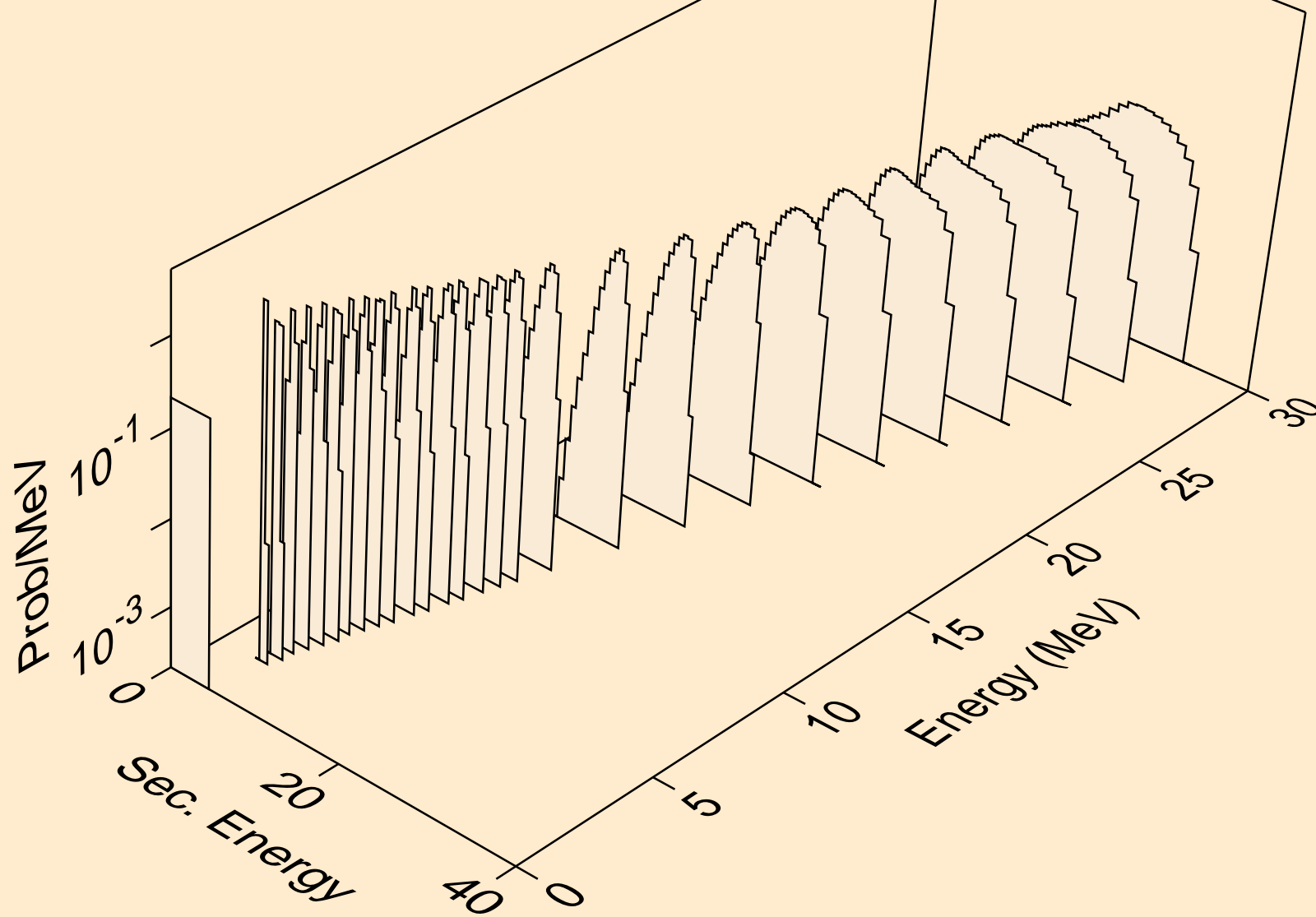

HO150 NEUTRON ACER TENDL-2021 LIBRARY; T=293.6K  
alphas from (n,2n)a

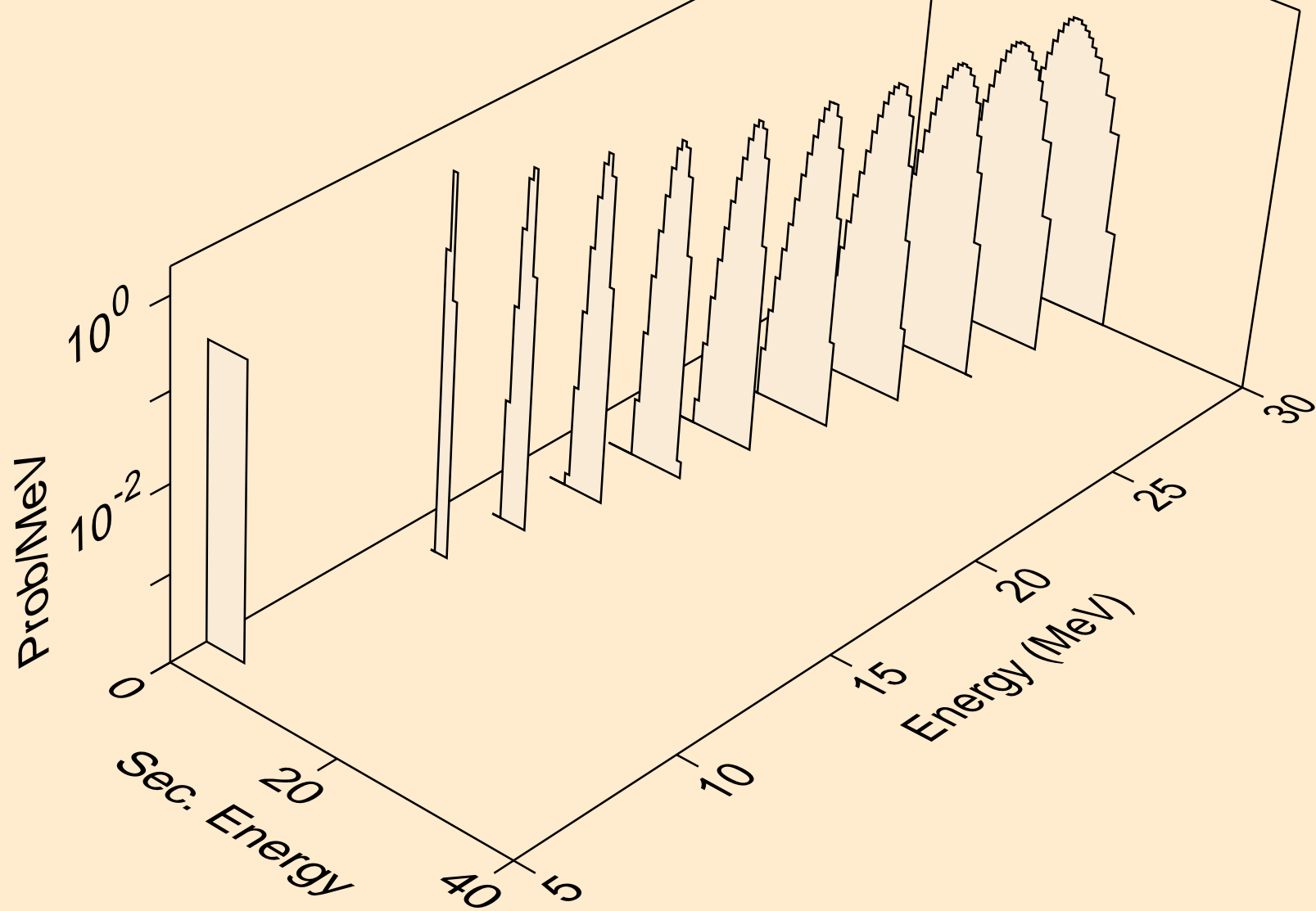

HO150 NEUTRON ACER TENDL-2021 LIBRARY; T=293.6K  
alphas from (n,3n)a

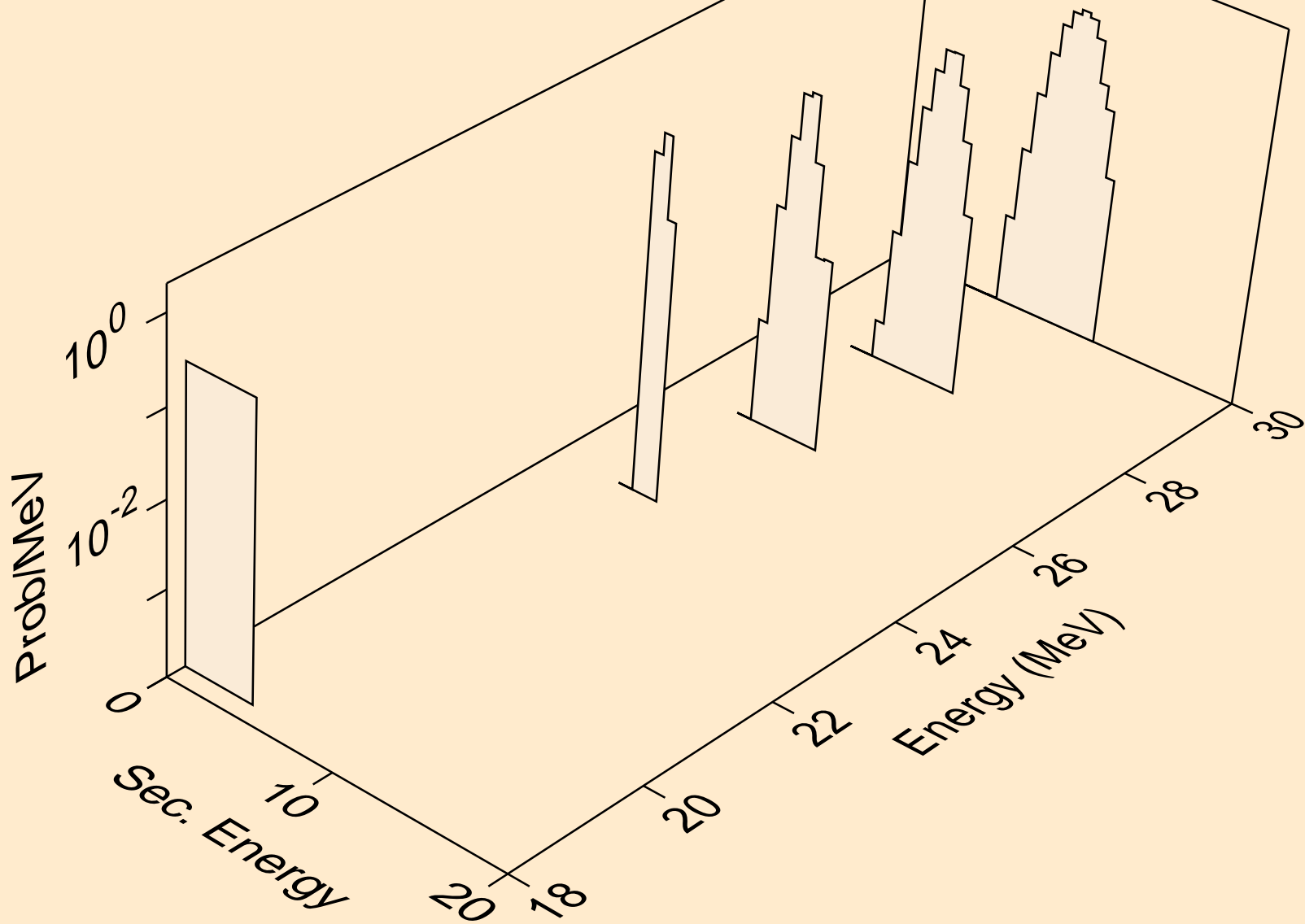

HO150 NEUTRON ACER TENDL-2021 LIBRARY; T=293.6K  
alphas from (n,n\*)2a

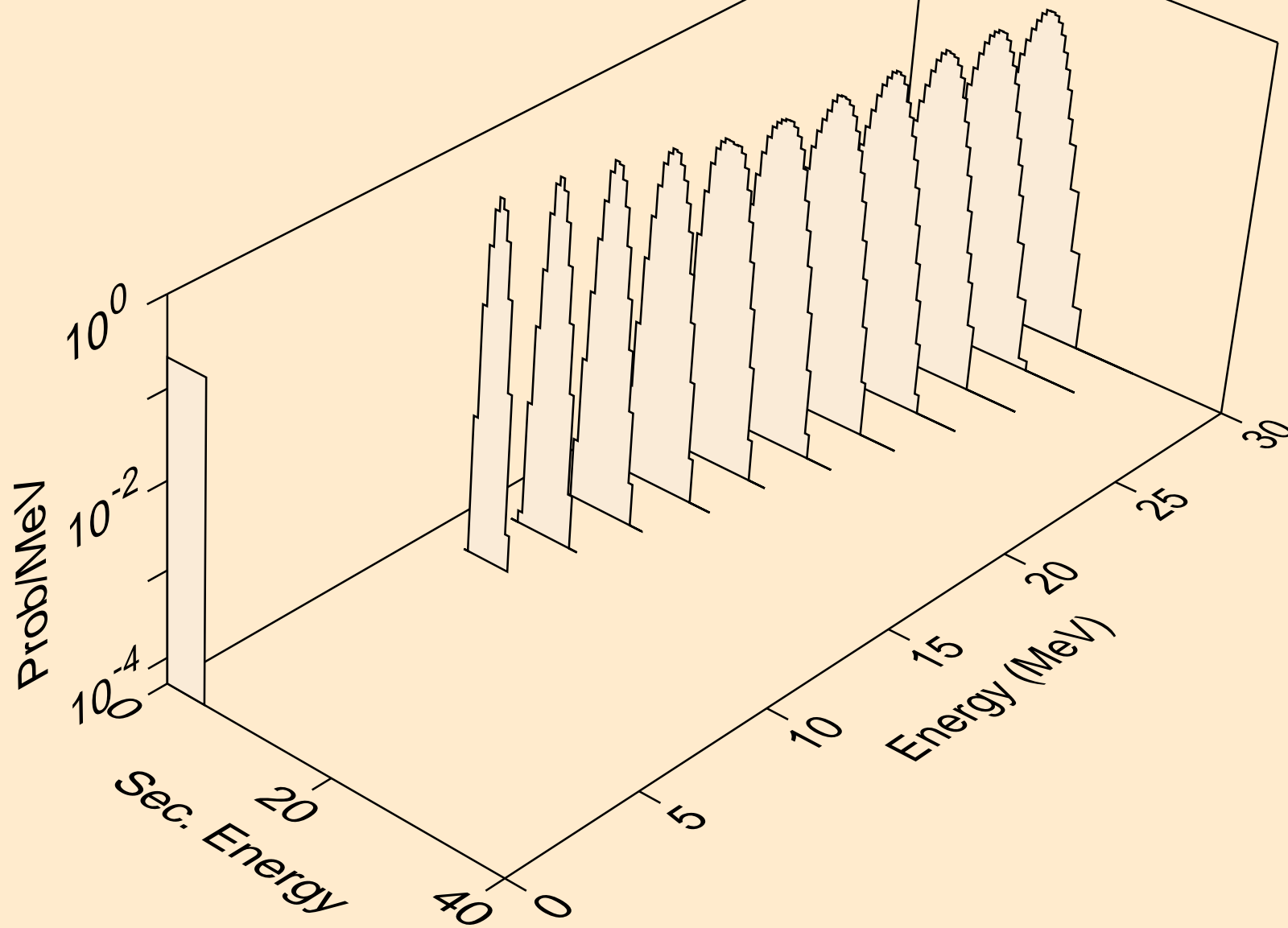

HO150 NEUTRON ACER TENDL-2021 LIBRARY; T=293.6K  
alphas from (n,2n)2a

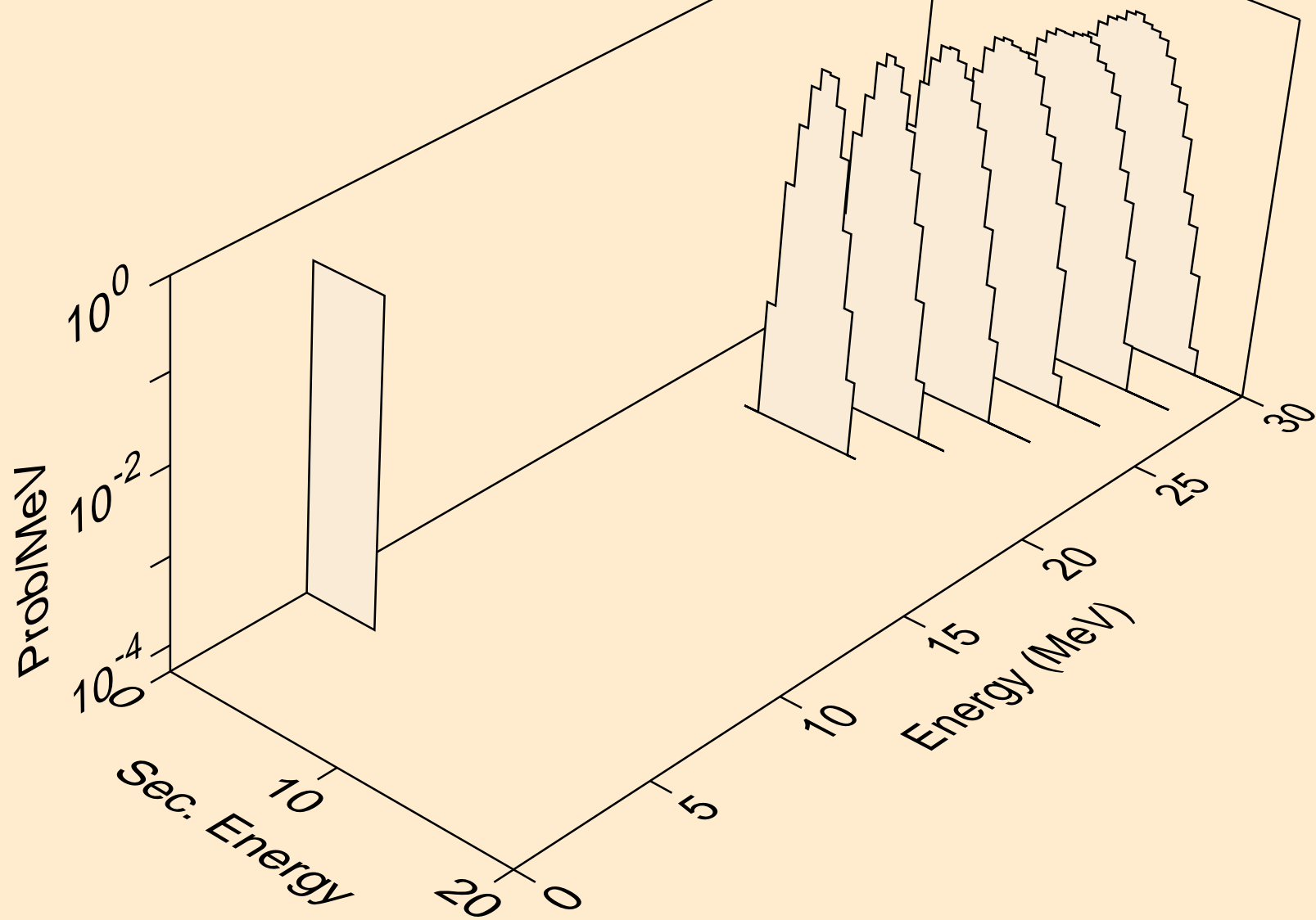



HO150 NEUTRON ACER TENDL-2021 LIBRARY; T=293.6K  
alphas from (n,npa)

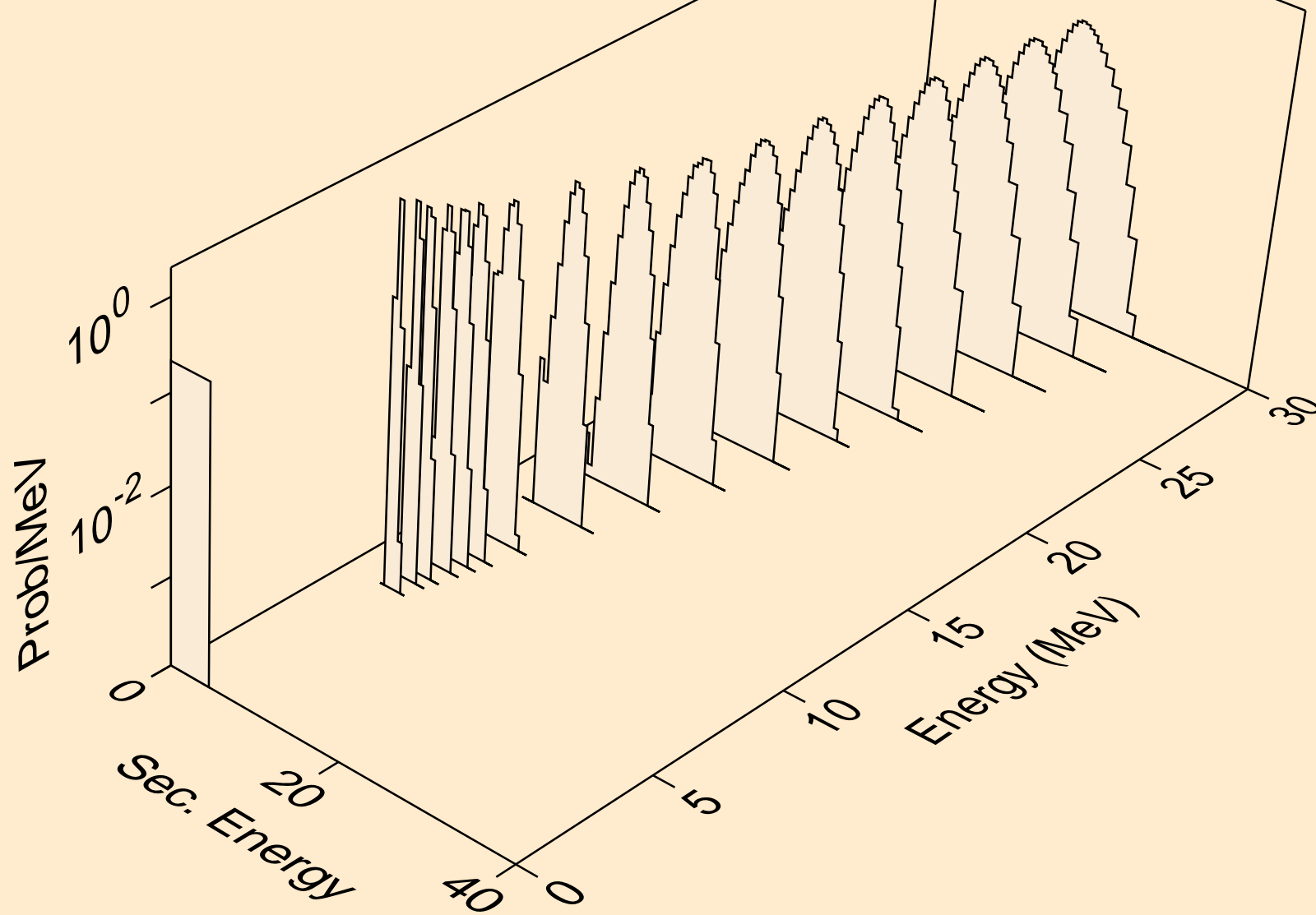

HO150 NEUTRON ACER TENDL-2021 LIBRARY; T=293.6K  
alphas from (n,a)

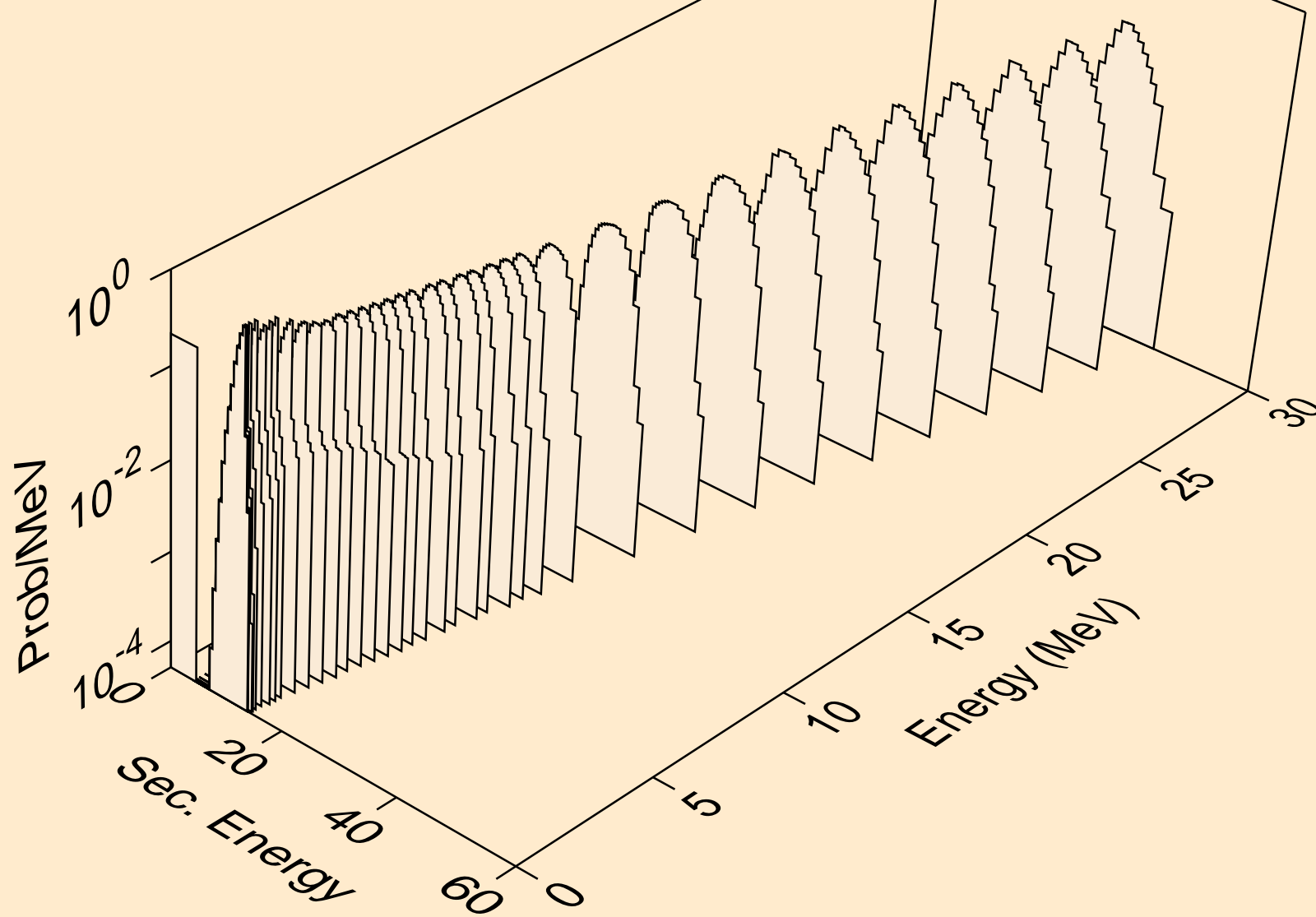

HO150 NEUTRON ACER TENDL-2021 LIBRARY; T=293.6K  
alphas from (n,2a)

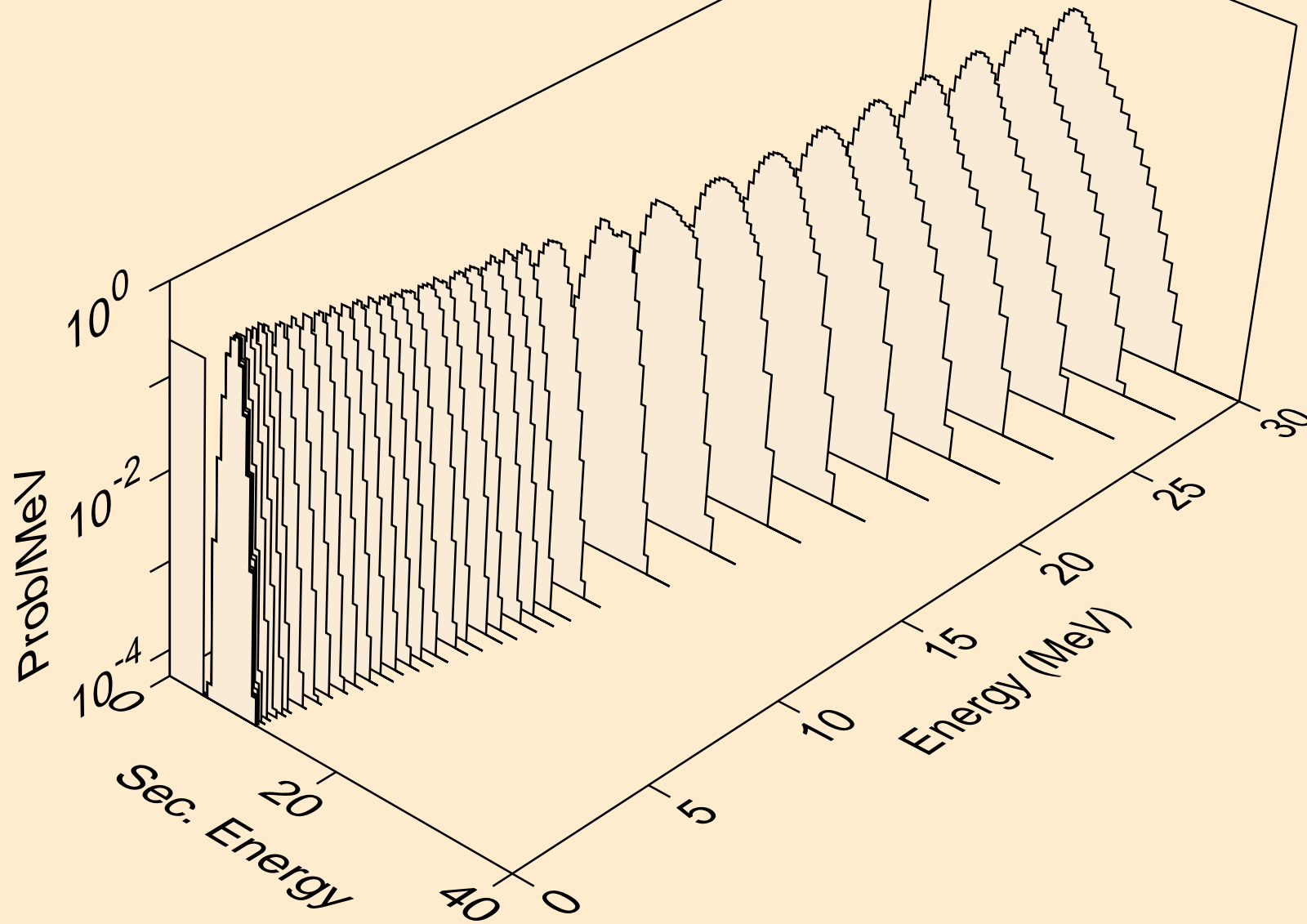

HO150 NEUTRON ACER TENDL-2021 LIBRARY; T=293.6K  
alphas from (n,3a)

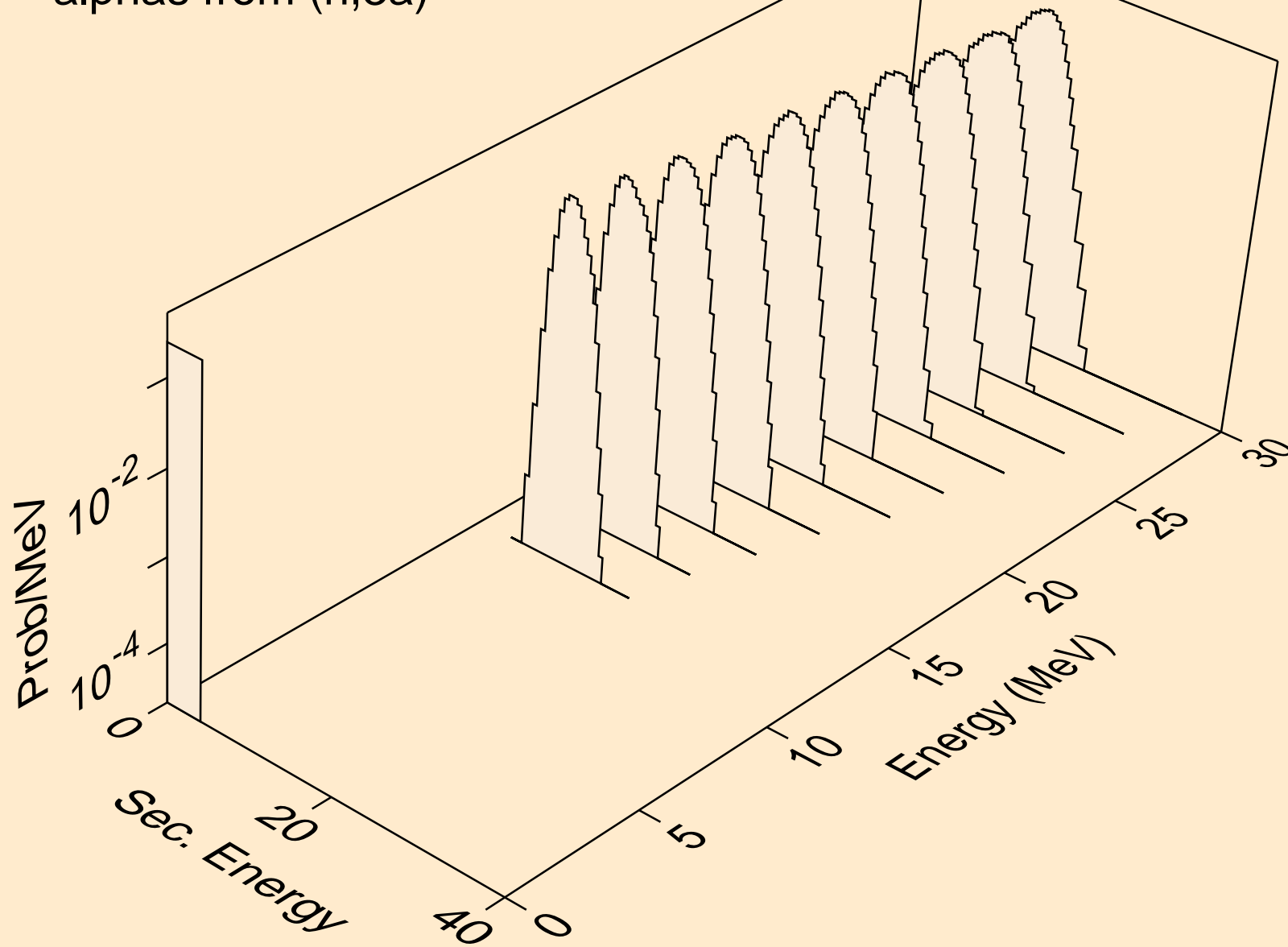

HO150 NEUTRON ACER TENDL-2021 LIBRARY; T=293.6K  
alphas from (n,pa)

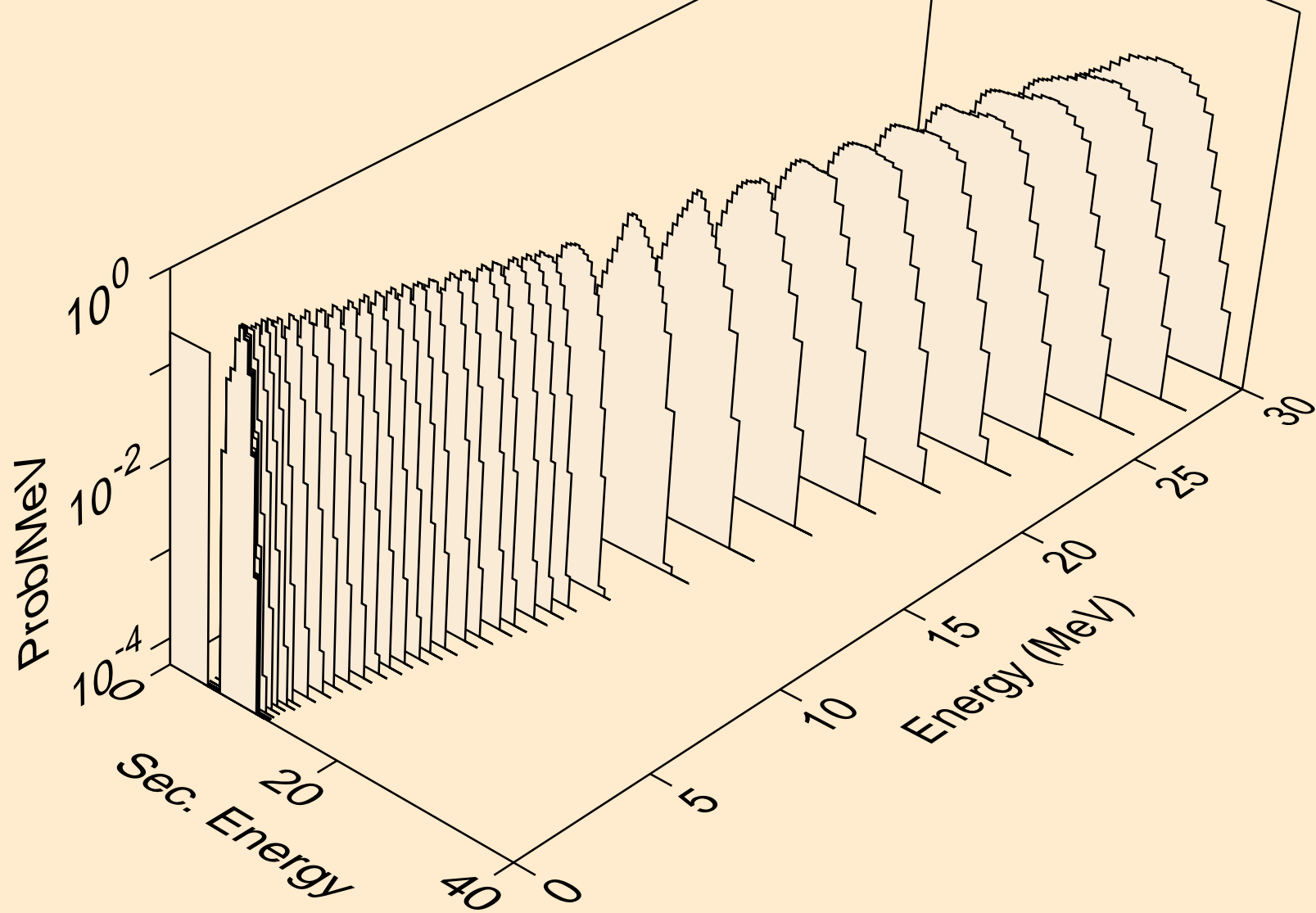

HO150 NEUTRON ACER TENDL-2021 LIBRARY; T=293.6K  
alphas from (n,da)

