

# HO158N NEUTRON ACER TENDL-2021 LIBRARY; T=293.6K

## Principal cross sections

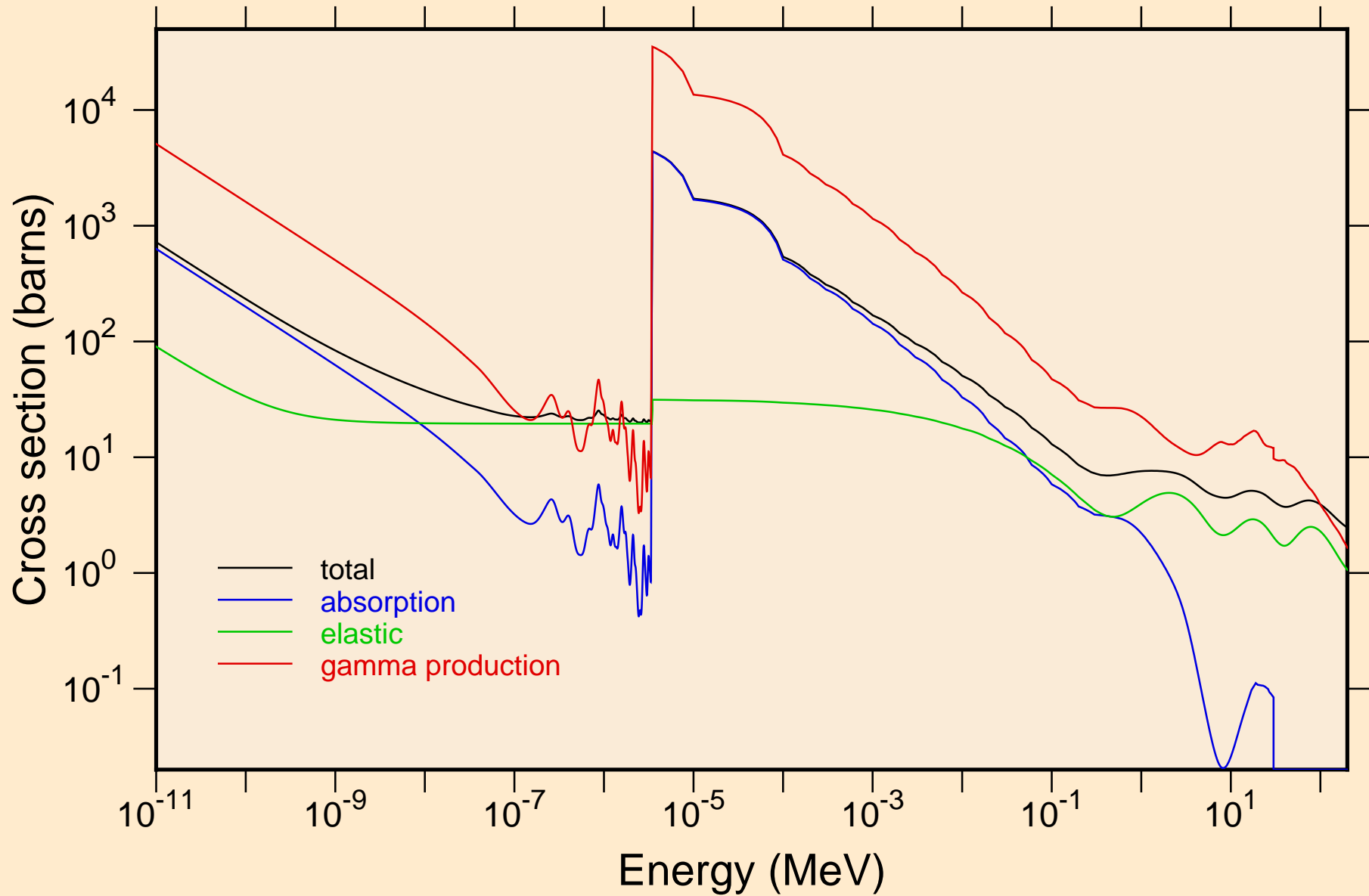

$\bar{H}O158N$  NEUTRON ACER TENDL-2021 LIBRARY; T=293.6K  
resonance total cross section

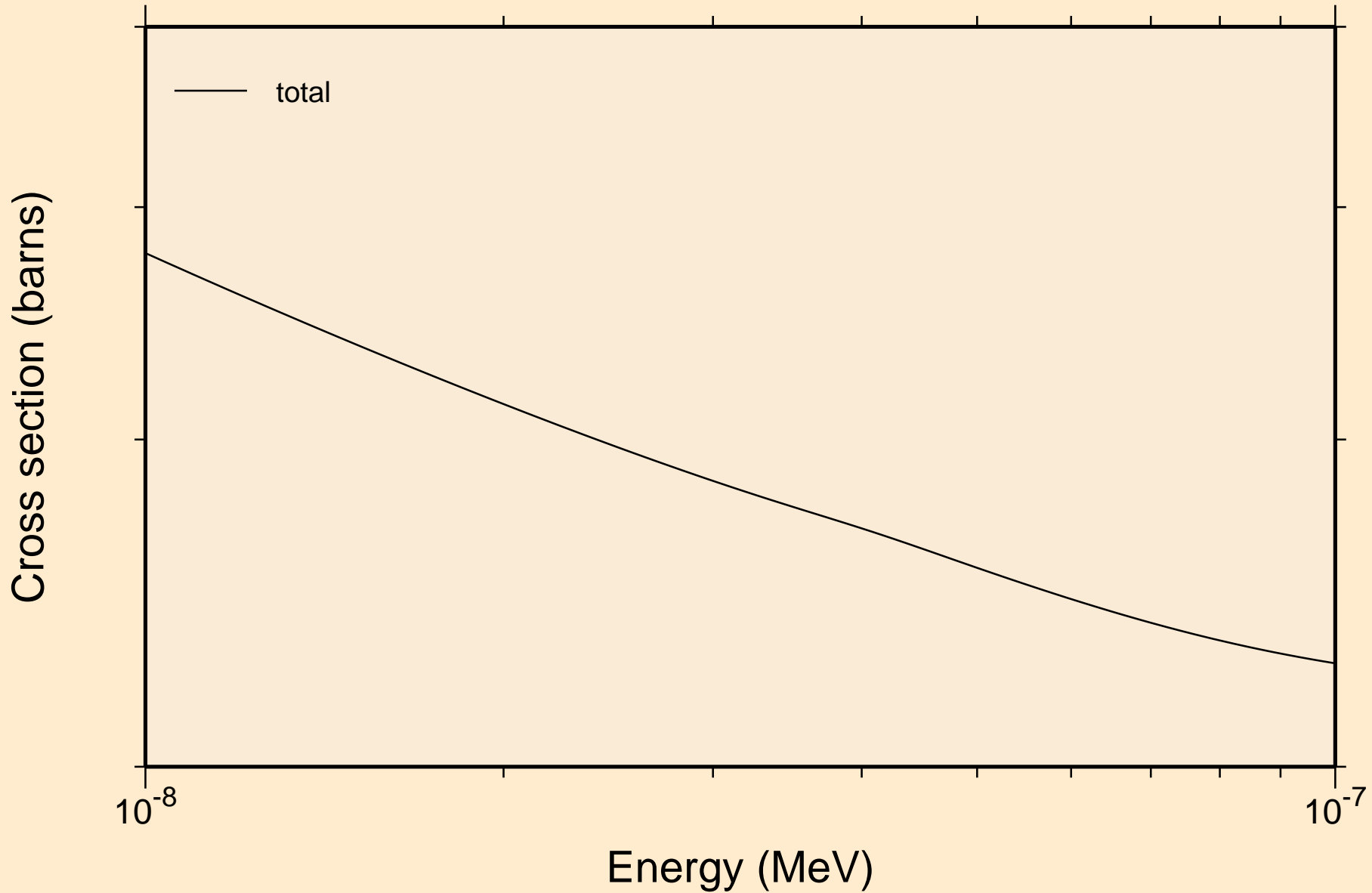

$\bar{H}O158N$  NEUTRON ACER TENDL-2021 LIBRARY; T=293.6K  
resonance total cross section

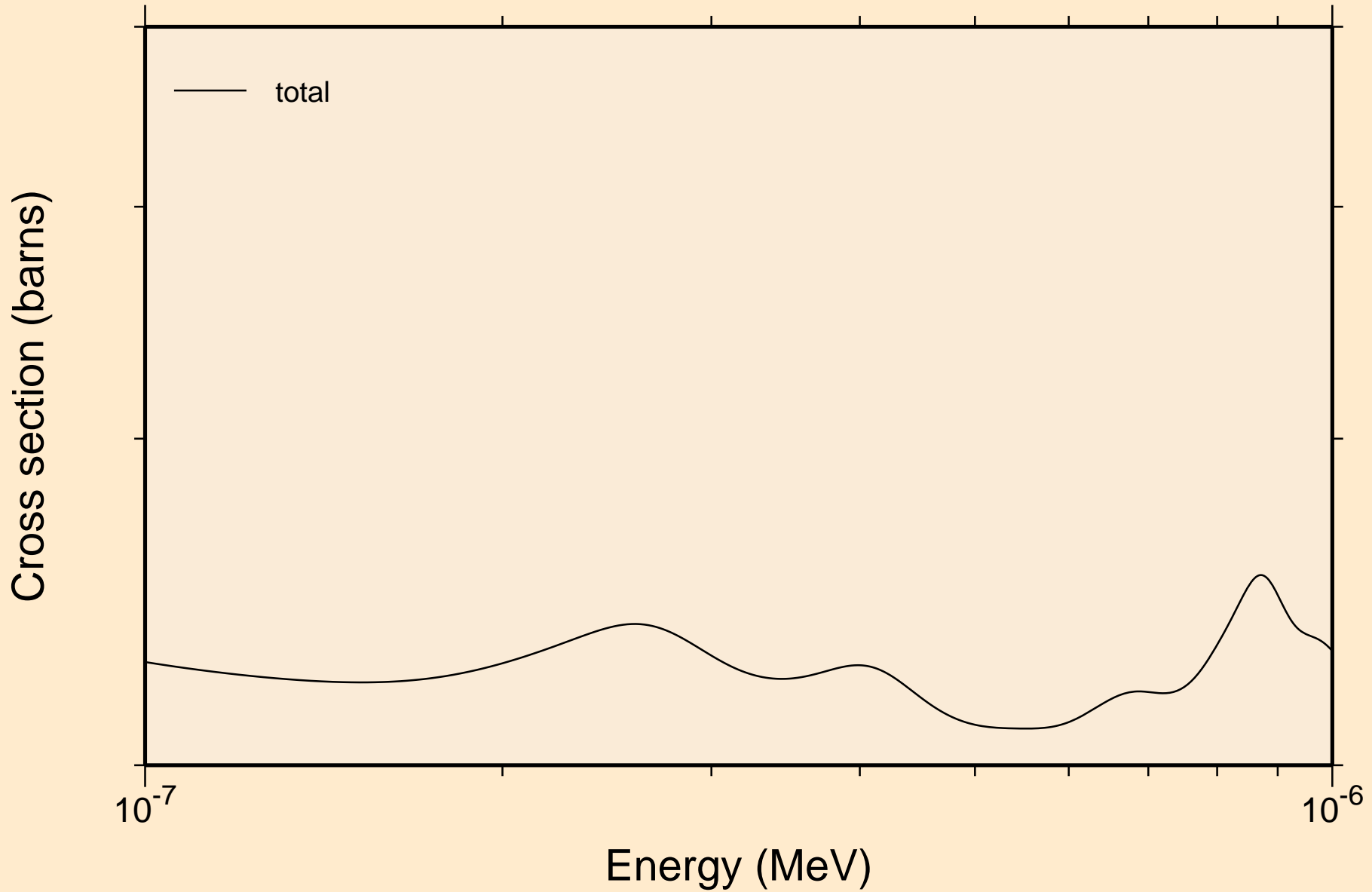

HO158N NEUTRON ACER TENDL-2021 LIBRARY; T=293.6K  
resonance total cross section

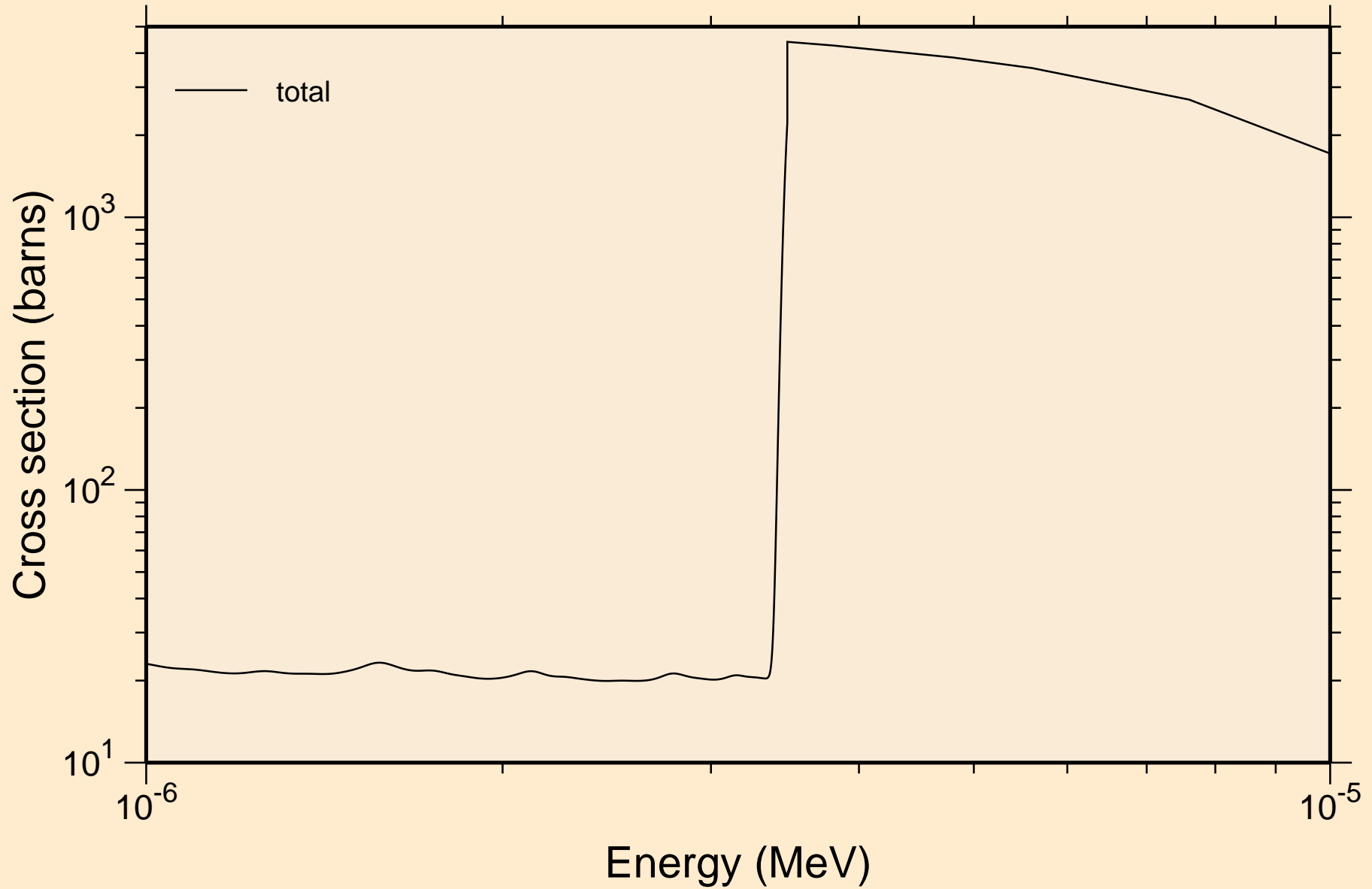

HO158N NEUTRON ACER TENDL-2021 LIBRARY; T=293.6K  
resonance total cross section

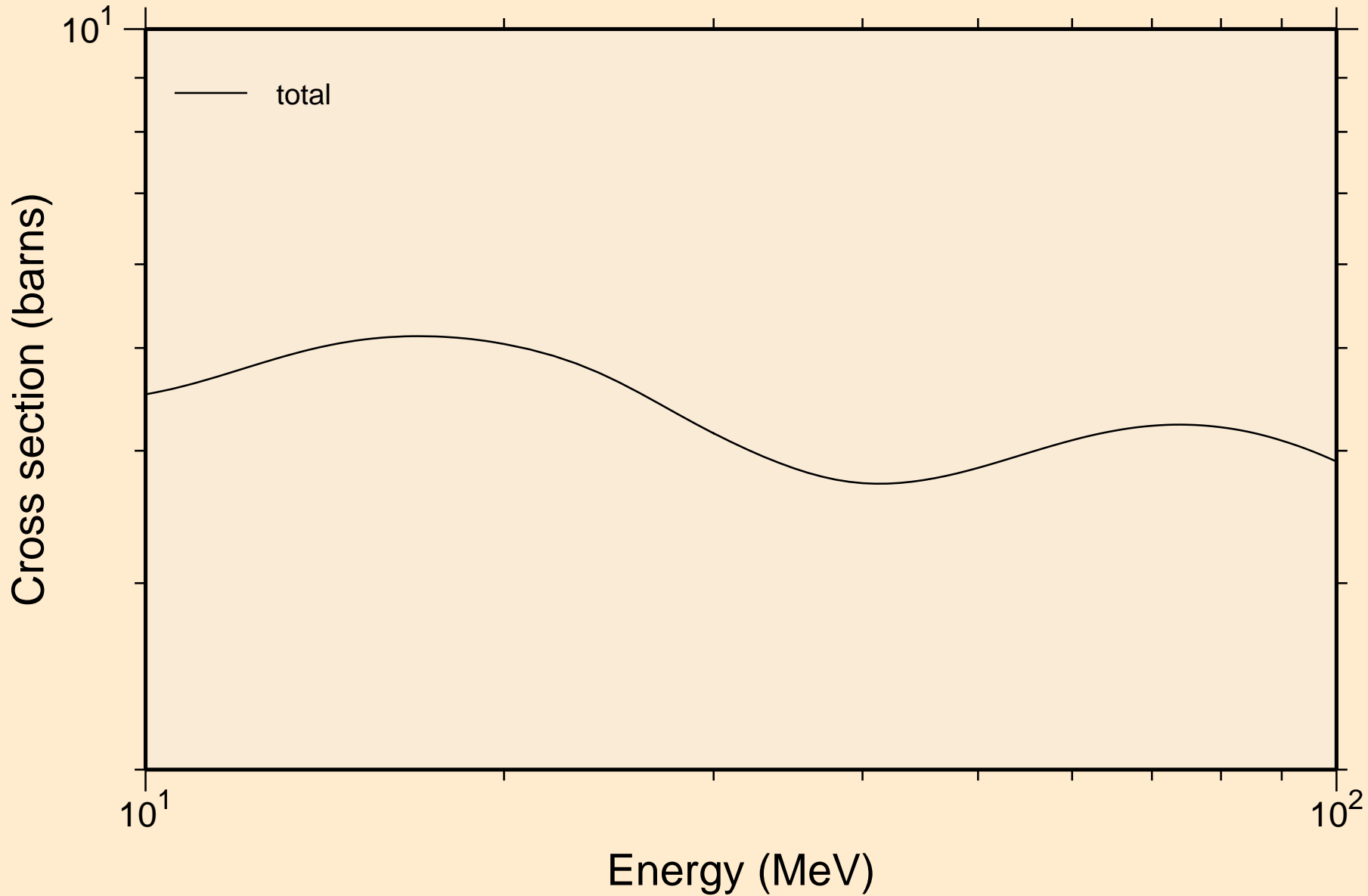

HO158N NEUTRON ACER TENDL-2021 LIBRARY; T=293.6K  
resonance absorption cross sections

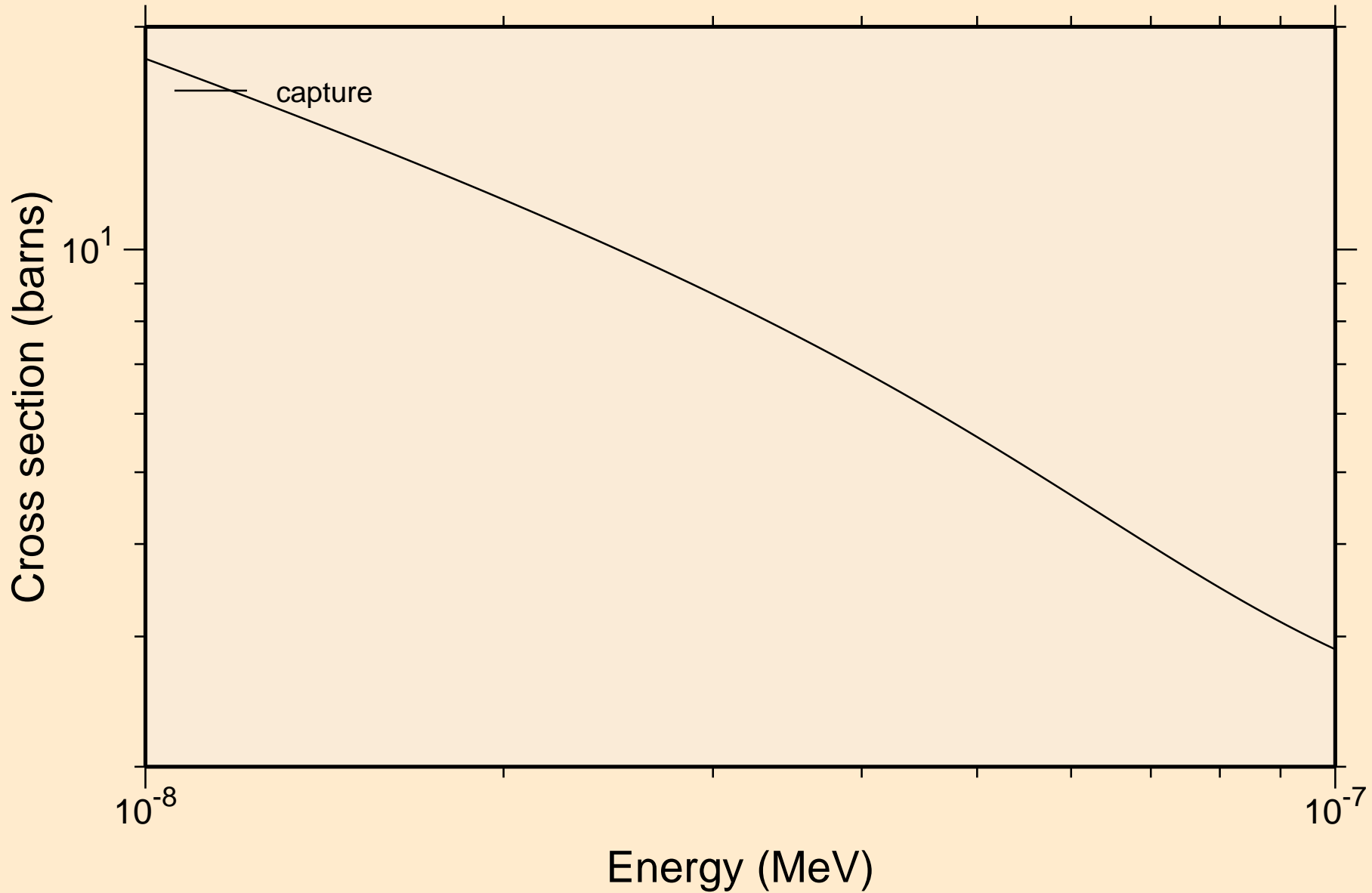

HO158N NEUTRON ACER TENDL-2021 LIBRARY; T=293.6K  
resonance absorption cross sections

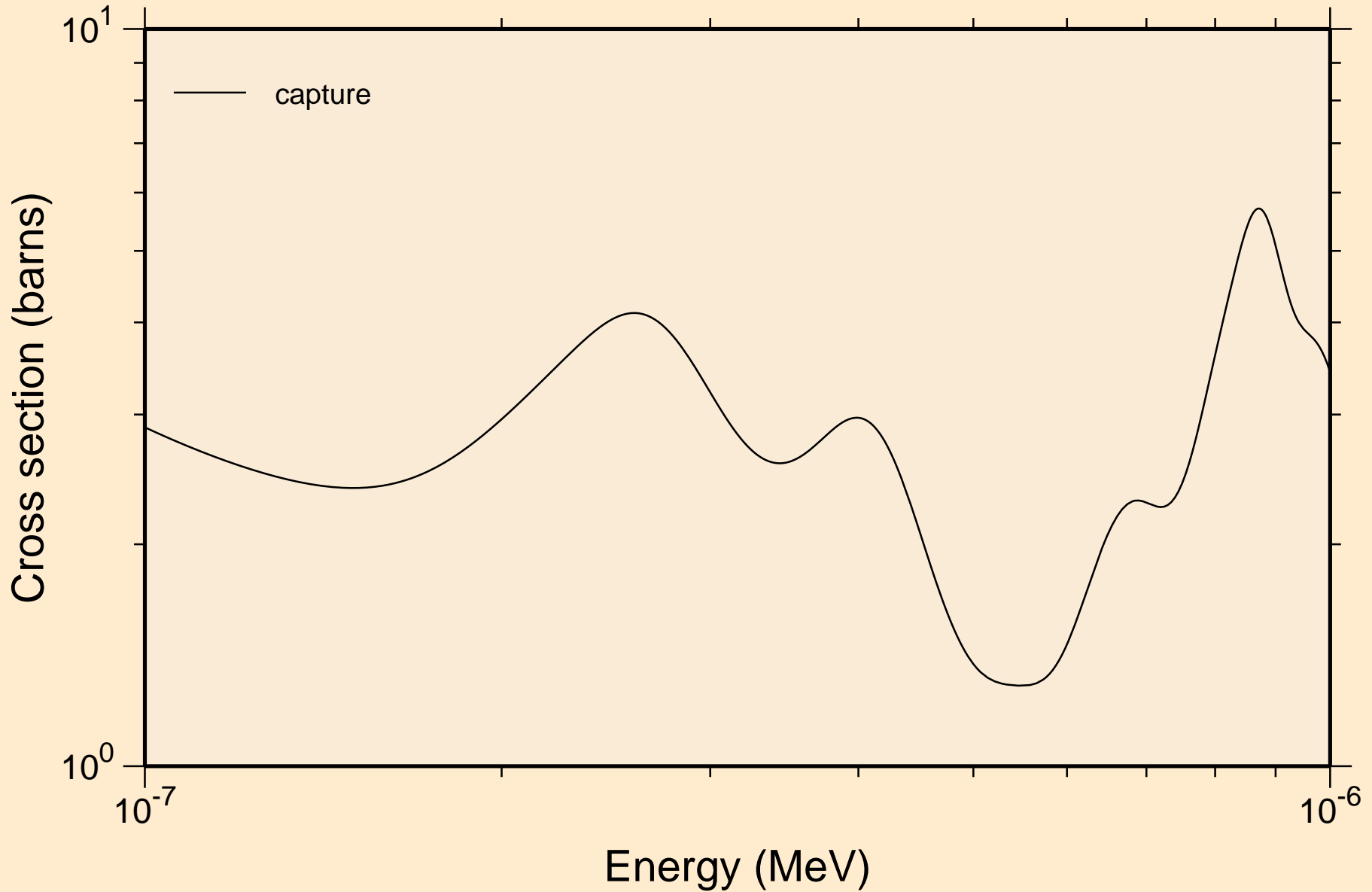

HO158N NEUTRON ACER TENDL-2021 LIBRARY; T=293.6K  
resonance absorption cross sections

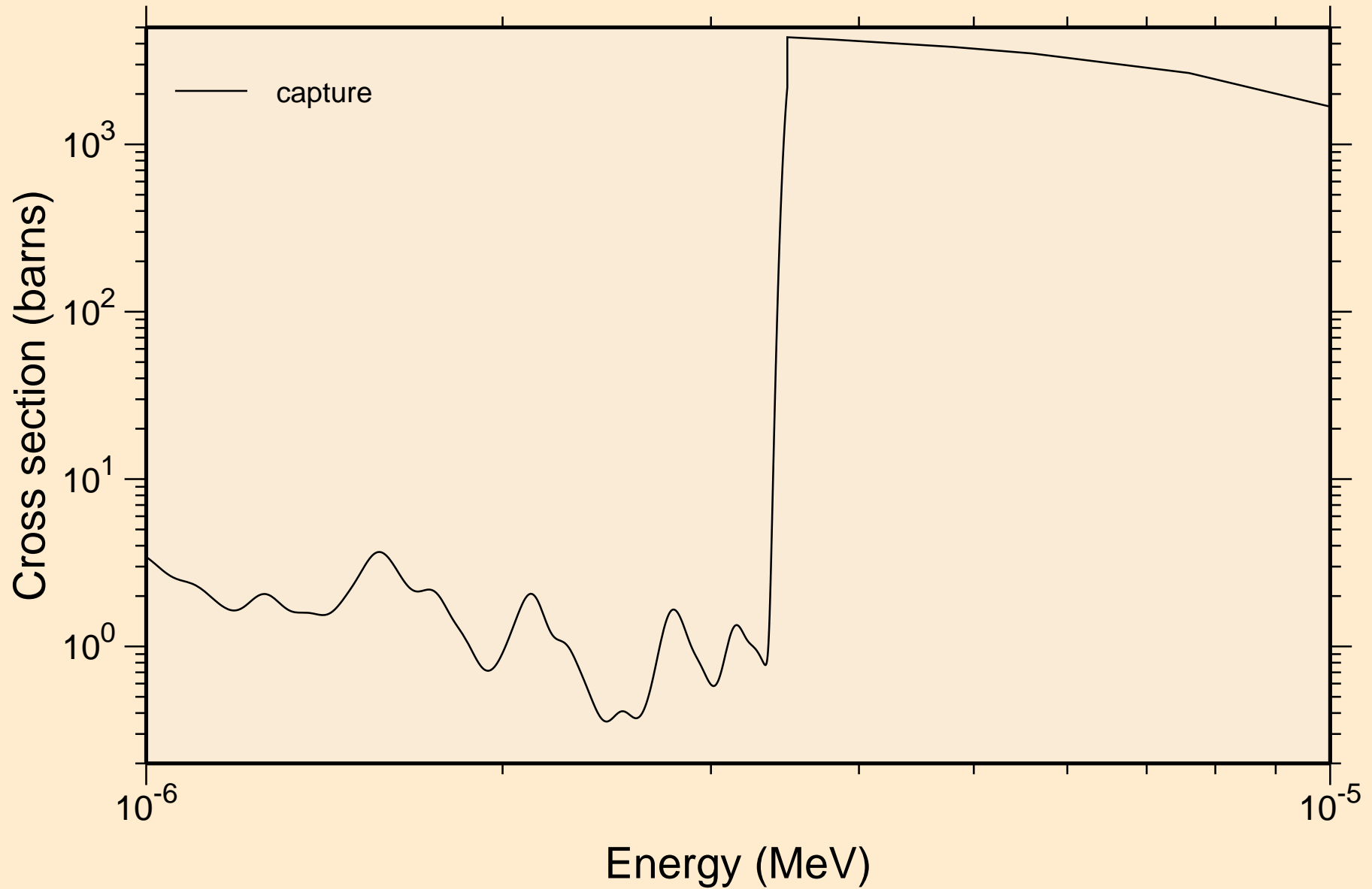



HO158N NEUTRON ACER TENDL-2021 LIBRARY; T=293.6K  
resonance absorption cross sections

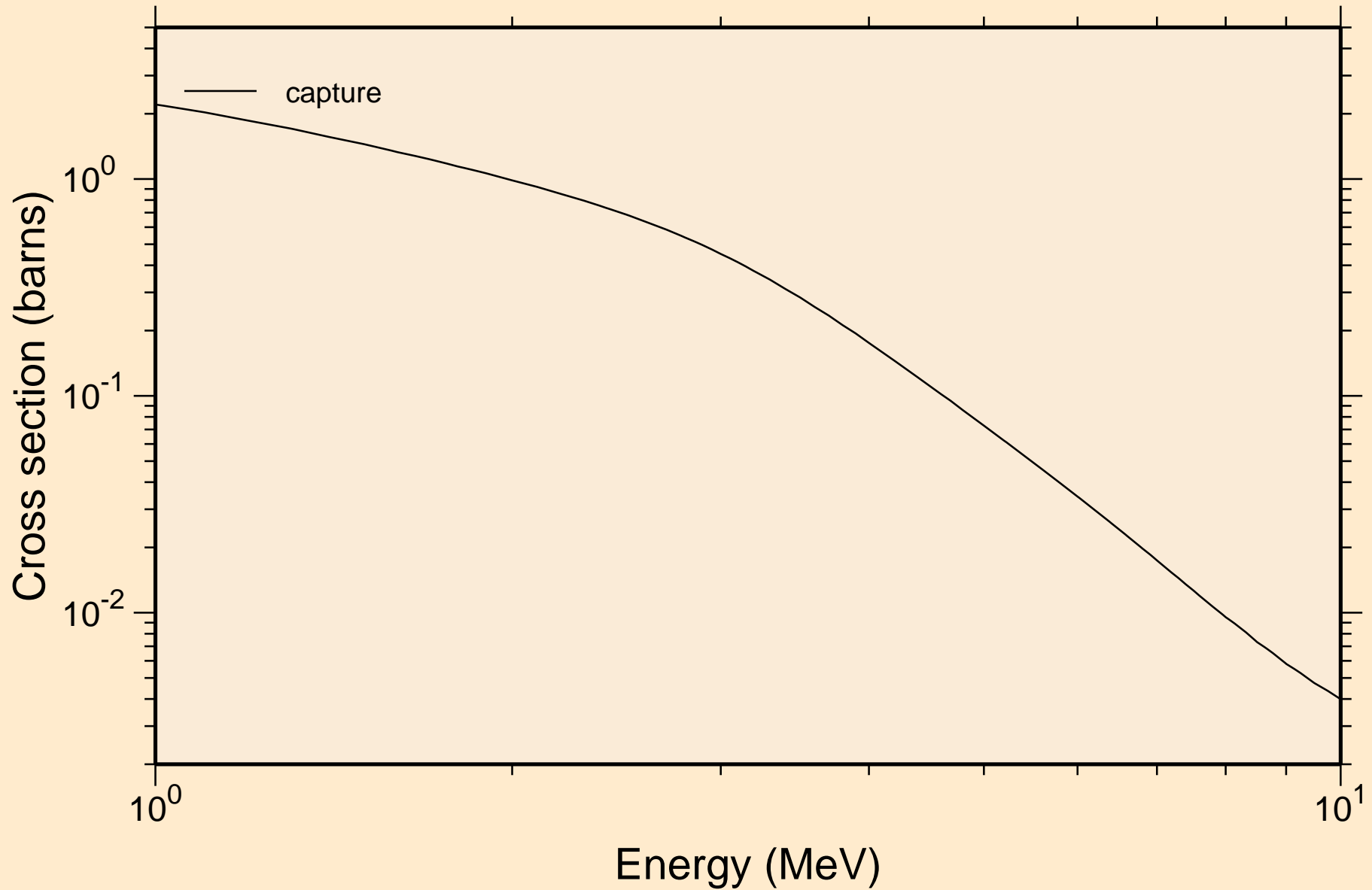

HO158N NEUTRON ACER TENDL-2021 LIBRARY; T=293.6K  
Heating

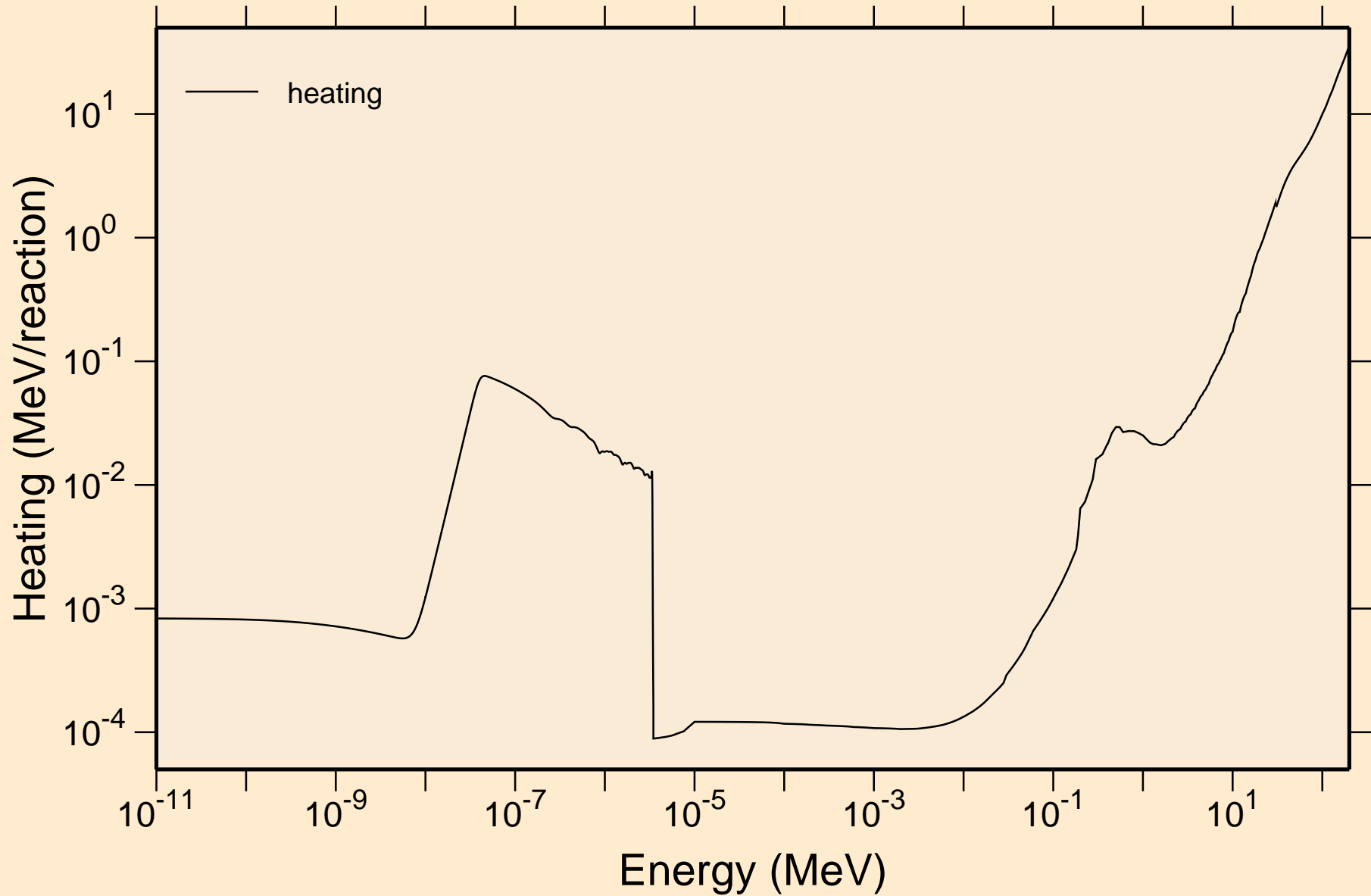

# HO158N NEUTRON ACER TENDL-2021 LIBRARY; T=293.6K Damage

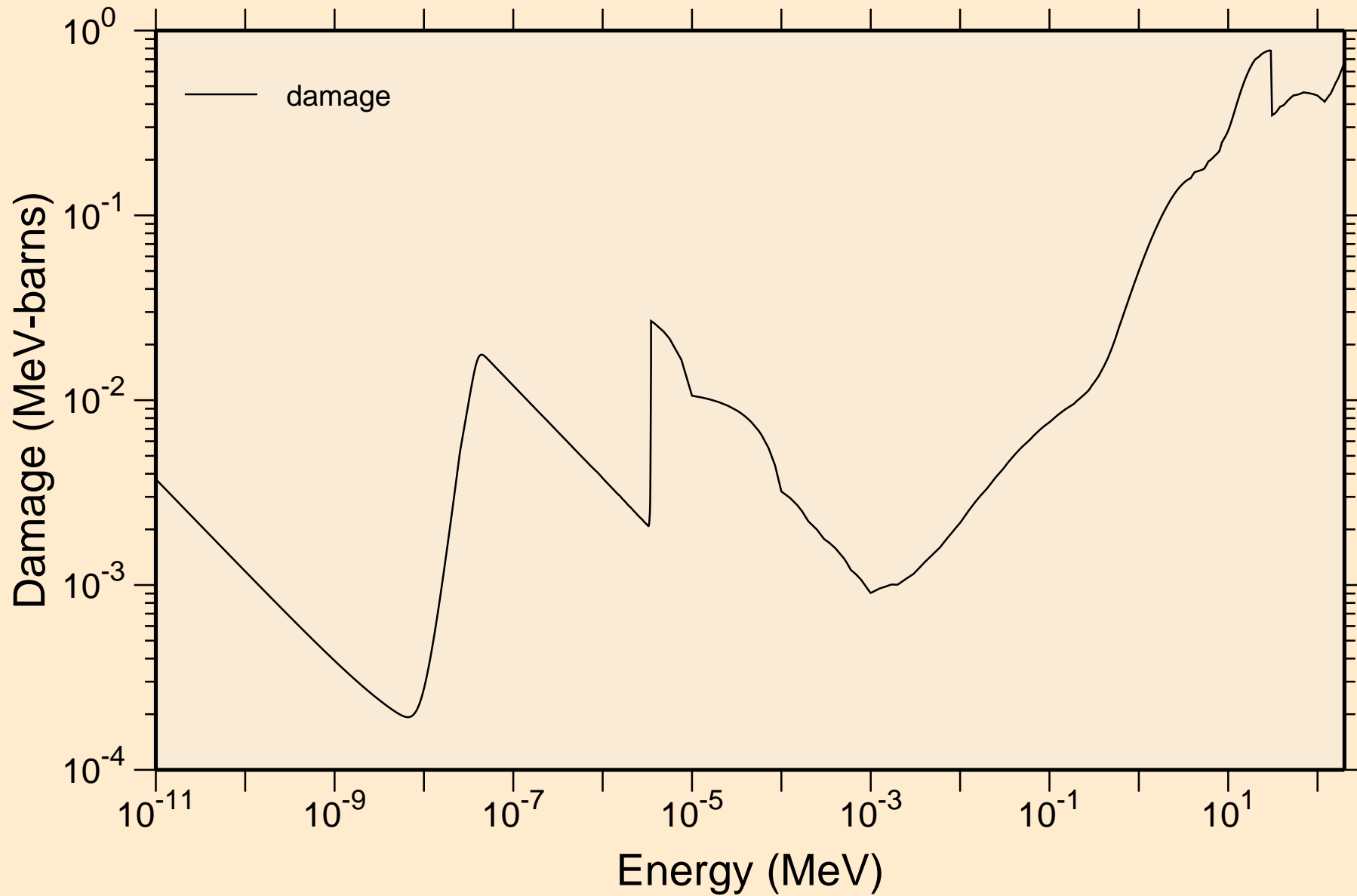

# HO158N NEUTRON ACER TENDL-2021 LIBRARY; T=293.6K

## Non-threshold reactions

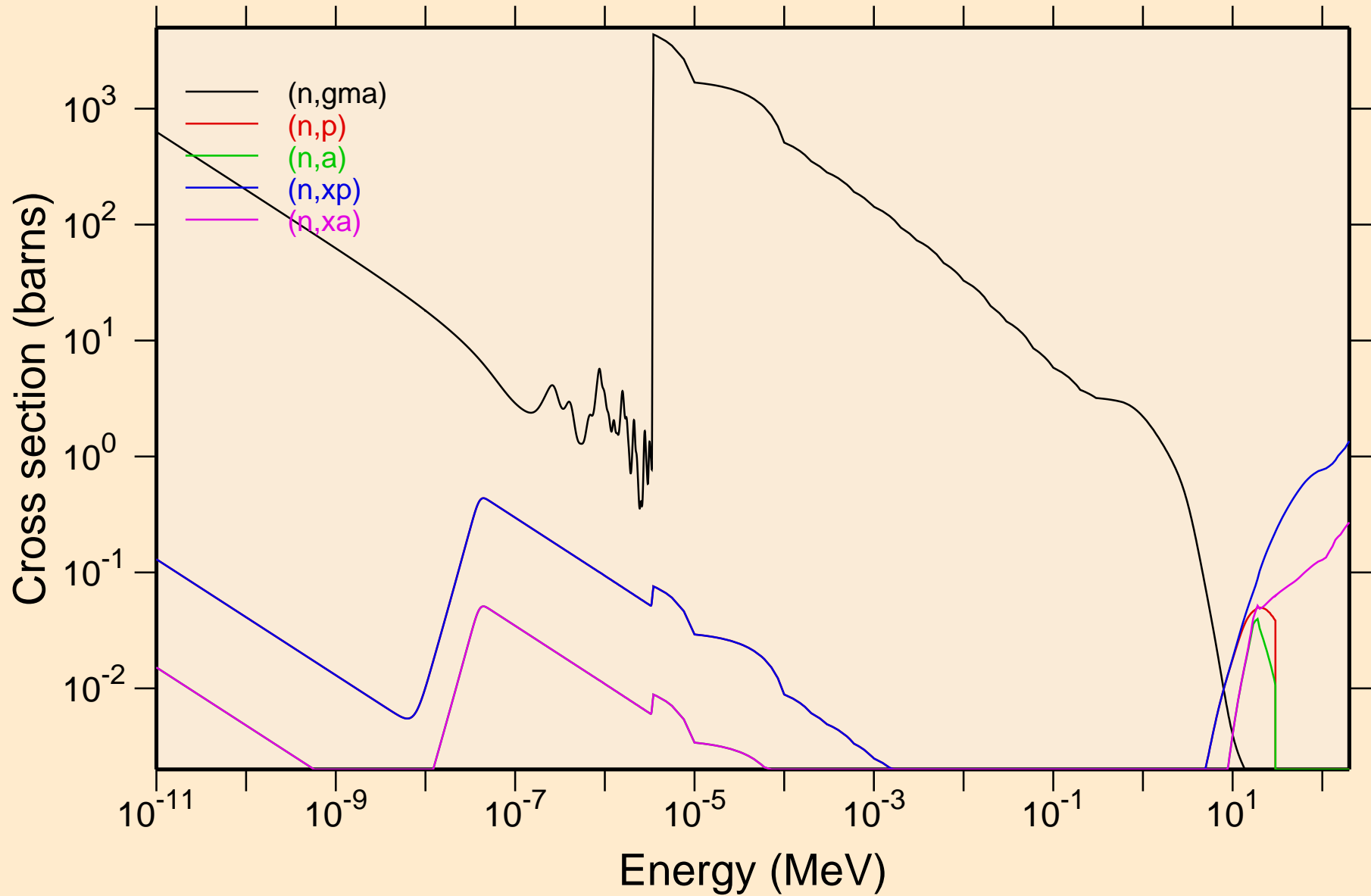

HO158N NEUTRON ACER TENDL-2021 LIBRARY; T=293.6K  
Principal cross sections

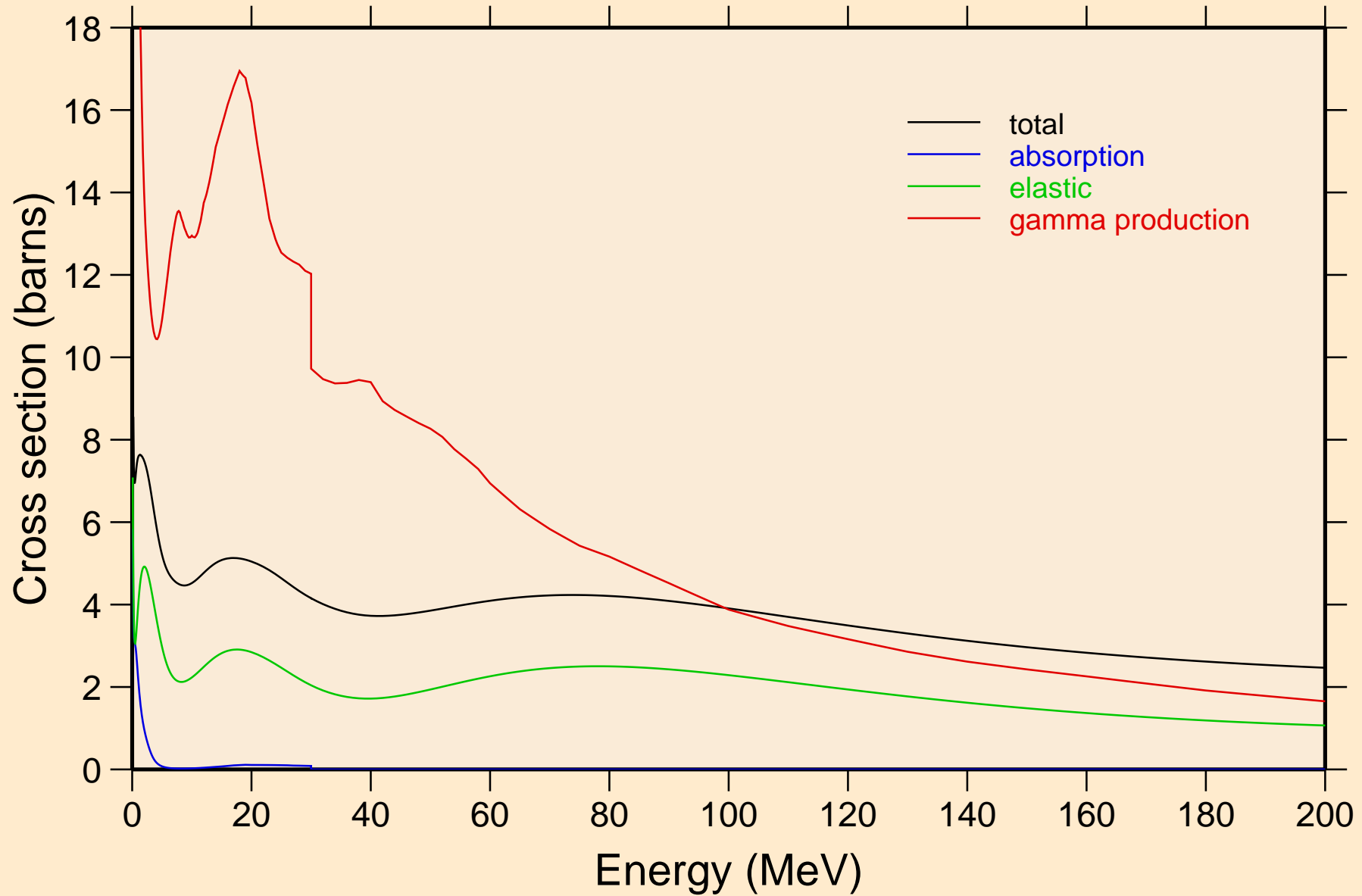

HO158N NEUTRON ACER TENDL-2021 LIBRARY; T=293.6K  
Heating

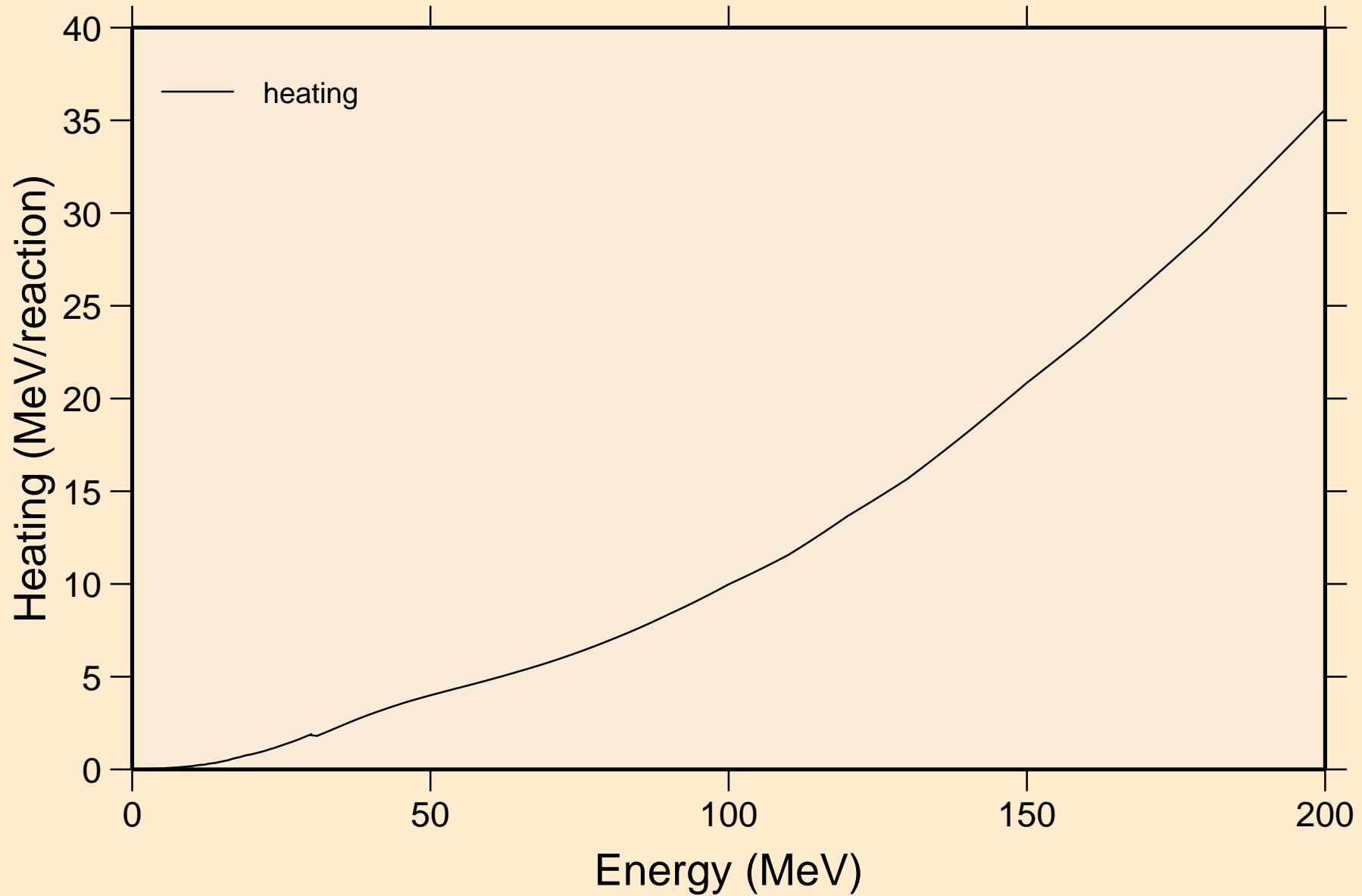

# HO158N NEUTRON ACER TENDL-2021 LIBRARY; T=293.6K Damage

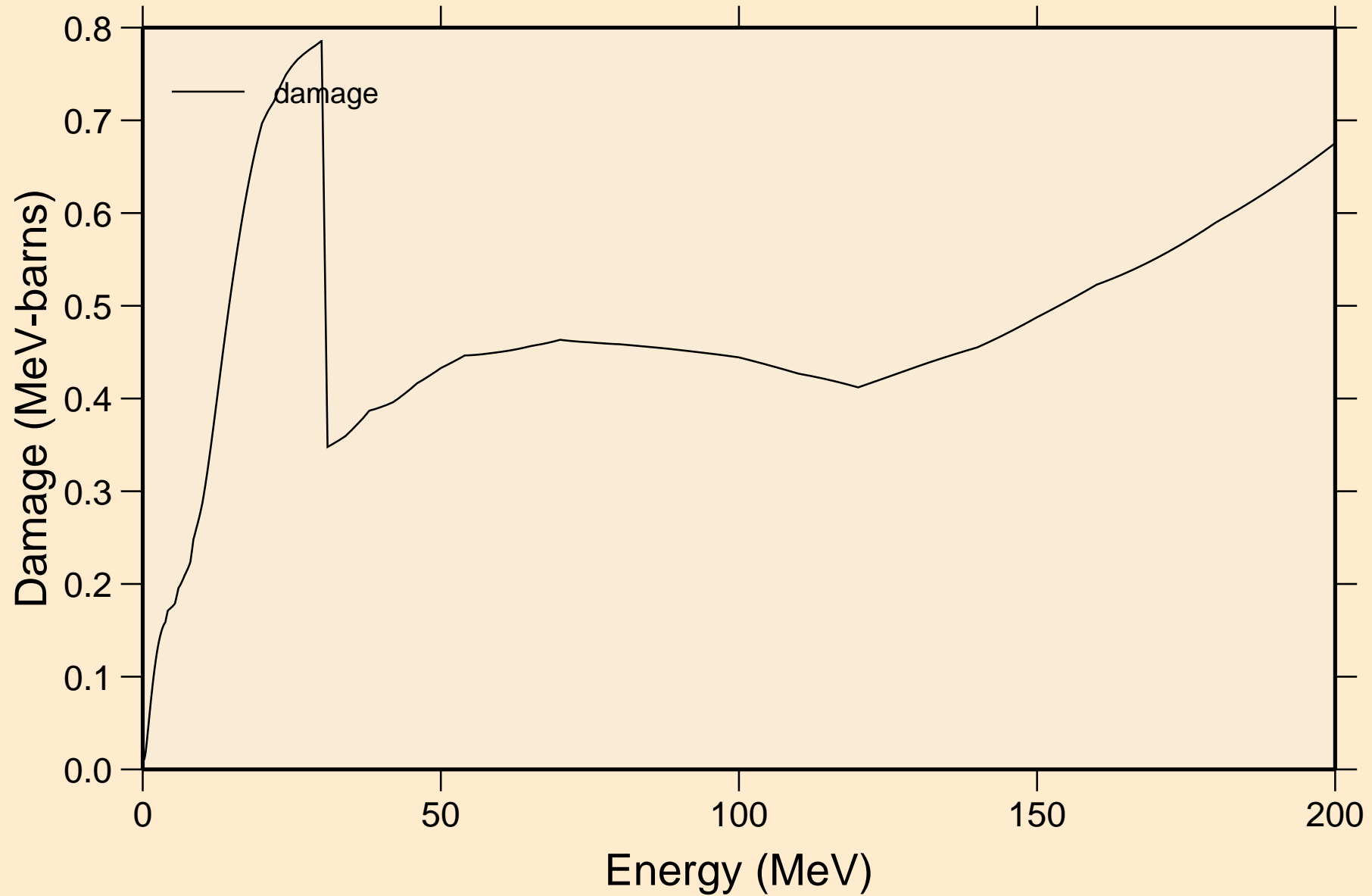

HO158N NEUTRON ACER TENDL-2021 LIBRARY; T=293.6K  
Non-threshold reactions

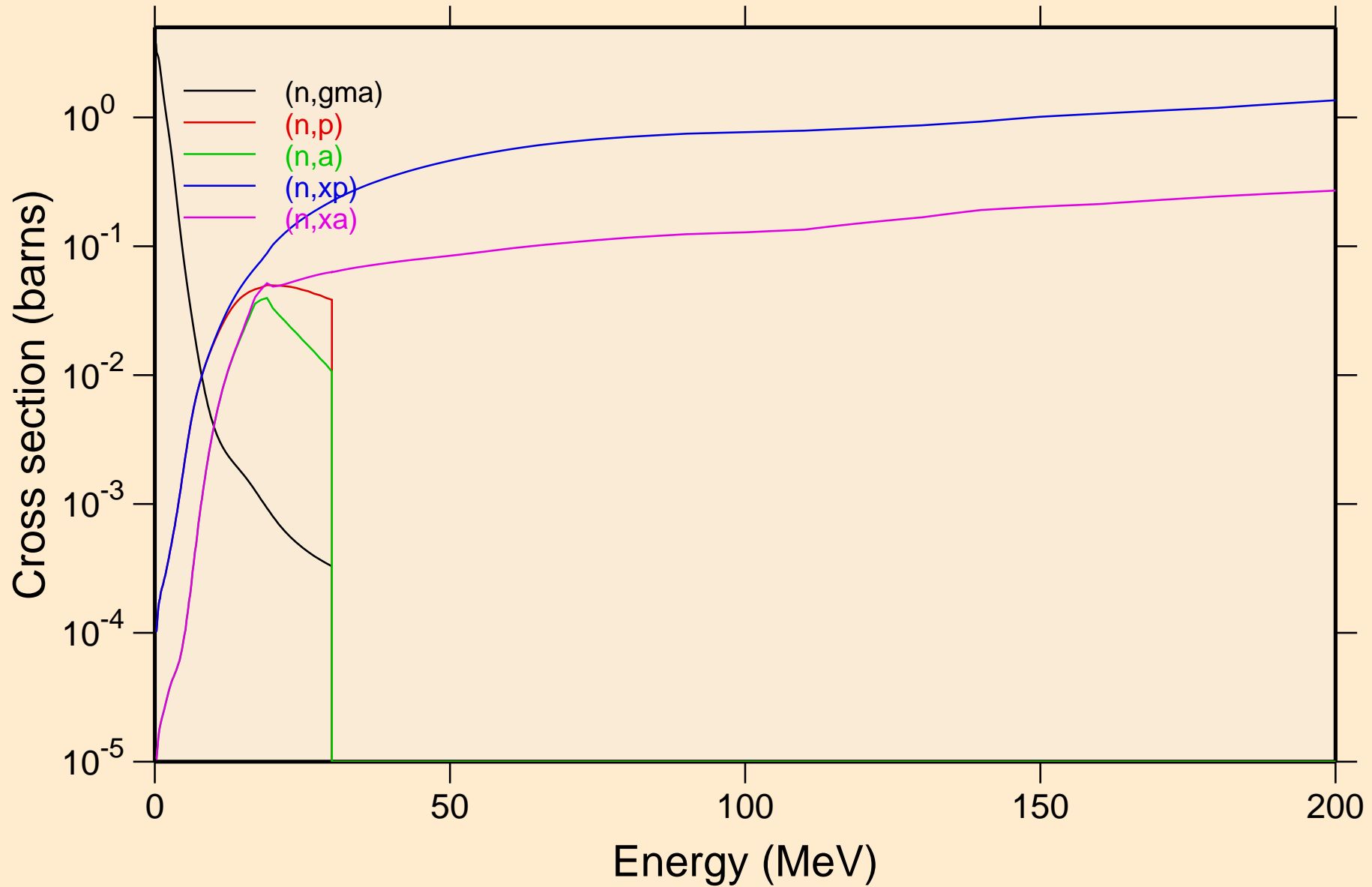



HO158N NEUTRON ACER TENDL-2021 LIBRARY; T=293.6K  
Inelastic levels

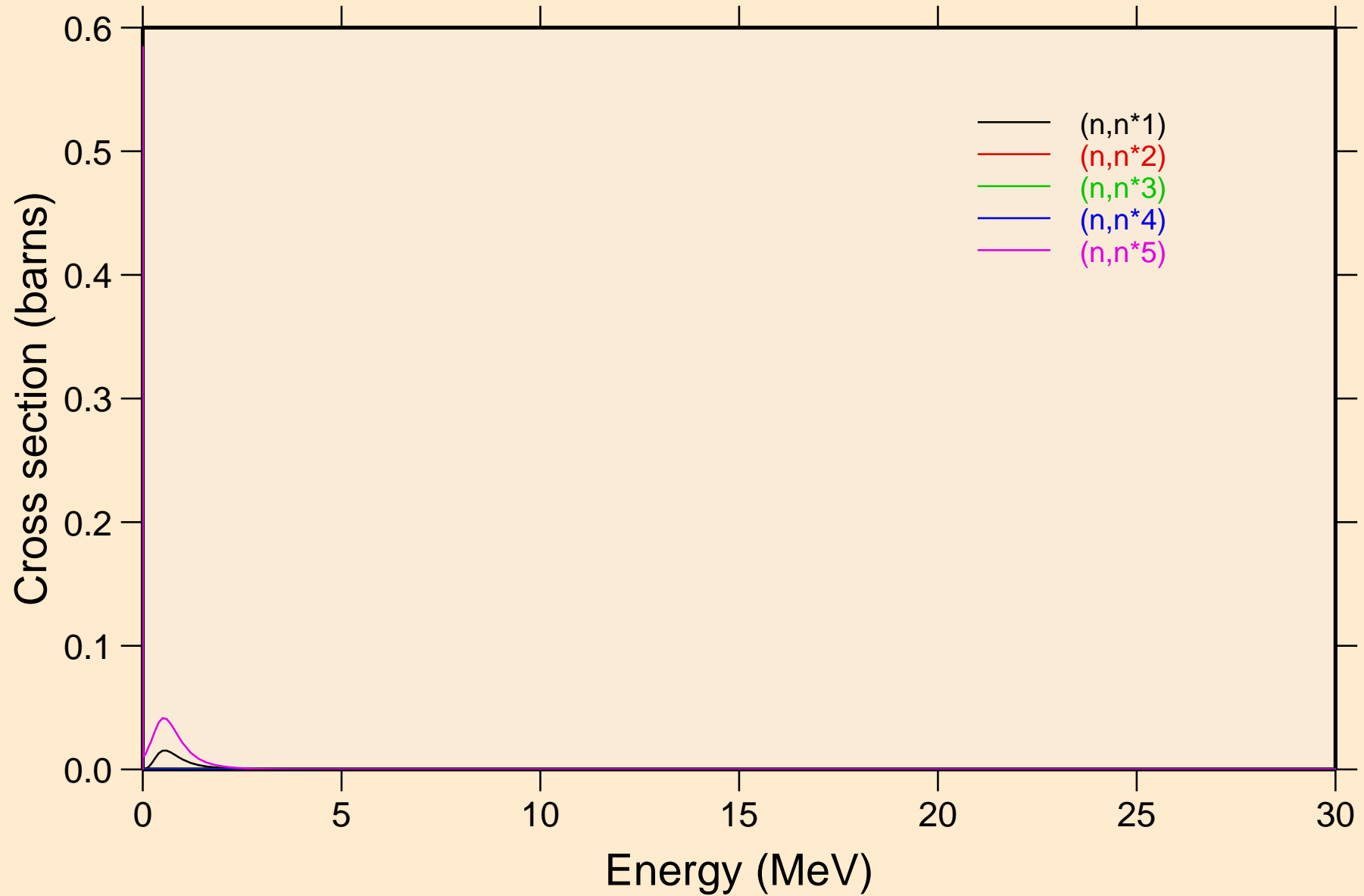

HO158N NEUTRON ACER TENDL-2021 LIBRARY; T=293.6K  
Inelastic levels

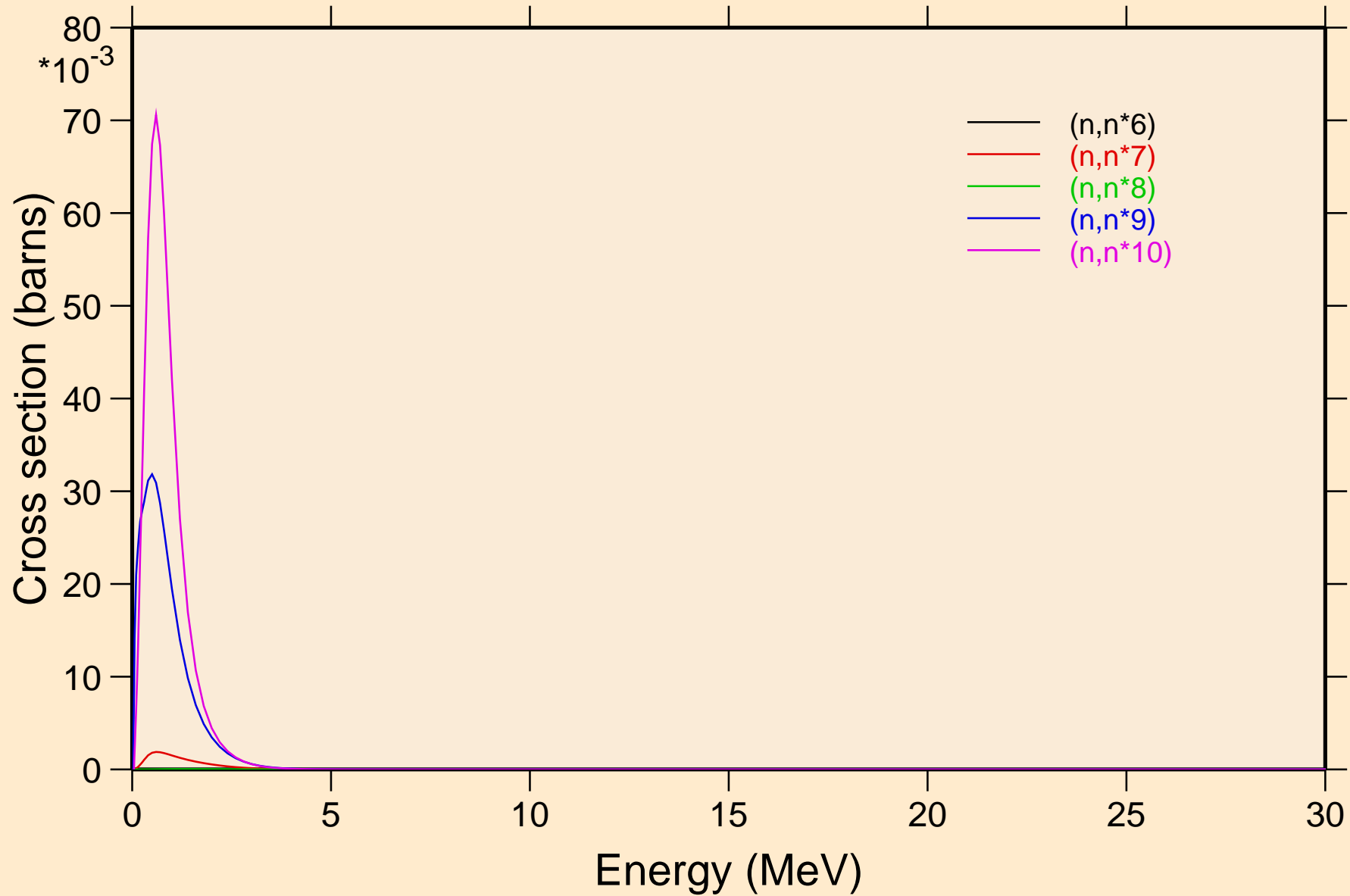

HO158N NEUTRON ACER TENDL-2021 LIBRARY; T=293.6K  
Inelastic levels

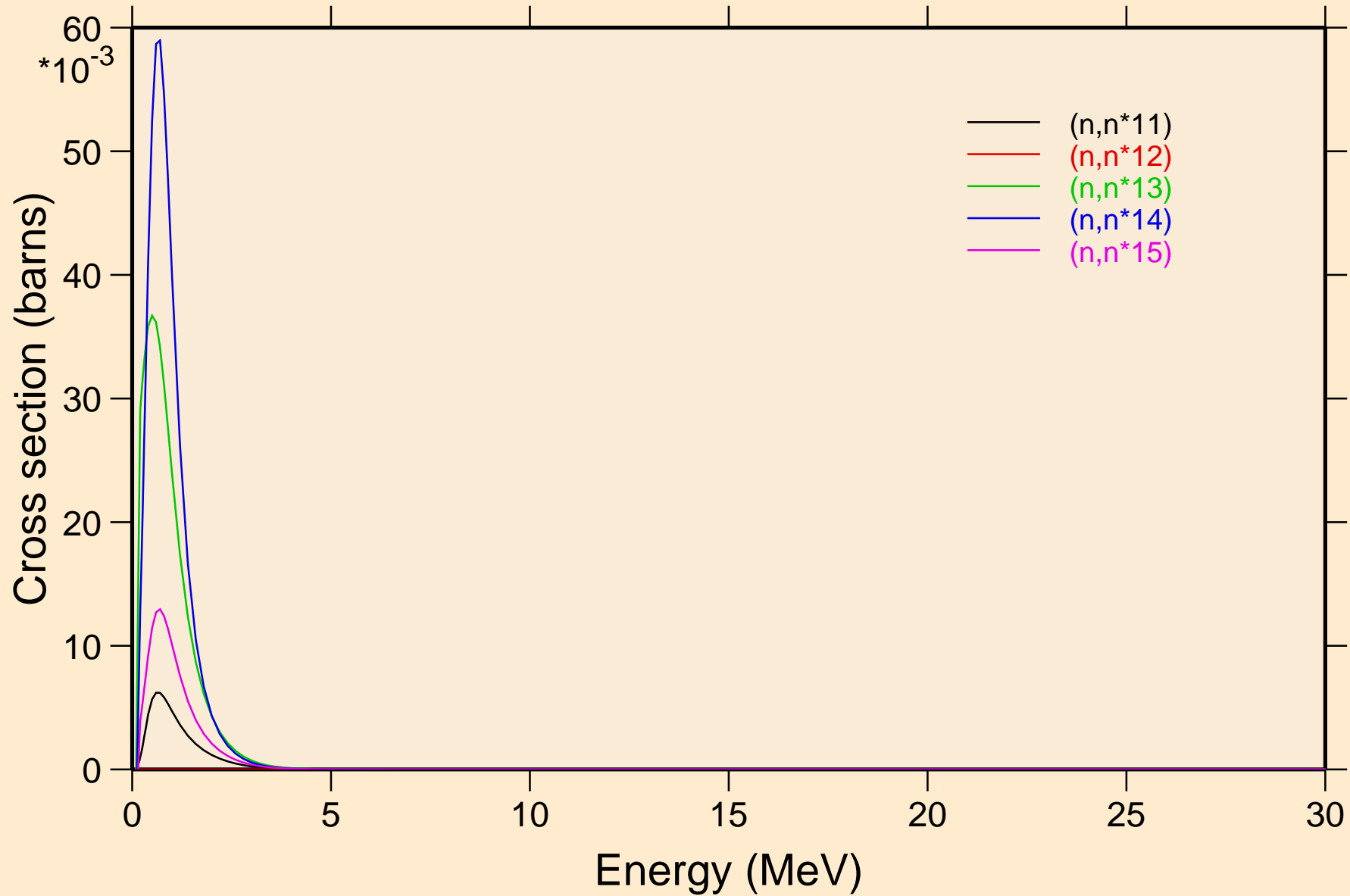

HO158N NEUTRON ACER TENDL-2021 LIBRARY; T=293.6K  
Inelastic levels

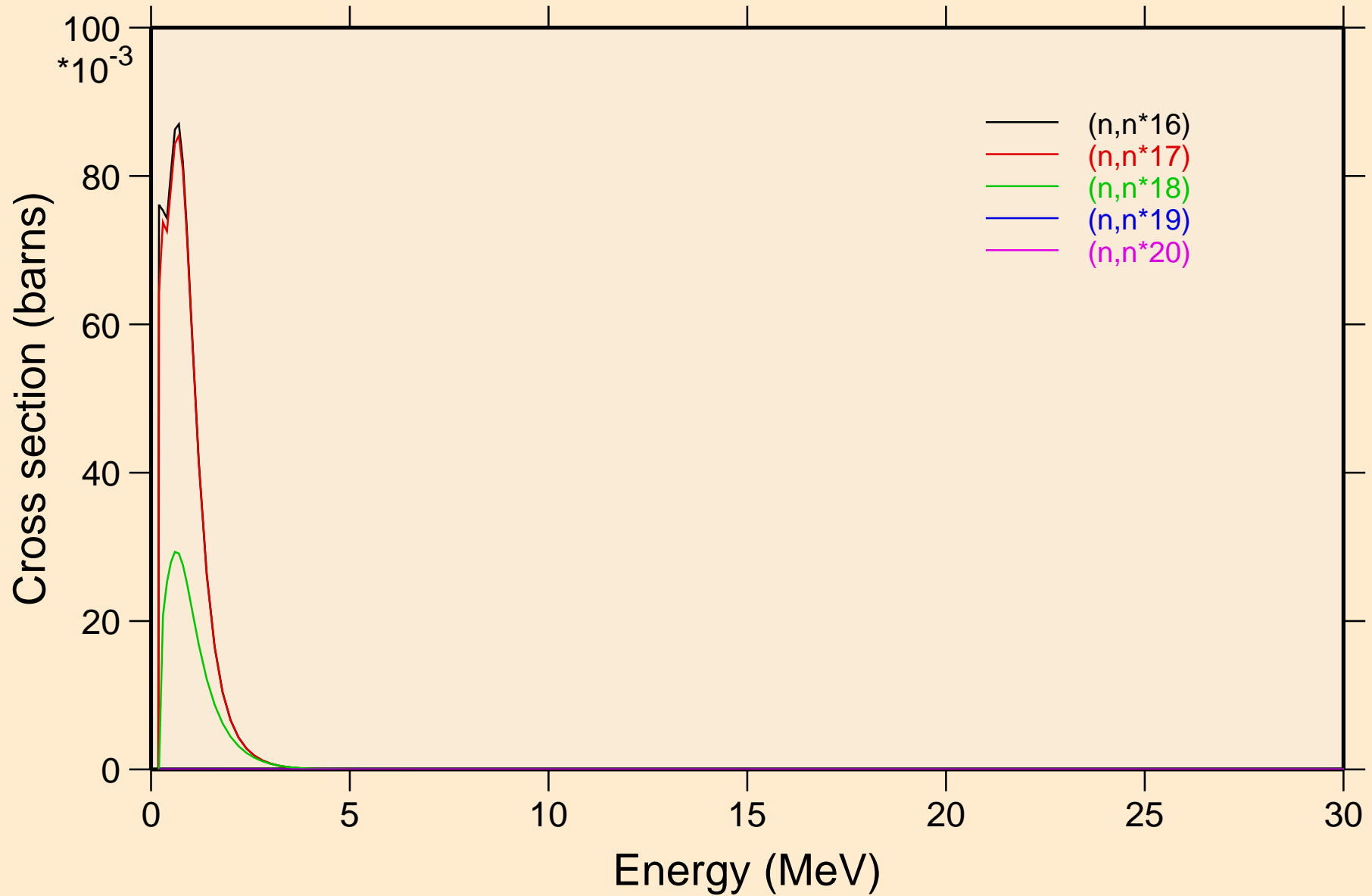

HO158N NEUTRON ACER TENDL-2021 LIBRARY; T=293.6K  
Inelastic levels

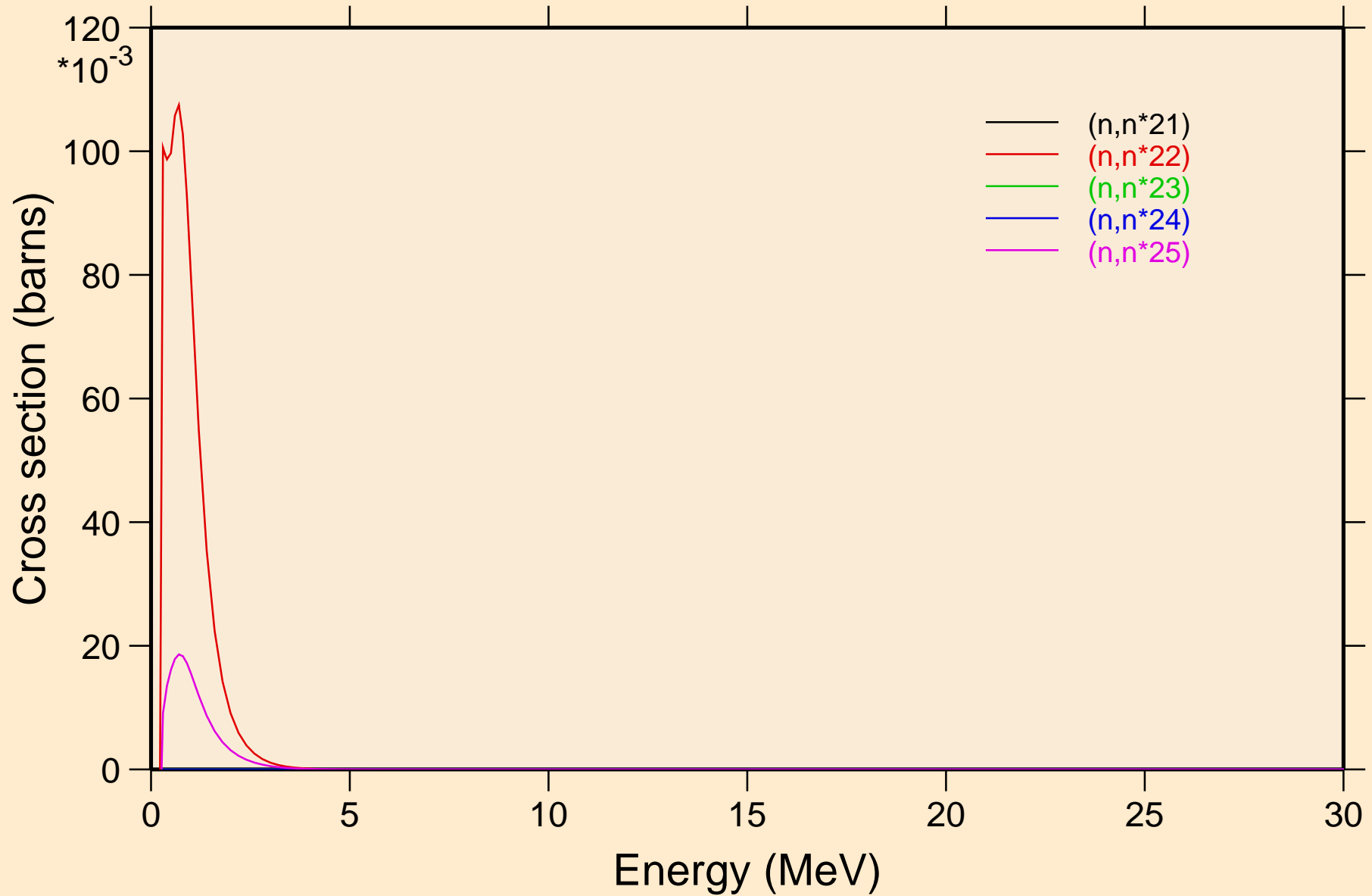

HO158N NEUTRON ACER TENDL-2021 LIBRARY; T=293.6K  
Inelastic levels

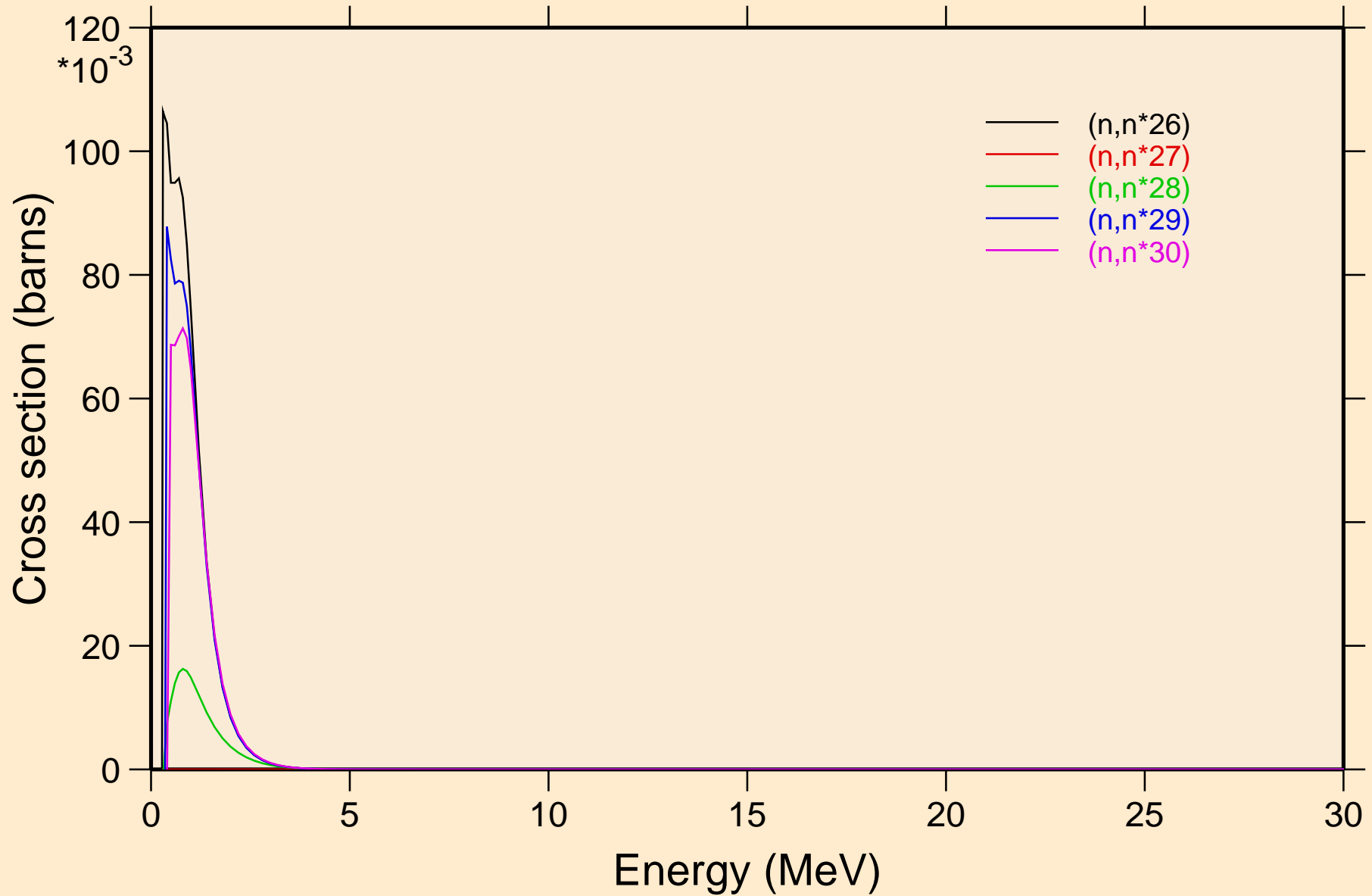

# HO158N NEUTRON ACER TENDL-2021 LIBRARY; T=293.6K

## Threshold reactions

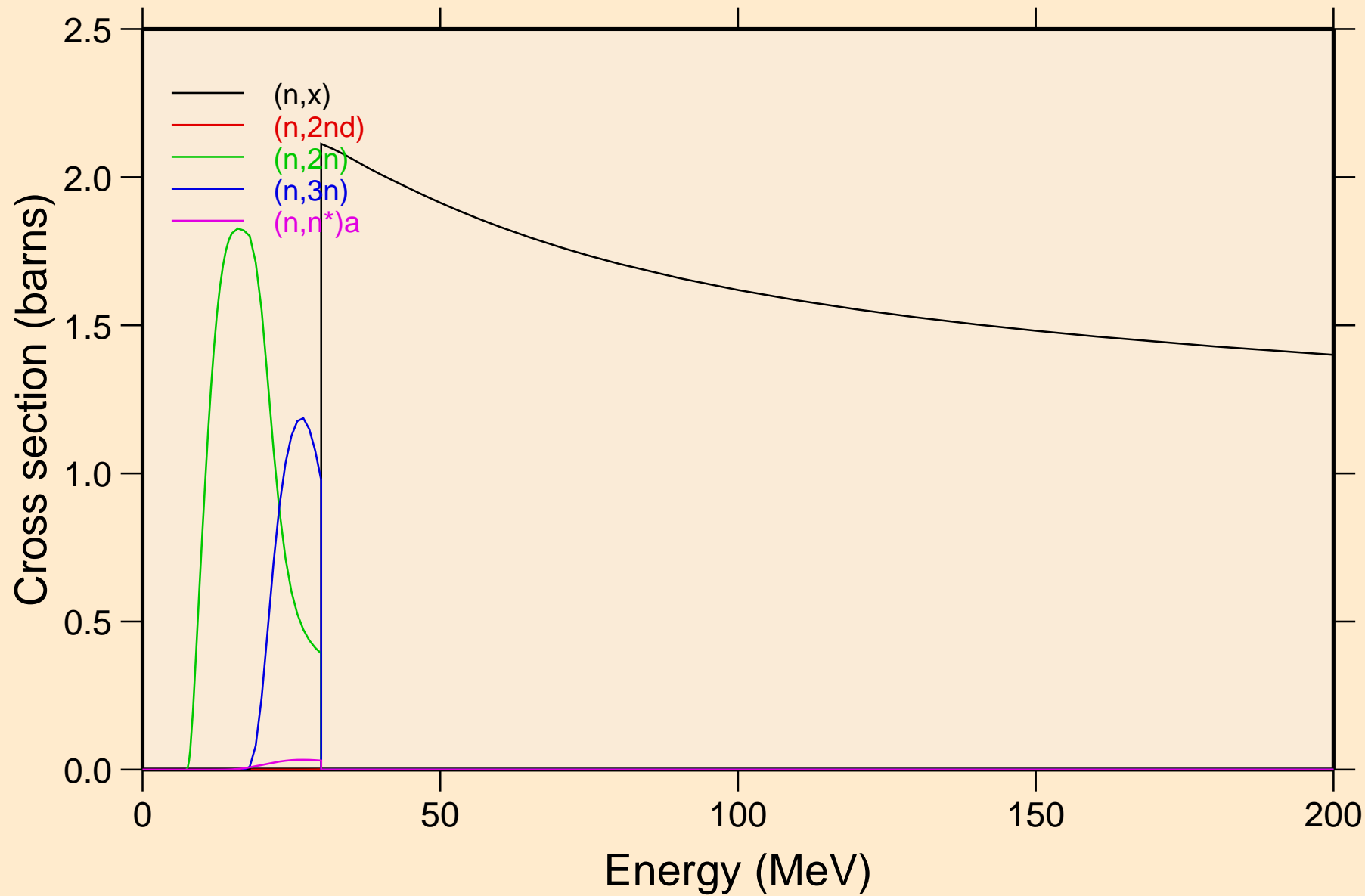

# HO158N NEUTRON ACER TENDL-2021 LIBRARY; T=293.6K

## Threshold reactions

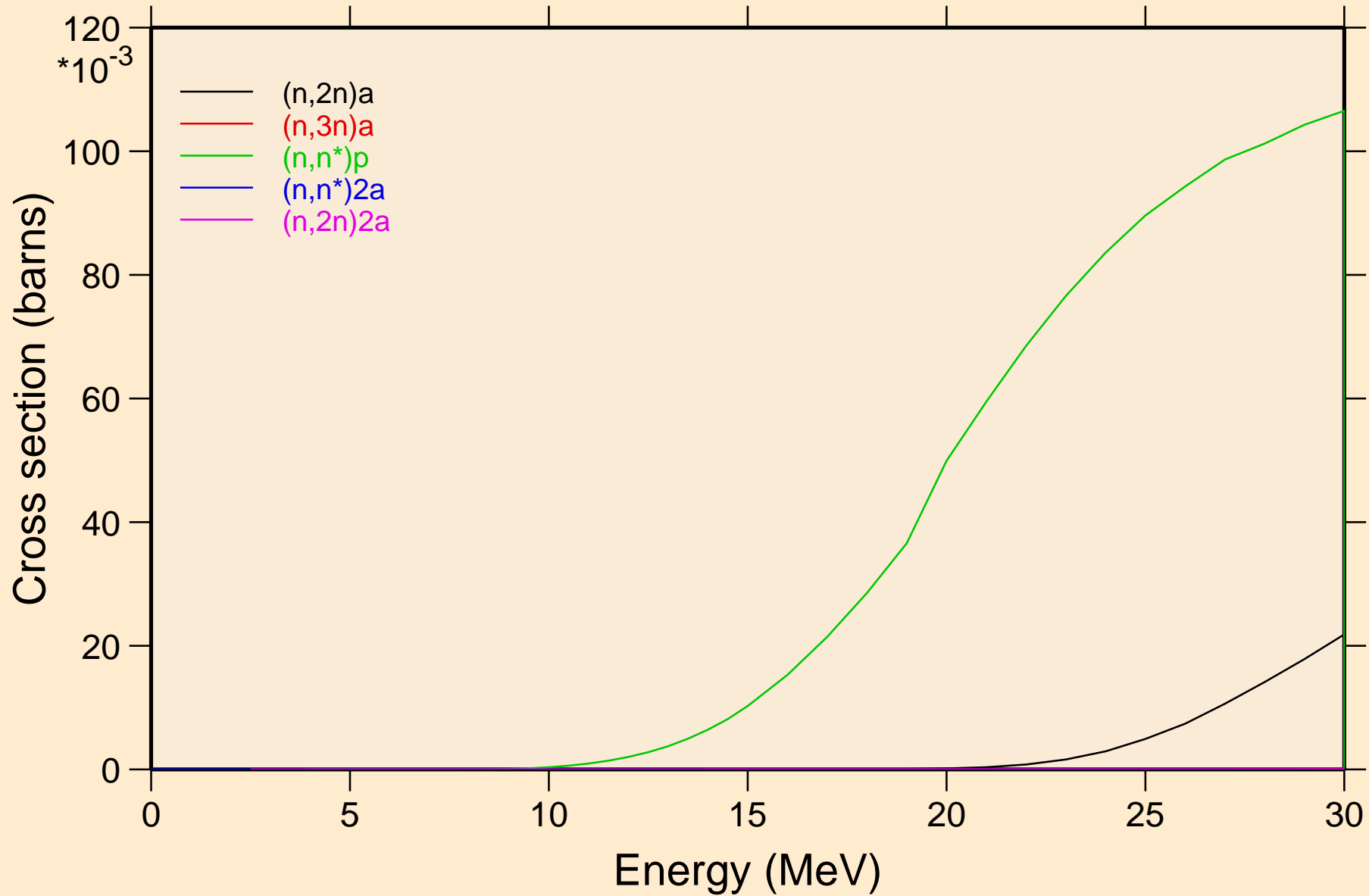



# HO158N NEUTRON ACER TENDL-2021 LIBRARY; T=293.6K

## Threshold reactions

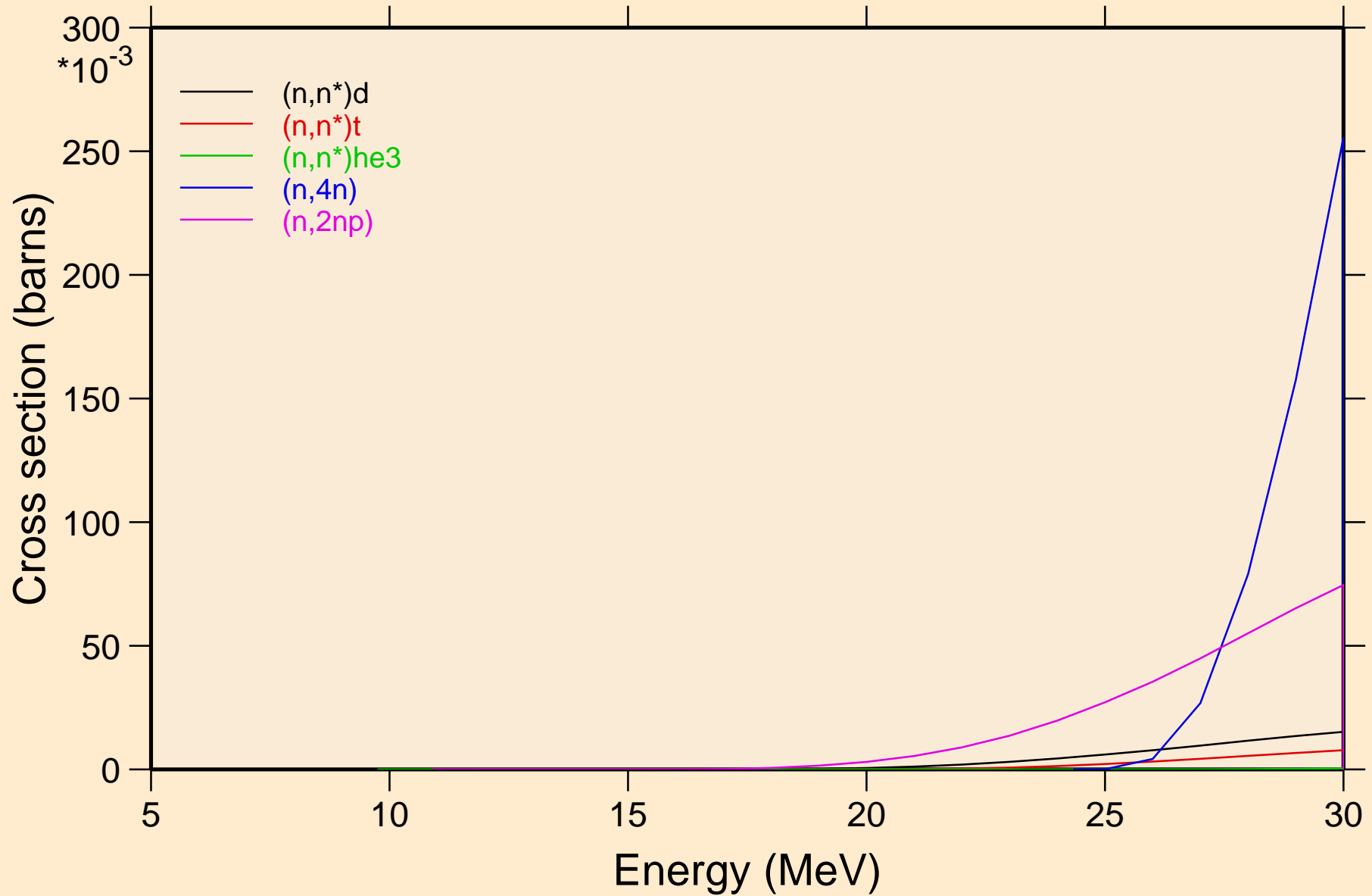

# HO158N NEUTRON ACER TENDL-2021 LIBRARY; T=293.6K

## Threshold reactions

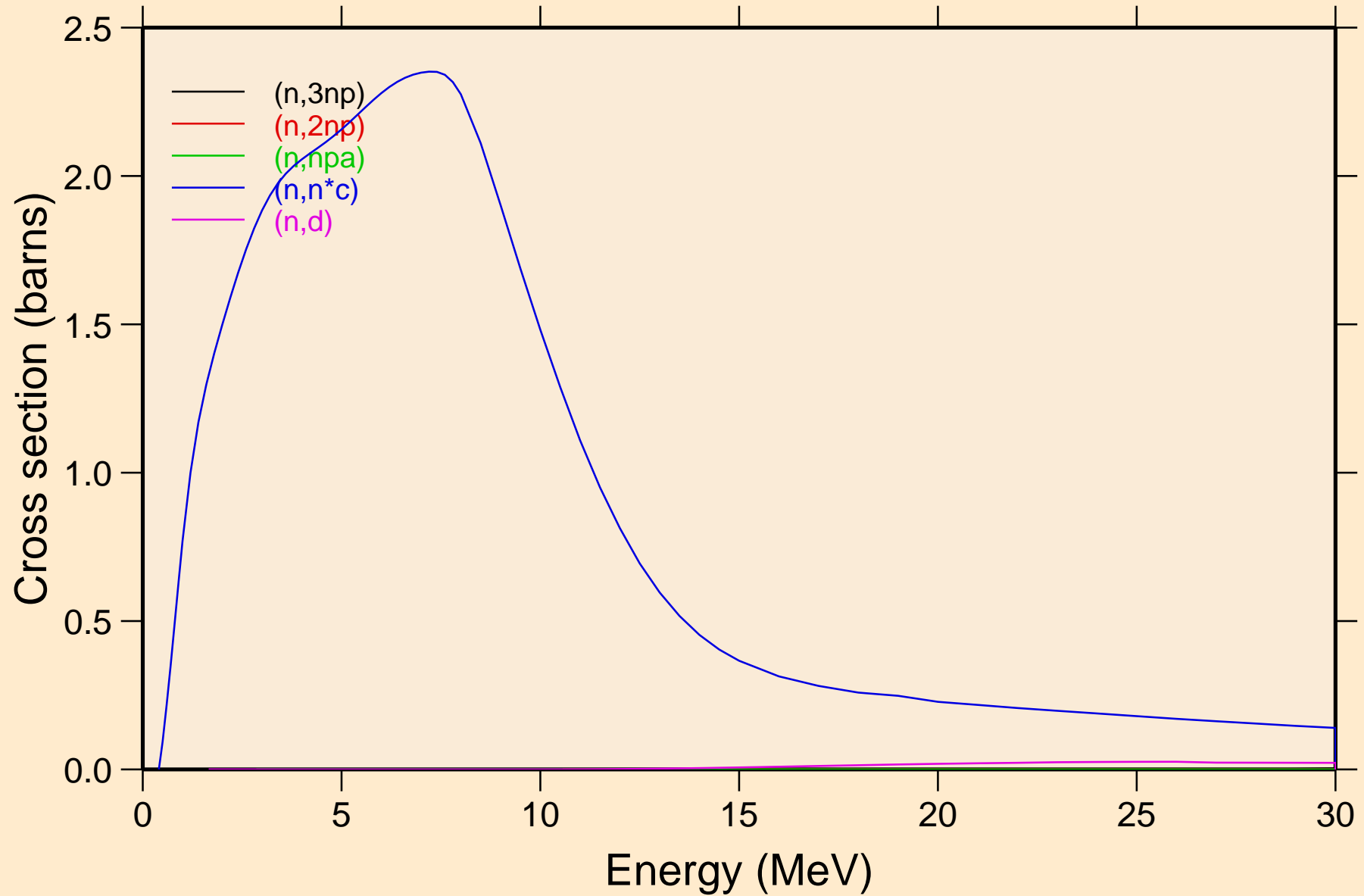

HO158N NEUTRON ACER TENDL-2021 LIBRARY; T=293.6K  
Threshold reactions

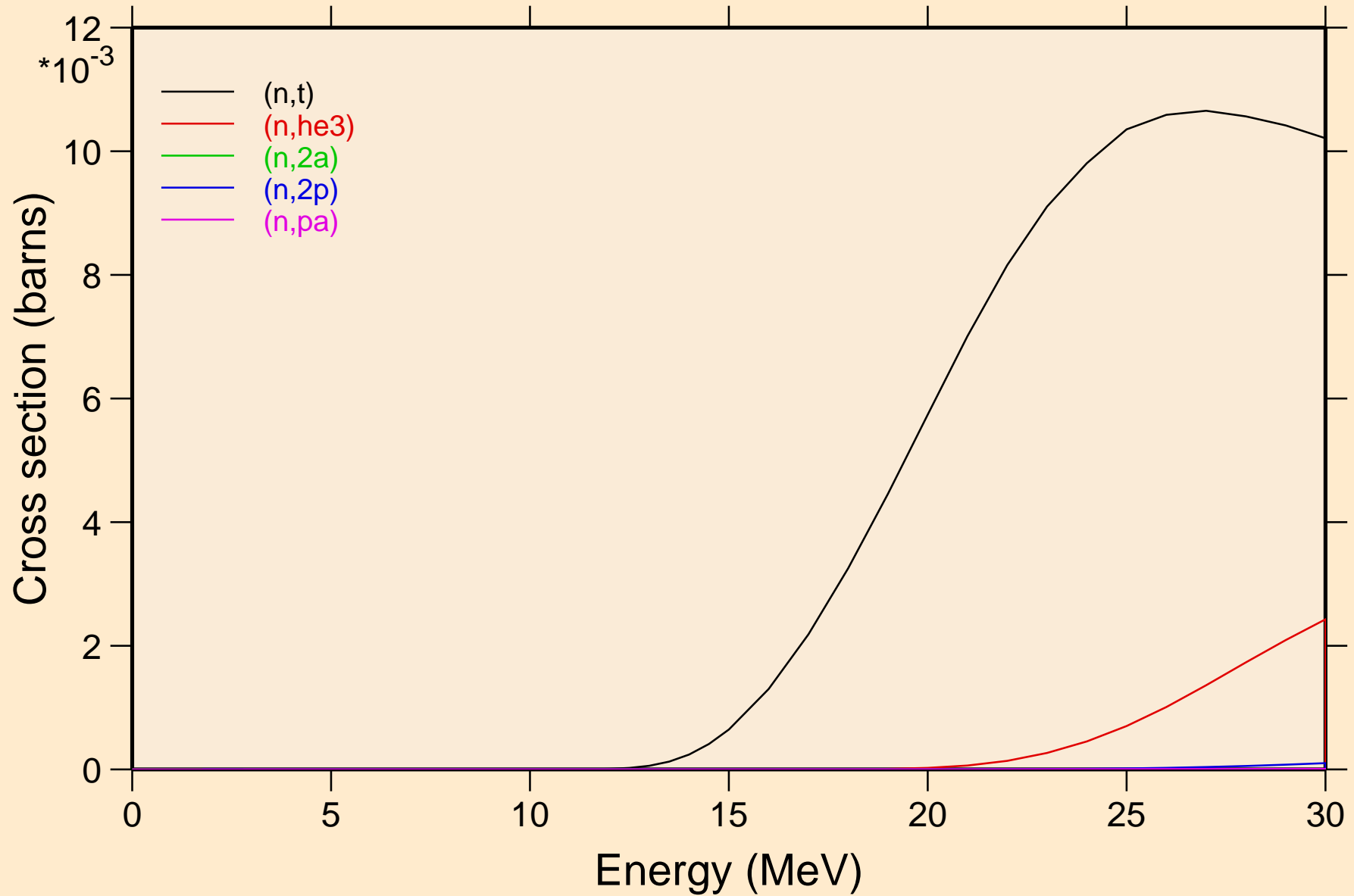

HO158N NEUTRON ACER TENDL-2021 LIBRARY; T=293.6K  
Threshold reactions

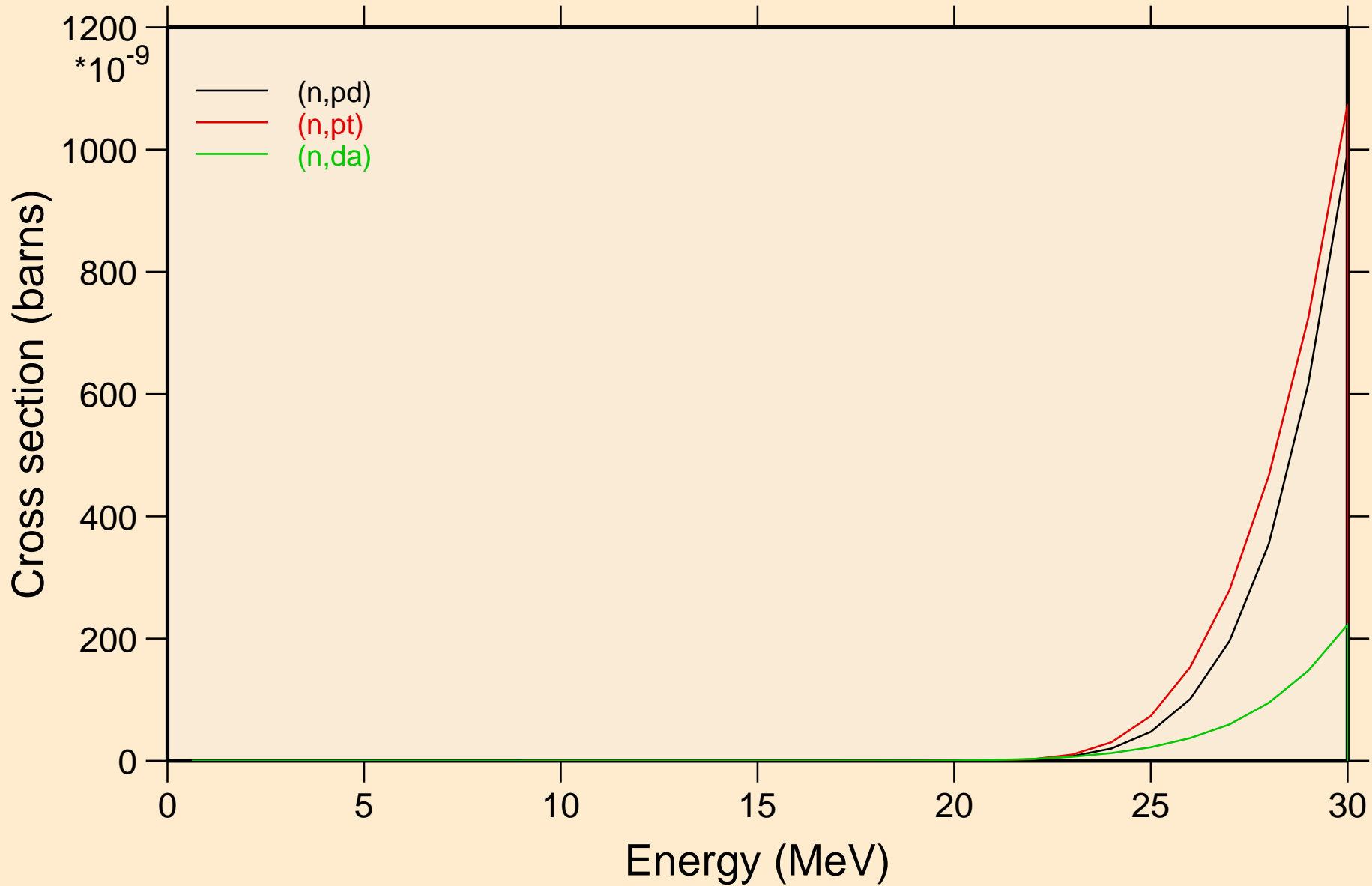

# HO158N NEUTRON ACER TENDL-2021 LIBRARY; T=293.6K

## Threshold reactions

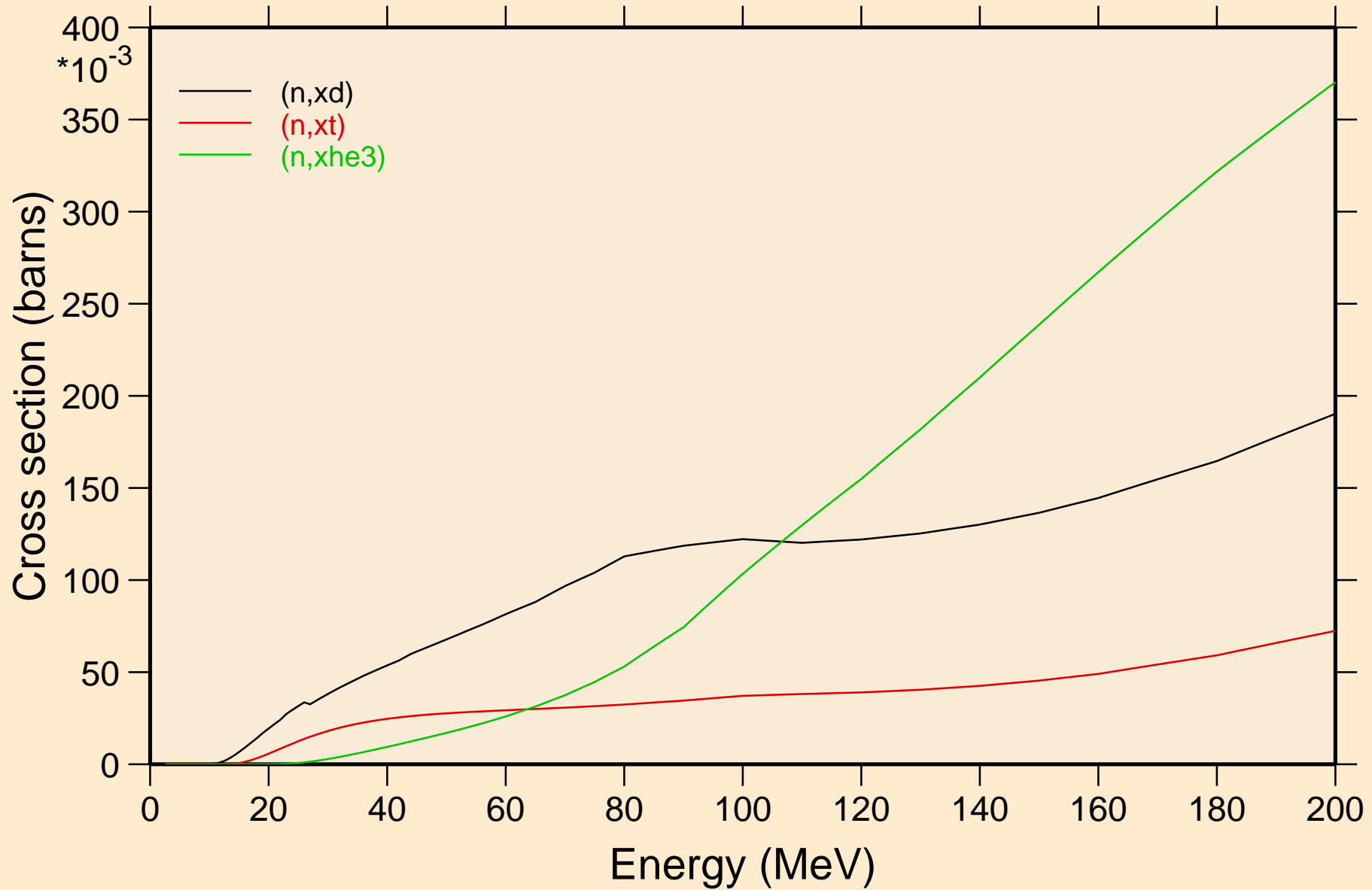

HO158N NEUTRON ACER TENDL-2021 LIBRARY; T=293.6K  
angular distribution for elastic

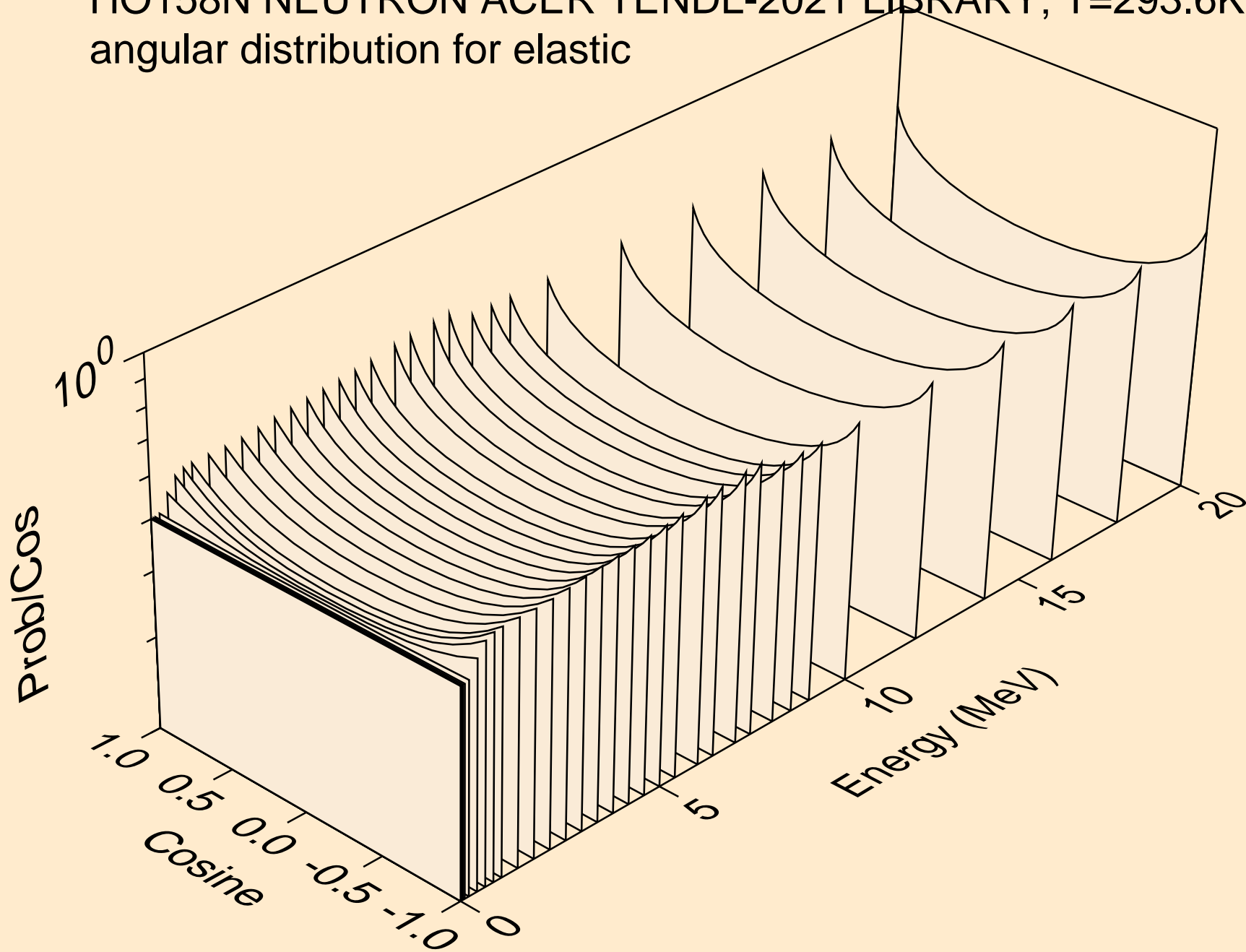

HO158N NEUTRON ACER TENDL-2021 LIBRARY; T=293.6K  
angular distribution for elastic

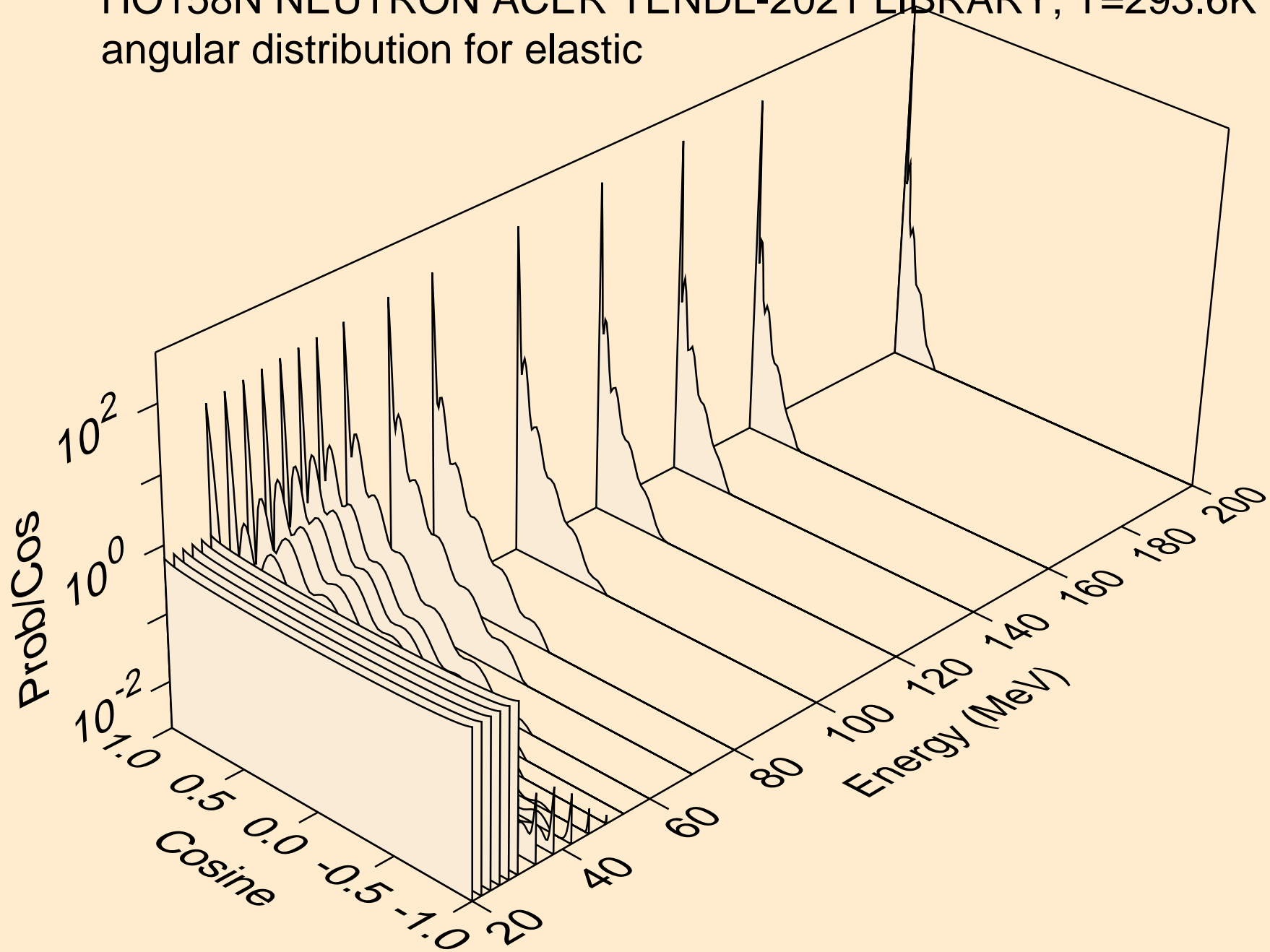

HO158N NEUTRON ACER TENDL-2021 LIBRARY; T=293.6K  
angular distribution for (n,n\*1)

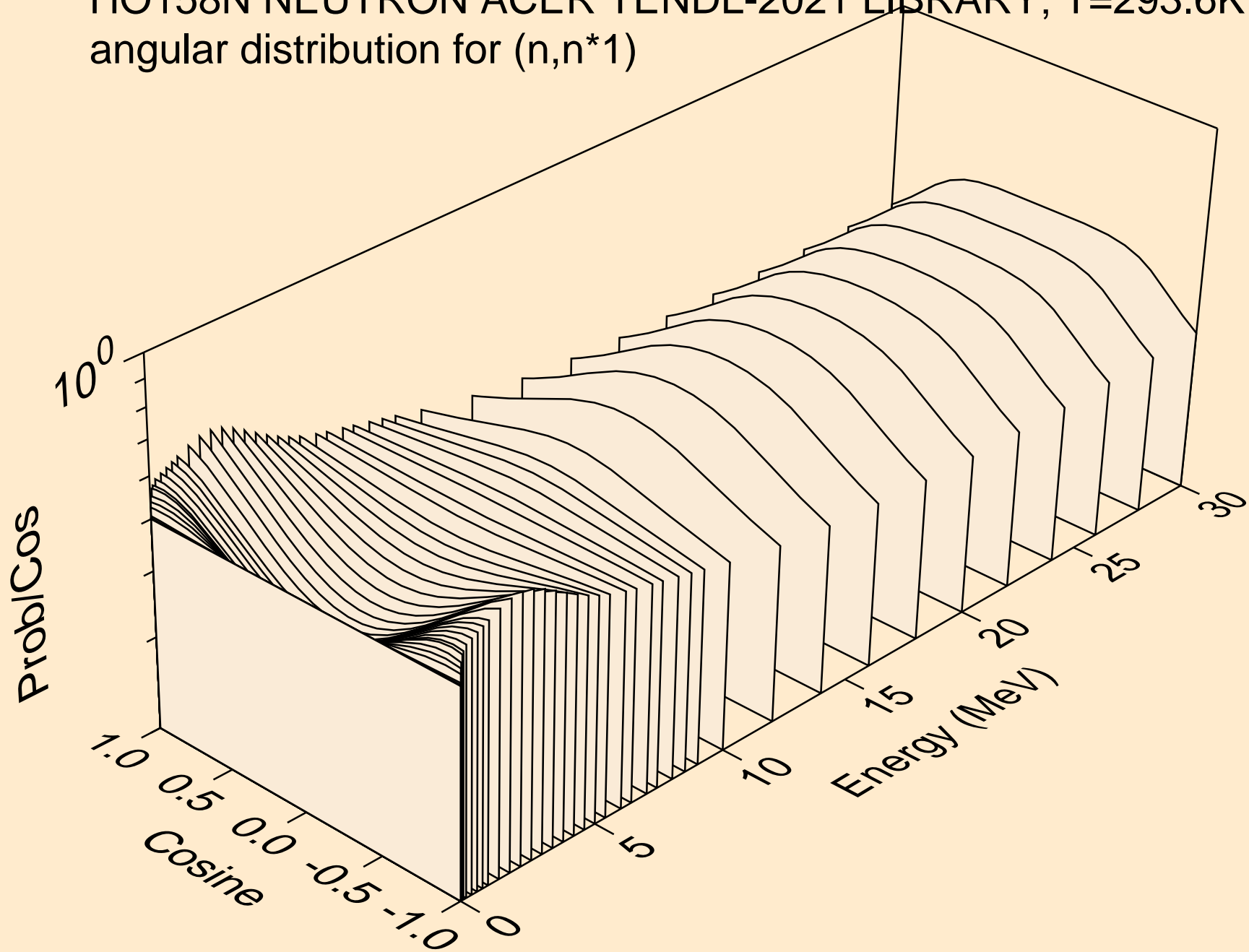



HO158N NEUTRON ACER TENDL-2021 LIBRARY; T=293.6K  
angular distribution for (n,n\*2)

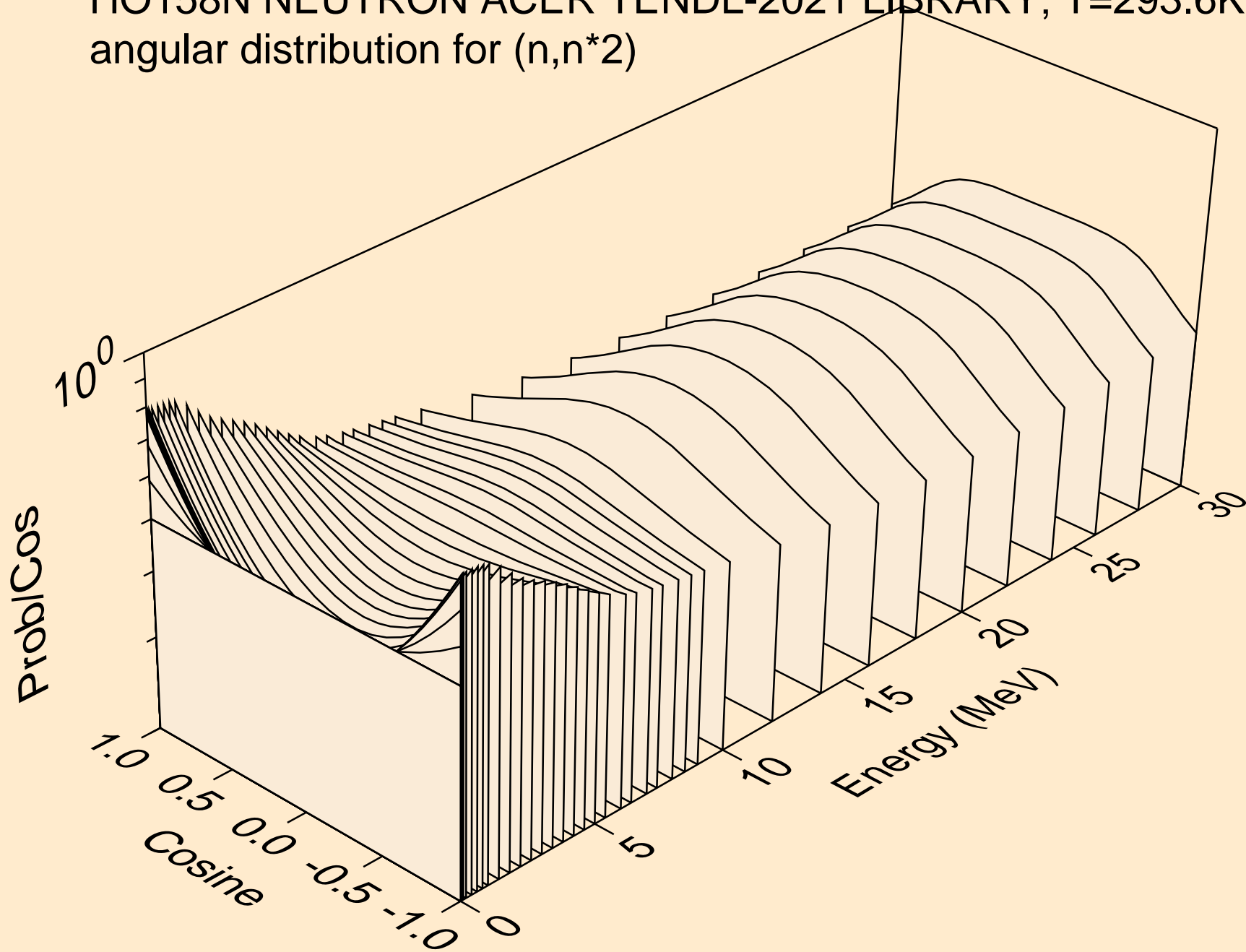

HO158N NEUTRON ACER TENDL-2021 LIBRARY; T=293.6K  
angular distribution for (n,n\*3)

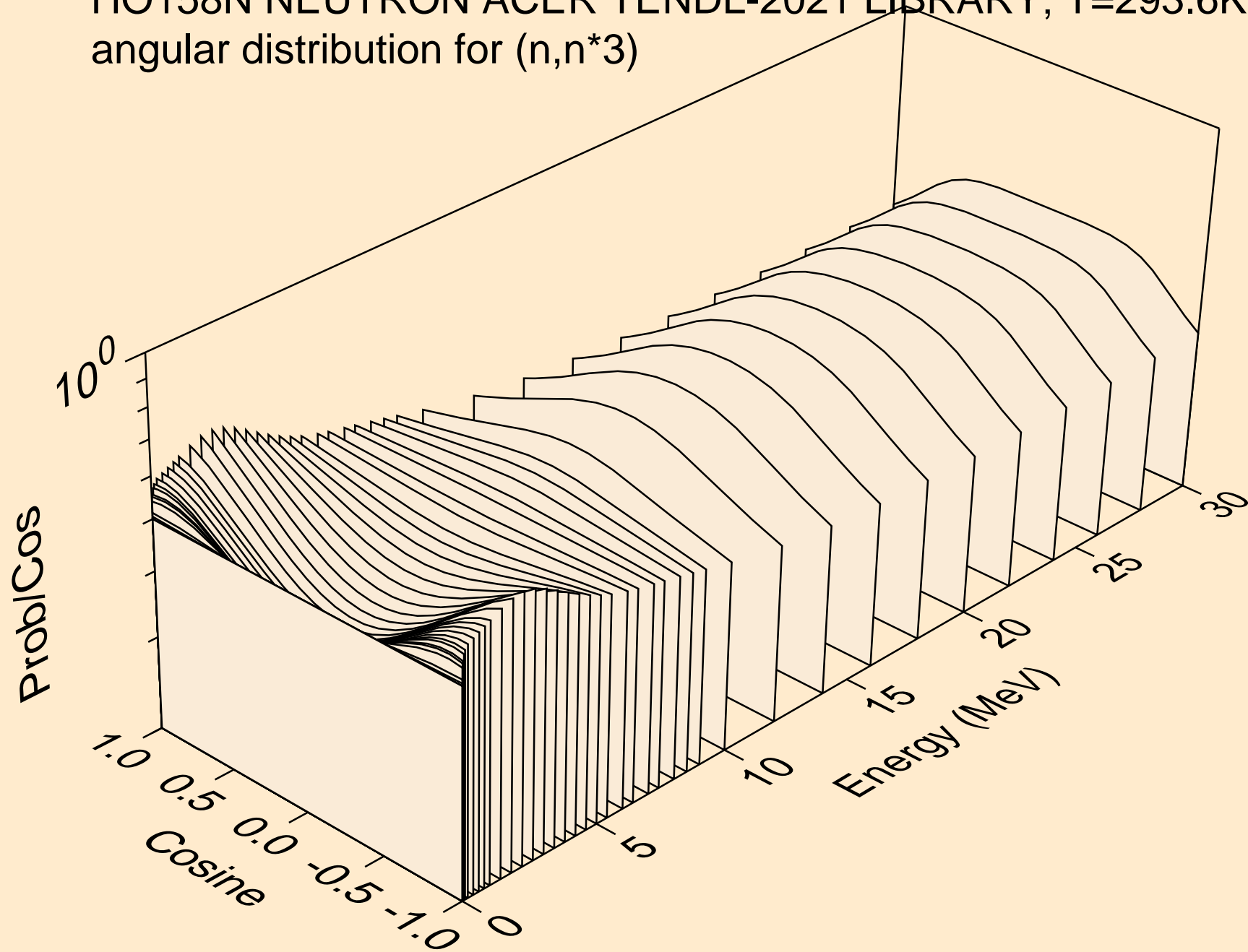

HO158N NEUTRON ACER TENDL-2021 LIBRARY; T=293.6K  
angular distribution for (n,n\*4)

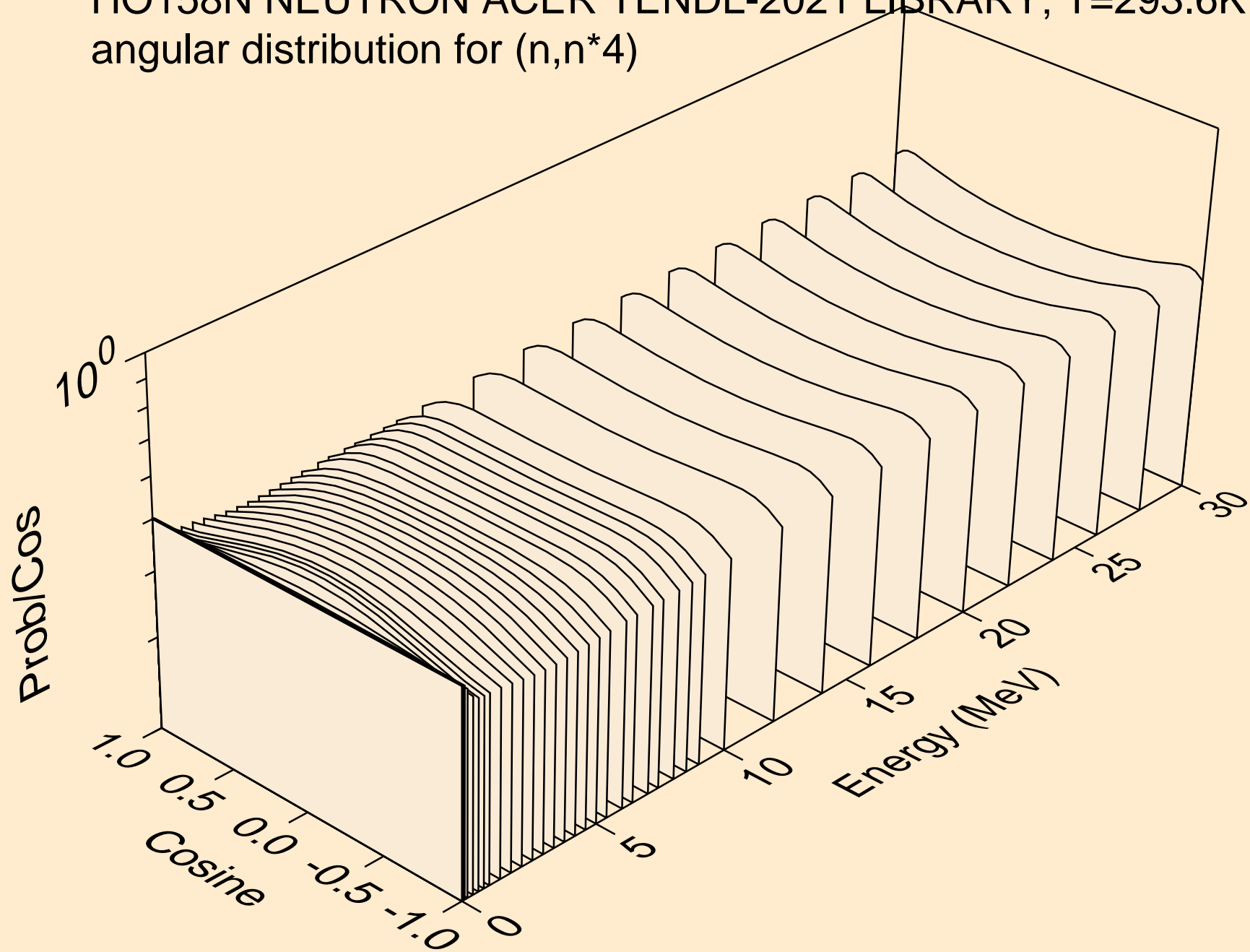

HO158N NEUTRON ACER TENDL-2021 LIBRARY; T=293.6K  
angular distribution for (n,n\*5)

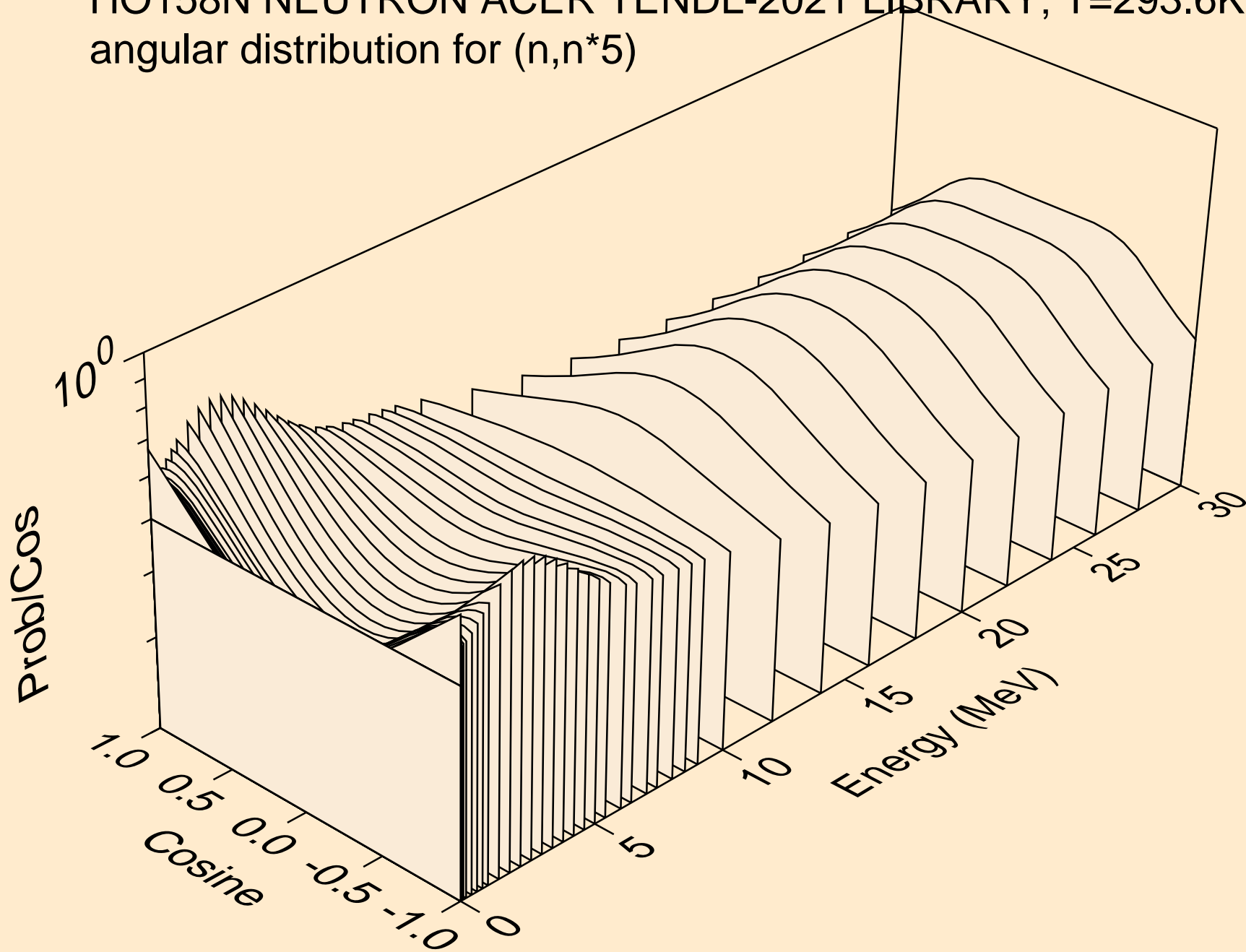

HO158N NEUTRON ACER TENDL-2021 LIBRARY; T=293.6K  
angular distribution for (n,n\*6)

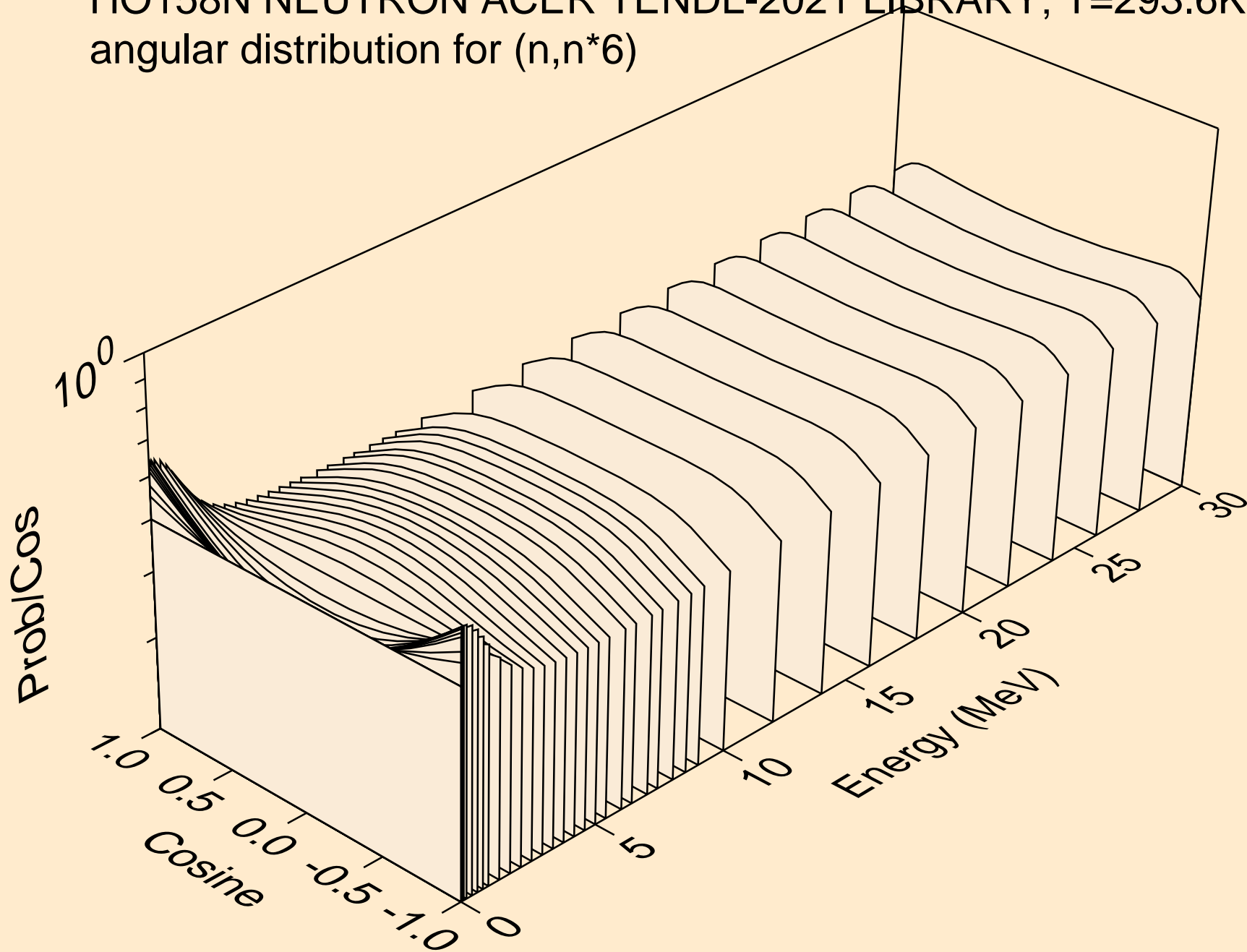

HO158N NEUTRON ACER TENDL-2021 LIBRARY; T=293.6K  
angular distribution for (n,n\*7)

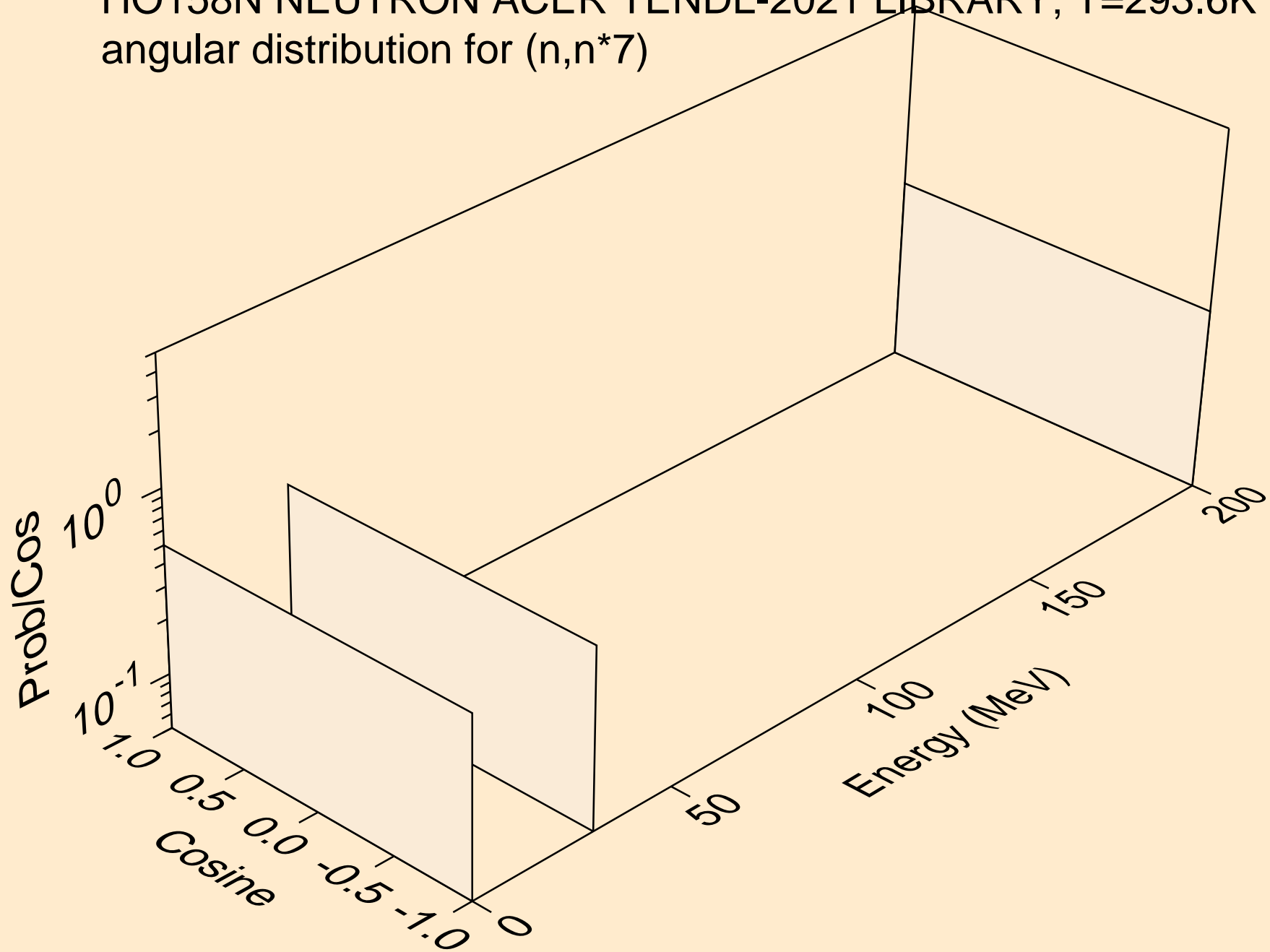

HO158N NEUTRON ACER TENDL-2021 LIBRARY; T=293.6K  
angular distribution for (n,n\*8)

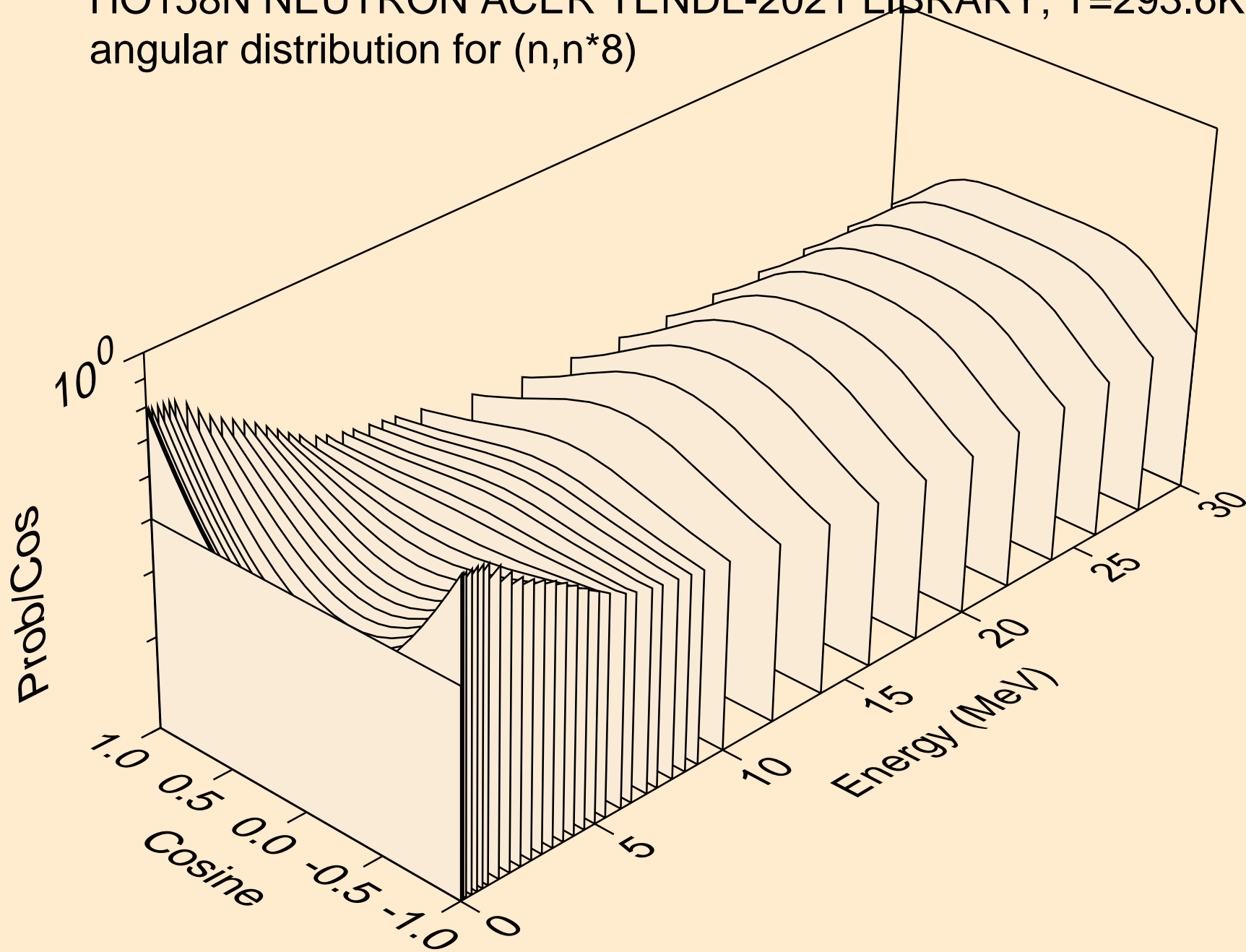

HO158N NEUTRON ACER TENDL-2021 LIBRARY; T=293.6K  
angular distribution for (n,n\*9)

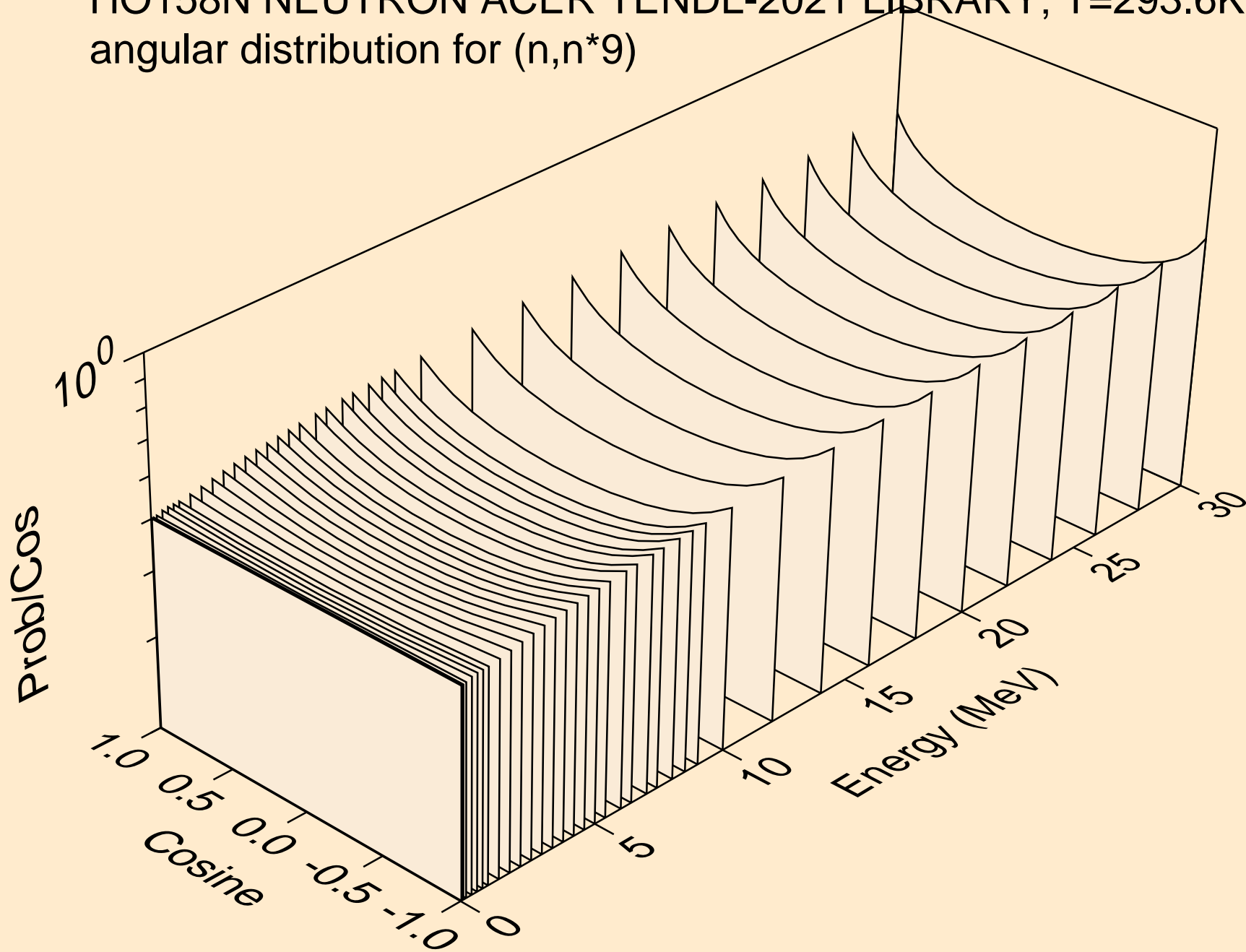



HO158N NEUTRON ACER TENDL-2021 LIBRARY; T=293.6K  
angular distribution for (n,n\*10)

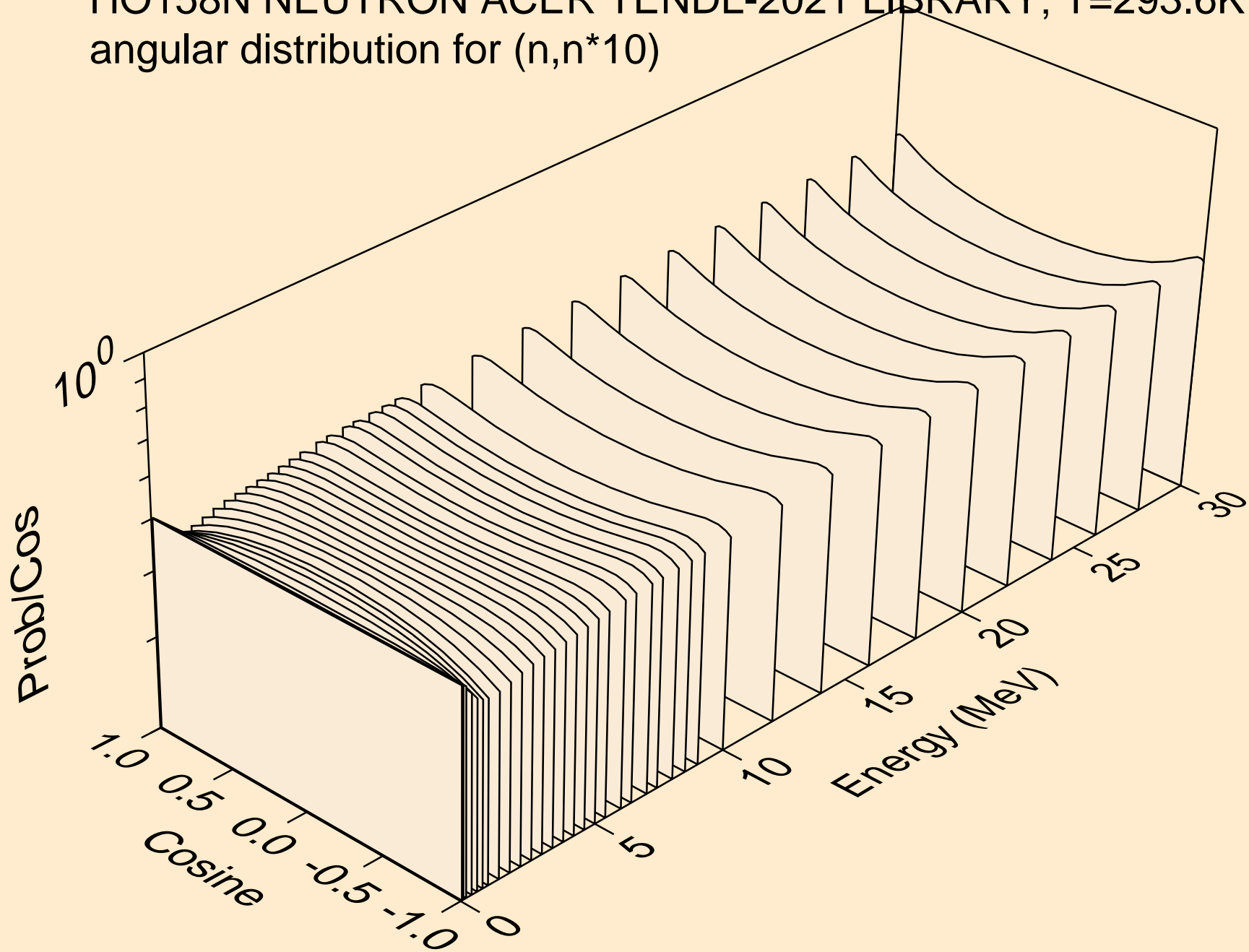

HO158N NEUTRON ACER TENDL-2021 LIBRARY; T=293.6K  
angular distribution for (n,n\*11)

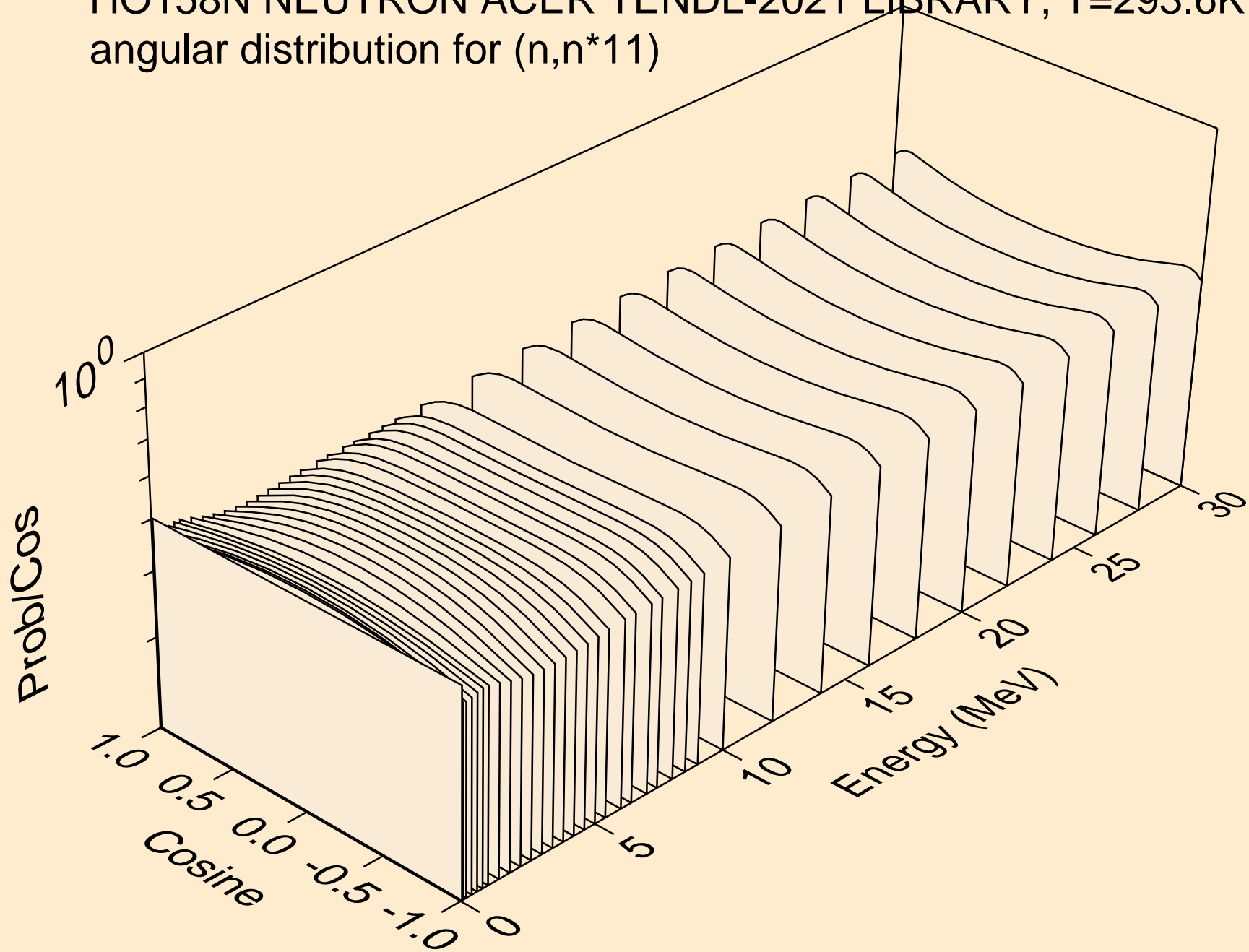

HO158N NEUTRON ACER TENDL-2021 LIBRARY; T=293.6K  
angular distribution for (n,n\*12)

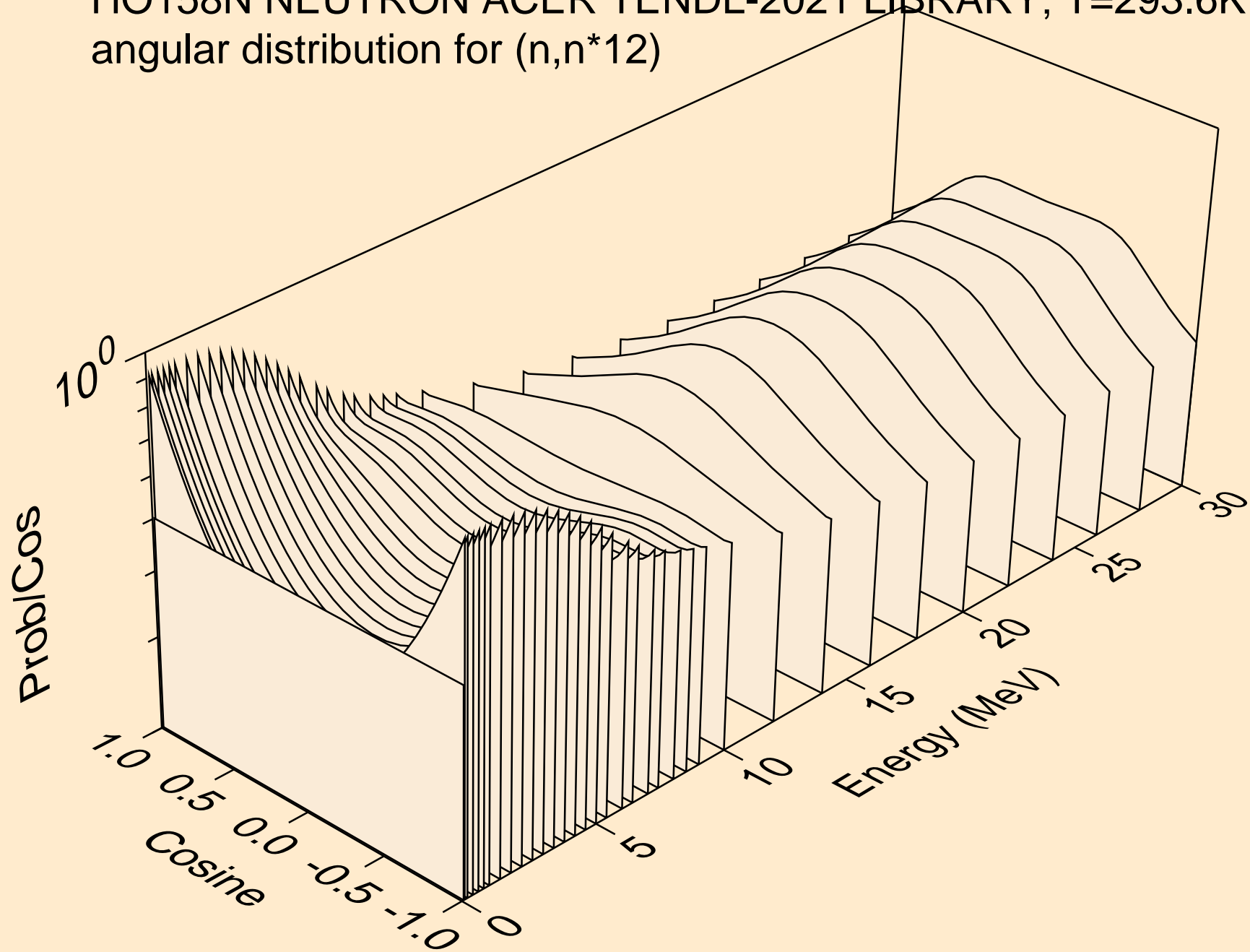

HO158N NEUTRON ACER TENDL-2021 LIBRARY; T=293.6K  
angular distribution for (n,n\*13)

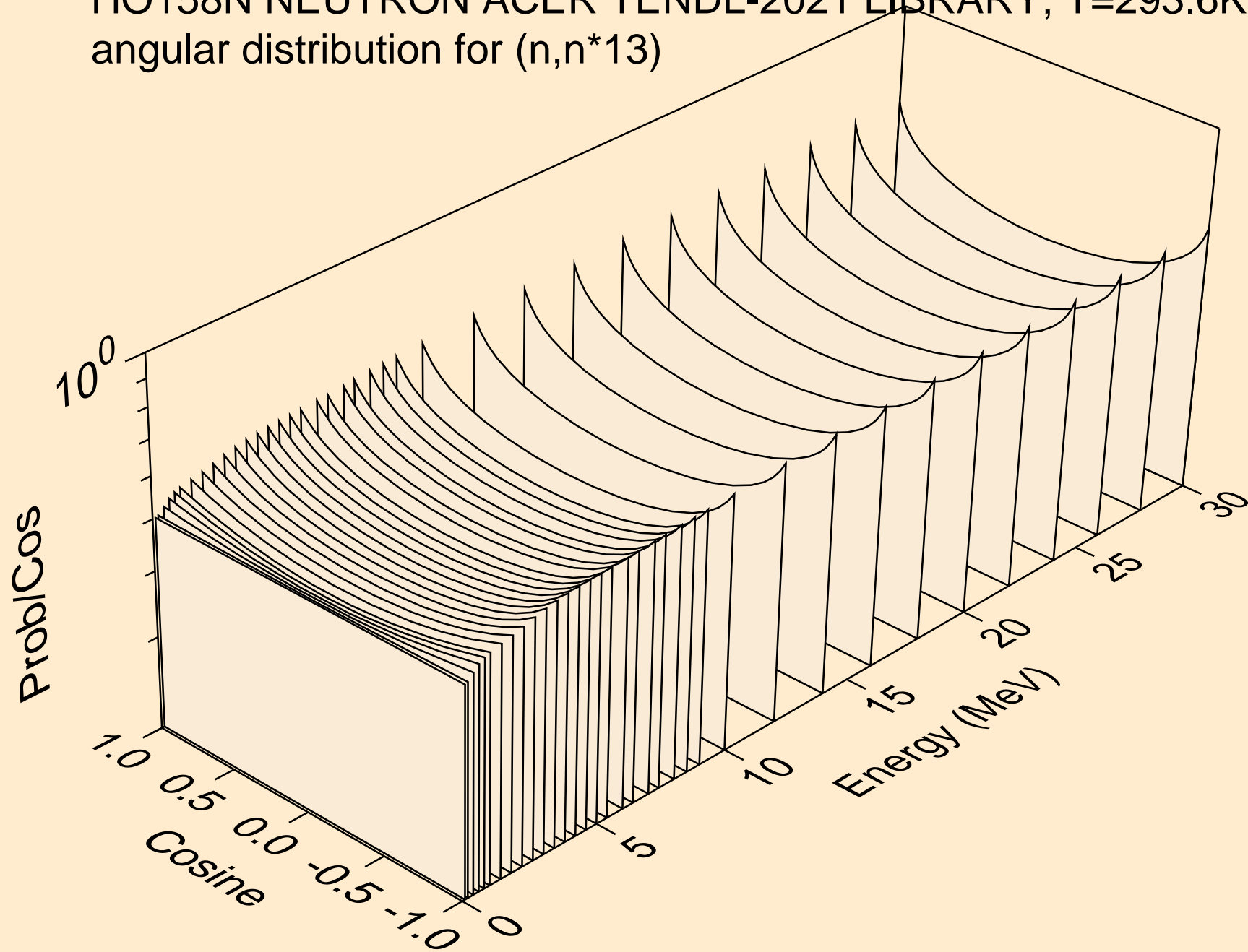

HO158N NEUTRON ACER TENDL-2021 LIBRARY; T=293.6K  
angular distribution for (n,n\*14)

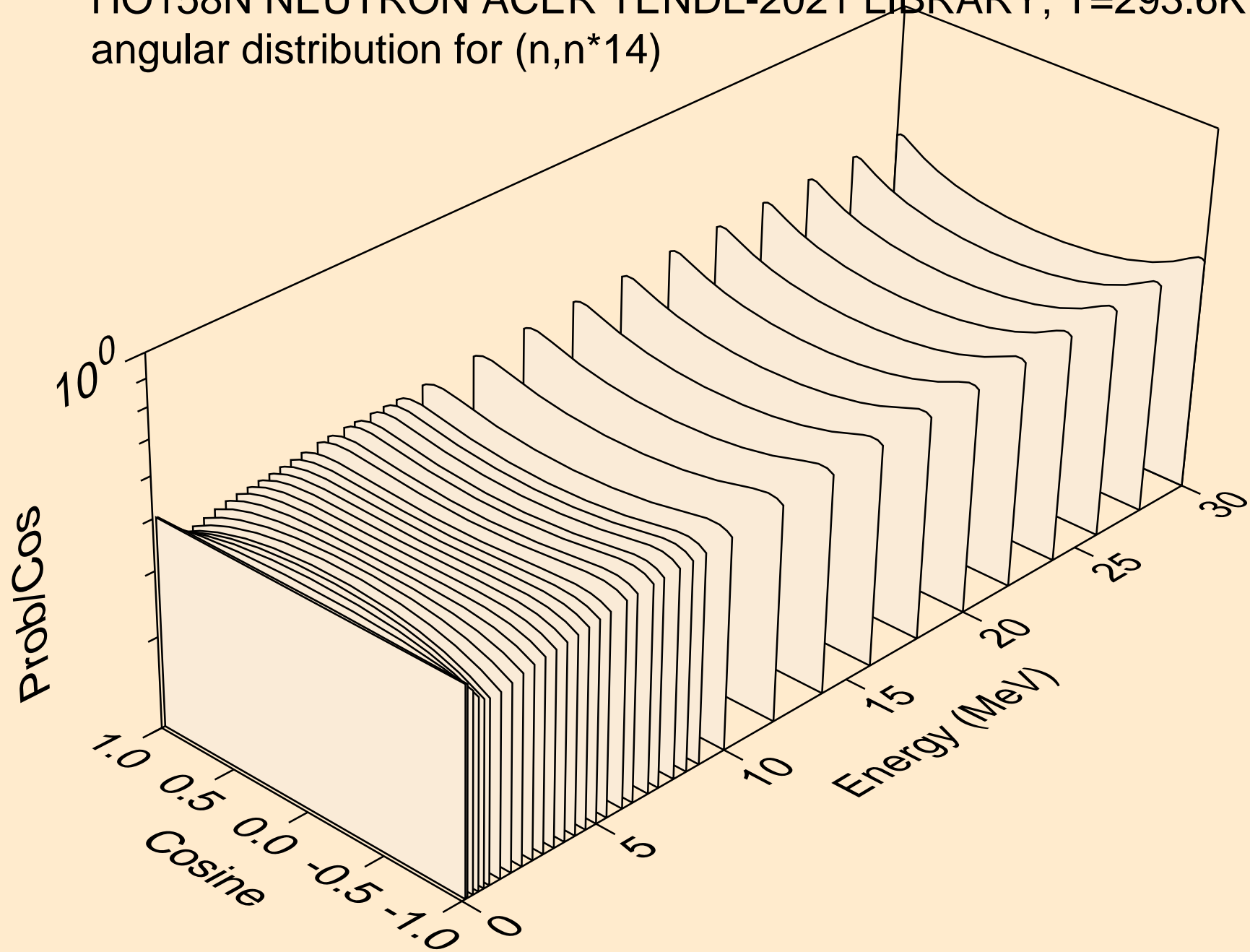

HO158N NEUTRON ACER TENDL-2021 LIBRARY; T=293.6K  
angular distribution for (n,n\*15)

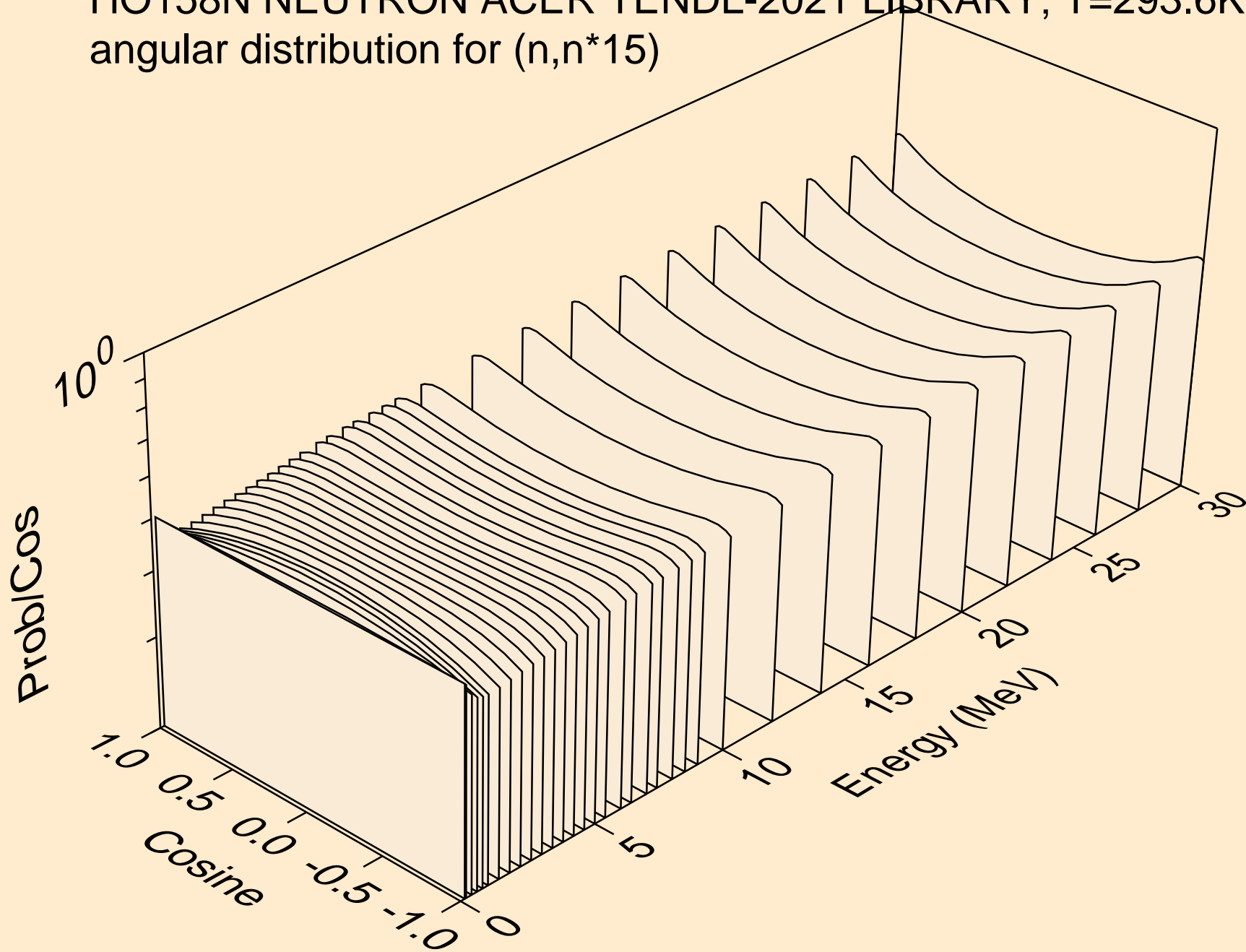

HO158N NEUTRON ACER TENDL-2021 LIBRARY; T=293.6K  
angular distribution for (n,n\*16)

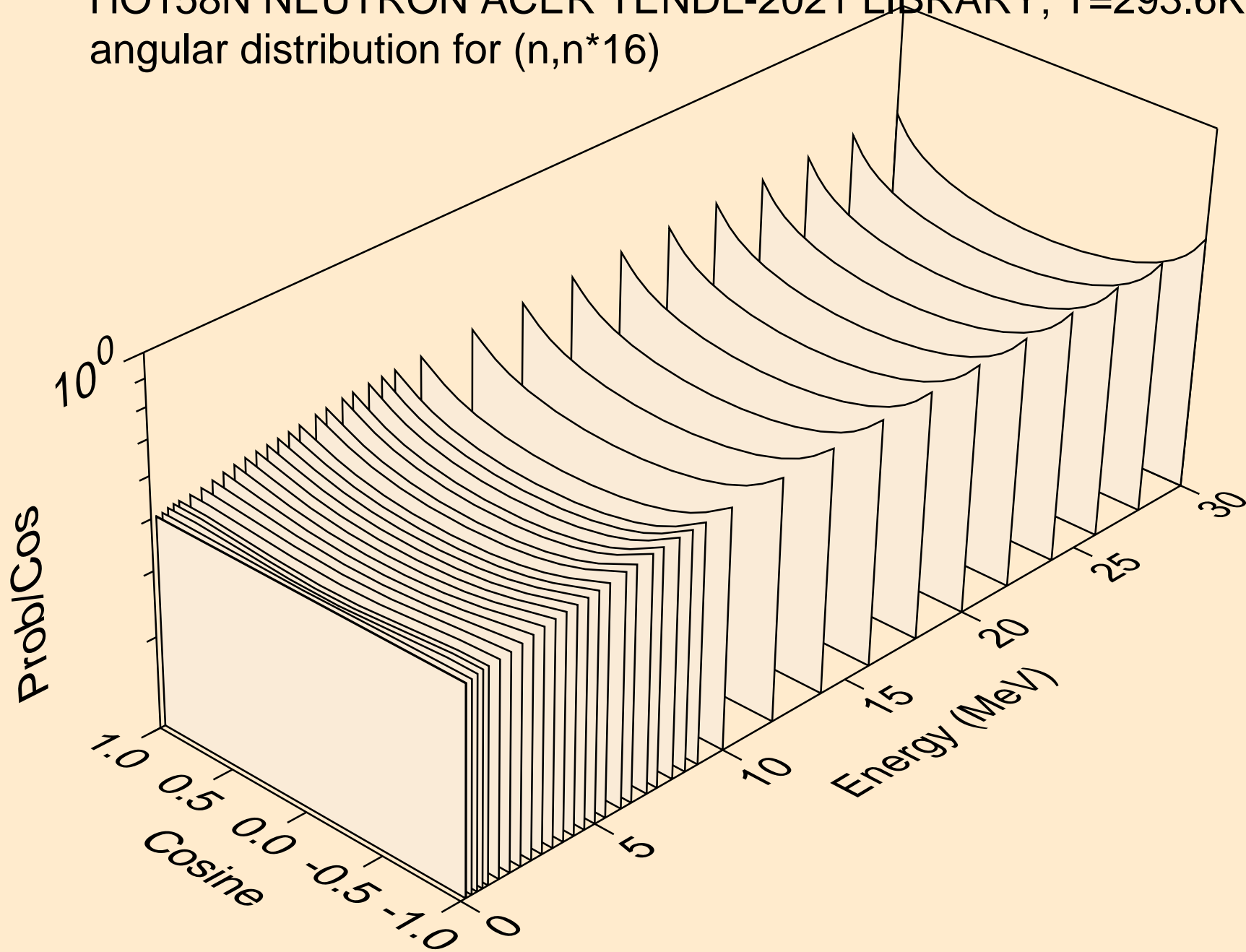

HO158N NEUTRON ACER TENDL-2021 LIBRARY; T=293.6K  
angular distribution for (n,n\*17)

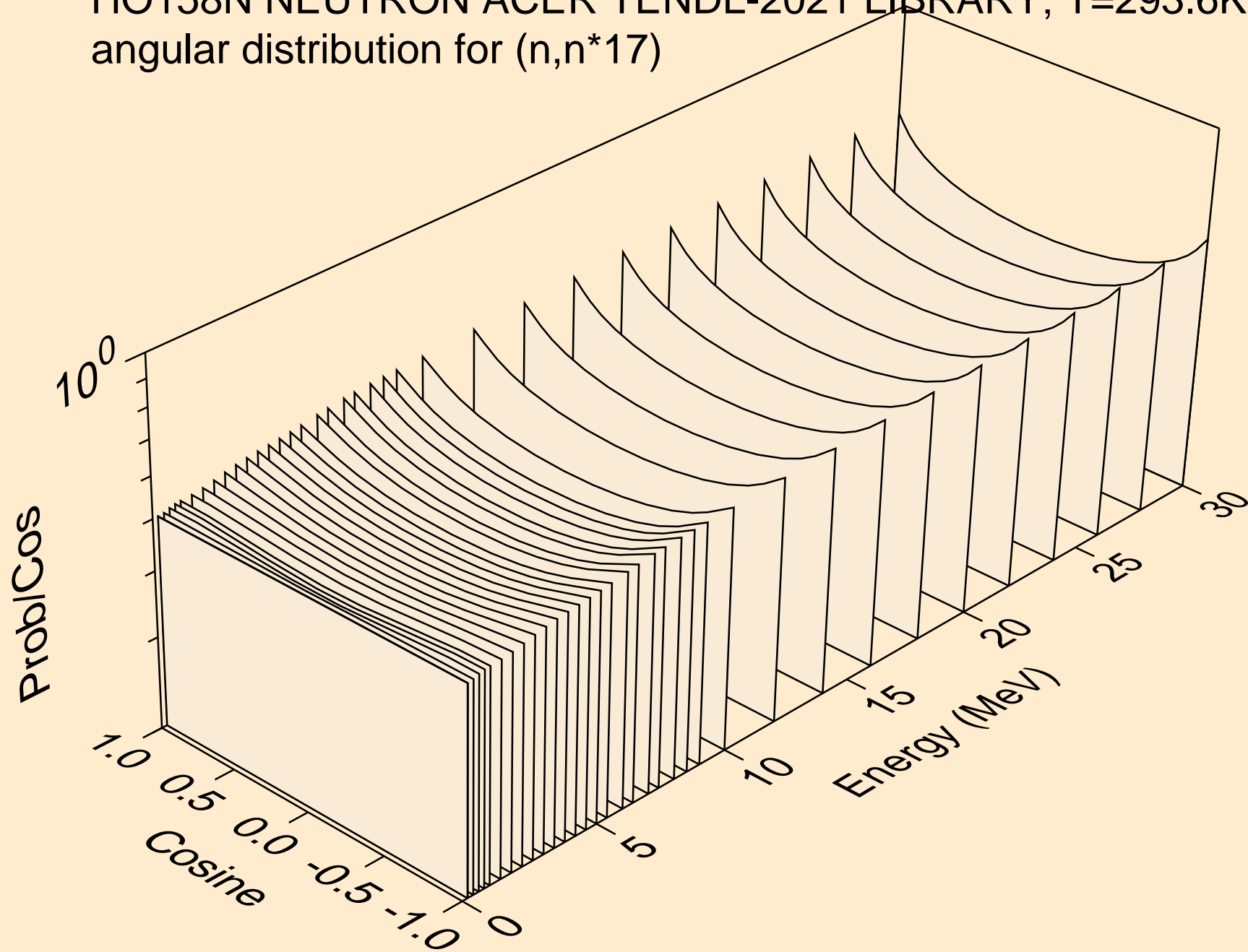



HO158N NEUTRON ACER TENDL-2021 LIBRARY; T=293.6K  
angular distribution for (n,n\*18)

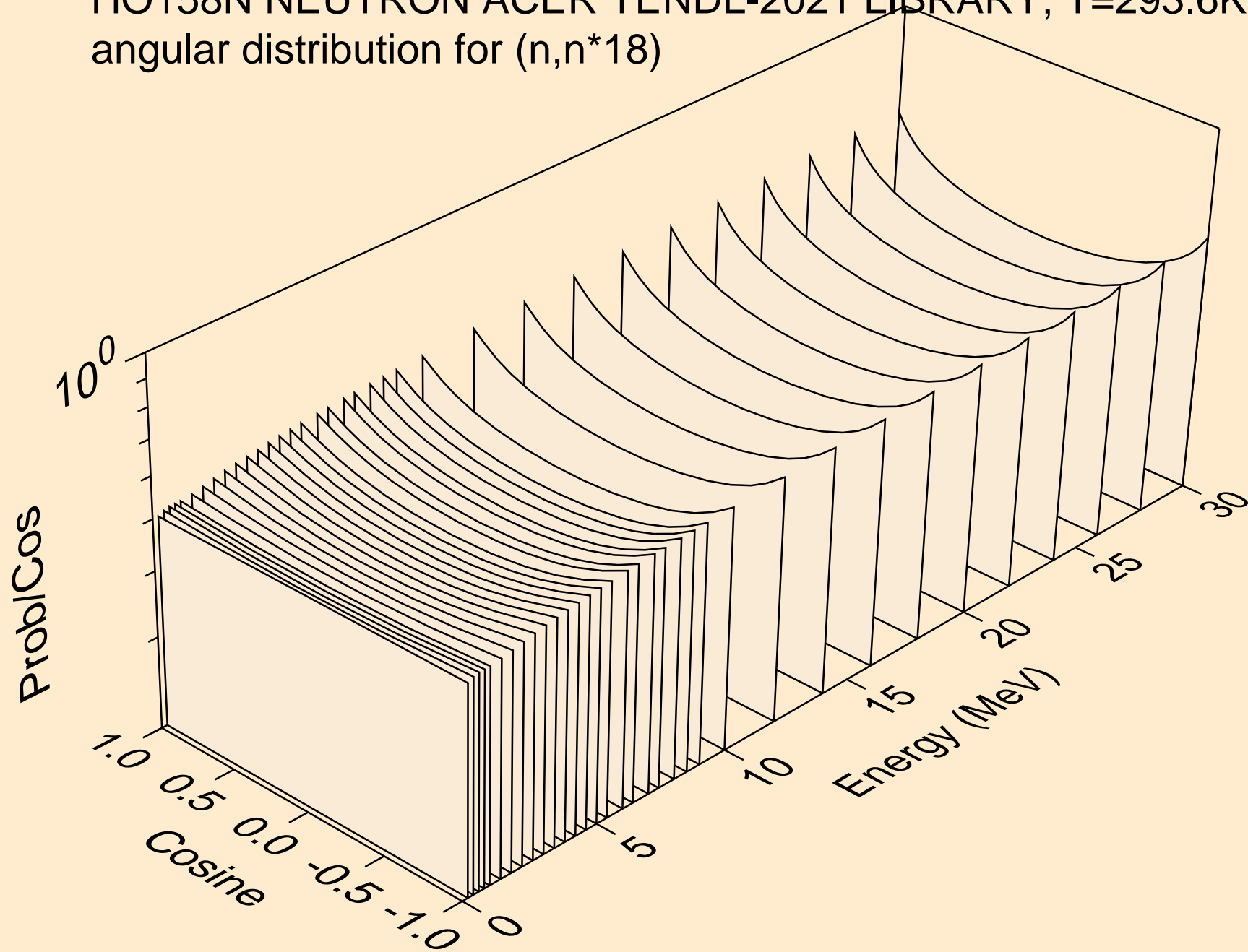

HO158N NEUTRON ACER TENDL-2021 LIBRARY; T=293.6K  
angular distribution for (n,n\*19)

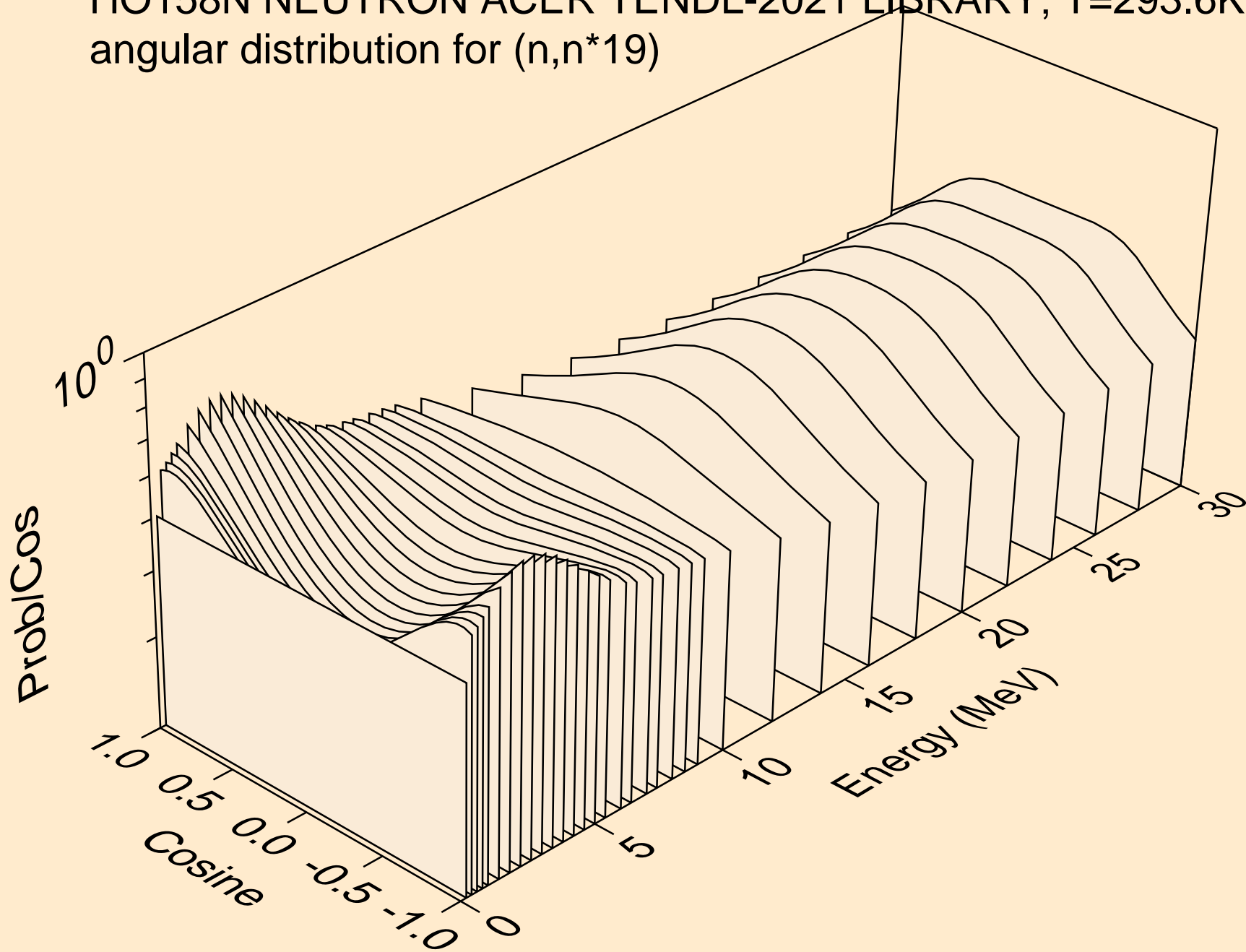

HO158N NEUTRON ACER TENDL-2021 LIBRARY; T=293.6K  
angular distribution for (n,n\*20)

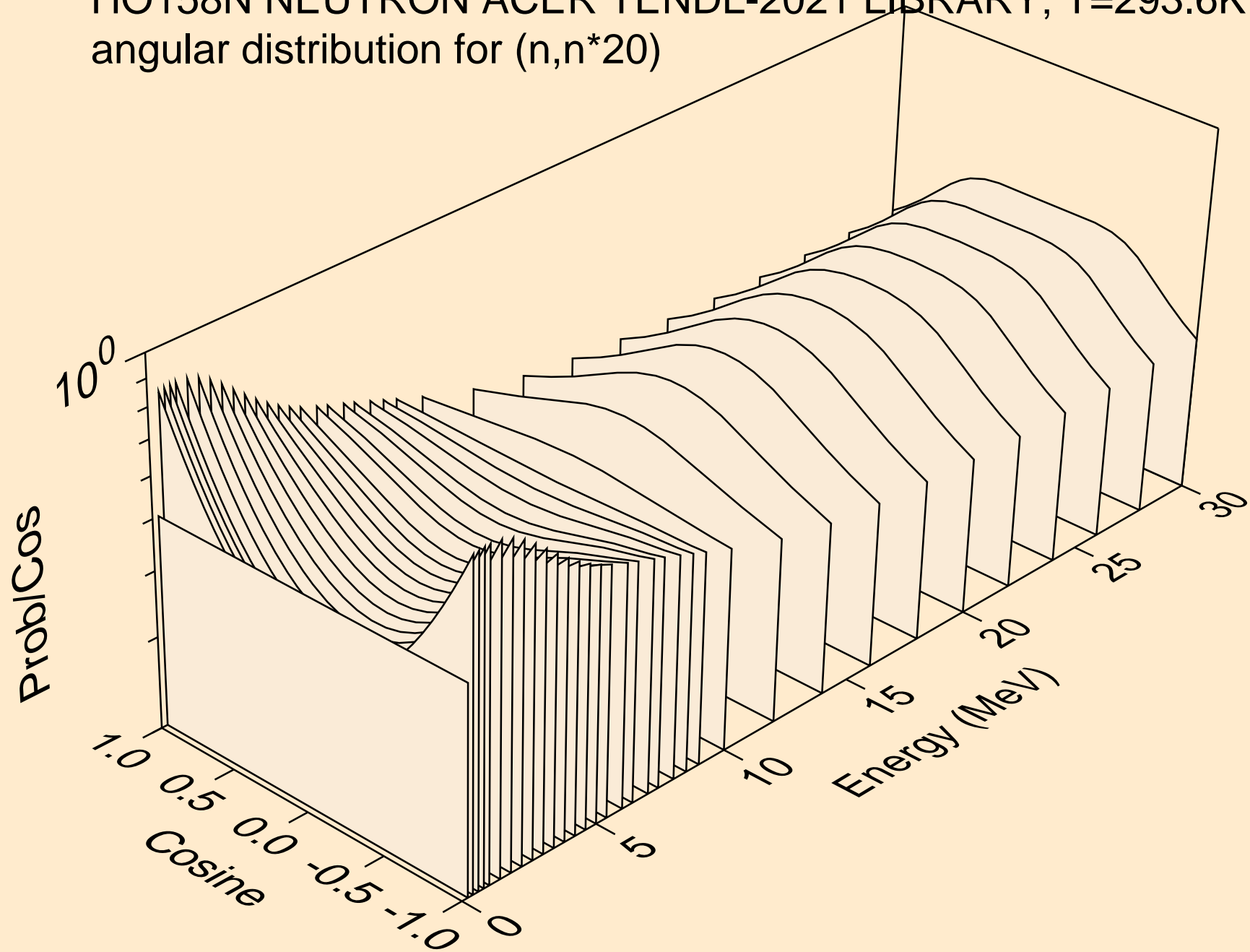

HO158N NEUTRON ACER TENDL-2021 LIBRARY; T=293.6K  
angular distribution for (n,n\*21)

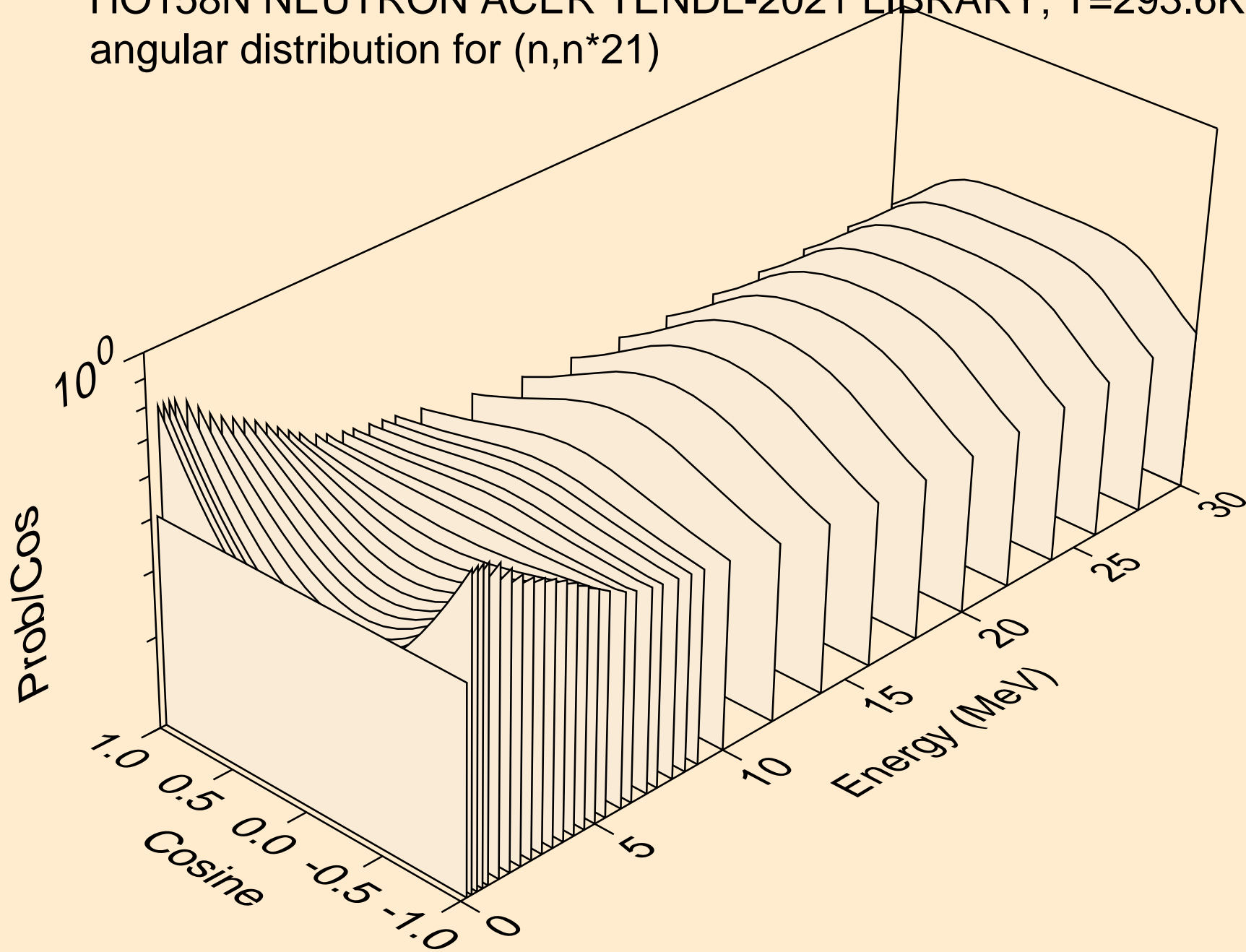

HO158N NEUTRON ACER TENDL-2021 LIBRARY; T=293.6K  
angular distribution for (n,n\*22)

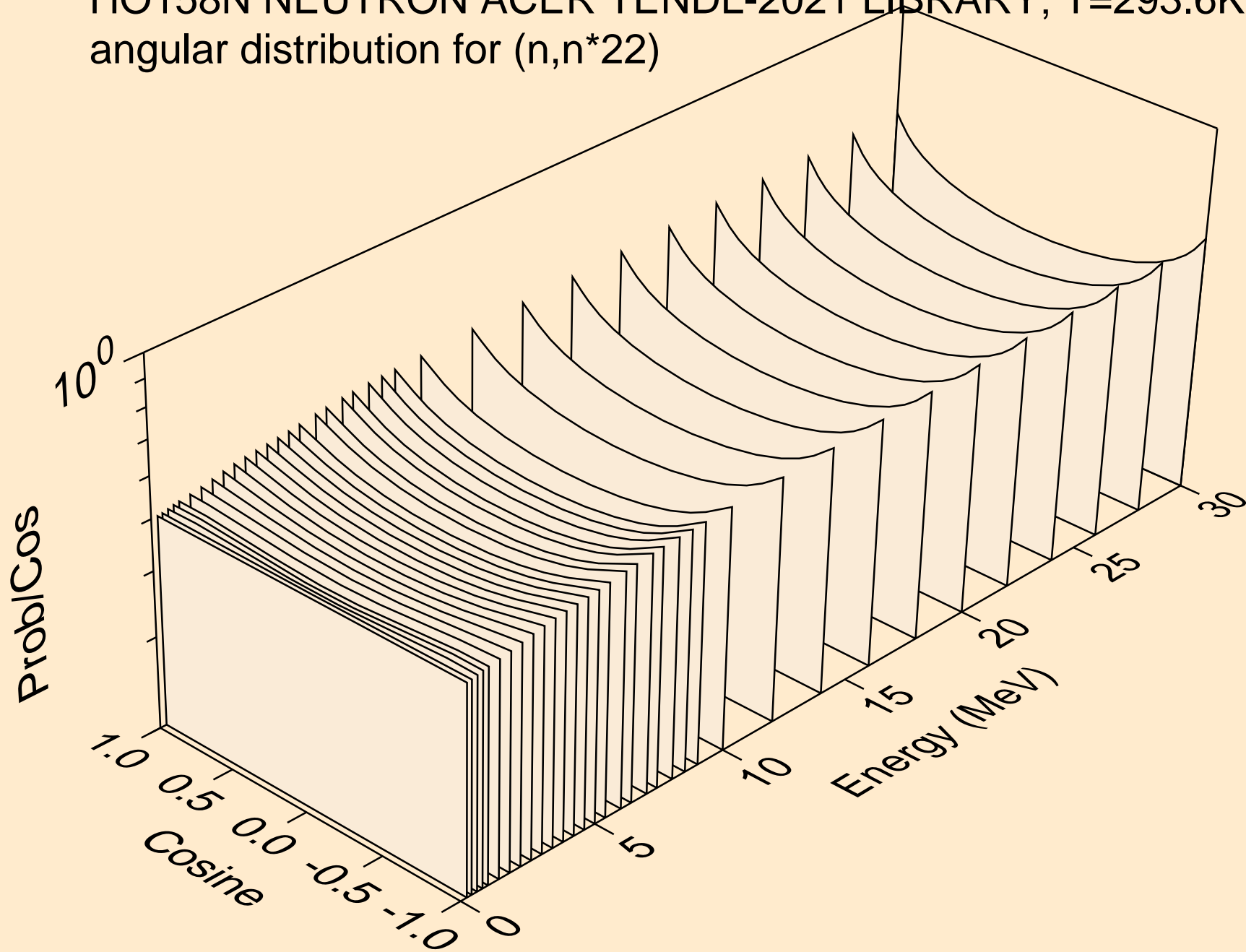

HO158N NEUTRON ACER TENDL-2021 LIBRARY; T=293.6K  
angular distribution for (n,n\*23)

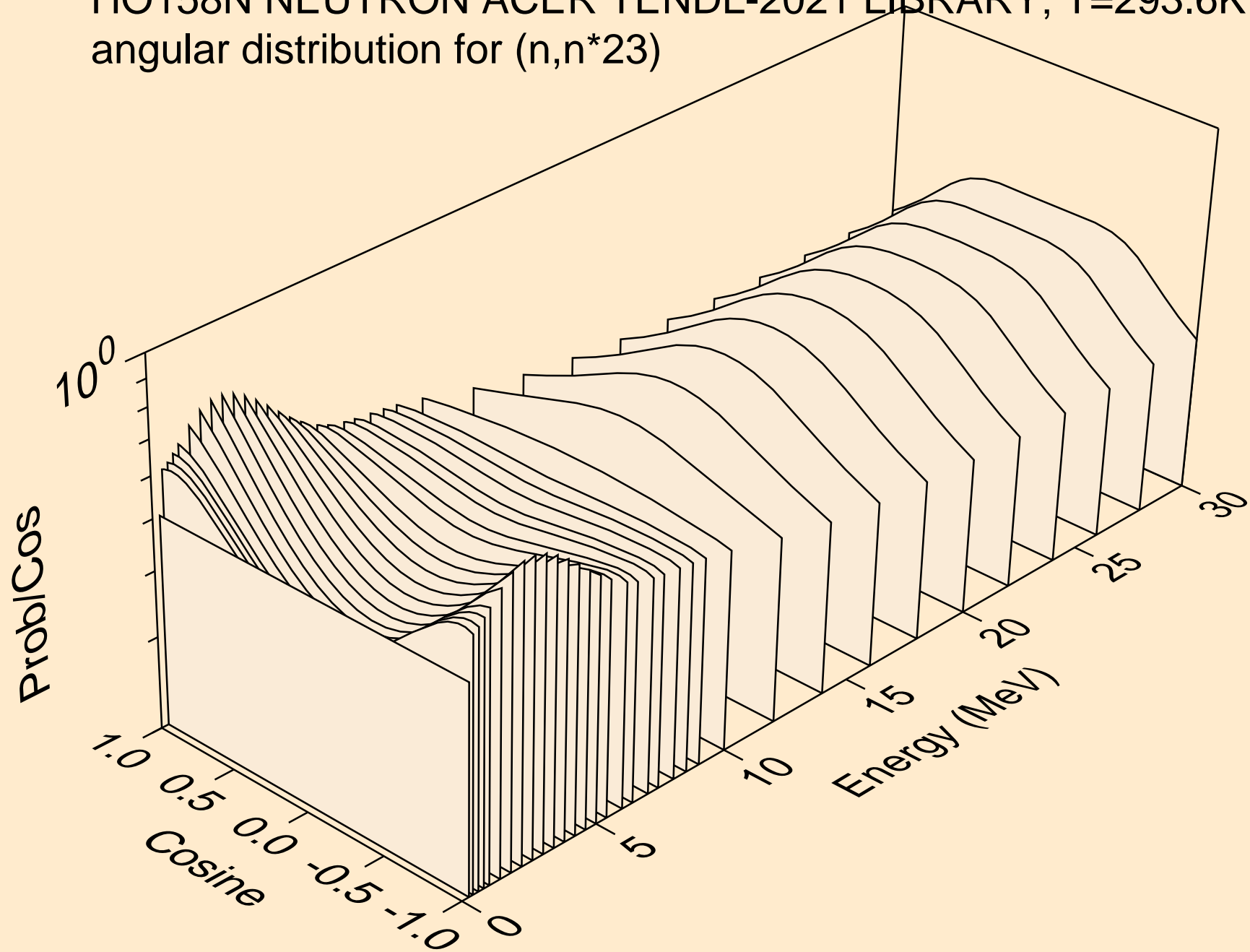

HO158N NEUTRON ACER TENDL-2021 LIBRARY; T=293.6K  
angular distribution for (n,n\*24)

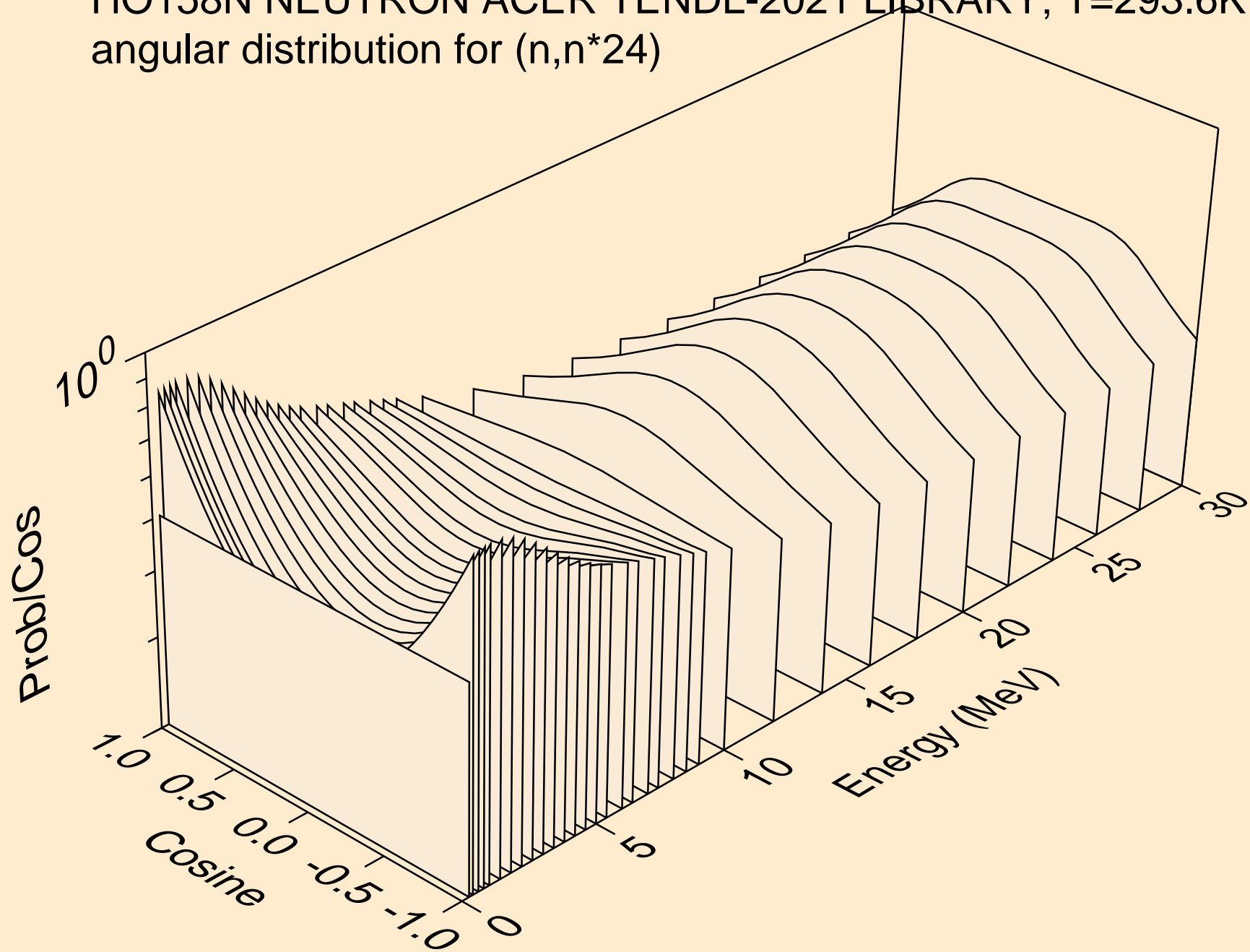

HO158N NEUTRON ACER TENDL-2021 LIBRARY; T=293.6K  
angular distribution for (n,n\*25)

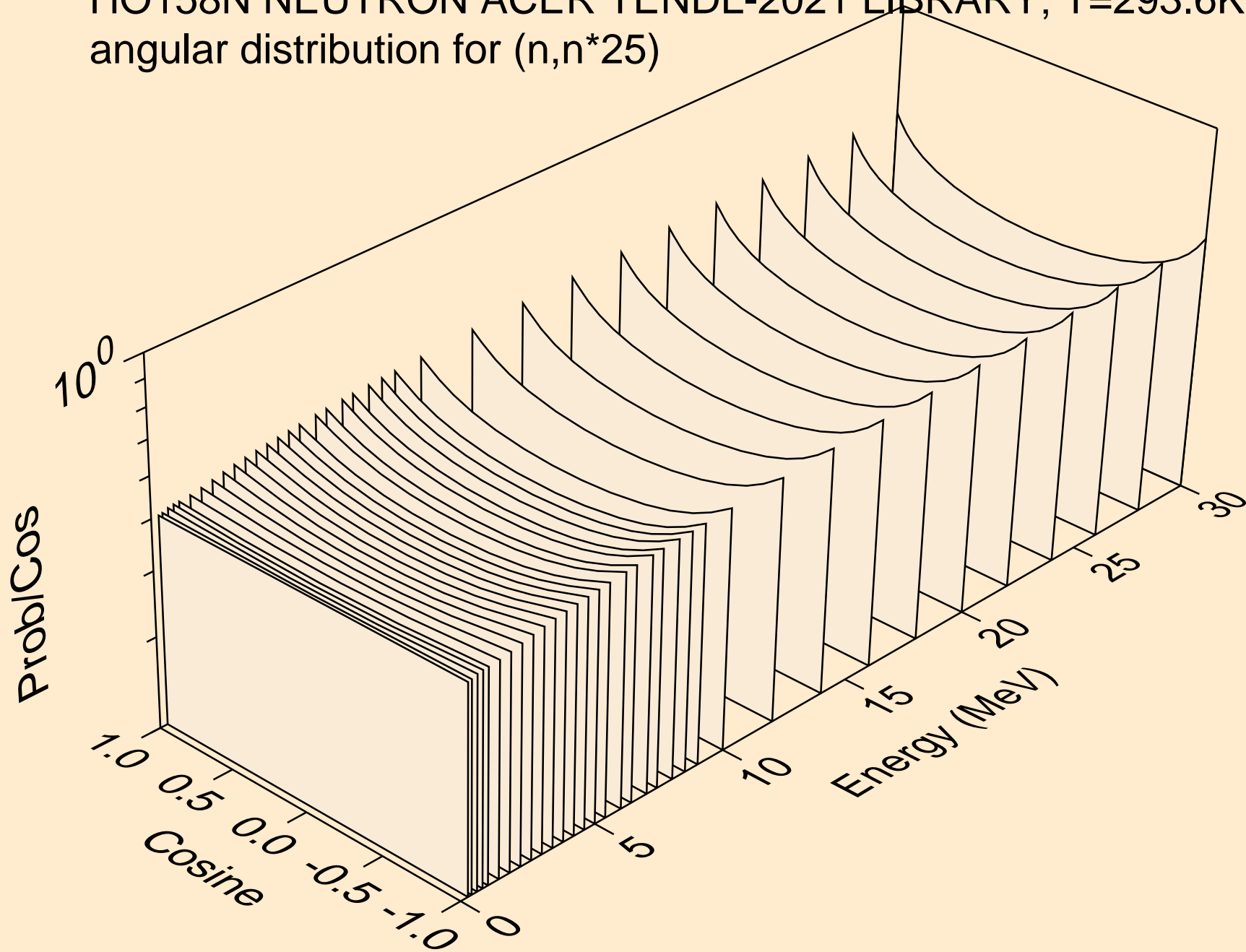



HO158N NEUTRON ACER TENDL-2021 LIBRARY; T=293.6K  
angular distribution for (n,n\*26)

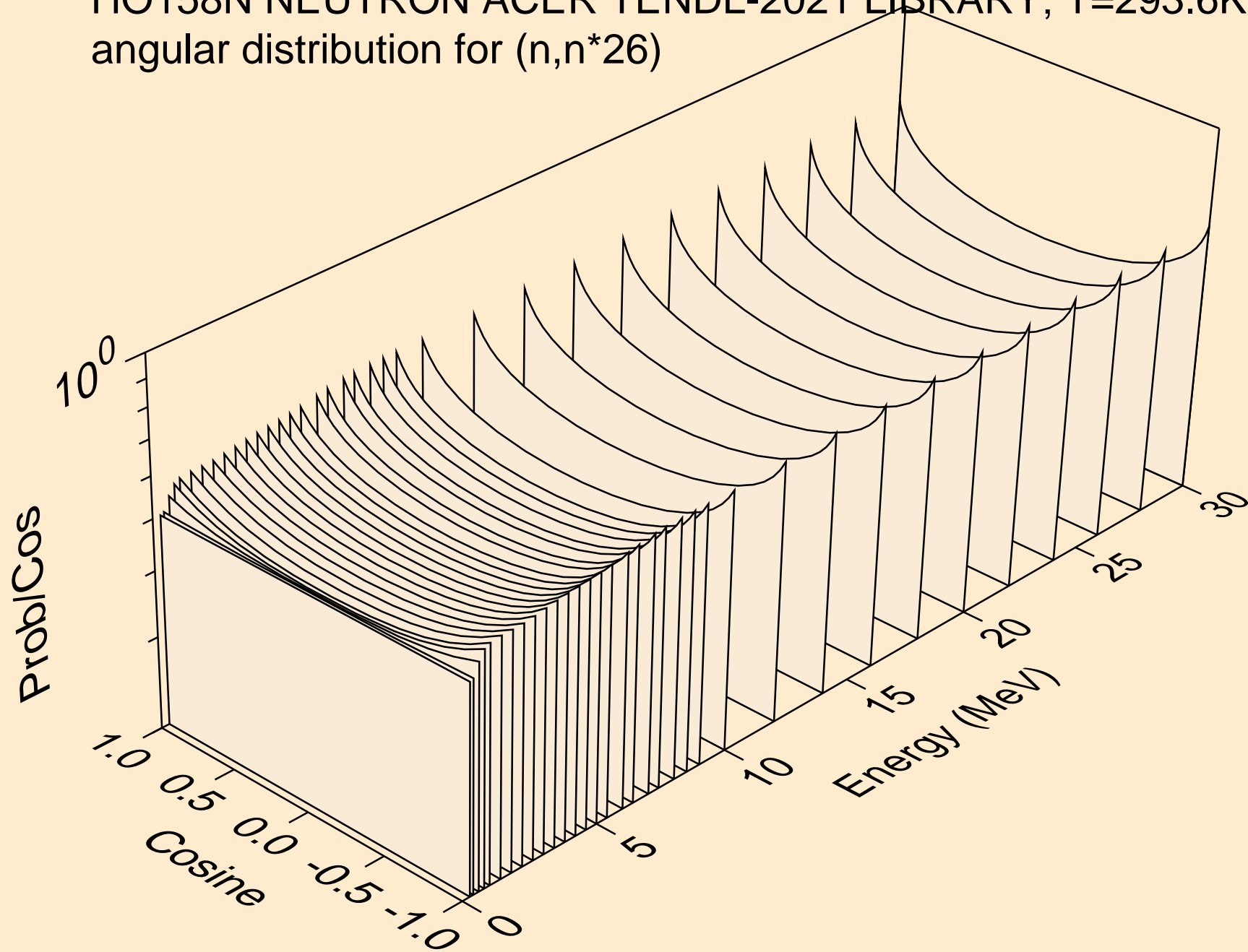

HO158N NEUTRON ACER TENDL-2021 LIBRARY; T=293.6K  
angular distribution for (n,n\*27)

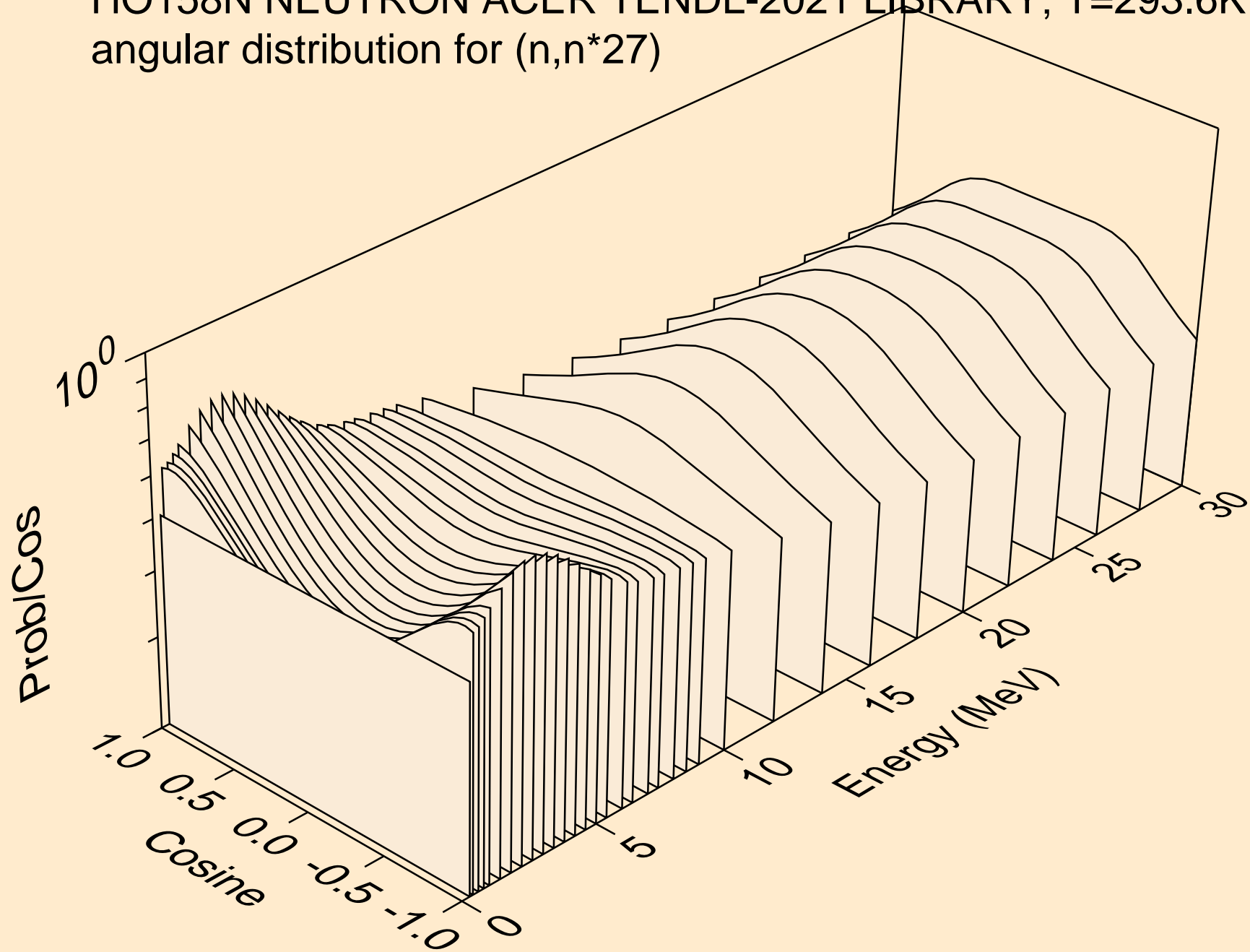

HO158N NEUTRON ACER TENDL-2021 LIBRARY; T=293.6K  
angular distribution for (n,n\*28)

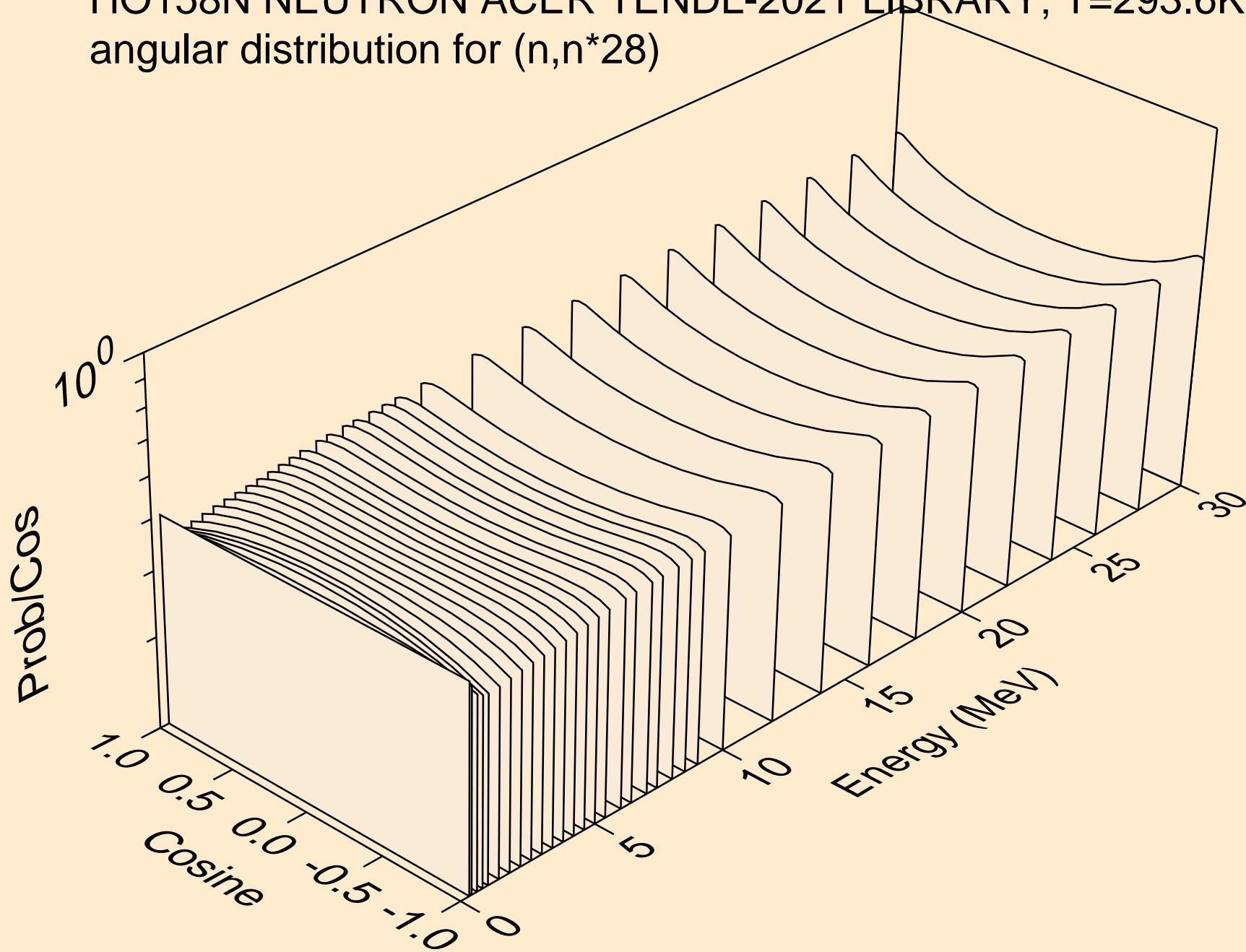

HO158N NEUTRON ACER TENDL-2021 LIBRARY; T=293.6K  
angular distribution for (n,n\*29)

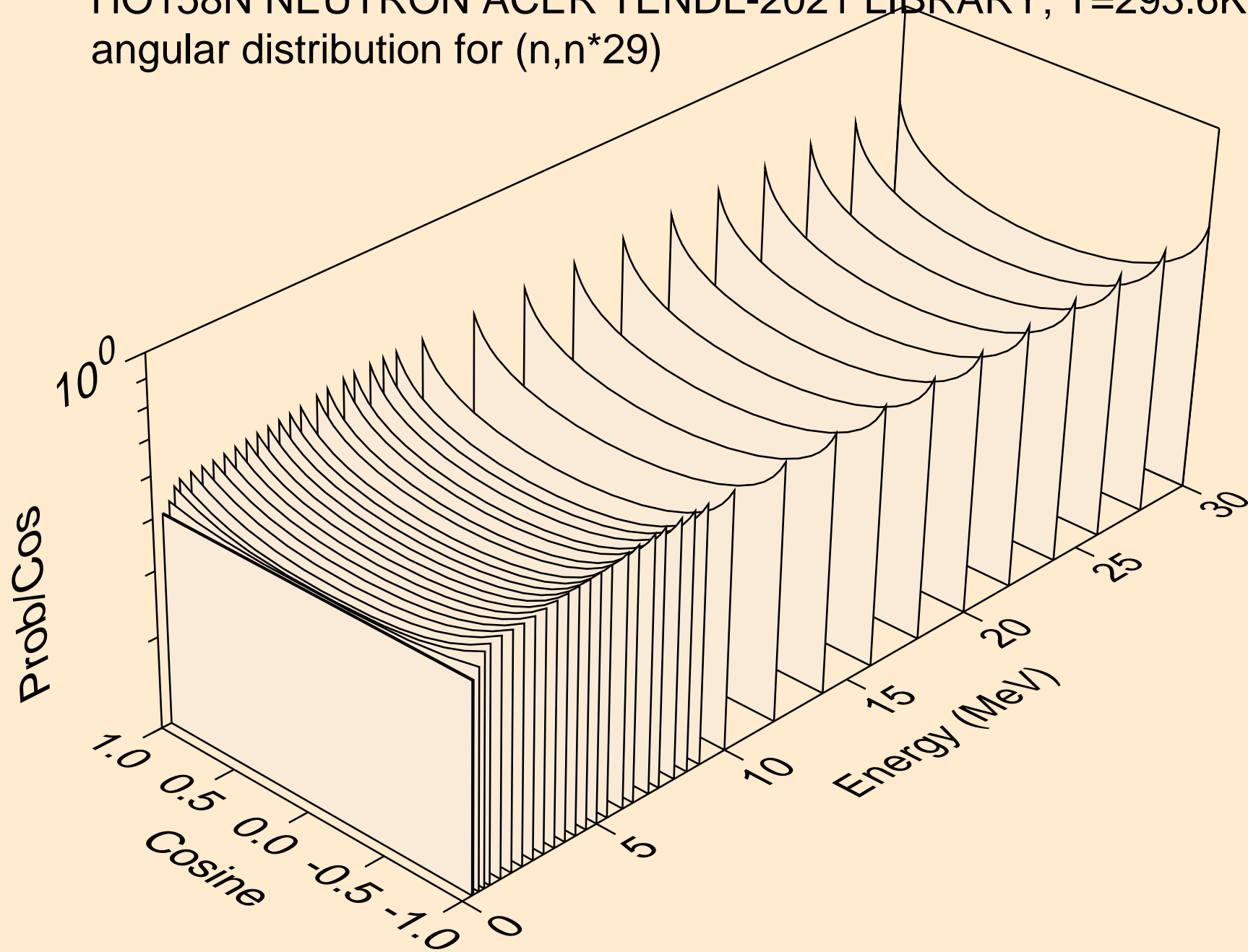

HO158N NEUTRON ACER TENDL-2021 LIBRARY; T=293.6K  
angular distribution for (n,n\*30)

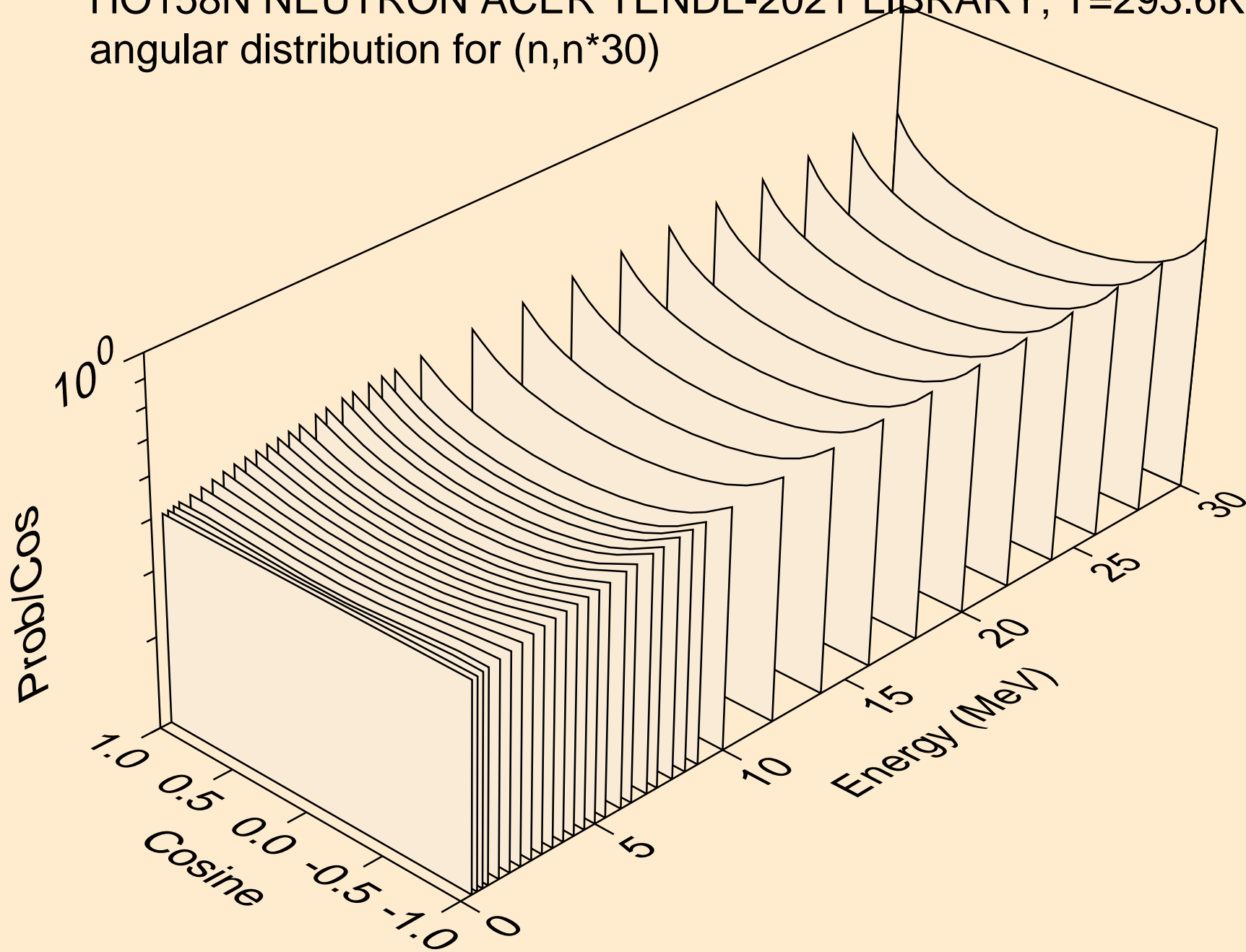

HO158N NEUTRON ACER TENDL-2021 LIBRARY; T=293.6K  
Neutron emission for (n,x)

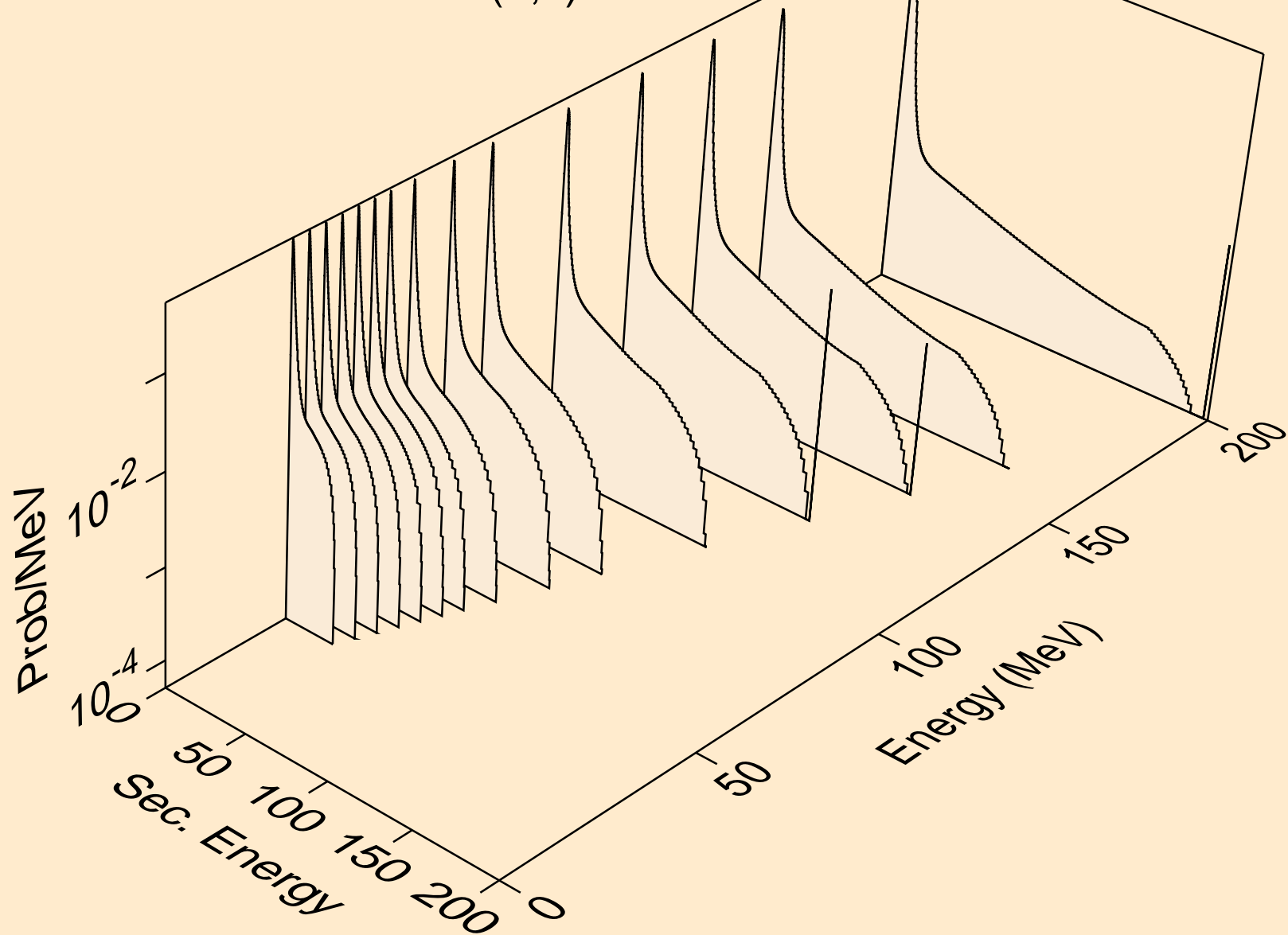

HO158N NEUTRON ACER TENDL-2021 LIBRARY; T=293.6K  
Neutron emission for (n,2nd)

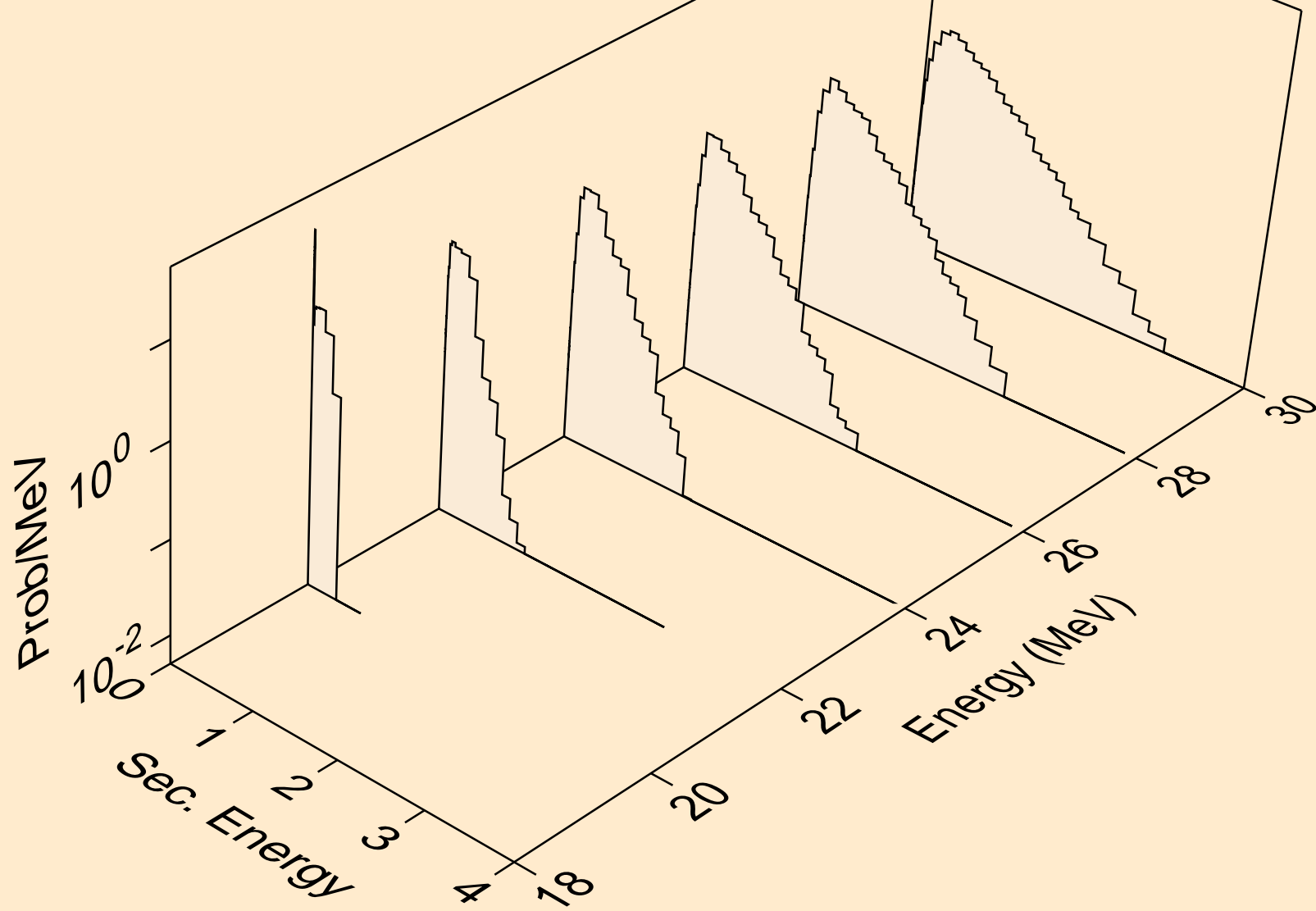

HO158N NEUTRON ACER TENDL-2021 LIBRARY; T=293.6K  
Neutron emission for (n,2n)

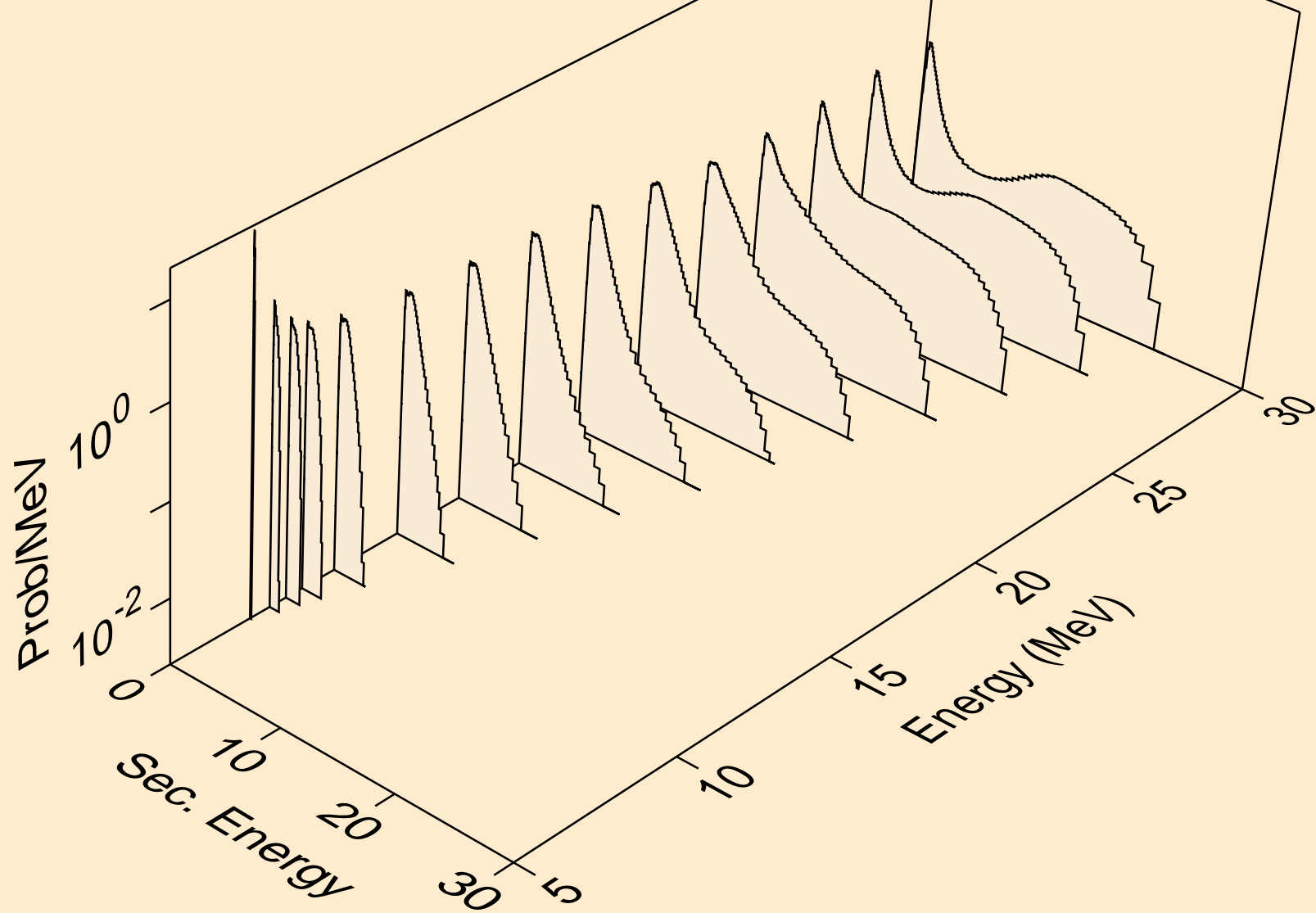



HO158N NEUTRON ACER TENDL-2021 LIBRARY; T=293.6K  
Neutron emission for (n,3n)

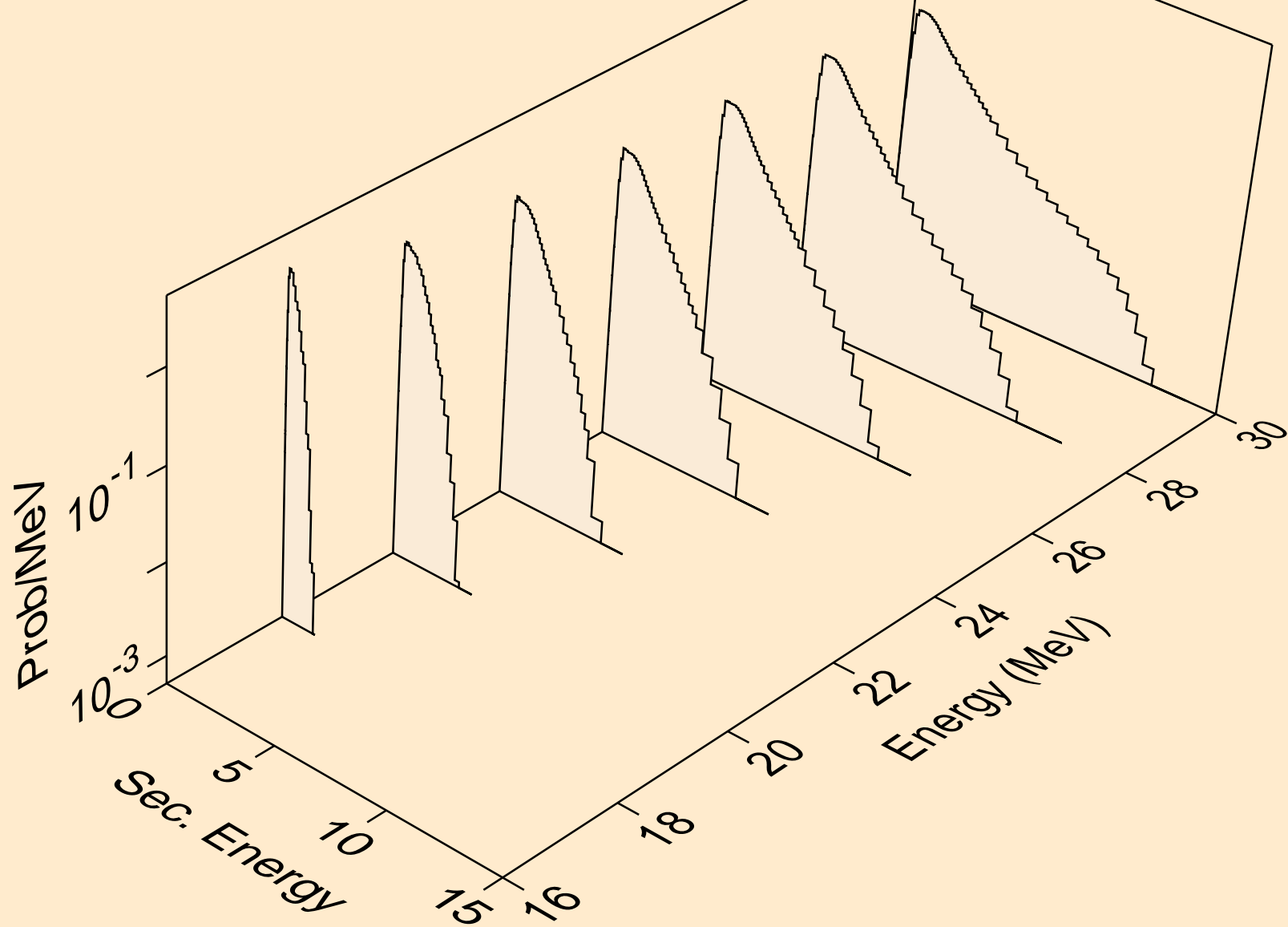

HO158N NEUTRON ACER TENDL-2021 LIBRARY; T=293.6K  
Neutron emission for (n,n\*)a

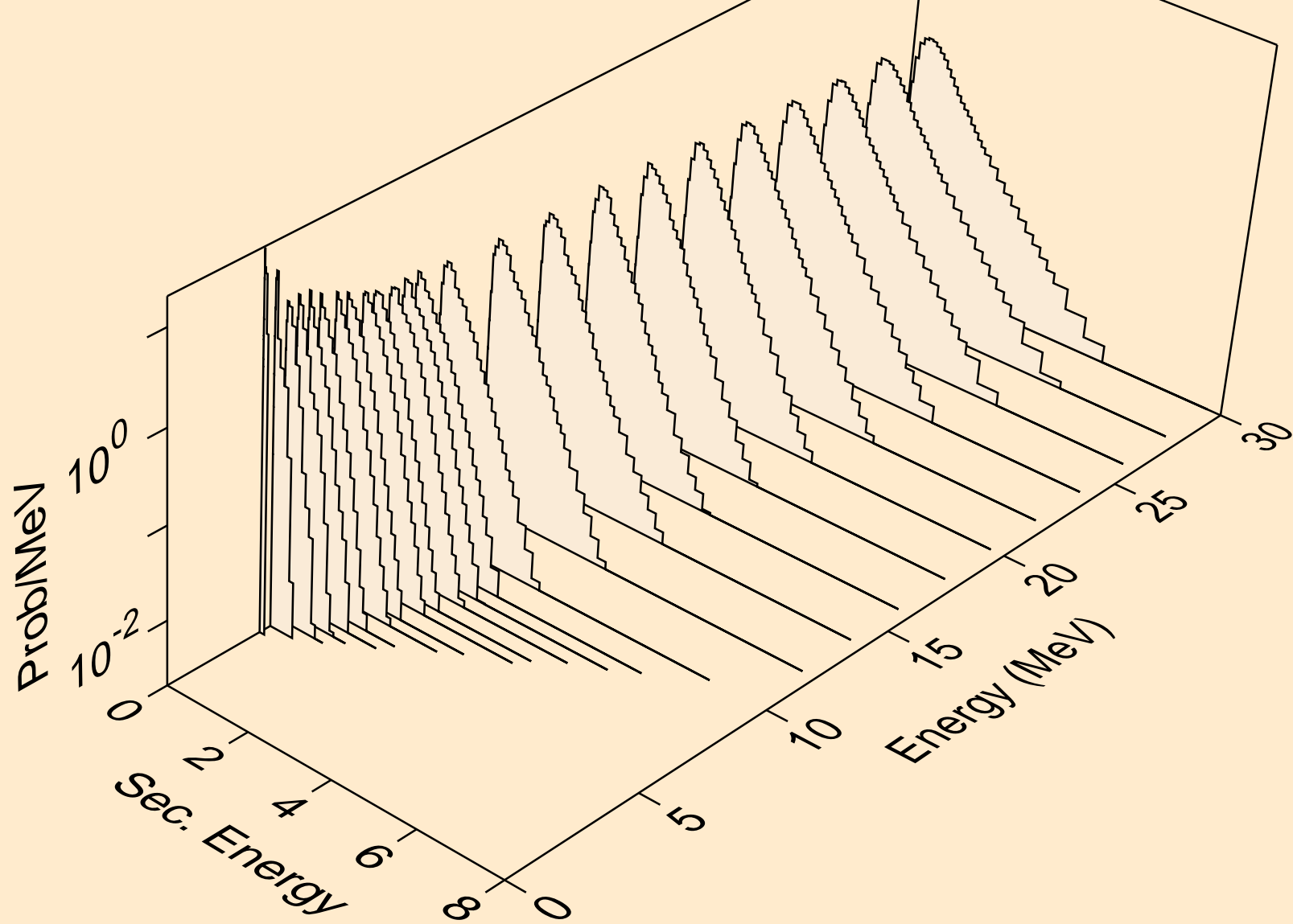

HO158N NEUTRON ACER TENDL-2021 LIBRARY; T=293.6K  
Neutron emission for (n,2n)a

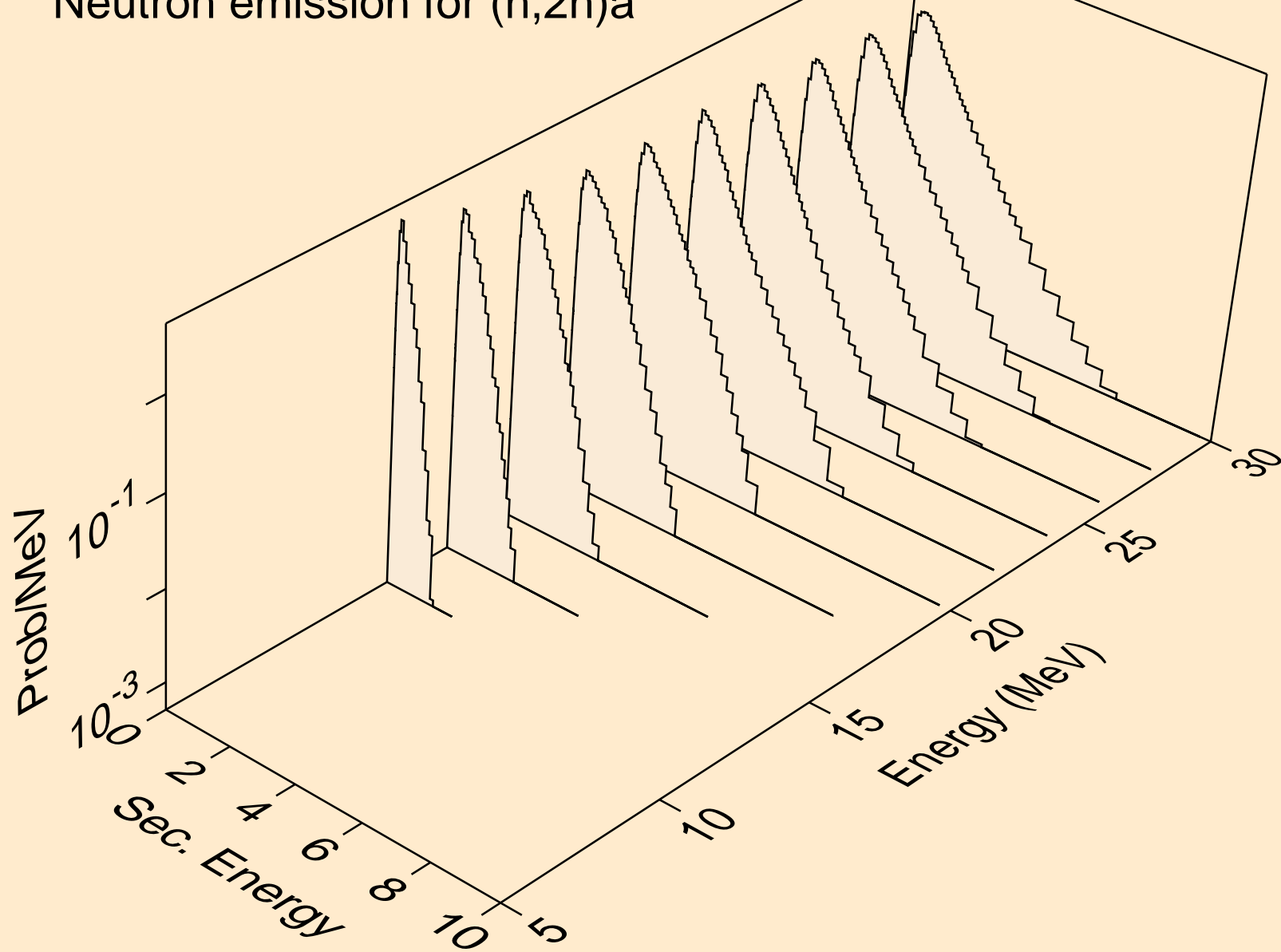

HO158N NEUTRON ACER TENDL-2021 LIBRARY; T=293.6K  
Neutron emission for (n,3n)a

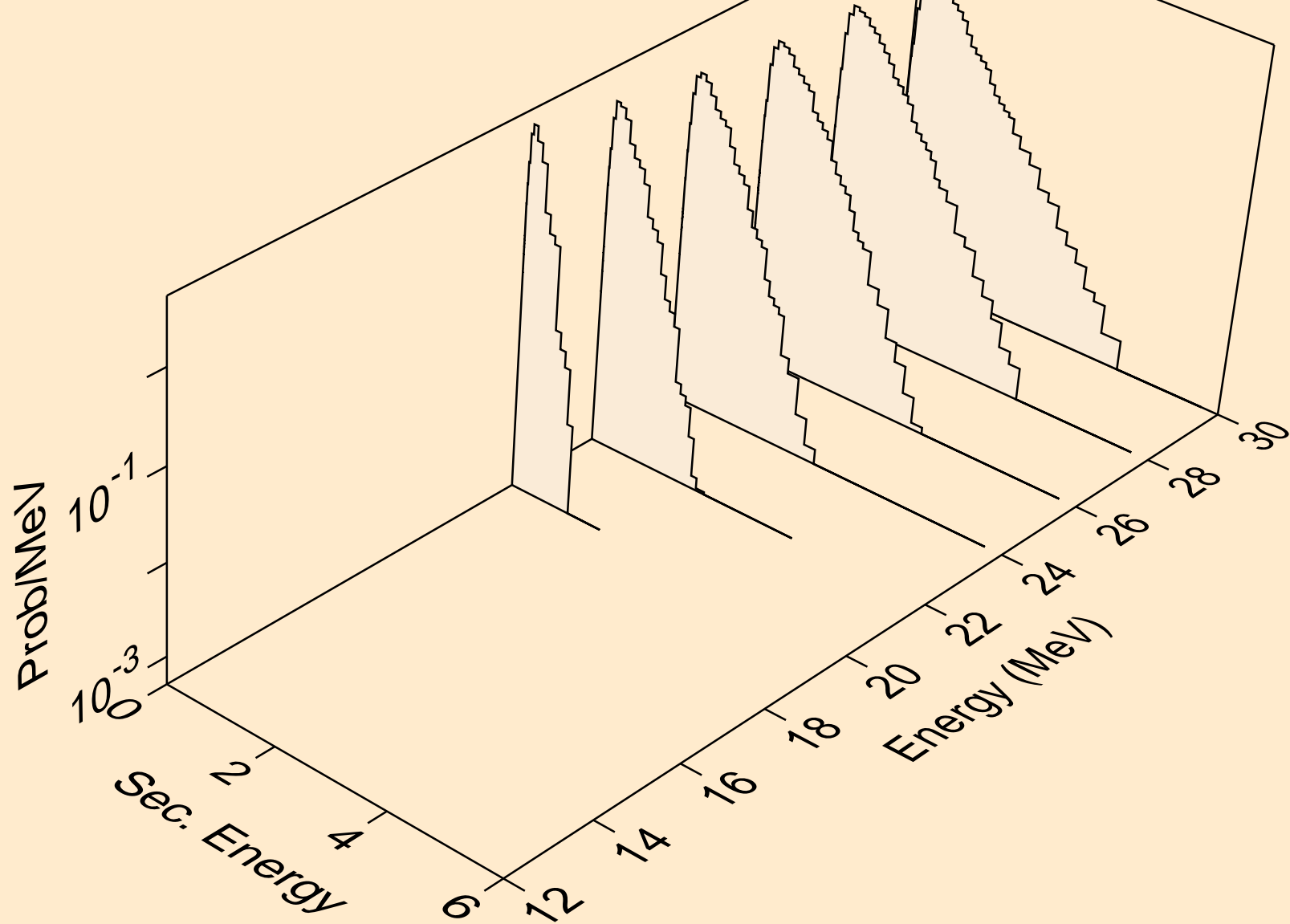

HO158N NEUTRON ACER TENDL-2021 LIBRARY; T=293.6K  
Neutron emission for (n,n\*)p

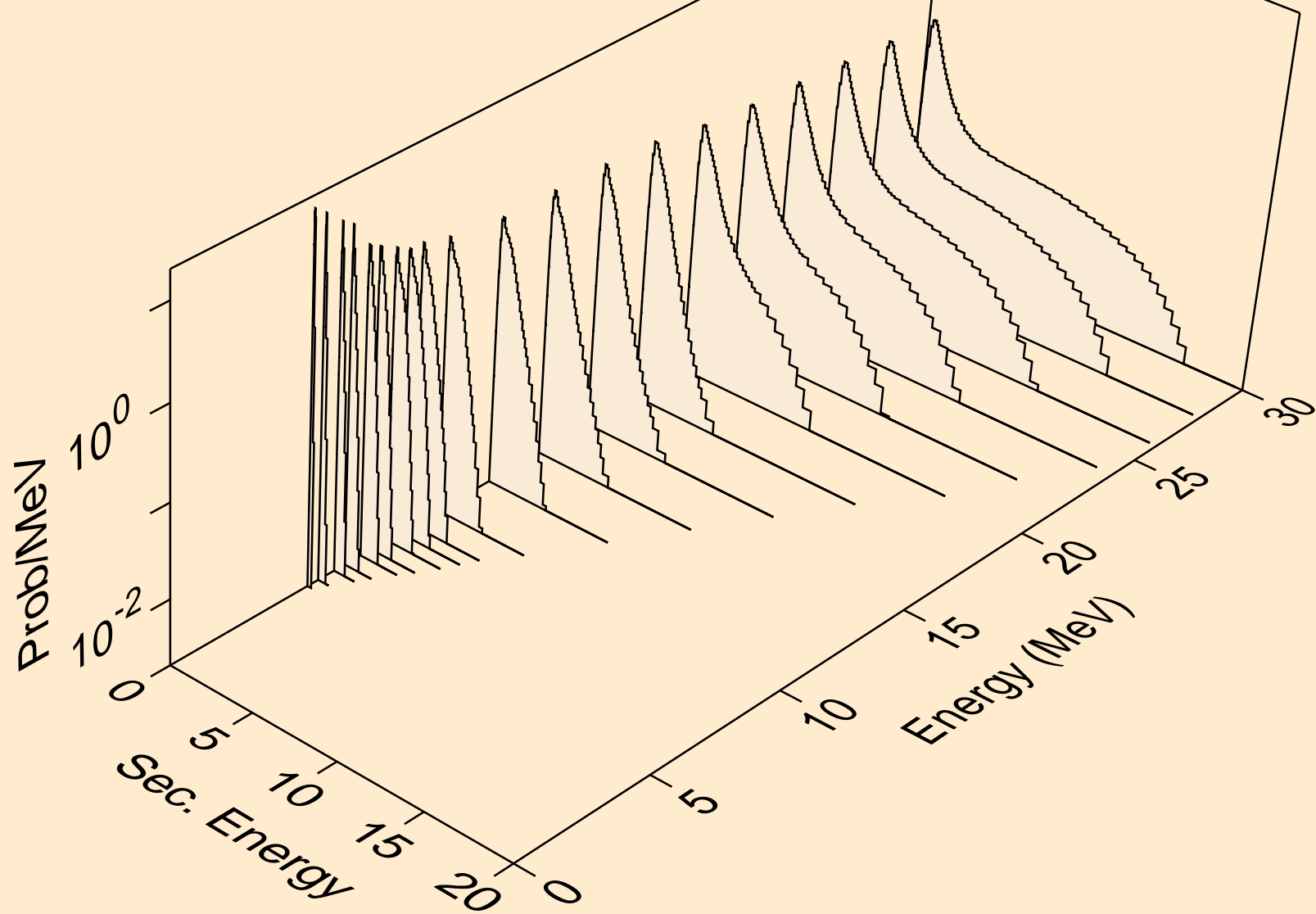

HO158N NEUTRON ACER TENDL-2021 LIBRARY; T=293.6K  
Neutron emission for (n,n\*)2a

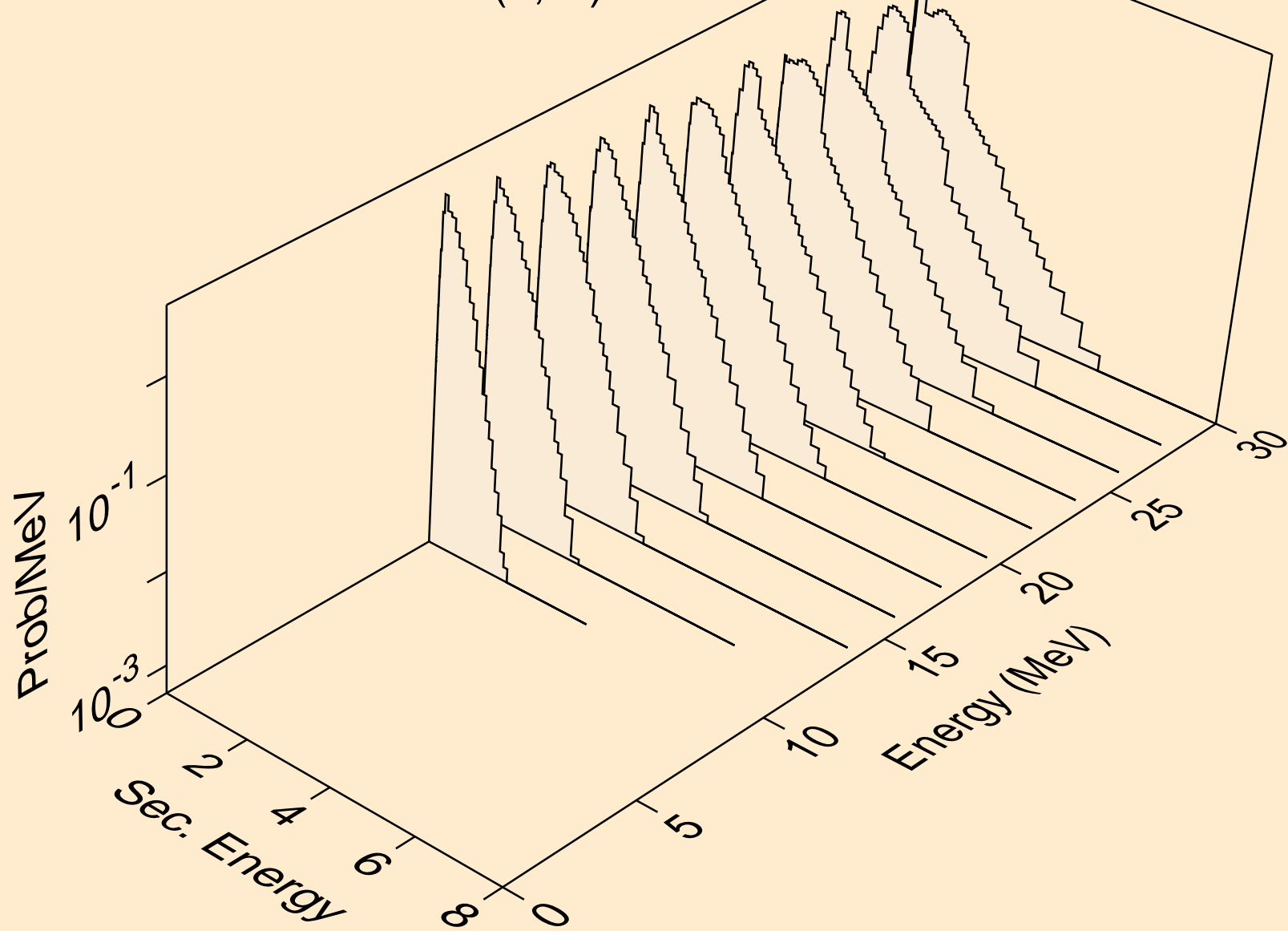

HO158N NEUTRON ACER TENDL-2021 LIBRARY; T=293.6K  
Neutron emission for (n,2n)2a

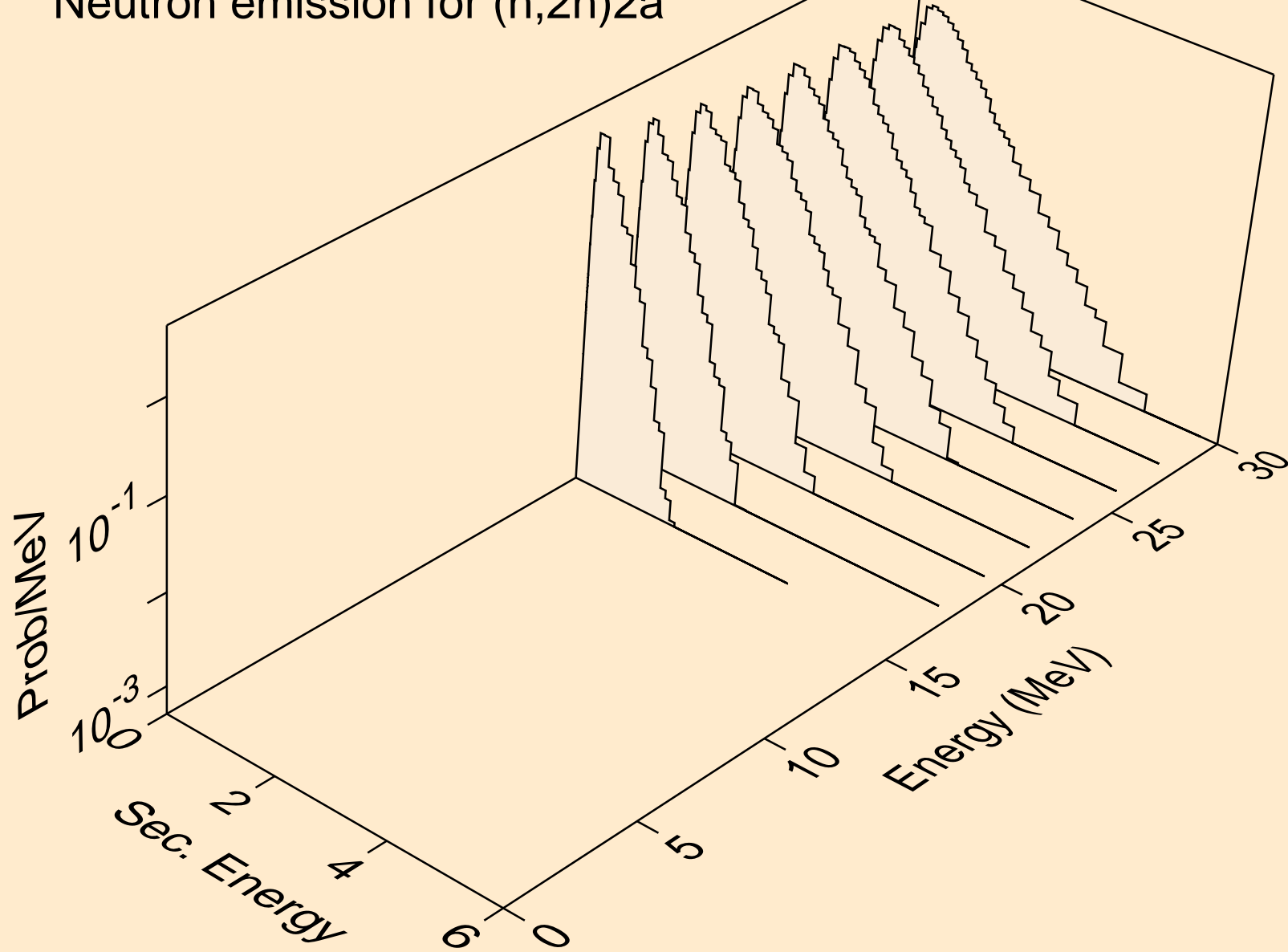

HO158N NEUTRON ACER TENDL-2021 LIBRARY; T=293.6K  
Neutron emission for (n,n\*)d

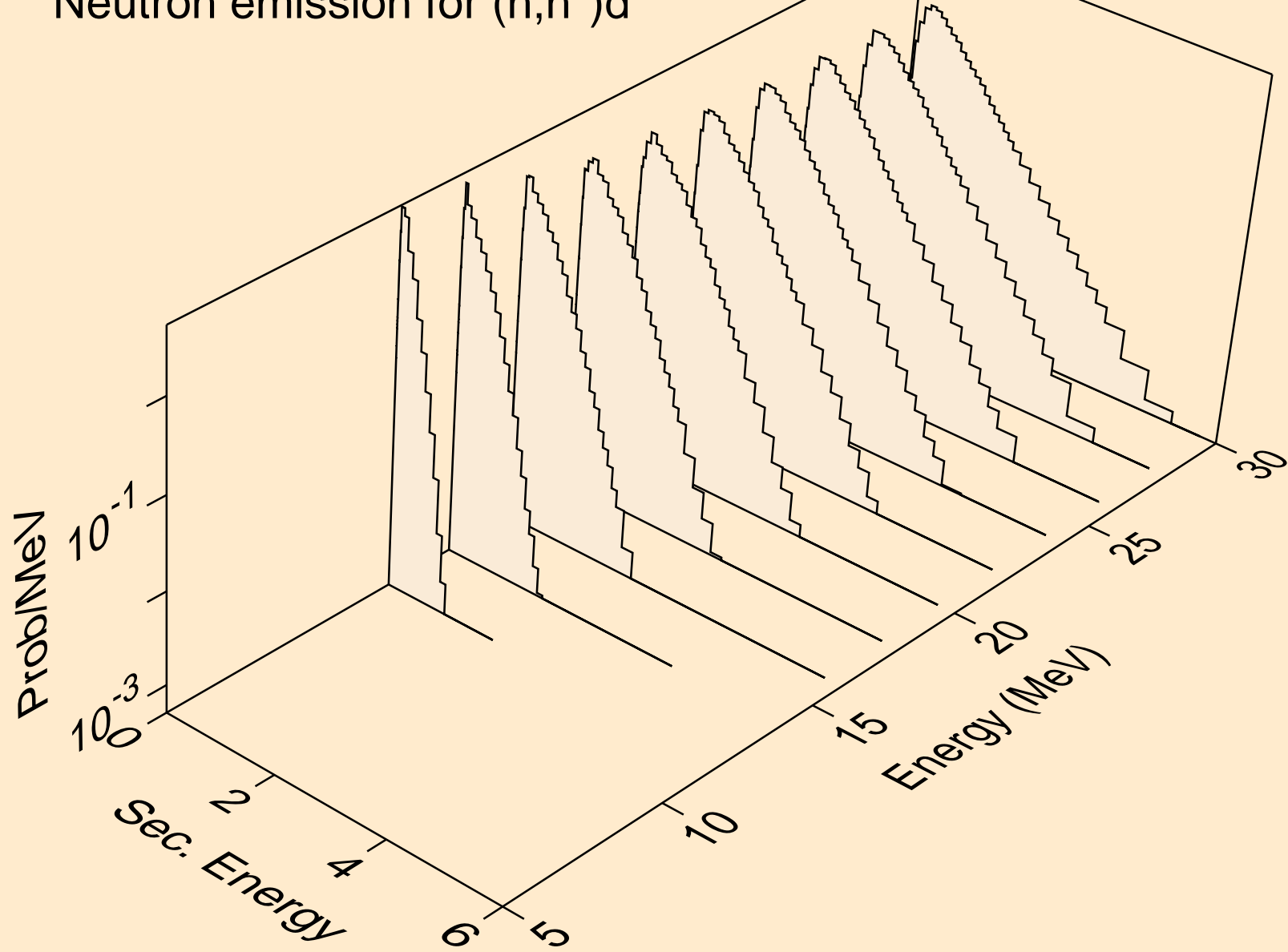



HO158N NEUTRON ACER TENDL-2021 LIBRARY; T=293.6K  
Neutron emission for (n,n\*)t

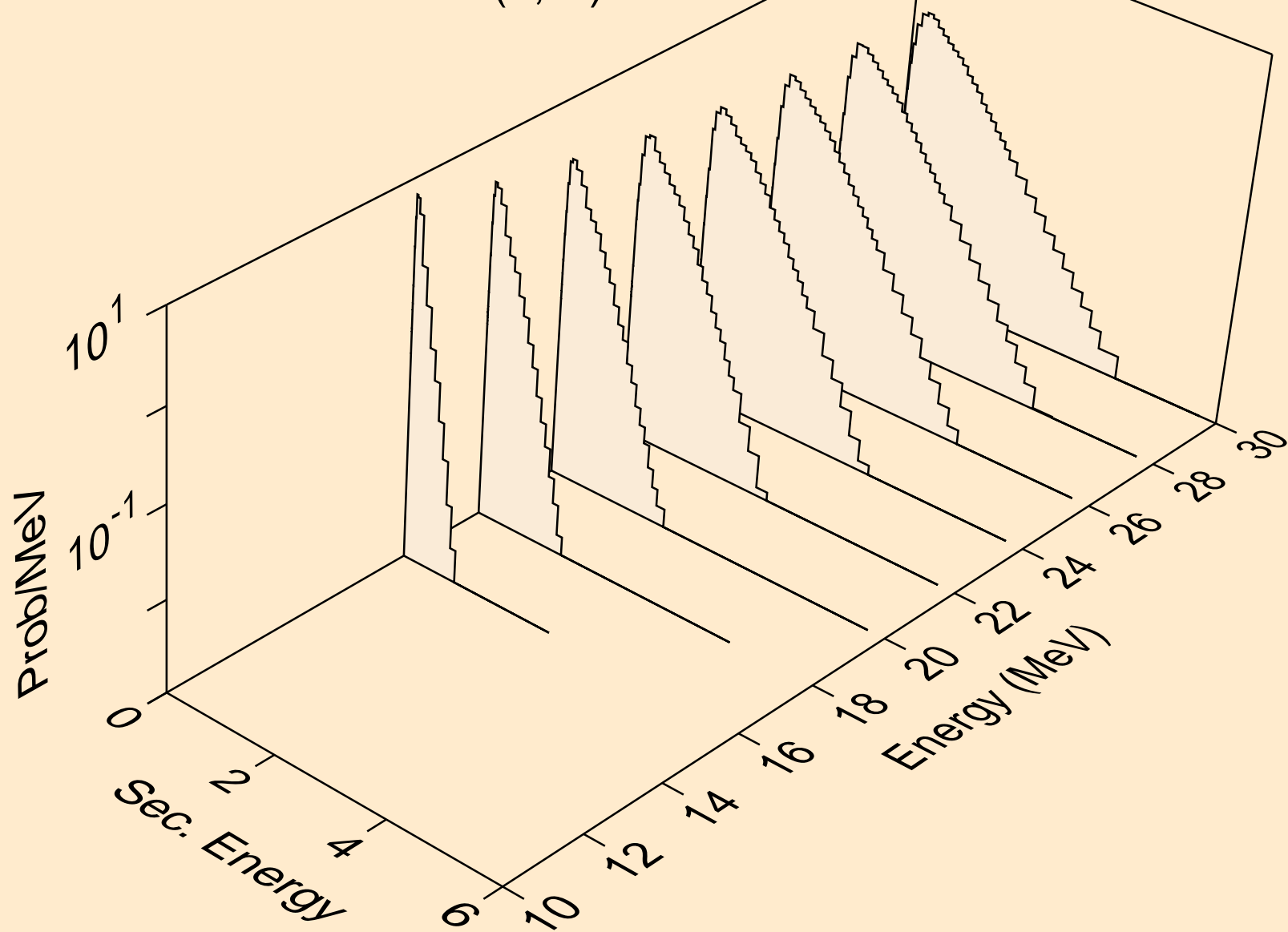

HO158N NEUTRON ACER TENDL-2021 LIBRARY; T=293.6K  
Neutron emission for (n,n\*)he3

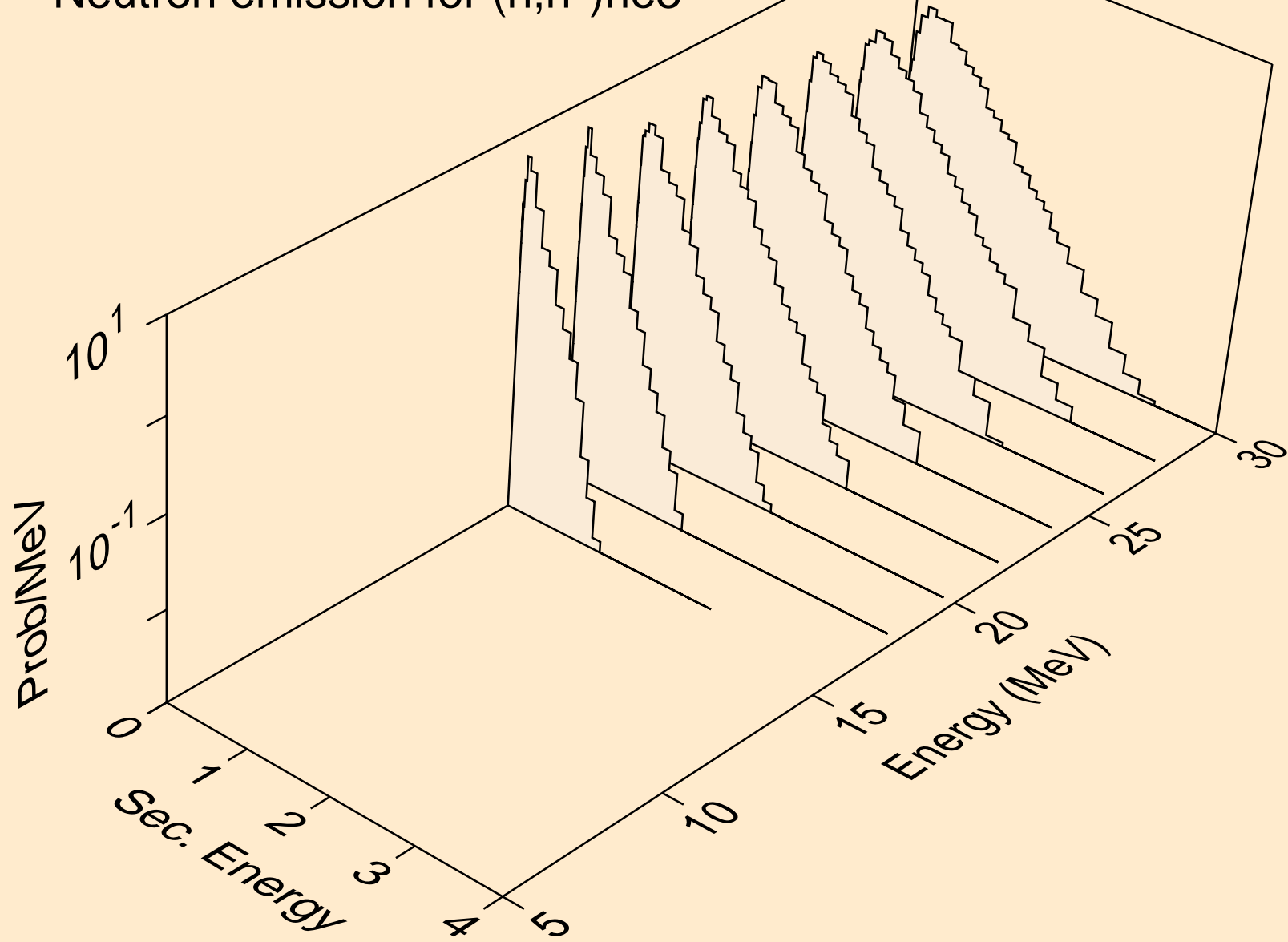

HO158N NEUTRON ACER TENDL-2021 LIBRARY; T=293.6K  
Neutron emission for (n,4n)

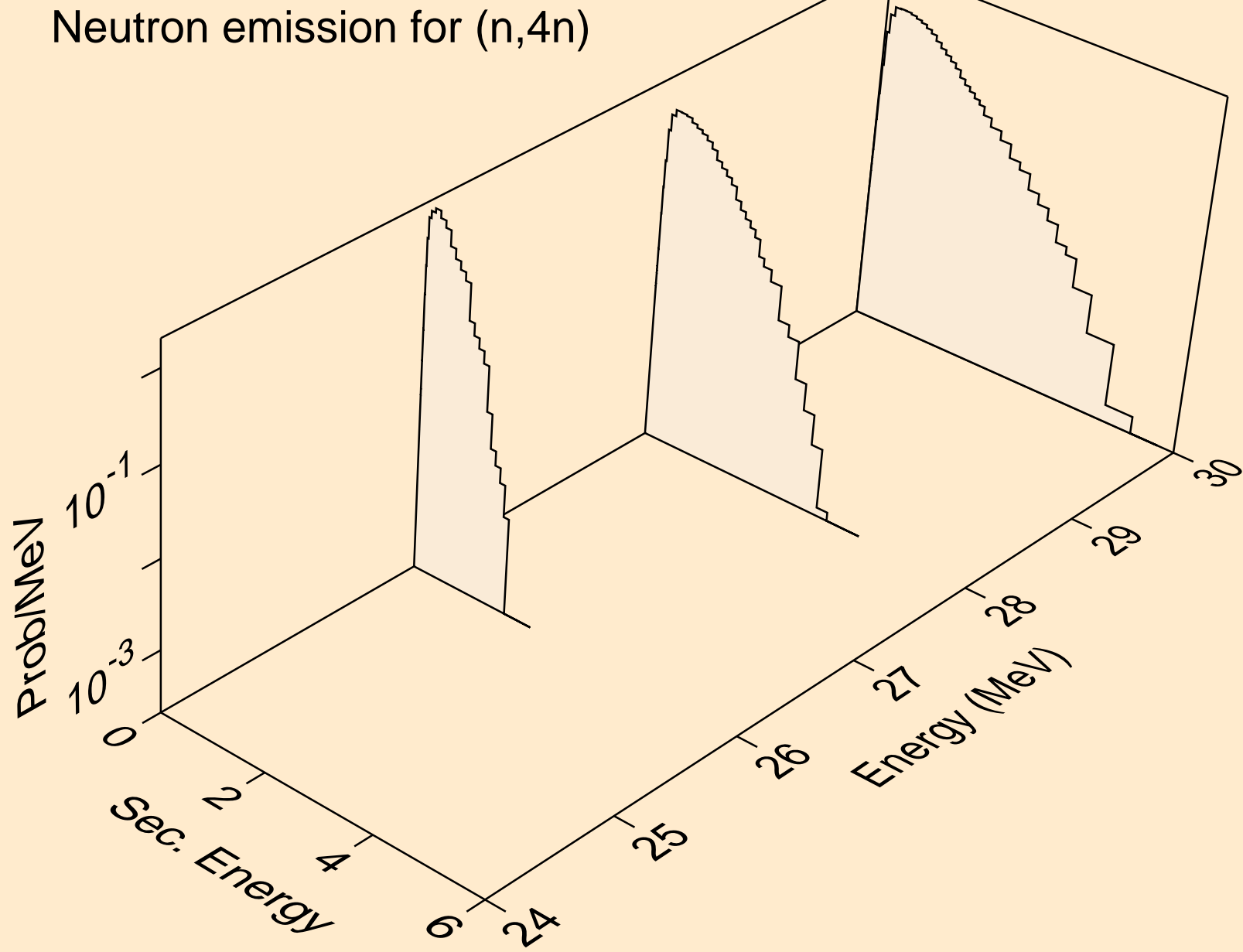

HO158N NEUTRON ACER TENDL-2021 LIBRARY; T=293.6K  
Neutron emission for (n,2np)

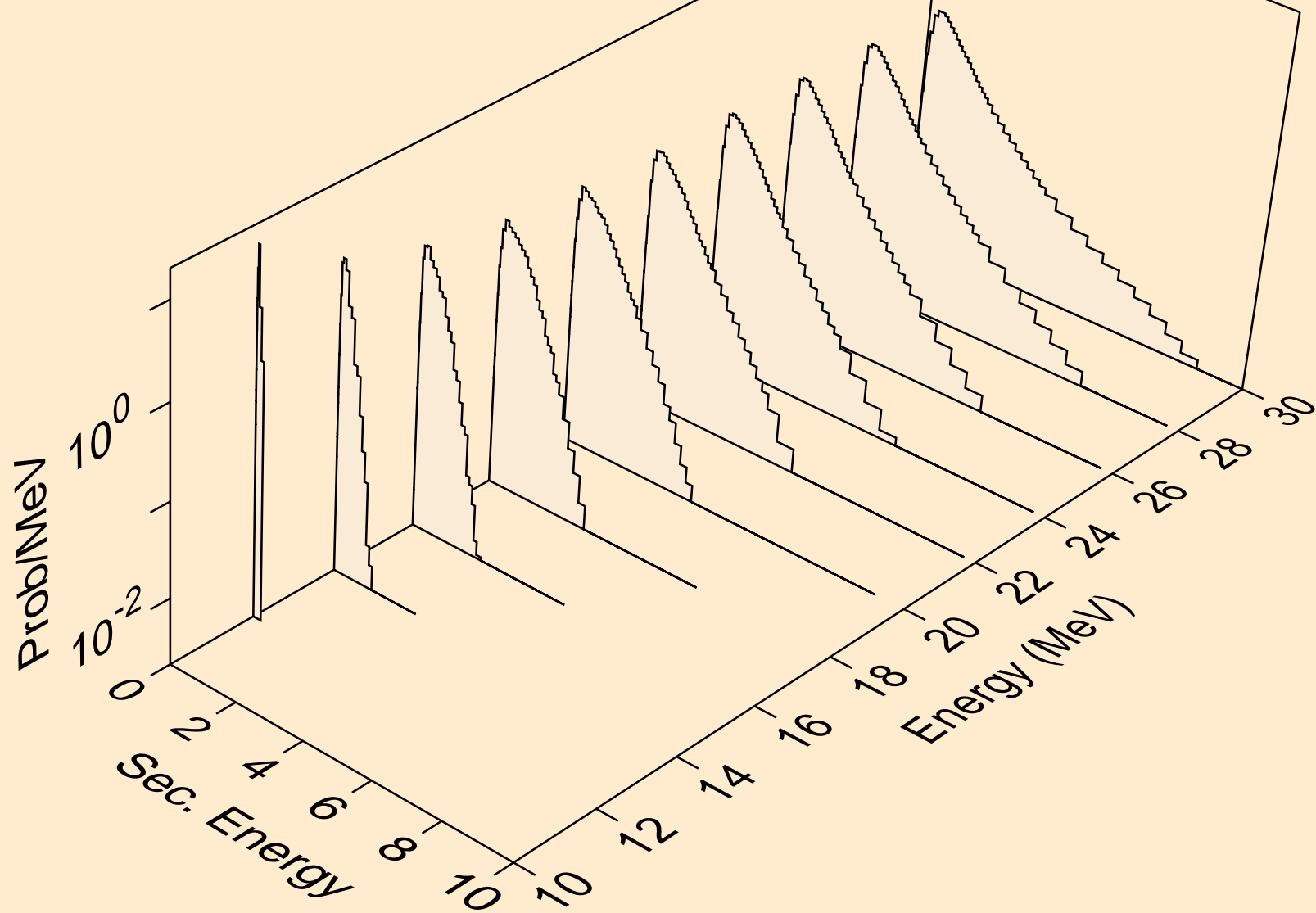

HO158N NEUTRON ACER TENDL-2021 LIBRARY; T=293.6K  
Neutron emission for (n,3np)

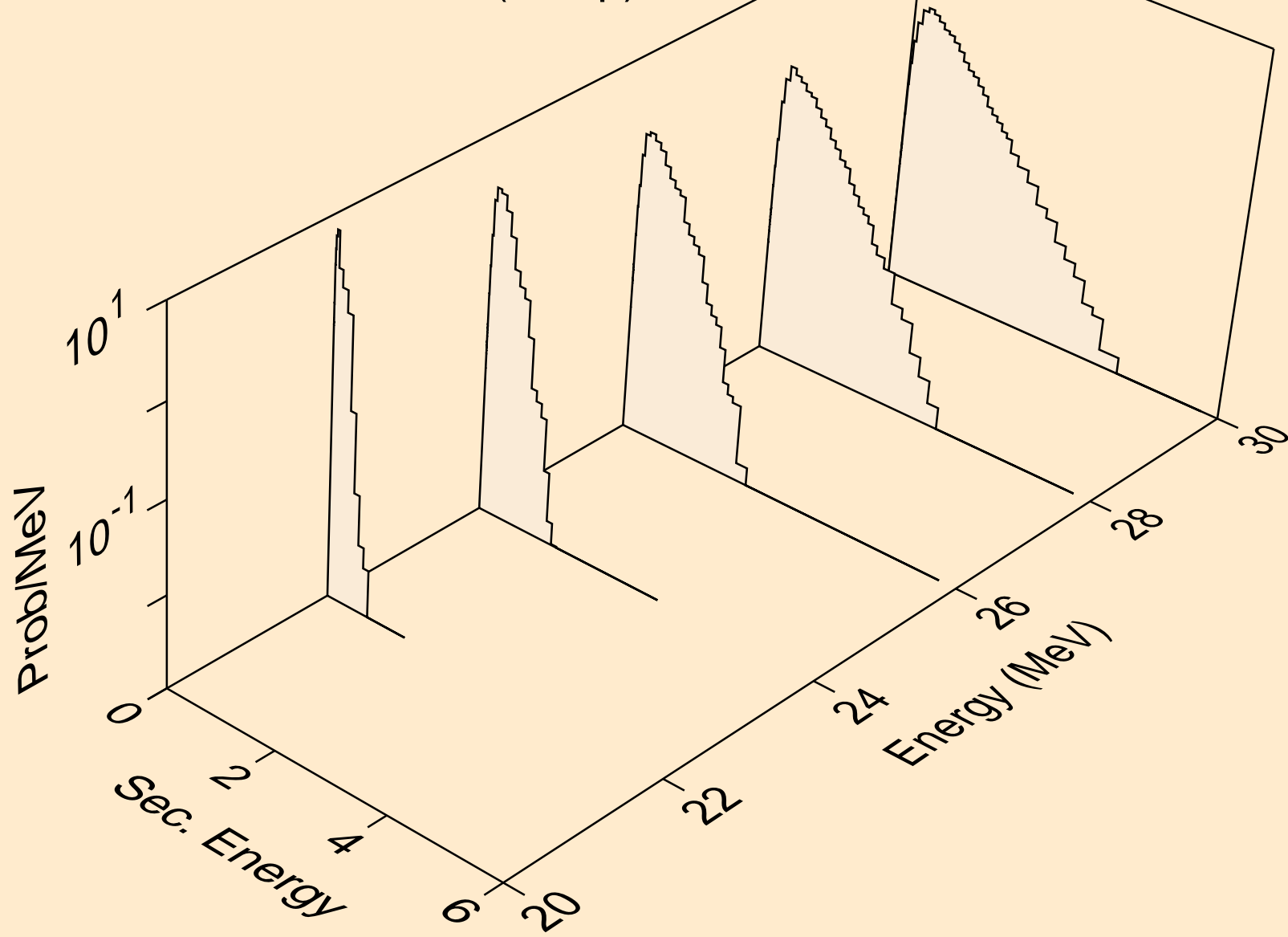

HO158N NEUTRON ACER TENDL-2021 LIBRARY; T=293.6K  
Neutron emission for (n,2np)

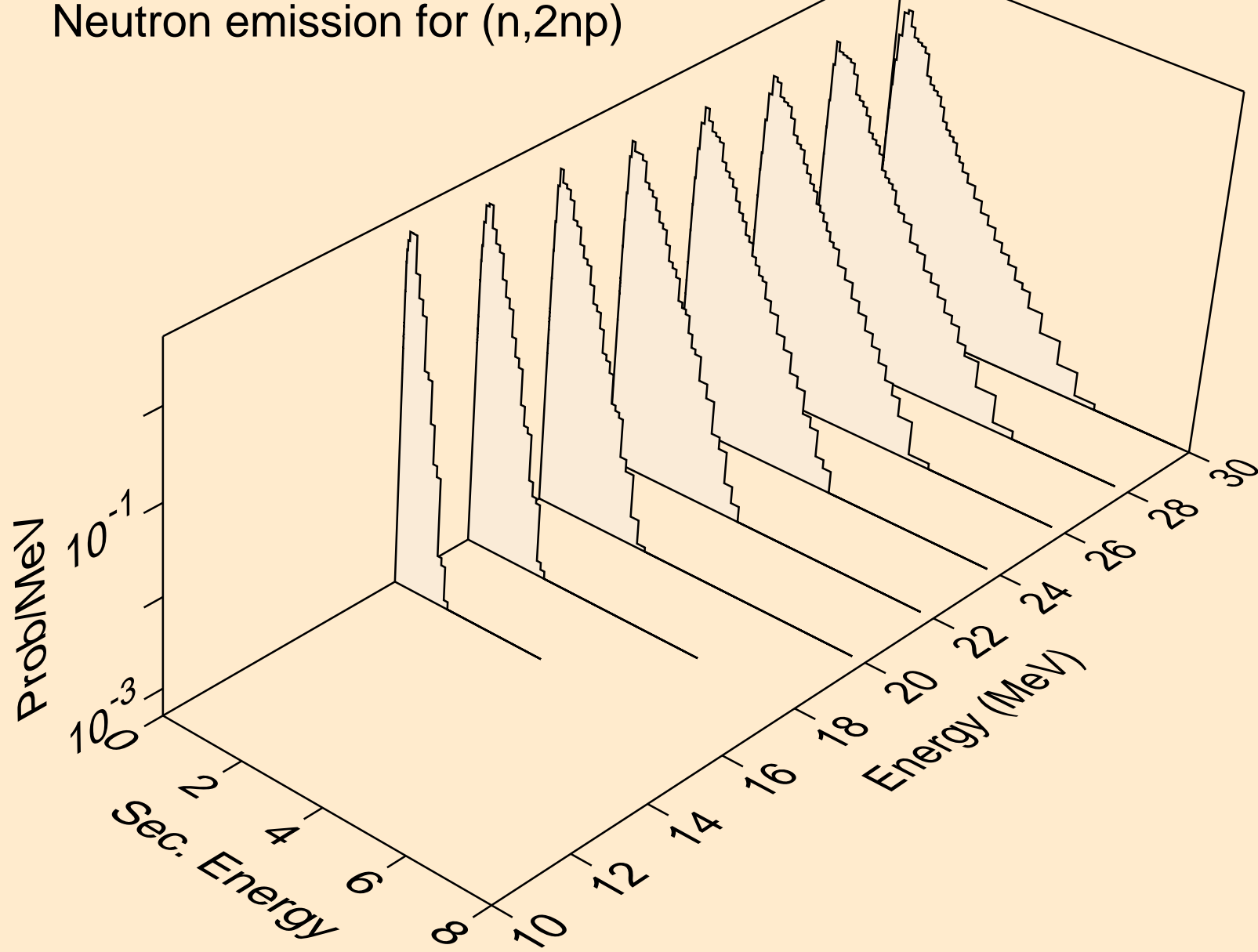

HO158N NEUTRON ACER TENDL-2021 LIBRARY; T=293.6K  
Neutron emission for (n,npa)

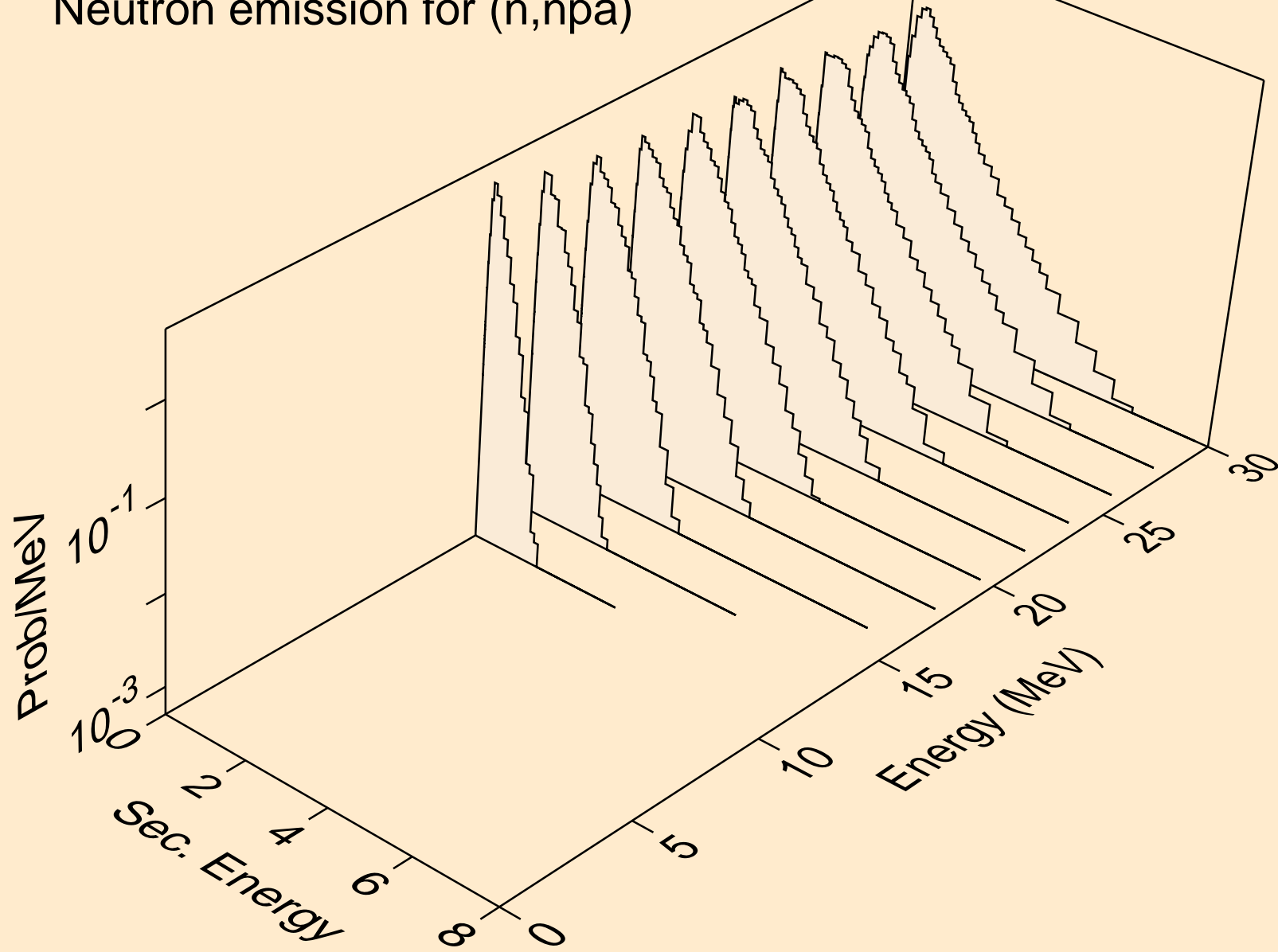

HO158N NEUTRON ACER TENDL-2021 LIBRARY; T=293.6K  
Neutron emission for (n,n\*c)

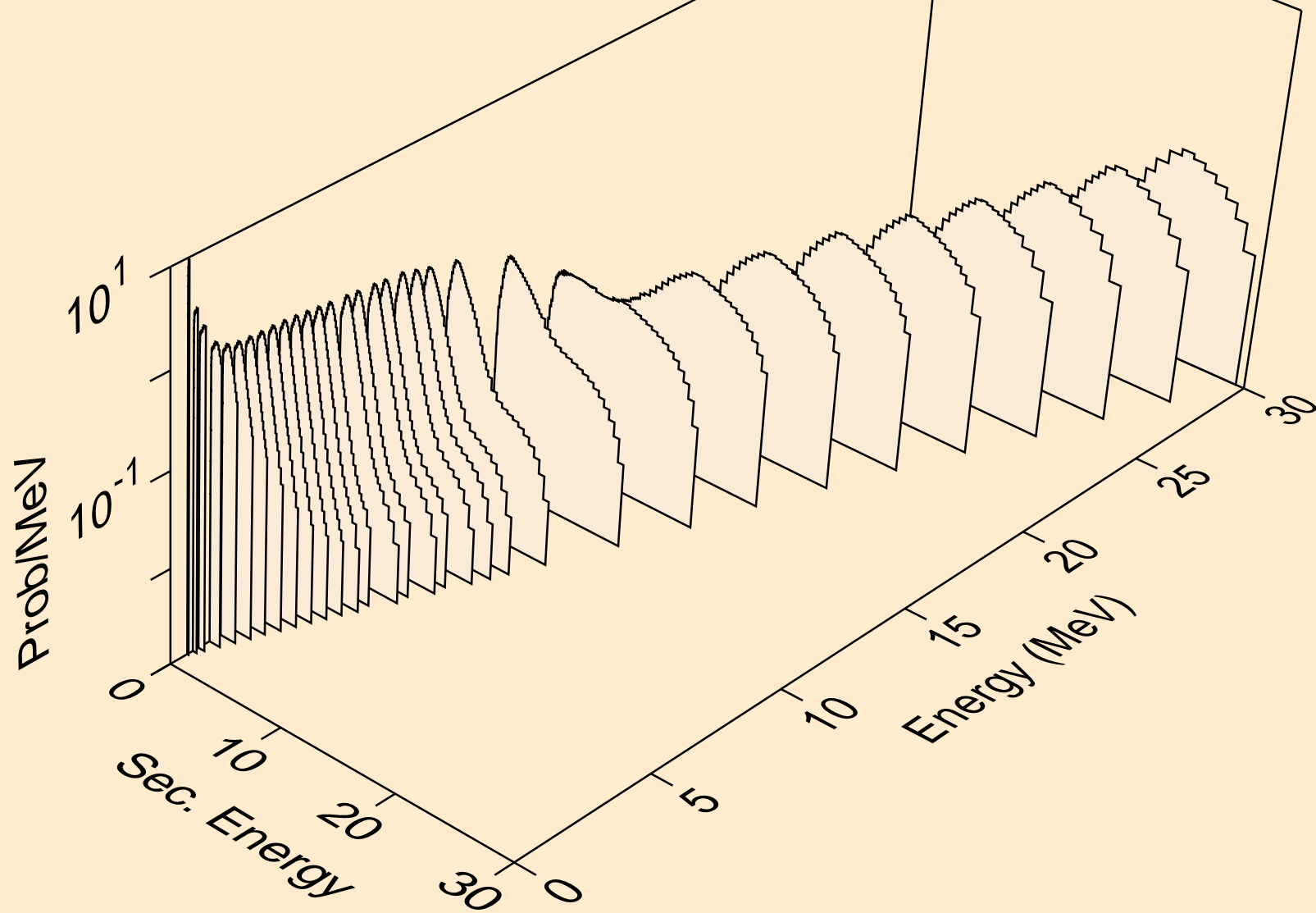



HO158N NEUTRON ACER TENDL-2021 LIBRARY; T=293.6K  
Photon emission for (n,x)

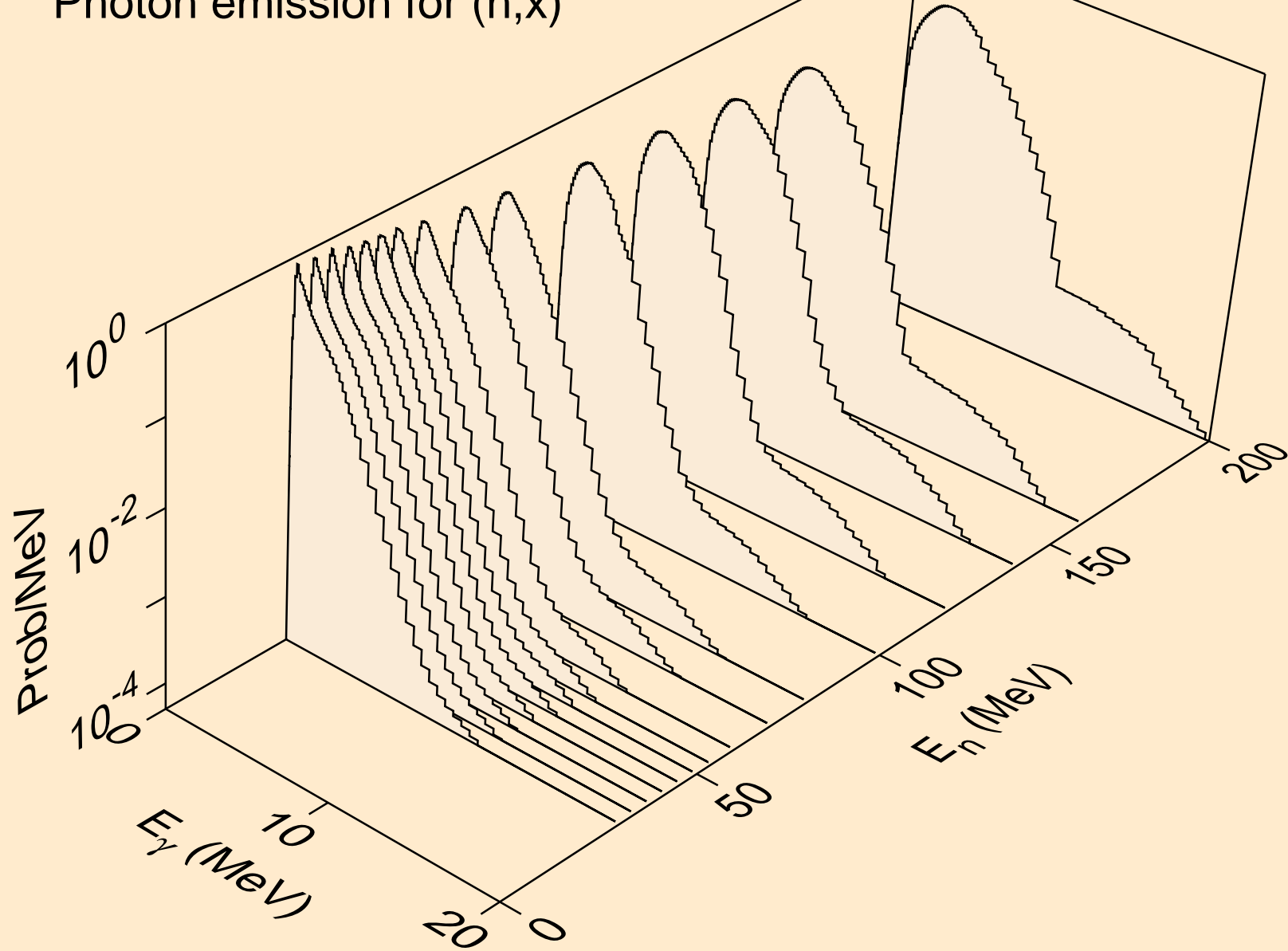

HO158N NEUTRON ACER TENDL-2021 LIBRARY; T=293.6K  
Photon emission for (n,2nd)

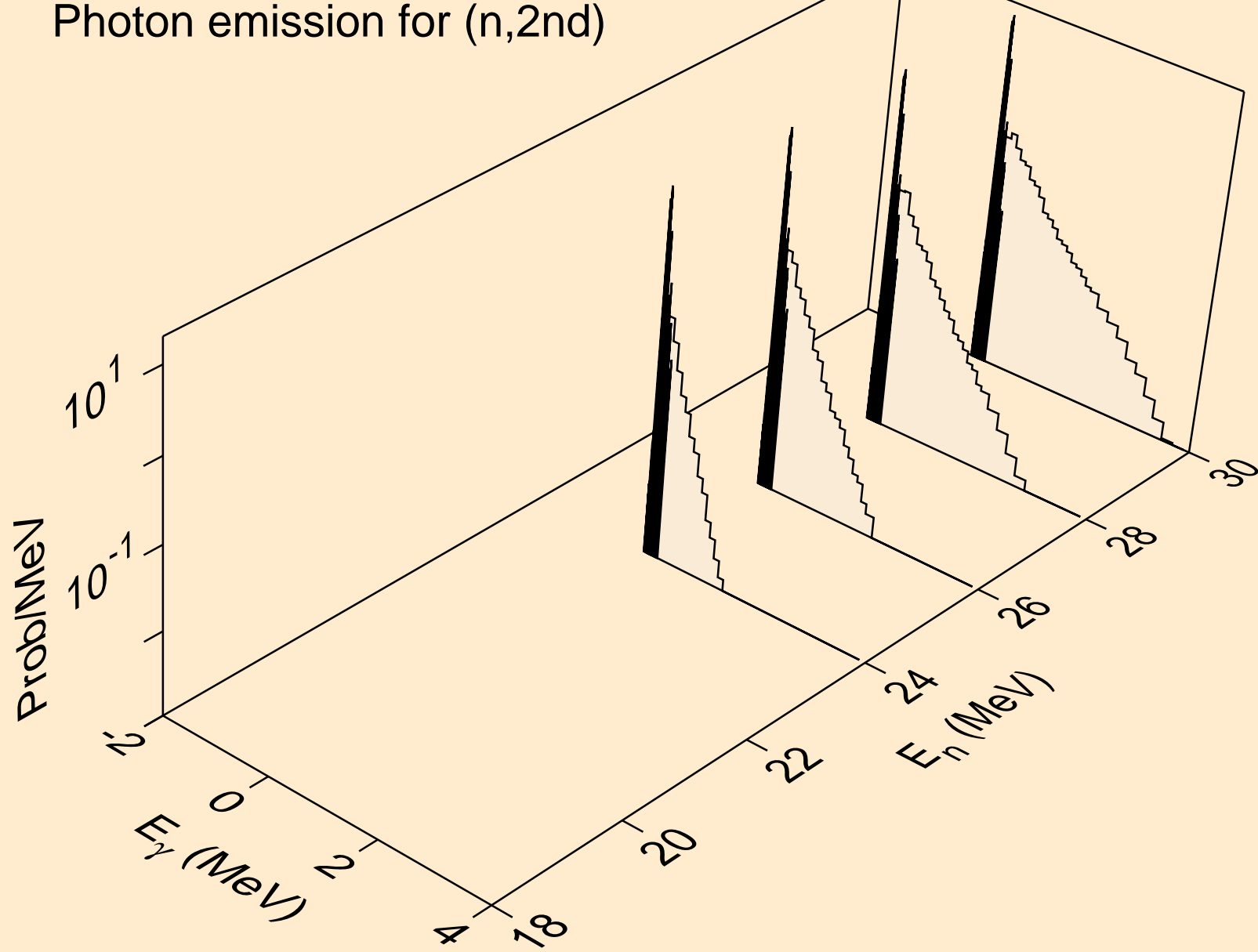

HO158N NEUTRON ACER TENDL-2021 LIBRARY; T=293.6K  
Photon emission for (n,2n)

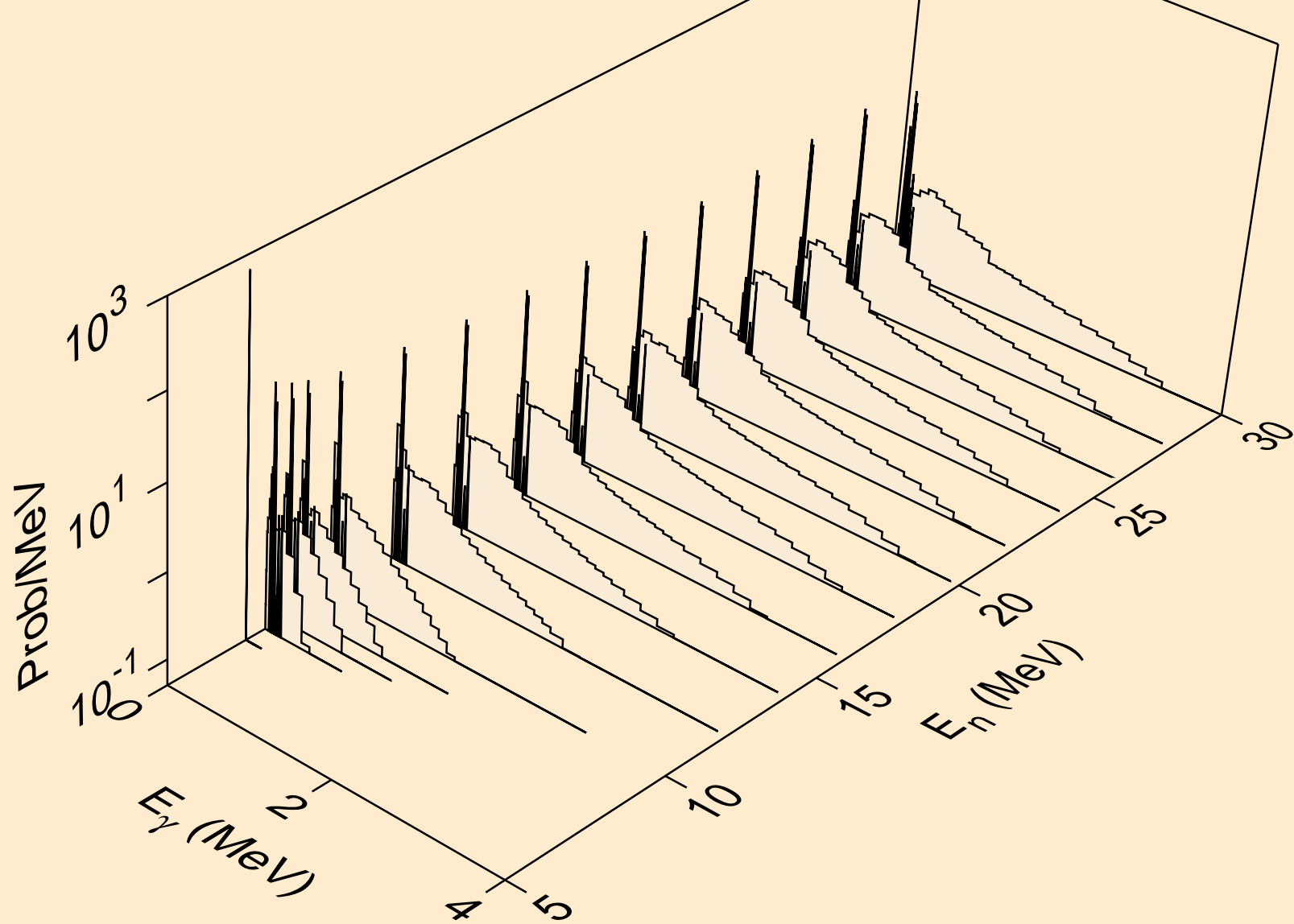

HO158N NEUTRON ACER TENDL-2021 LIBRARY; T=293.6K  
Photon emission for (n,3n)

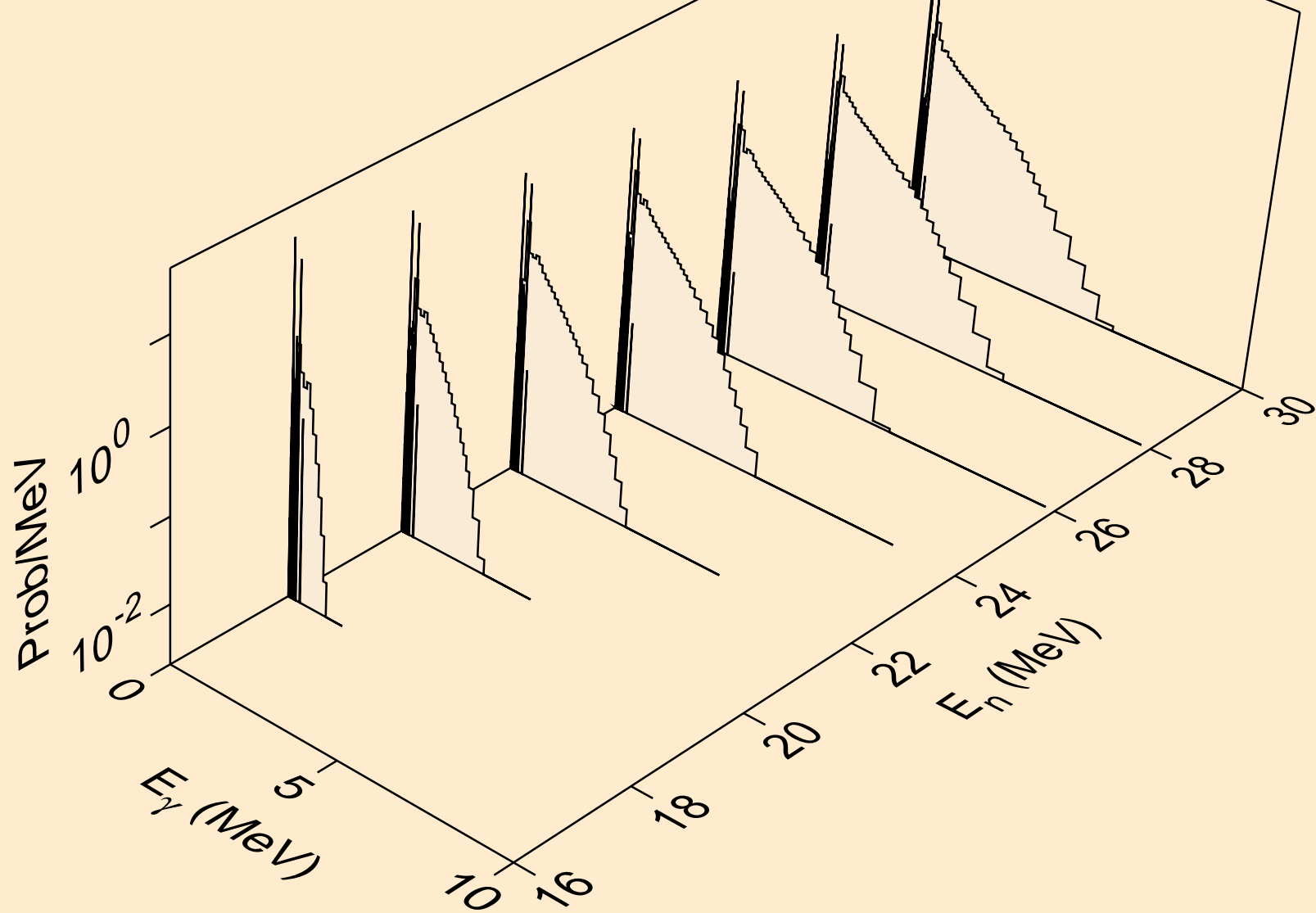

HO158N NEUTRON ACER TENDL-2021 LIBRARY; T=293.6K  
Photon emission for (n,n\*)a

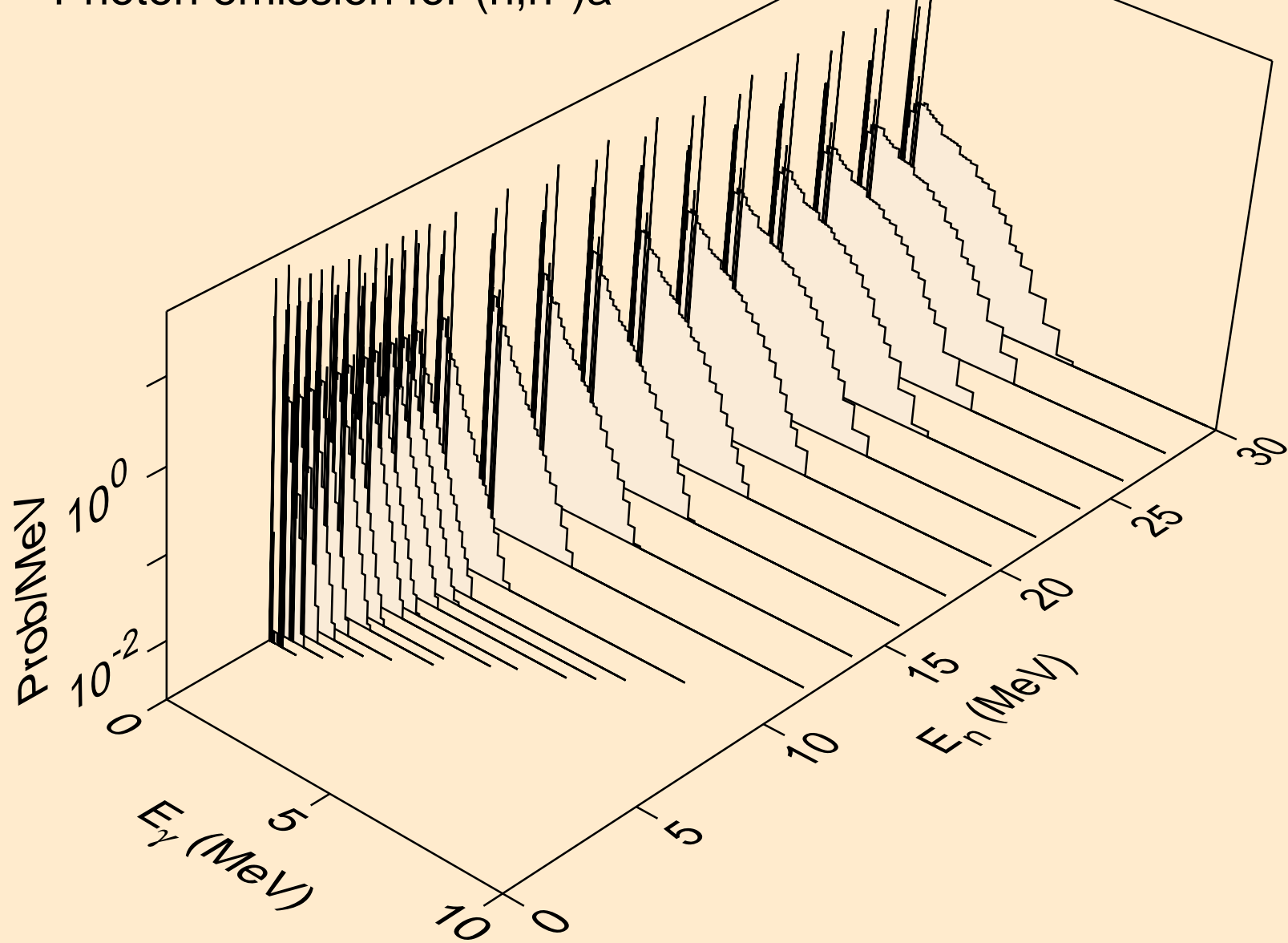

HO158N NEUTRON ACER TENDL-2021 LIBRARY; T=293.6K  
Photon emission for (n,2n)a

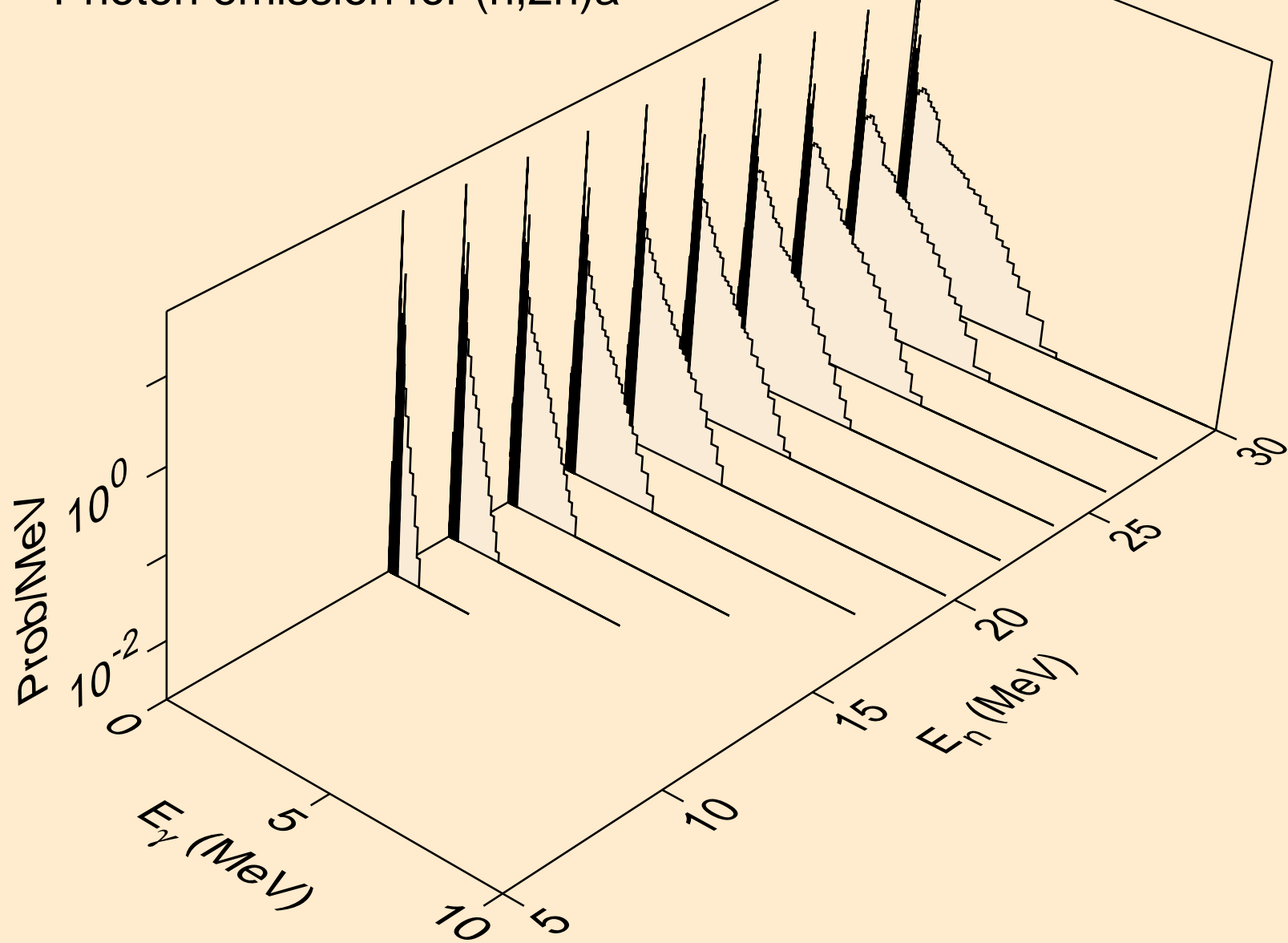

HO158N NEUTRON ACER TENDL-2021 LIBRARY; T=293.6K  
Photon emission for (n,3n)a

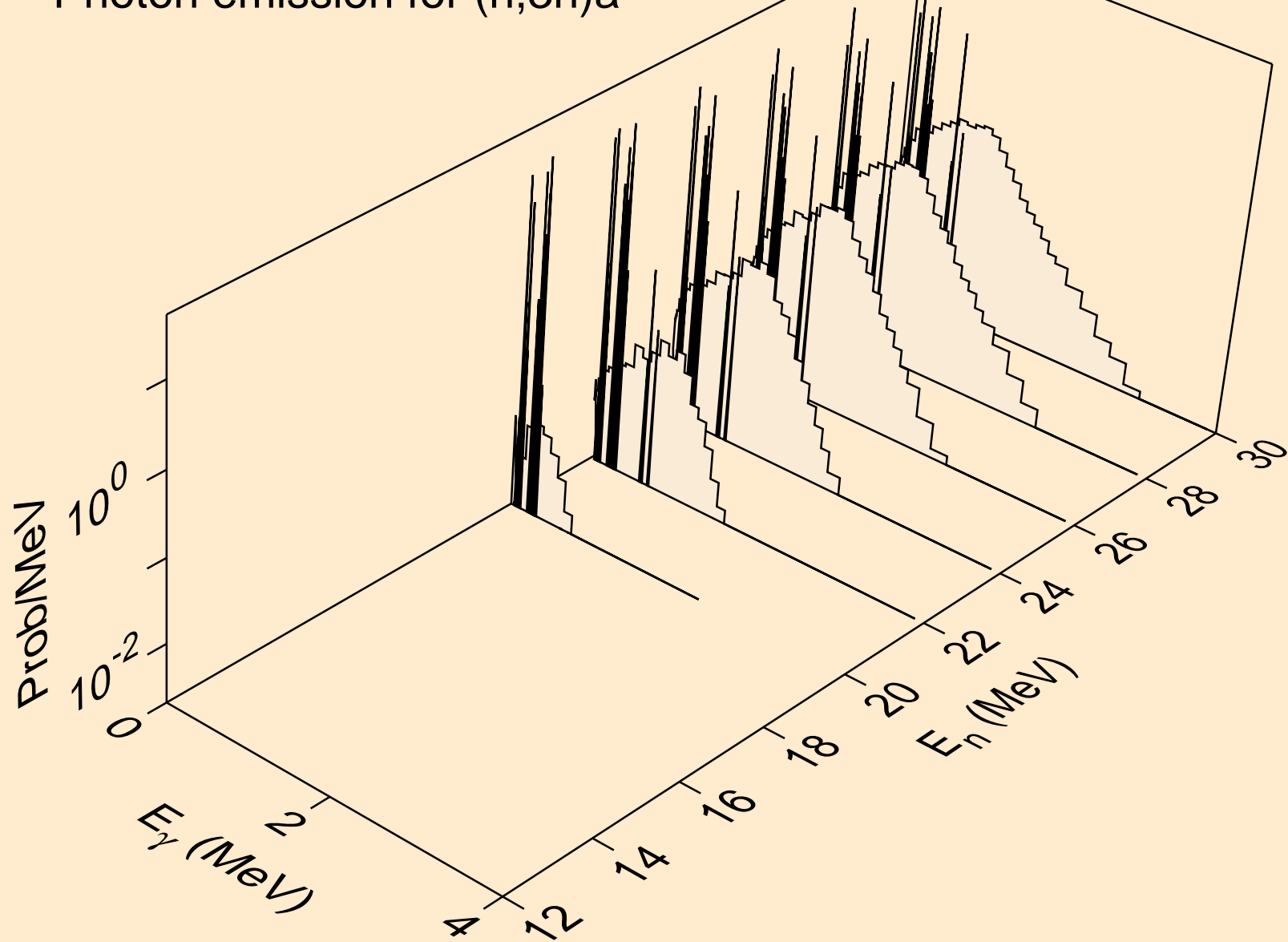

HO158N NEUTRON ACER TENDL-2021 LIBRARY; T=293.6K  
Photon emission for (n,n\*)p

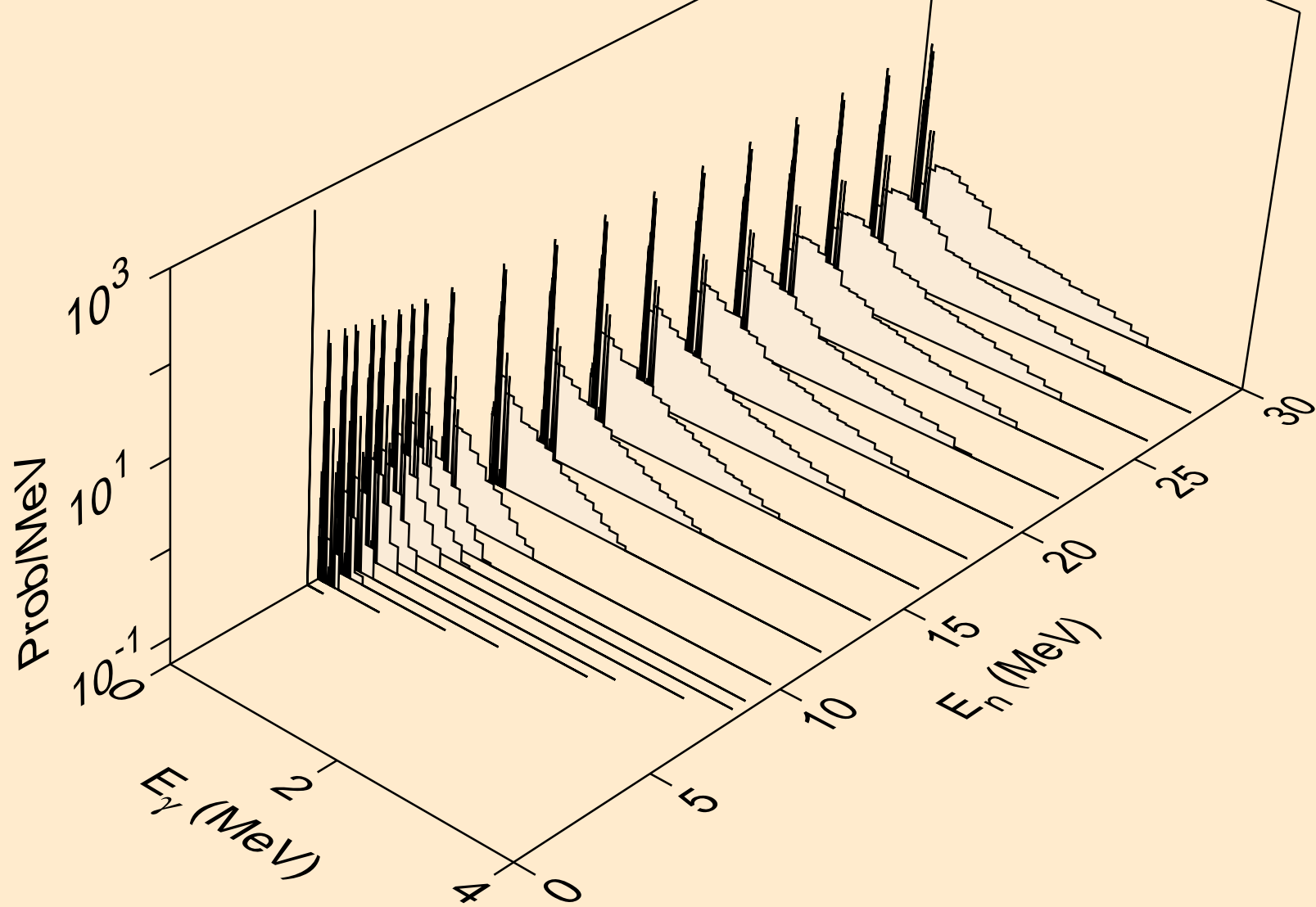



HO158N NEUTRON ACER TENDL-2021 LIBRARY; T=293.6K  
Photon emission for (n,n\*)2a

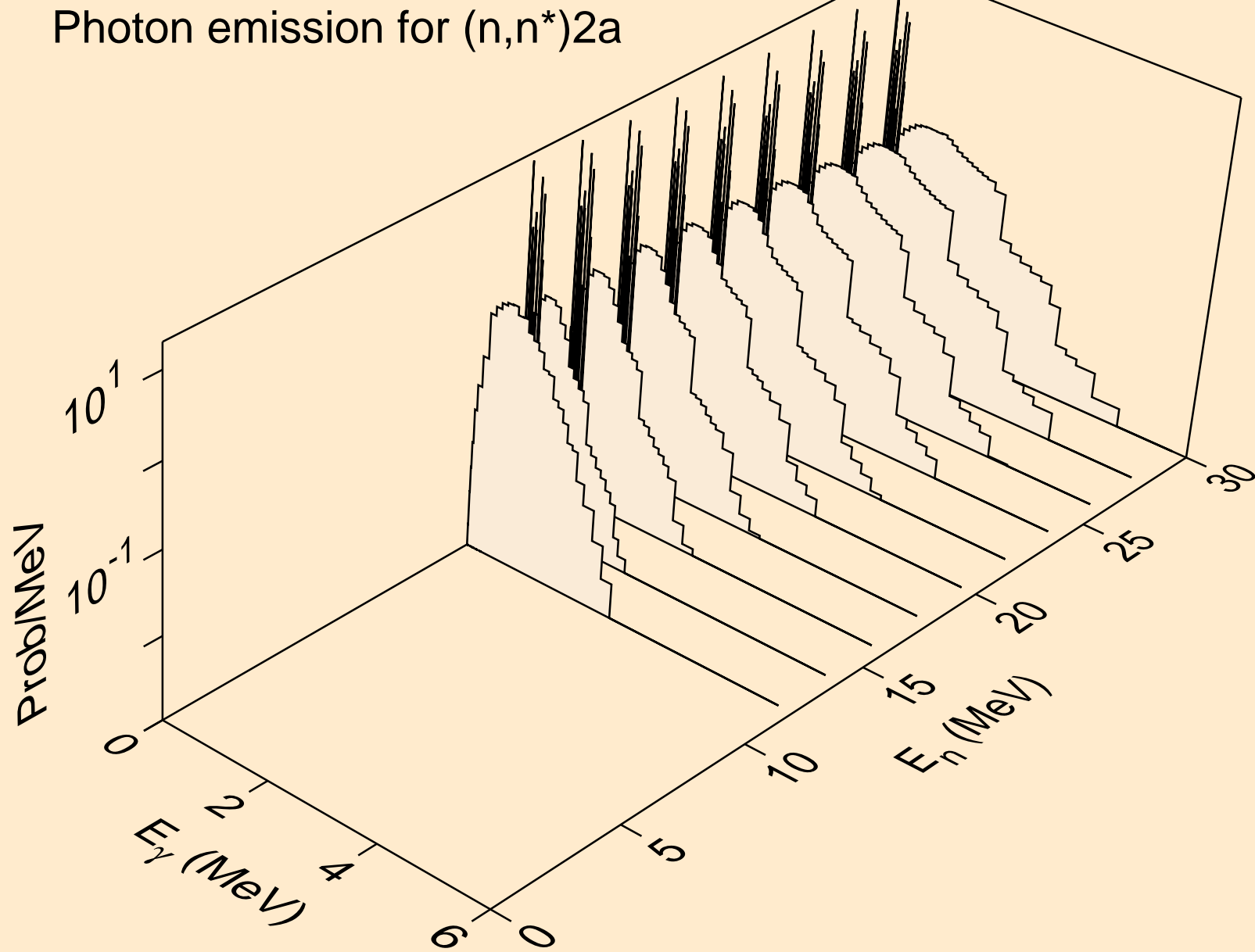

HO158N NEUTRON ACER TENDL-2021 LIBRARY; T=293.6K  
Photon emission for (n,2n)2a

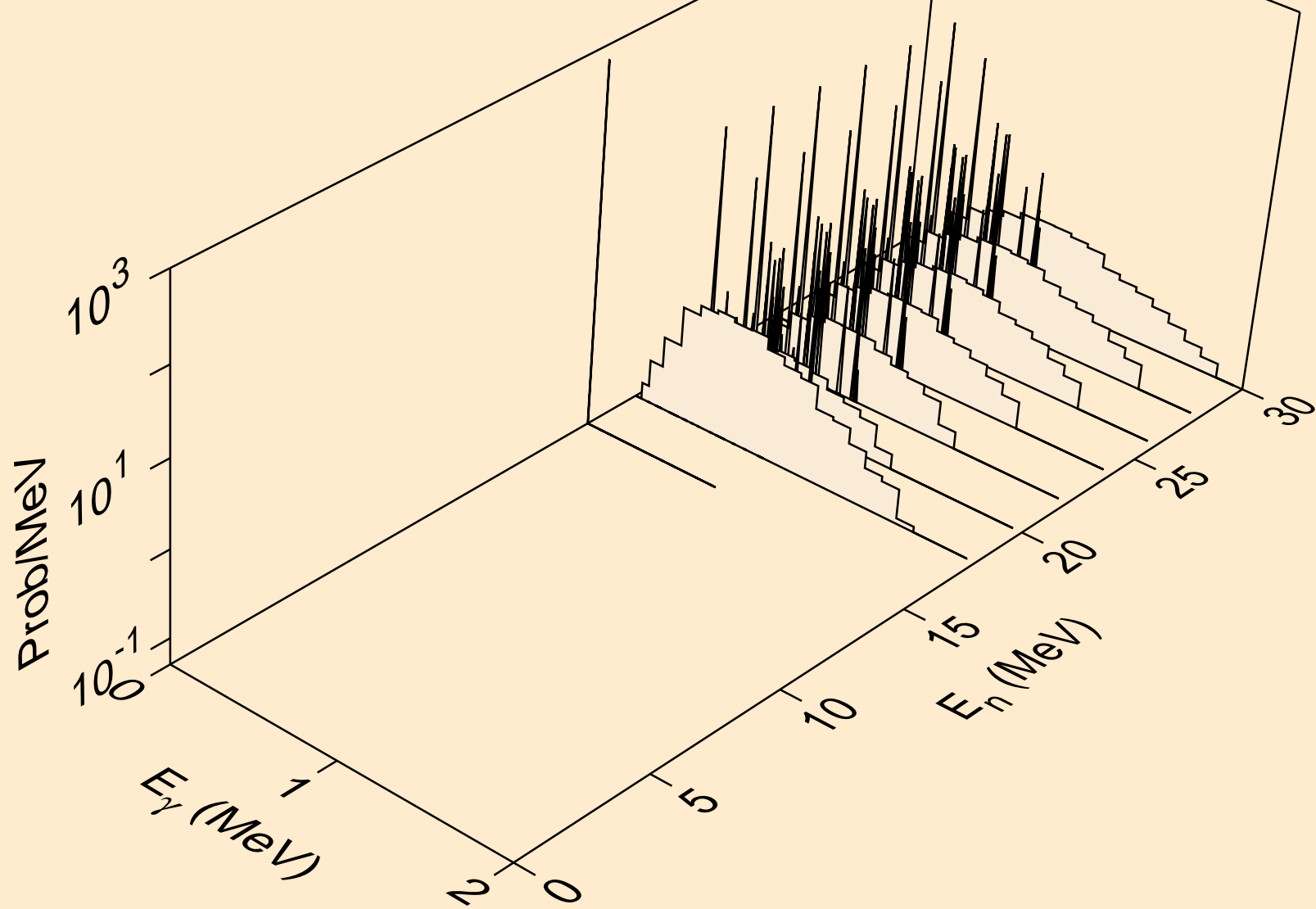

HO158N NEUTRON ACER TENDL-2021 LIBRARY; T=293.6K  
Photon emission for (n,n\*)d

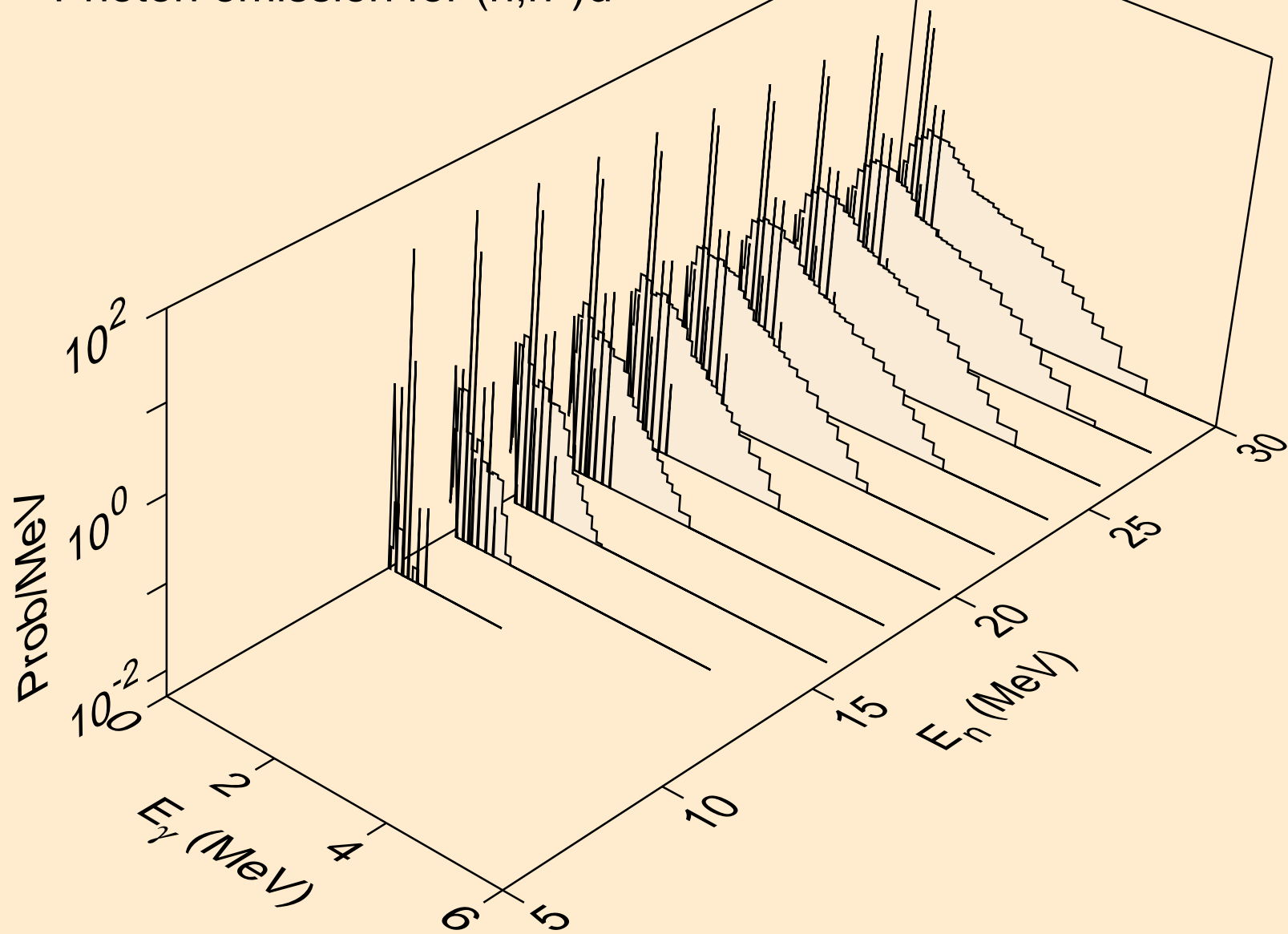

HO158N NEUTRON ACER TENDL-2021 LIBRARY; T=293.6K  
Photon emission for (n,n\*)t

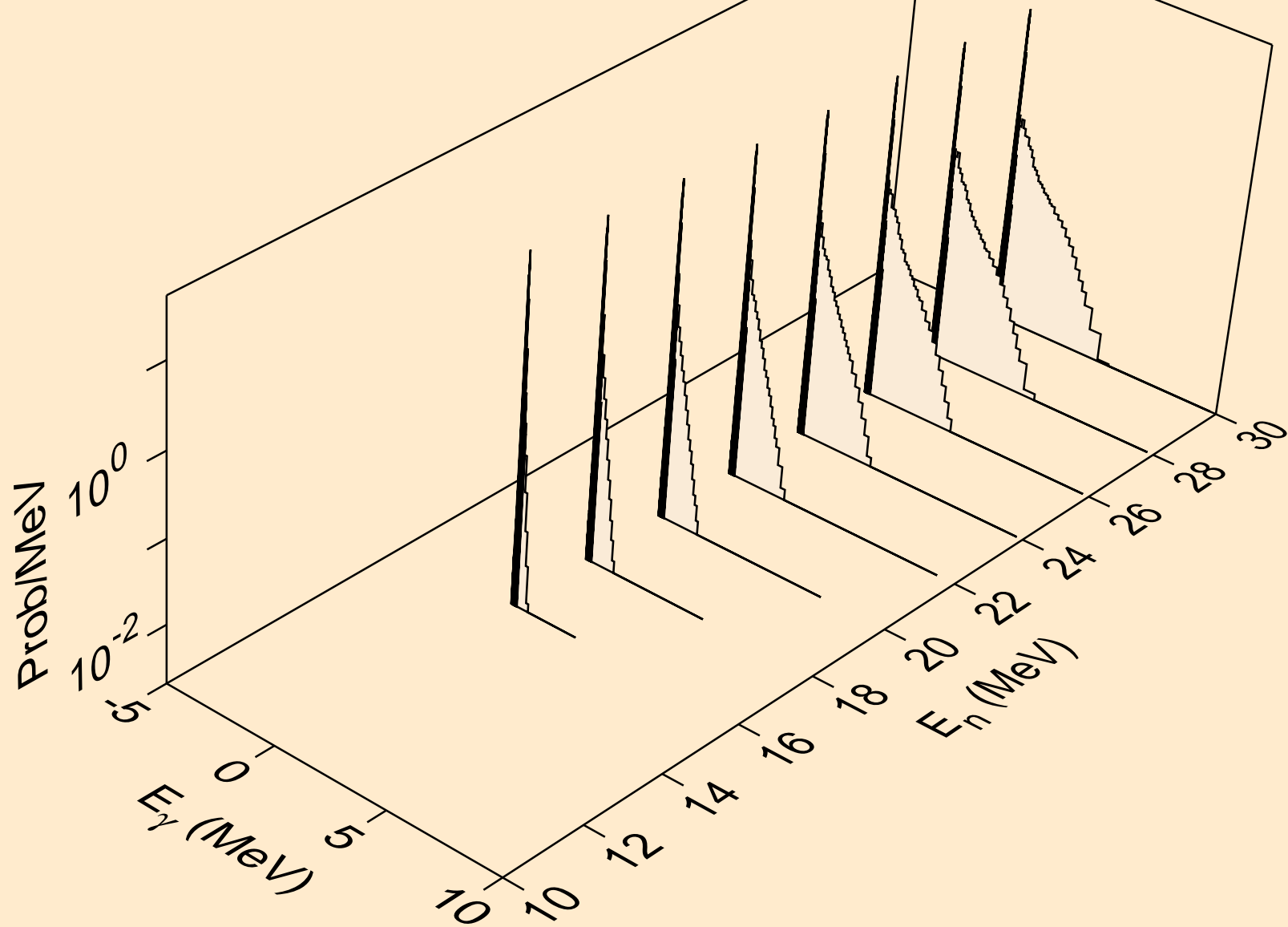

HO158N NEUTRON ACER TENDL-2021 LIBRARY; T=293.6K  
Photon emission for (n,n\*)he3

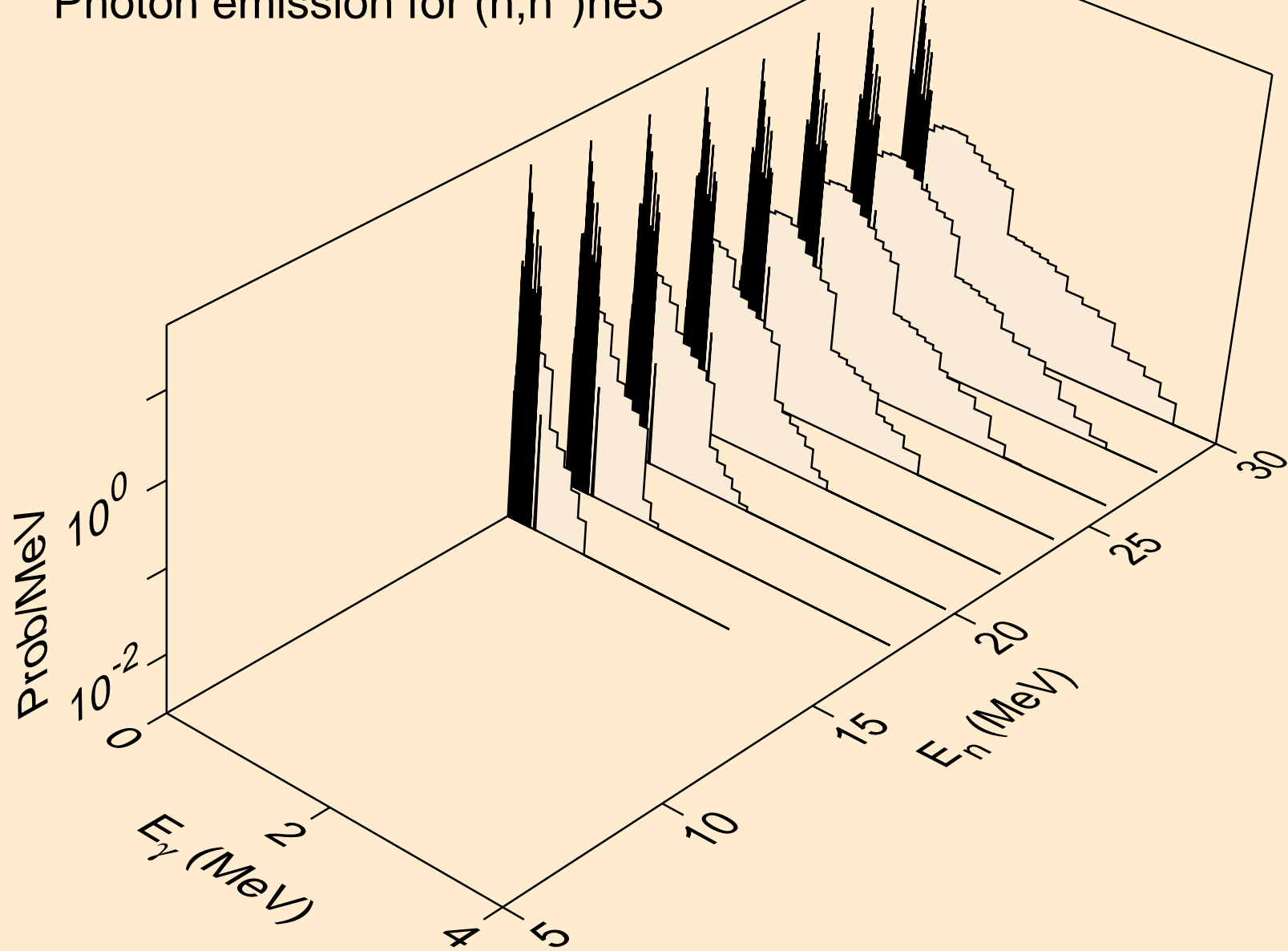

HO158N NEUTRON ACER TENDL-2021 LIBRARY; T=293.6K  
Photon emission for (n,4n)

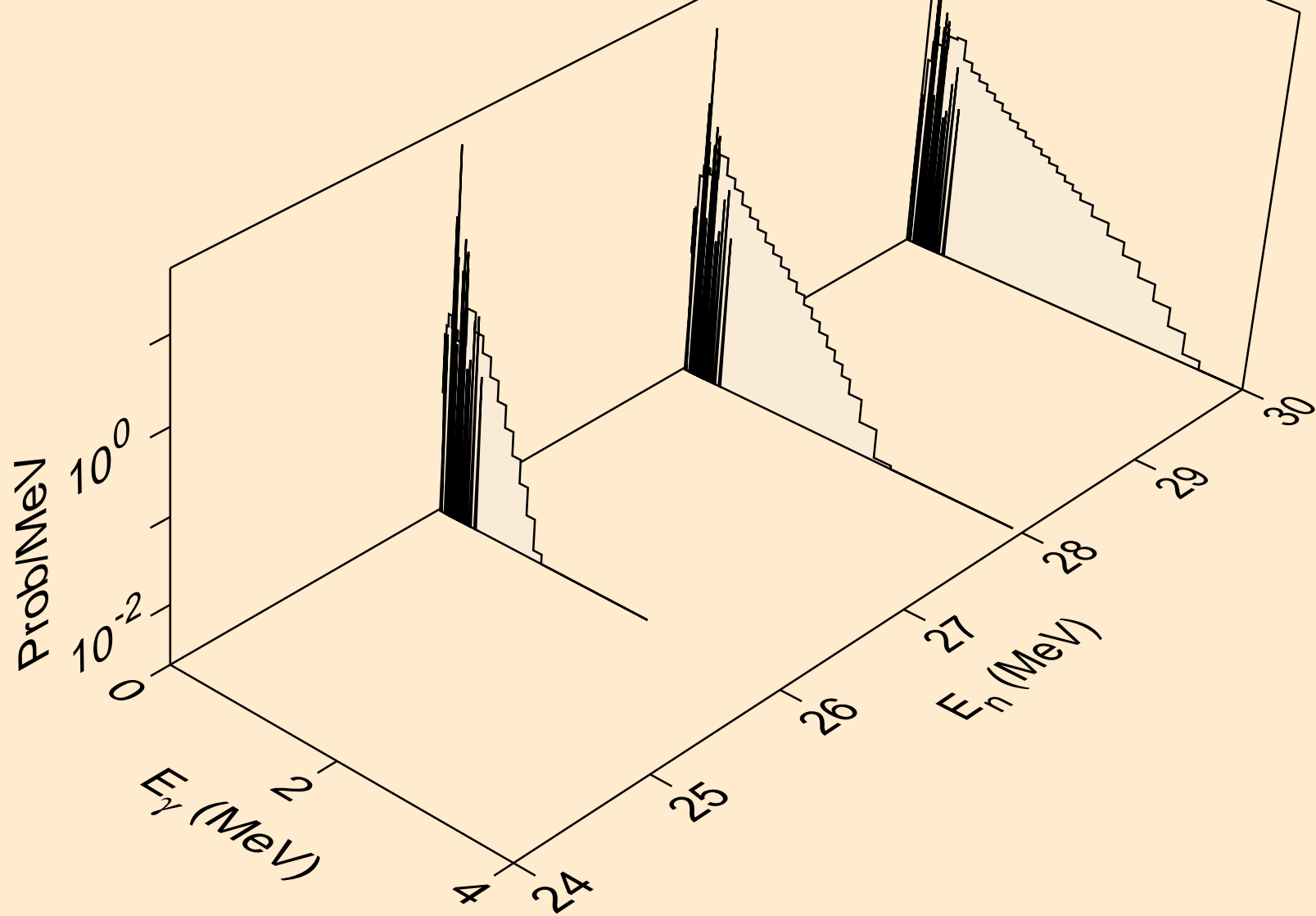

HO158N NEUTRON ACER TENDL-2021 LIBRARY; T=293.6K  
Photon emission for (n,2np)

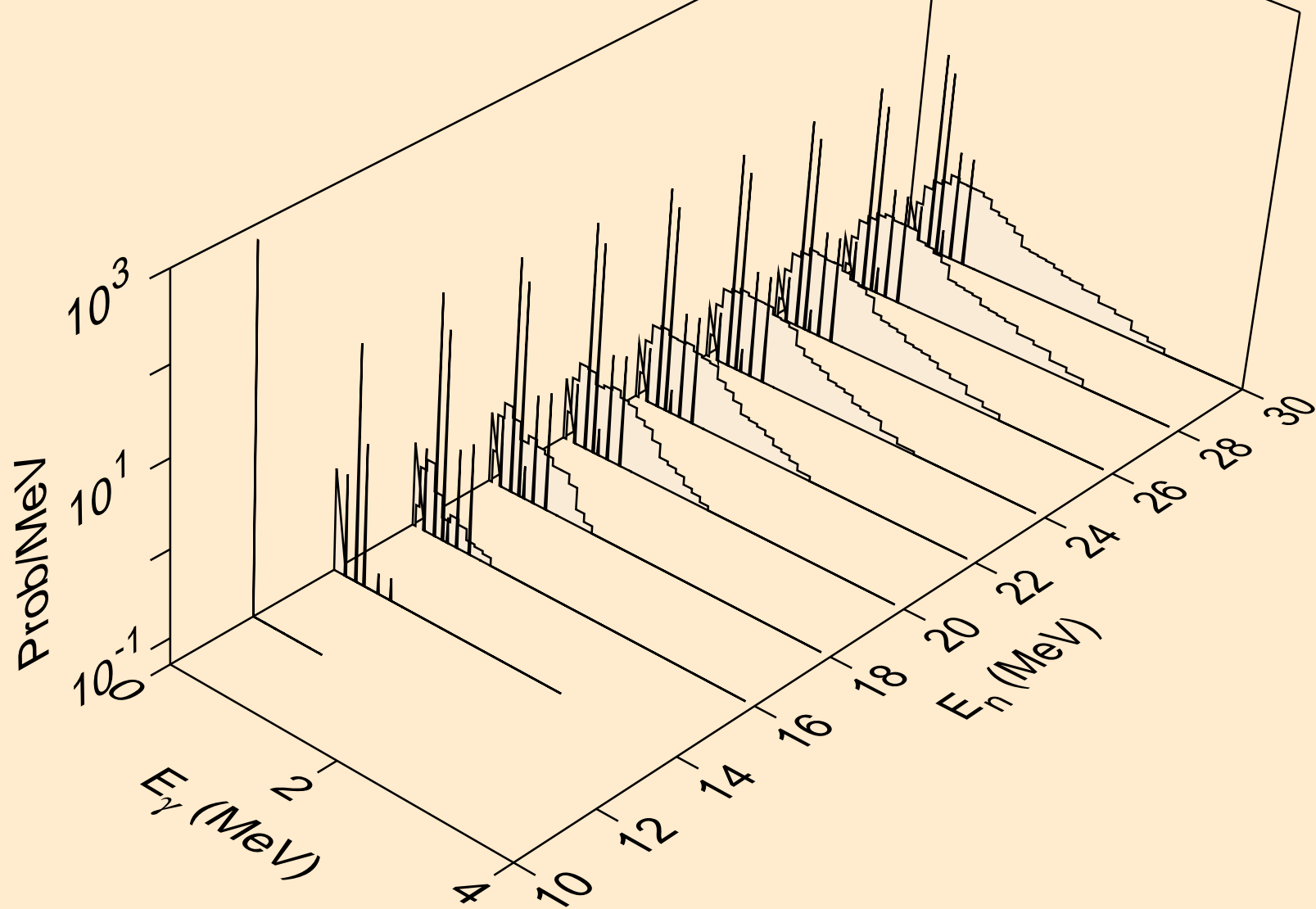

HO158N NEUTRON ACER TENDL-2021 LIBRARY; T=293.6K  
Photon emission for (n,3np)

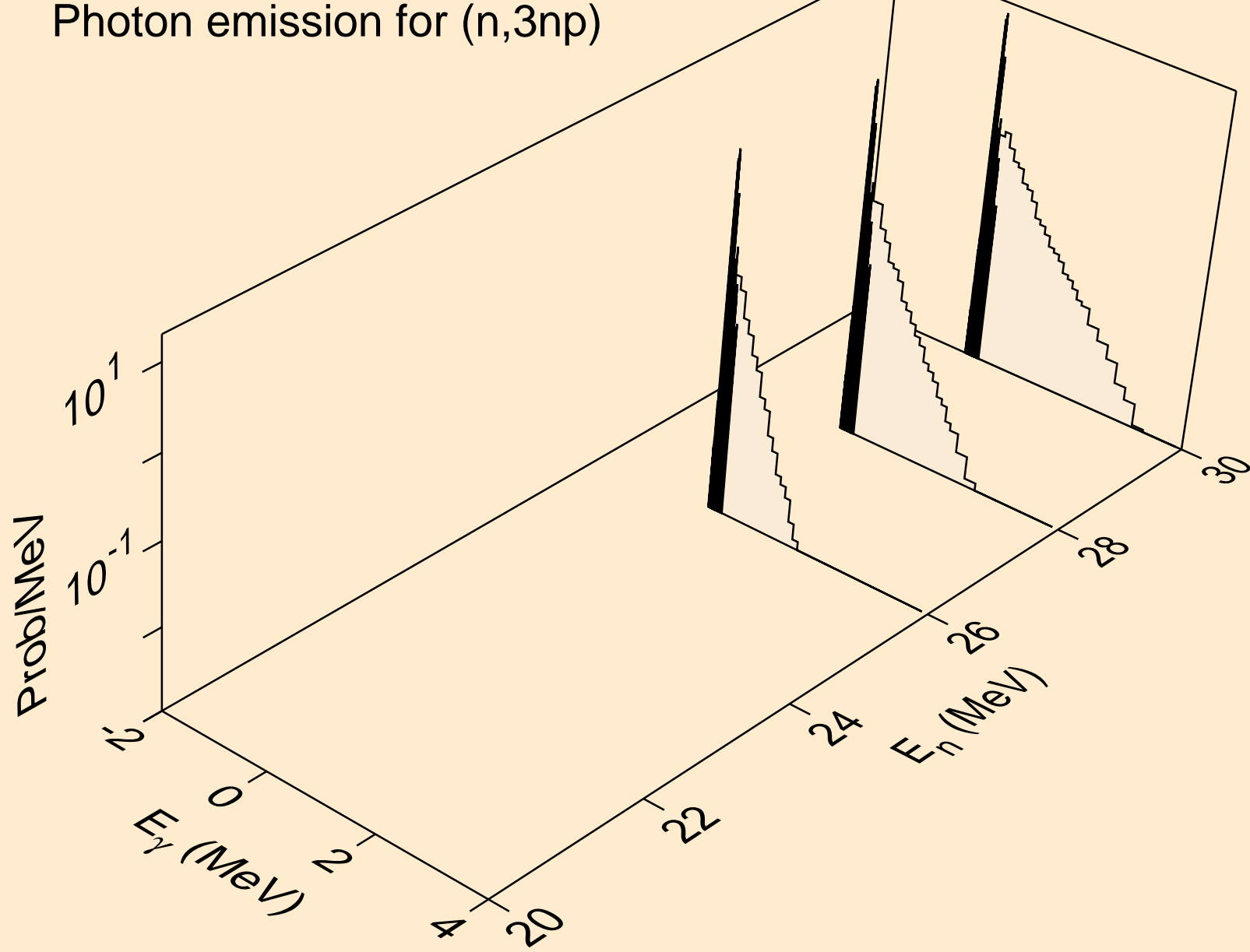



HO158N NEUTRON ACER TENDL-2021 LIBRARY; T=293.6K  
Photon emission for (n,2np)

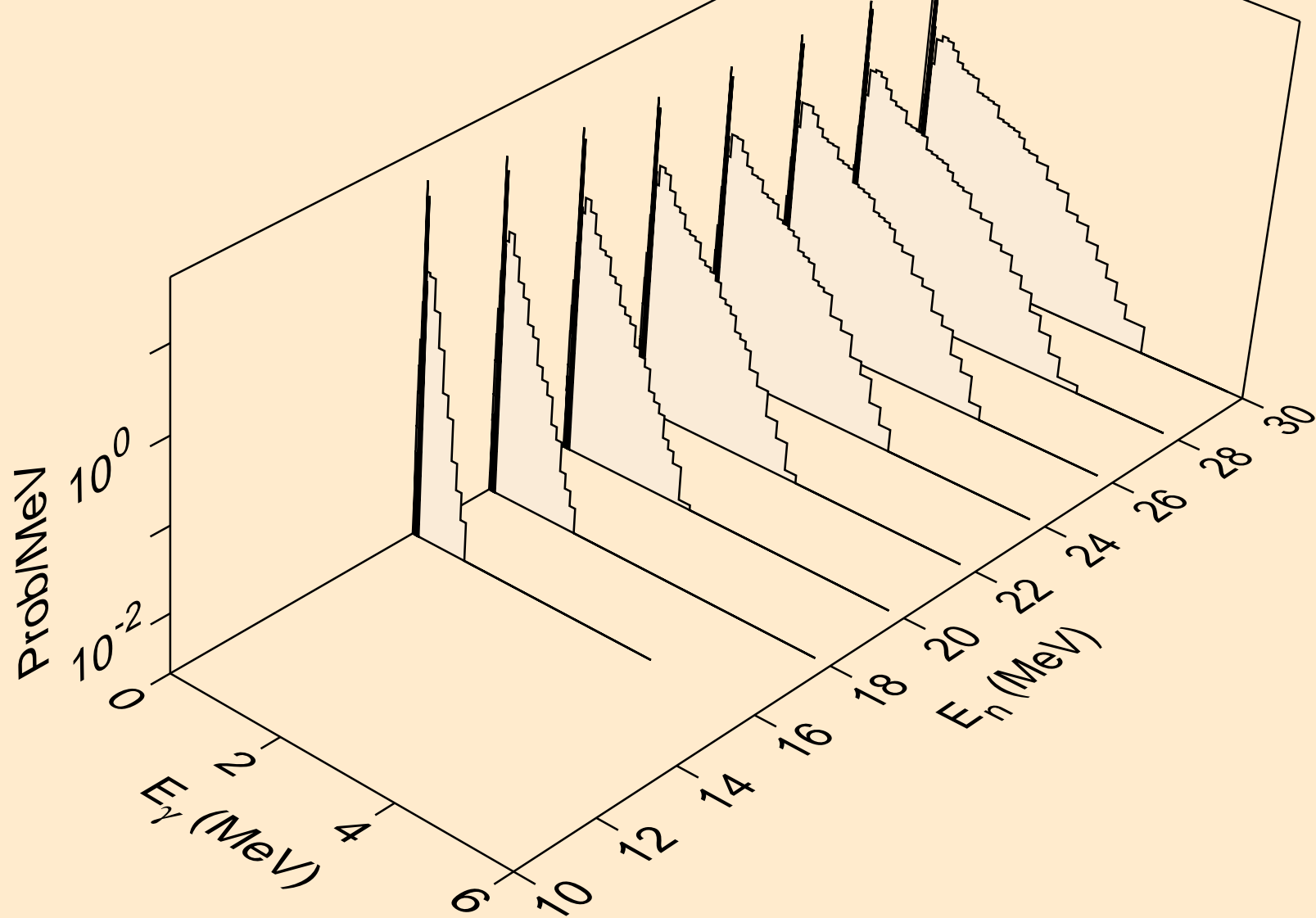

HO158N NEUTRON ACER TENDL-2021 LIBRARY; T=293.6K  
Photon emission for (n,npa)

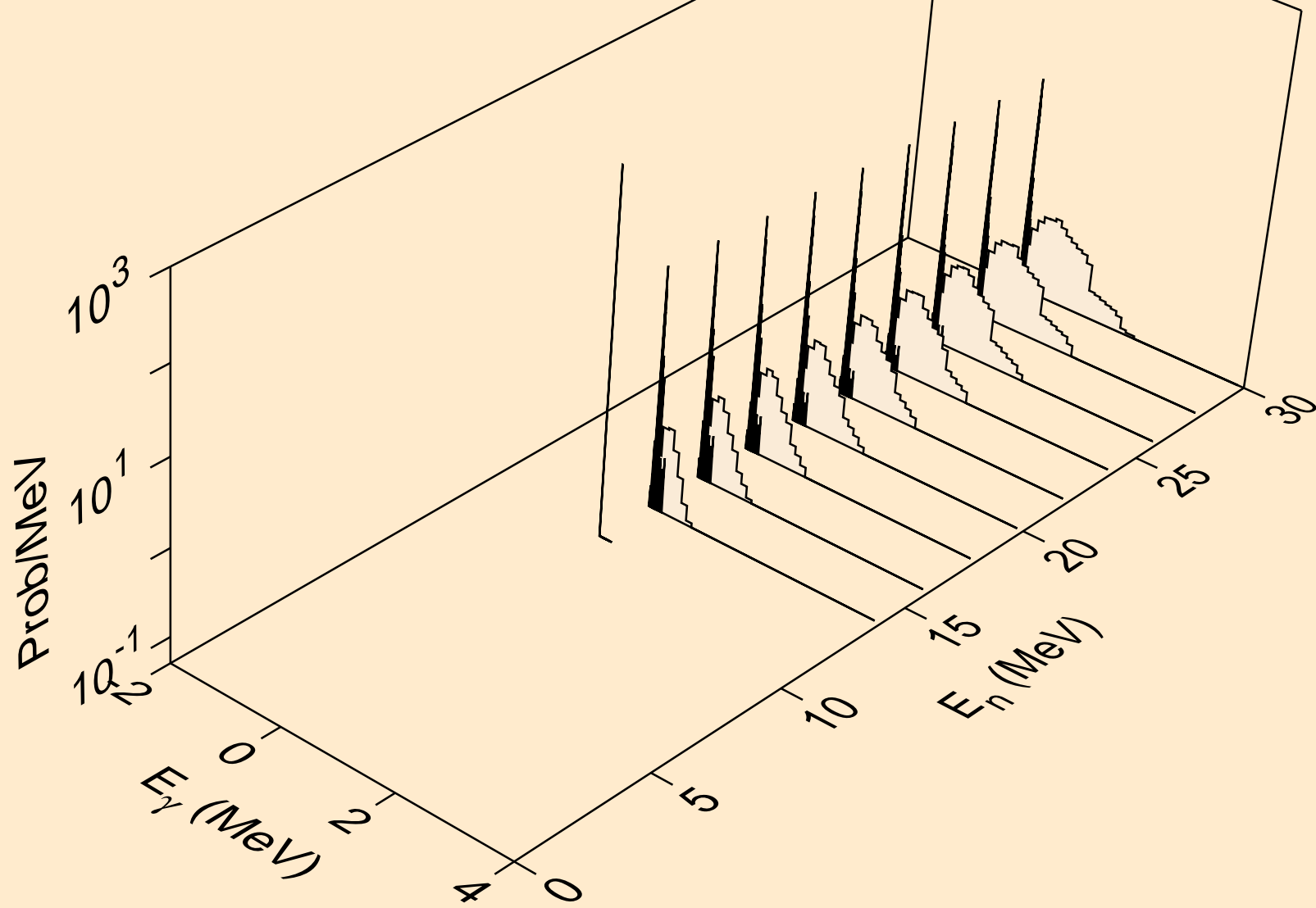

HO158N NEUTRON ACER TENDL-2021 LIBRARY; T=293.6K  
Photon emission for (n,n\*2)

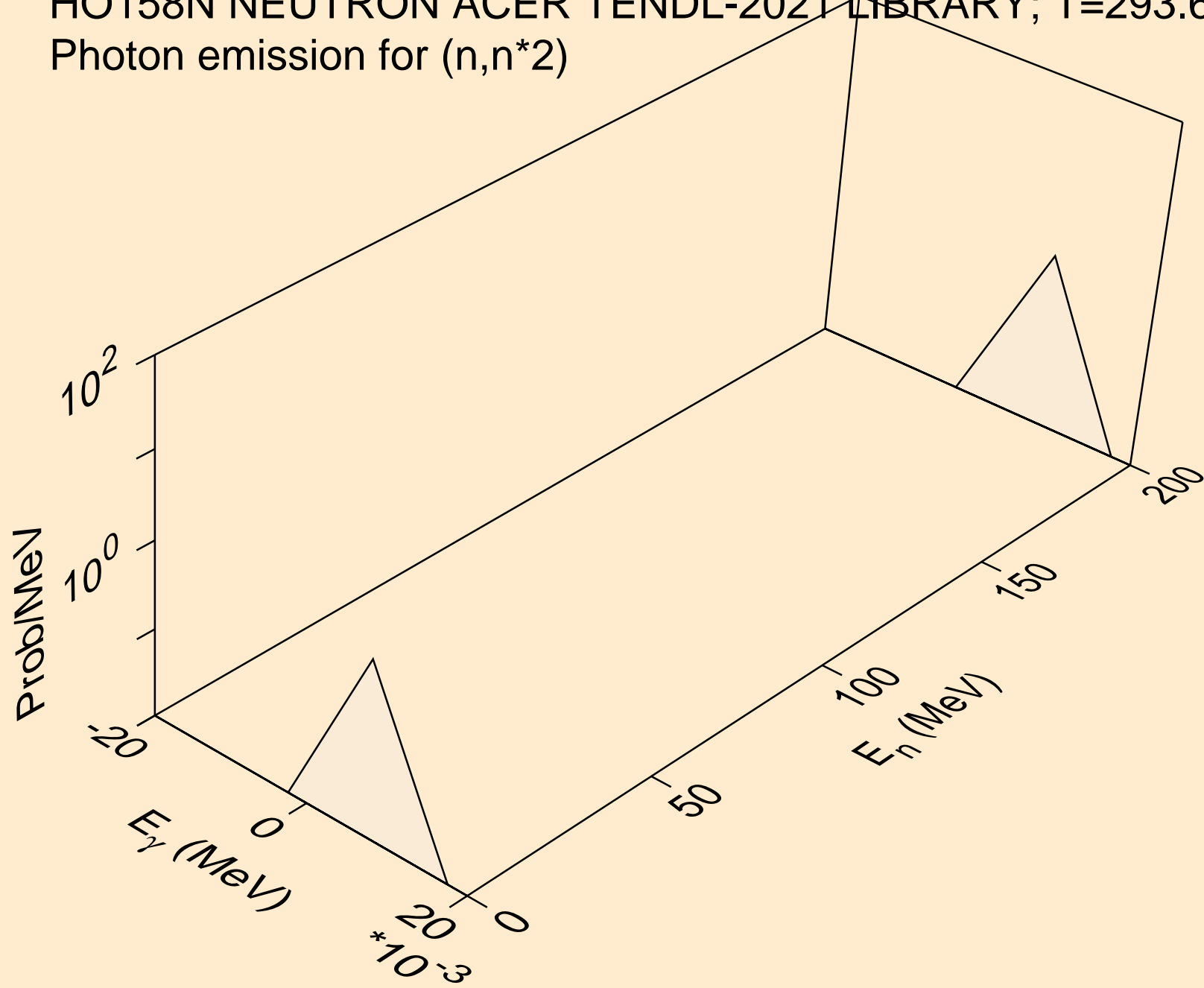

HO158N NEUTRON ACER TENDL-2021 LIBRARY; T=293.6K  
Photon emission for (n,n\*3)

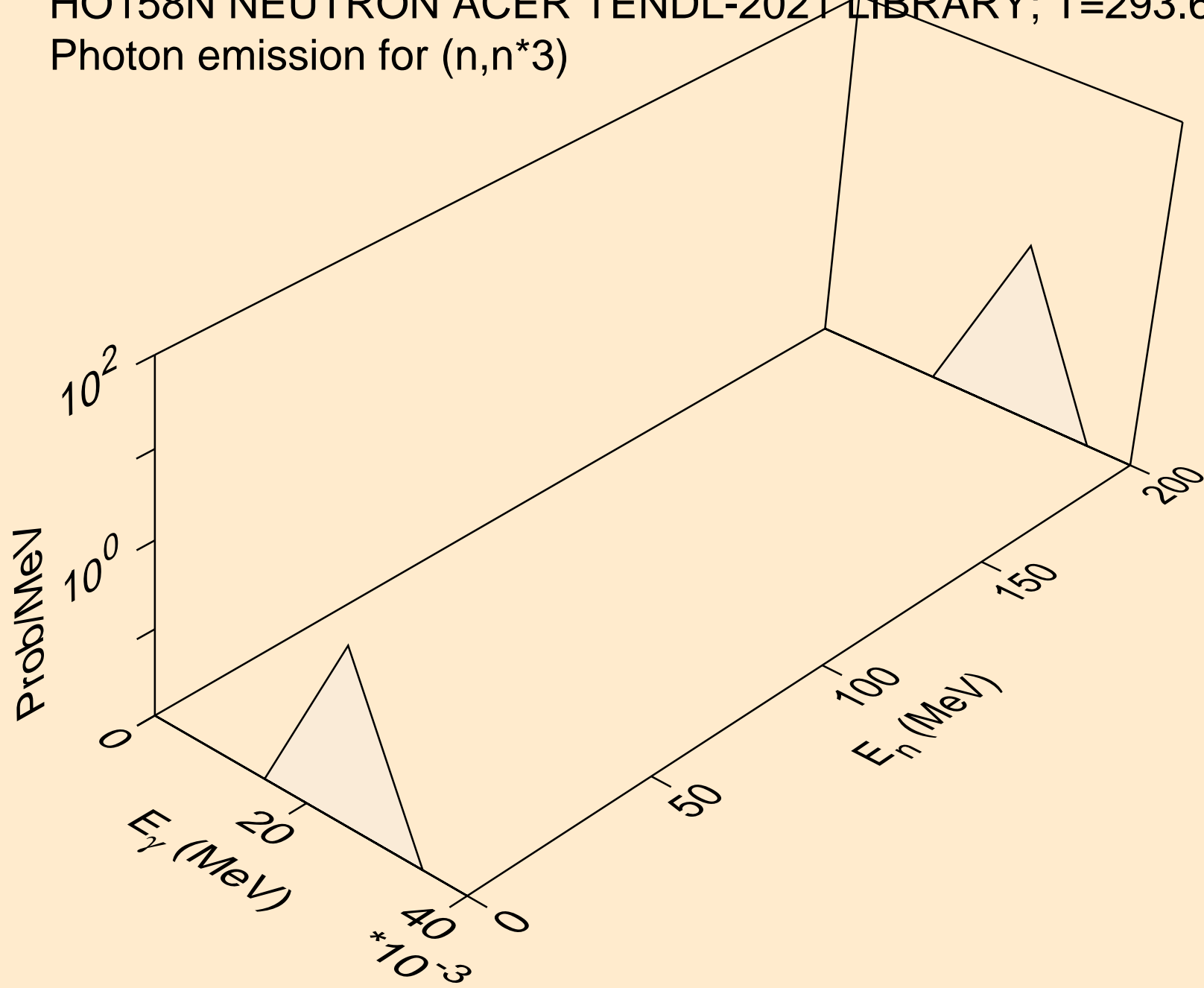

HO158N NEUTRON ACER TENDL-2021 LIBRARY; T=293.6K  
Photon emission for (n,n\*4)

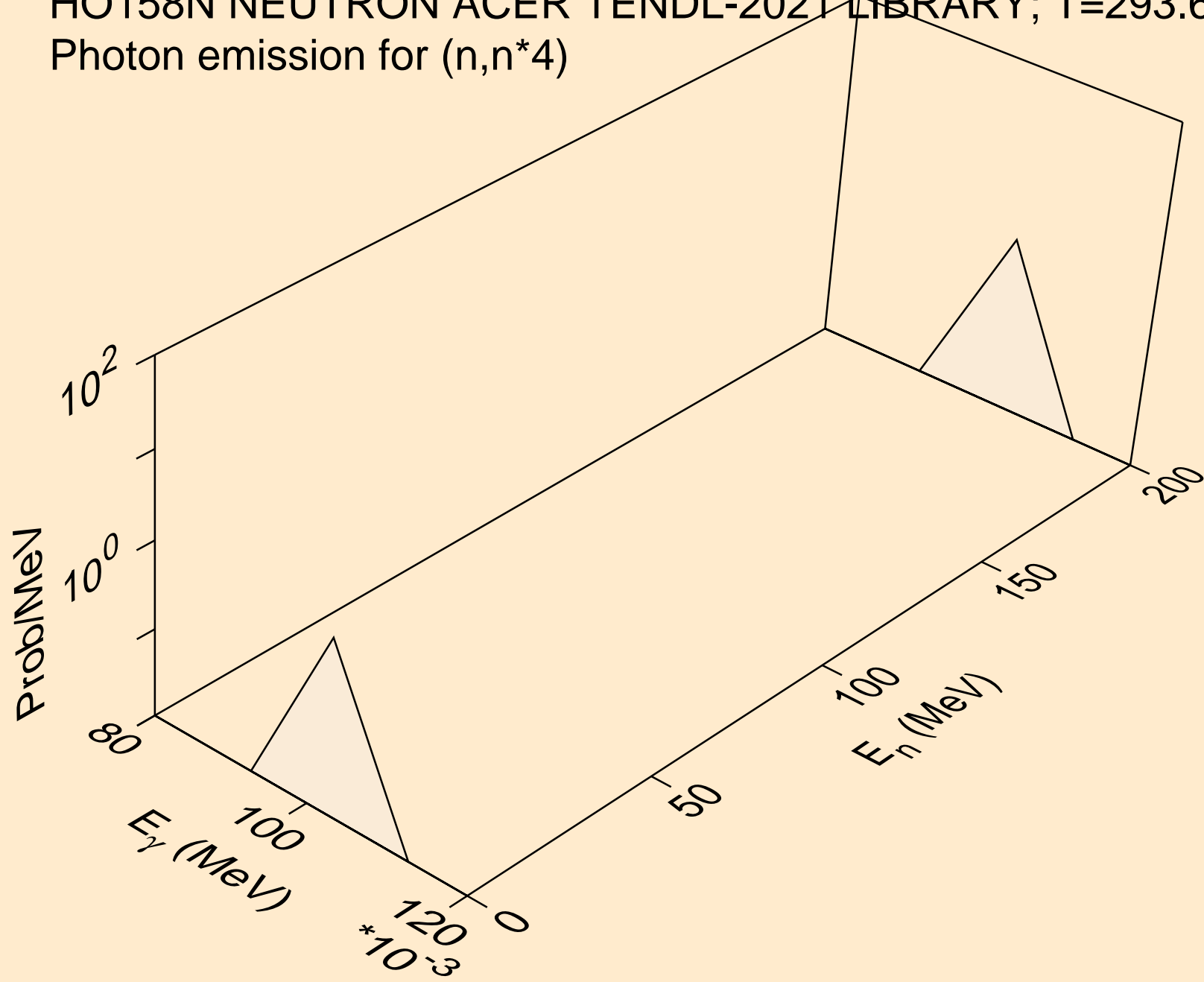

HO158N NEUTRON ACER TENDL-2021 LIBRARY; T=293.6K  
Photon emission for (n,n\*5)

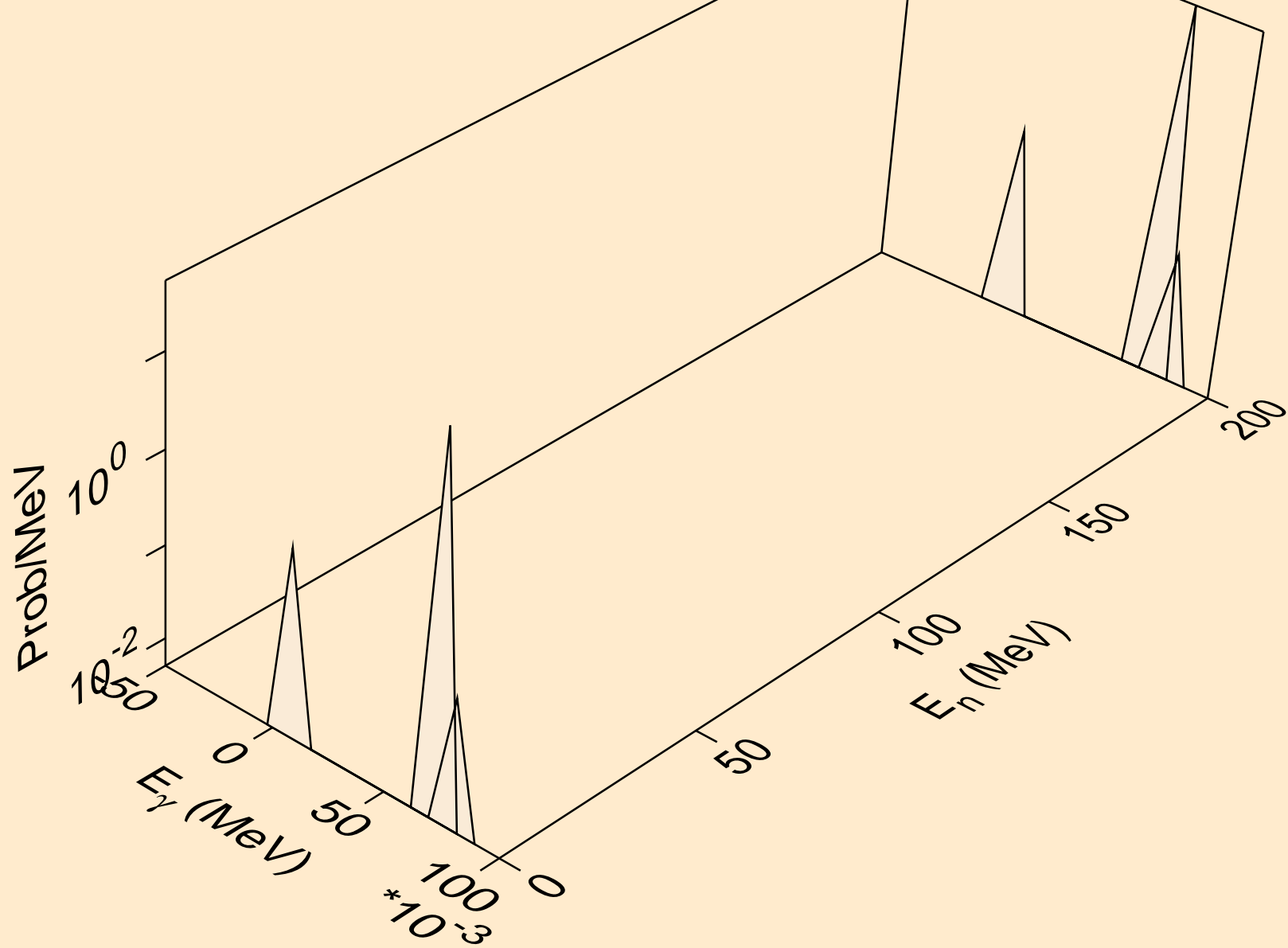

HO158N NEUTRON ACER TENDL-2021 LIBRARY; T=293.6K  
Photon emission for (n,n\*6)

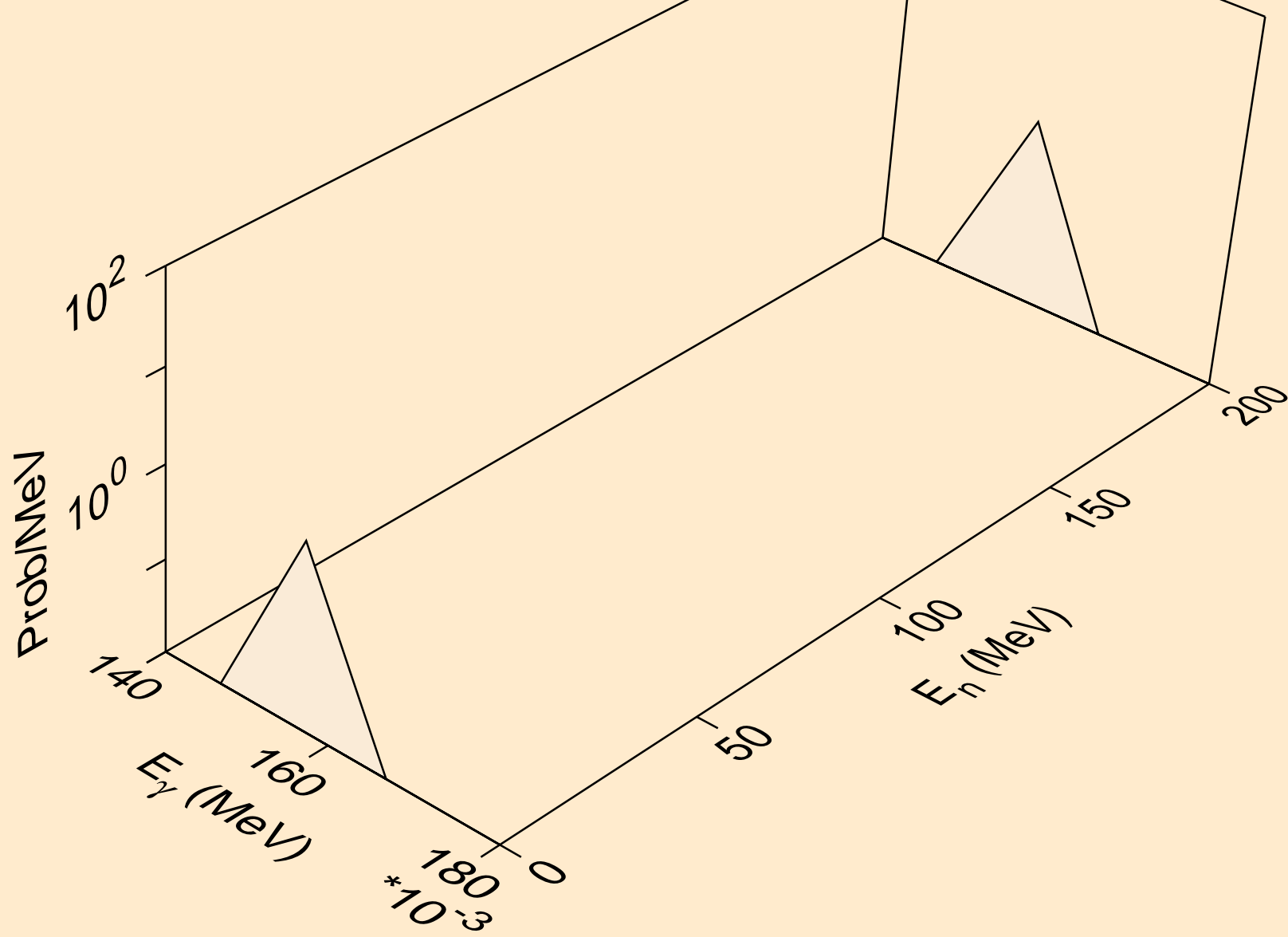

HO158N NEUTRON ACER TENDL-2021 LIBRARY; T=293.6K  
Photon emission for (n,n\*8)

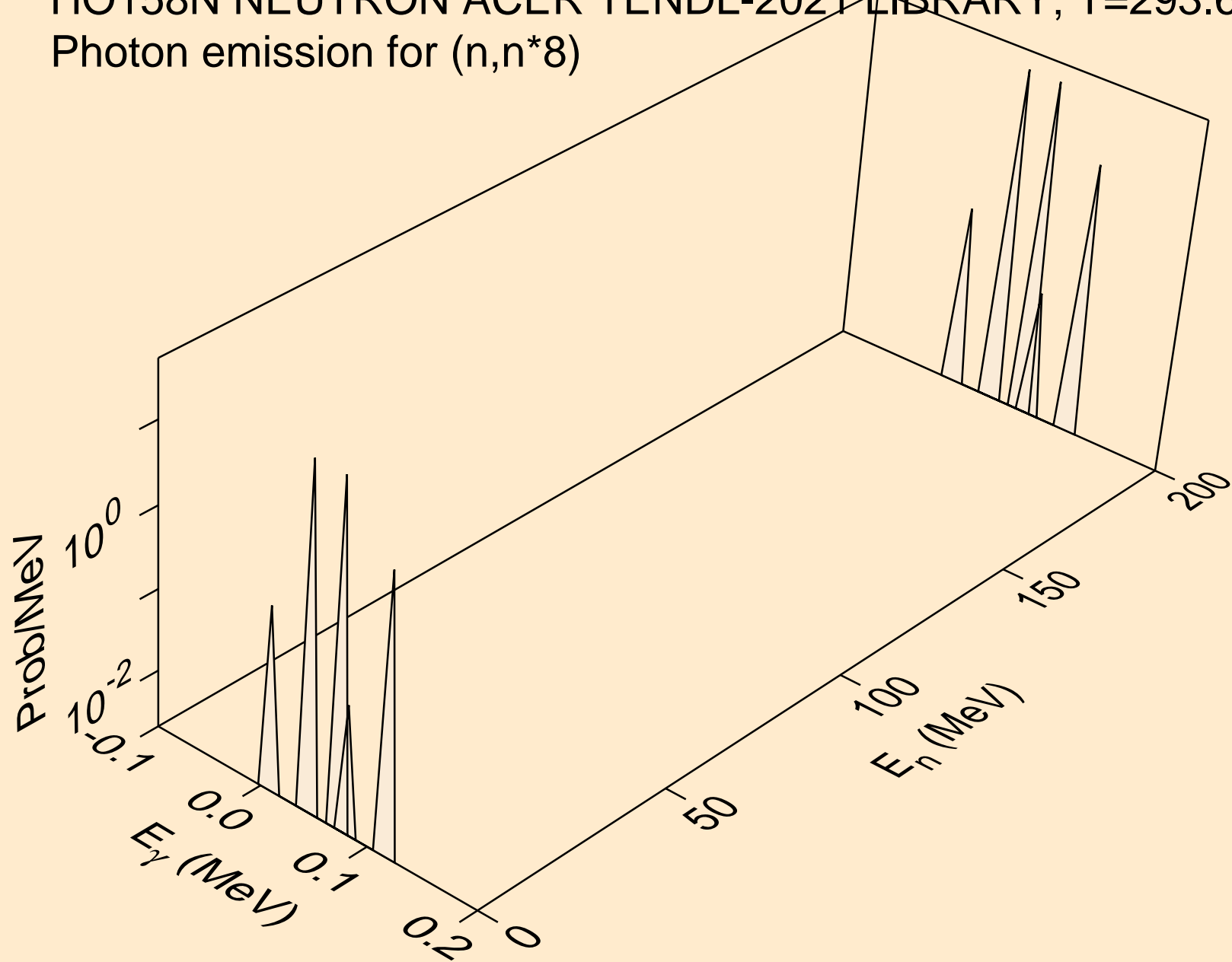



HO158N NEUTRON ACER TENDL-2021 LIBRARY; T=293.6K  
Photon emission for (n,n\*9)

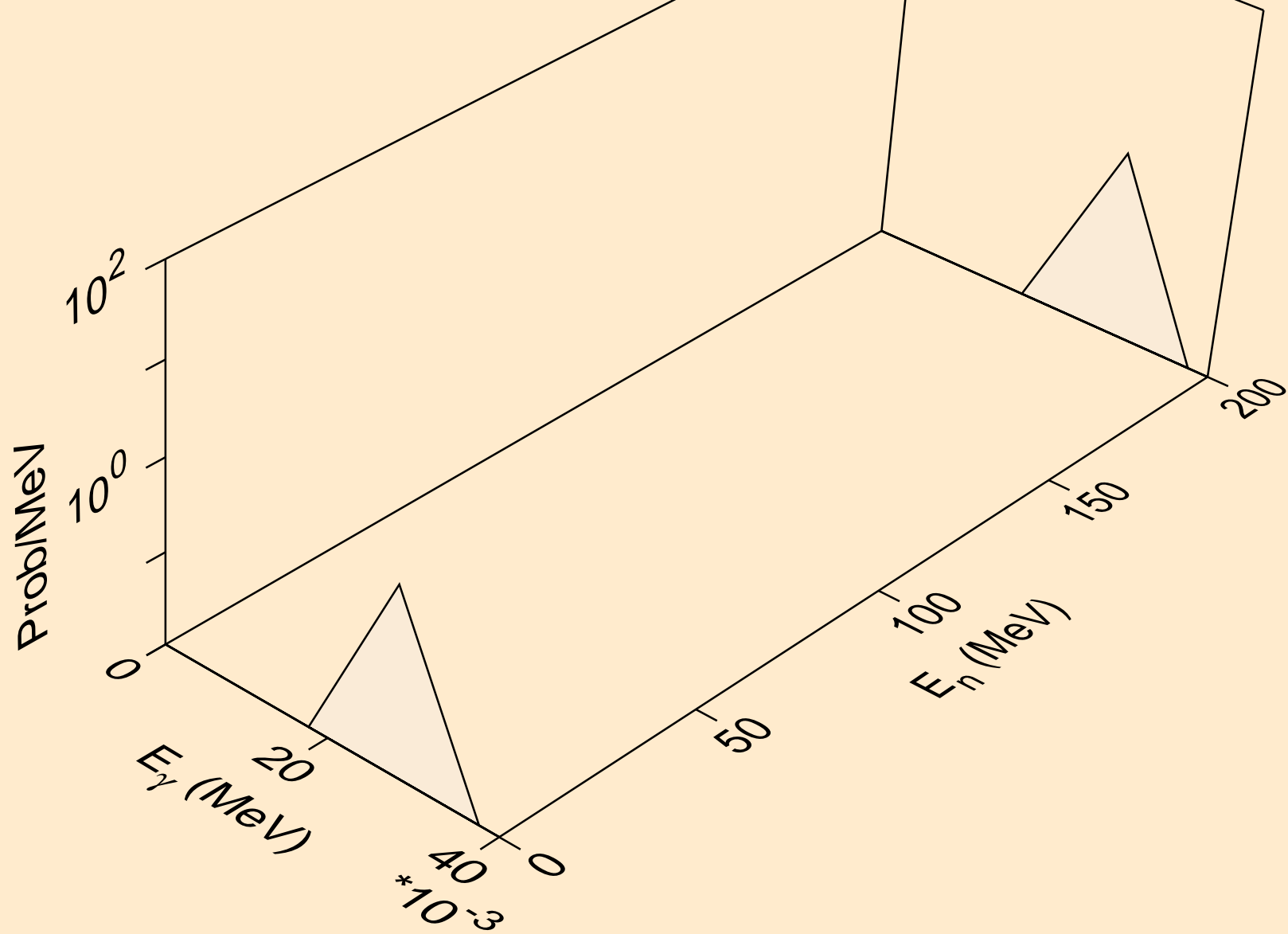

HO158N NEUTRON ACER TENDL-2021 LIBRARY; T=293.6K  
Photon emission for (n,n\*10)

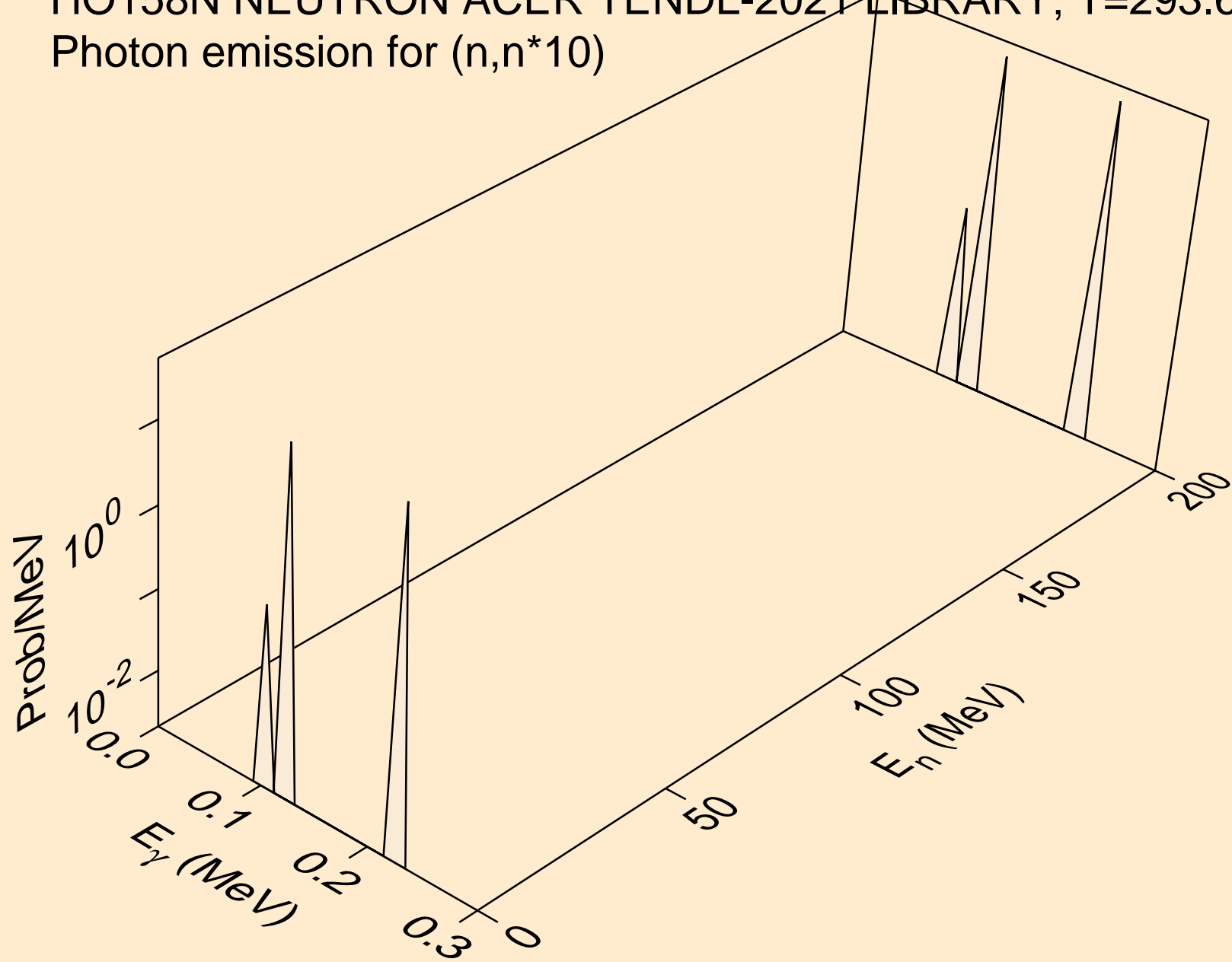

HO158N NEUTRON ACER TENDL-2021 LIBRARY; T=293.6K  
Photon emission for (n,n\*11)

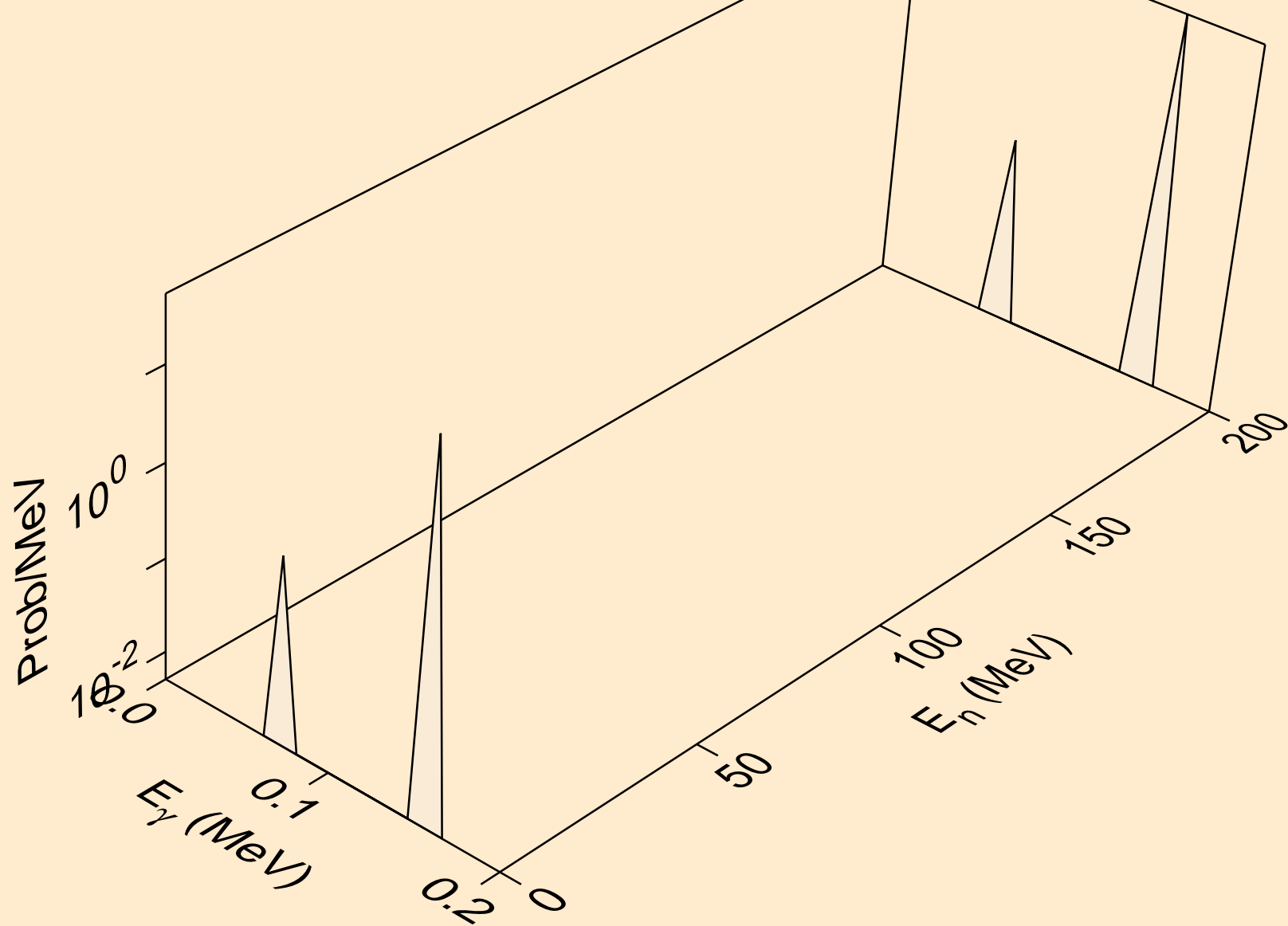

HO158N NEUTRON ACER TENDL-2021 LIBRARY; T=293.6K  
Photon emission for (n,n\*12)

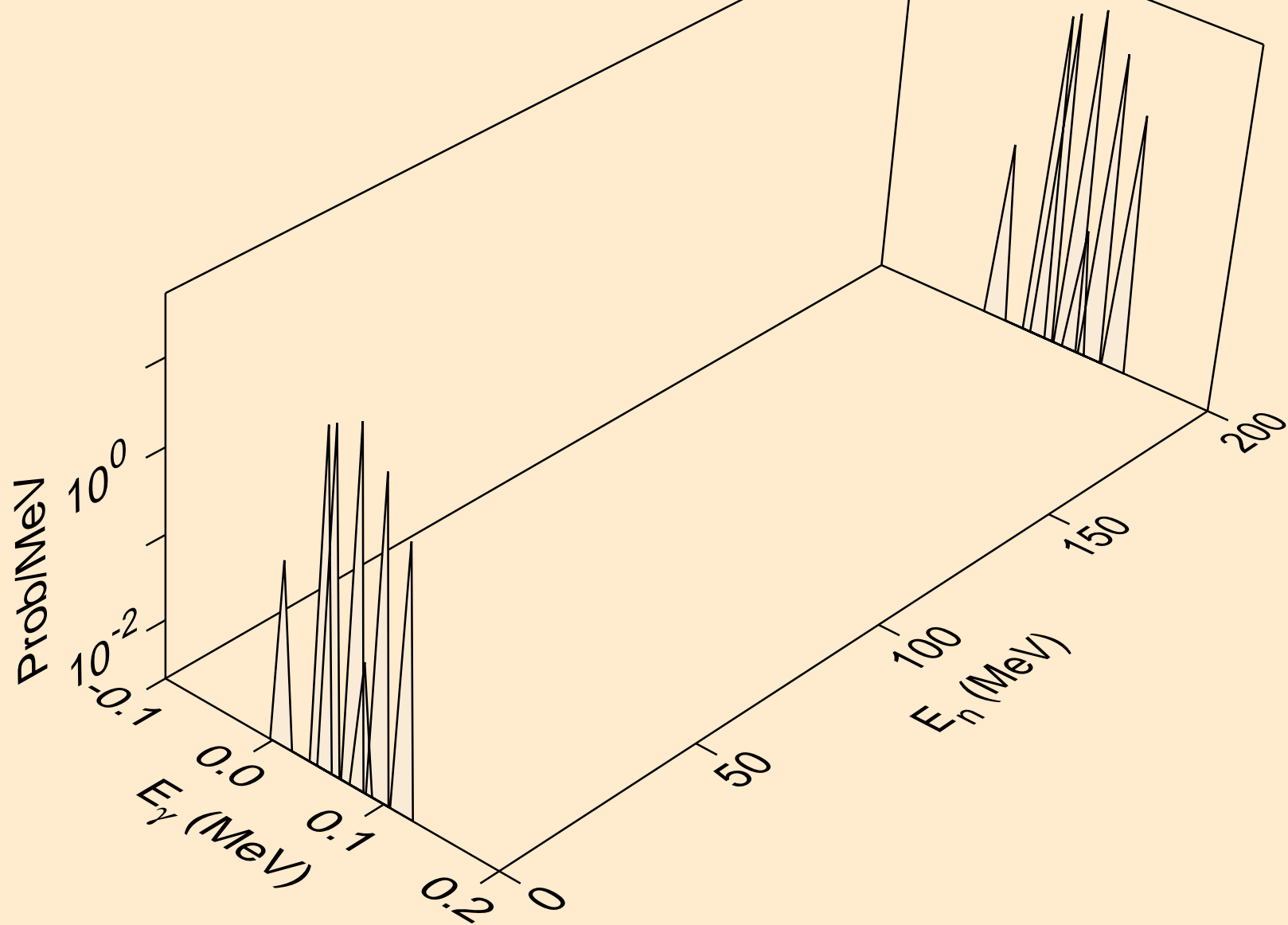

HO158N NEUTRON ACER TENDL-2021 LIBRARY; T=293.6K  
Photon emission for (n,n\*13)

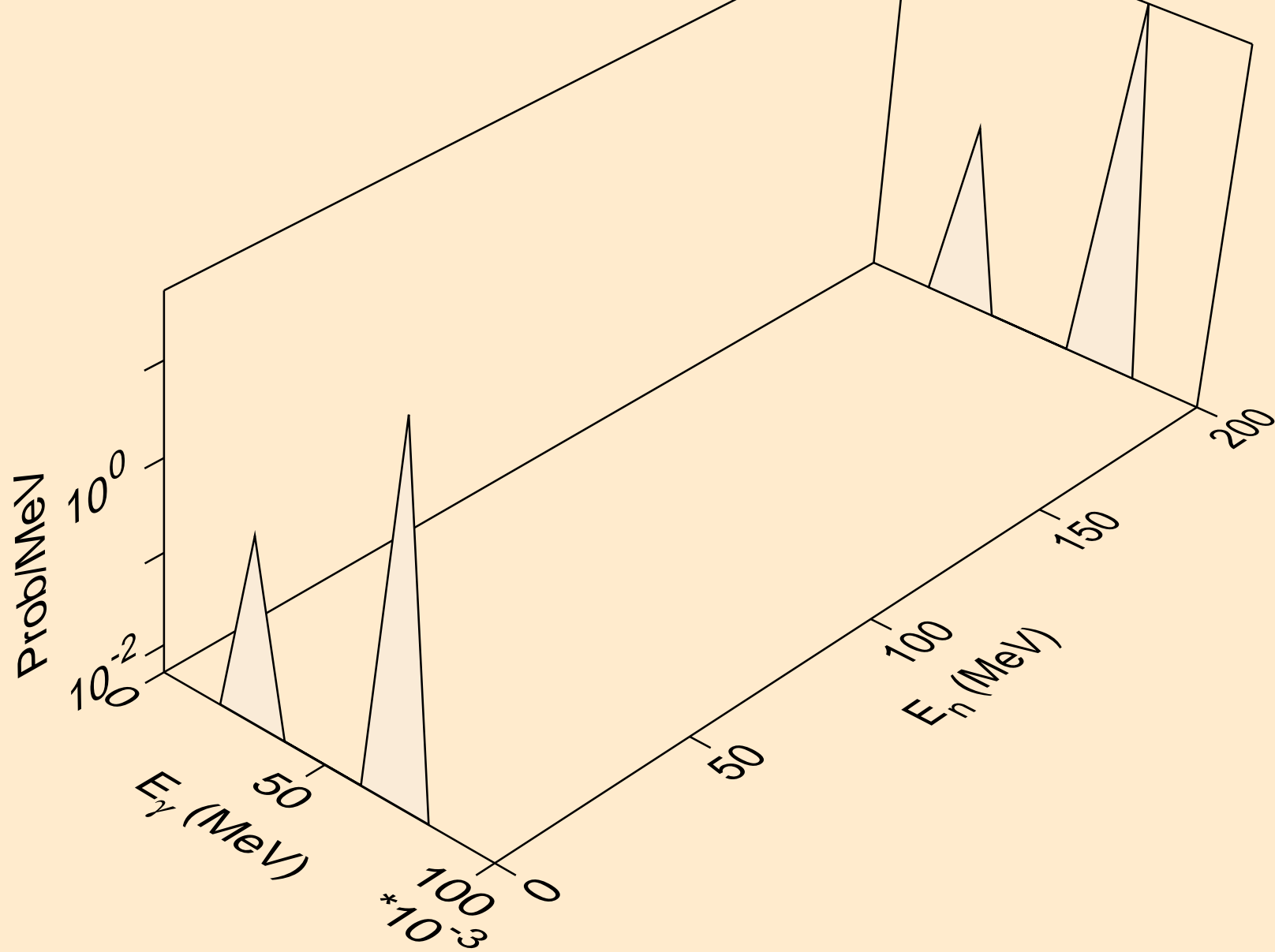

HO158N NEUTRON ACER TENDL-2021 LIBRARY; T=293.6K  
Photon emission for (n,n\*14)

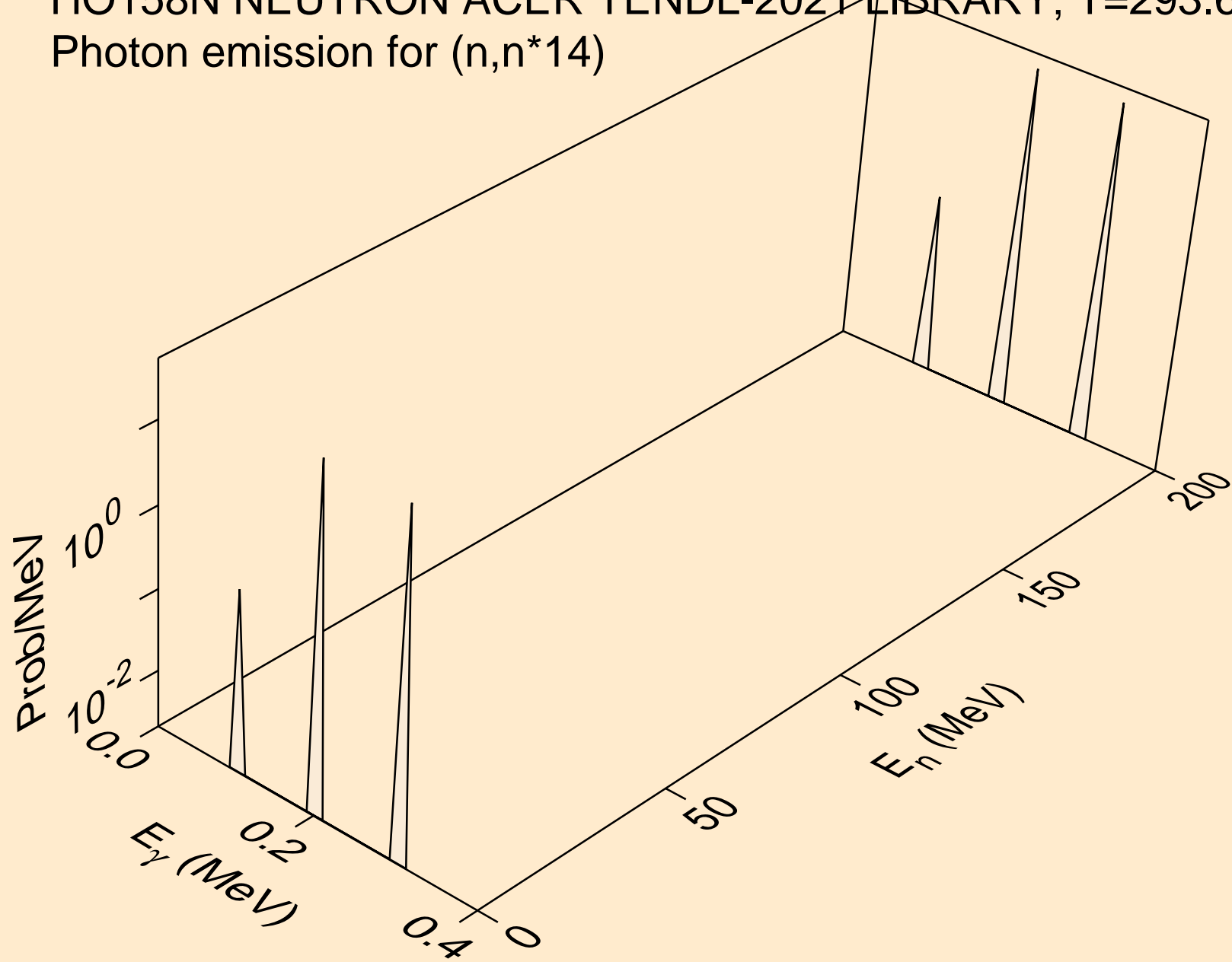

HO158N NEUTRON ACER TENDL-2021 LIBRARY; T=293.6K  
Photon emission for (n,n\*15)

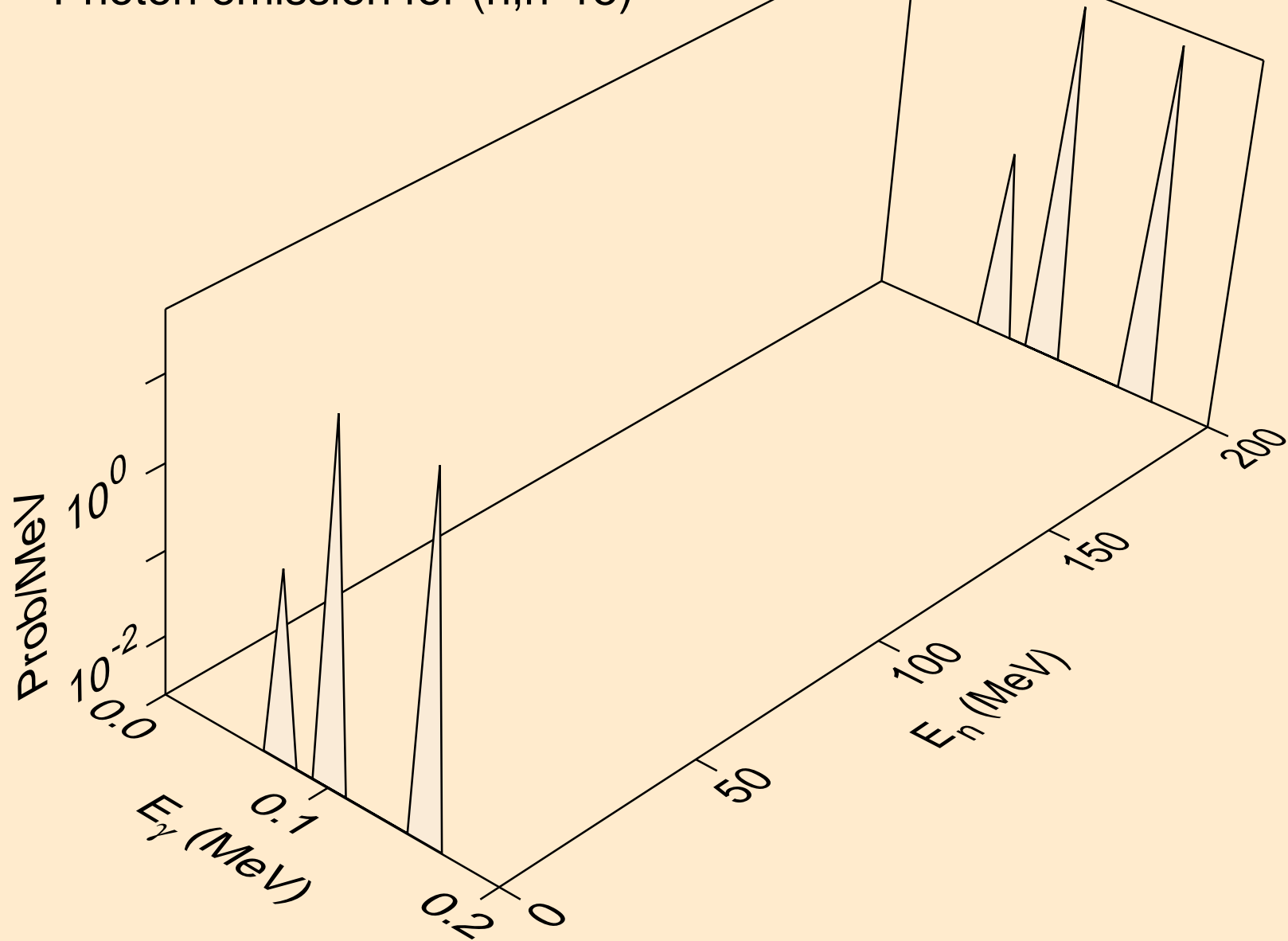

HO158N NEUTRON ACER TENDL-2021 LIBRARY; T=293.6K  
Photon emission for (n,n\*16)

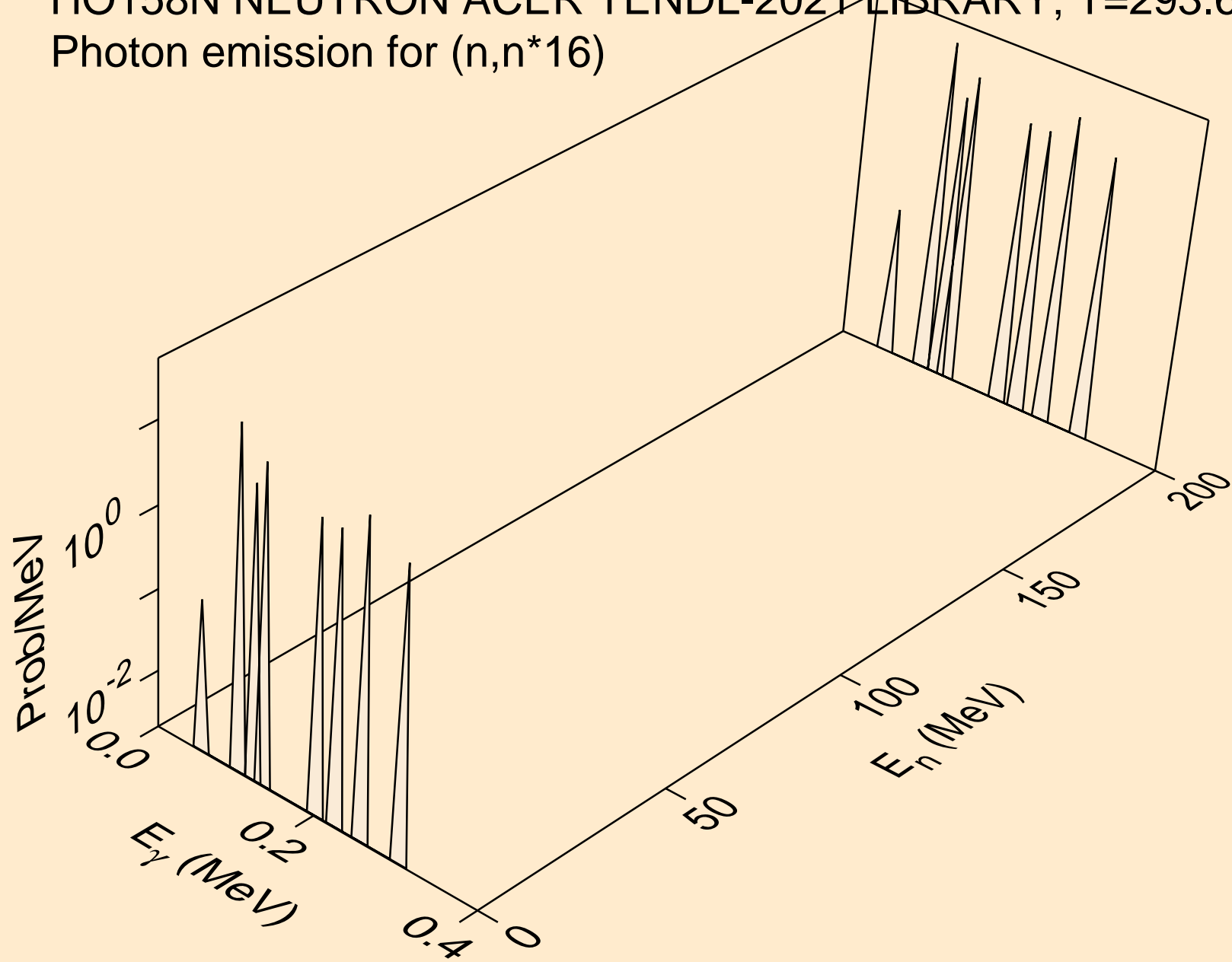



HO158N NEUTRON ACER TENDL-2021 LIBRARY; T=293.6K  
Photon emission for (n,n\*17)

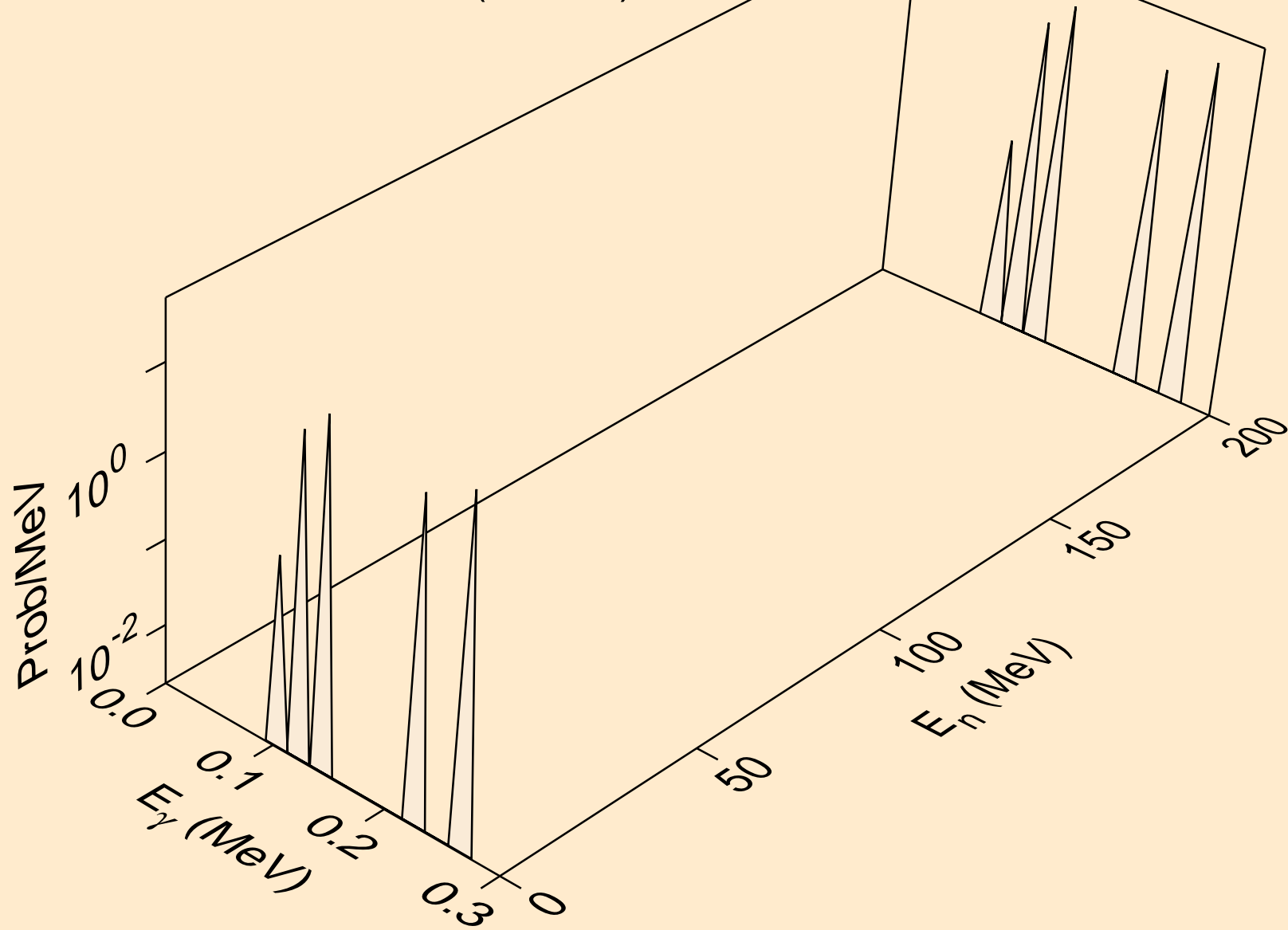

HO158N NEUTRON ACER TENDL-2021 LIBRARY; T=293.6K  
Photon emission for (n,n\*18)

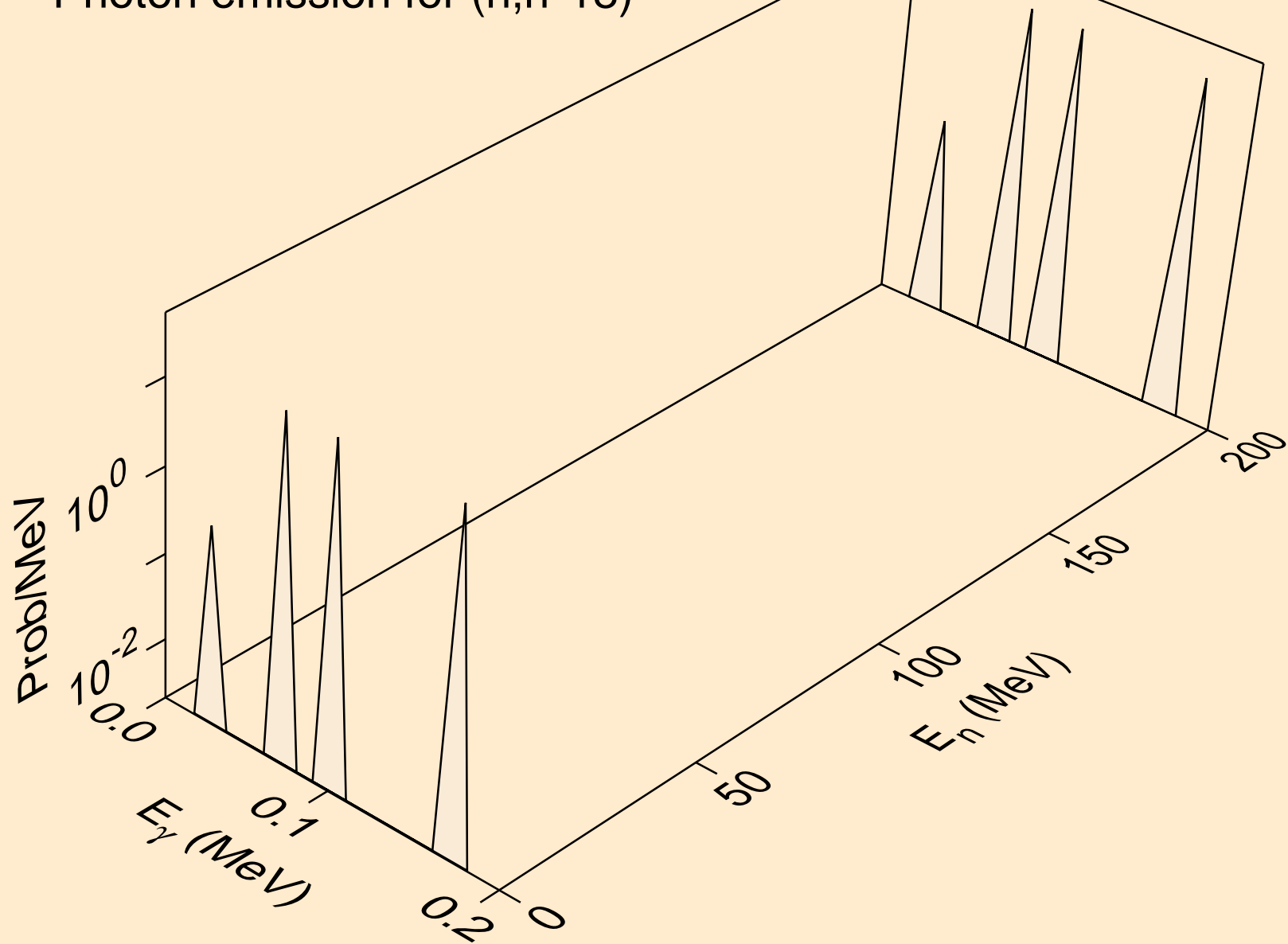

HO158N NEUTRON ACER TENDL-2021 LIBRARY; T=293.6K  
Photon emission for (n,n\*19)

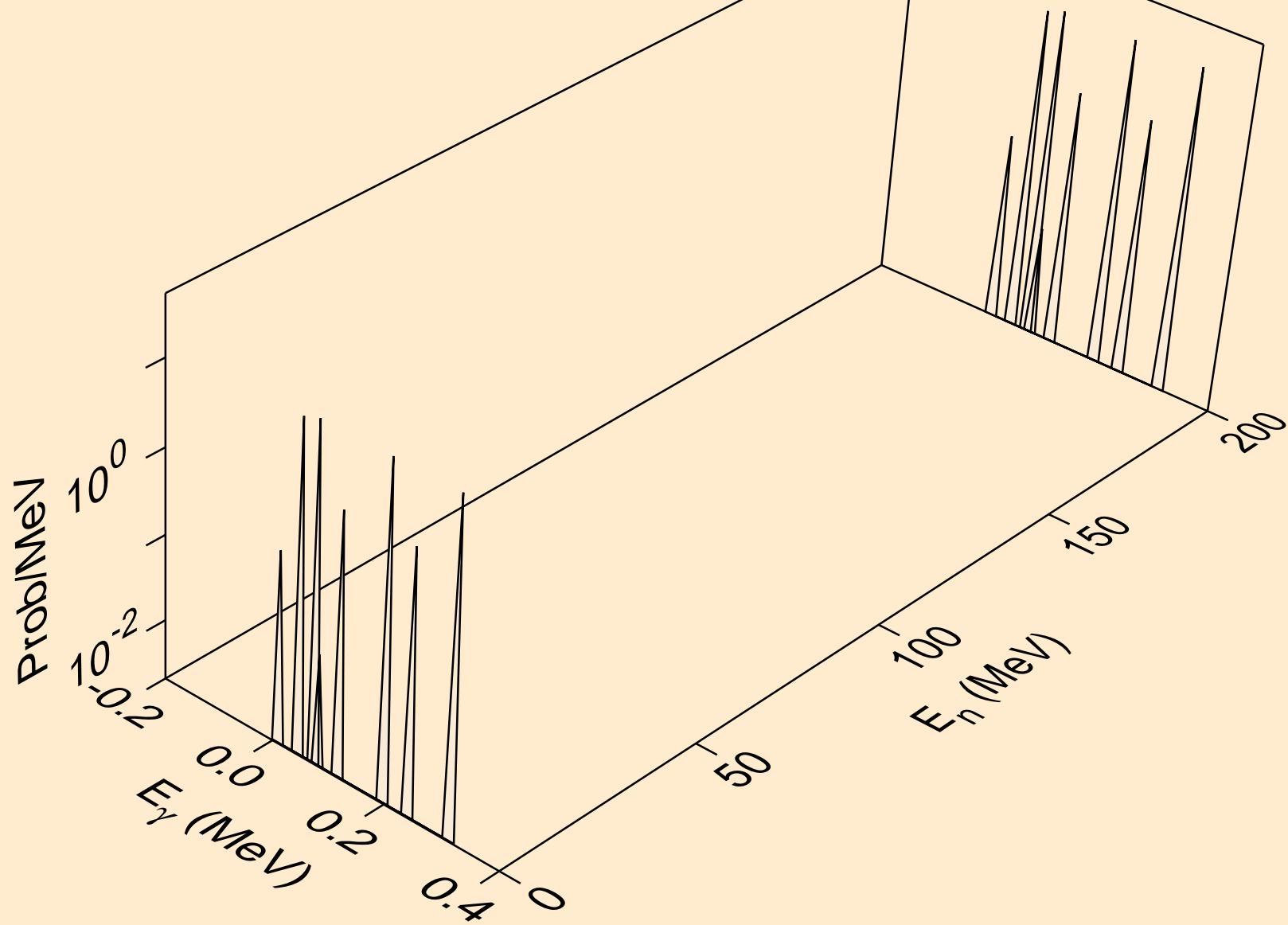

HO158N NEUTRON ACER TENDL-2021 LIBRARY; T=293.6K  
Photon emission for (n,n\*20)

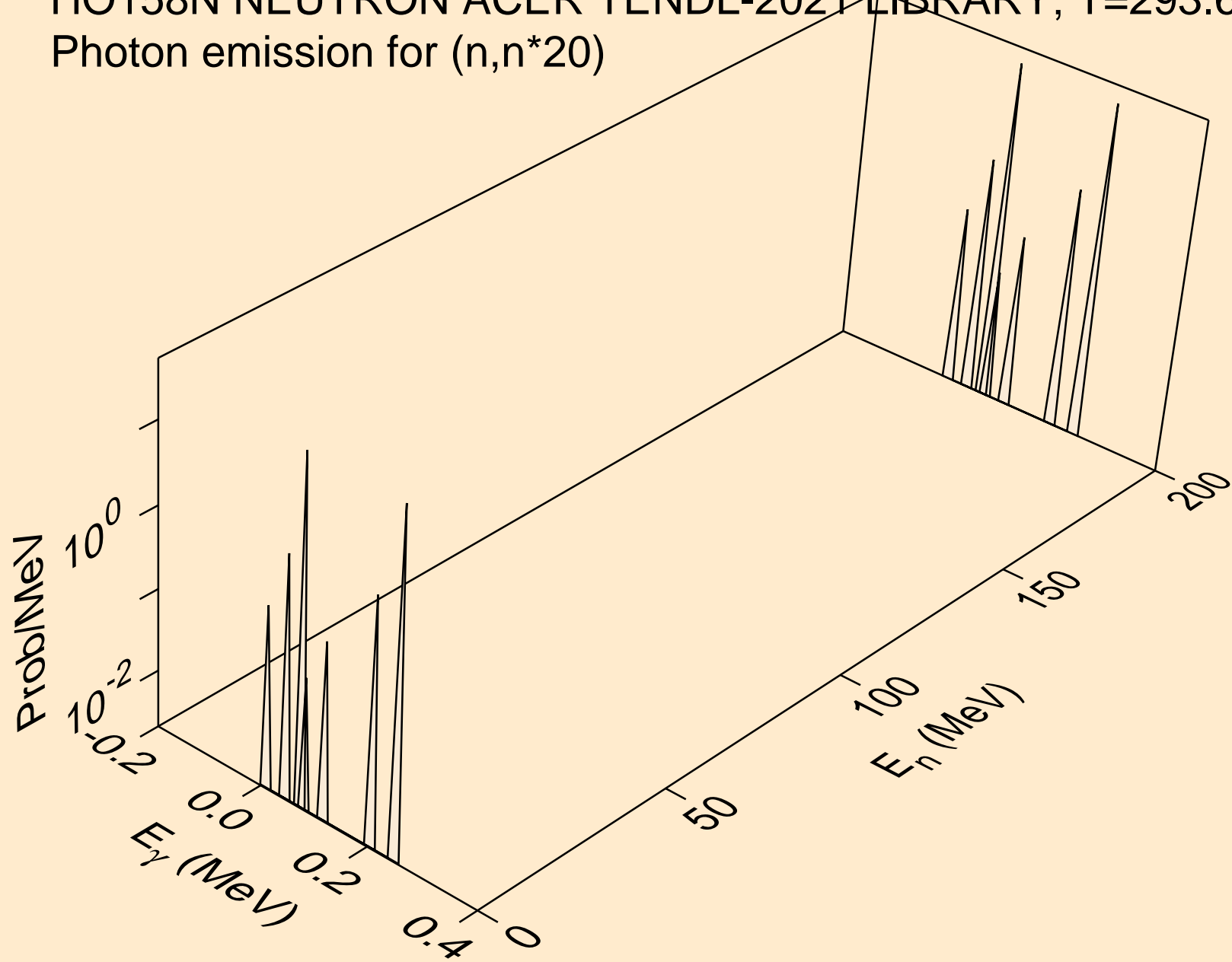

HO158N NEUTRON ACER TENDL-2021 LIBRARY; T=293.6K  
Photon emission for (n,n\*21)

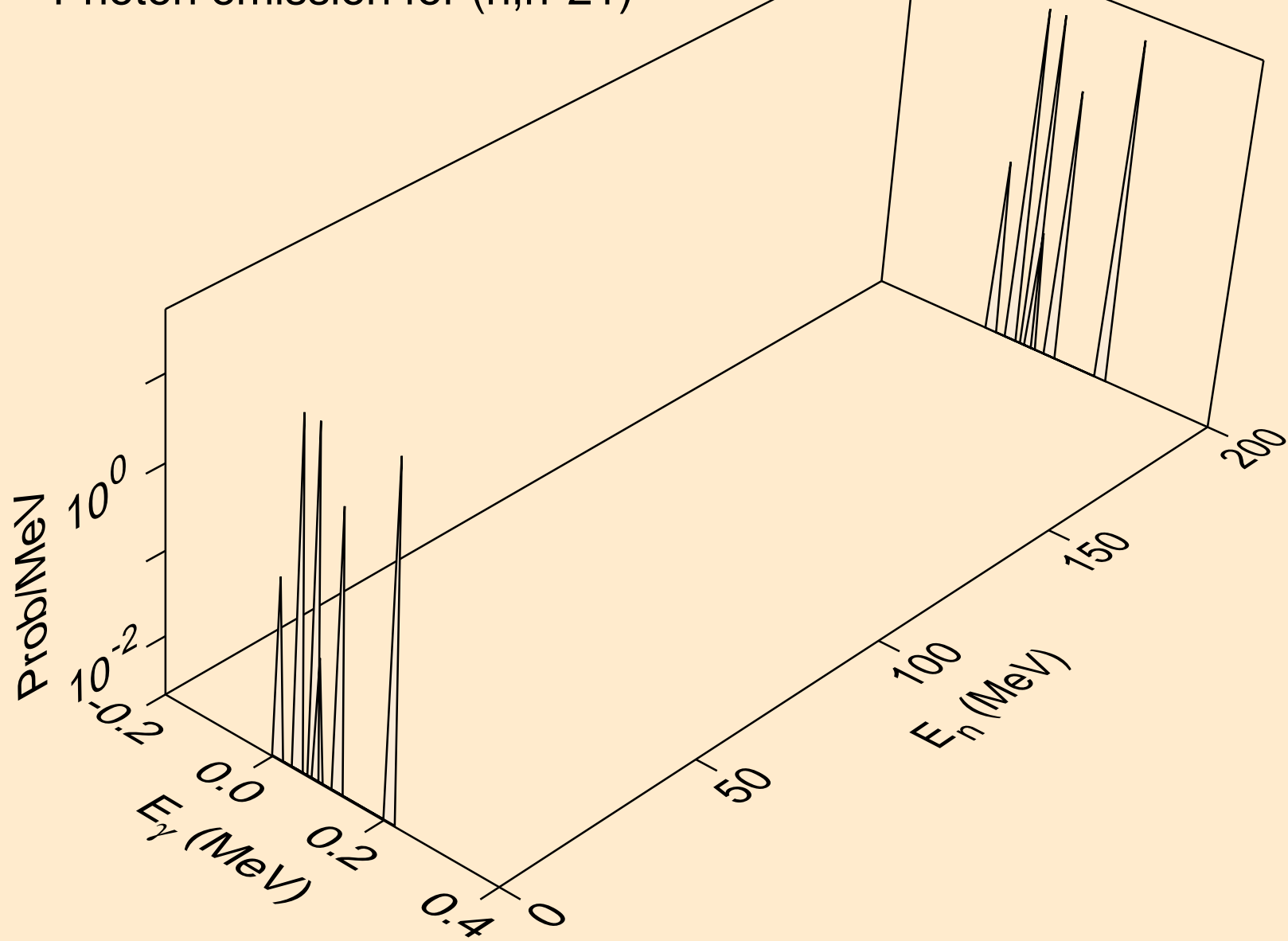

HO158N NEUTRON ACER TENDL-2021 LIBRARY; T=293.6K  
Photon emission for (n,n\*22)

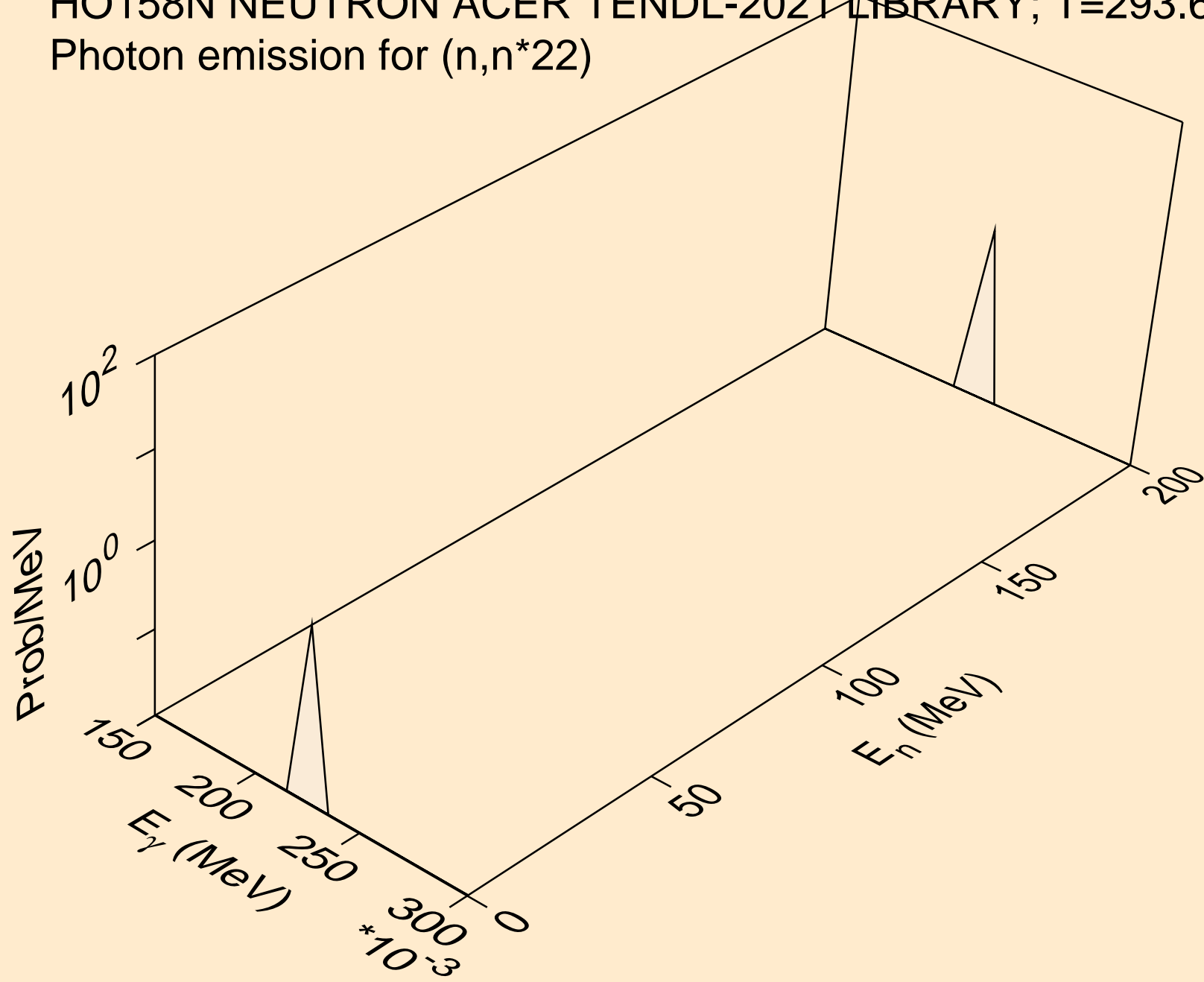

HO158N NEUTRON ACER TENDL-2021 LIBRARY; T=293.6K  
Photon emission for (n,n\*23)

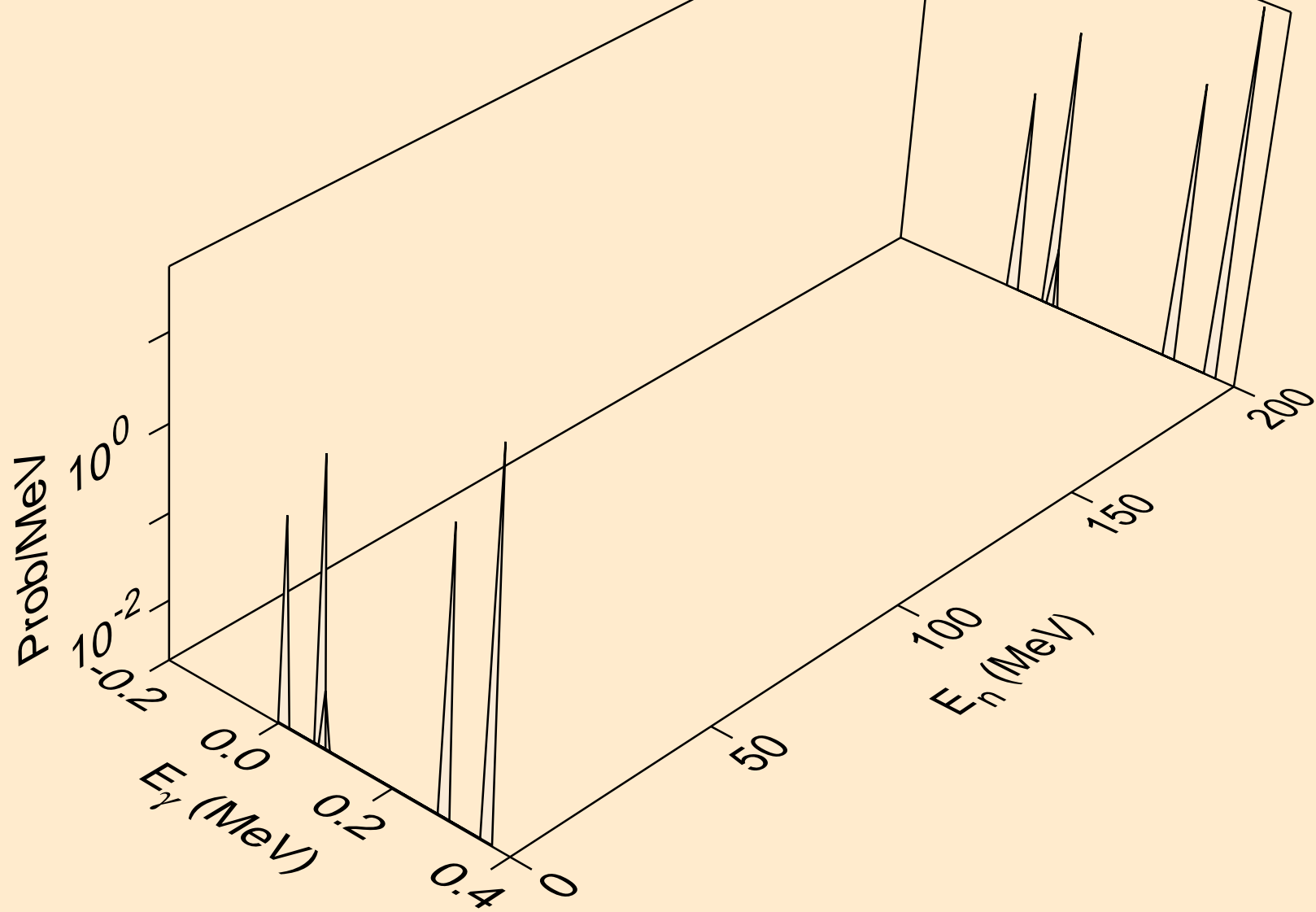

HO158N NEUTRON ACER TENDL-2021 LIBRARY; T=293.6K  
Photon emission for (n,n\*24)

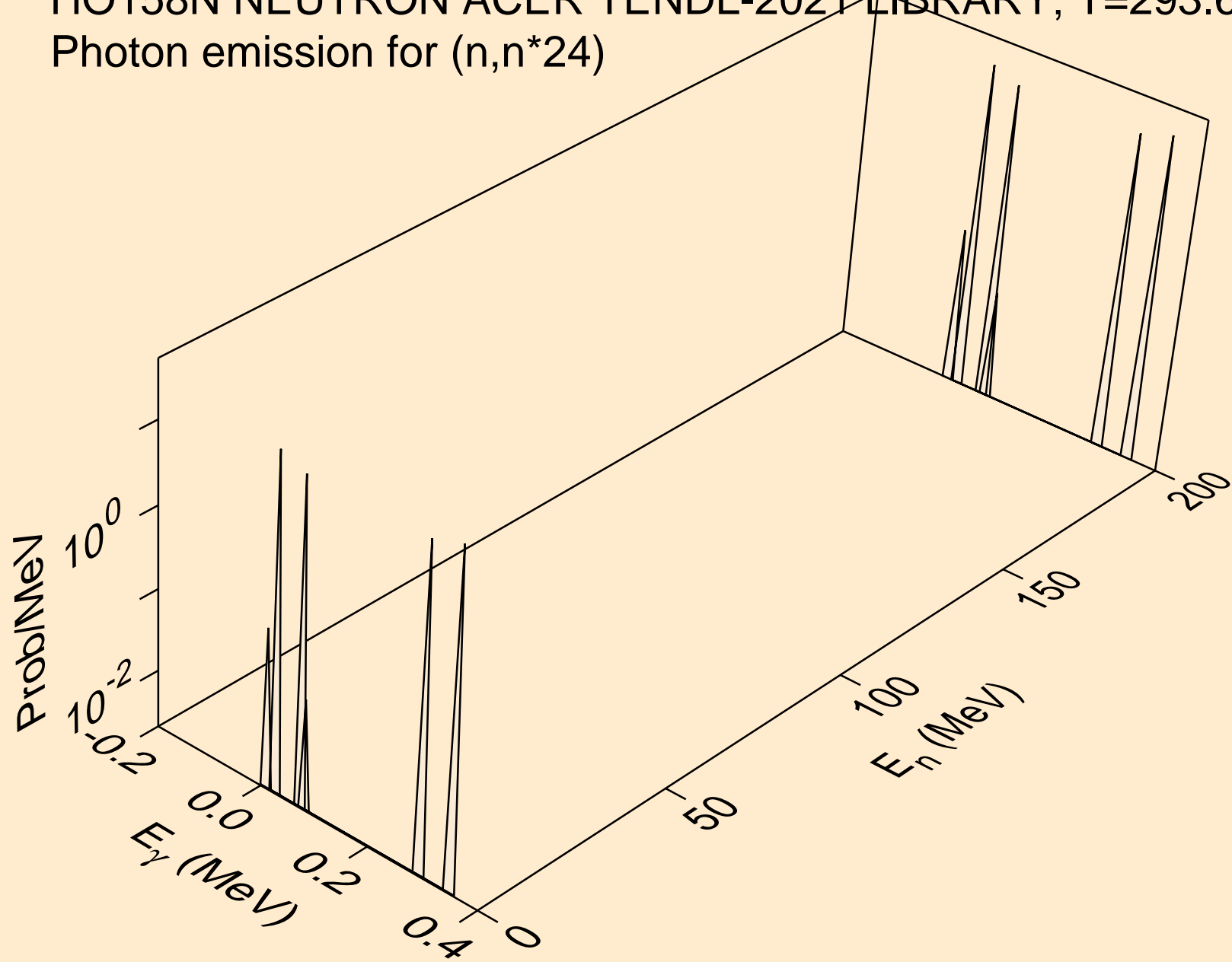



HO158N NEUTRON ACER TENDL-2021 LIBRARY; T=293.6K  
Photon emission for (n,n\*25)

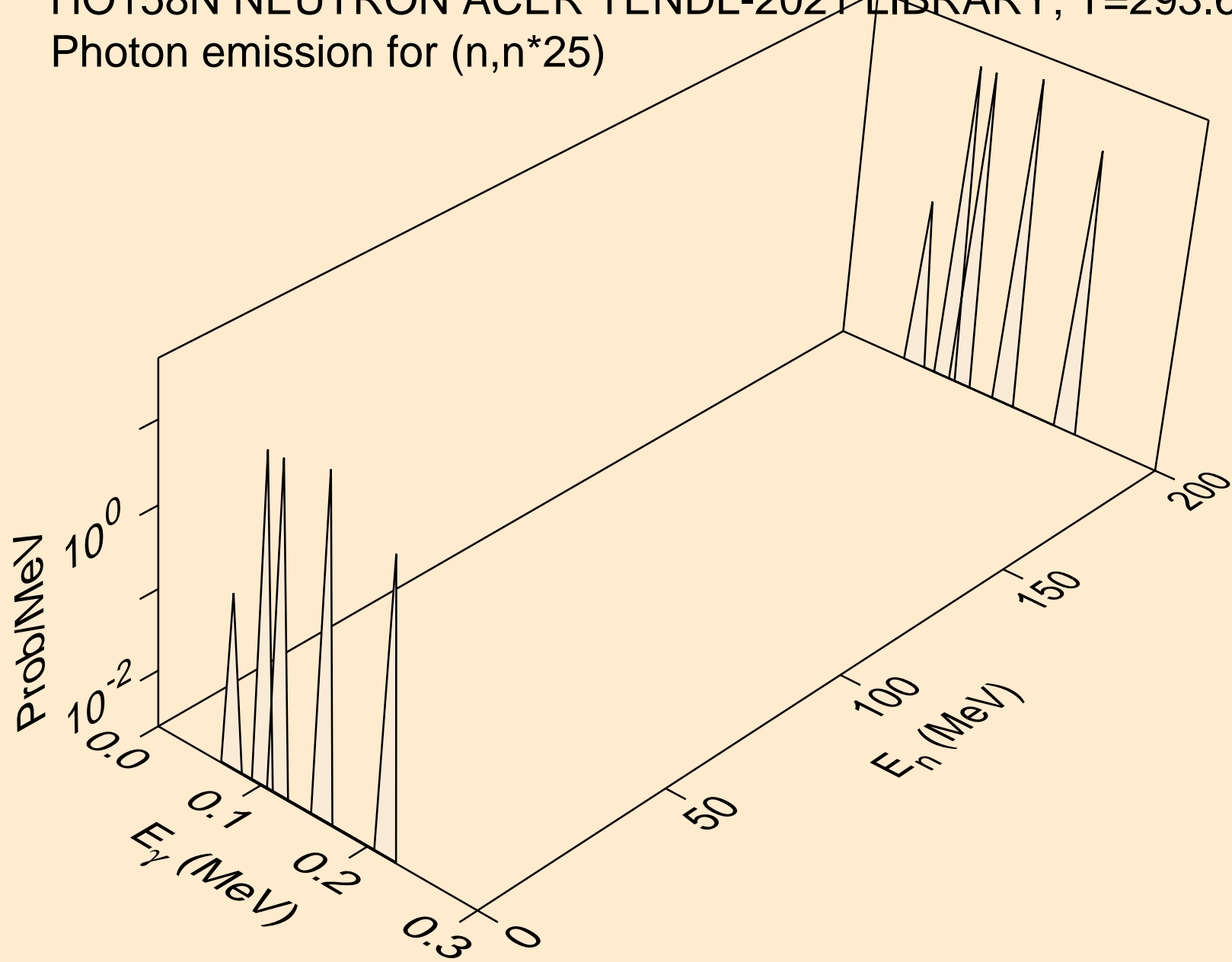

HO158N NEUTRON ACER TENDL-2021 LIBRARY; T=293.6K  
Photon emission for (n,n\*26)

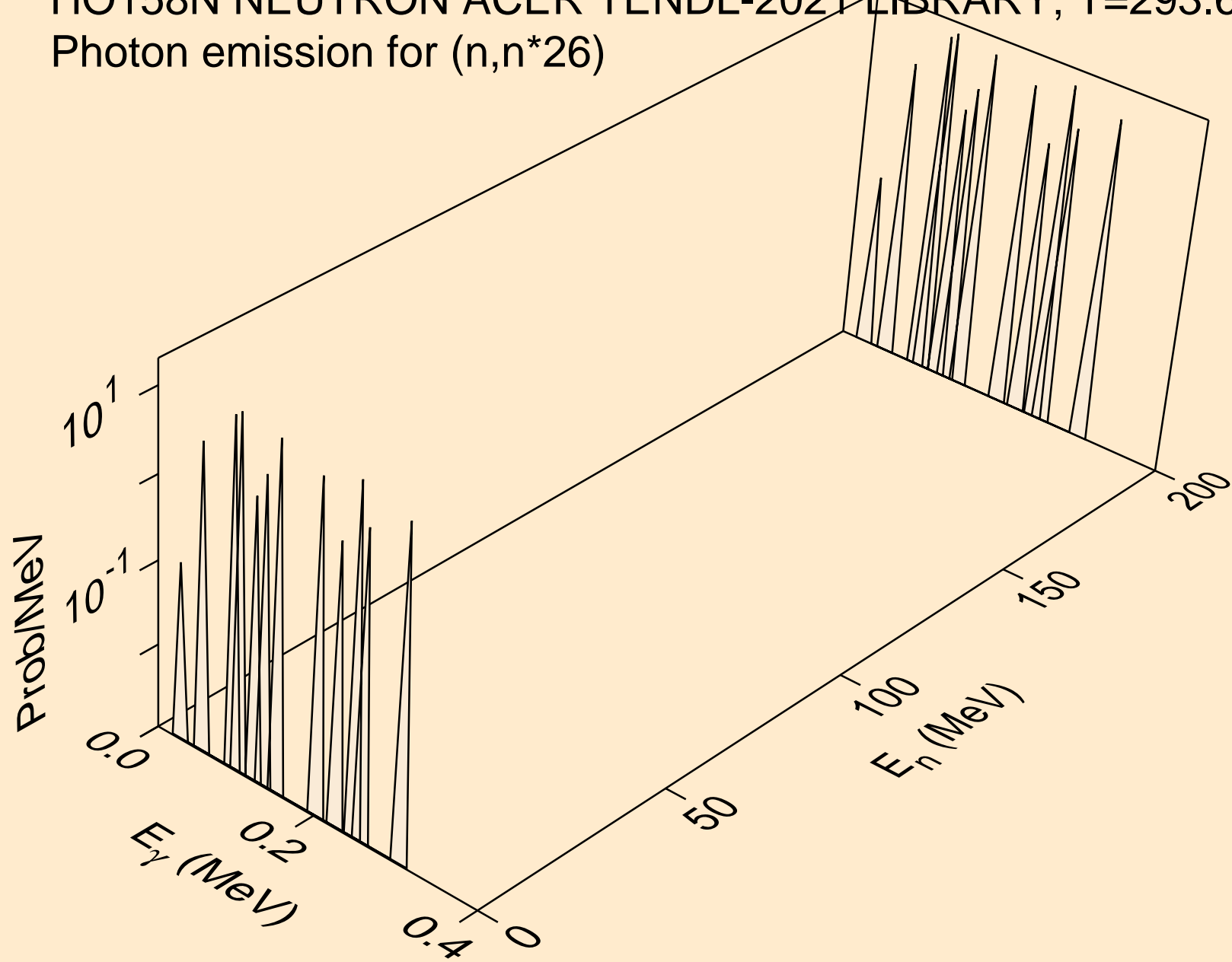

HO158N NEUTRON ACER TENDL-2021 LIBRARY; T=293.6K  
Photon emission for (n,n\*27)

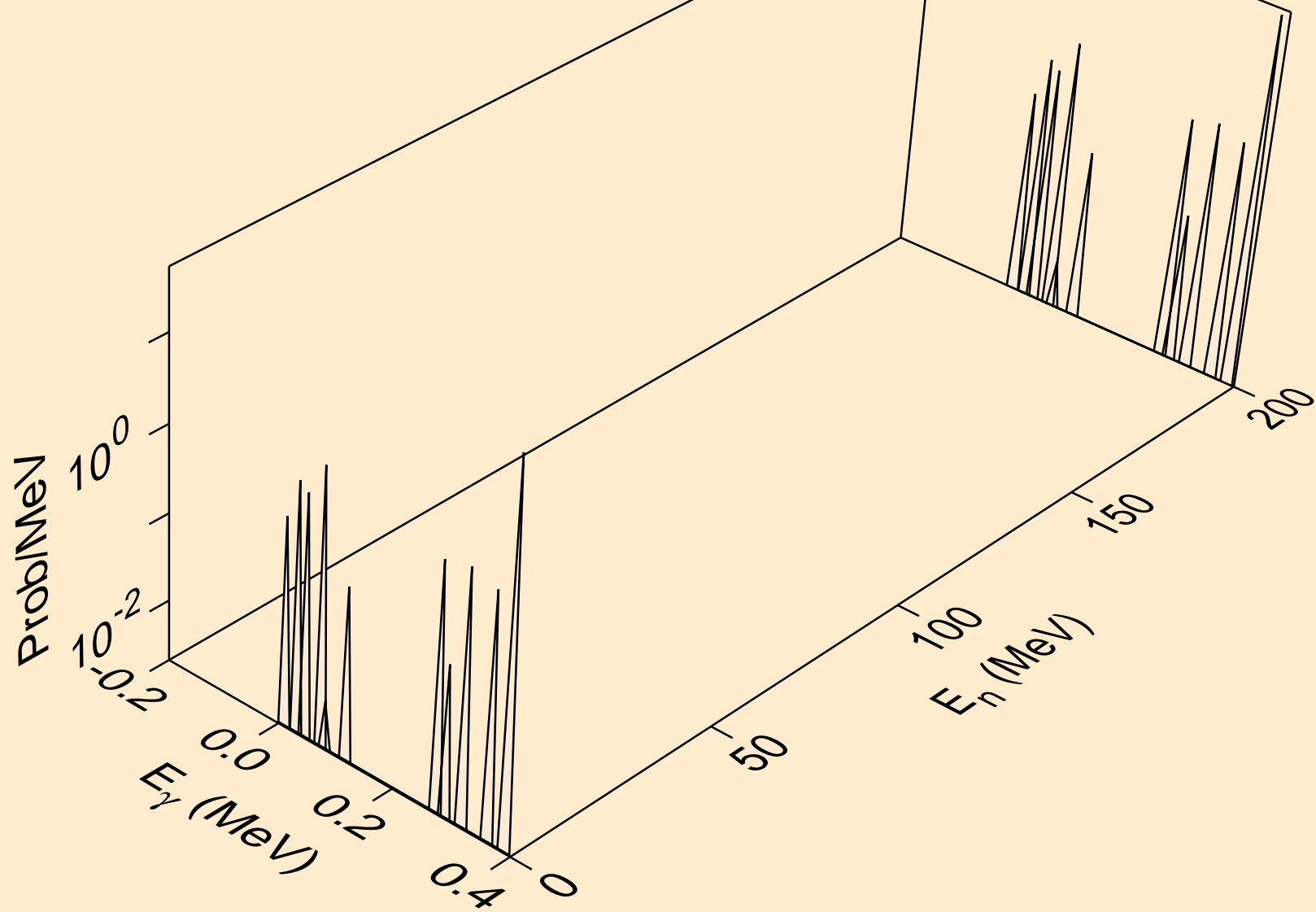

HO158N NEUTRON ACER TENDL-2021 LIBRARY; T=293.6K  
Photon emission for (n,n\*28)

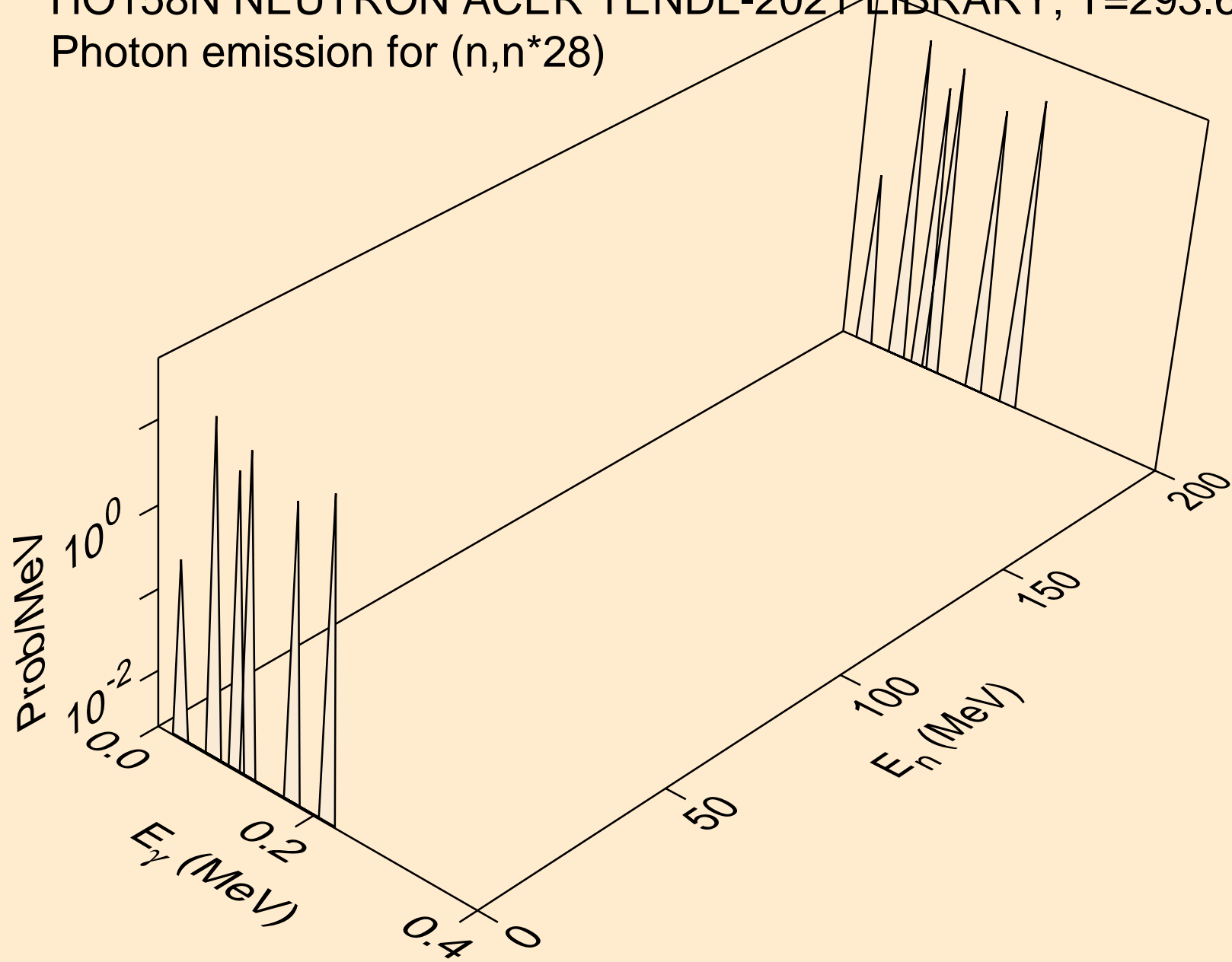

HO158N NEUTRON ACER TENDL-2021 LIBRARY; T=293.6K  
Photon emission for (n,n\*29)

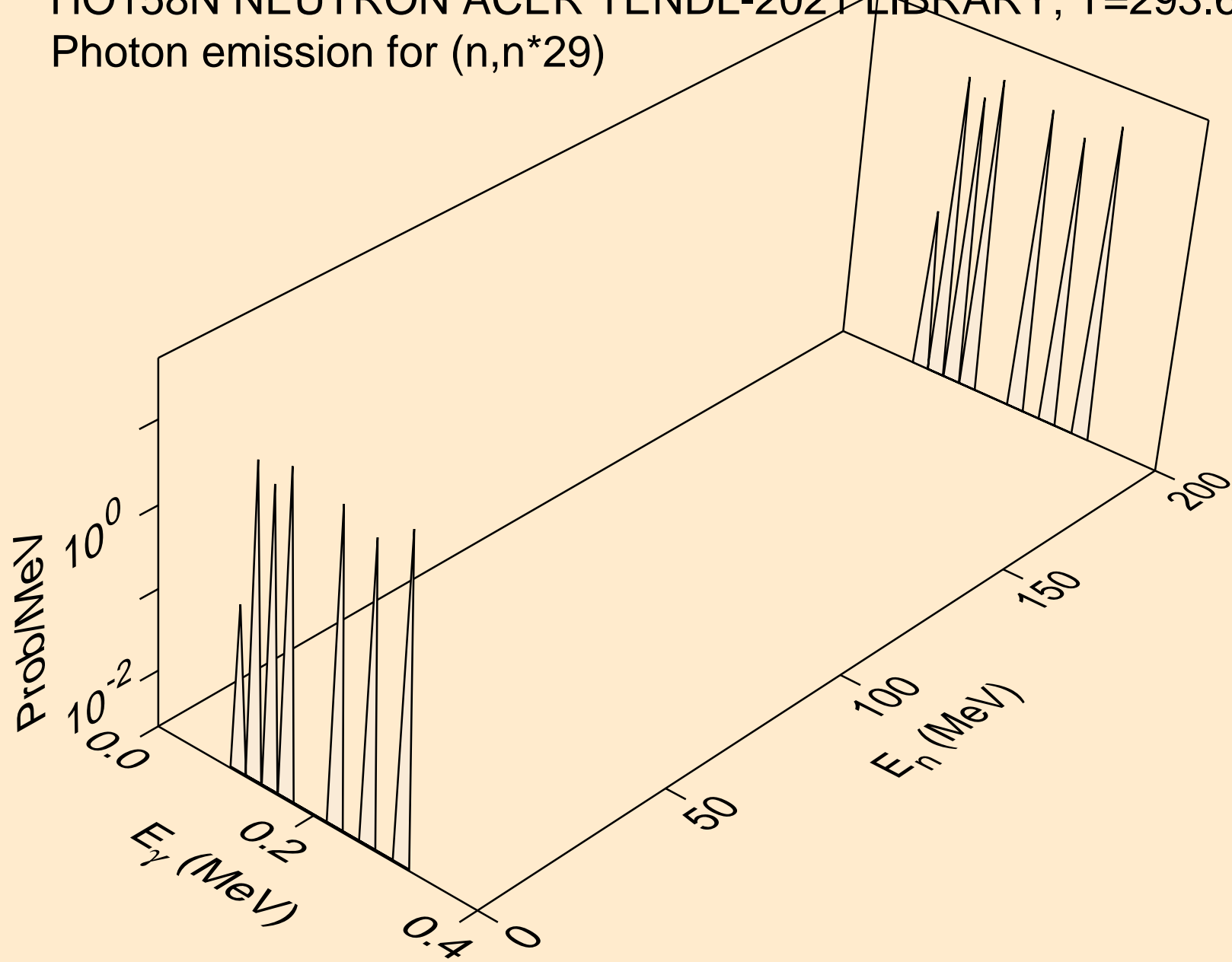

HO158N NEUTRON ACER TENDL-2021 LIBRARY; T=293.6K  
Photon emission for (n,n\*30)

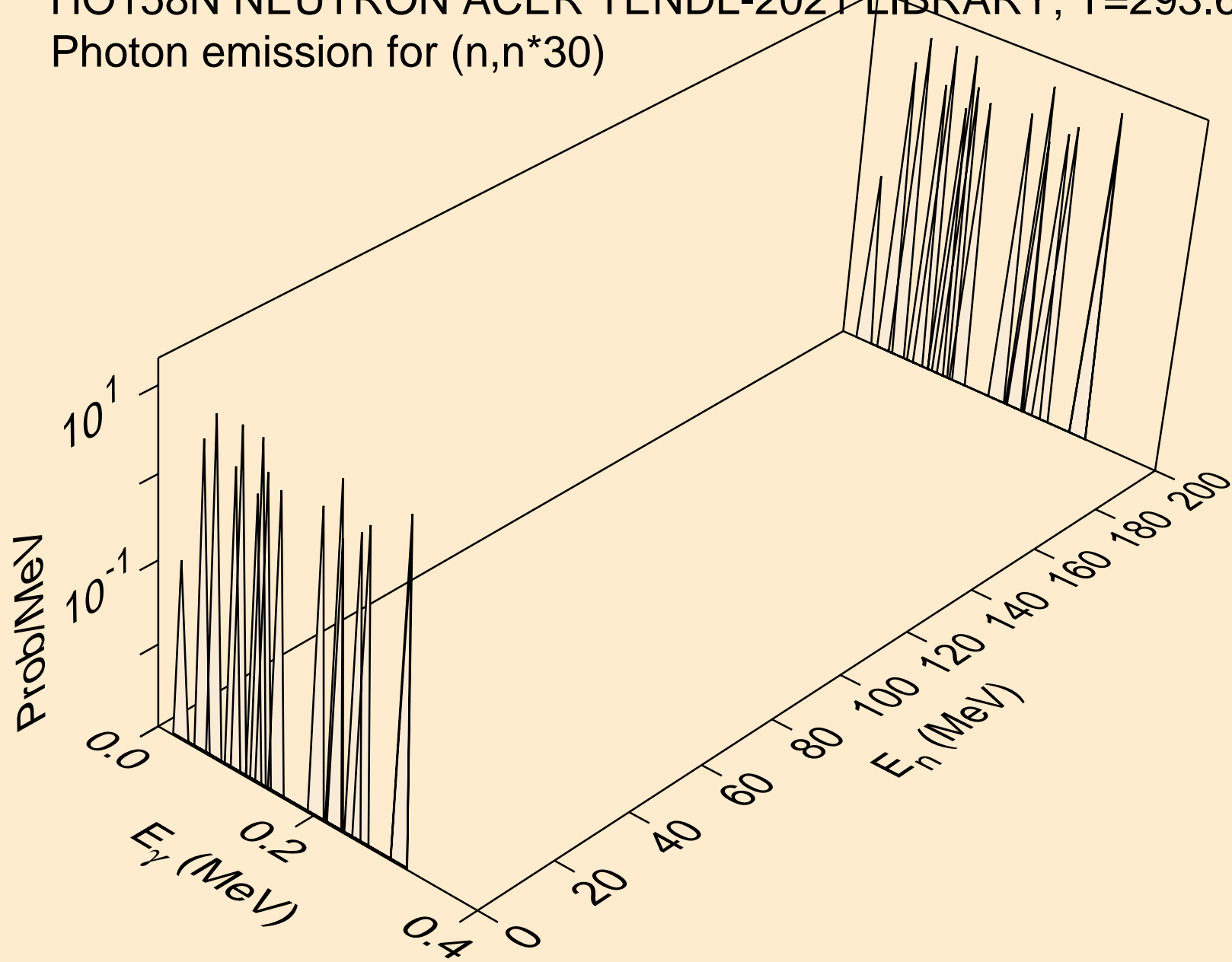

HO158N NEUTRON ACER TENDL-2021 LIBRARY; T=293.6K  
Photon emission for (n,n\*c)

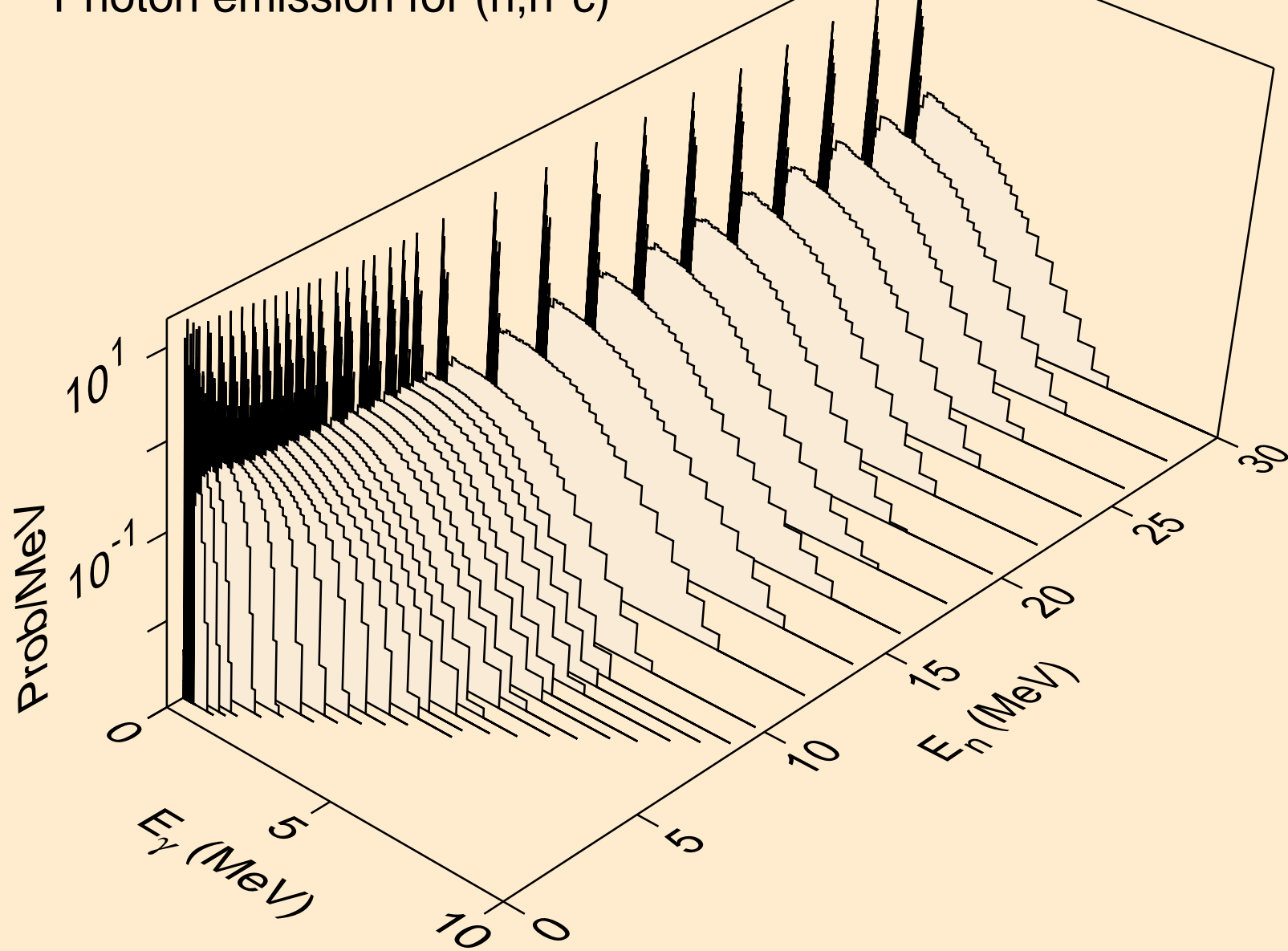

HO158N NEUTRON ACER TENDL-2021 LIBRARY; T=293.6K  
Photon emission for (n,gma)

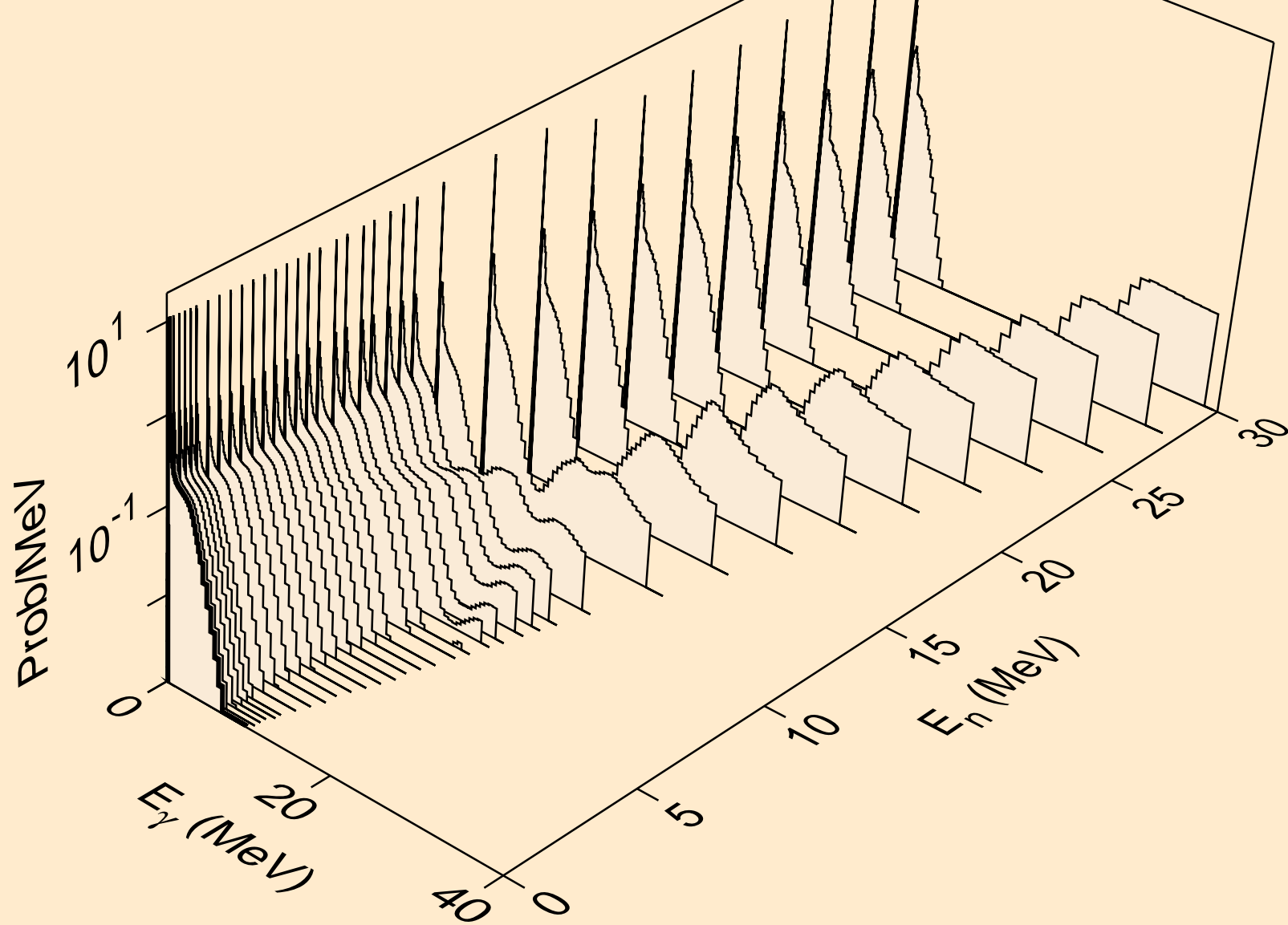



HO158N NEUTRON ACER TENDL-2021 LIBRARY; T=293.6K  
Photon emission for (n,p)

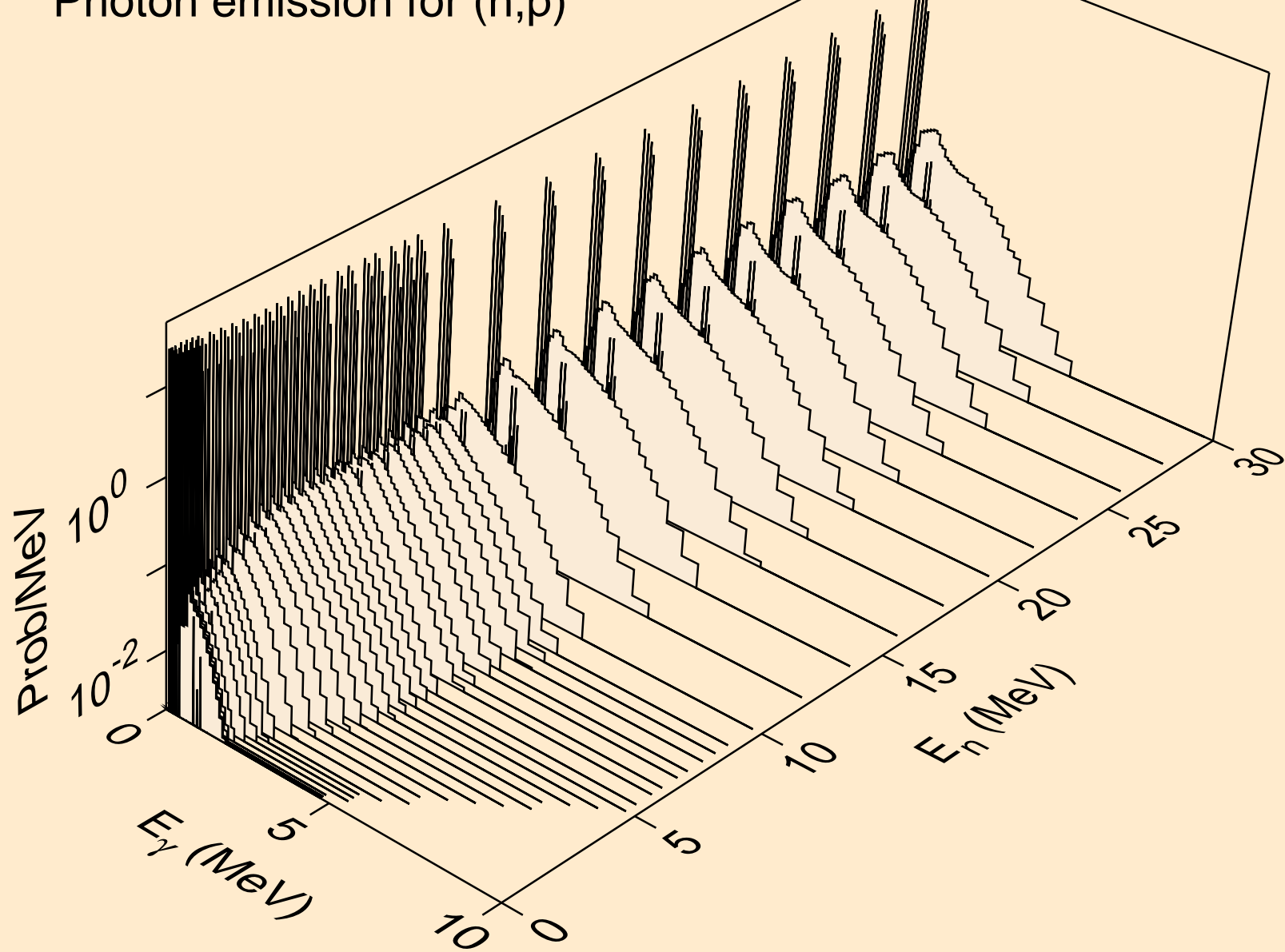

HO158N NEUTRON ACER TENDL-2021 LIBRARY; T=293.6K  
Photon emission for (n,d)

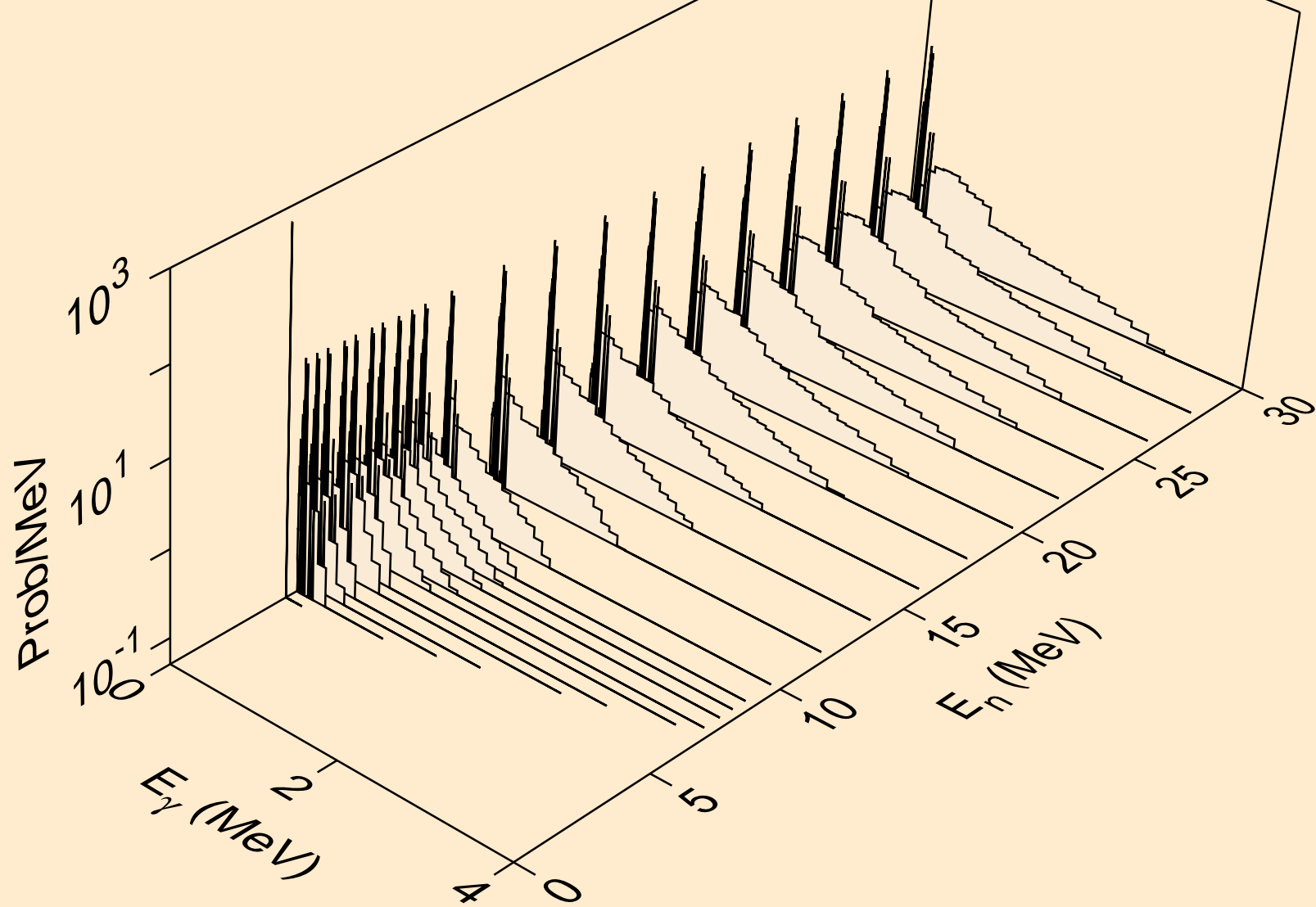

HO158N NEUTRON ACER TENDL-2021 LIBRARY; T=293.6K  
Photon emission for (n,t)

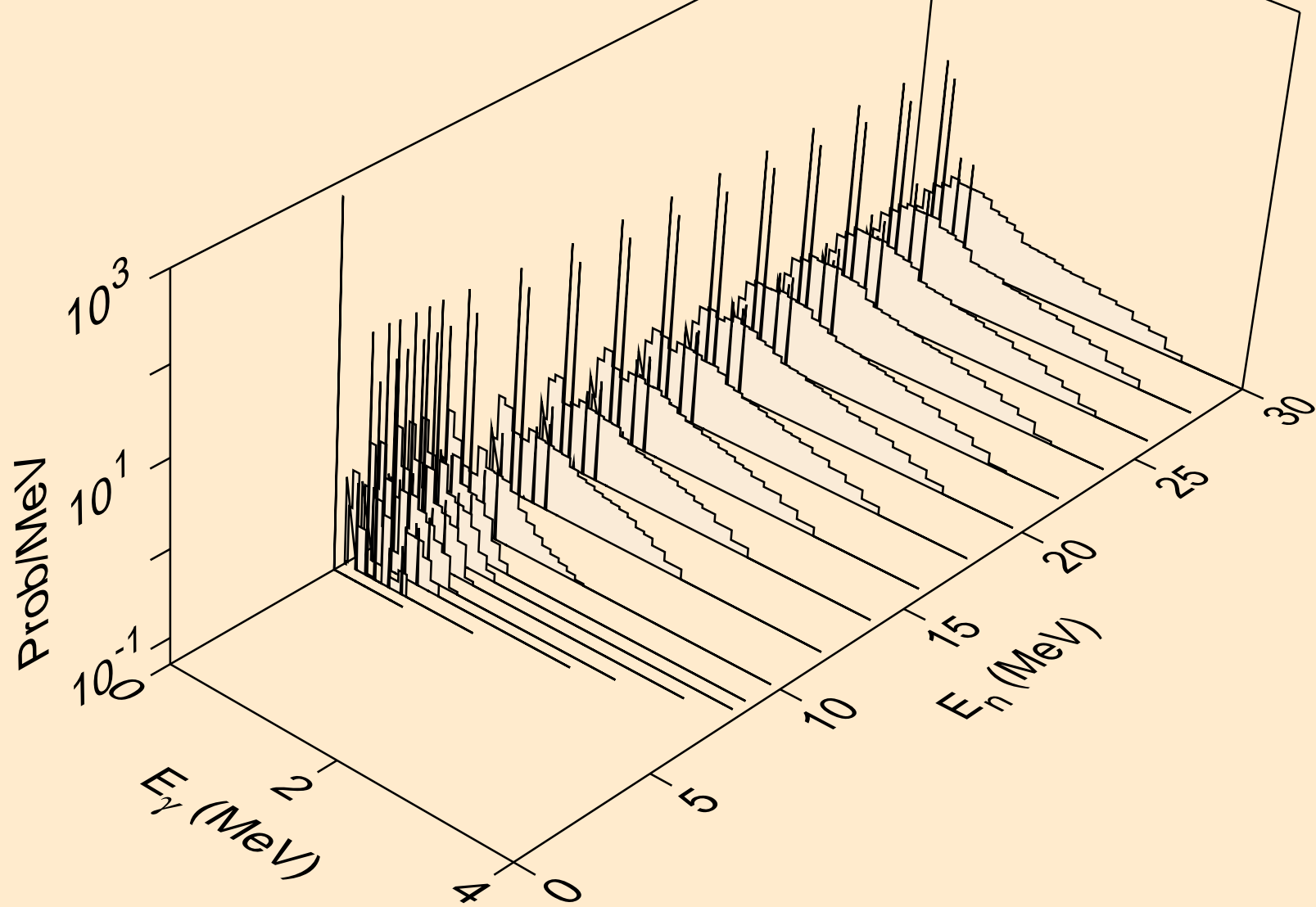

HO158N NEUTRON ACER TENDL-2021 LIBRARY; T=293.6K  
Photon emission for (n,he3)

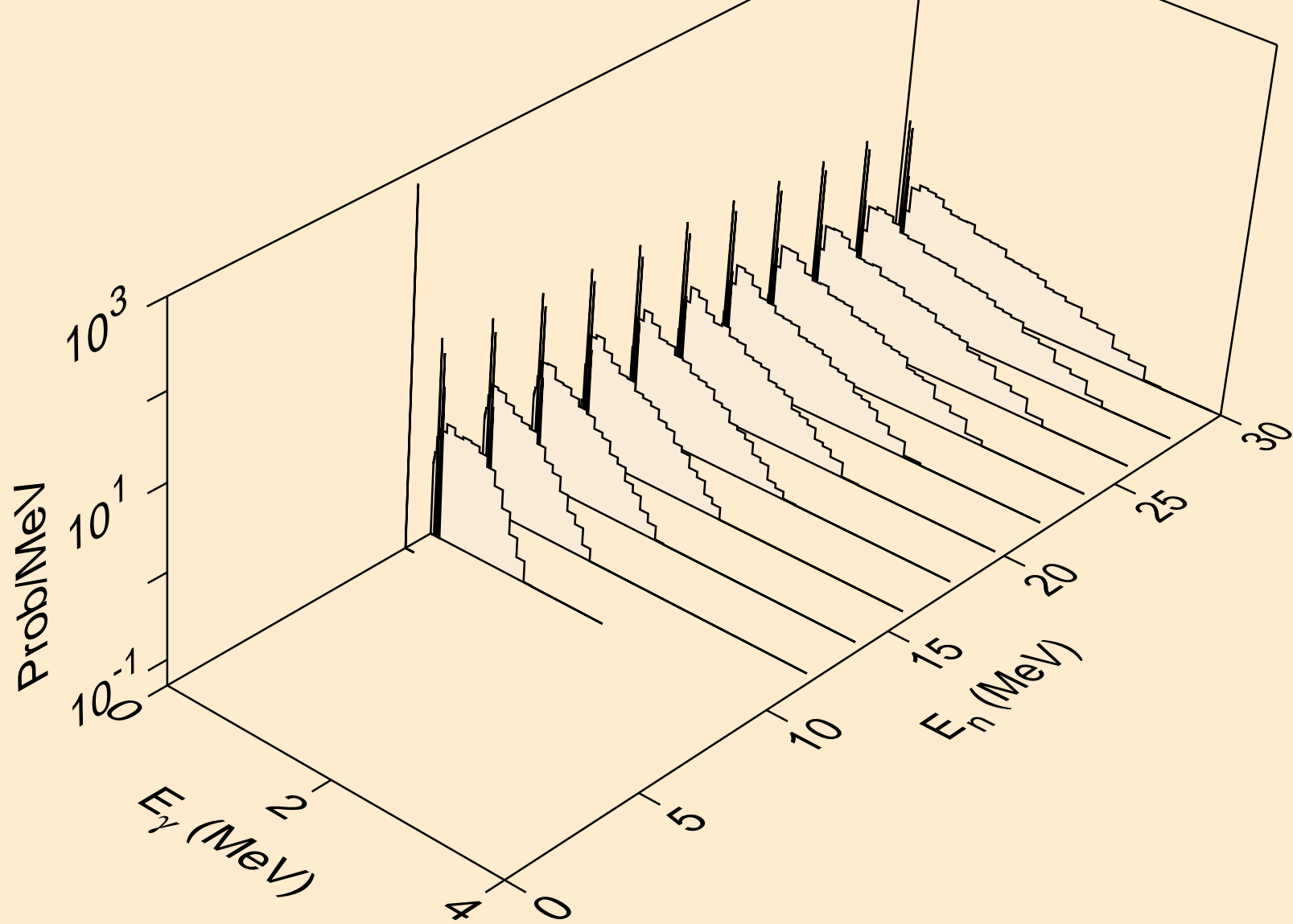

HO158N NEUTRON ACER TENDL-2021 LIBRARY; T=293.6K  
Photon emission for (n,a)

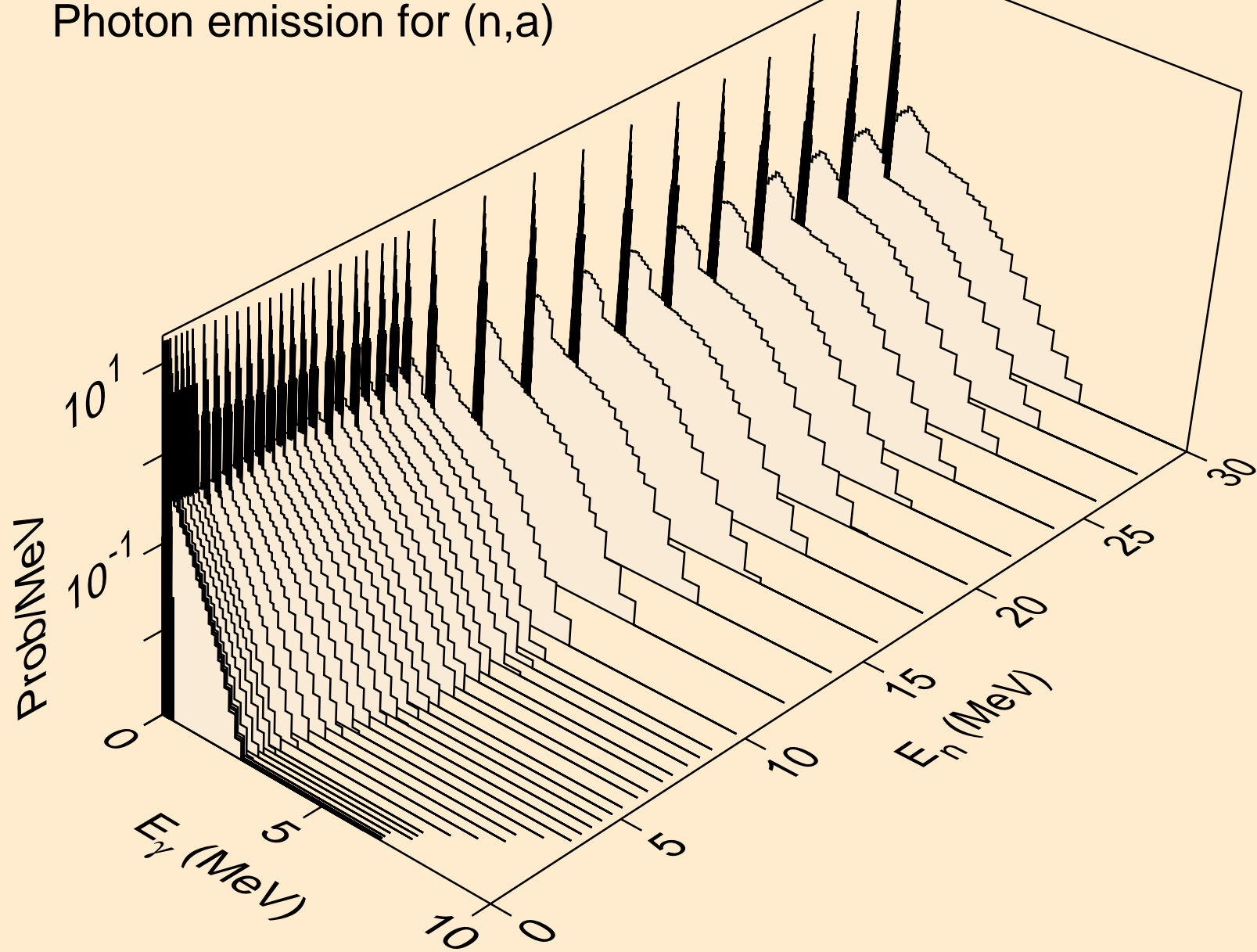

HO158N NEUTRON ACER TENDL-2021 LIBRARY; T=293.6K  
Photon emission for (n,2a)

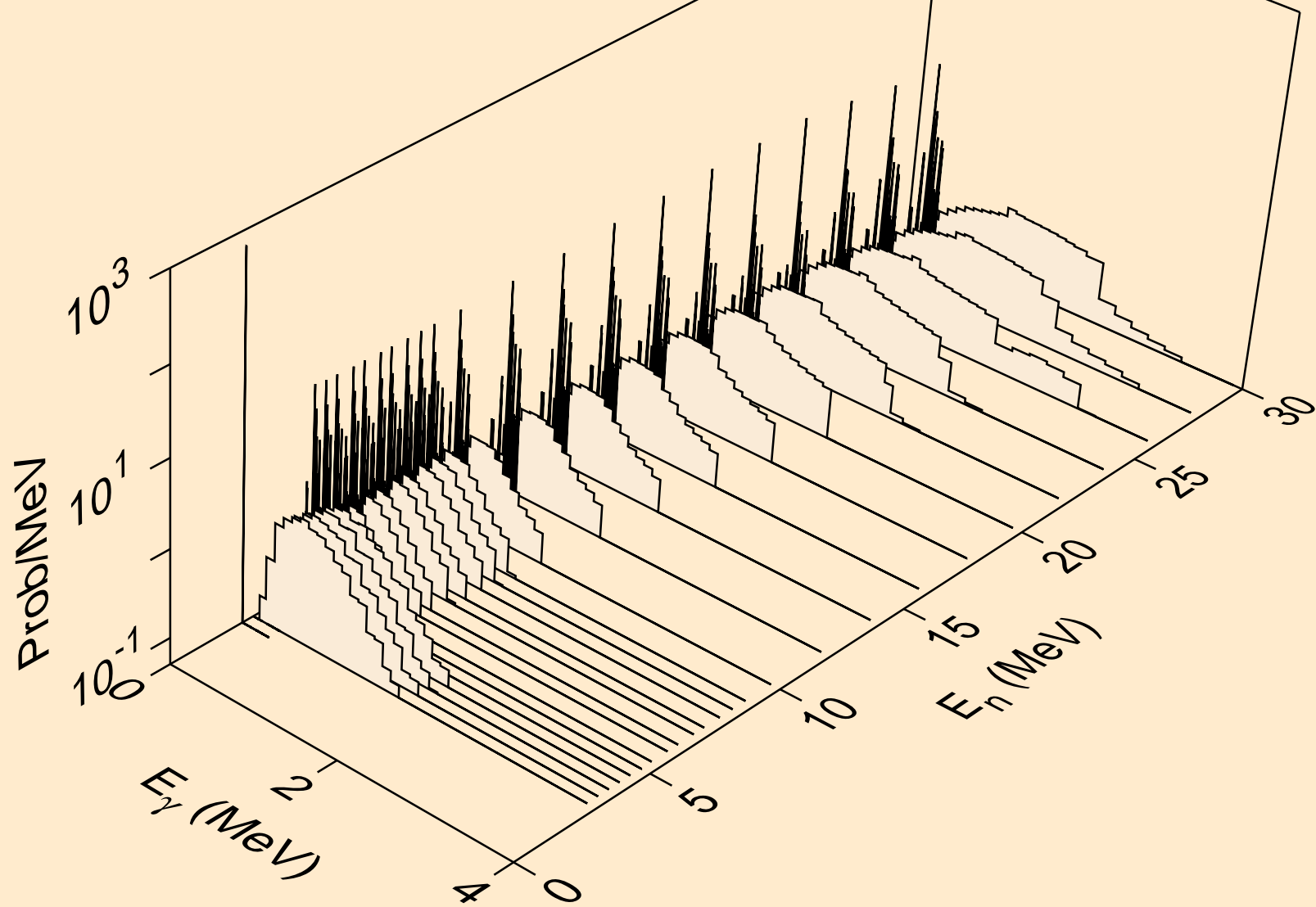

HO158N NEUTRON ACER TENDL-2021 LIBRARY; T=293.6K  
Photon emission for (n,2p)

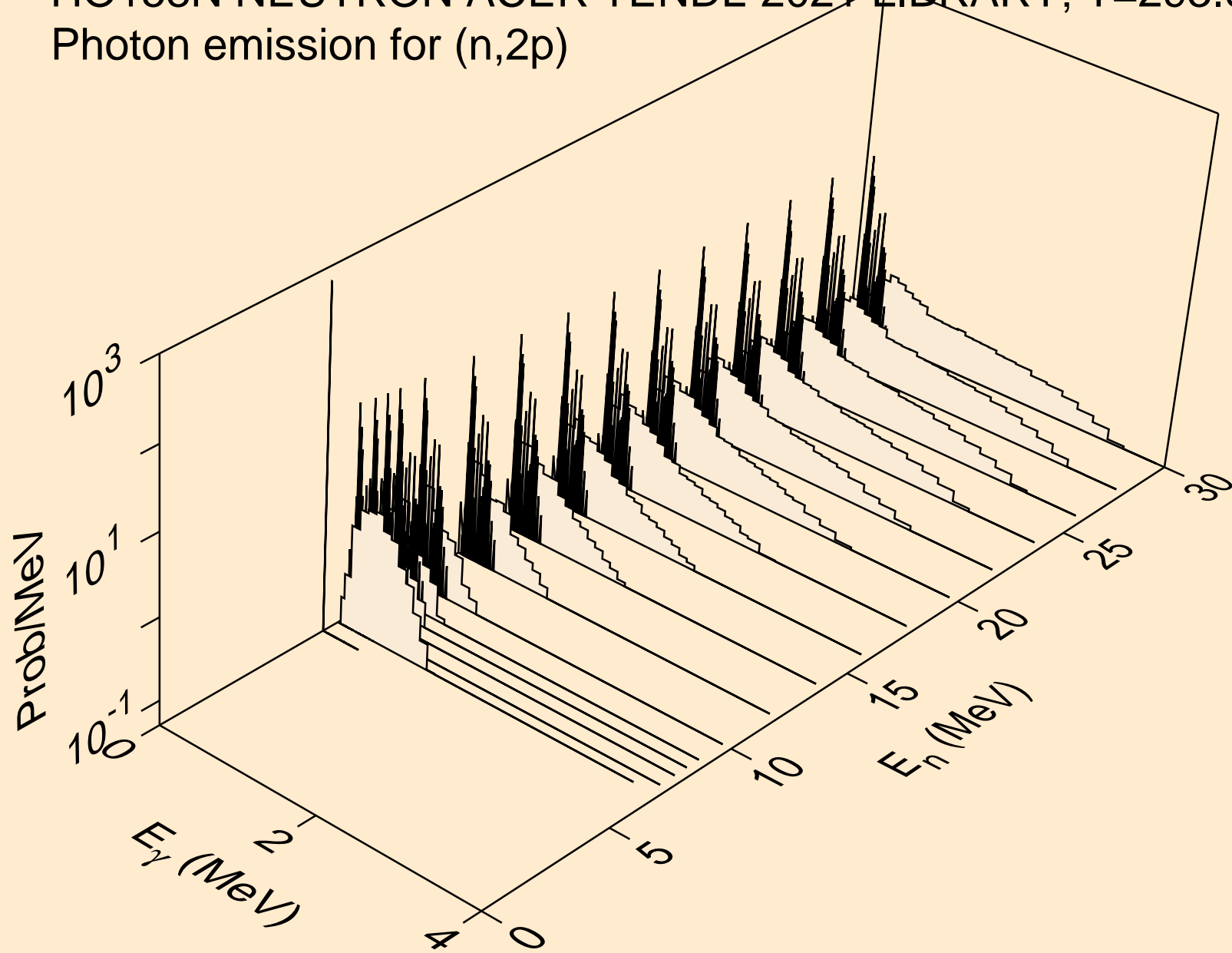

HO158N NEUTRON ACER TENDL-2021 LIBRARY; T=293.6K  
Photon emission for (n,p)

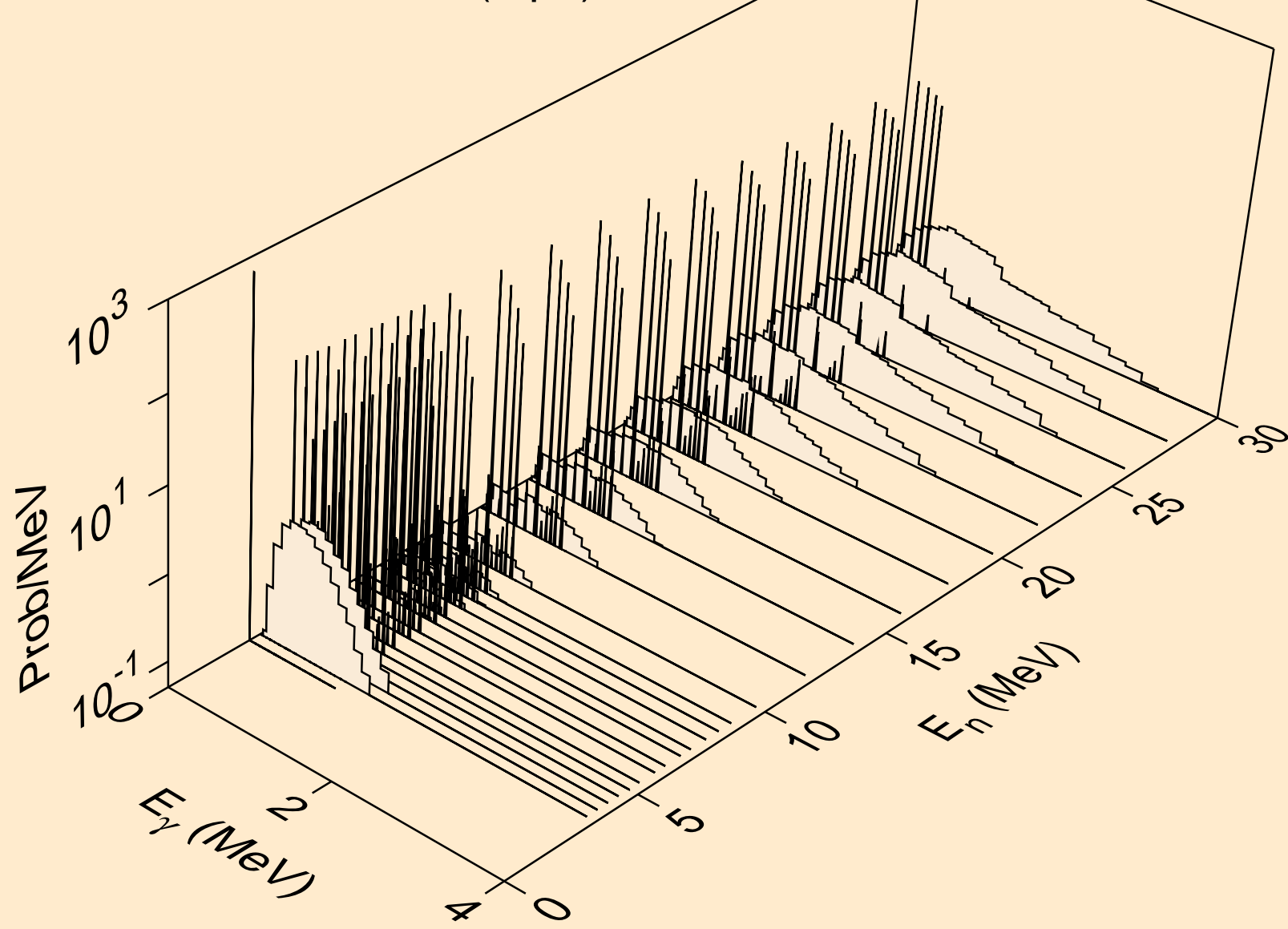



HO158N NEUTRON ACER TENDL-2021 LIBRARY; T=293.6K  
Photon emission for (n,pd)

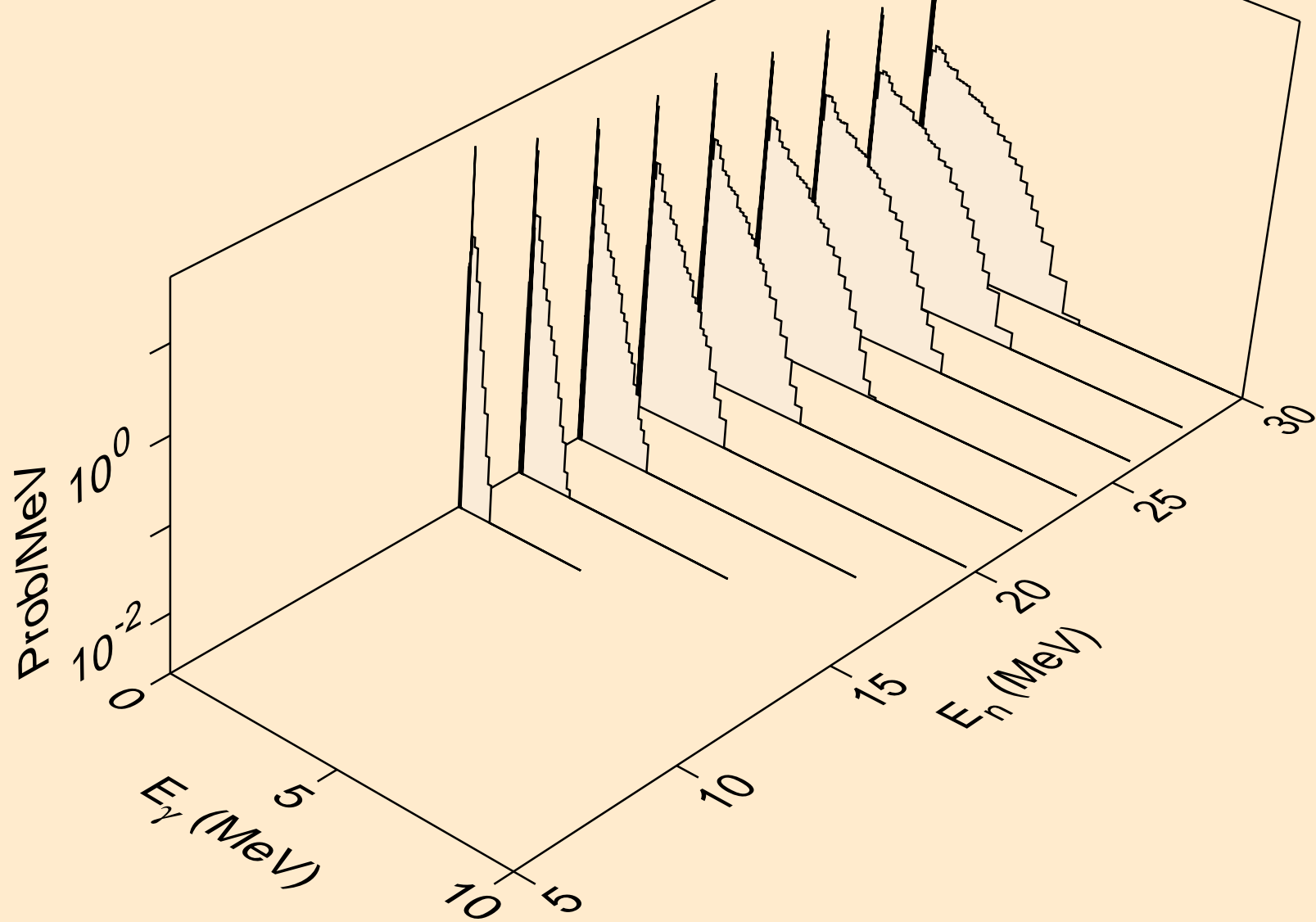

HO158N NEUTRON ACER TENDL-2021 LIBRARY; T=293.6K  
Photon emission for (n,pt)

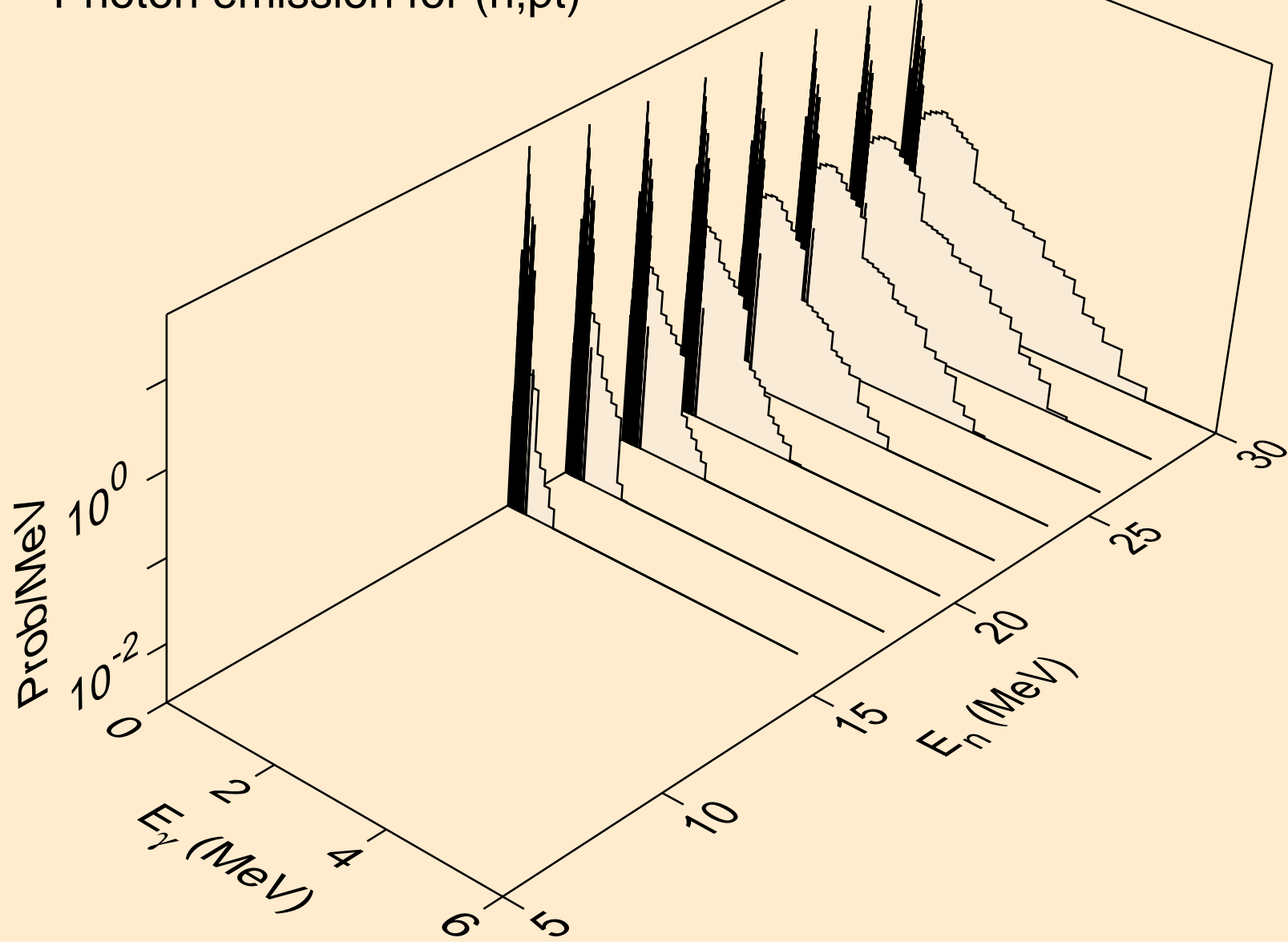

HO158N NEUTRON ACER TENDL-2021 LIBRARY; T=293.6K  
Photon emission for (n,da)

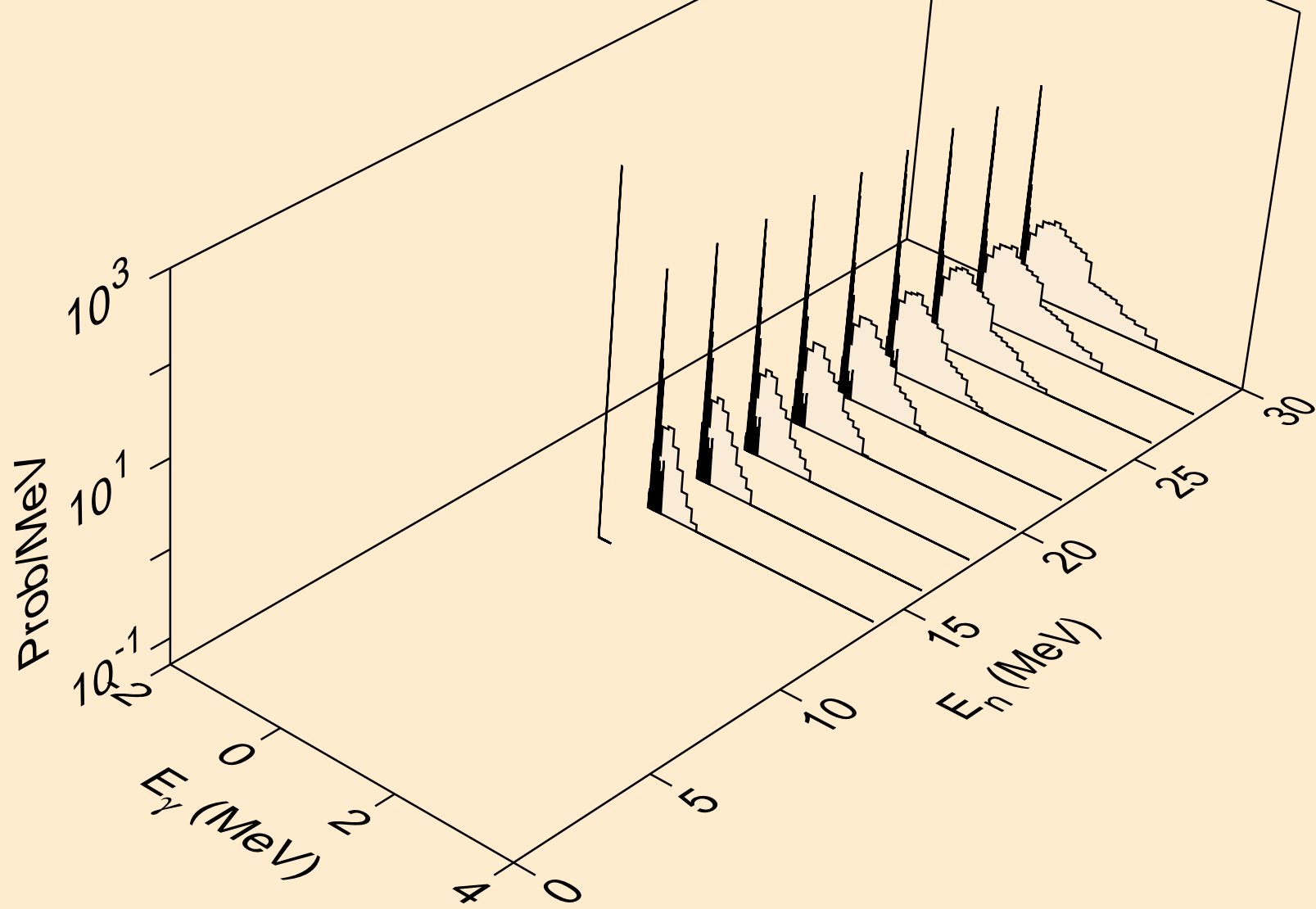

HO158N NEUTRON ACER TENDL-2021 LIBRARY; T=293.6K  
thermal capture photon spectrum

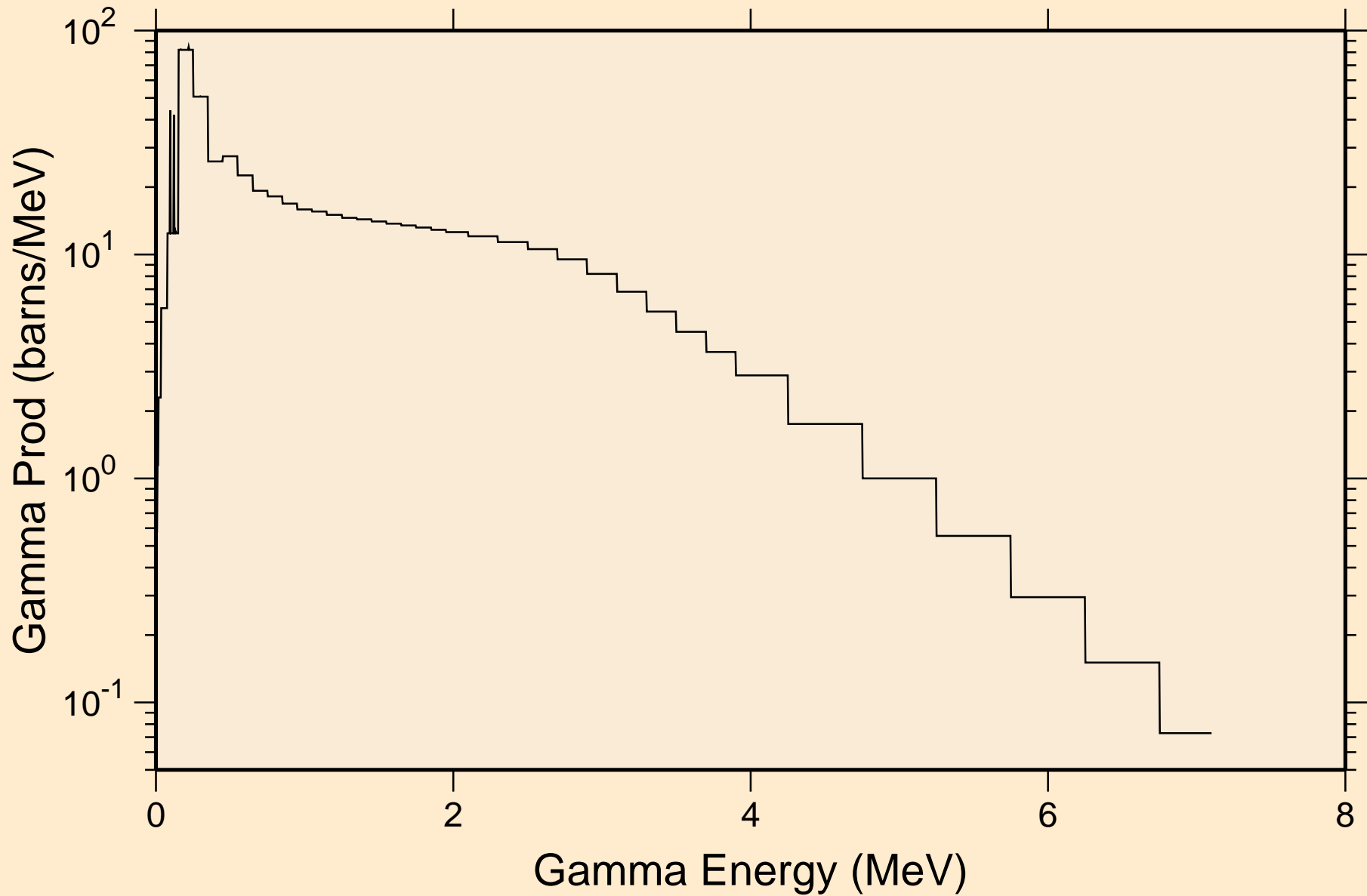

HO158N NEUTRON ACER TENDL-2021 LIBRARY; T=293.6K  
14 MeV photon spectrum

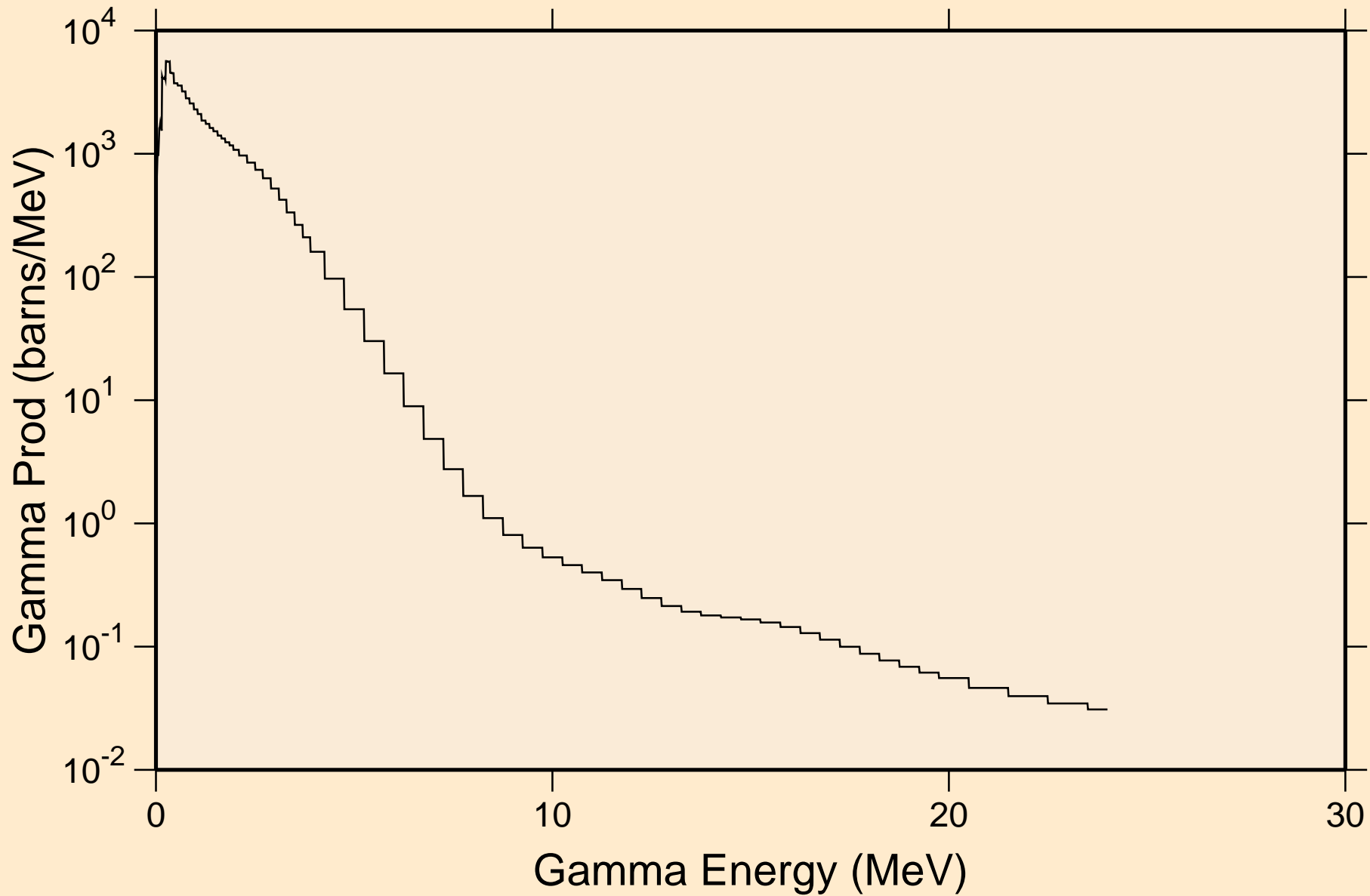

# HO158N NEUTRON ACER TENDL-2021 LIBRARY; T=293.6K

## Particle heating contributions

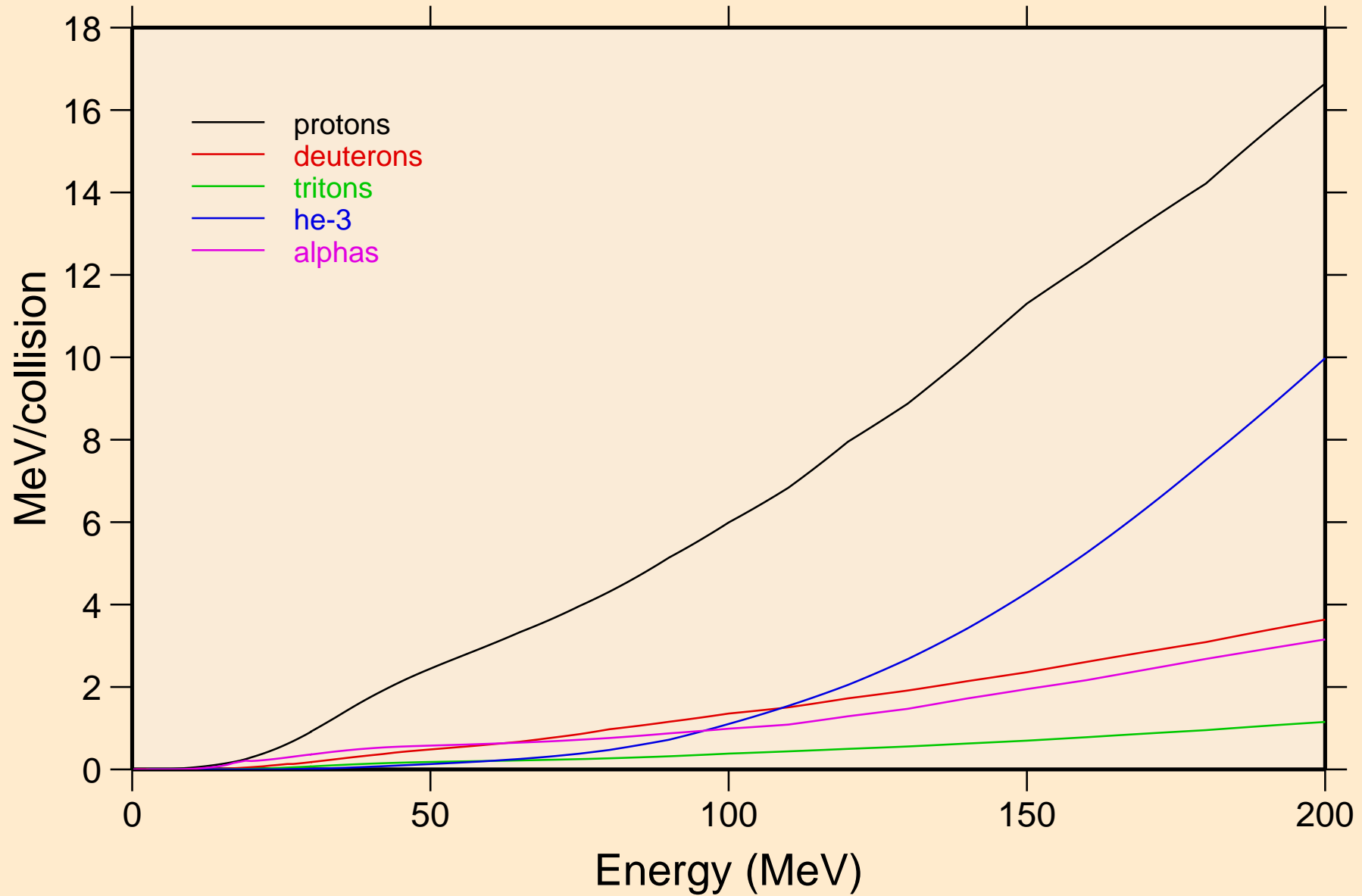

HO158N NEUTRON ACER TENDL-2021 LIBRARY; T=293.6K  
Recoil Heating

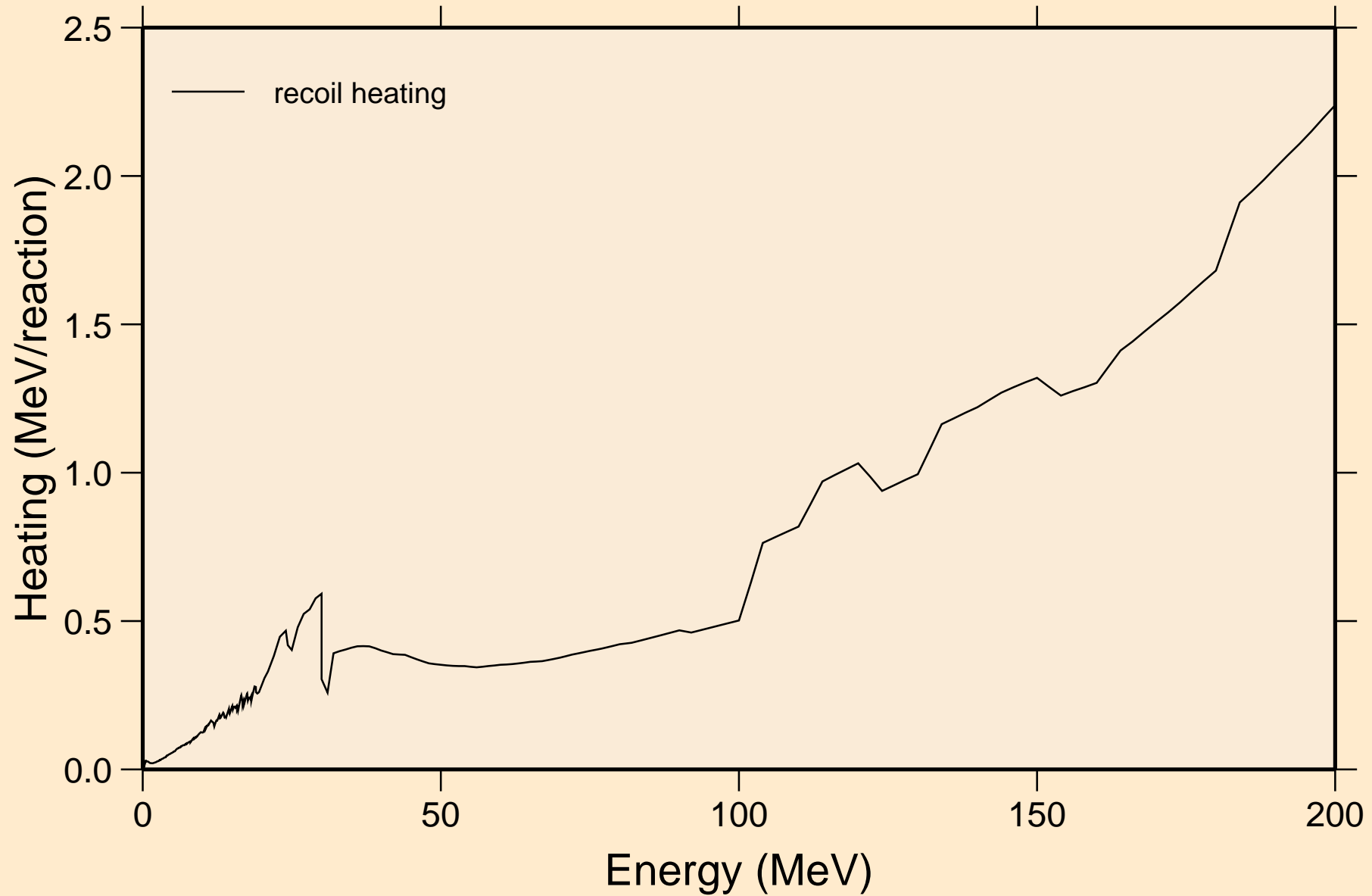

HO158N NEUTRON ACER TENDL-2021 LIBRARY; T=293.6K  
Particle production cross sections

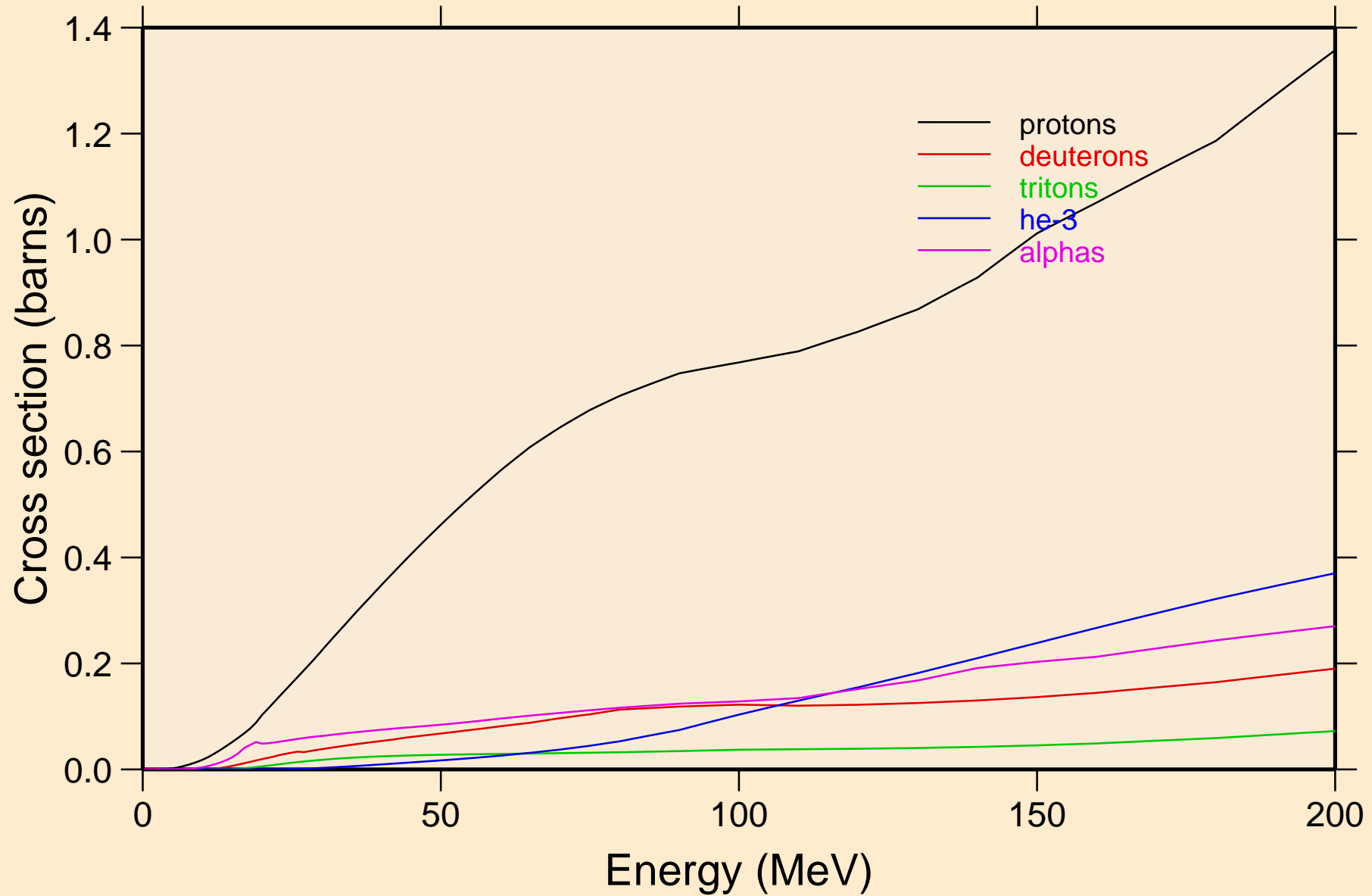



HO158N NEUTRON ACER TENDL-2021 LIBRARY; T=293.6K  
protons from (n,x)

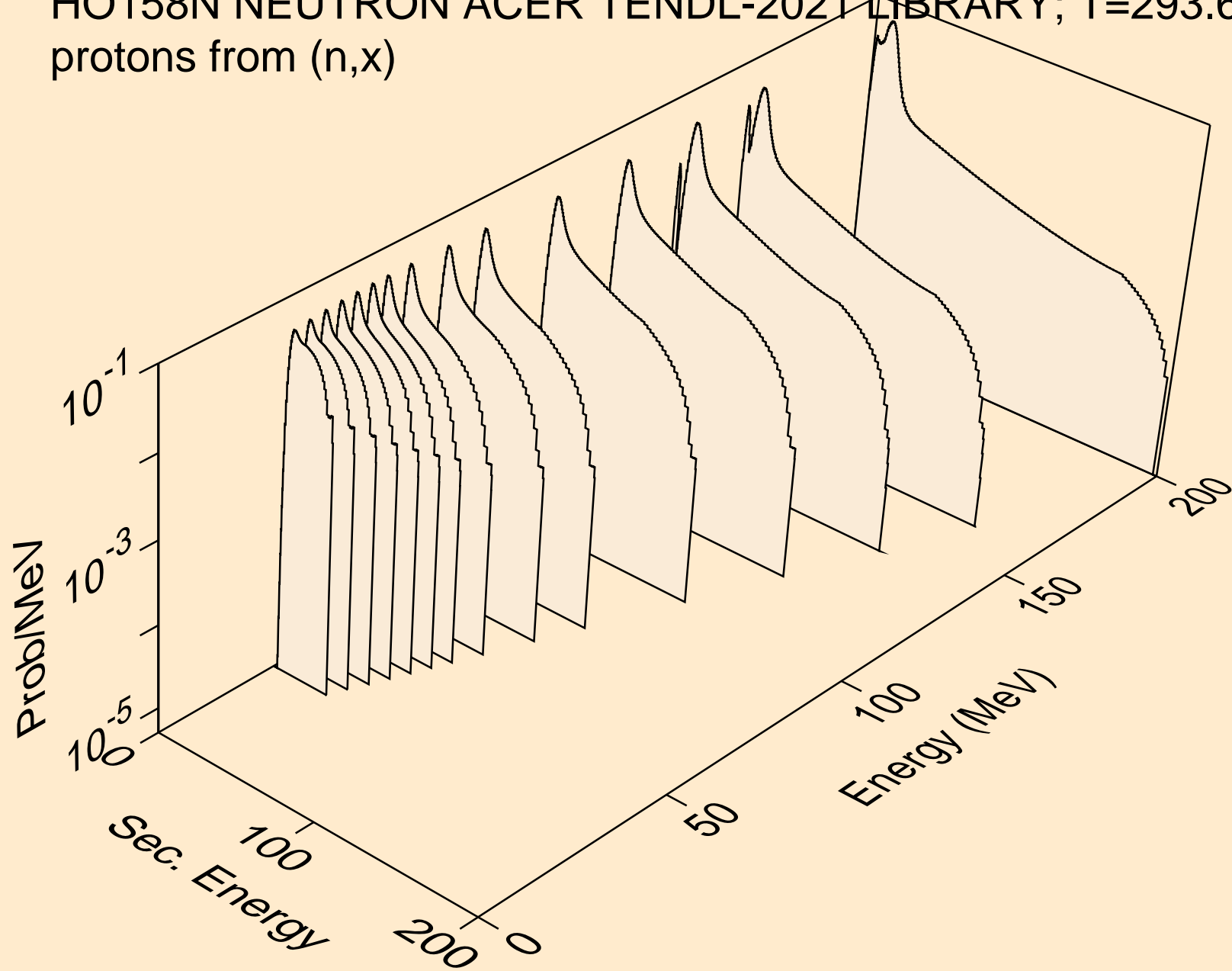

HO158N NEUTRON ACER TENDL-2021 LIBRARY; T=293.6K  
protons from (n,n\*)p

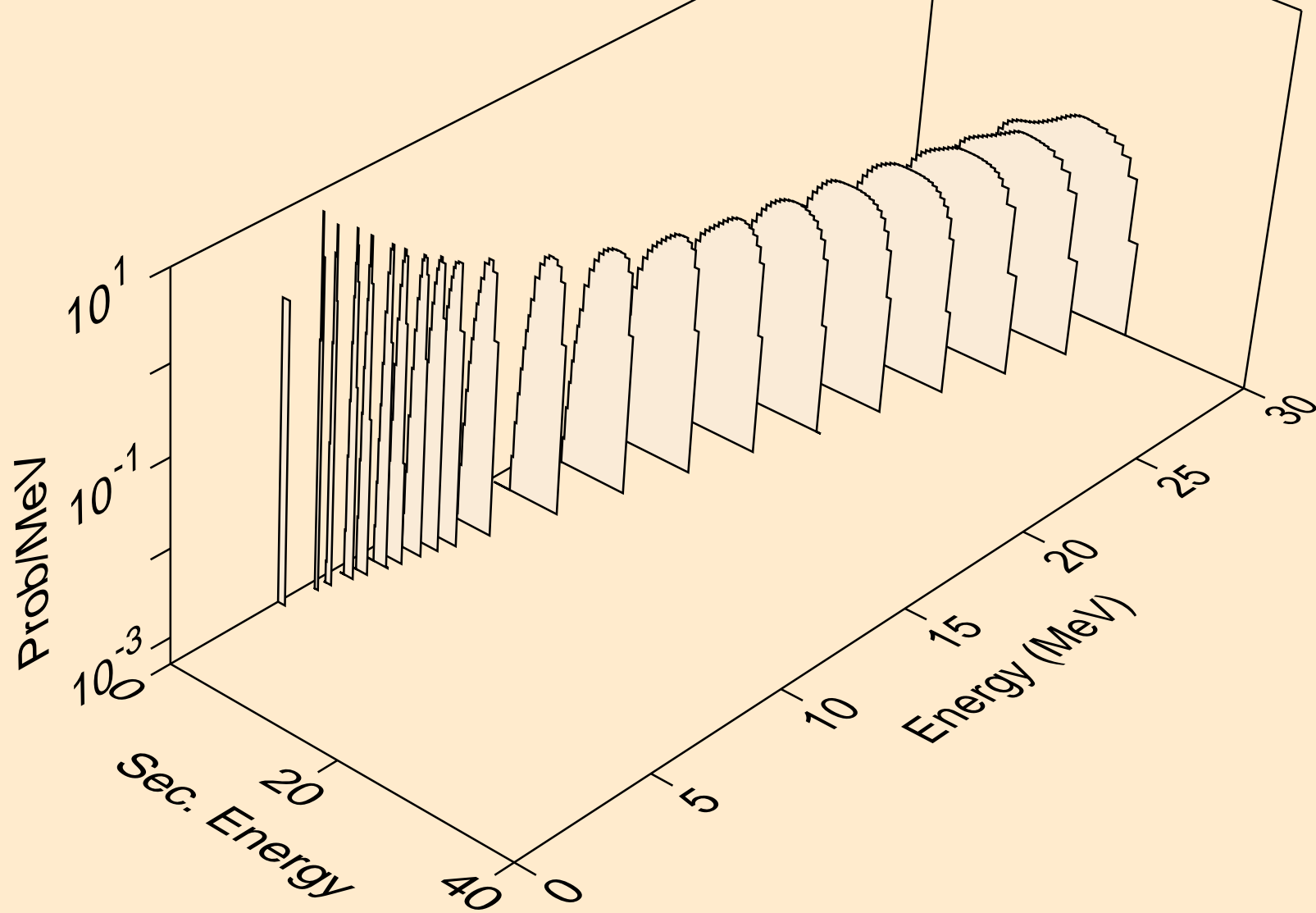

HO158N NEUTRON ACER TENDL-2021 LIBRARY; T=293.6K  
protons from (n,2np)

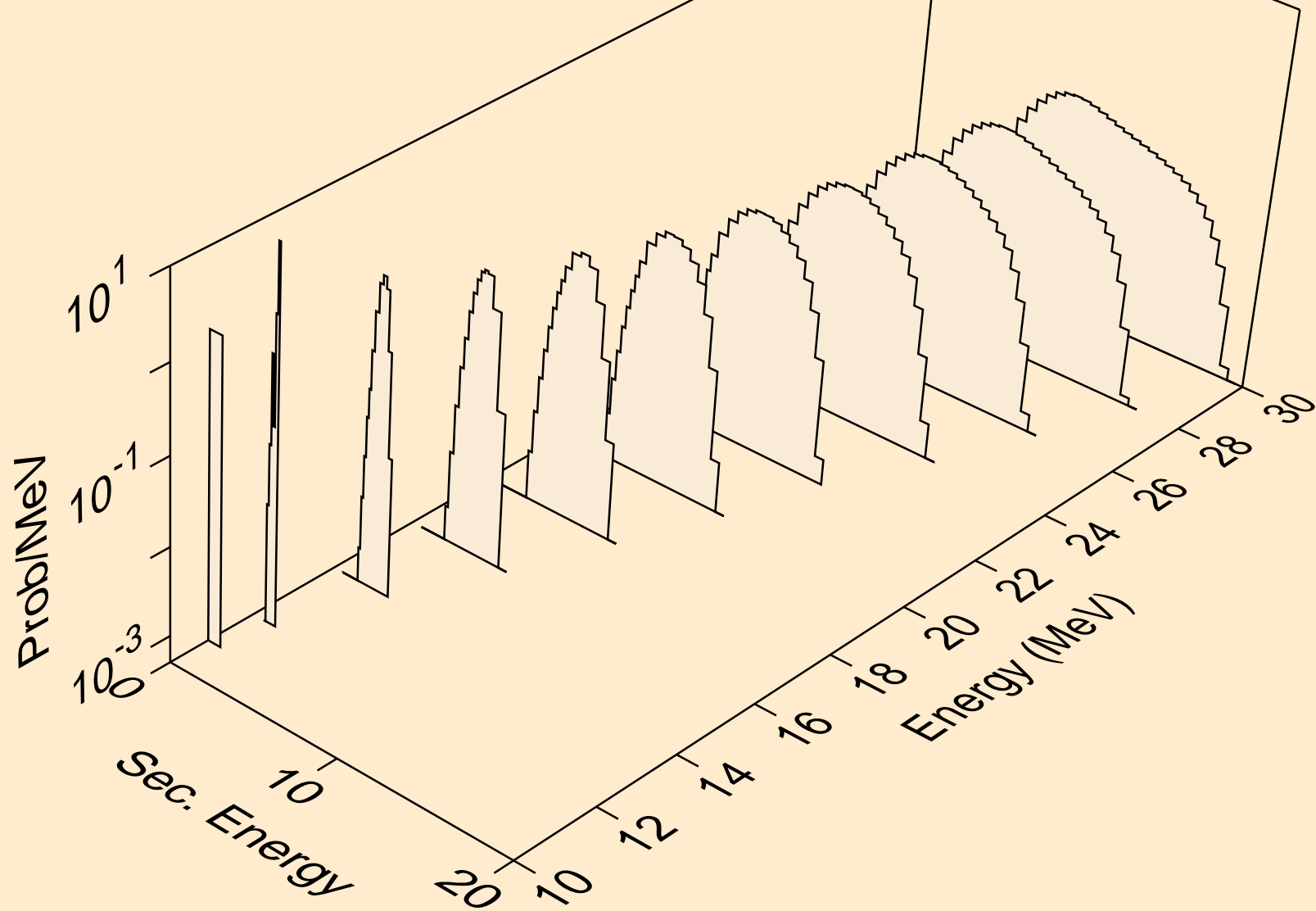

HO158N NEUTRON ACER TENDL-2021 LIBRARY; T=293.6K  
protons from (n,3np)

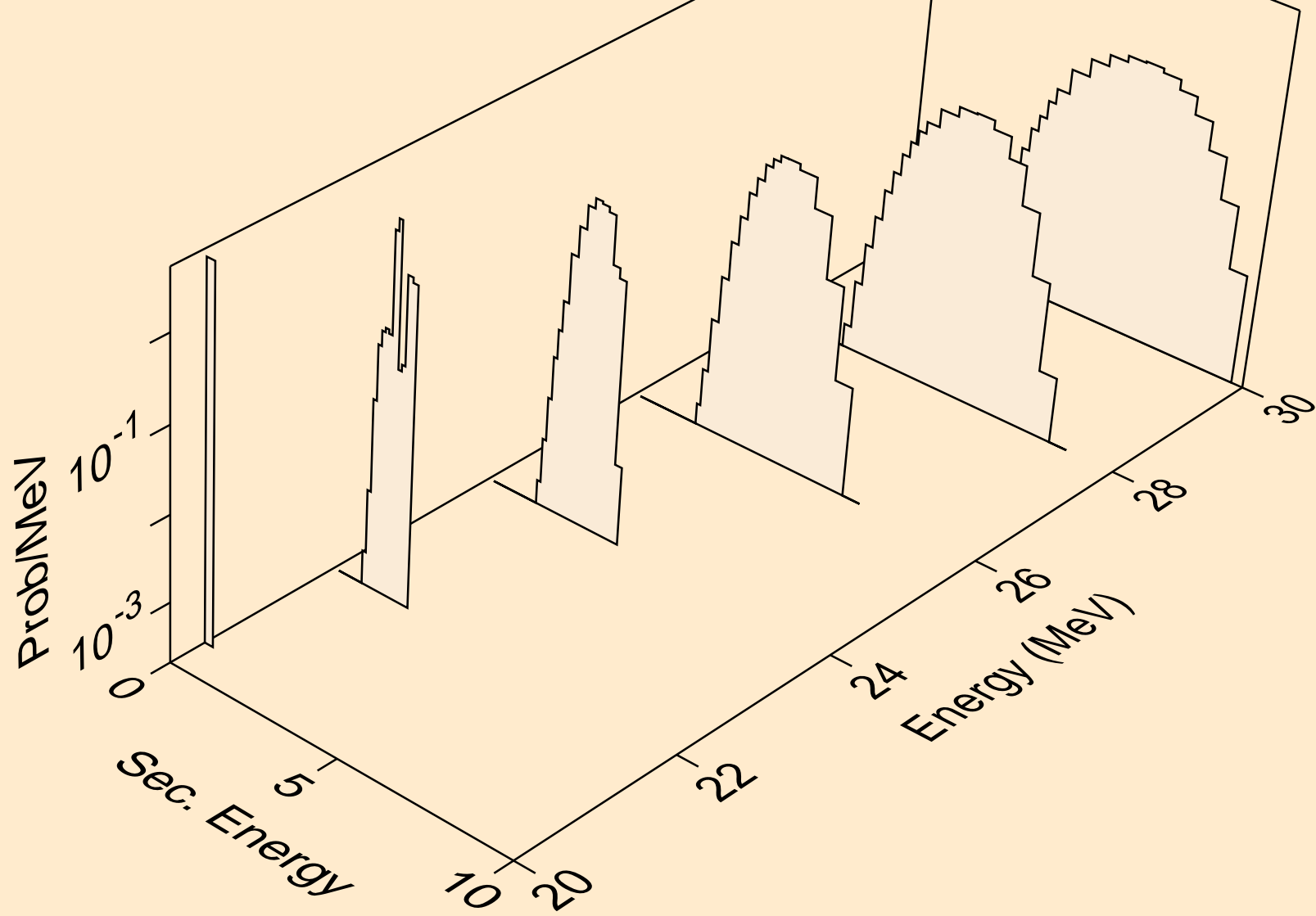

HO158N NEUTRON ACER TENDL-2021 LIBRARY; T=293.6K  
protons from (n,2np)

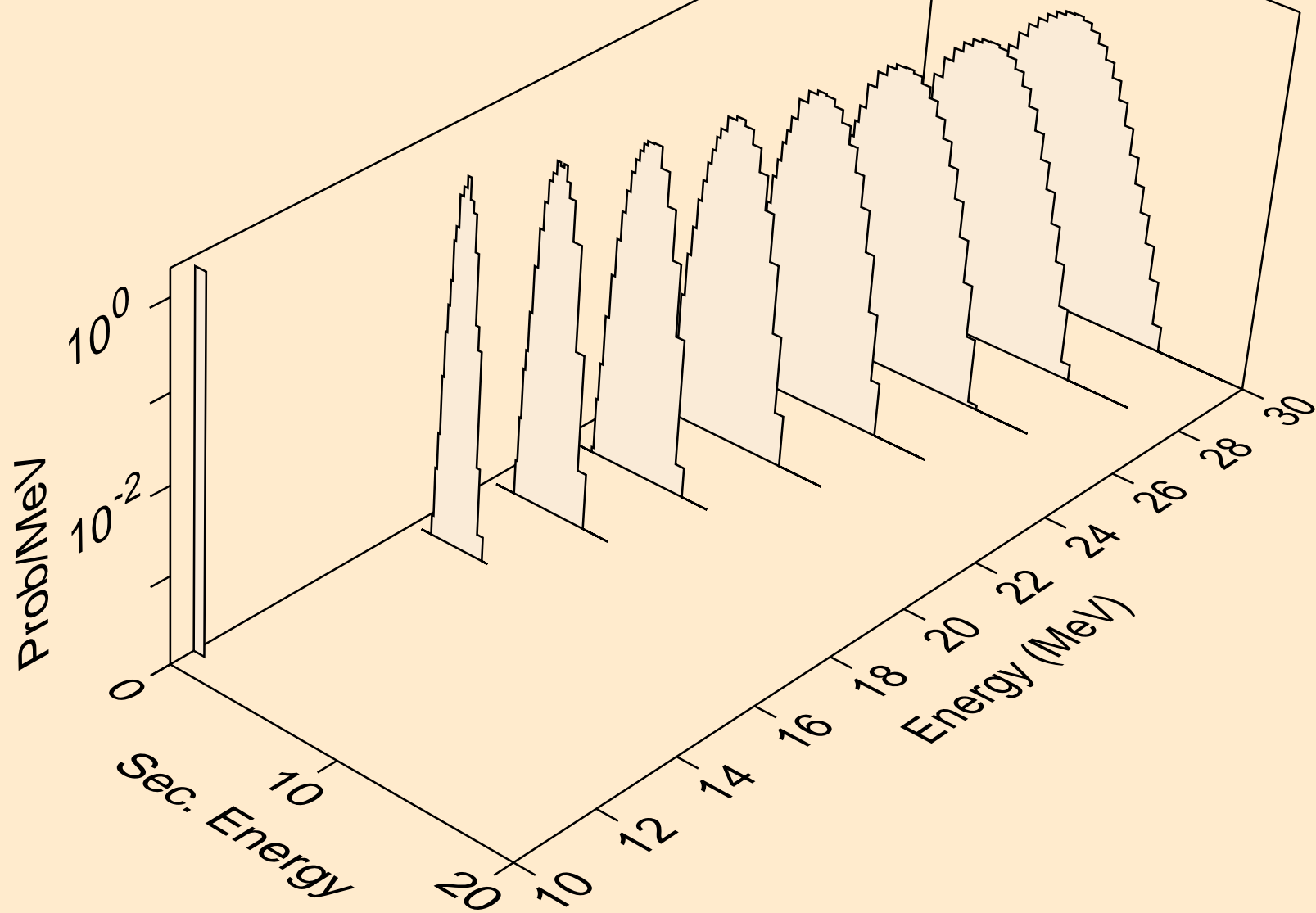

HO158N NEUTRON ACER TENDL-2021 LIBRARY; T=293.6K  
protons from (n,npa)

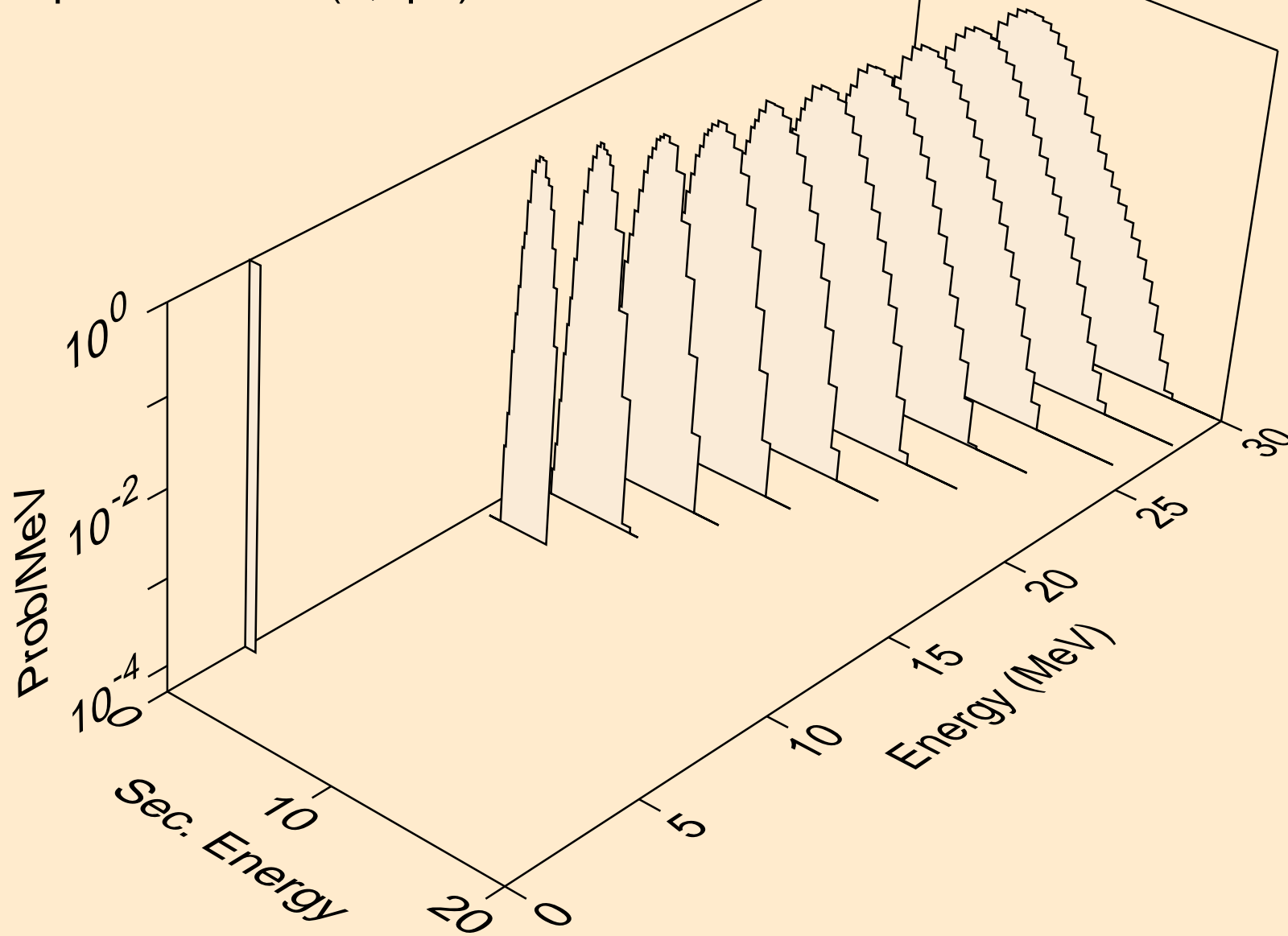

HO158N NEUTRON ACER TENDL-2021 LIBRARY; T=293.6K  
protons from (n,p)

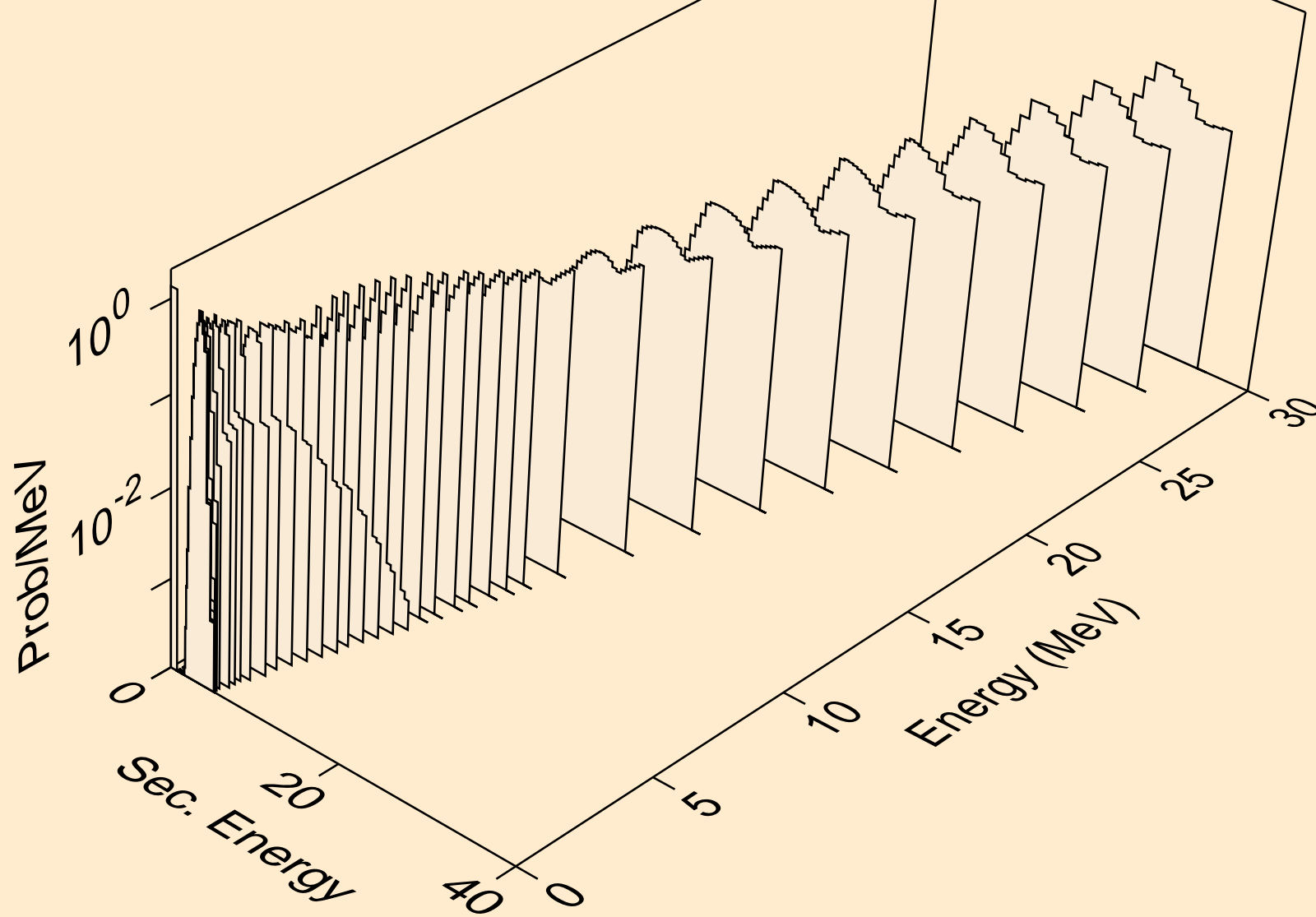

HO158N NEUTRON ACER TENDL-2021 LIBRARY; T=293.6K  
protons from (n,2p)

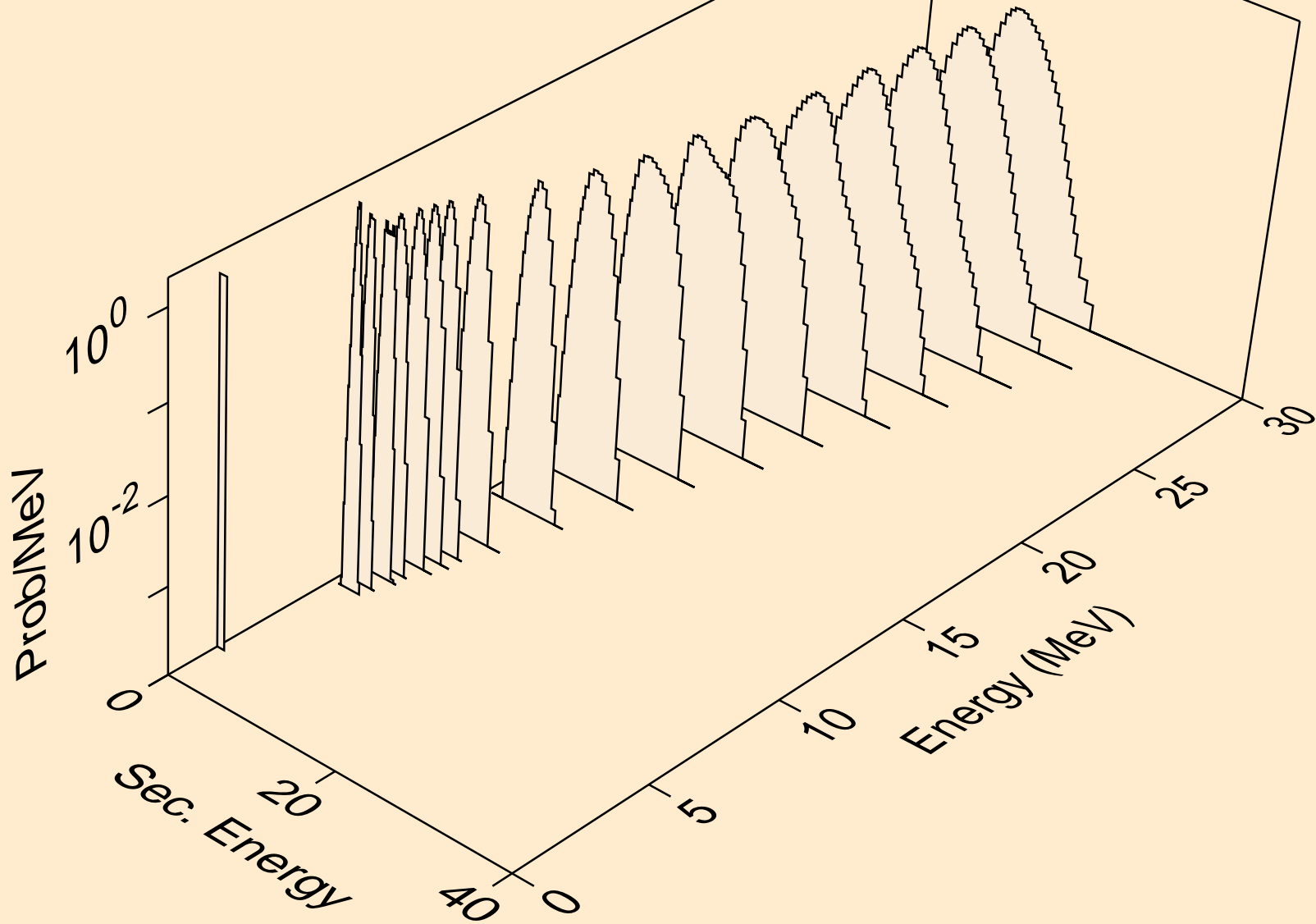



HO158N NEUTRON ACER TENDL-2021 LIBRARY; T=293.6K  
protons from (n,p)

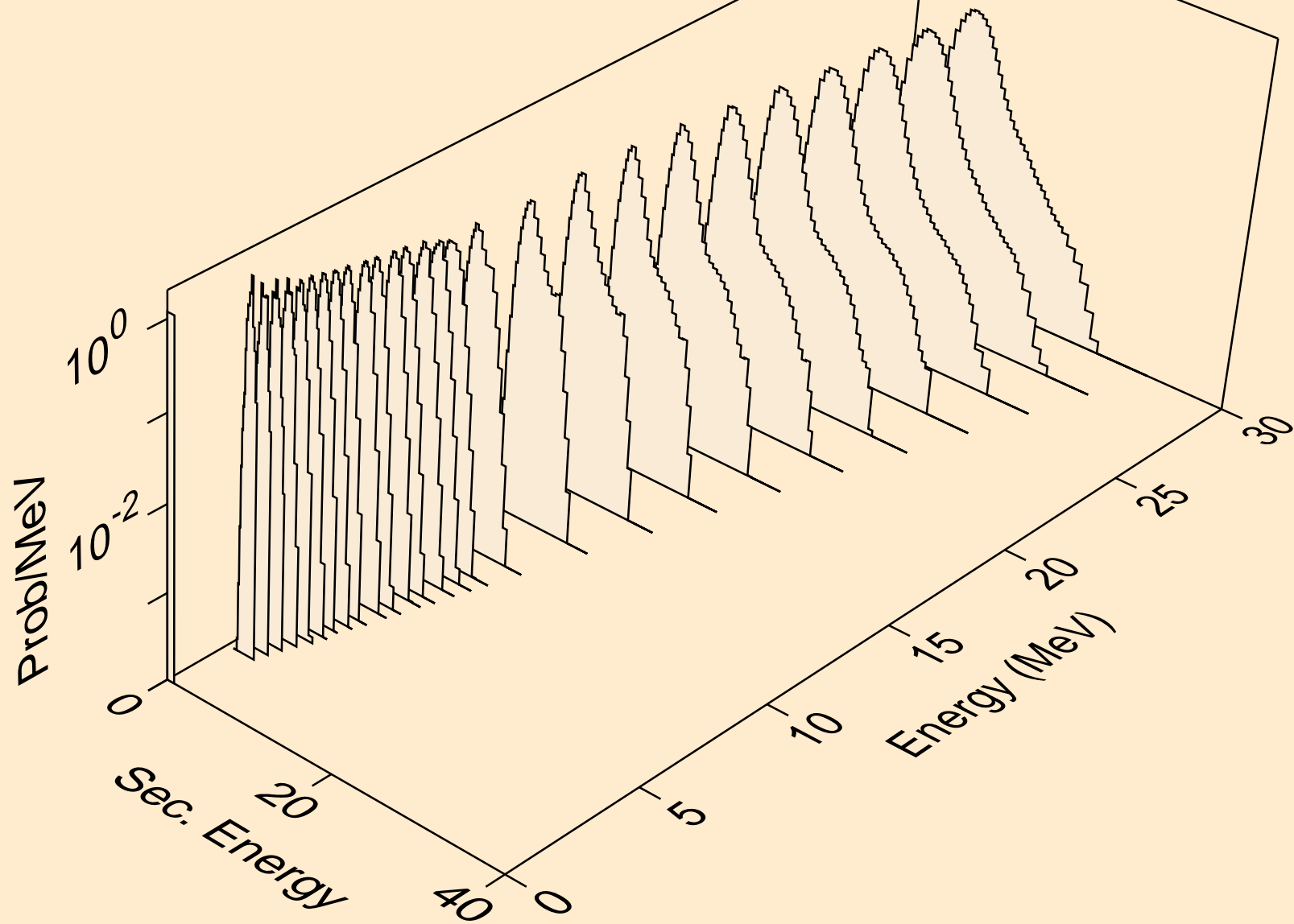

HO158N NEUTRON ACER TENDL-2021 LIBRARY; T=293.6K  
protons from (n,pd)

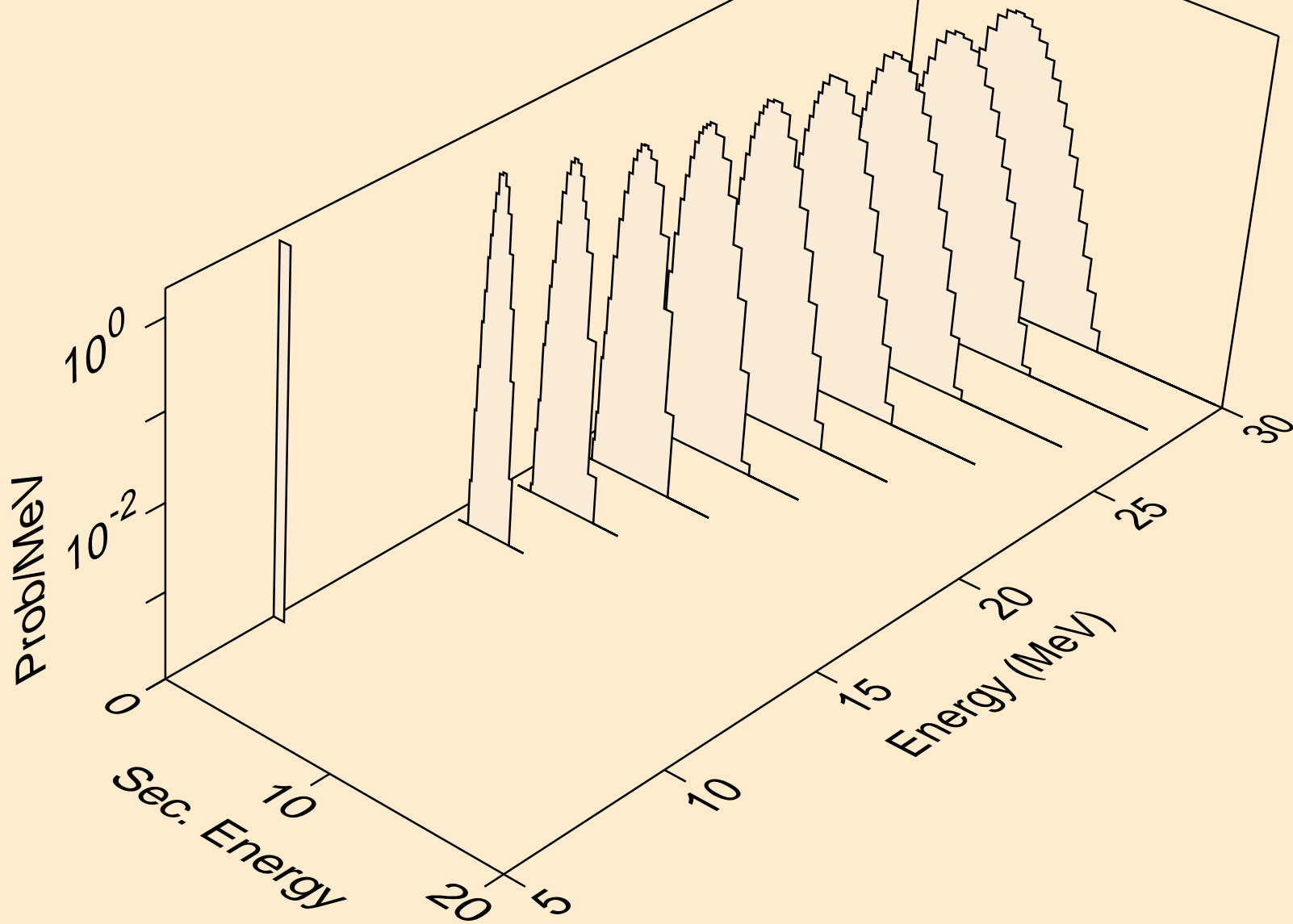

HO158N NEUTRON ACER TENDL-2021 LIBRARY; T=293.6K  
protons from (n,pt)

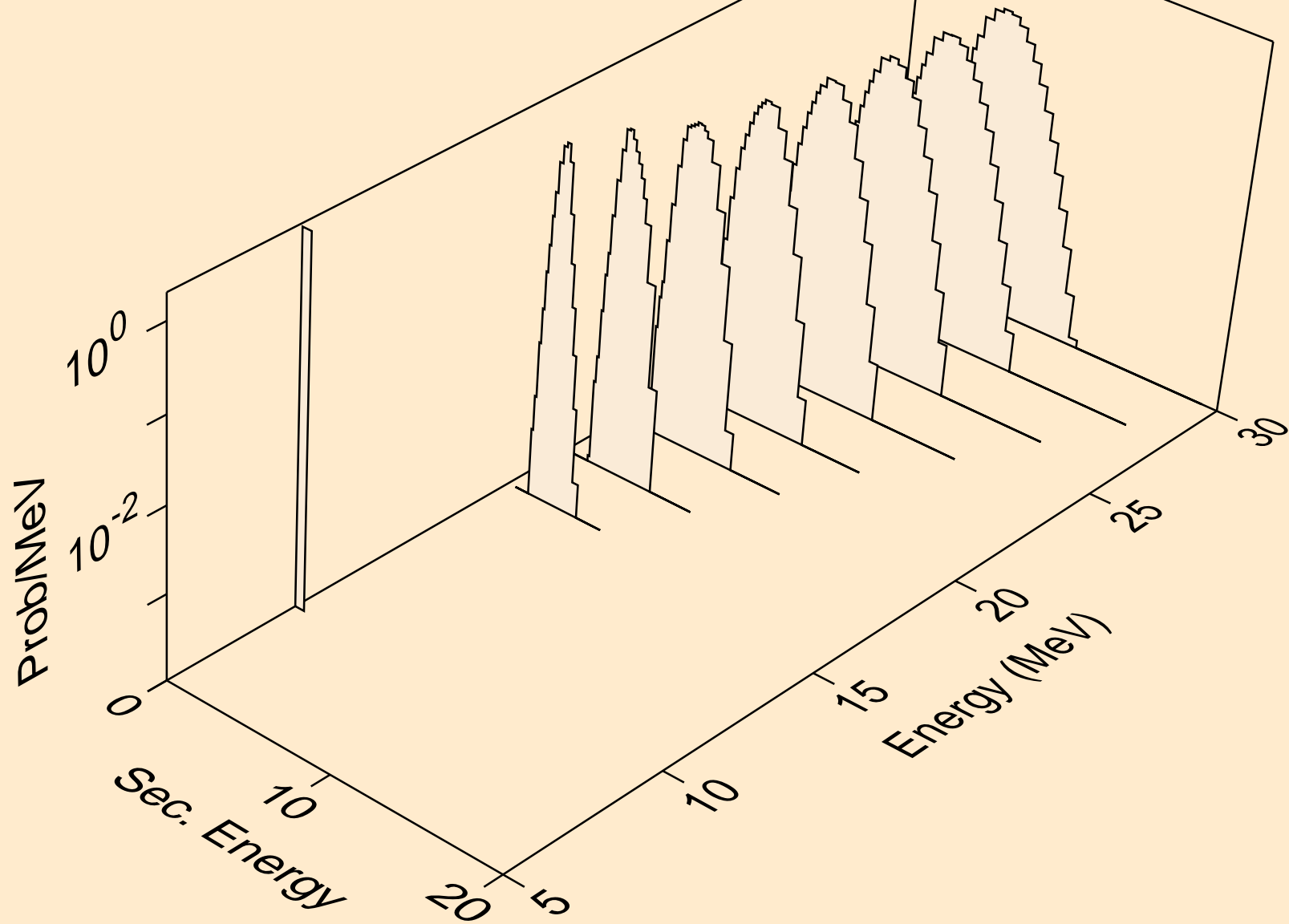

HO158N NEUTRON ACER TENDL-2021 LIBRARY; T=293.6K  
deuterons from (n,x)

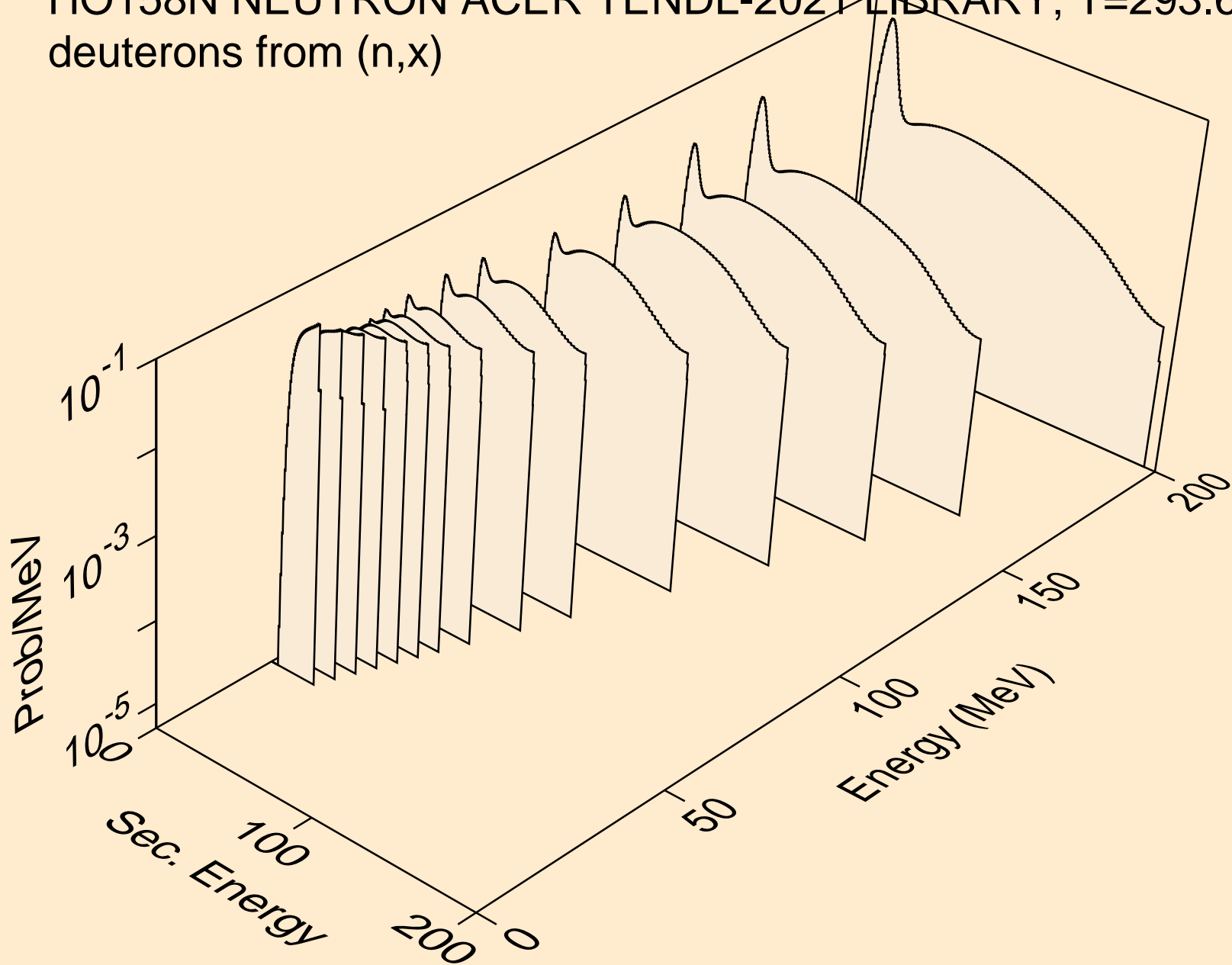

HO158N NEUTRON ACER TENDL-2021 LIBRARY; T=293.6K  
deuterons from (n,2nd)

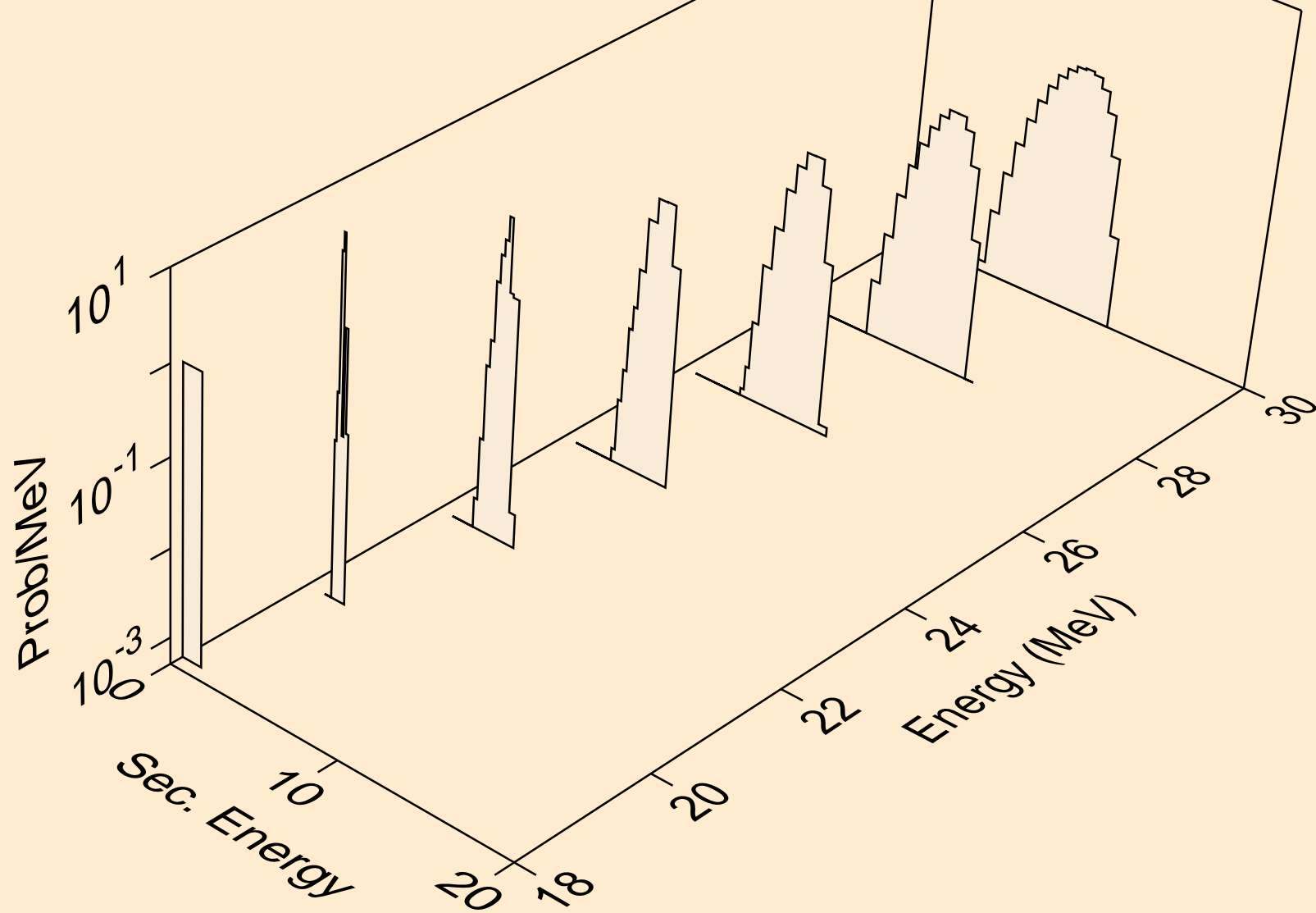

HO158N NEUTRON ACER TENDL-2021 LIBRARY; T=293.6K  
deuterons from (n,n\*)d

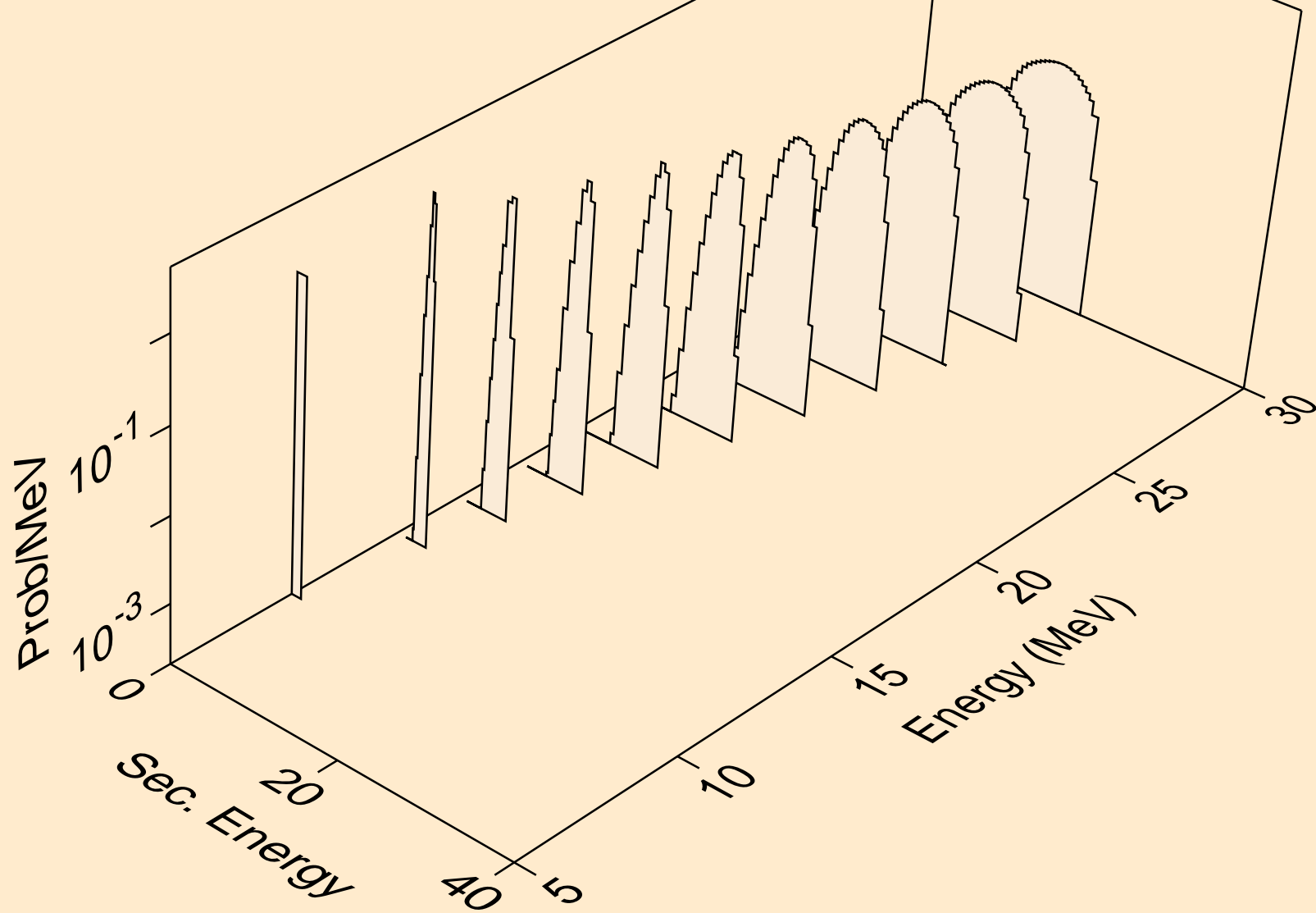

HO158N NEUTRON ACER TENDL-2021 LIBRARY; T=293.6K  
deuterons from (n,d)

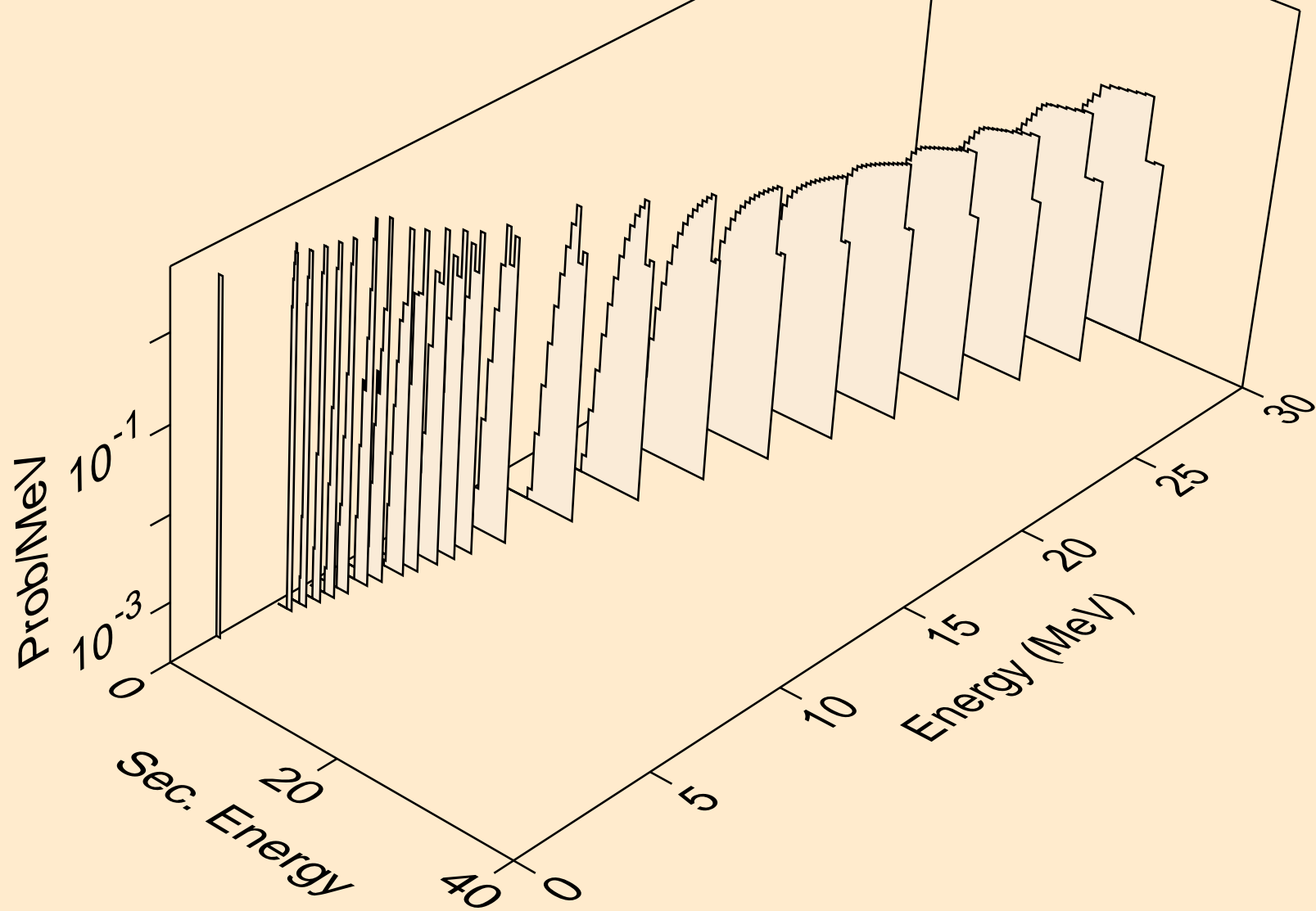

HO158N NEUTRON ACER TENDL-2021 LIBRARY; T=293.6K  
deuterons from (n,pd)

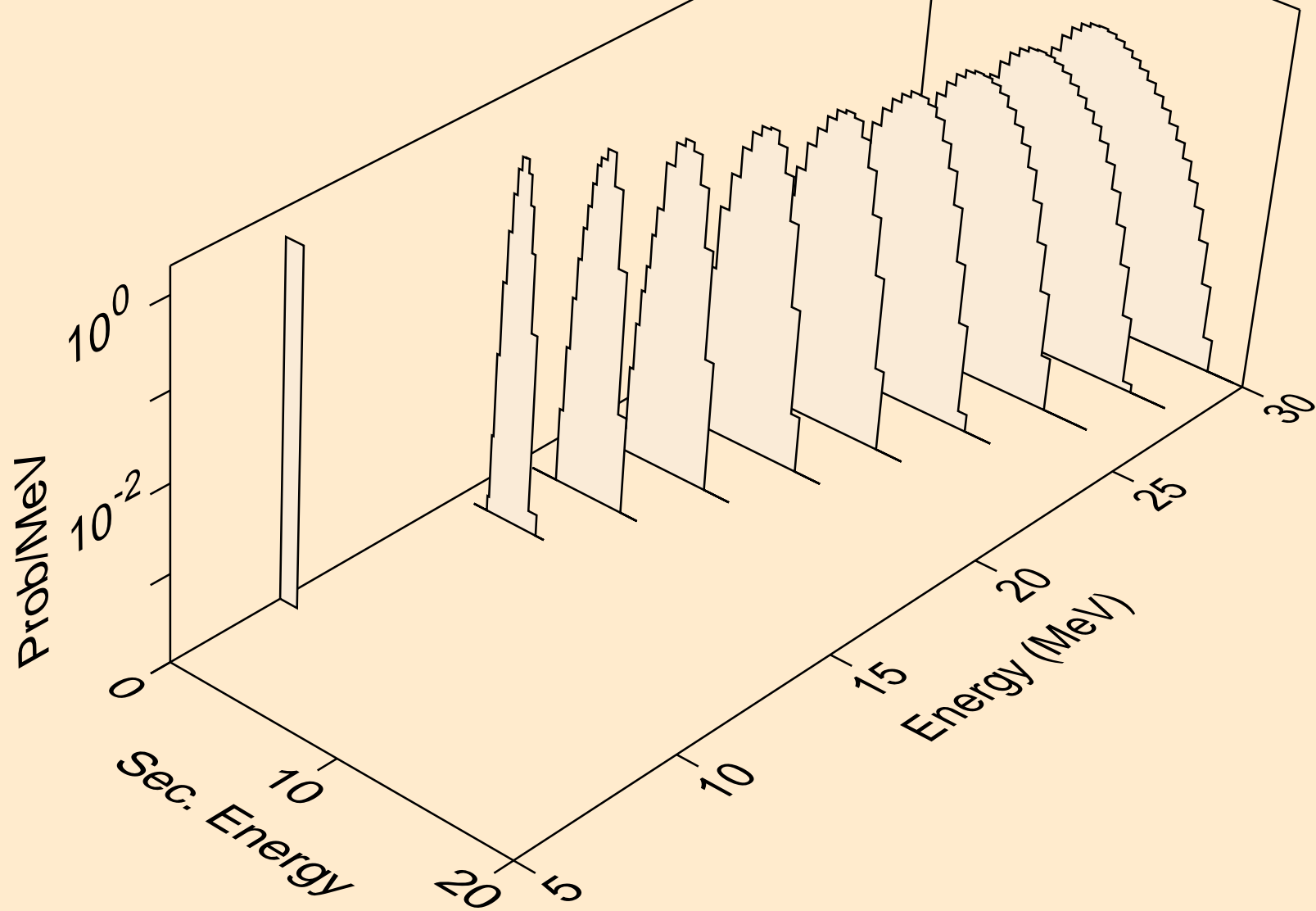



HO158N NEUTRON ACER TENDL-2021 LIBRARY; T=293.6K  
deuterons from (n,da)

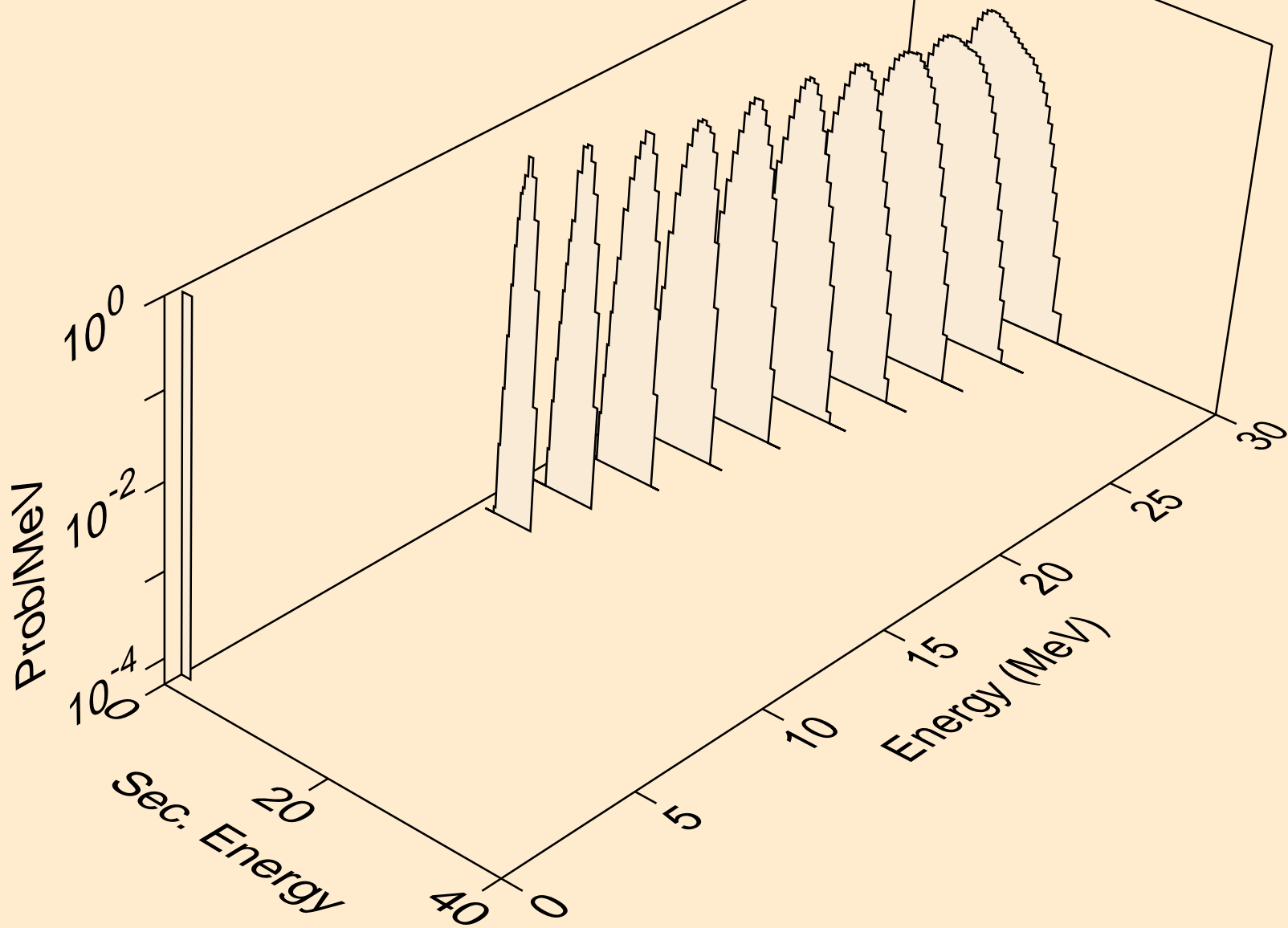

HO158N NEUTRON ACER TENDL-2021 LIBRARY; T=293.6K  
tritons from (n,x)

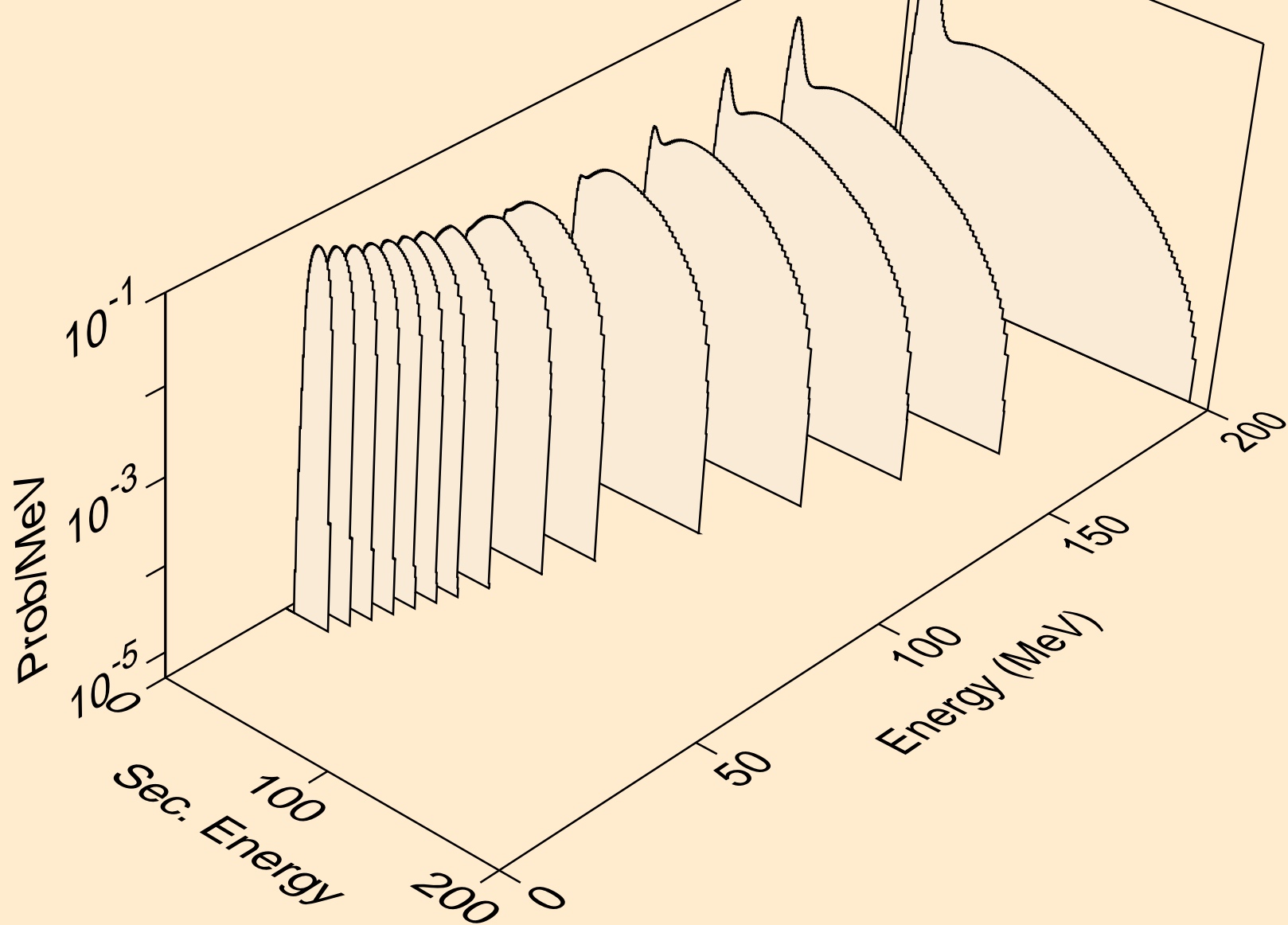

HO158N NEUTRON ACER TENDL-2021 LIBRARY; T=293.6K  
tritons from (n,n\*)t

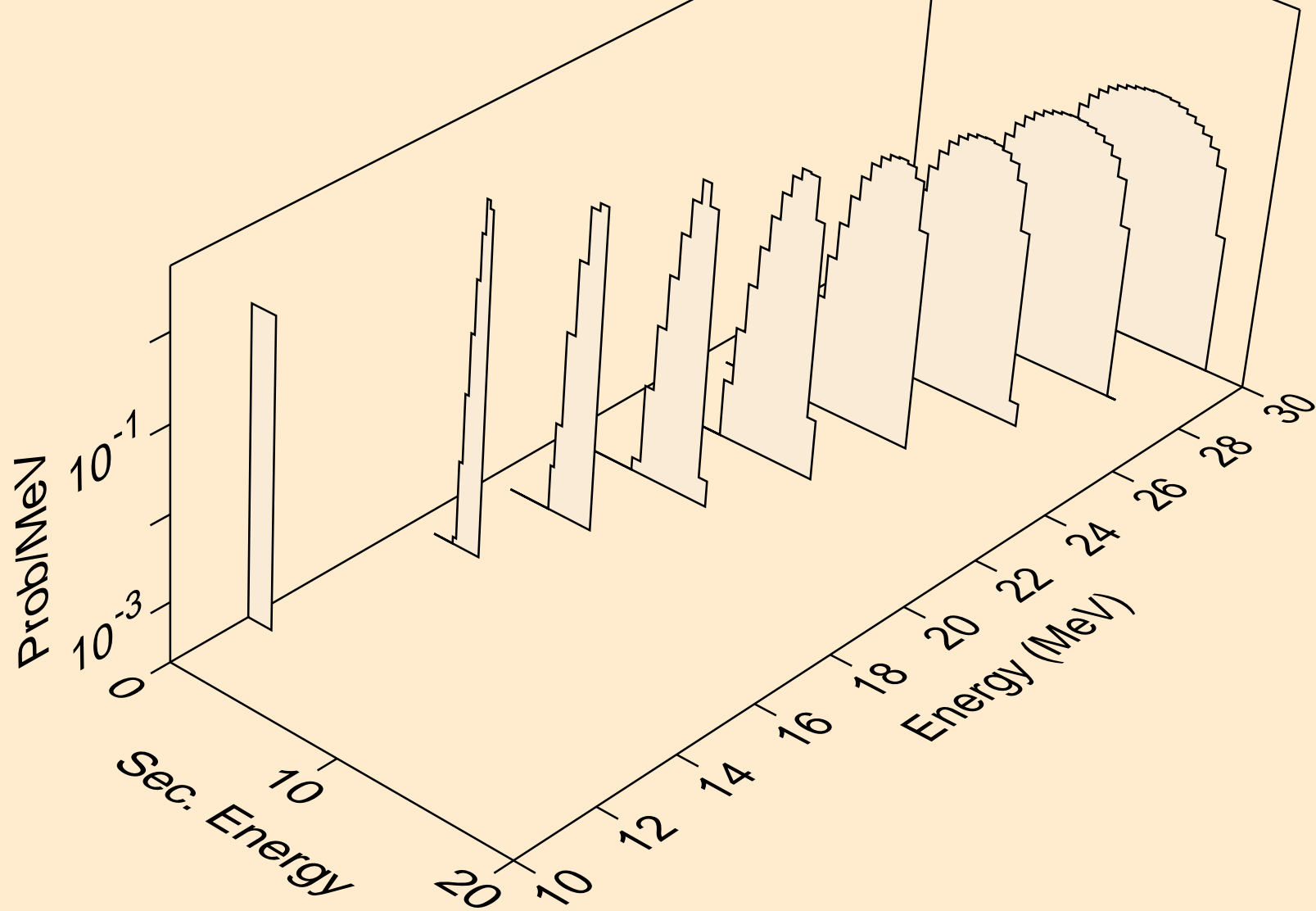

HO158N NEUTRON ACER TENDL-2021 LIBRARY; T=293.6K  
tritons from (n,t)

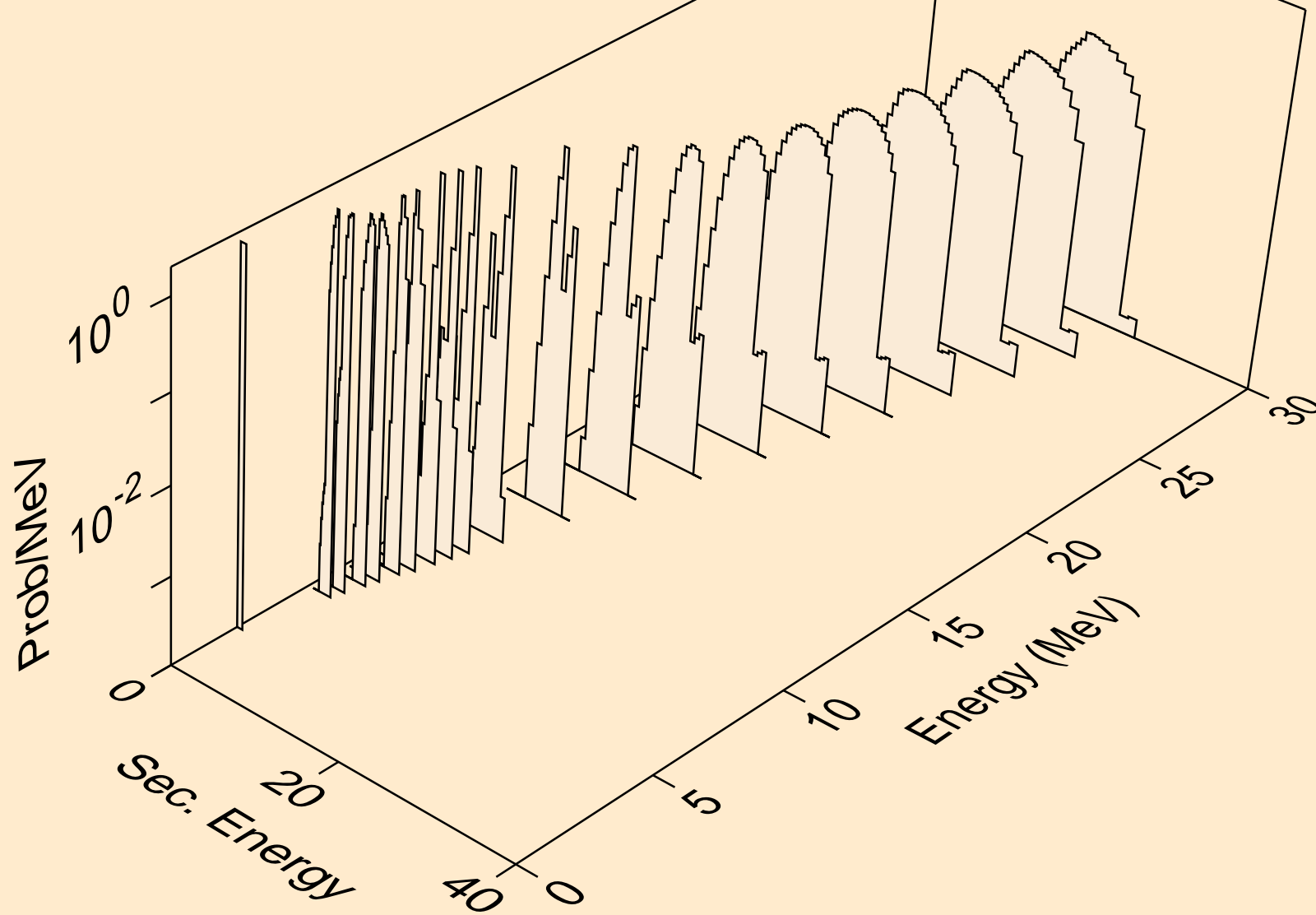

HO158N NEUTRON ACER TENDL-2021 LIBRARY; T=293.6K  
tritons from (n,pt)

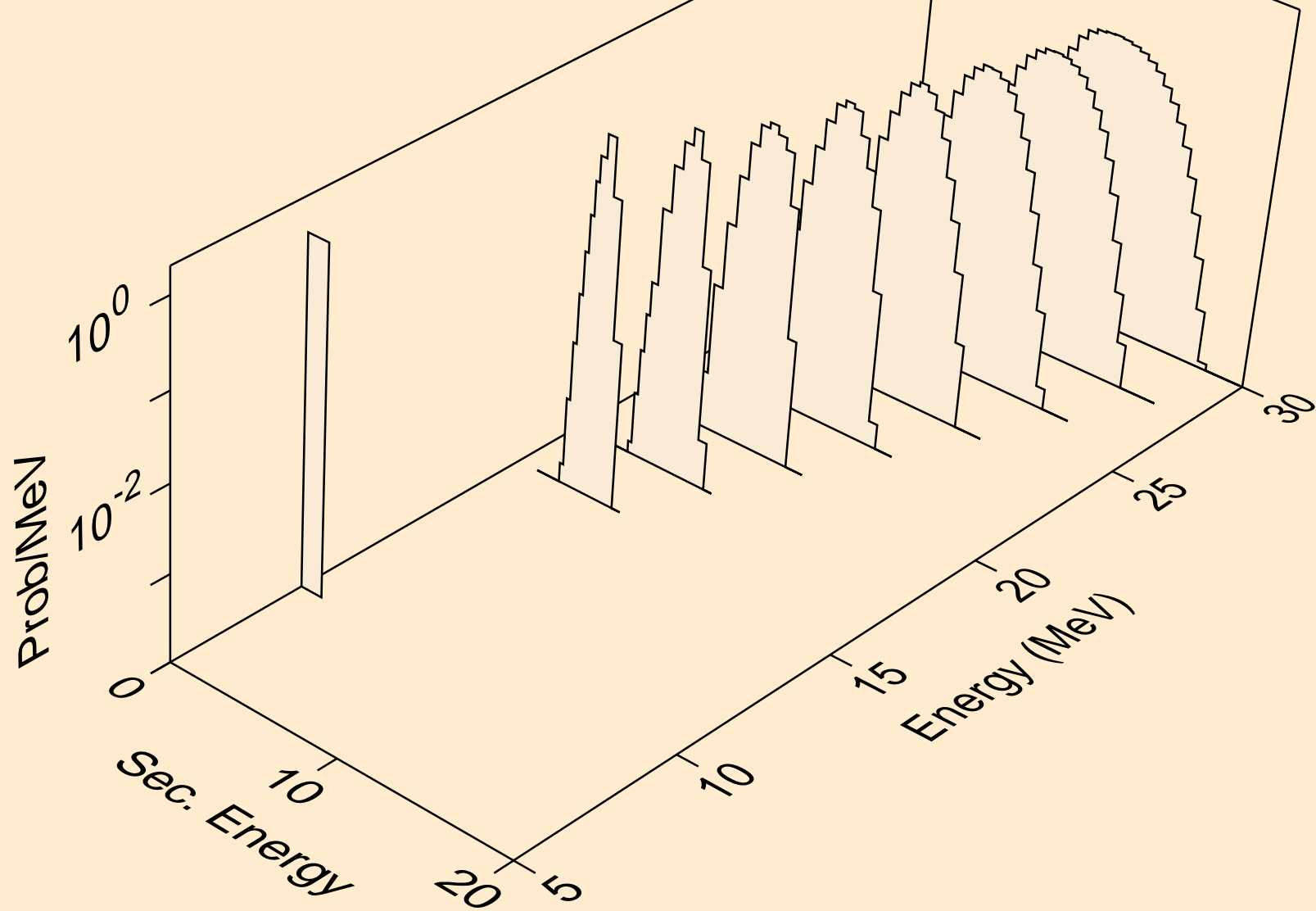

HO158N NEUTRON ACER TENDL-2021 LIBRARY; T=293.6K  
he3s from (n,x)

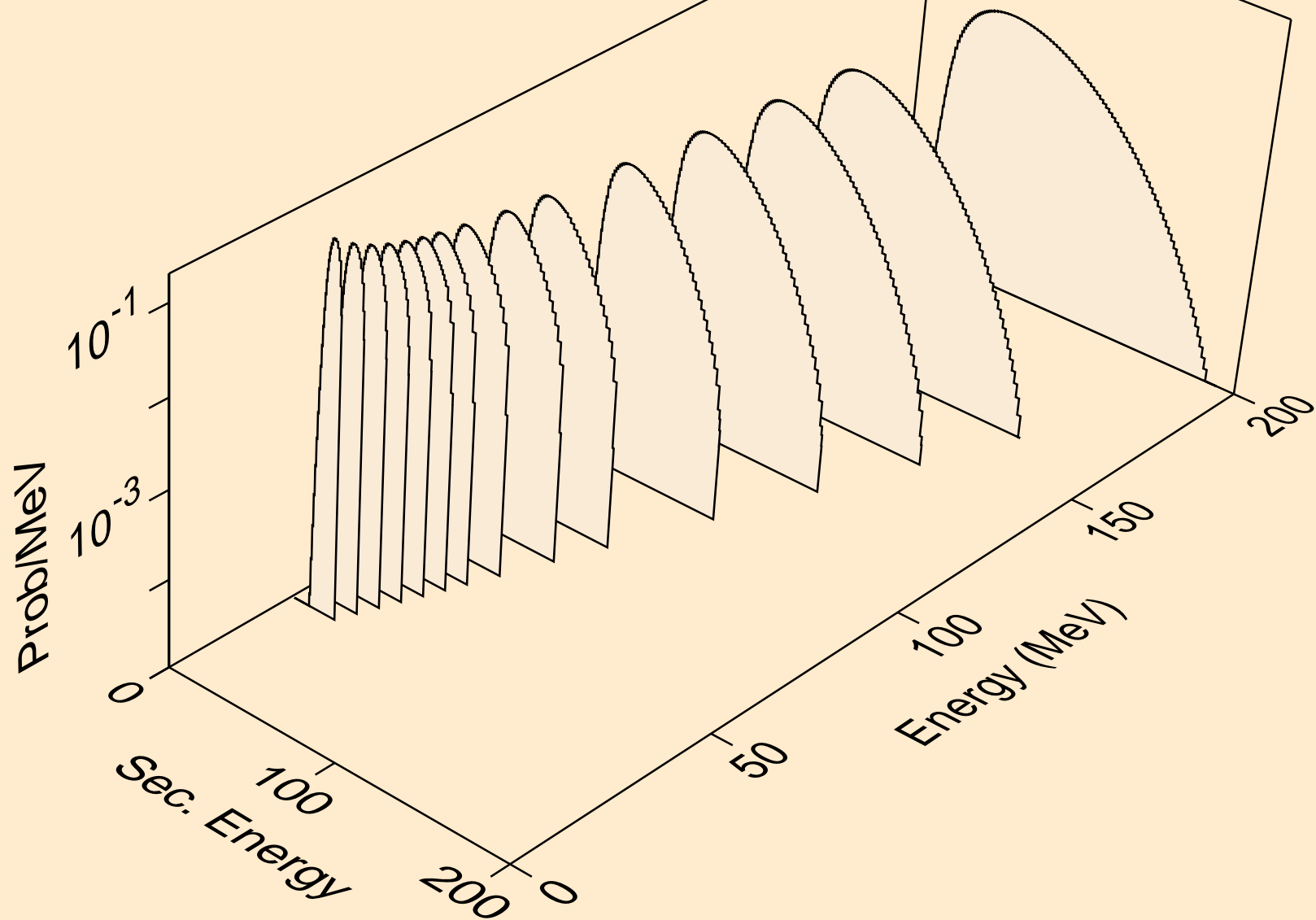

HO158N NEUTRON ACER TENDL-2021 LIBRARY; T=293.6K  
he3s from (n,n\*)he3

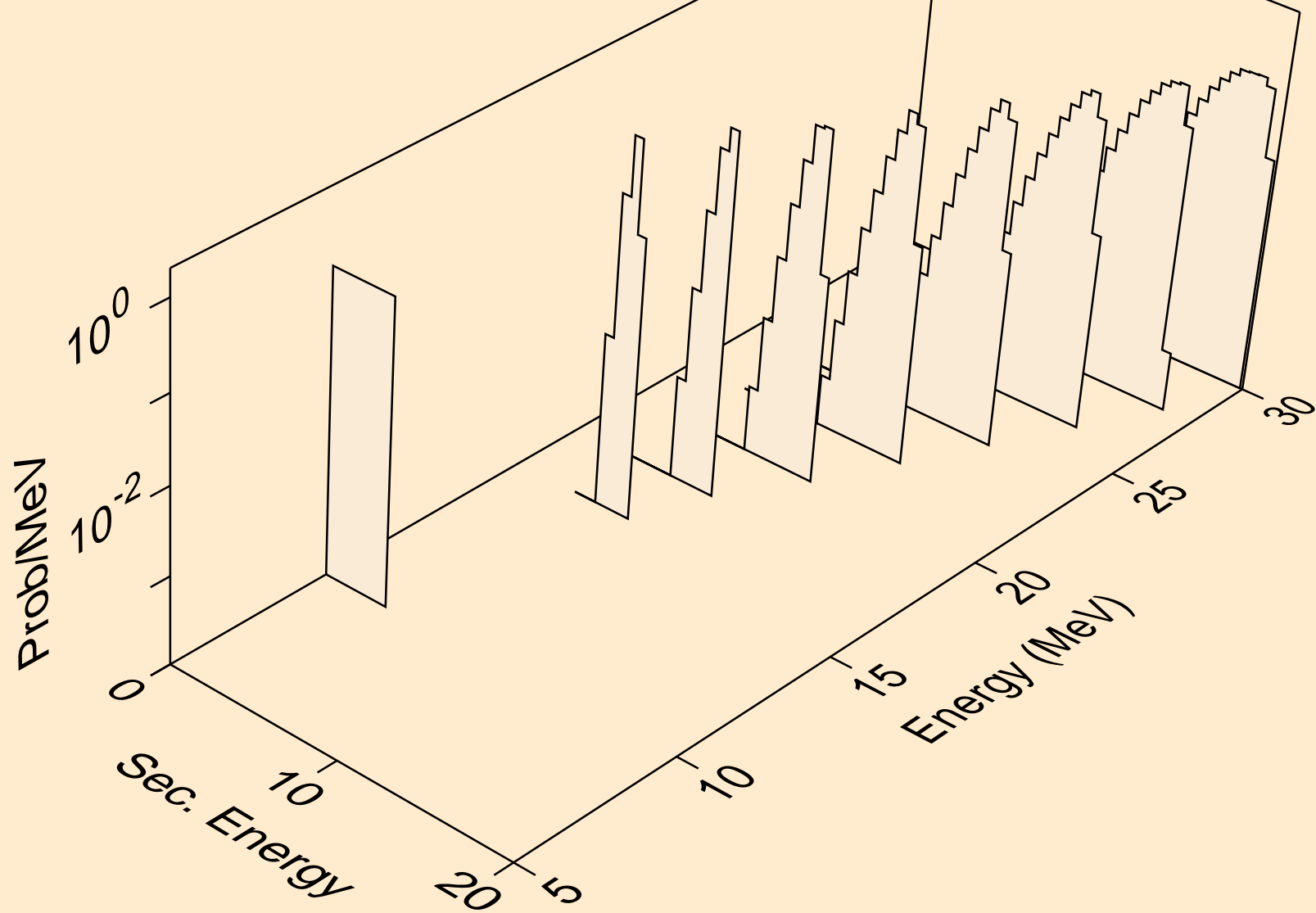

HO158N NEUTRON ACER TENDL-2021 LIBRARY; T=293.6K  
he3s from (n,he3)

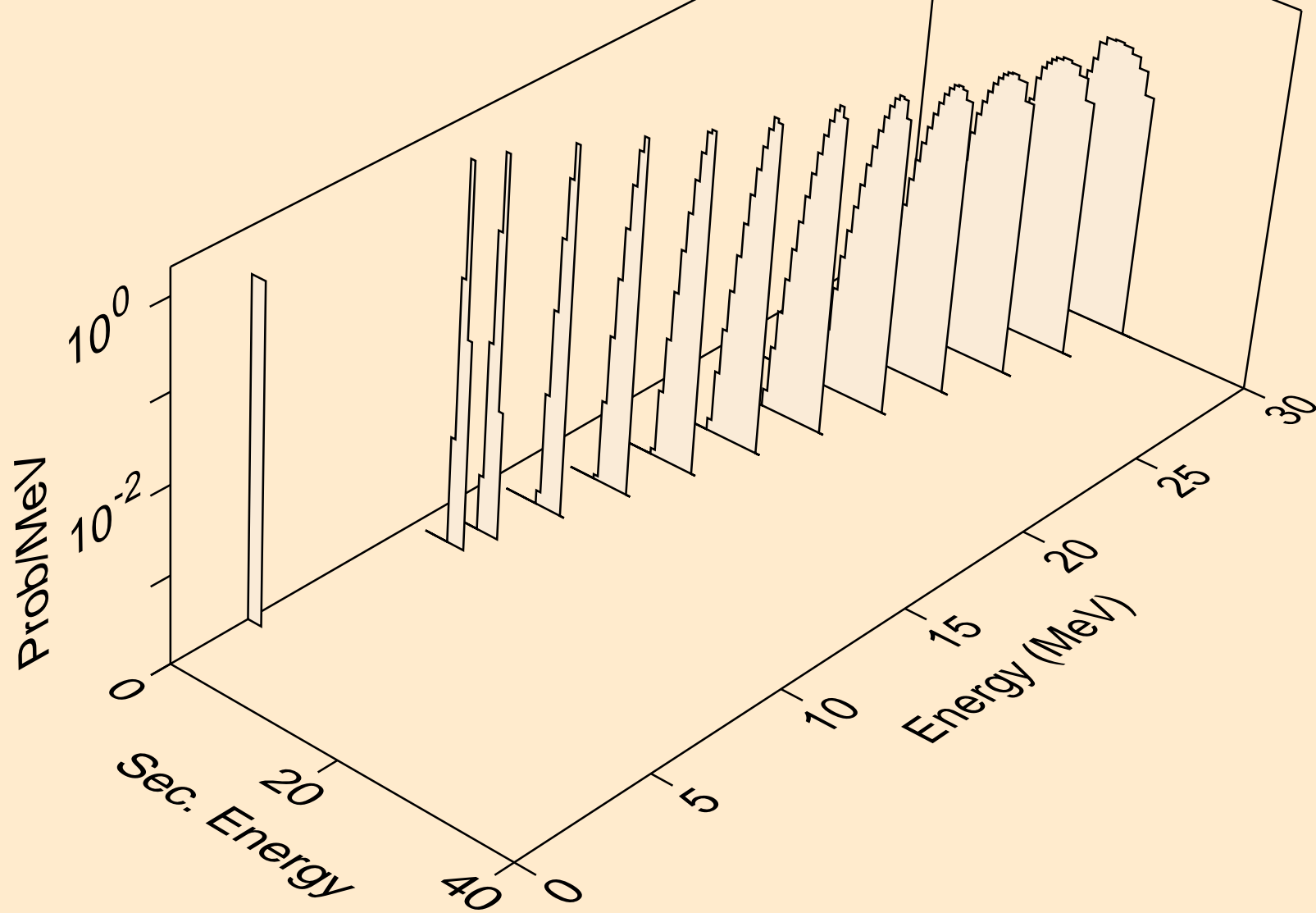



HO158N NEUTRON ACER TENDL-2021 LIBRARY; T=293.6K  
alphas from (n,x)

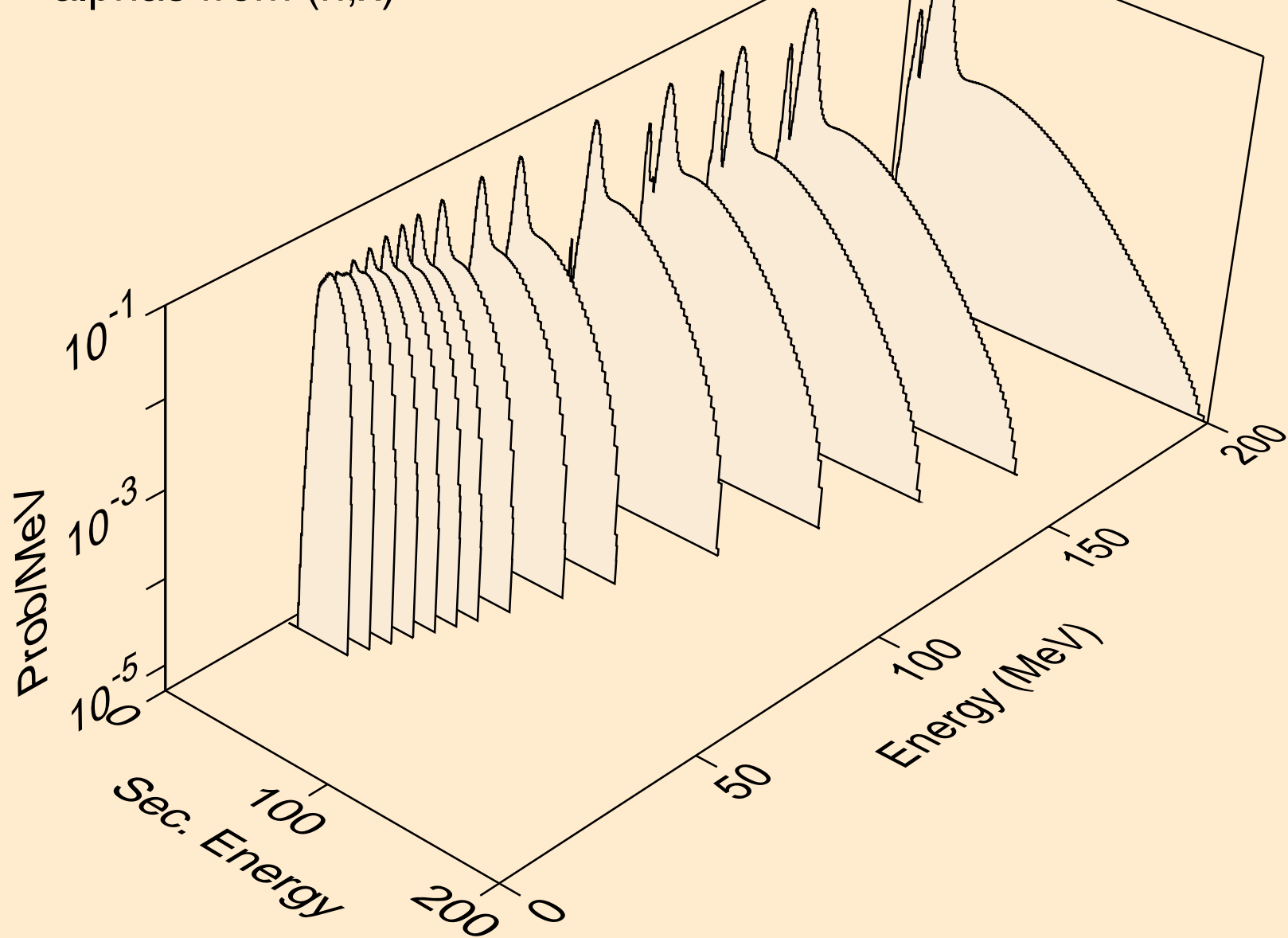

HO158N NEUTRON ACER TENDL-2021 LIBRARY; T=293.6K  
alphas from (n,n\*)a

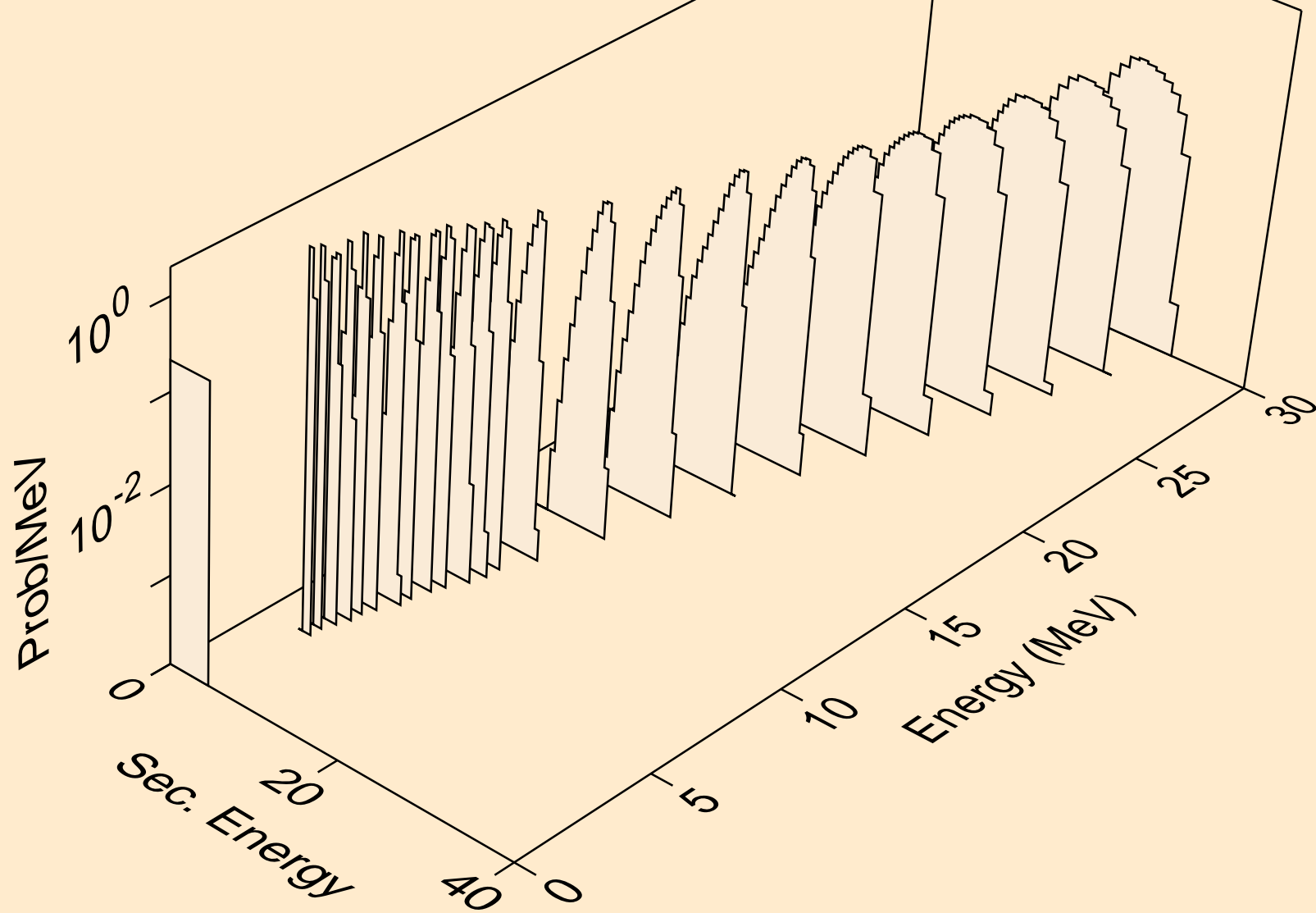

HO158N NEUTRON ACER TENDL-2021 LIBRARY; T=293.6K  
alphas from (n,2n)a

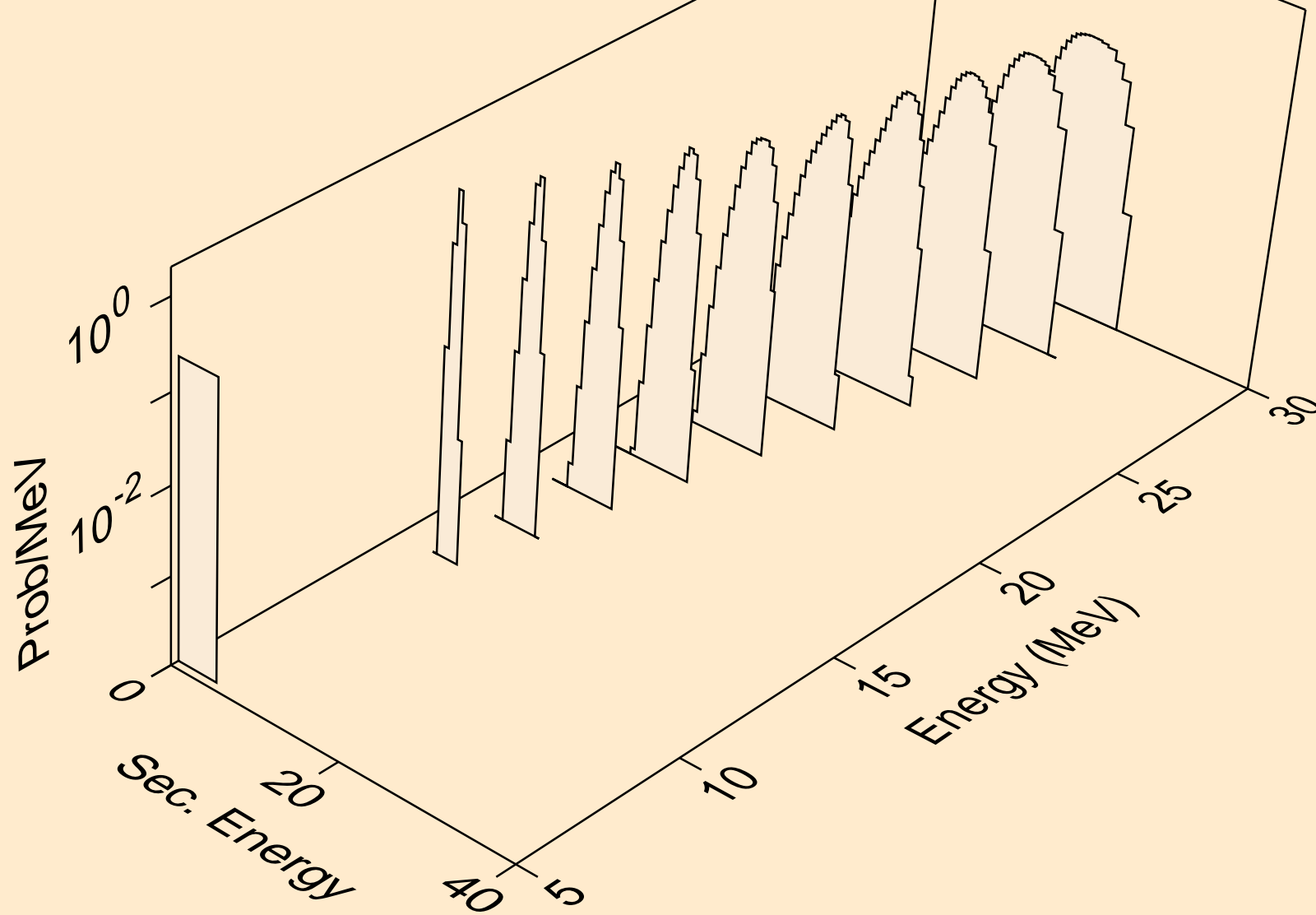

HO158N NEUTRON ACER TENDL-2021 LIBRARY; T=293.6K  
alphas from (n,3n)a

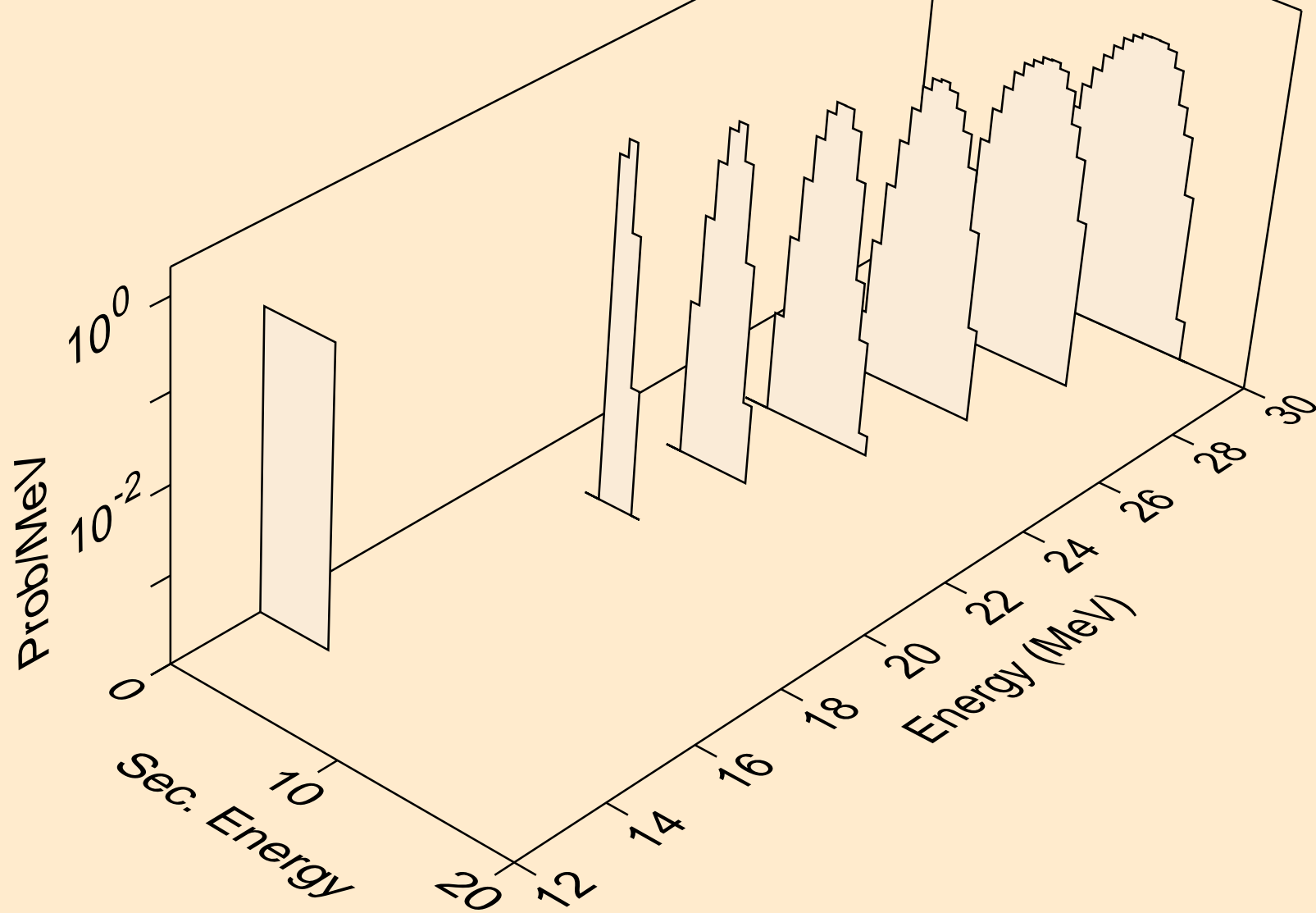

HO158N NEUTRON ACER TENDL-2021 LIBRARY; T=293.6K  
alphas from (n,n\*)2a

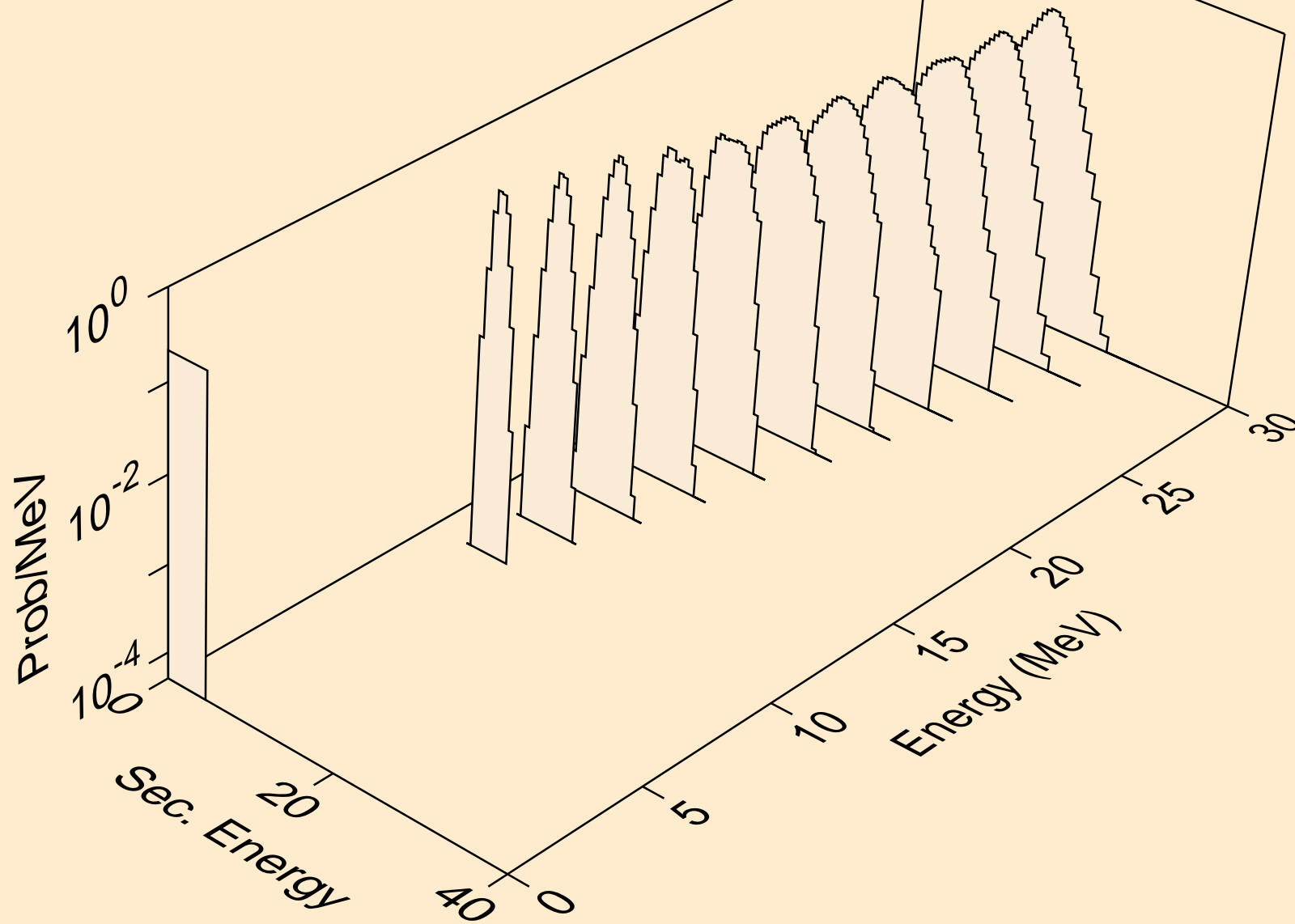

HO158N NEUTRON ACER TENDL-2021 LIBRARY; T=293.6K  
alphas from (n,2n)2a

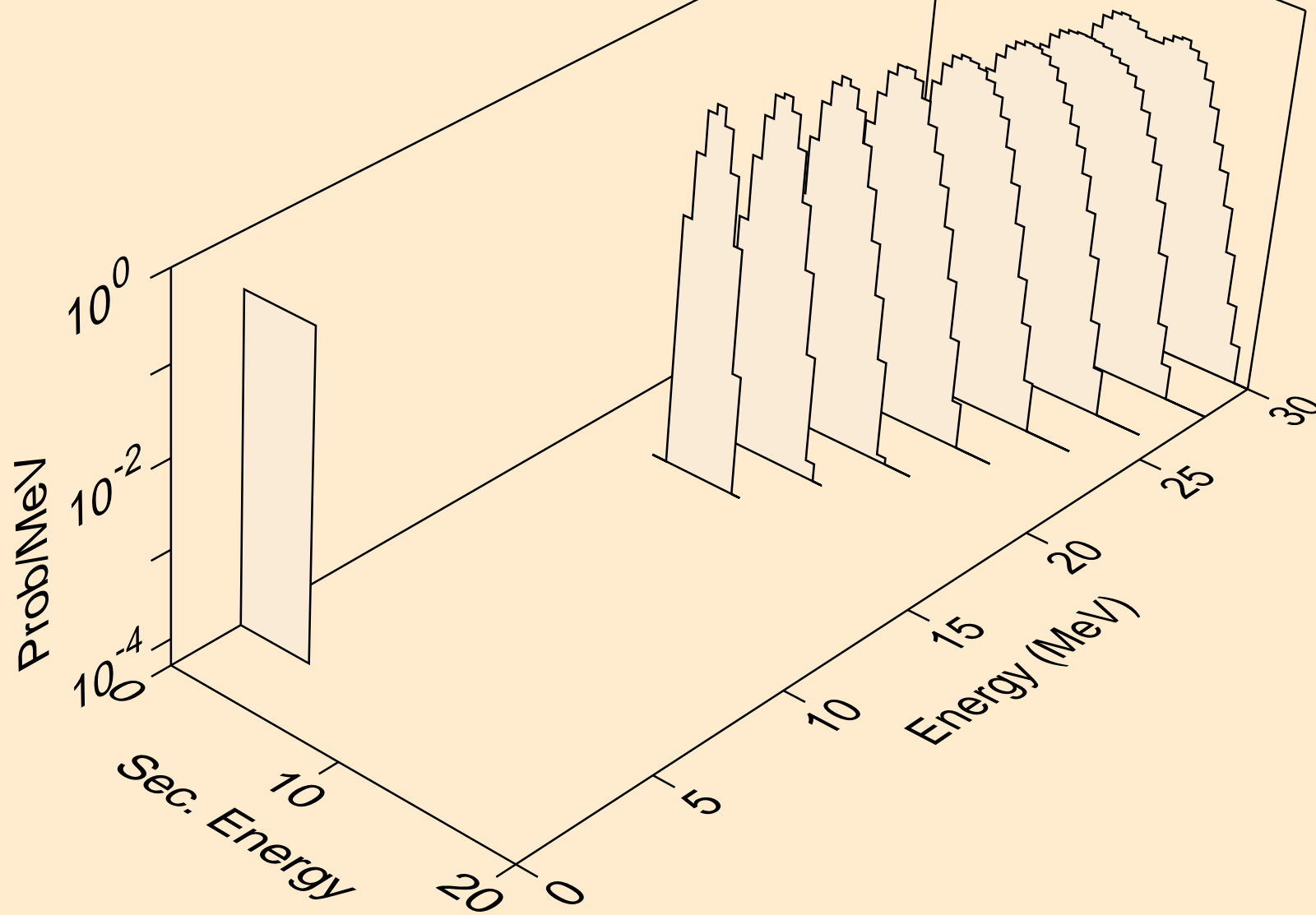

HO158N NEUTRON ACER TENDL-2021 LIBRARY; T=293.6K  
alphas from (n,npa)

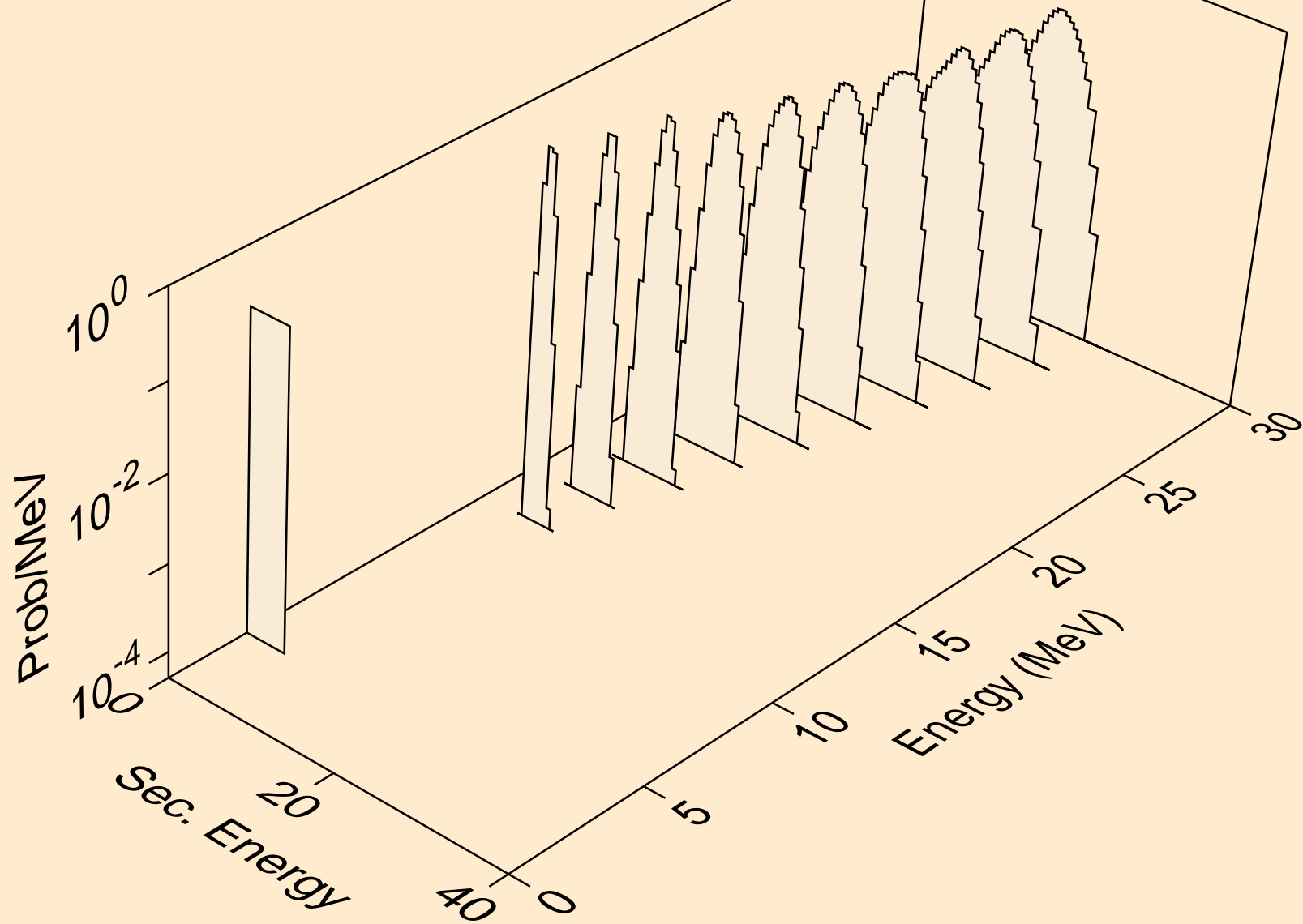

HO158N NEUTRON ACER TENDL-2021 LIBRARY; T=293.6K  
alphas from (n,a)

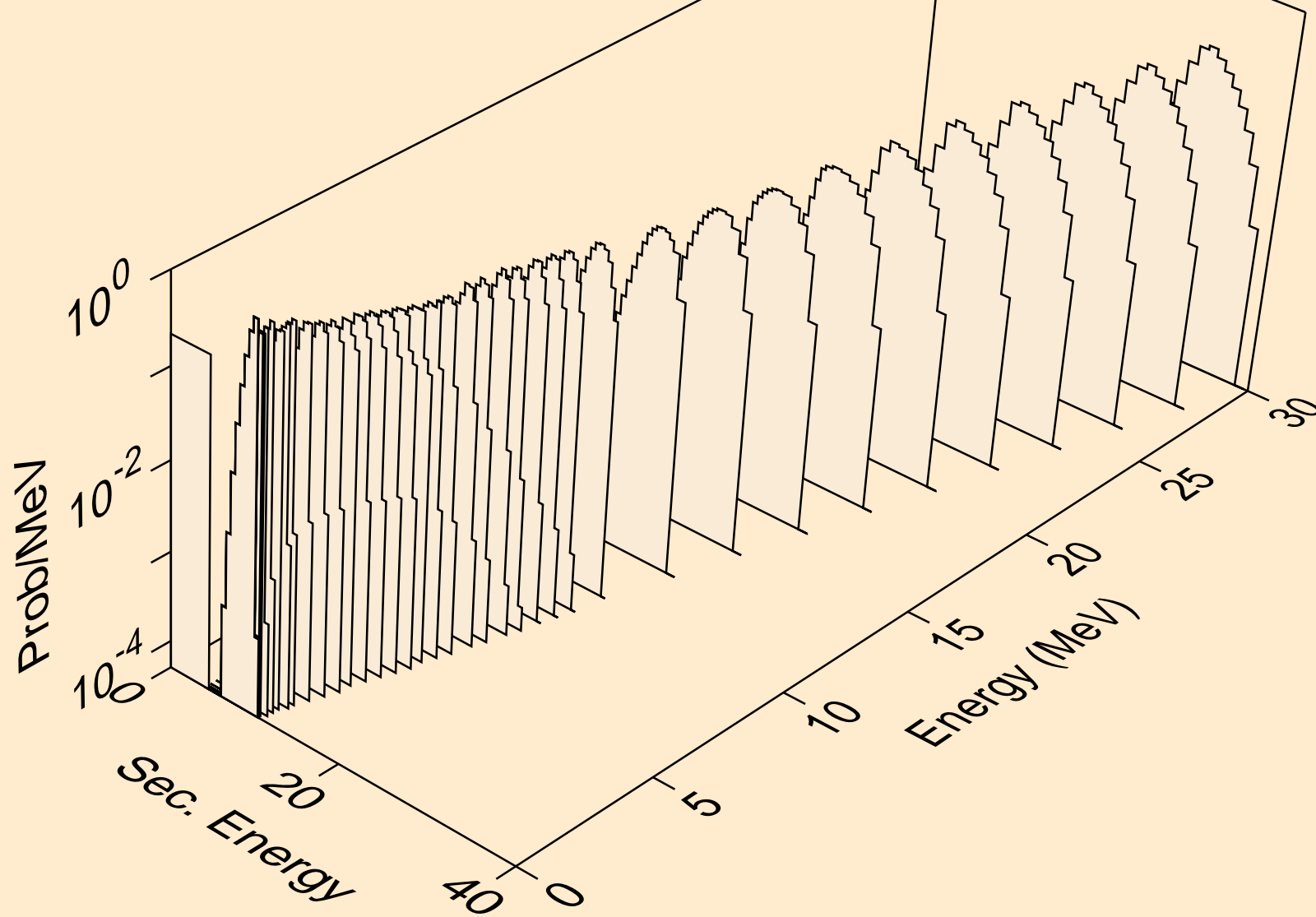



HO158N NEUTRON ACER TENDL-2021 LIBRARY; T=293.6K  
alphas from (n,2a)

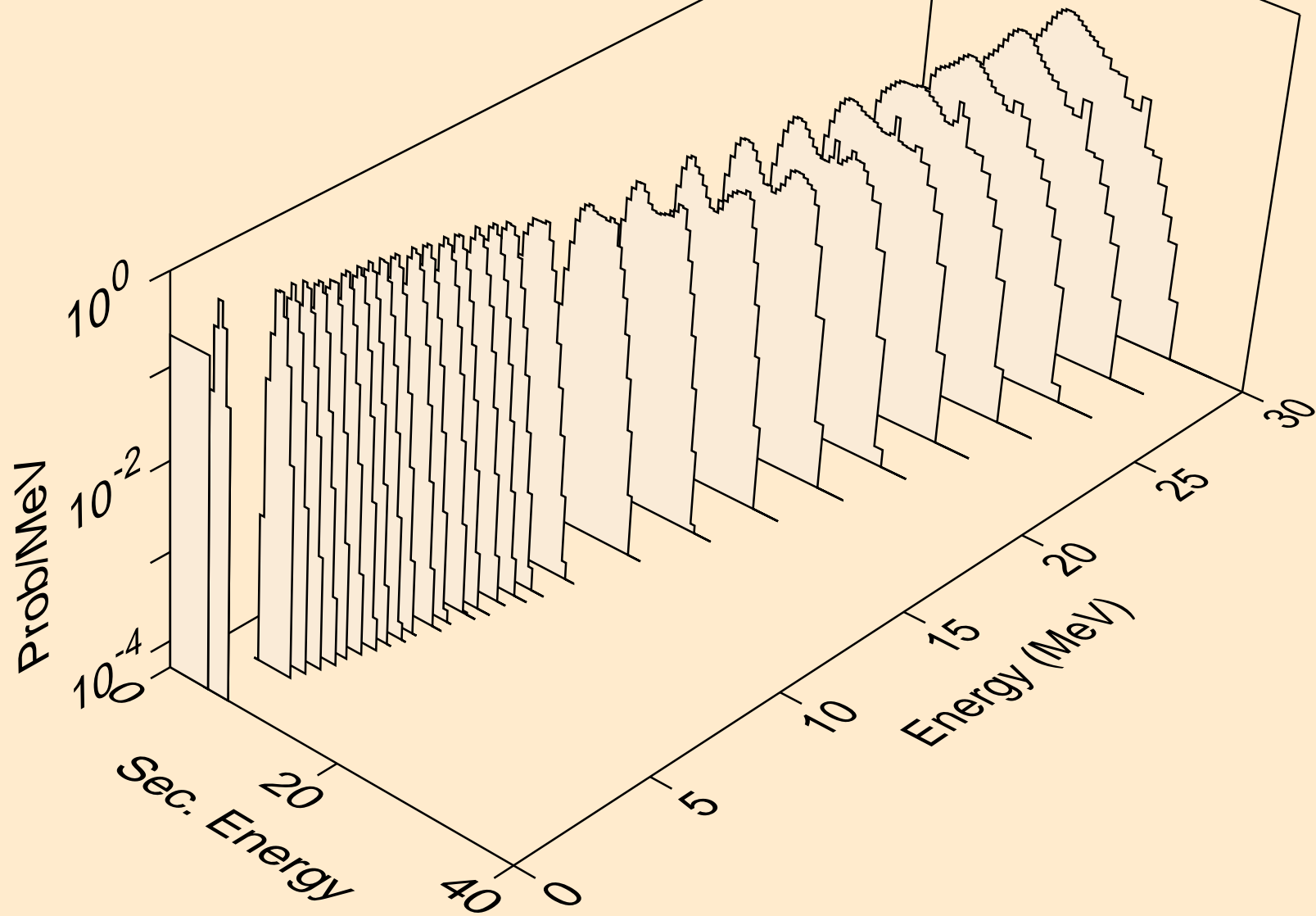

HO158N NEUTRON ACER TENDL-2021 LIBRARY; T=293.6K  
alphas from (n,pa)

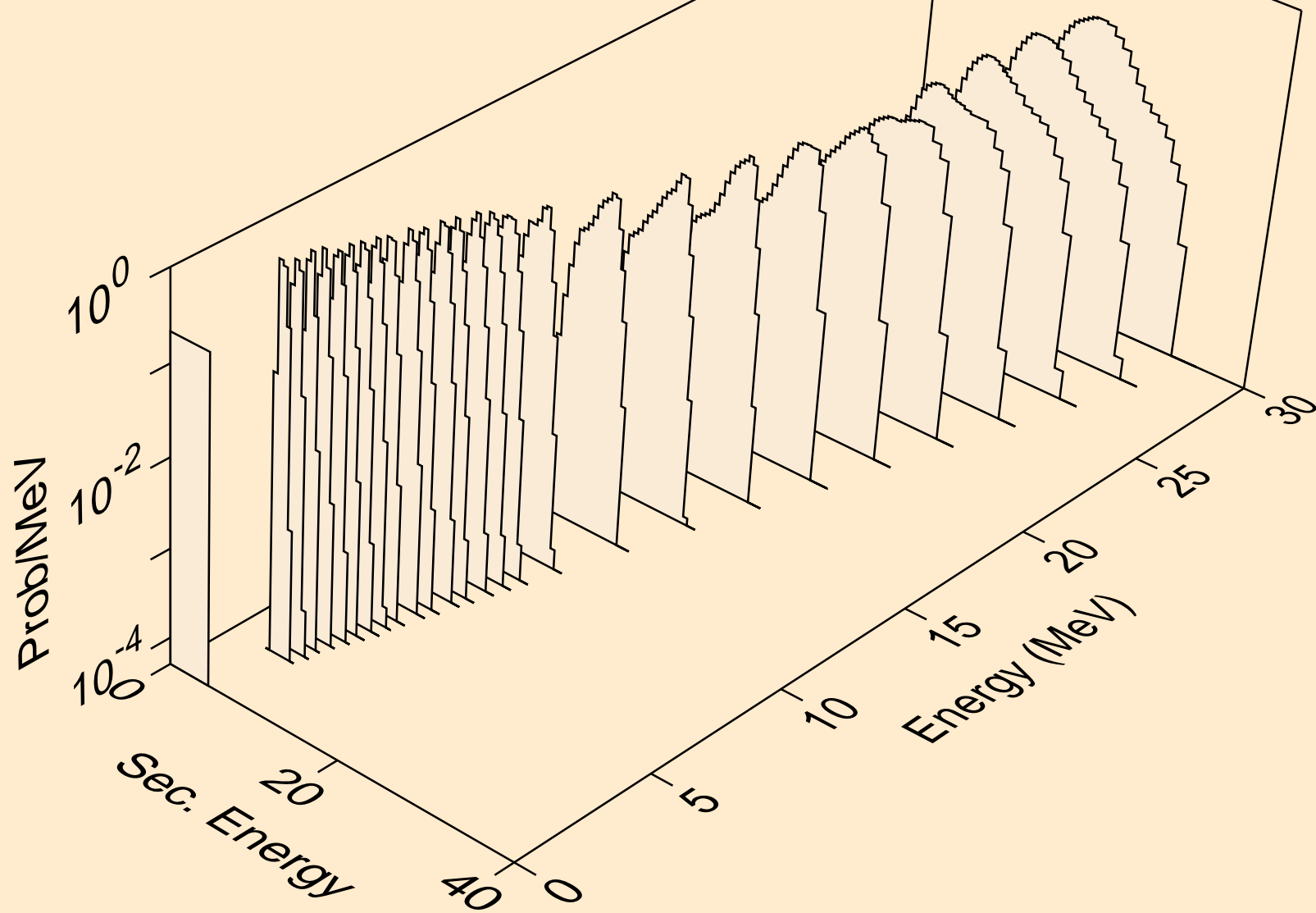

HO158N NEUTRON ACER TENDL-2021 LIBRARY; T=293.6K  
alphas from (n,da)

