

HO160N NEUTRON ACER TENDL-2021 LIBRARY; T=293.6K  
Principal cross sections

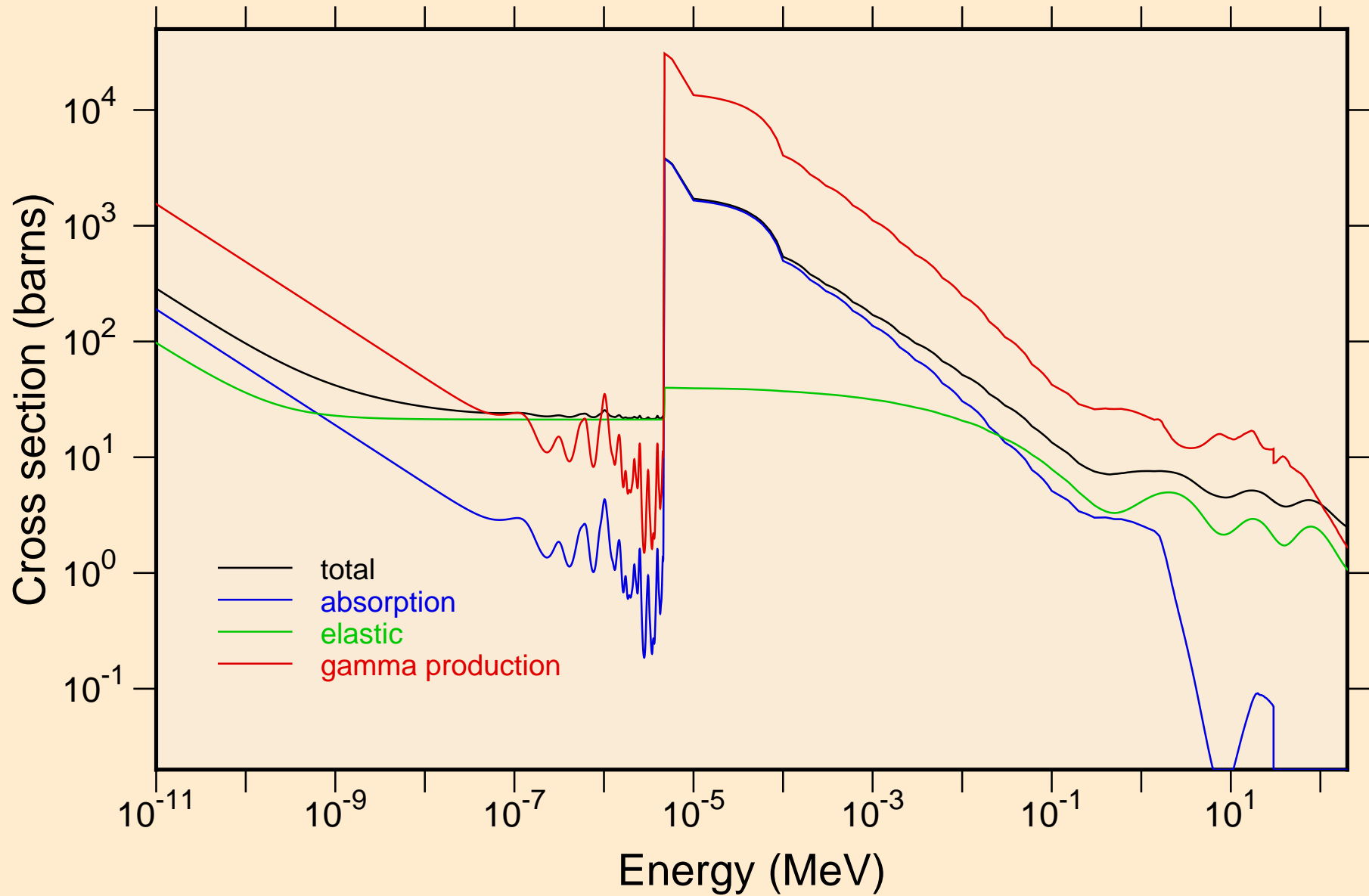

H<sup>160</sup>N NEUTRON ACER TENDL-2021 LIBRARY; T=293.6K  
resonance total cross section

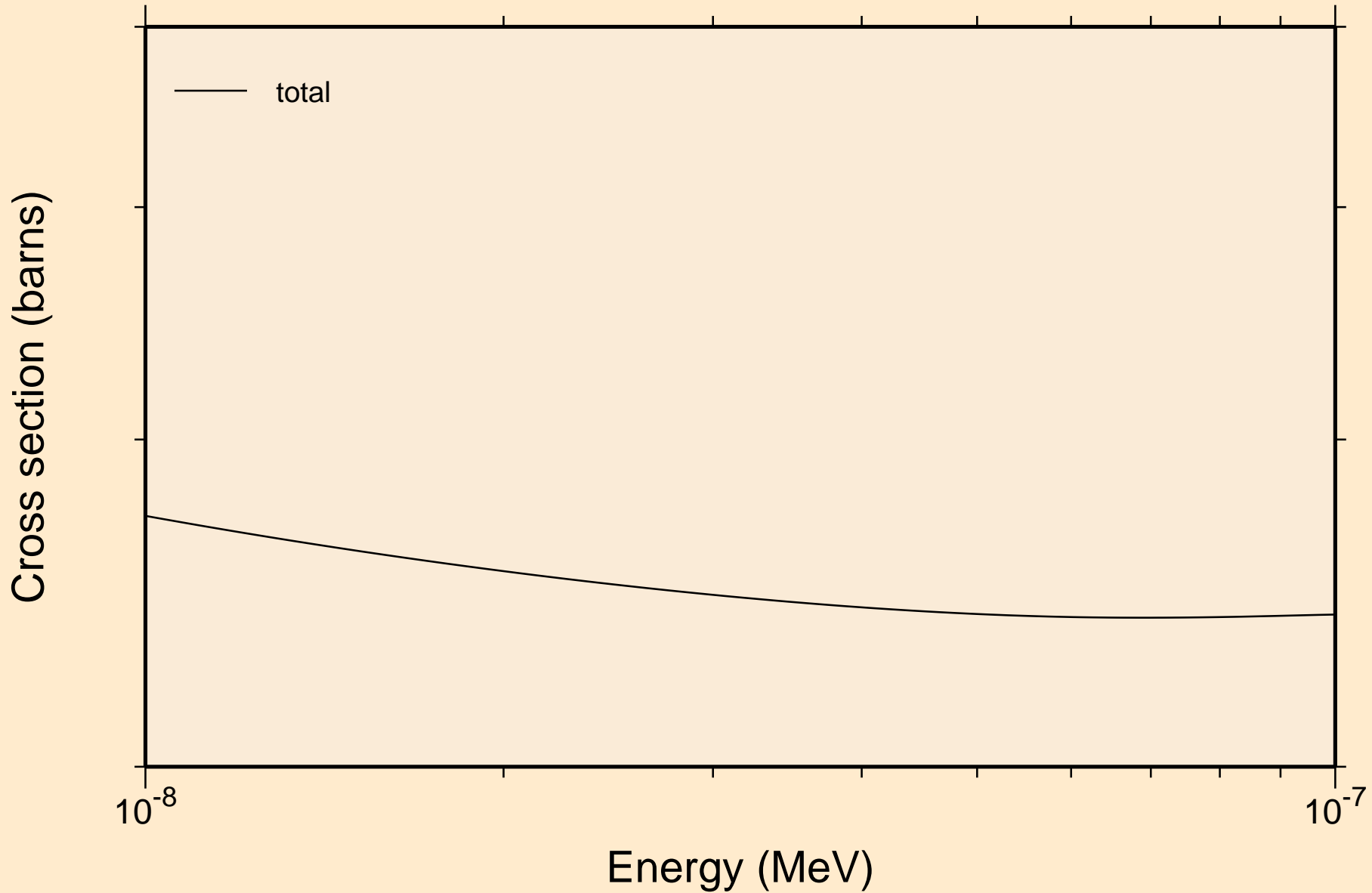

H<sup>160</sup>N NEUTRON ACER TENDL-2021 LIBRARY; T=293.6K  
resonance total cross section

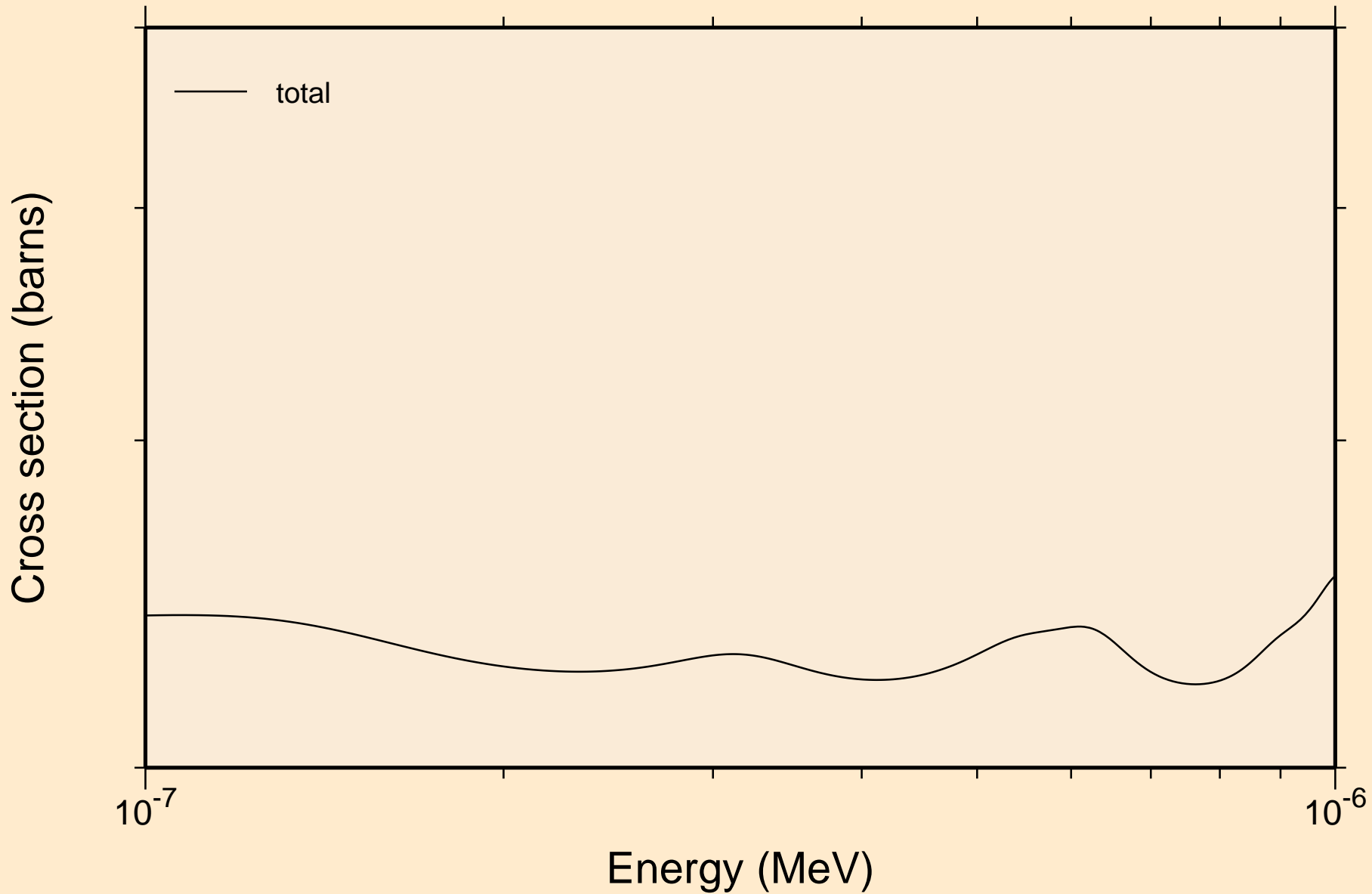

HO160N NEUTRON ACER TENDL-2021 LIBRARY; T=293.6K  
resonance total cross section

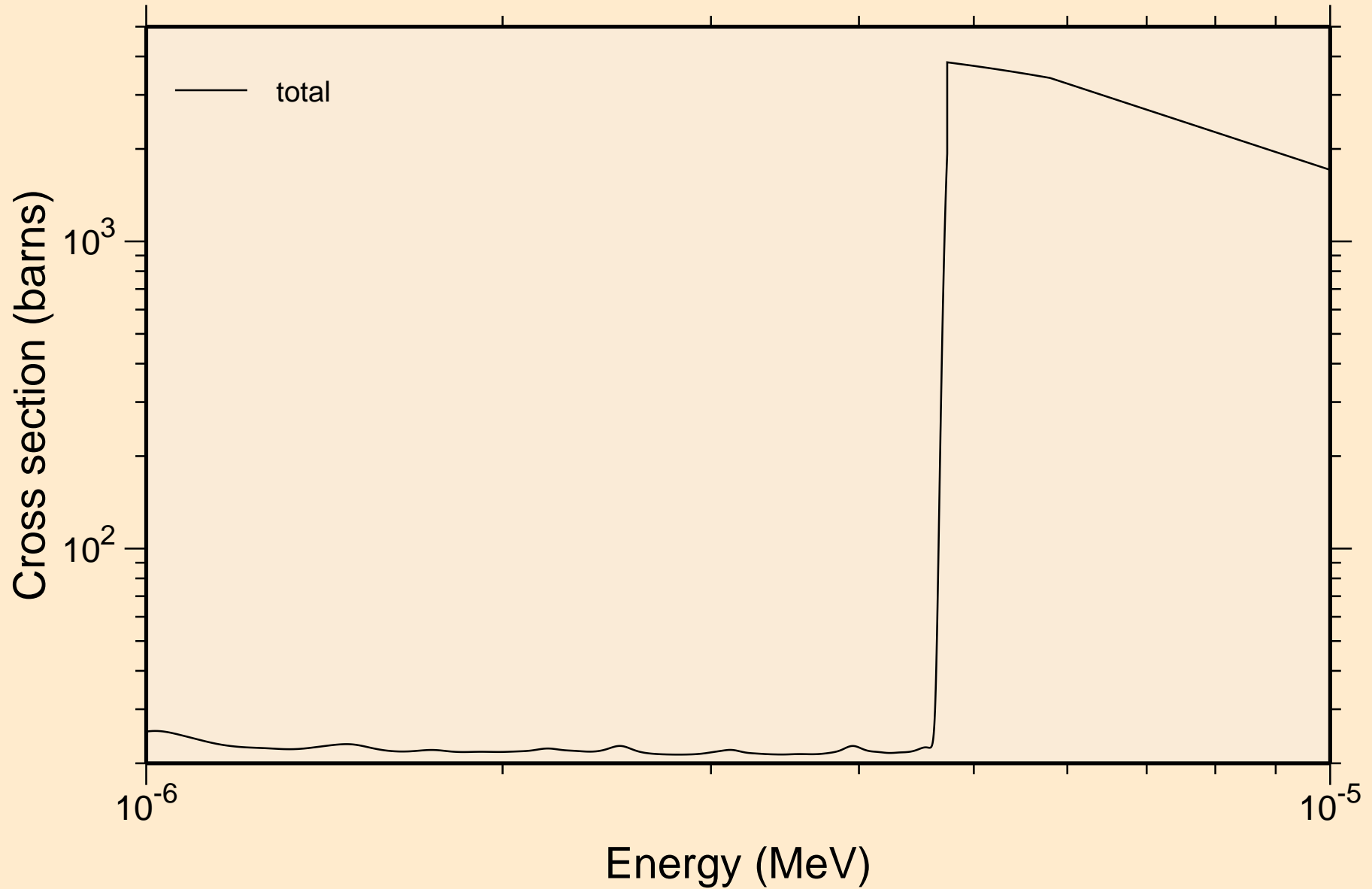

HO160N NEUTRON ACER TENDL-2021 LIBRARY; T=293.6K  
resonance total cross section

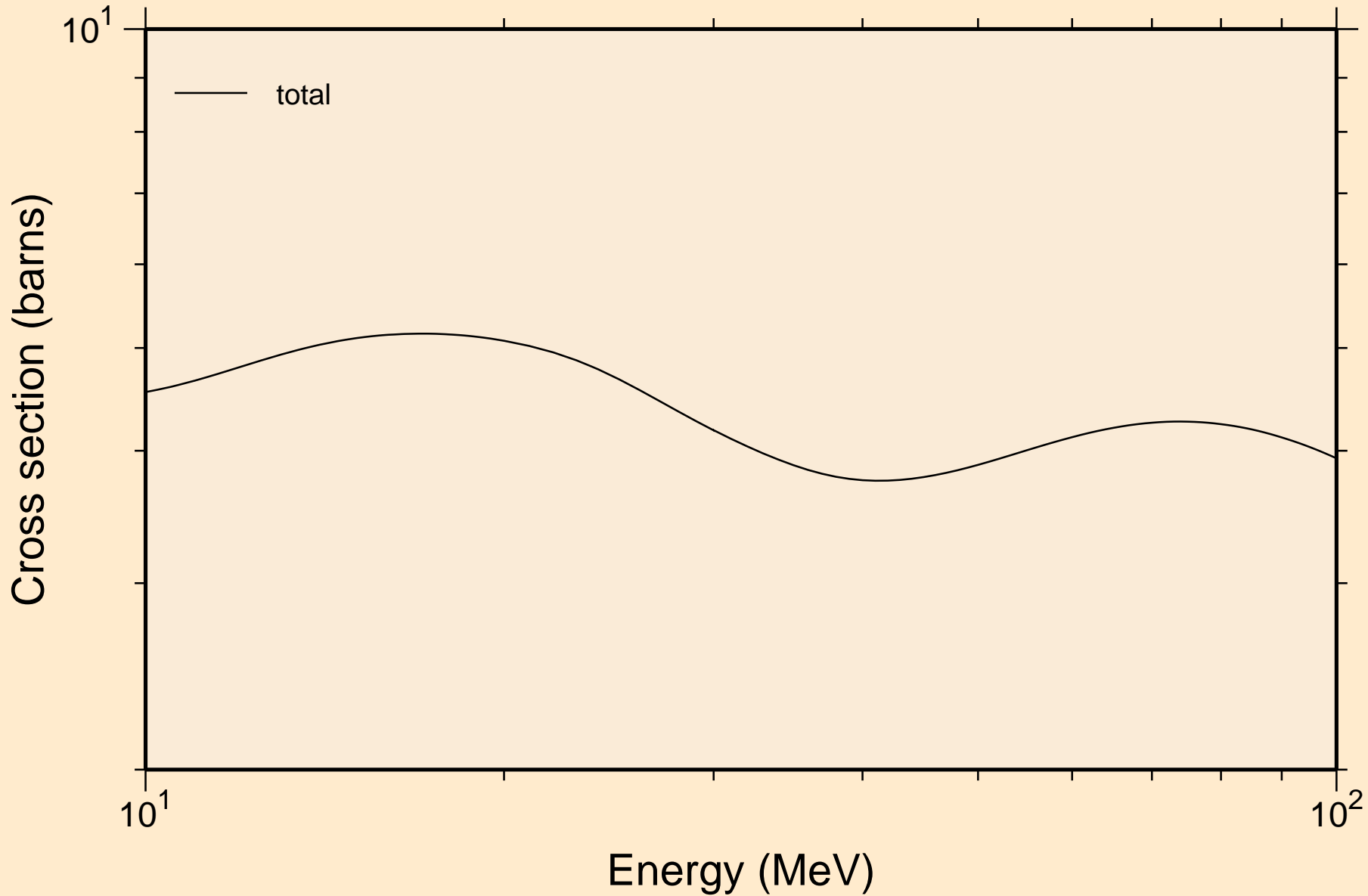

HO160N NEUTRON ACER TENDL-2021 LIBRARY; T=293.6K  
resonance absorption cross sections

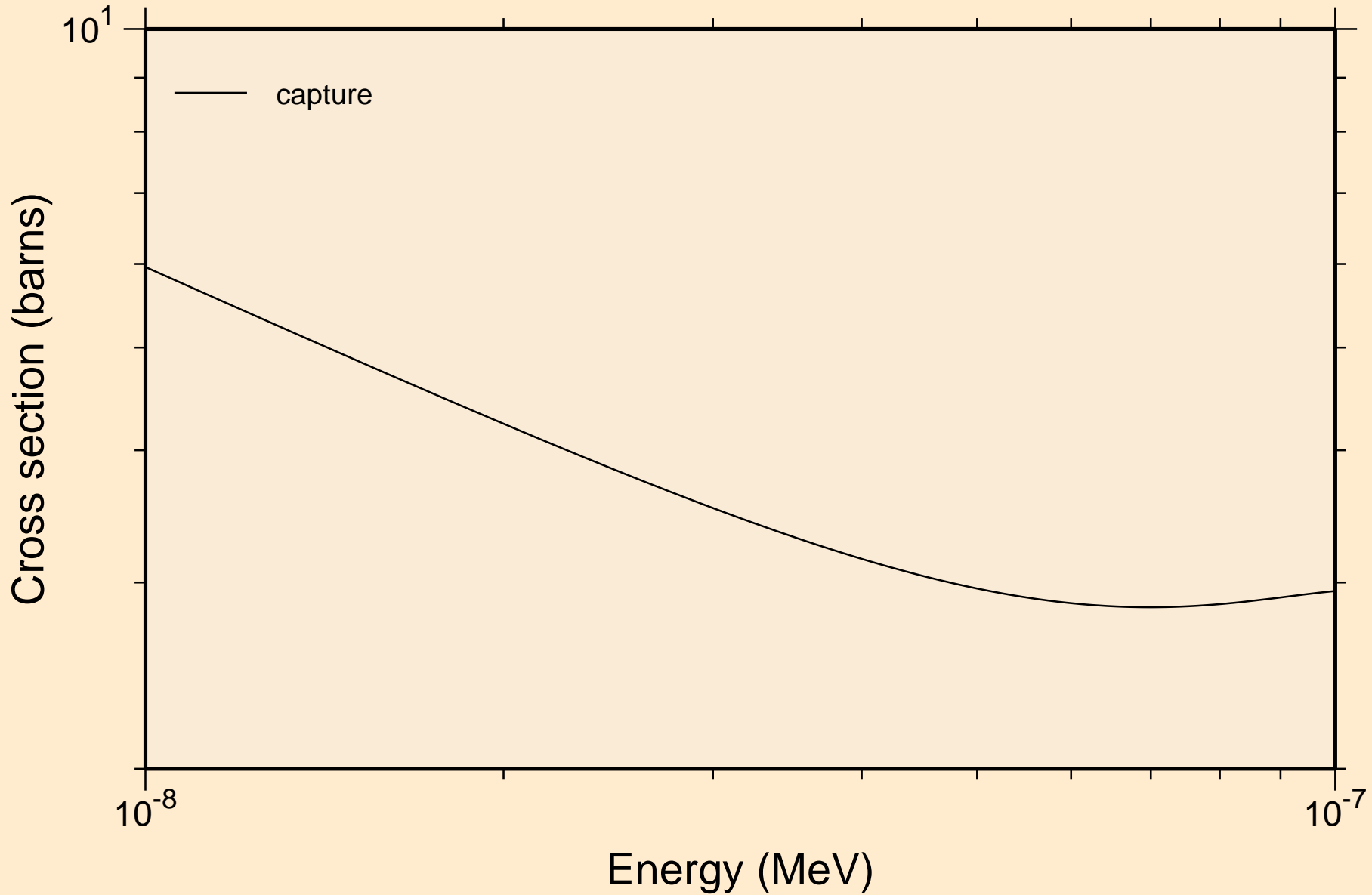

HO160N NEUTRON ACER TENDL-2021 LIBRARY; T=293.6K  
resonance absorption cross sections

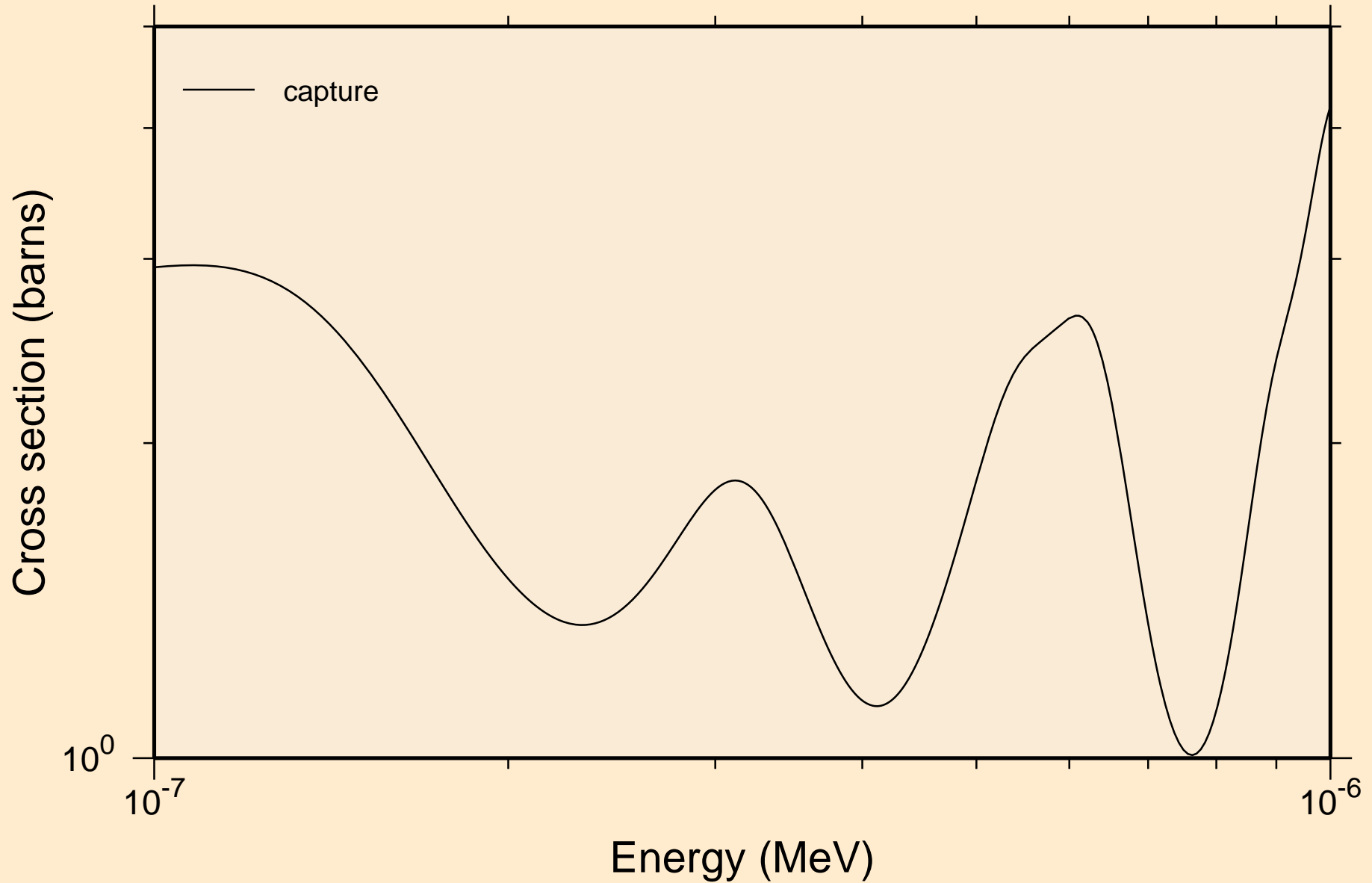

HO160N NEUTRON ACER TENDL-2021 LIBRARY; T=293.6K  
resonance absorption cross sections

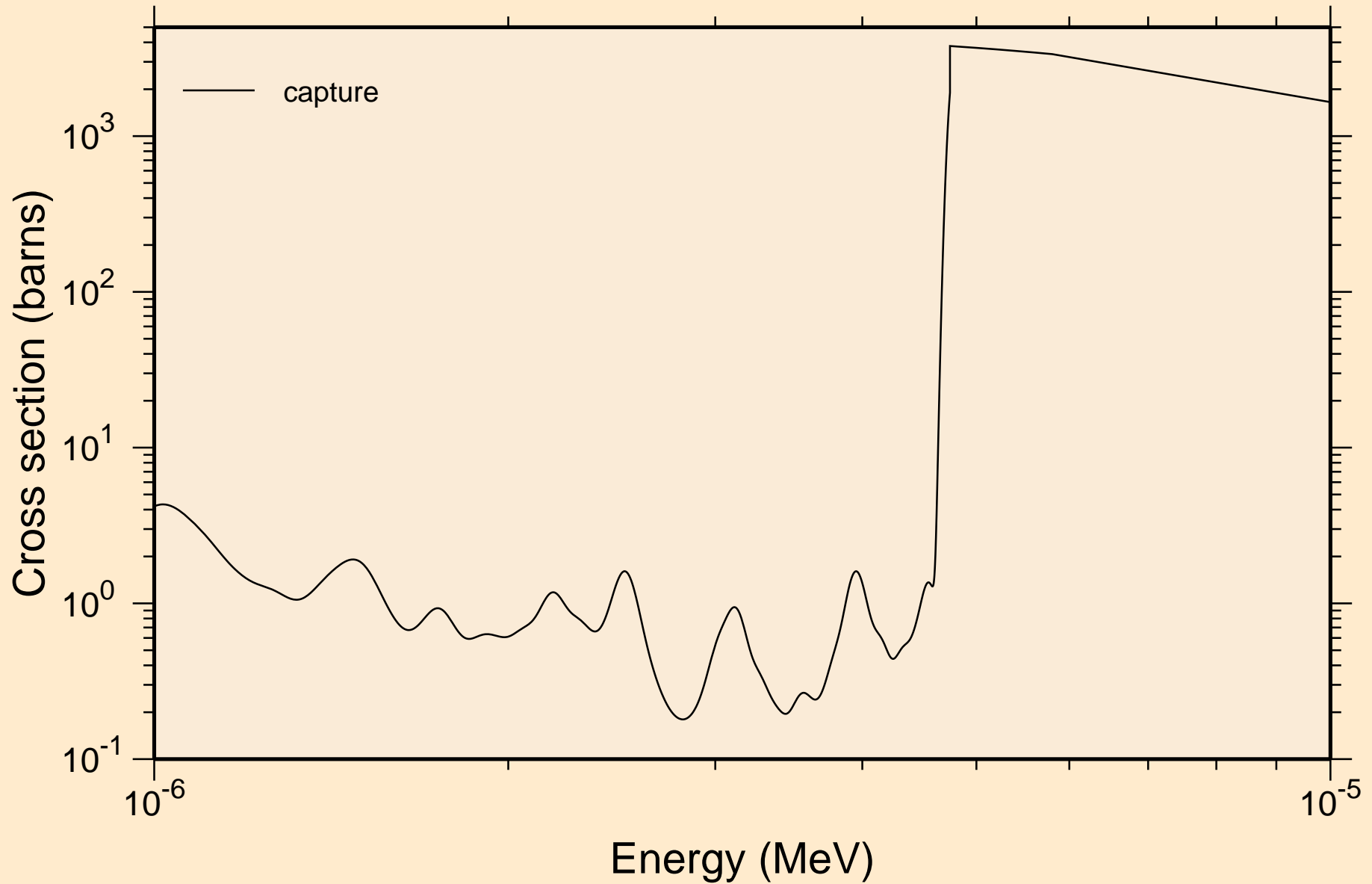



HO160N NEUTRON ACER TENDL-2021 LIBRARY; T=293.6K  
resonance absorption cross sections

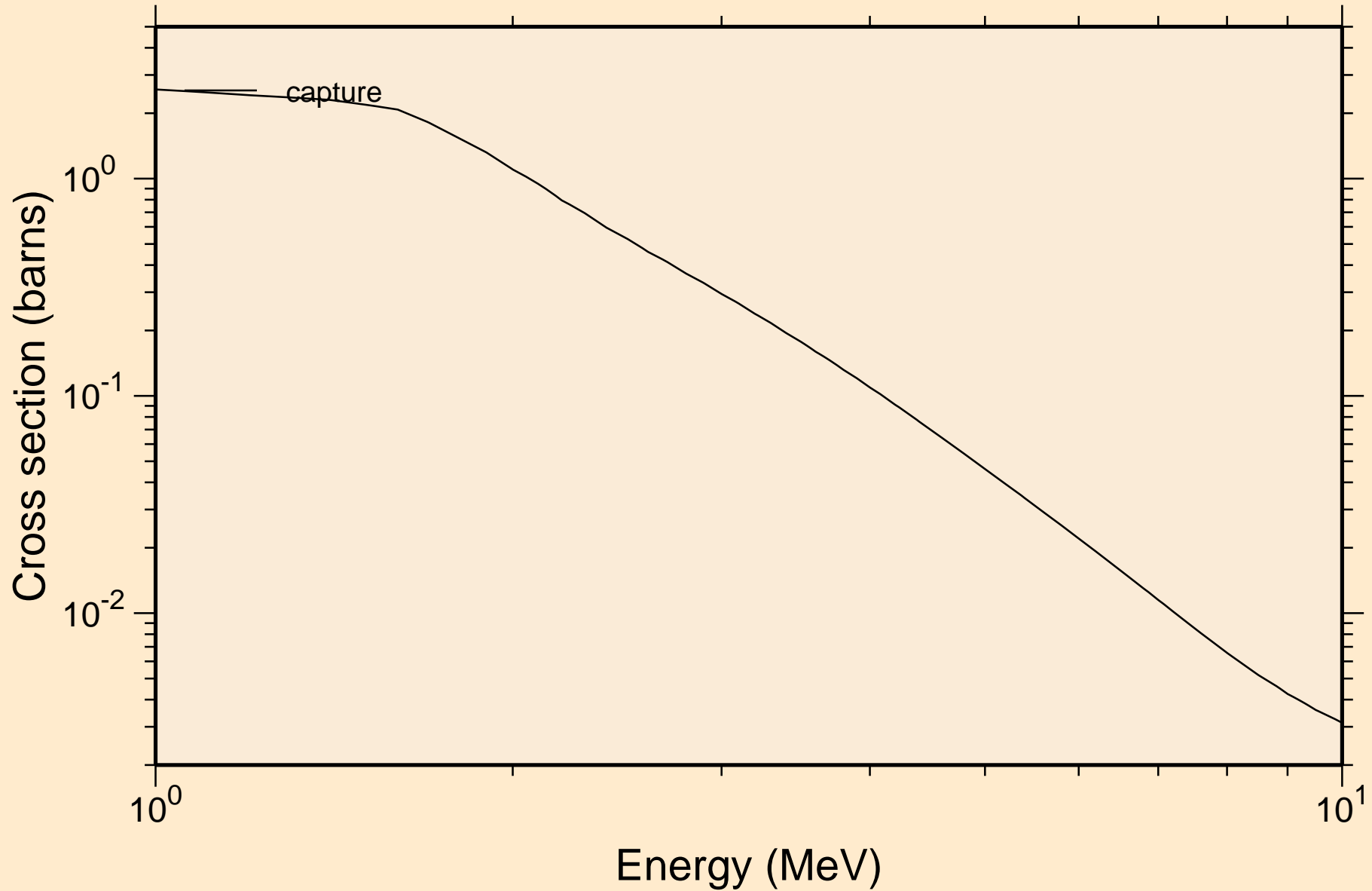

HO160N NEUTRON ACER TENDL-2021 LIBRARY; T=293.6K  
Heating

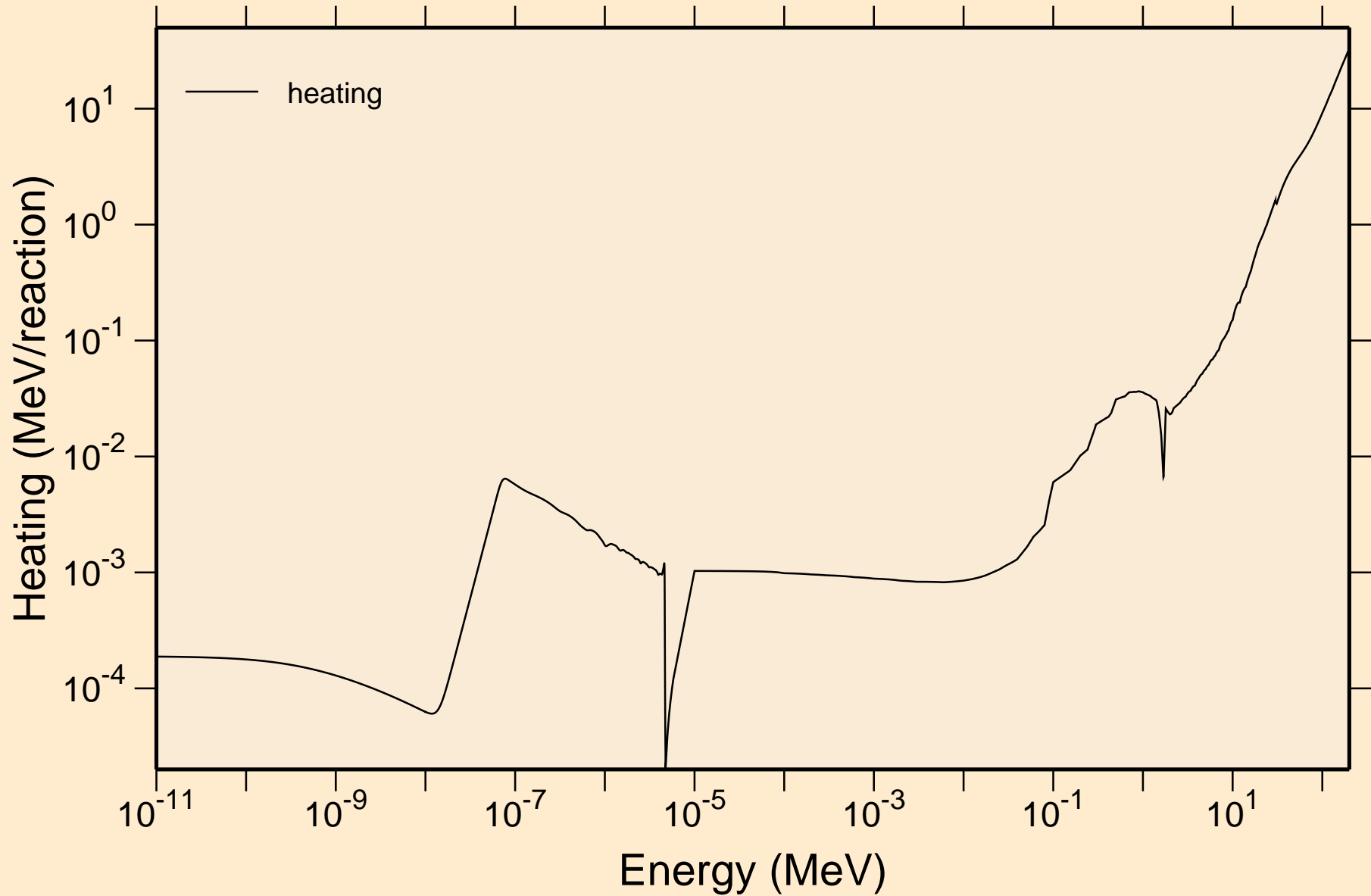

# HO160N NEUTRON ACER TENDL-2021 LIBRARY; T=293.6K Damage

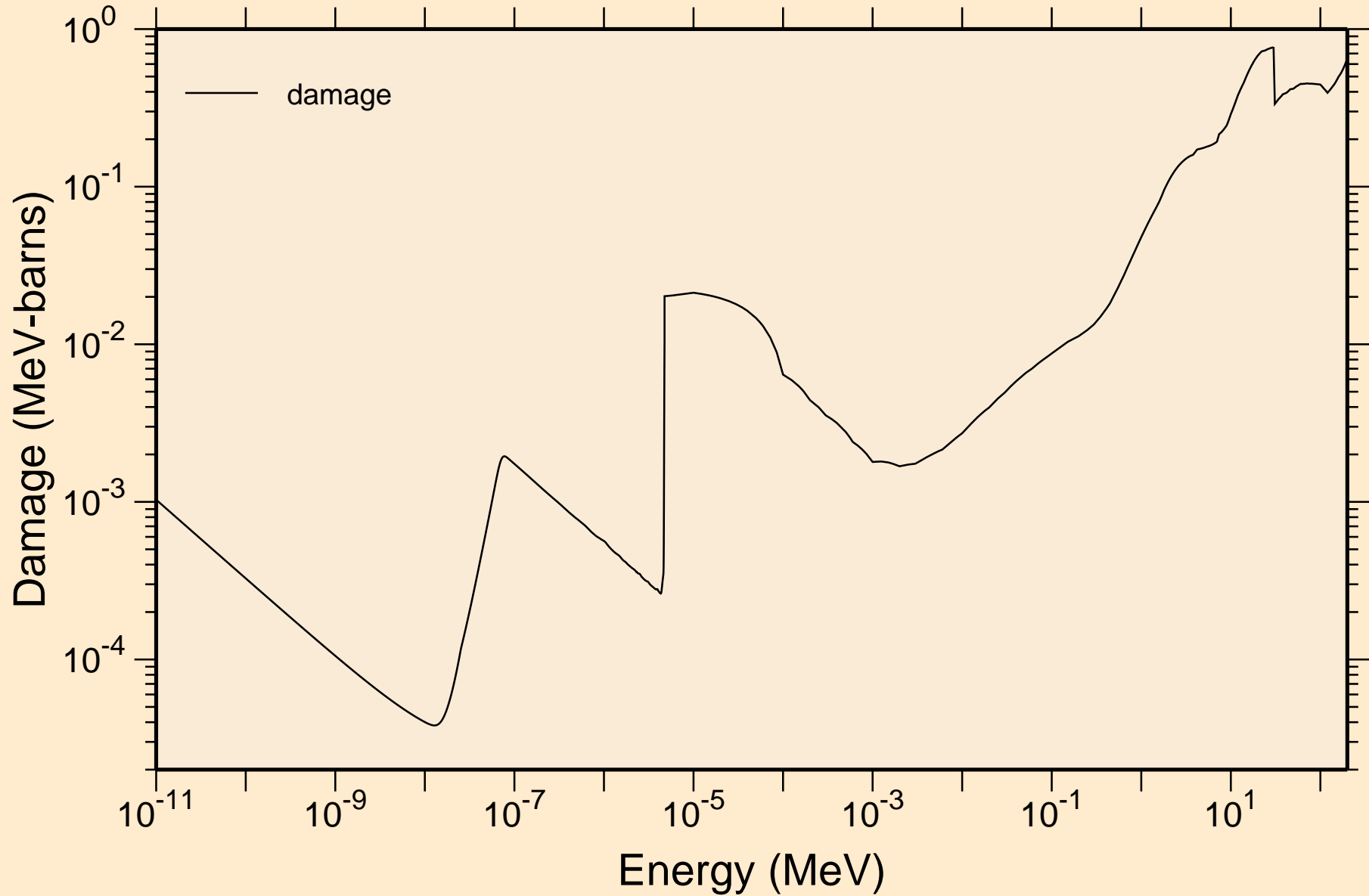

# HO160N NEUTRON ACER TENDL-2021 LIBRARY; T=293.6K

## Non-threshold reactions

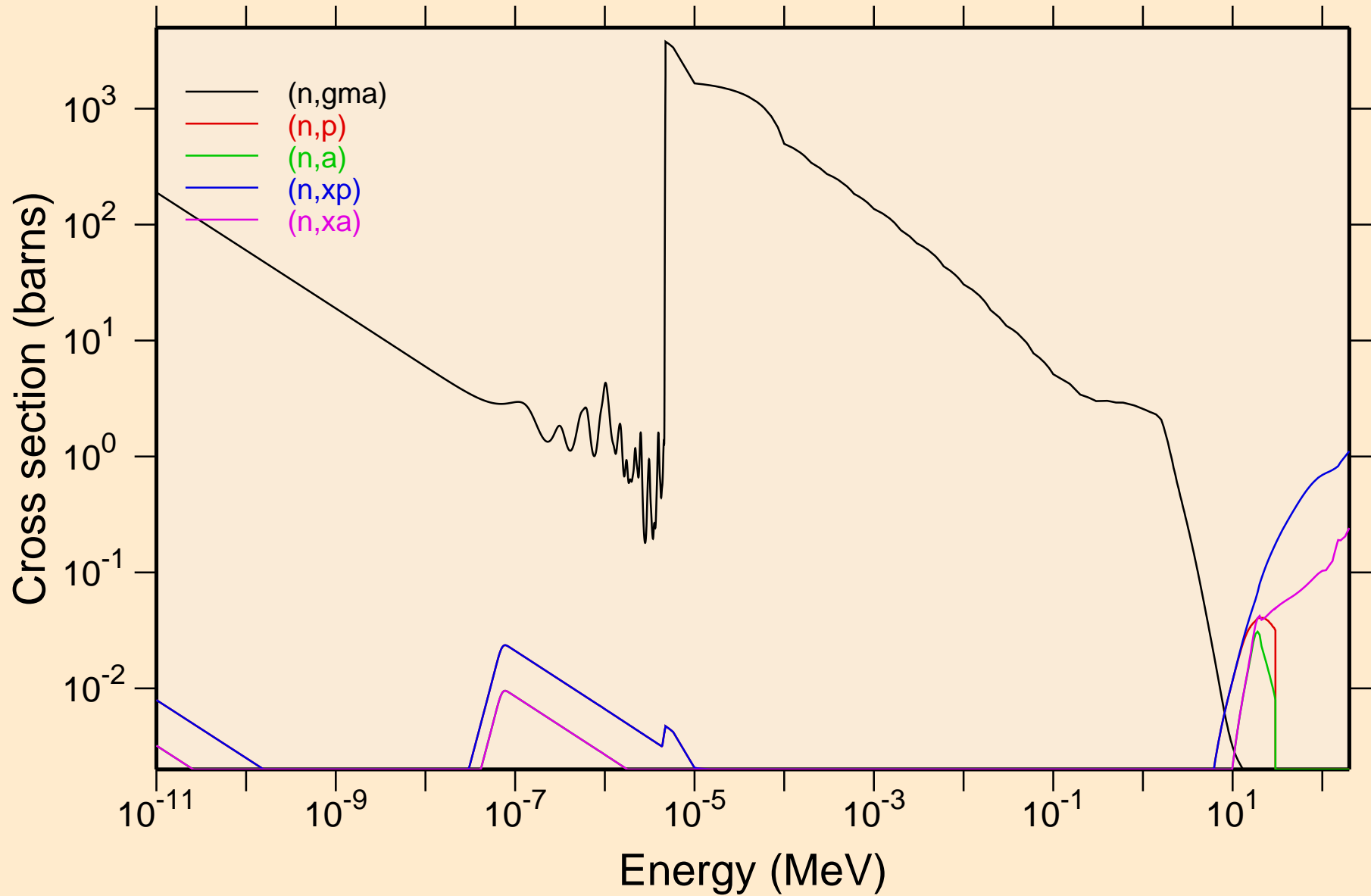

# HO160N NEUTRON ACER TENDL-2021 LIBRARY; T=293.6K

## Principal cross sections

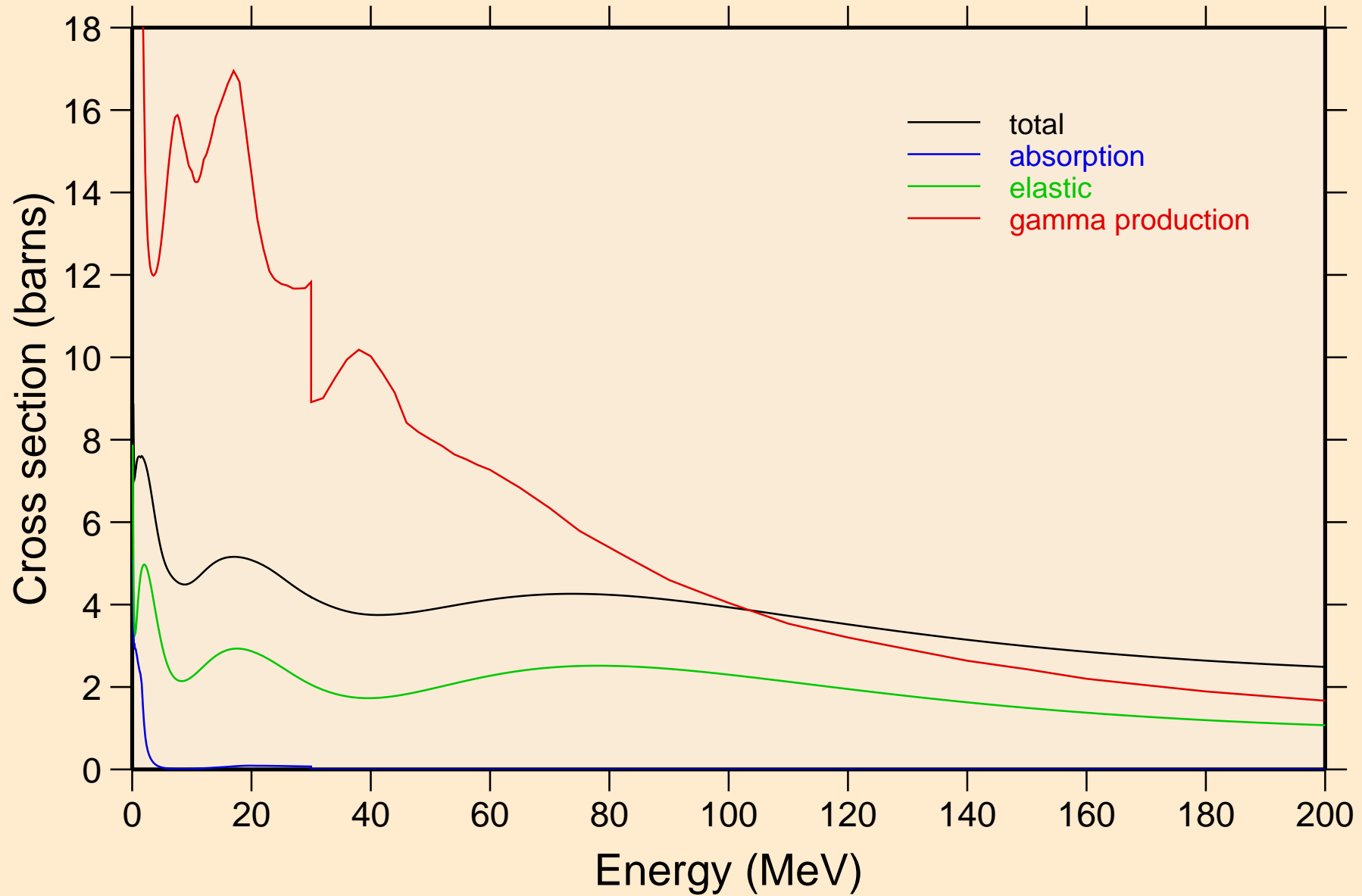

HO160N NEUTRON ACER TENDL-2021 LIBRARY; T=293.6K  
Heating

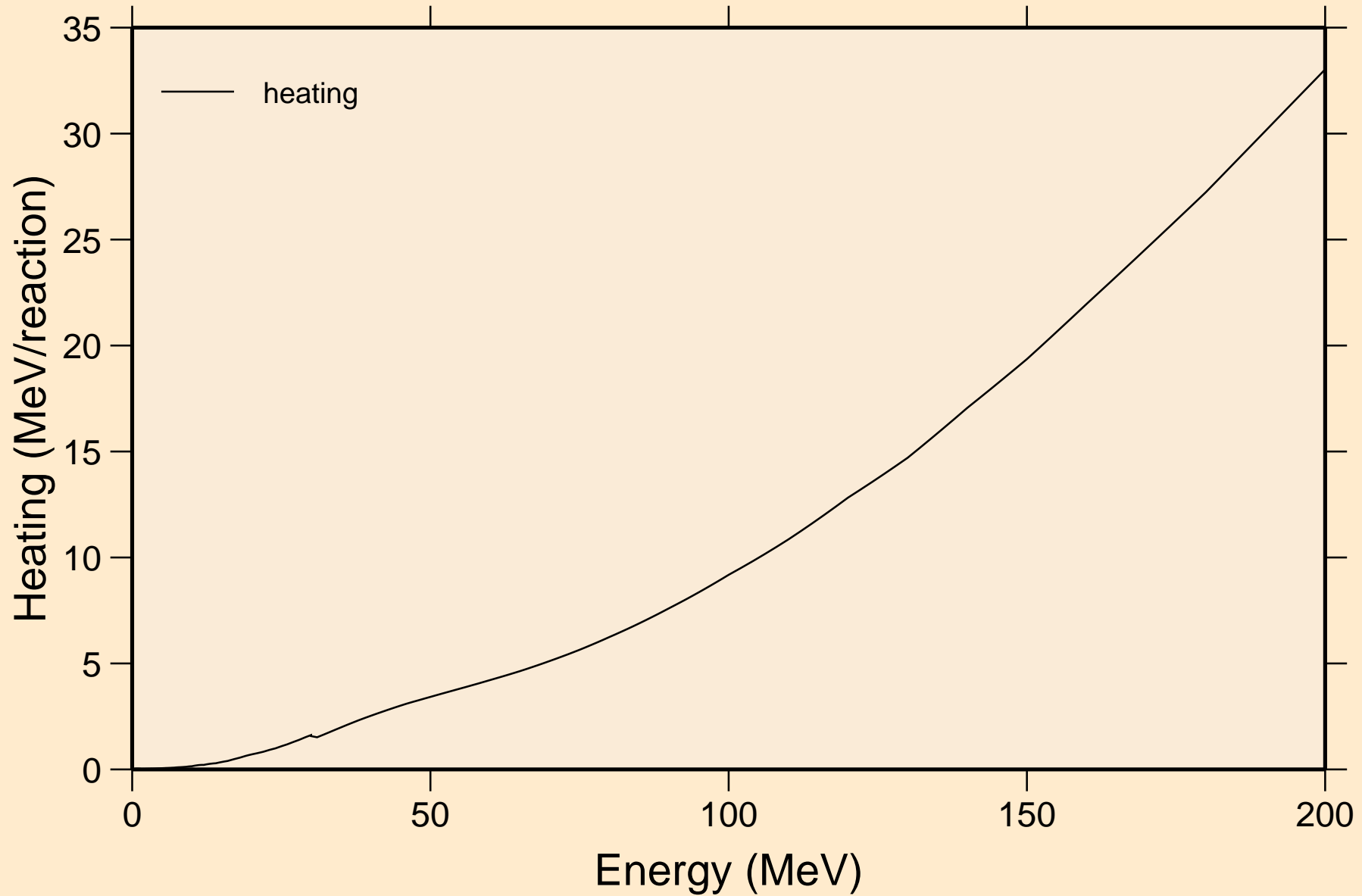

HO160N NEUTRON ACER TENDL-2021 LIBRARY; T=293.6K  
Damage

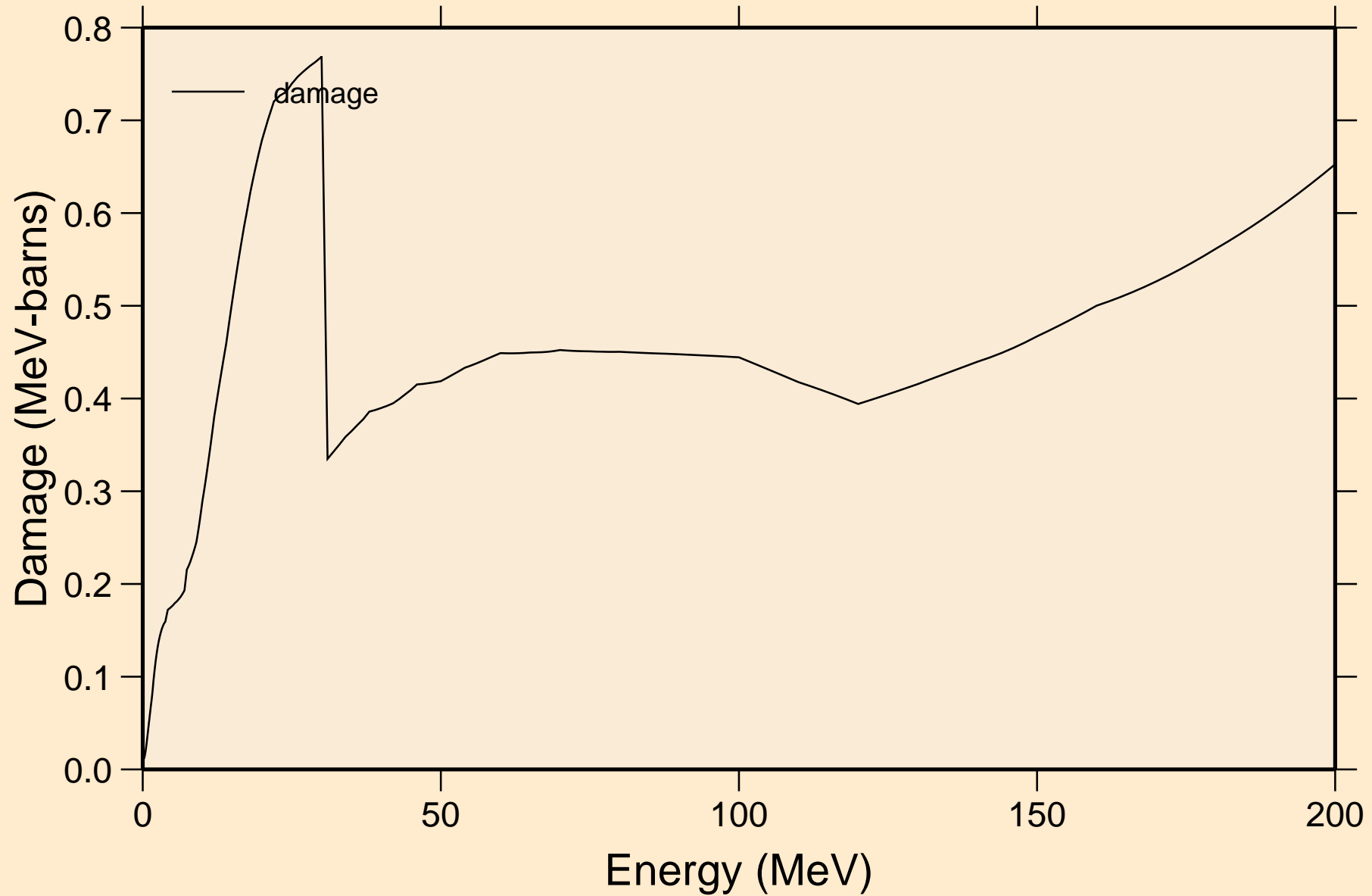

HO160N NEUTRON ACER TENDL-2021 LIBRARY; T=293.6K  
Non-threshold reactions

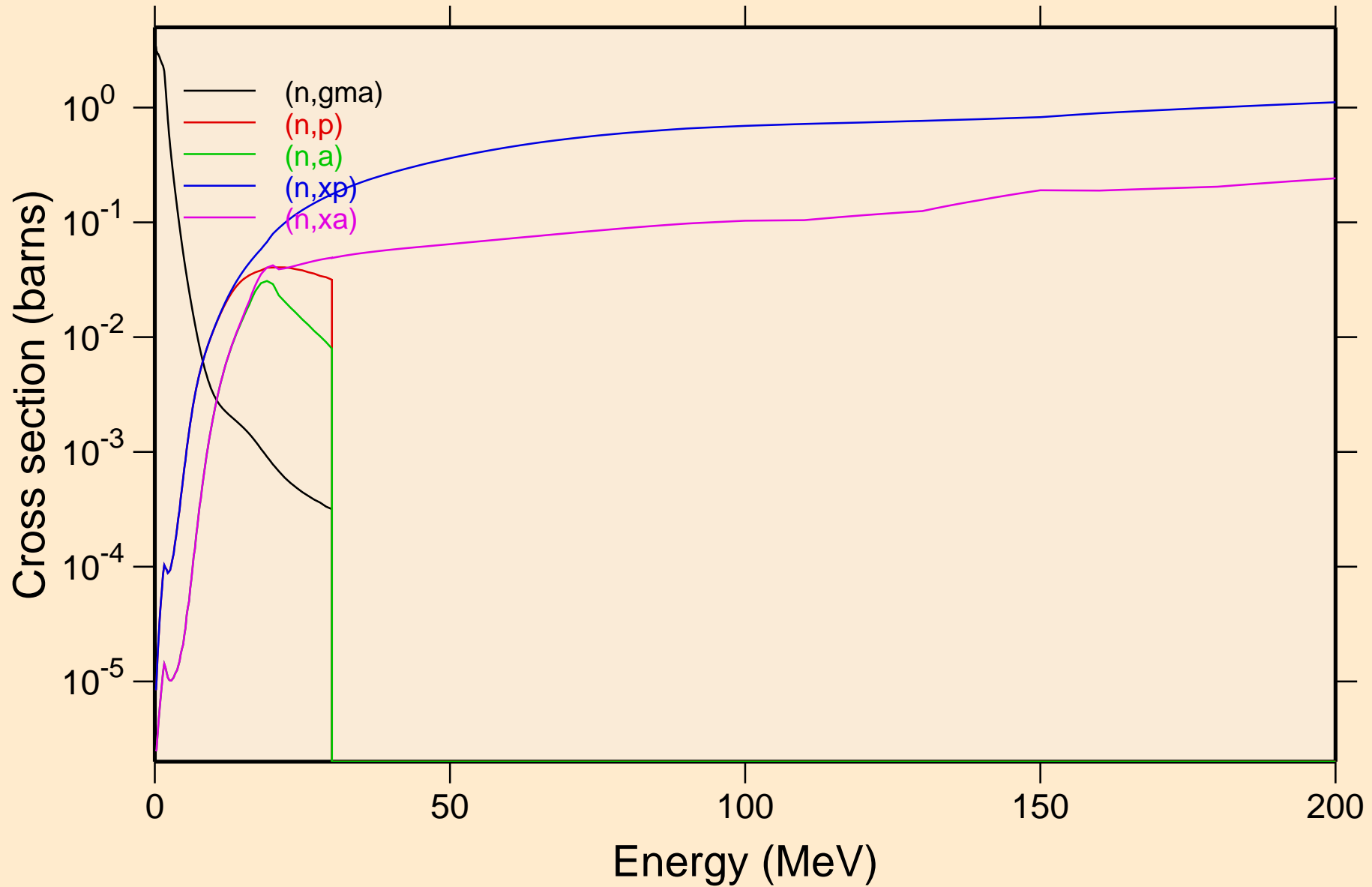



HO160N NEUTRON ACER TENDL-2021 LIBRARY; T=293.6K  
Inelastic levels

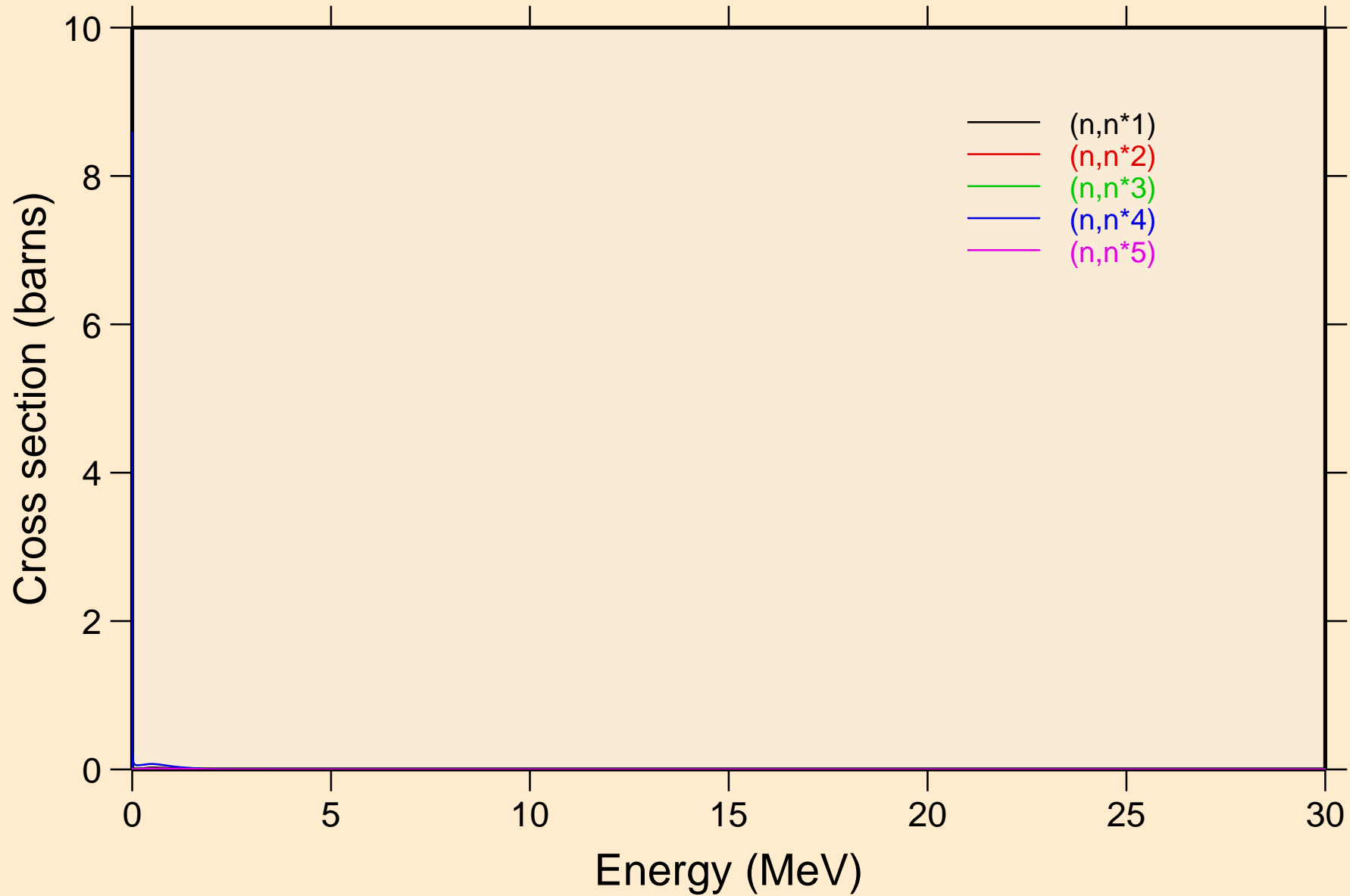

HO160N NEUTRON ACER TENDL-2021 LIBRARY; T=293.6K  
Inelastic levels

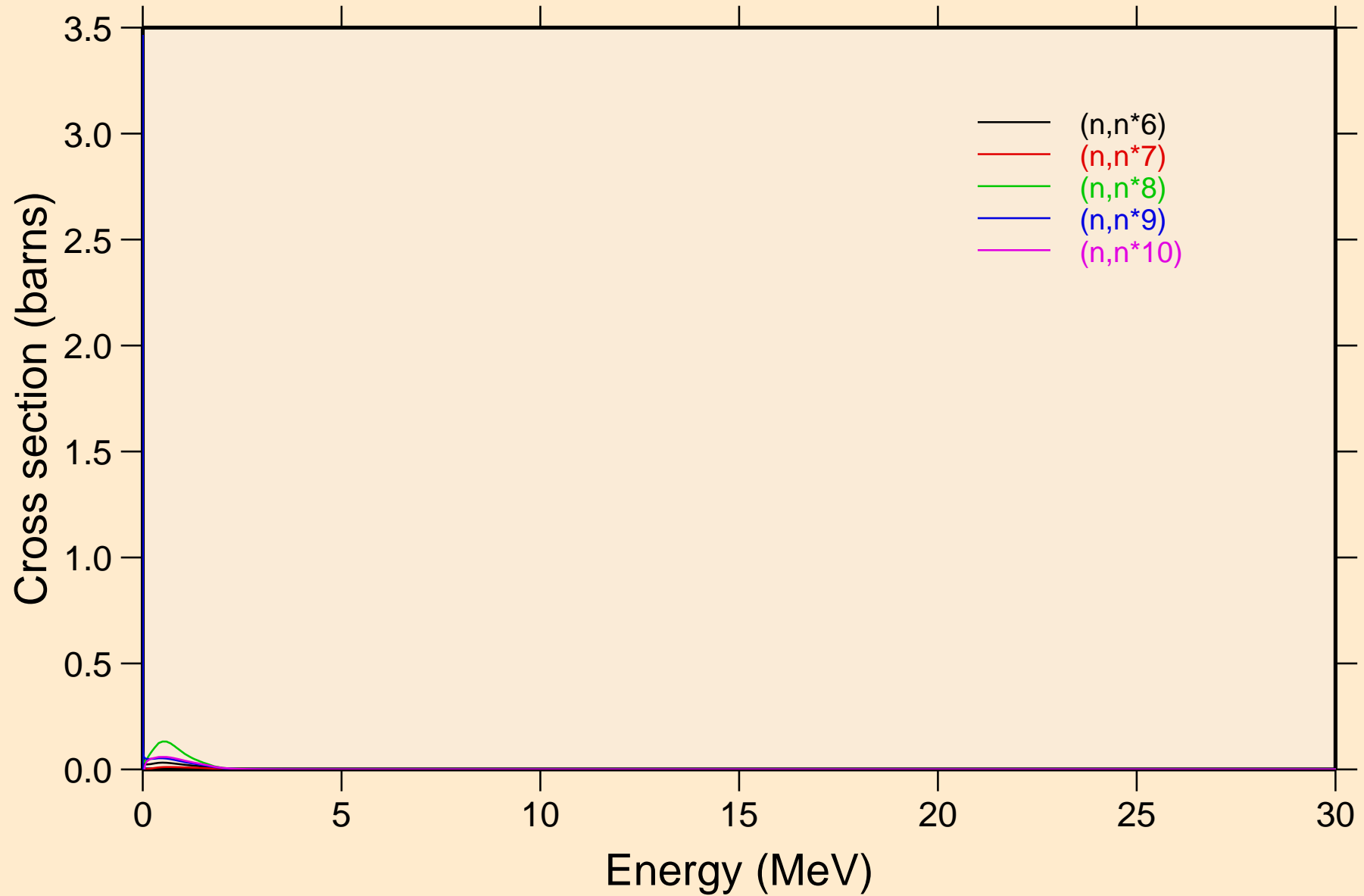

HO160N NEUTRON ACER TENDL-2021 LIBRARY; T=293.6K  
Inelastic levels

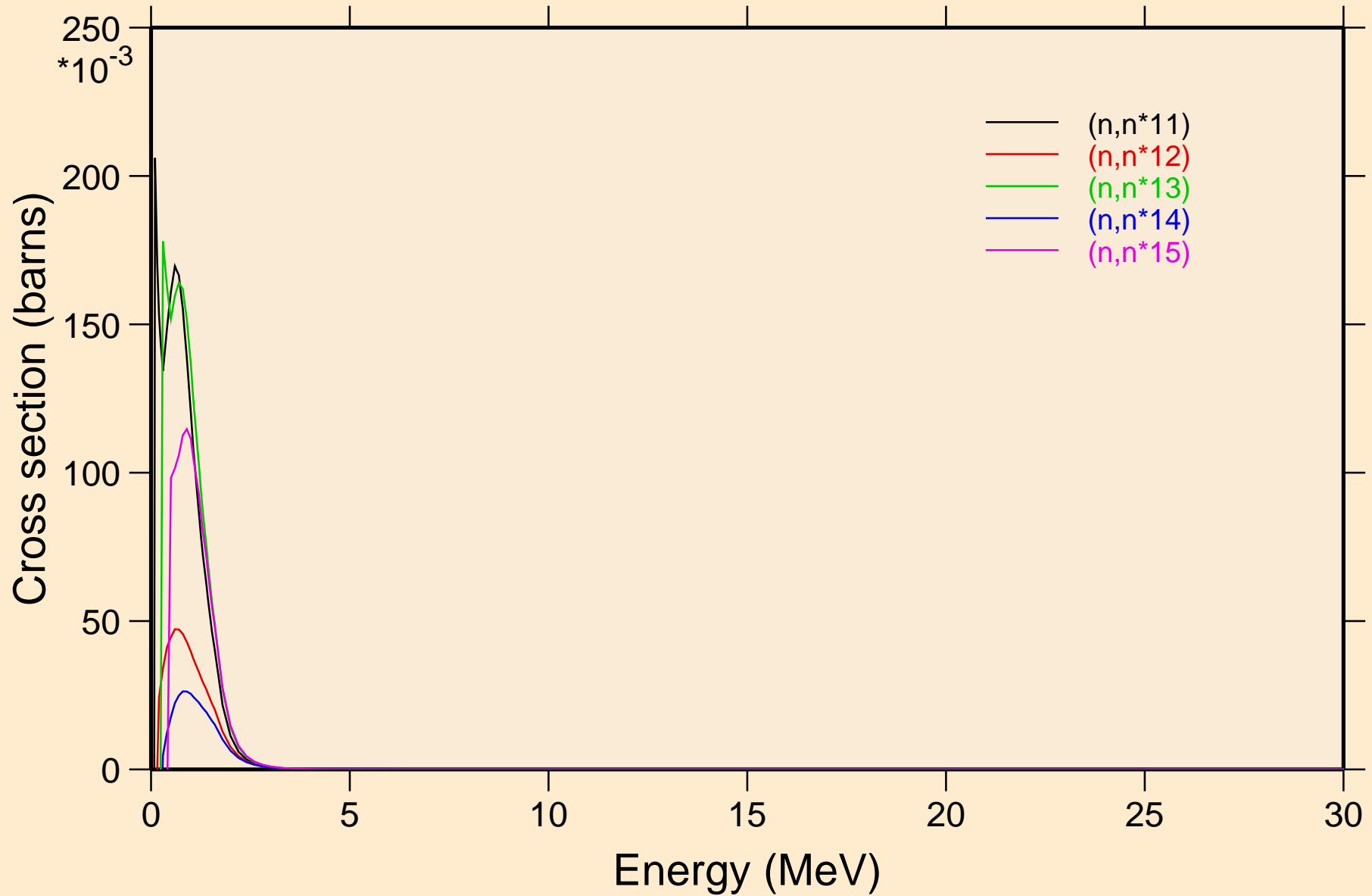

HO160N NEUTRON ACER TENDL-2021 LIBRARY; T=293.6K  
Inelastic levels

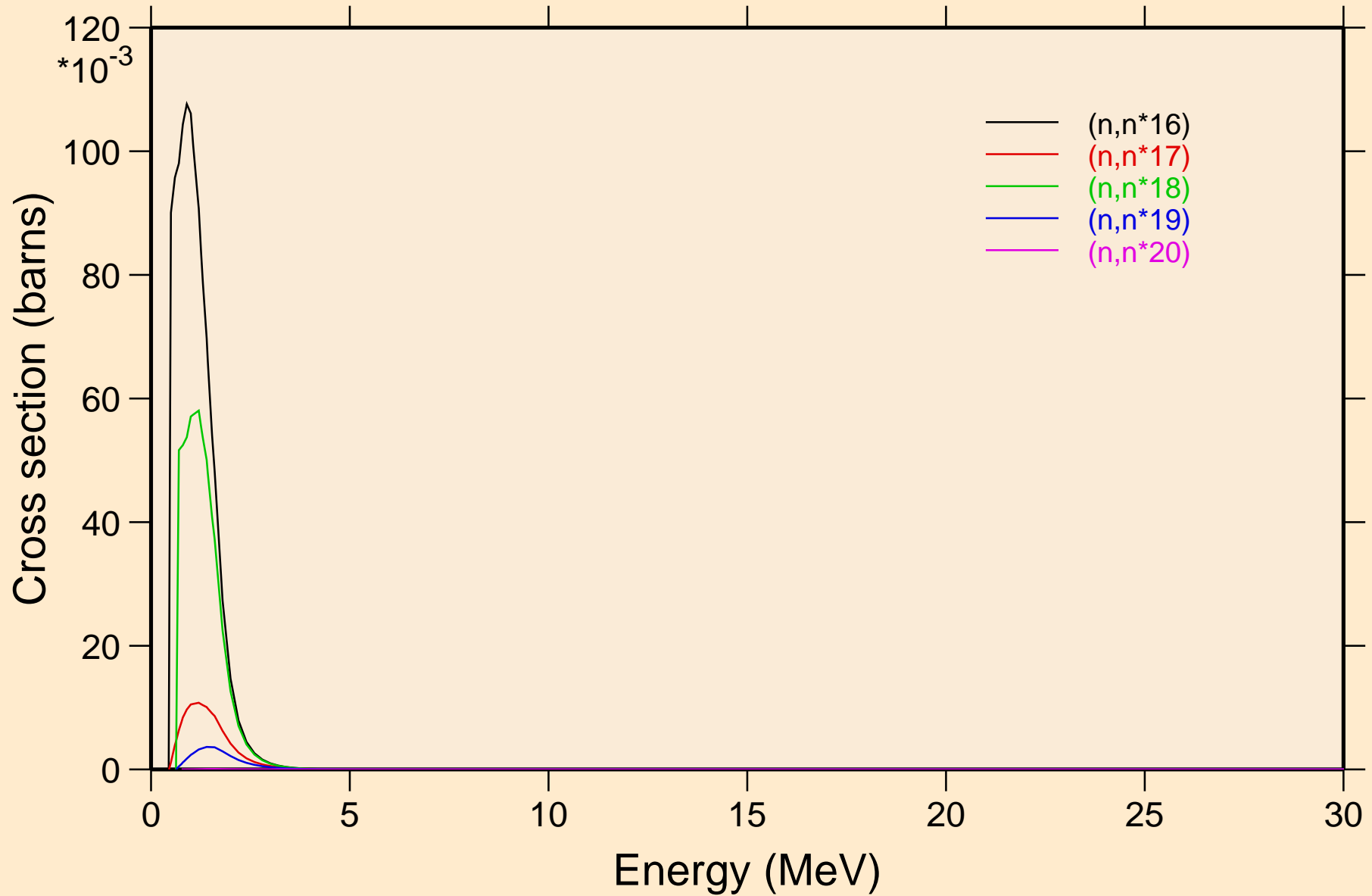

HO160N NEUTRON ACER TENDL-2021 LIBRARY; T=293.6K  
Inelastic levels

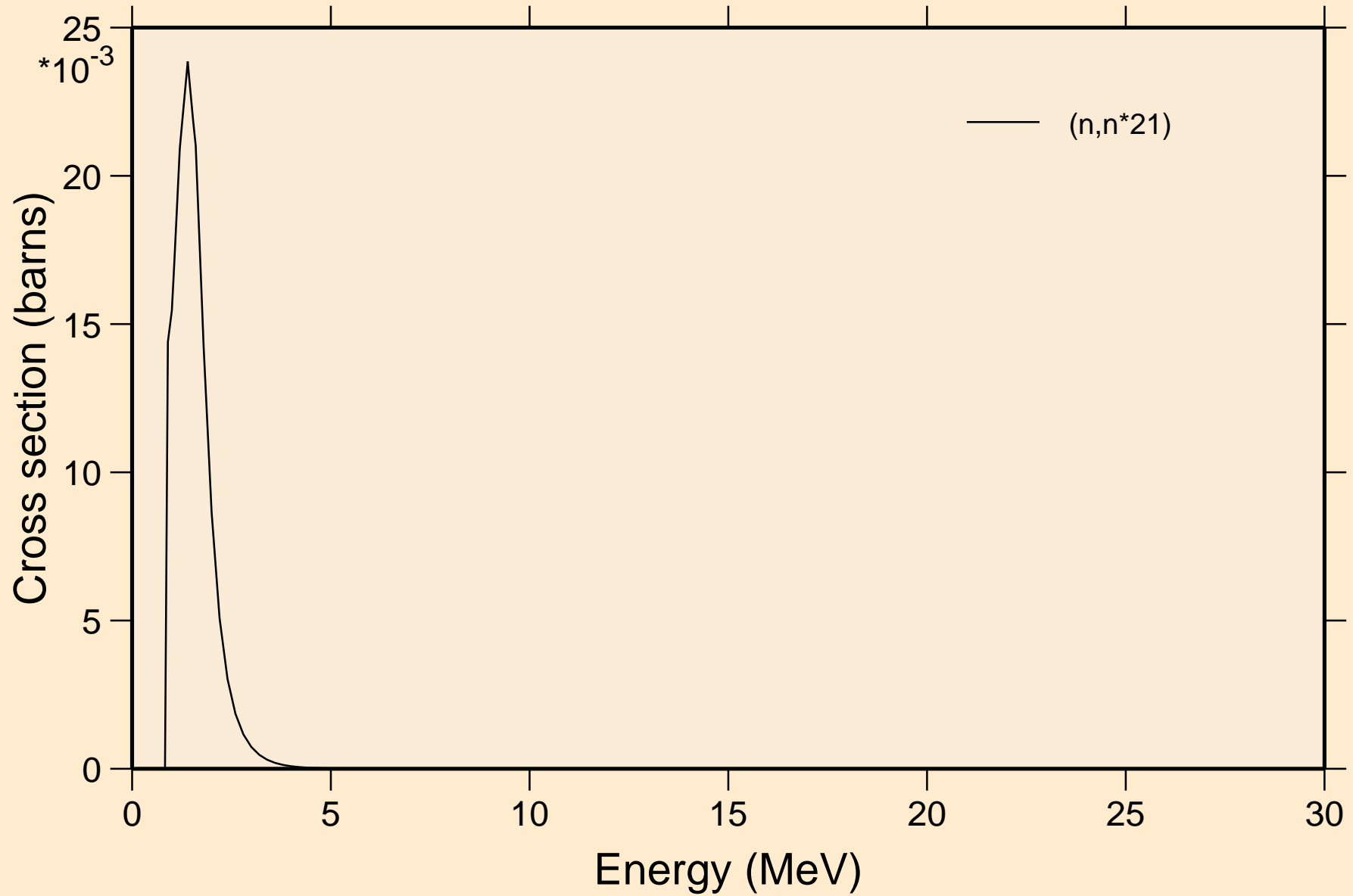

# HO160N NEUTRON ACER TENDL-2021 LIBRARY; T=293.6K

## Threshold reactions

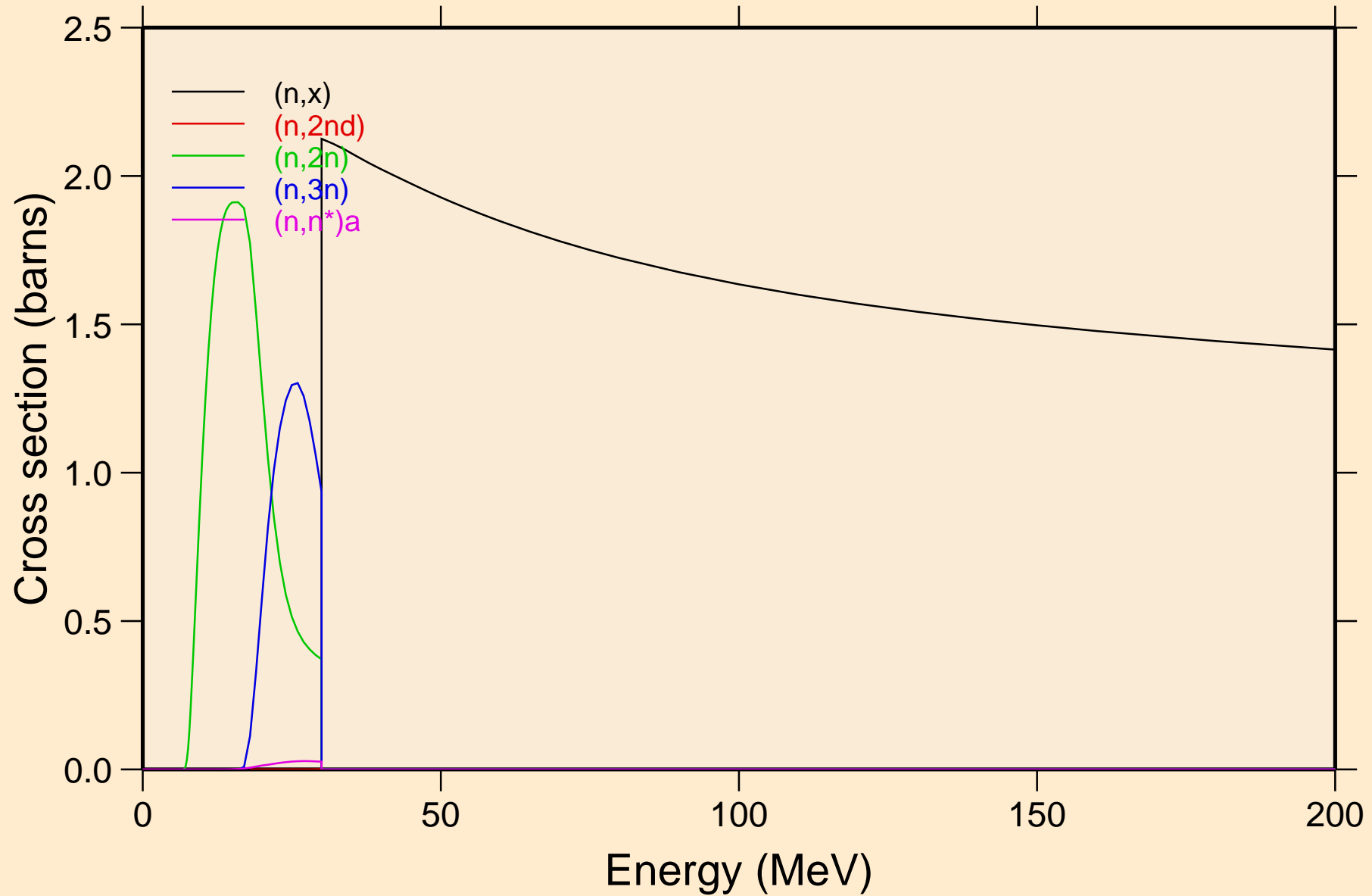

HO160N NEUTRON ACER TENDL-2021 LIBRARY; T=293.6K  
Threshold reactions

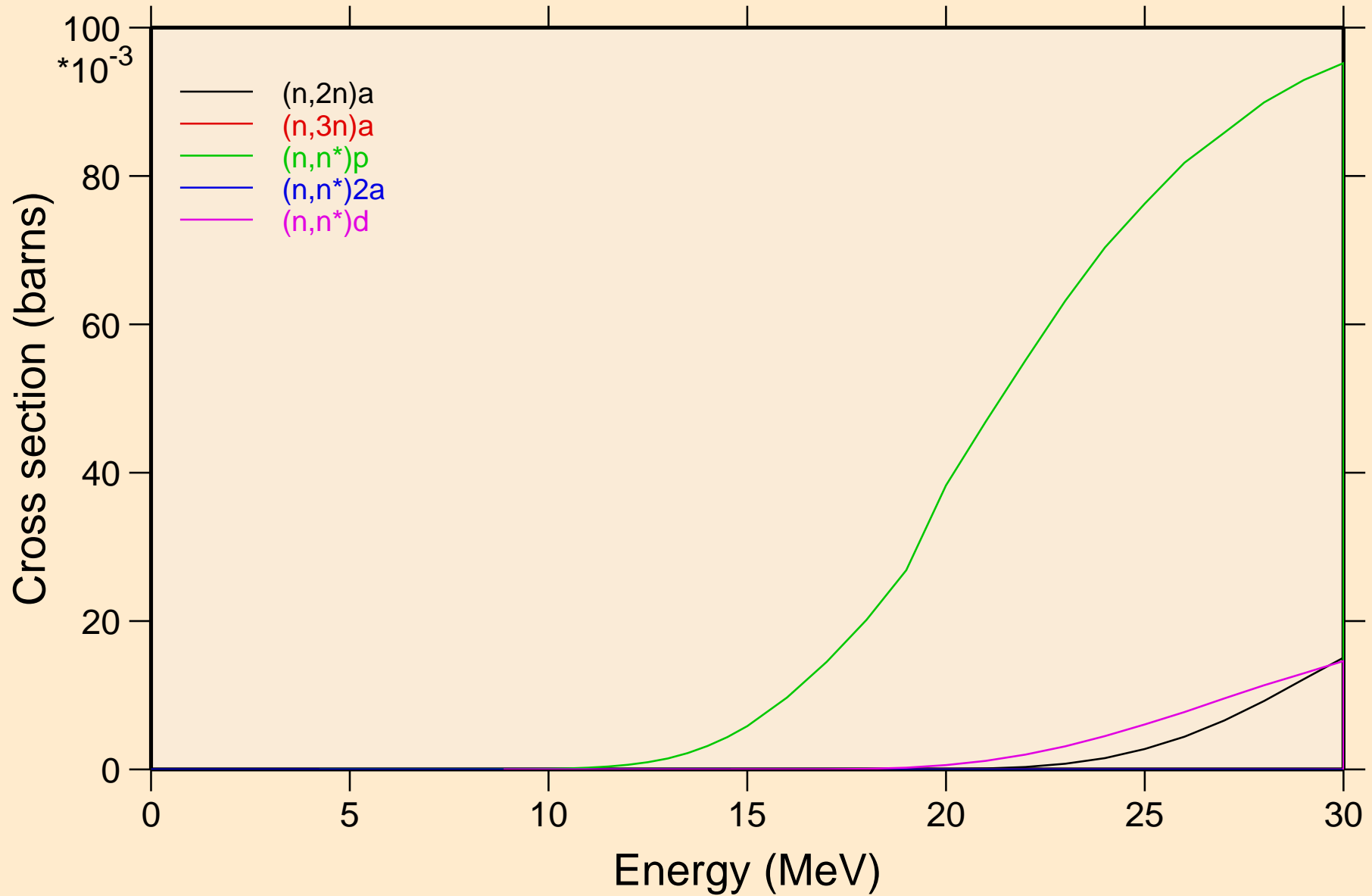

HO160N NEUTRON ACER TENDL-2021 LIBRARY; T=293.6K  
Threshold reactions

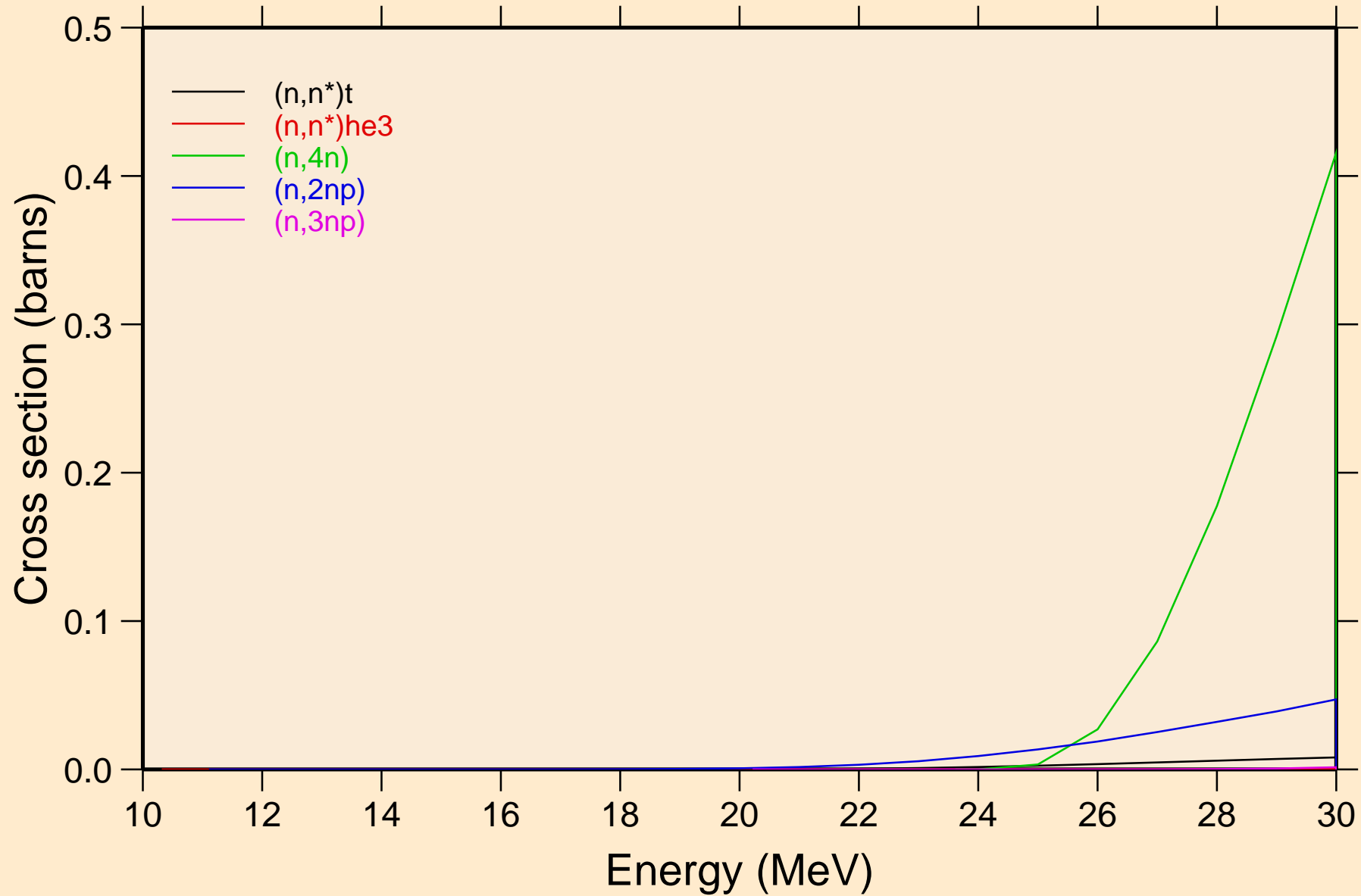



HO160N NEUTRON ACER TENDL-2021 LIBRARY; T=293.6K  
Threshold reactions

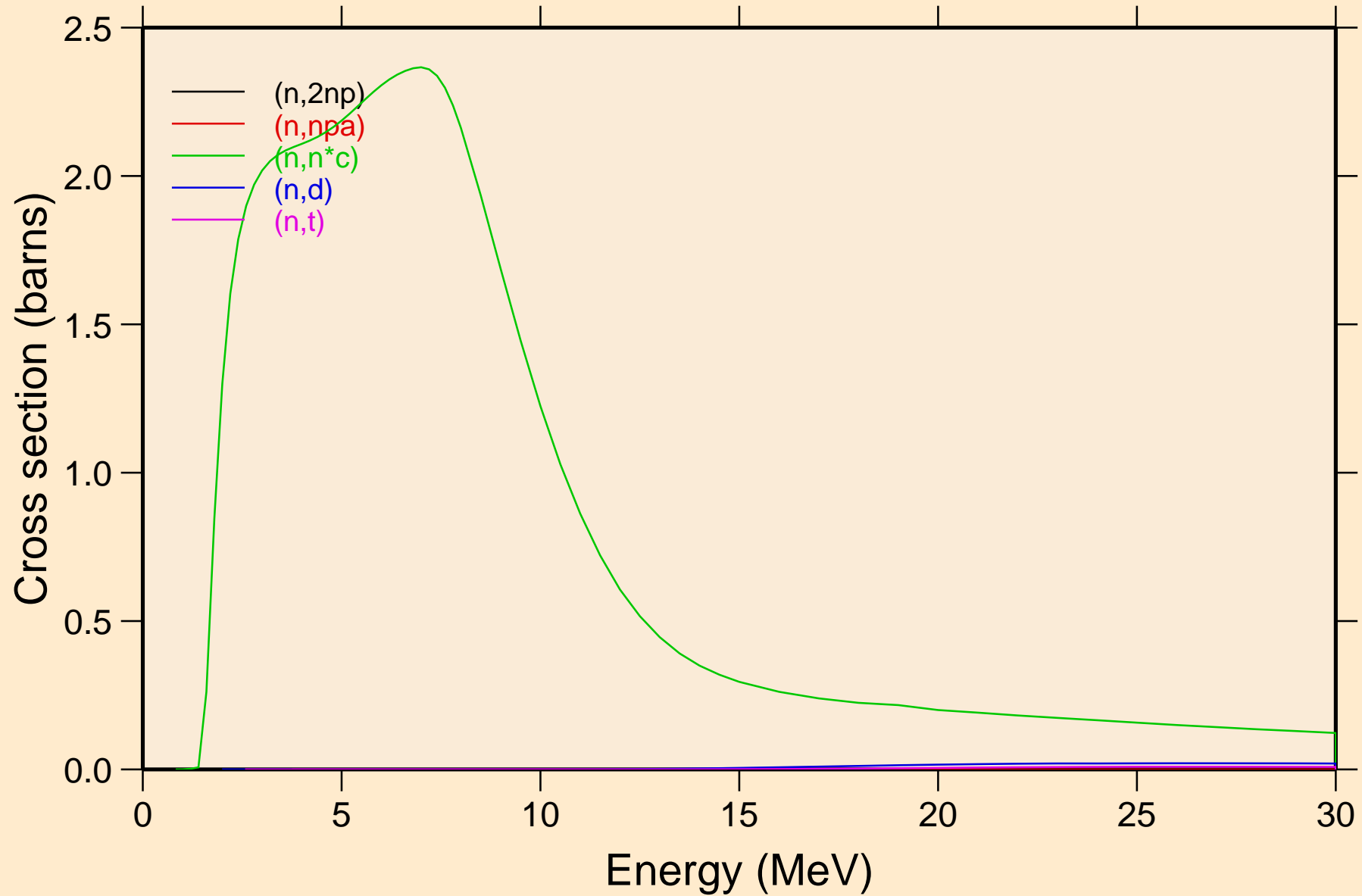

HO160N NEUTRON ACER TENDL-2021 LIBRARY; T=293.6K  
Threshold reactions

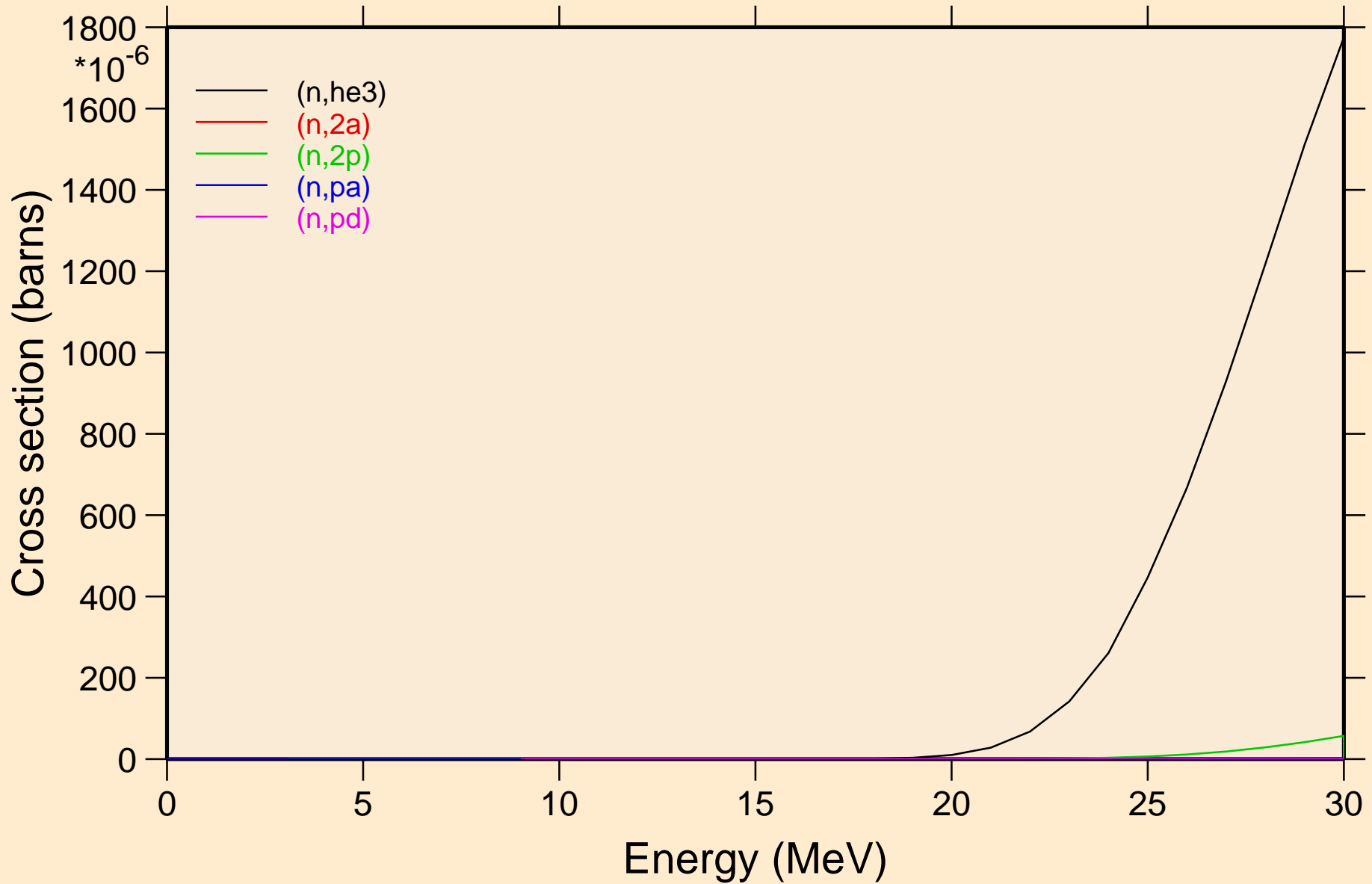

HO160N NEUTRON ACER TENDL-2021 LIBRARY; T=293.6K  
Threshold reactions

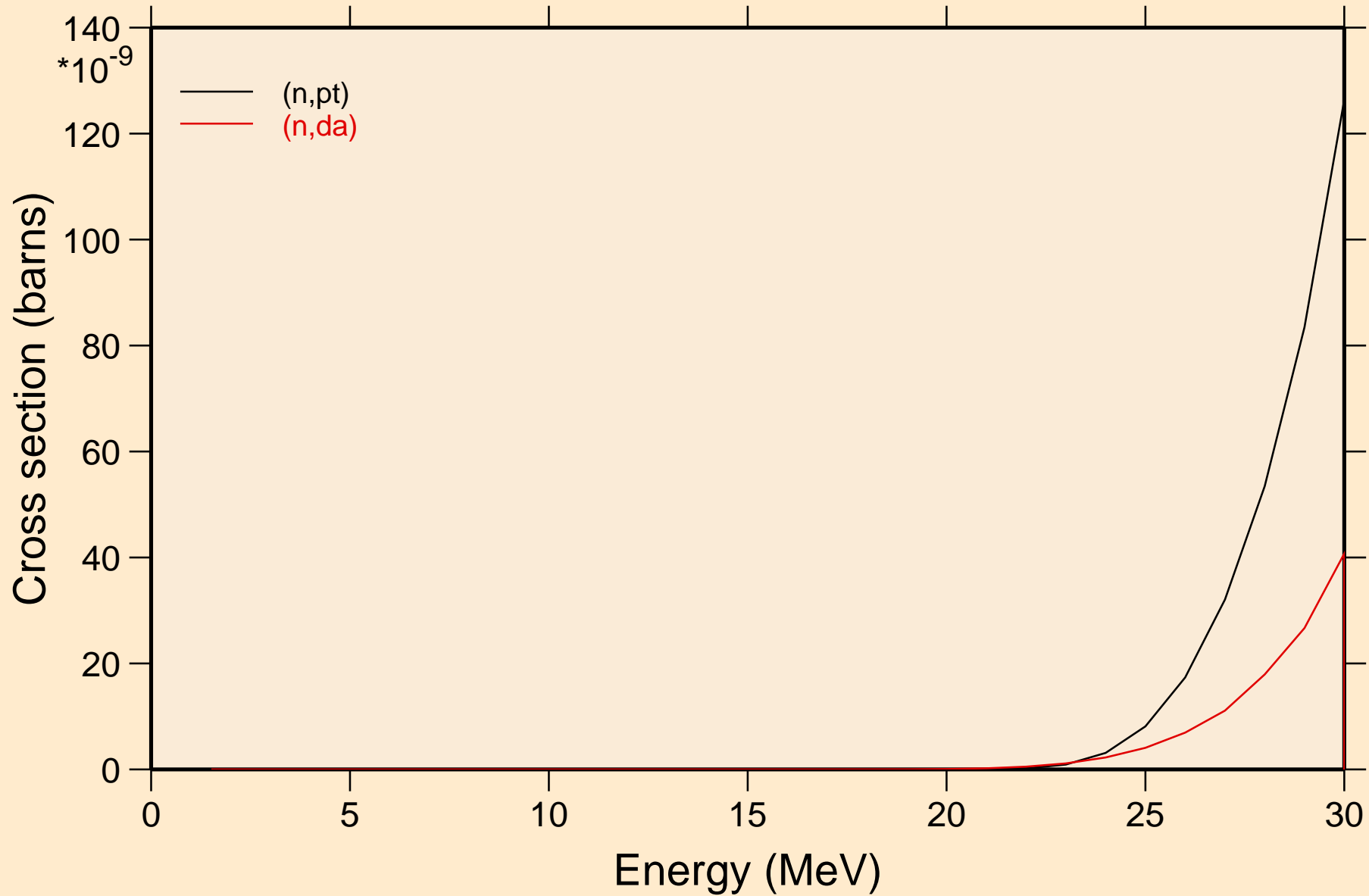

# HO160N NEUTRON ACER TENDL-2021 LIBRARY; T=293.6K

## Threshold reactions

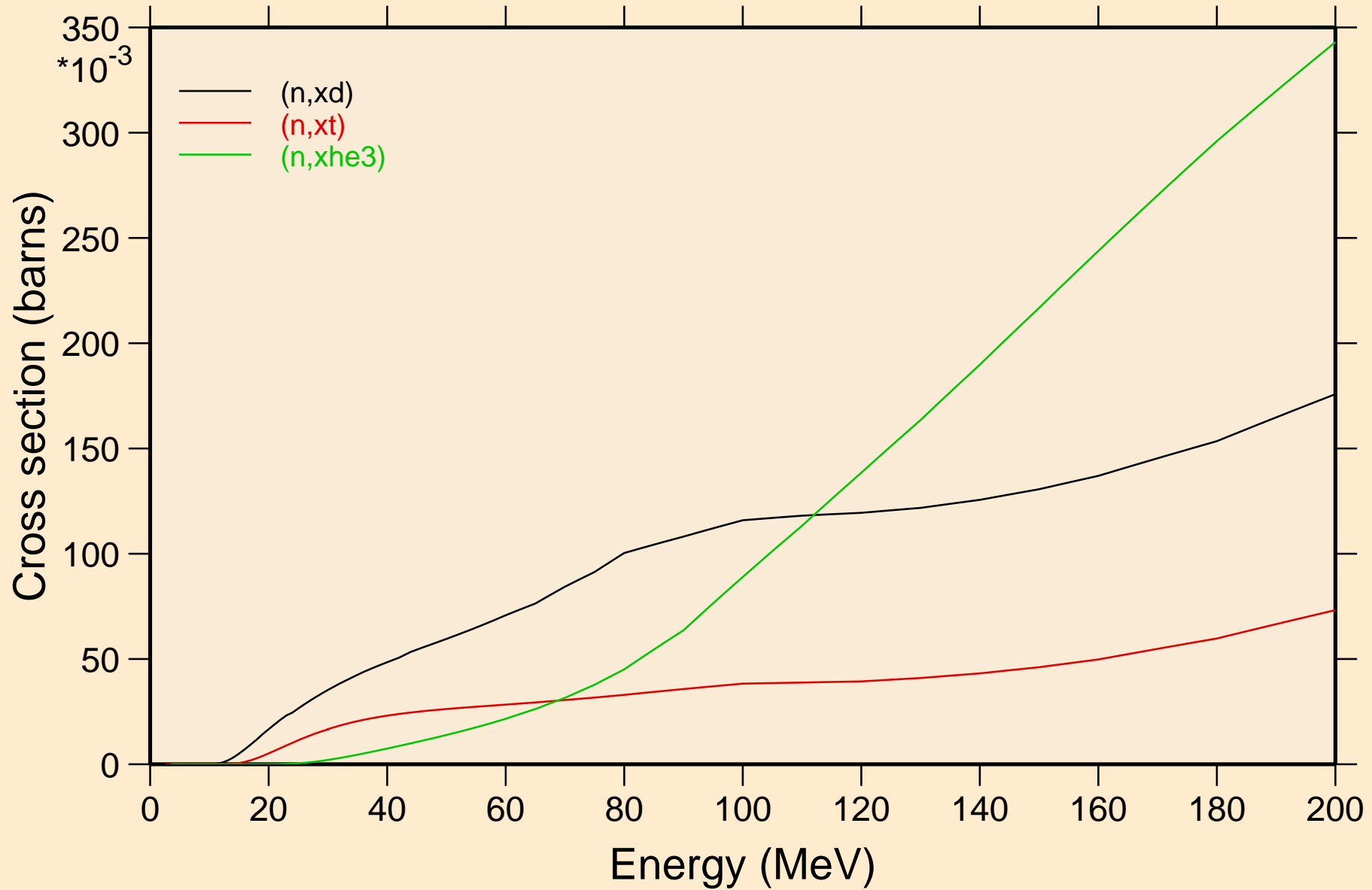

HO160N NEUTRON ACER TENDL-2021 LIBRARY; T=293.6K  
angular distribution for elastic

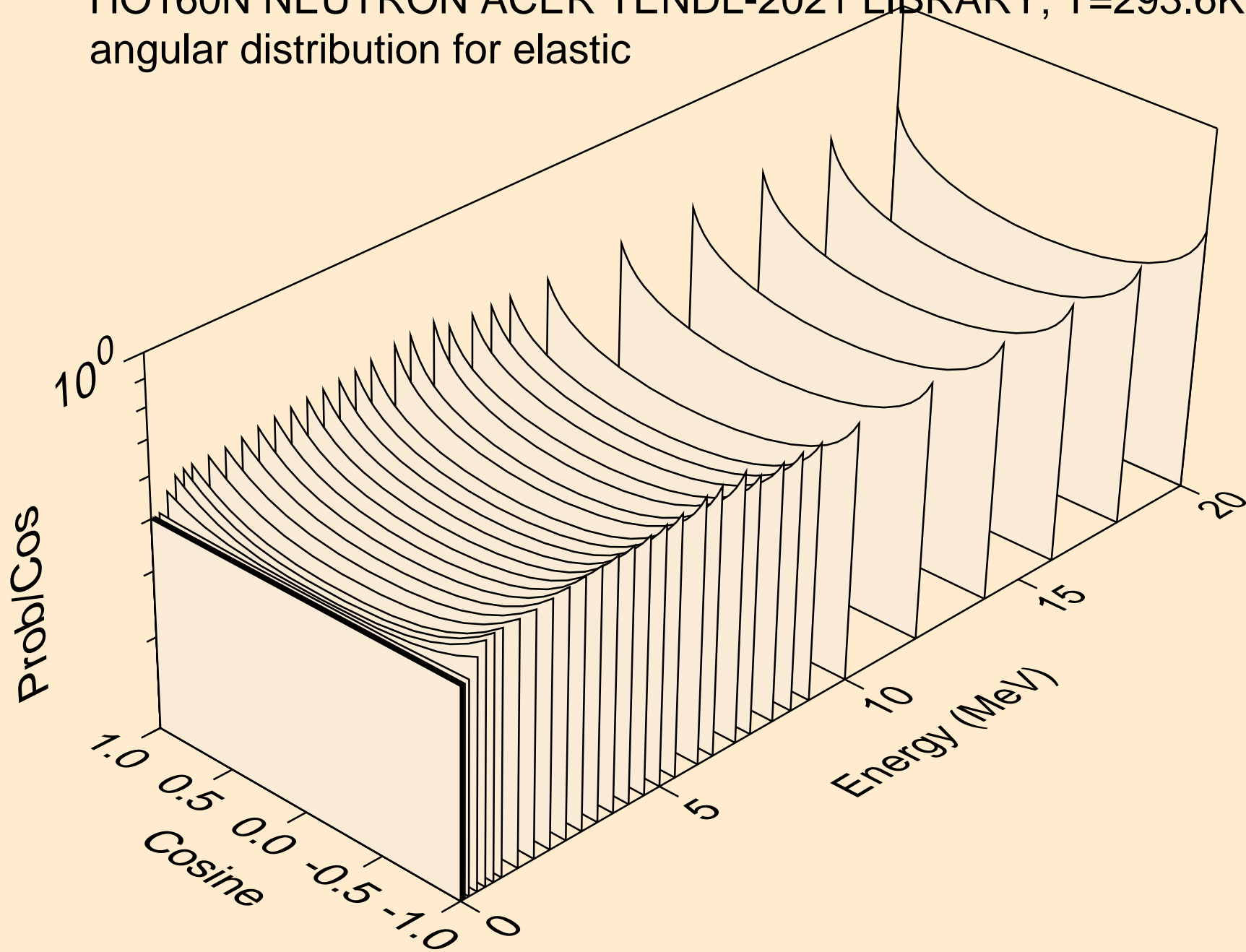

HO160N NEUTRON ACER TENDL-2021 LIBRARY; T=293.6K  
angular distribution for elastic

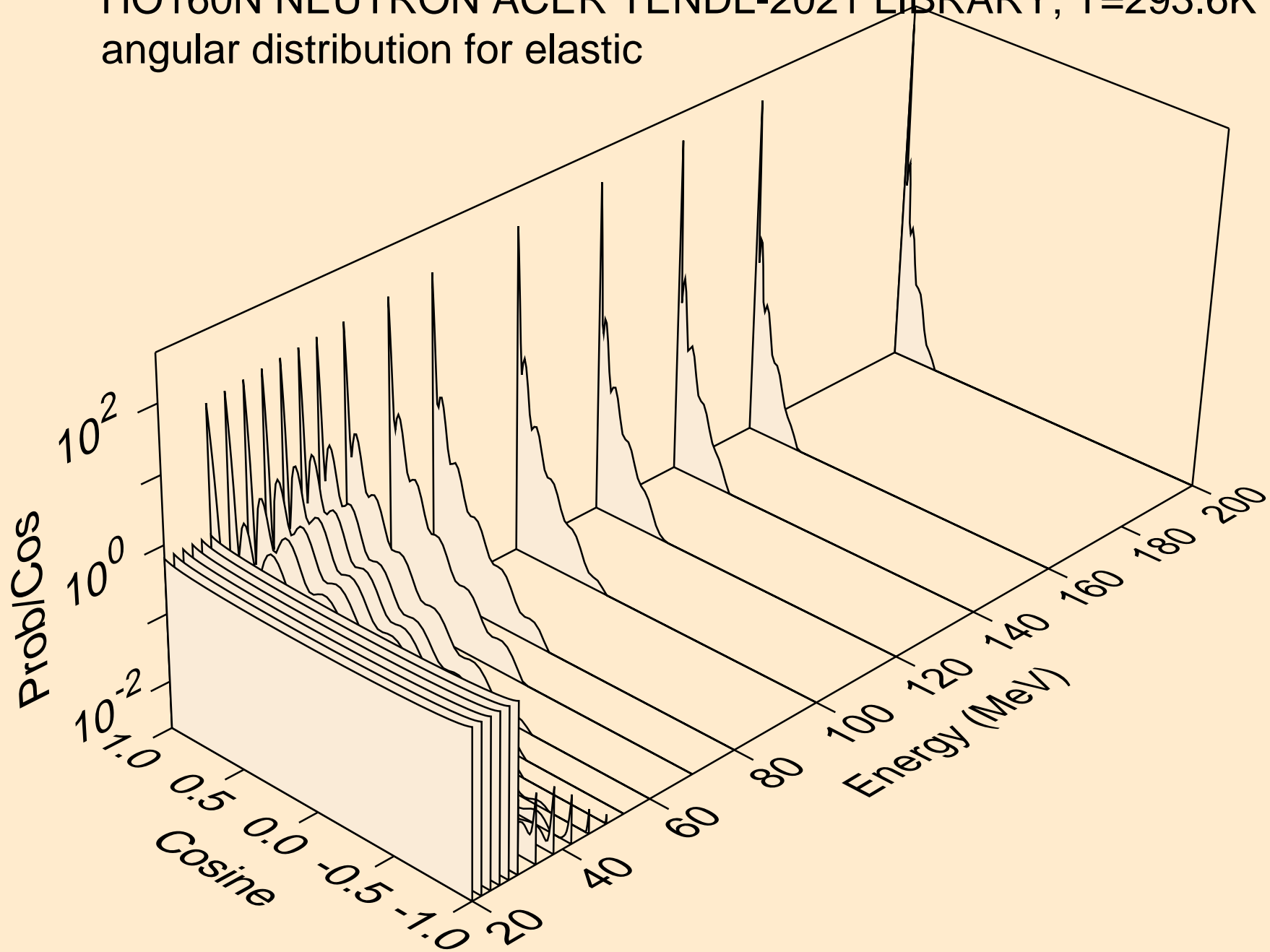

HO160N NEUTRON ACER TENDL-2021 LIBRARY; T=293.6K  
angular distribution for (n,n\*1)

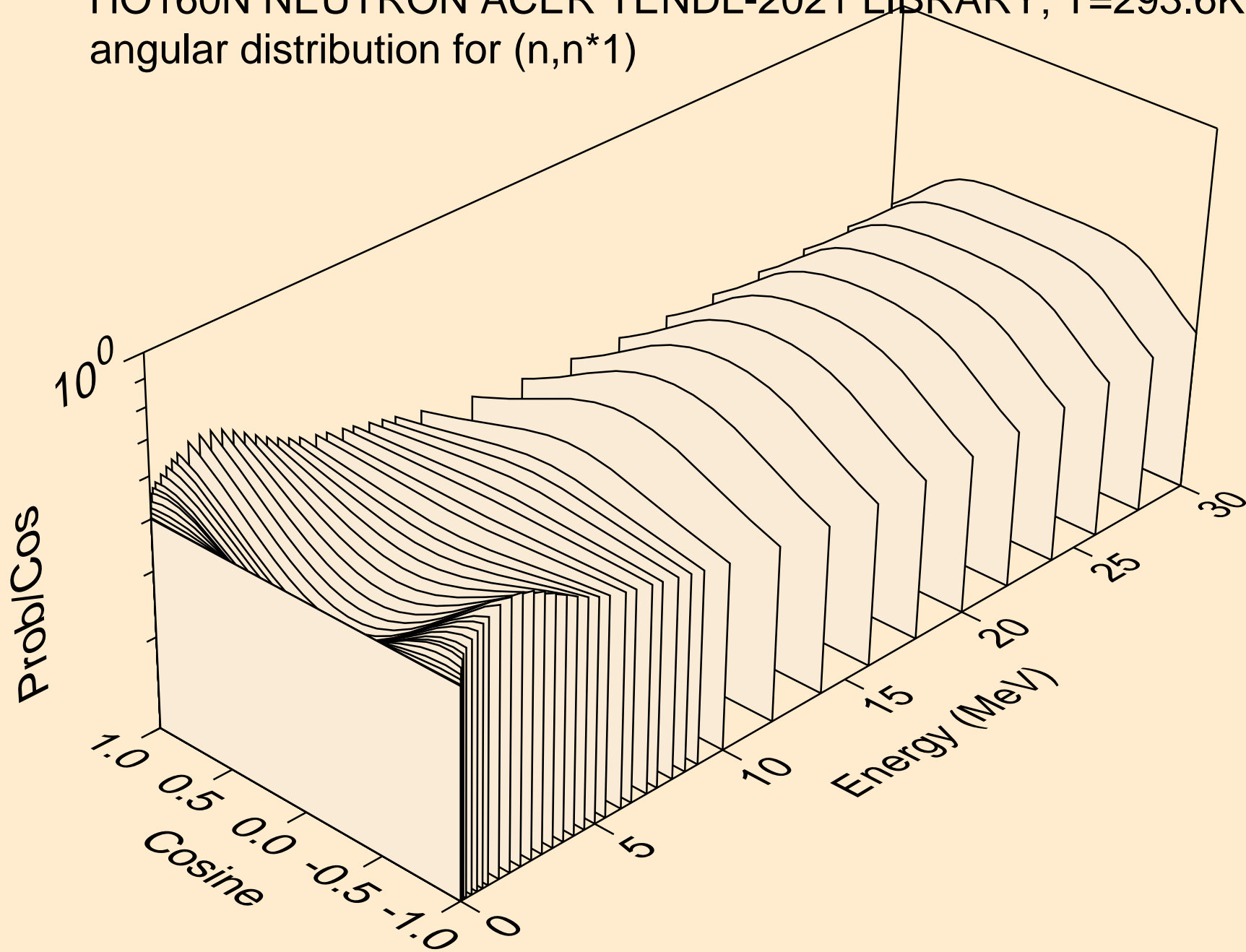

HO160N NEUTRON ACER TENDL-2021 LIBRARY; T=293.6K  
angular distribution for (n,n\*2)

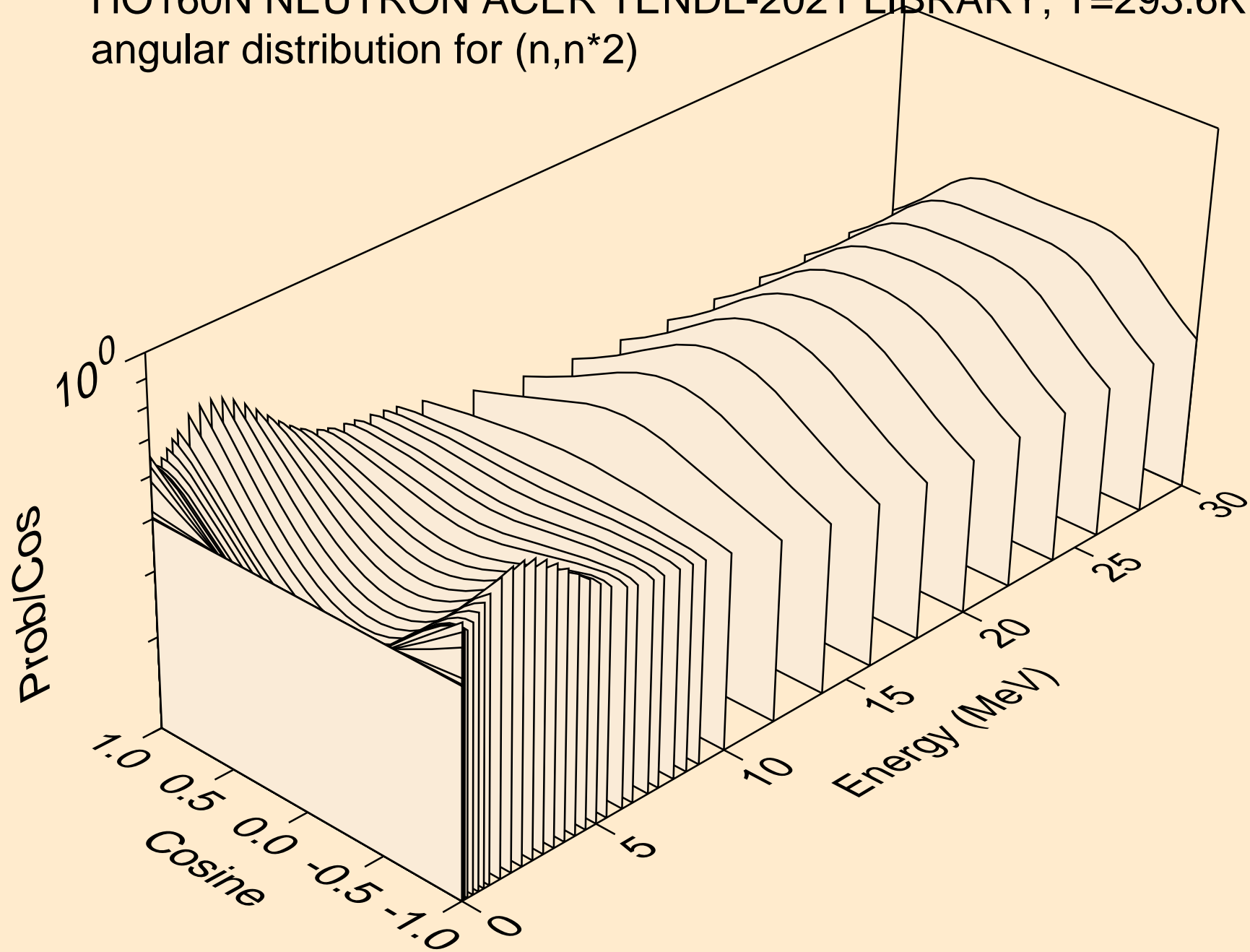



HO160N NEUTRON ACER TENDL-2021 LIBRARY; T=293.6K  
angular distribution for (n,n\*3)

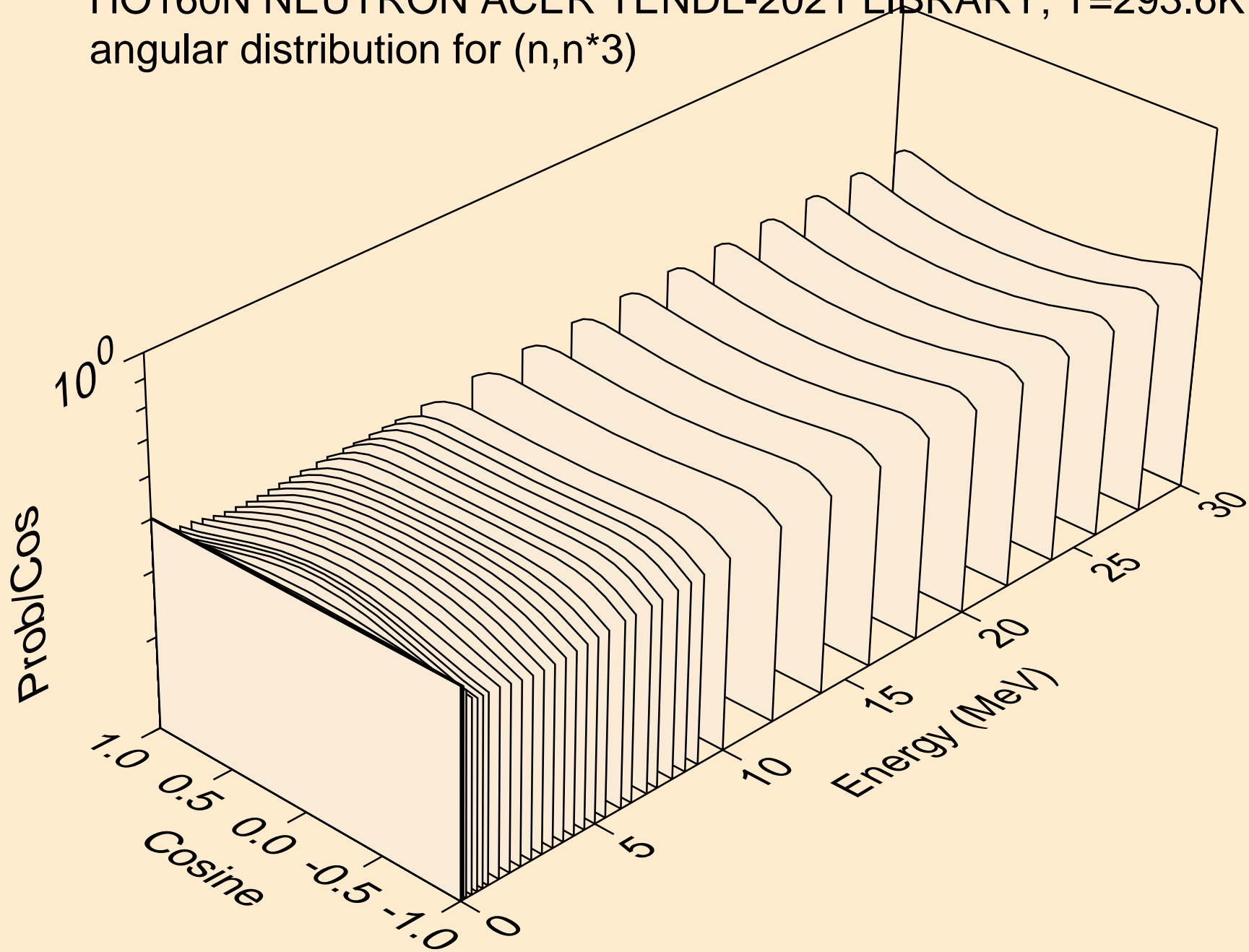

HO160N NEUTRON ACER TENDL-2021 LIBRARY; T=293.6K  
angular distribution for (n,n\*4)

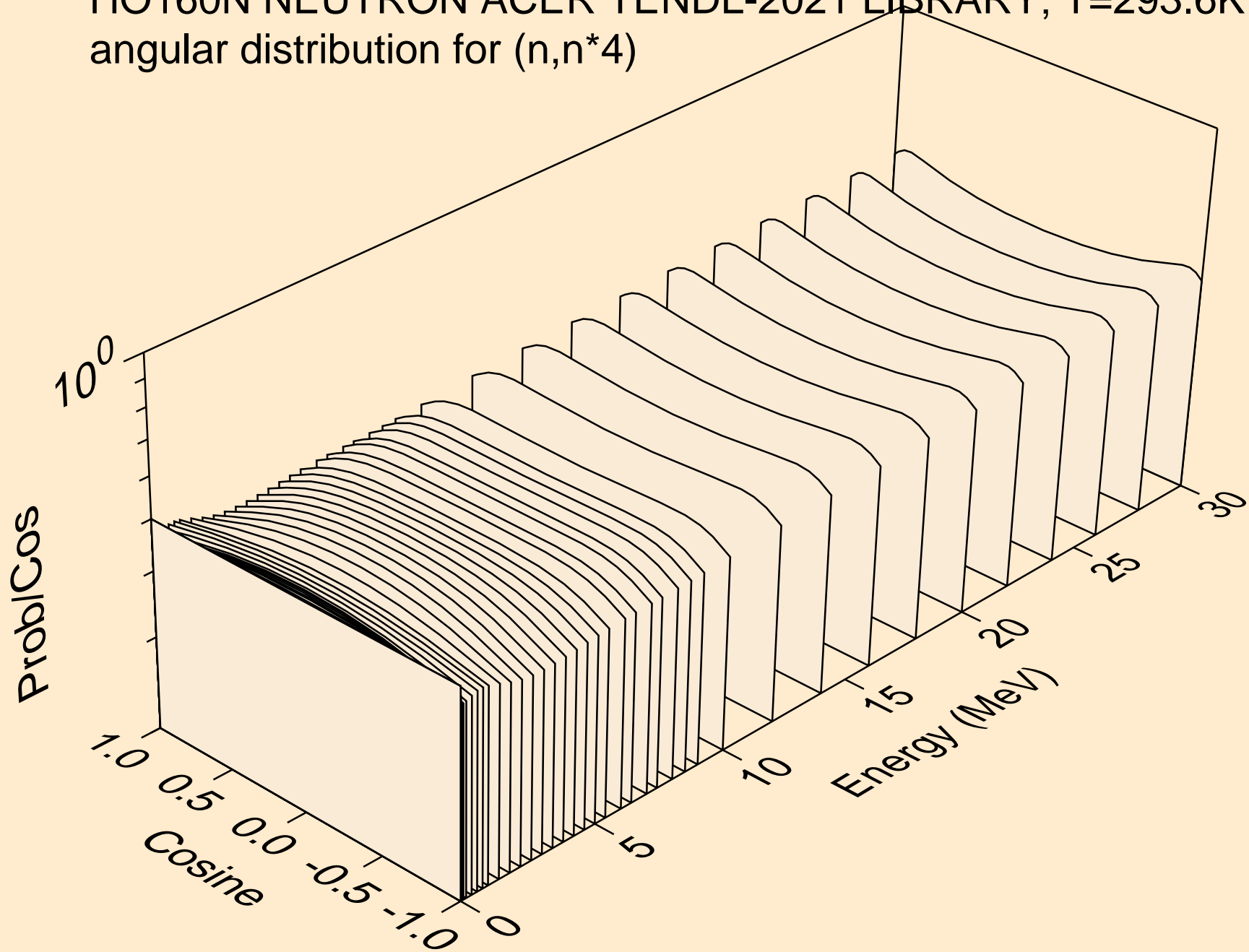

HO160N NEUTRON ACER TENDL-2021 LIBRARY; T=293.6K  
angular distribution for (n,n\*5)

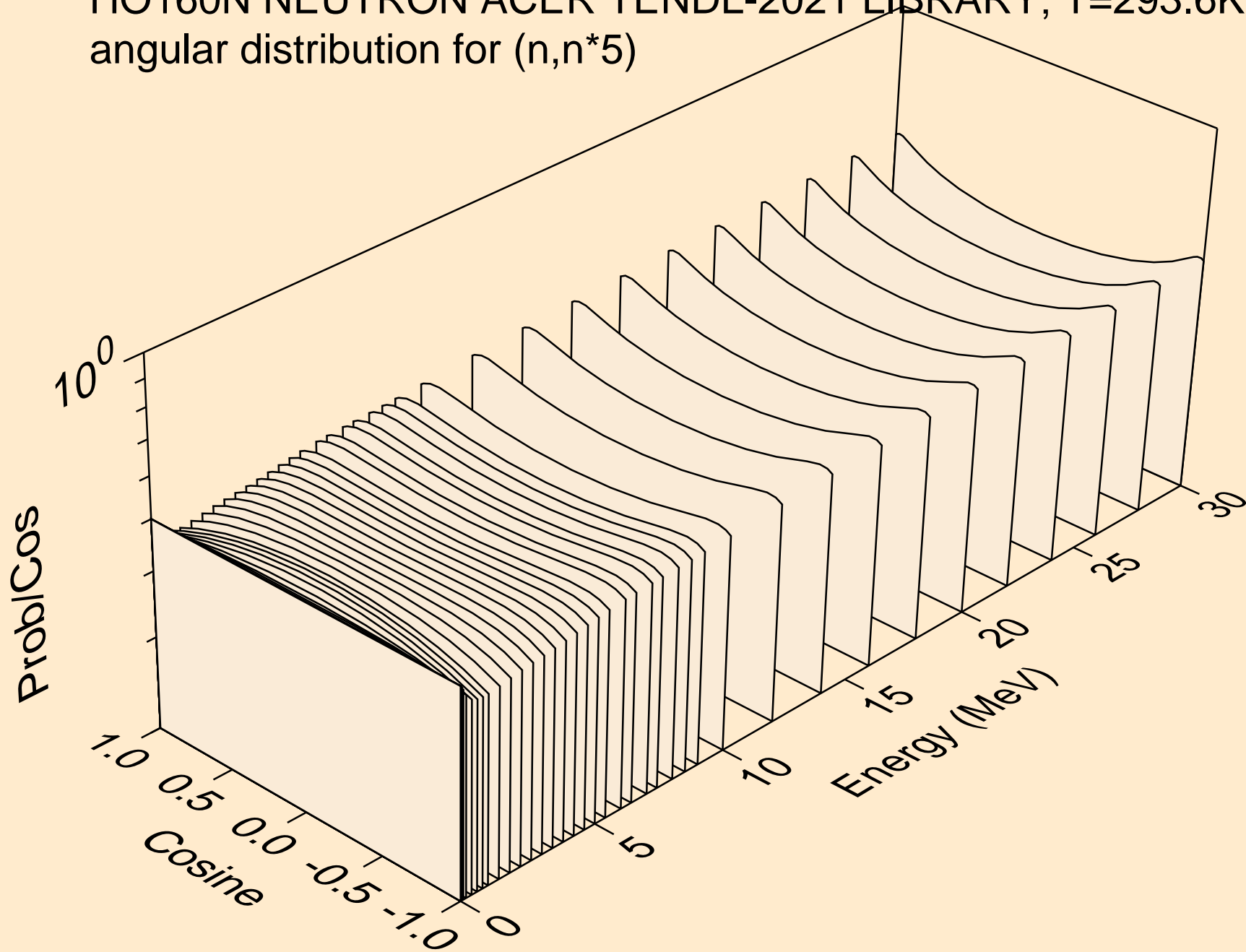

HO160N NEUTRON ACER TENDL-2021 LIBRARY; T=293.6K  
angular distribution for (n,n\*6)

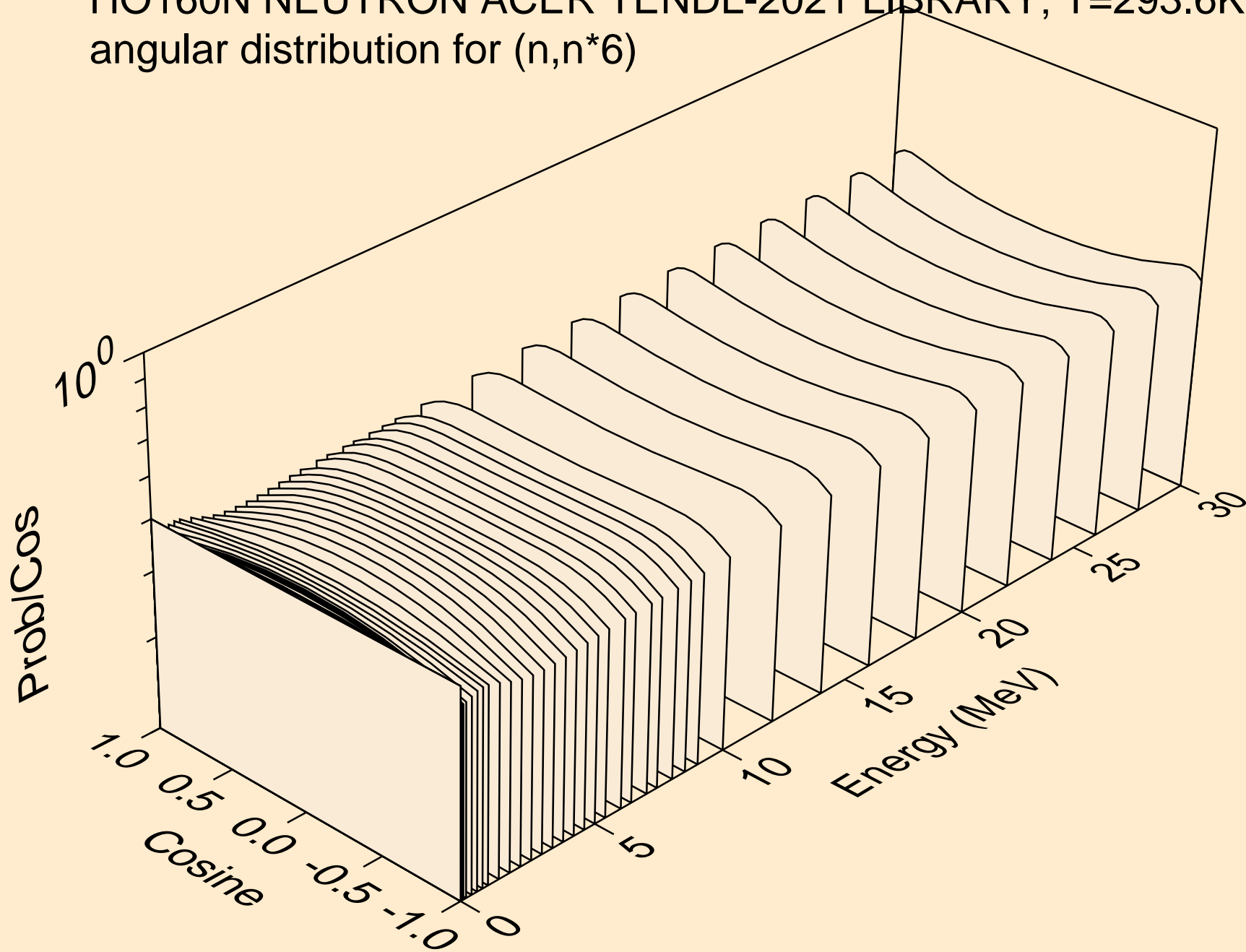

HO160N NEUTRON ACER TENDL-2021 LIBRARY; T=293.6K  
angular distribution for (n,n\*7)

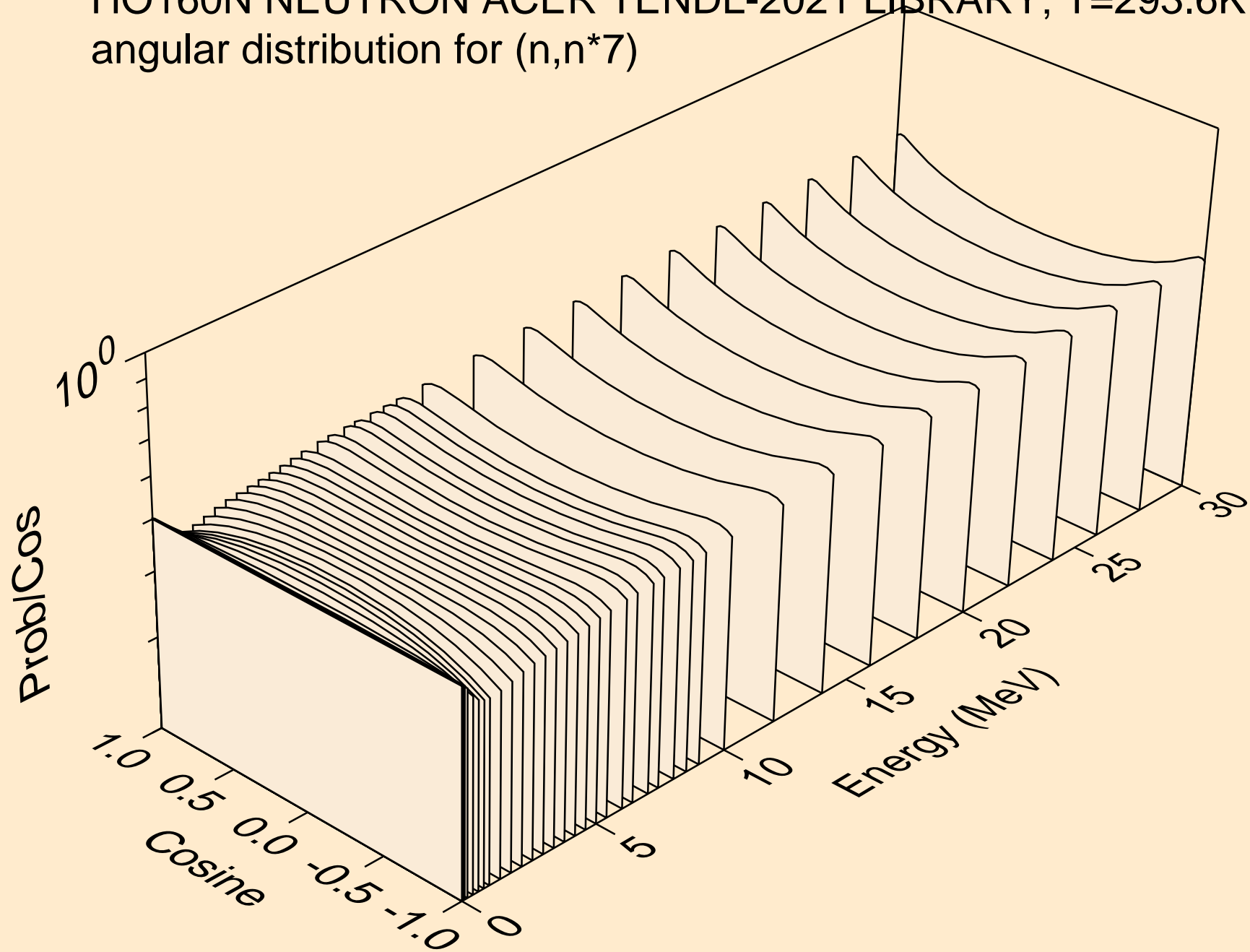

HO160N NEUTRON ACER TENDL-2021 LIBRARY; T=293.6K  
angular distribution for (n,n\*8)

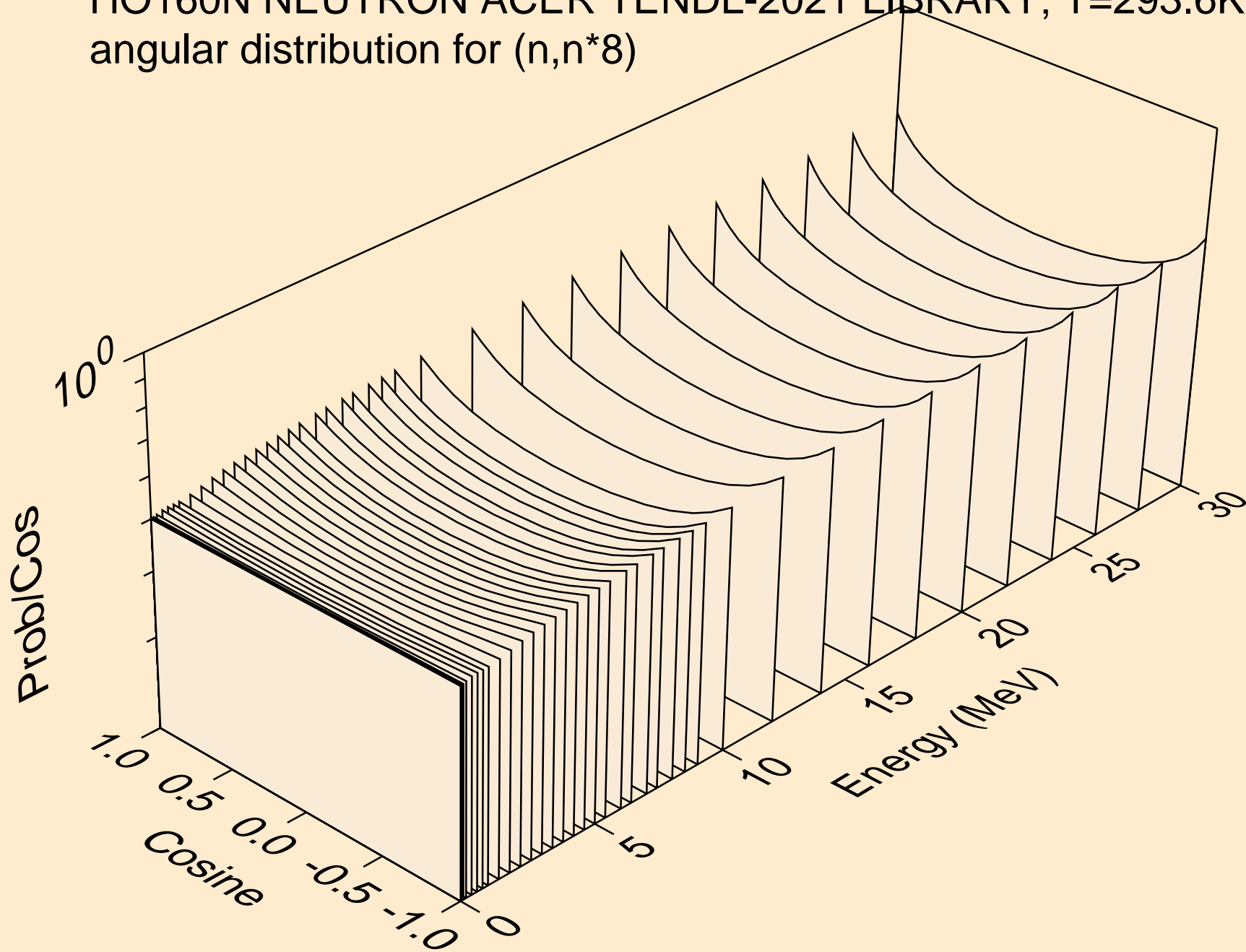

HO160N NEUTRON ACER TENDL-2021 LIBRARY; T=293.6K  
angular distribution for (n,n\*9)

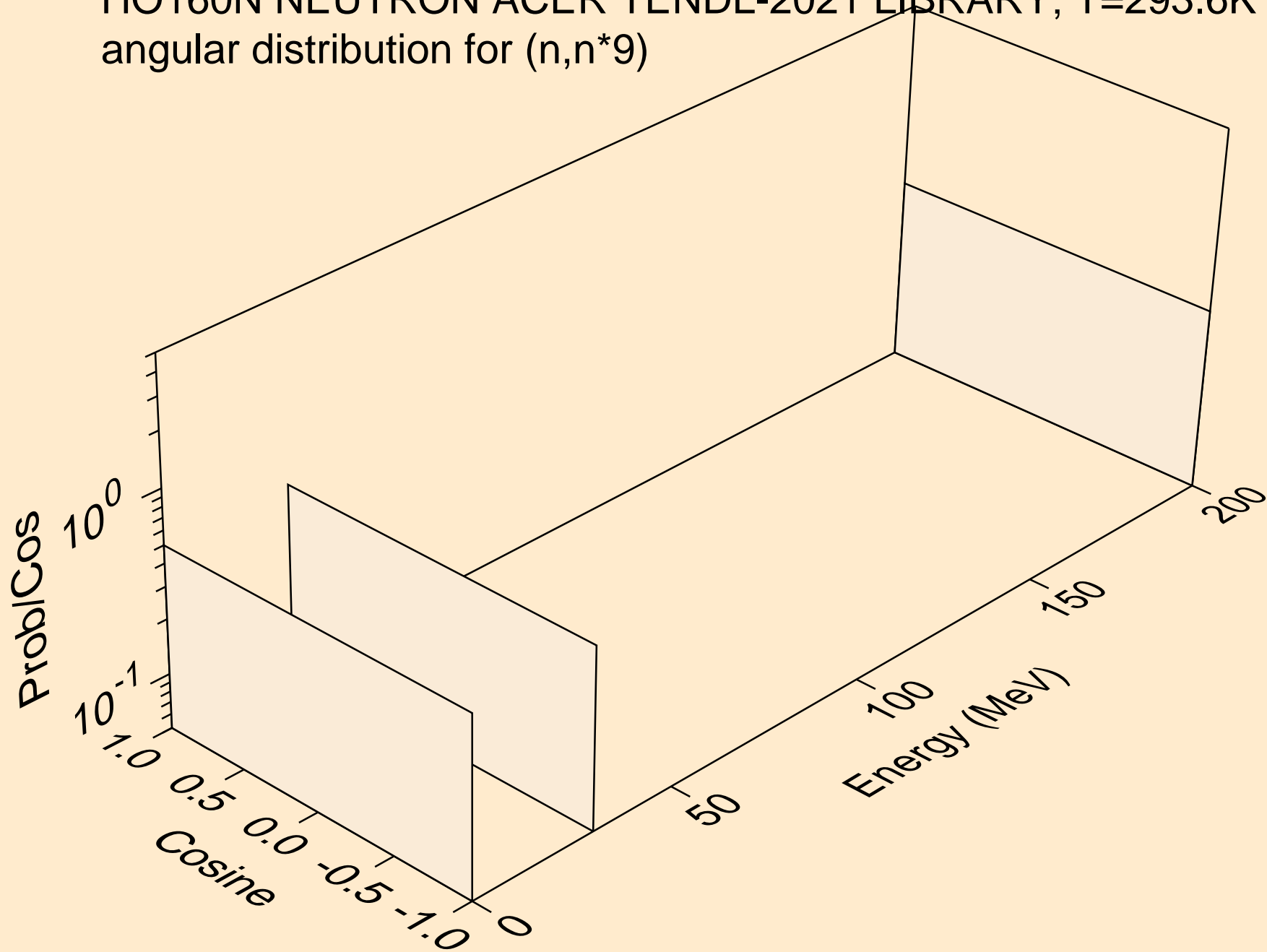

HO160N NEUTRON ACER TENDL-2021 LIBRARY; T=293.6K  
angular distribution for (n,n\*10)

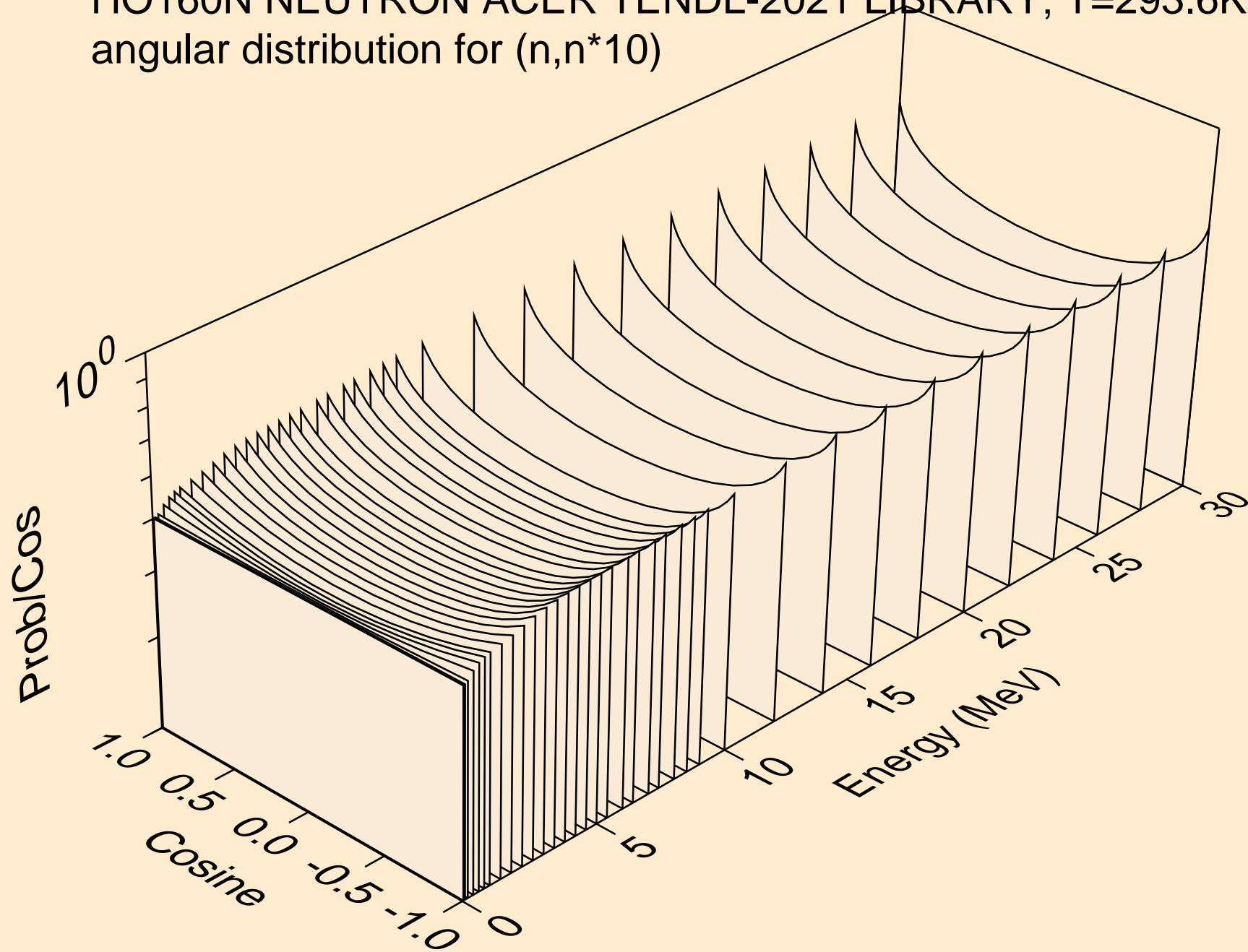



HO160N NEUTRON ACER TENDL-2021 LIBRARY; T=293.6K  
angular distribution for (n,n\*11)

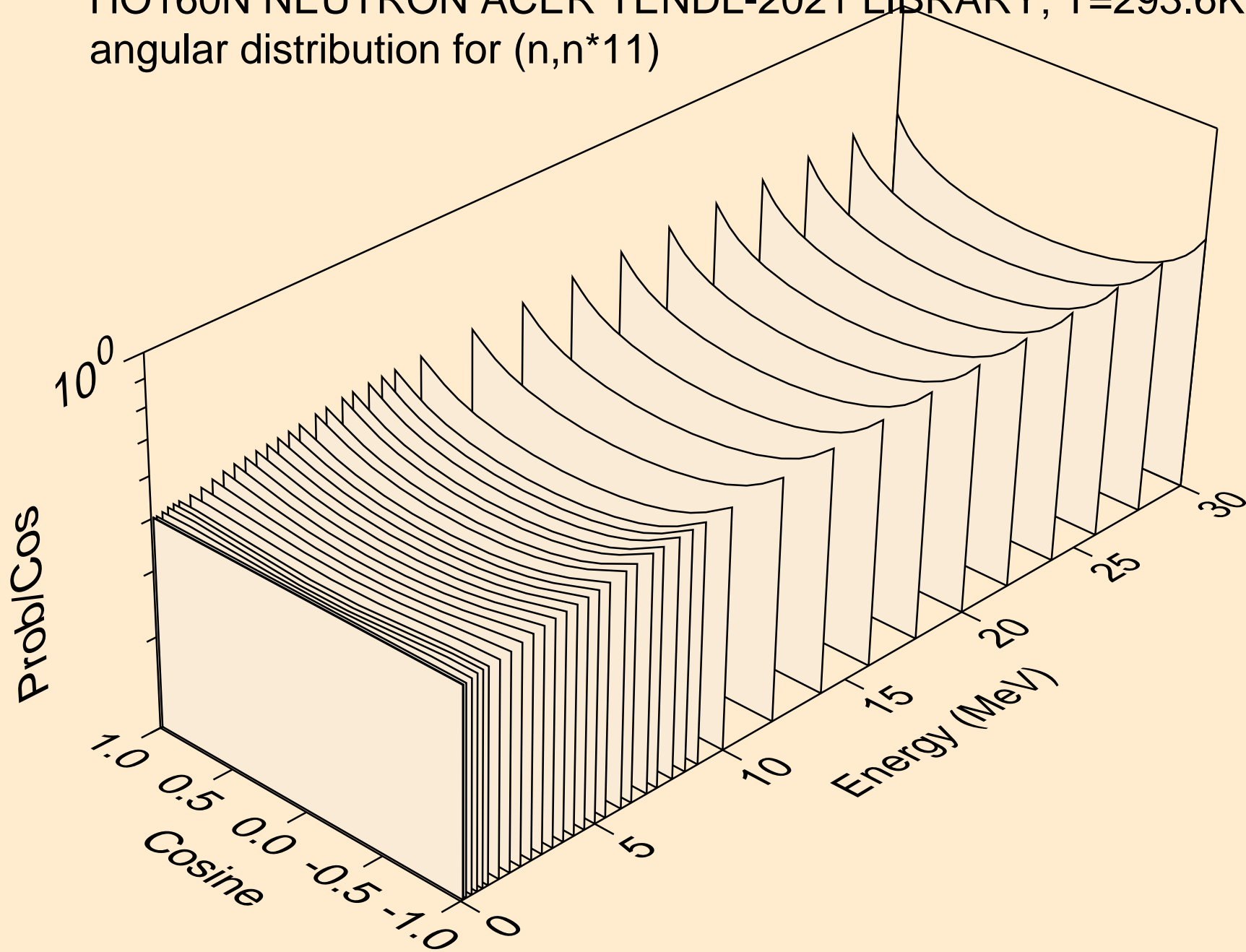

HO160N NEUTRON ACER TENDL-2021 LIBRARY; T=293.6K  
angular distribution for (n,n\*12)

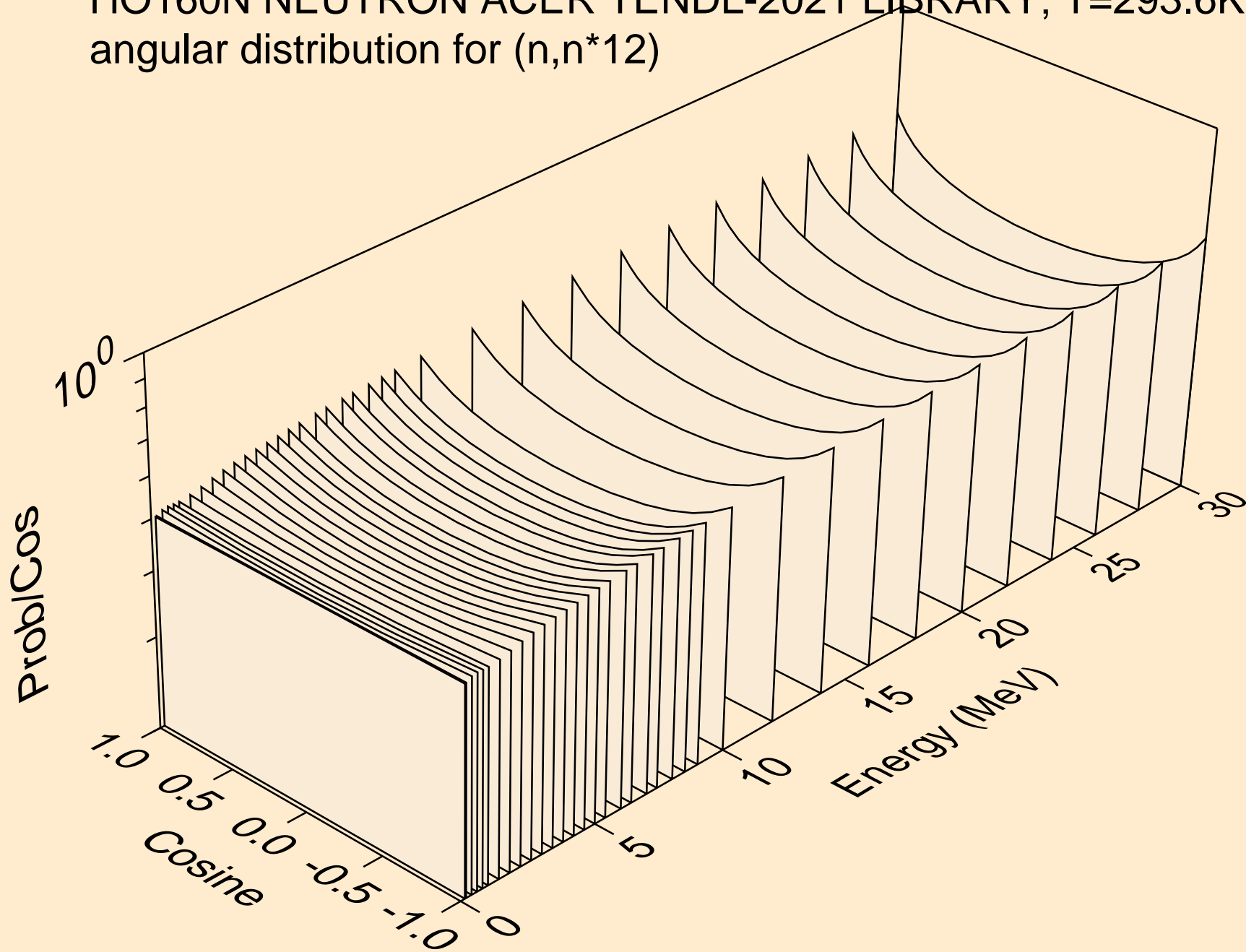

HO160N NEUTRON ACER TENDL-2021 LIBRARY; T=293.6K  
angular distribution for (n,n\*13)

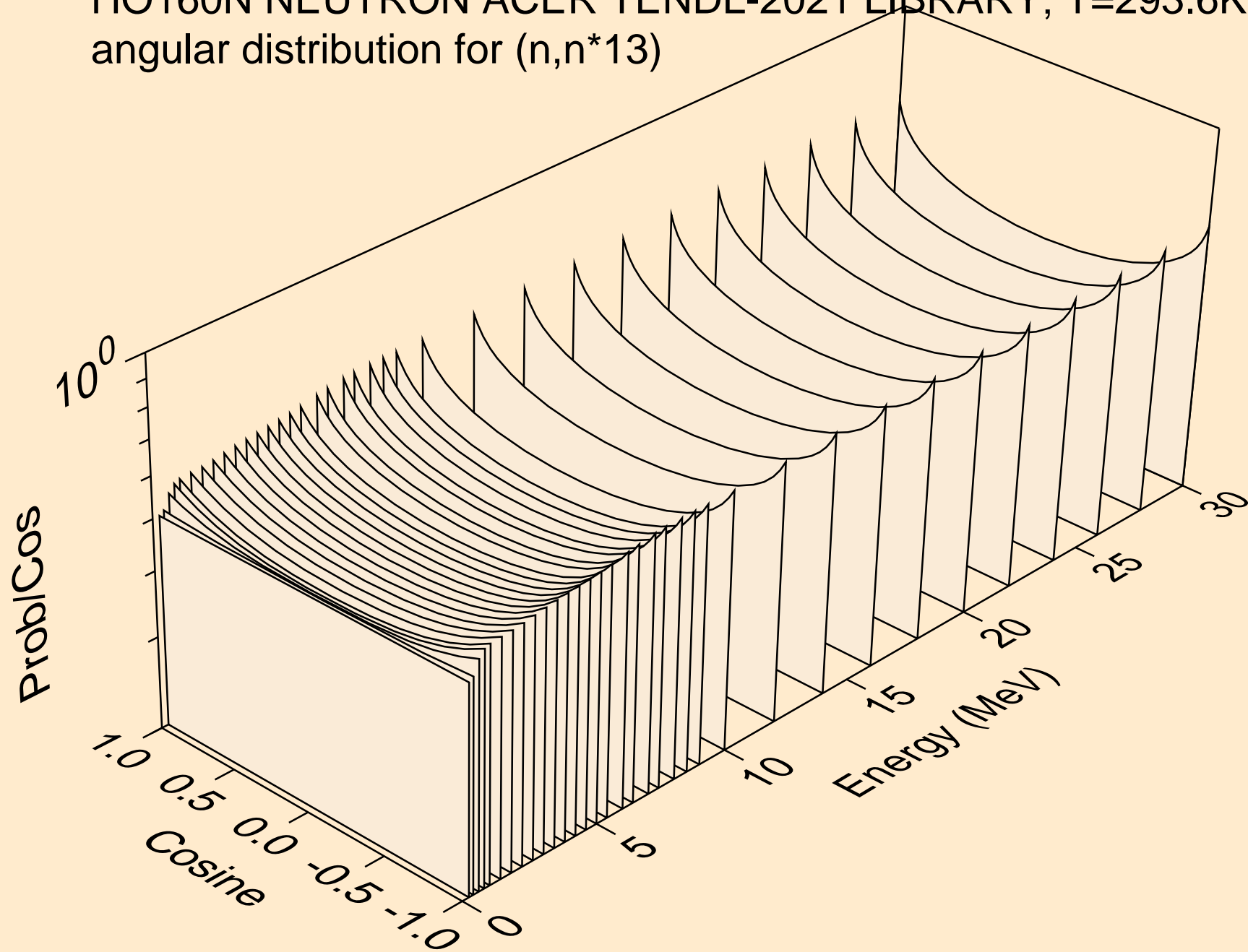

HO160N NEUTRON ACER TENDL-2021 LIBRARY; T=293.6K  
angular distribution for (n,n\*14)

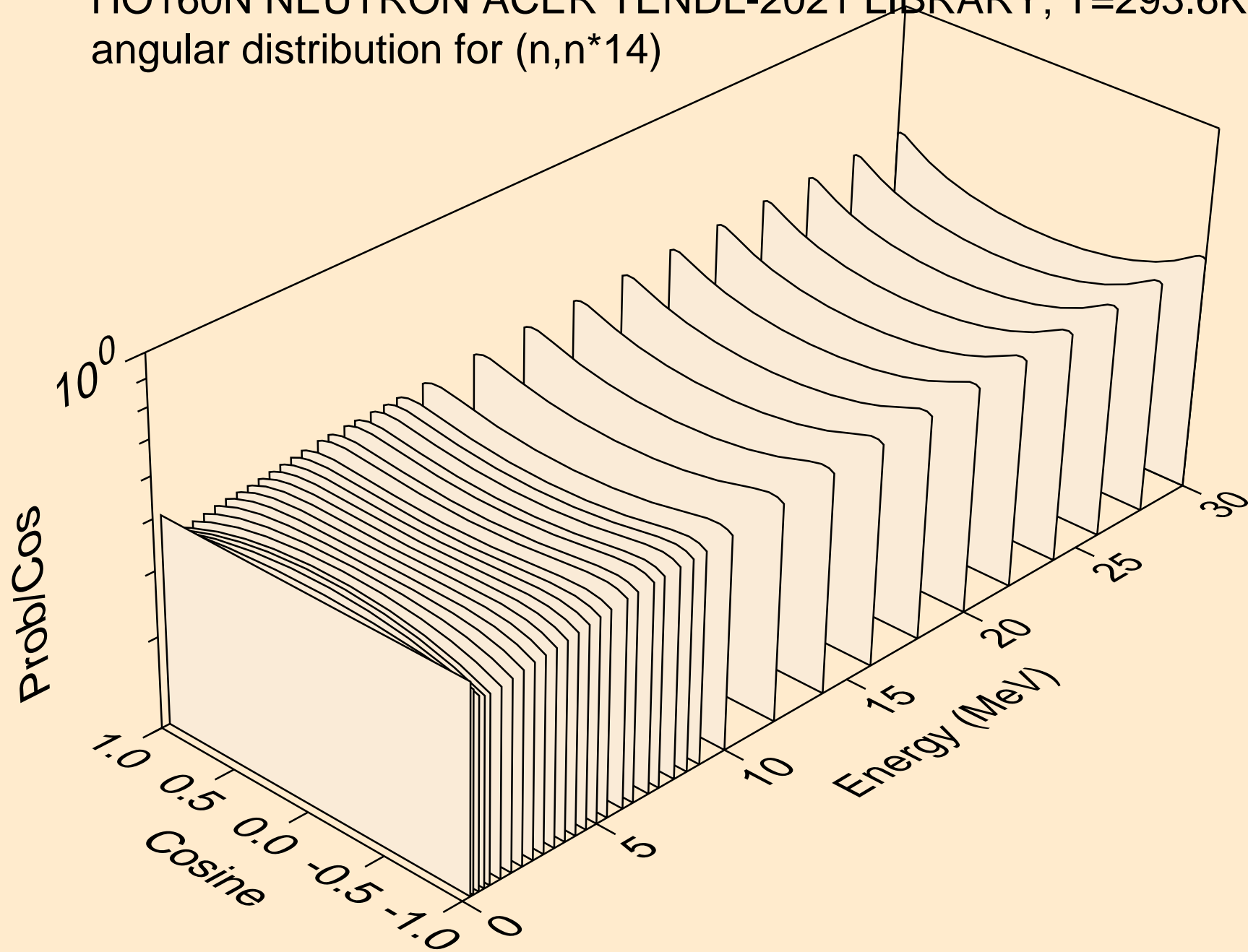

HO160N NEUTRON ACER TENDL-2021 LIBRARY; T=293.6K  
angular distribution for (n,n\*15)

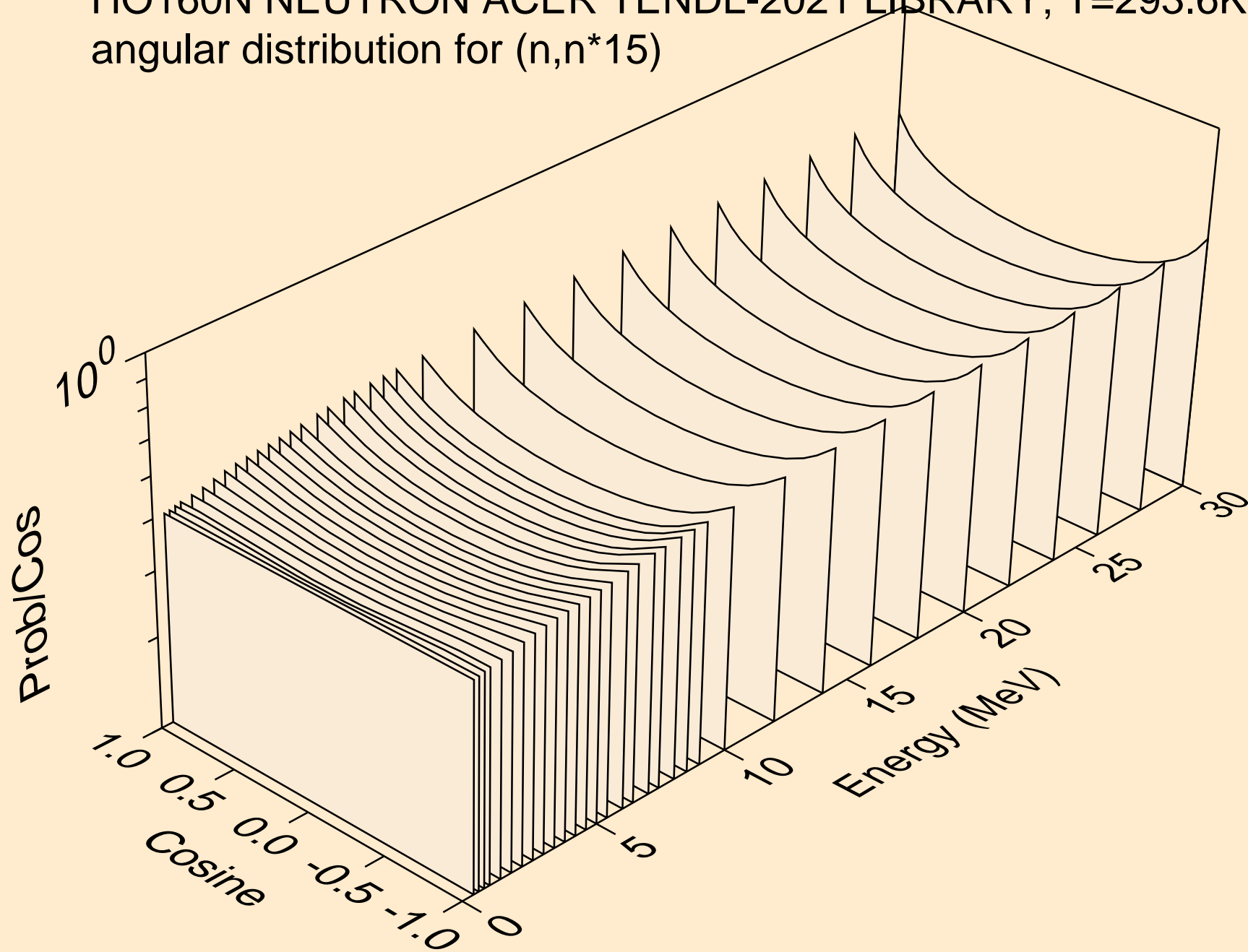

HO160N NEUTRON ACER TENDL-2021 LIBRARY; T=293.6K  
angular distribution for (n,n\*16)

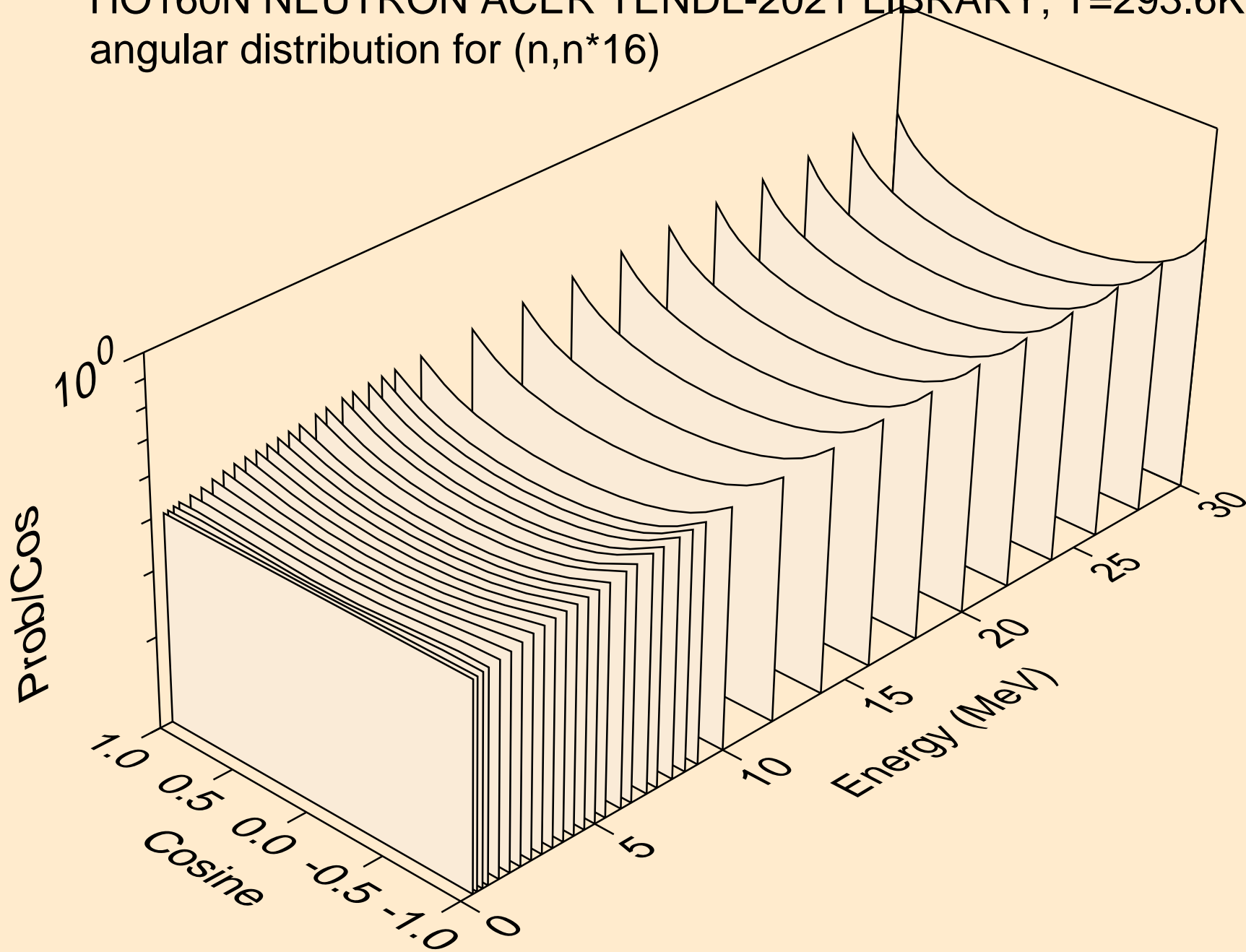

HO160N NEUTRON ACER TENDL-2021 LIBRARY; T=293.6K  
angular distribution for (n,n\*17)

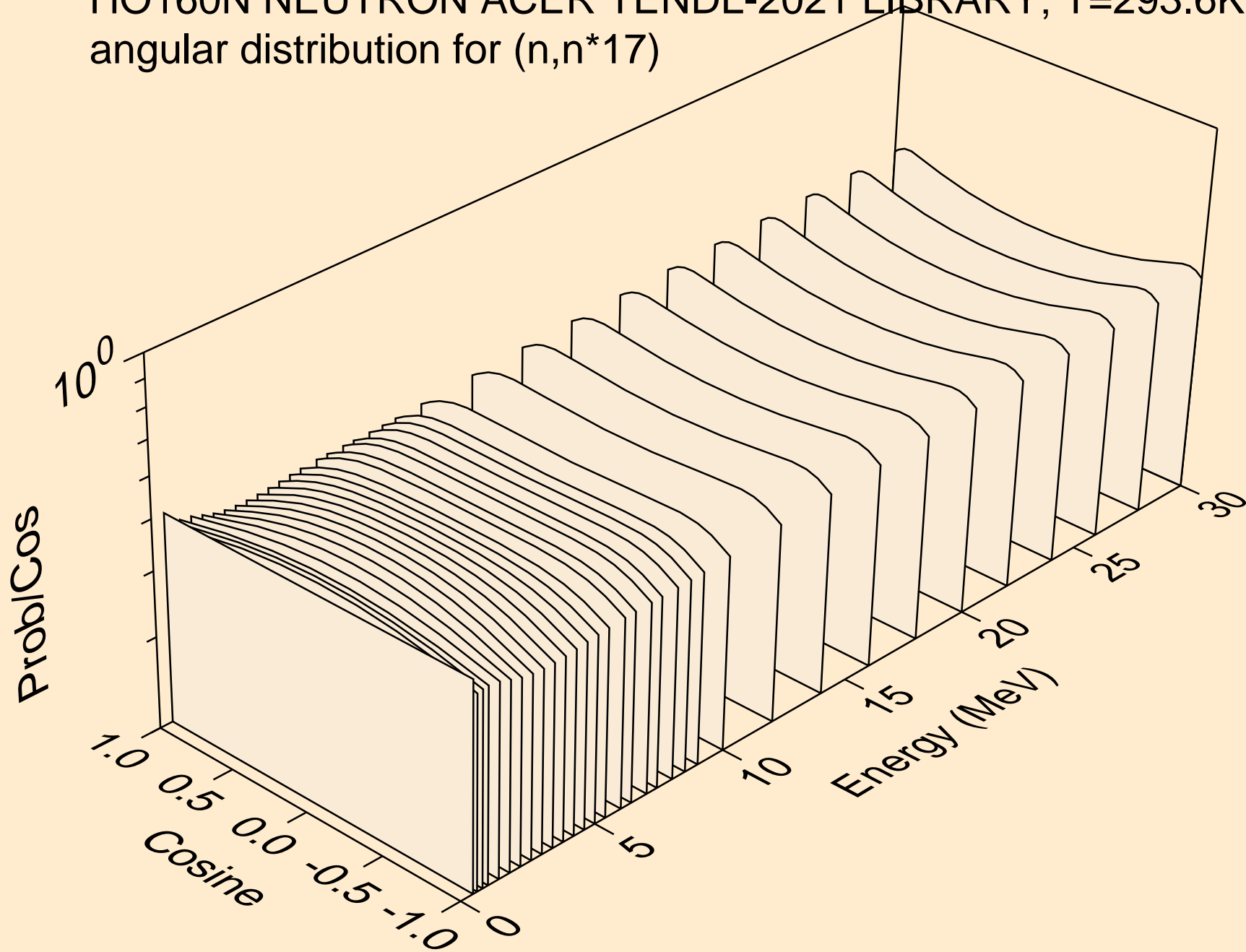

HO160N NEUTRON ACER TENDL-2021 LIBRARY; T=293.6K  
angular distribution for (n,n\*18)

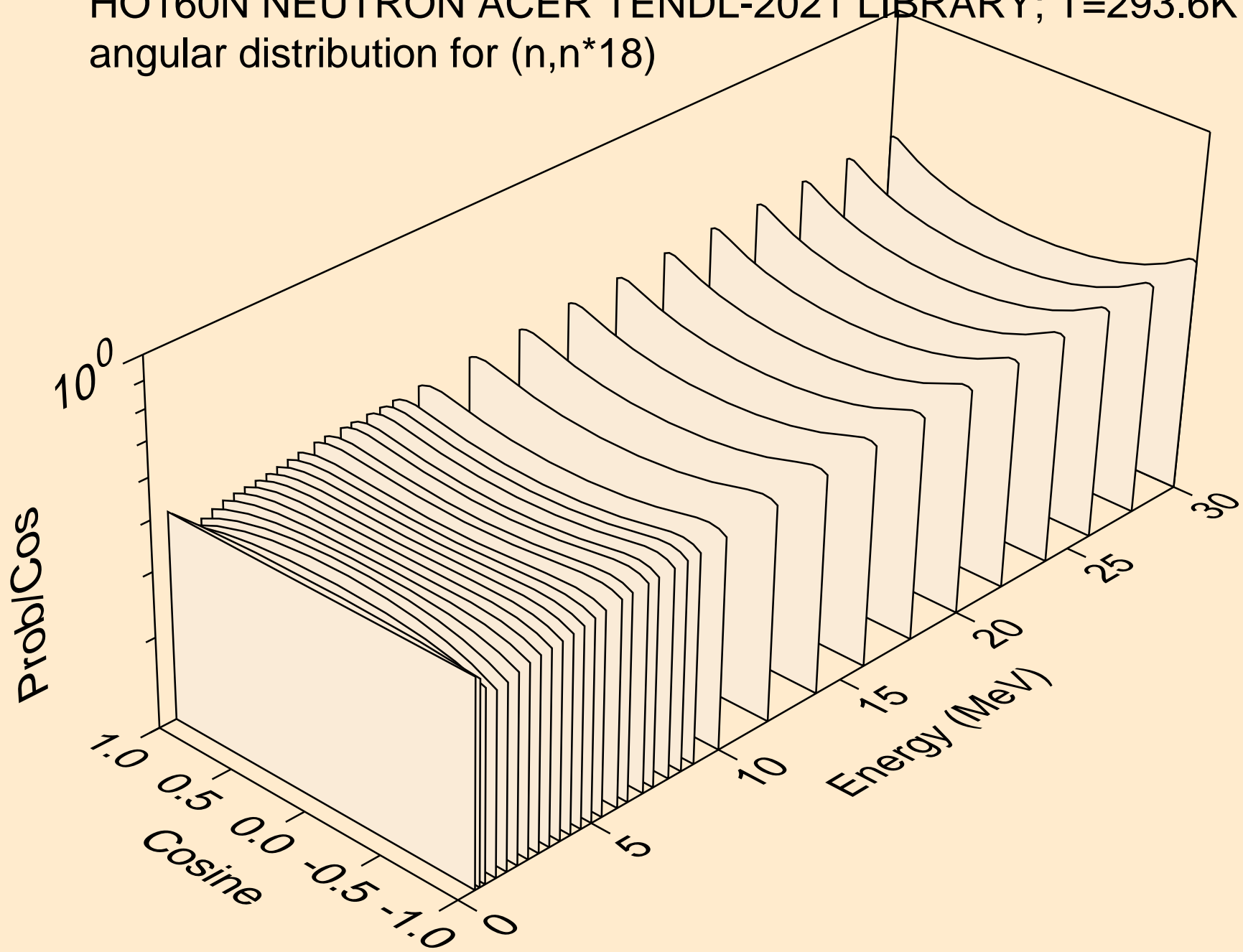



HO160N NEUTRON ACER TENDL-2021 LIBRARY; T=293.6K  
angular distribution for (n,n\*19)

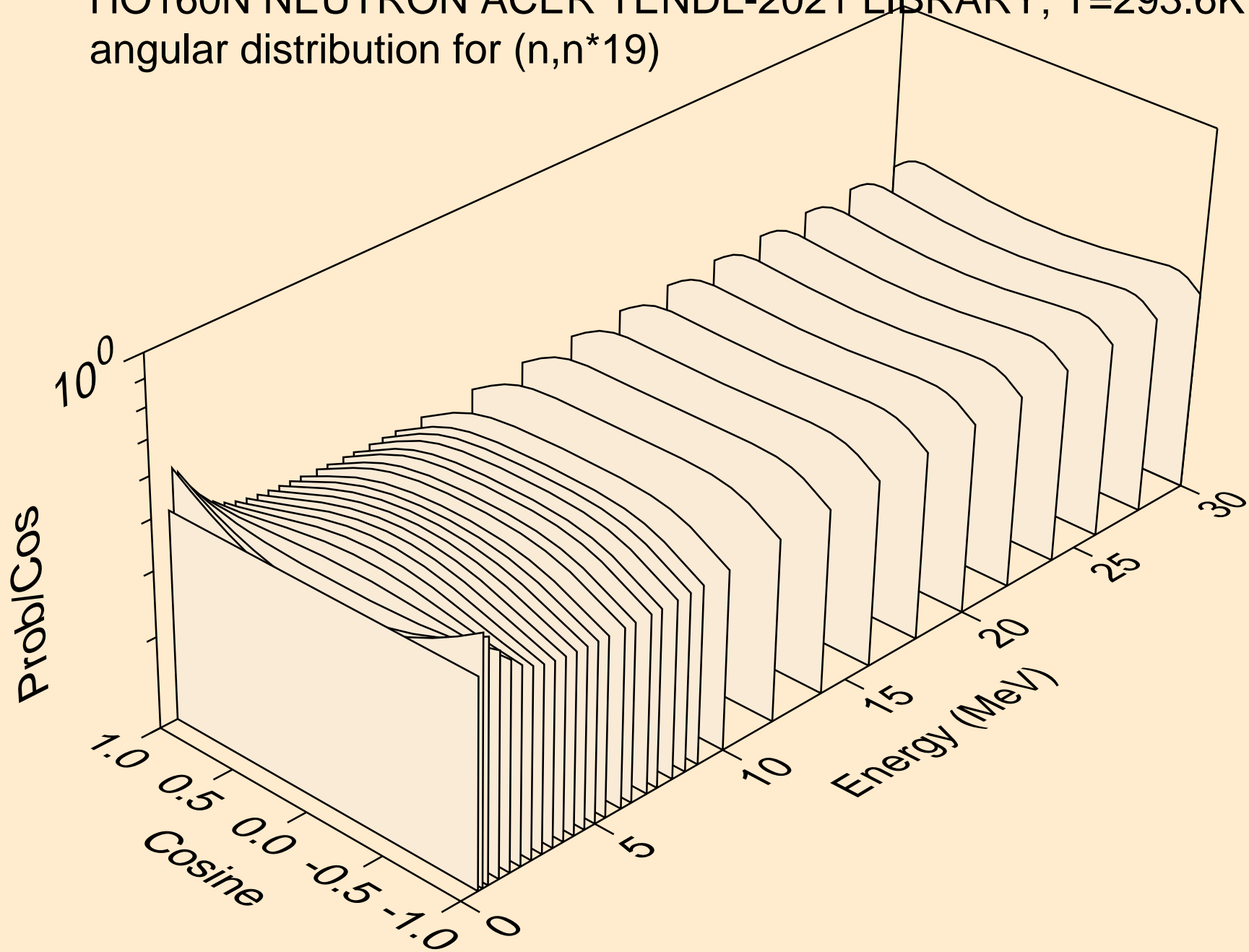

HO160N NEUTRON ACER TENDL-2021 LIBRARY; T=293.6K  
angular distribution for (n,n\*20)

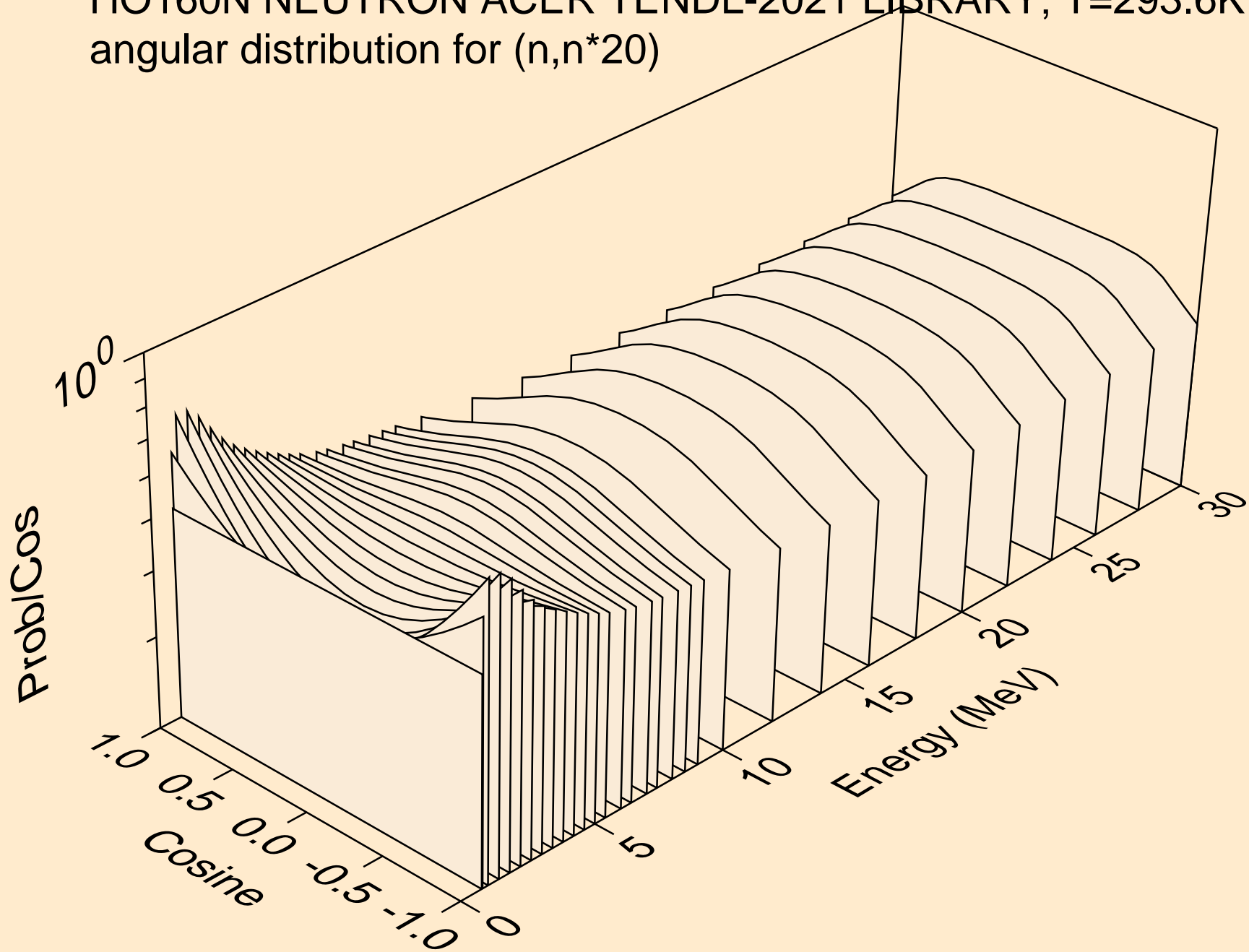

HO160N NEUTRON ACER TENDL-2021 LIBRARY; T=293.6K  
angular distribution for (n,n\*21)

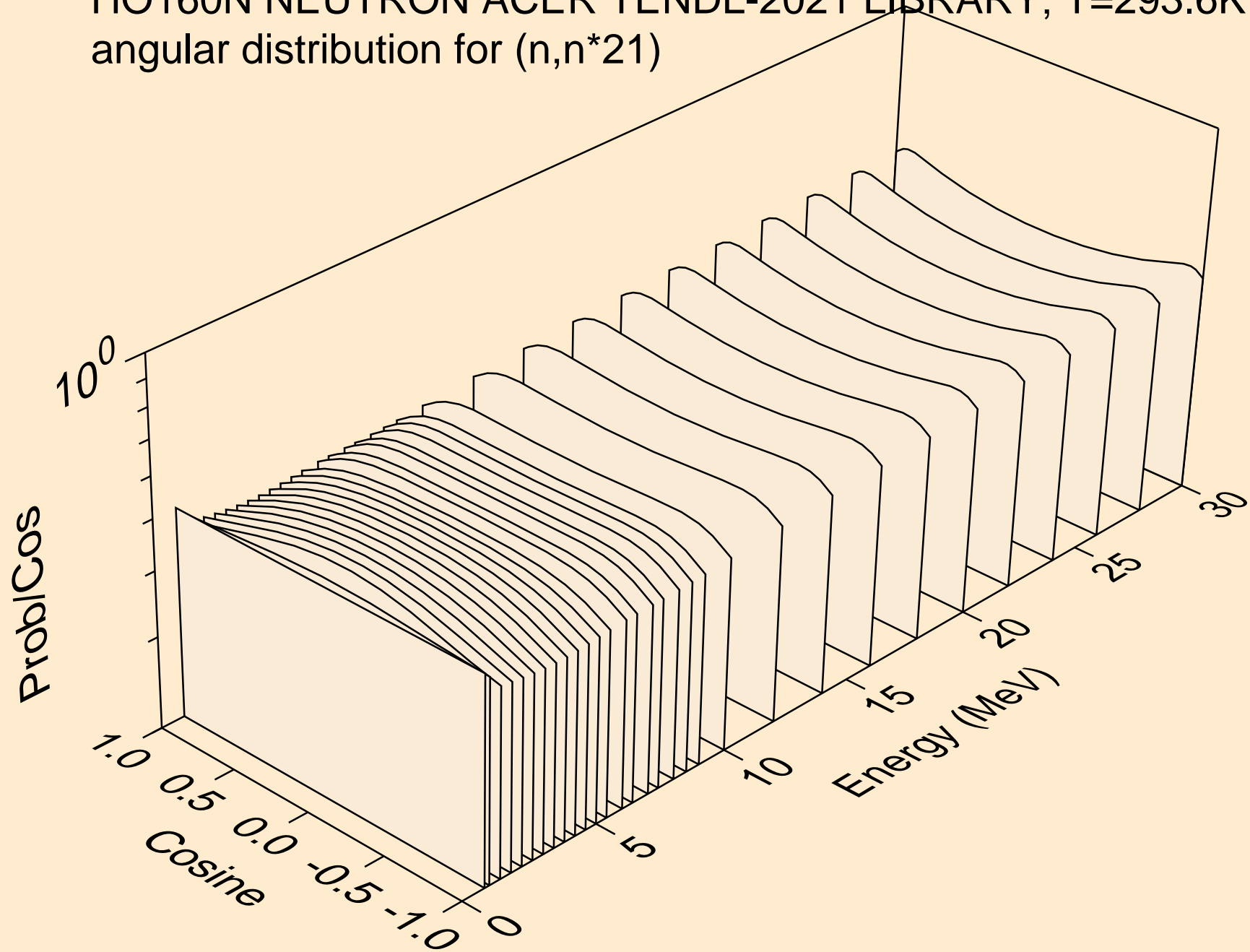

HO160N NEUTRON ACER TENDL-2021 LIBRARY; T=293.6K  
Neutron emission for (n,x)

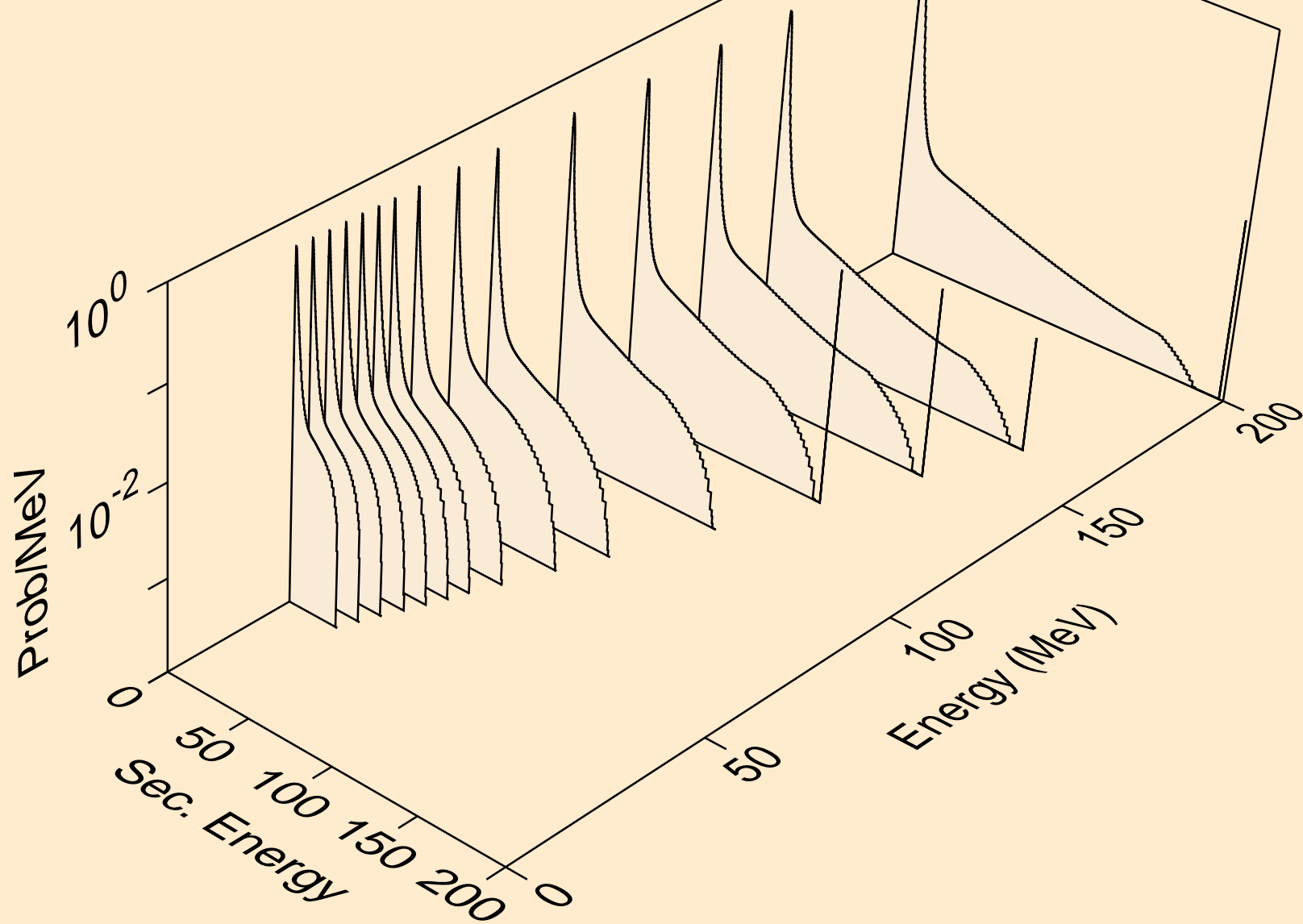

HO160N NEUTRON ACER TENDL-2021 LIBRARY; T=293.6K  
Neutron emission for (n,2nd)

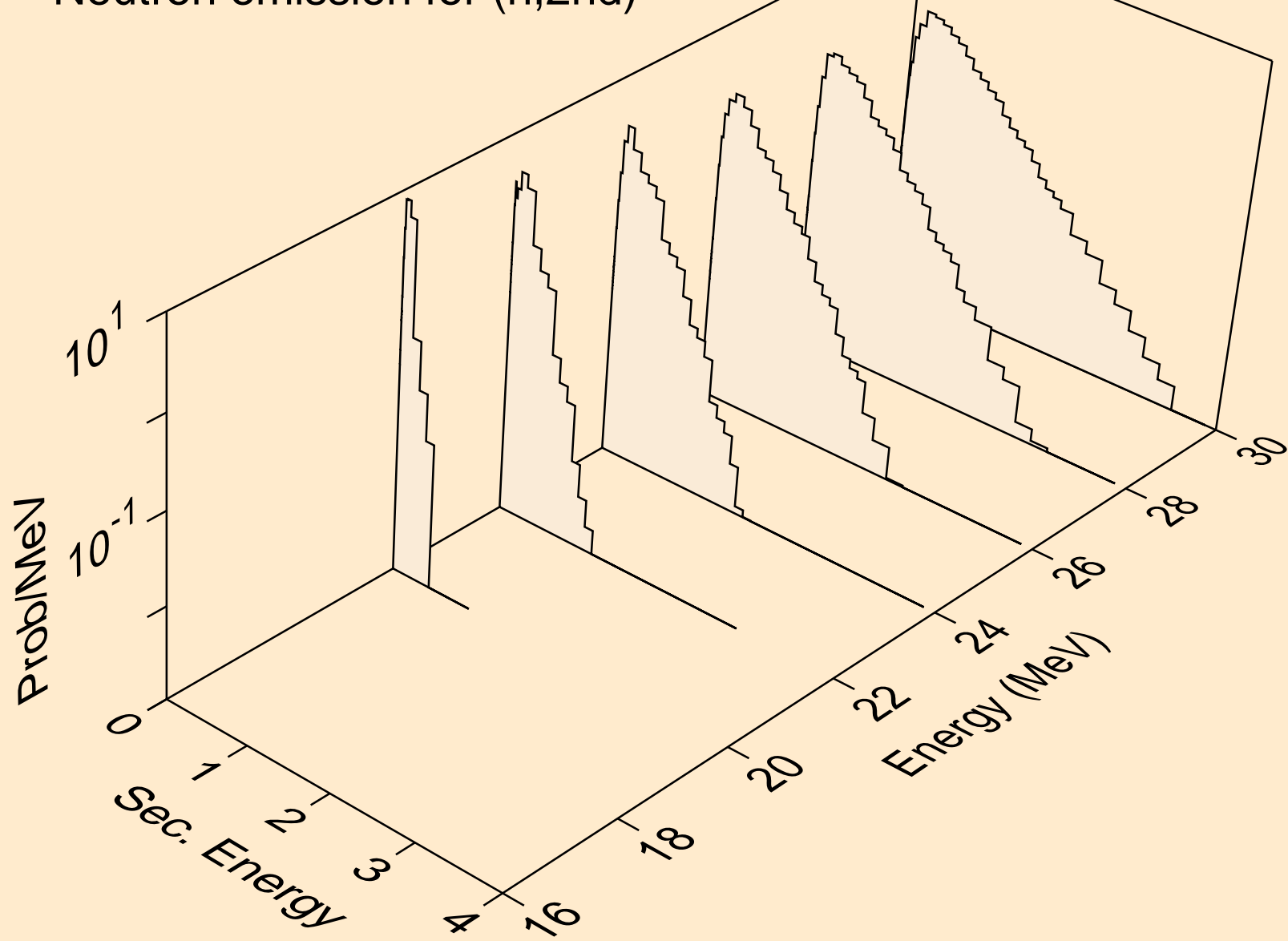

HO160N NEUTRON ACER TENDL-2021 LIBRARY; T=293.6K  
Neutron emission for (n,2n)

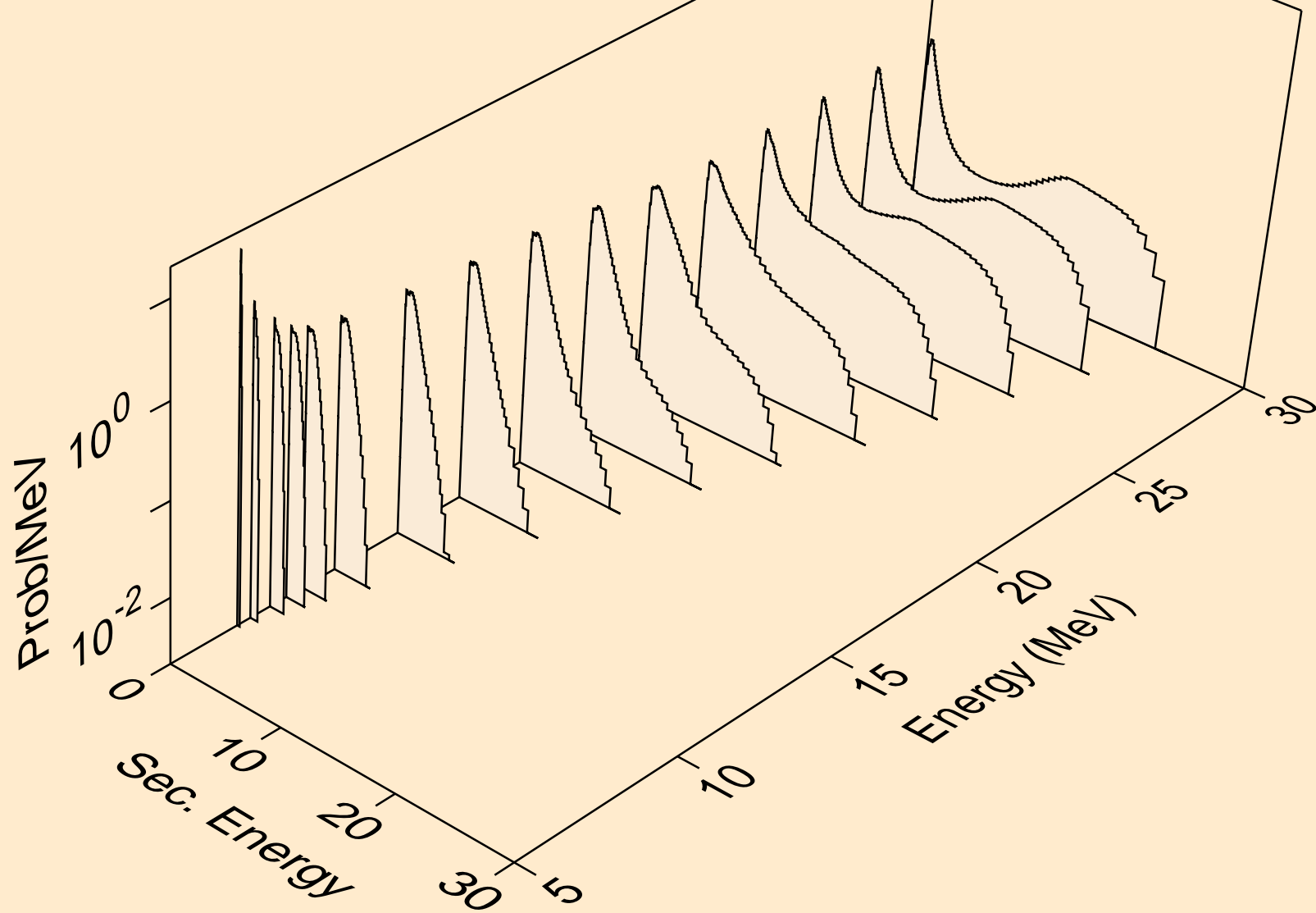

HO160N NEUTRON ACER TENDL-2021 LIBRARY; T=293.6K  
Neutron emission for (n,3n)

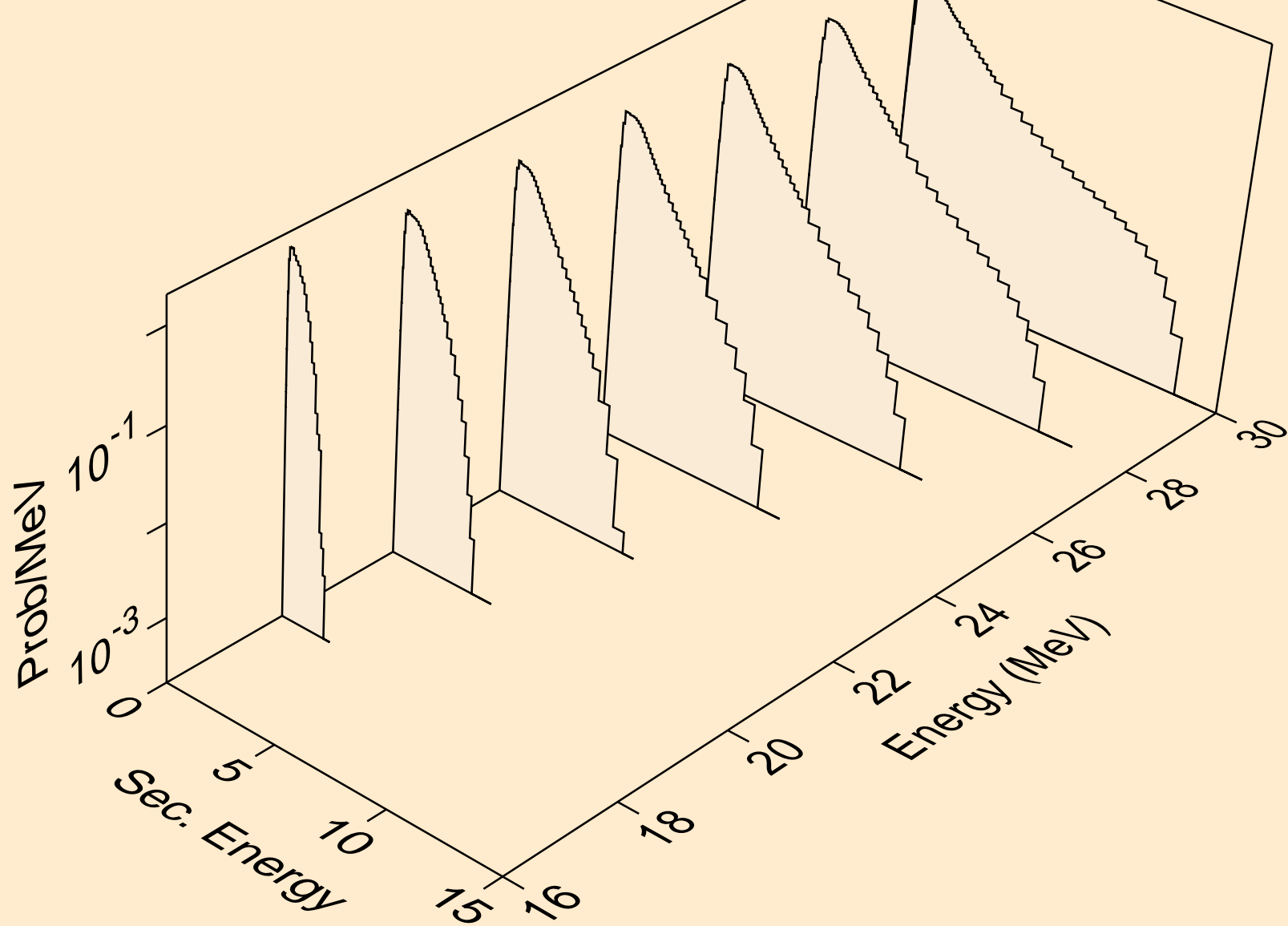

HO160N NEUTRON ACER TENDL-2021 LIBRARY; T=293.6K  
Neutron emission for (n,n\*)a

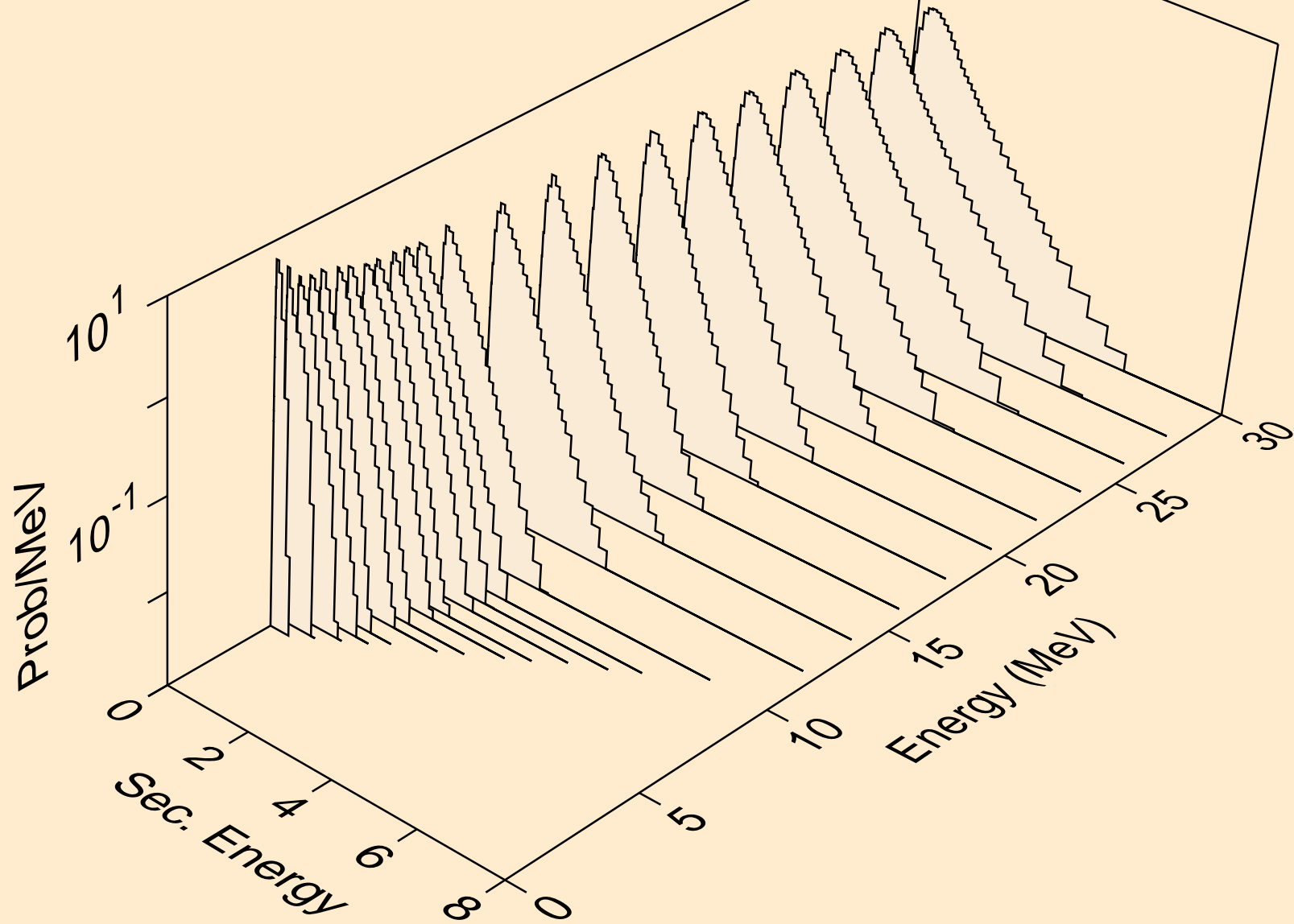



HO160N NEUTRON ACER TENDL-2021 LIBRARY; T=293.6K  
Neutron emission for (n,2n)a

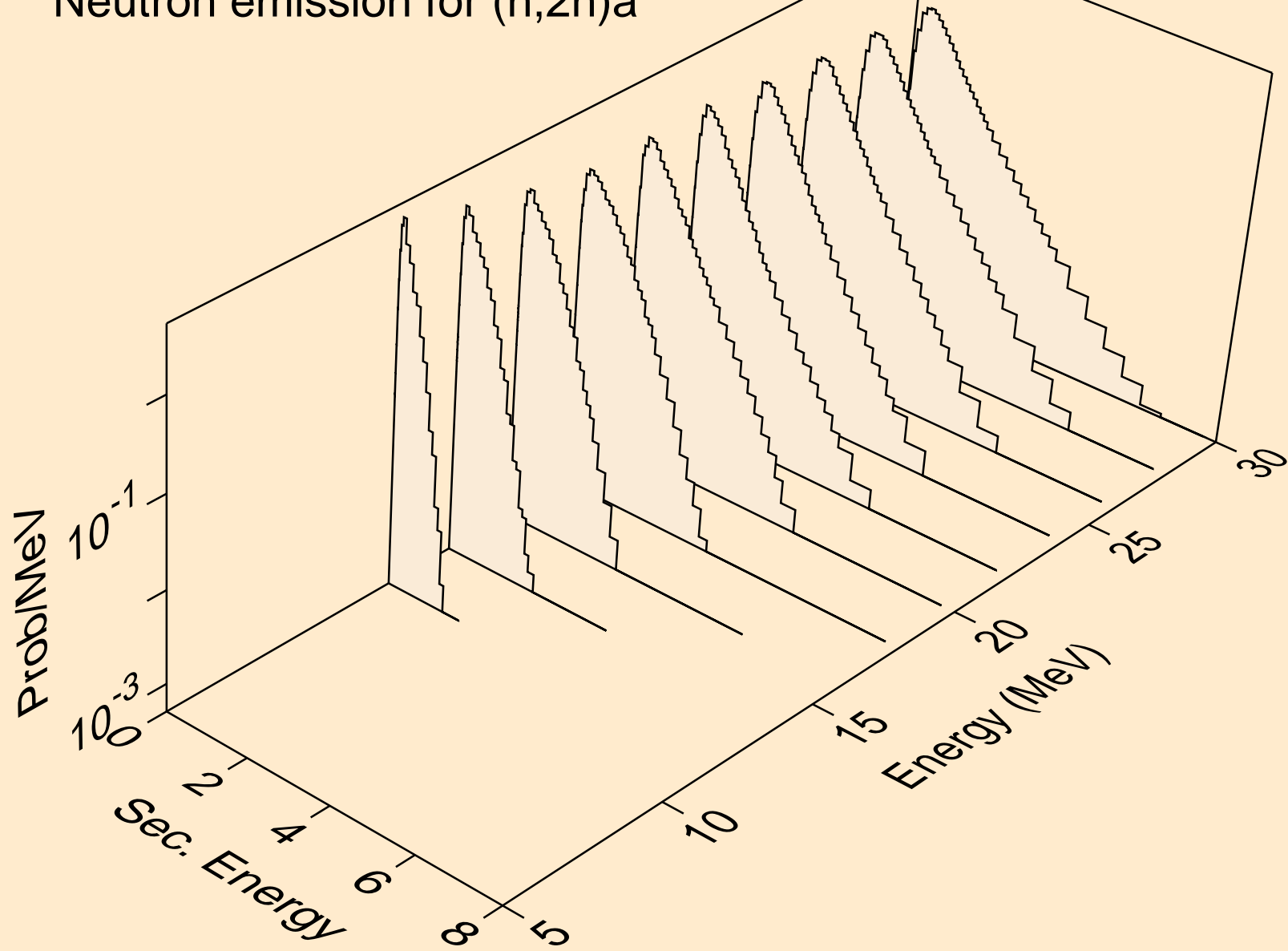

HO160N NEUTRON ACER TENDL-2021 LIBRARY; T=293.6K  
Neutron emission for (n,3n)a

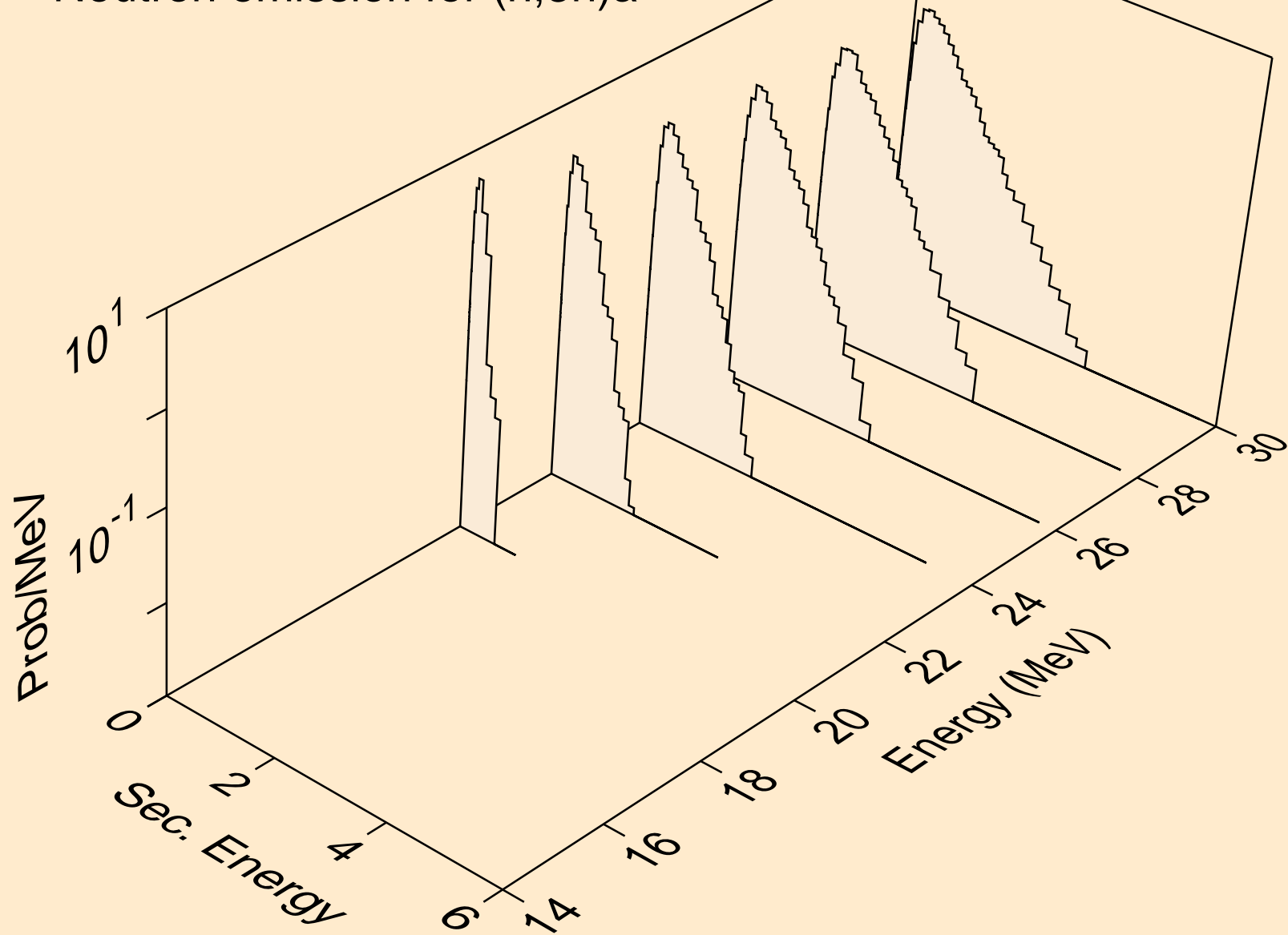

HO160N NEUTRON ACER TENDL-2021 LIBRARY; T=293.6K  
Neutron emission for (n,n\*)p

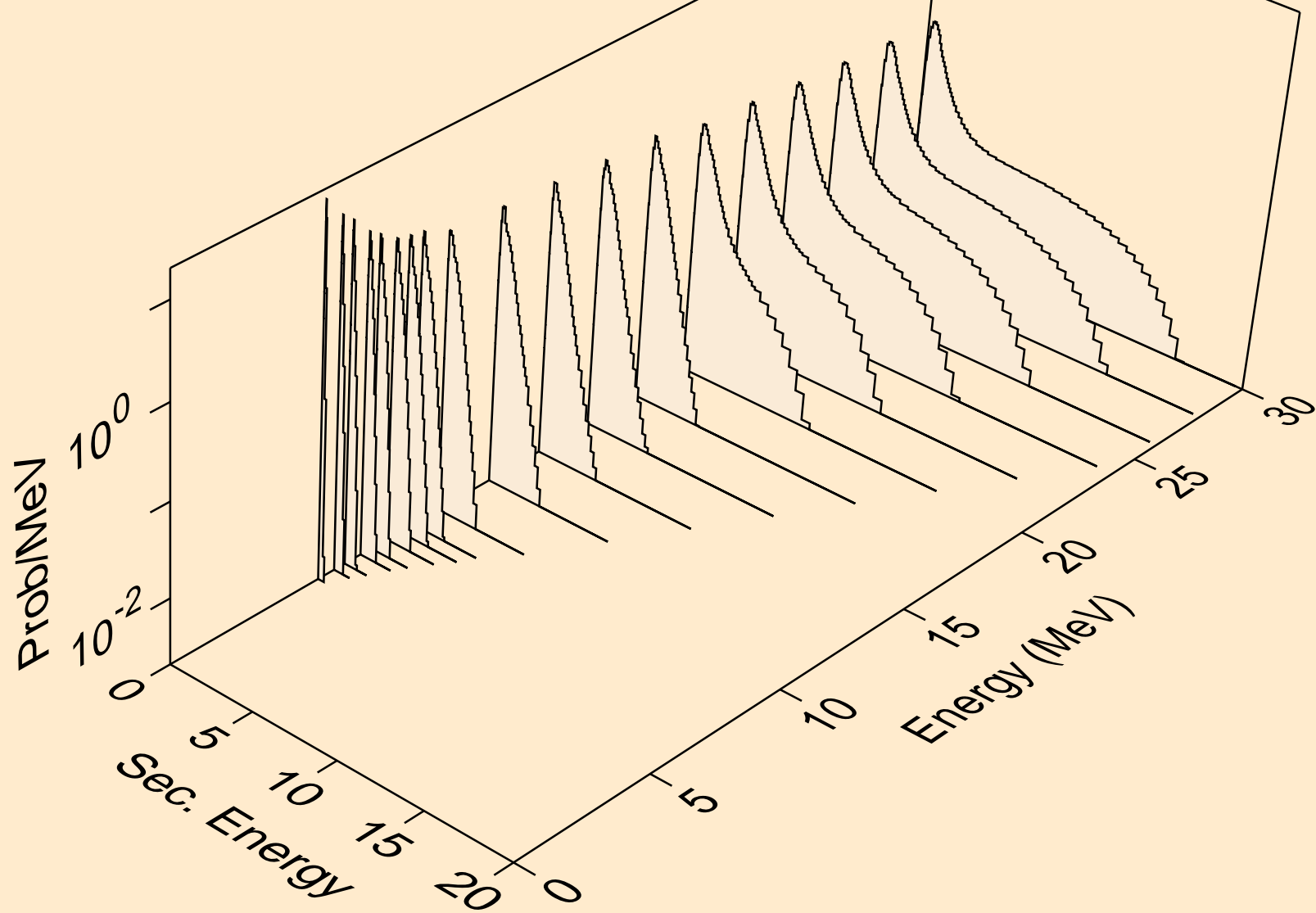

HO160N NEUTRON ACER TENDL-2021 LIBRARY; T=293.6K  
Neutron emission for (n,n\*)2a

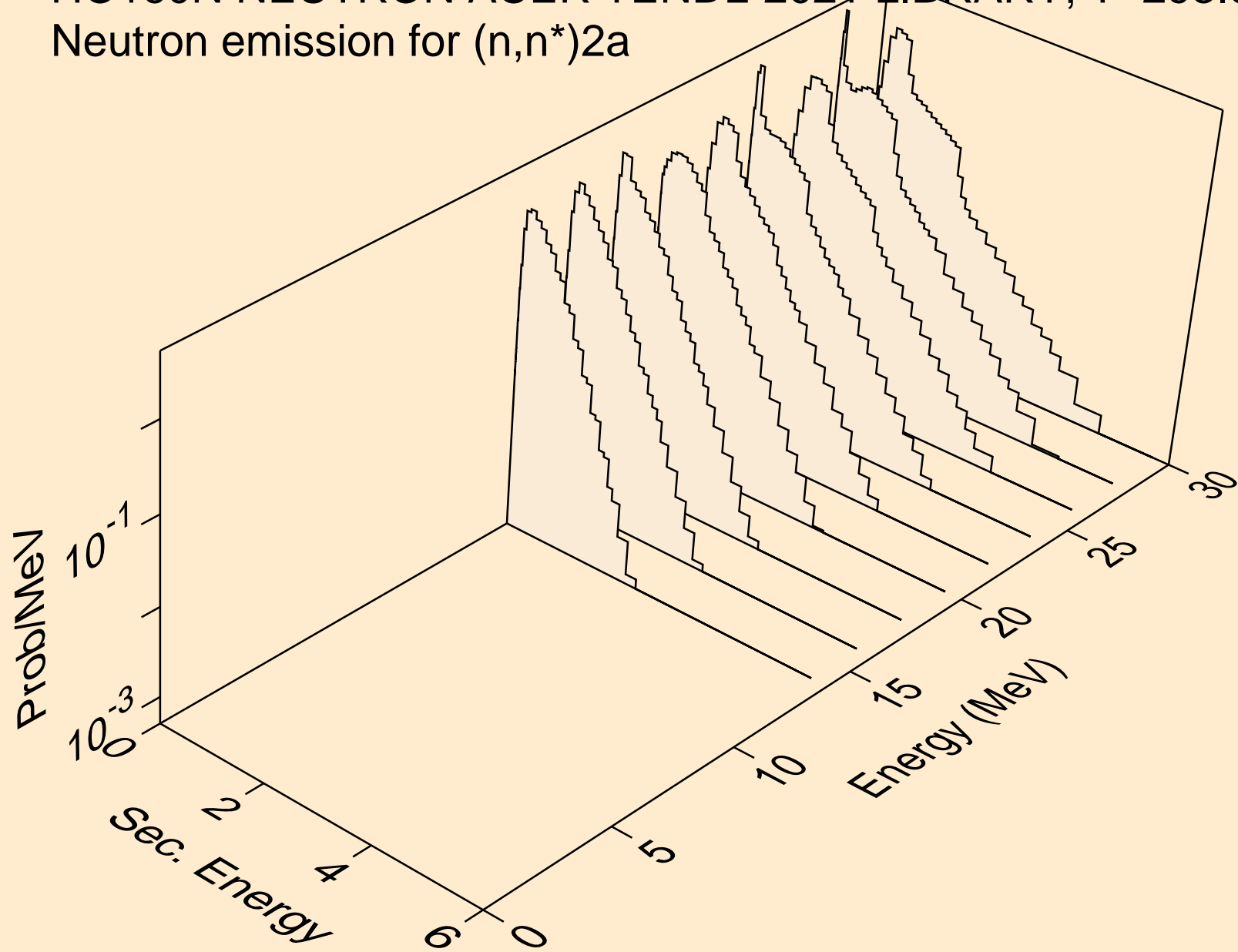

HO160N NEUTRON ACER TENDL-2021 LIBRARY; T=293.6K  
Neutron emission for (n,n\*)d

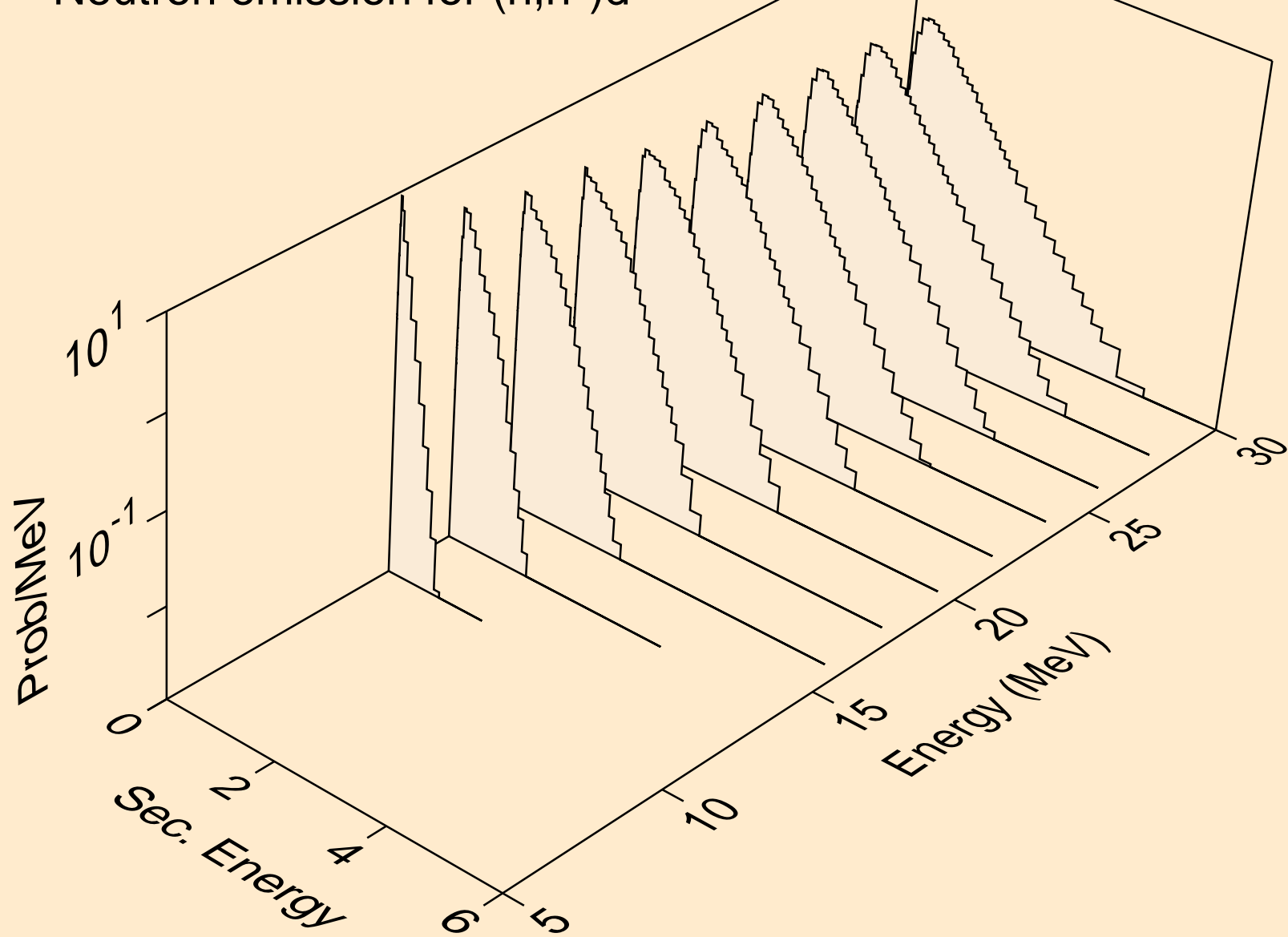

HO160N NEUTRON ACER TENDL-2021 LIBRARY; T=293.6K  
Neutron emission for (n,n\*)t

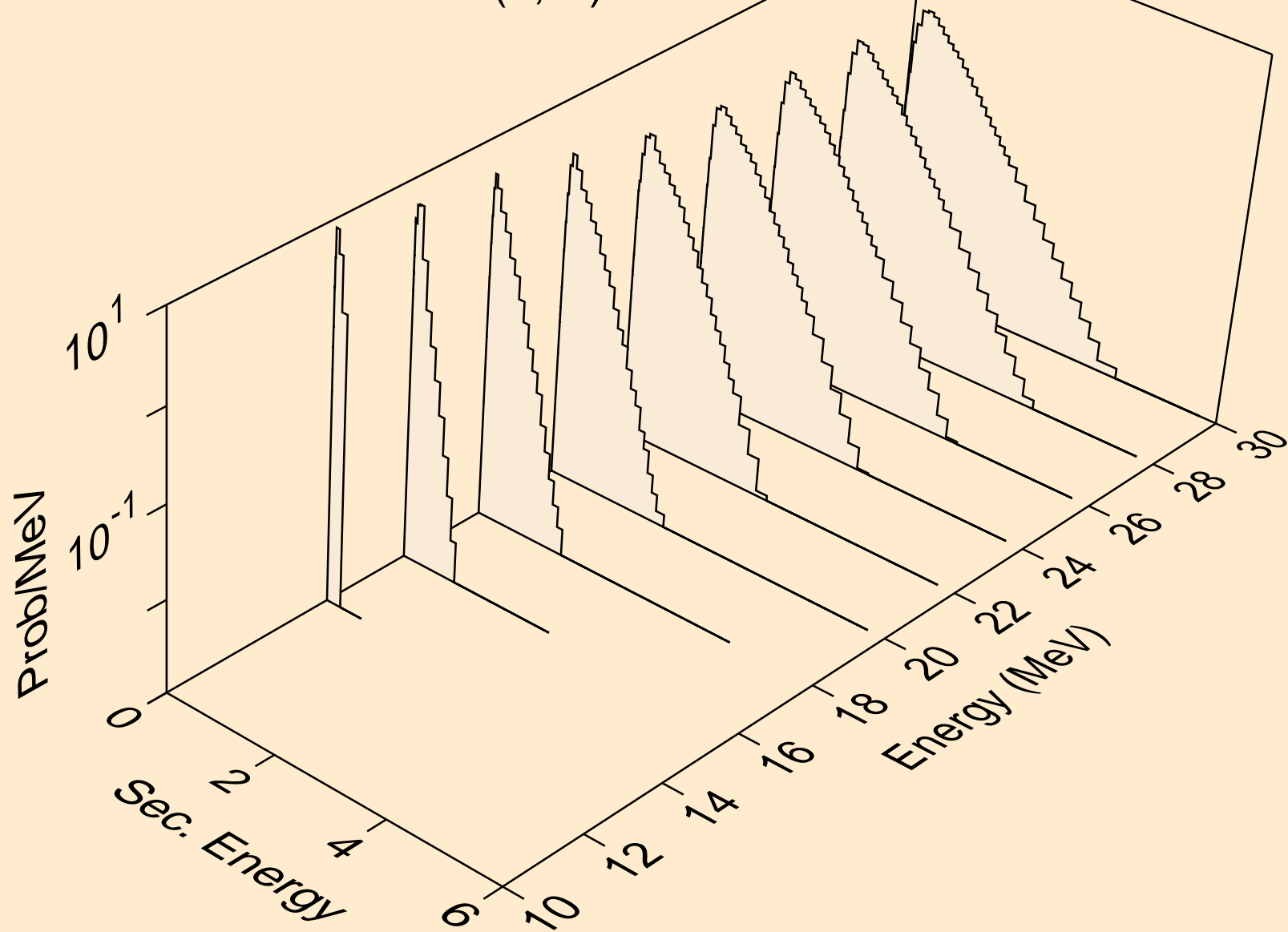

HO160N NEUTRON ACER TENDL-2021 LIBRARY; T=293.6K  
Neutron emission for (n,n\*)he3

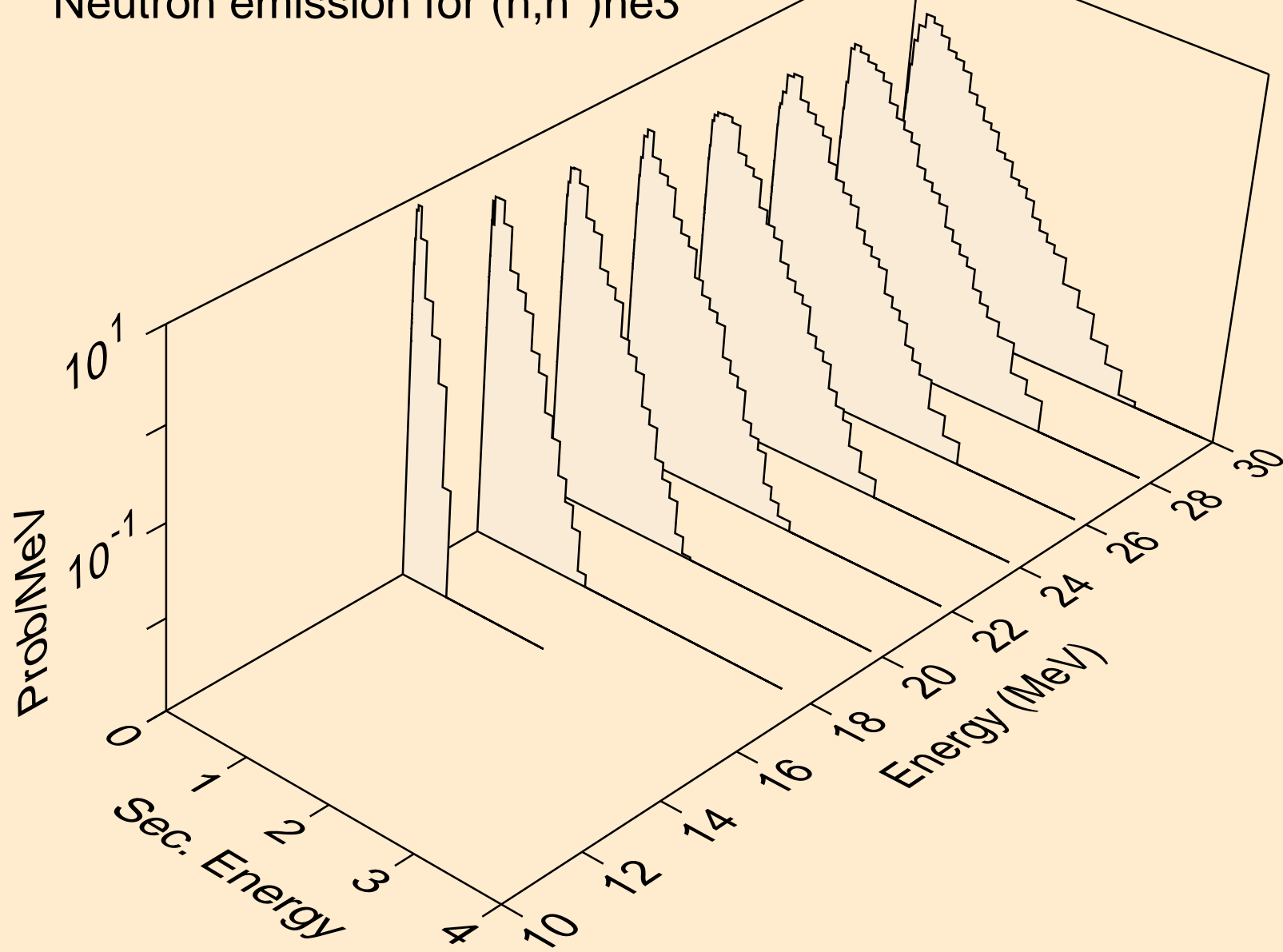

HO160N NEUTRON ACER TENDL-2021 LIBRARY; T=293.6K  
Neutron emission for (n,4n)

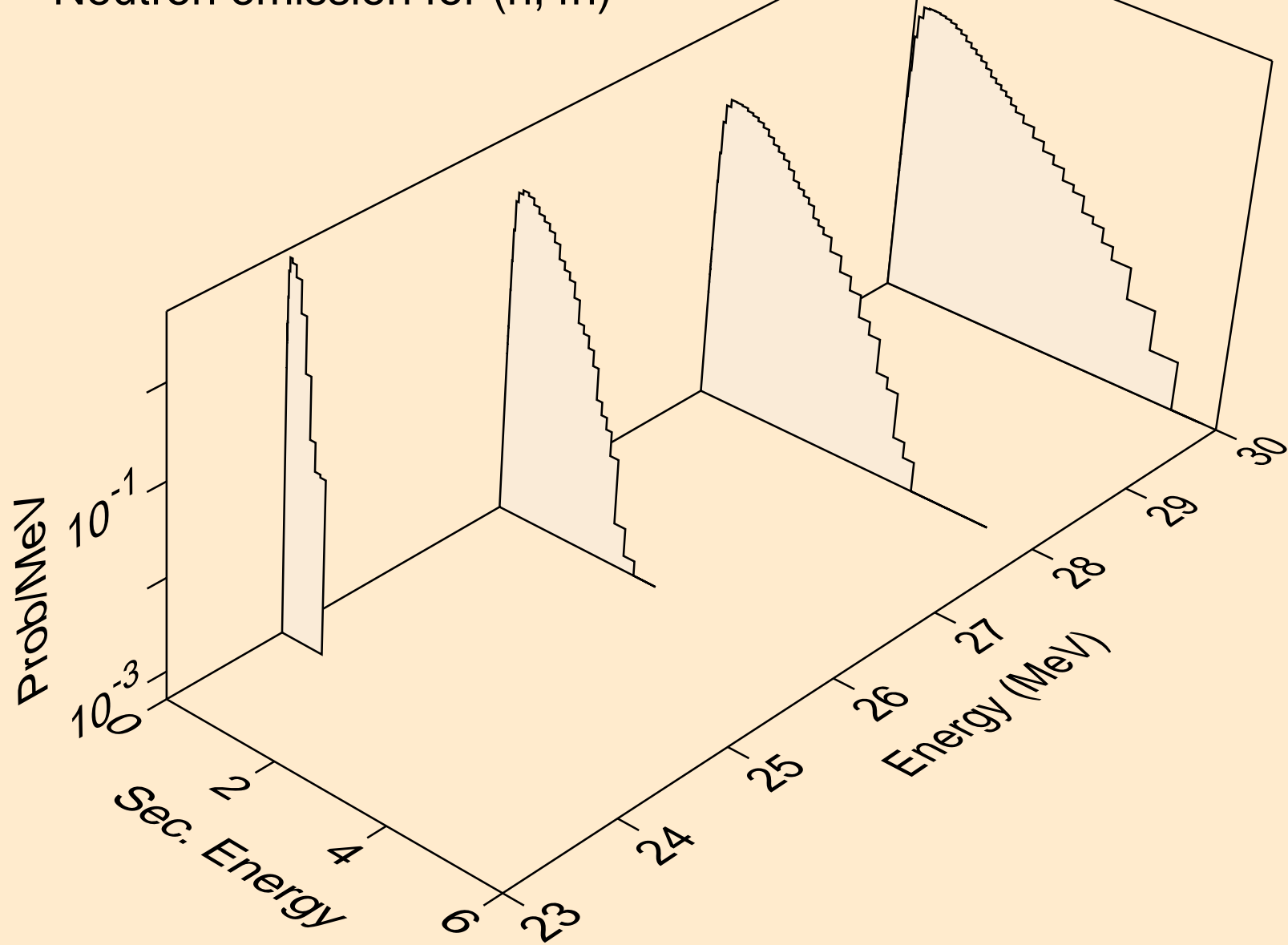



HO160N NEUTRON ACER TENDL-2021 LIBRARY; T=293.6K  
Neutron emission for (n,2np)

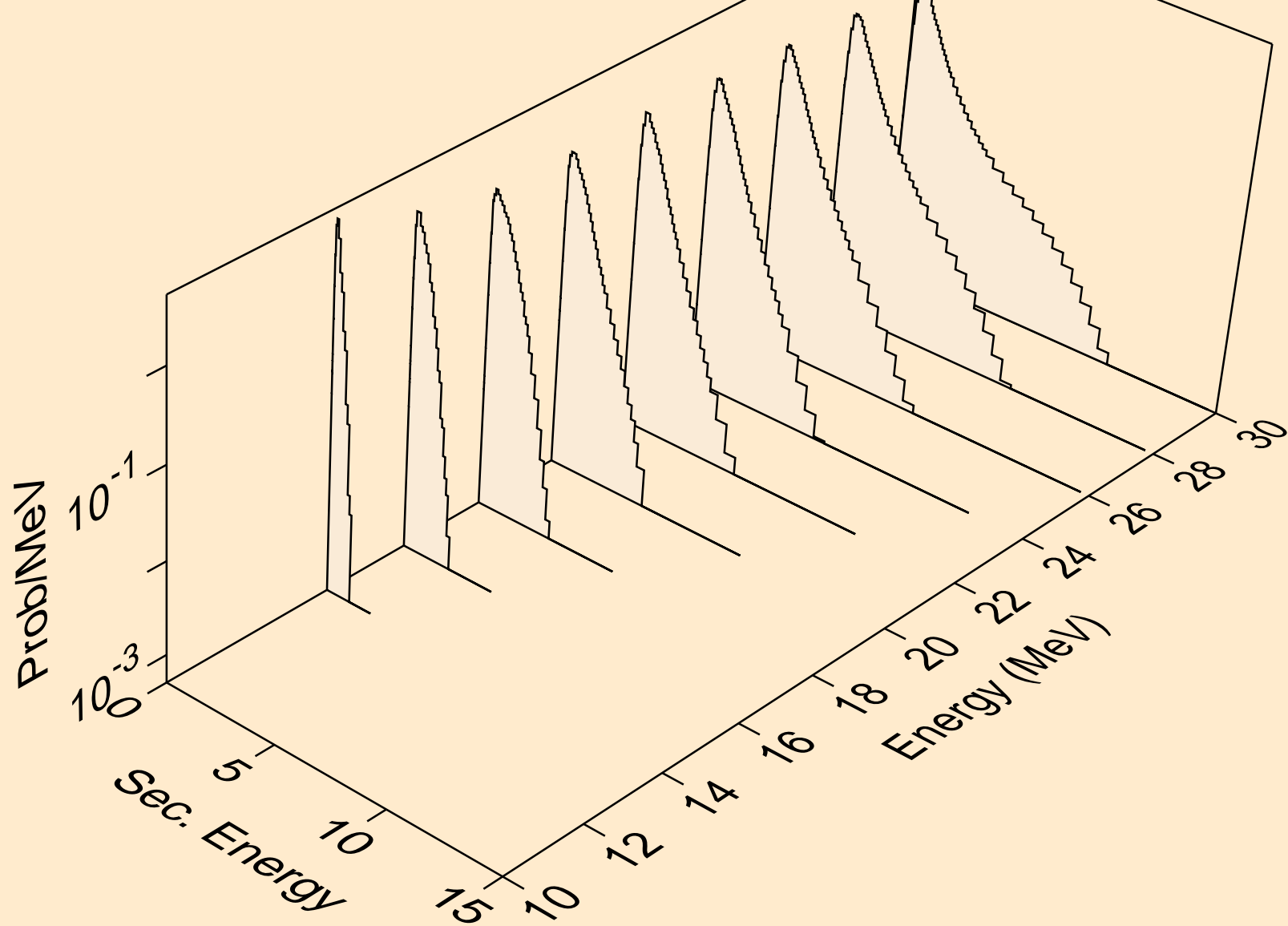

HO160N NEUTRON ACER TENDL-2021 LIBRARY; T=293.6K  
Neutron emission for (n,3np)

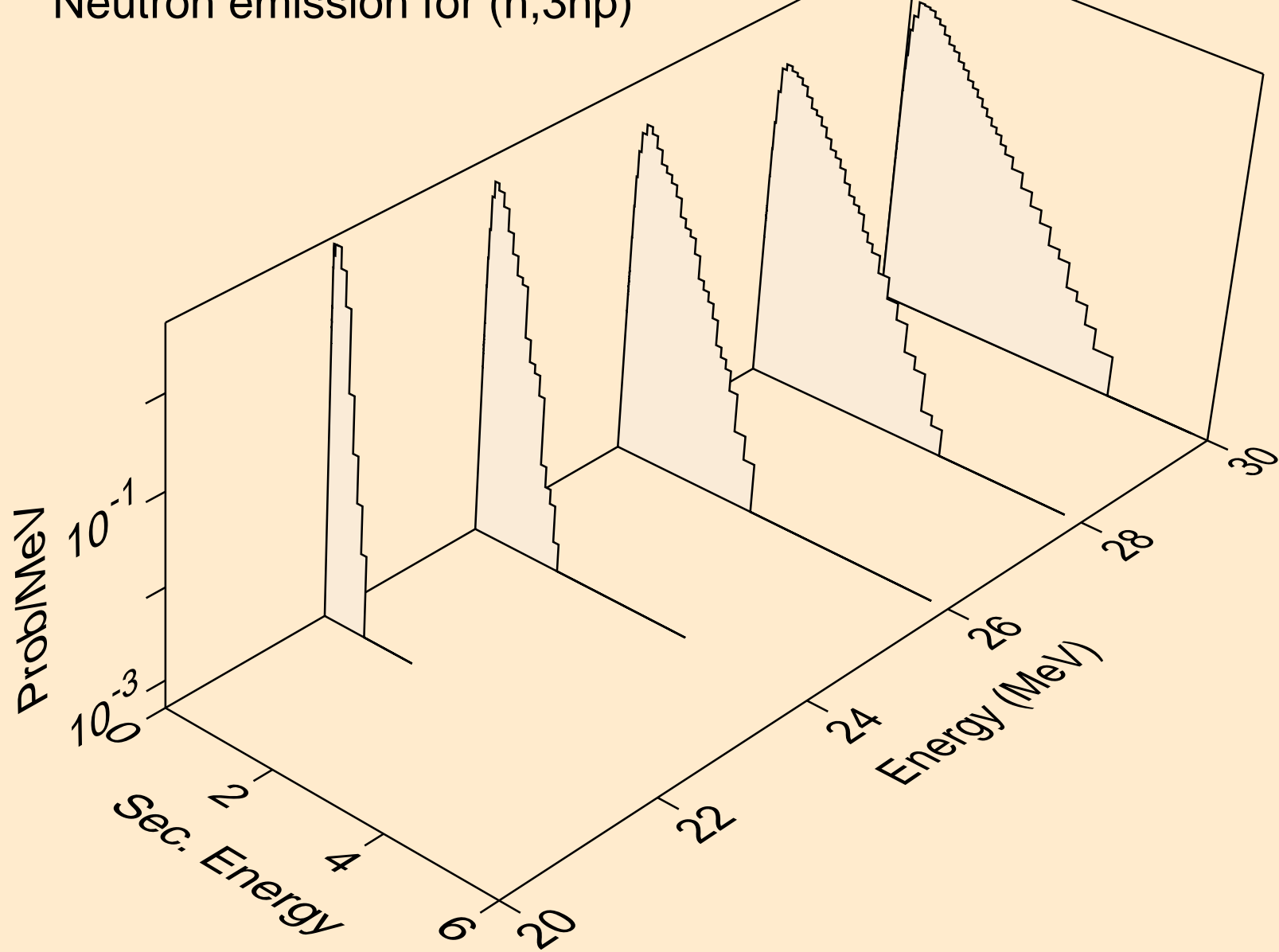

HO160N NEUTRON ACER TENDL-2021 LIBRARY; T=293.6K  
Neutron emission for (n,2np)

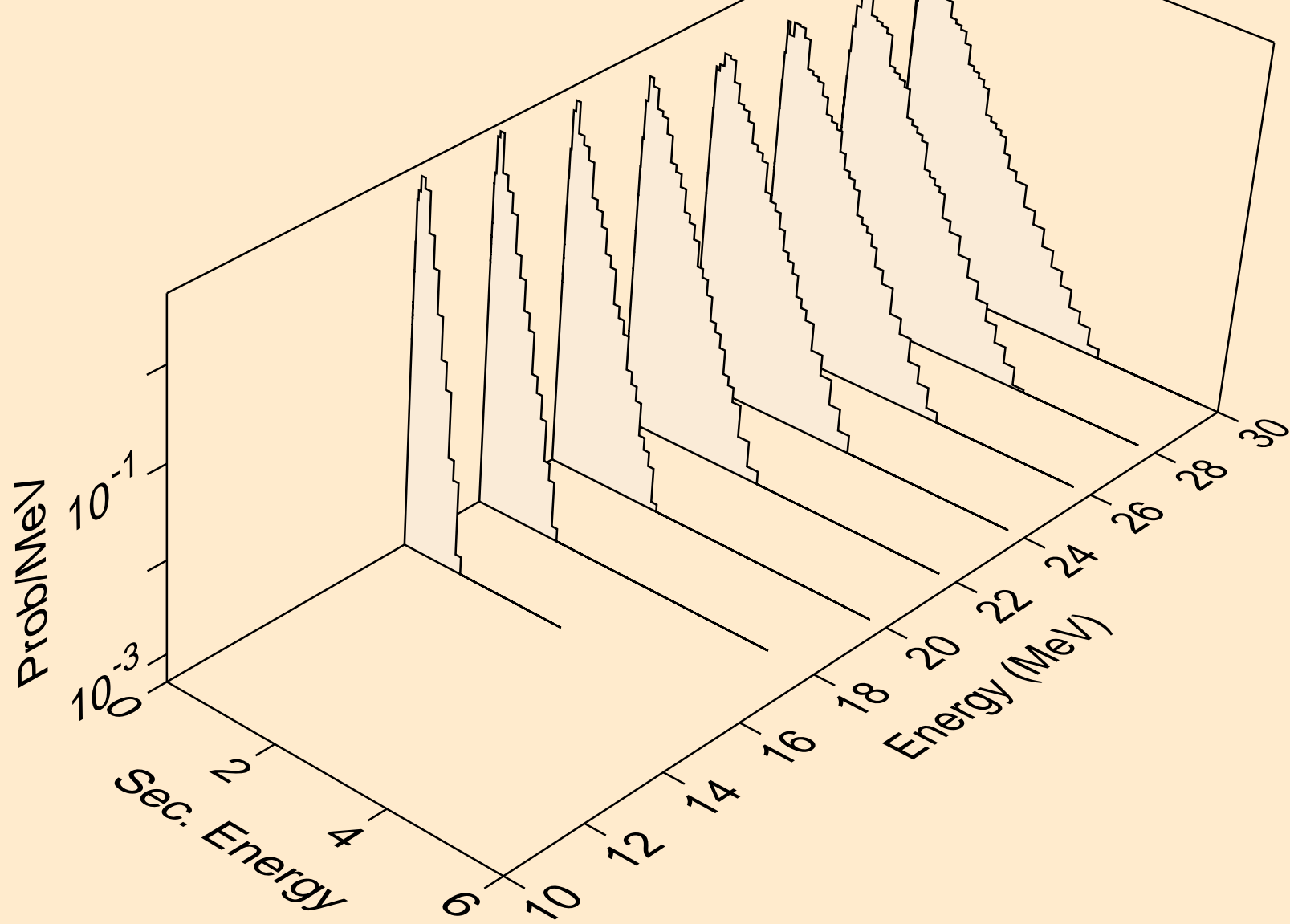

HO160N NEUTRON ACER TENDL-2021 LIBRARY; T=293.6K  
Neutron emission for (n,npa)

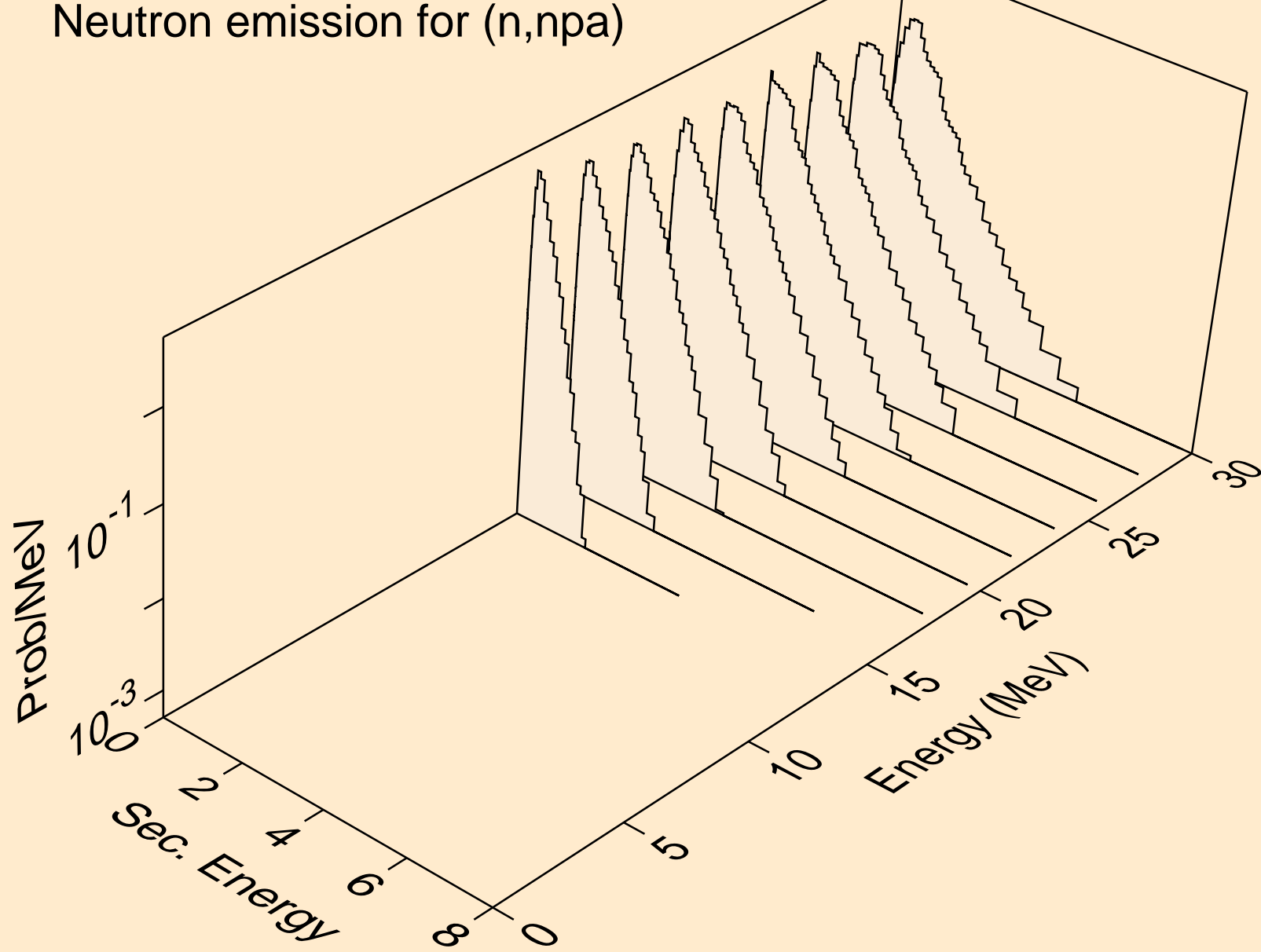

HO160N NEUTRON ACER TENDL-2021 LIBRARY; T=293.6K  
Neutron emission for (n,n\*c)

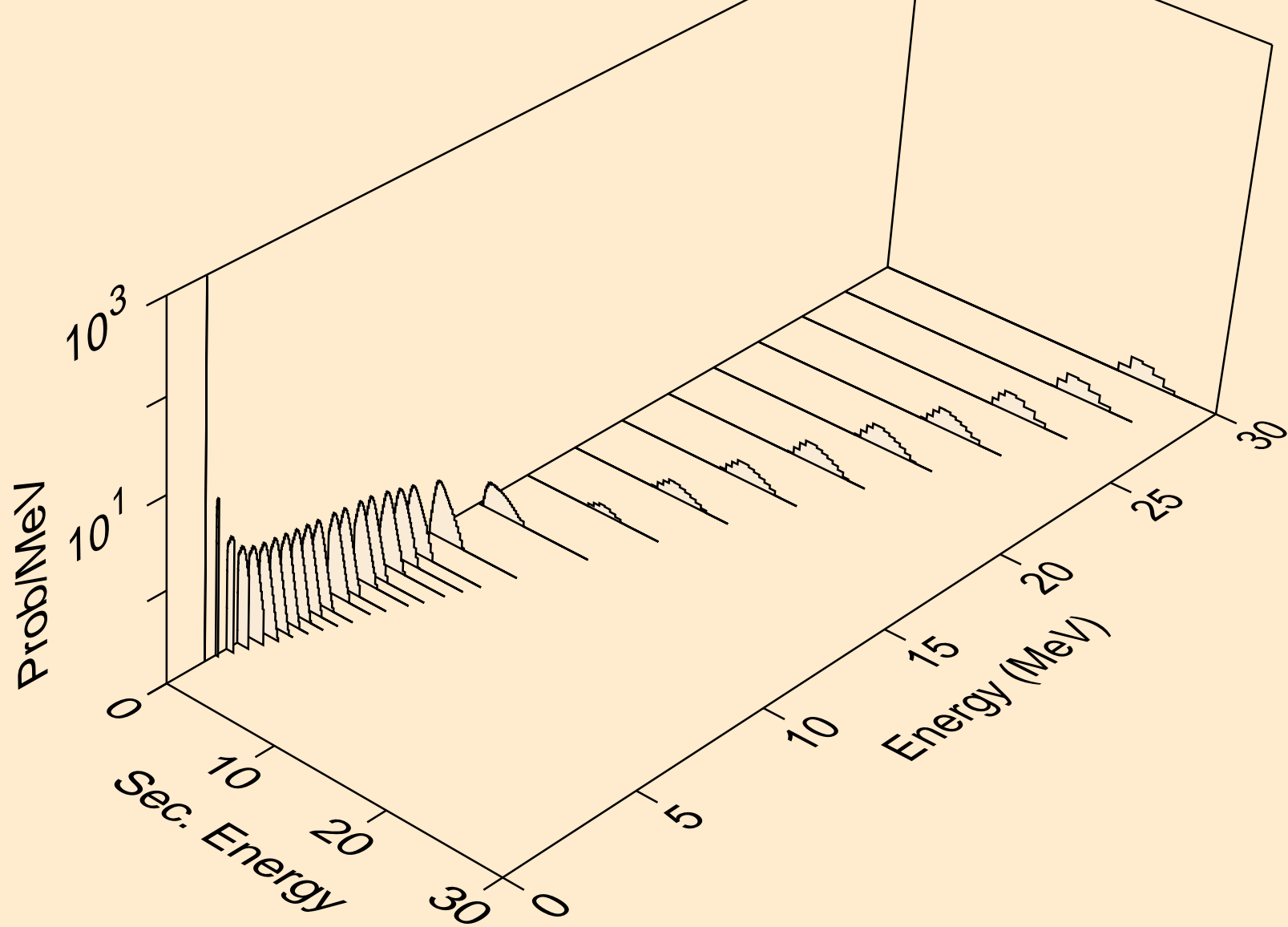

HO160N NEUTRON ACER TENDL-2021 LIBRARY; T=293.6K  
Photon emission for (n,x)

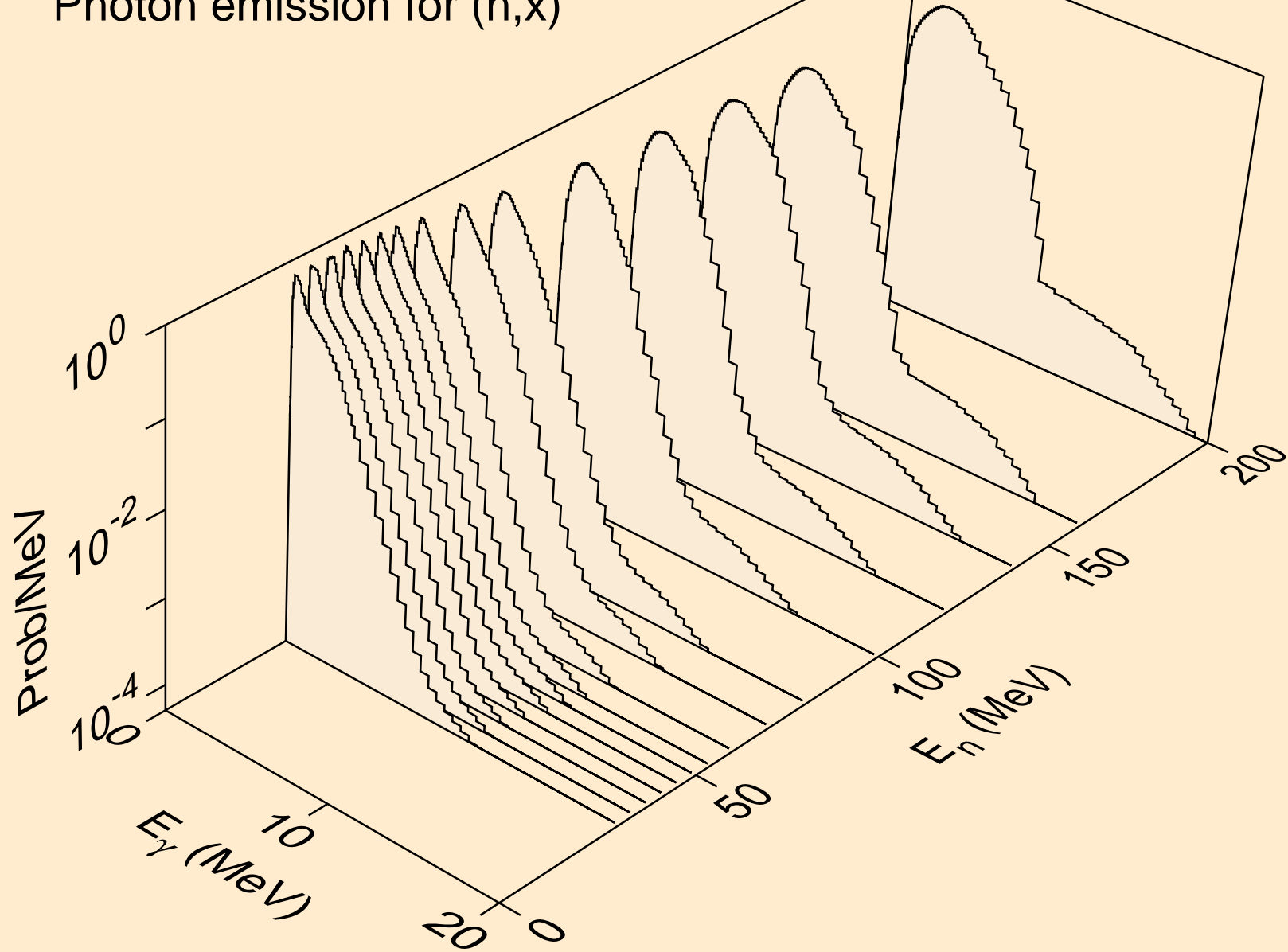

HO160N NEUTRON ACER TENDL-2021 LIBRARY; T=293.6K  
Photon emission for (n,2nd)

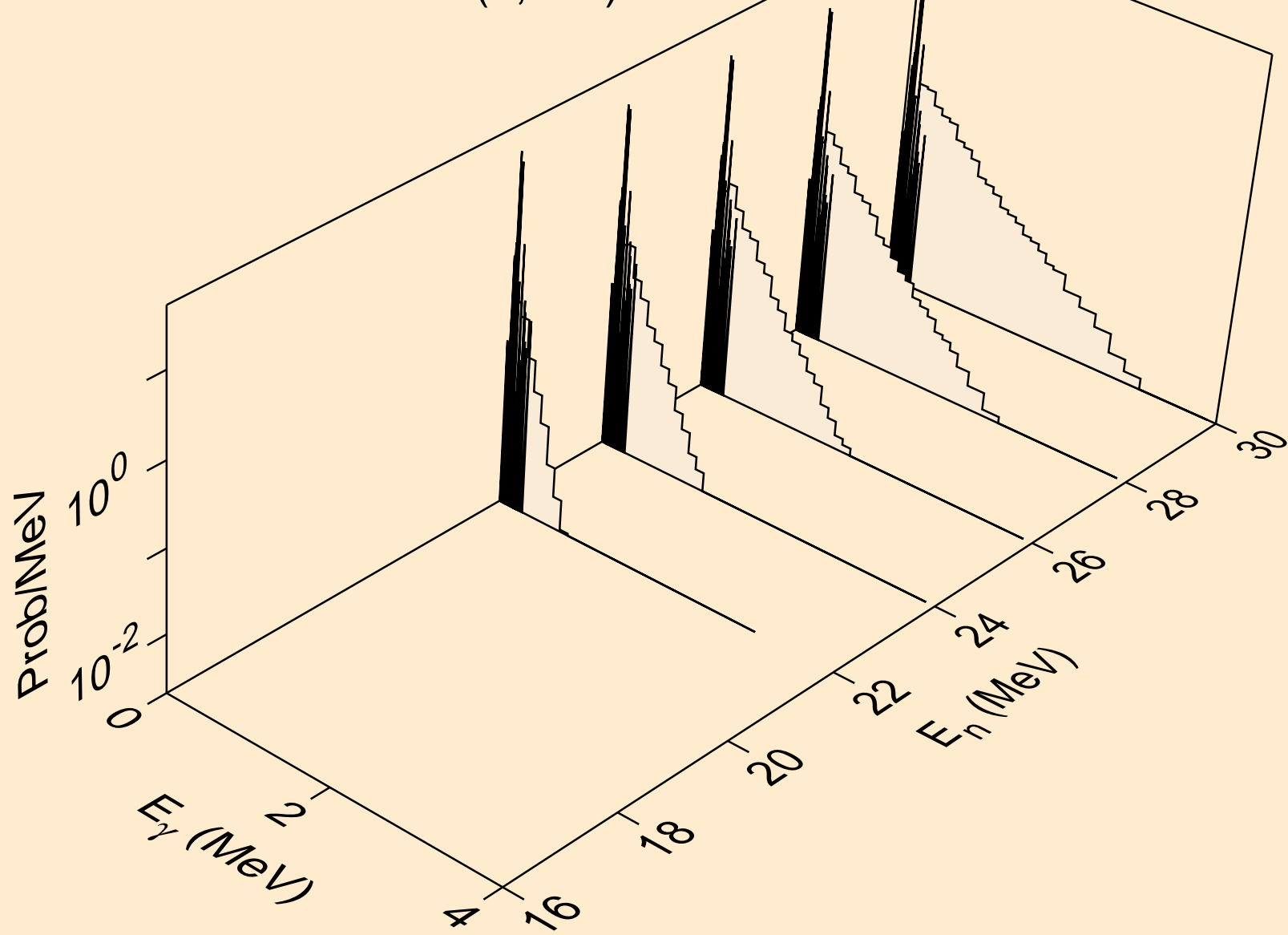

HO160N NEUTRON ACER TENDL-2021 LIBRARY; T=293.6K  
Photon emission for (n,2n)

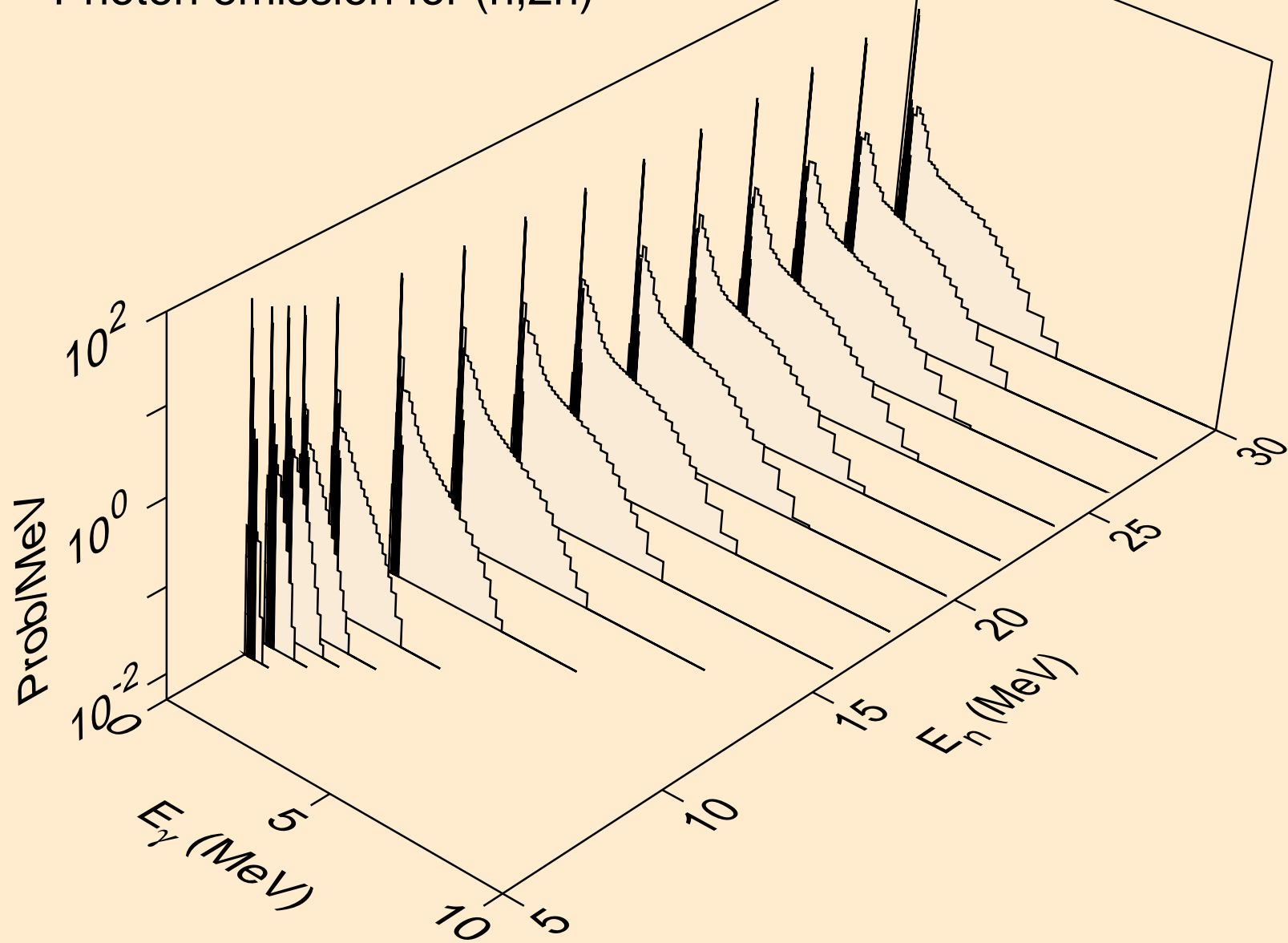



HO160N NEUTRON ACER TENDL-2021 LIBRARY; T=293.6K  
Photon emission for (n,3n)

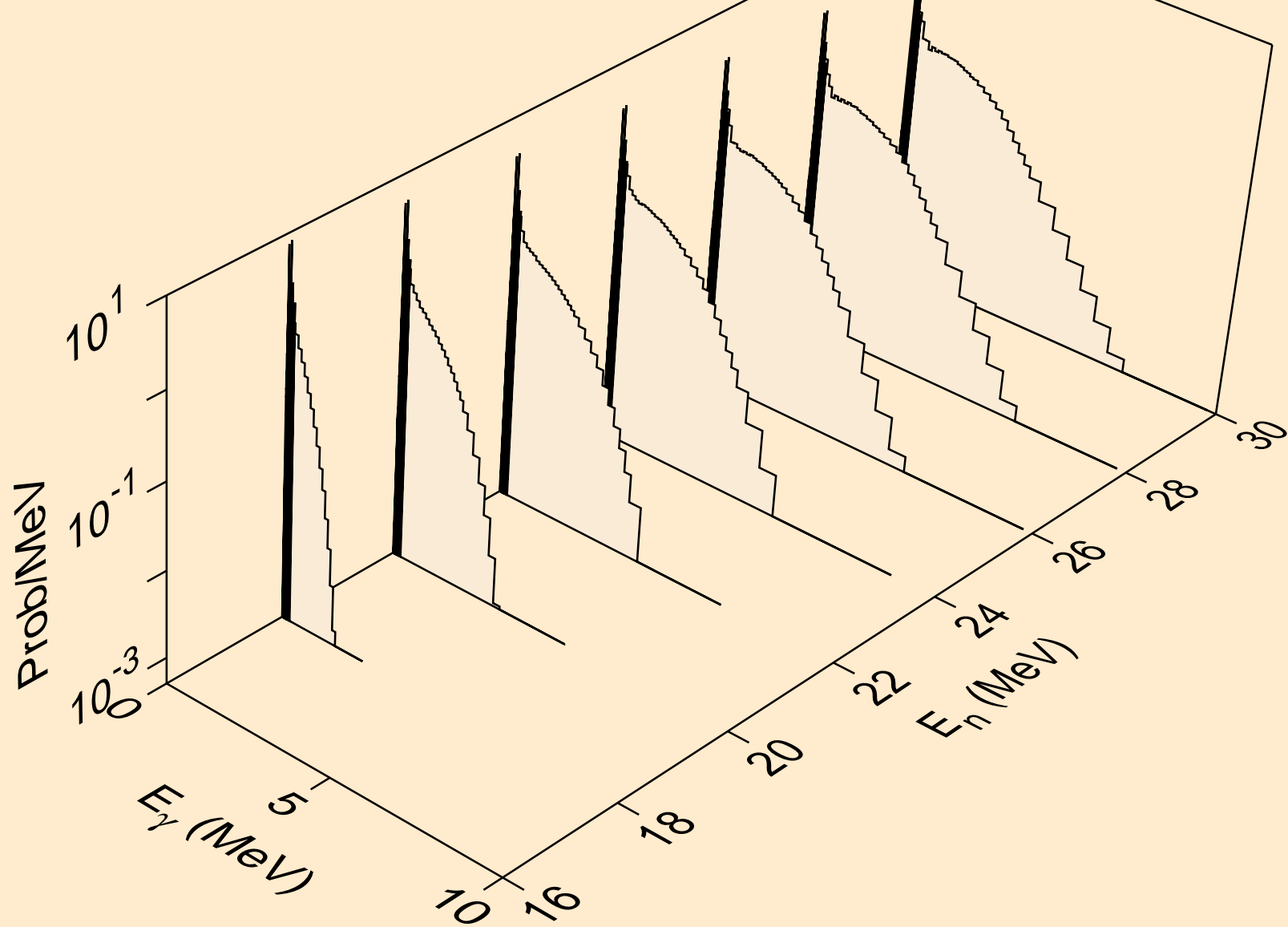

HO160N NEUTRON ACER TENDL-2021 LIBRARY; T=293.6K  
Photon emission for (n,n\*)a

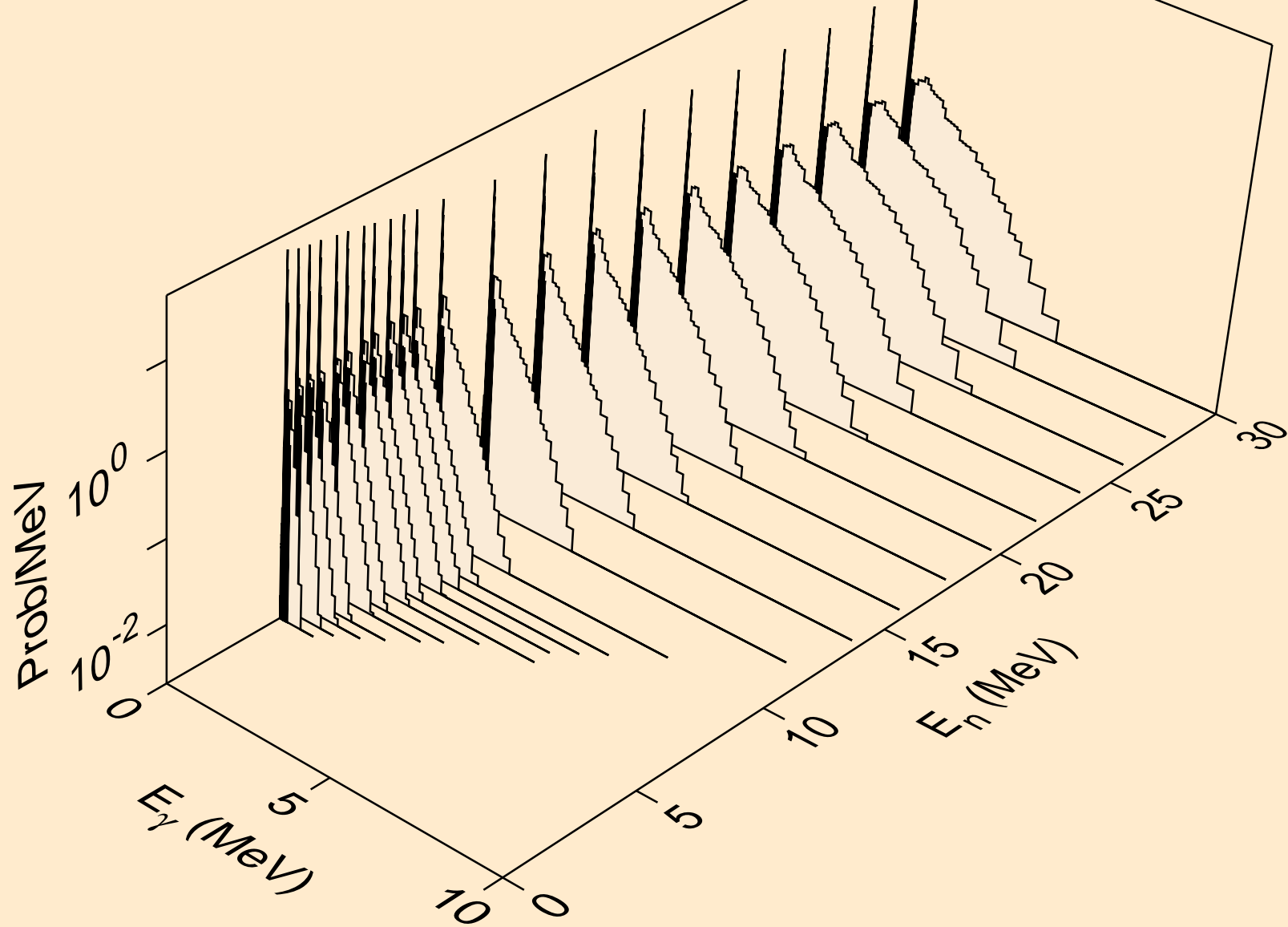

HO160N NEUTRON ACER TENDL-2021 LIBRARY; T=293.6K  
Photon emission for (n,2n)a

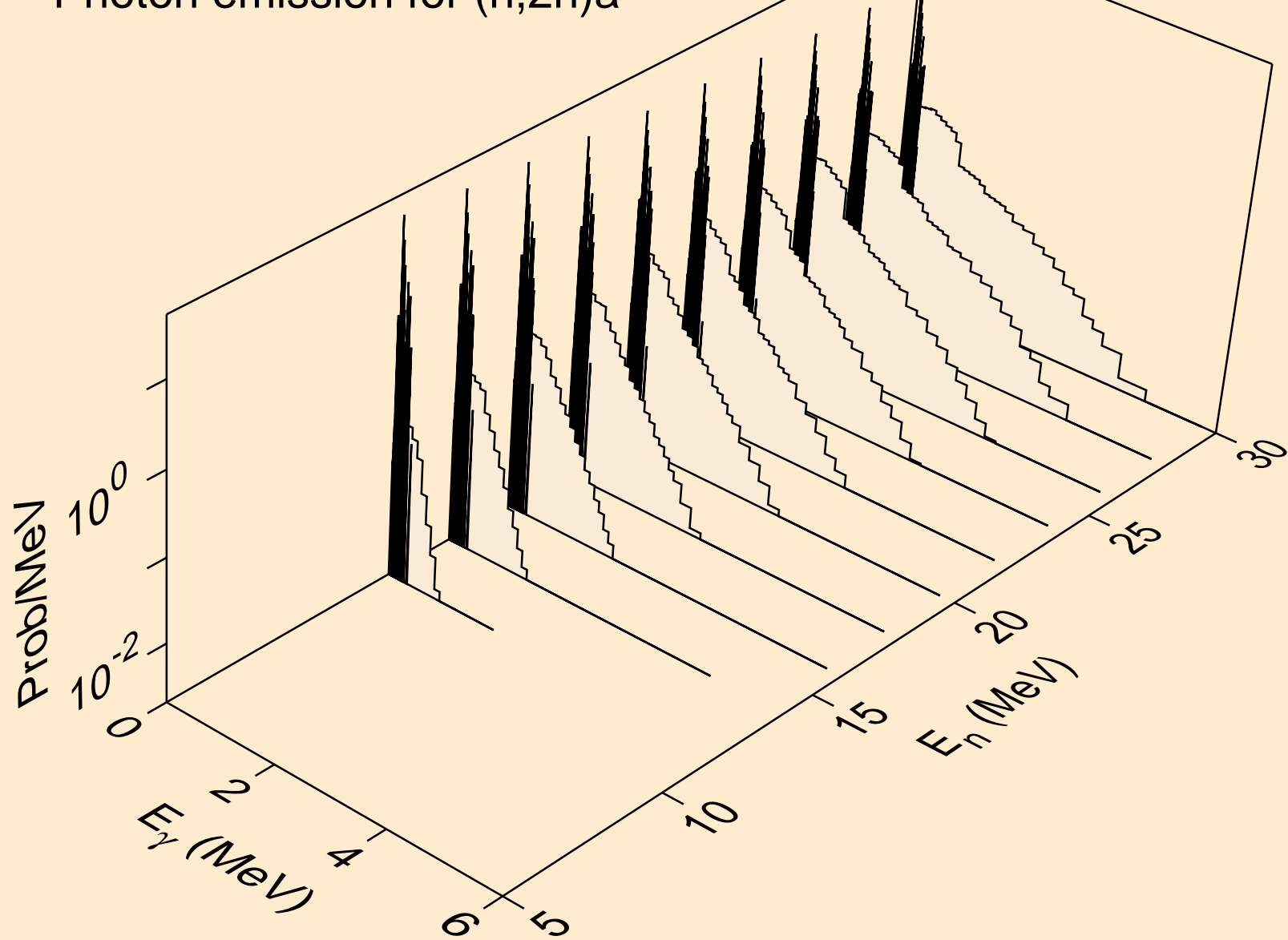

HO160N NEUTRON ACER TENDL-2021 LIBRARY; T=293.6K  
Photon emission for (n,3n)a

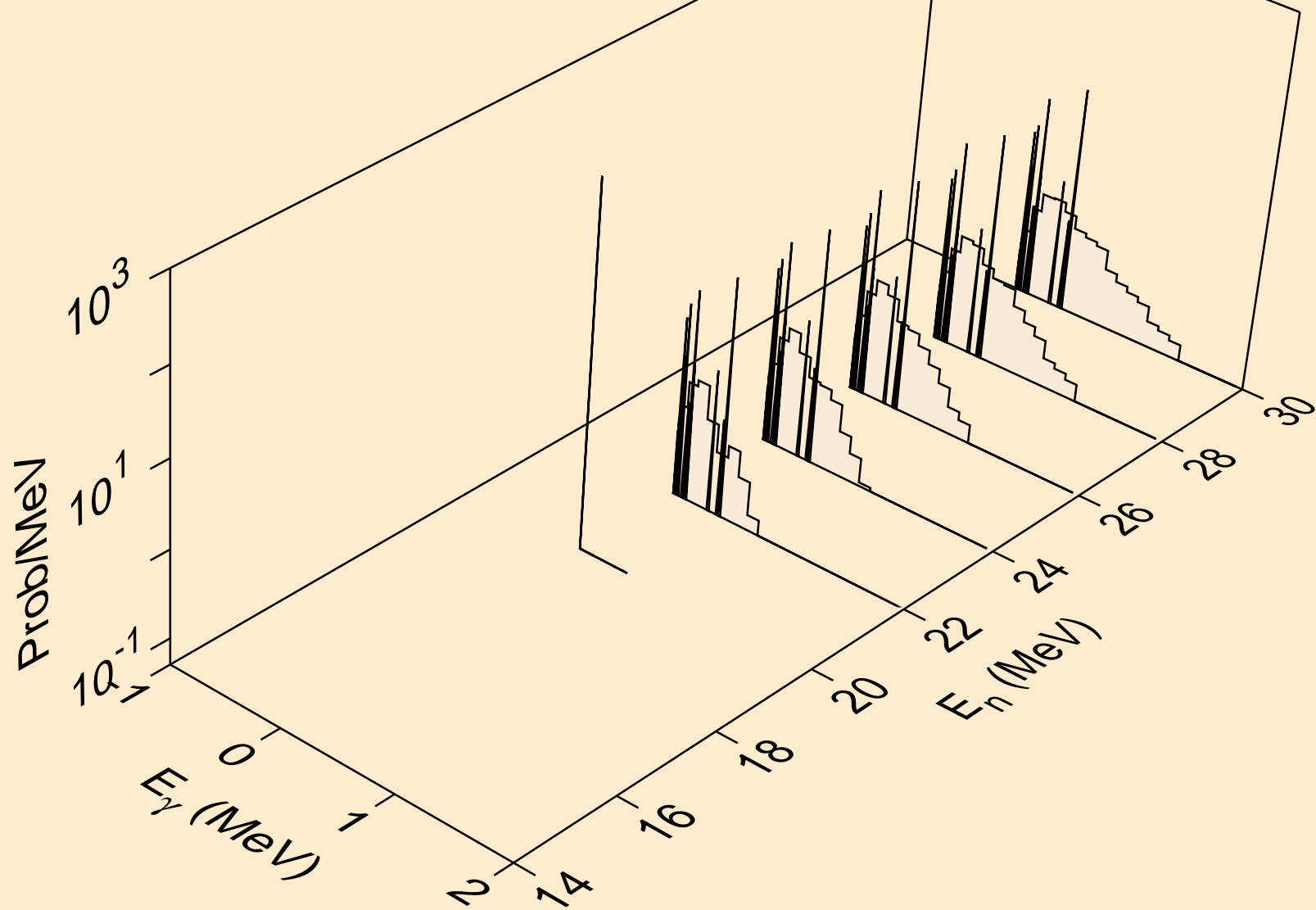

HO160N NEUTRON ACER TENDL-2021 LIBRARY; T=293.6K  
Photon emission for (n,n\*)p

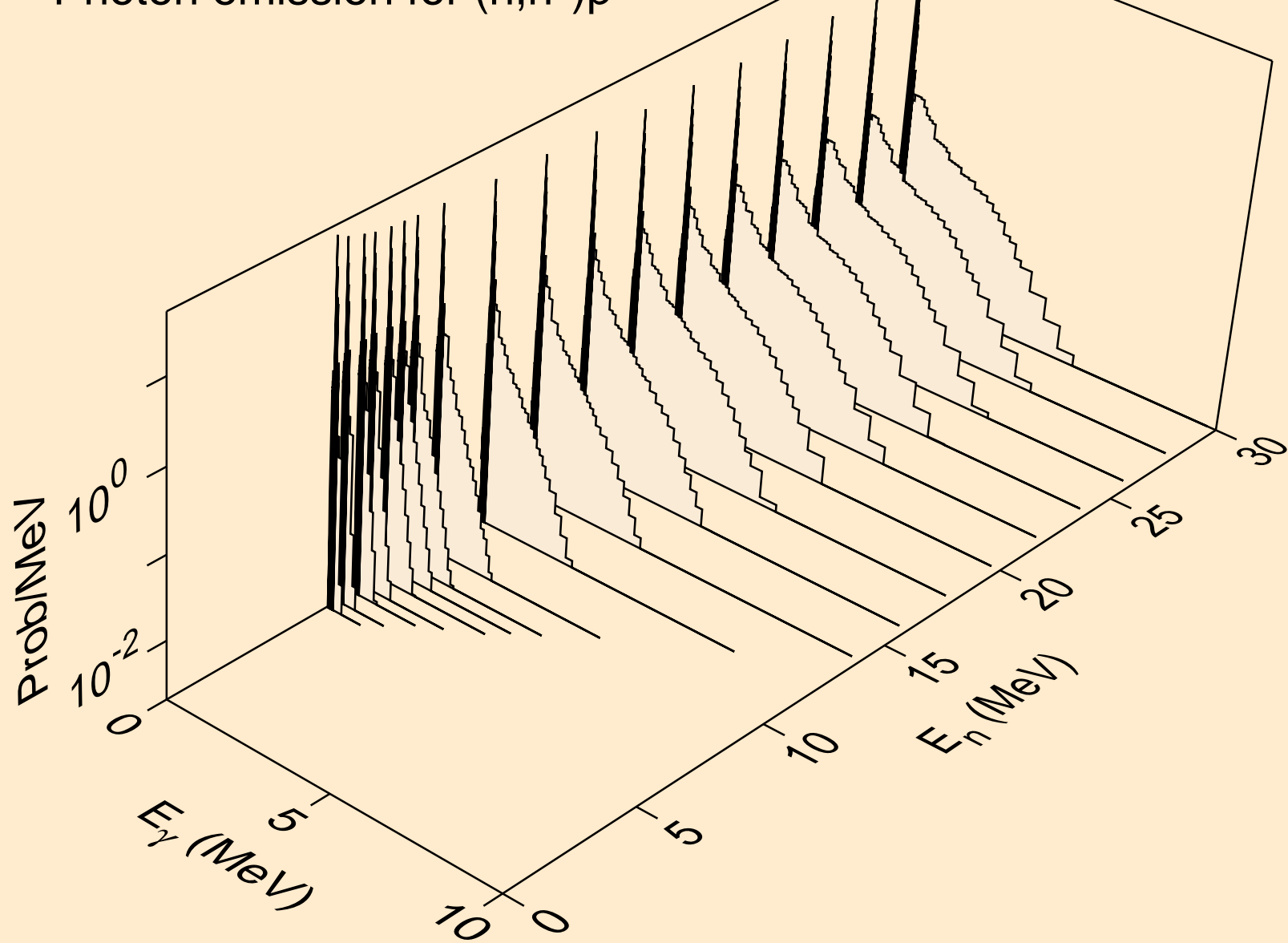

HO160N NEUTRON ACER TENDL-2021 LIBRARY; T=293.6K  
Photon emission for (n,n\*)2a

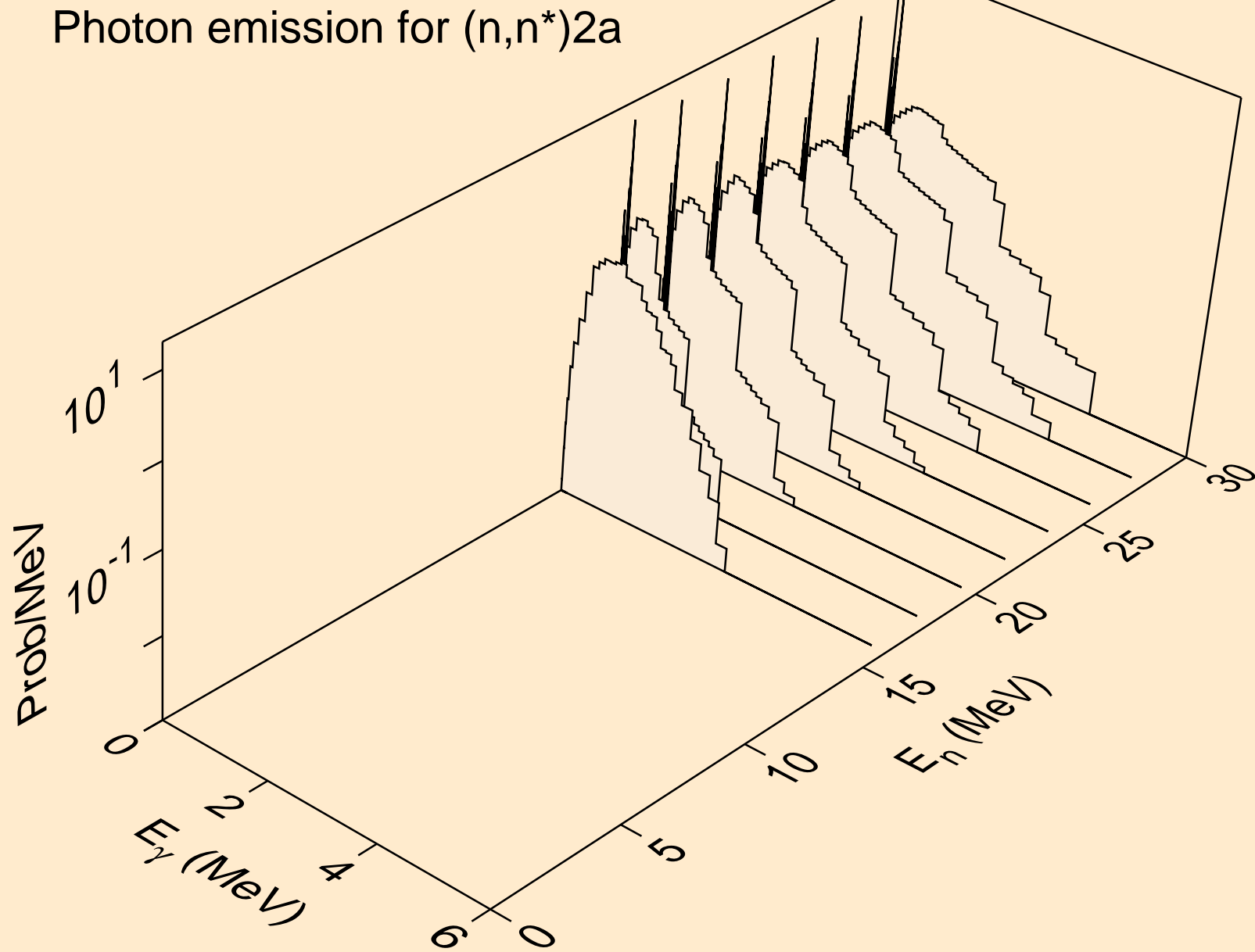

HO160N NEUTRON ACER TENDL-2021 LIBRARY; T=293.6K  
Photon emission for (n,n\*)d

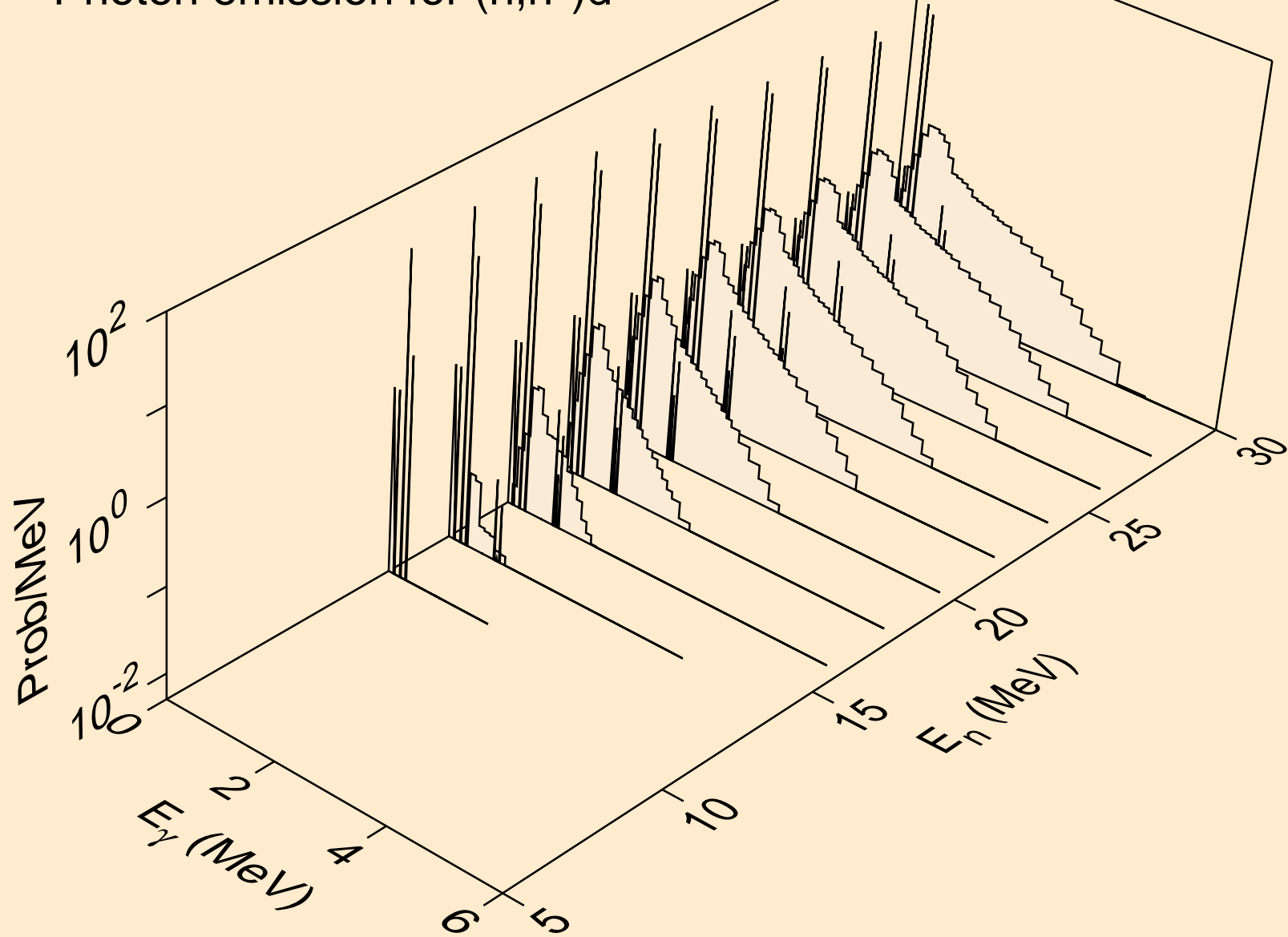

HO160N NEUTRON ACER TENDL-2021 LIBRARY; T=293.6K  
Photon emission for (n,n\*)t

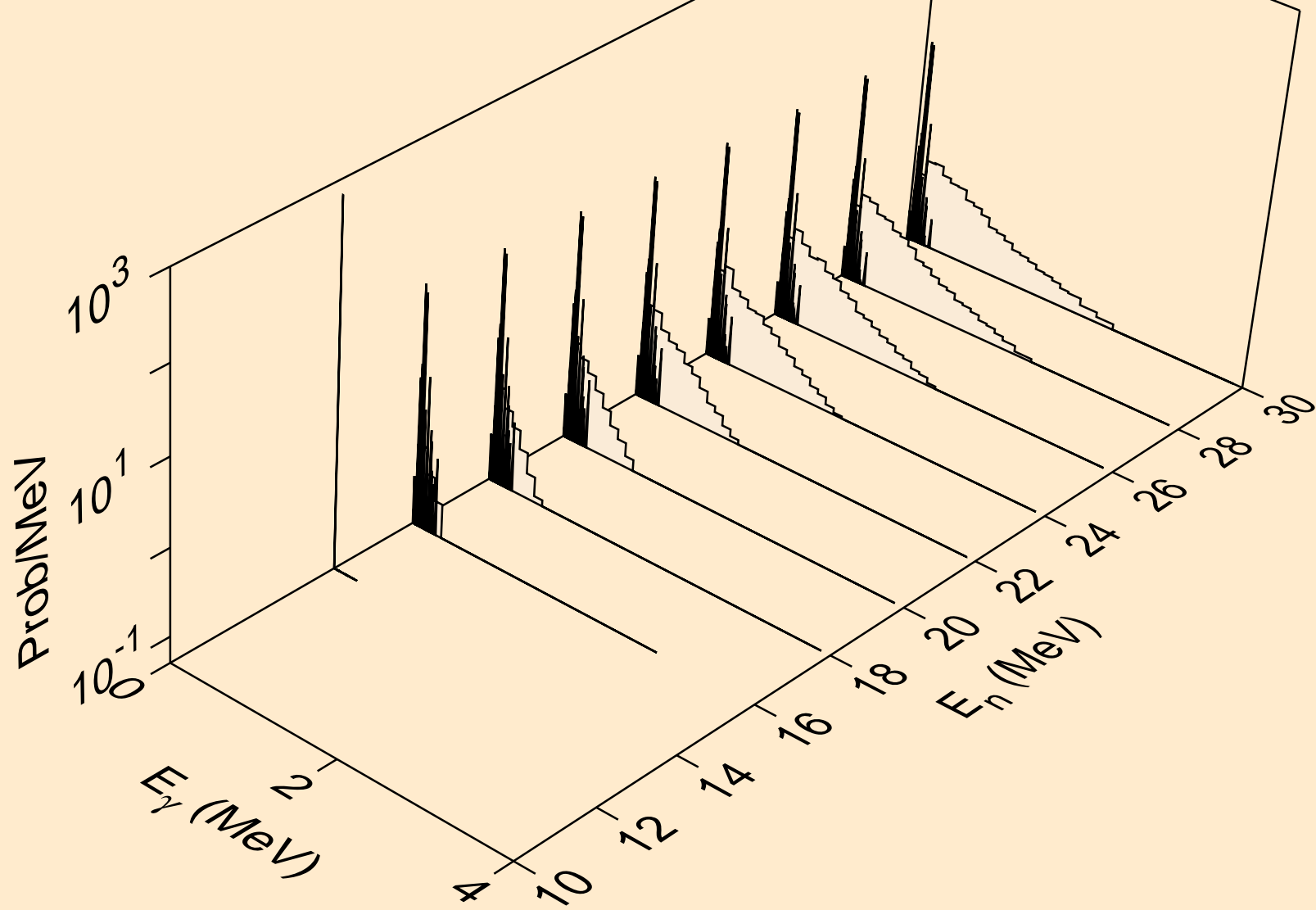



HO160N NEUTRON ACER TENDL-2021 LIBRARY; T=293.6K  
Photon emission for (n,n\*)he3

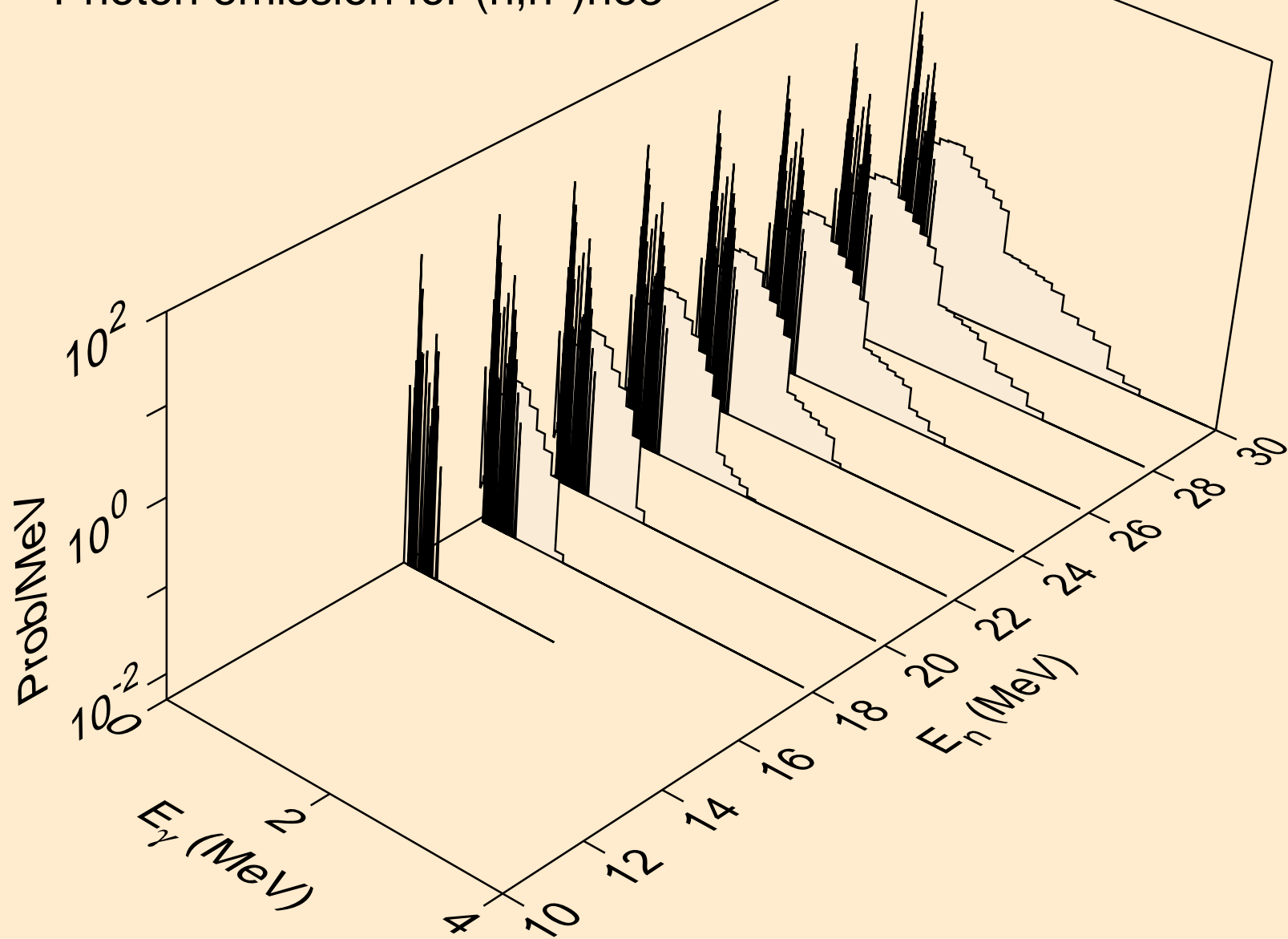

HO160N NEUTRON ACER TENDL-2021 LIBRARY; T=293.6K  
Photon emission for (n,4n)

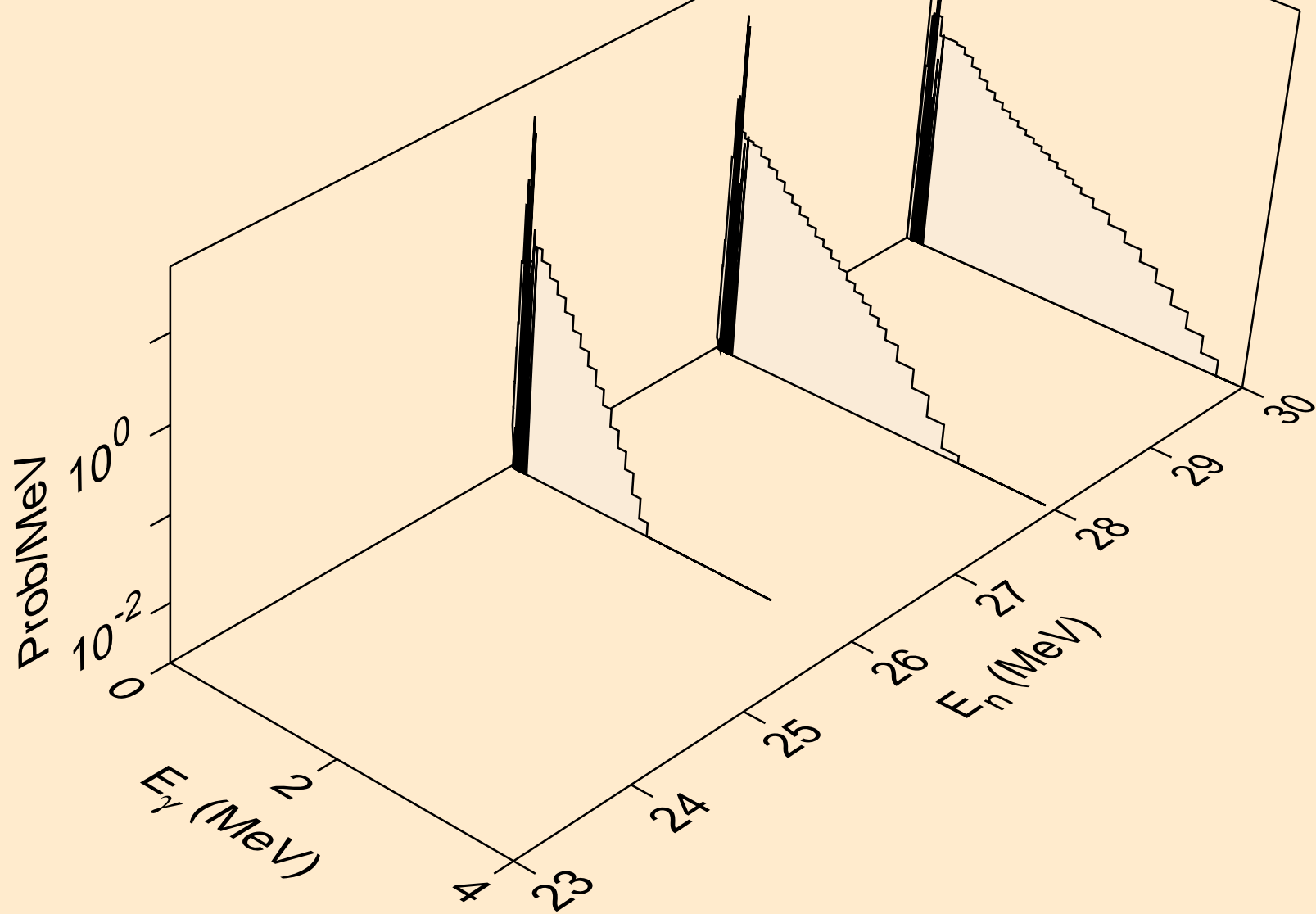

HO160N NEUTRON ACER TENDL-2021 LIBRARY; T=293.6K  
Photon emission for (n,2np)

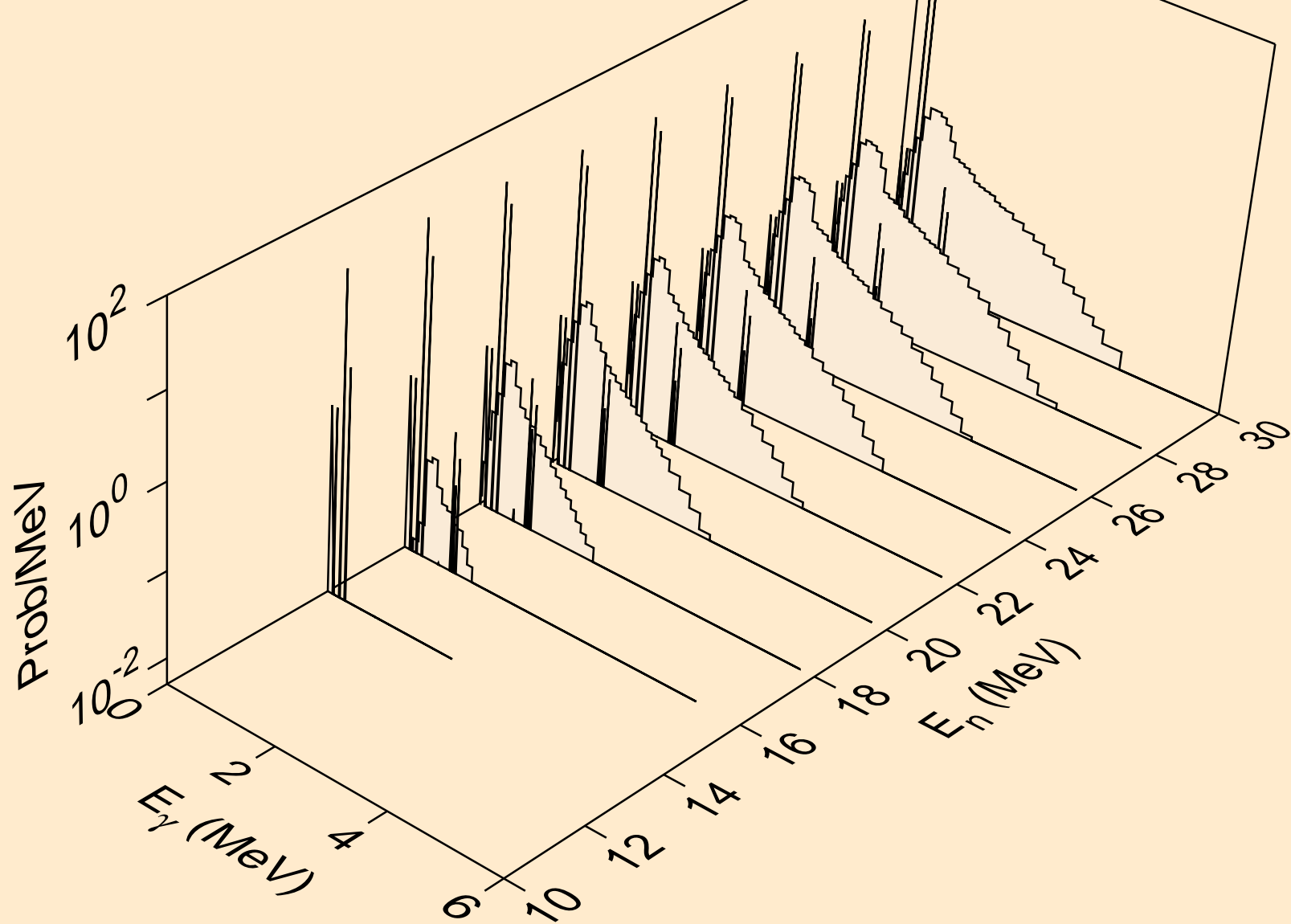

HO160N NEUTRON ACER TENDL-2021 LIBRARY; T=293.6K  
Photon emission for (n,3np)

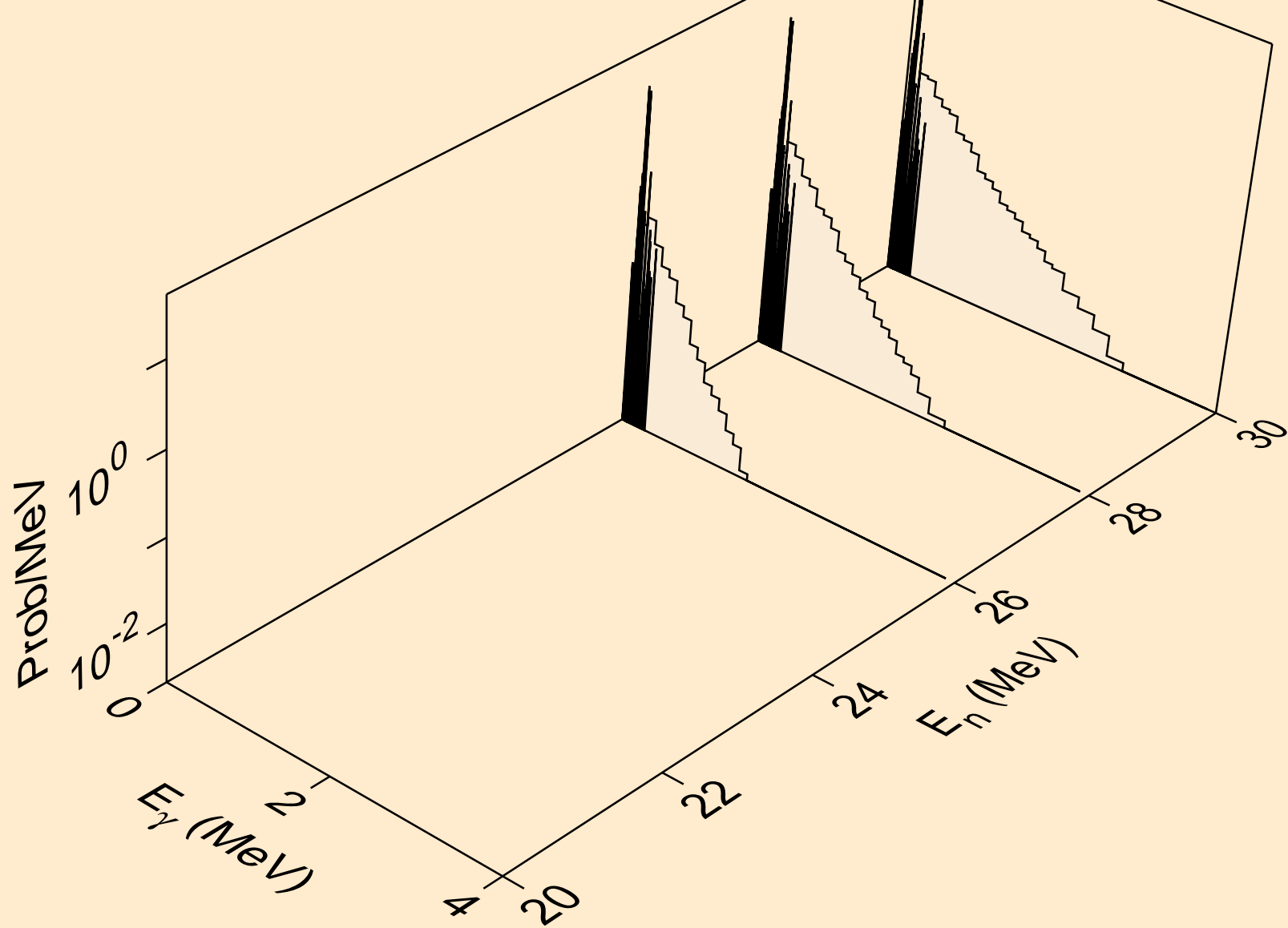

HO160N NEUTRON ACER TENDL-2021 LIBRARY; T=293.6K  
Photon emission for (n,2np)

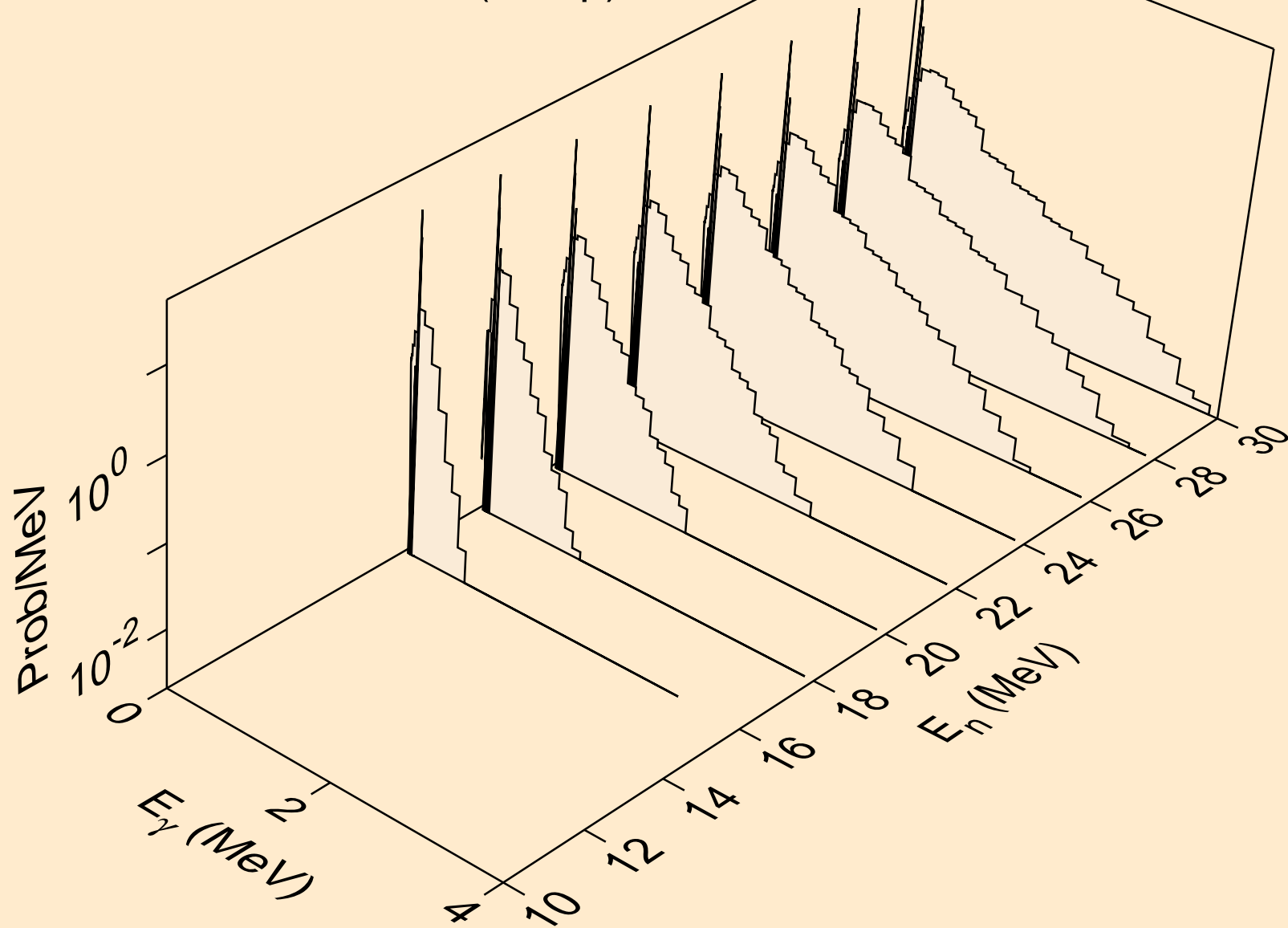

HO160N NEUTRON ACER TENDL-2021 LIBRARY; T=293.6K  
Photon emission for (n,npa)

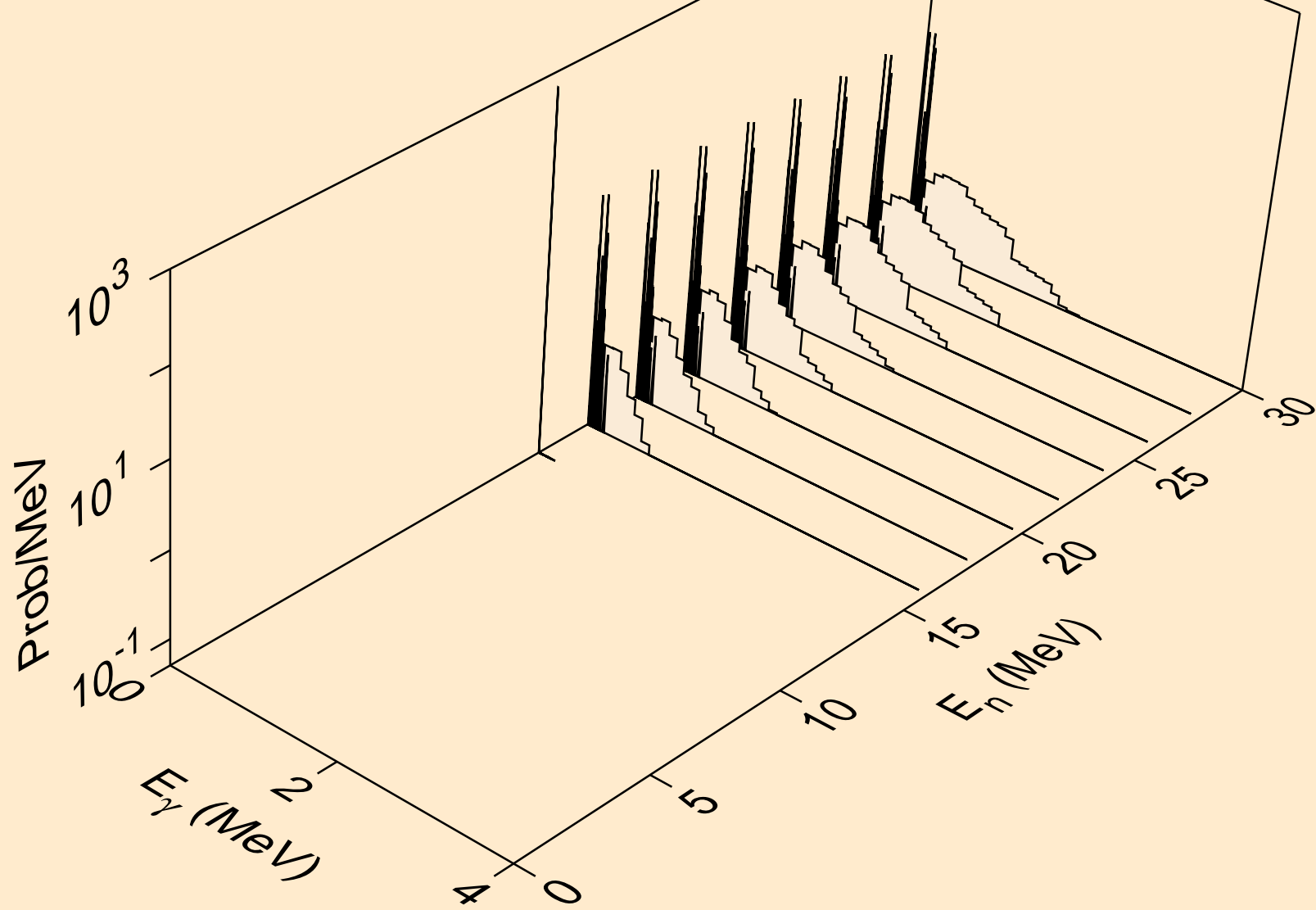

HO160N NEUTRON ACER TENDL-2021 LIBRARY; T=293.6K  
Photon emission for (n,n\*2)

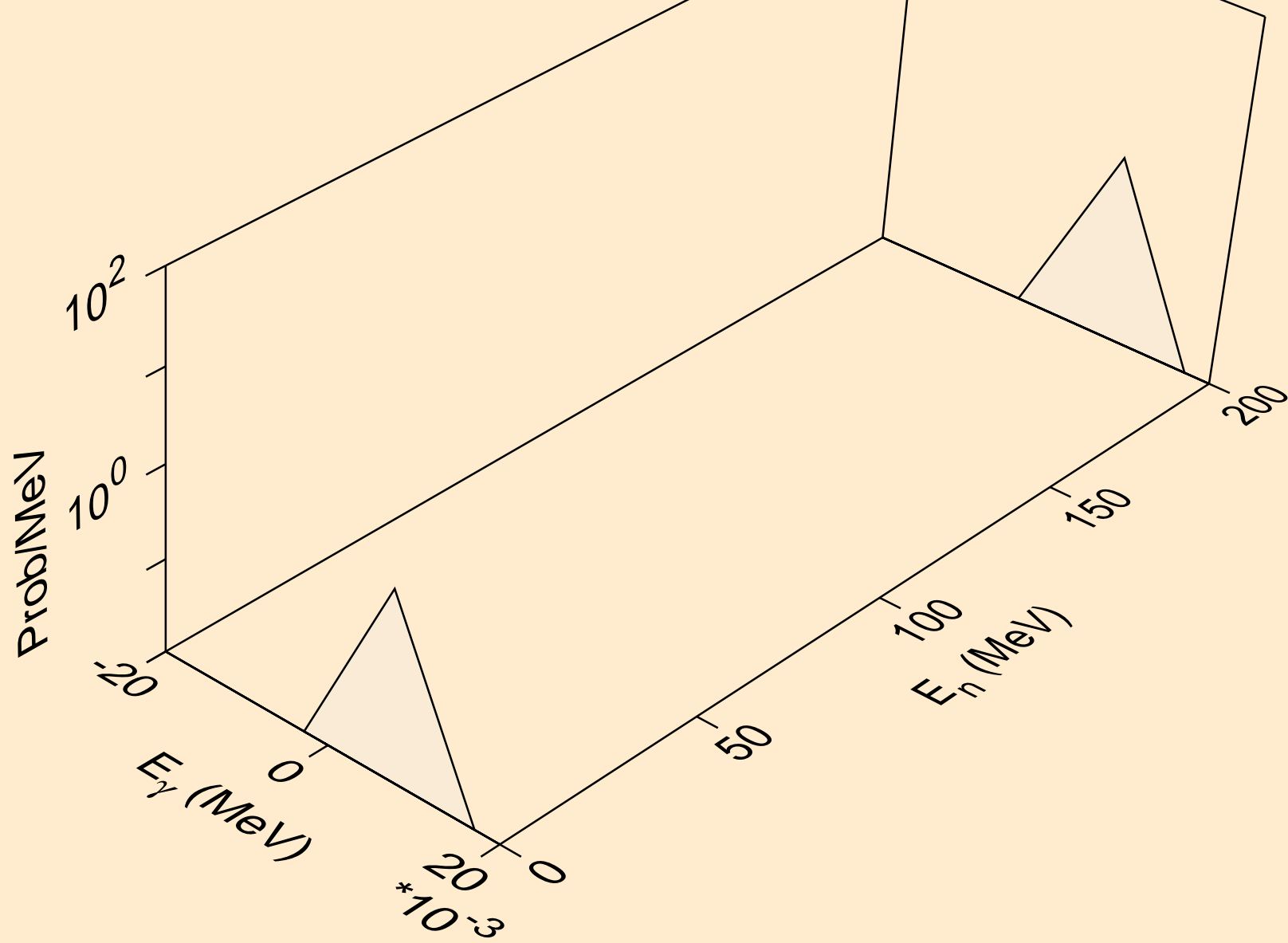

HO160N NEUTRON ACER TENDL-2021 LIBRARY; T=293.6K  
Photon emission for (n,n\*3)

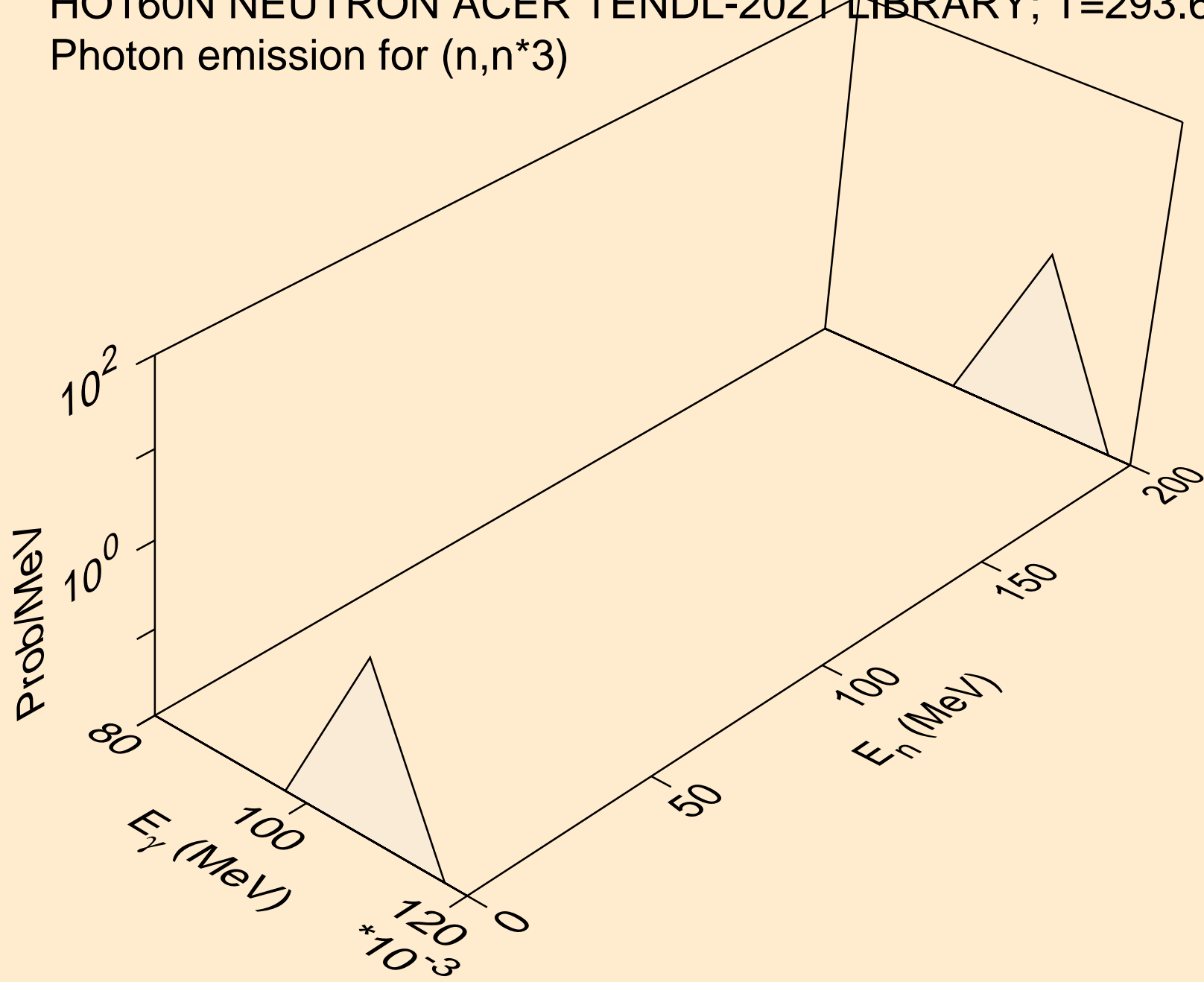



HO160N NEUTRON ACER TENDL-2021 LIBRARY; T=293.6K  
Photon emission for (n,n\*4)

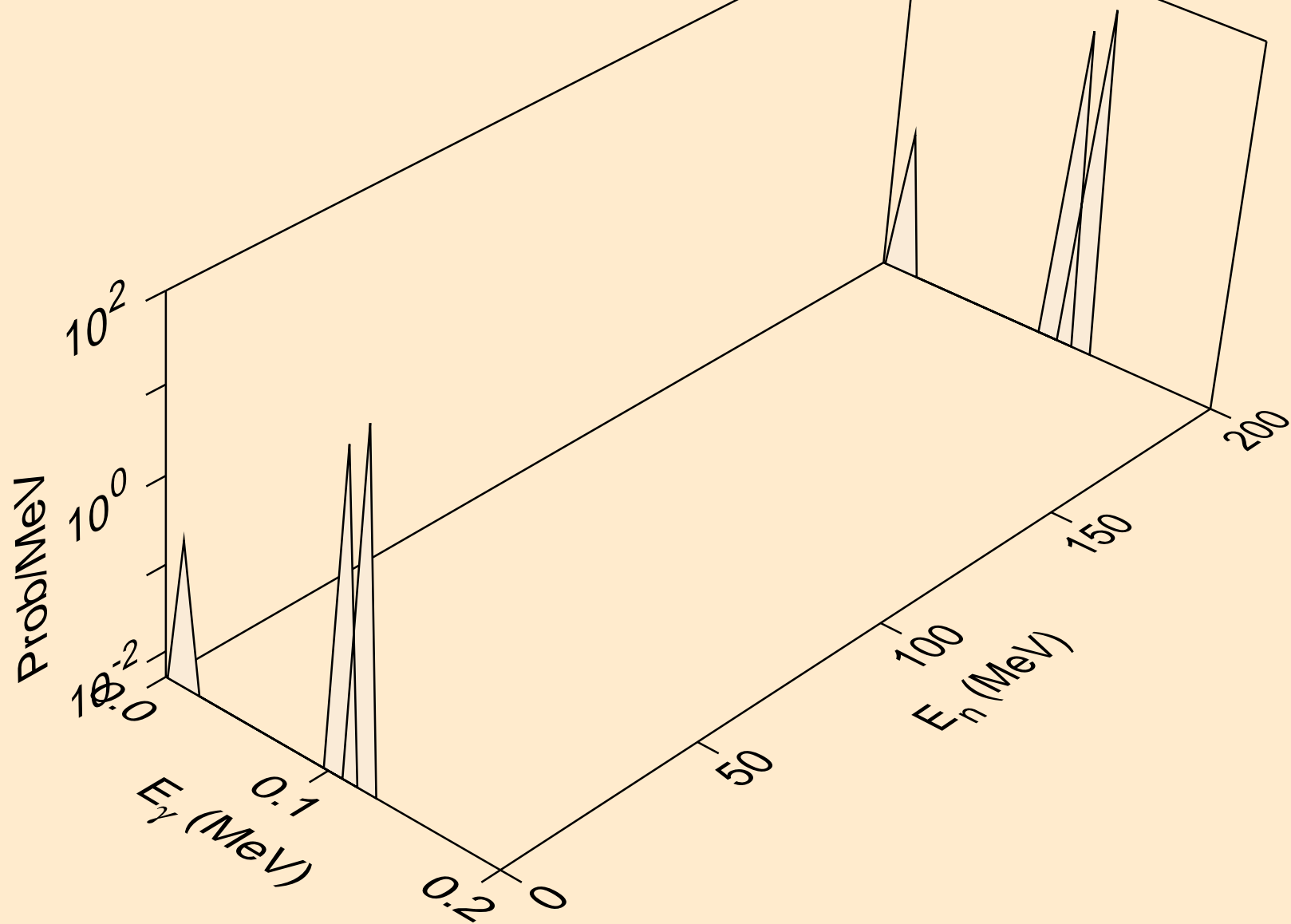

HO160N NEUTRON ACER TENDL-2021 LIBRARY; T=293.6K  
Photon emission for (n,n\*5)

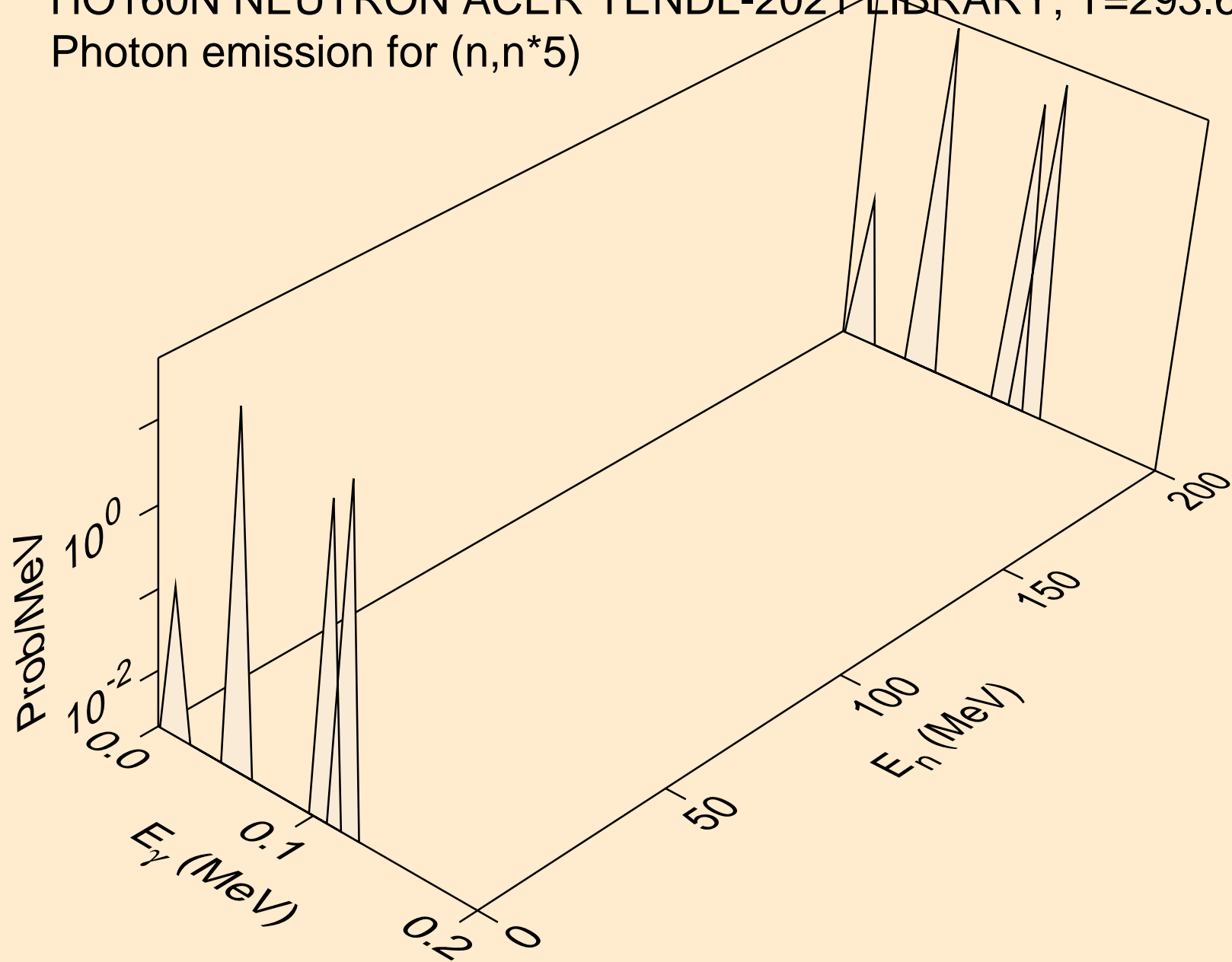

HO160N NEUTRON ACER TENDL-2021 LIBRARY; T=293.6K  
Photon emission for (n,n\*6)

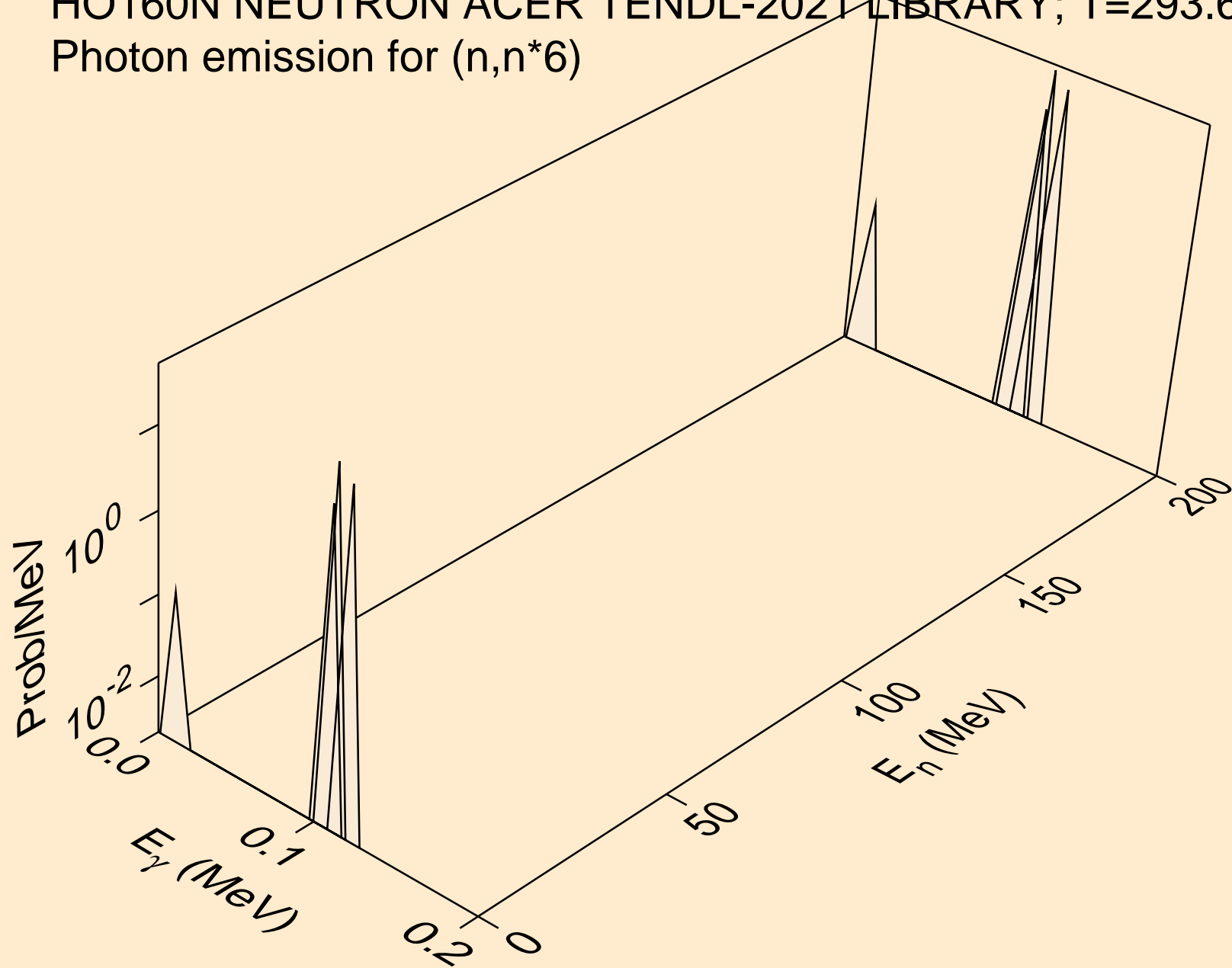

HO160N NEUTRON ACER TENDL-2021 LIBRARY; T=293.6K  
Photon emission for (n,n\*7)

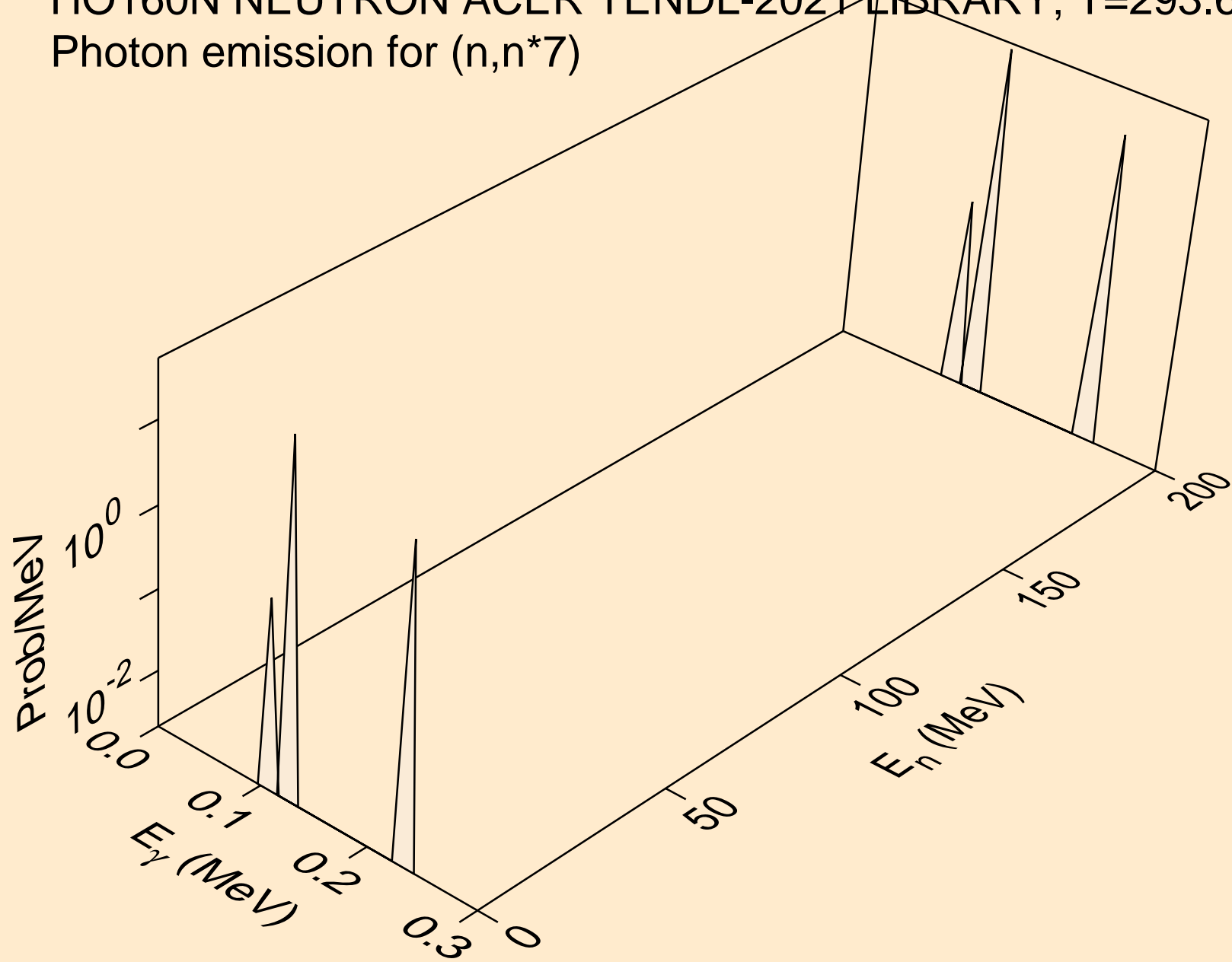

HO160N NEUTRON ACER TENDL-2021 LIBRARY; T=293.6K  
Photon emission for (n,n\*8)

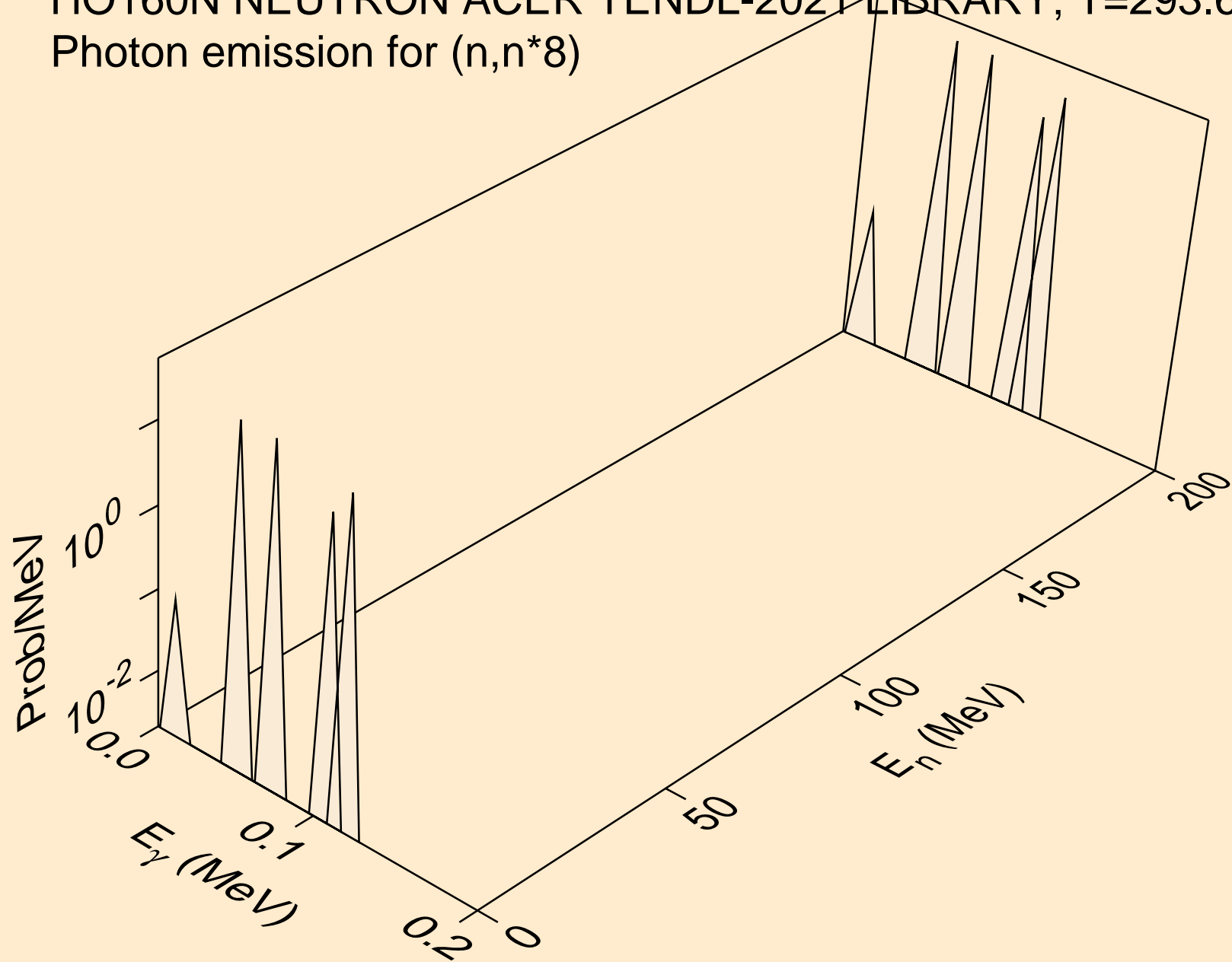

HO160N NEUTRON ACER TENDL-2021 LIBRARY; T=293.6K  
Photon emission for (n,n\*10)

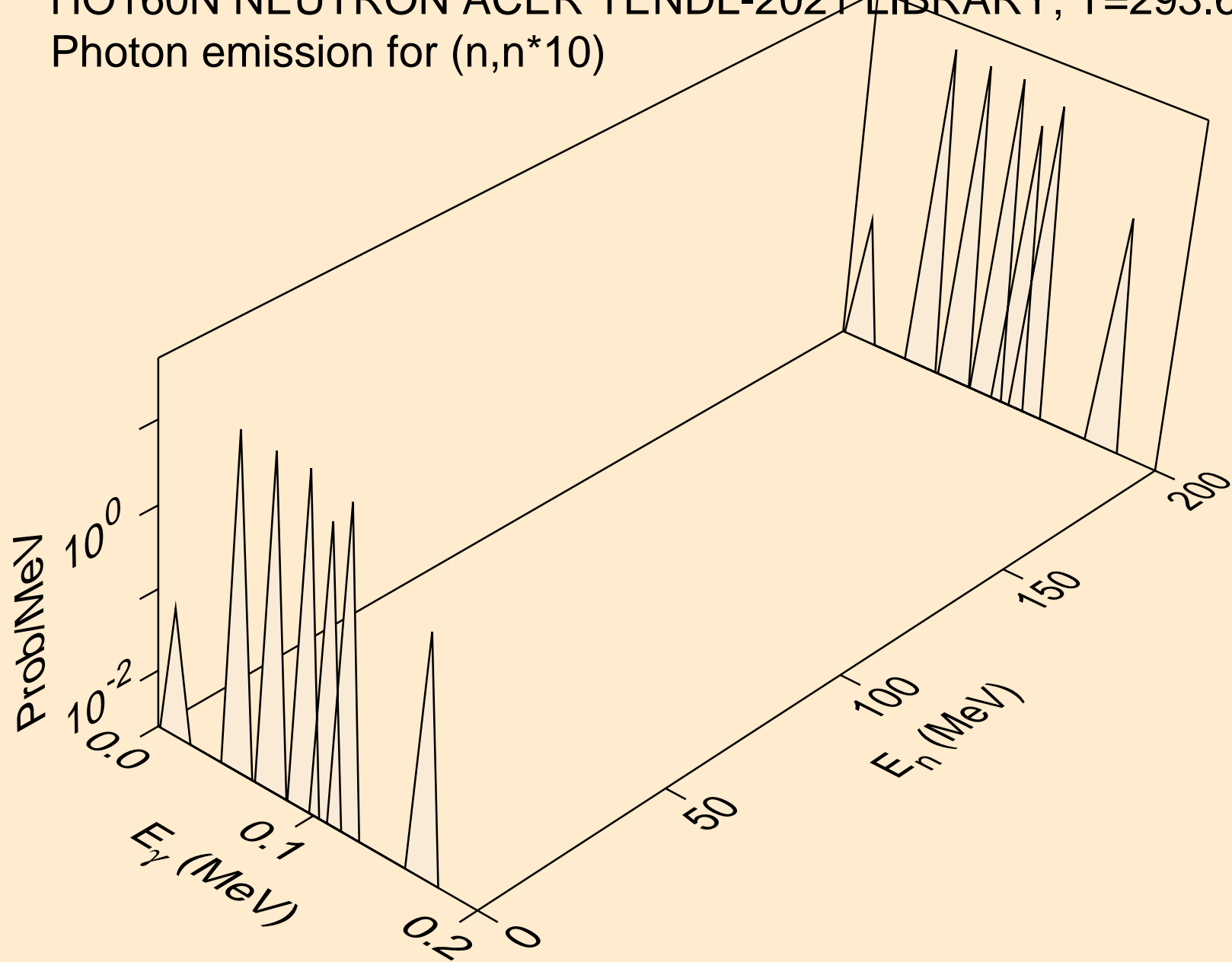

HO160N NEUTRON ACER TENDL-2021 LIBRARY; T=293.6K  
Photon emission for (n,n\*11)

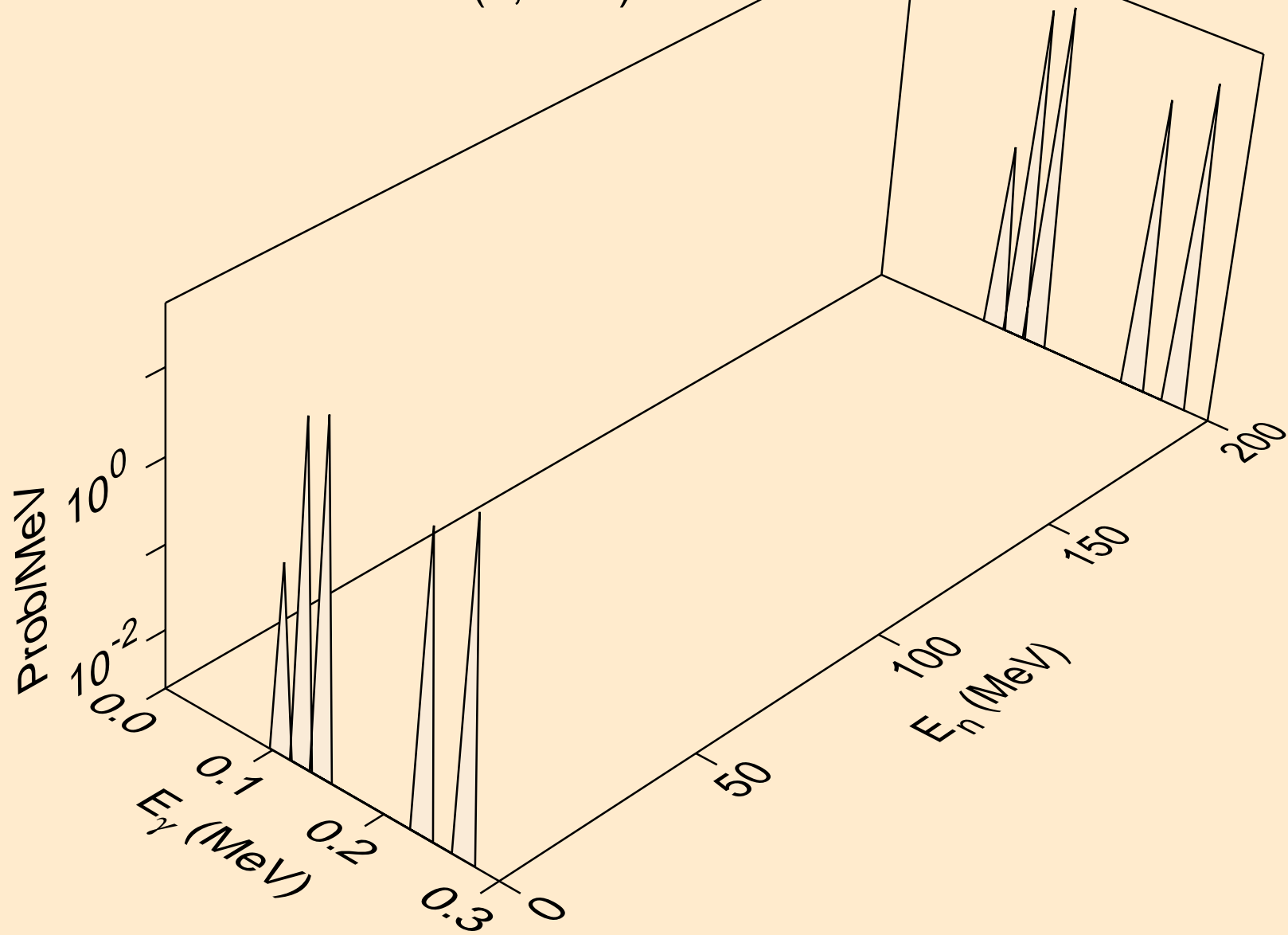

HO160N NEUTRON ACER TENDL-2021 LIBRARY; T=293.6K  
Photon emission for (n,n\*12)

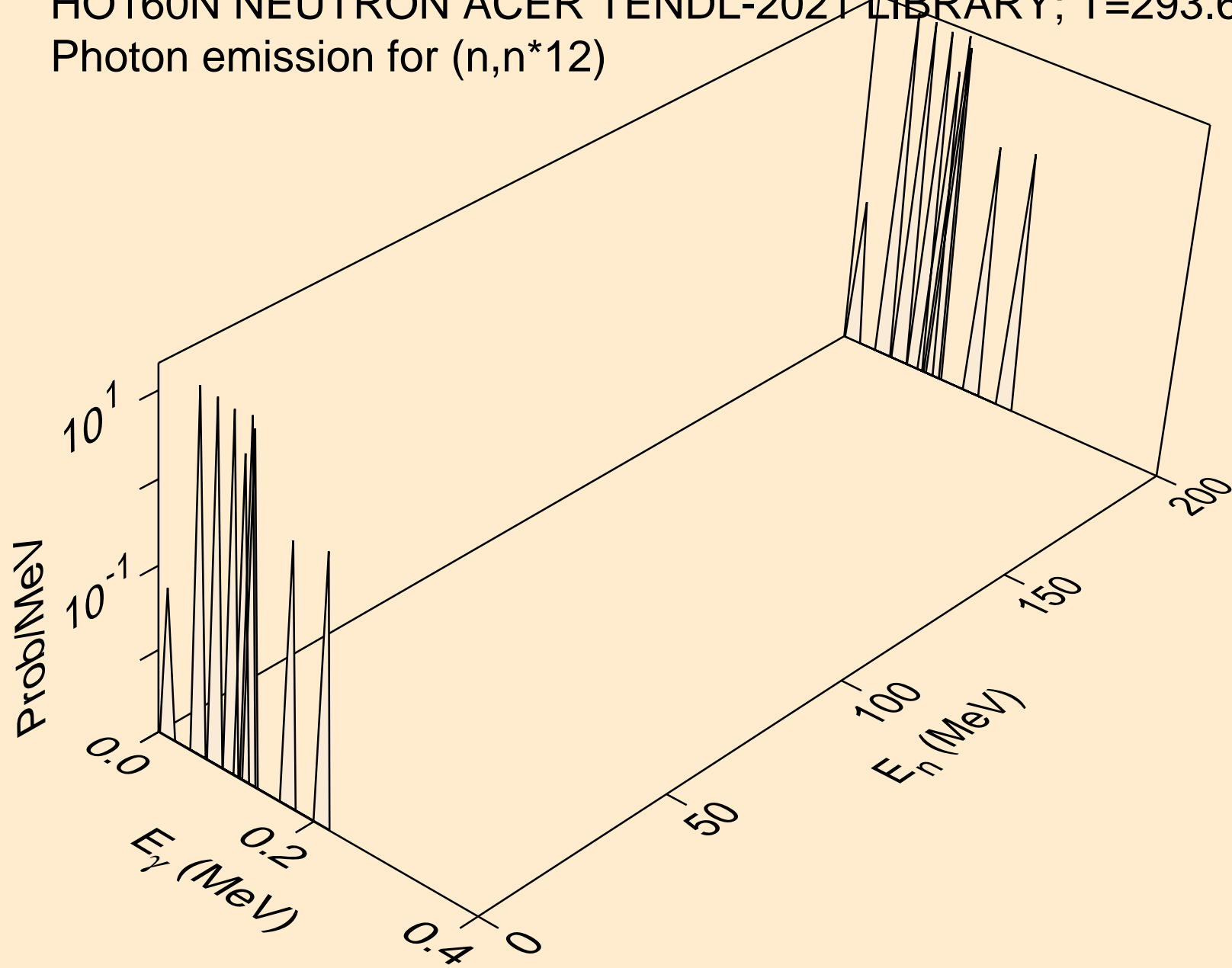



HO160N NEUTRON ACER TENDL-2021 LIBRARY; T=293.6K  
Photon emission for (n,n\*13)

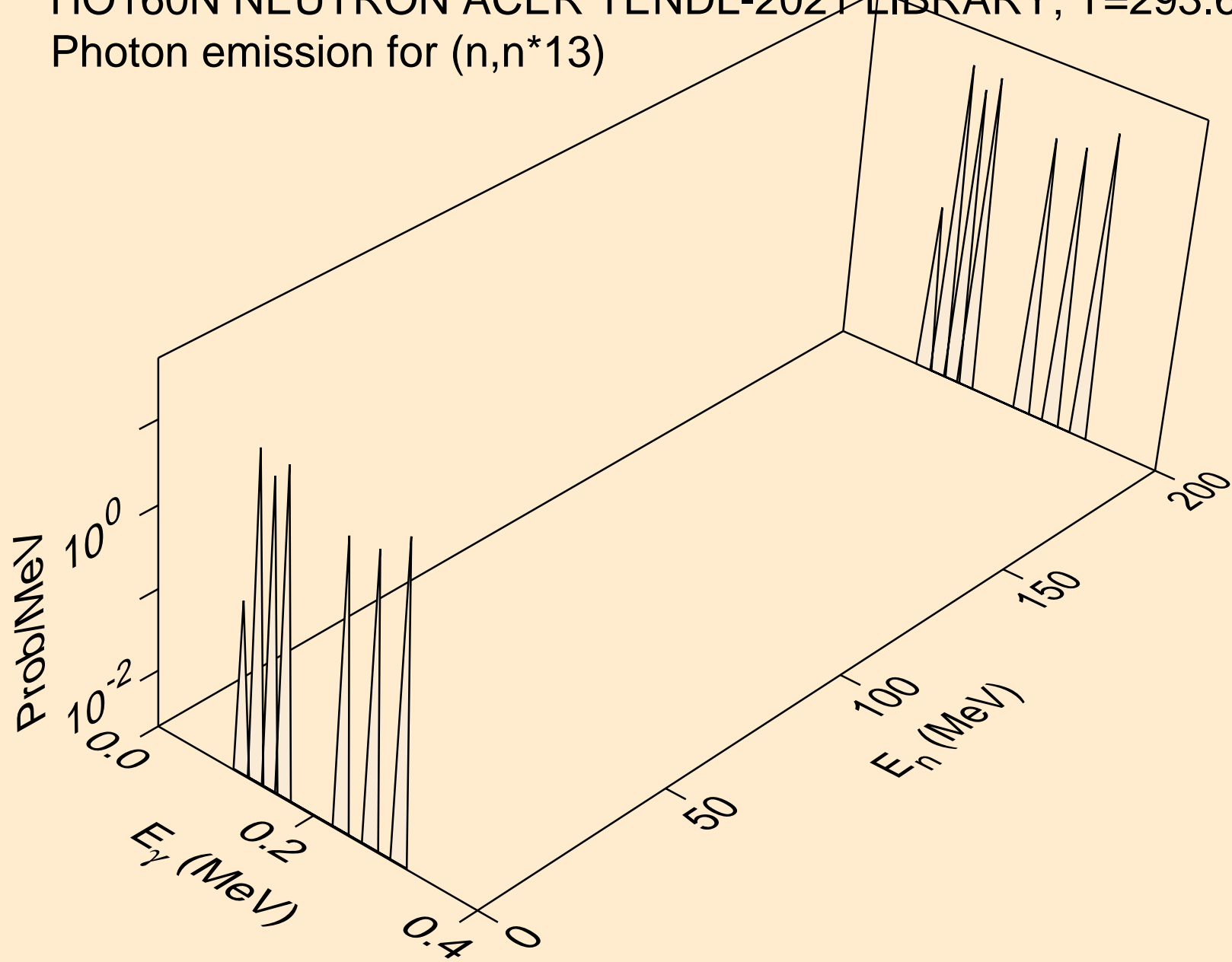

HO160N NEUTRON ACER TENDL-2021 LIBRARY; T=293.6K  
Photon emission for (n,n\*14)

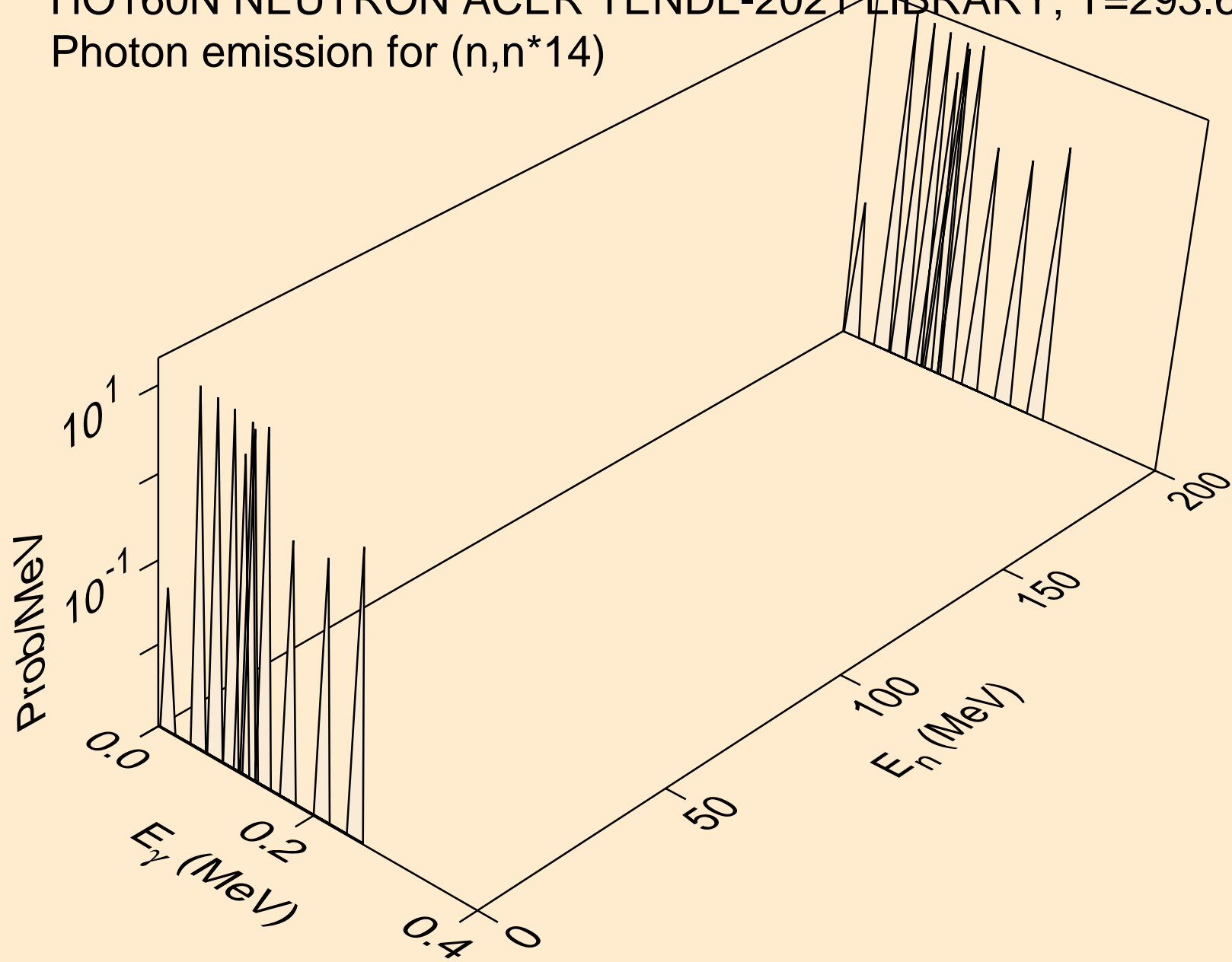

HO160N NEUTRON ACER TENDL-2021 LIBRARY; T=293.6K  
Photon emission for (n,n\*15)

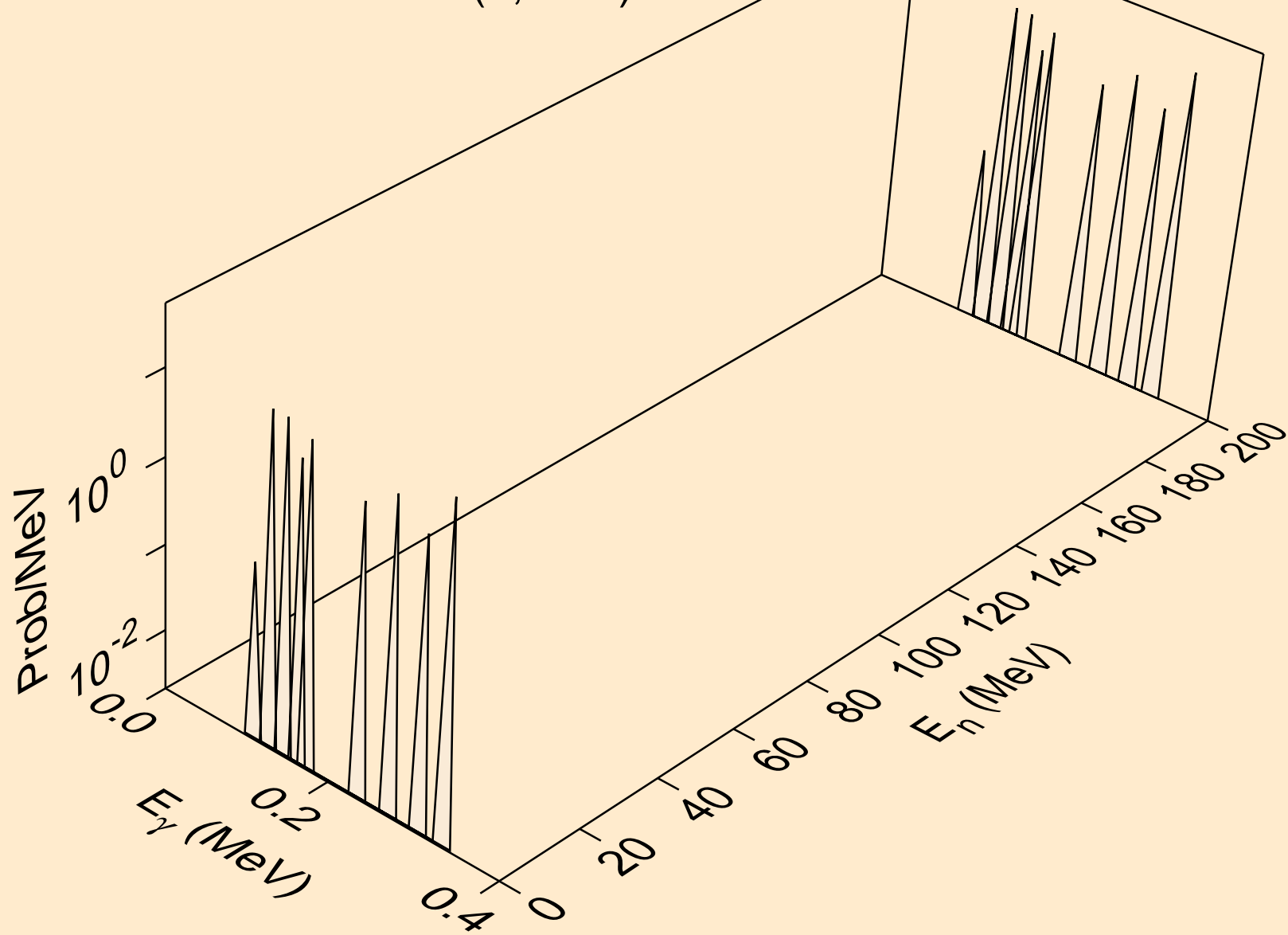

HO160N NEUTRON ACER TENDL-2021 LIBRARY; T=293.6K  
Photon emission for (n,n\*16)

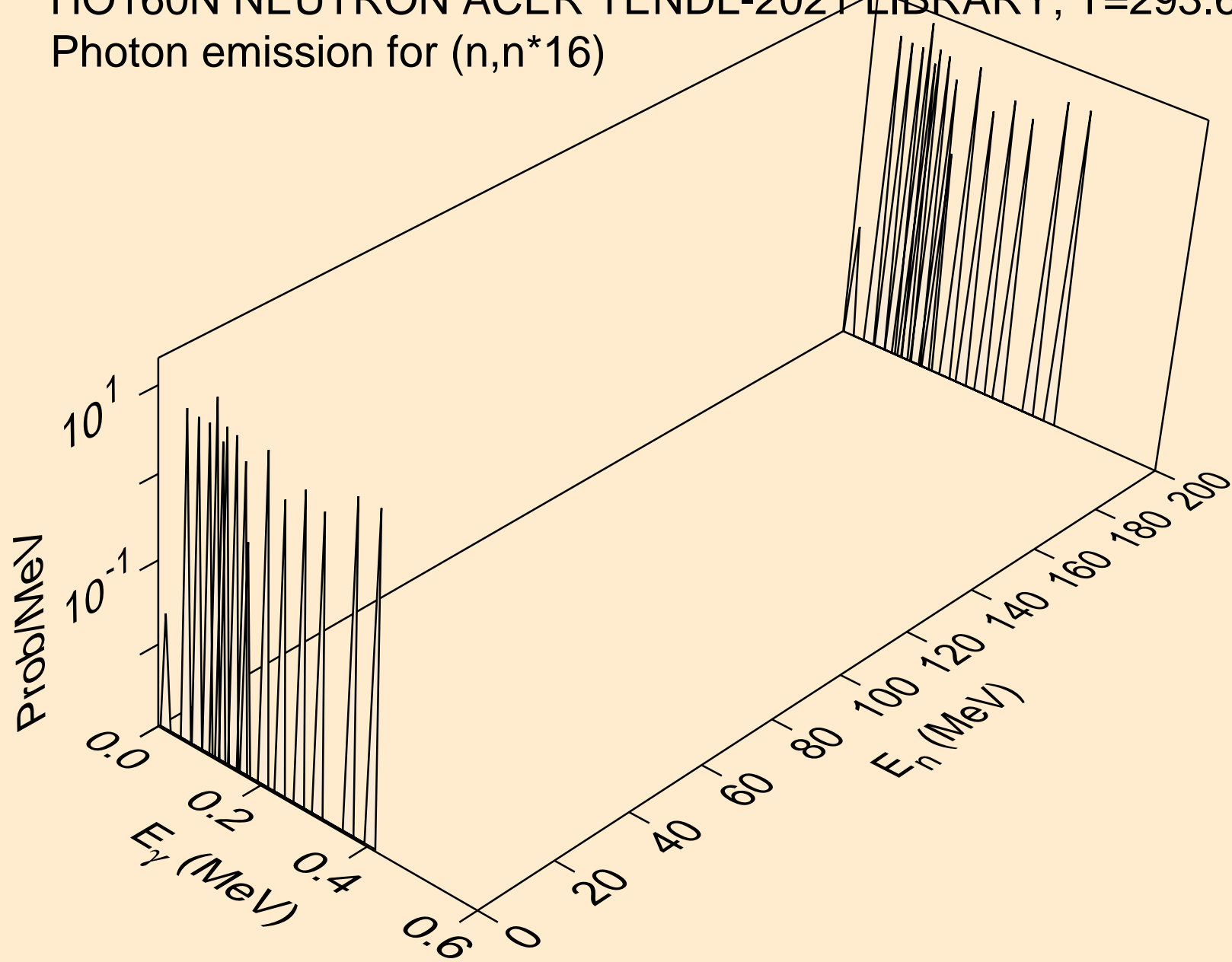

HO160N NEUTRON ACER TENDL-2021 LIBRARY; T=293.6K  
Photon emission for (n,n\*17)

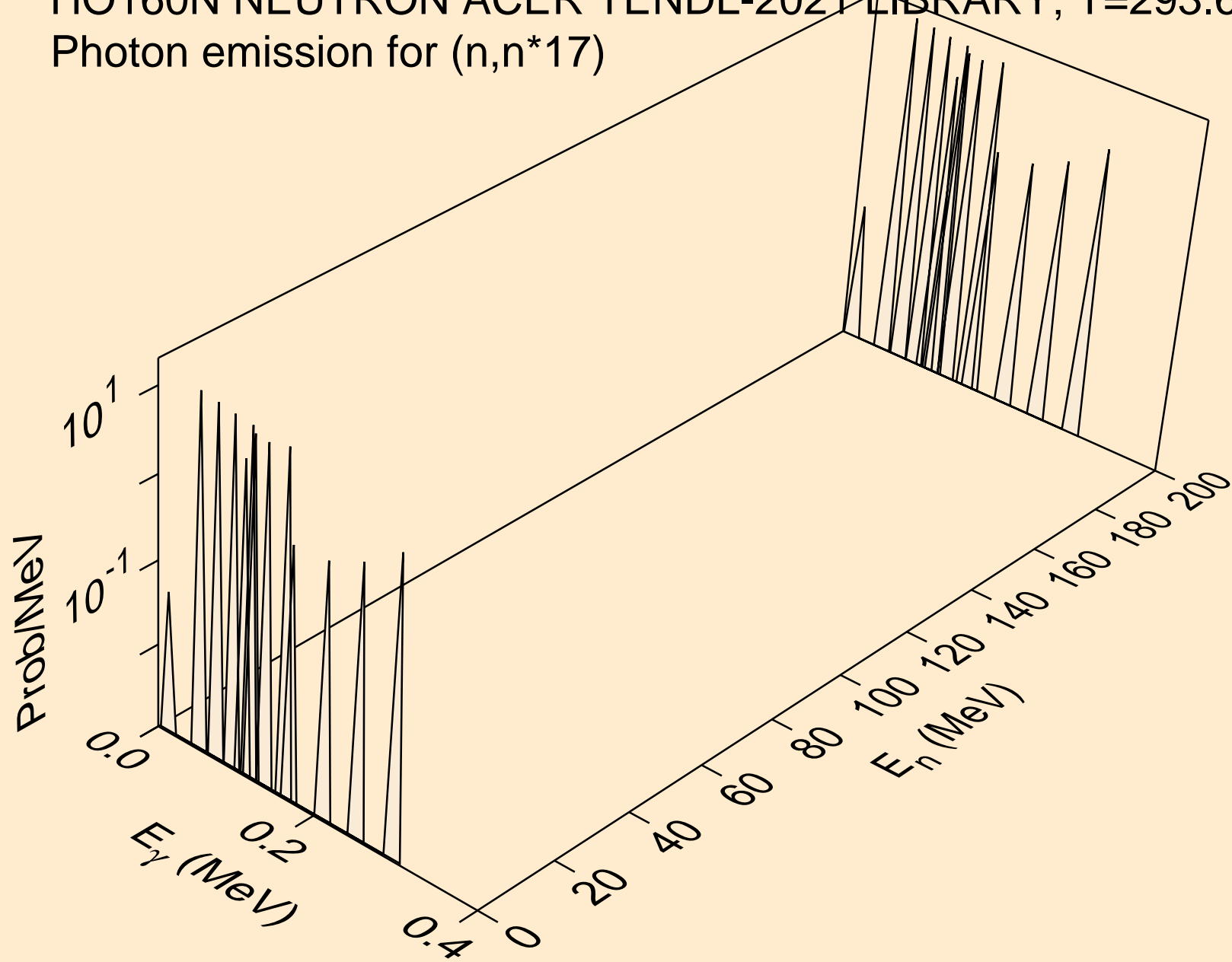

HO160N NEUTRON ACER TENDL-2021 LIBRARY; T=293.6K  
Photon emission for (n,n\*18)

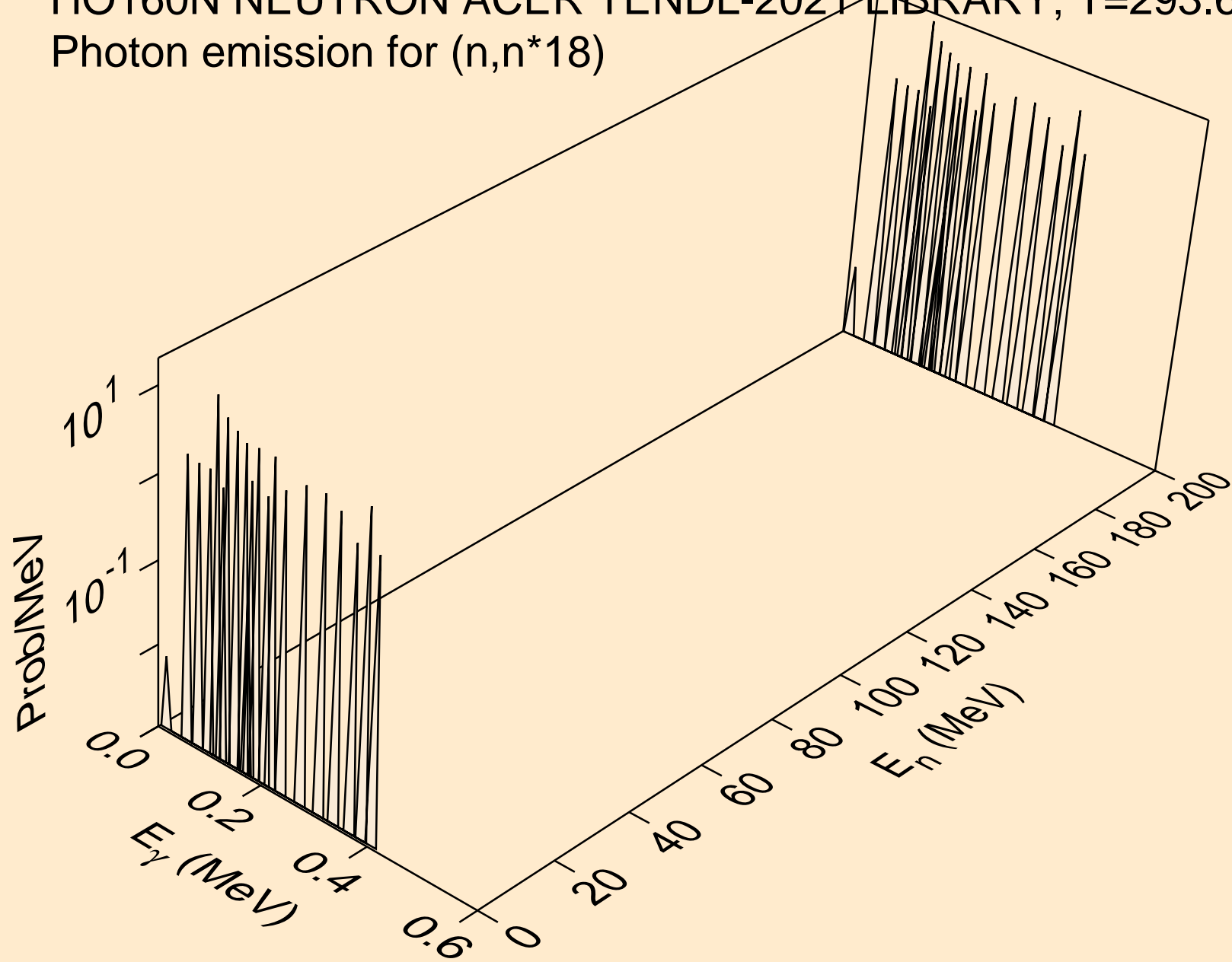

HO160N NEUTRON ACER TENDL-2021 LIBRARY; T=293.6K  
Photon emission for (n,n\*19)

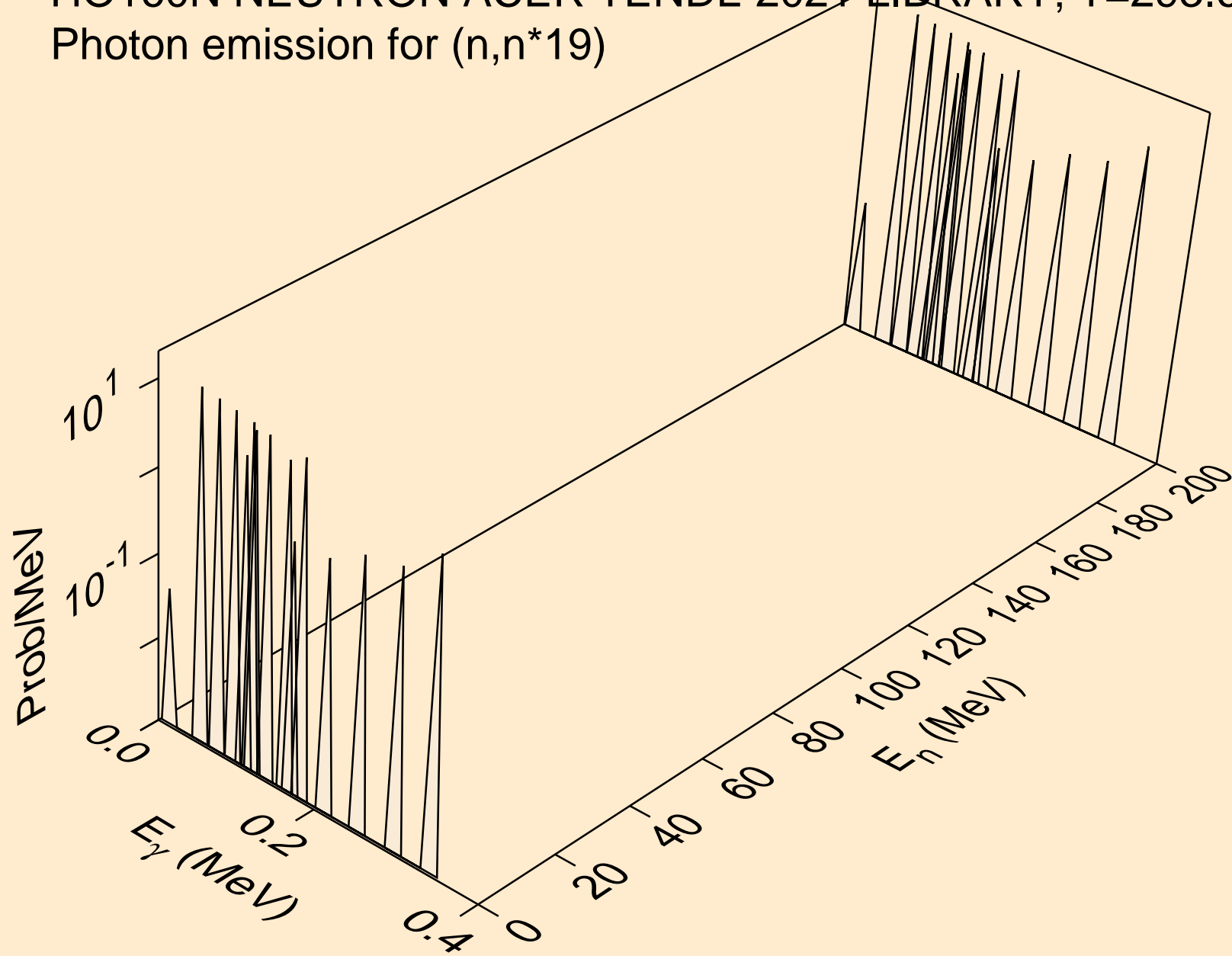

HO160N NEUTRON ACER TENDL-2021 LIBRARY; T=293.6K  
Photon emission for (n,n\*20)

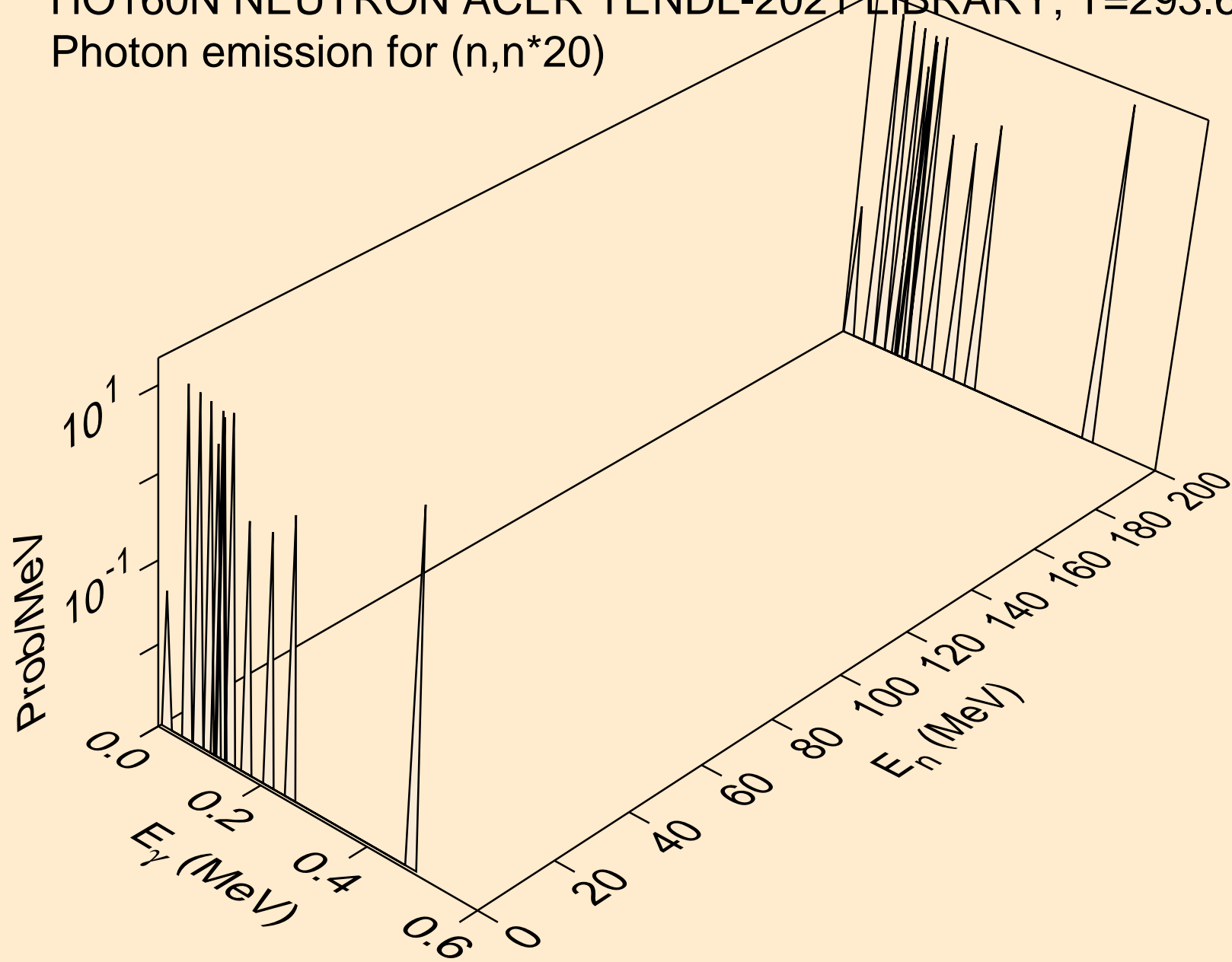



HO160N NEUTRON ACER TENDL-2021 LIBRARY; T=293.6K  
Photon emission for (n,n\*21)

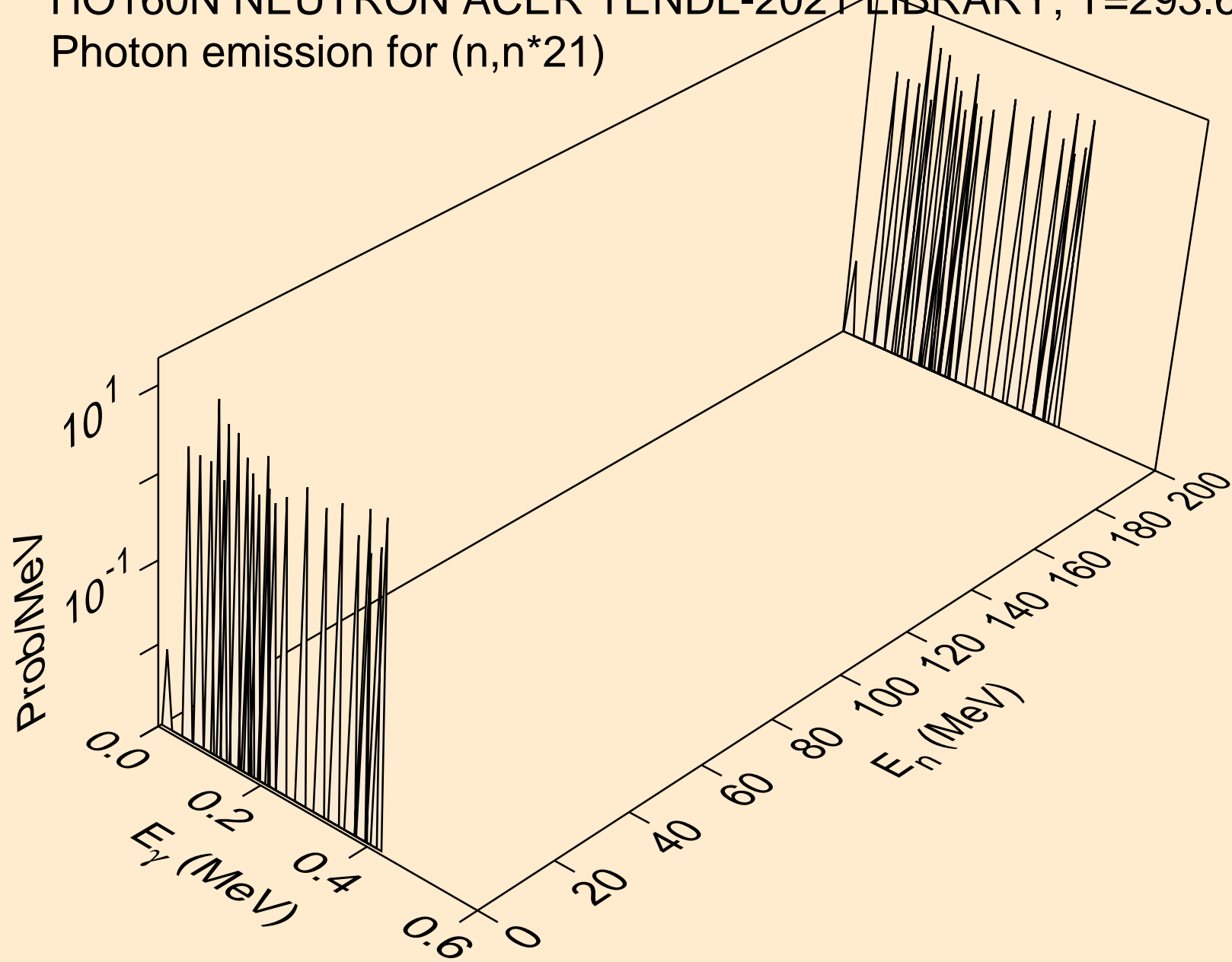

HO160N NEUTRON ACER TENDL-2021 LIBRARY; T=293.6K  
Photon emission for (n,n\*c)

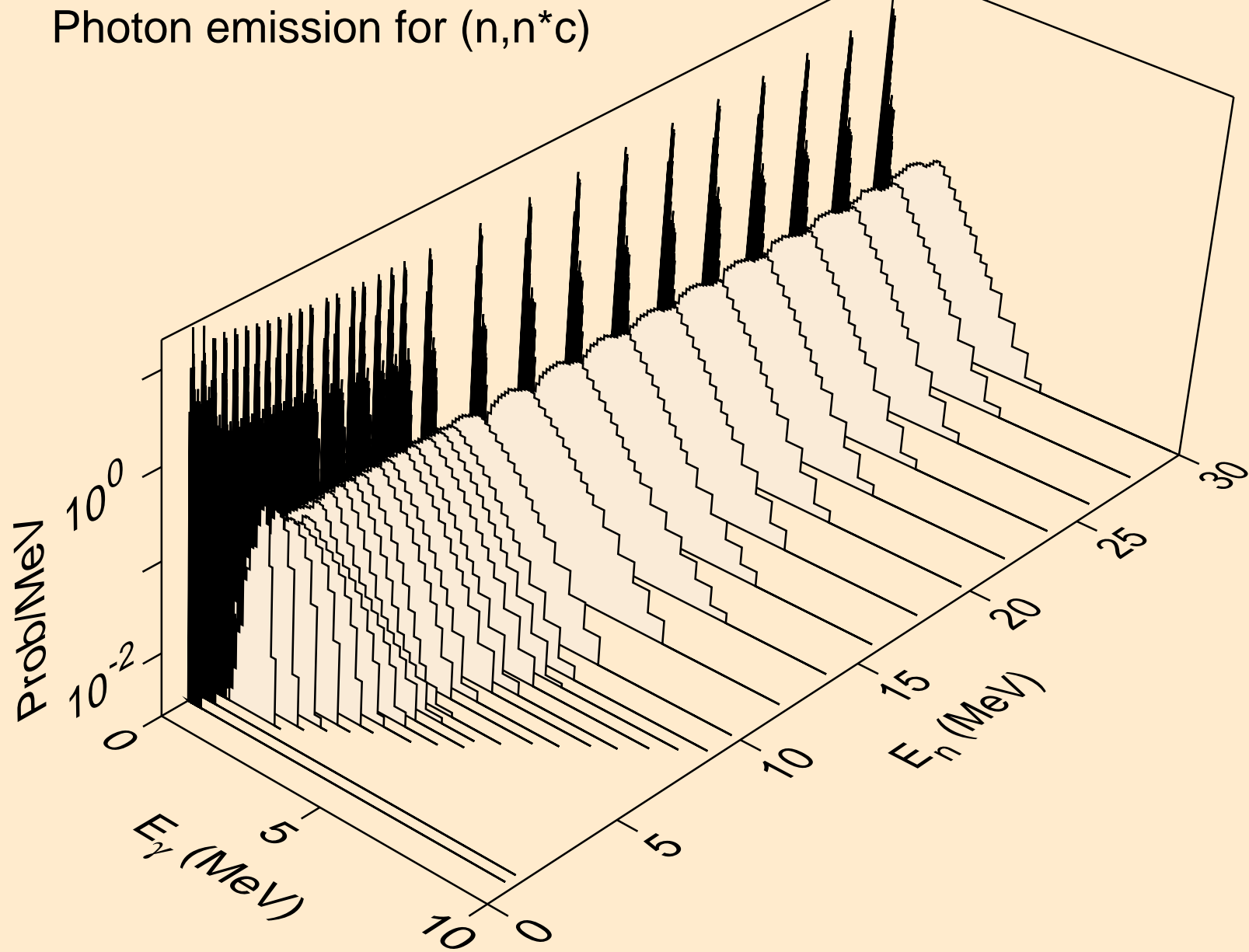

HO160N NEUTRON ACER TENDL-2021 LIBRARY; T=293.6K  
Photon emission for (n,gma)

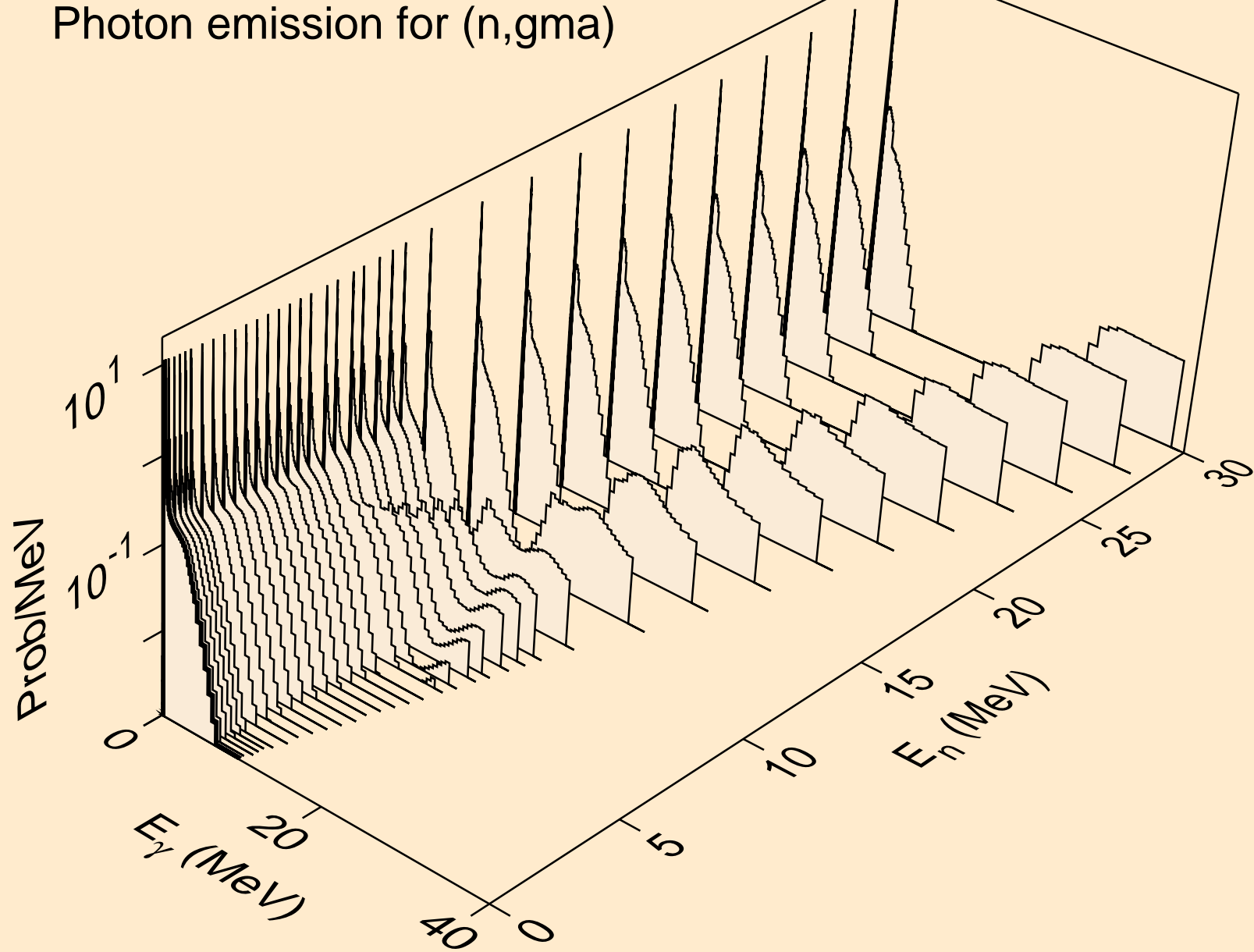

HO160N NEUTRON ACER TENDL-2021 LIBRARY; T=293.6K  
Photon emission for (n,p)

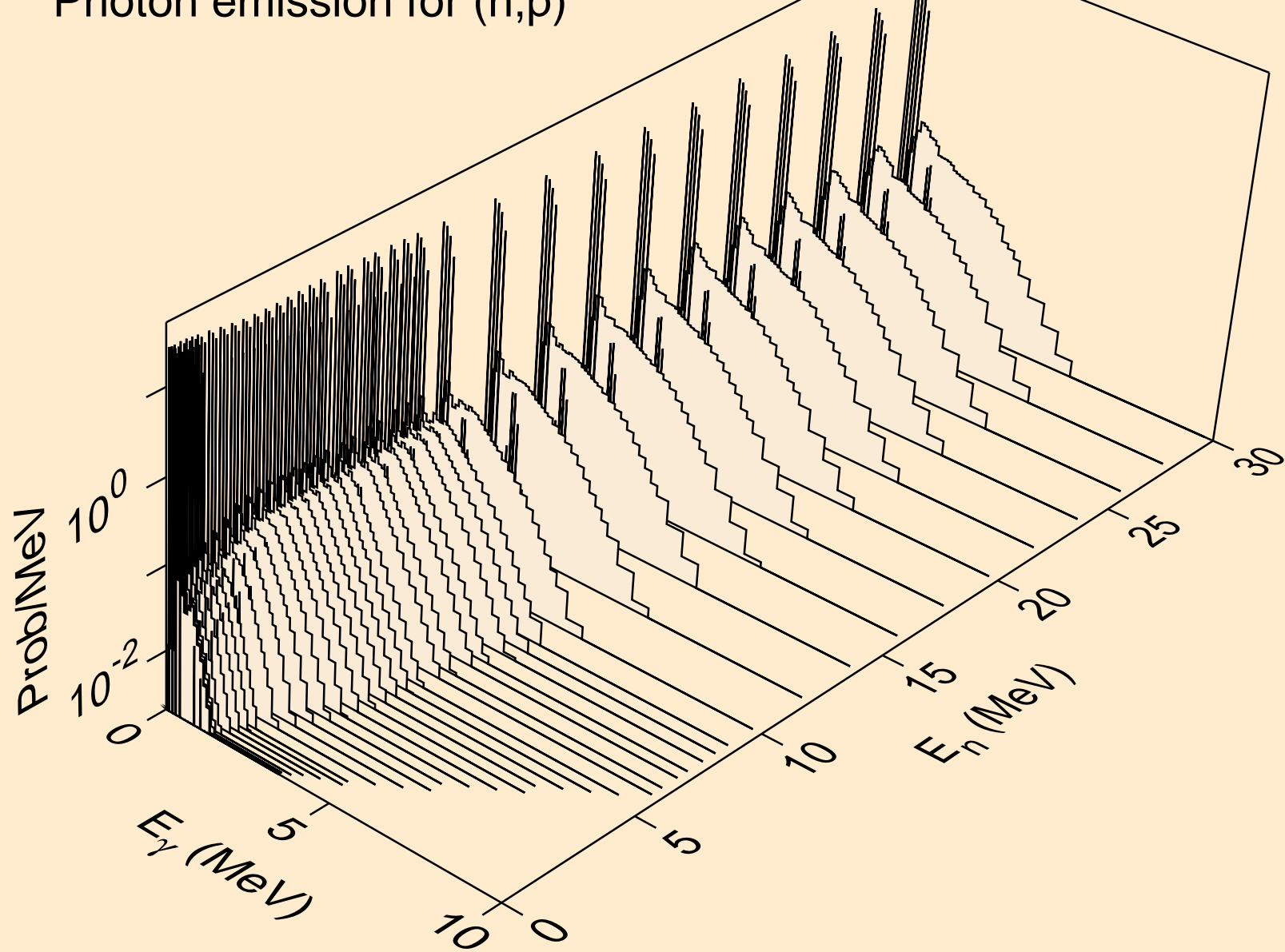

HO160N NEUTRON ACER TENDL-2021 LIBRARY; T=293.6K  
Photon emission for (n,d)

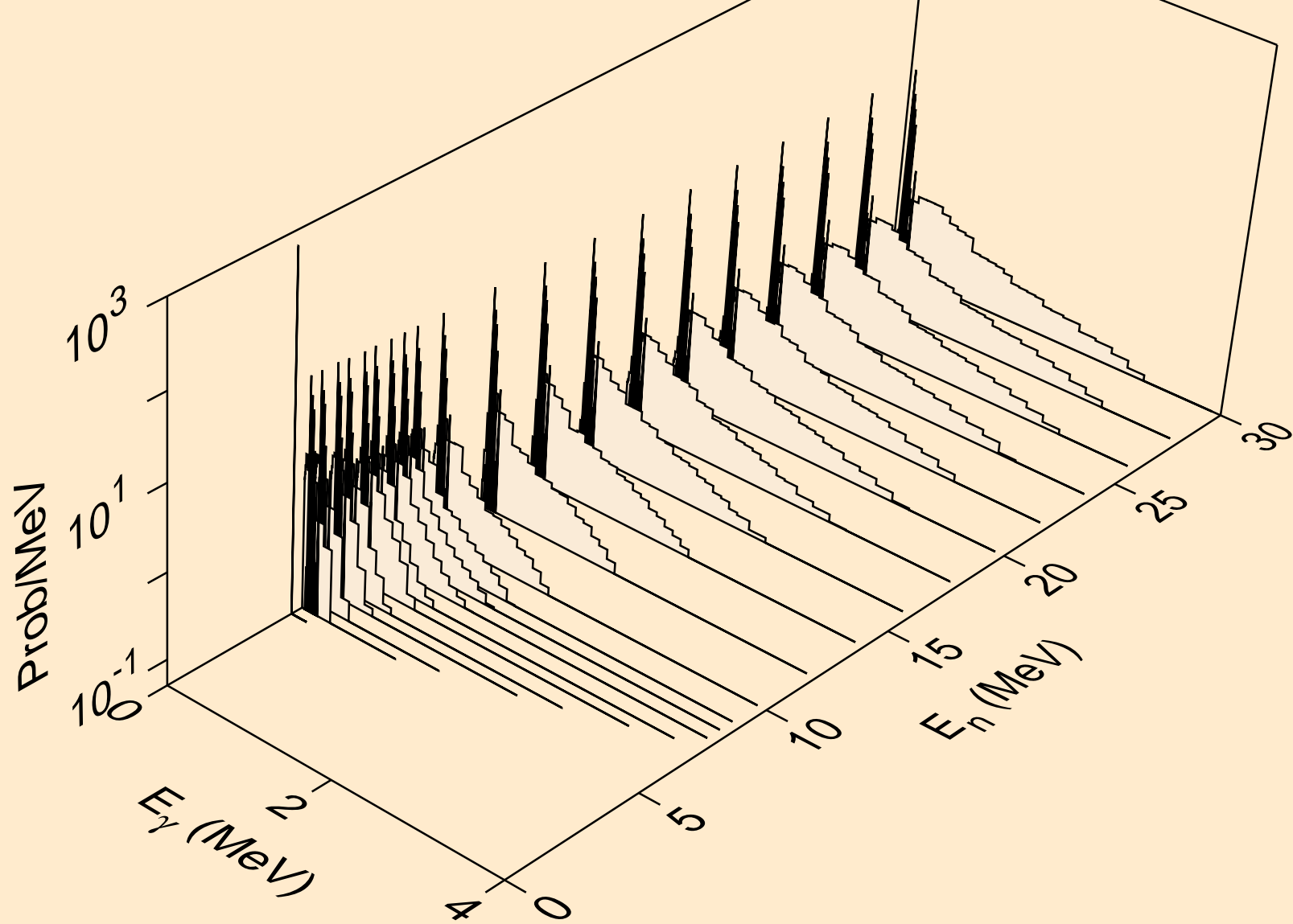

HO160N NEUTRON ACER TENDL-2021 LIBRARY; T=293.6K  
Photon emission for (n,t)

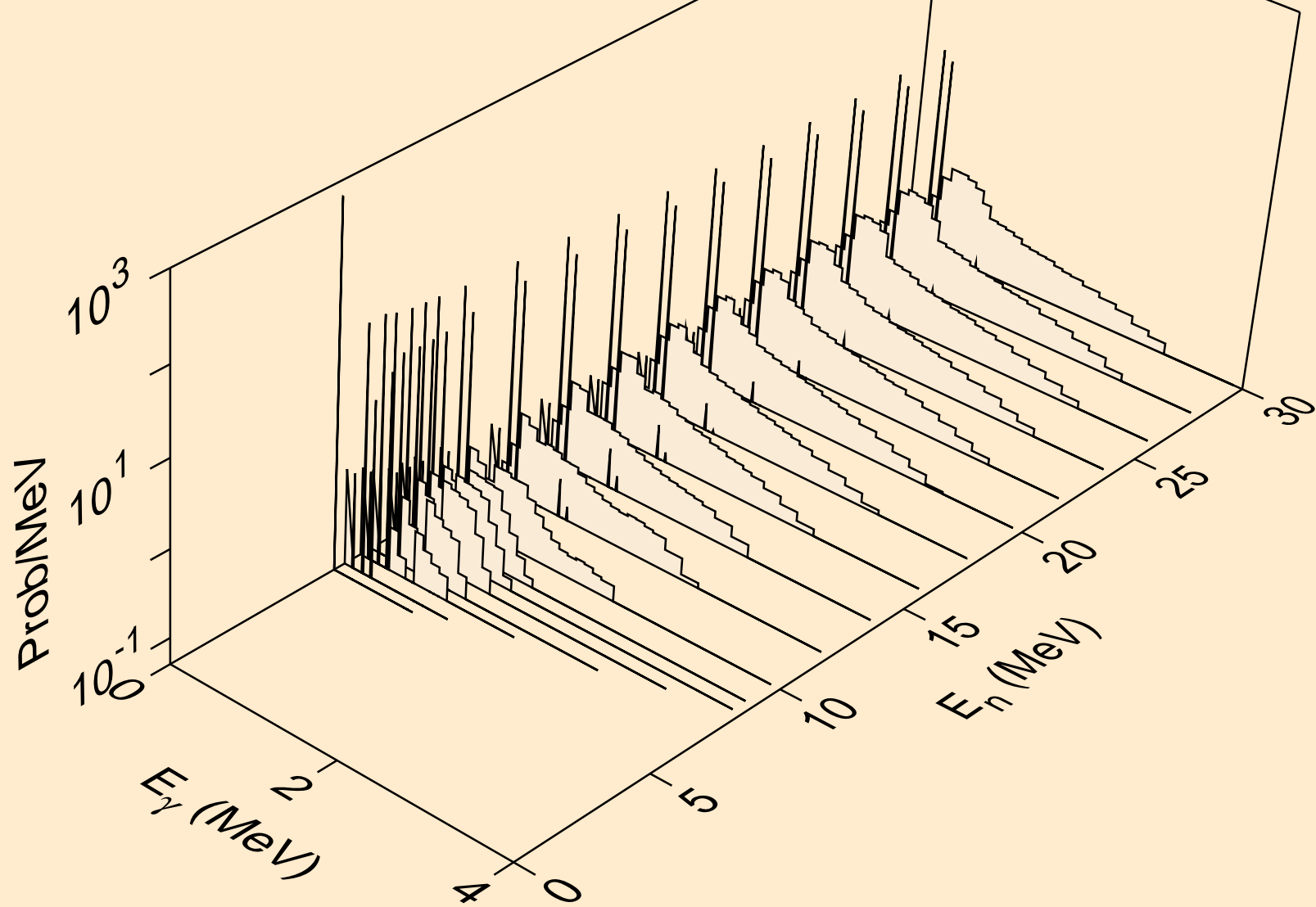

HO160N NEUTRON ACER TENDL-2021 LIBRARY; T=293.6K  
Photon emission for (n,he3)

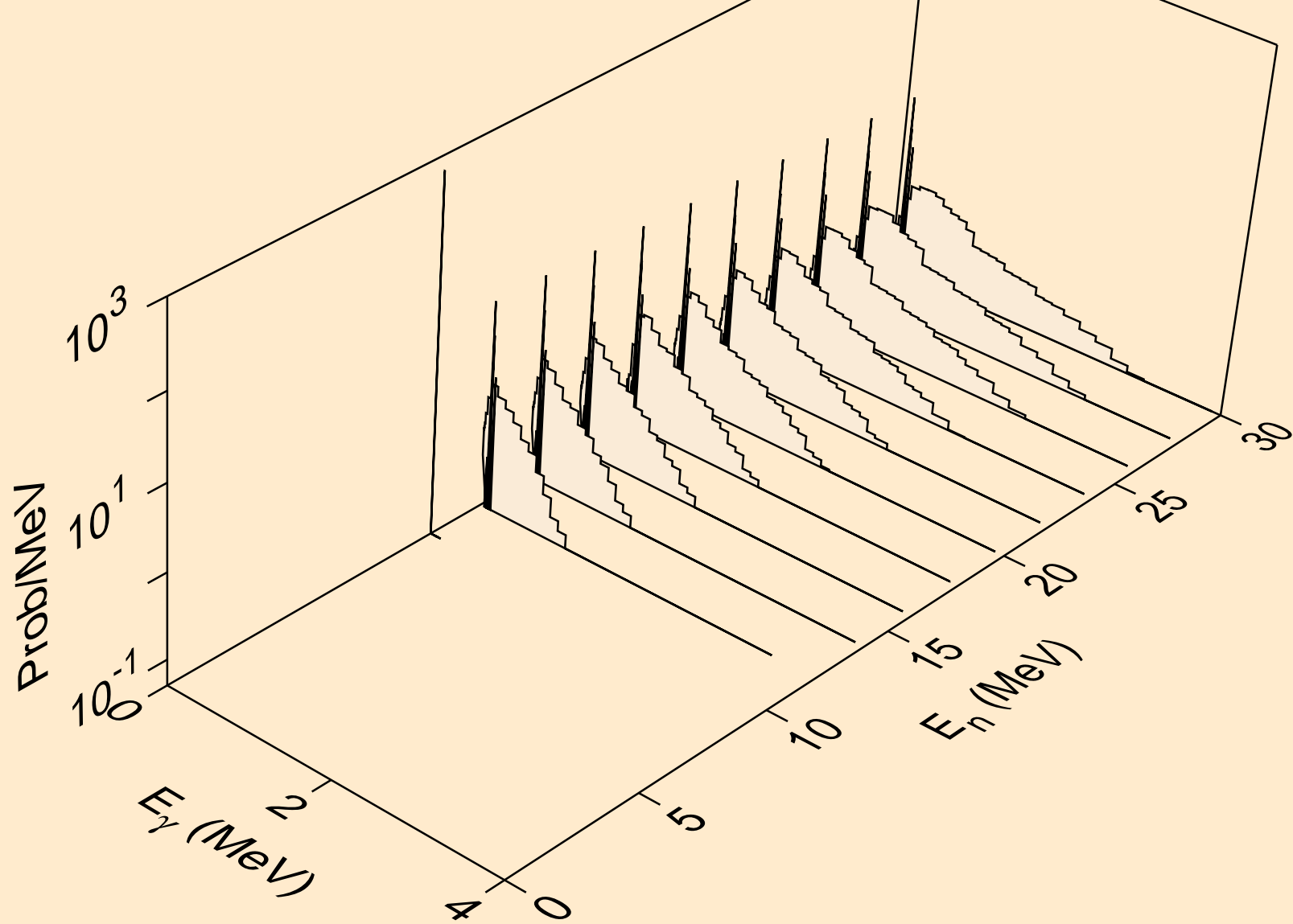

HO160N NEUTRON ACER TENDL-2021 LIBRARY; T=293.6K  
Photon emission for (n,a)

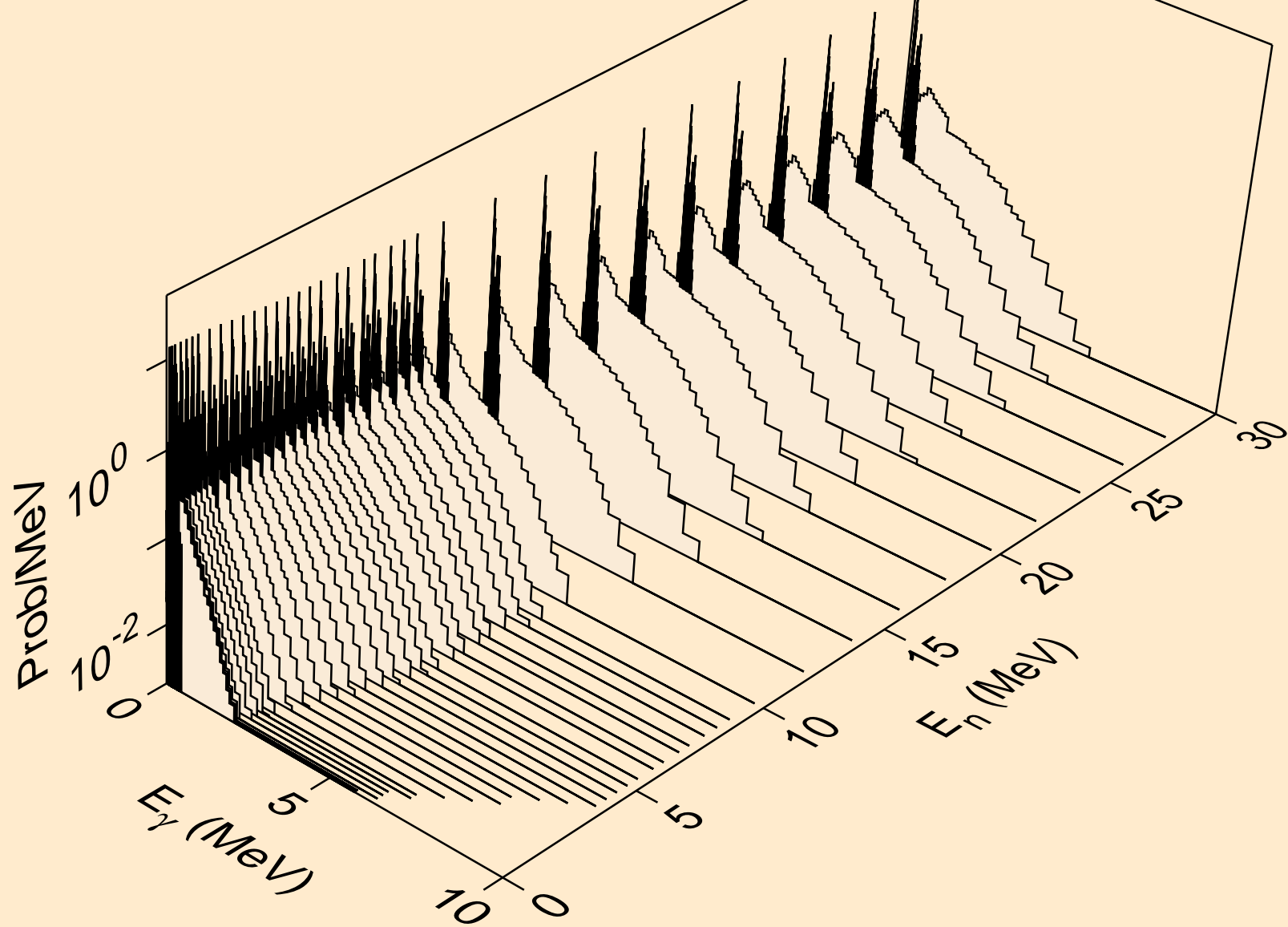



HO160N NEUTRON ACER TENDL-2021 LIBRARY; T=293.6K  
Photon emission for (n,2a)

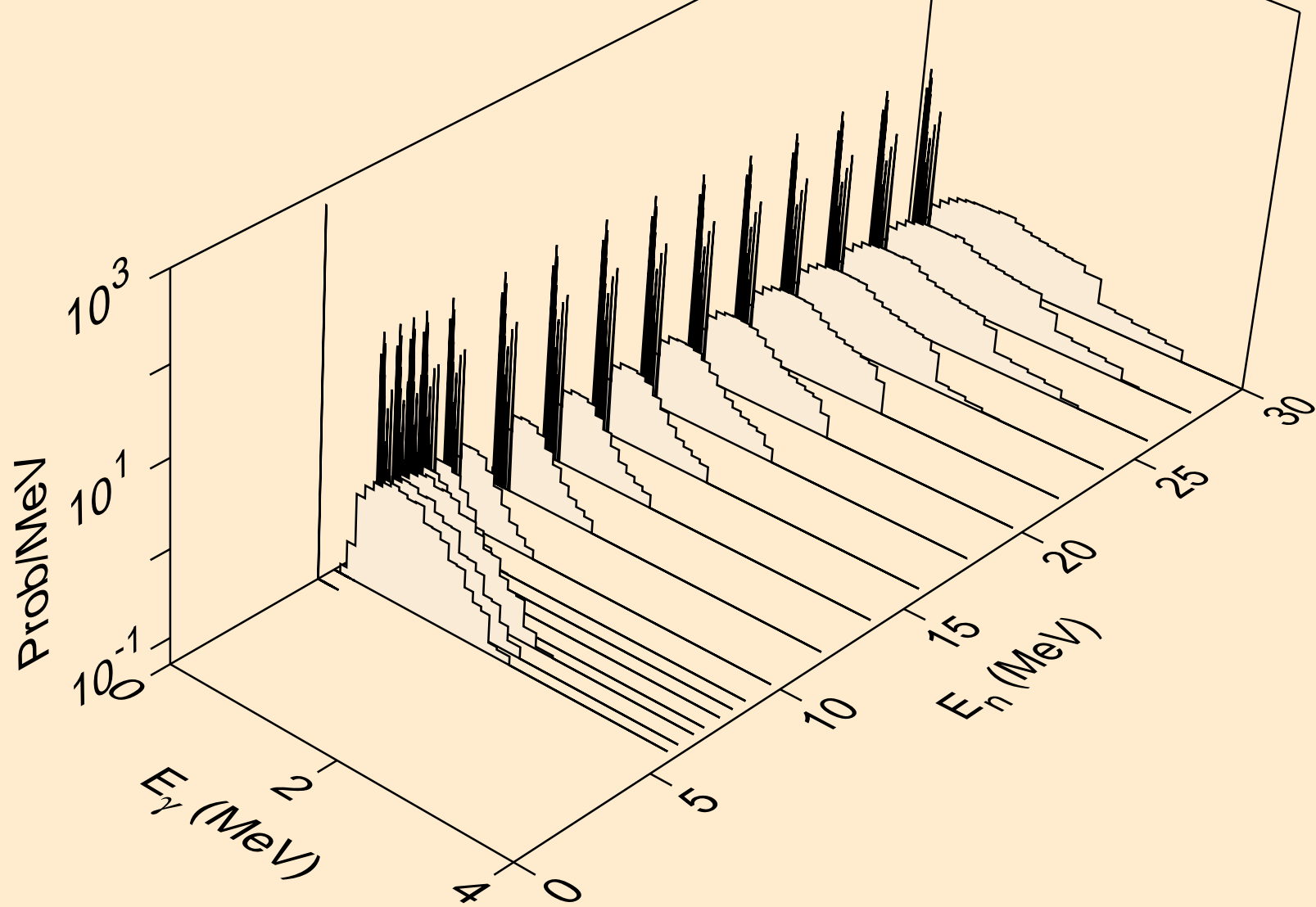

HO160N NEUTRON ACER TENDL-2021 LIBRARY; T=293.6K  
Photon emission for (n,2p)

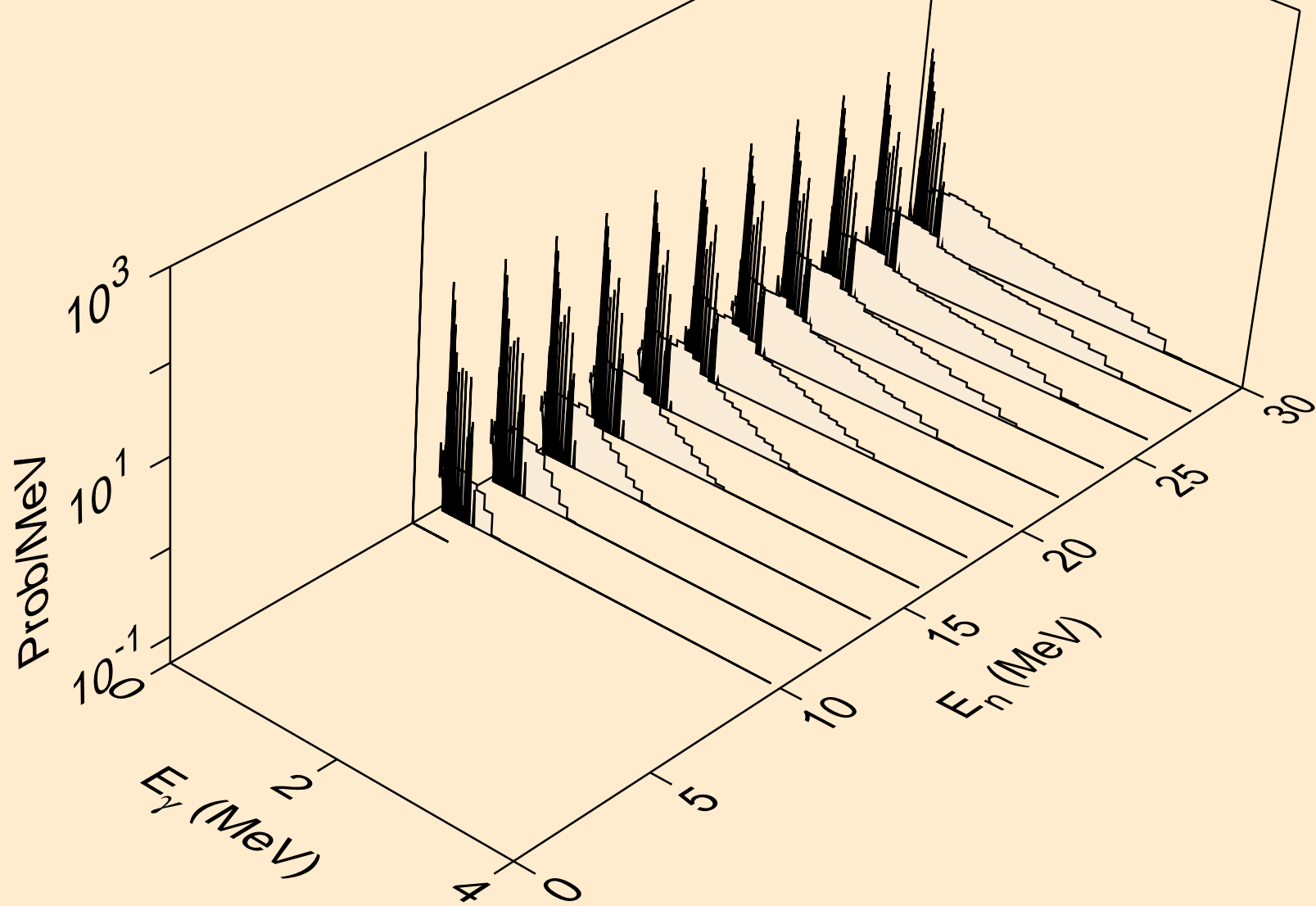

HO160N NEUTRON ACER TENDL-2021 LIBRARY; T=293.6K  
Photon emission for (n,p $\alpha$ )

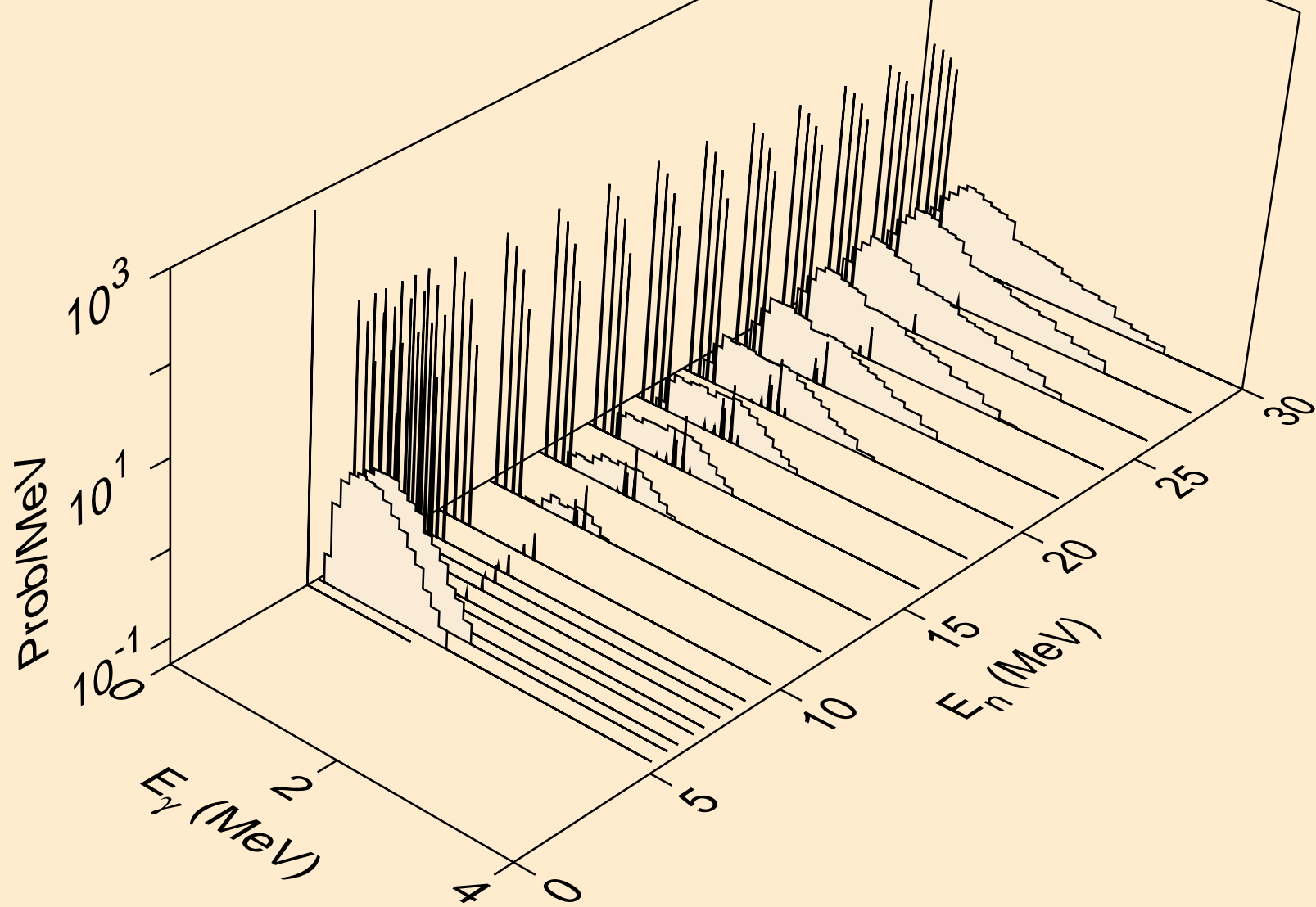

HO160N NEUTRON ACER TENDL-2021 LIBRARY; T=293.6K  
Photon emission for (n,pd)

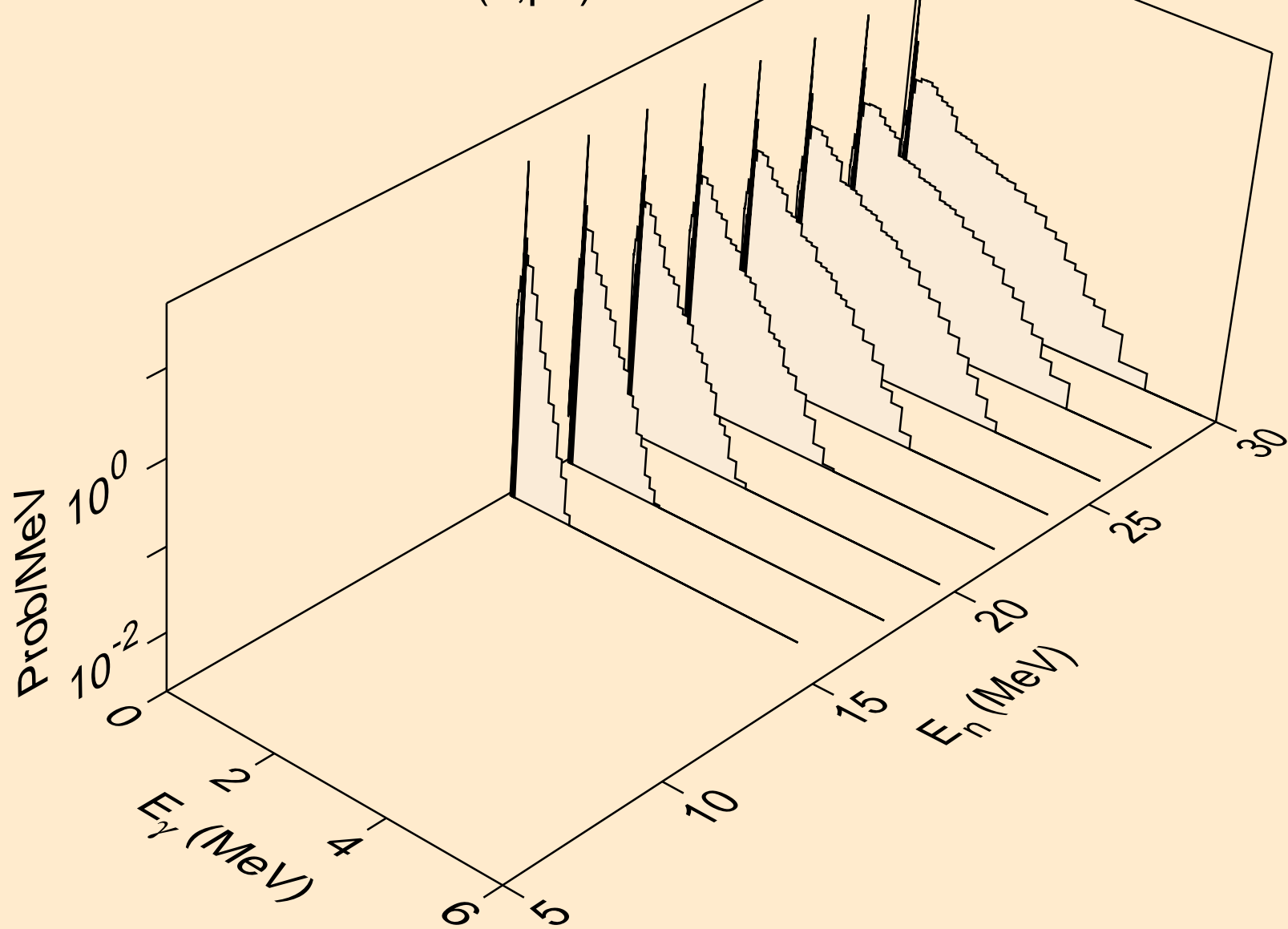

HO160N NEUTRON ACER TENDL-2021 LIBRARY; T=293.6K  
Photon emission for (n,pt)

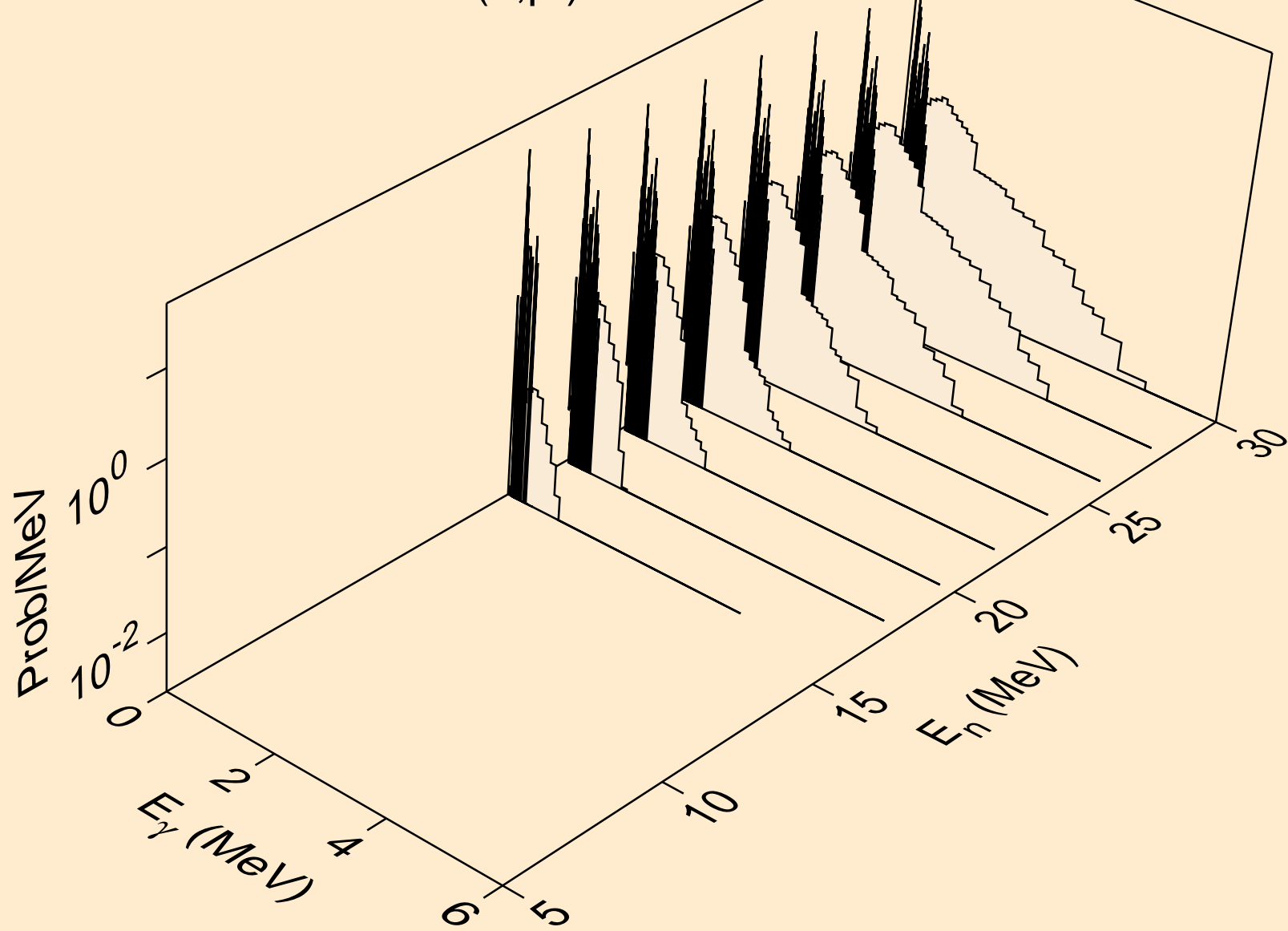

HO160N NEUTRON ACER TENDL-2021 LIBRARY; T=293.6K  
Photon emission for (n,da)

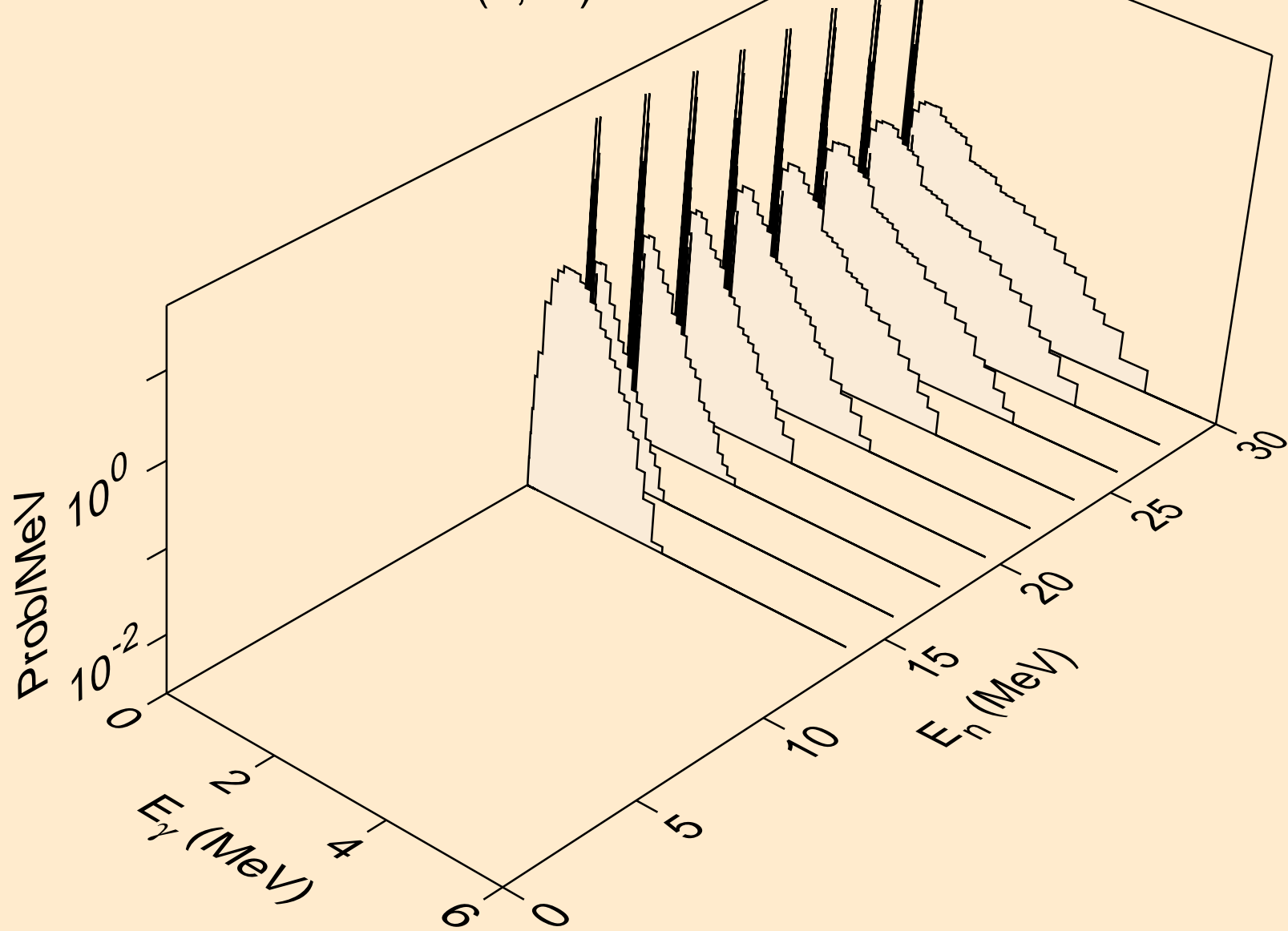

HO160N NEUTRON ACER TENDL-2021 LIBRARY; T=293.6K  
thermal capture photon spectrum

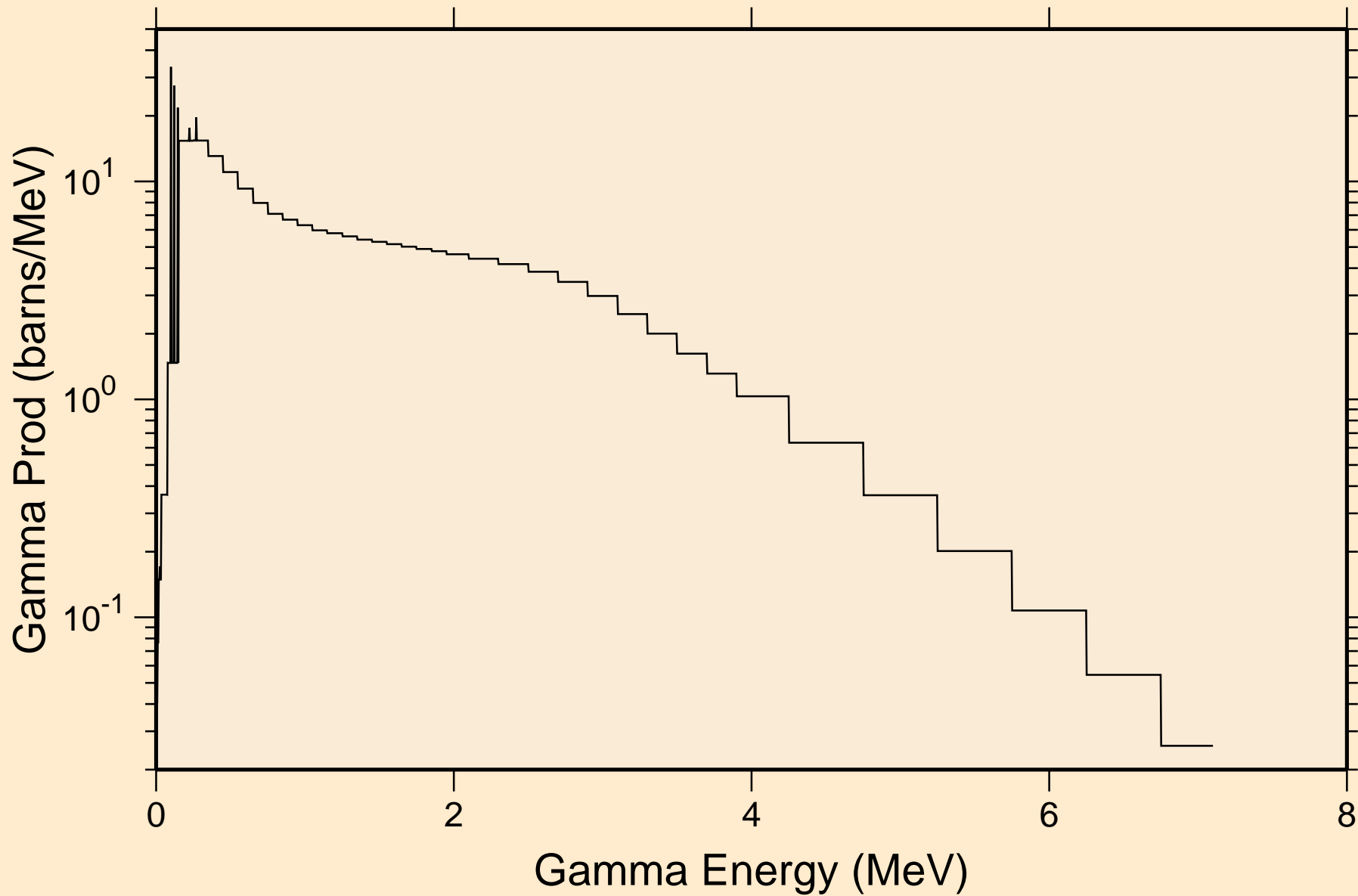

HO160N NEUTRON ACER TENDL-2021 LIBRARY; T=293.6K  
14 MeV photon spectrum

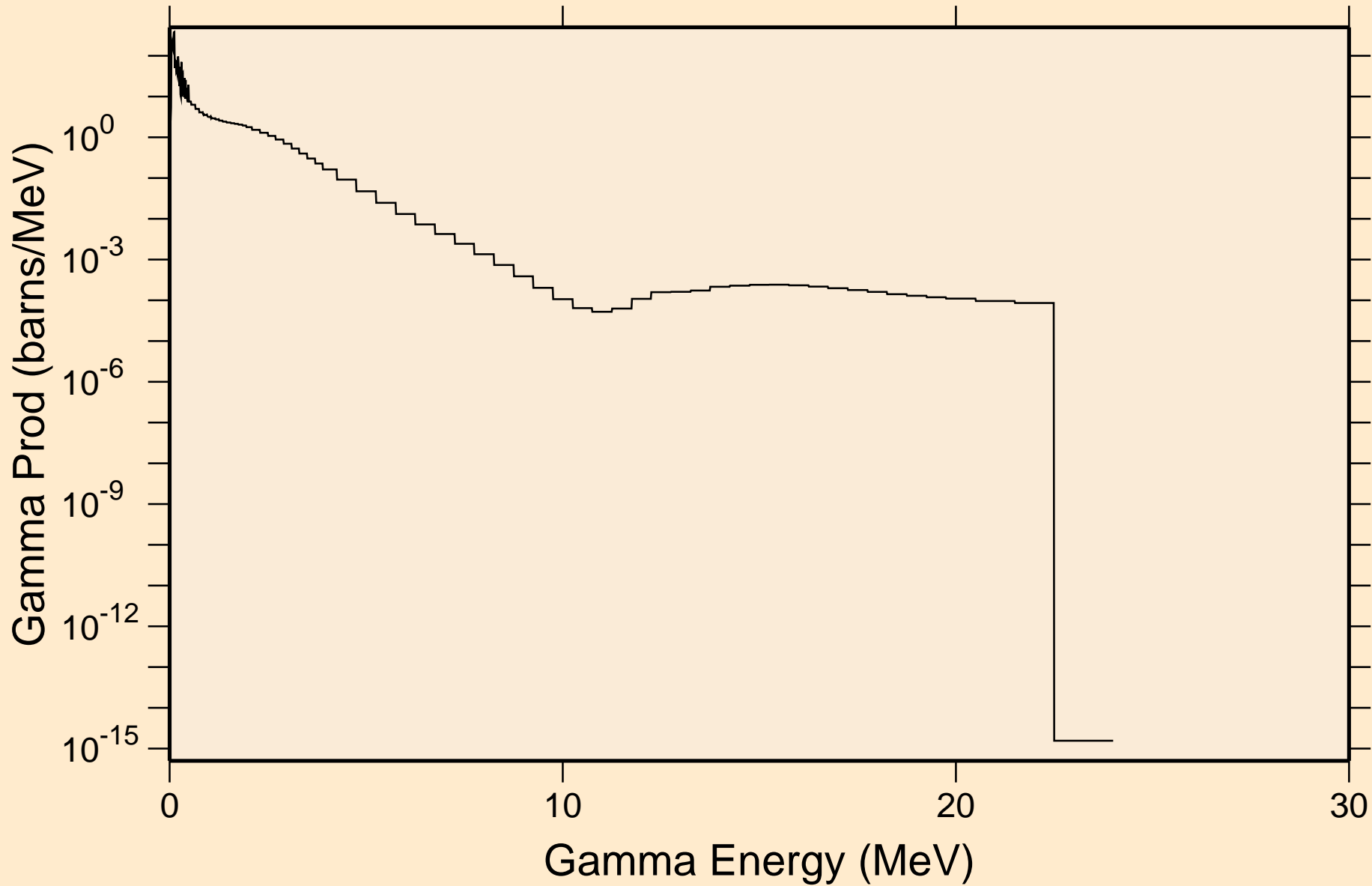



# HO160N NEUTRON ACER TENDL-2021 LIBRARY; T=293.6K

## Particle heating contributions

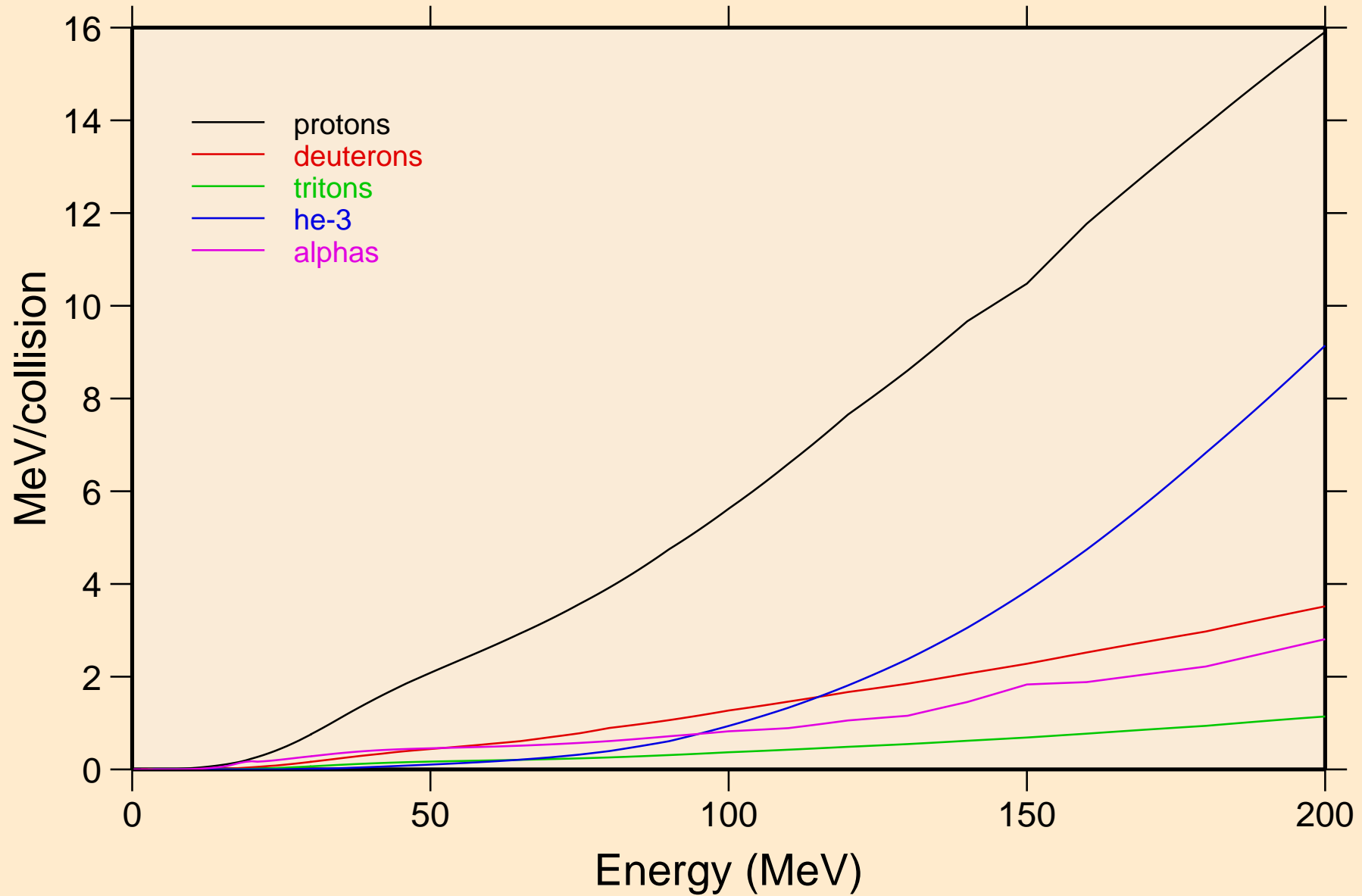

HO160N NEUTRON ACER TENDL-2021 LIBRARY; T=293.6K  
Recoil Heating

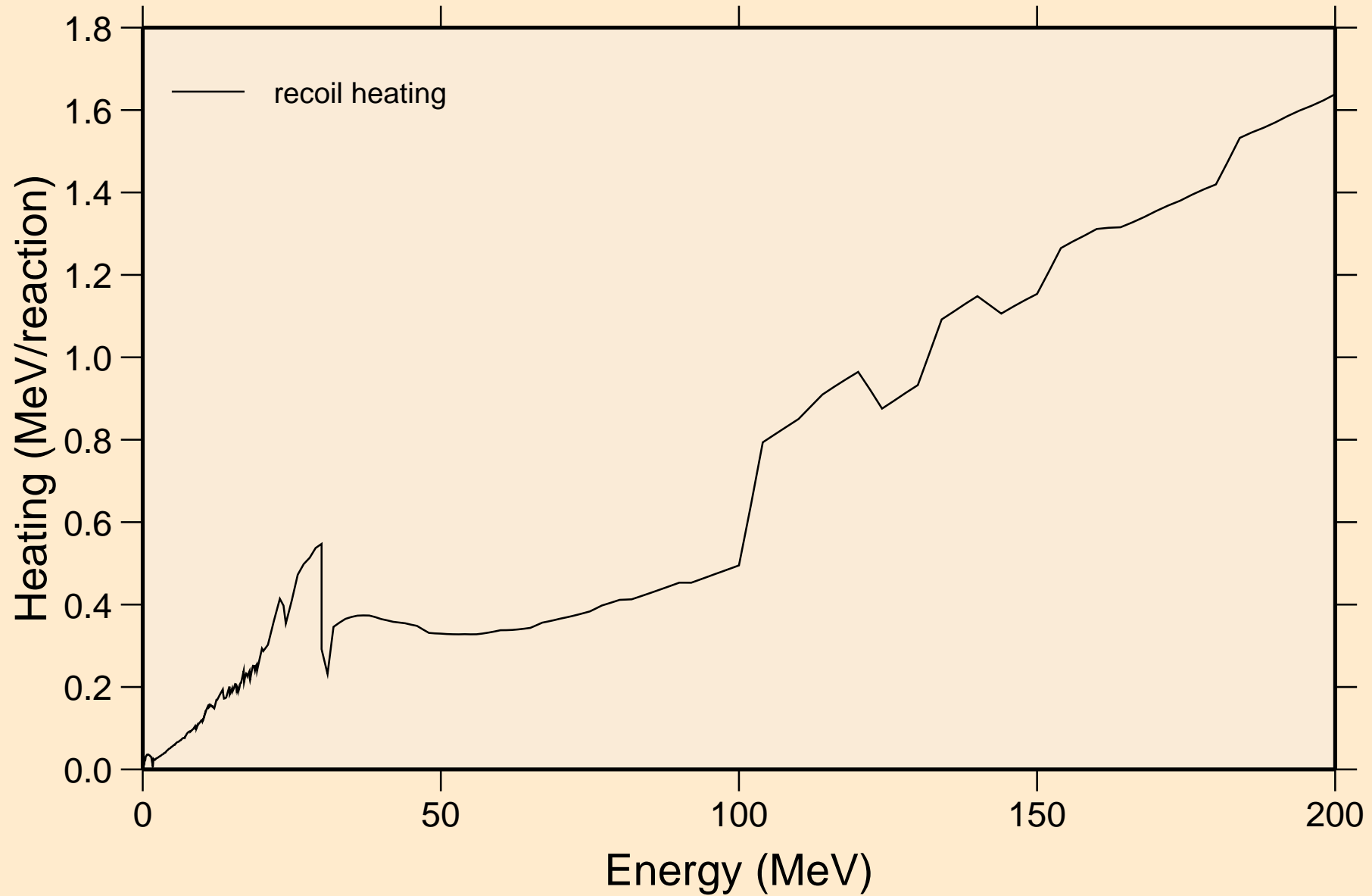

HO160N NEUTRON ACER TENDL-2021 LIBRARY; T=293.6K  
Particle production cross sections

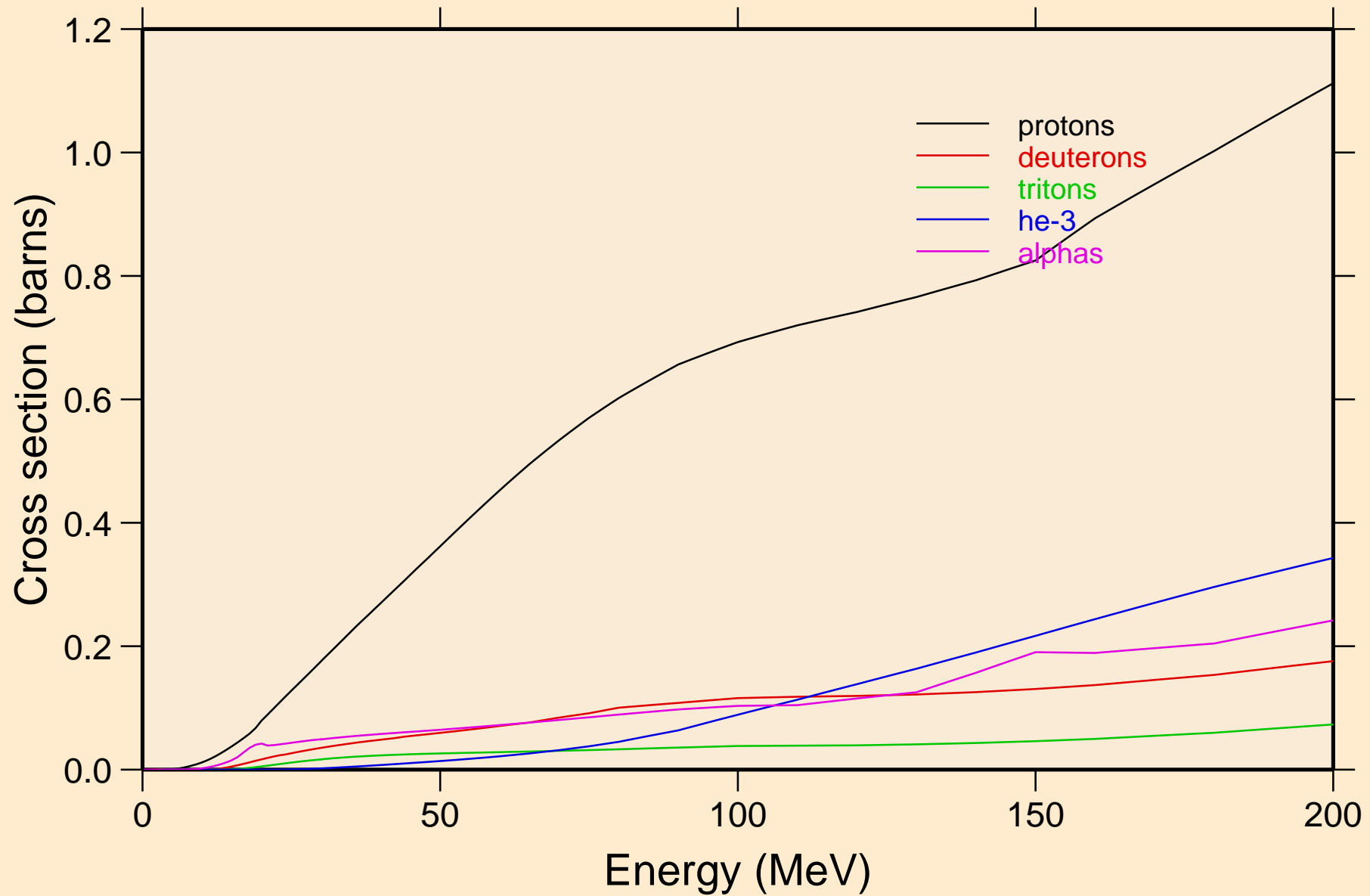

HO160N NEUTRON ACER TENDL-2021 LIBRARY; T=293.6K  
protons from (n,x)

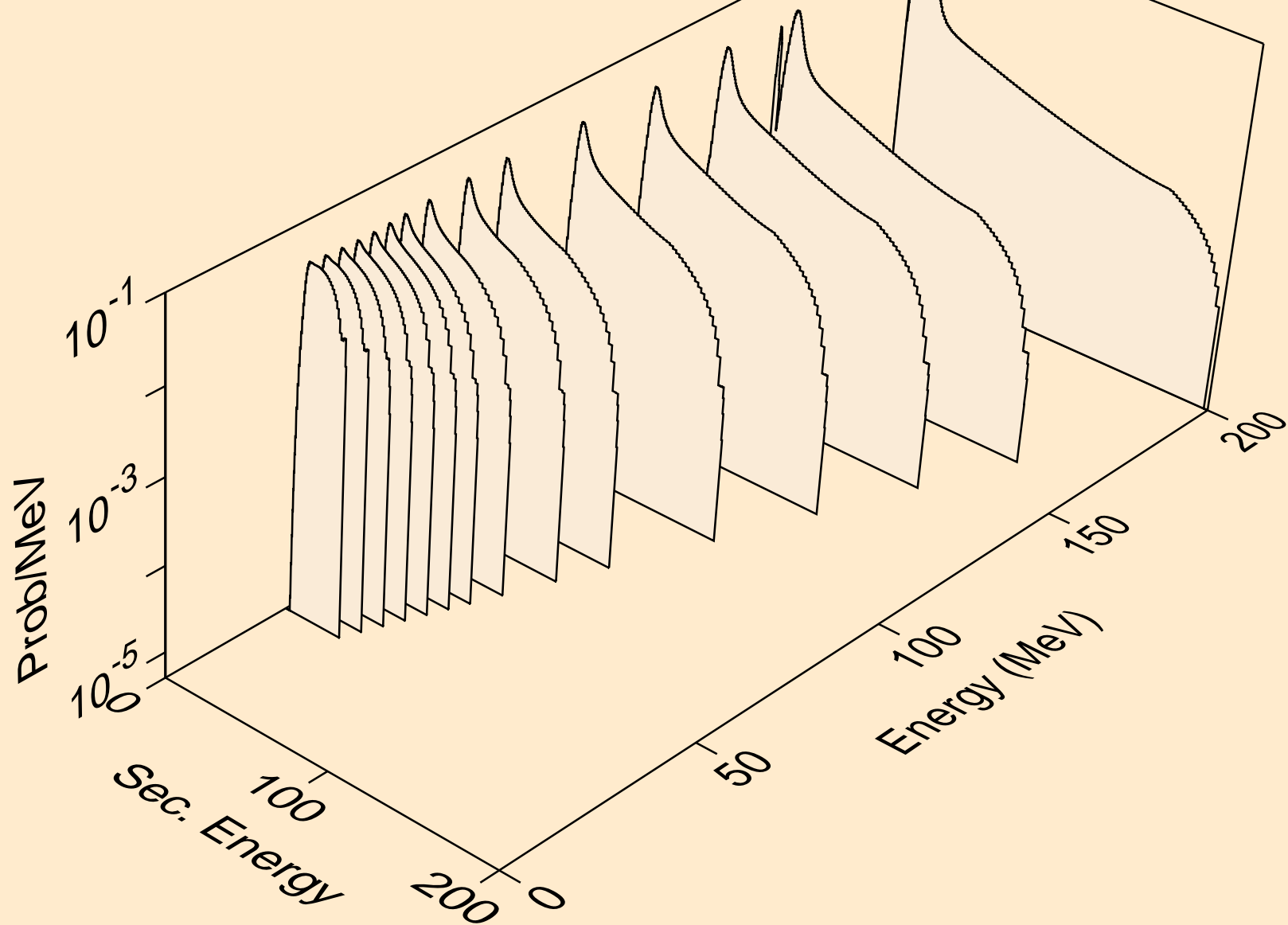

HO160N NEUTRON ACER TENDL-2021 LIBRARY; T=293.6K  
protons from (n,n\*)p

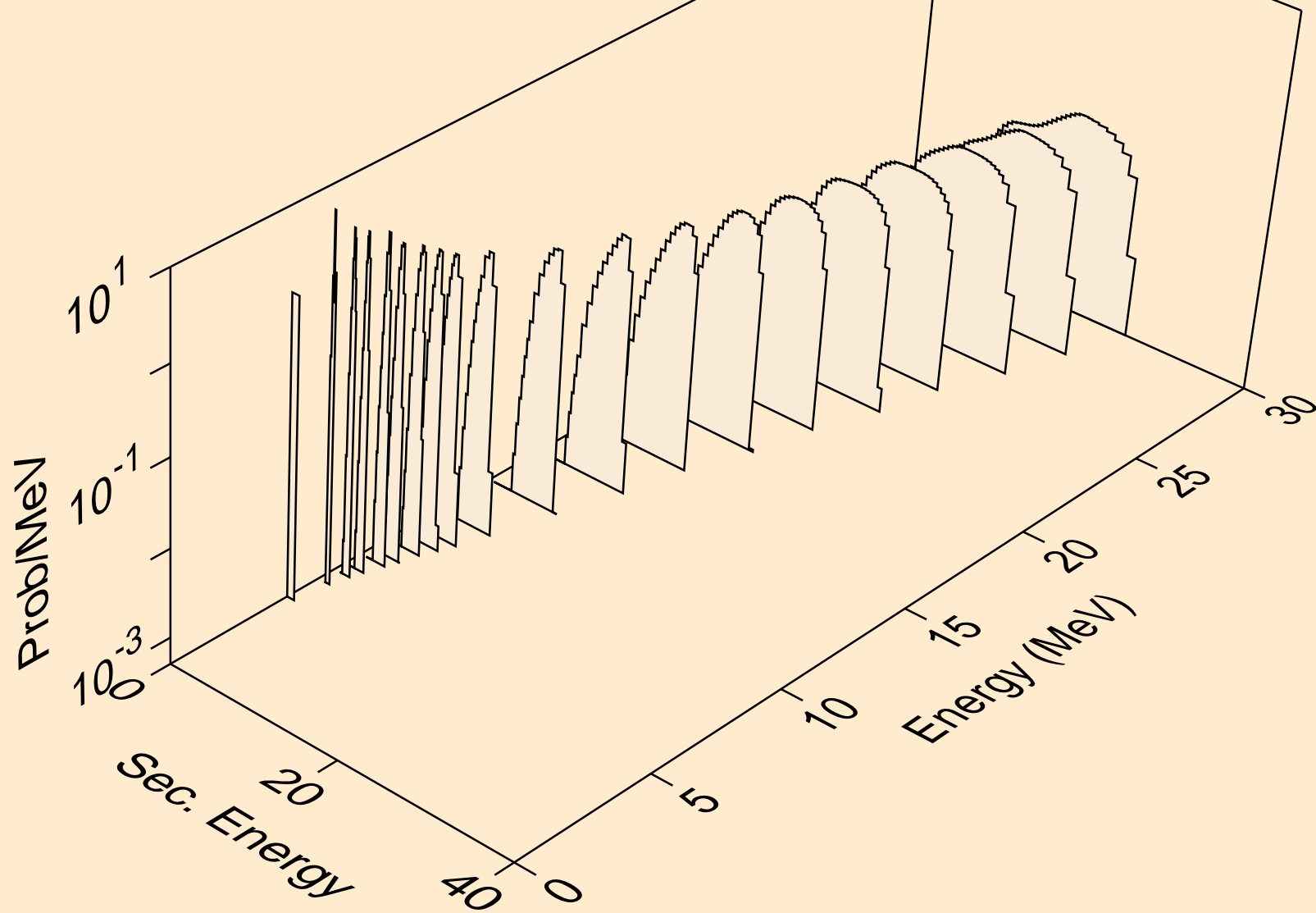

HO160N NEUTRON ACER TENDL-2021 LIBRARY; T=293.6K  
protons from (n,2np)

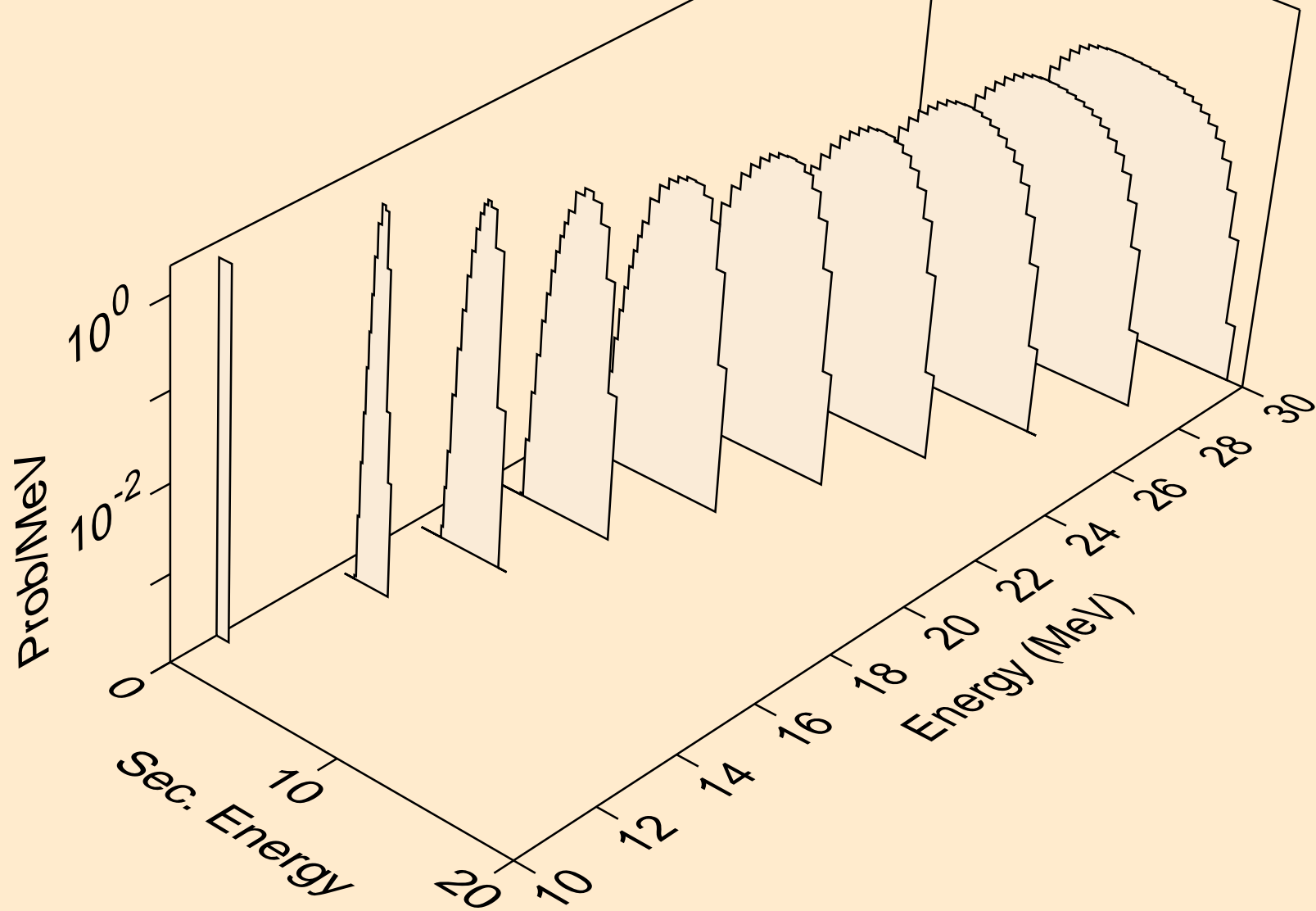

HO160N NEUTRON ACER TENDL-2021 LIBRARY; T=293.6K  
protons from (n,3np)

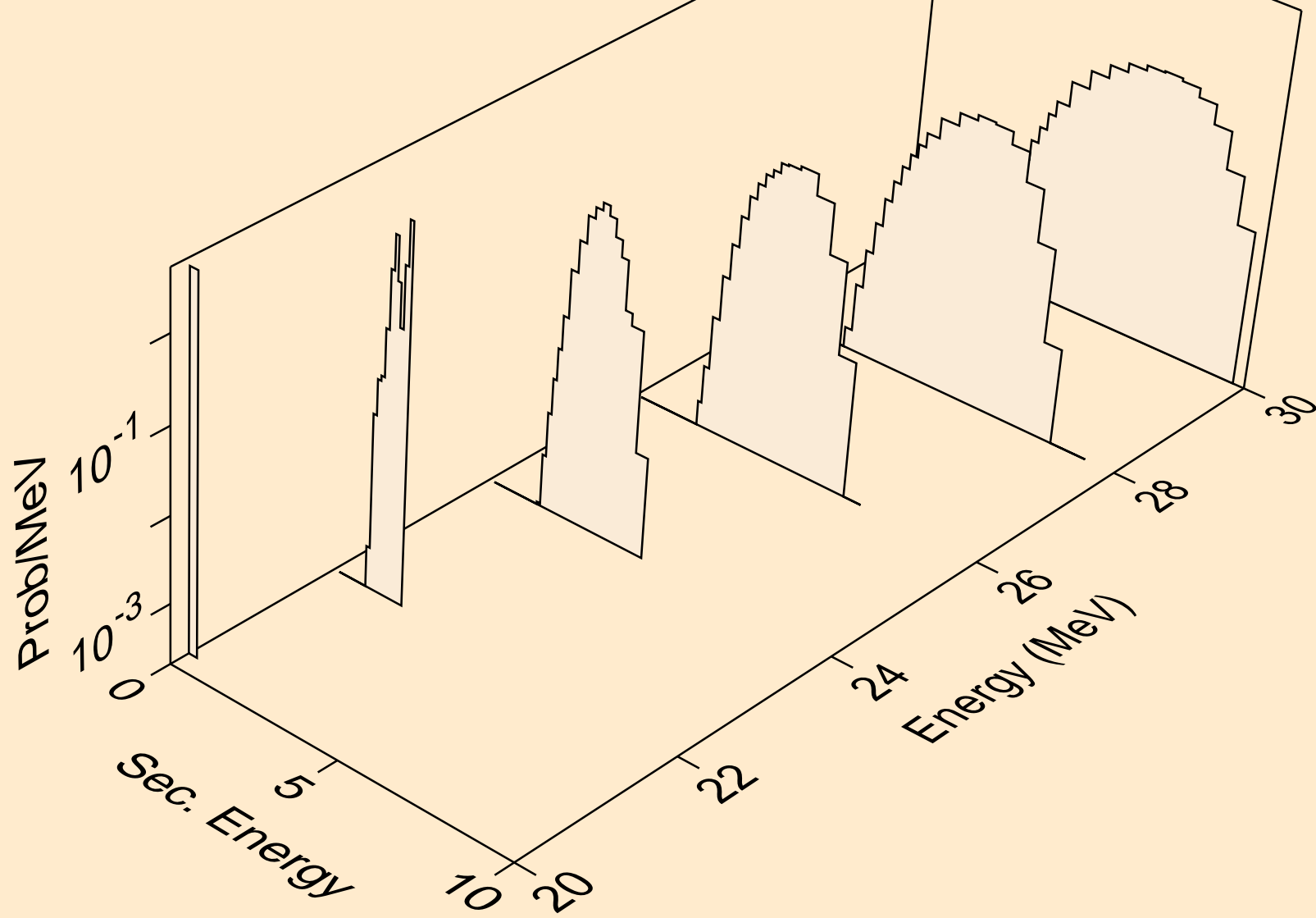

HO160N NEUTRON ACER TENDL-2021 LIBRARY; T=293.6K  
protons from (n,2np)

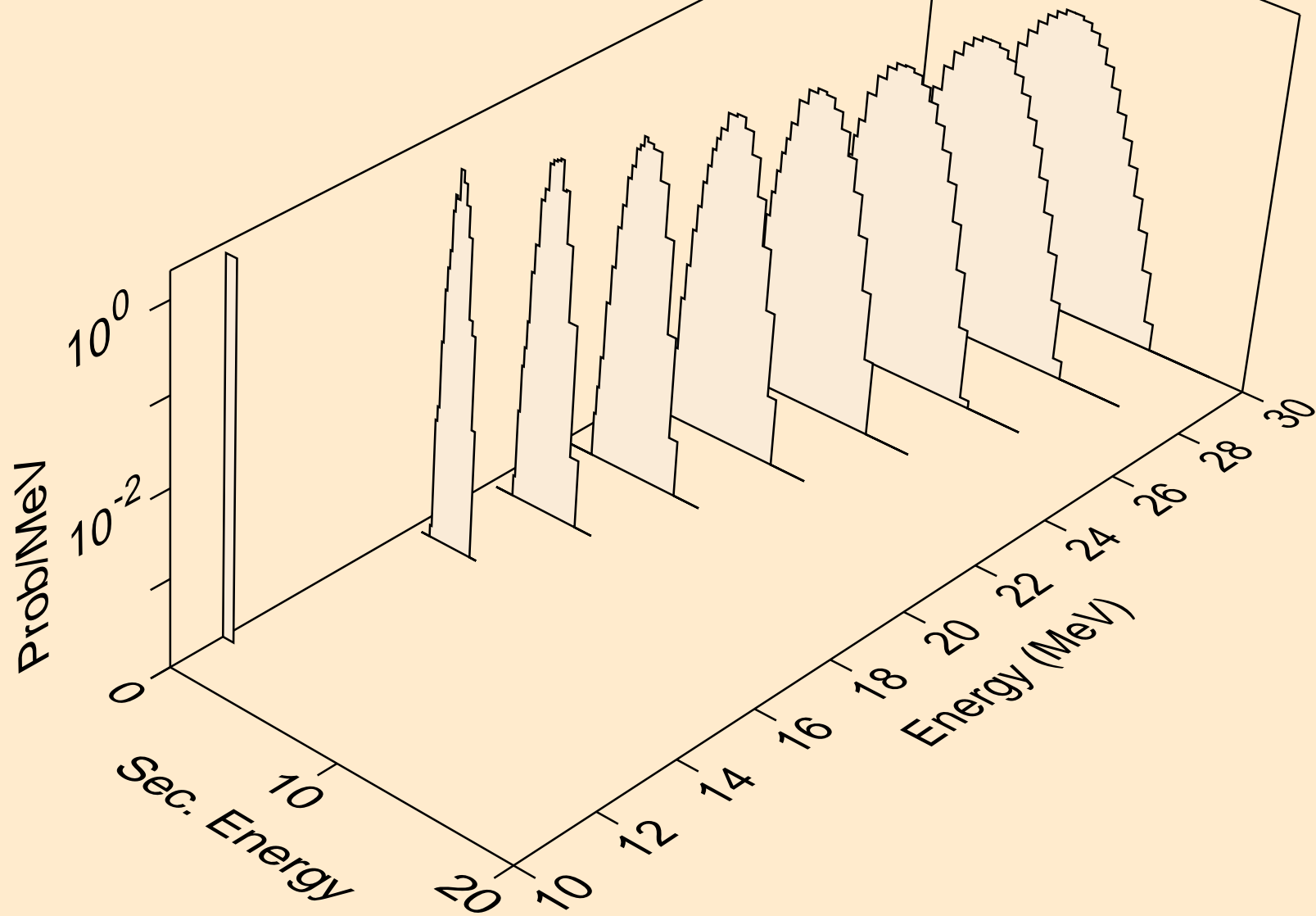



HO160N NEUTRON ACER TENDL-2021 LIBRARY; T=293.6K  
protons from (n,npa)

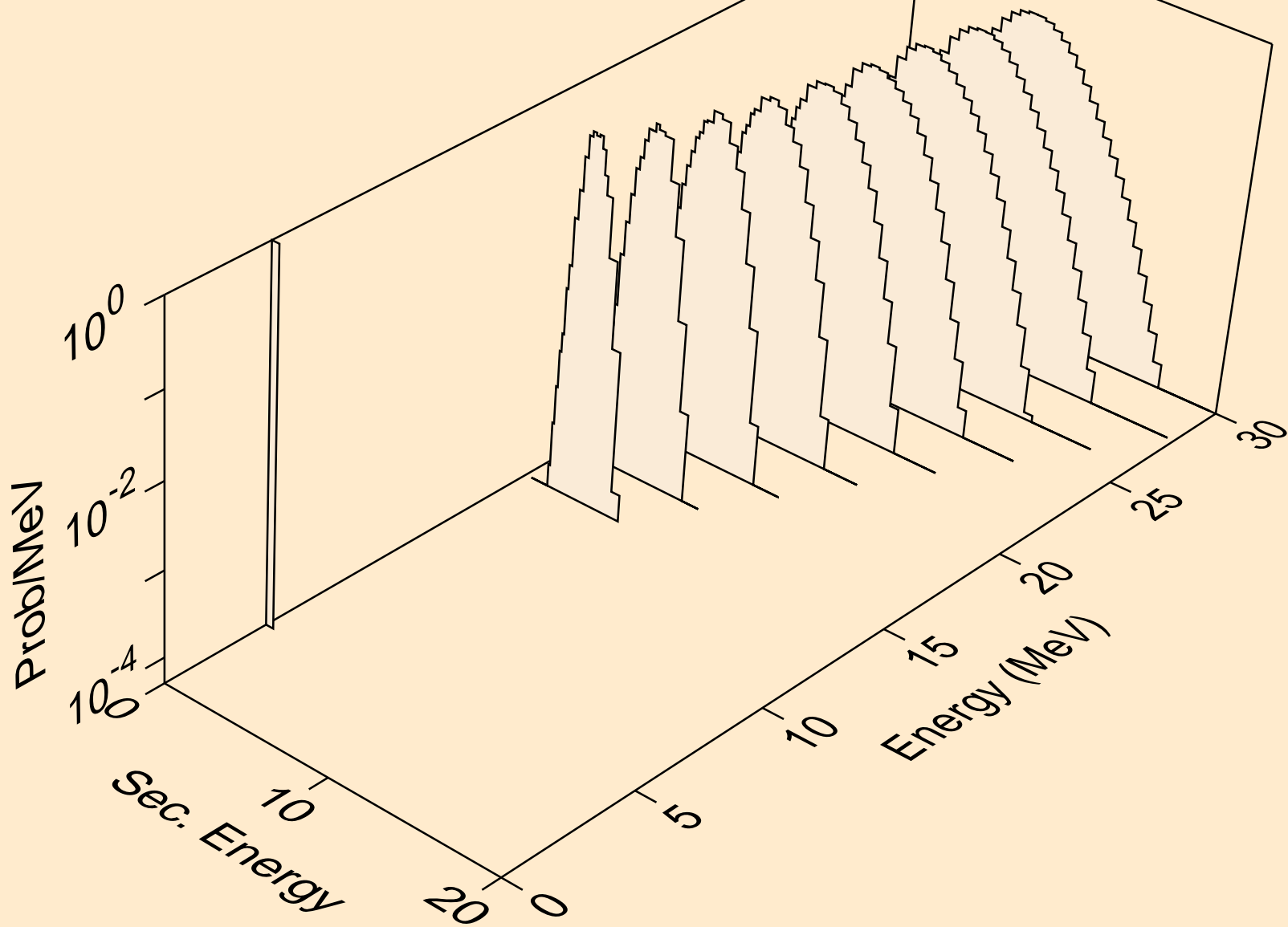

HO160N NEUTRON ACER TENDL-2021 LIBRARY; T=293.6K  
protons from (n,p)

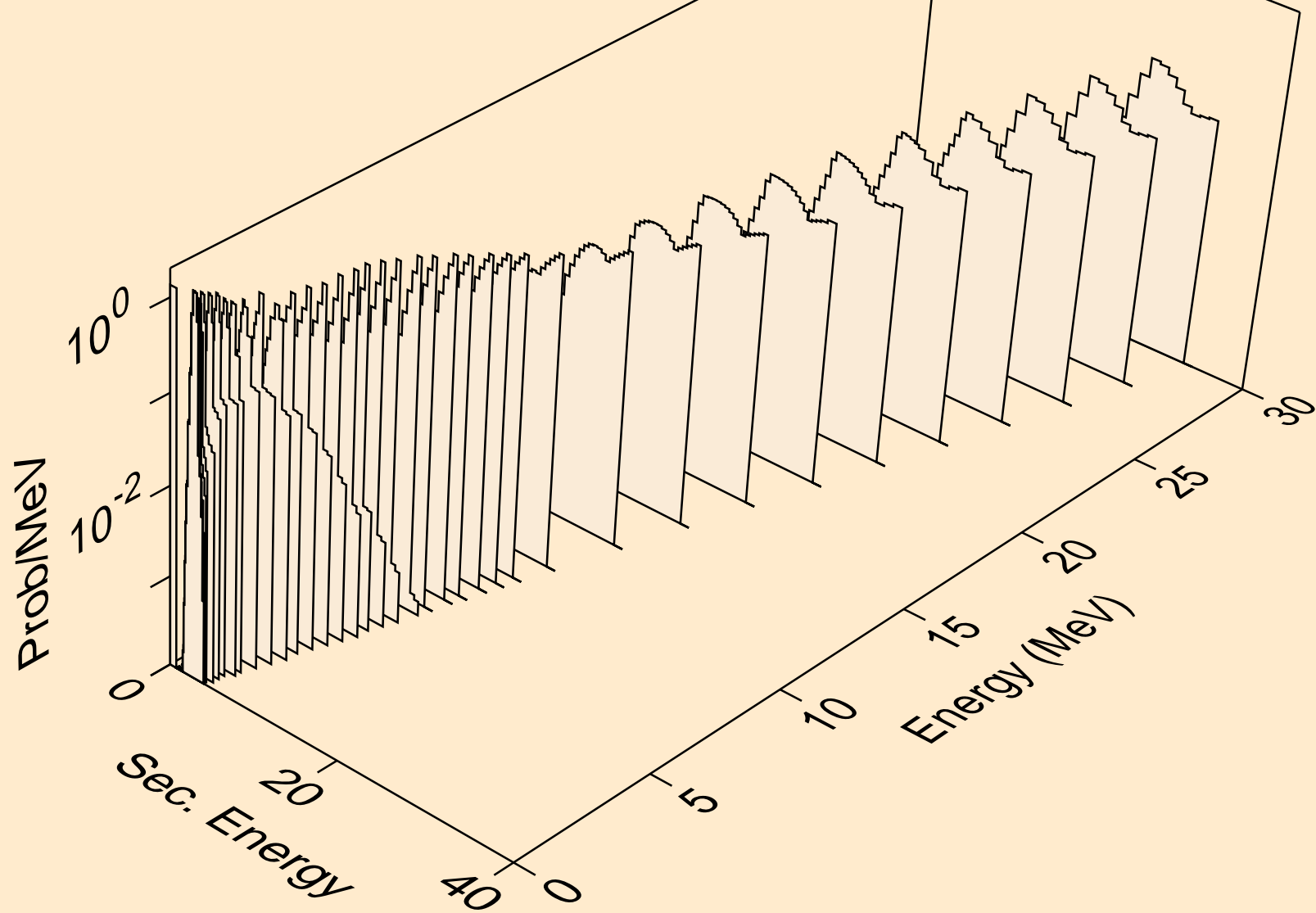

HO160N NEUTRON ACER TENDL-2021 LIBRARY; T=293.6K  
protons from (n,2p)

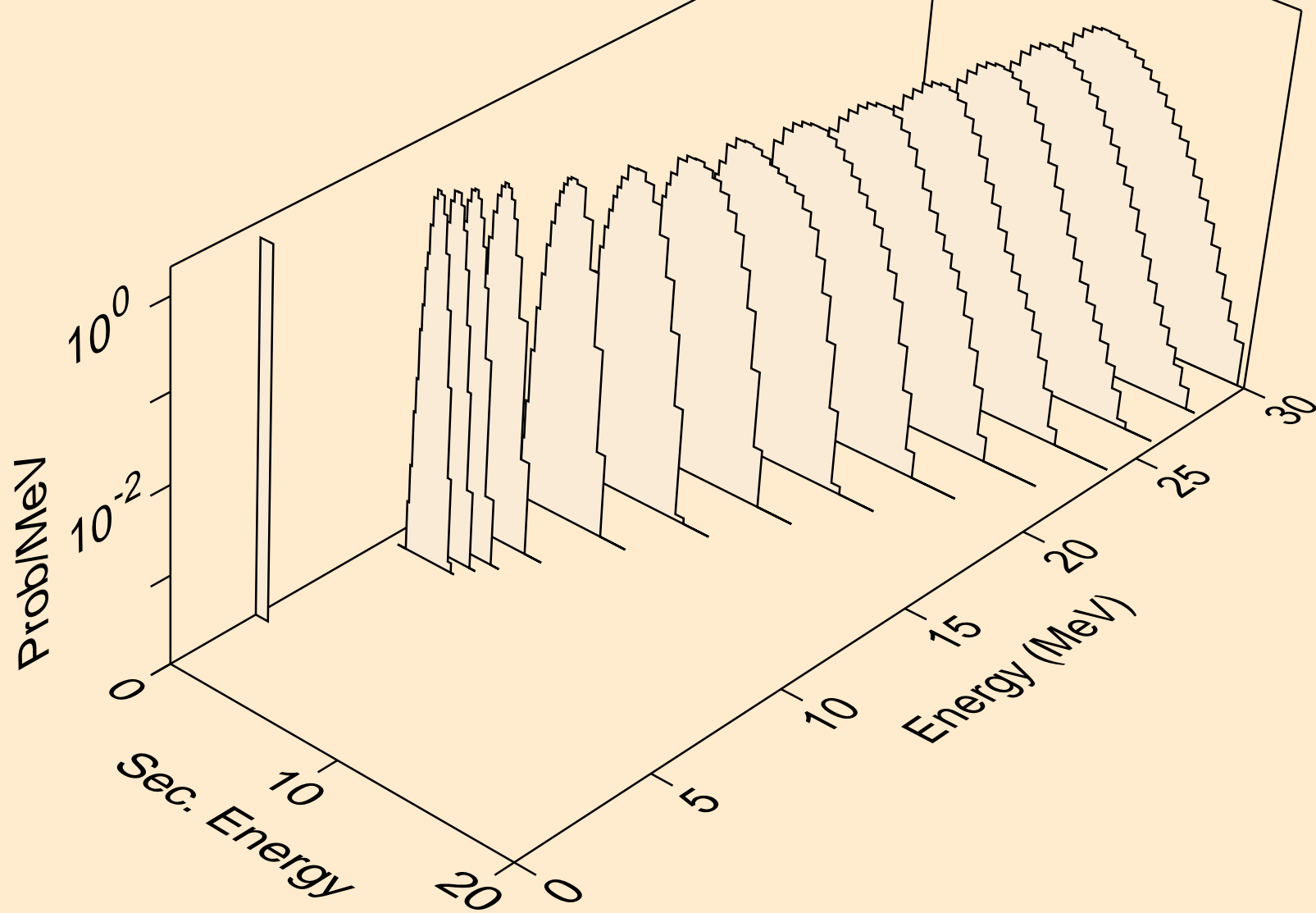

HO160N NEUTRON ACER TENDL-2021 LIBRARY; T=293.6K  
protons from (n,p)

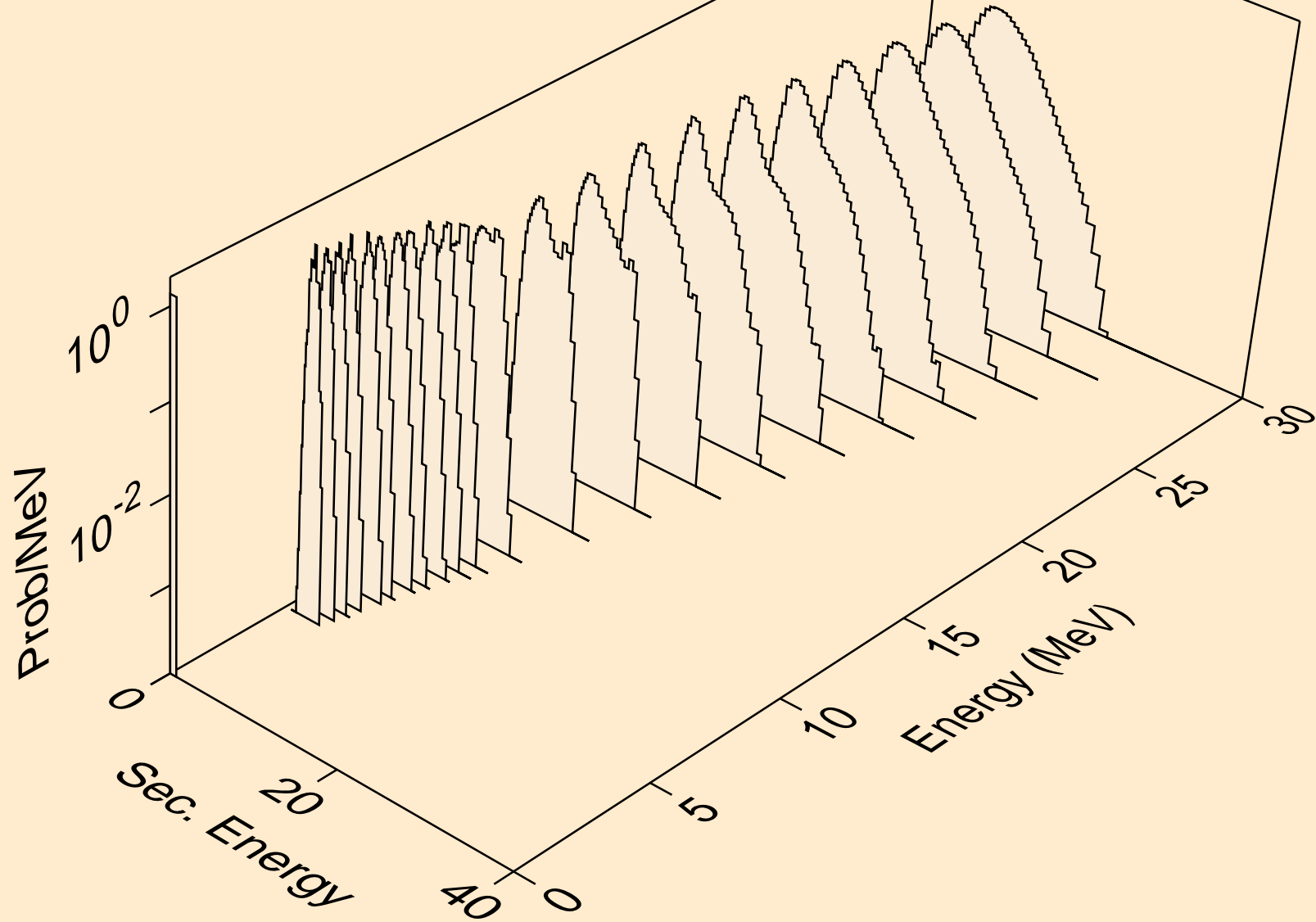

HO160N NEUTRON ACER TENDL-2021 LIBRARY; T=293.6K  
protons from (n,pd)

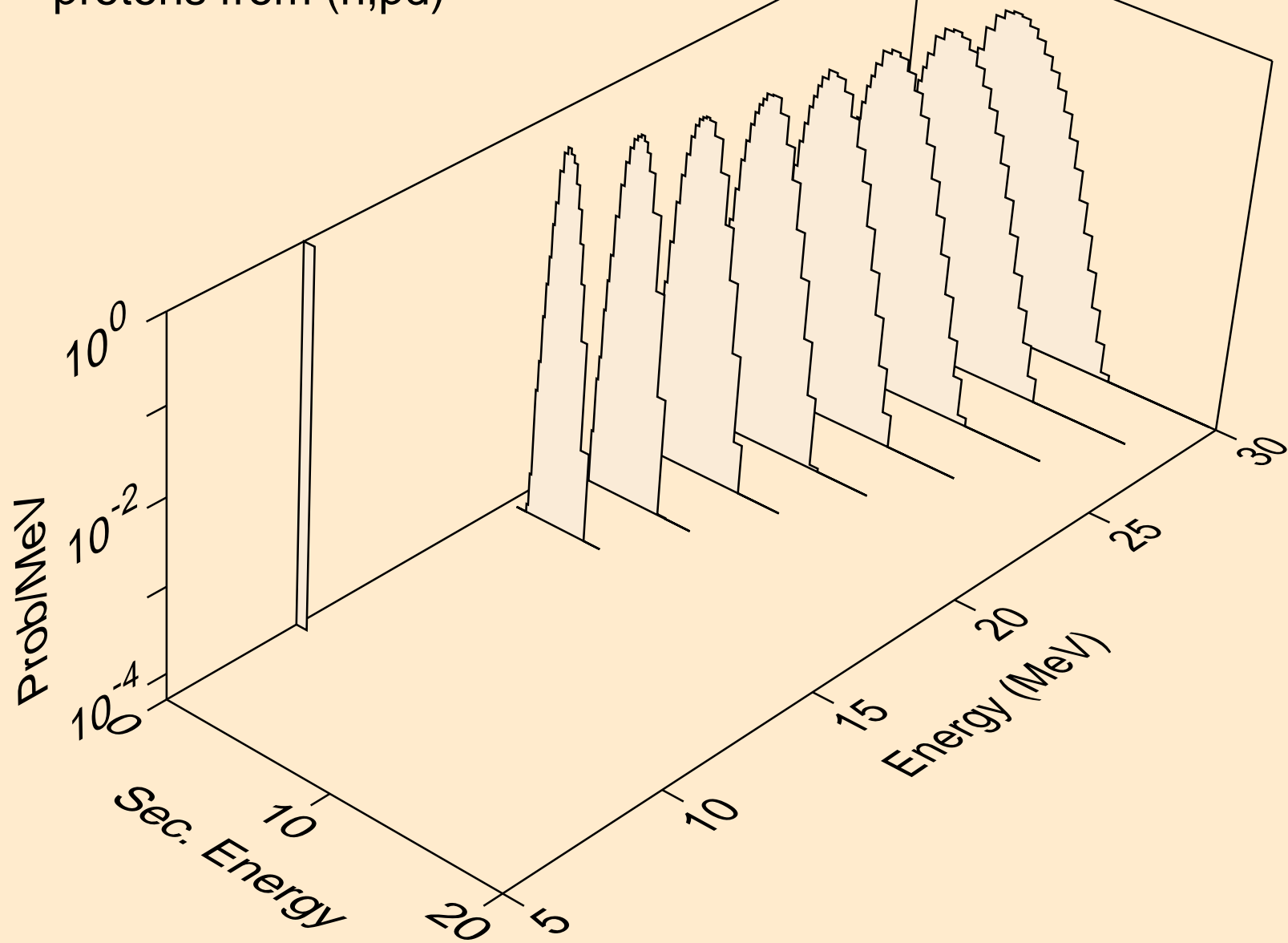

HO160N NEUTRON ACER TENDL-2021 LIBRARY; T=293.6K  
protons from (n,pt)

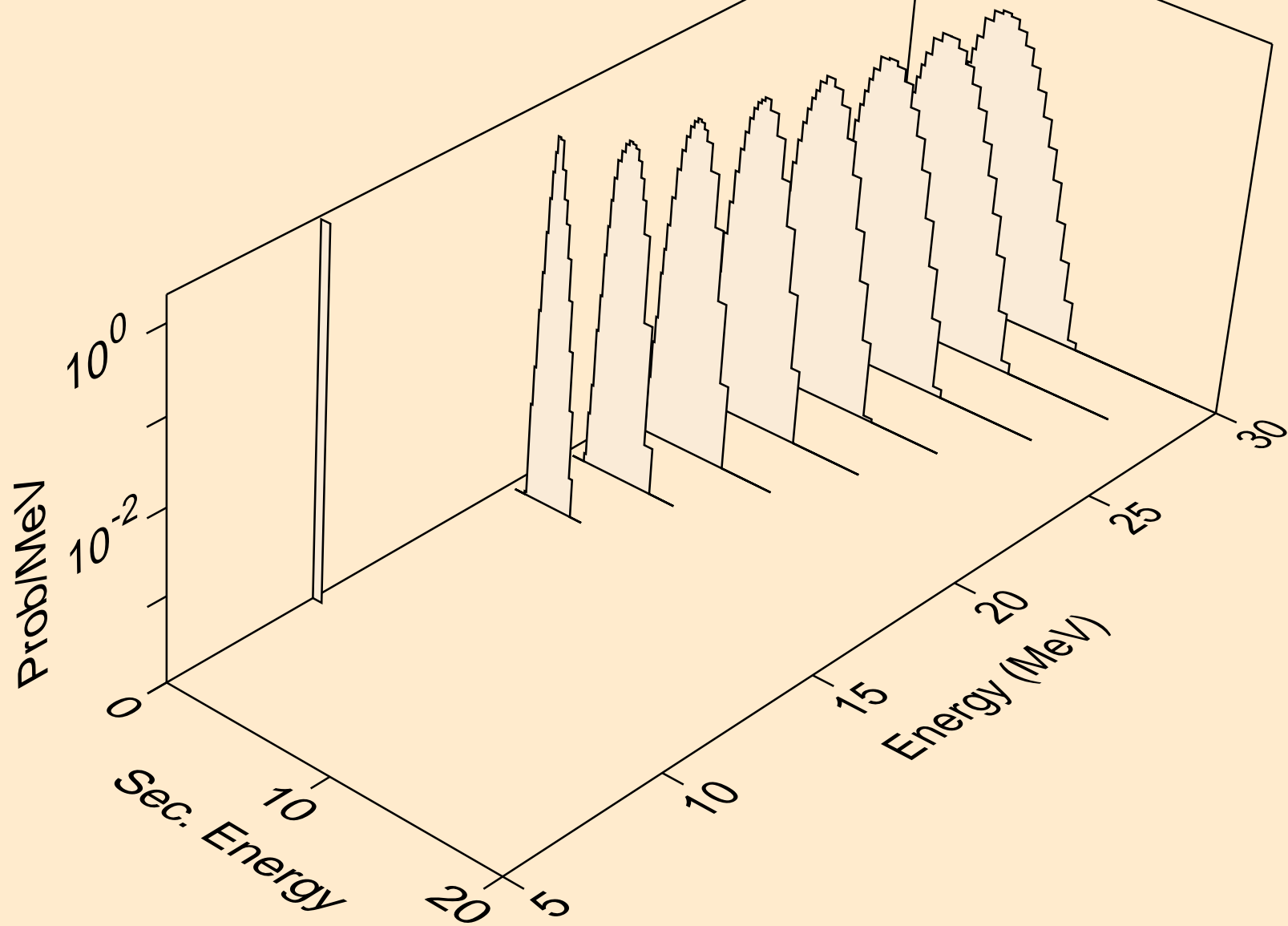

HO160N NEUTRON ACER TENDL-2021 LIBRARY; T=293.6K  
deuterons from (n,x)

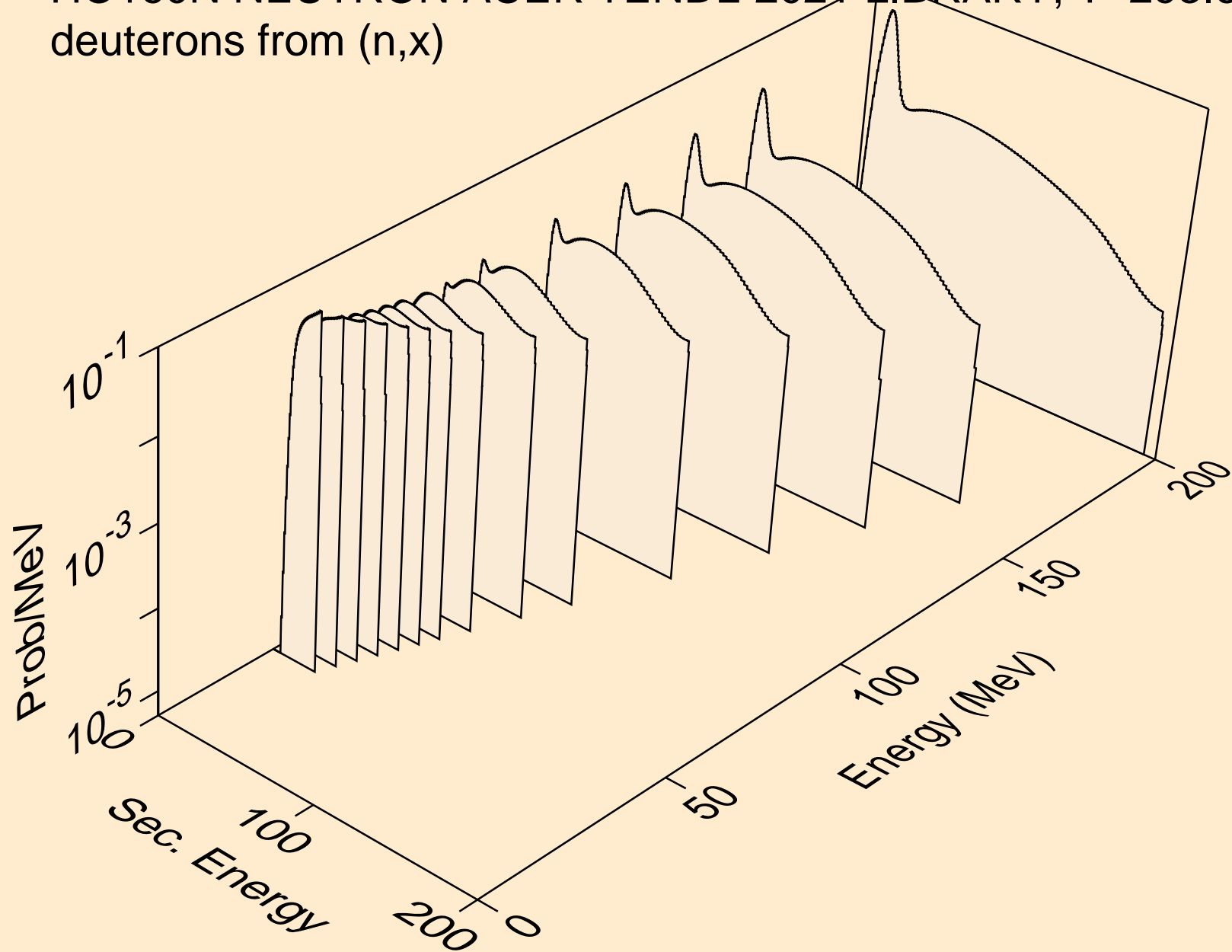

HO160N NEUTRON ACER TENDL-2021 LIBRARY; T=293.6K  
deuterons from (n,2nd)

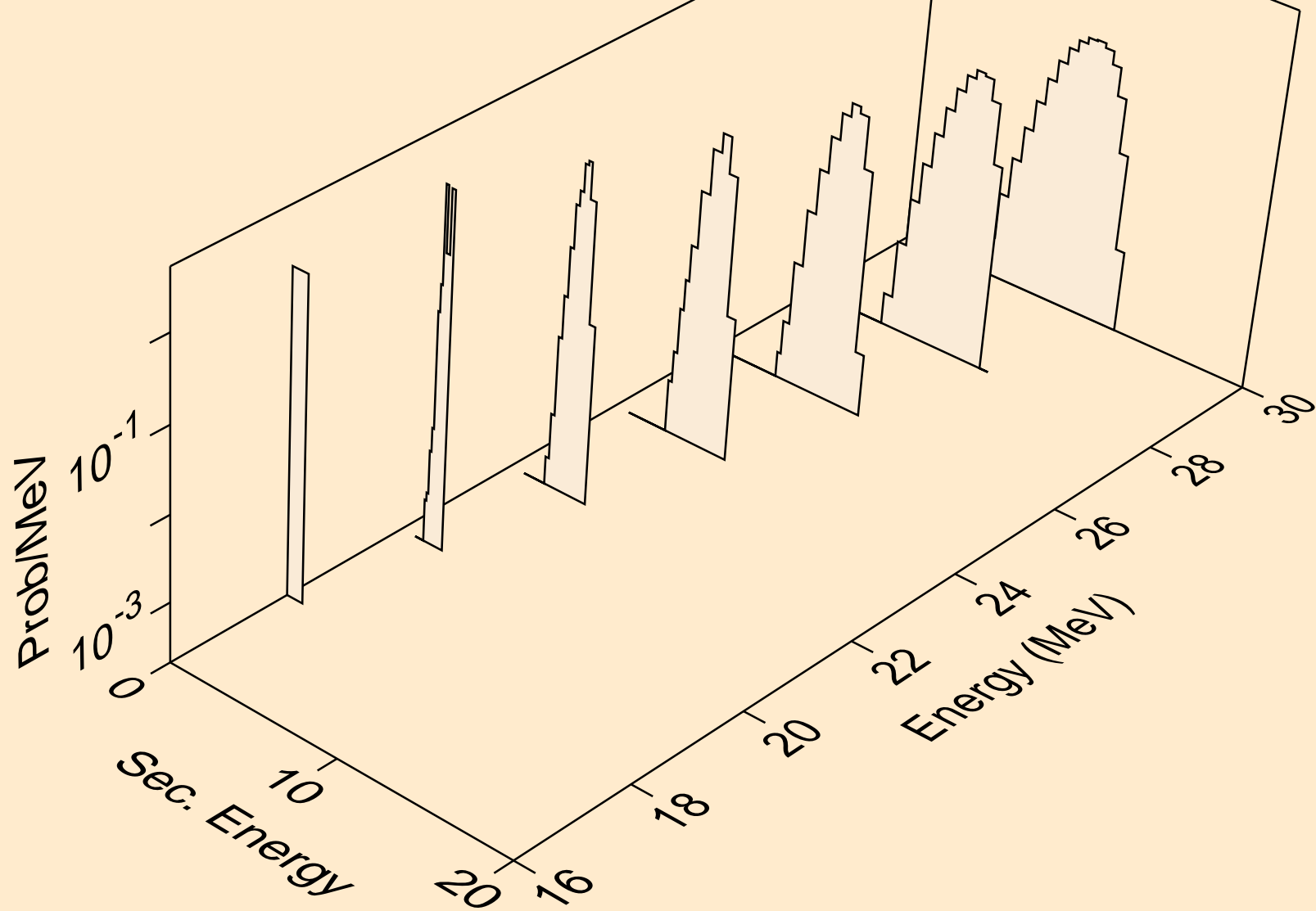



HO160N NEUTRON ACER TENDL-2021 LIBRARY; T=293.6K  
deuterons from (n,n\*)d

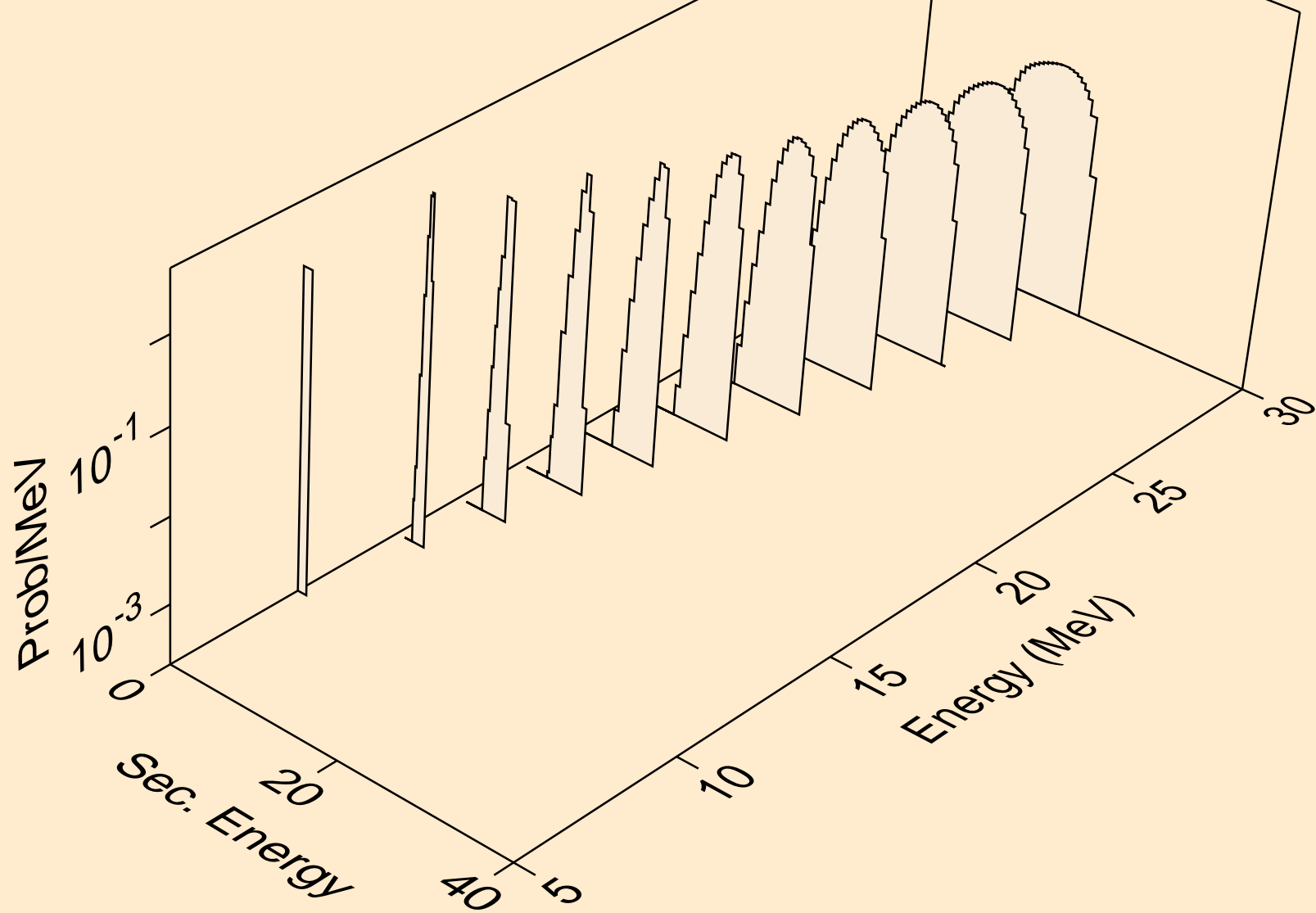

HO160N NEUTRON ACER TENDL-2021 LIBRARY; T=293.6K  
deuterons from (n,d)

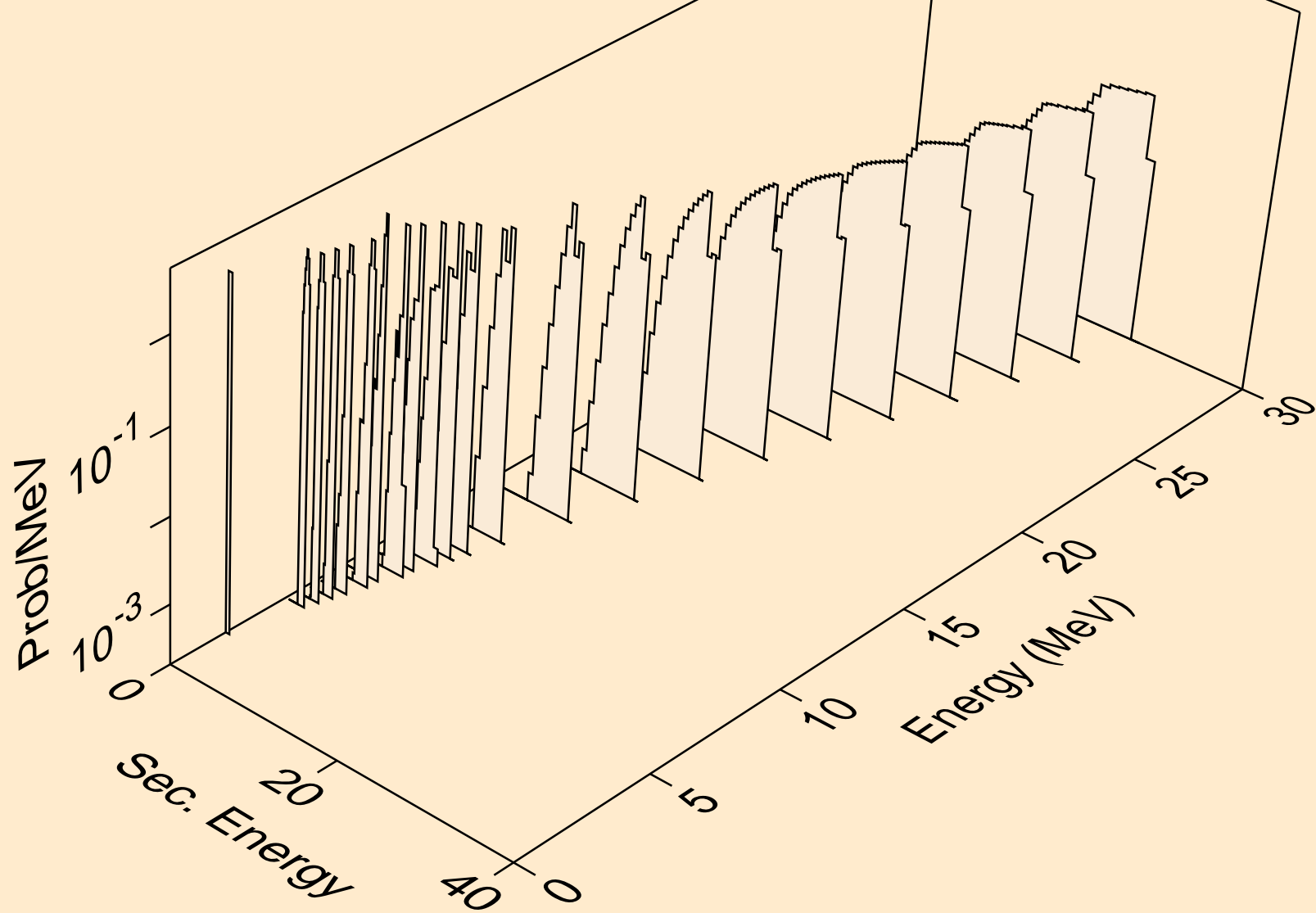

HO160N NEUTRON ACER TENDL-2021 LIBRARY; T=293.6K  
deuterons from (n,pd)

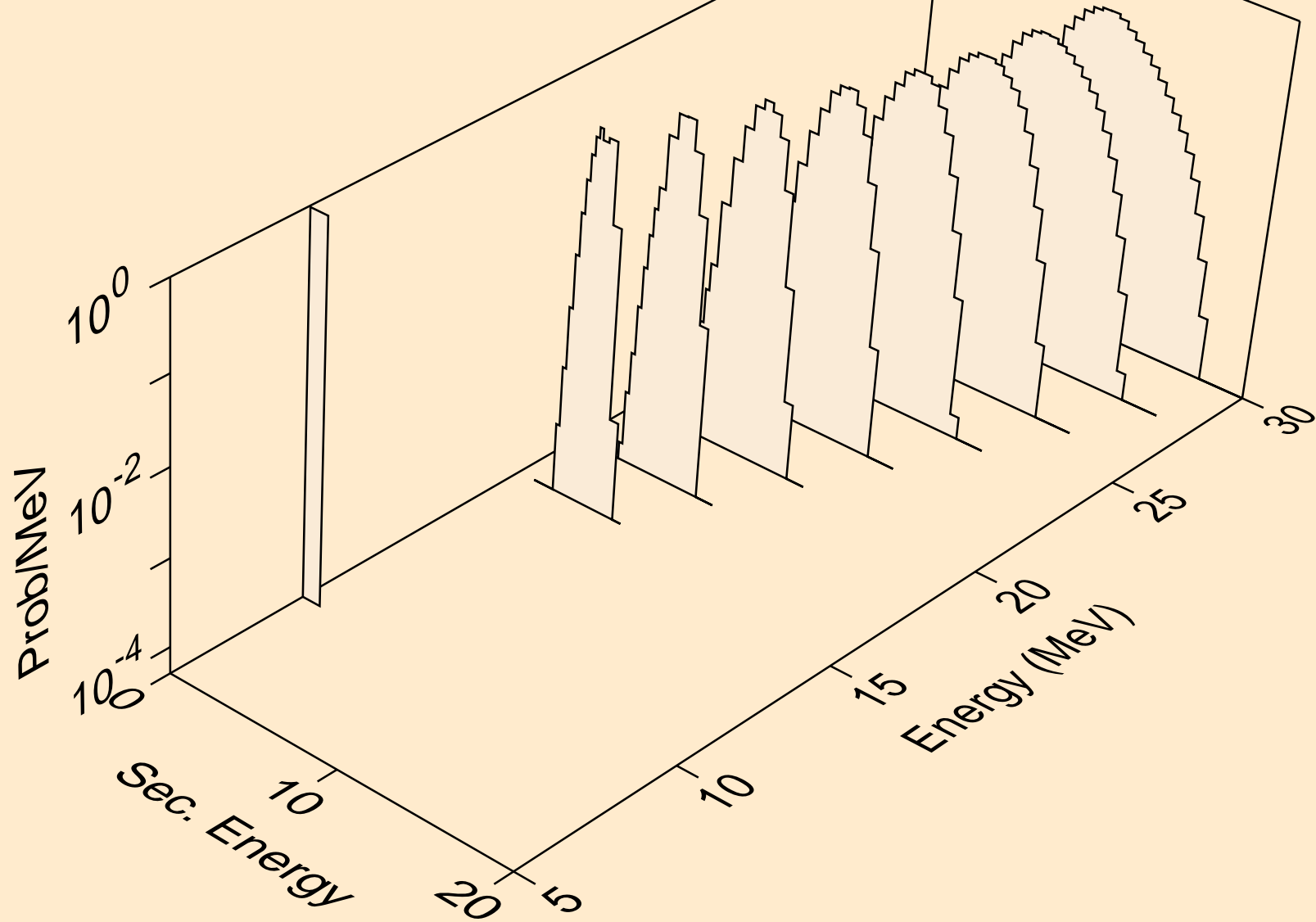

HO160N NEUTRON ACER TENDL-2021 LIBRARY; T=293.6K  
deuterons from (n,da)

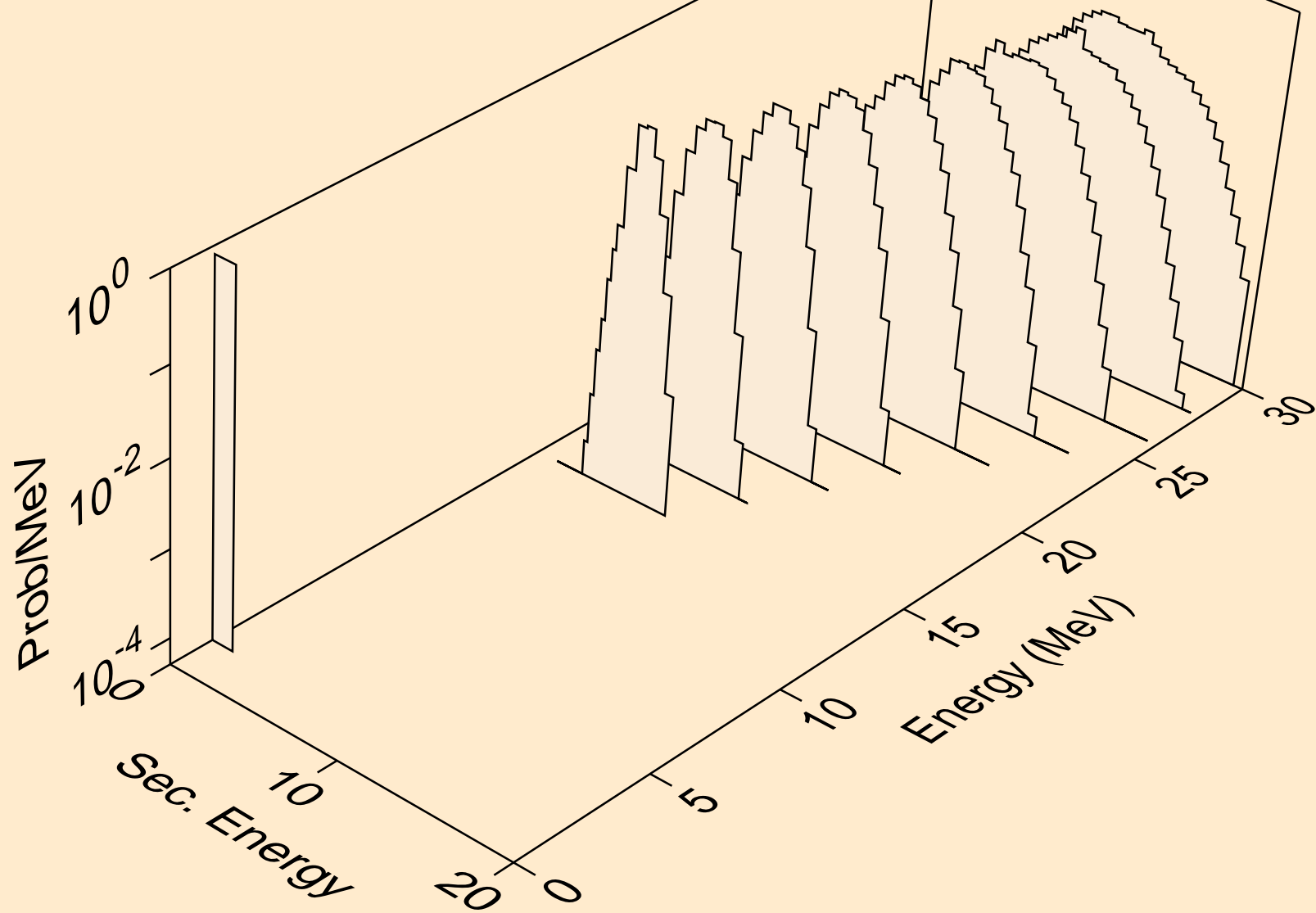

HO160N NEUTRON ACER TENDL-2021 LIBRARY; T=293.6K  
tritons from (n,x)

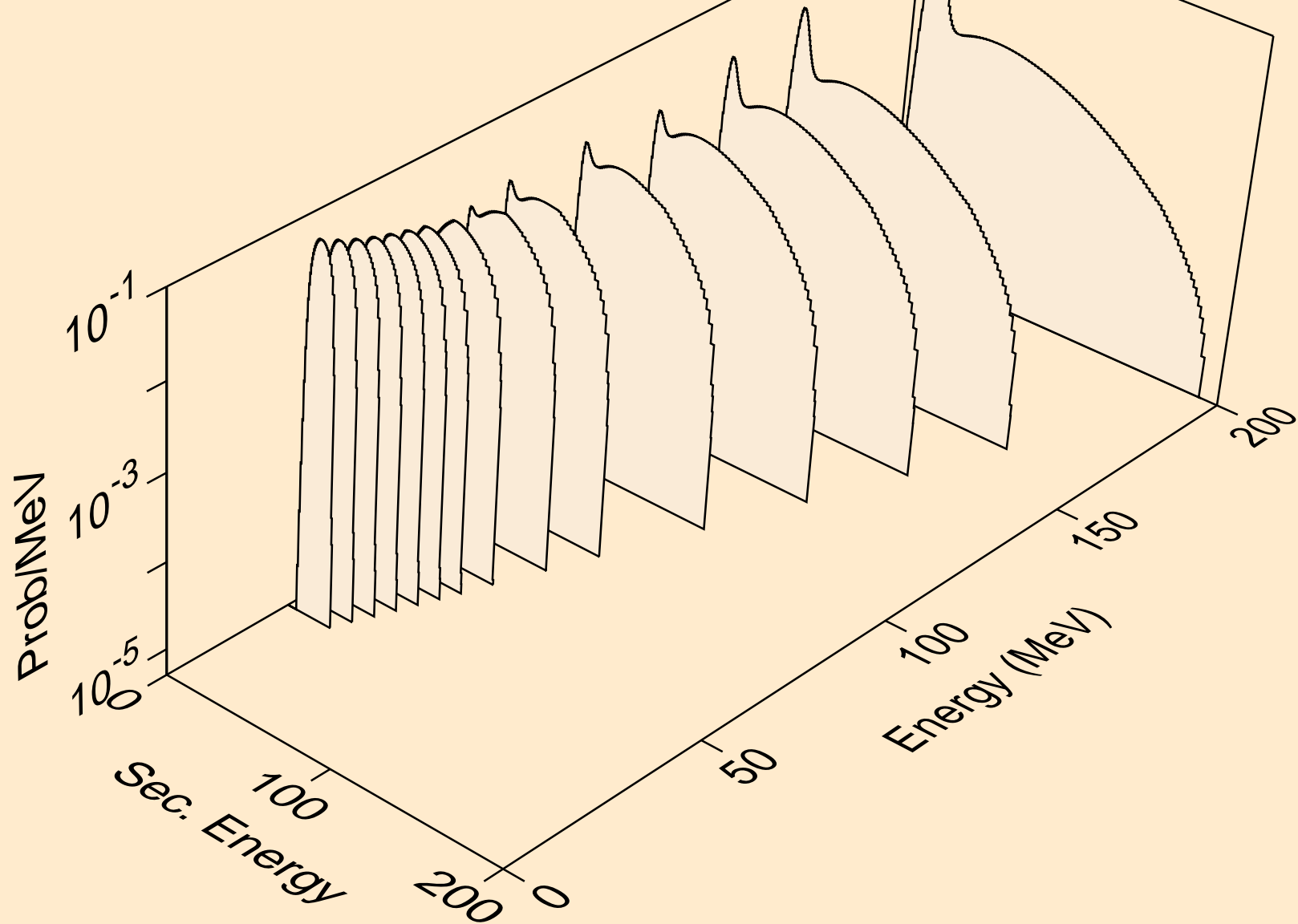

HO160N NEUTRON ACER TENDL-2021 LIBRARY; T=293.6K  
tritons from (n,n\*)t

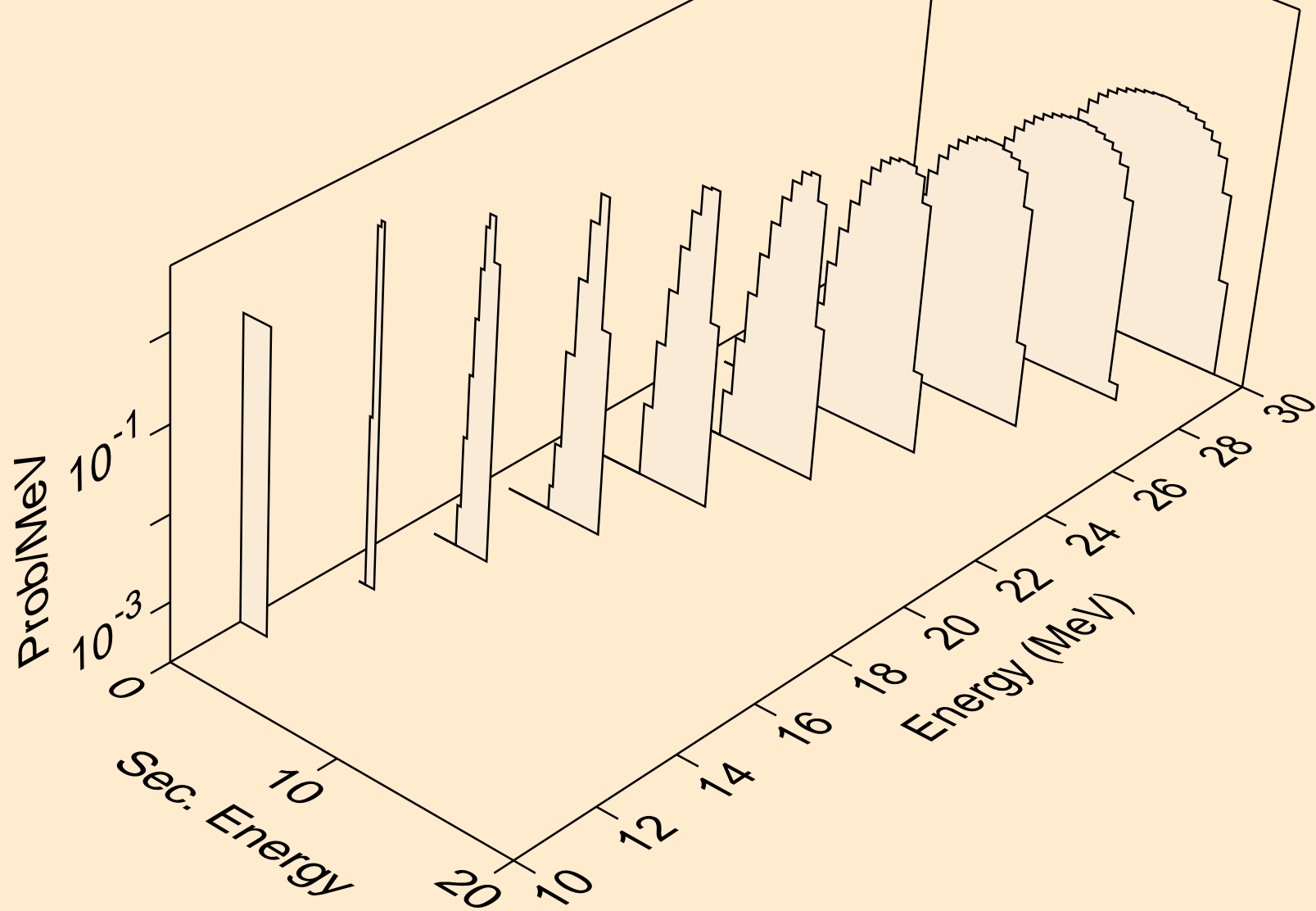

HO160N NEUTRON ACER TENDL-2021 LIBRARY; T=293.6K  
tritons from (n,t)

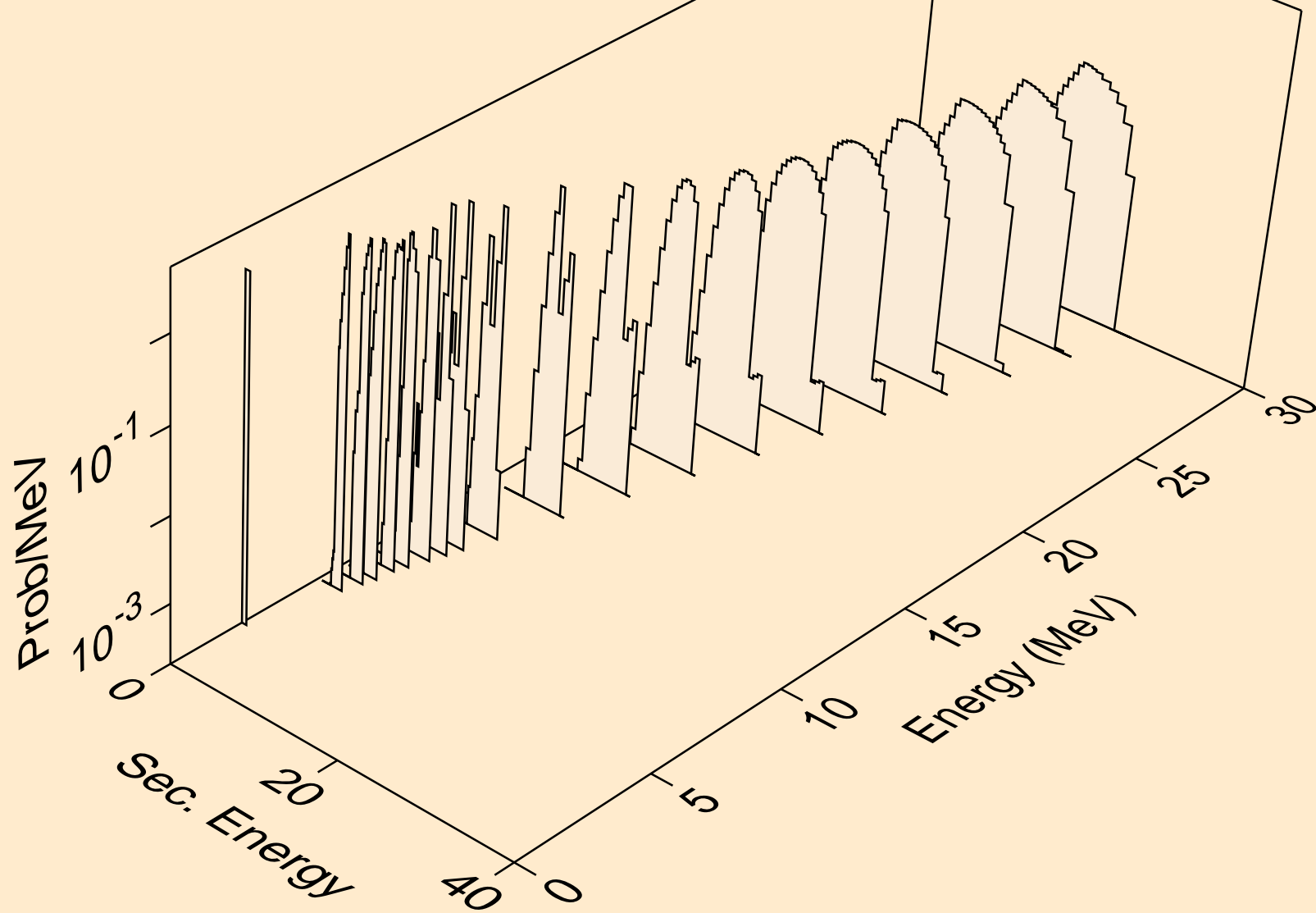

HO160N NEUTRON ACER TENDL-2021 LIBRARY; T=293.6K  
tritons from (n,pt)

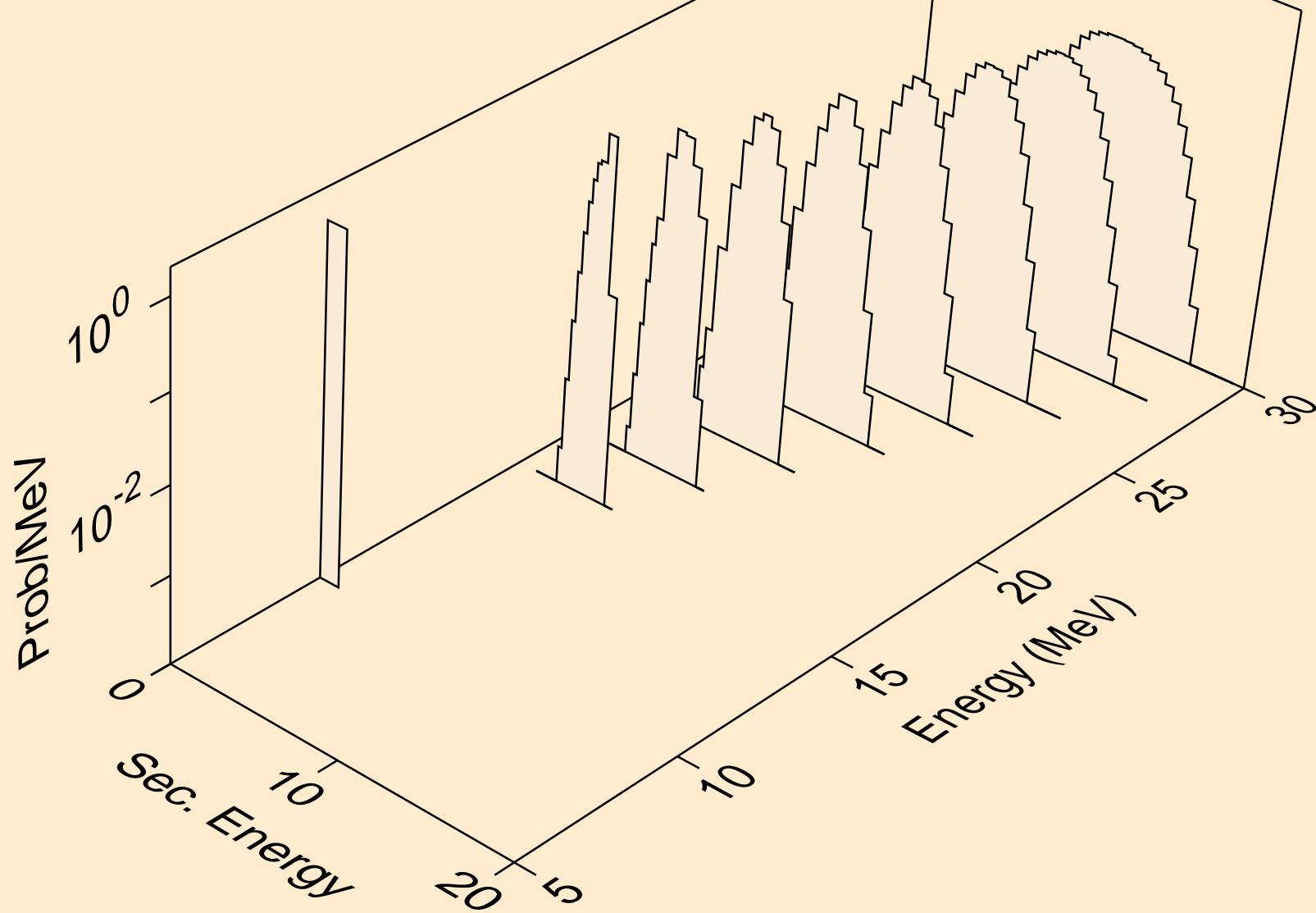



HO160N NEUTRON ACER TENDL-2021 LIBRARY; T=293.6K  
he3s from (n,x)

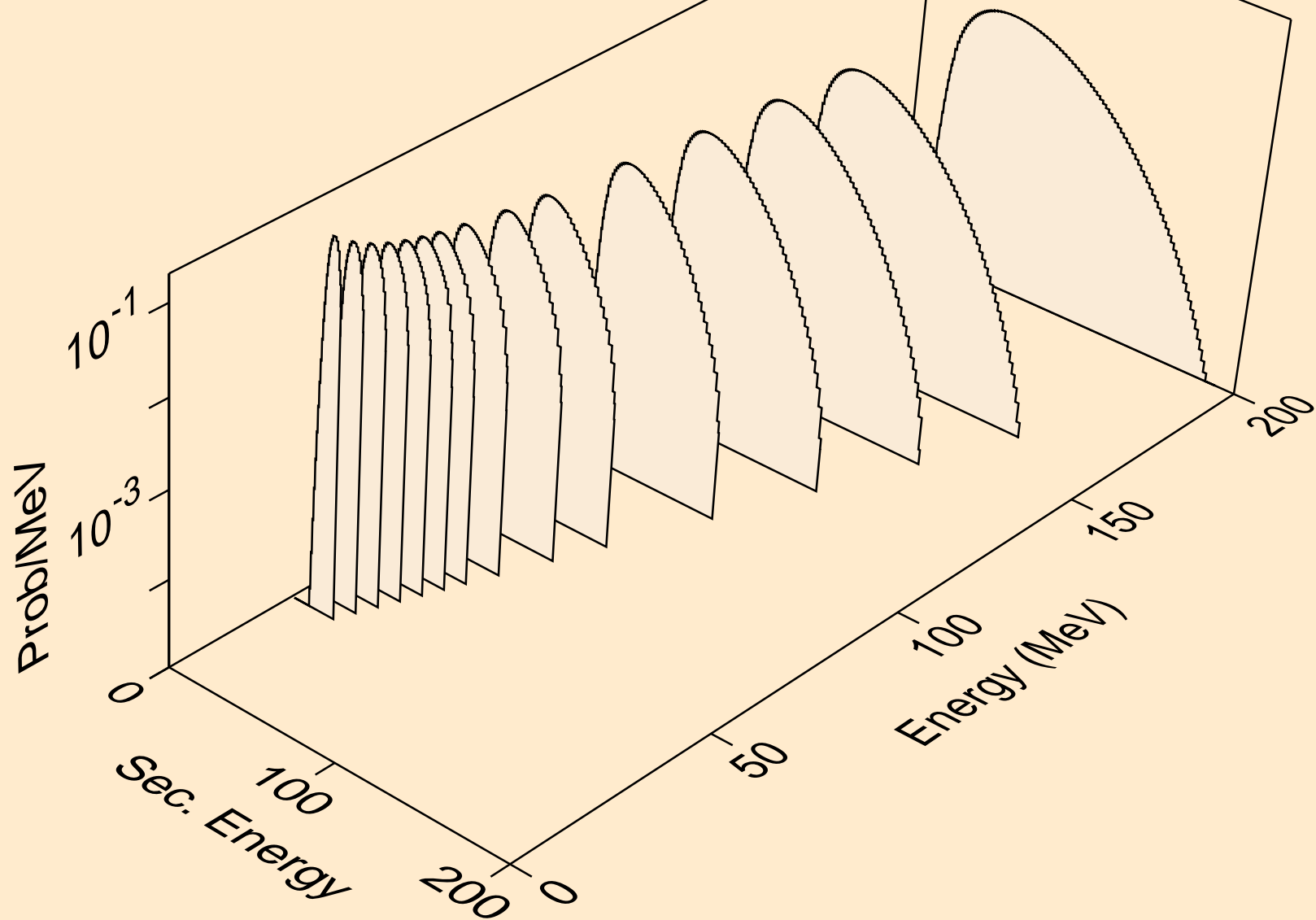

HO160N NEUTRON ACER TENDL-2021 LIBRARY; T=293.6K  
he3s from (n,n\*)he3

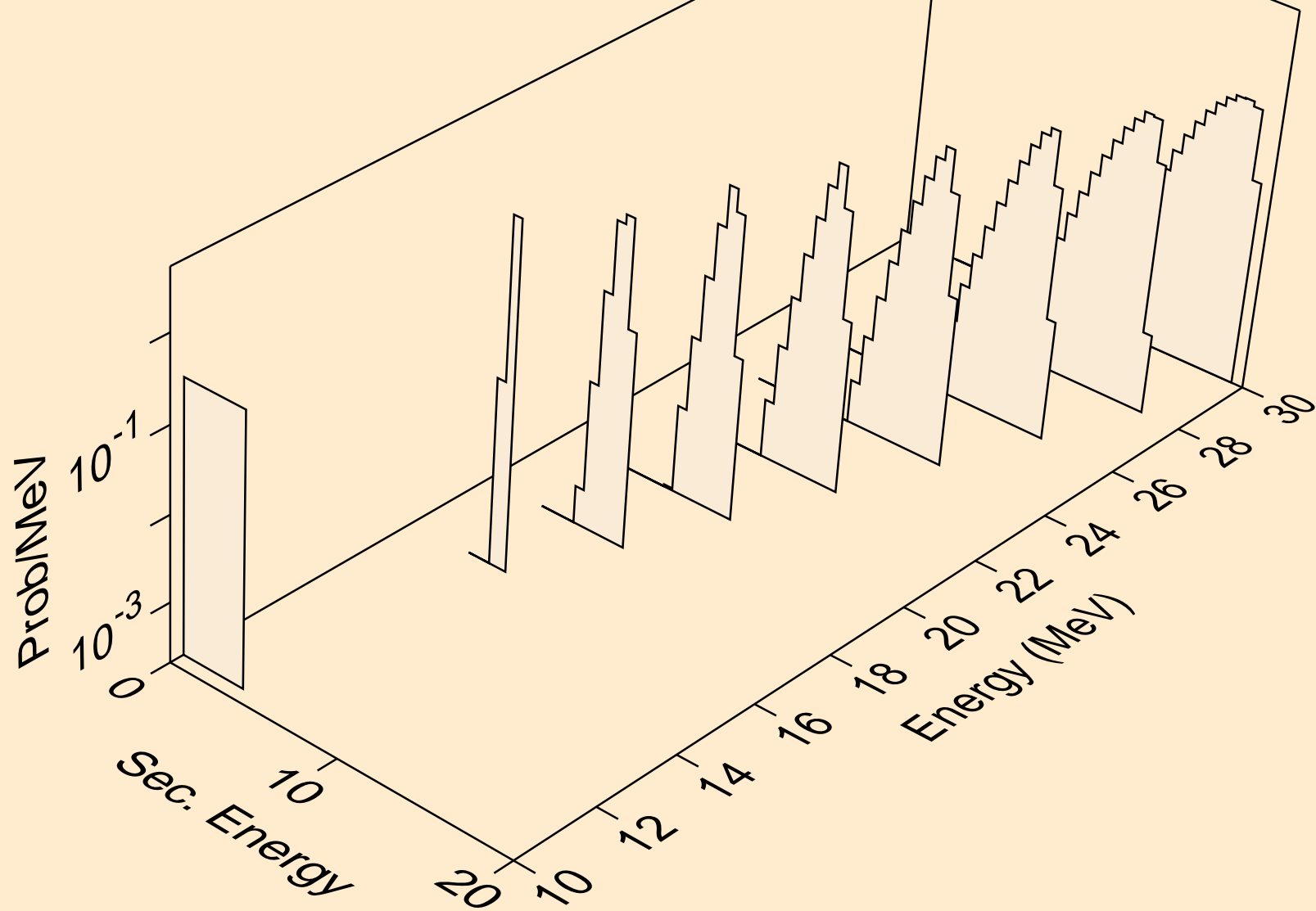

HO160N NEUTRON ACER TENDL-2021 LIBRARY; T=293.6K  
he3s from (n,he3)

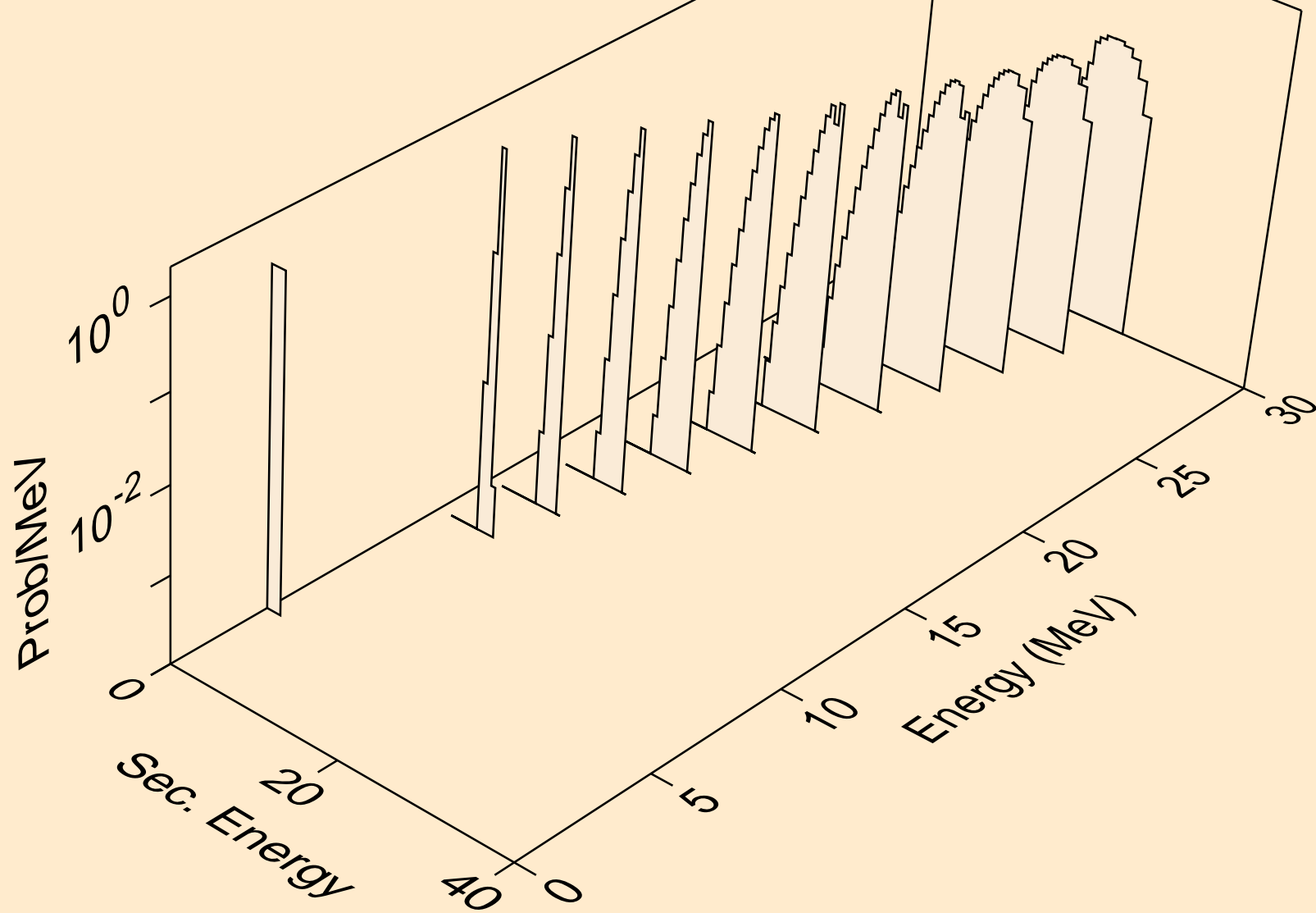

HO160N NEUTRON ACER TENDL-2021 LIBRARY; T=293.6K  
alphas from (n,x)

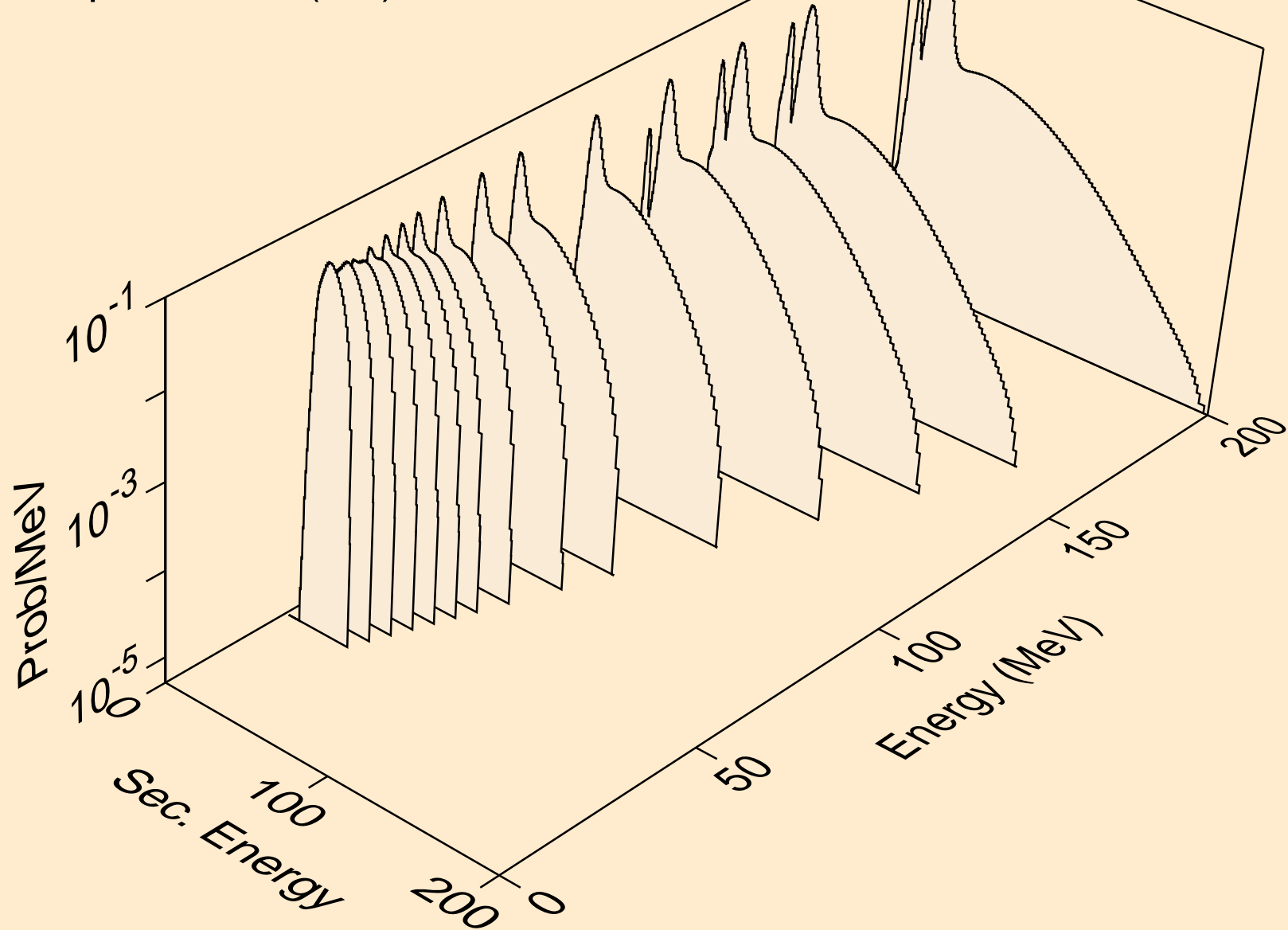

HO160N NEUTRON ACER TENDL-2021 LIBRARY; T=293.6K  
alphas from (n,n\*)a

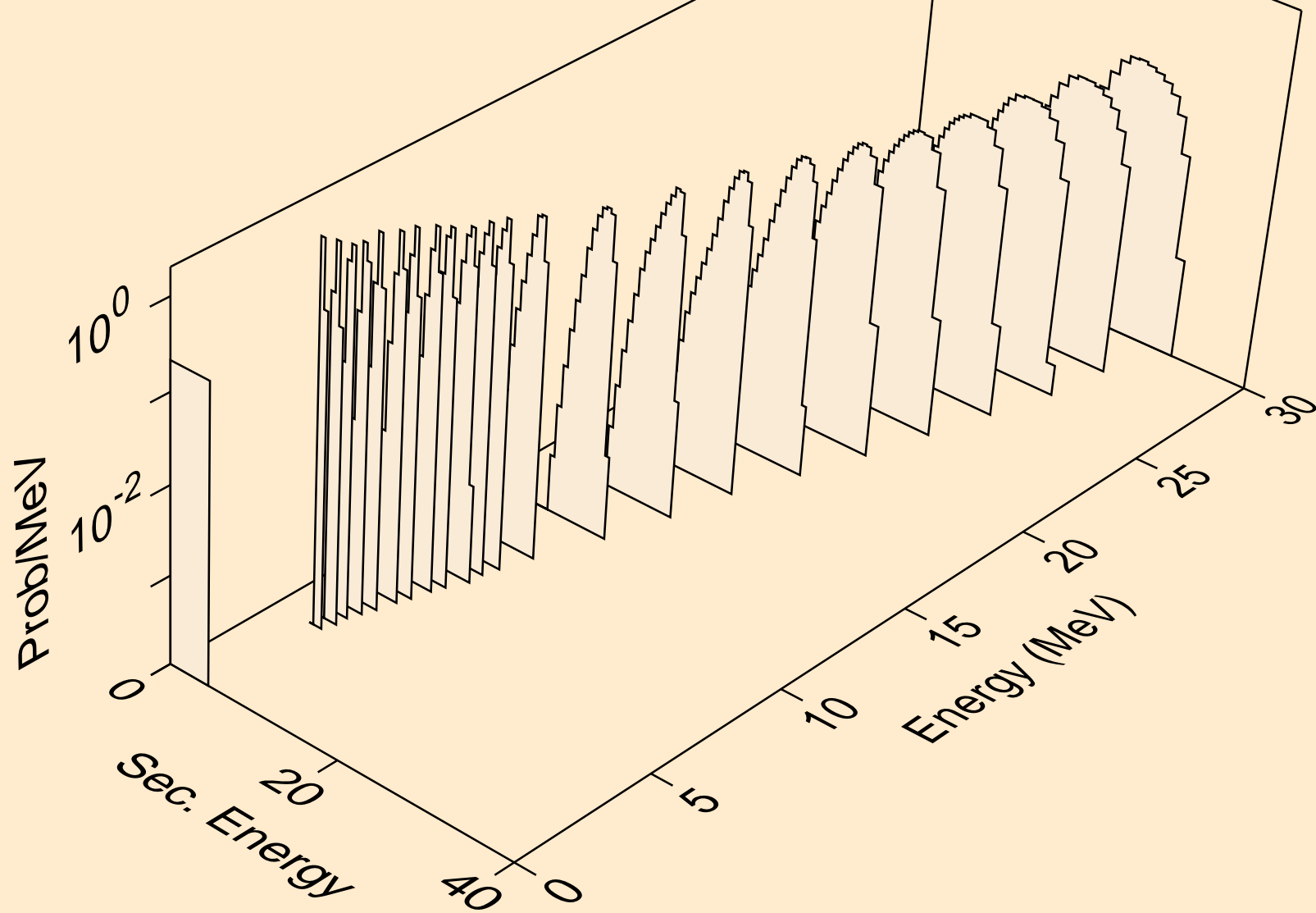

HO160N NEUTRON ACER TENDL-2021 LIBRARY; T=293.6K  
alphas from (n,2n)a

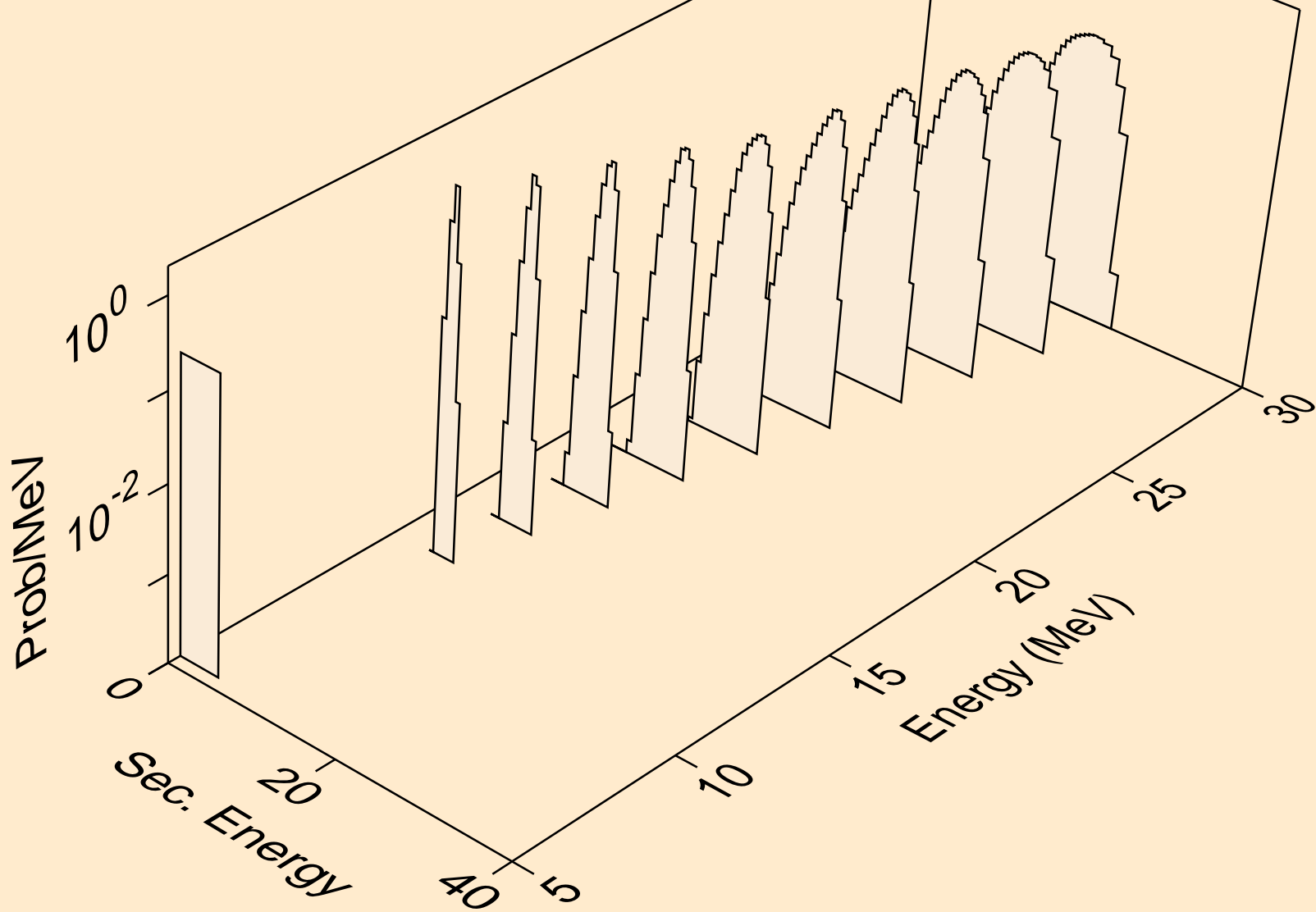

HO160N NEUTRON ACER TENDL-2021 LIBRARY; T=293.6K  
alphas from (n,3n)a

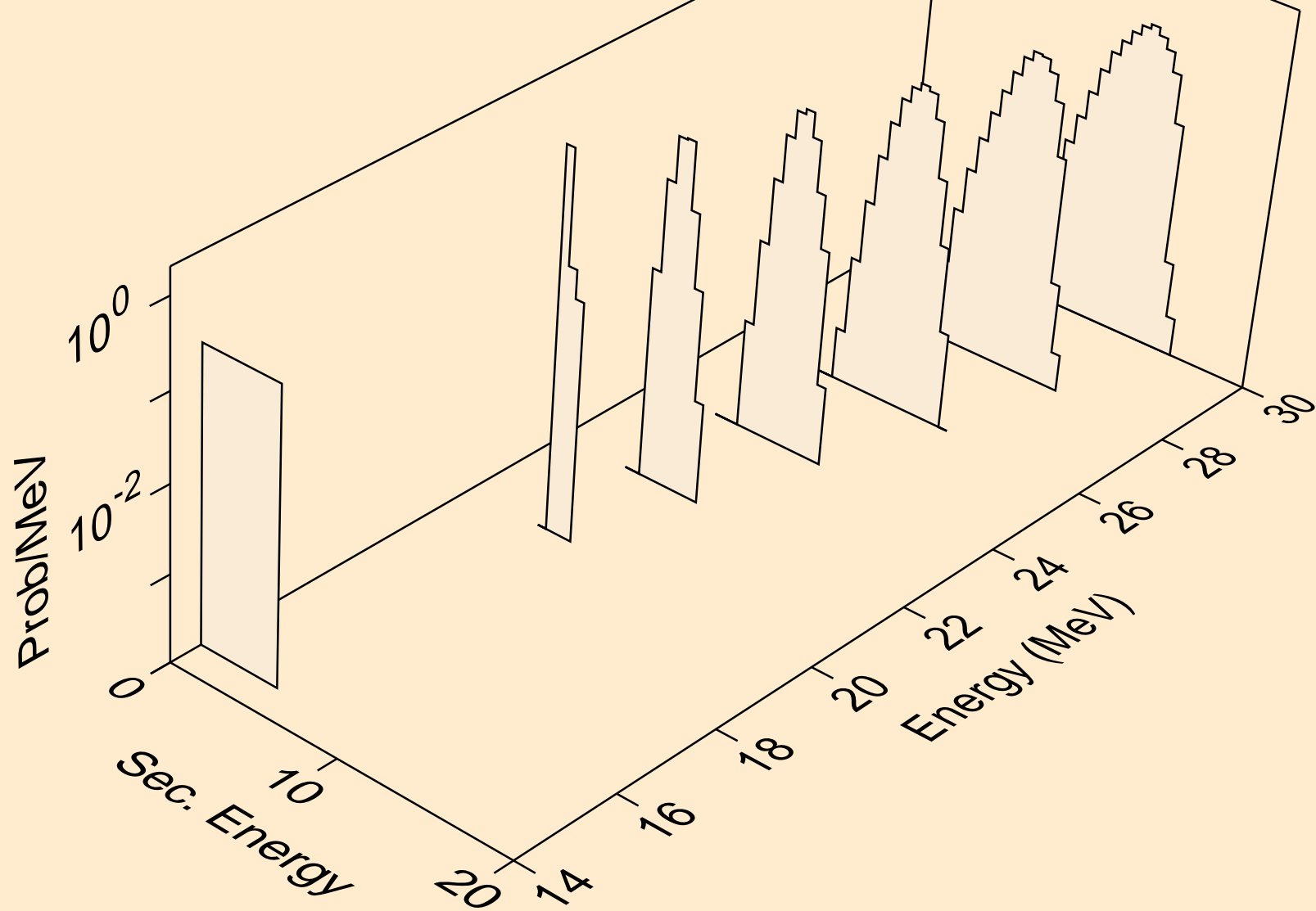

HO160N NEUTRON ACER TENDL-2021 LIBRARY; T=293.6K  
alphas from (n,n\*)2a

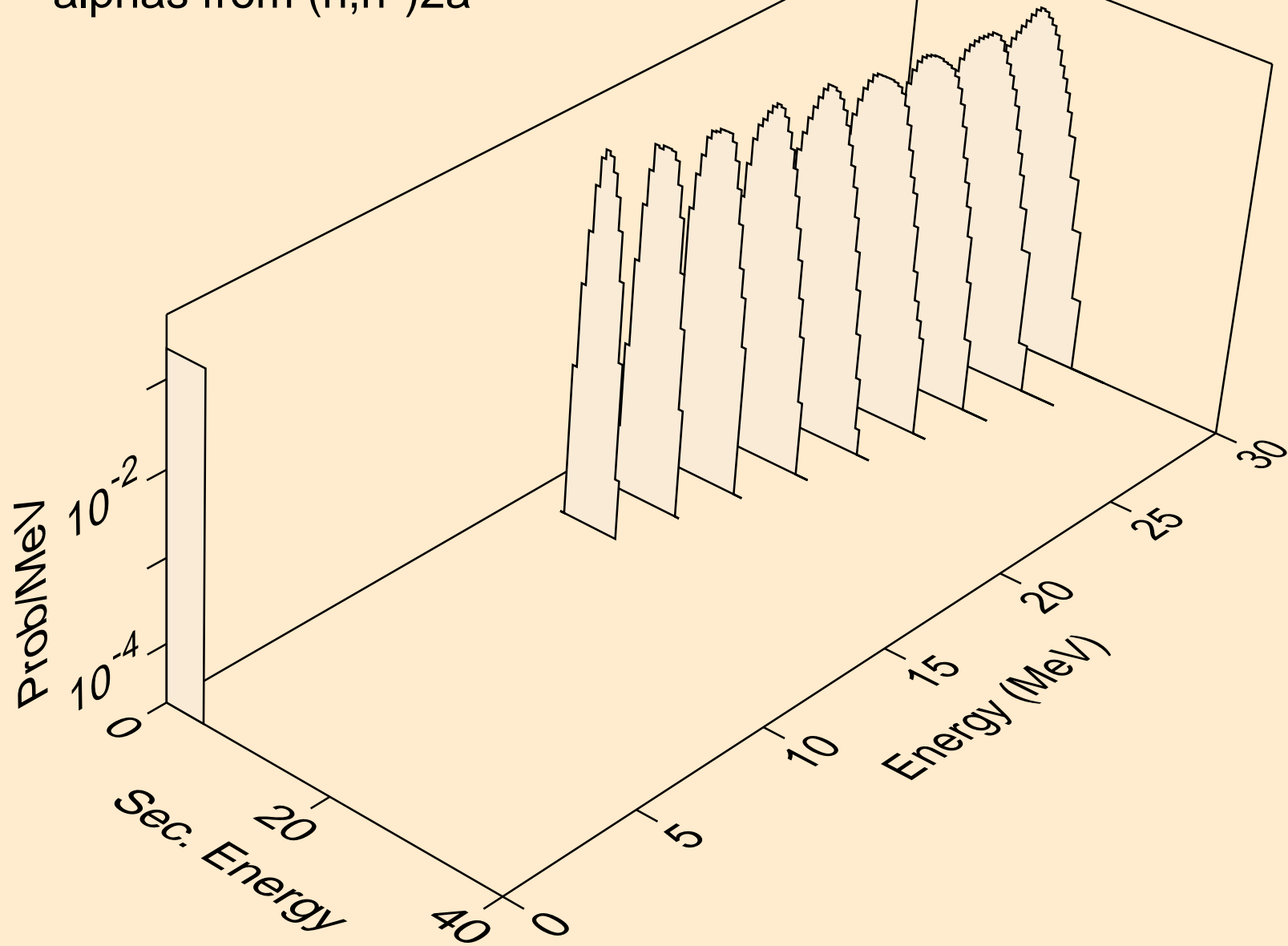



HO160N NEUTRON ACER TENDL-2021 LIBRARY; T=293.6K  
alphas from (n,npa)

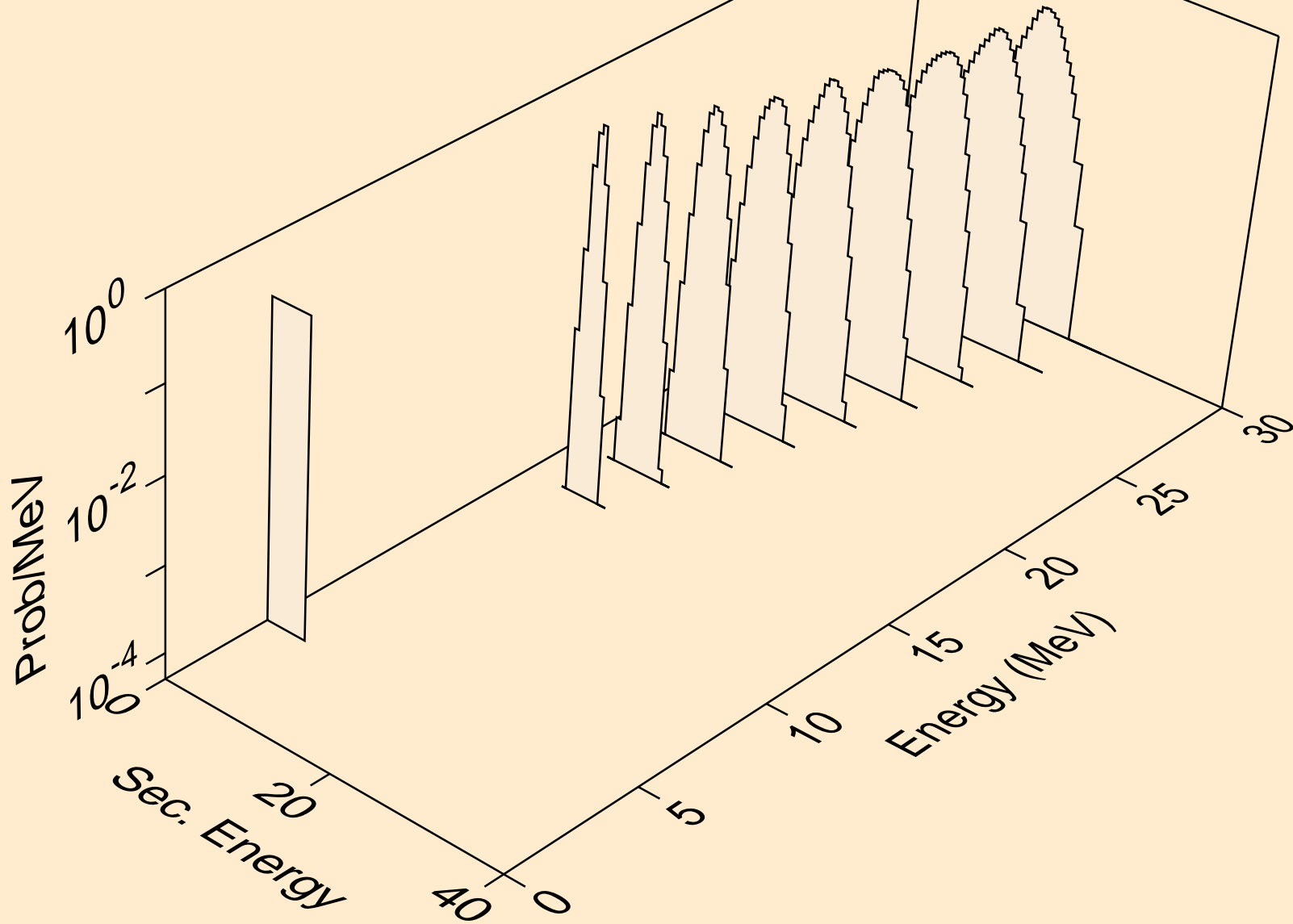

HO160N NEUTRON ACER TENDL-2021 LIBRARY; T=293.6K  
alphas from (n,a)

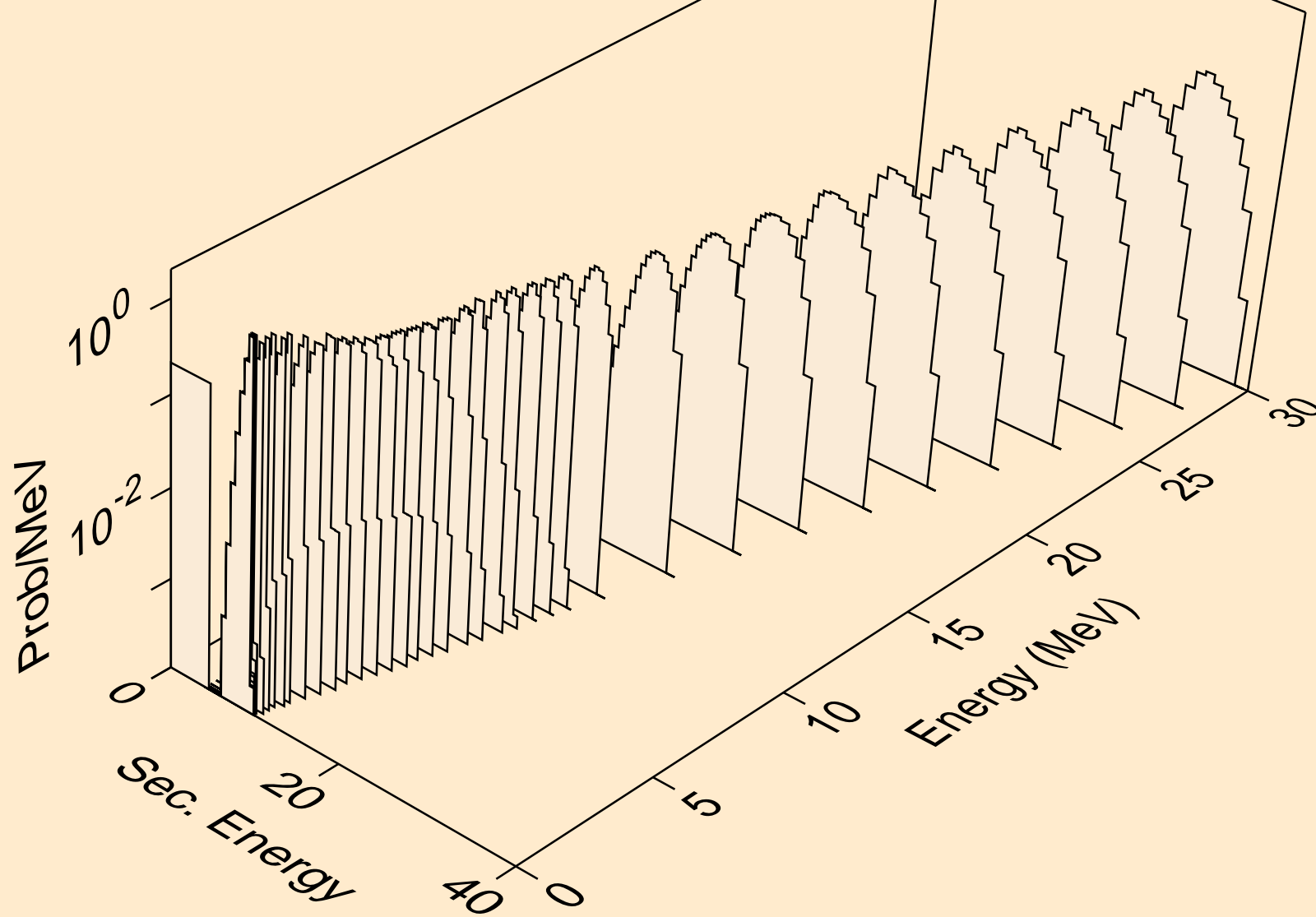

HO160N NEUTRON ACER TENDL-2021 LIBRARY; T=293.6K  
alphas from (n,2a)

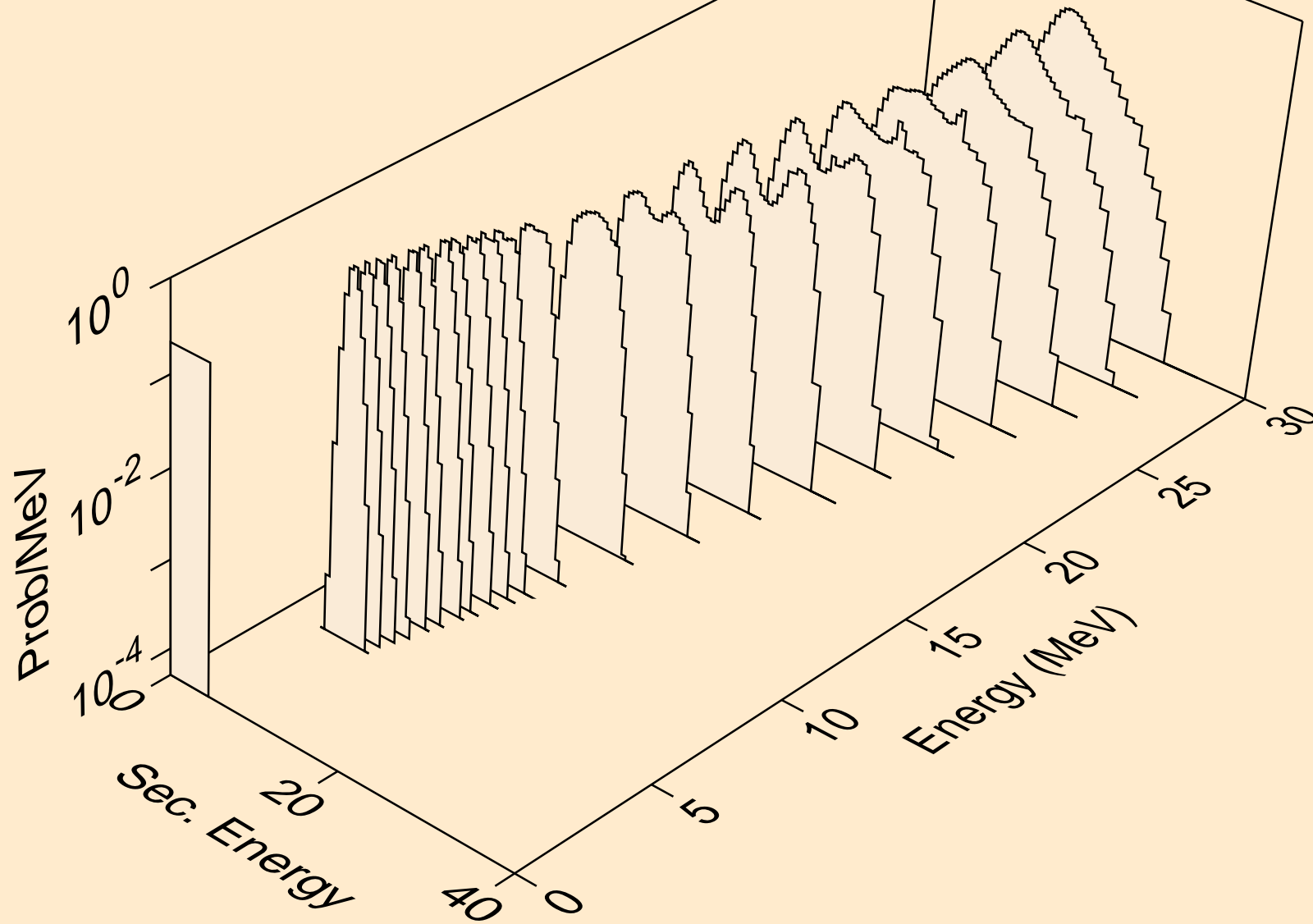

HO160N NEUTRON ACER TENDL-2021 LIBRARY; T=293.6K  
alphas from (n,pa)

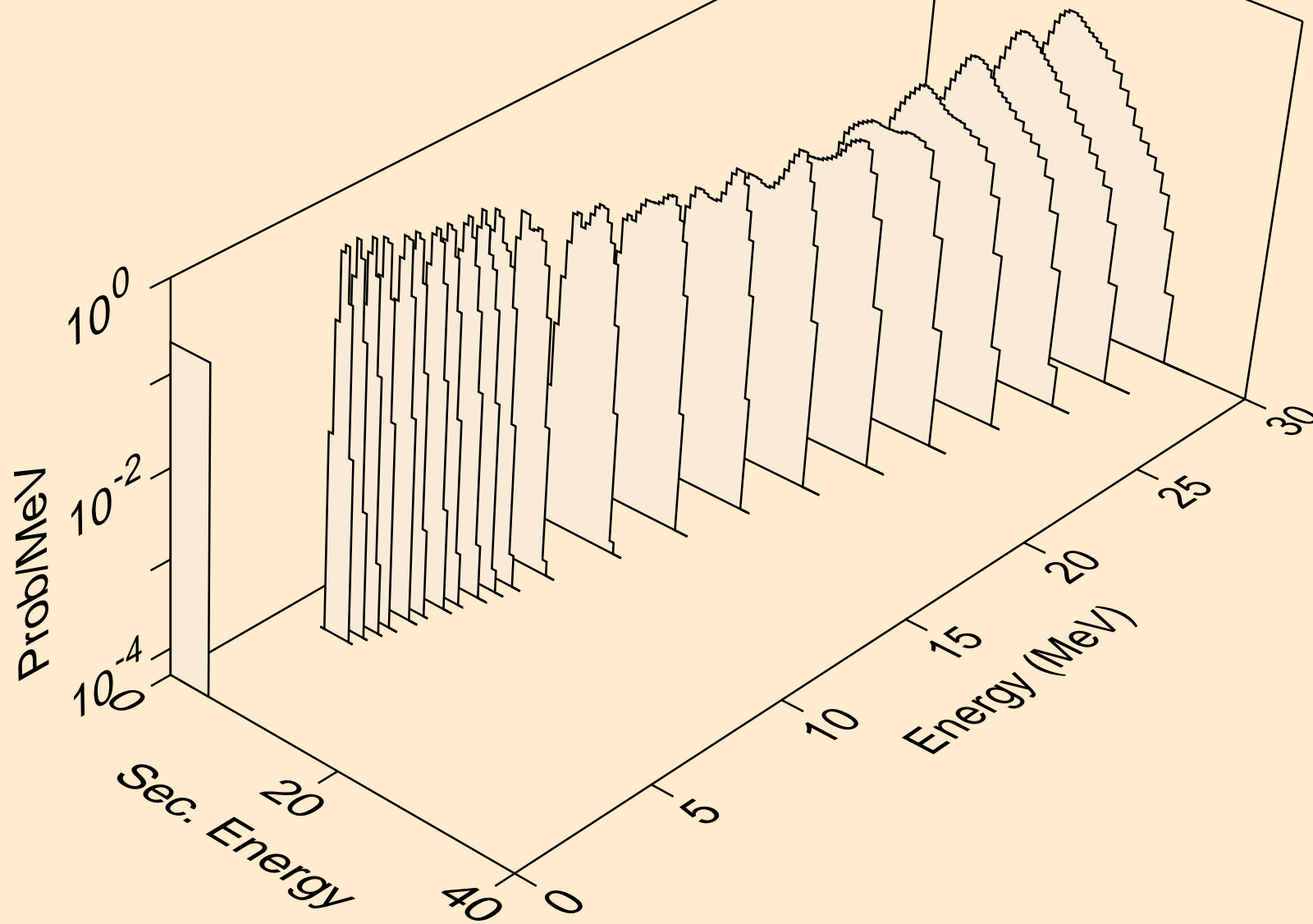

HO160N NEUTRON ACER TENDL-2021 LIBRARY; T=293.6K  
alphas from (n,da)

