

# HO171 NEUTRON ACER TENDL-2021 LIBRARY; T=293.6K

## Principal cross sections

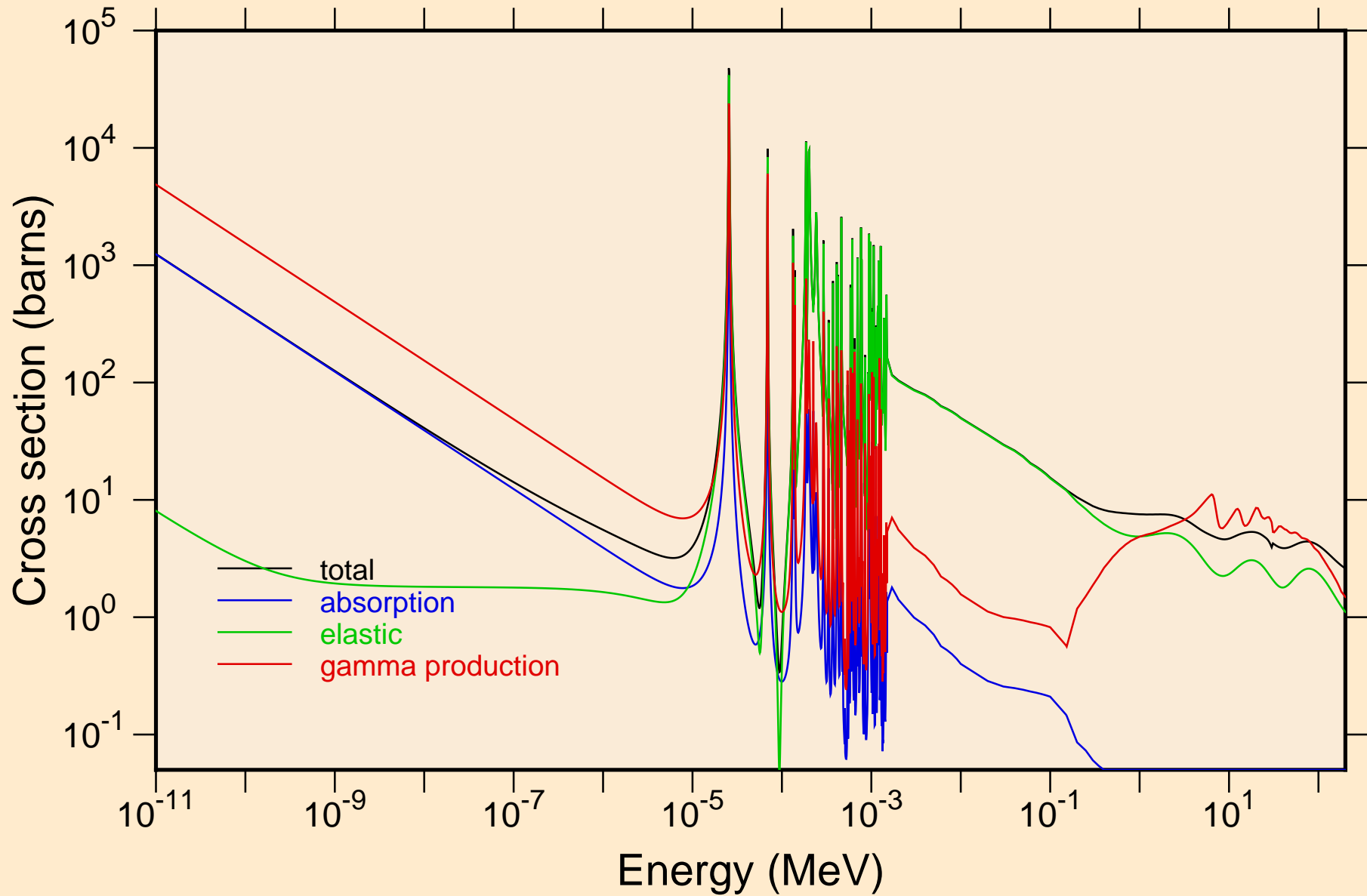

HO171 NEUTRON ACER TENDL-2021 LIBRARY; T=293.6K  
resonance total cross section

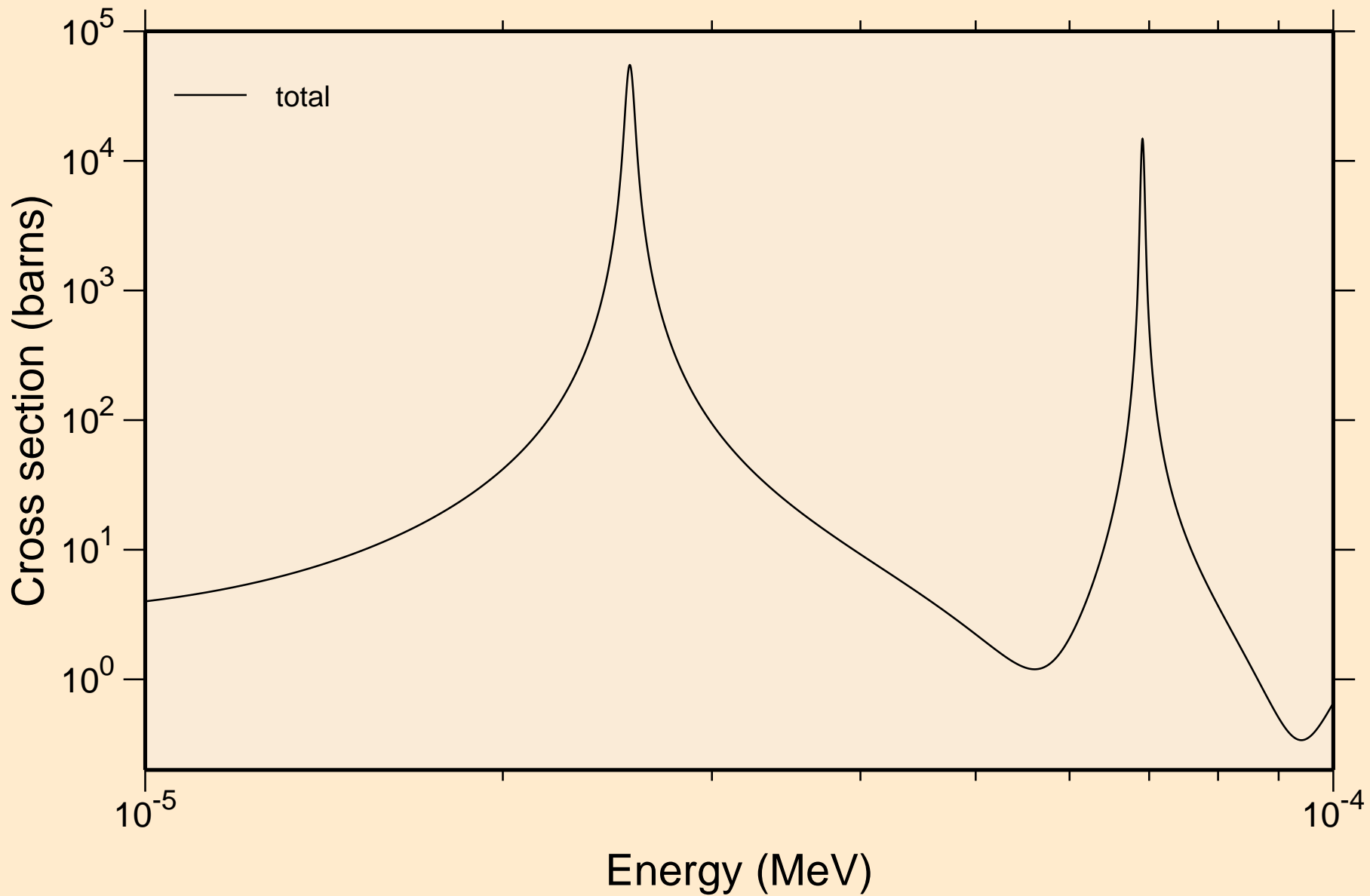

HO171 NEUTRON ACER TENDL-2021 LIBRARY; T=293.6K  
resonance total cross section

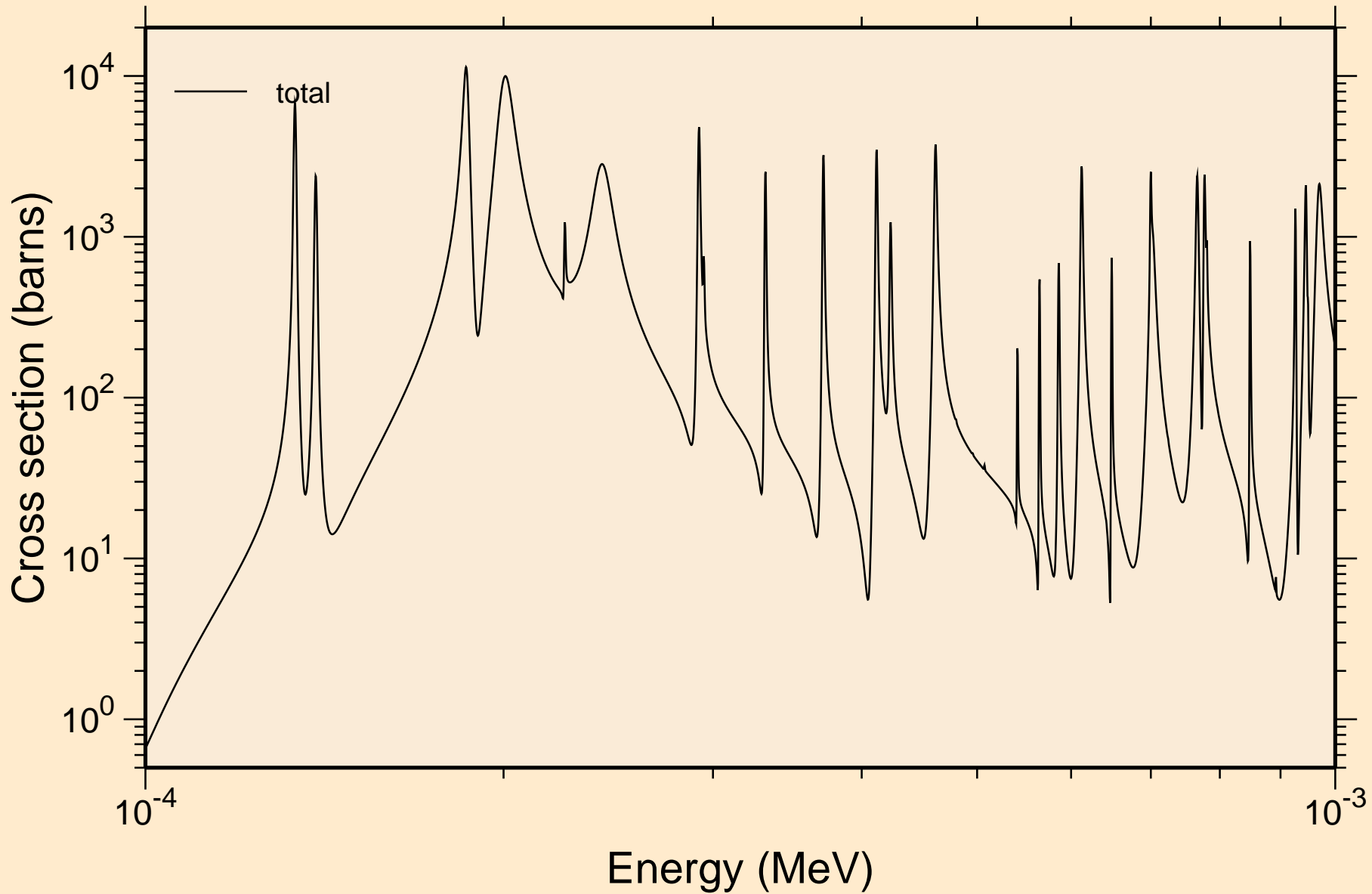

HO171 NEUTRON ACER TENDL-2021 LIBRARY; T=293.6K  
resonance total cross section

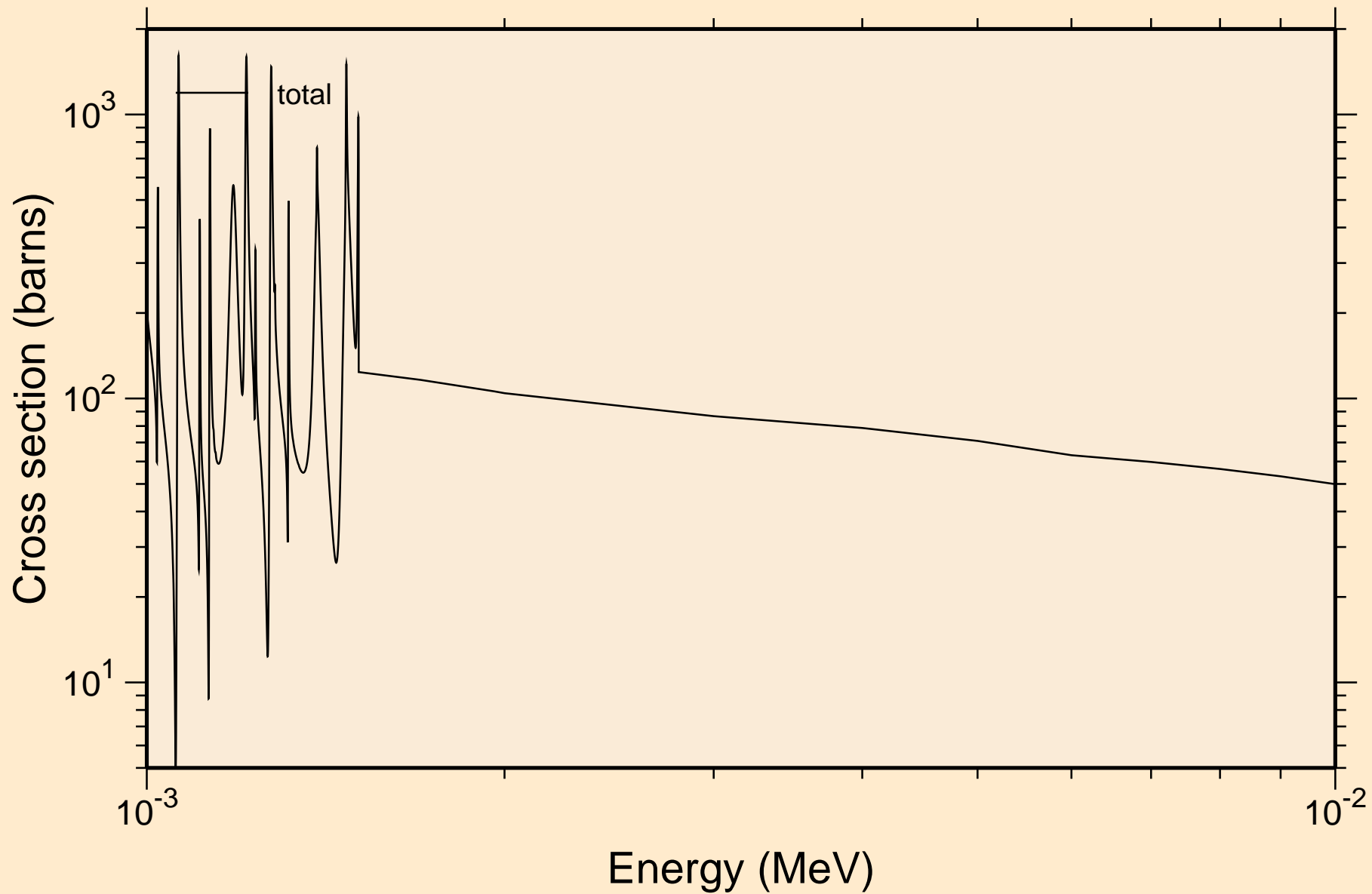

HO171 NEUTRON ACER TENDL-2021 LIBRARY; T=293.6K  
resonance total cross section

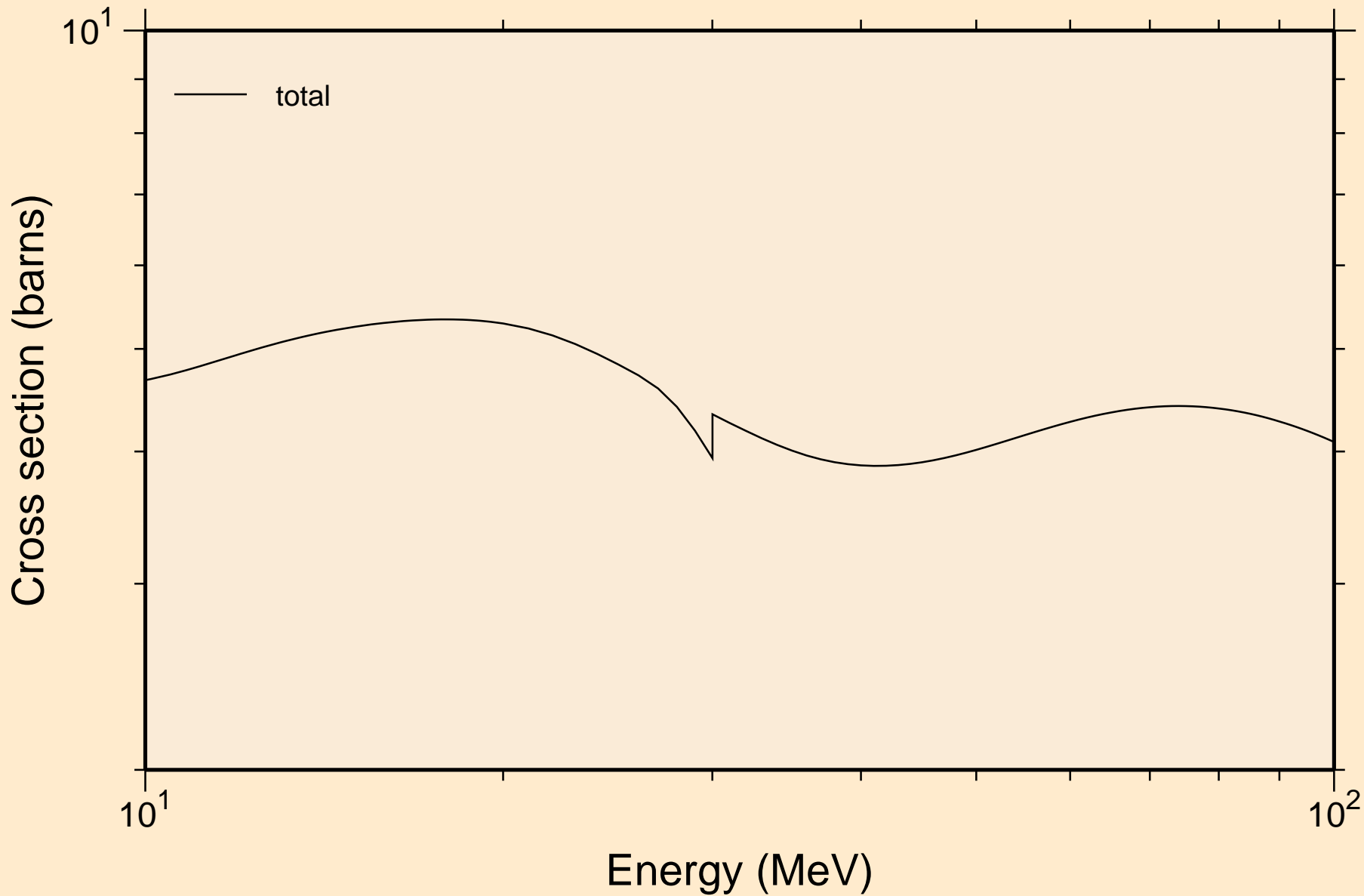

HO171 NEUTRON ACER TENDL-2021 LIBRARY; T=293.6K  
resonance absorption cross sections

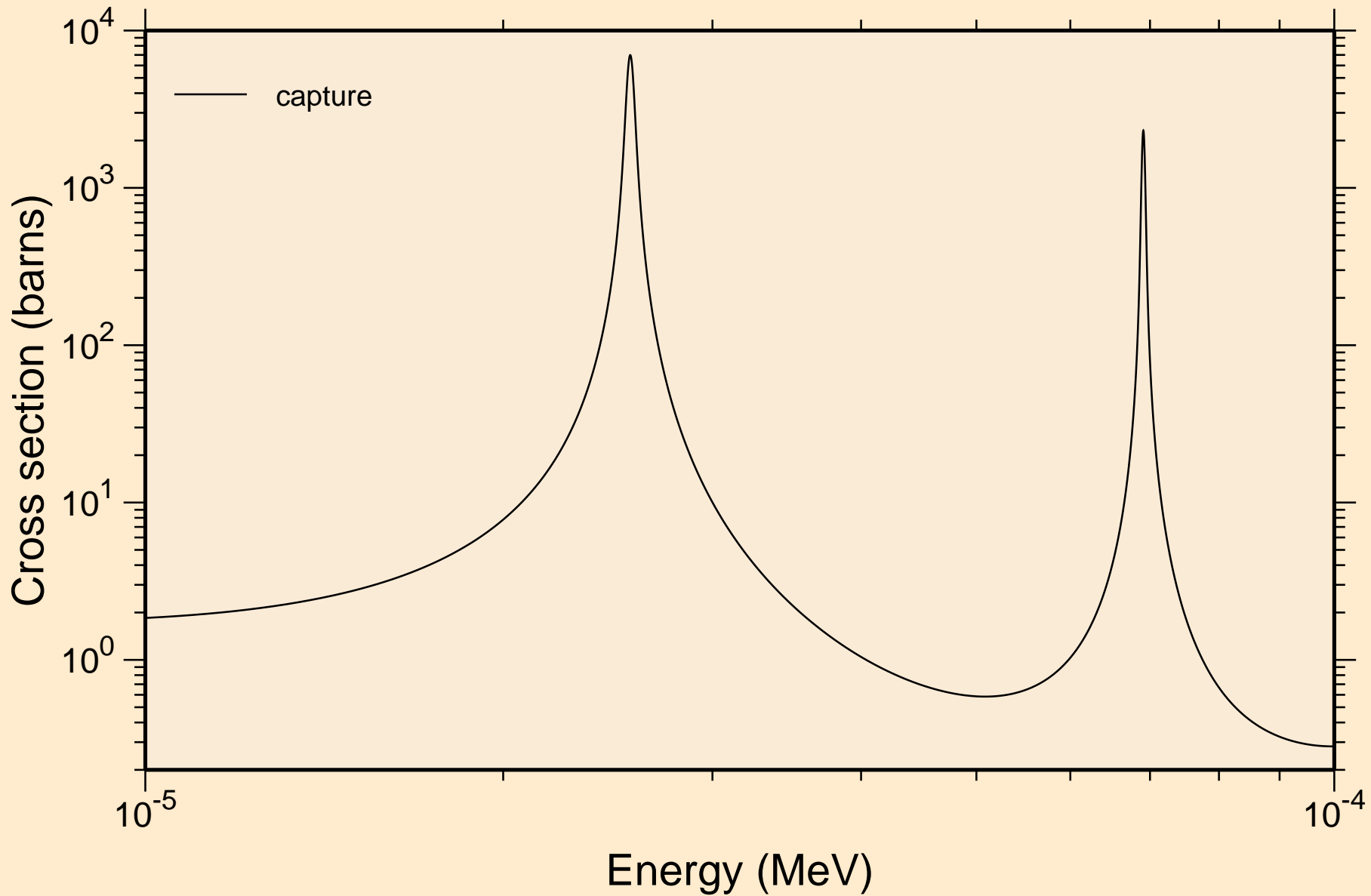

HO171 NEUTRON ACER TENDL-2021 LIBRARY; T=293.6K  
resonance absorption cross sections

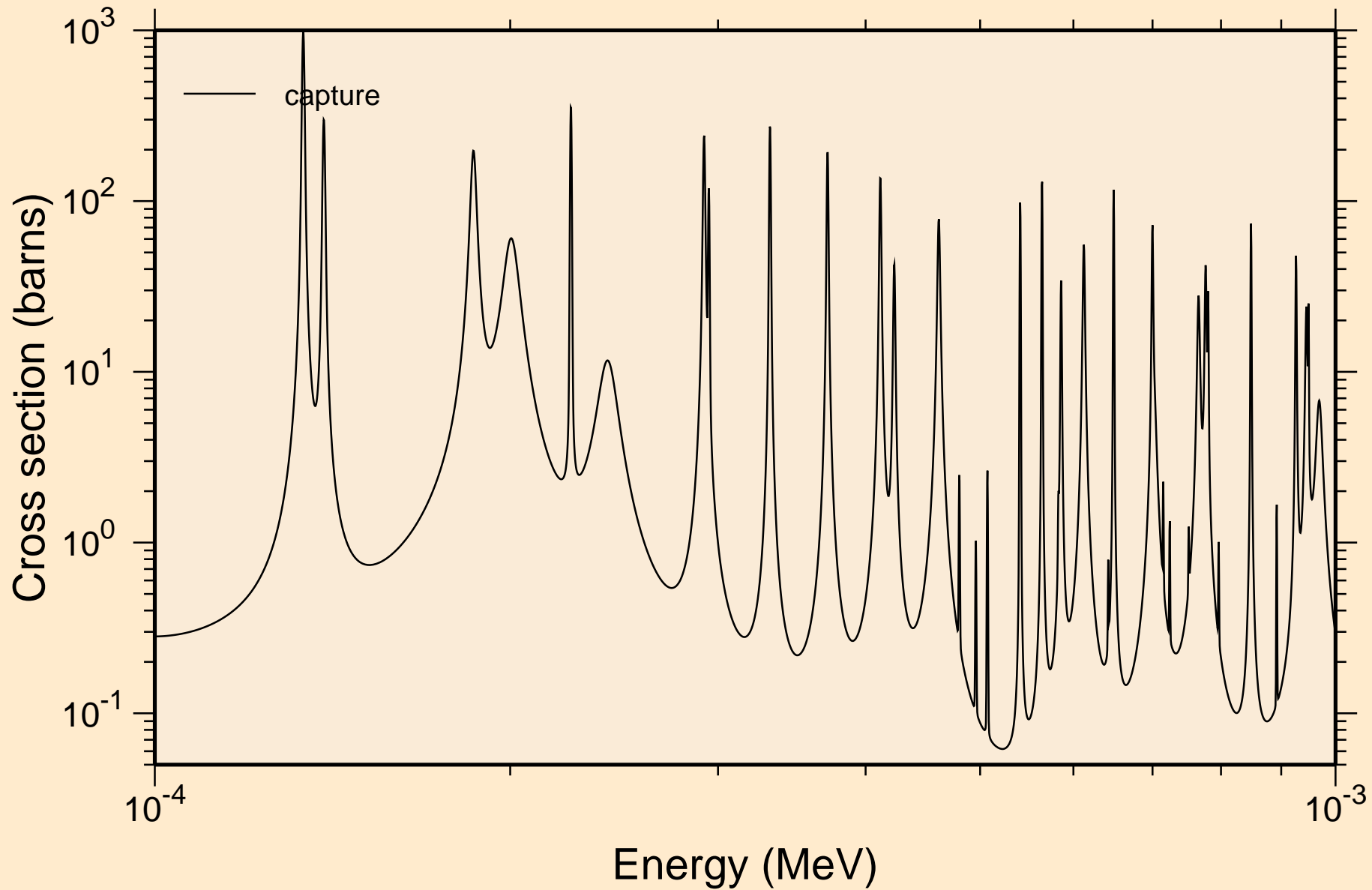

HO171 NEUTRON ACER TENDL-2021 LIBRARY; T=293.6K  
resonance absorption cross sections

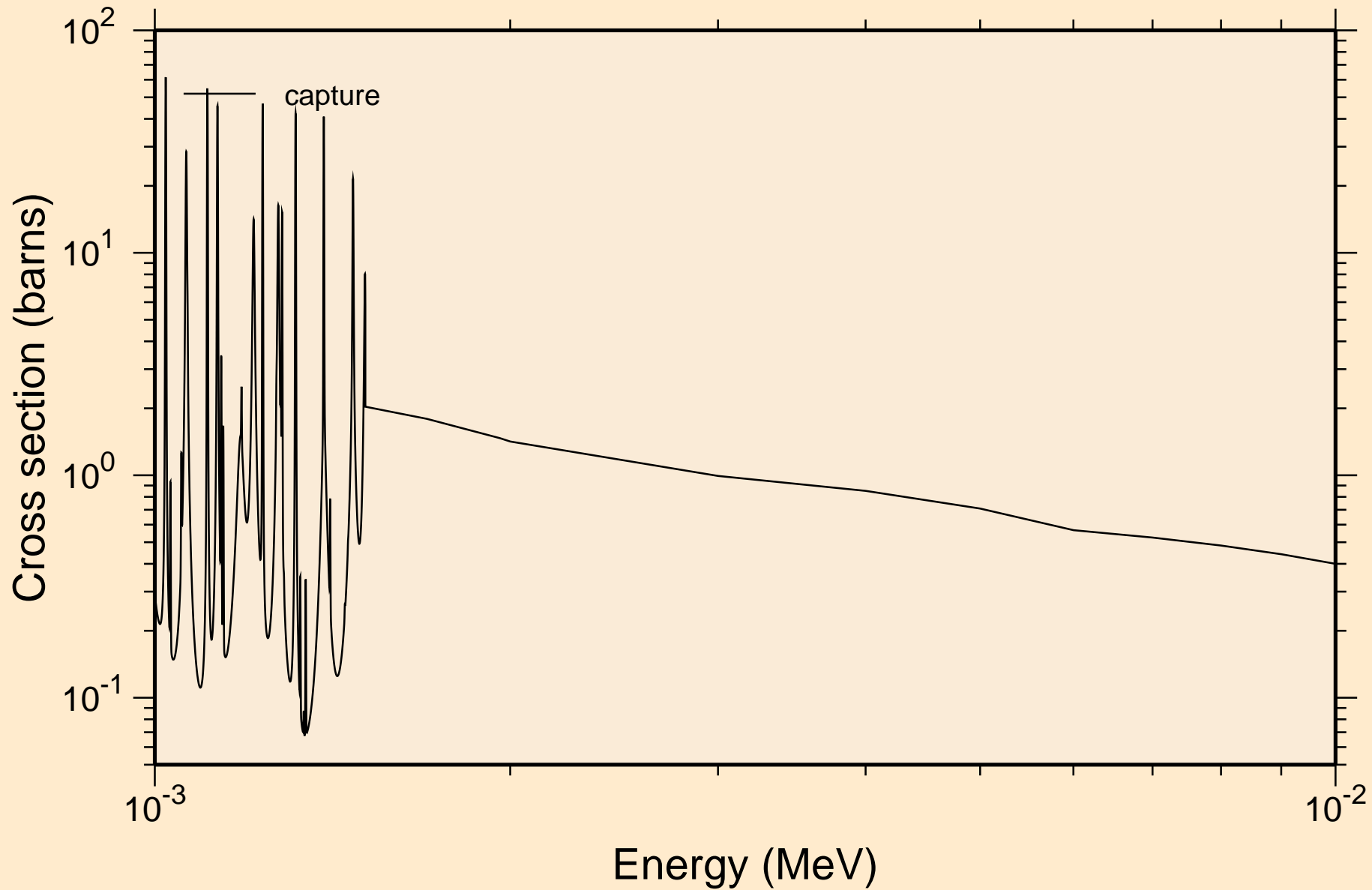



HO171 NEUTRON ACER TENDL-2021 LIBRARY; T=293.6K  
resonance absorption cross sections

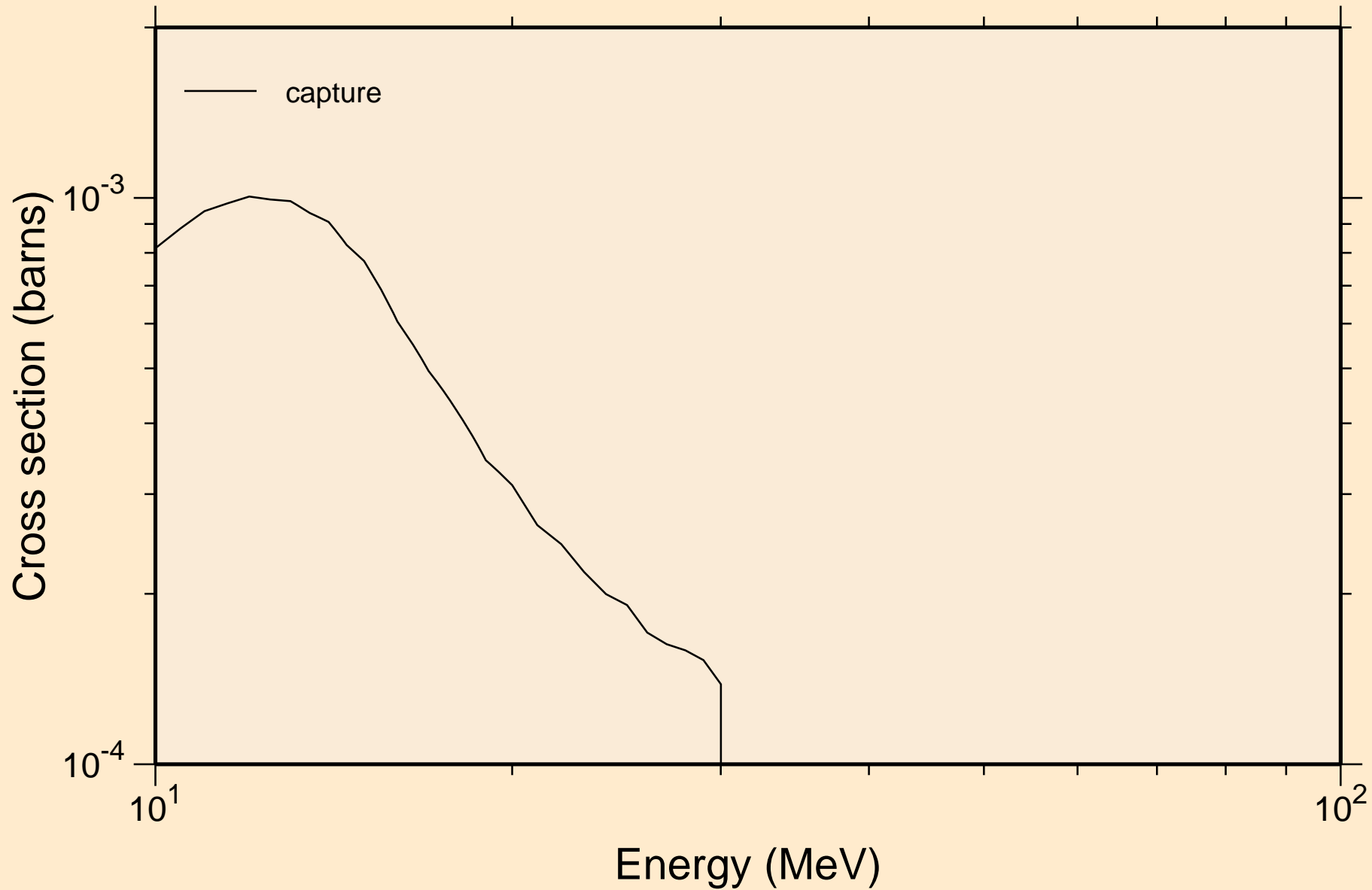

HO171 NEUTRON ACER TENDL-2021 LIBRARY; T=293.6K  
Heating

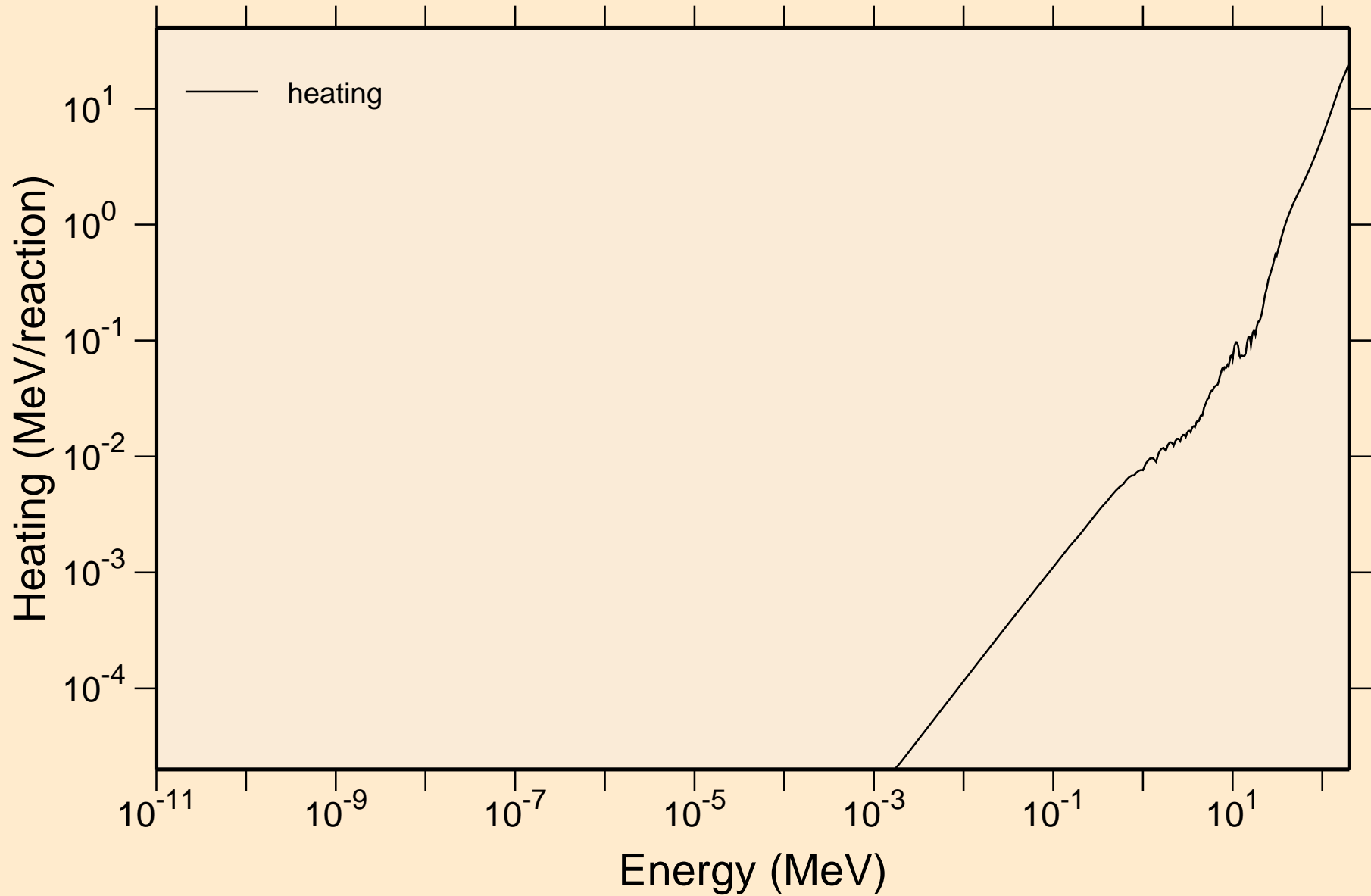

HO171 NEUTRON ACER TENDL-2021 LIBRARY; T=293.6K  
Damage

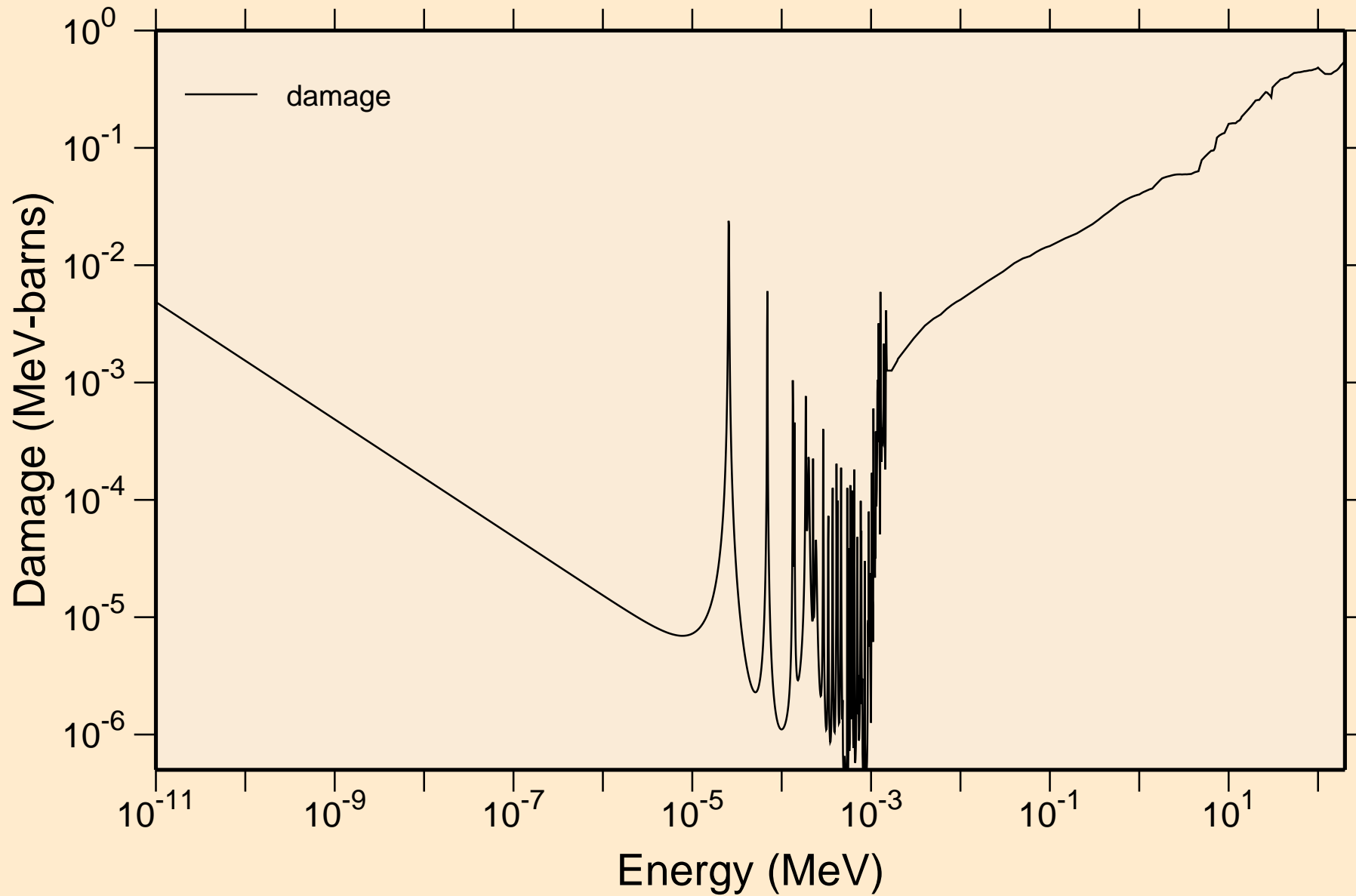

HO171 NEUTRON ACER TENDL-2021 LIBRARY; T=293.6K  
Non-threshold reactions

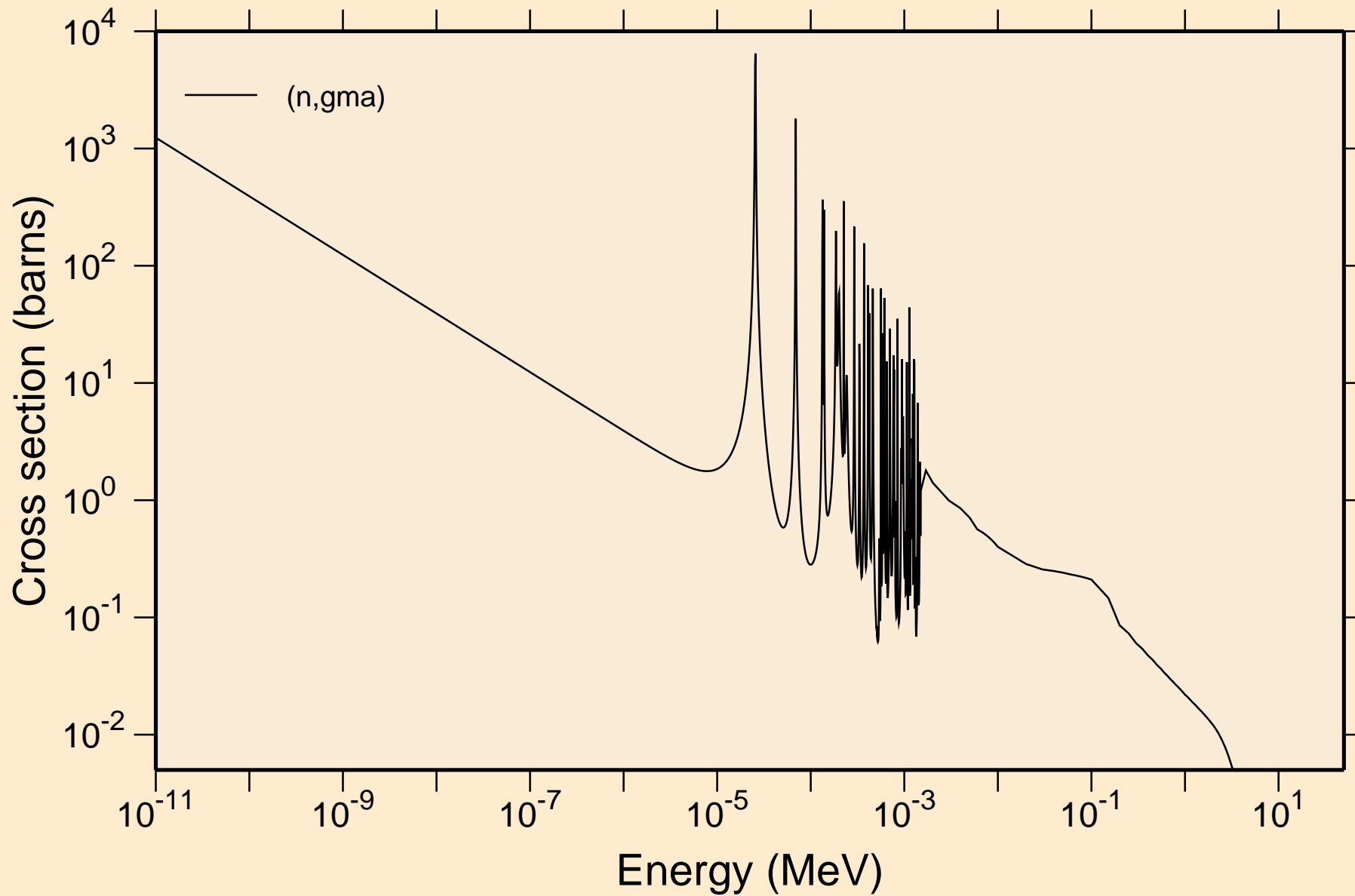

# HO171 NEUTRON ACER TENDL-2021 LIBRARY; T=293.6K

## Principal cross sections

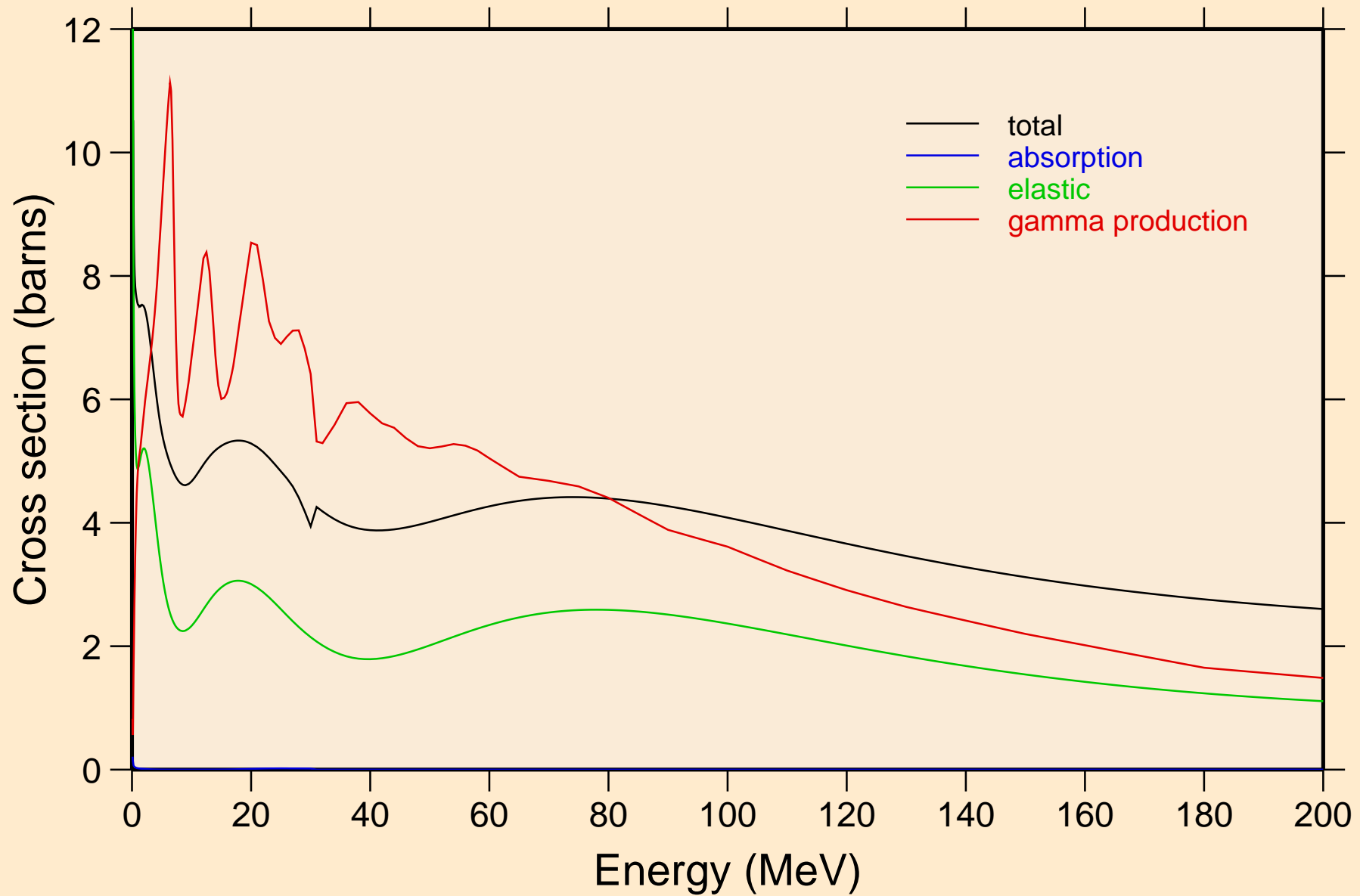

HO171 NEUTRON ACER TENDL-2021 LIBRARY; T=293.6K  
Heating

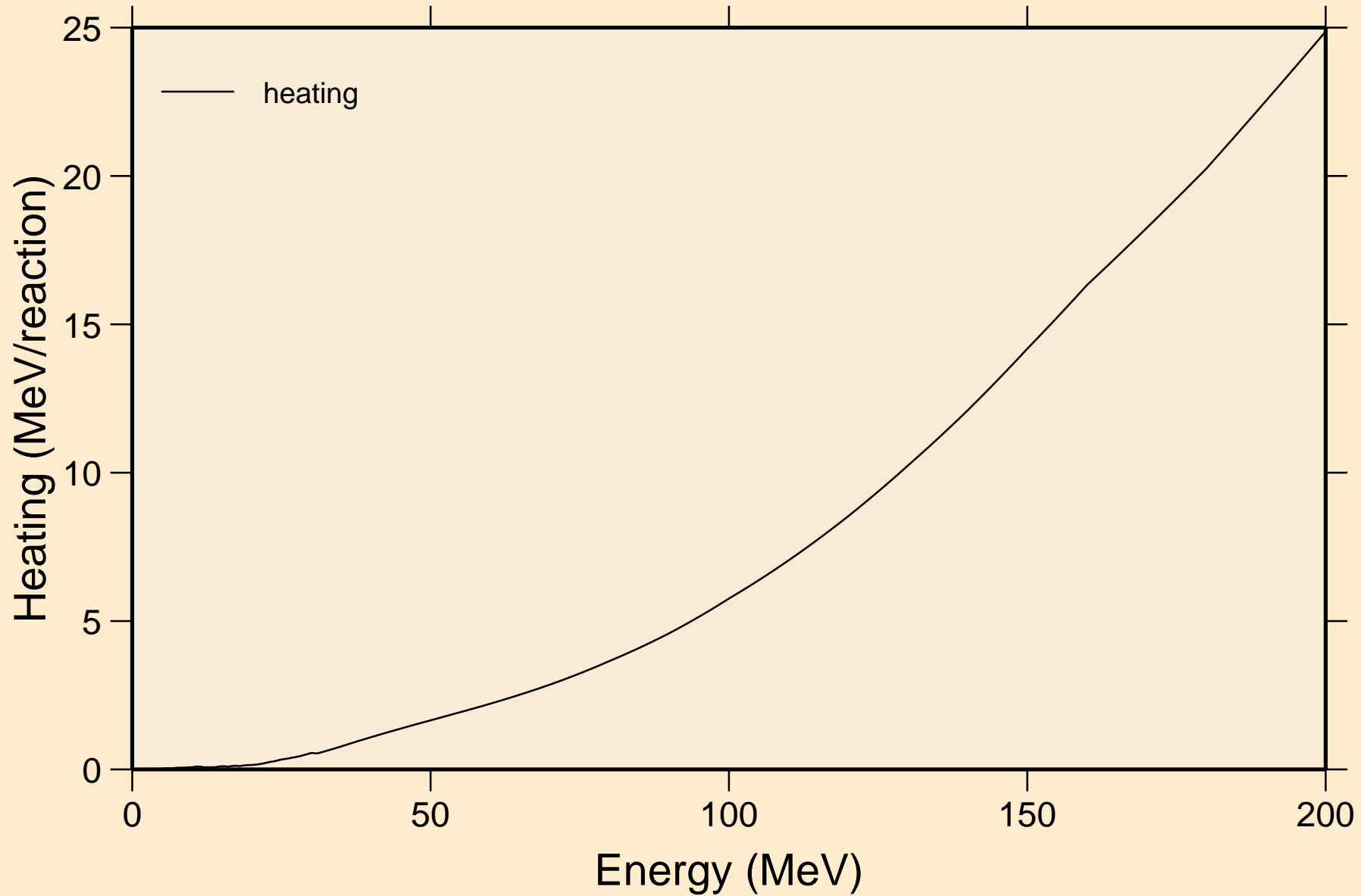

# HO171 NEUTRON ACER TENDL-2021 LIBRARY; T=293.6K

## Damage

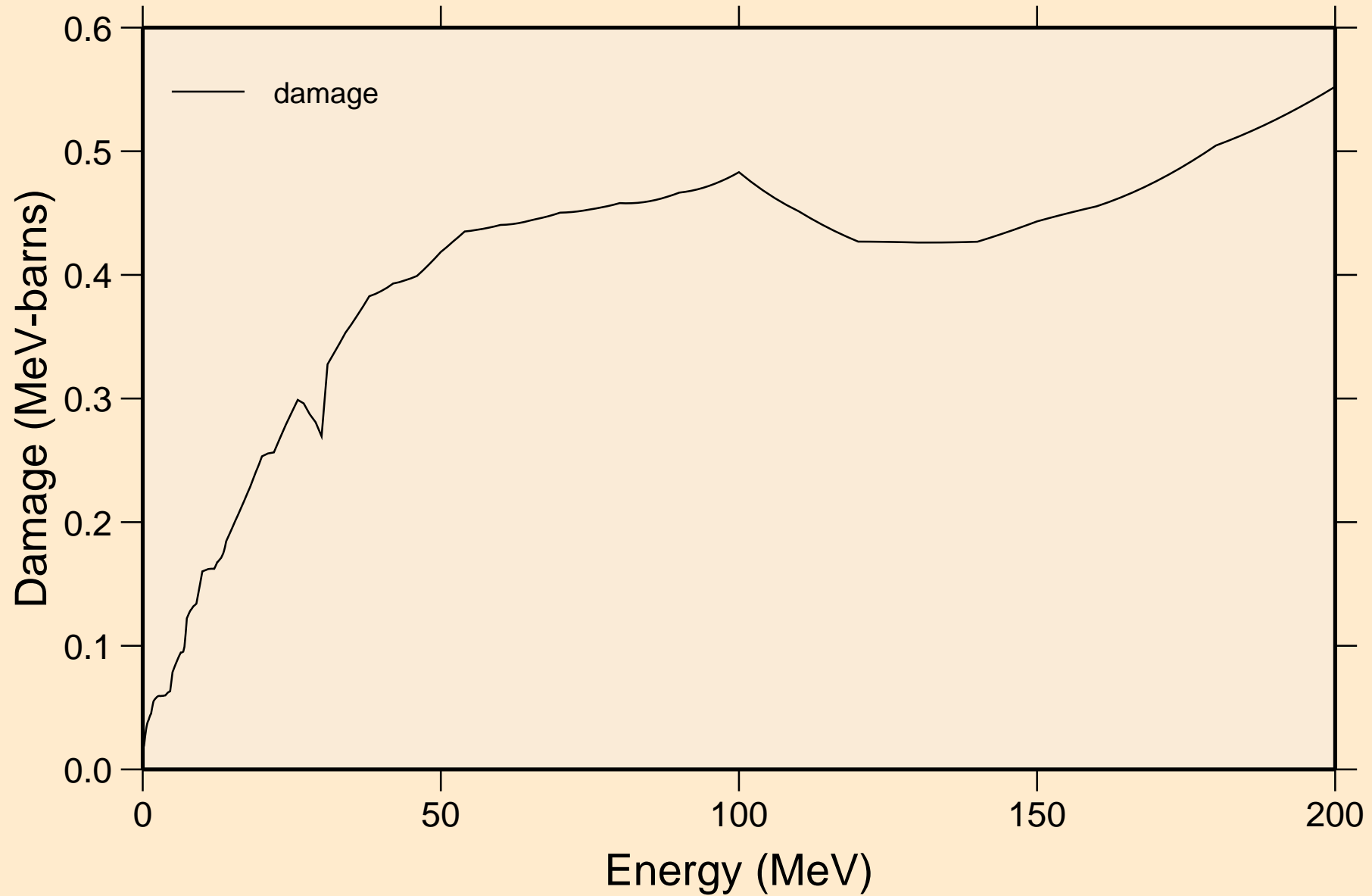

HO171 NEUTRON ACER TENDL-2021 LIBRARY; T=293.6K  
Non-threshold reactions

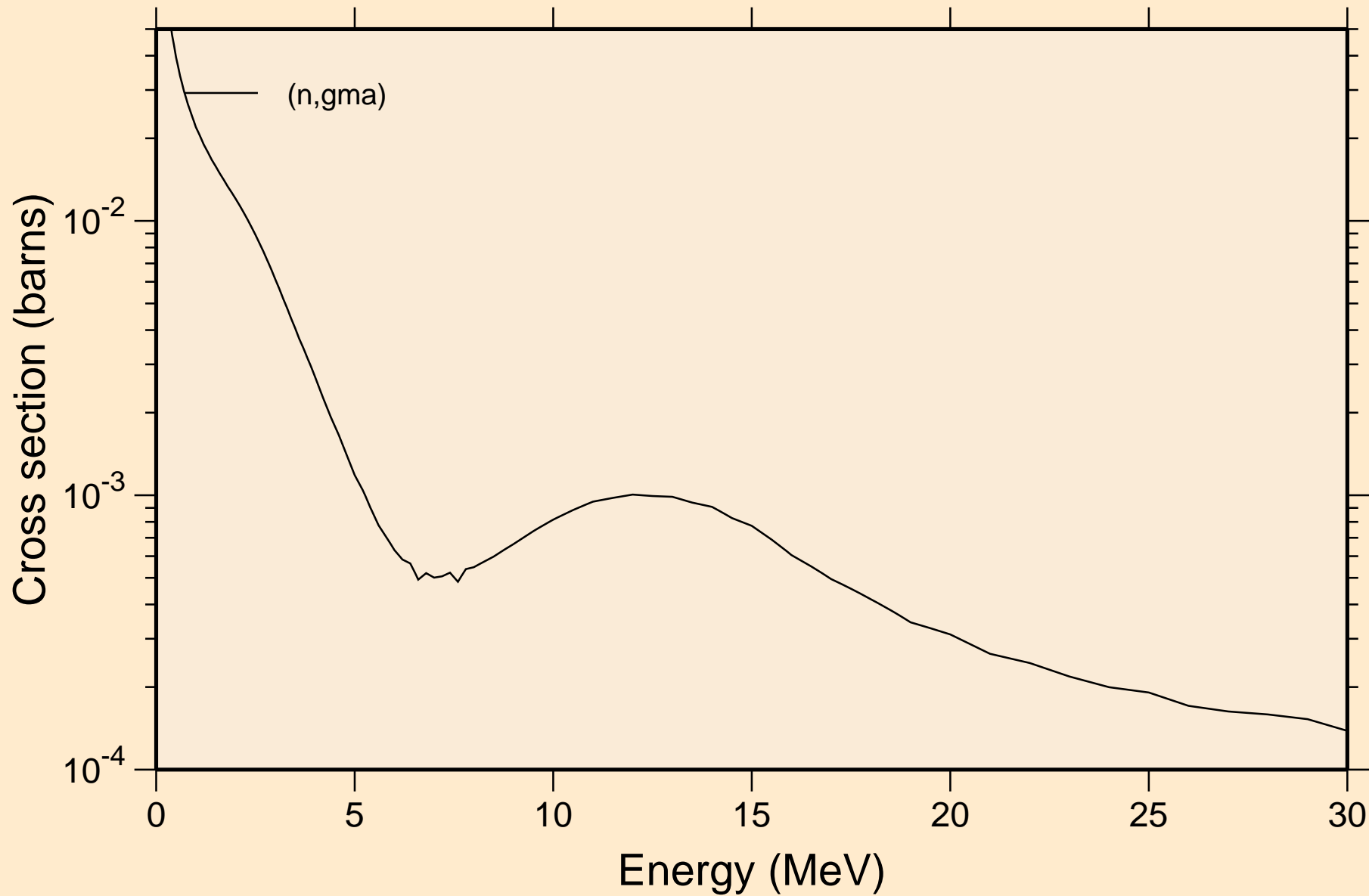



HO171 NEUTRON ACER TENDL-2021 LIBRARY; T=293.6K  
Inelastic levels

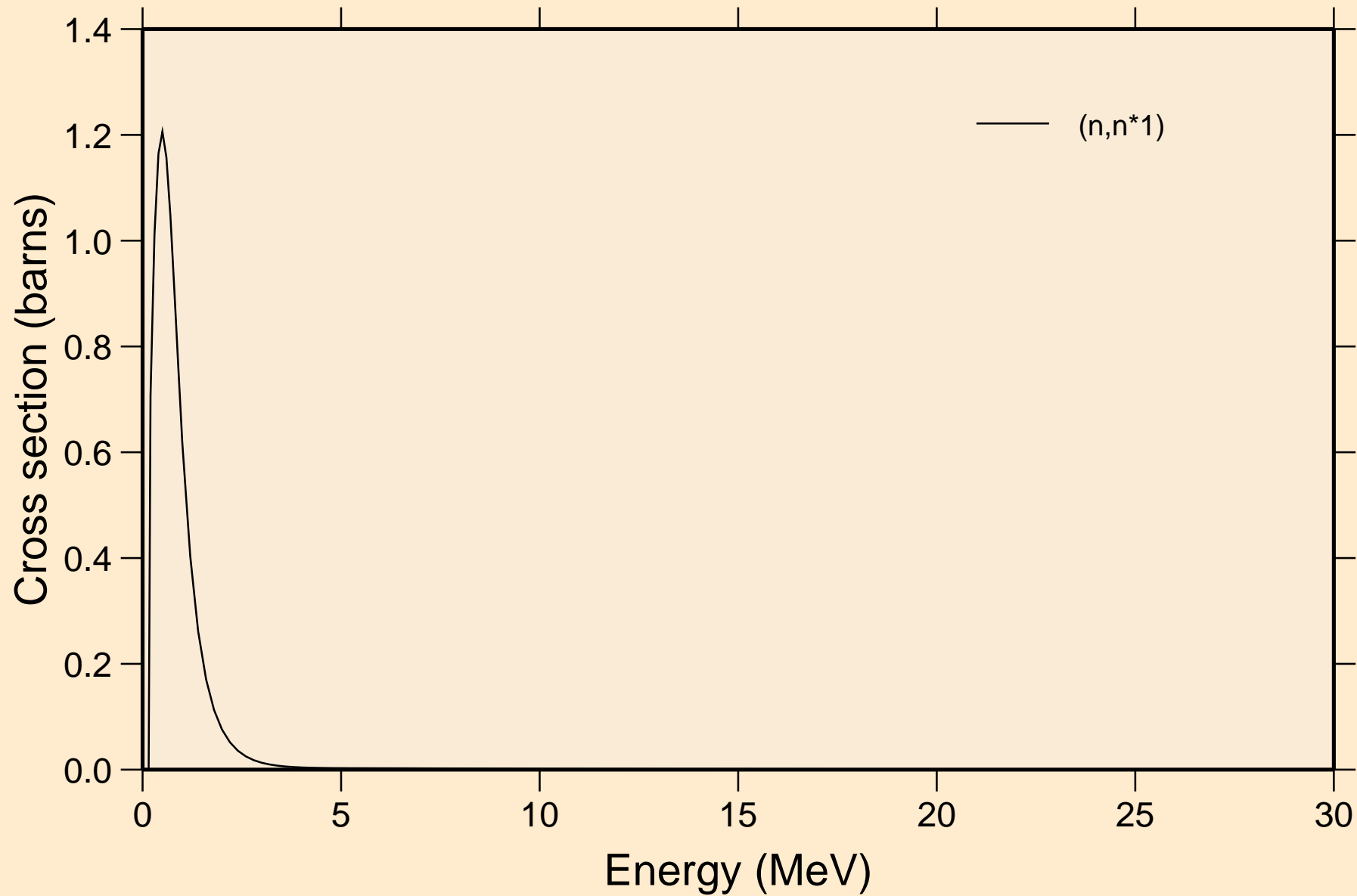

# HO171 NEUTRON ACER TENDL-2021 LIBRARY; T=293.6K

## Threshold reactions

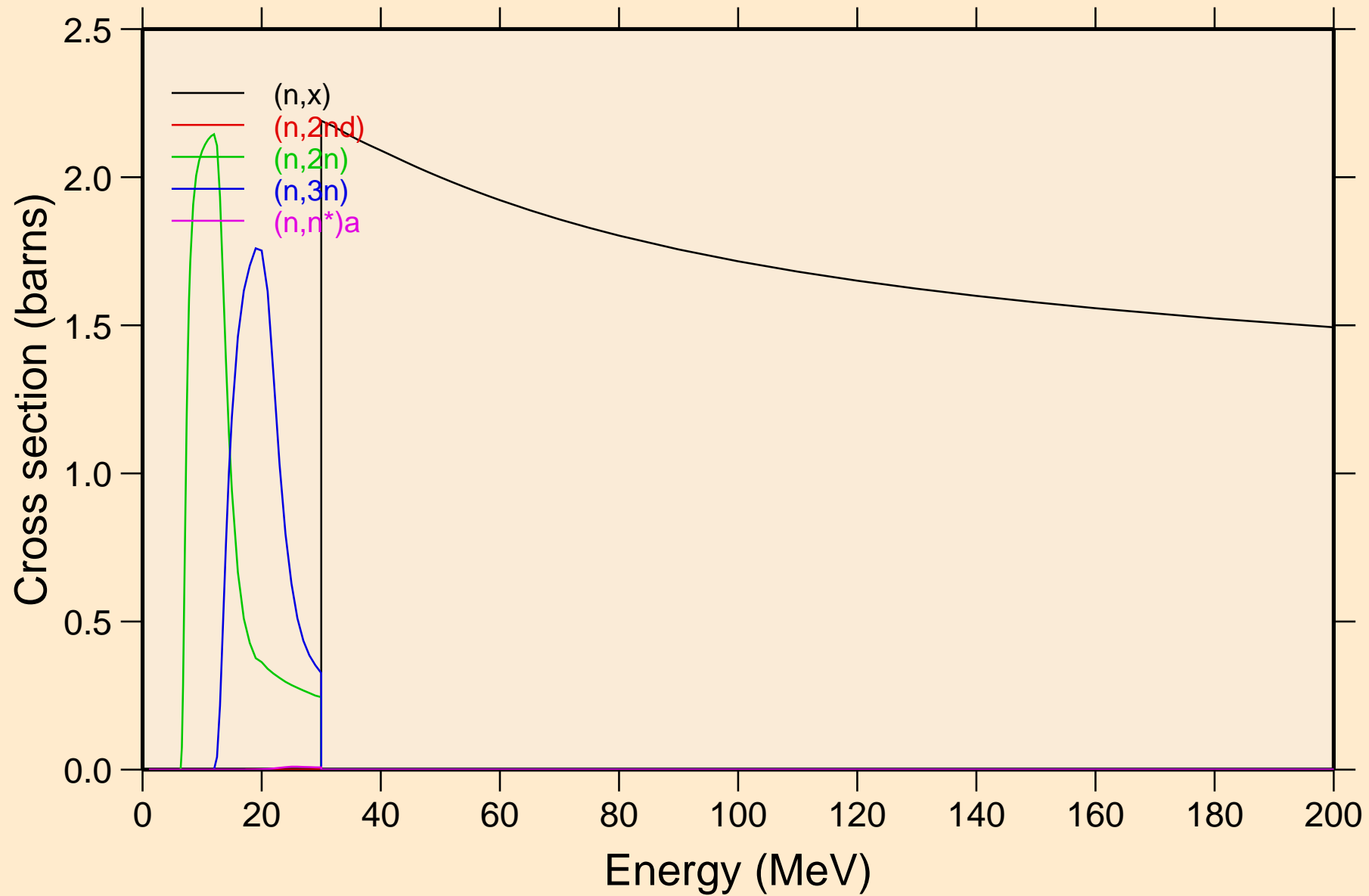

# HO171 NEUTRON ACER TENDL-2021 LIBRARY; T=293.6K

## Threshold reactions

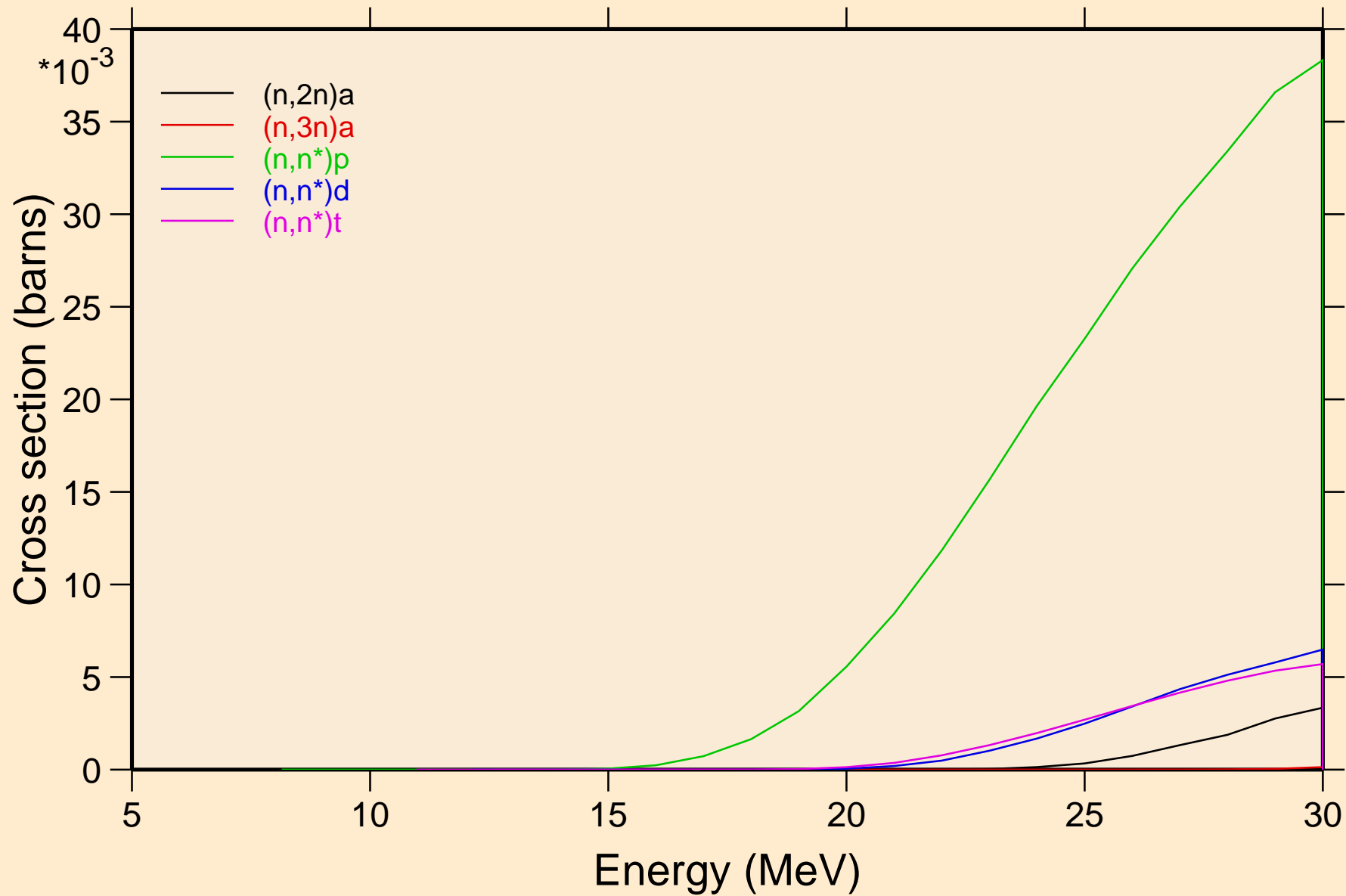

HO171 NEUTRON ACER TENDL-2021 LIBRARY; T=293.6K  
Threshold reactions

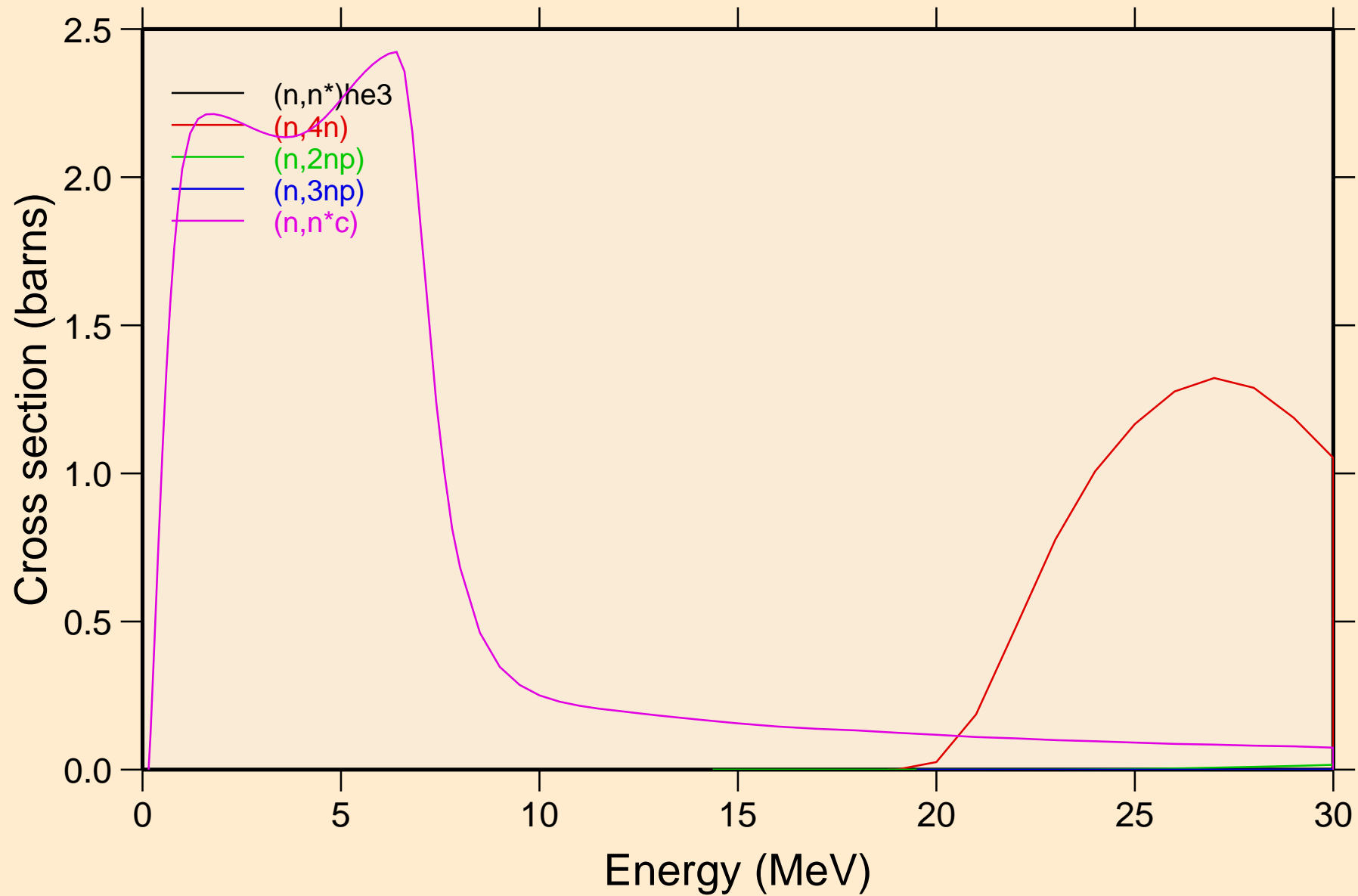

HO171 NEUTRON ACER TENDL-2021 LIBRARY; T=293.6K  
Threshold reactions

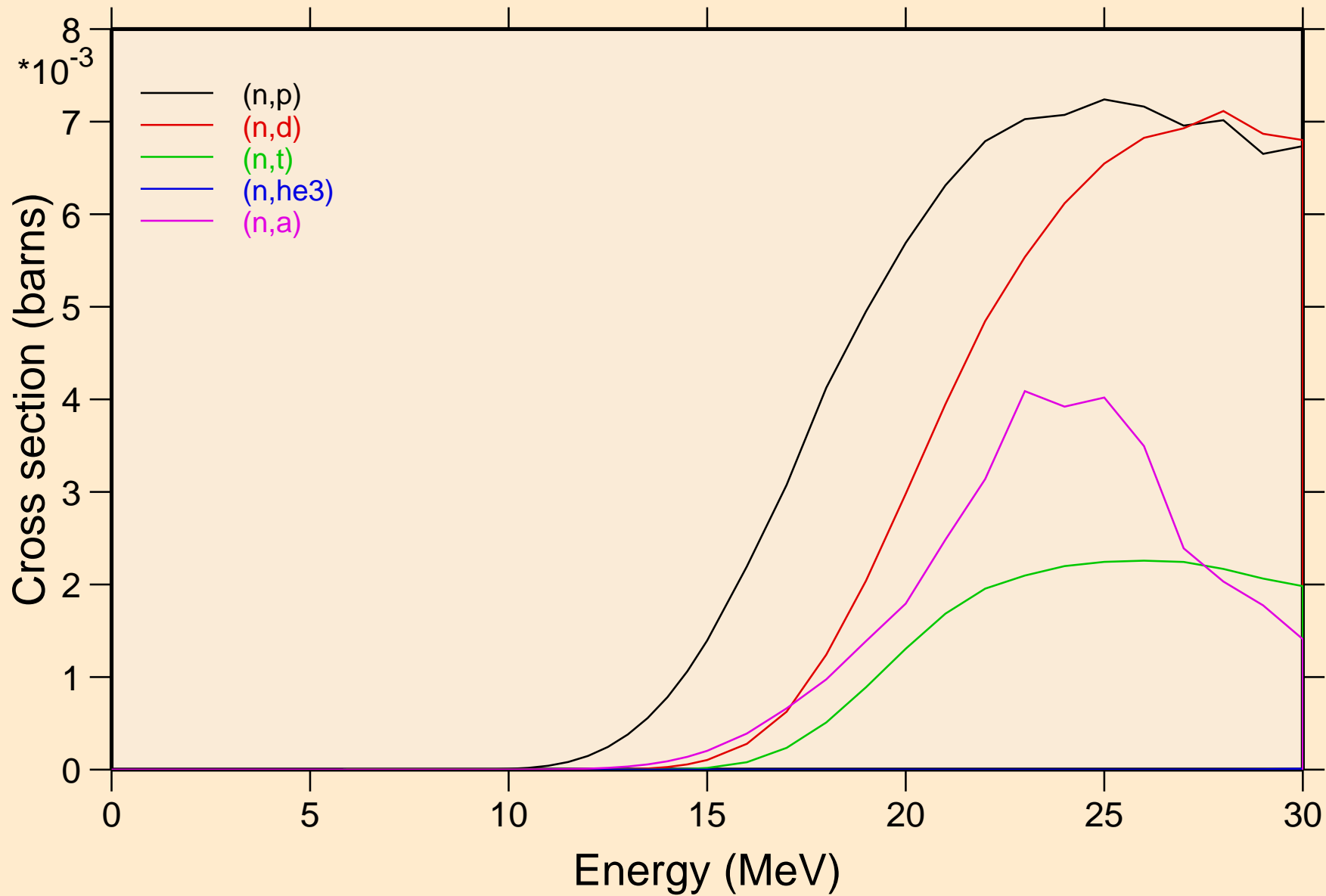

HO171 NEUTRON ACER TENDL-2021 LIBRARY; T=293.6K  
Threshold reactions

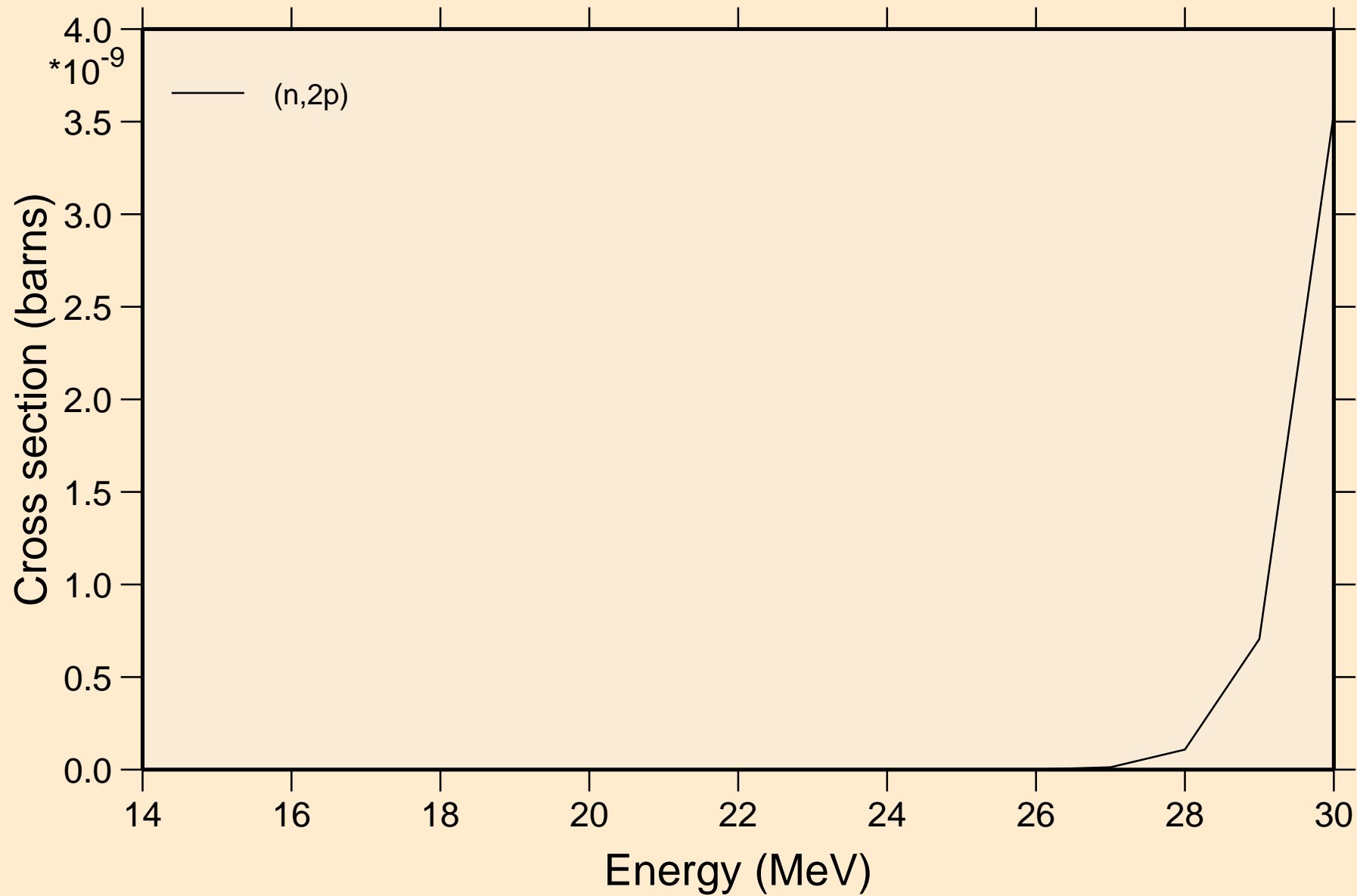

# HO171 NEUTRON ACER TENDL-2021 LIBRARY; T=293.6K

## Threshold reactions

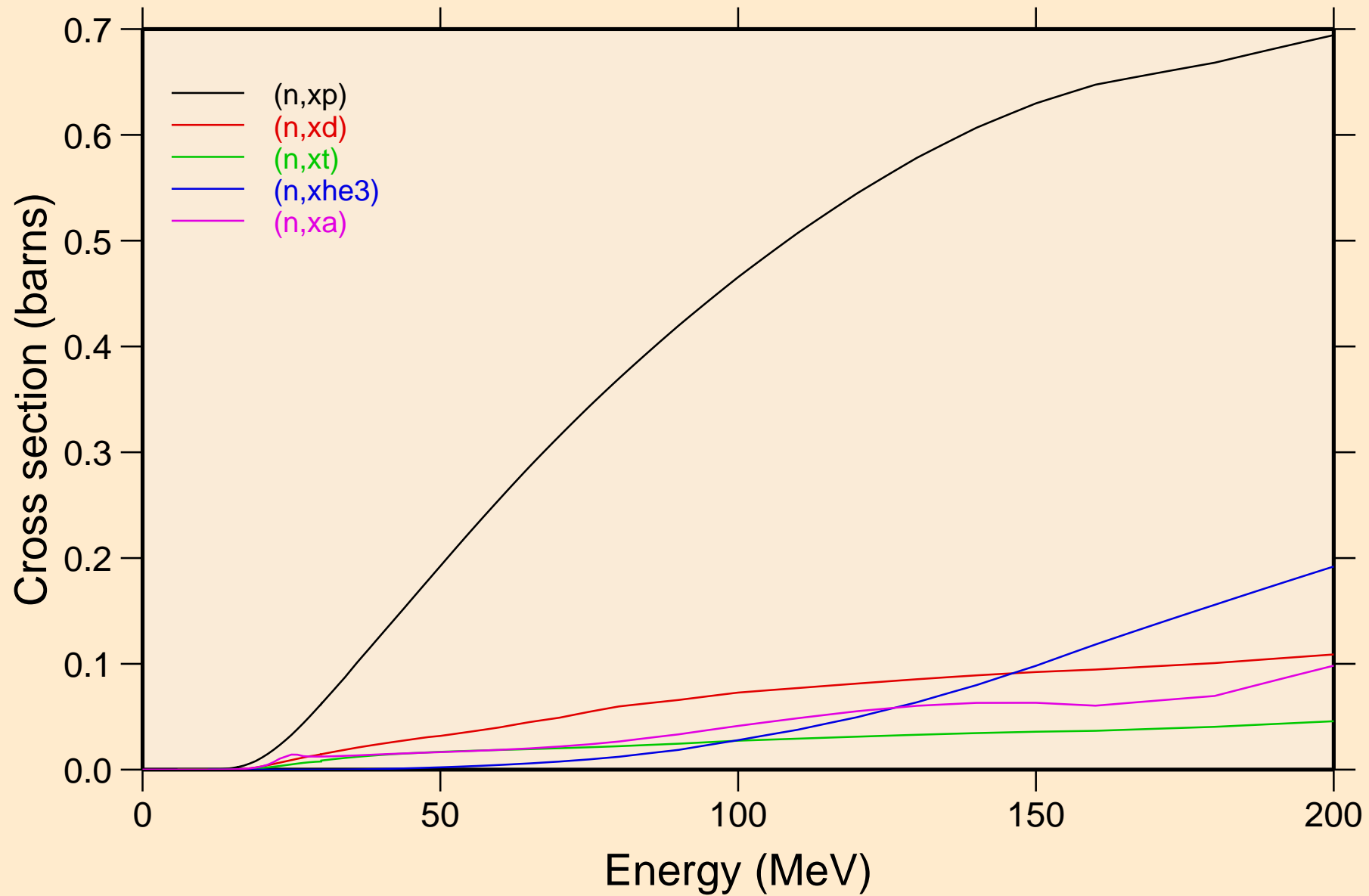

HO171 NEUTRON ACER TENDL-2021 LIBRARY; T=293.6K  
angular distribution for elastic

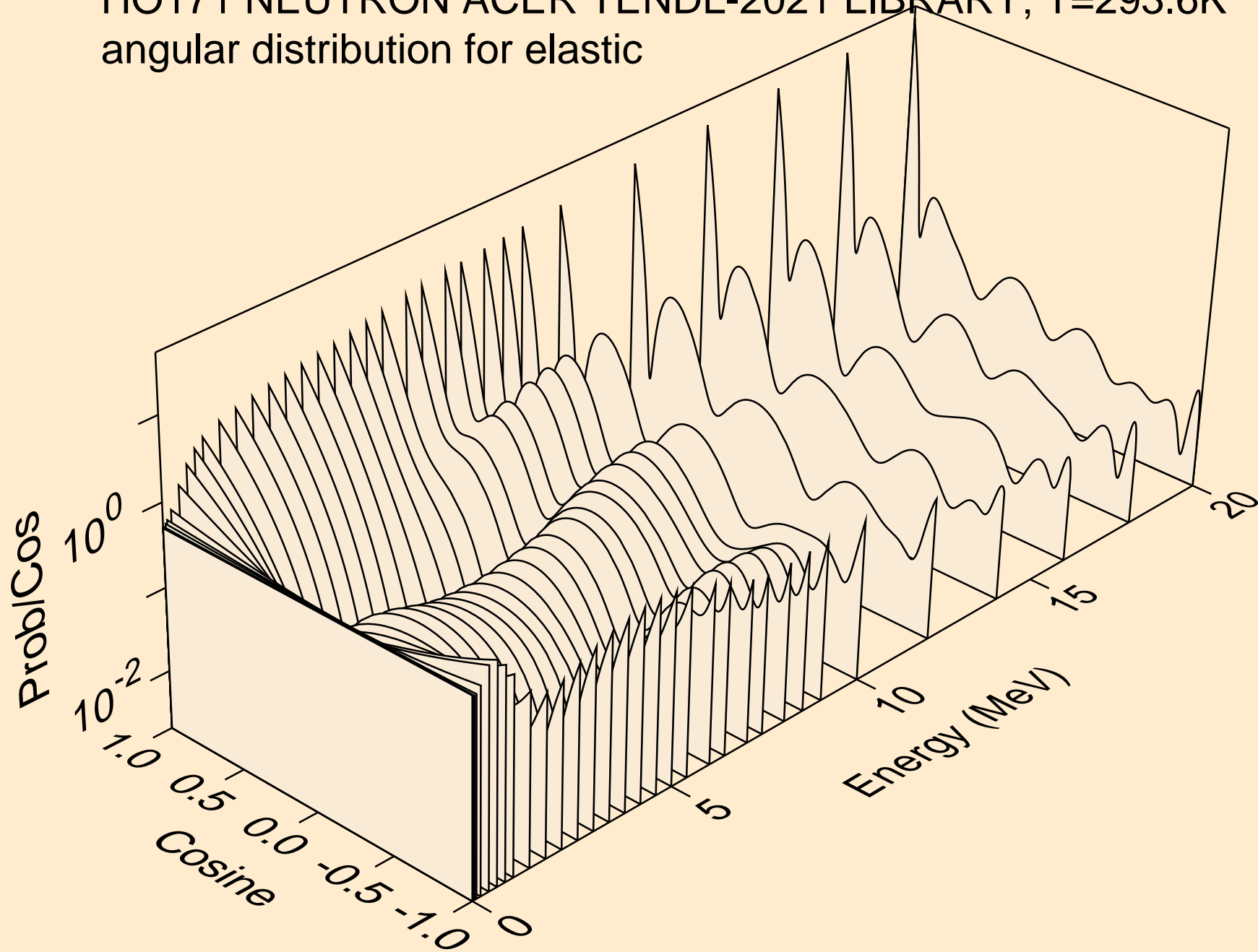



HO171 NEUTRON ACER TENDL-2021 LIBRARY; T=293.6K  
angular distribution for elastic

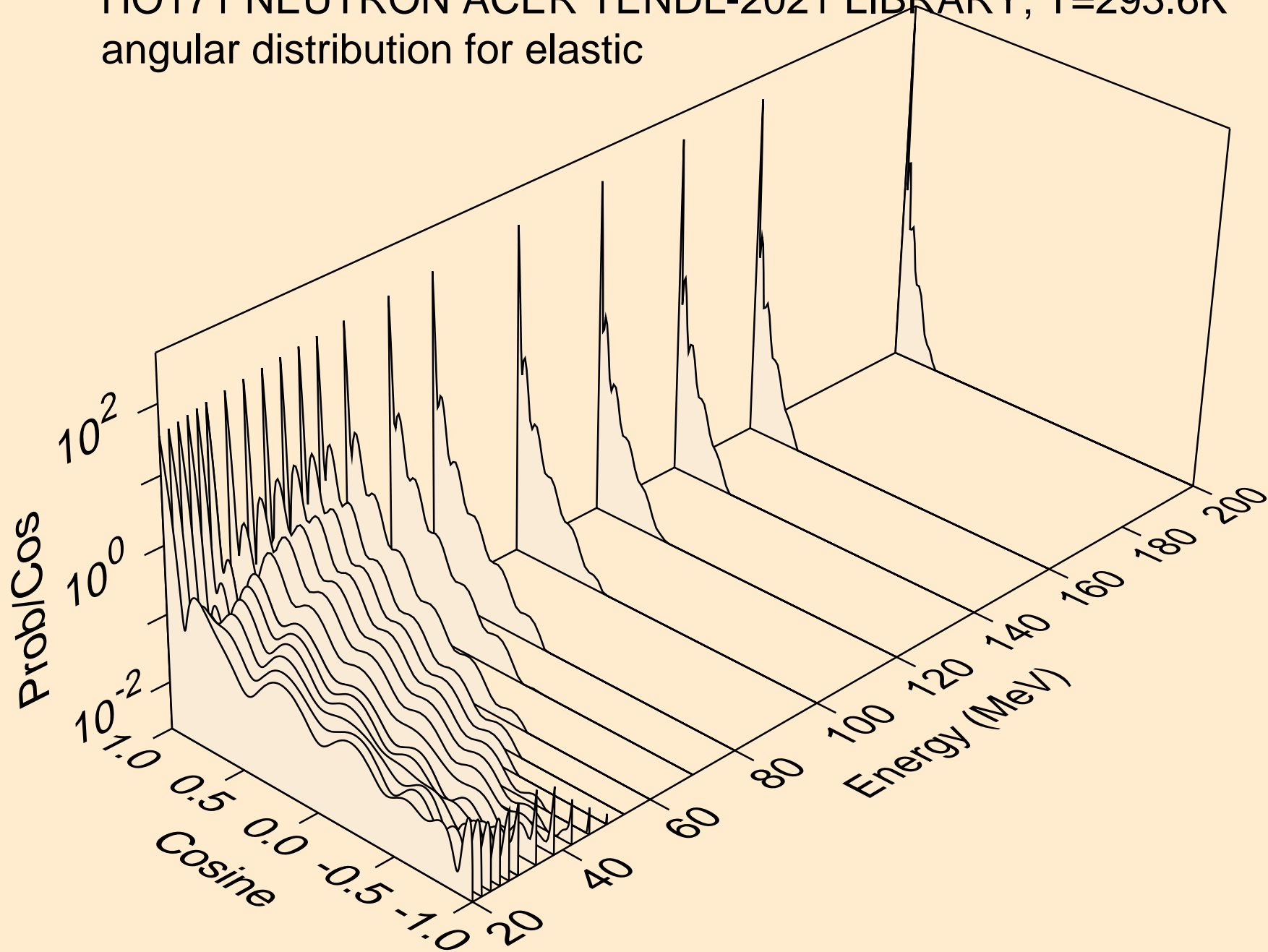

HO171 NEUTRON ACER TENDL-2021 LIBRARY; T=293.6K  
angular distribution for (n,n\*1)

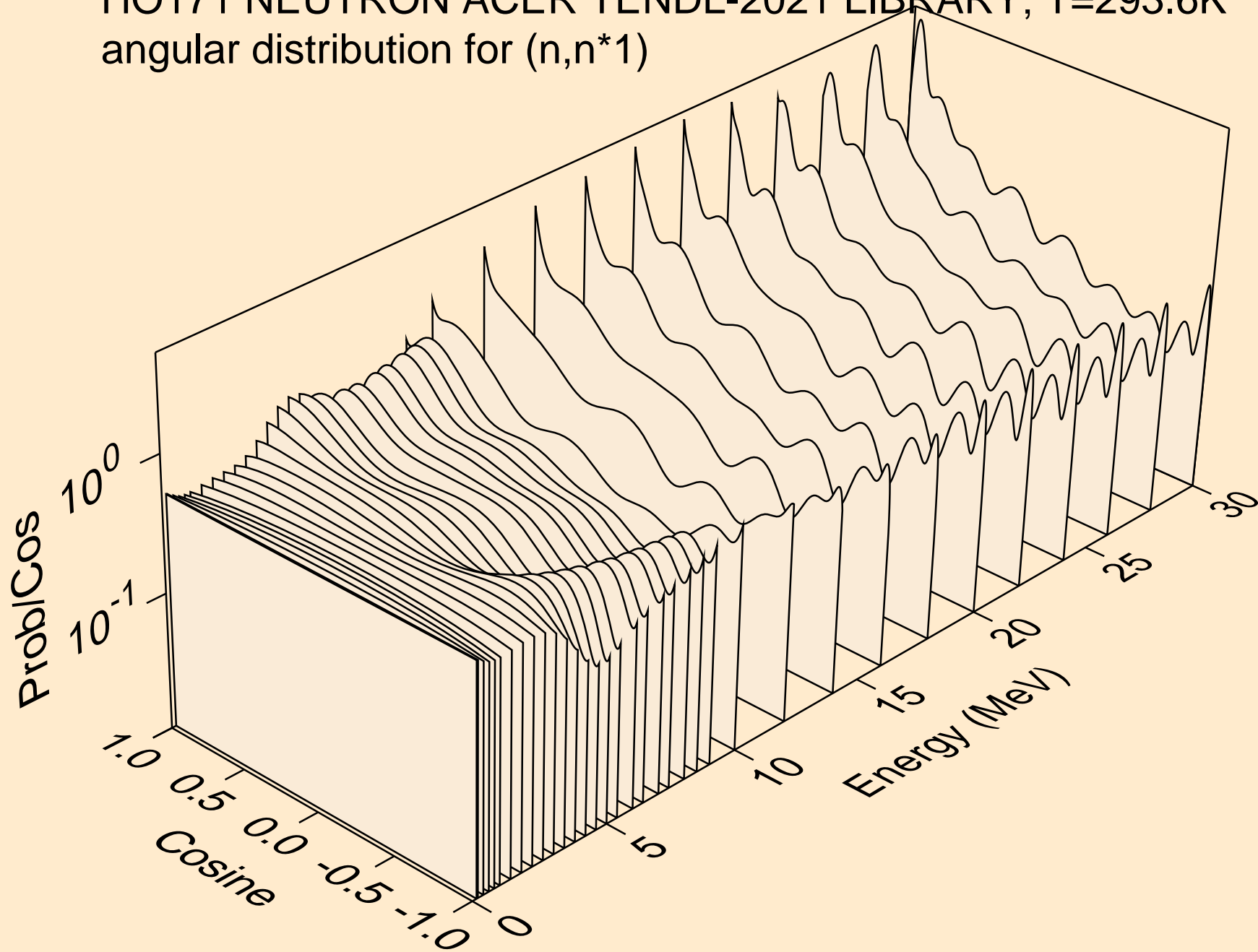

HO171 NEUTRON ACER TENDL-2021 LIBRARY; T=293.6K  
Neutron emission for (n,x)

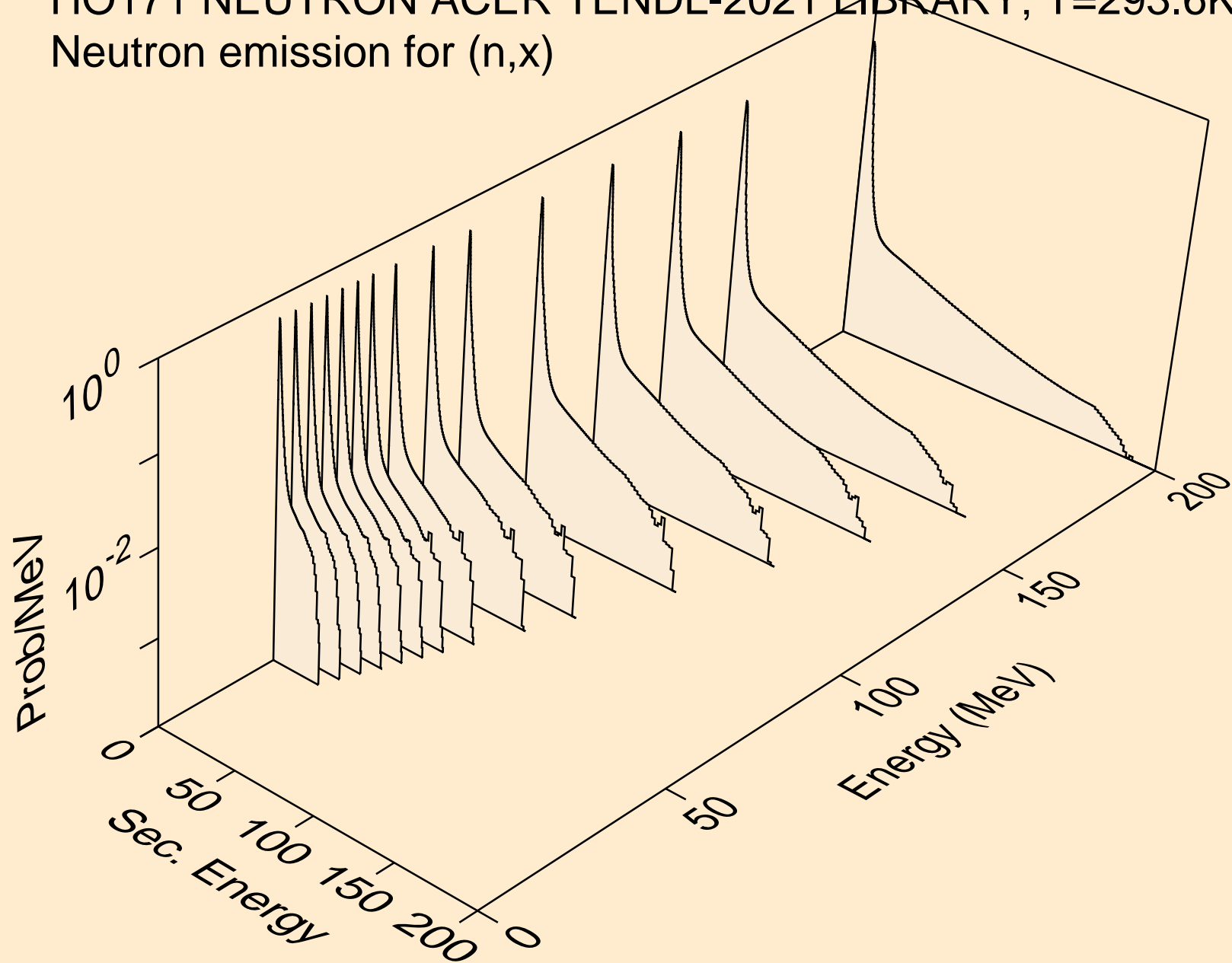

HO171 NEUTRON ACER TENDL-2021 LIBRARY; T=293.6K  
Neutron emission for (n,2nd)

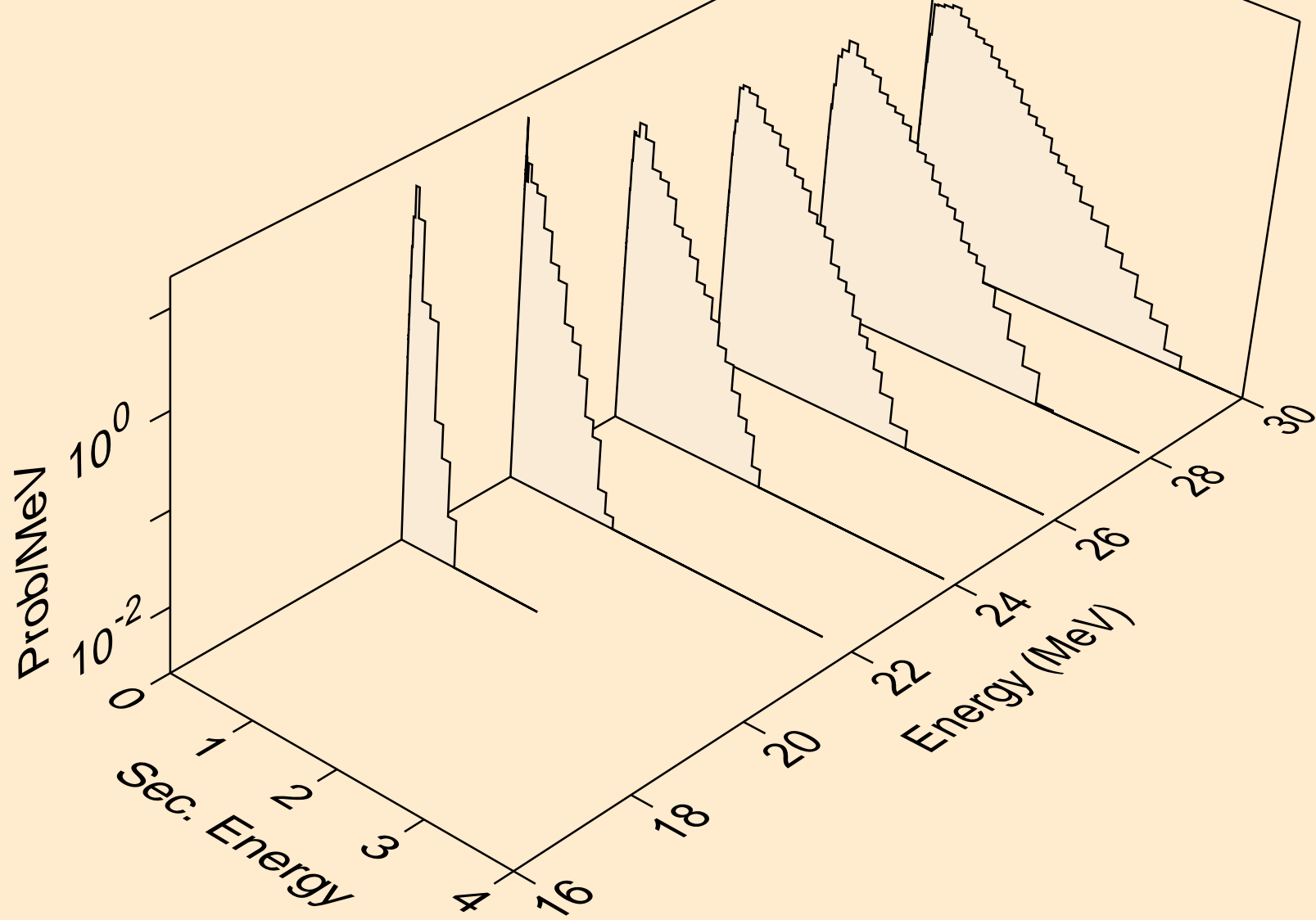

HO171 NEUTRON ACER TENDL-2021 LIBRARY; T=293.6K  
Neutron emission for (n,2n)

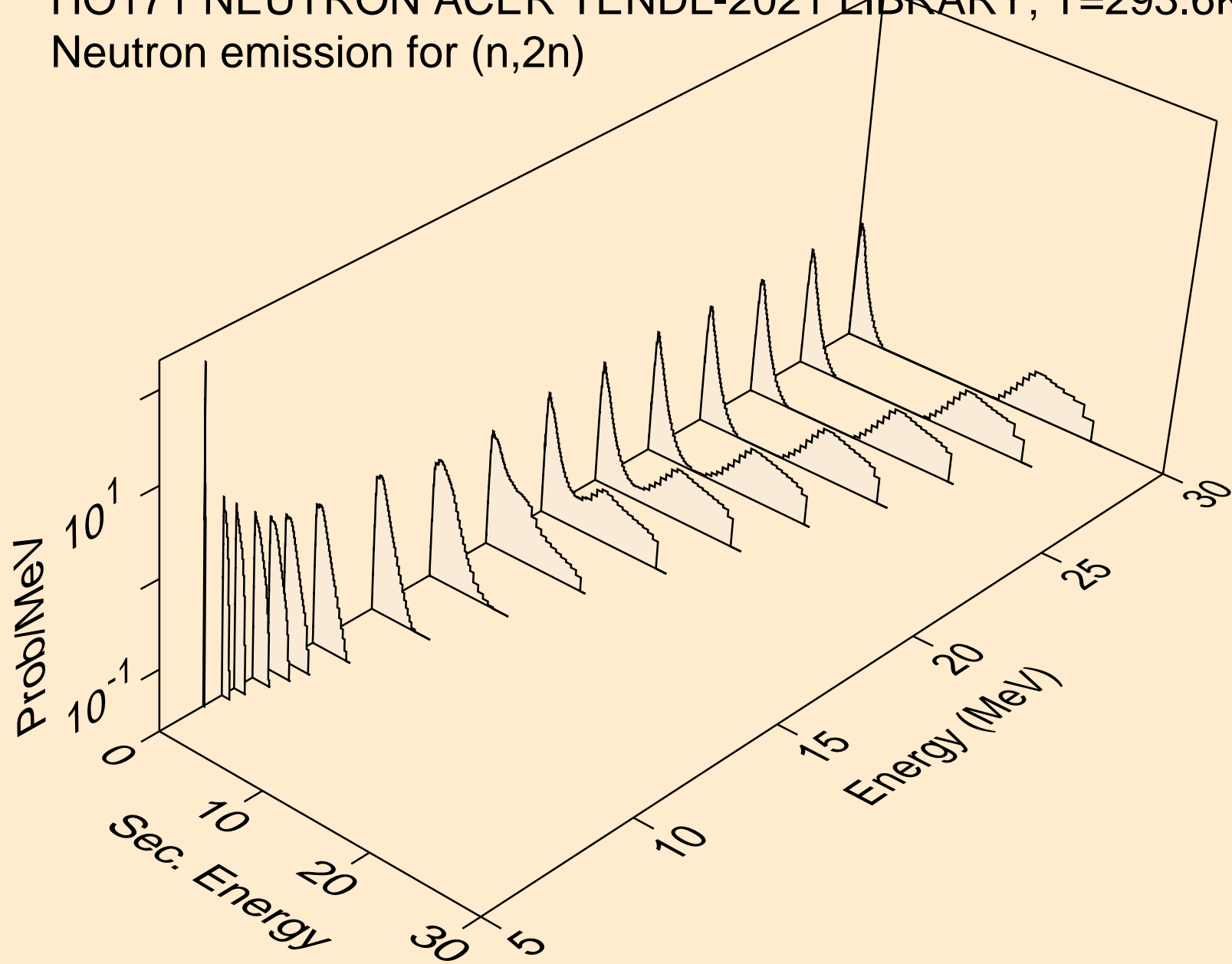

HO171 NEUTRON ACER TENDL-2021 LIBRARY; T=293.6K  
Neutron emission for (n,3n)

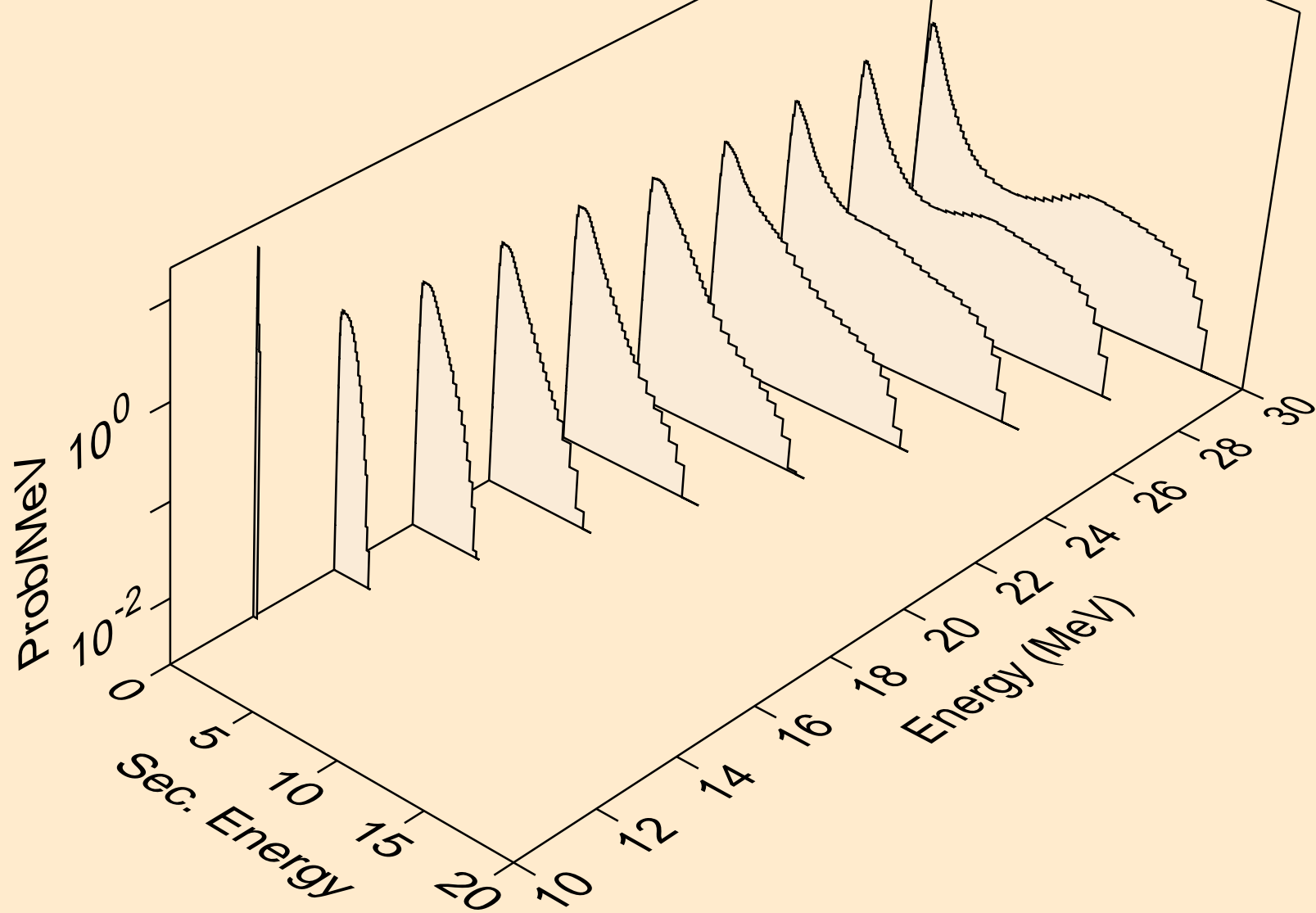

HO171 NEUTRON ACER TENDL-2021 LIBRARY; T=293.6K  
Neutron emission for (n,n\*)a

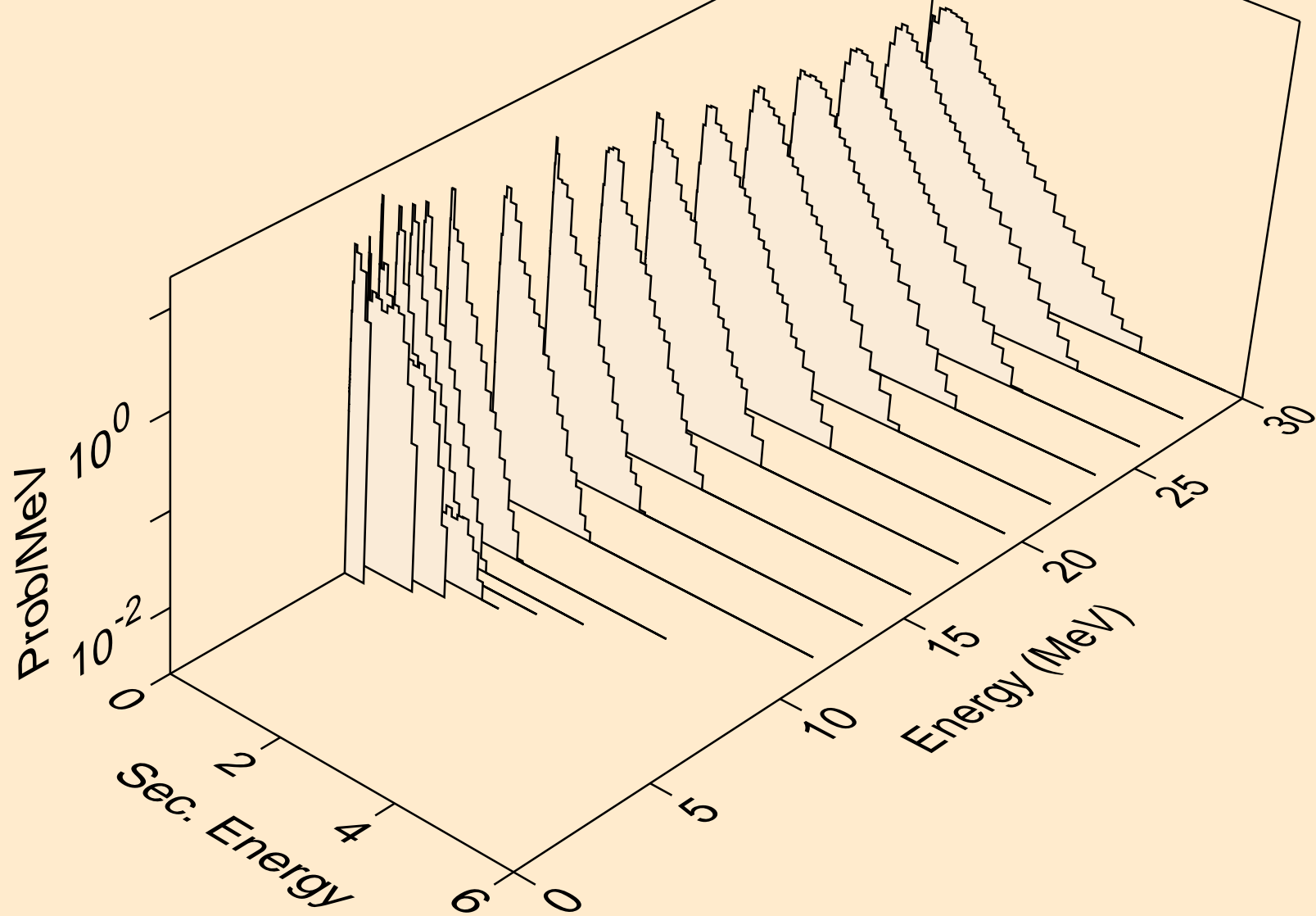

HO171 NEUTRON ACER TENDL-2021 LIBRARY; T=293.6K  
Neutron emission for (n,2n)a

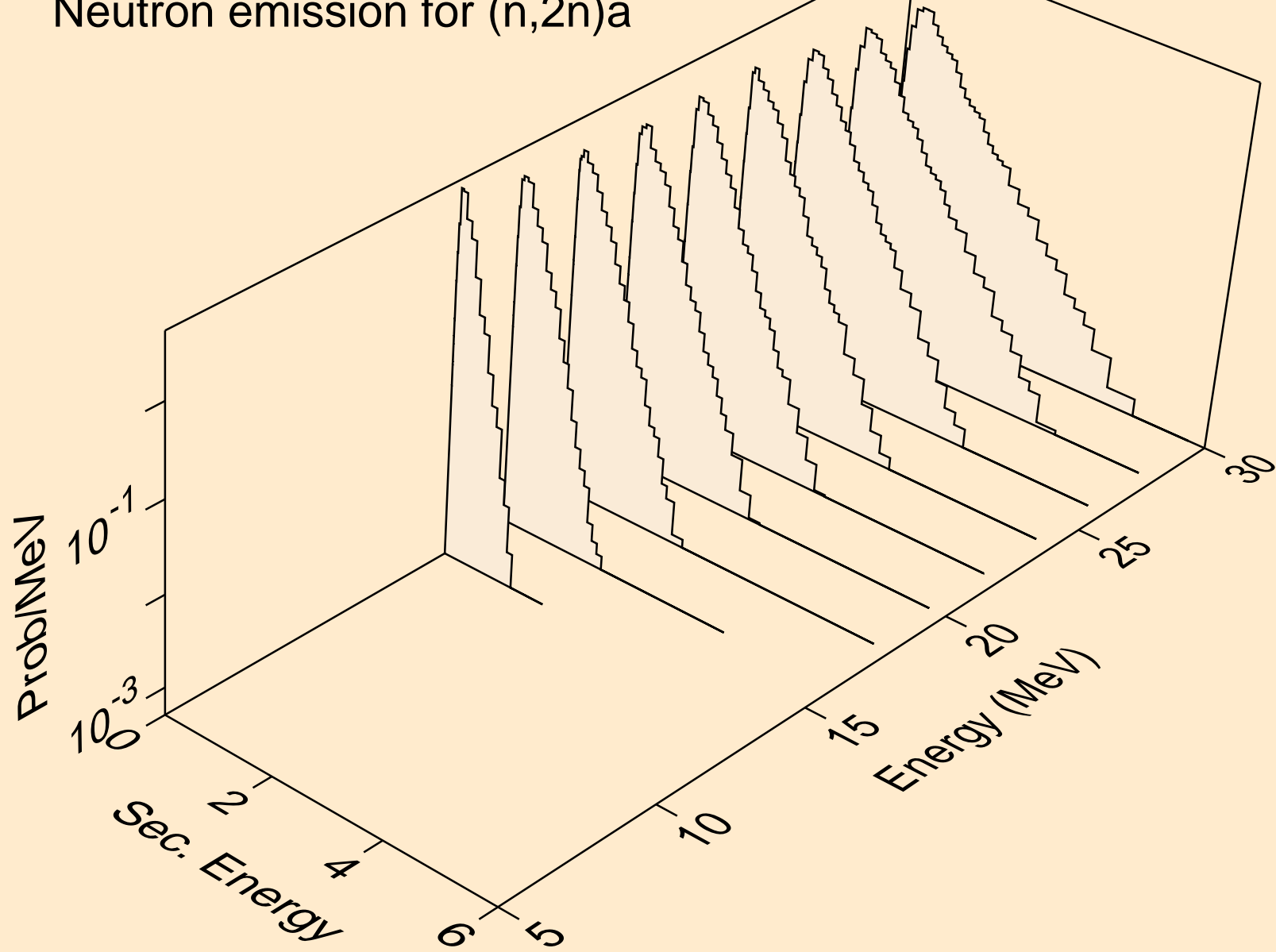



HO171 NEUTRON ACER TENDL-2021 LIBRARY; T=293.6K  
Neutron emission for (n,3n)a

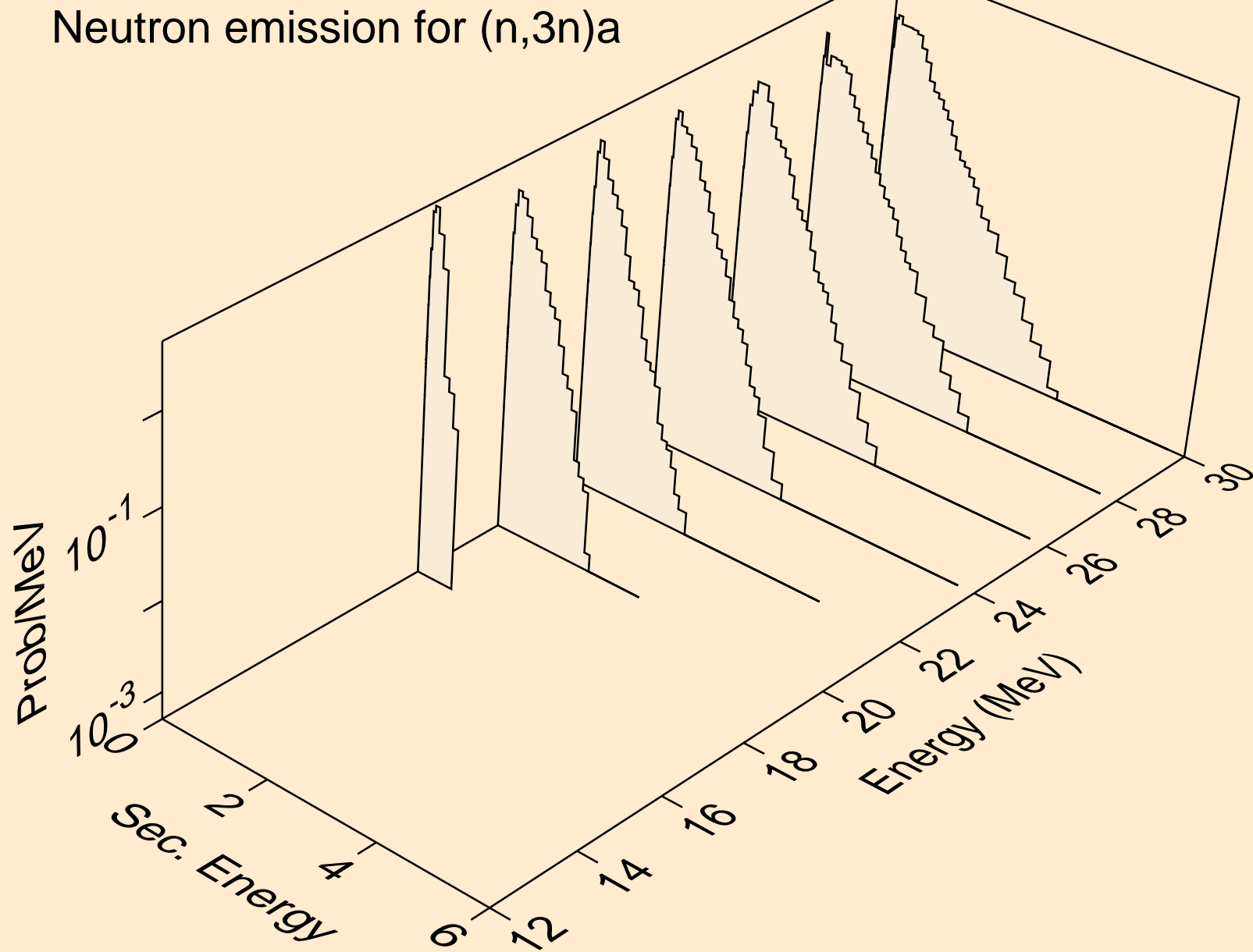

HO171 NEUTRON ACER TENDL-2021 LIBRARY; T=293.6K  
Neutron emission for (n,n\*)p

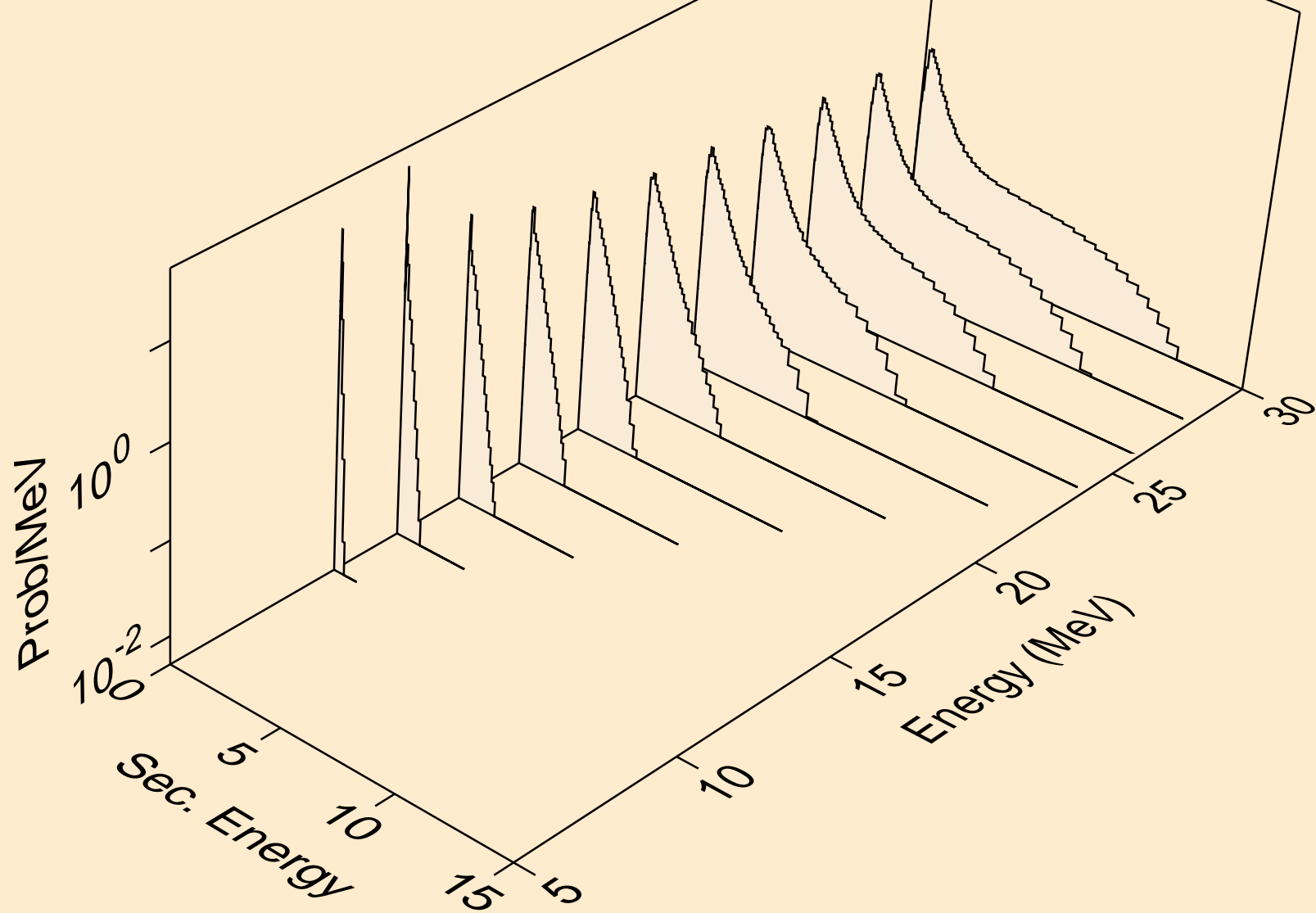

HO171 NEUTRON ACER TENDL-2021 LIBRARY; T=293.6K  
Neutron emission for (n,n\*)d

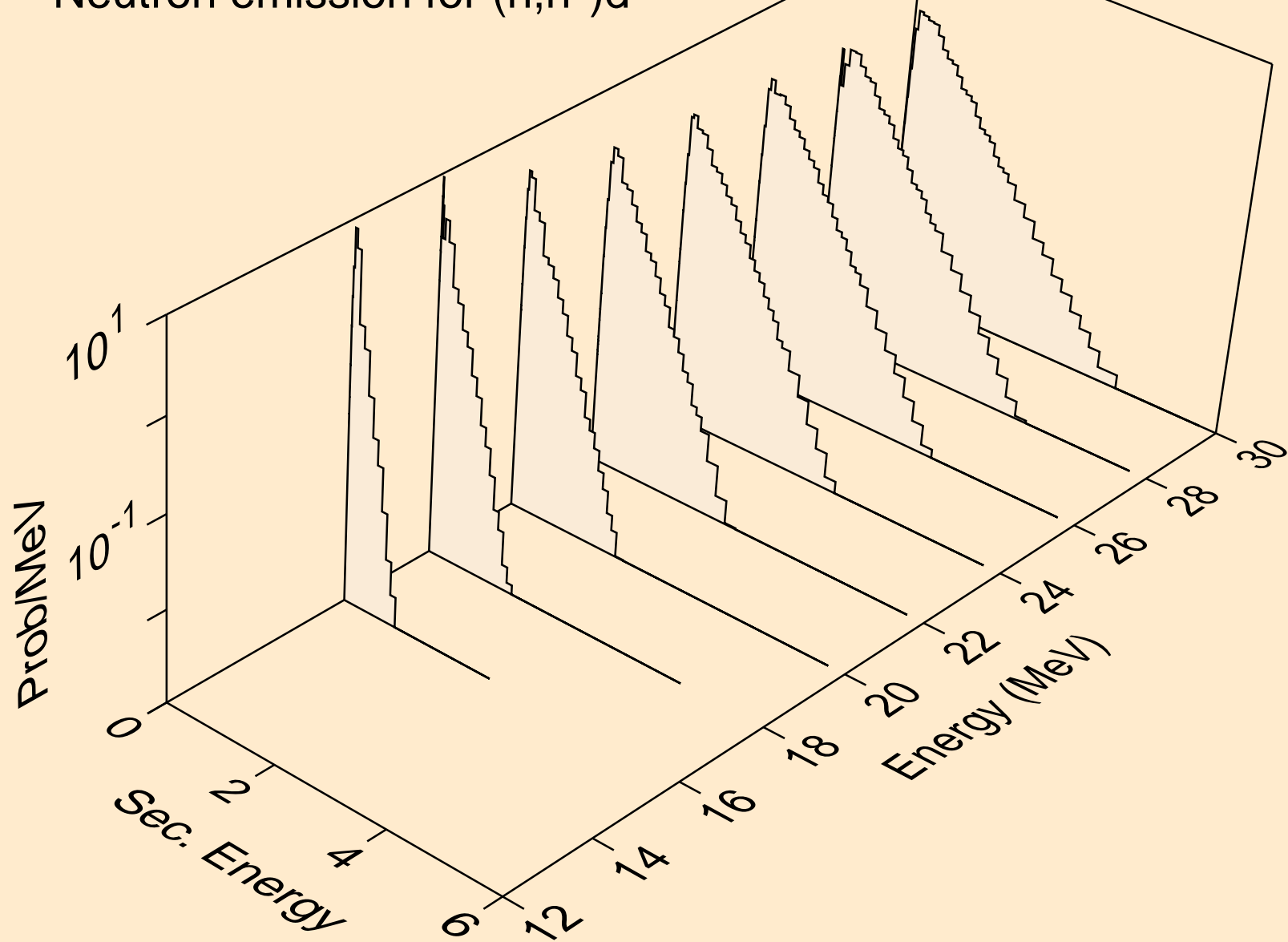

HO171 NEUTRON ACER TENDL-2021 LIBRARY; T=293.6K  
Neutron emission for (n,n\*)t

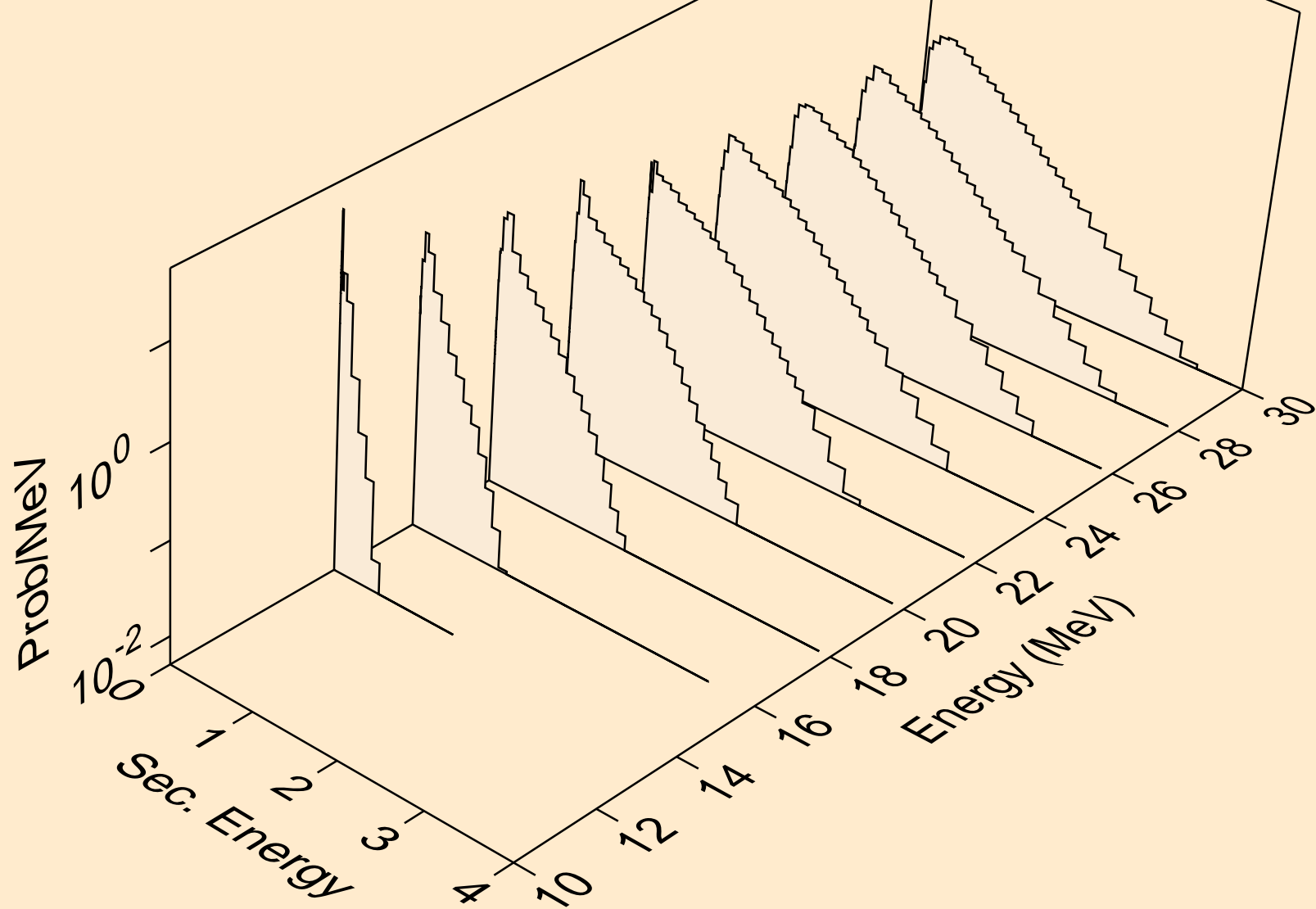

HO171 NEUTRON ACER TENDL-2021 LIBRARY; T=293.6K  
Neutron emission for (n,n\*)he3

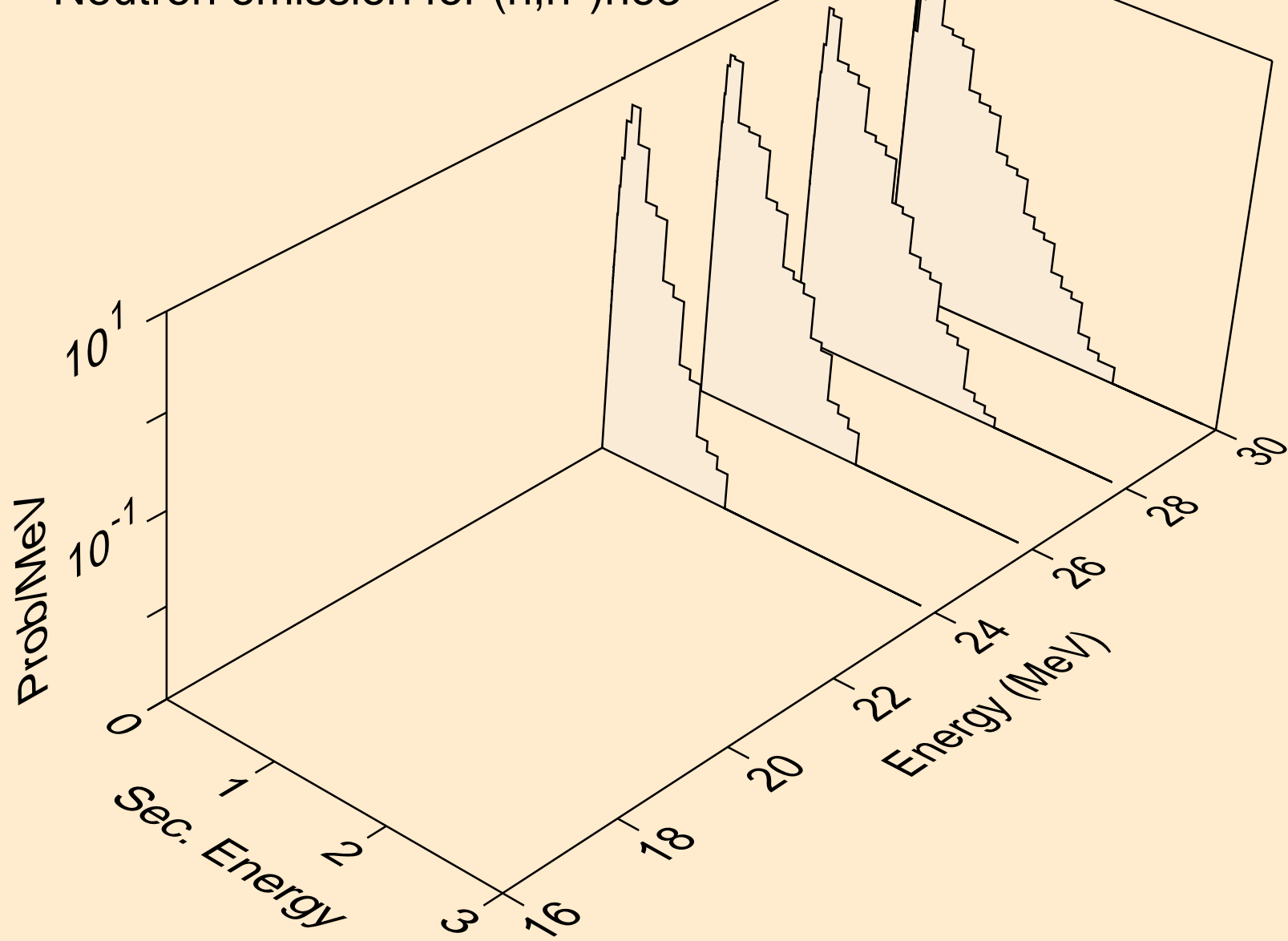

HO171 NEUTRON ACER TENDL-2021 LIBRARY; T=293.6K  
Neutron emission for (n,4n)

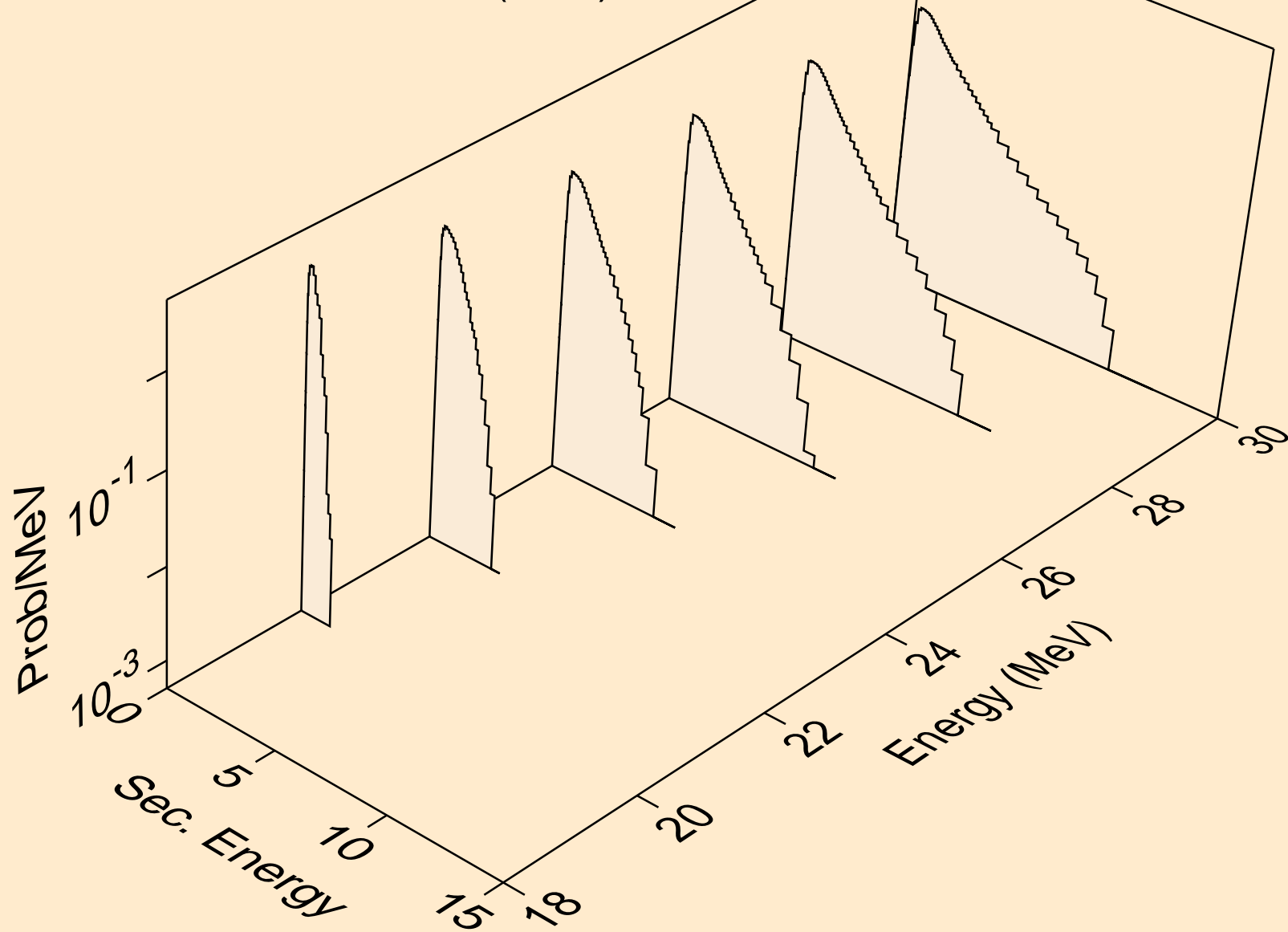

HO171 NEUTRON ACER TENDL-2021 LIBRARY; T=293.6K  
Neutron emission for (n,2np)

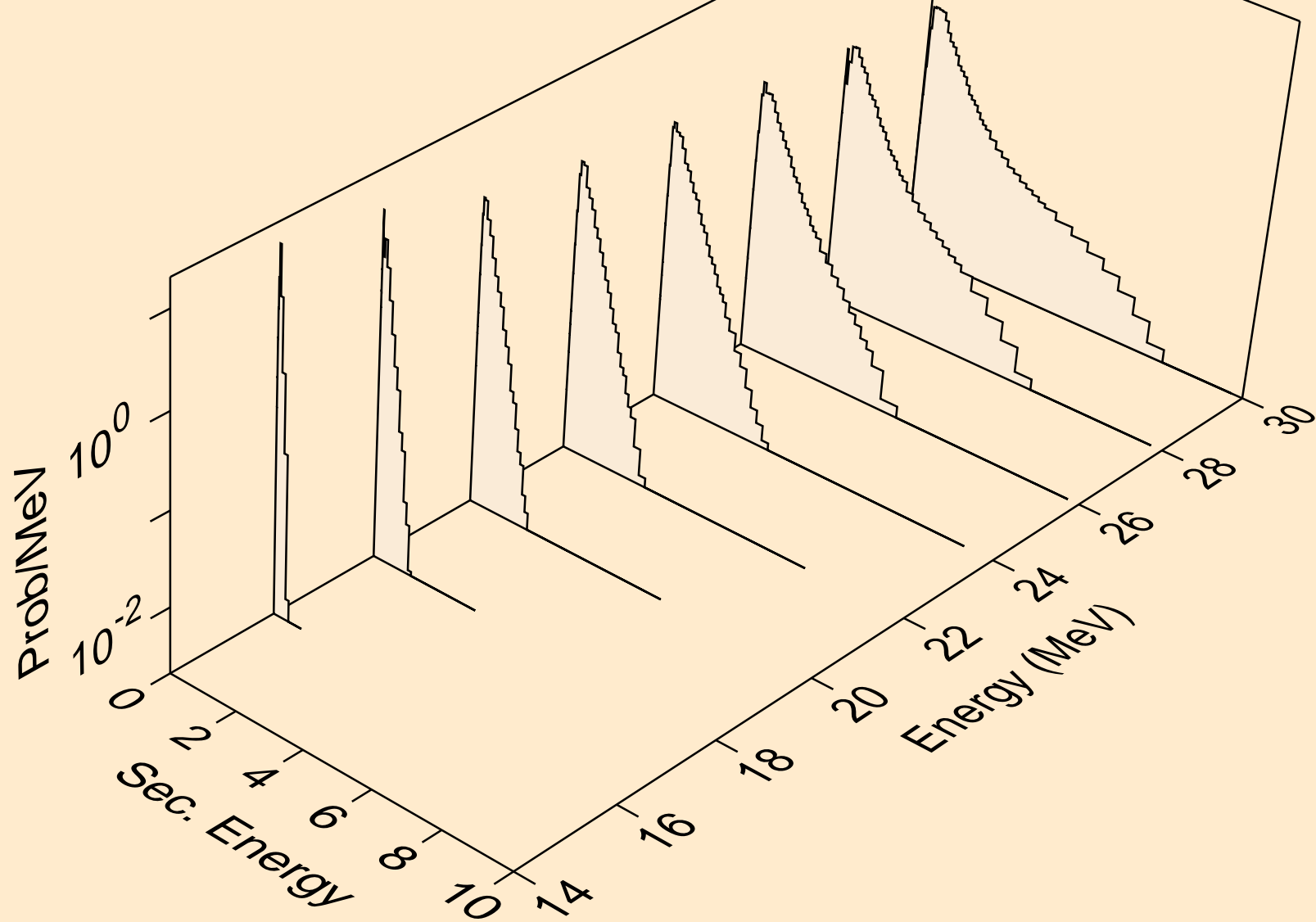

HO171 NEUTRON ACER TENDL-2021 LIBRARY; T=293.6K  
Neutron emission for (n,3np)

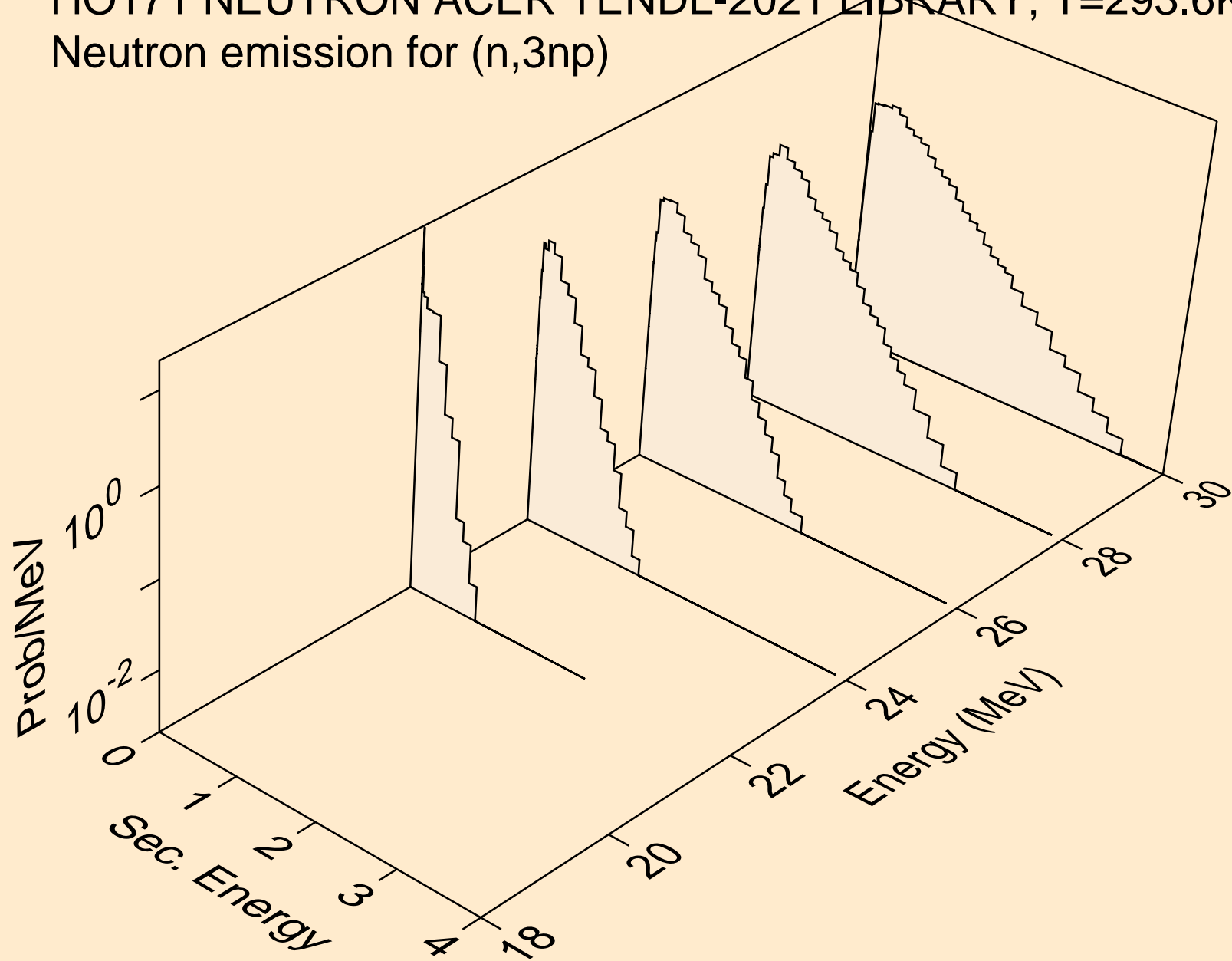



HO171 NEUTRON ACER TENDL-2021 LIBRARY; T=293.6K  
Neutron emission for (n,n\*c)

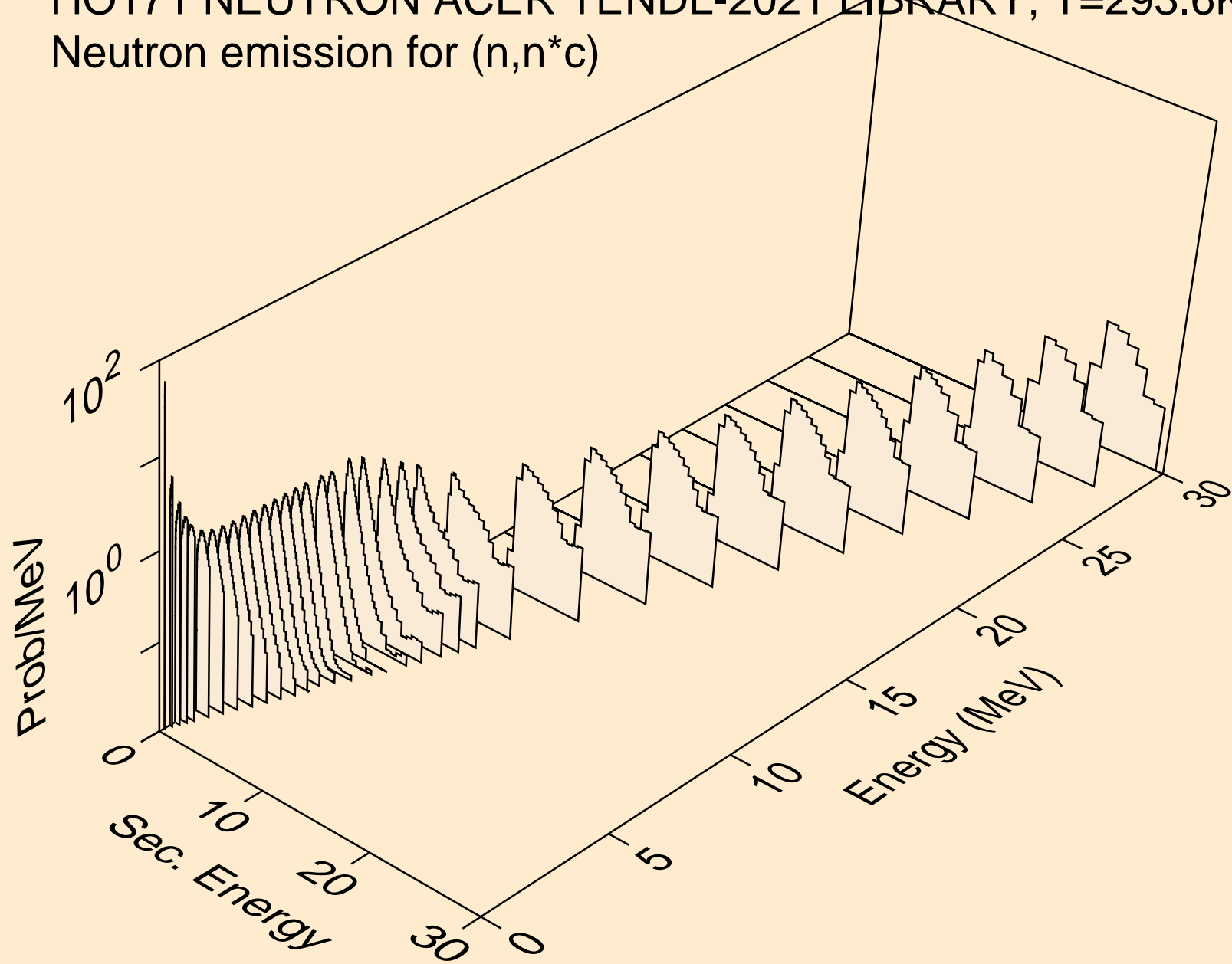

HO171 NEUTRON ACER TENDL-2021 LIBRARY; T=293.6K  
Photon emission for (n,x)

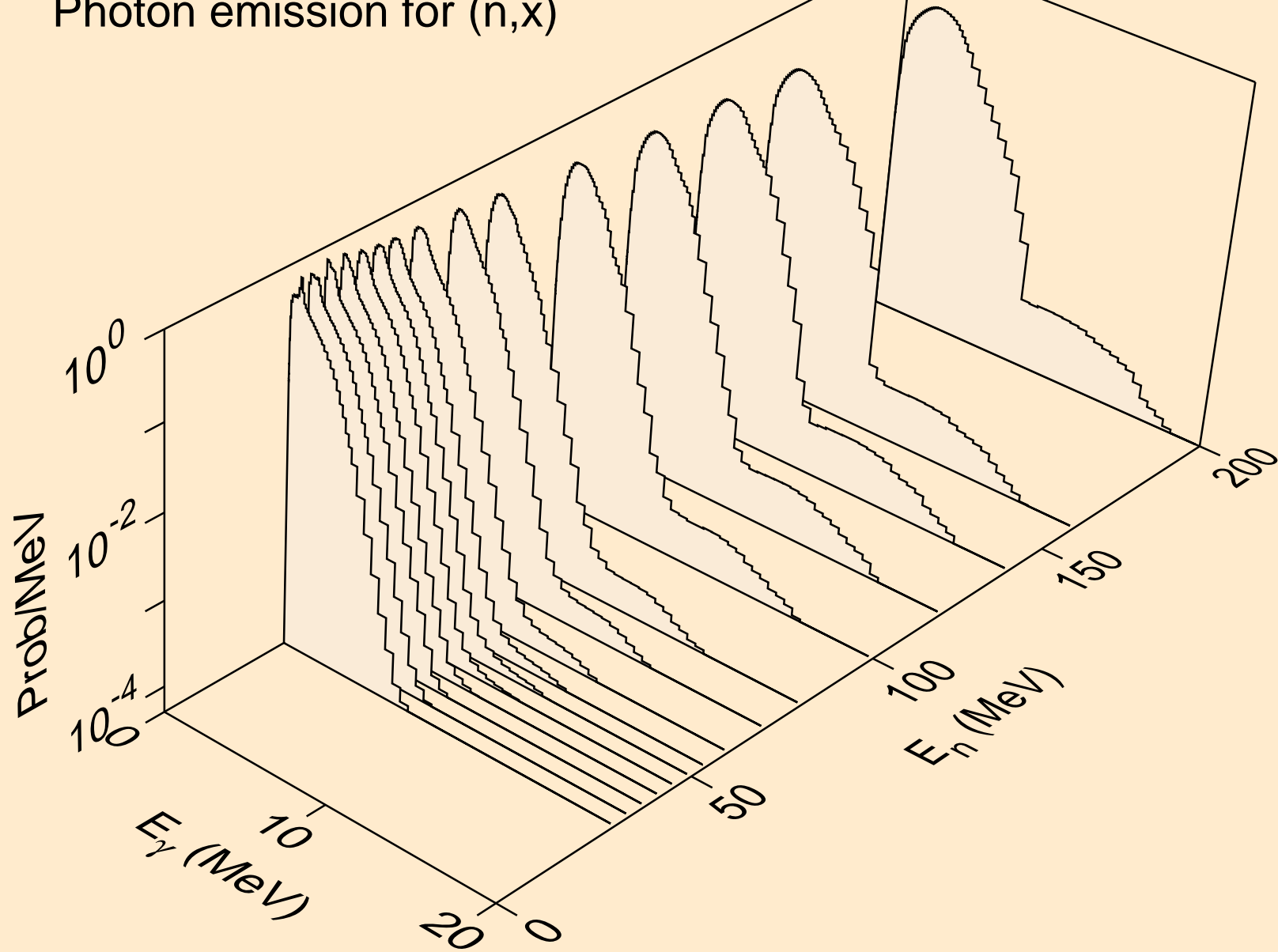

HO171 NEUTRON ACER TENDL-2021 LIBRARY; T=293.6K  
Photon emission for (n,2nd)

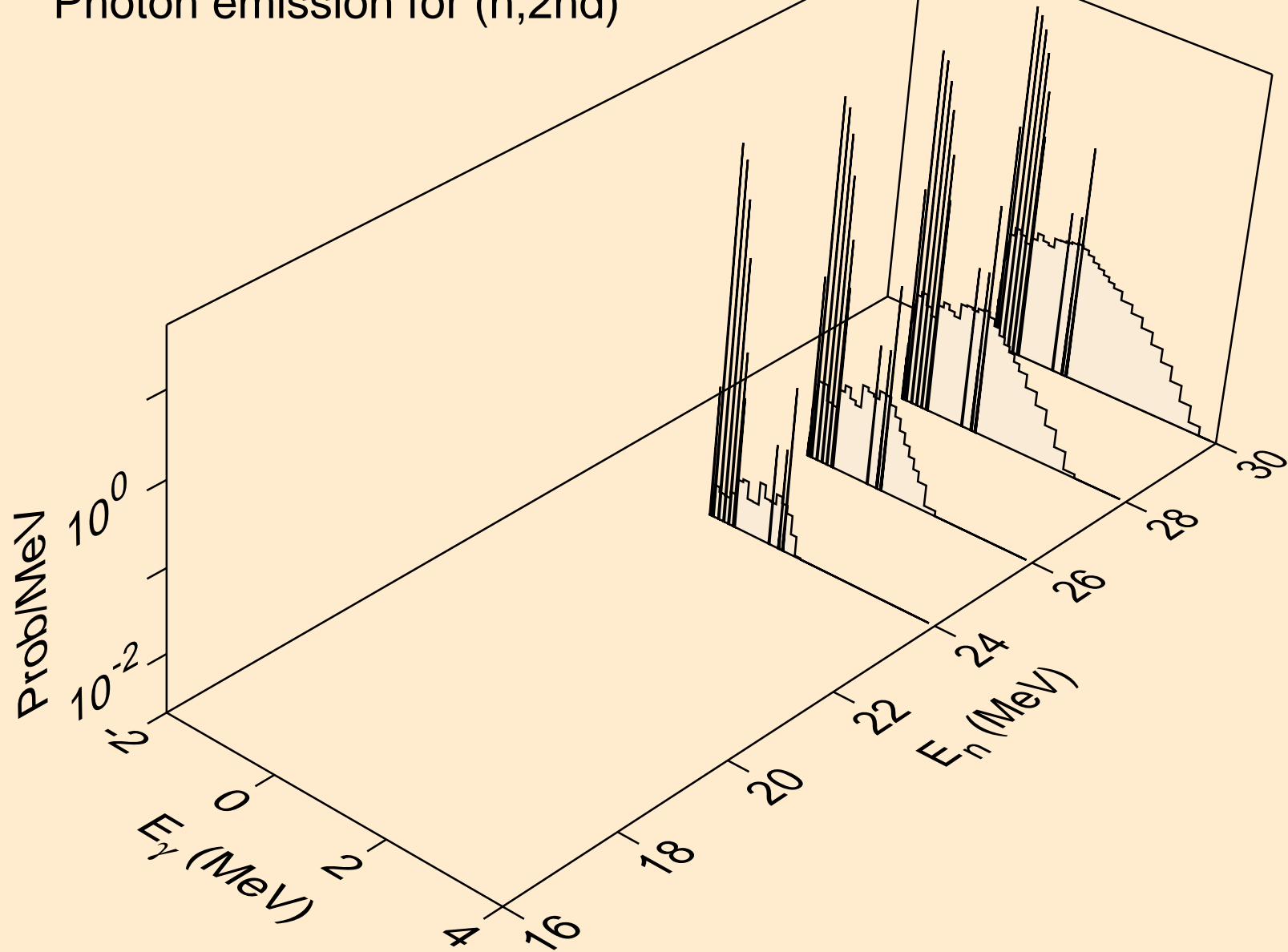

HO171 NEUTRON ACER TENDL-2021 LIBRARY; T=293.6K  
Photon emission for (n,2n)

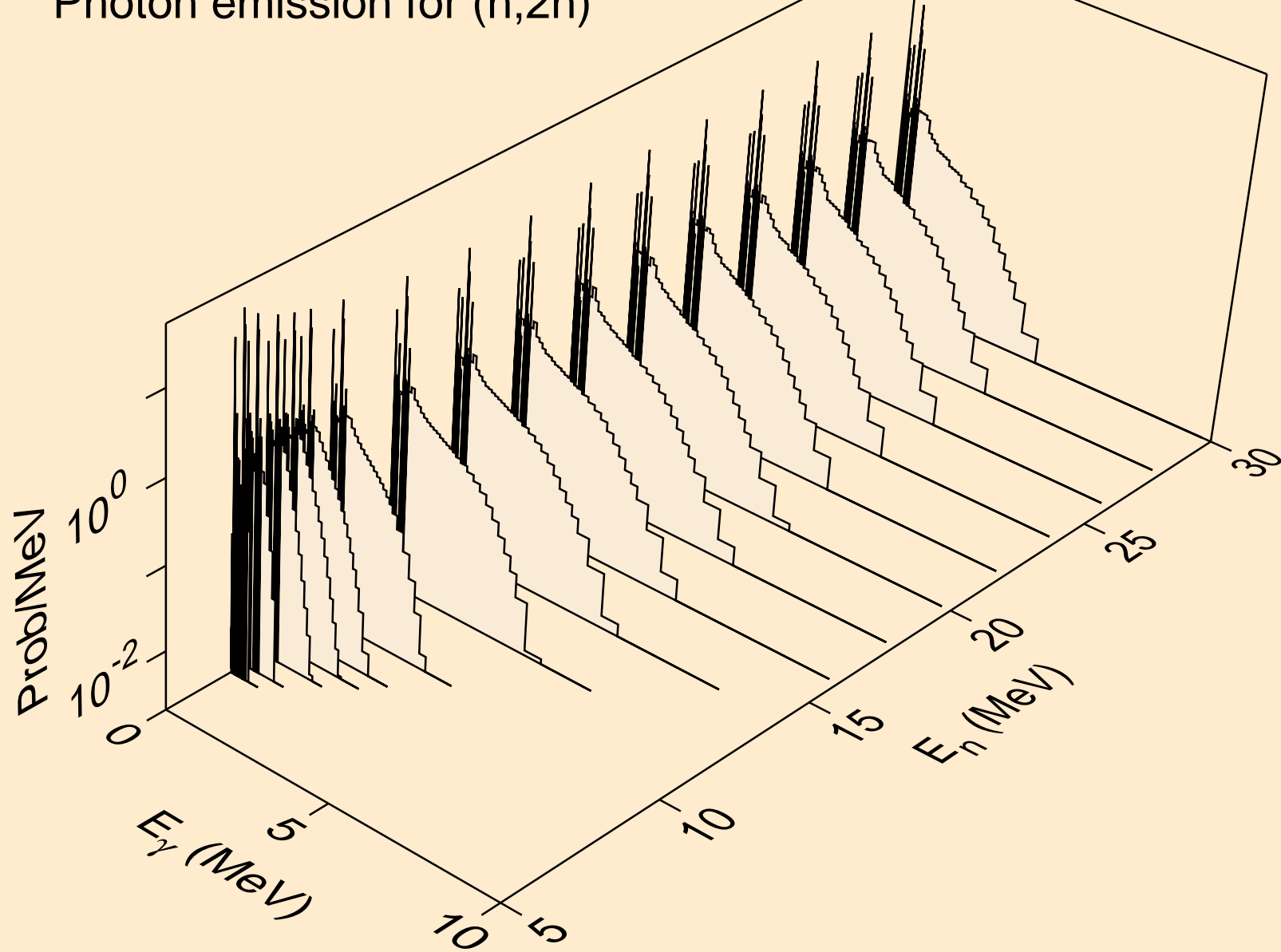

HO171 NEUTRON ACER TENDL-2021 LIBRARY; T=293.6K  
Photon emission for (n,3n)

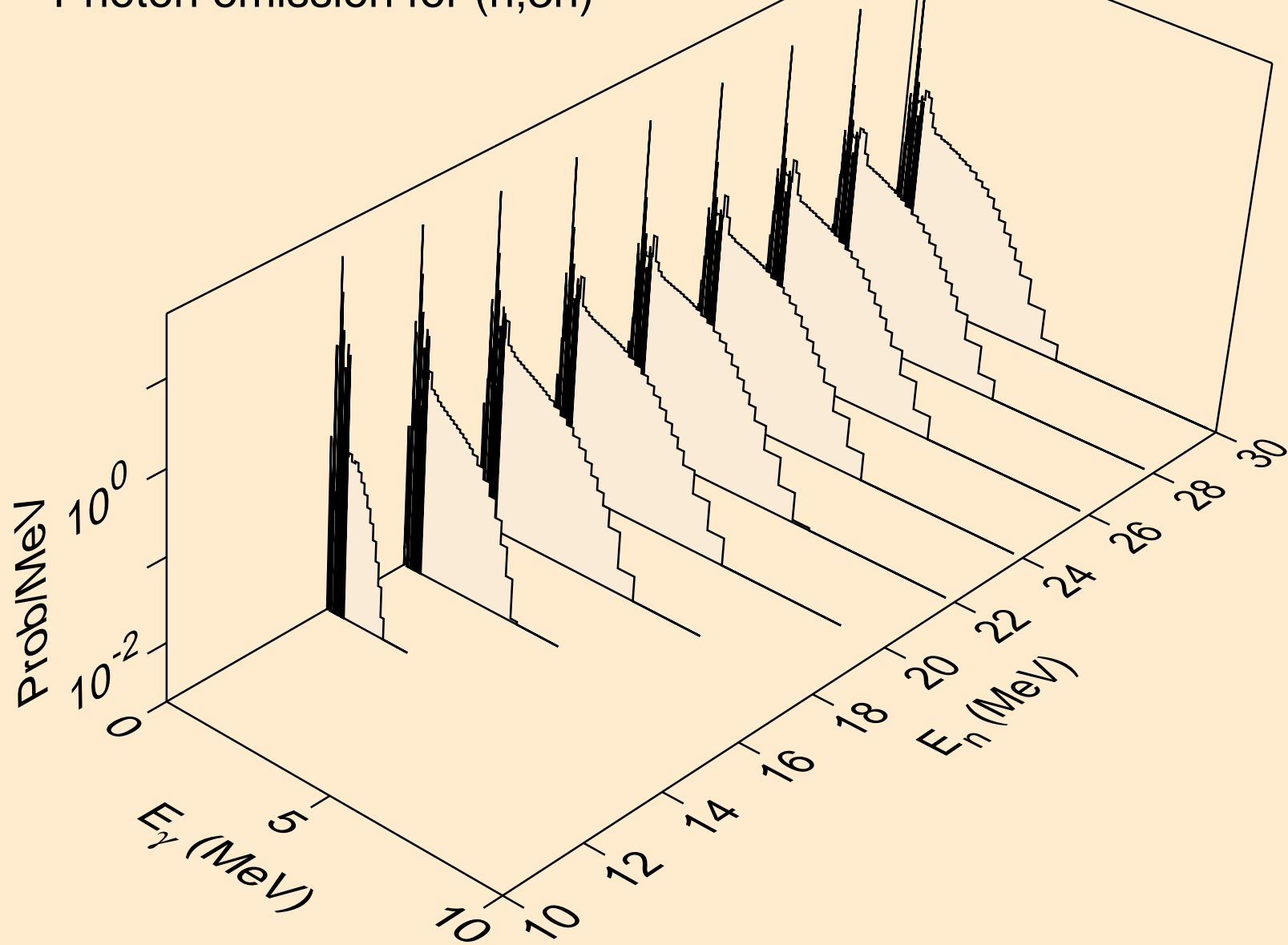

HO171 NEUTRON ACER TENDL-2021 LIBRARY; T=293.6K  
Photon emission for (n,n\*)a

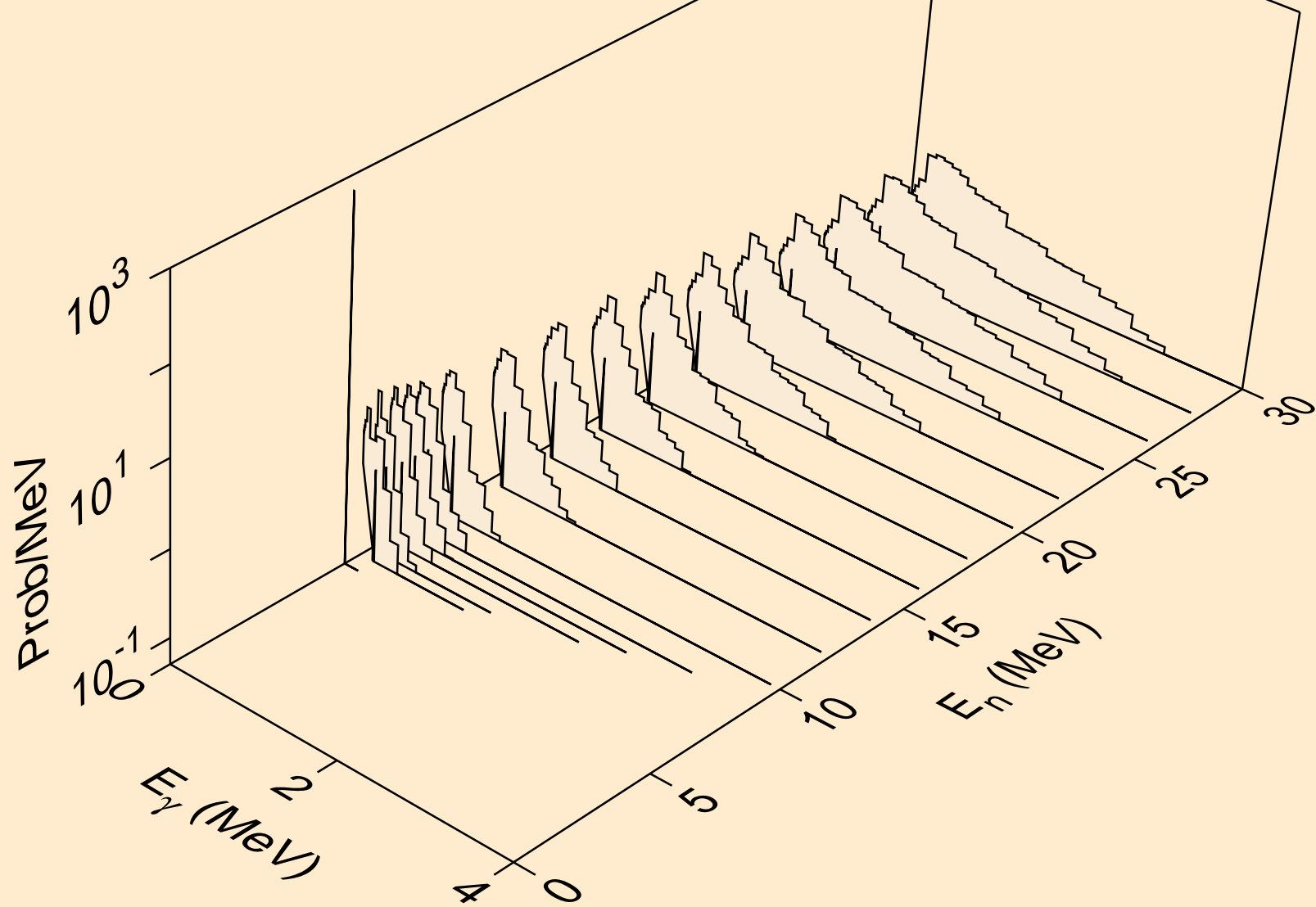

HO171 NEUTRON ACER TENDL-2021 LIBRARY; T=293.6K  
Photon emission for (n,2n)a

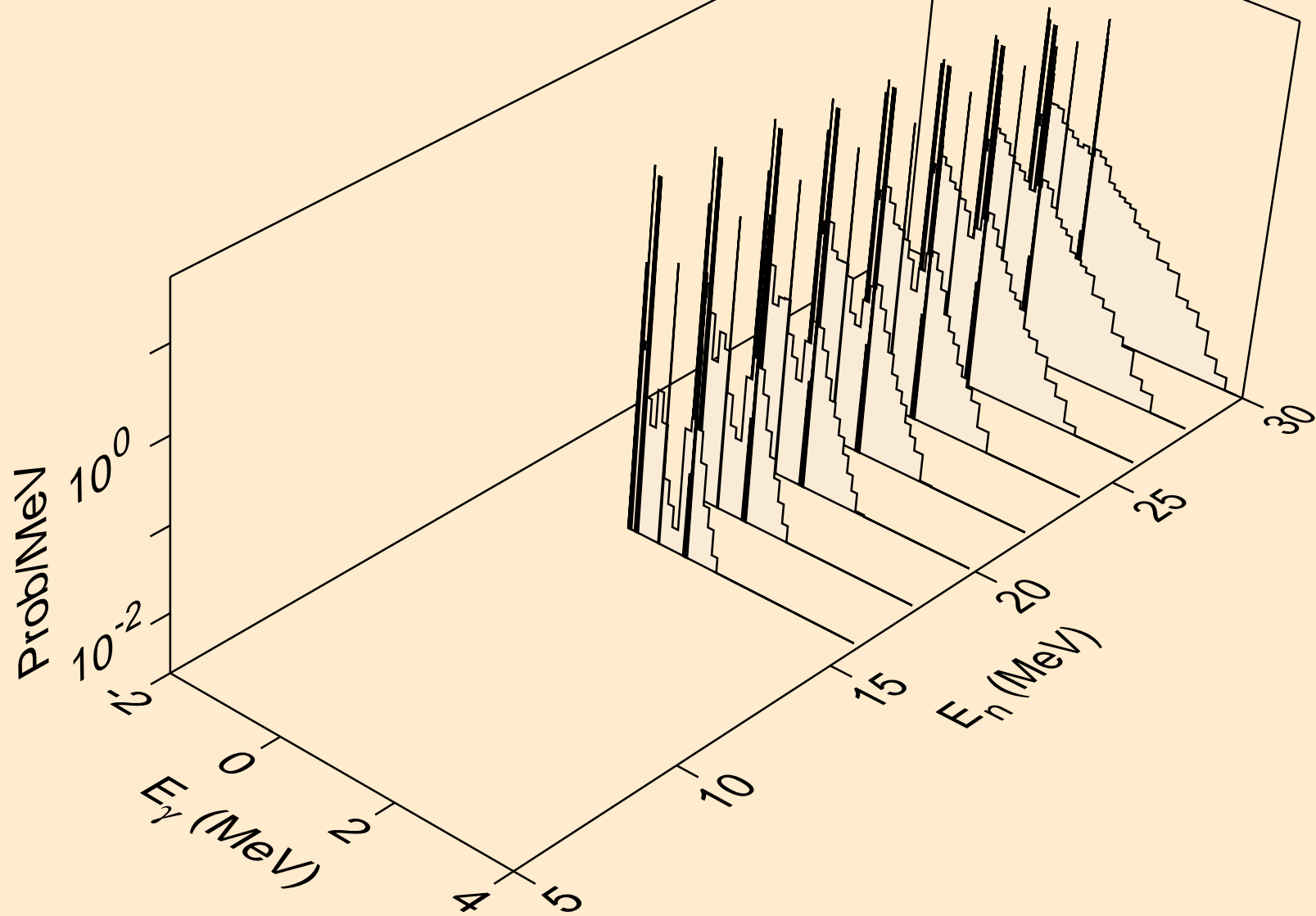

HO171 NEUTRON ACER TENDL-2021 LIBRARY; T=293.6K  
Photon emission for (n,3n)a

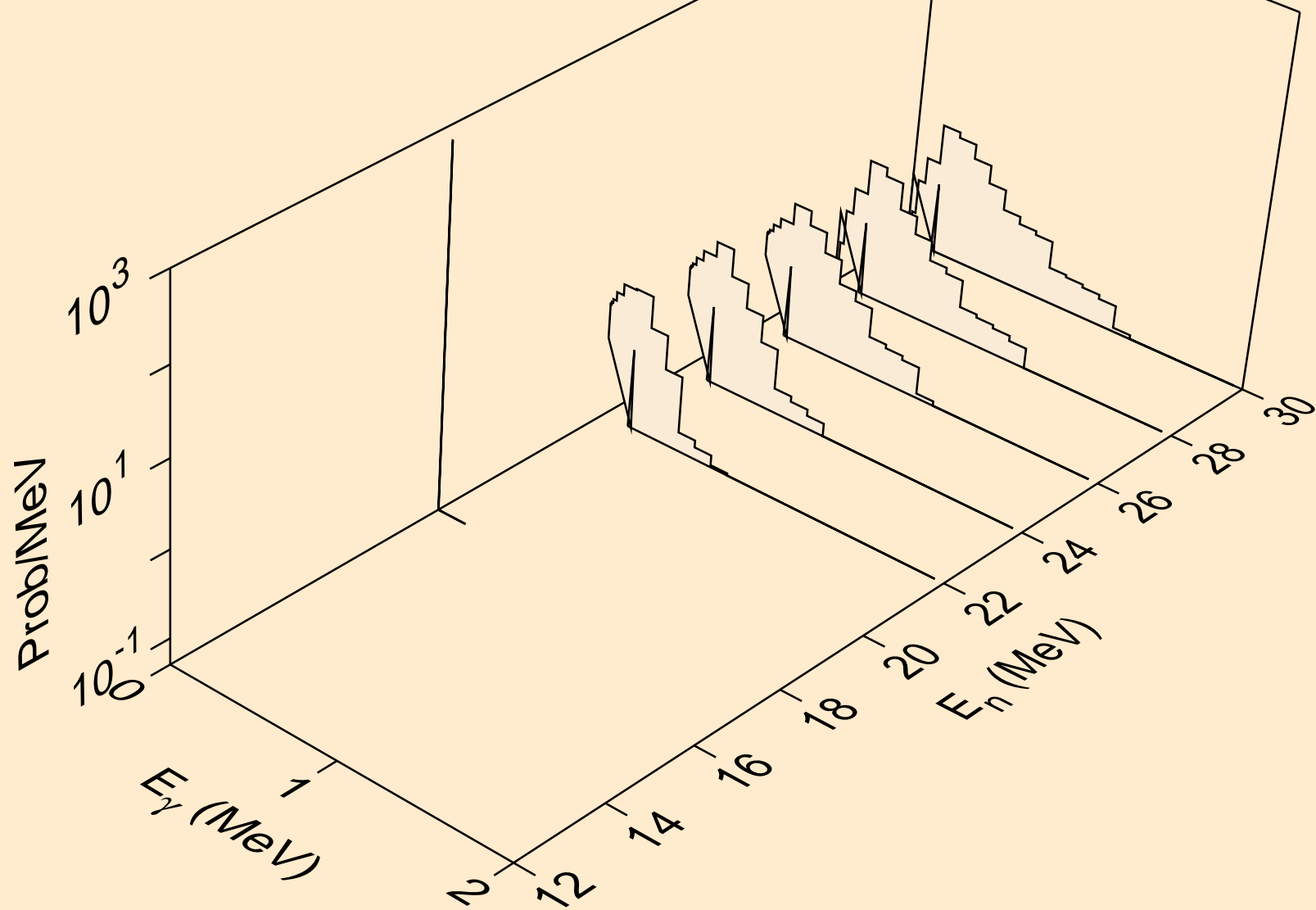



HO171 NEUTRON ACER TENDL-2021 LIBRARY; T=293.6K  
Photon emission for (n,n\*)p

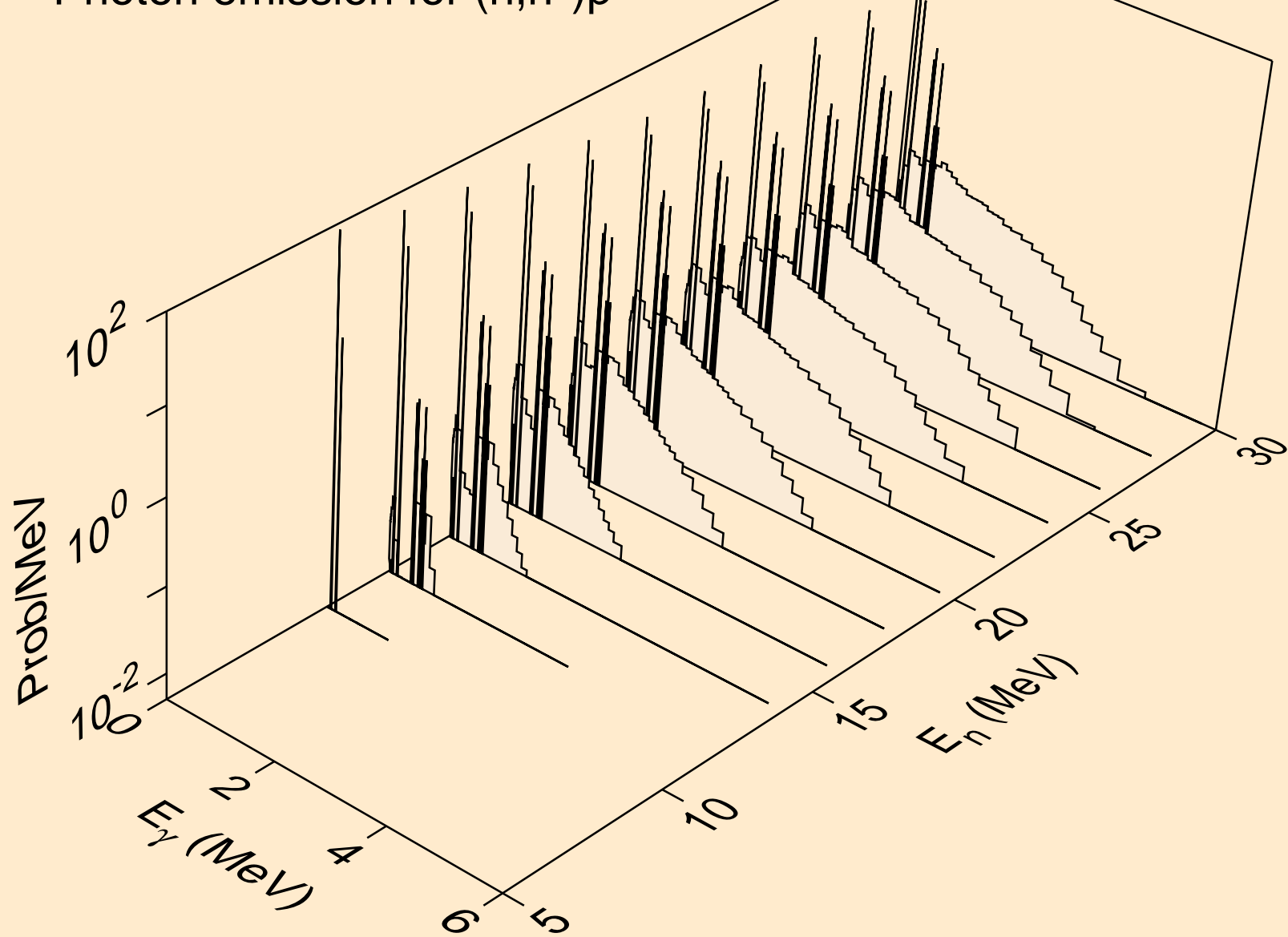

HO171 NEUTRON ACER TENDL-2021 LIBRARY; T=293.6K  
Photon emission for (n,n\*)d

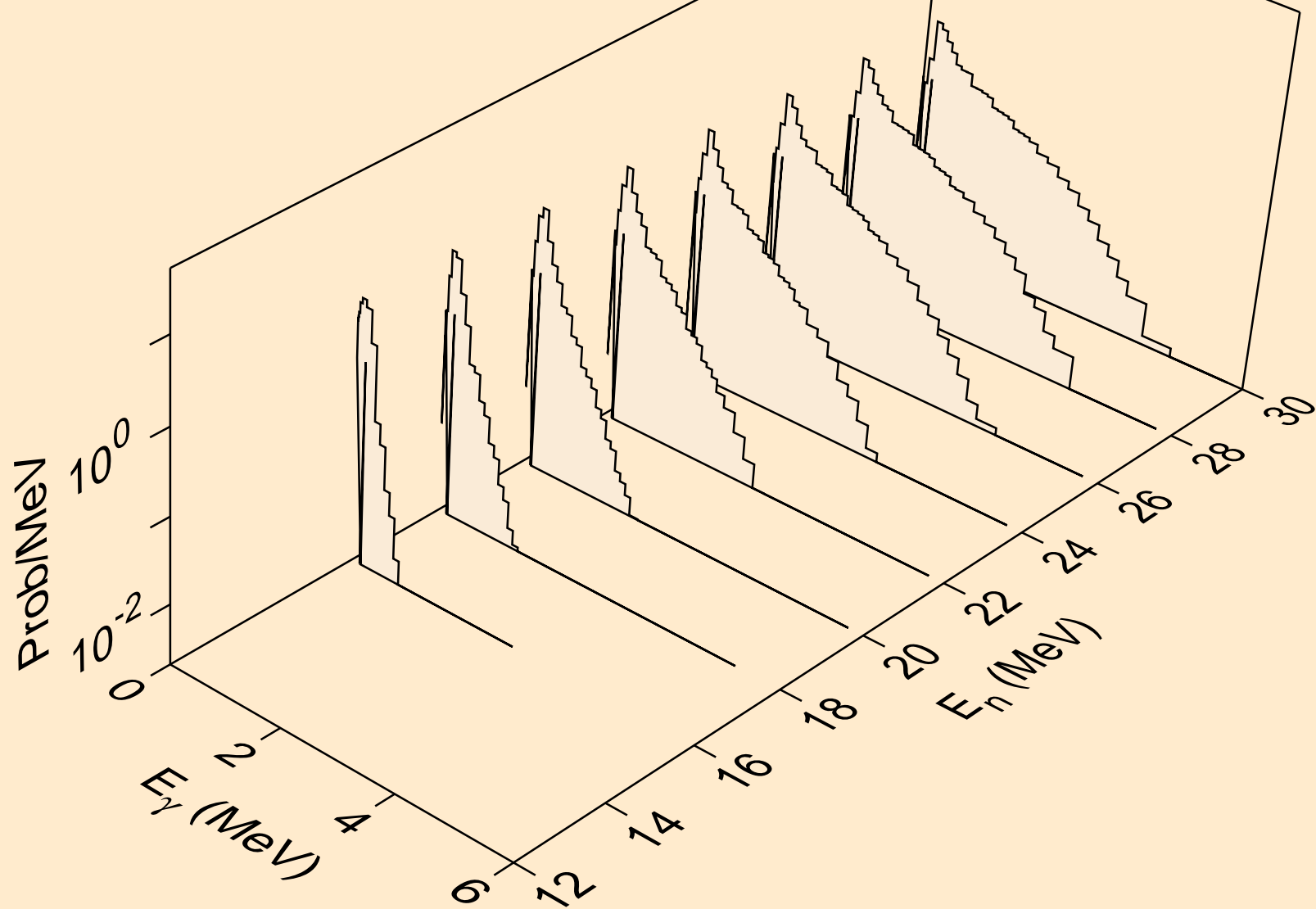

HO171 NEUTRON ACER TENDL-2021 LIBRARY; T=293.6K  
Photon emission for (n,n\*)t

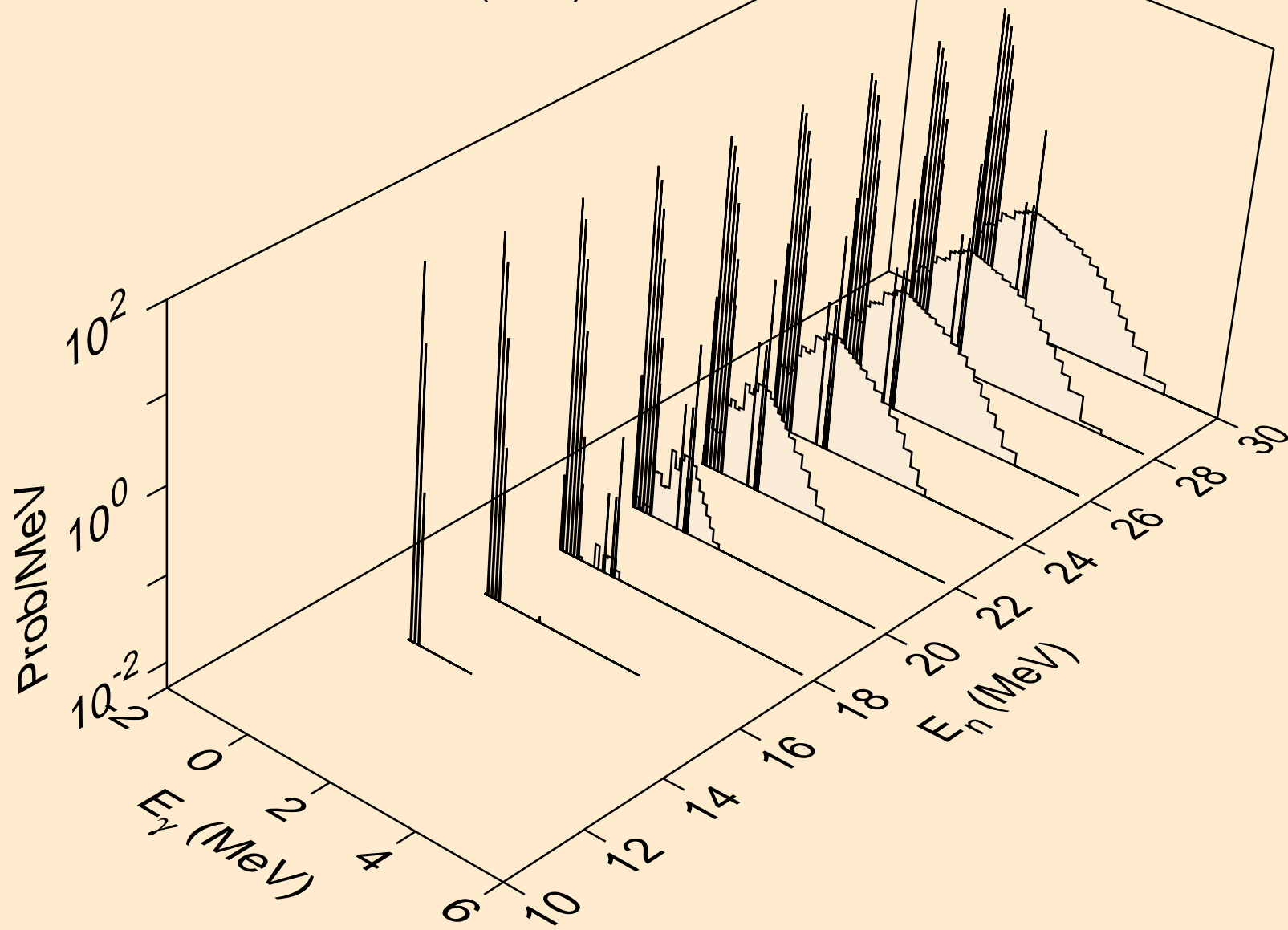

HO171 NEUTRON ACER TENDL-2021 LIBRARY; T=293.6K  
Photon emission for (n,n\*)he3

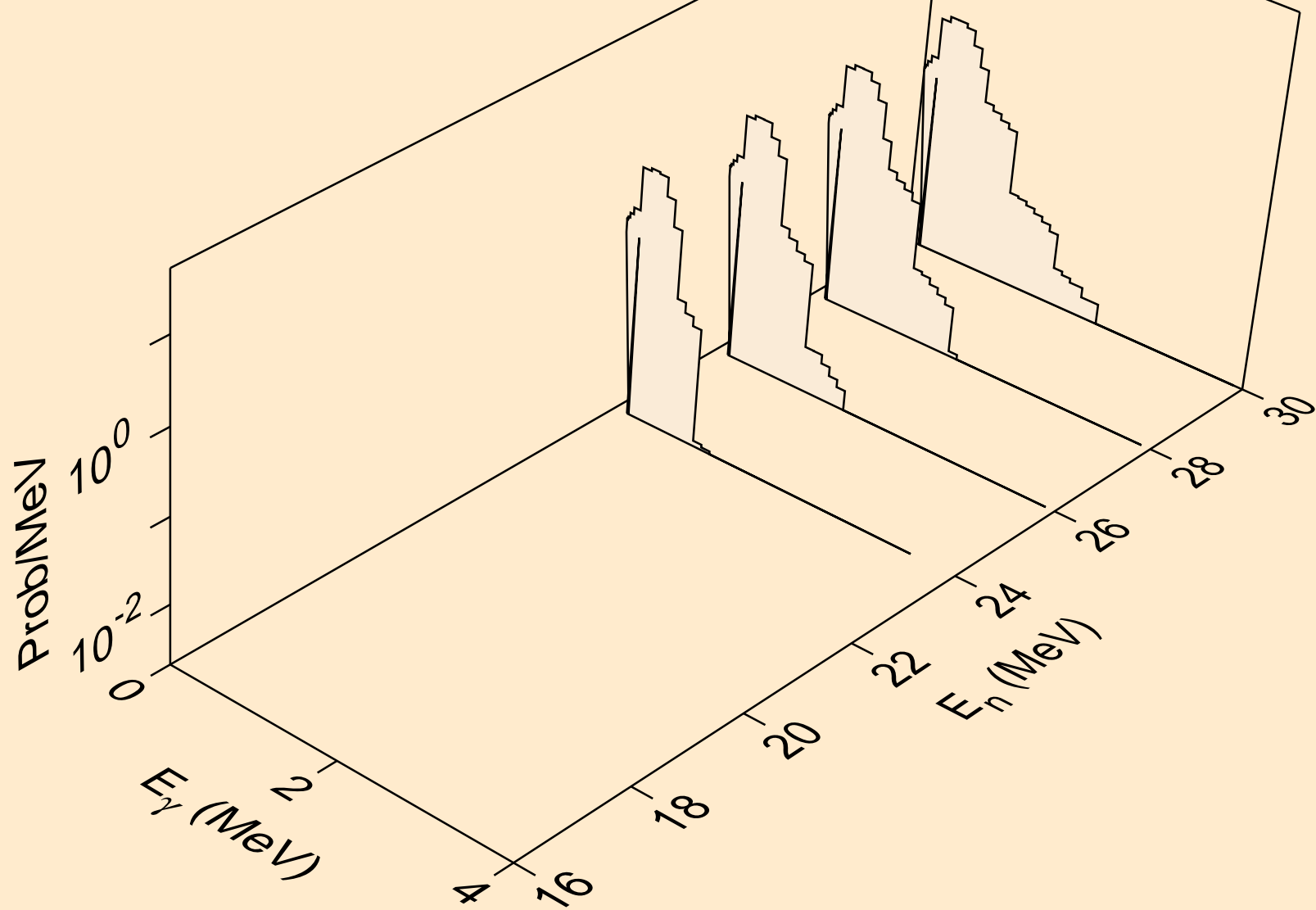

HO171 NEUTRON ACER TENDL-2021 LIBRARY; T=293.6K  
Photon emission for (n,4n)

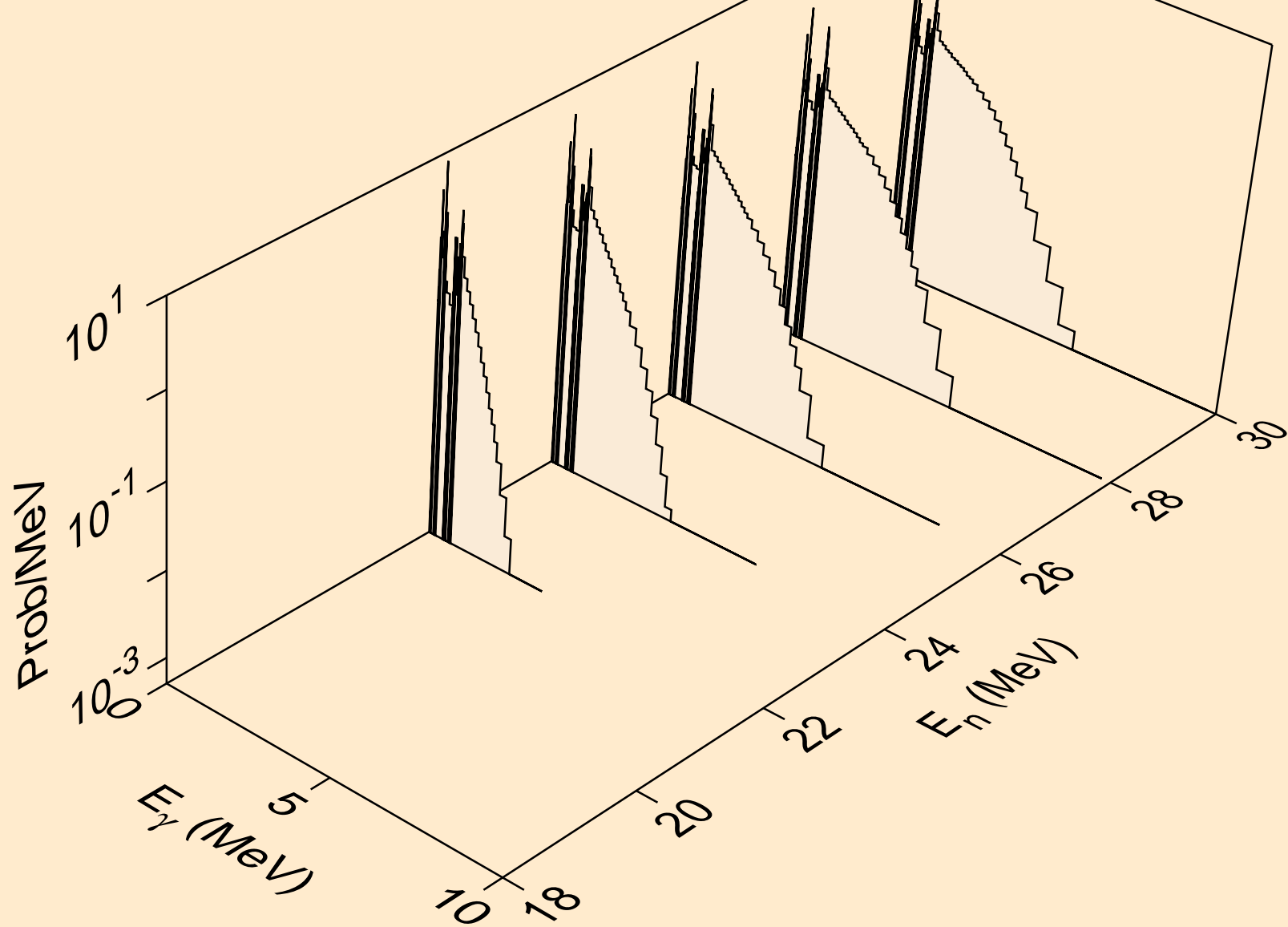

HO171 NEUTRON ACER TENDL-2021 LIBRARY; T=293.6K  
Photon emission for (n,2np)

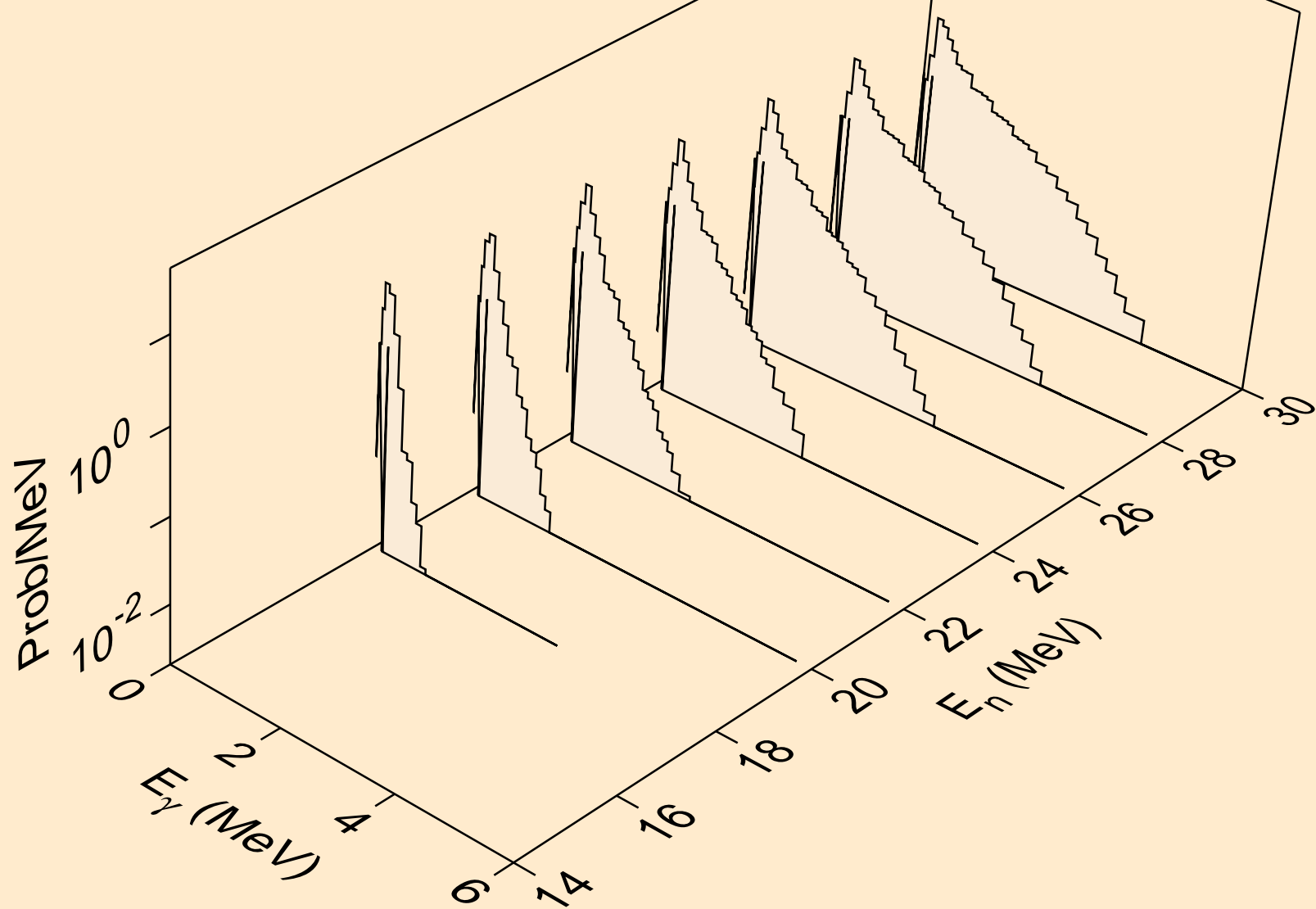

HO171 NEUTRON ACER TENDL-2021 LIBRARY; T=293.6K  
Photon emission for (n,3np)

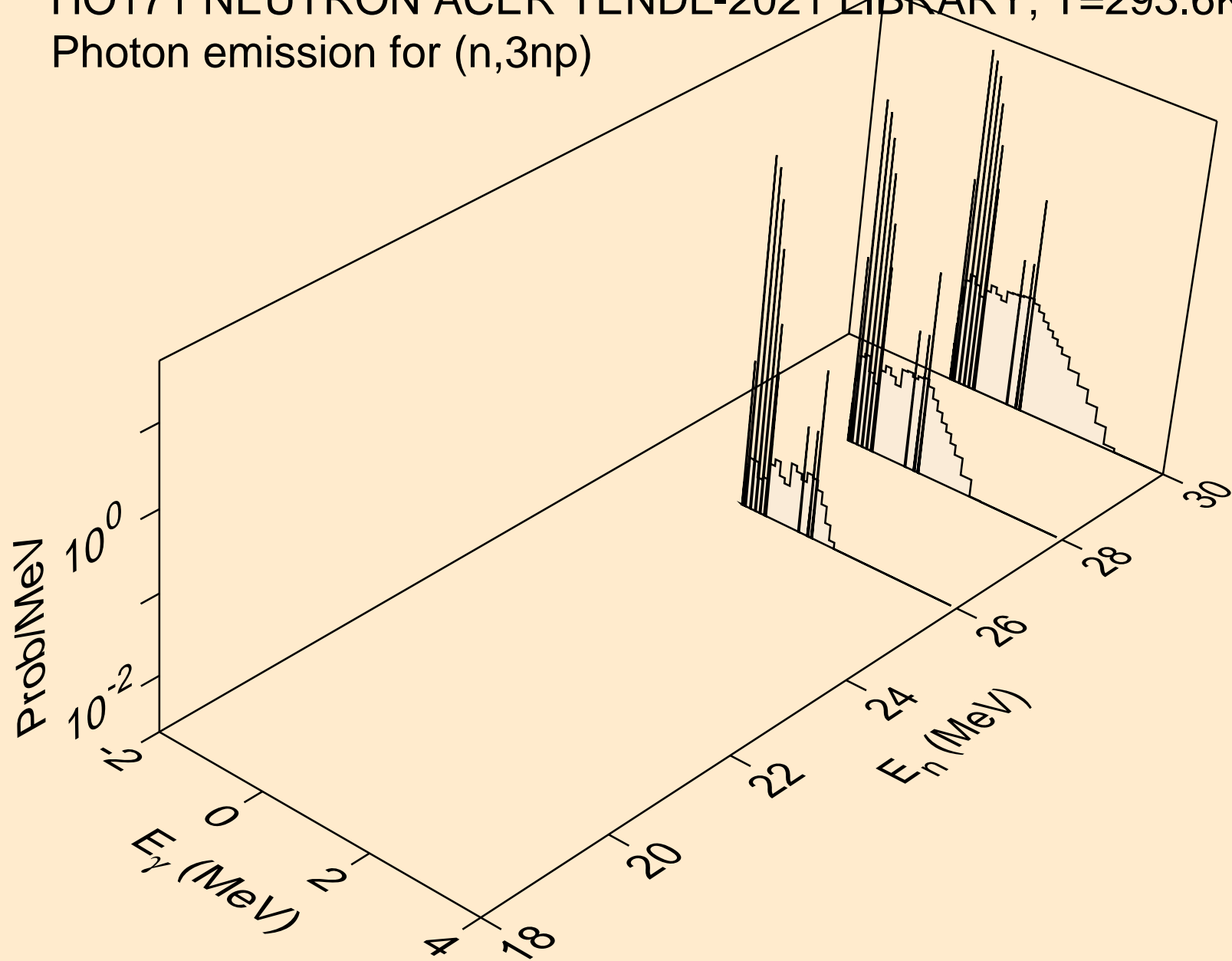

HO171 NEUTRON ACER TENDL-2021 LIBRARY; T=293.6K  
Photon emission for (n,n\*c)

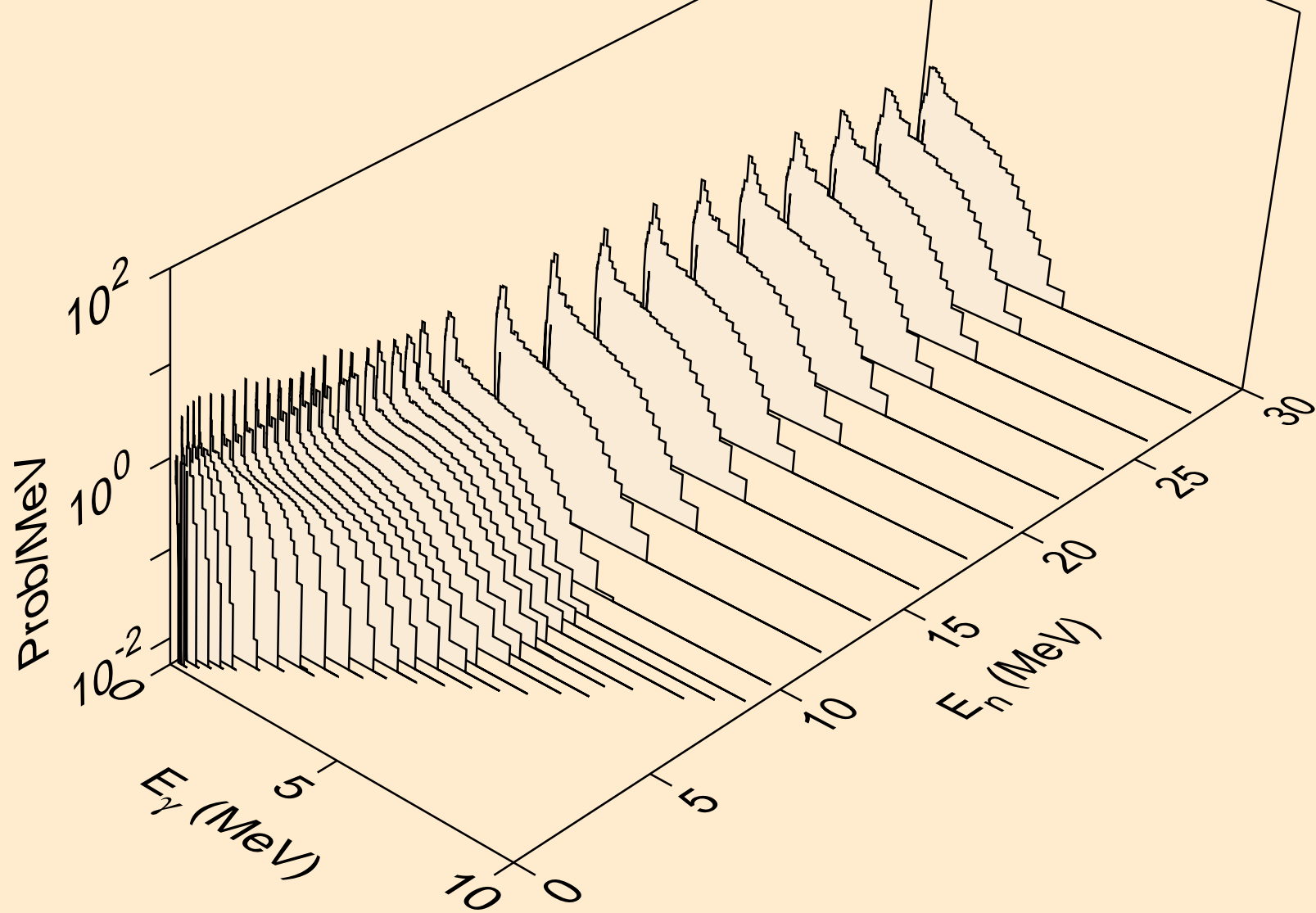



HO171 NEUTRON ACER TENDL-2021 LIBRARY; T=293.6K  
Photon emission for (n,gma)

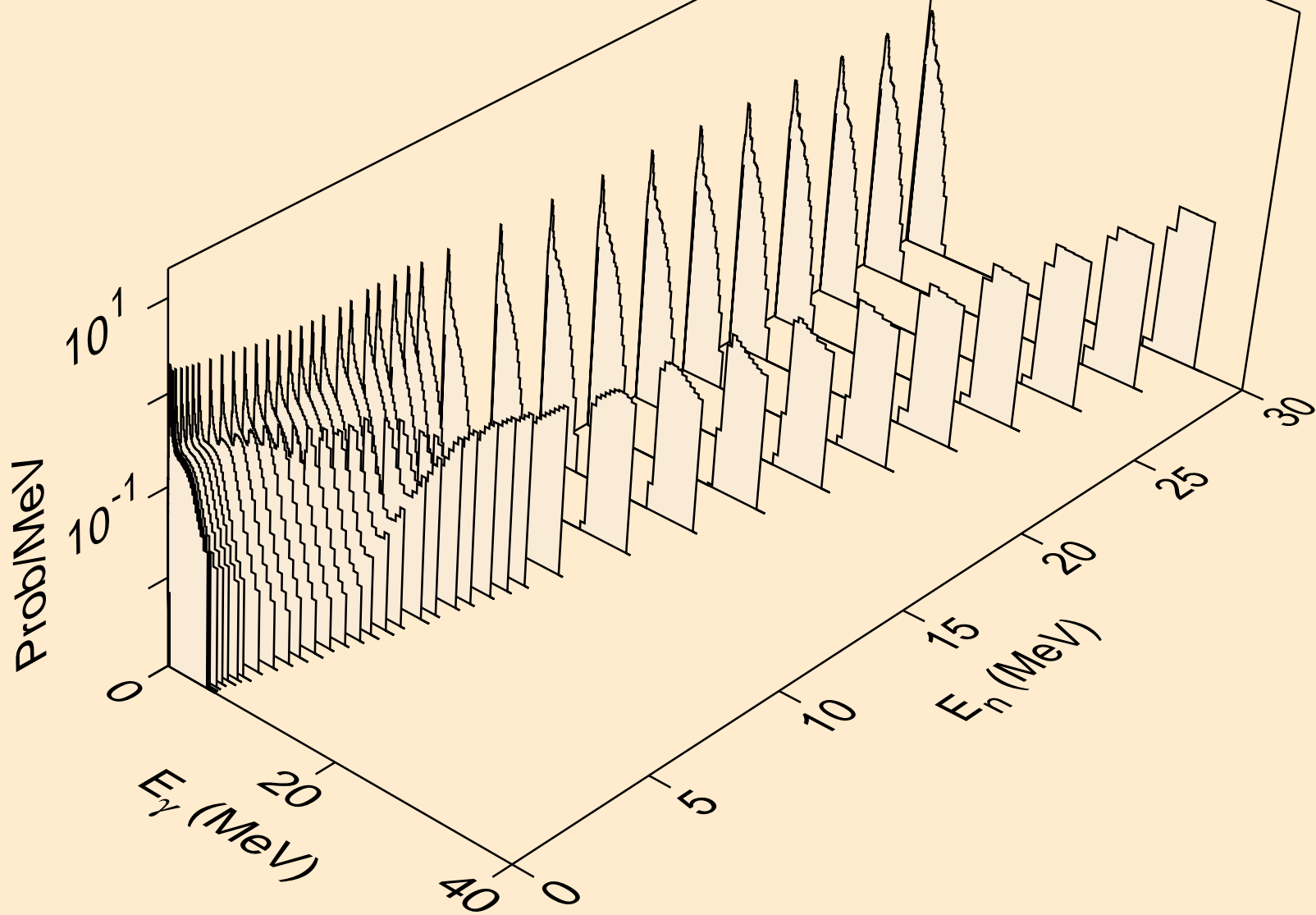

HO171 NEUTRON ACER TENDL-2021 LIBRARY; T=293.6K  
Photon emission for (n,p)

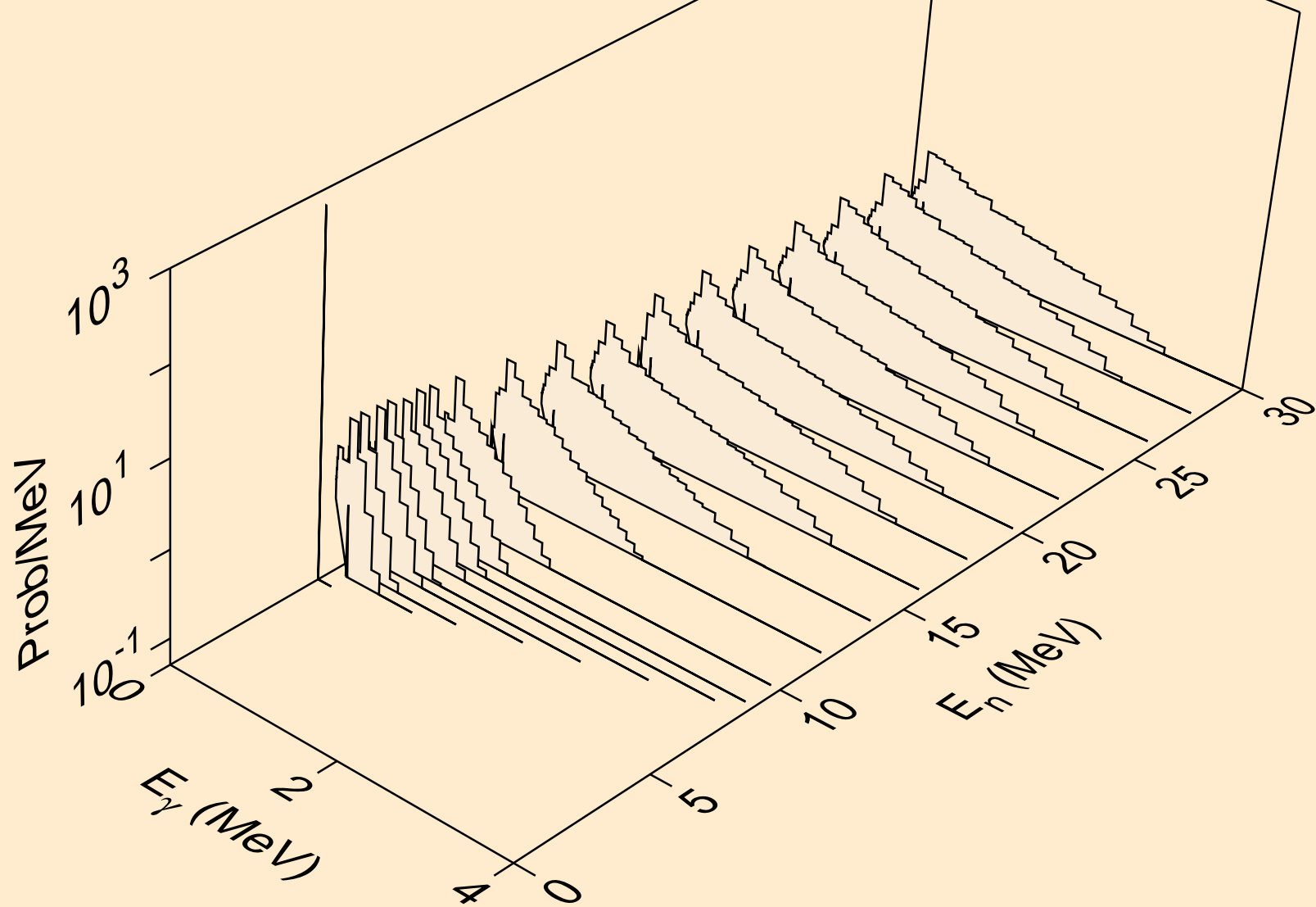

HO171 NEUTRON ACER TENDL-2021 LIBRARY; T=293.6K  
Photon emission for (n,d)

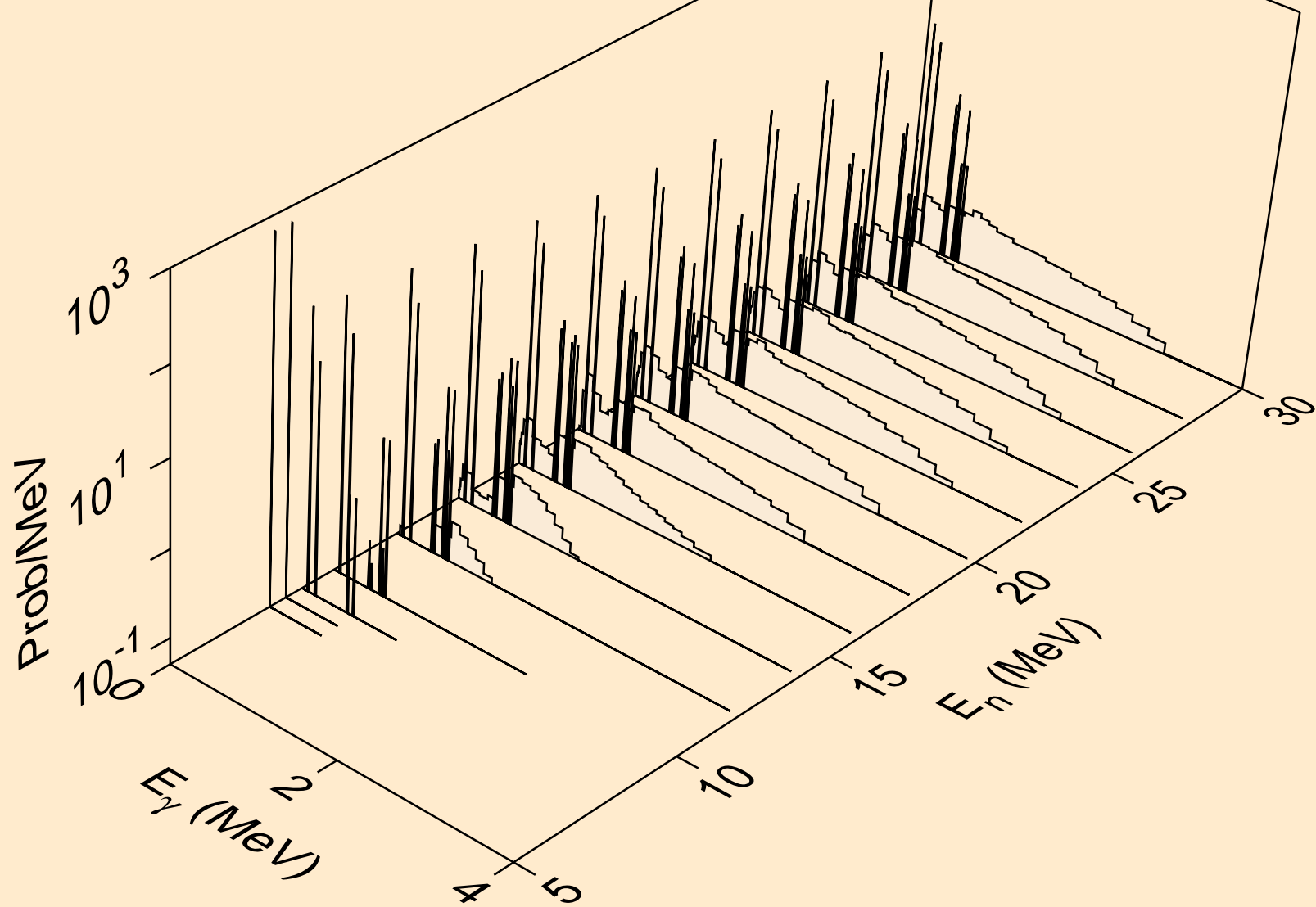

HO171 NEUTRON ACER TENDL-2021 LIBRARY; T=293.6K  
Photon emission for (n,t)

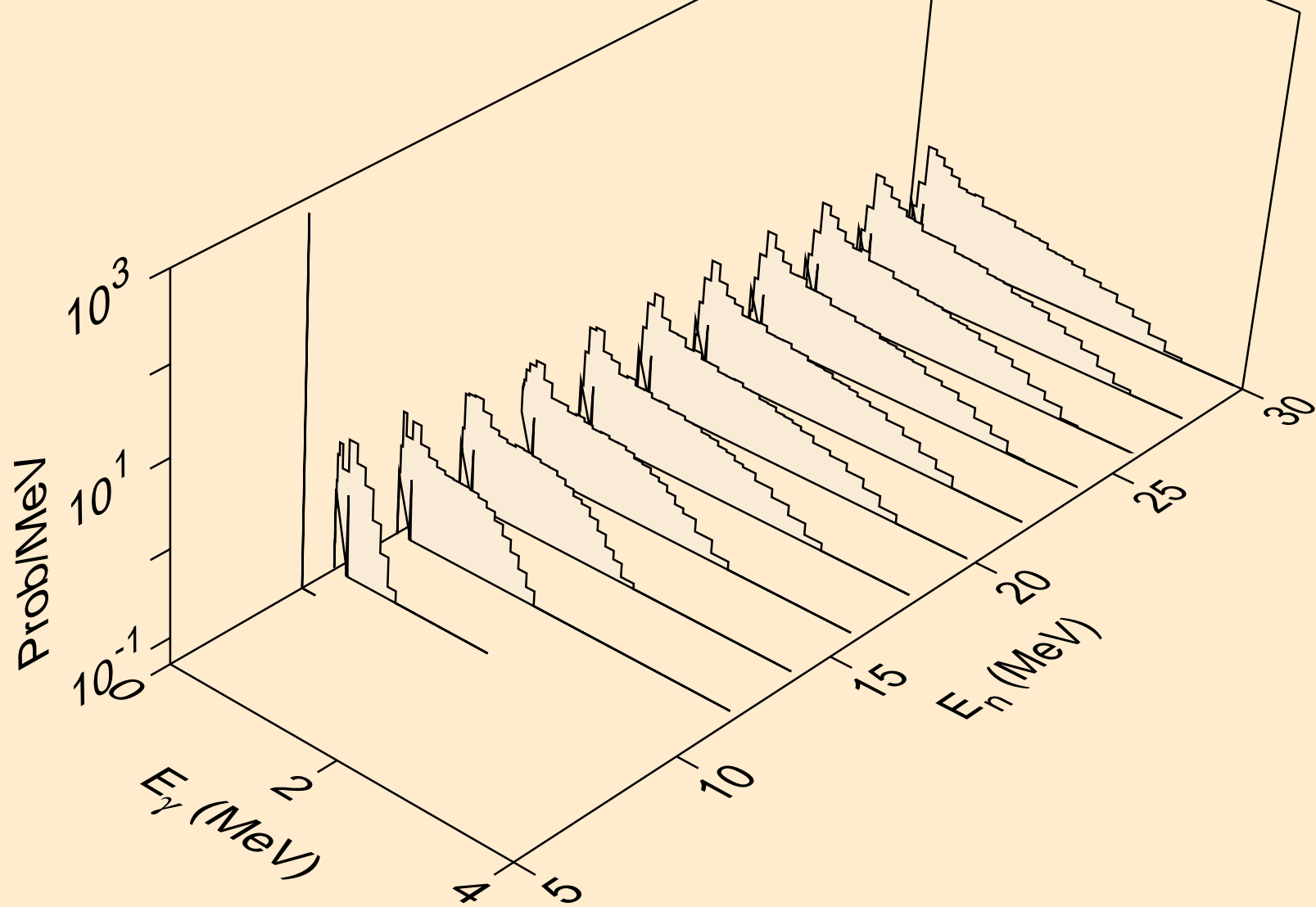

HO171 NEUTRON ACER TENDL-2021 LIBRARY; T=293.6K  
Photon emission for (n,he3)

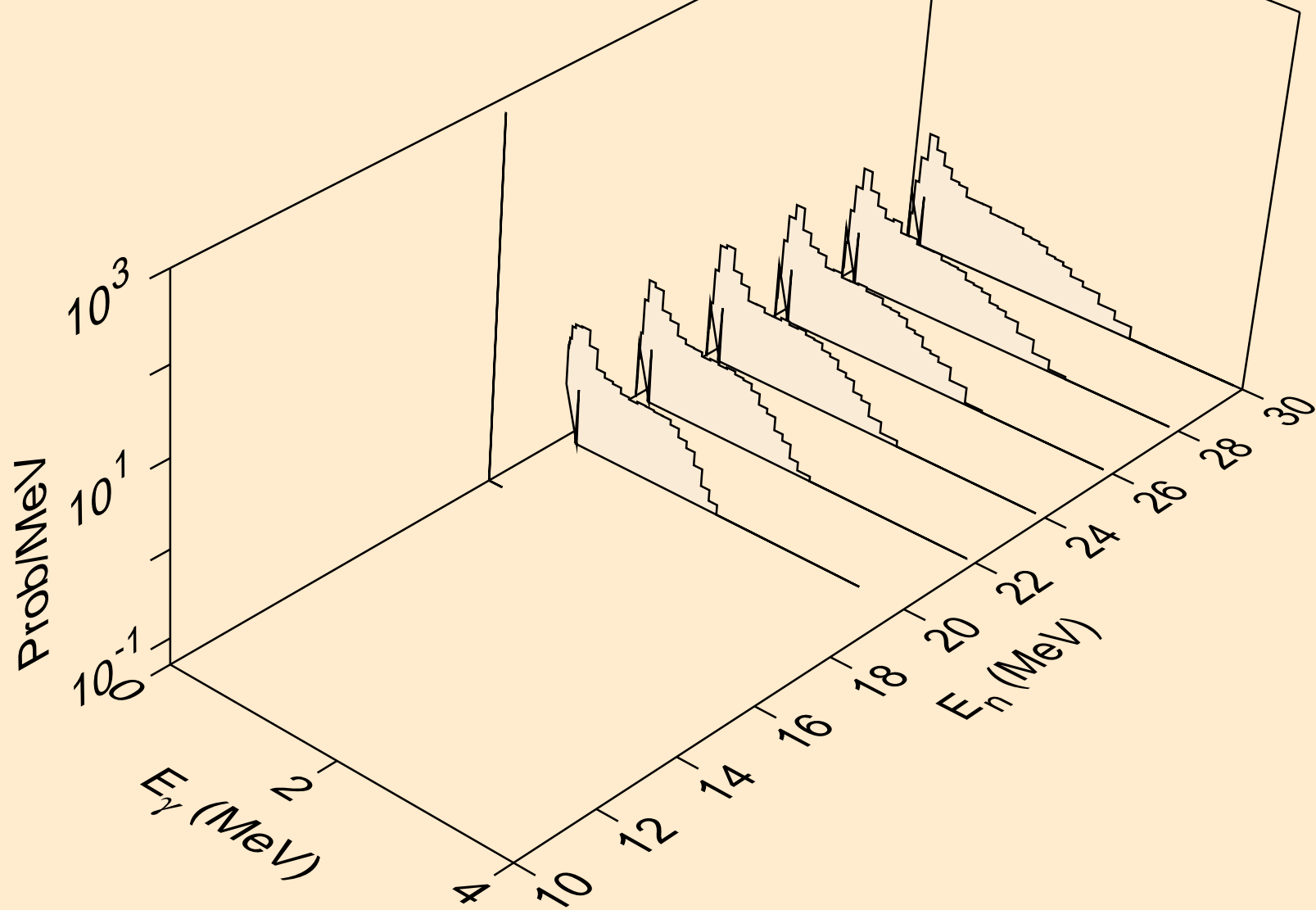

HO171 NEUTRON ACER TENDL-2021 LIBRARY; T=293.6K  
Photon emission for (n,a)

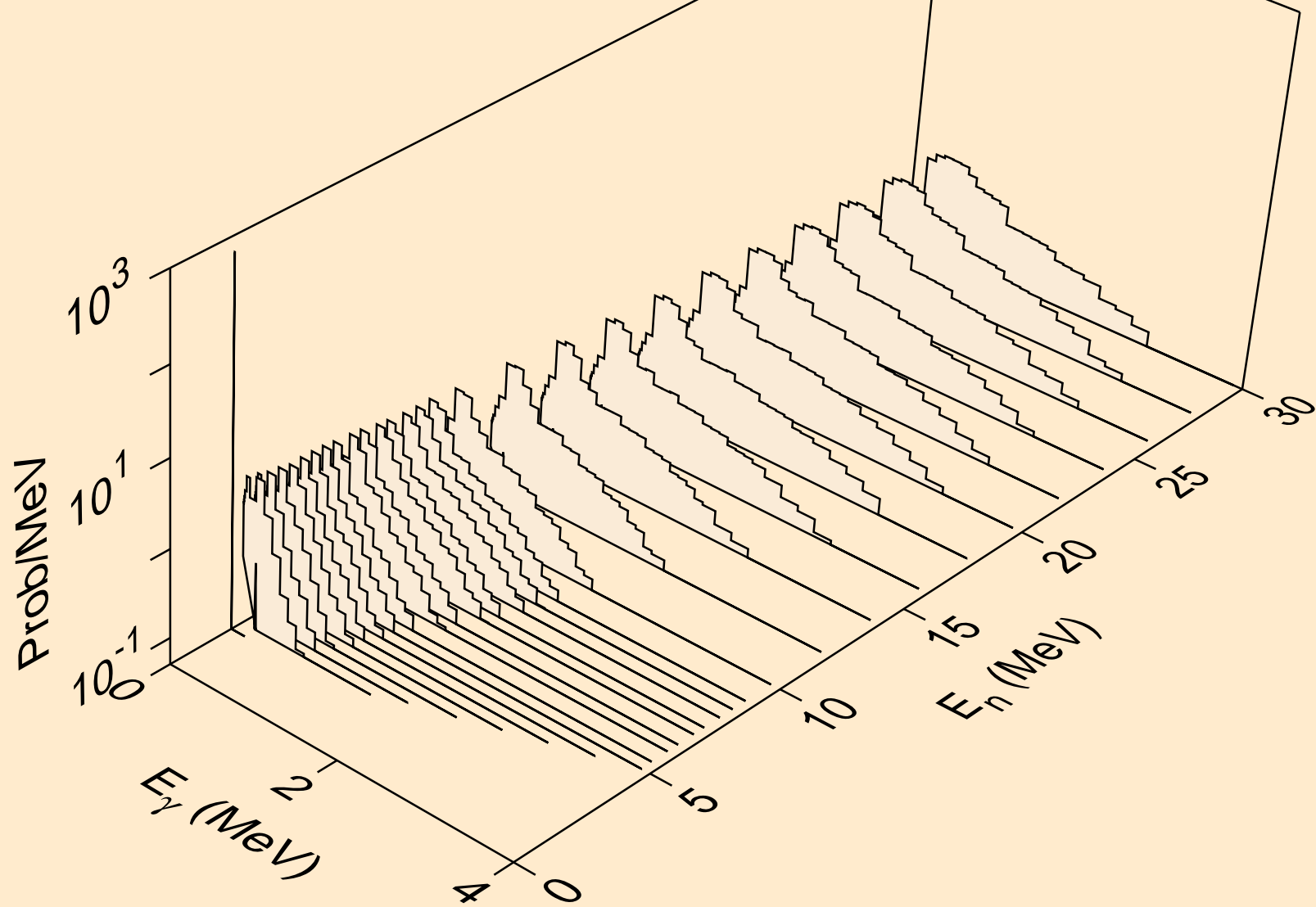

HO171 NEUTRON ACER TENDL-2021 LIBRARY; T=293.6K  
Photon emission for (n,2p)

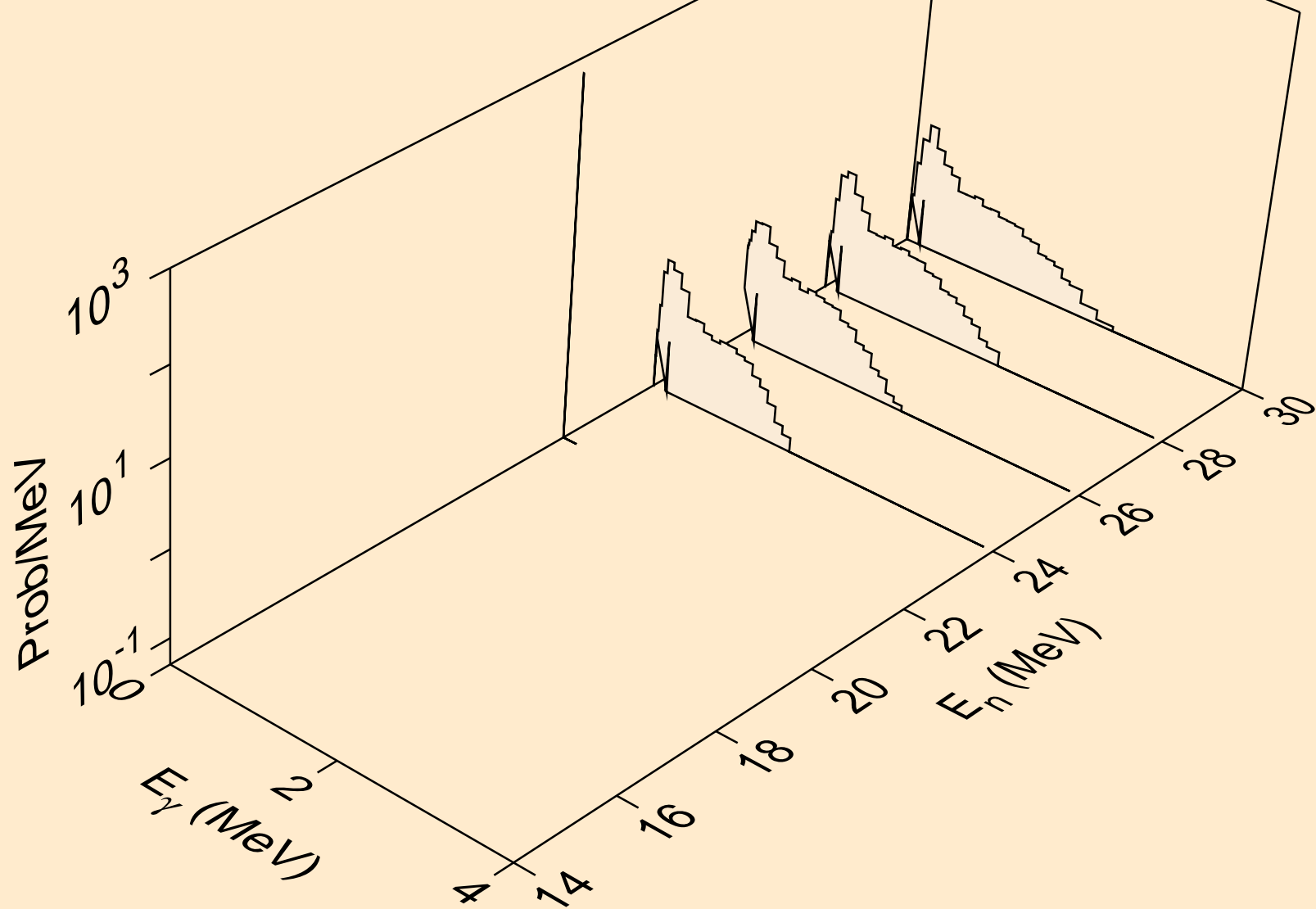

HO171 NEUTRON ACER TENDL-2021 LIBRARY; T=293.6K  
thermal capture photon spectrum

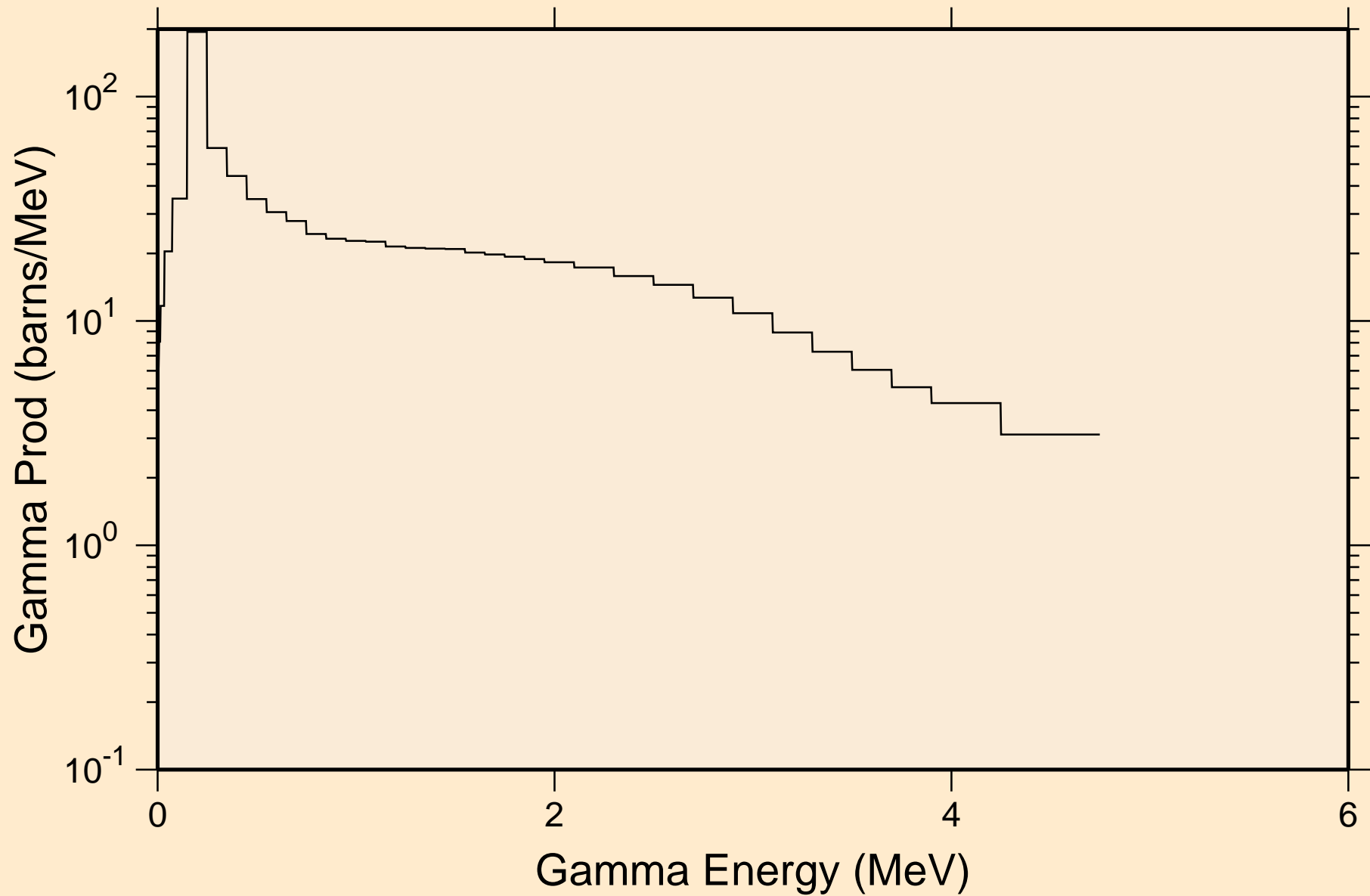



HO171 NEUTRON ACER TENDL-2021 LIBRARY; T=293.6K  
14 MeV photon spectrum

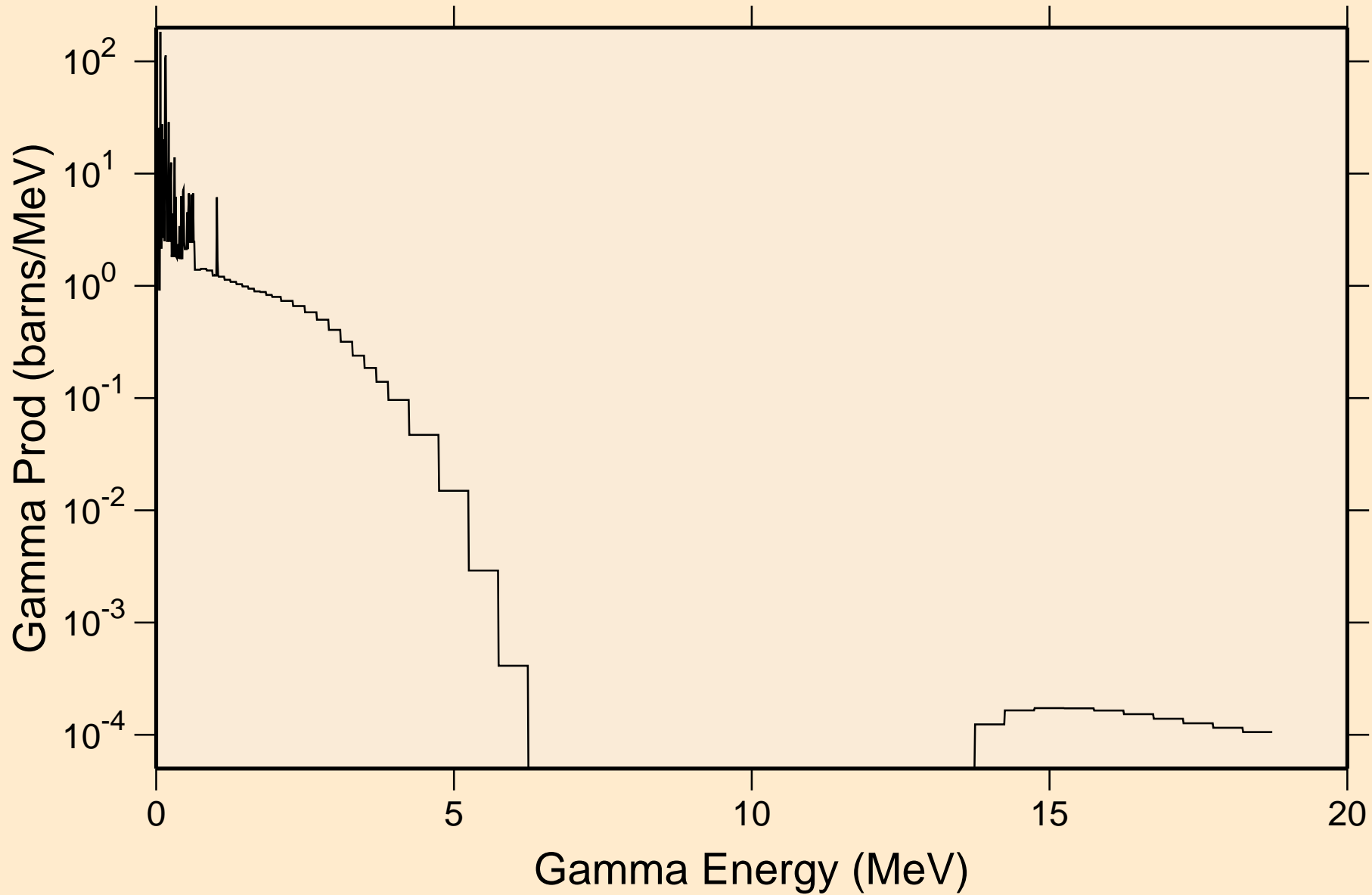

HO171 NEUTRON ACER TENDL-2021 LIBRARY; T=293.6K  
Particle heating contributions

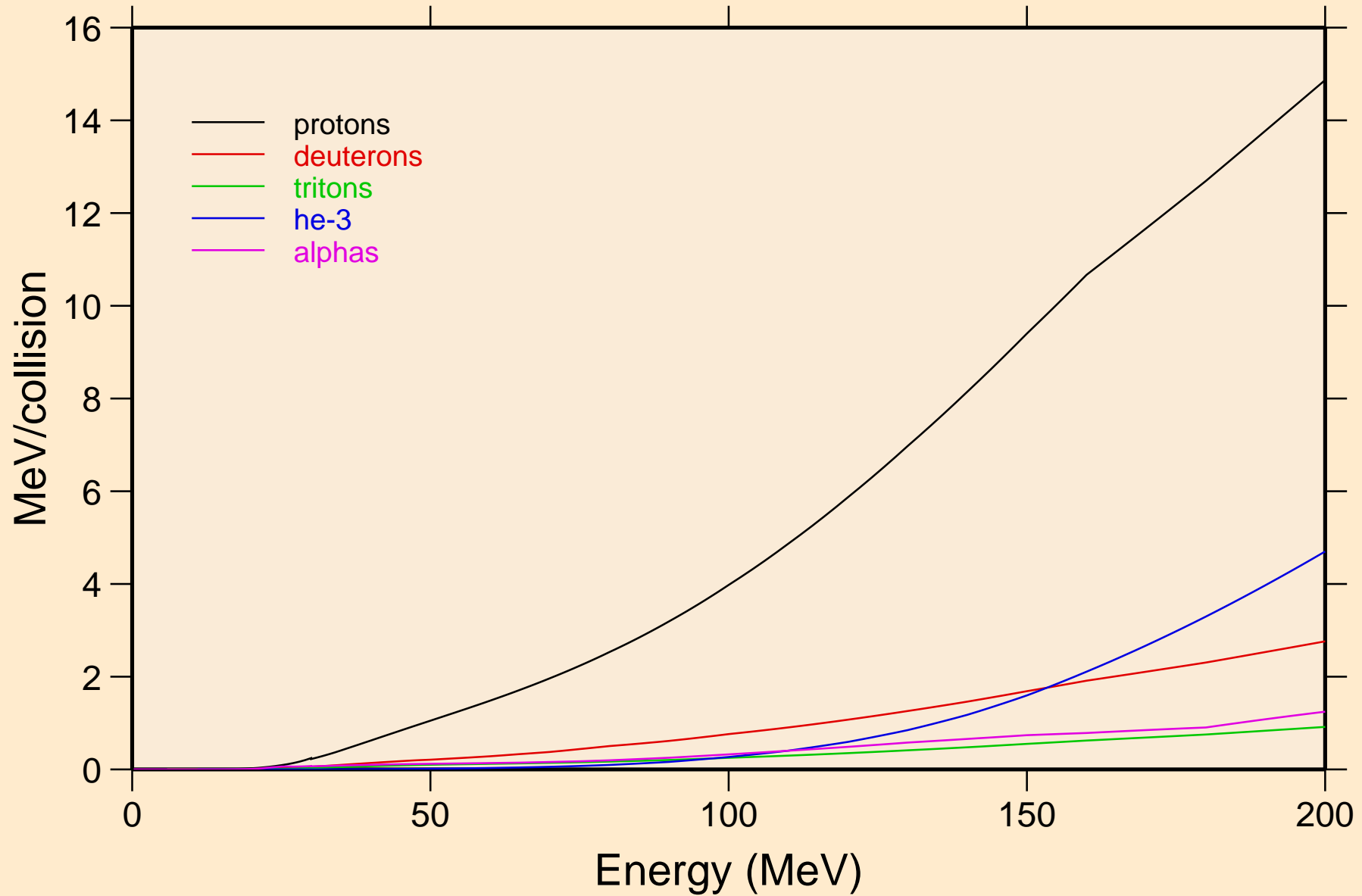

HO171 NEUTRON ACER TENDL-2021 LIBRARY; T=293.6K  
Recoil Heating

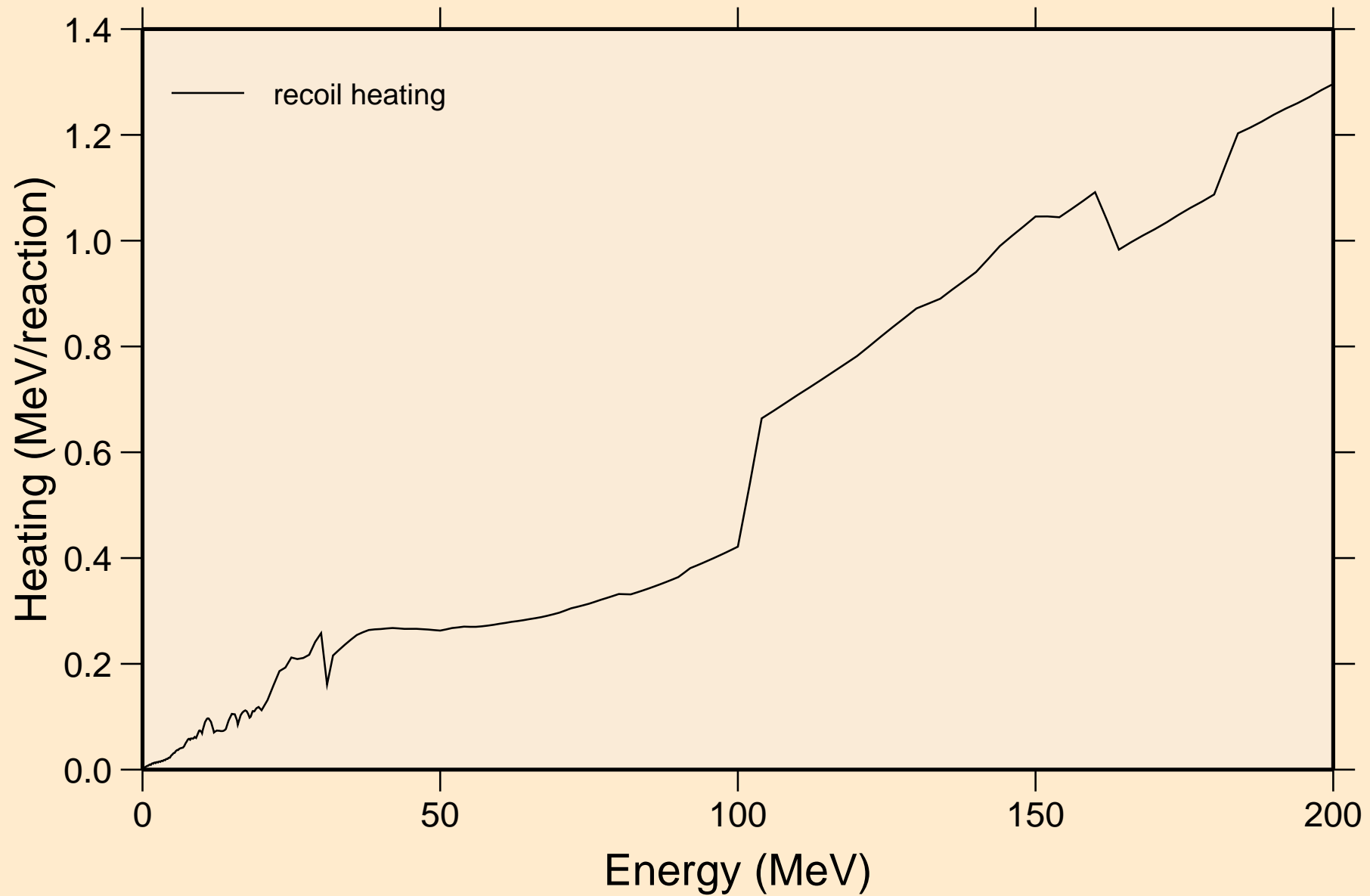

HO171 NEUTRON ACER TENDL-2021 LIBRARY; T=293.6K  
Particle production cross sections

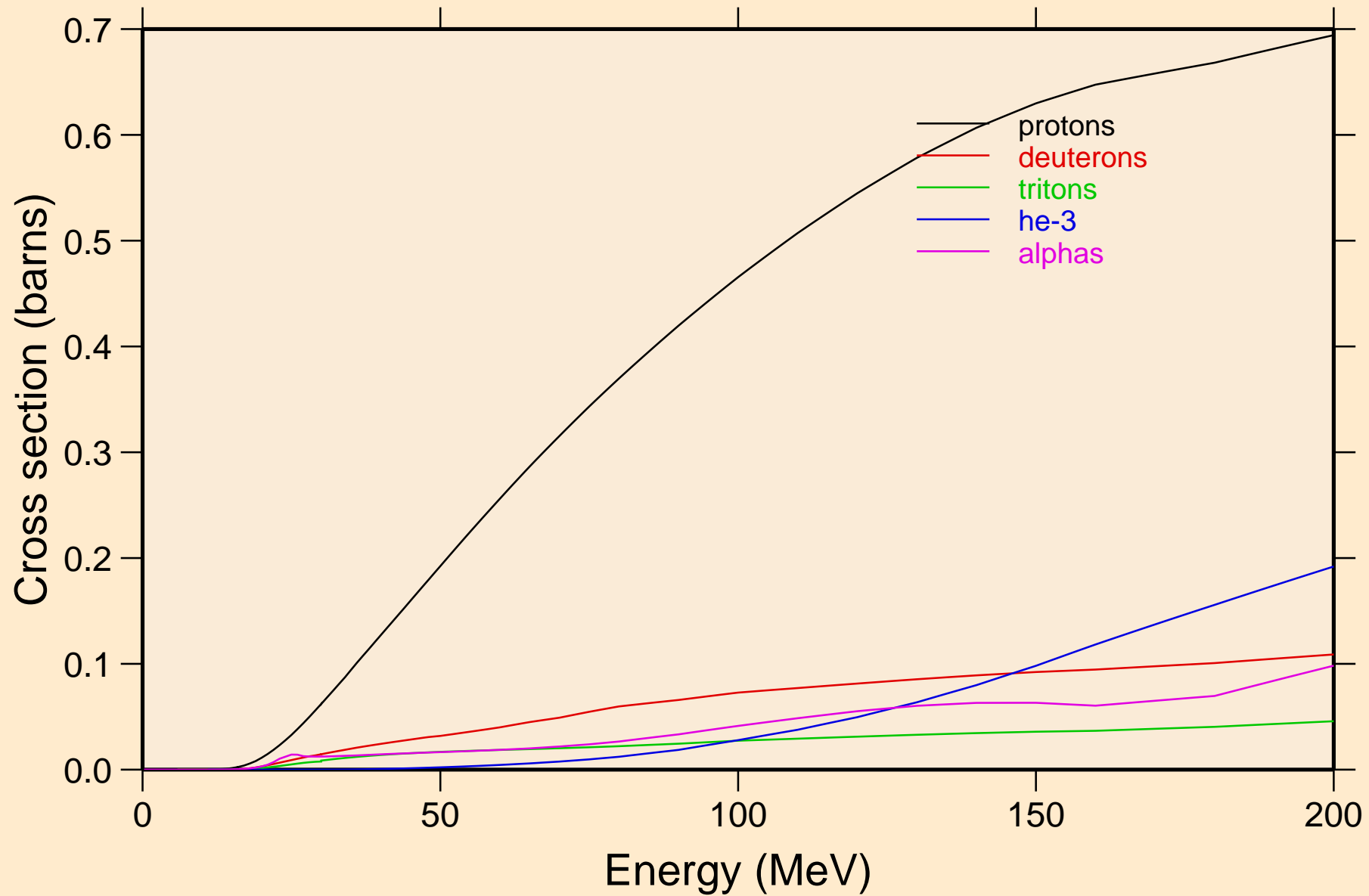

HO171 NEUTRON ACER TENDL-2021 LIBRARY; T=293.6K  
protons from (n,x)

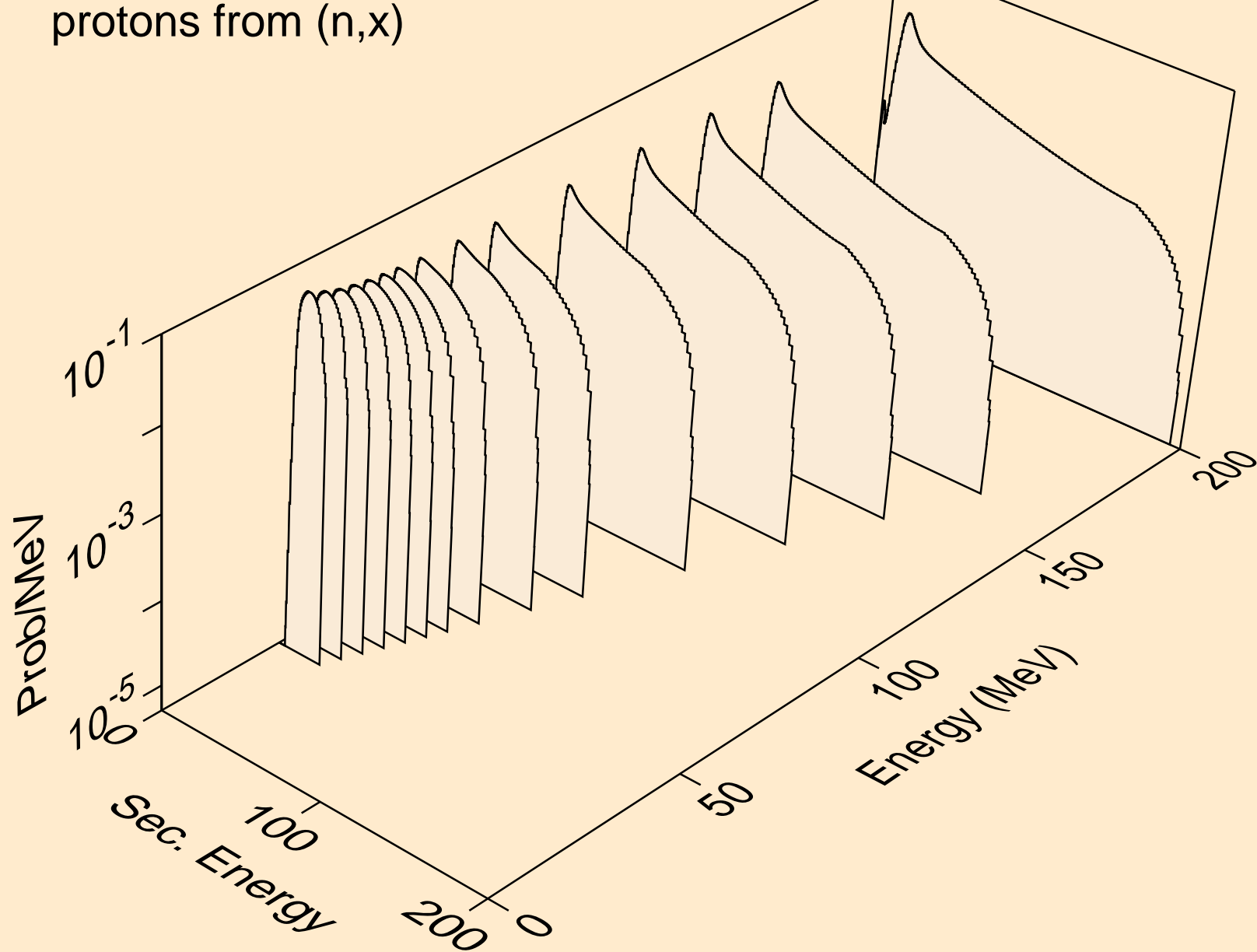

HO171 NEUTRON ACER TENDL-2021 LIBRARY; T=293.6K  
protons from (n,n\*)p

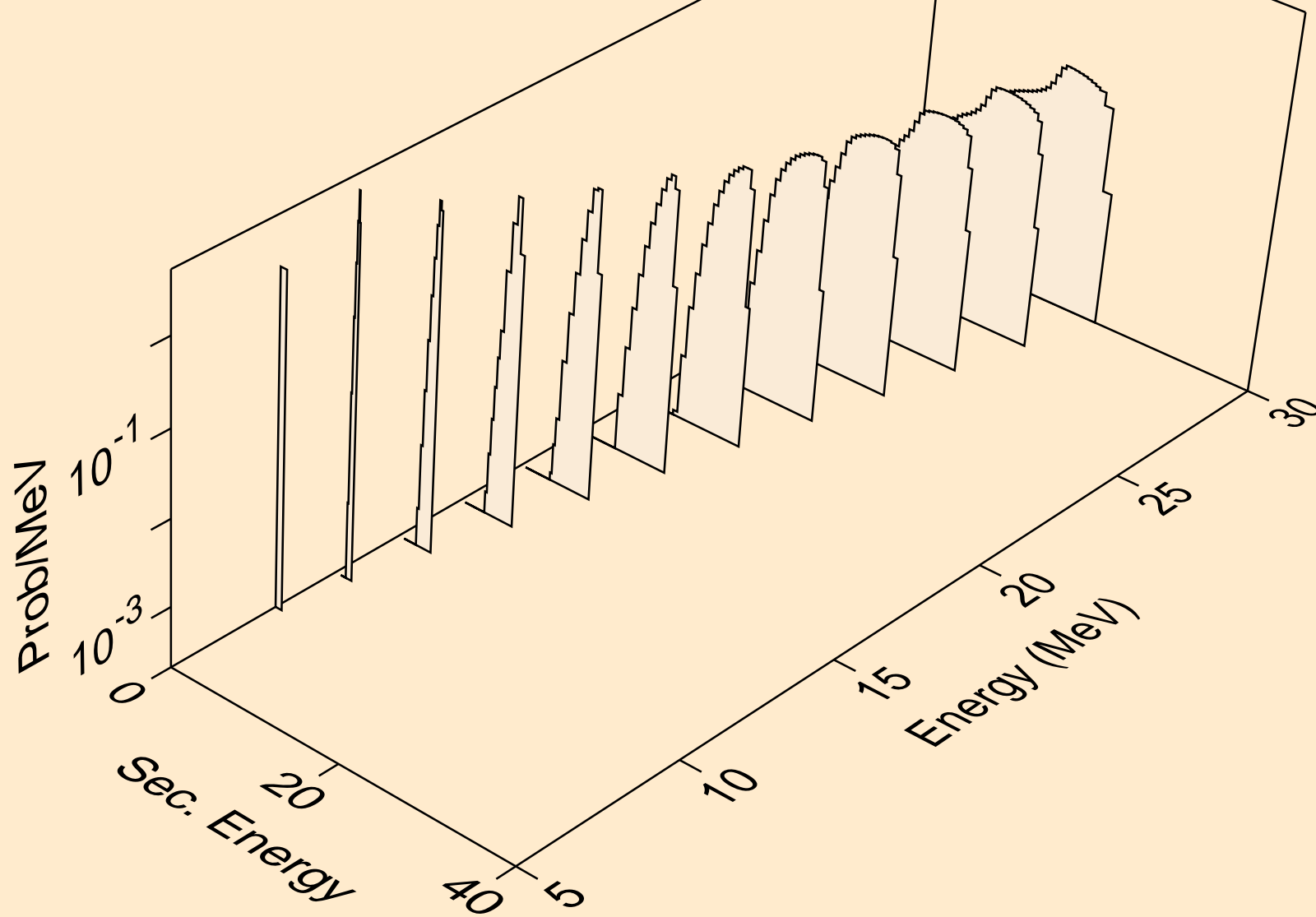

HO171 NEUTRON ACER TENDL-2021 LIBRARY; T=293.6K  
protons from (n,2np)

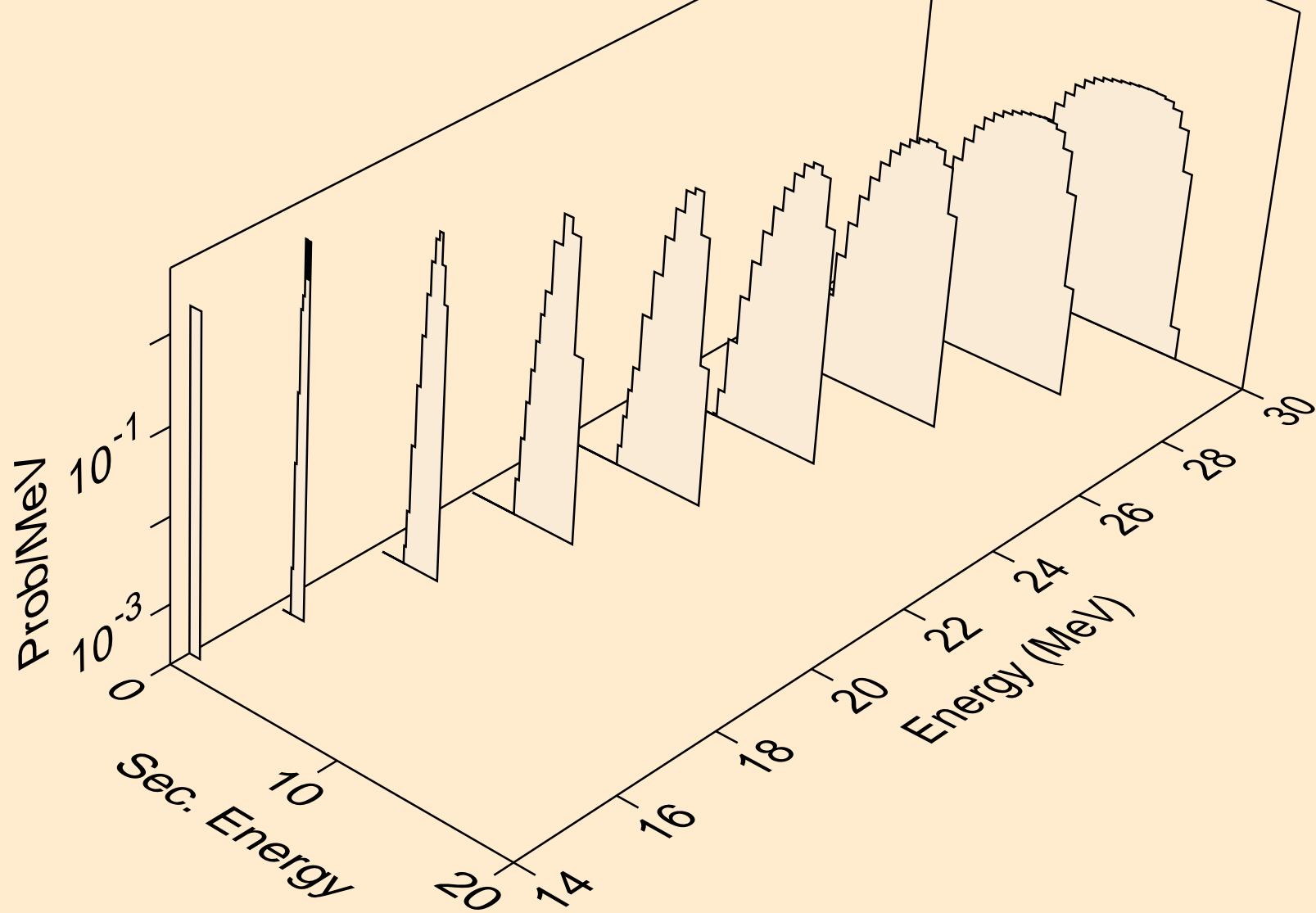

HO171 NEUTRON ACER TENDL-2021 LIBRARY; T=293.6K  
protons from (n,3np)

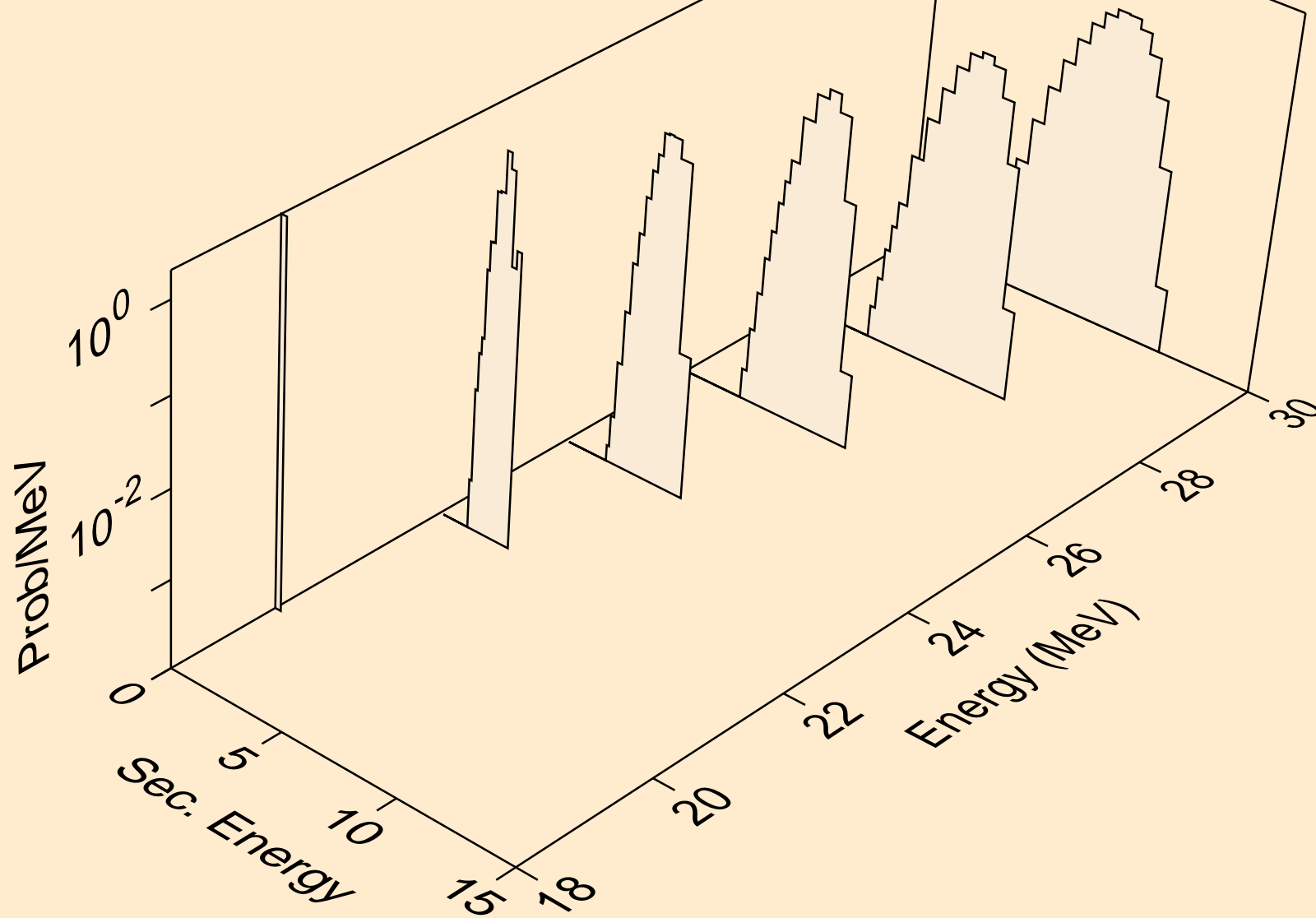



HO171 NEUTRON ACER TENDL-2021 LIBRARY; T=293.6K  
protons from (n,p)

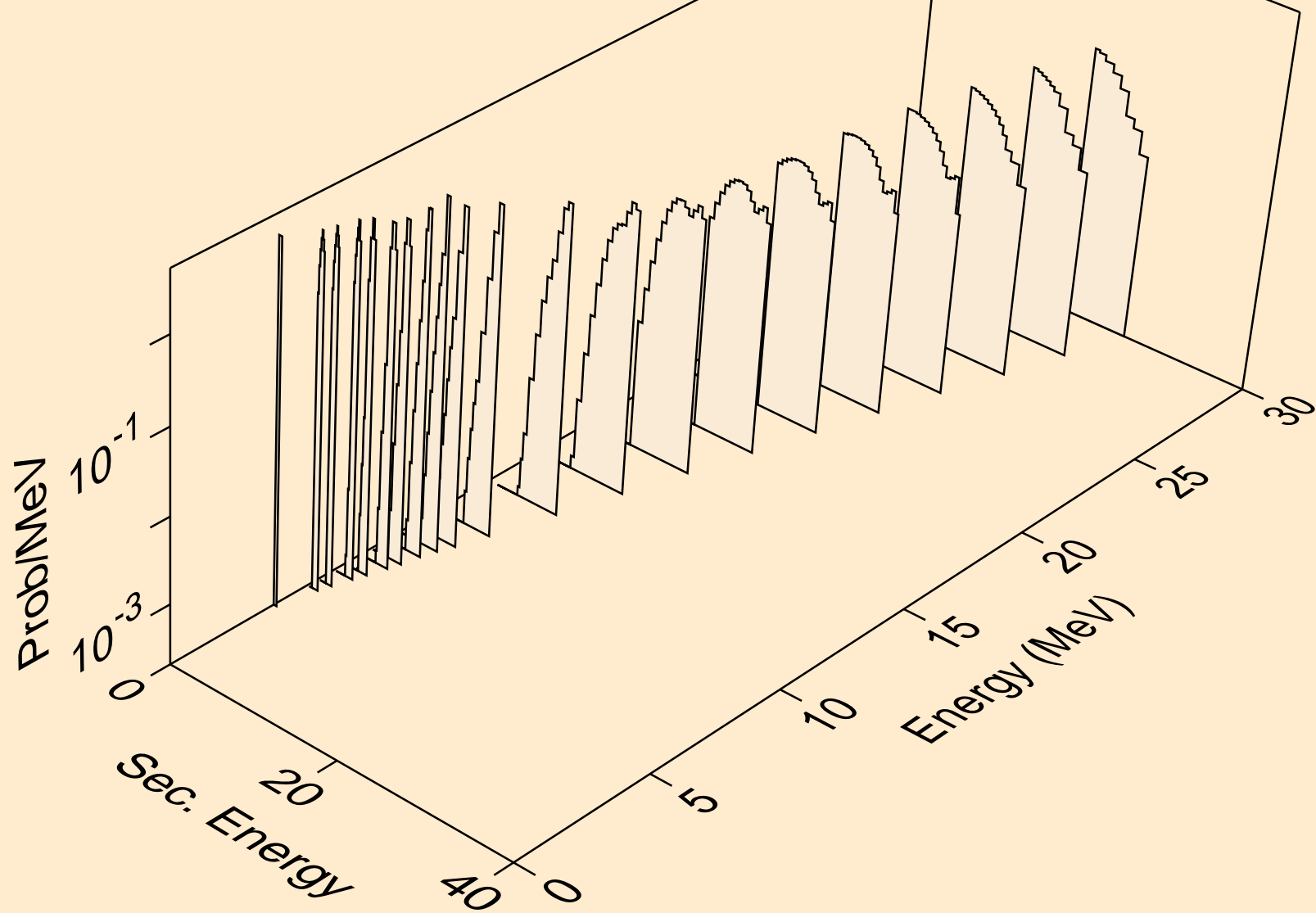

HO171 NEUTRON ACER TENDL-2021 LIBRARY; T=293.6K  
protons from (n,2p)

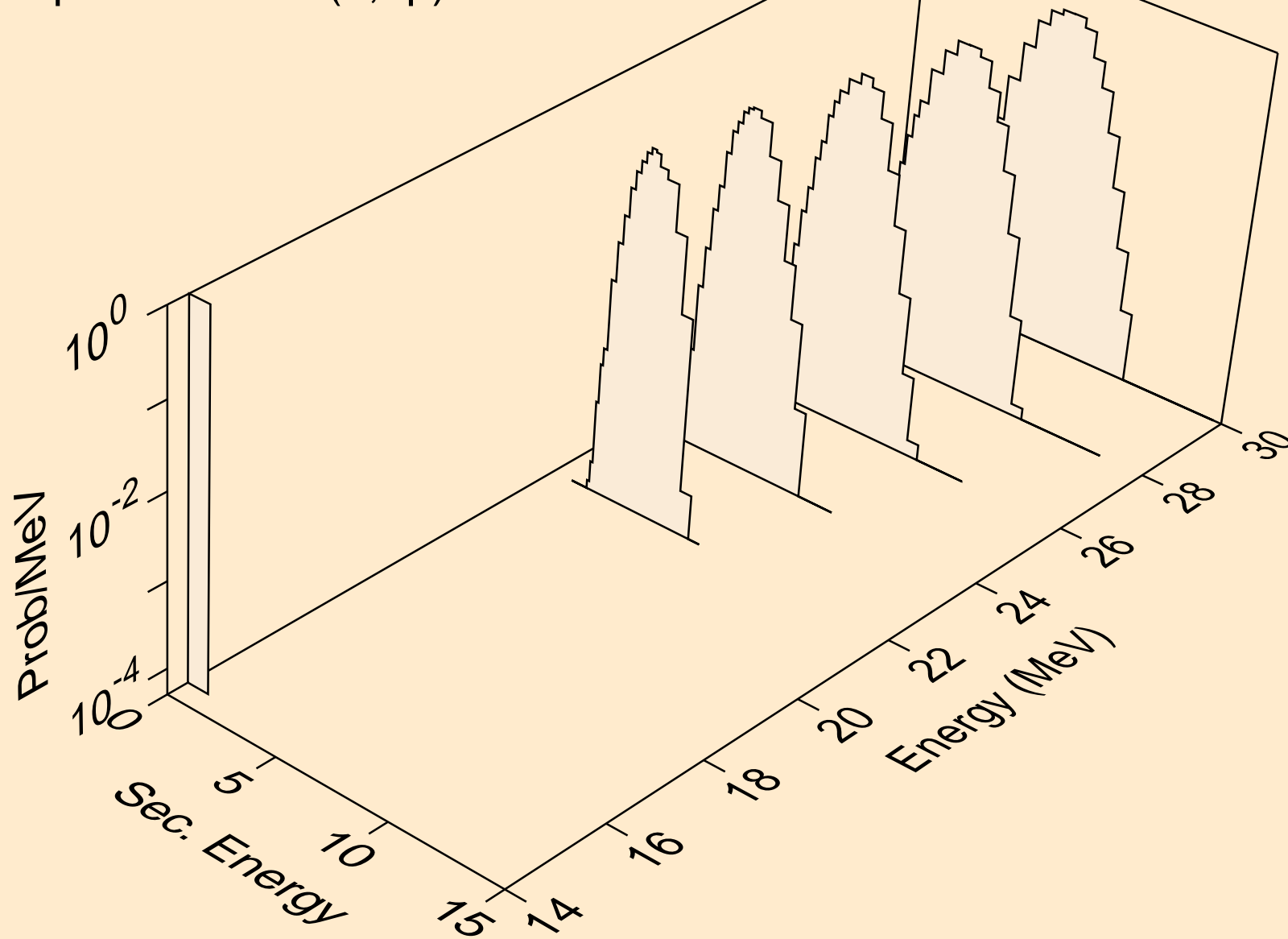

HO171 NEUTRON ACER TENDL-2021 LIBRARY; T=293.6K  
deuterons from (n,x)

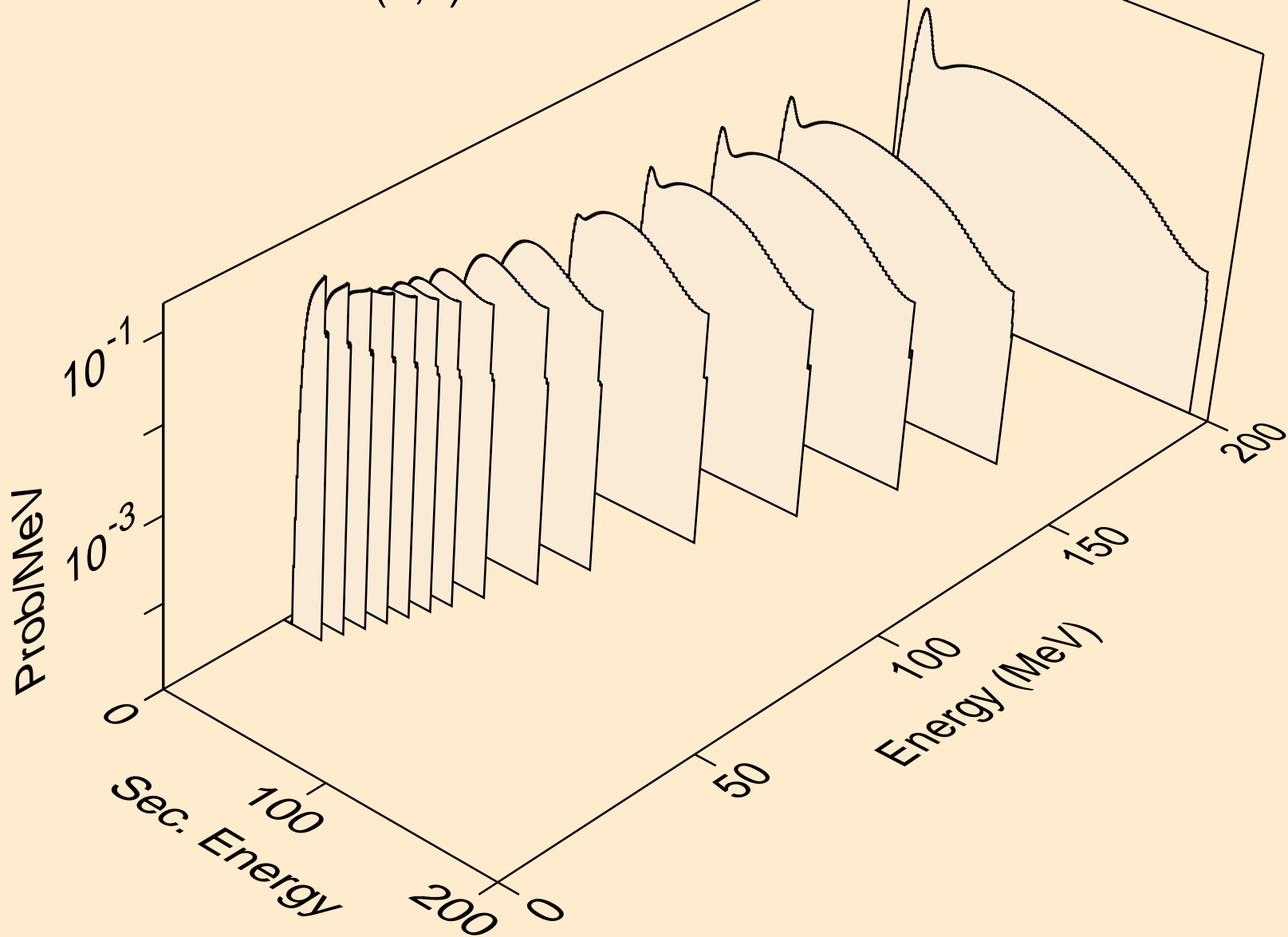

HO171 NEUTRON ACER TENDL-2021 LIBRARY; T=293.6K  
deuterons from (n,2nd)

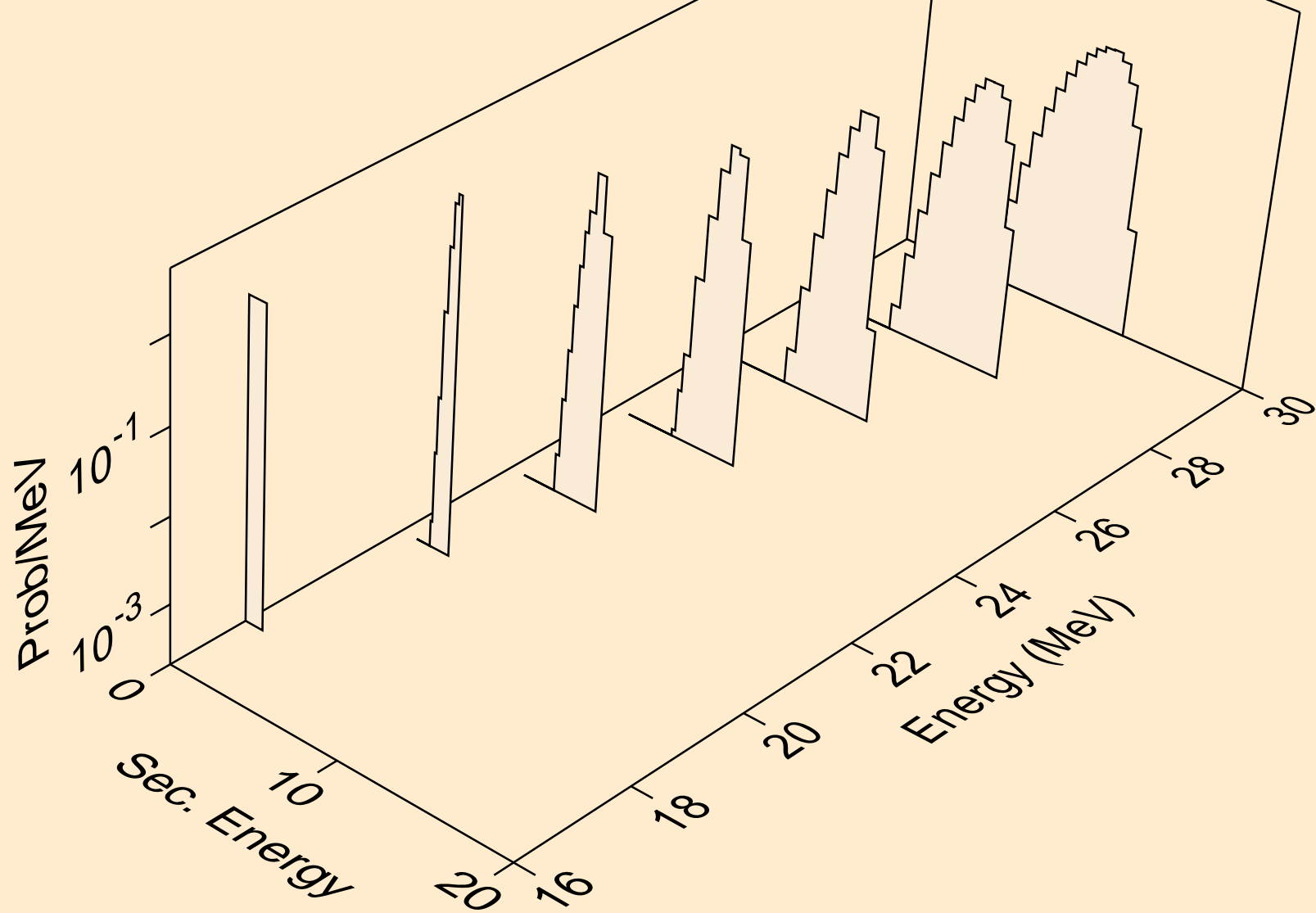

HO171 NEUTRON ACER TENDL-2021 LIBRARY; T=293.6K  
deuterons from (n,n\*)d

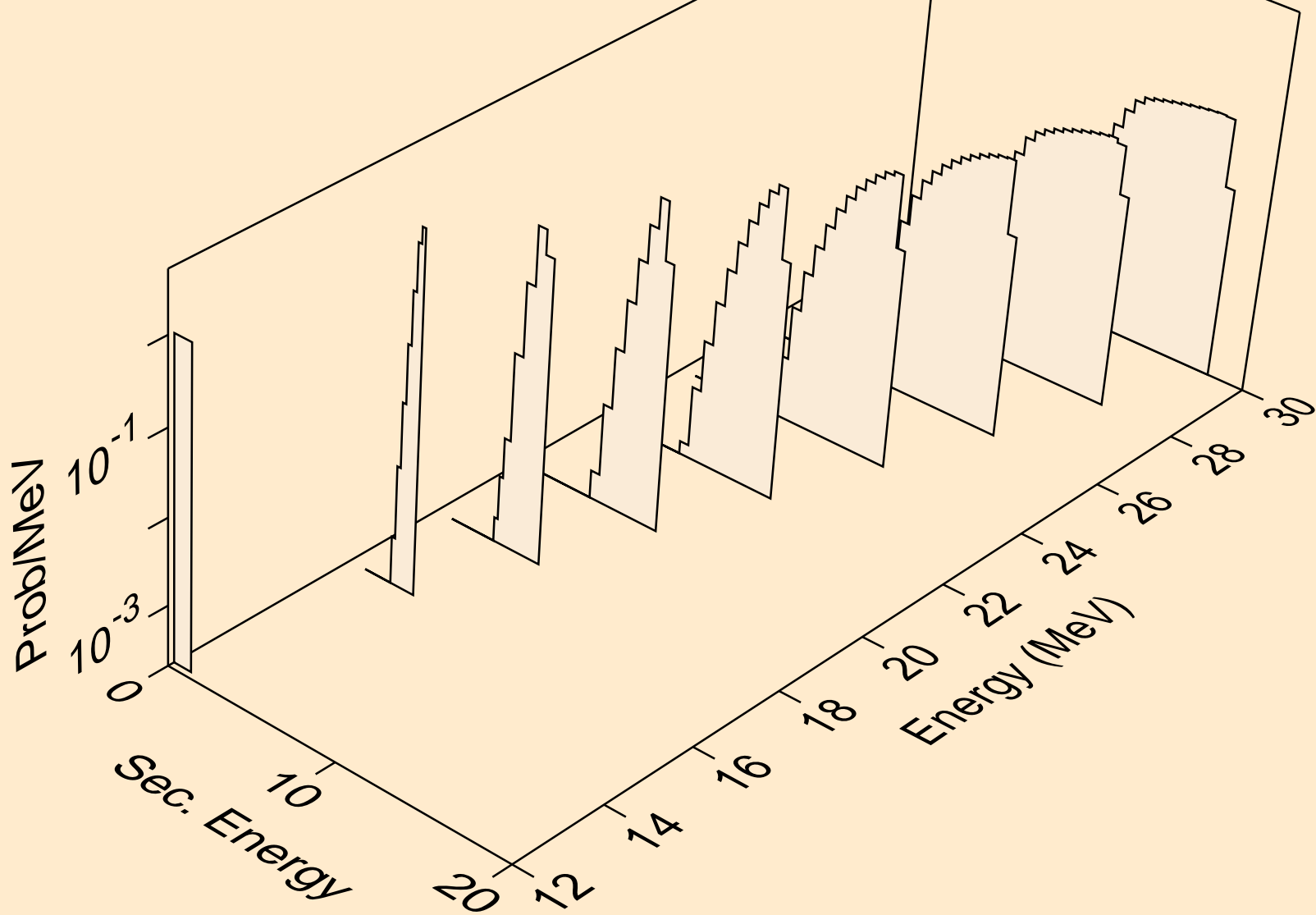

HO171 NEUTRON ACER TENDL-2021 LIBRARY; T=293.6K  
deuterons from (n,d)

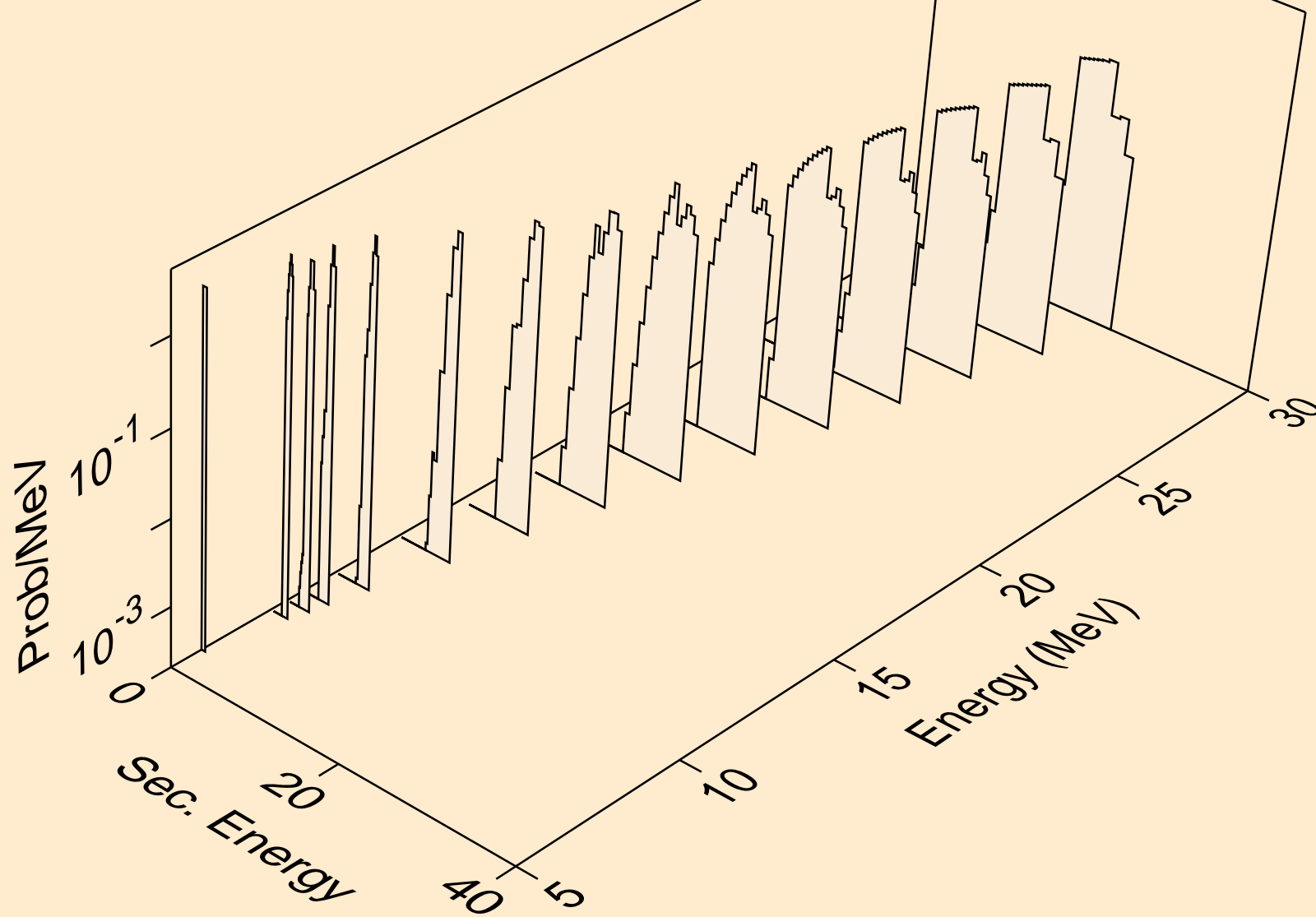

HO171 NEUTRON ACER TENDL-2021 LIBRARY; T=293.6K  
tritons from (n,x)

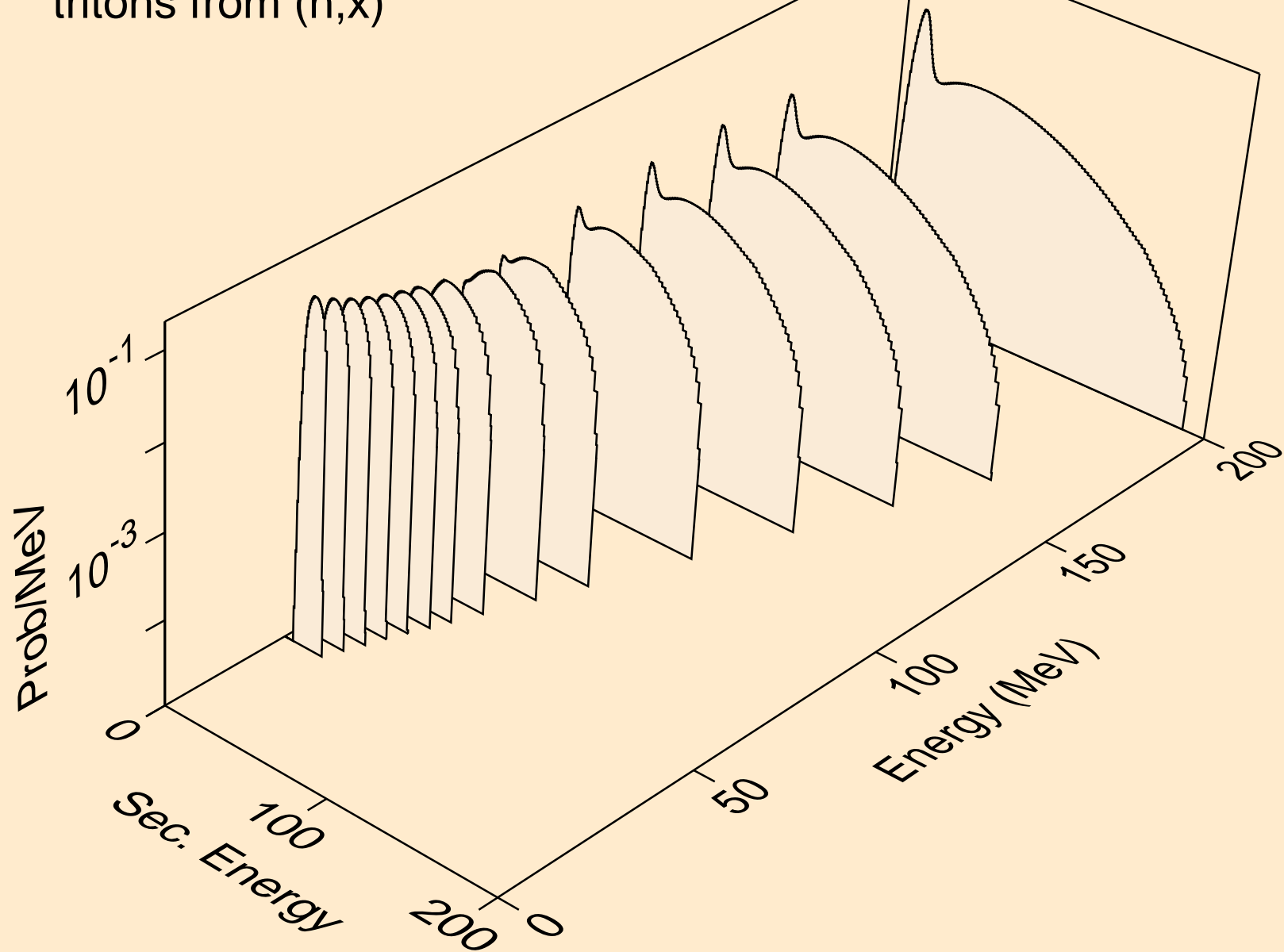

HO171 NEUTRON ACER TENDL-2021 LIBRARY; T=293.6K  
tritons from (n,n\*)t

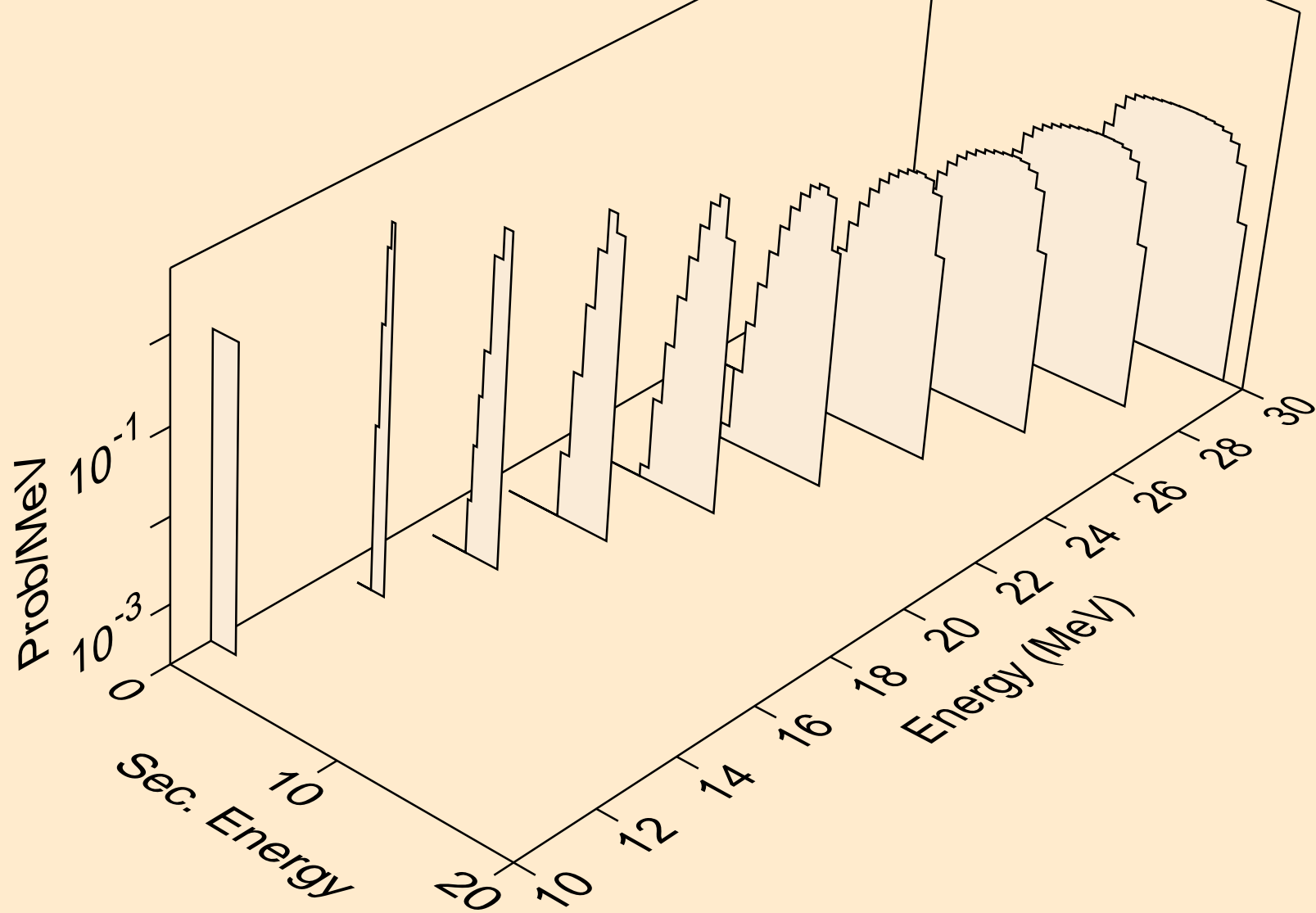



HO171 NEUTRON ACER TENDL-2021 LIBRARY; T=293.6K  
tritons from (n,t)

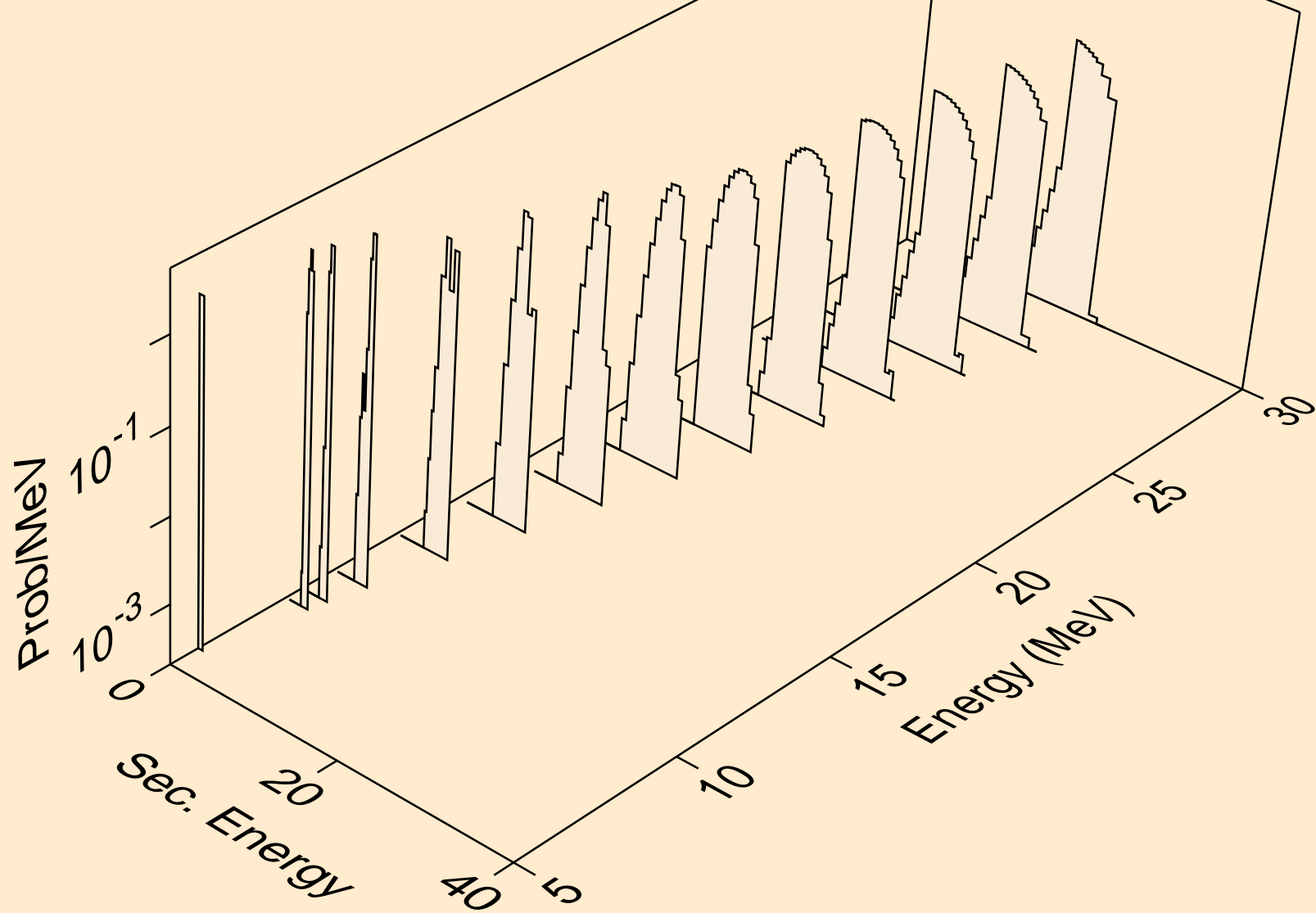

HO171 NEUTRON ACER TENDL-2021 LIBRARY; T=293.6K  
he3s from (n,x)

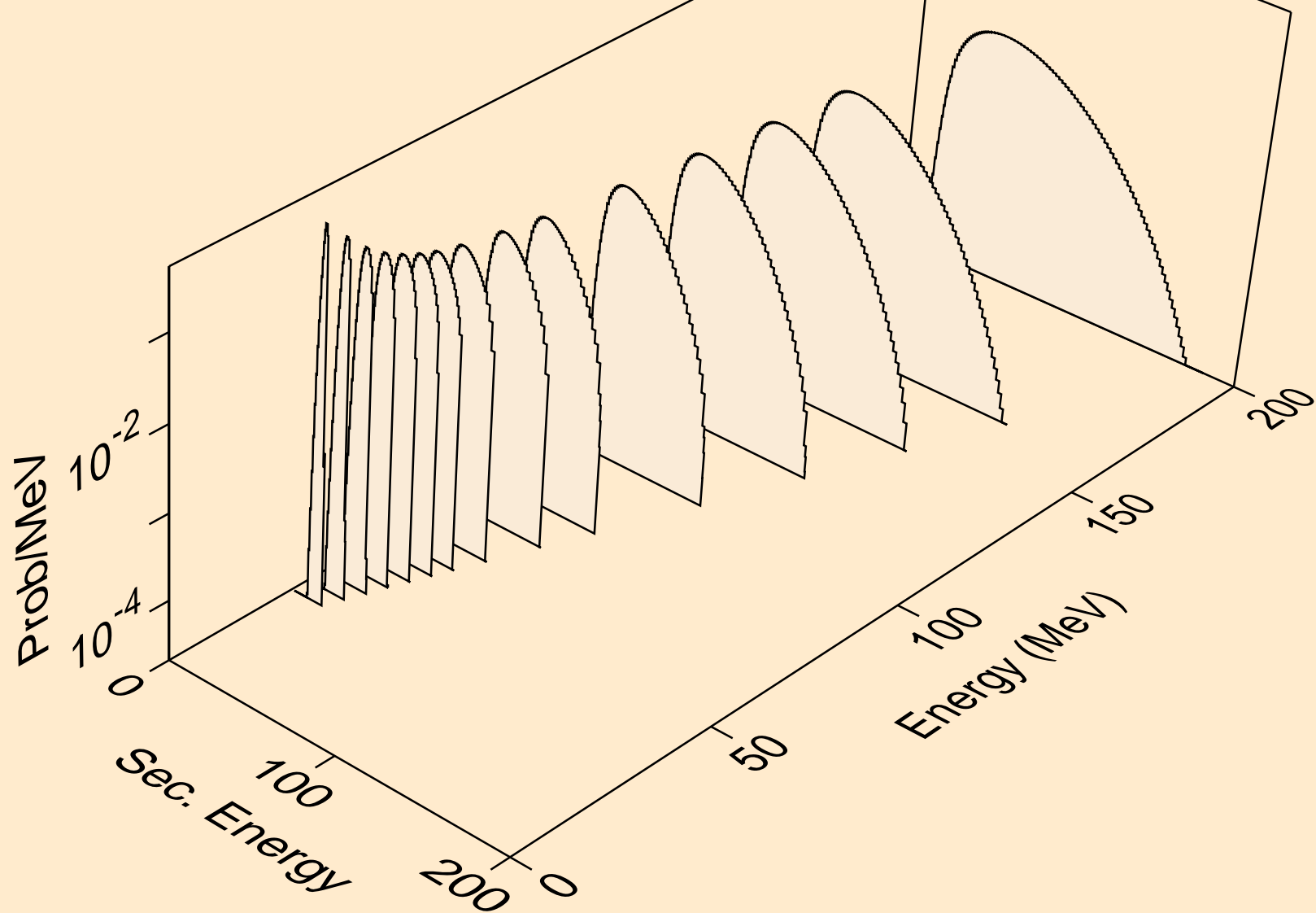

HO171 NEUTRON ACER TENDL-2021 LIBRARY; T=293.6K  
he3s from (n,n\*)he3

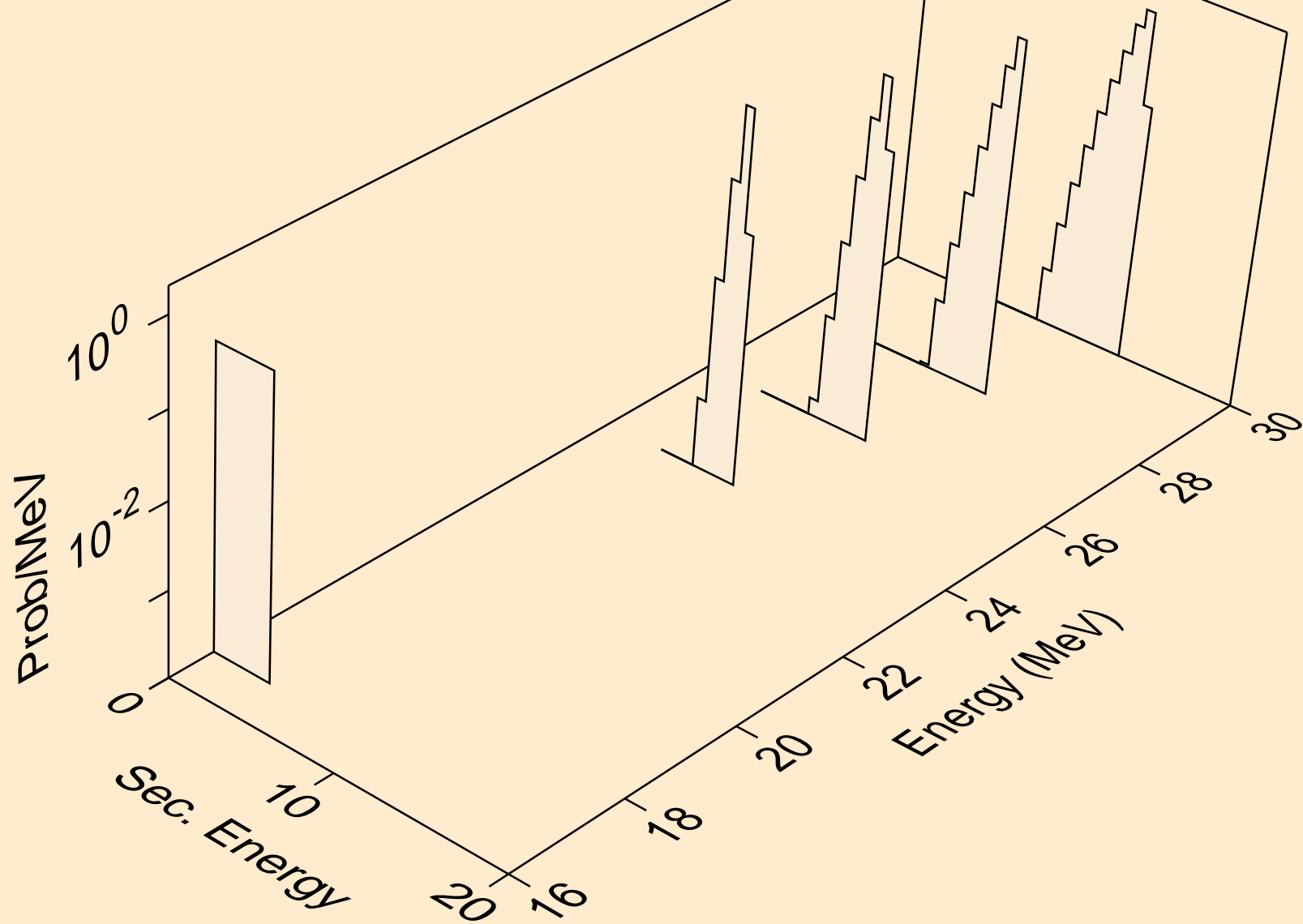

HO171 NEUTRON ACER TENDL-2021 LIBRARY; T=293.6K  
he3s from (n,he3)

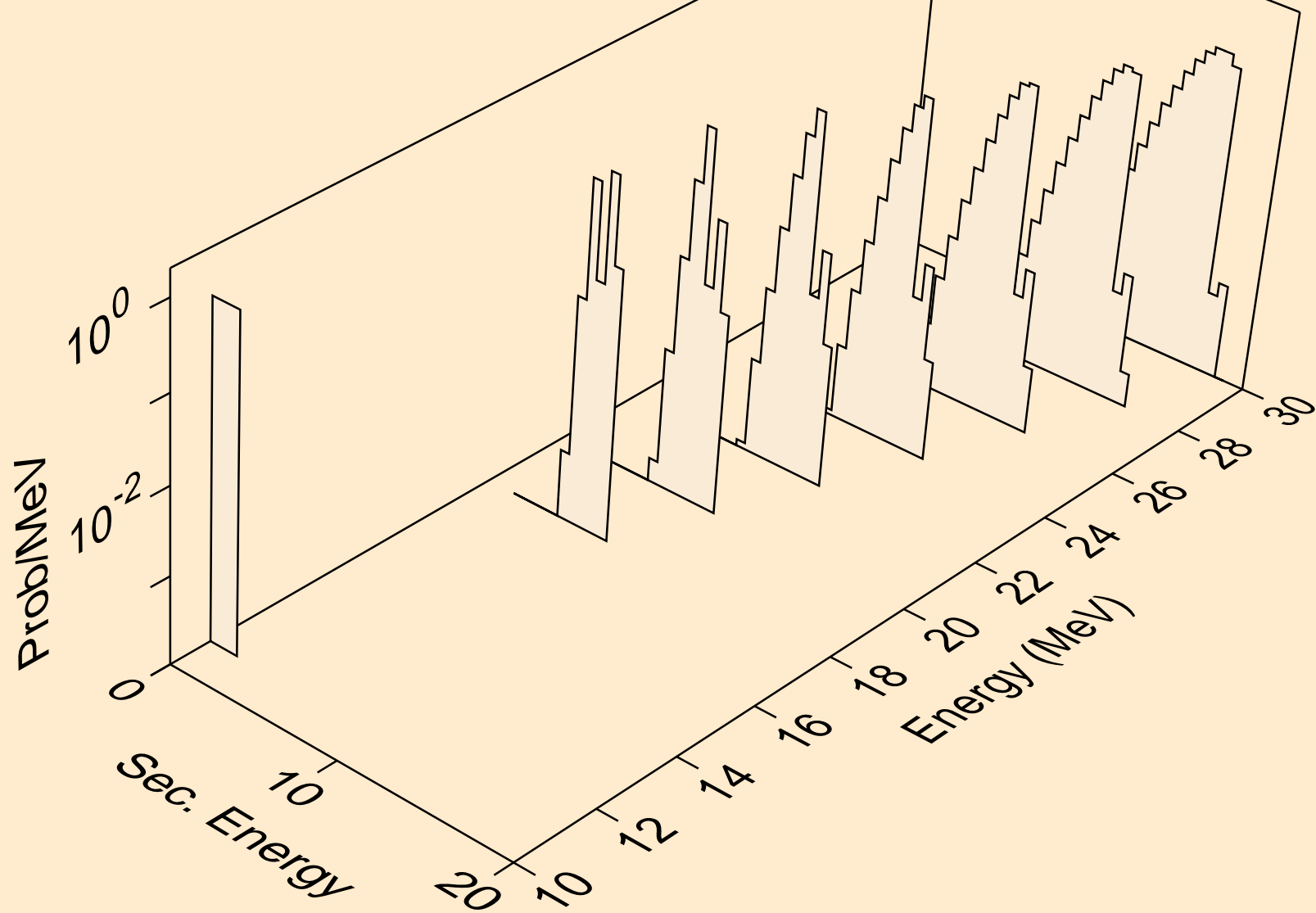

HO171 NEUTRON ACER TENDL-2021 LIBRARY; T=293.6K  
alphas from (n,x)

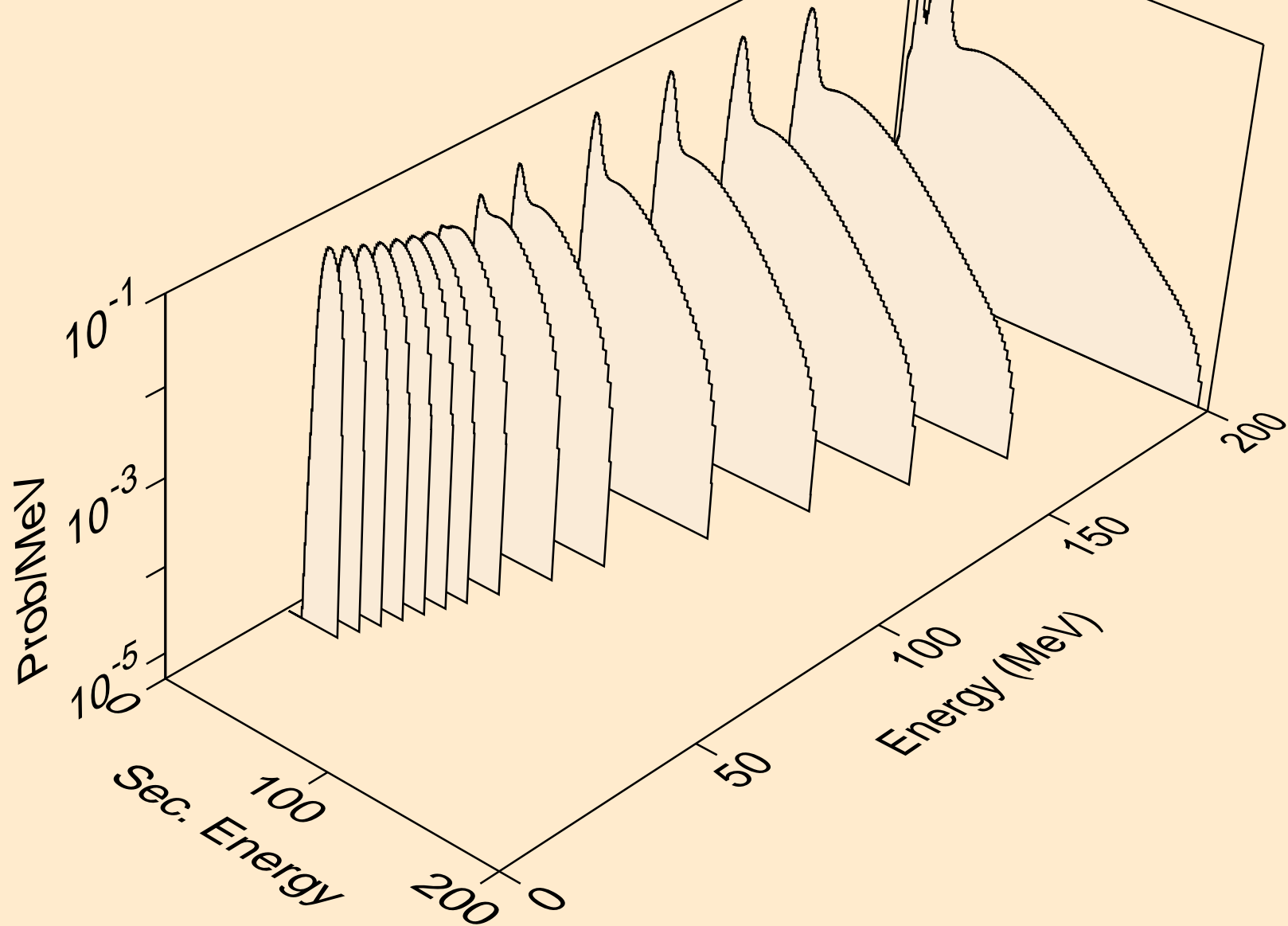

HO171 NEUTRON ACER TENDL-2021 LIBRARY; T=293.6K  
alphas from (n,n\*)a

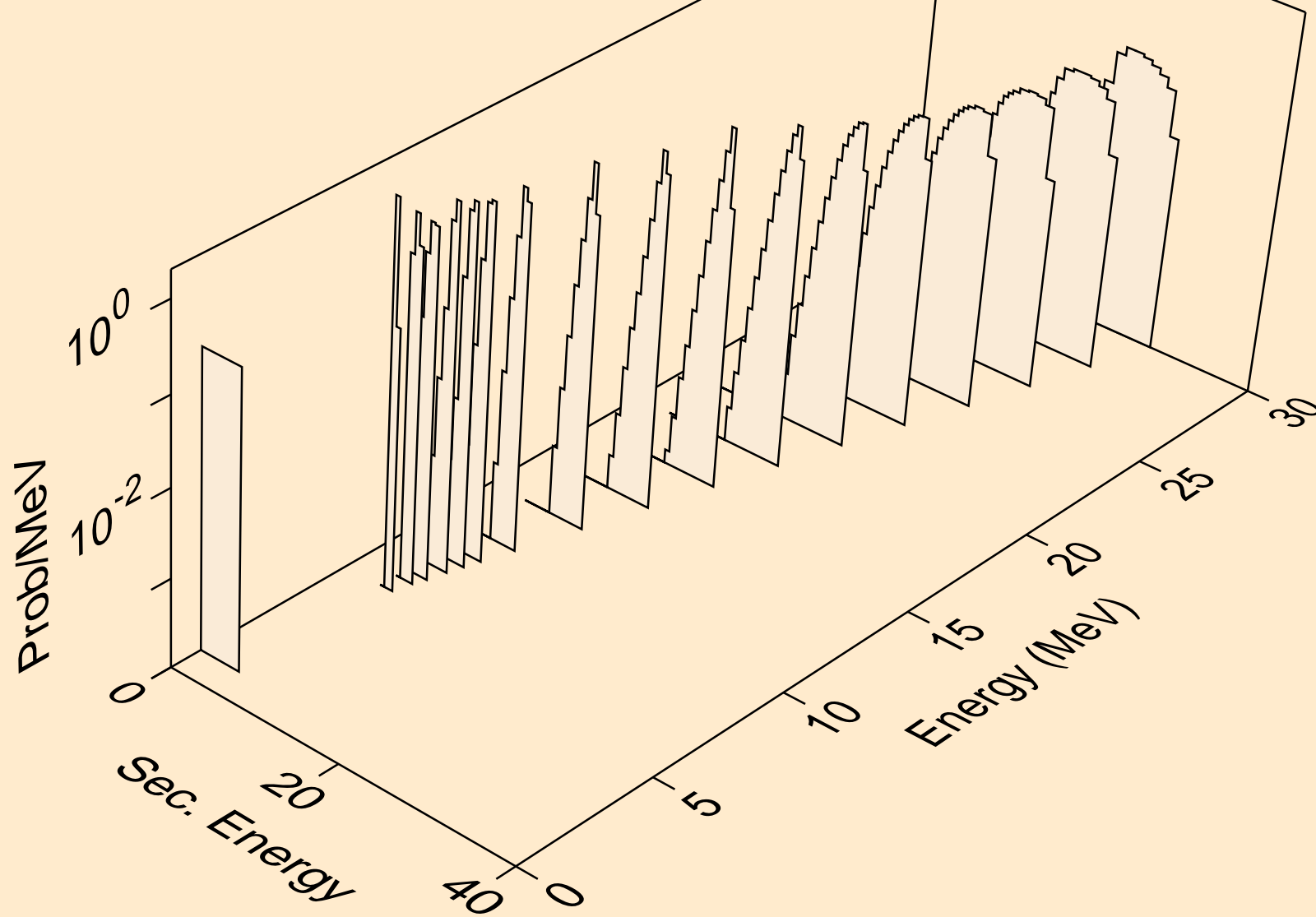

HO171 NEUTRON ACER TENDL-2021 LIBRARY; T=293.6K  
alphas from (n,2n)a

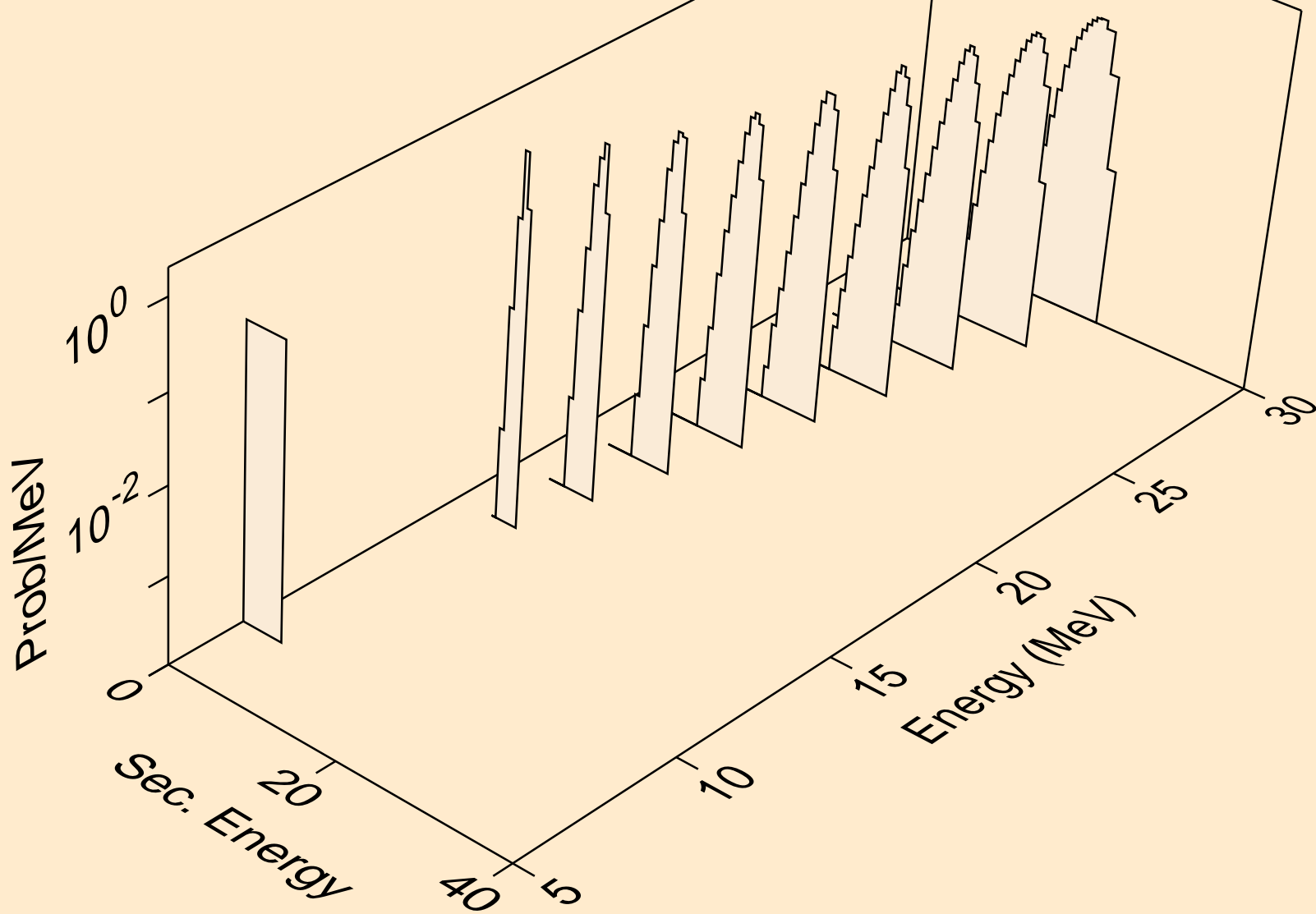

HO171 NEUTRON ACER TENDL-2021 LIBRARY; T=293.6K  
alphas from (n,3n)a

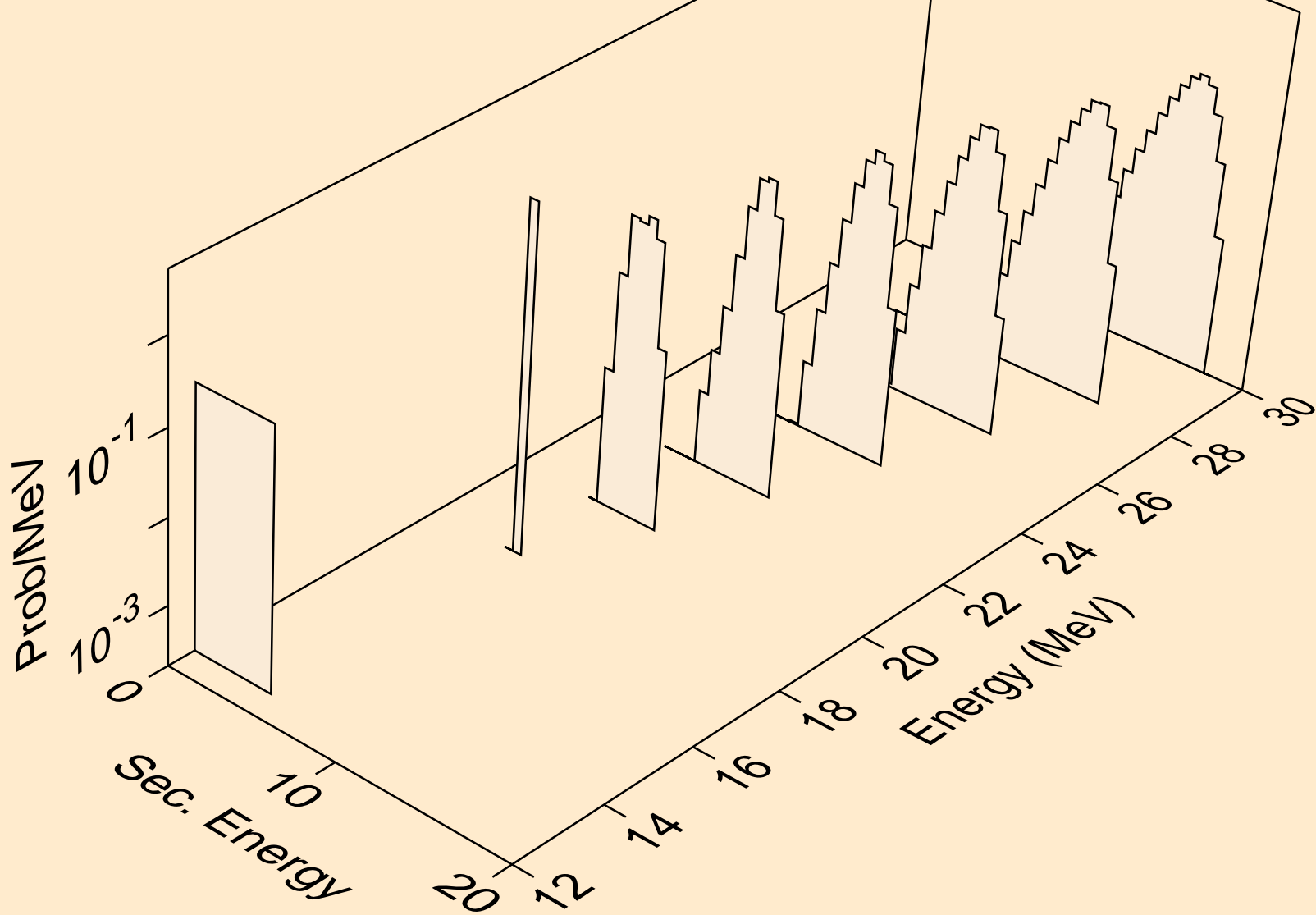



HO171 NEUTRON ACER TENDL-2021 LIBRARY; T=293.6K  
alphas from (n,a)

