

# HO173 NEUTRON ACER TENDL-2021 LIBRARY; T=293.6K

## Principal cross sections

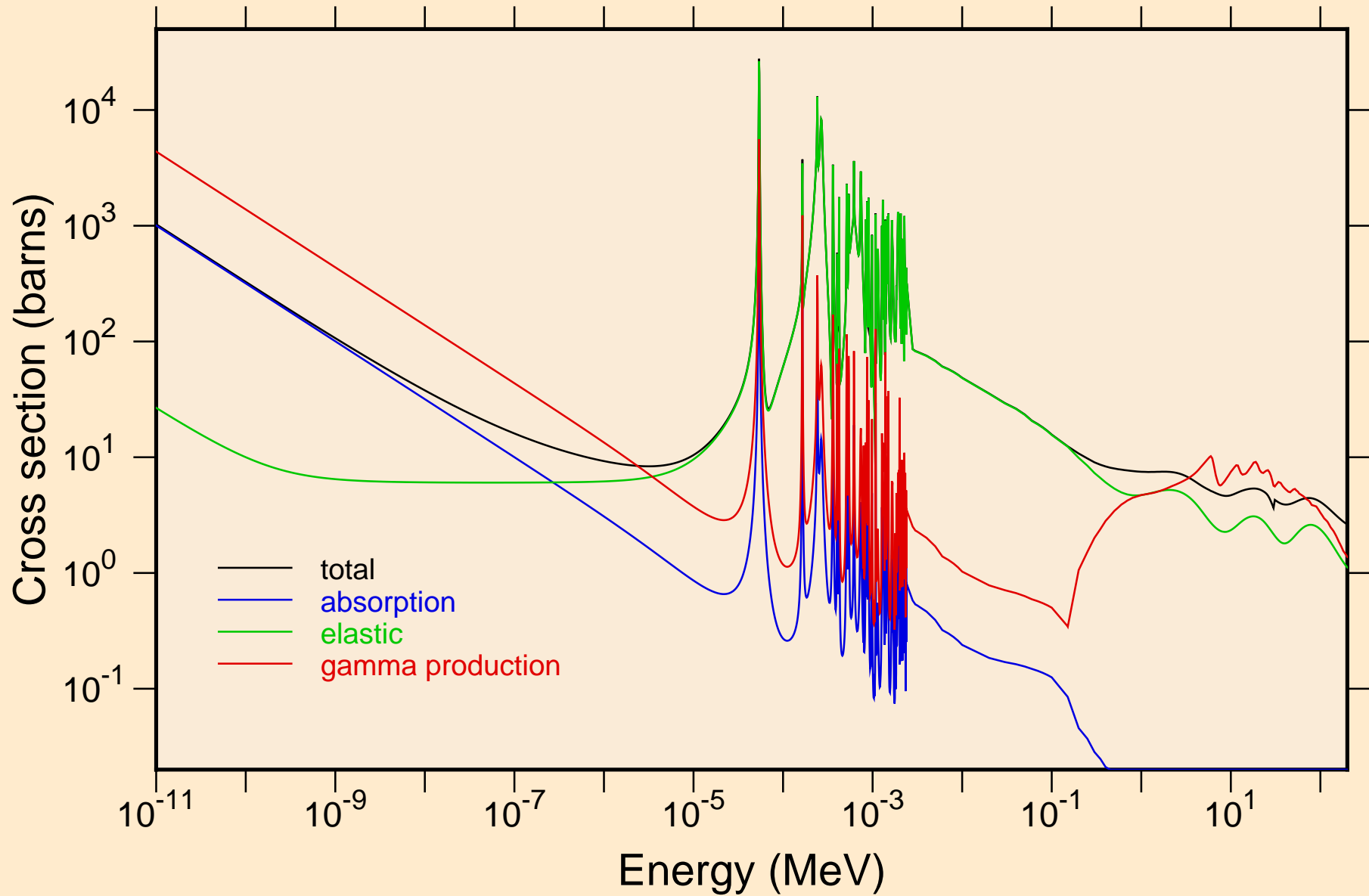

HO173 NEUTRON ACER TENDL-2021 LIBRARY; T=293.6K  
resonance total cross section

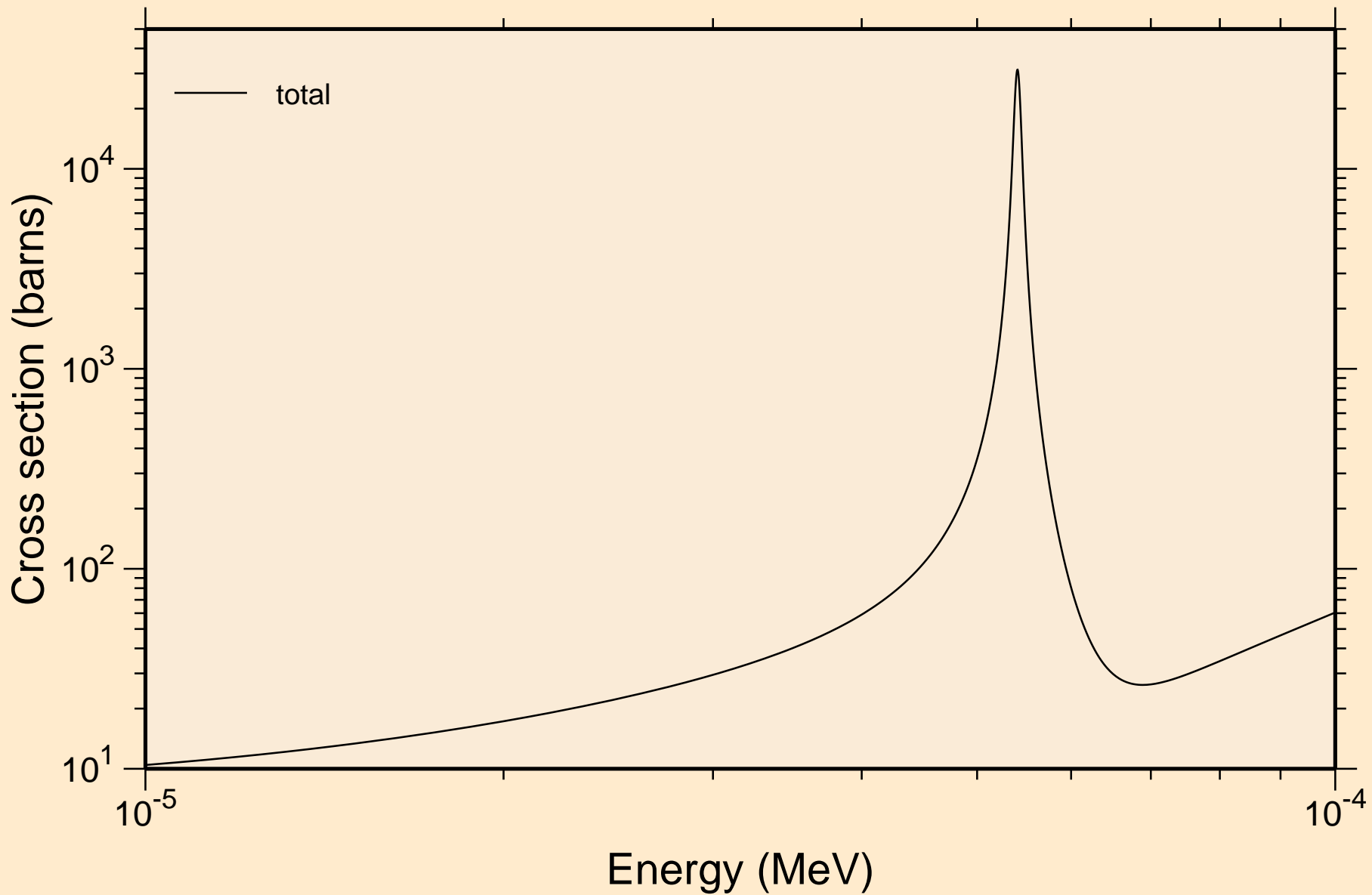

HO173 NEUTRON ACER TENDL-2021 LIBRARY; T=293.6K  
resonance total cross section

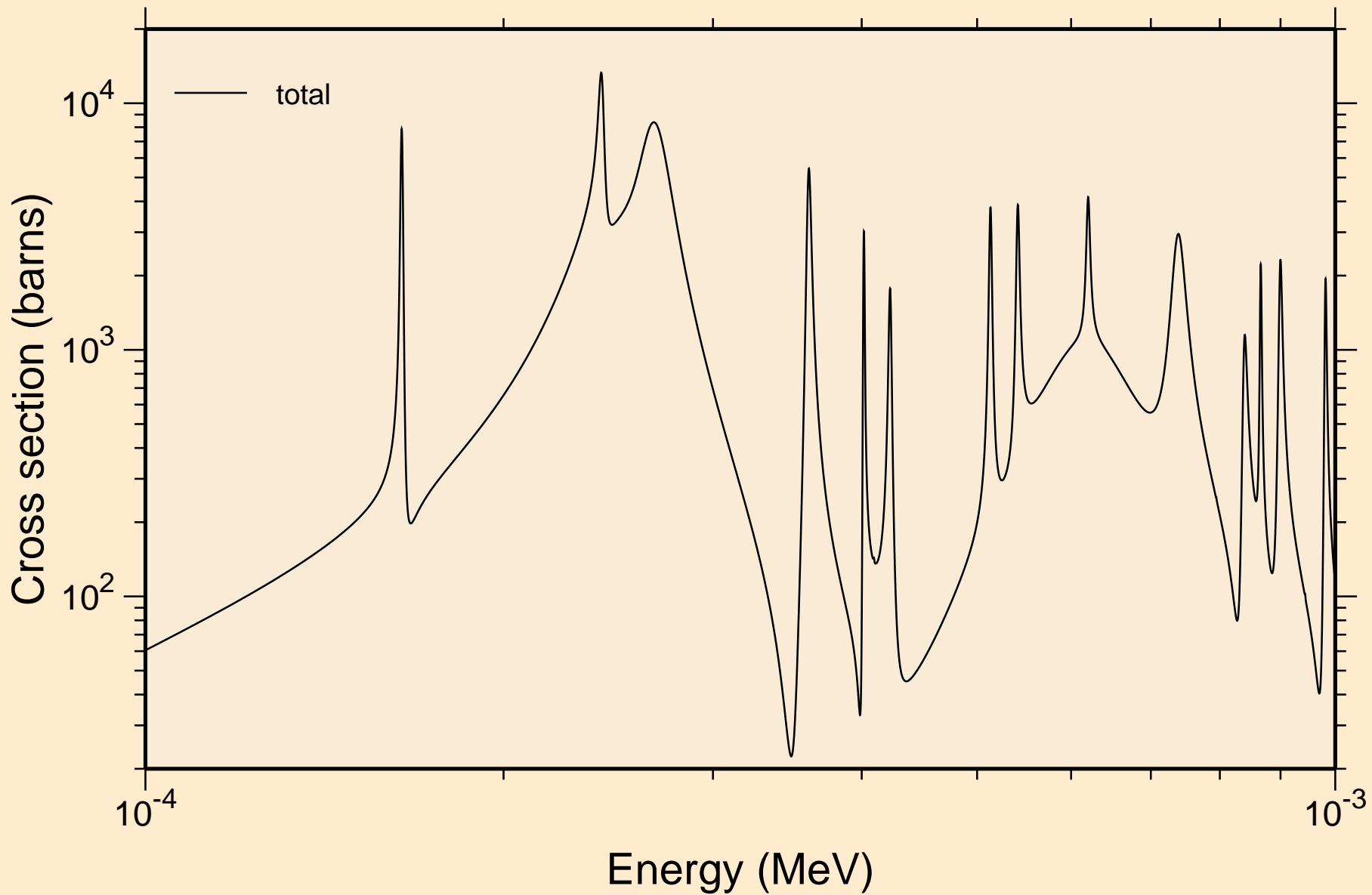

HO173 NEUTRON ACER TENDL-2021 LIBRARY; T=293.6K  
resonance total cross section

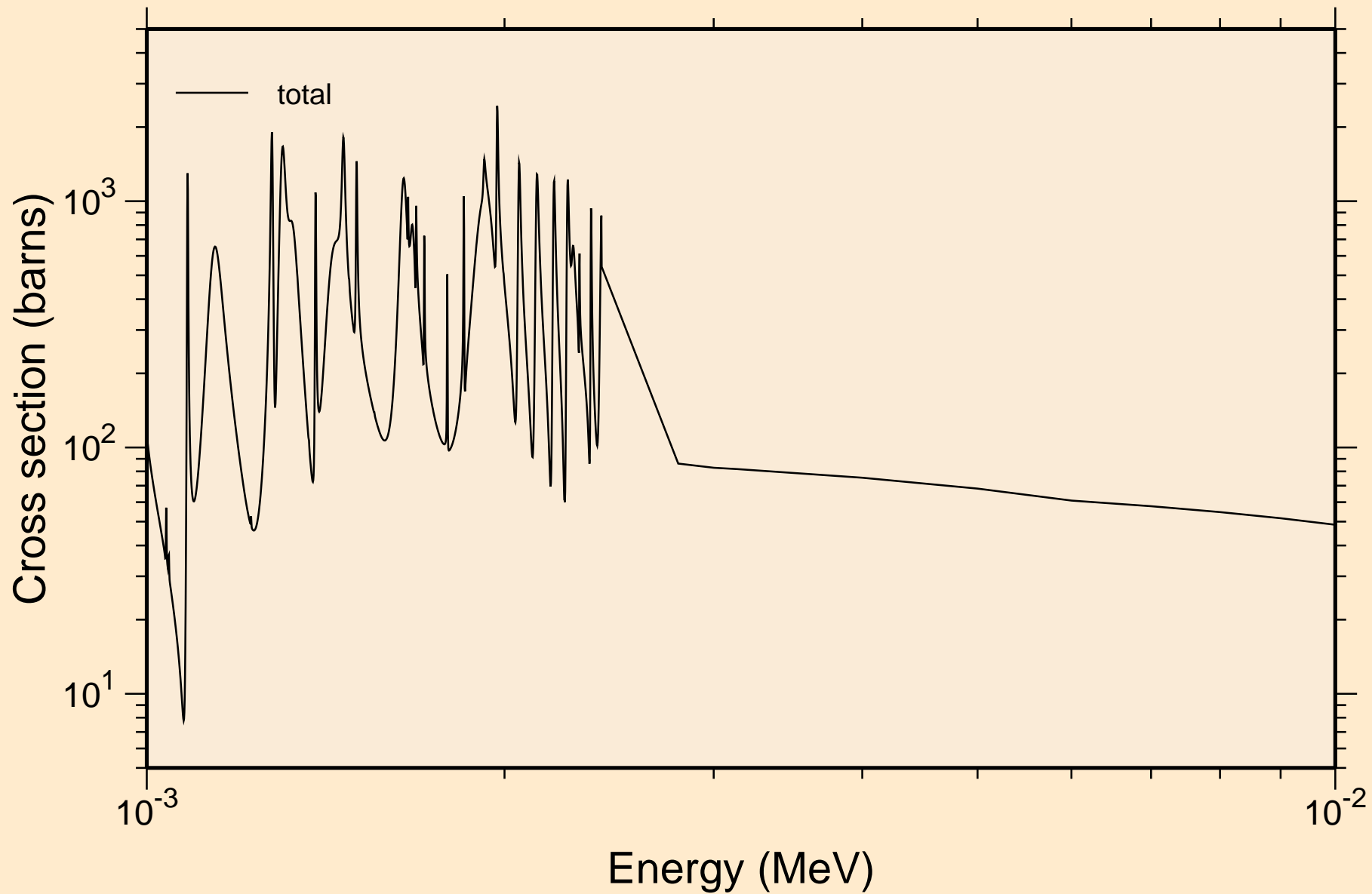

HO173 NEUTRON ACER TENDL-2021 LIBRARY; T=293.6K  
resonance total cross section

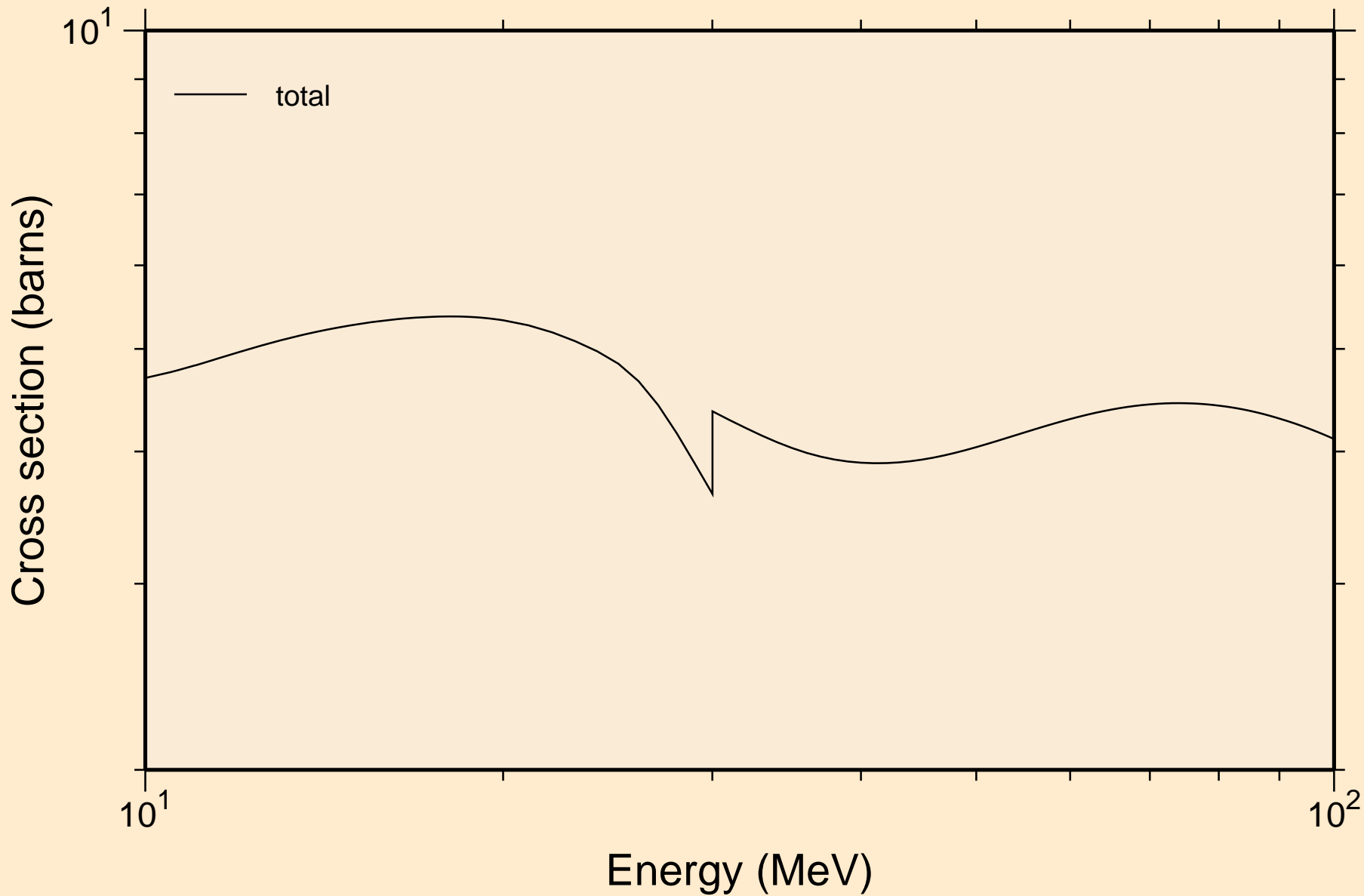

HO173 NEUTRON ACER TENDL-2021 LIBRARY; T=293.6K  
resonance absorption cross sections

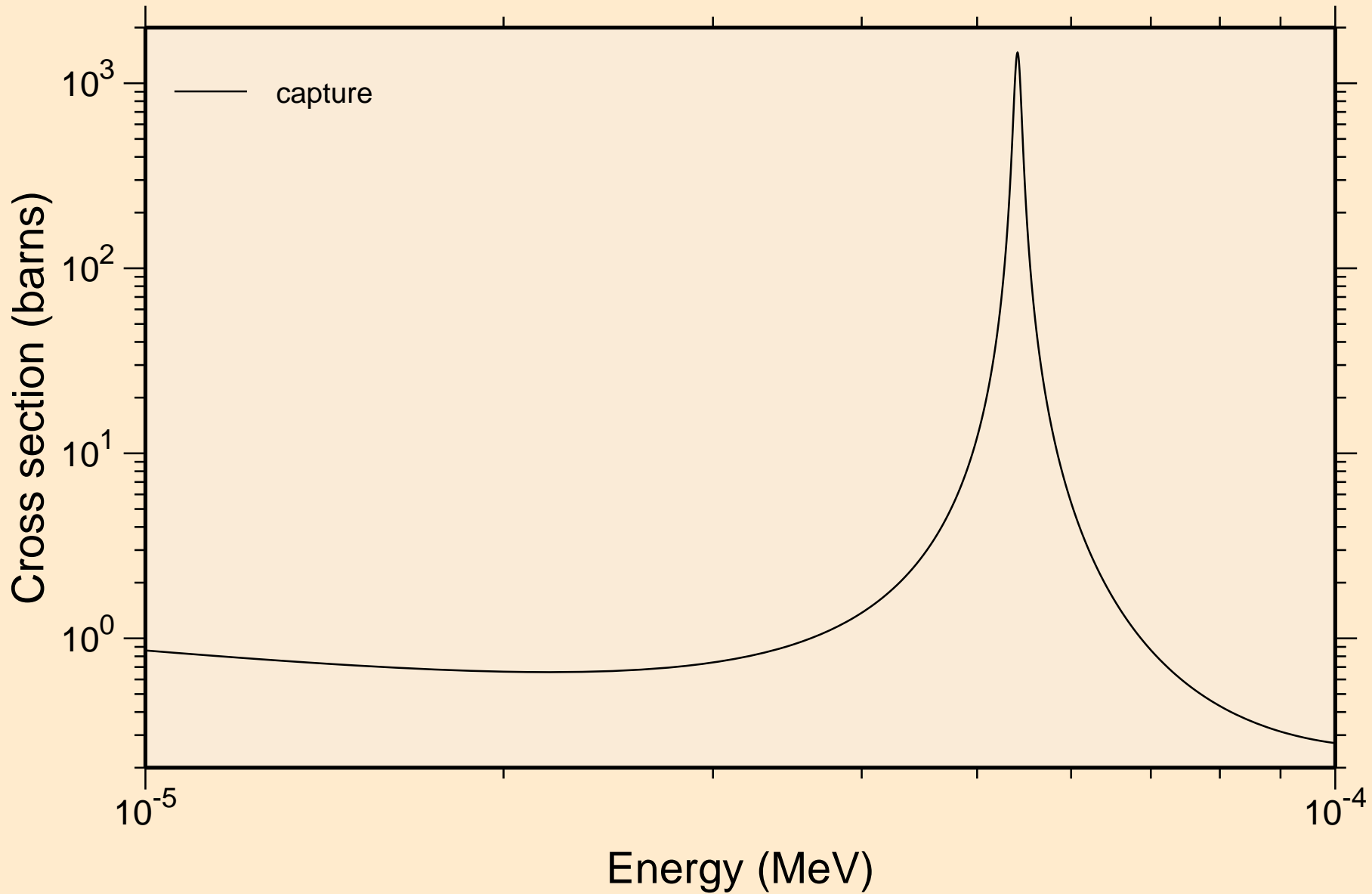

HO173 NEUTRON ACER TENDL-2021 LIBRARY; T=293.6K  
resonance absorption cross sections

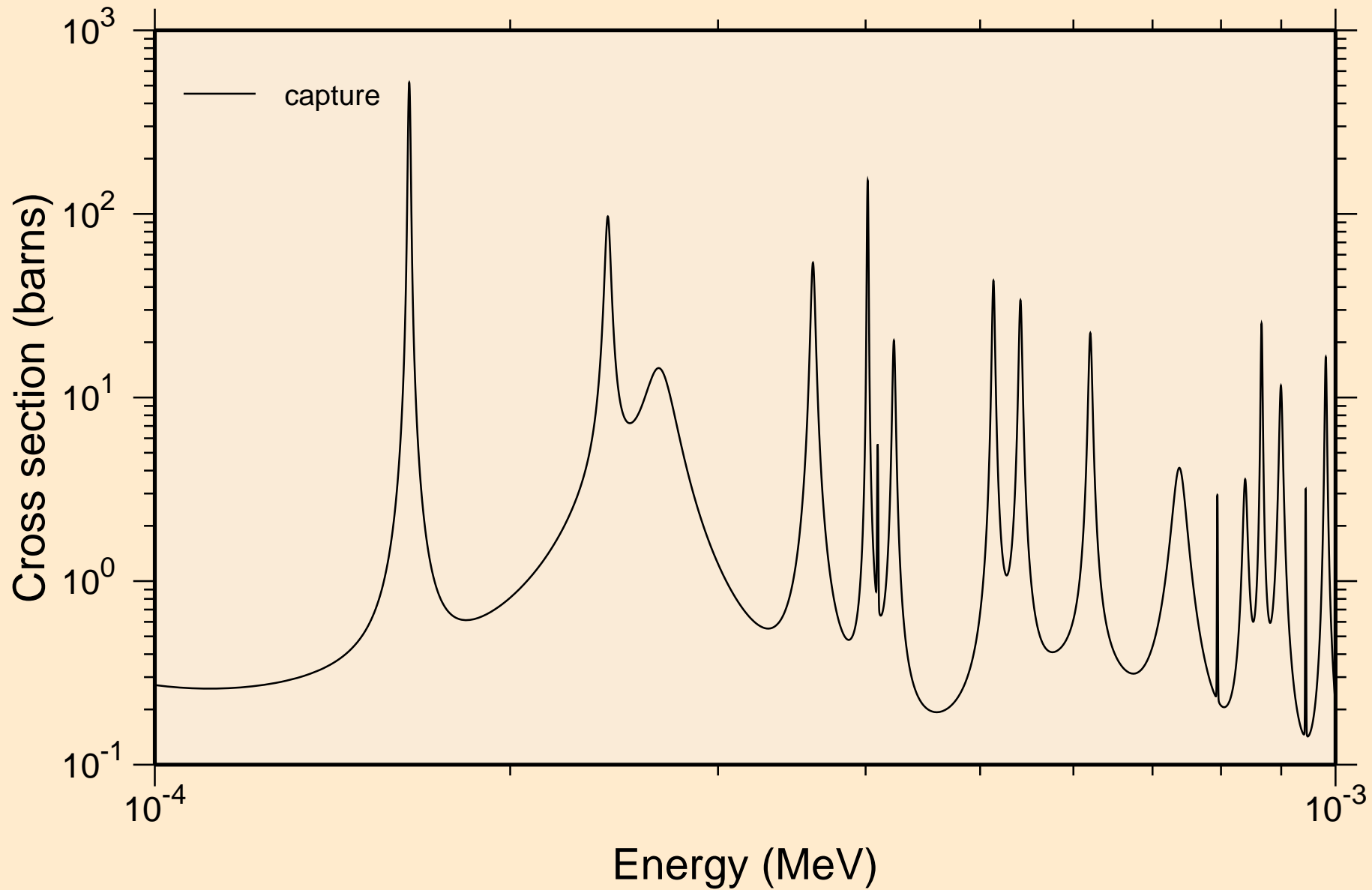

HO173 NEUTRON ACER TENDL-2021 LIBRARY; T=293.6K  
resonance absorption cross sections

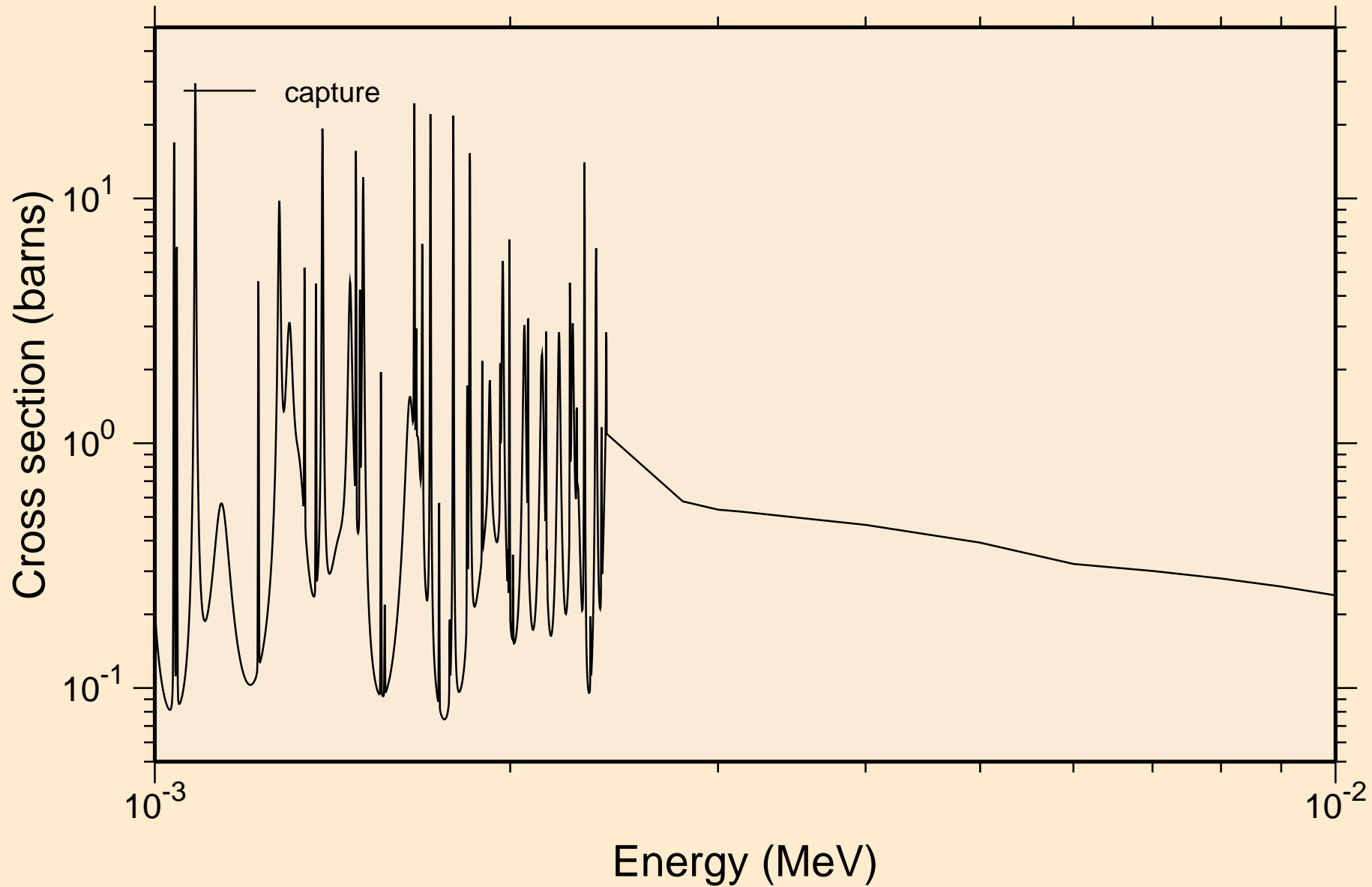



HO173 NEUTRON ACER TENDL-2021 LIBRARY; T=293.6K  
resonance absorption cross sections

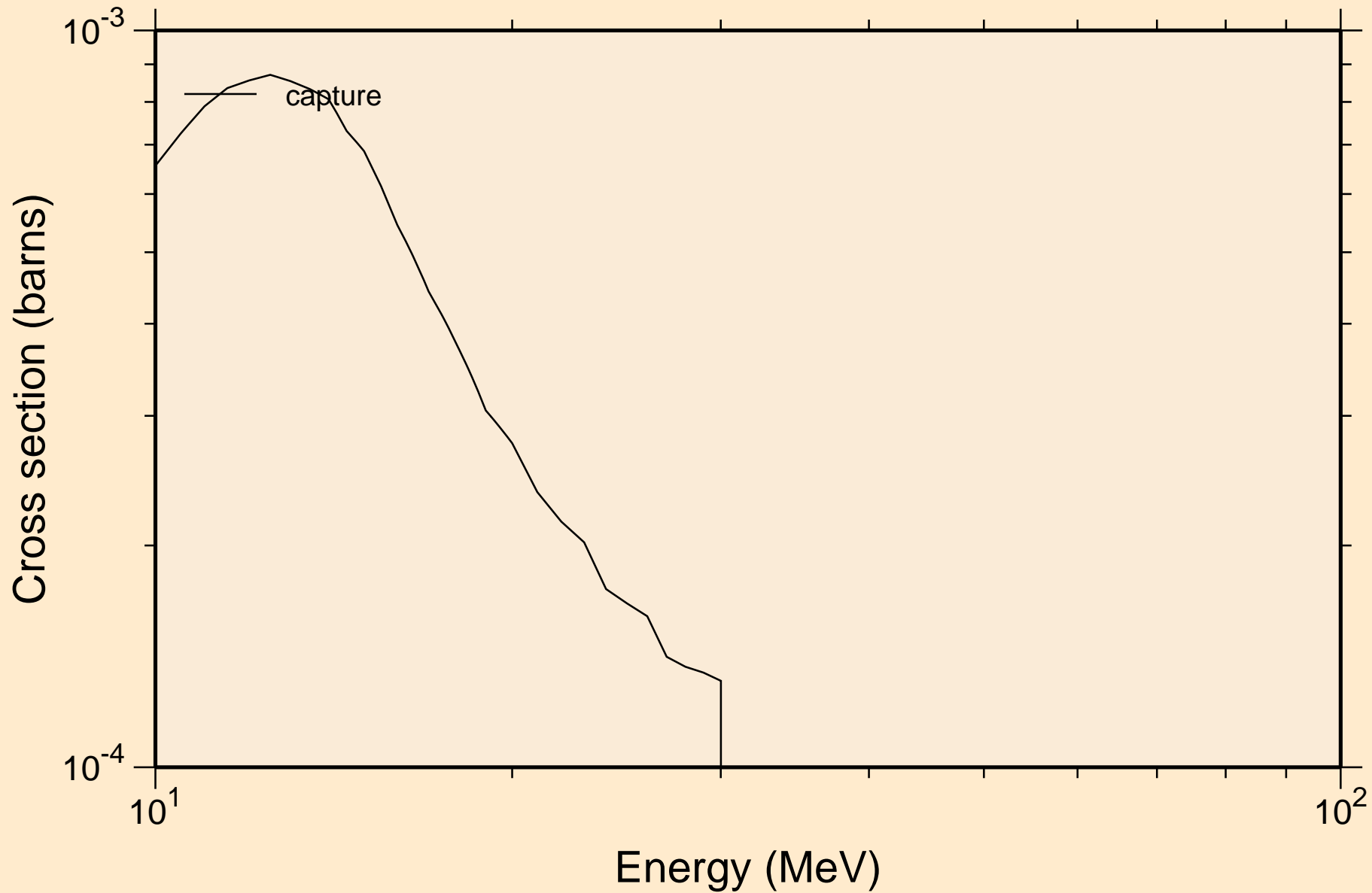

HO173 NEUTRON ACER TENDL-2021 LIBRARY; T=293.6K  
Heating

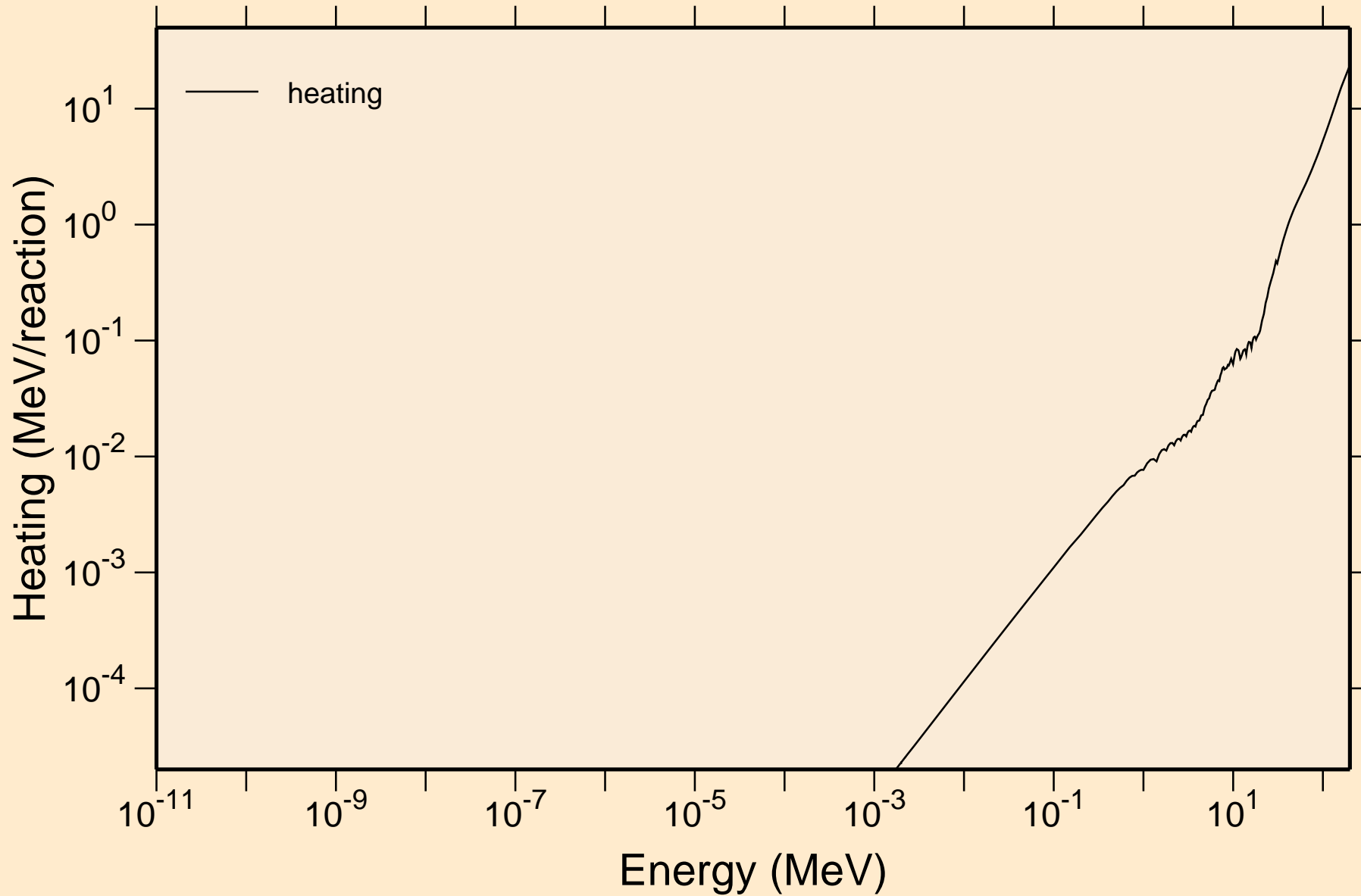

# HO173 NEUTRON ACER TENDL-2021 LIBRARY; T=293.6K

## Damage

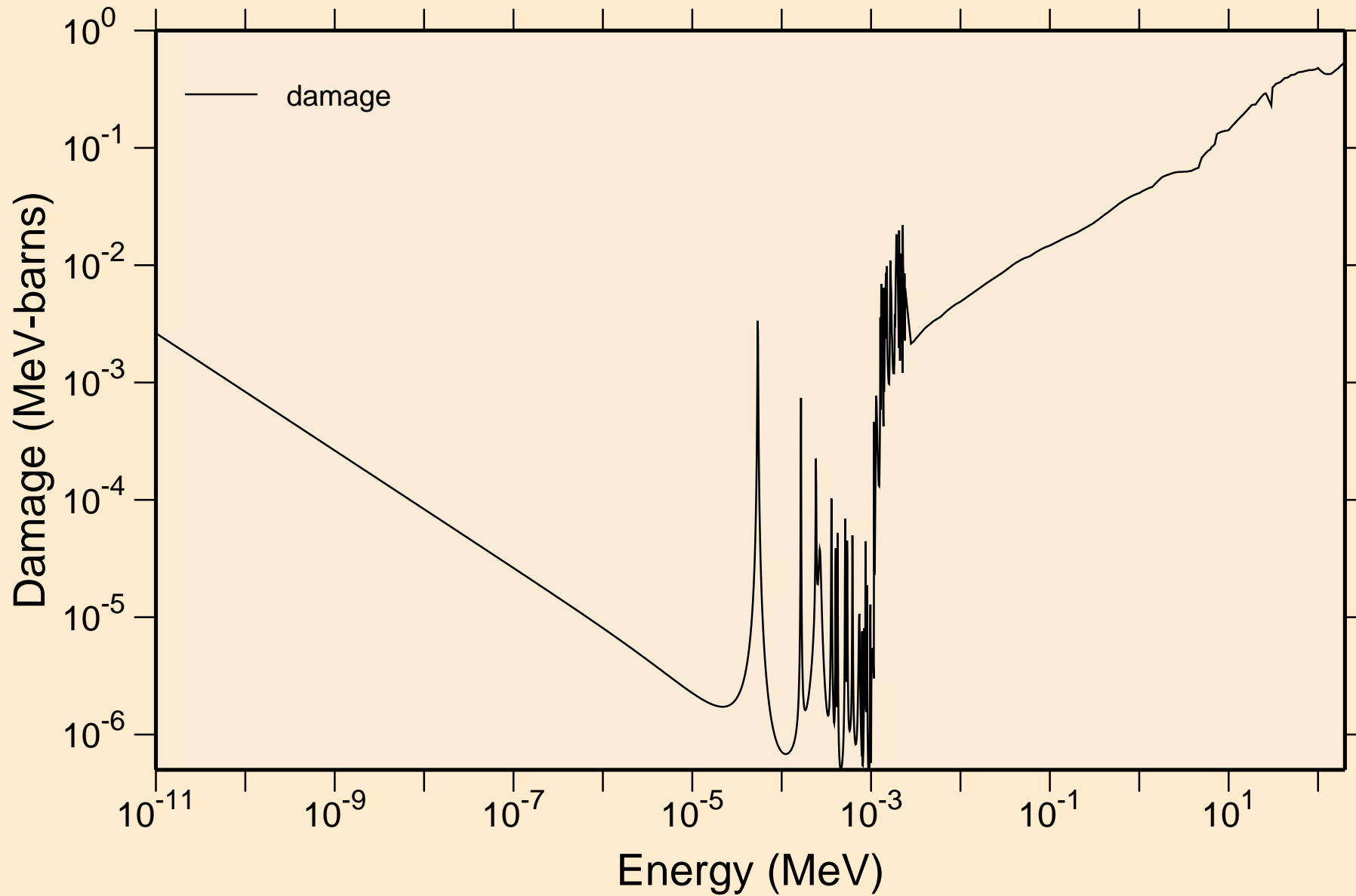

HO173 NEUTRON ACER TENDL-2021 LIBRARY; T=293.6K  
Non-threshold reactions

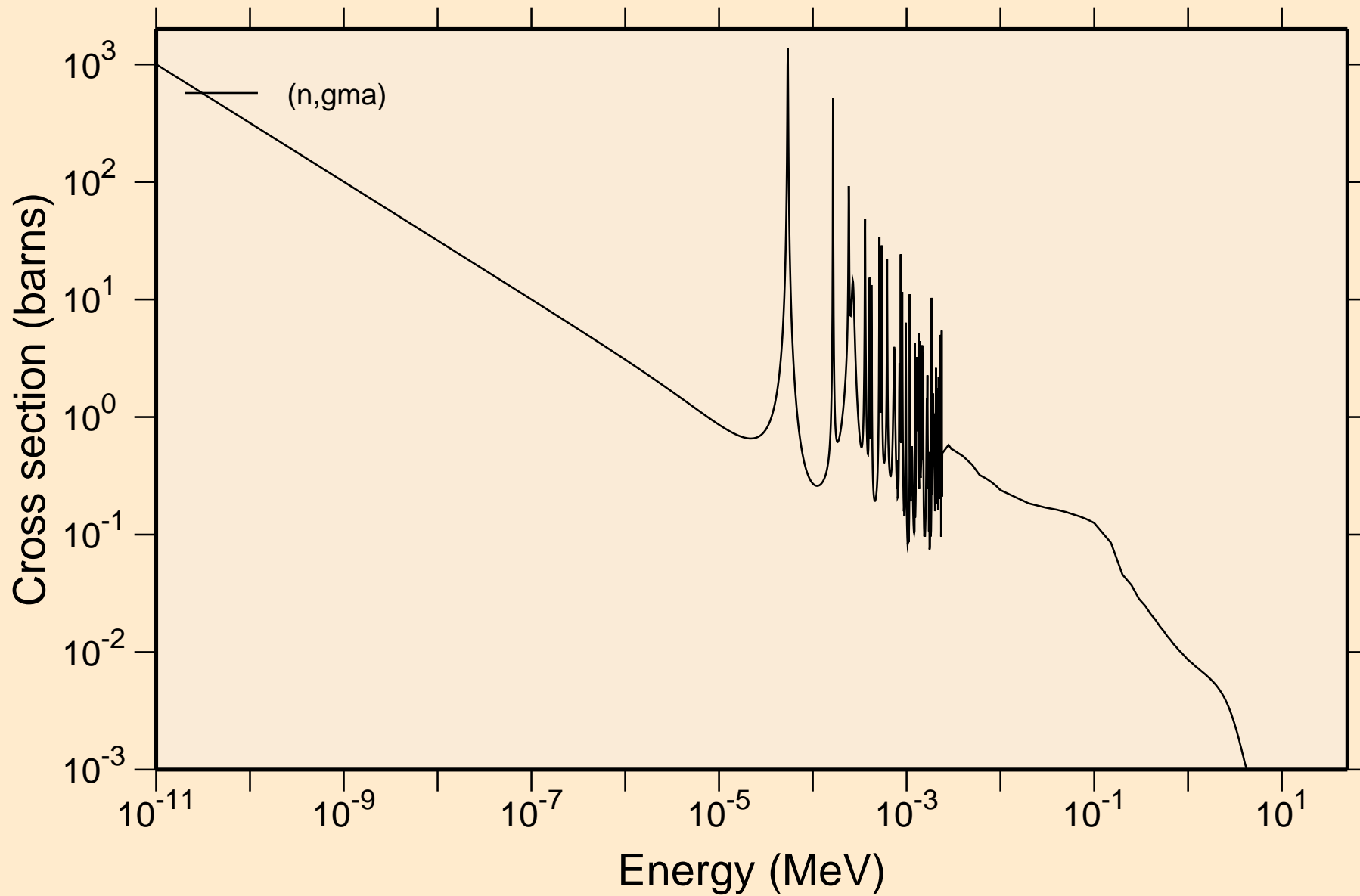

HO173 NEUTRON ACER TENDL-2021 LIBRARY; T=293.6K  
Principal cross sections

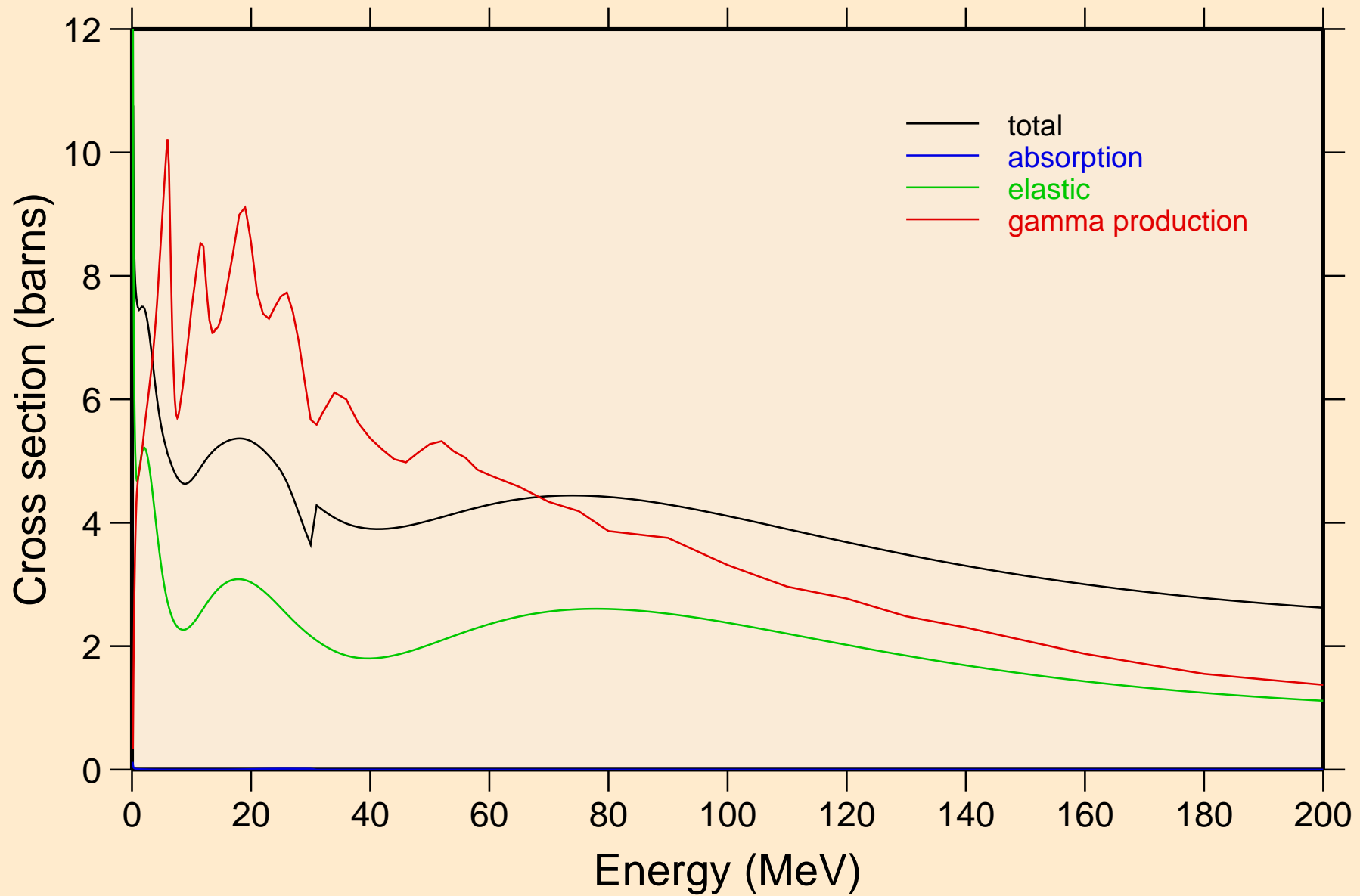

HO173 NEUTRON ACER TENDL-2021 LIBRARY; T=293.6K  
Heating

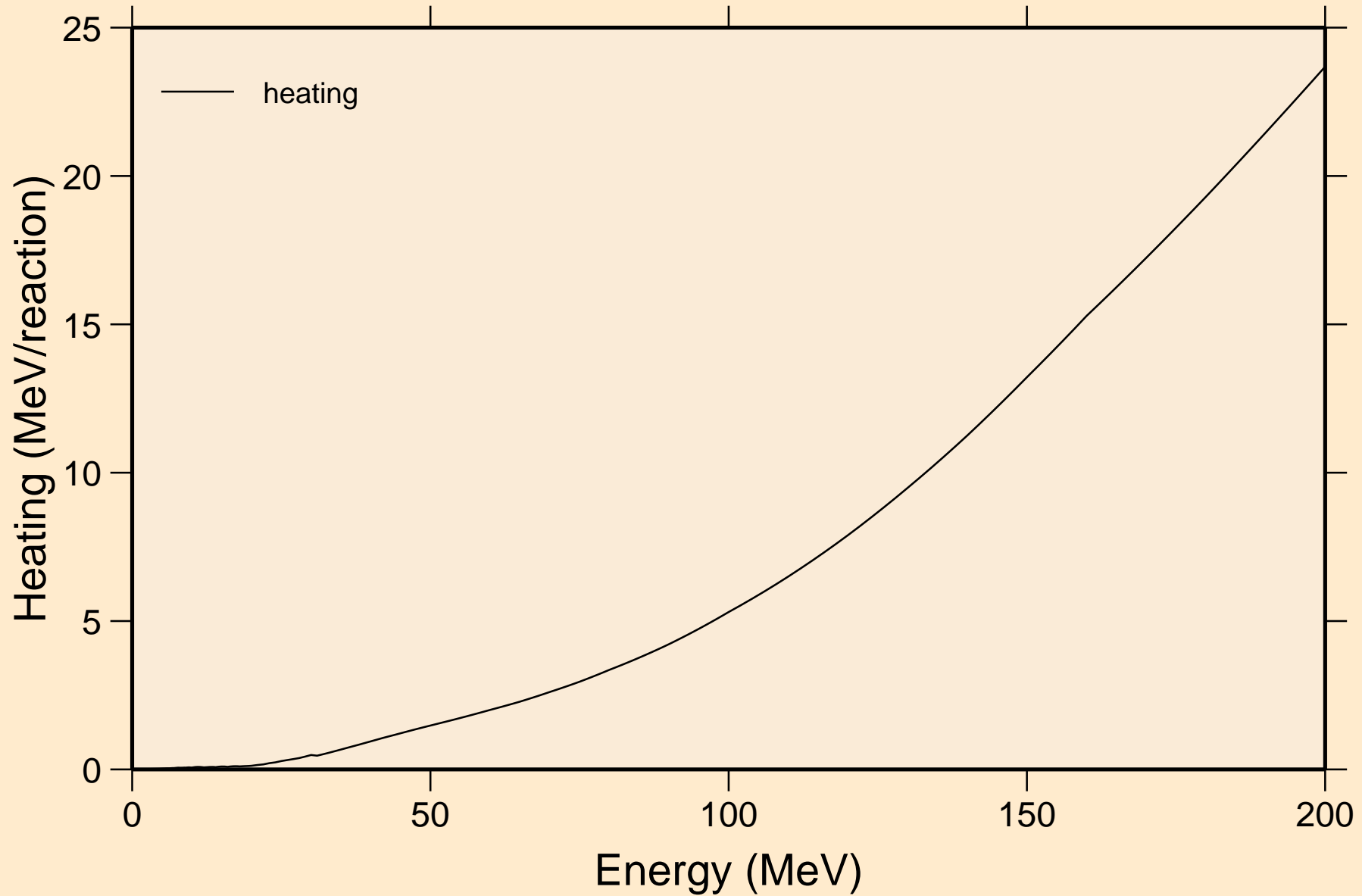

HO173 NEUTRON ACER TENDL-2021 LIBRARY; T=293.6K  
Damage

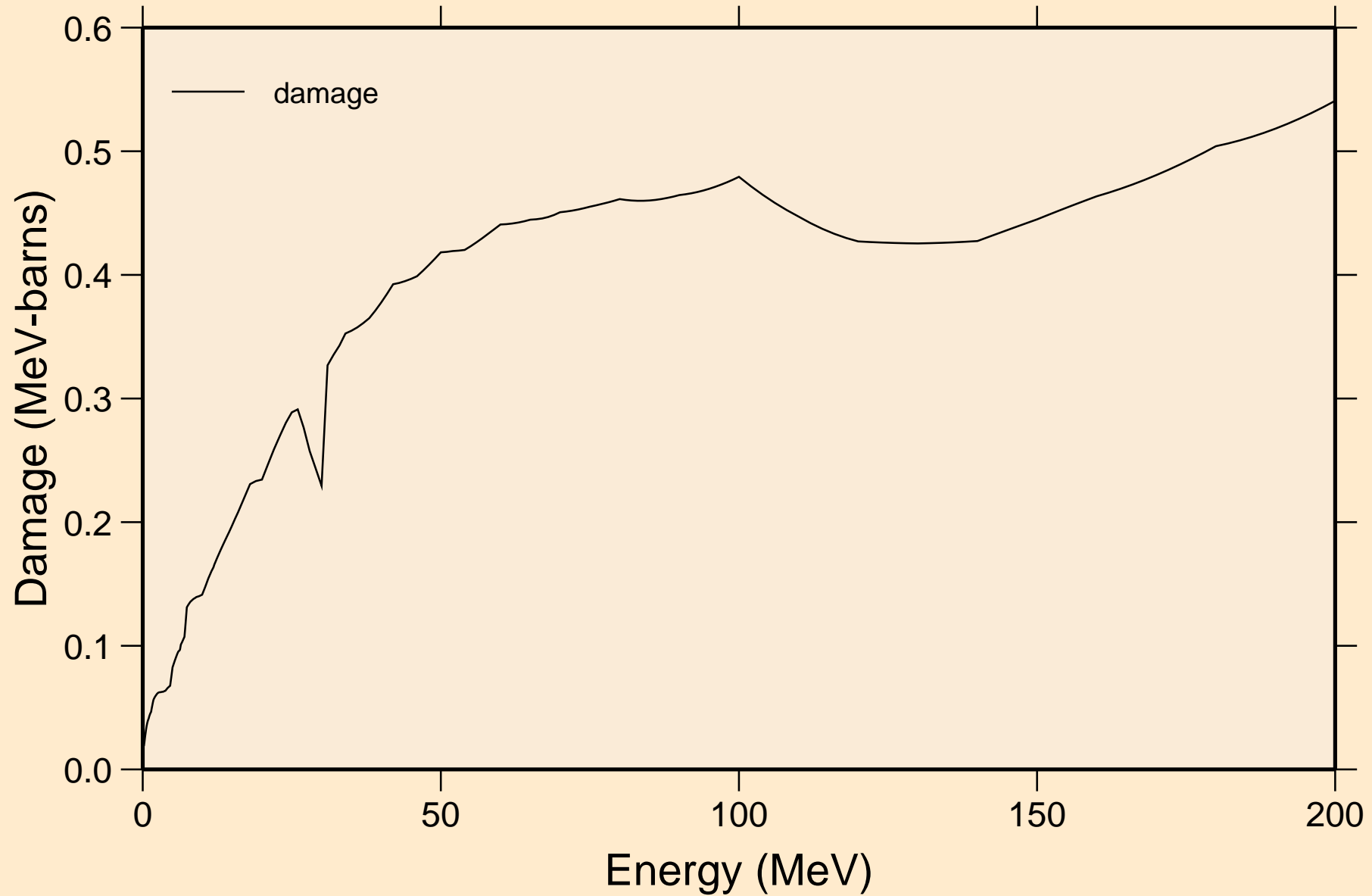

HO173 NEUTRON ACER TENDL-2021 LIBRARY; T=293.6K  
Non-threshold reactions

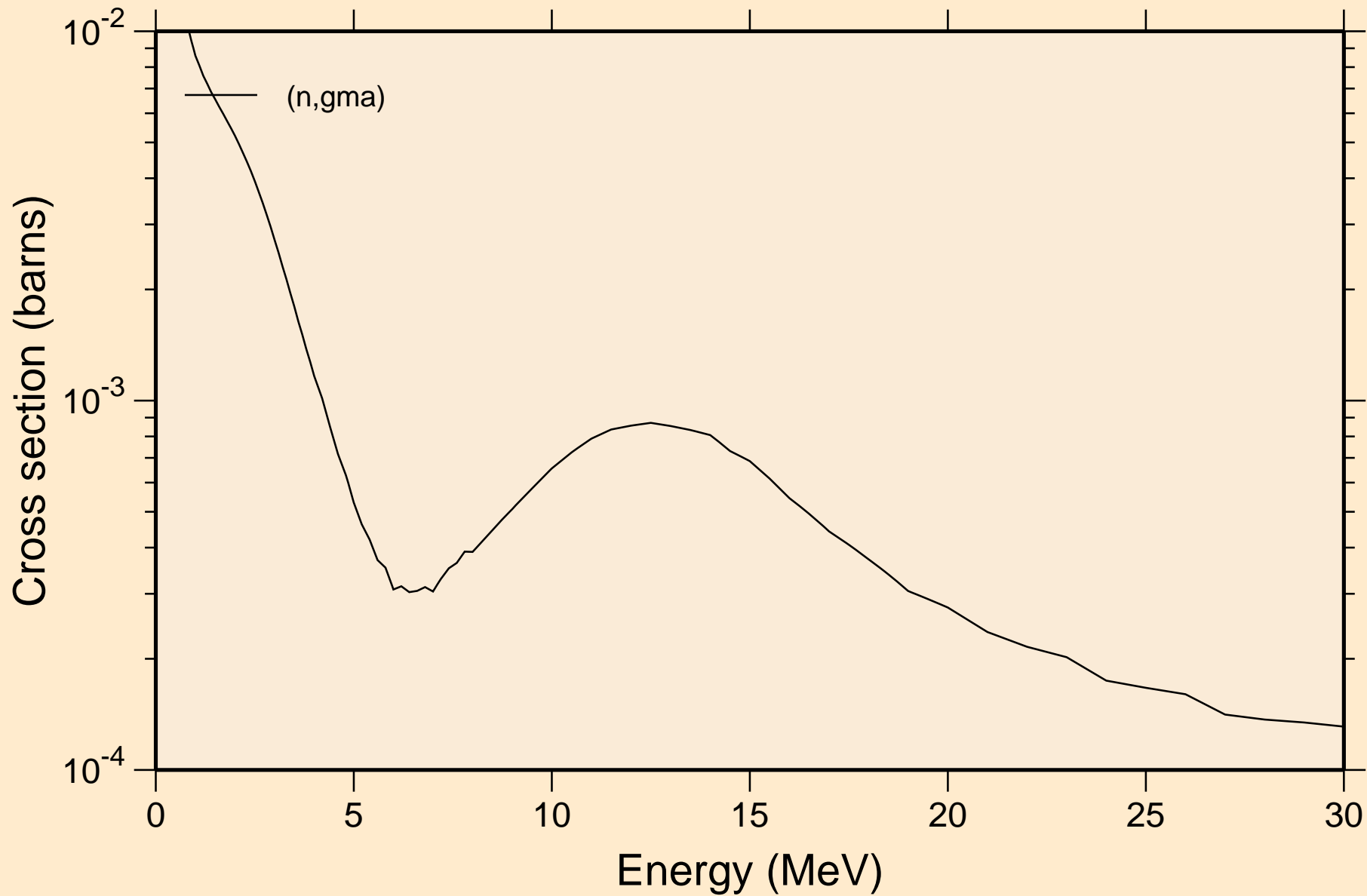



HO173 NEUTRON ACER TENDL-2021 LIBRARY; T=293.6K  
Inelastic levels

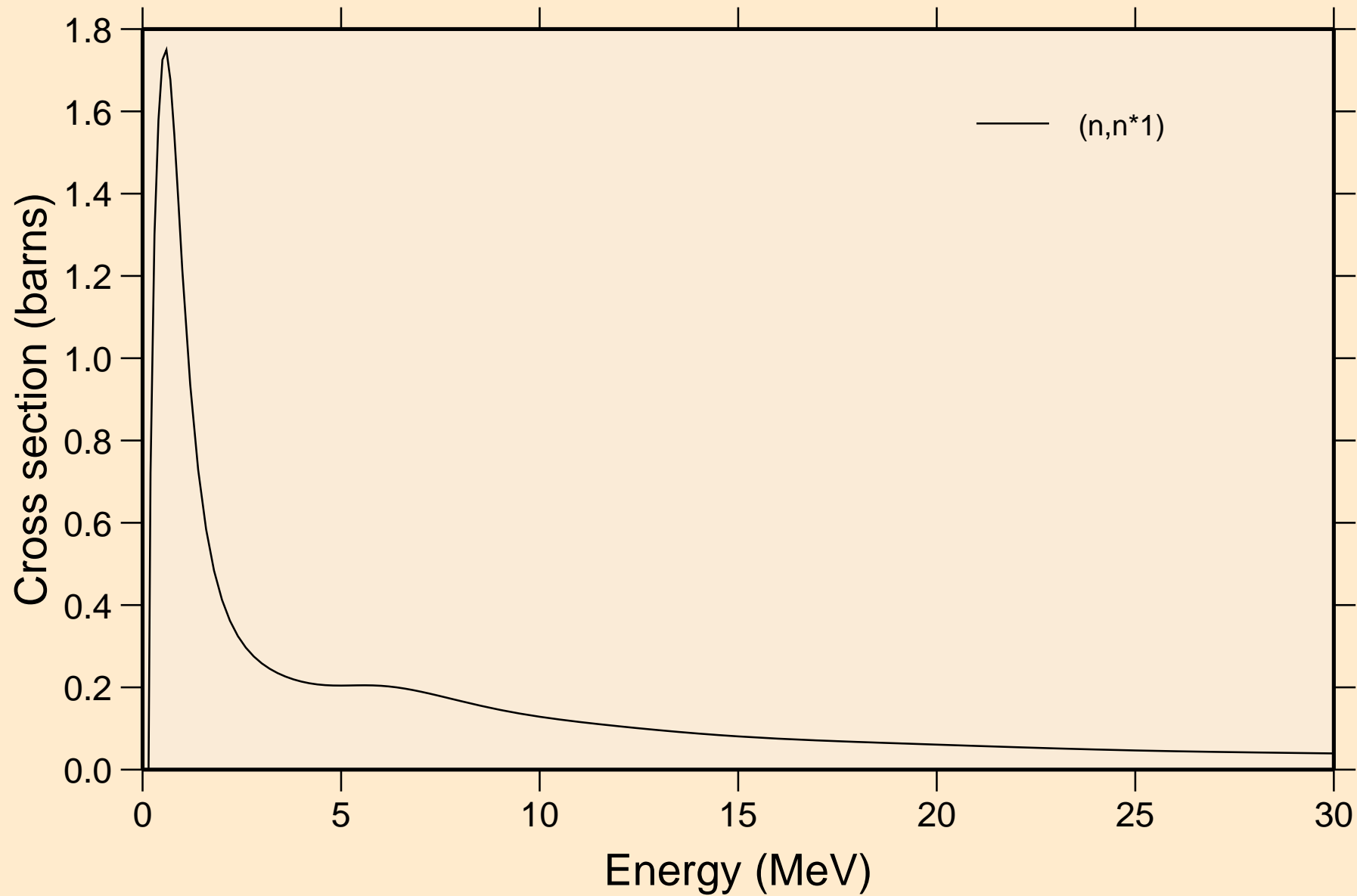

# HO173 NEUTRON ACER TENDL-2021 LIBRARY; T=293.6K

## Threshold reactions

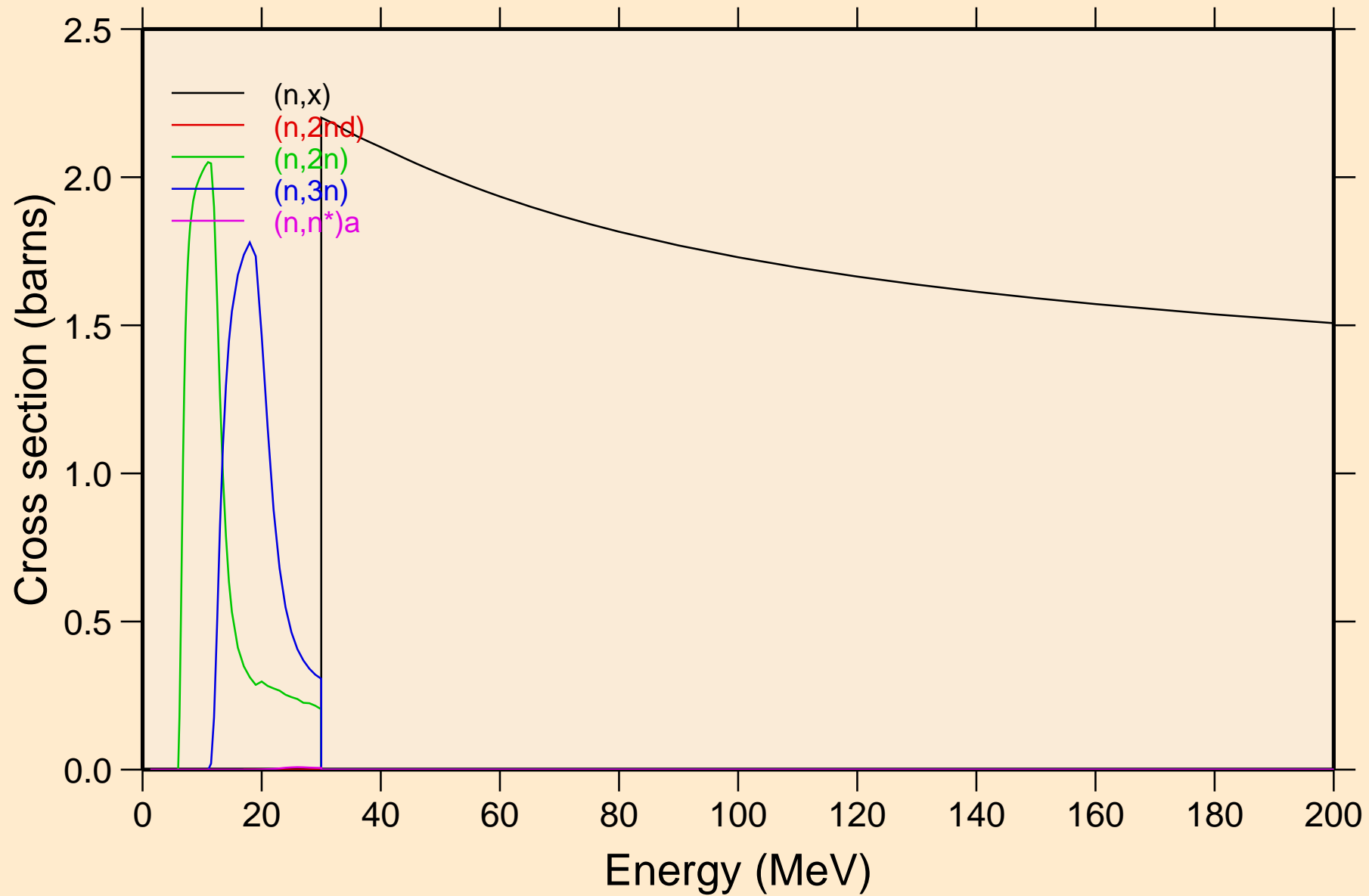

# HO173 NEUTRON ACER TENDL-2021 LIBRARY; T=293.6K

## Threshold reactions

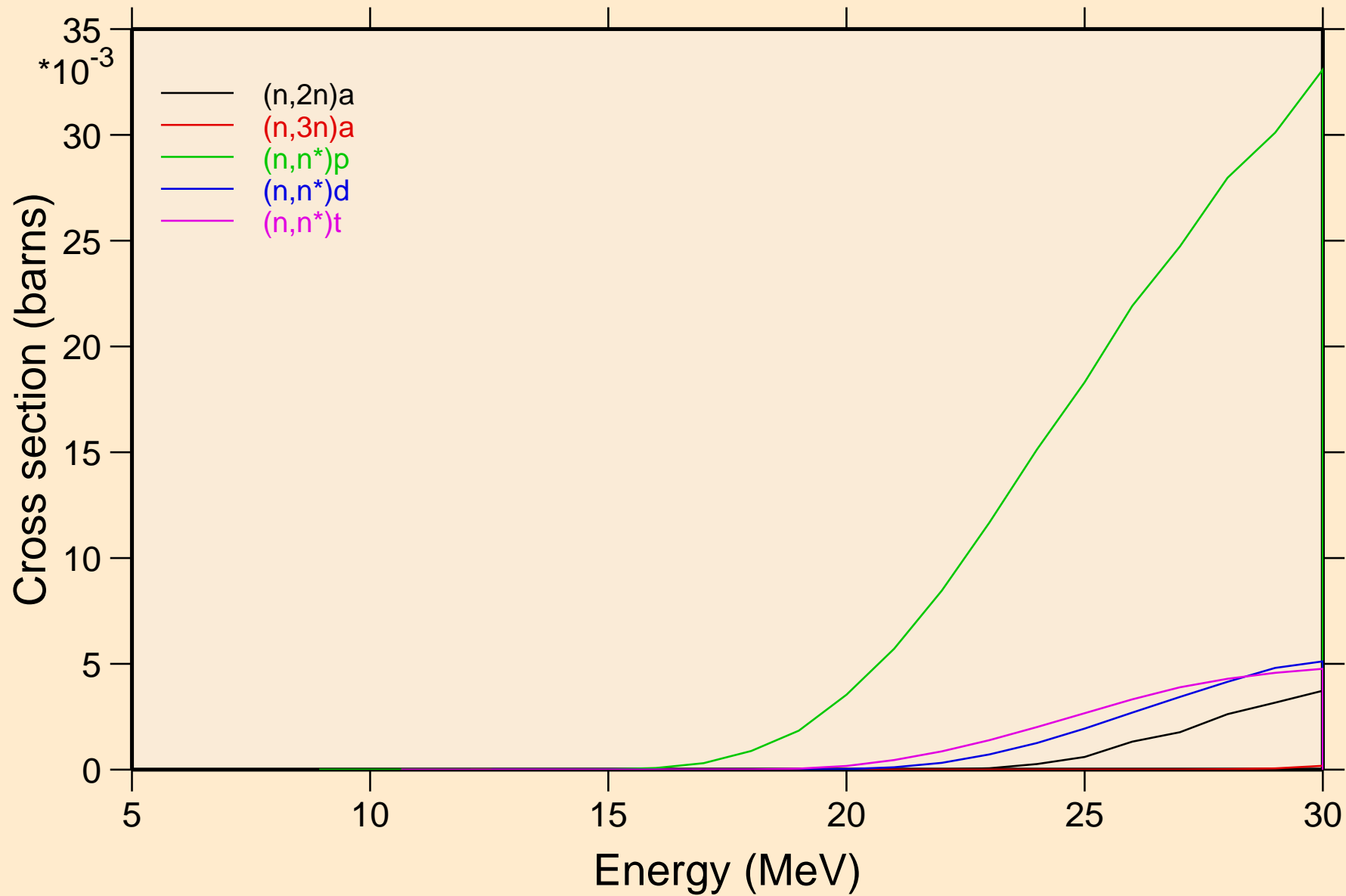

# HO173 NEUTRON ACER TENDL-2021 LIBRARY; T=293.6K

## Threshold reactions

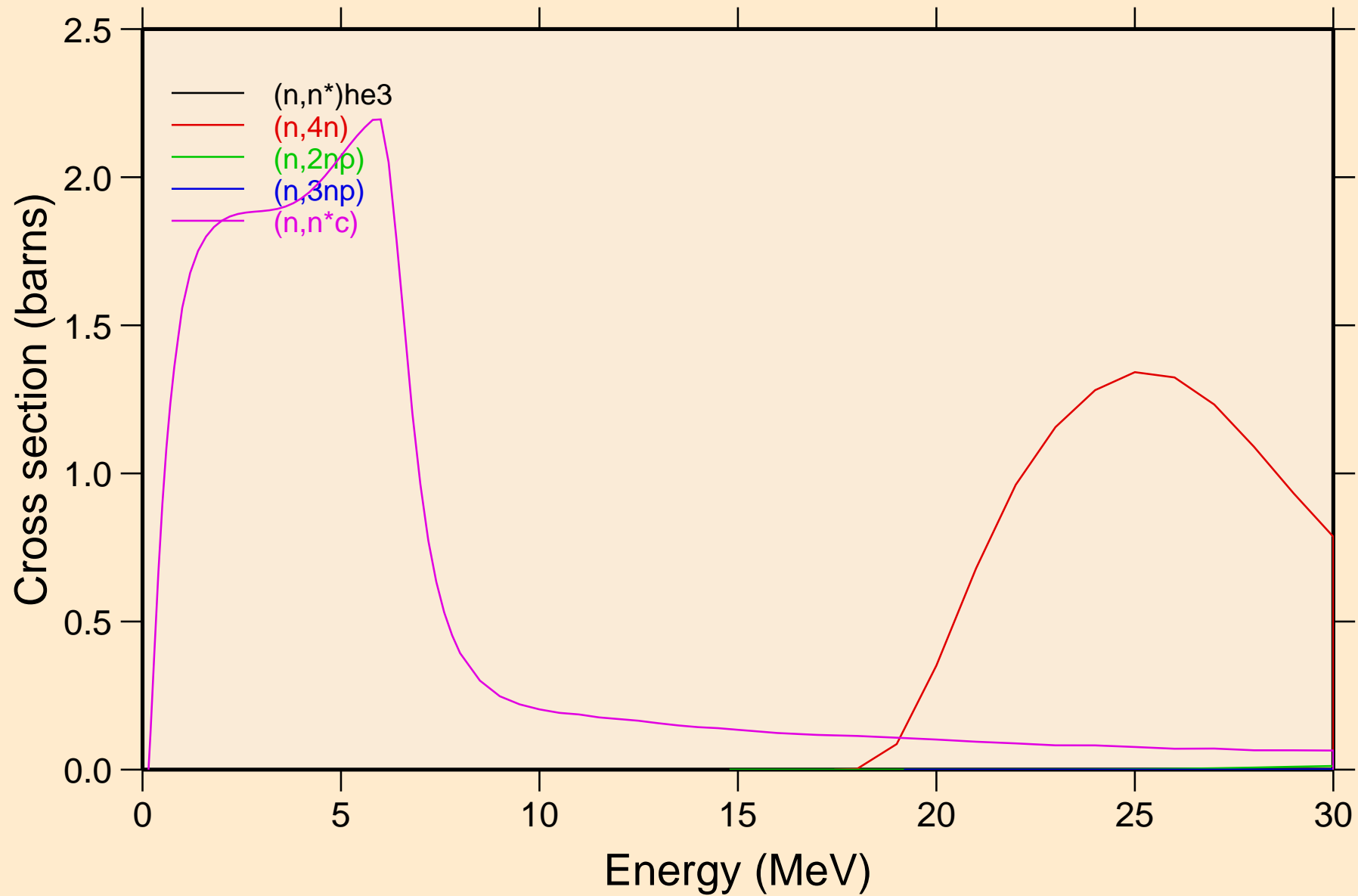

# HO173 NEUTRON ACER TENDL-2021 LIBRARY; T=293.6K

## Threshold reactions

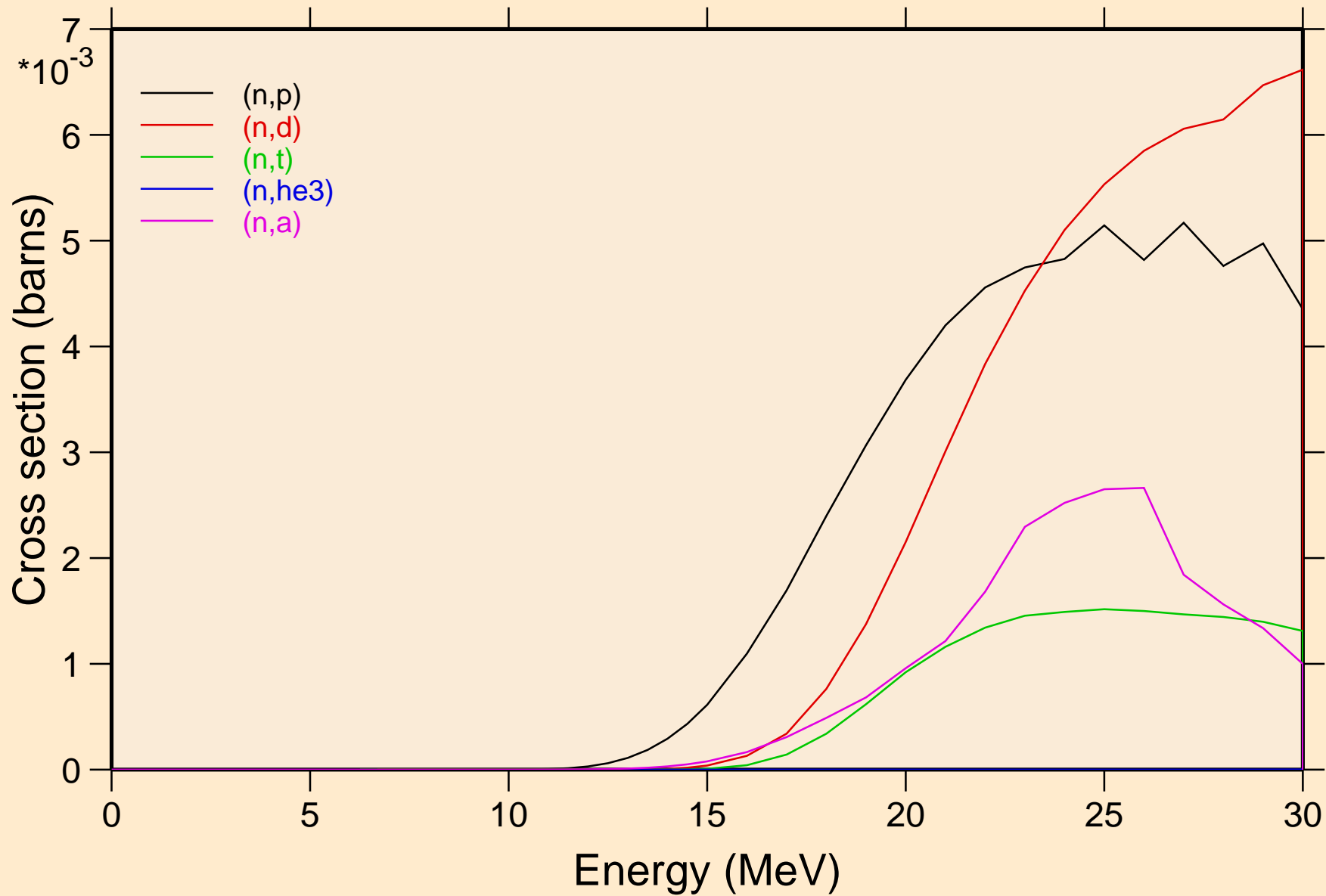

HO173 NEUTRON ACER TENDL-2021 LIBRARY; T=293.6K  
Threshold reactions

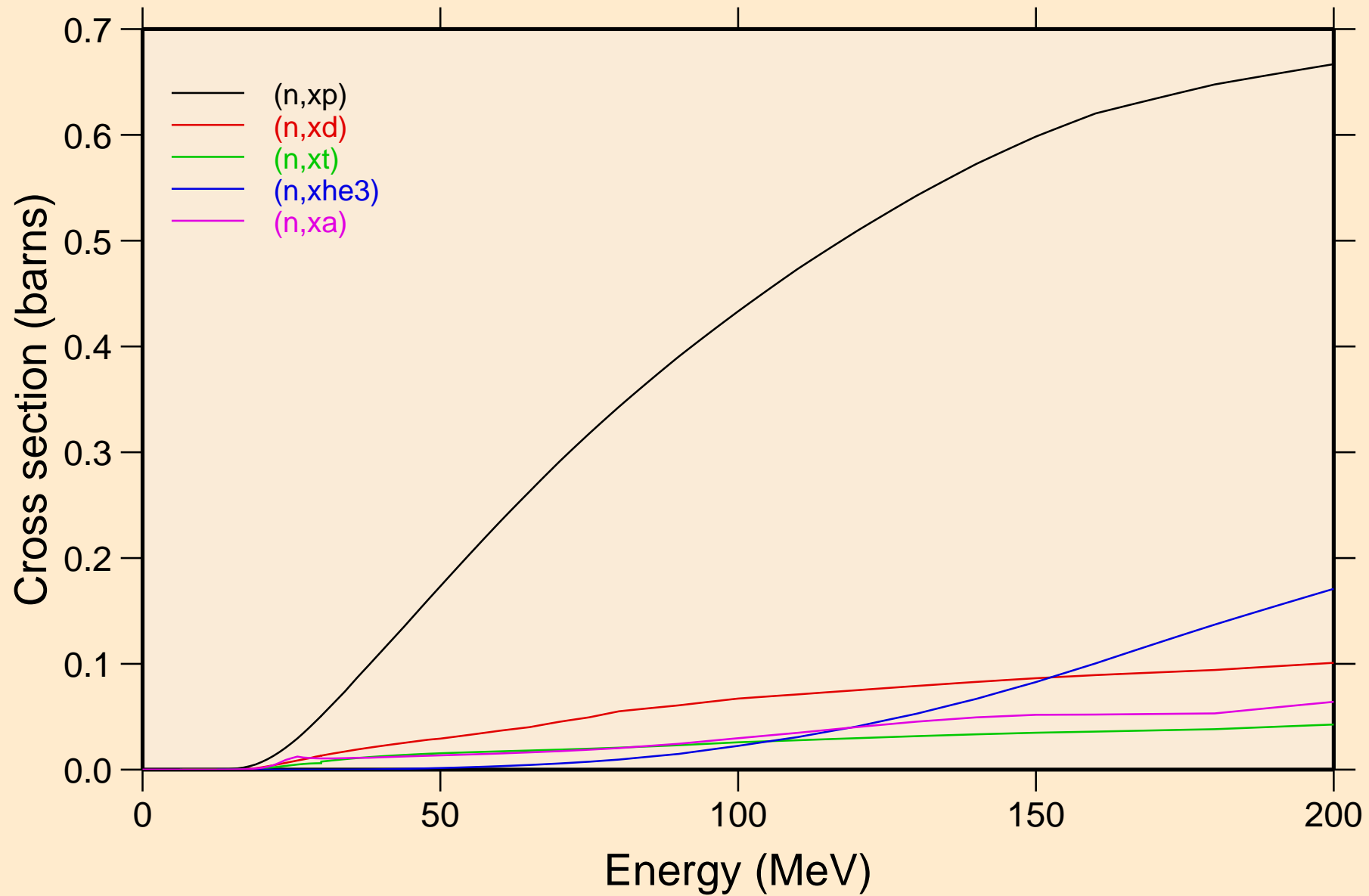

HO173 NEUTRON ACER TENDL-2021 LIBRARY; T=293.6K  
angular distribution for elastic

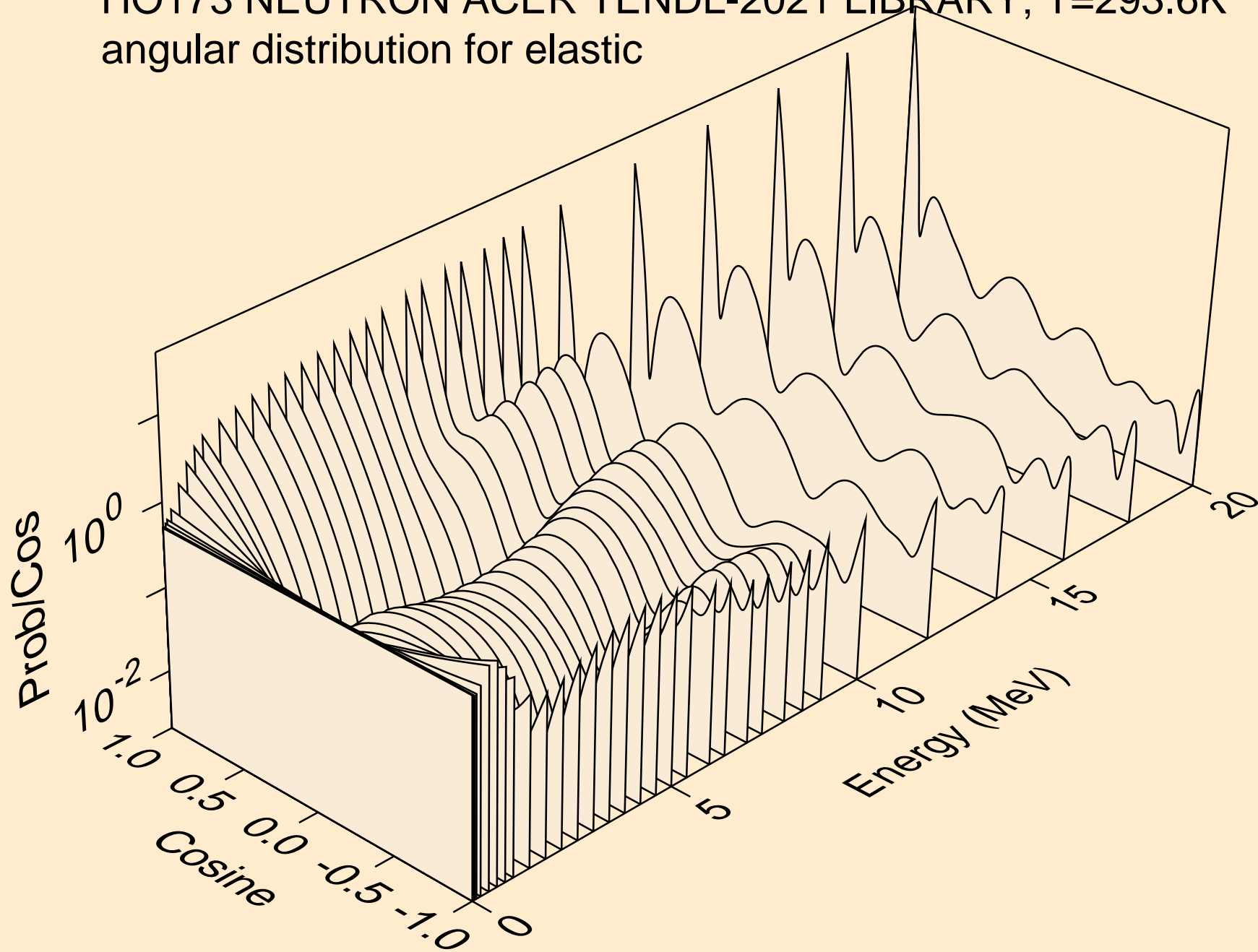

HO173 NEUTRON ACER TENDL-2021 LIBRARY; T=293.6K  
angular distribution for elastic

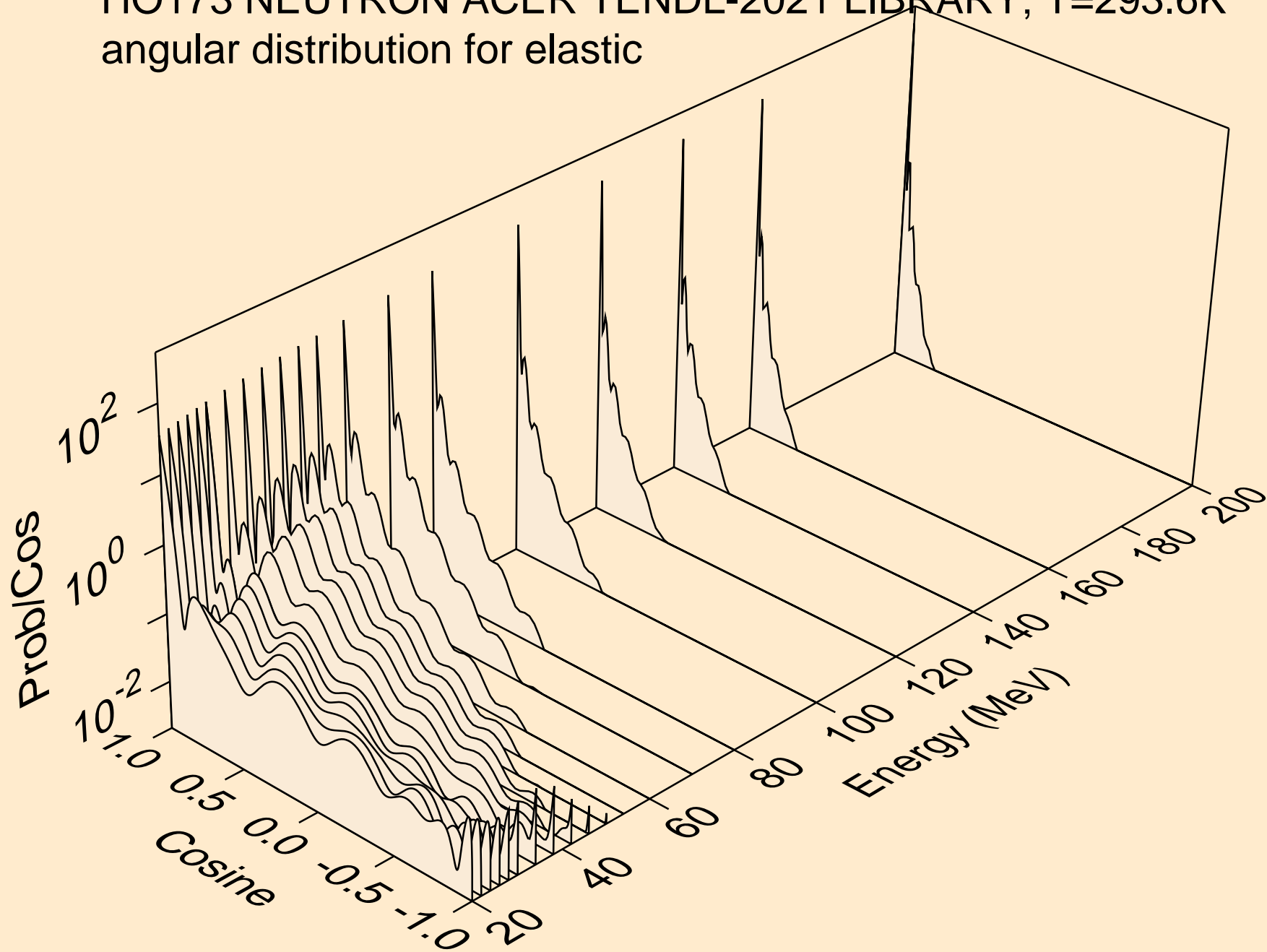



HO173 NEUTRON ACER TENDL-2021 LIBRARY; T=293.6K  
angular distribution for (n,n\*1)

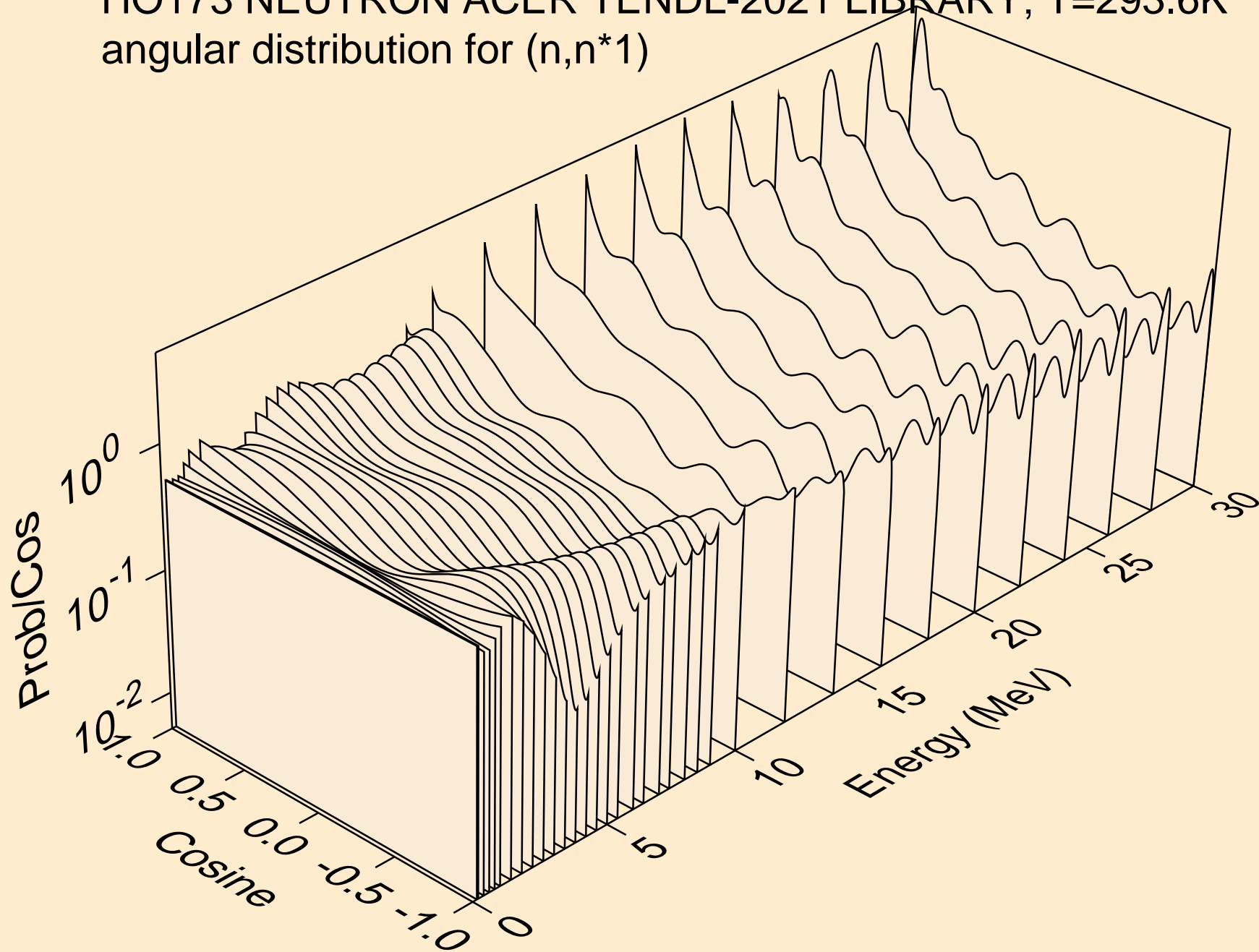

HO173 NEUTRON ACER TENDL-2021 LIBRARY; T=293.6K  
Neutron emission for (n,x)

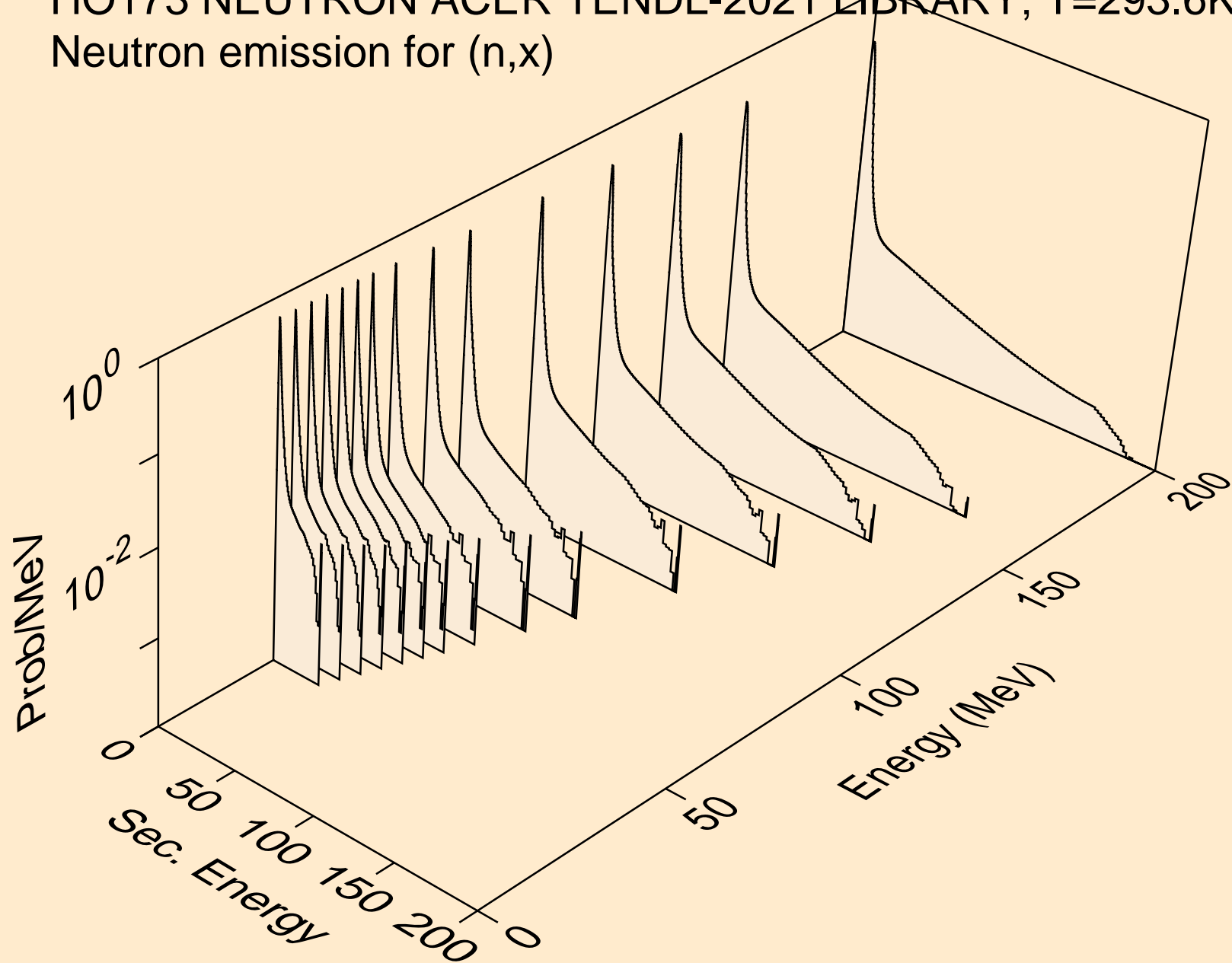

HO173 NEUTRON ACER TENDL-2021 LIBRARY; T=293.6K  
Neutron emission for (n,2nd)

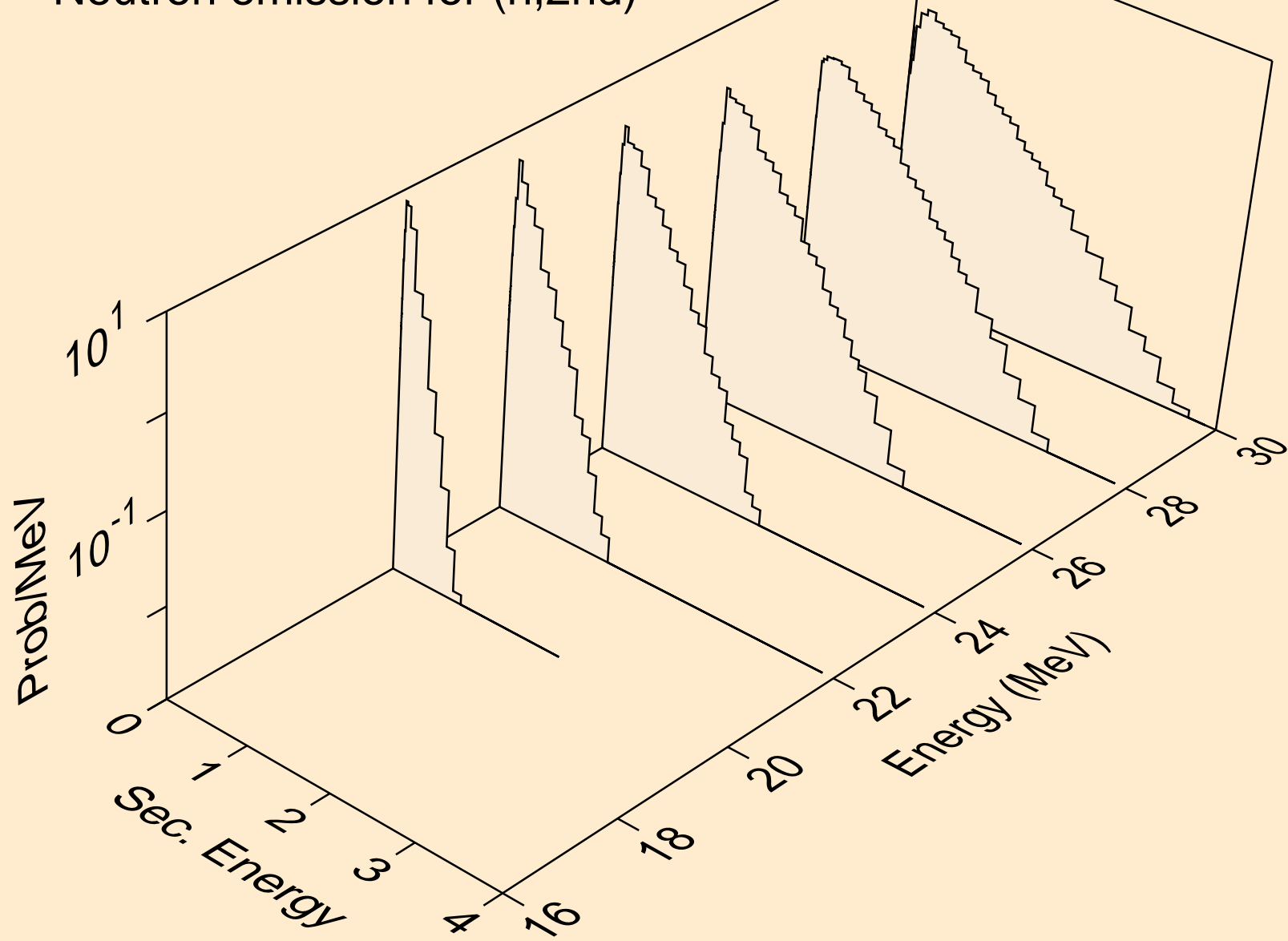

HO173 NEUTRON ACER TENDL-2021 LIBRARY; T=293.6K  
Neutron emission for (n,2n)

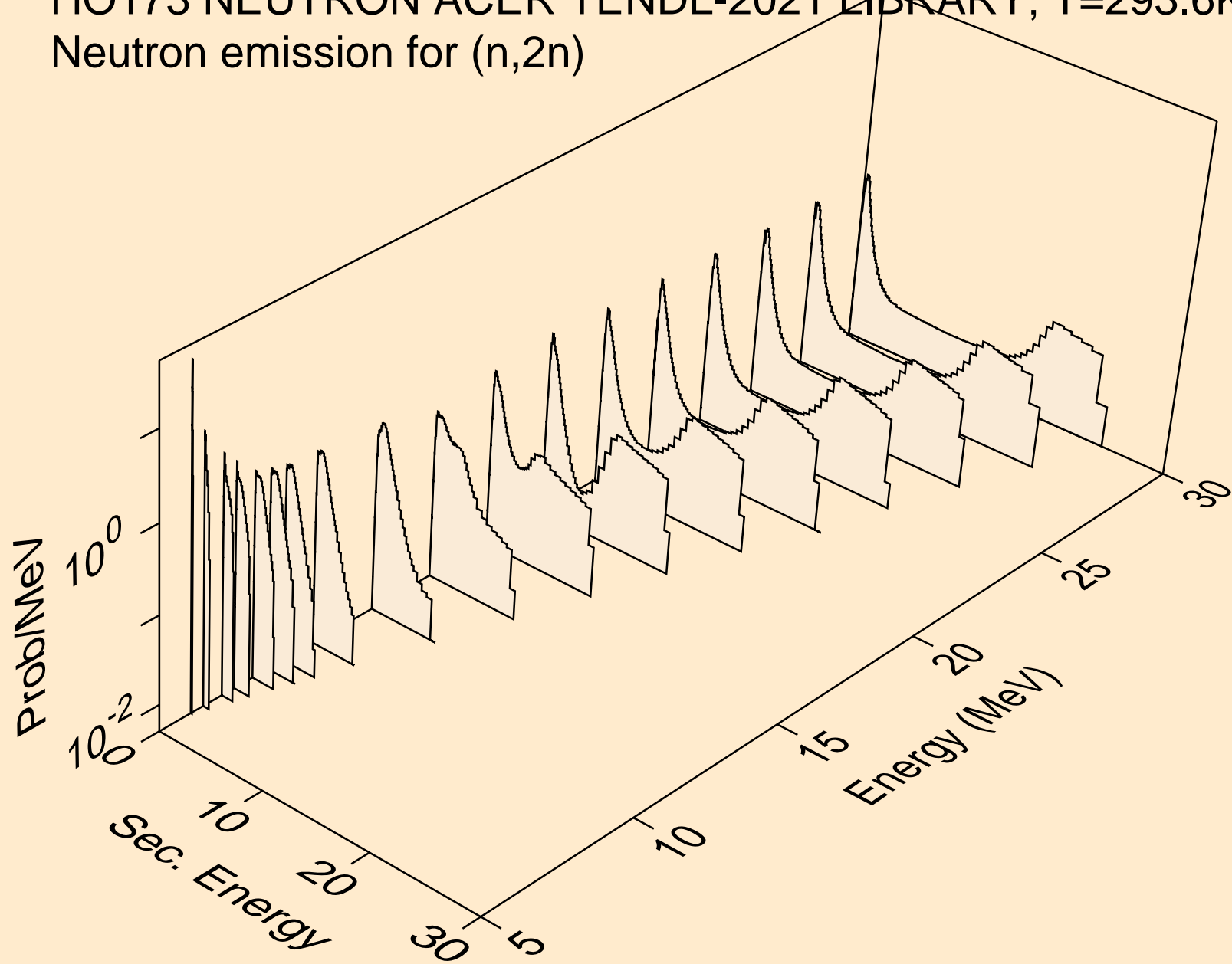

HO173 NEUTRON ACER TENDL-2021 LIBRARY; T=293.6K  
Neutron emission for (n,3n)

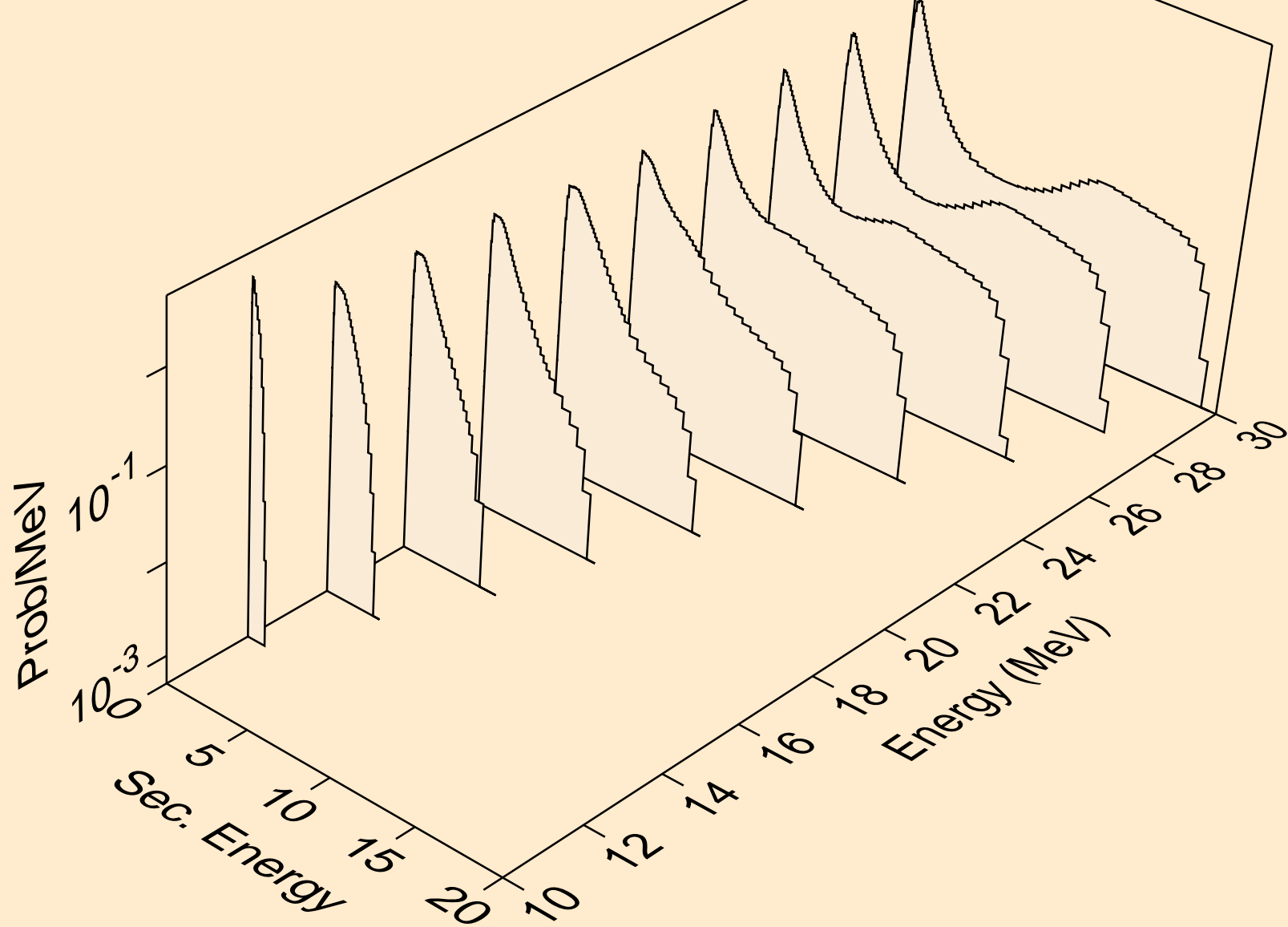

HO173 NEUTRON ACER TENDL-2021 LIBRARY; T=293.6K  
Neutron emission for (n,n\*)a

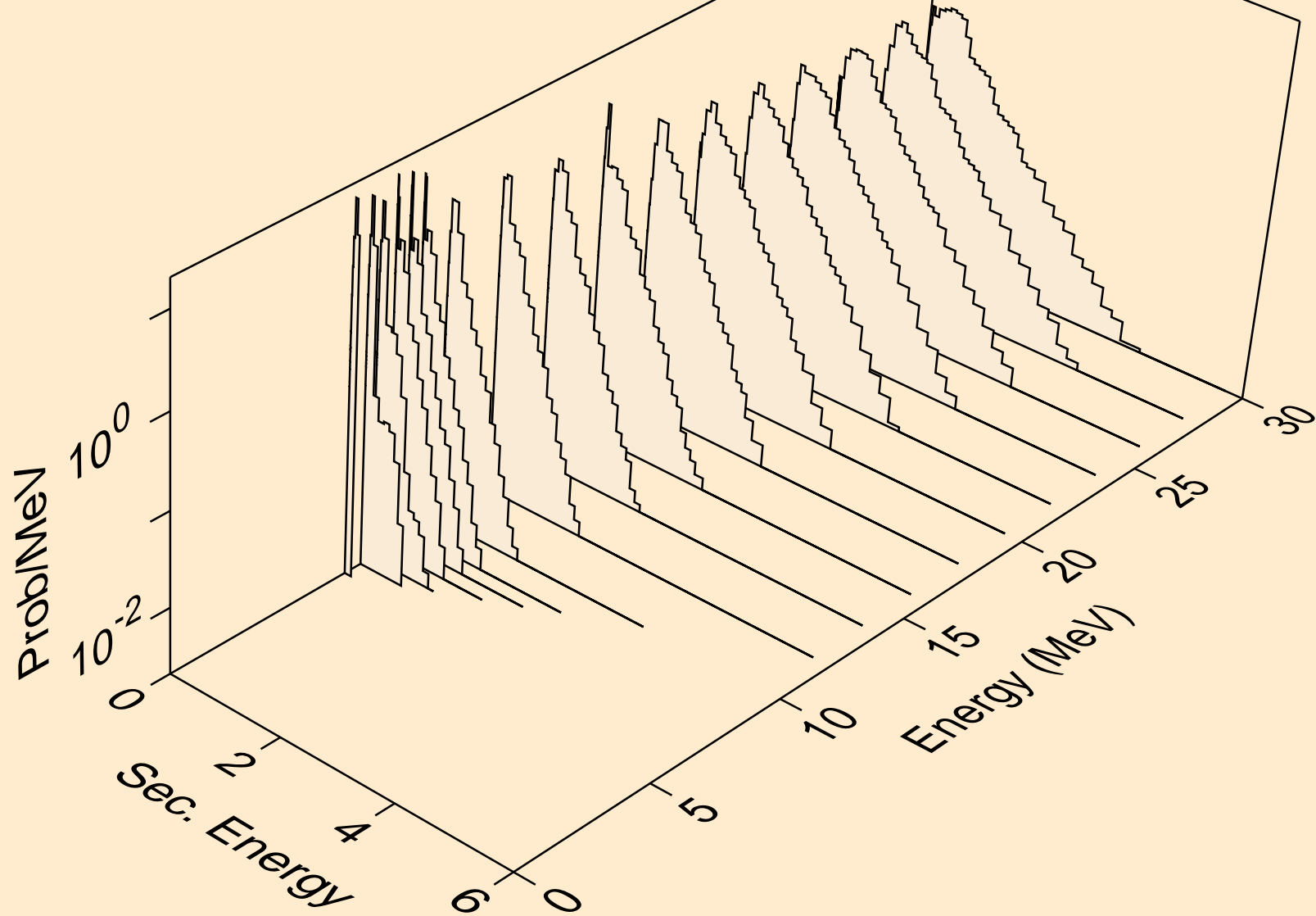

HO173 NEUTRON ACER TENDL-2021 LIBRARY; T=293.6K  
Neutron emission for (n,2n)a

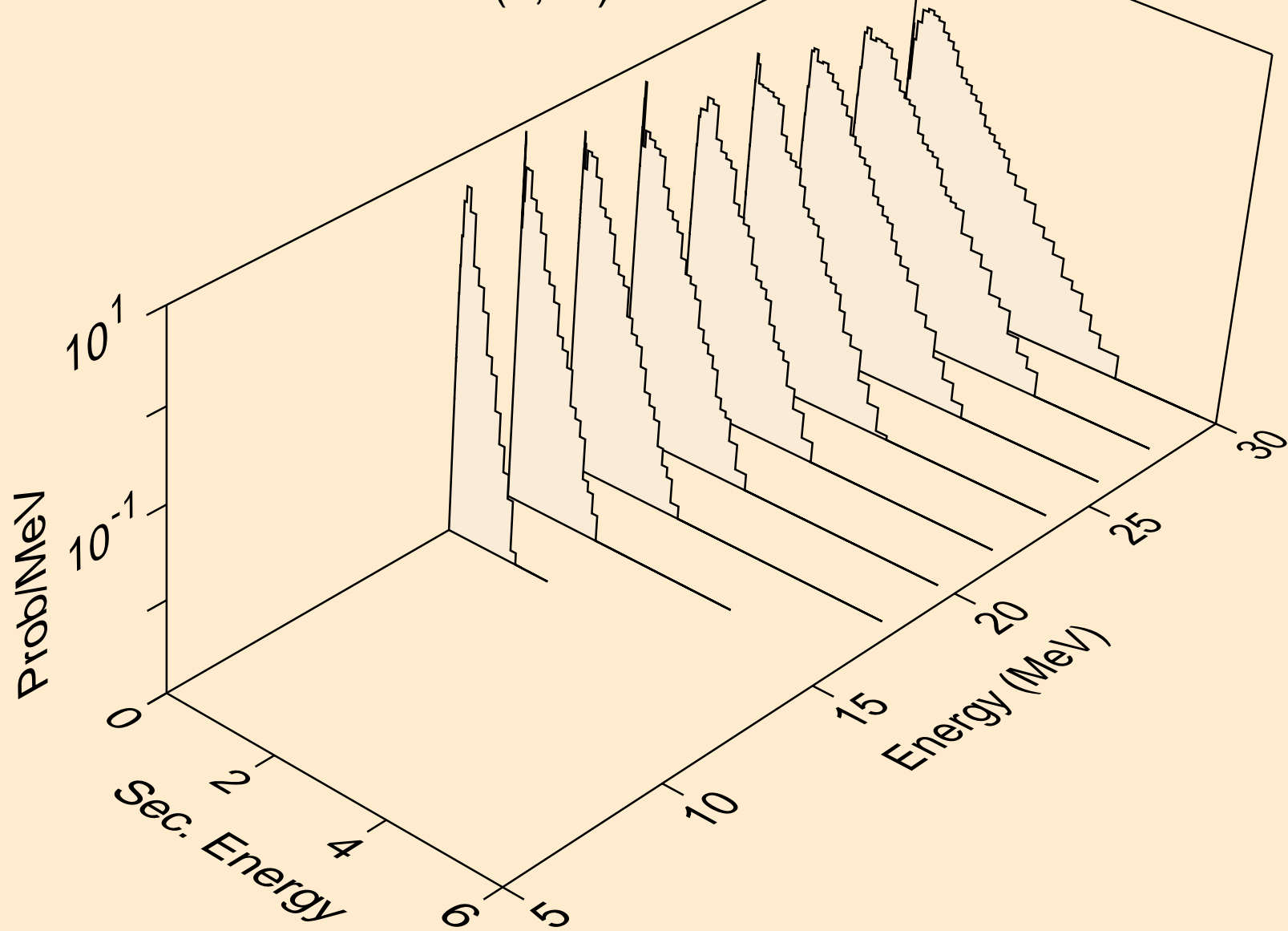

HO173 NEUTRON ACER TENDL-2021 LIBRARY; T=293.6K  
Neutron emission for (n,3n)a

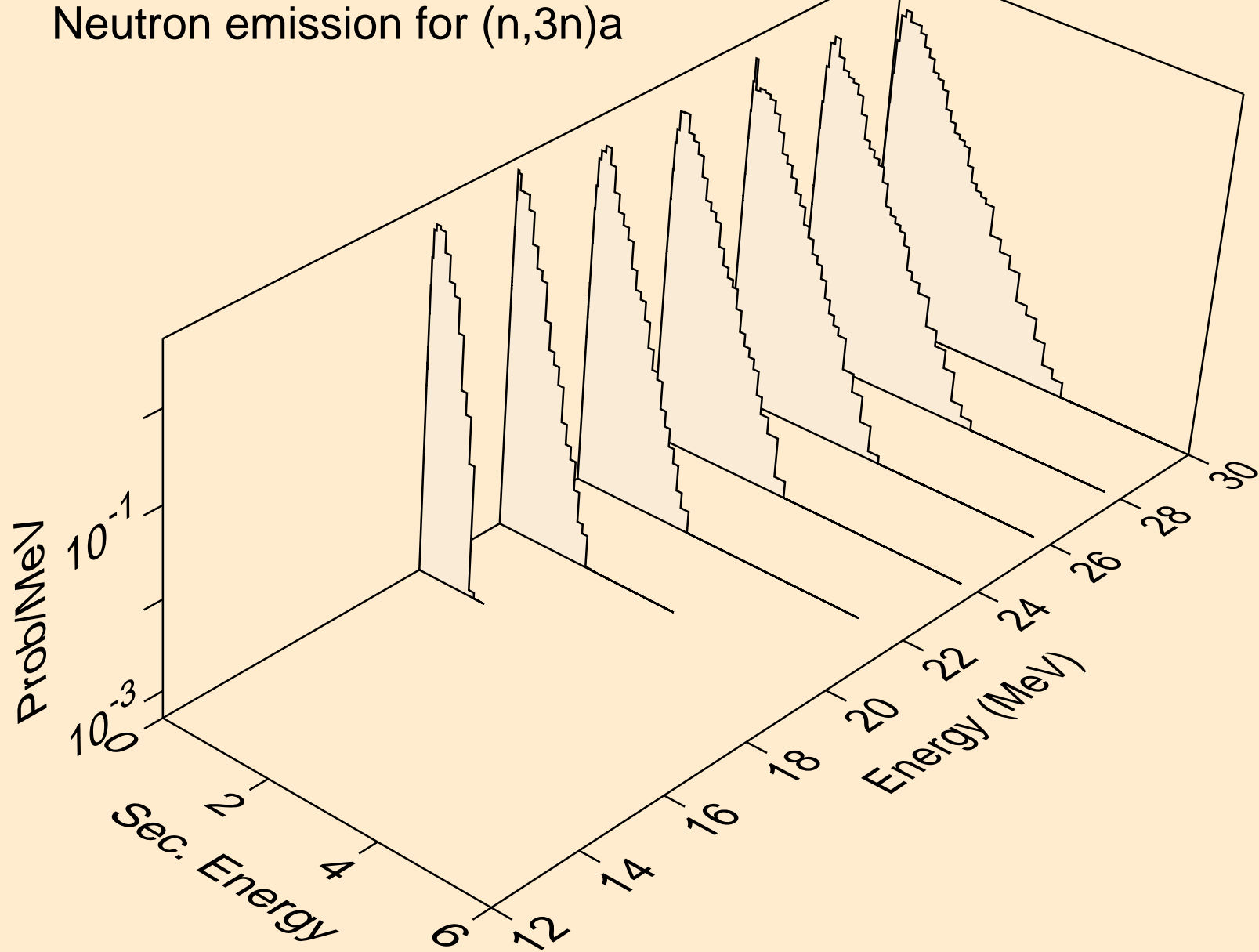



HO173 NEUTRON ACER TENDL-2021 LIBRARY; T=293.6K  
Neutron emission for (n,n\*)p

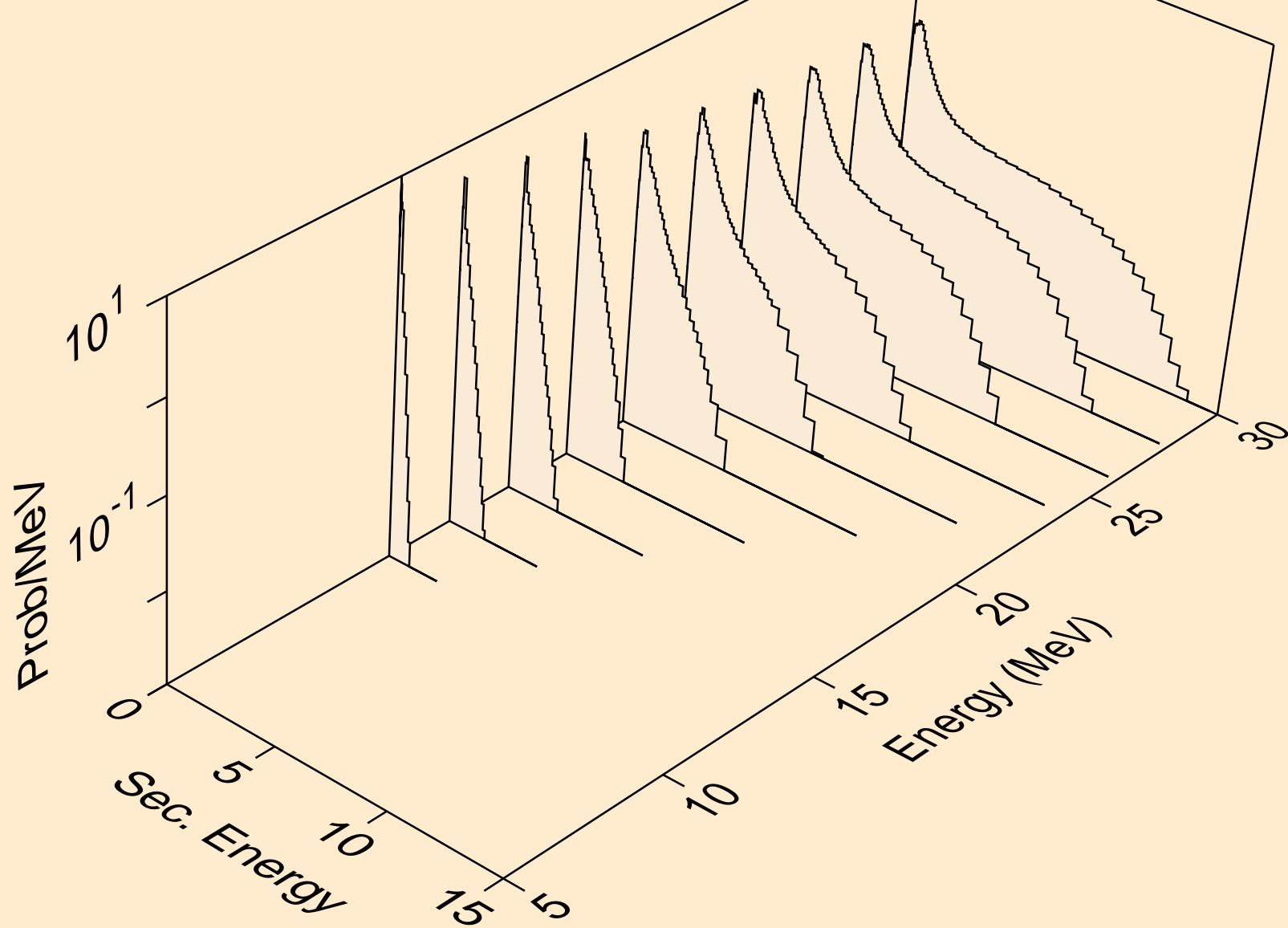

HO173 NEUTRON ACER TENDL-2021 LIBRARY; T=293.6K  
Neutron emission for (n,n\*)d

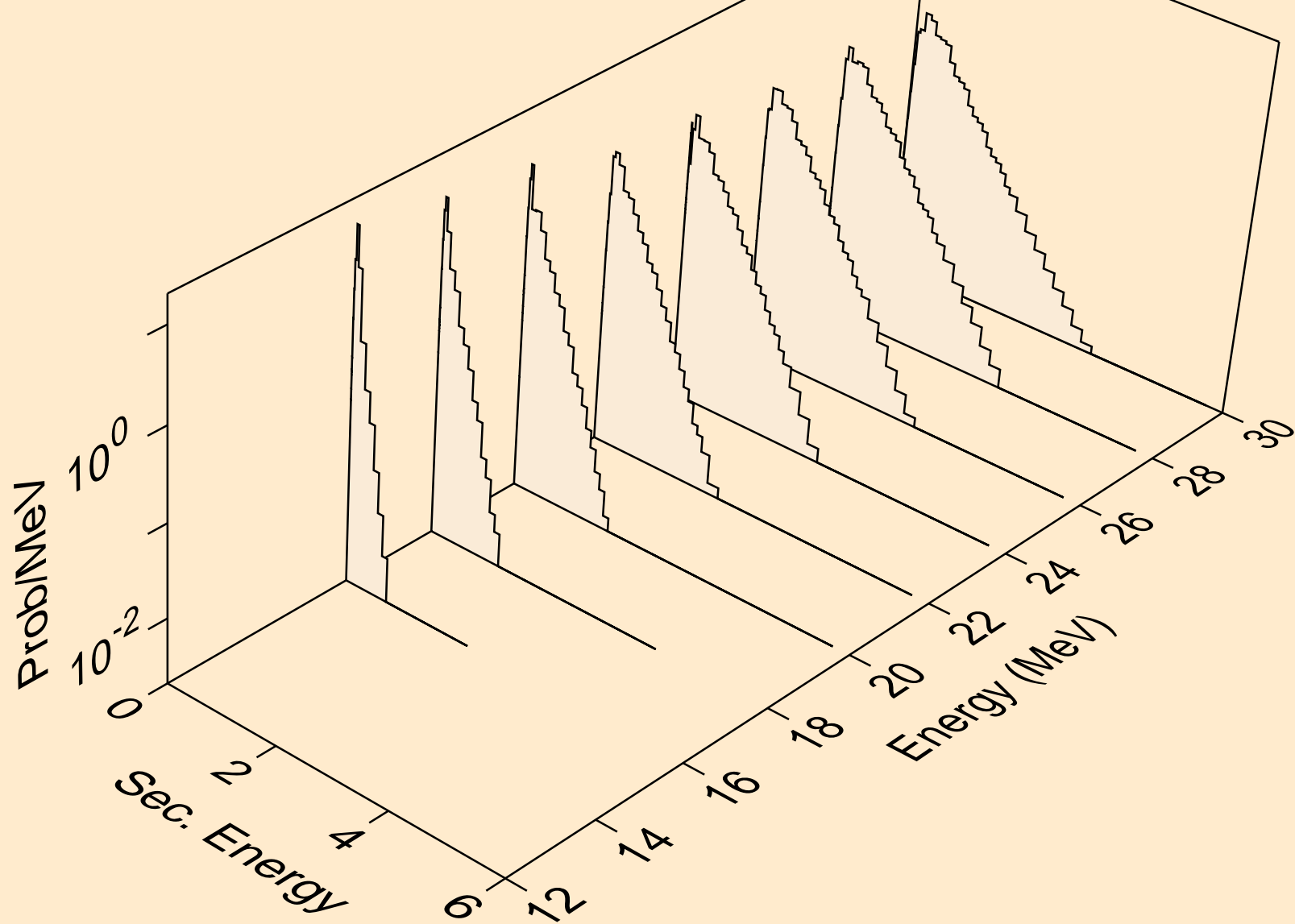

HO173 NEUTRON ACER TENDL-2021 LIBRARY; T=293.6K  
Neutron emission for (n,n\*)t

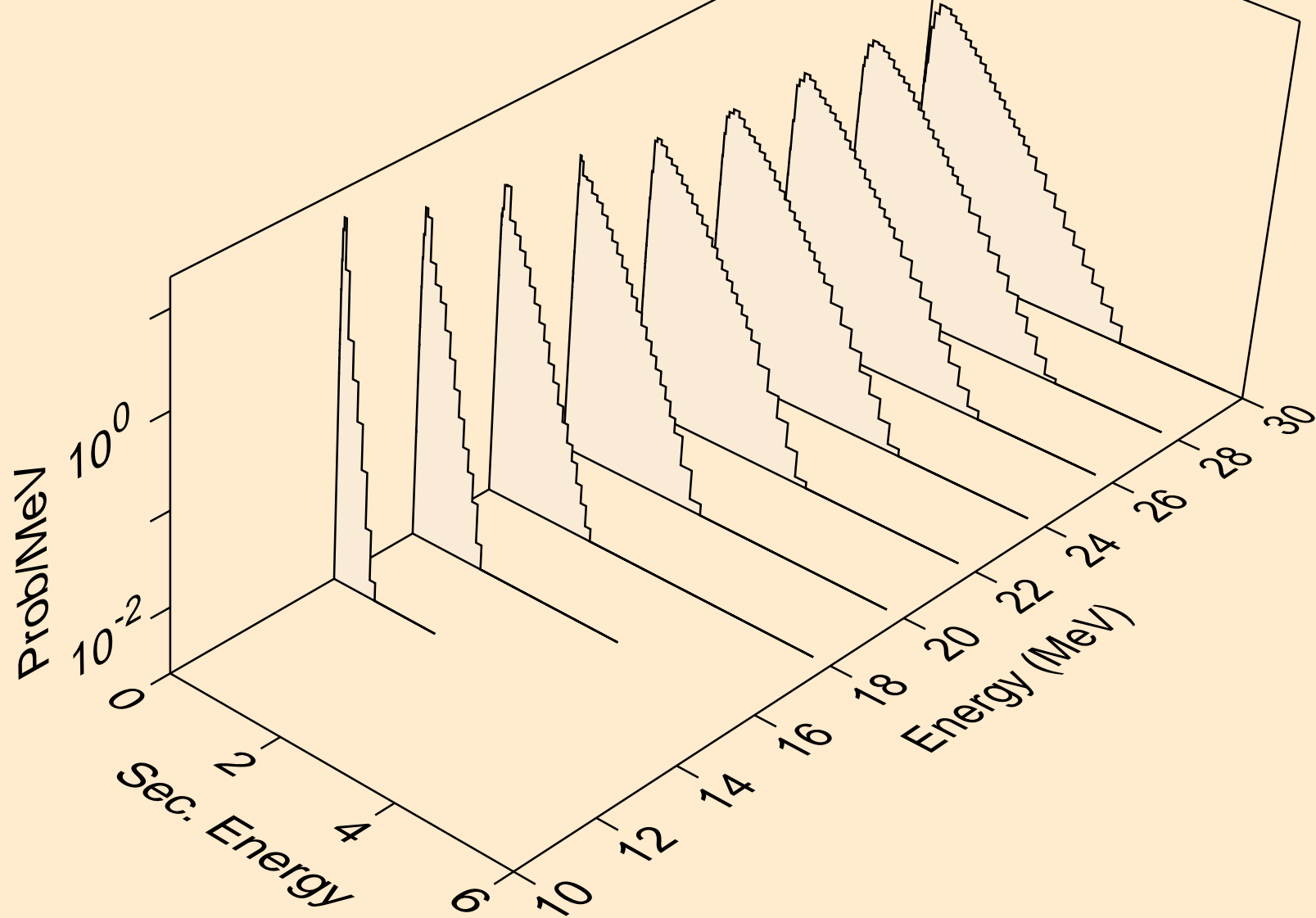

HO173 NEUTRON ACER TENDL-2021 LIBRARY; T=293.6K  
Neutron emission for (n,n\*)he3

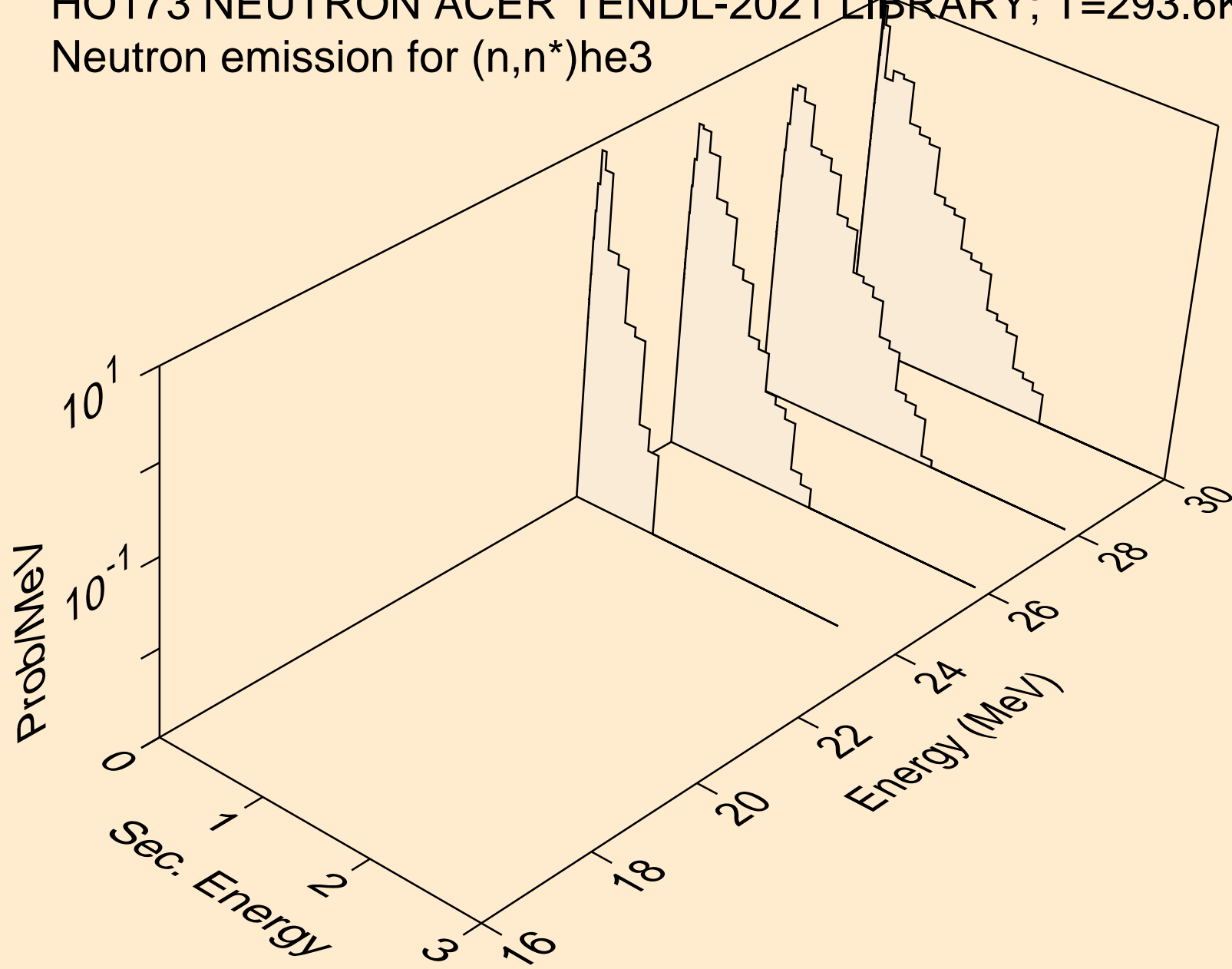

HO173 NEUTRON ACER TENDL-2021 LIBRARY; T=293.6K  
Neutron emission for (n,4n)

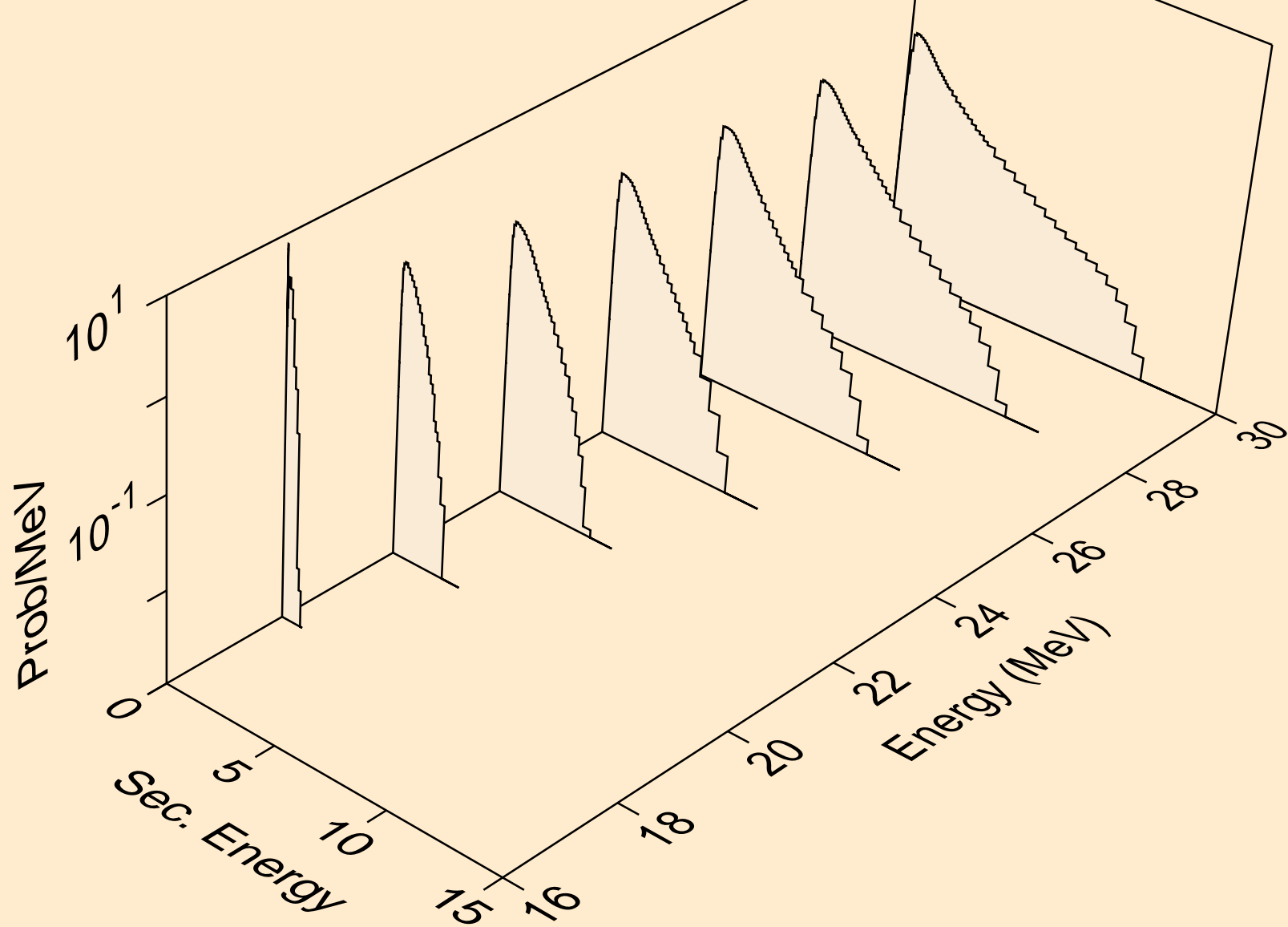

HO173 NEUTRON ACER TENDL-2021 LIBRARY; T=293.6K  
Neutron emission for (n,2np)

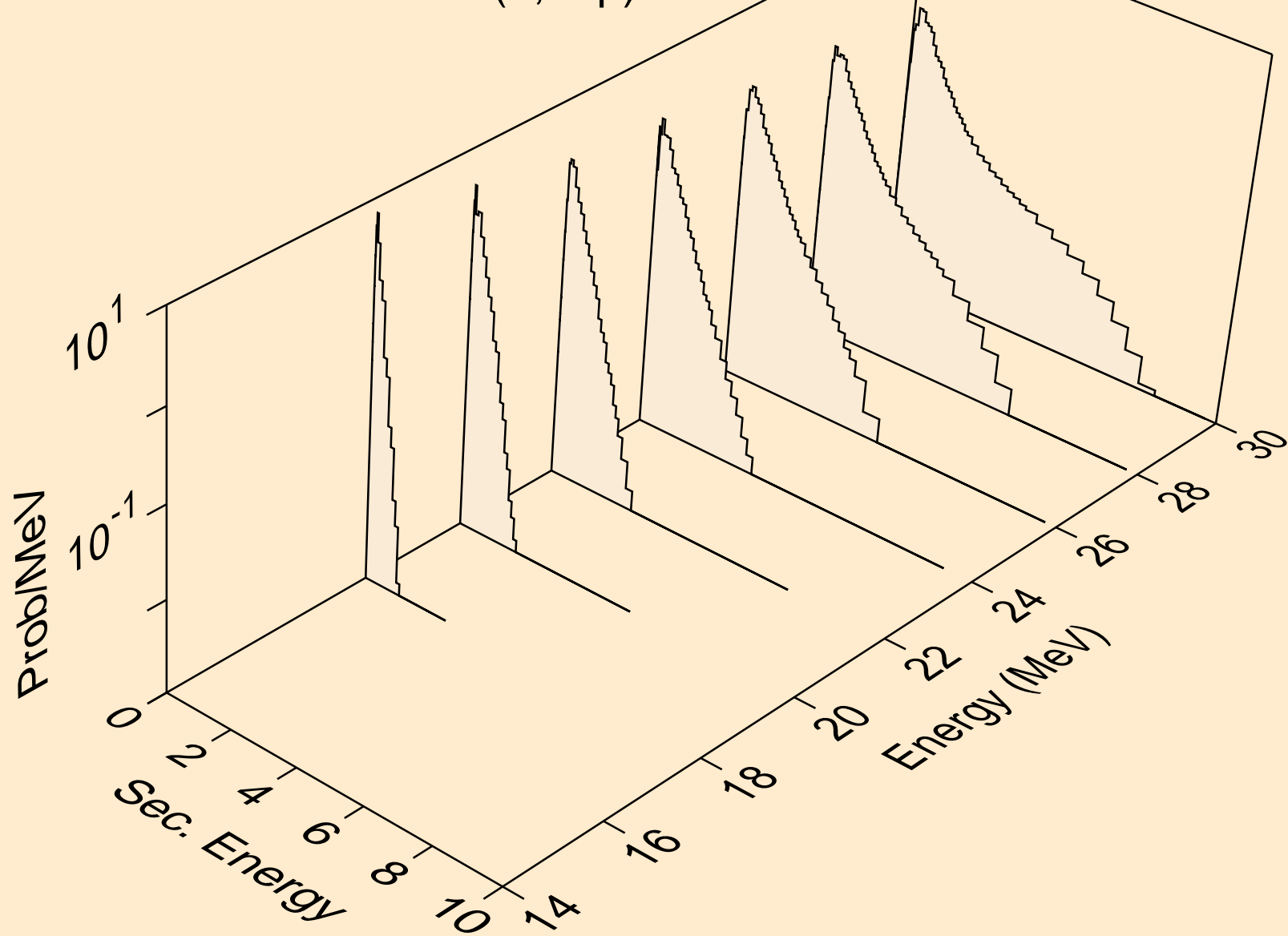

HO173 NEUTRON ACER TENDL-2021 LIBRARY; T=293.6K  
Neutron emission for (n,3np)

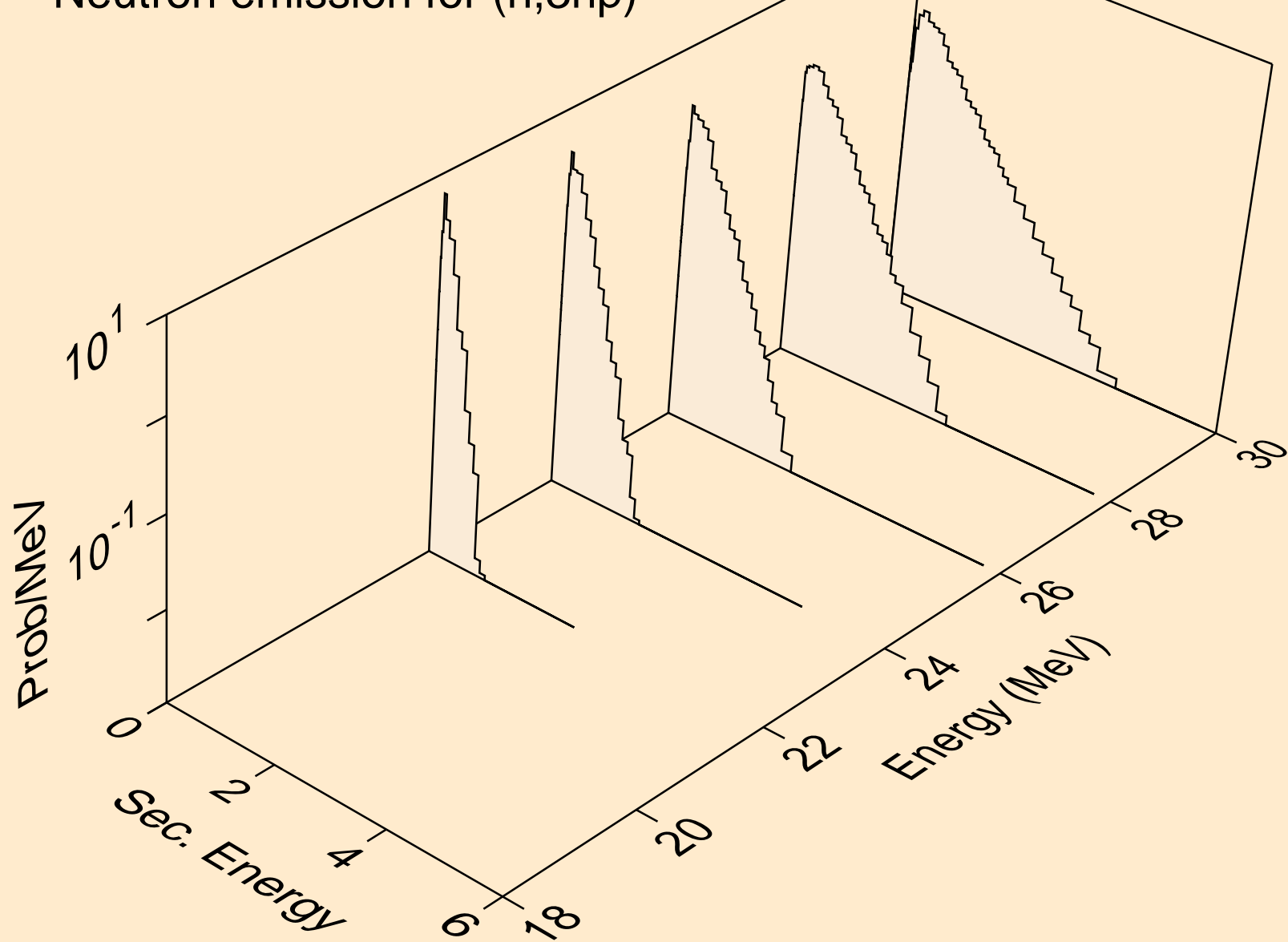

HO173 NEUTRON ACER TENDL-2021 LIBRARY; T=293.6K  
Neutron emission for (n,n\*c)

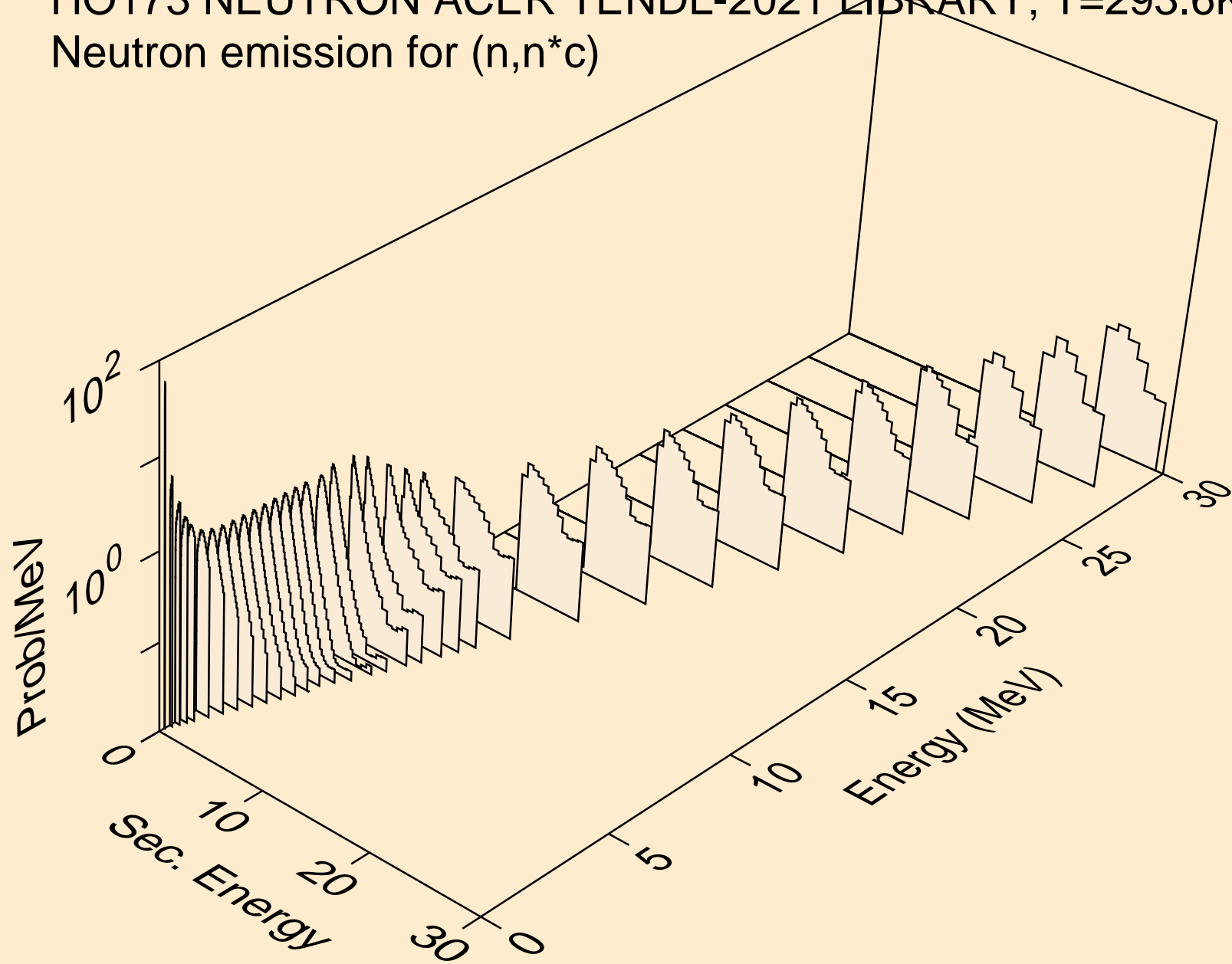



HO173 NEUTRON ACER TENDL-2021 LIBRARY; T=293.6K  
Photon emission for (n,x)

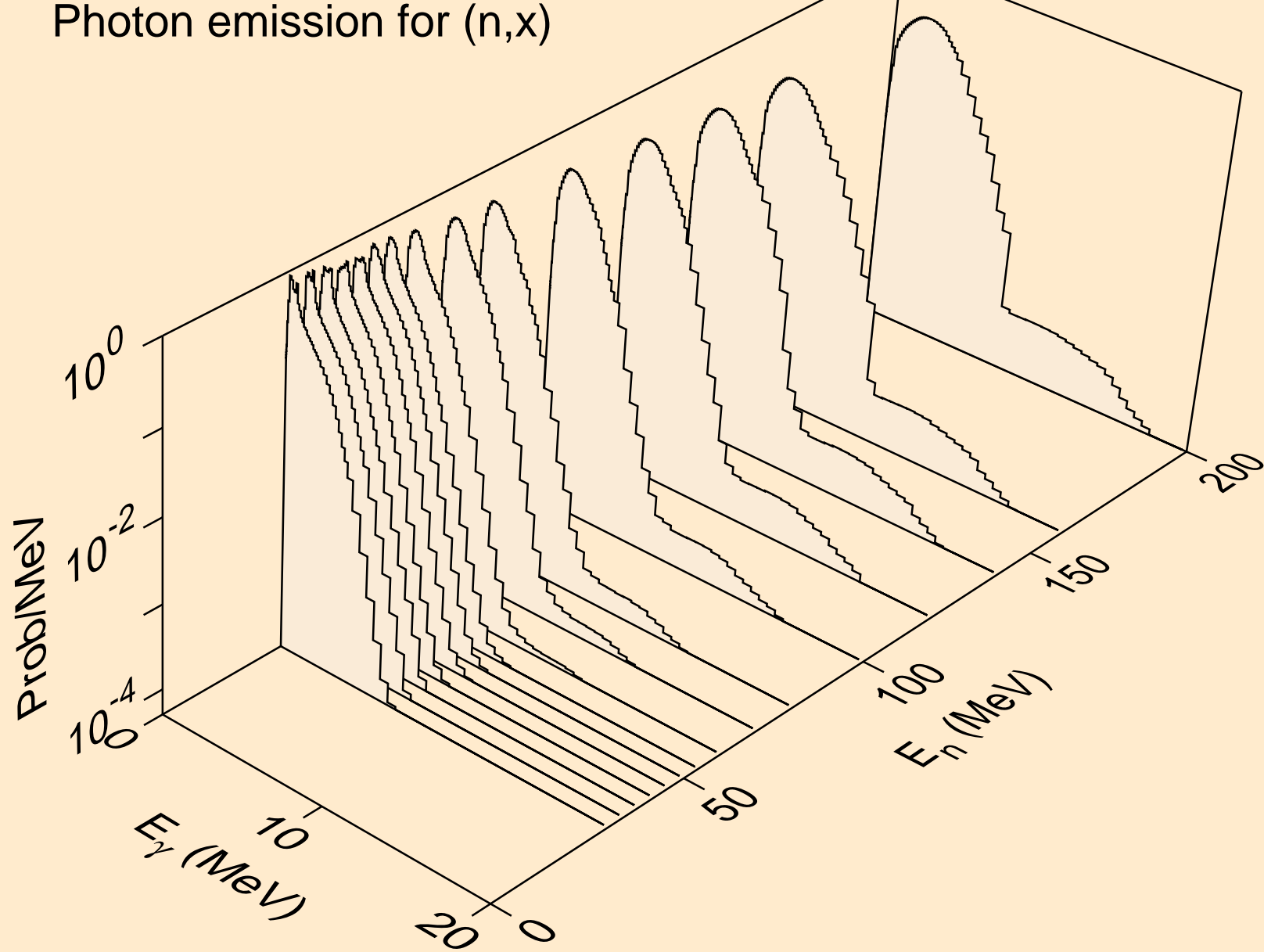

HO173 NEUTRON ACER TENDL-2021 LIBRARY; T=293.6K  
Photon emission for (n,2nd)

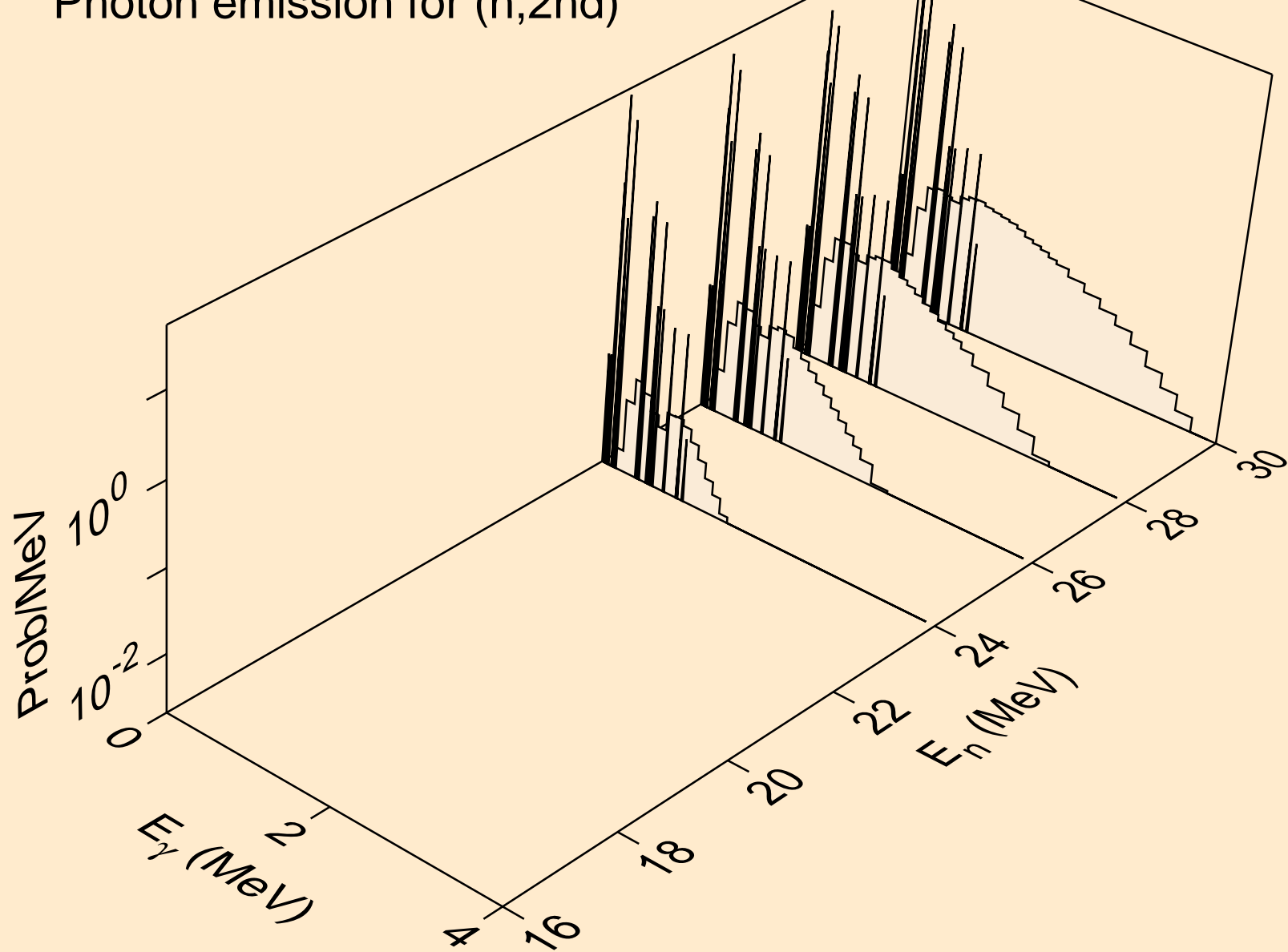

HO173 NEUTRON ACER TENDL-2021 LIBRARY; T=293.6K  
Photon emission for (n,2n)

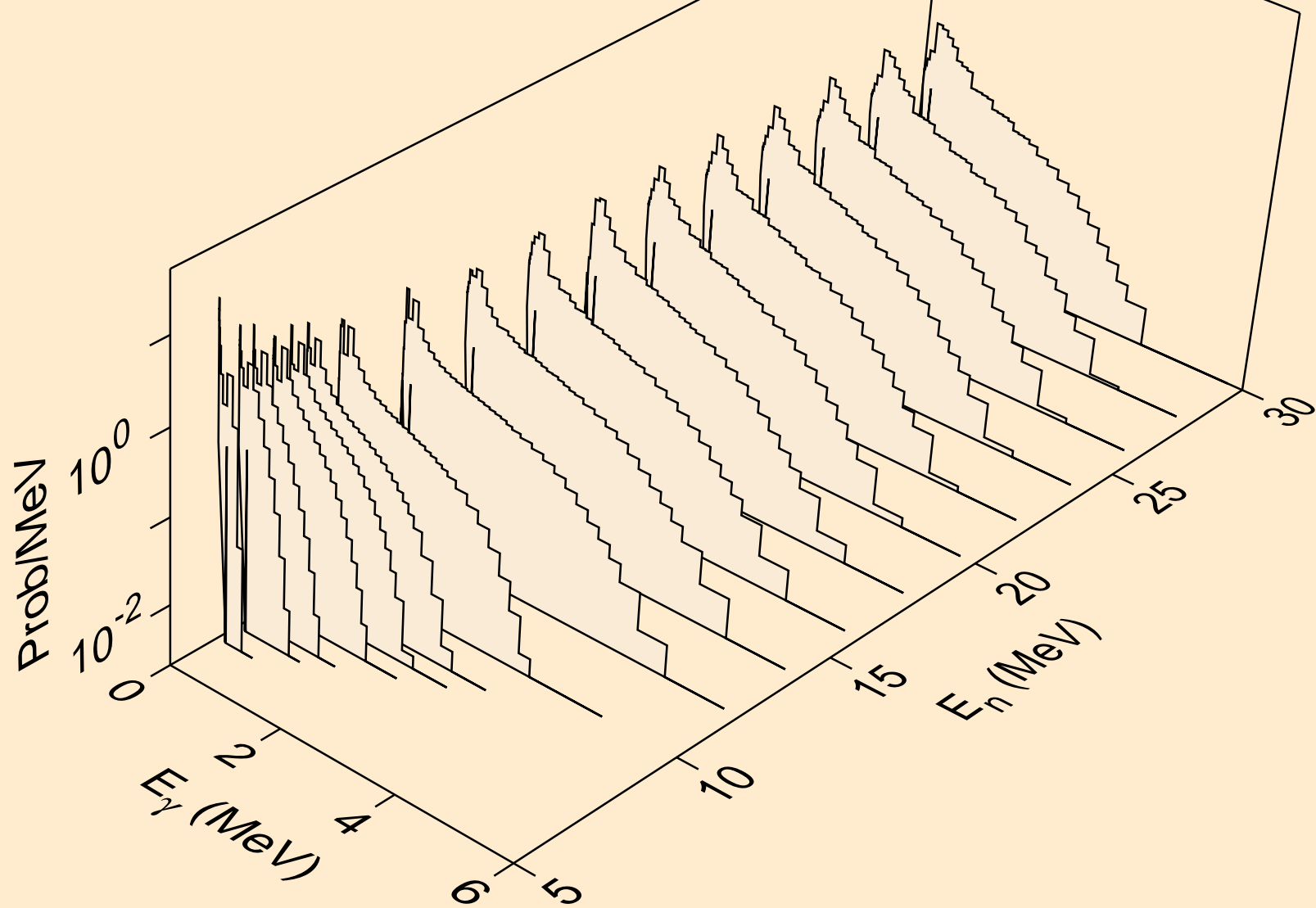

HO173 NEUTRON ACER TENDL-2021 LIBRARY; T=293.6K  
Photon emission for (n,3n)

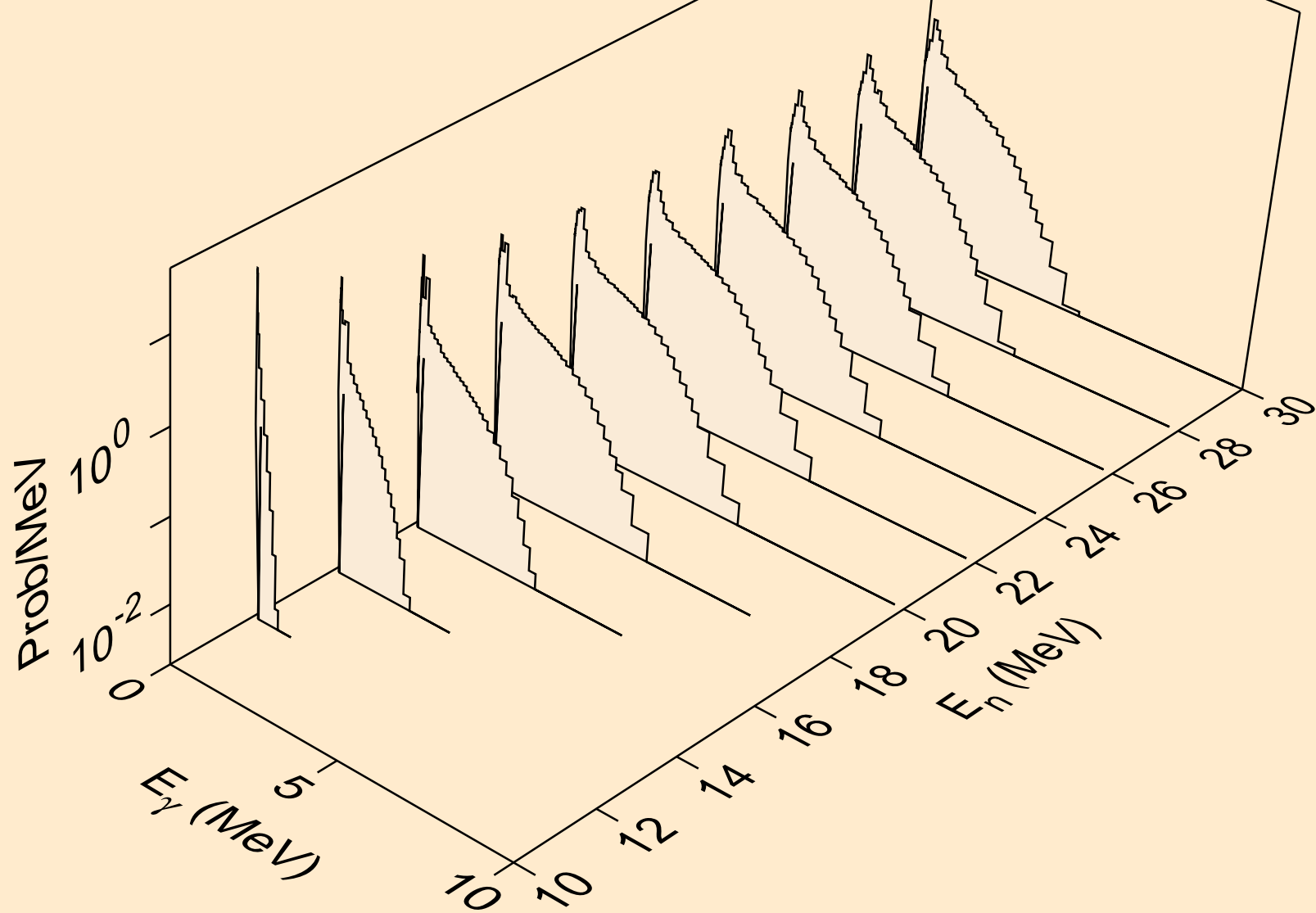

HO173 NEUTRON ACER TENDL-2021 LIBRARY; T=293.6K  
Photon emission for (n,n\*)a

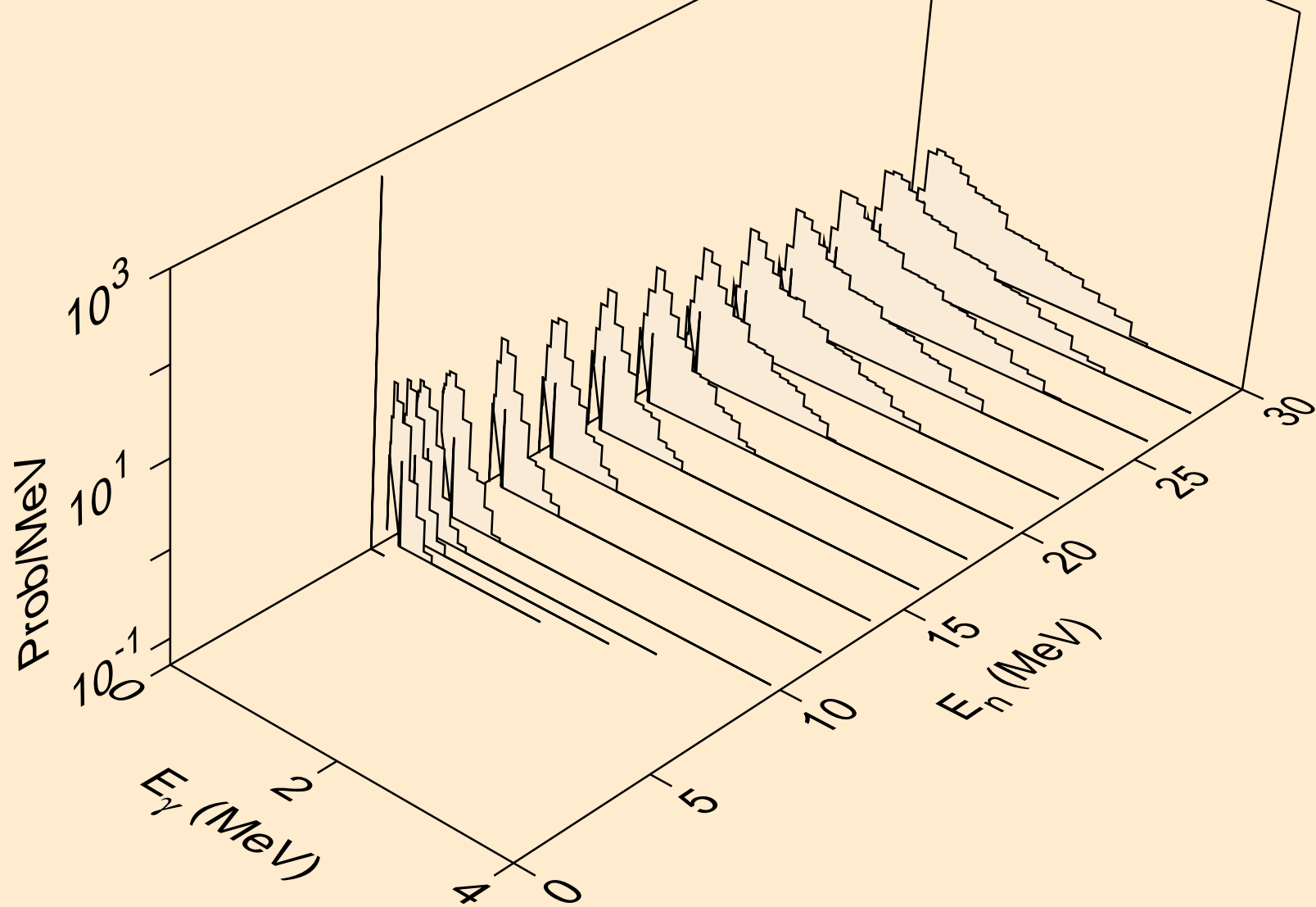

HO173 NEUTRON ACER TENDL-2021 LIBRARY; T=293.6K  
Photon emission for (n,2n)a

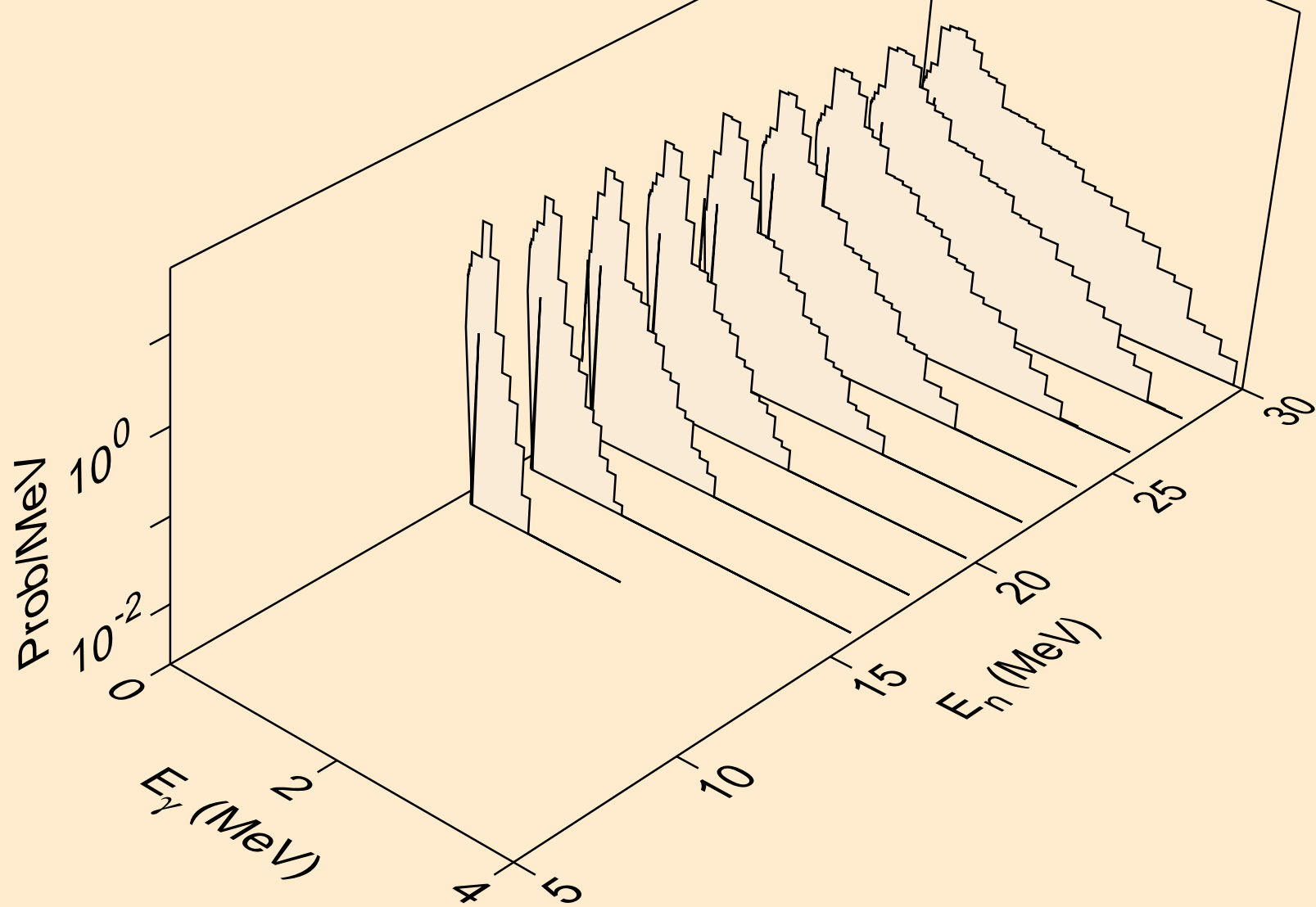

HO173 NEUTRON ACER TENDL-2021 LIBRARY; T=293.6K  
Photon emission for (n,3n)a

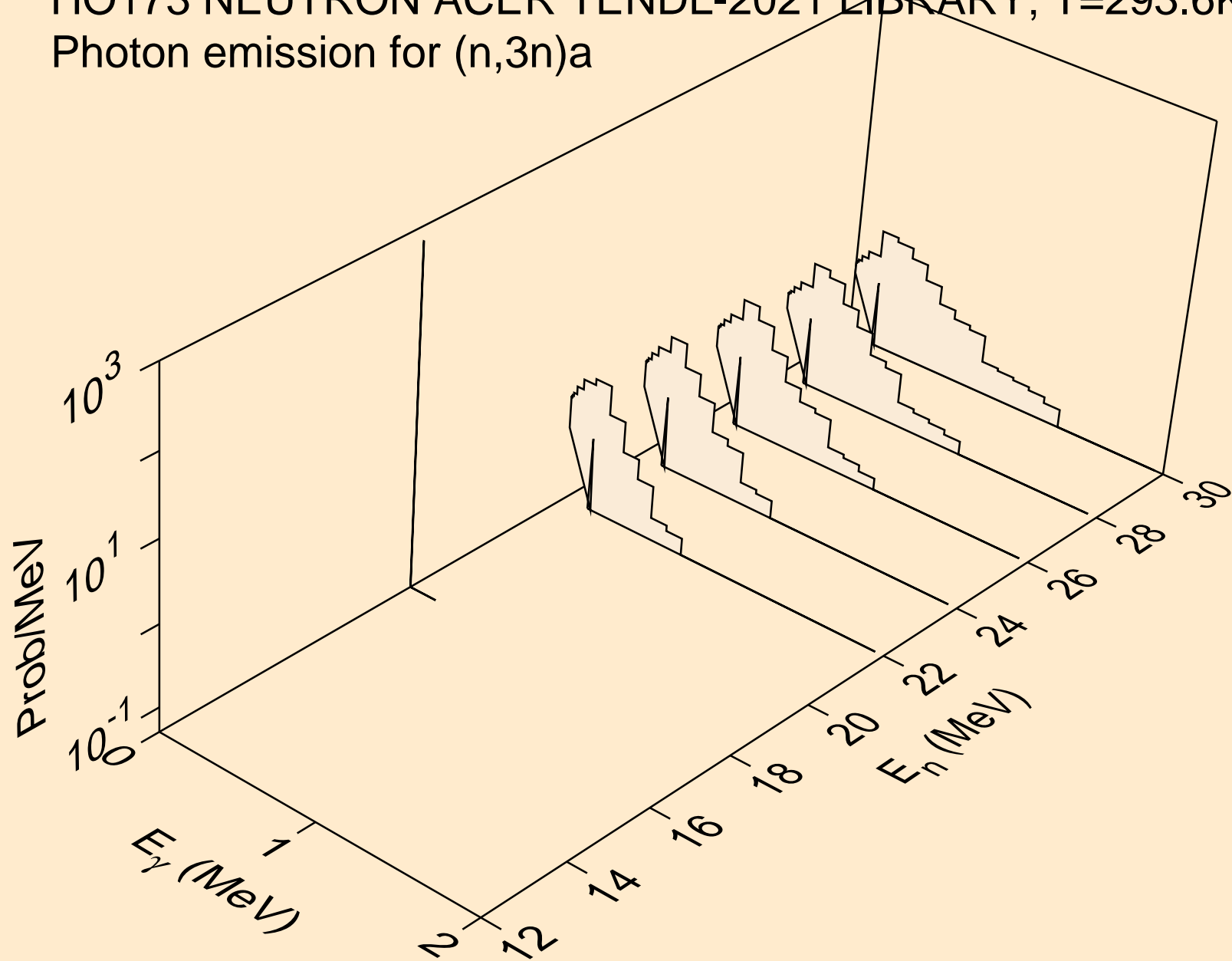

HO173 NEUTRON ACER TENDL-2021 LIBRARY; T=293.6K  
Photon emission for (n,n\*)p

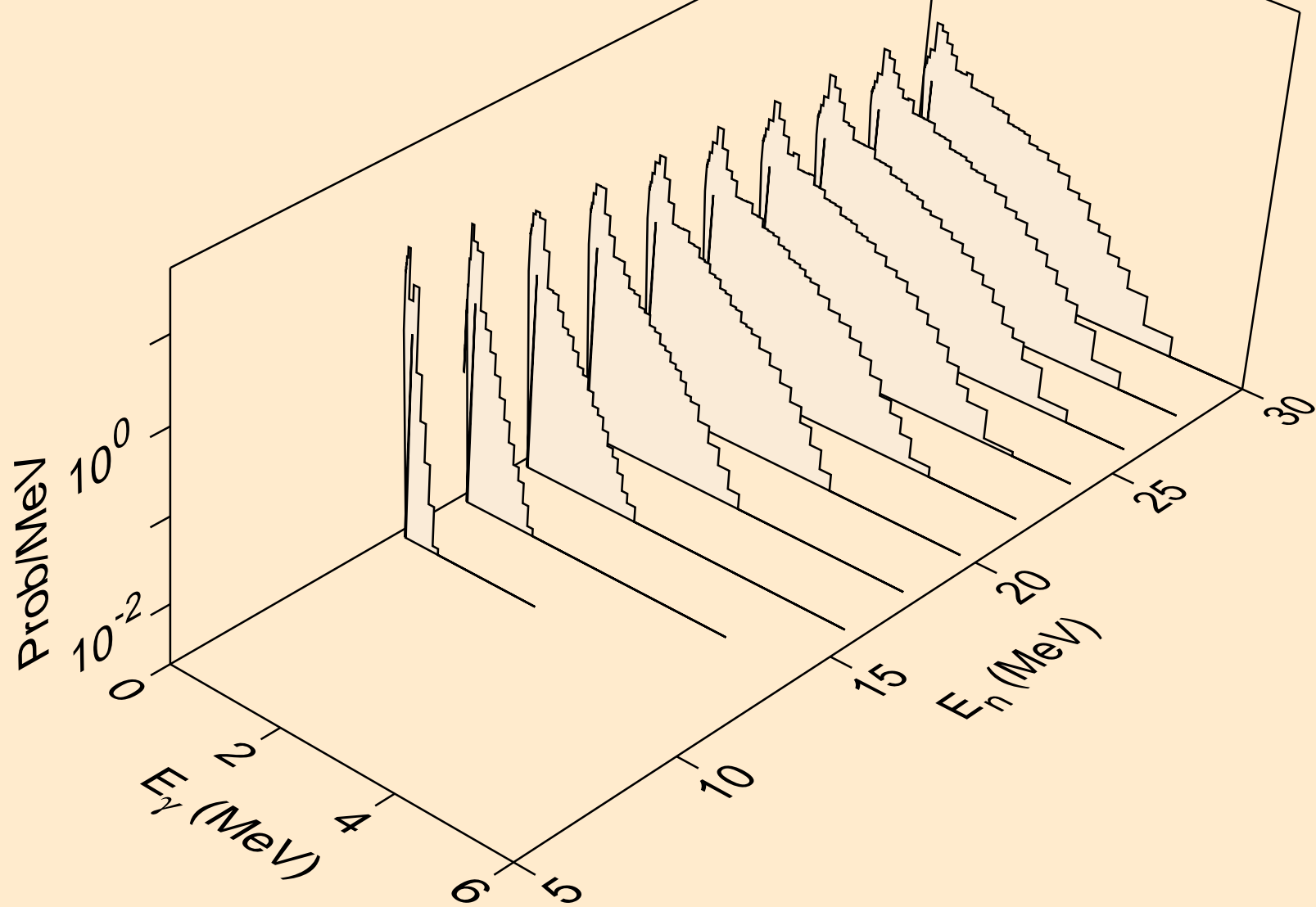



HO173 NEUTRON ACER TENDL-2021 LIBRARY; T=293.6K  
Photon emission for (n,n\*)d

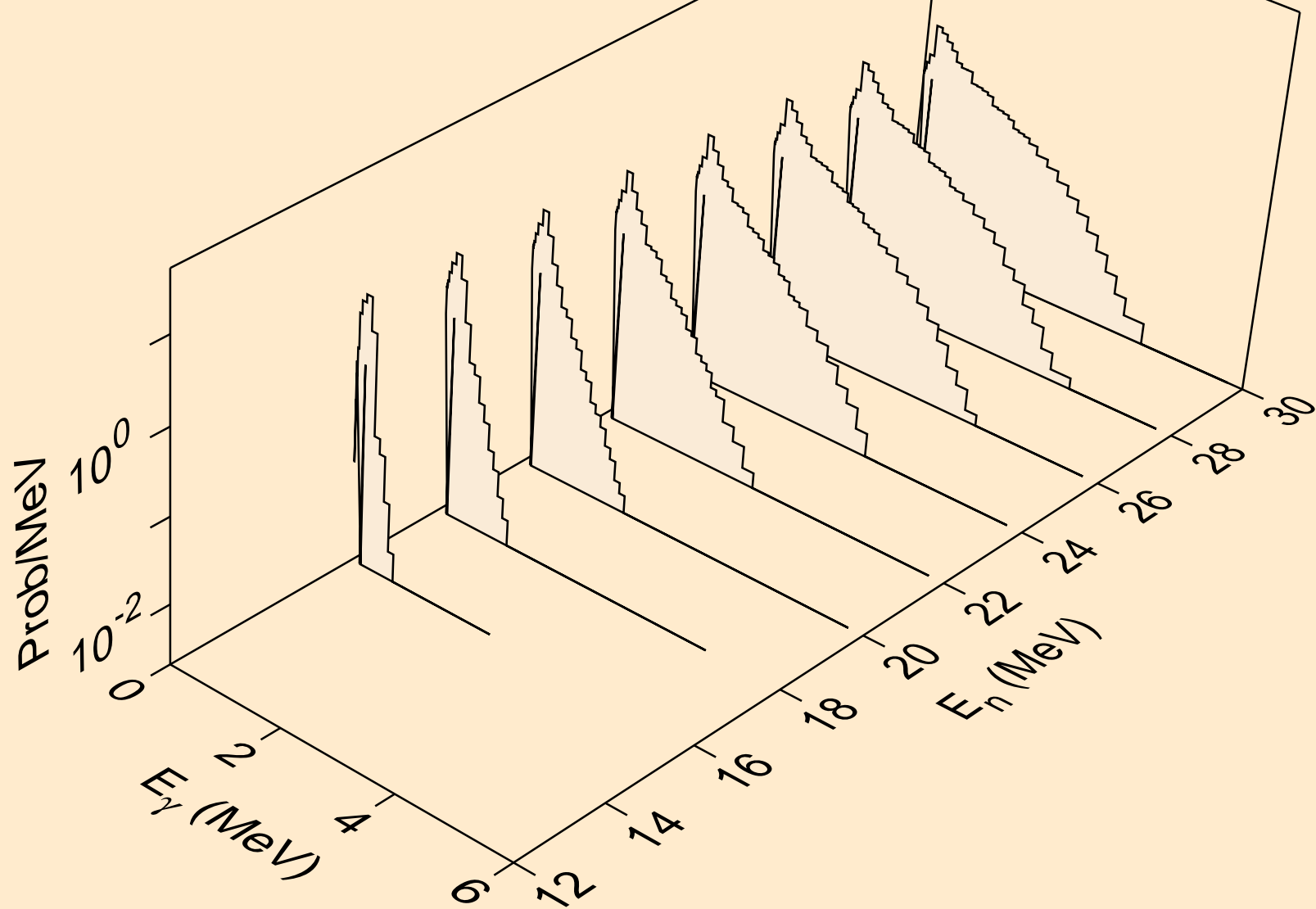

HO173 NEUTRON ACER TENDL-2021 LIBRARY; T=293.6K  
Photon emission for (n,n\*)t

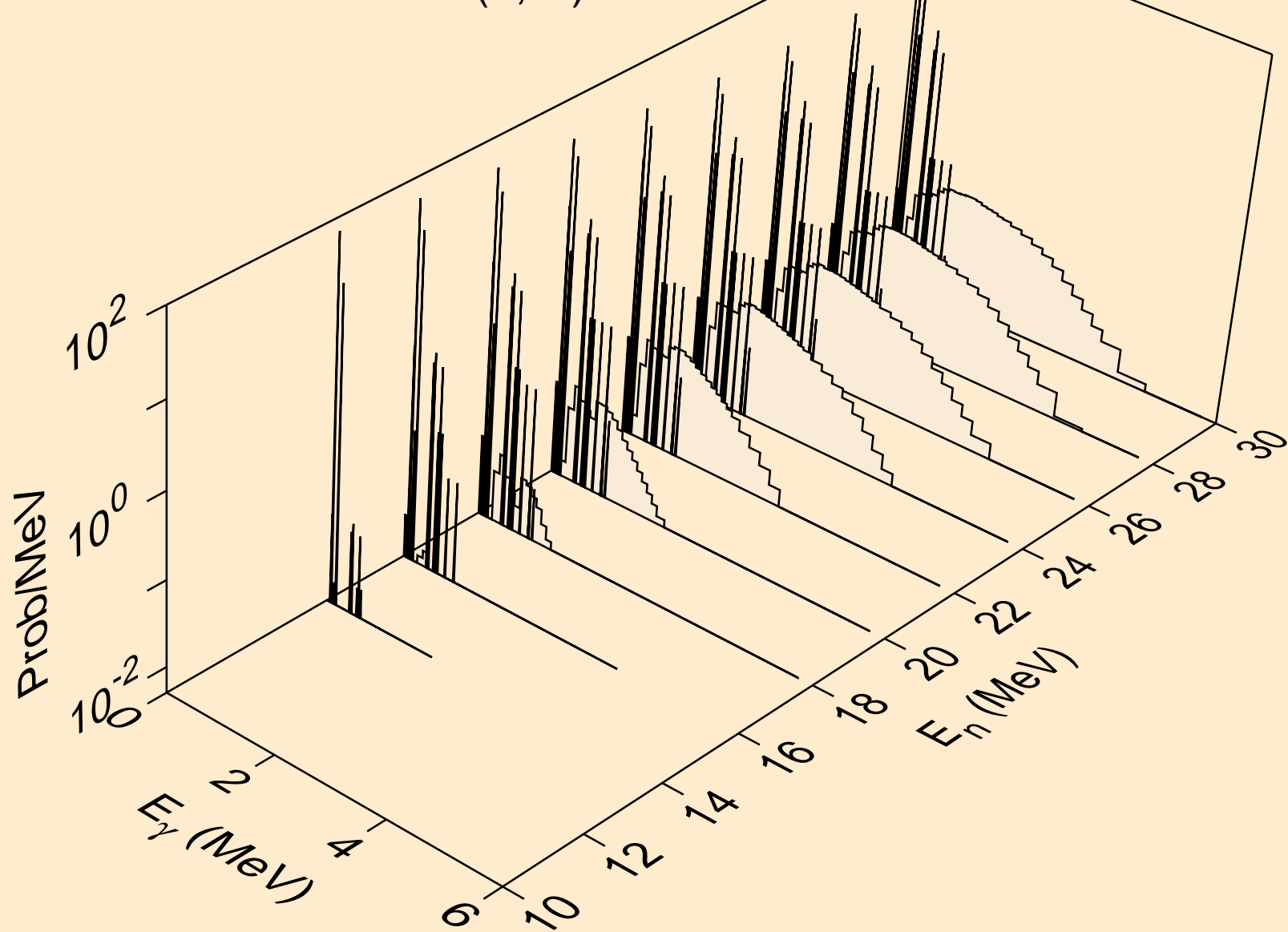

HO173 NEUTRON ACER TENDL-2021 LIBRARY; T=293.6K  
Photon emission for (n,n\*)he3

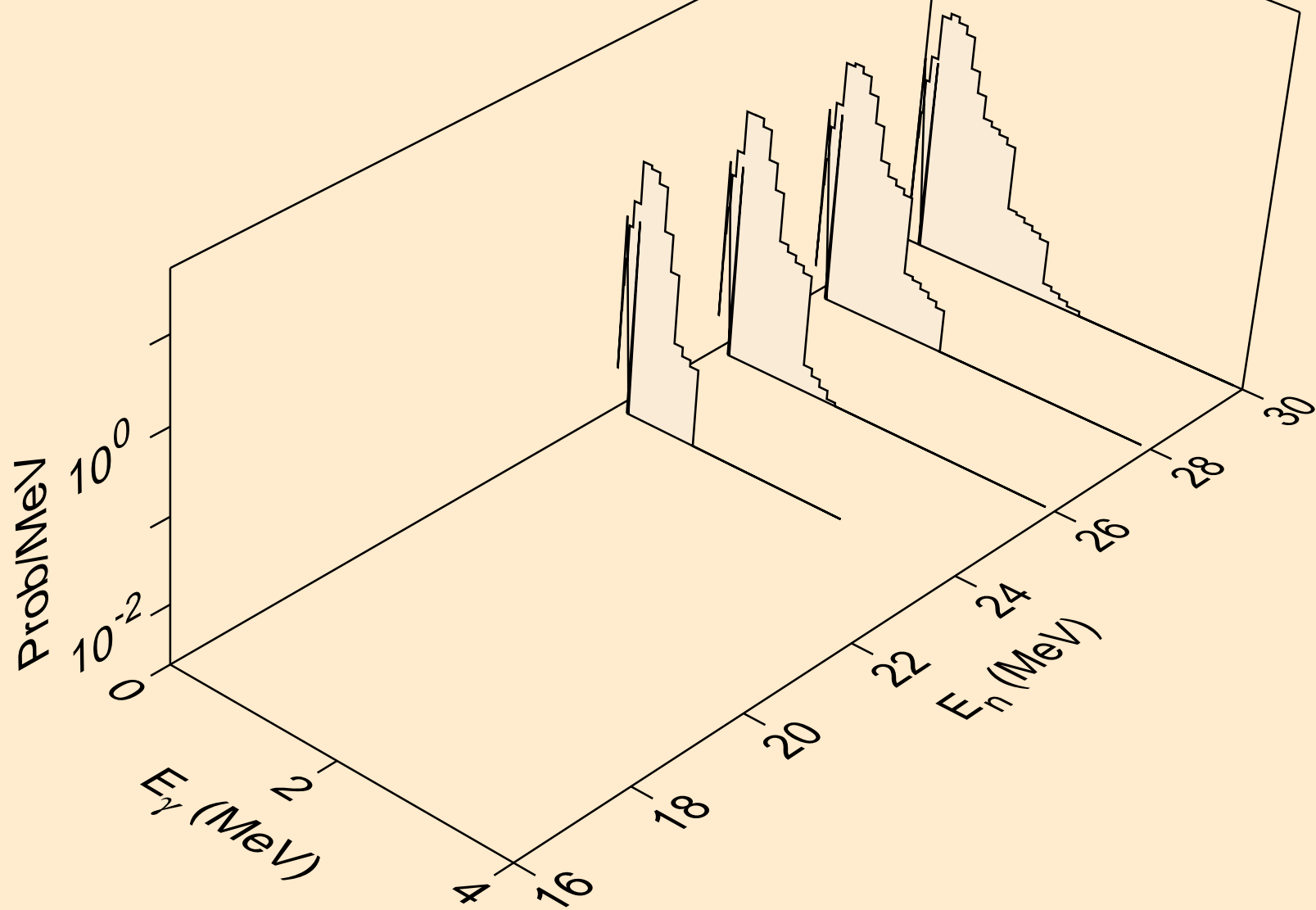

HO173 NEUTRON ACER TENDL-2021 LIBRARY; T=293.6K  
Photon emission for (n,4n)

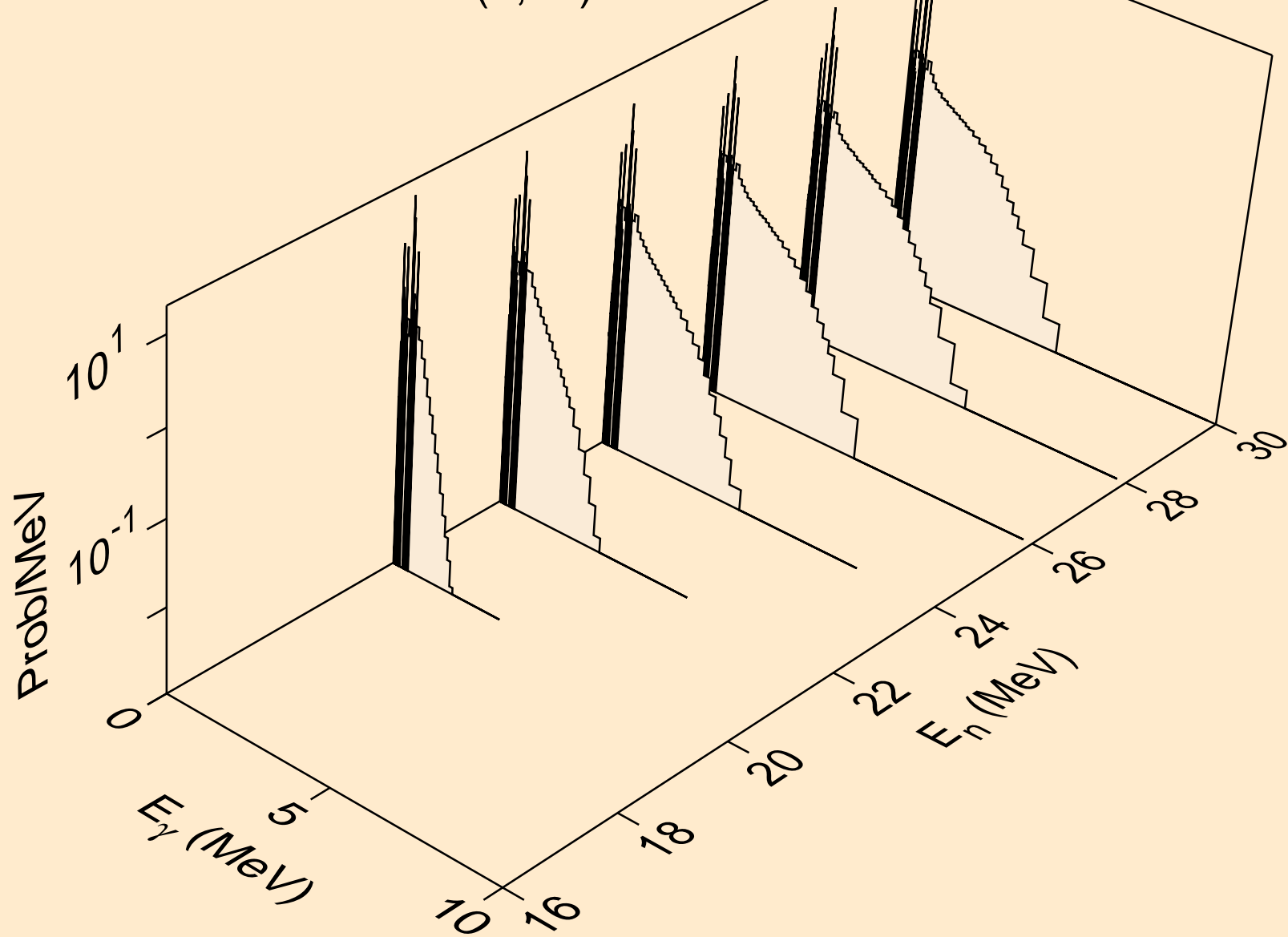

HO173 NEUTRON ACER TENDL-2021 LIBRARY; T=293.6K  
Photon emission for (n,2np)

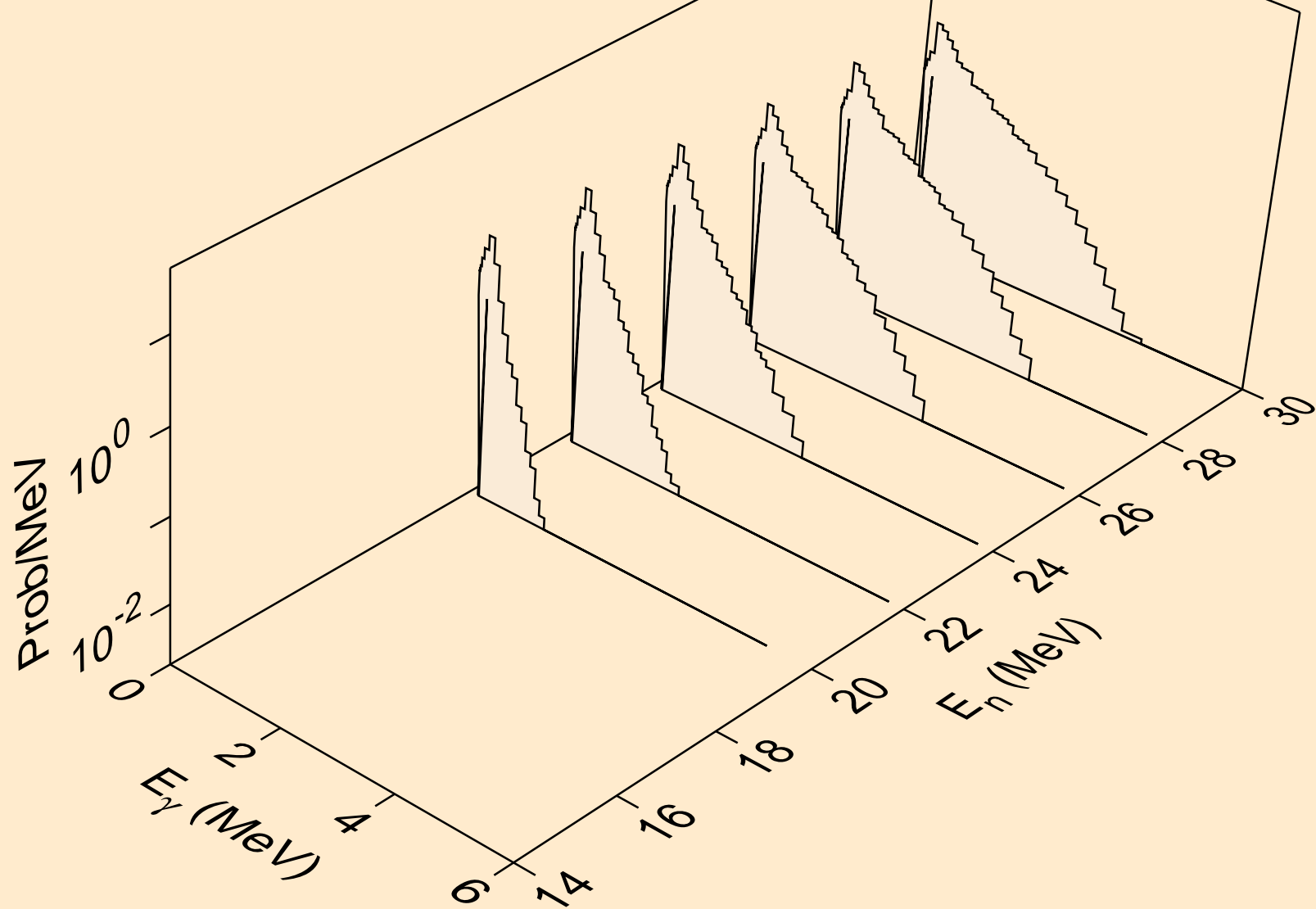

HO173 NEUTRON ACER TENDL-2021 LIBRARY; T=293.6K  
Photon emission for (n,3np)

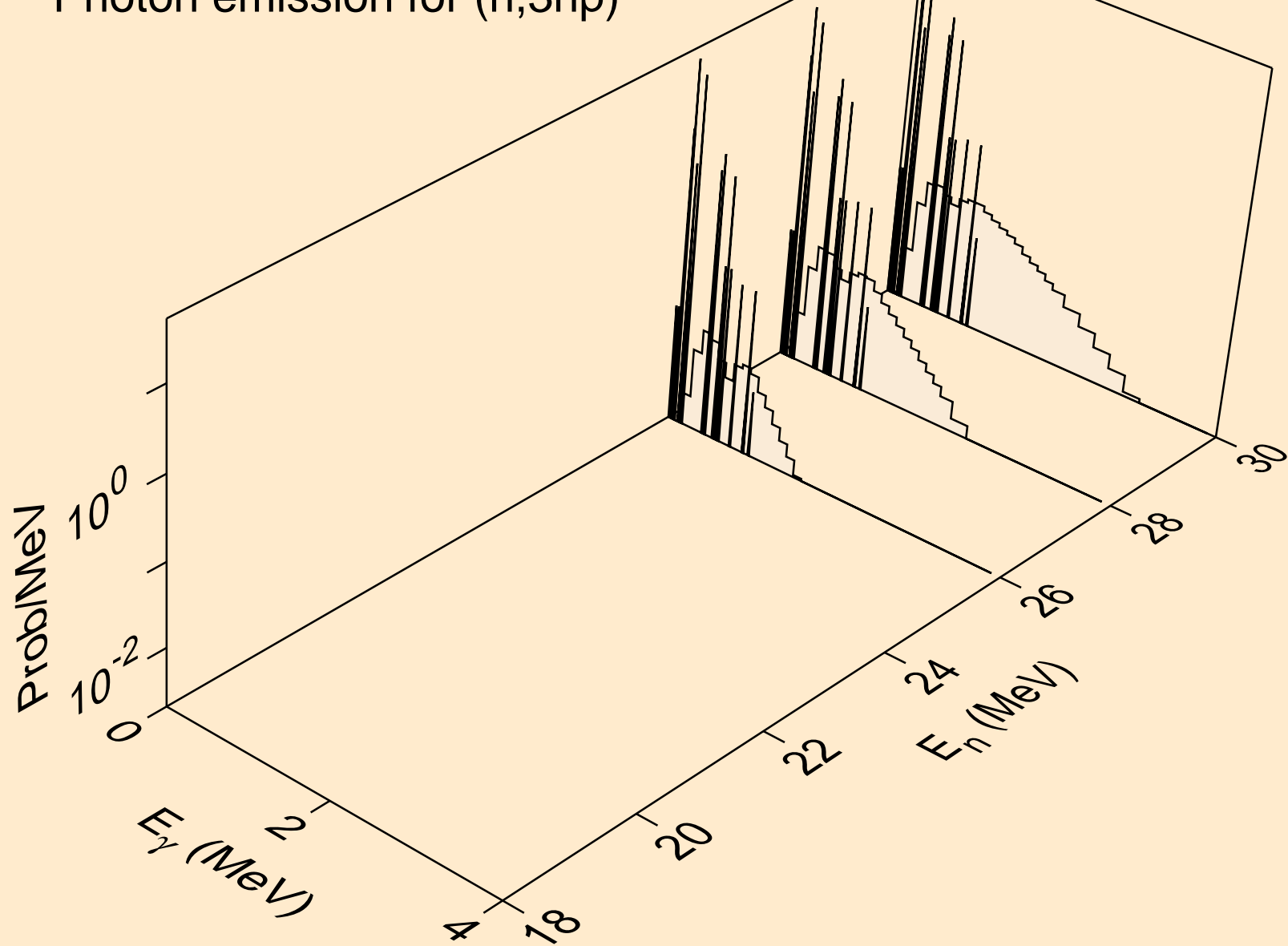

HO173 NEUTRON ACER TENDL-2021 LIBRARY; T=293.6K  
Photon emission for (n,n\*c)

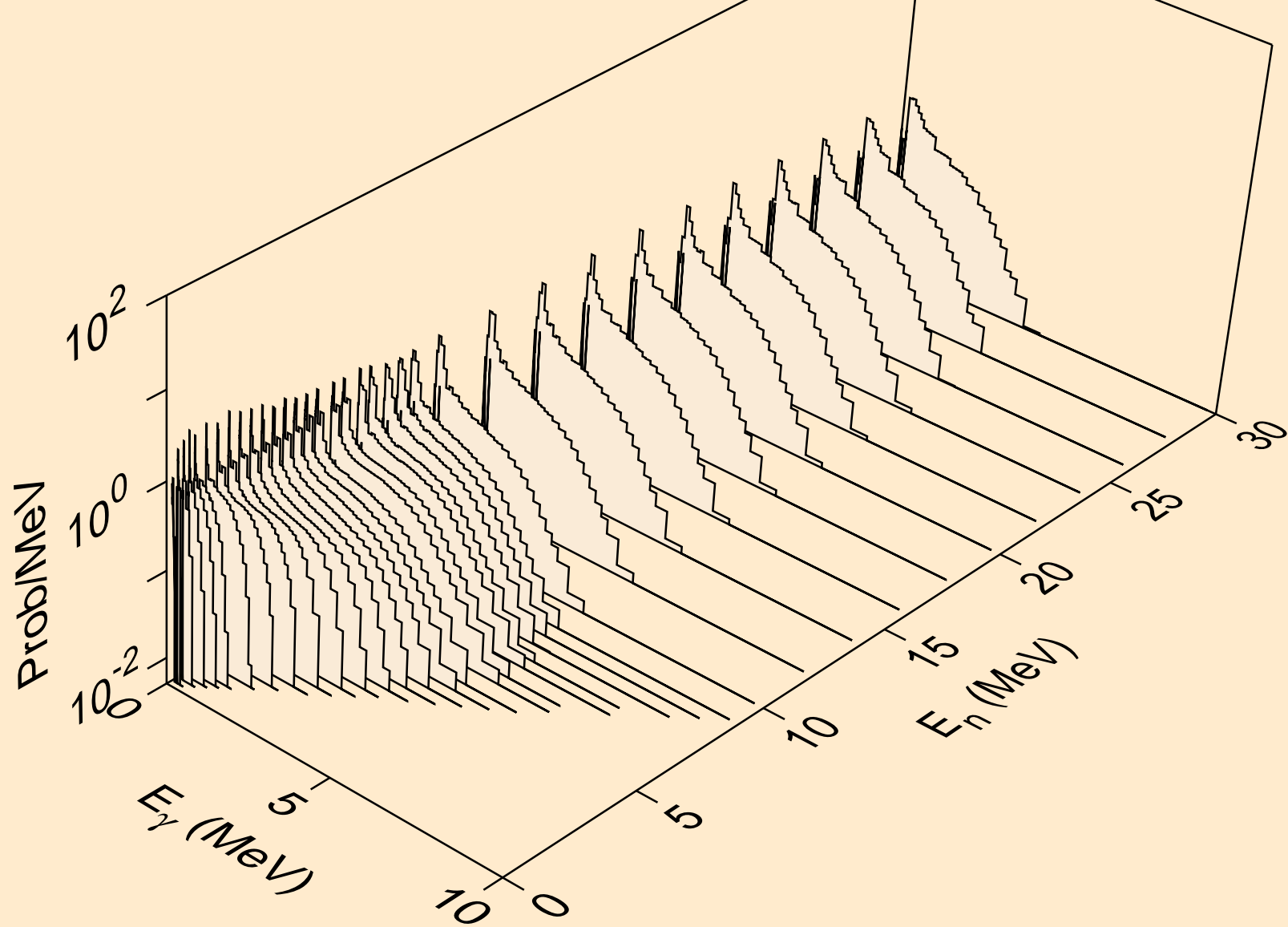

HO173 NEUTRON ACER TENDL-2021 LIBRARY; T=293.6K  
Photon emission for (n,gma)

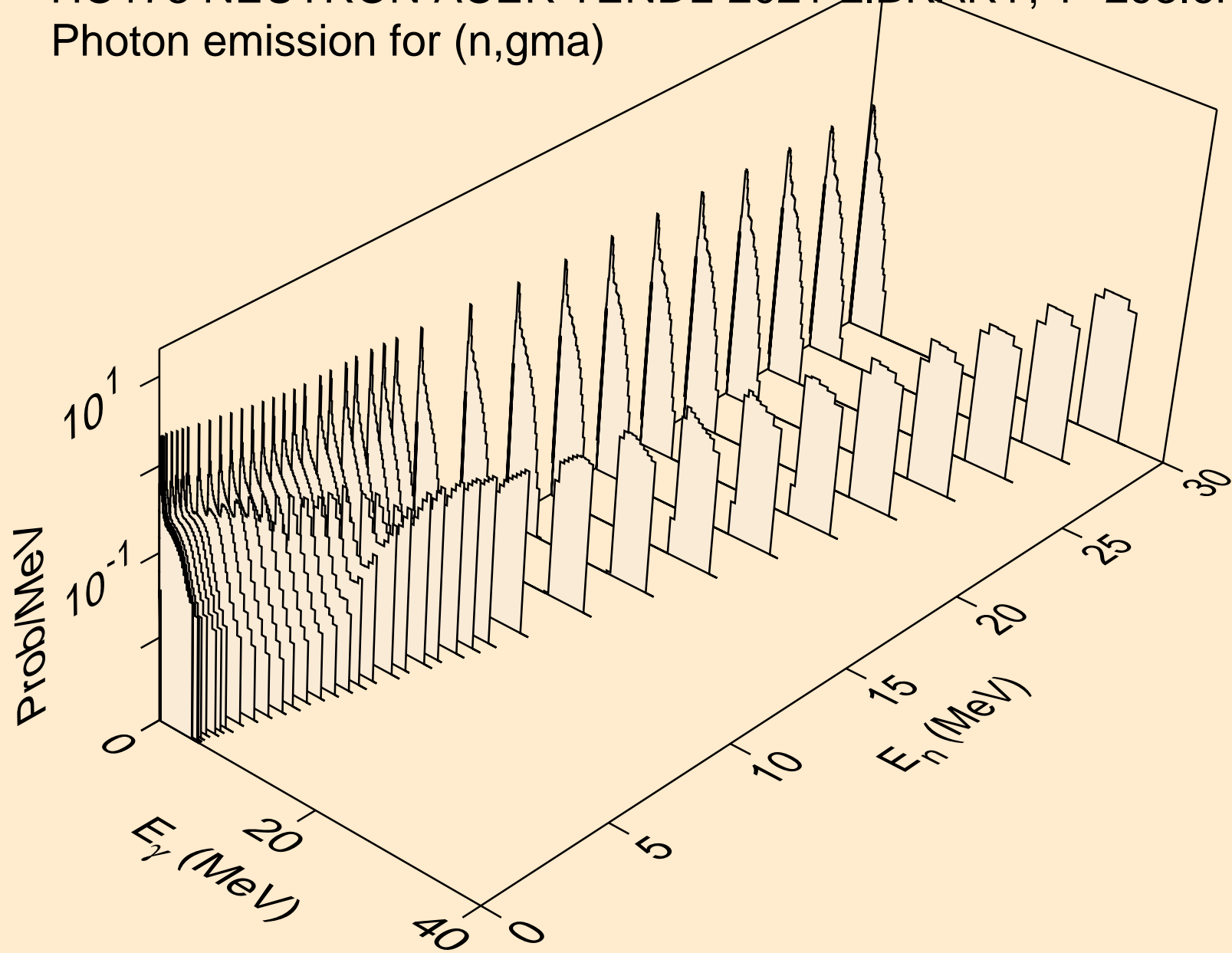



HO173 NEUTRON ACER TENDL-2021 LIBRARY; T=293.6K  
Photon emission for (n,p)

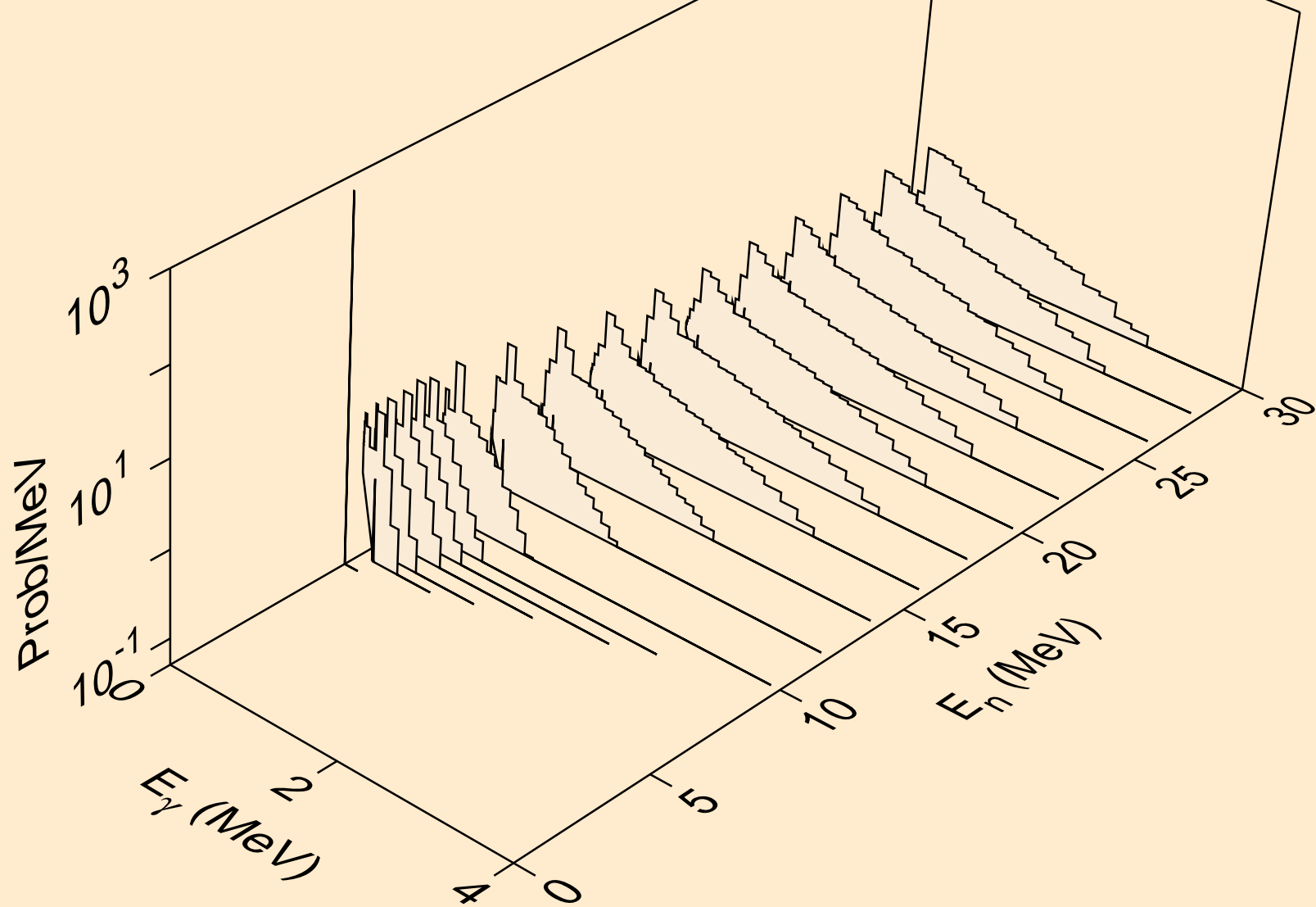

HO173 NEUTRON ACER TENDL-2021 LIBRARY; T=293.6K  
Photon emission for (n,d)

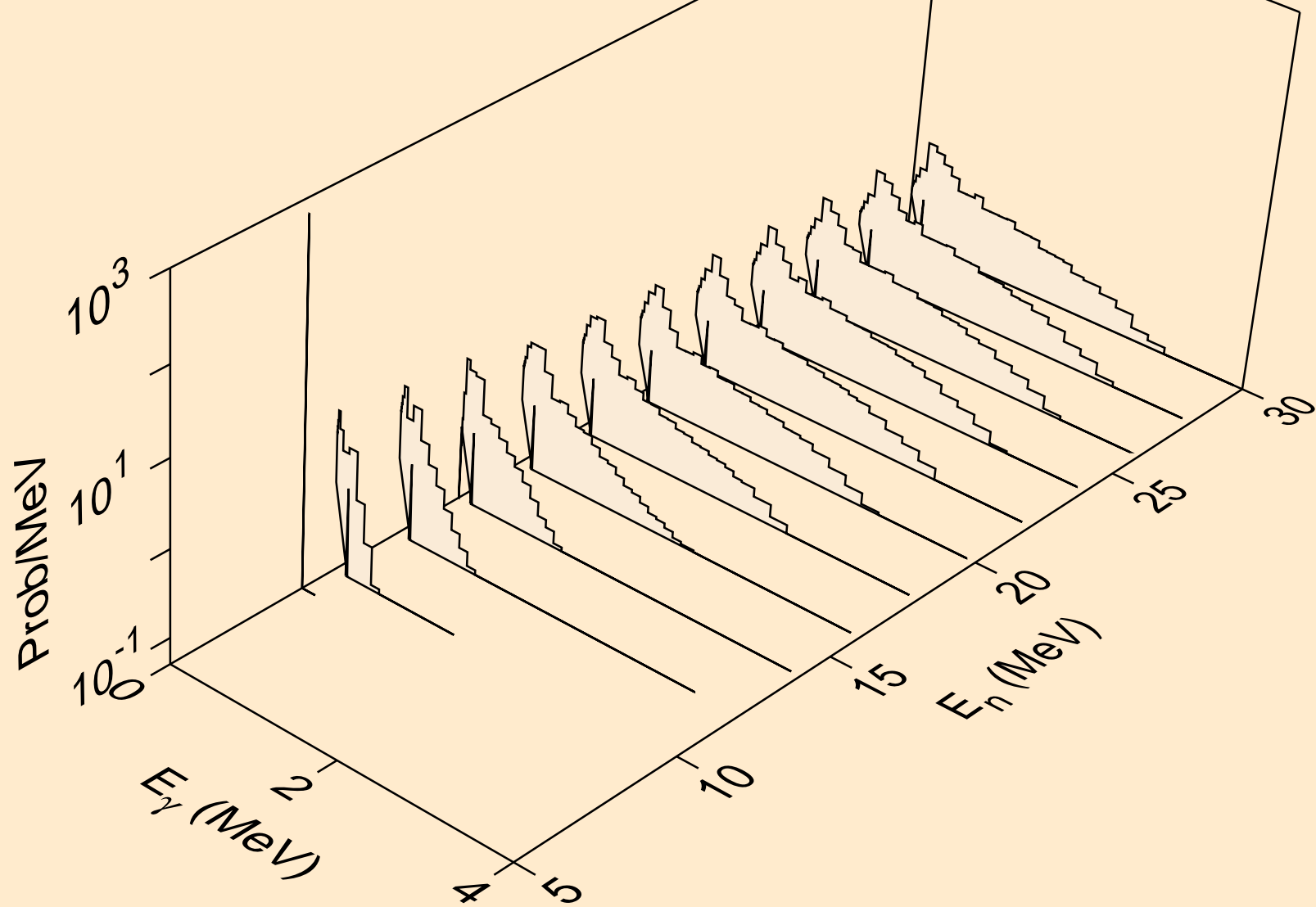

HO173 NEUTRON ACER TENDL-2021 LIBRARY; T=293.6K  
Photon emission for (n,t)

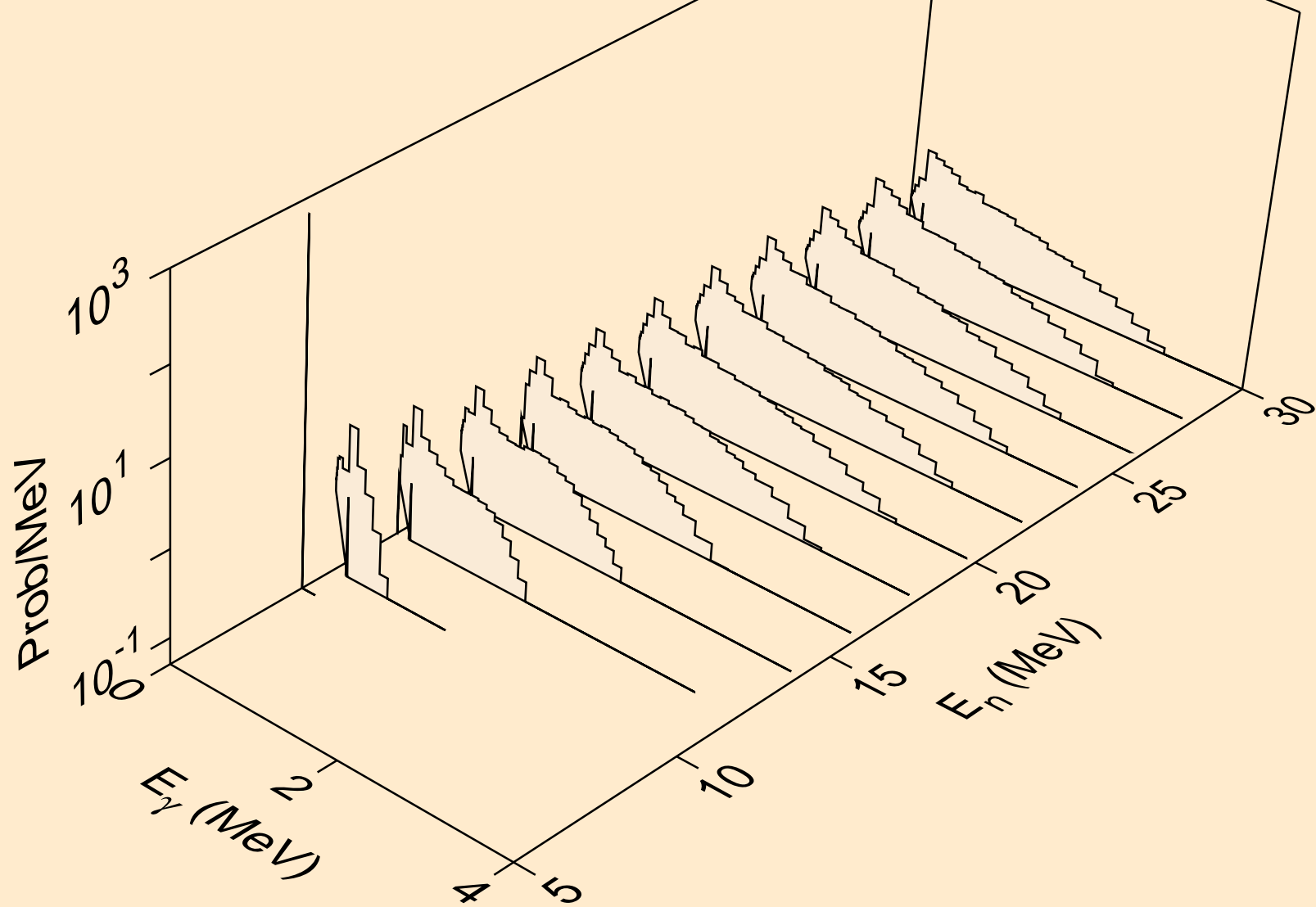

HO173 NEUTRON ACER TENDL-2021 LIBRARY; T=293.6K  
Photon emission for (n,he3)

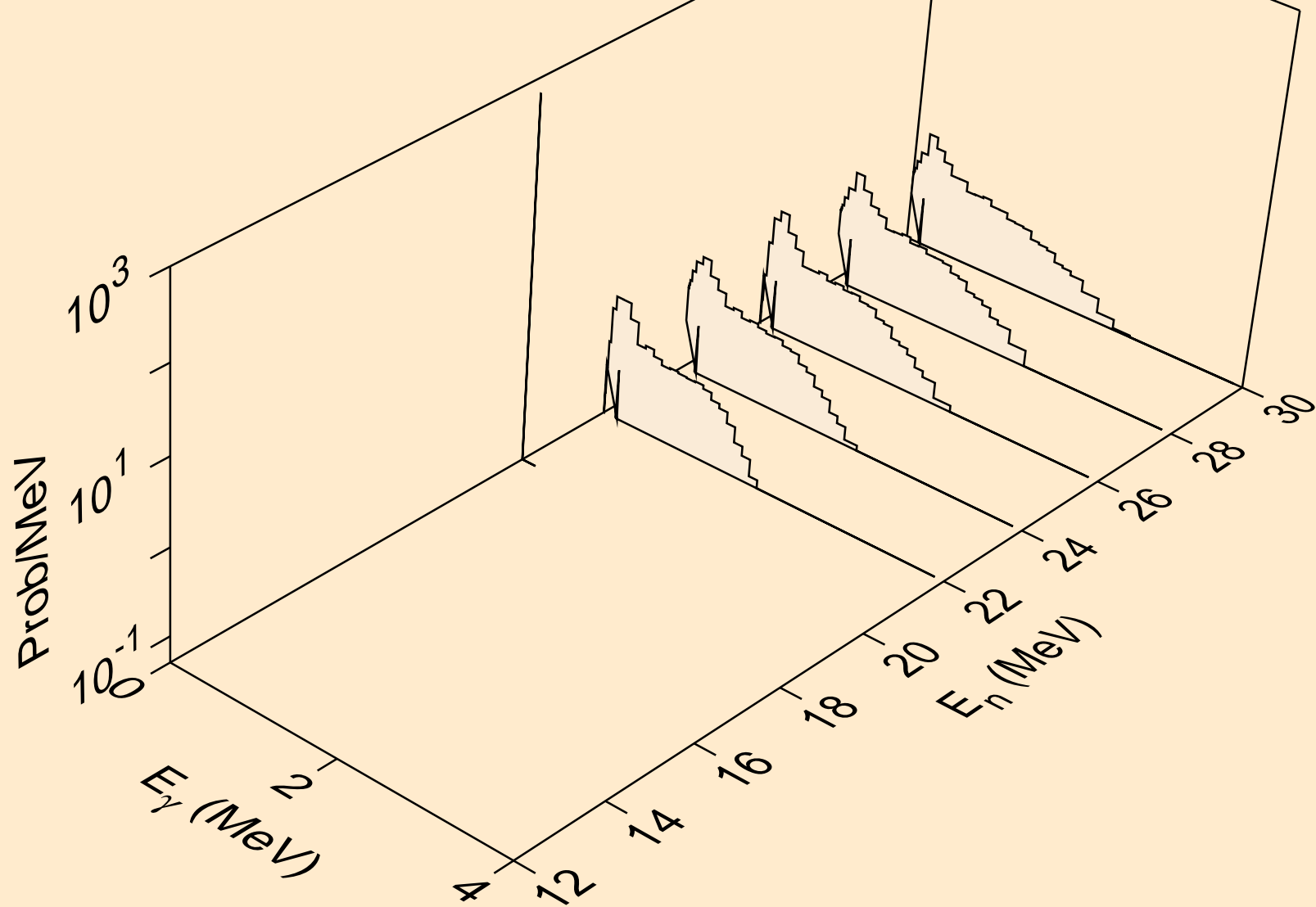

HO173 NEUTRON ACER TENDL-2021 LIBRARY; T=293.6K  
Photon emission for (n,a)

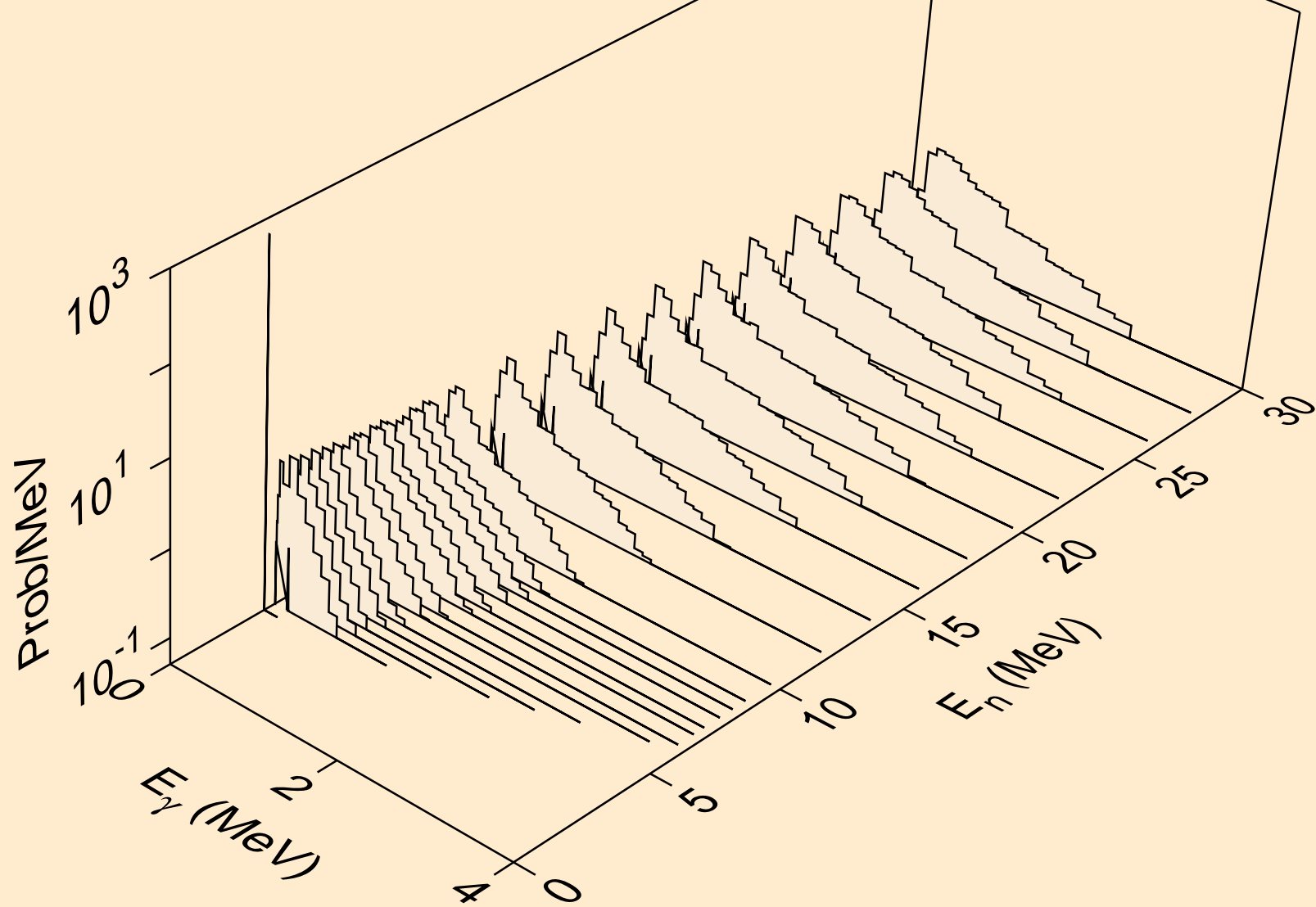

HO173 NEUTRON ACER TENDL-2021 LIBRARY; T=293.6K  
thermal capture photon spectrum

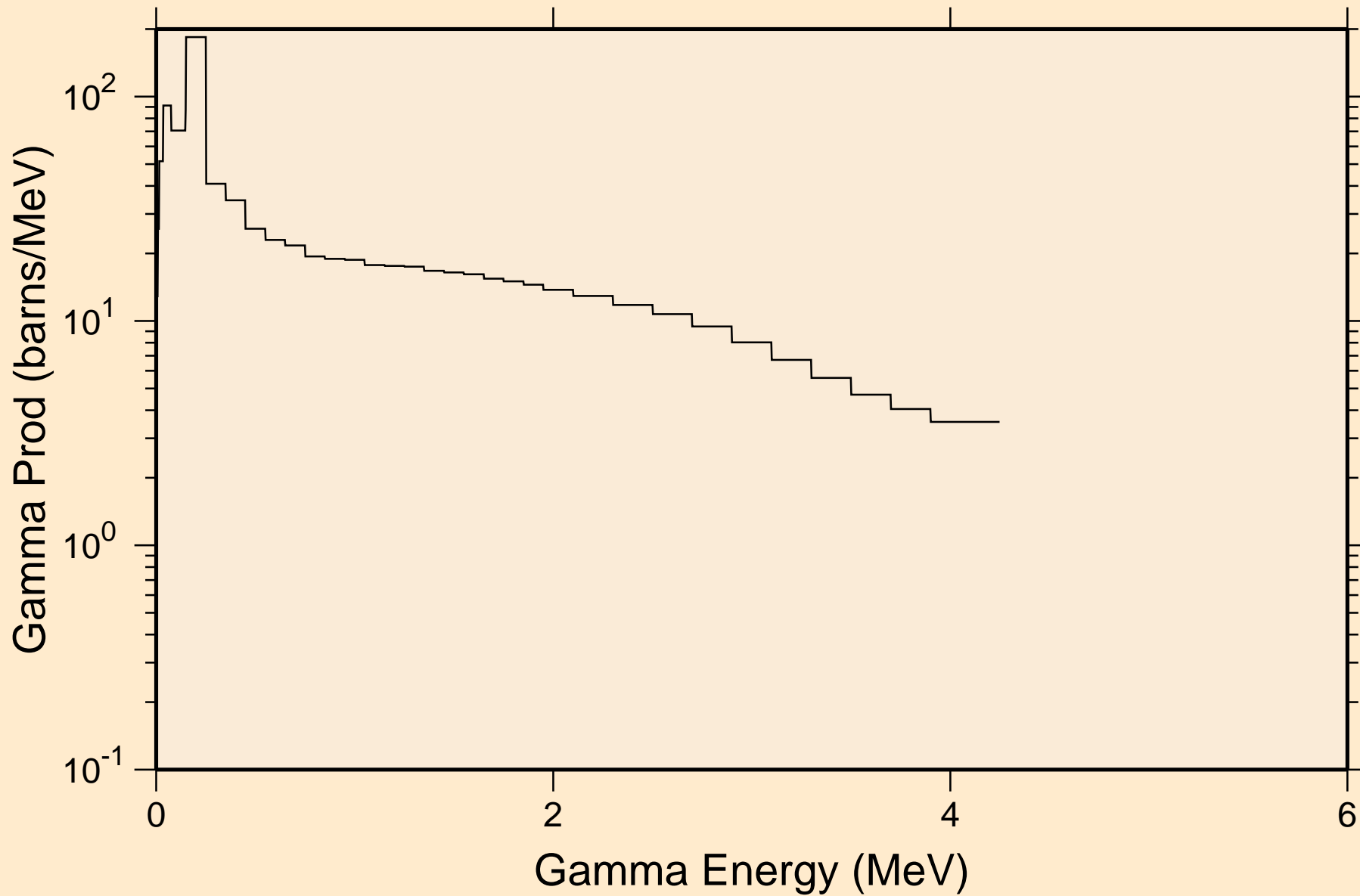

HO173 NEUTRON ACER TENDL-2021 LIBRARY; T=293.6K  
14 MeV photon spectrum

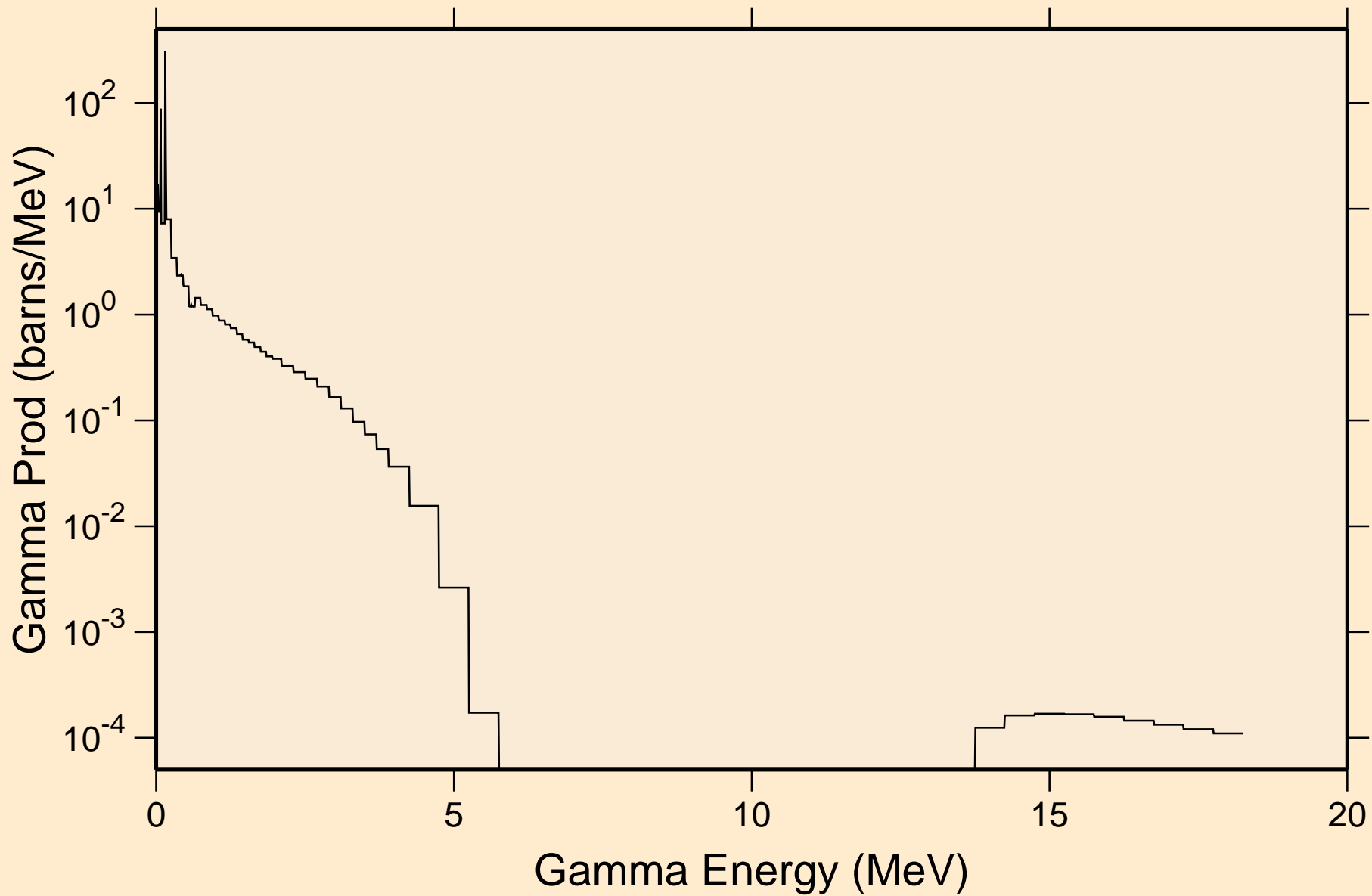

# HO173 NEUTRON ACER TENDL-2021 LIBRARY; T=293.6K

## Particle heating contributions

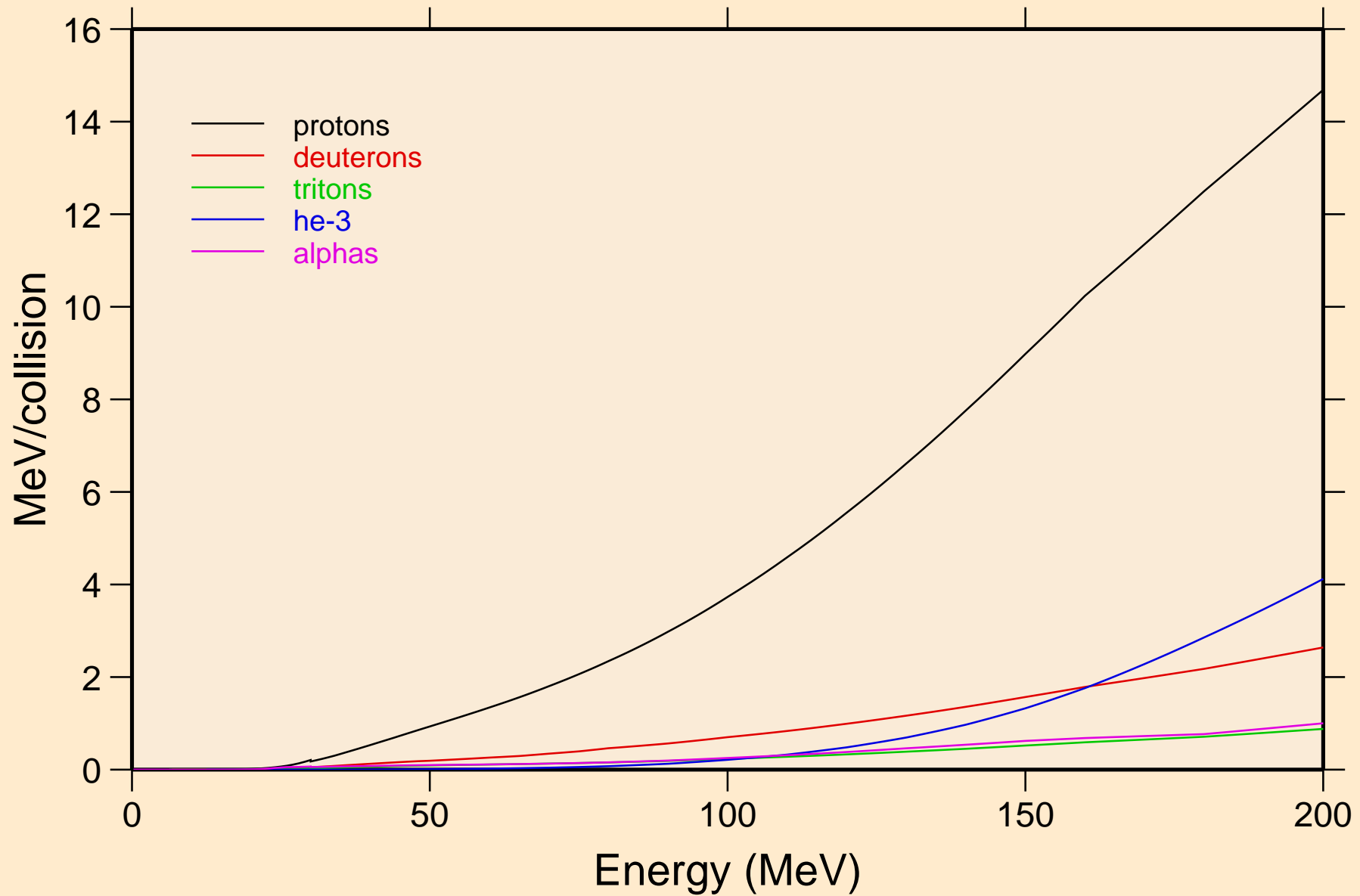



HO173 NEUTRON ACER TENDL-2021 LIBRARY; T=293.6K  
Recoil Heating

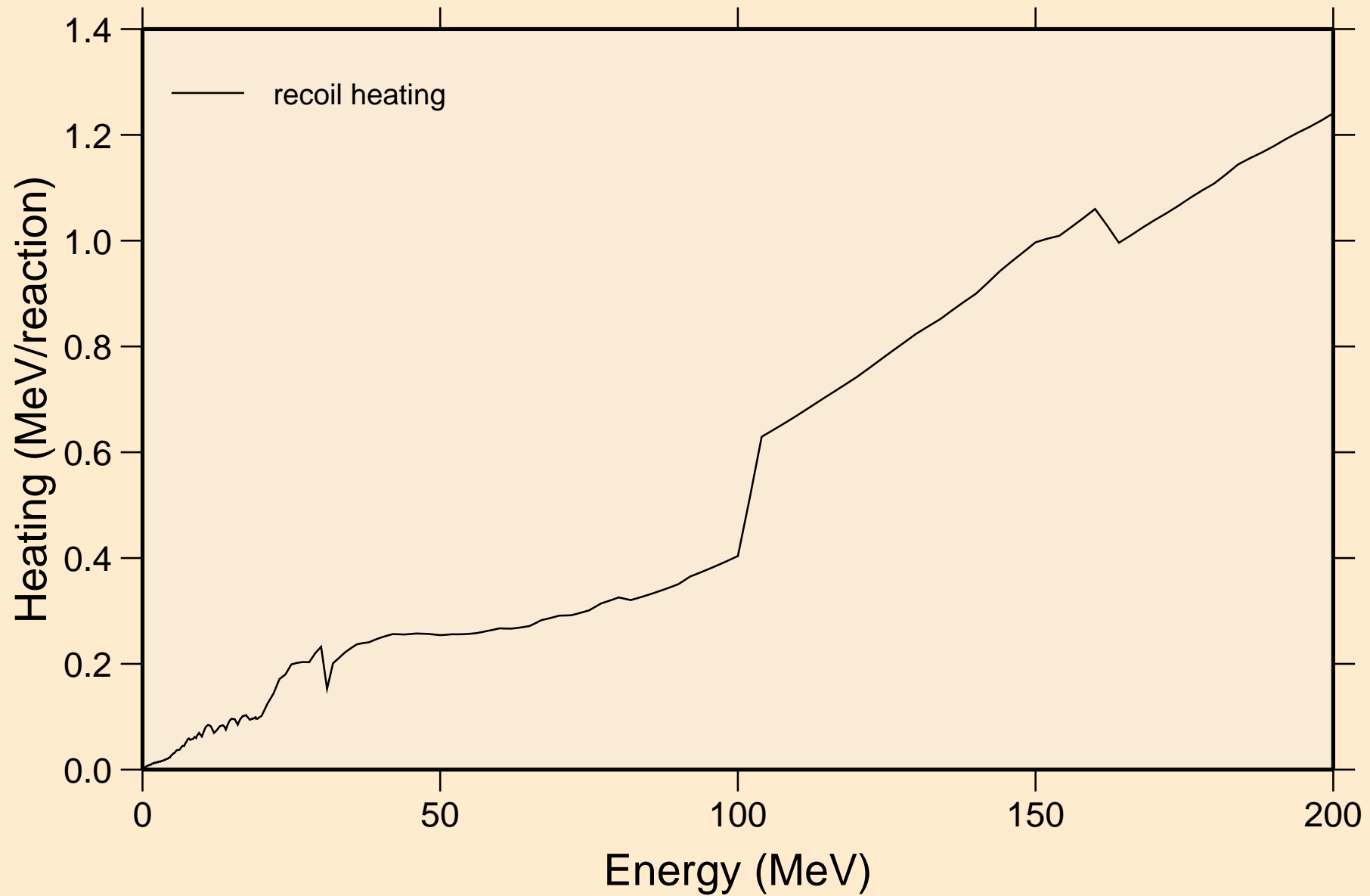

HO173 NEUTRON ACER TENDL-2021 LIBRARY; T=293.6K  
Particle production cross sections

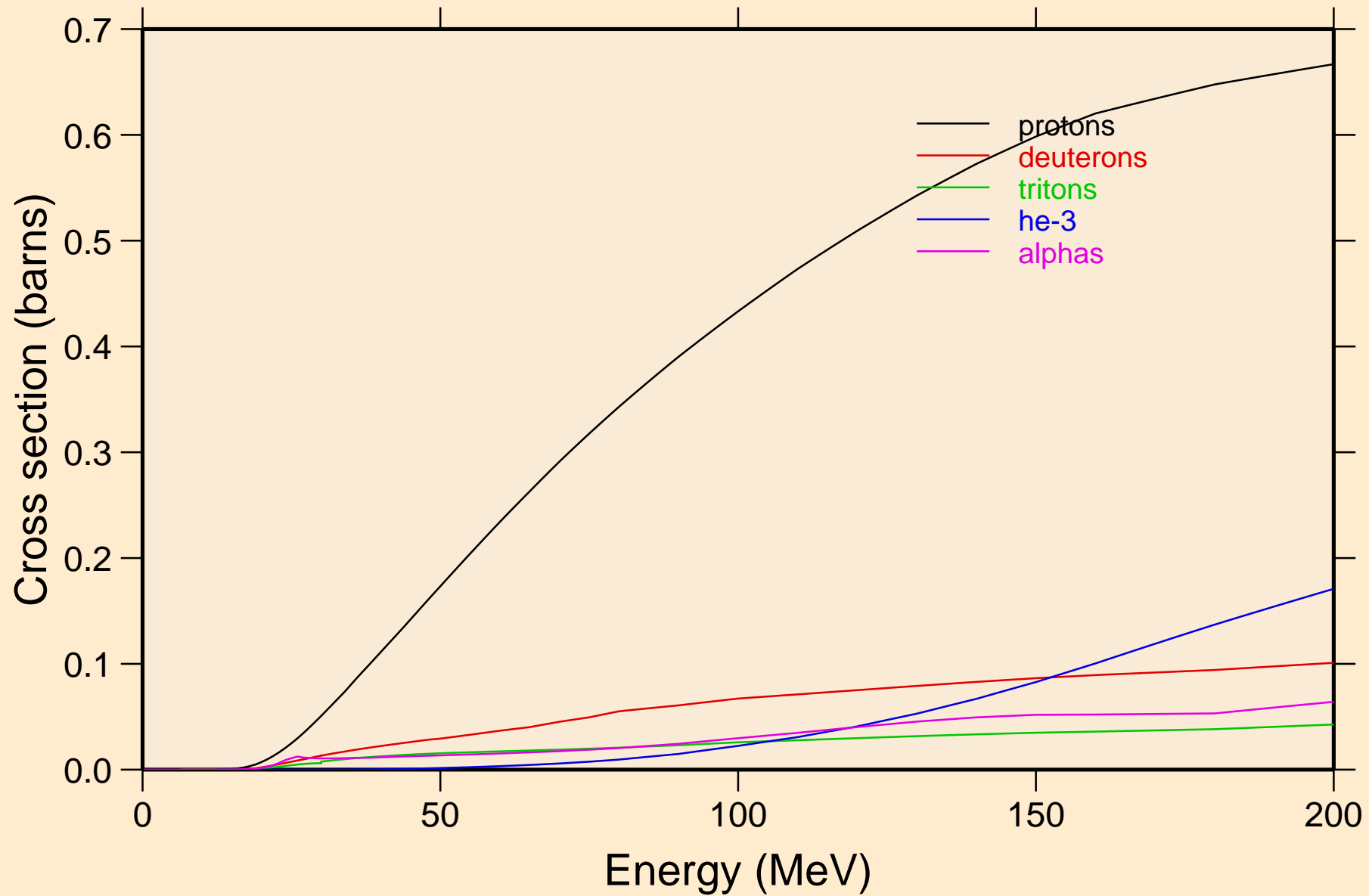

HO173 NEUTRON ACER TENDL-2021 LIBRARY; T=293.6K  
protons from (n,x)

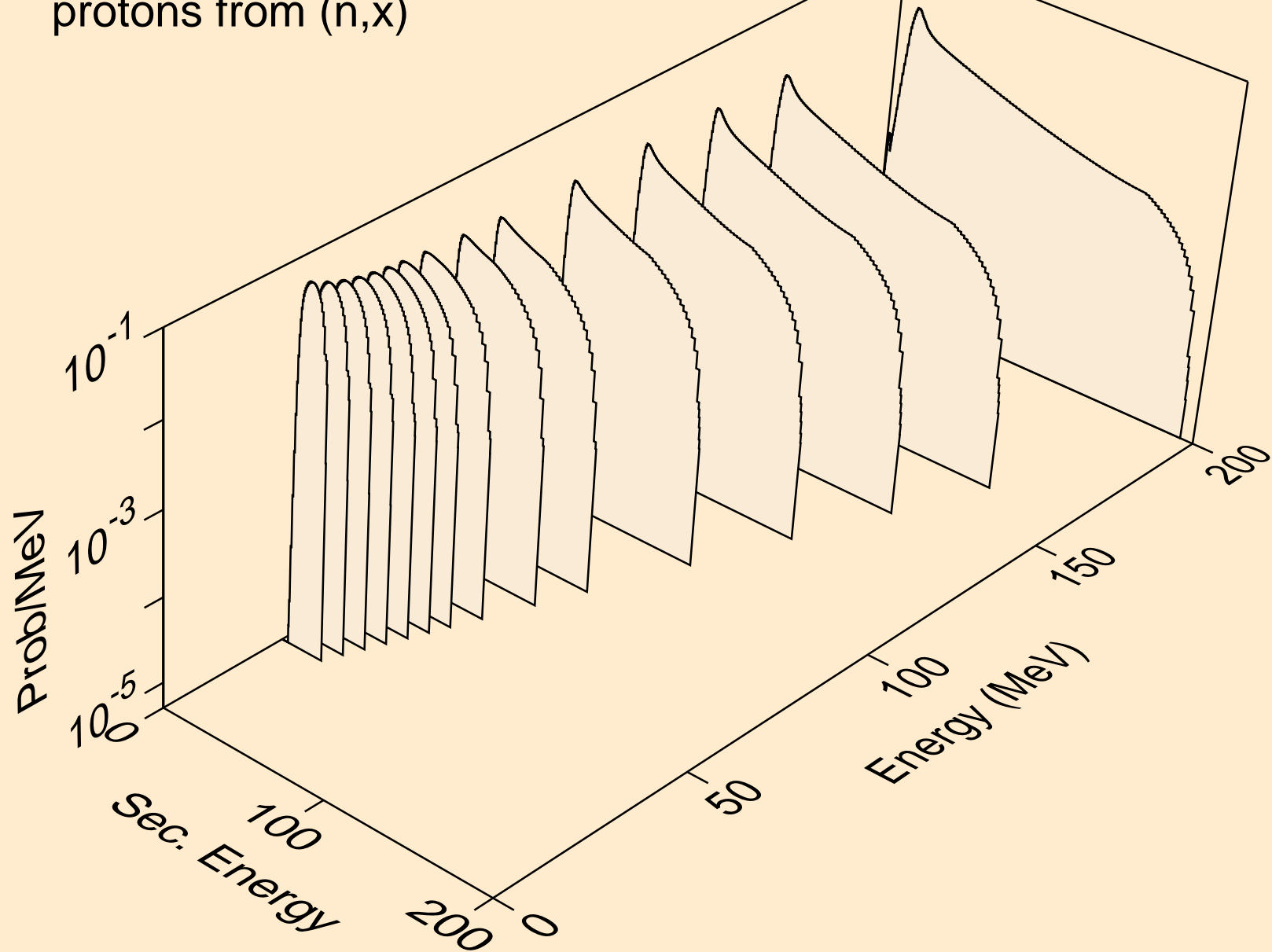

HO173 NEUTRON ACER TENDL-2021 LIBRARY; T=293.6K  
protons from (n,n\*)p

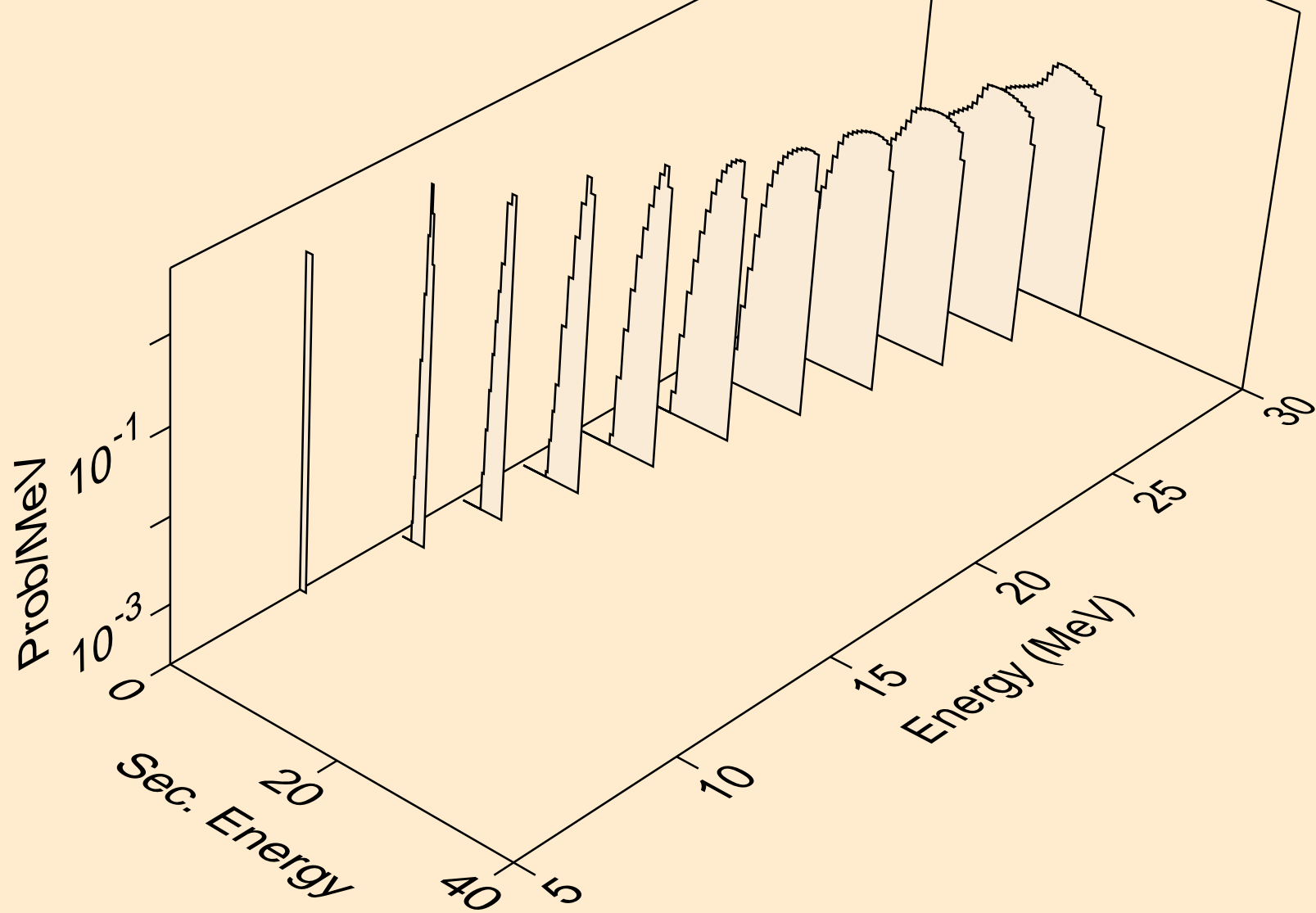

HO173 NEUTRON ACER TENDL-2021 LIBRARY; T=293.6K  
protons from (n,2np)

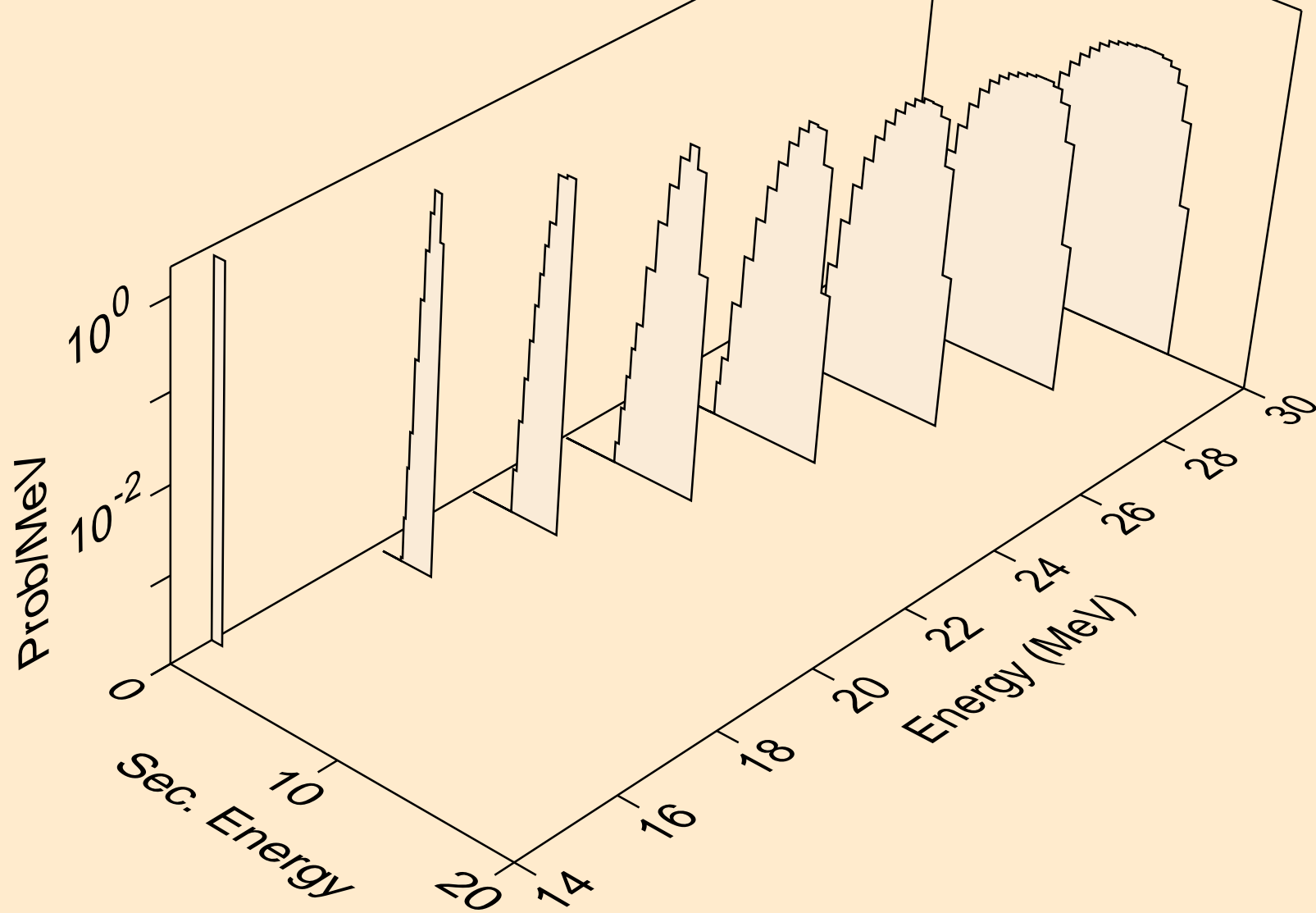

HO173 NEUTRON ACER TENDL-2021 LIBRARY; T=293.6K  
protons from (n,3np)

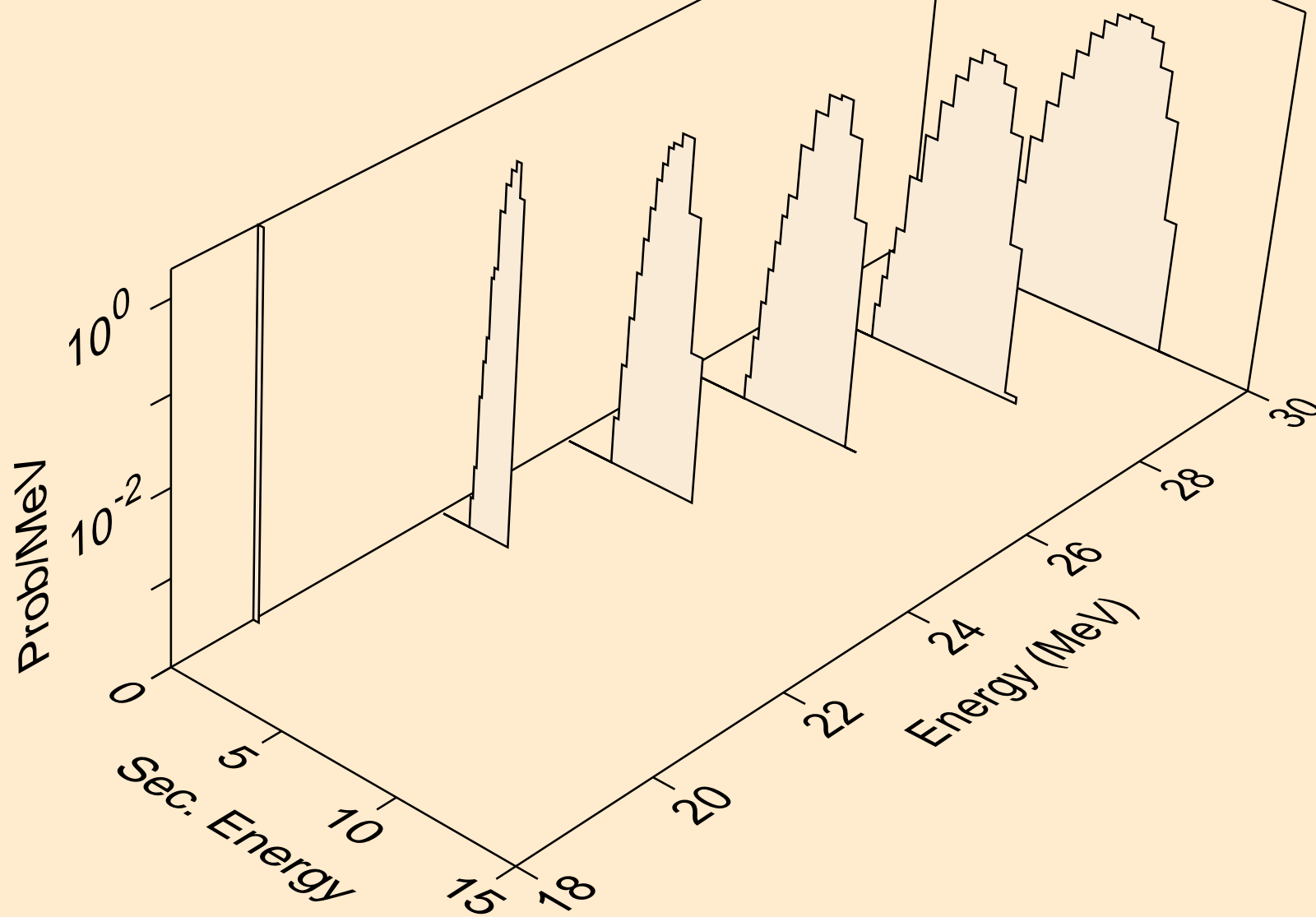

HO173 NEUTRON ACER TENDL-2021 LIBRARY; T=293.6K  
protons from (n,p)

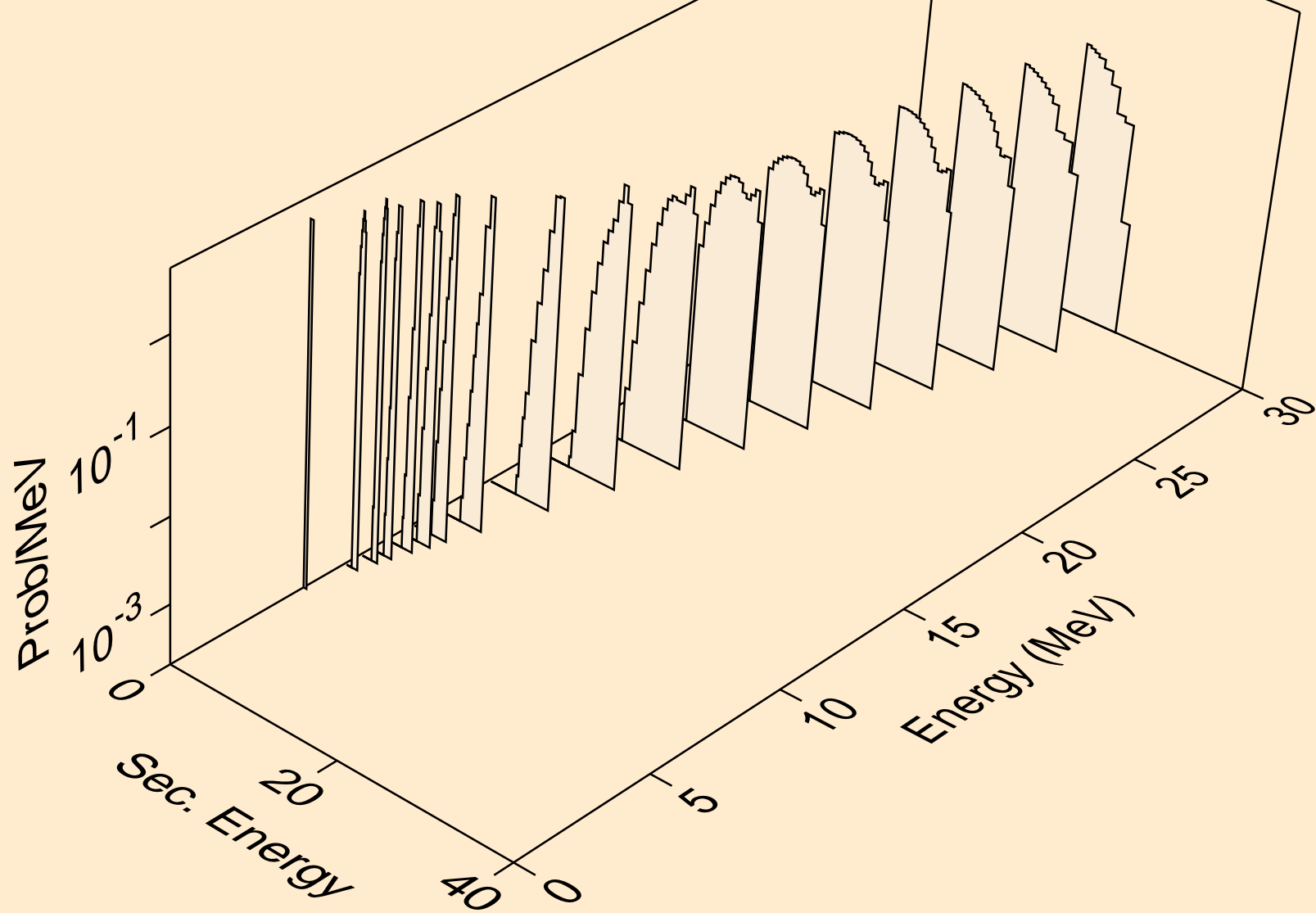

HO173 NEUTRON ACER TENDL-2021 LIBRARY; T=293.6K  
deuterons from (n,x)

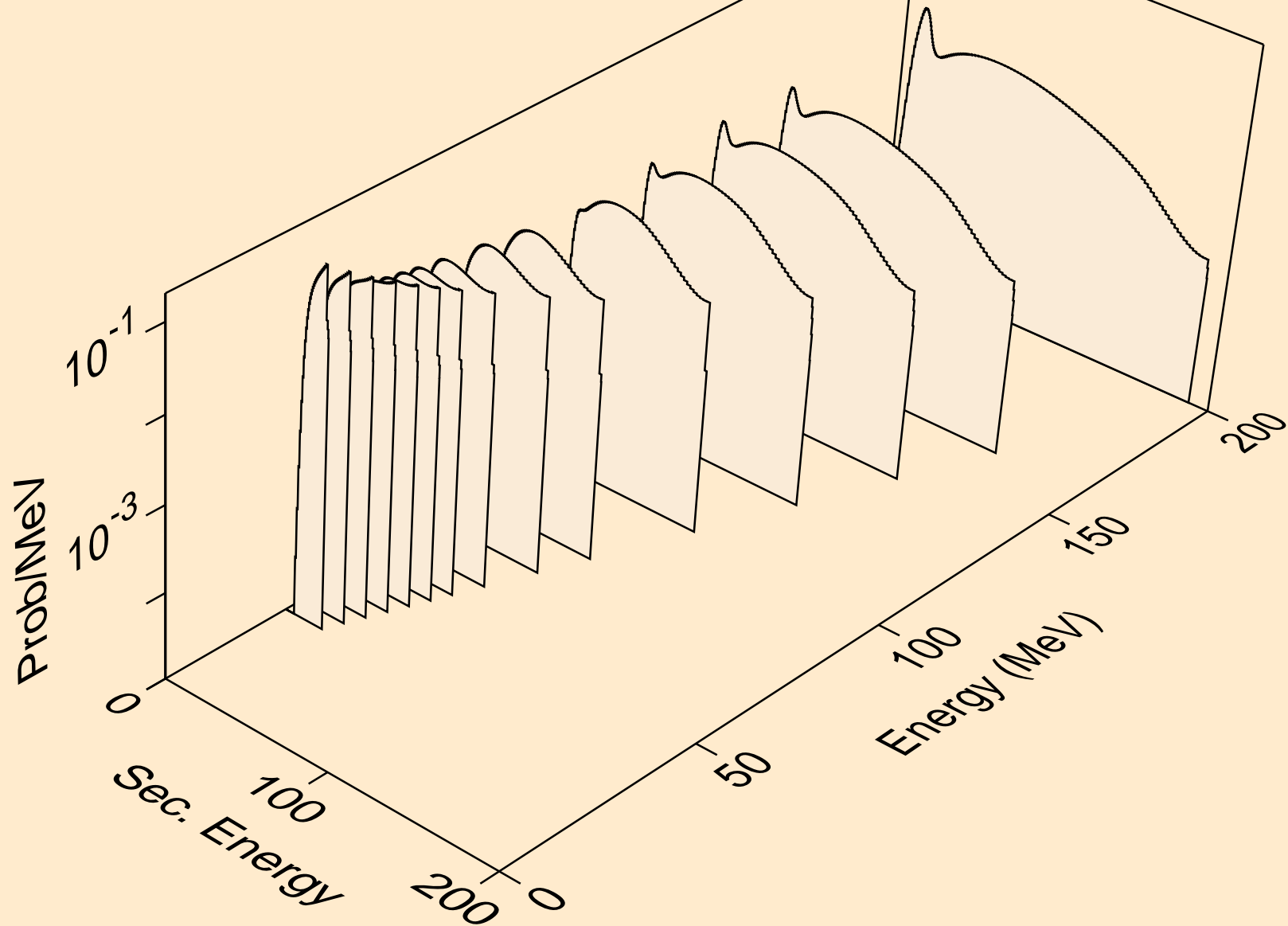



HO173 NEUTRON ACER TENDL-2021 LIBRARY; T=293.6K  
deuterons from (n,2nd)

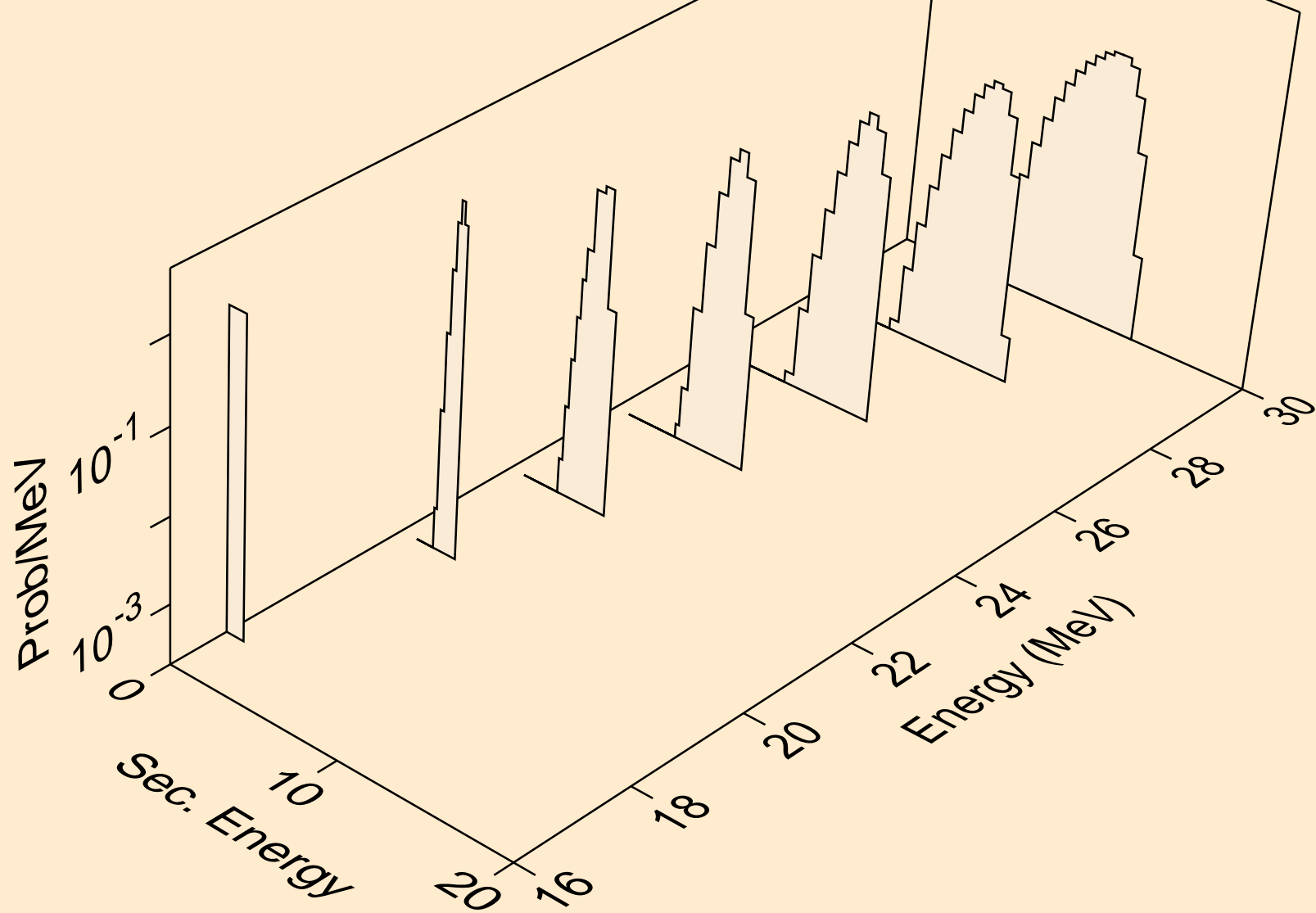

HO173 NEUTRON ACER TENDL-2021 LIBRARY; T=293.6K  
deuterons from (n,n\*)d

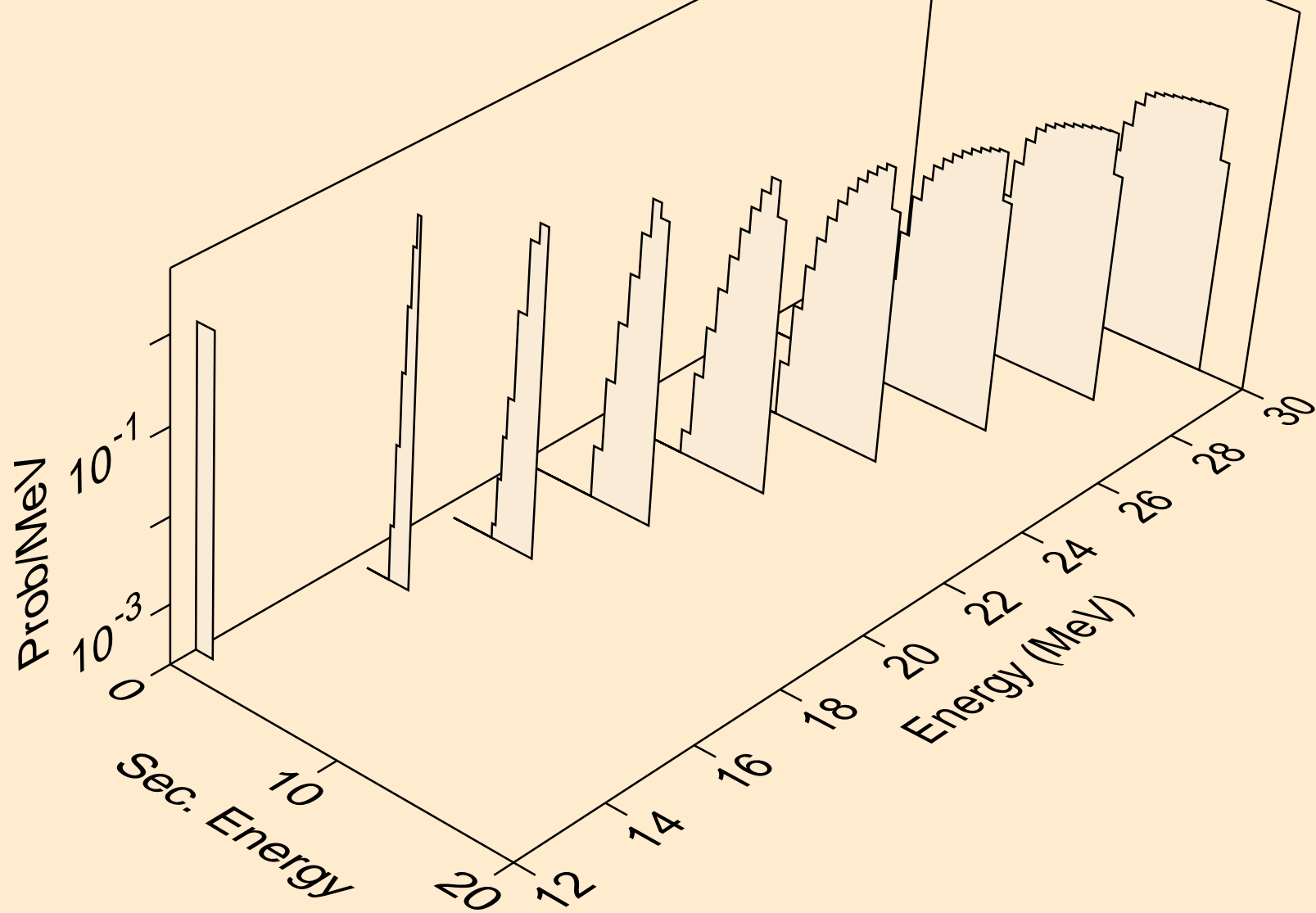

HO173 NEUTRON ACER TENDL-2021 LIBRARY; T=293.6K  
deuterons from (n,d)

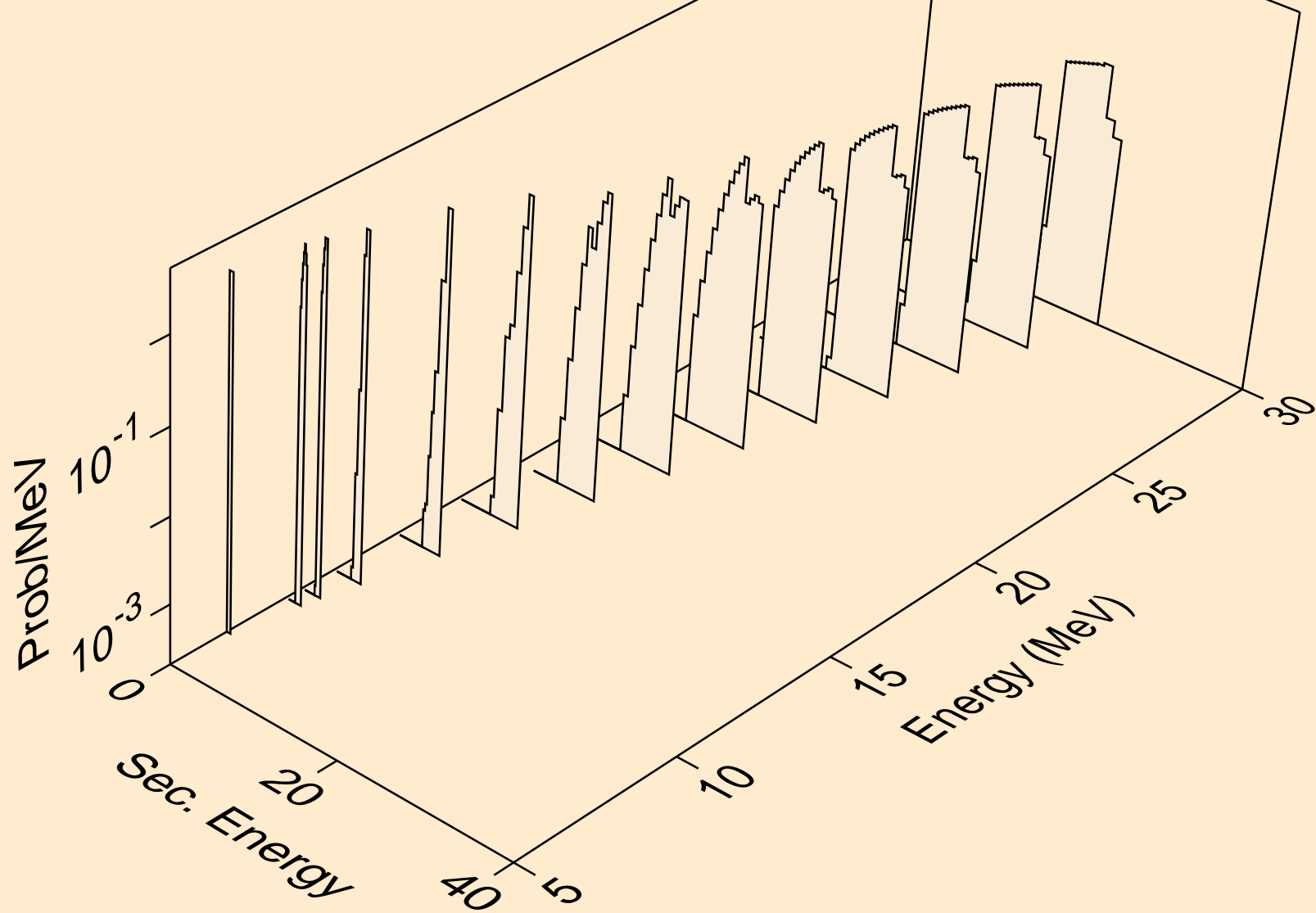

HO173 NEUTRON ACER TENDL-2021 LIBRARY; T=293.6K  
tritons from (n,x)

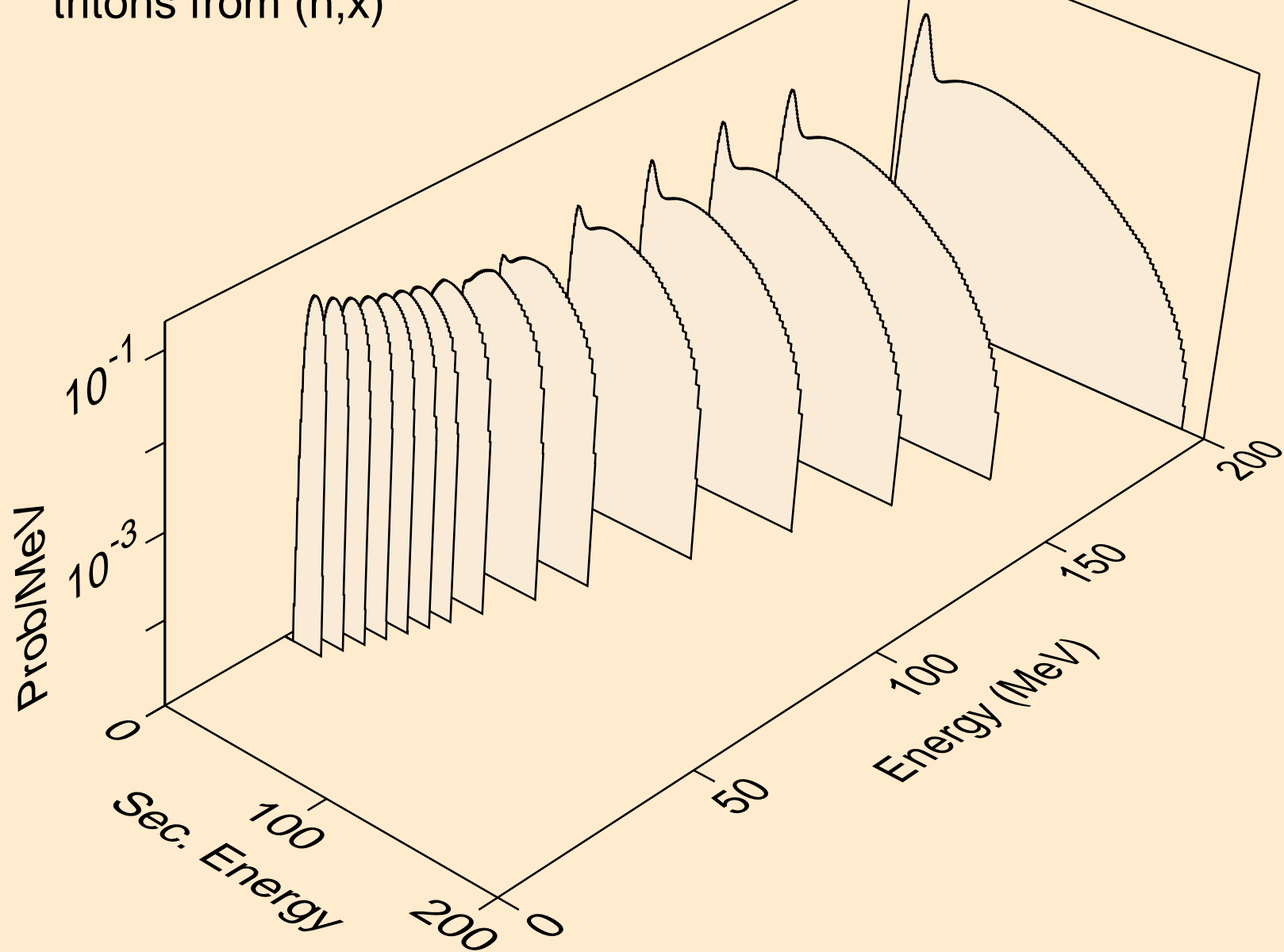

HO173 NEUTRON ACER TENDL-2021 LIBRARY; T=293.6K  
tritons from (n,n\*)t

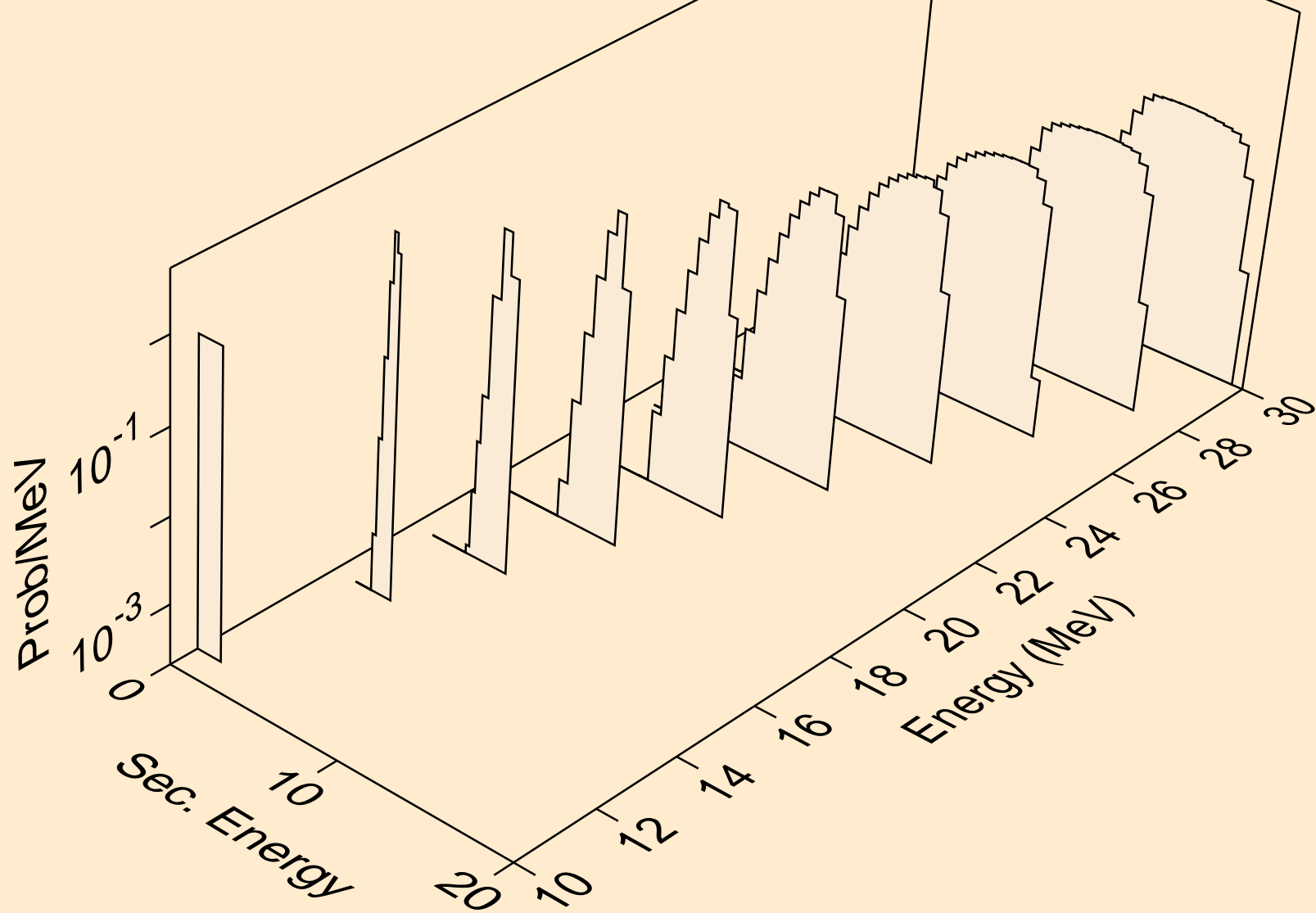

HO173 NEUTRON ACER TENDL-2021 LIBRARY; T=293.6K  
tritons from (n,t)

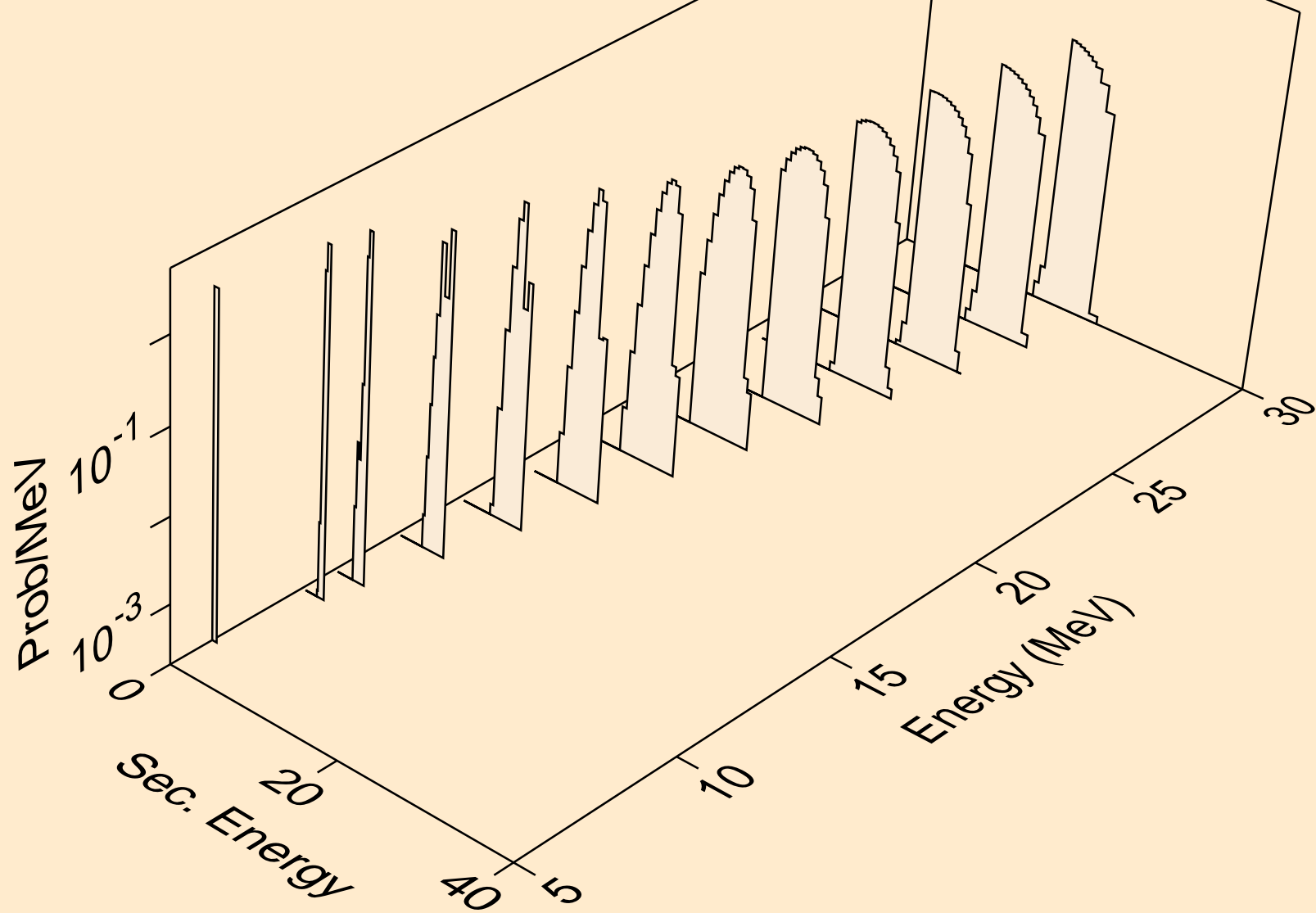

HO173 NEUTRON ACER TENDL-2021 LIBRARY; T=293.6K  
he3s from (n,x)

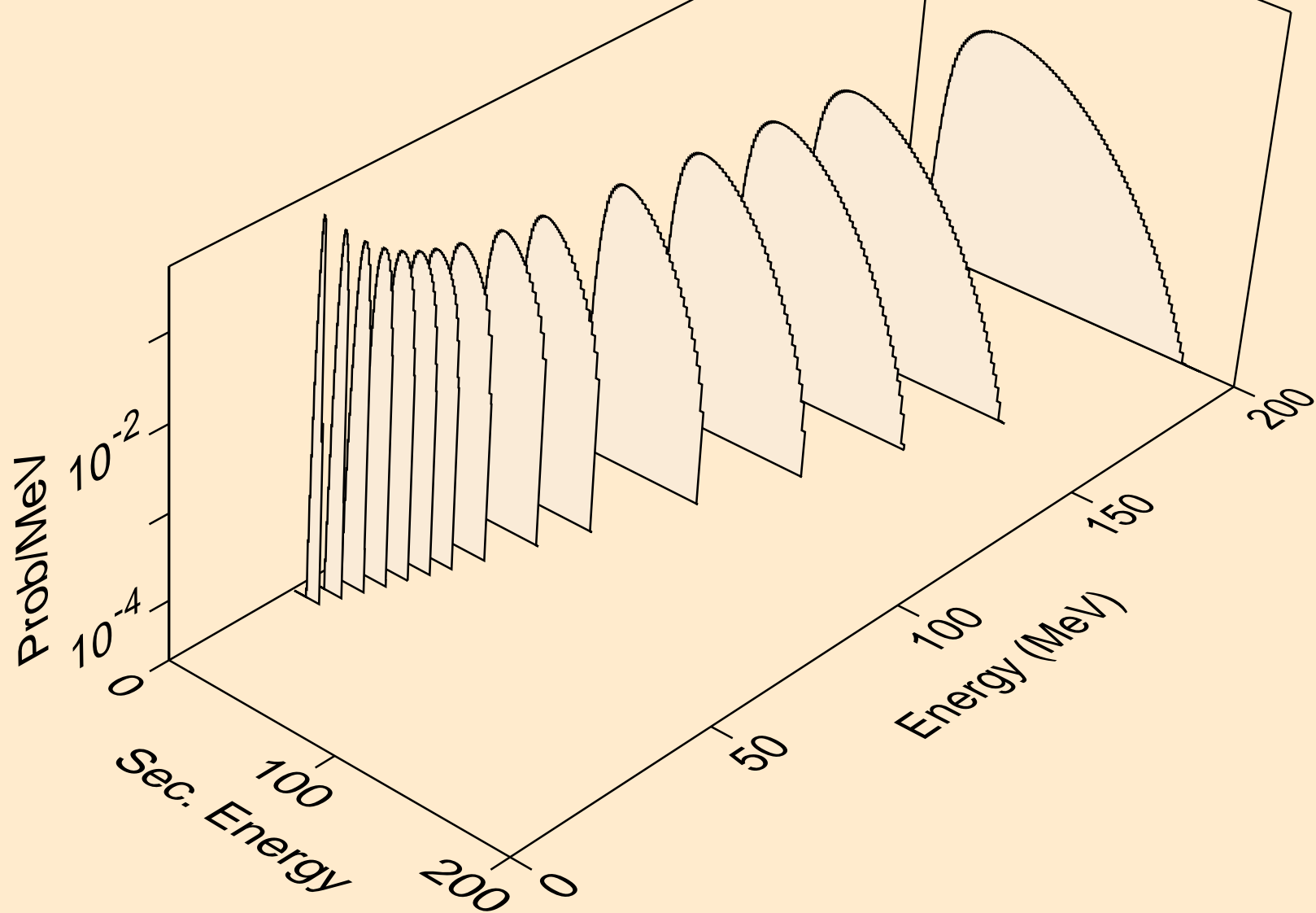

HO173 NEUTRON ACER TENDL-2021 LIBRARY; T=293.6K  
he3s from (n,n\*)he3

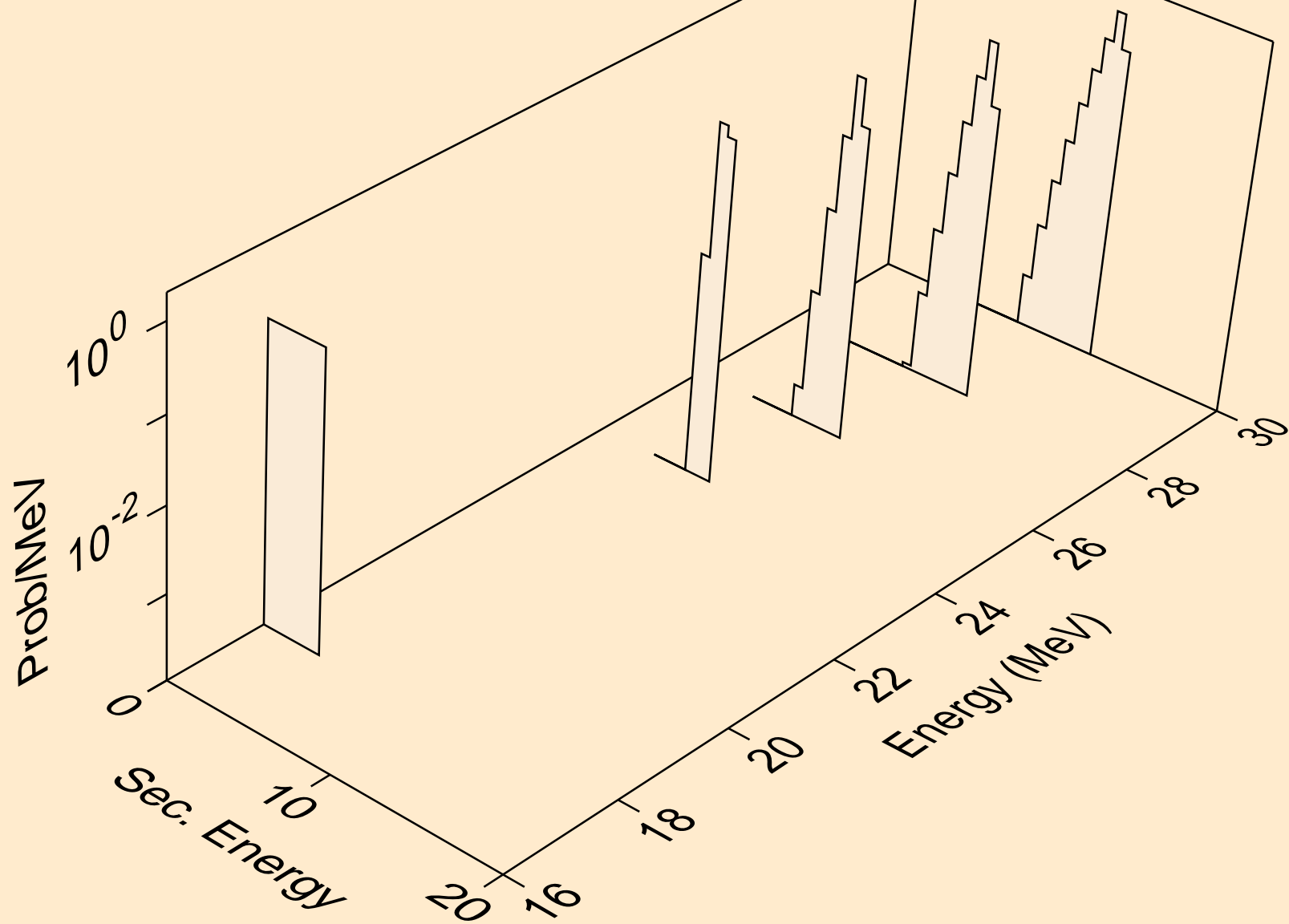



HO173 NEUTRON ACER TENDL-2021 LIBRARY; T=293.6K  
he3s from (n,he3)

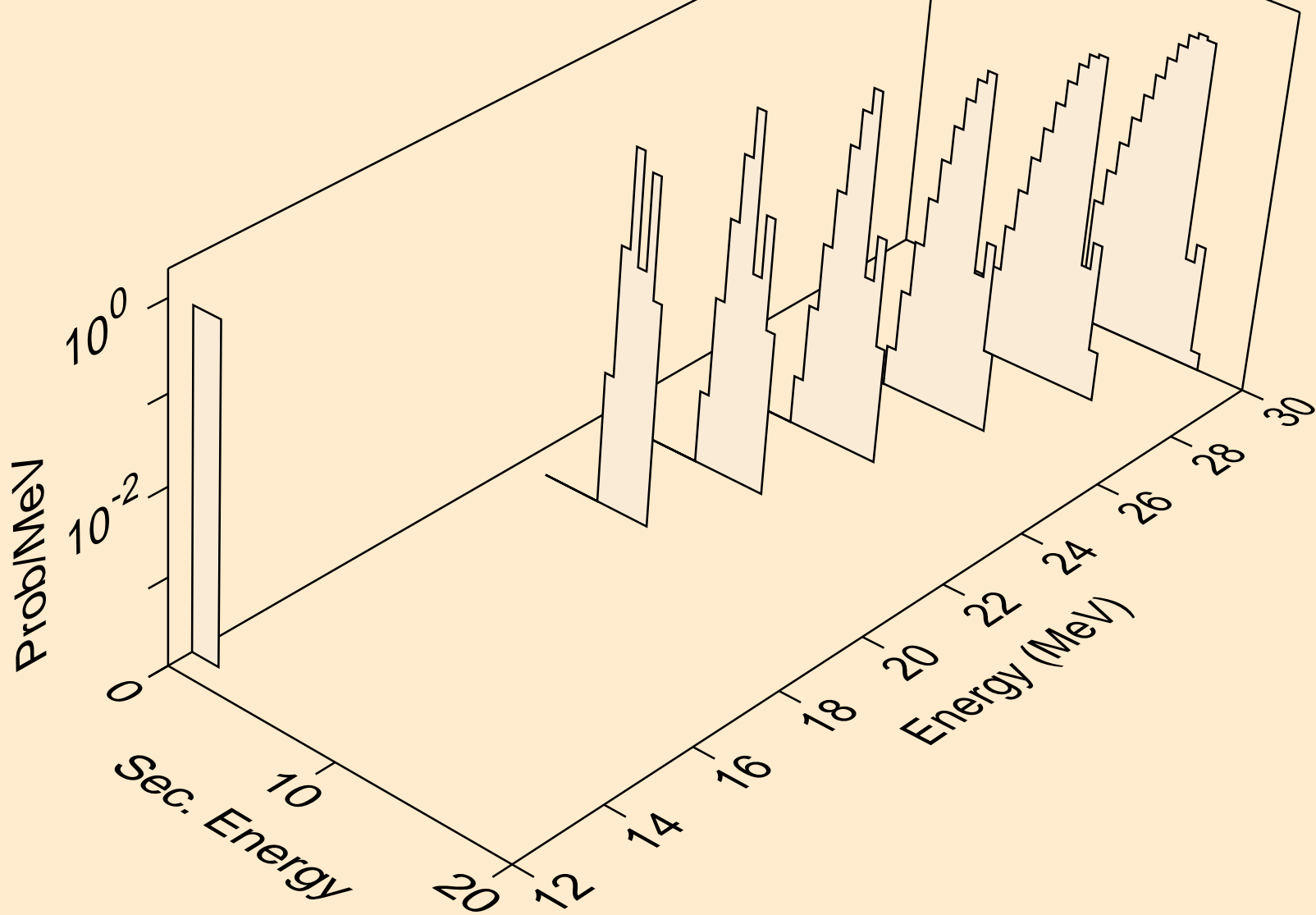

HO173 NEUTRON ACER TENDL-2021 LIBRARY; T=293.6K  
alphas from (n,x)

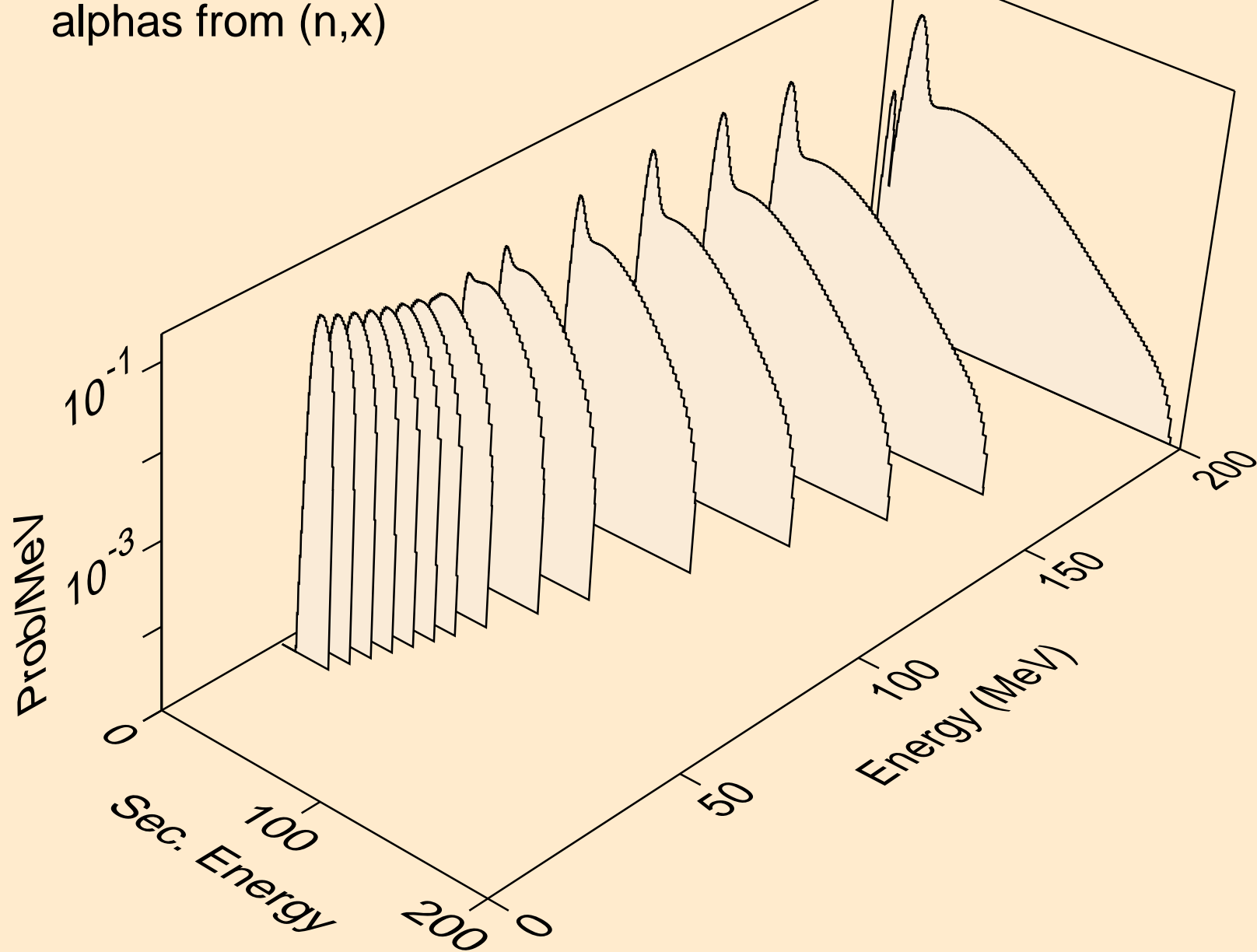

HO173 NEUTRON ACER TENDL-2021 LIBRARY; T=293.6K  
alphas from (n,n\*)a

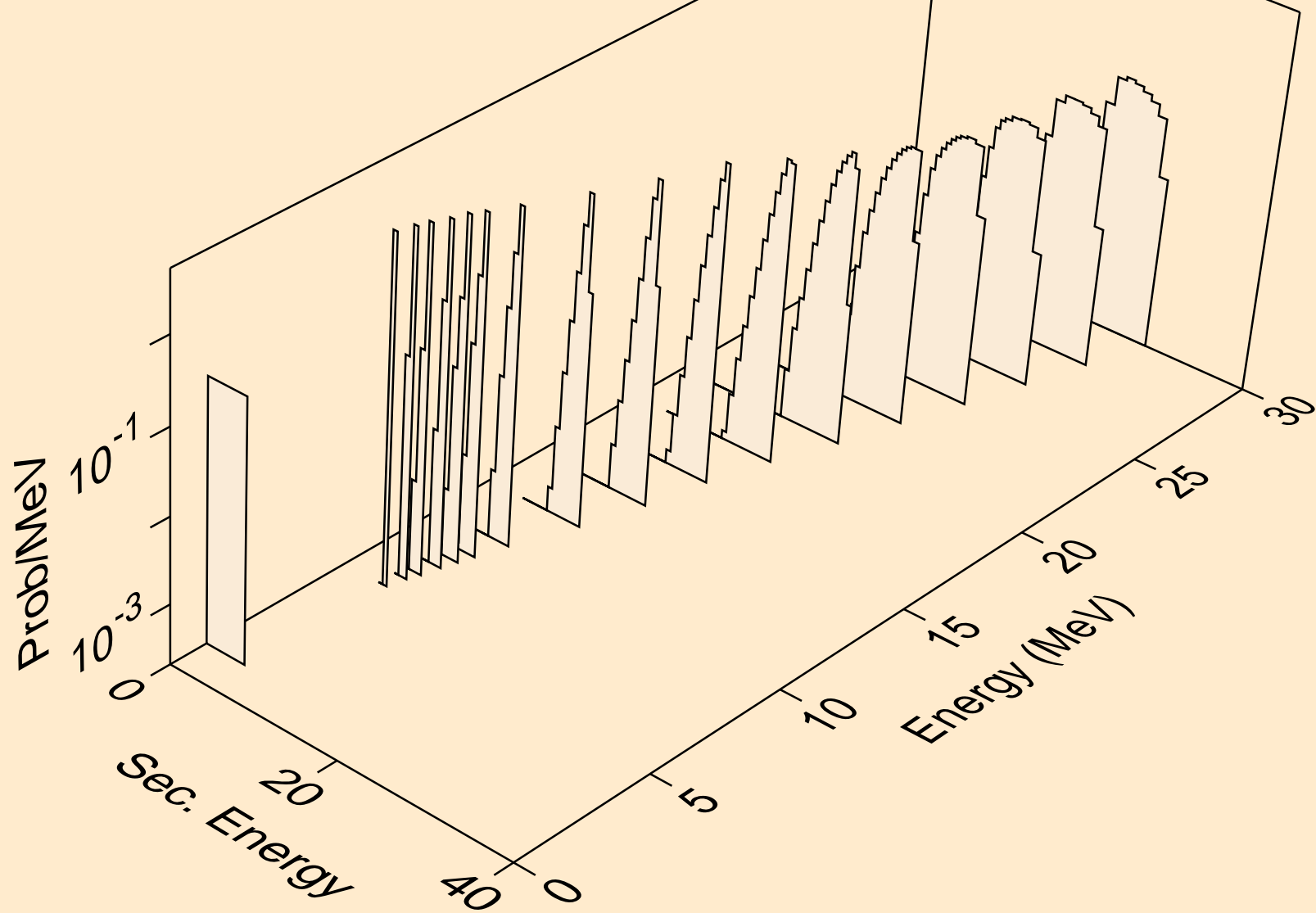

HO173 NEUTRON ACER TENDL-2021 LIBRARY; T=293.6K  
alphas from (n,2n)a

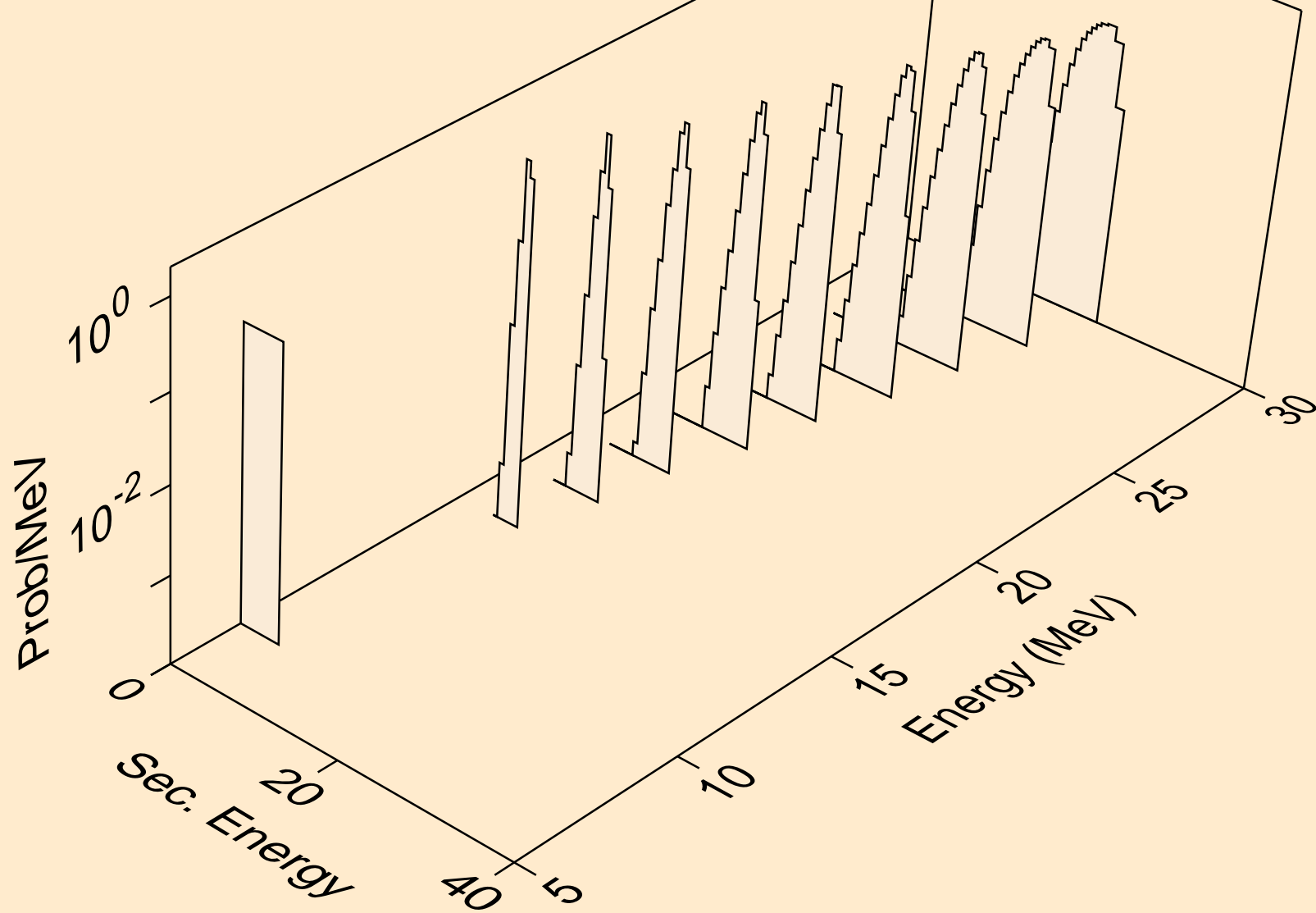

HO173 NEUTRON ACER TENDL-2021 LIBRARY; T=293.6K  
alphas from (n,3n)a

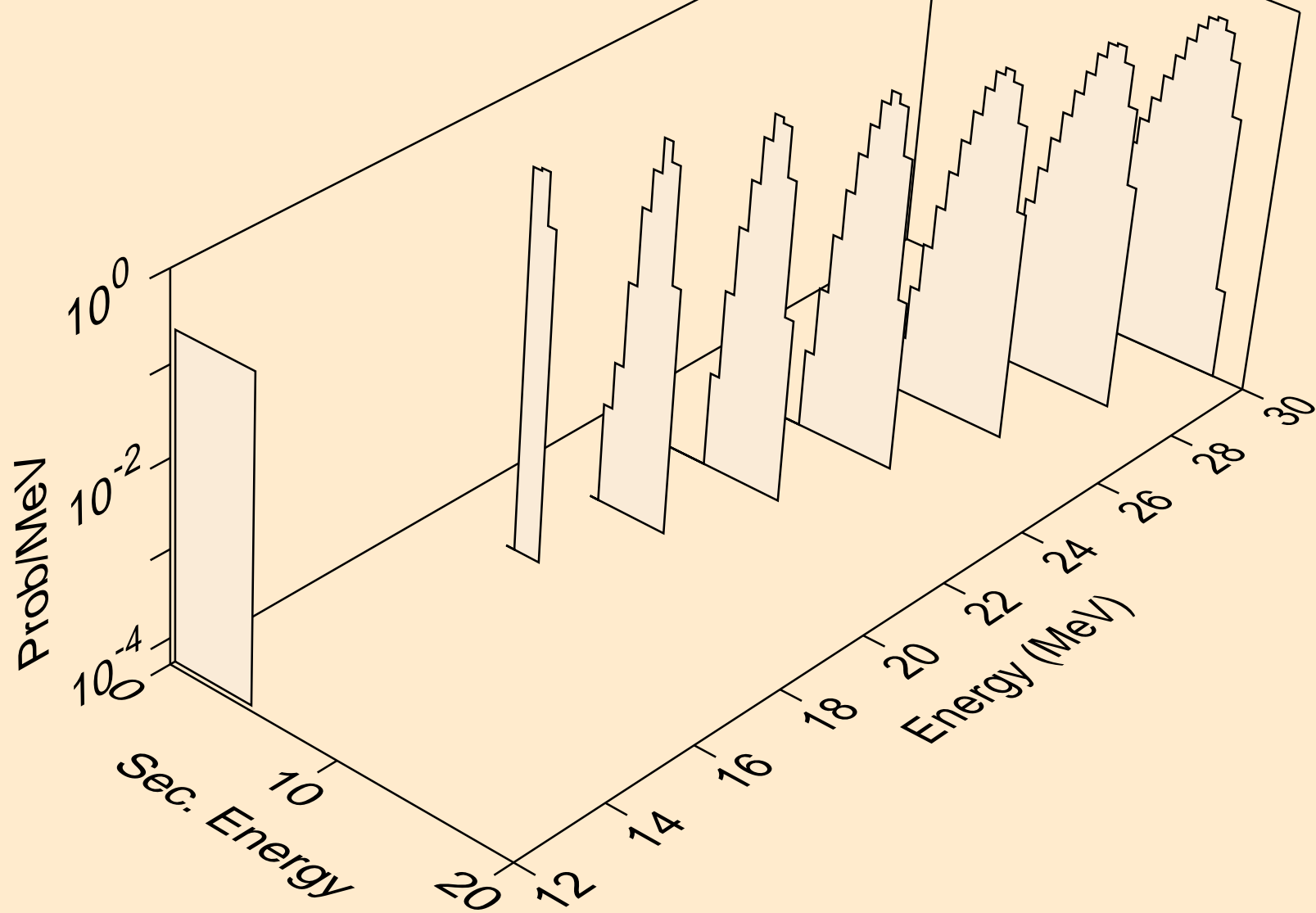

HO173 NEUTRON ACER TENDL-2021 LIBRARY; T=293.6K  
alphas from (n,a)

