

HO174 NEUTRON ACER TENDL-2021 LIBRARY; T=293.6K

Principal cross sections

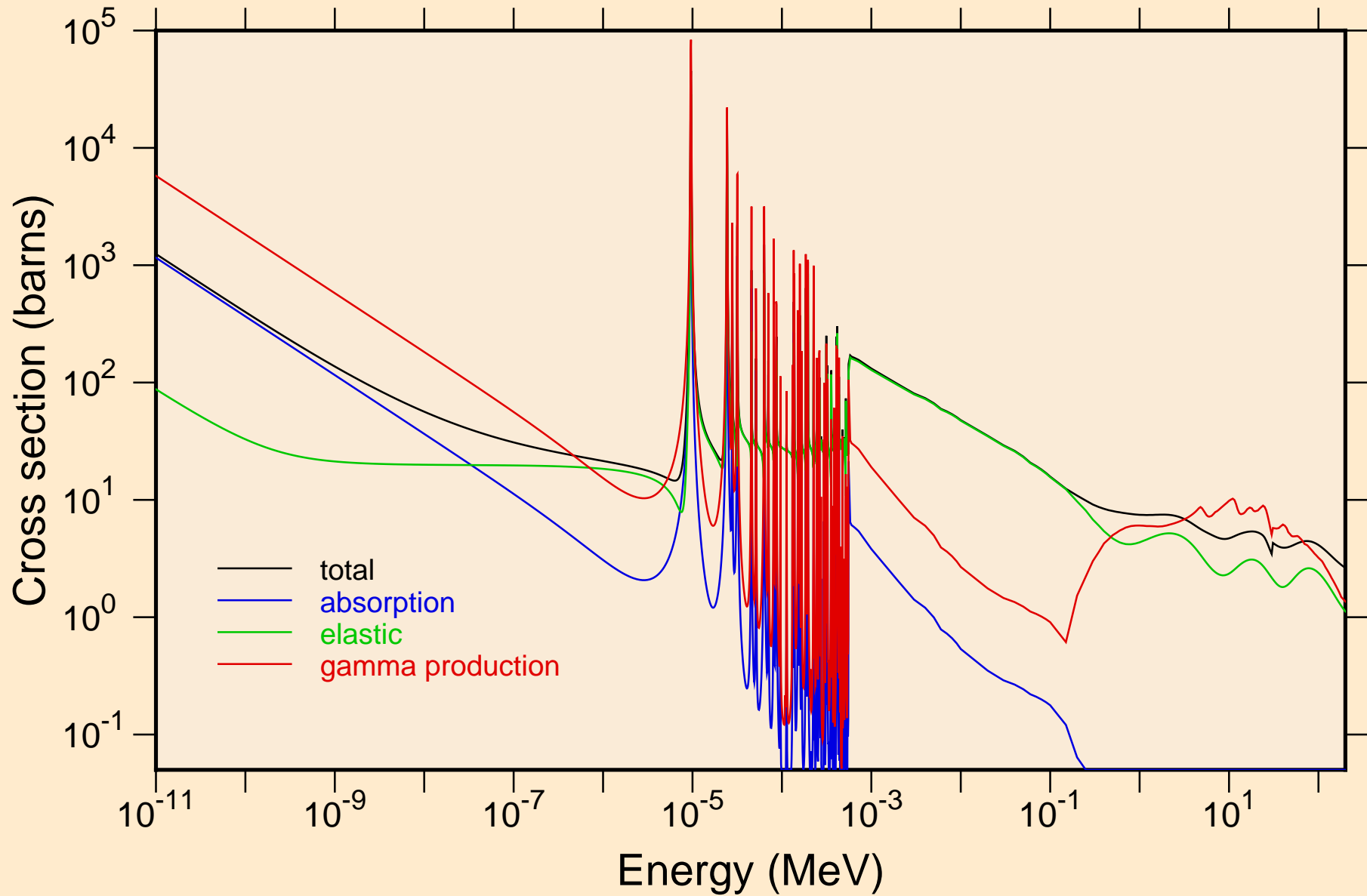

HO174 NEUTRON ACER TENDL-2021 LIBRARY; T=293.6K
resonance total cross section

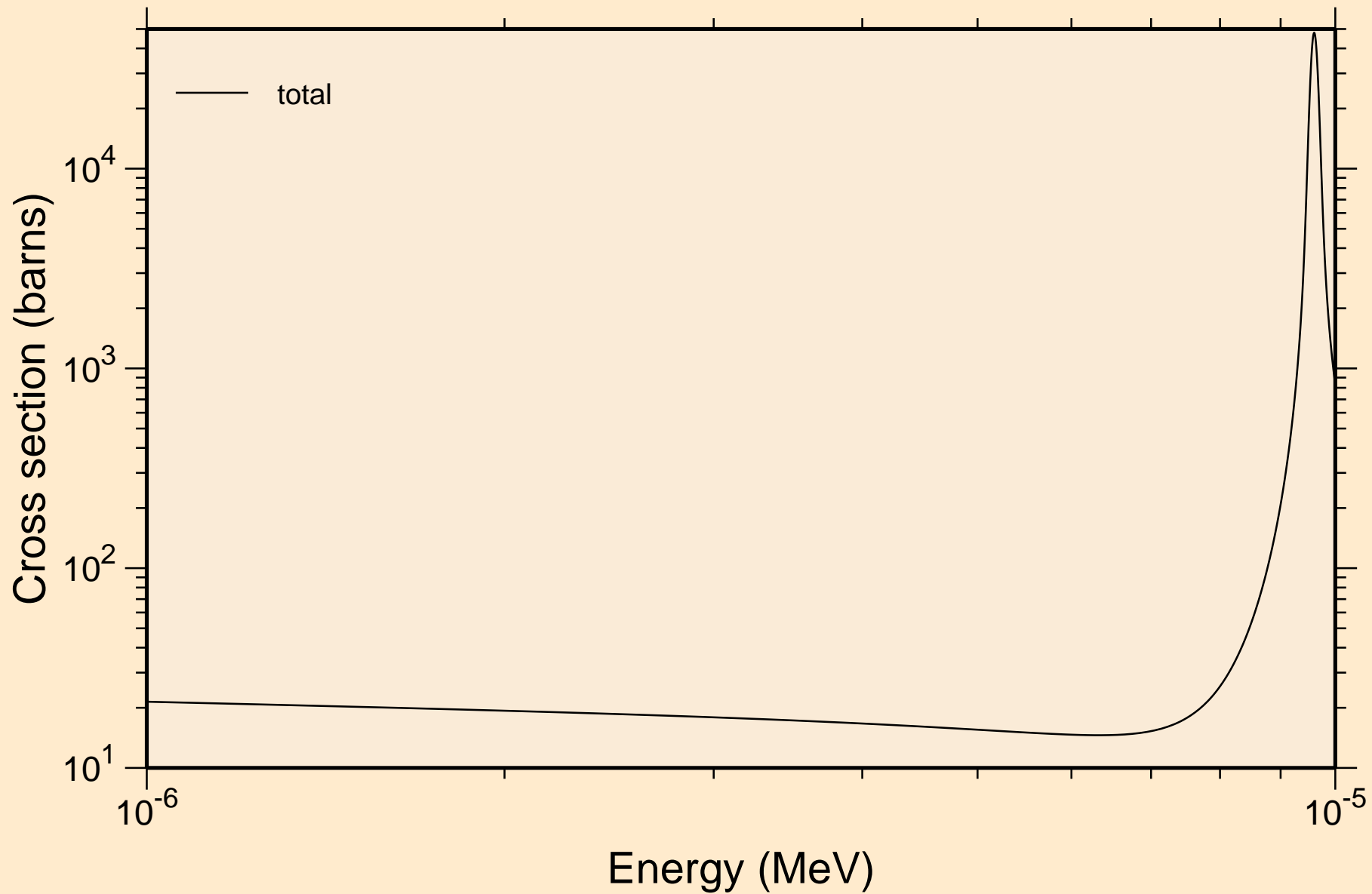

HO174 NEUTRON ACER TENDL-2021 LIBRARY; T=293.6K
resonance total cross section

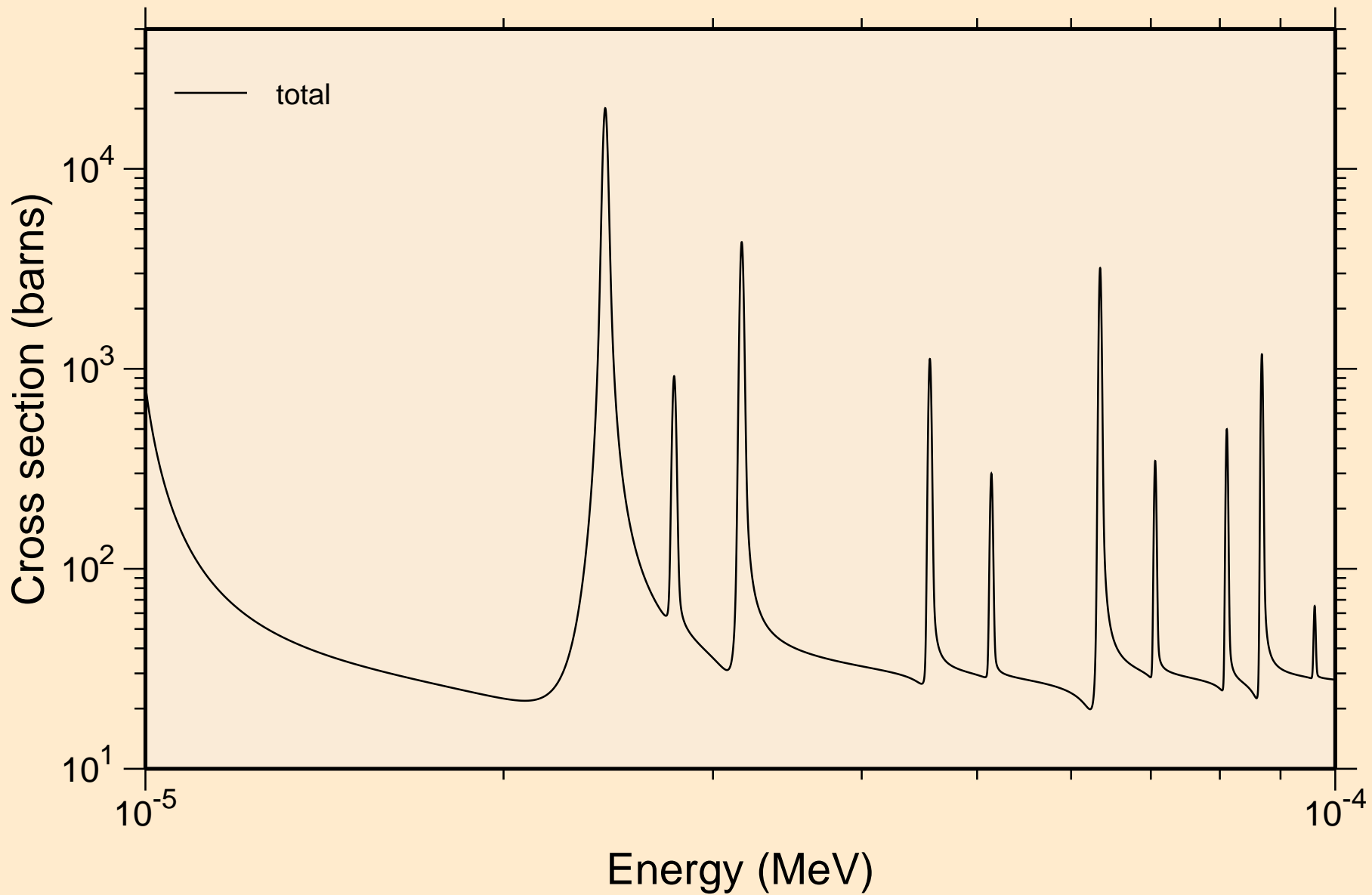

HO174 NEUTRON ACER TENDL-2021 LIBRARY; T=293.6K
resonance total cross section

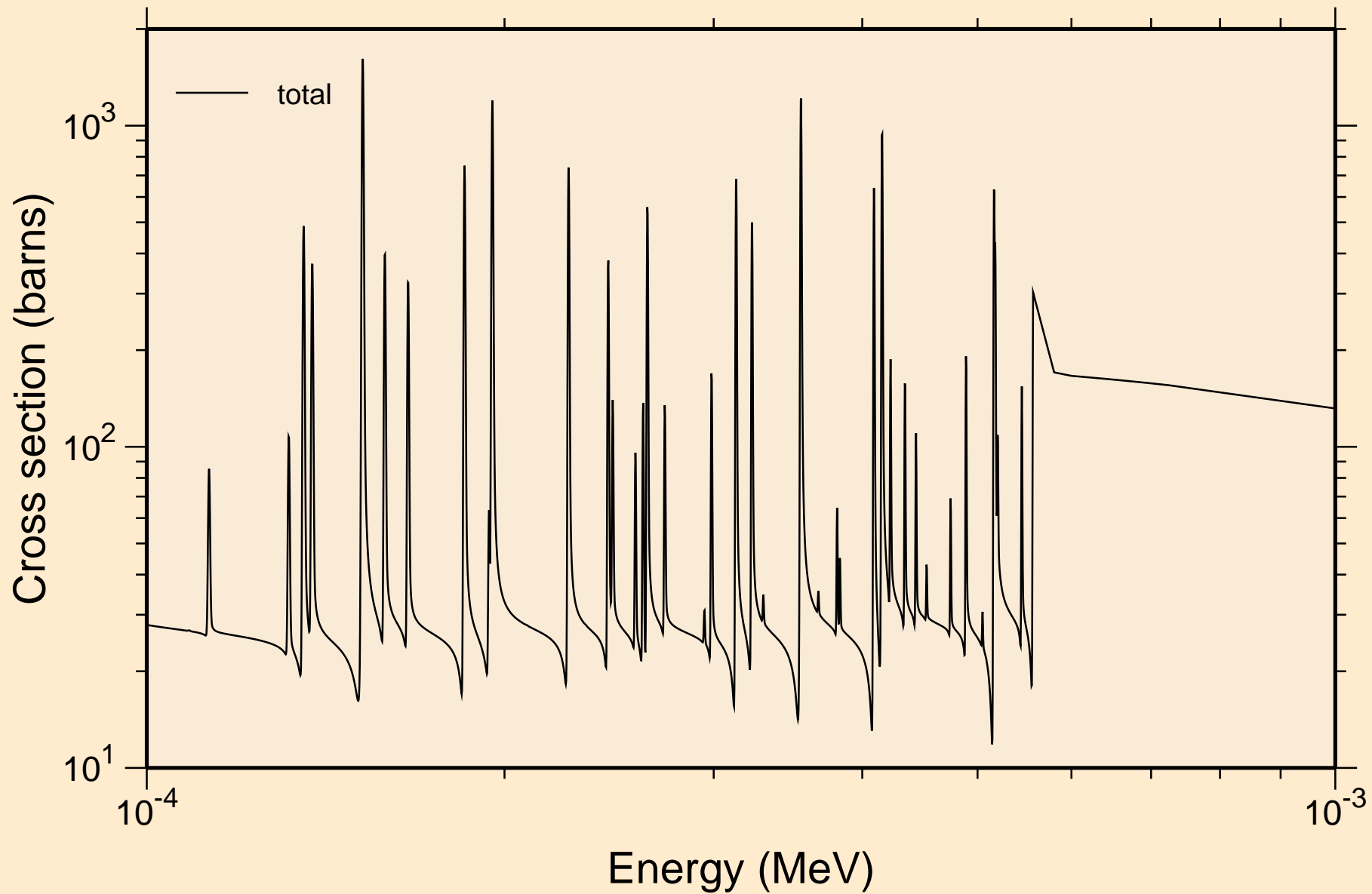

HO174 NEUTRON ACER TENDL-2021 LIBRARY; T=293.6K
resonance total cross section

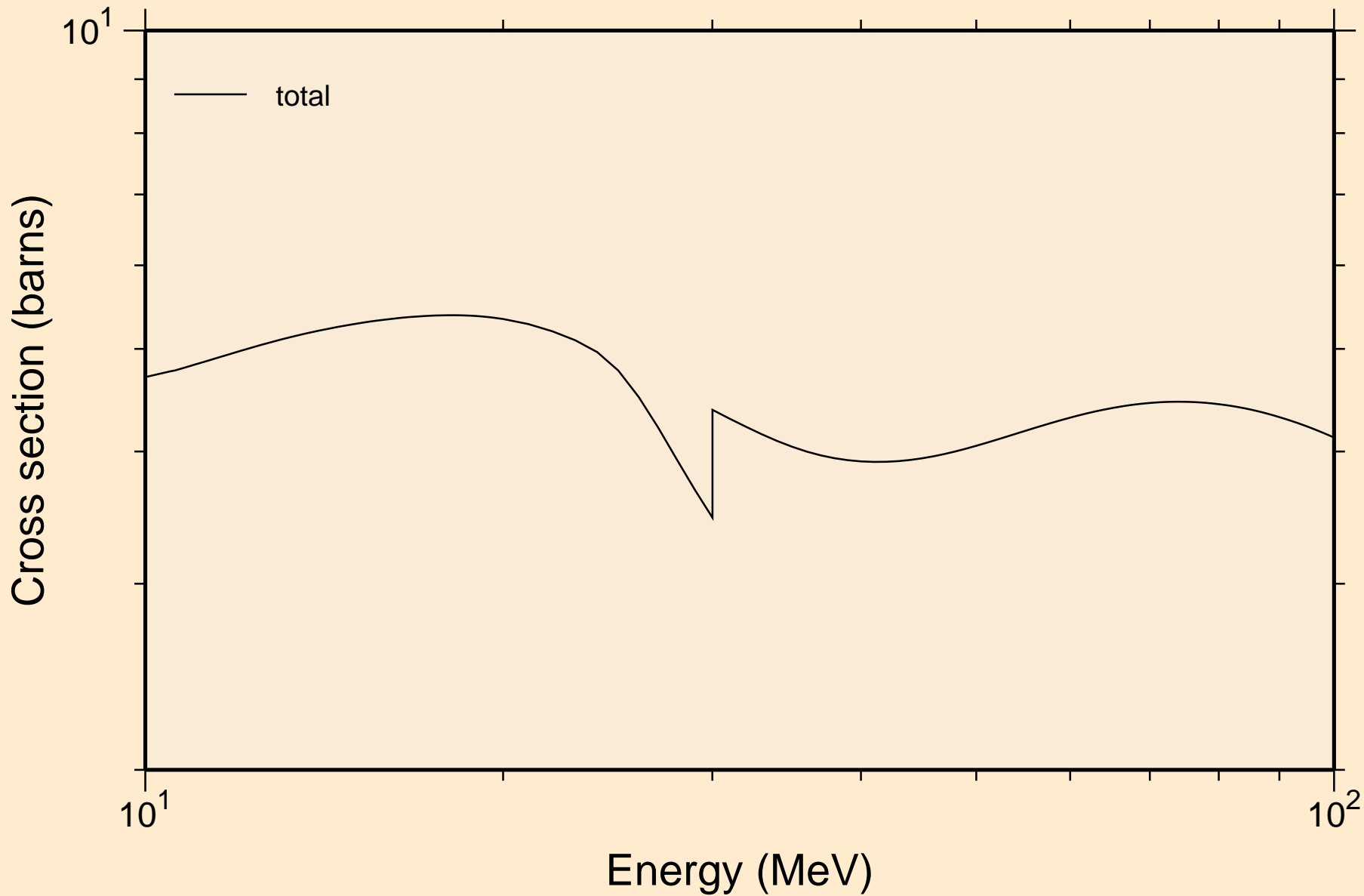

HO174 NEUTRON ACER TENDL-2021 LIBRARY; T=293.6K
resonance absorption cross sections

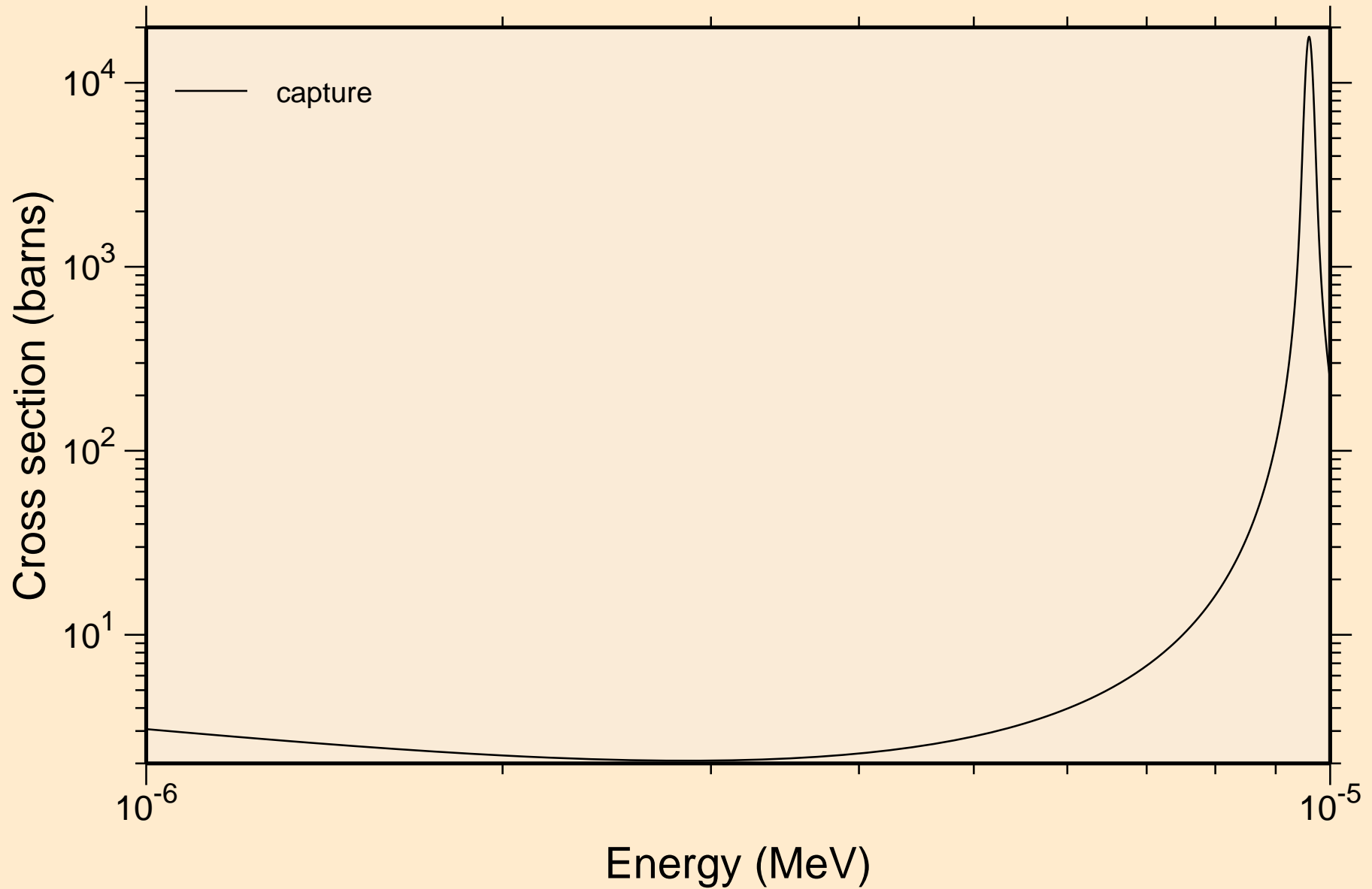

HO174 NEUTRON ACER TENDL-2021 LIBRARY; T=293.6K
resonance absorption cross sections

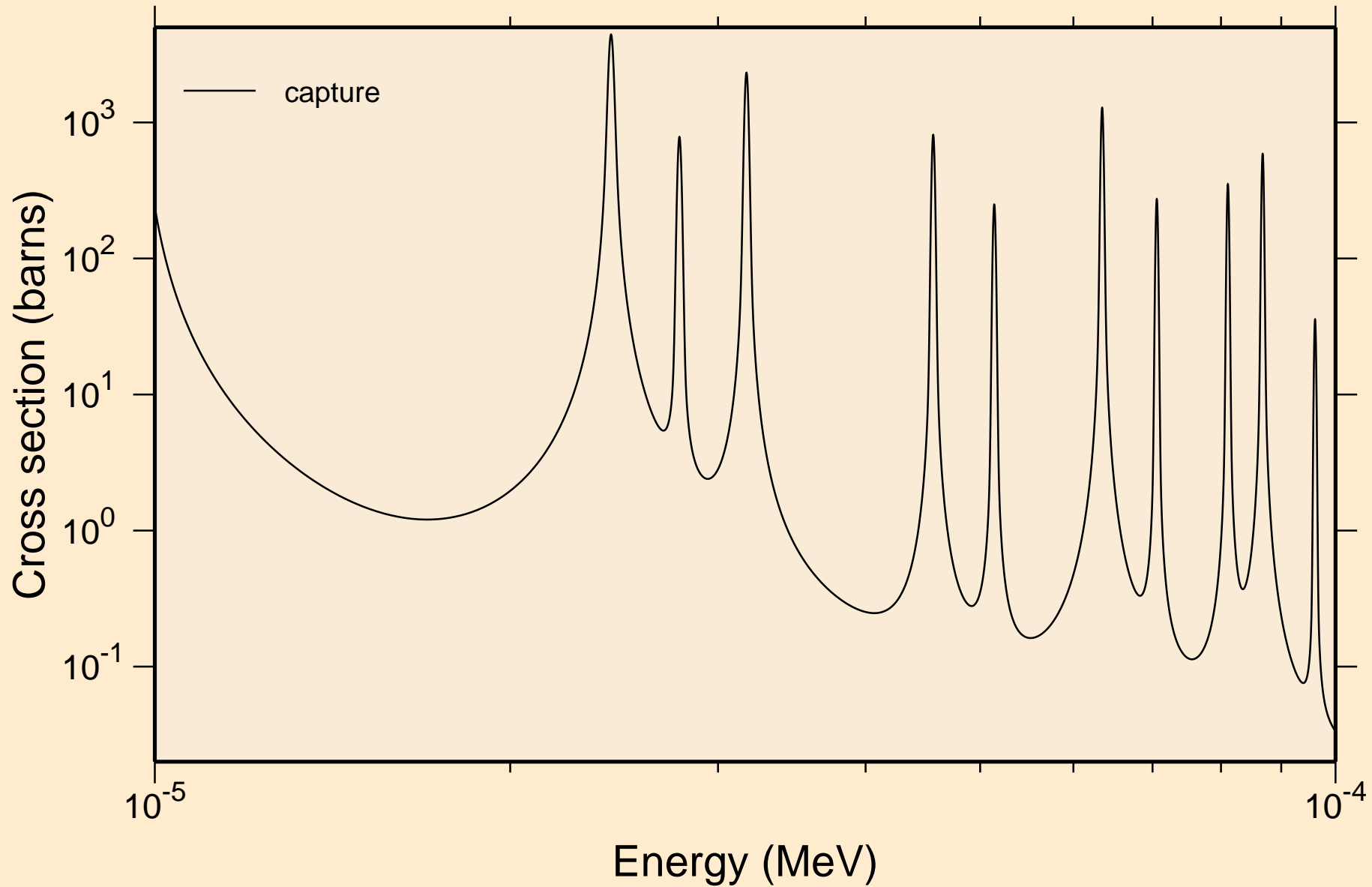

HO174 NEUTRON ACER TENDL-2021 LIBRARY; T=293.6K
resonance absorption cross sections

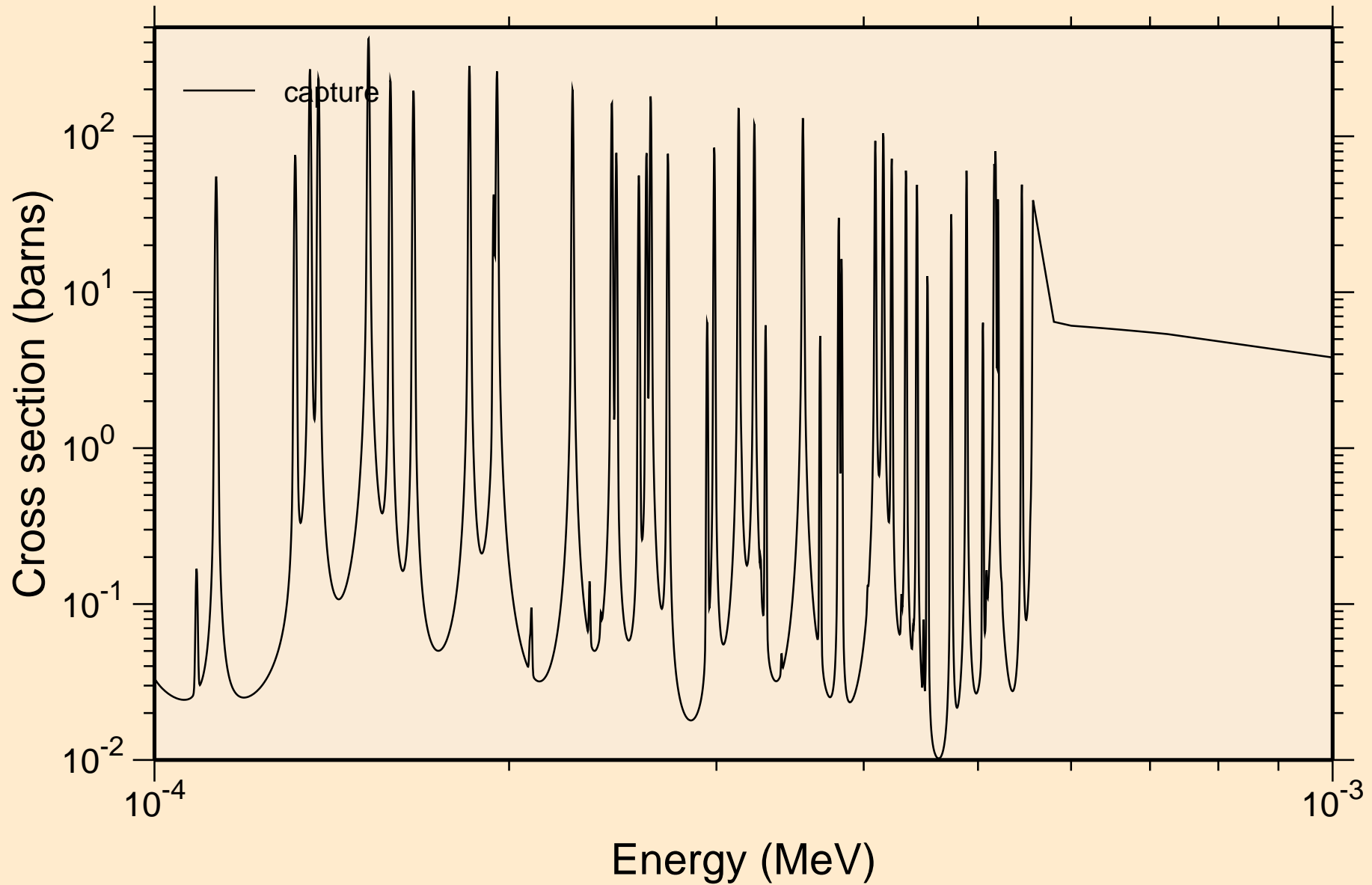

HO174 NEUTRON ACER TENDL-2021 LIBRARY; T=293.6K
resonance absorption cross sections

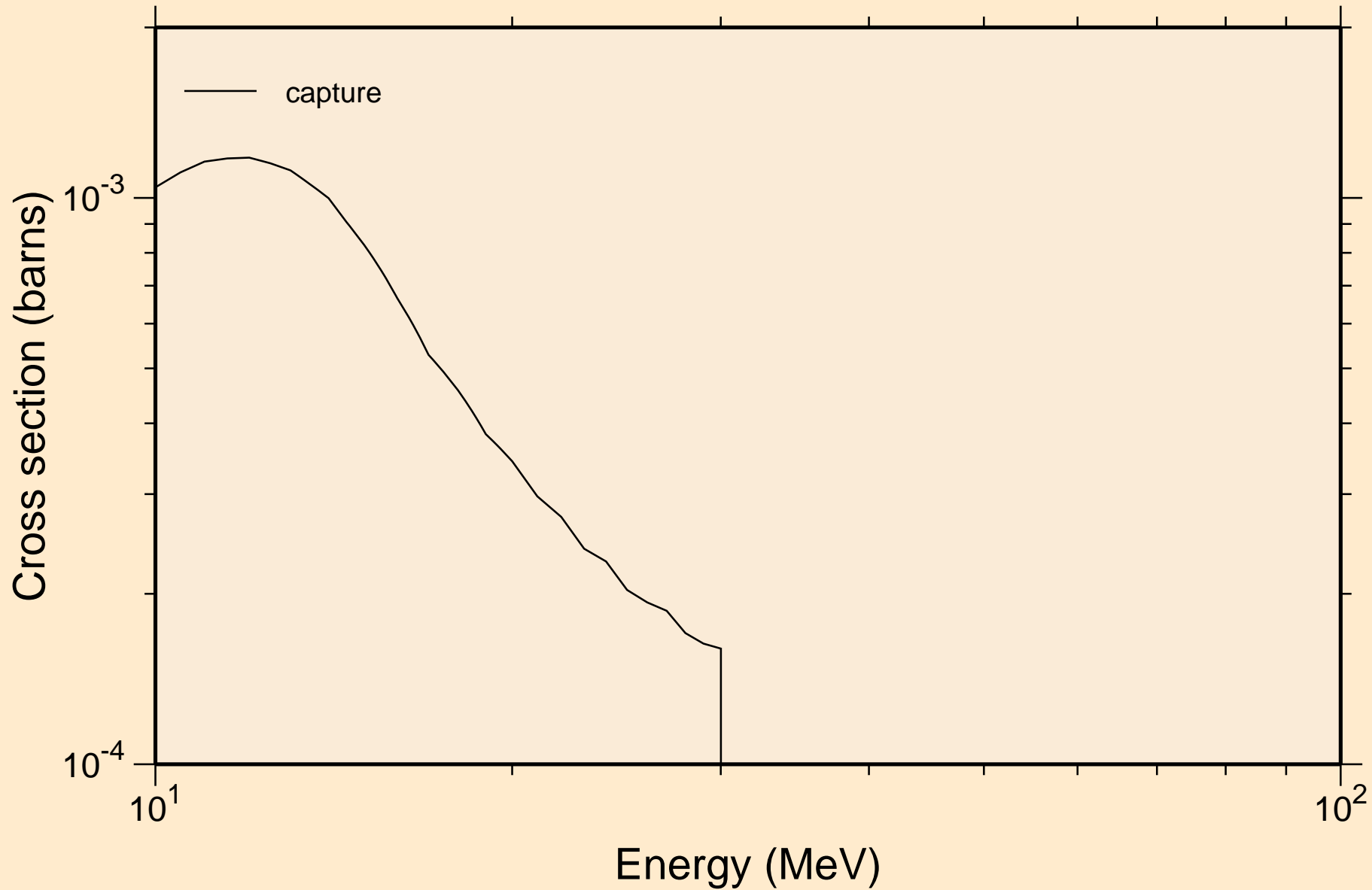

HO174 NEUTRON ACER TENDL-2021 LIBRARY; T=293.6K
Heating

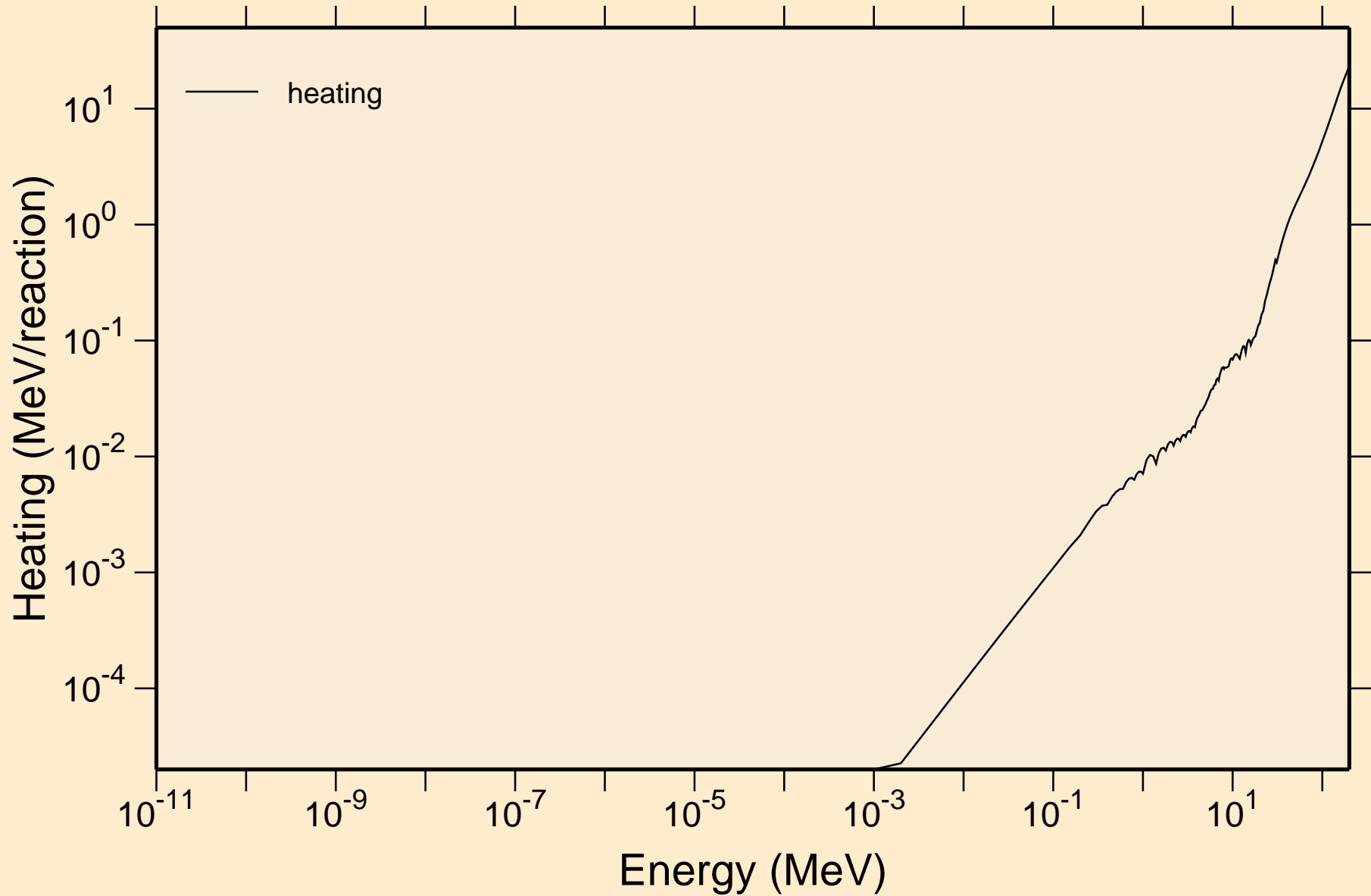

HO174 NEUTRON ACER TENDL-2021 LIBRARY; T=293.6K

Damage

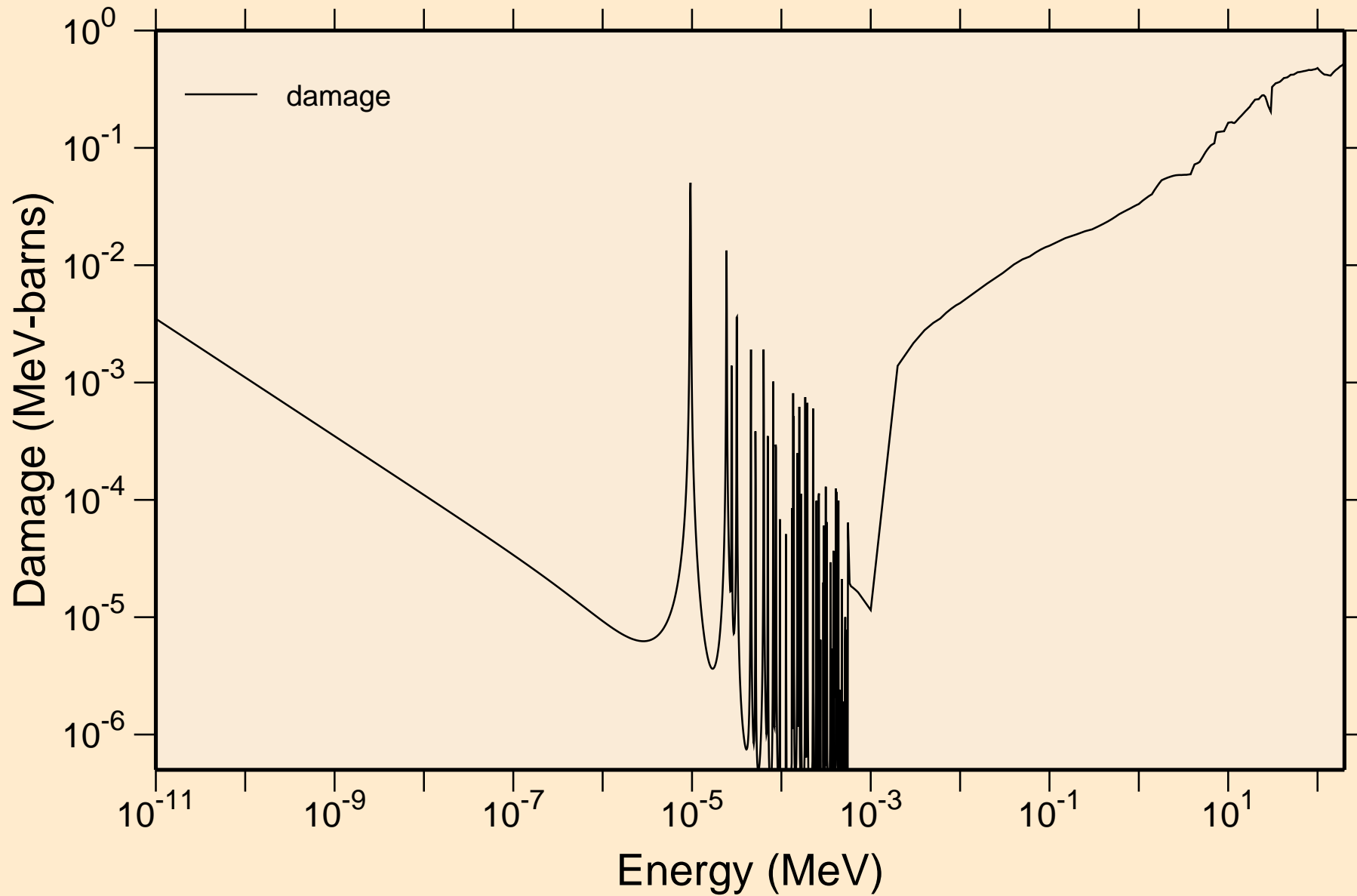

HO174 NEUTRON ACER TENDL-2021 LIBRARY; T=293.6K
Non-threshold reactions

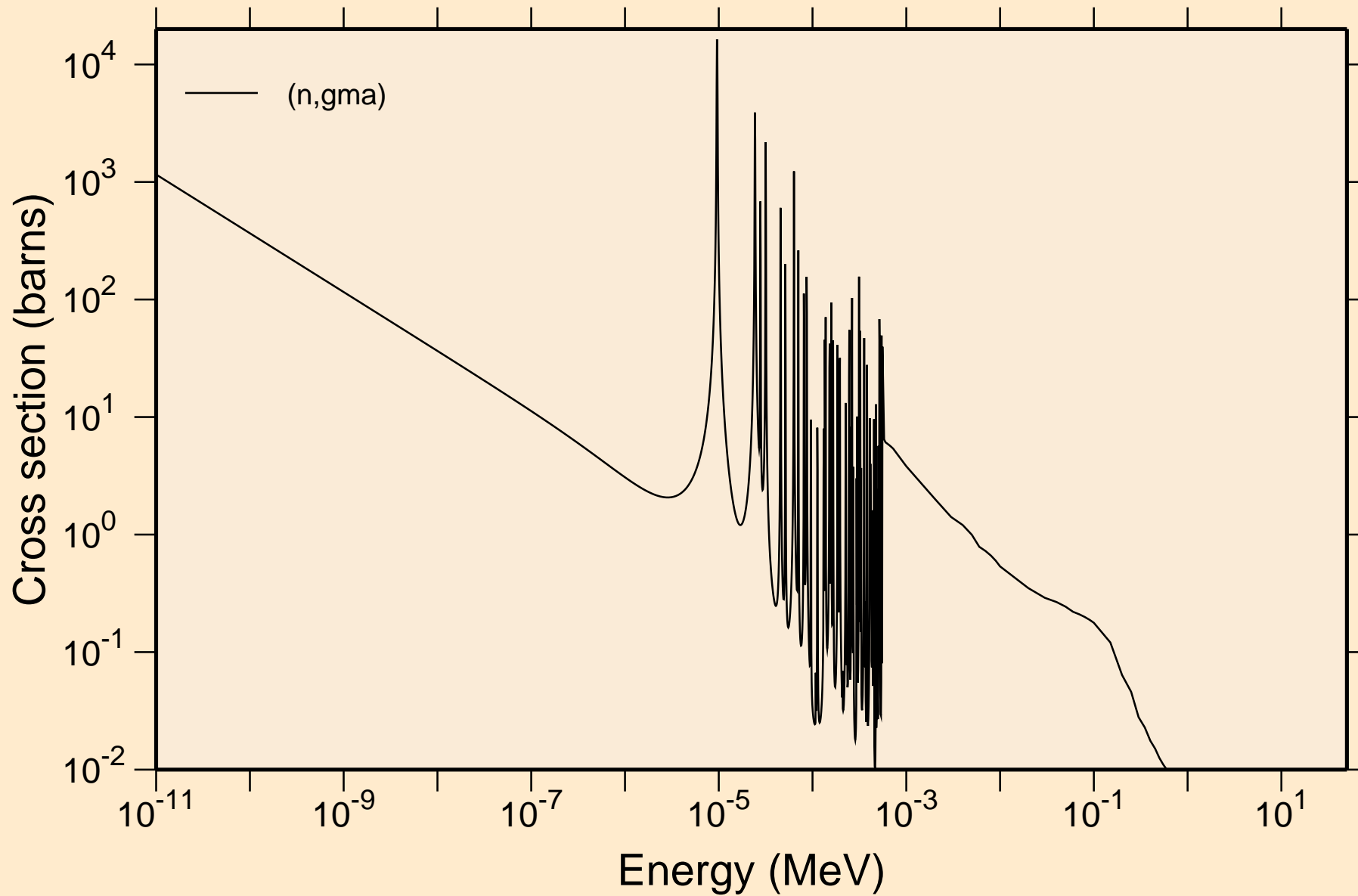

HO174 NEUTRON ACER TENDL-2021 LIBRARY; T=293.6K

Principal cross sections

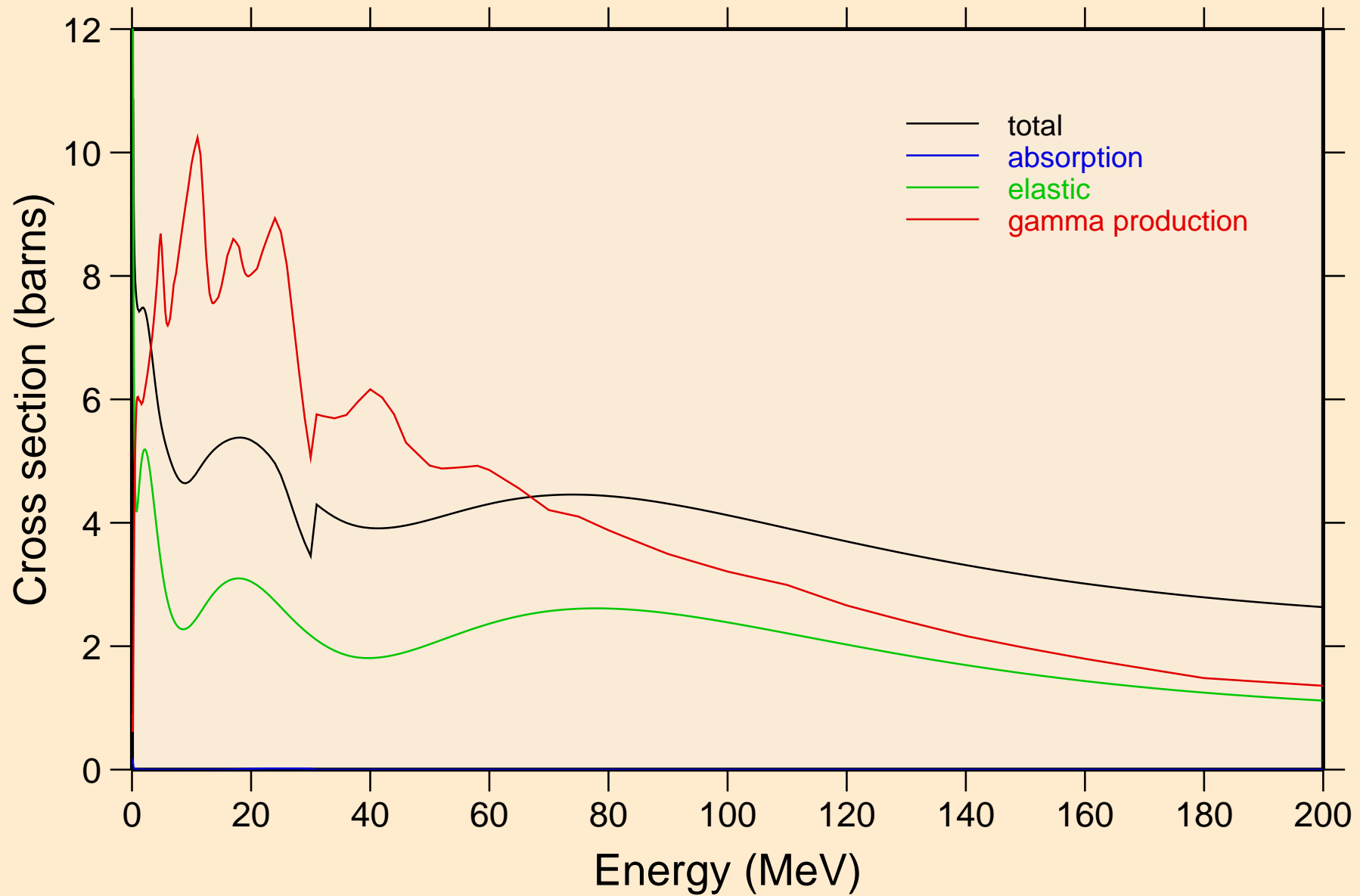

HO174 NEUTRON ACER TENDL-2021 LIBRARY; T=293.6K
Heating

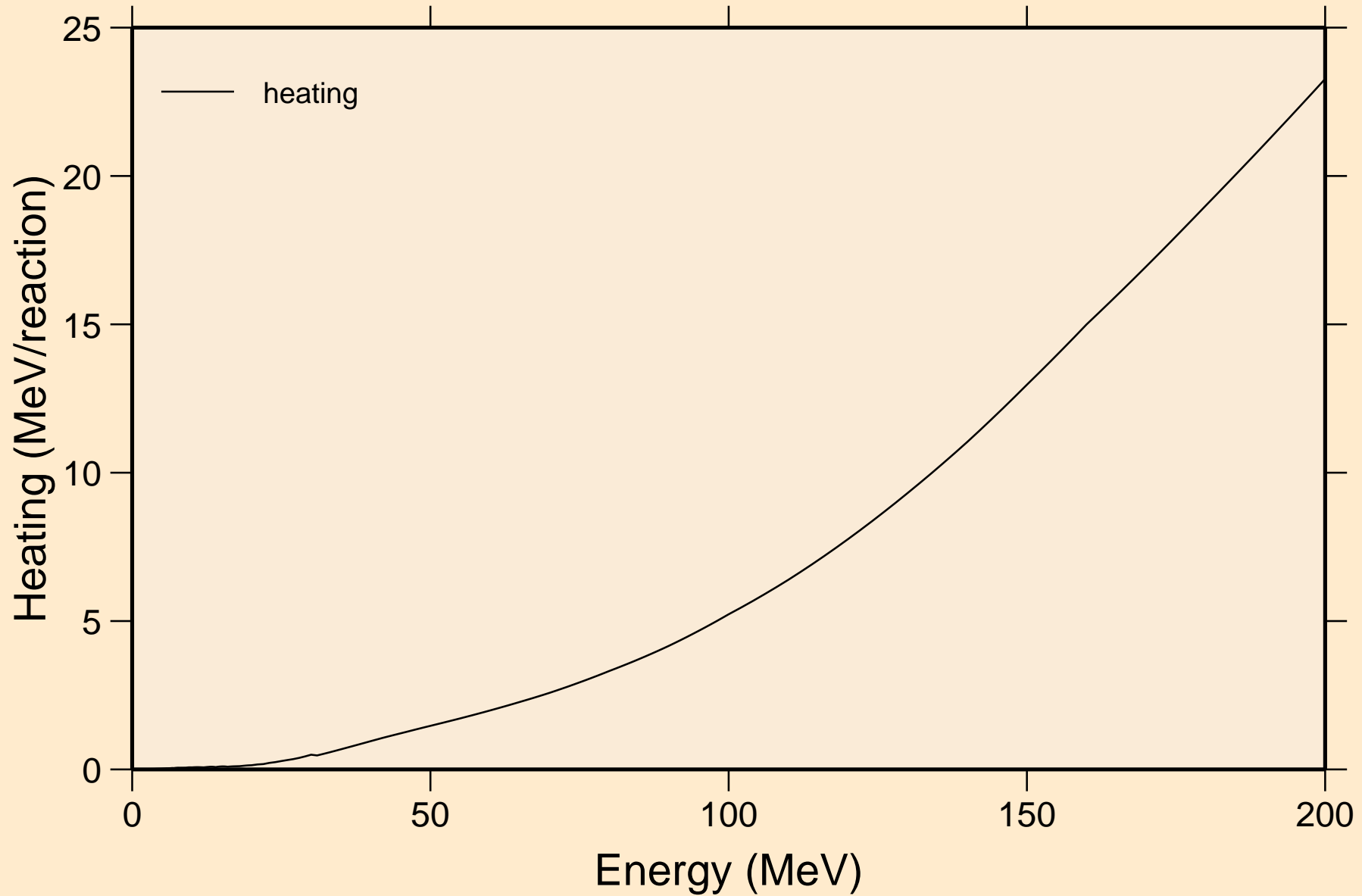

HO174 NEUTRON ACER TENDL-2021 LIBRARY; T=293.6K

Damage

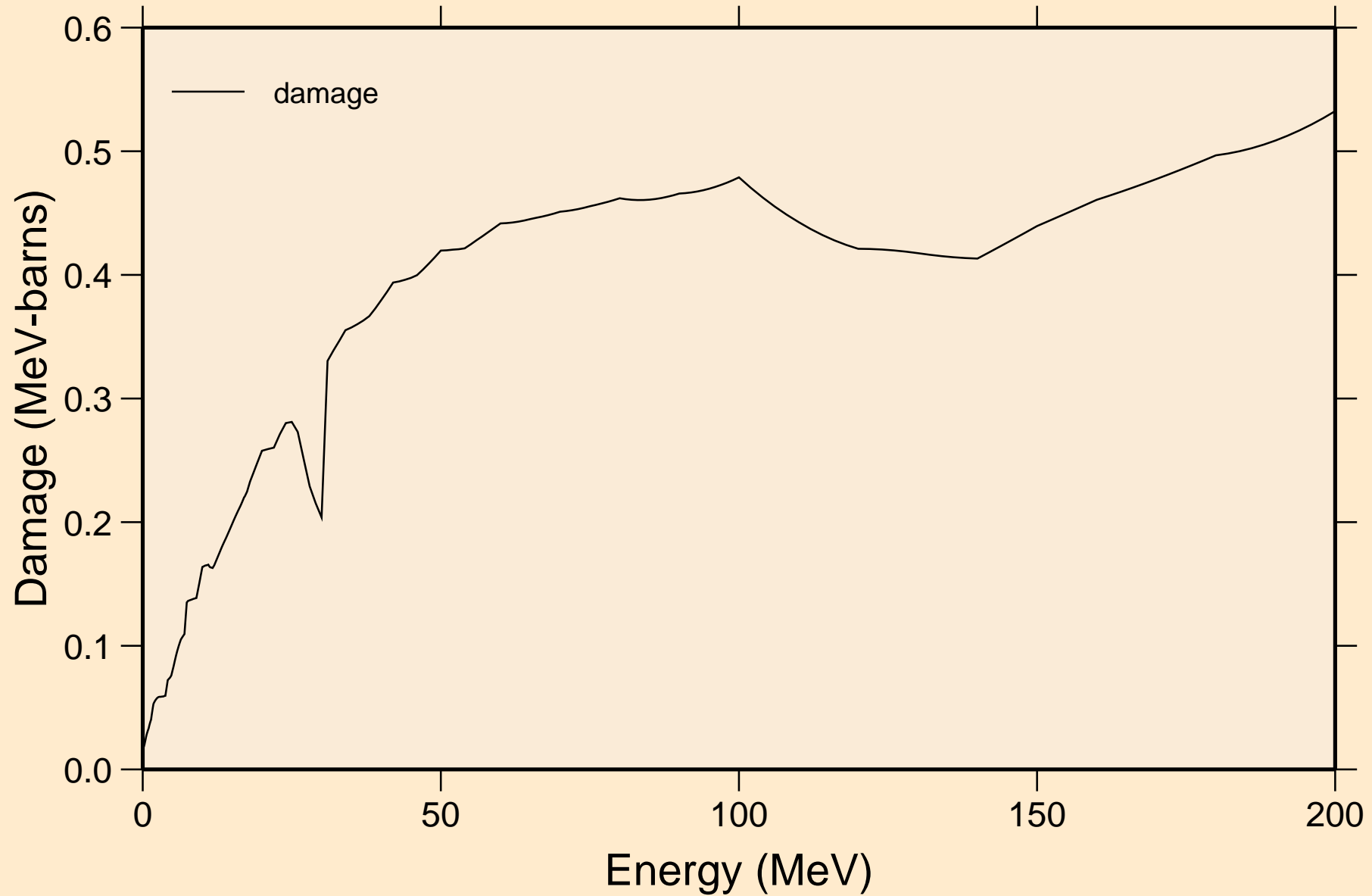

HO174 NEUTRON ACER TENDL-2021 LIBRARY; T=293.6K
Non-threshold reactions

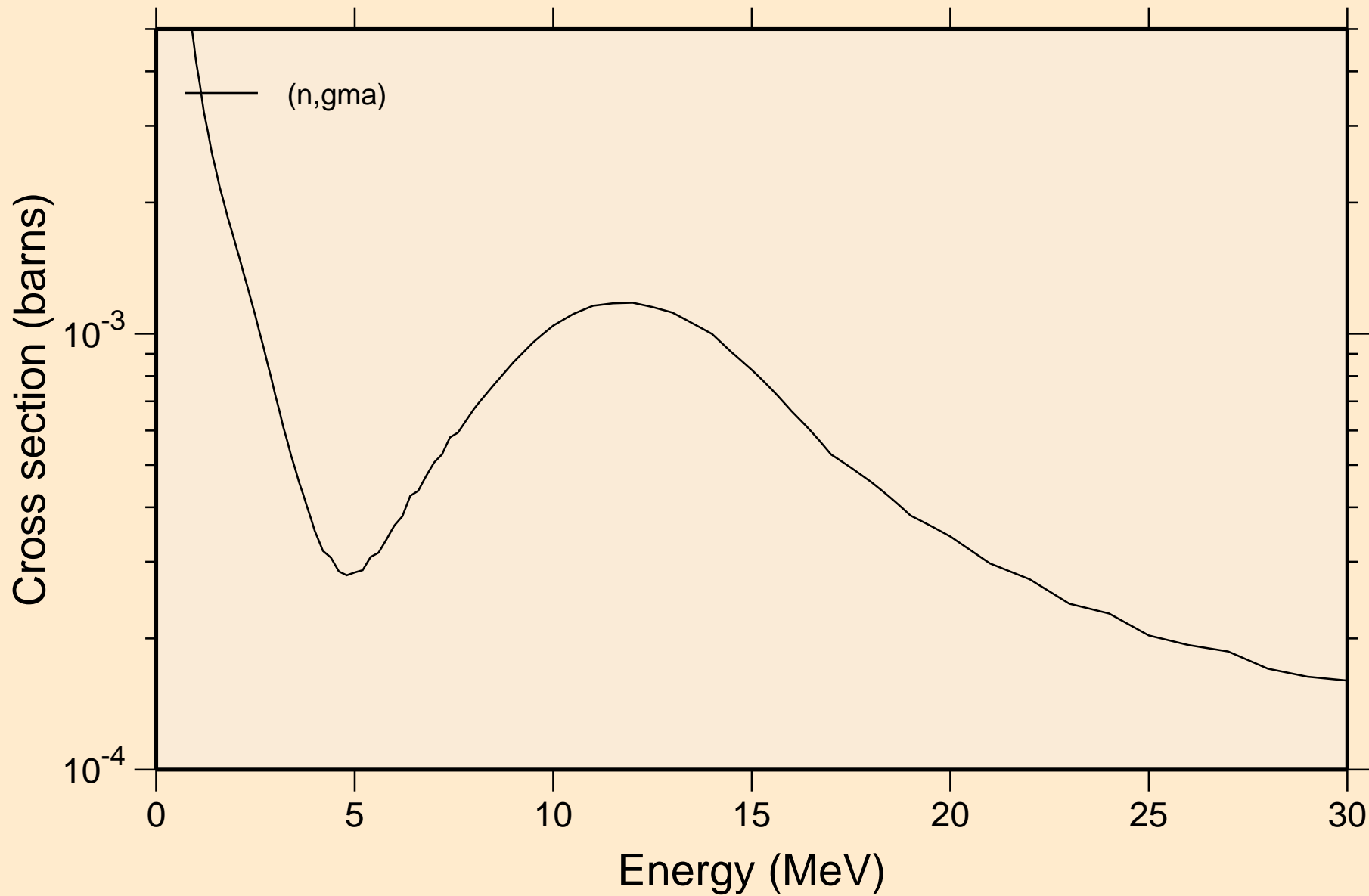

HO174 NEUTRON ACER TENDL-2021 LIBRARY; T=293.6K
Inelastic levels

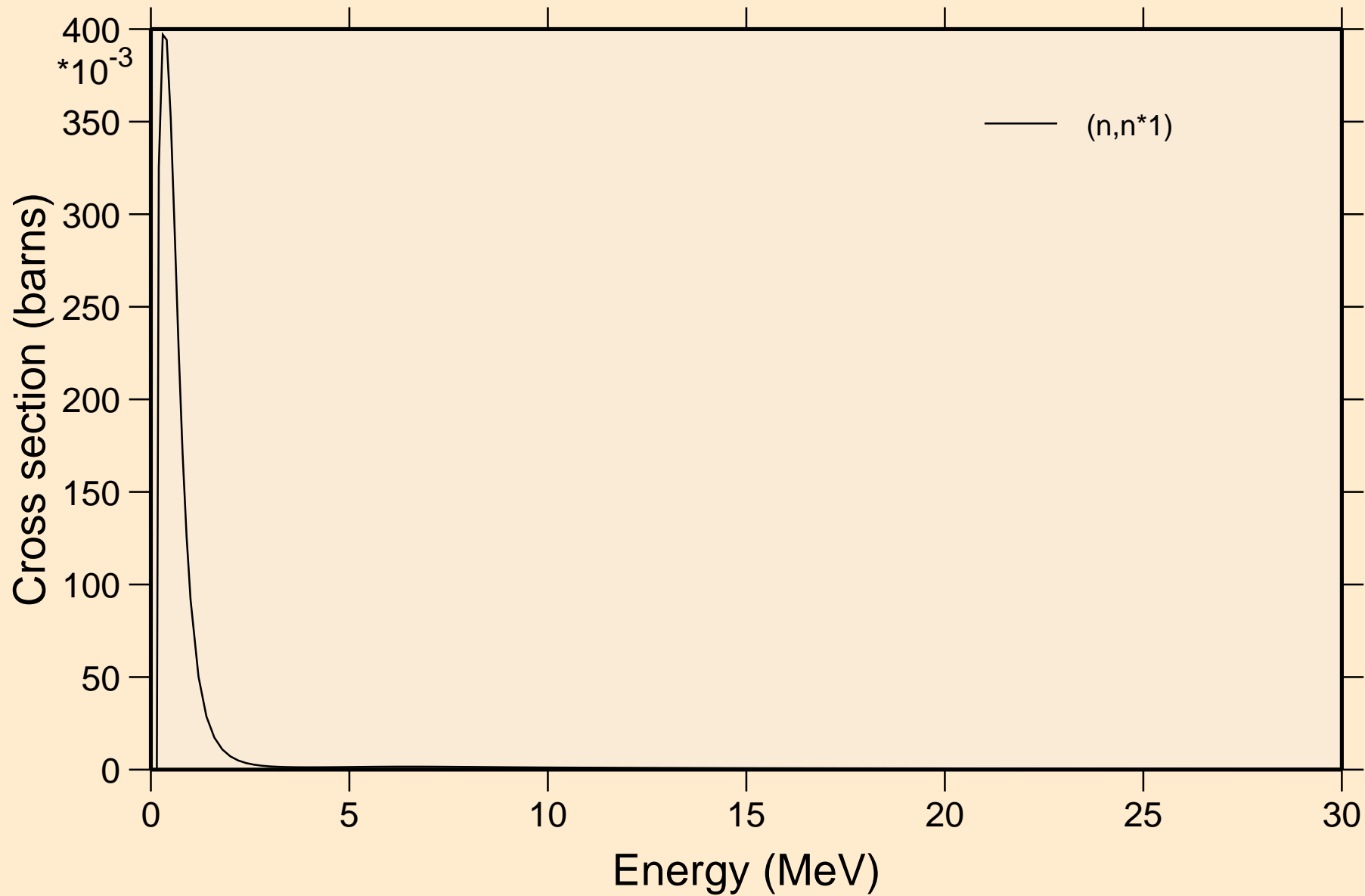

HO174 NEUTRON ACER TENDL-2021 LIBRARY; T=293.6K
Threshold reactions

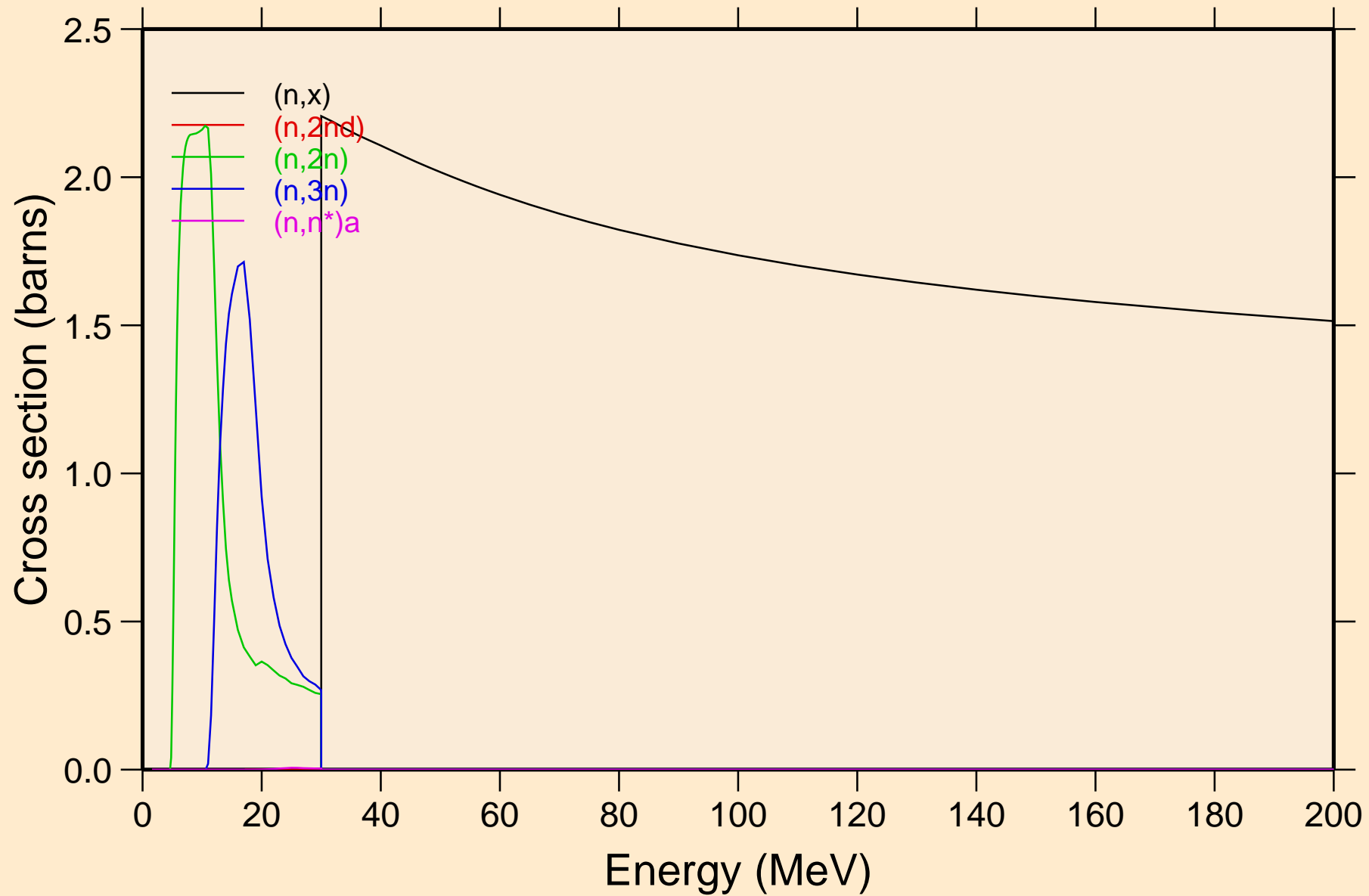

HO174 NEUTRON ACER TENDL-2021 LIBRARY; T=293.6K

Threshold reactions

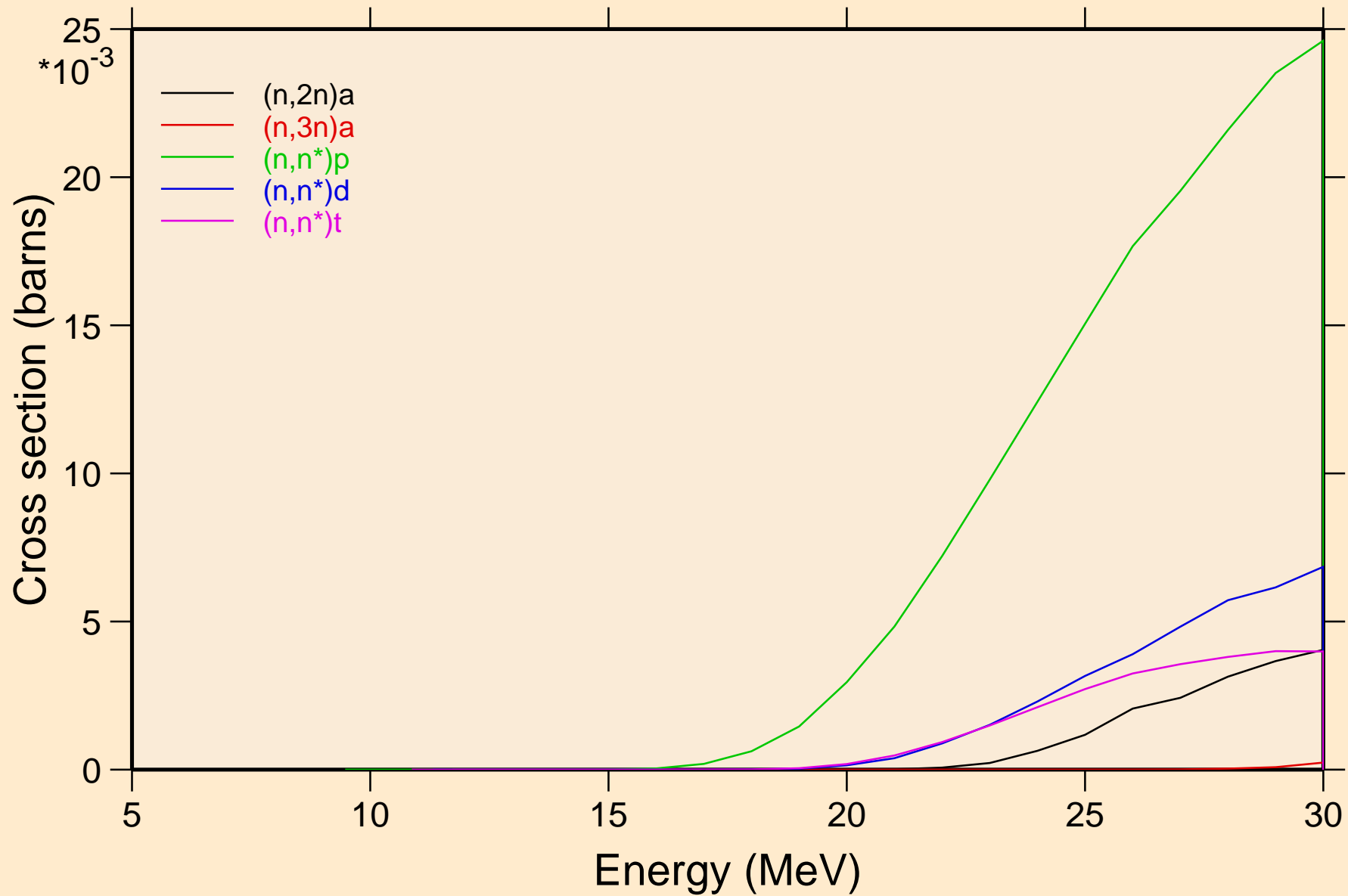

HO174 NEUTRON ACER TENDL-2021 LIBRARY; T=293.6K
Threshold reactions

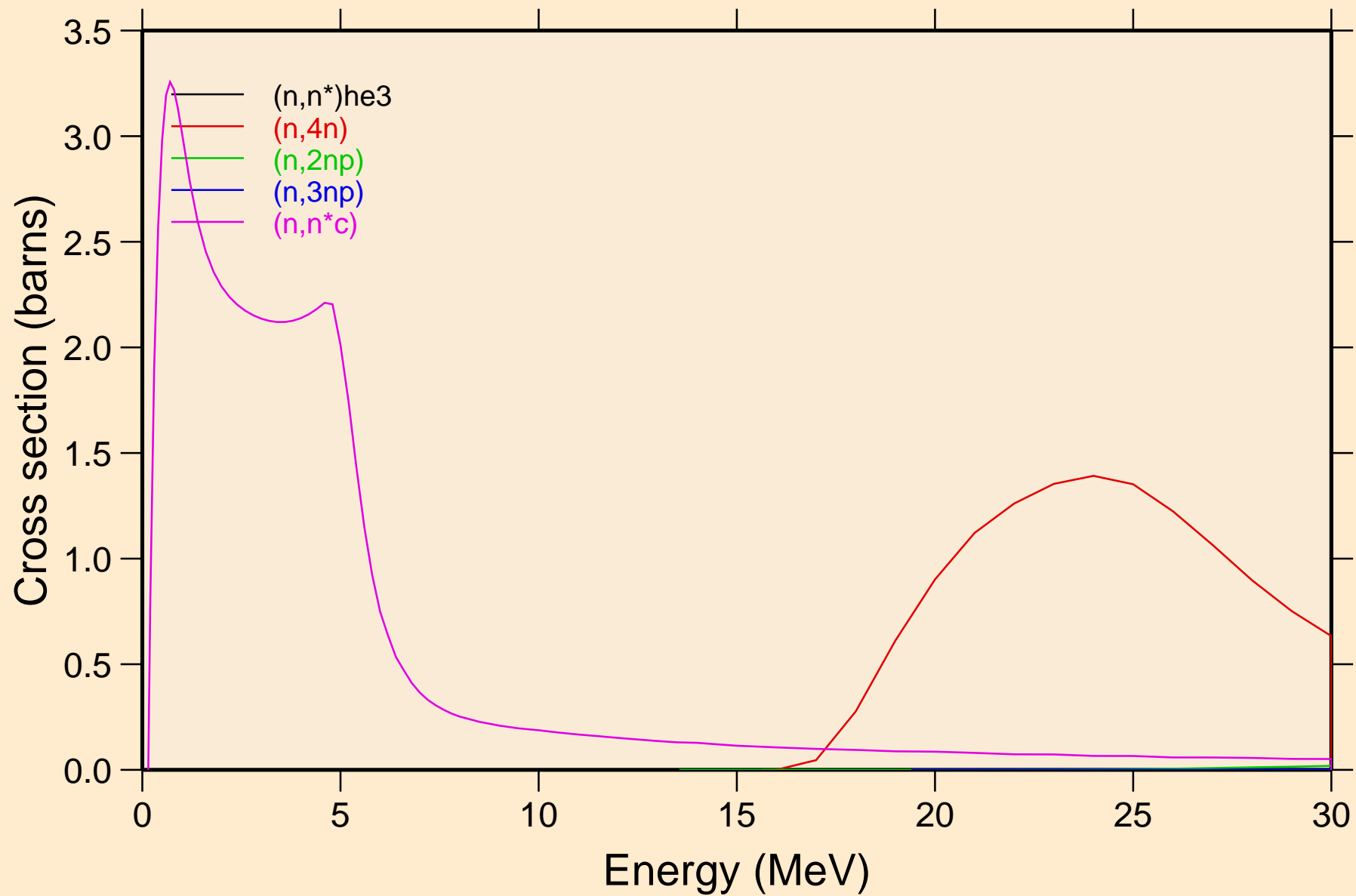

HO174 NEUTRON ACER TENDL-2021 LIBRARY; T=293.6K
Threshold reactions

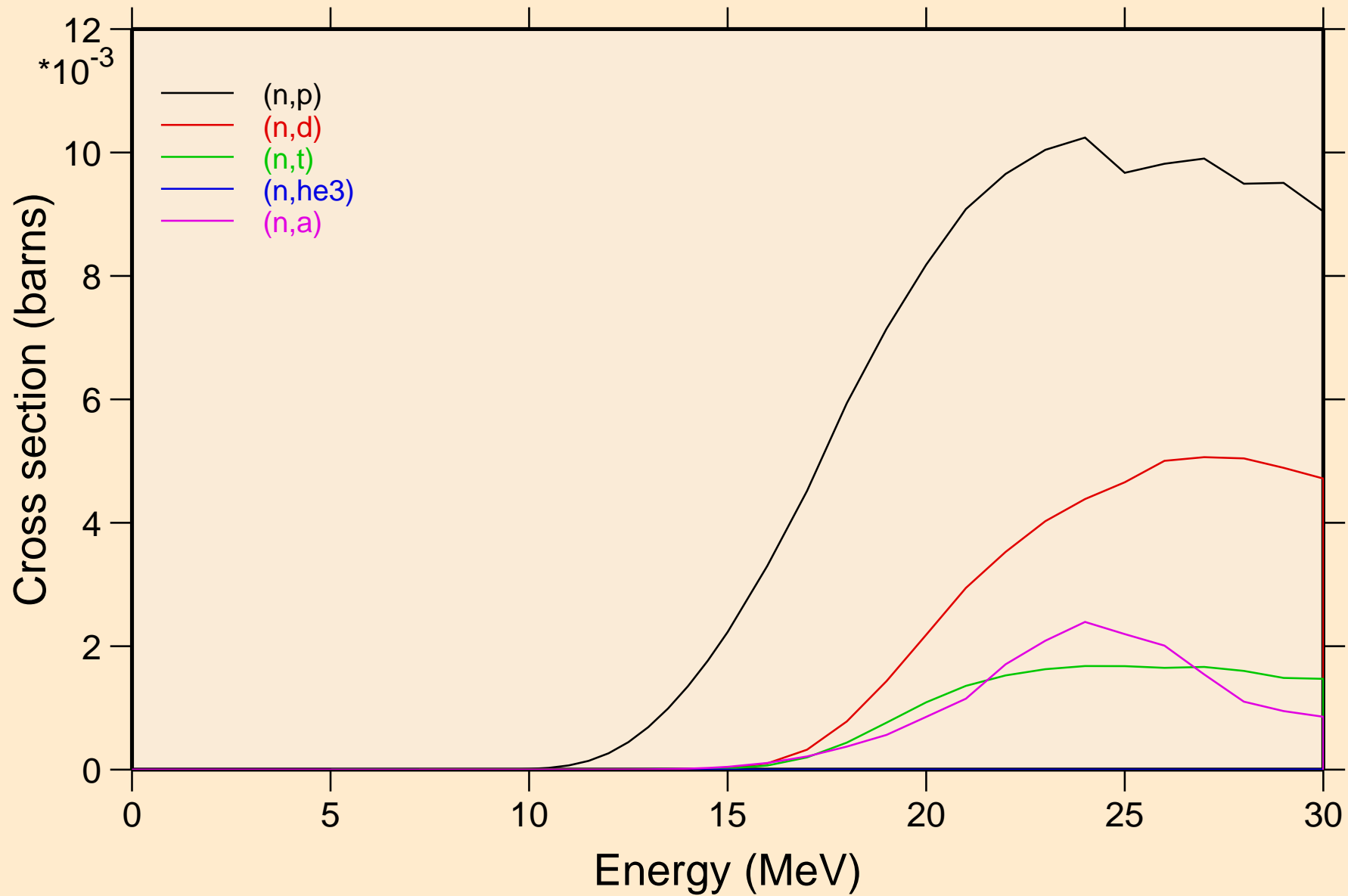

HO174 NEUTRON ACER TENDL-2021 LIBRARY; T=293.6K
Threshold reactions

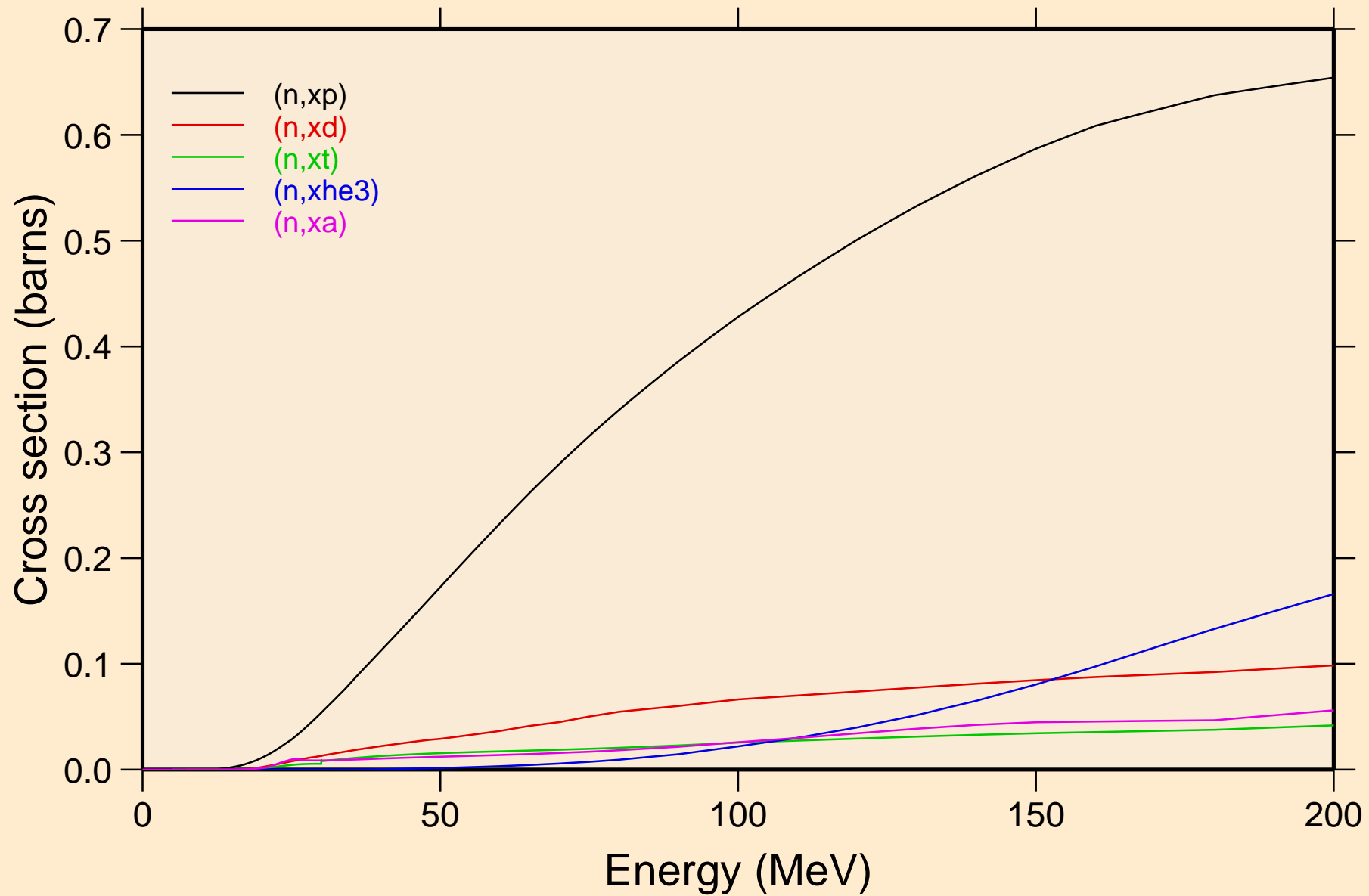

HO174 NEUTRON ACER TENDL-2021 LIBRARY; T=293.6K
angular distribution for elastic

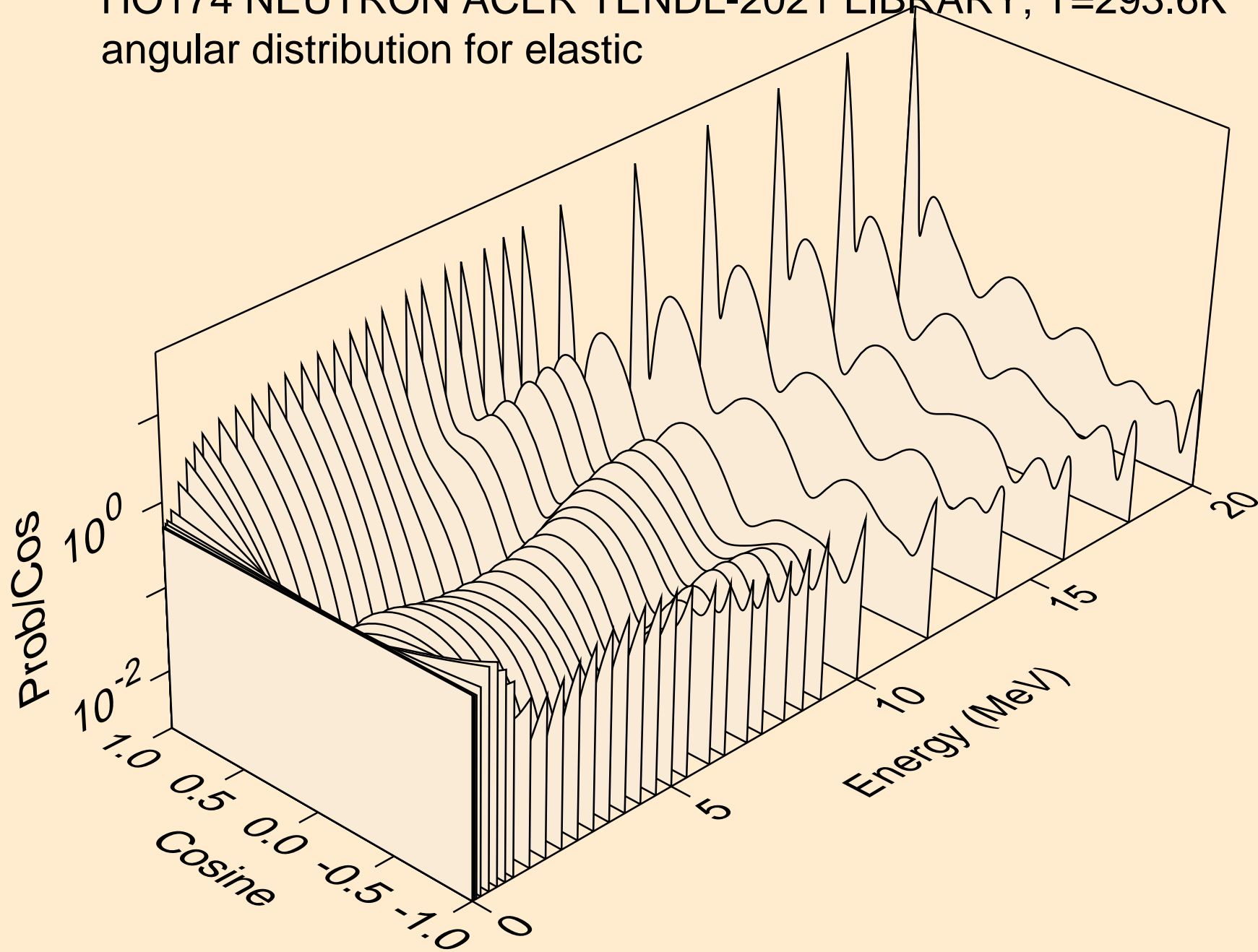

HO174 NEUTRON ACER TENDL-2021 LIBRARY; T=293.6K
angular distribution for elastic

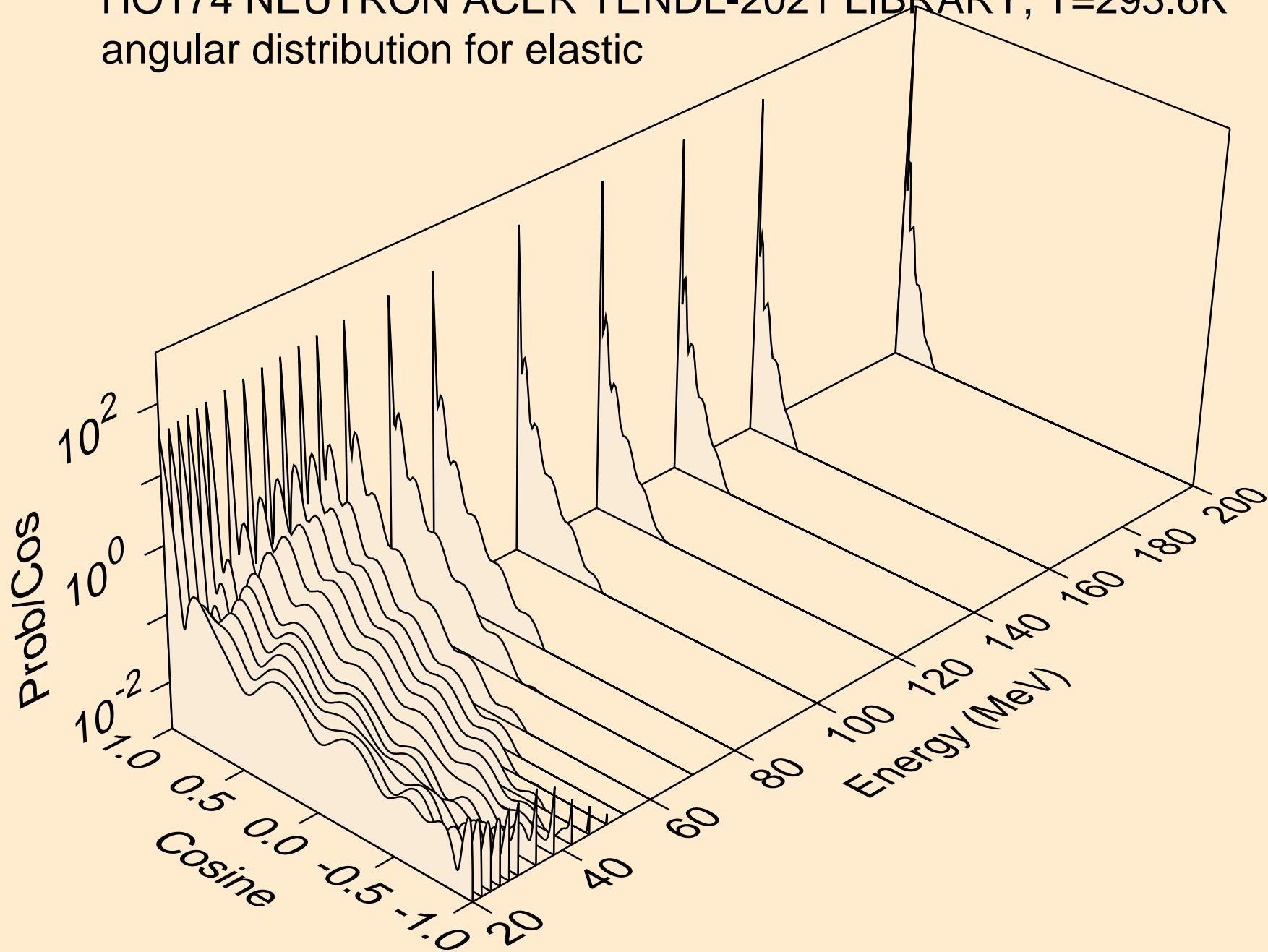

HO174 NEUTRON ACER TENDL-2021 LIBRARY; T=293.6K
angular distribution for (n,n*1)

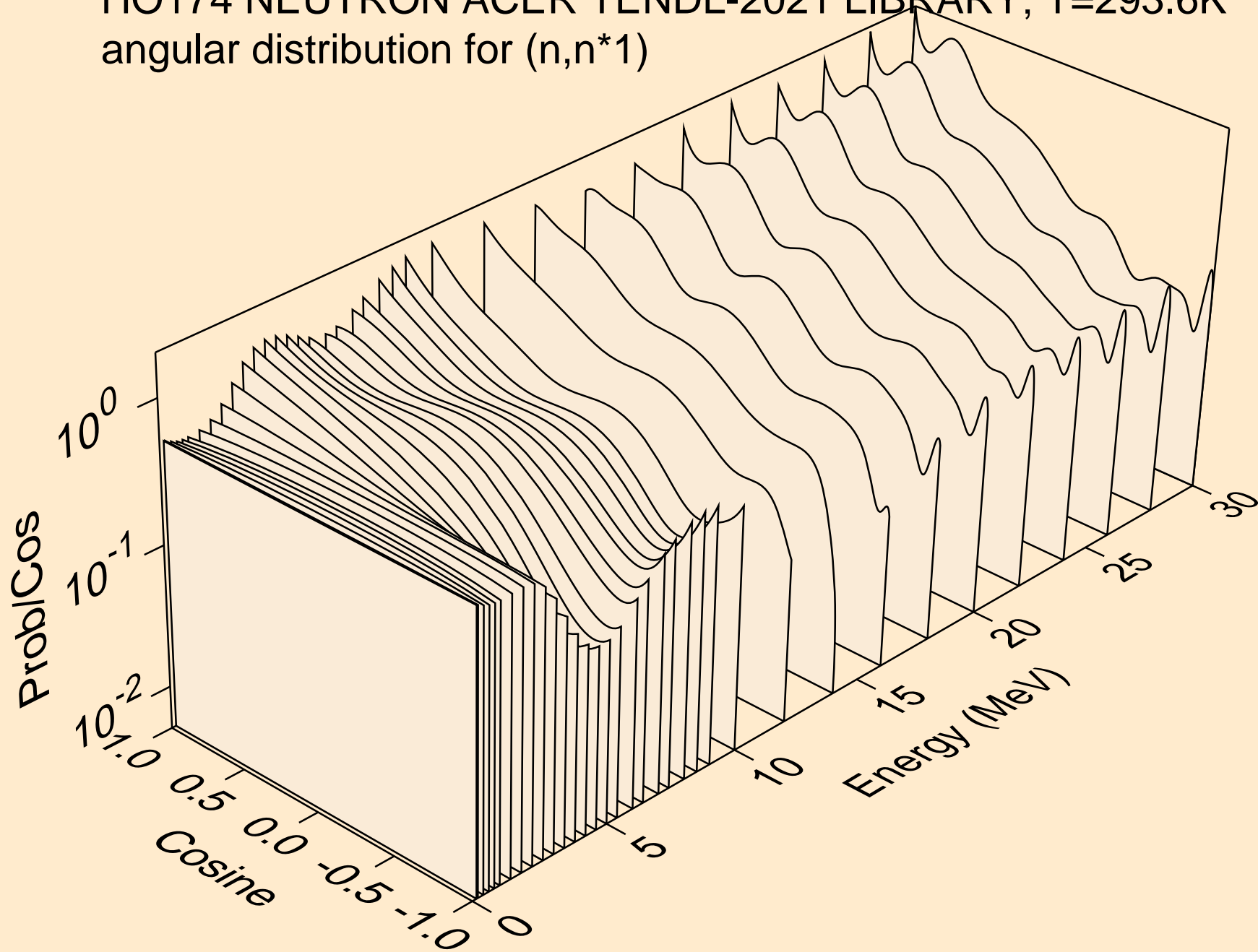

HO174 NEUTRON ACER TENDL-2021 LIBRARY; T=293.6K
Neutron emission for (n,x)

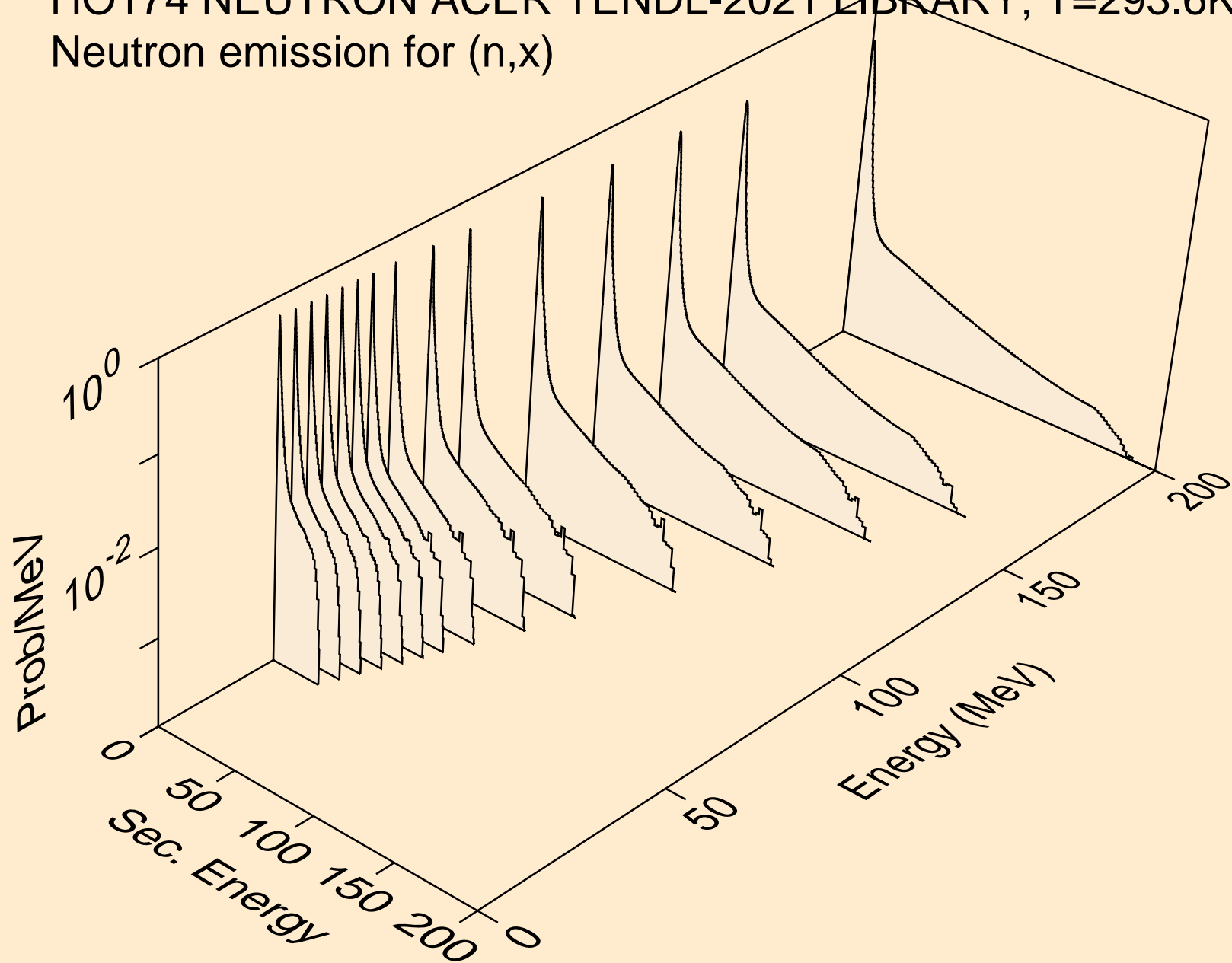

HO174 NEUTRON ACER TENDL-2021 LIBRARY; T=293.6K
Neutron emission for (n,2nd)

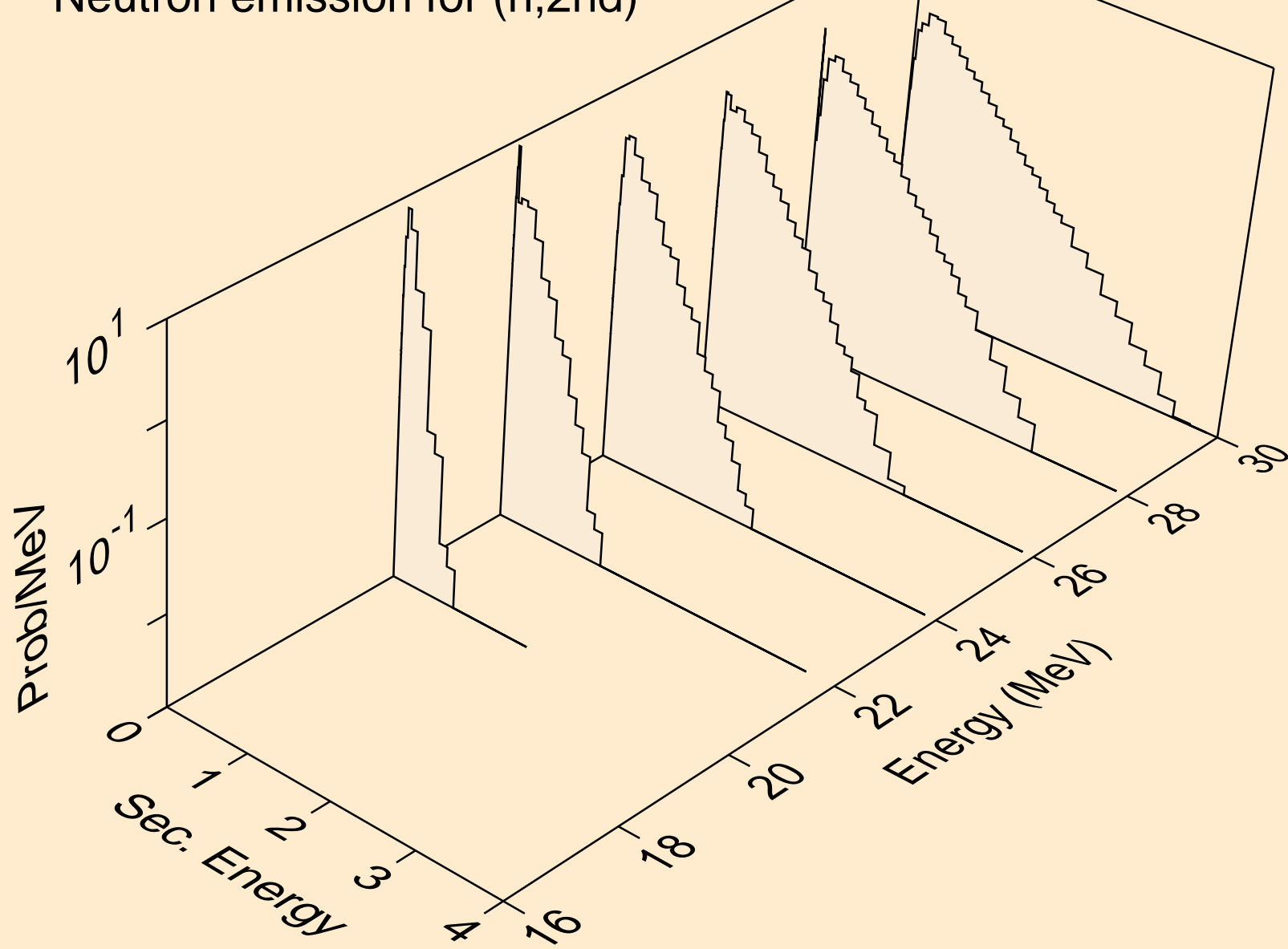

HO174 NEUTRON ACER TENDL-2021 LIBRARY; T=293.6K
Neutron emission for (n,2n)

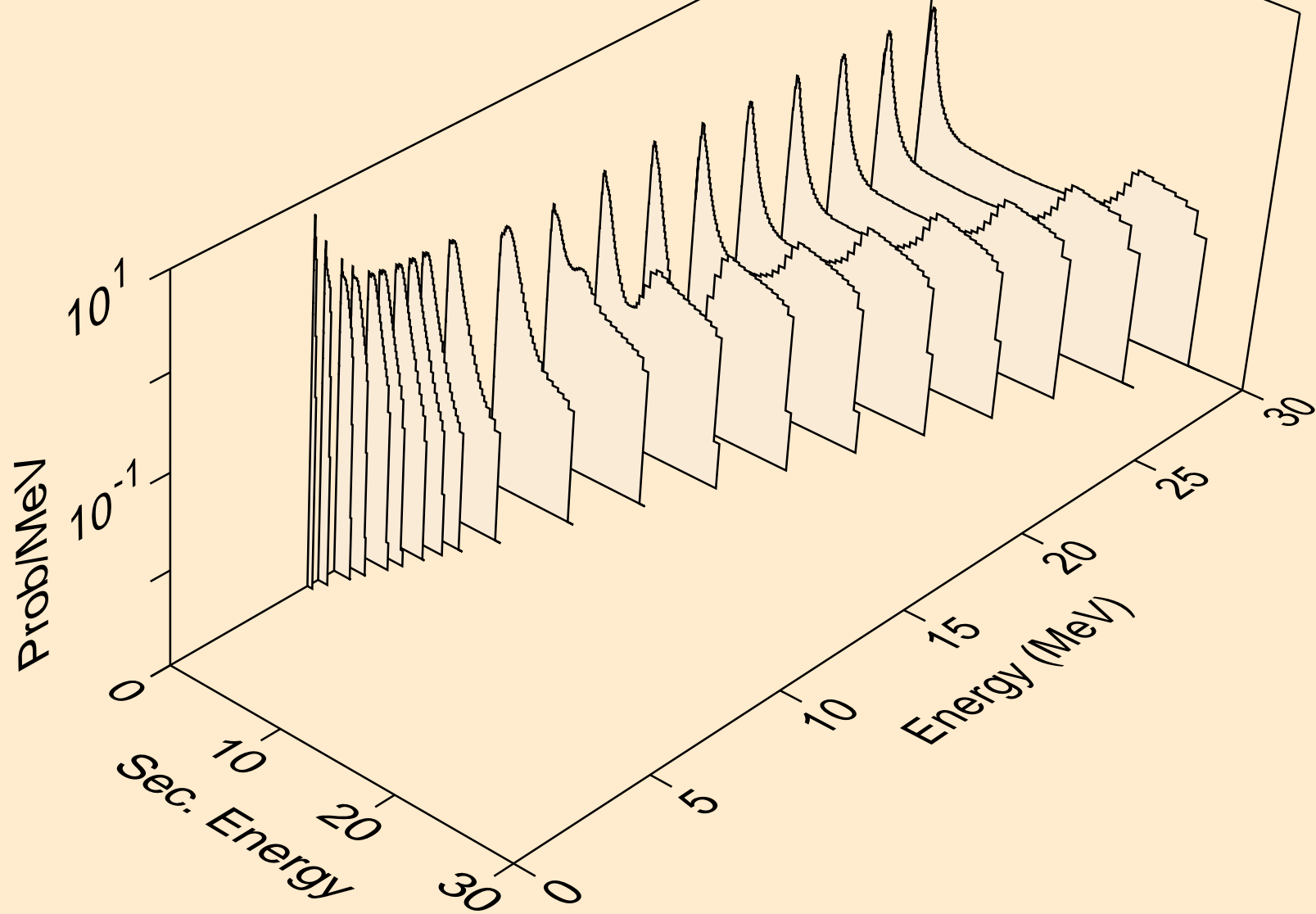

HO174 NEUTRON ACER TENDL-2021 LIBRARY; T=293.6K
Neutron emission for (n,3n)

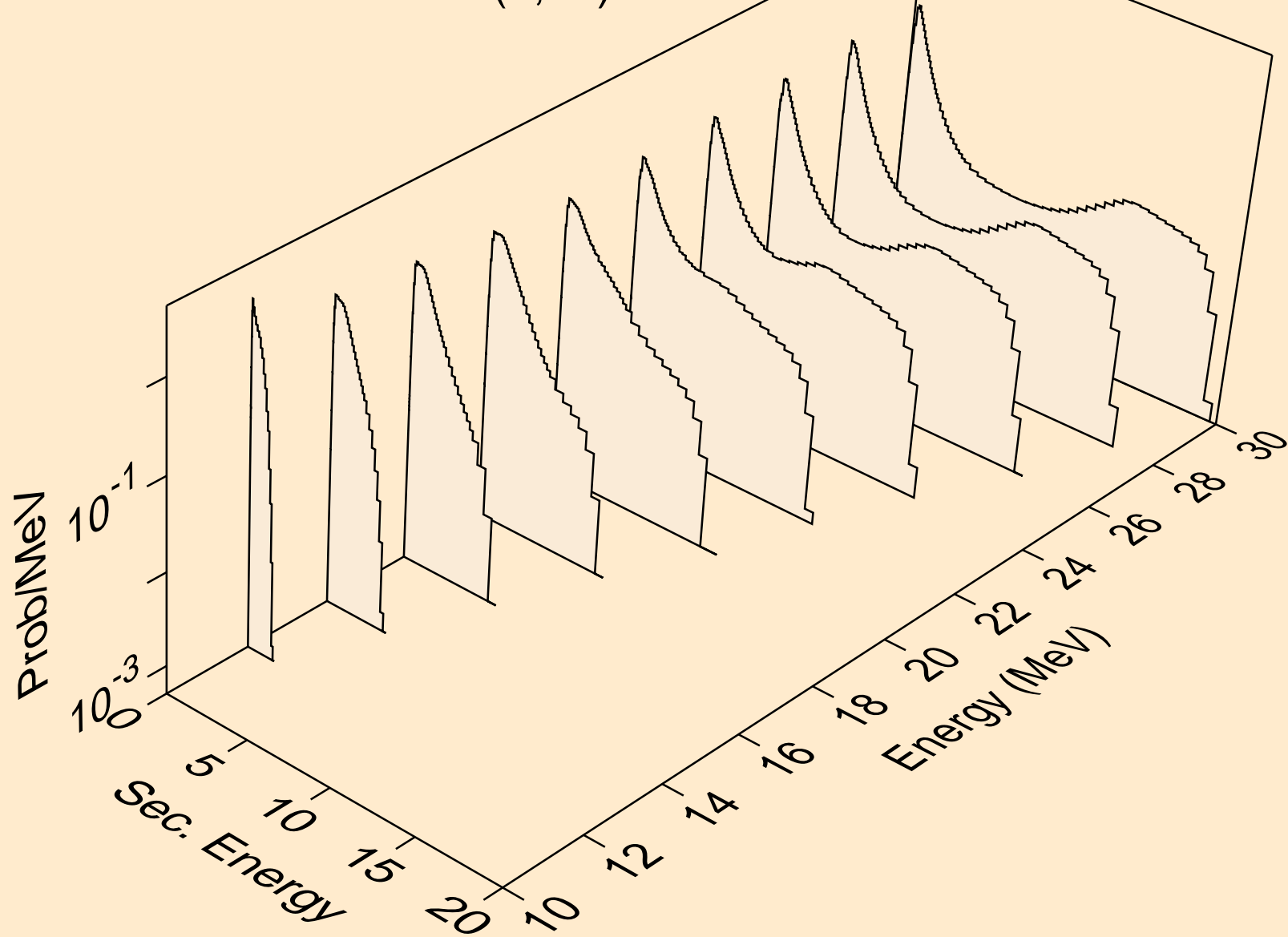

HO174 NEUTRON ACER TENDL-2021 LIBRARY; T=293.6K
Neutron emission for (n,n*)a

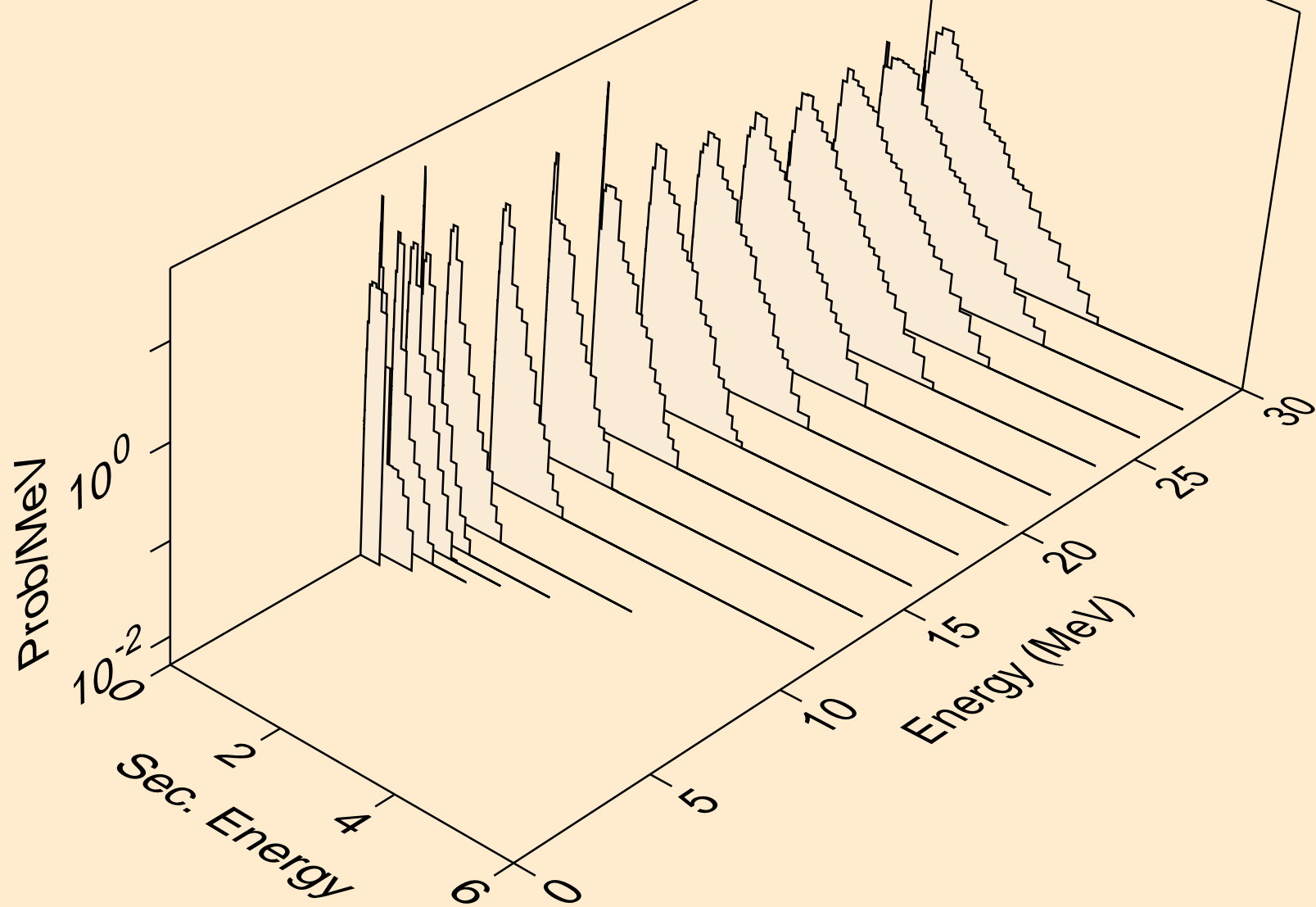

HO174 NEUTRON ACER TENDL-2021 LIBRARY; T=293.6K
Neutron emission for (n,2n)a

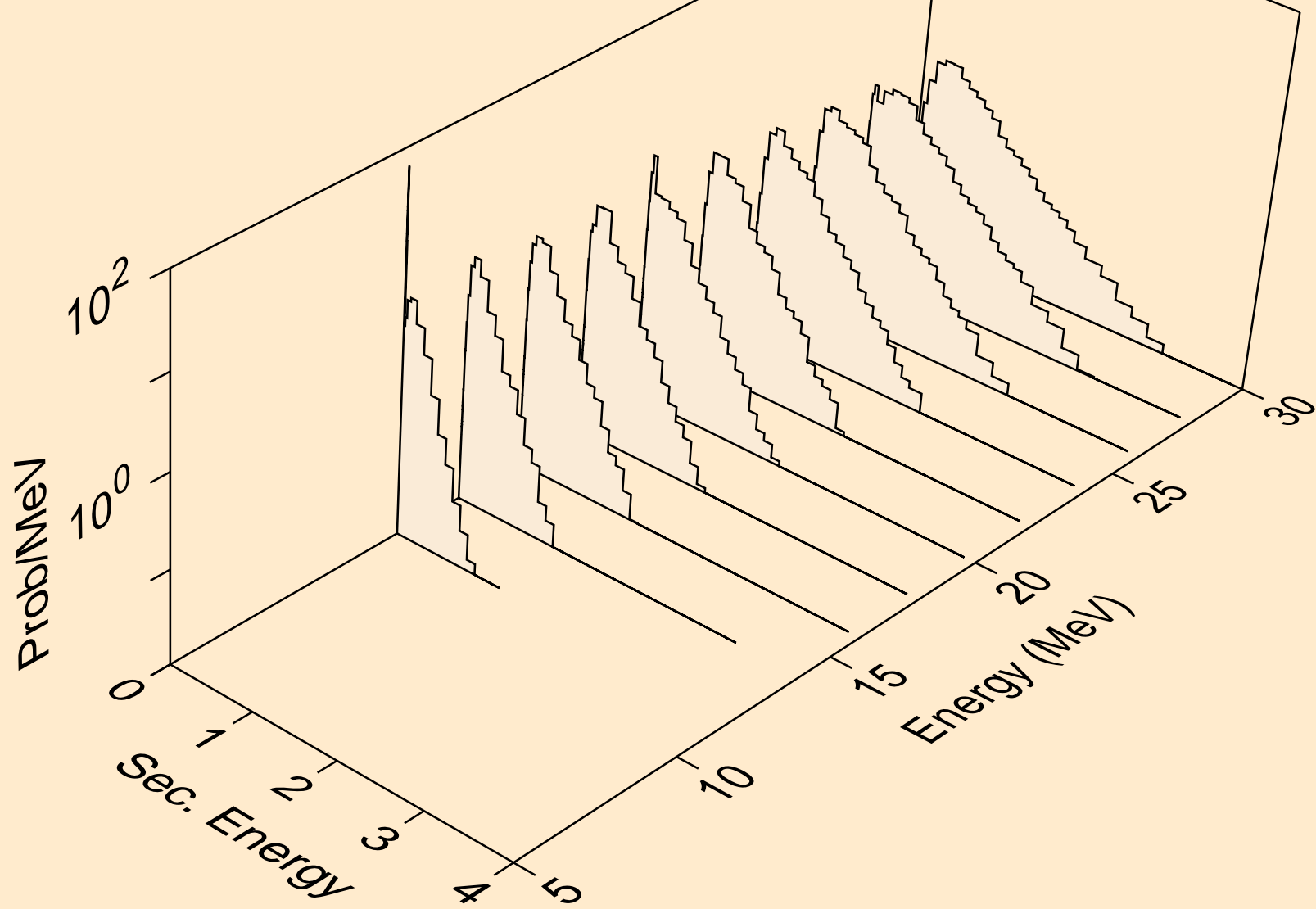

HO174 NEUTRON ACER TENDL-2021 LIBRARY; T=293.6K
Neutron emission for (n,3n)a

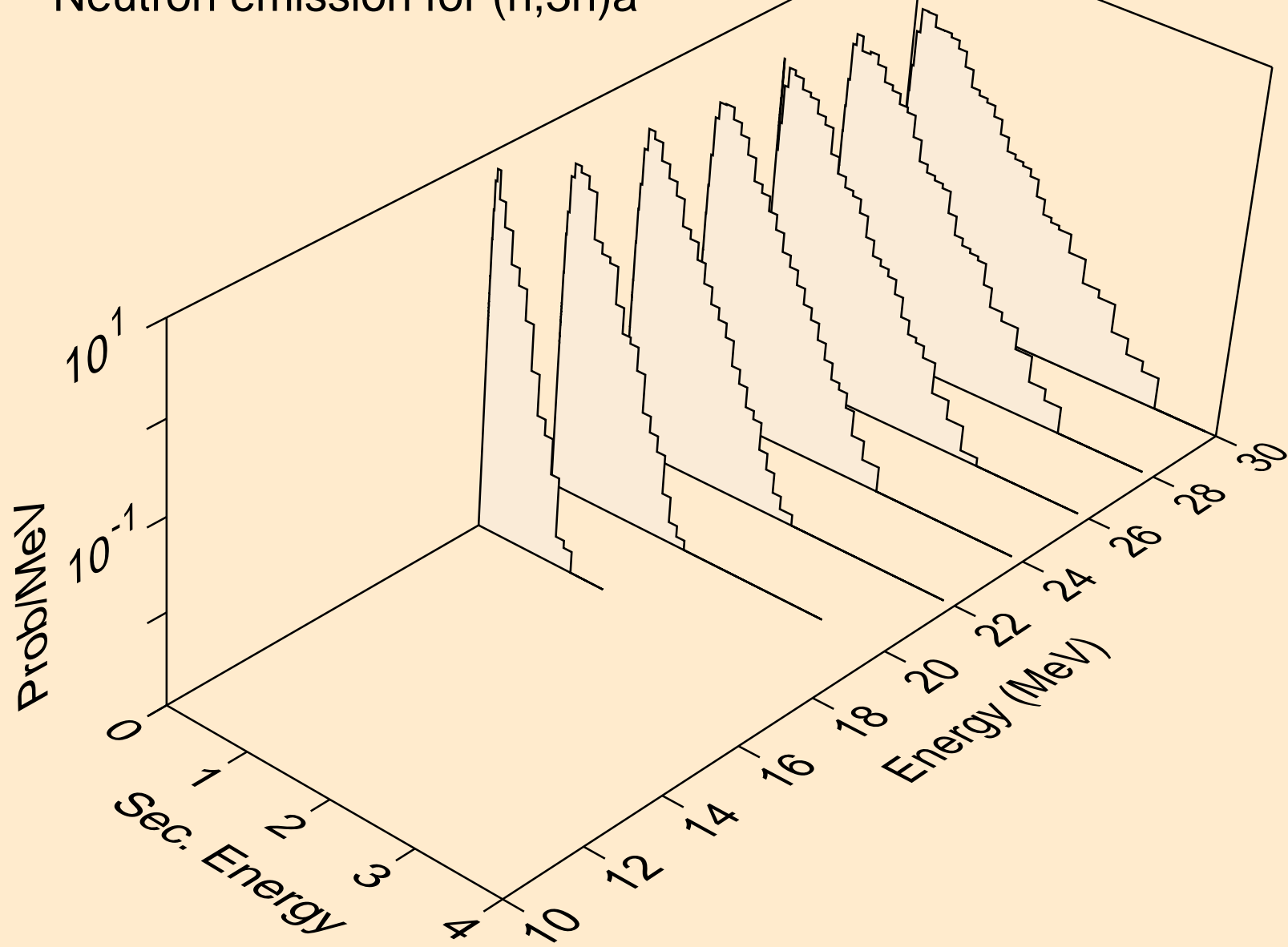

HO174 NEUTRON ACER TENDL-2021 LIBRARY; T=293.6K
Neutron emission for (n,n*)p

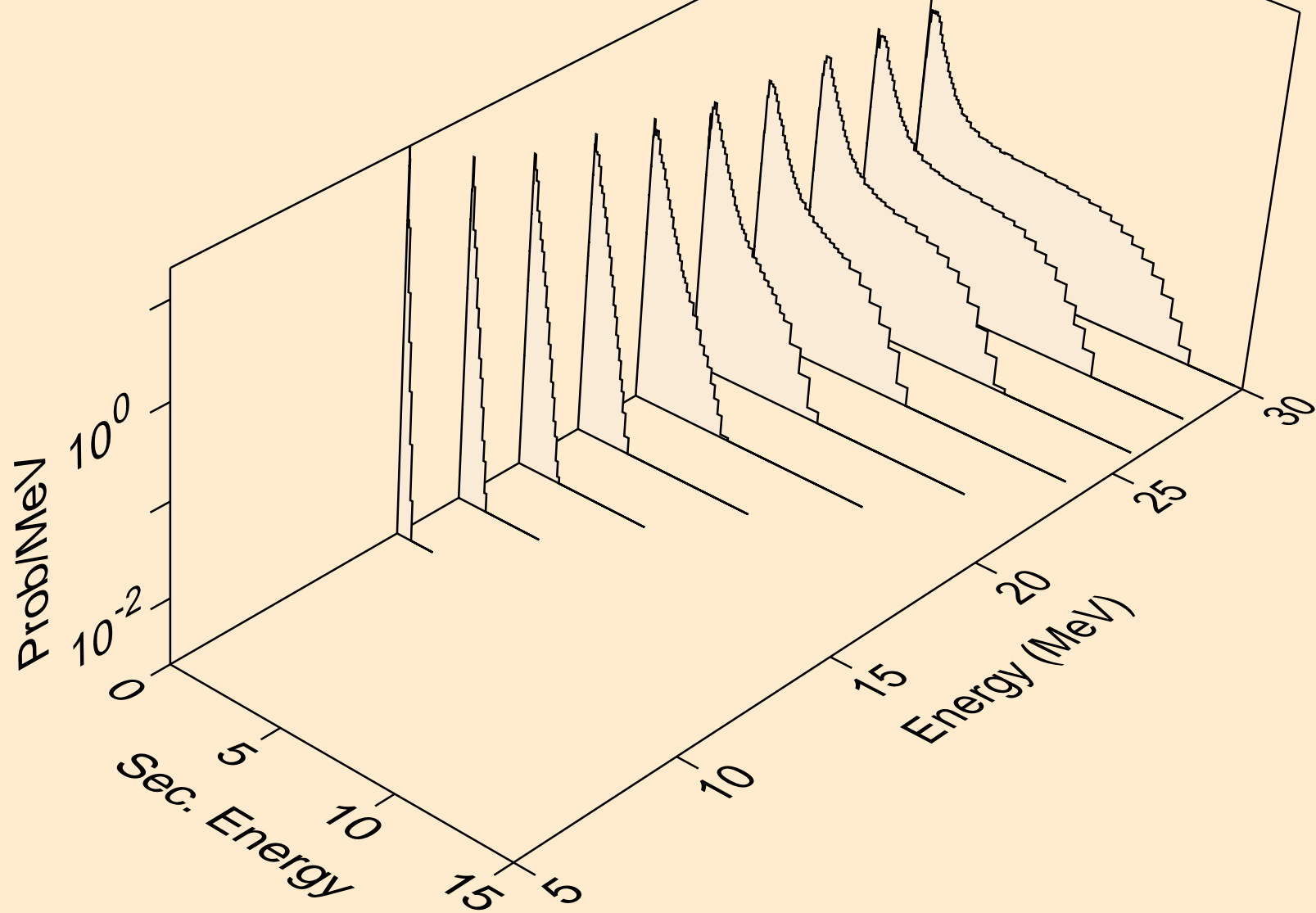

HO174 NEUTRON ACER TENDL-2021 LIBRARY; T=293.6K
Neutron emission for (n,n*)d

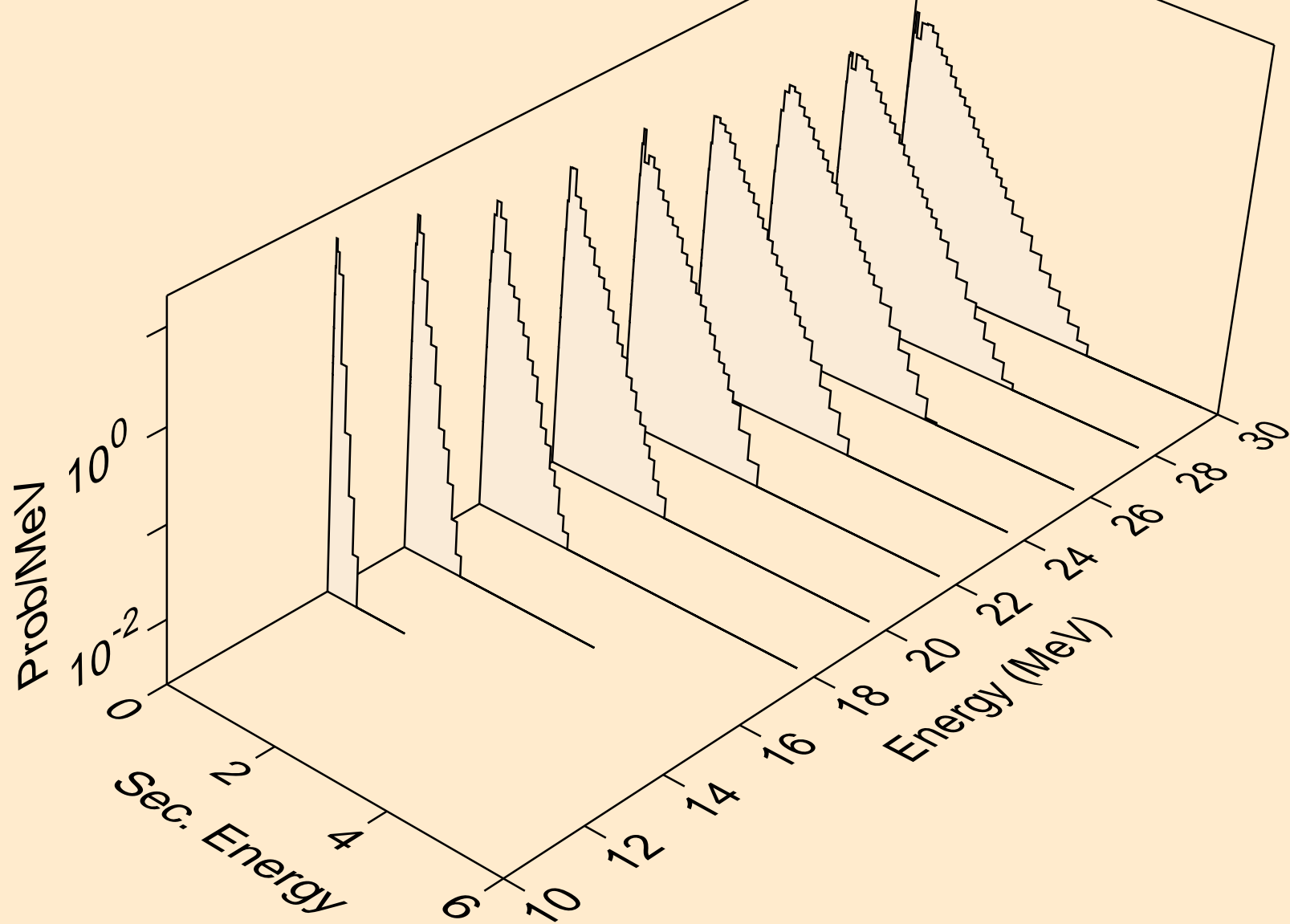

HO174 NEUTRON ACER TENDL-2021 LIBRARY; T=293.6K
Neutron emission for (n,n*)t

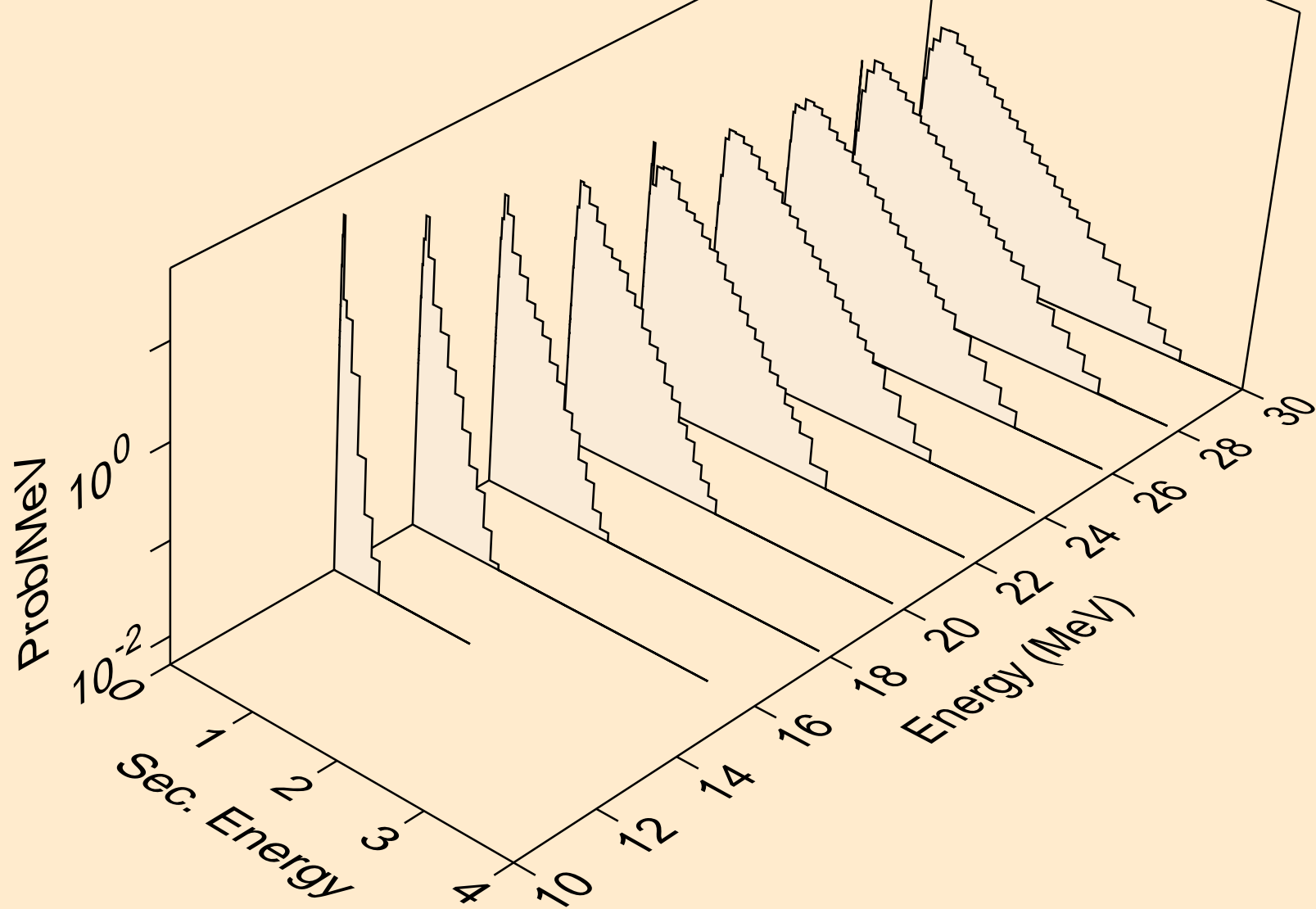

HO174 NEUTRON ACER TENDL-2021 LIBRARY; T=293.6K
Neutron emission for (n,n*)he3

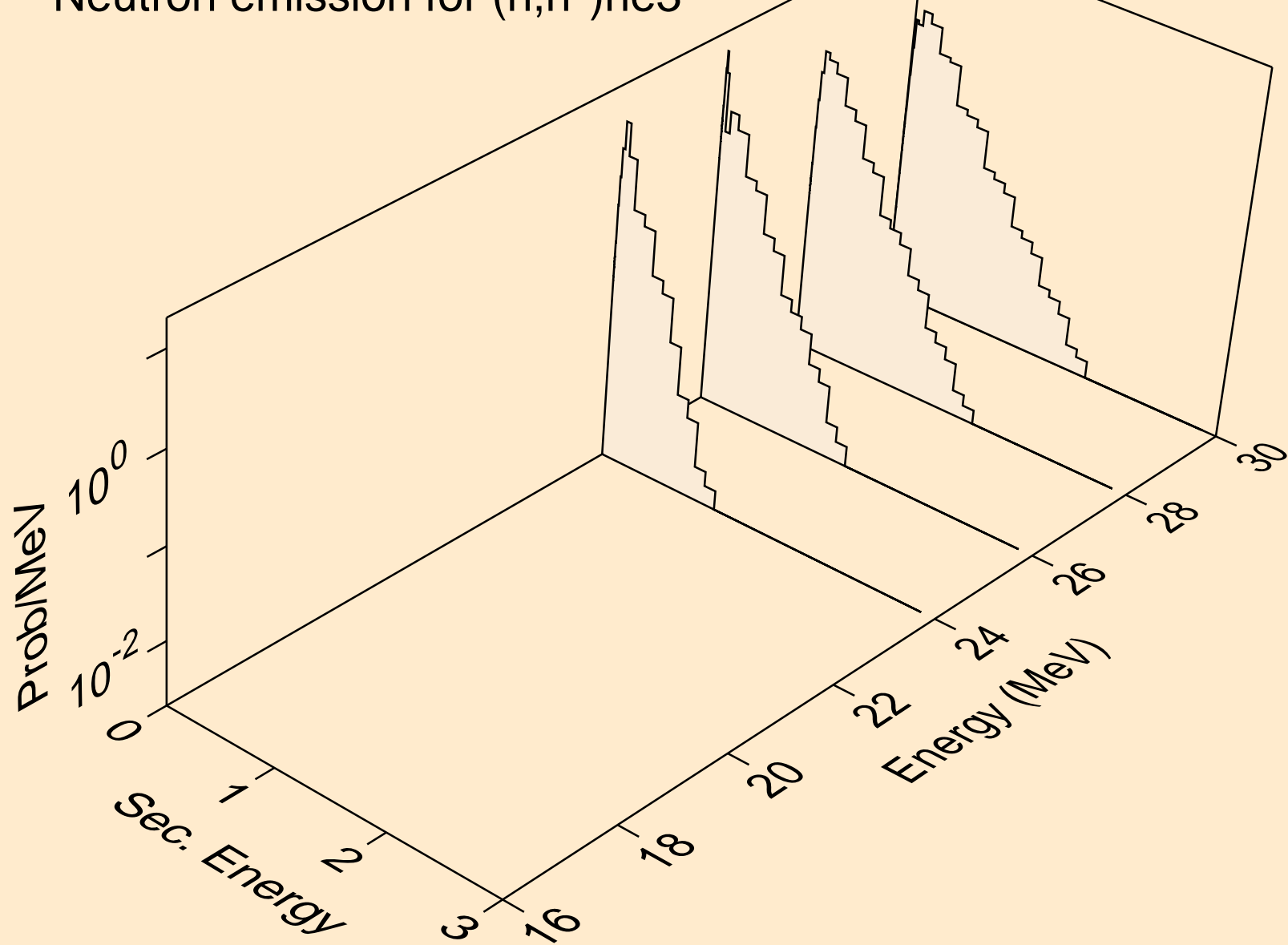

HO174 NEUTRON ACER TENDL-2021 LIBRARY; T=293.6K
Neutron emission for (n,4n)

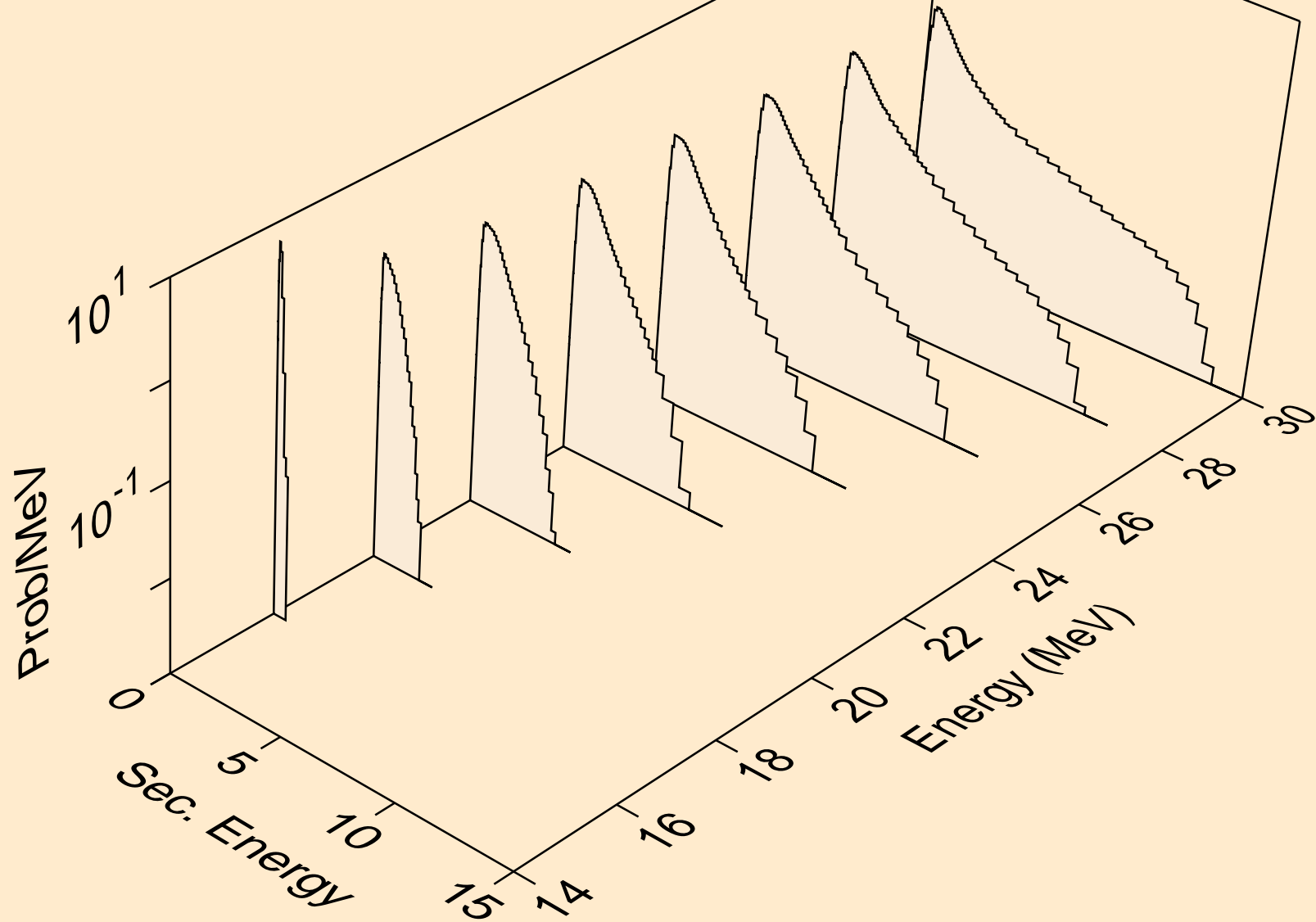

HO174 NEUTRON ACER TENDL-2021 LIBRARY; T=293.6K
Neutron emission for (n,2np)

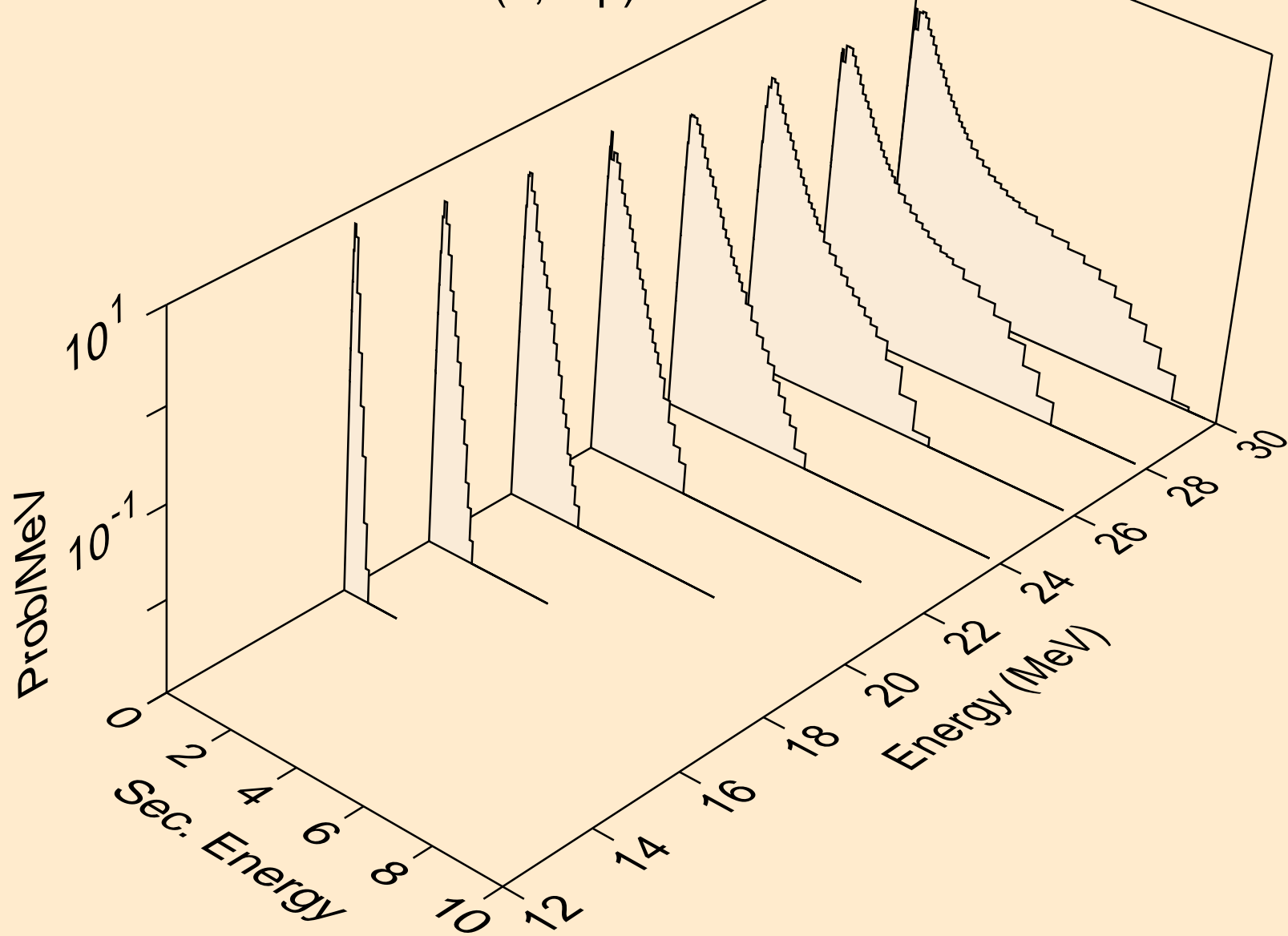

HO174 NEUTRON ACER TENDL-2021 LIBRARY; T=293.6K
Neutron emission for (n,3np)

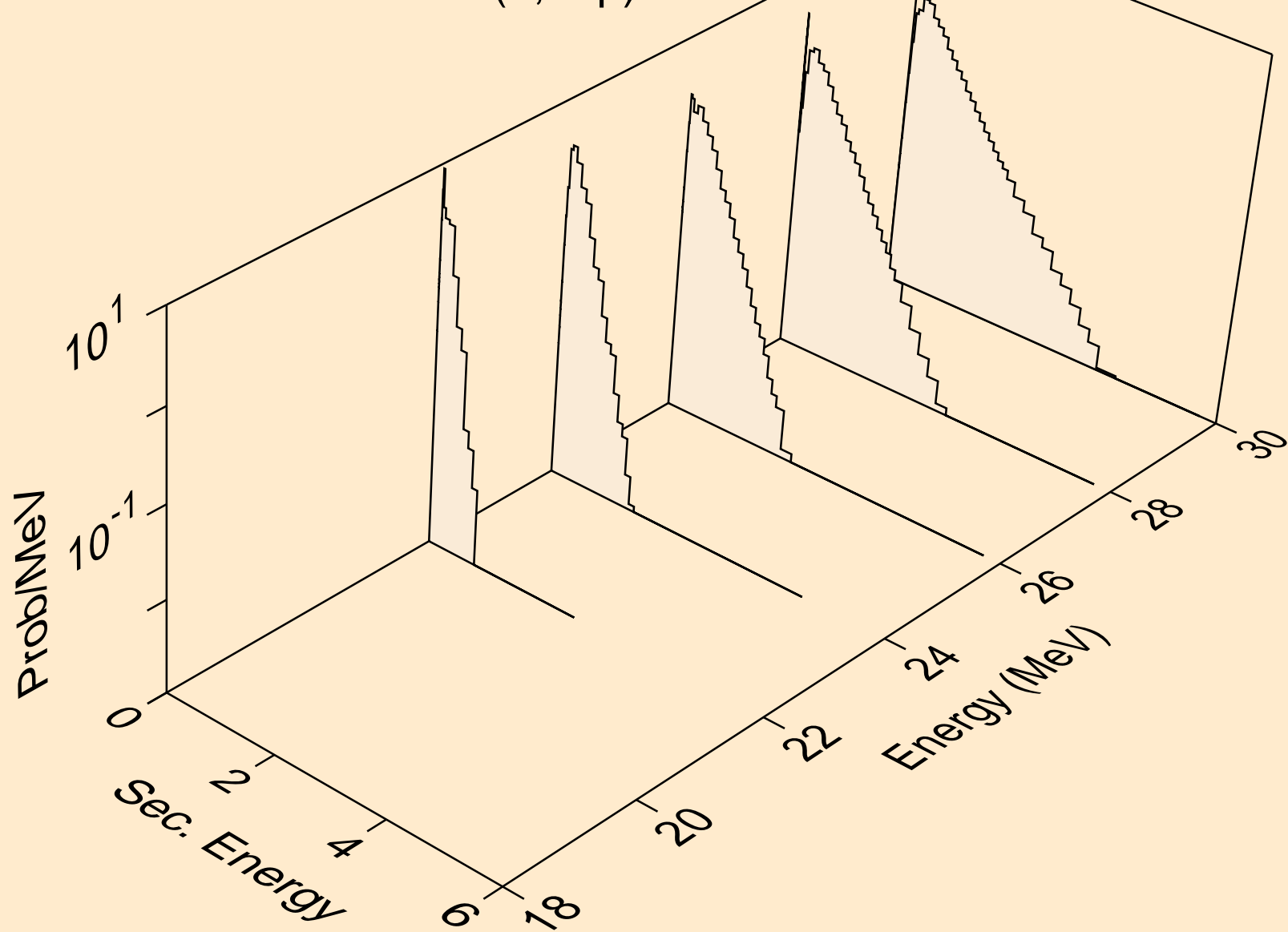

HO174 NEUTRON ACER TENDL-2021 LIBRARY; T=293.6K
Neutron emission for (n,n*c)

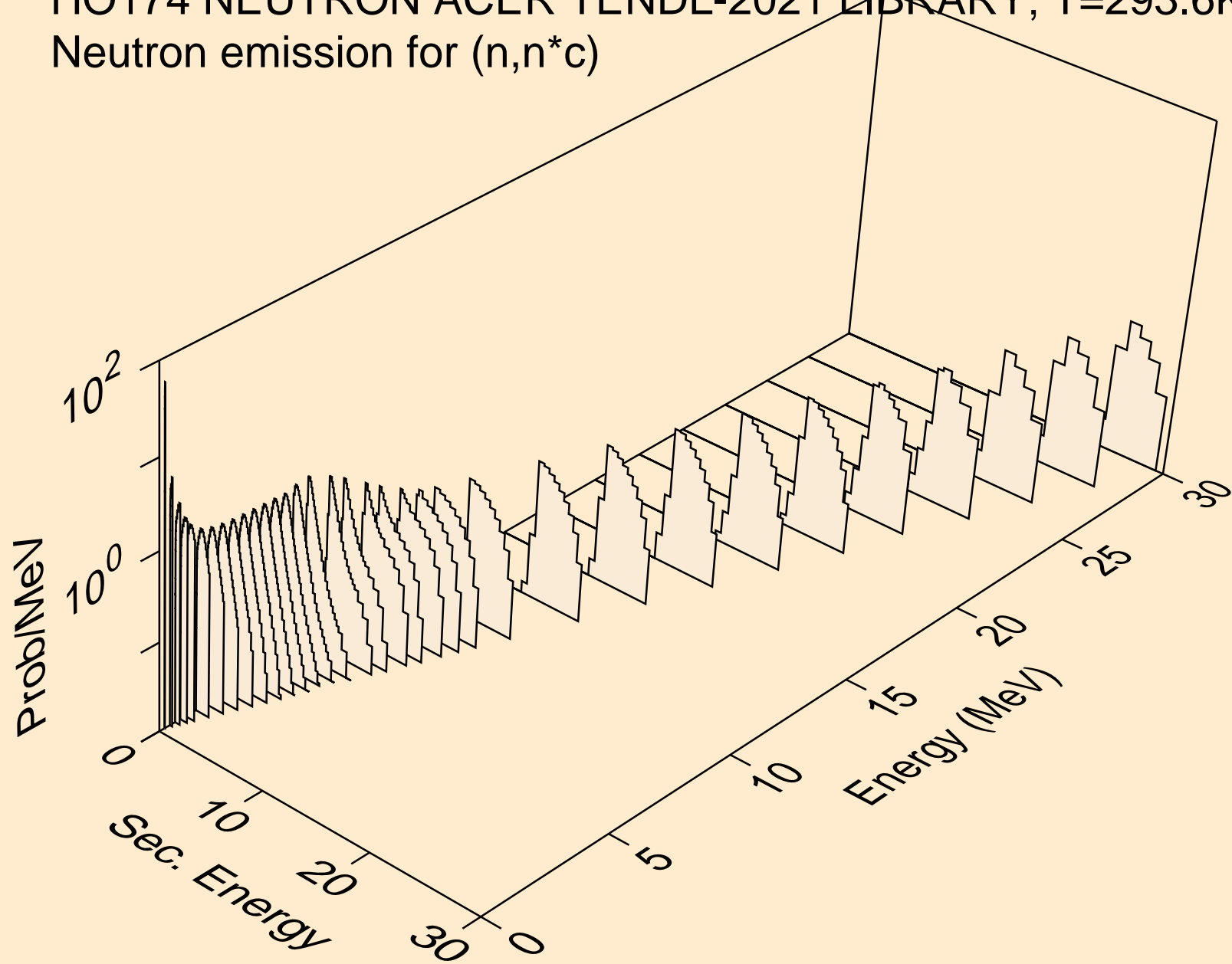

HO174 NEUTRON ACER TENDL-2021 LIBRARY; T=293.6K
Photon emission for (n,x)

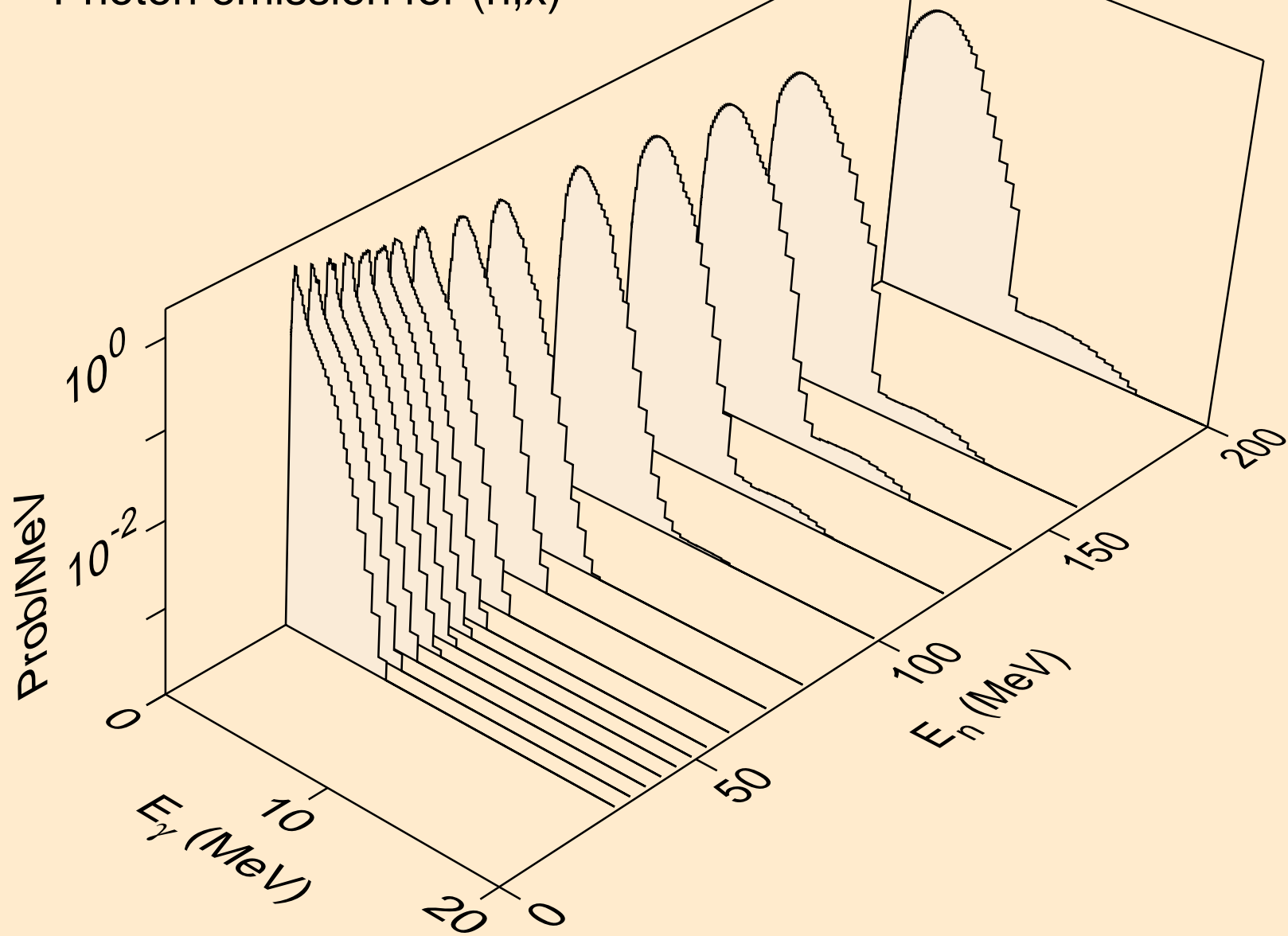

HO174 NEUTRON ACER TENDL-2021 LIBRARY; T=293.6K
Photon emission for (n,2nd)

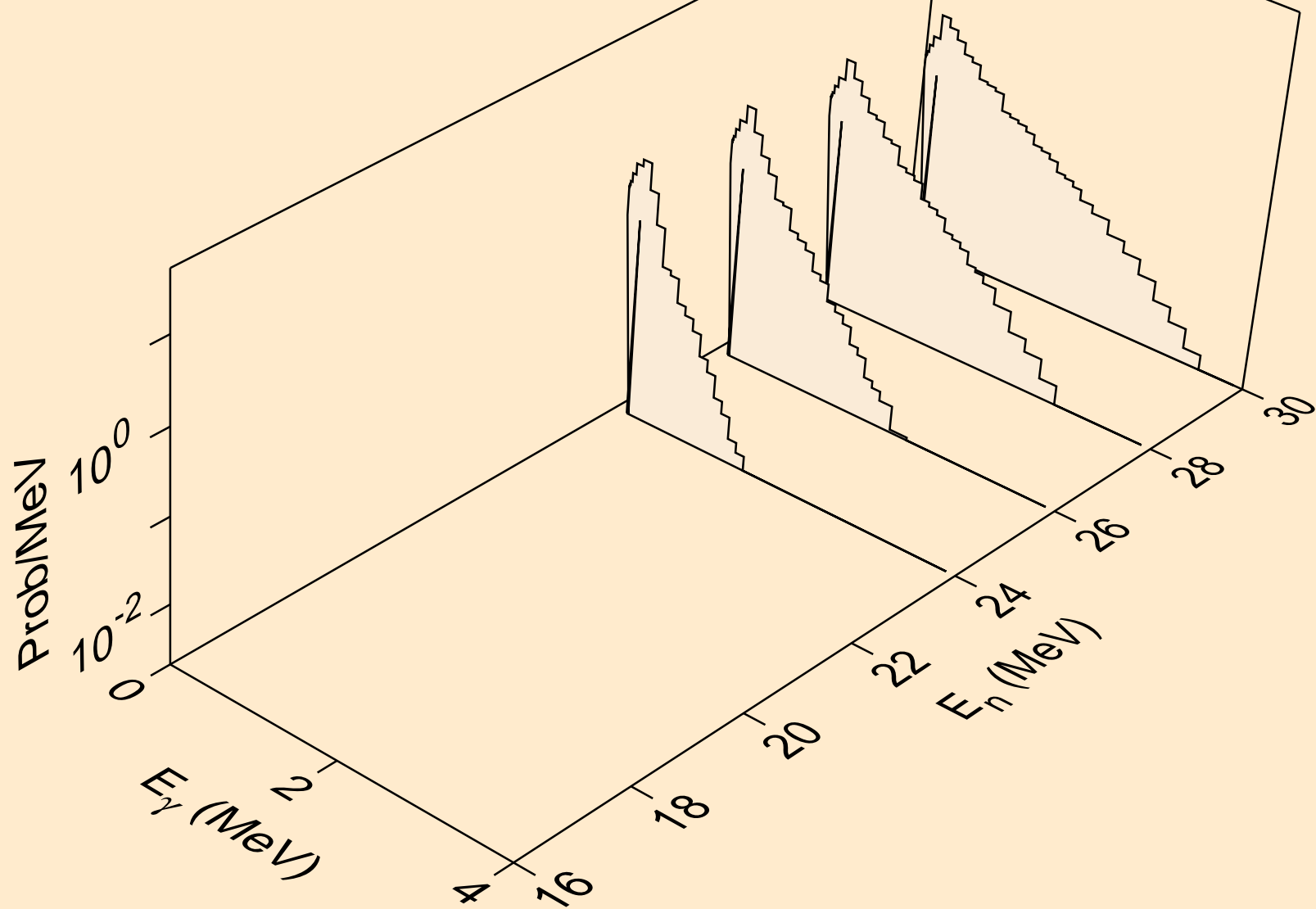

HO174 NEUTRON ACER TENDL-2021 LIBRARY; T=293.6K
Photon emission for (n,2n)

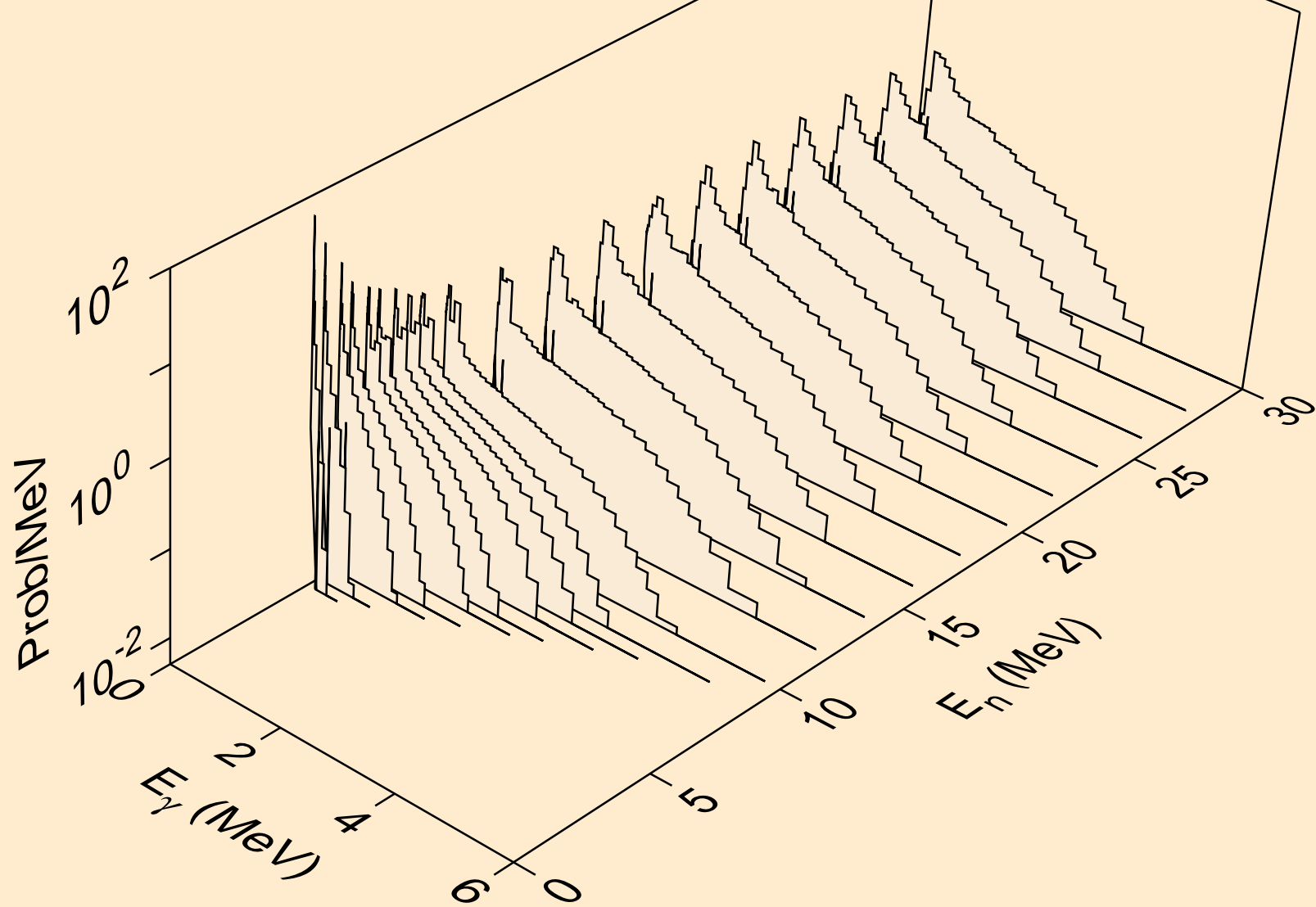

HO174 NEUTRON ACER TENDL-2021 LIBRARY; T=293.6K
Photon emission for (n,3n)

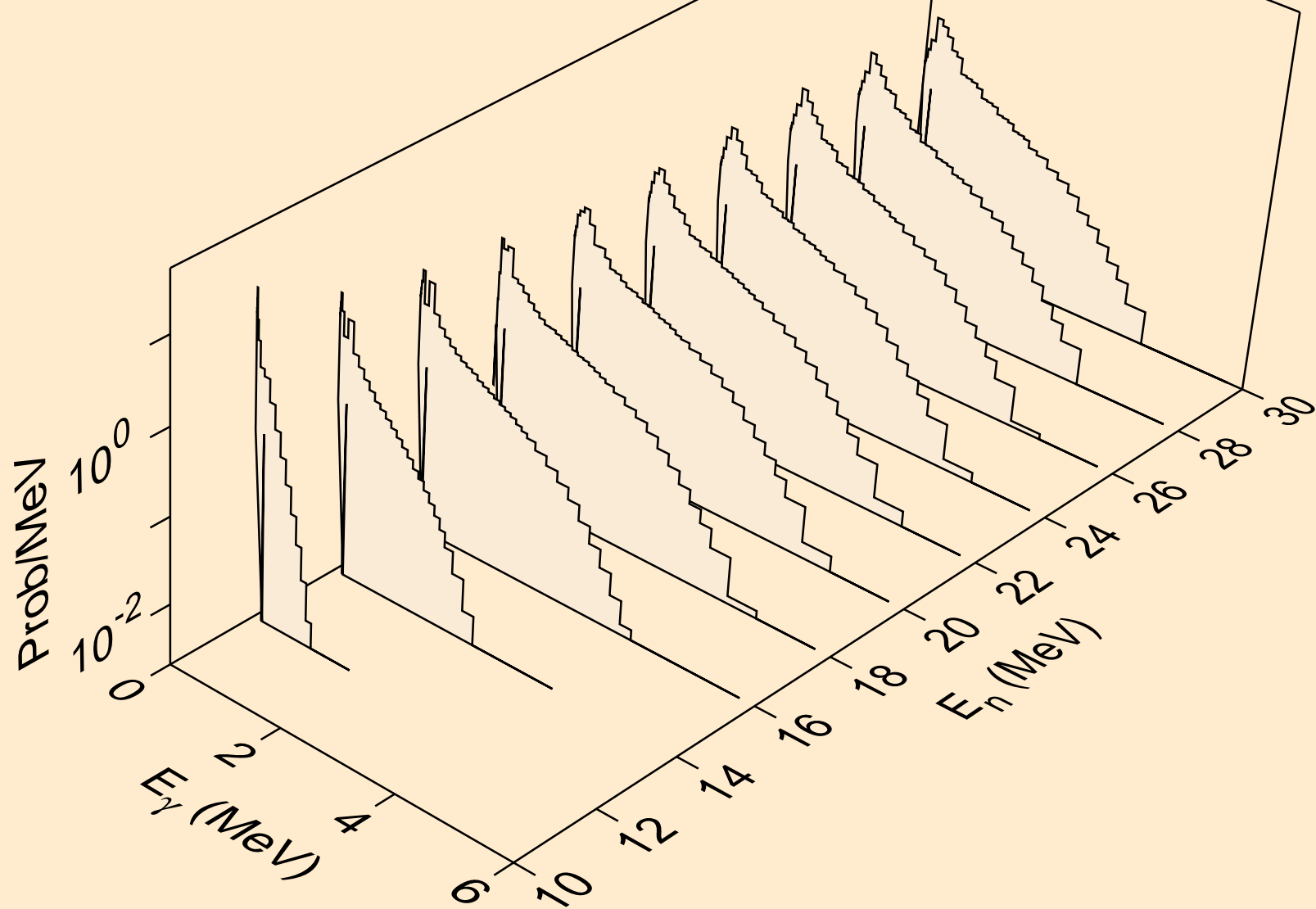

HO174 NEUTRON ACER TENDL-2021 LIBRARY; T=293.6K
Photon emission for (n,n*)a

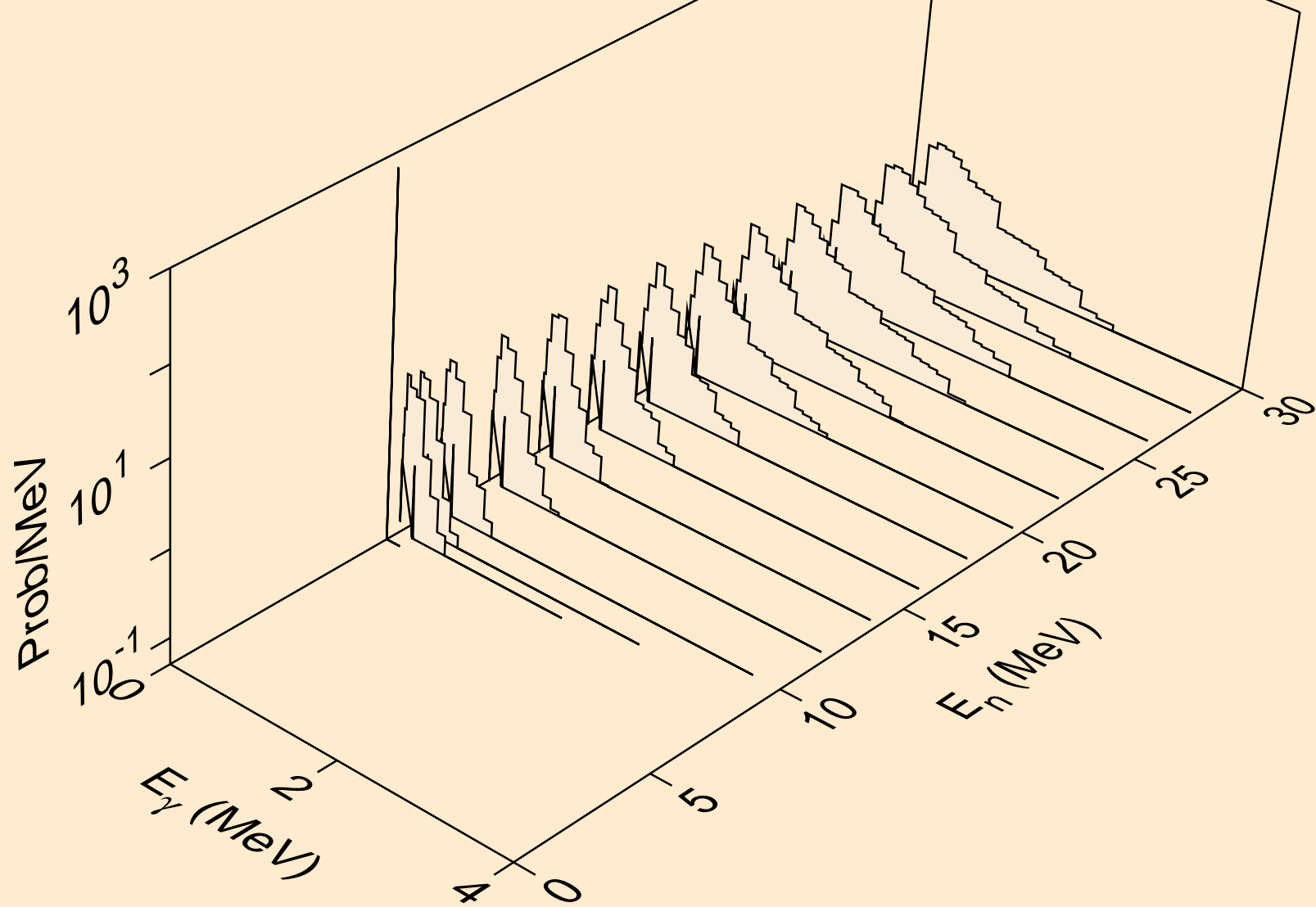

HO174 NEUTRON ACER TENDL-2021 LIBRARY; T=293.6K
Photon emission for (n,2n)a

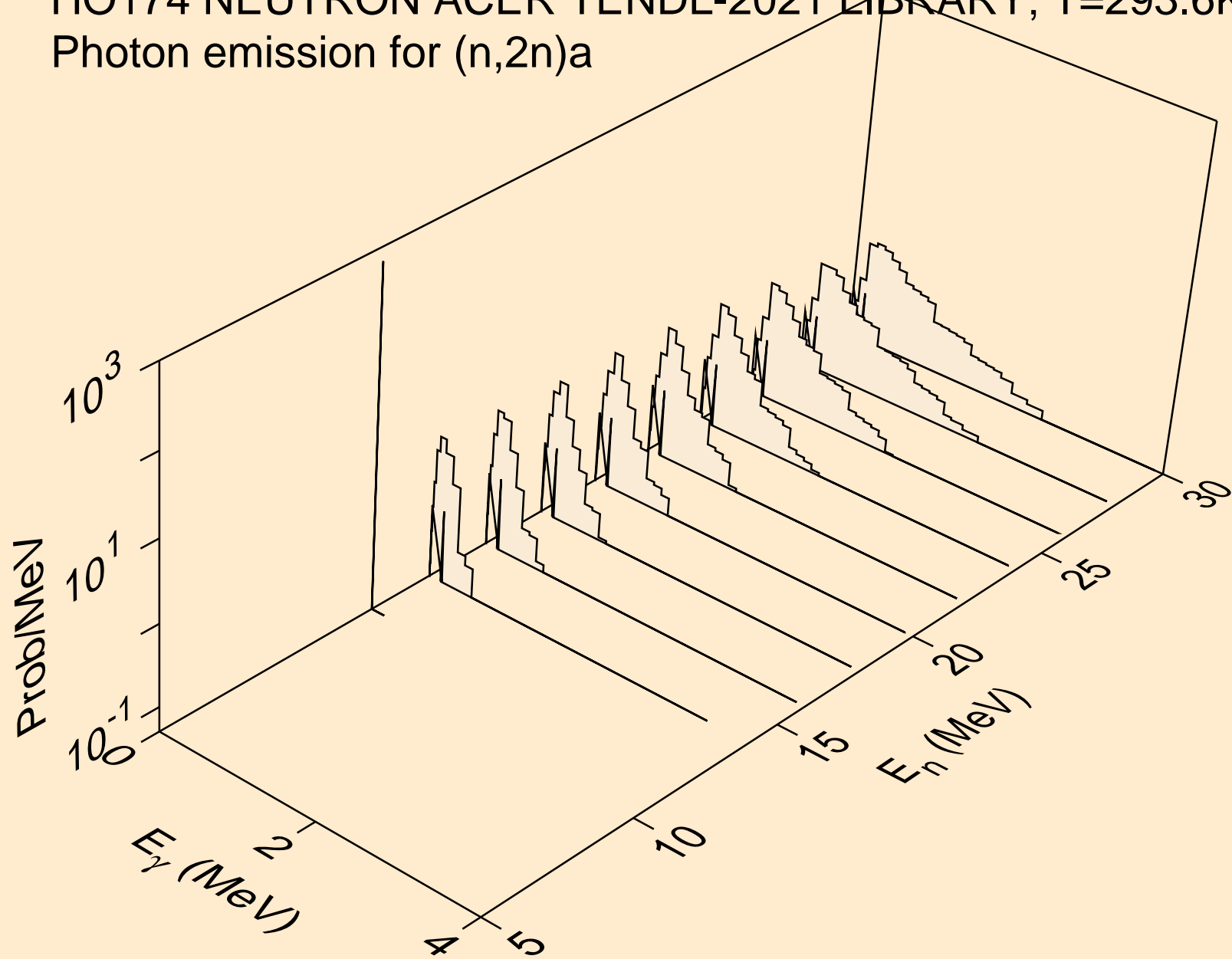

HO174 NEUTRON ACER TENDL-2021 LIBRARY; T=293.6K
Photon emission for (n,3n)a

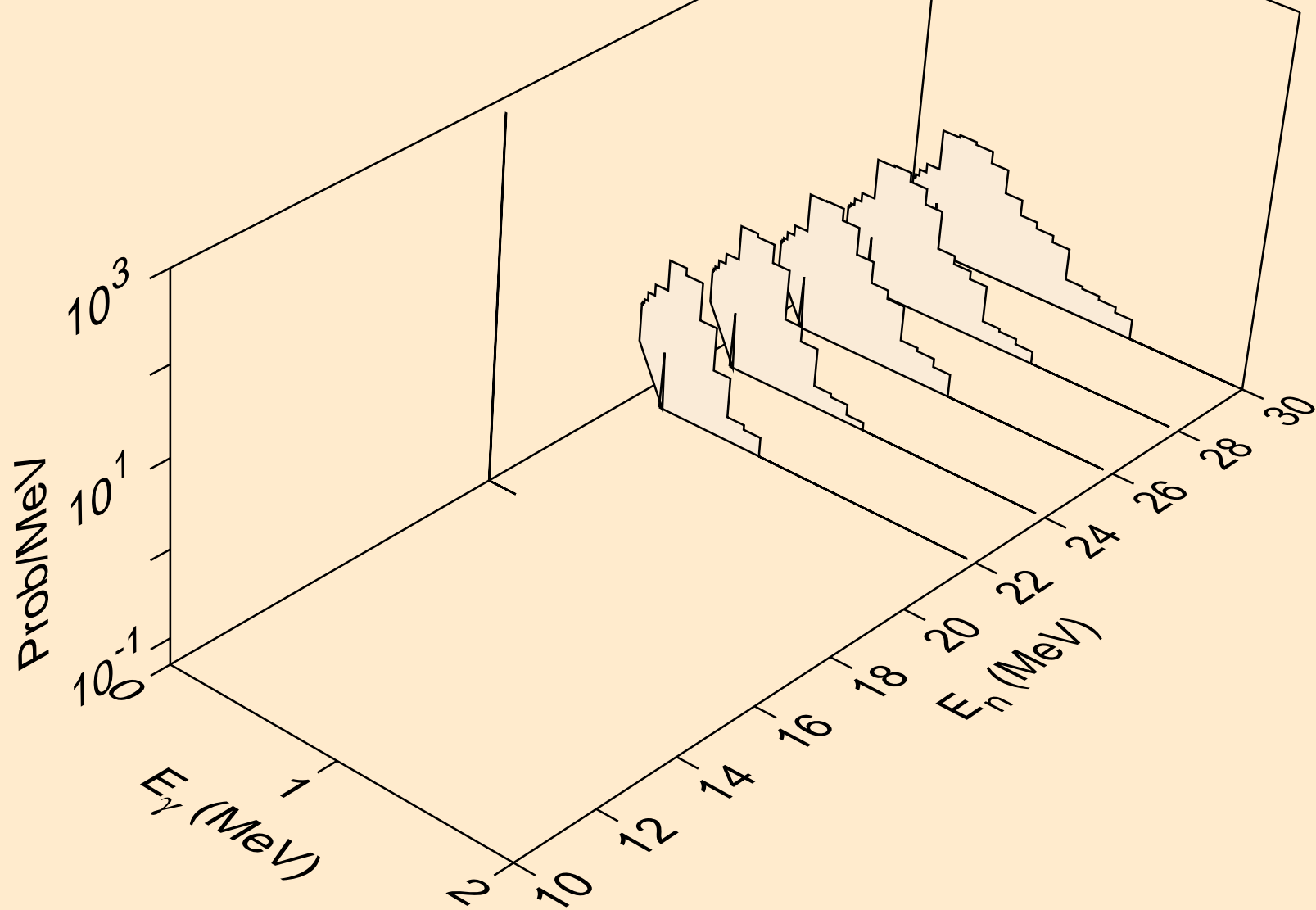

HO174 NEUTRON ACER TENDL-2021 LIBRARY; T=293.6K
Photon emission for (n,n*)p

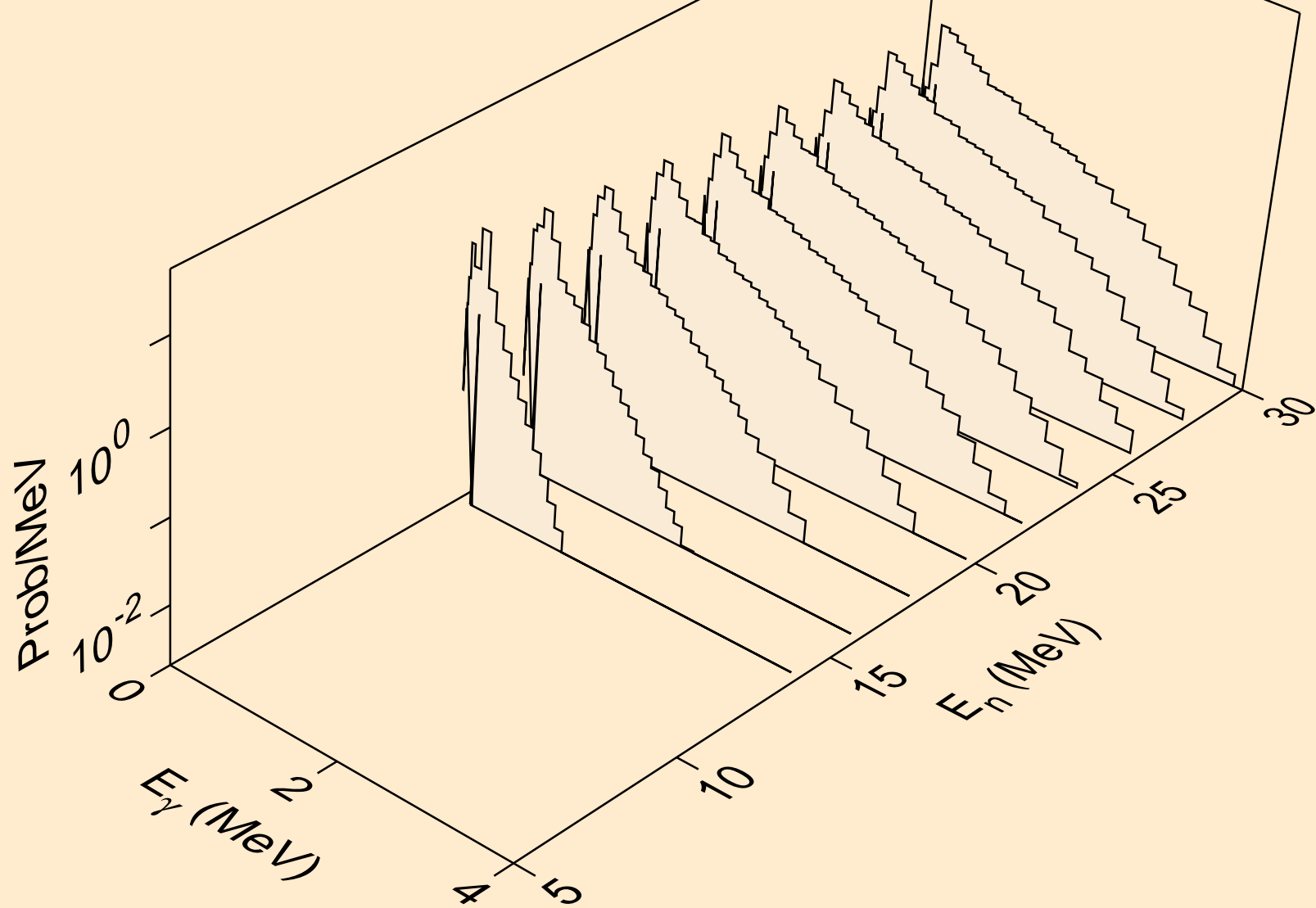

HO174 NEUTRON ACER TENDL-2021 LIBRARY; T=293.6K
Photon emission for (n,n*)d

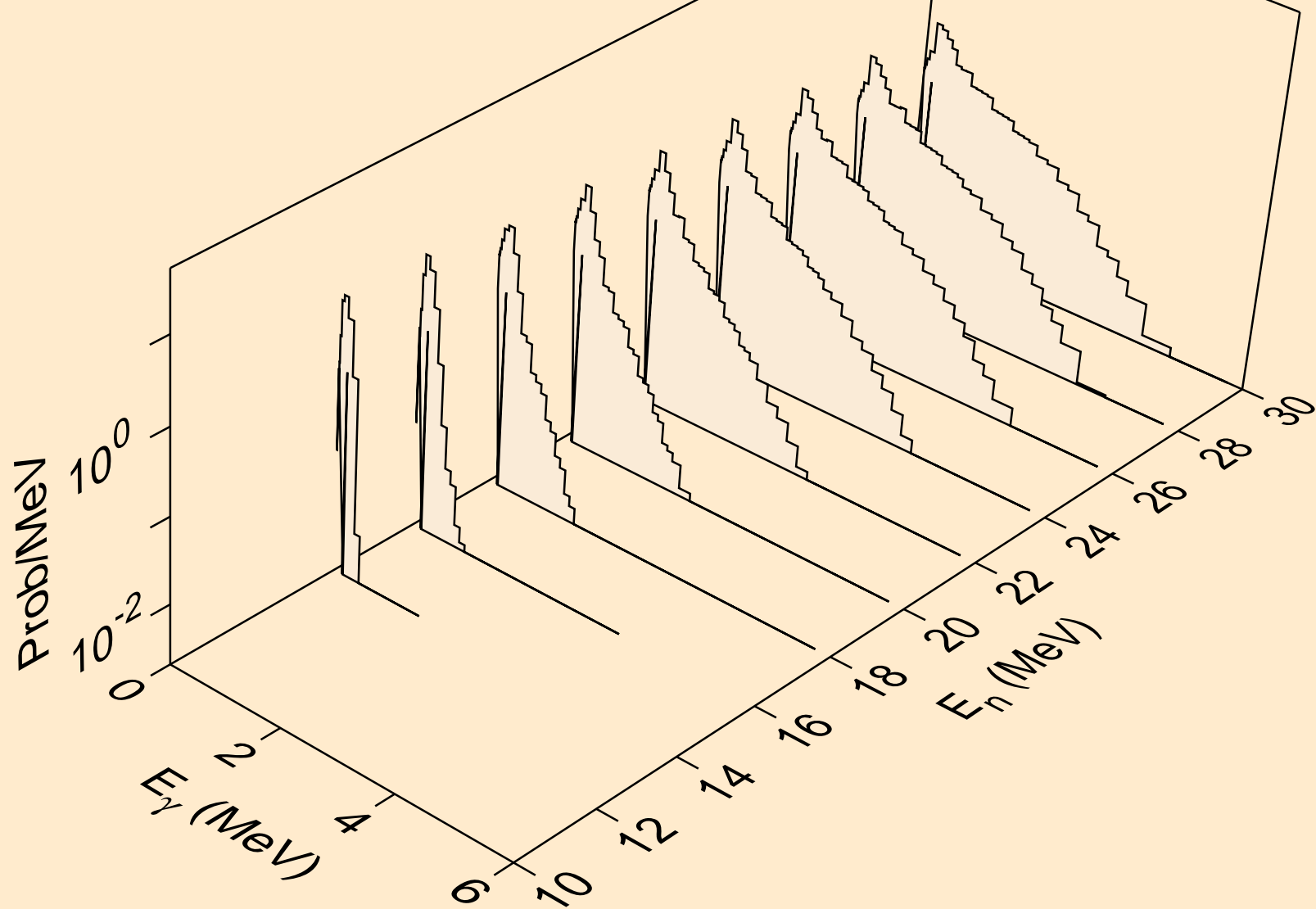

HO174 NEUTRON ACER TENDL-2021 LIBRARY; T=293.6K
Photon emission for (n,n*)t

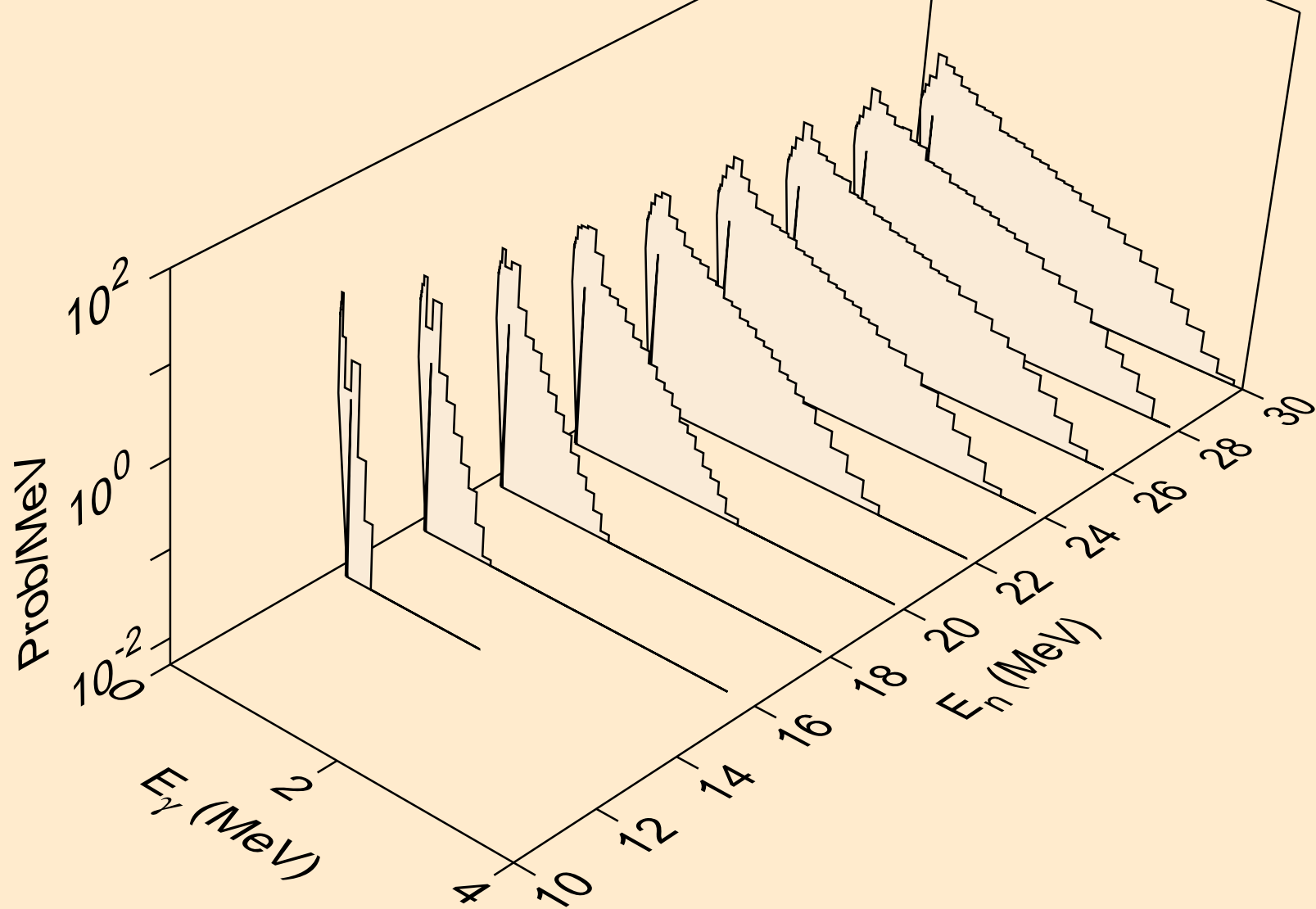

HO174 NEUTRON ACER TENDL-2021 LIBRARY; T=293.6K
Photon emission for (n,n*)he3

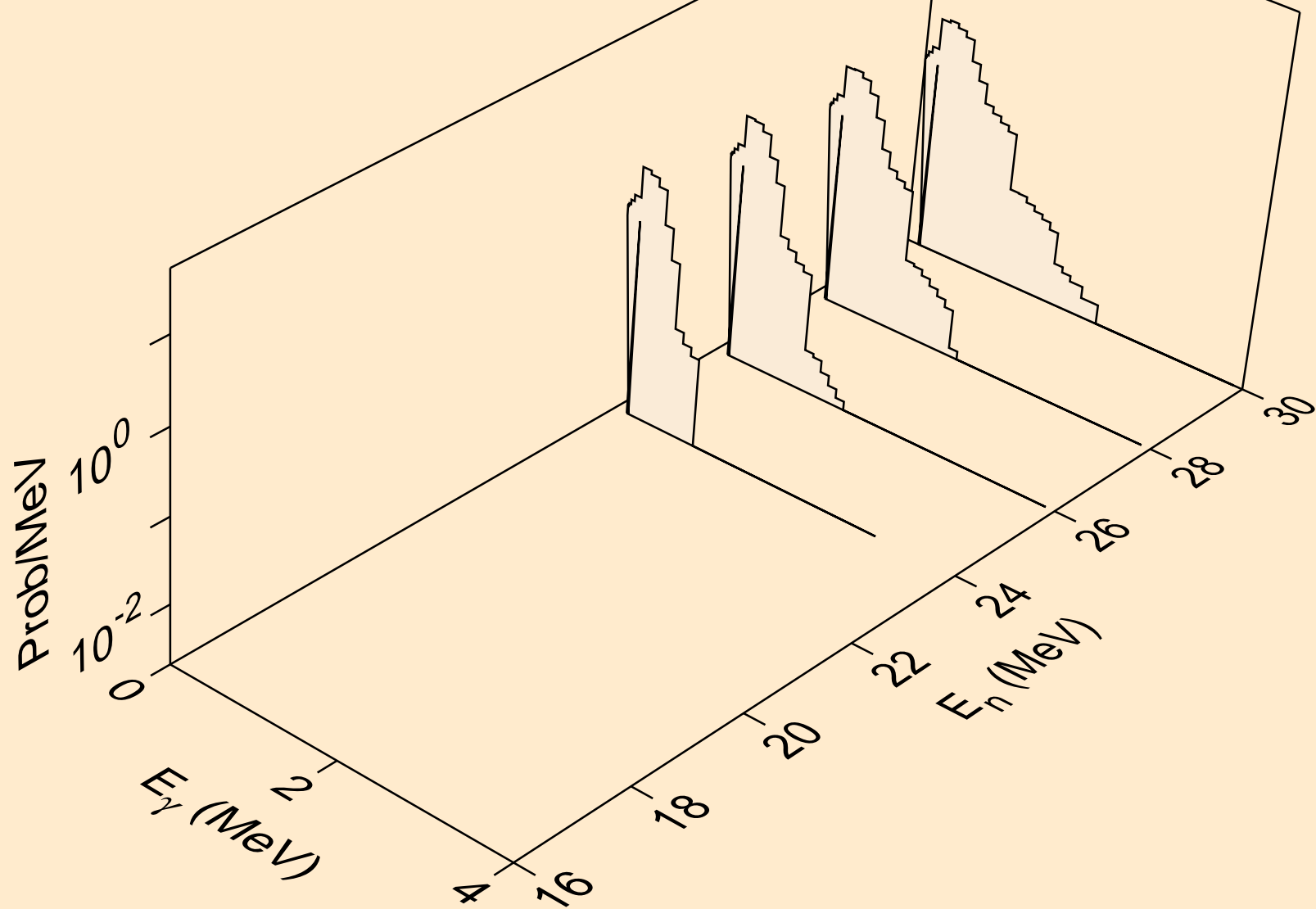

HO174 NEUTRON ACER TENDL-2021 LIBRARY; T=293.6K
Photon emission for (n,4n)

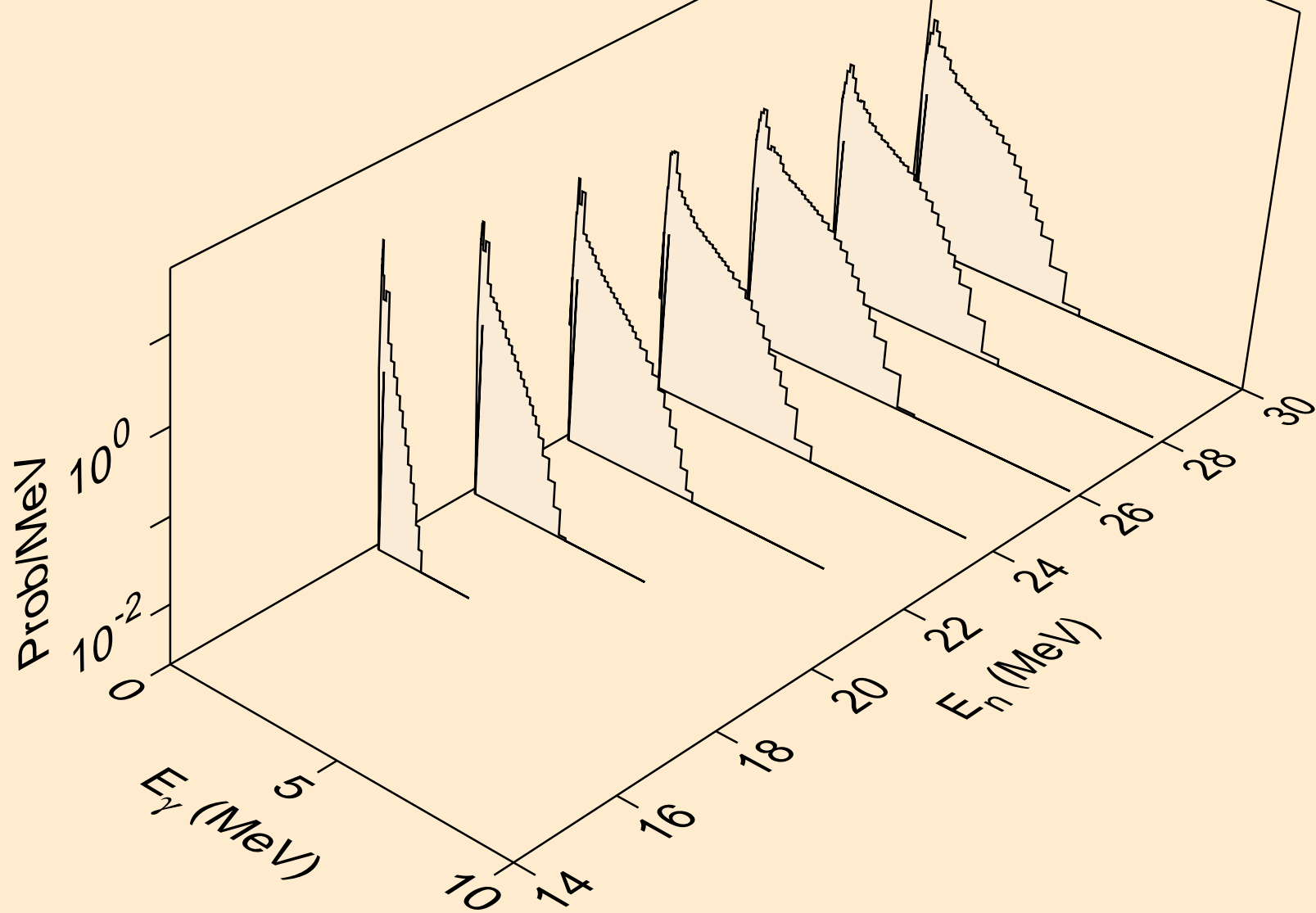

HO174 NEUTRON ACER TENDL-2021 LIBRARY; T=293.6K
Photon emission for (n,2np)

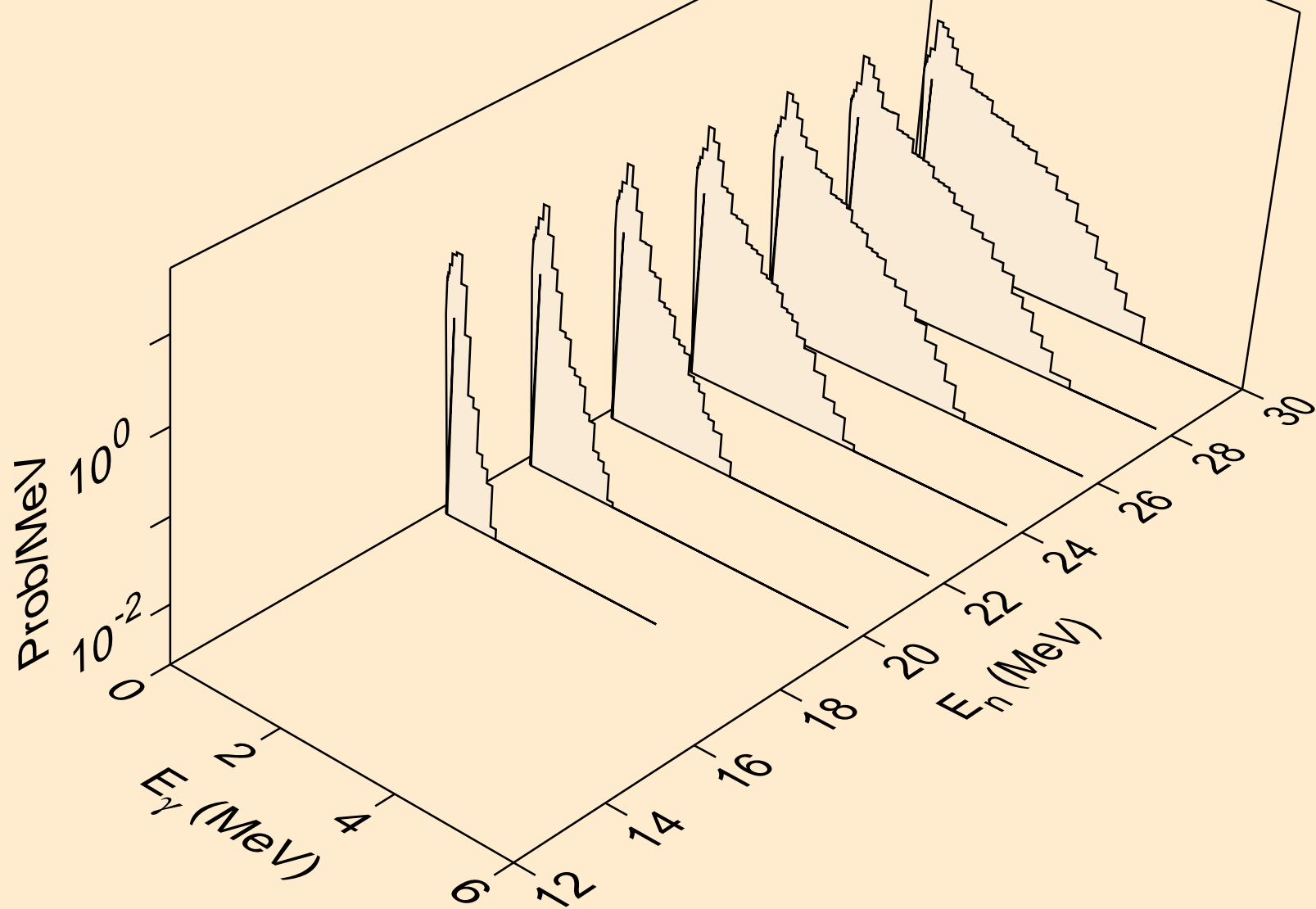

HO174 NEUTRON ACER TENDL-2021 LIBRARY; T=293.6K
Photon emission for (n,3np)

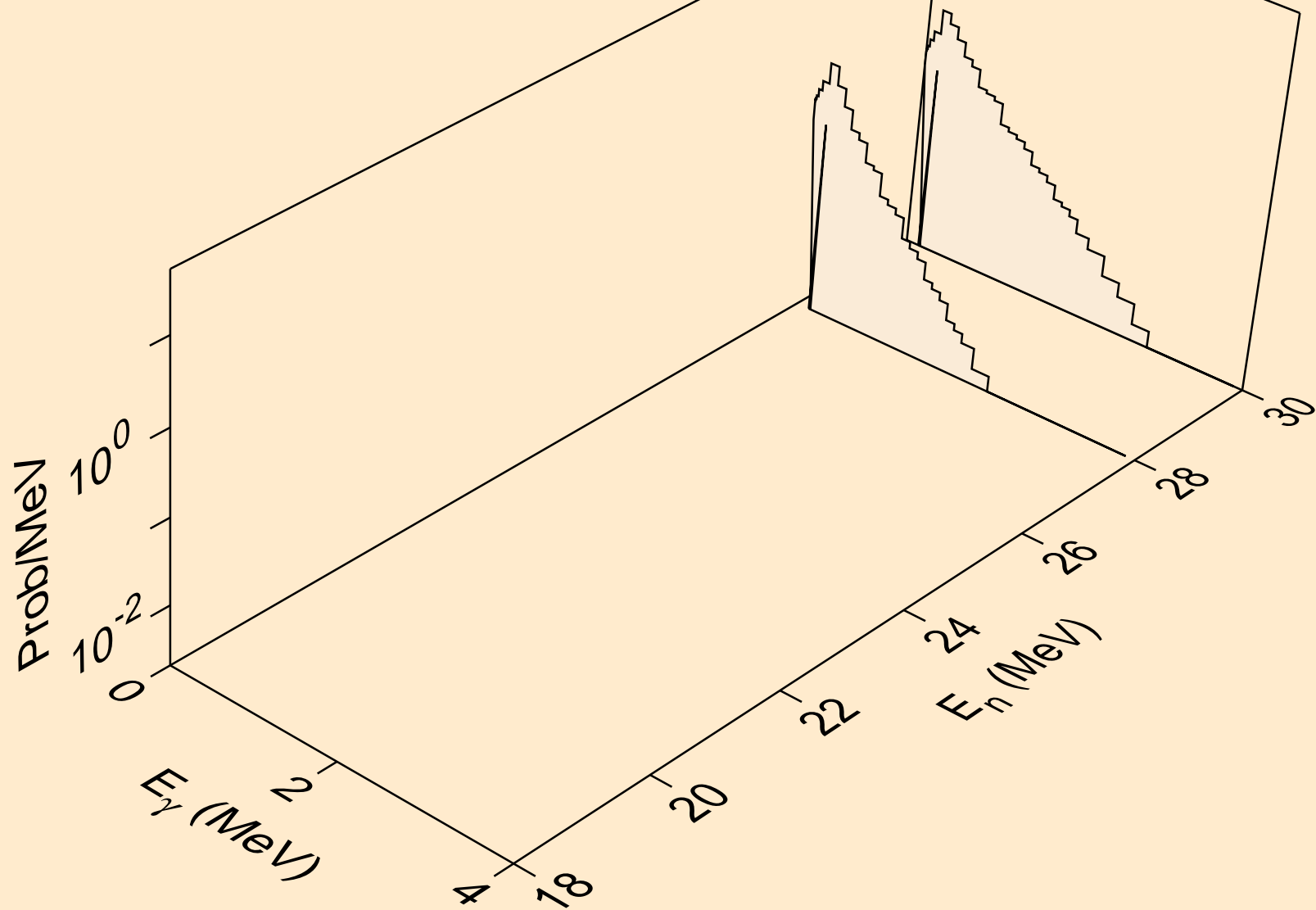

HO174 NEUTRON ACER TENDL-2021 LIBRARY; T=293.6K
Photon emission for (n,n*c)

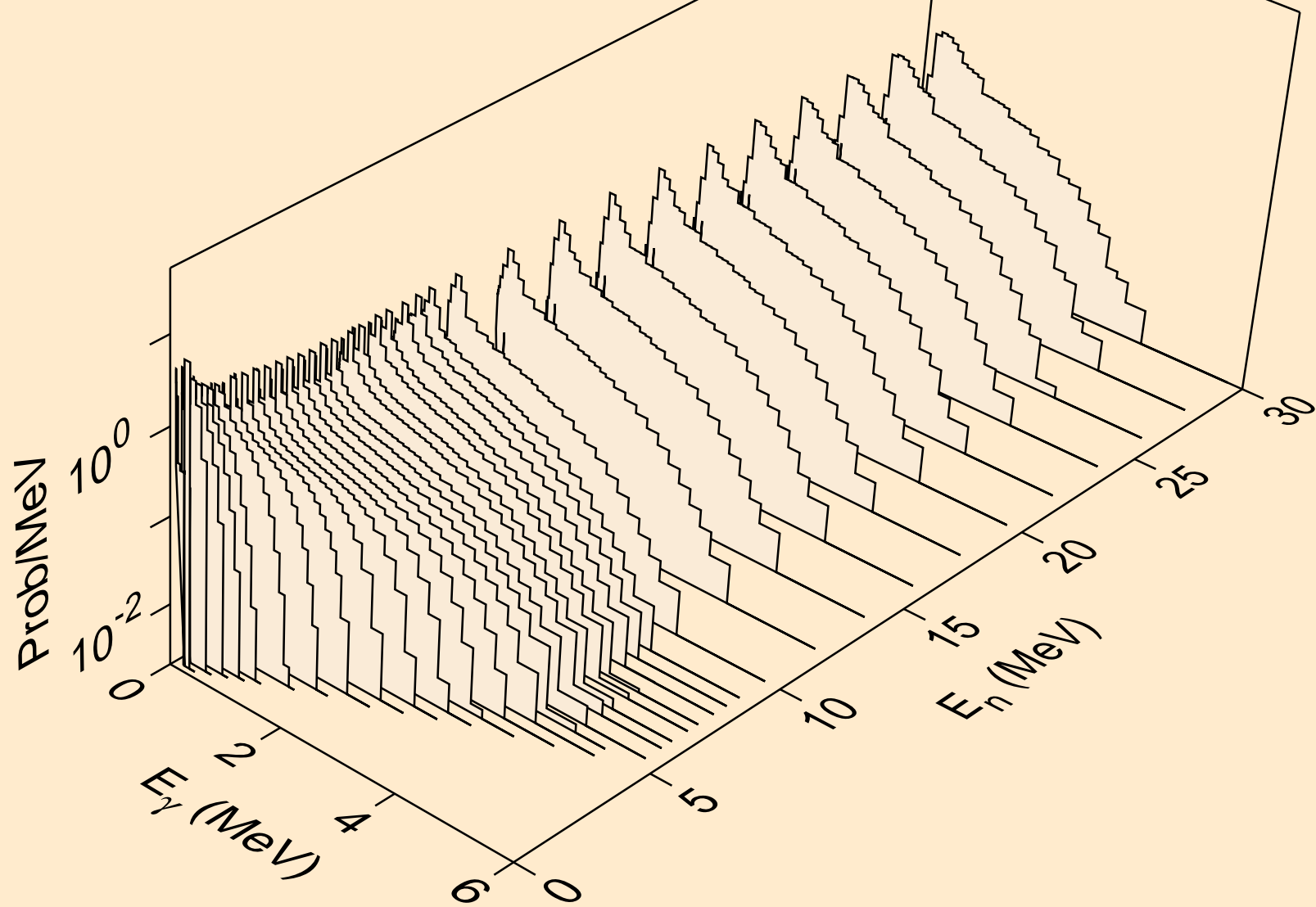

HO174 NEUTRON ACER TENDL-2021 LIBRARY; T=293.6K
Photon emission for (n,gma)

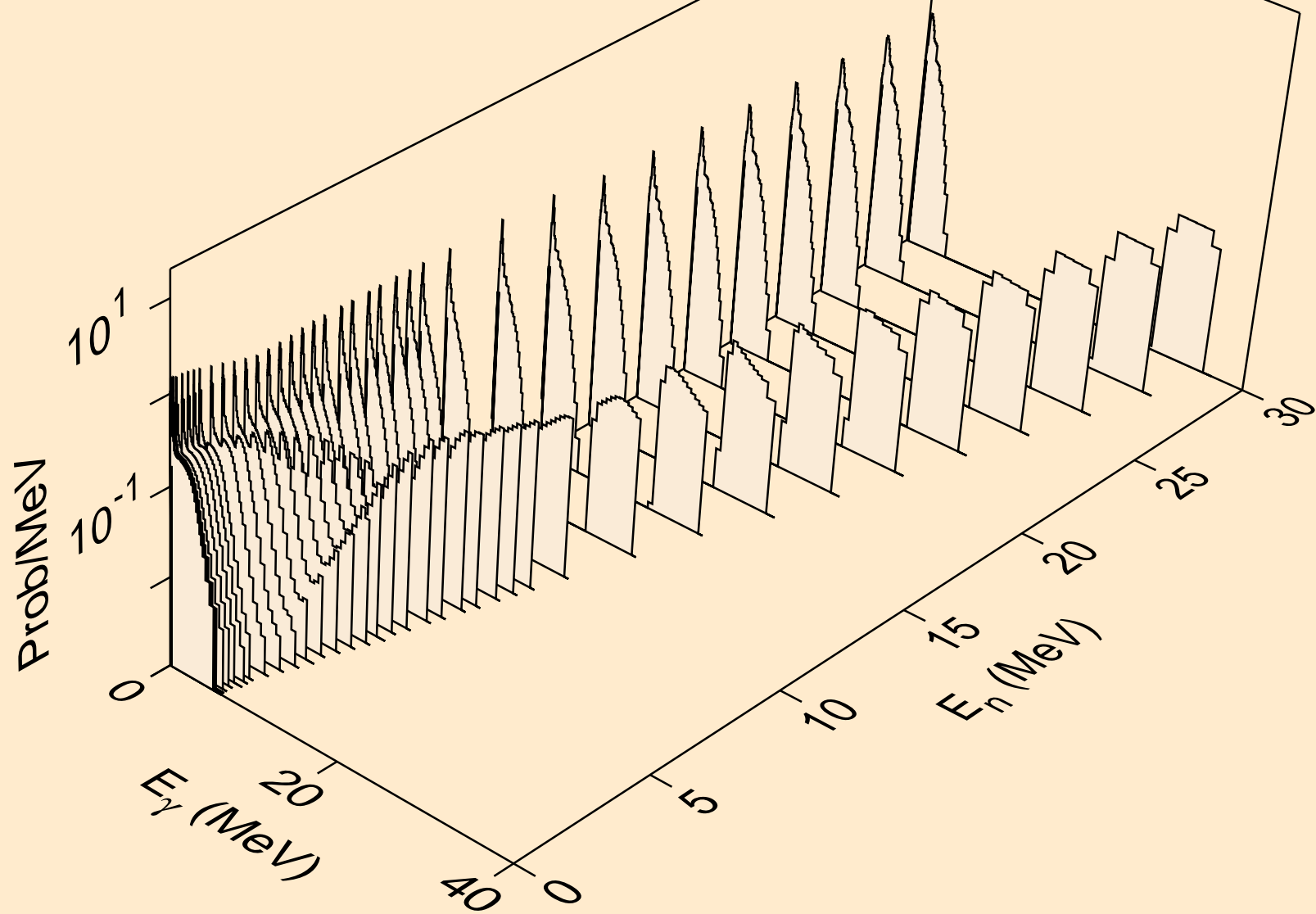

HO174 NEUTRON ACER TENDL-2021 LIBRARY; T=293.6K
Photon emission for (n,p)

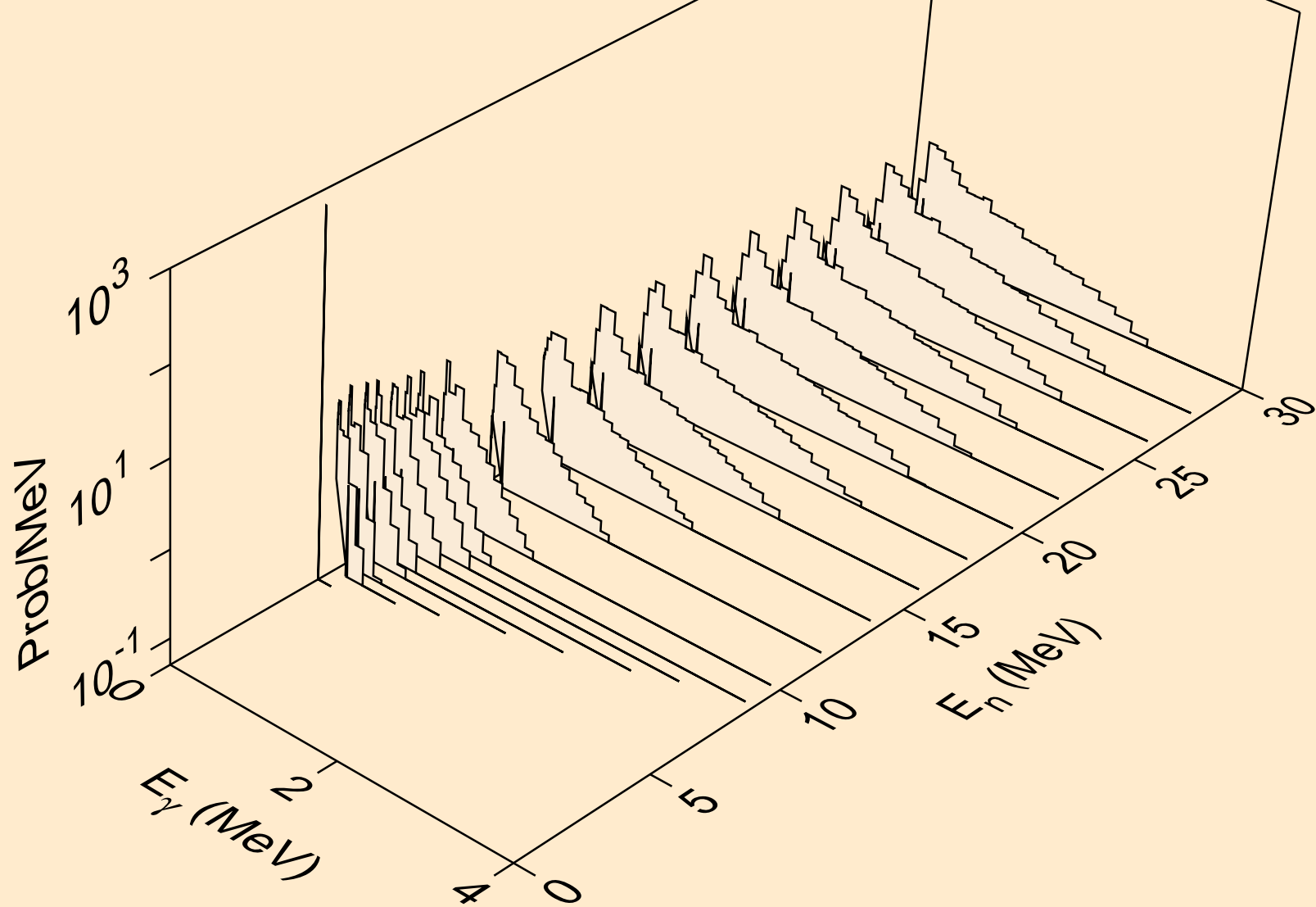

HO174 NEUTRON ACER TENDL-2021 LIBRARY; T=293.6K
Photon emission for (n,d)

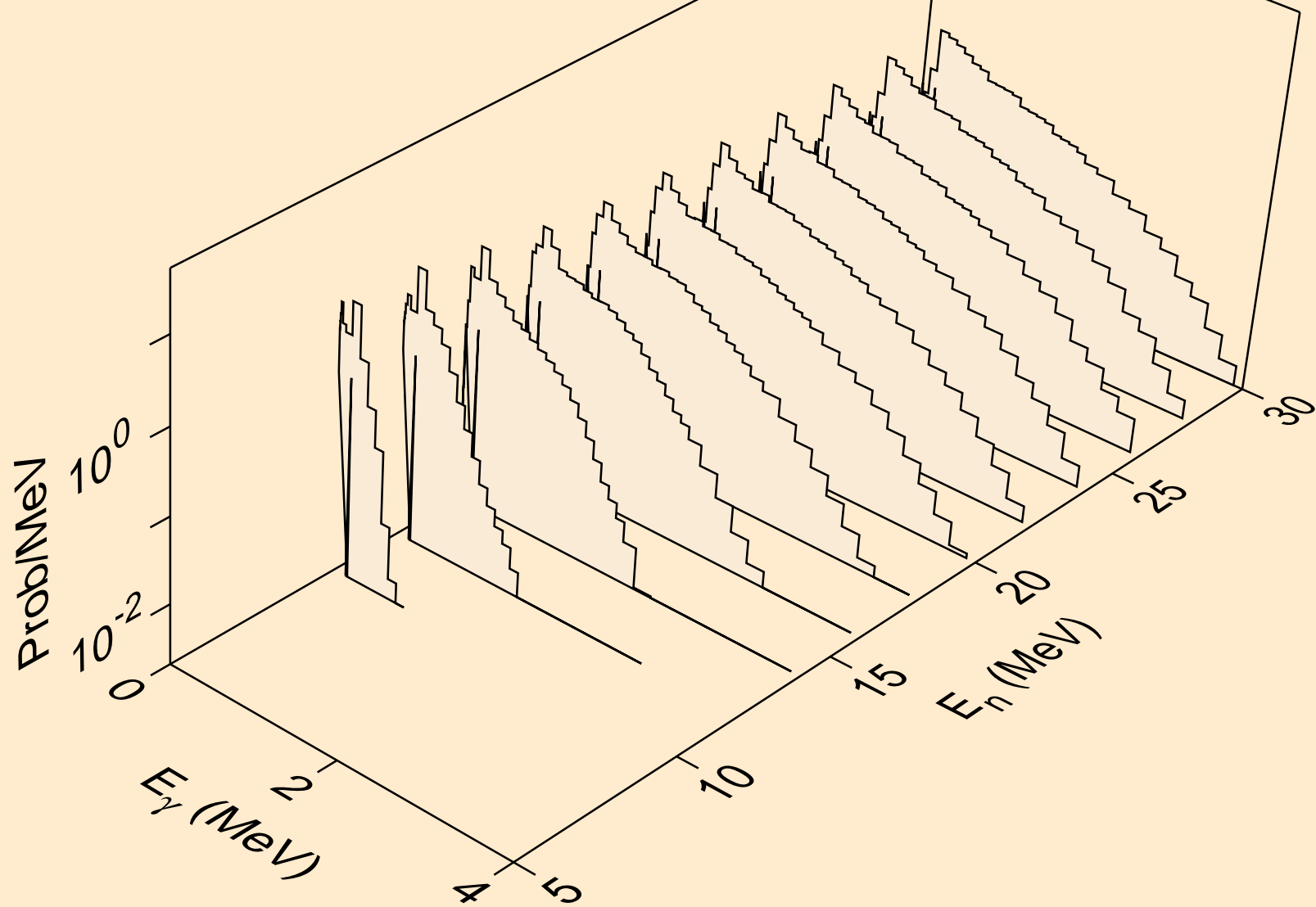

HO174 NEUTRON ACER TENDL-2021 LIBRARY; T=293.6K
Photon emission for (n,t)

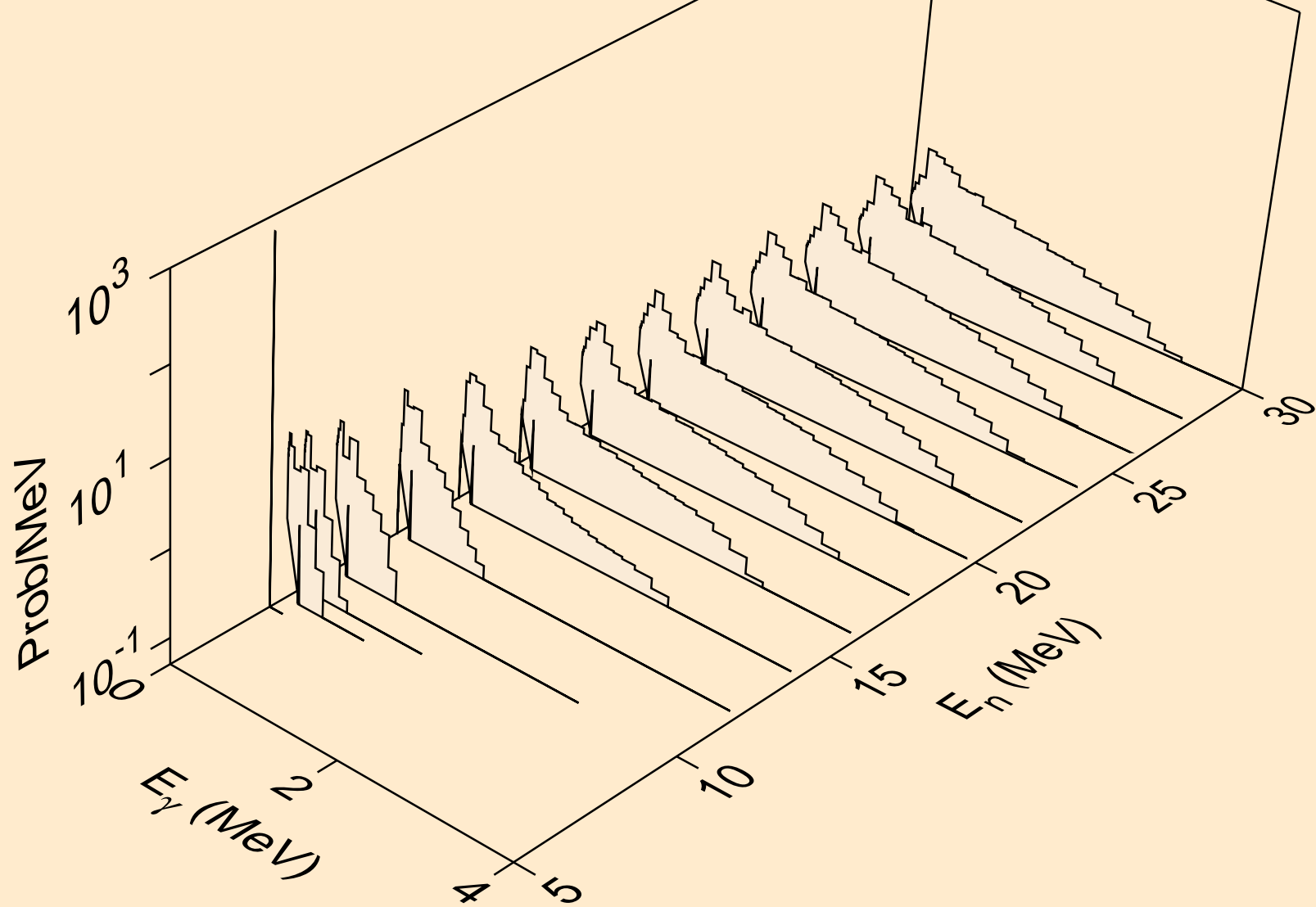

HO174 NEUTRON ACER TENDL-2021 LIBRARY; T=293.6K
Photon emission for (n,he3)

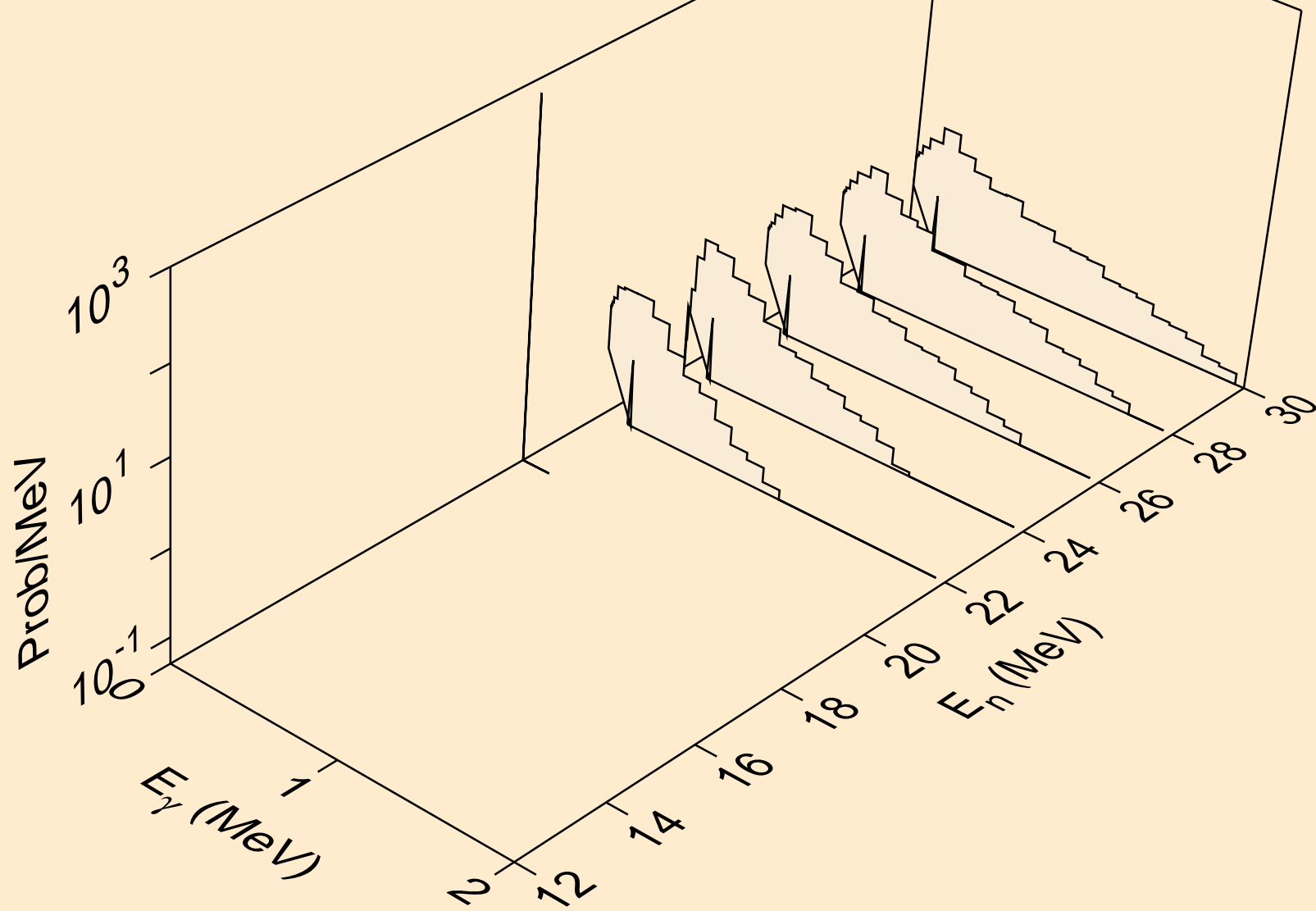

HO174 NEUTRON ACER TENDL-2021 LIBRARY; T=293.6K
Photon emission for (n,a)

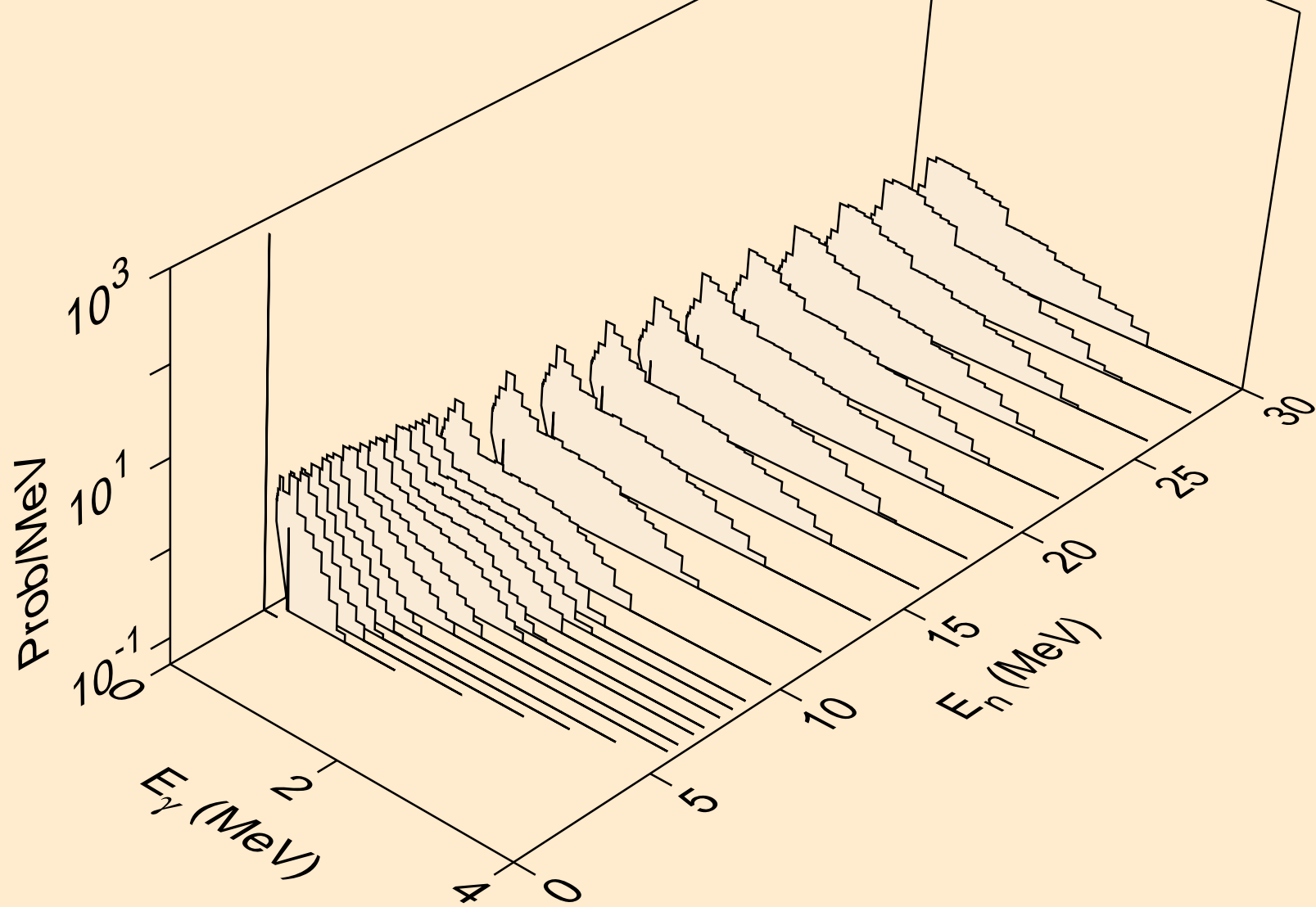

HO174 NEUTRON ACER TENDL-2021 LIBRARY; T=293.6K
thermal capture photon spectrum

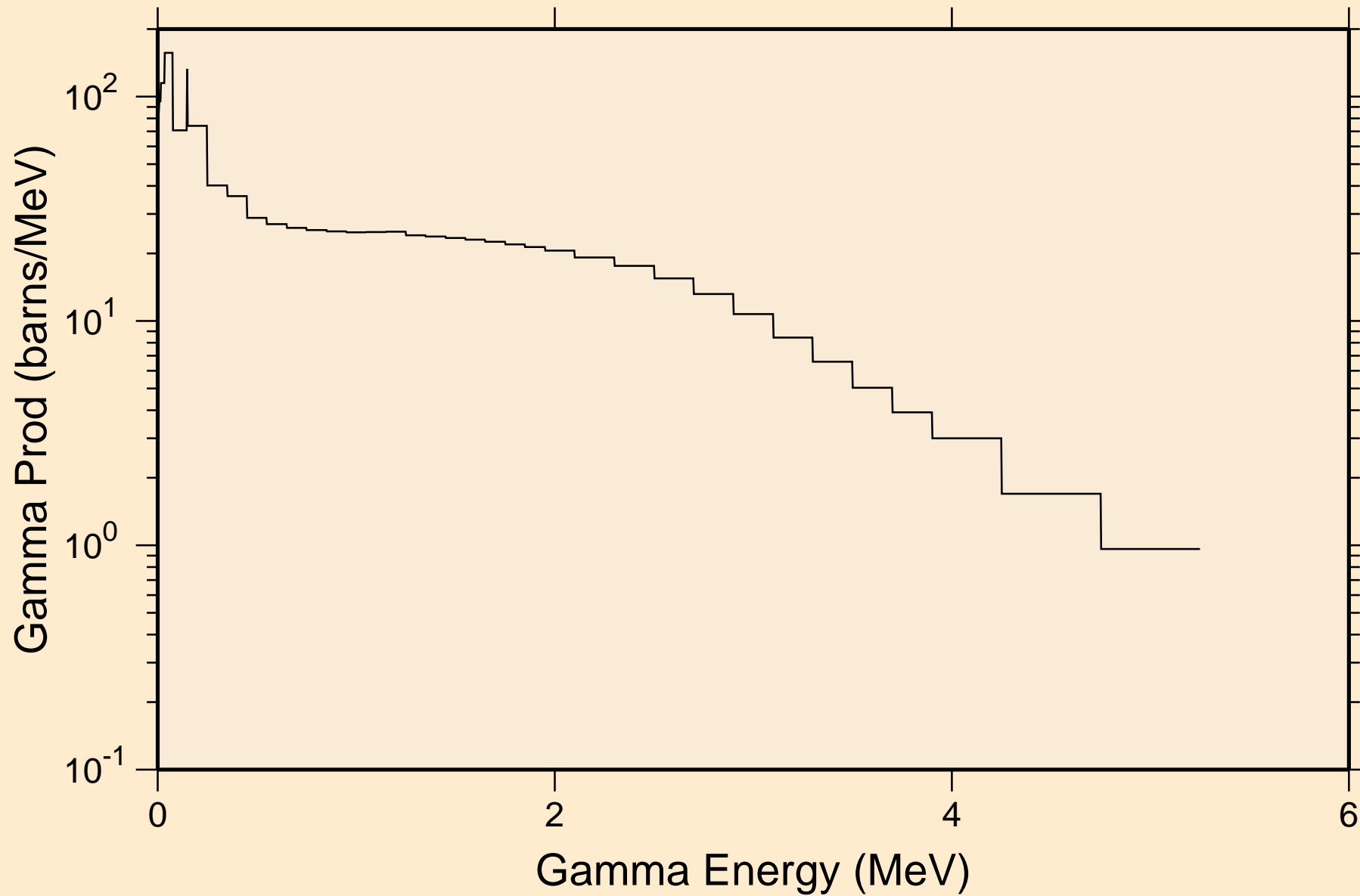

HO174 NEUTRON ACER TENDL-2021 LIBRARY; T=293.6K
14 MeV photon spectrum

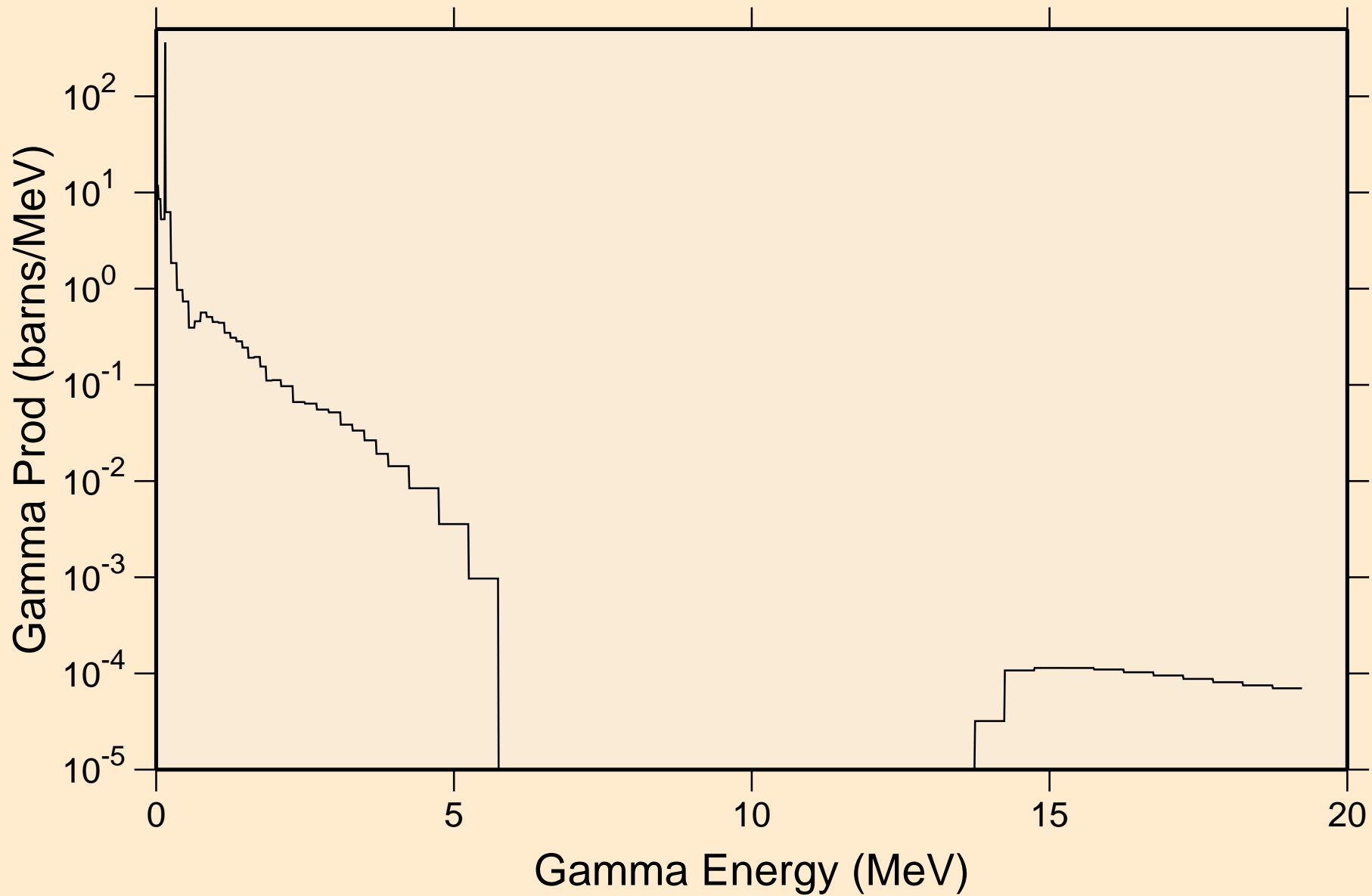

HO174 NEUTRON ACER TENDL-2021 LIBRARY; T=293.6K

Particle heating contributions

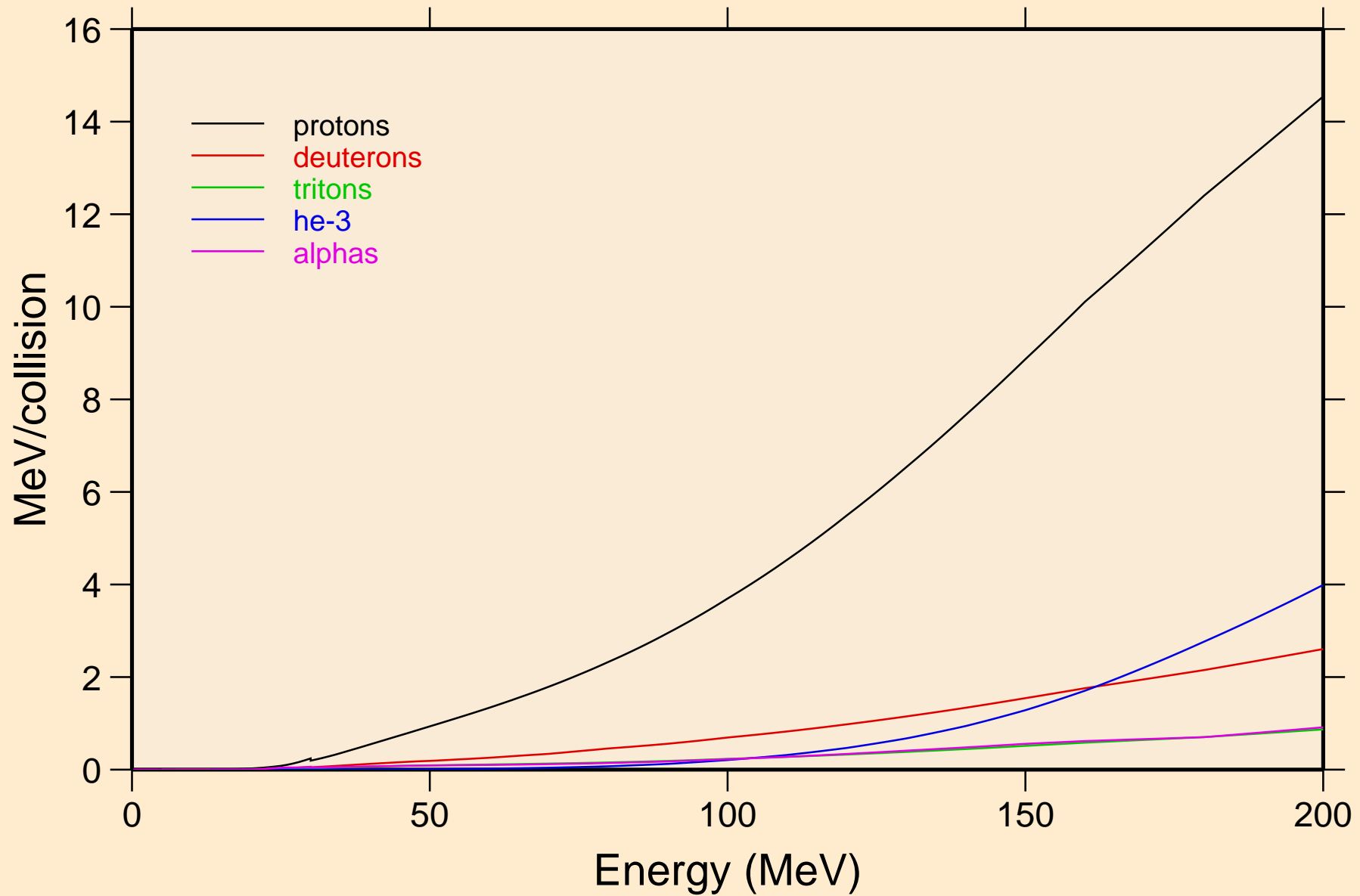

HO174 NEUTRON ACER TENDL-2021 LIBRARY; T=293.6K
Recoil Heating

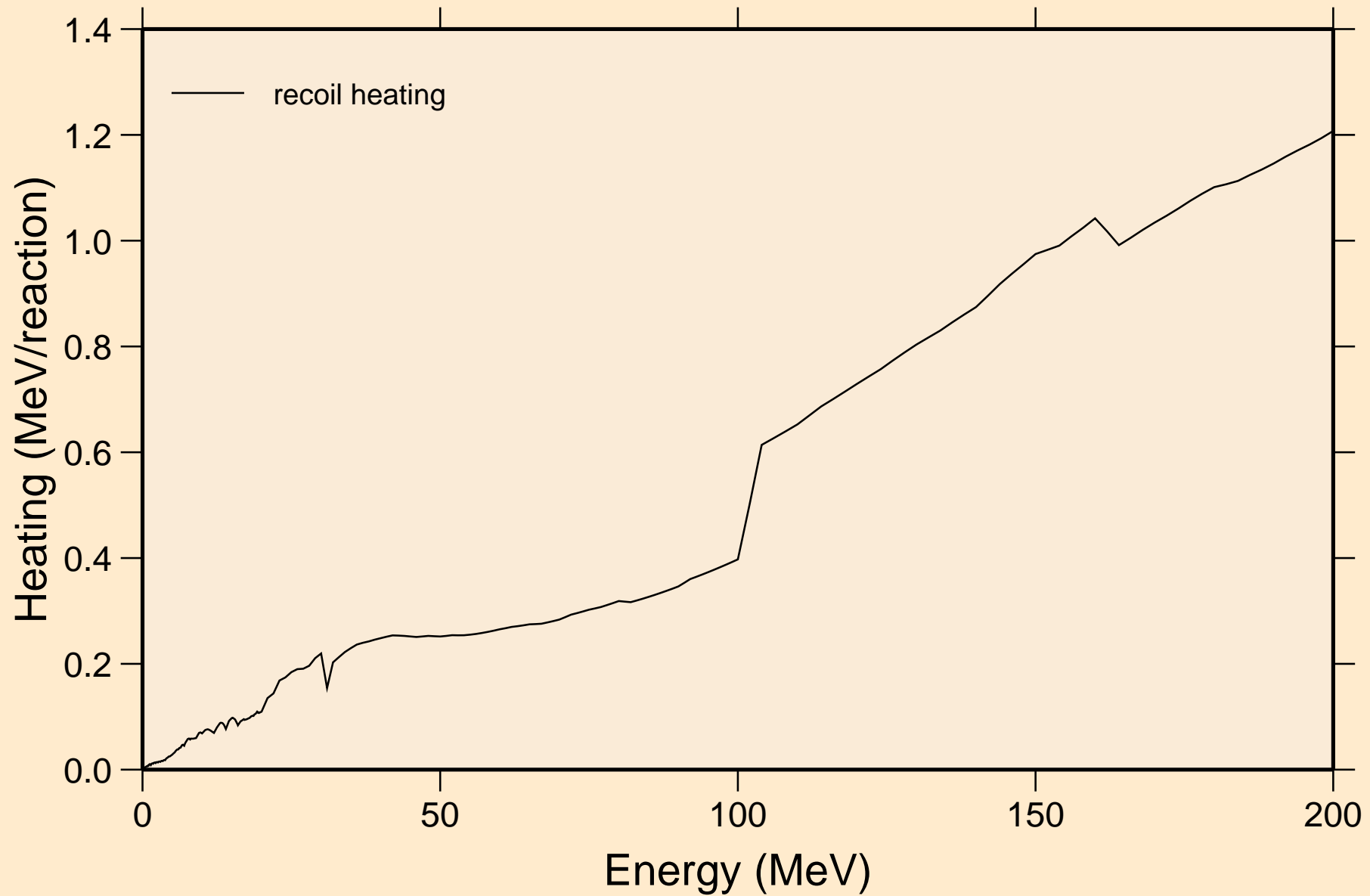

HO174 NEUTRON ACER TENDL-2021 LIBRARY; T=293.6K
Particle production cross sections

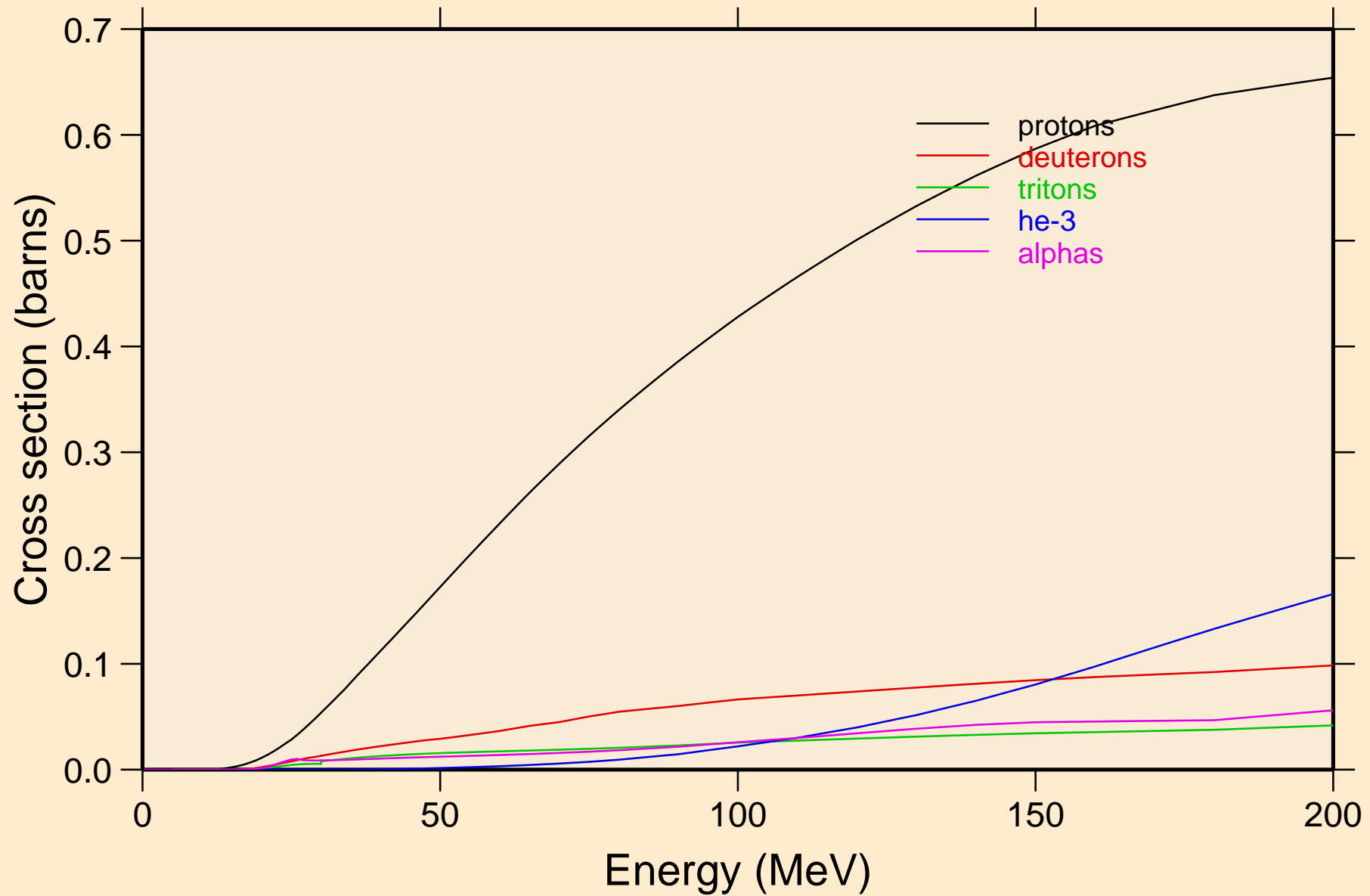

HO174 NEUTRON ACER TENDL-2021 LIBRARY; T=293.6K
protons from (n,x)

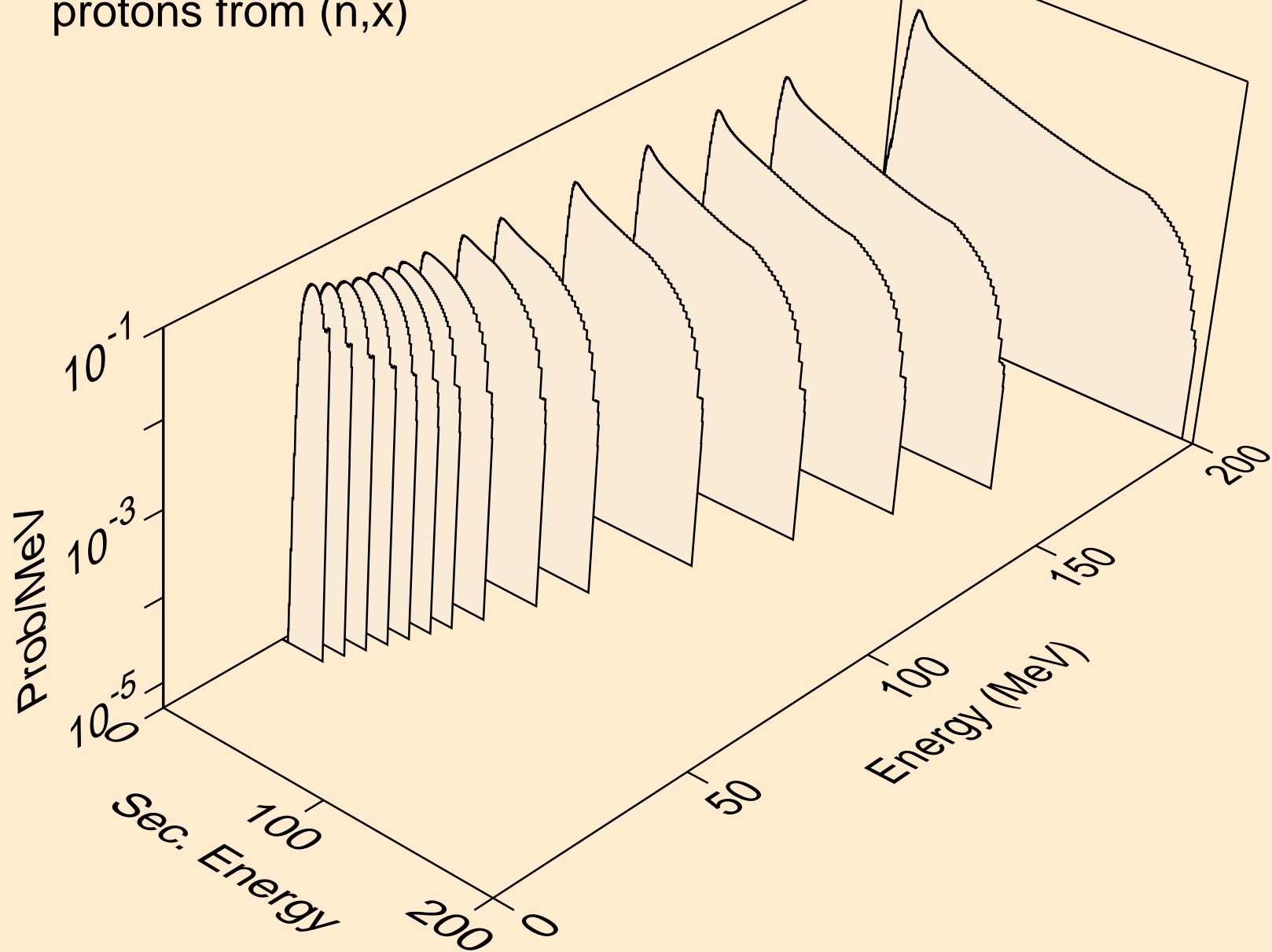

HO174 NEUTRON ACER TENDL-2021 LIBRARY; T=293.6K
protons from (n,n*)p

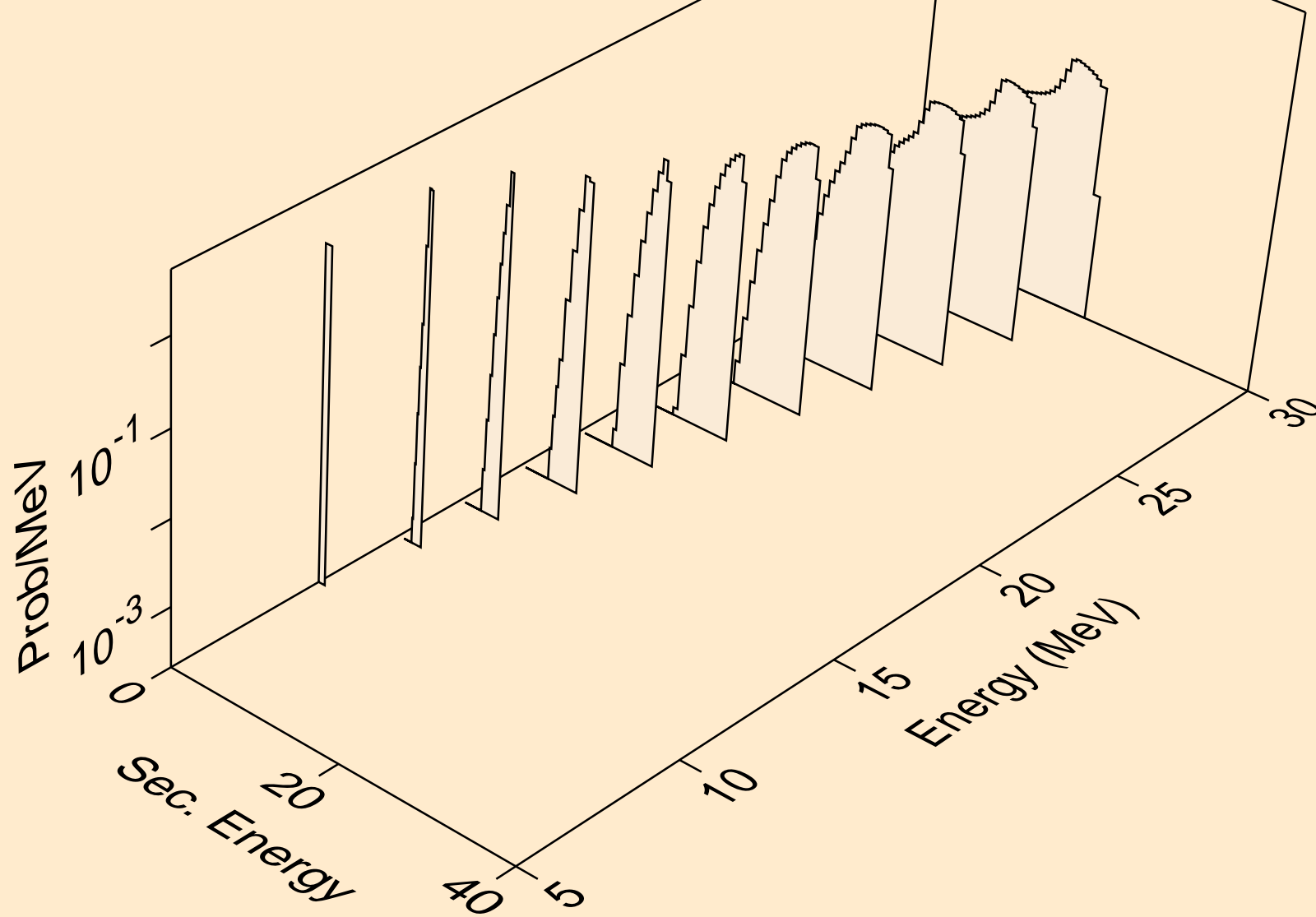

HO174 NEUTRON ACER TENDL-2021 LIBRARY; T=293.6K
protons from (n,2np)

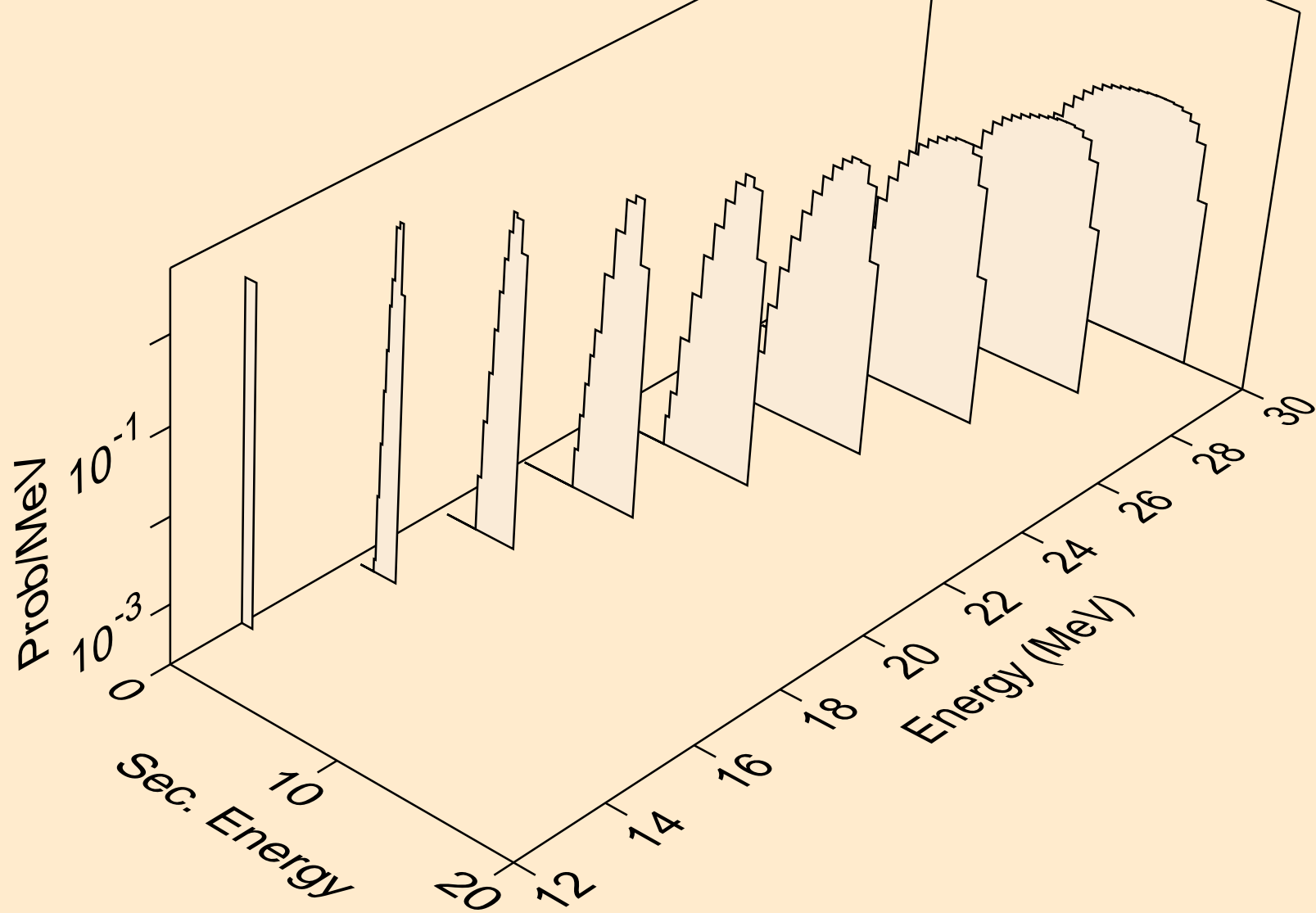

HO174 NEUTRON ACER TENDL-2021 LIBRARY; T=293.6K
protons from (n,3np)

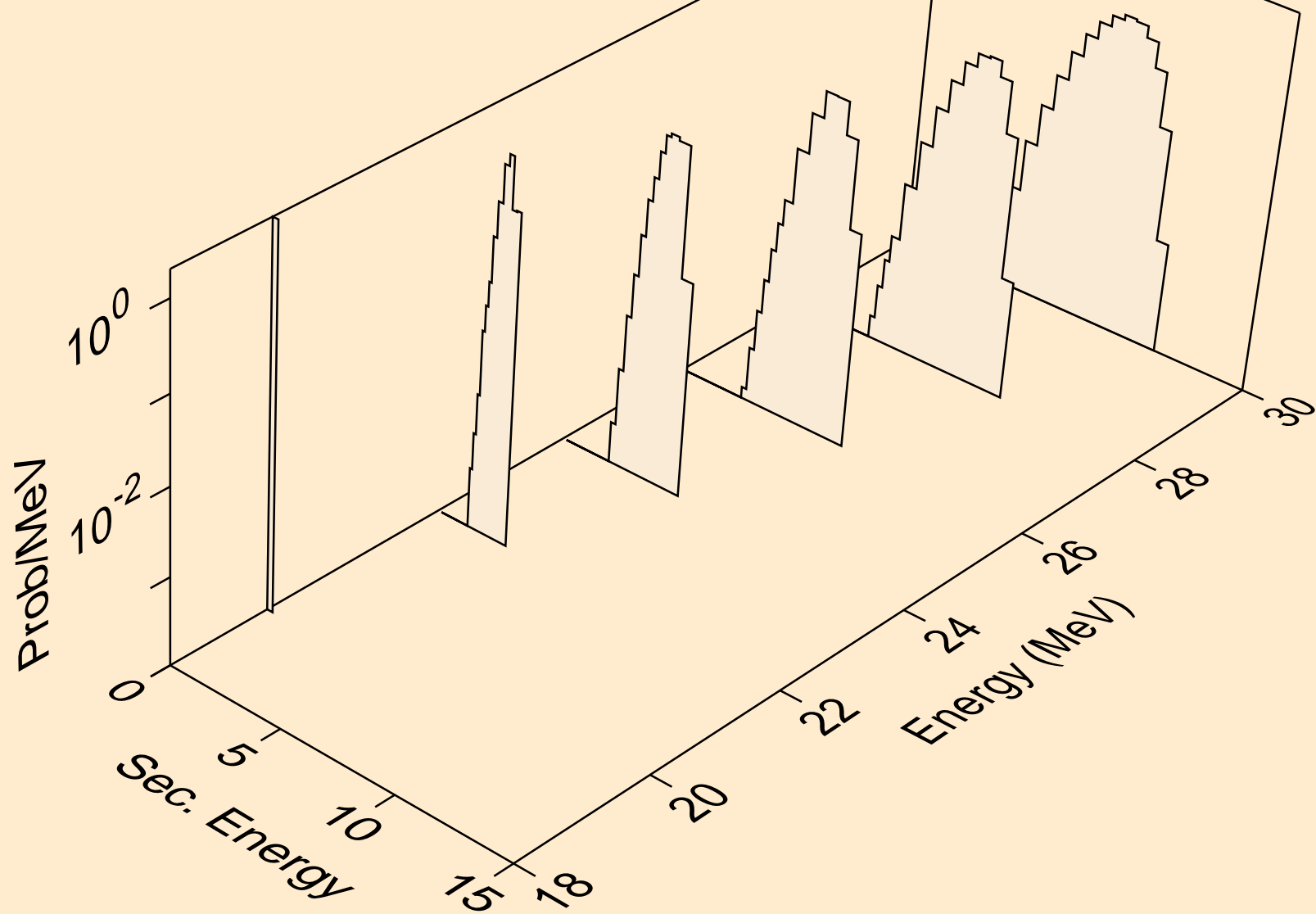

HO174 NEUTRON ACER TENDL-2021 LIBRARY; T=293.6K
protons from (n,p)

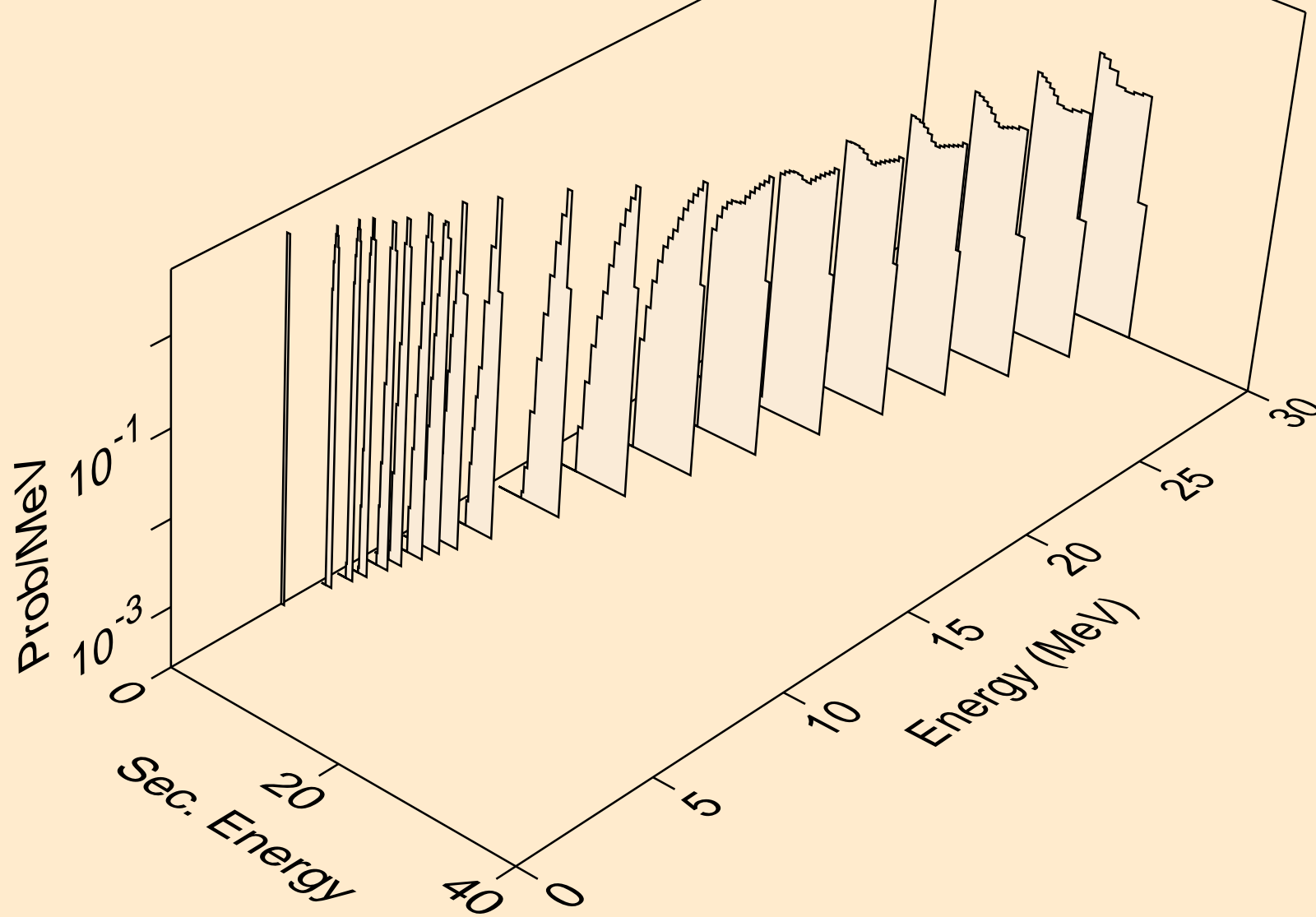

HO174 NEUTRON ACER TENDL-2021 LIBRARY; T=293.6K
deuterons from (n,x)

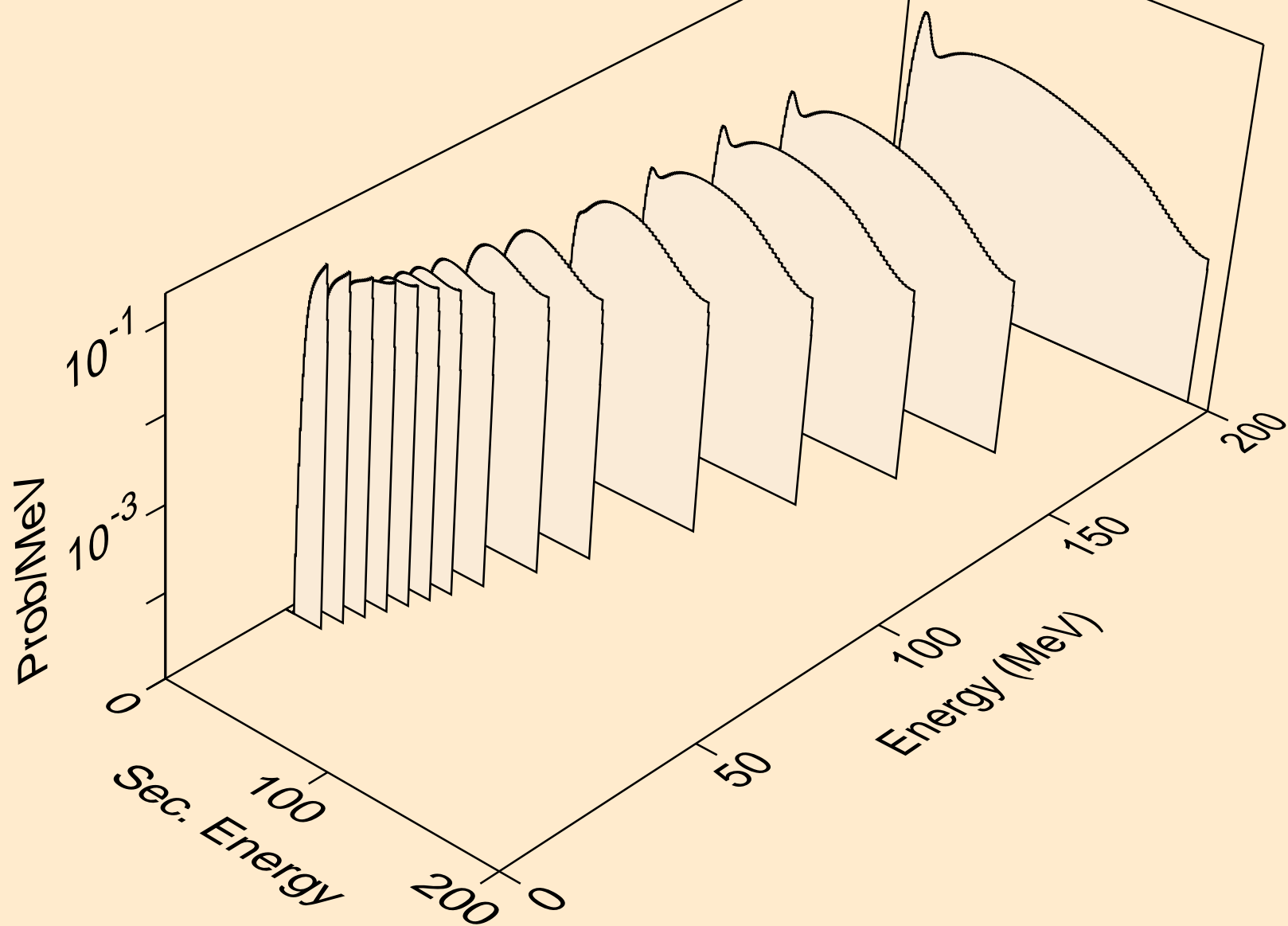

HO174 NEUTRON ACER TENDL-2021 LIBRARY; T=293.6K
deuterons from (n,2nd)

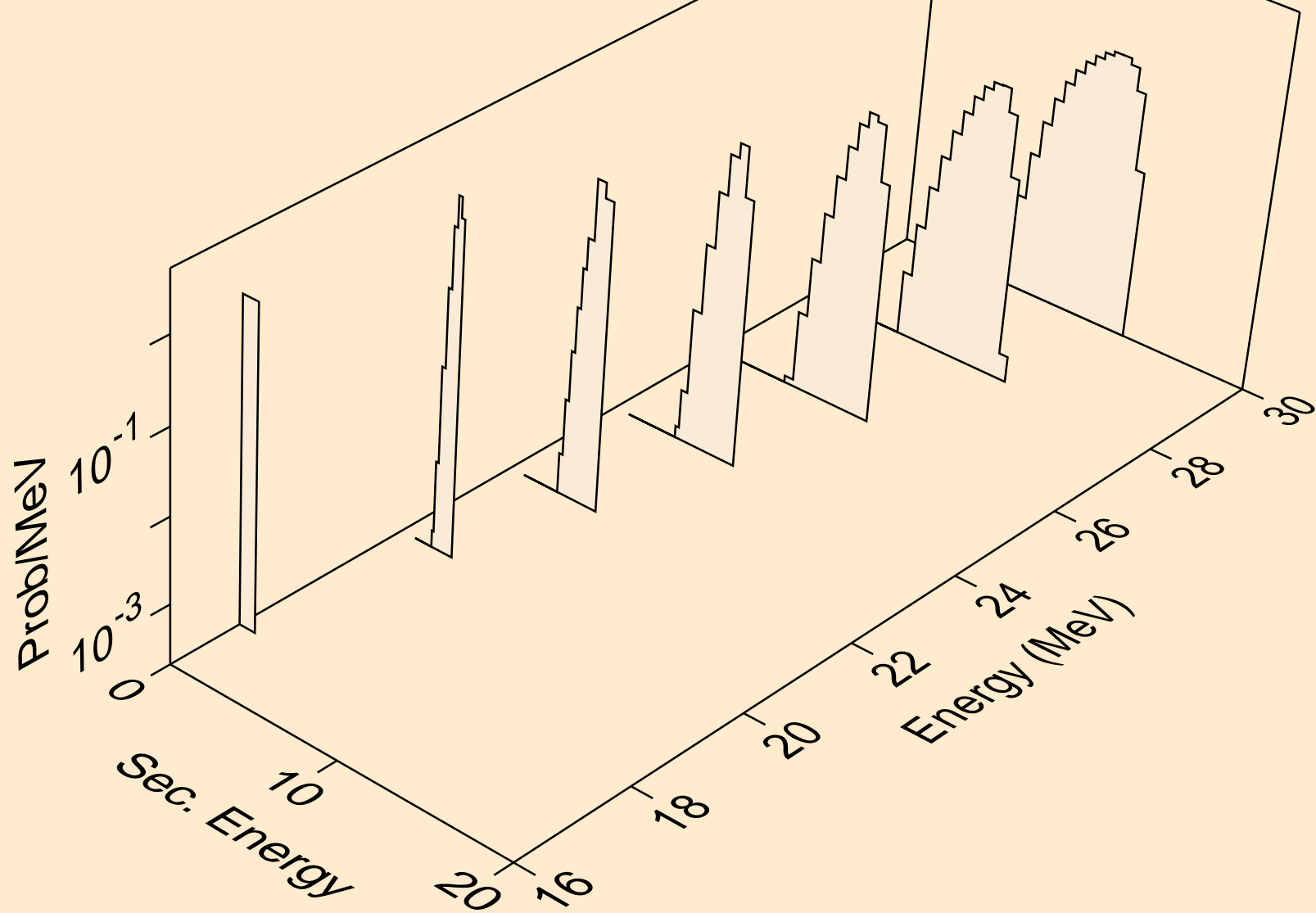

HO174 NEUTRON ACER TENDL-2021 LIBRARY; T=293.6K
deuterons from (n,n*)d

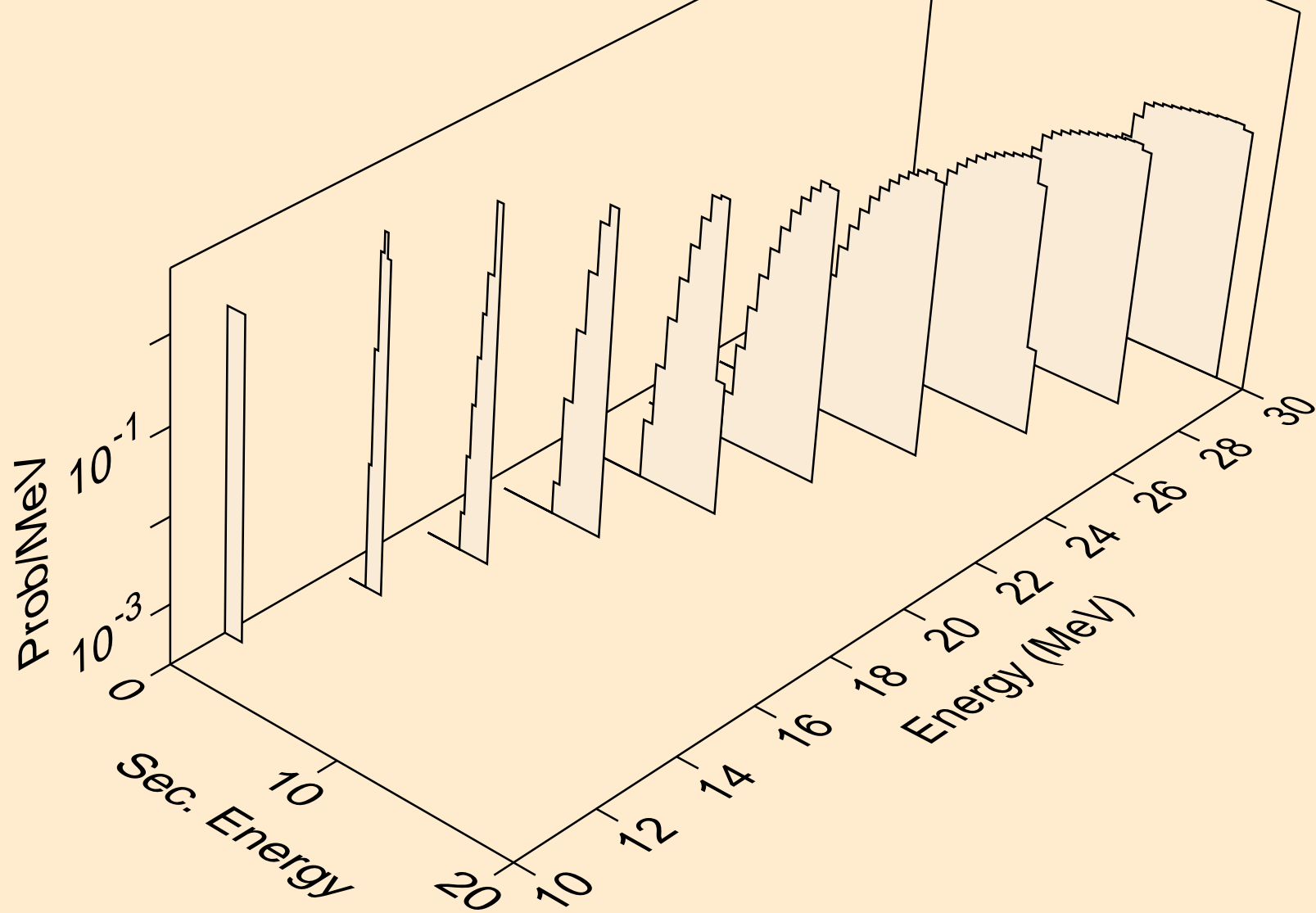

HO174 NEUTRON ACER TENDL-2021 LIBRARY; T=293.6K
deuterons from (n,d)

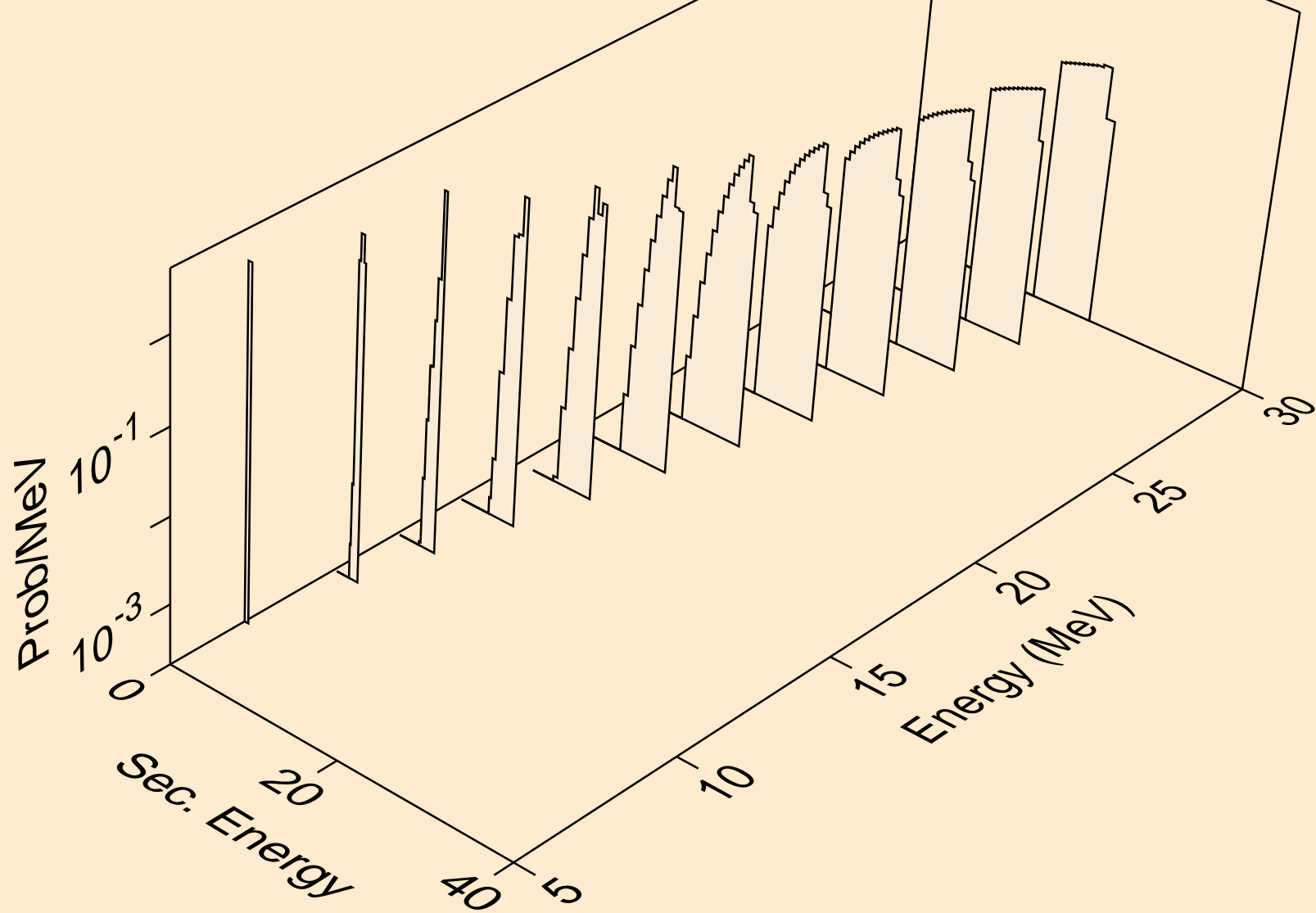

HO174 NEUTRON ACER TENDL-2021 LIBRARY; T=293.6K
tritons from (n,x)

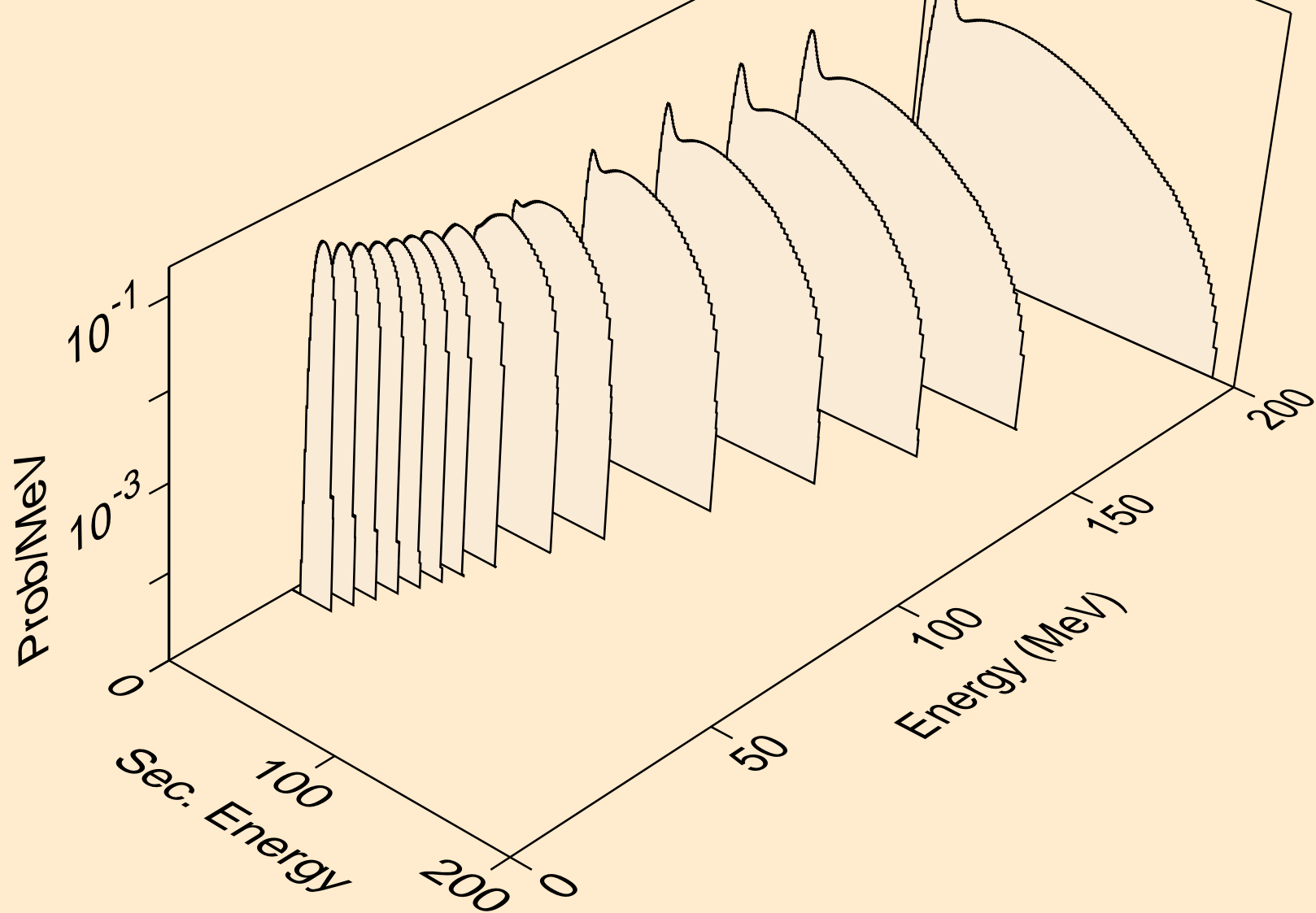

HO174 NEUTRON ACER TENDL-2021 LIBRARY; T=293.6K
tritons from (n,n*)t

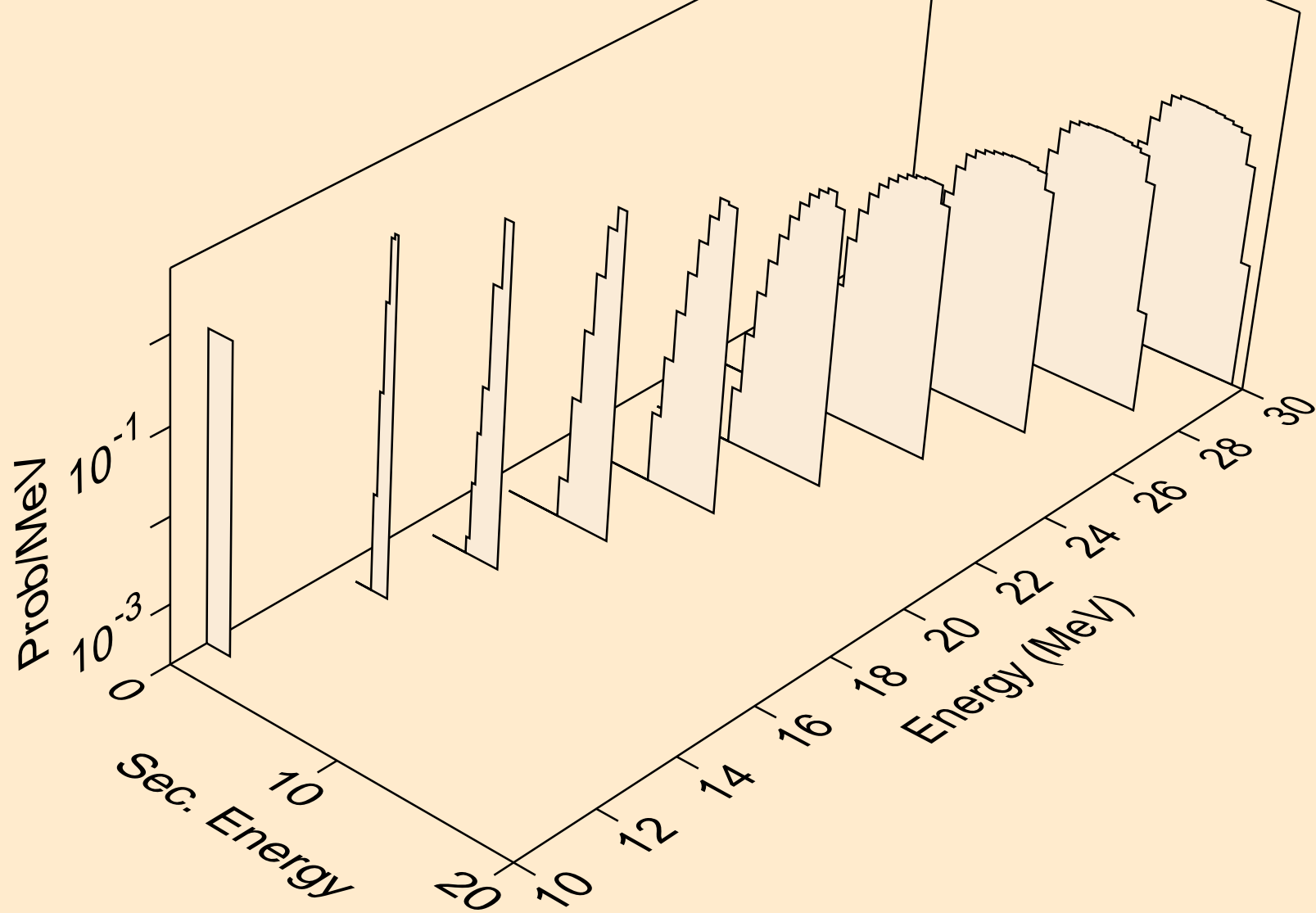

HO174 NEUTRON ACER TENDL-2021 LIBRARY; T=293.6K
tritons from (n,t)

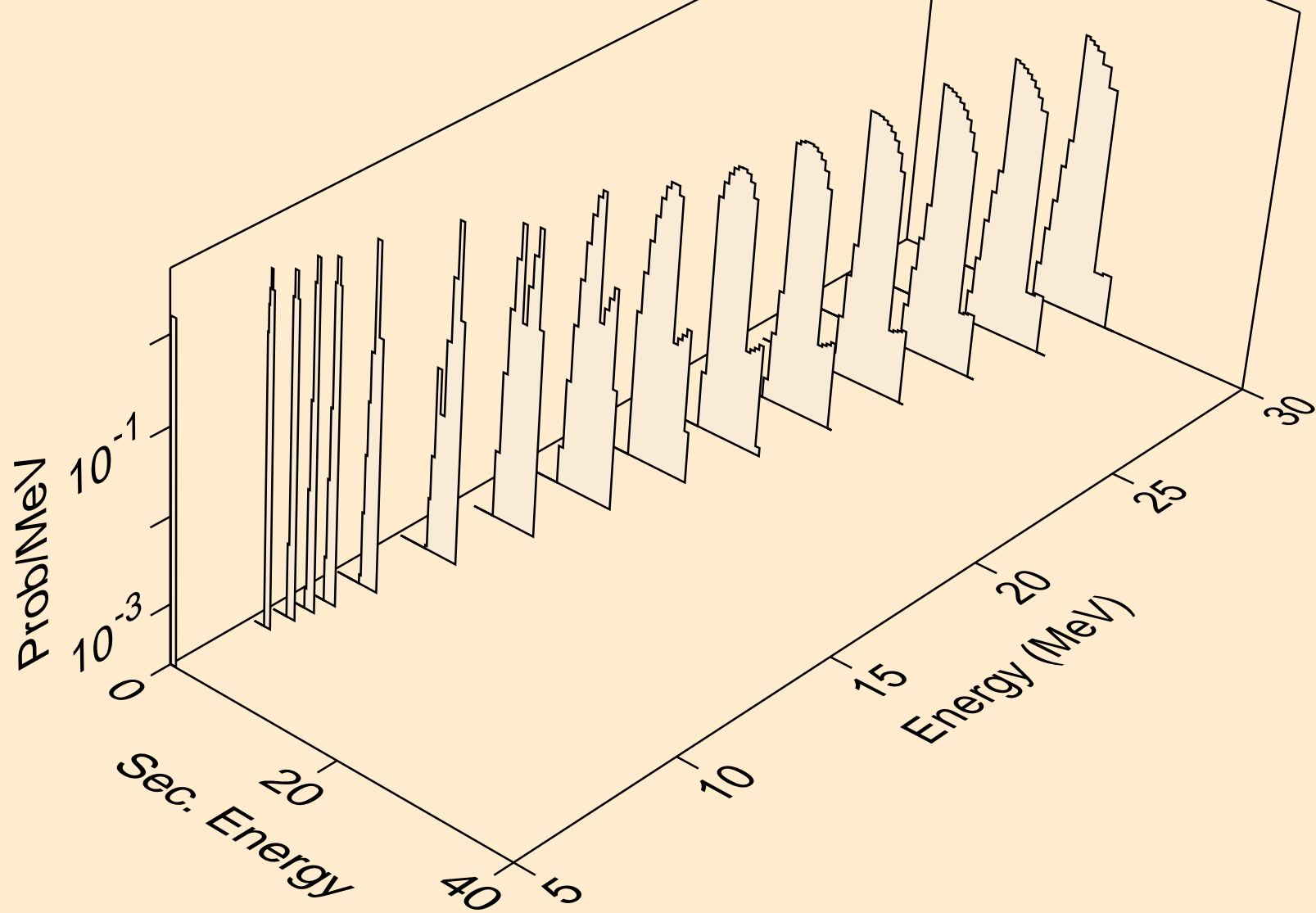

HO174 NEUTRON ACER TENDL-2021 LIBRARY; T=293.6K
he3s from (n,x)

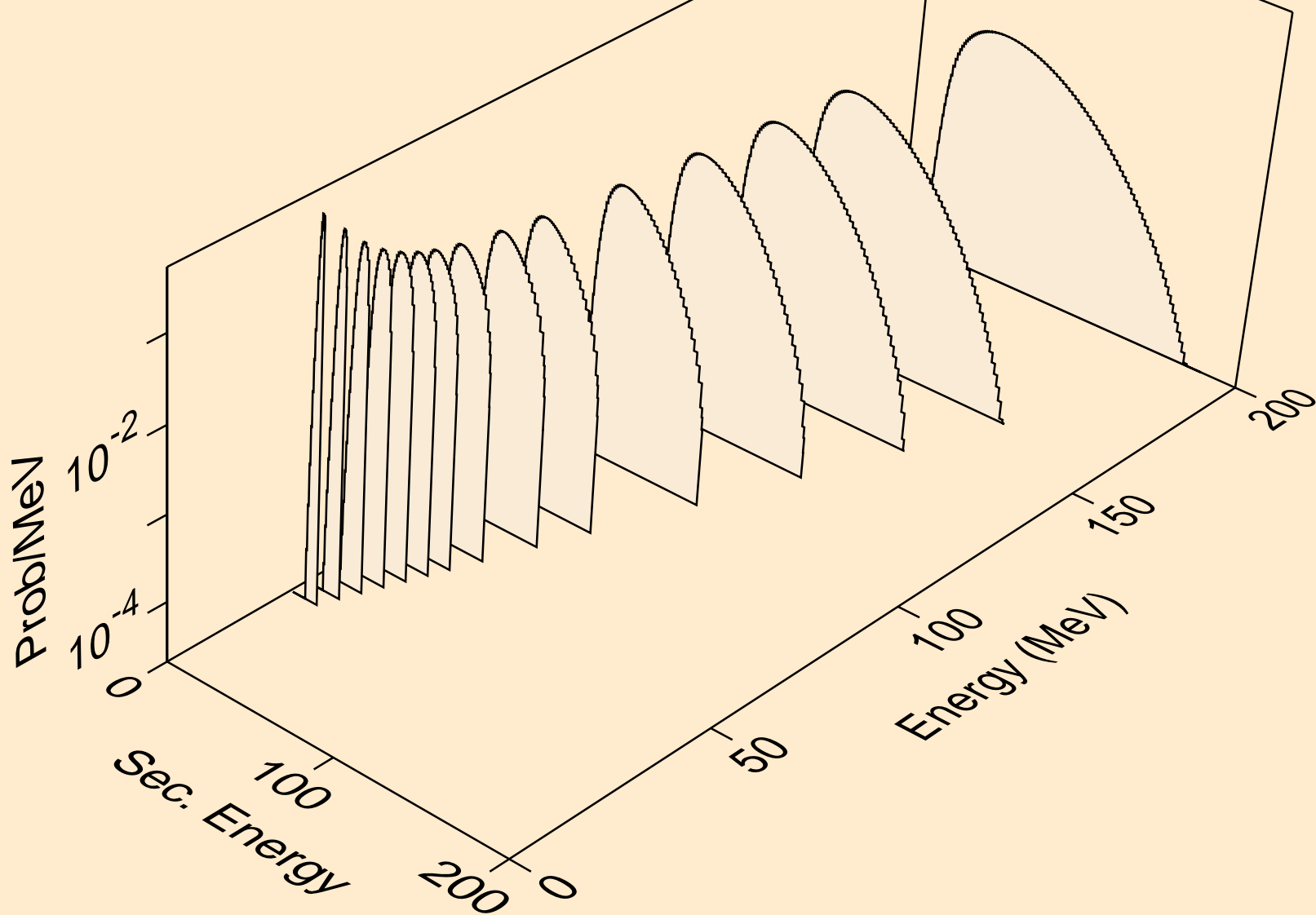

HO174 NEUTRON ACER TENDL-2021 LIBRARY; T=293.6K
he3s from (n,n*)he3

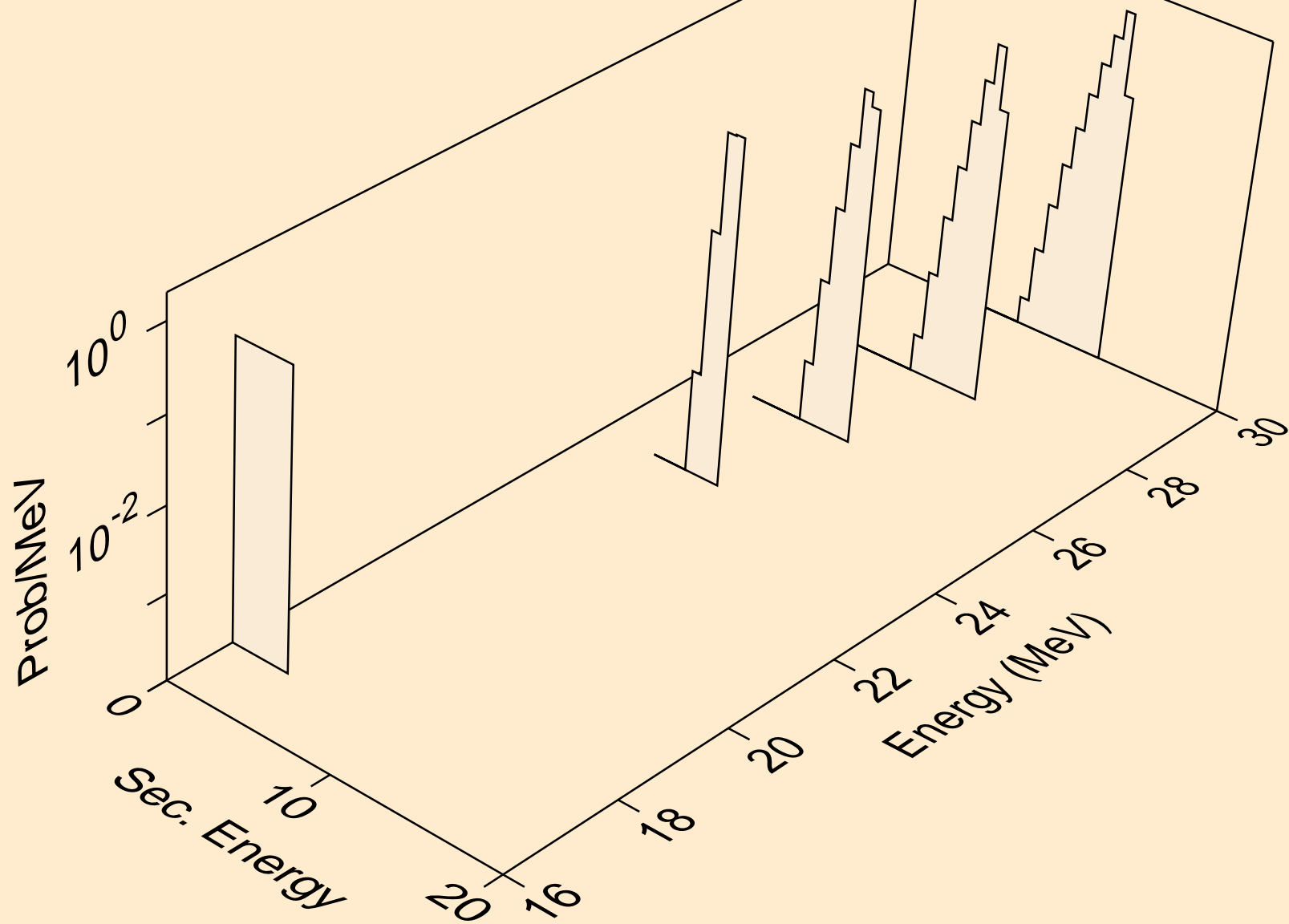

HO174 NEUTRON ACER TENDL-2021 LIBRARY; T=293.6K
he3s from (n,he3)

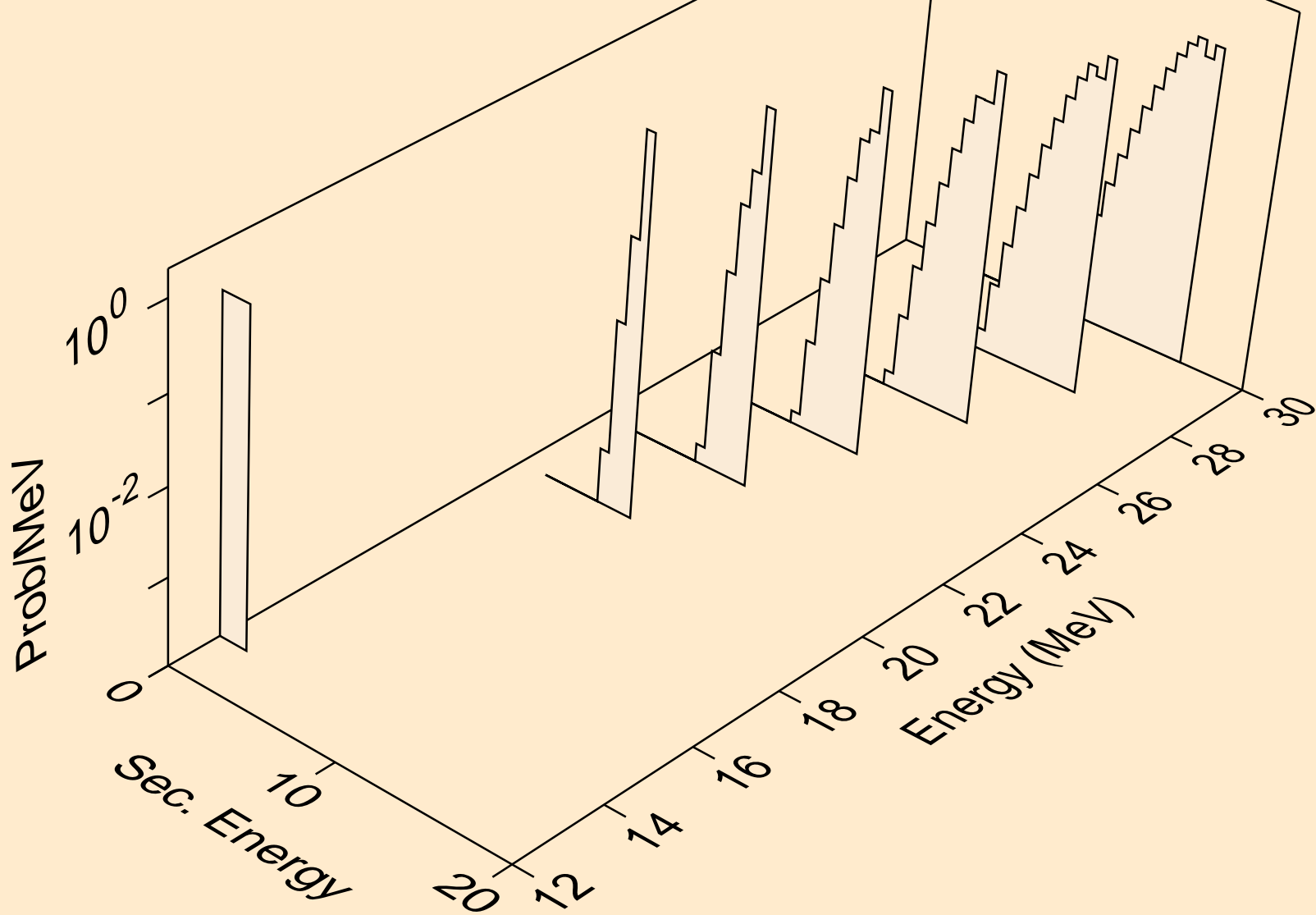

HO174 NEUTRON ACER TENDL-2021 LIBRARY; T=293.6K
alphas from (n,x)

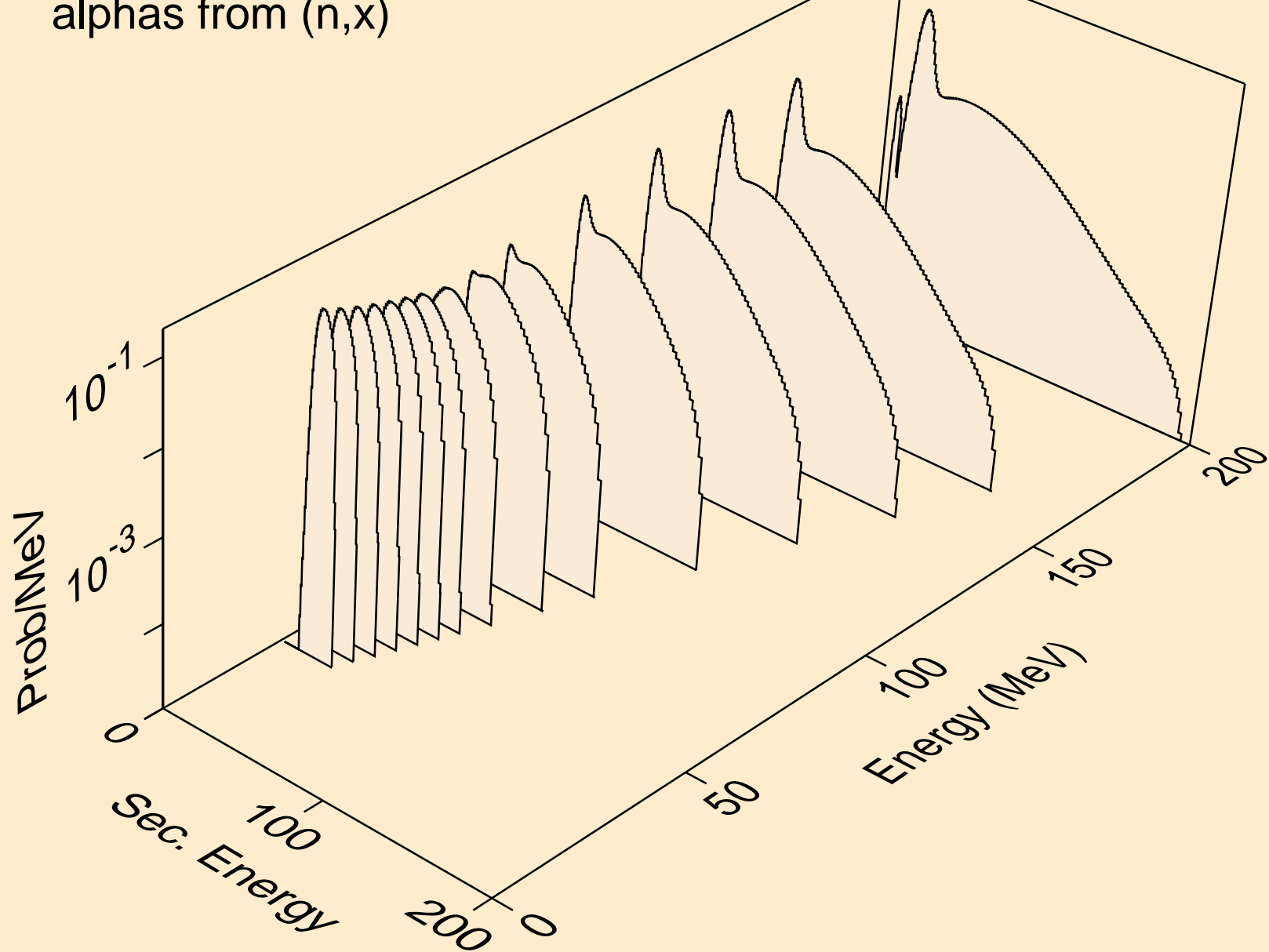

HO174 NEUTRON ACER TENDL-2021 LIBRARY; T=293.6K
alphas from (n,n*)a

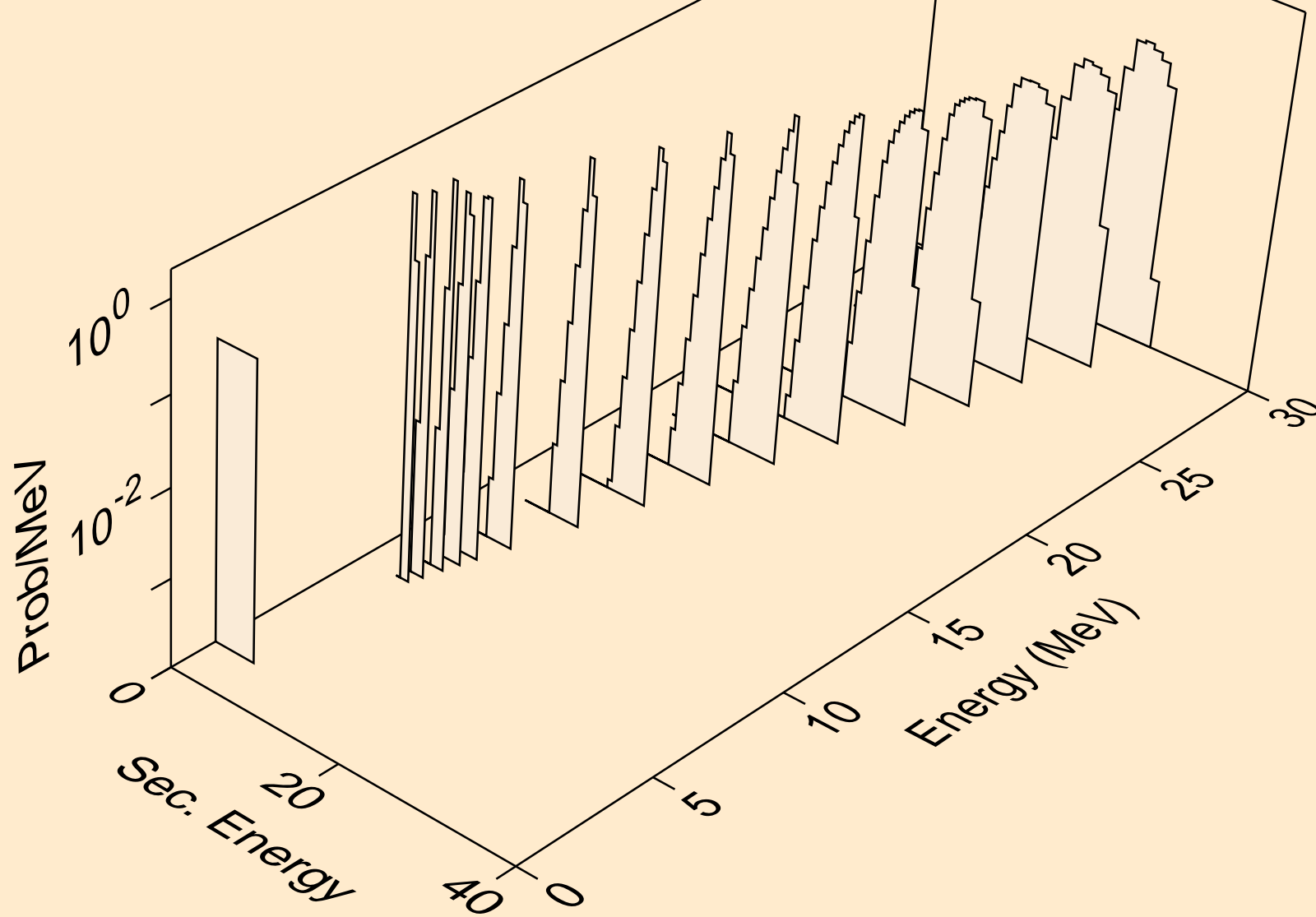

HO174 NEUTRON ACER TENDL-2021 LIBRARY; T=293.6K
alphas from (n,2n)a

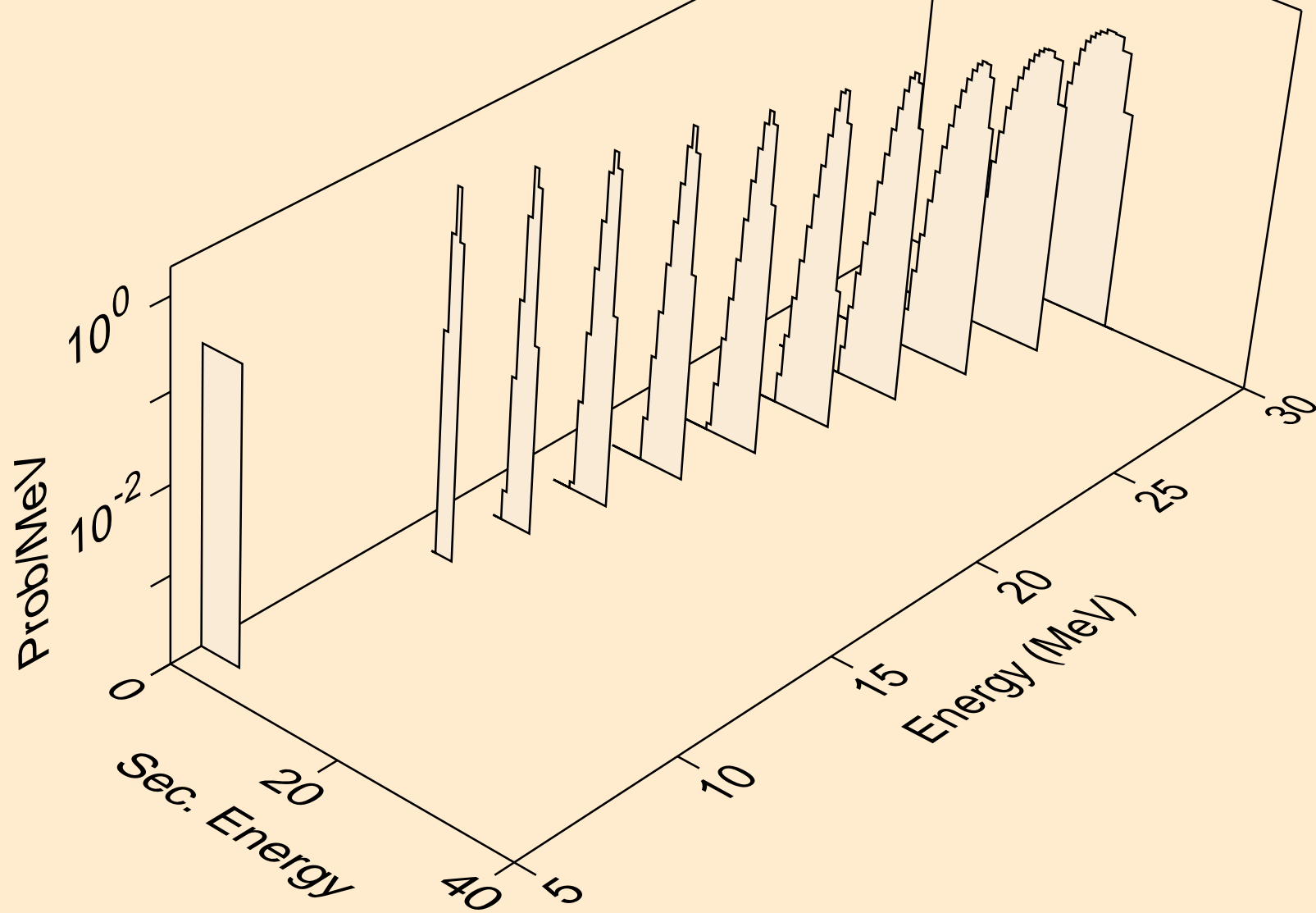

HO174 NEUTRON ACER TENDL-2021 LIBRARY; T=293.6K
alphas from (n,3n)a

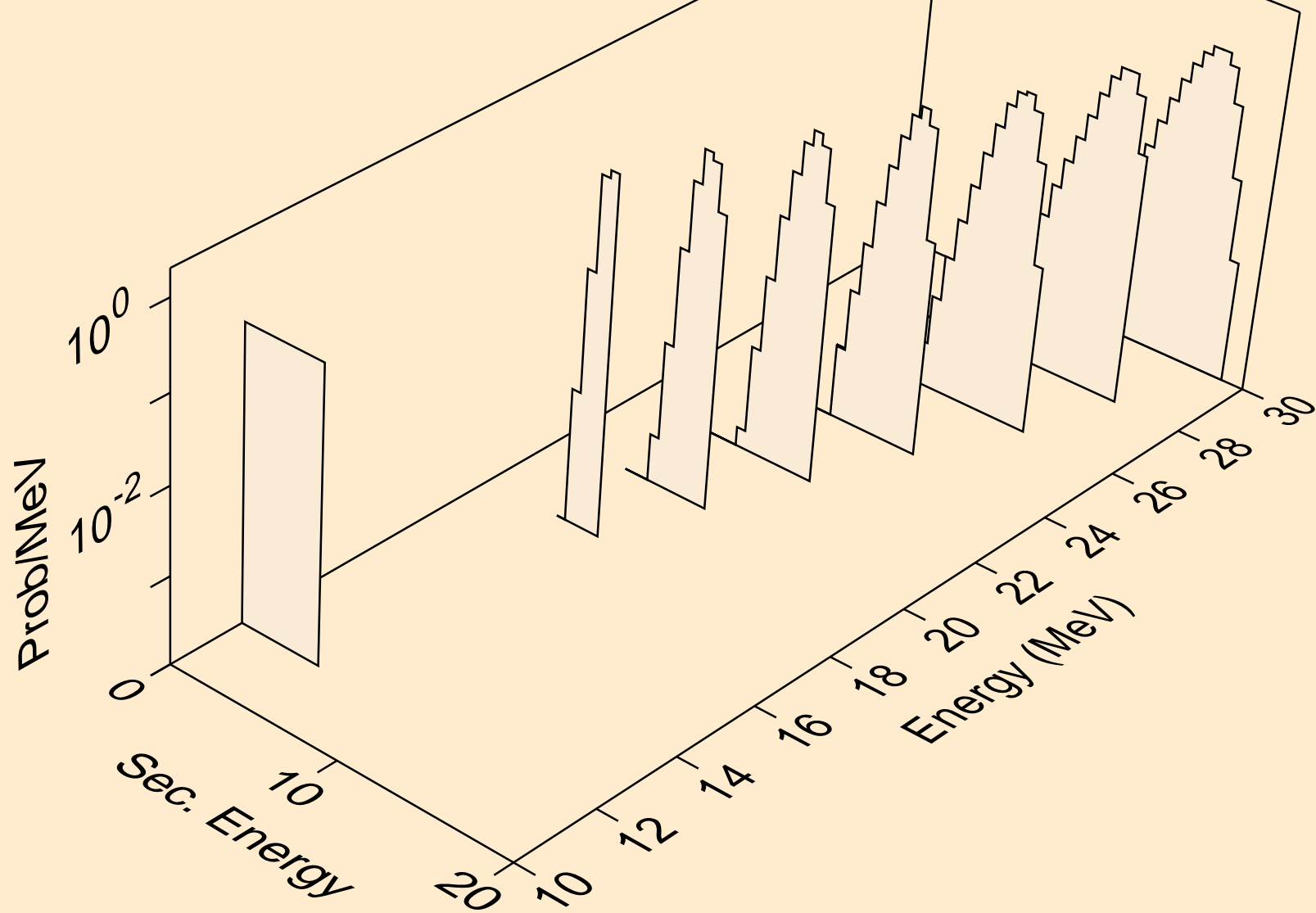

HO174 NEUTRON ACER TENDL-2021 LIBRARY; T=293.6K
alphas from (n,a)

