

HS268 NEUTRON ACER TENDL-2021 LIBRARY; T=293.6K

Principal cross sections

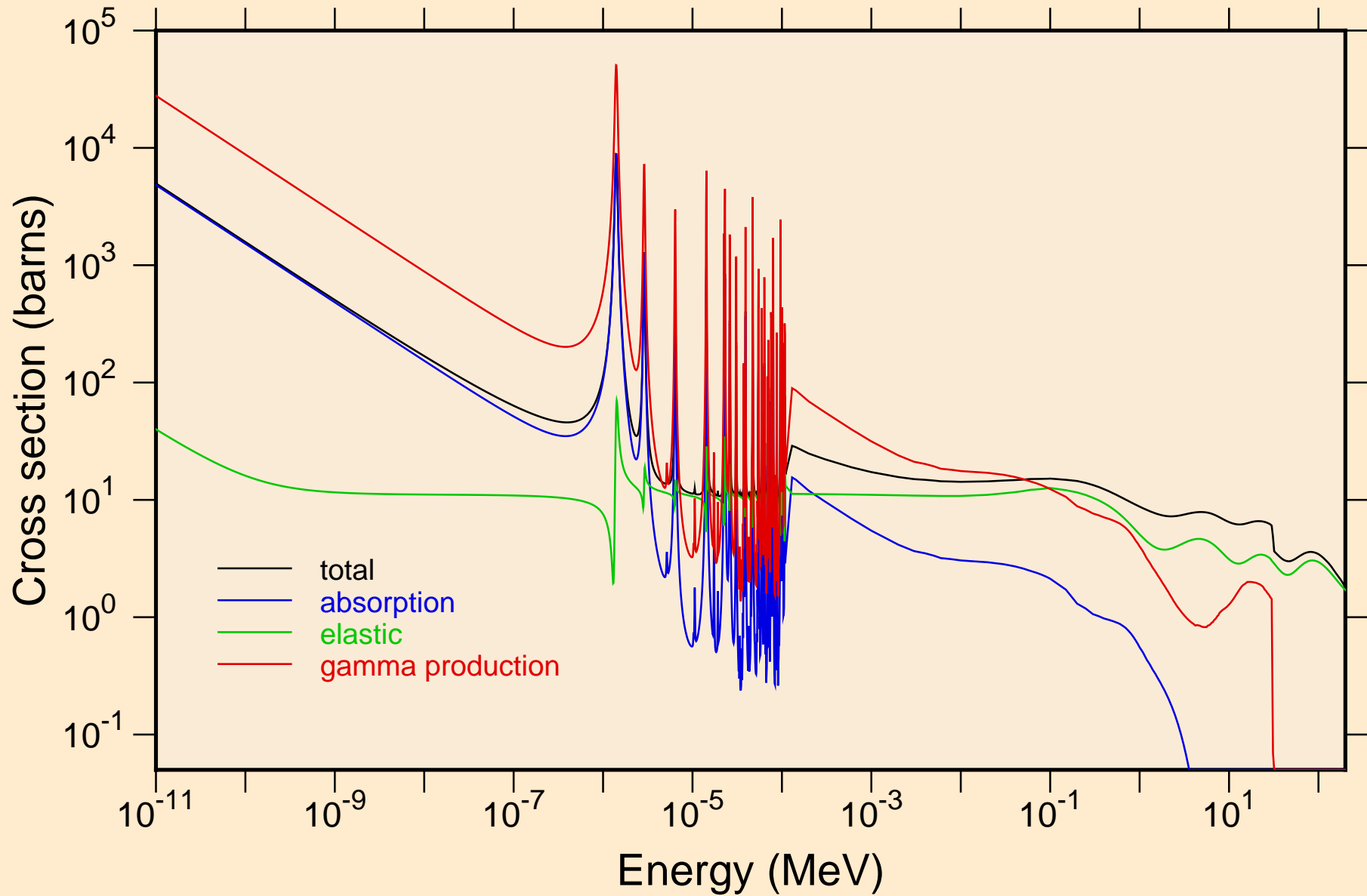

HS268 NEUTRON ACER TENDL-2021 LIBRARY; T=293.6K
resonance total cross section

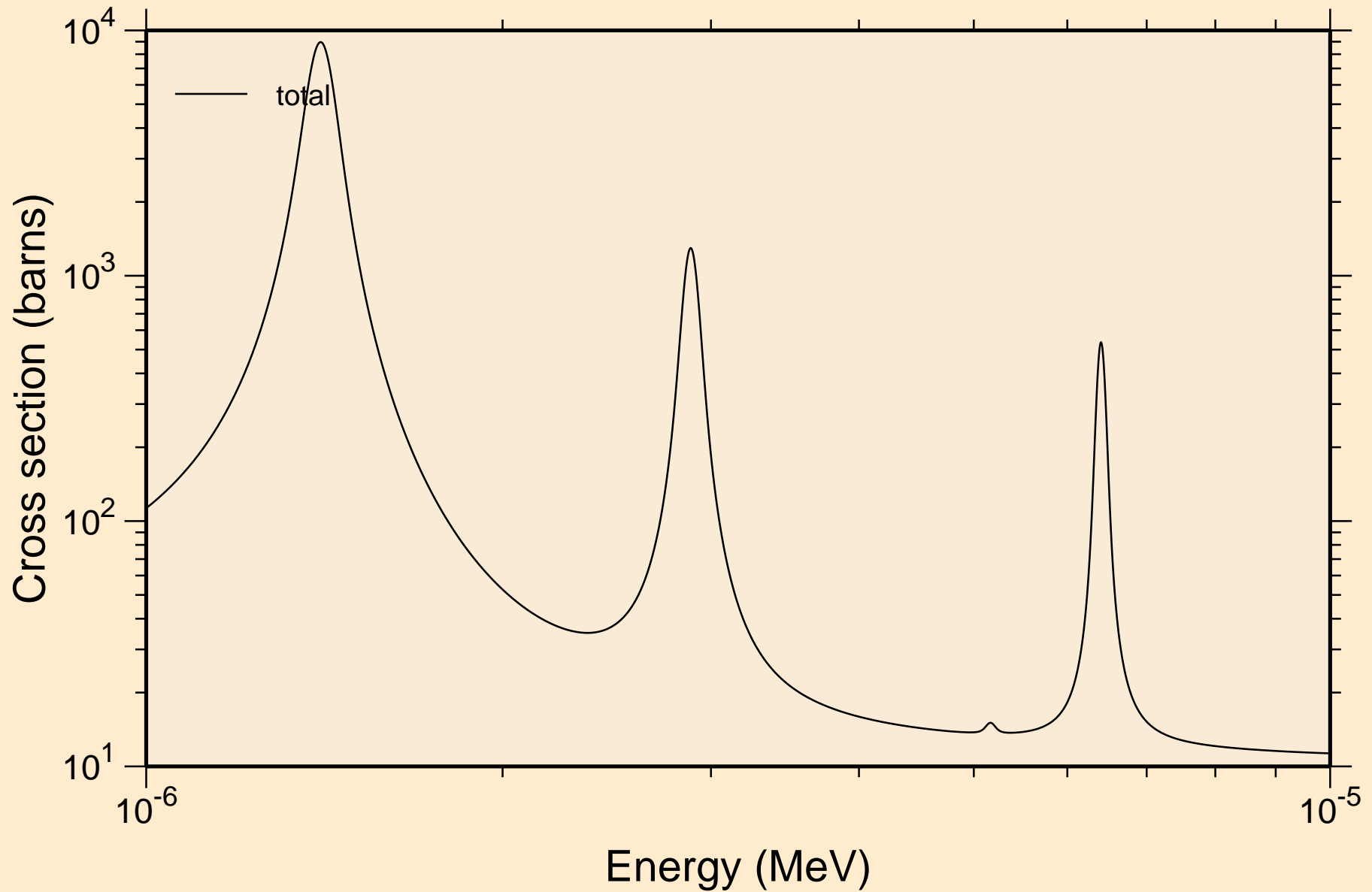

HS268 NEUTRON ACER TENDL-2021 LIBRARY; T=293.6K
resonance total cross section

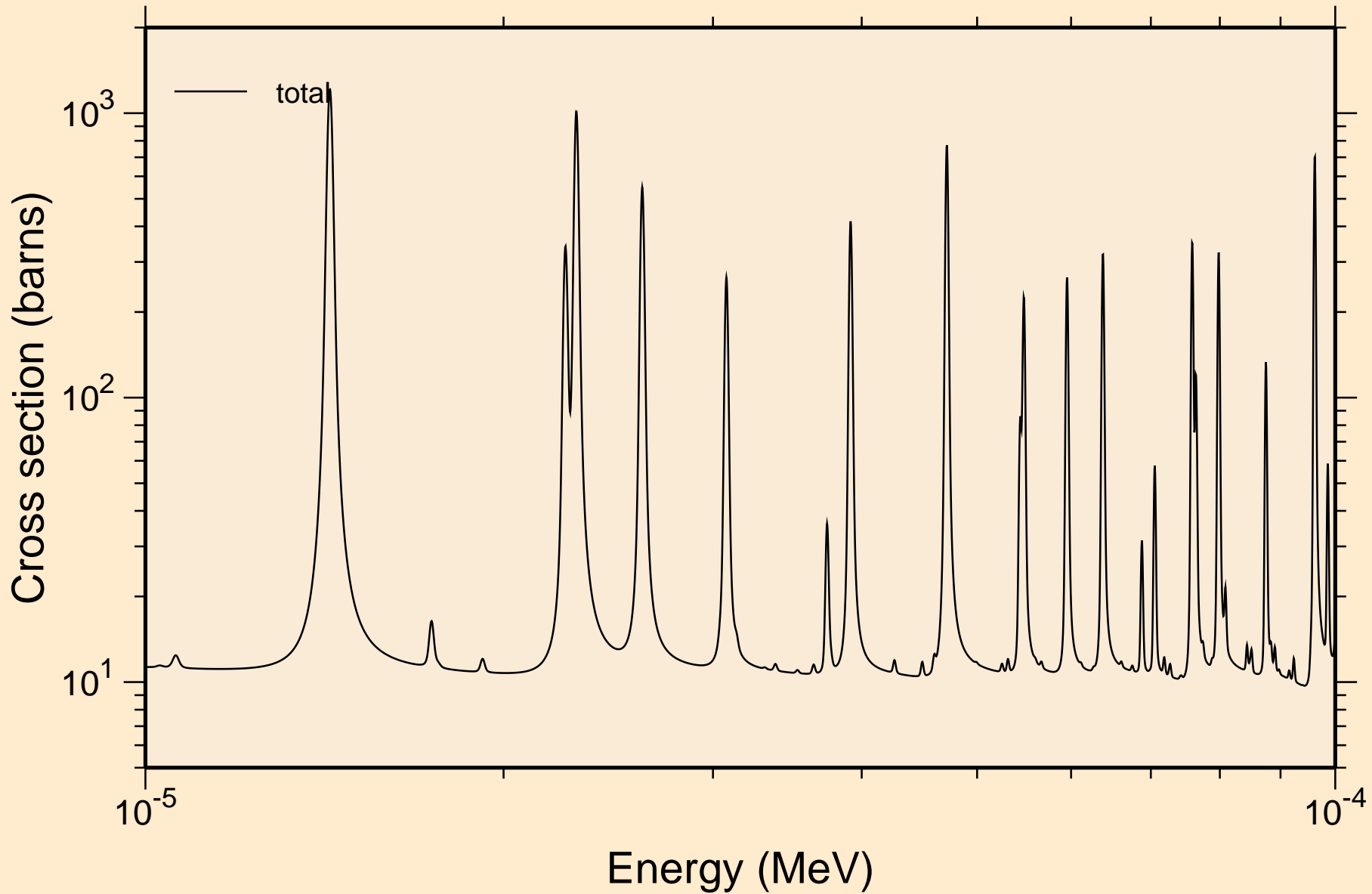

HS268 NEUTRON ACER TENDL-2021 LIBRARY; T=293.6K
resonance total cross section

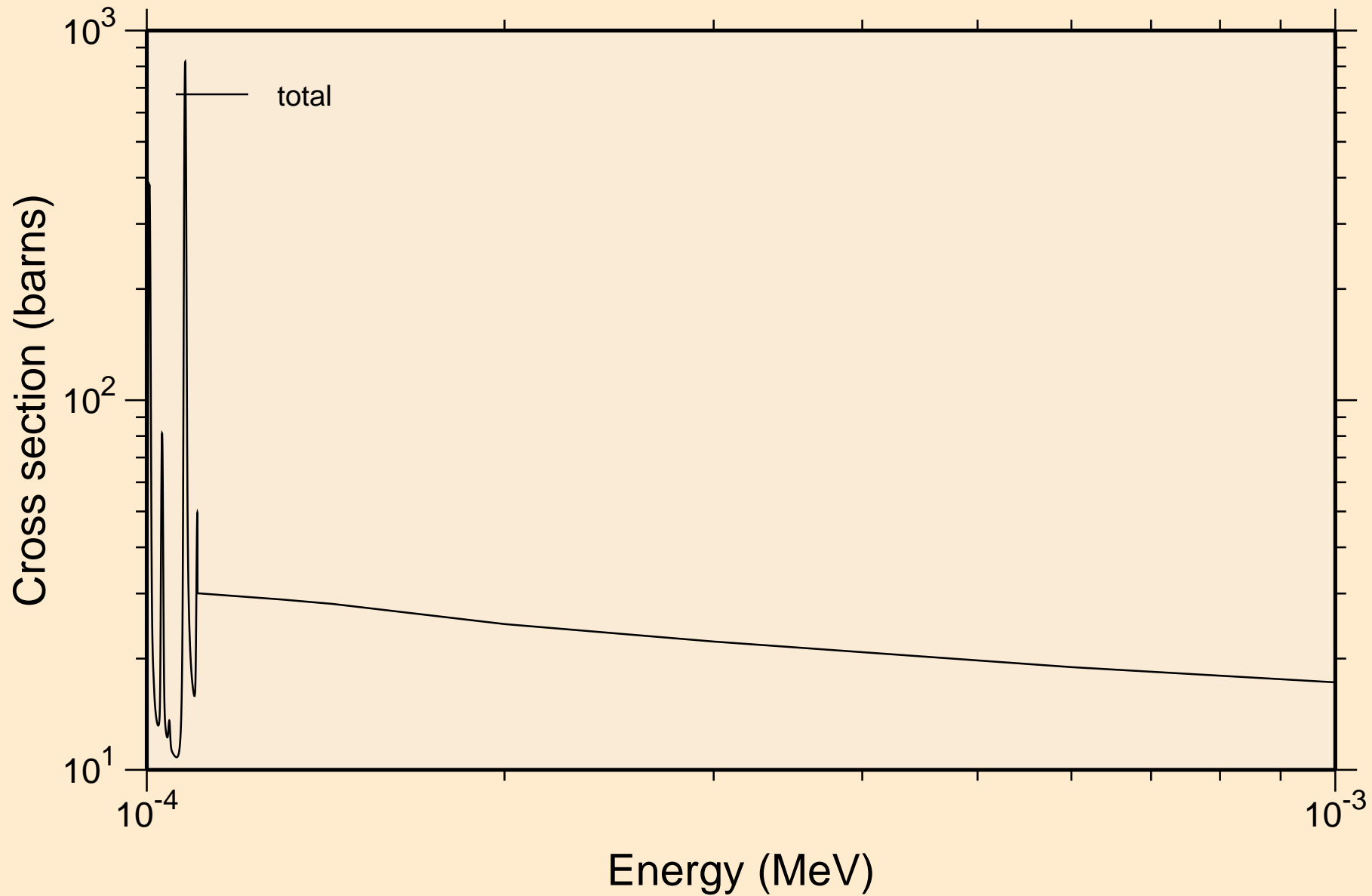

HS268 NEUTRON ACER TENDL-2021 LIBRARY; T=293.6K
resonance total cross section

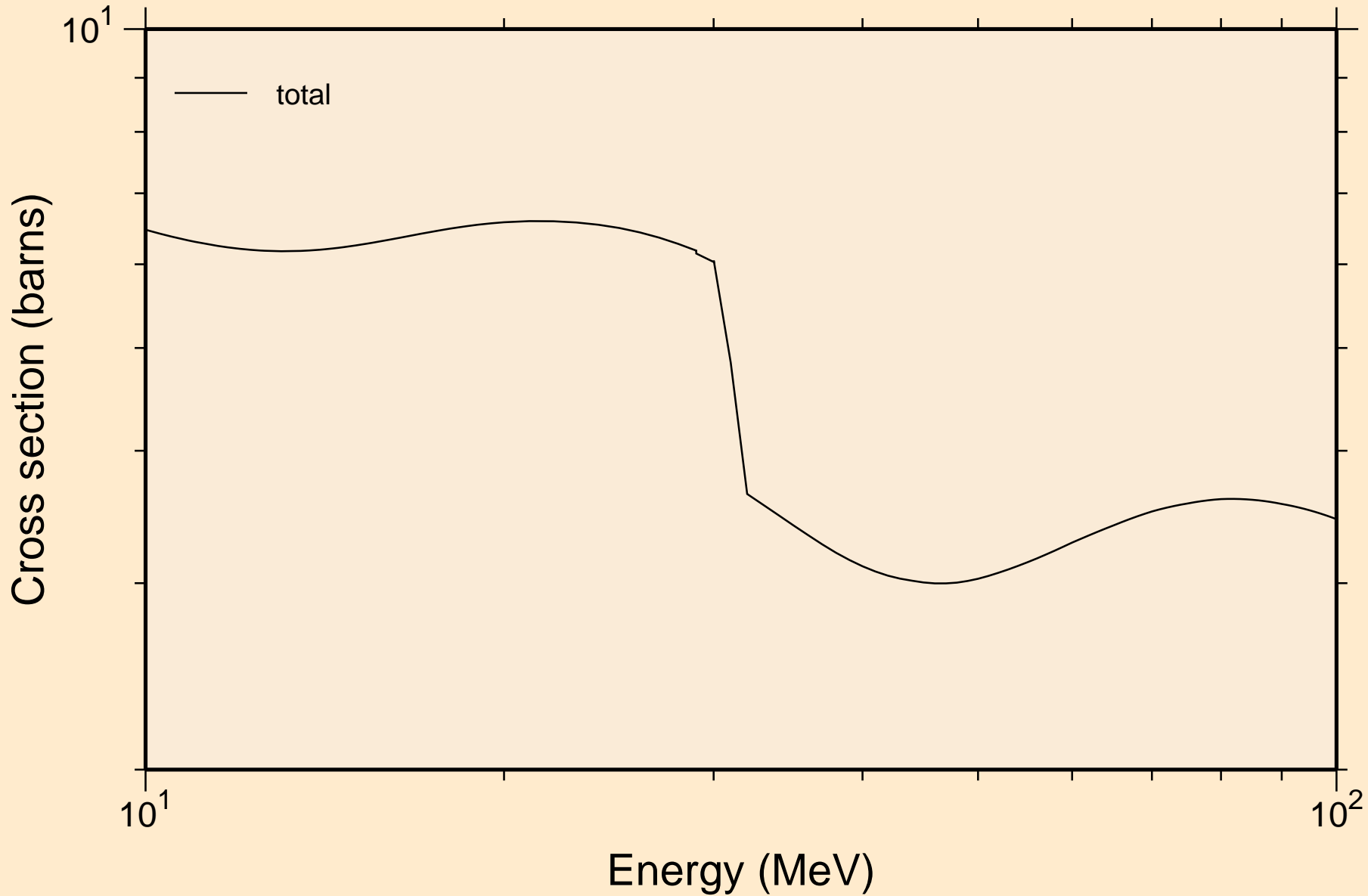

HS268 NEUTRON ACER TENDL-2021 LIBRARY; T=293.6K
resonance absorption cross sections

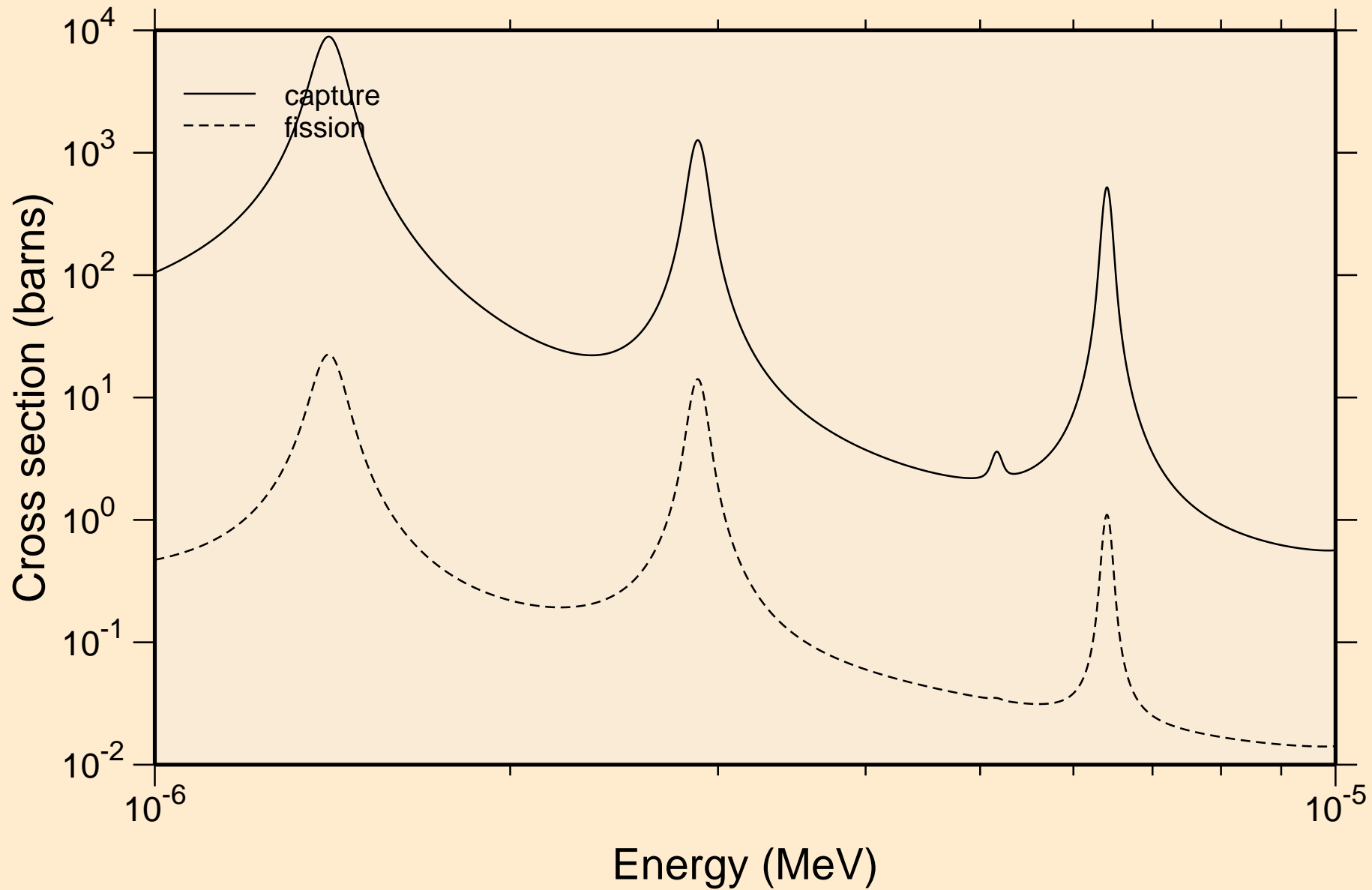

HS268 NEUTRON ACER TENDL-2021 LIBRARY; T=293.6K
resonance absorption cross sections

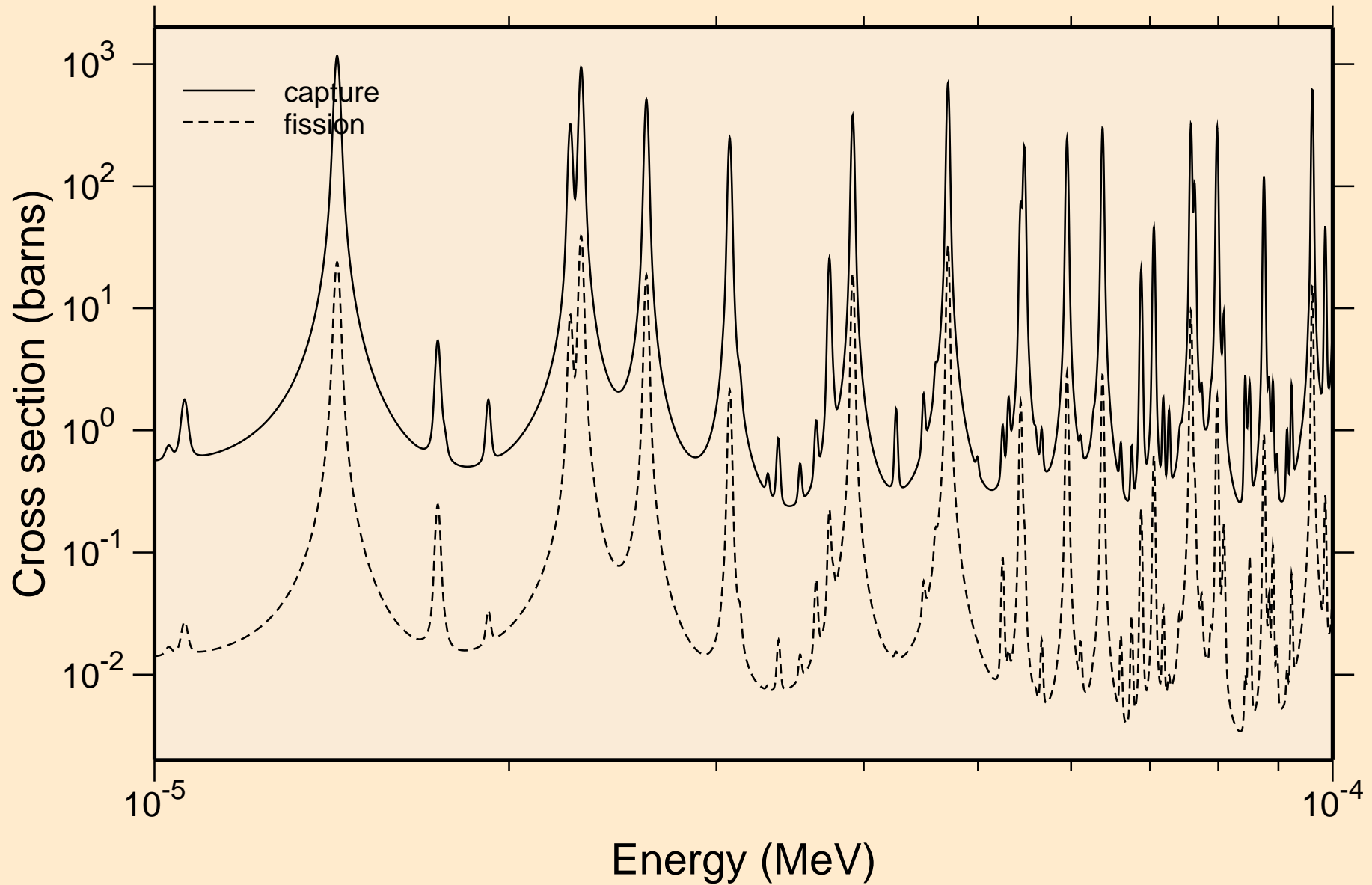

HS268 NEUTRON ACER TENDL-2021 LIBRARY; T=293.6K
resonance absorption cross sections

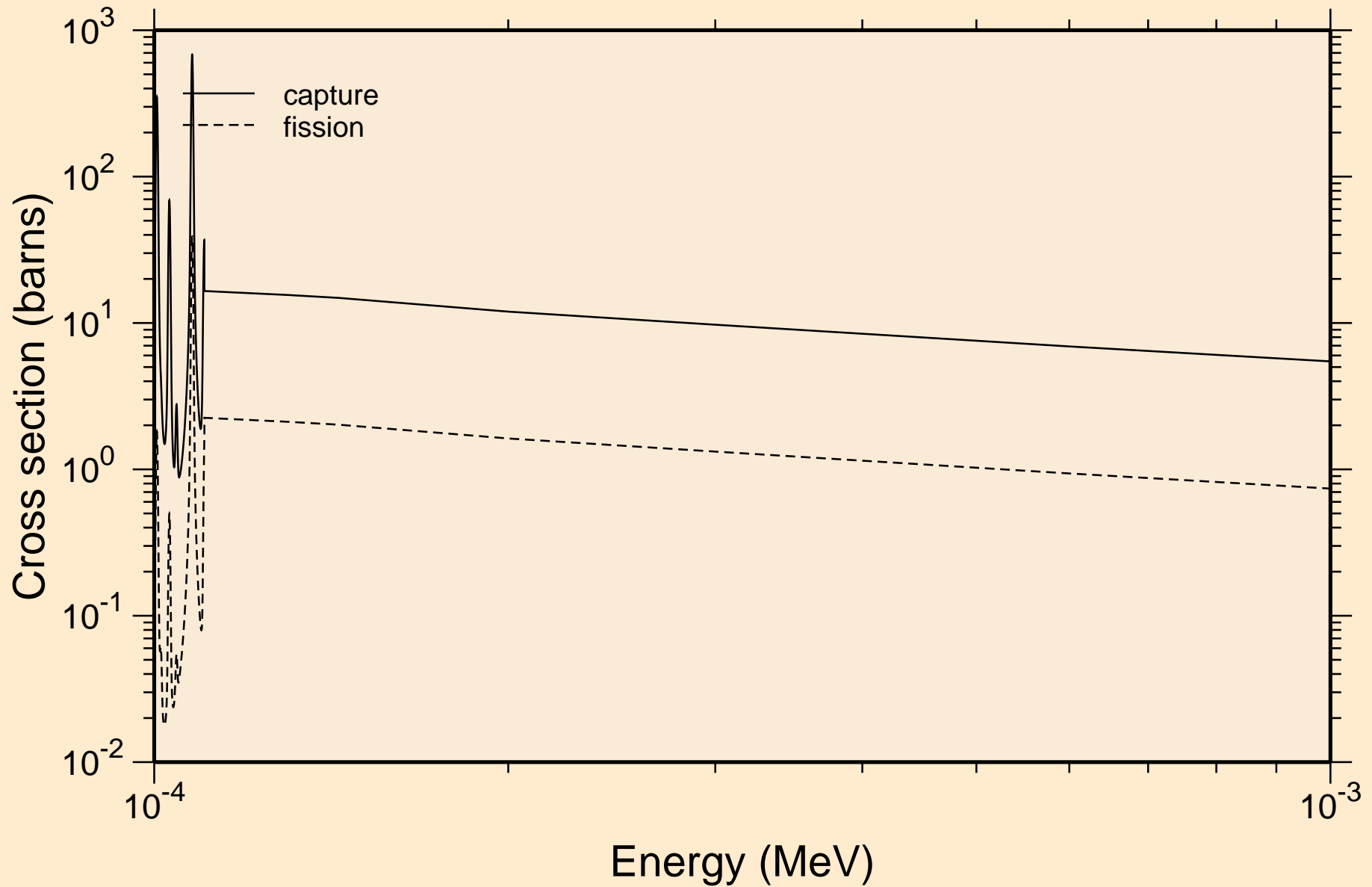

HS268 NEUTRON ACER TENDL-2021 LIBRARY; T=293.6K
resonance absorption cross sections

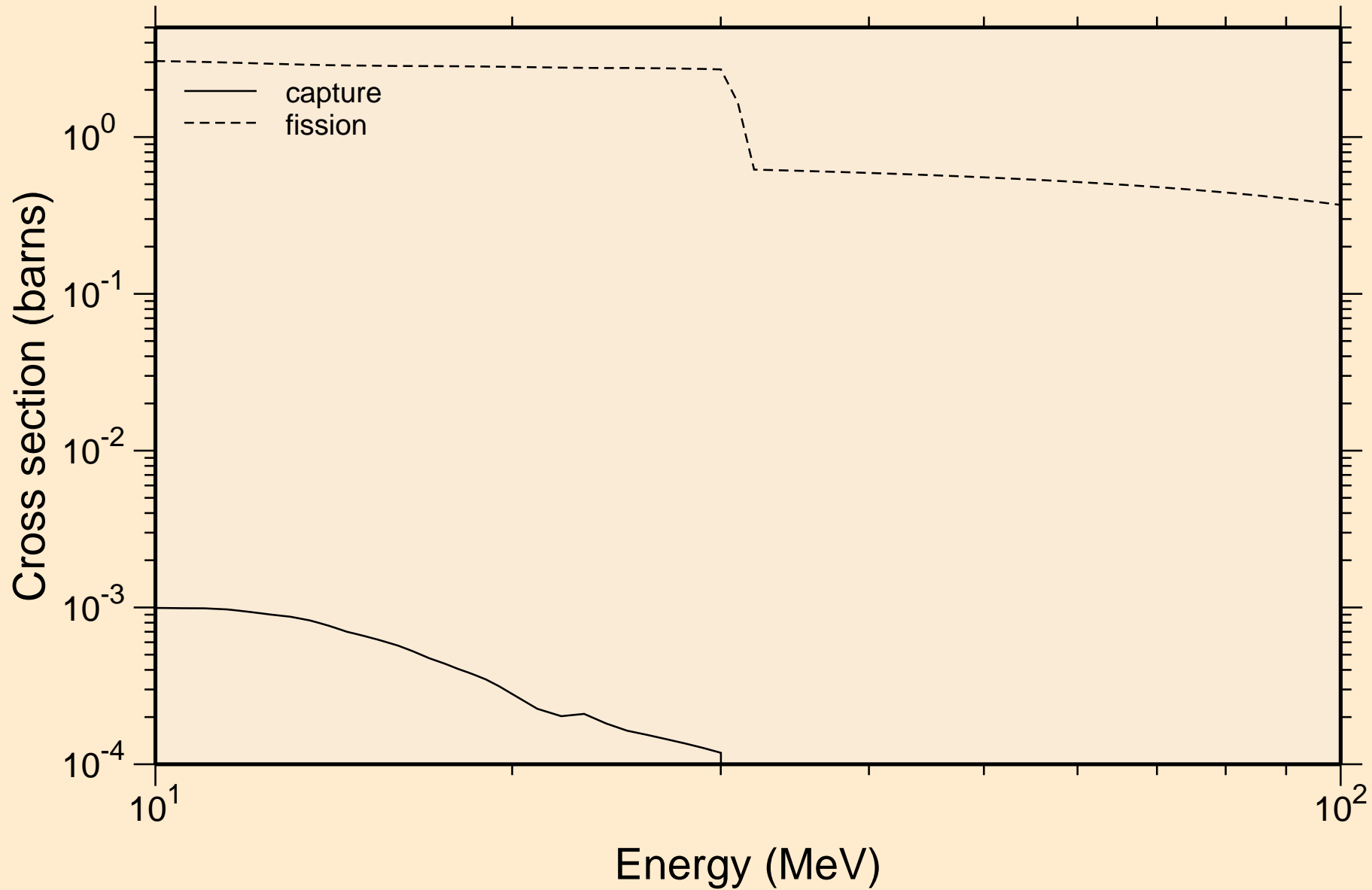

HS268 NEUTRON ACER TENDL-2021 LIBRARY; T=293.6K
Heating

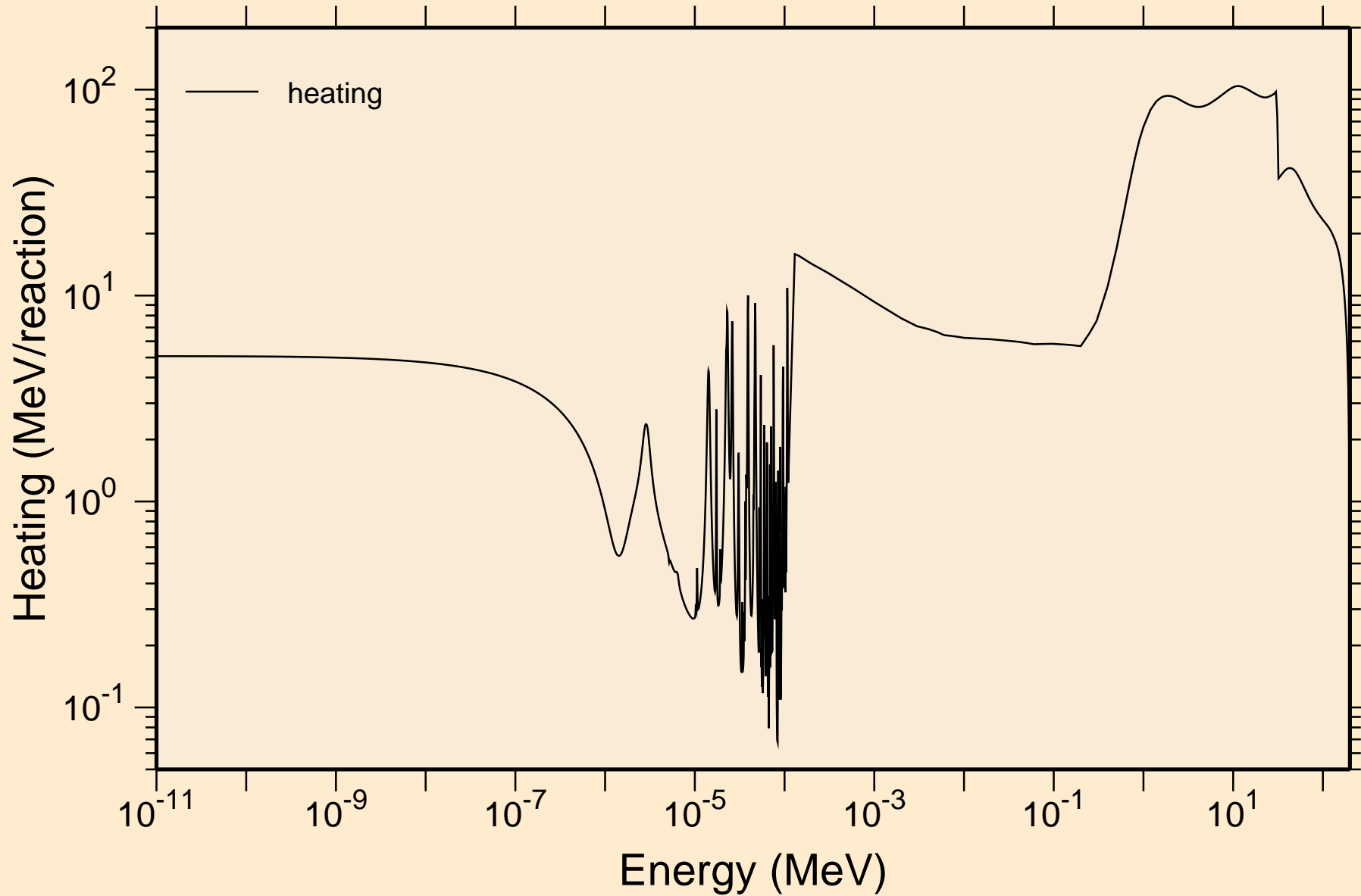

HS268 NEUTRON ACER TENDL-2021 LIBRARY; T=293.6K
Damage

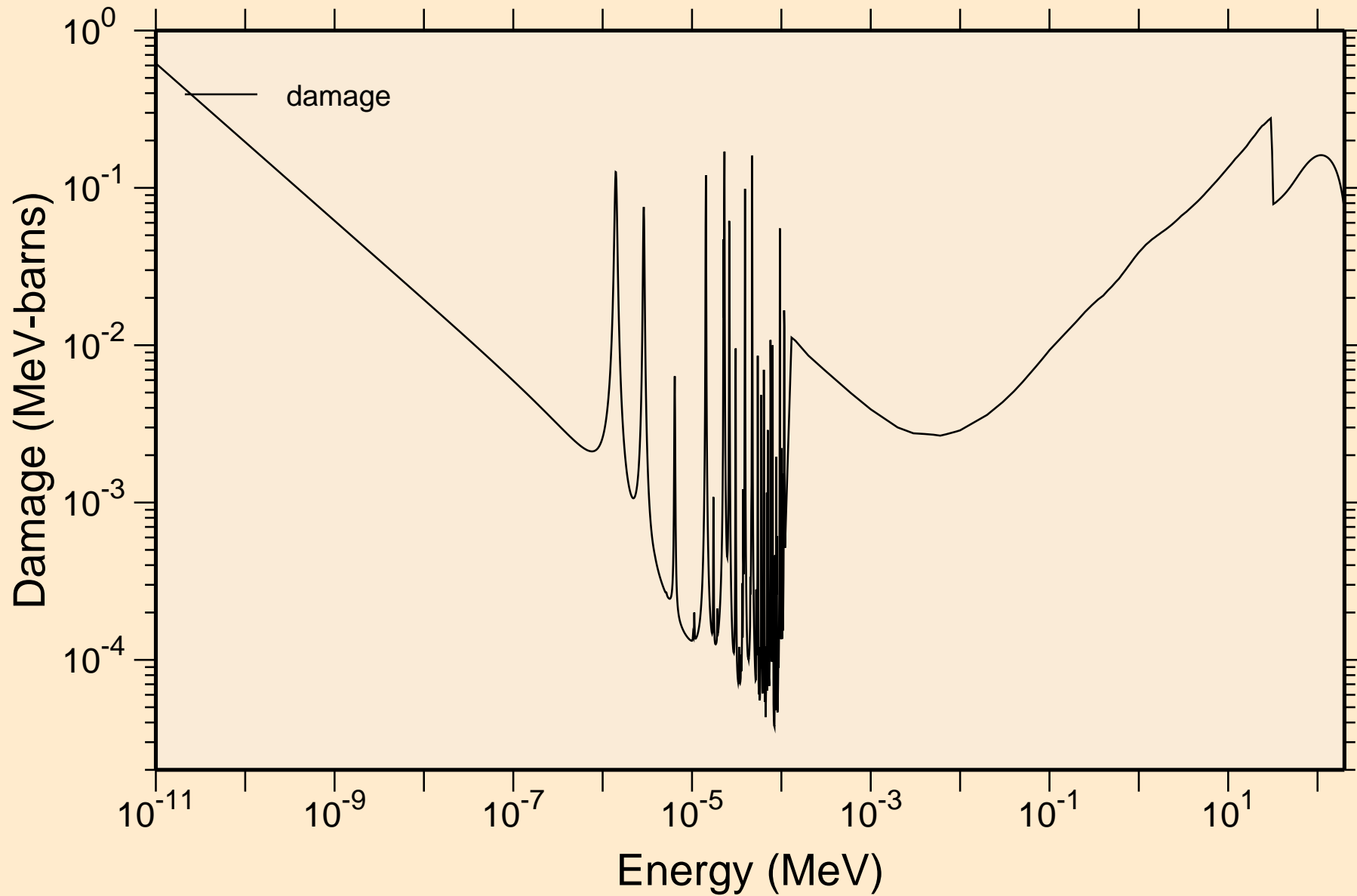

HS268 NEUTRON ACER TENDL-2021 LIBRARY; T=293.6K

Non-threshold reactions

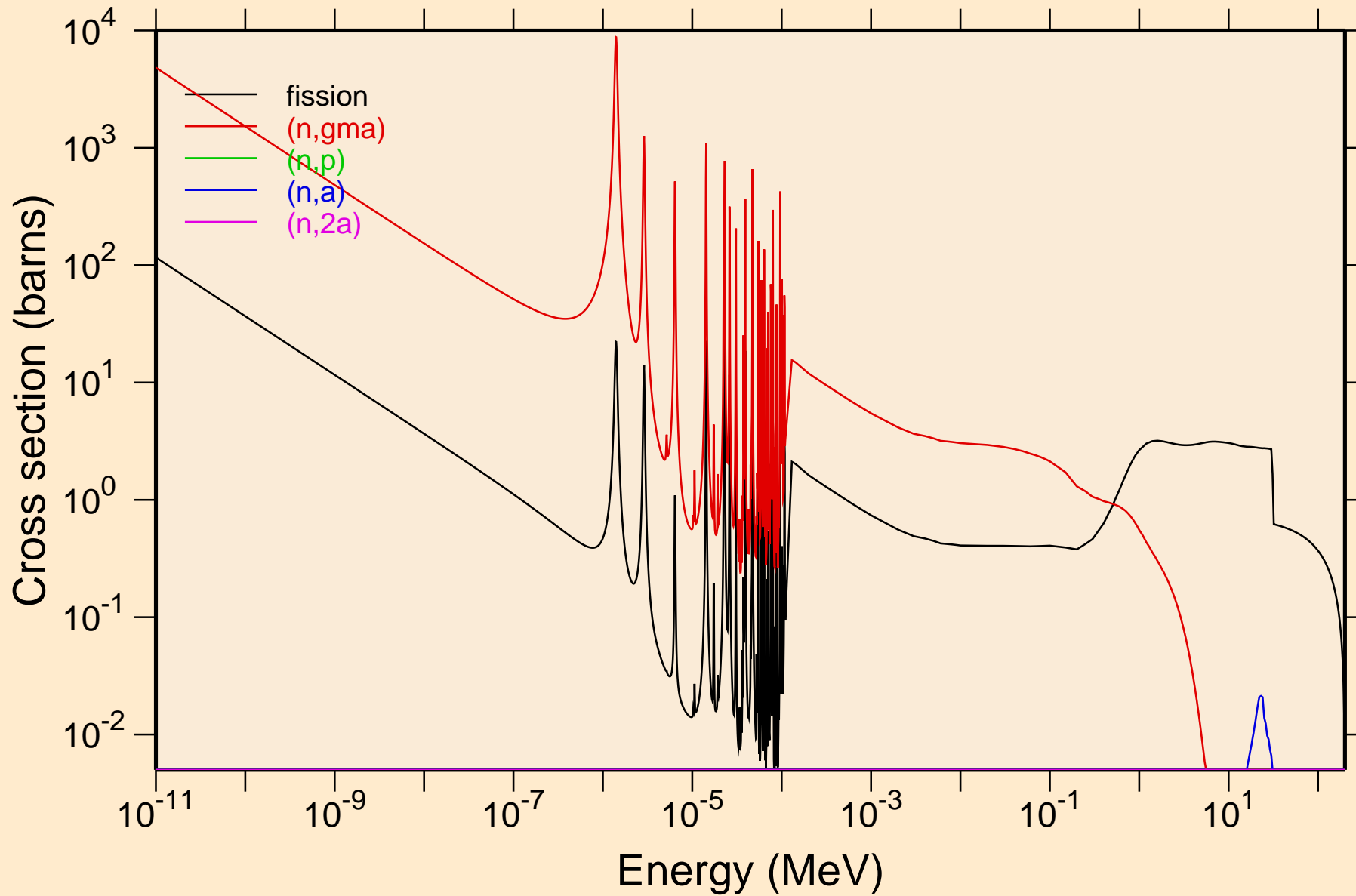

HS268 NEUTRON ACER TENDL-2021 LIBRARY; T=293.6K
Non-threshold reactions

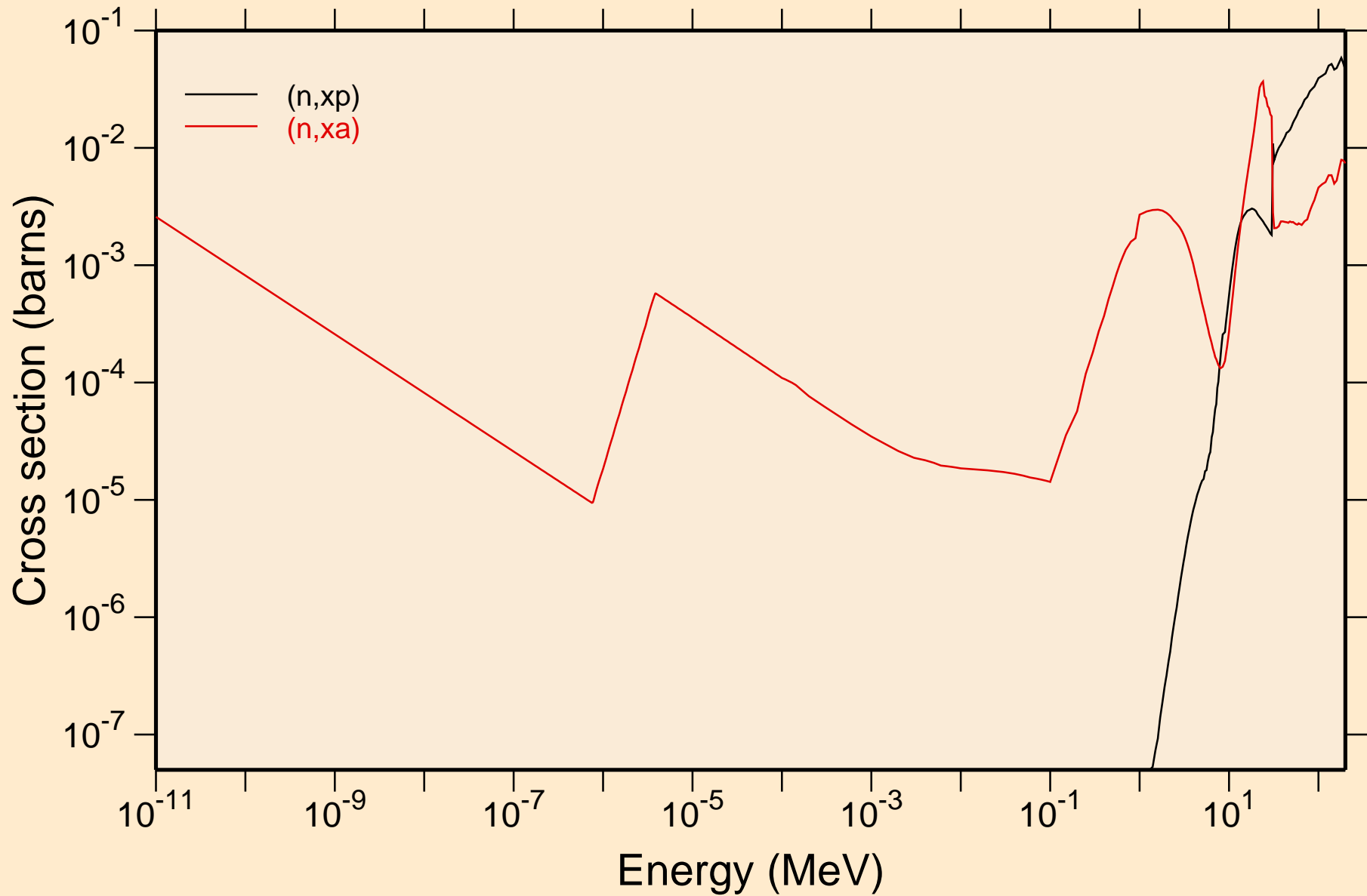

HS268 NEUTRON ACER TENDL-2021 LIBRARY; T=293.6K

Principal cross sections

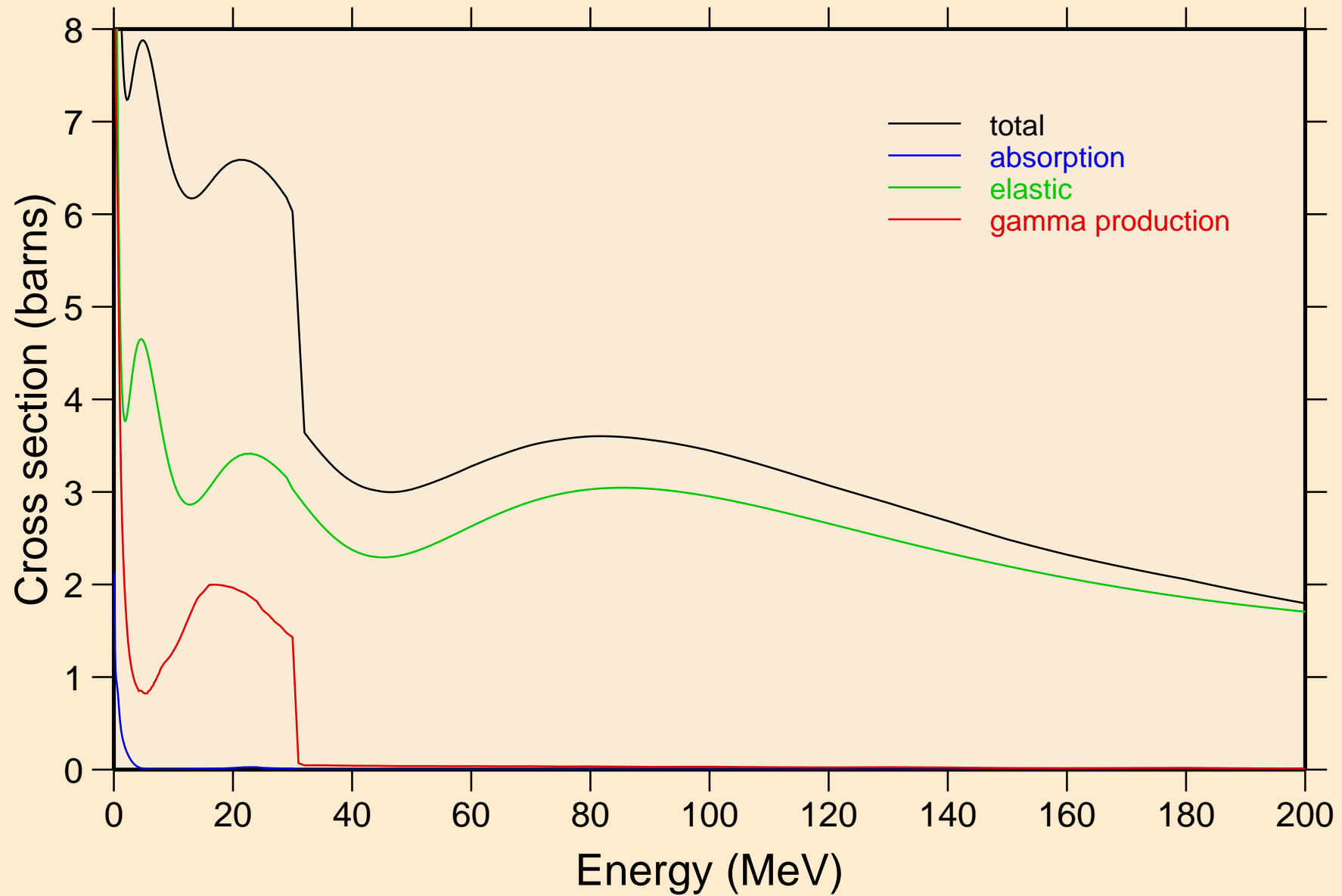

HS268 NEUTRON ACER TENDL-2021 LIBRARY; T=293.6K
Heating

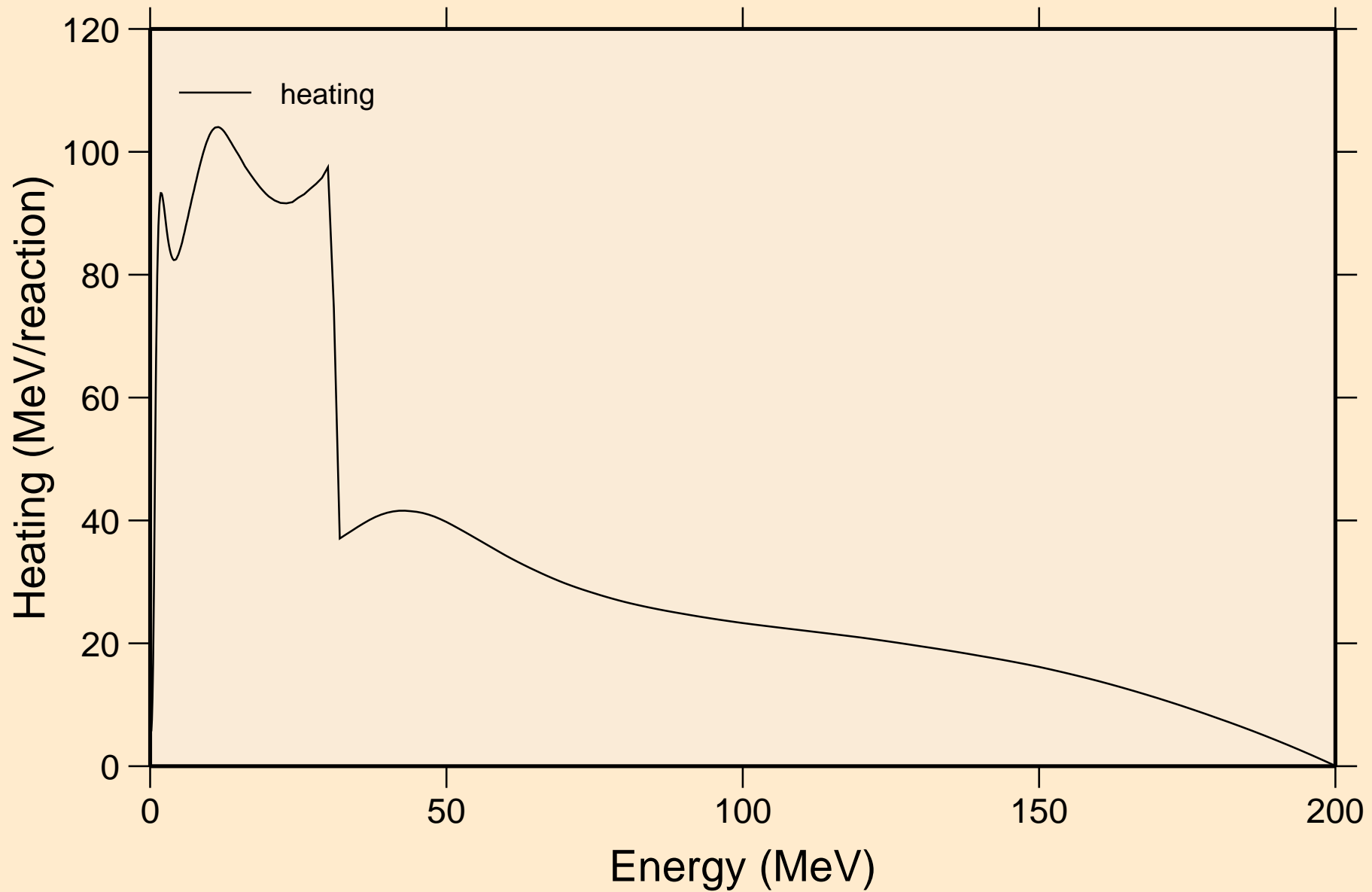

HS268 NEUTRON ACER TENDL-2021 LIBRARY; T=293.6K
Damage

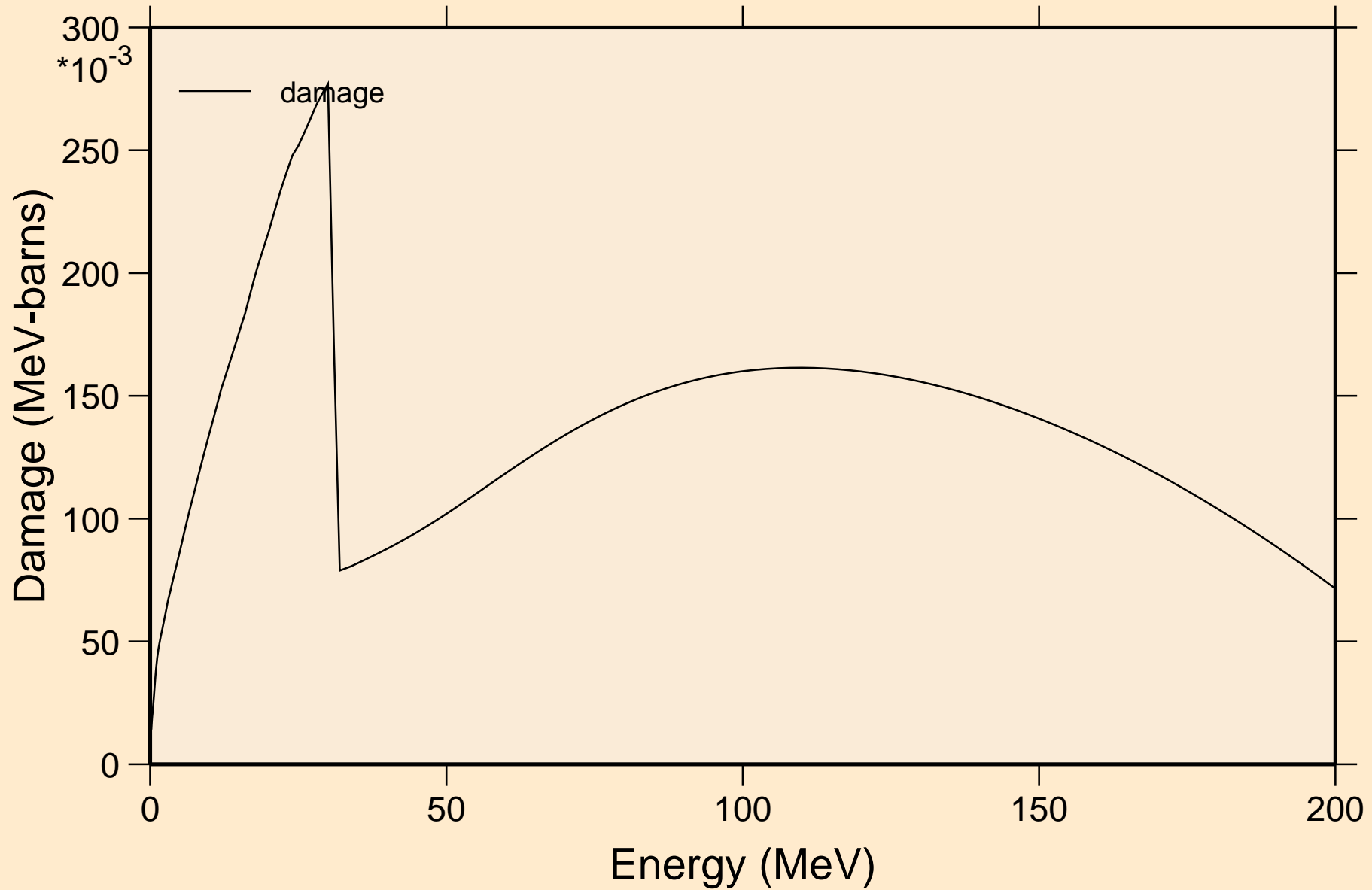

HS268 NEUTRON ACER TENDL-2021 LIBRARY; T=293.6K

Non-threshold reactions

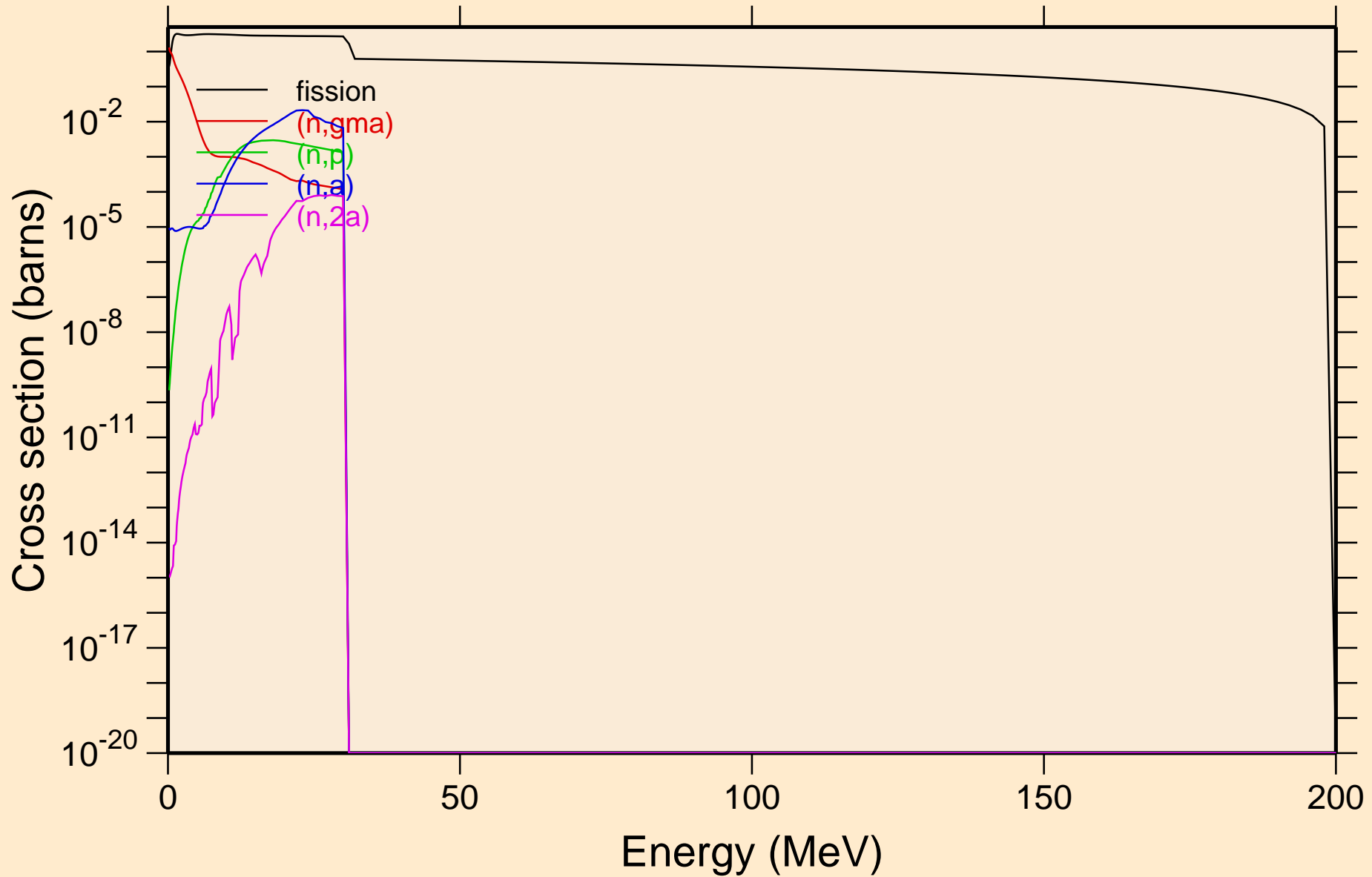

HS268 NEUTRON ACER TENDL-2021 LIBRARY; T=293.6K
Non-threshold reactions

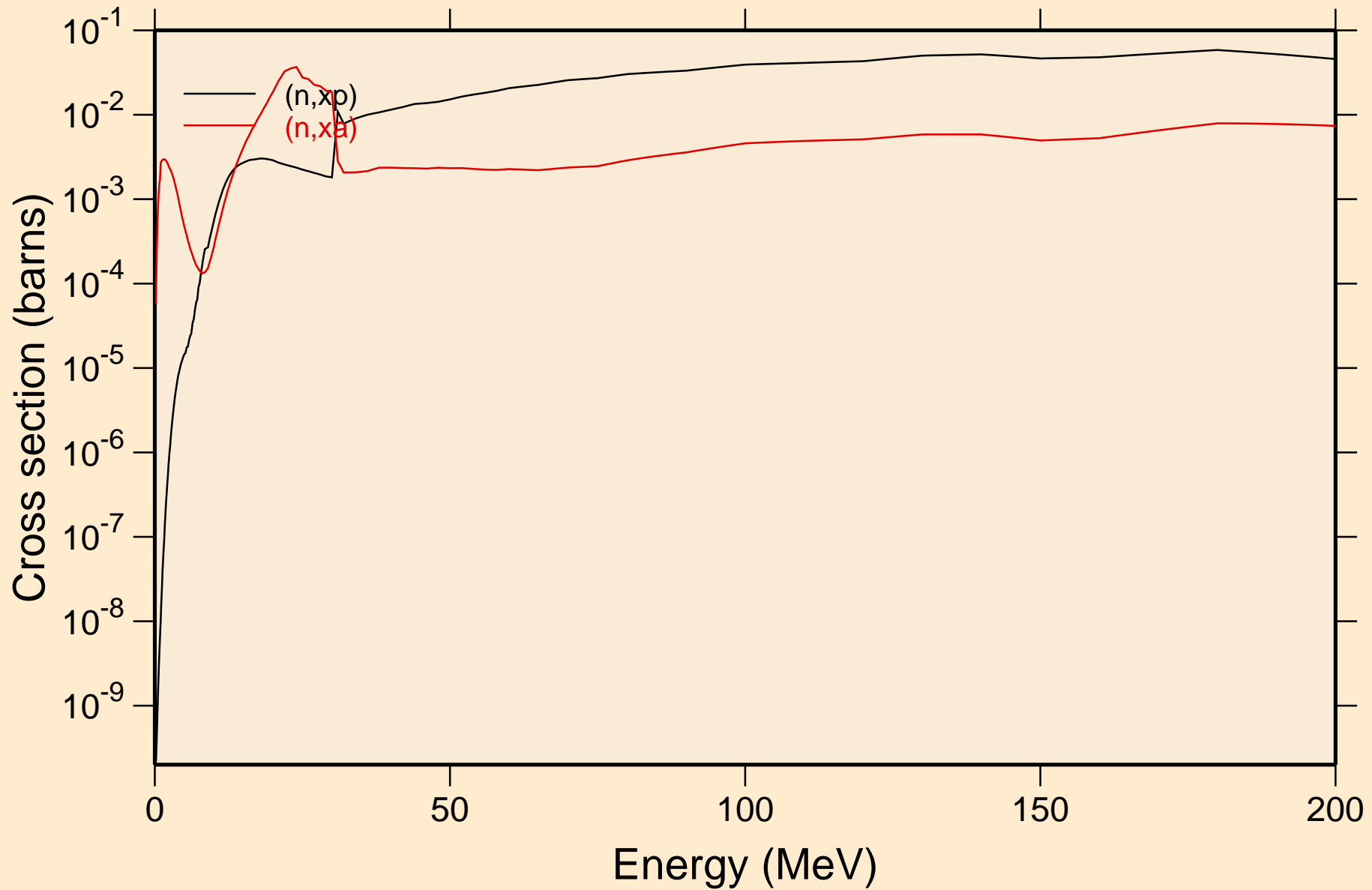

HS268 NEUTRON ACER TENDL-2021 LIBRARY; T=293.6K
Inelastic levels

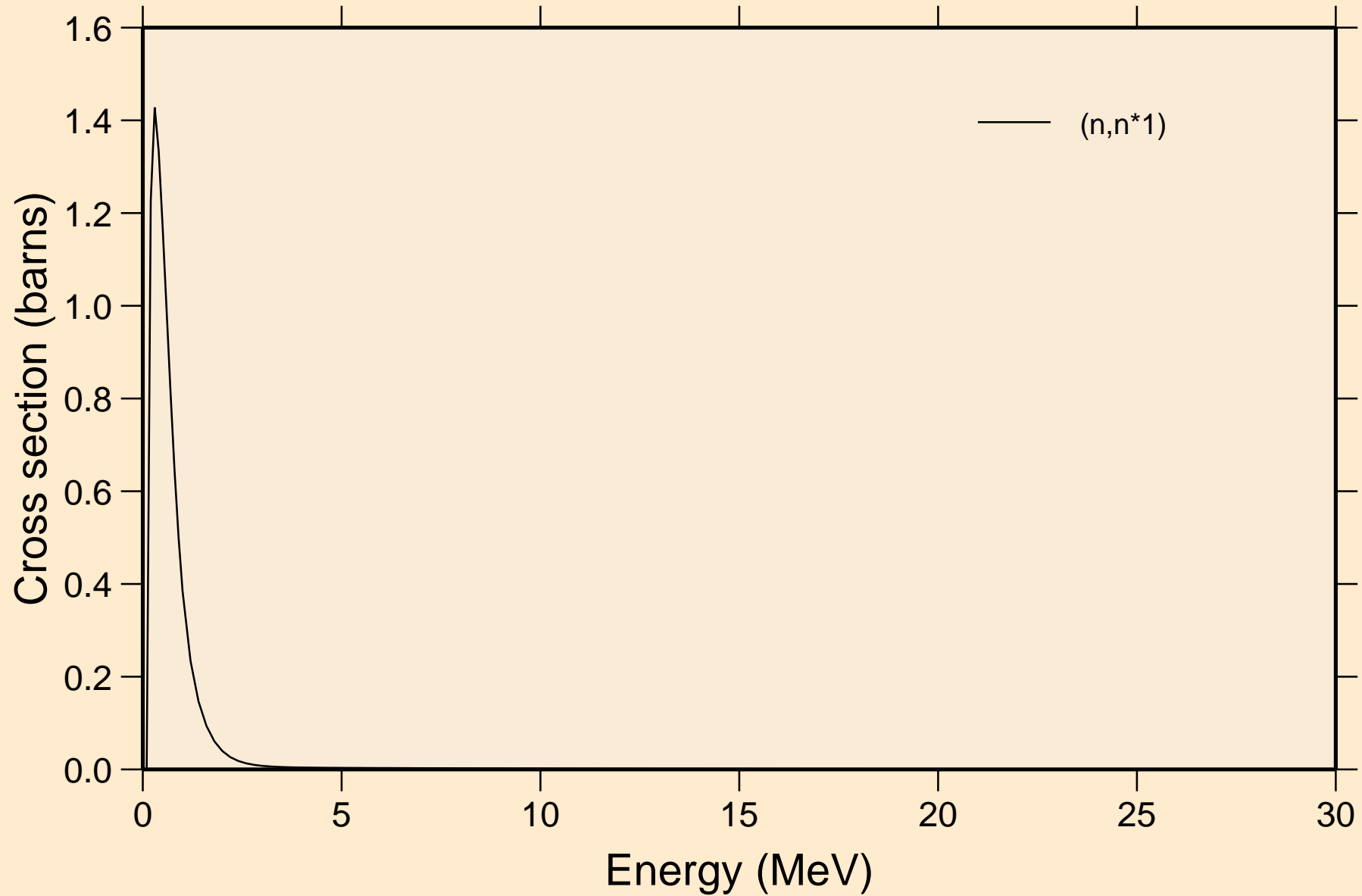

HS268 NEUTRON ACER TENDL-2021 LIBRARY; T=293.6K

Threshold reactions

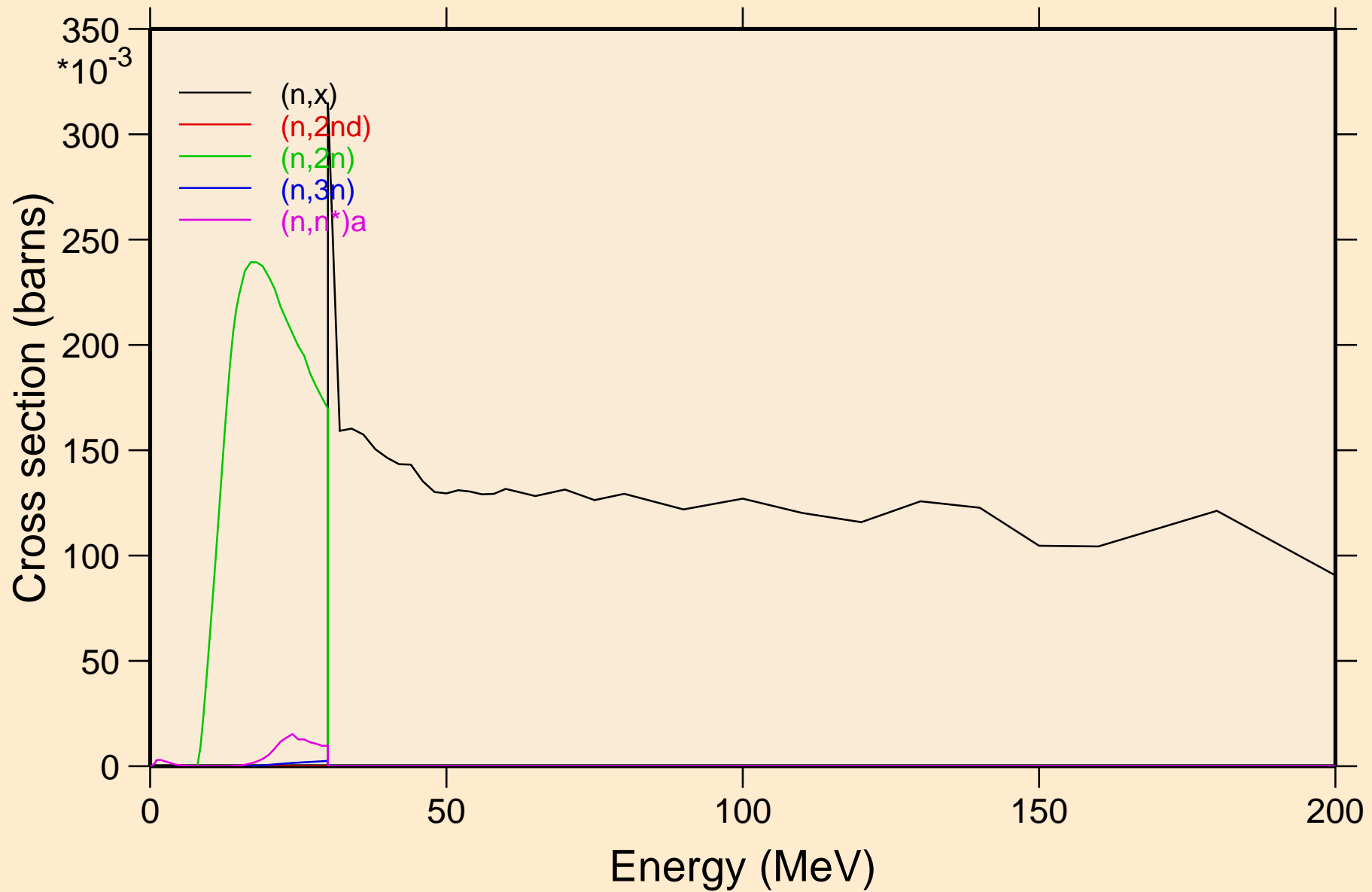

HS268 NEUTRON ACER TENDL-2021 LIBRARY; T=293.6K

Threshold reactions

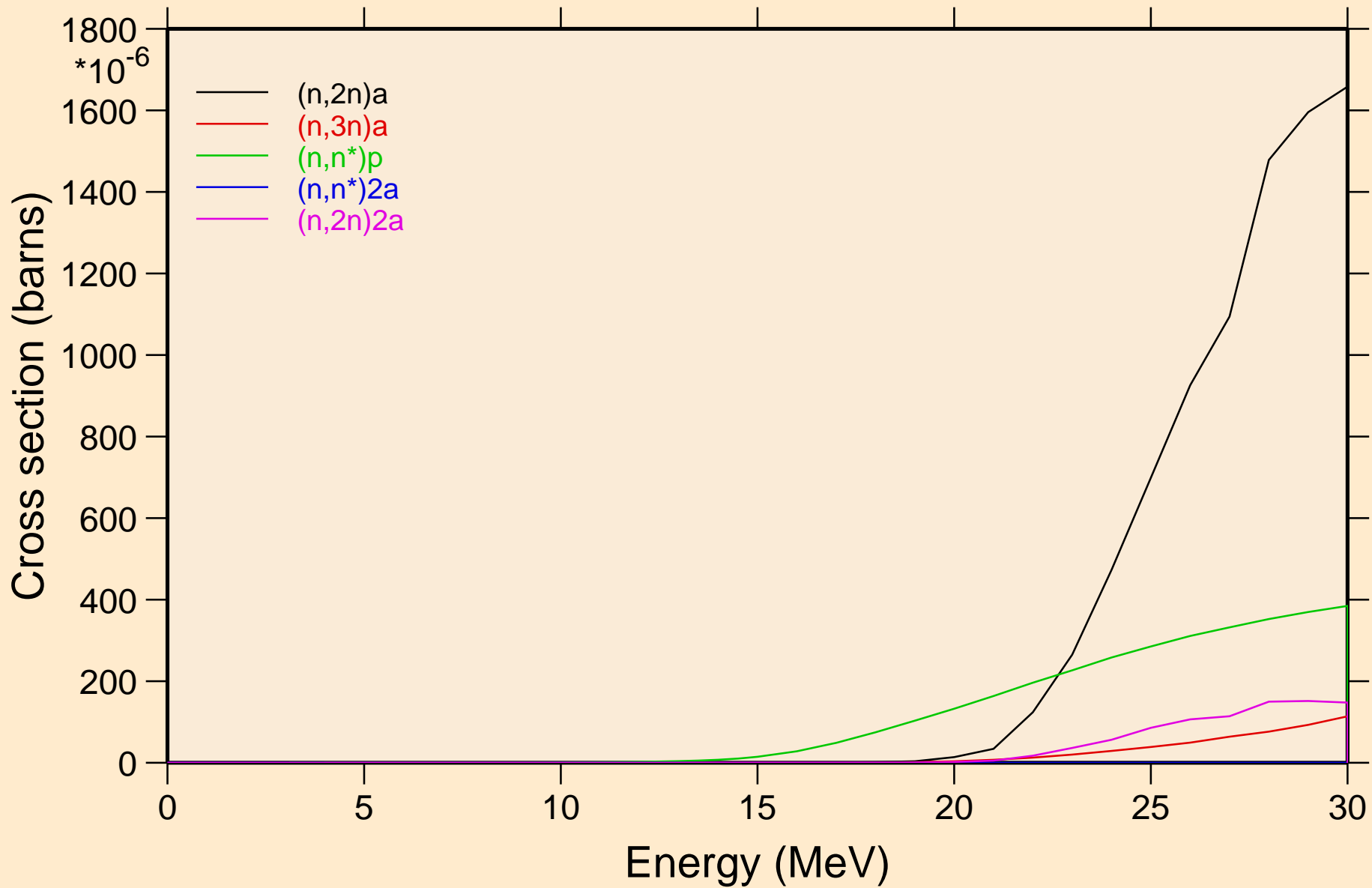

HS268 NEUTRON ACER TENDL-2021 LIBRARY; T=293.6K

Threshold reactions

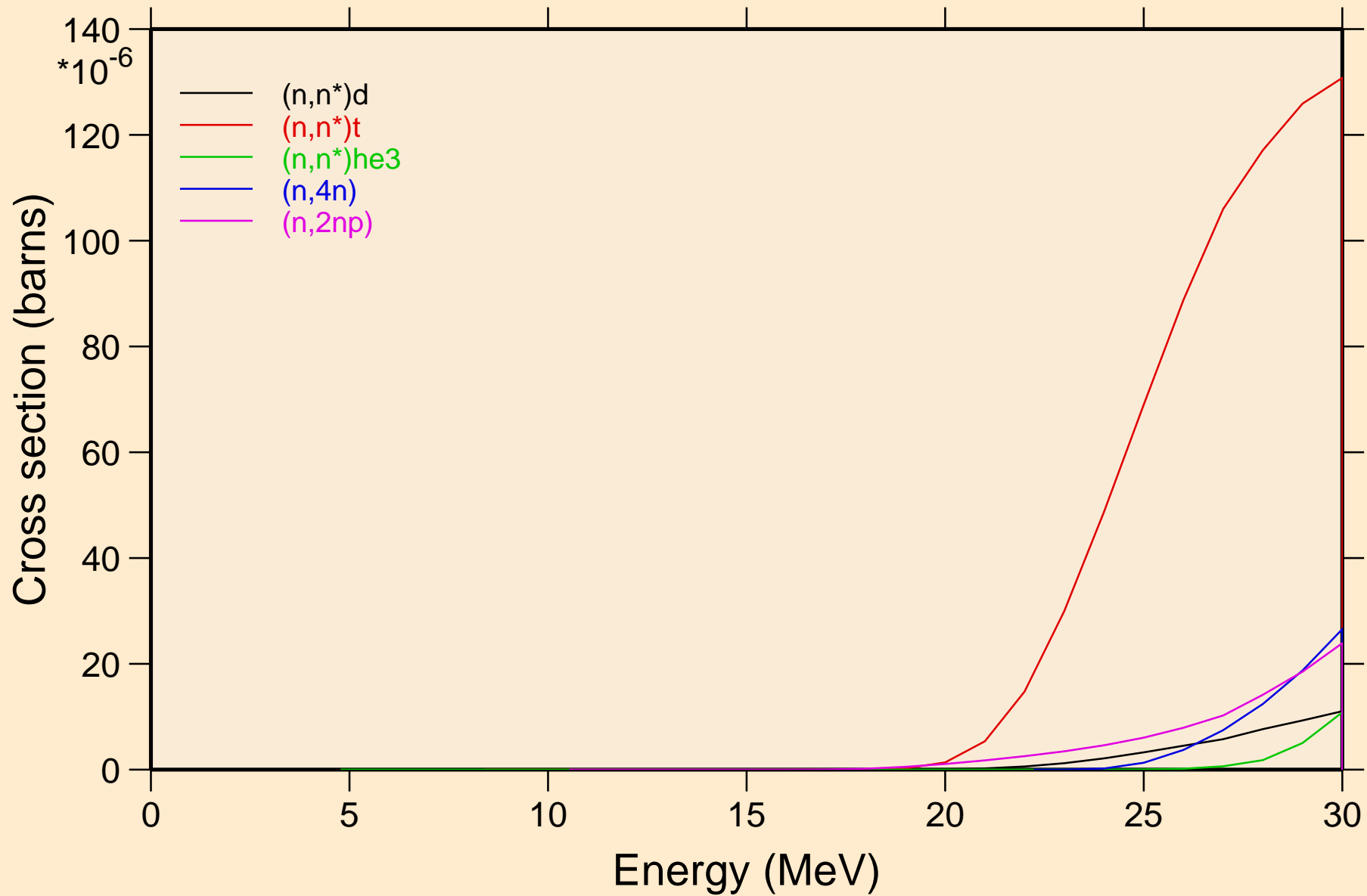

HS268 NEUTRON ACER TENDL-2021 LIBRARY; T=293.6K

Threshold reactions

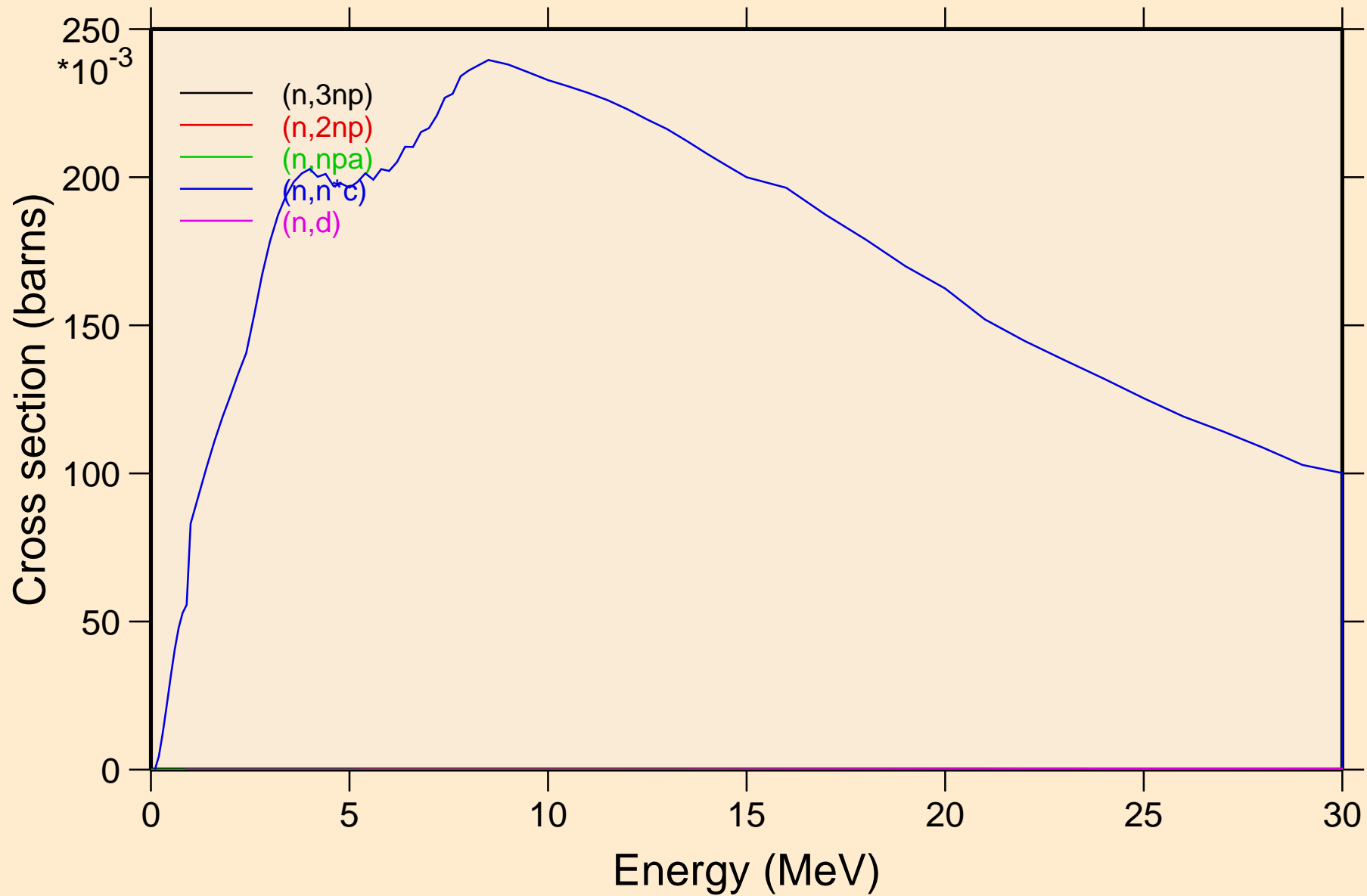

HS268 NEUTRON ACER TENDL-2021 LIBRARY; T=293.6K

Threshold reactions

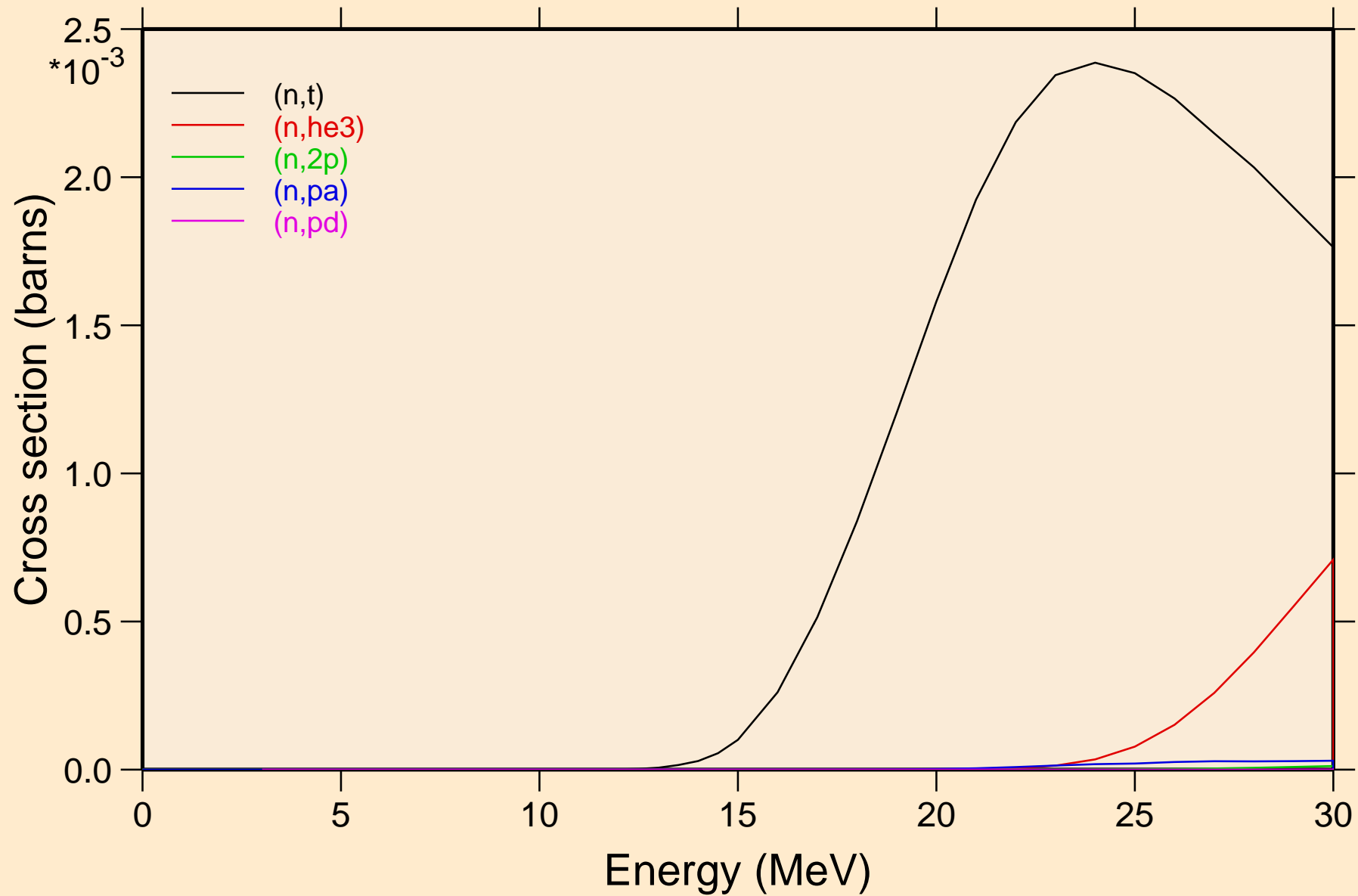

HS268 NEUTRON ACER TENDL-2021 LIBRARY; T=293.6K
Threshold reactions

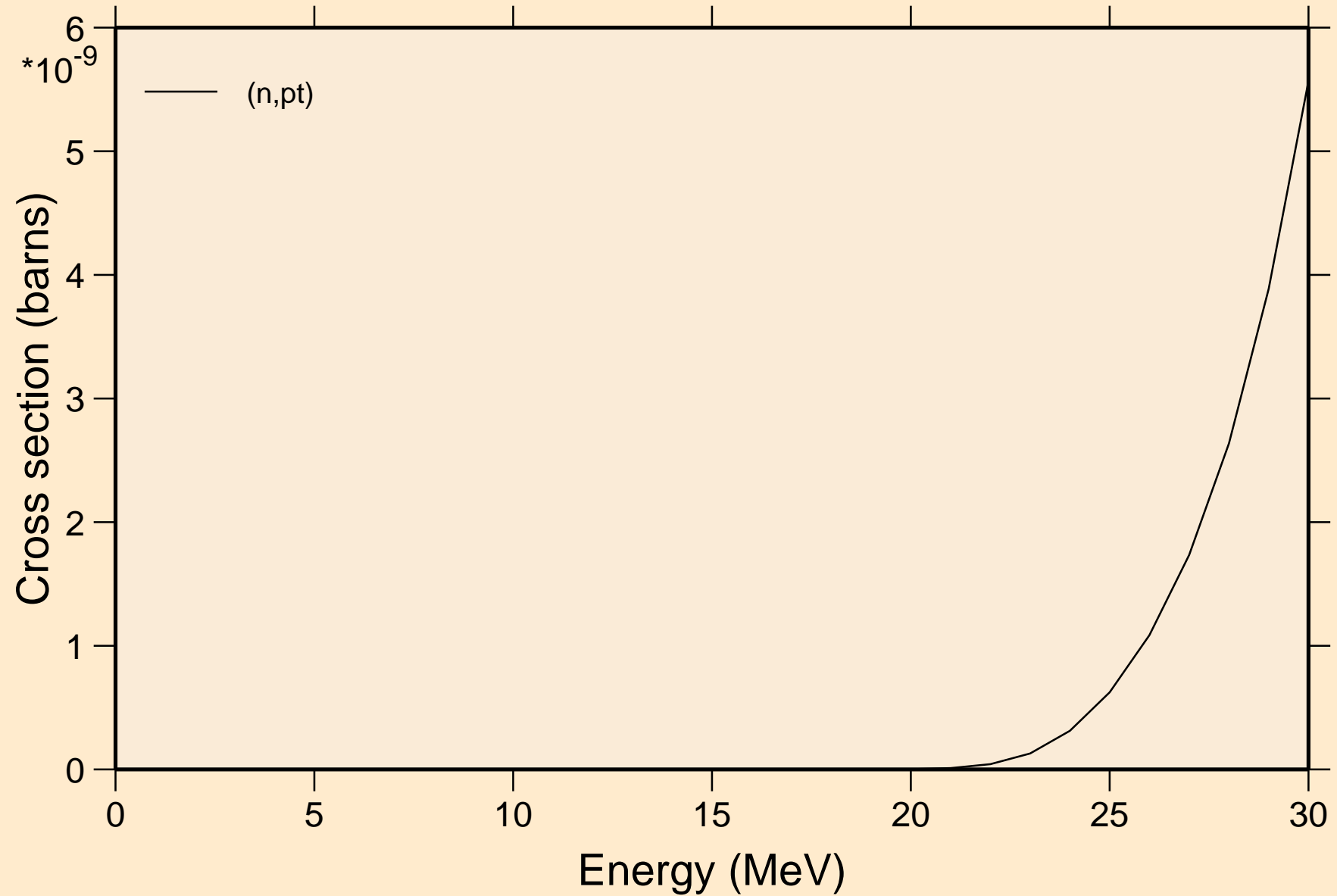

HS268 NEUTRON ACER TENDL-2021 LIBRARY; T=293.6K

Threshold reactions

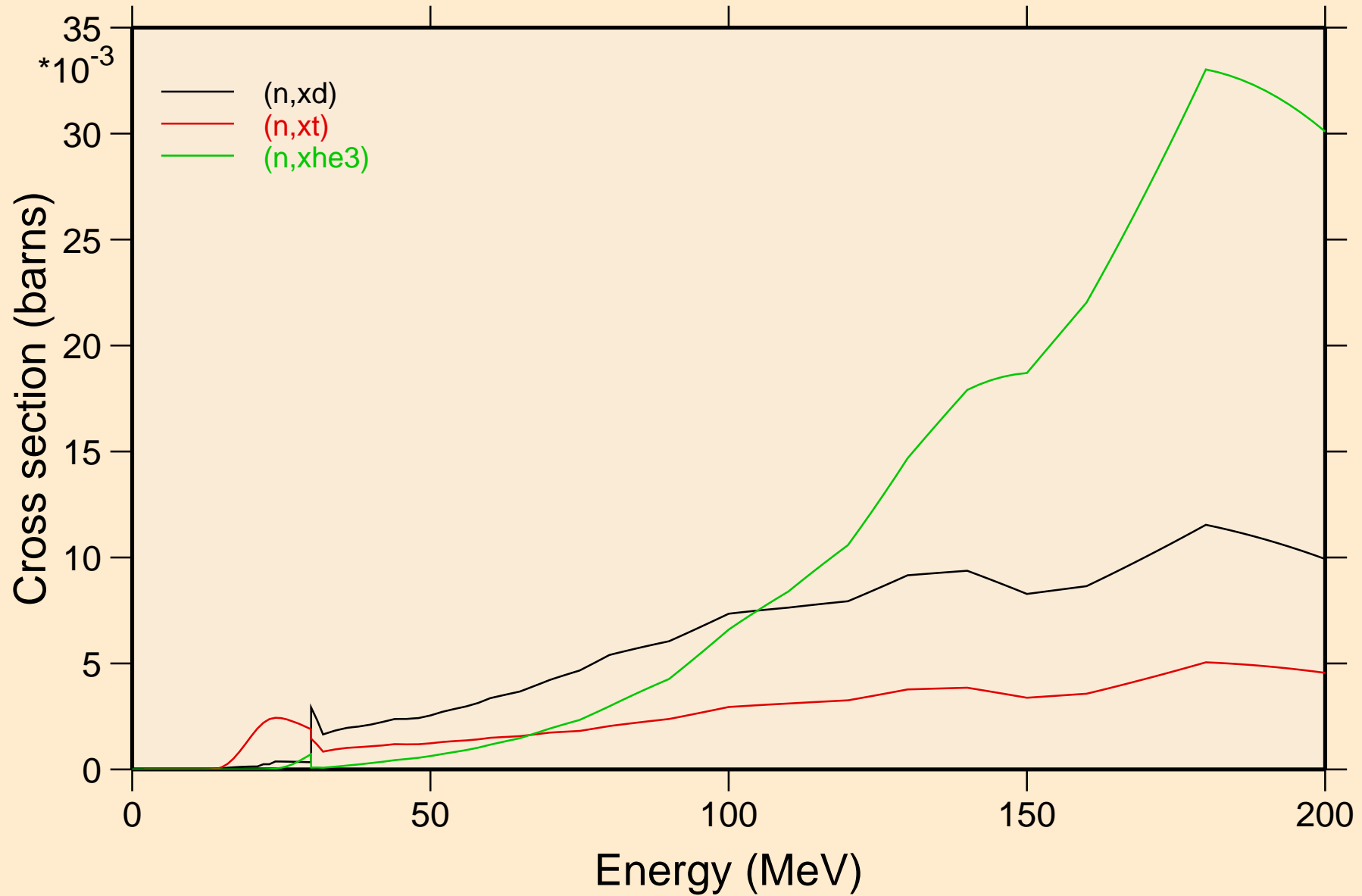

HS268 NEUTRON ACER TENDL-2021 LIBRARY; T=293.6K
angular distribution for elastic

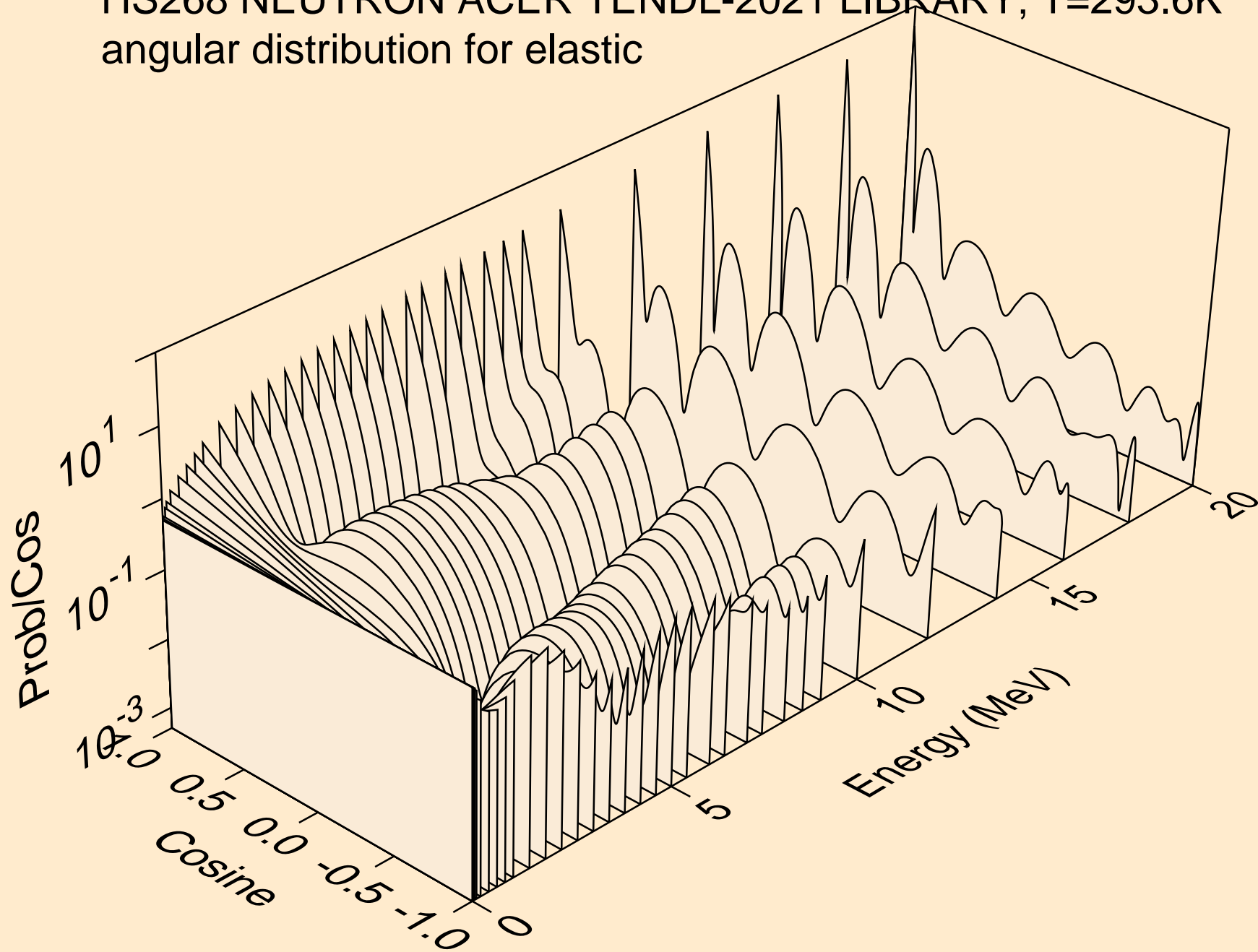

HS268 NEUTRON ACER TENDL-2021 LIBRARY; T=293.6K
angular distribution for elastic

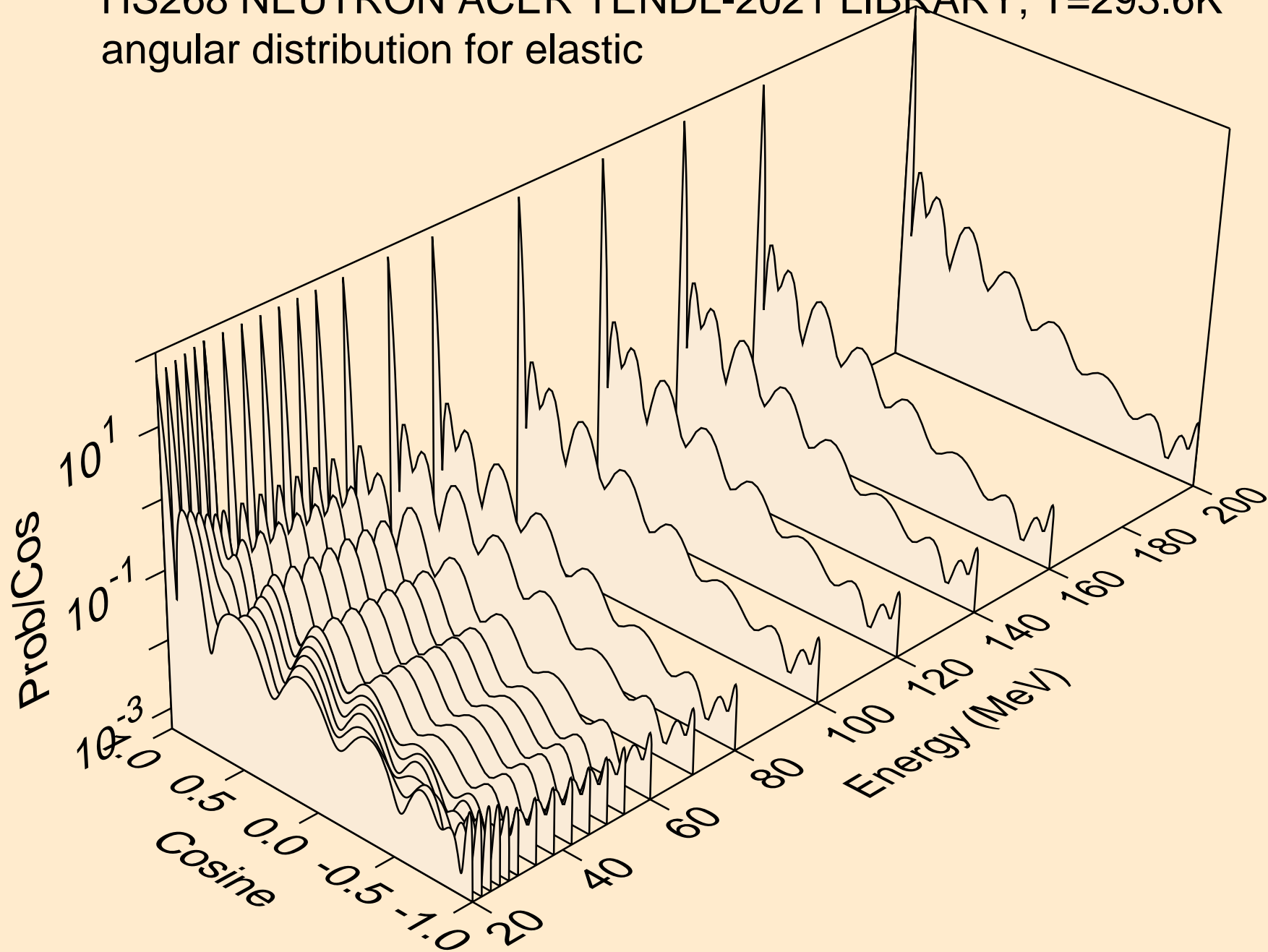

HS268 NEUTRON ACER TENDL-2021 LIBRARY; T=293.6K
angular distribution for (n,n*1)

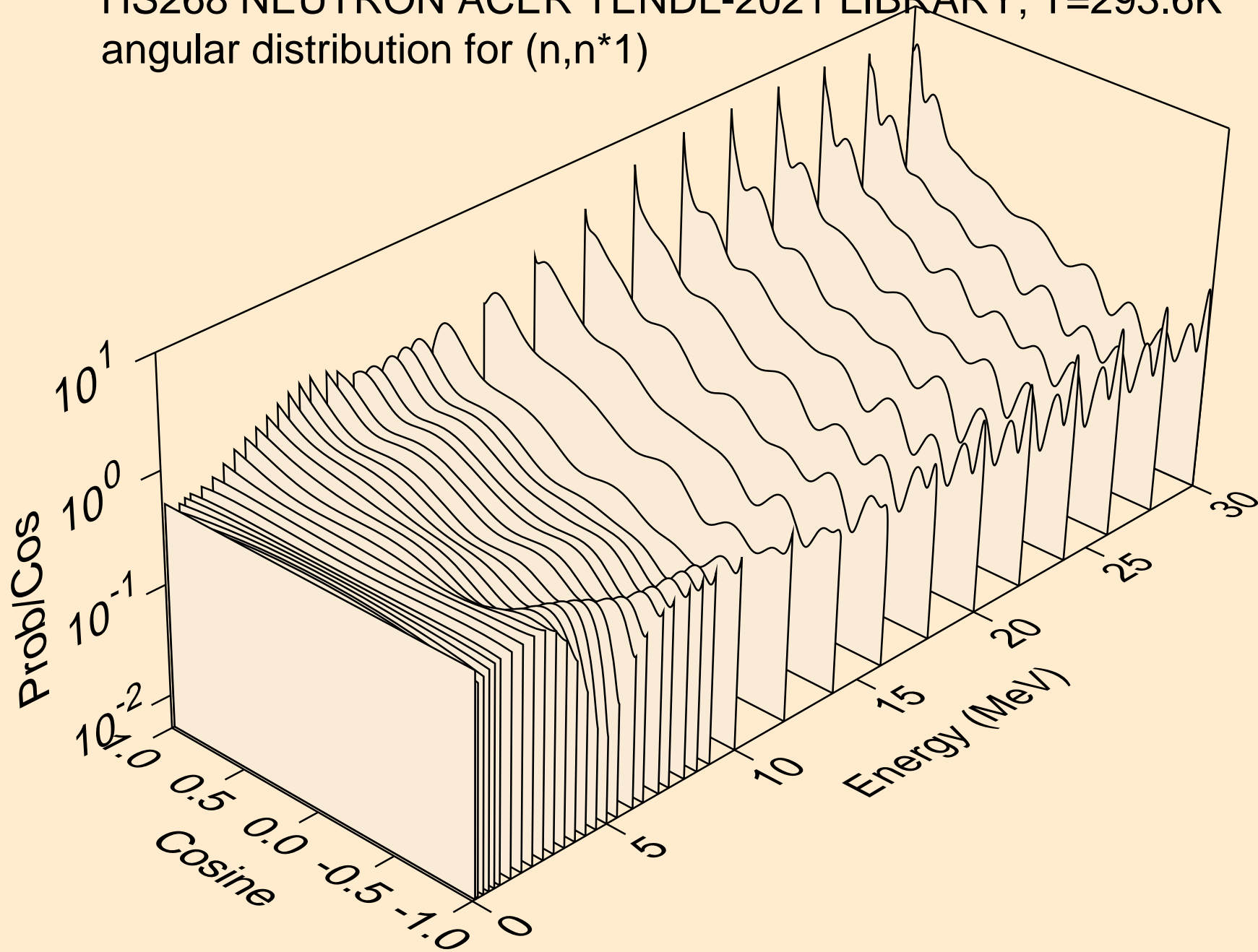

HS268 NEUTRON ACER TENDL-2021 LIBRARY; T=293.6K
Total fission nubar

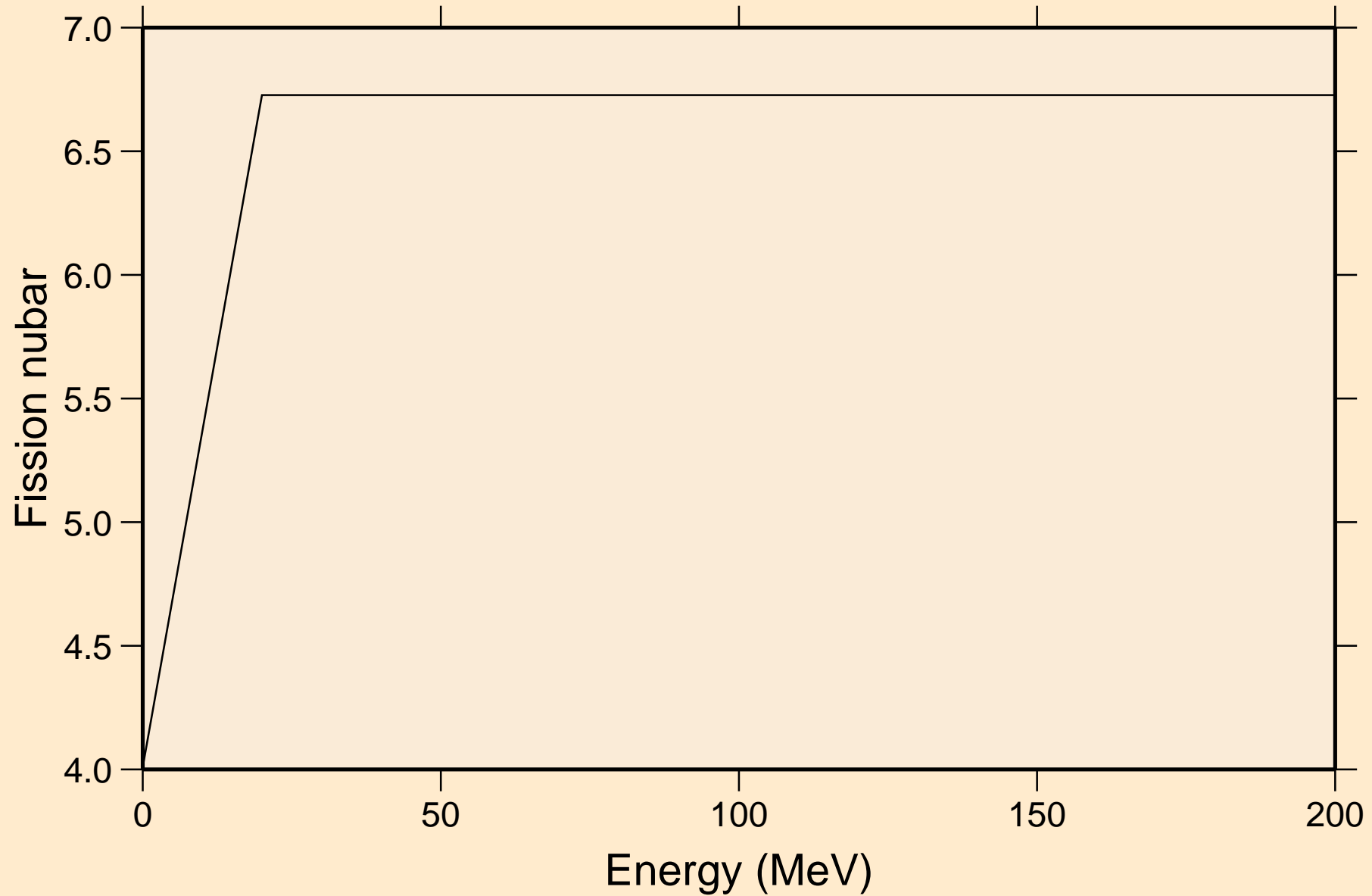

HS268 NEUTRON ACER TENDL-2021 LIBRARY; T=293.6K
Neutron emission for (n,x)

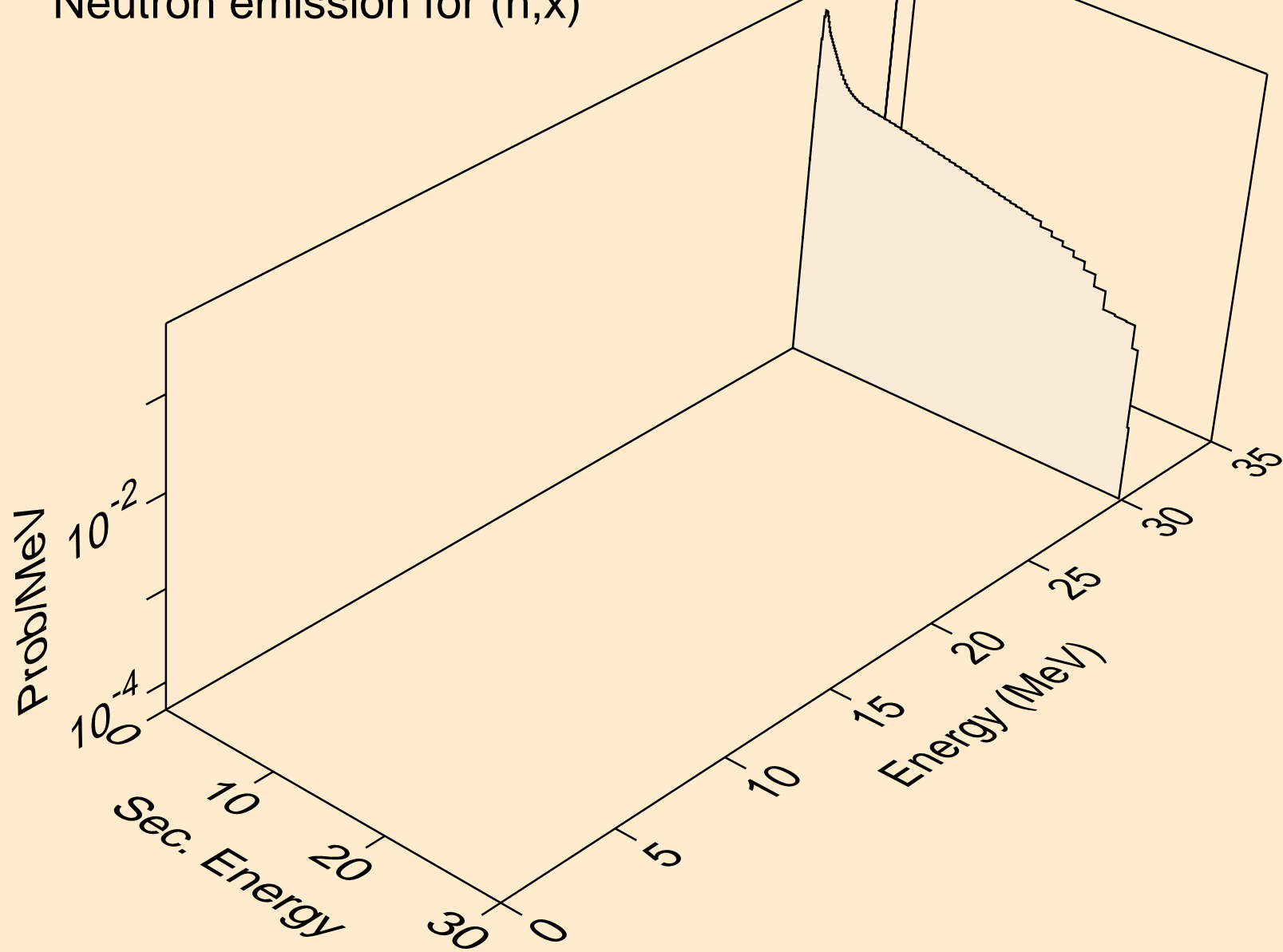

HS268 NEUTRON ACER TENDL-2021 LIBRARY; T=293.6K
Neutron emission for (n,2nd)

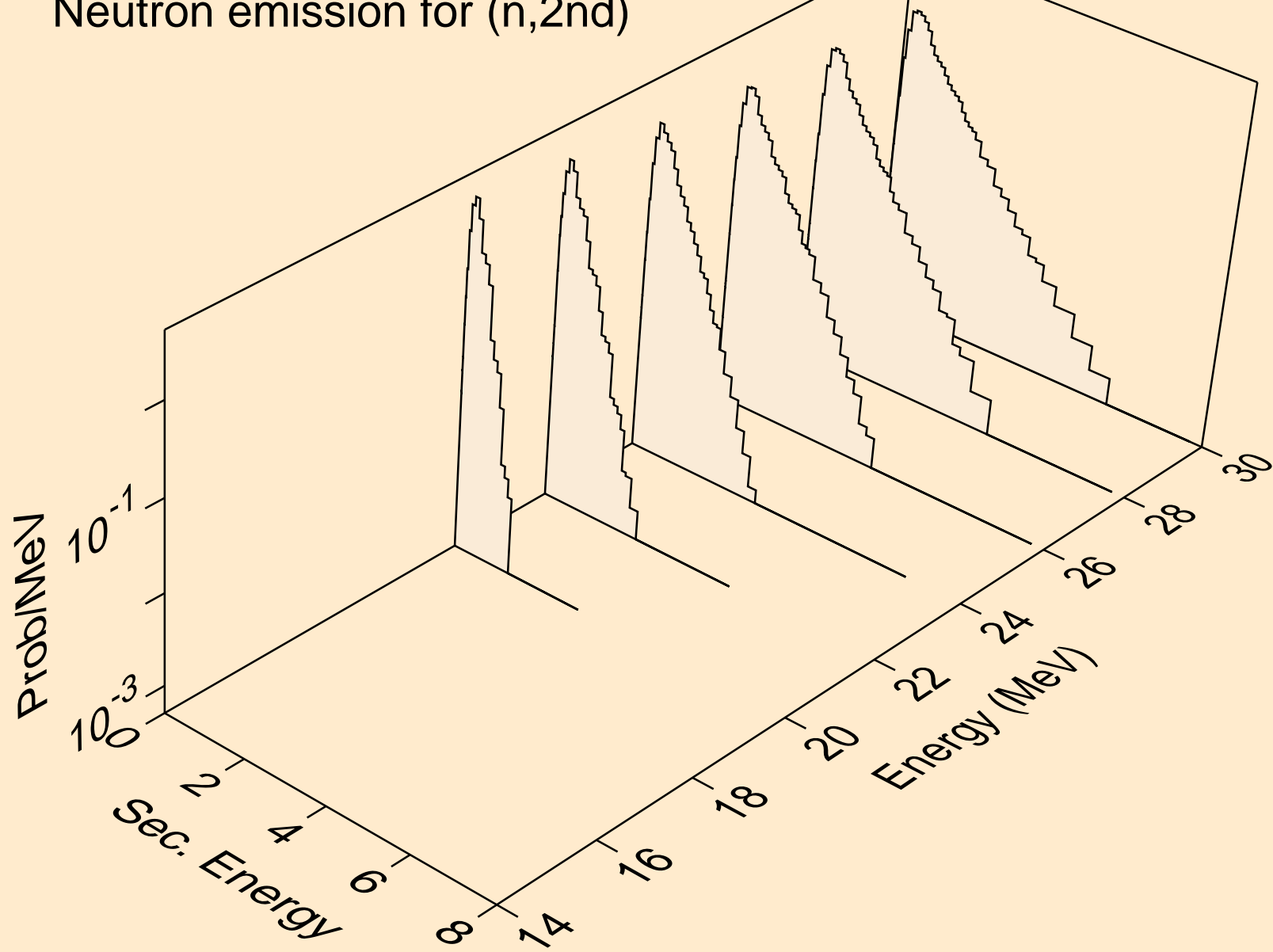

HS268 NEUTRON ACER TENDL-2021 LIBRARY; T=293.6K
Neutron emission for (n,2n)

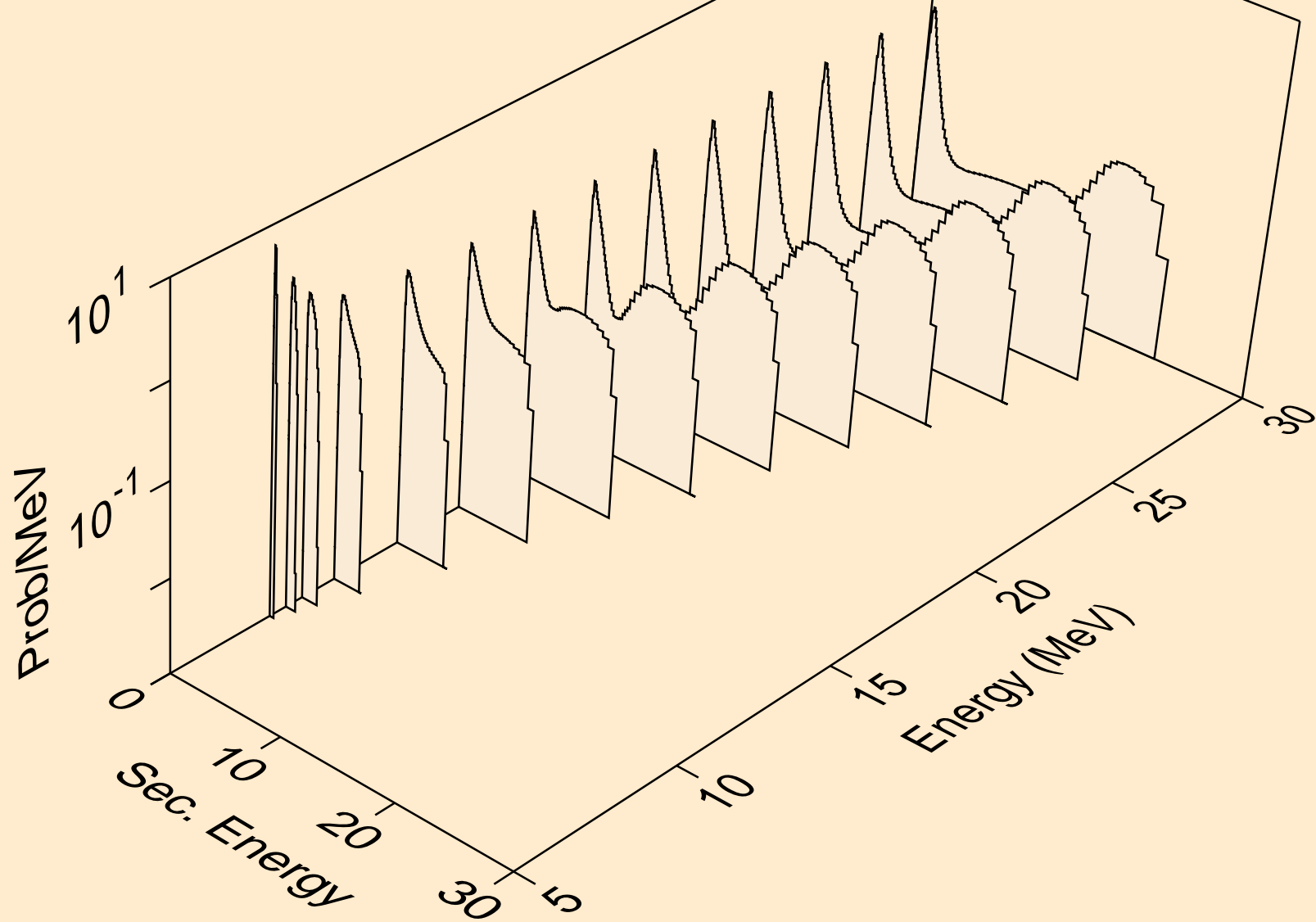

HS268 NEUTRON ACER TENDL-2021 LIBRARY; T=293.6K
Neutron emission for (n,3n)

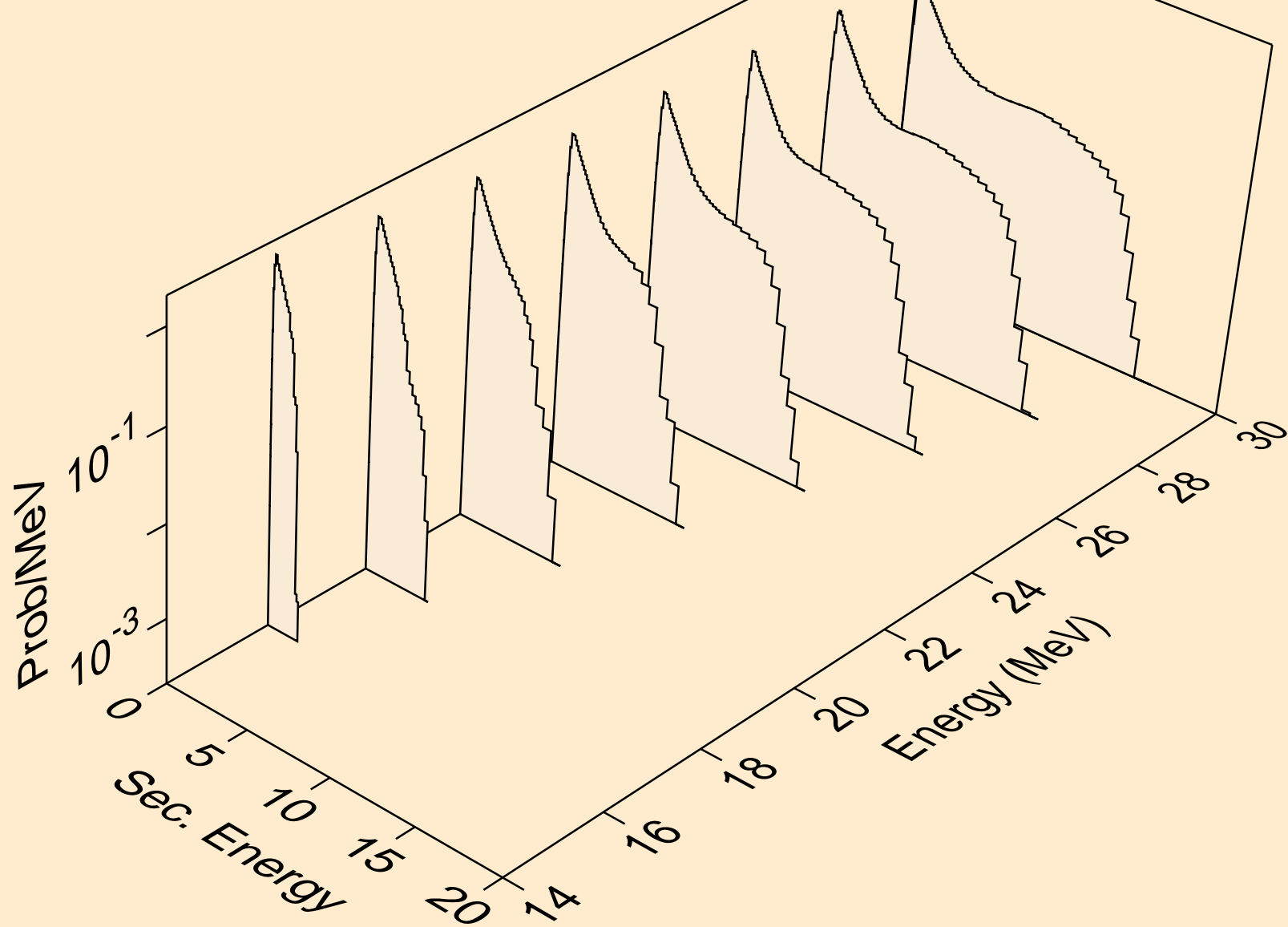

HS268 NEUTRON ACER TENDL-2021 LIBRARY; T=293.6K
Neutron emission for fission

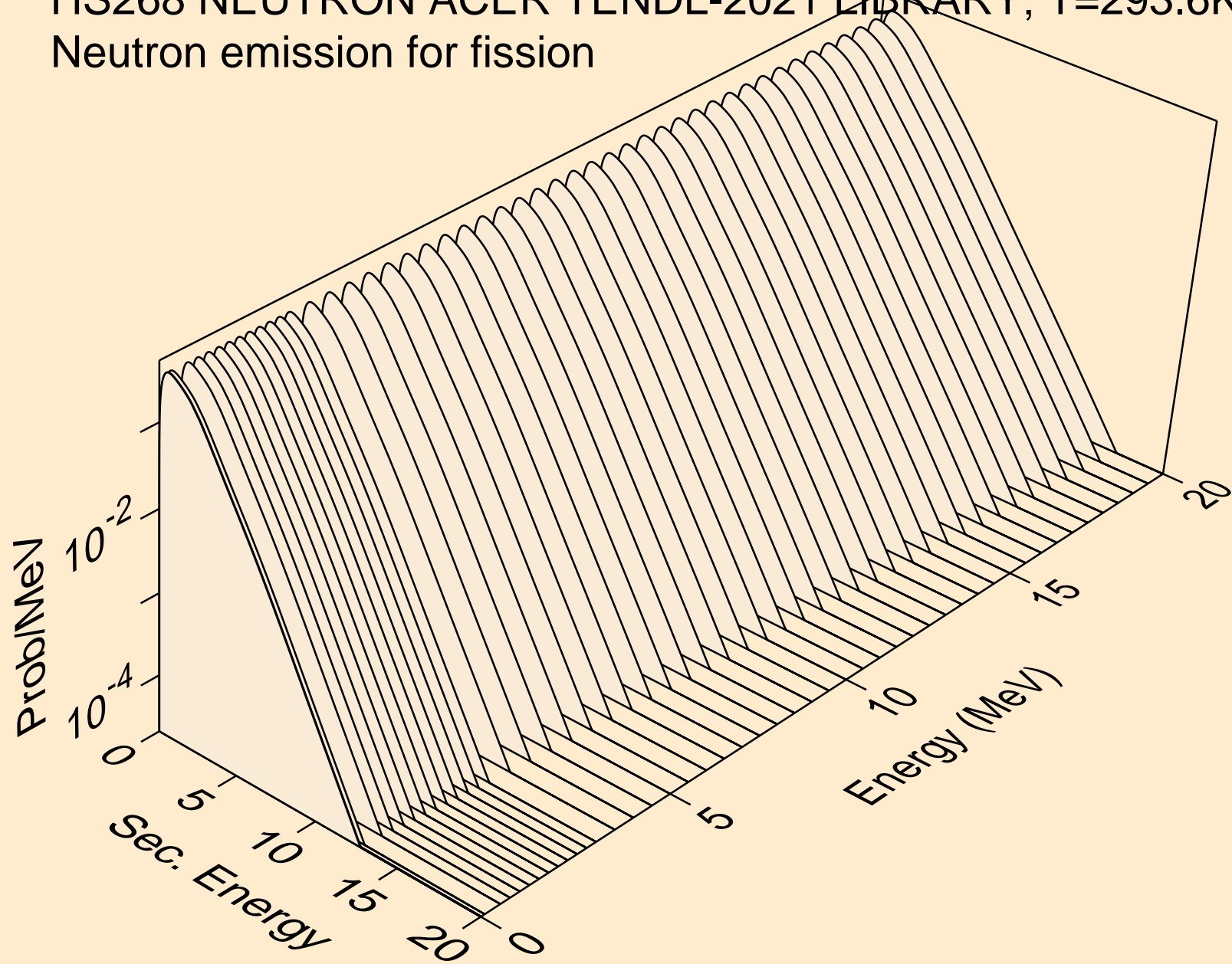

HS268 NEUTRON ACER TENDL-2021 LIBRARY; T=293.6K
Neutron emission for (n,n*)a

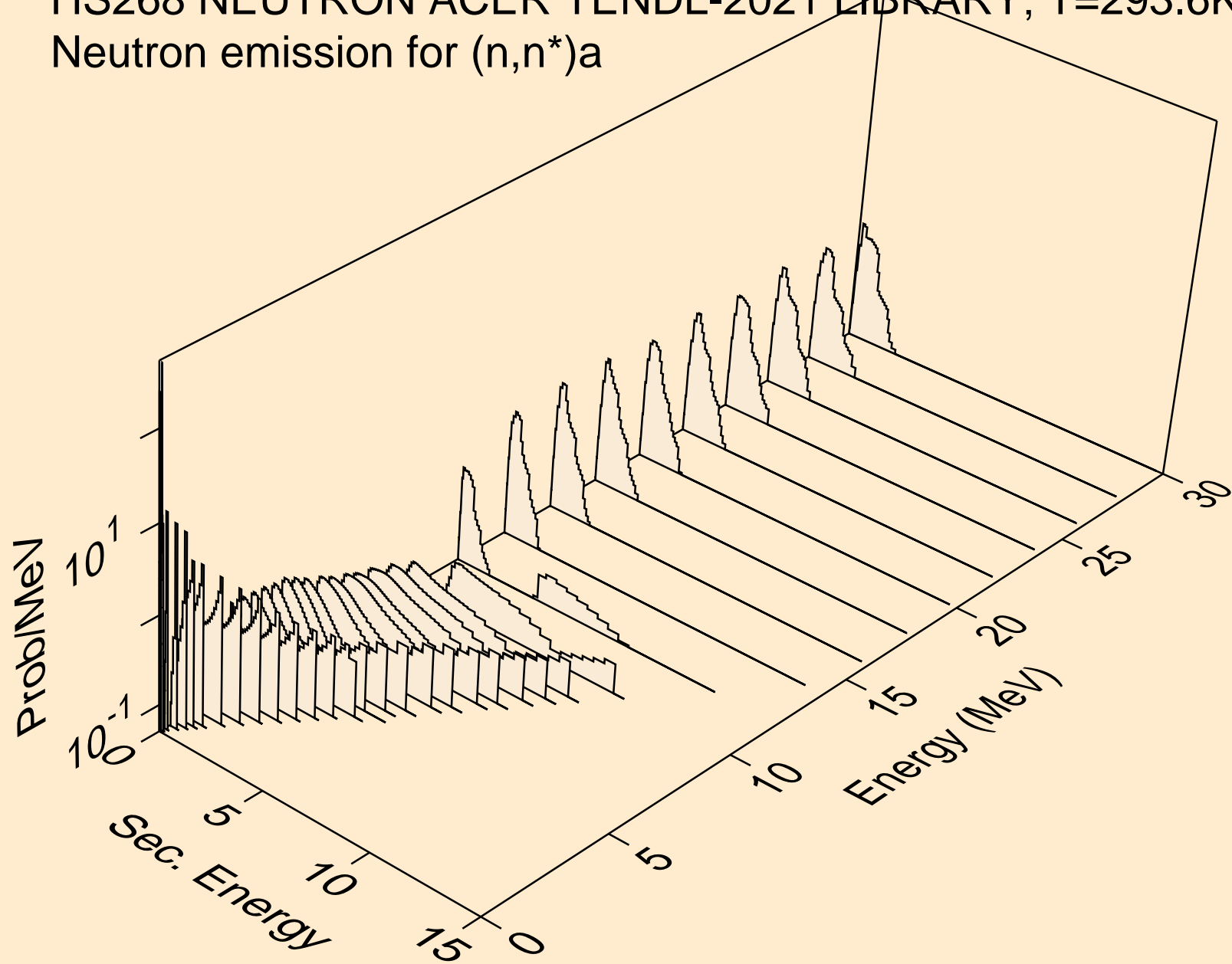

HS268 NEUTRON ACER TENDL-2021 LIBRARY; T=293.6K
Neutron emission for (n,2n)a

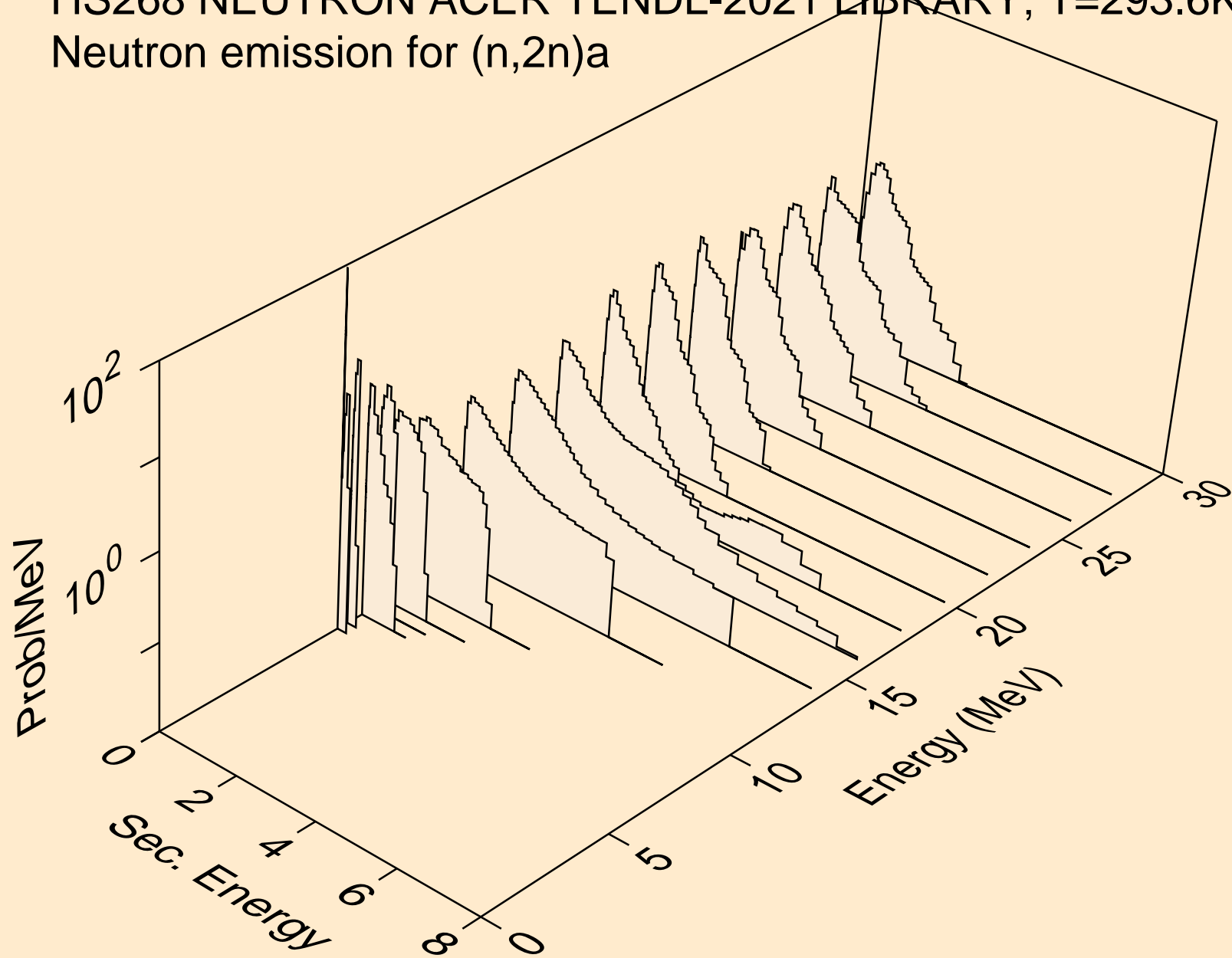

HS268 NEUTRON ACER TENDL-2021 LIBRARY; T=293.6K
Neutron emission for (n,3n)a

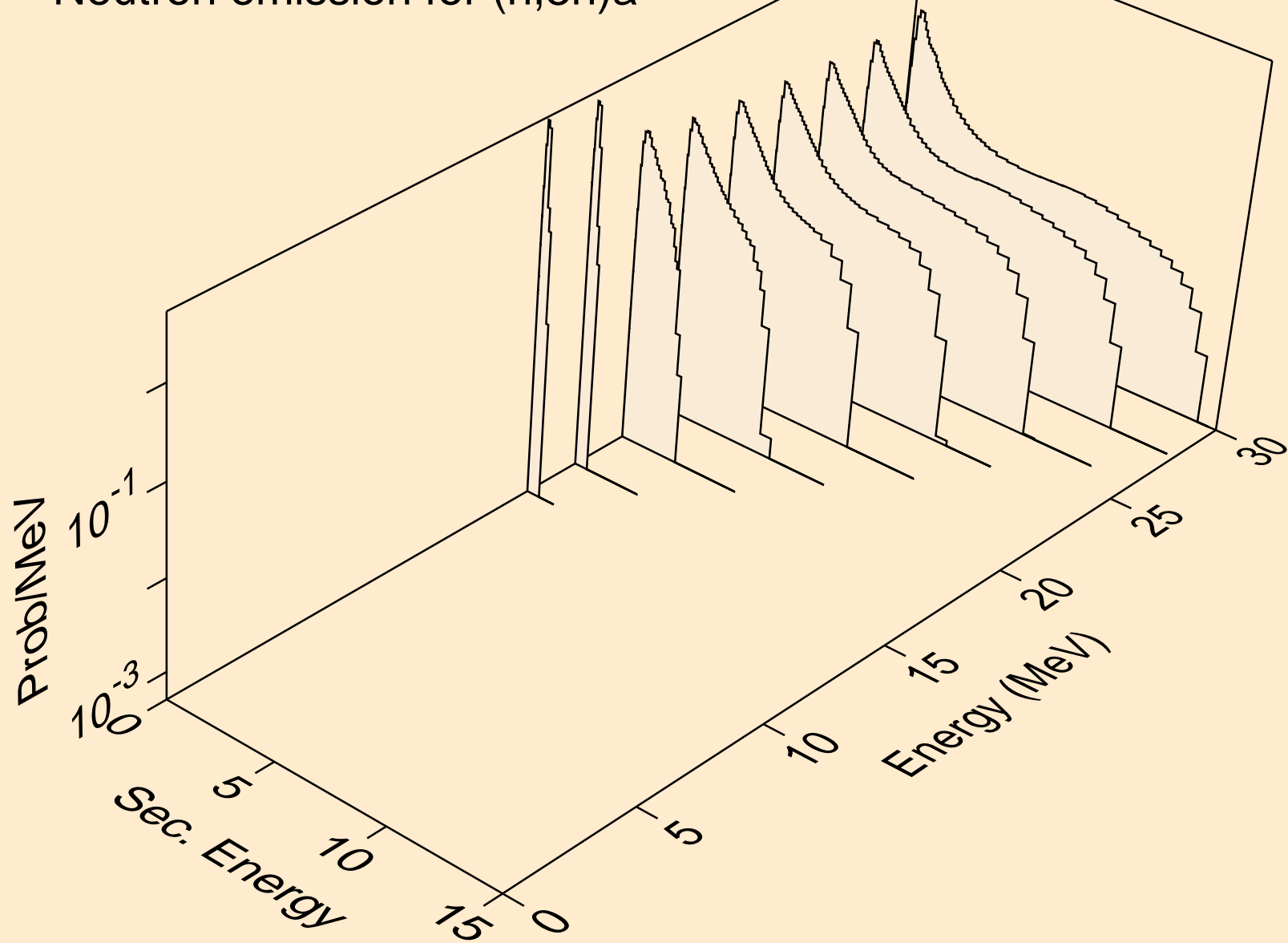

HS268 NEUTRON ACER TENDL-2021 LIBRARY; T=293.6K
Neutron emission for (n,n*)p

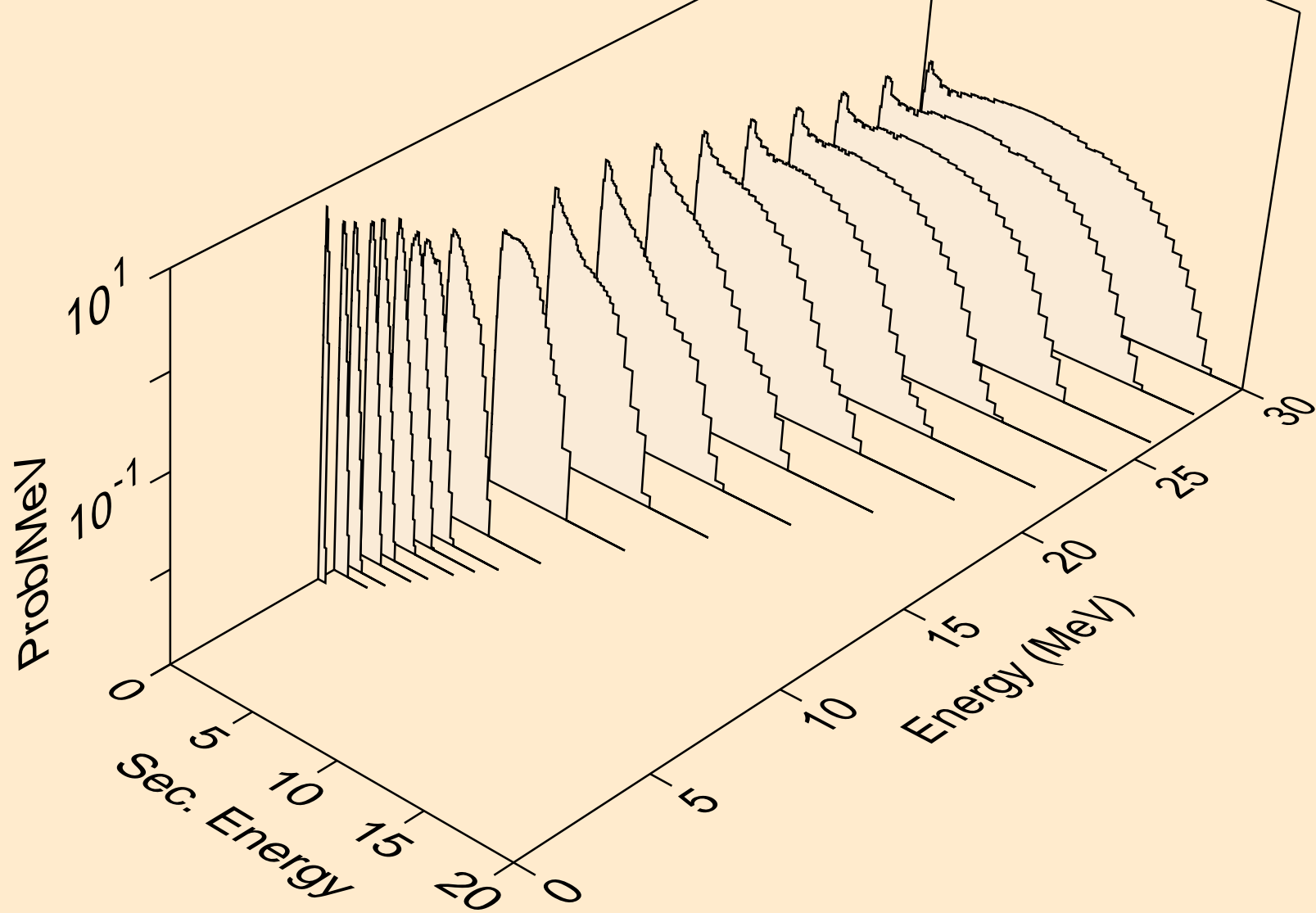

HS268 NEUTRON ACER TENDL-2021 LIBRARY; T=293.6K
Neutron emission for (n,n*)2a

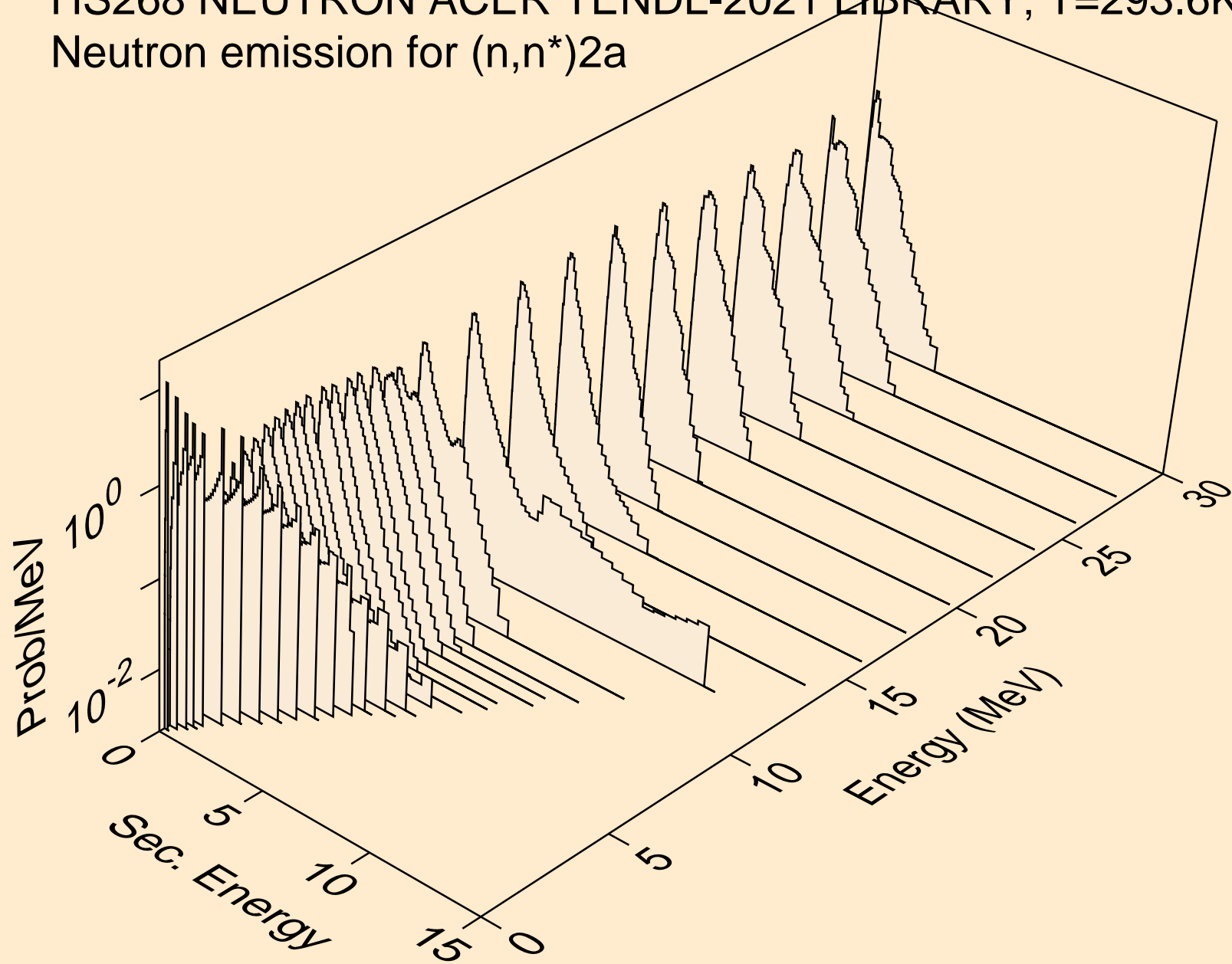

HS268 NEUTRON ACER TENDL-2021 LIBRARY; T=293.6K
Neutron emission for (n,2n)2a

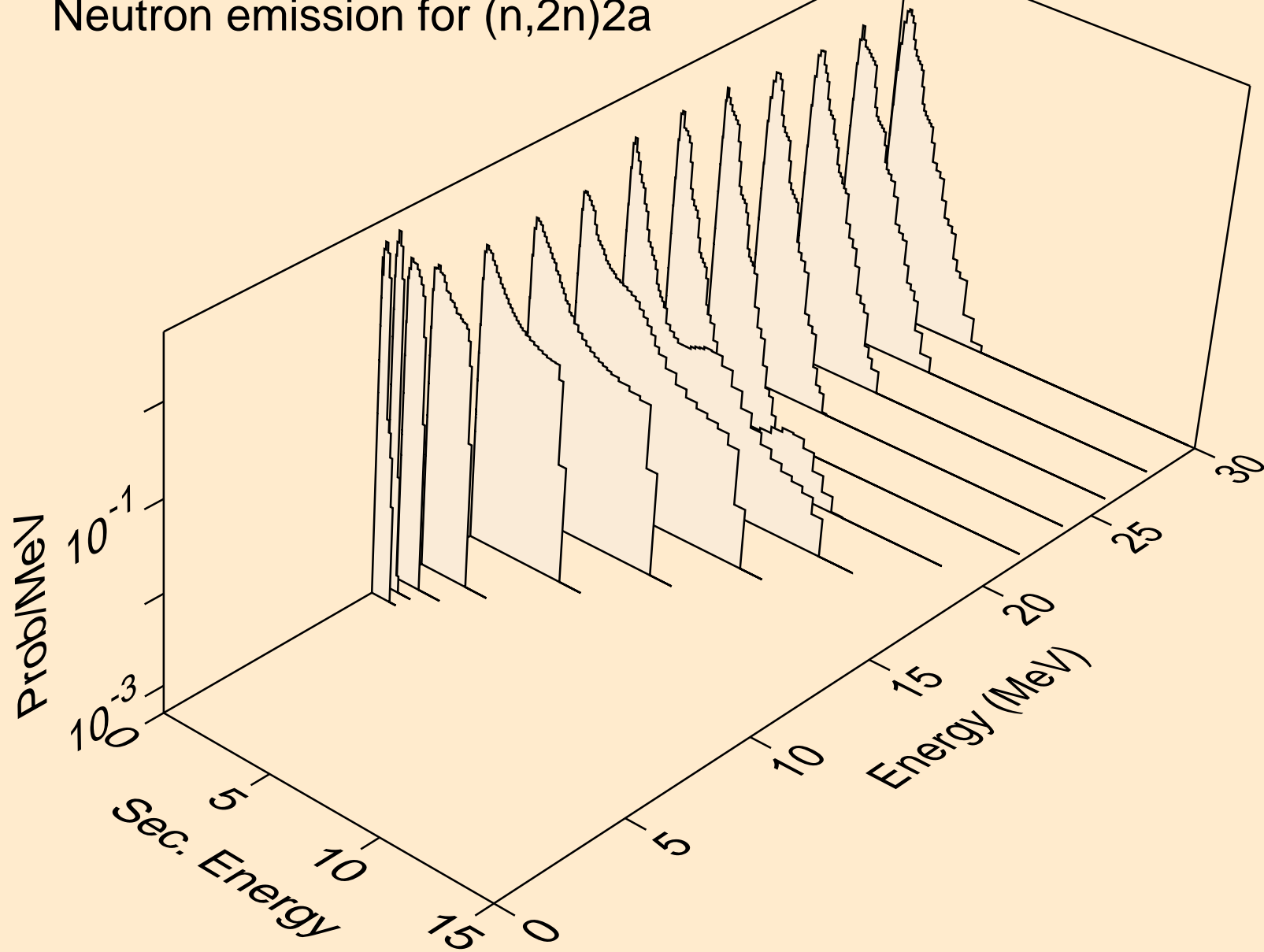

HS268 NEUTRON ACER TENDL-2021 LIBRARY; T=293.6K
Neutron emission for (n,n*)d

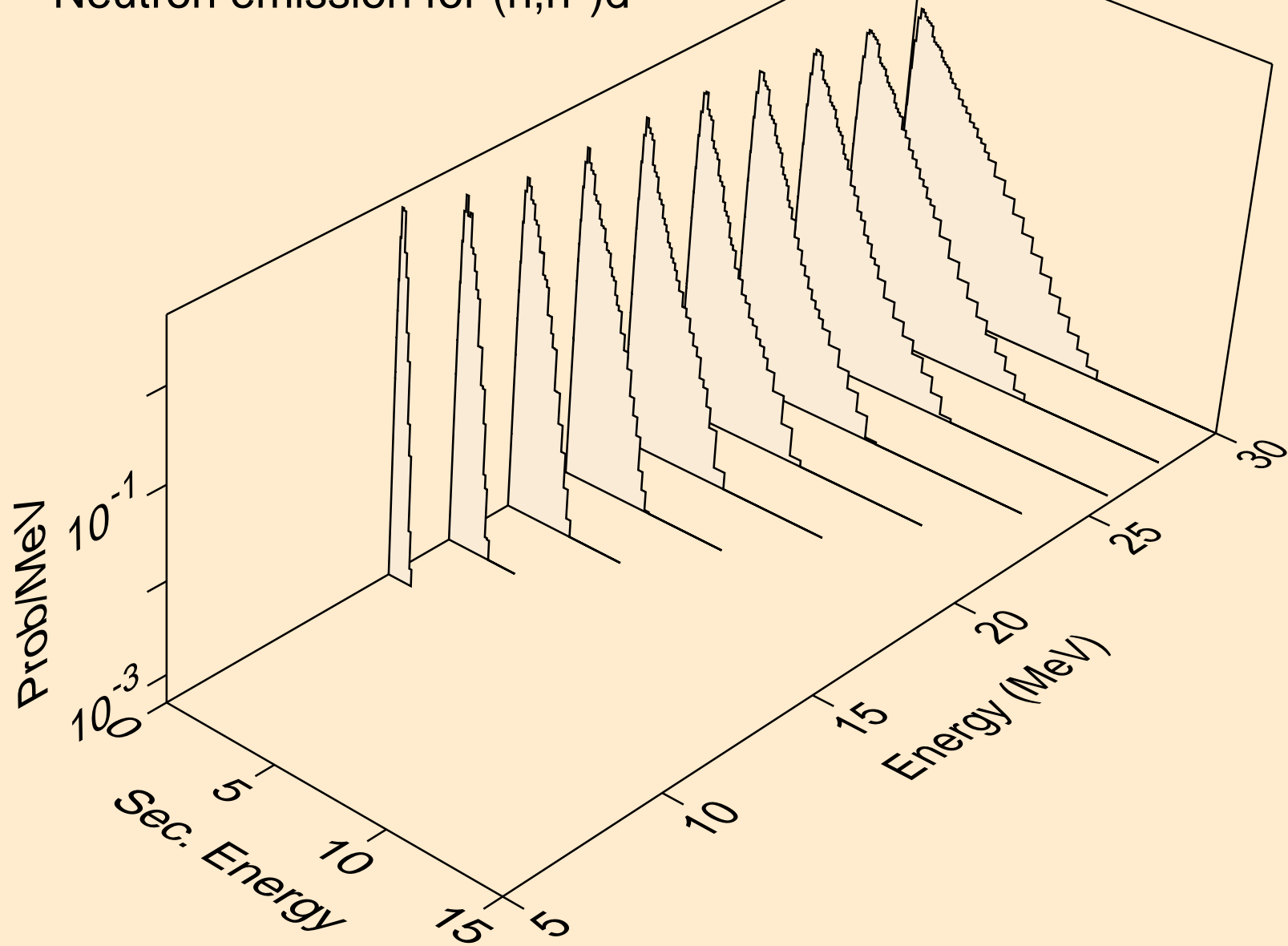

HS268 NEUTRON ACER TENDL-2021 LIBRARY; T=293.6K
Neutron emission for (n,n*)t

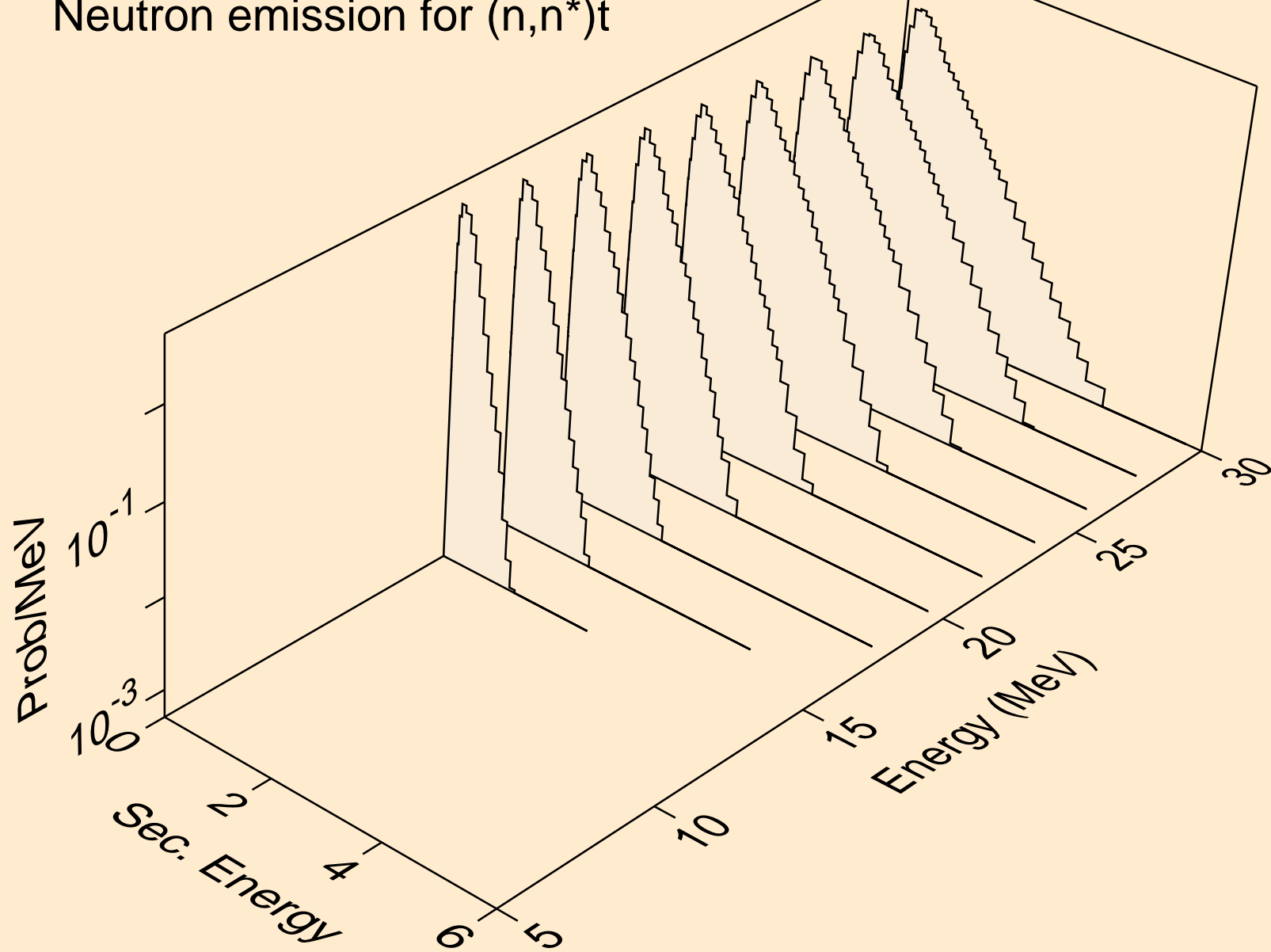

HS268 NEUTRON ACER TENDL-2021 LIBRARY; T=293.6K
Neutron emission for (n,n*)he3

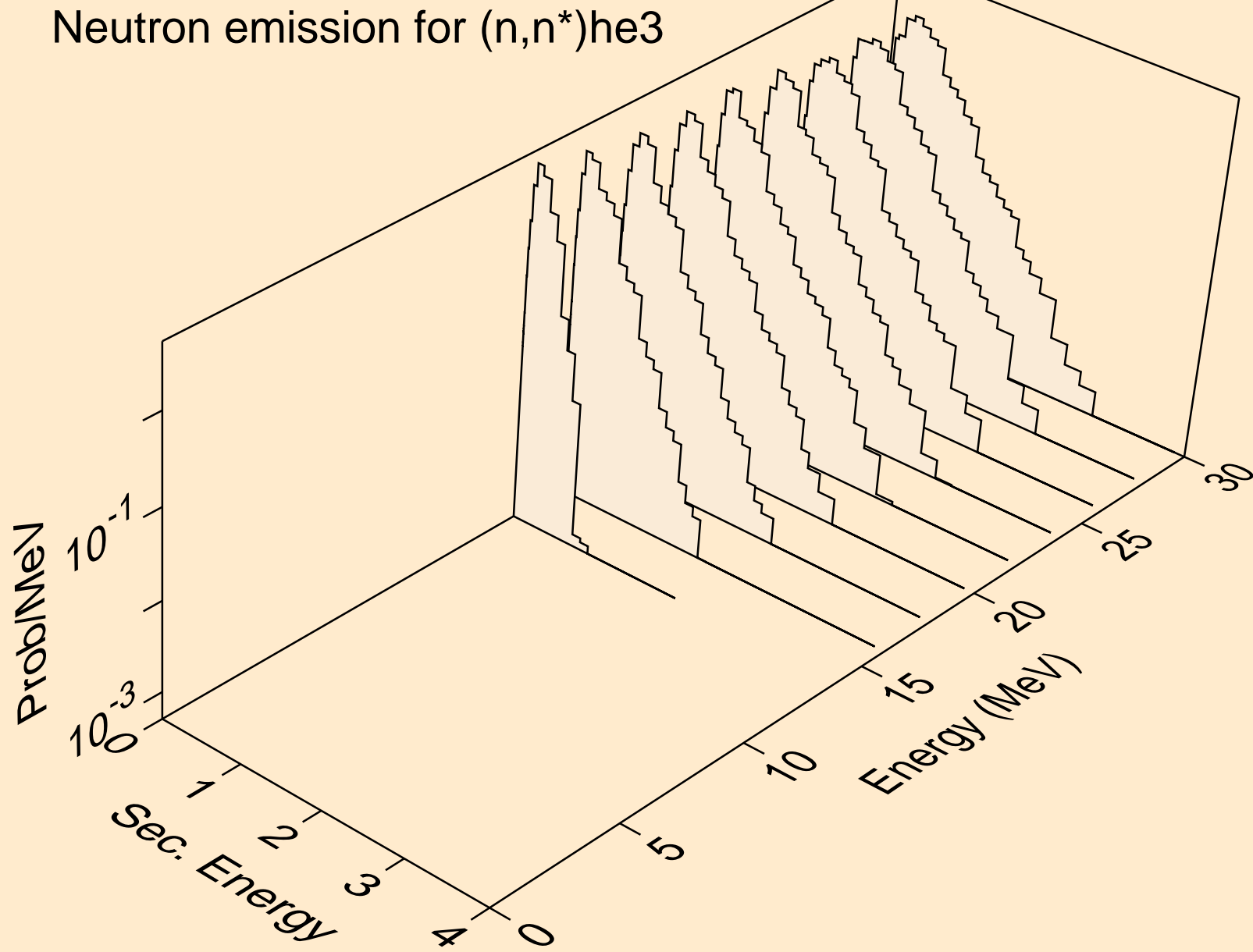

HS268 NEUTRON ACER TENDL-2021 LIBRARY; T=293.6K
Neutron emission for (n,4n)

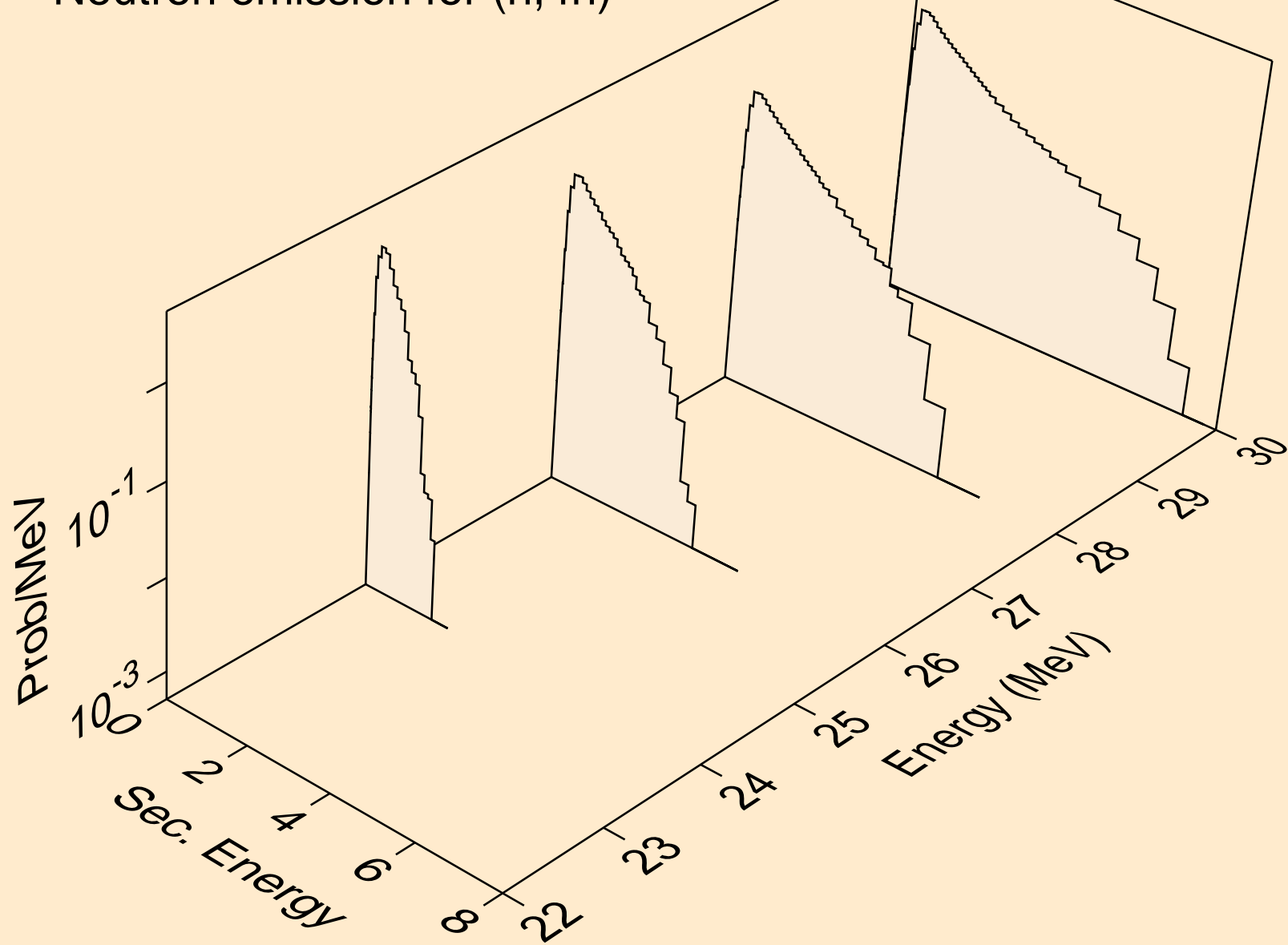

HS268 NEUTRON ACER TENDL-2021 LIBRARY; T=293.6K
Neutron emission for (n,2np)

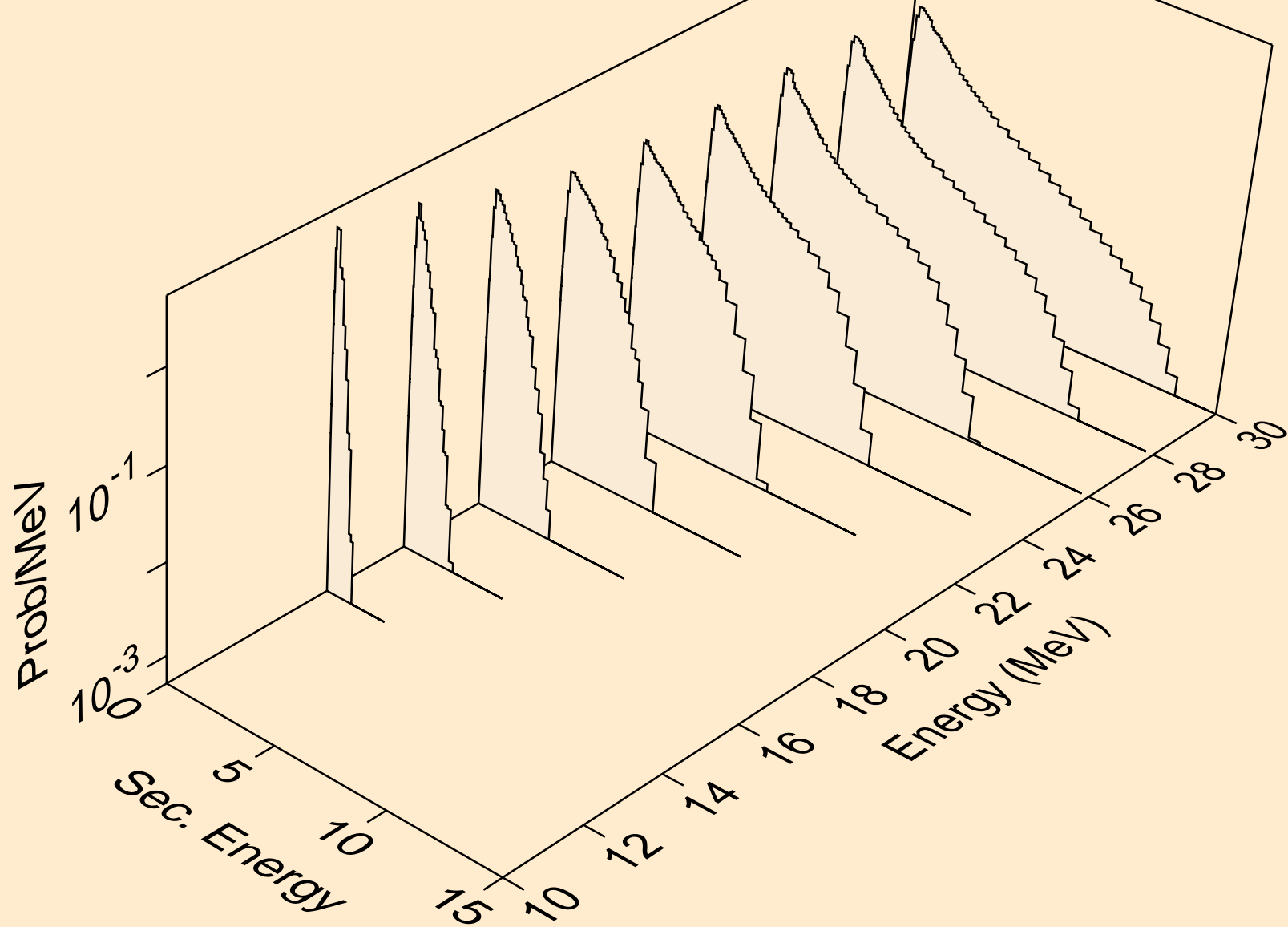

HS268 NEUTRON ACER TENDL-2021 LIBRARY; T=293.6K
Neutron emission for (n,3np)

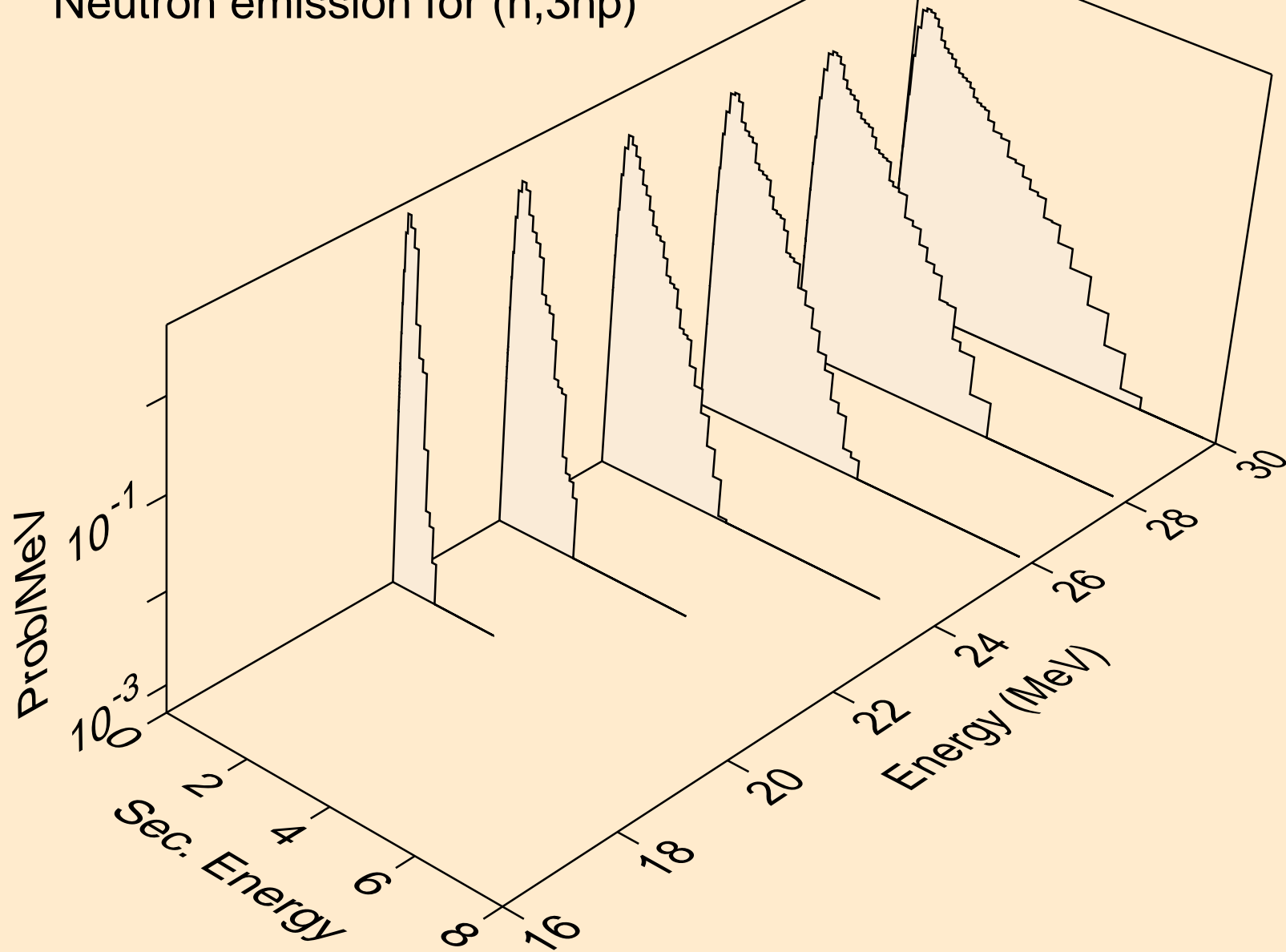

HS268 NEUTRON ACER TENDL-2021 LIBRARY; T=293.6K
Neutron emission for (n,2np)

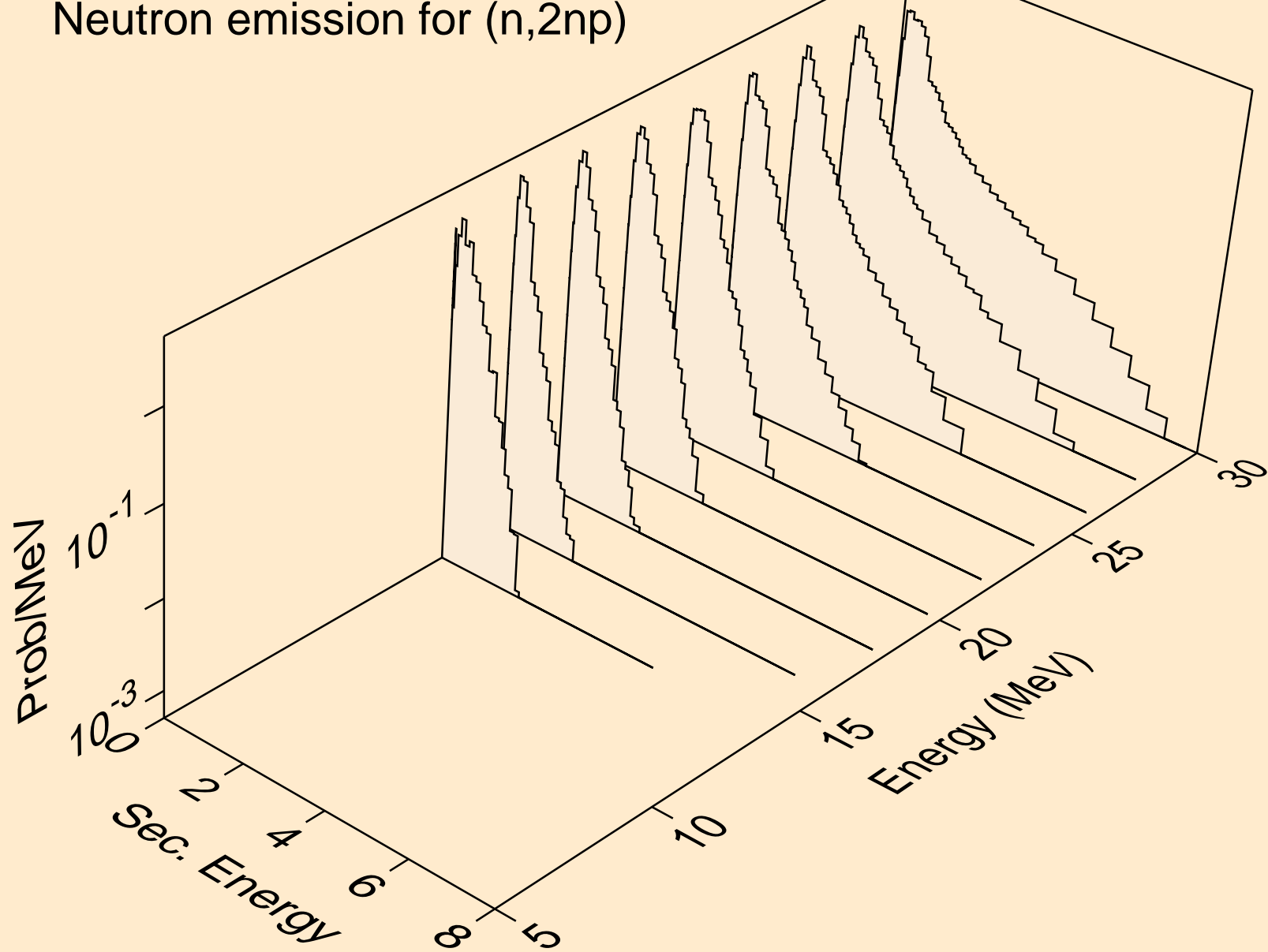

HS268 NEUTRON ACER TENDL-2021 LIBRARY; T=293.6K
Neutron emission for (n,npa)

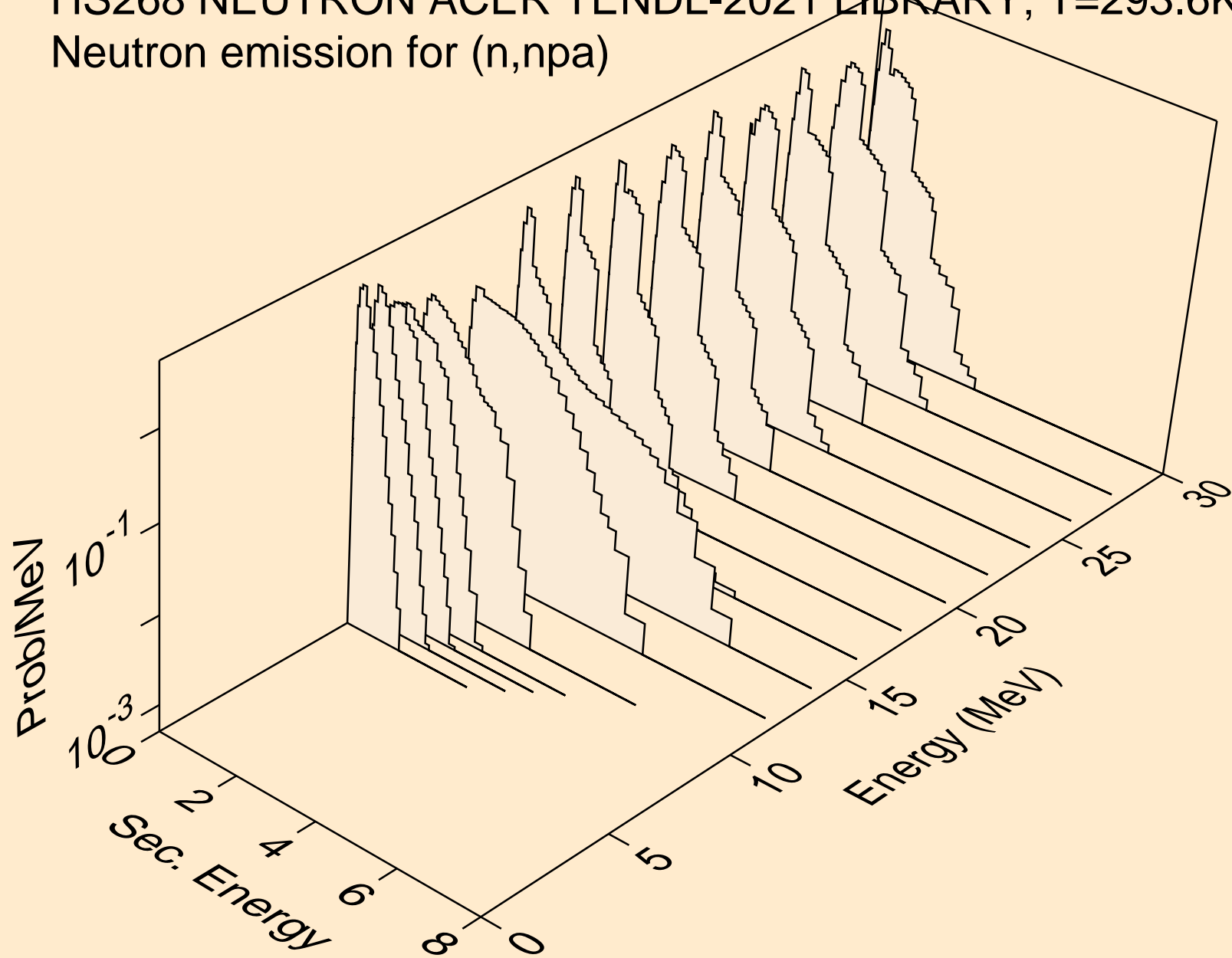

HS268 NEUTRON ACER TENDL-2021 LIBRARY; T=293.6K
Neutron emission for (n,n*c)

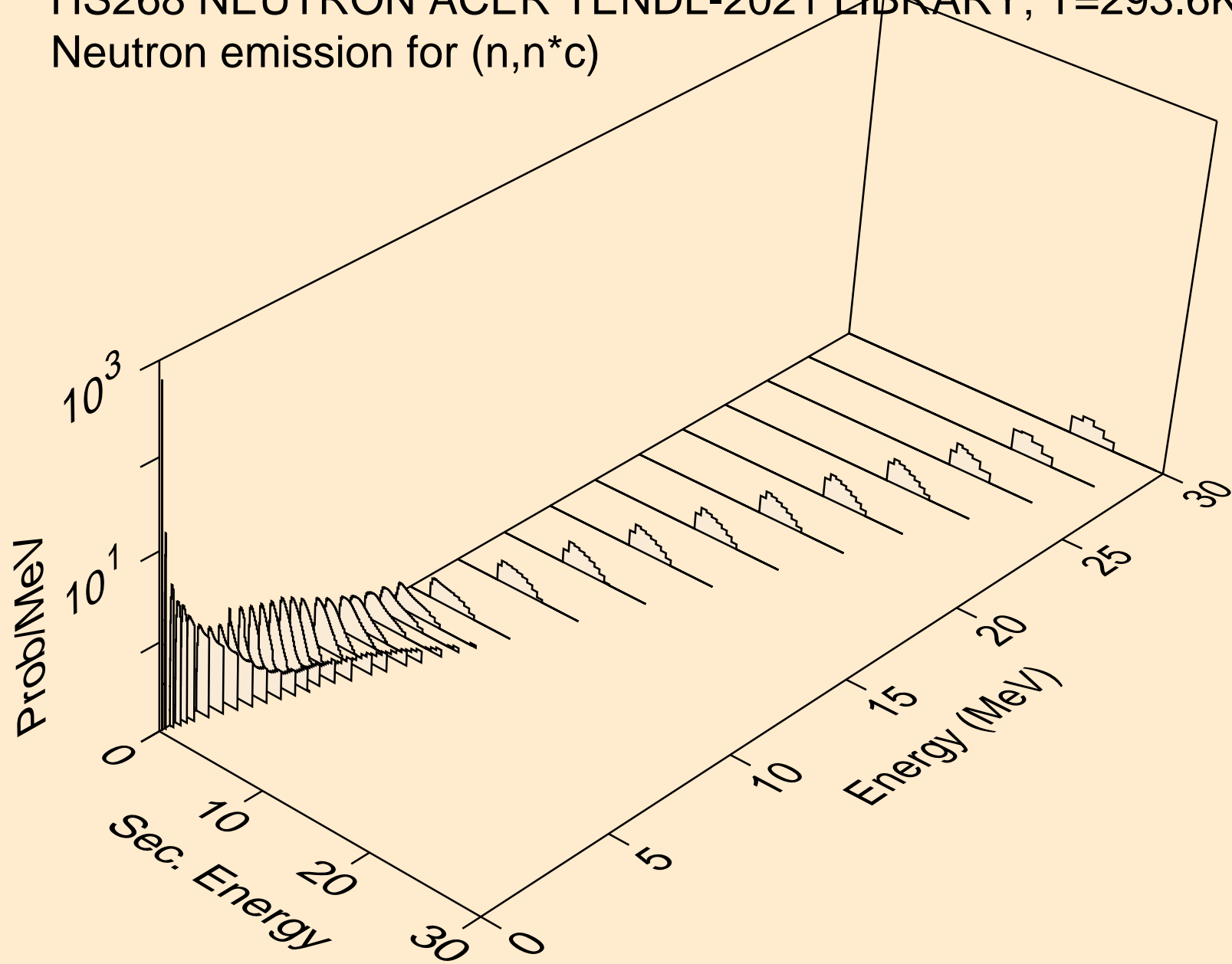

HS268 NEUTRON ACER TENDL-2021 LIBRARY; T=293.6K

Delayed nubar

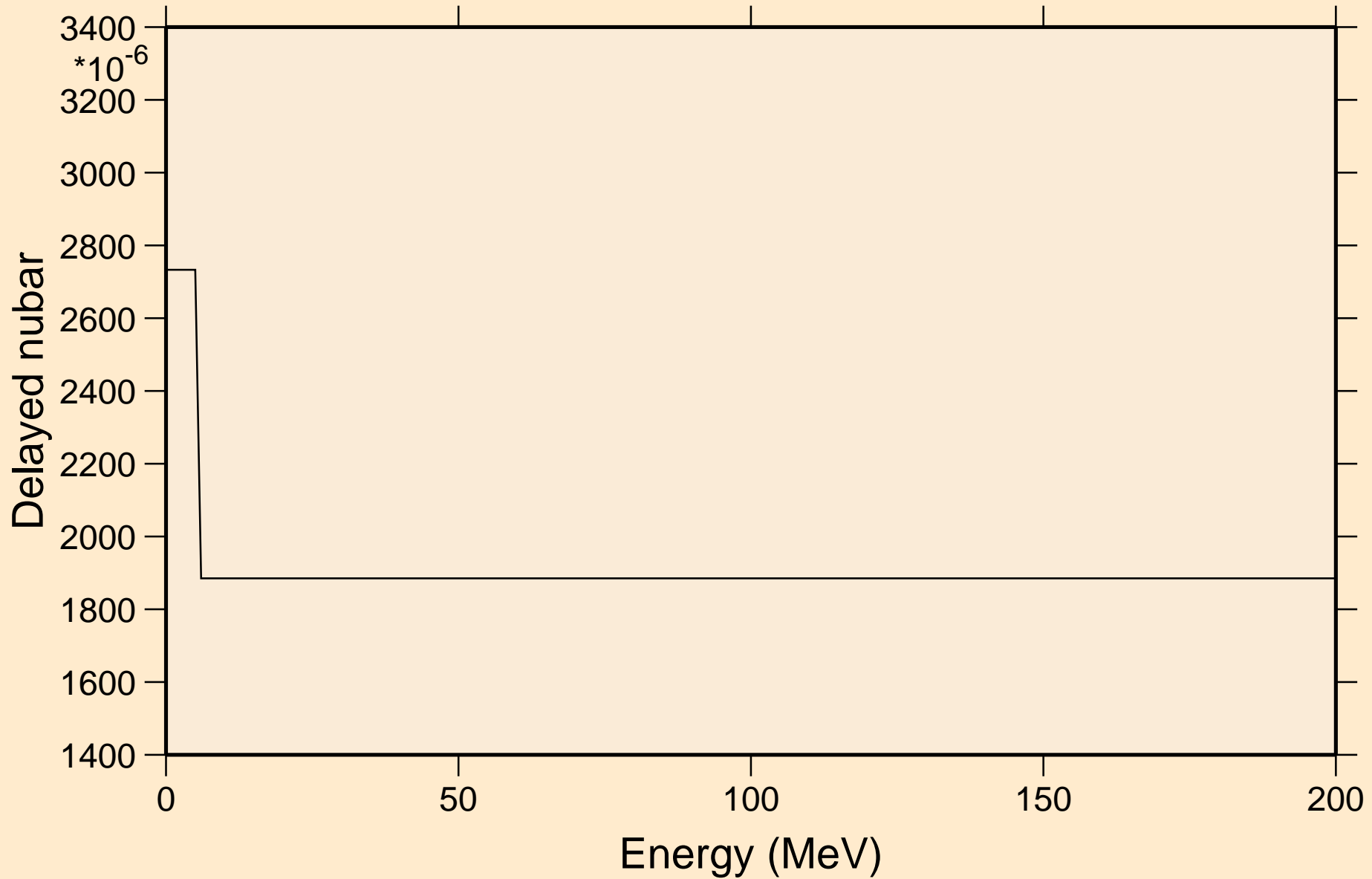

HS268 NEUTRON ACER TENDL-2021 LIBRARY; T=293.6K

Delayed neutron spectra

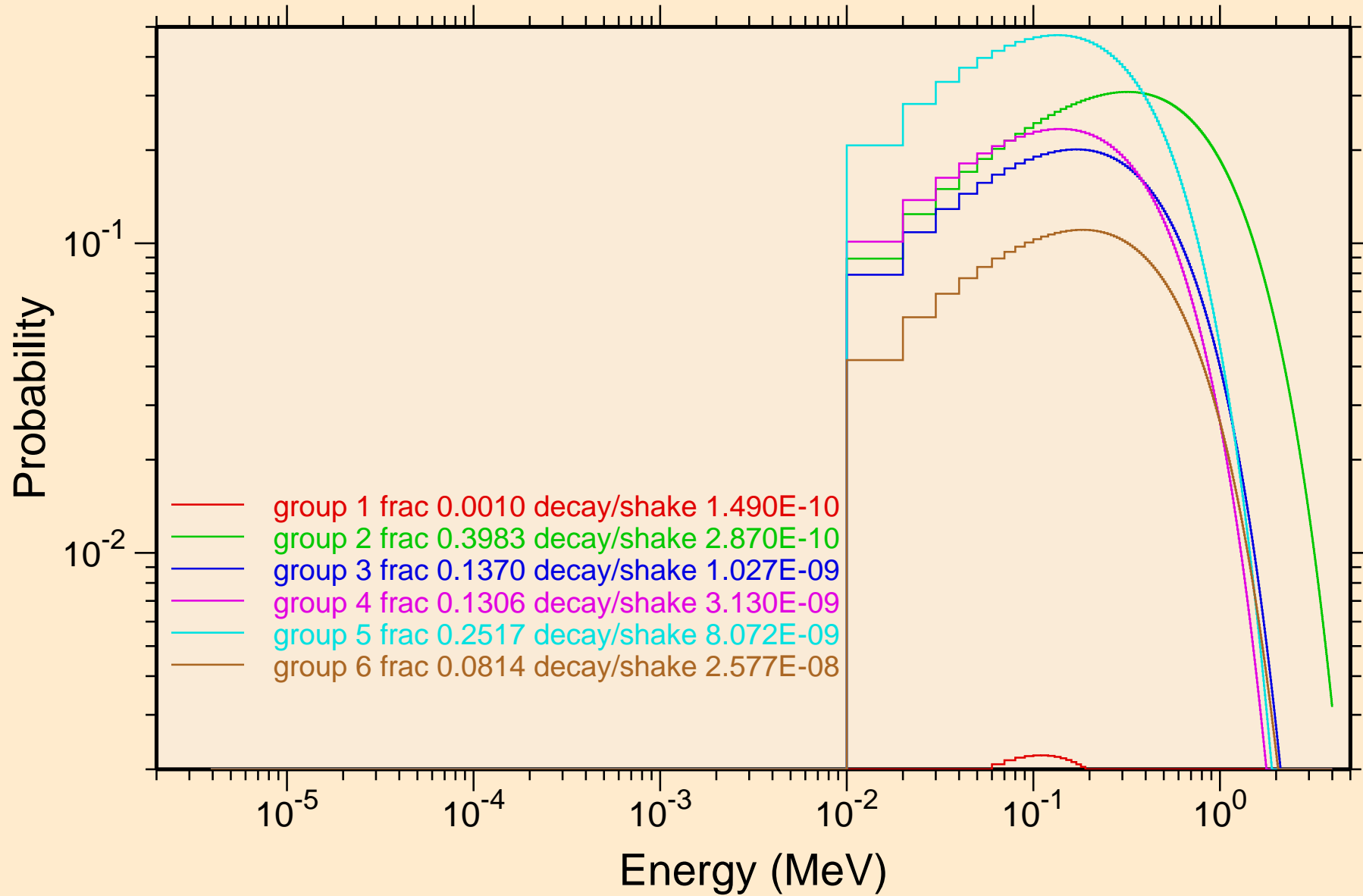

HS268 NEUTRON ACER TENDL-2021 LIBRARY; T=293.6K
Photon emission for (n,x)

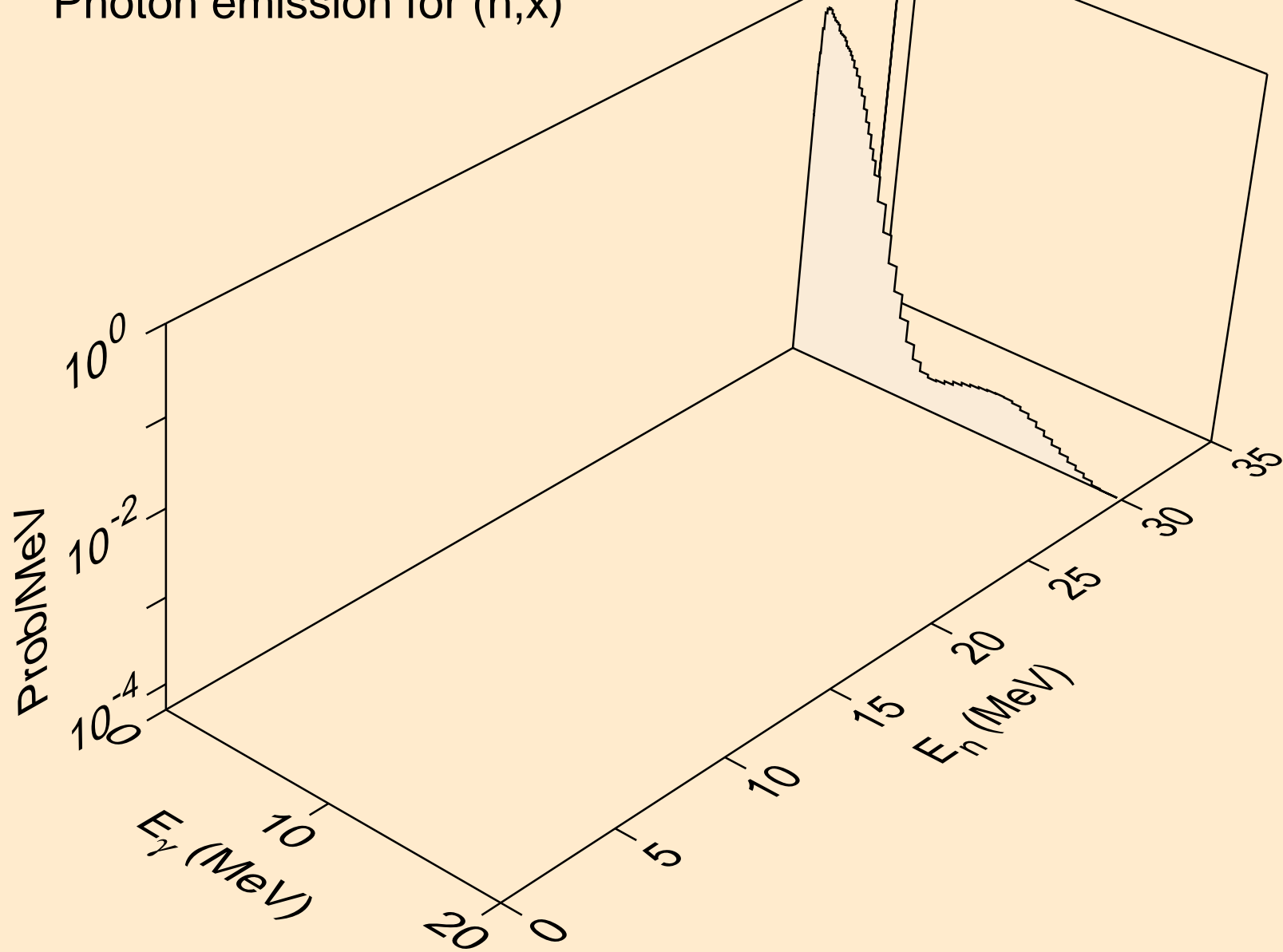

HS268 NEUTRON ACER TENDL-2021 LIBRARY; T=293.6K
Photon emission for (n,2nd)

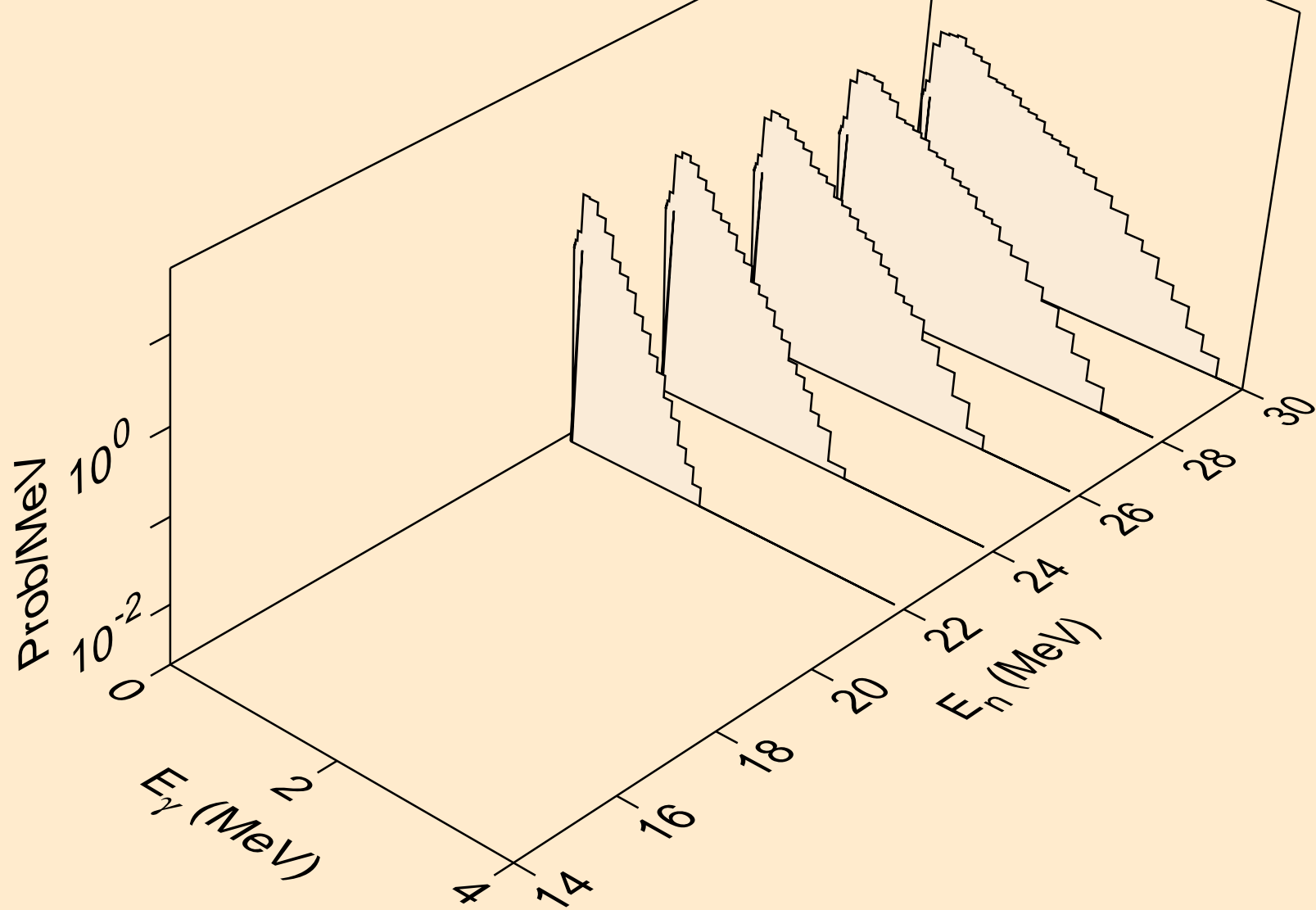

HS268 NEUTRON ACER TENDL-2021 LIBRARY; T=293.6K
Photon emission for (n,2n)

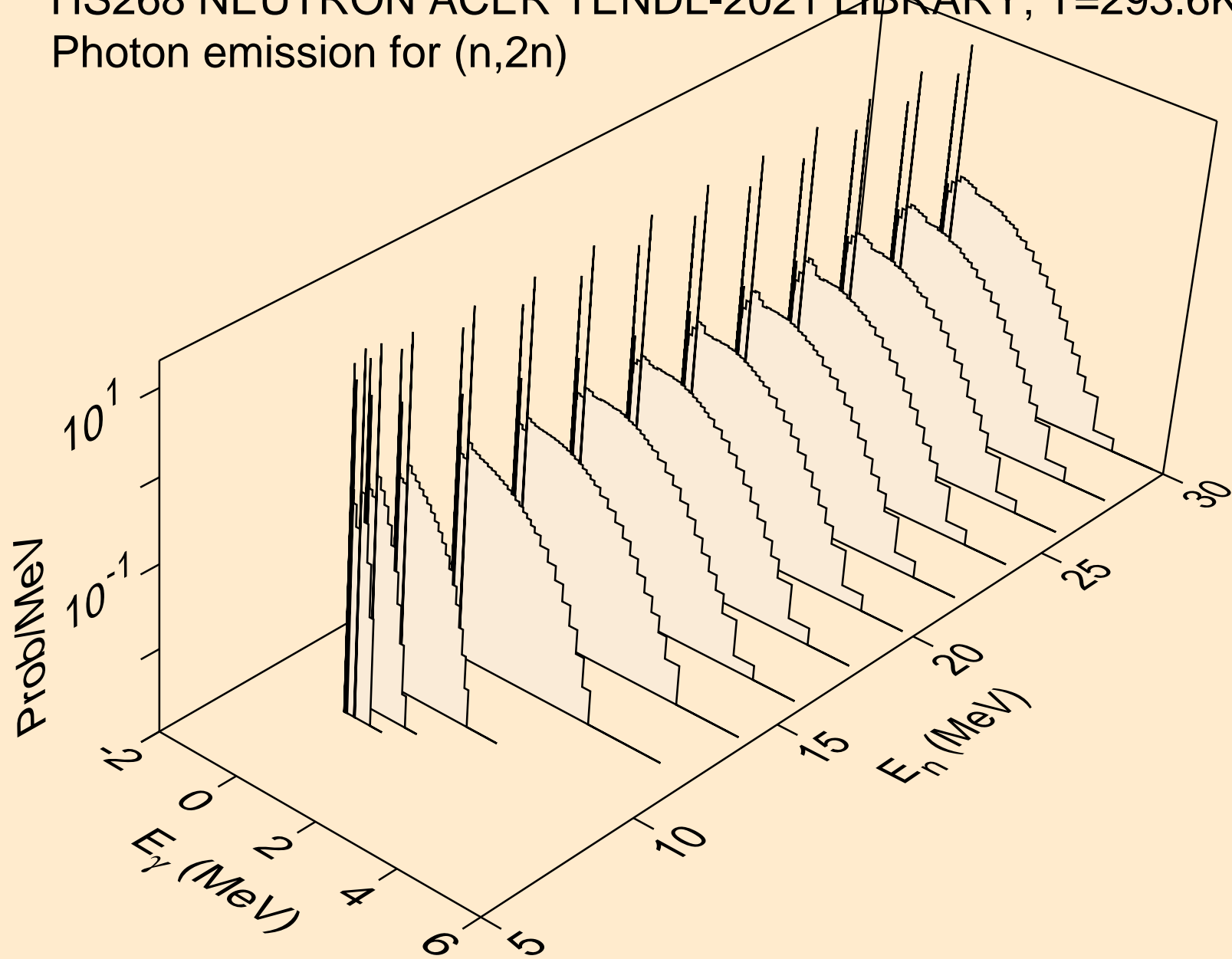

HS268 NEUTRON ACER TENDL-2021 LIBRARY; T=293.6K
Photon emission for (n,3n)

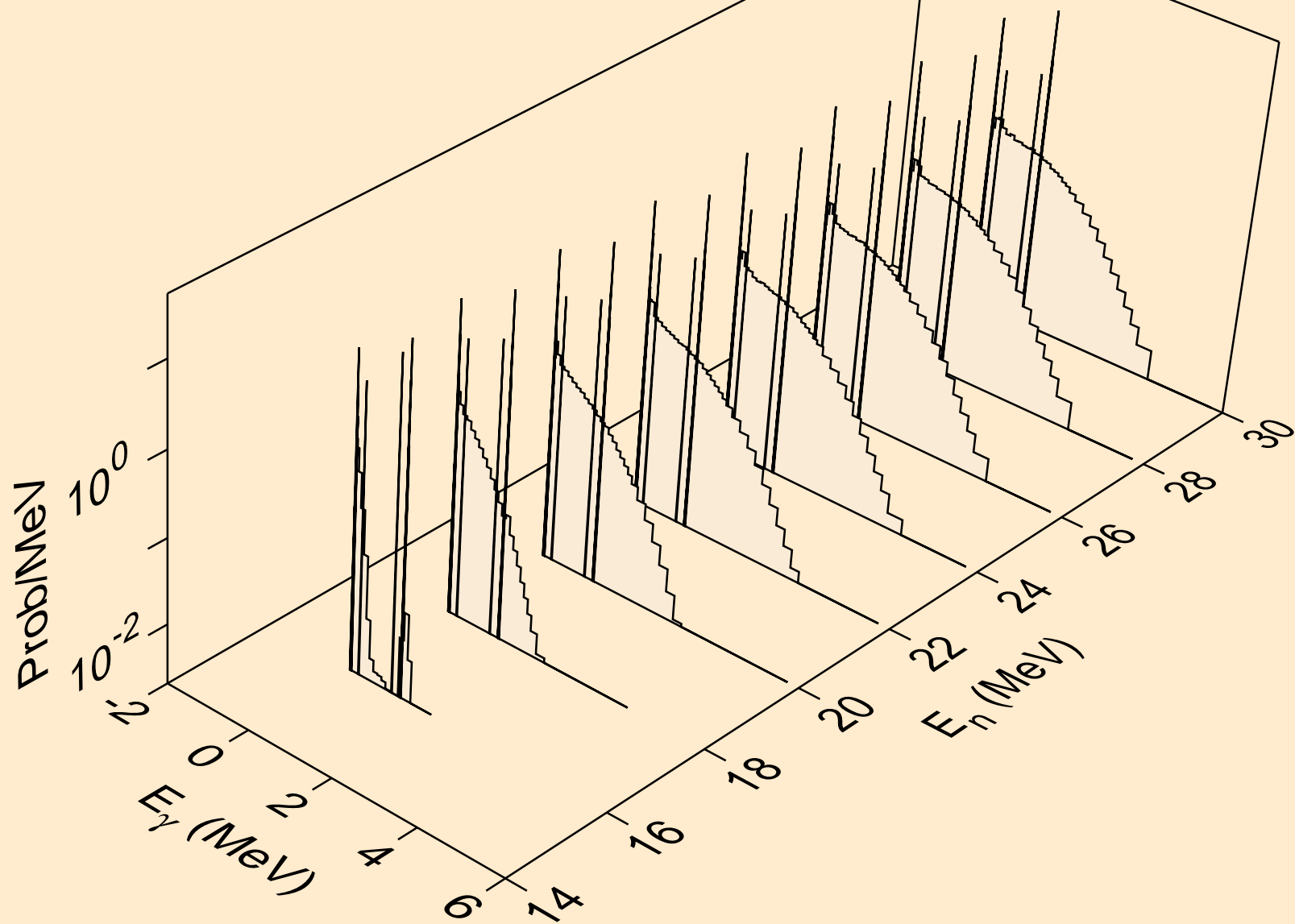

HS268 NEUTRON ACER TENDL-2021 LIBRARY; T=293.6K
Photon emission for (n,n*)a

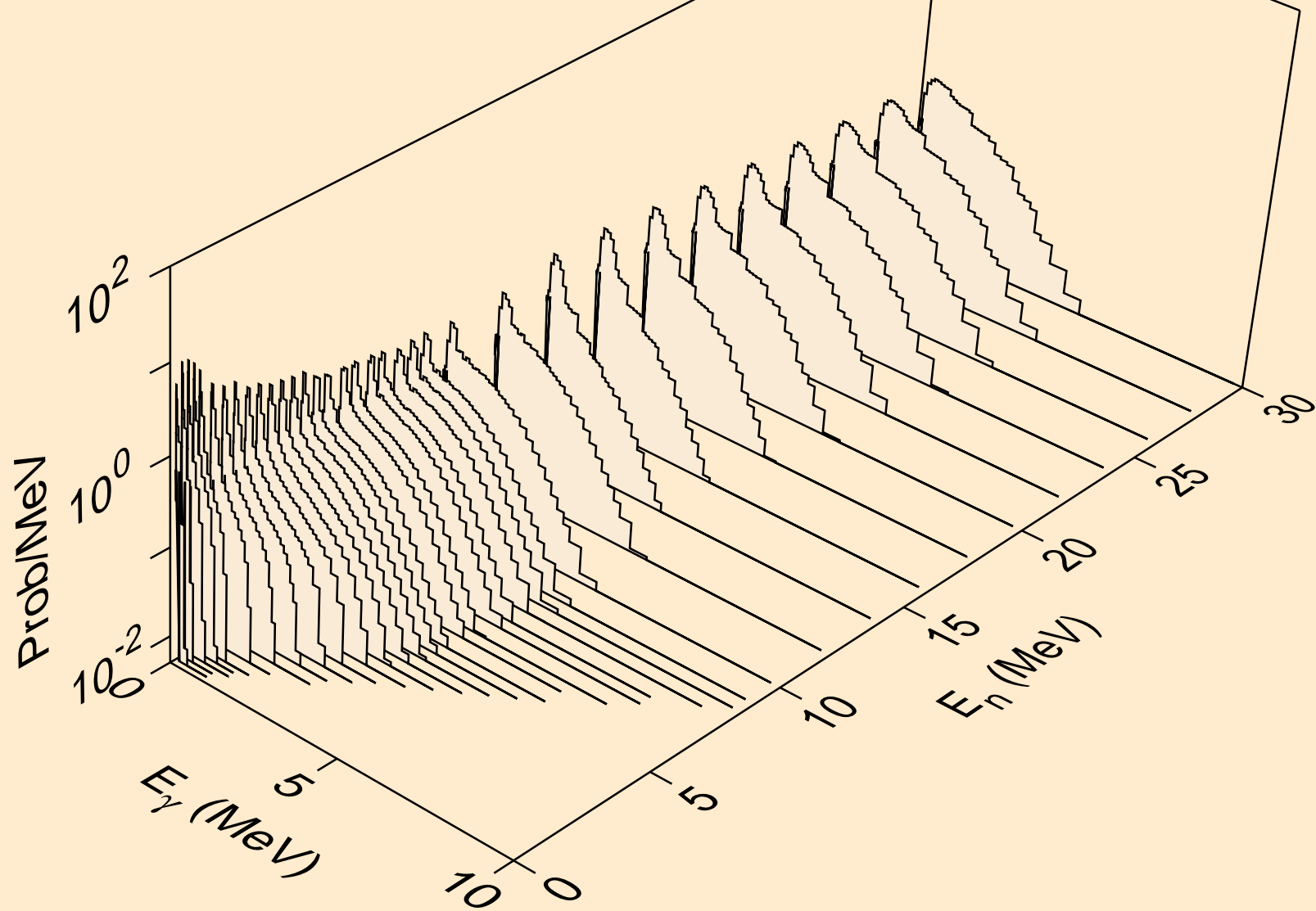

HS268 NEUTRON ACER TENDL-2021 LIBRARY; T=293.6K
Photon emission for (n,2n)a

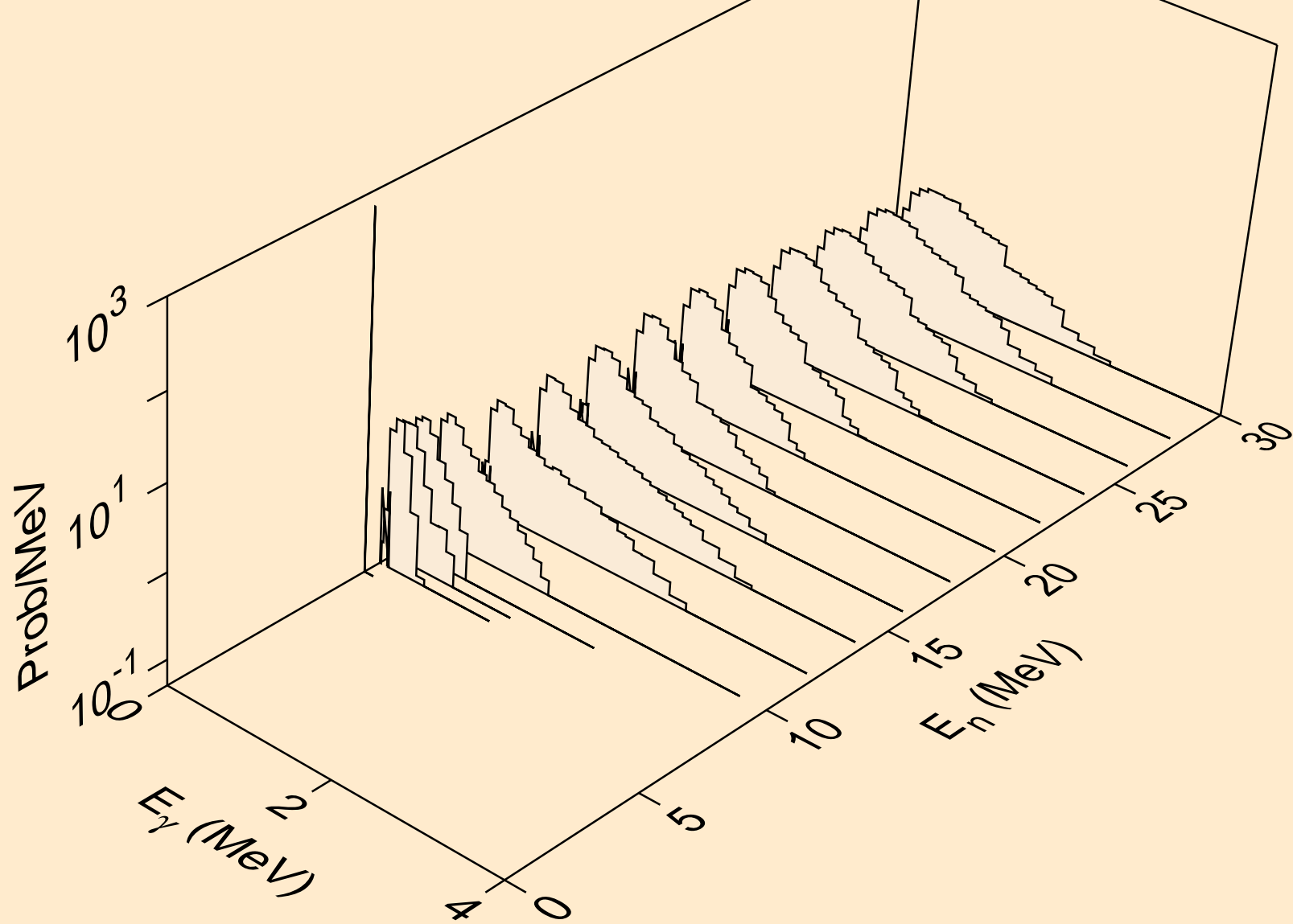

HS268 NEUTRON ACER TENDL-2021 LIBRARY; T=293.6K
Photon emission for (n,3n)a

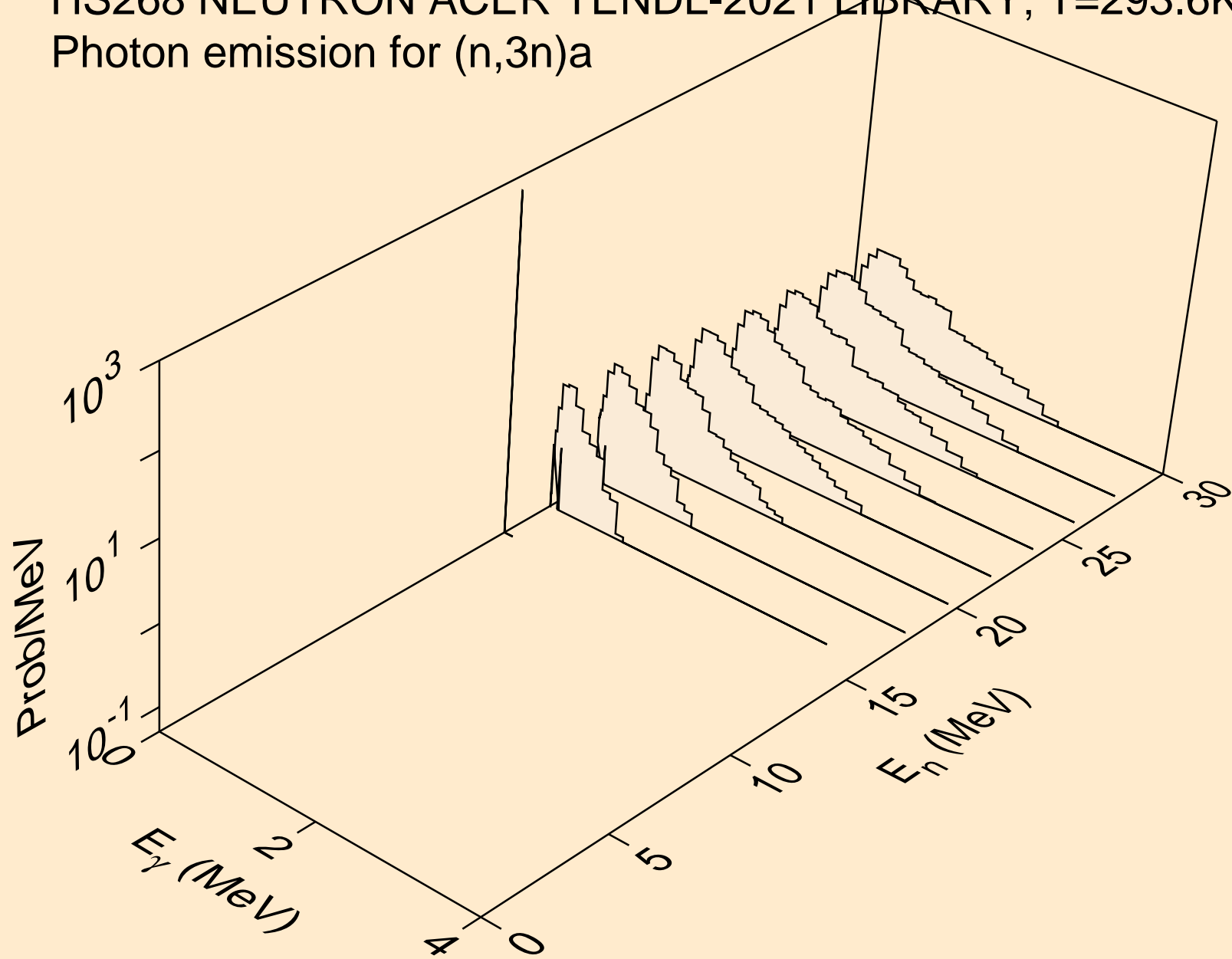

HS268 NEUTRON ACER TENDL-2021 LIBRARY; T=293.6K
Photon emission for (n,n*)p

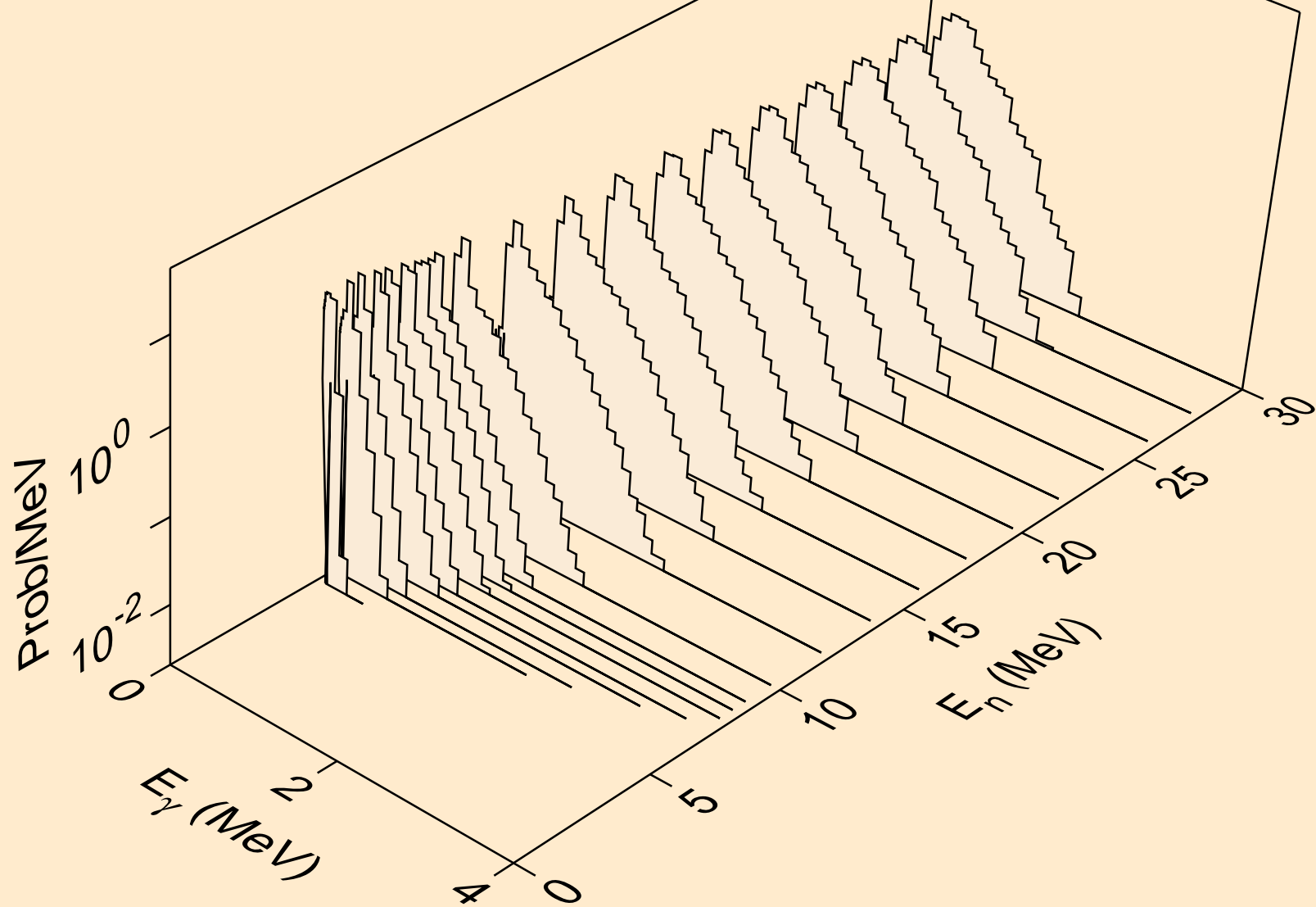

HS268 NEUTRON ACER TENDL-2021 LIBRARY; T=293.6K
Photon emission for (n,n*)2a

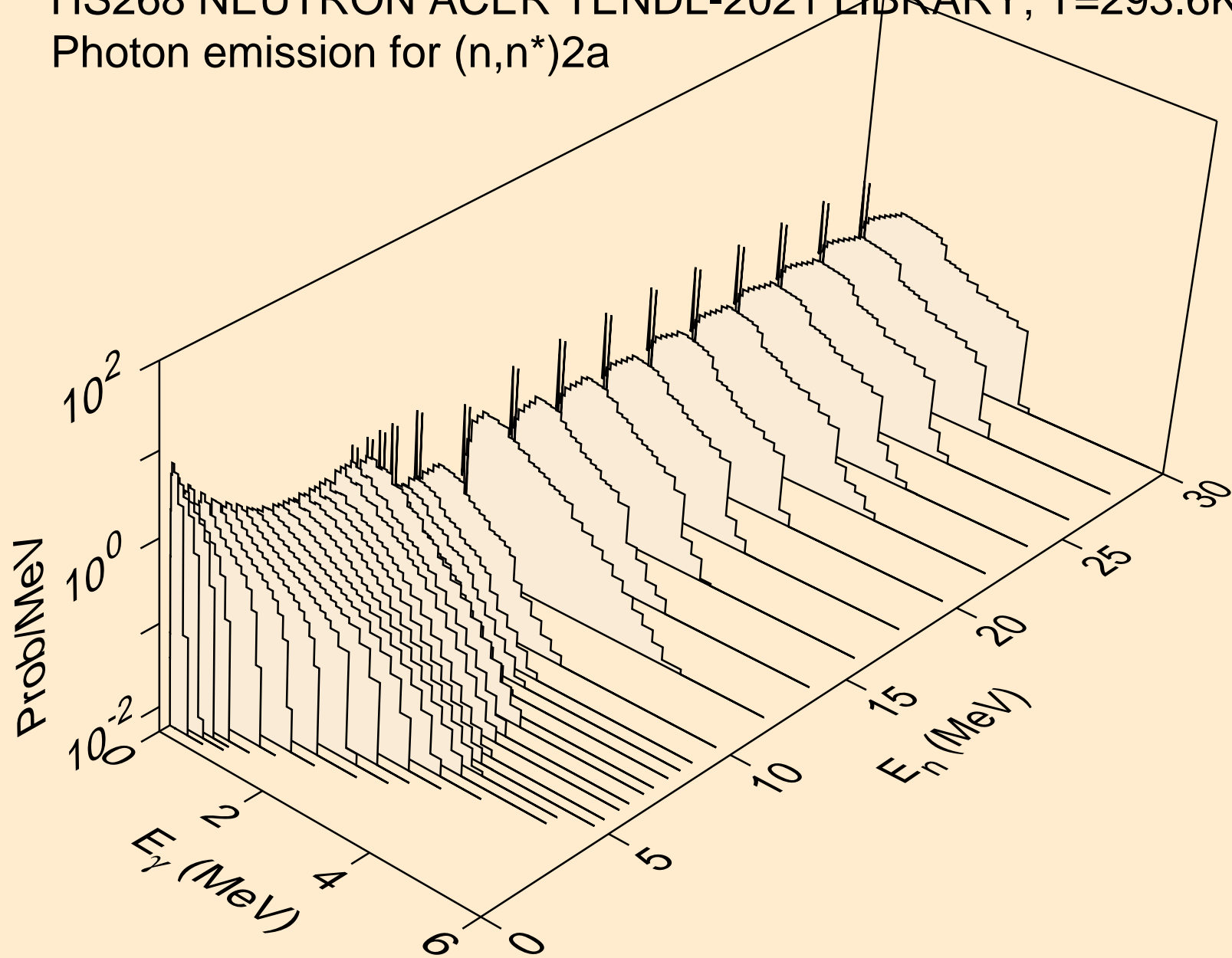

HS268 NEUTRON ACER TENDL-2021 LIBRARY; T=293.6K
Photon emission for (n,2n)2a

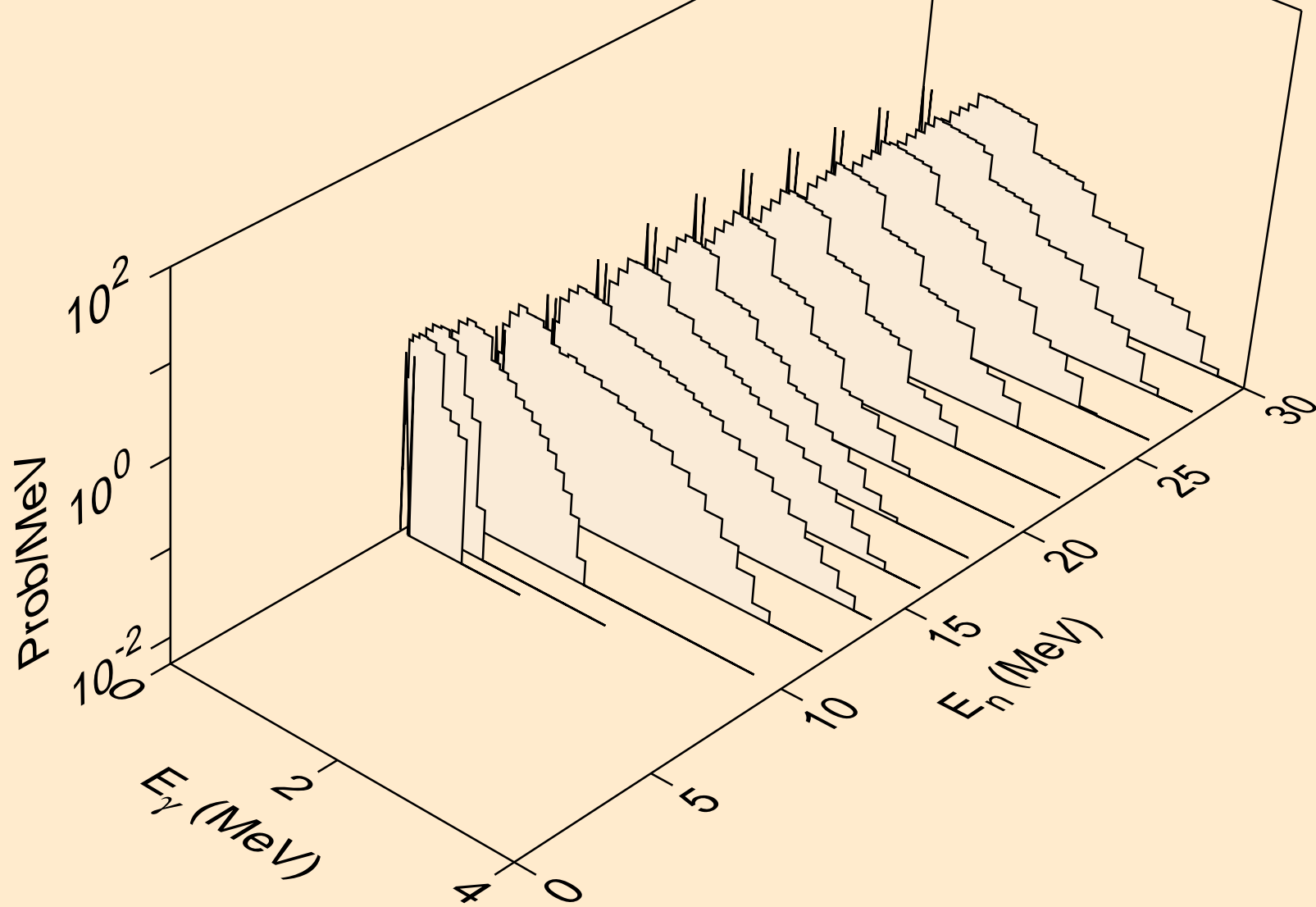

HS268 NEUTRON ACER TENDL-2021 LIBRARY; T=293.6K
Photon emission for (n,n*)d

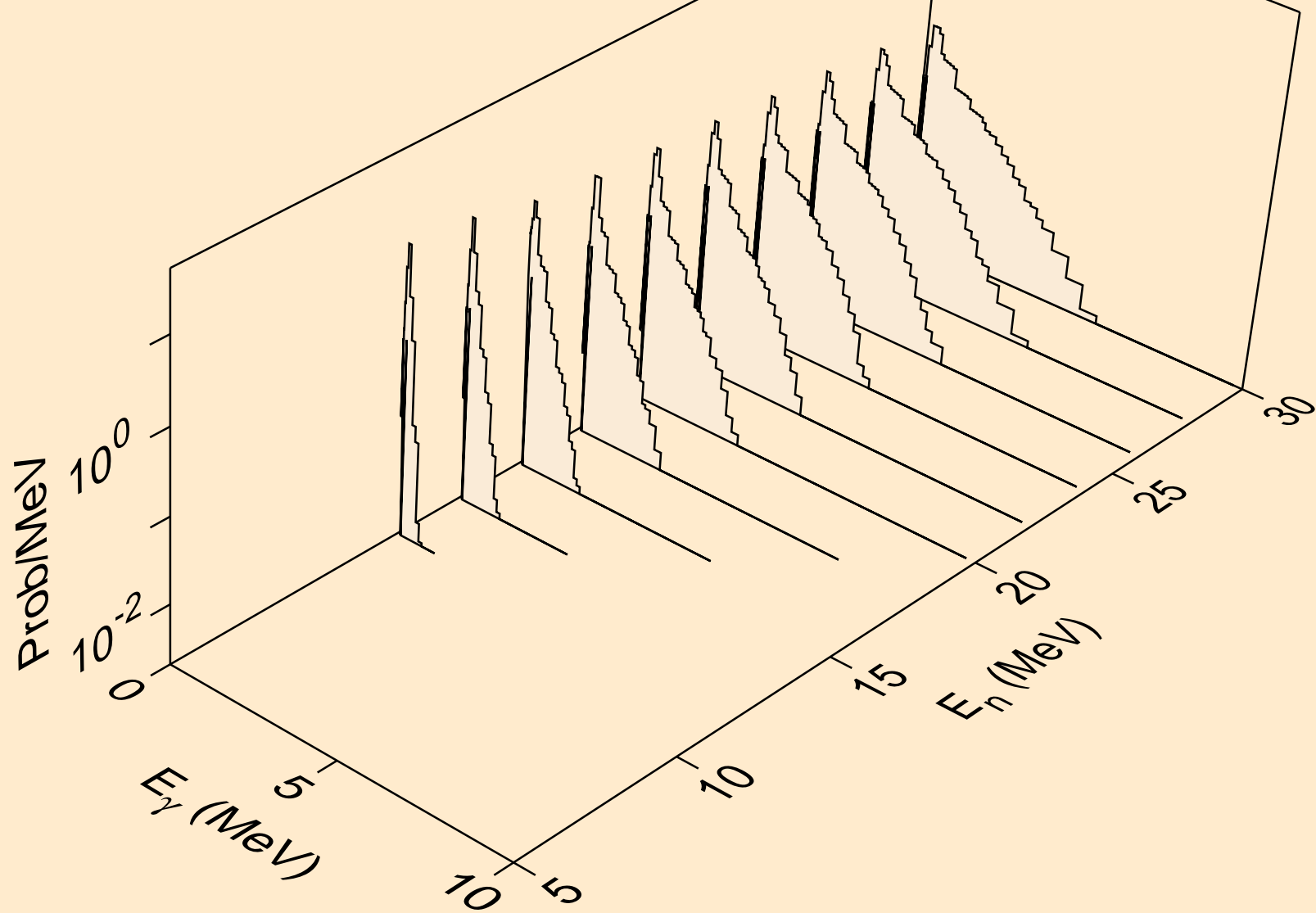

HS268 NEUTRON ACER TENDL-2021 LIBRARY; T=293.6K
Photon emission for (n,n*)t

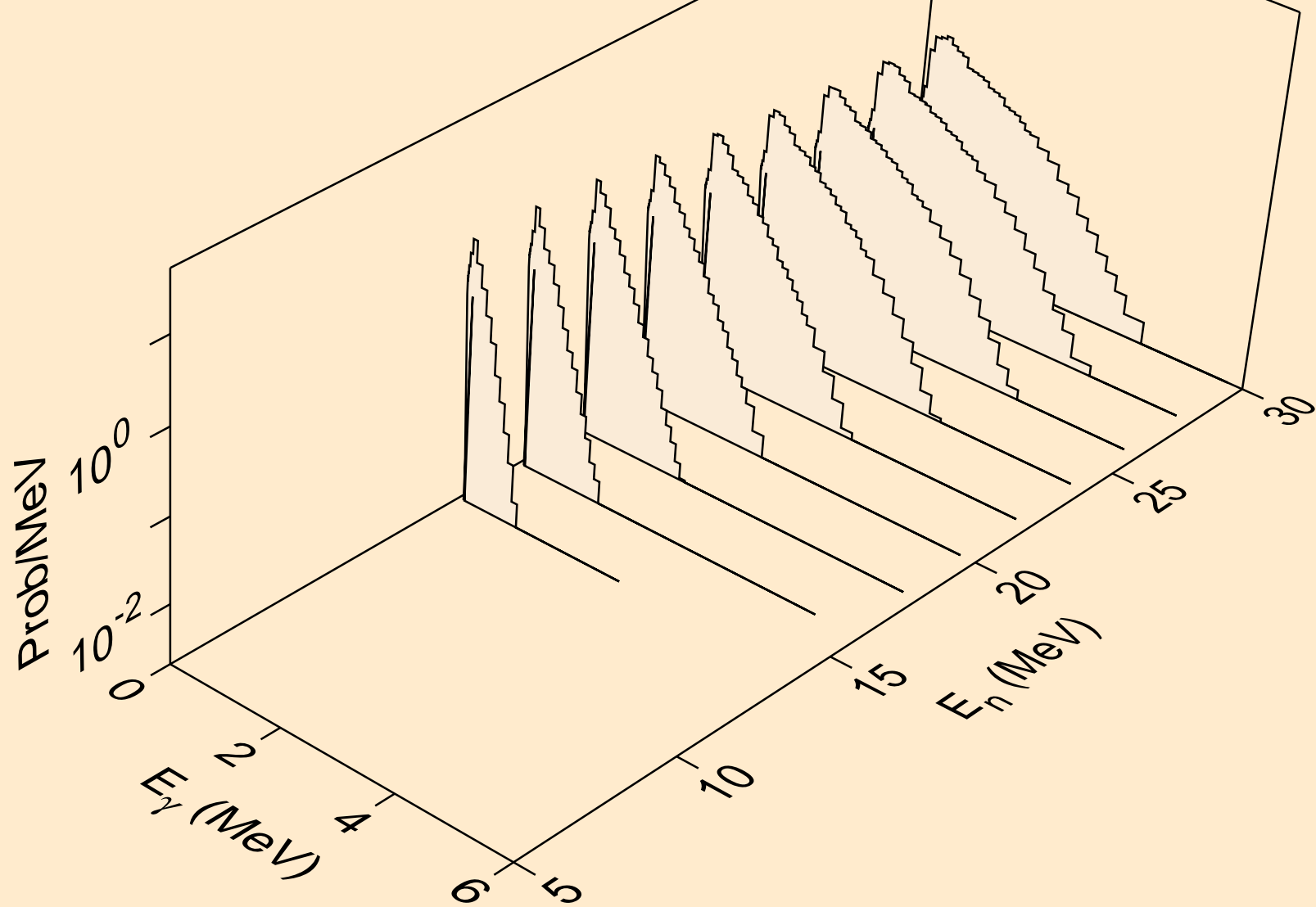

HS268 NEUTRON ACER TENDL-2021 LIBRARY; T=293.6K
Photon emission for (n,n*)he3

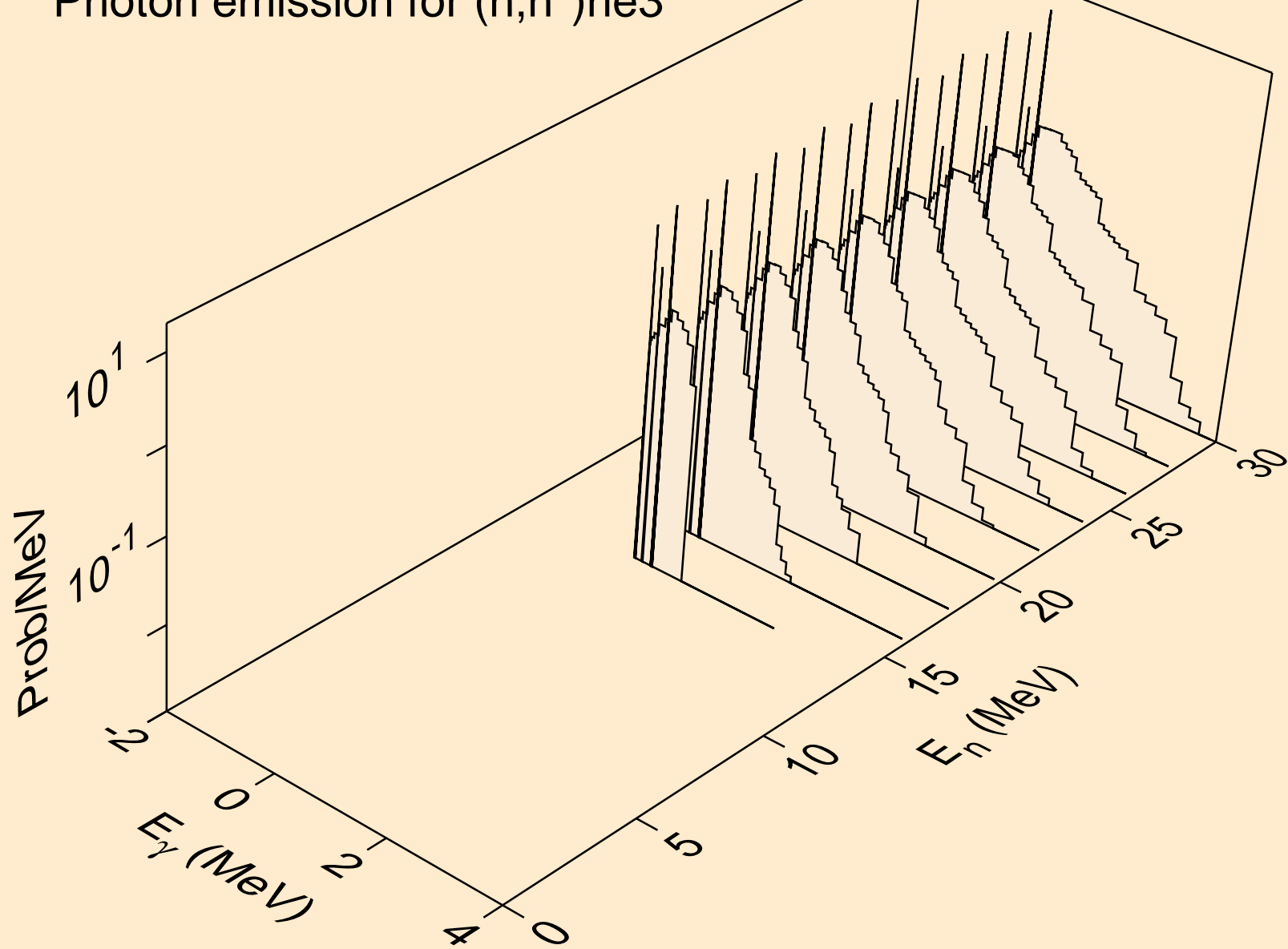

HS268 NEUTRON ACER TENDL-2021 LIBRARY; T=293.6K
Photon emission for (n,4n)

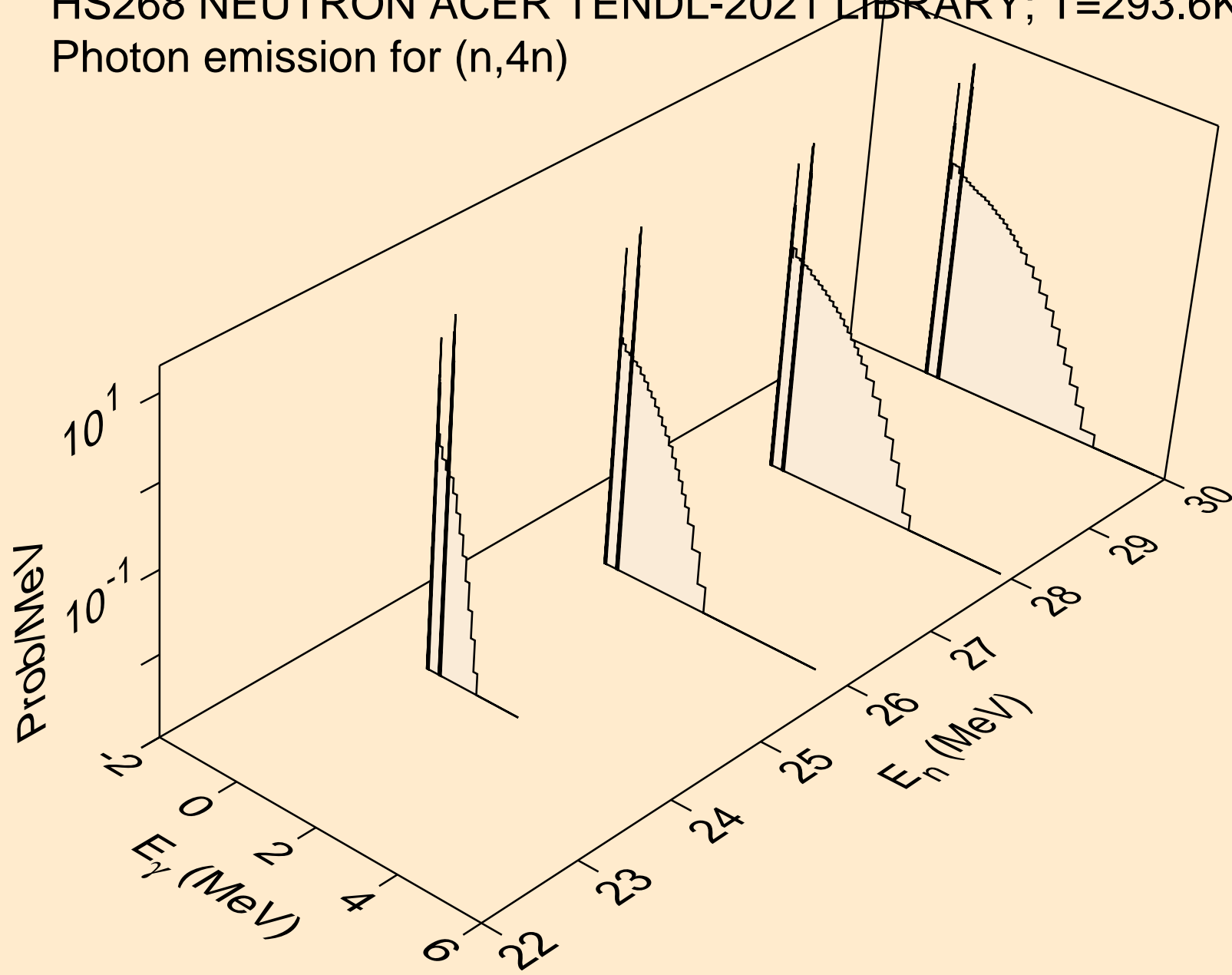

HS268 NEUTRON ACER TENDL-2021 LIBRARY; T=293.6K
Photon emission for (n,2np)

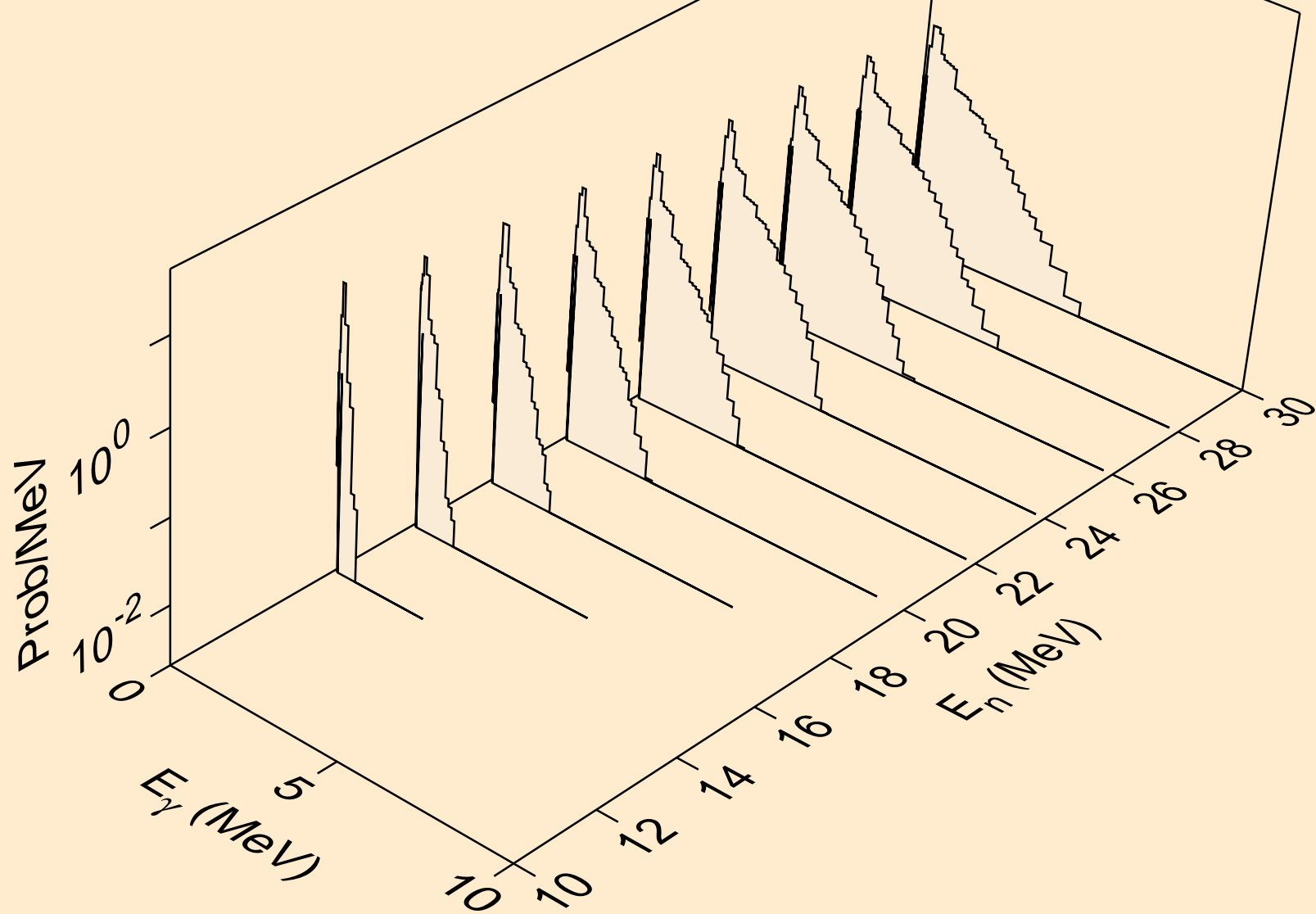

HS268 NEUTRON ACER TENDL-2021 LIBRARY; T=293.6K
Photon emission for (n,3np)

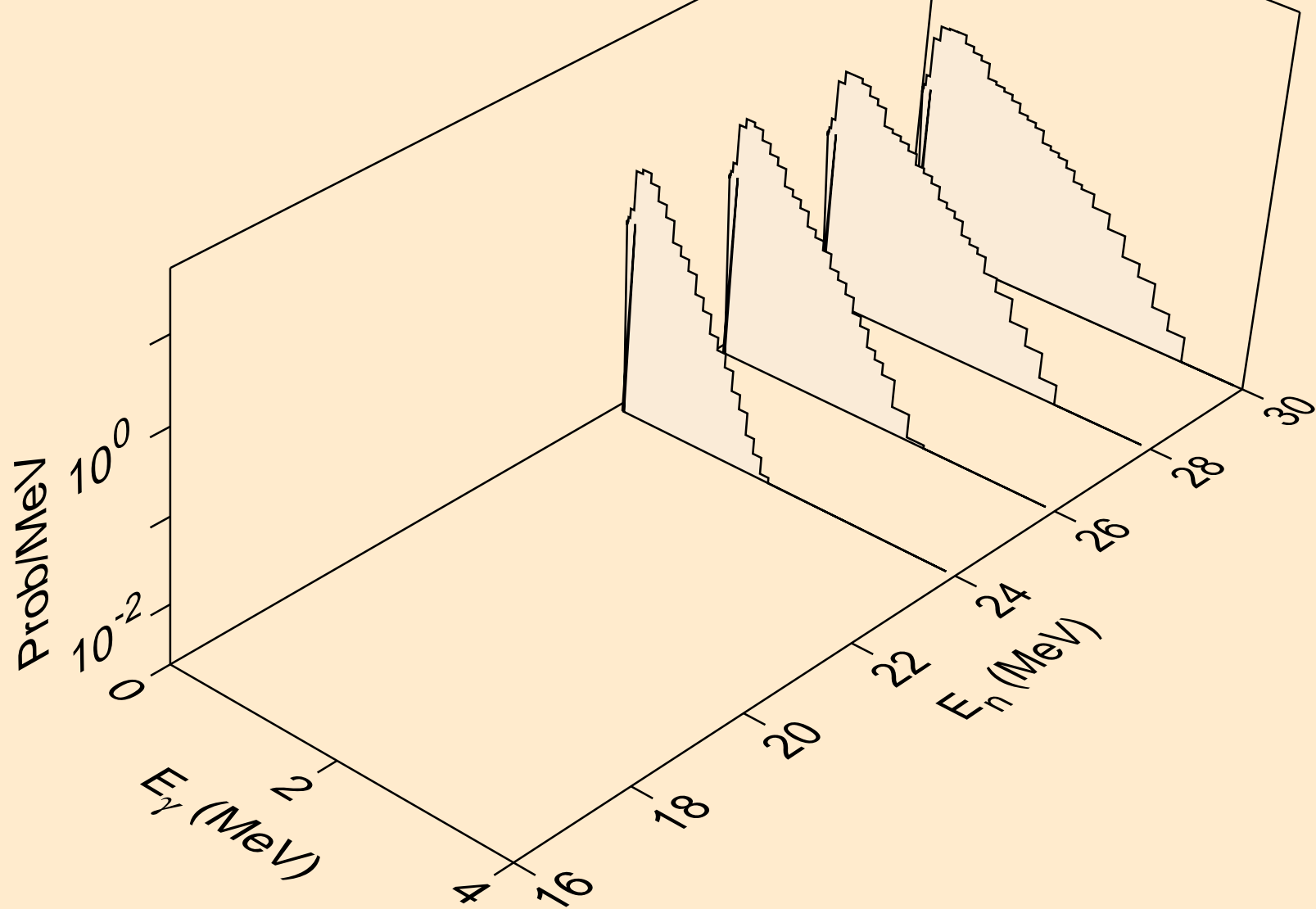

HS268 NEUTRON ACER TENDL-2021 LIBRARY; T=293.6K
Photon emission for (n,2np)

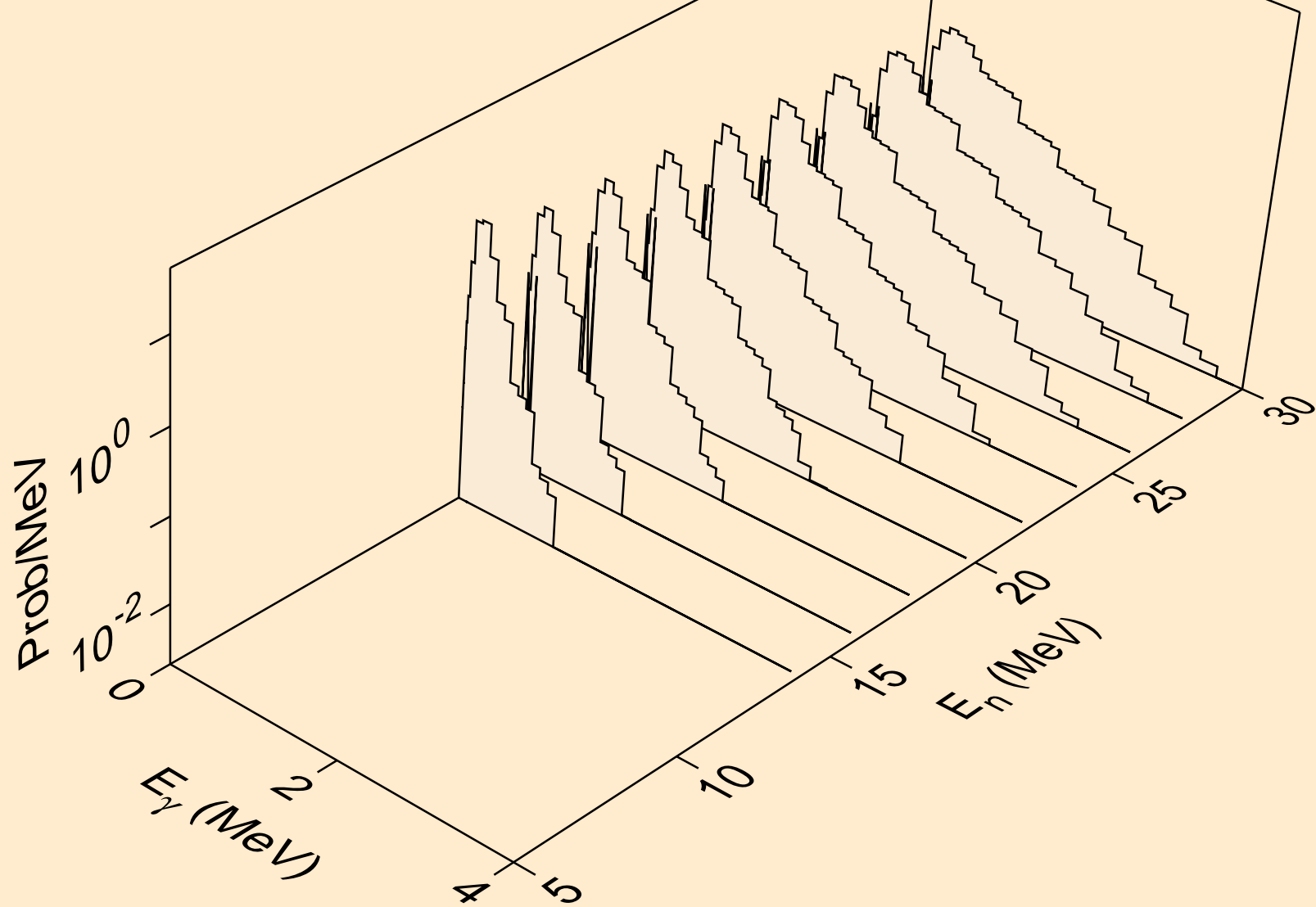

HS268 NEUTRON ACER TENDL-2021 LIBRARY; T=293.6K
Photon emission for (n,npa)

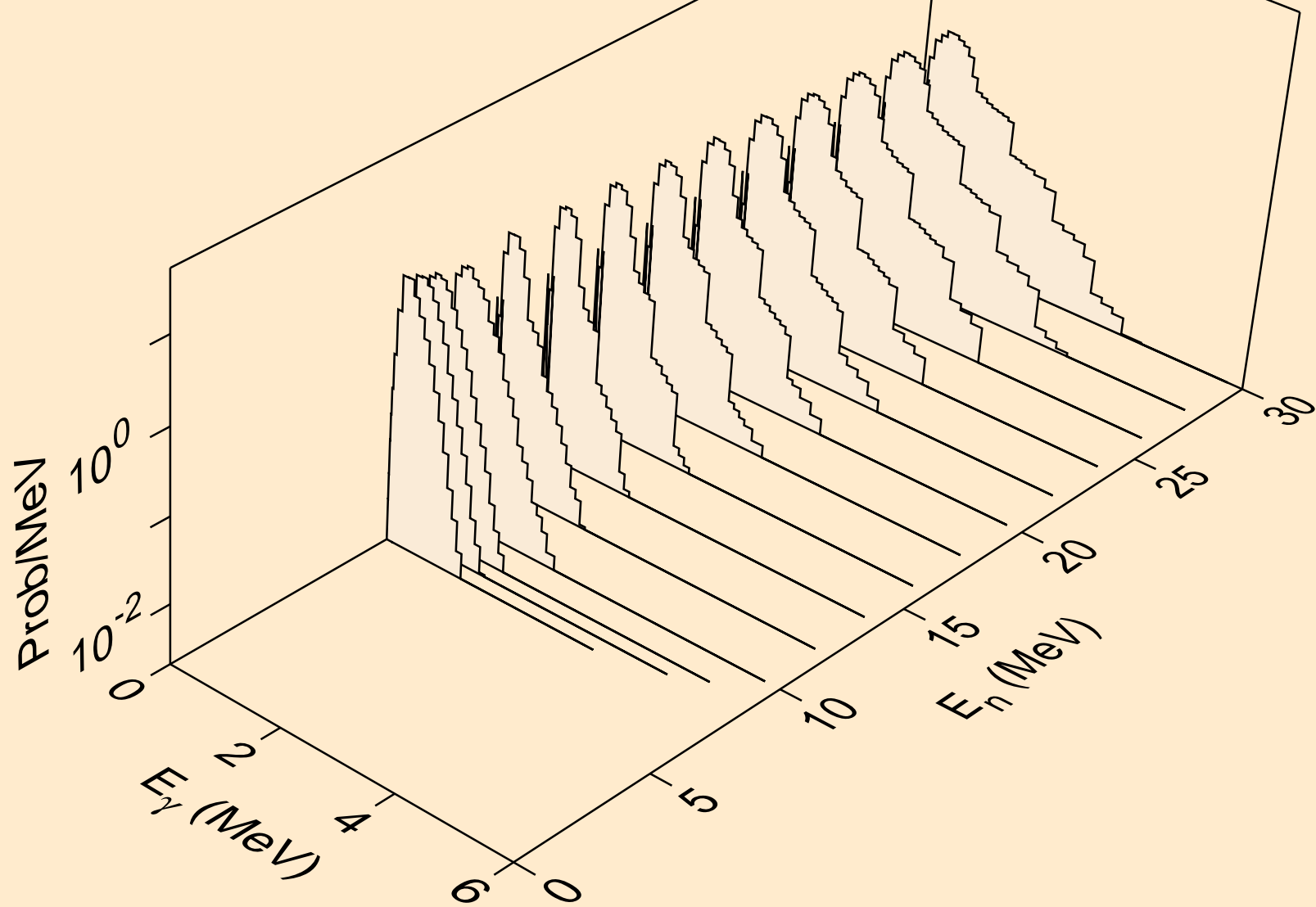

HS268 NEUTRON ACER TENDL-2021 LIBRARY; T=293.6K
Photon emission for (n,n*c)

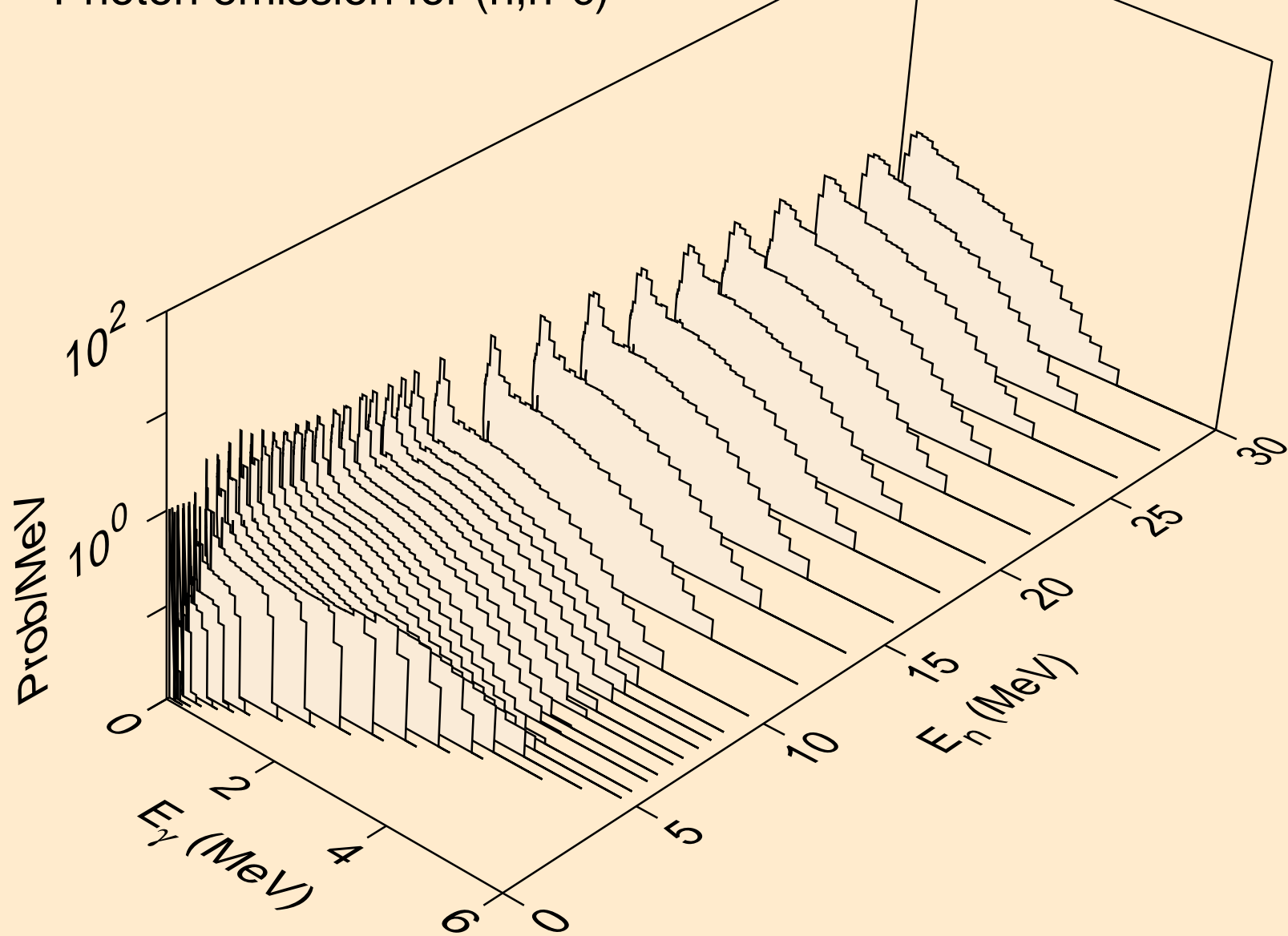

HS268 NEUTRON ACER TENDL-2021 LIBRARY; T=293.6K
Photon emission for (n,gma)

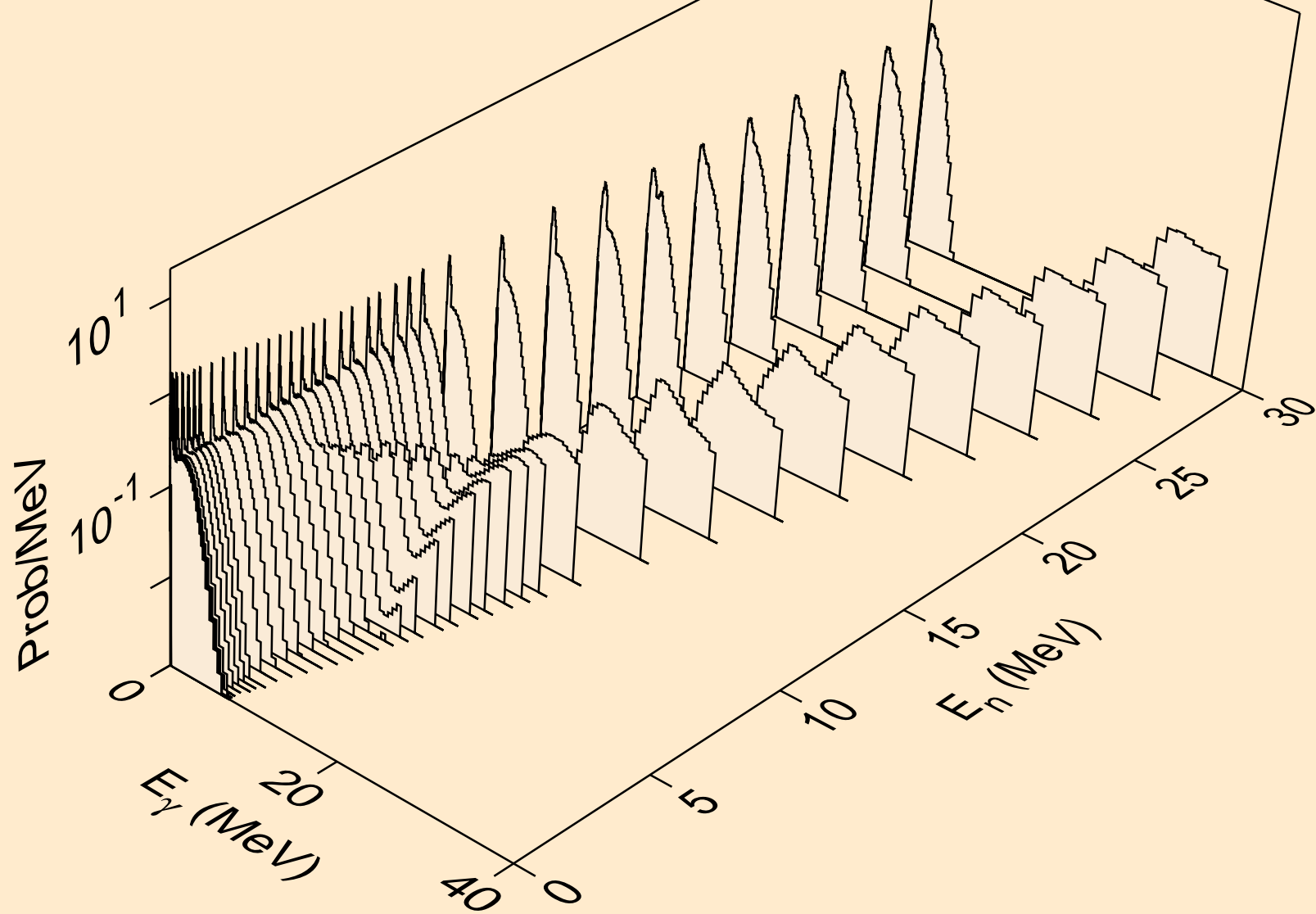

HS268 NEUTRON ACER TENDL-2021 LIBRARY; T=293.6K
Photon emission for (n,p)

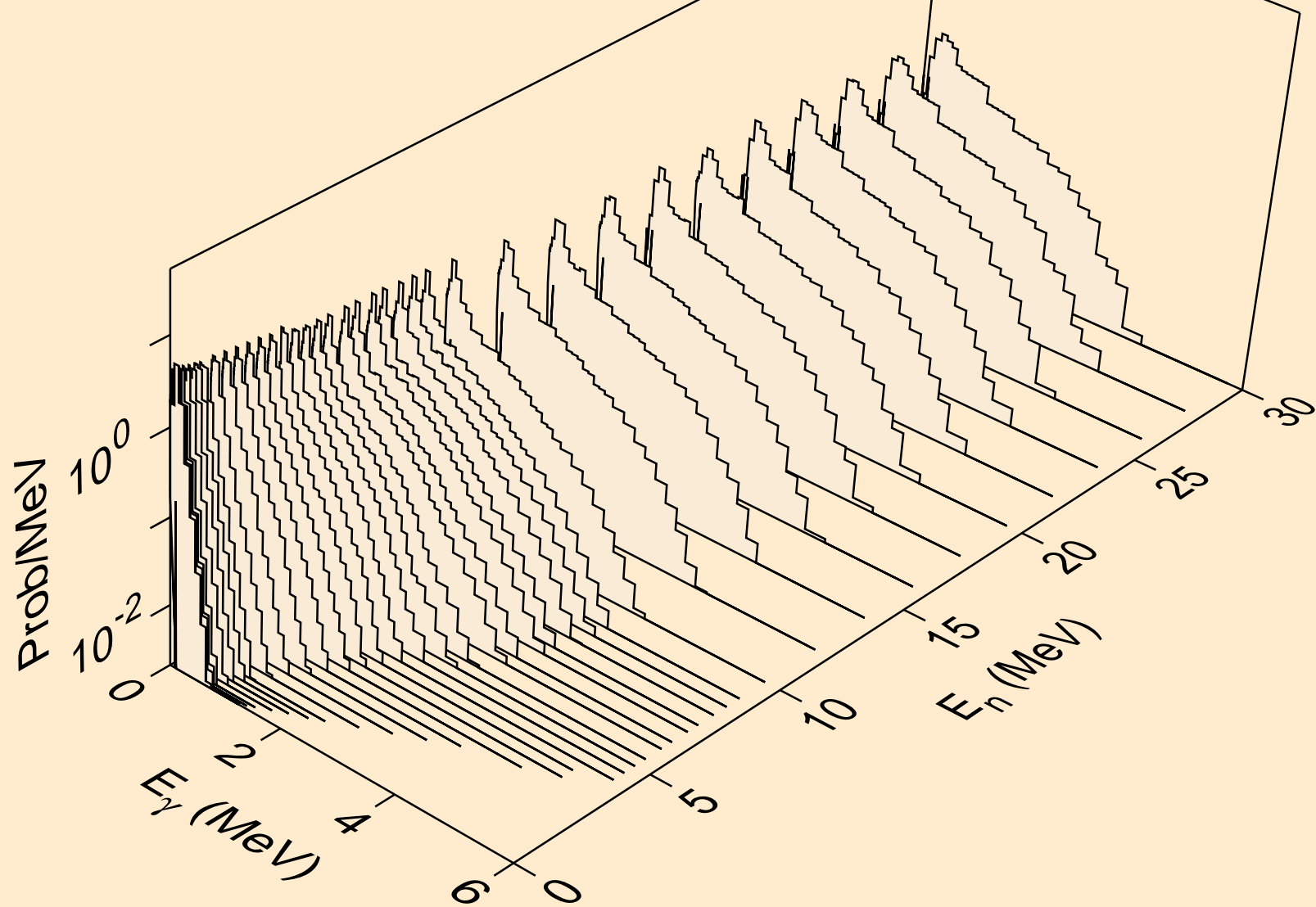

HS268 NEUTRON ACER TENDL-2021 LIBRARY; T=293.6K
Photon emission for (n,d)

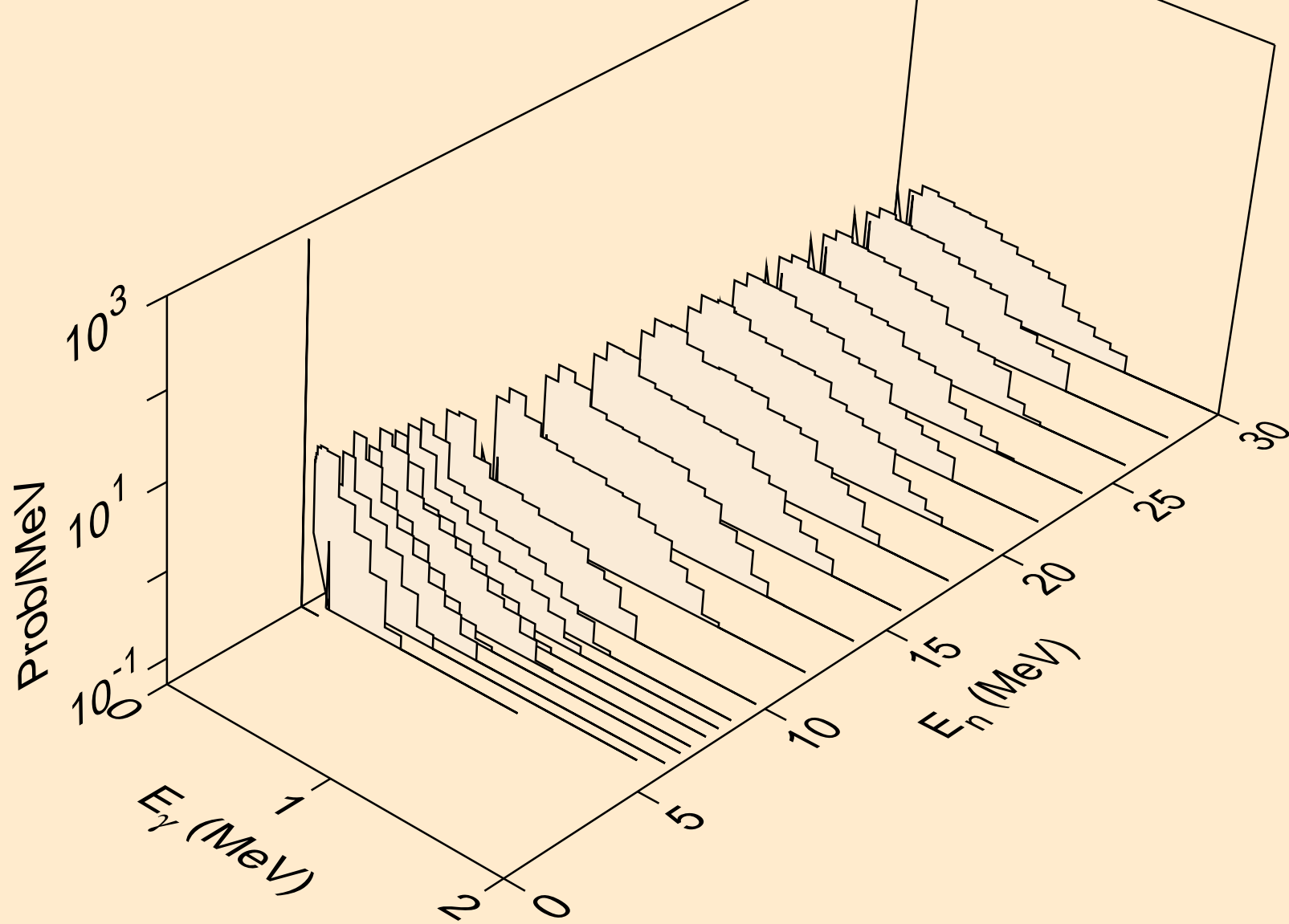

HS268 NEUTRON ACER TENDL-2021 LIBRARY; T=293.6K
Photon emission for (n,t)

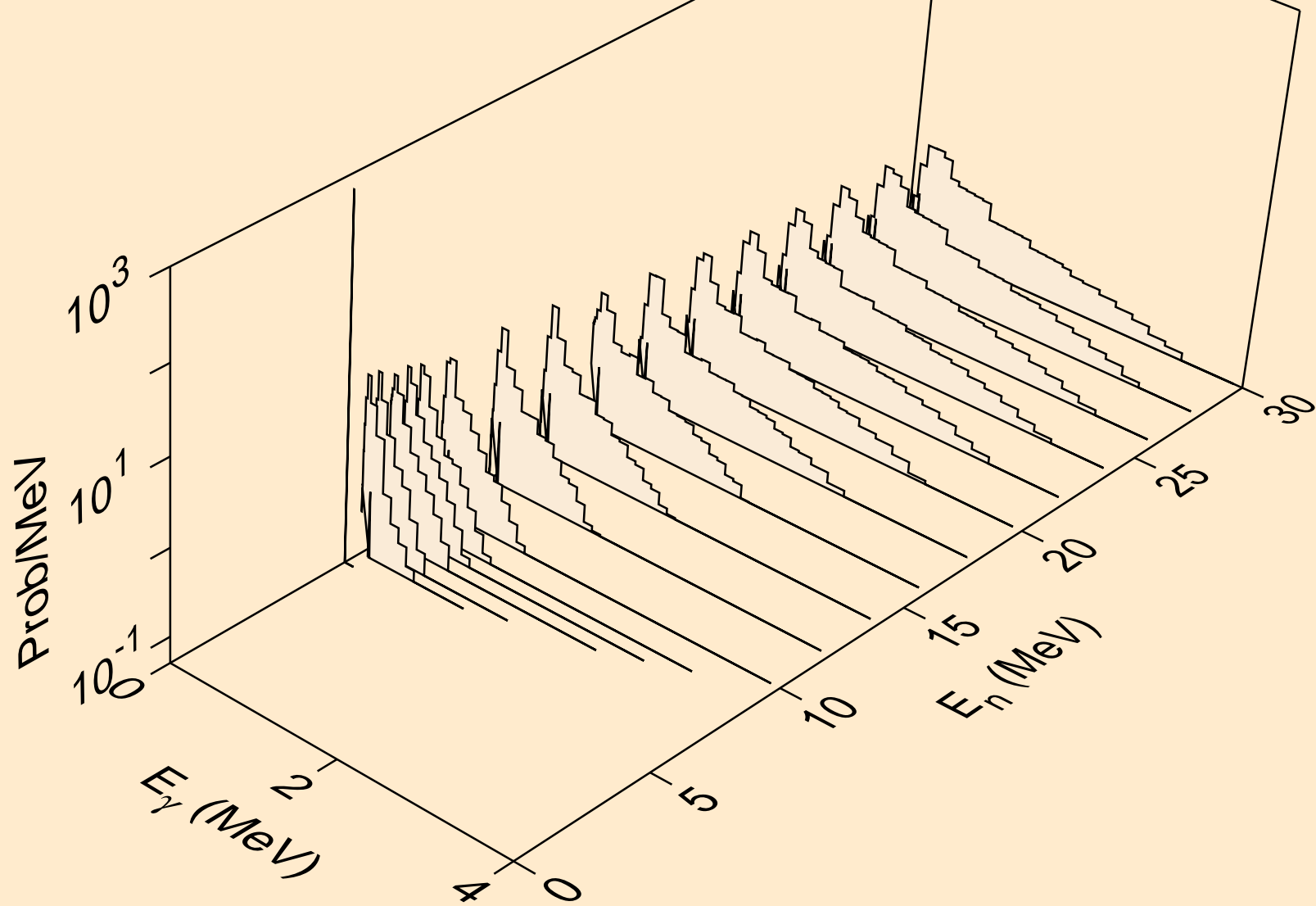

HS268 NEUTRON ACER TENDL-2021 LIBRARY; T=293.6K
Photon emission for (n,he3)

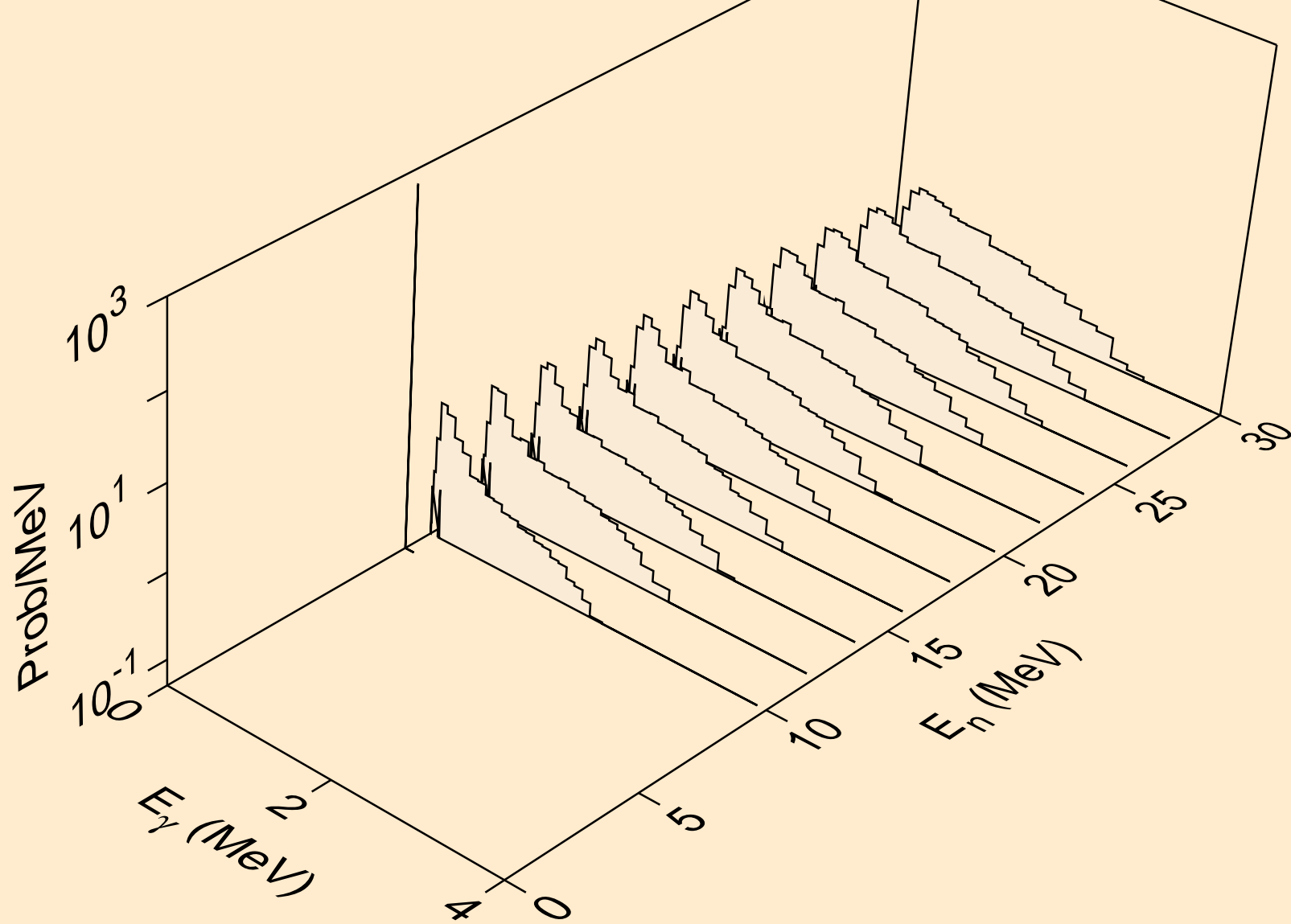

HS268 NEUTRON ACER TENDL-2021 LIBRARY; T=293.6K
Photon emission for (n,a)

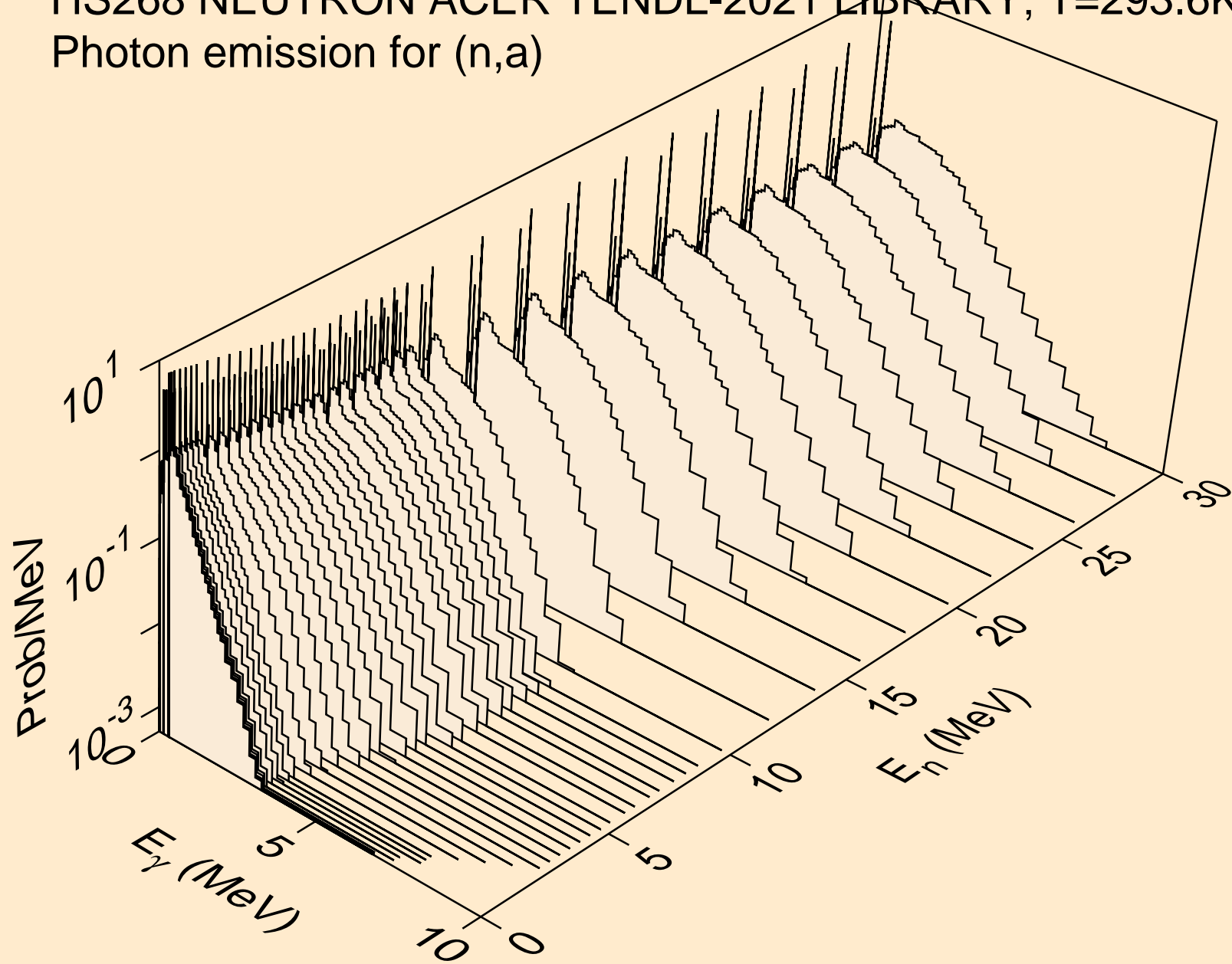

HS268 NEUTRON ACER TENDL-2021 LIBRARY; T=293.6K
Photon emission for (n,2a)

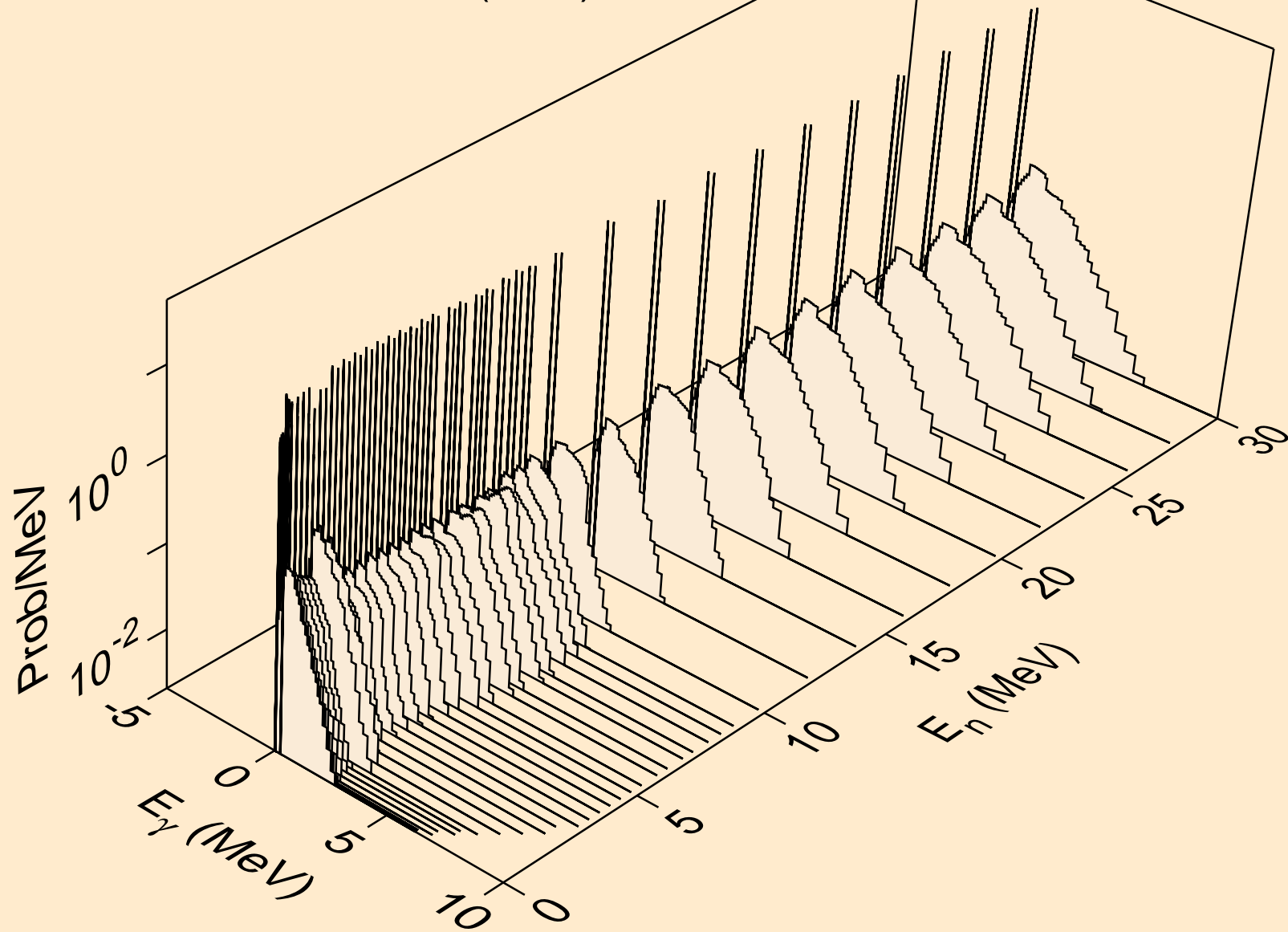

HS268 NEUTRON ACER TENDL-2021 LIBRARY; T=293.6K
Photon emission for (n,2p)

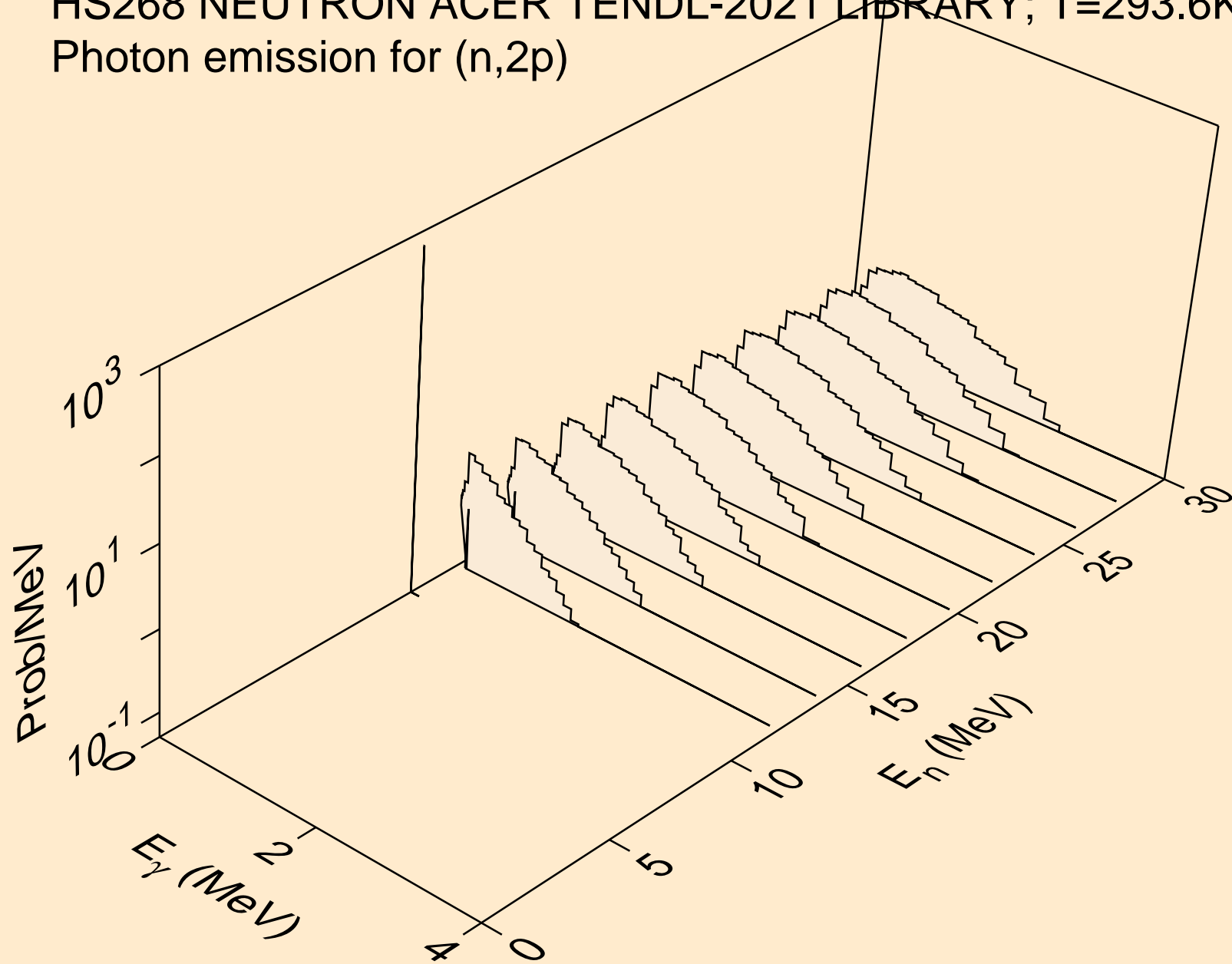

HS268 NEUTRON ACER TENDL-2021 LIBRARY; T=293.6K
Photon emission for (n,p)

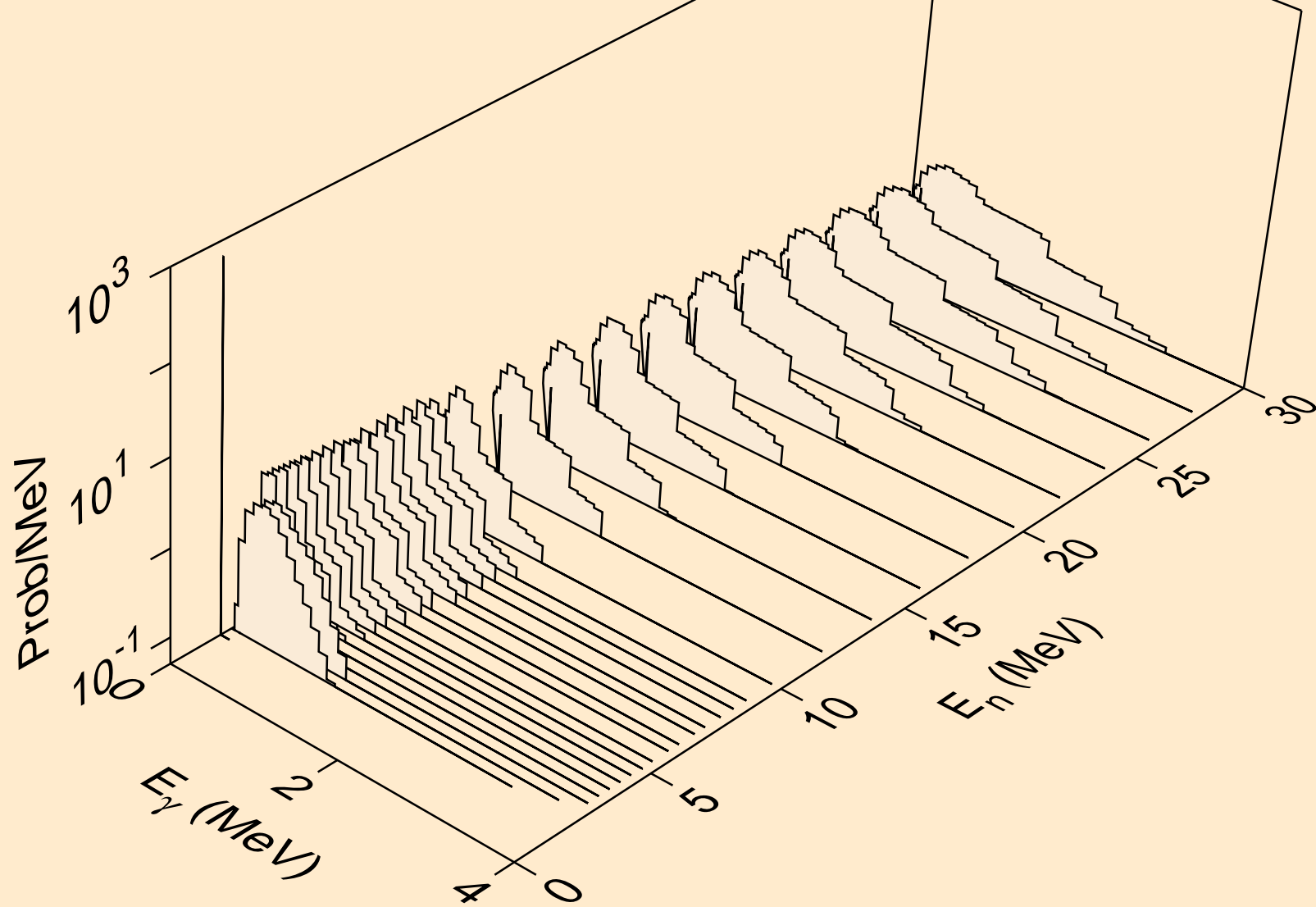

HS268 NEUTRON ACER TENDL-2021 LIBRARY; T=293.6K
Photon emission for (n,pd)

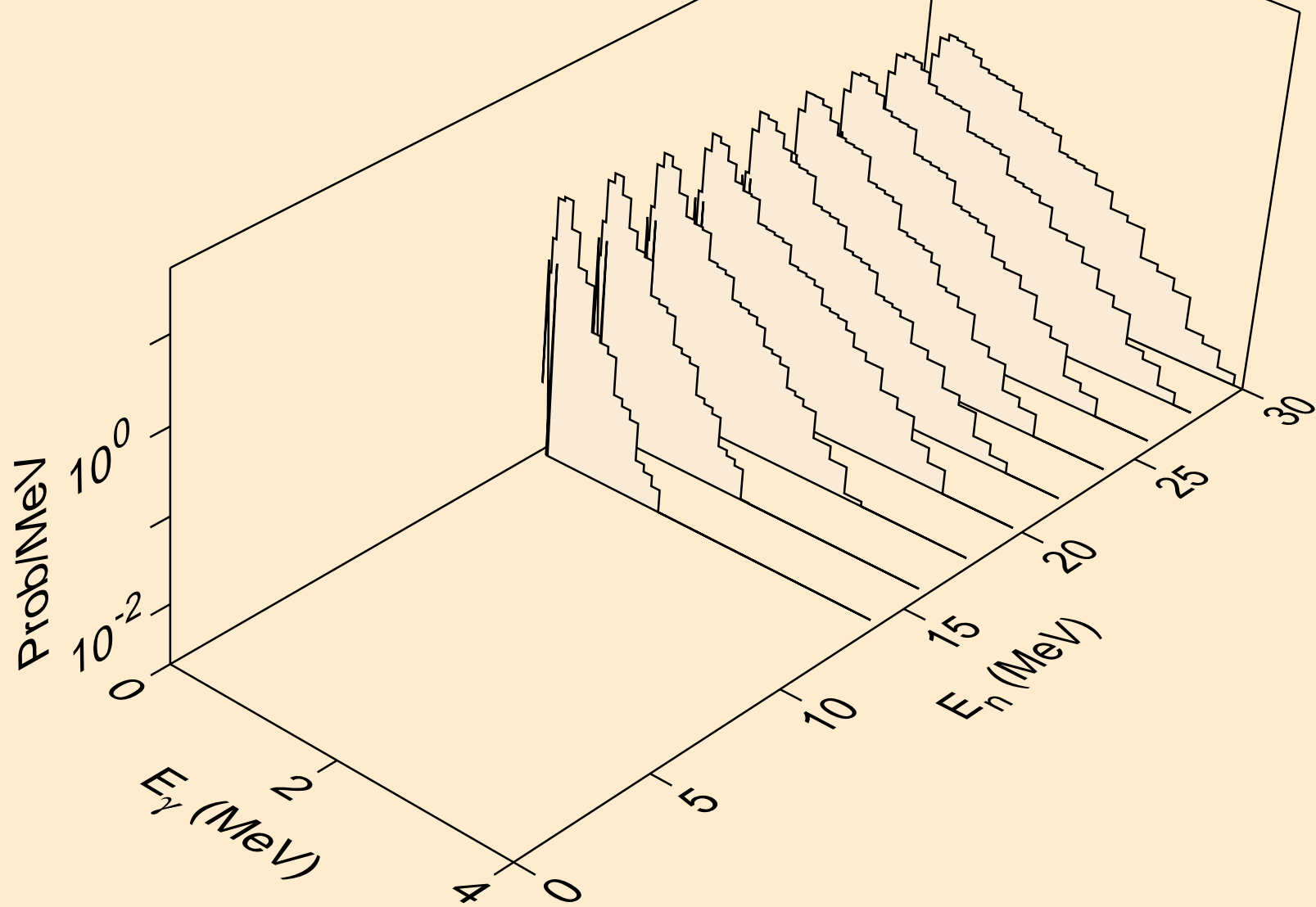

HS268 NEUTRON ACER TENDL-2021 LIBRARY; T=293.6K
Photon emission for (n,pt)

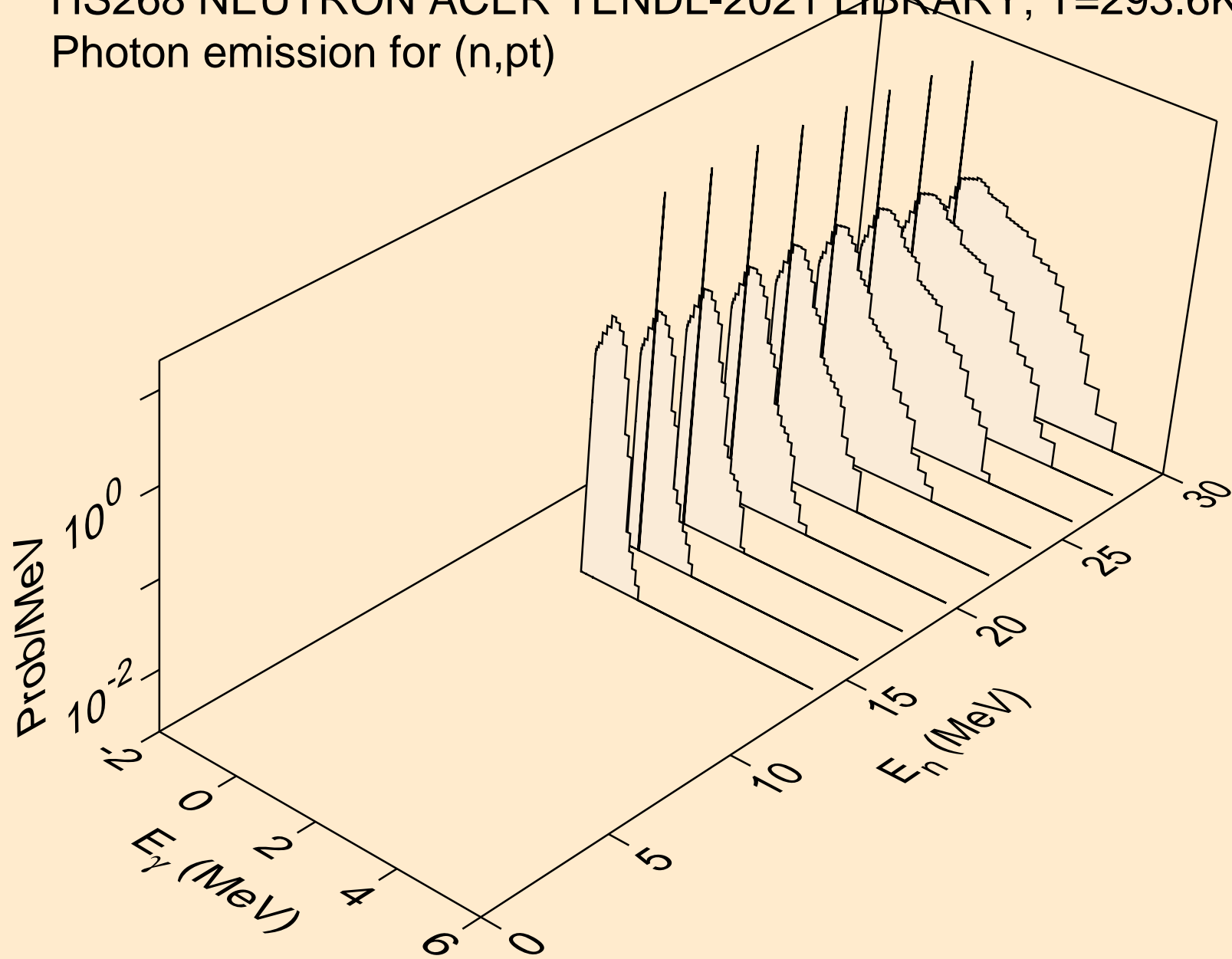

HS268 NEUTRON ACER TENDL-2021 LIBRARY; T=293.6K
thermal capture photon spectrum

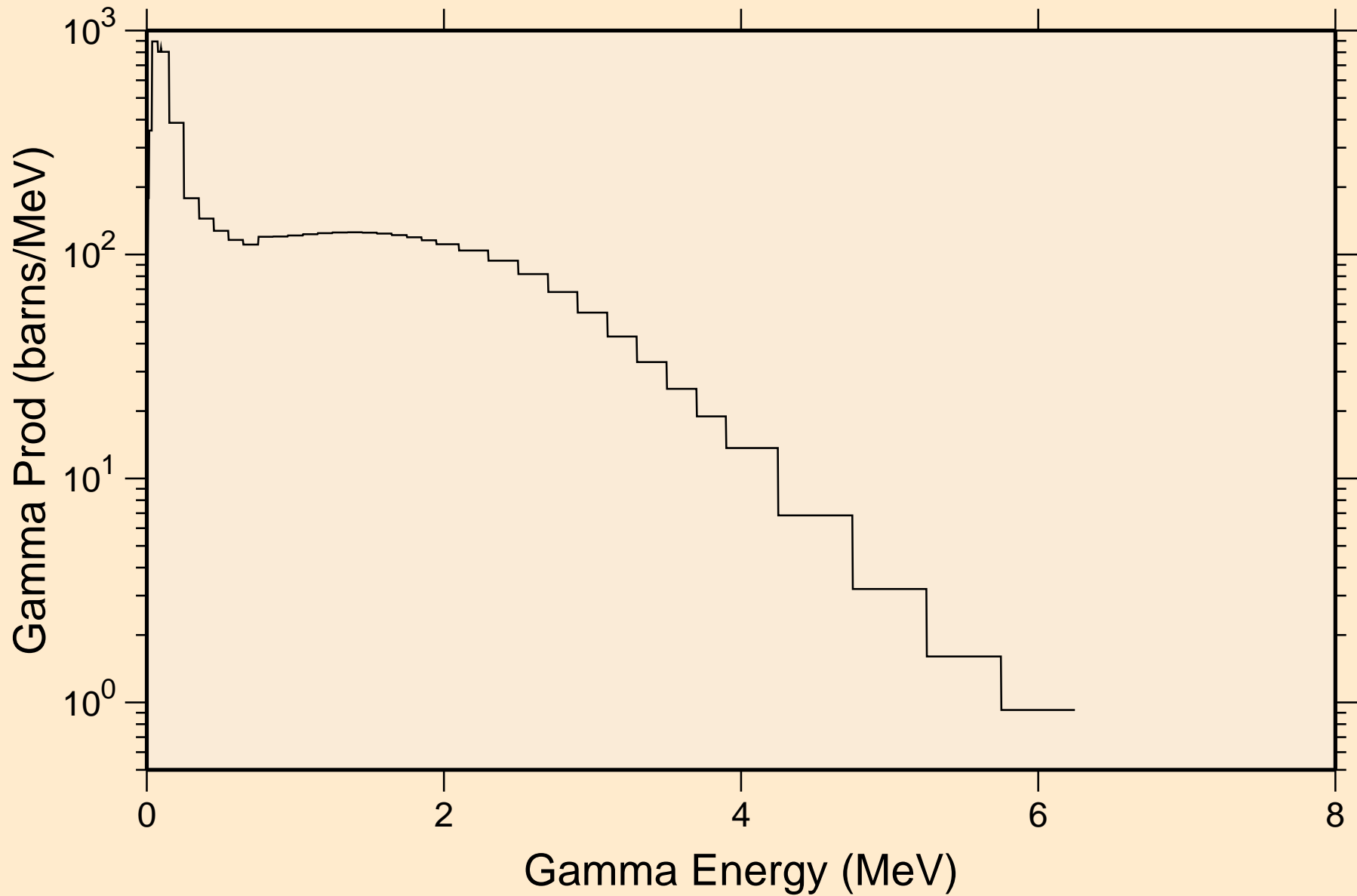

HS268 NEUTRON ACER TENDL-2021 LIBRARY; T=293.6K
14 MeV photon spectrum

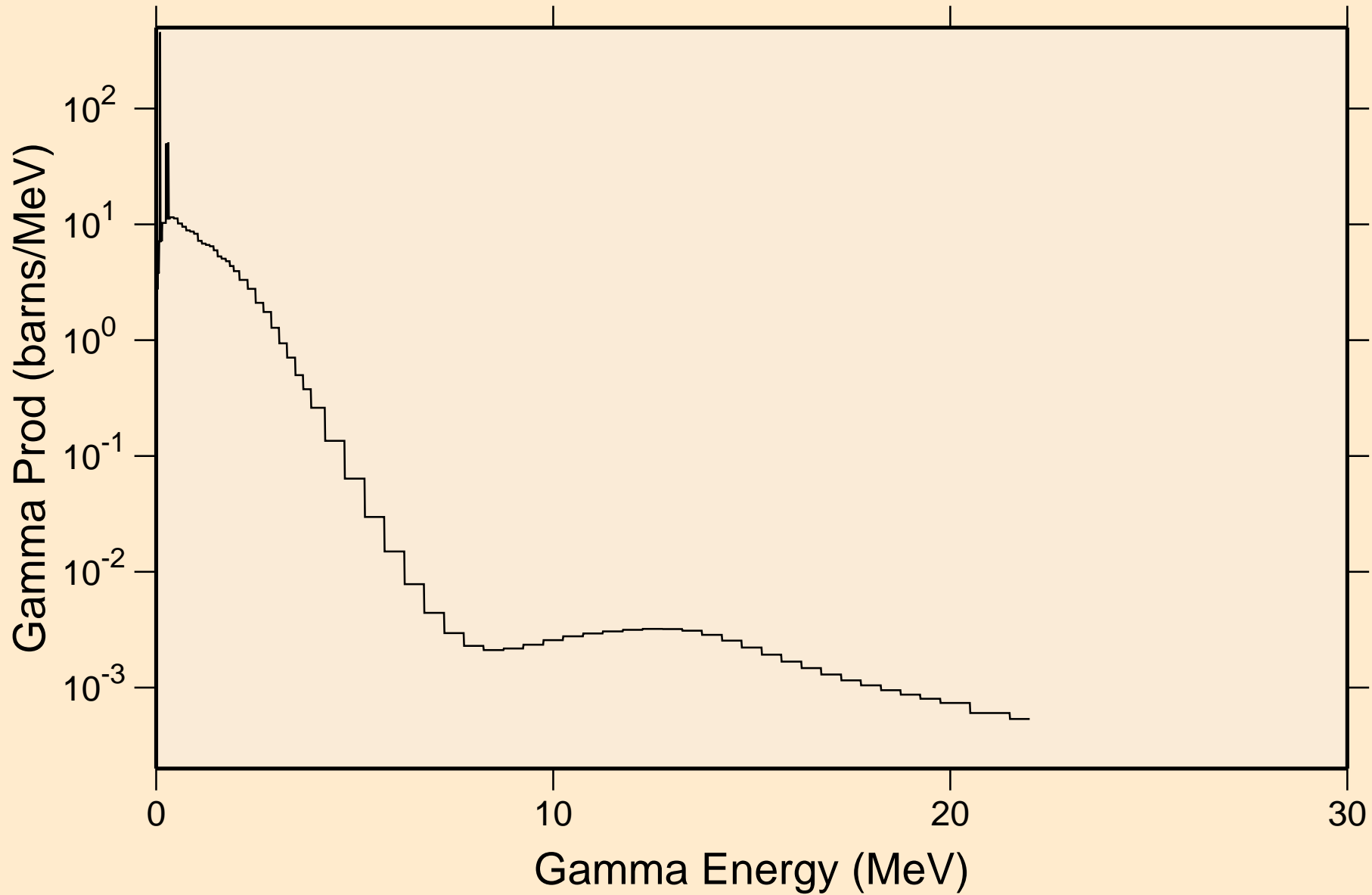

HS268 NEUTRON ACER TENDL-2021 LIBRARY; T=293.6K

Particle heating contributions

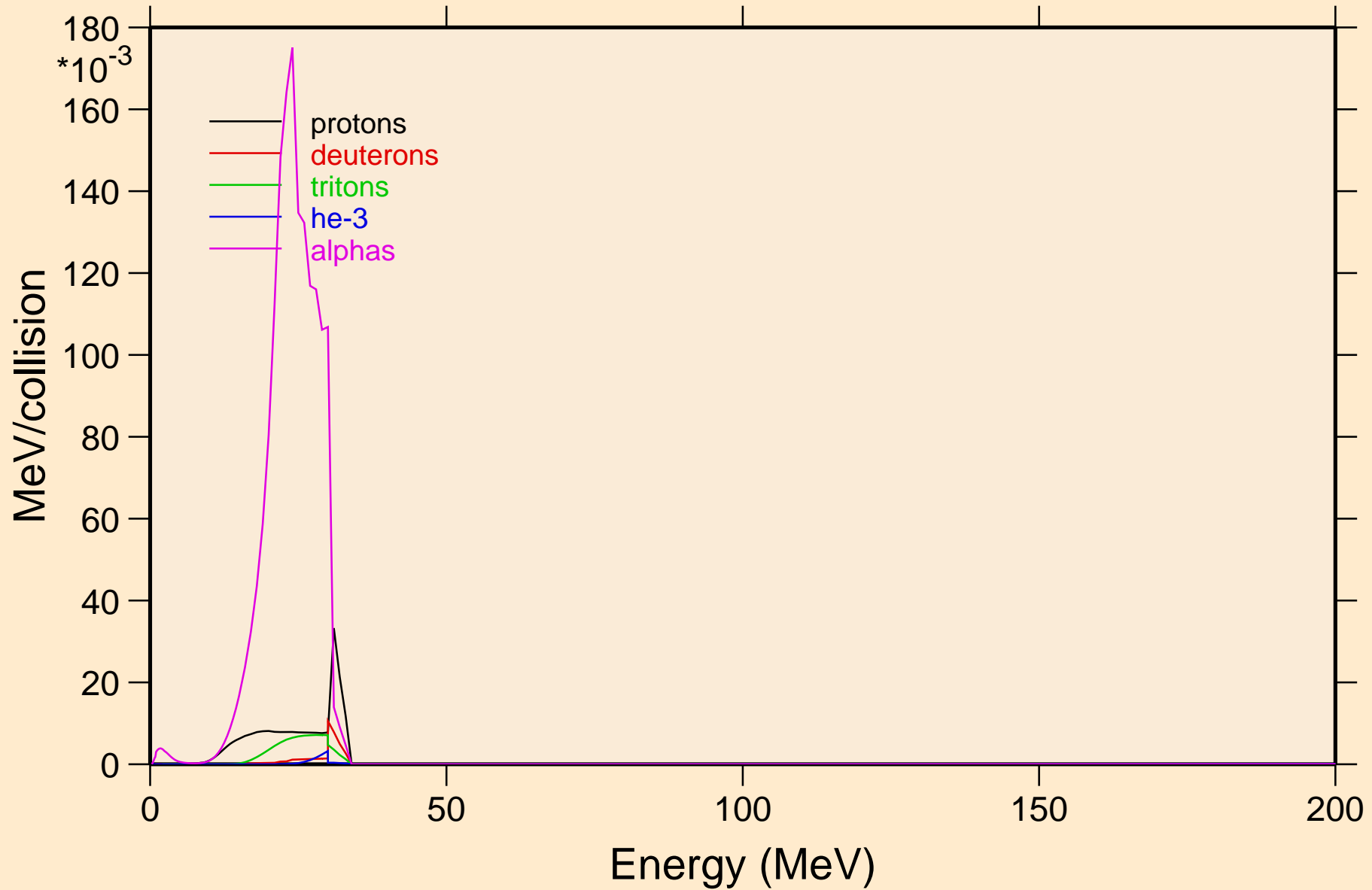

HS268 NEUTRON ACER TENDL-2021 LIBRARY; T=293.6K
Recoil Heating

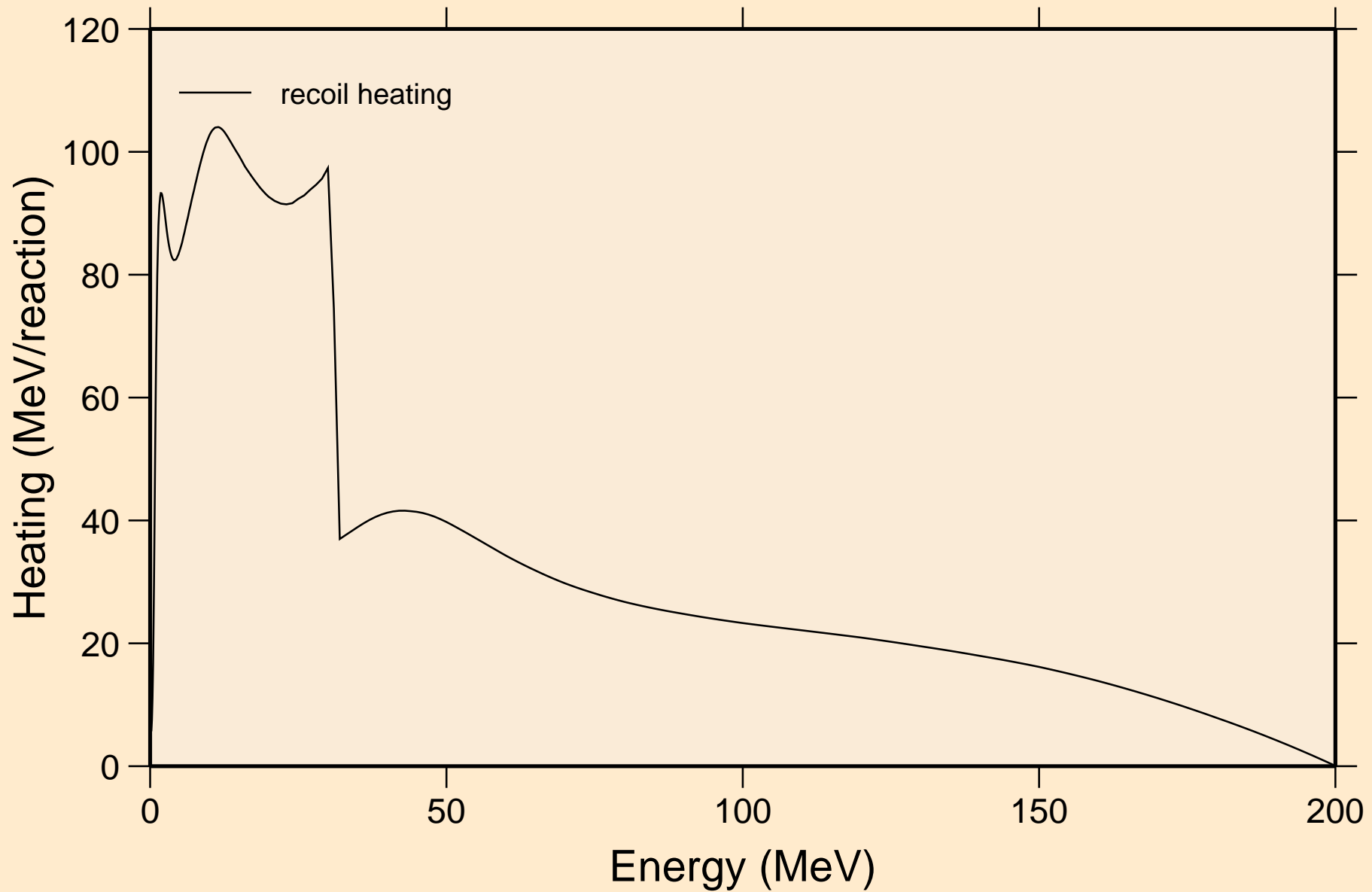

HS268 NEUTRON ACER TENDL-2021 LIBRARY; T=293.6K

Particle production cross sections

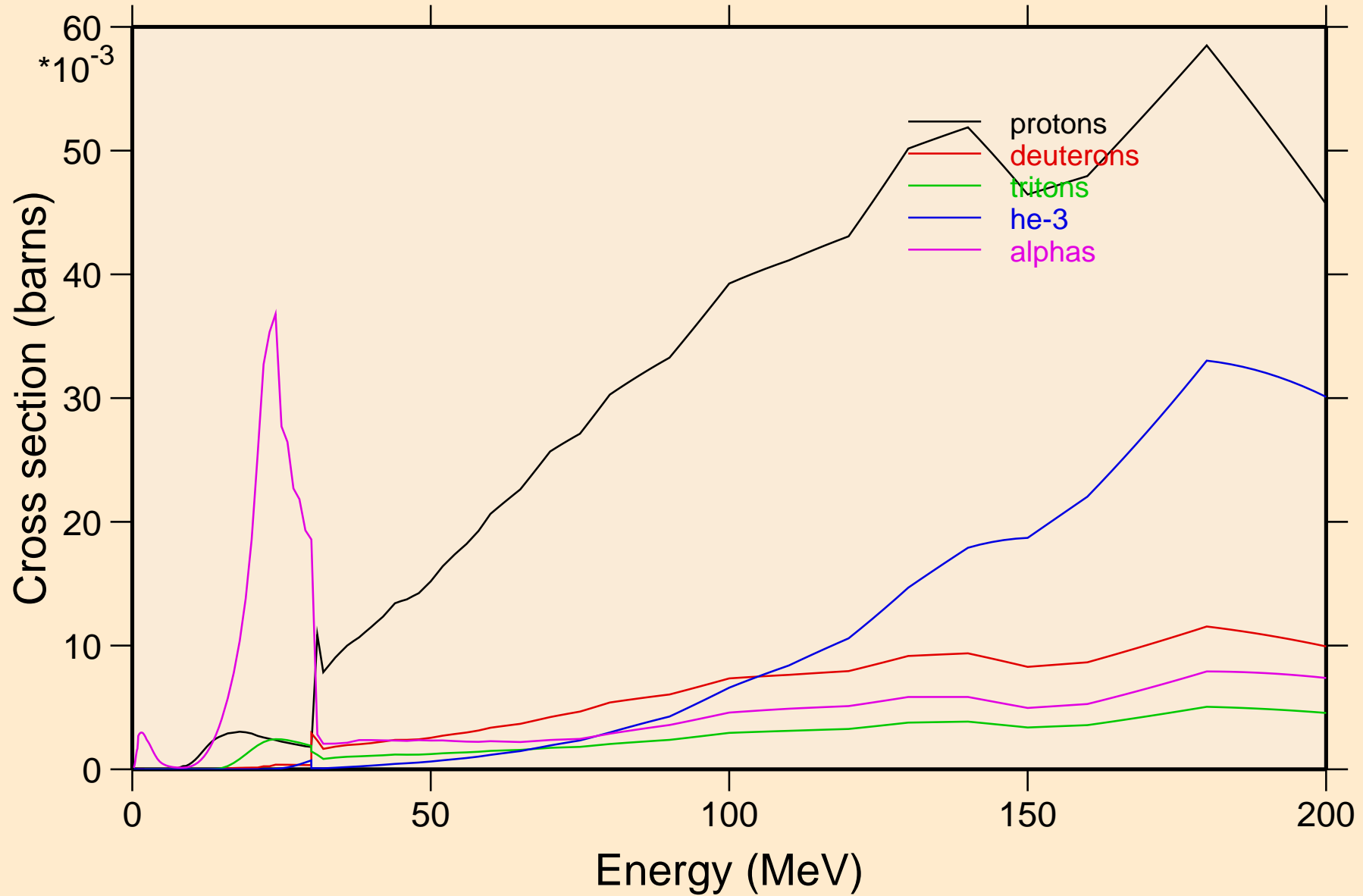

HS268 NEUTRON ACER TENDL-2021 LIBRARY; T=293.6K
protons from (n,x)

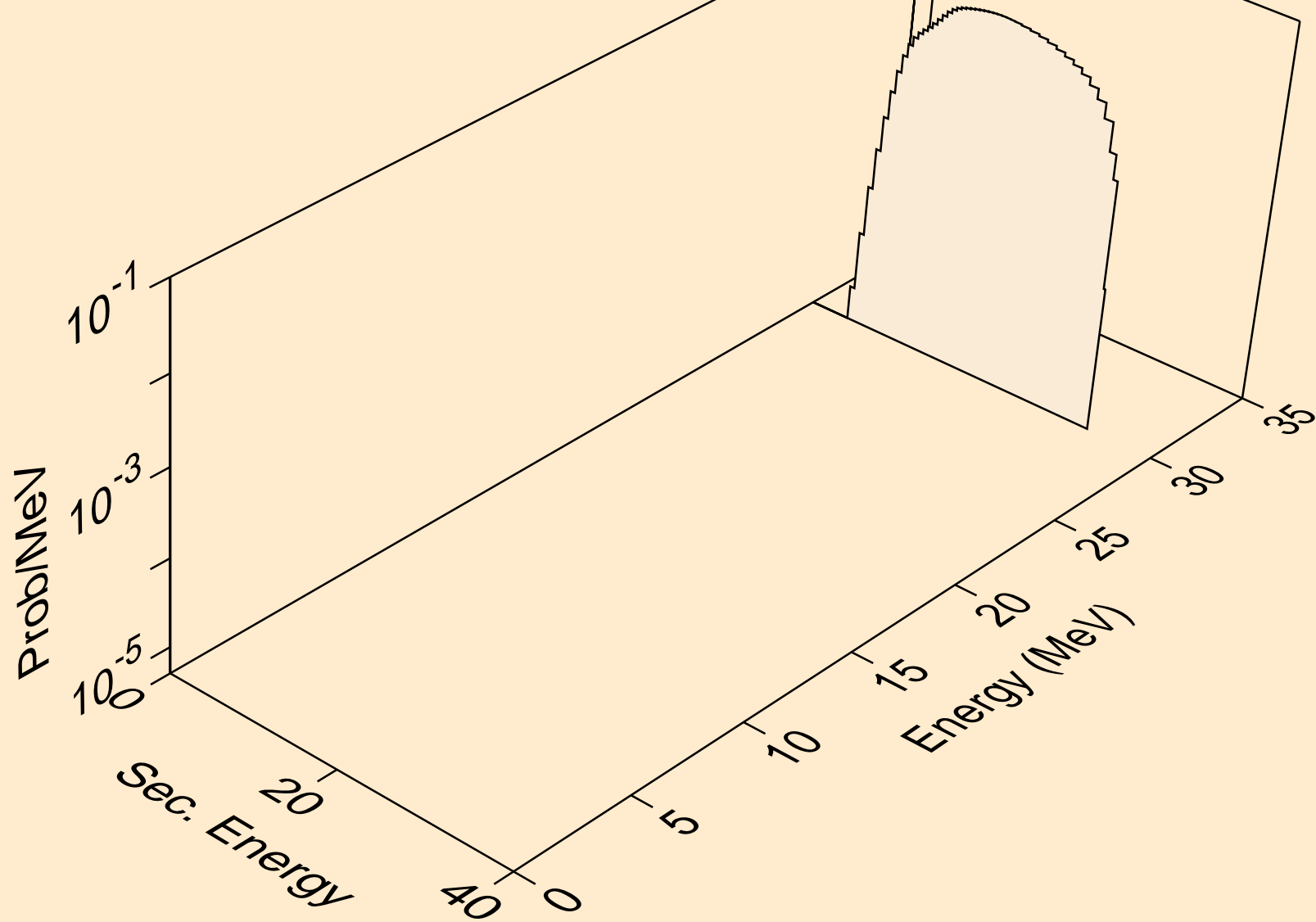

HS268 NEUTRON ACER TENDL-2021 LIBRARY; T=293.6K
protons from (n,n*)p

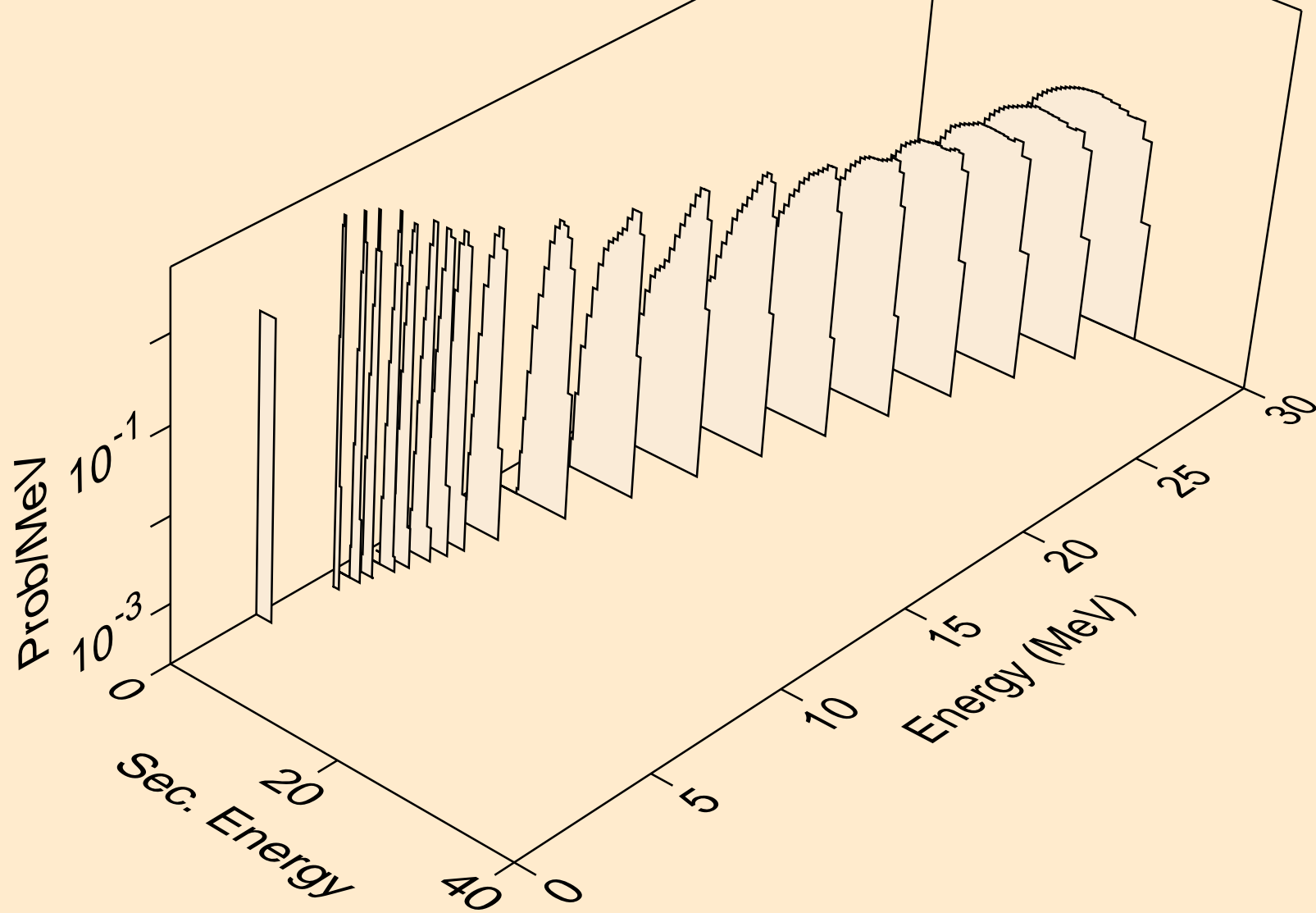

HS268 NEUTRON ACER TENDL-2021 LIBRARY; T=293.6K
protons from (n,2np)

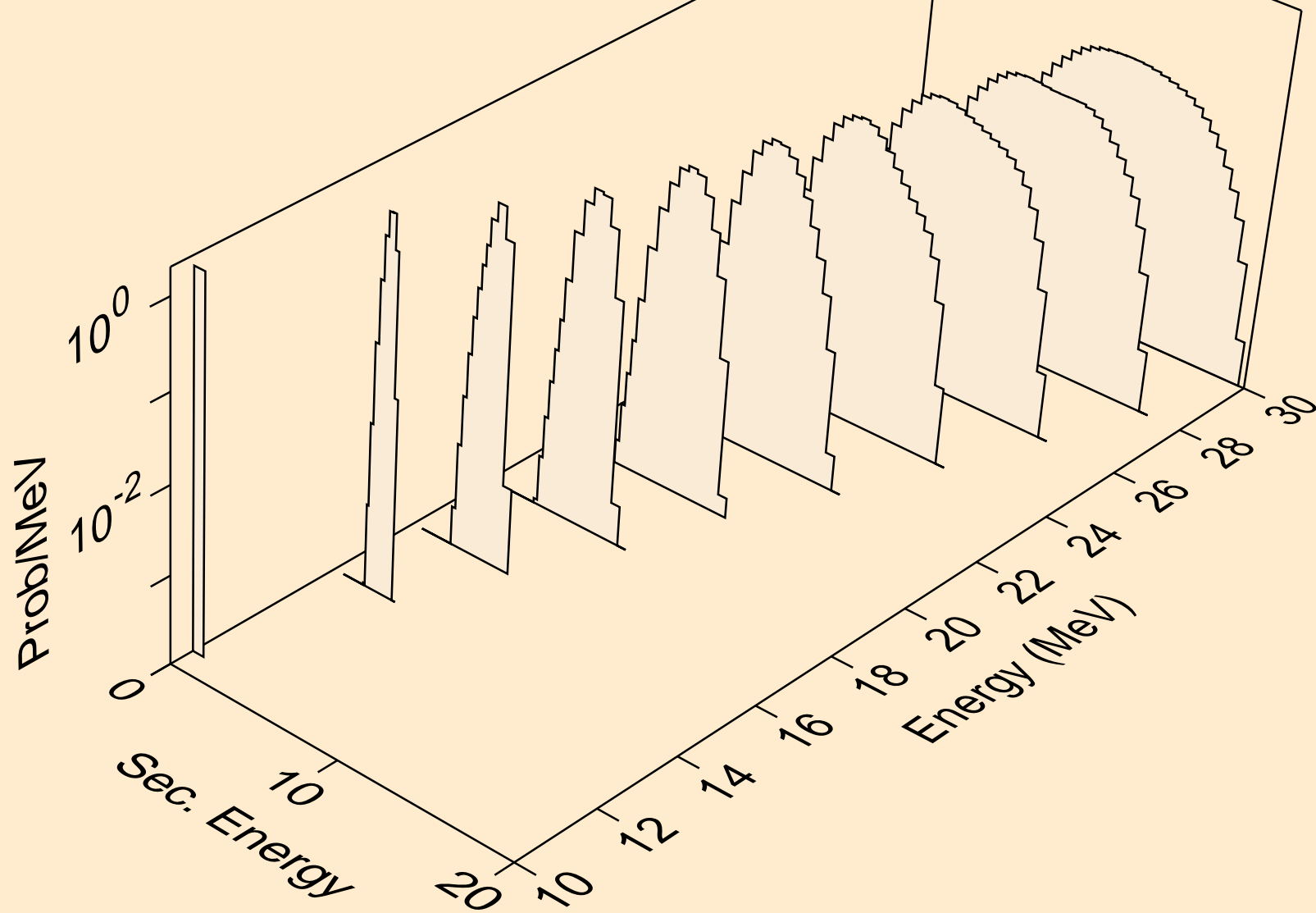

HS268 NEUTRON ACER TENDL-2021 LIBRARY; T=293.6K
protons from (n,3np)

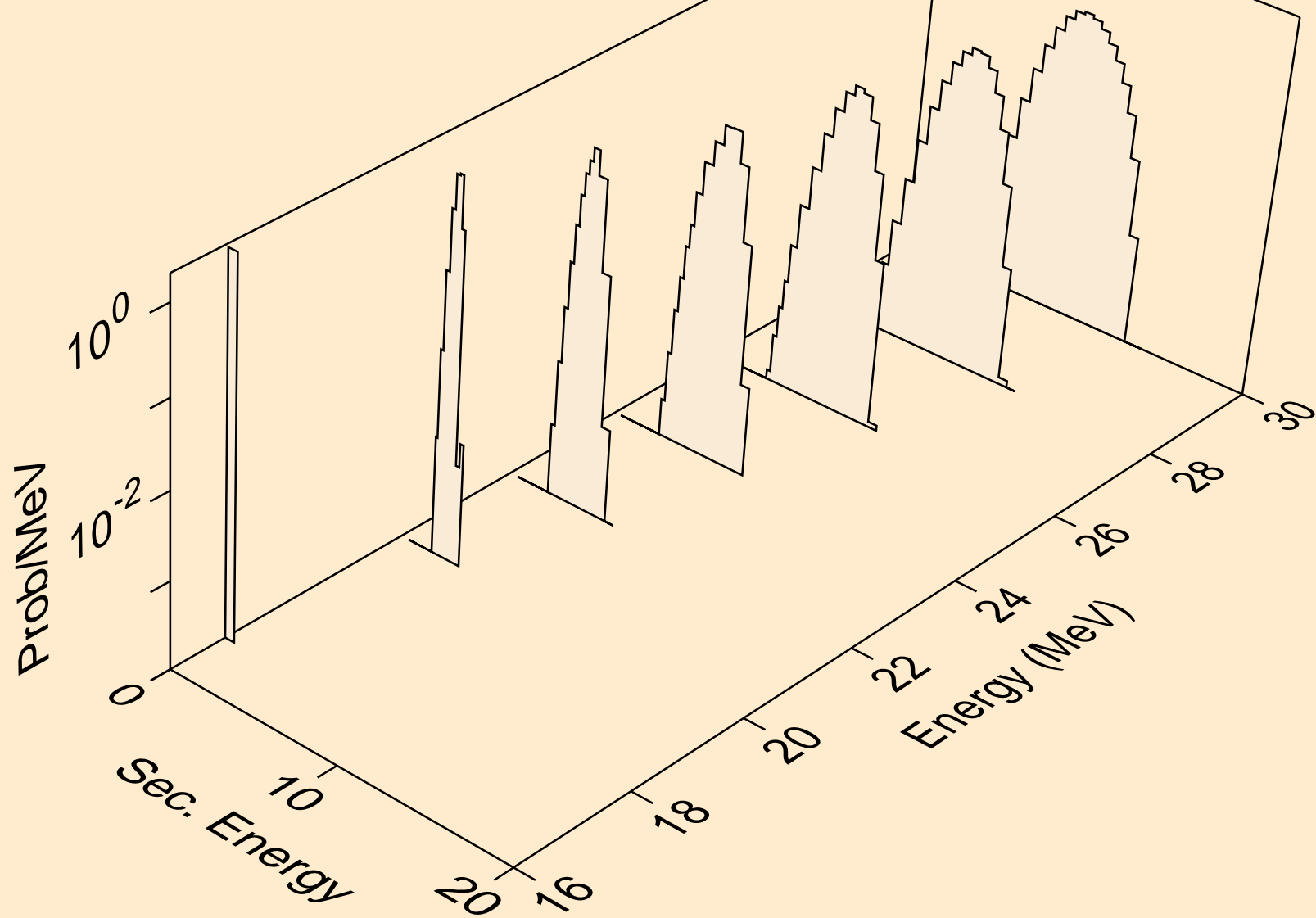

HS268 NEUTRON ACER TENDL-2021 LIBRARY; T=293.6K
protons from (n,2np)

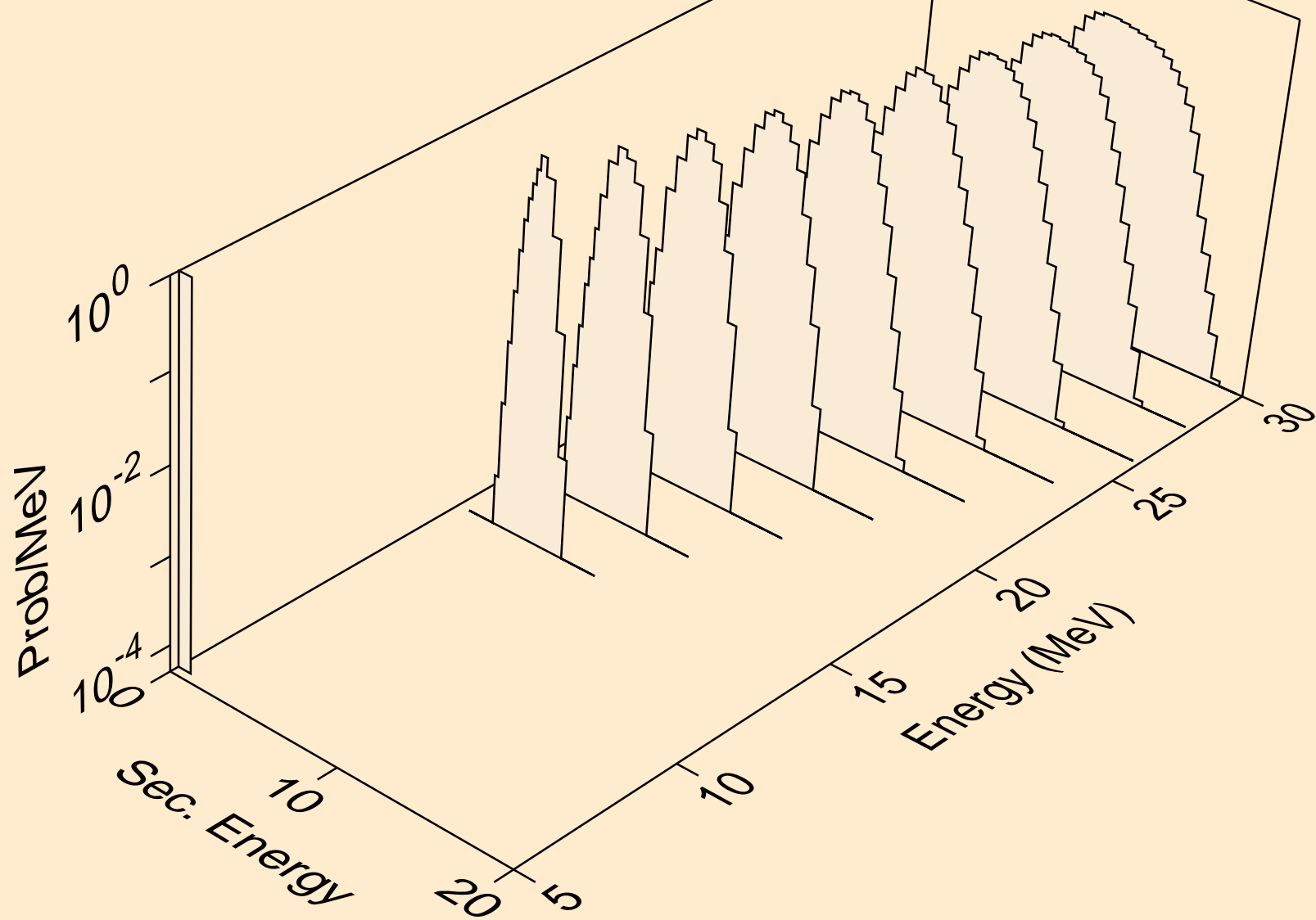

HS268 NEUTRON ACER TENDL-2021 LIBRARY; T=293.6K
protons from (n,npa)

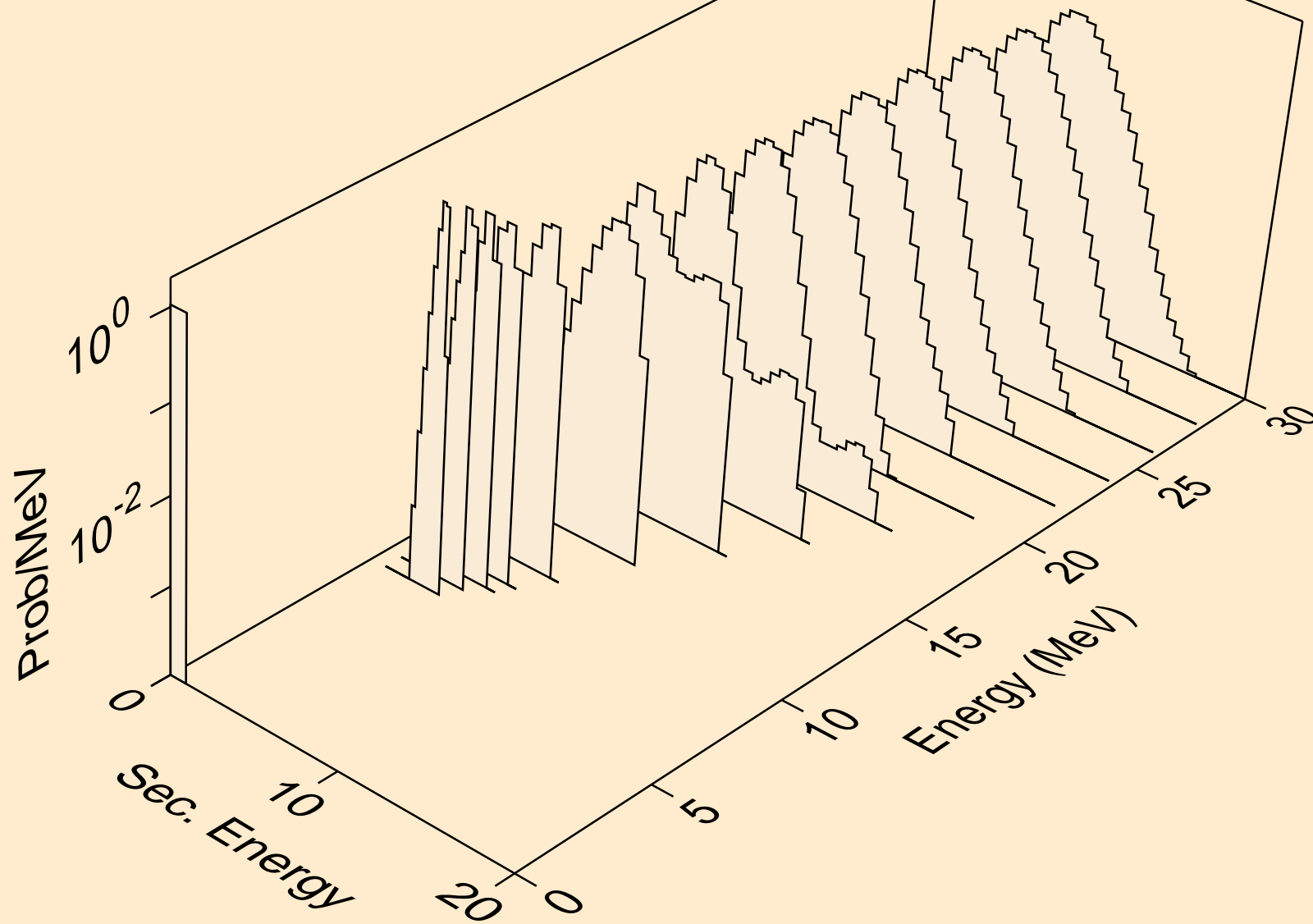

HS268 NEUTRON ACER TENDL-2021 LIBRARY; T=293.6K
protons from (n,p)

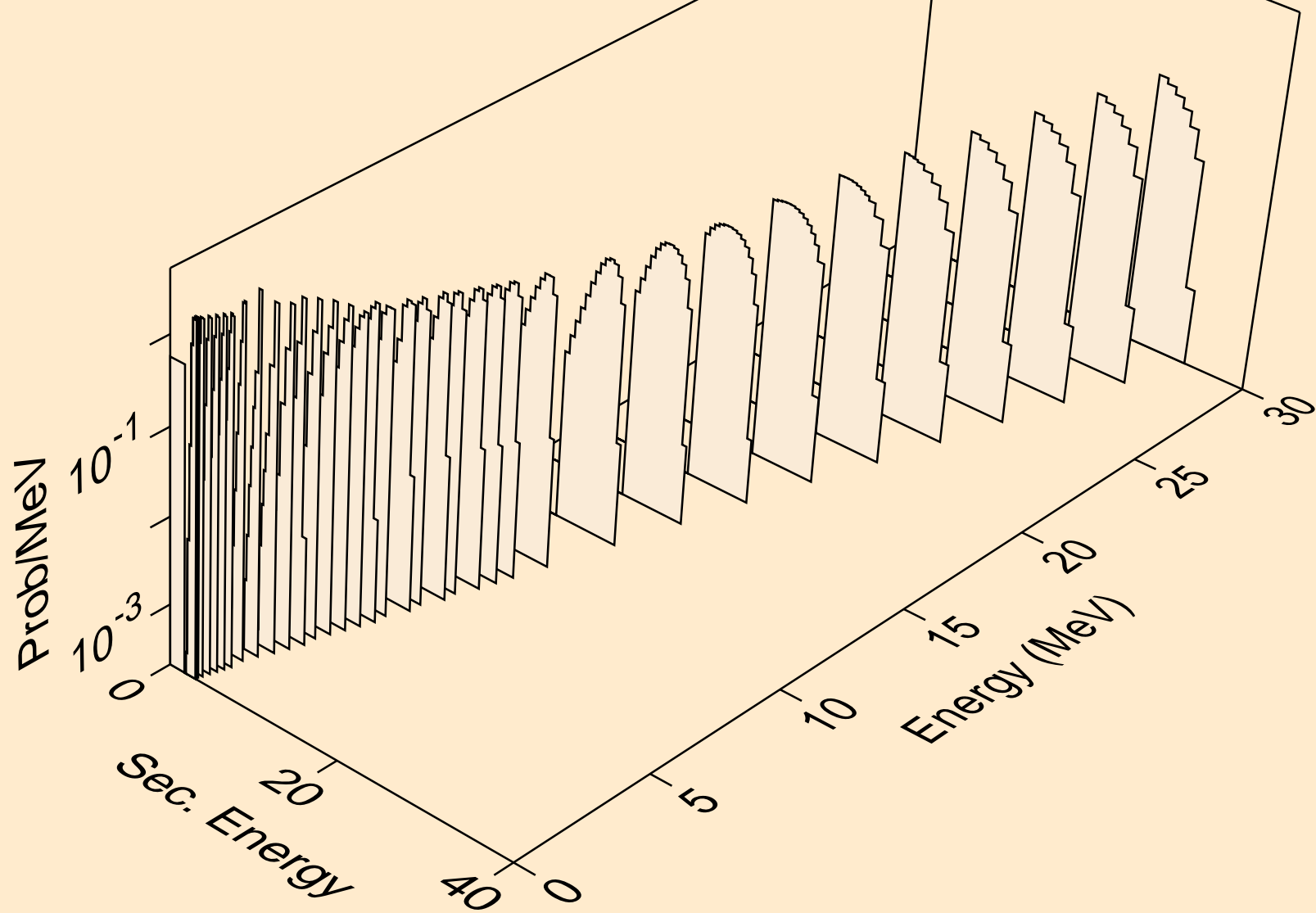

HS268 NEUTRON ACER TENDL-2021 LIBRARY; T=293.6K
protons from (n,2p)

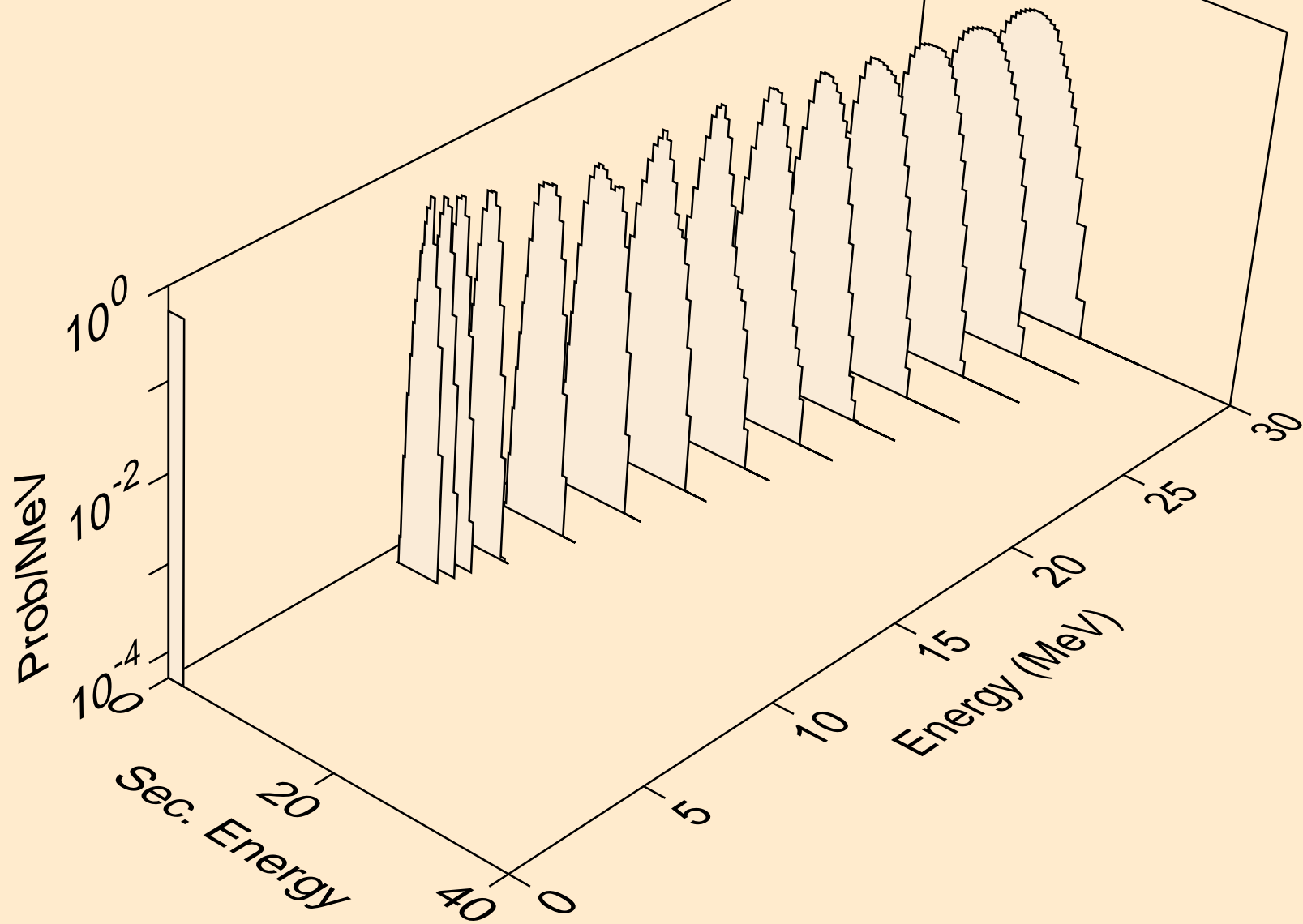

HS268 NEUTRON ACER TENDL-2021 LIBRARY; T=293.6K
protons from (n,p)

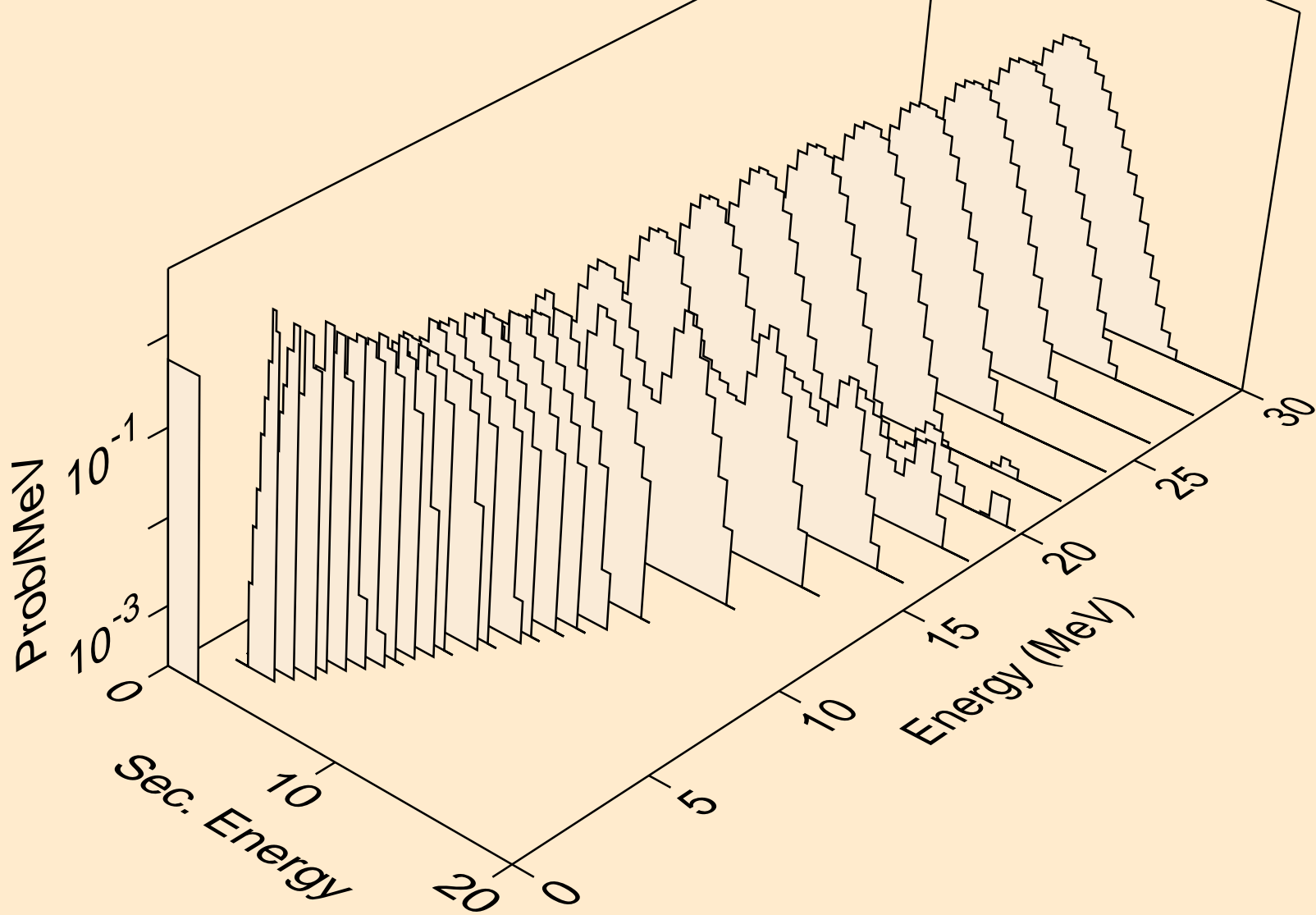

HS268 NEUTRON ACER TENDL-2021 LIBRARY; T=293.6K
protons from (n,pd)

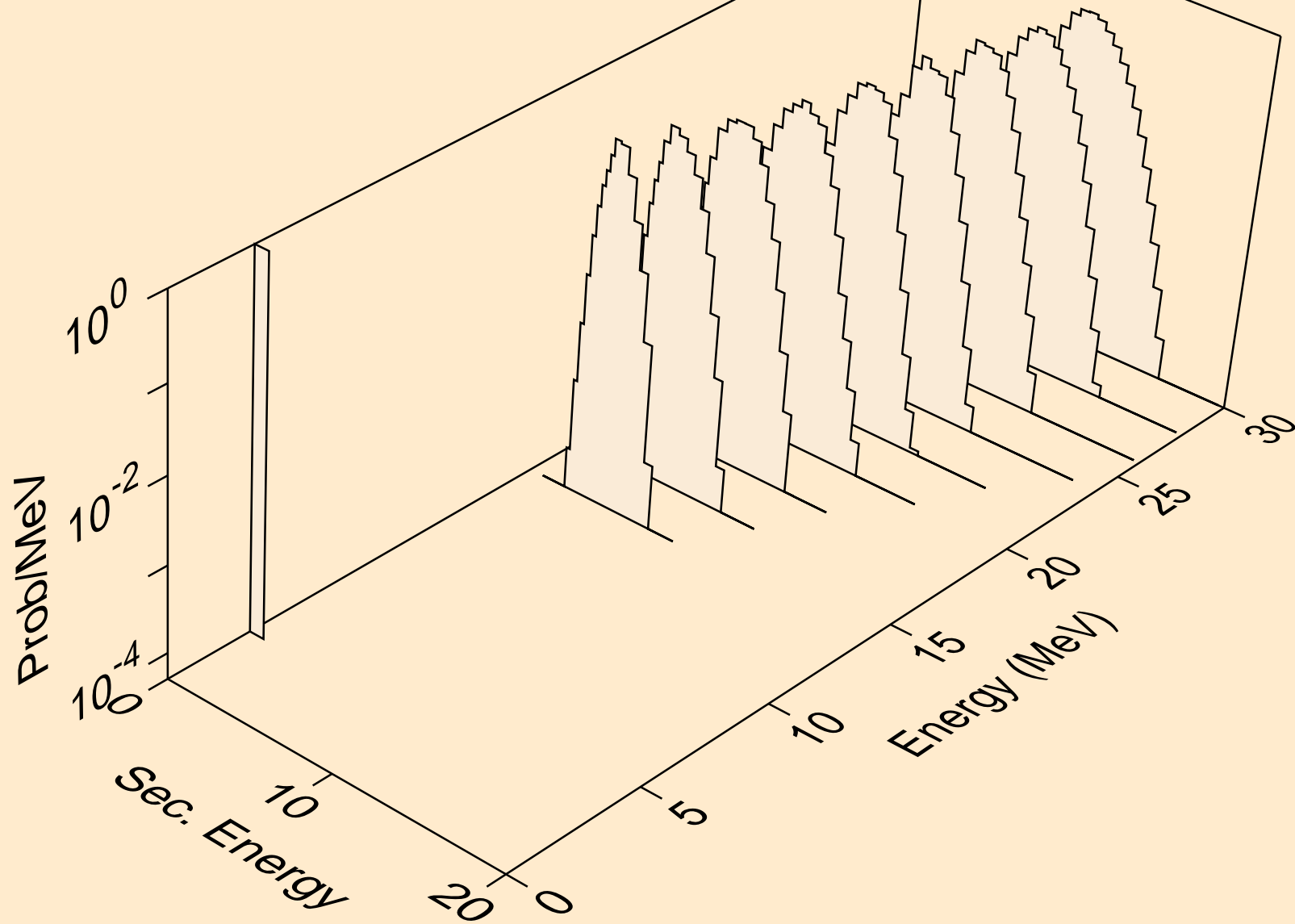

HS268 NEUTRON ACER TENDL-2021 LIBRARY; T=293.6K
protons from (n,pt)

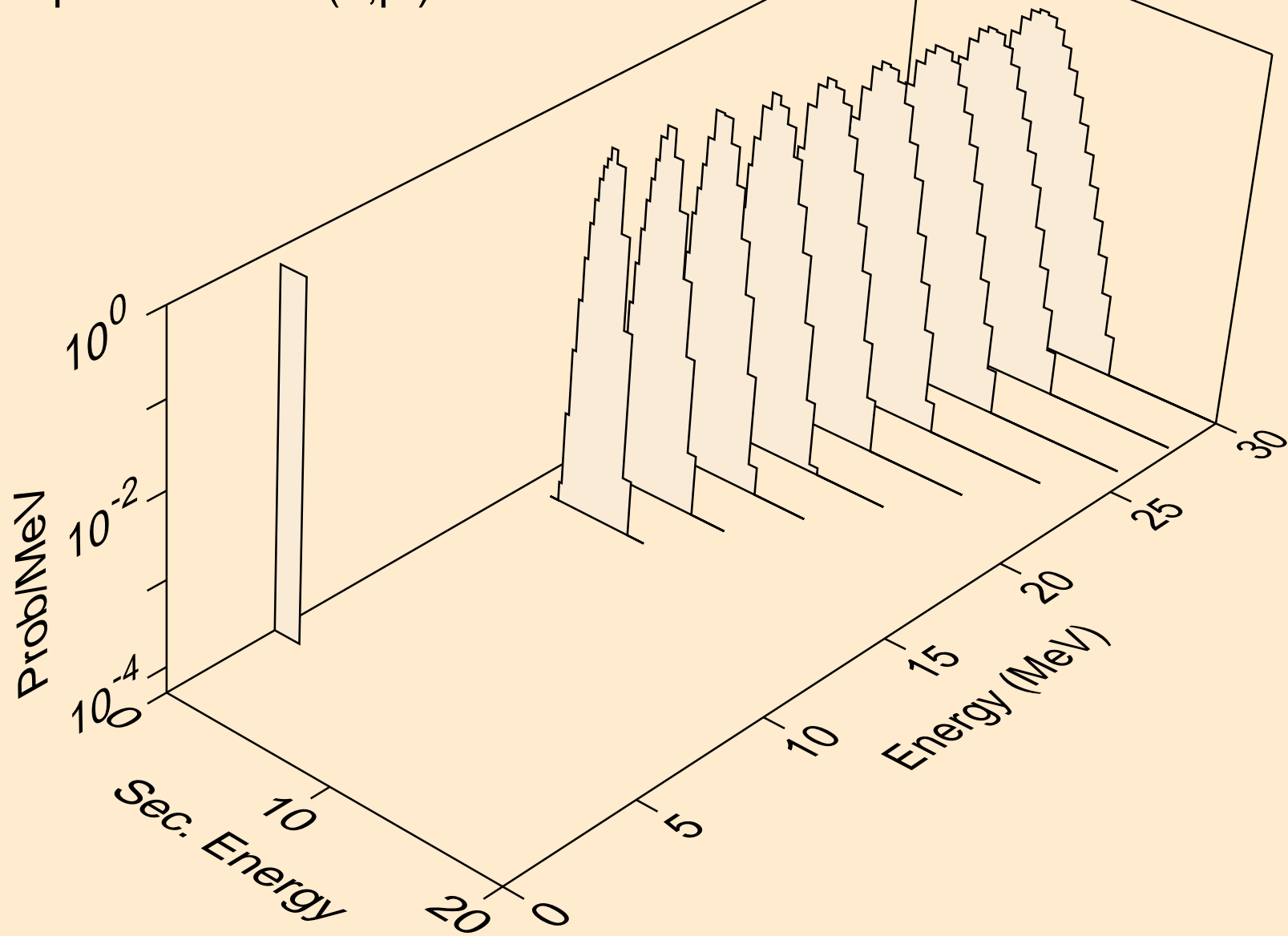

HS268 NEUTRON ACER TENDL-2021 LIBRARY; T=293.6K
deuterons from (n,x)

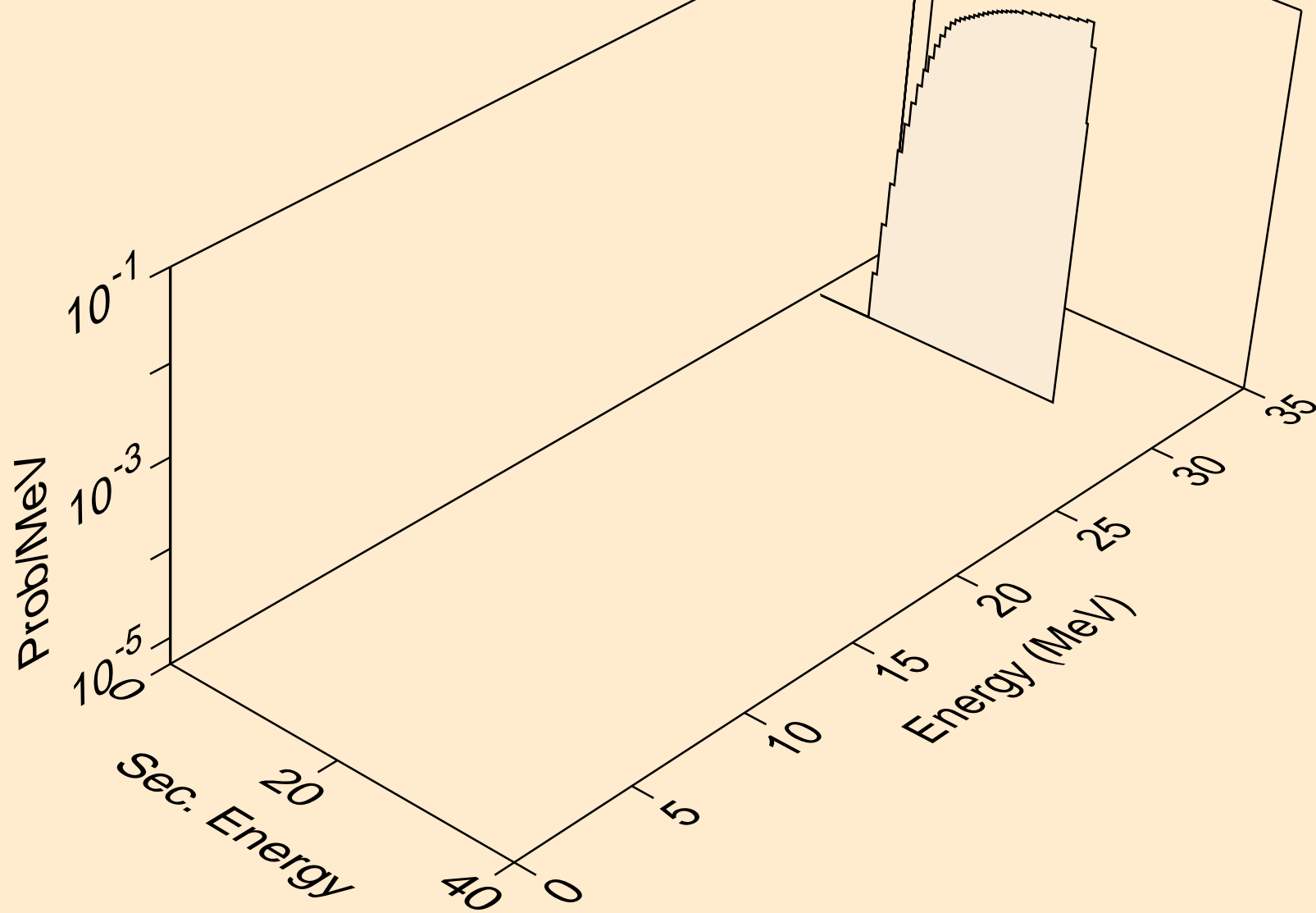

HS268 NEUTRON ACER TENDL-2021 LIBRARY; T=293.6K
deuterons from (n,2nd)

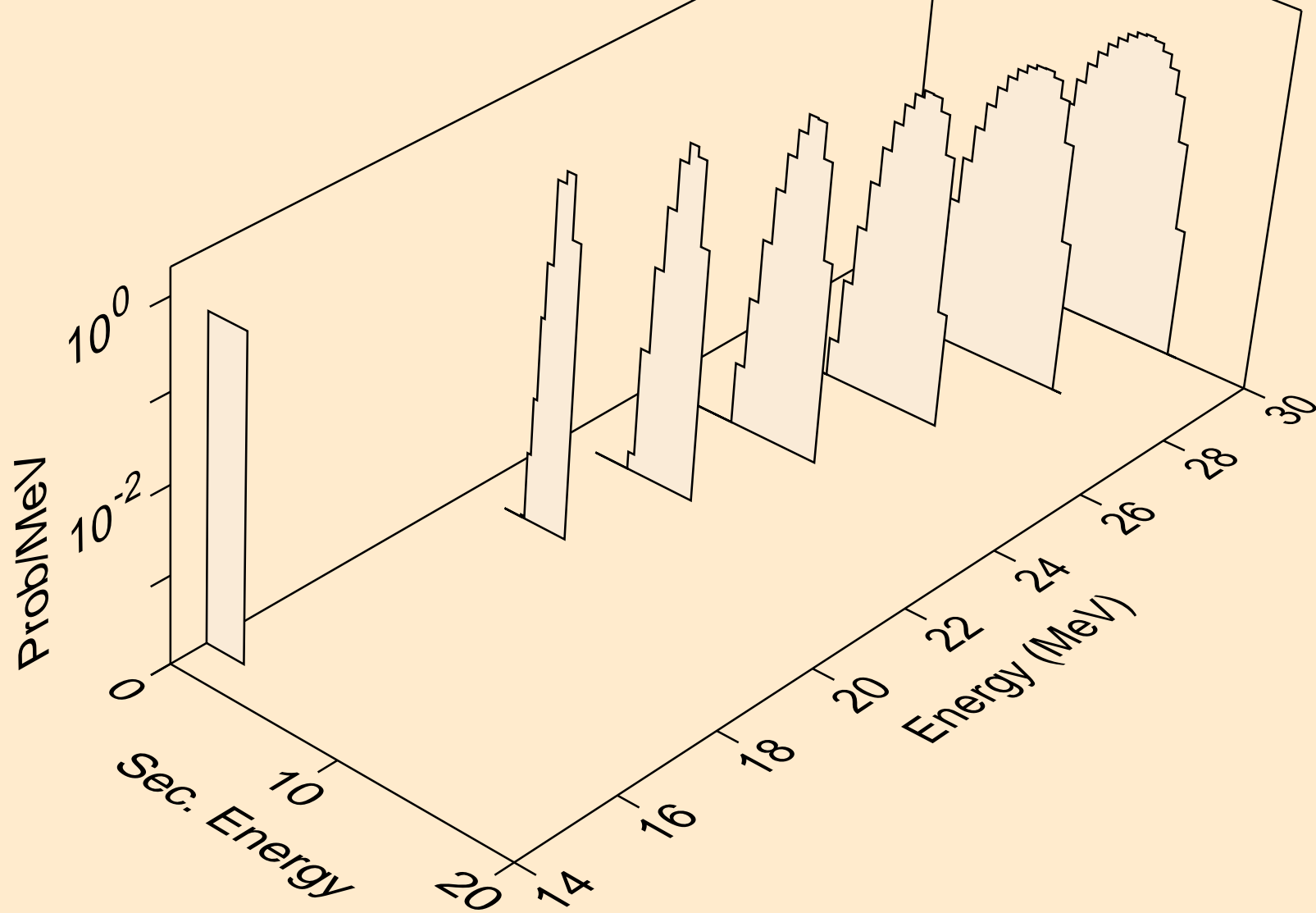

HS268 NEUTRON ACER TENDL-2021 LIBRARY; T=293.6K
deuterons from (n,n*)d

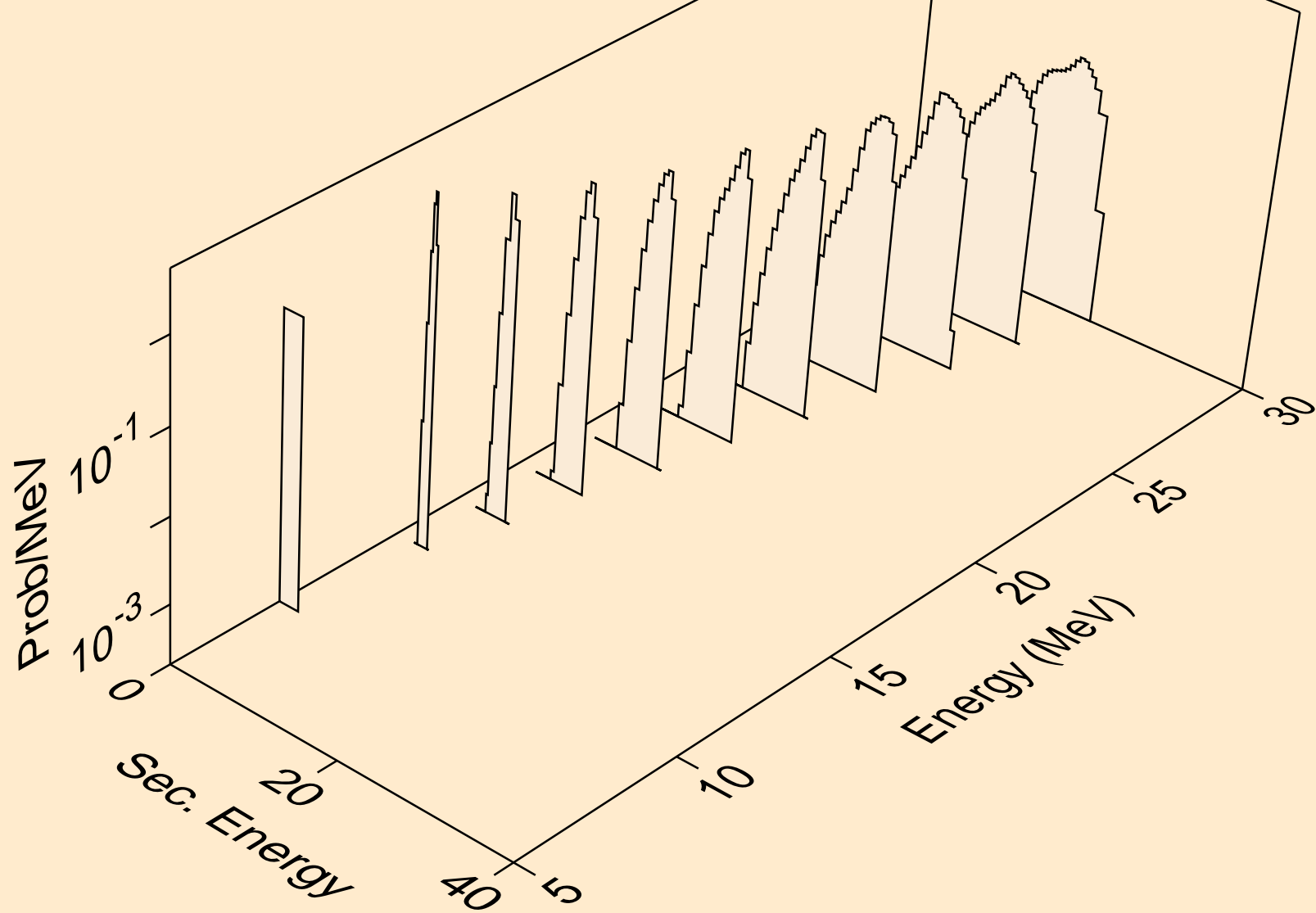

HS268 NEUTRON ACER TENDL-2021 LIBRARY; T=293.6K
deuterons from (n,d)

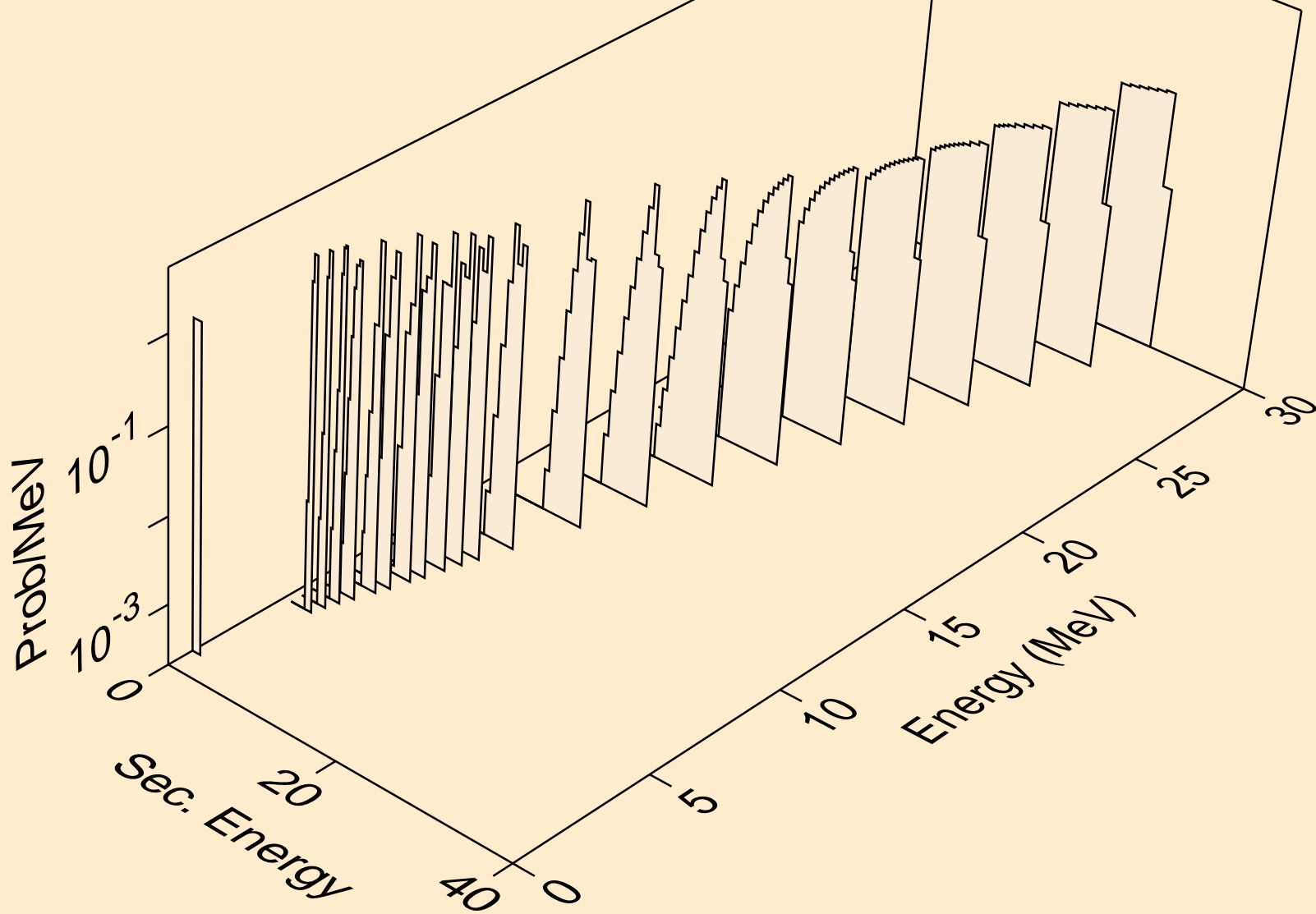

HS268 NEUTRON ACER TENDL-2021 LIBRARY; T=293.6K
deuterons from (n,pd)

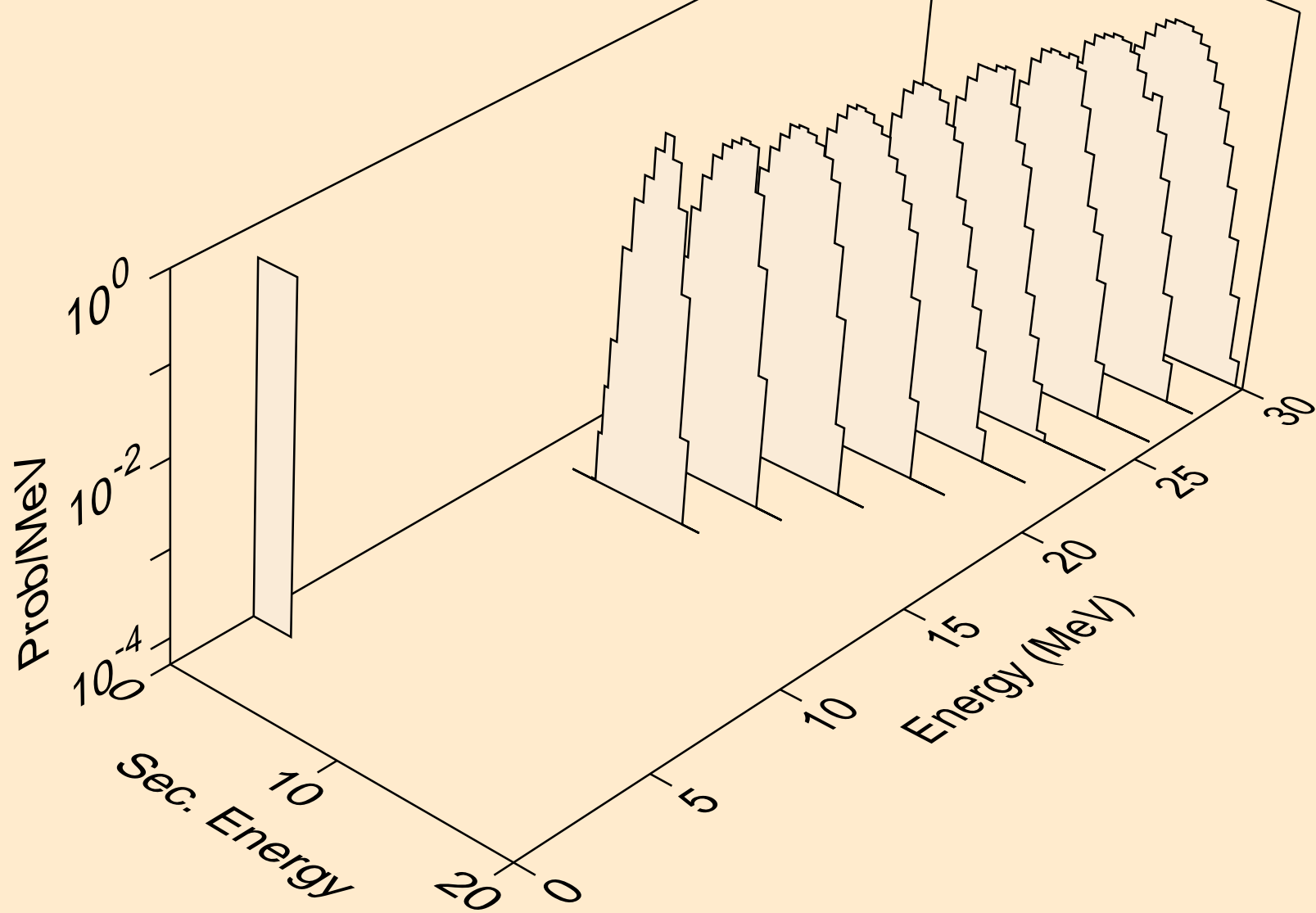

HS268 NEUTRON ACER TENDL-2021 LIBRARY; T=293.6K
tritons from (n,x)

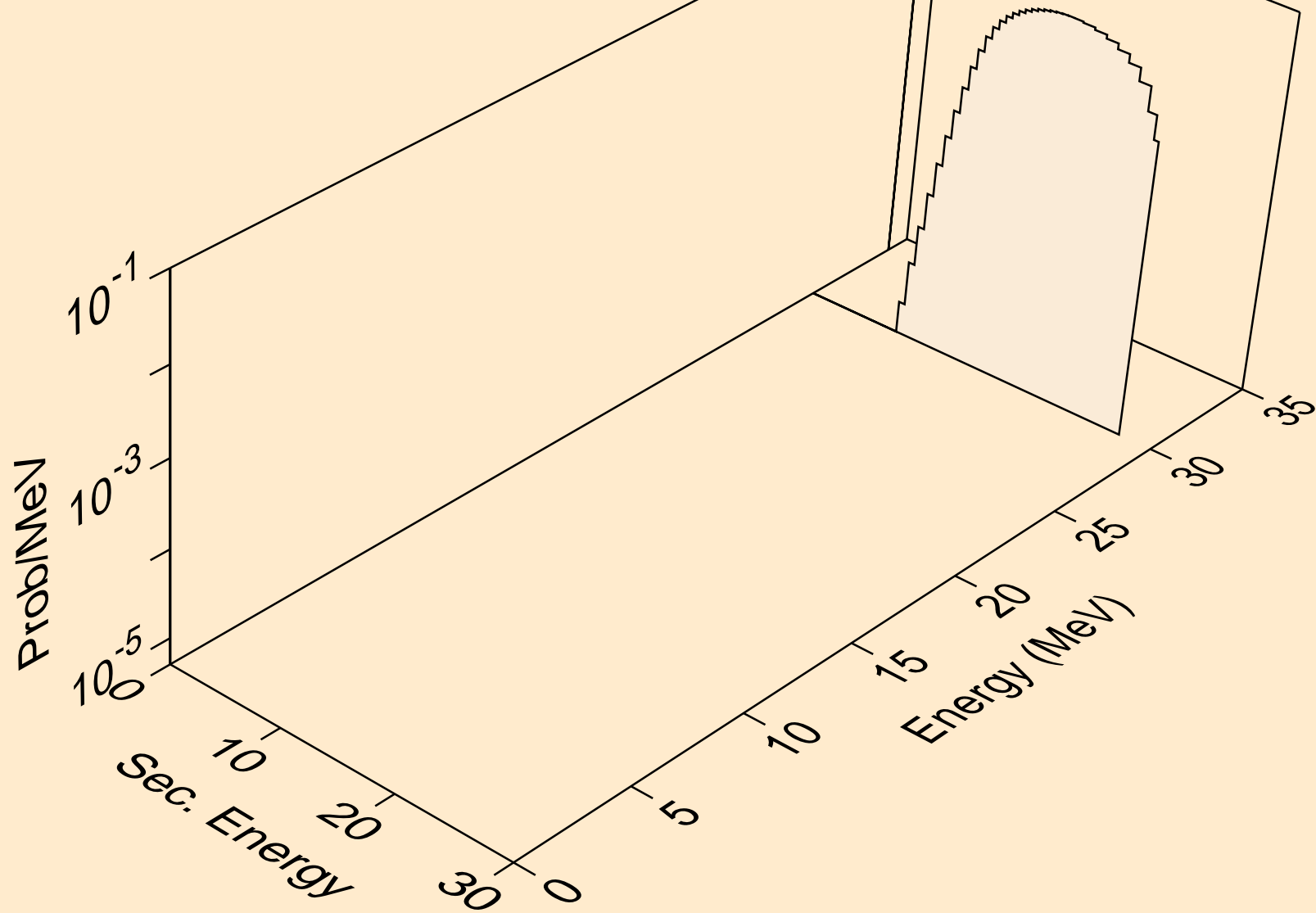

HS268 NEUTRON ACER TENDL-2021 LIBRARY; T=293.6K
tritons from (n,n*)t

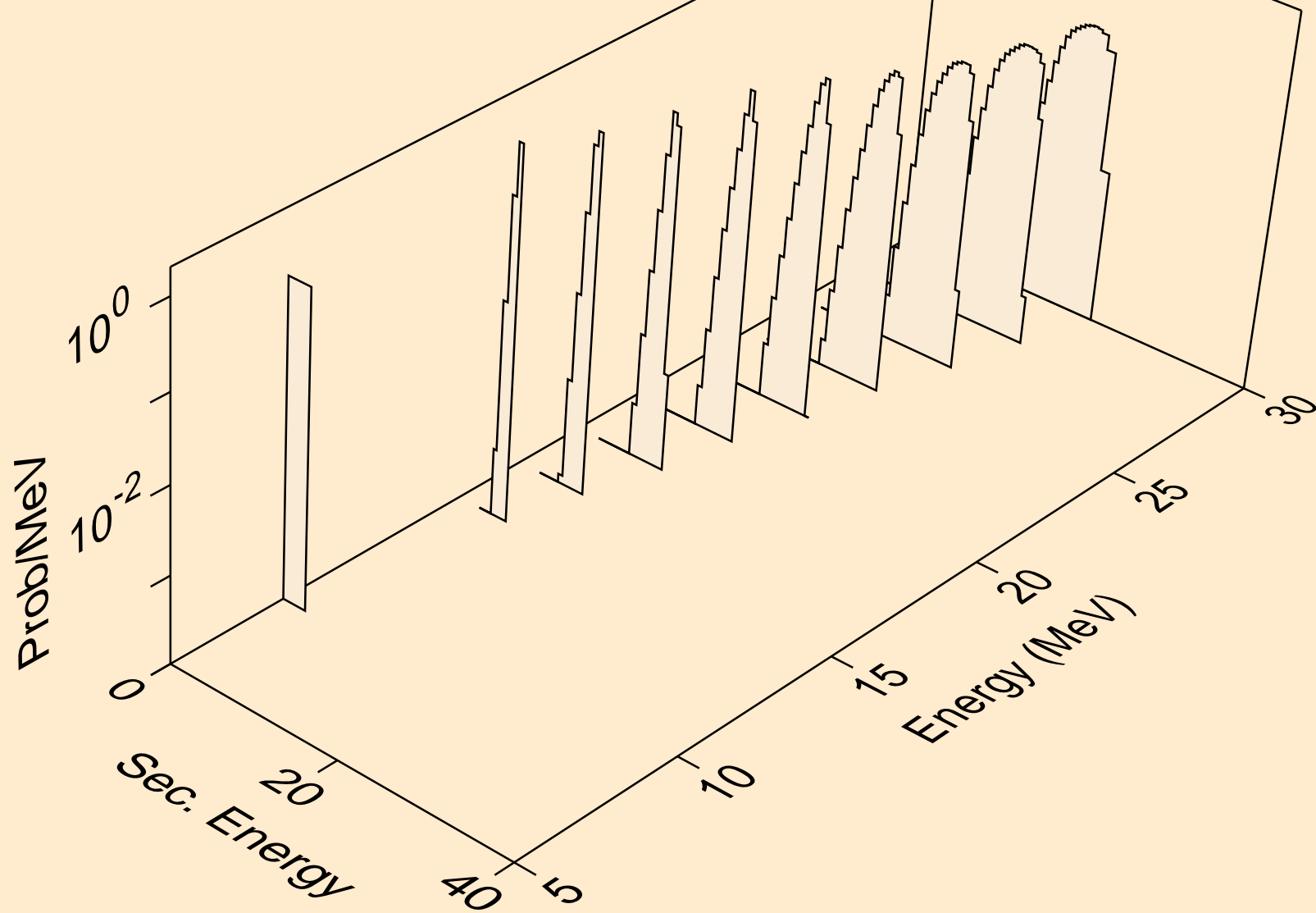

HS268 NEUTRON ACER TENDL-2021 LIBRARY; T=293.6K
tritons from (n,t)

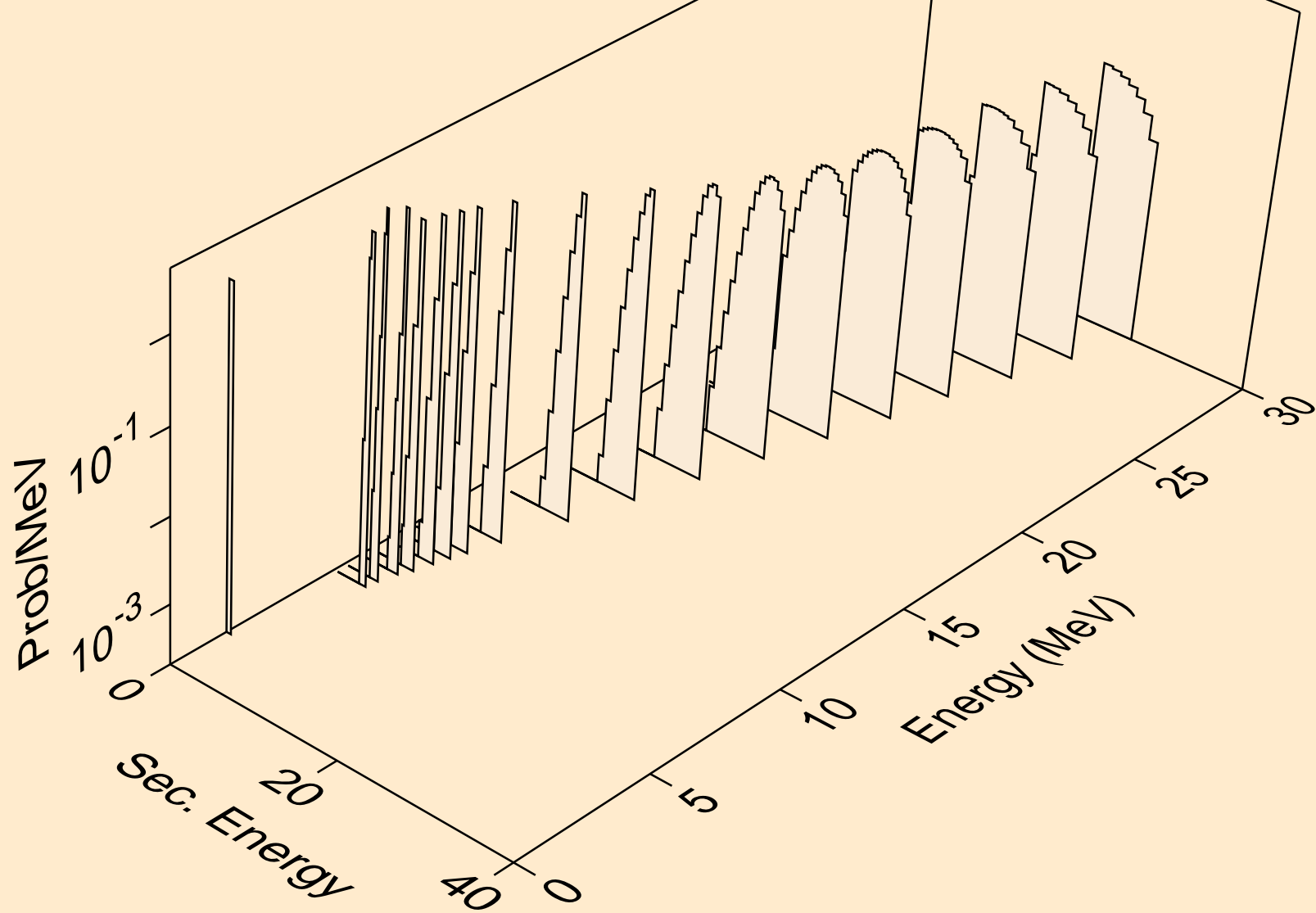

HS268 NEUTRON ACER TENDL-2021 LIBRARY; T=293.6K
tritons from (n,pt)

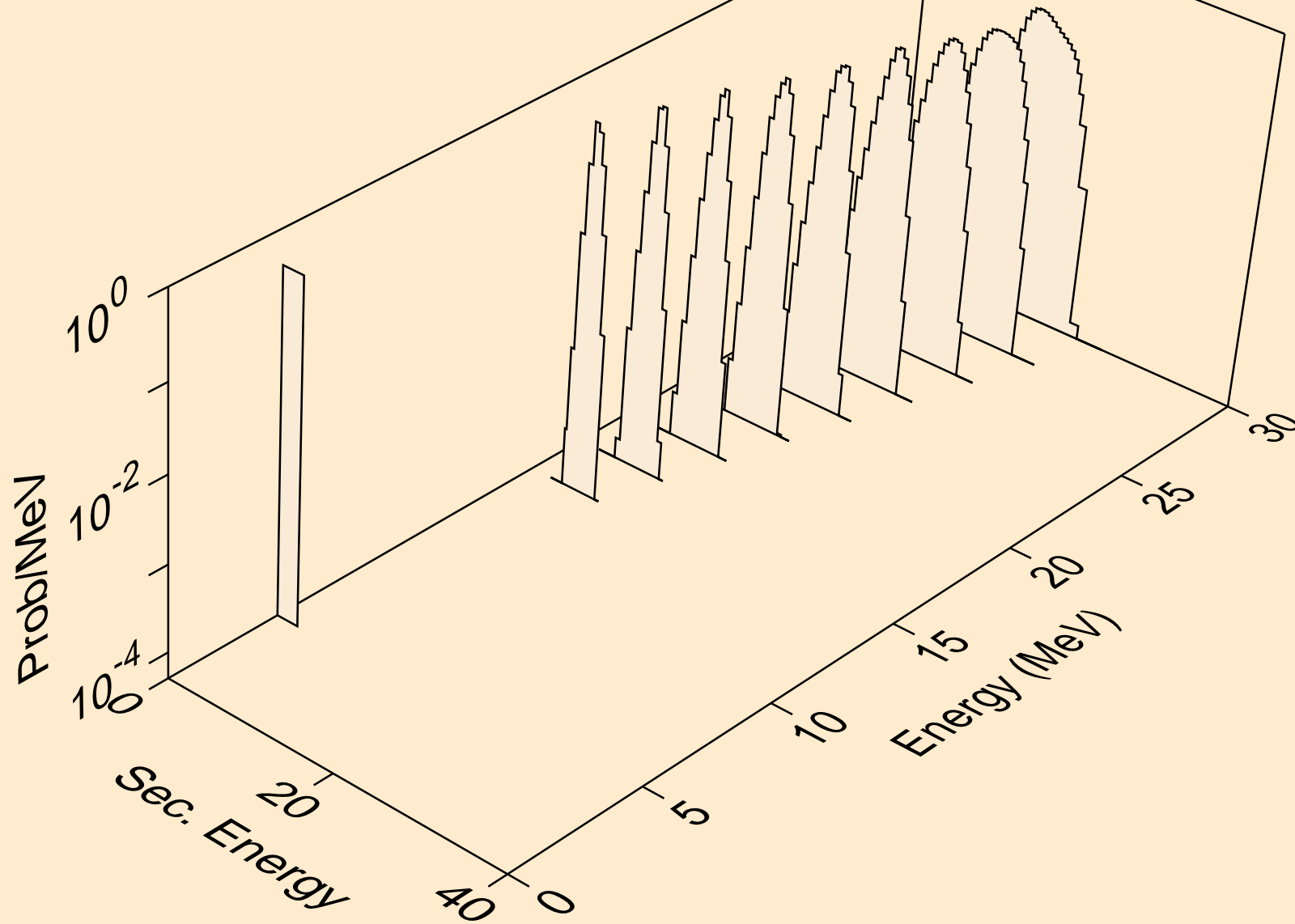

HS268 NEUTRON ACER TENDL-2021 LIBRARY; T=293.6K
he3s from (n,x)

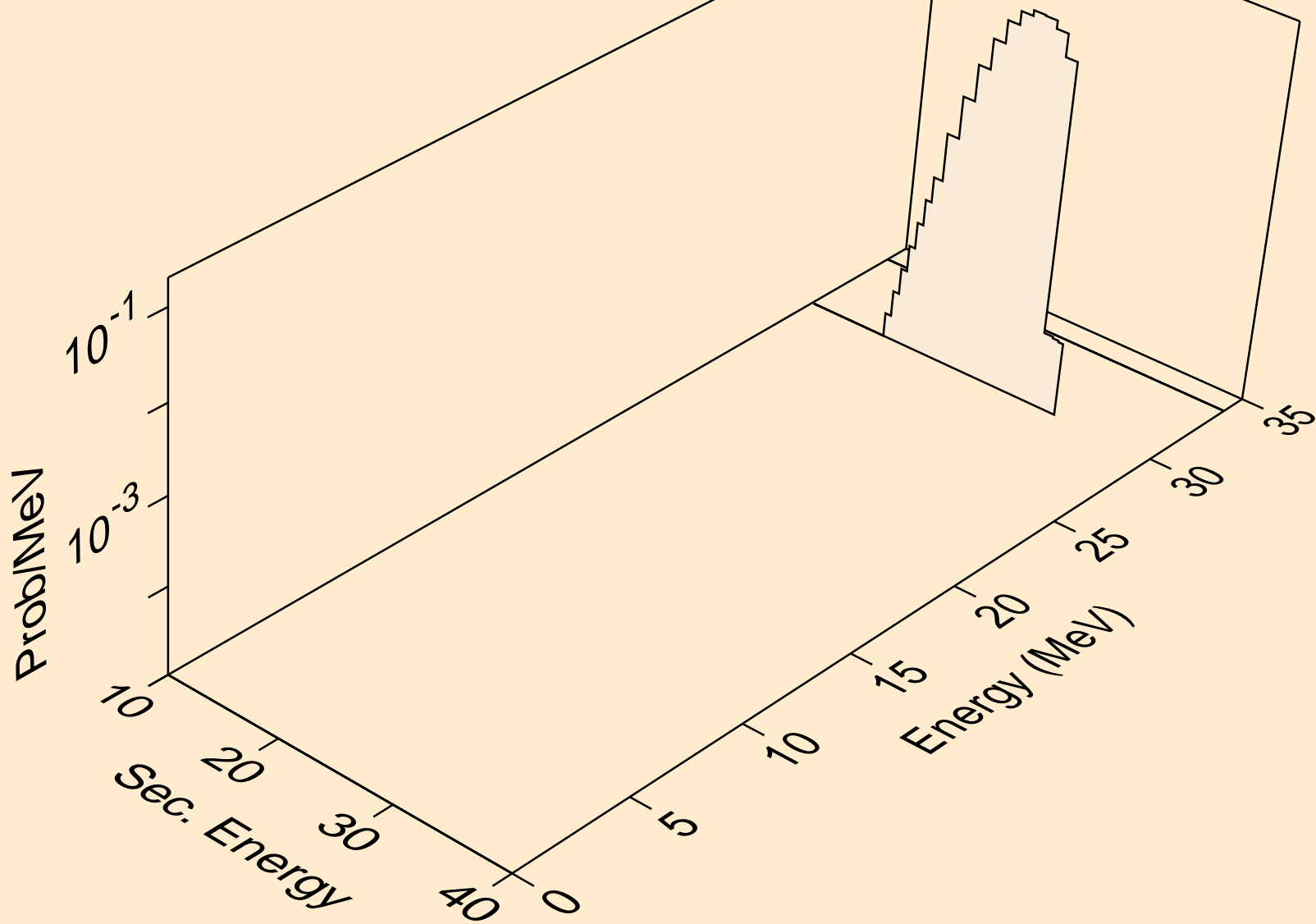

HS268 NEUTRON ACER TENDL-2021 LIBRARY; T=293.6K
he3s from (n,n*)he3

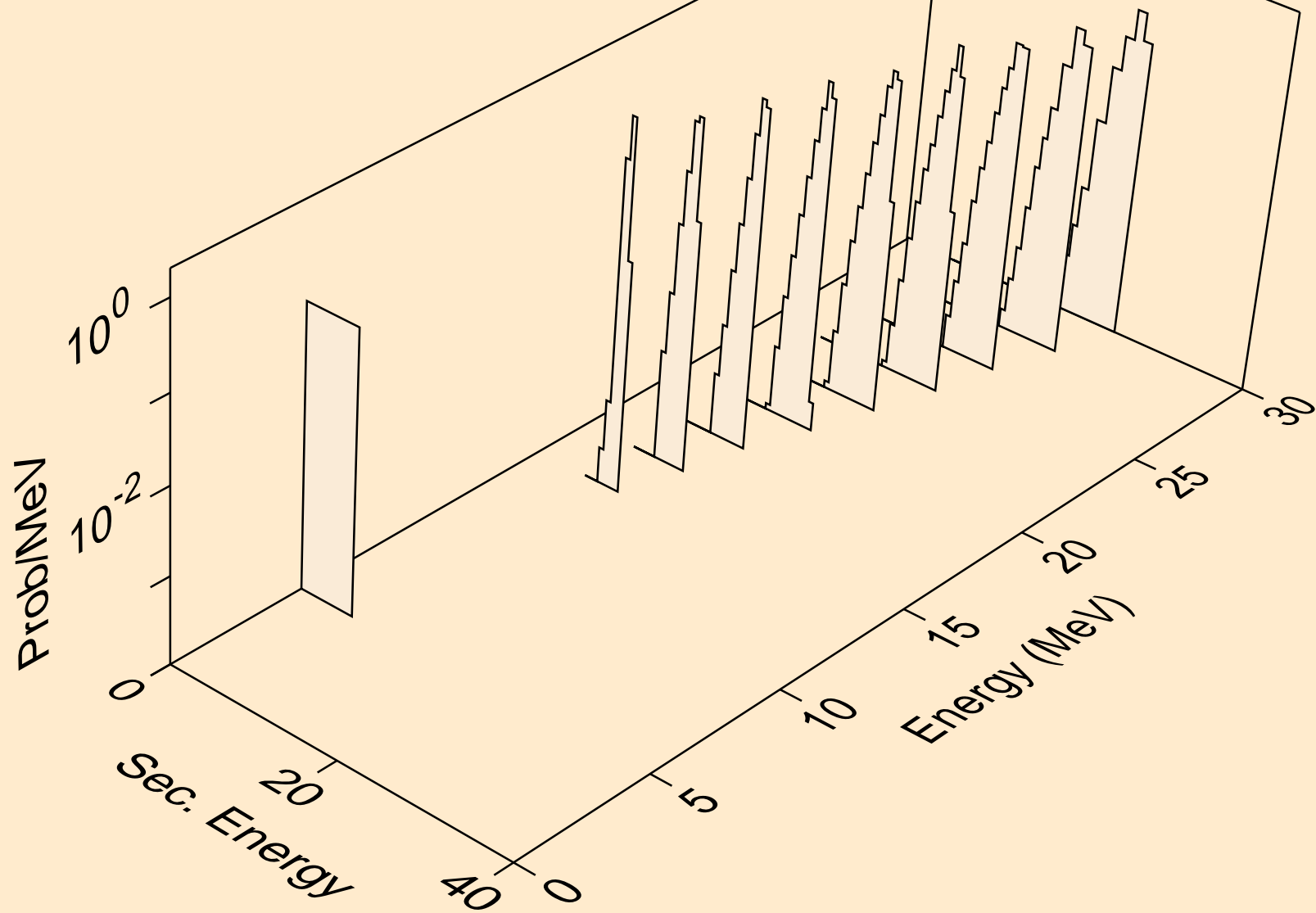

HS268 NEUTRON ACER TENDL-2021 LIBRARY; T=293.6K
he3s from (n,he3)

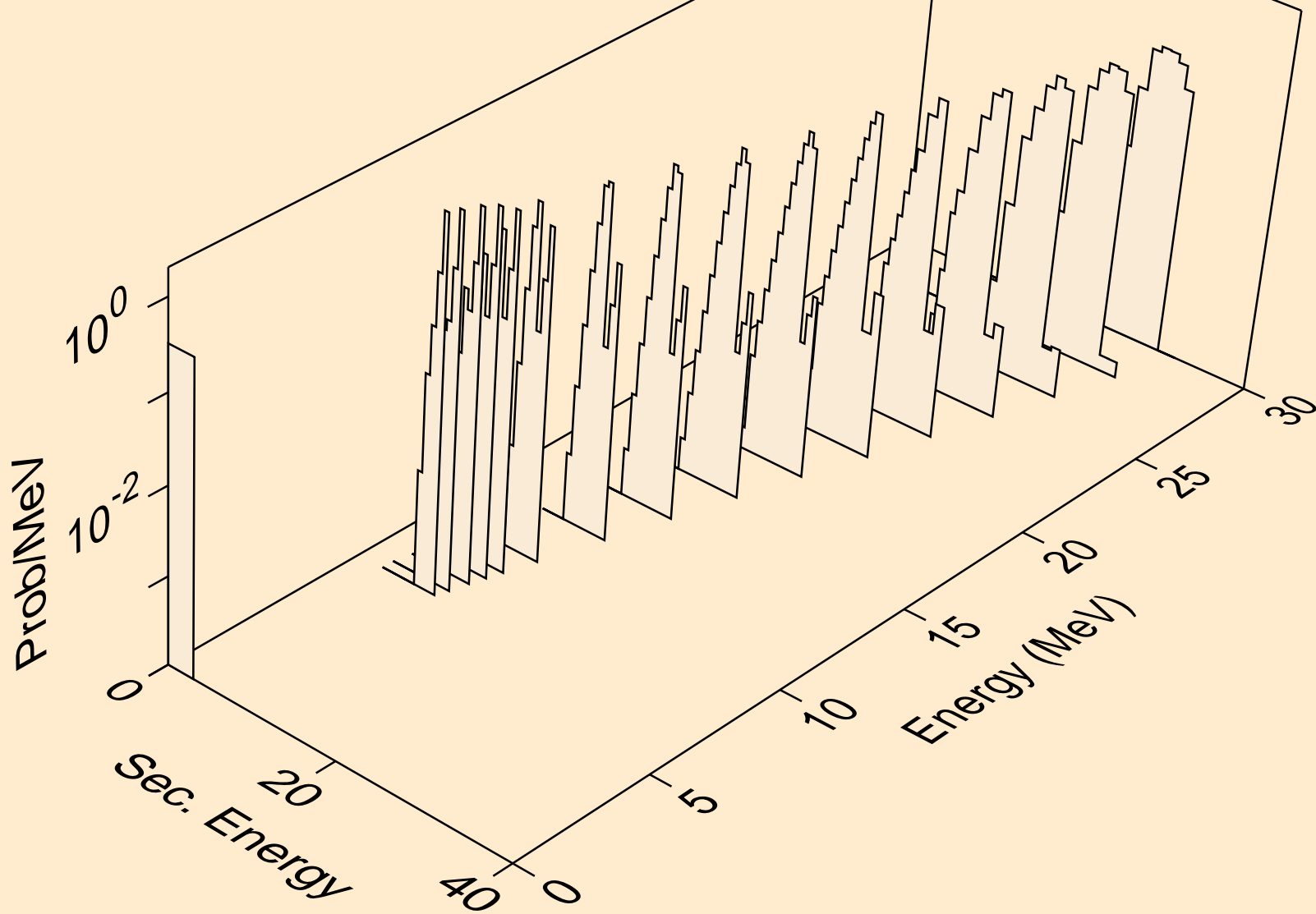

HS268 NEUTRON ACER TENDL-2021 LIBRARY; T=293.6K
alphas from (n,x)

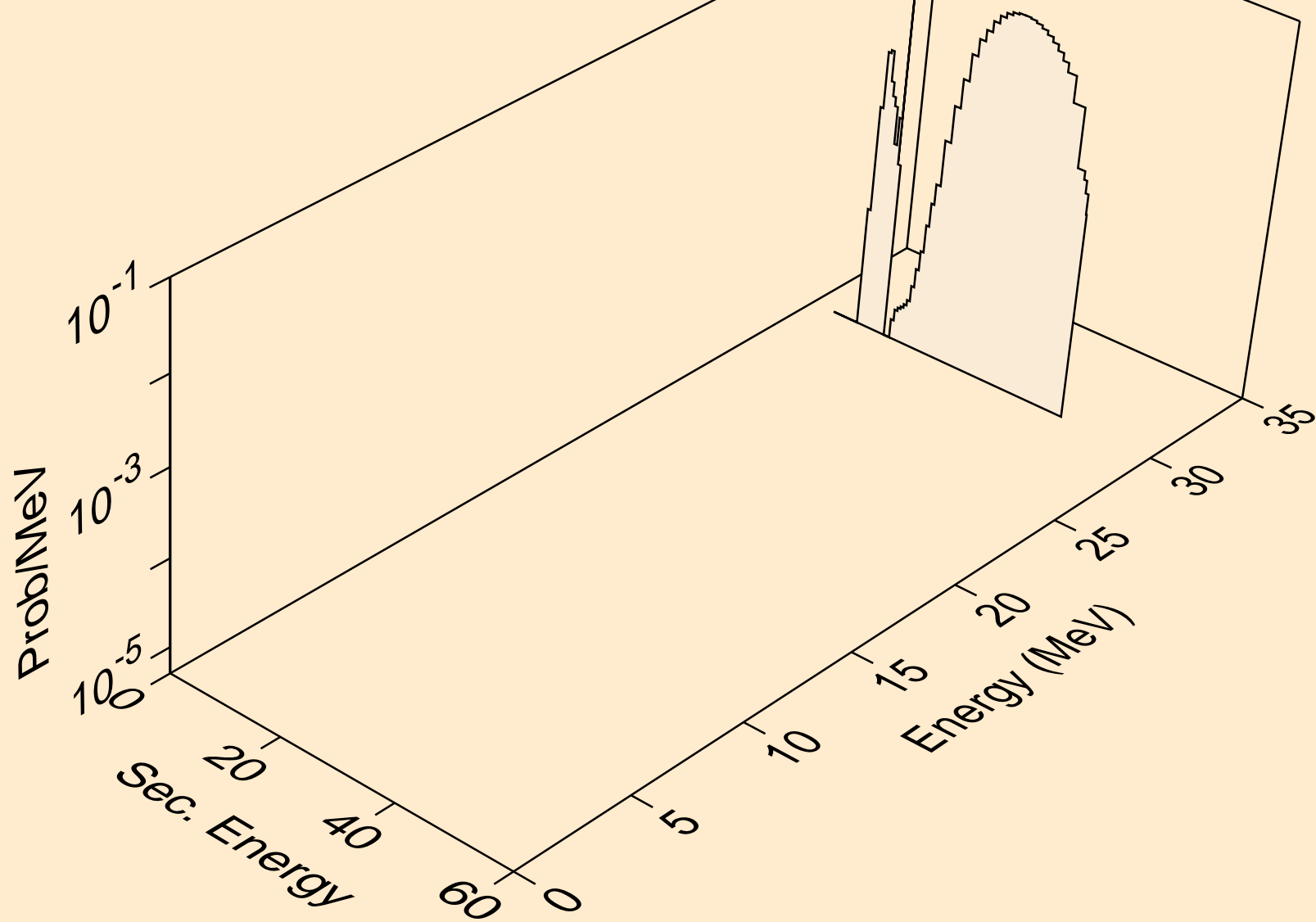

HS268 NEUTRON ACER TENDL-2021 LIBRARY; T=293.6K
alphas from (n,n*)a

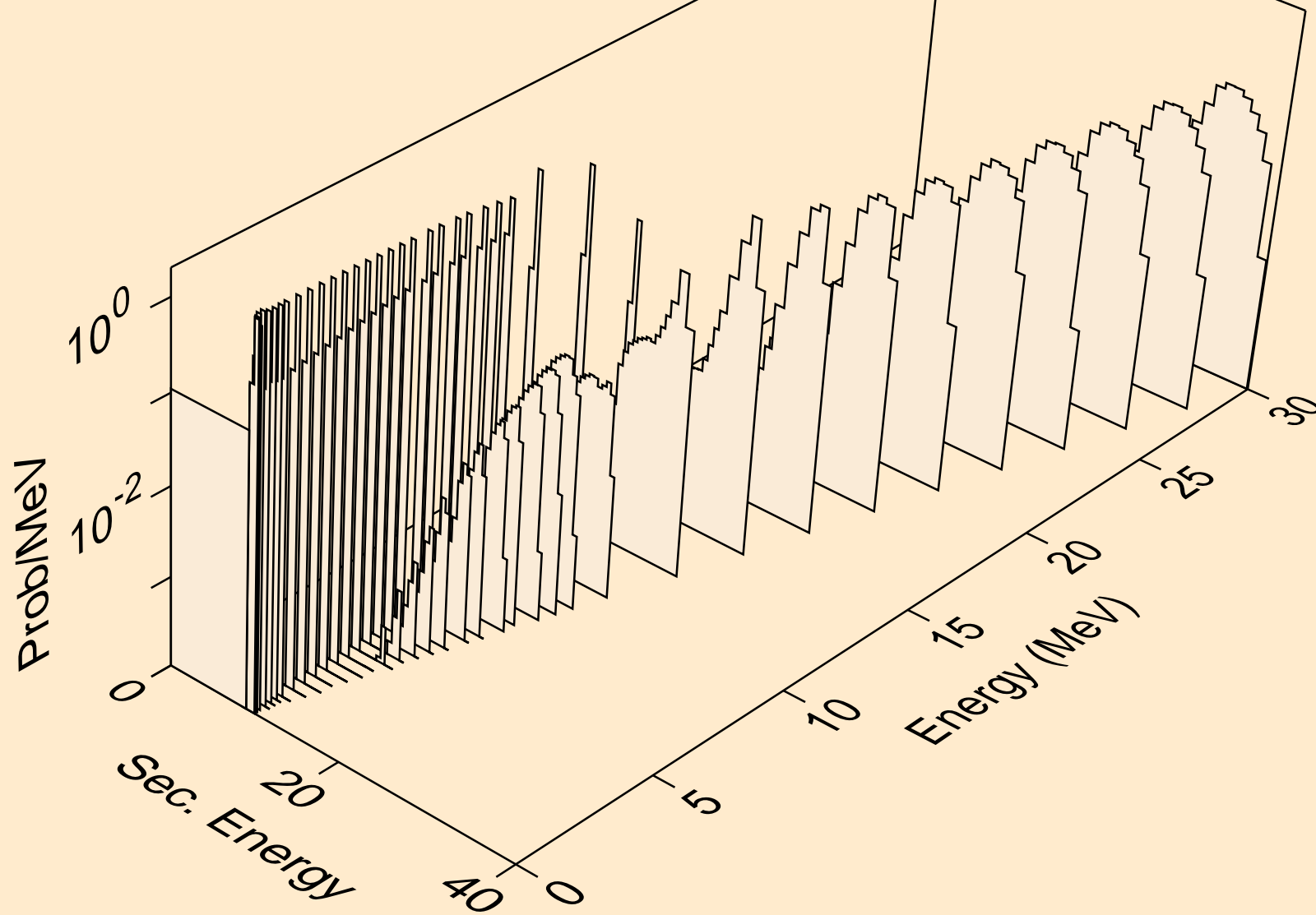

HS268 NEUTRON ACER TENDL-2021 LIBRARY; T=293.6K
alphas from (n,2n)a

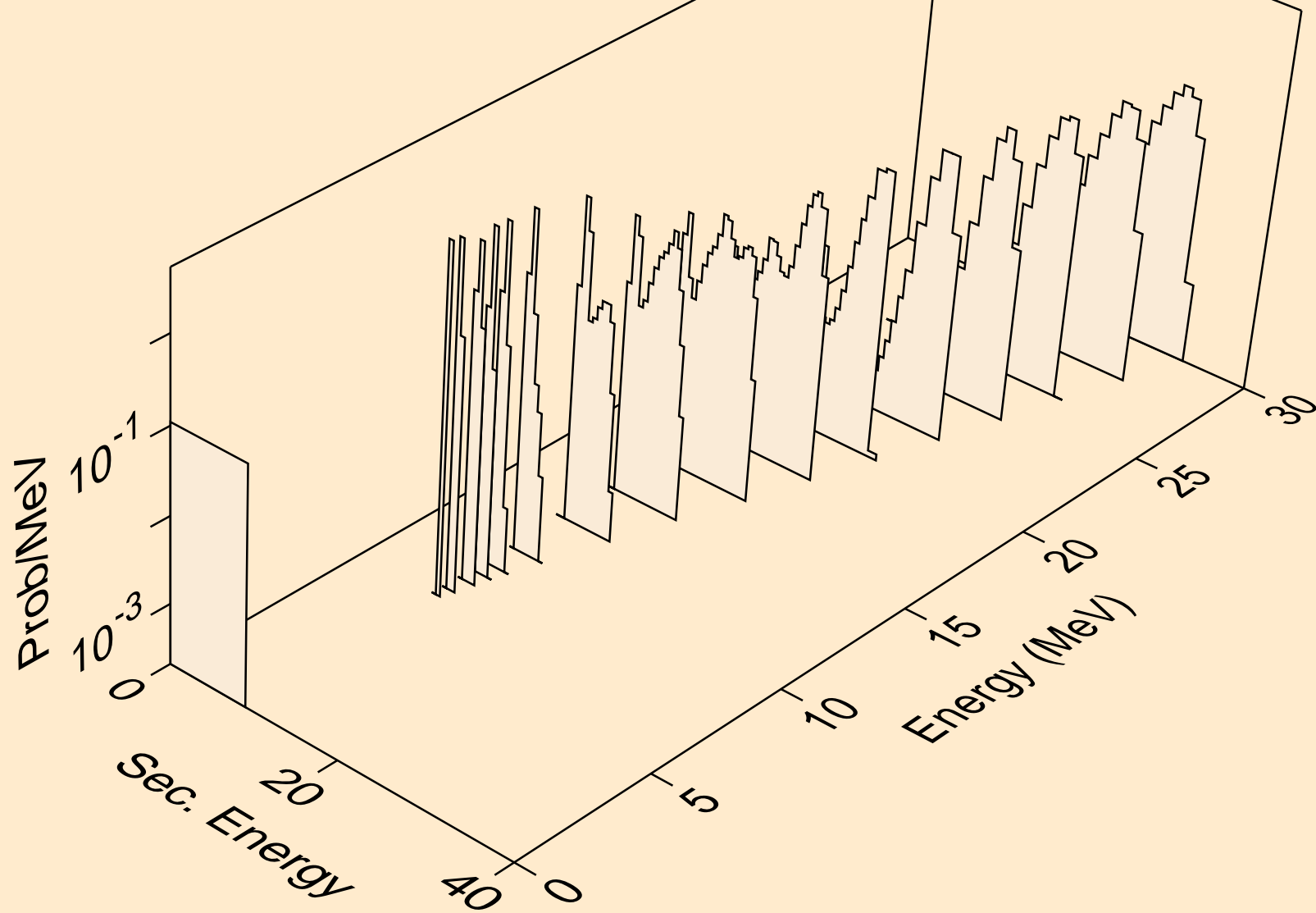

HS268 NEUTRON ACER TENDL-2021 LIBRARY; T=293.6K
alphas from (n,3n)a

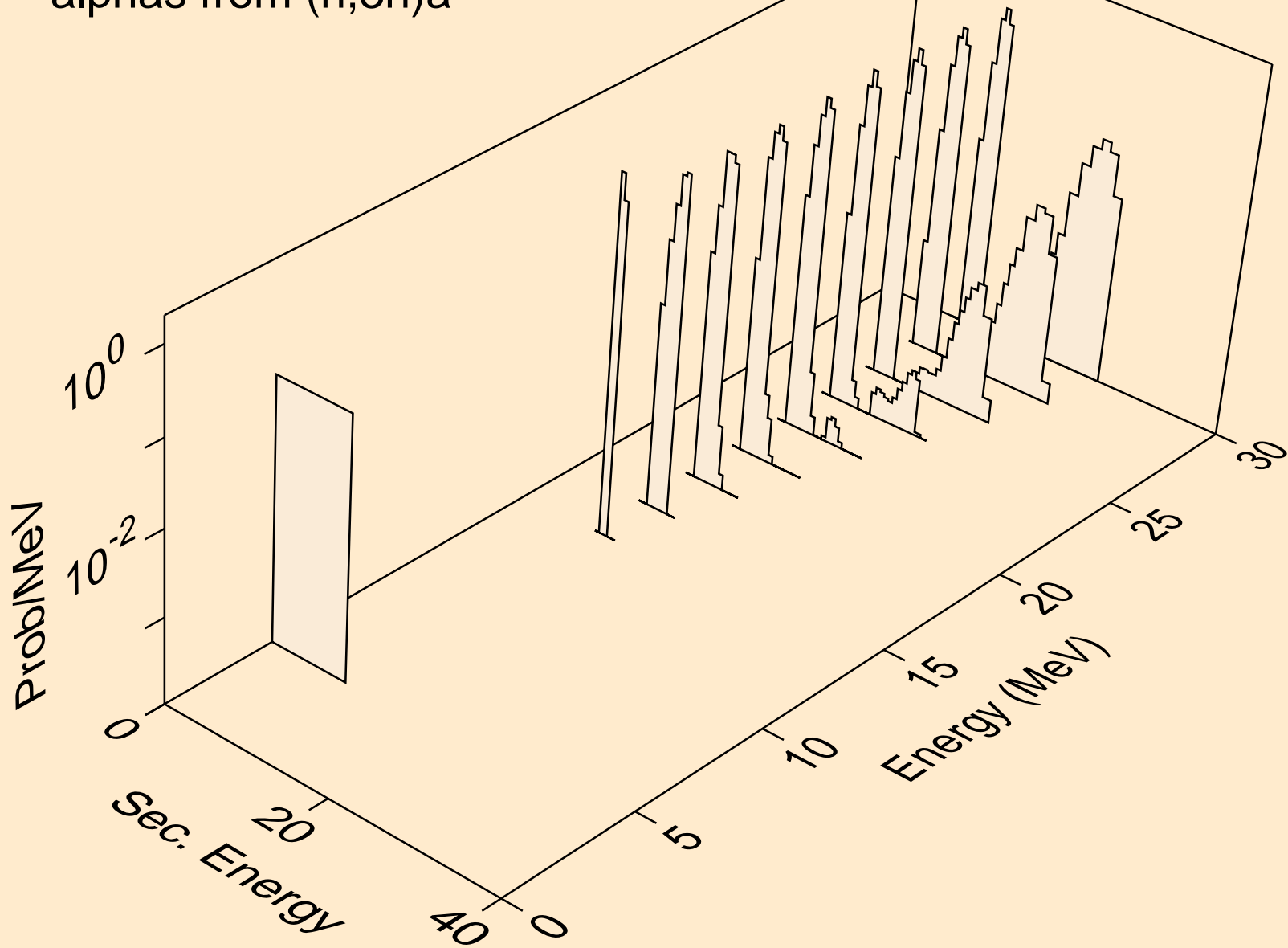

HS268 NEUTRON ACER TENDL-2021 LIBRARY; T=293.6K
alphas from (n,n*)2a

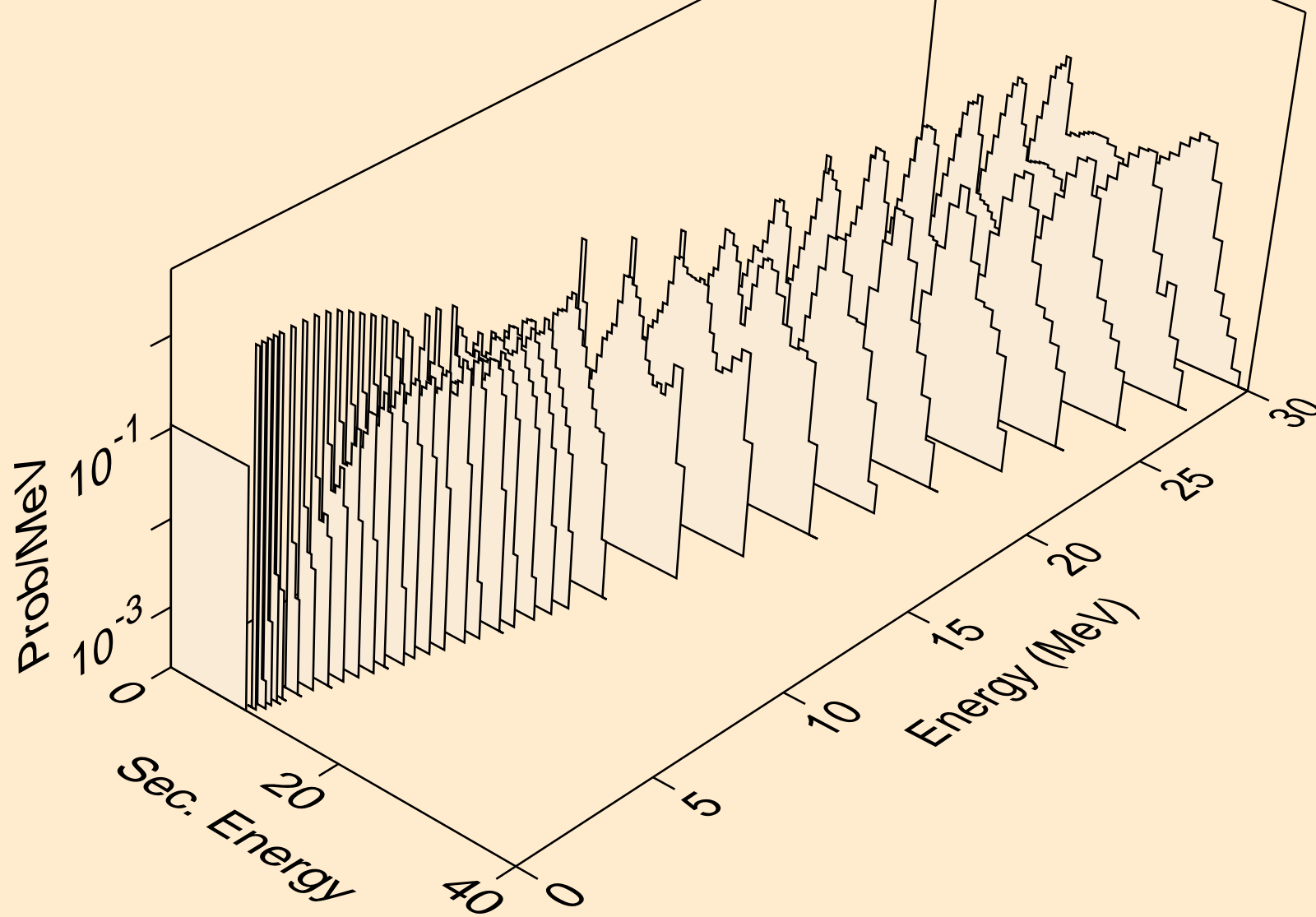

HS268 NEUTRON ACER TENDL-2021 LIBRARY; T=293.6K
alphas from (n,2n)2a

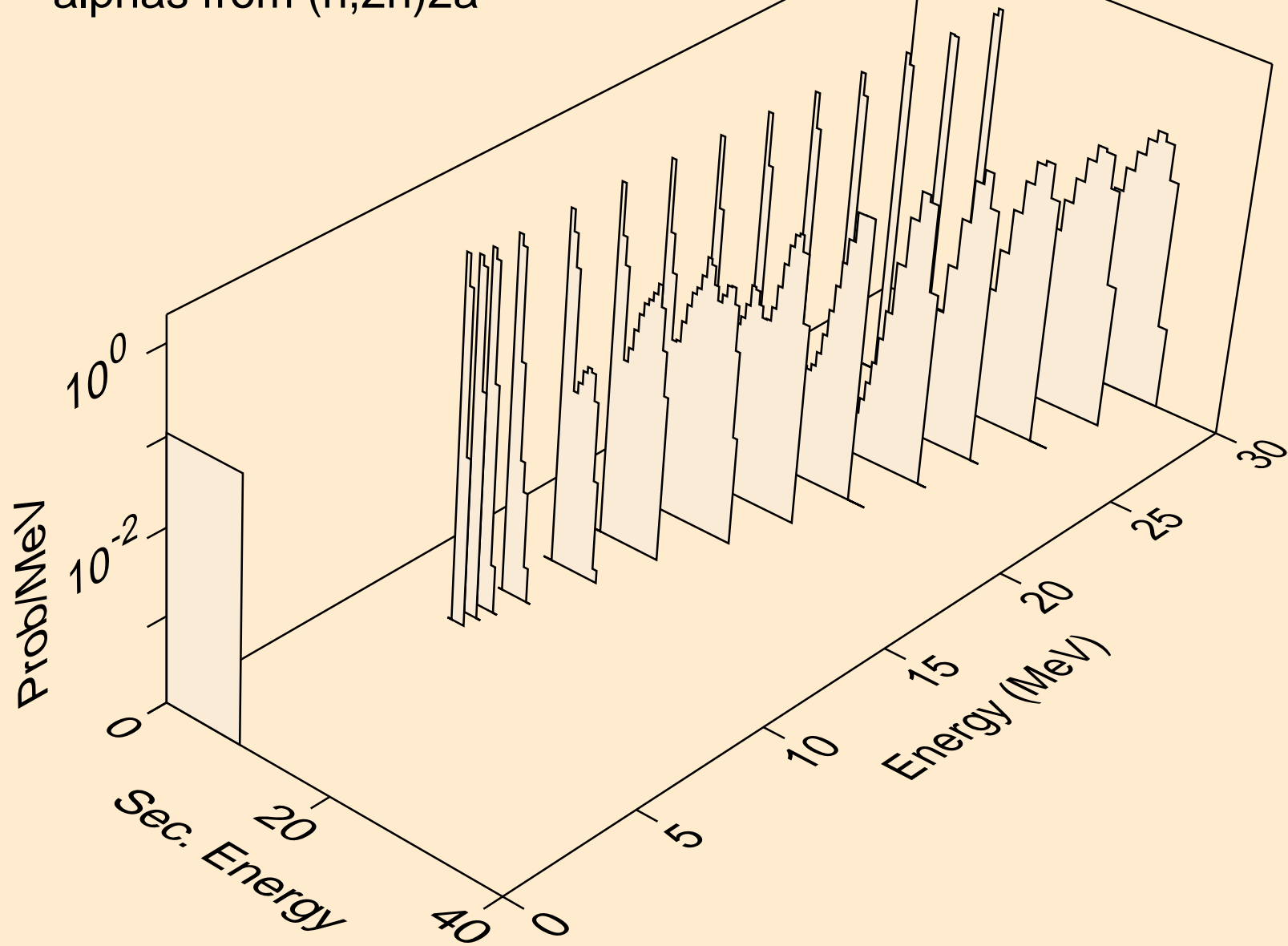

HS268 NEUTRON ACER TENDL-2021 LIBRARY; T=293.6K
alphas from (n,npa)

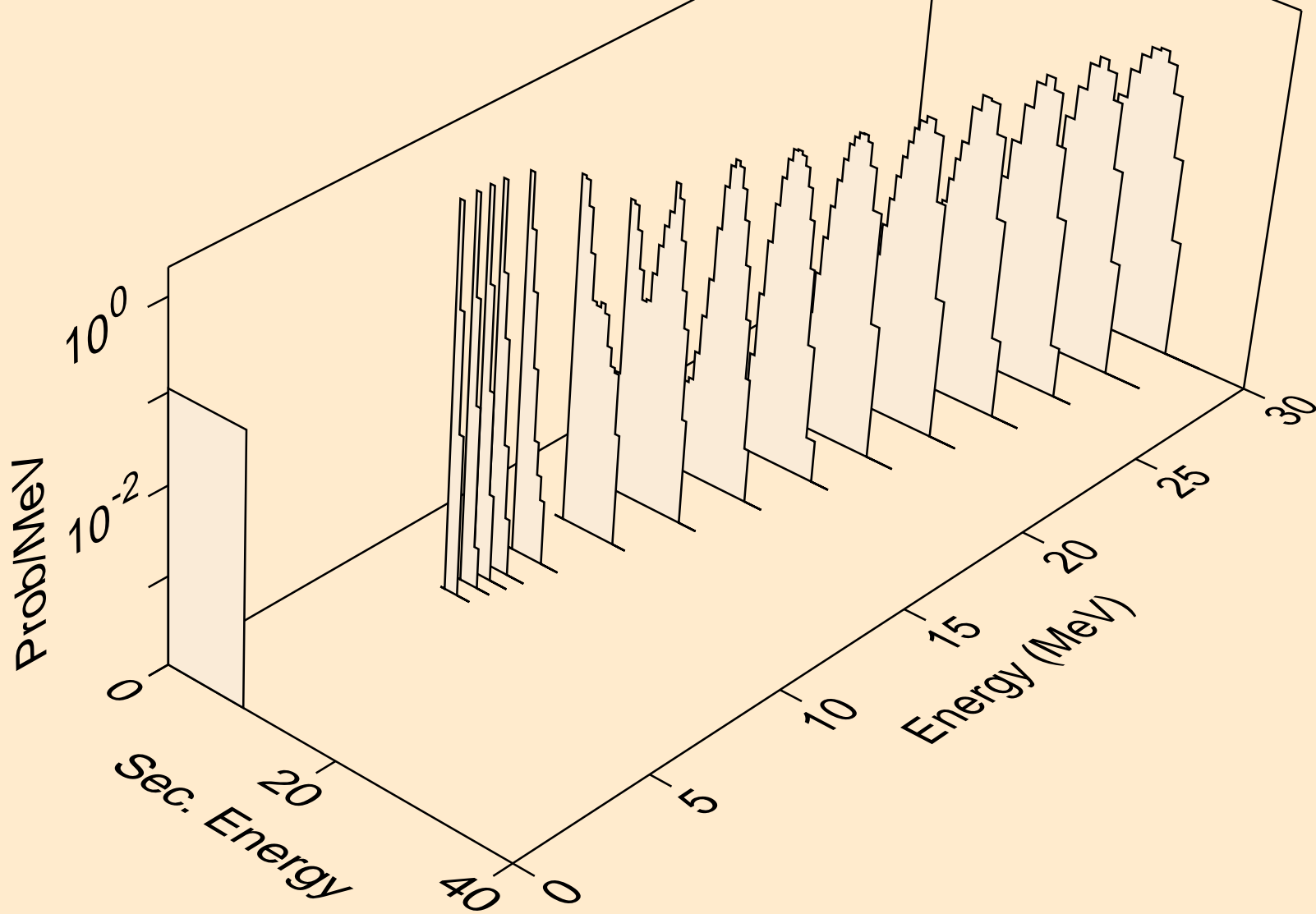

HS268 NEUTRON ACER TENDL-2021 LIBRARY; T=293.6K
alphas from (n,a)

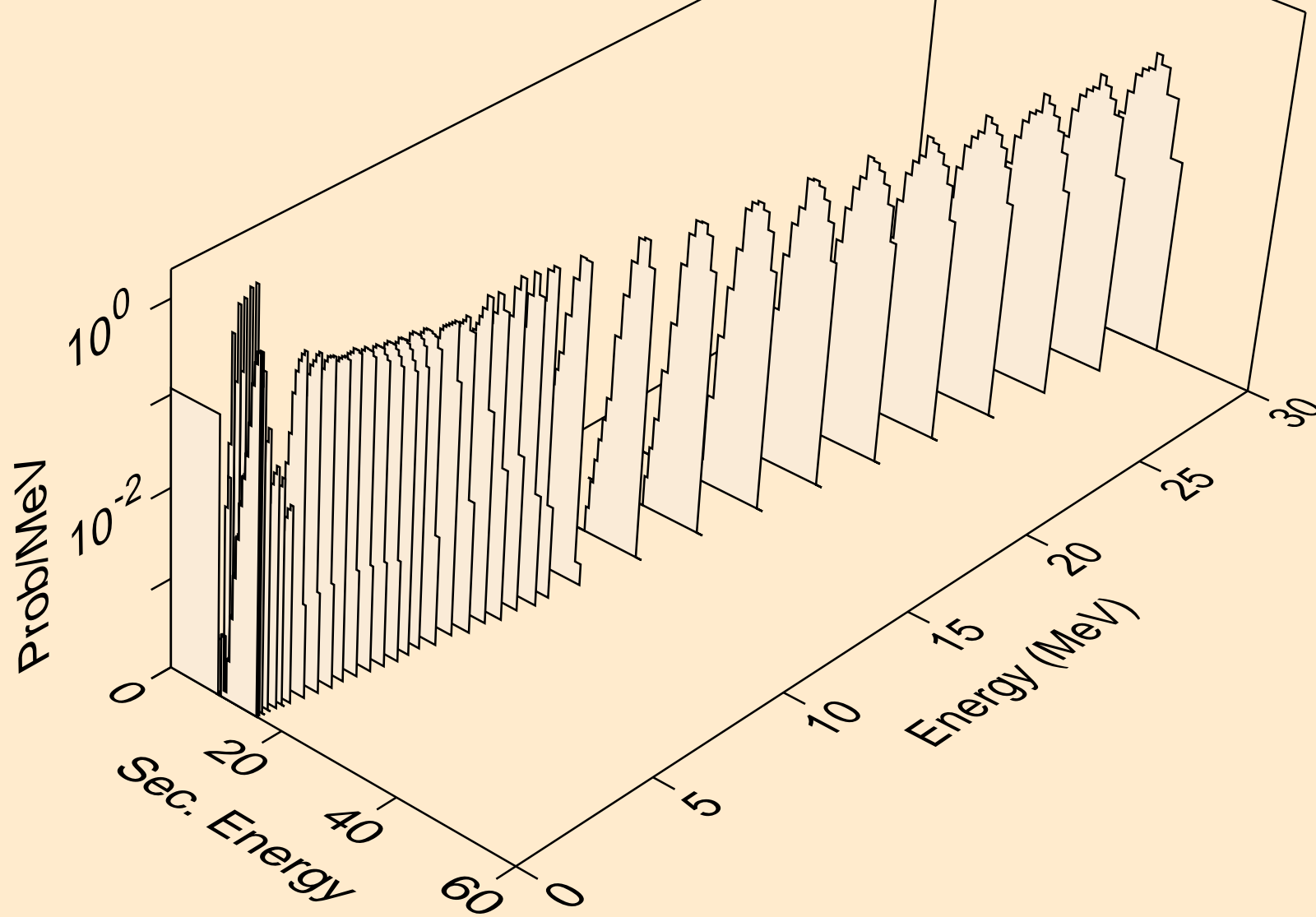

HS268 NEUTRON ACER TENDL-2021 LIBRARY; T=293.6K
alphas from (n,2a)

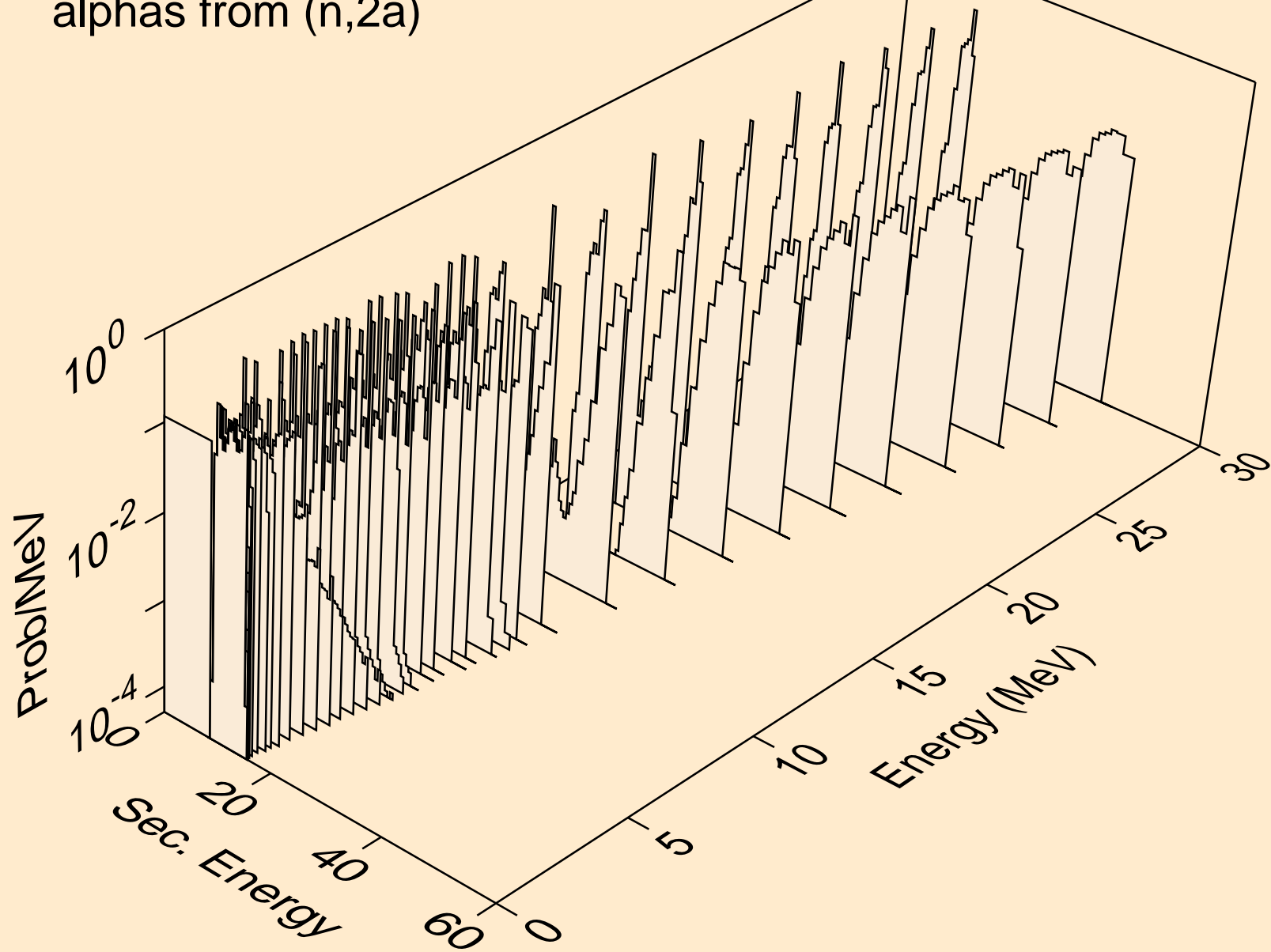

HS268 NEUTRON ACER TENDL-2021 LIBRARY; T=293.6K
alphas from (n,pa)

