

I114 NEUTRON ACER TENDL-2021 LIBRARY; T=293.6K

Principal cross sections

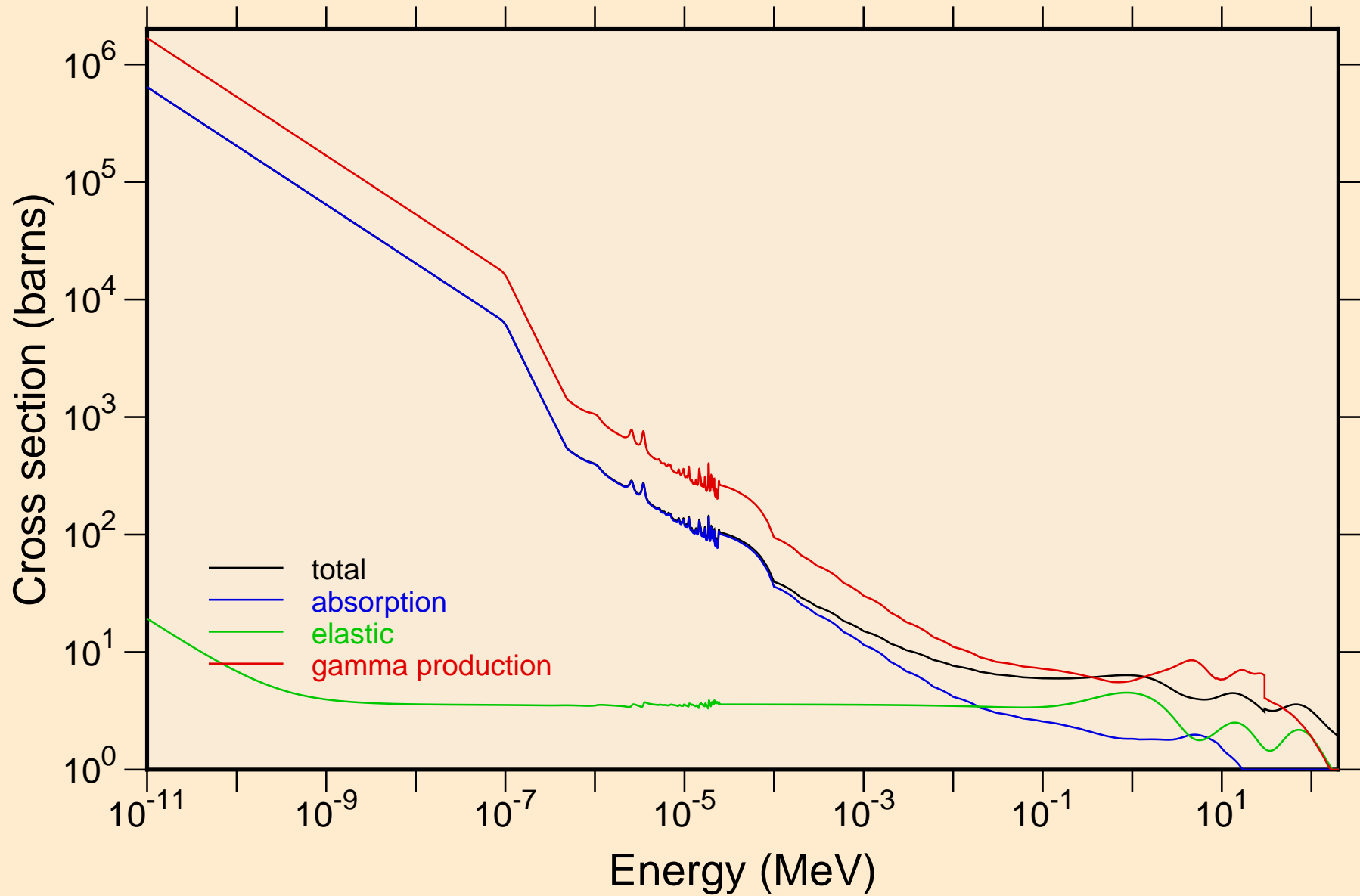

I114 NEUTRON ACER TENDL-2021 LIBRARY; T=293.6K
resonance total cross section

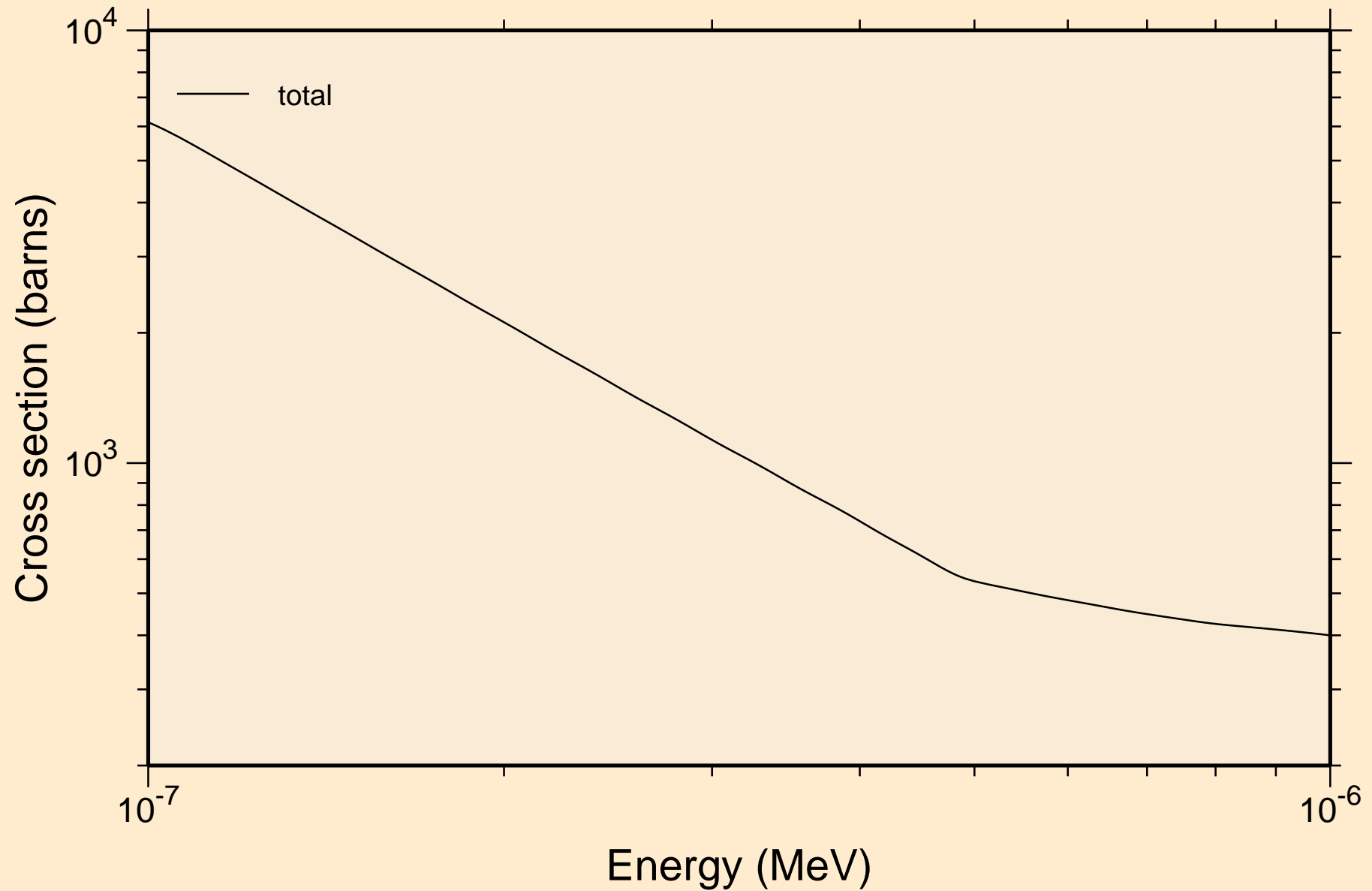

I114 NEUTRON ACER TENDL-2021 LIBRARY; T=293.6K
resonance total cross section

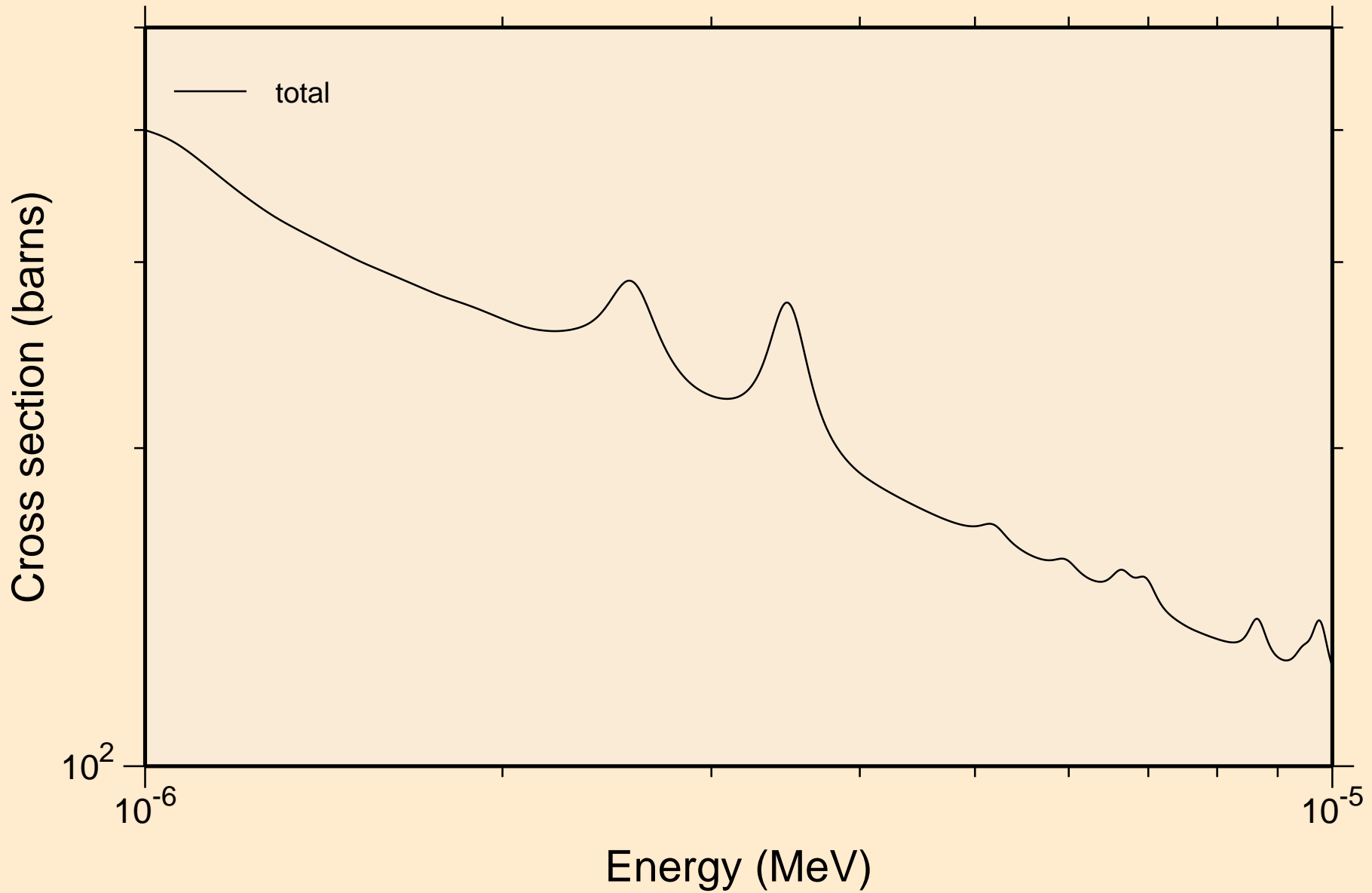

I114 NEUTRON ACER TENDL-2021 LIBRARY; T=293.6K
resonance total cross section

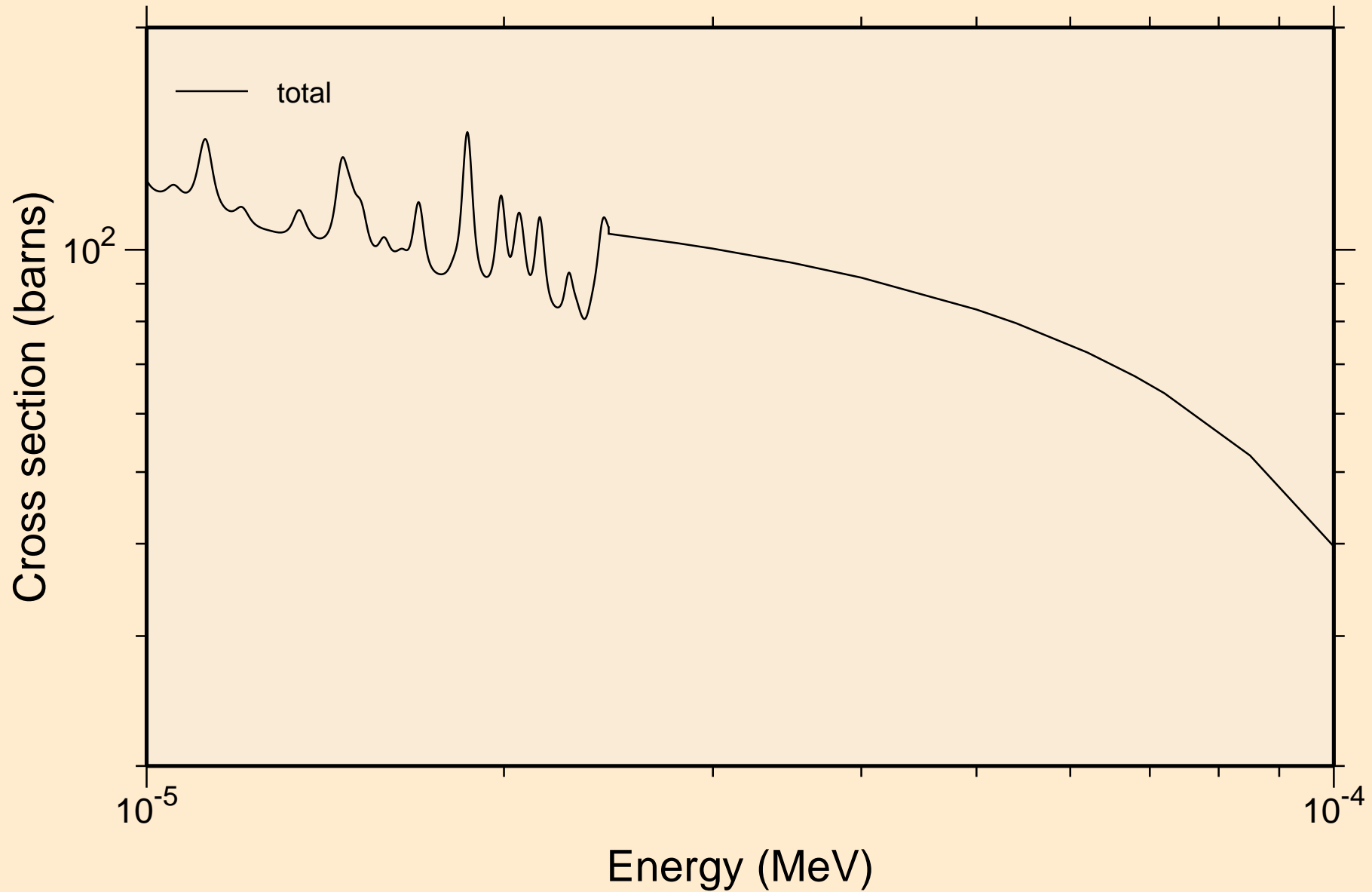

I114 NEUTRON ACER TENDL-2021 LIBRARY; T=293.6K
resonance total cross section

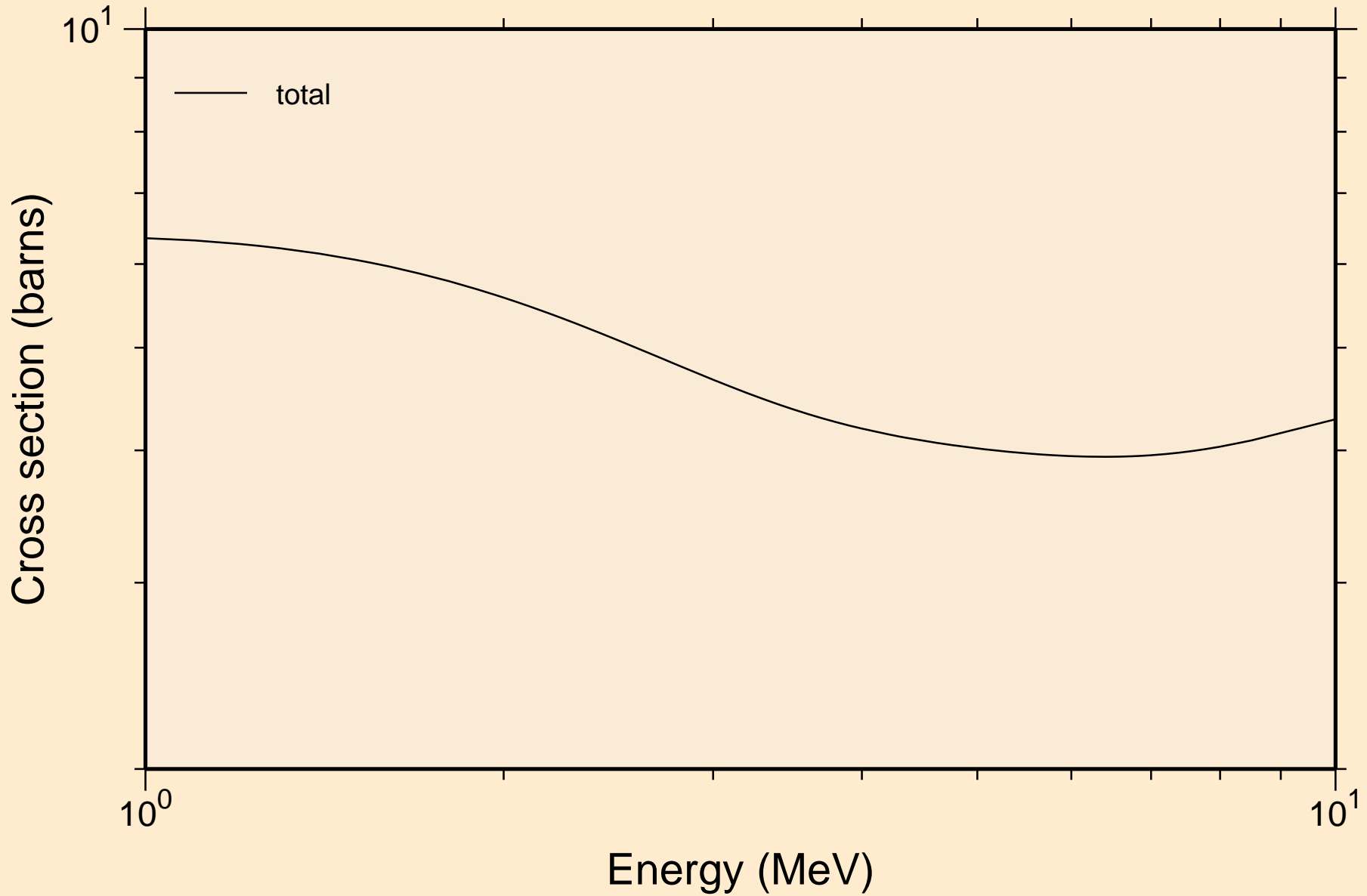

I114 NEUTRON ACER TENDL-2021 LIBRARY; T=293.6K
resonance absorption cross sections

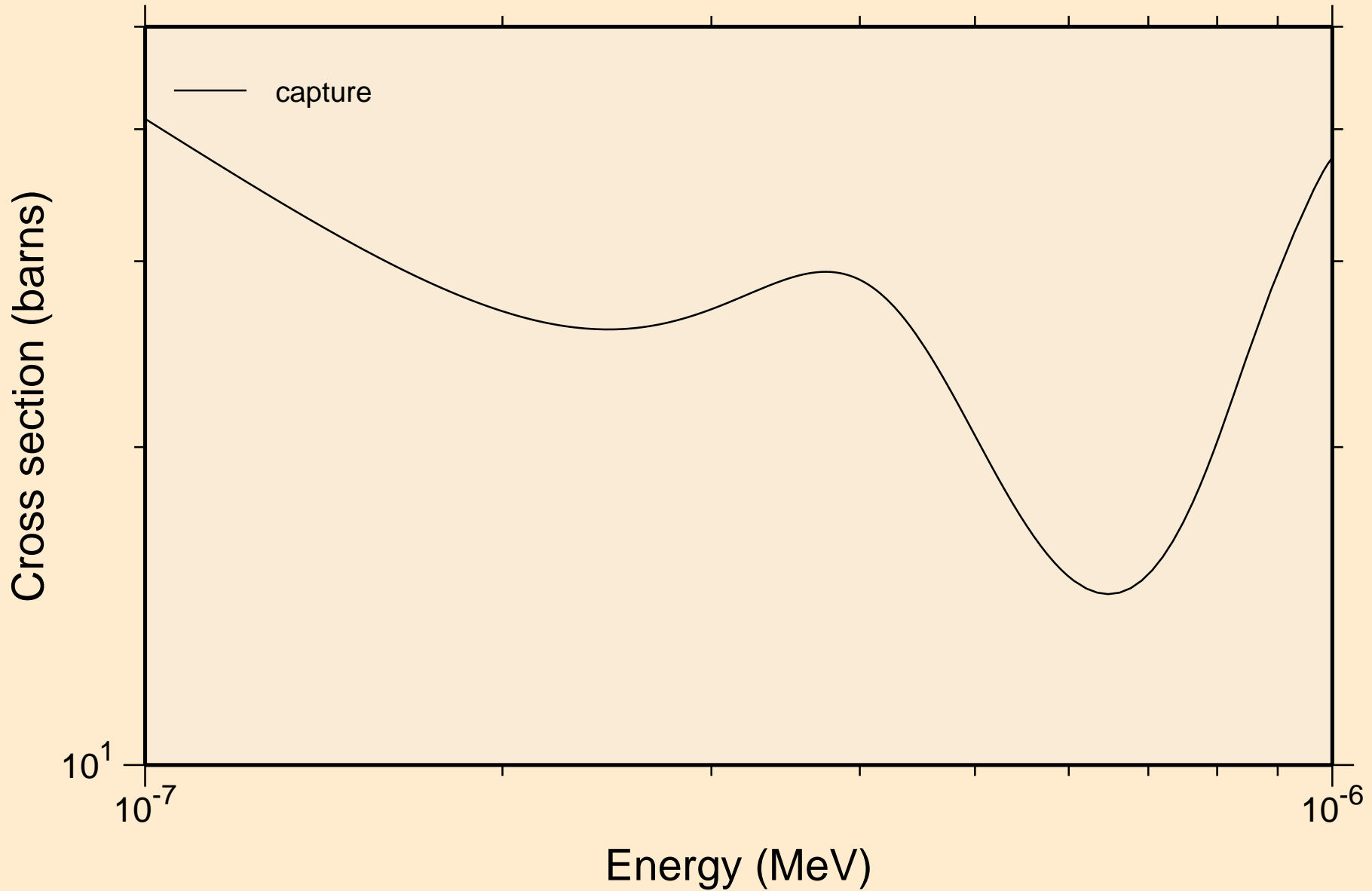

I114 NEUTRON ACER TENDL-2021 LIBRARY; T=293.6K
resonance absorption cross sections

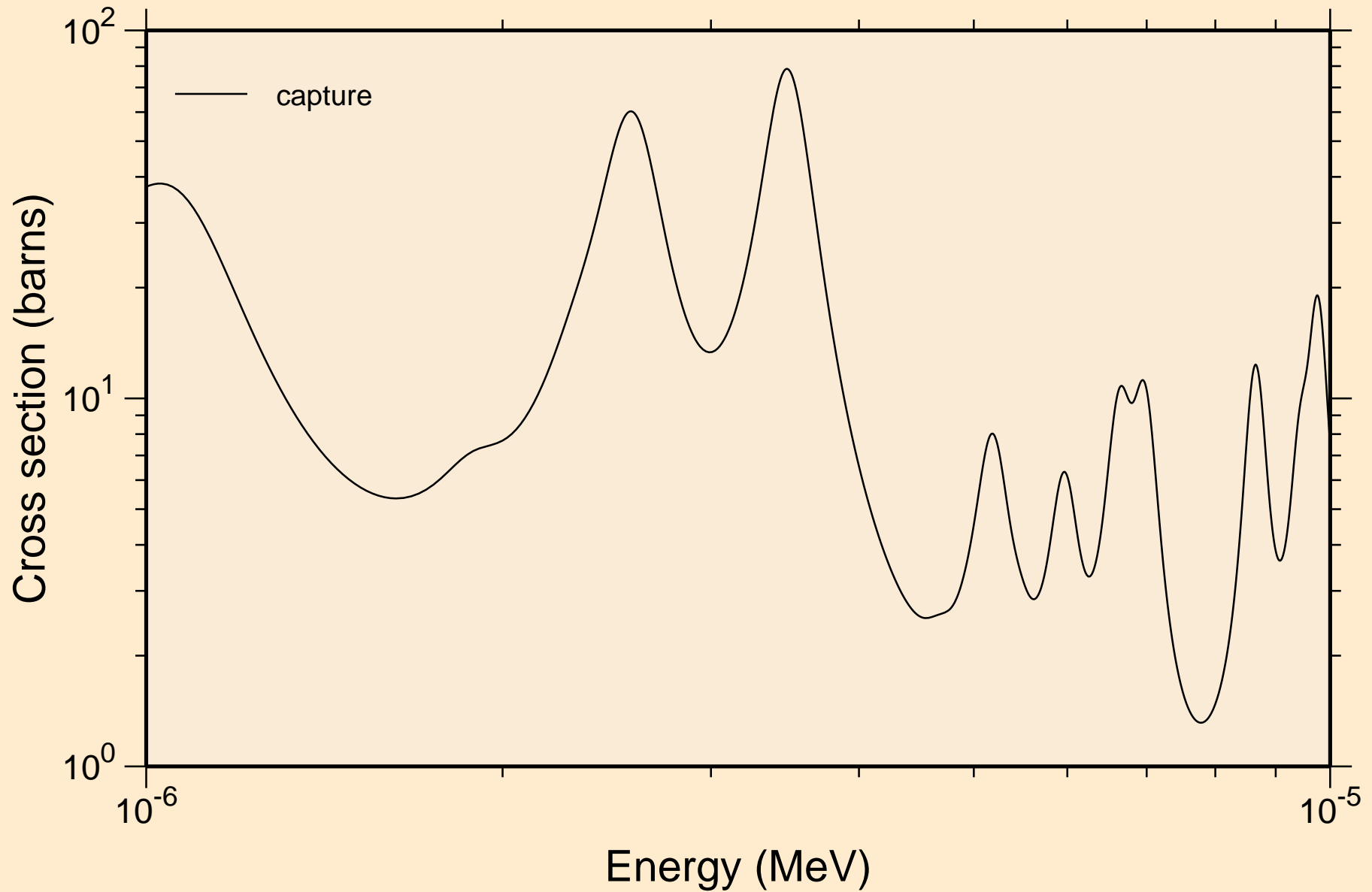

I114 NEUTRON ACER TENDL-2021 LIBRARY; T=293.6K
resonance absorption cross sections

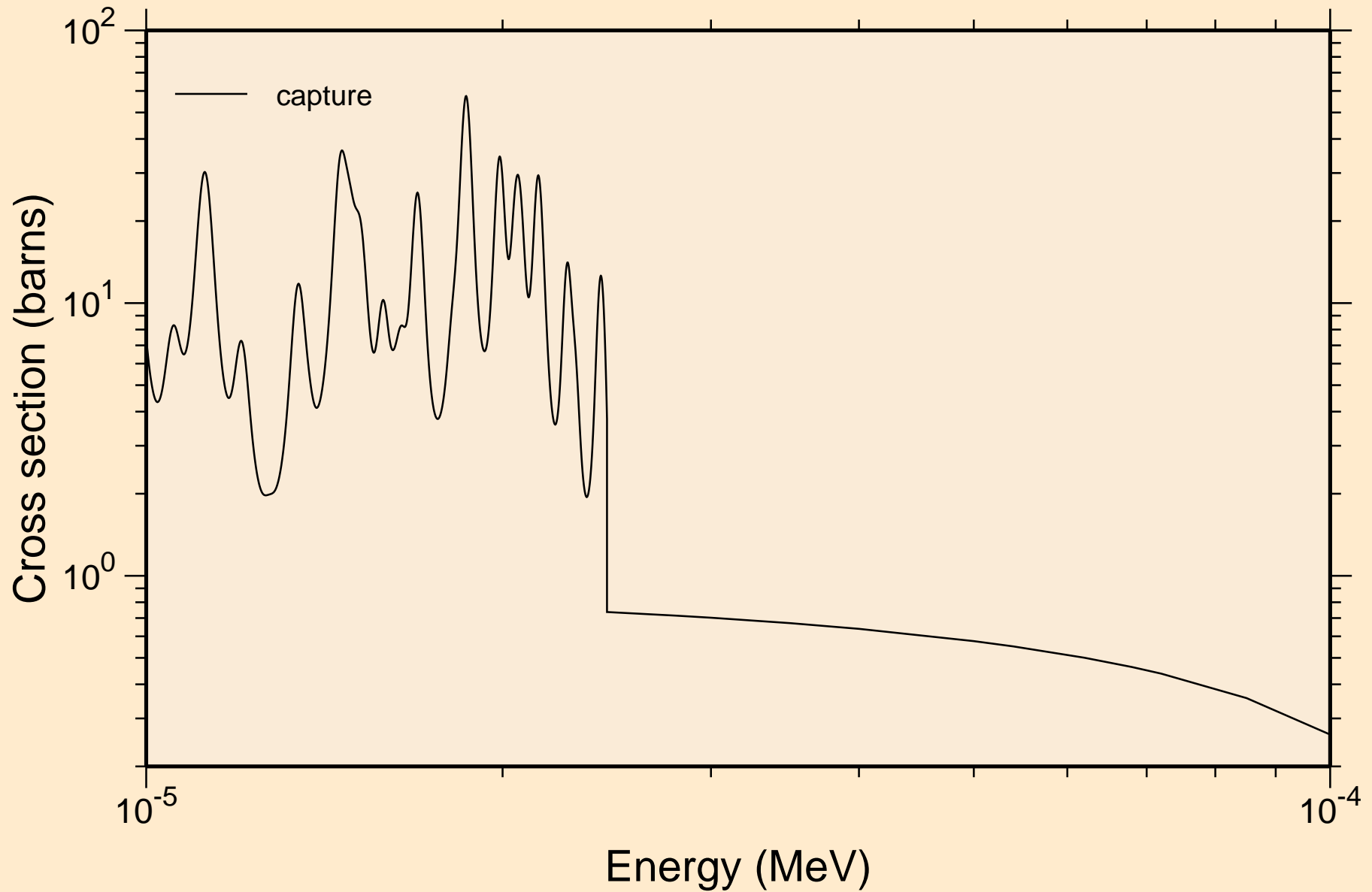

I114 NEUTRON ACER TENDL-2021 LIBRARY; T=293.6K
resonance absorption cross sections

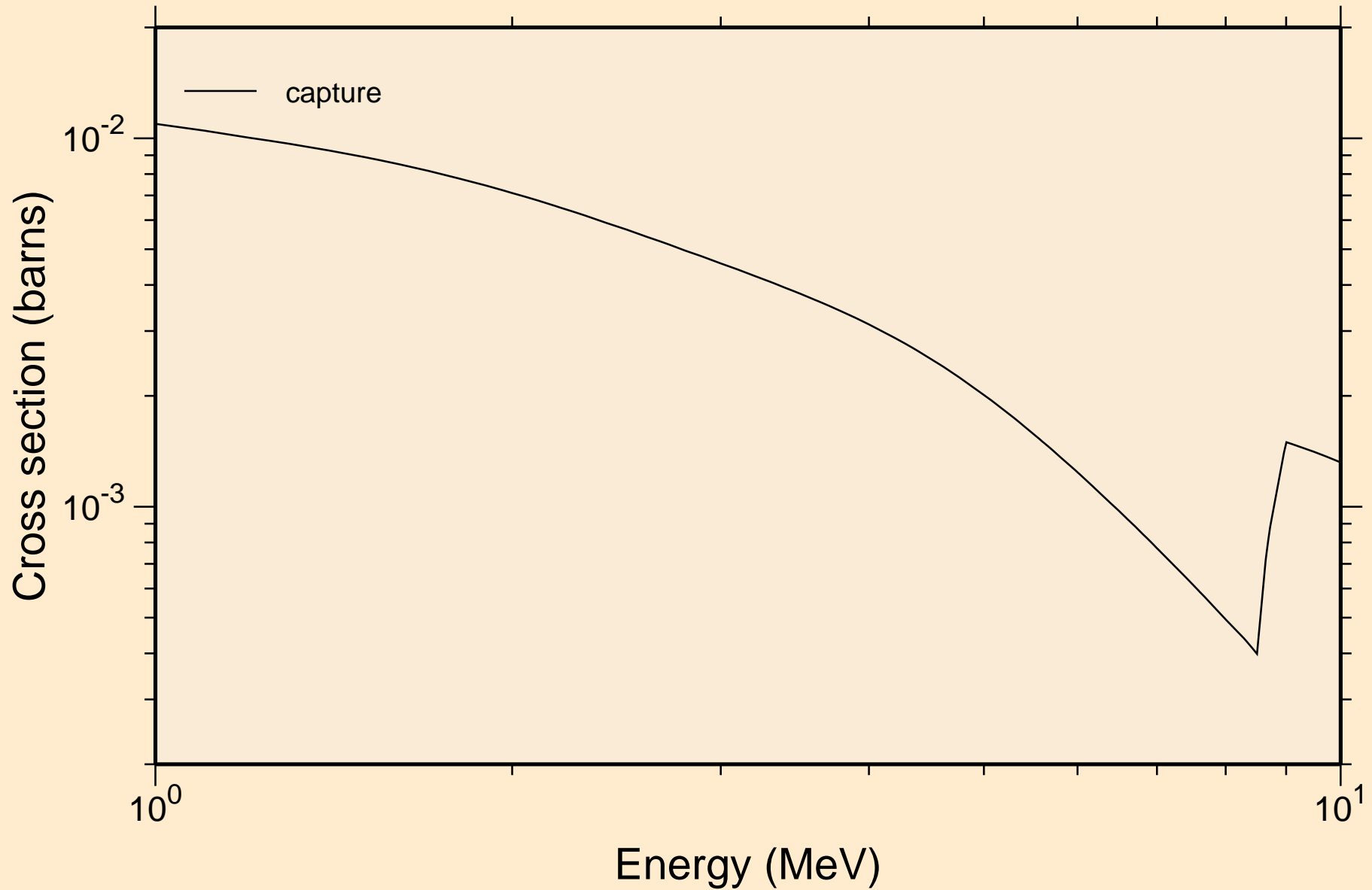

I114 NEUTRON ACER TENDL-2021 LIBRARY; T=293.6K

Heating

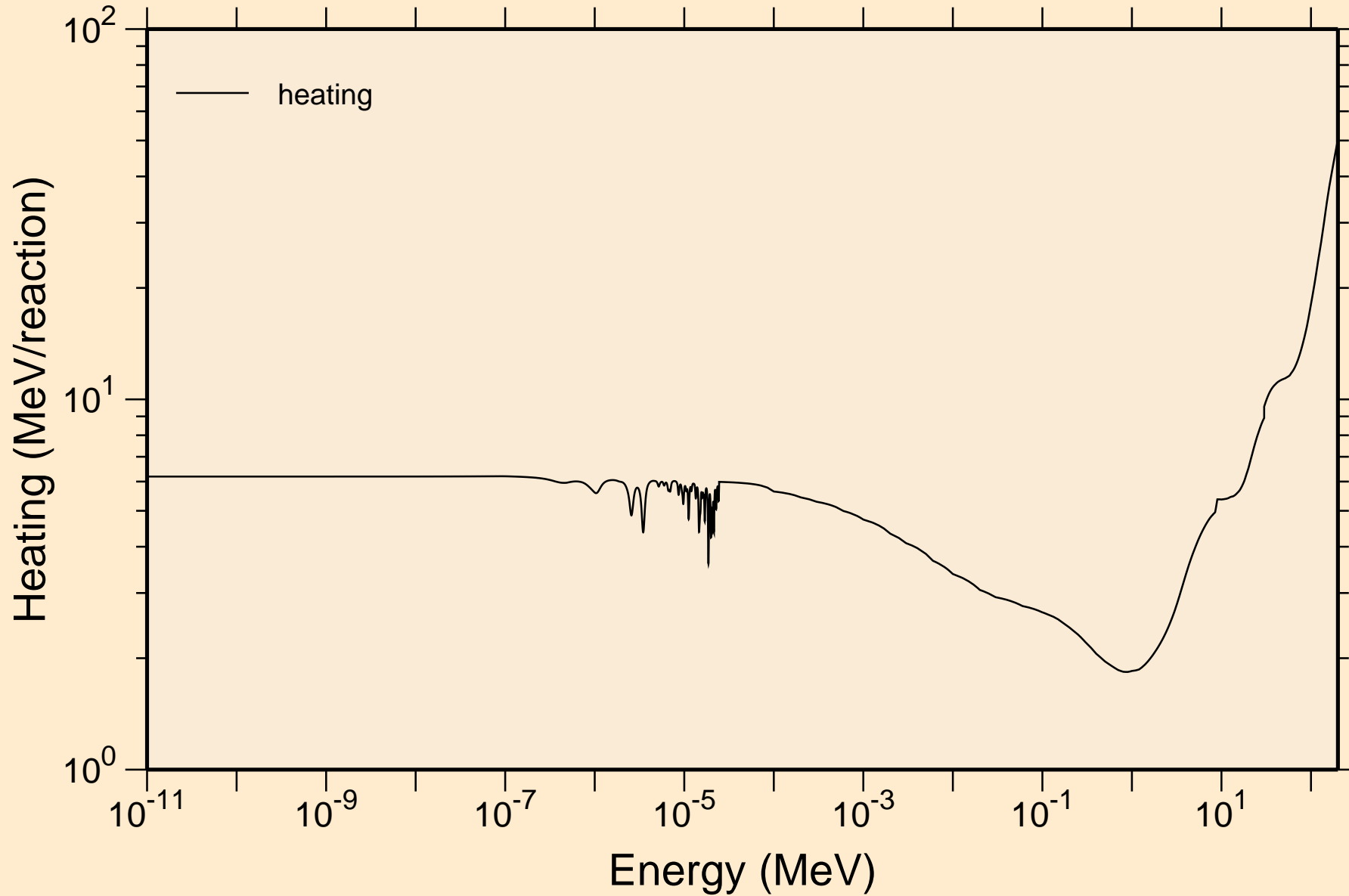

I114 NEUTRON ACER TENDL-2021 LIBRARY; T=293.6K
Damage

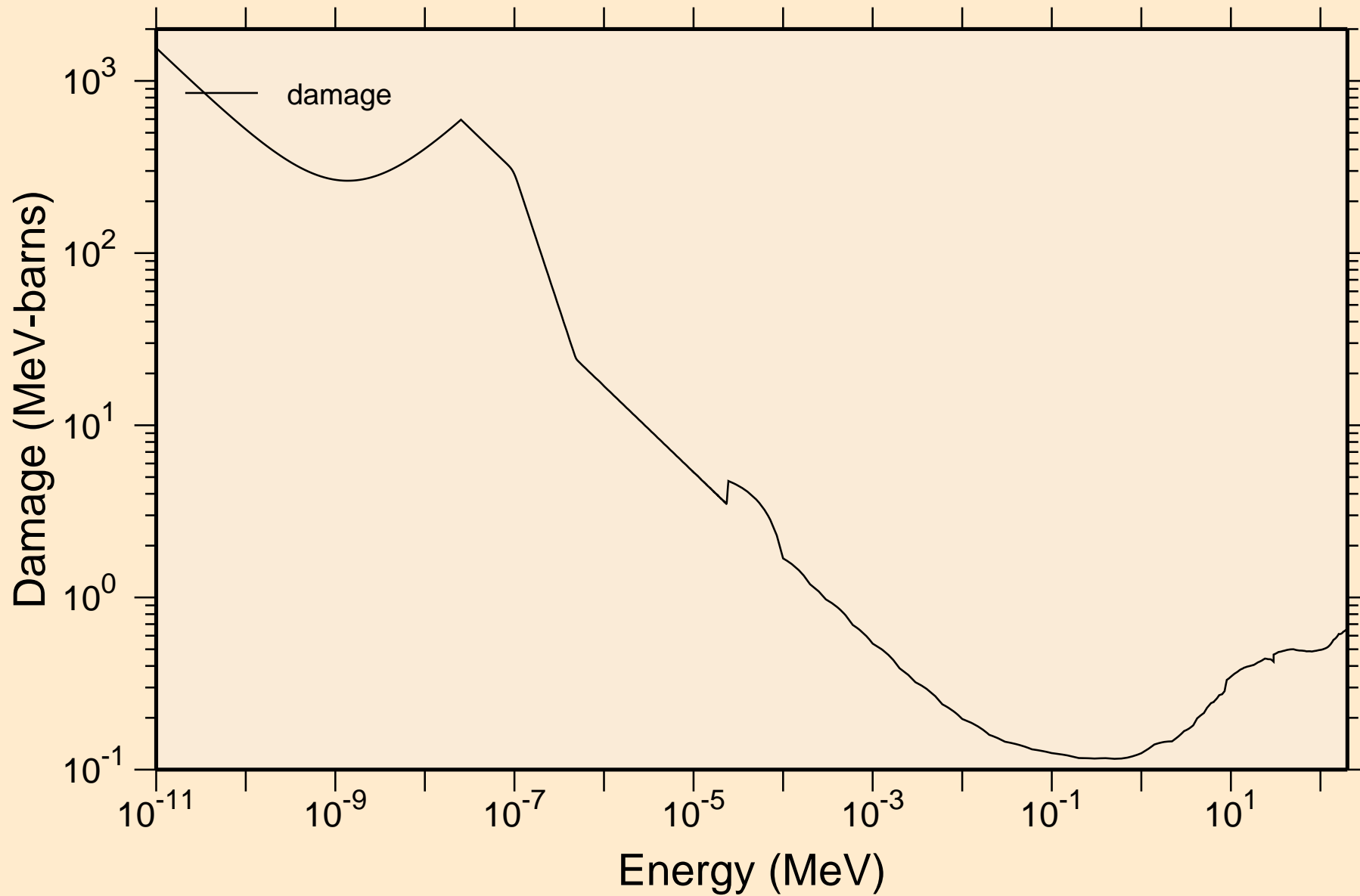

I114 NEUTRON ACER TENDL-2021 LIBRARY; T=293.6K

Non-threshold reactions

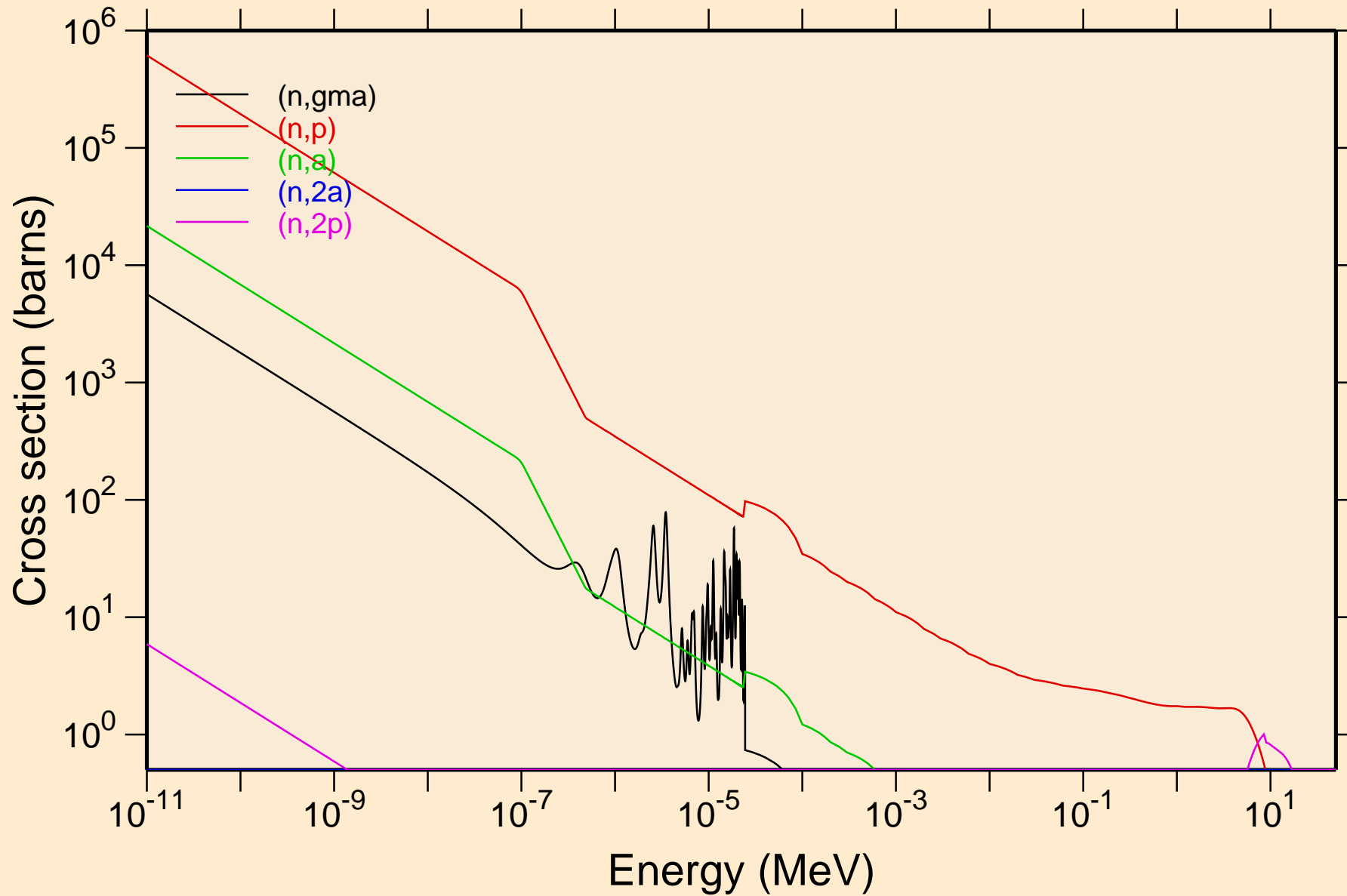

I114 NEUTRON ACER TENDL-2021 LIBRARY; T=293.6K

Non-threshold reactions

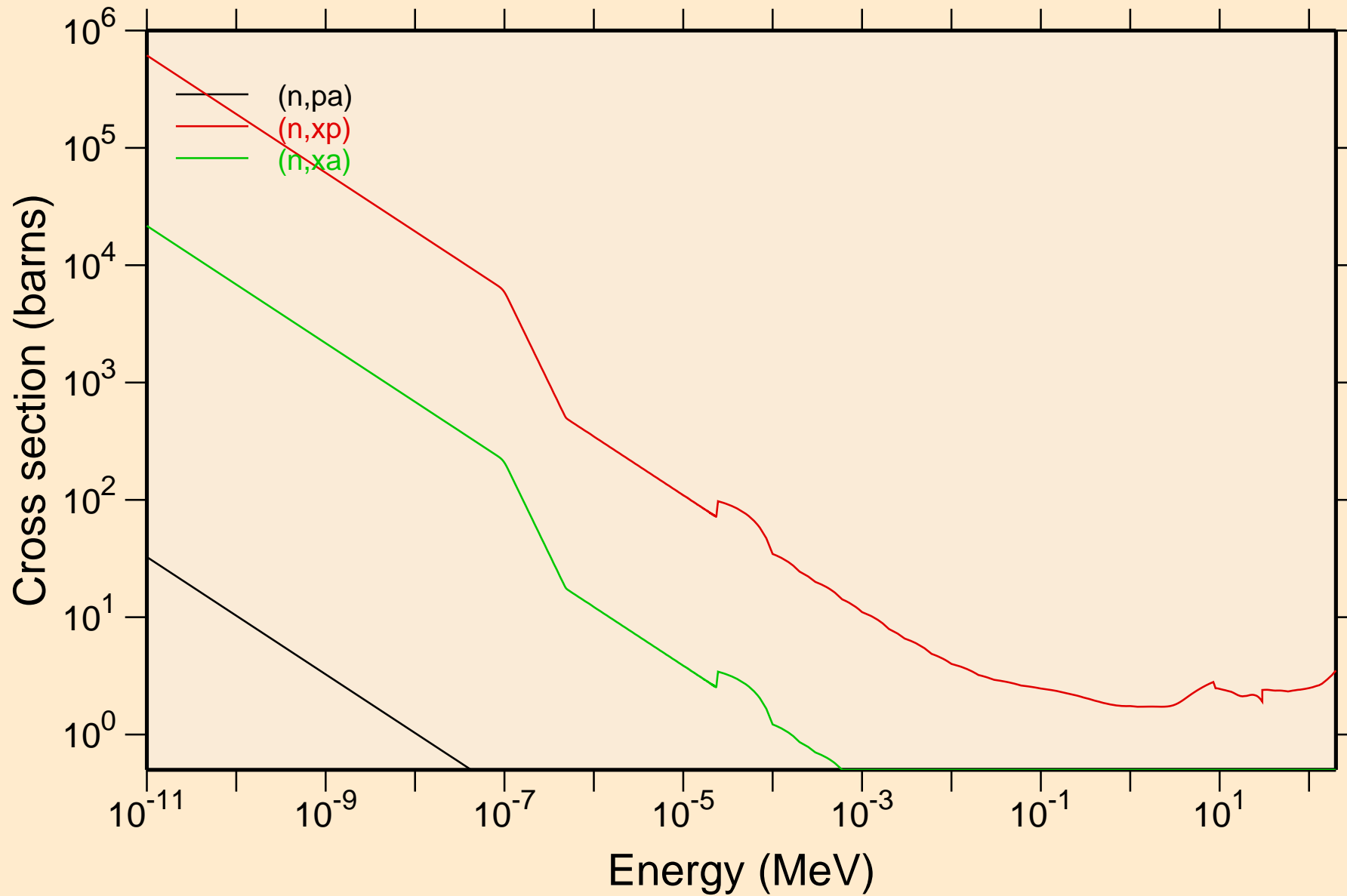

I114 NEUTRON ACER TENDL-2021 LIBRARY; T=293.6K

Principal cross sections

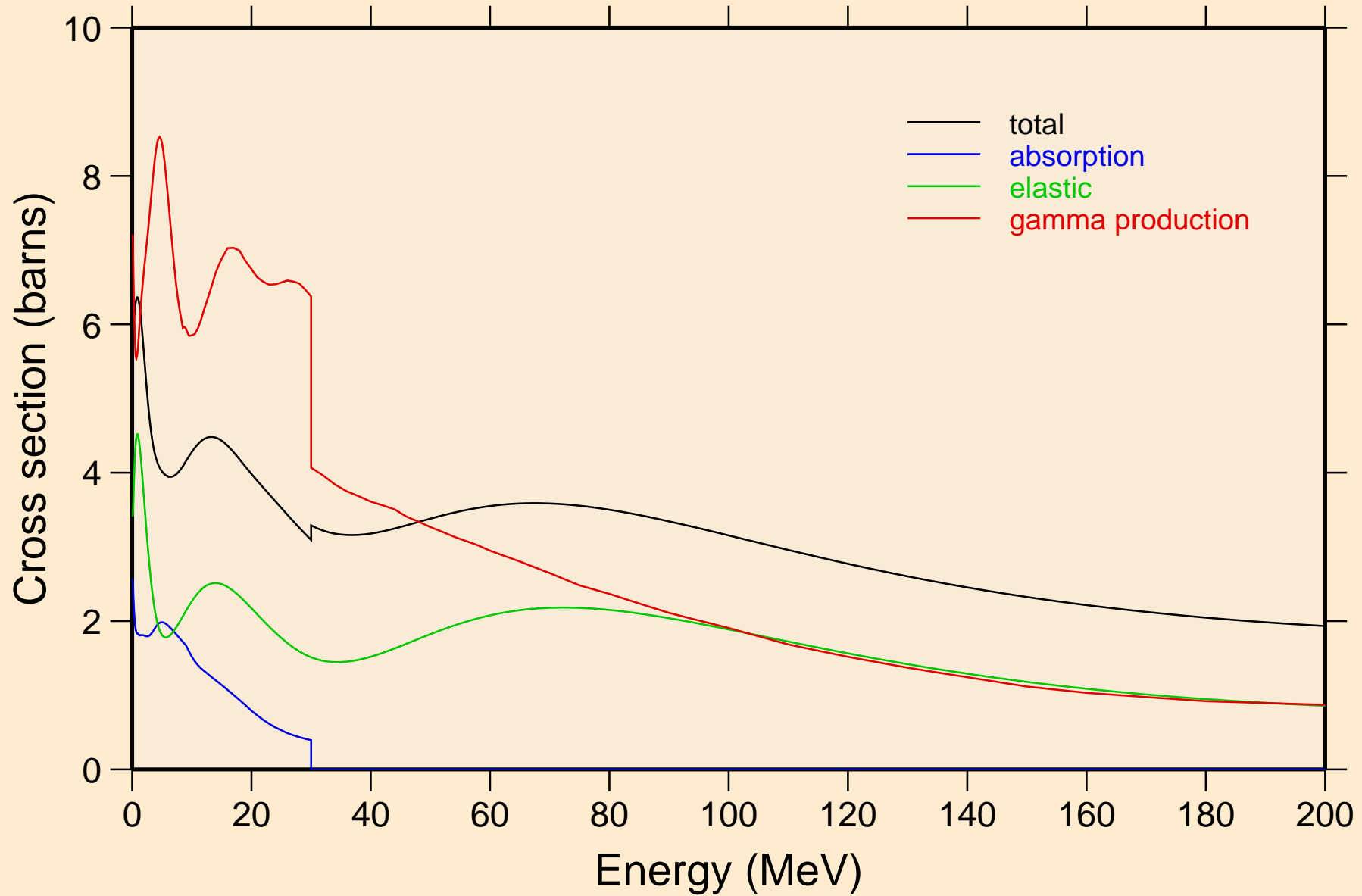

I114 NEUTRON ACER TENDL-2021 LIBRARY; T=293.6K

Heating

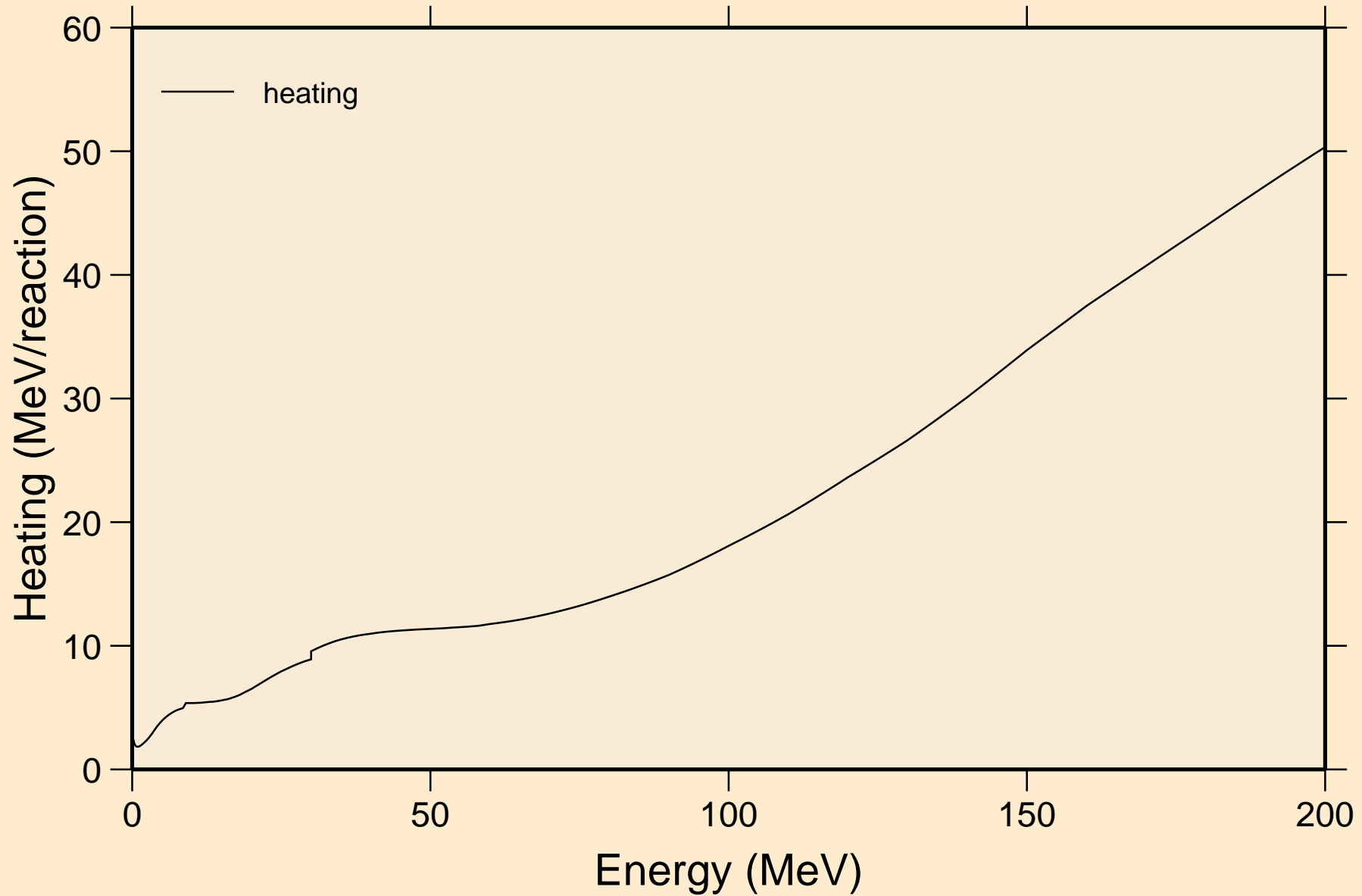

I114 NEUTRON ACER TENDL-2021 LIBRARY; T=293.6K
Damage

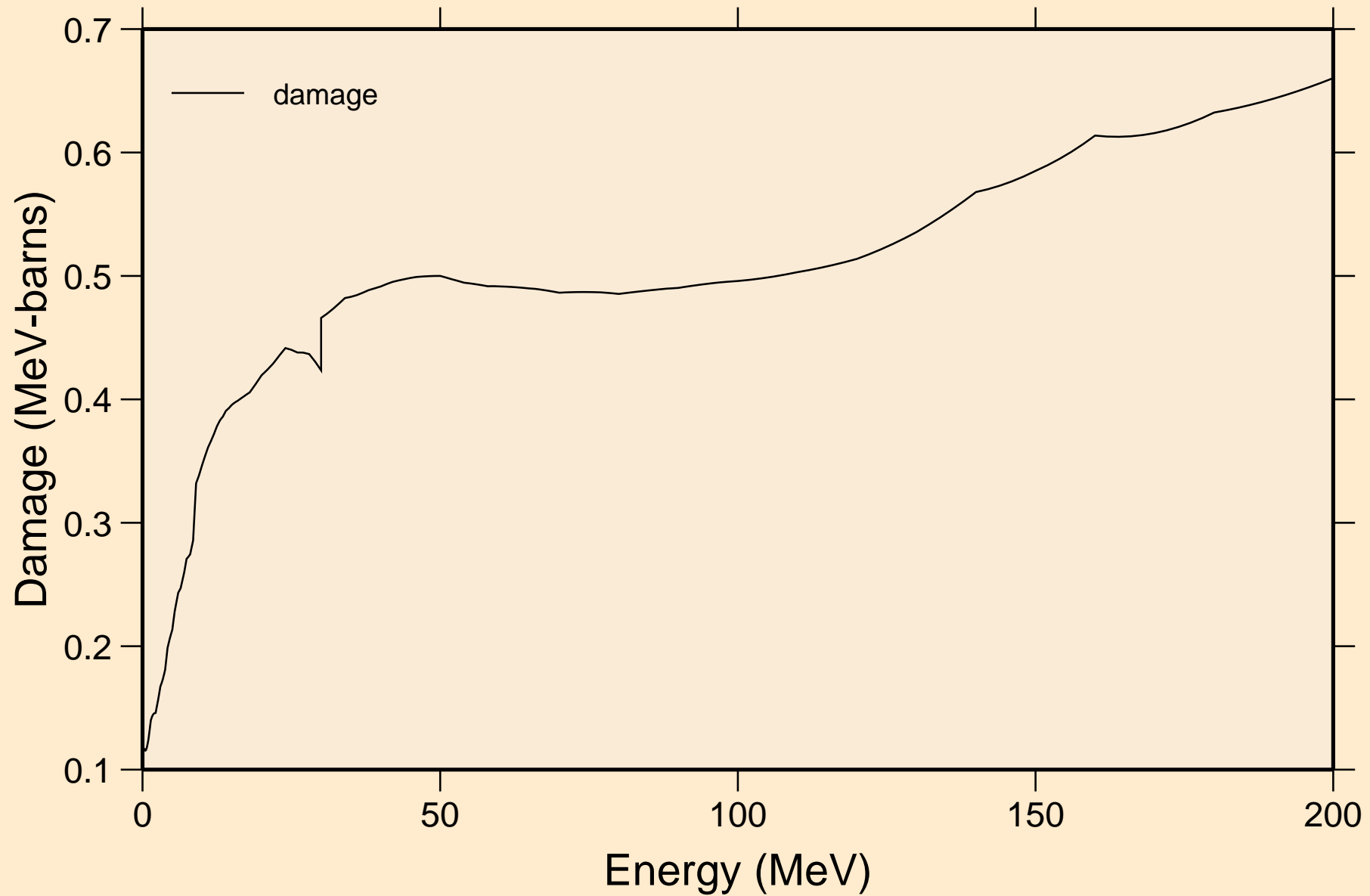

I114 NEUTRON ACER TENDL-2021 LIBRARY; T=293.6K
Non-threshold reactions

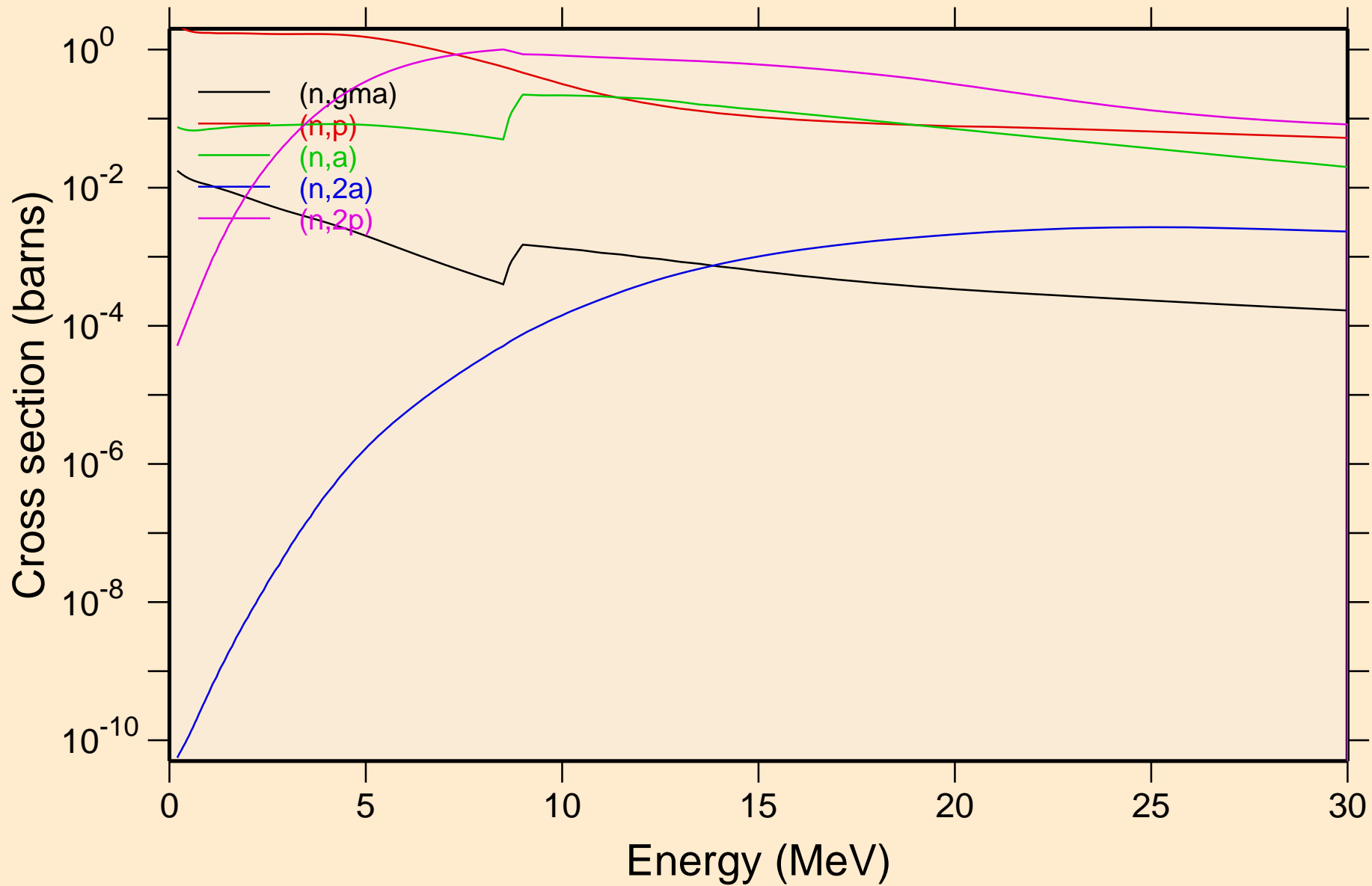

I114 NEUTRON ACER TENDL-2021 LIBRARY; T=293.6K
Non-threshold reactions

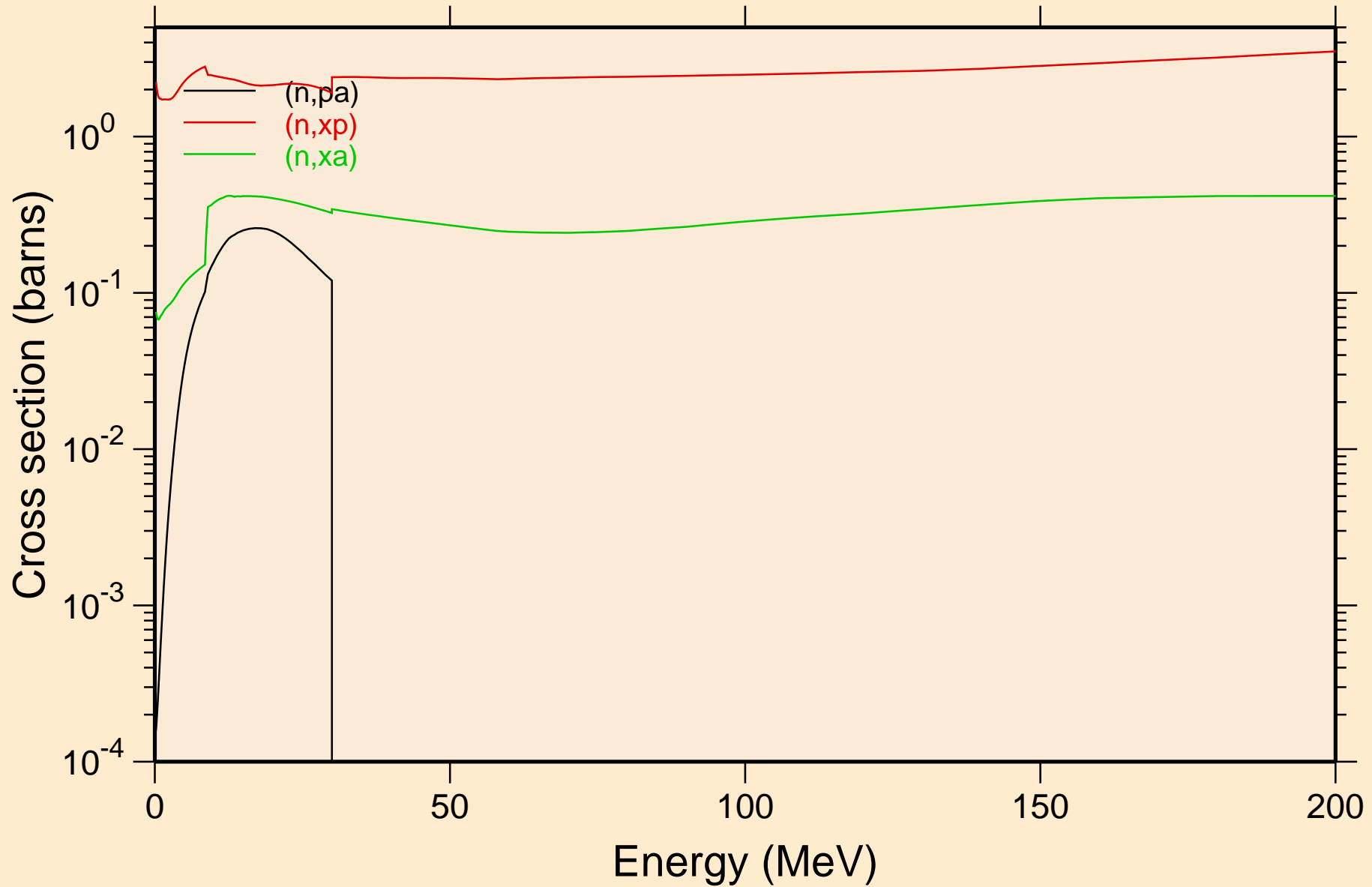

I114 NEUTRON ACER TENDL-2021 LIBRARY; T=293.6K
Inelastic levels

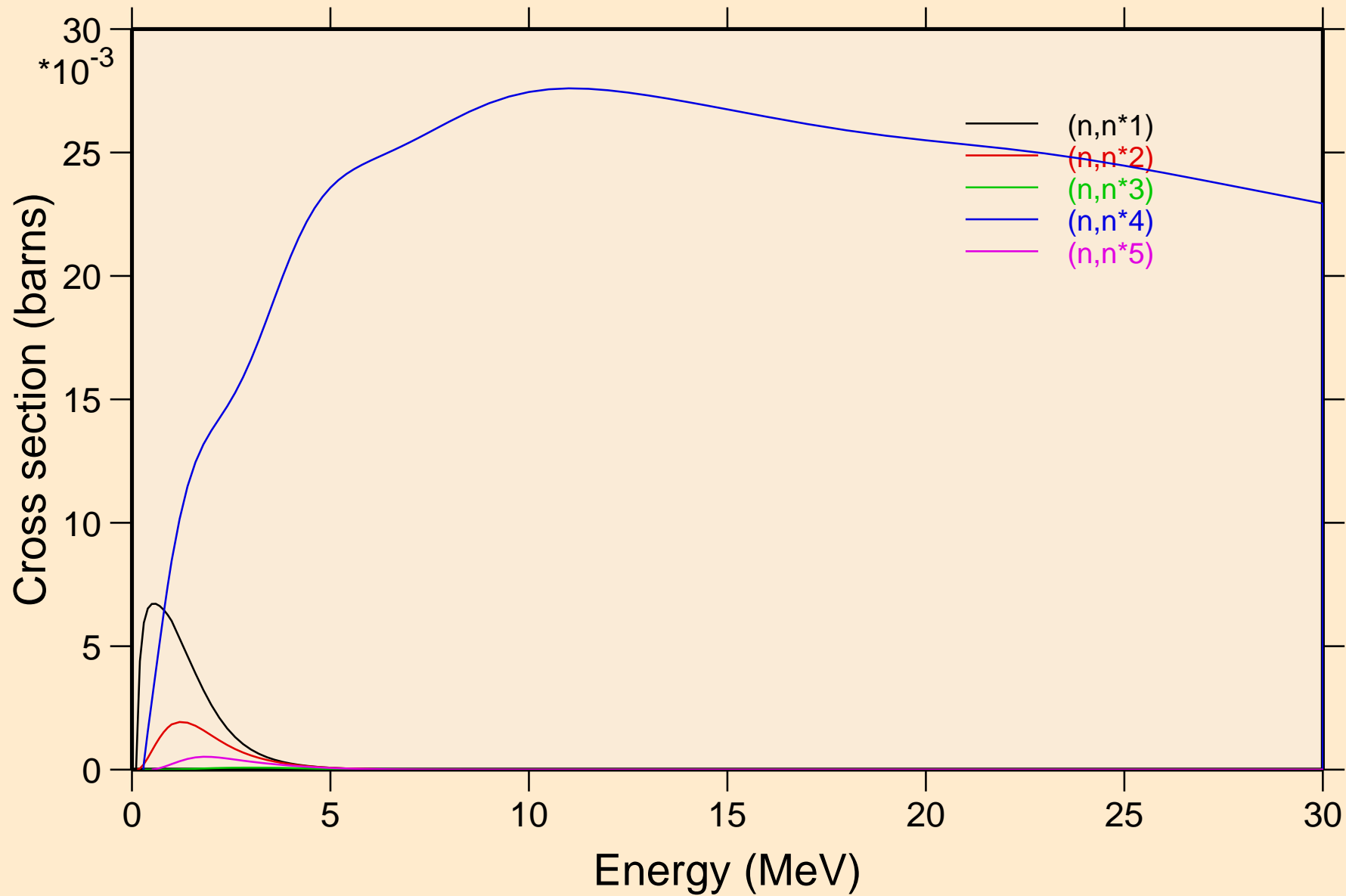

I114 NEUTRON ACER TENDL-2021 LIBRARY; T=293.6K
Inelastic levels

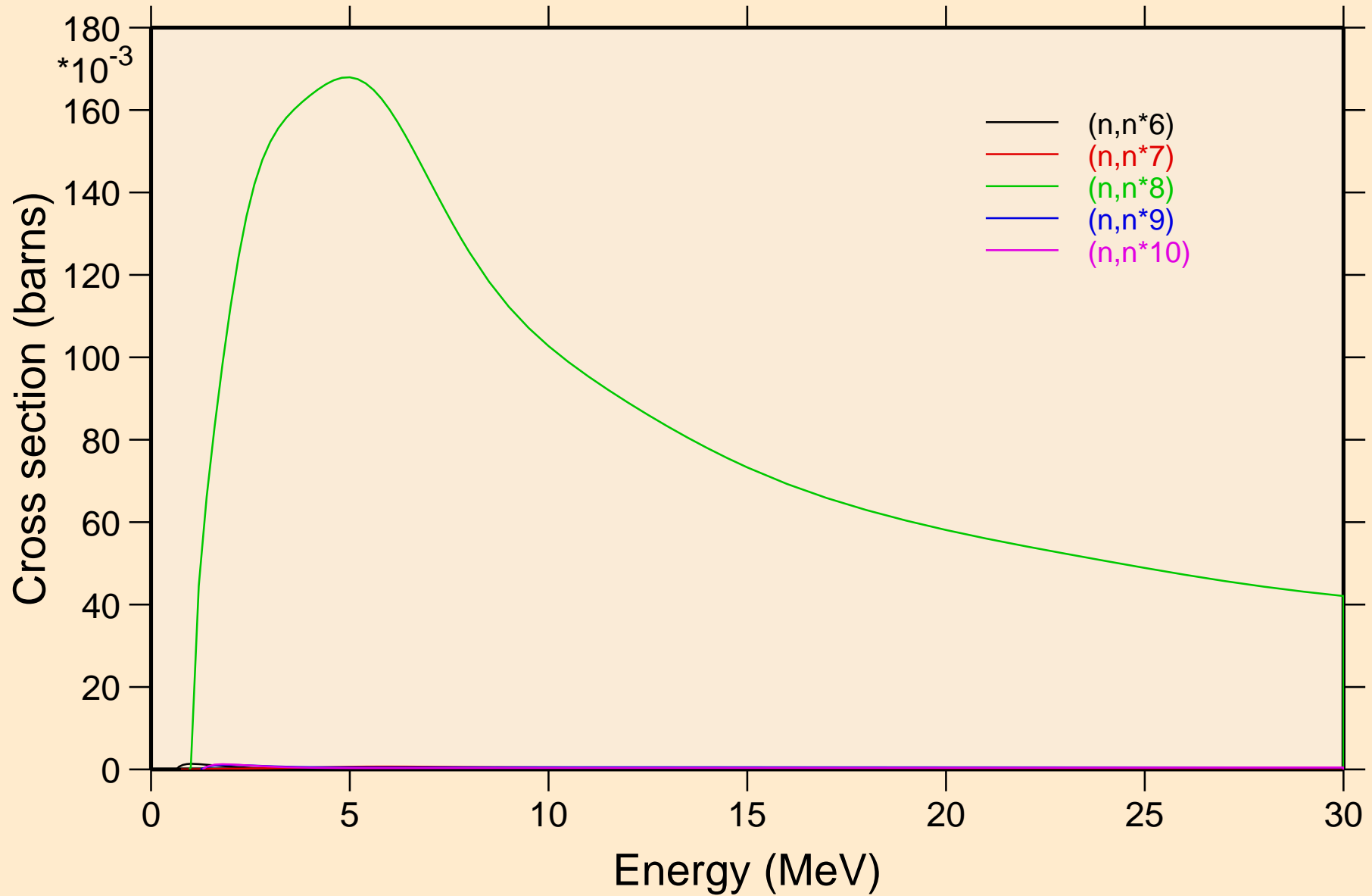

I114 NEUTRON ACER TENDL-2021 LIBRARY; T=293.6K
Inelastic levels

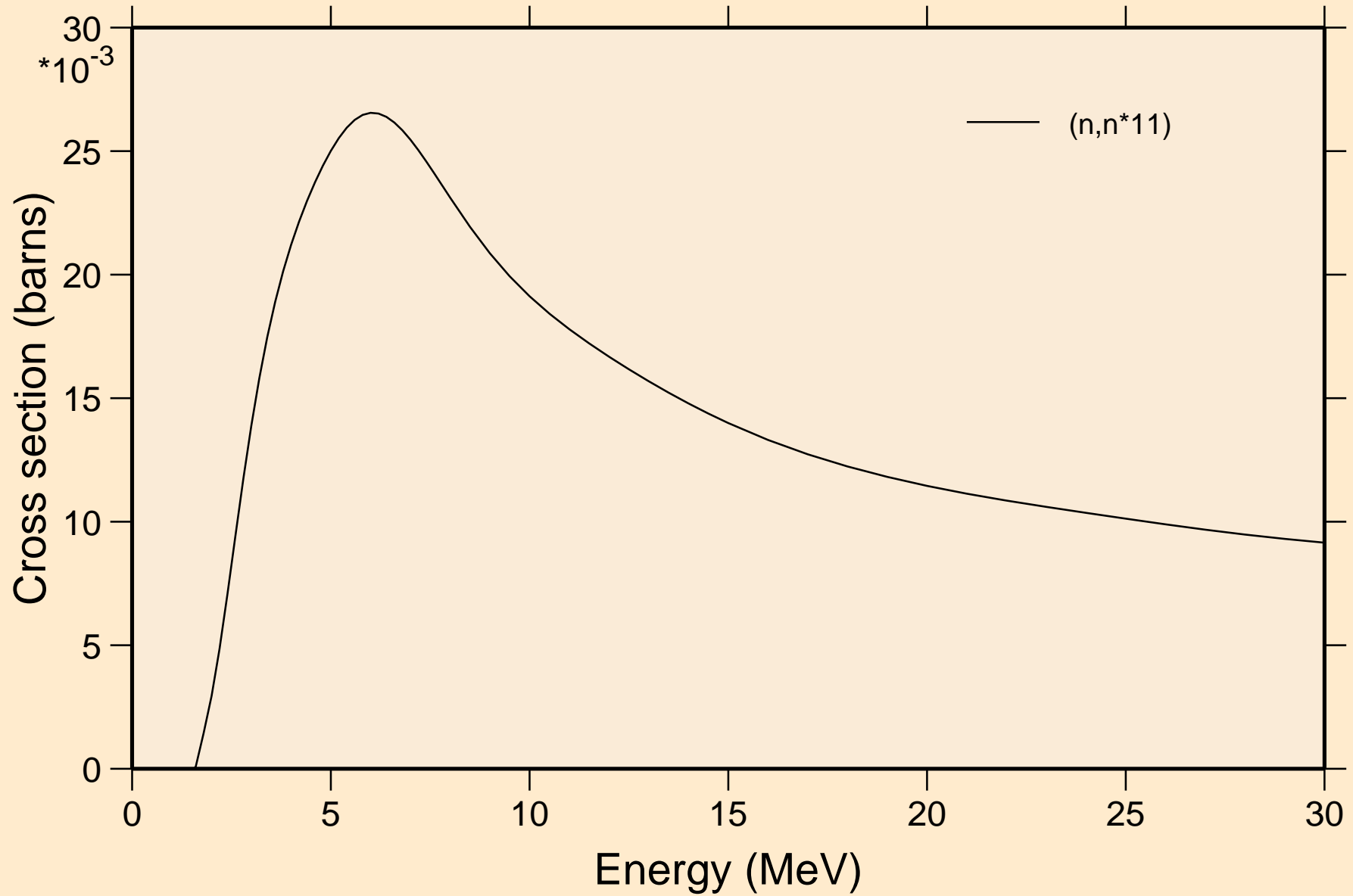

I114 NEUTRON ACER TENDL-2021 LIBRARY; T=293.6K

Threshold reactions

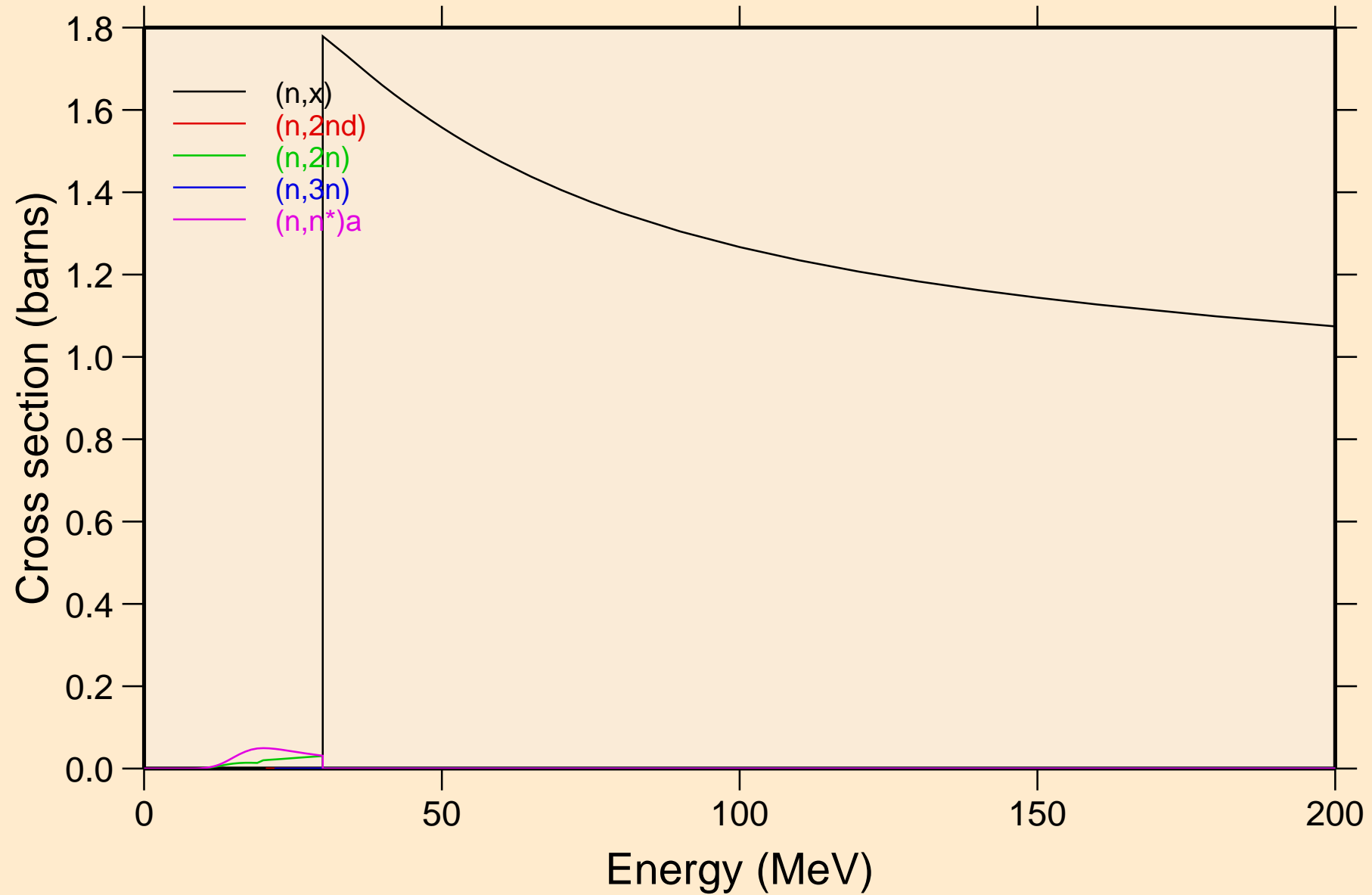

I114 NEUTRON ACER TENDL-2021 LIBRARY; T=293.6K
Threshold reactions

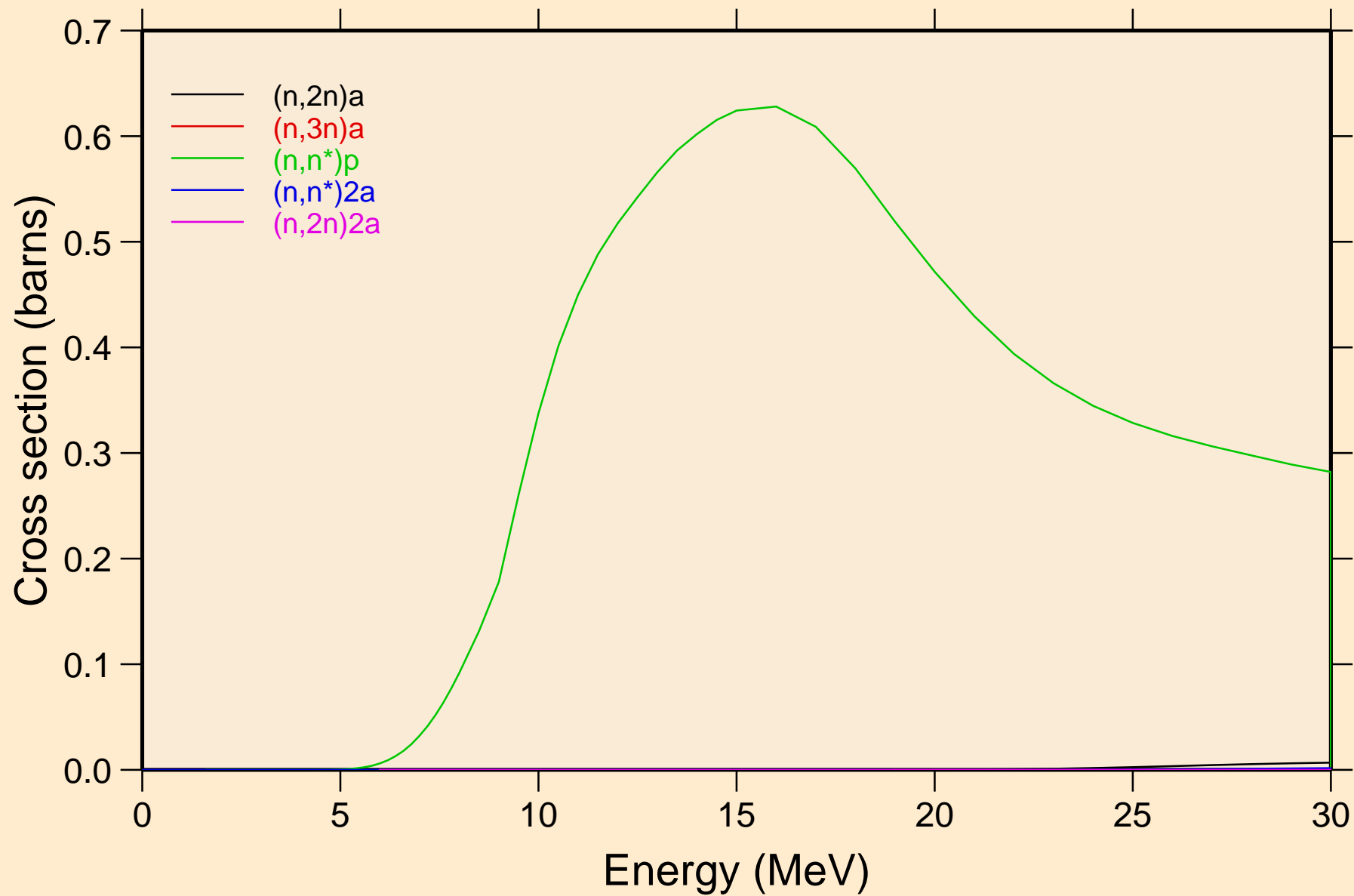

I114 NEUTRON ACER TENDL-2021 LIBRARY; T=293.6K

Threshold reactions

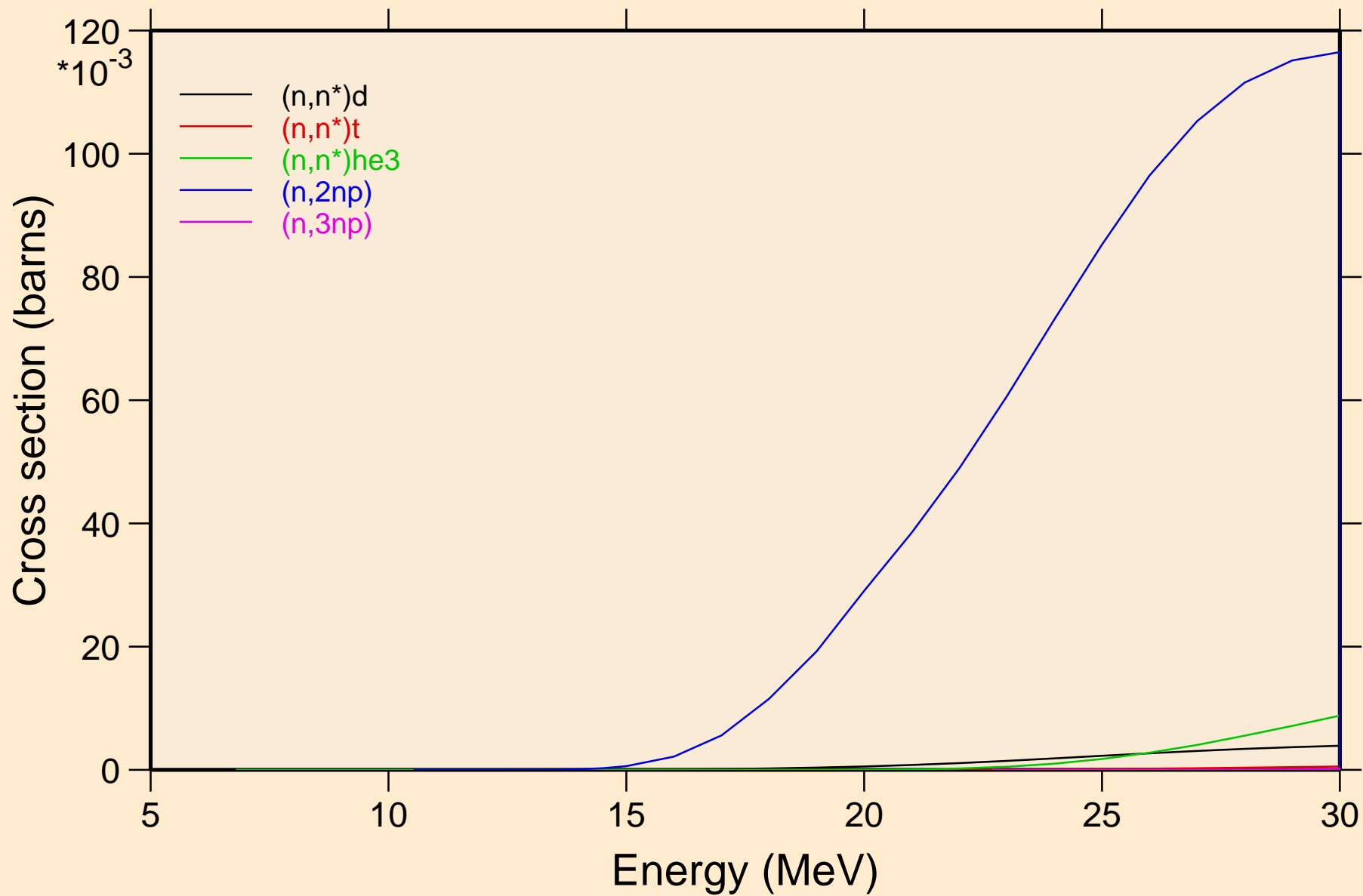

I114 NEUTRON ACER TENDL-2021 LIBRARY; T=293.6K
Threshold reactions

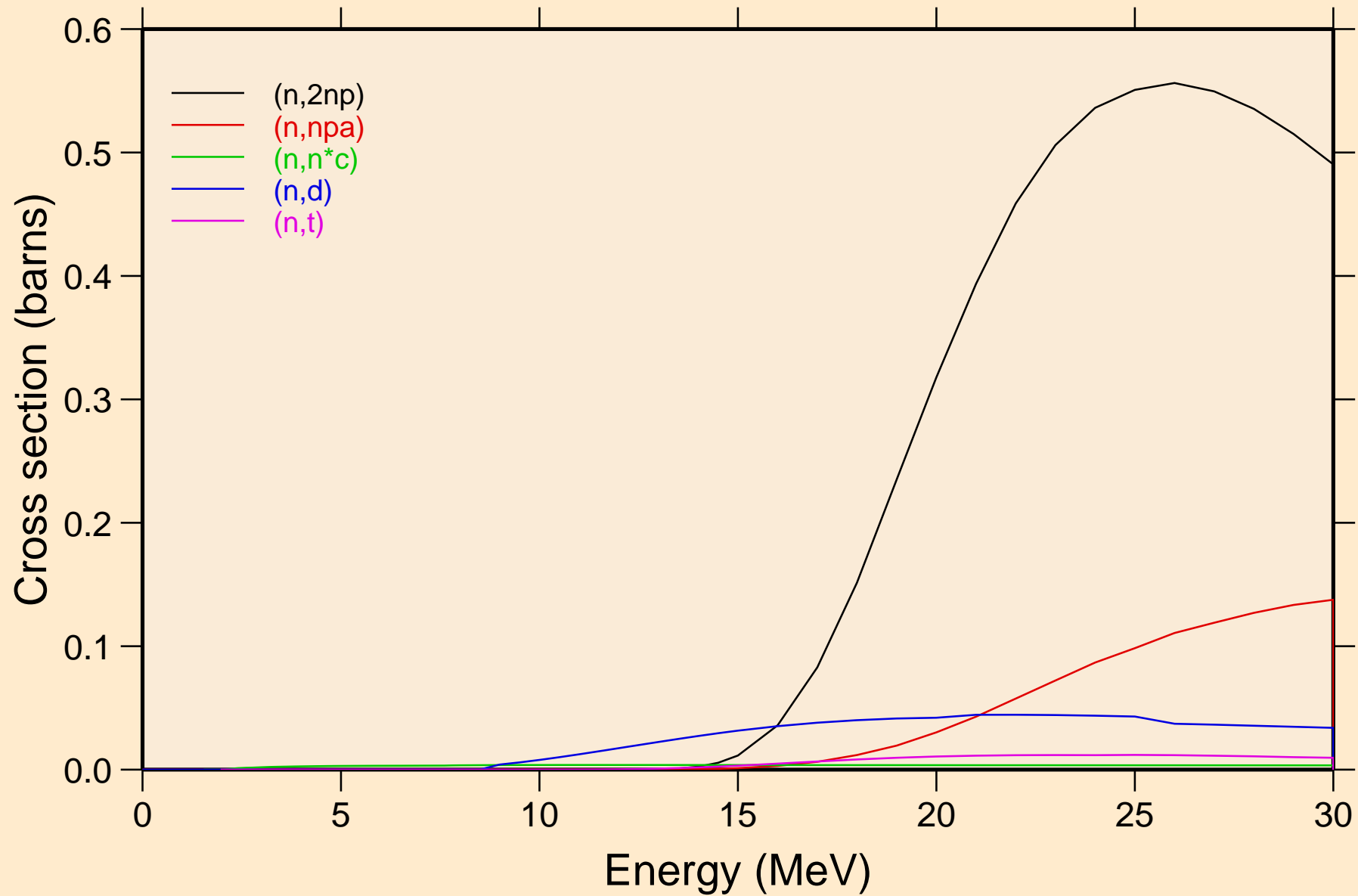

I114 NEUTRON ACER TENDL-2021 LIBRARY; T=293.6K
Threshold reactions

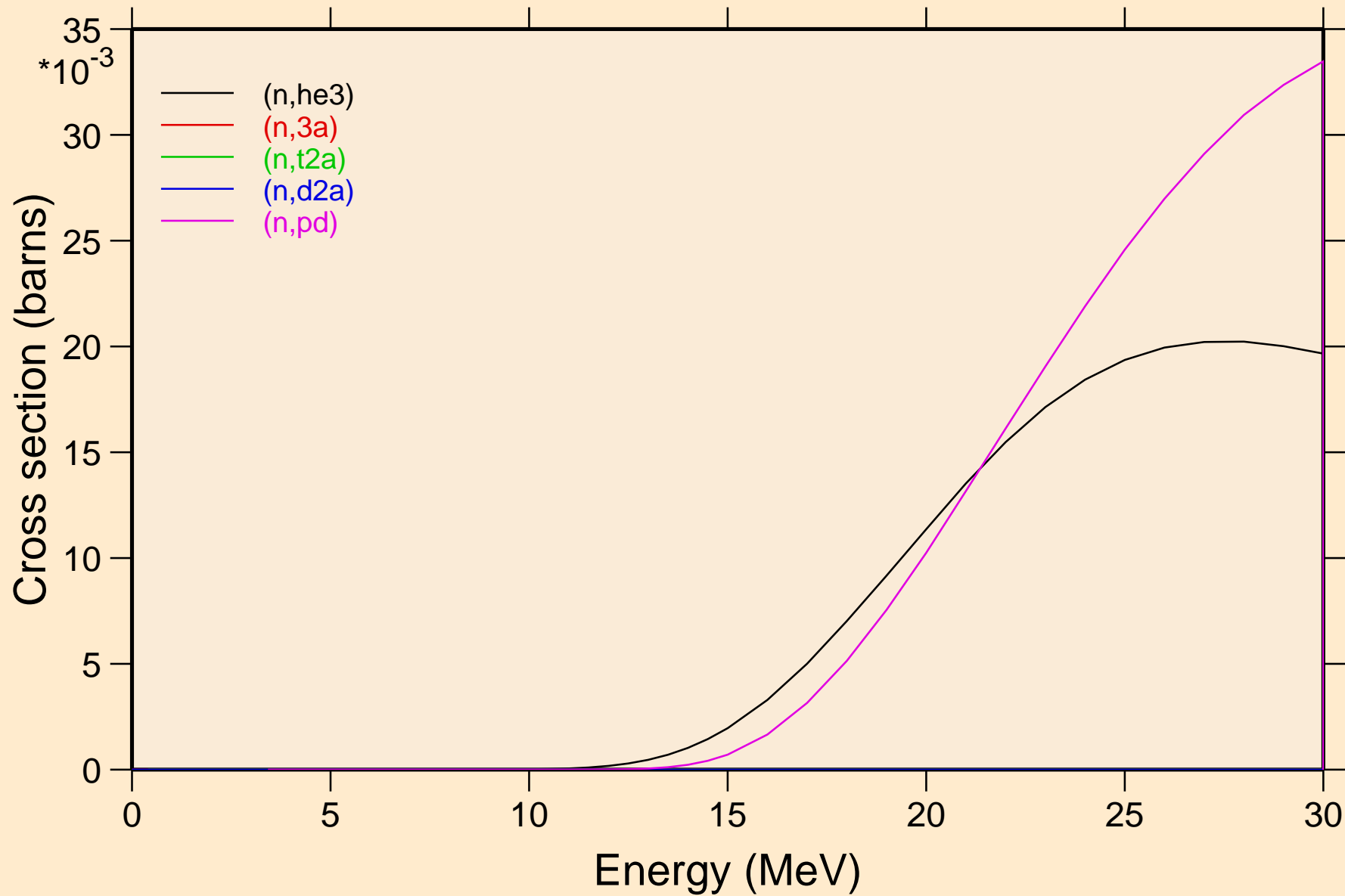

I114 NEUTRON ACER TENDL-2021 LIBRARY; T=293.6K
Threshold reactions

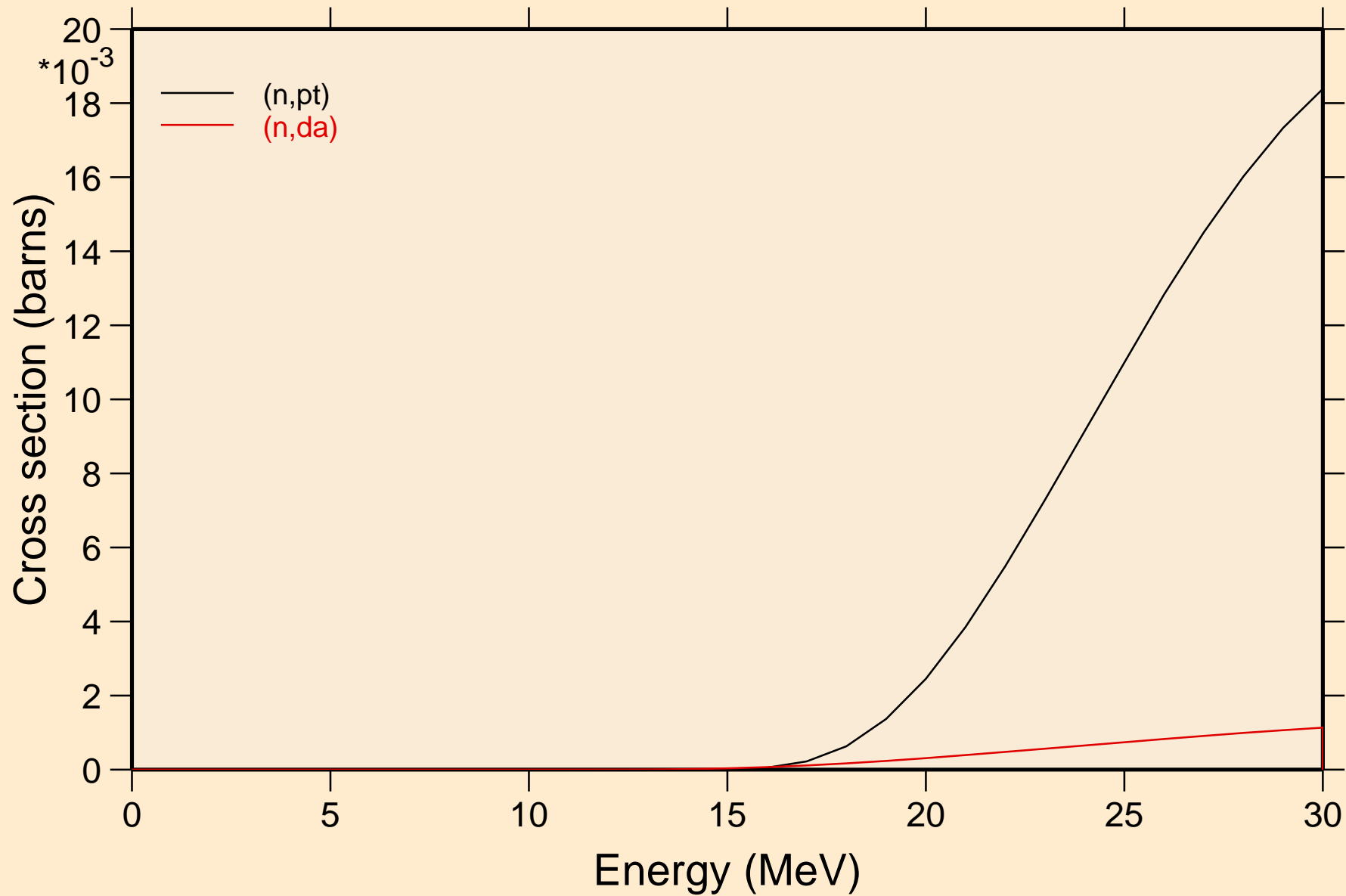

I114 NEUTRON ACER TENDL-2021 LIBRARY; T=293.6K
Threshold reactions

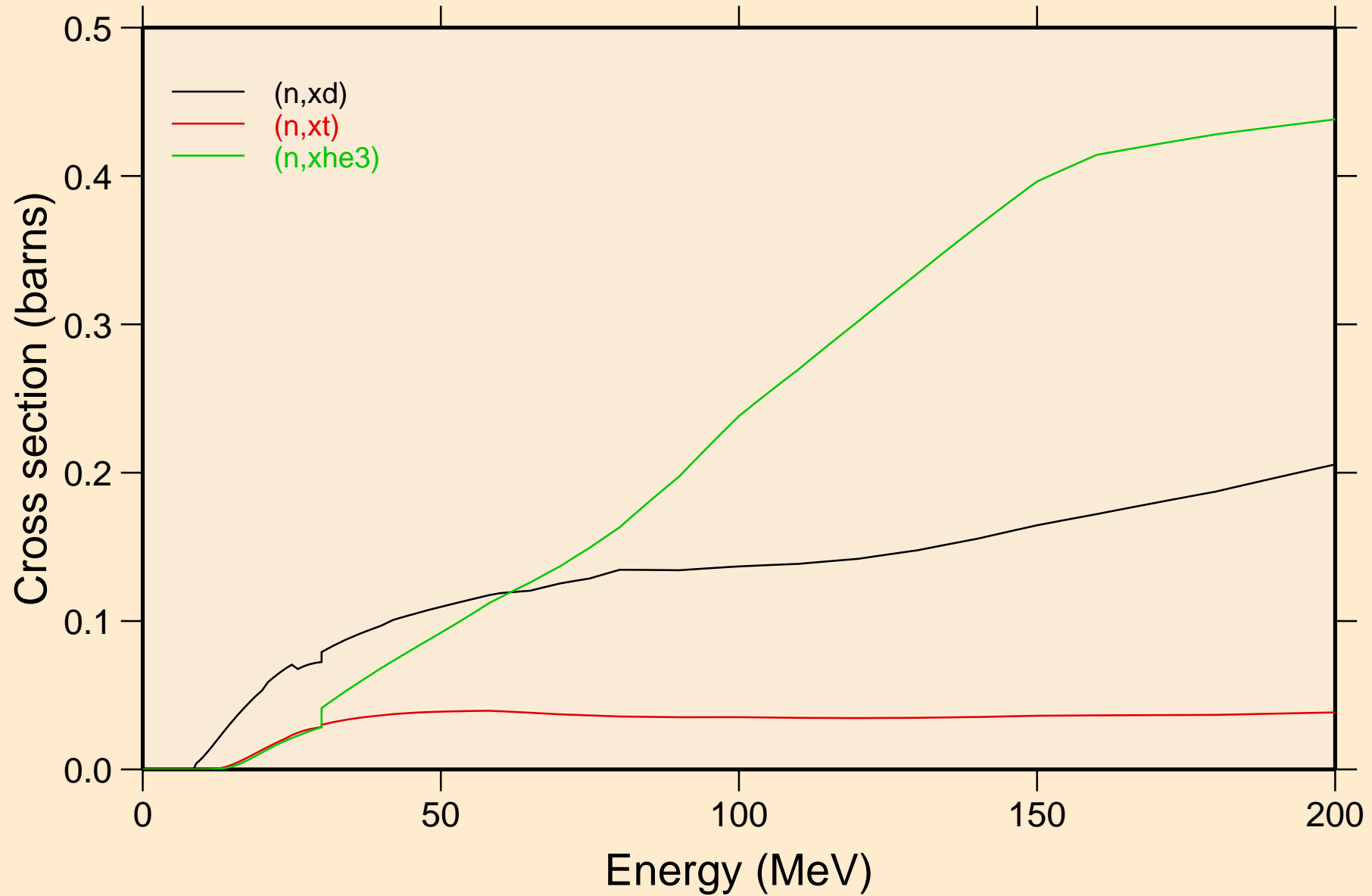

I114 NEUTRON ACER TENDL-2021 LIBRARY; T=293.6K
angular distribution for elastic

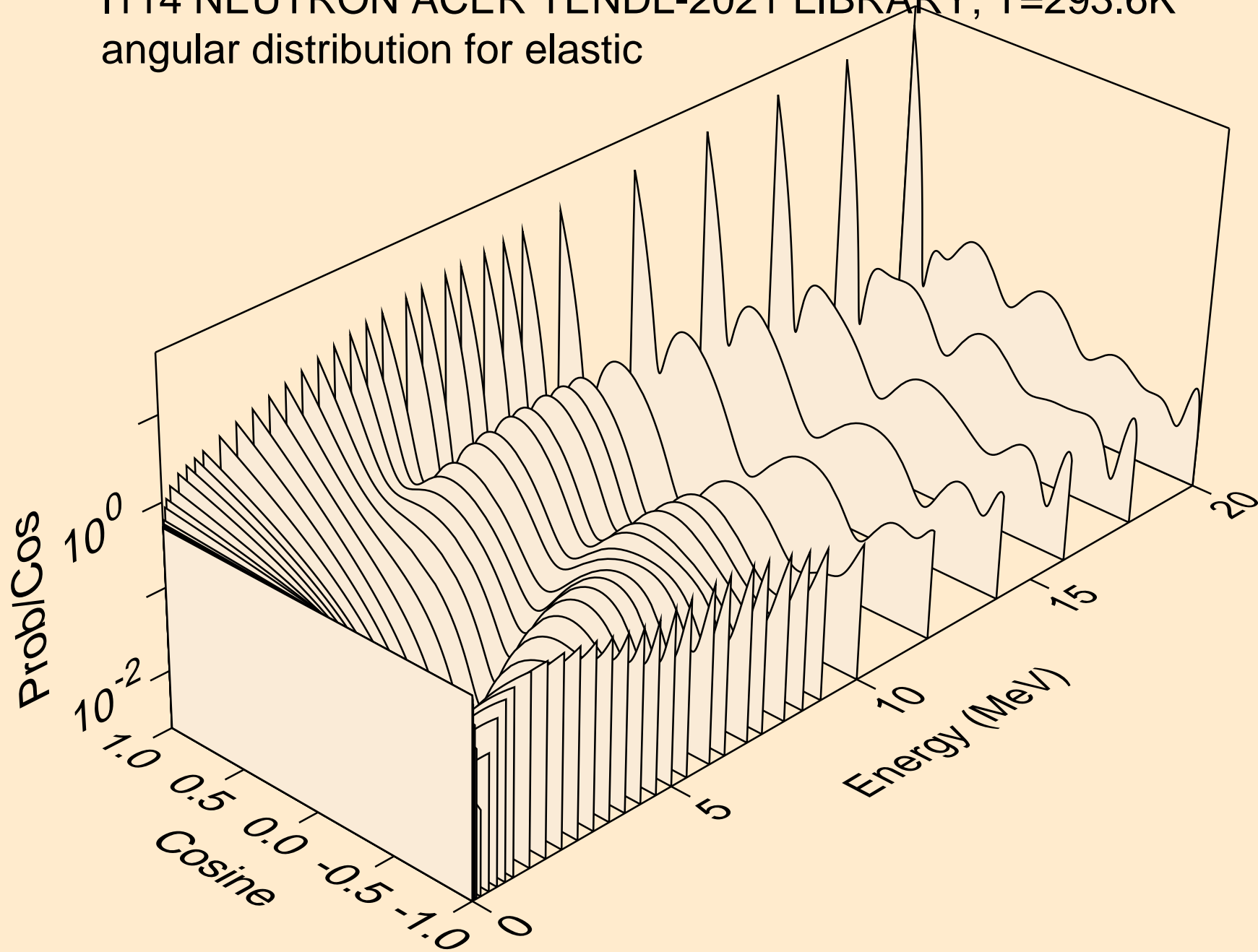

I114 NEUTRON ACER TENDL-2021 LIBRARY; T=293.6K
angular distribution for elastic

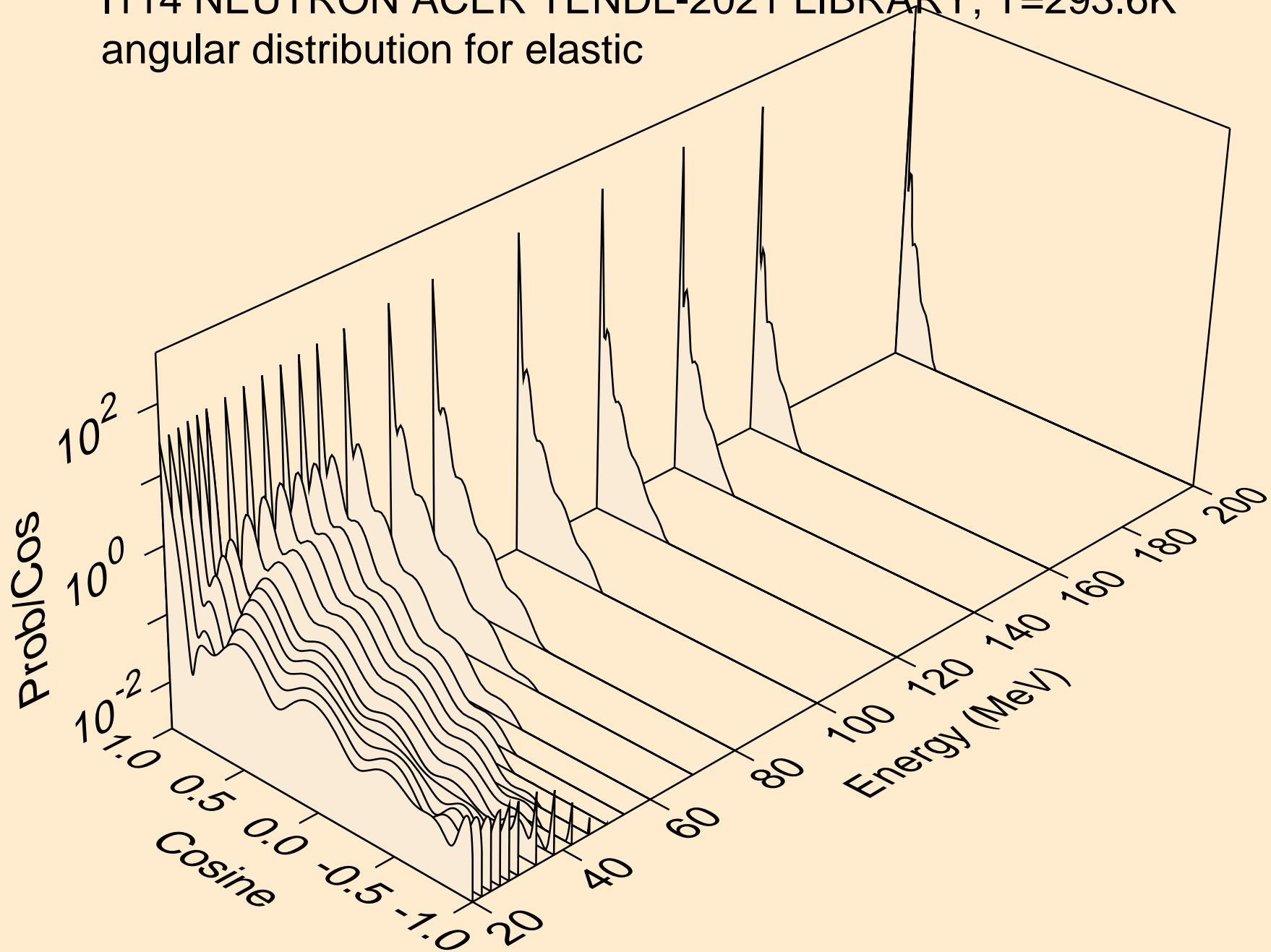

I114 NEUTRON ACER TENDL-2021 LIBRARY; T=293.6K
angular distribution for (n,n*1)

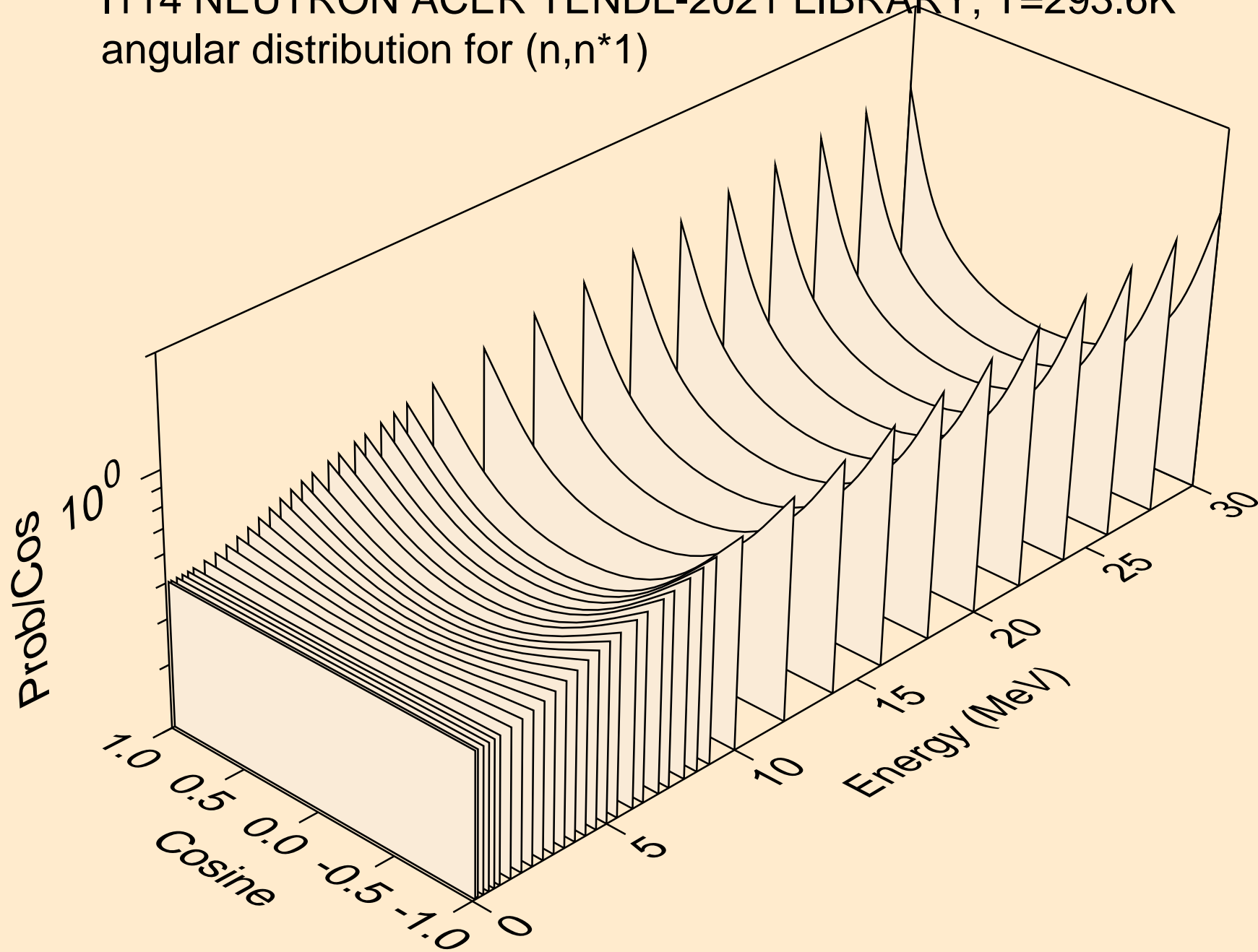

I114 NEUTRON ACER TENDL-2021 LIBRARY; T=293.6K
angular distribution for (n,n*2)

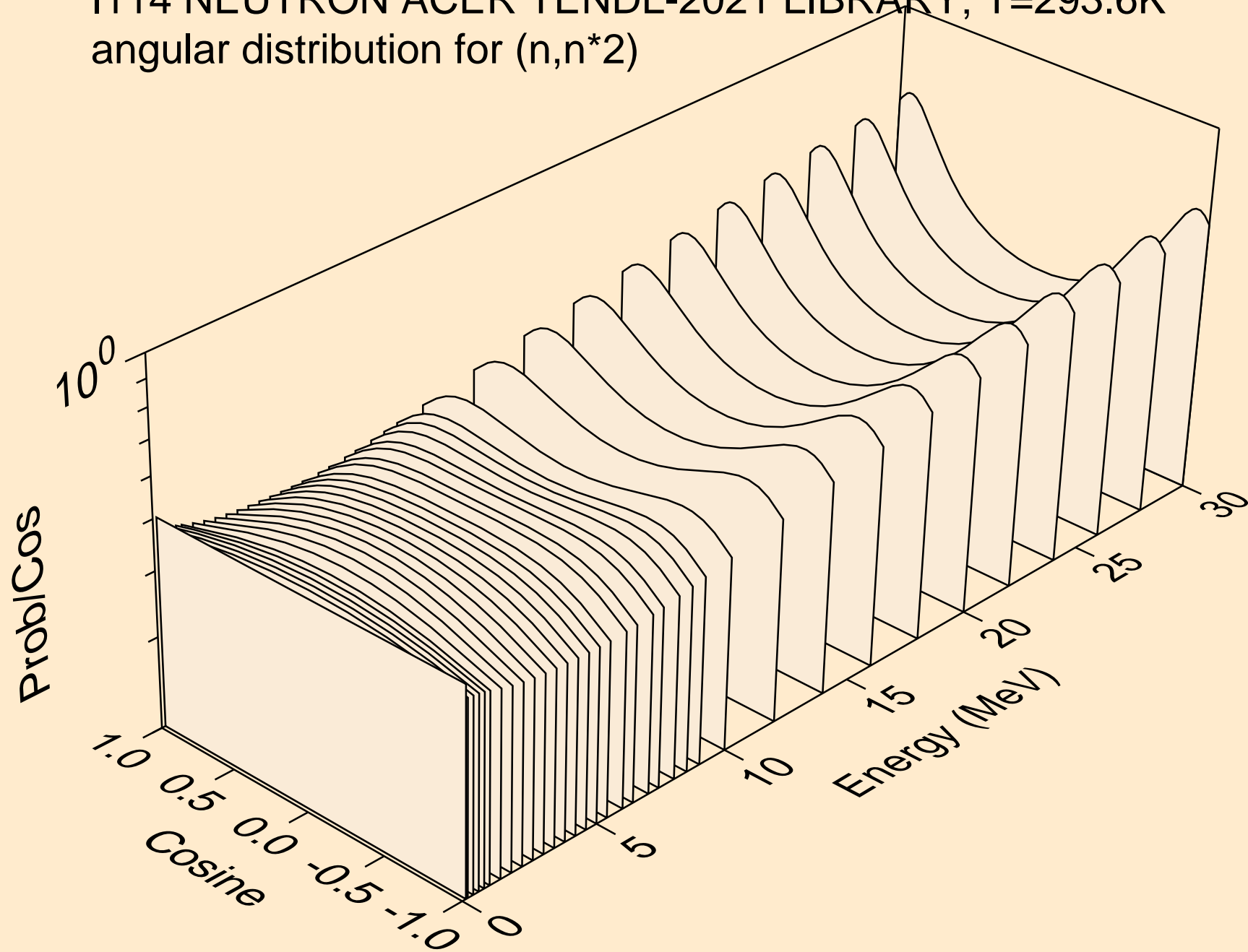

I114 NEUTRON ACER TENDL-2021 LIBRARY; T=293.6K
angular distribution for (n,n*3)

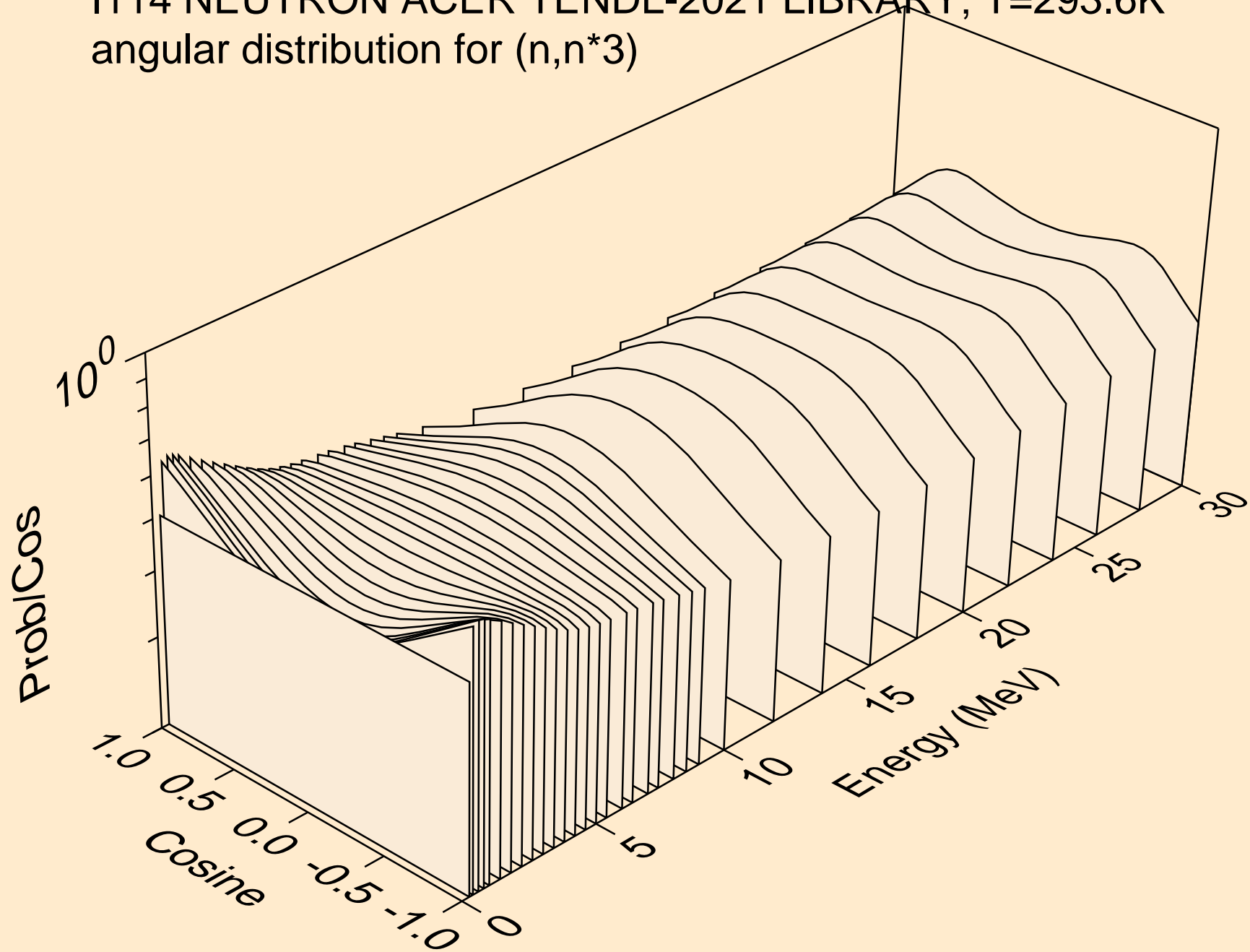

I114 NEUTRON ACER TENDL-2021 LIBRARY; T=293.6K
angular distribution for (n,n*4)

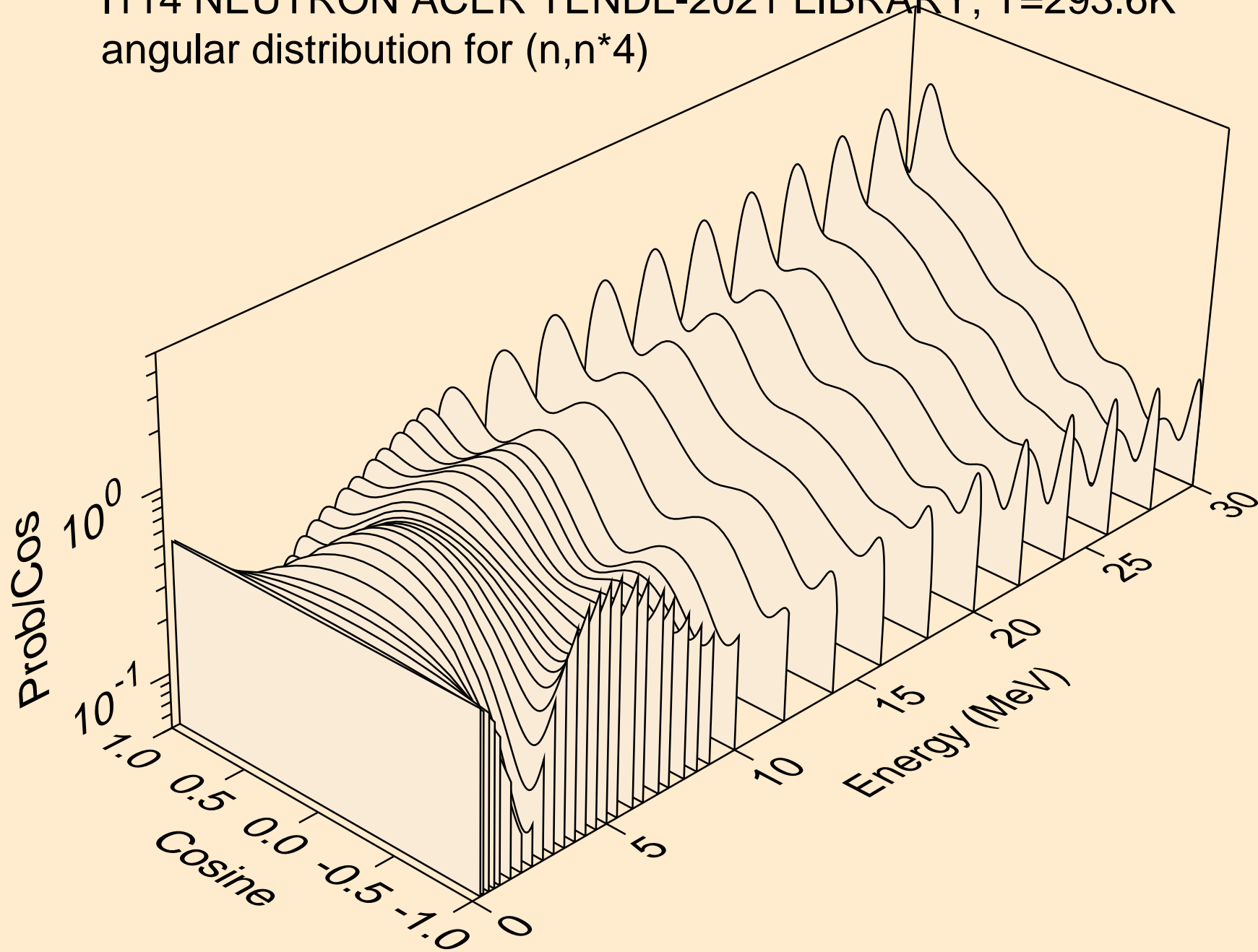

I114 NEUTRON ACER TENDL-2021 LIBRARY; T=293.6K
angular distribution for (n,n*5)

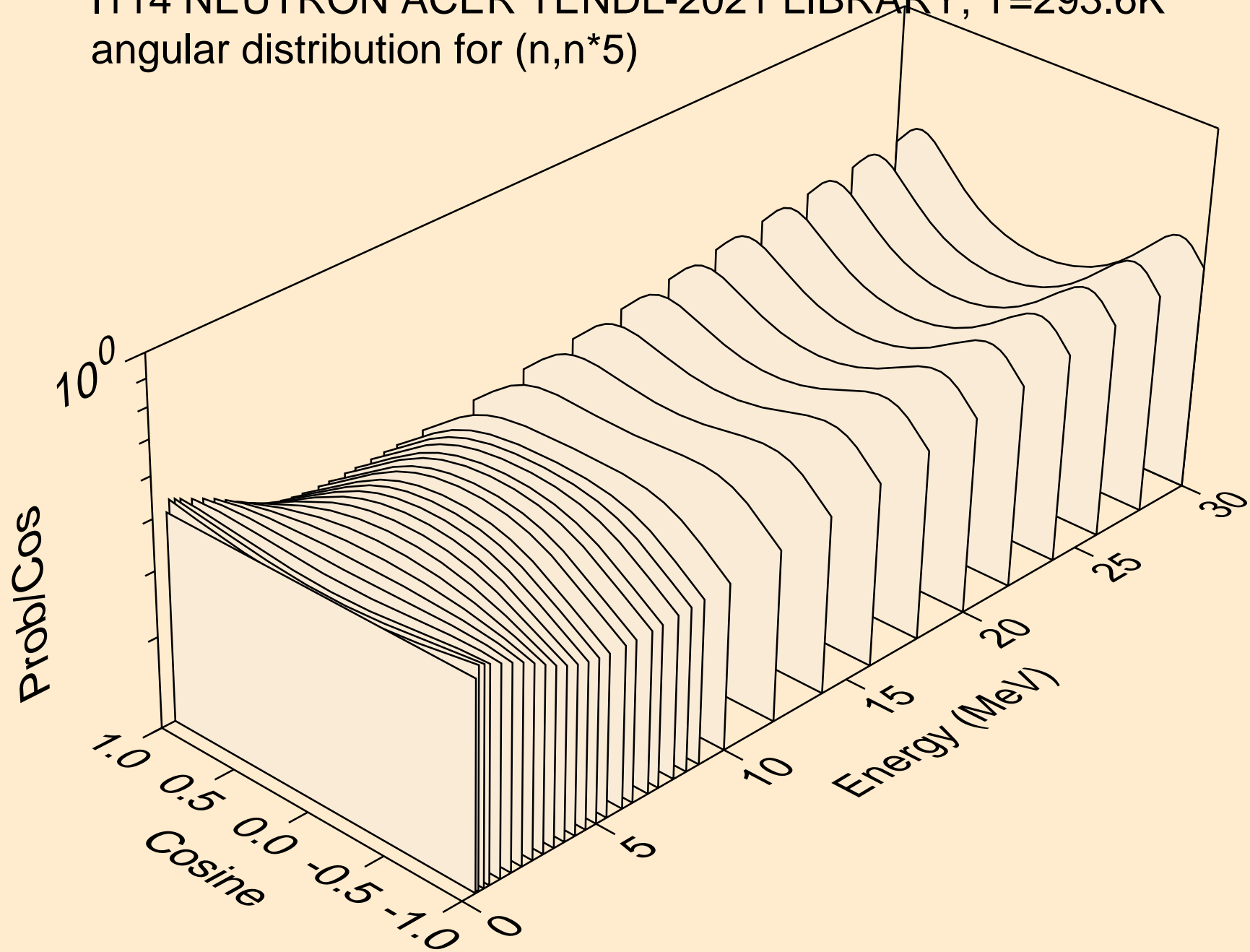

I114 NEUTRON ACER TENDL-2021 LIBRARY; T=293.6K
angular distribution for (n,n*6)

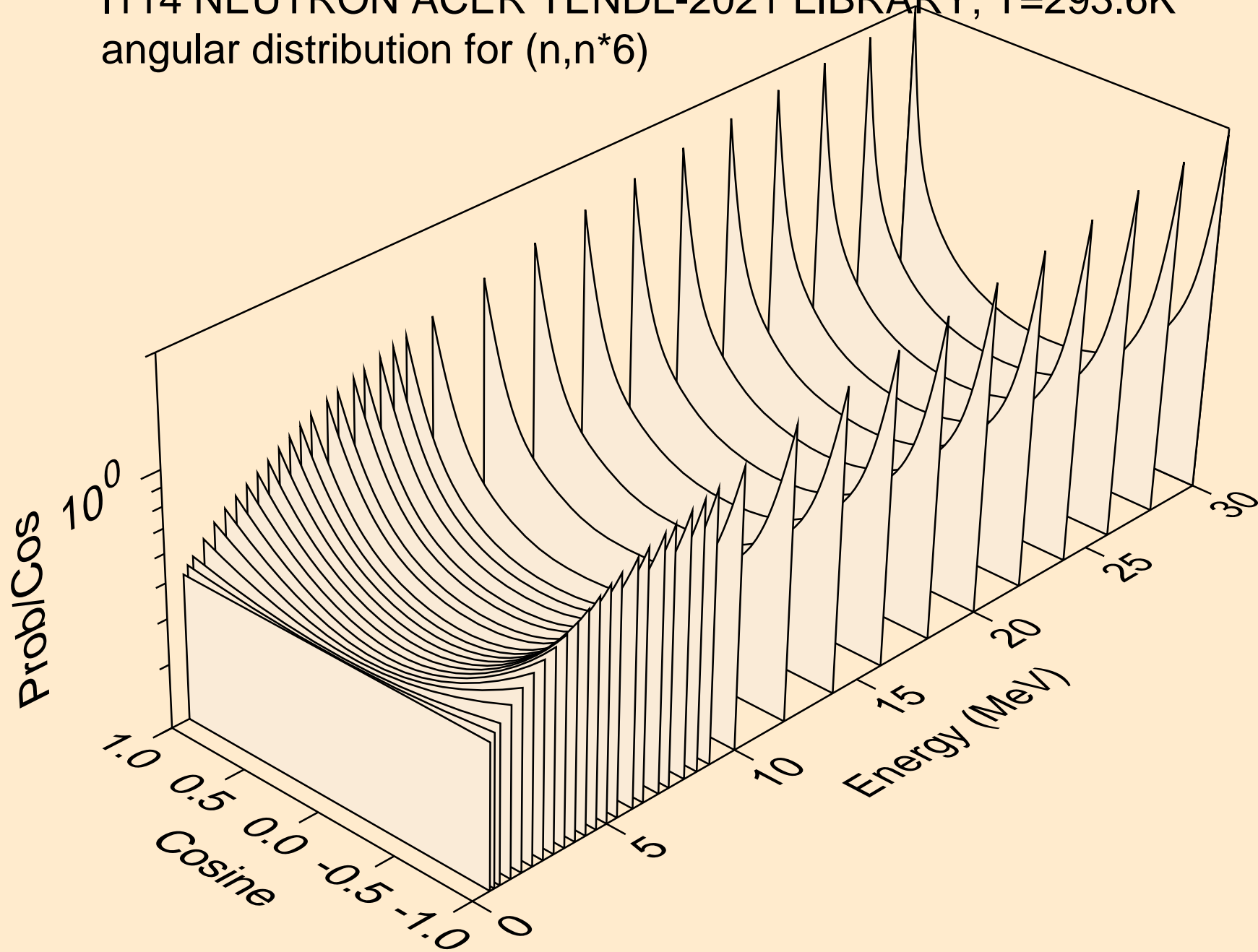

I114 NEUTRON ACER TENDL-2021 LIBRARY; T=293.6K
angular distribution for (n,n*7)

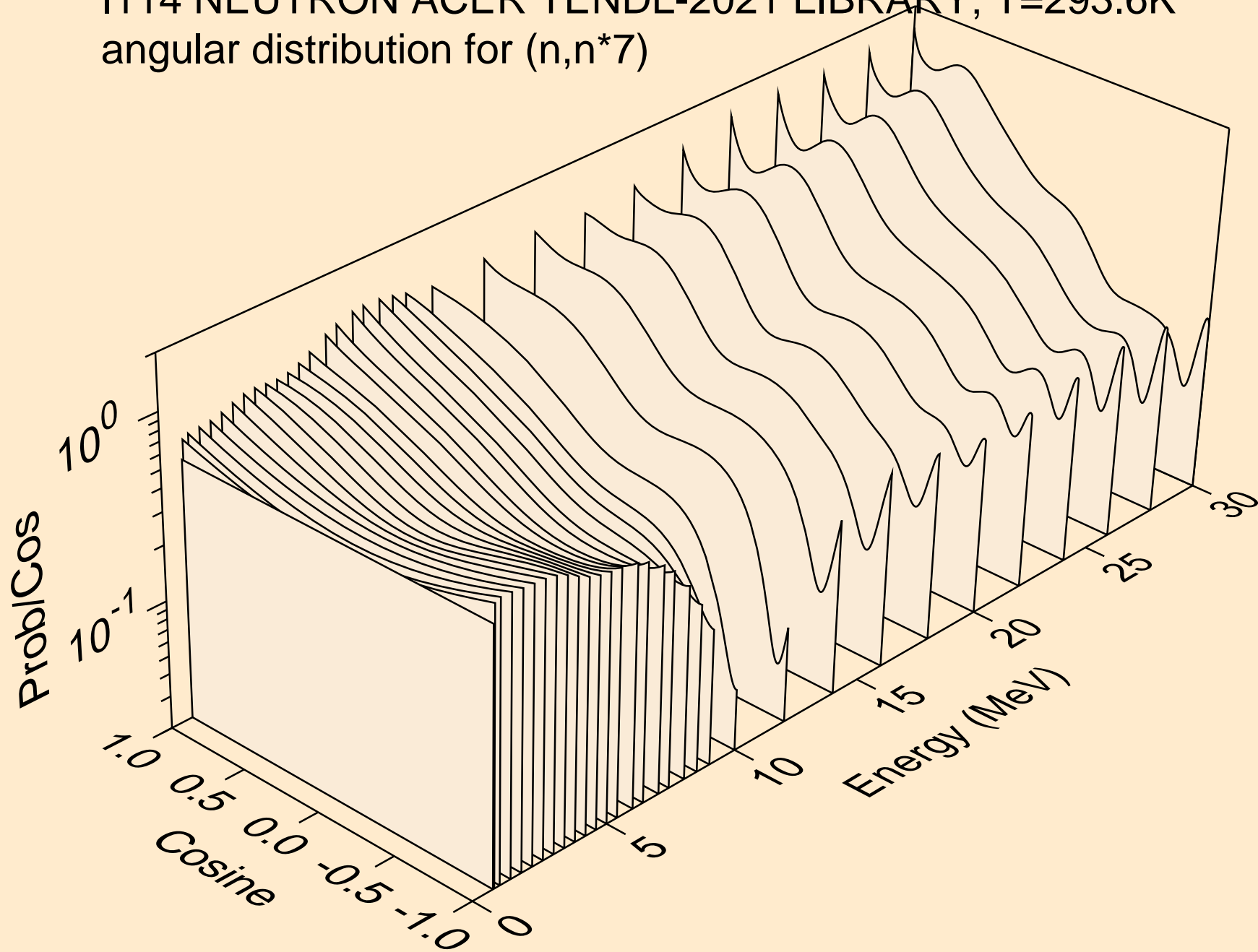

I114 NEUTRON ACER TENDL-2021 LIBRARY; T=293.6K
angular distribution for (n,n*8)

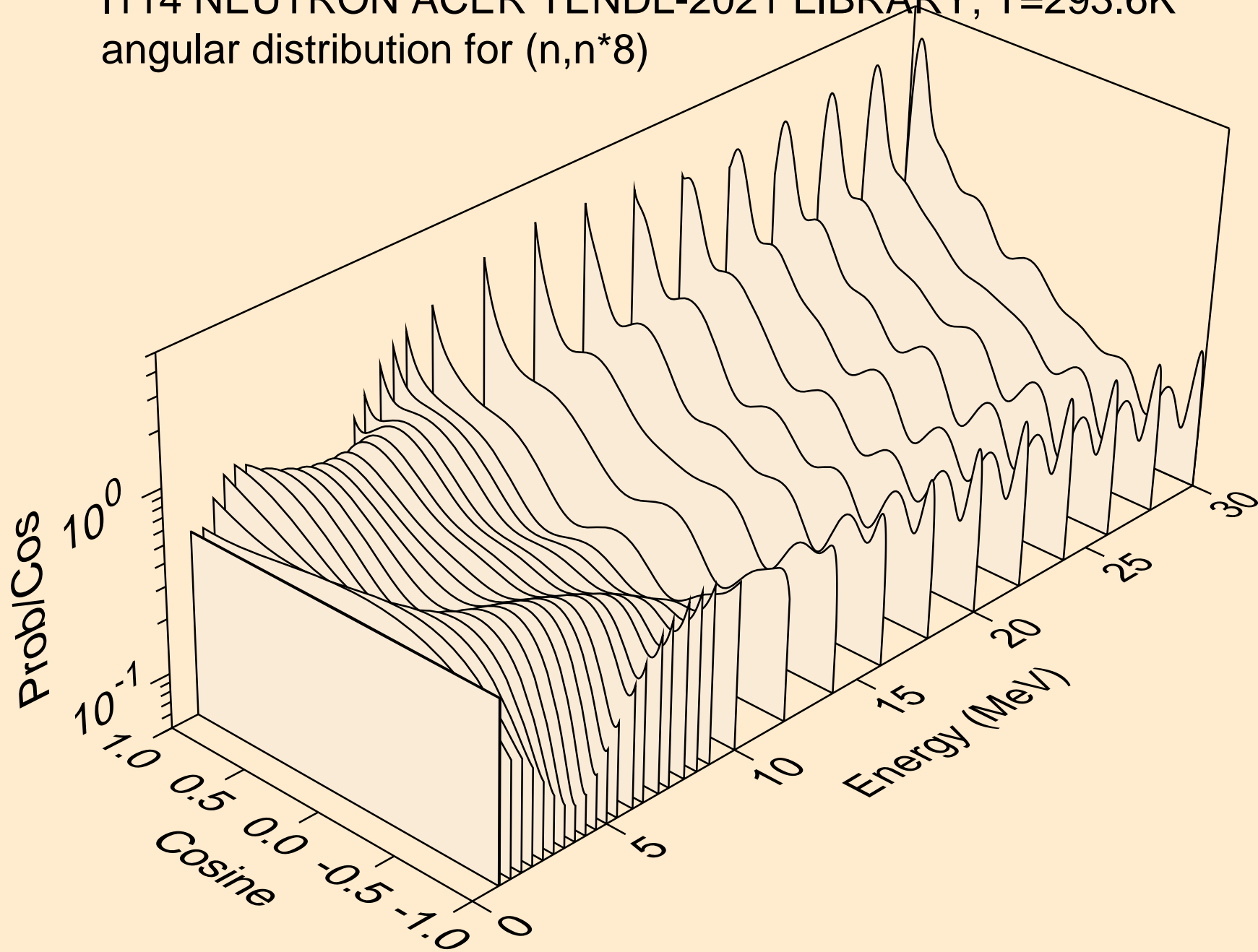

I114 NEUTRON ACER TENDL-2021 LIBRARY; T=293.6K
angular distribution for (n,n*9)

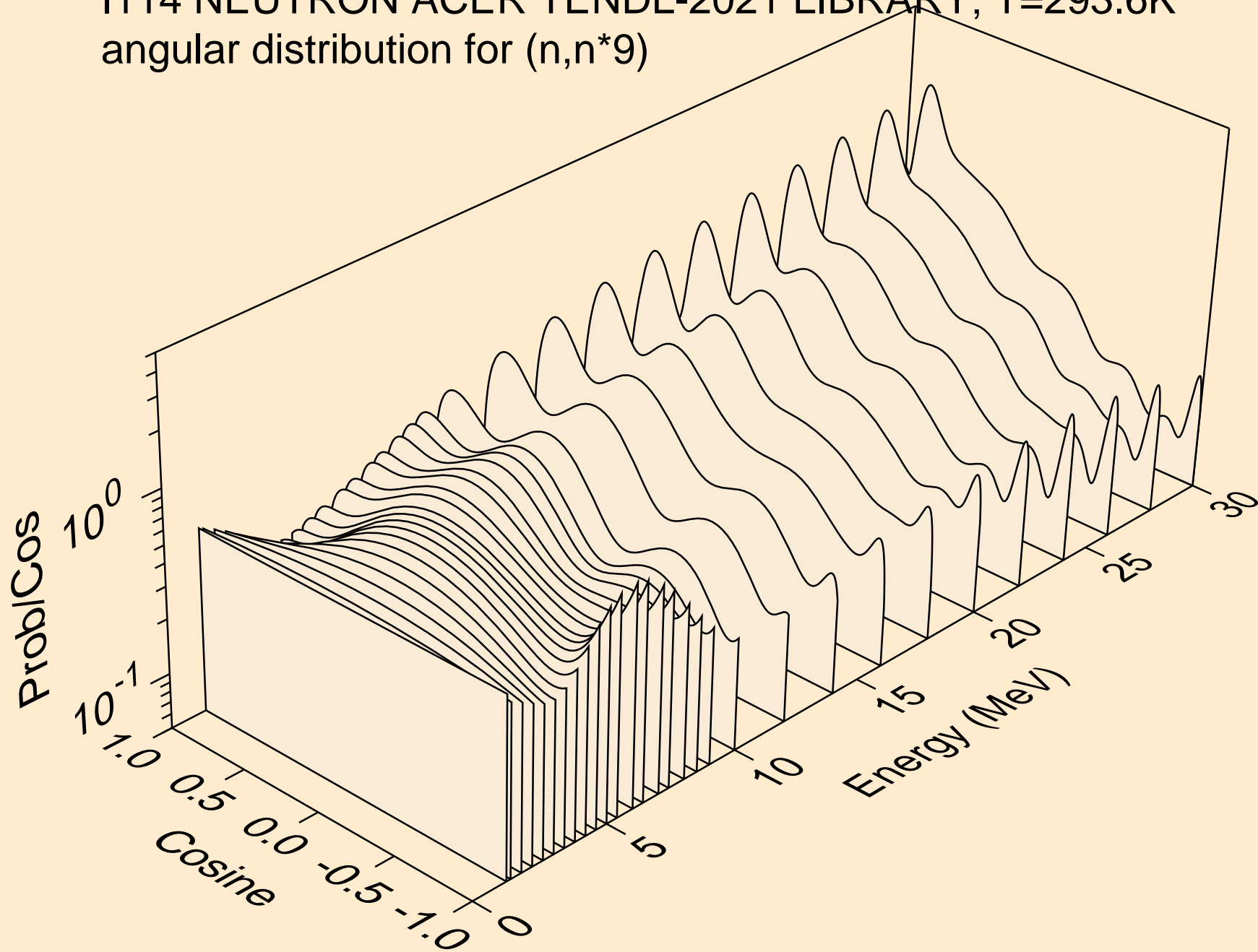

I114 NEUTRON ACER TENDL-2021 LIBRARY; T=293.6K
angular distribution for (n,n*10)

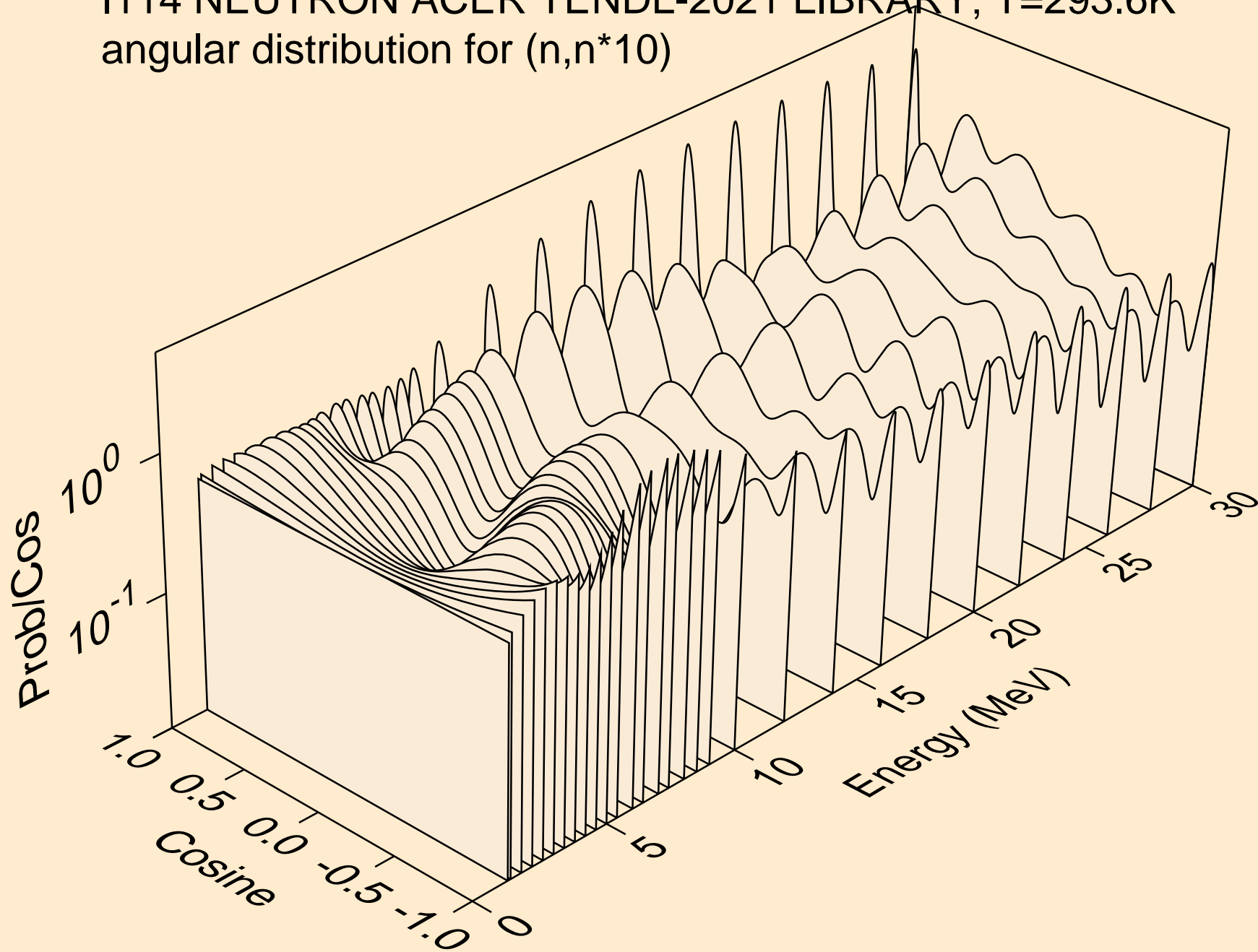

I114 NEUTRON ACER TENDL-2021 LIBRARY; T=293.6K
angular distribution for (n,n*11)

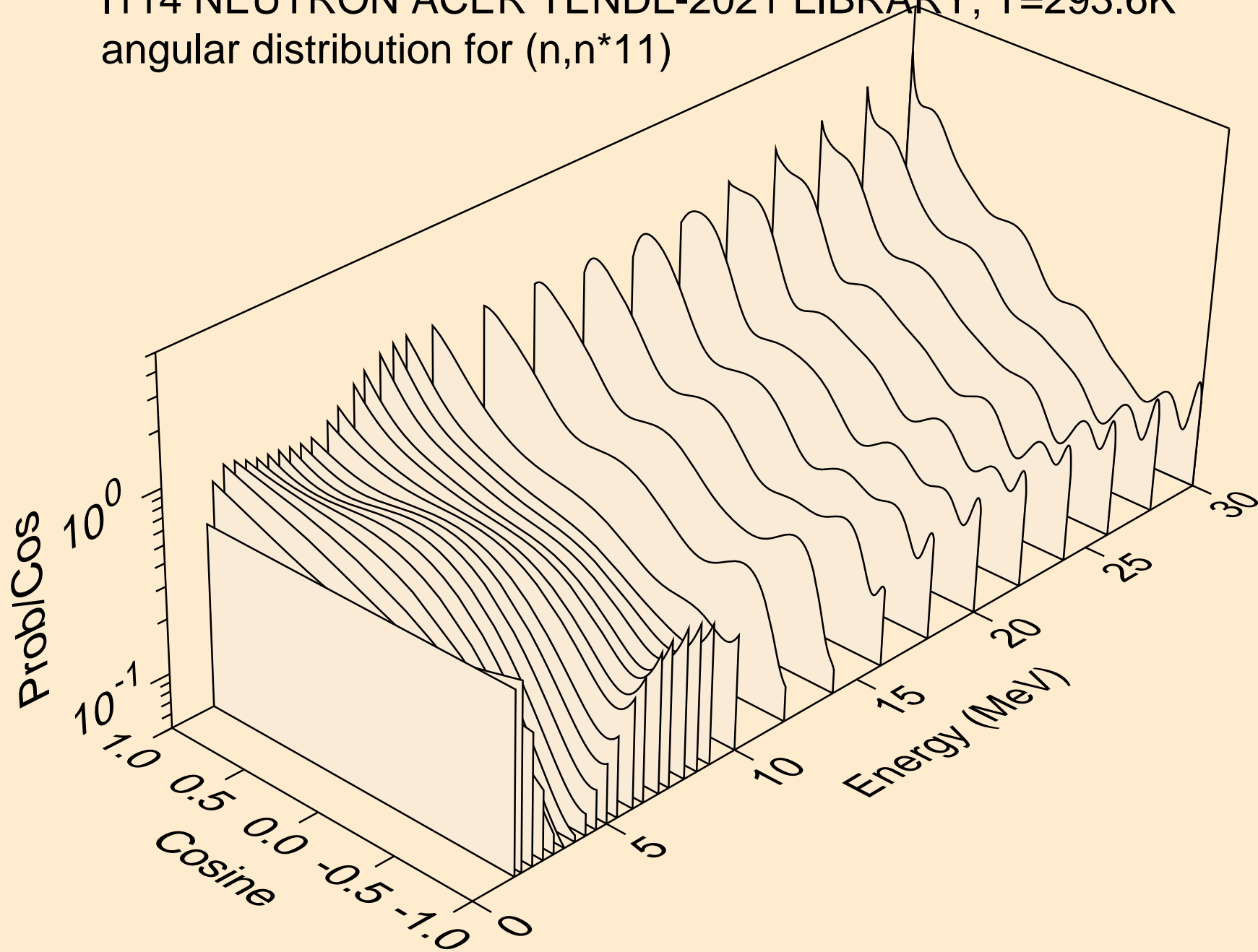

I114 NEUTRON ACER TENDL-2021 LIBRARY; T=293.6K
Neutron emission for (n,x)

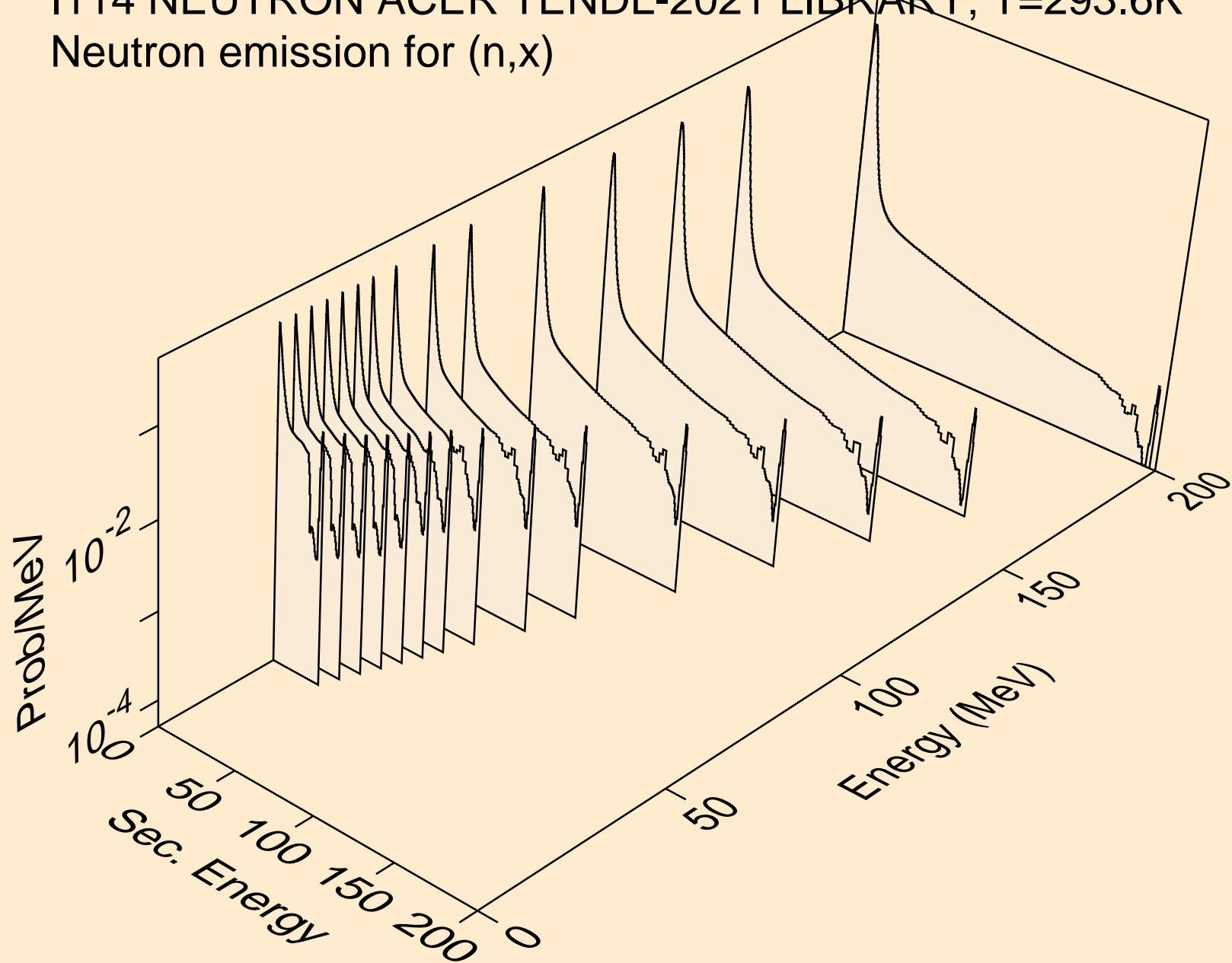

I114 NEUTRON ACER TENDL-2021 LIBRARY; T=293.6K
Neutron emission for (n,2nd)

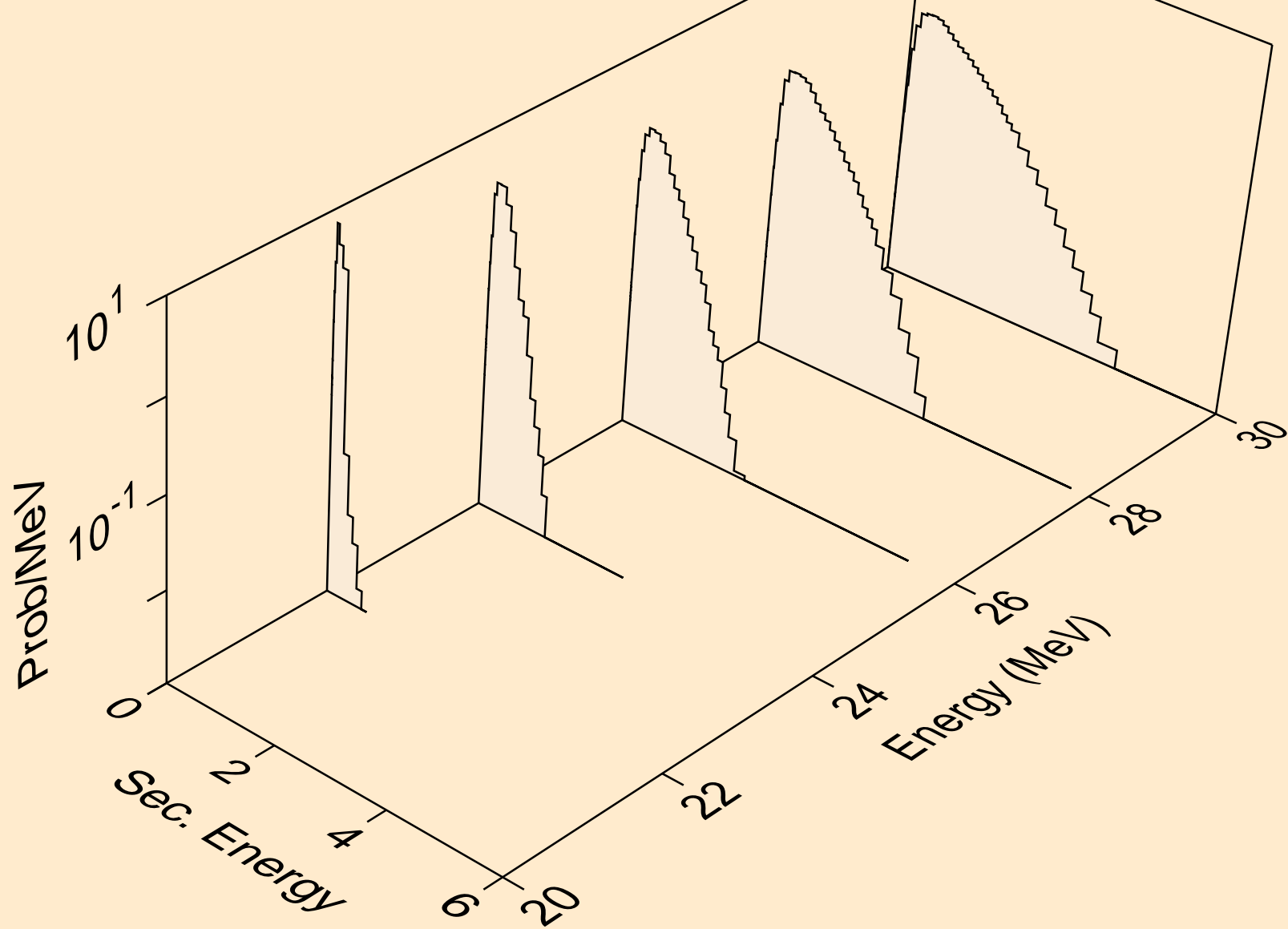

I114 NEUTRON ACER TENDL-2021 LIBRARY; T=293.6K
Neutron emission for (n,2n)

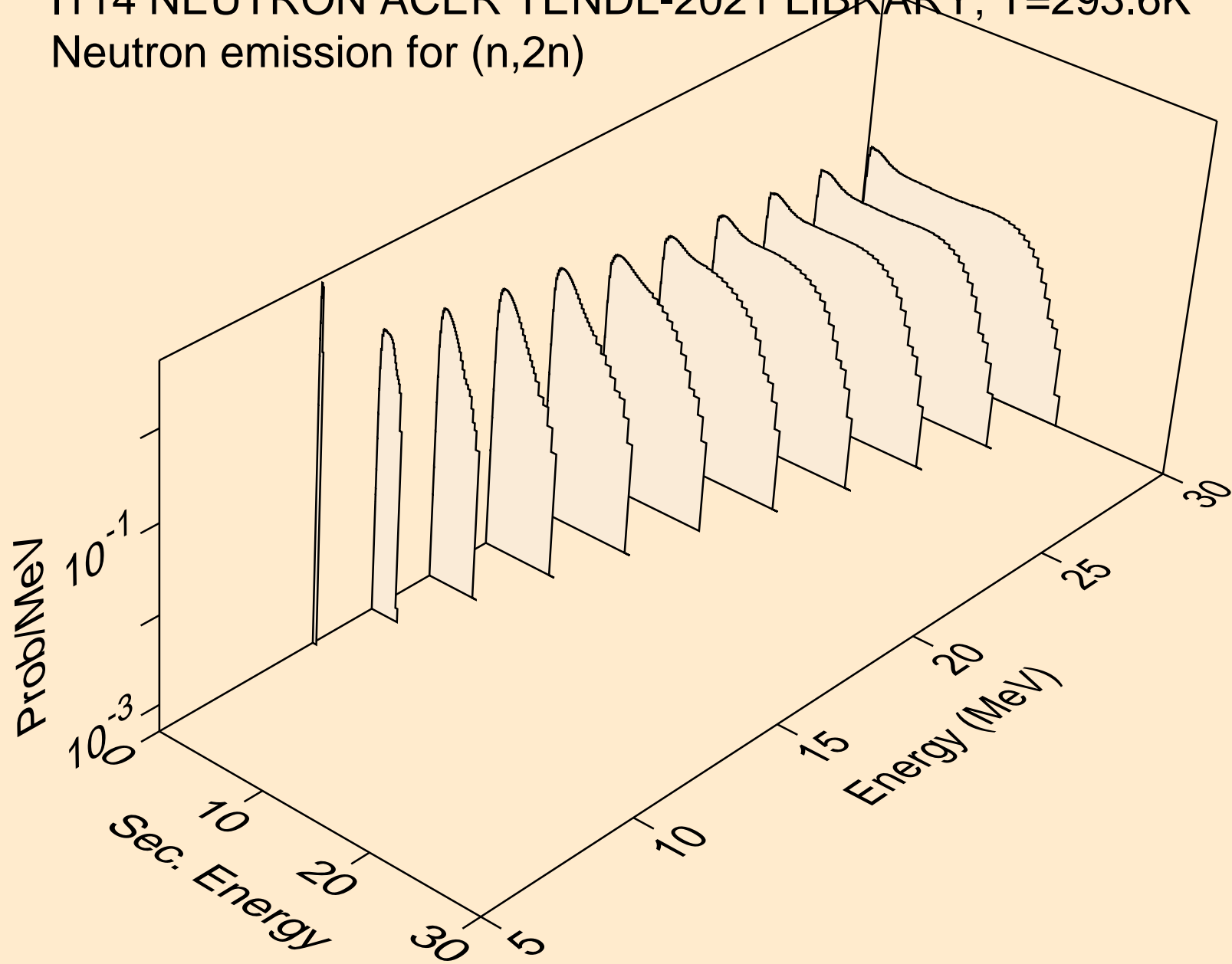

I114 NEUTRON ACER TENDL-2021 LIBRARY; T=293.6K
Neutron emission for (n,3n)

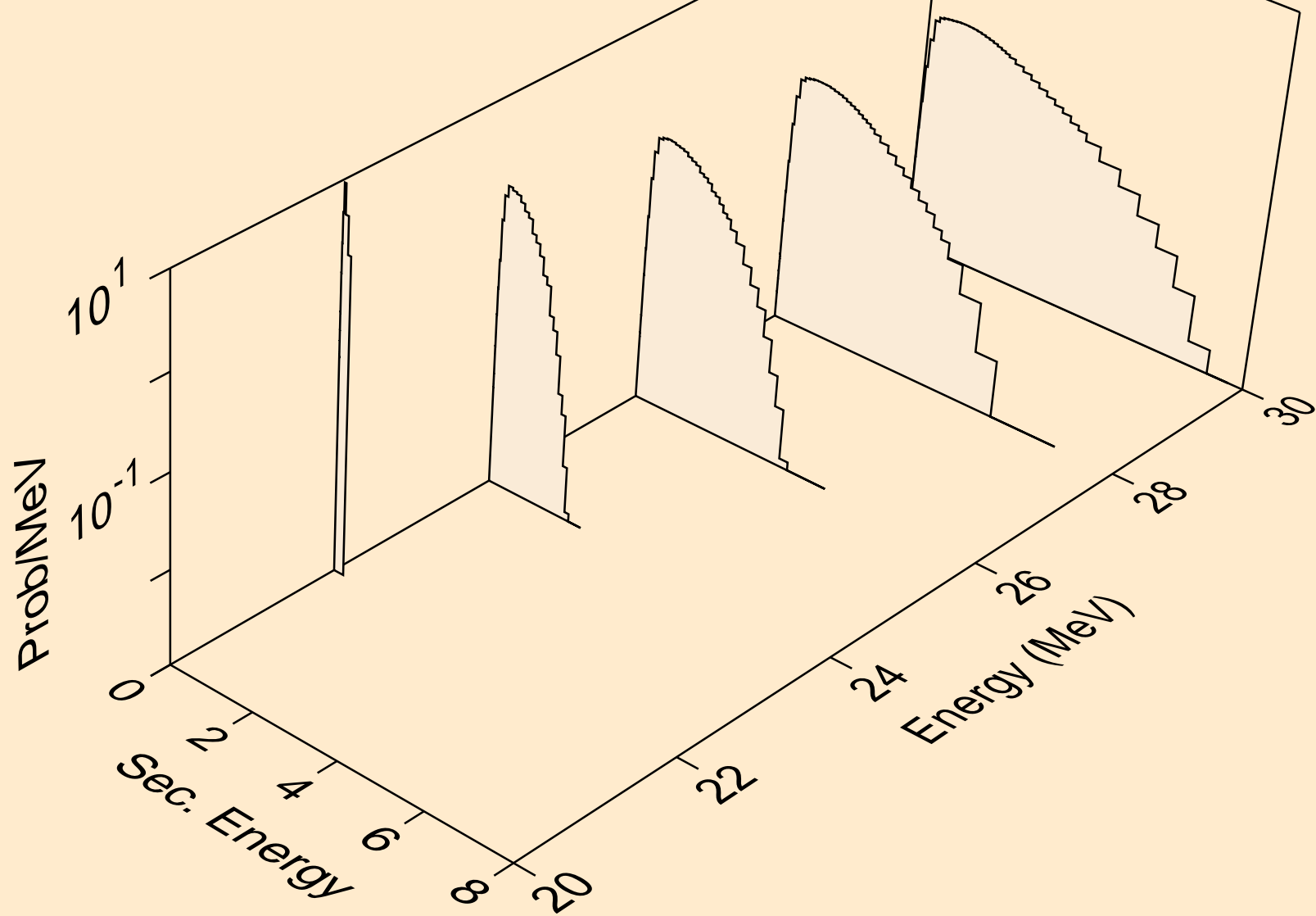

I114 NEUTRON ACER TENDL-2021 LIBRARY; T=293.6K
Neutron emission for (n,n*)a

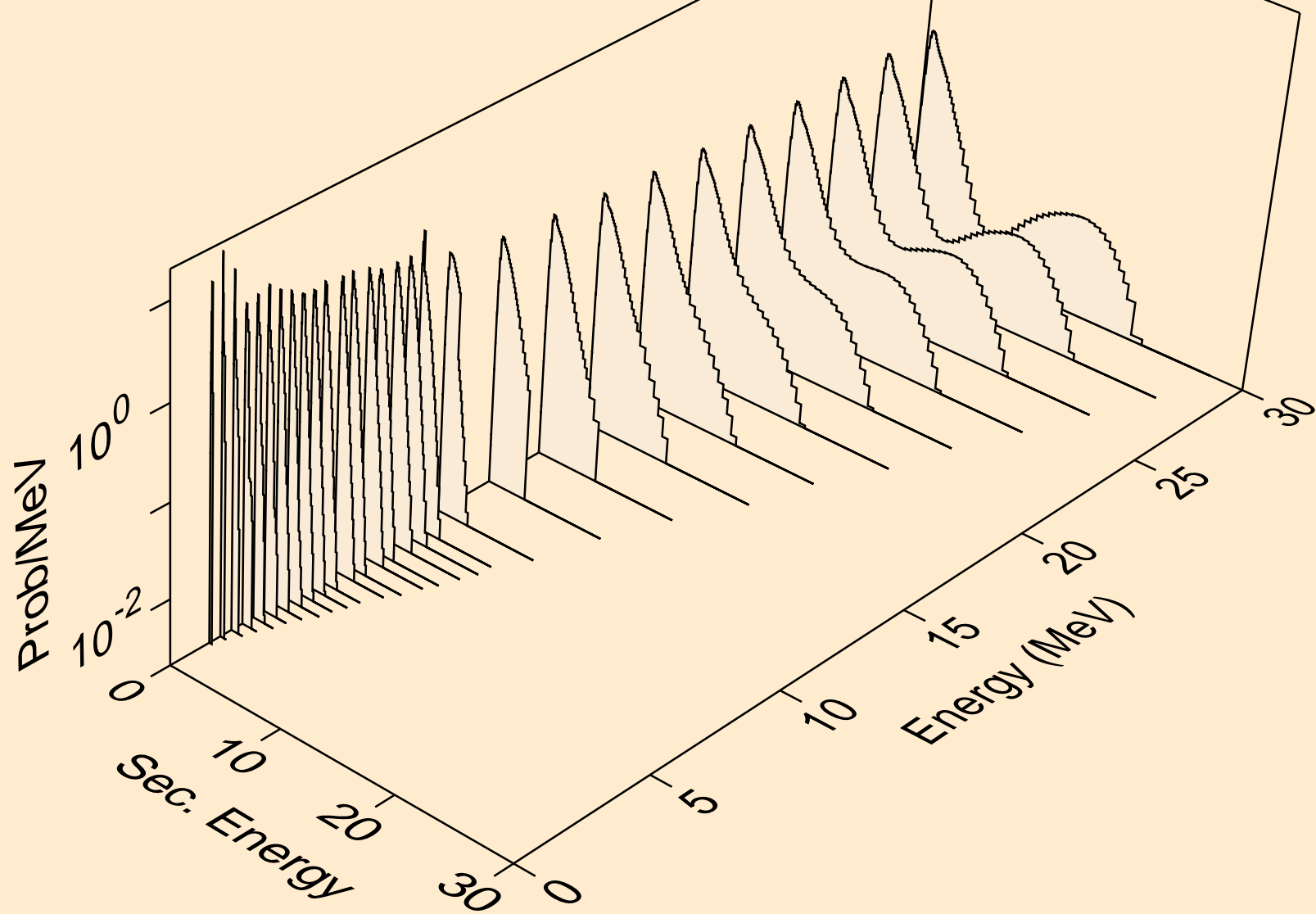

I114 NEUTRON ACER TENDL-2021 LIBRARY; T=293.6K
Neutron emission for (n,2n)a

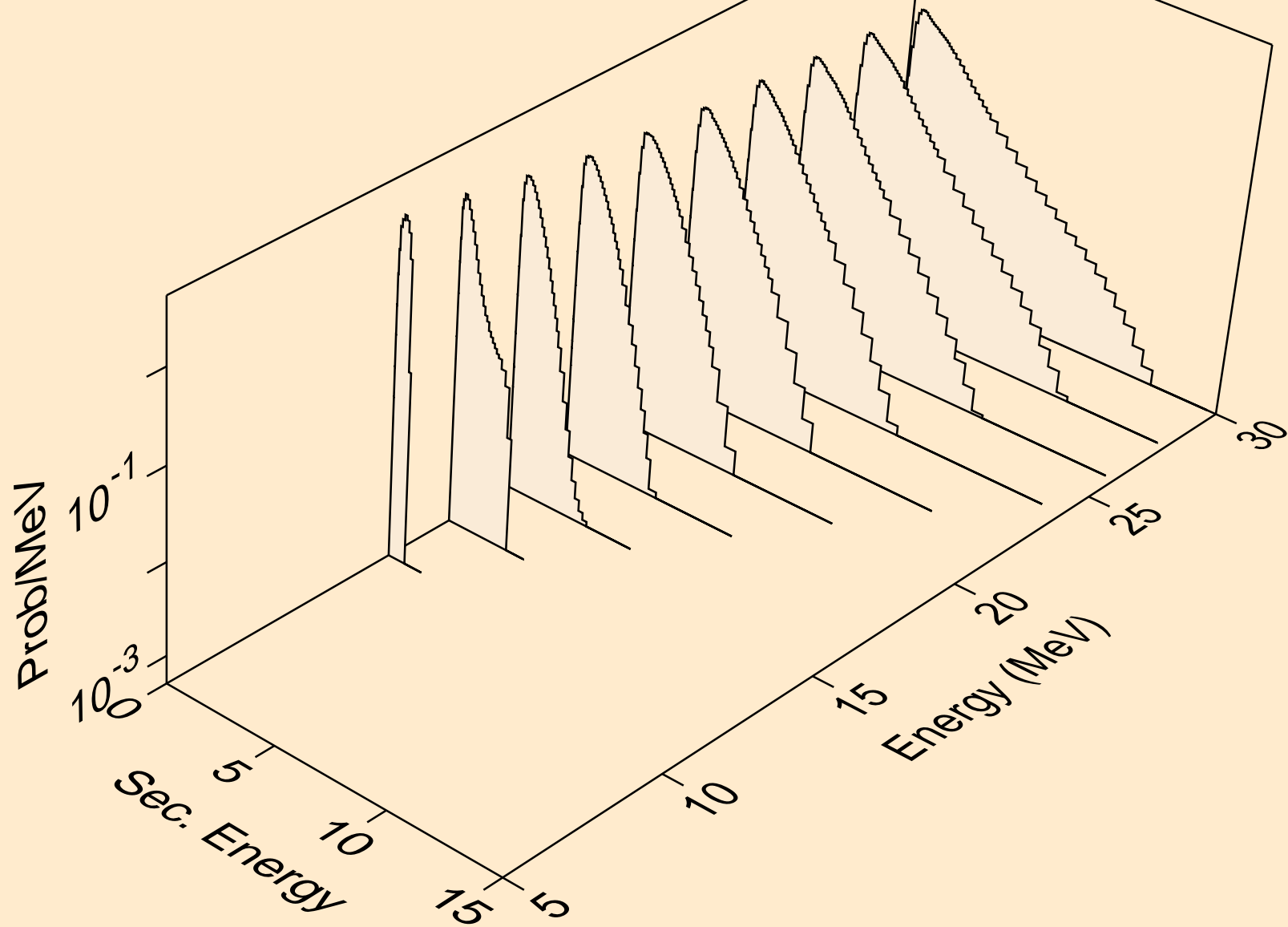

I114 NEUTRON ACER TENDL-2021 LIBRARY; T=293.6K
Neutron emission for (n,3n)a

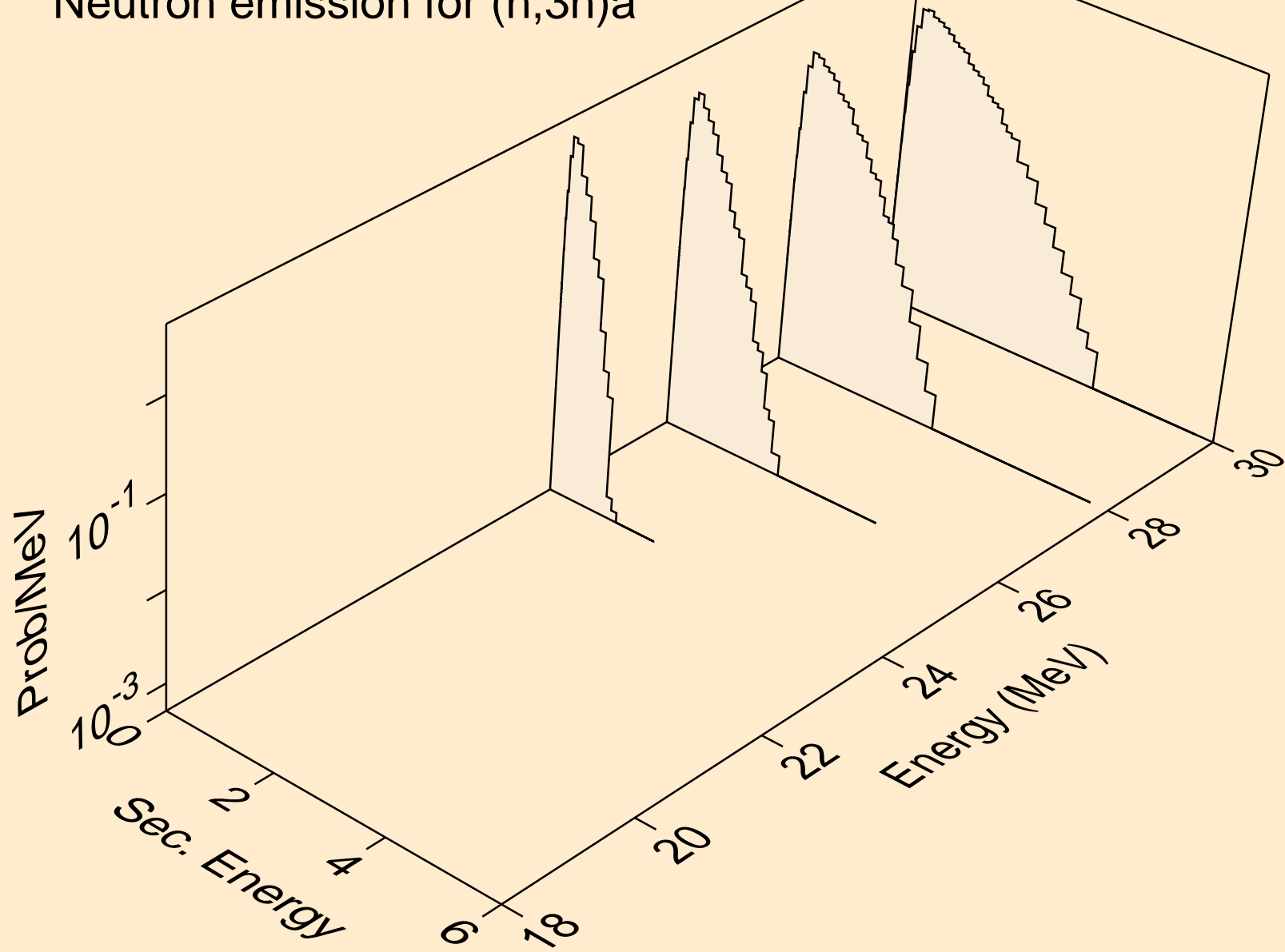

I114 NEUTRON ACER TENDL-2021 LIBRARY; T=293.6K
Neutron emission for (n,n*)p

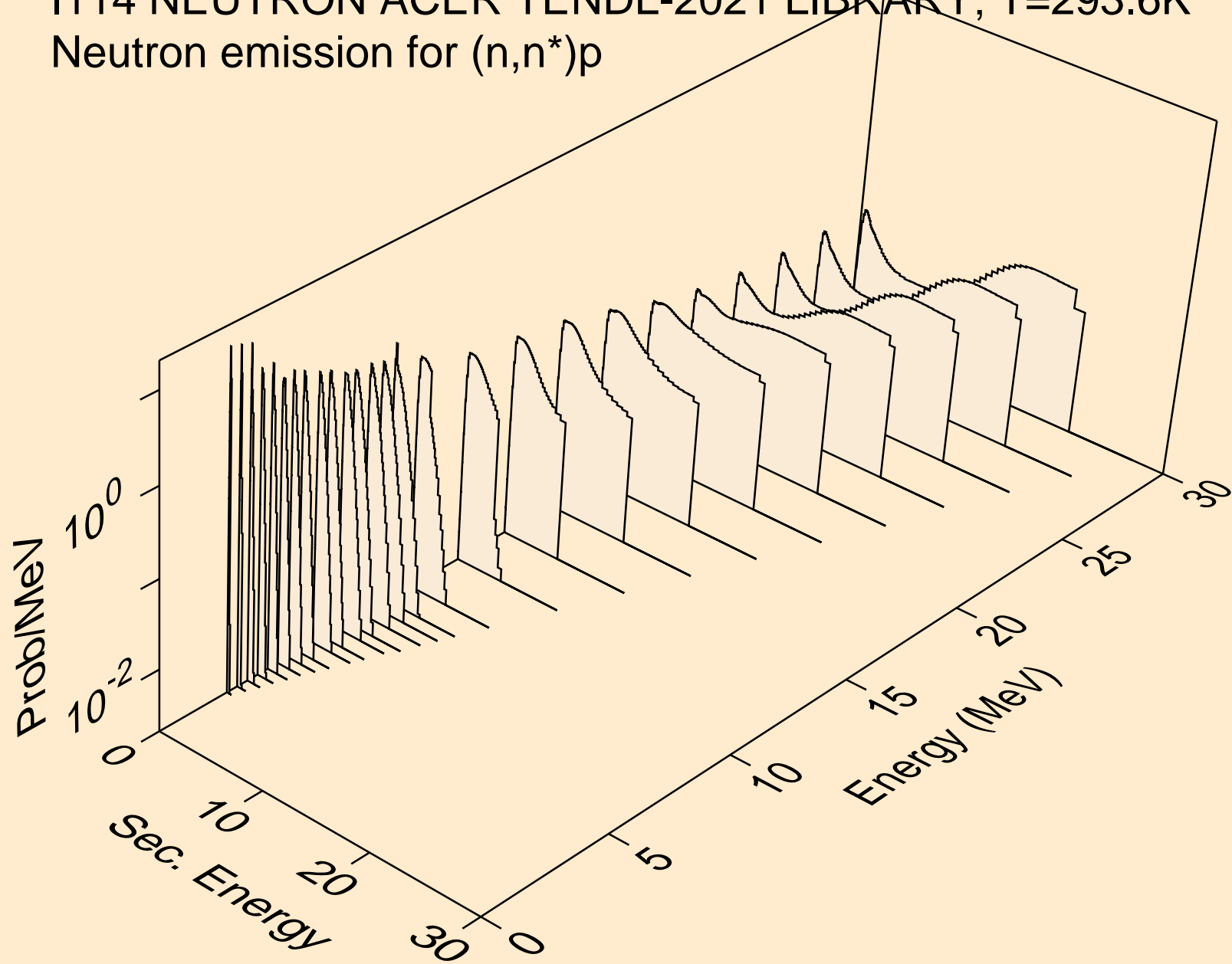

I114 NEUTRON ACER TENDL-2021 LIBRARY; T=293.6K
Neutron emission for (n,n*)2a

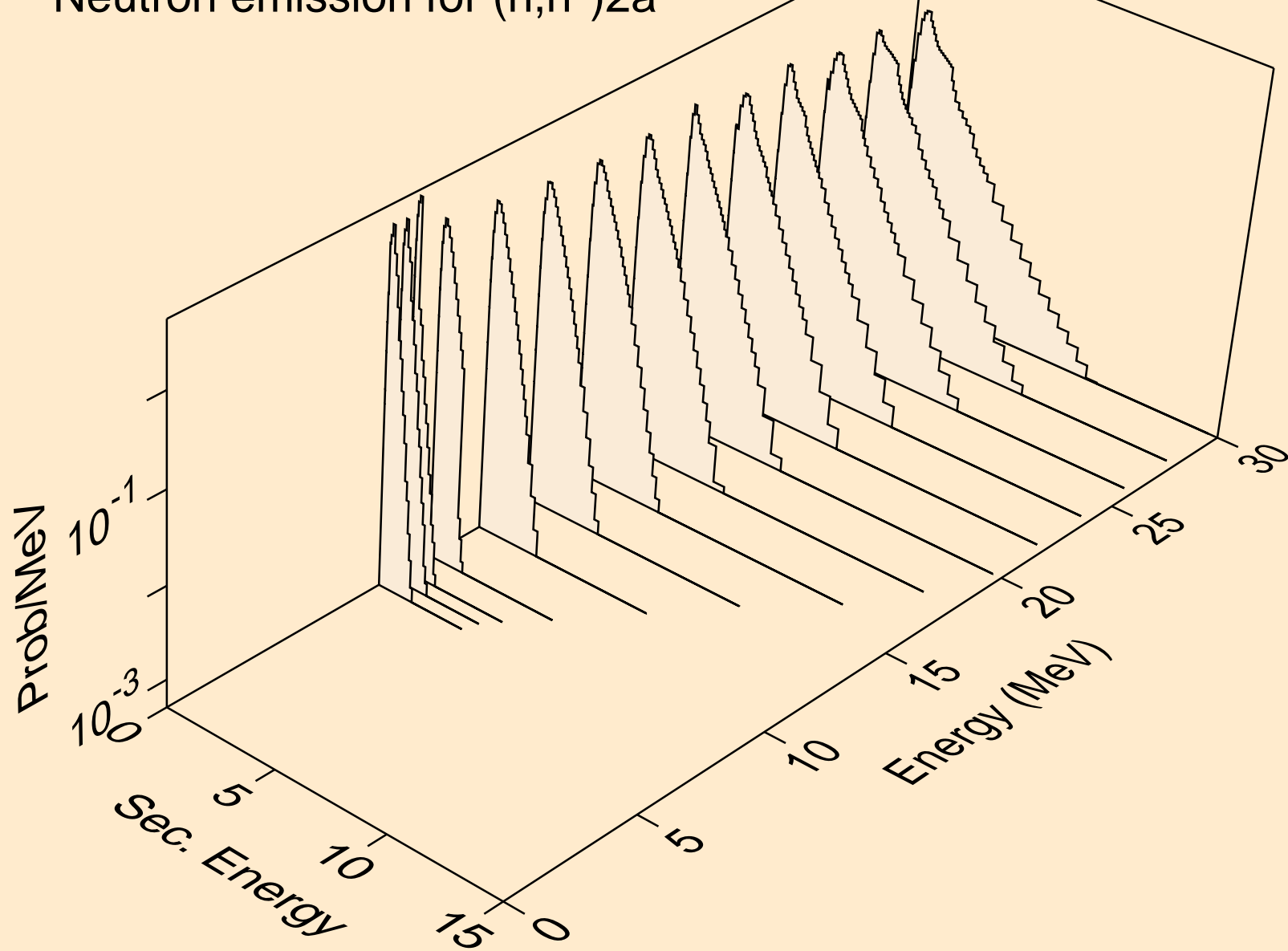

I114 NEUTRON ACER TENDL-2021 LIBRARY; T=293.6K
Neutron emission for (n,2n)2a

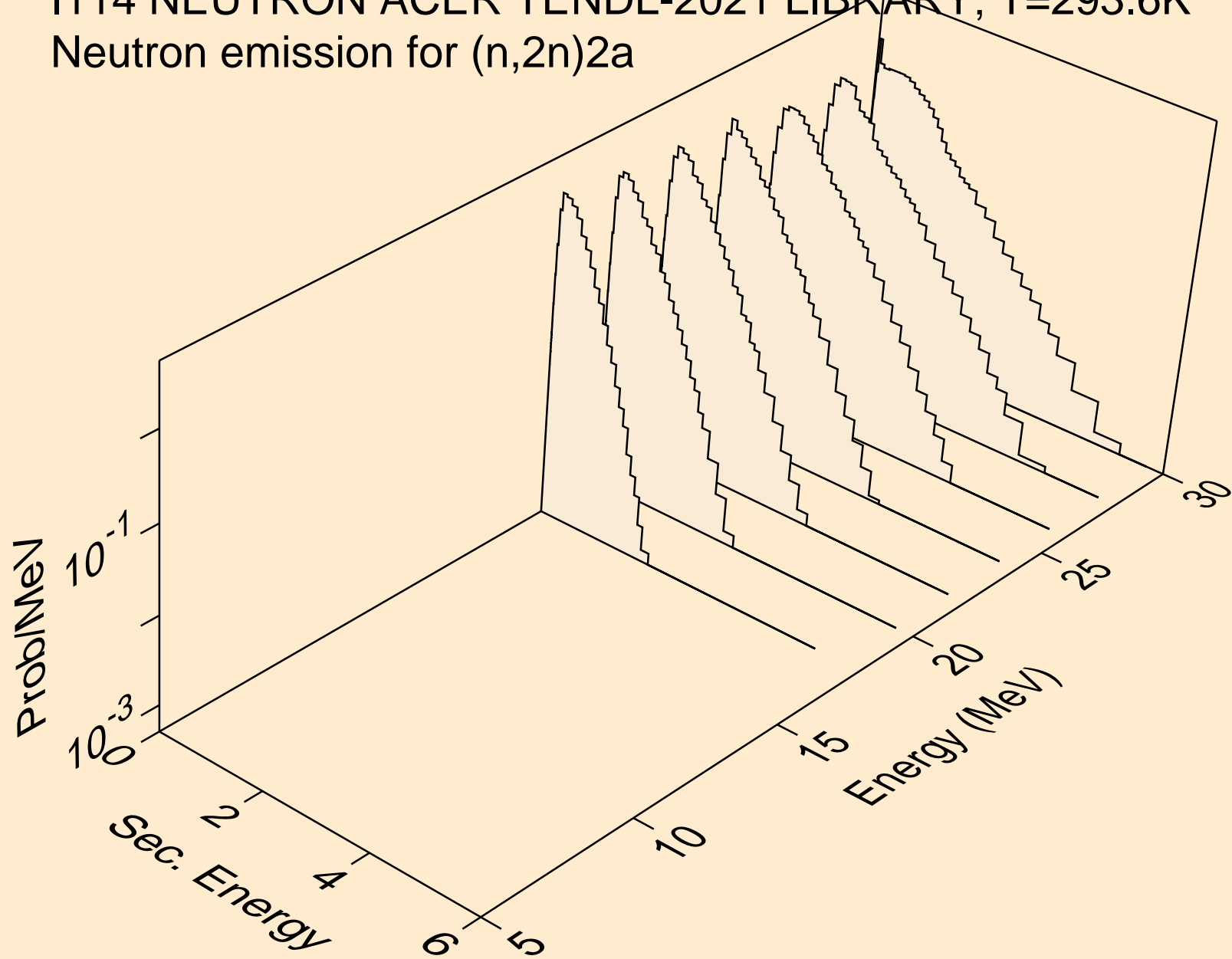

I114 NEUTRON ACER TENDL-2021 LIBRARY; T=293.6K
Neutron emission for (n,n*)d

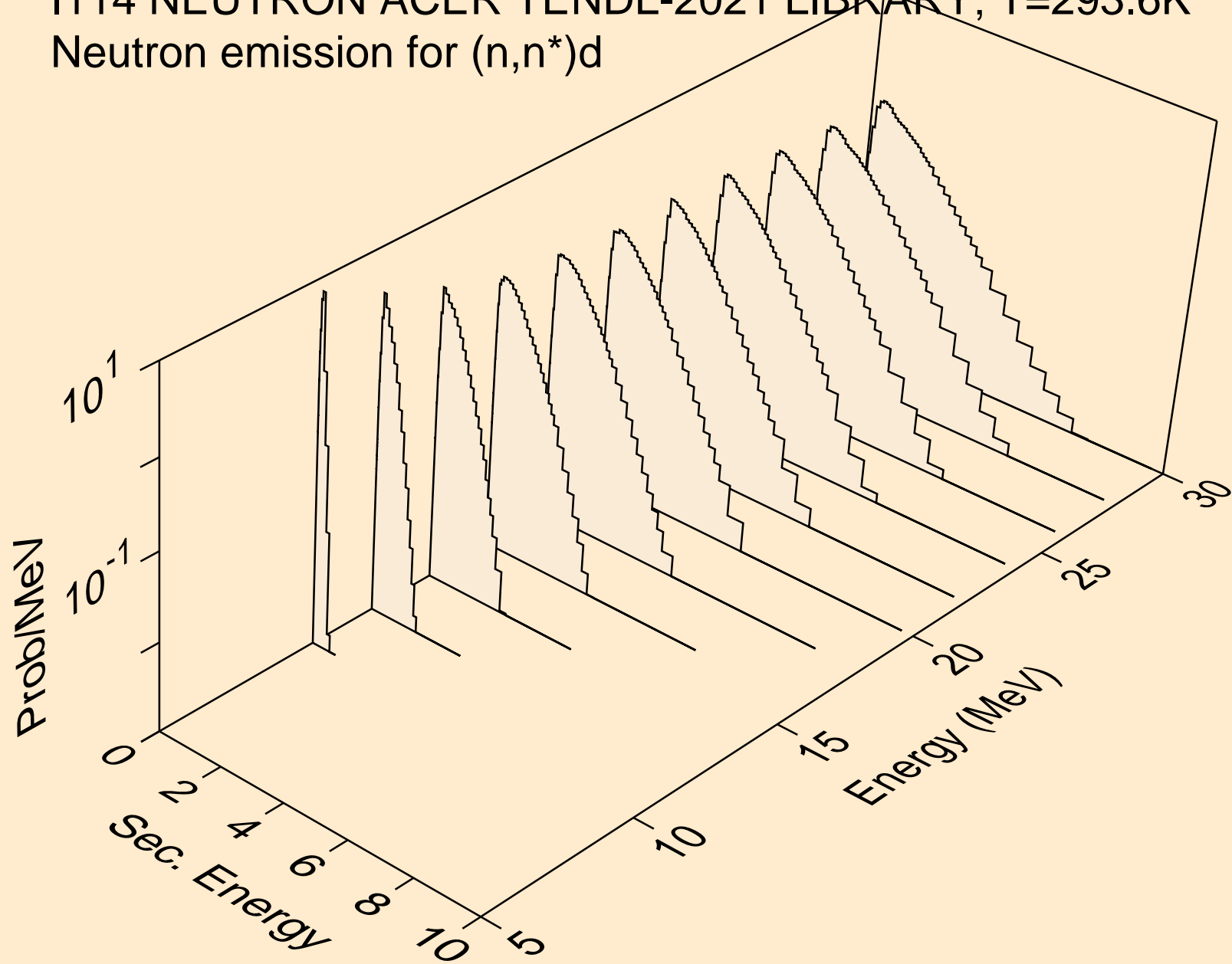

I114 NEUTRON ACER TENDL-2021 LIBRARY; T=293.6K
Neutron emission for (n,n*)t

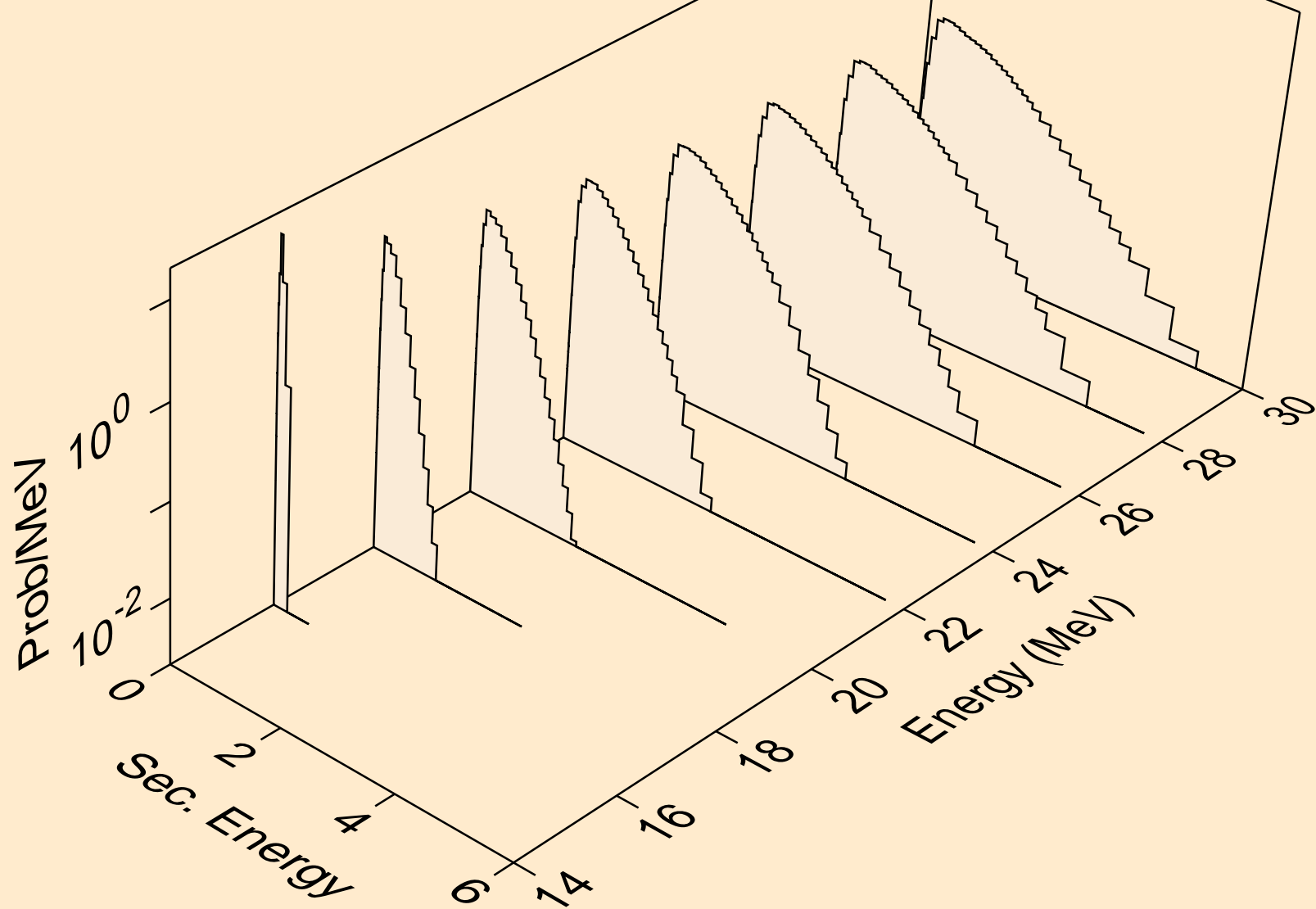

I114 NEUTRON ACER TENDL-2021 LIBRARY; T=293.6K
Neutron emission for (n,n*)he3

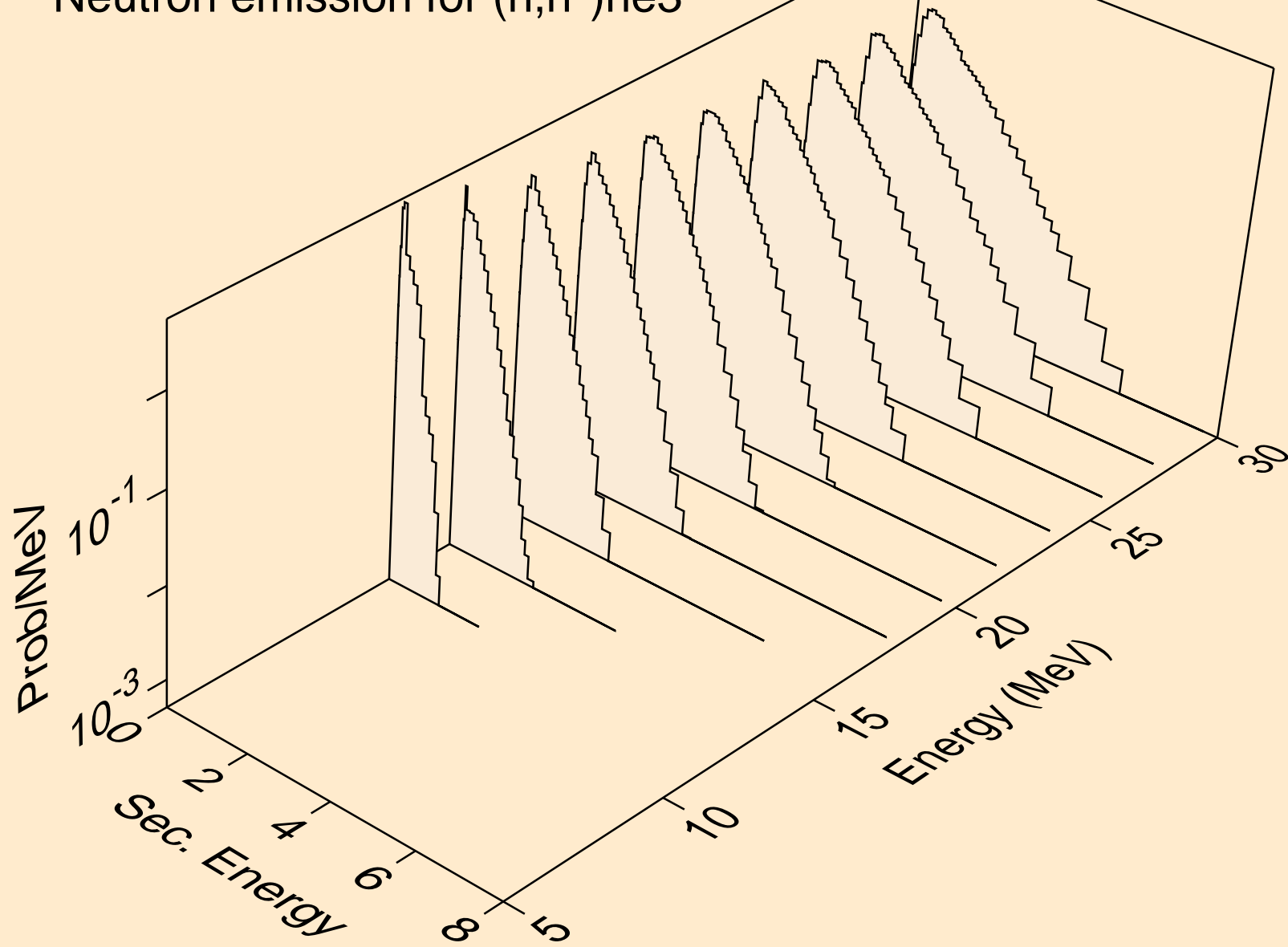

I114 NEUTRON ACER TENDL-2021 LIBRARY; T=293.6K
Neutron emission for (n,2np)

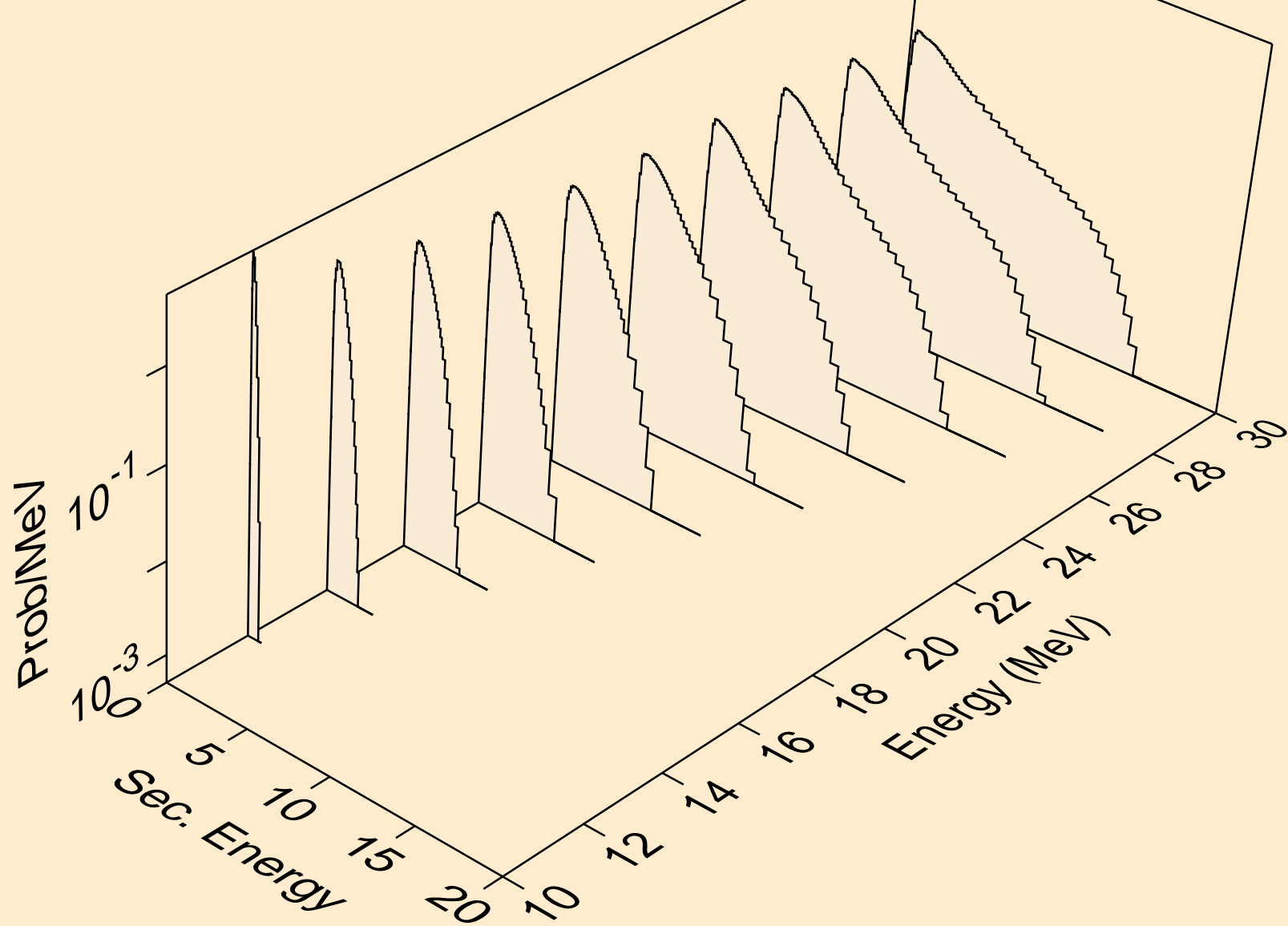

I114 NEUTRON ACER TENDL-2021 LIBRARY; T=293.6K
Neutron emission for (n,3np)

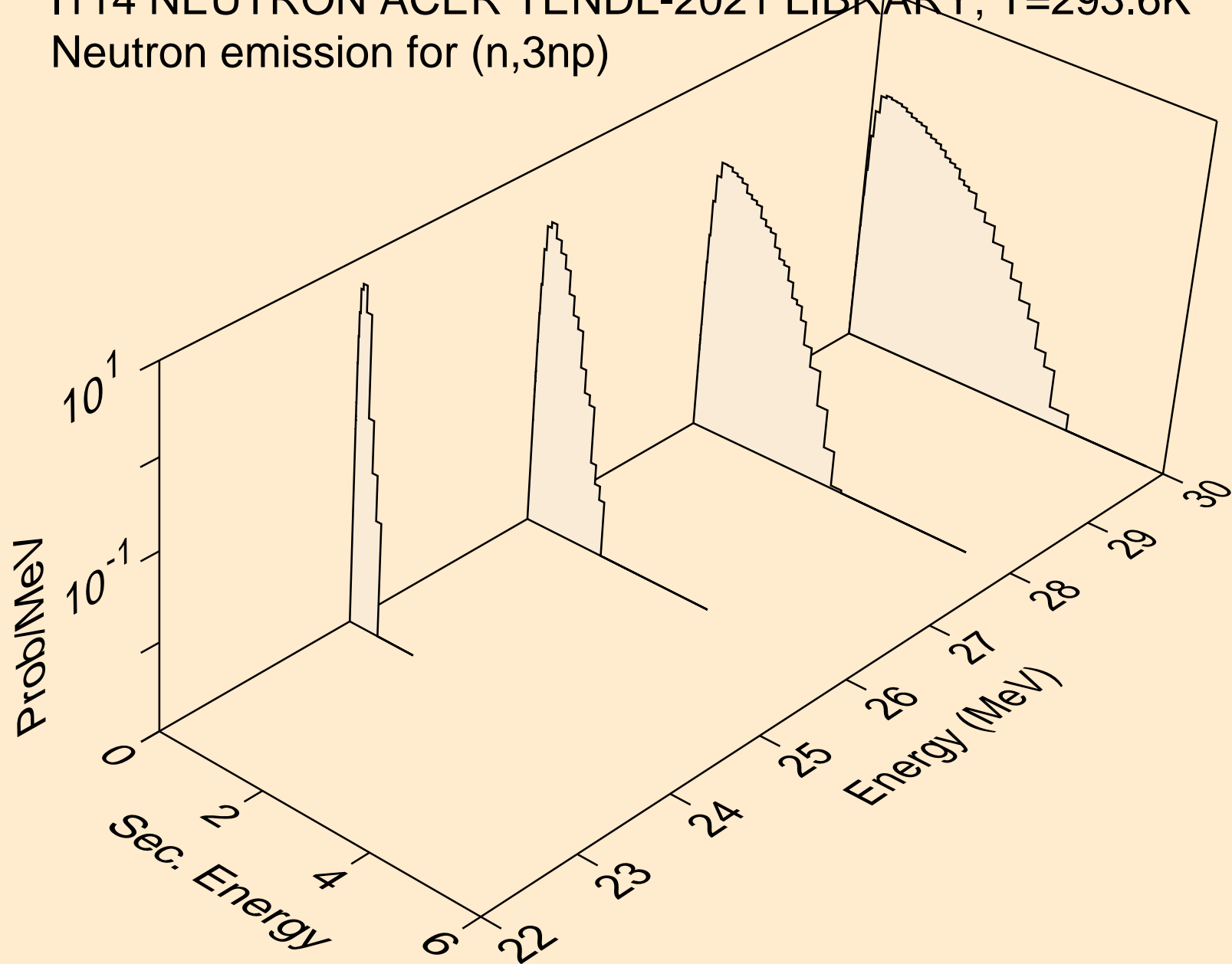

I114 NEUTRON ACER TENDL-2021 LIBRARY; T=293.6K
Neutron emission for (n,2np)

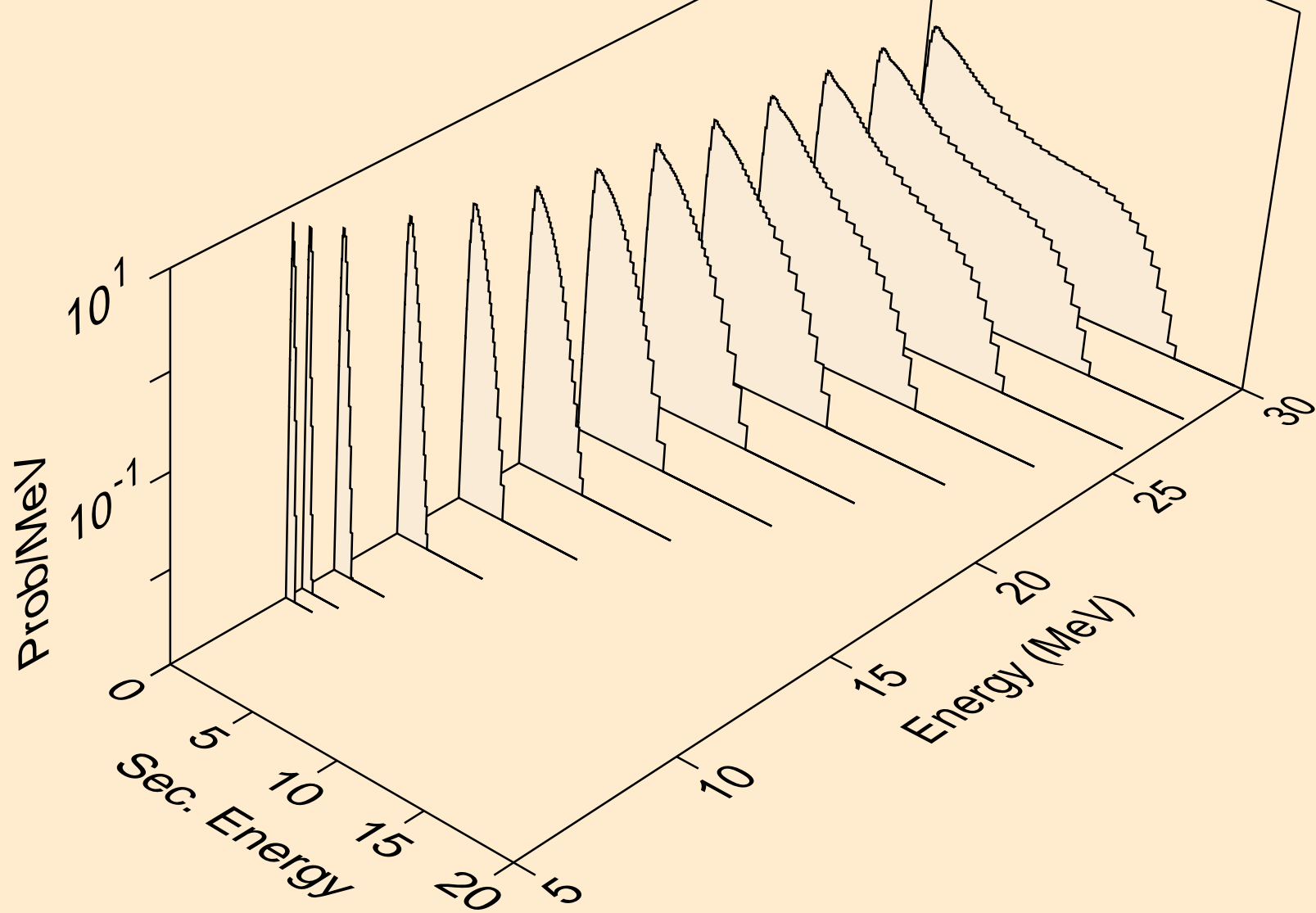

I114 NEUTRON ACER TENDL-2021 LIBRARY; T=293.6K
Neutron emission for (n,npa)

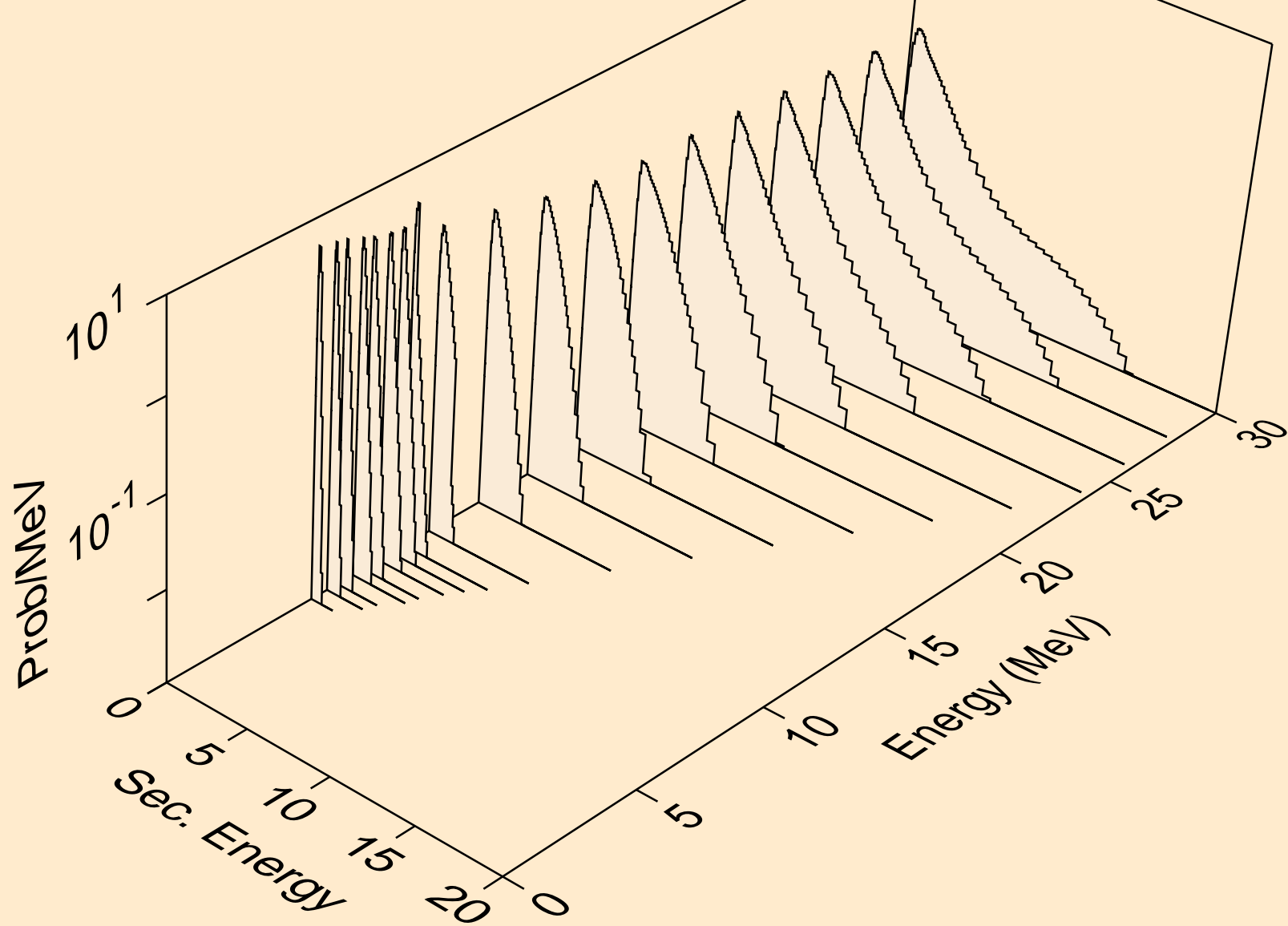

I114 NEUTRON ACER TENDL-2021 LIBRARY; T=293.6K
Neutron emission for (n,n*c)

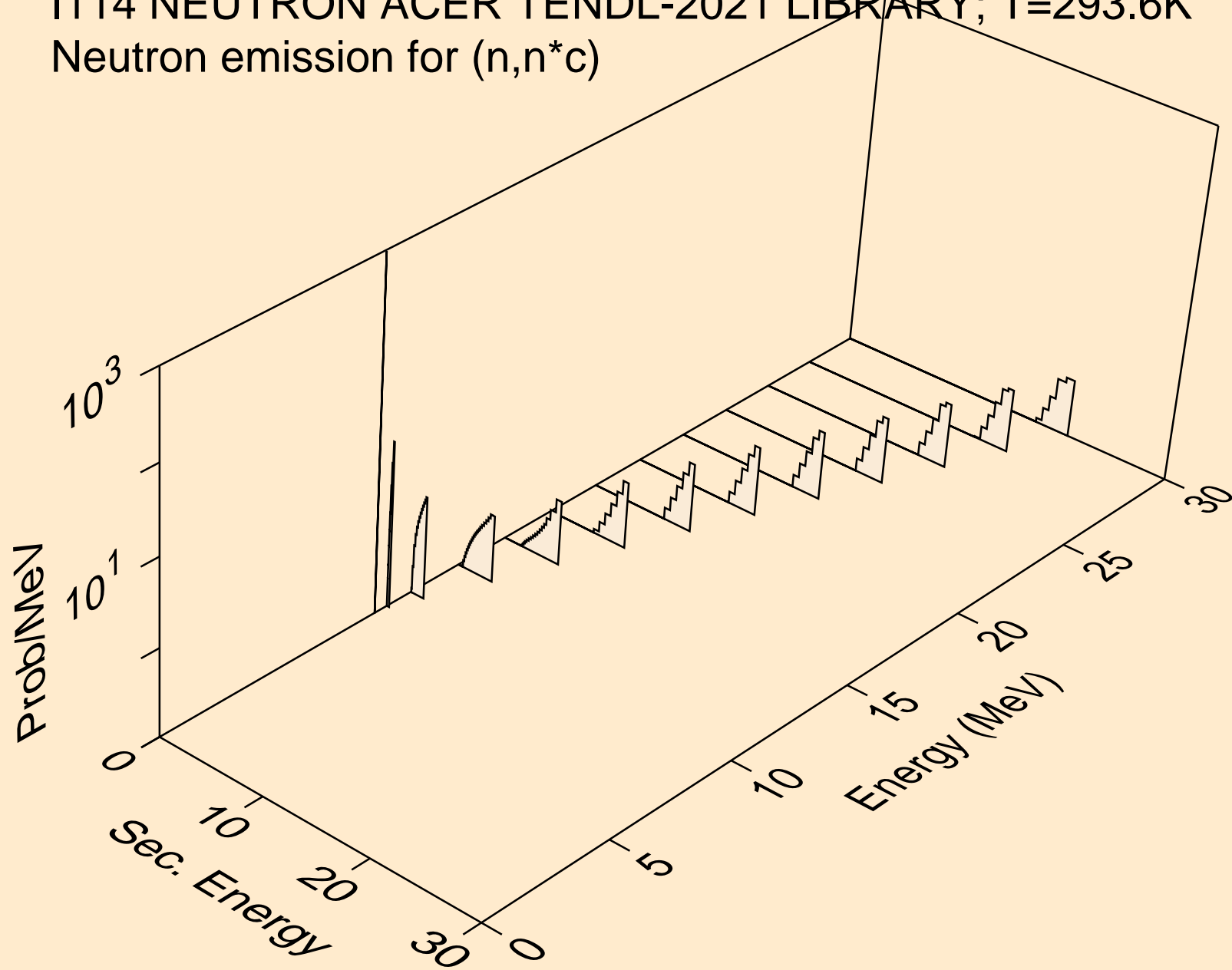

I114 NEUTRON ACER TENDL-2021 LIBRARY; T=293.6K
Photon emission for (n,x)

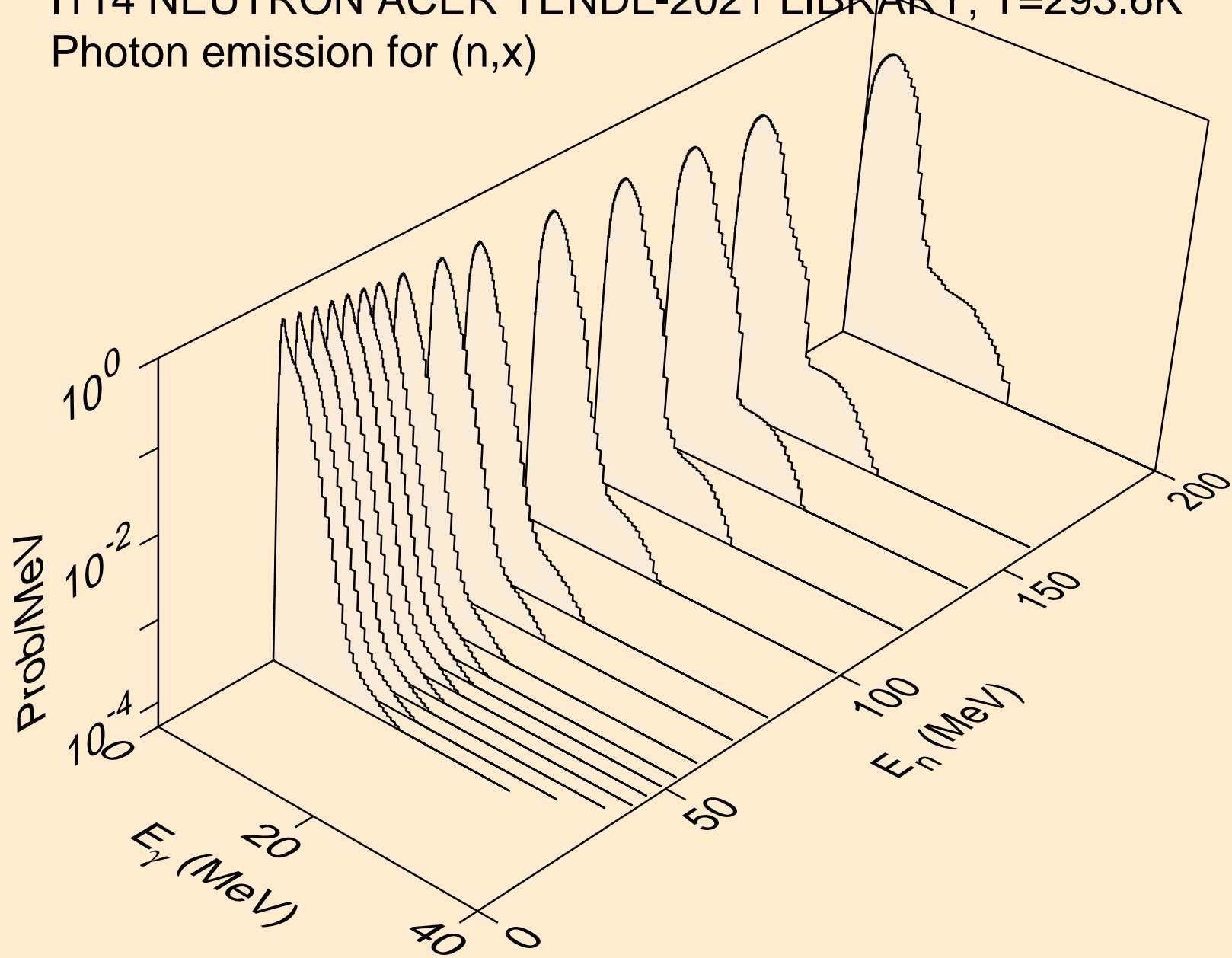

I114 NEUTRON ACER TENDL-2021 LIBRARY; T=293.6K
Photon emission for (n,2nd)

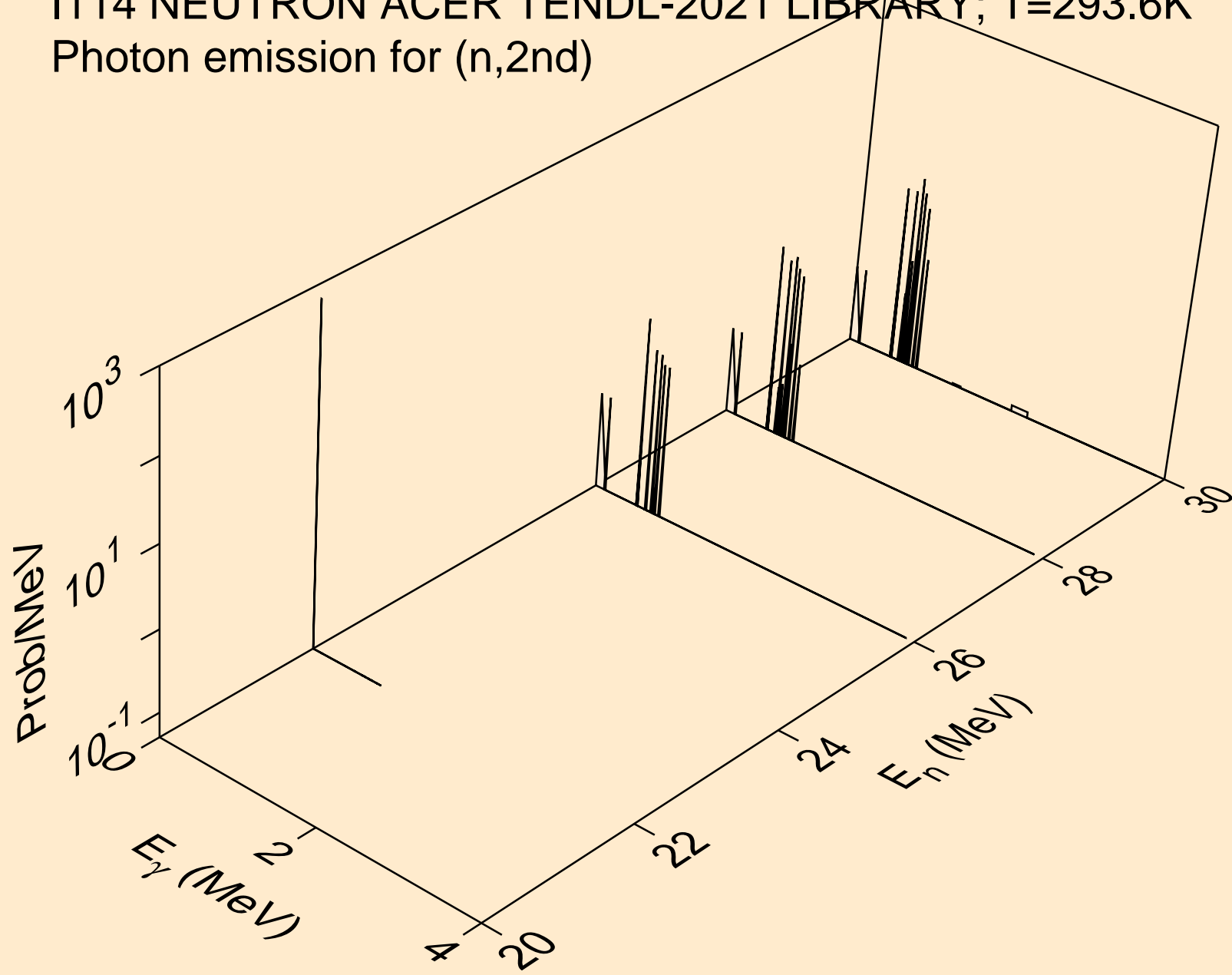

I114 NEUTRON ACER TENDL-2021 LIBRARY; T=293.6K
Photon emission for (n,2n)

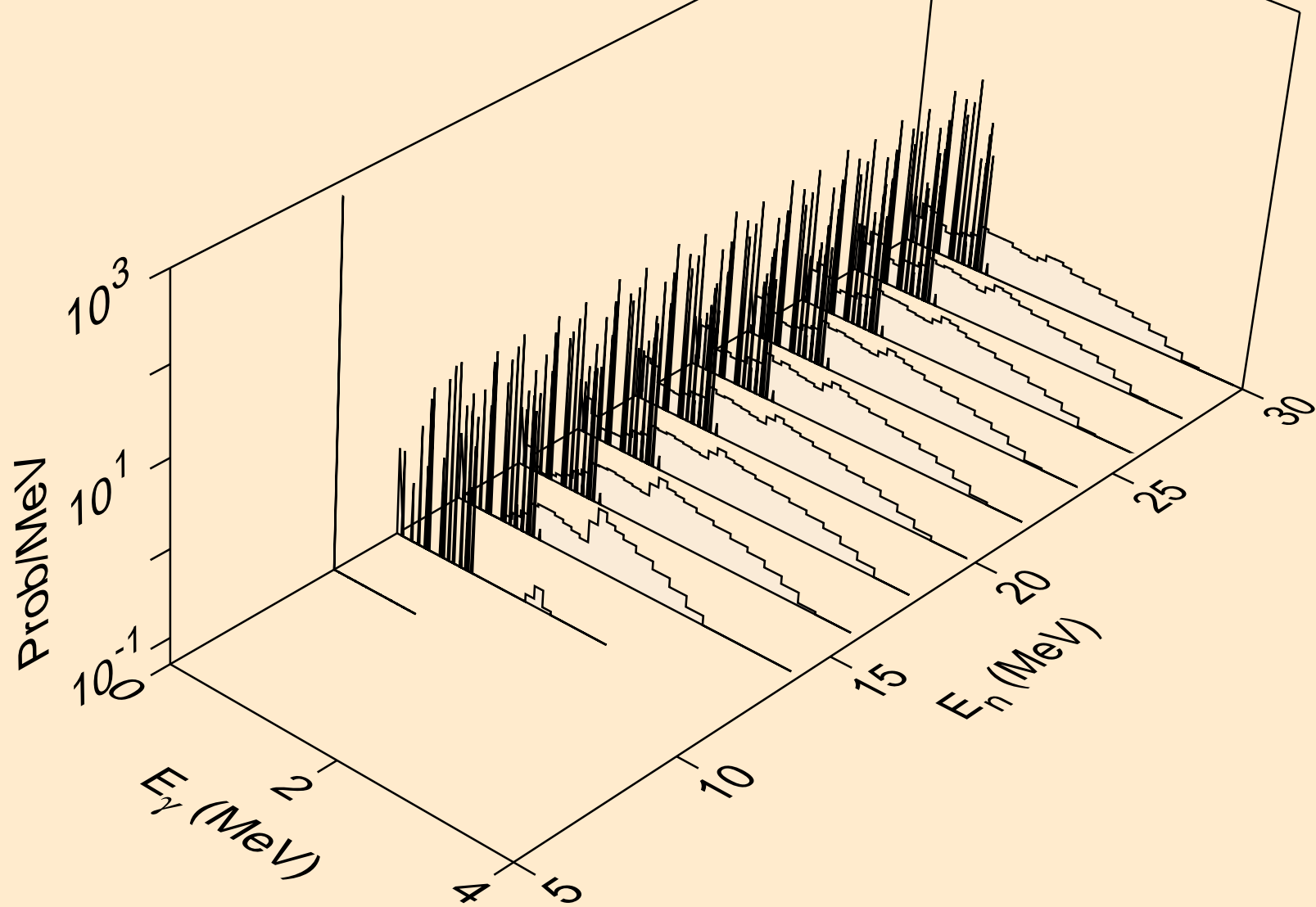

I114 NEUTRON ACER TENDL-2021 LIBRARY; T=293.6K
Photon emission for (n,3n)

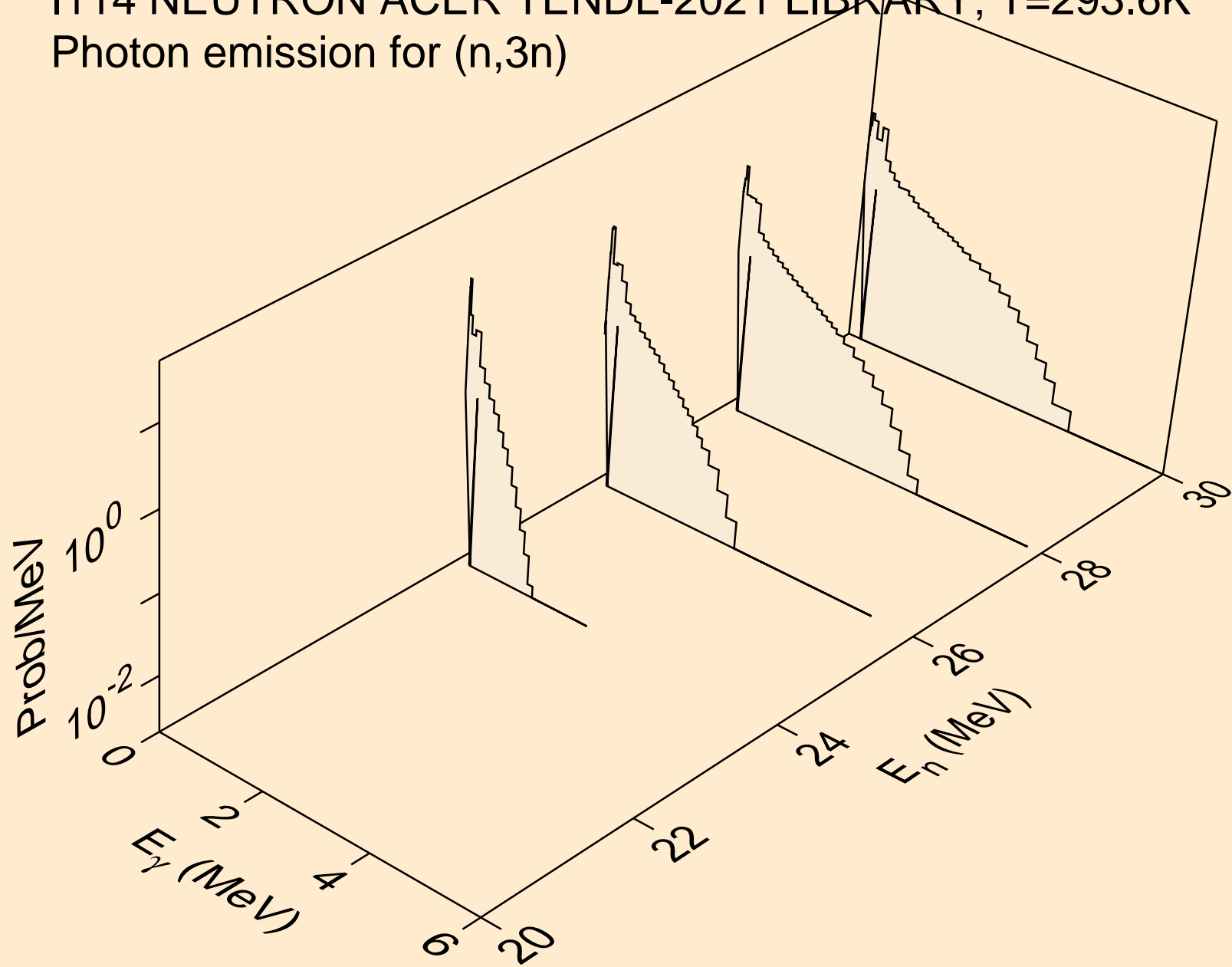

I114 NEUTRON ACER TENDL-2021 LIBRARY; T=293.6K
Photon emission for (n,n*)a

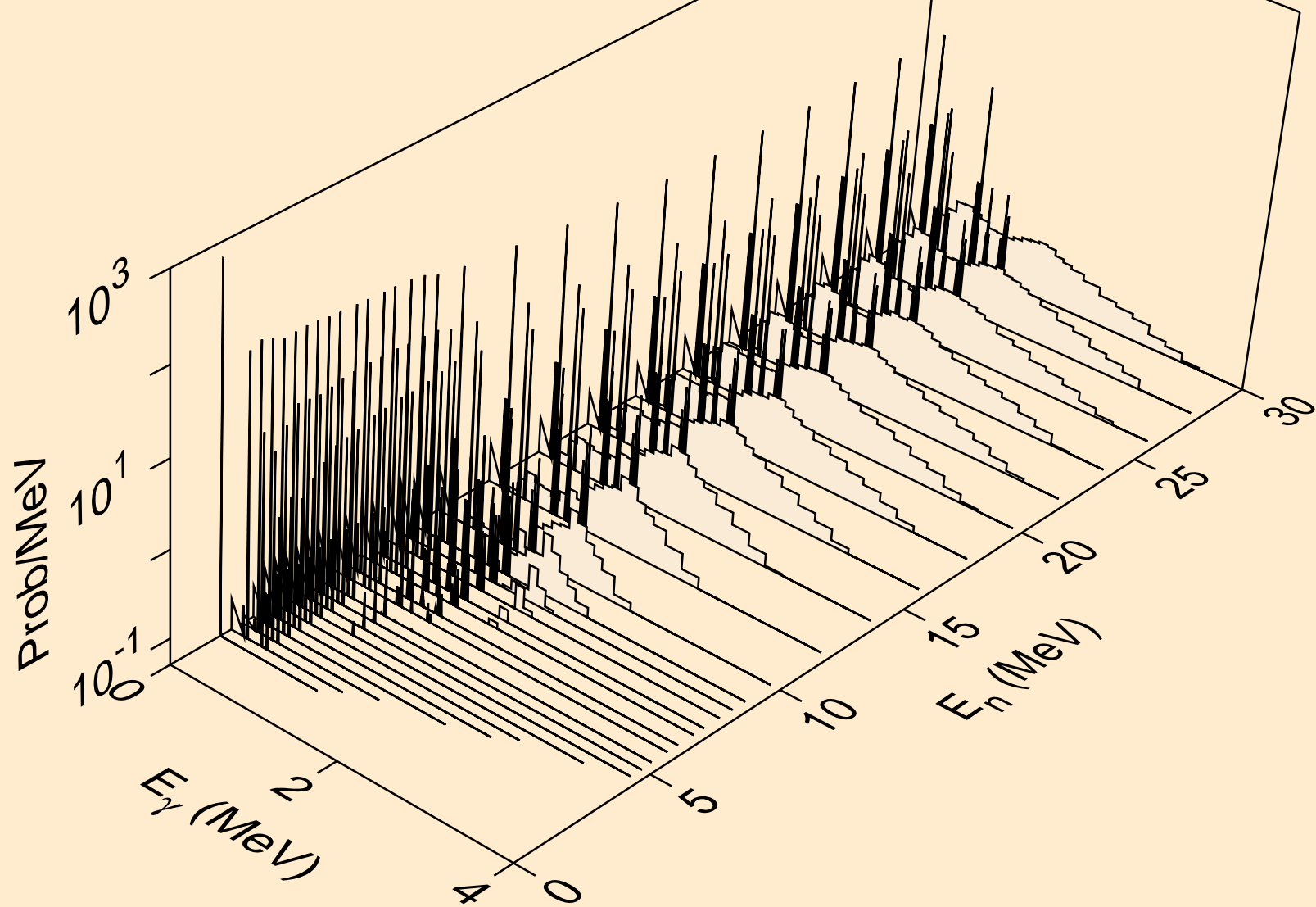

I114 NEUTRON ACER TENDL-2021 LIBRARY; T=293.6K
Photon emission for (n,2n)a

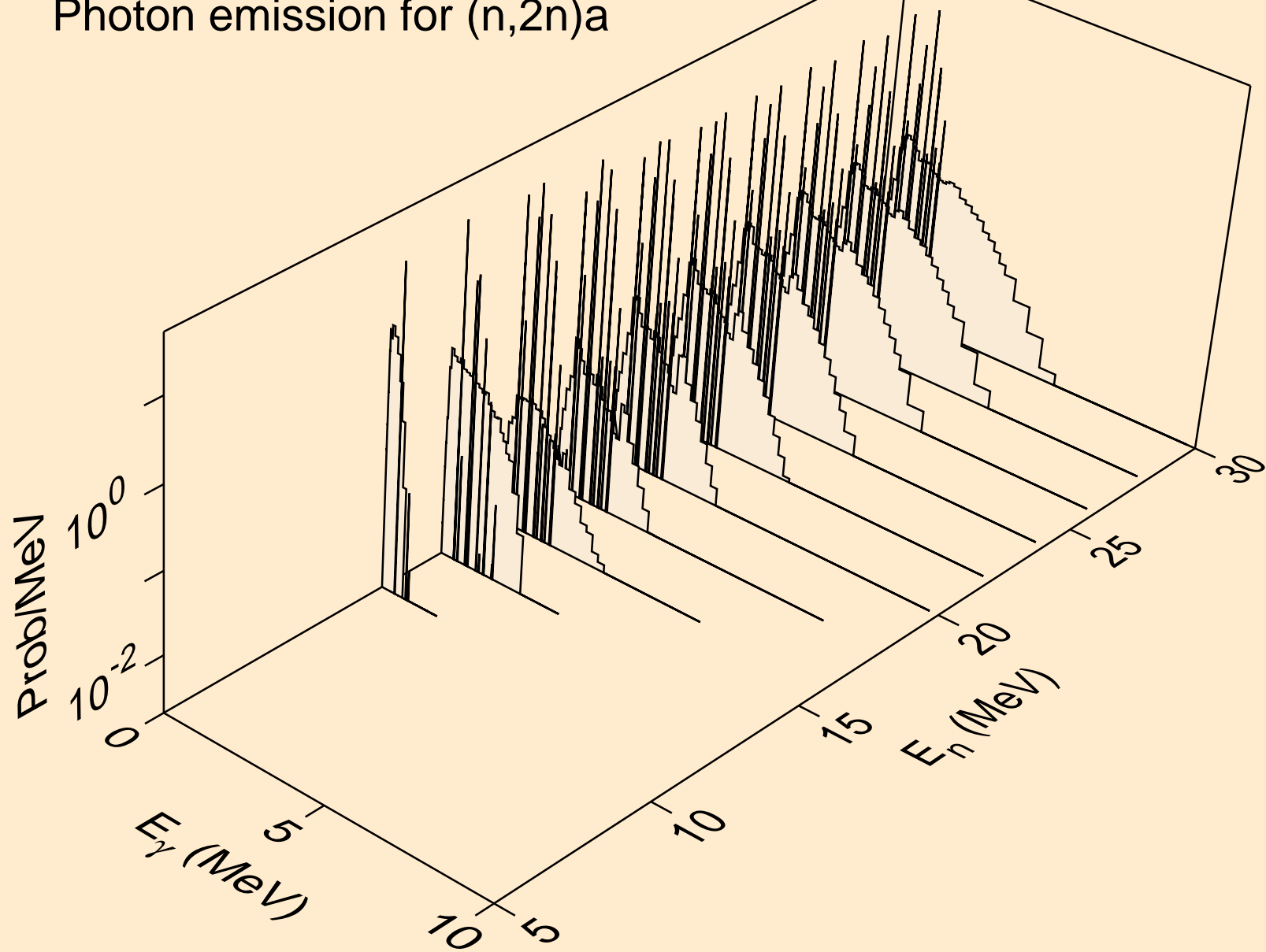

I114 NEUTRON ACER TENDL-2021 LIBRARY; T=293.6K
Photon emission for (n,3n)a

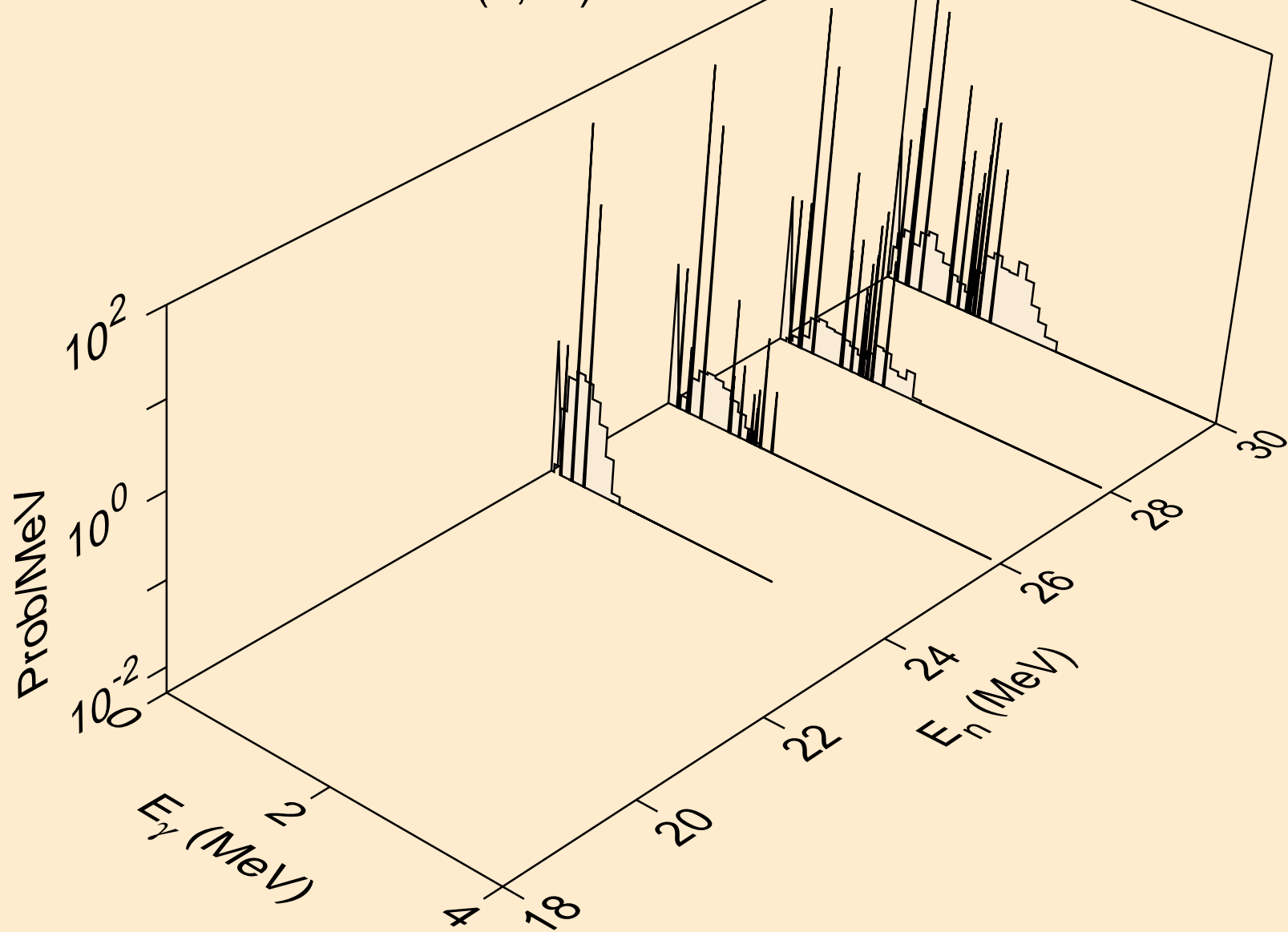

I114 NEUTRON ACER TENDL-2021 LIBRARY; T=293.6K
Photon emission for (n,n*)p

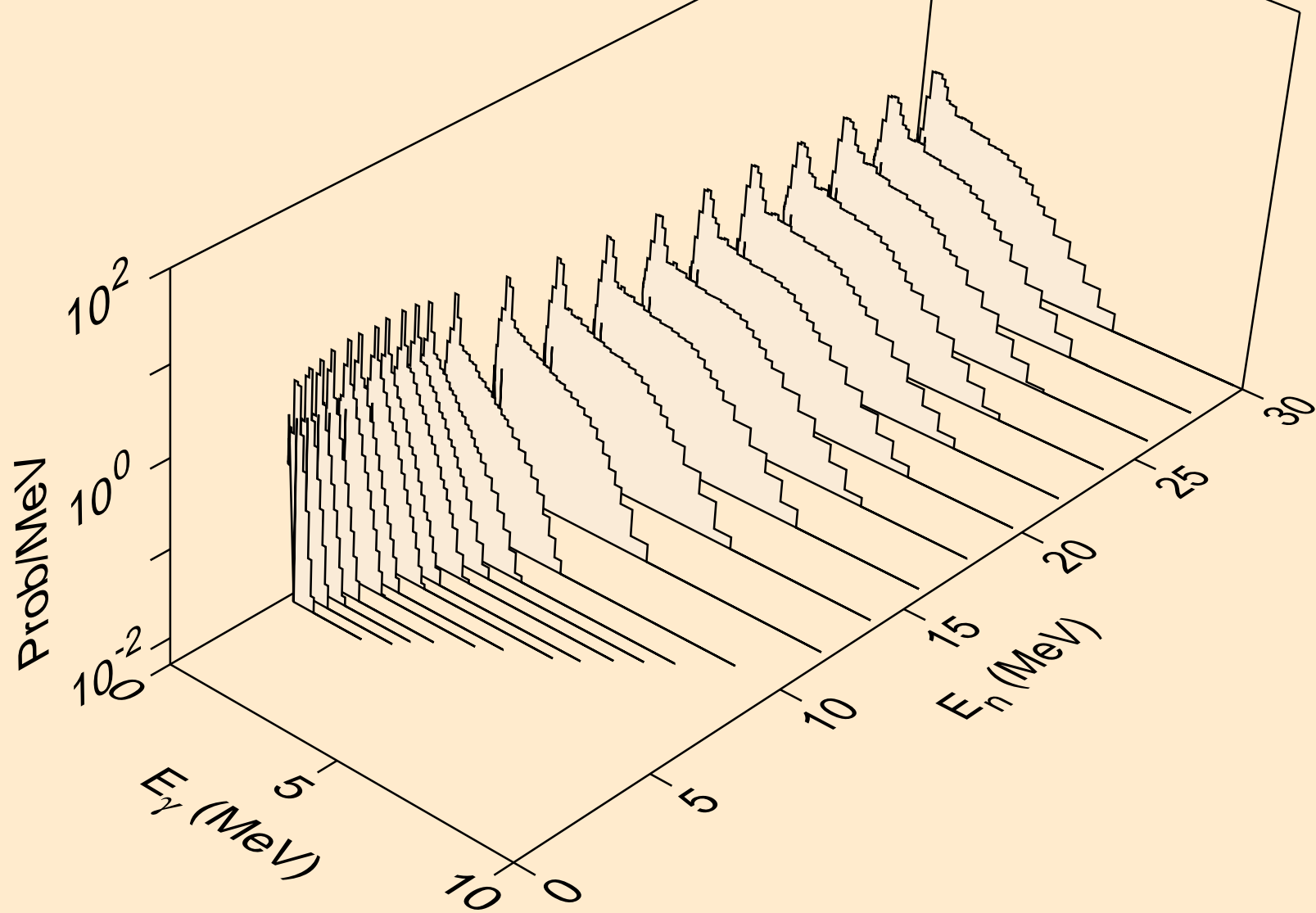

I114 NEUTRON ACER TENDL-2021 LIBRARY; T=293.6K
Photon emission for (n,n*)2a

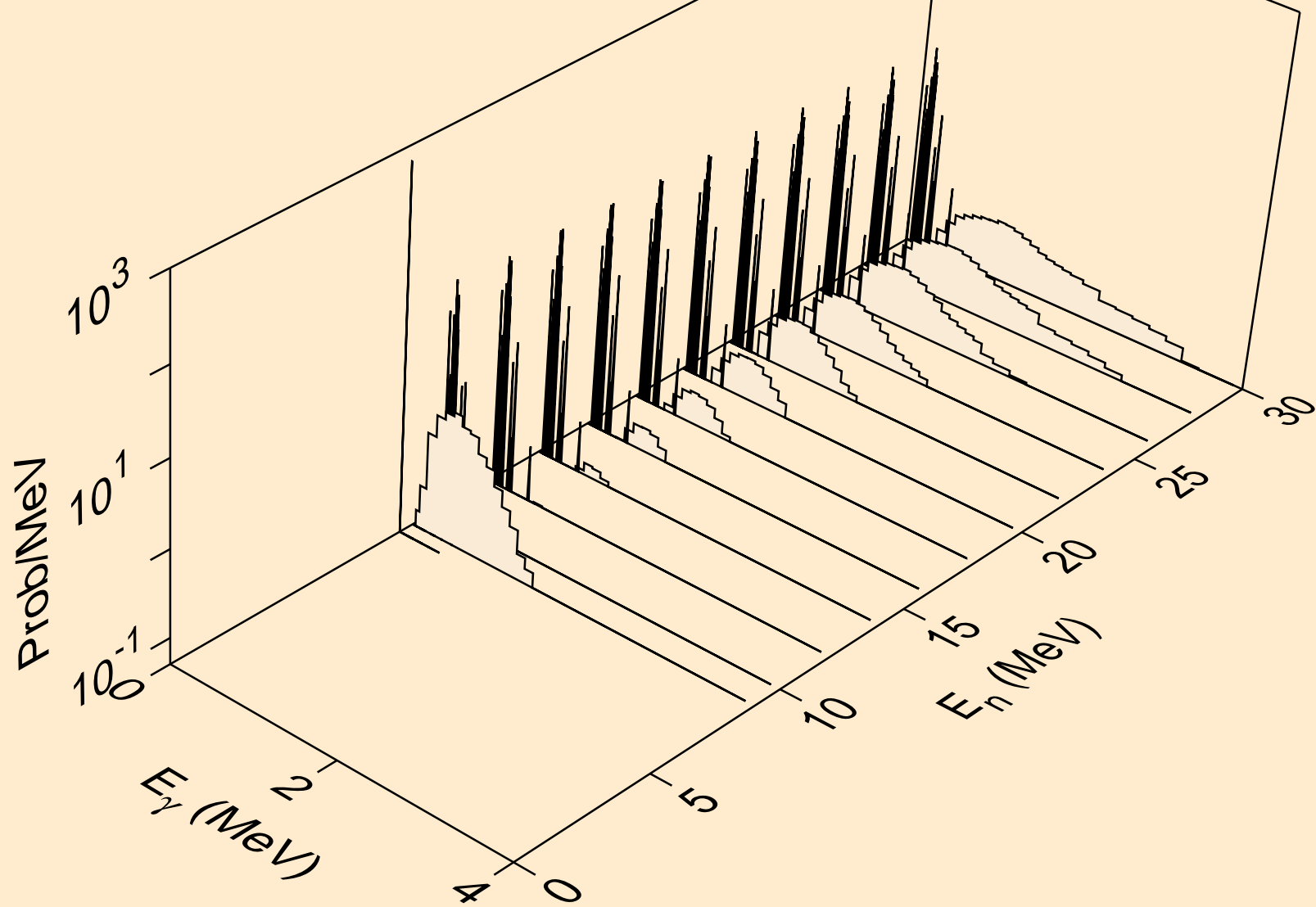

I114 NEUTRON ACER TENDL-2021 LIBRARY; T=293.6K
Photon emission for (n,2n)2a

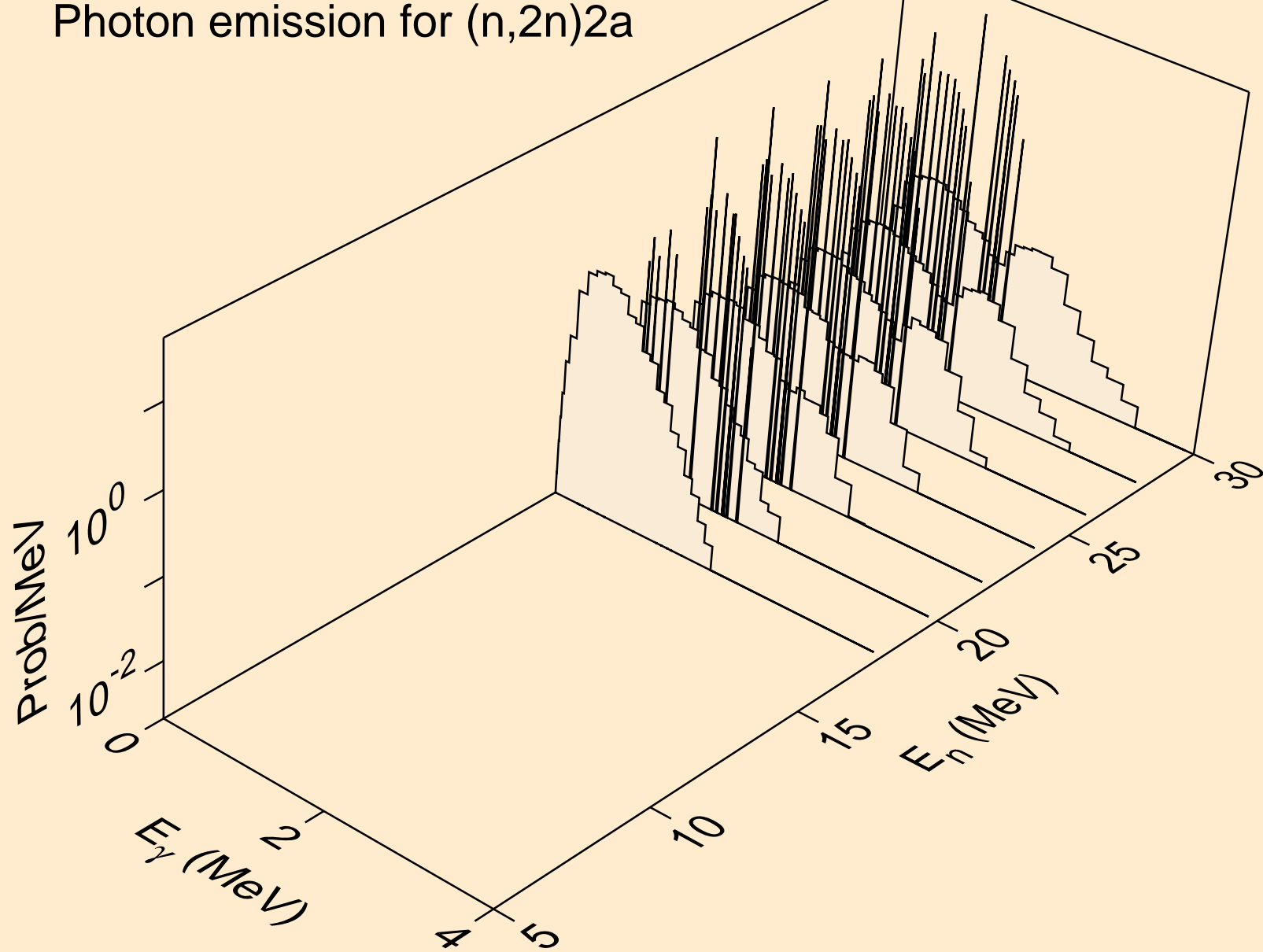

I114 NEUTRON ACER TENDL-2021 LIBRARY; T=293.6K
Photon emission for (n,n*)d

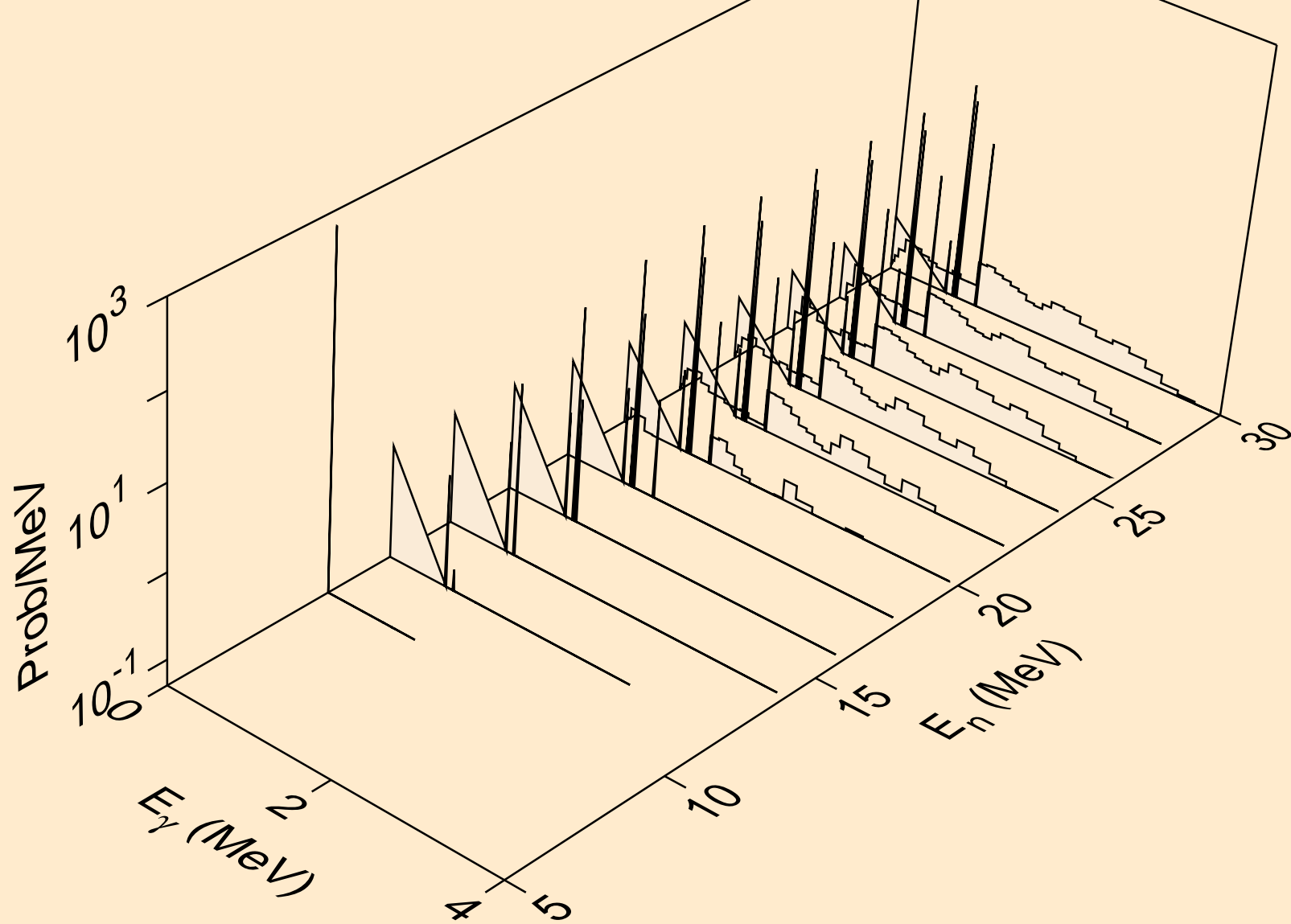

I114 NEUTRON ACER TENDL-2021 LIBRARY; T=293.6K
Photon emission for (n,n*)t

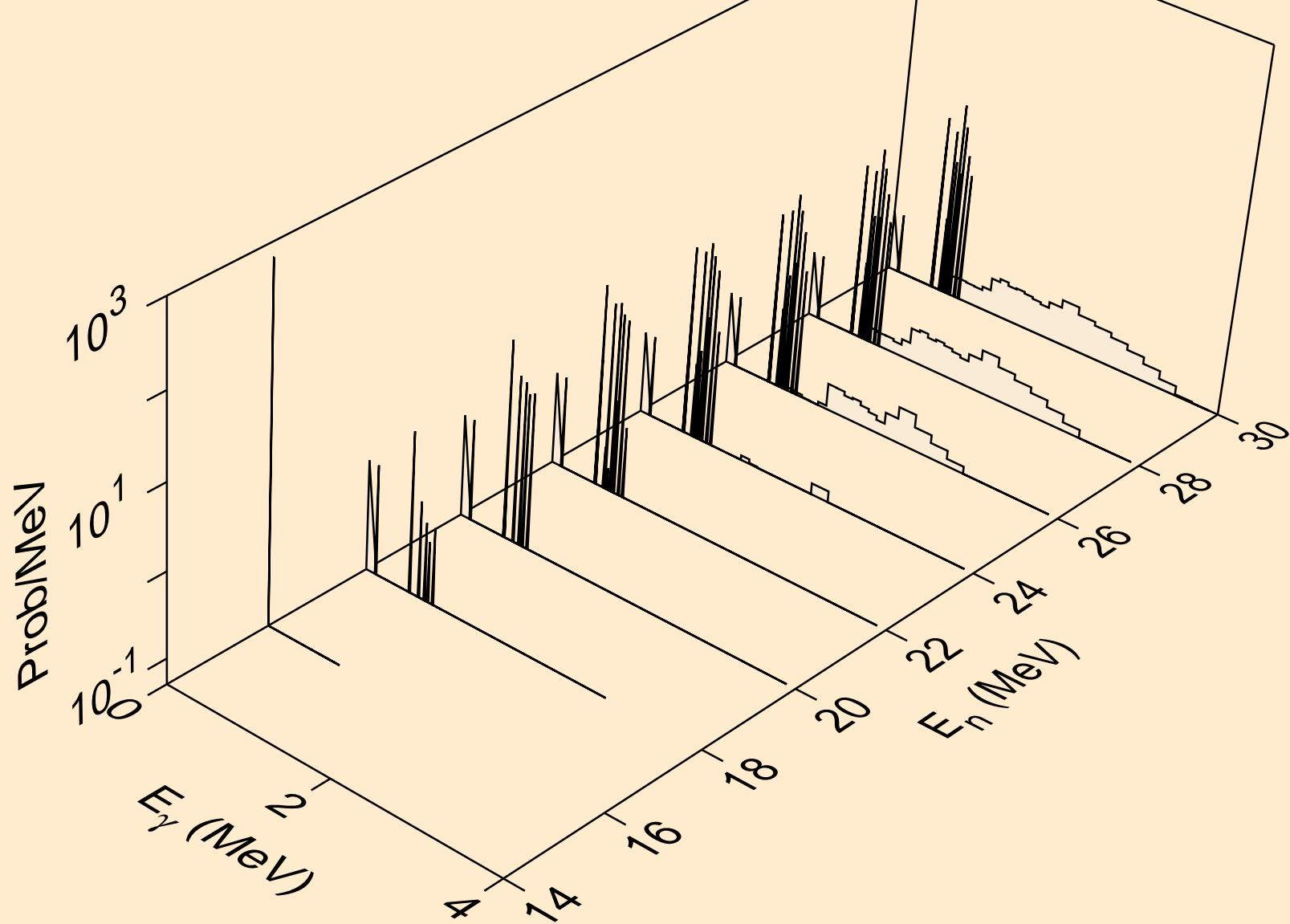

I114 NEUTRON ACER TENDL-2021 LIBRARY; T=293.6K
Photon emission for (n,n*)he3

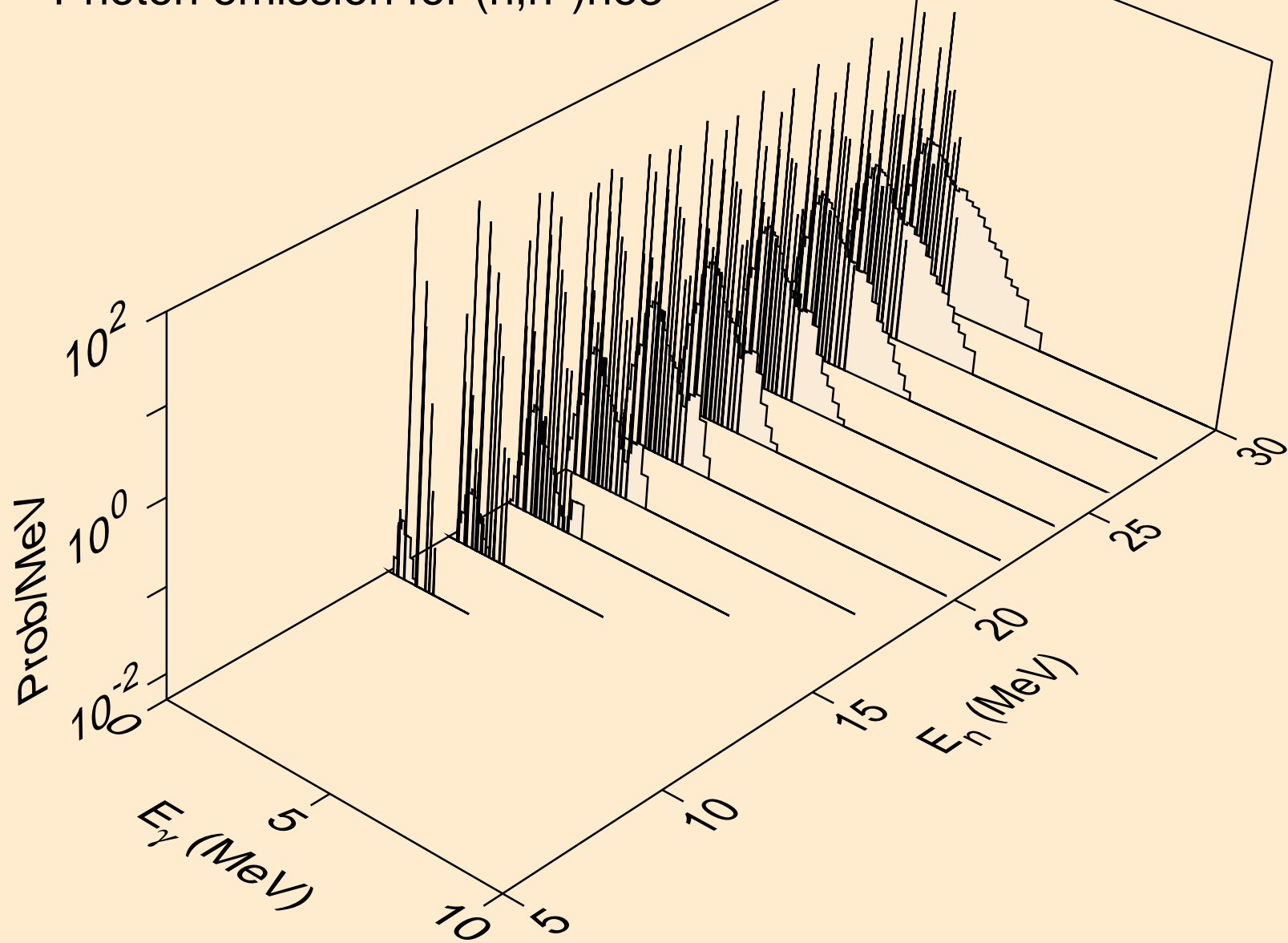

I114 NEUTRON ACER TENDL-2021 LIBRARY; T=293.6K
Photon emission for (n,2np)

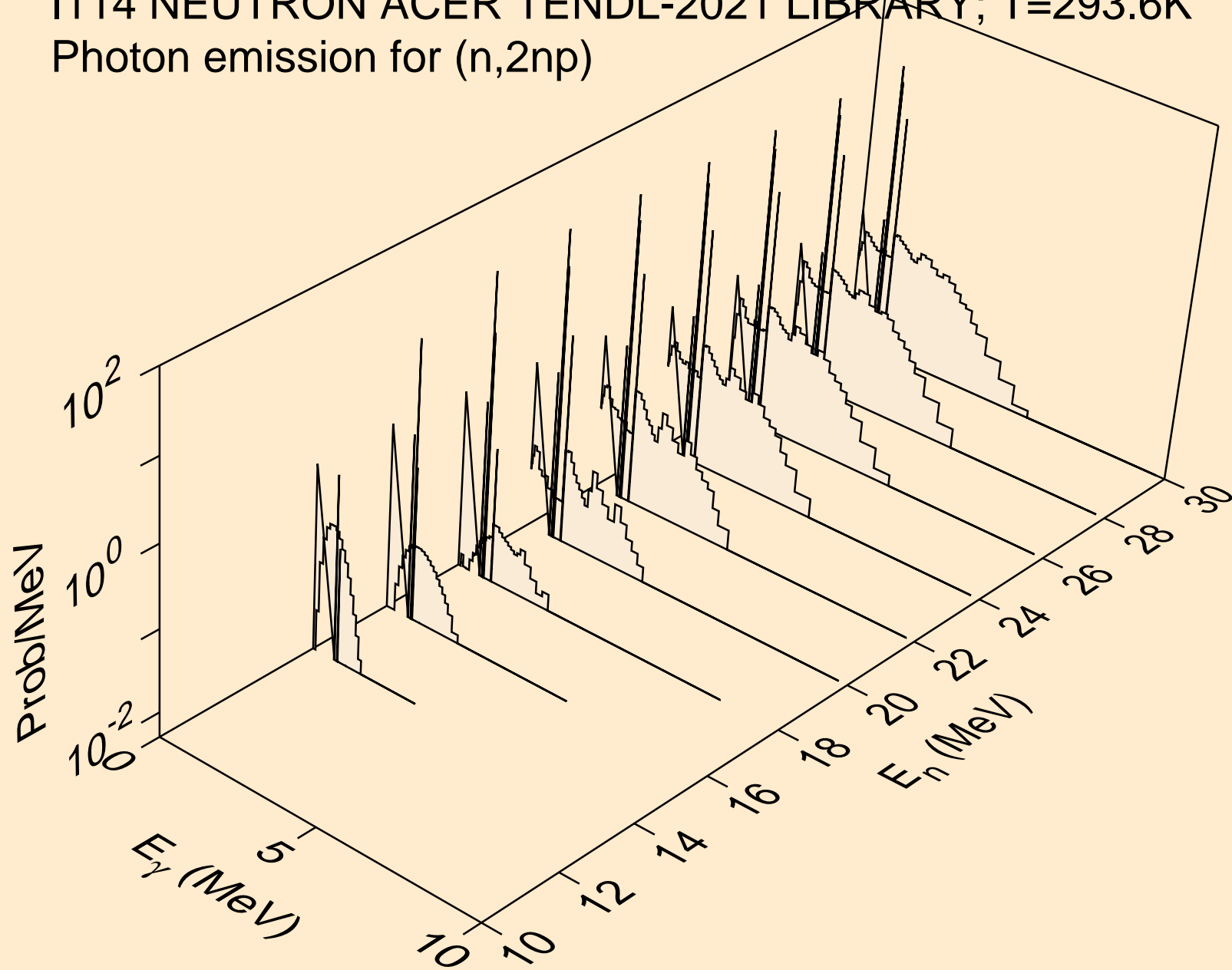

I114 NEUTRON ACER TENDL-2021 LIBRARY; T=293.6K
Photon emission for (n,3np)

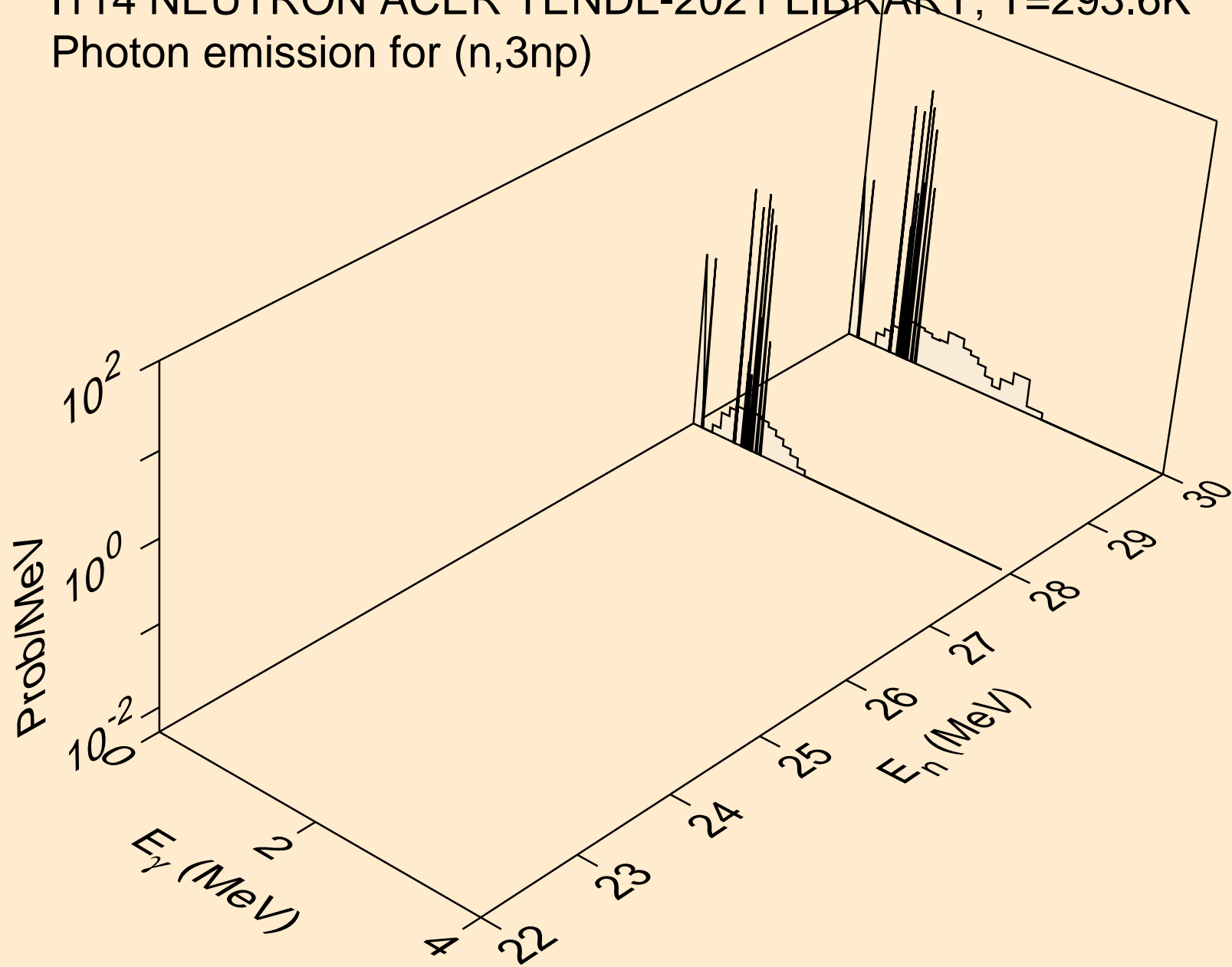

I114 NEUTRON ACER TENDL-2021 LIBRARY; T=293.6K
Photon emission for (n,2np)

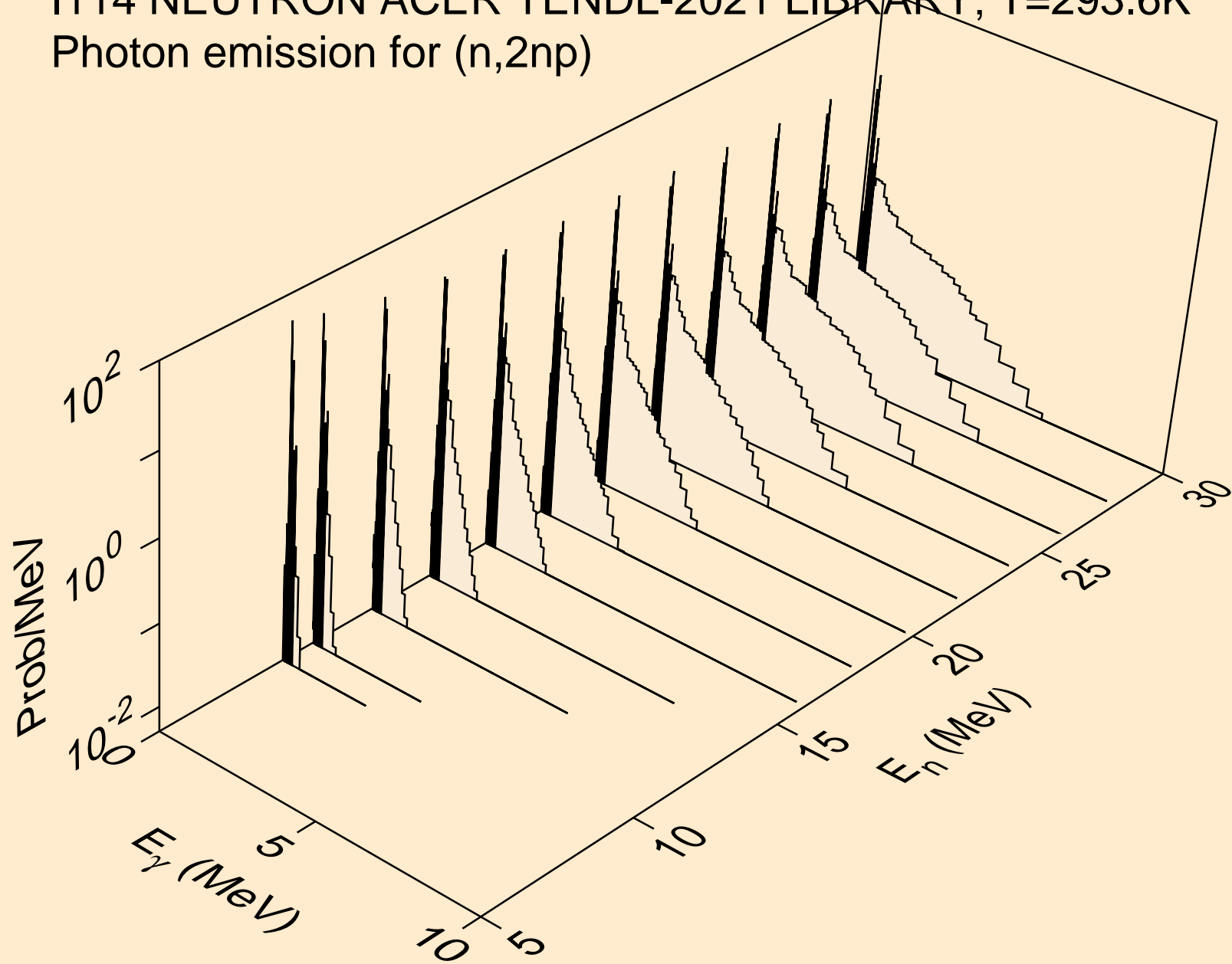

I114 NEUTRON ACER TENDL-2021 LIBRARY; T=293.6K
Photon emission for (n,npa)

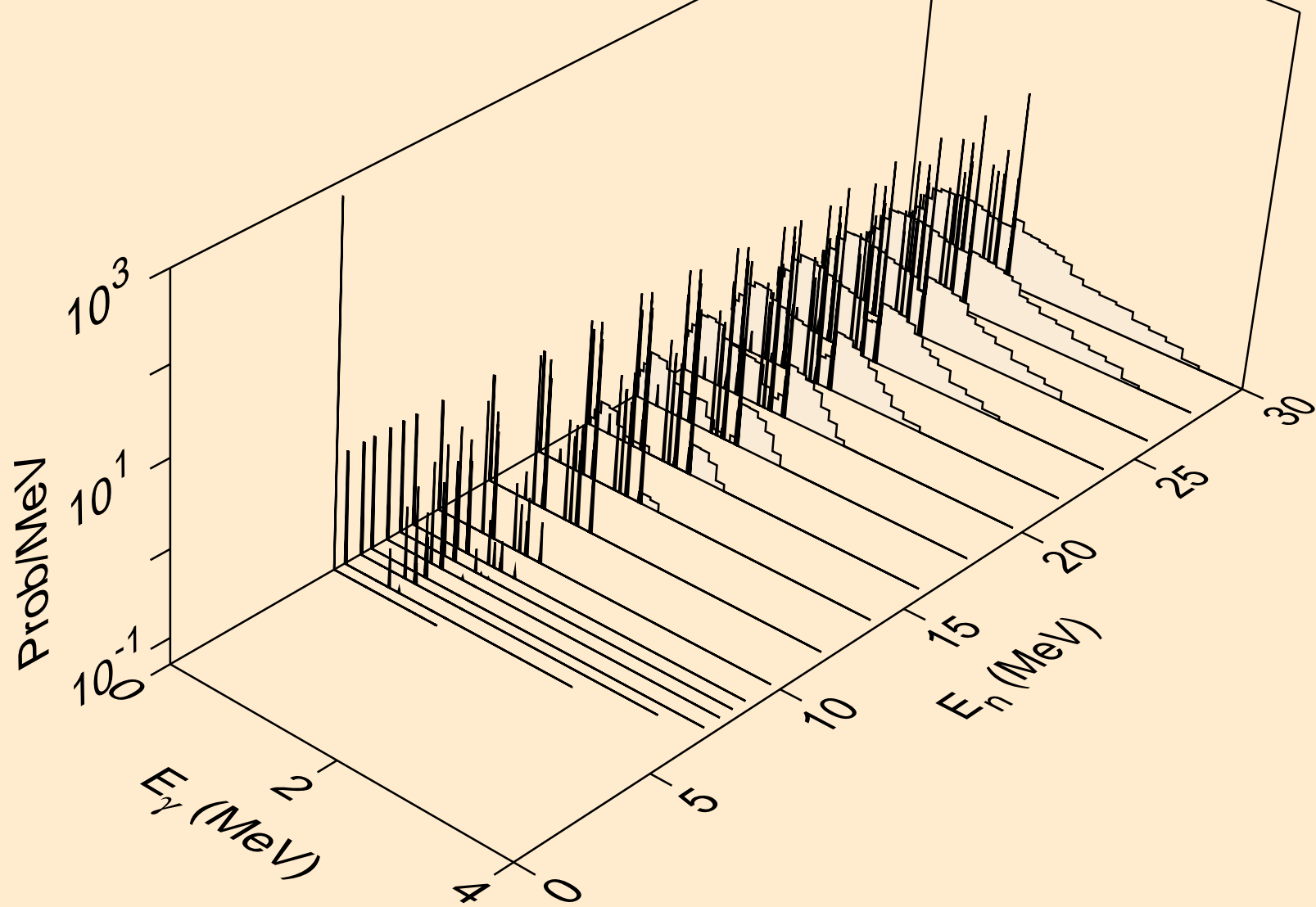

I114 NEUTRON ACER TENDL-2021 LIBRARY; T=293.6K
Photon emission for (n,n*c)

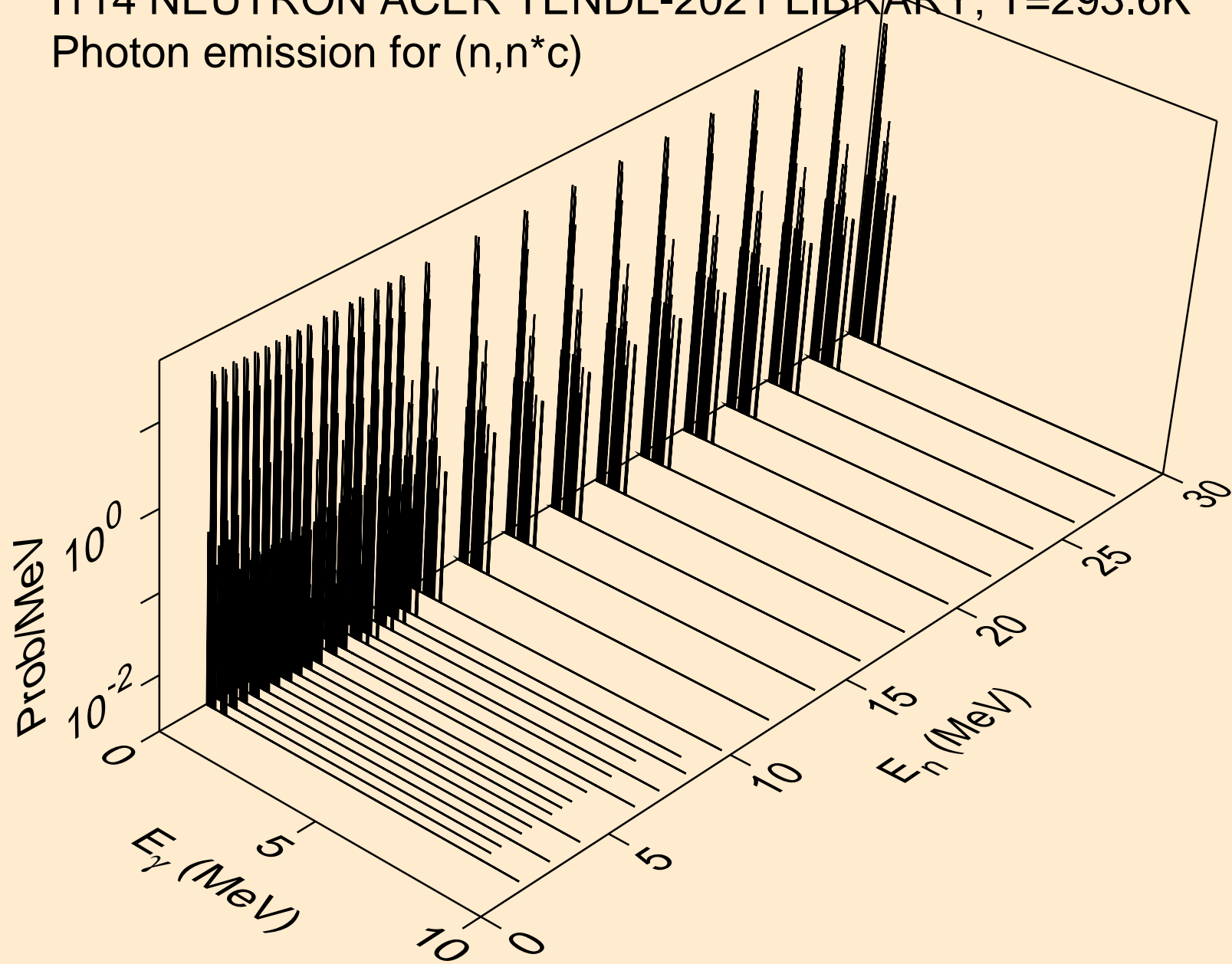

I114 NEUTRON ACER TENDL-2021 LIBRARY; T=293.6K
Photon emission for (n,gma)

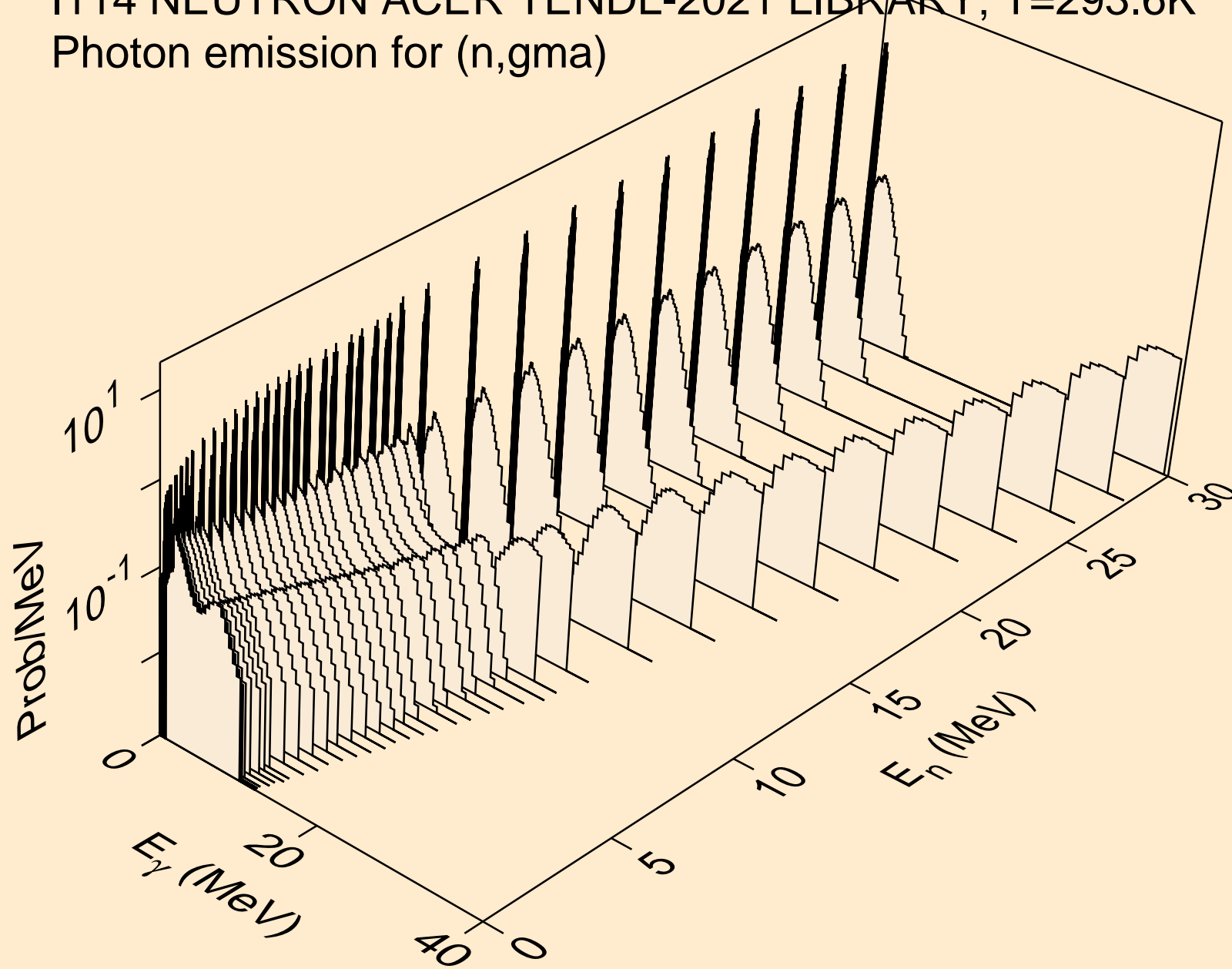

I114 NEUTRON ACER TENDL-2021 LIBRARY; T=293.6K
Photon emission for (n,p)

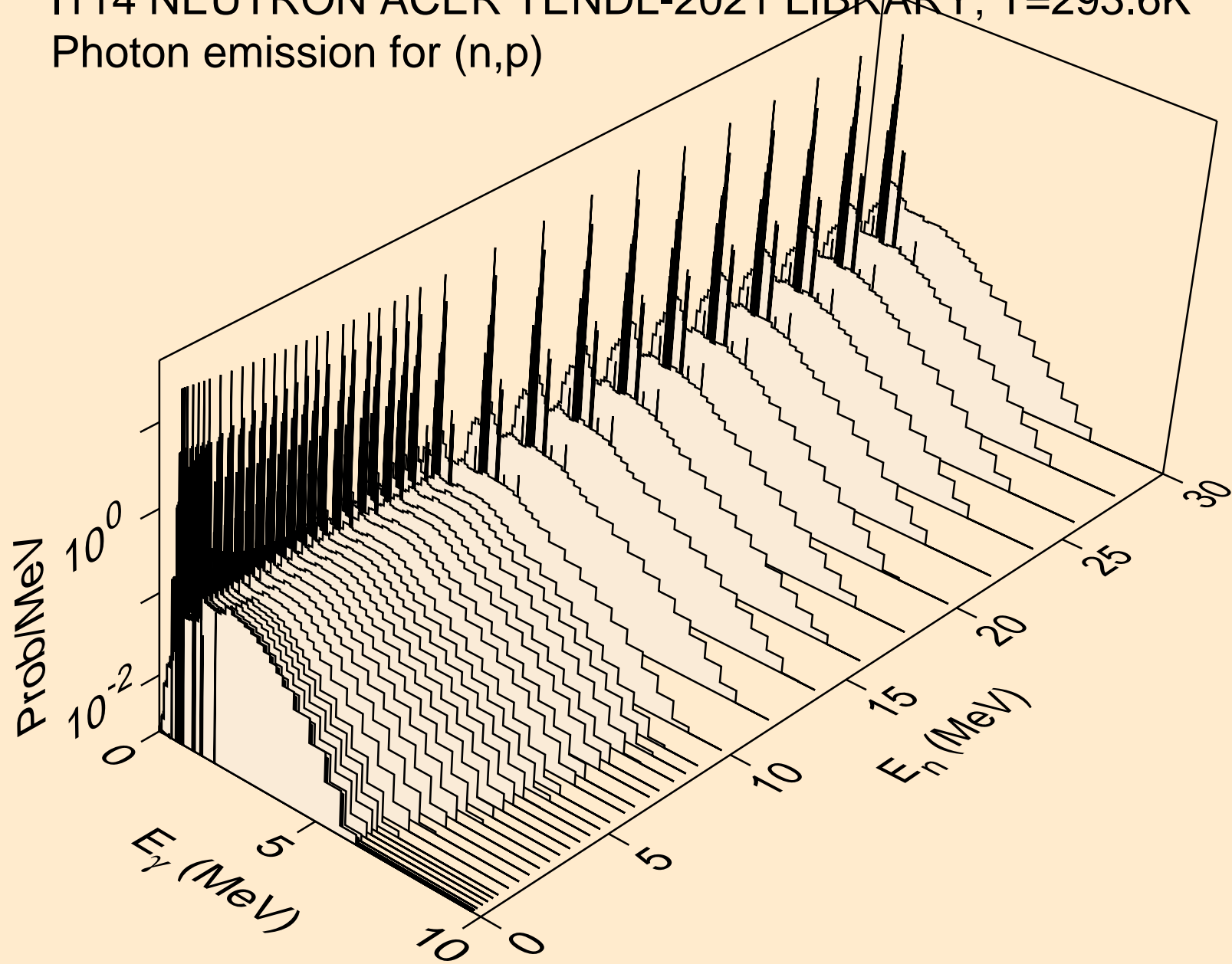

I114 NEUTRON ACER TENDL-2021 LIBRARY; T=293.6K
Photon emission for (n,d)

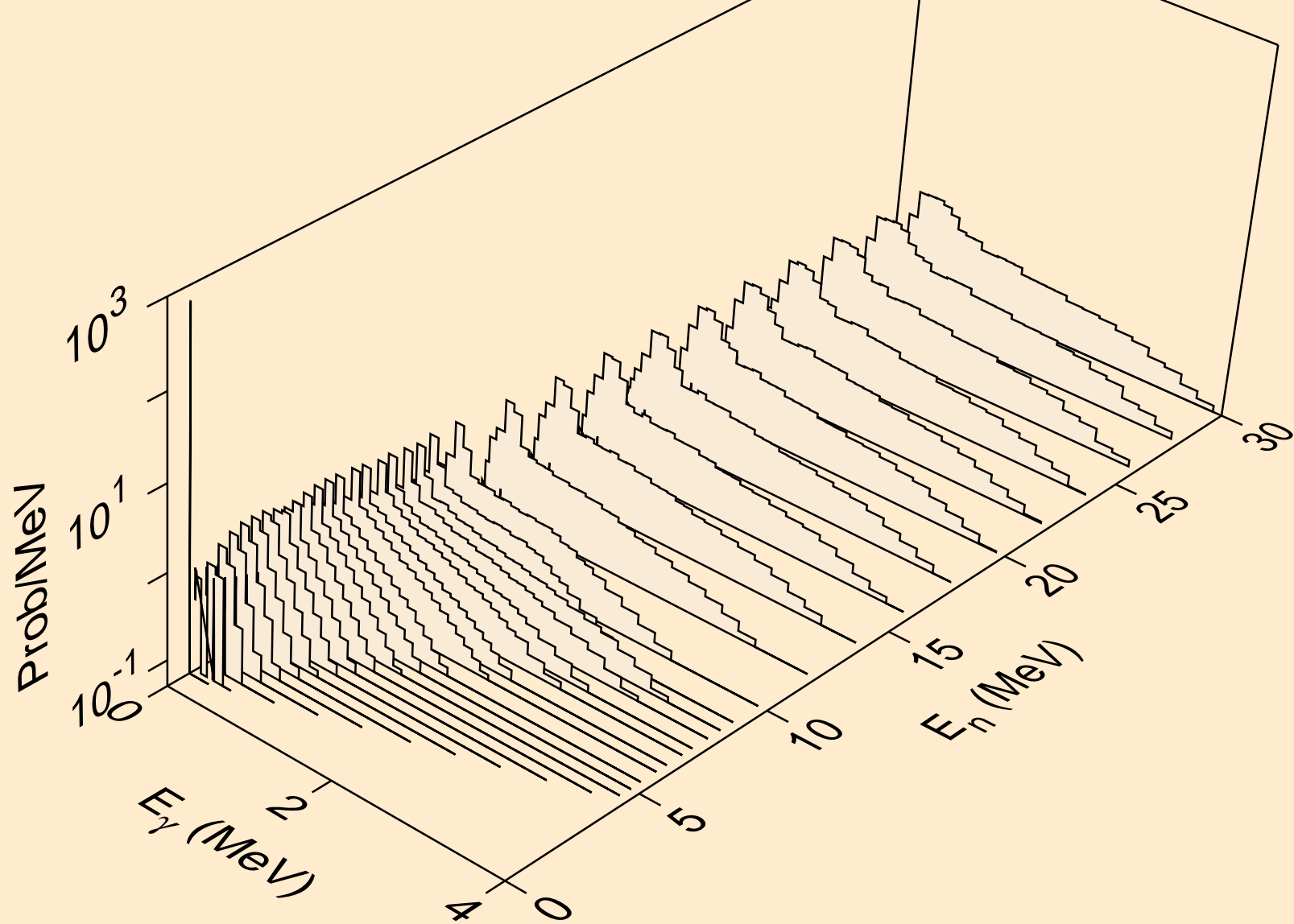

I114 NEUTRON ACER TENDL-2021 LIBRARY; T=293.6K
Photon emission for (n,t)

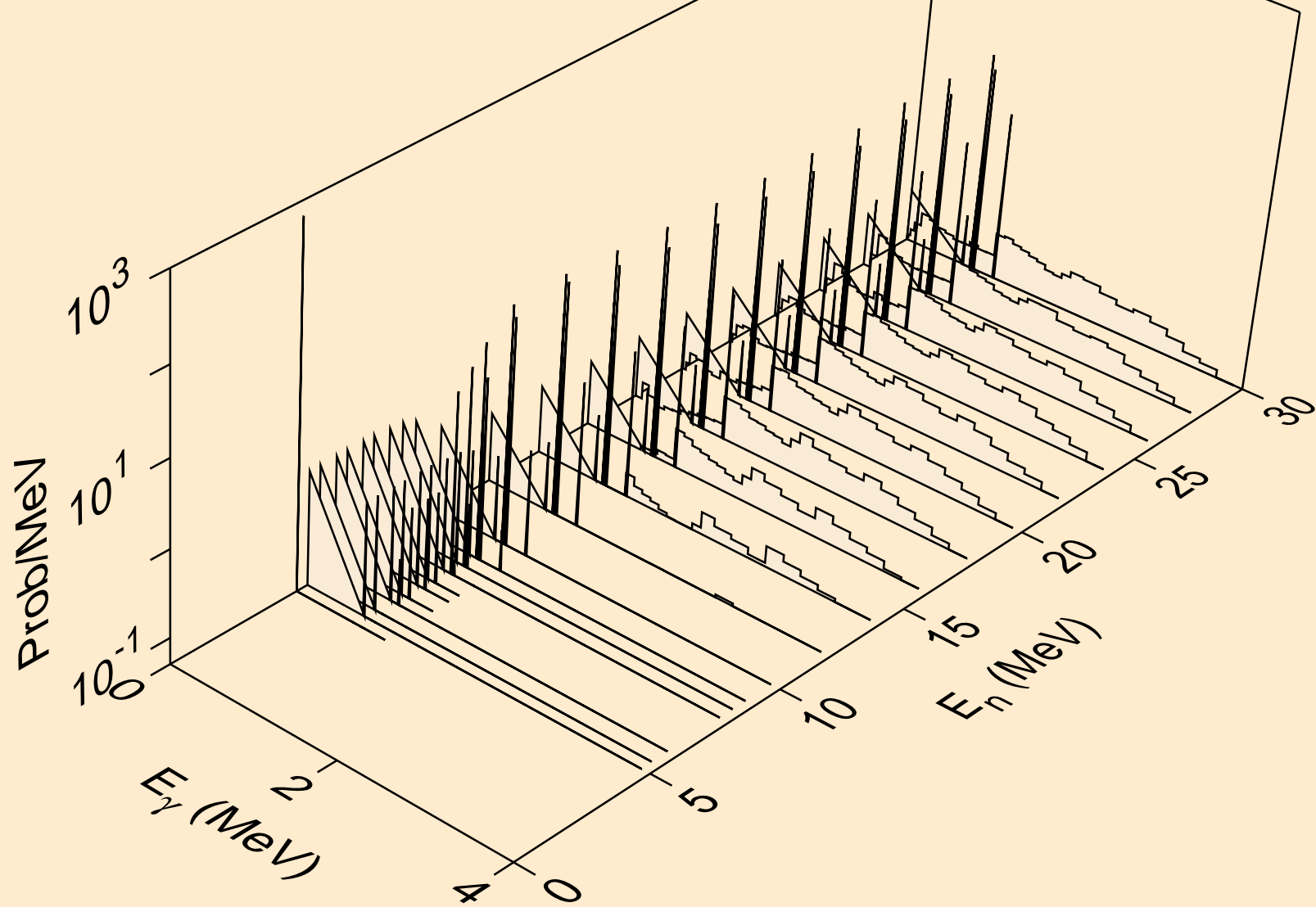

I114 NEUTRON ACER TENDL-2021 LIBRARY; T=293.6K
Photon emission for (n,he3)

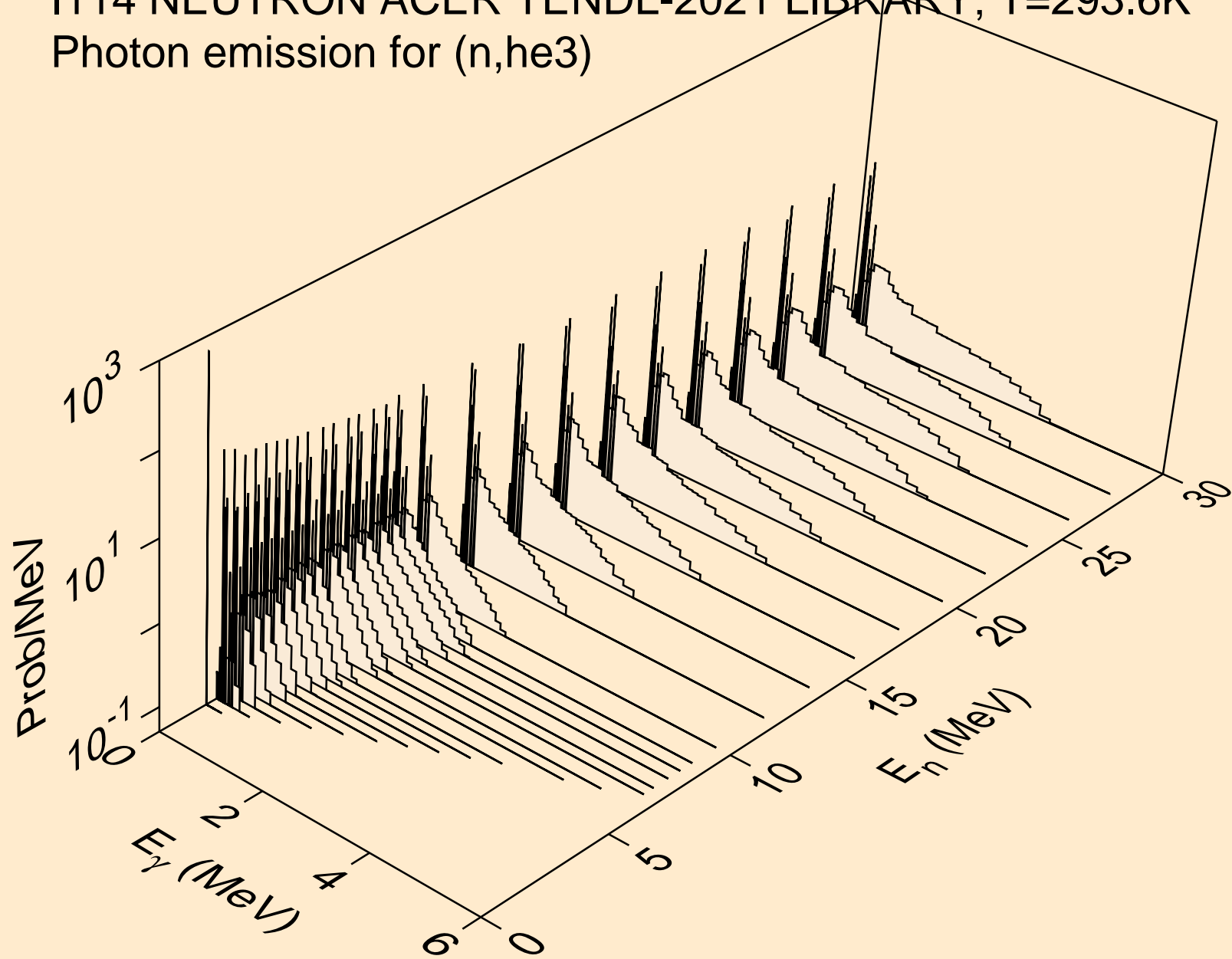

I114 NEUTRON ACER TENDL-2021 LIBRARY; T=293.6K
Photon emission for (n,a)

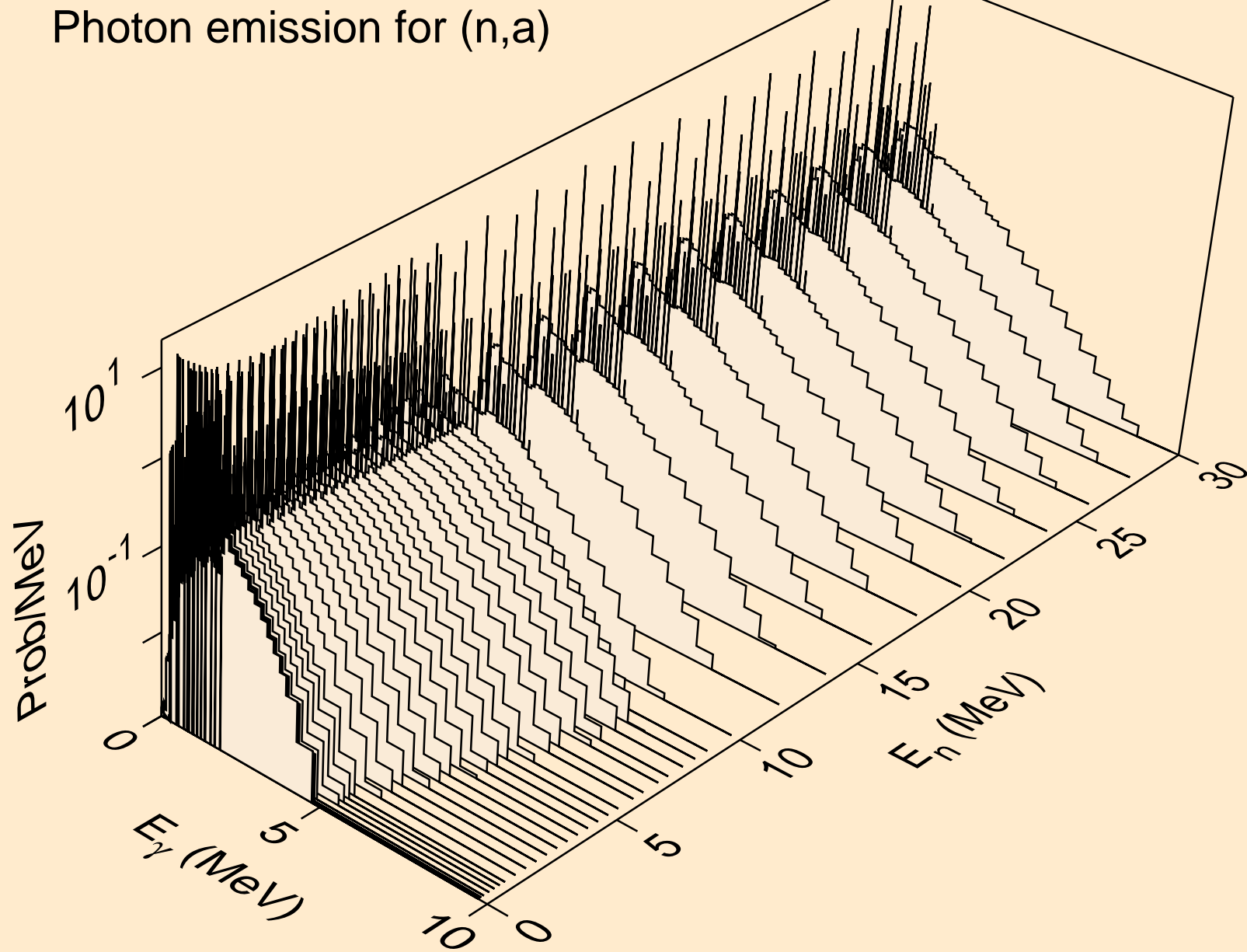

I114 NEUTRON ACER TENDL-2021 LIBRARY; T=293.6K
Photon emission for (n,2a)

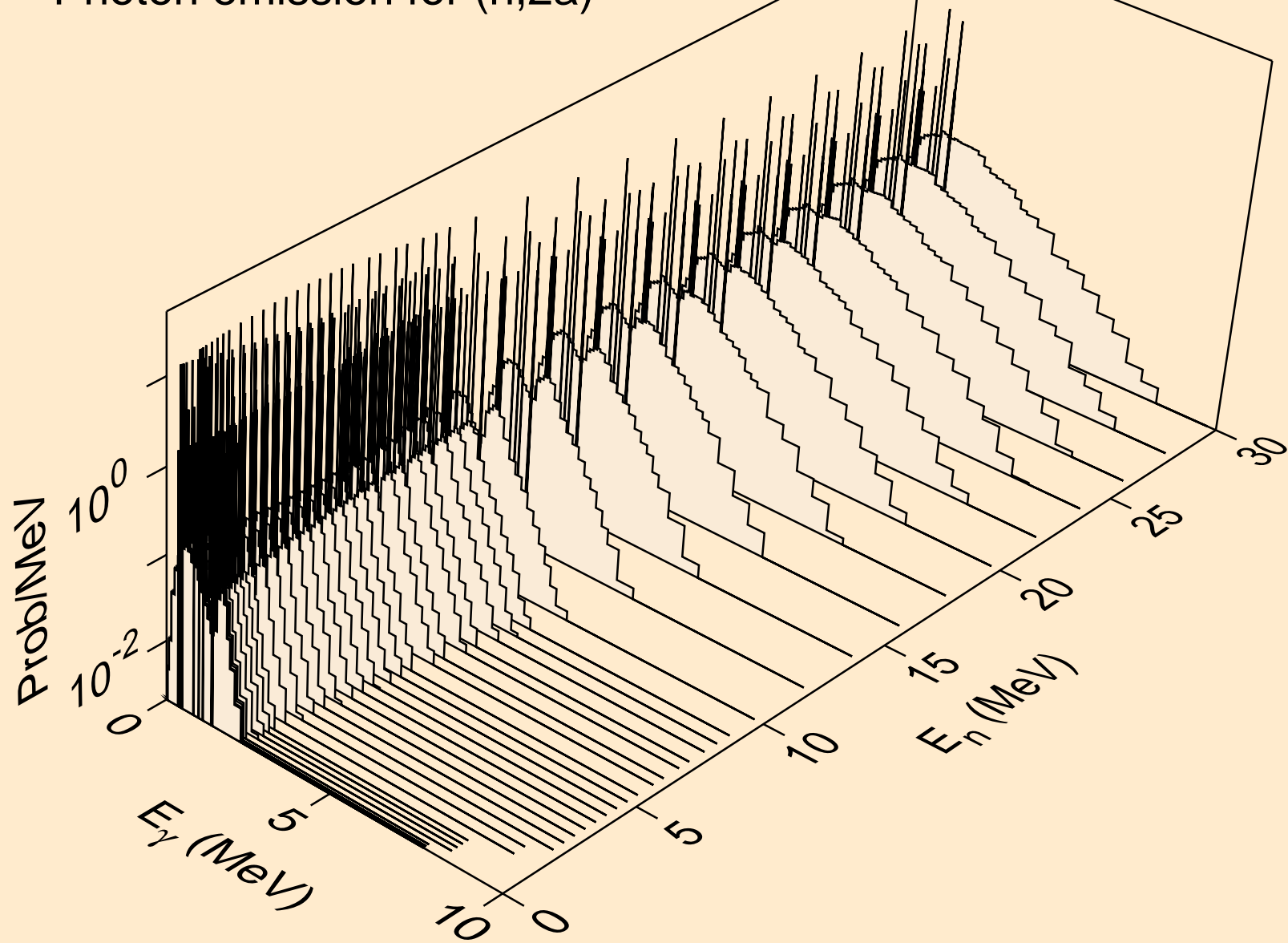

I114 NEUTRON ACER TENDL-2021 LIBRARY; T=293.6K
Photon emission for (n,3a)

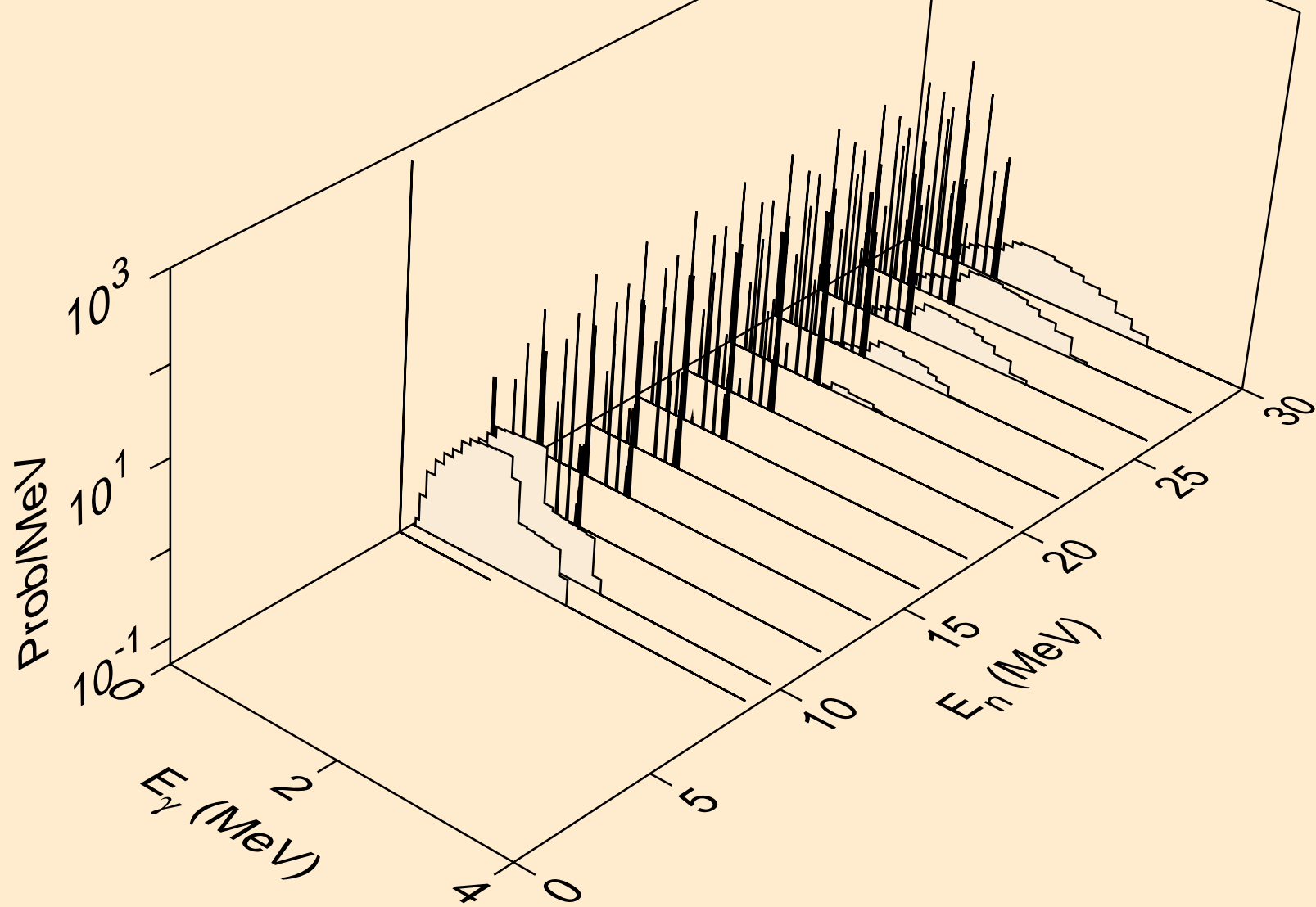

I114 NEUTRON ACER TENDL-2021 LIBRARY; T=293.6K
Photon emission for (n,2p)

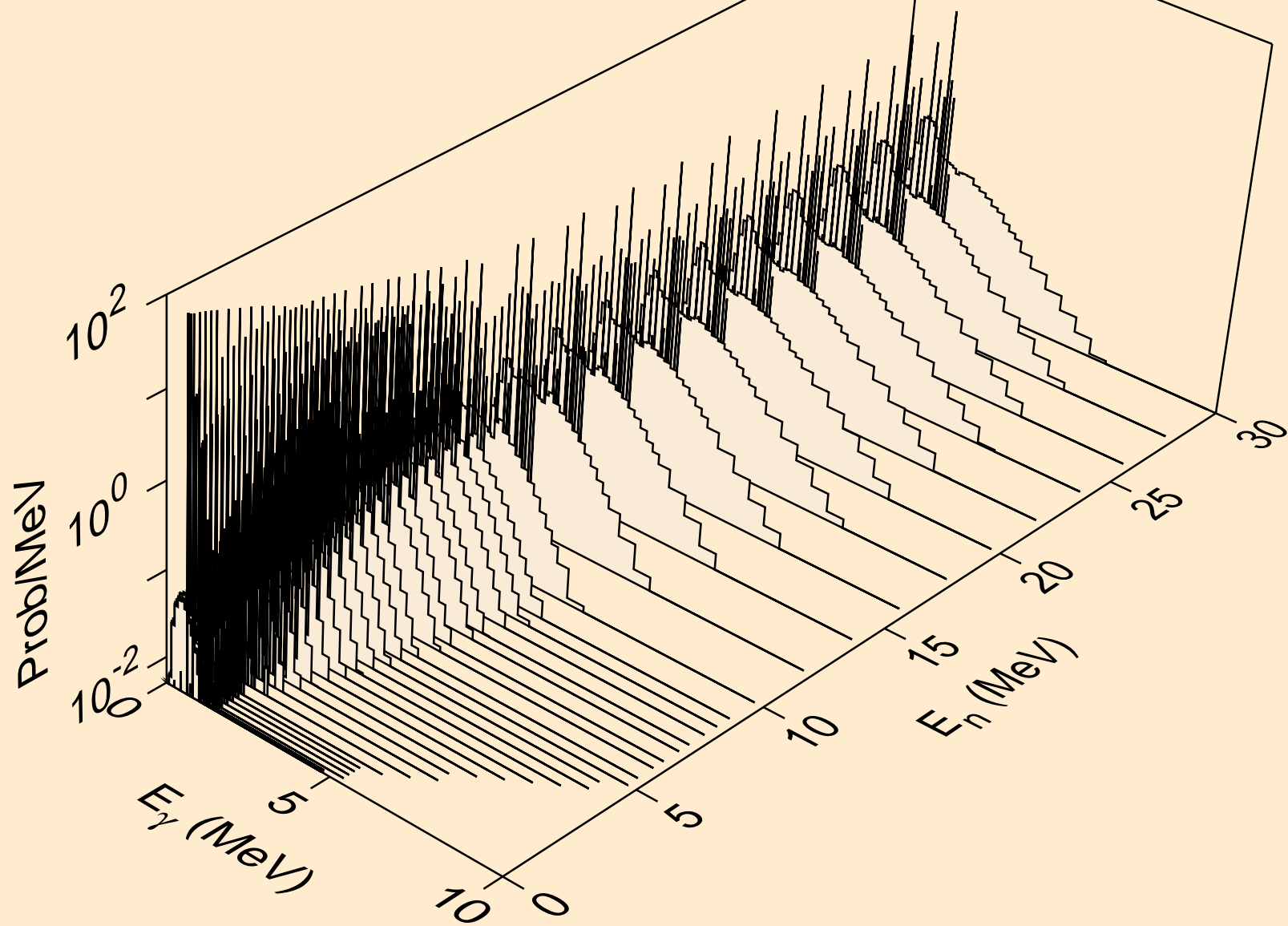

I114 NEUTRON ACER TENDL-2021 LIBRARY; T=293.6K
Photon emission for (n,p α)

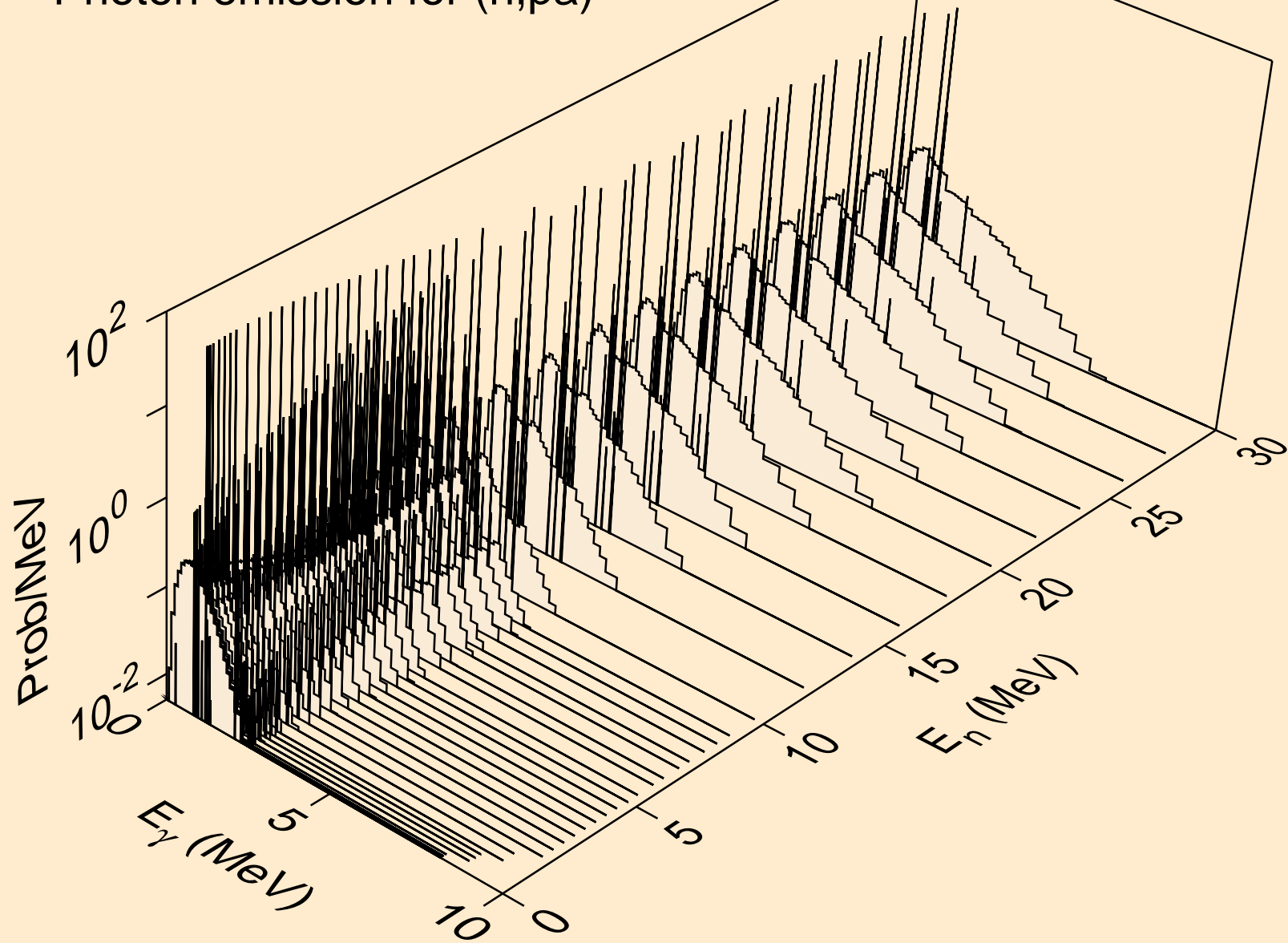

I114 NEUTRON ACER TENDL-2021 LIBRARY; T=293.6K
Photon emission for (n,t2a)

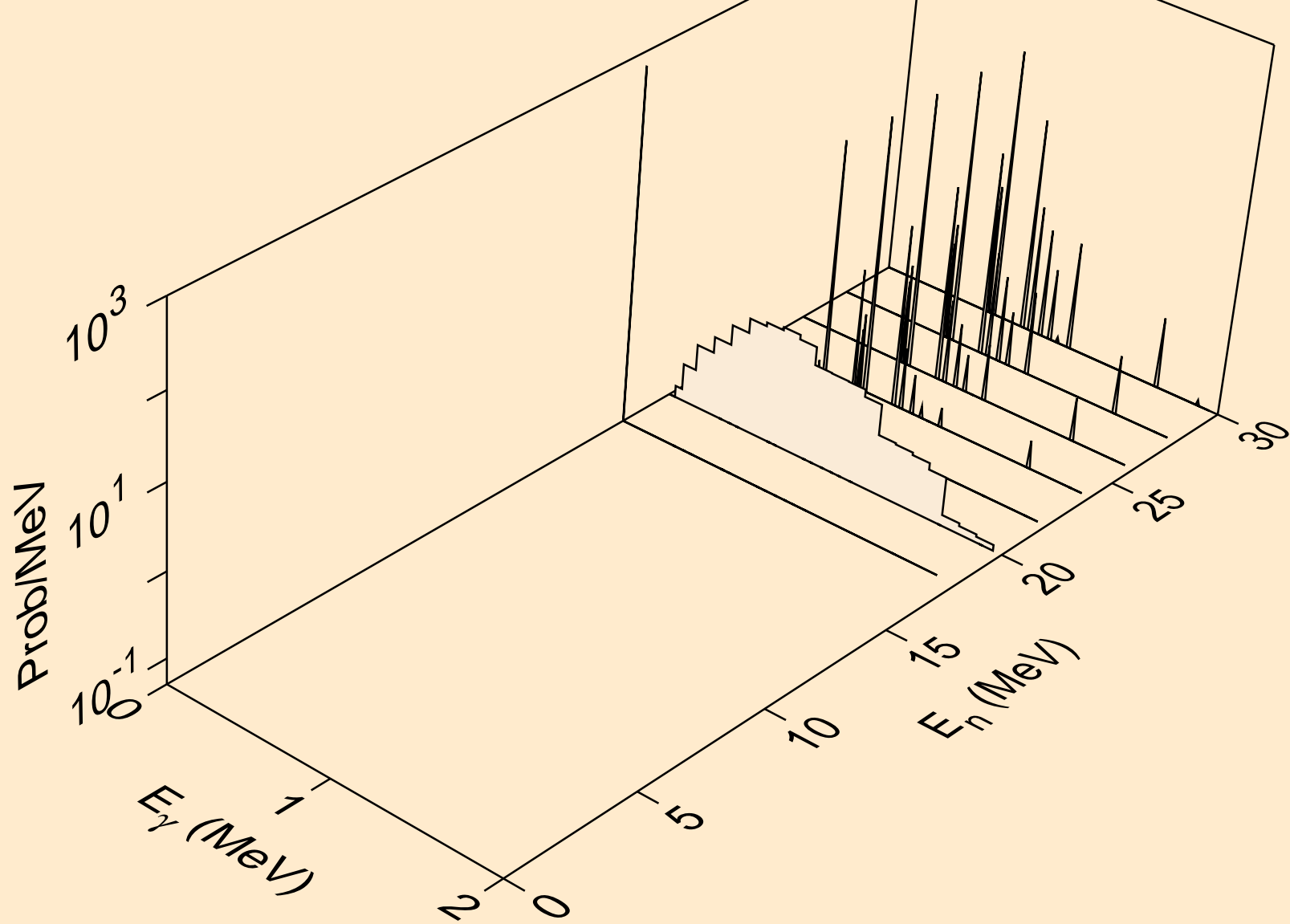

I114 NEUTRON ACER TENDL-2021 LIBRARY; T=293.6K
Photon emission for (n,d2a)

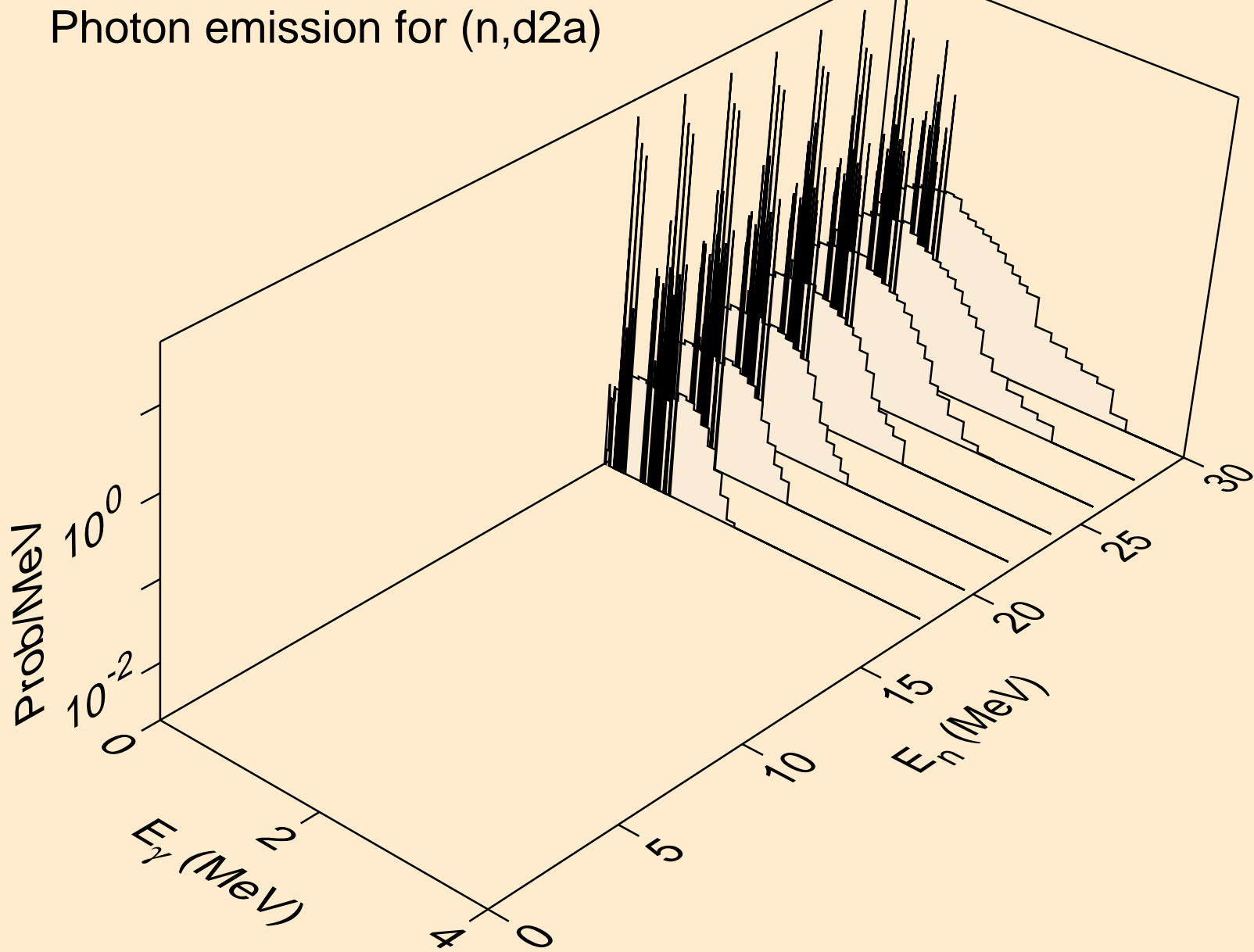

I114 NEUTRON ACER TENDL-2021 LIBRARY; T=293.6K
Photon emission for (n,pd)

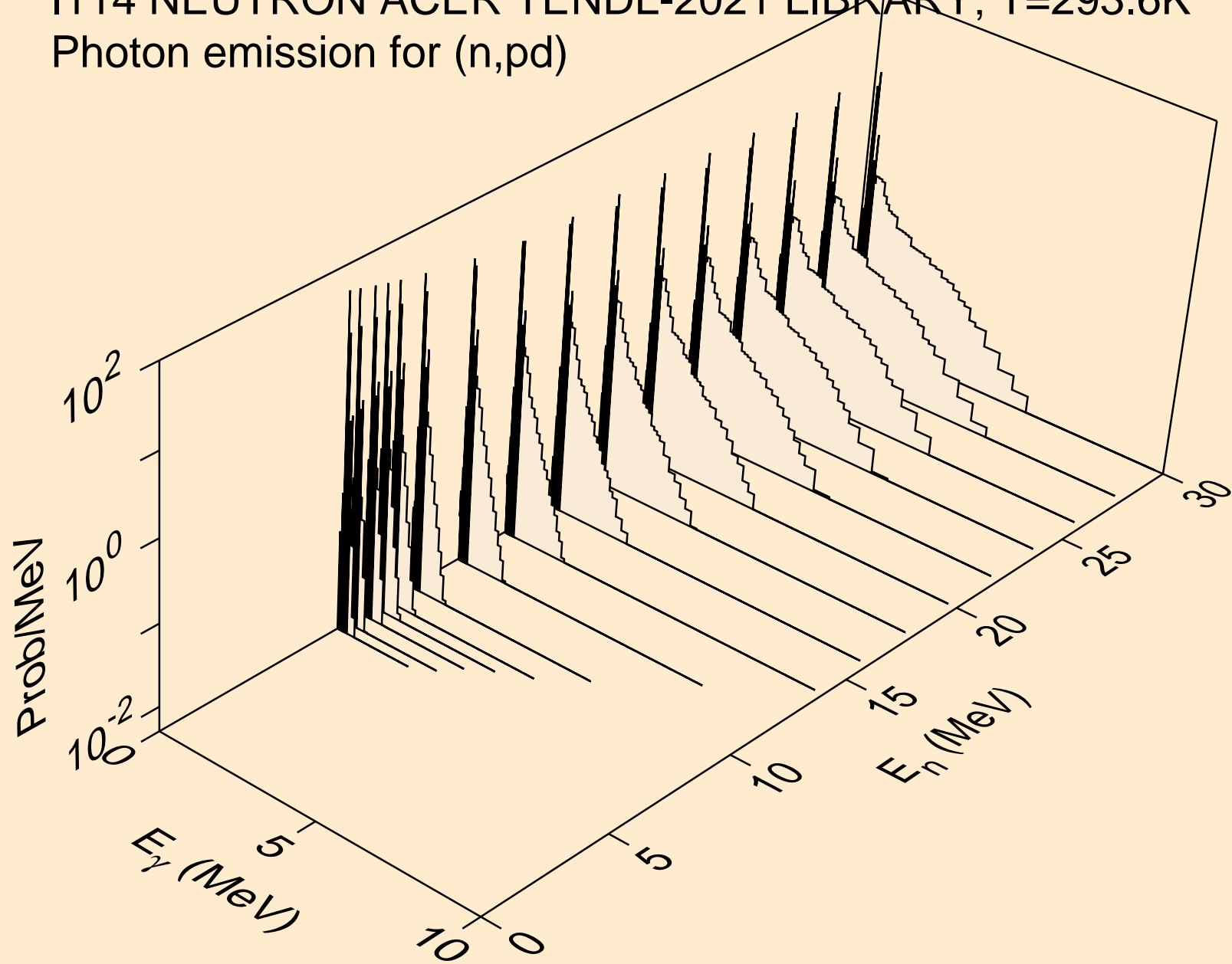

I114 NEUTRON ACER TENDL-2021 LIBRARY; T=293.6K
Photon emission for (n,pt)

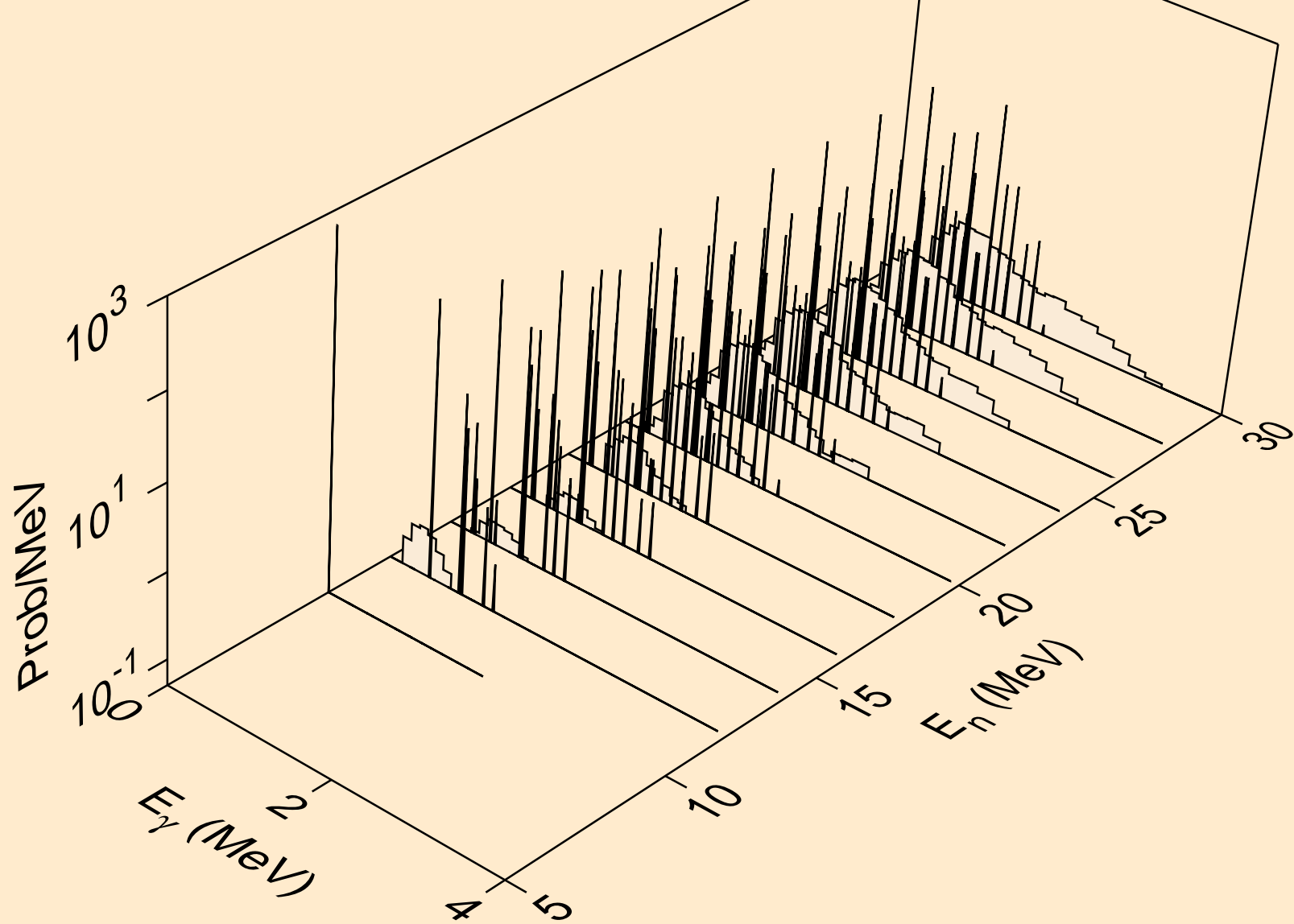

I114 NEUTRON ACER TENDL-2021 LIBRARY; T=293.6K
Photon emission for (n,da)

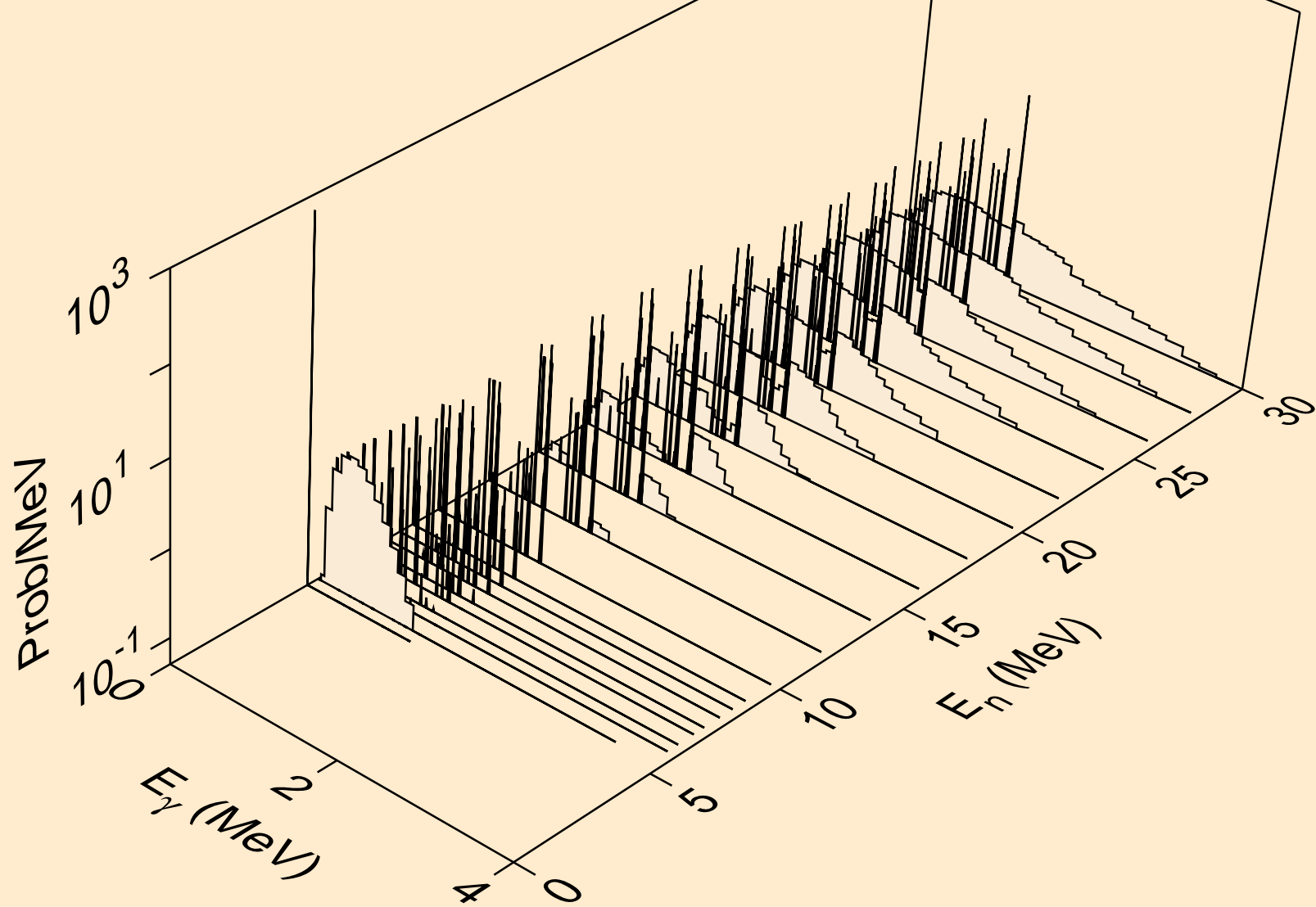

I114 NEUTRON ACER TENDL-2021 LIBRARY; T=293.6K
thermal capture photon spectrum

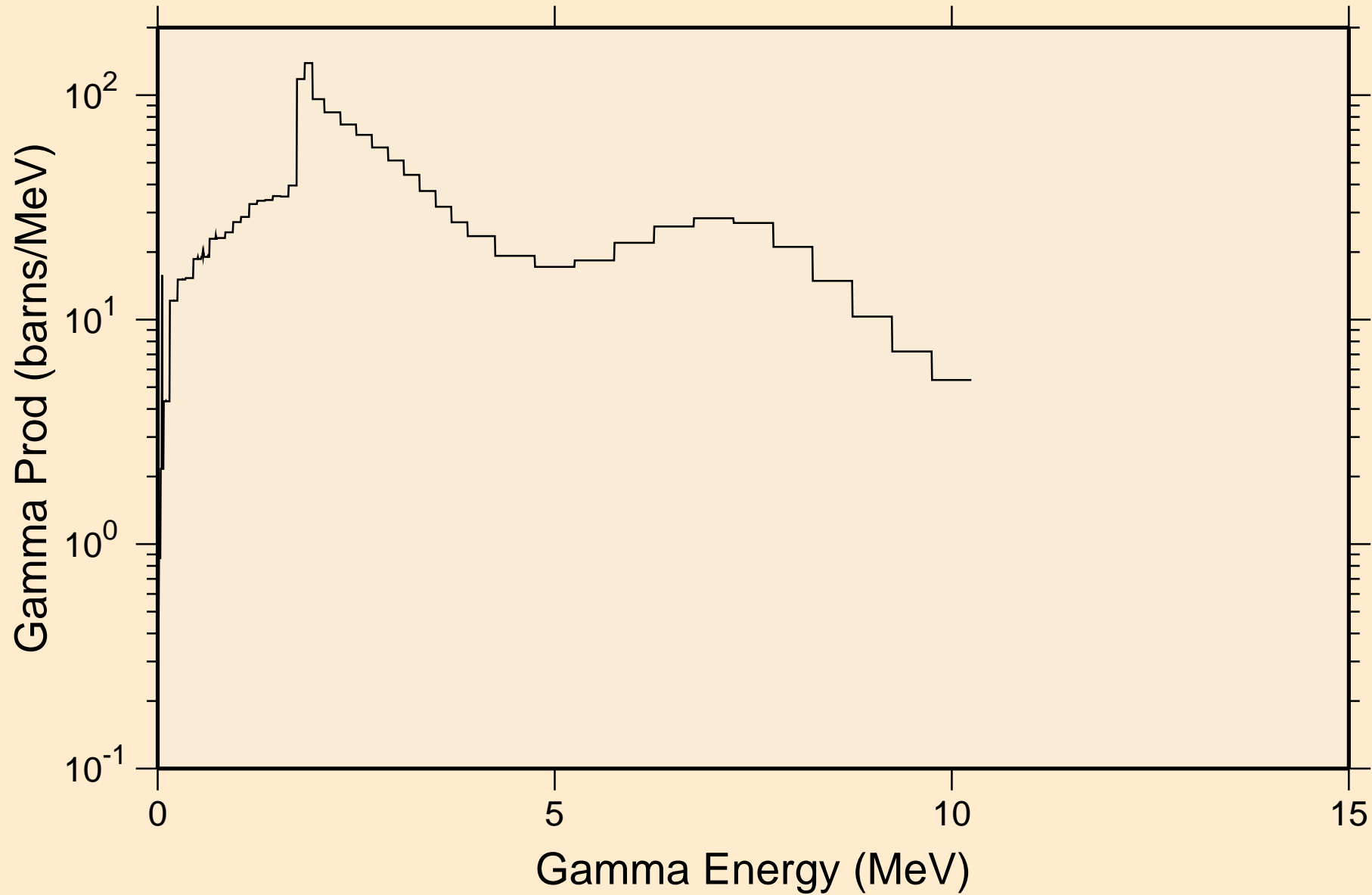

I114 NEUTRON ACER TENDL-2021 LIBRARY; T=293.6K
14 MeV photon spectrum

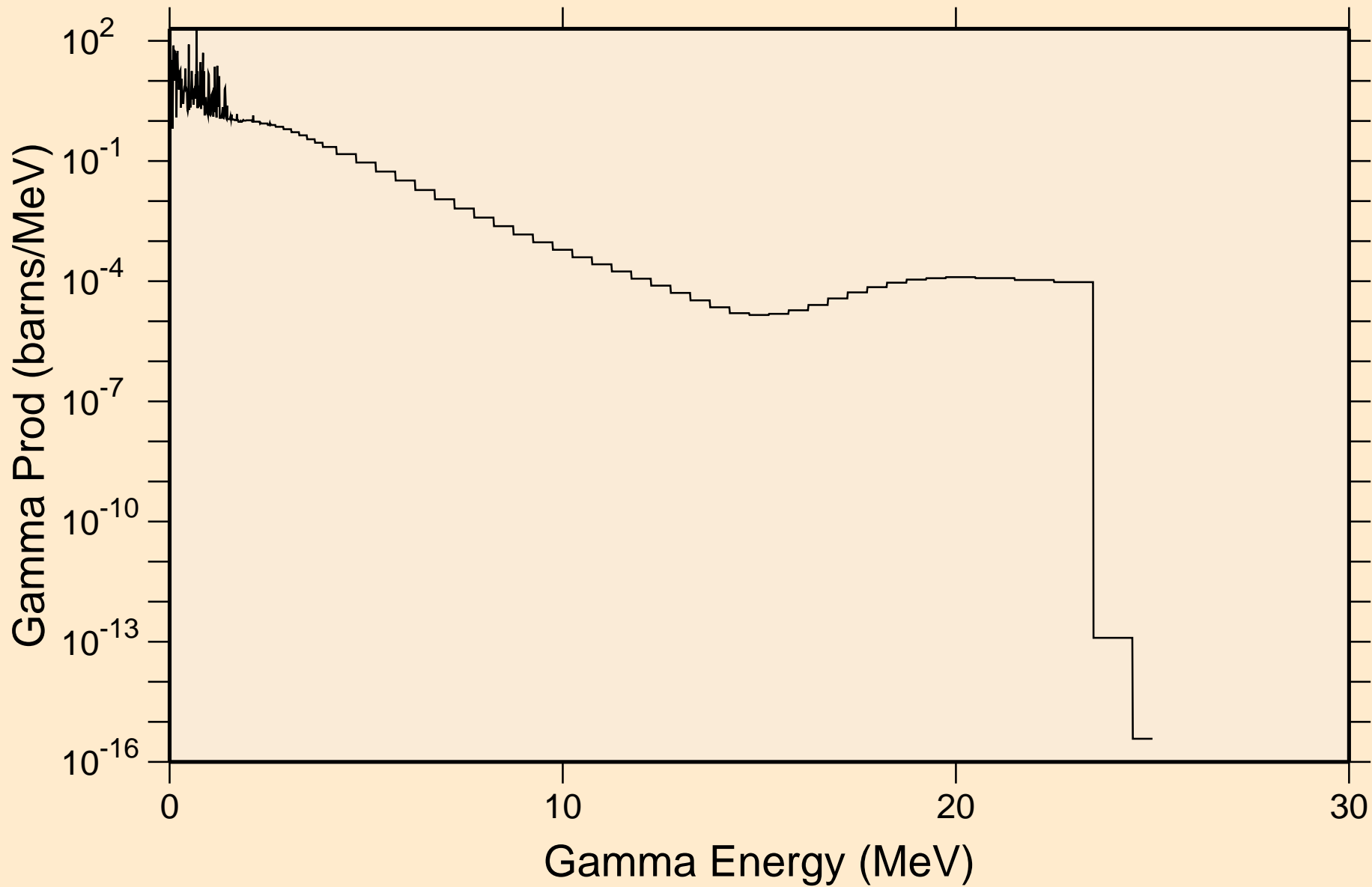

I114 NEUTRON ACER TENDL-2021 LIBRARY; T=293.6K

Particle heating contributions

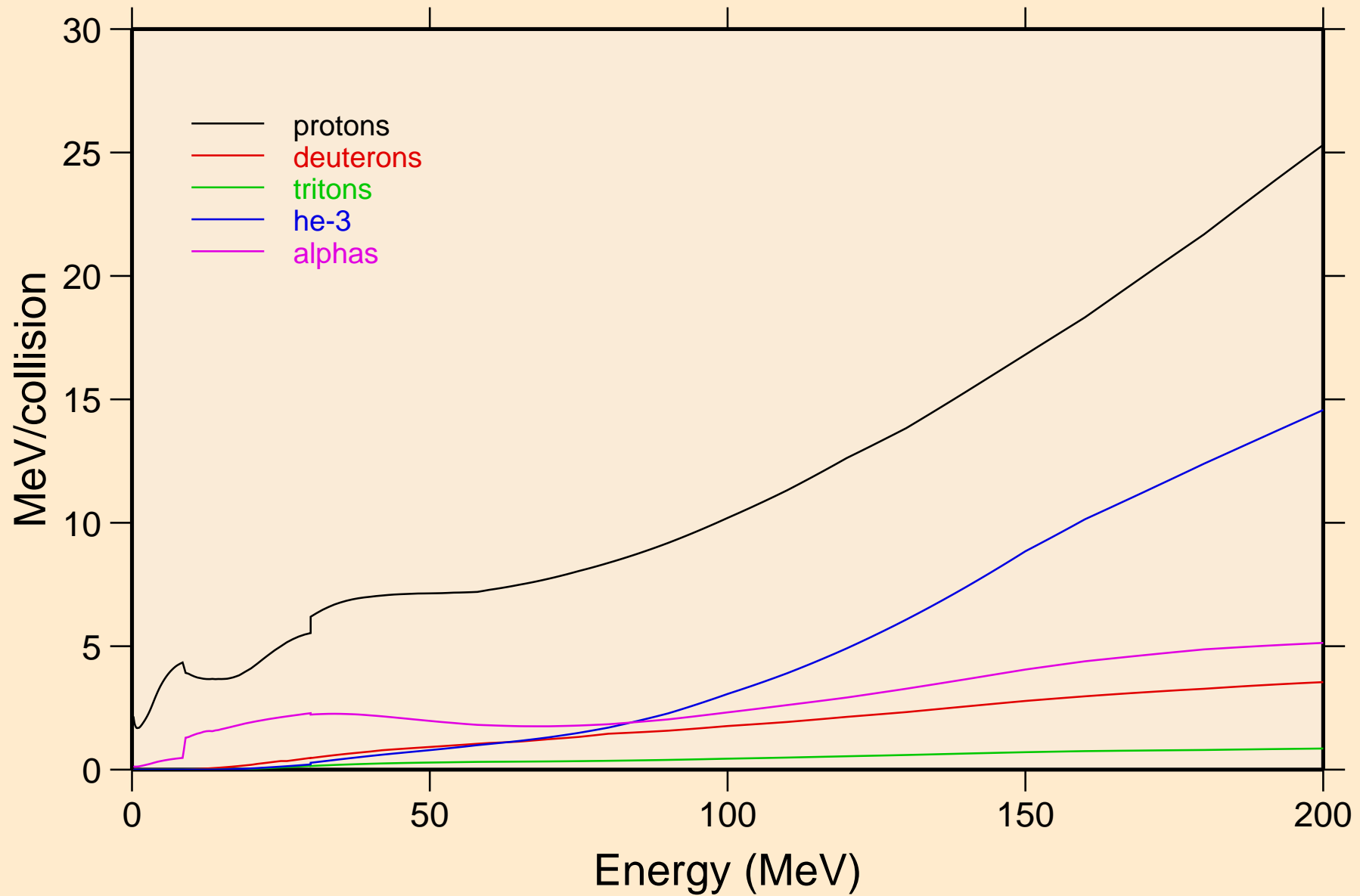

I114 NEUTRON ACER TENDL-2021 LIBRARY; T=293.6K
Recoil Heating

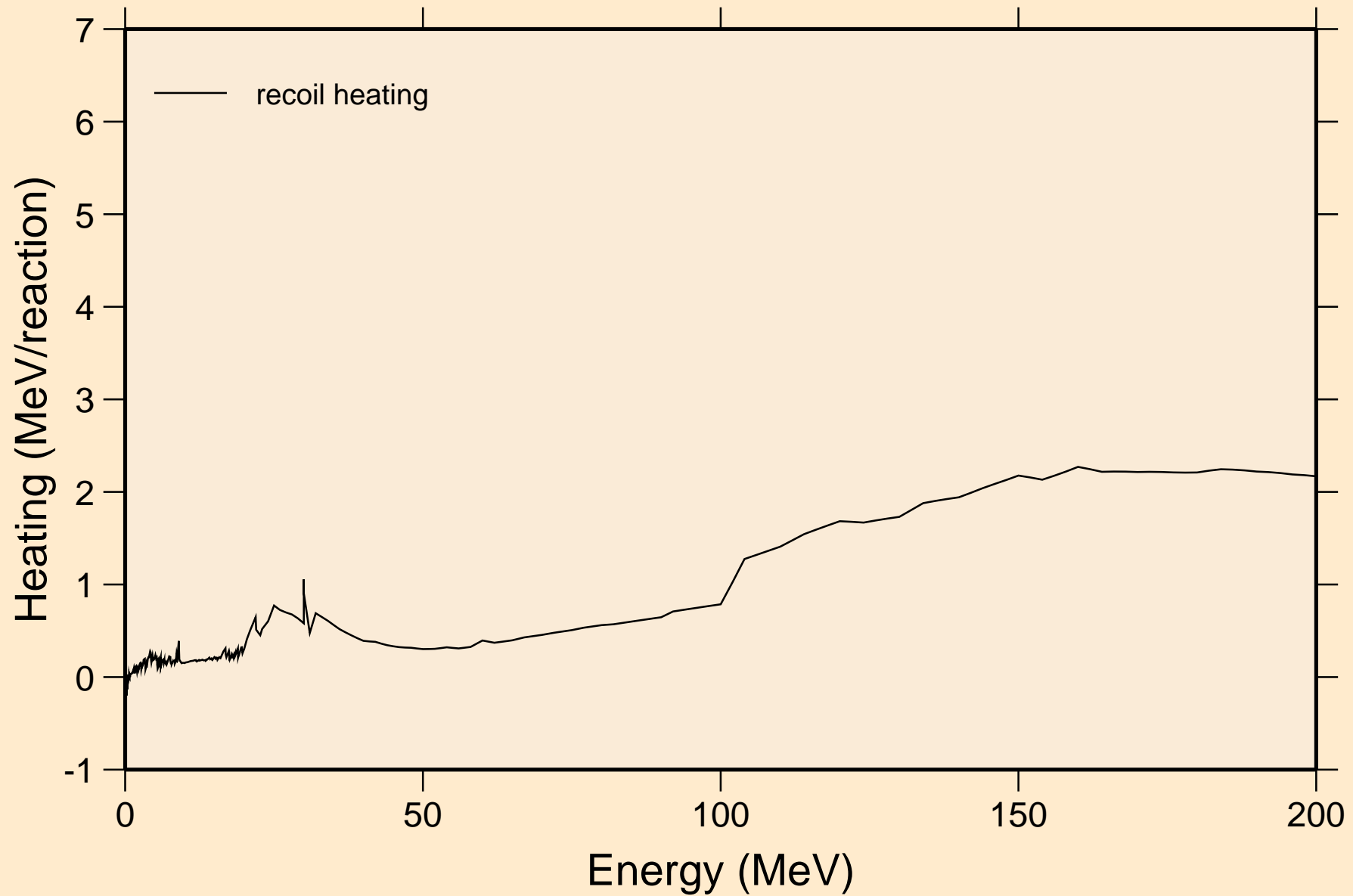

I114 NEUTRON ACER TENDL-2021 LIBRARY; T=293.6K

Particle production cross sections

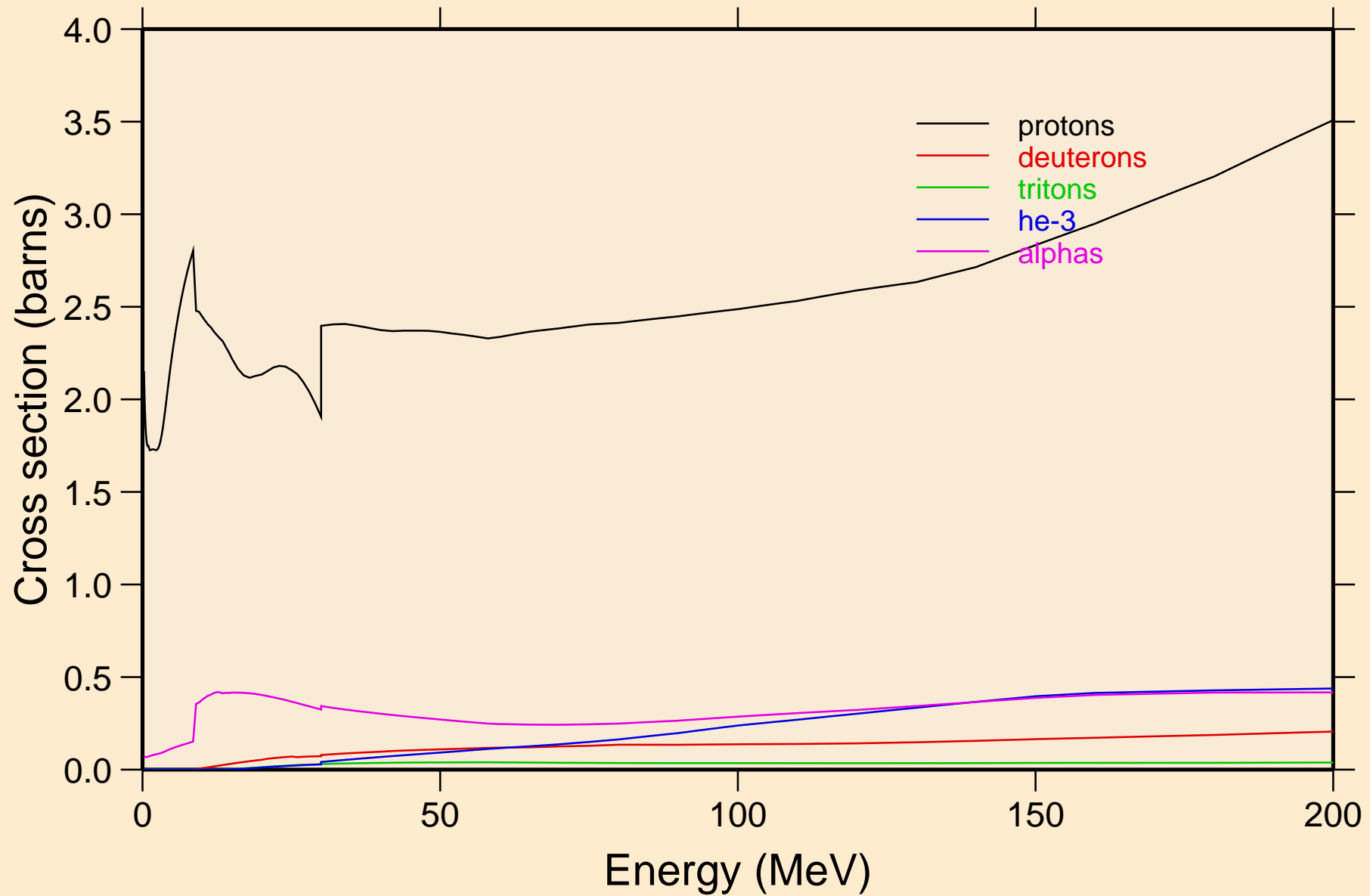

I114 NEUTRON ACER TENDL-2021 LIBRARY; T=293.6K
protons from (n,x)

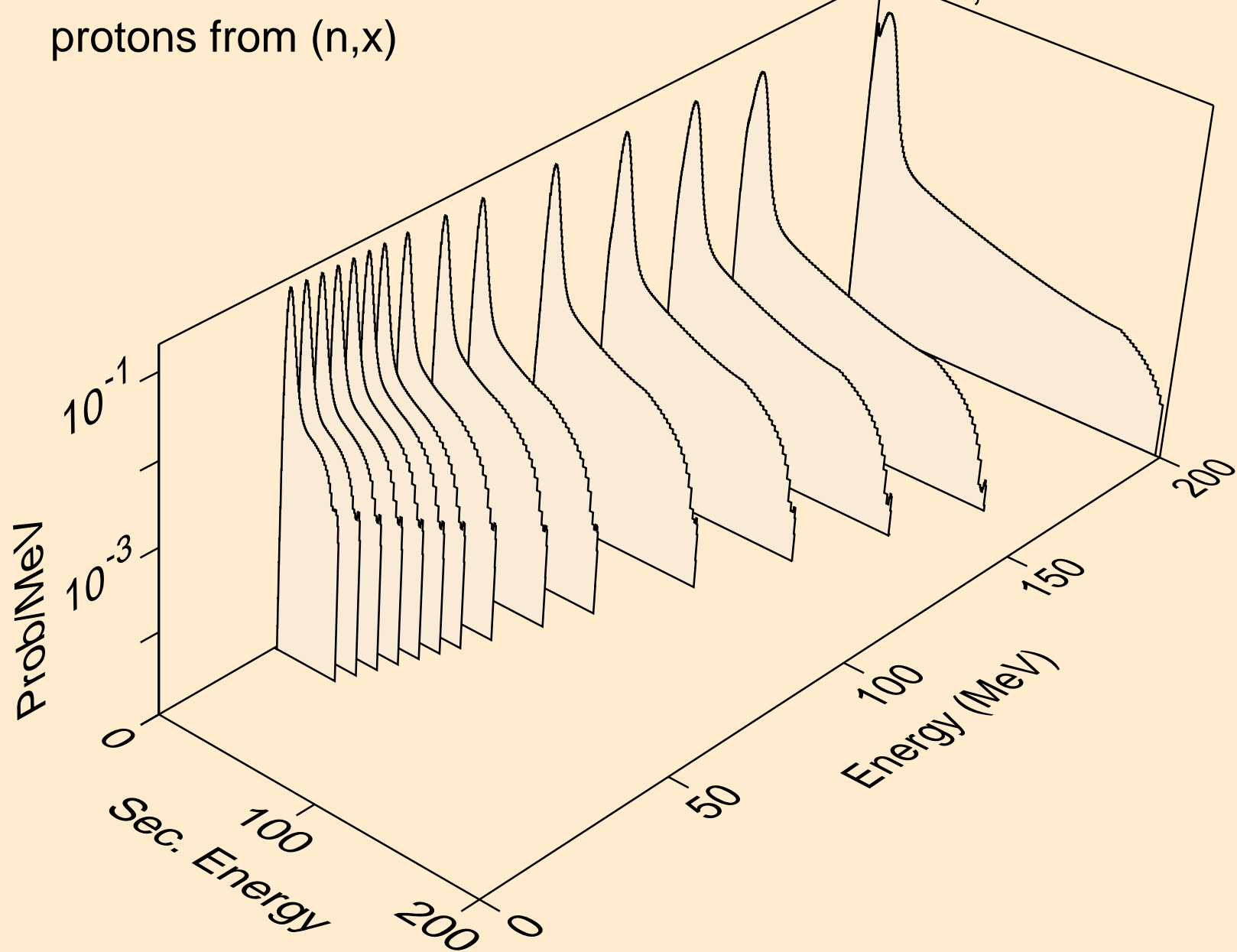

I114 NEUTRON ACER TENDL-2021 LIBRARY; T=293.6K
protons from (n,n*)p

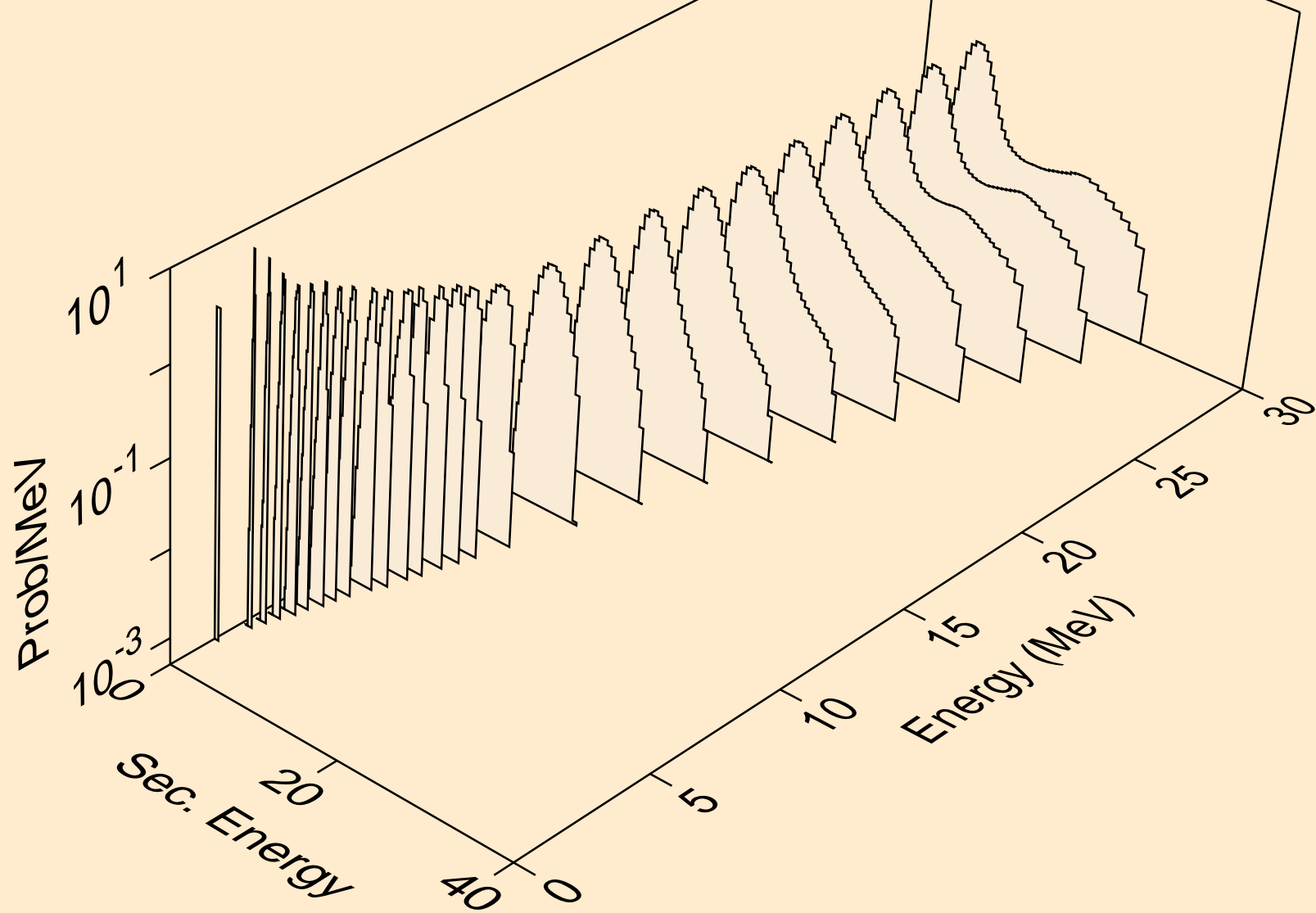

I114 NEUTRON ACER TENDL-2021 LIBRARY; T=293.6K
protons from (n,2np)

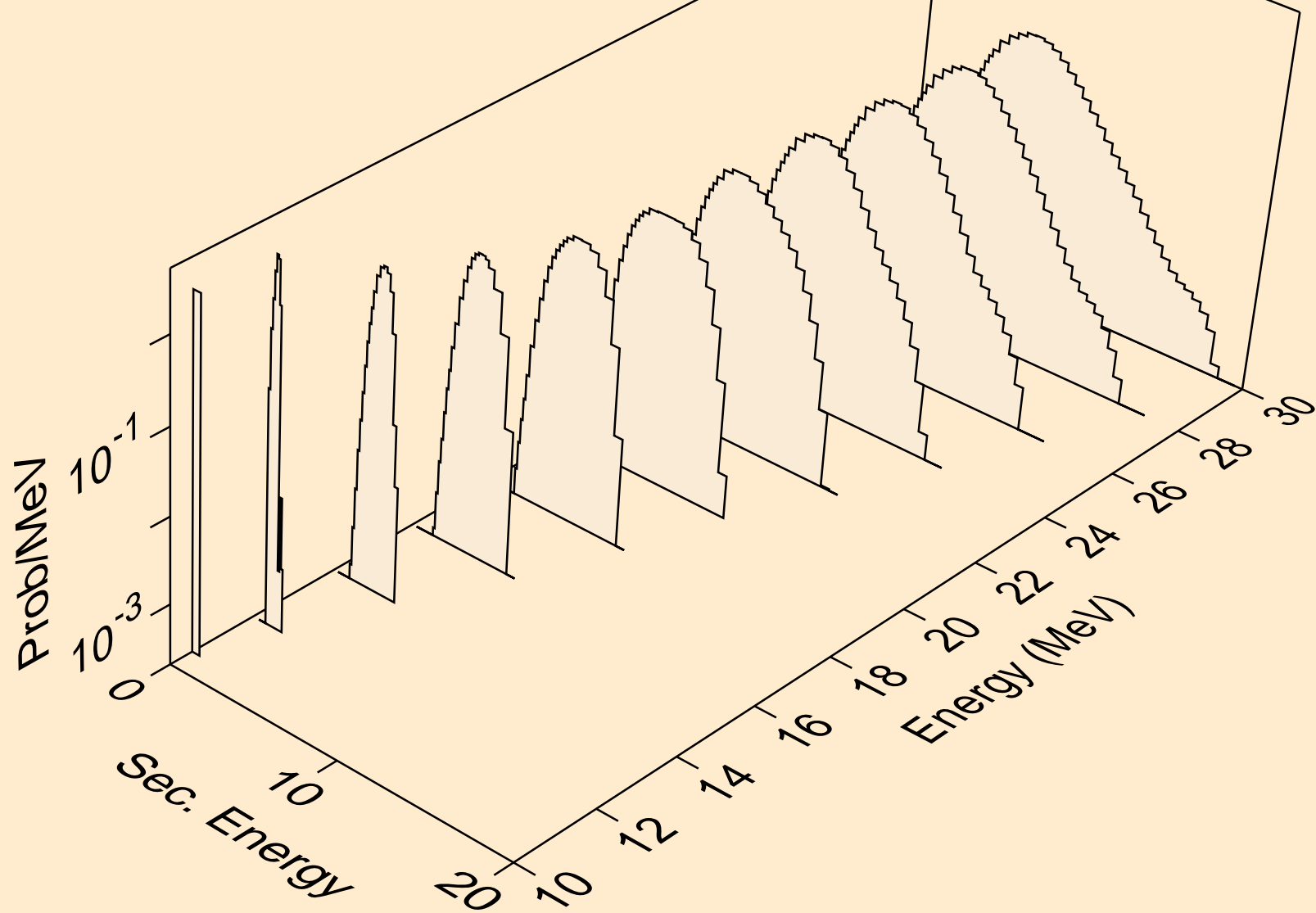

I114 NEUTRON ACER TENDL-2021 LIBRARY; T=293.6K
protons from (n,3np)

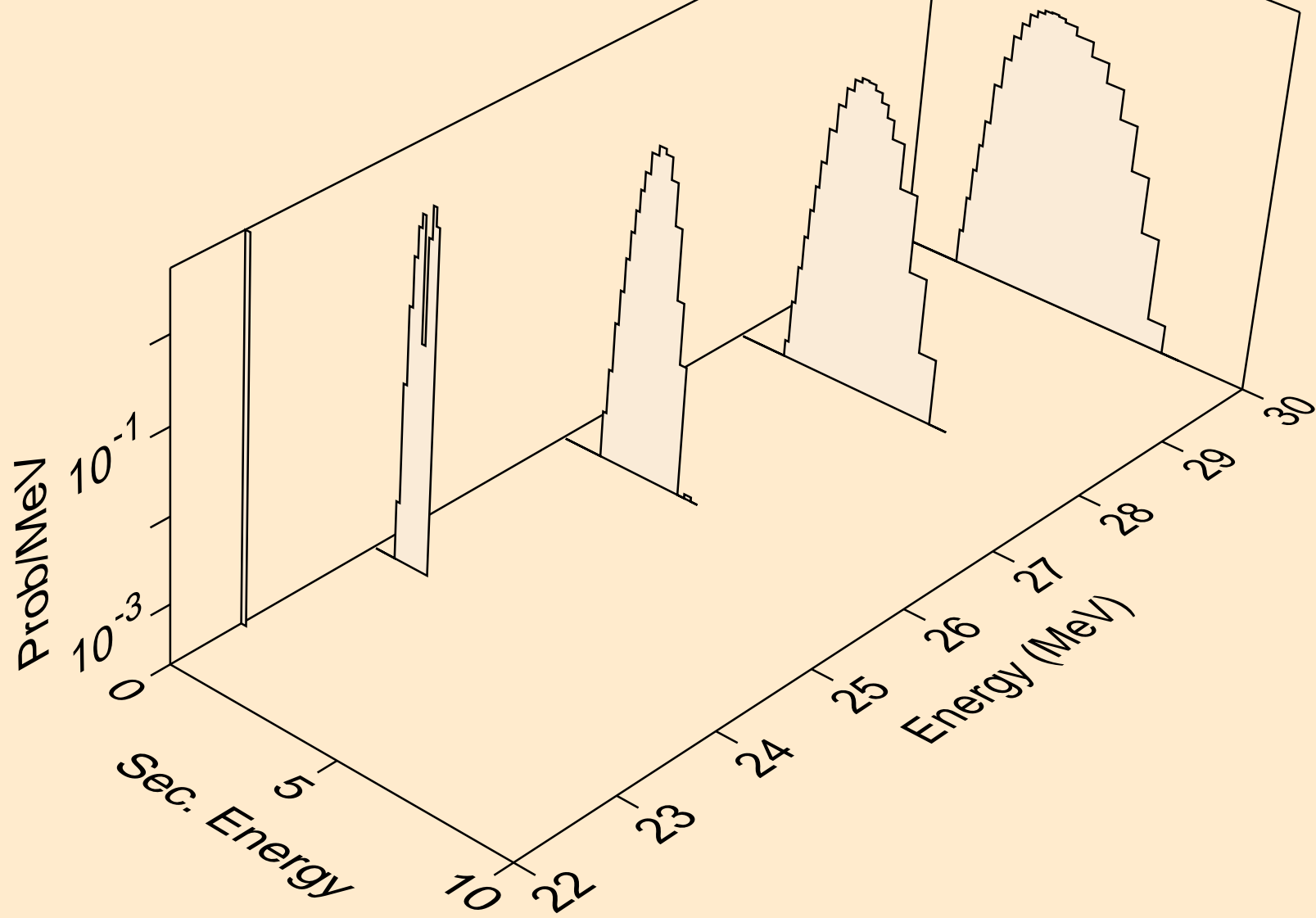

I114 NEUTRON ACER TENDL-2021 LIBRARY; T=293.6K
protons from (n,2np)

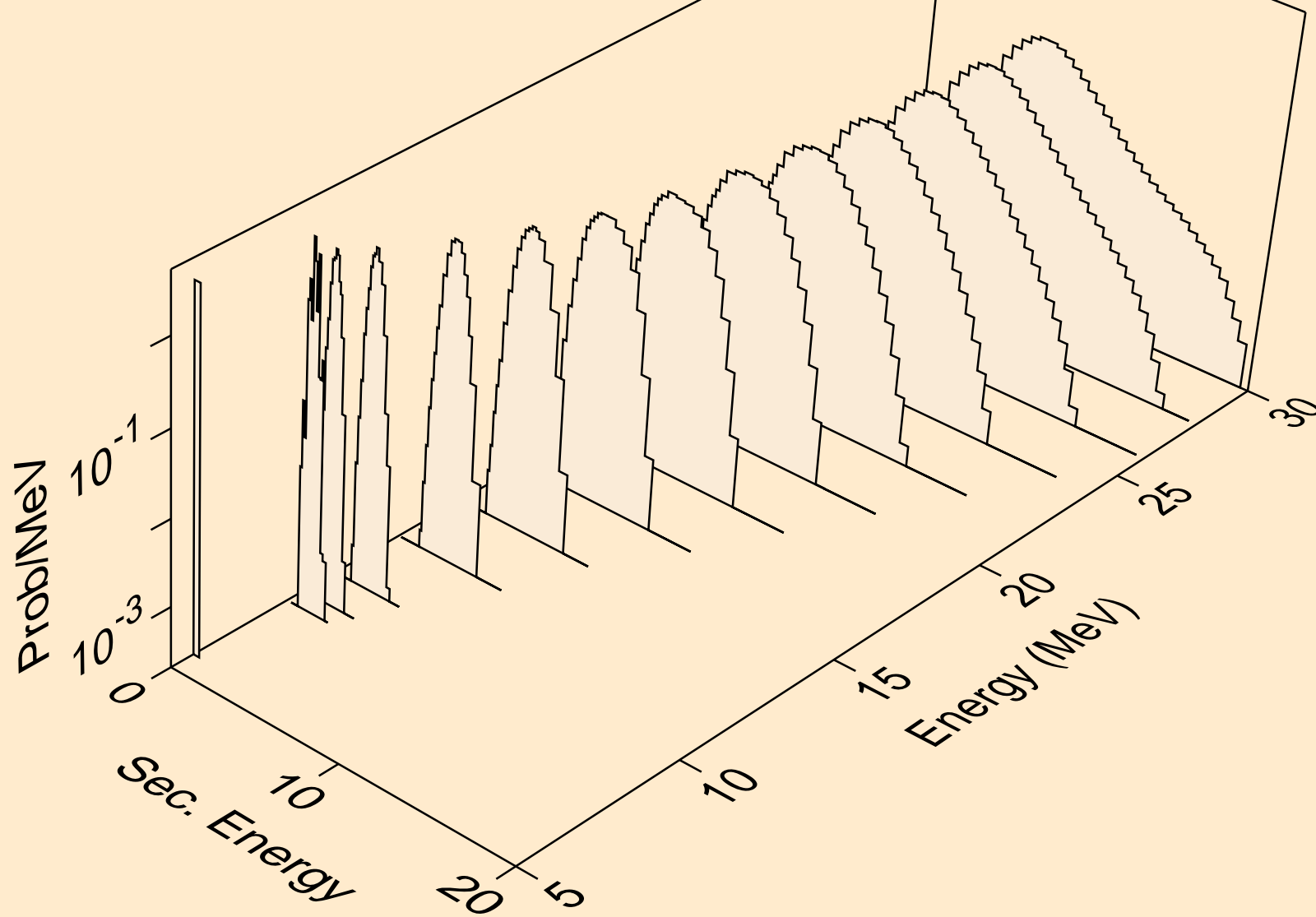

I114 NEUTRON ACER TENDL-2021 LIBRARY; T=293.6K
protons from (n,npa)

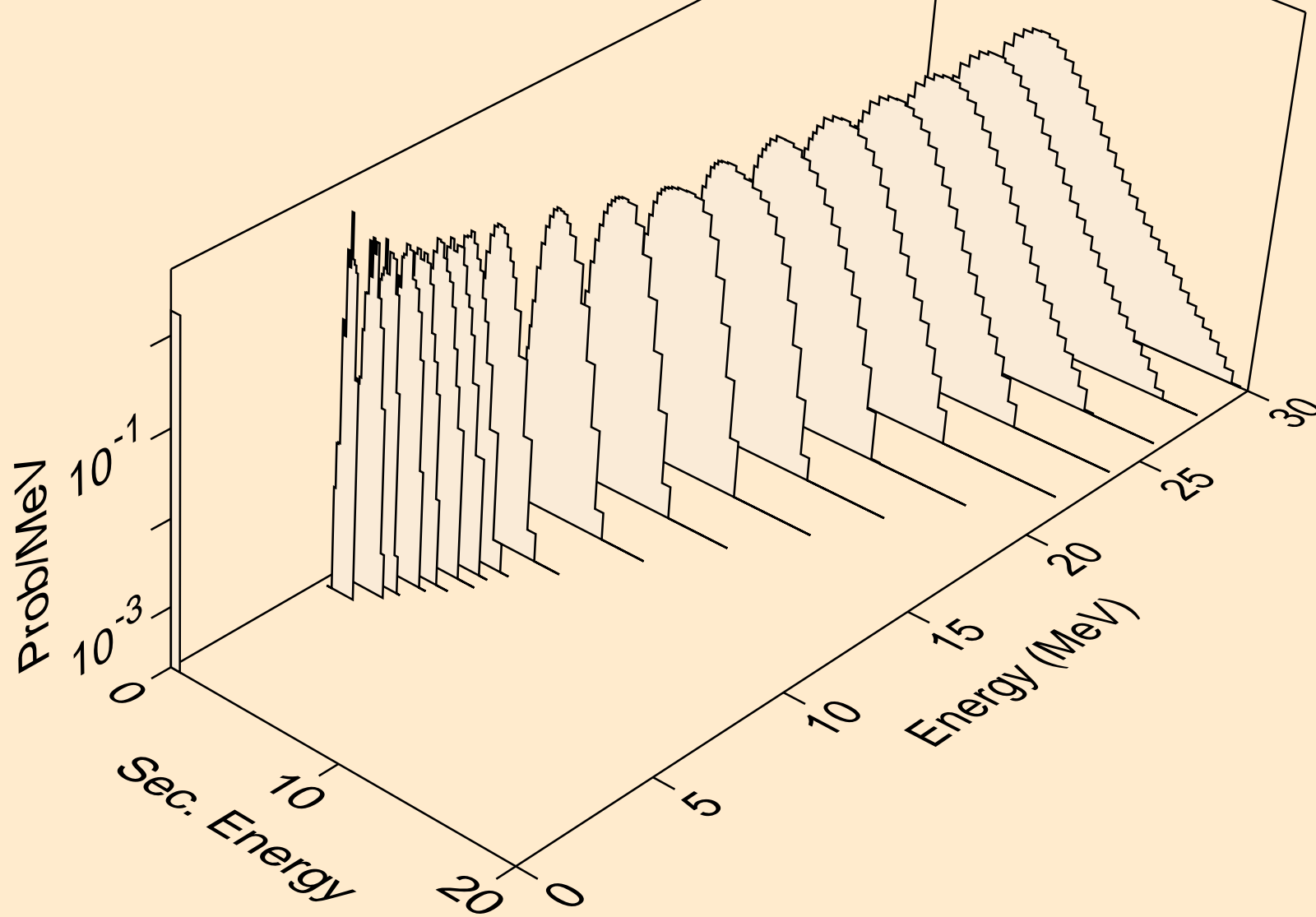

I114 NEUTRON ACER TENDL-2021 LIBRARY; T=293.6K
protons from (n,p)

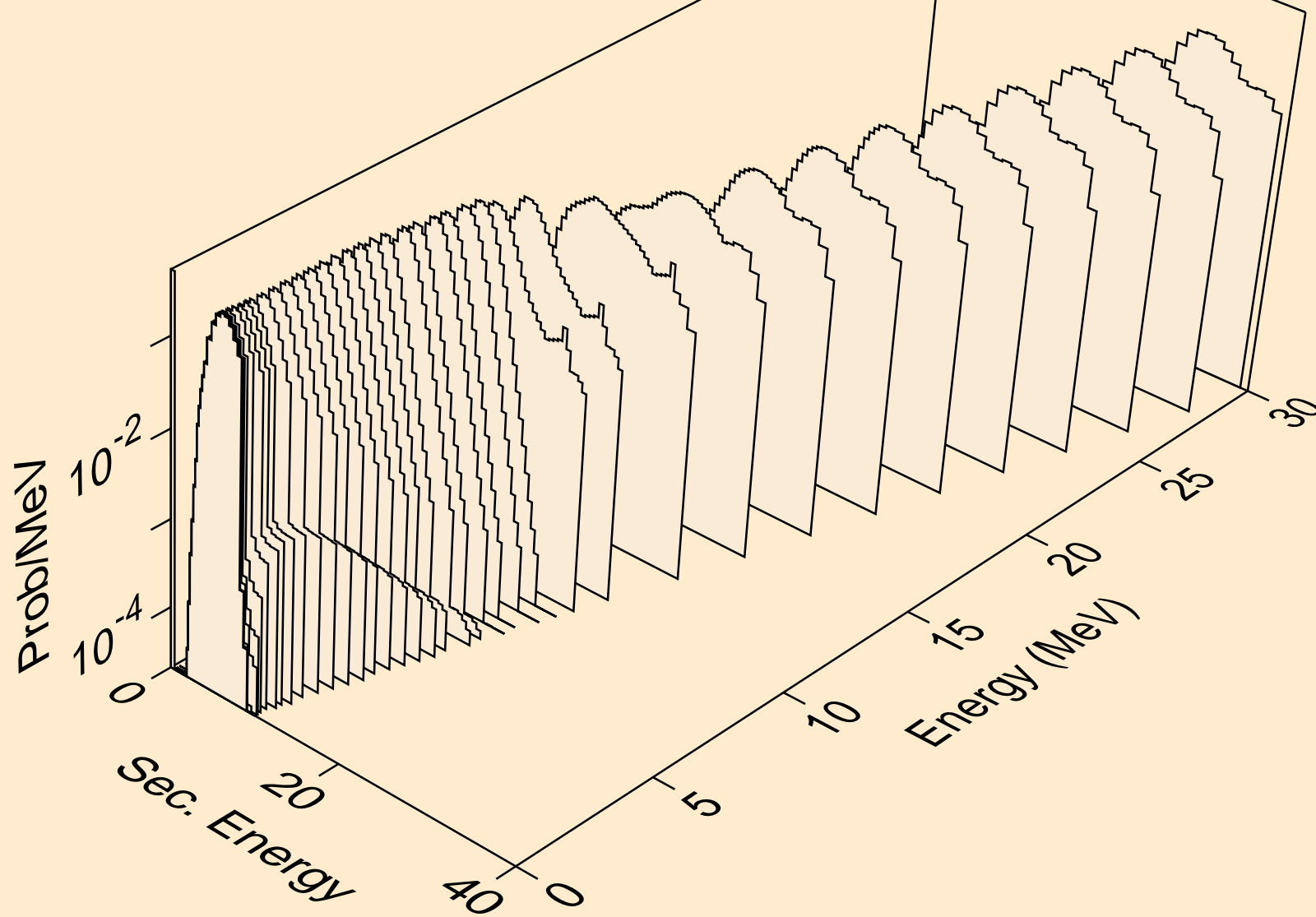

I114 NEUTRON ACER TENDL-2021 LIBRARY; T=293.6K
protons from (n,2p)

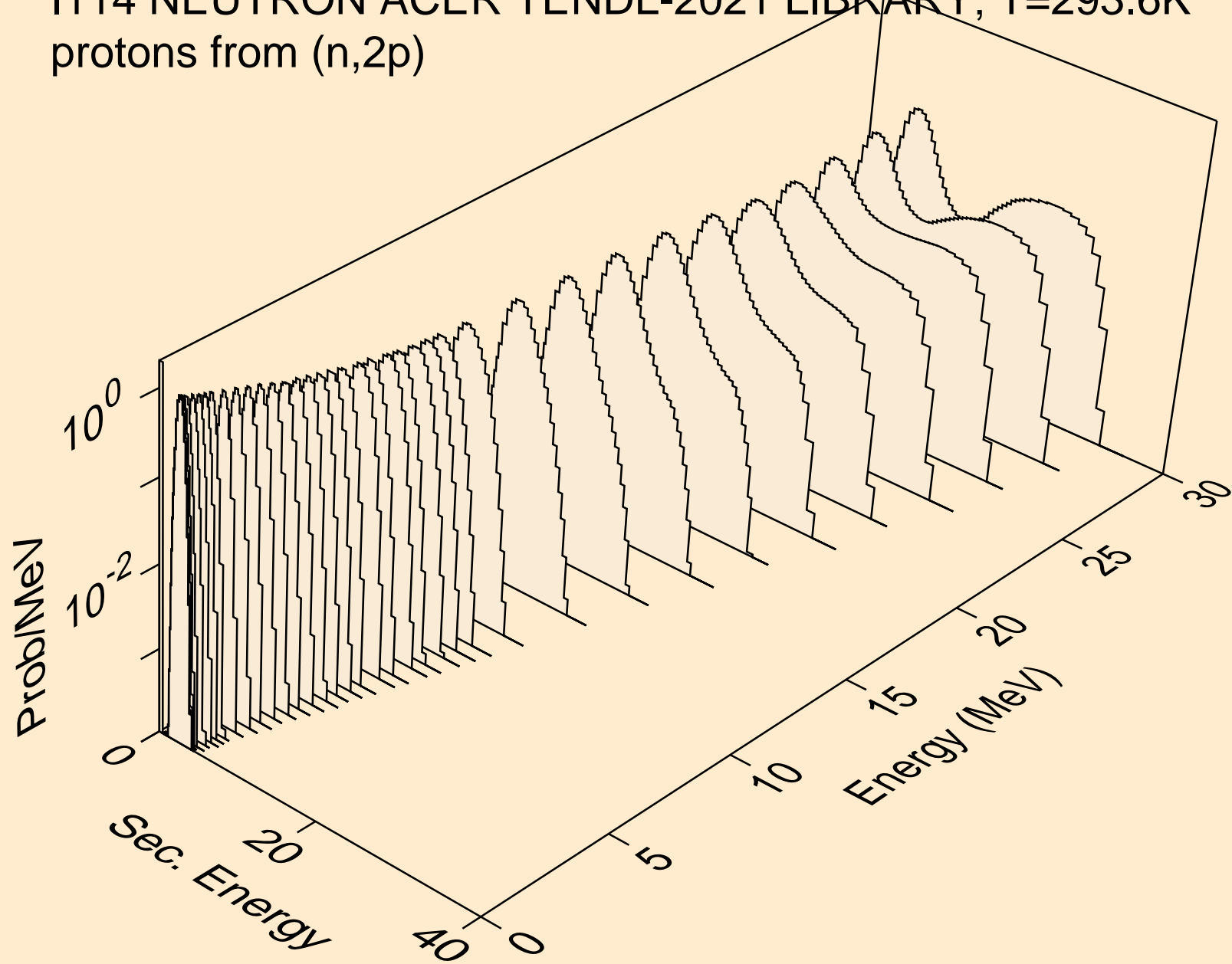

I114 NEUTRON ACER TENDL-2021 LIBRARY; T=293.6K
protons from (n,p)

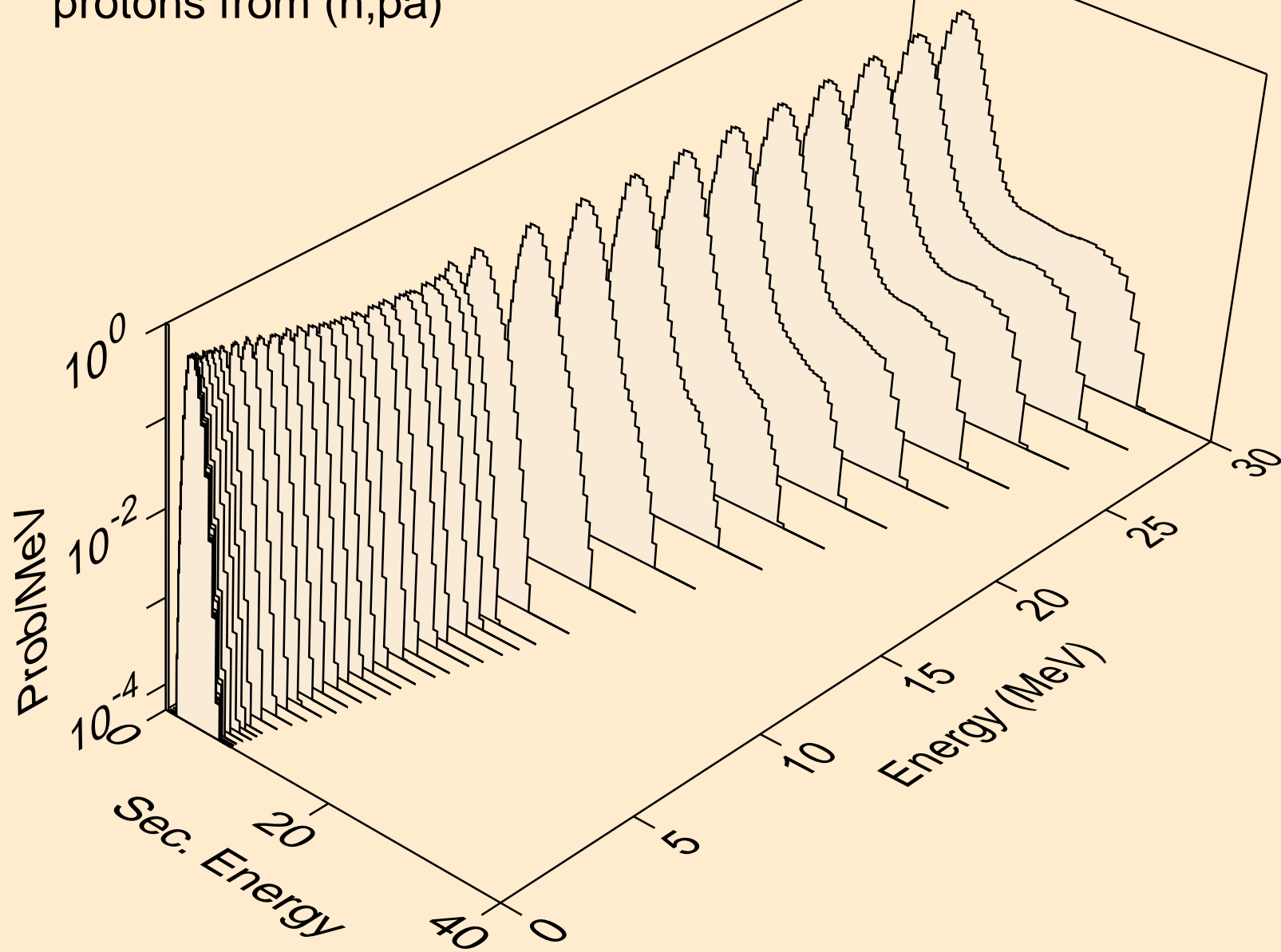

I114 NEUTRON ACER TENDL-2021 LIBRARY; T=293.6K
protons from (n,pd)

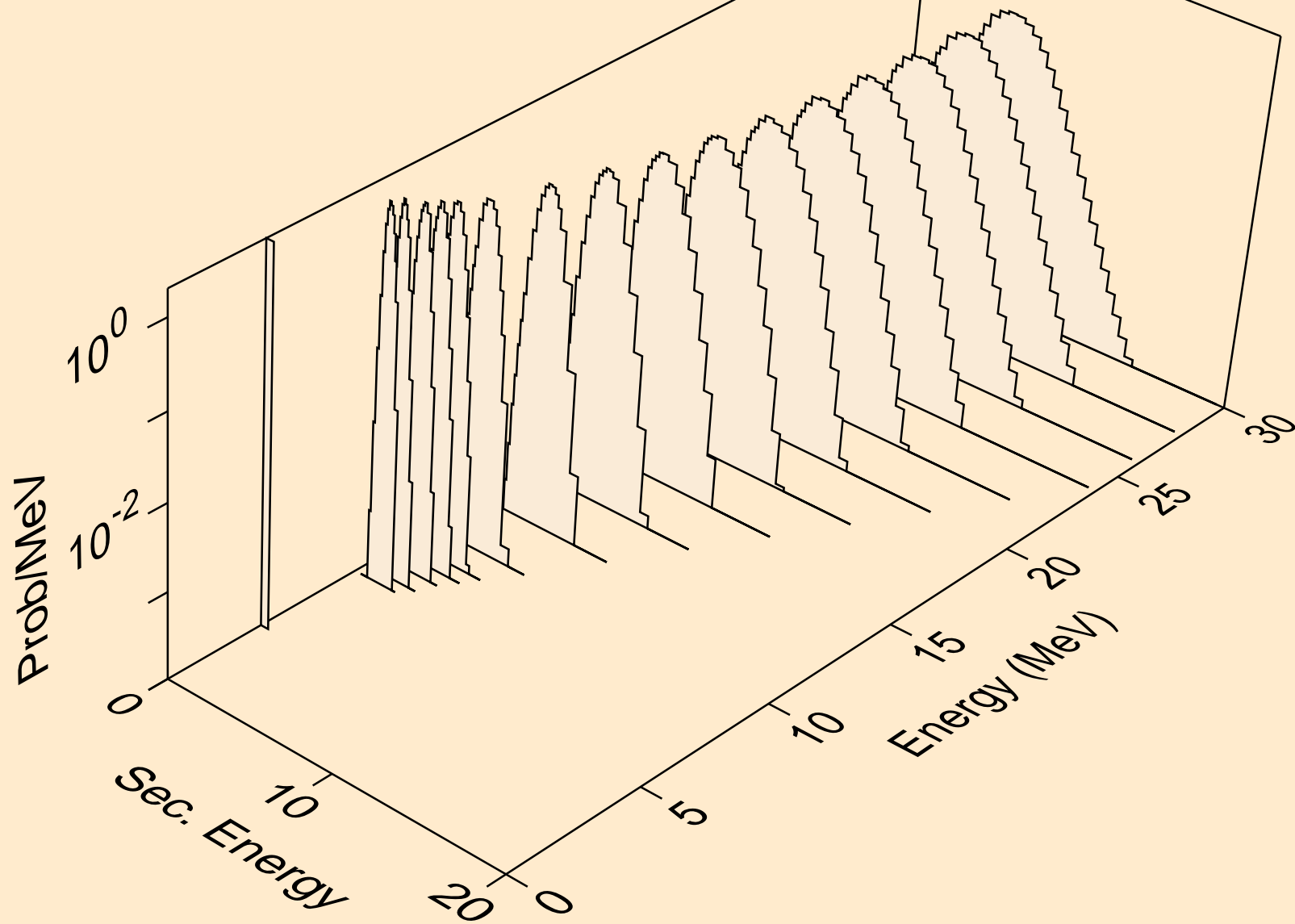

I114 NEUTRON ACER TENDL-2021 LIBRARY; T=293.6K
protons from (n,pt)

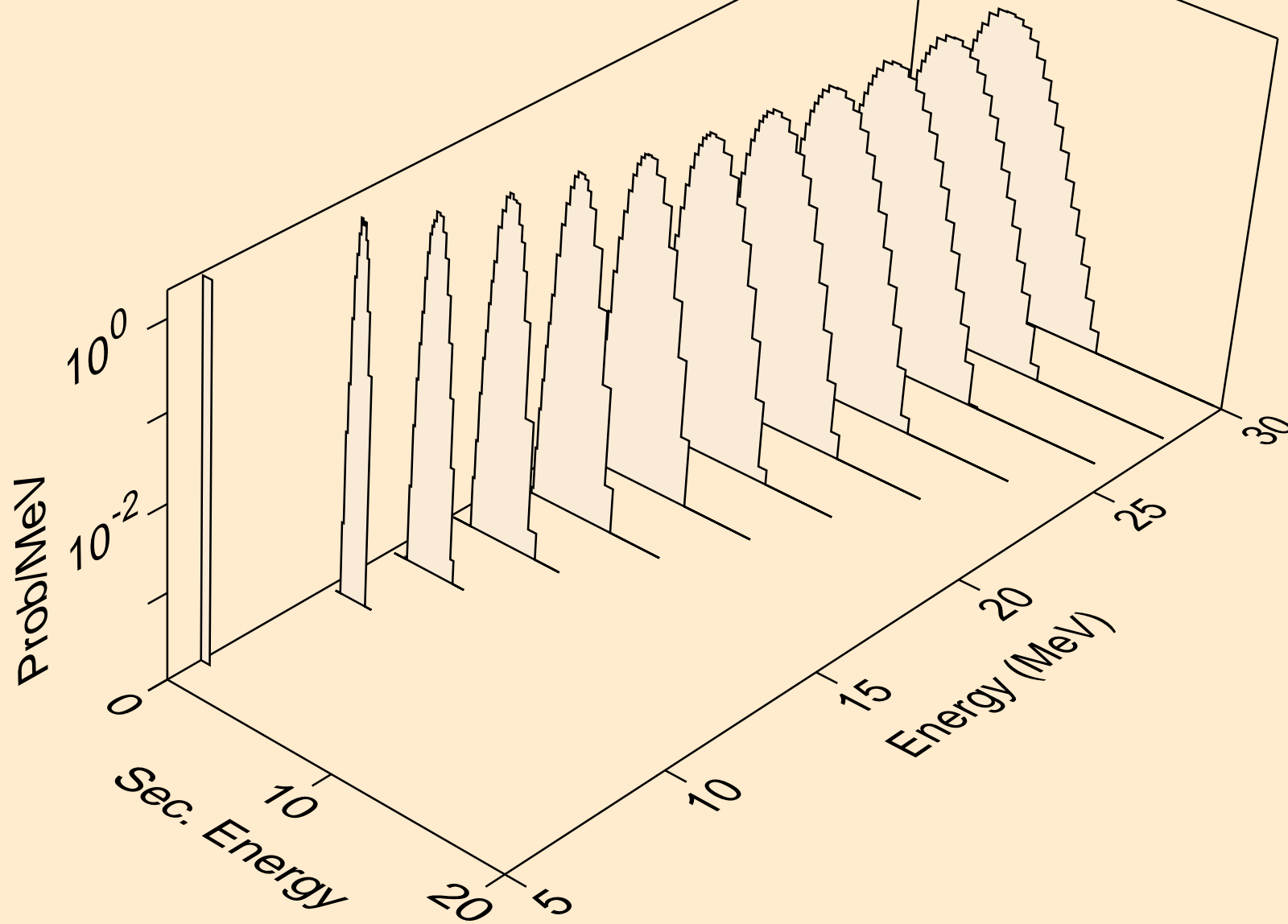

I114 NEUTRON ACER TENDL-2021 LIBRARY; T=293.6K
deuterons from (n,x)

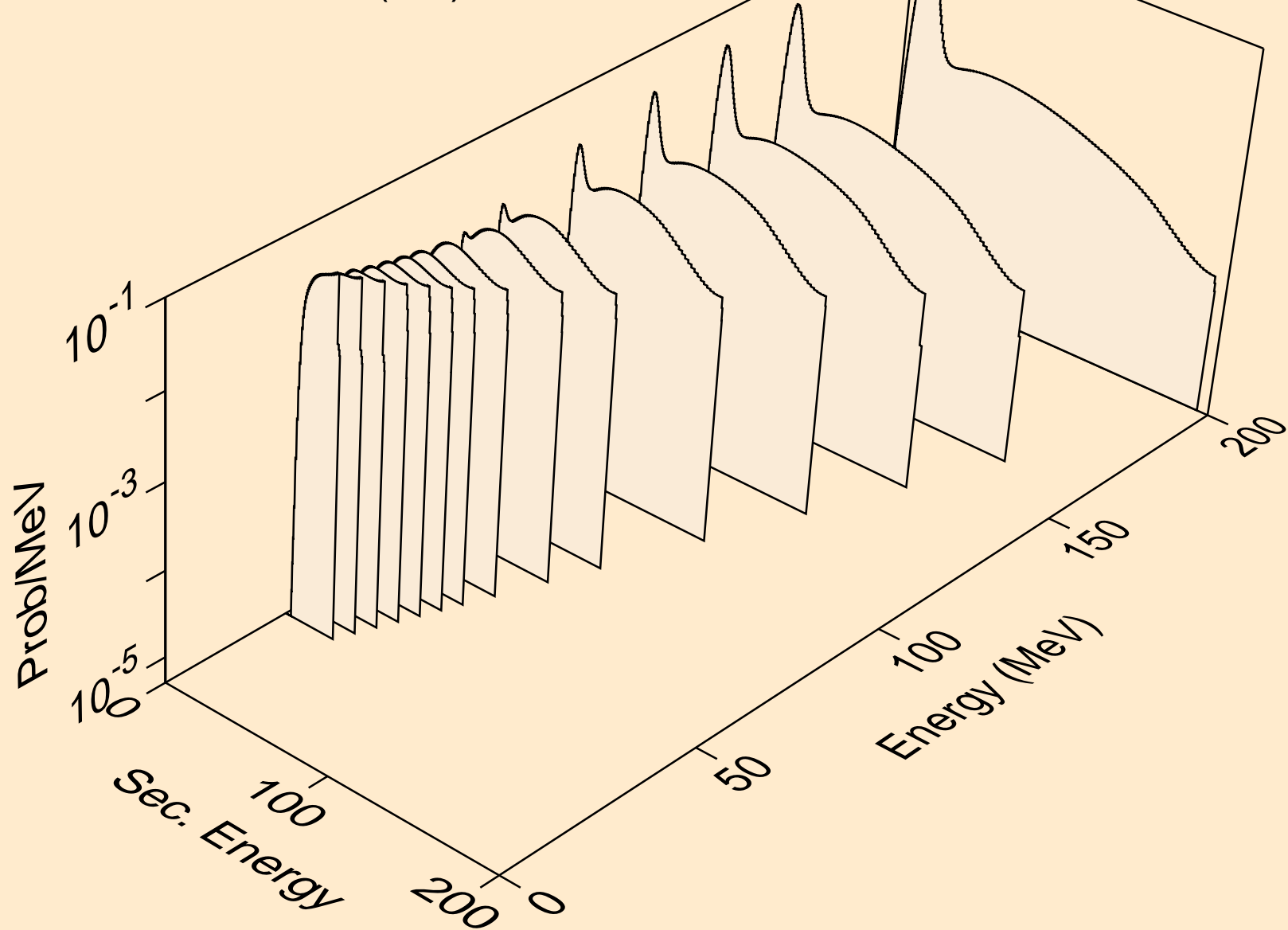

I114 NEUTRON ACER TENDL-2021 LIBRARY; T=293.6K
deuterons from (n,2nd)

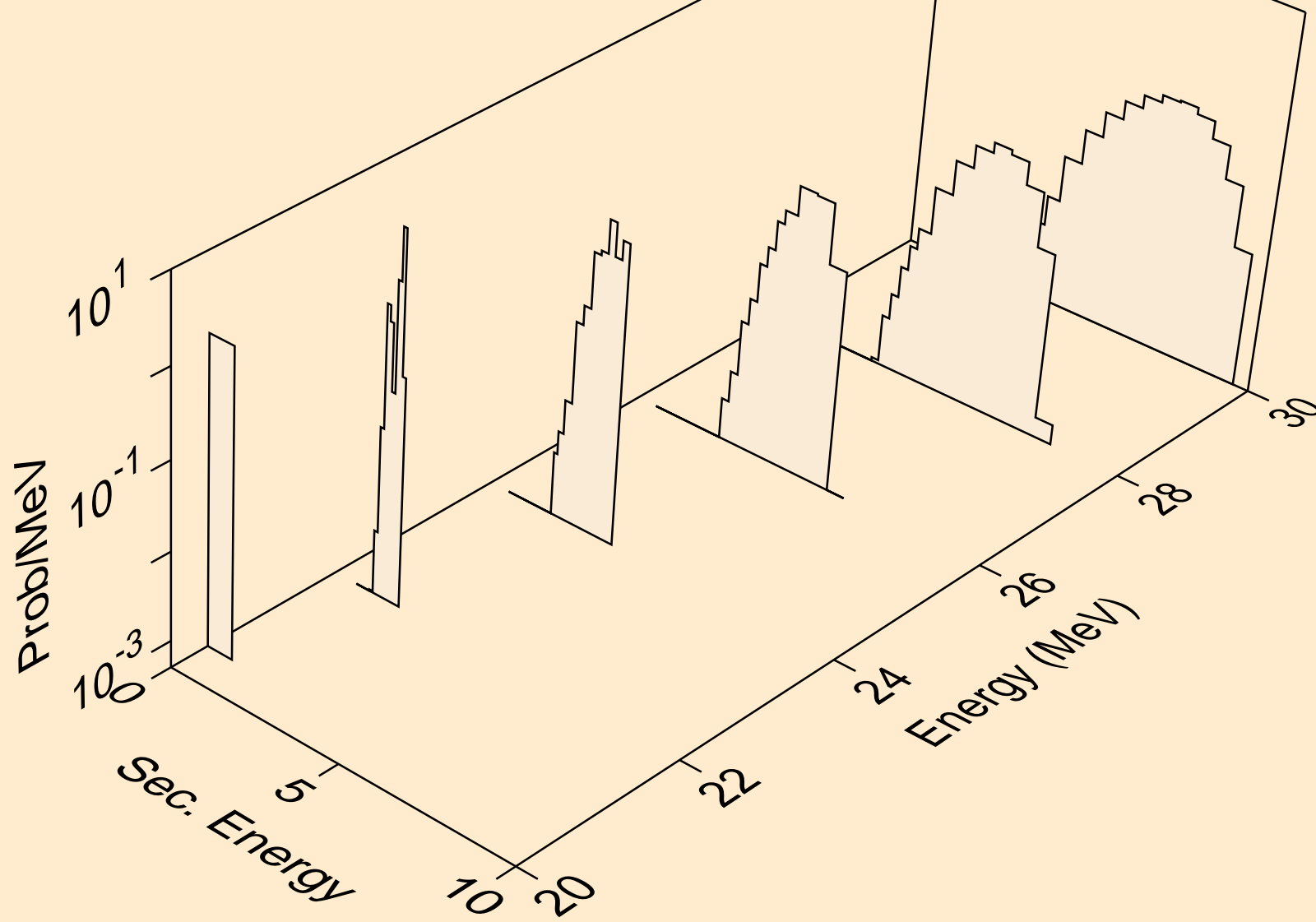

I114 NEUTRON ACER TENDL-2021 LIBRARY; T=293.6K
deuterons from (n,n*)d

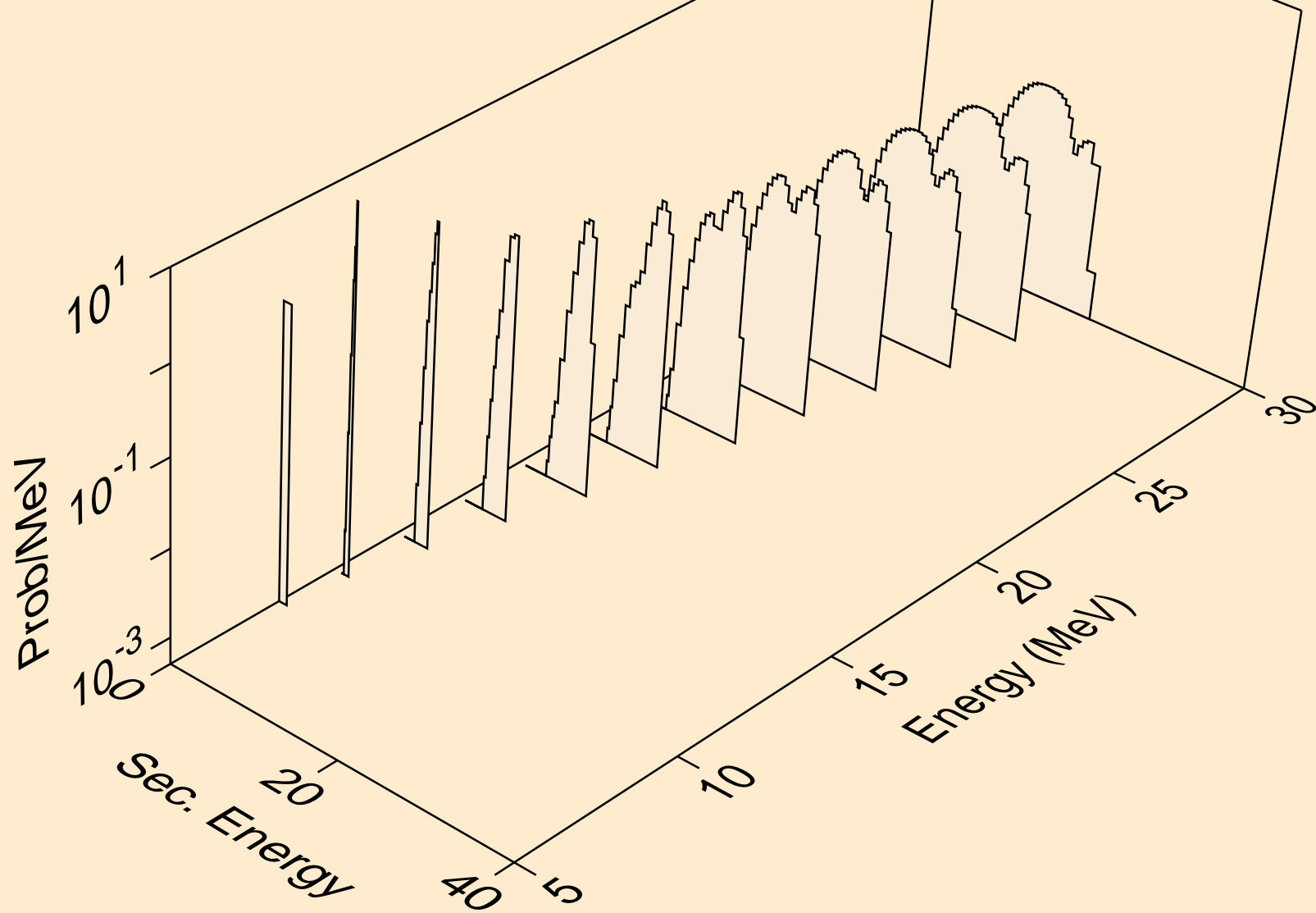

I114 NEUTRON ACER TENDL-2021 LIBRARY; T=293.6K
deuterons from (n,d)

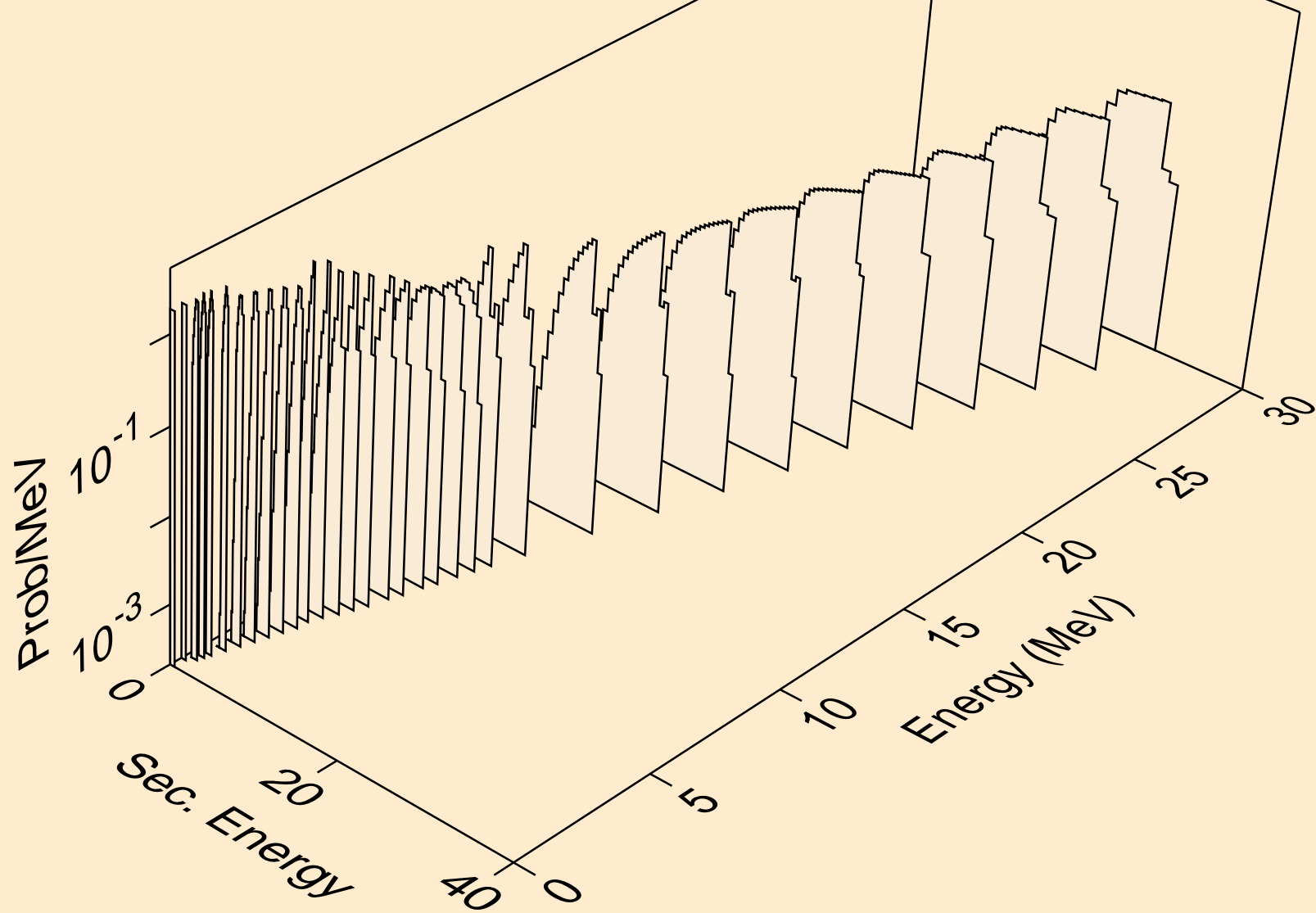

I114 NEUTRON ACER TENDL-2021 LIBRARY; T=293.6K
deuterons from (n,d2a)

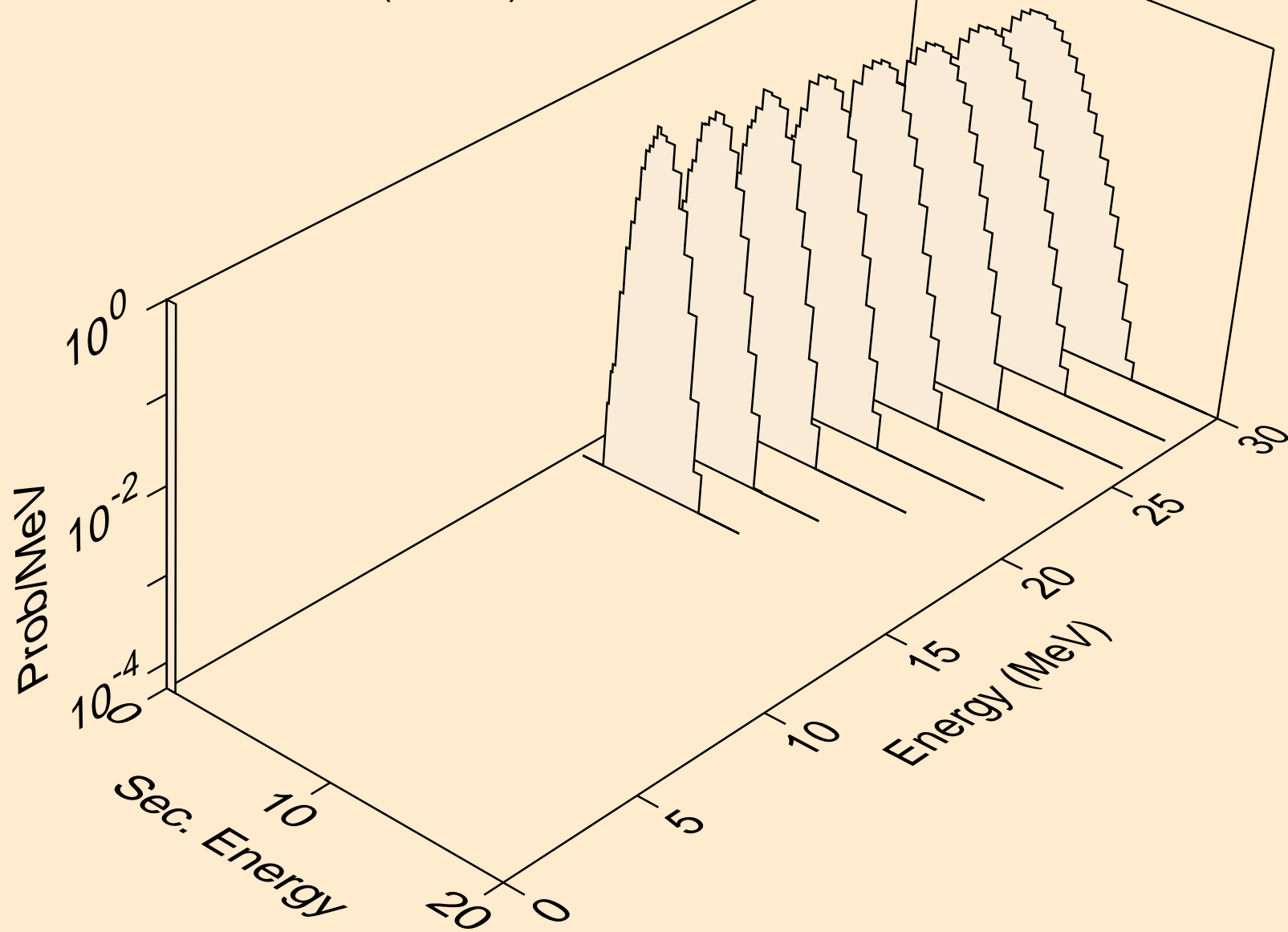

I114 NEUTRON ACER TENDL-2021 LIBRARY; T=293.6K
deuterons from (n,pd)

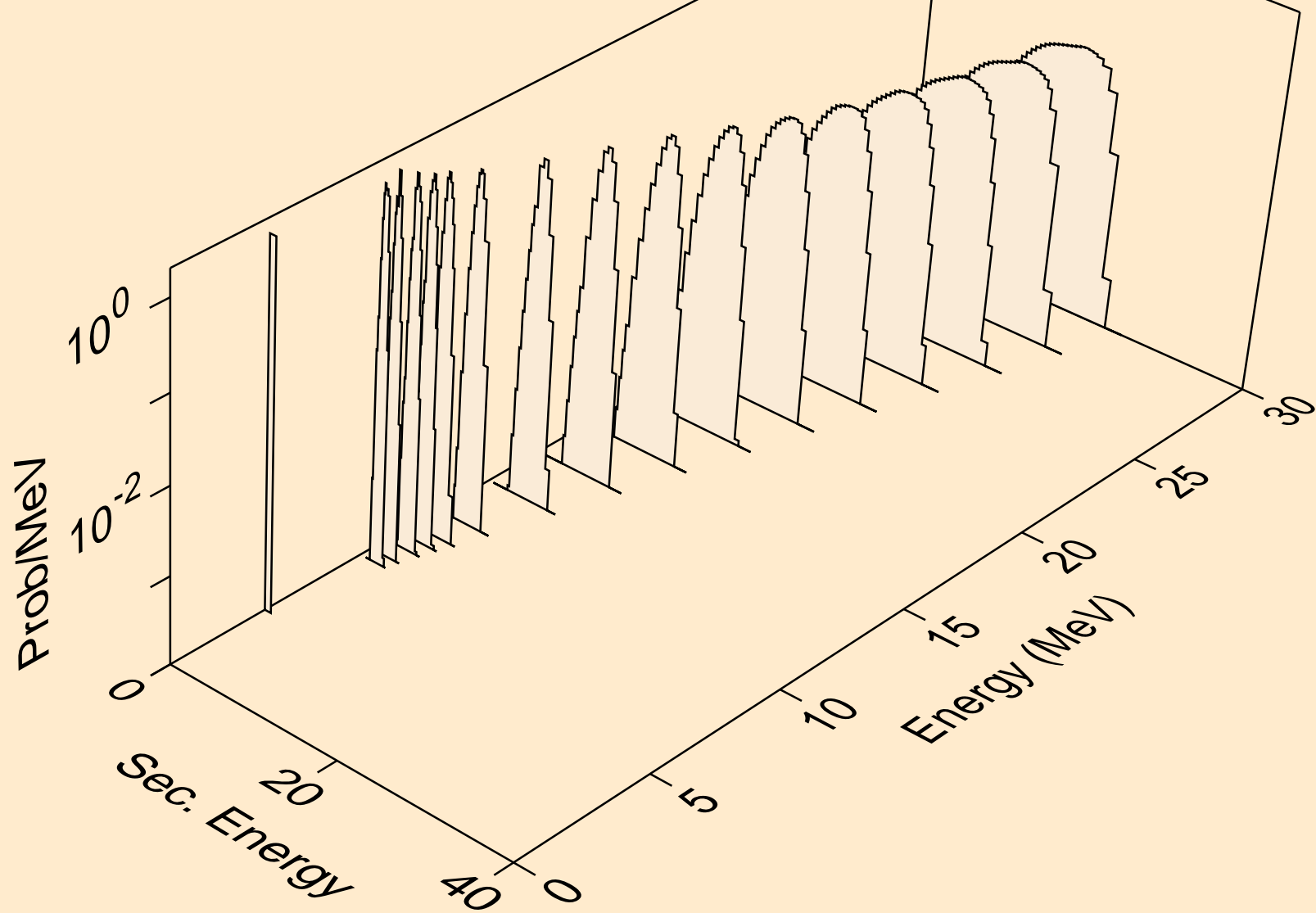

I114 NEUTRON ACER TENDL-2021 LIBRARY; T=293.6K
deuterons from (n,da)

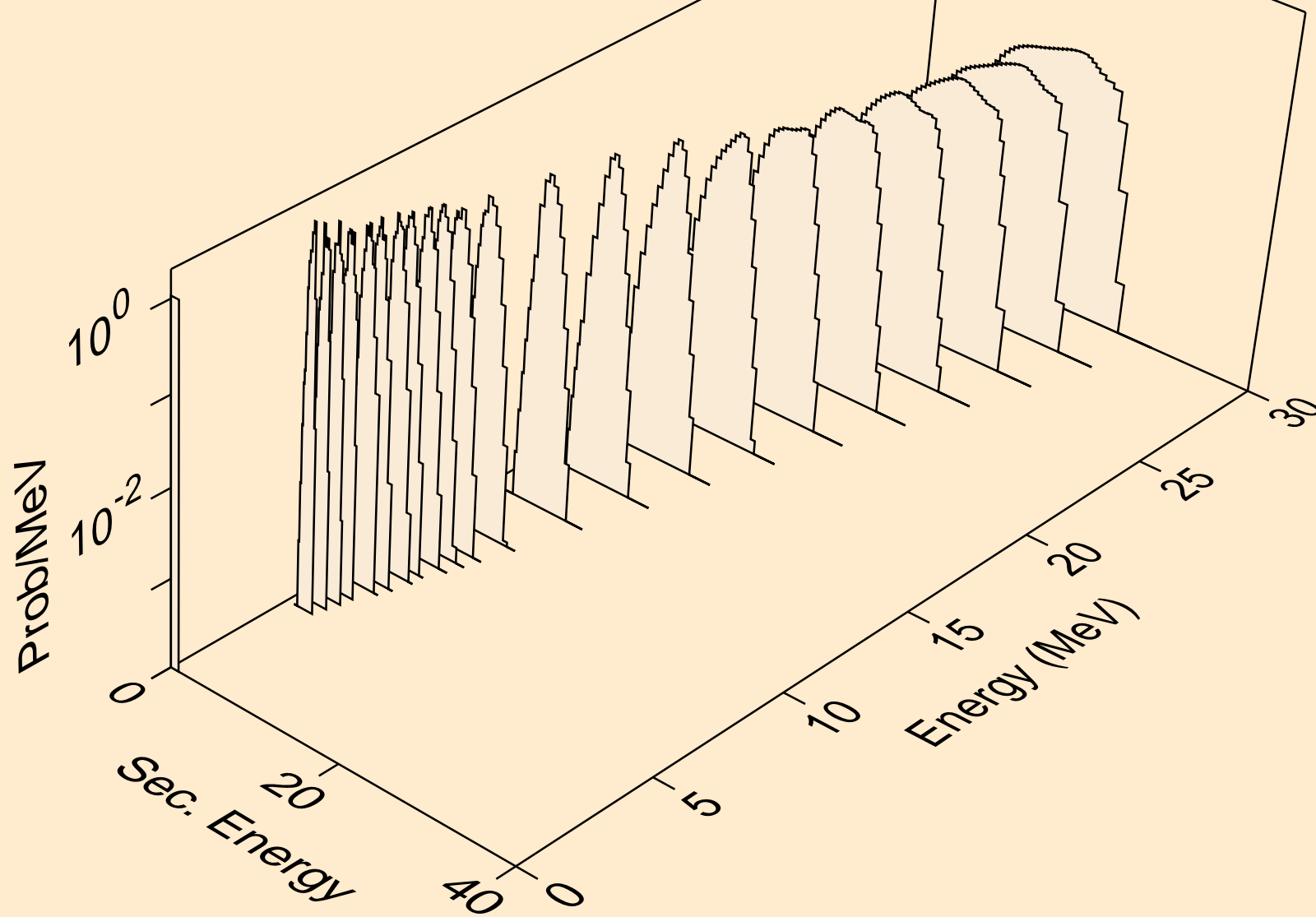

I114 NEUTRON ACER TENDL-2021 LIBRARY; T=293.6K
tritons from (n,x)

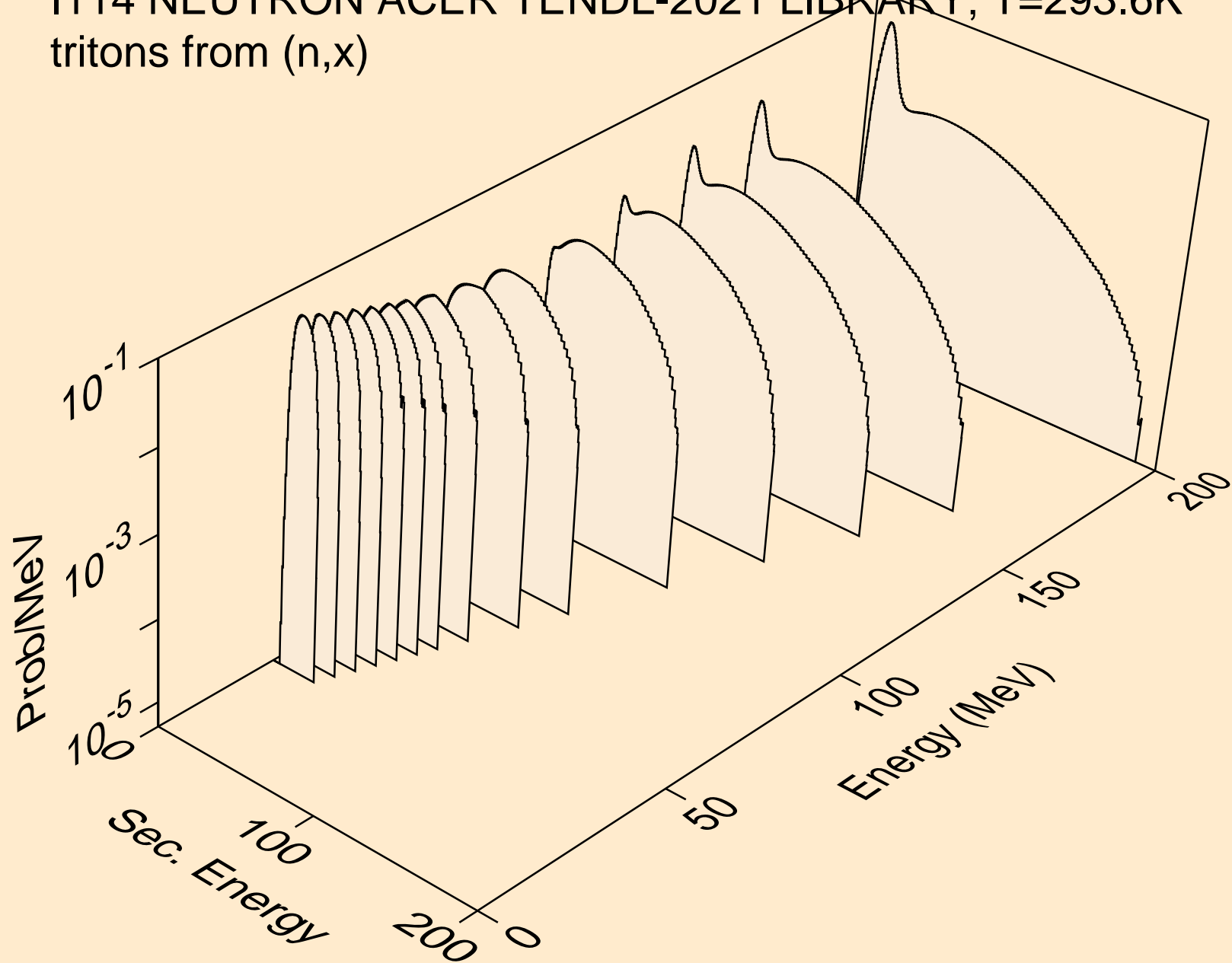

I114 NEUTRON ACER TENDL-2021 LIBRARY; T=293.6K
tritons from (n,n*)t

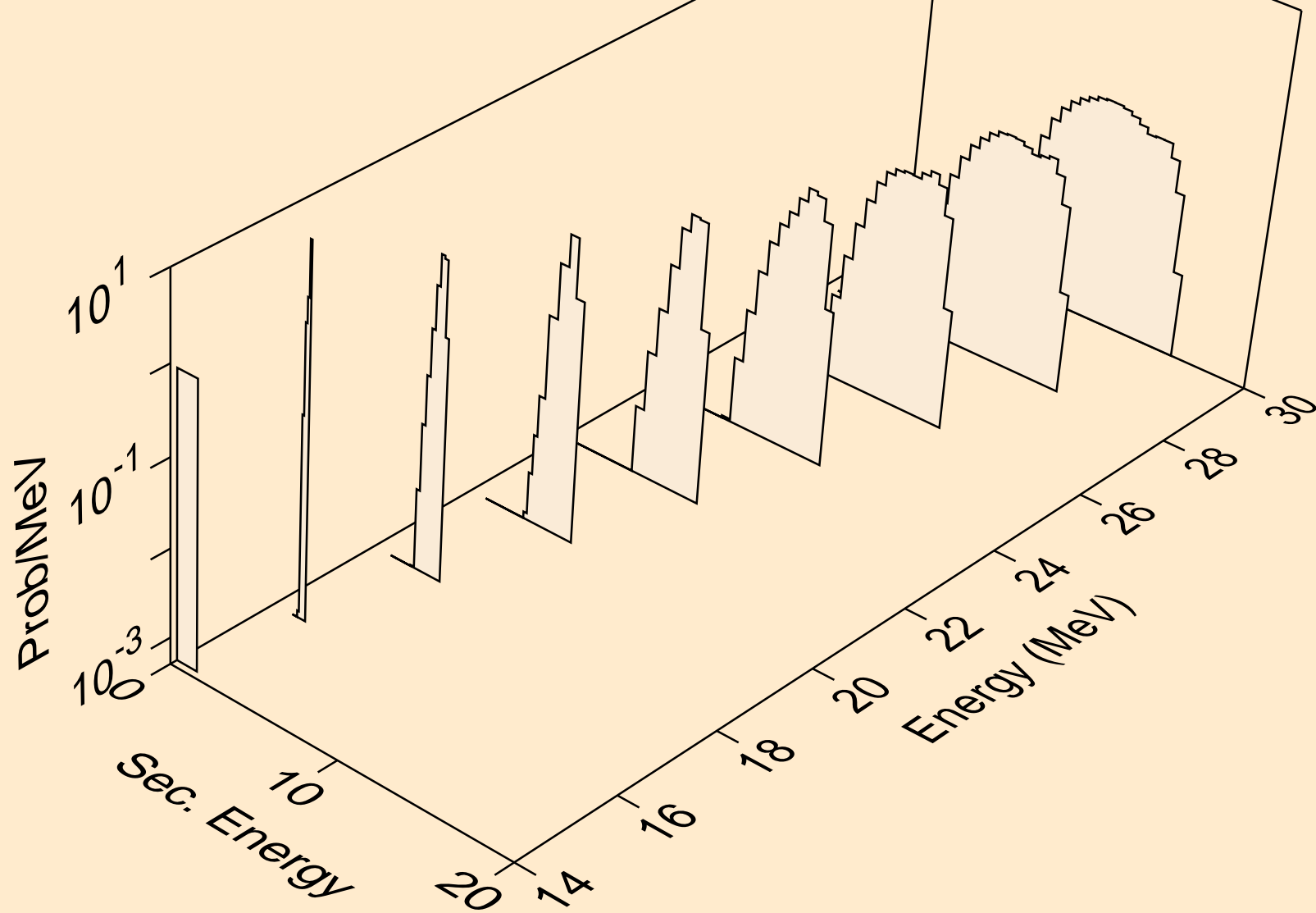

I114 NEUTRON ACER TENDL-2021 LIBRARY; T=293.6K
tritons from (n,t)

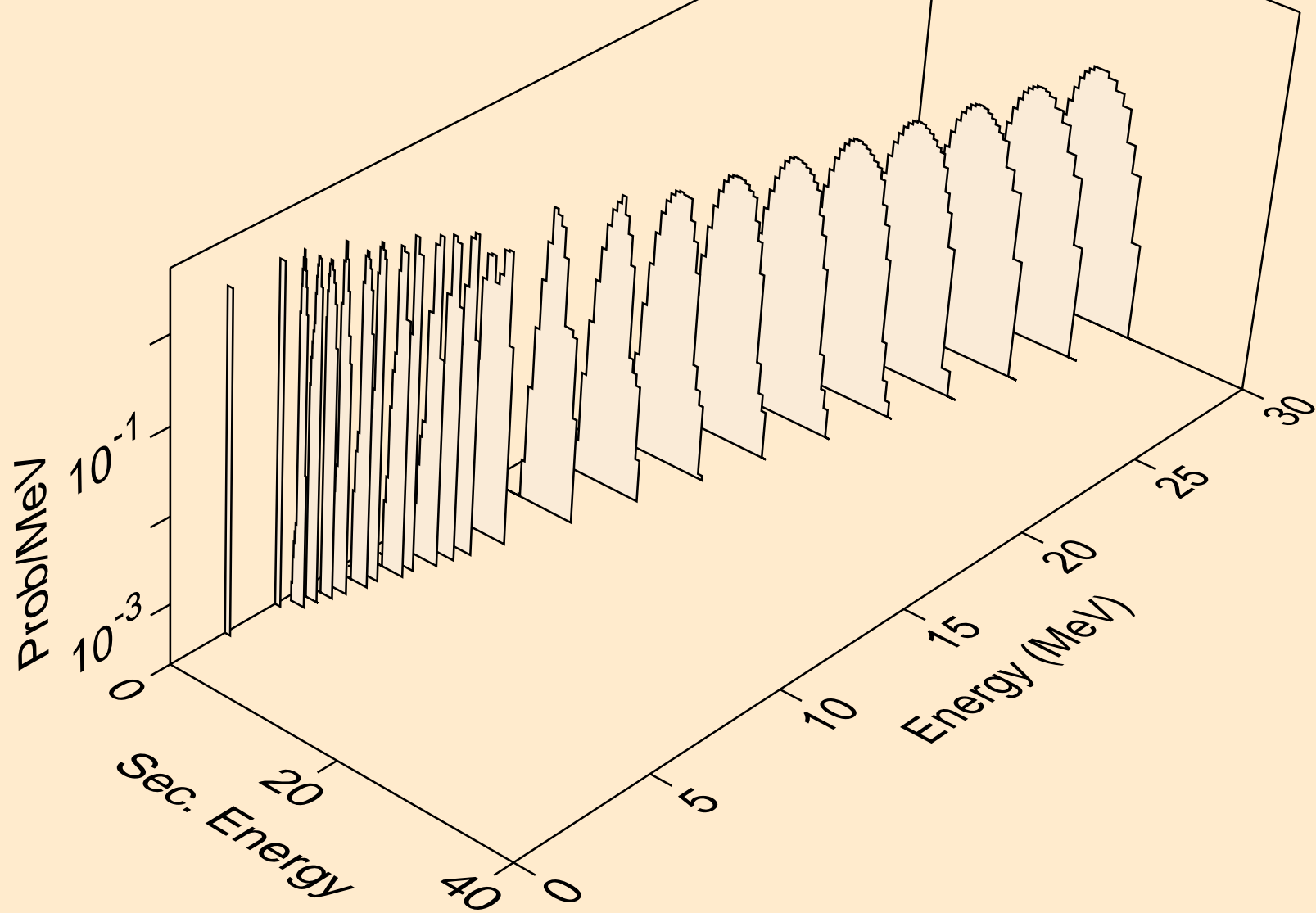

I114 NEUTRON ACER TENDL-2021 LIBRARY; T=293.6K
tritons from (n,t2a)

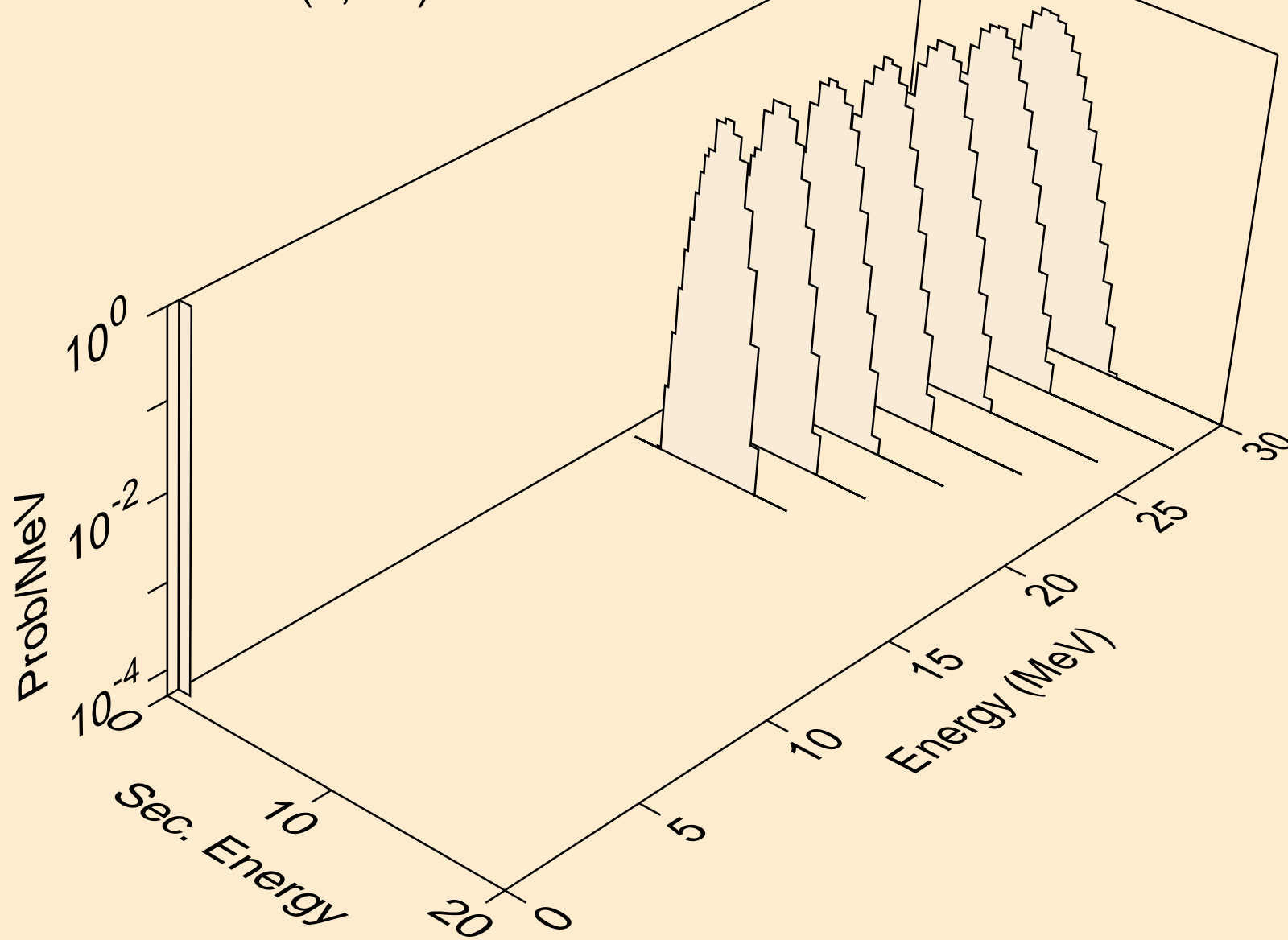

I114 NEUTRON ACER TENDL-2021 LIBRARY; T=293.6K
tritons from (n,pt)

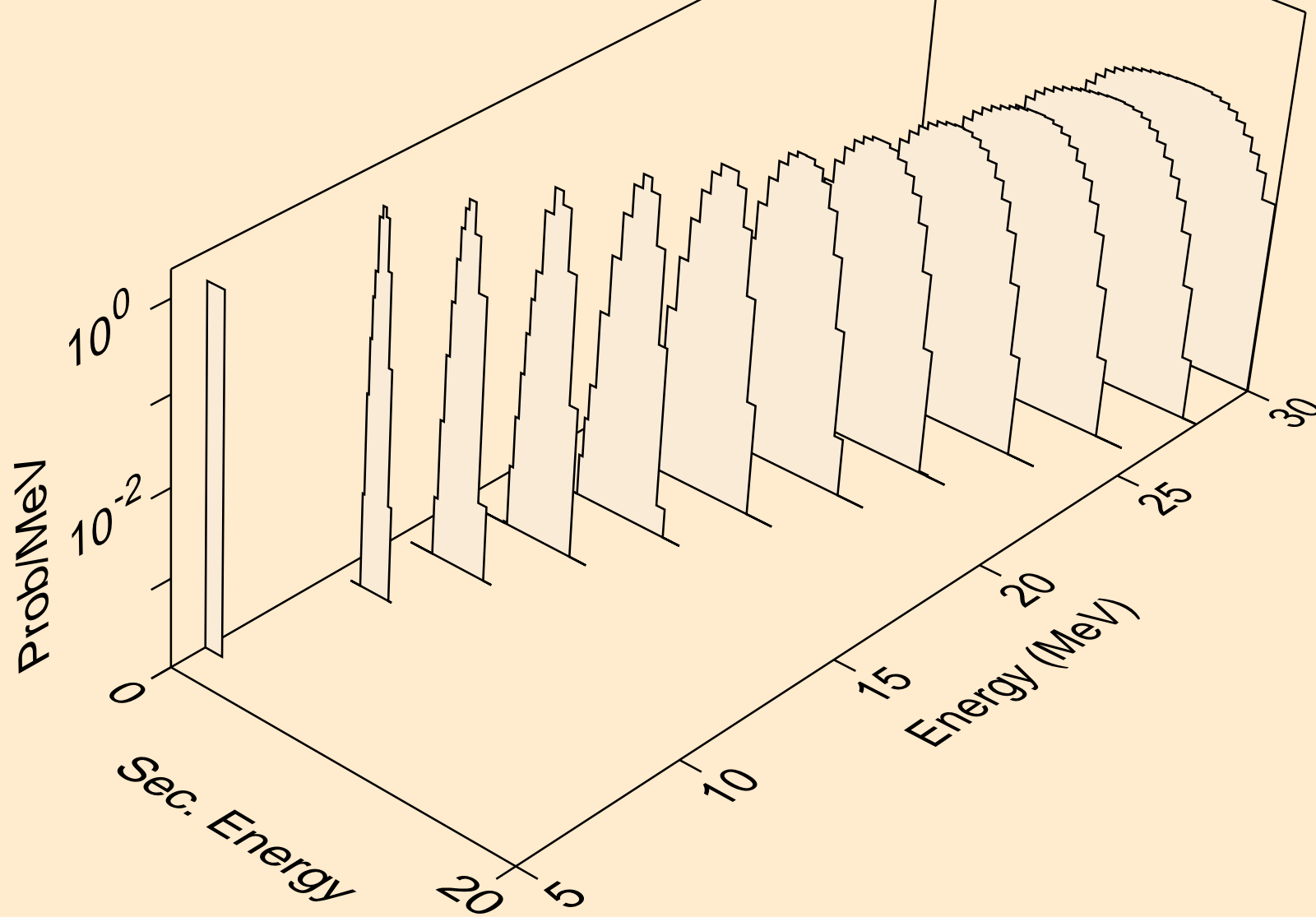

I114 NEUTRON ACER TENDL-2021 LIBRARY; T=293.6K
he3s from (n,x)

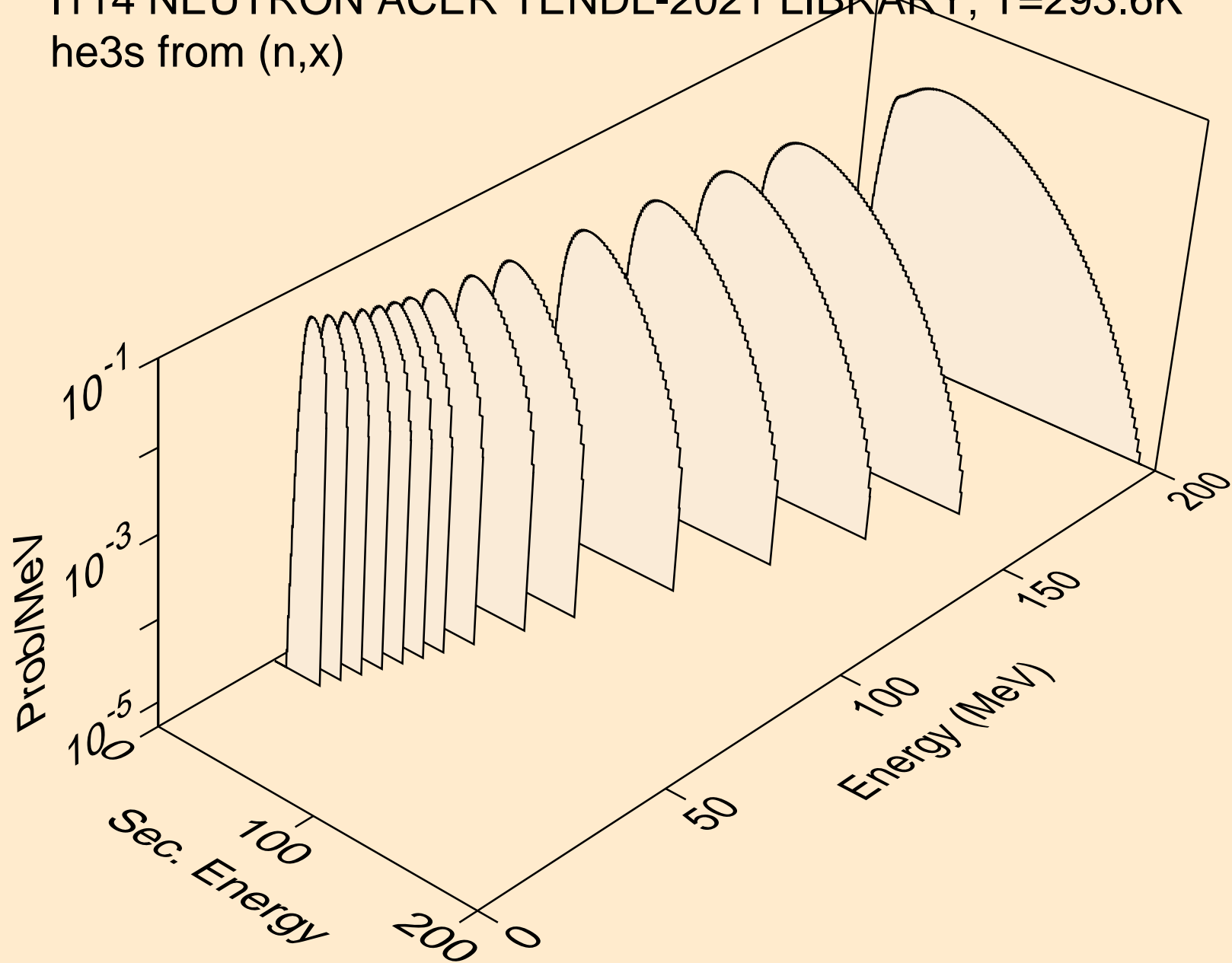

I114 NEUTRON ACER TENDL-2021 LIBRARY; T=293.6K
he3s from (n,n*)he3

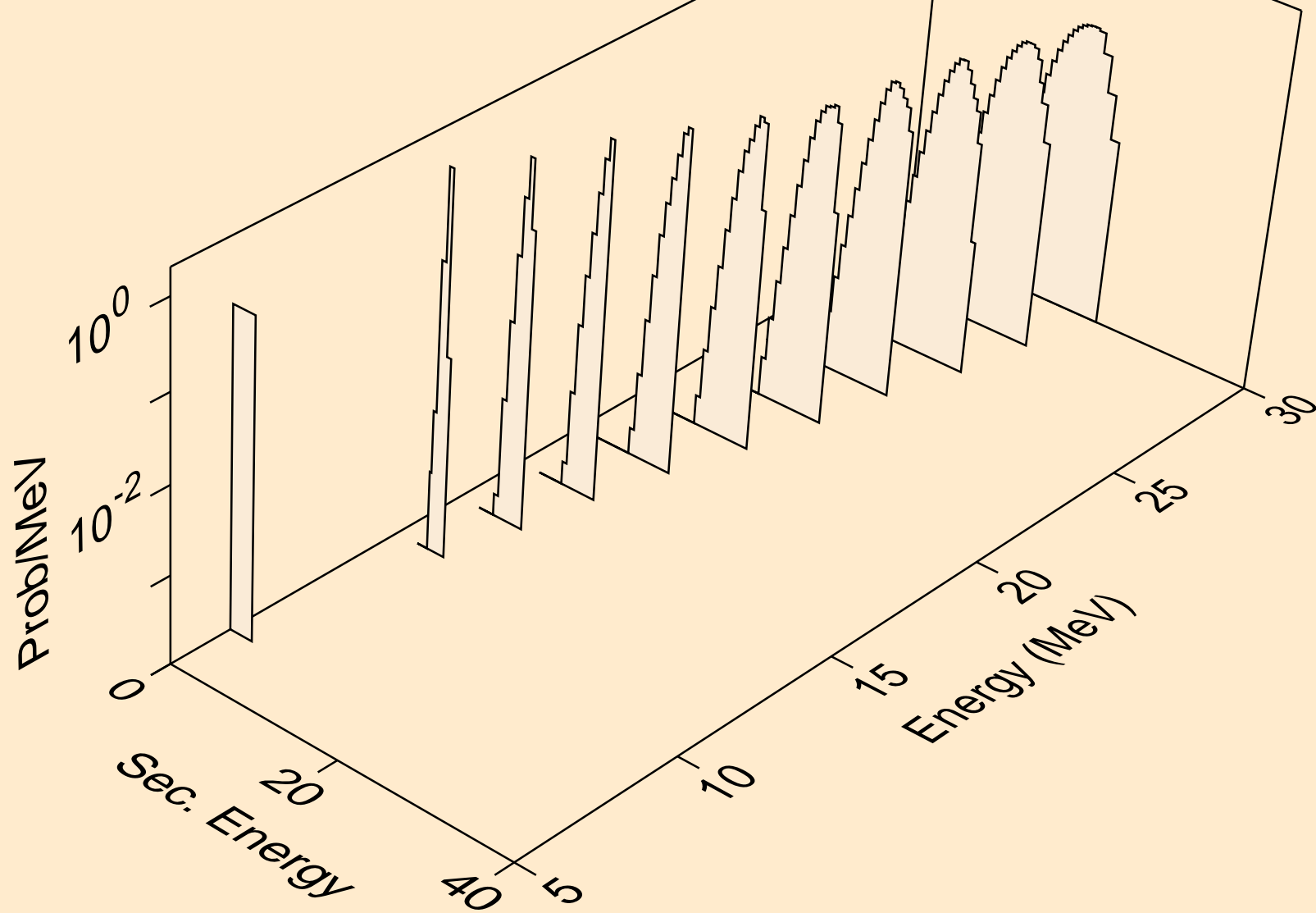

I114 NEUTRON ACER TENDL-2021 LIBRARY; T=293.6K
he3s from (n,he3)

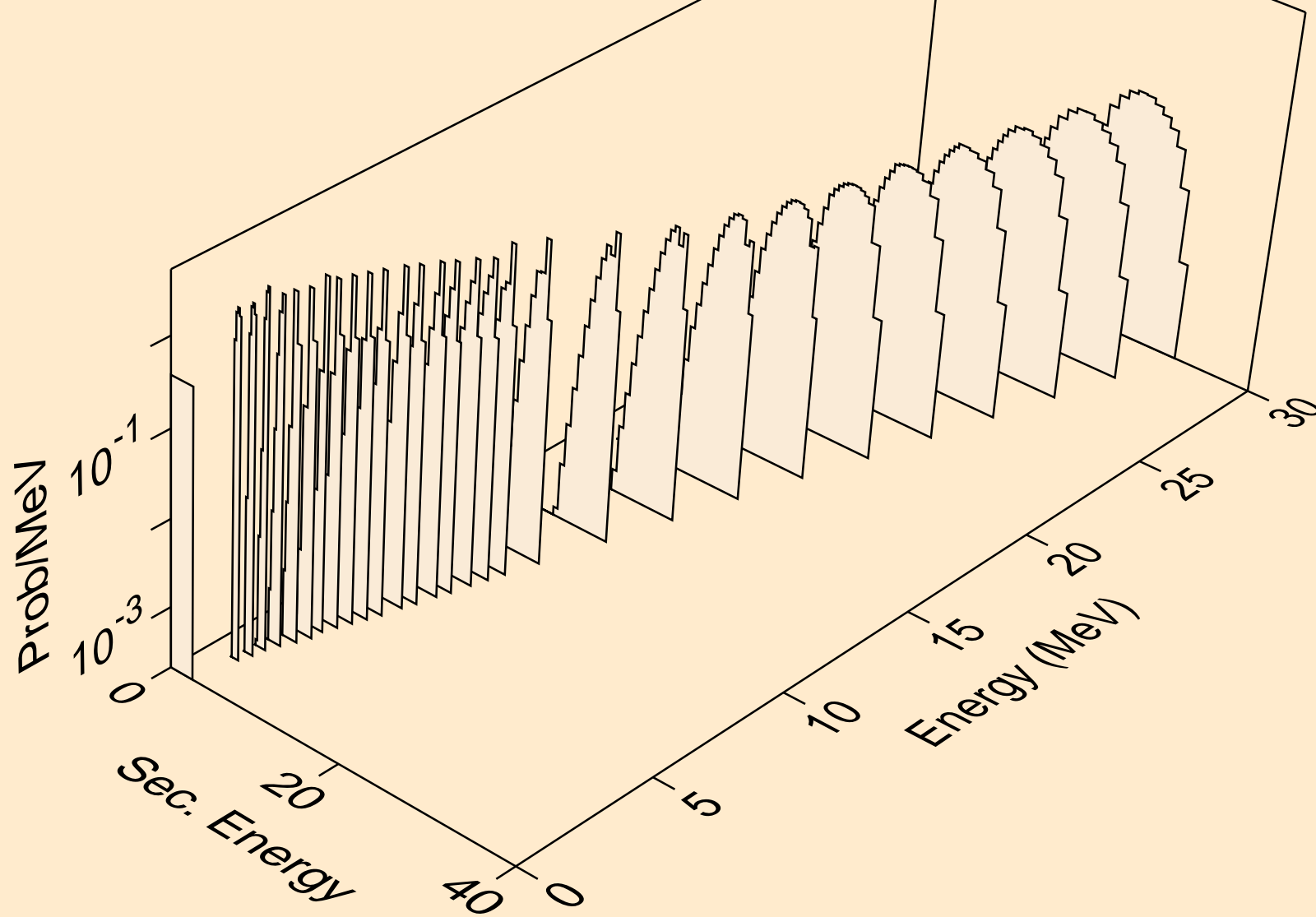

I114 NEUTRON ACER TENDL-2021 LIBRARY; T=293.6K
alphas from (n,x)

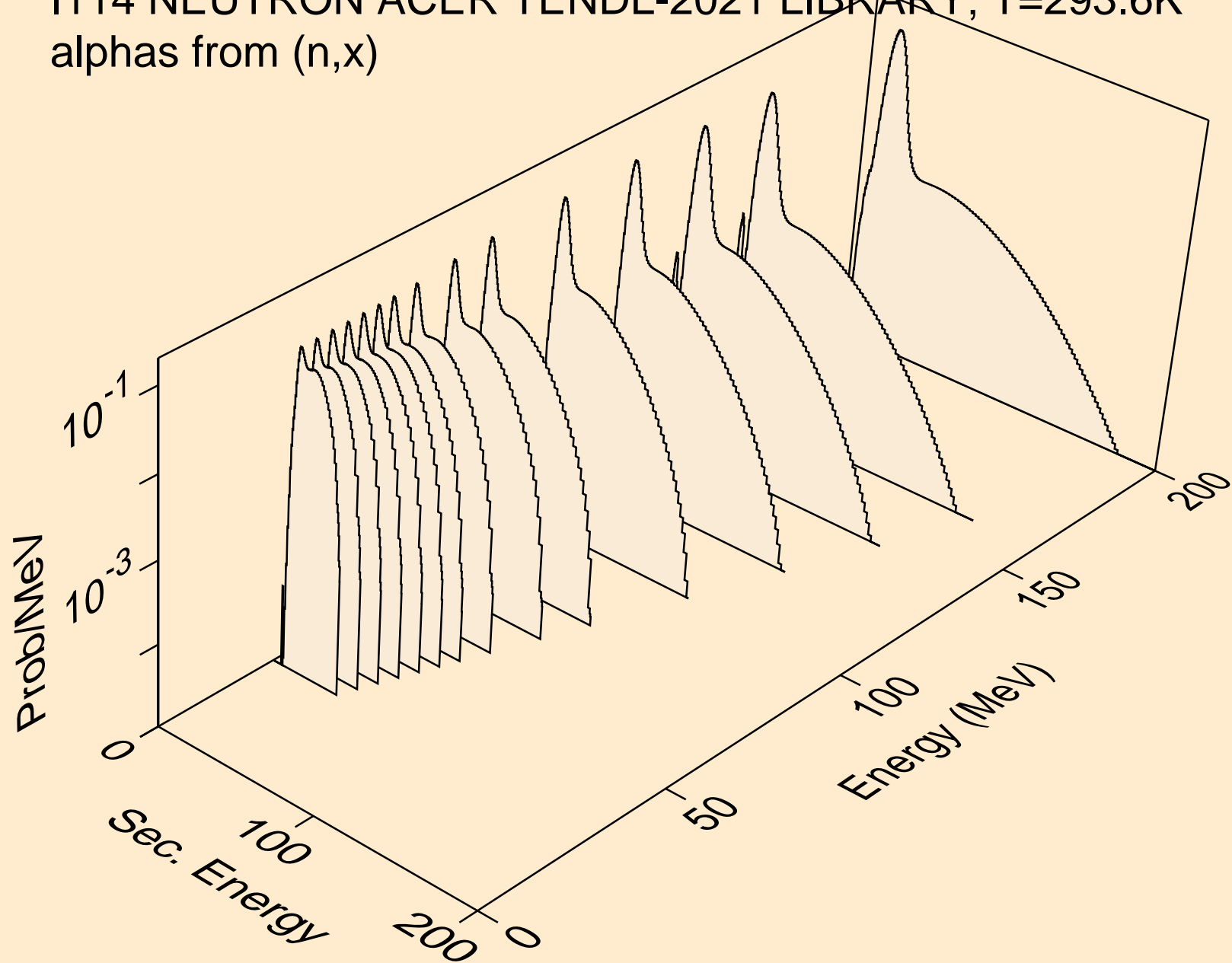

I114 NEUTRON ACER TENDL-2021 LIBRARY; T=293.6K
alphas from (n,n*)a

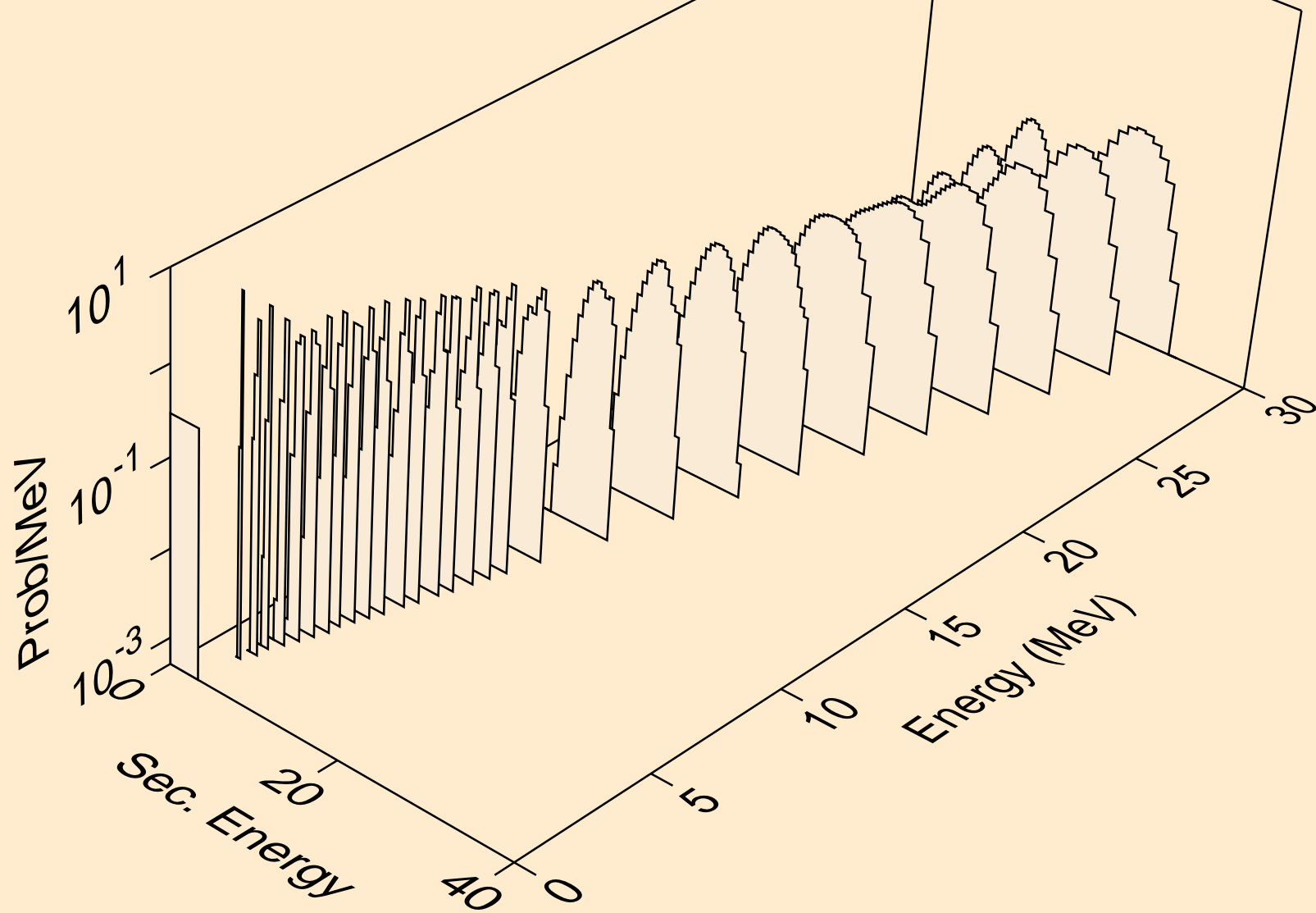

I114 NEUTRON ACER TENDL-2021 LIBRARY; T=293.6K
alphas from (n,2n)a

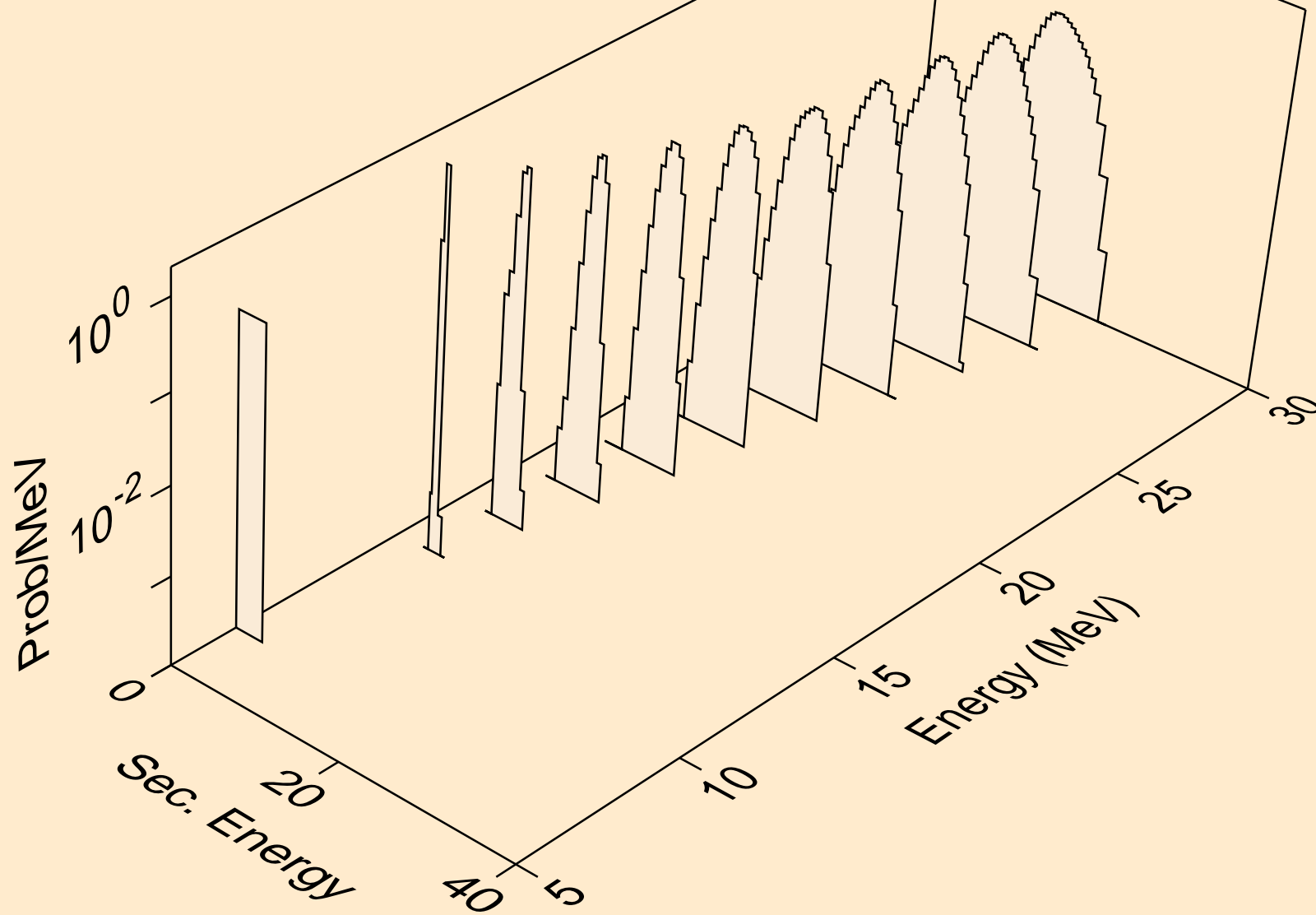

I114 NEUTRON ACER TENDL-2021 LIBRARY; T=293.6K
alphas from (n,3n)a

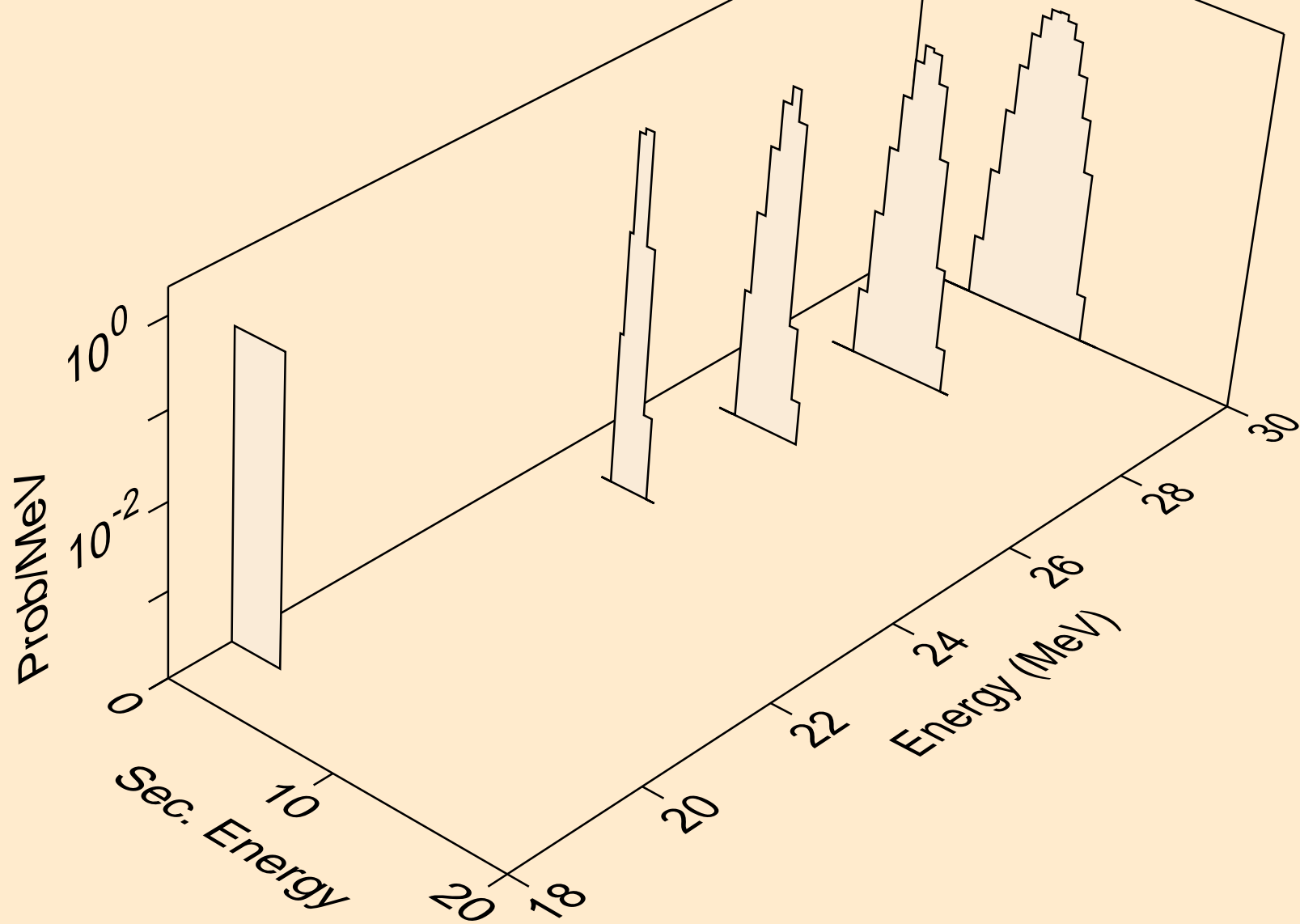

I114 NEUTRON ACER TENDL-2021 LIBRARY; T=293.6K
alphas from (n,n*)2a

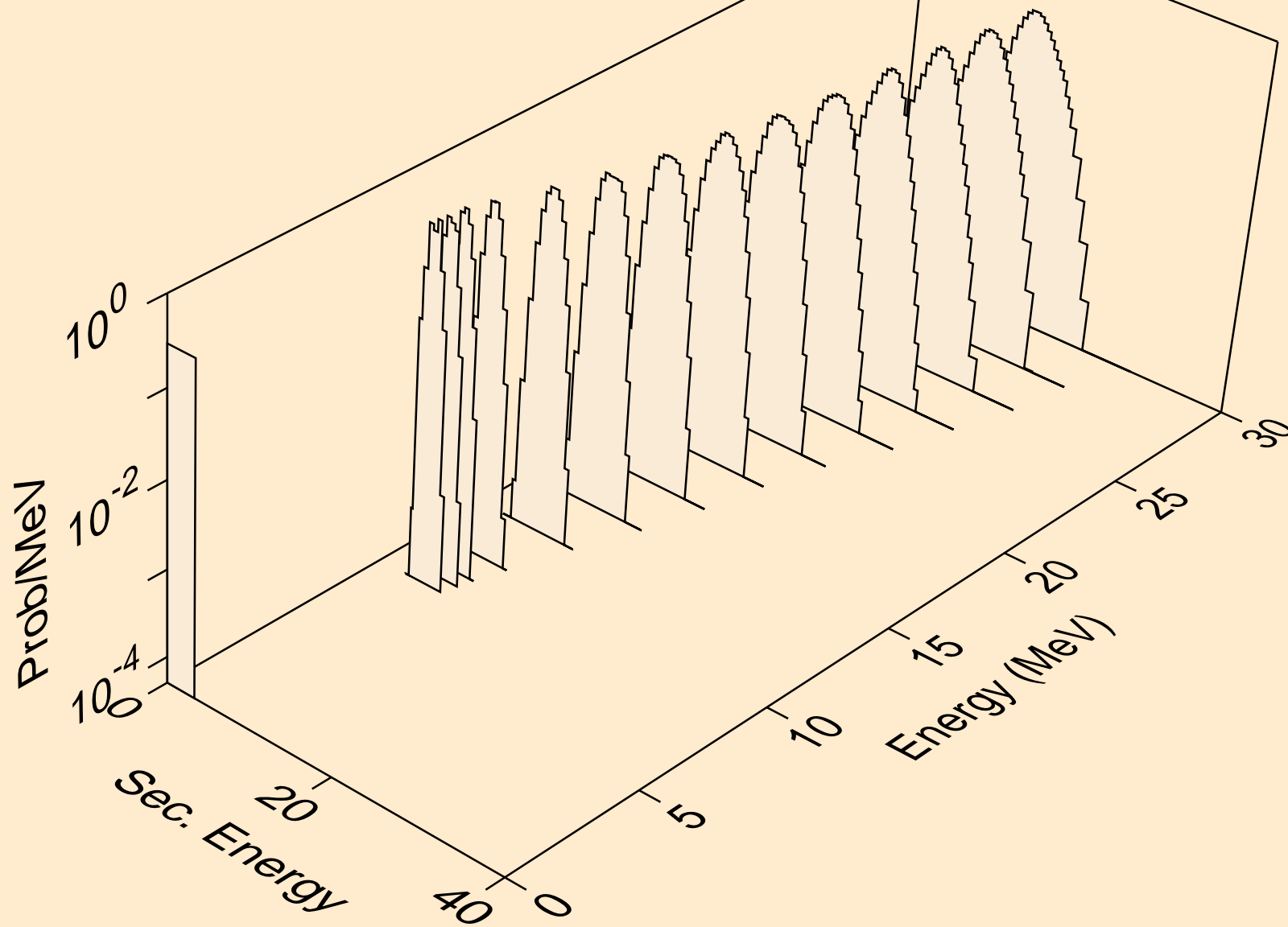

I114 NEUTRON ACER TENDL-2021 LIBRARY; T=293.6K
alphas from (n,2n)2a

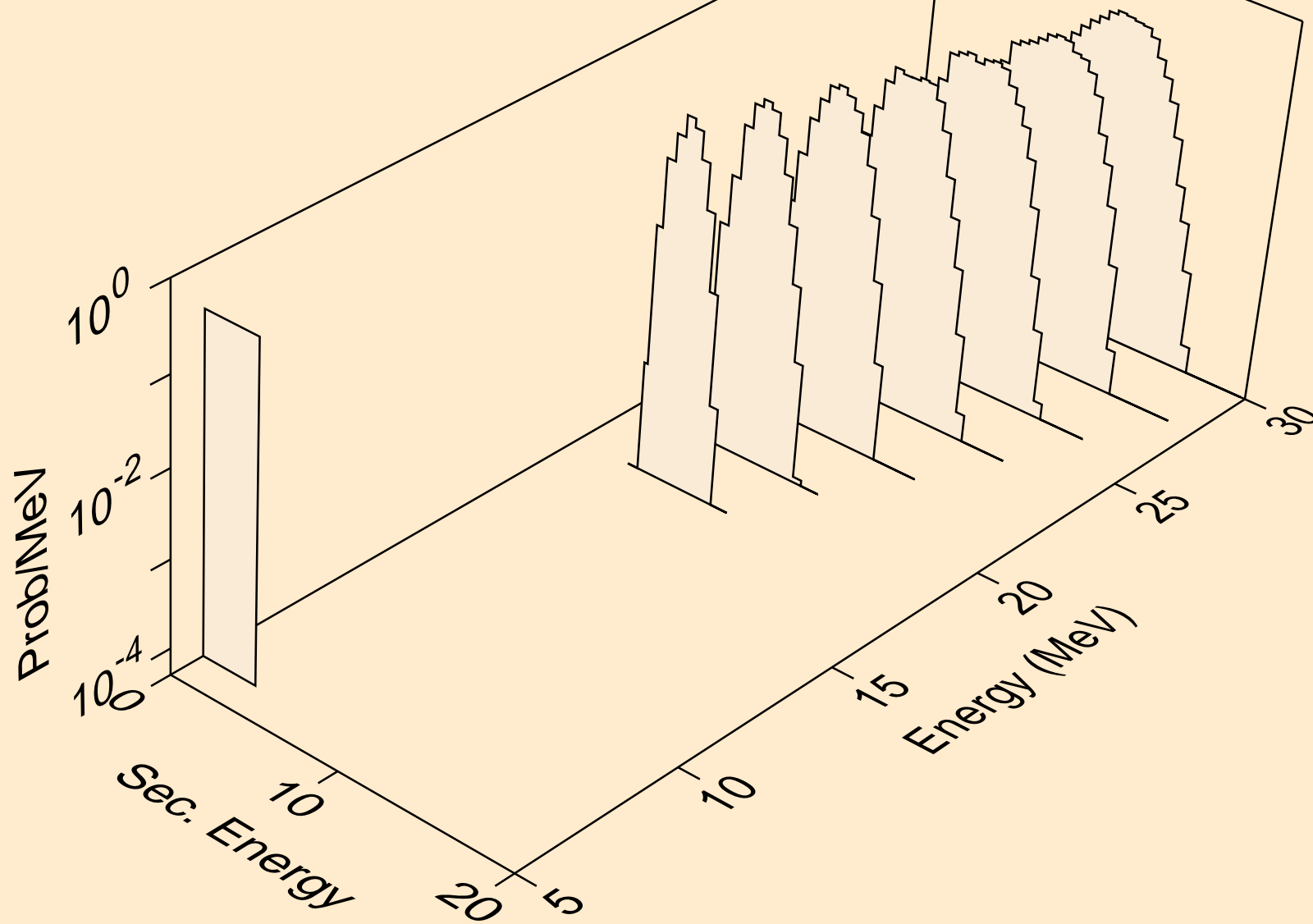

I114 NEUTRON ACER TENDL-2021 LIBRARY; T=293.6K
alphas from (n,npa)

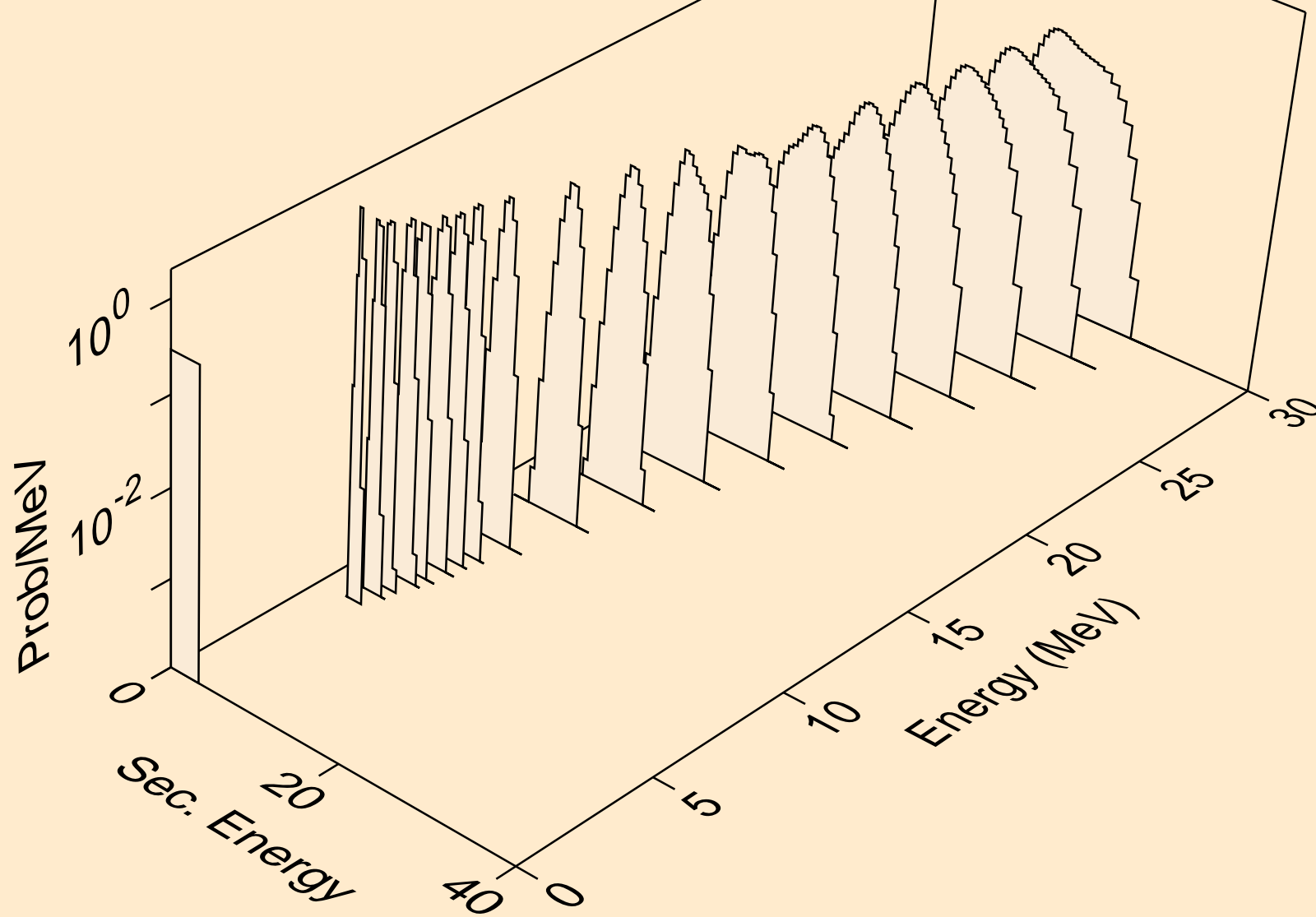

I114 NEUTRON ACER TENDL-2021 LIBRARY; T=293.6K
alphas from (n,a)

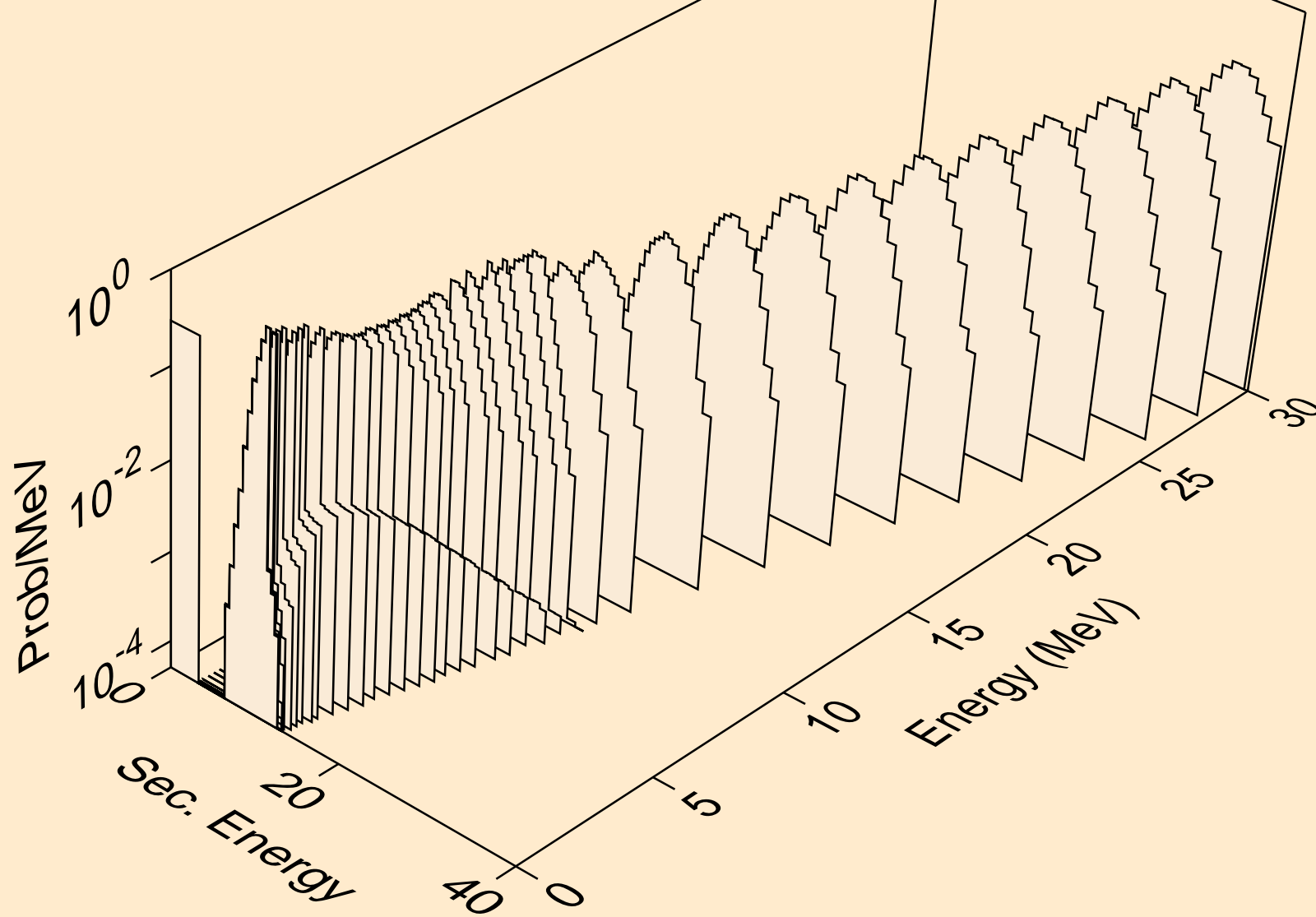

I114 NEUTRON ACER TENDL-2021 LIBRARY; T=293.6K
alphas from (n,2a)

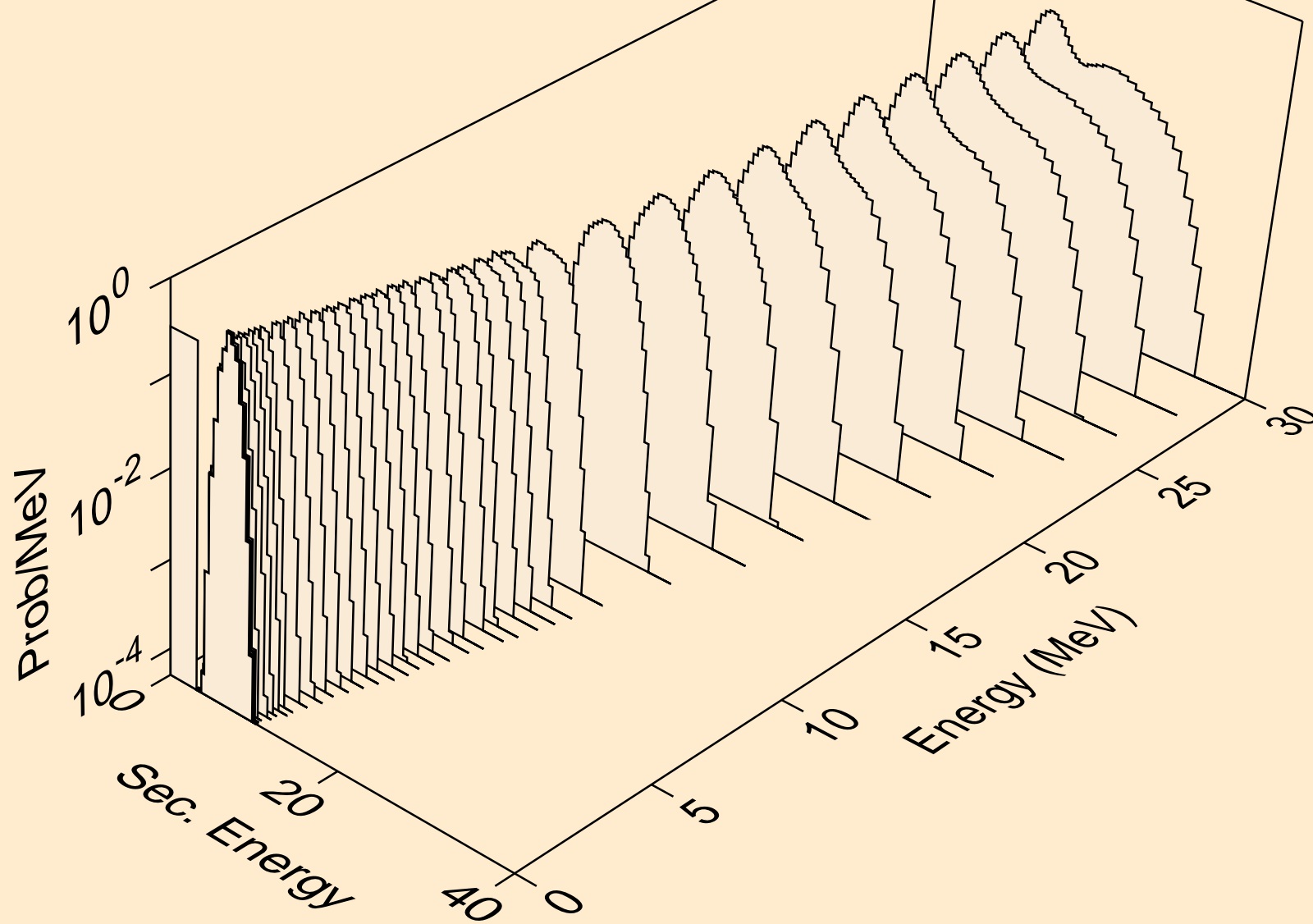

I114 NEUTRON ACER TENDL-2021 LIBRARY; T=293.6K
alphas from (n,3a)

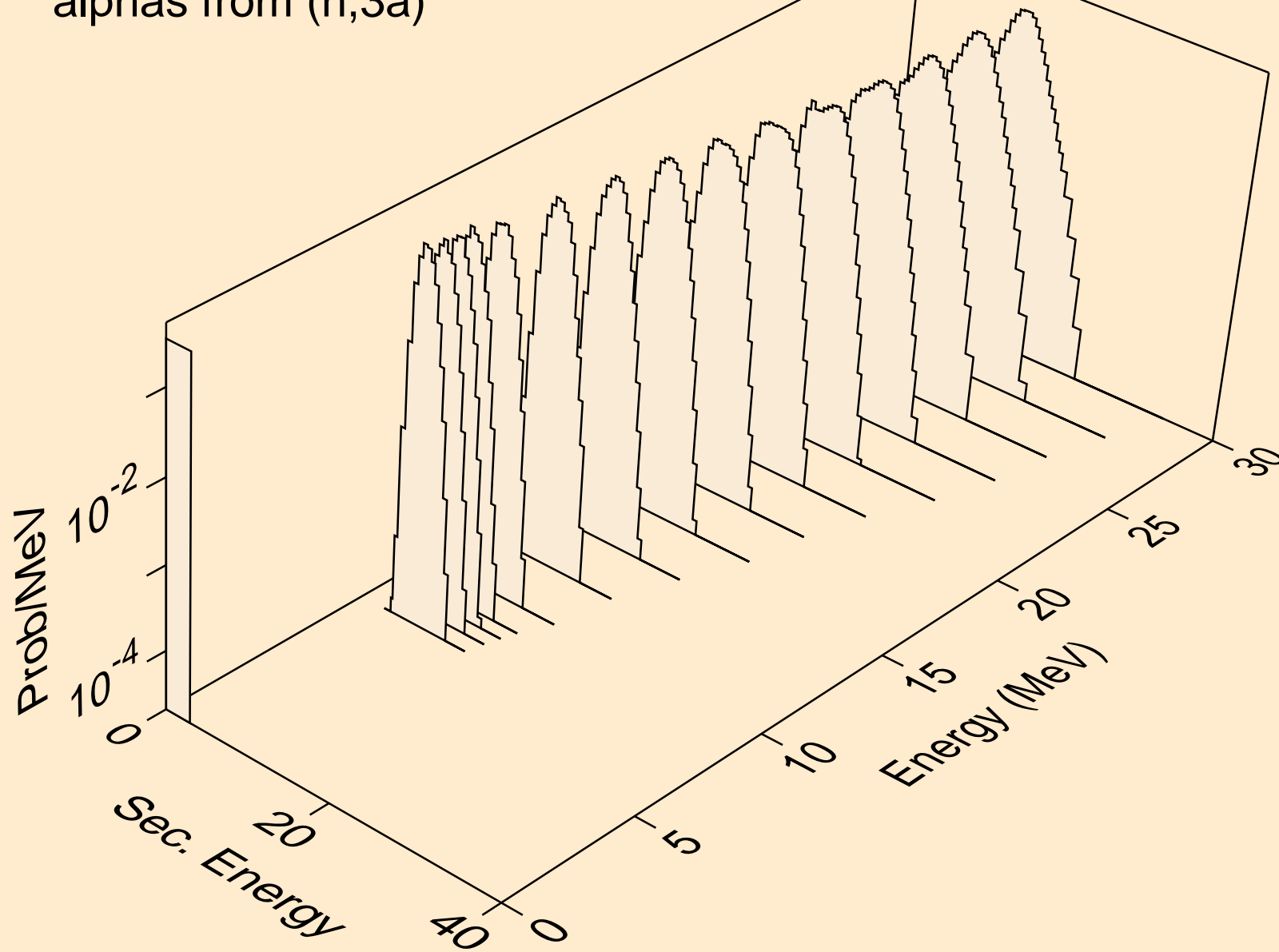

I114 NEUTRON ACER TENDL-2021 LIBRARY; T=293.6K
alphas from (n,pa)

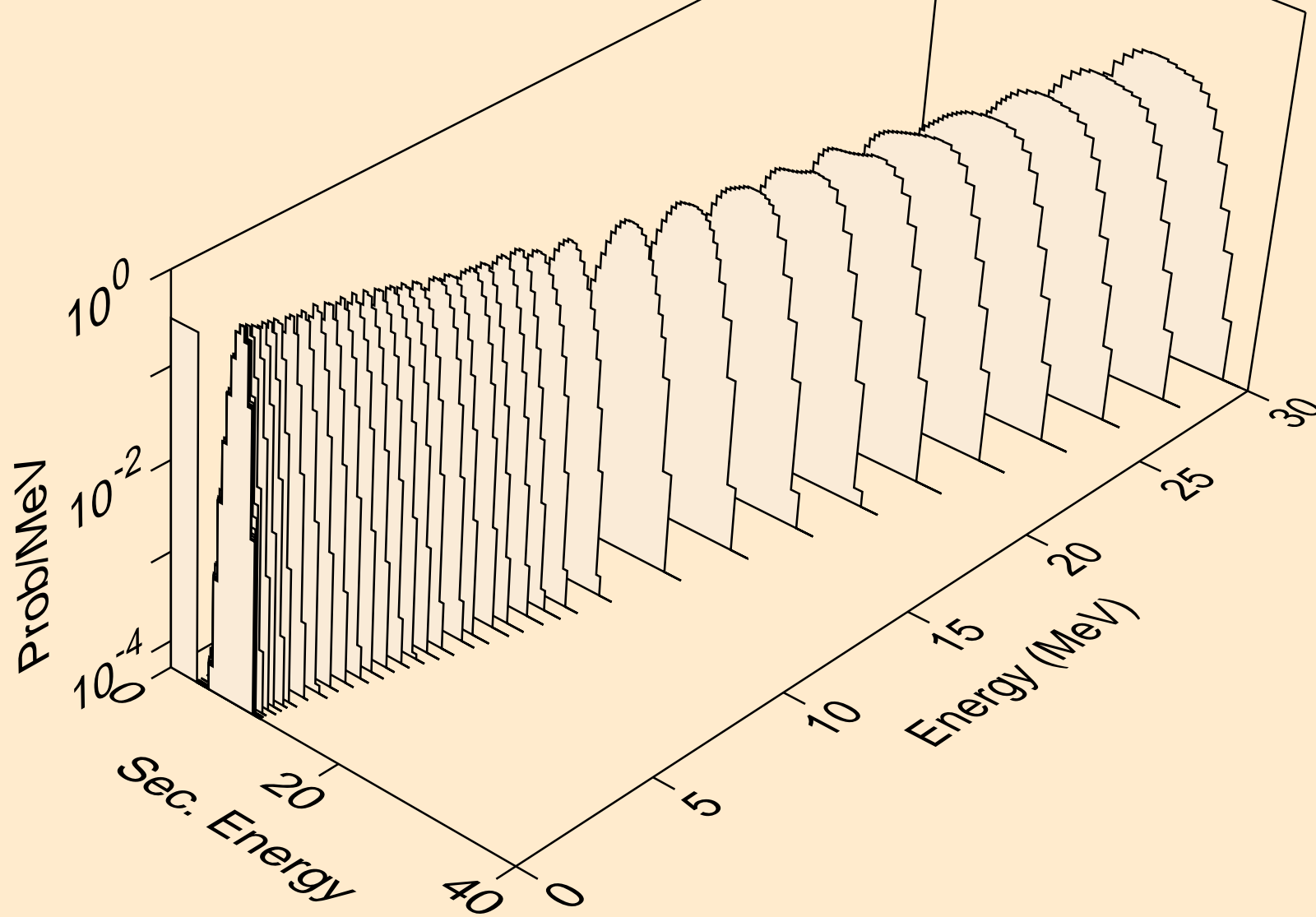

I114 NEUTRON ACER TENDL-2021 LIBRARY; T=293.6K
alphas from (n,t2a)

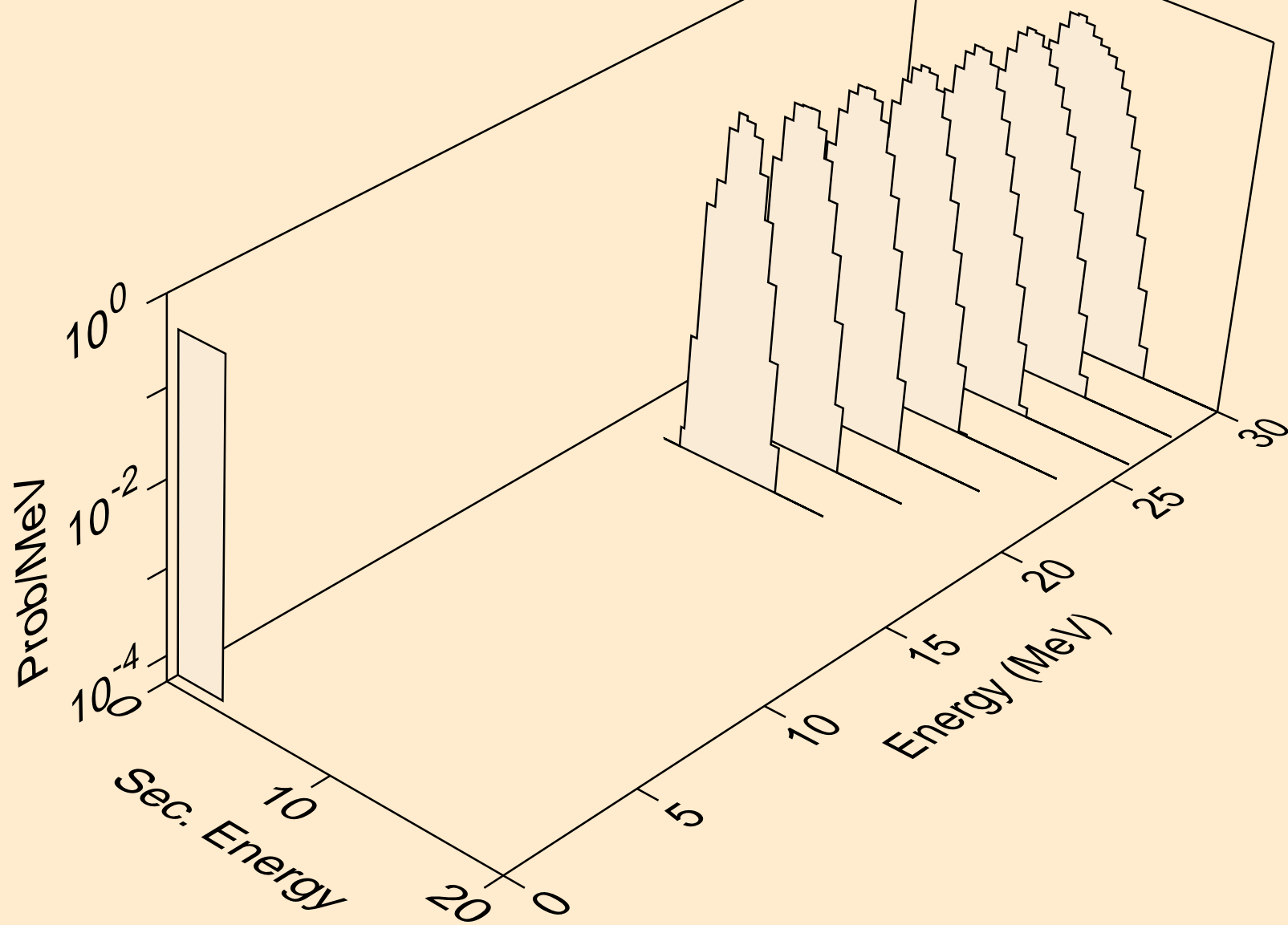

I114 NEUTRON ACER TENDL-2021 LIBRARY; T=293.6K
alphas from (n,d2a)

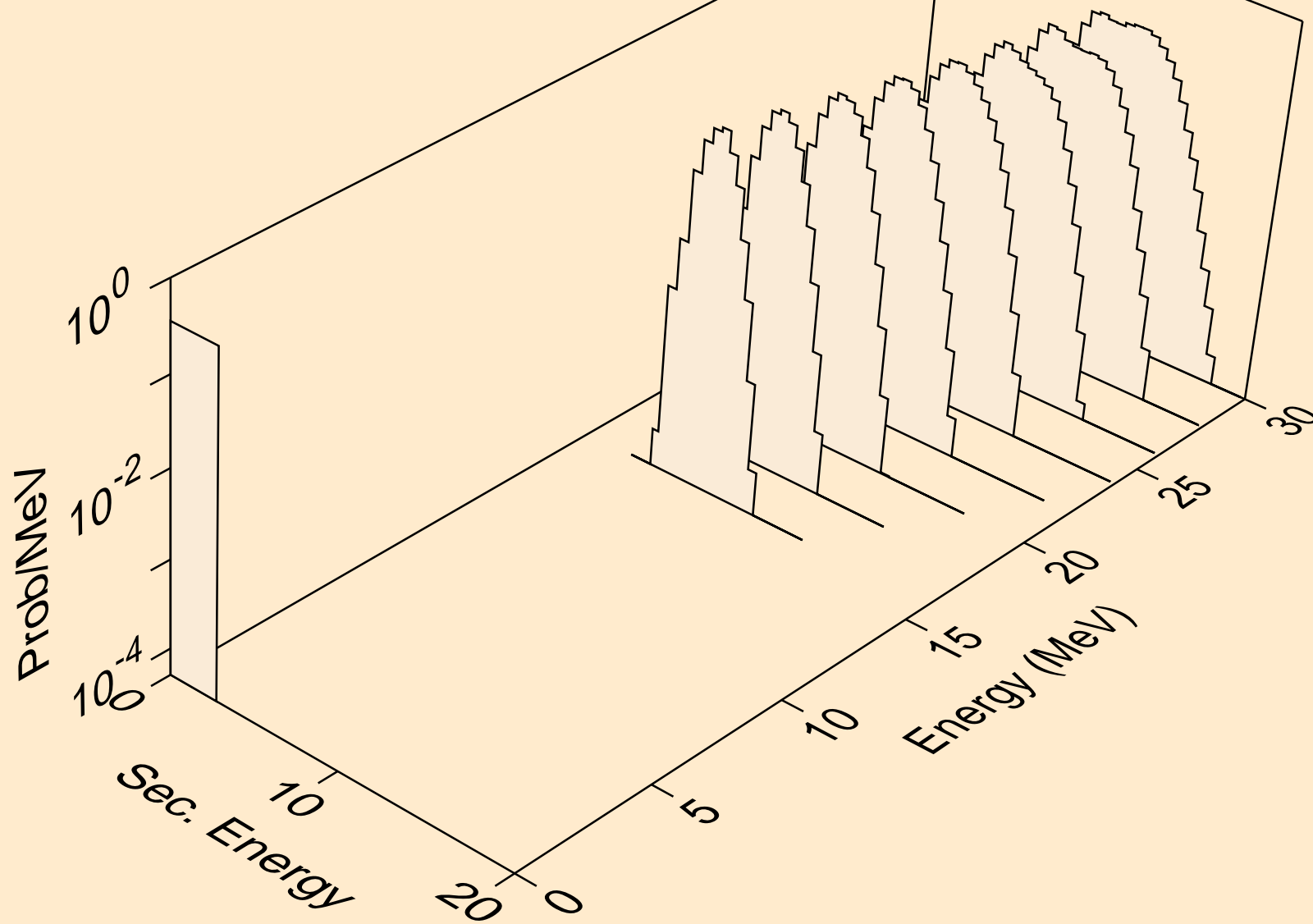

I114 NEUTRON ACER TENDL-2021 LIBRARY; T=293.6K
alphas from (n,da)

