

# I117 NEUTRON ACER TENDL-2021 LIBRARY; T=293.6K

## Principal cross sections

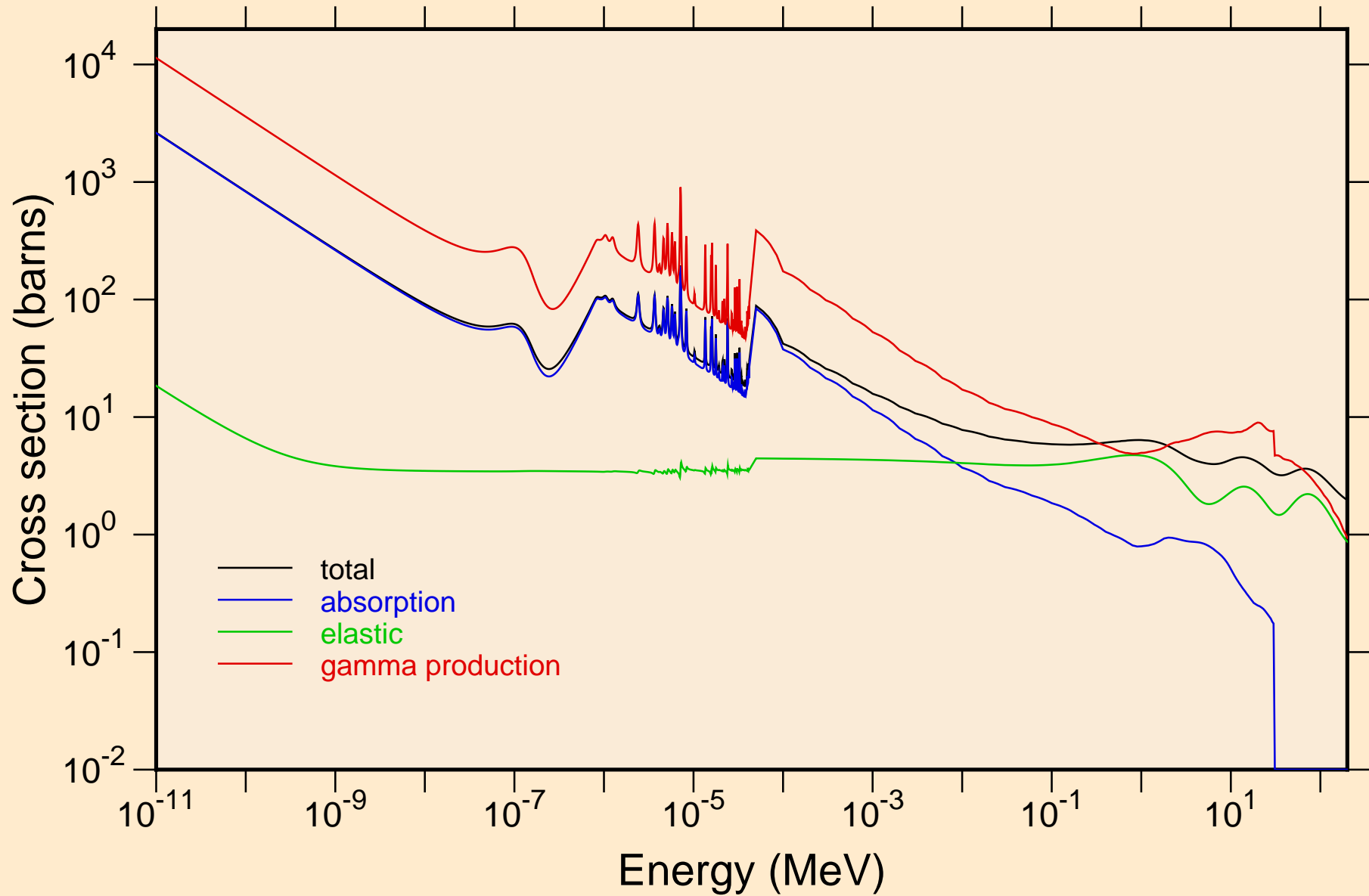

I117 NEUTRON ACER TENDL-2021 LIBRARY; T=293.6K  
resonance total cross section

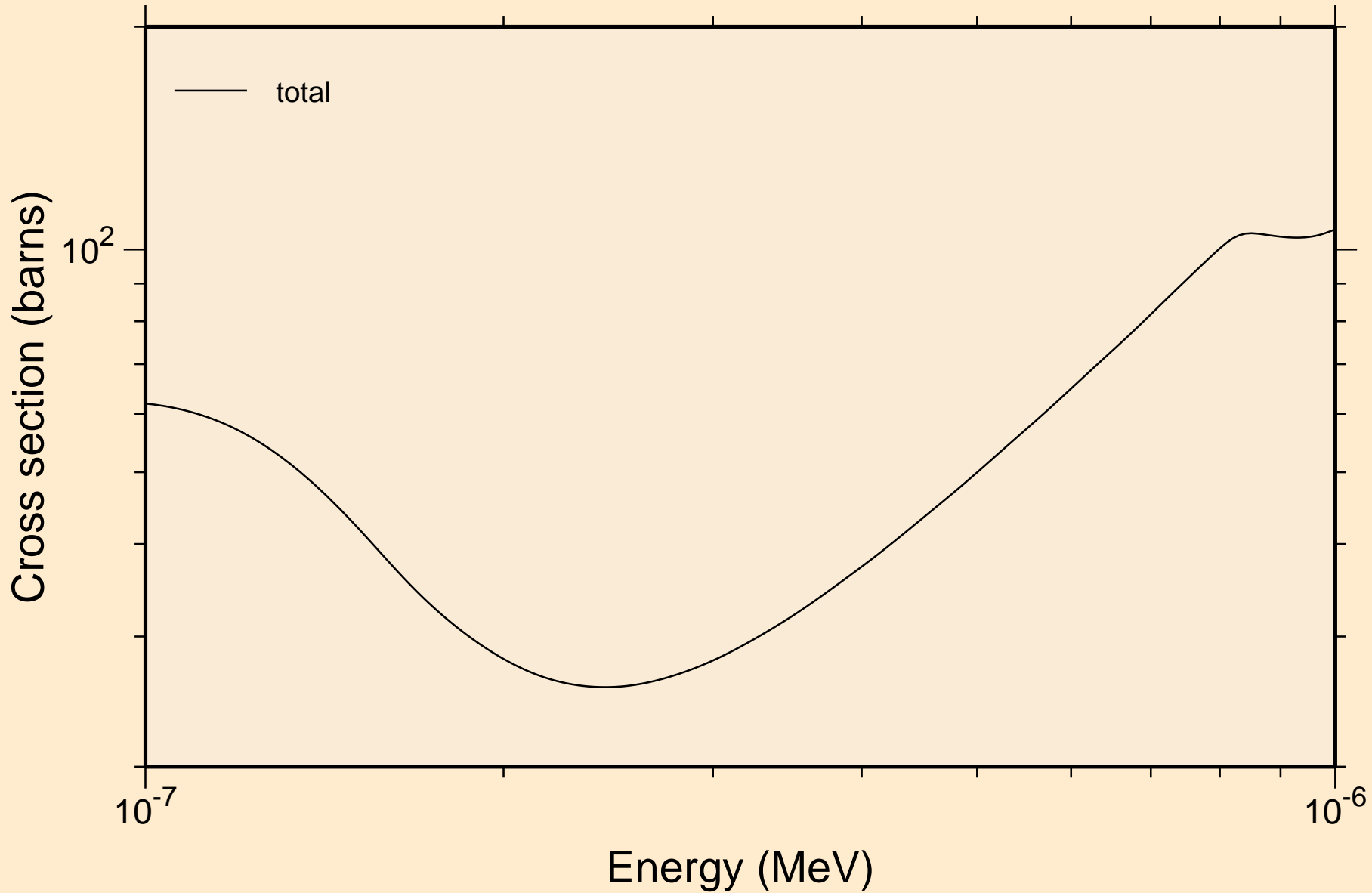

I117 NEUTRON ACER TENDL-2021 LIBRARY; T=293.6K  
resonance total cross section

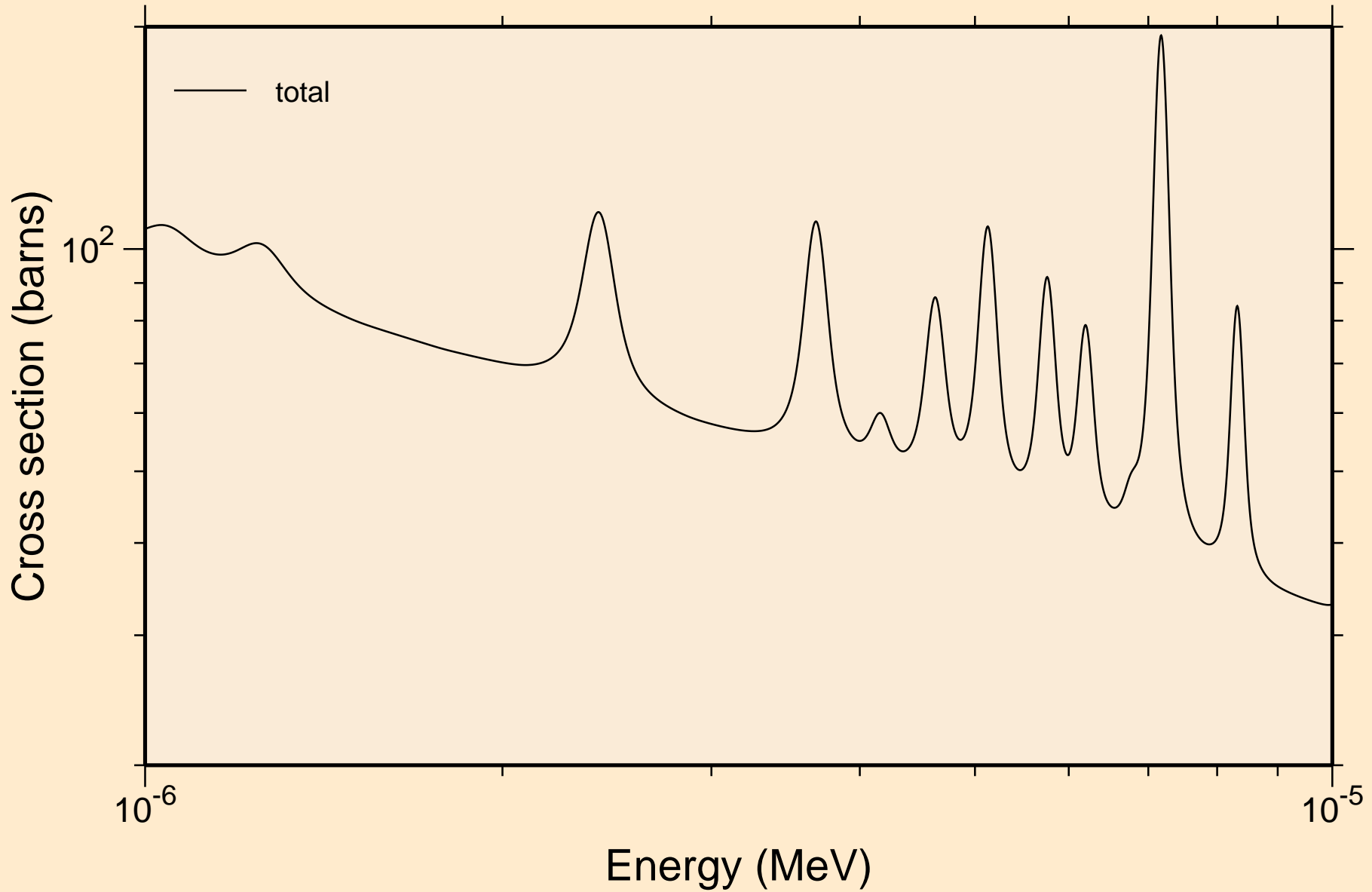

I117 NEUTRON ACER TENDL-2021 LIBRARY; T=293.6K  
resonance total cross section

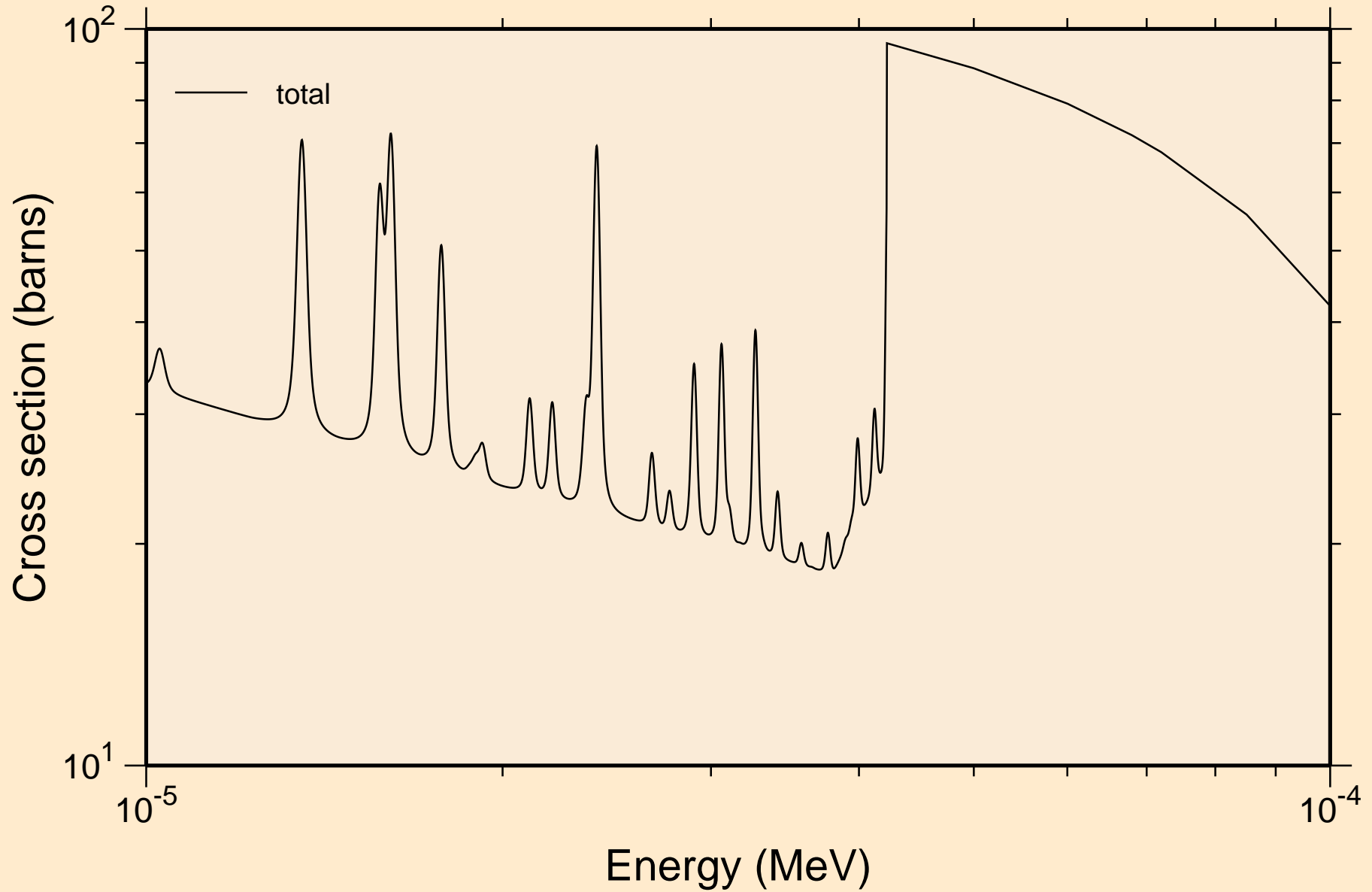

I117 NEUTRON ACER TENDL-2021 LIBRARY; T=293.6K  
resonance total cross section

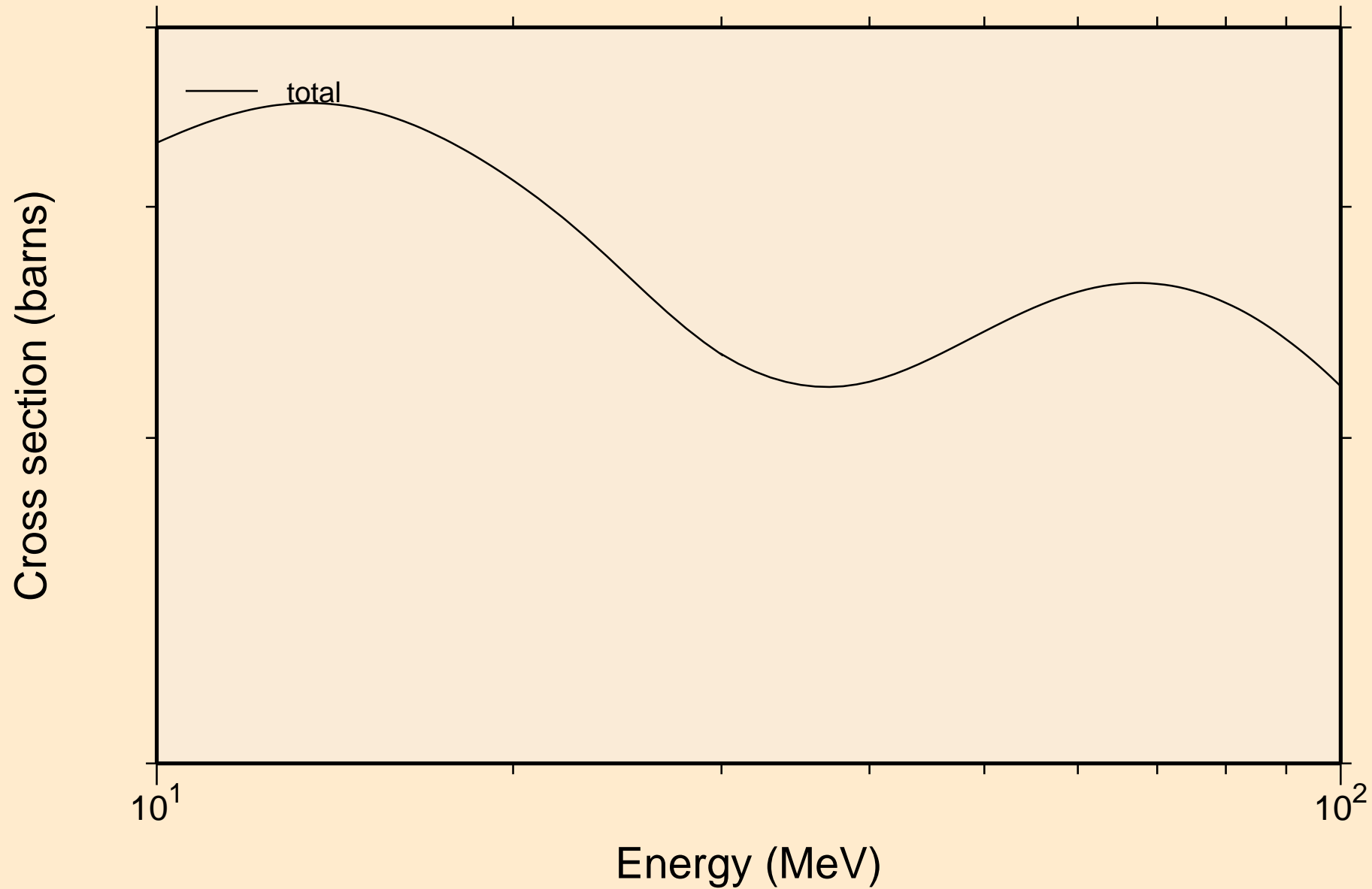

I117 NEUTRON ACER TENDL-2021 LIBRARY; T=293.6K  
resonance absorption cross sections

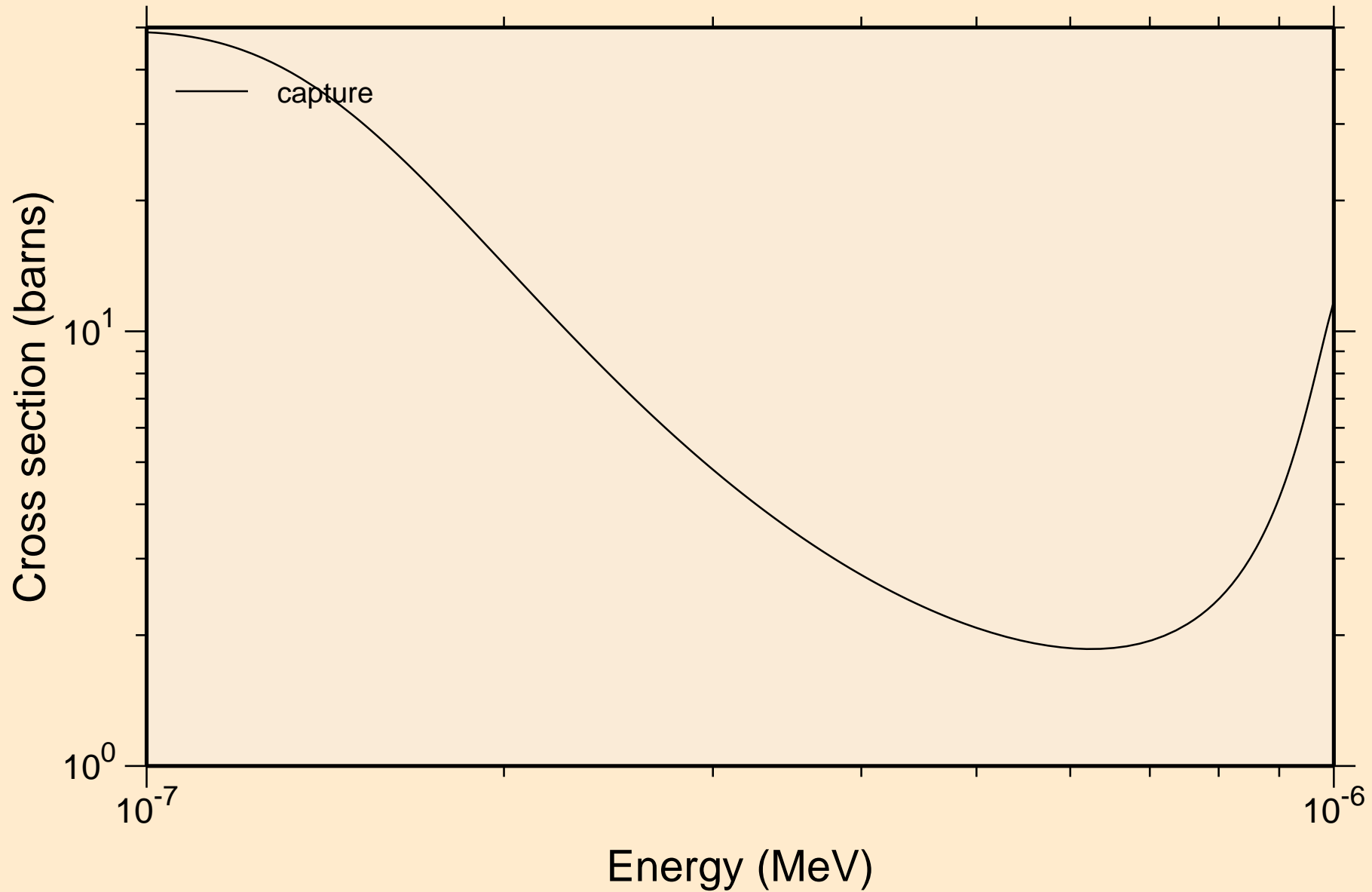

I117 NEUTRON ACER TENDL-2021 LIBRARY; T=293.6K  
resonance absorption cross sections

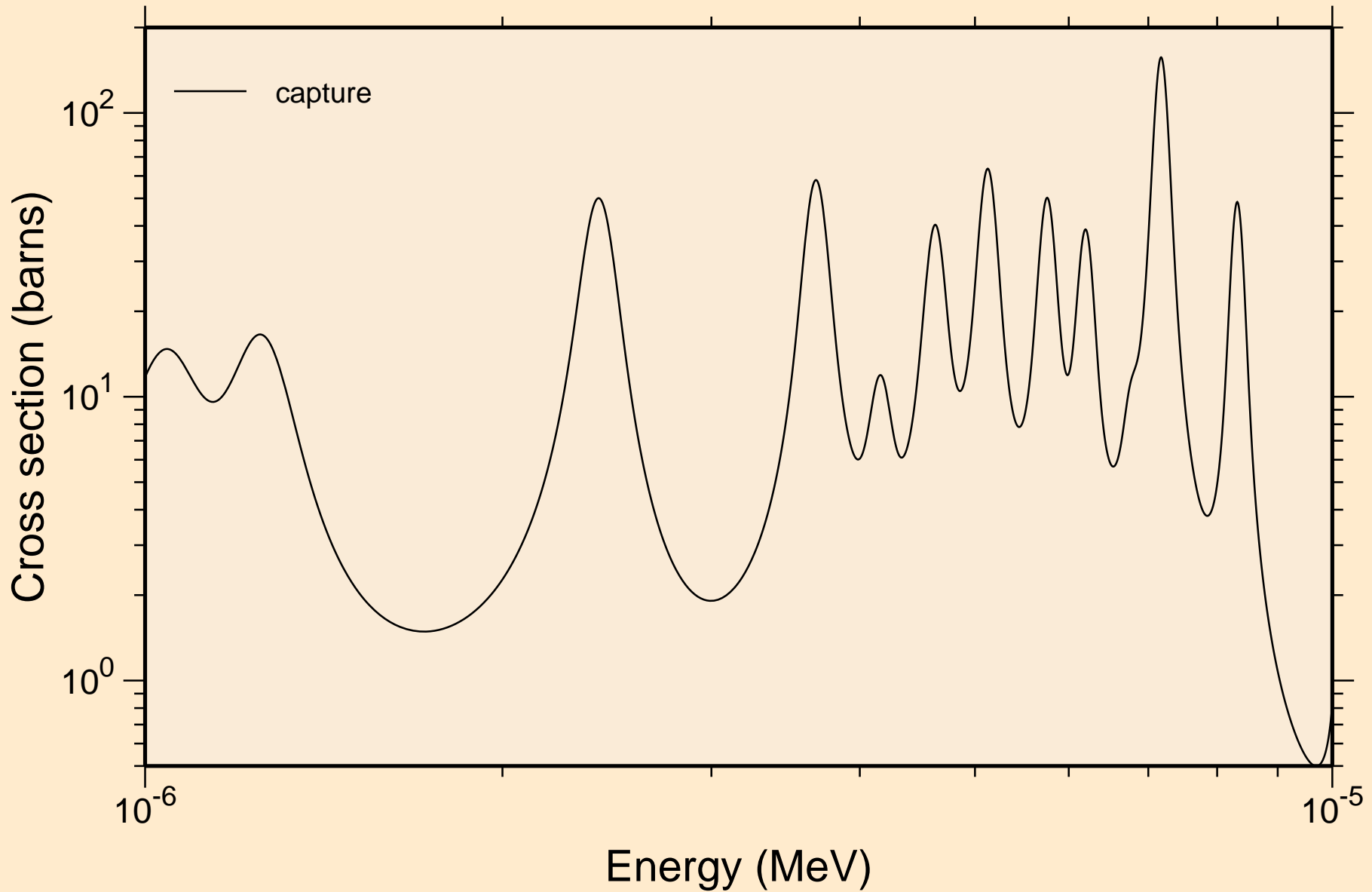

I117 NEUTRON ACER TENDL-2021 LIBRARY; T=293.6K  
resonance absorption cross sections

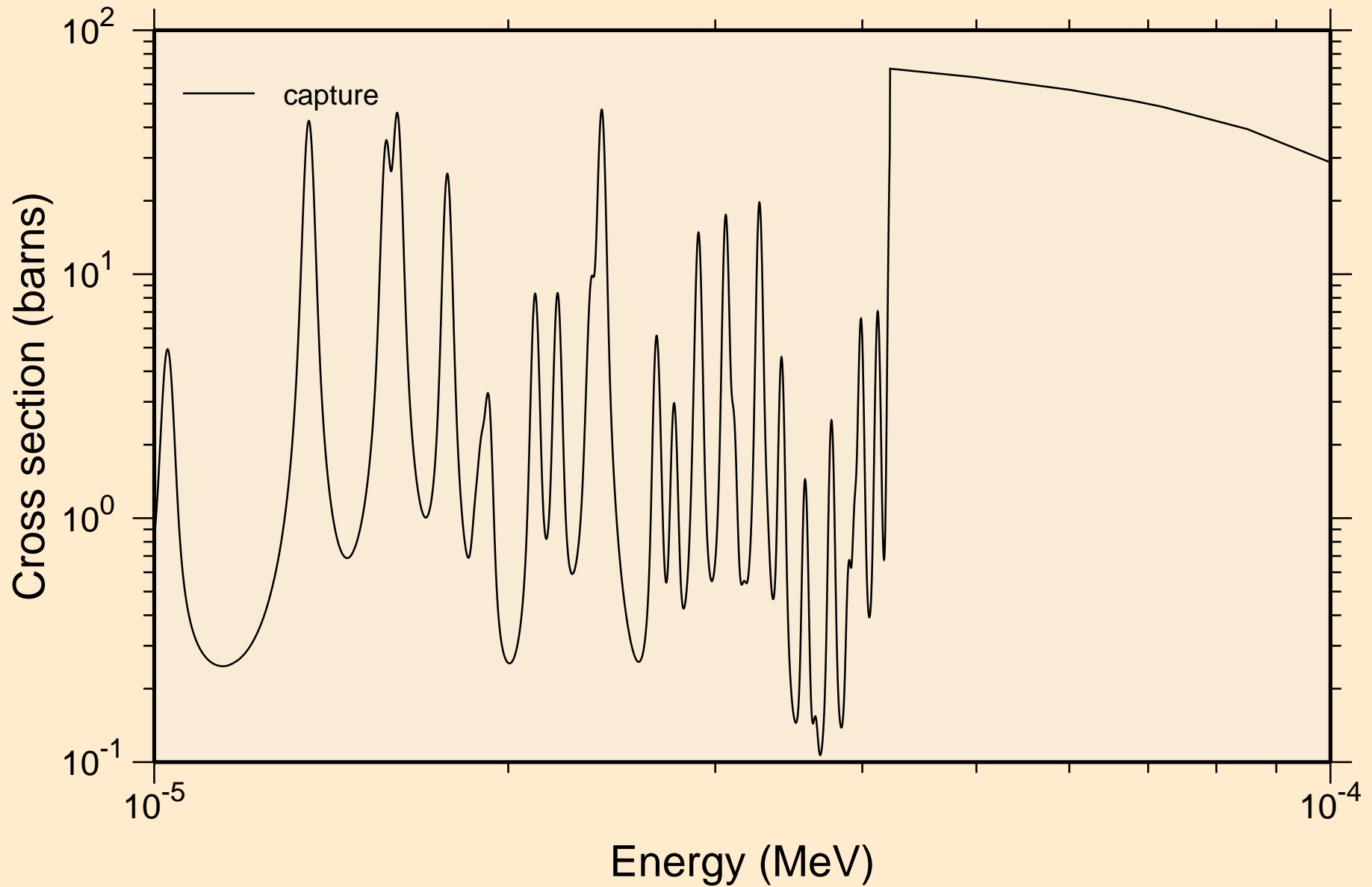



I117 NEUTRON ACER TENDL-2021 LIBRARY; T=293.6K  
resonance absorption cross sections

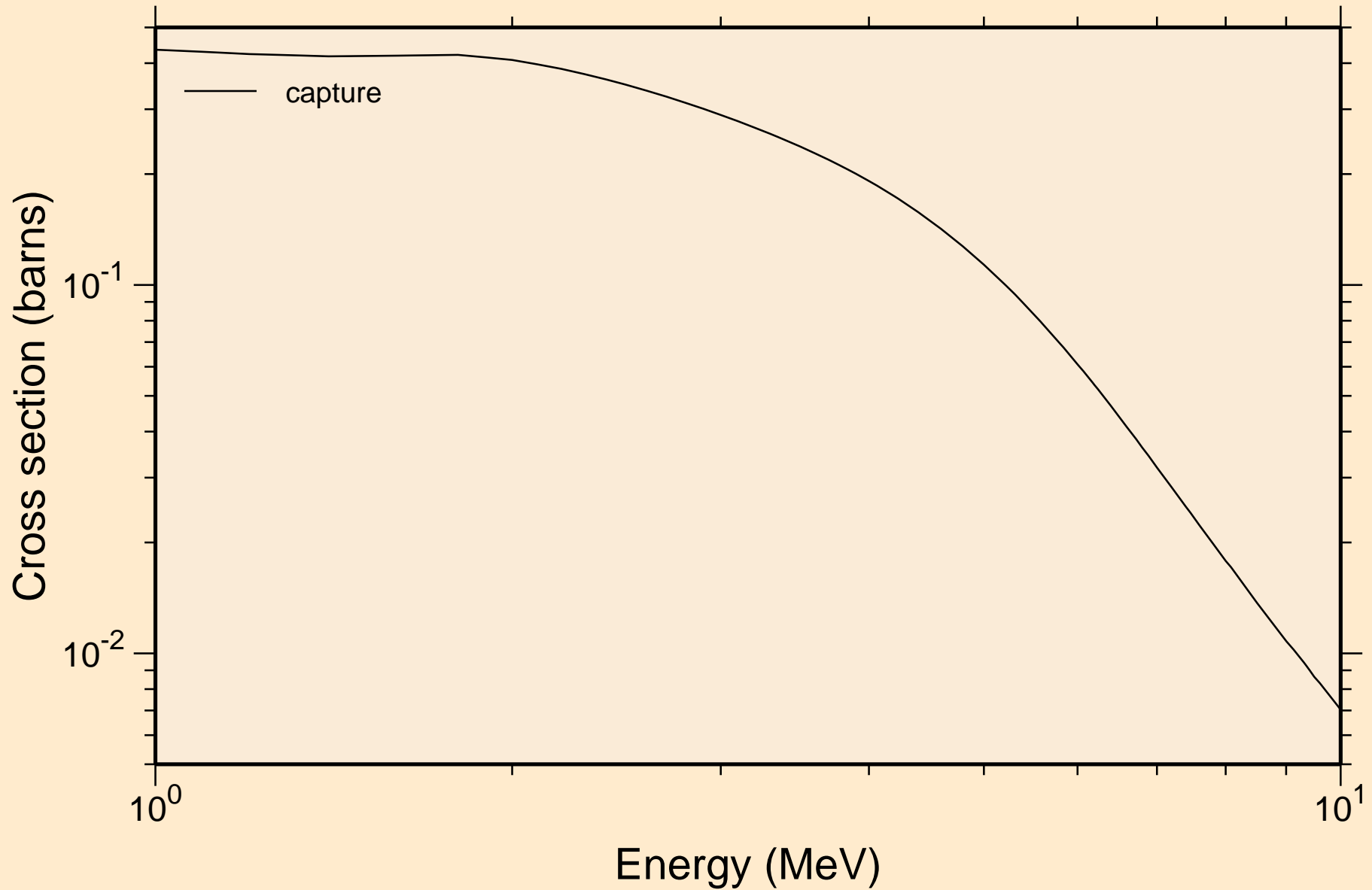

# I117 NEUTRON ACER TENDL-2021 LIBRARY; T=293.6K

## Heating

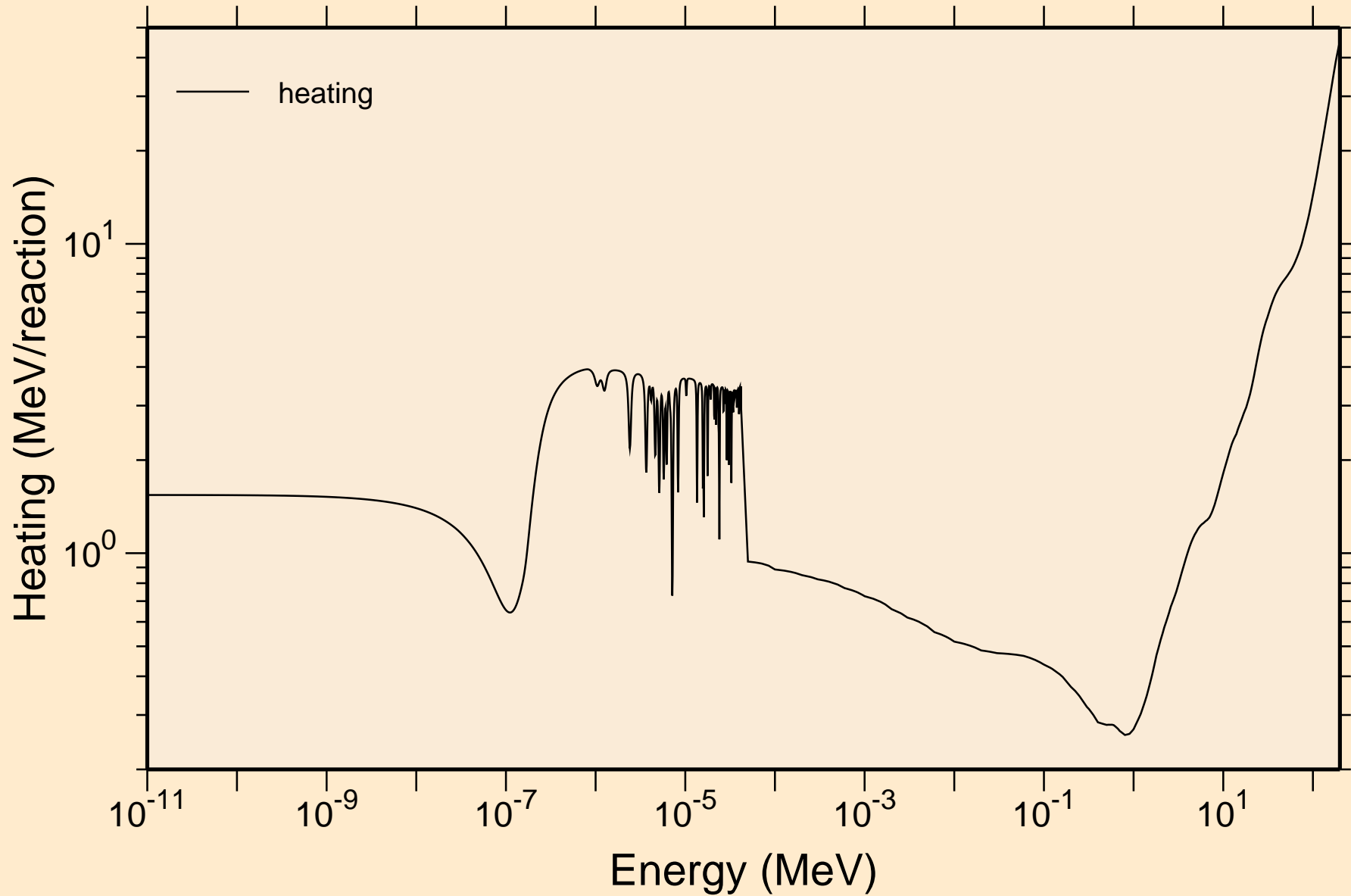

I117 NEUTRON ACER TENDL-2021 LIBRARY; T=293.6K  
Damage

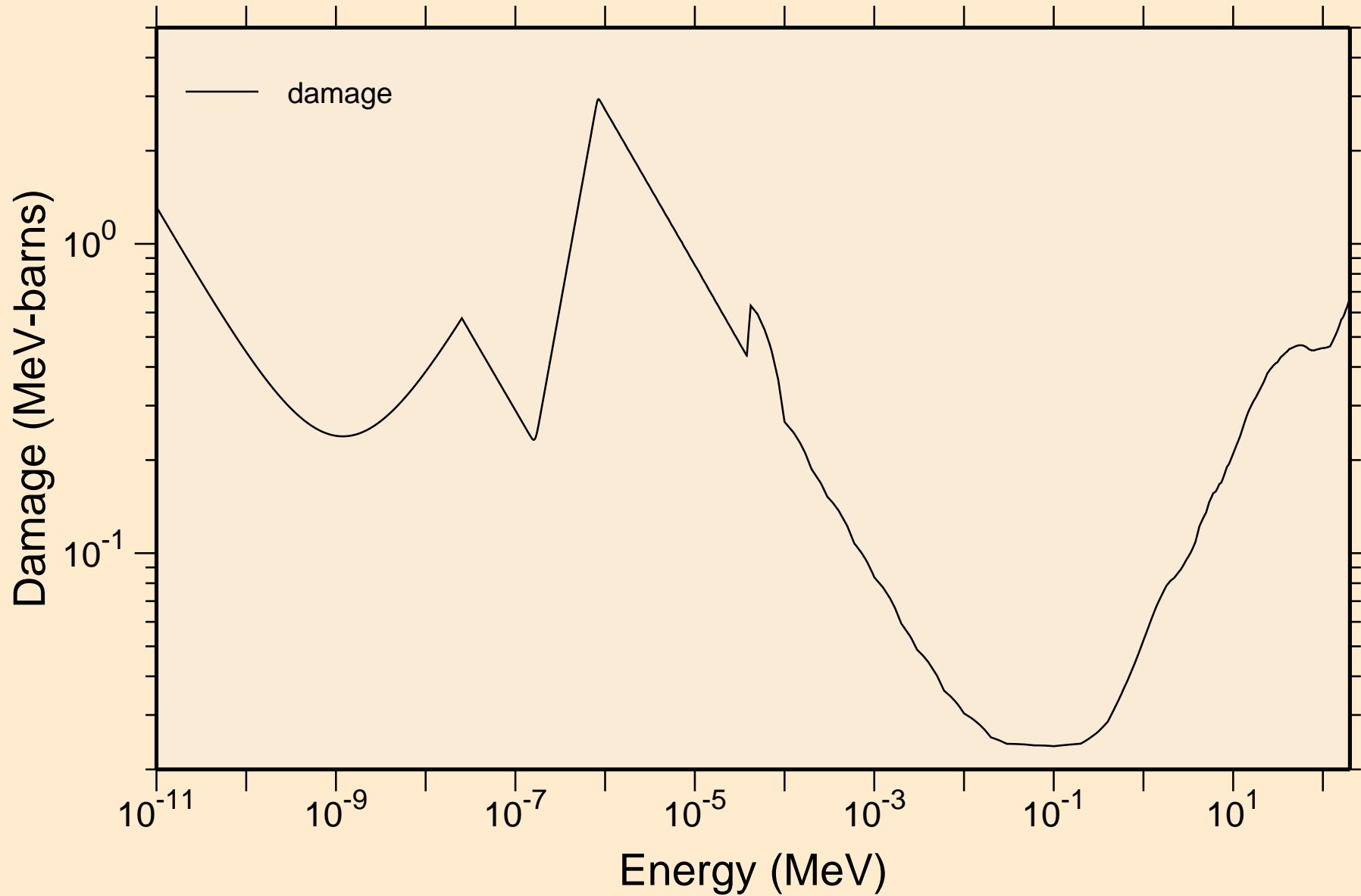

# I117 NEUTRON ACER TENDL-2021 LIBRARY; T=293.6K

## Non-threshold reactions

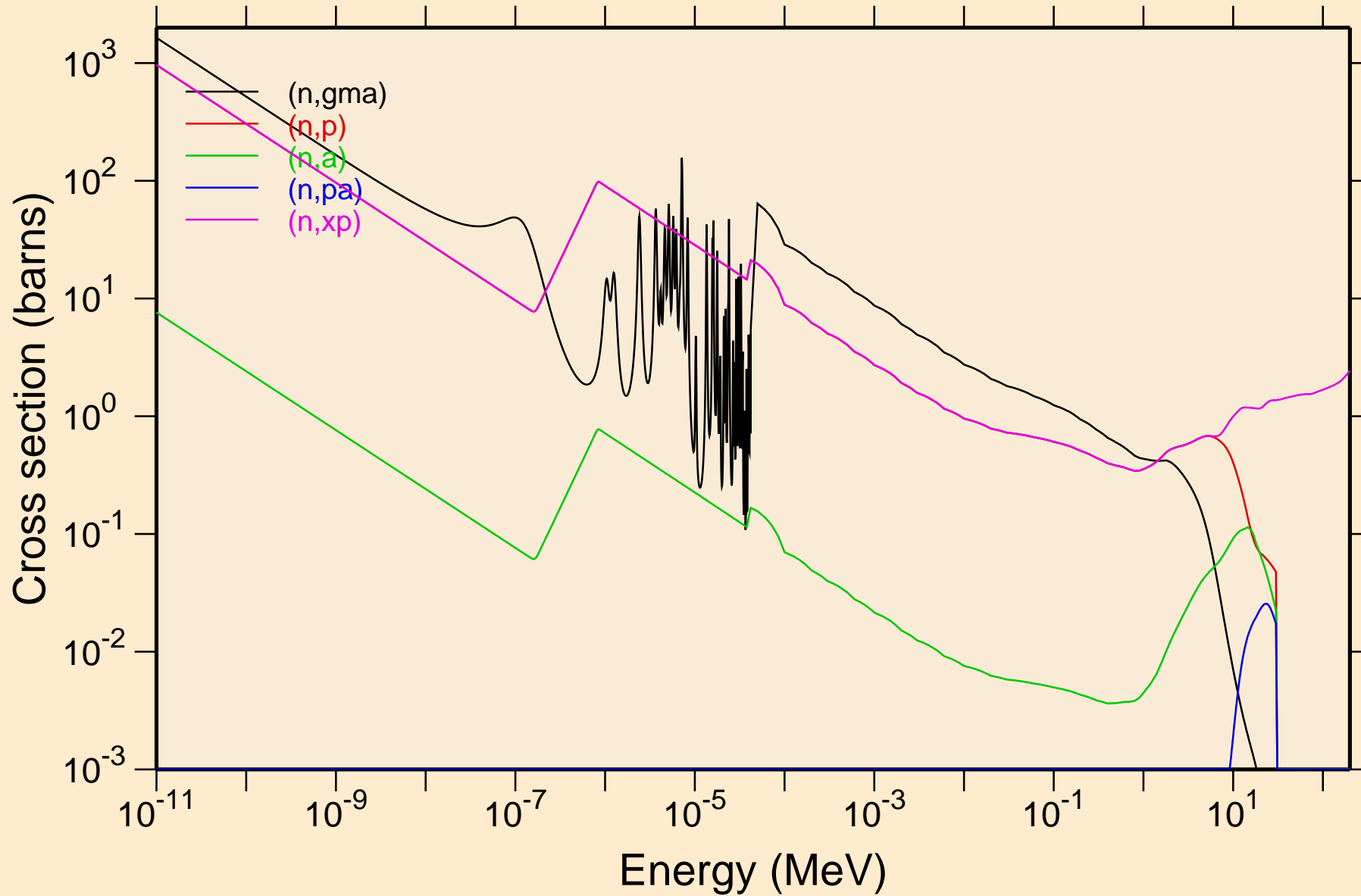

I117 NEUTRON ACER TENDL-2021 LIBRARY; T=293.6K  
Non-threshold reactions

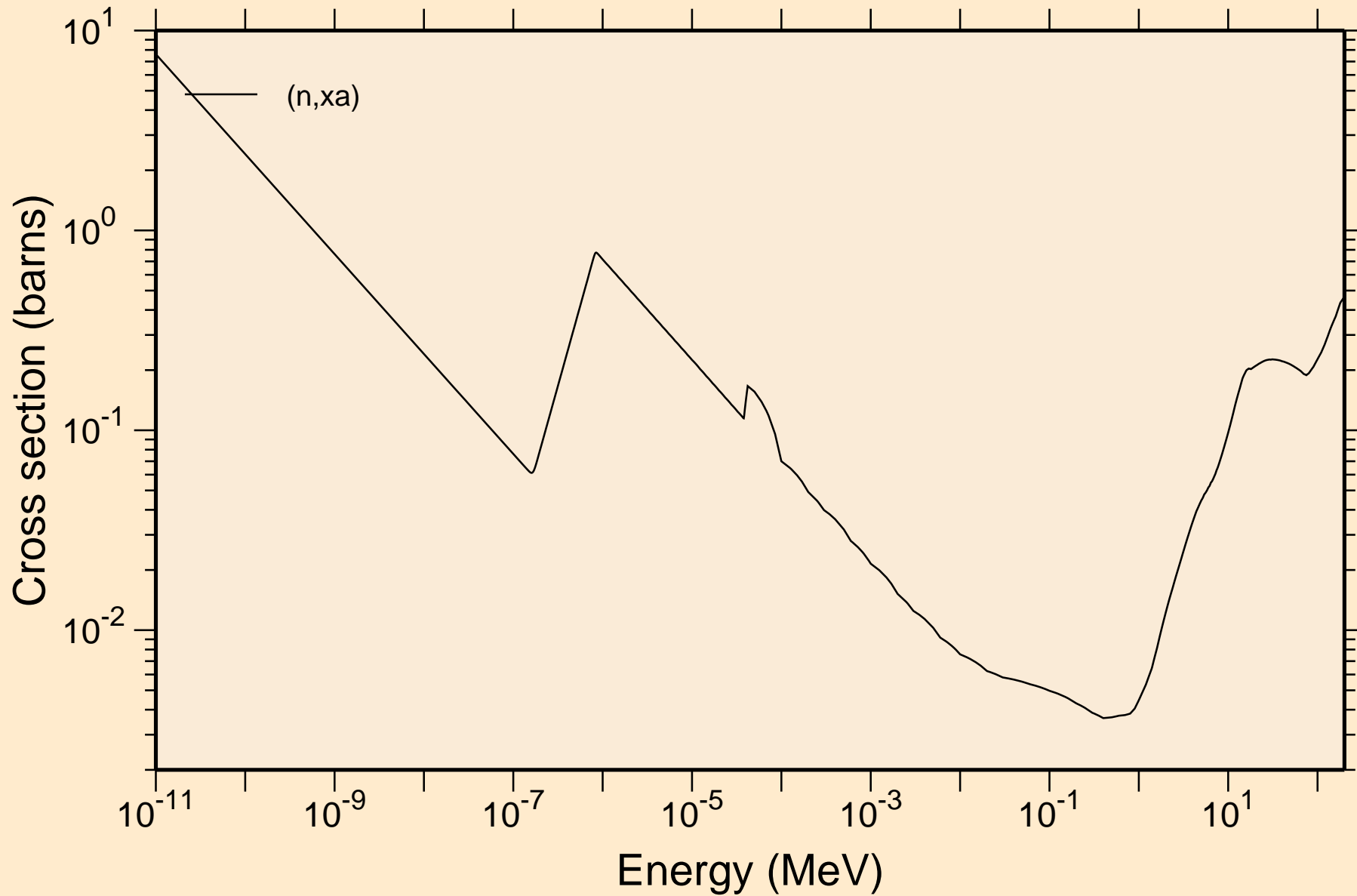

# I117 NEUTRON ACER TENDL-2021 LIBRARY; T=293.6K

## Principal cross sections

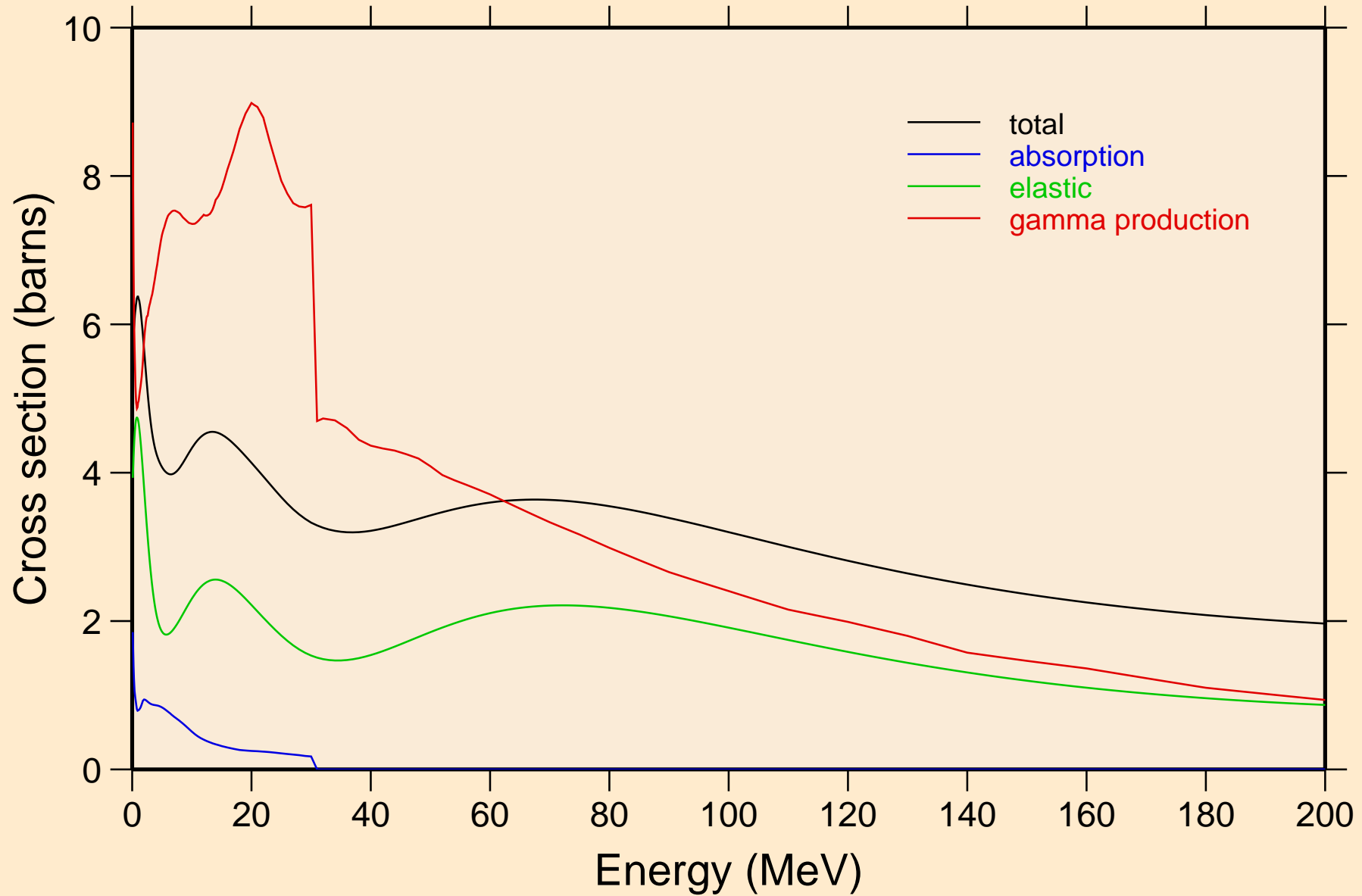

I117 NEUTRON ACER TENDL-2021 LIBRARY; T=293.6K

Heating

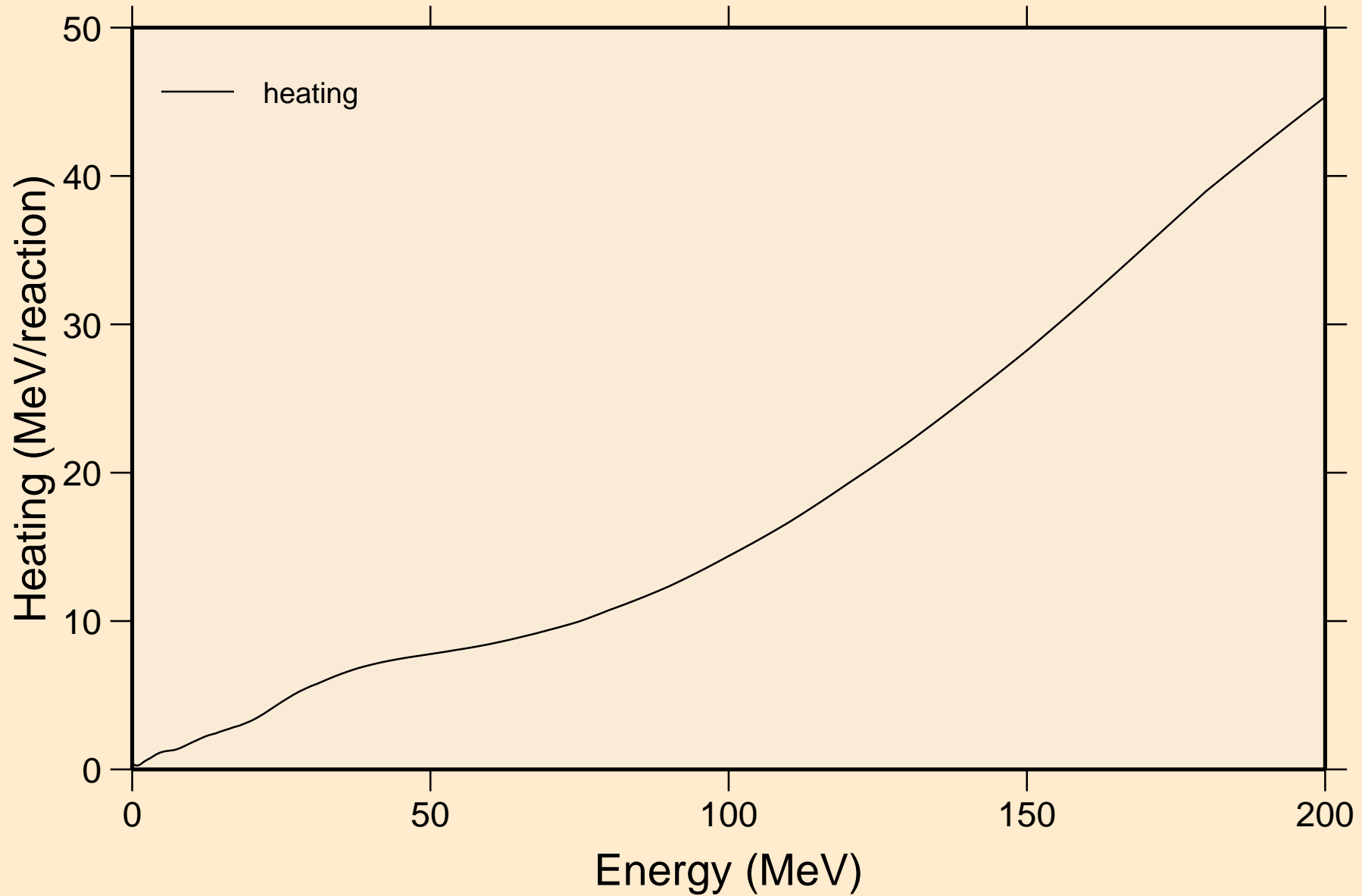

I117 NEUTRON ACER TENDL-2021 LIBRARY; T=293.6K  
Damage

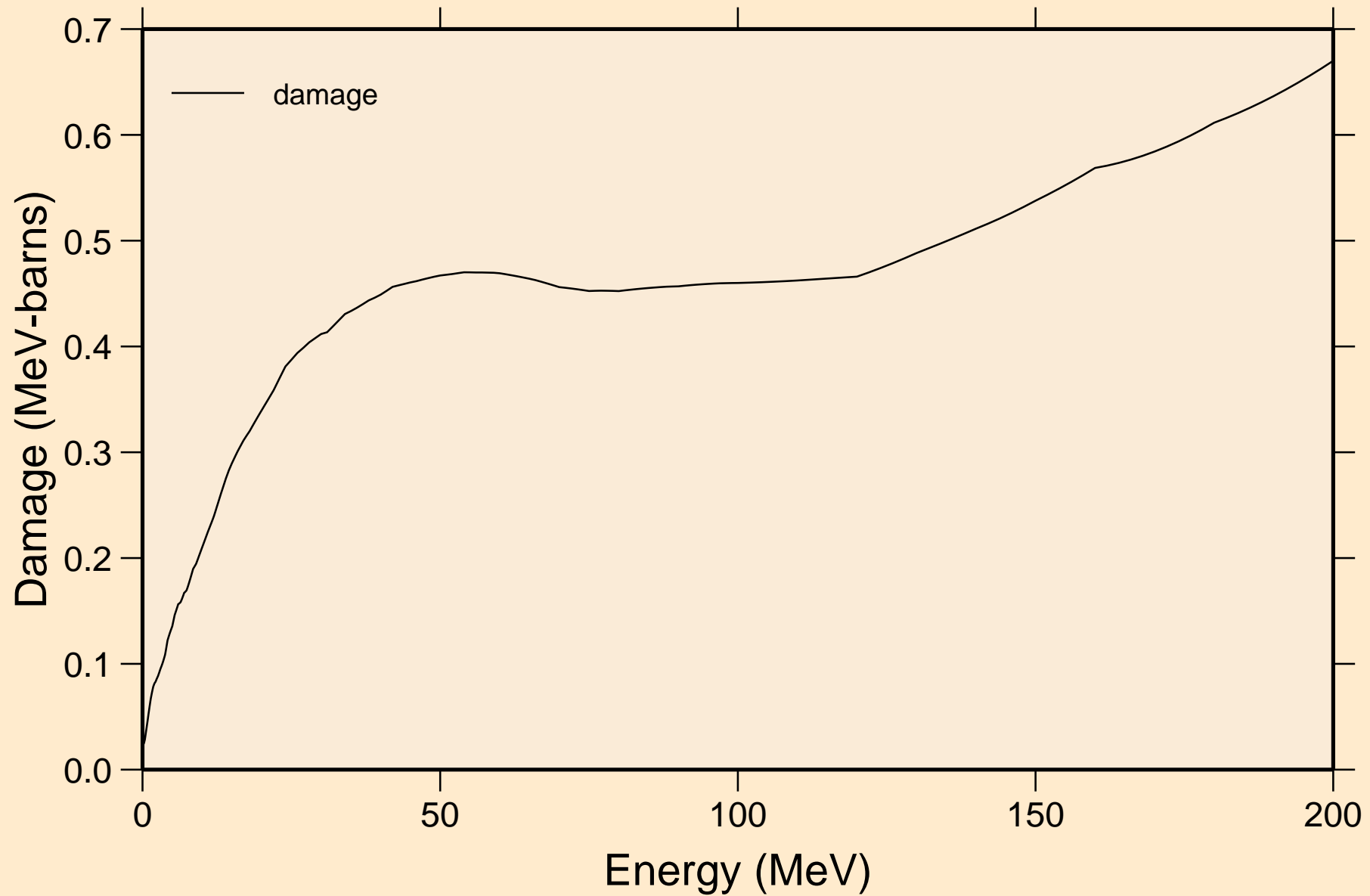



# I117 NEUTRON ACER TENDL-2021 LIBRARY; T=293.6K

## Non-threshold reactions

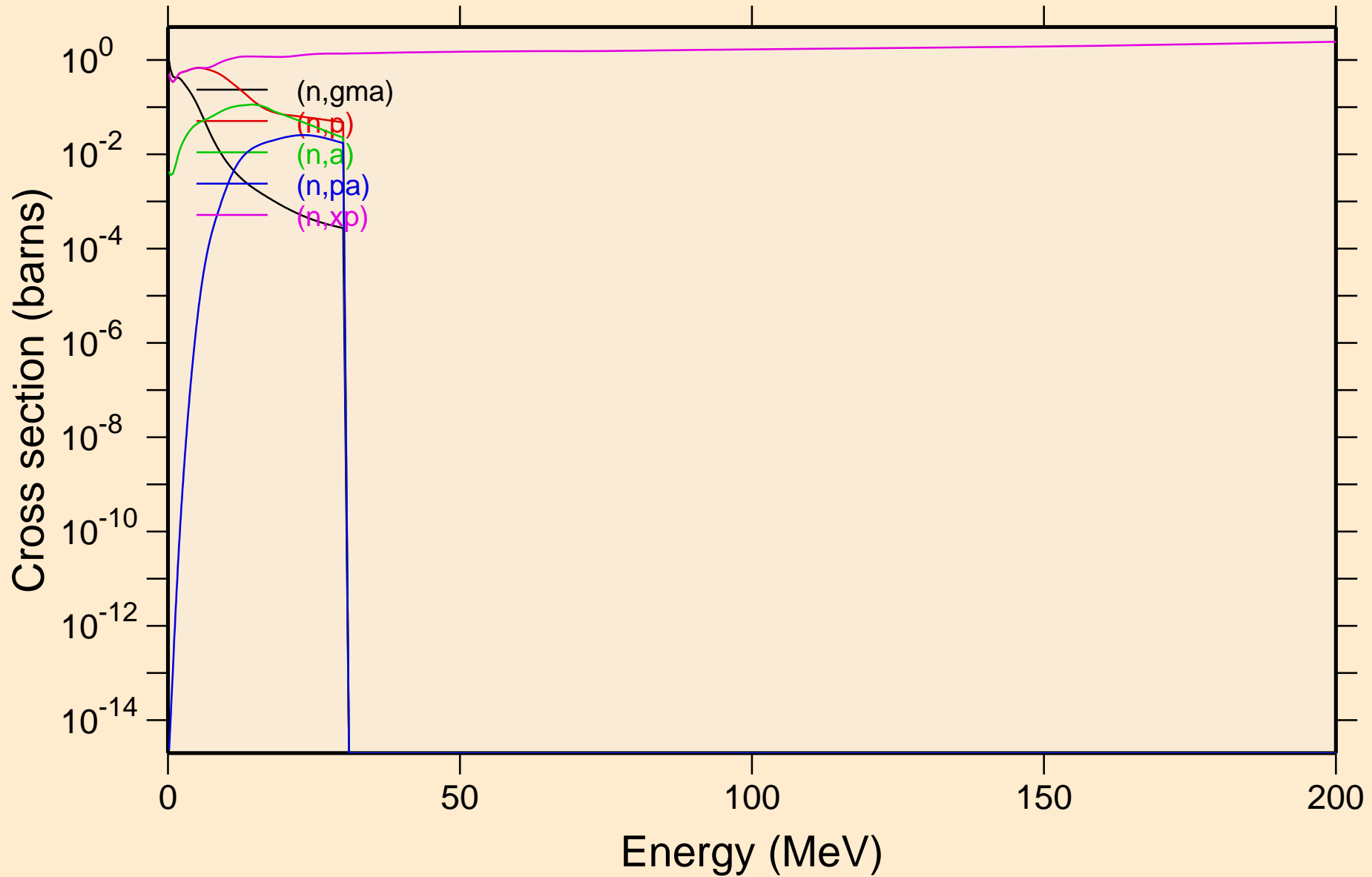

I117 NEUTRON ACER TENDL-2021 LIBRARY; T=293.6K  
Non-threshold reactions

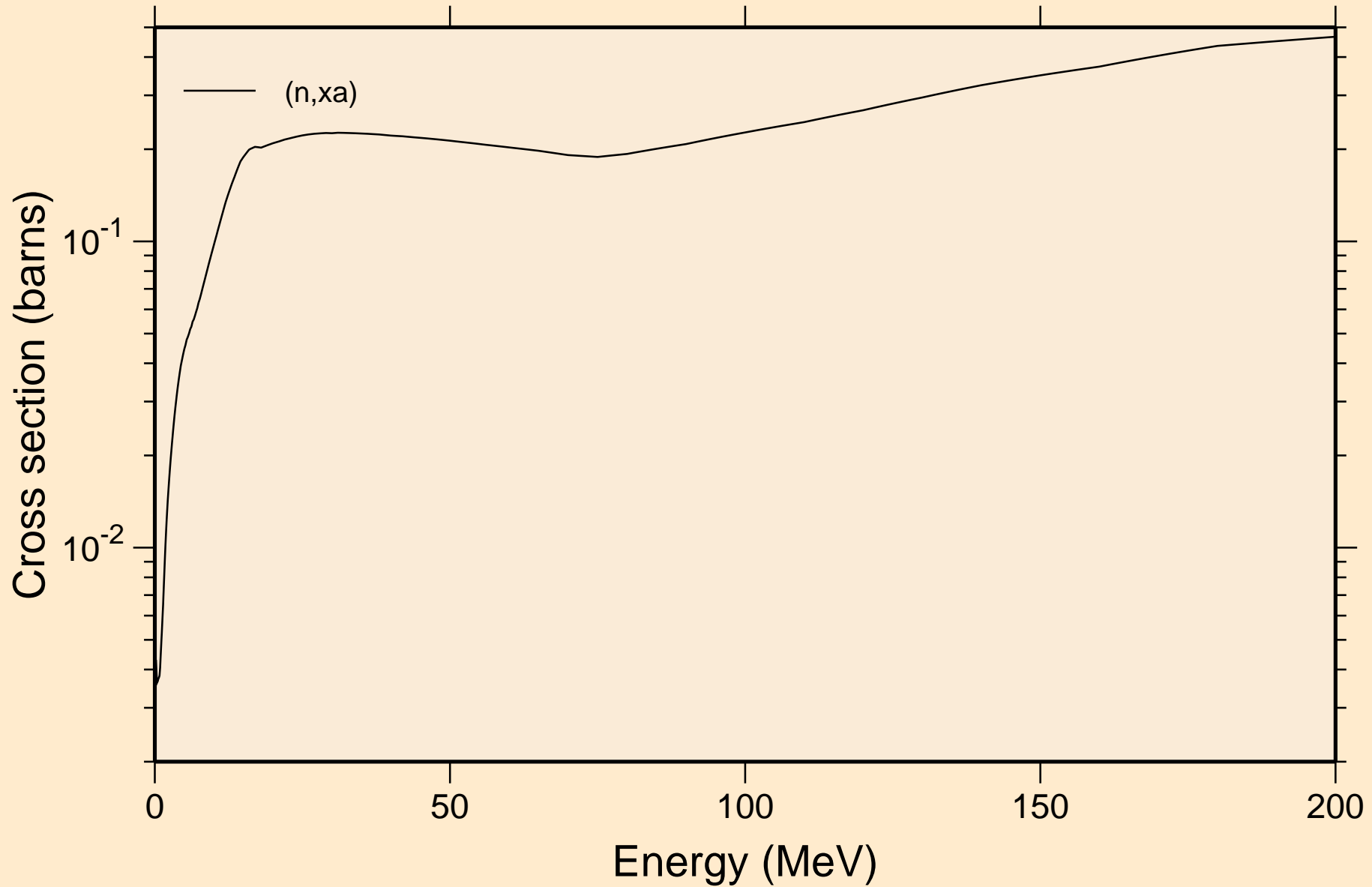

I117 NEUTRON ACER TENDL-2021 LIBRARY; T=293.6K  
Inelastic levels

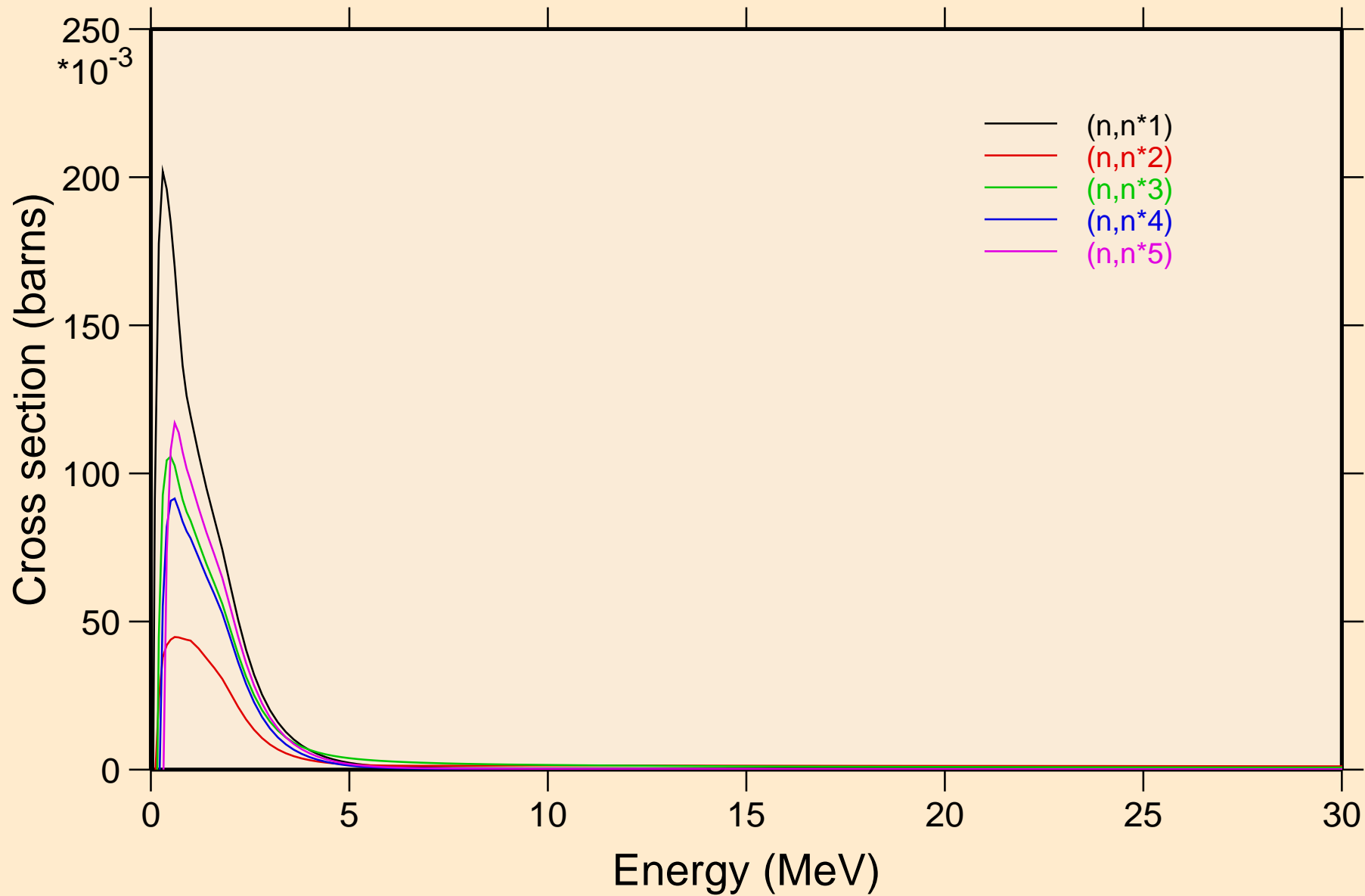

I117 NEUTRON ACER TENDL-2021 LIBRARY; T=293.6K  
Inelastic levels

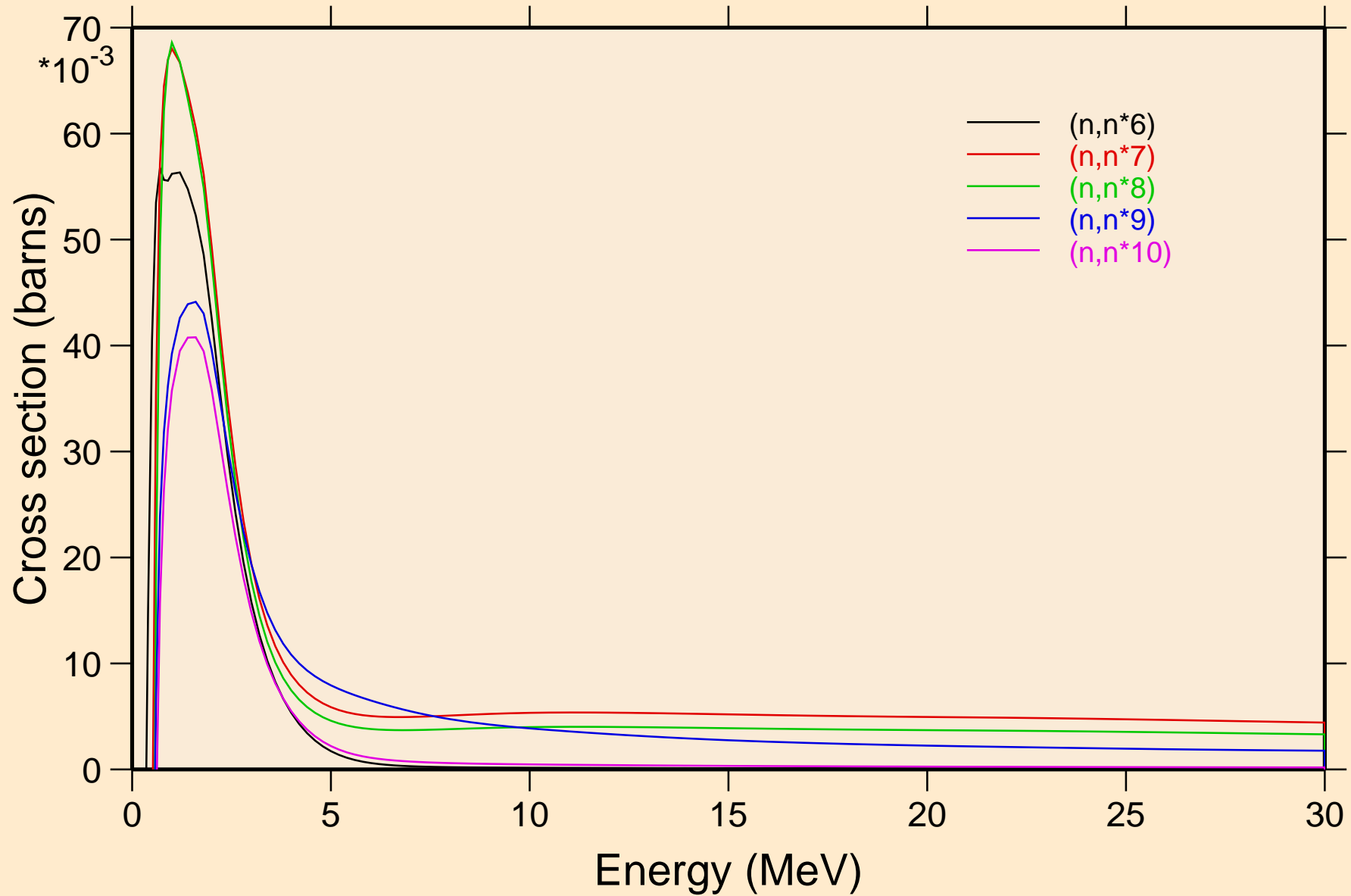

I117 NEUTRON ACER TENDL-2021 LIBRARY; T=293.6K  
Inelastic levels

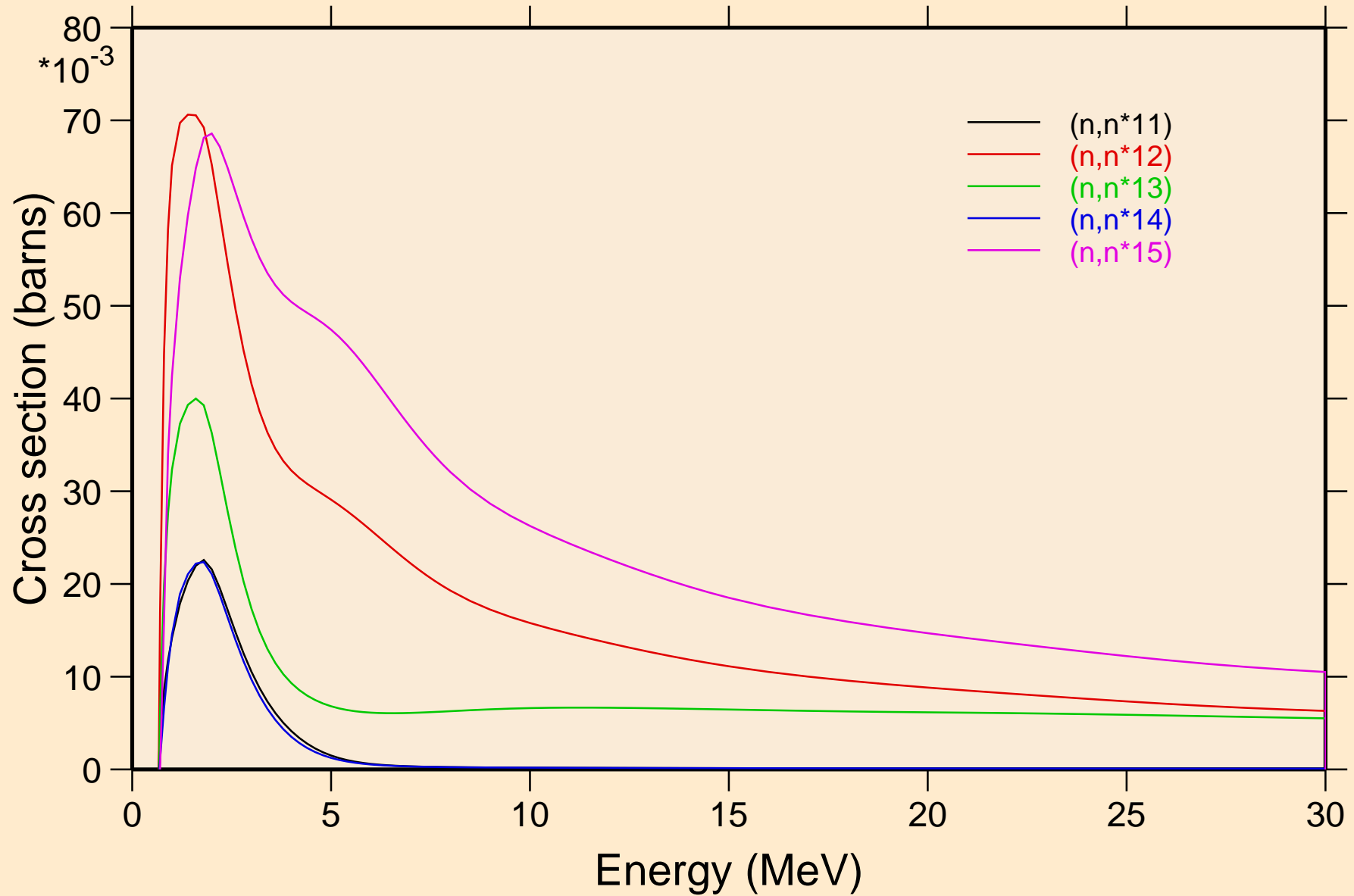

I117 NEUTRON ACER TENDL-2021 LIBRARY; T=293.6K  
Inelastic levels

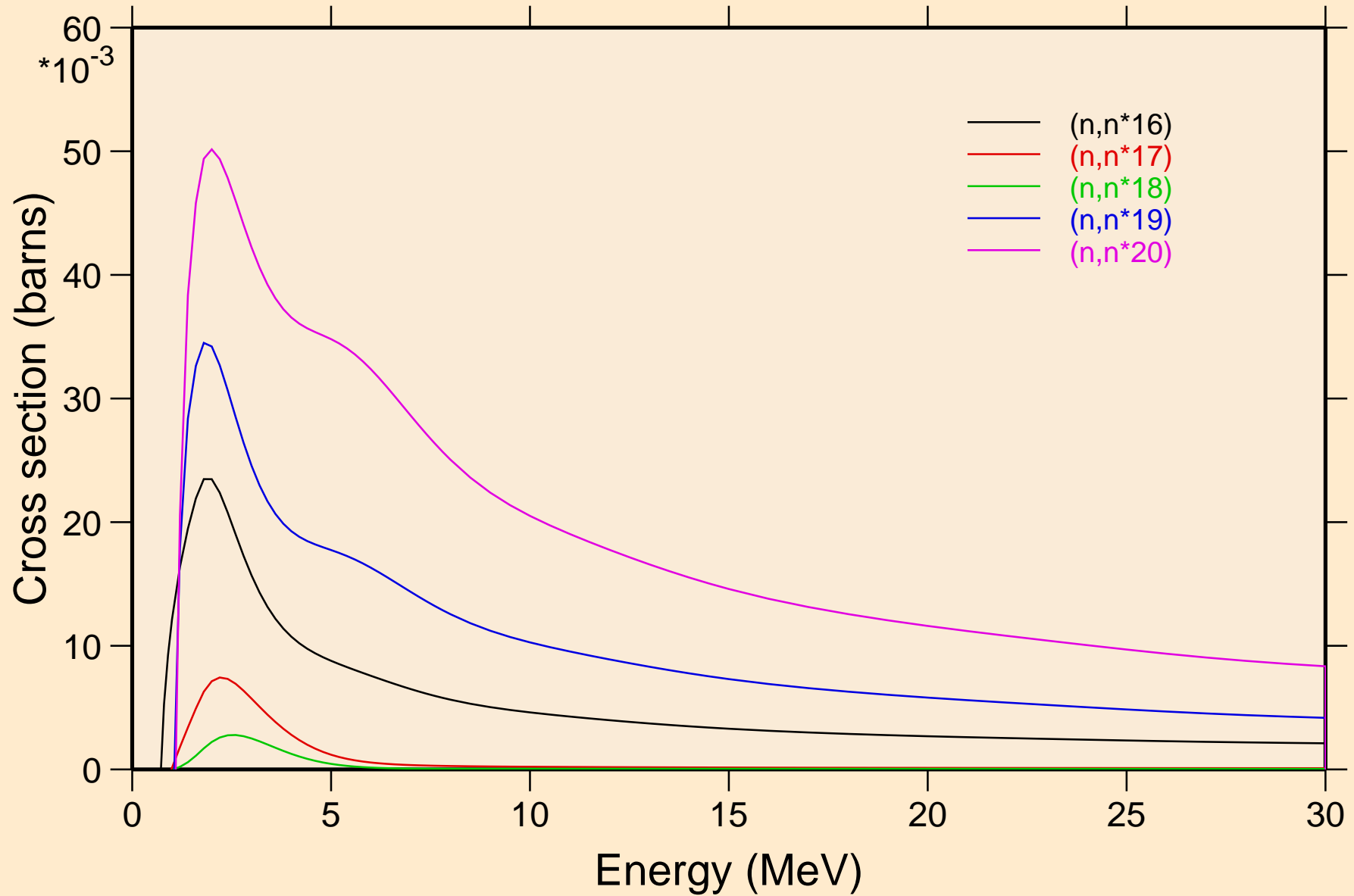

I117 NEUTRON ACER TENDL-2021 LIBRARY; T=293.6K  
Inelastic levels

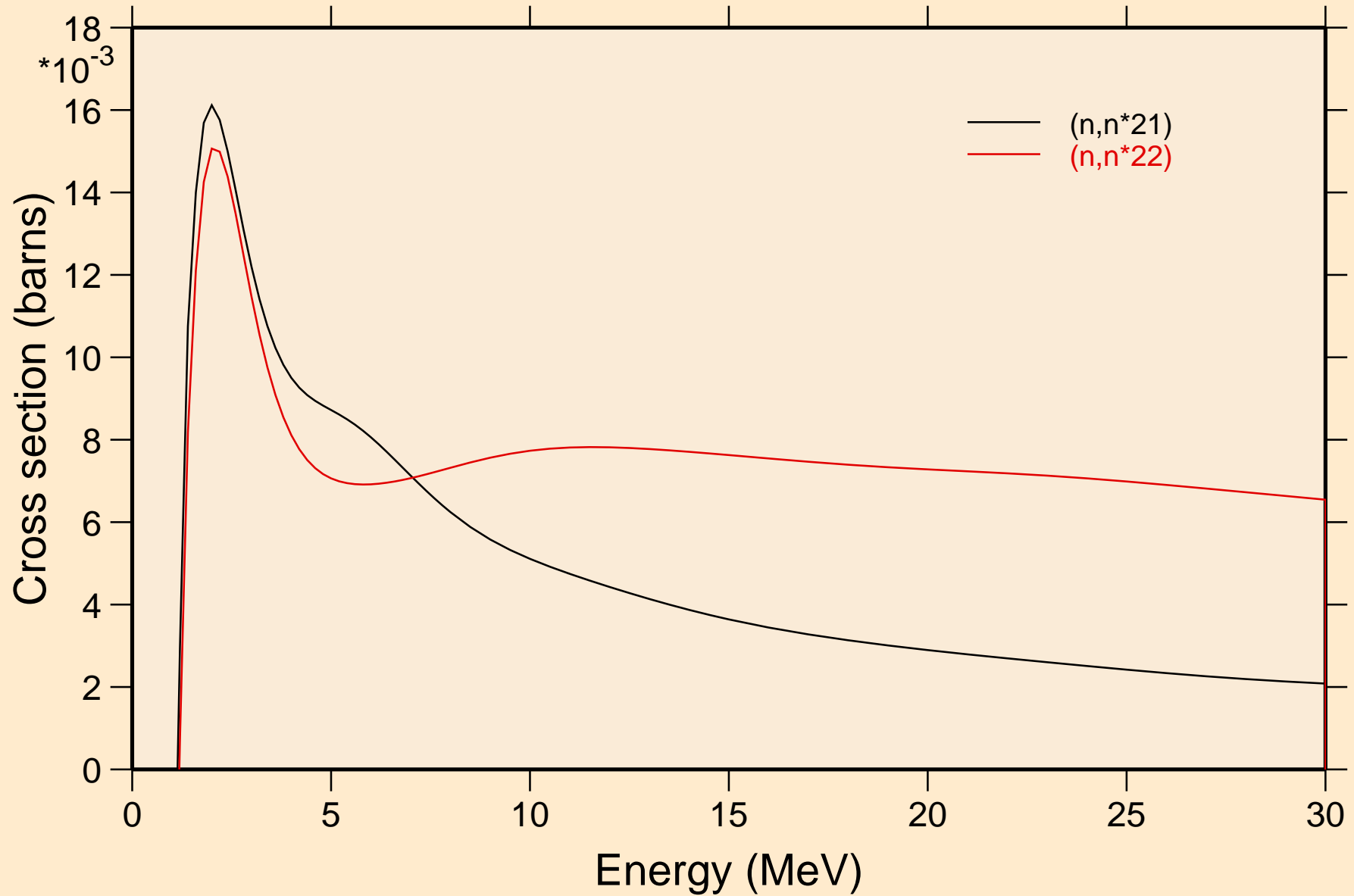

I117 NEUTRON ACER TENDL-2021 LIBRARY; T=293.6K  
Threshold reactions

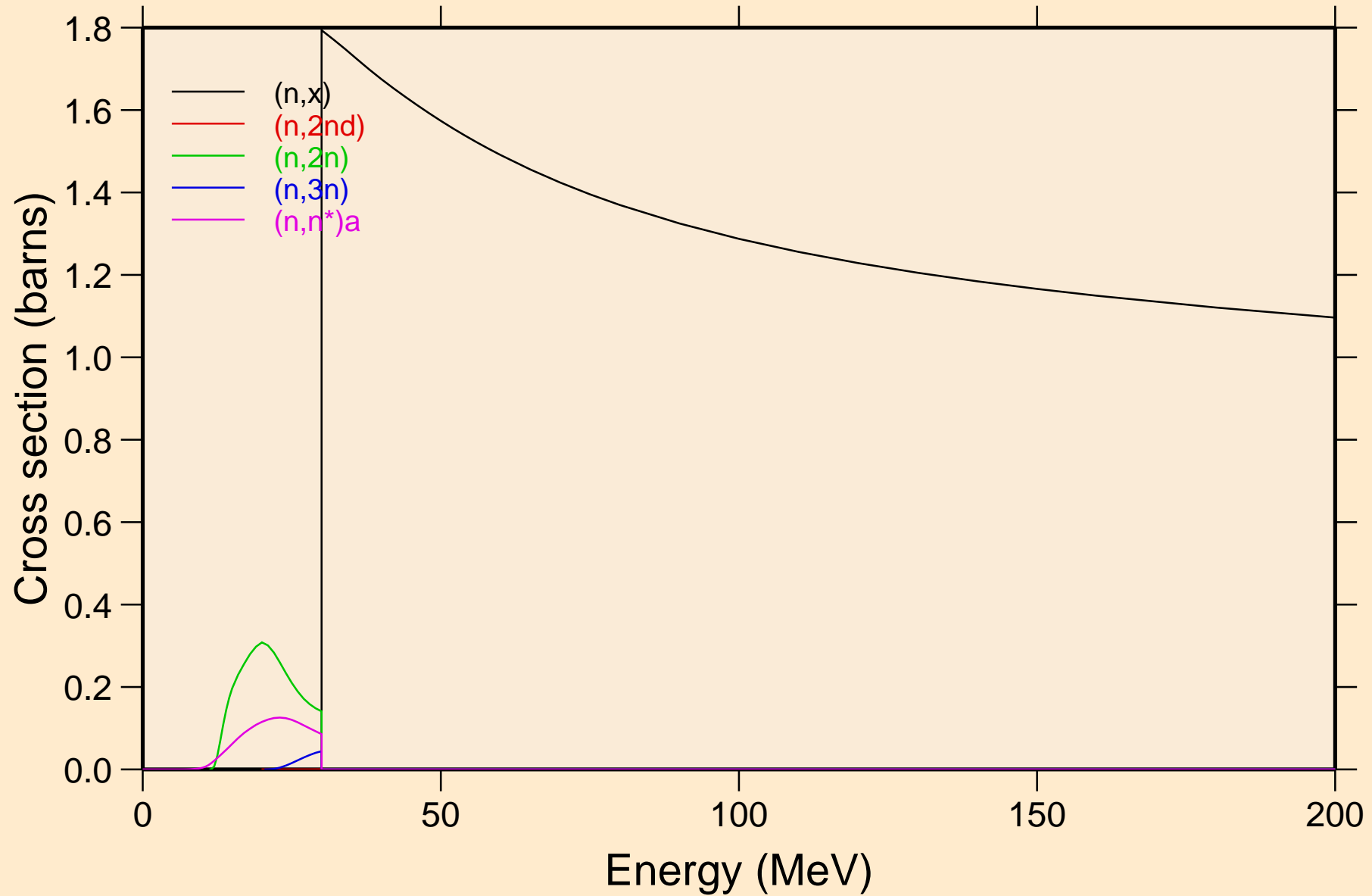



I117 NEUTRON ACER TENDL-2021 LIBRARY; T=293.6K  
Threshold reactions

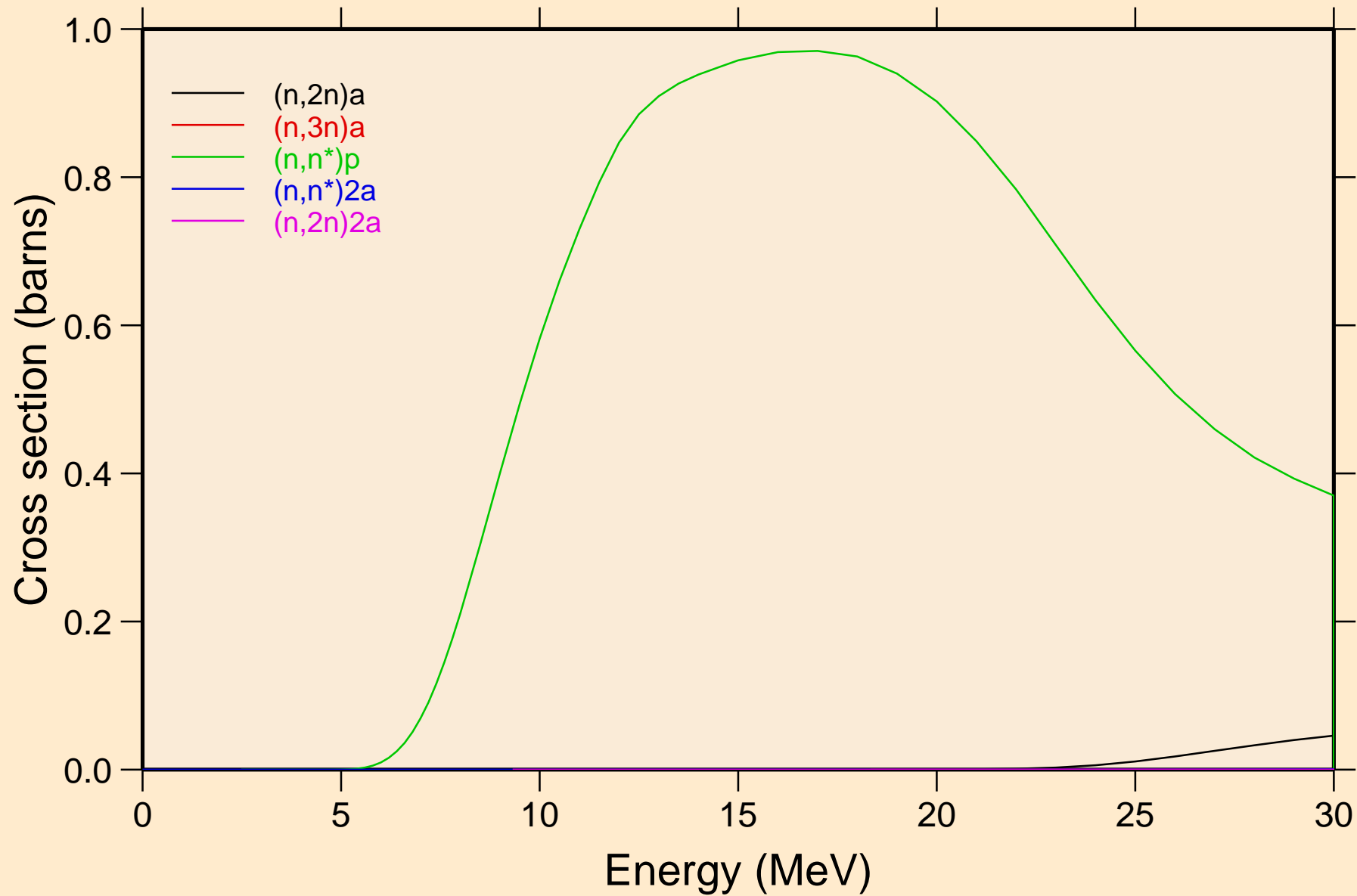

I117 NEUTRON ACER TENDL-2021 LIBRARY; T=293.6K  
Threshold reactions

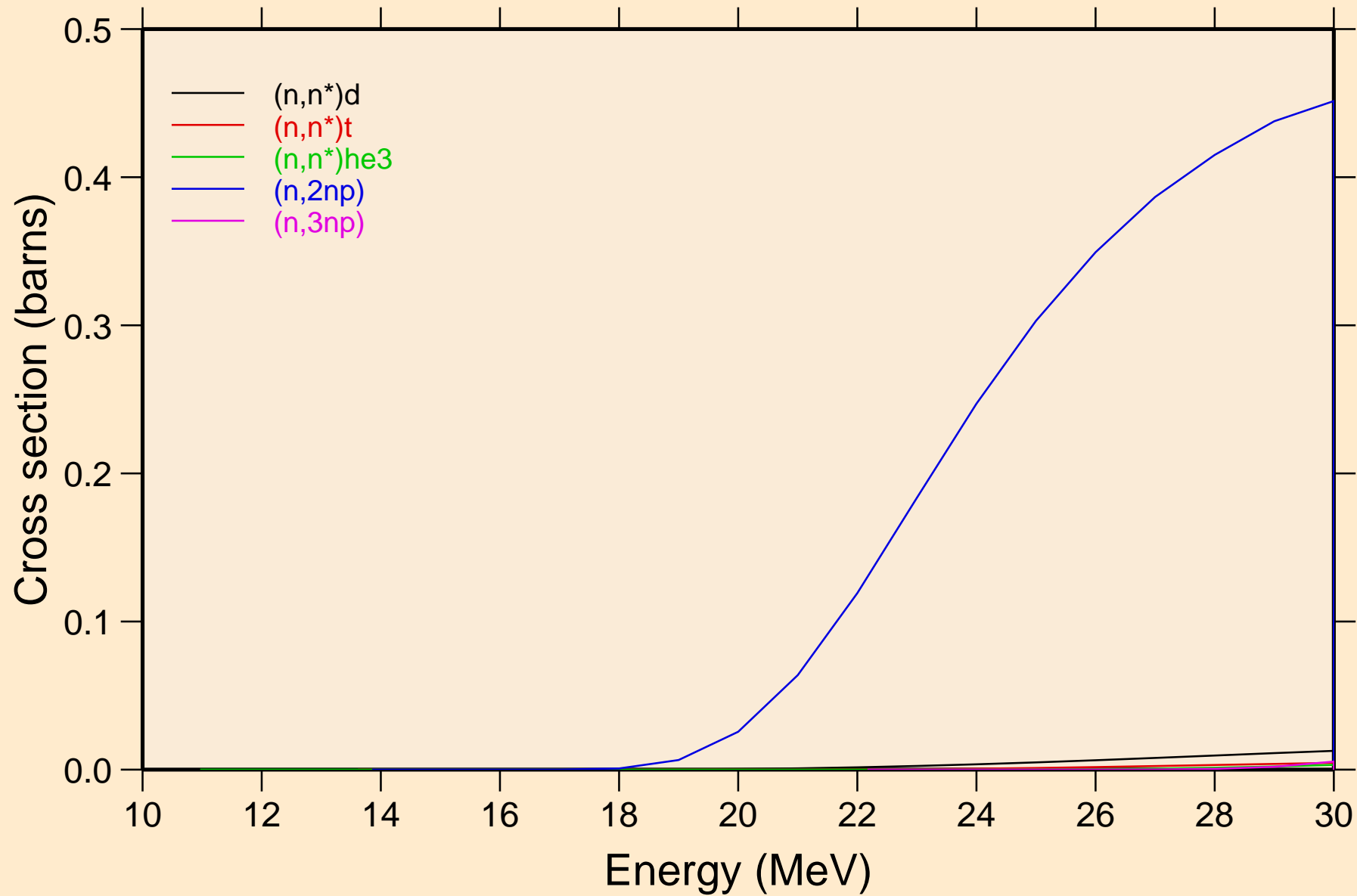

I117 NEUTRON ACER TENDL-2021 LIBRARY; T=293.6K  
Threshold reactions

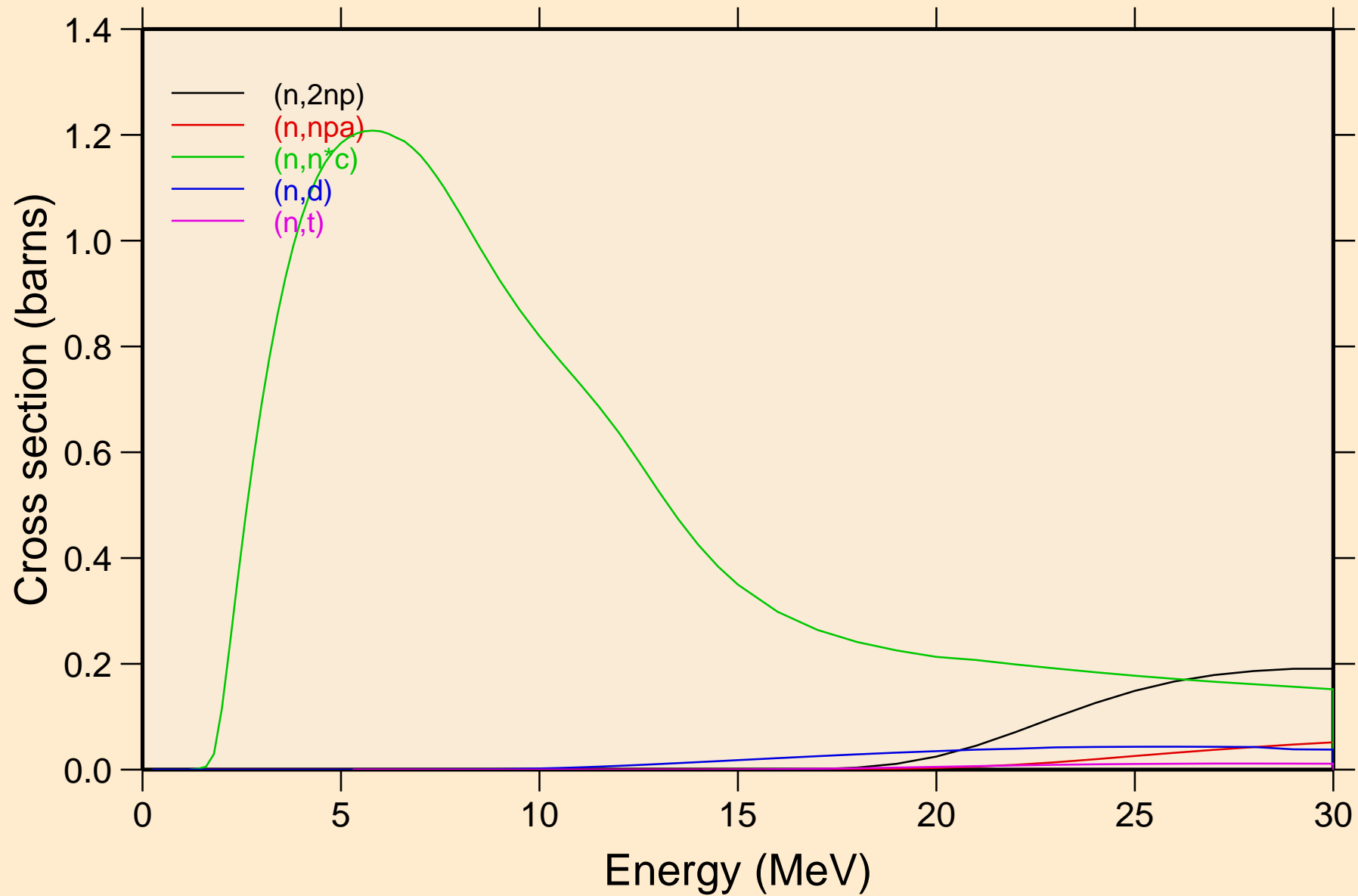

I117 NEUTRON ACER TENDL-2021 LIBRARY; T=293.6K  
Threshold reactions

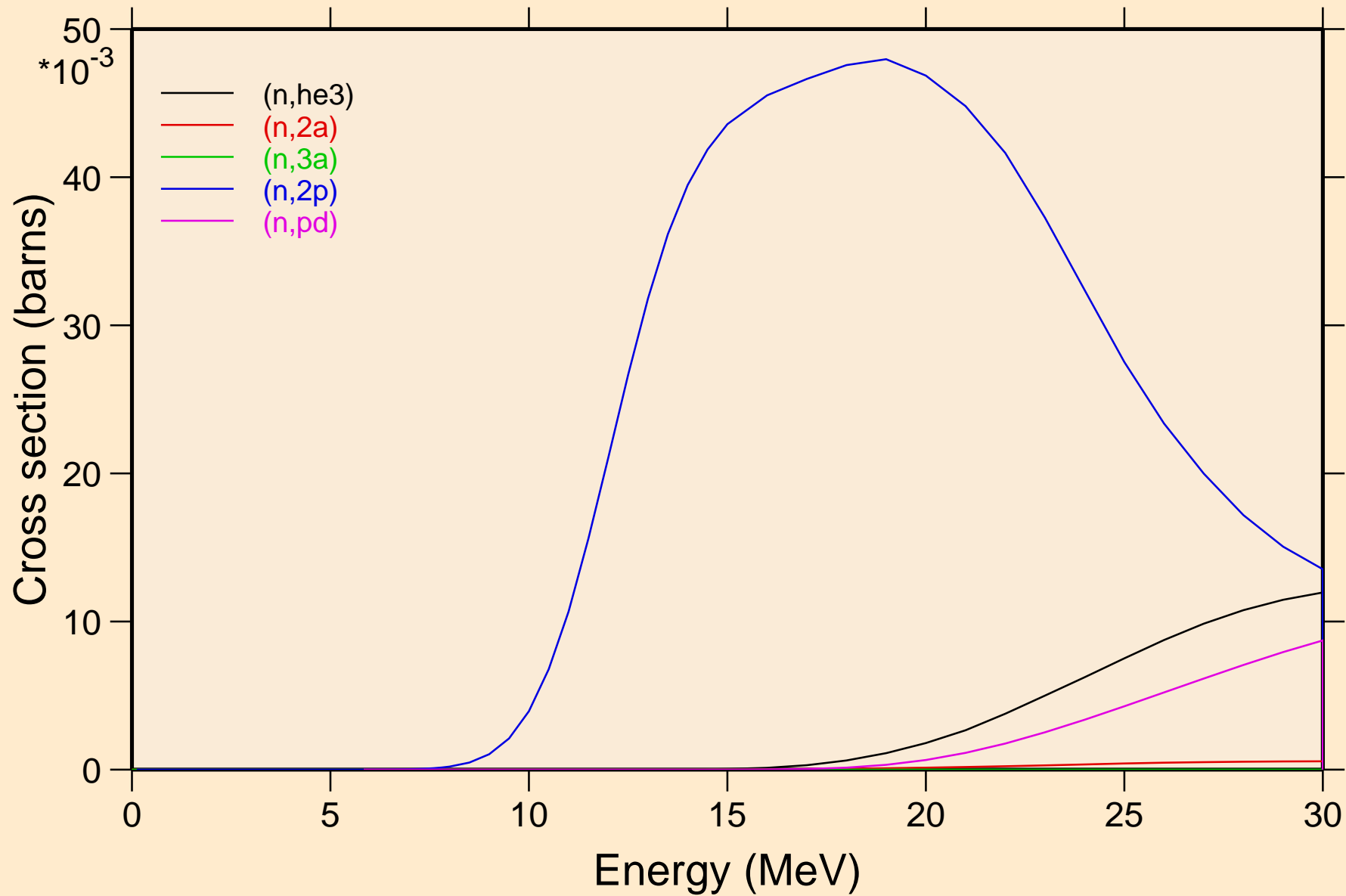

I117 NEUTRON ACER TENDL-2021 LIBRARY; T=293.6K  
Threshold reactions

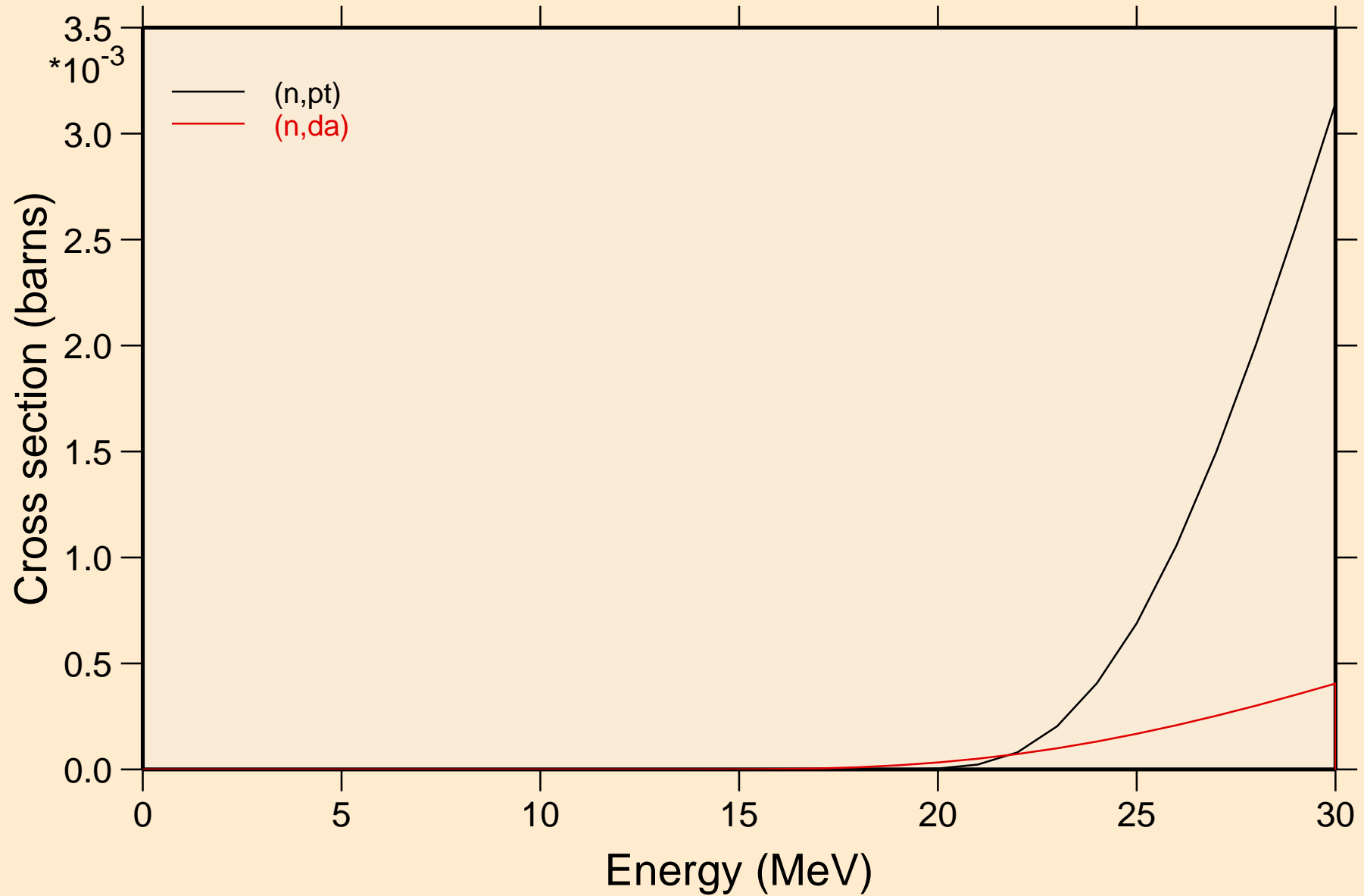

I117 NEUTRON ACER TENDL-2021 LIBRARY; T=293.6K  
Threshold reactions

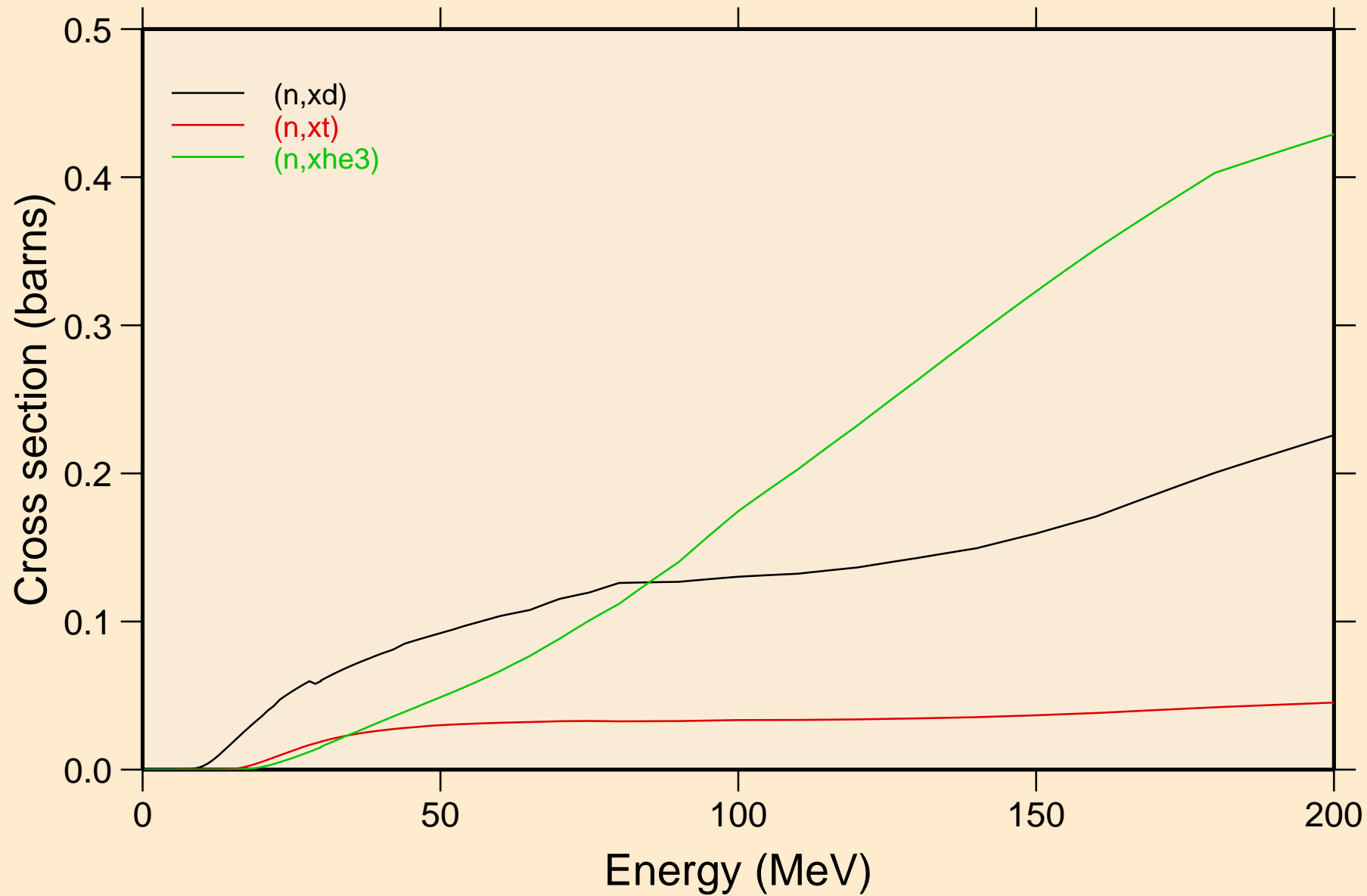

I117 NEUTRON ACER TENDL-2021 LIBRARY; T=293.6K  
angular distribution for elastic

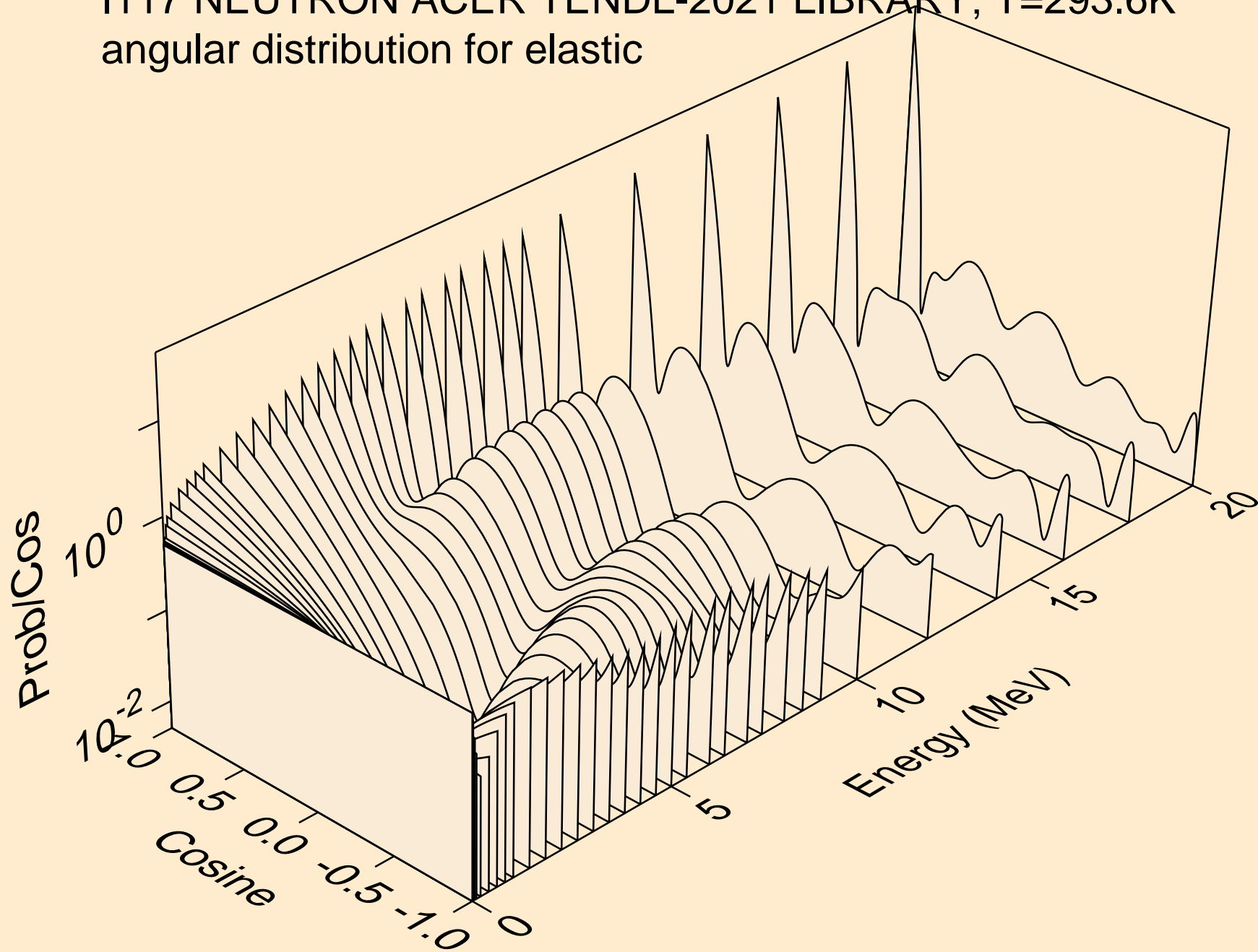

I117 NEUTRON ACER TENDL-2021 LIBRARY; T=293.6K  
angular distribution for elastic

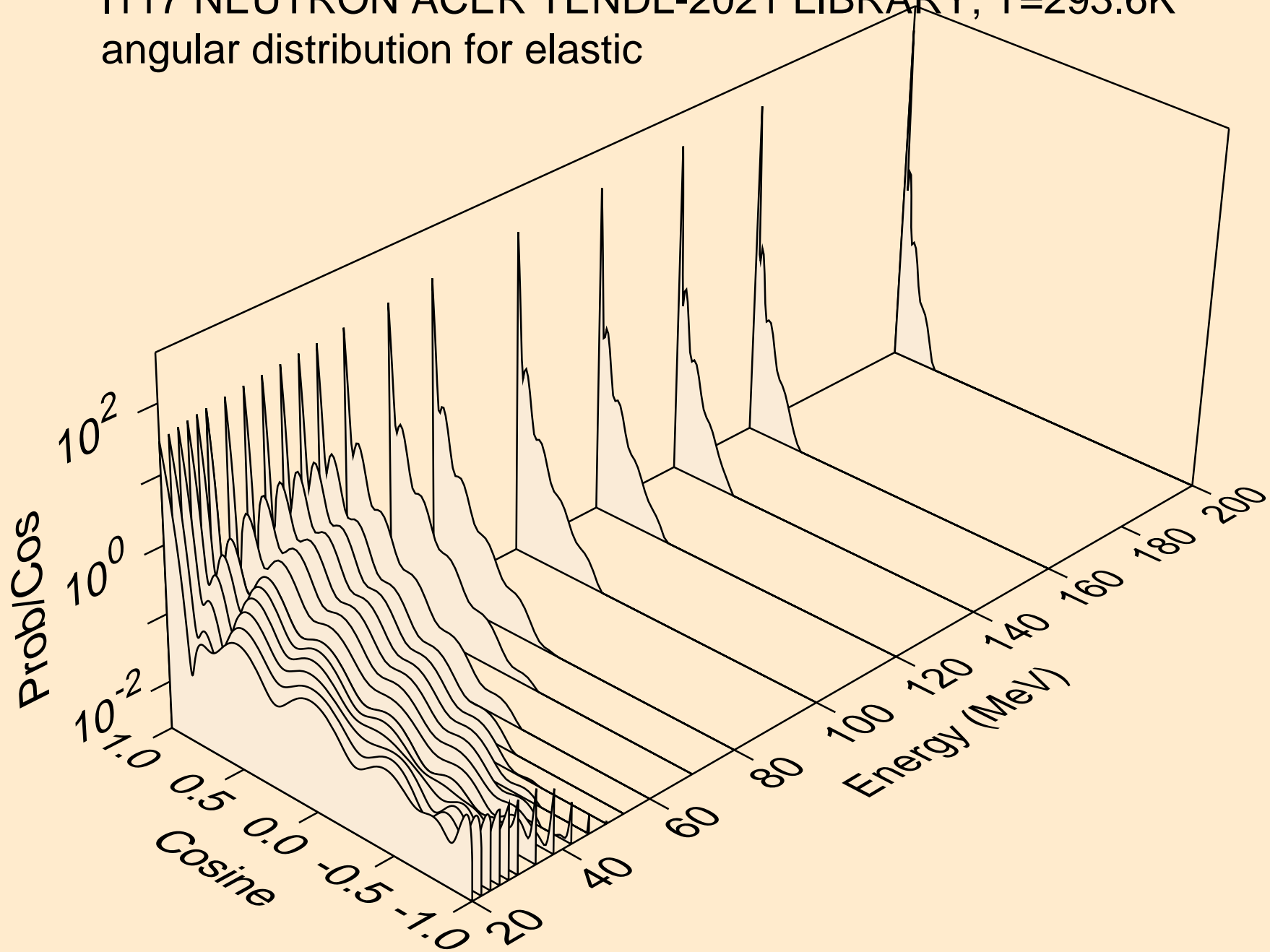



I117 NEUTRON ACER TENDL-2021 LIBRARY; T=293.6K  
angular distribution for (n,n\*1)

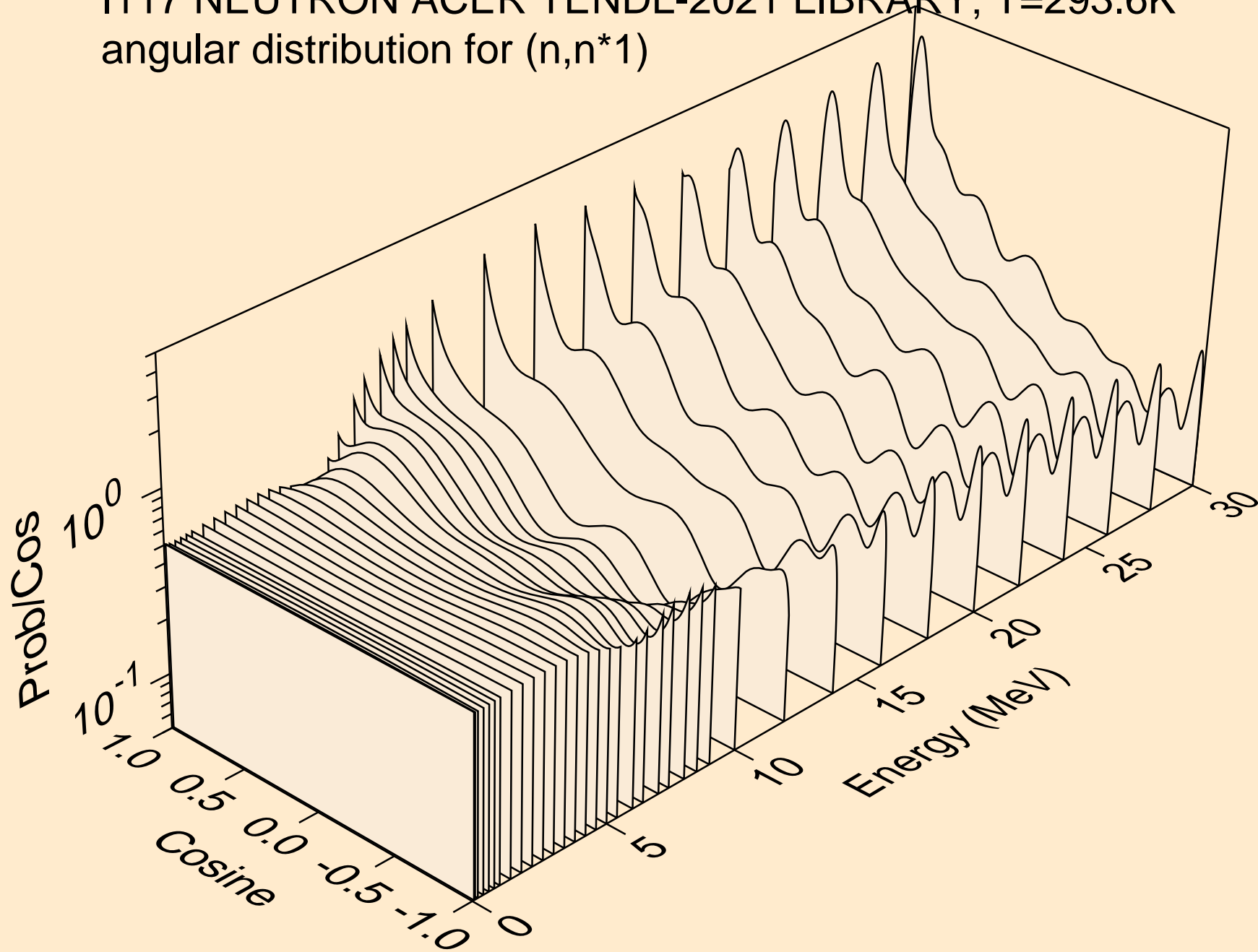

I117 NEUTRON ACER TENDL-2021 LIBRARY; T=293.6K  
angular distribution for (n,n\*2)

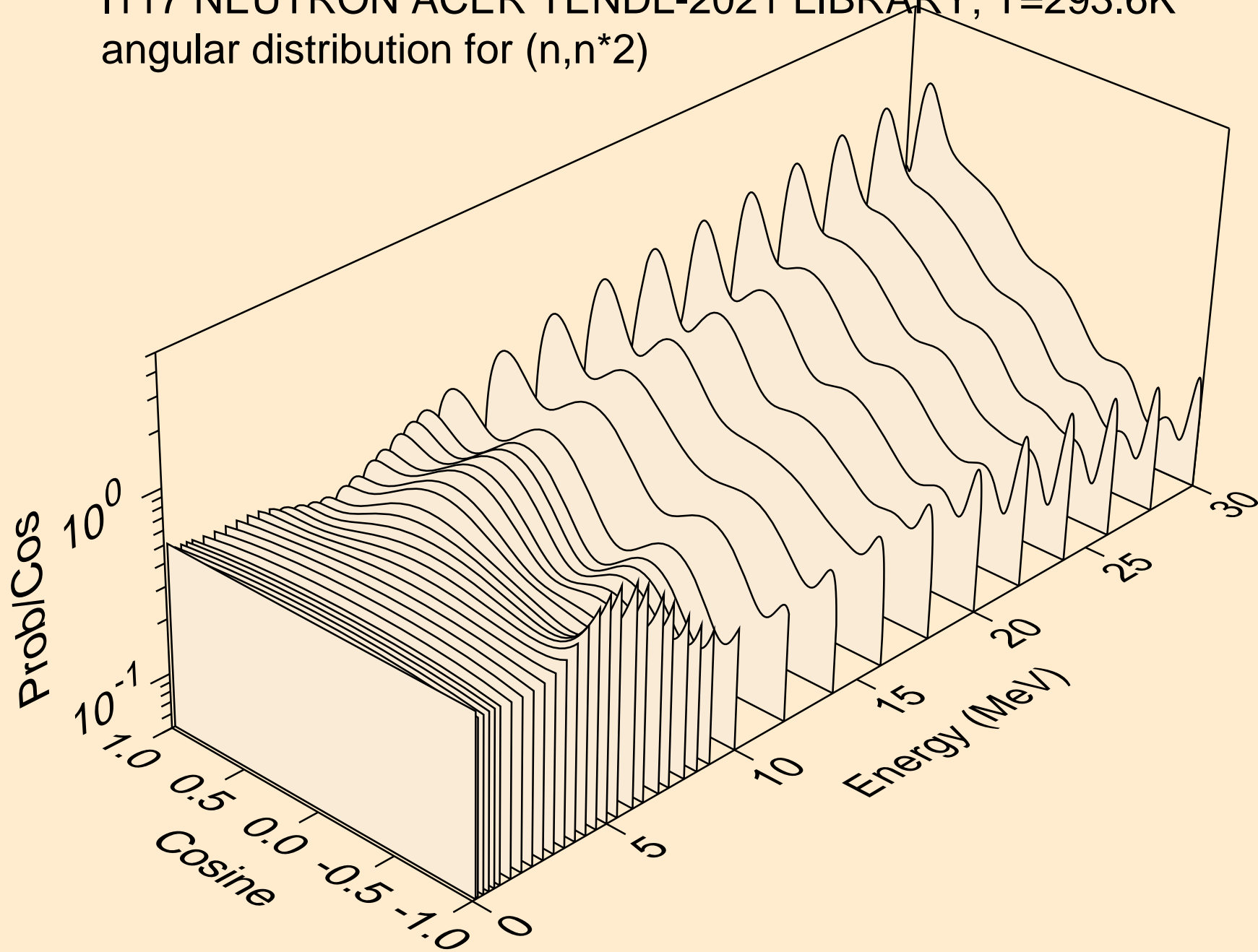

I117 NEUTRON ACER TENDL-2021 LIBRARY; T=293.6K  
angular distribution for (n,n\*3)

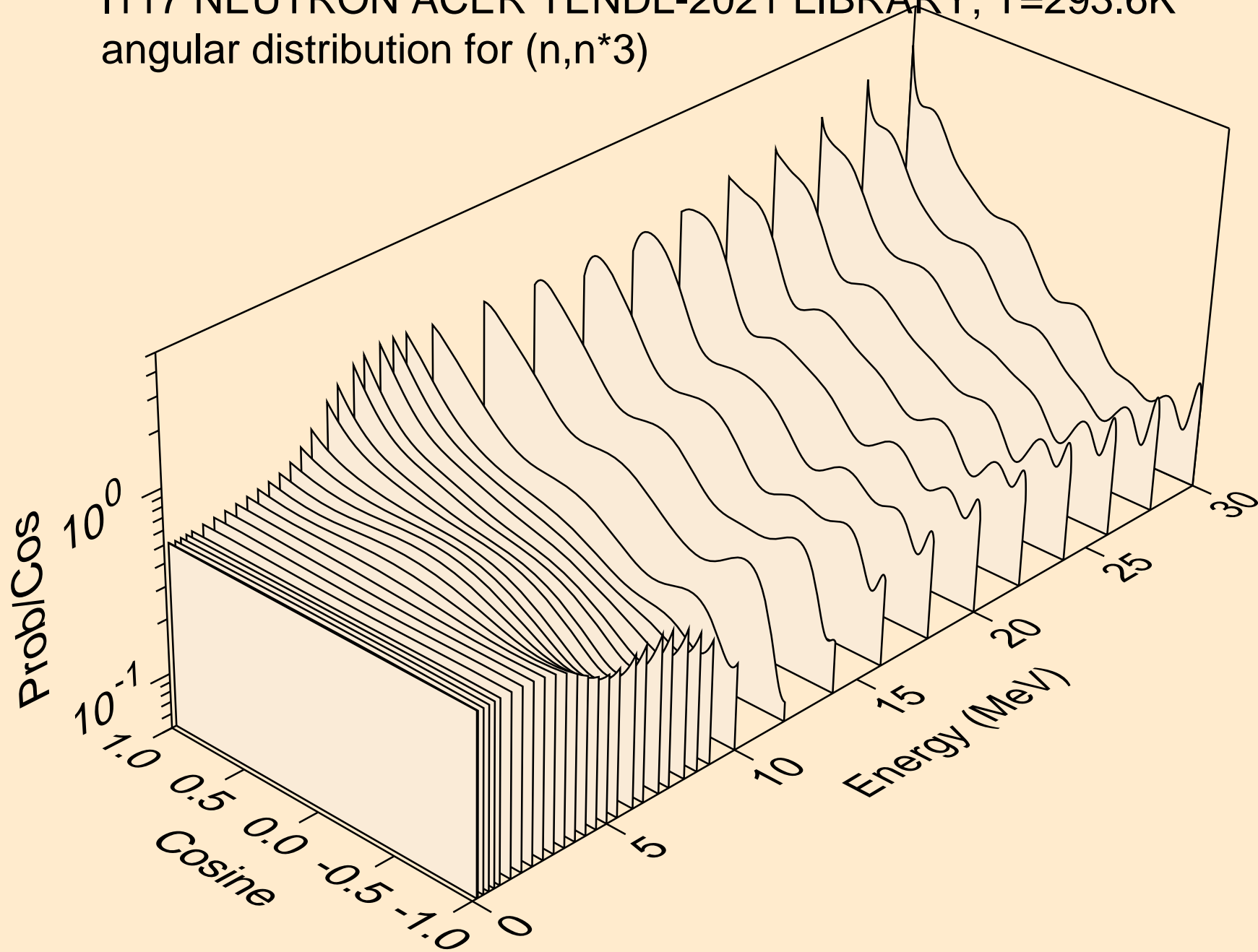

I117 NEUTRON ACER TENDL-2021 LIBRARY; T=293.6K  
angular distribution for (n,n\*4)

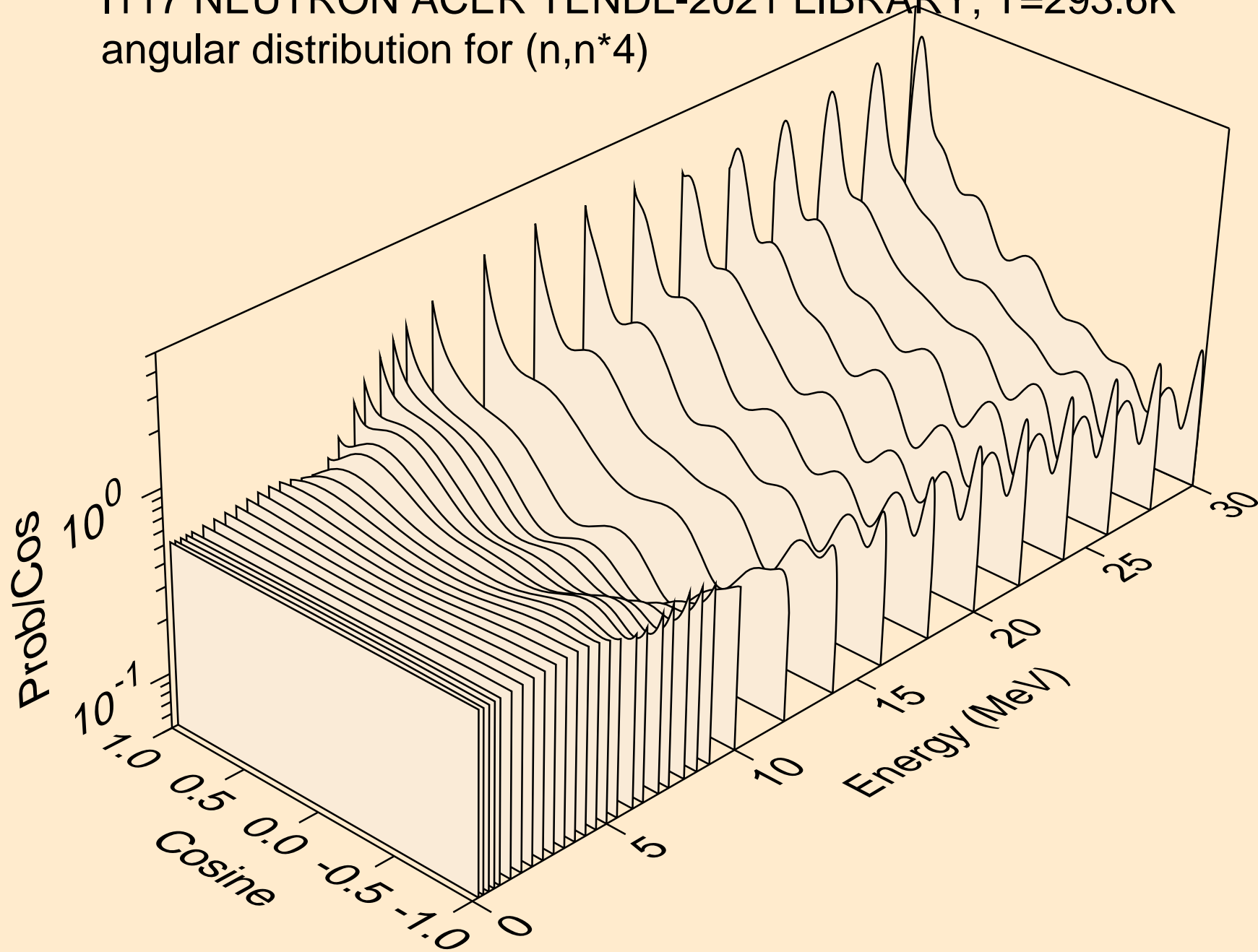

I117 NEUTRON ACER TENDL-2021 LIBRARY; T=293.6K  
angular distribution for (n,n\*5)

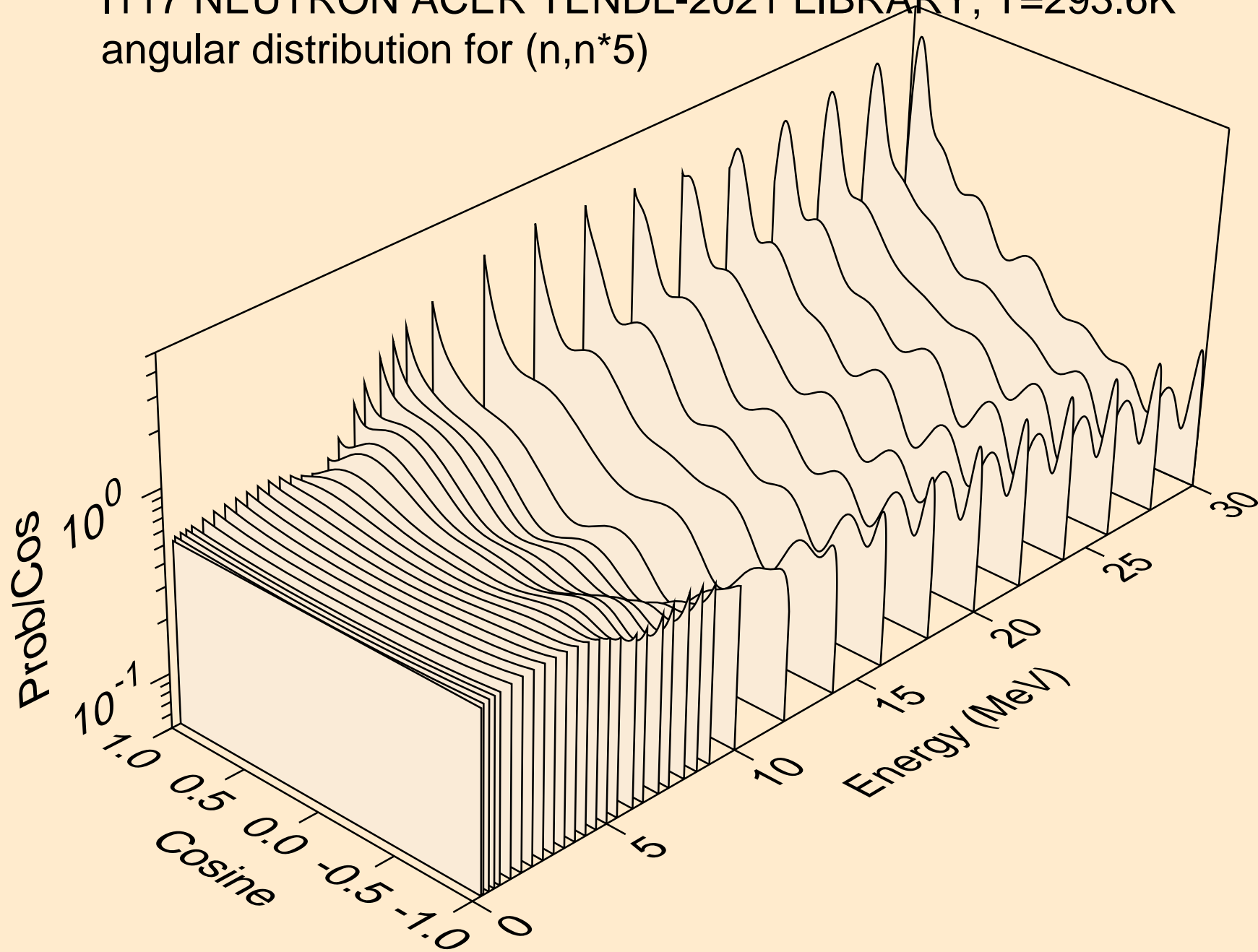

I117 NEUTRON ACER TENDL-2021 LIBRARY; T=293.6K  
angular distribution for (n,n\*6)

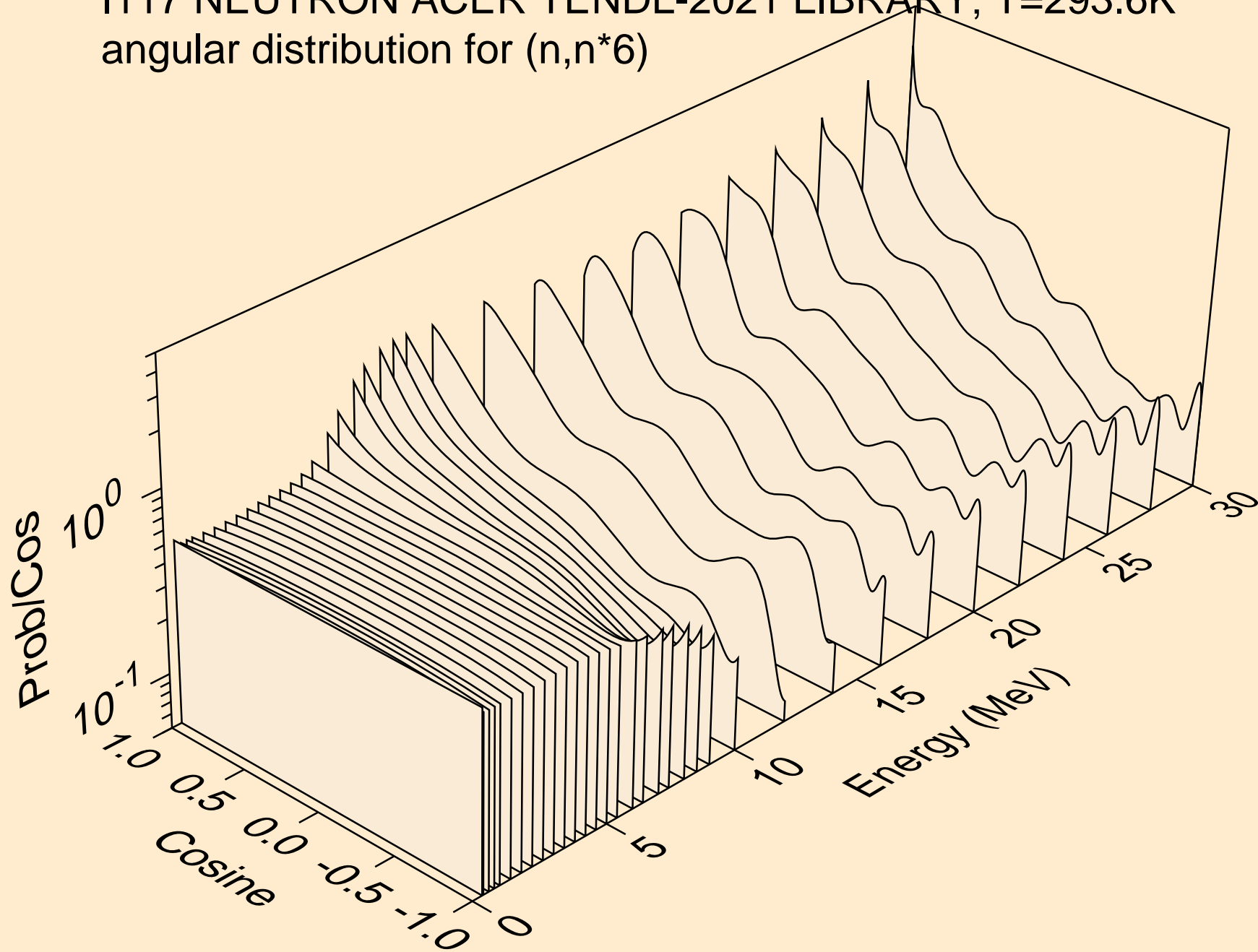

I117 NEUTRON ACER TENDL-2021 LIBRARY; T=293.6K  
angular distribution for (n,n\*7)

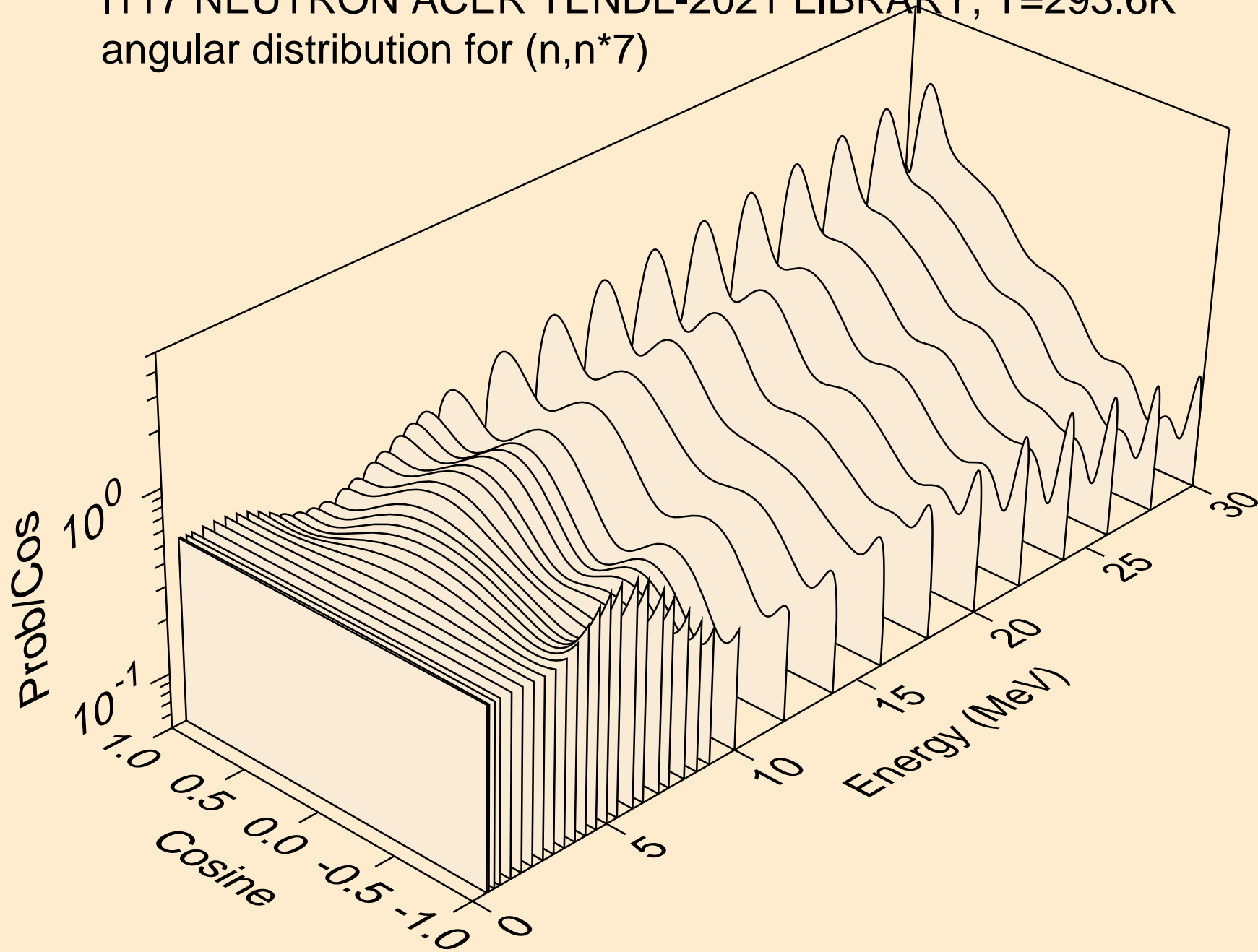

I117 NEUTRON ACER TENDL-2021 LIBRARY; T=293.6K  
angular distribution for (n,n\*8)

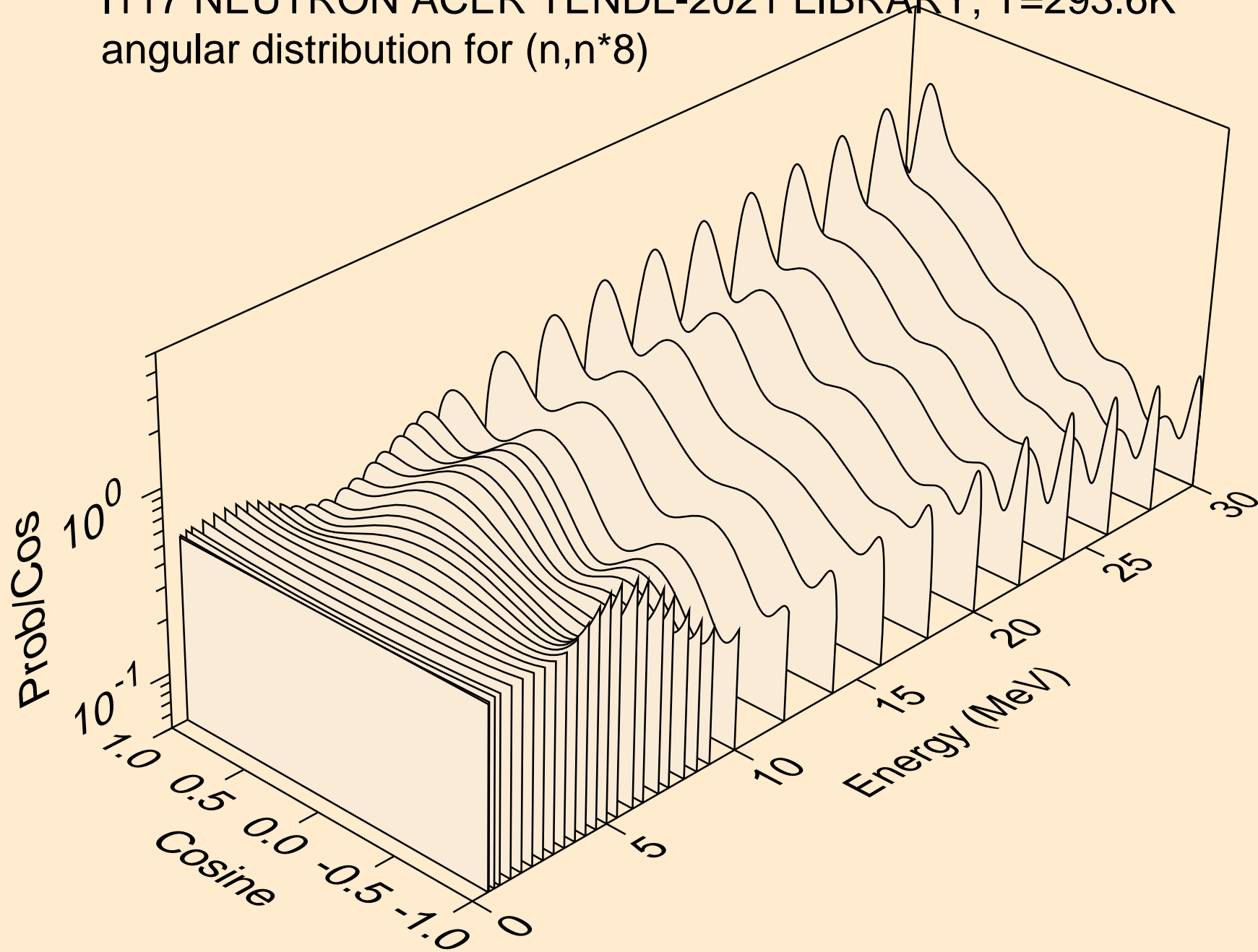



I117 NEUTRON ACER TENDL-2021 LIBRARY; T=293.6K  
angular distribution for (n,n\*9)

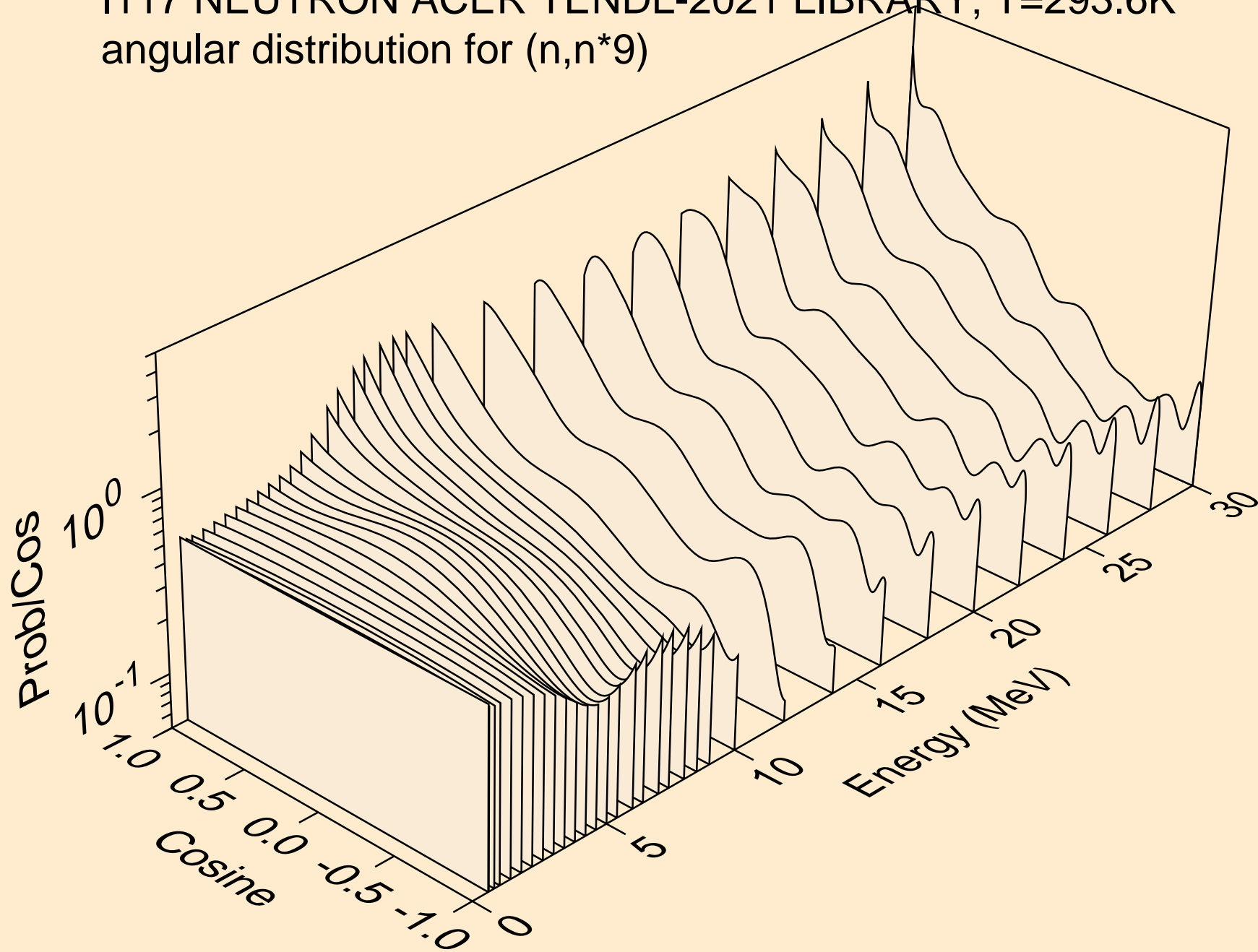

I117 NEUTRON ACER TENDL-2021 LIBRARY; T=293.6K  
angular distribution for (n,n\*10)

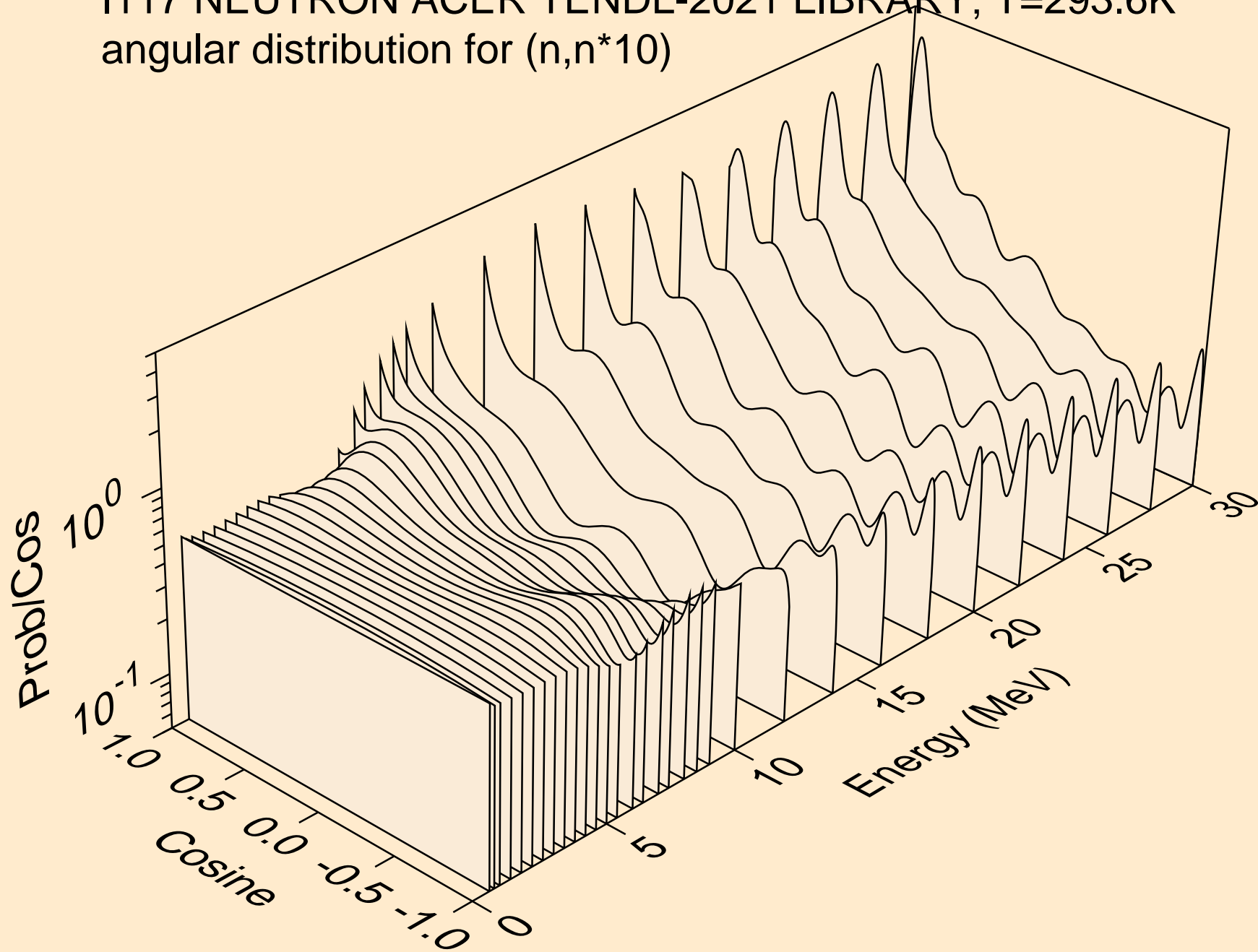

I117 NEUTRON ACER TENDL-2021 LIBRARY; T=293.6K  
angular distribution for (n,n\*11)

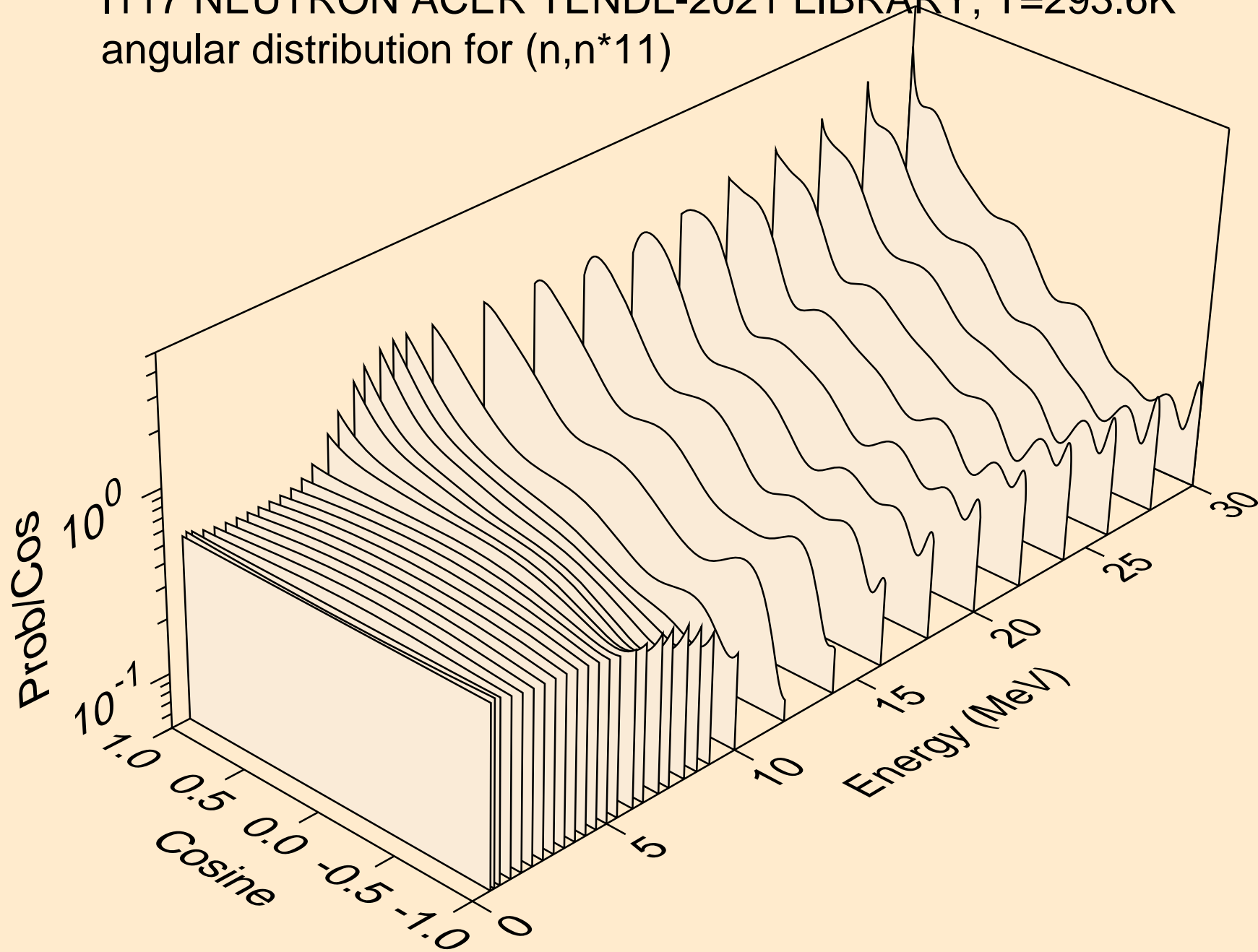

I117 NEUTRON ACER TENDL-2021 LIBRARY; T=293.6K  
angular distribution for (n,n\*12)

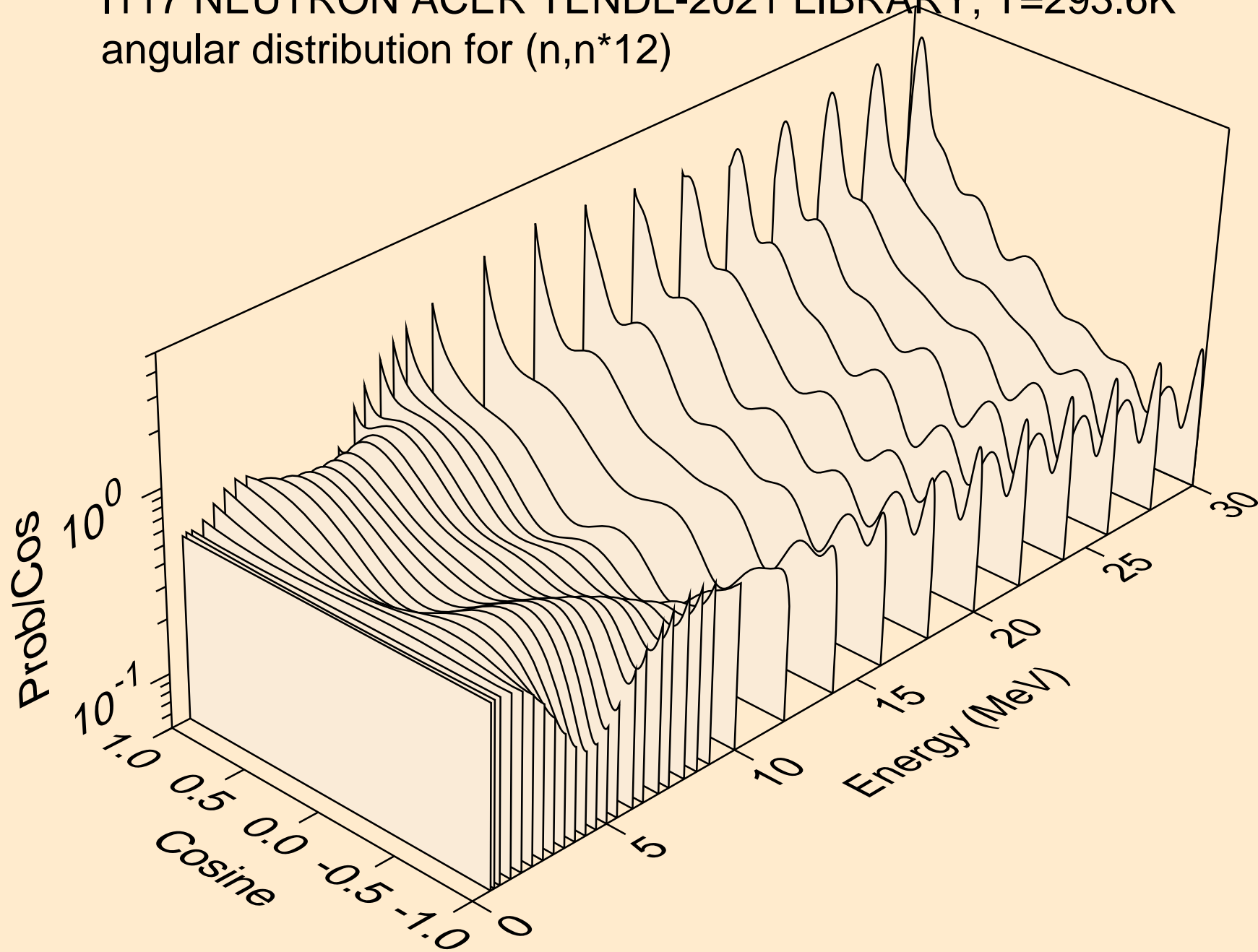

I117 NEUTRON ACER TENDL-2021 LIBRARY; T=293.6K  
angular distribution for (n,n\*13)

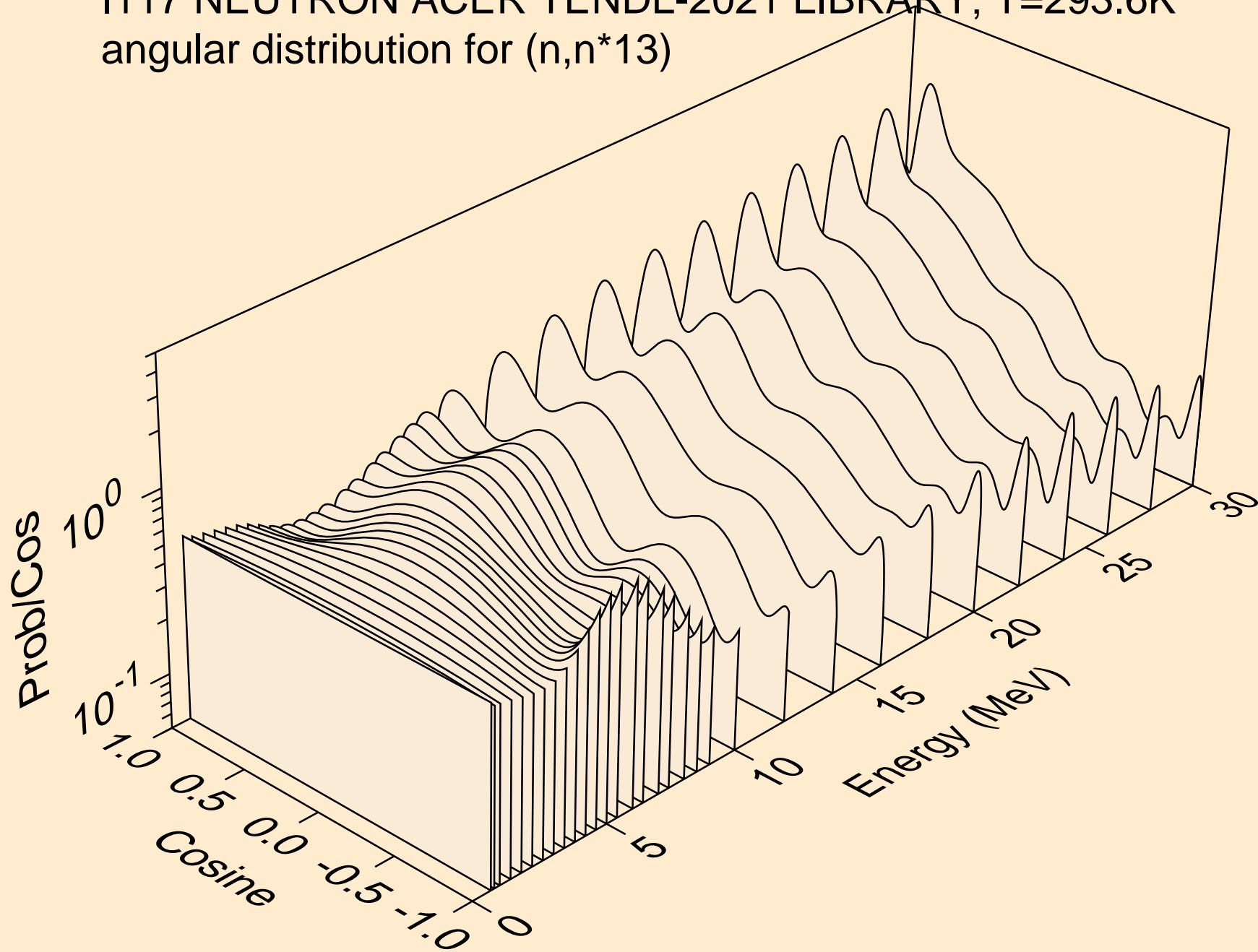

I117 NEUTRON ACER TENDL-2021 LIBRARY; T=293.6K  
angular distribution for (n,n\*14)

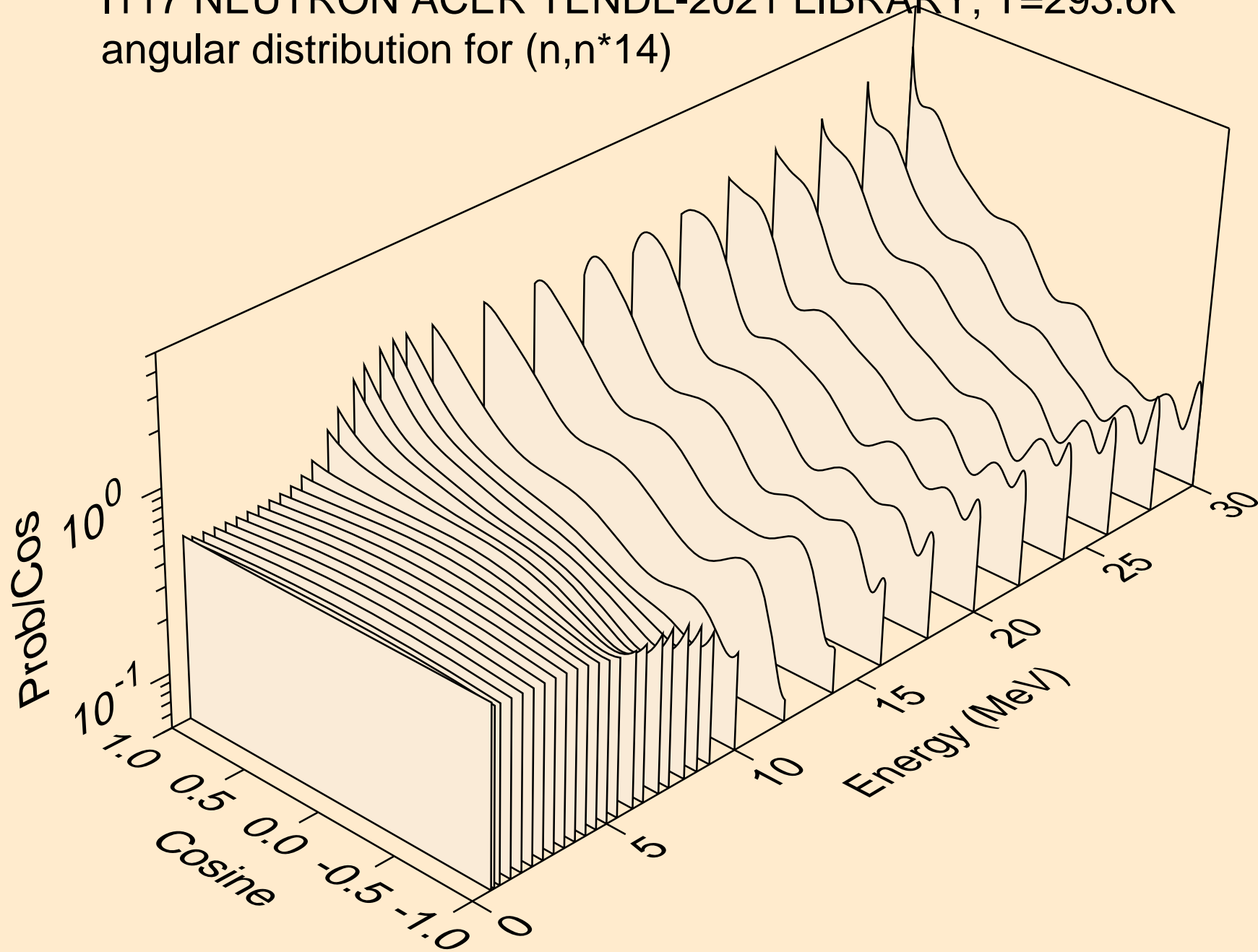

I117 NEUTRON ACER TENDL-2021 LIBRARY; T=293.6K  
angular distribution for (n,n\*15)

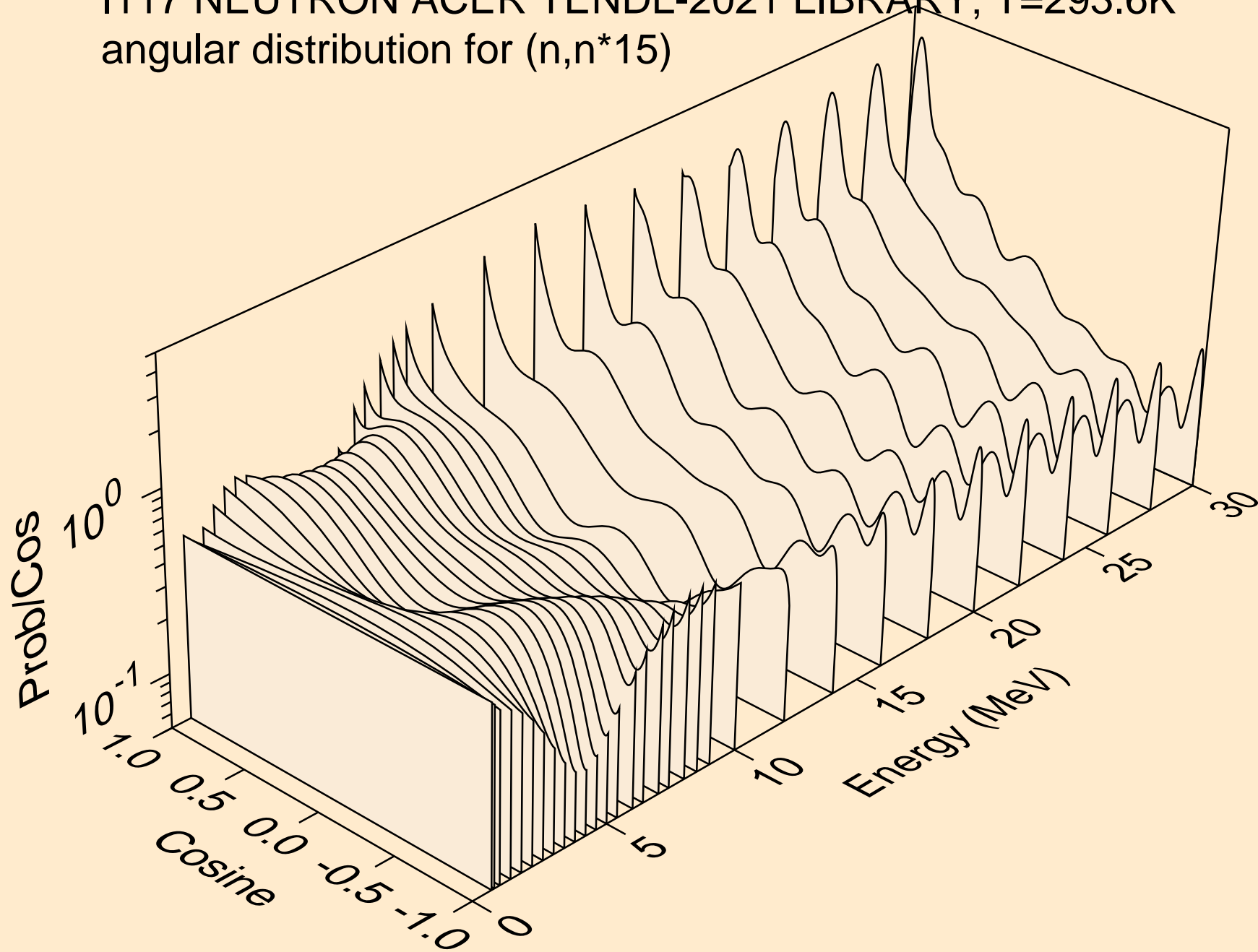

I117 NEUTRON ACER TENDL-2021 LIBRARY; T=293.6K  
angular distribution for (n,n\*16)

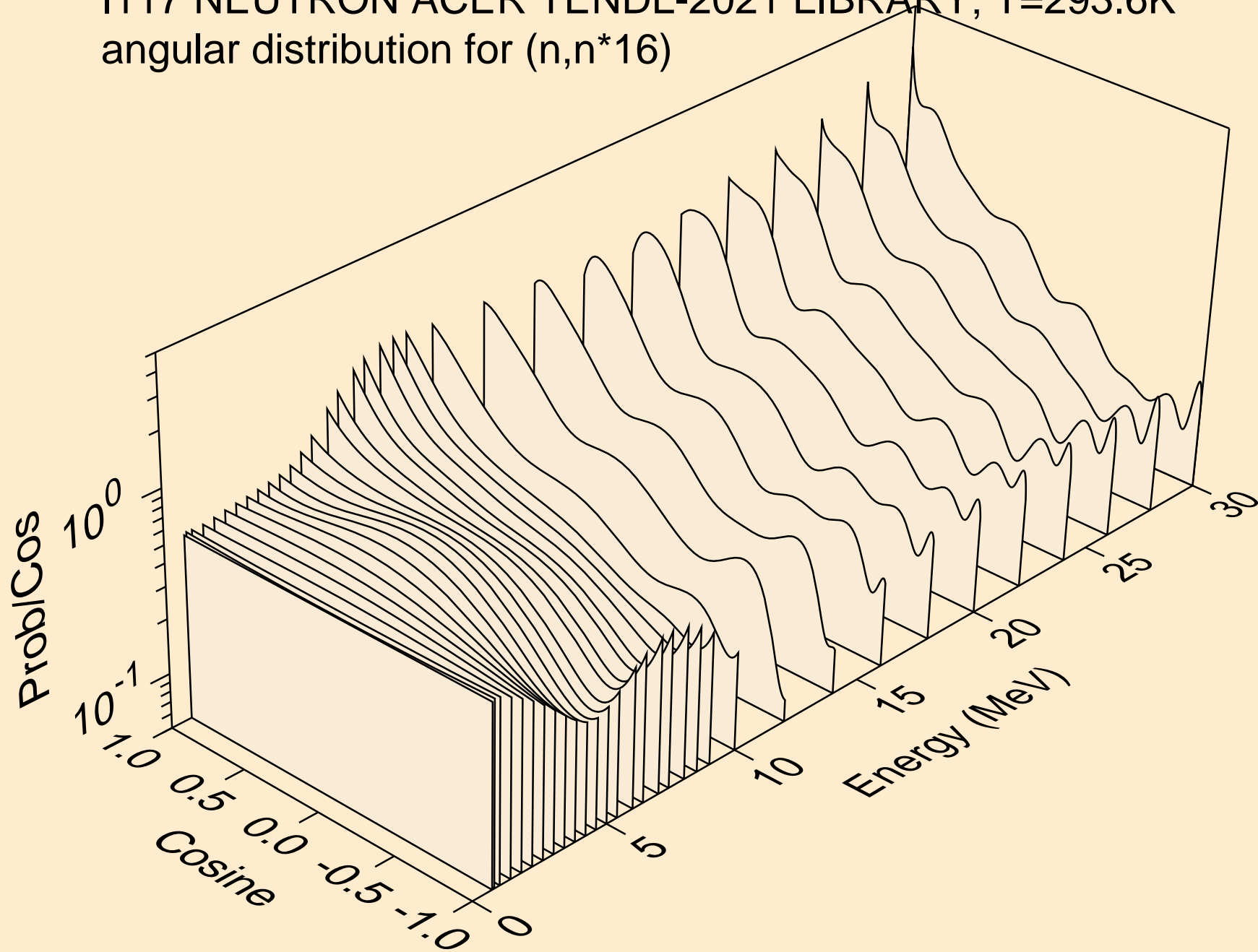



I117 NEUTRON ACER TENDL-2021 LIBRARY; T=293.6K  
angular distribution for (n,n\*17)

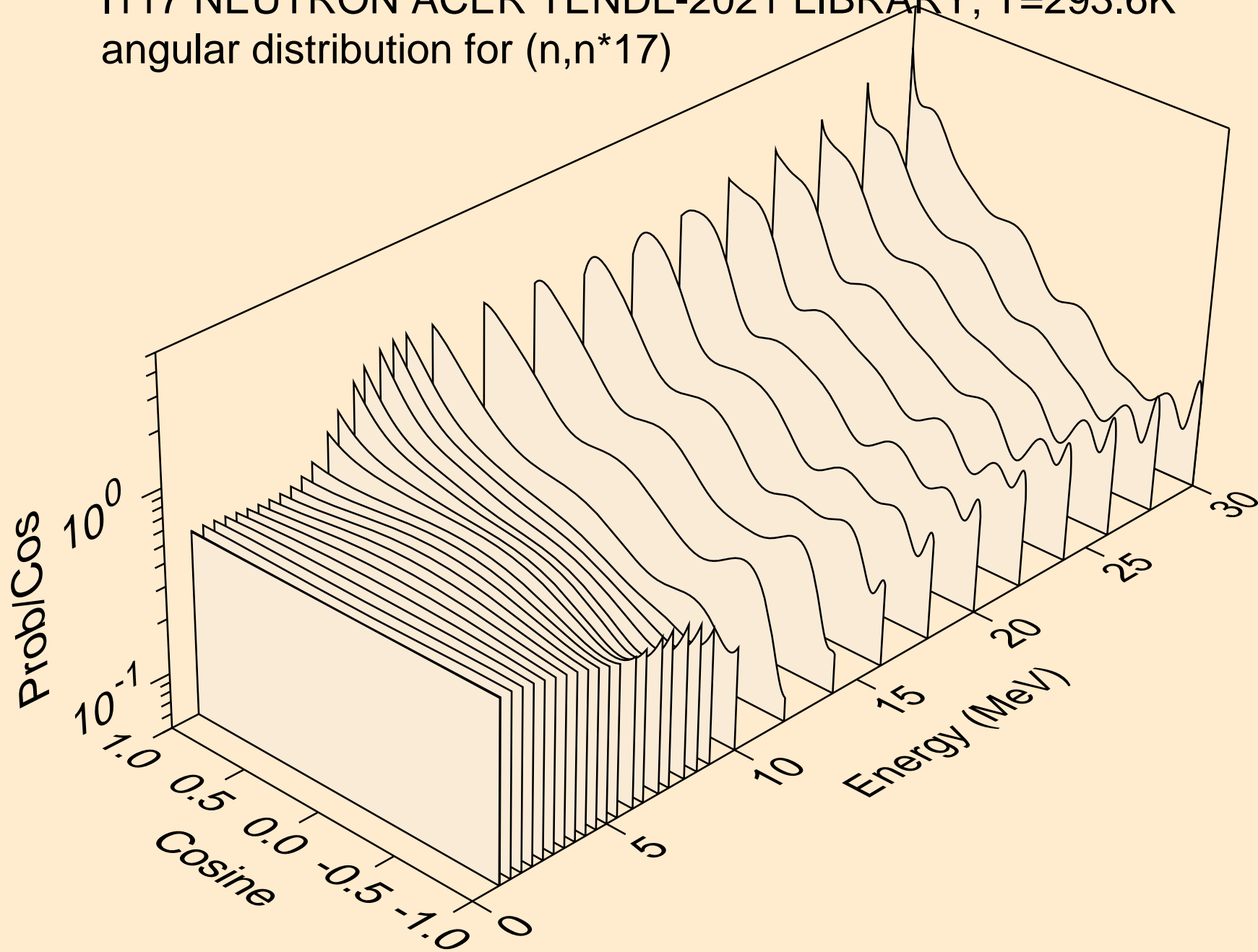

I117 NEUTRON ACER TENDL-2021 LIBRARY; T=293.6K  
angular distribution for (n,n\*18)

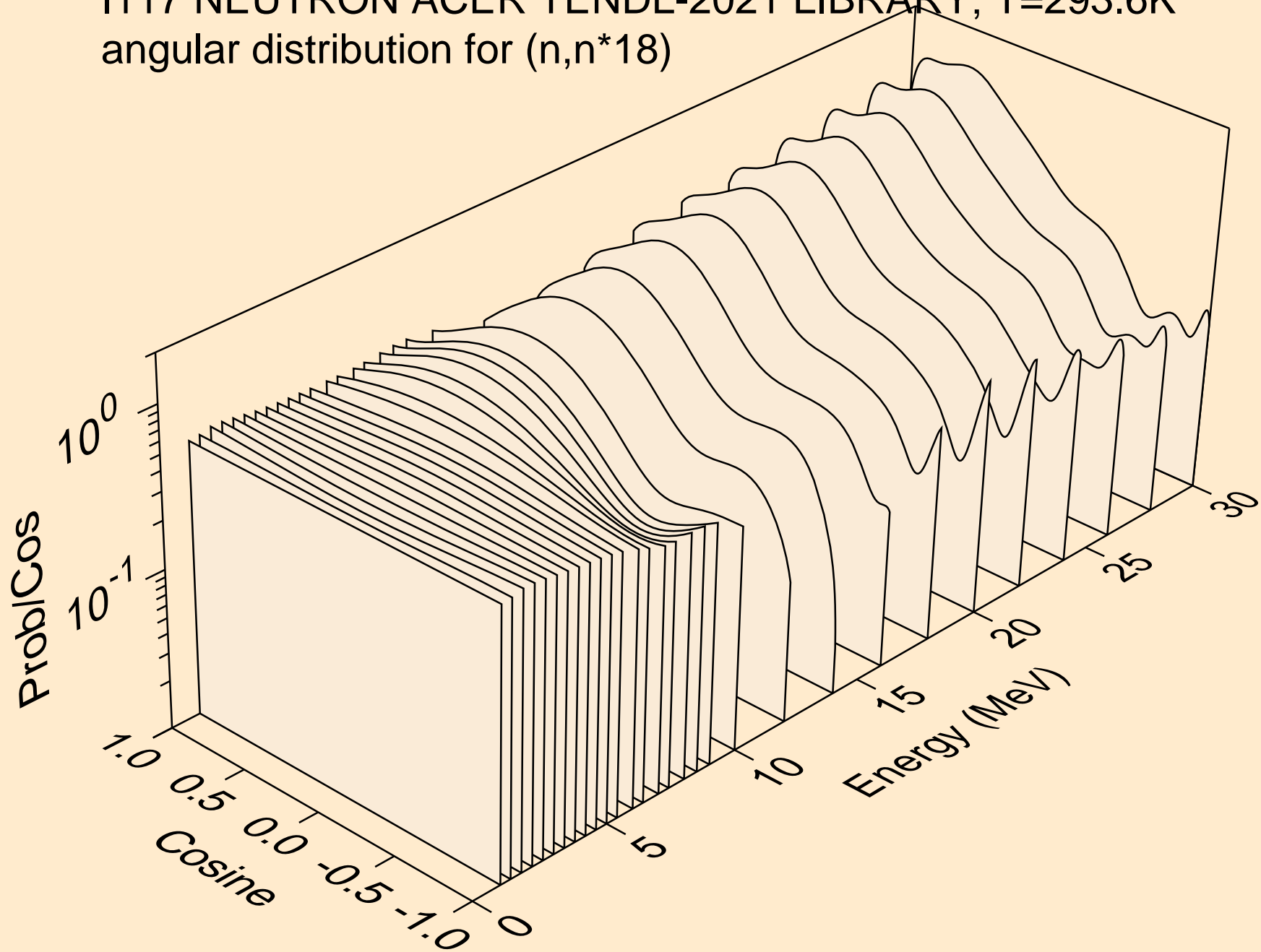

I117 NEUTRON ACER TENDL-2021 LIBRARY; T=293.6K  
angular distribution for (n,n\*19)

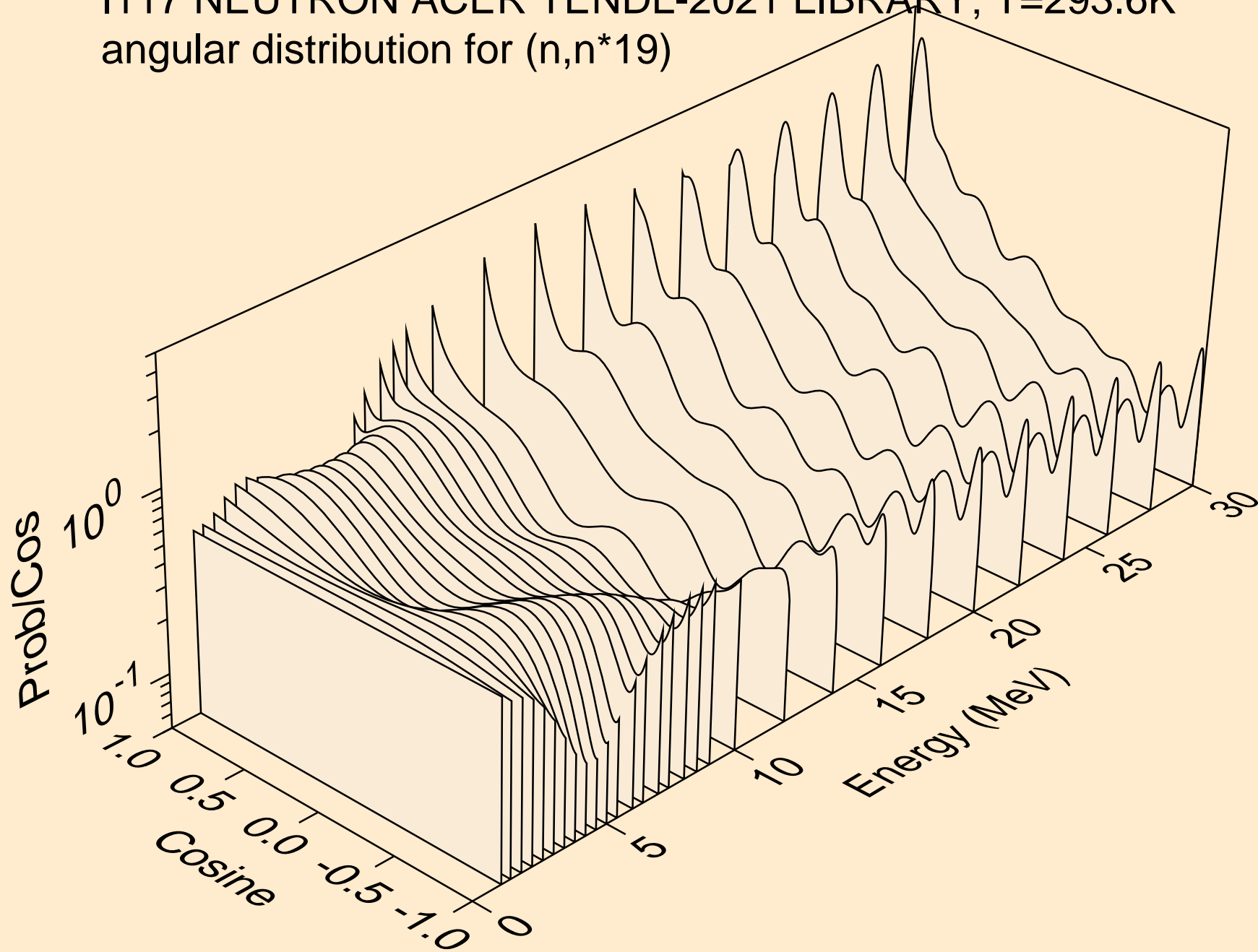

I117 NEUTRON ACER TENDL-2021 LIBRARY; T=293.6K  
angular distribution for (n,n\*20)

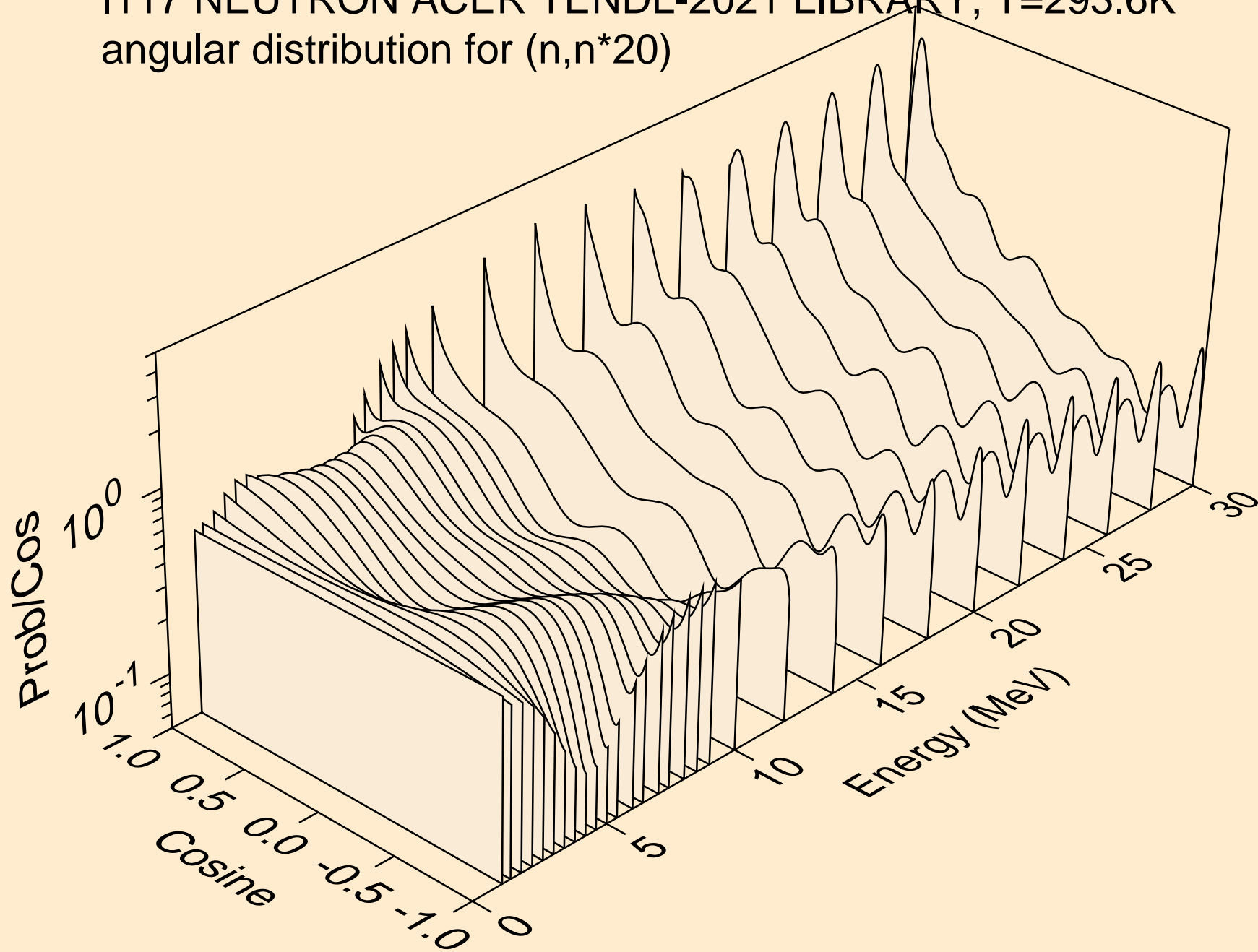

I117 NEUTRON ACER TENDL-2021 LIBRARY; T=293.6K  
angular distribution for (n,n\*21)

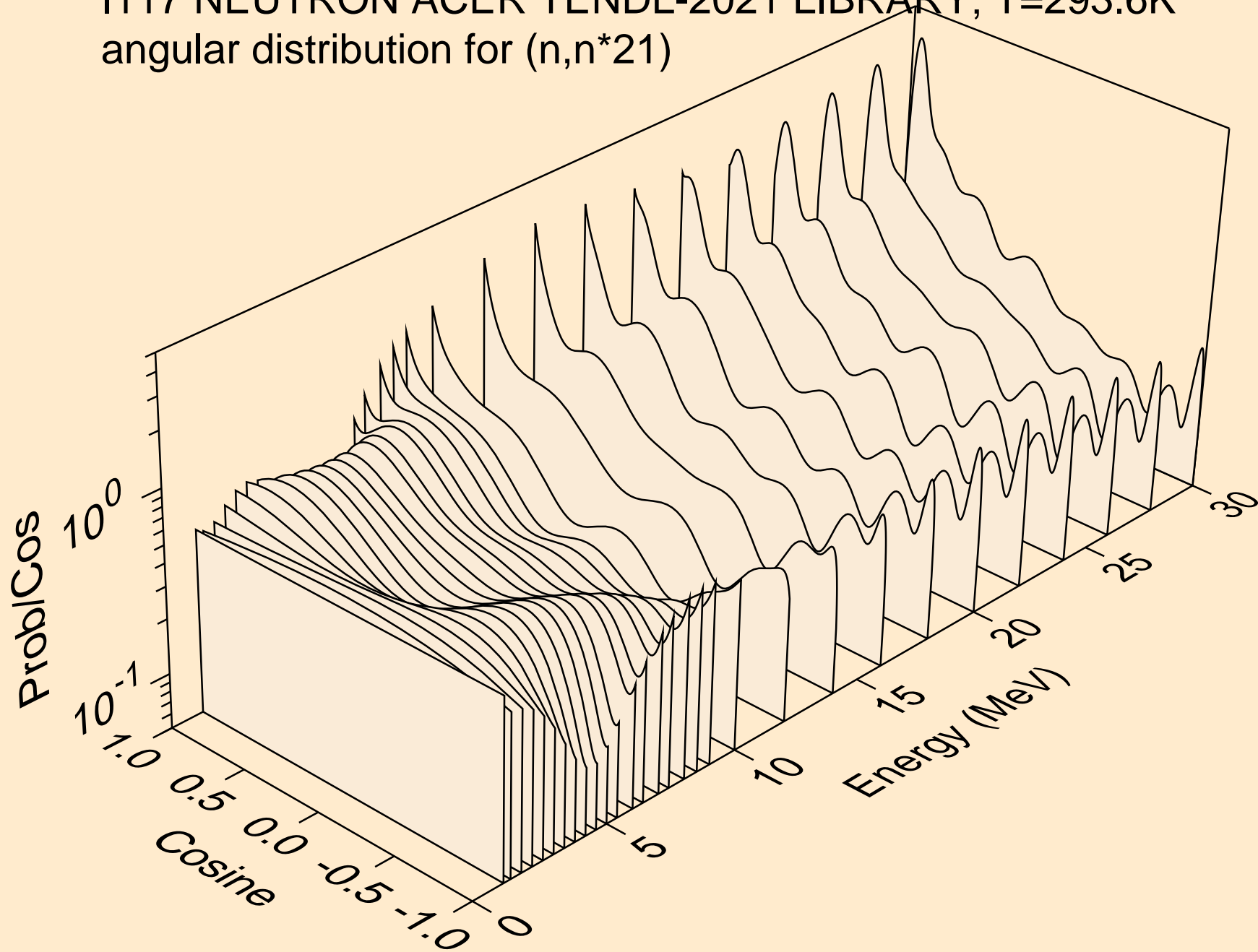

I117 NEUTRON ACER TENDL-2021 LIBRARY; T=293.6K  
angular distribution for (n,n\*22)

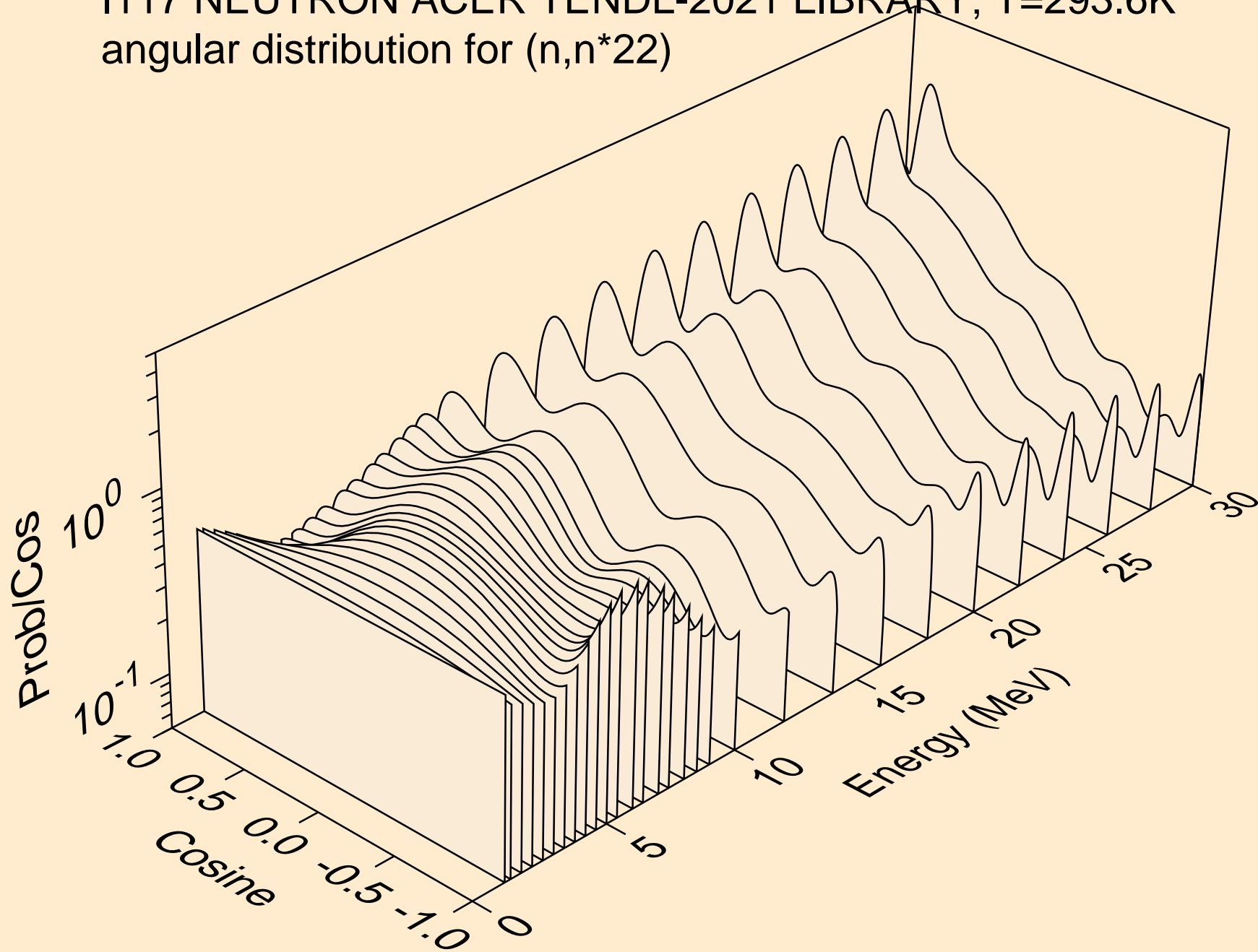

I117 NEUTRON ACER TENDL-2021 LIBRARY; T=293.6K  
Neutron emission for (n,x)

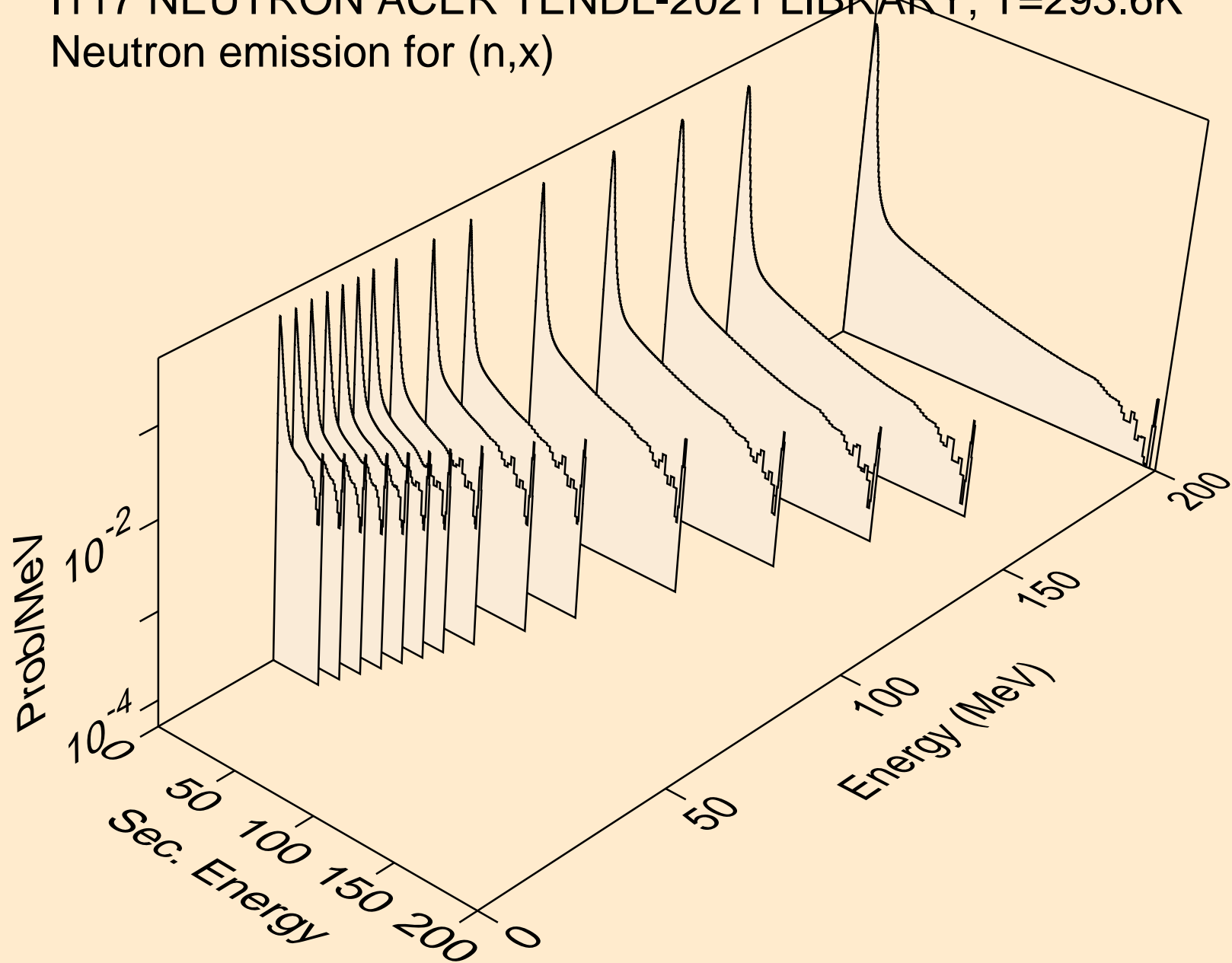

I117 NEUTRON ACER TENDL-2021 LIBRARY; T=293.6K  
Neutron emission for (n,2nd)

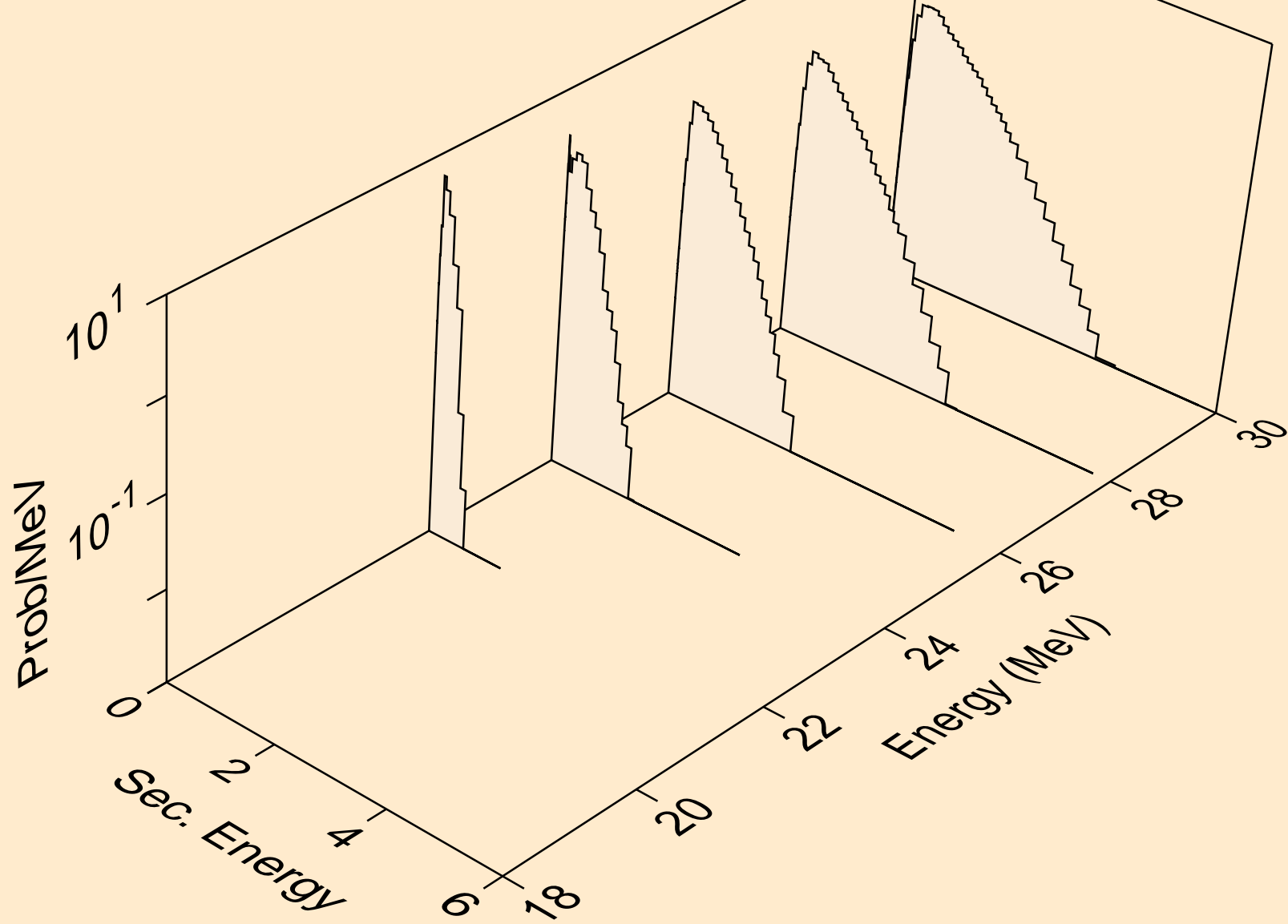



I117 NEUTRON ACER TENDL-2021 LIBRARY; T=293.6K  
Neutron emission for (n,2n)

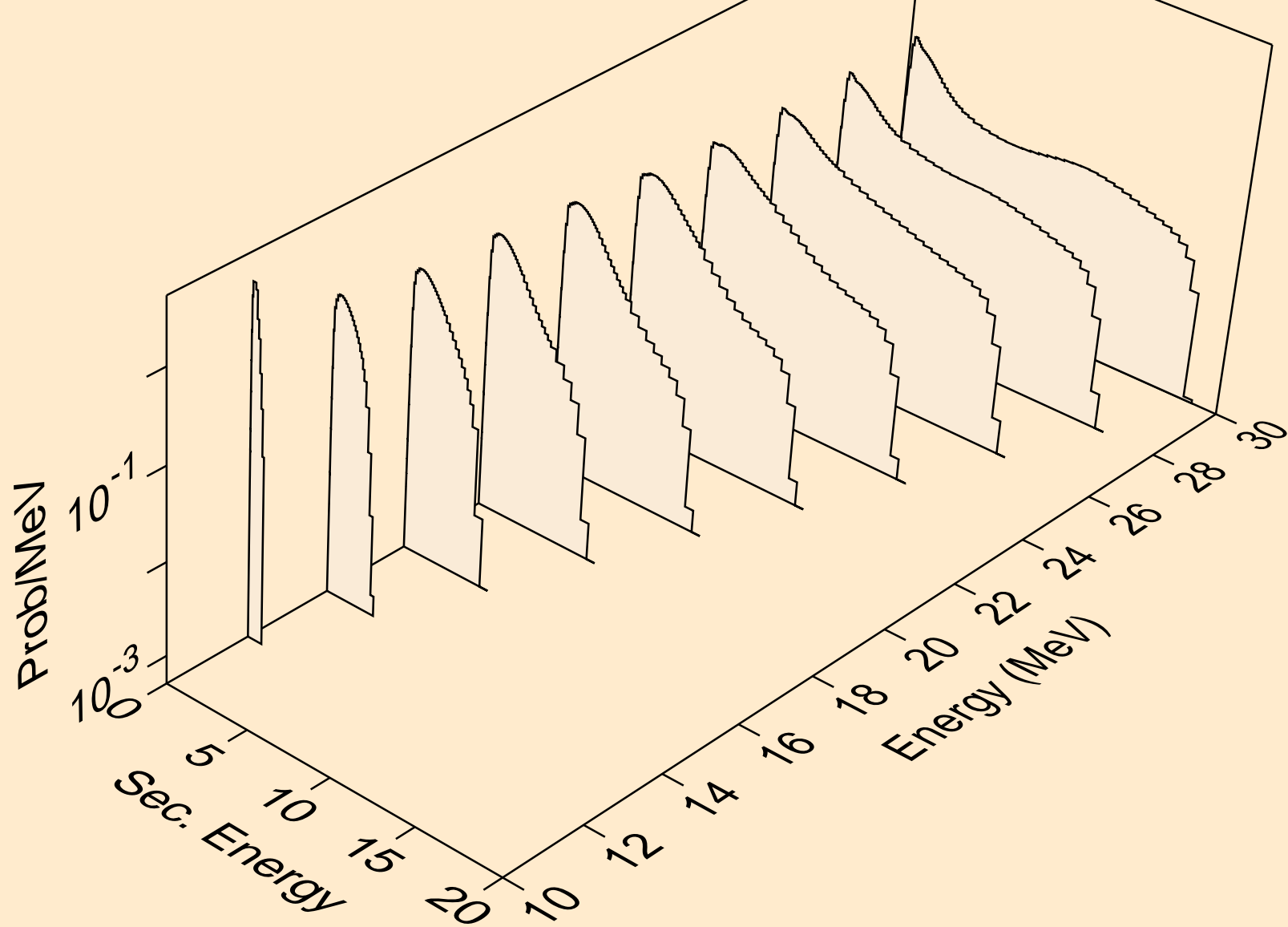

I117 NEUTRON ACER TENDL-2021 LIBRARY; T=293.6K  
Neutron emission for (n,3n)

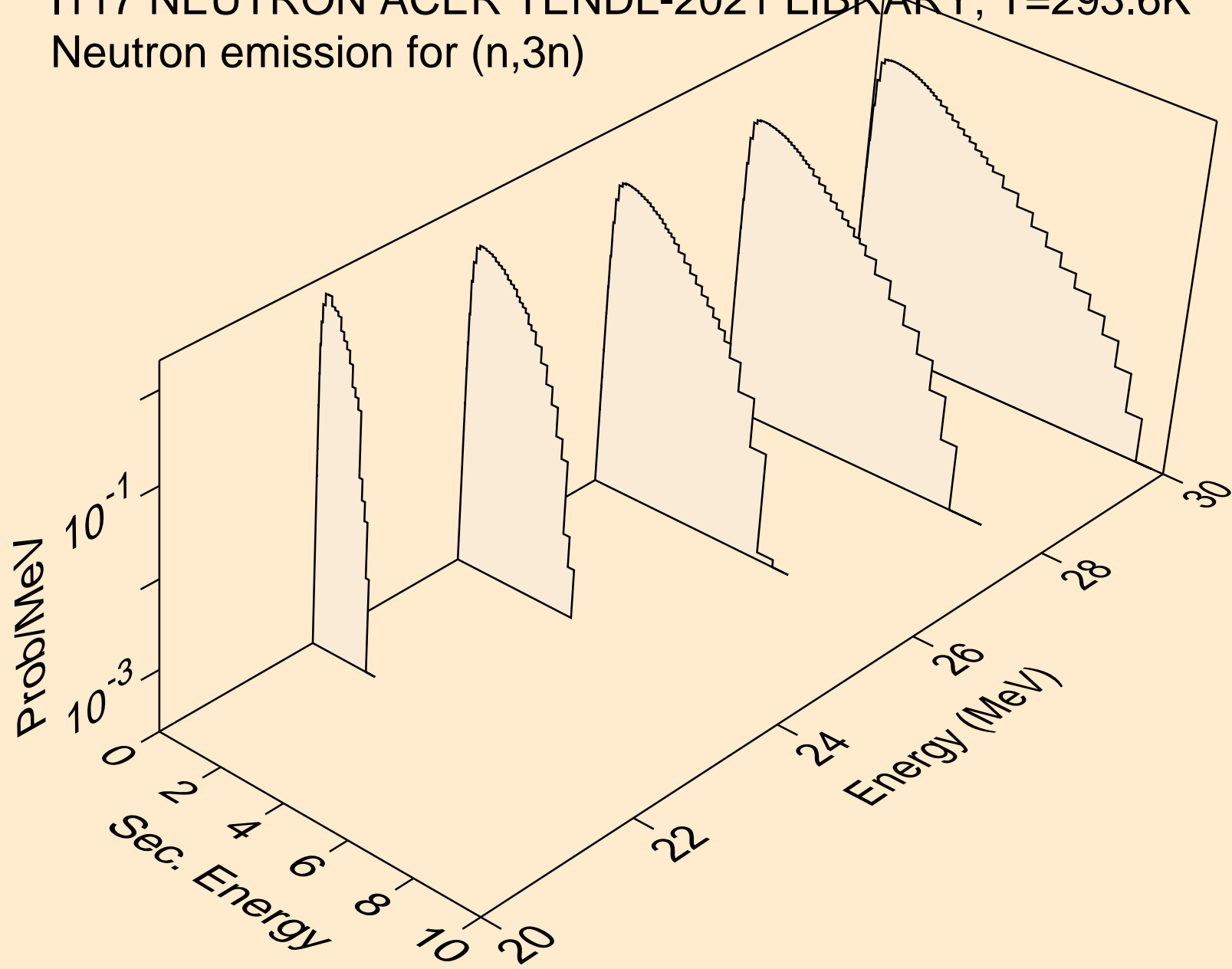

I117 NEUTRON ACER TENDL-2021 LIBRARY; T=293.6K  
Neutron emission for (n,n\*)a

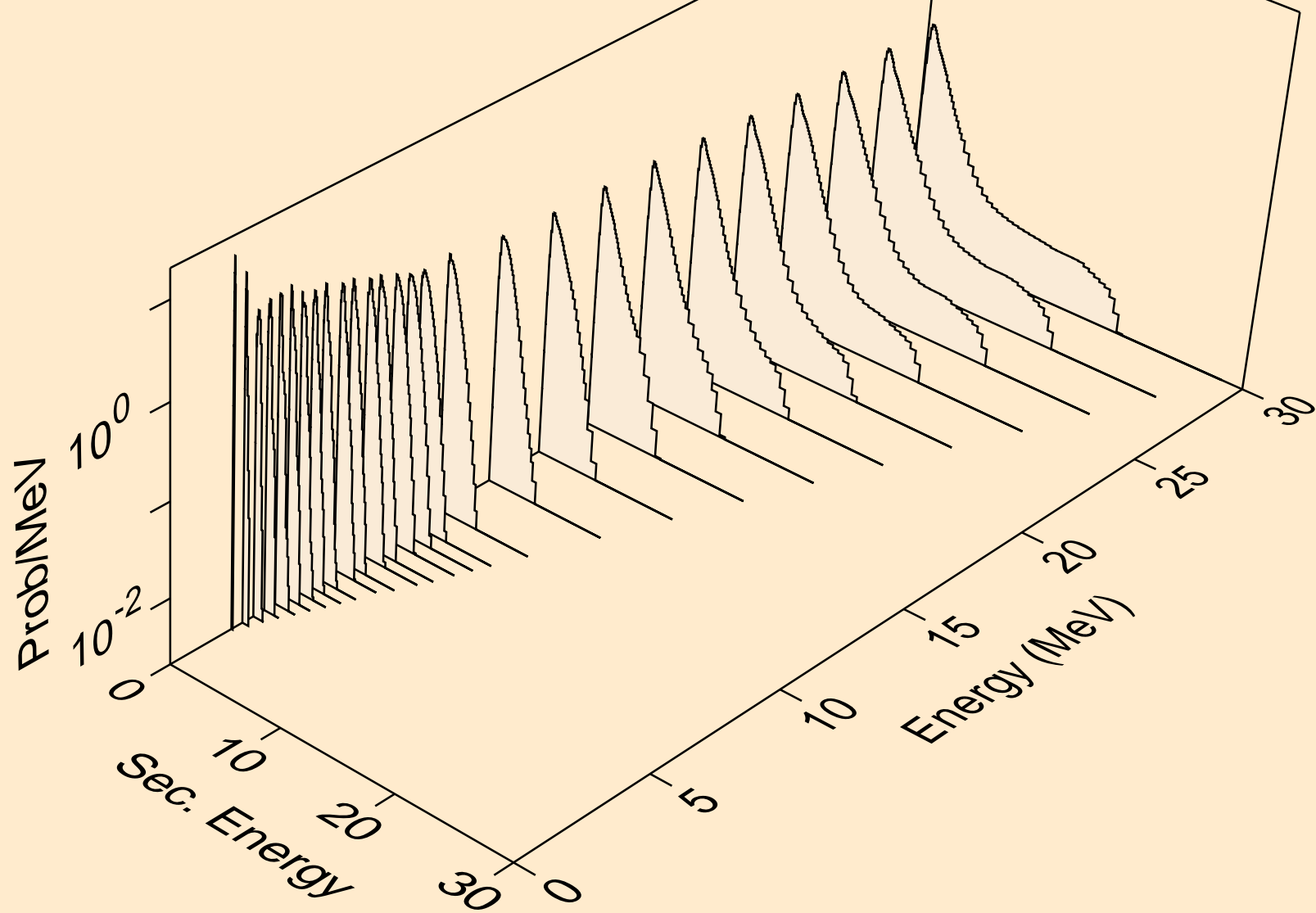

I117 NEUTRON ACER TENDL-2021 LIBRARY; T=293.6K  
Neutron emission for (n,2n)<sub>a</sub>

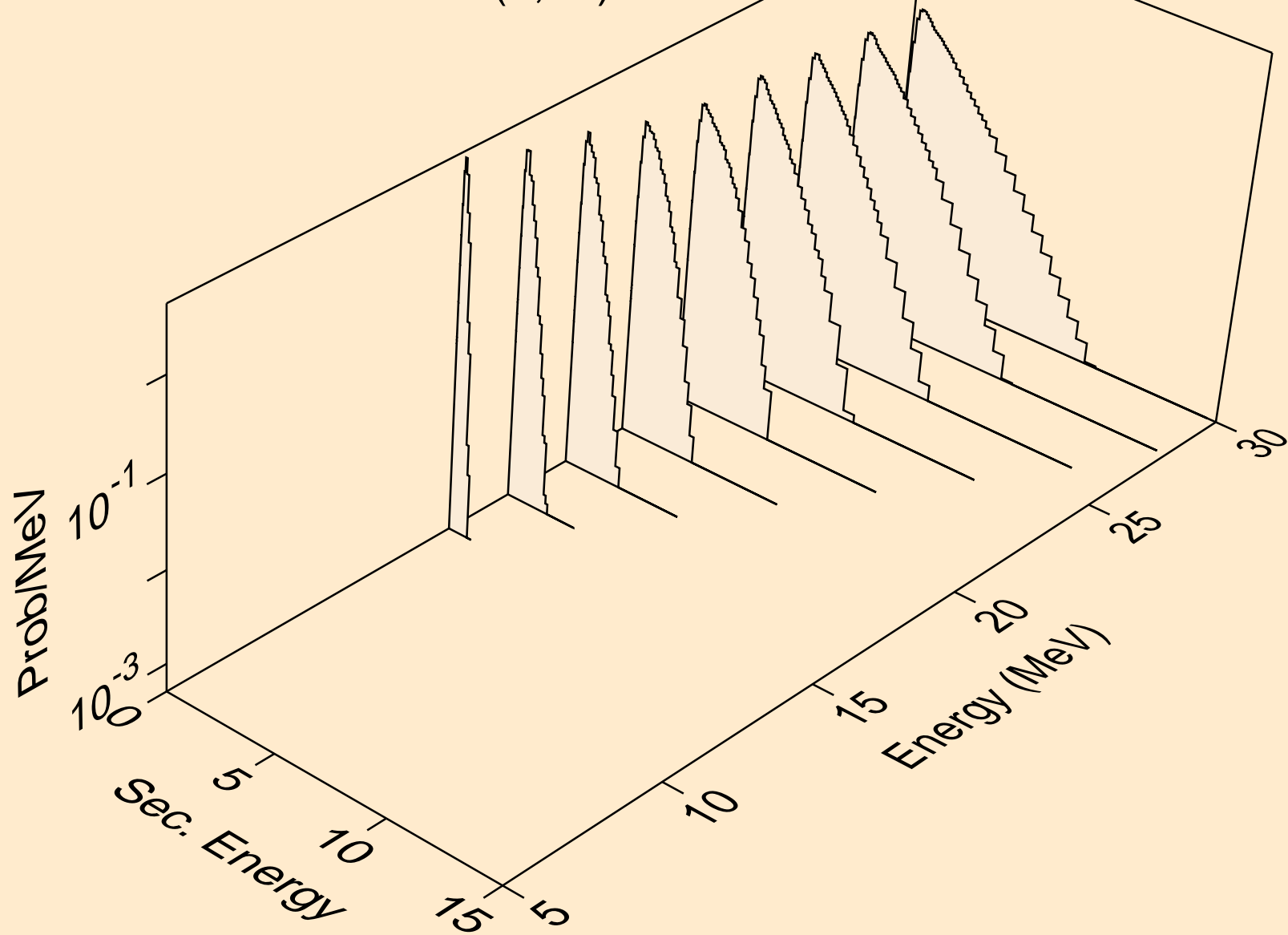

I117 NEUTRON ACER TENDL-2021 LIBRARY; T=293.6K  
Neutron emission for (n,3n)a

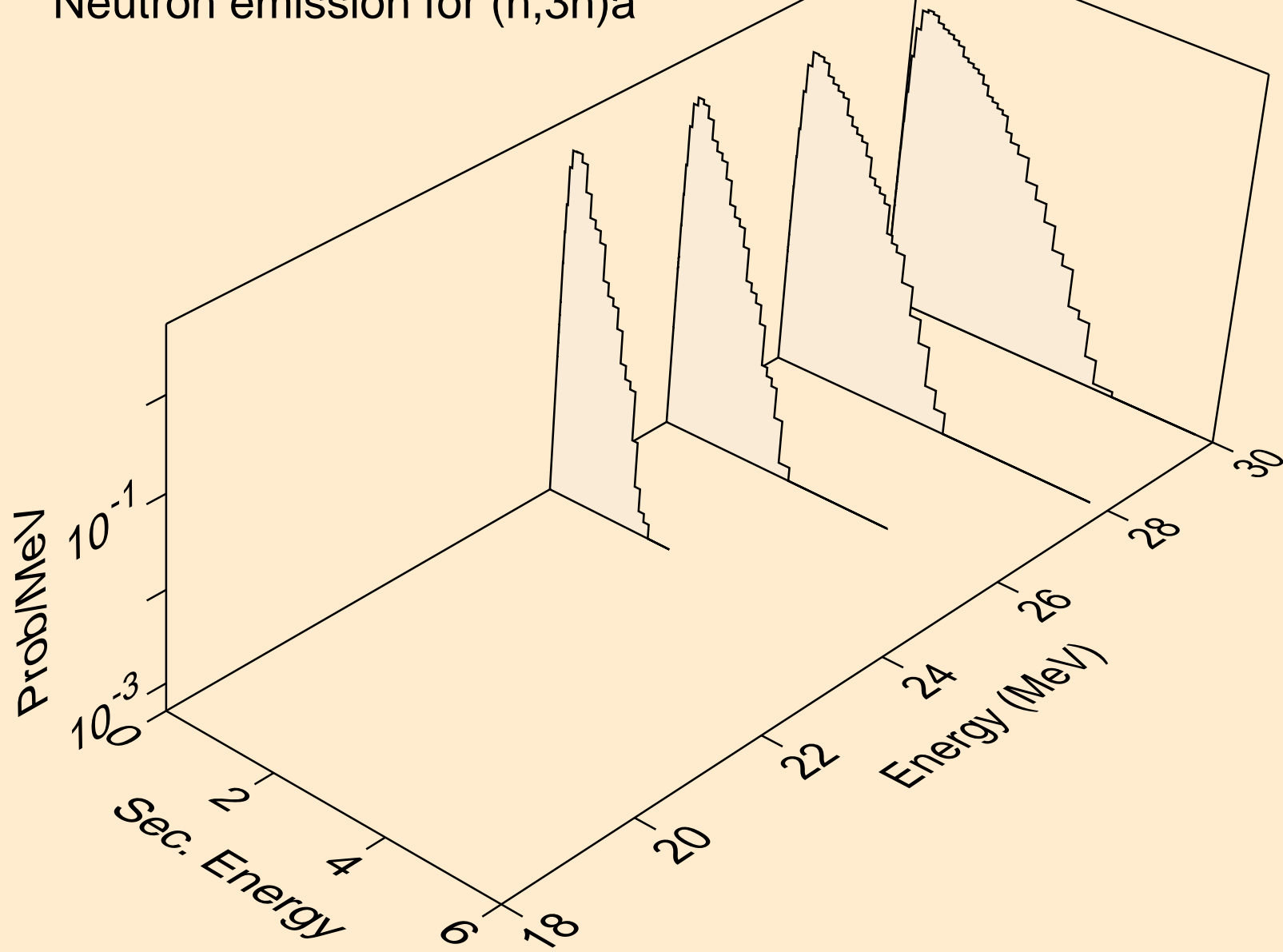

I117 NEUTRON ACER TENDL-2021 LIBRARY; T=293.6K  
Neutron emission for (n,n\*)p

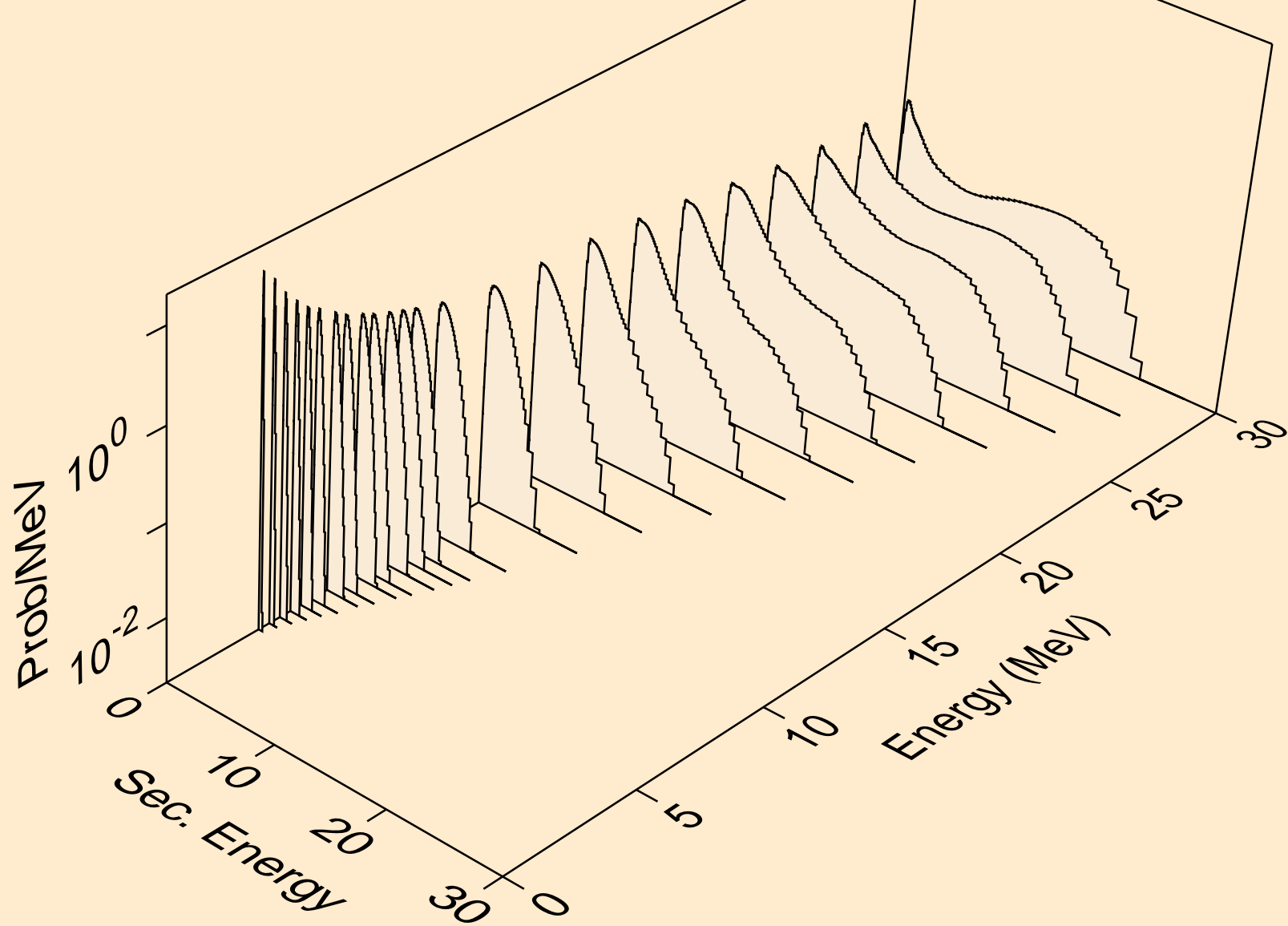

I117 NEUTRON ACER TENDL-2021 LIBRARY; T=293.6K  
Neutron emission for (n,n\*)2a

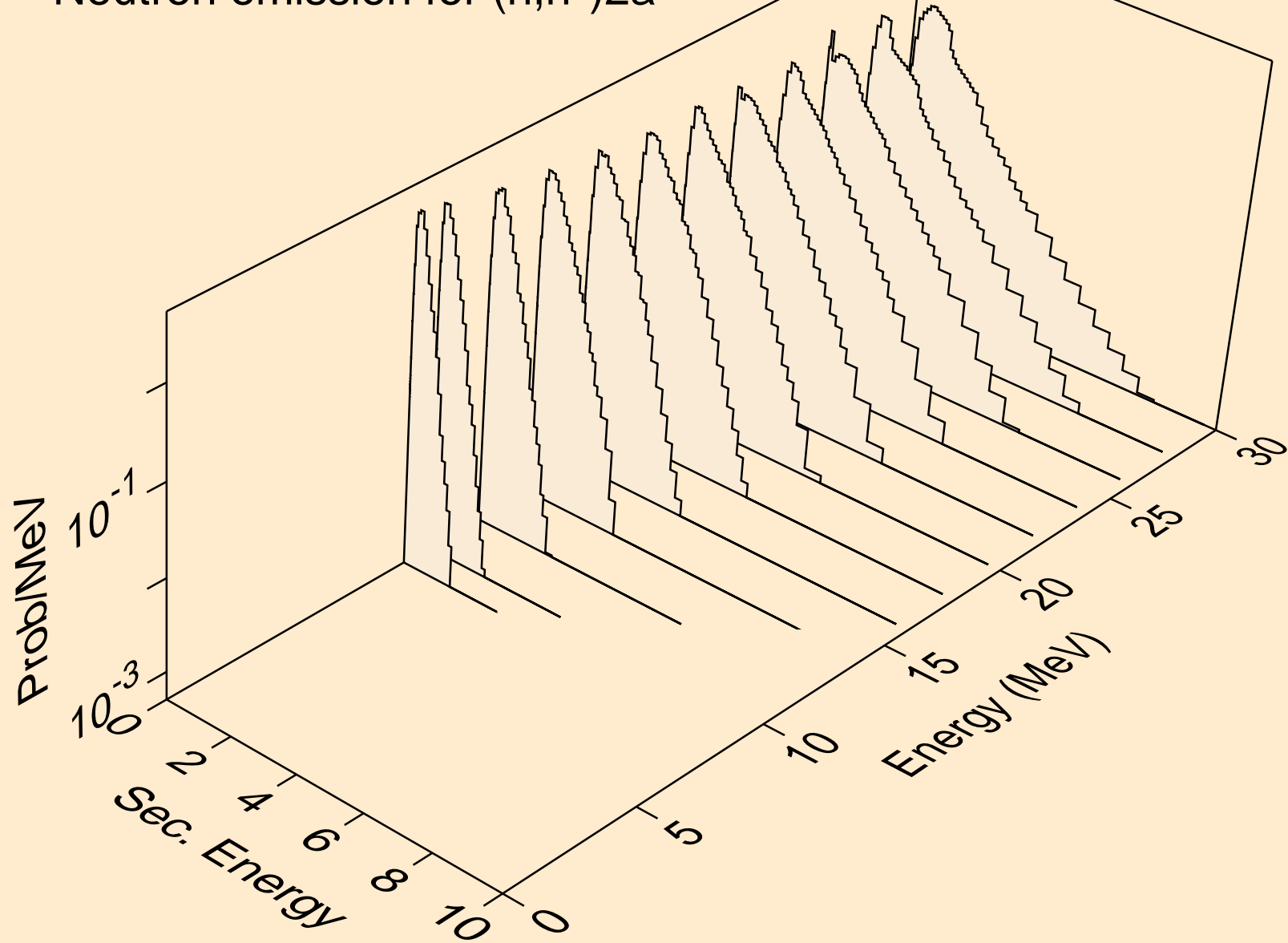

I117 NEUTRON ACER TENDL-2021 LIBRARY; T=293.6K  
Neutron emission for (n,2n)2a

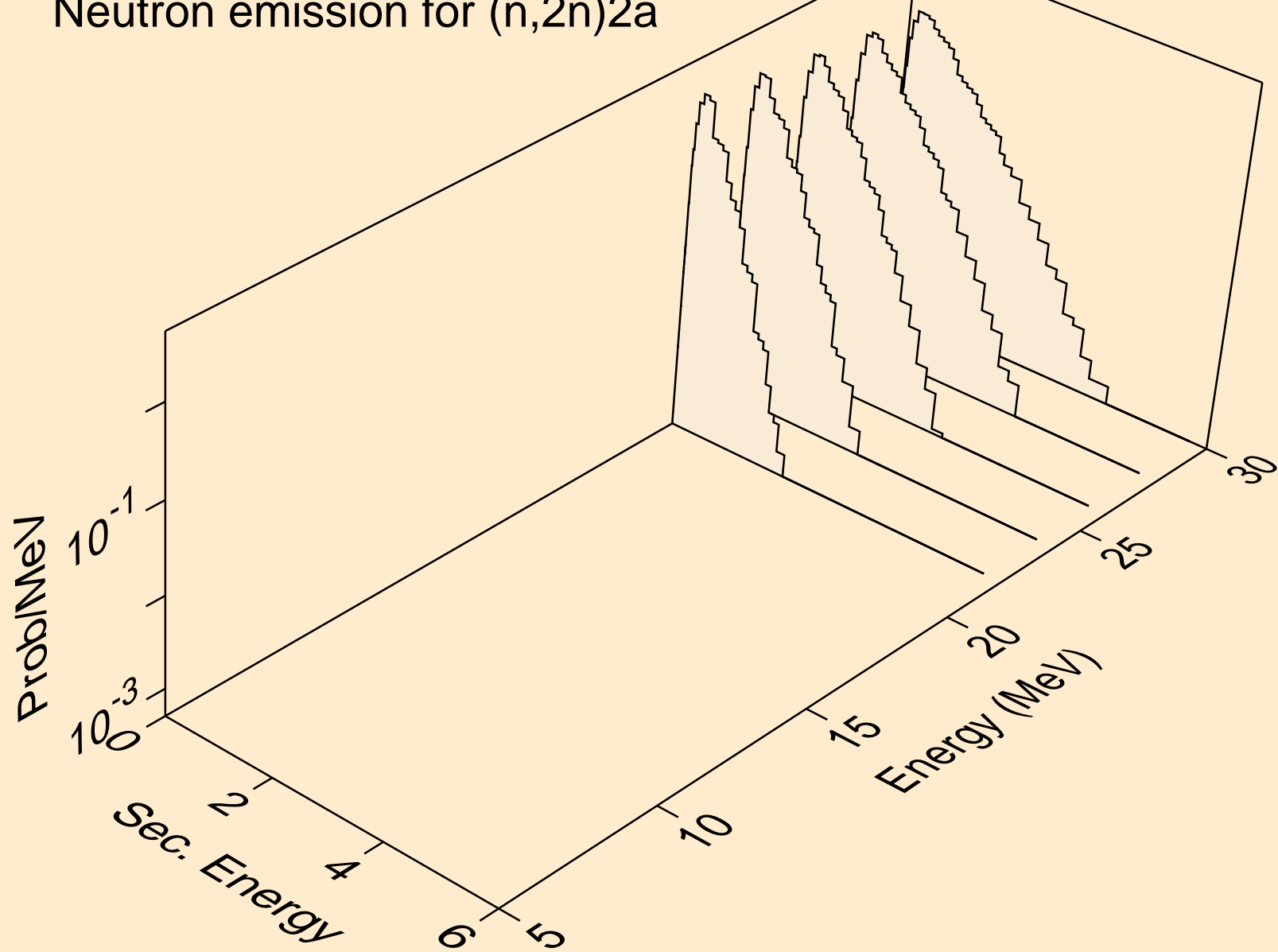



I117 NEUTRON ACER TENDL-2021 LIBRARY; T=293.6K  
Neutron emission for (n,n\*)d

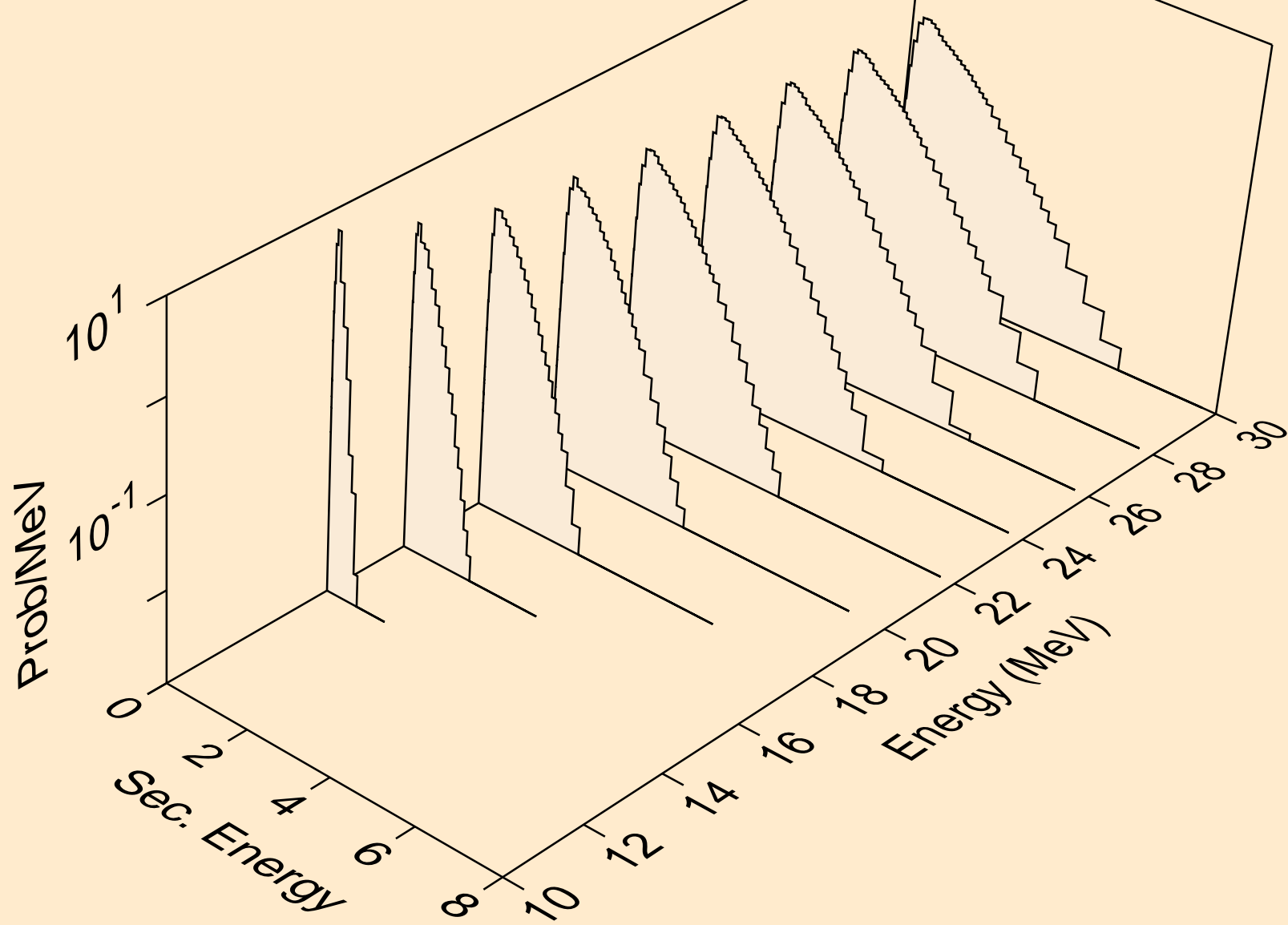

I117 NEUTRON ACER TENDL-2021 LIBRARY; T=293.6K  
Neutron emission for (n,n\*)t

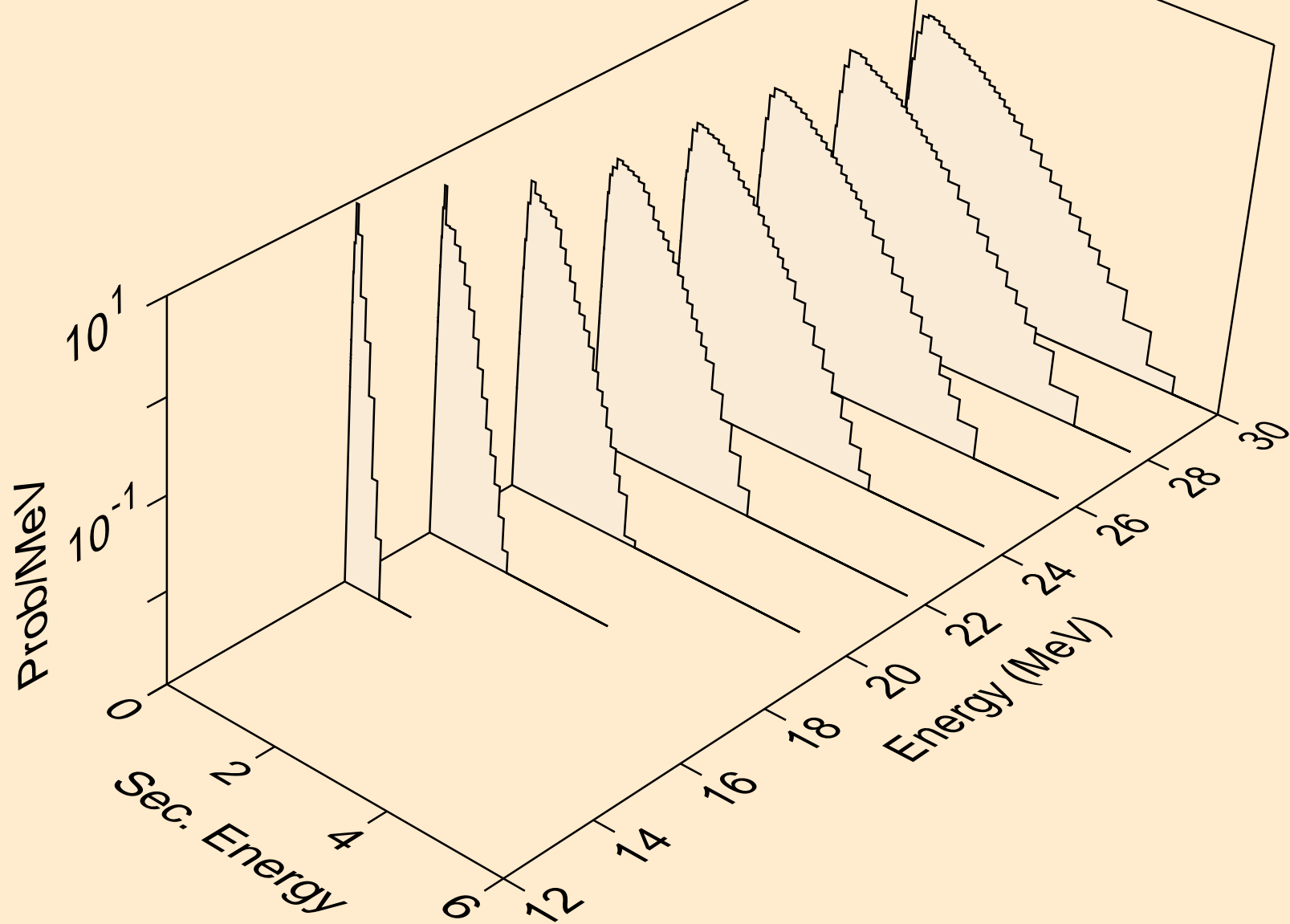

I117 NEUTRON ACER TENDL-2021 LIBRARY; T=293.6K  
Neutron emission for (n,n\*)he3

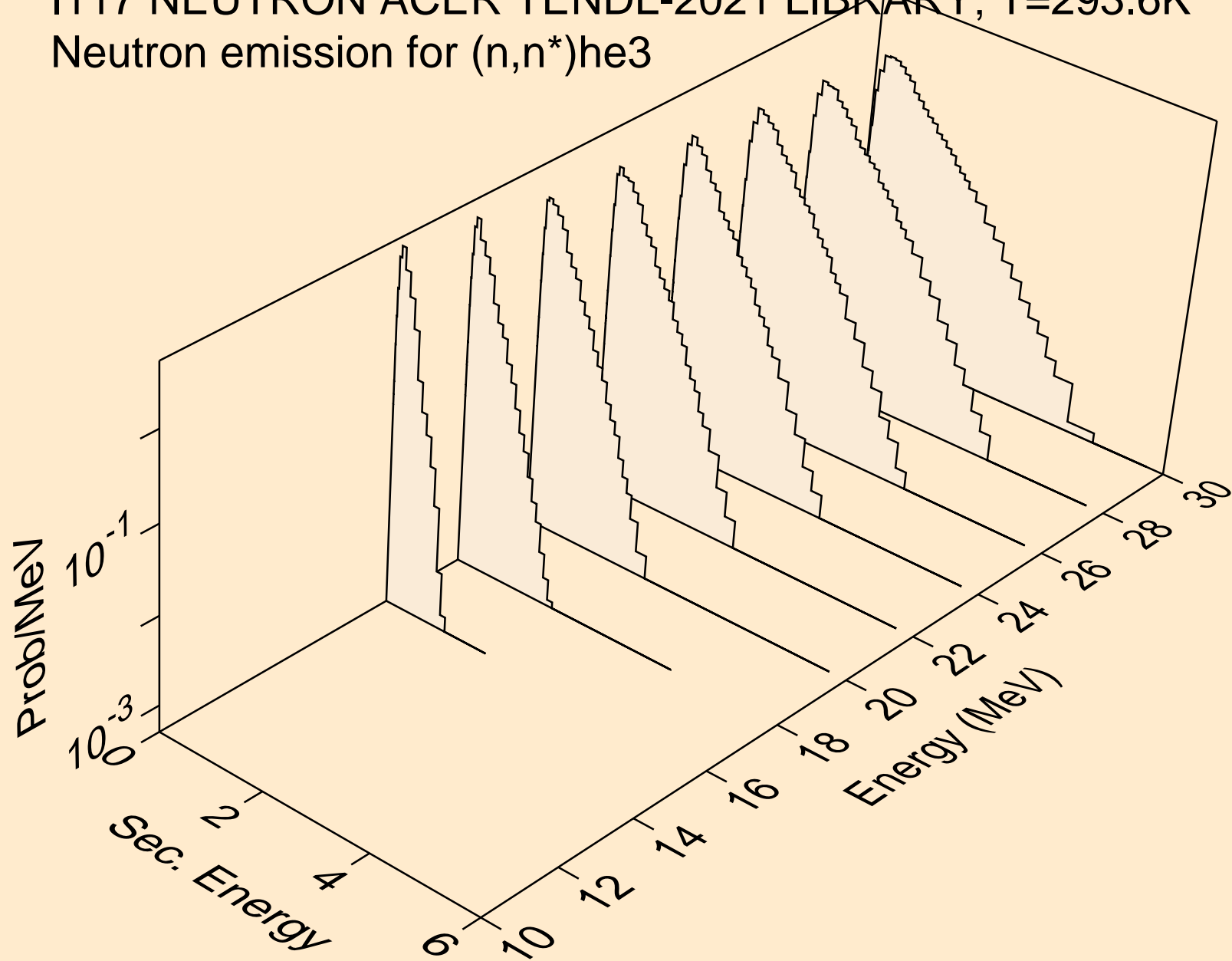

I117 NEUTRON ACER TENDL-2021 LIBRARY; T=293.6K  
Neutron emission for (n,2np)

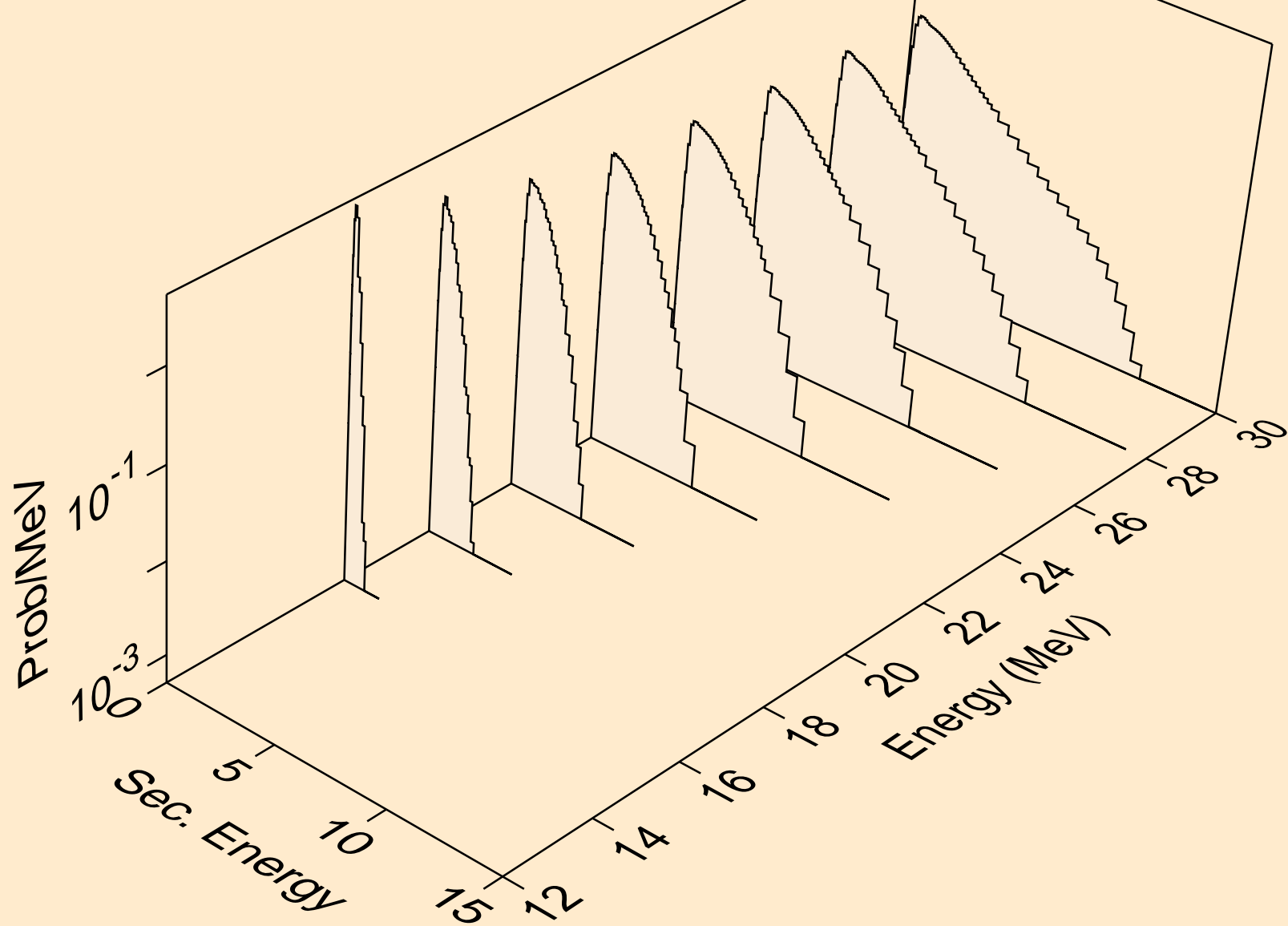

I117 NEUTRON ACER TENDL-2021 LIBRARY; T=293.6K  
Neutron emission for (n,3np)

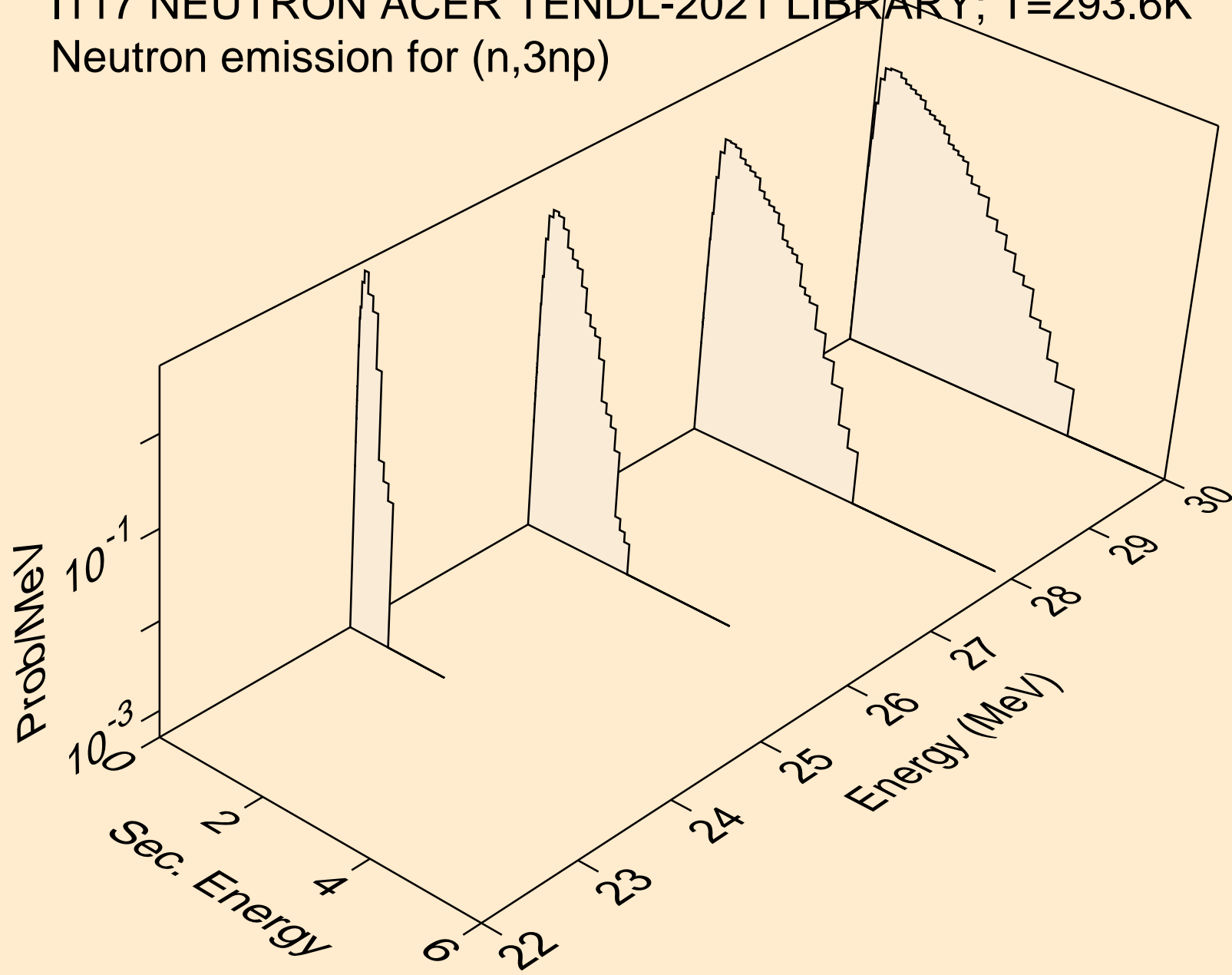

I117 NEUTRON ACER TENDL-2021 LIBRARY; T=293.6K  
Neutron emission for (n,2np)

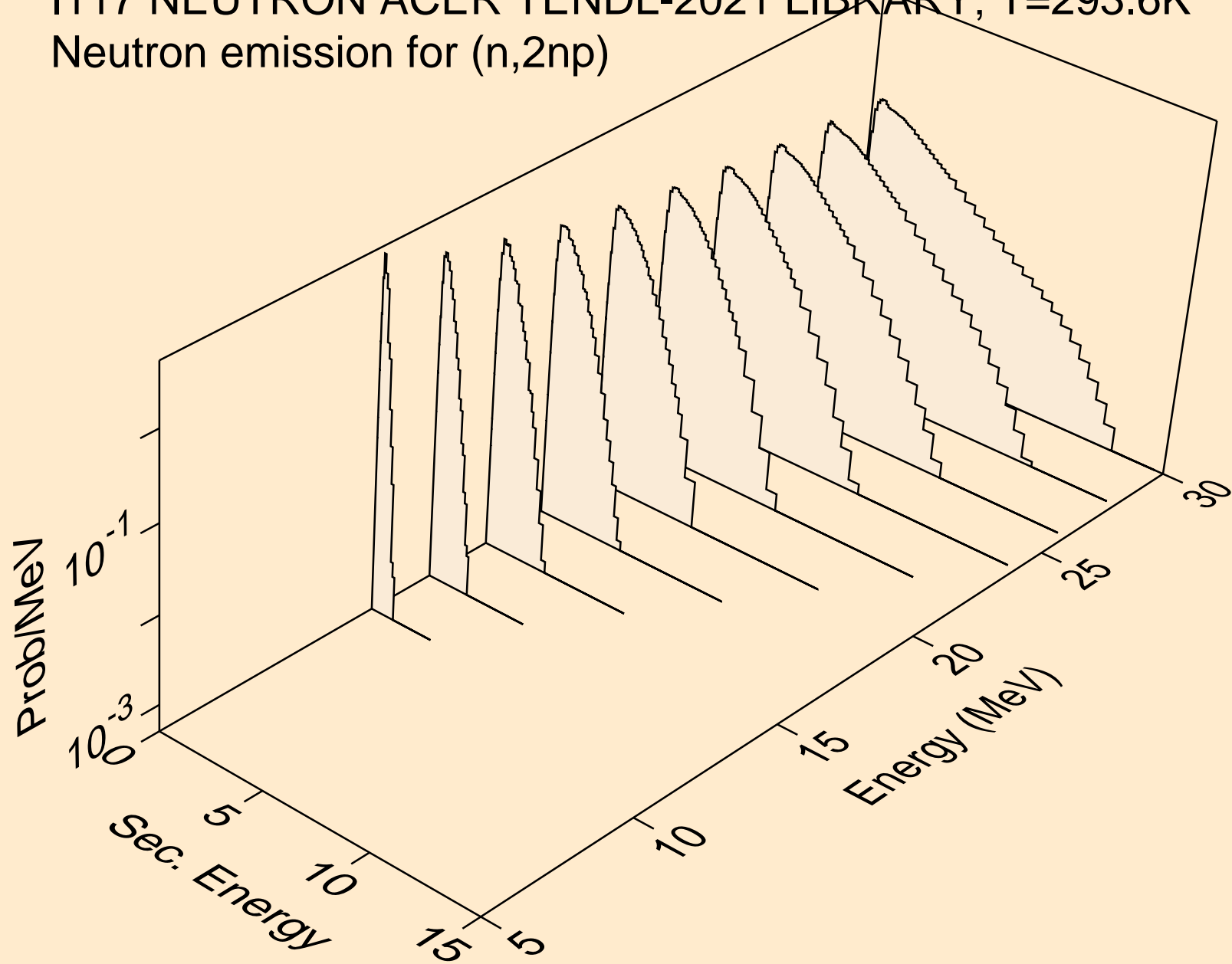

I117 NEUTRON ACER TENDL-2021 LIBRARY; T=293.6K  
Neutron emission for (n,npa)

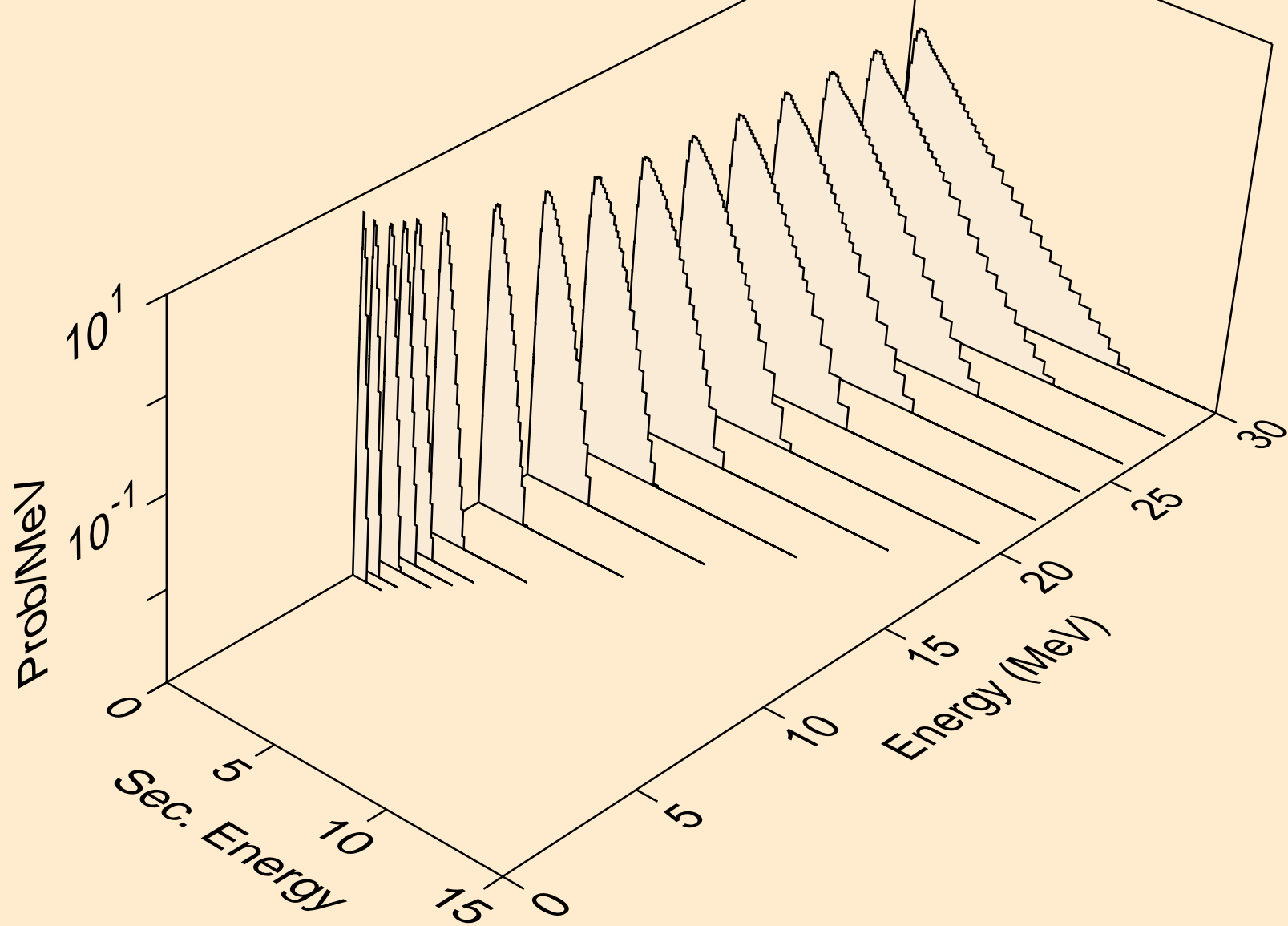

I117 NEUTRON ACER TENDL-2021 LIBRARY; T=293.6K  
Neutron emission for (n,n\*c)

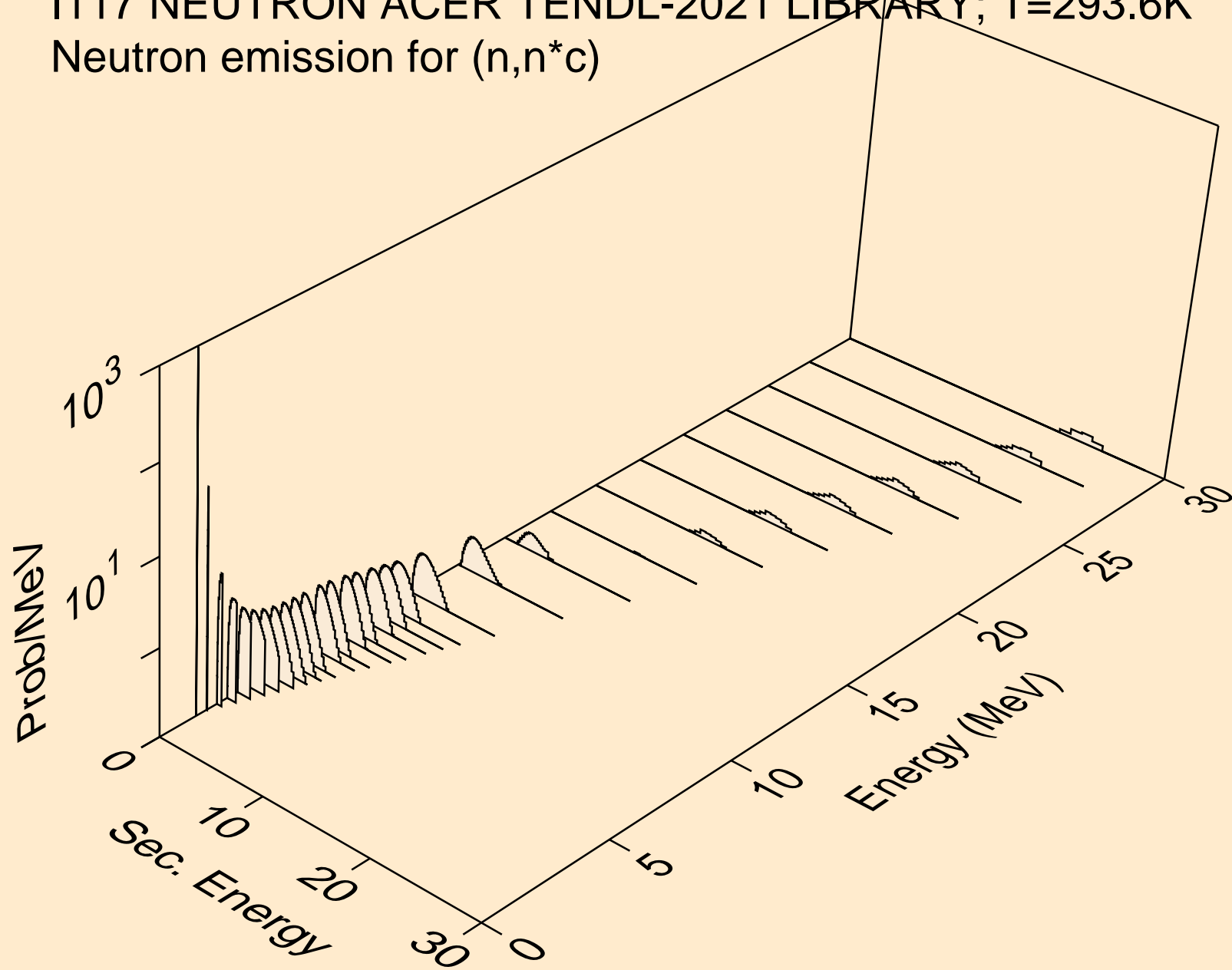



I117 NEUTRON ACER TENDL-2021 LIBRARY; T=293.6K  
Photon emission for (n,x)

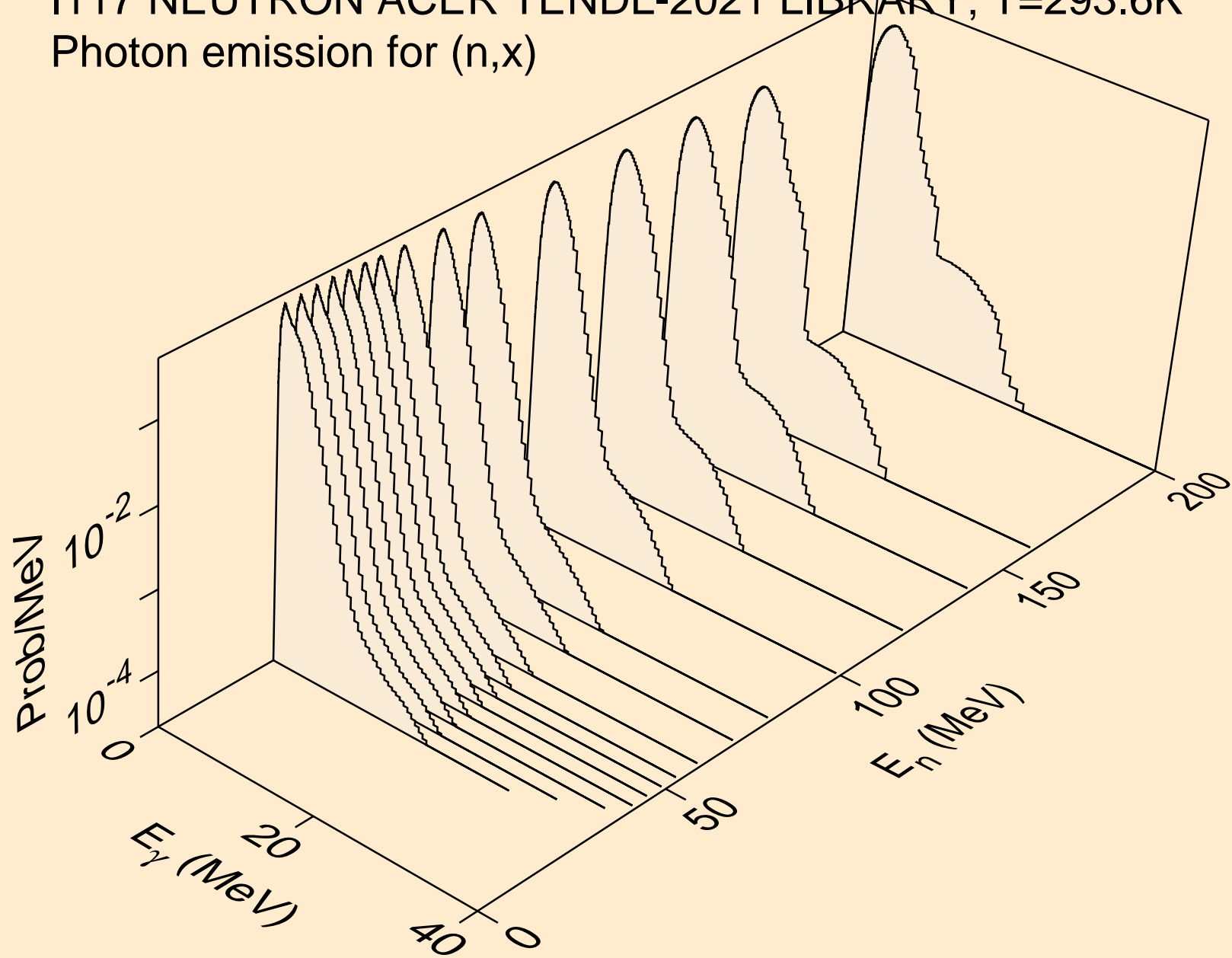

I117 NEUTRON ACER TENDL-2021 LIBRARY; T=293.6K  
Photon emission for (n,2nd)

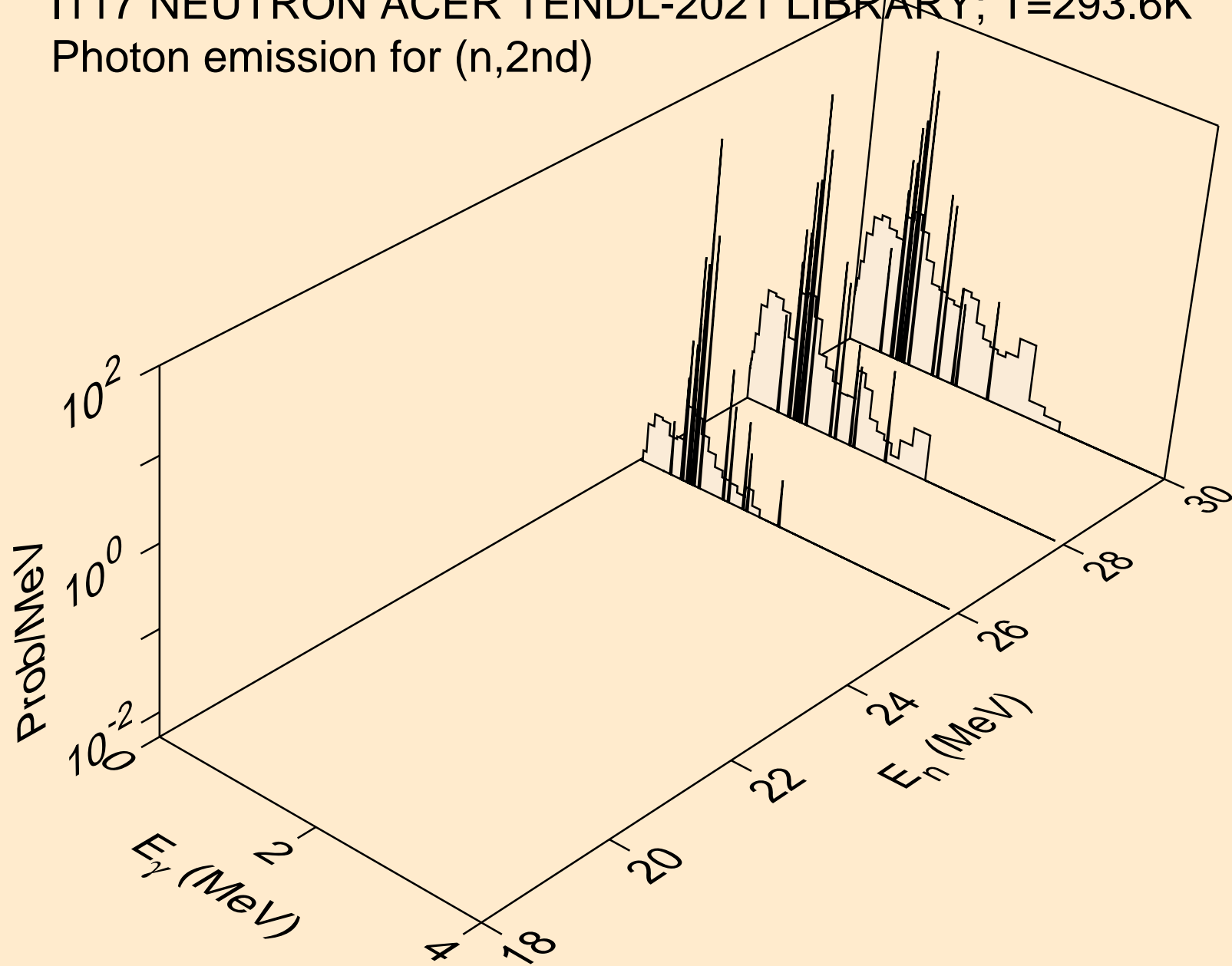

I117 NEUTRON ACER TENDL-2021 LIBRARY; T=293.6K  
Photon emission for (n,2n)

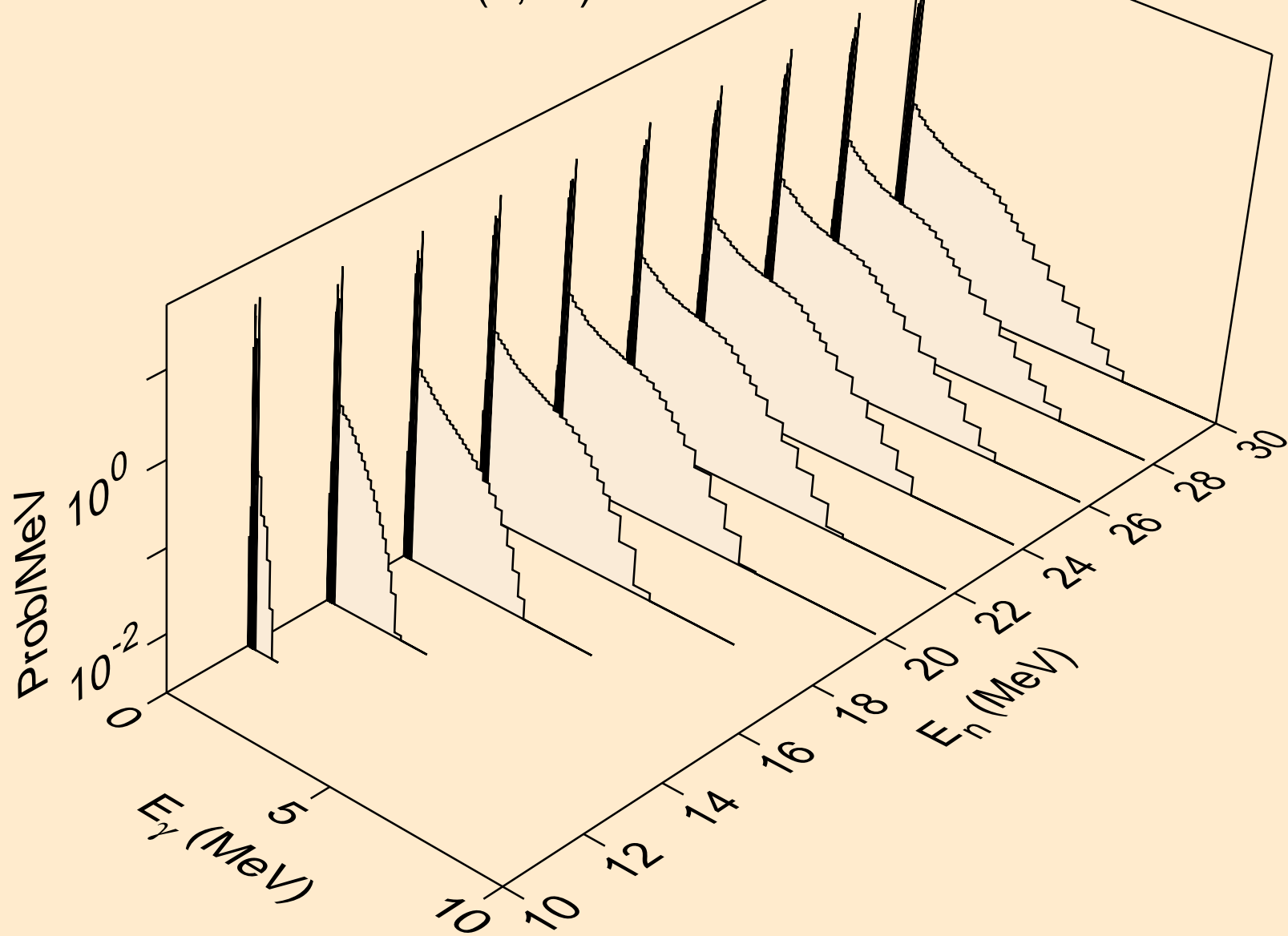

I117 NEUTRON ACER TENDL-2021 LIBRARY; T=293.6K  
Photon emission for (n,3n)

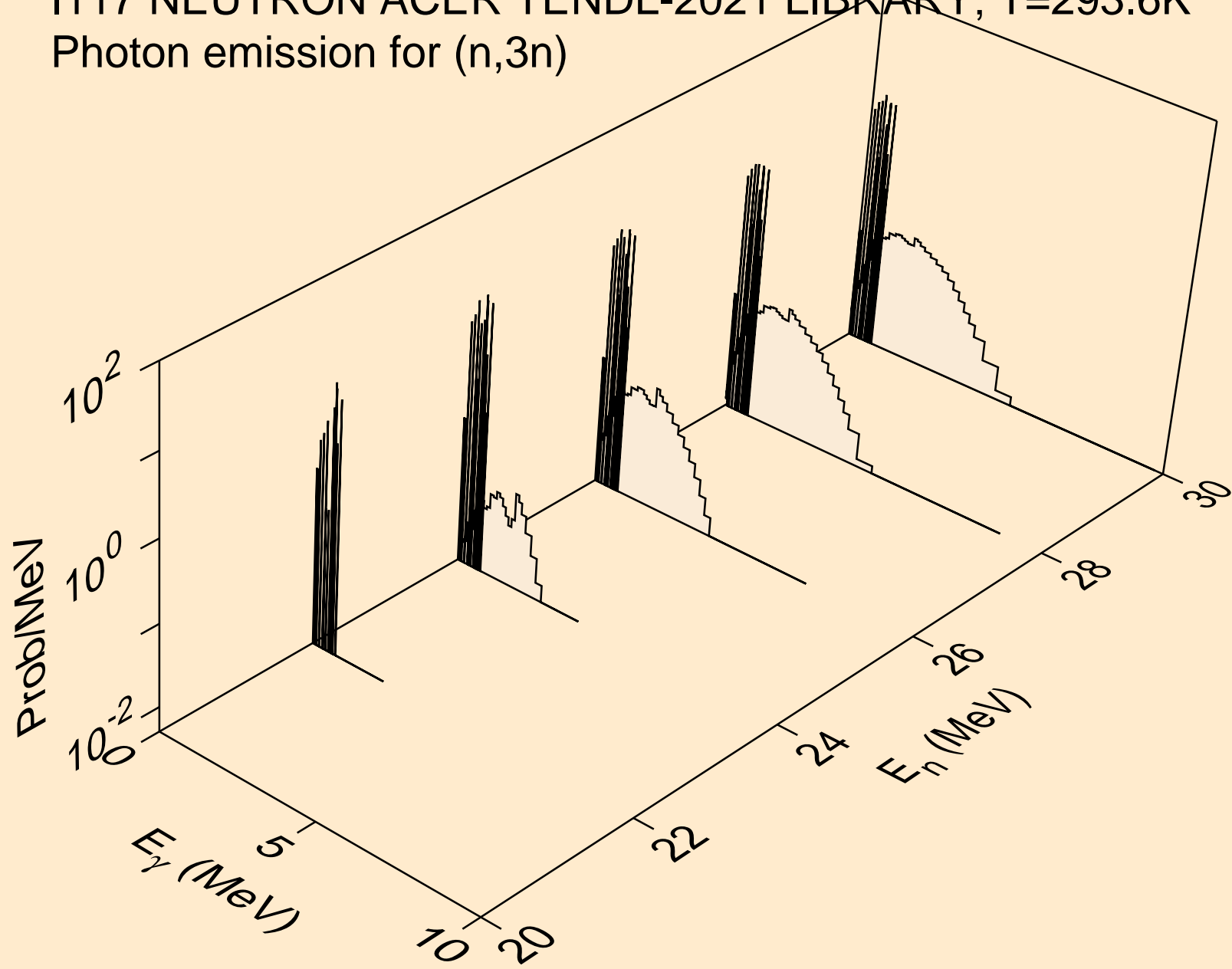

I117 NEUTRON ACER TENDL-2021 LIBRARY; T=293.6K  
Photon emission for (n,n\*)a

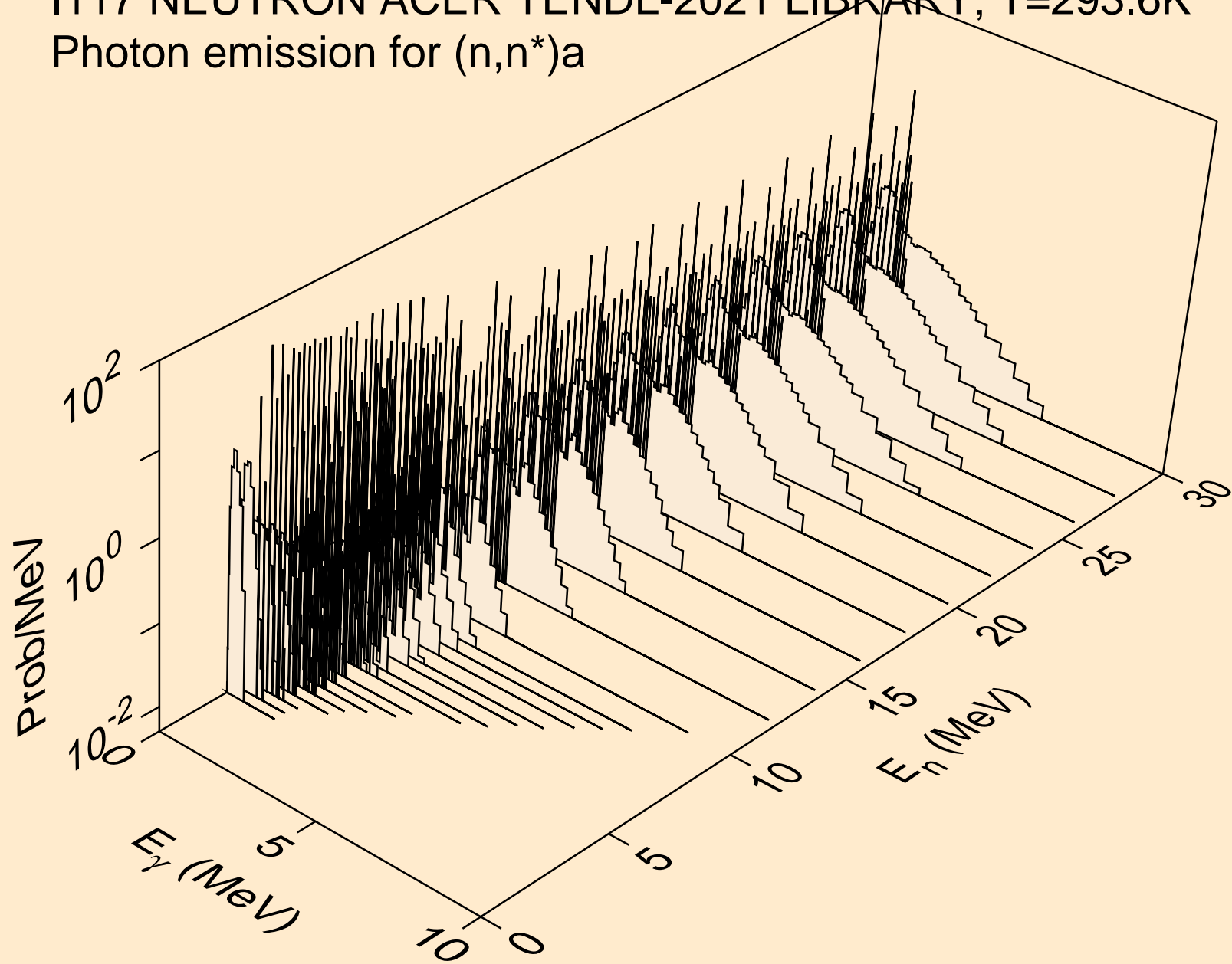

I117 NEUTRON ACER TENDL-2021 LIBRARY; T=293.6K  
Photon emission for (n,2n)a

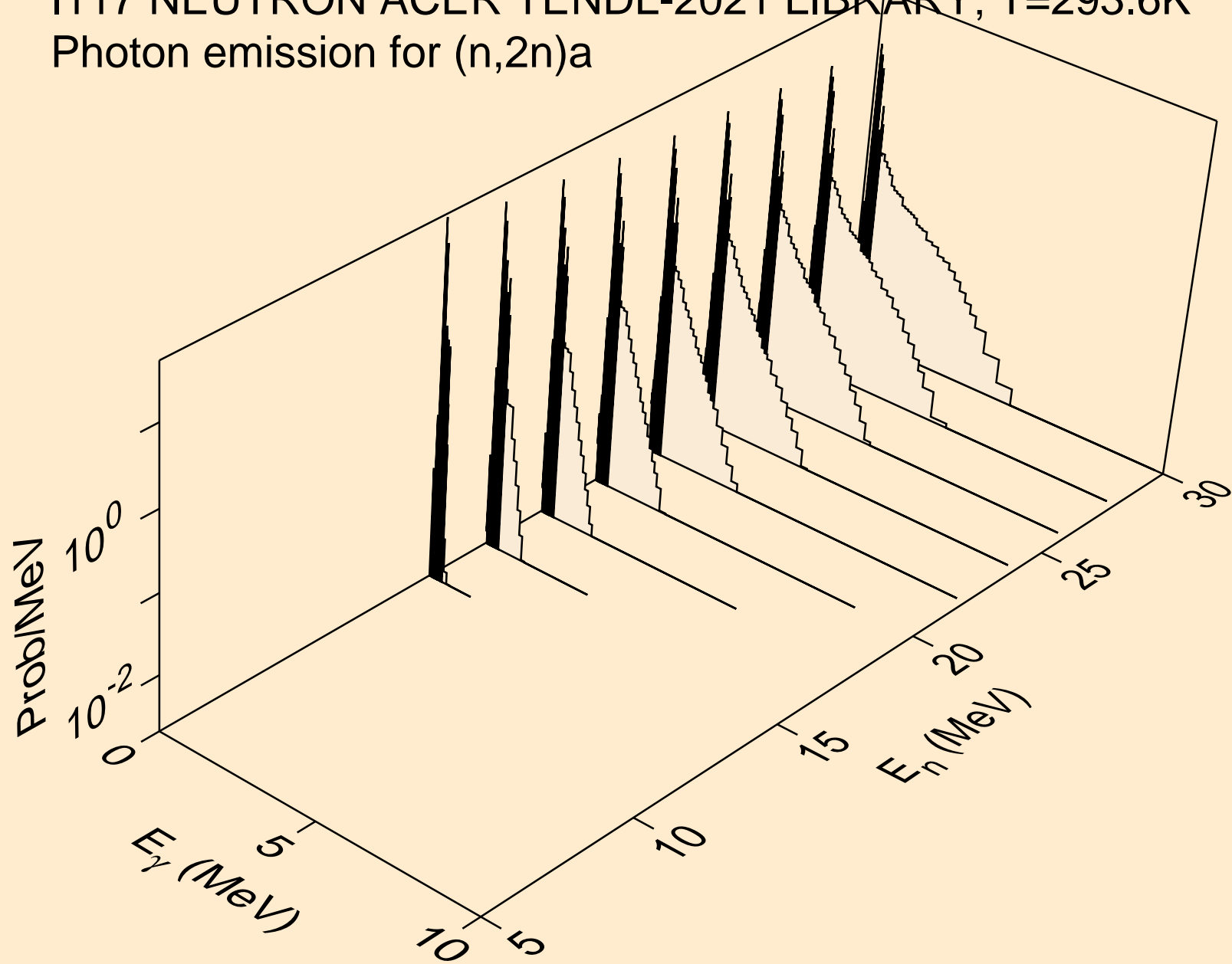

I117 NEUTRON ACER TENDL-2021 LIBRARY; T=293.6K  
Photon emission for (n,3n)a

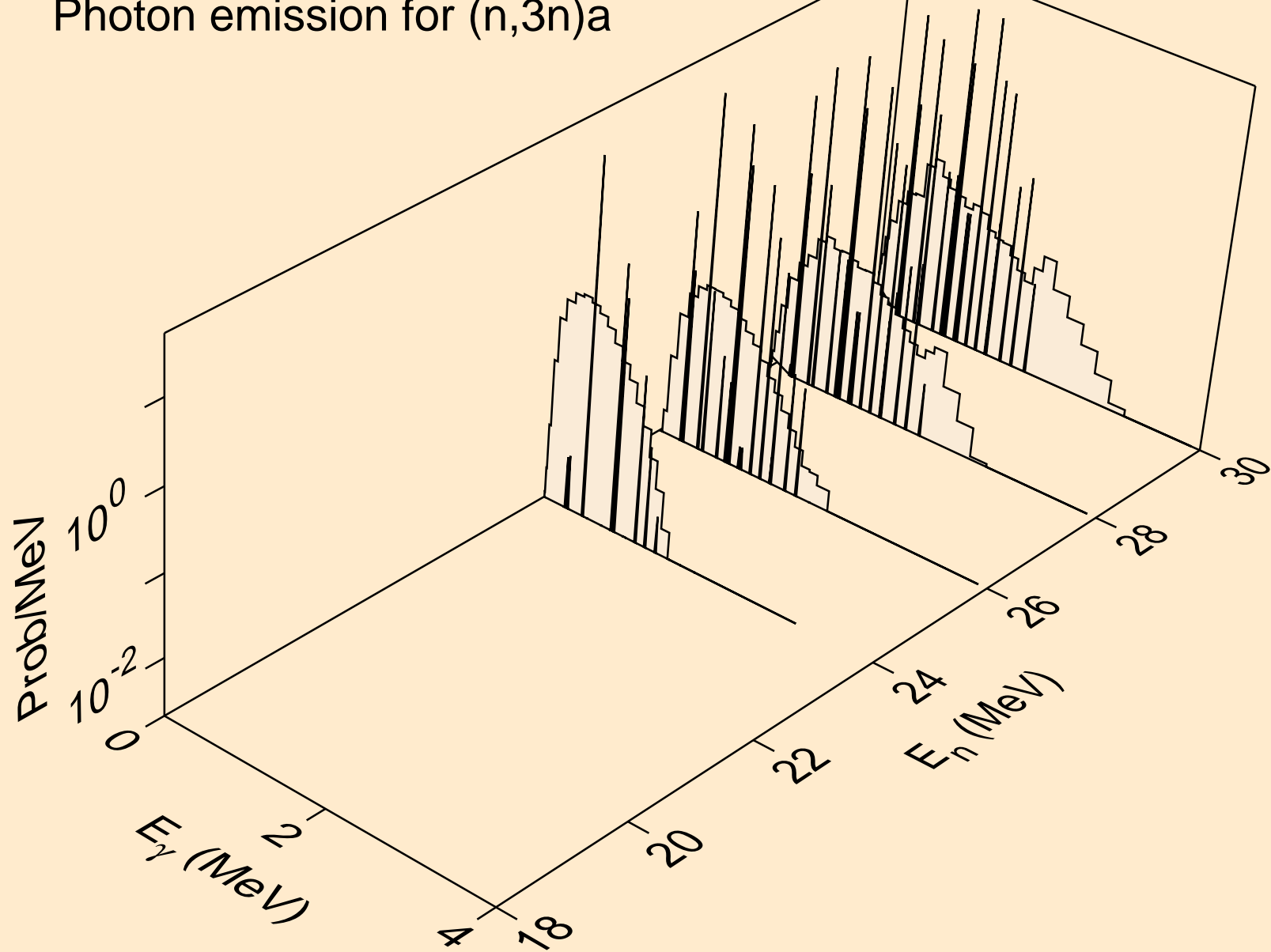

I117 NEUTRON ACER TENDL-2021 LIBRARY; T=293.6K  
Photon emission for (n,n\*)p

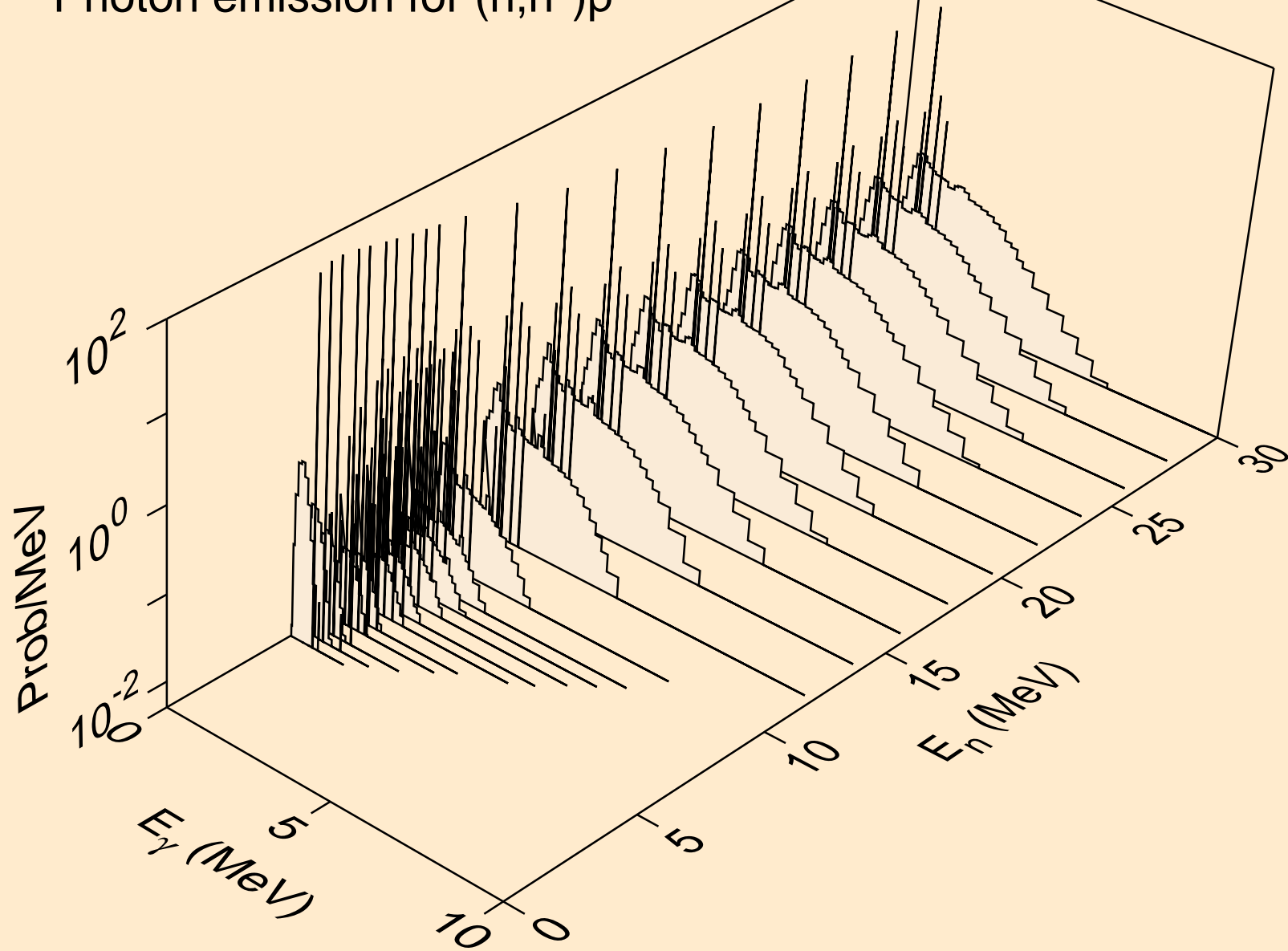



I117 NEUTRON ACER TENDL-2021 LIBRARY; T=293.6K  
Photon emission for (n,n\*)2a

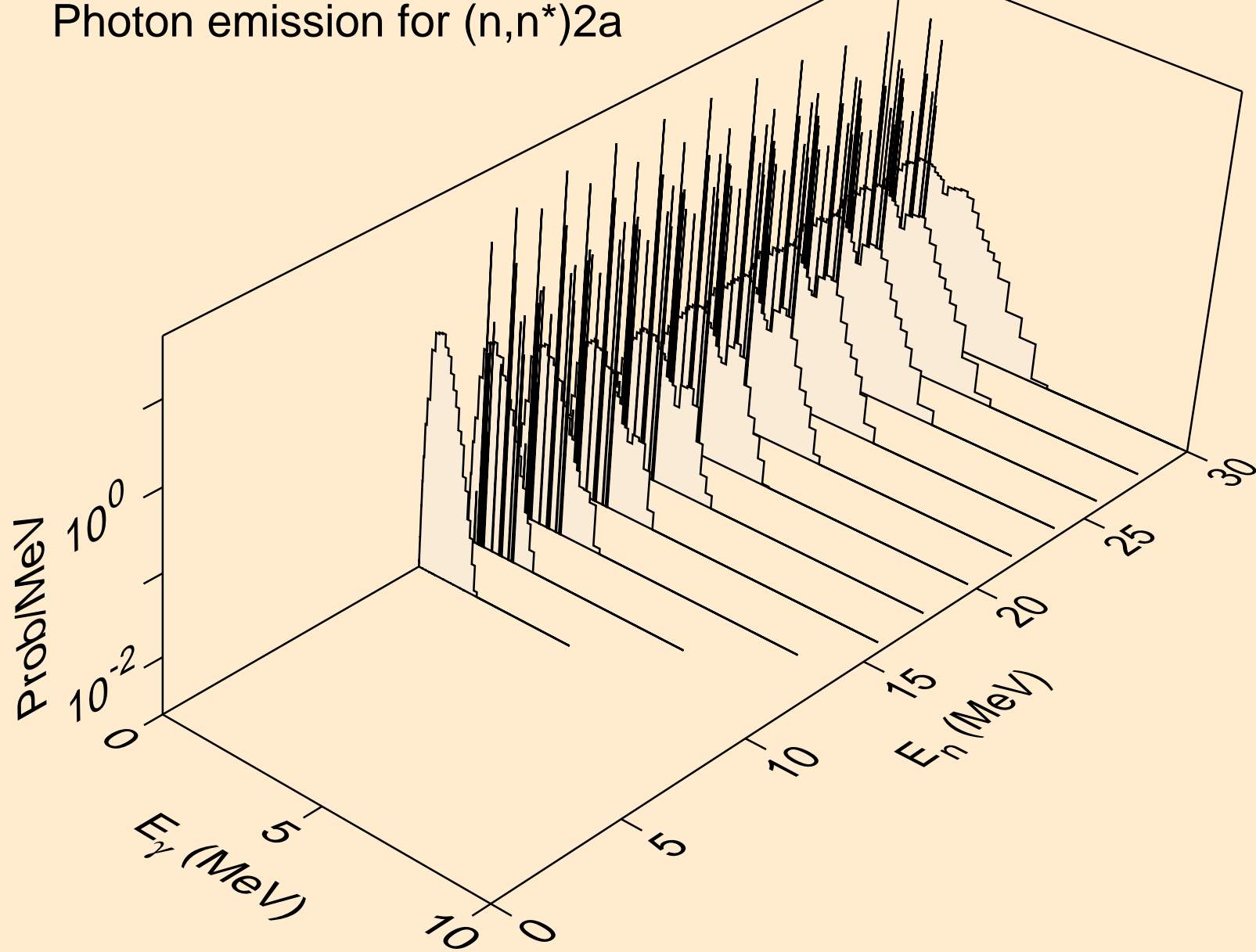

I117 NEUTRON ACER TENDL-2021 LIBRARY; T=293.6K  
Photon emission for (n,2n)2a

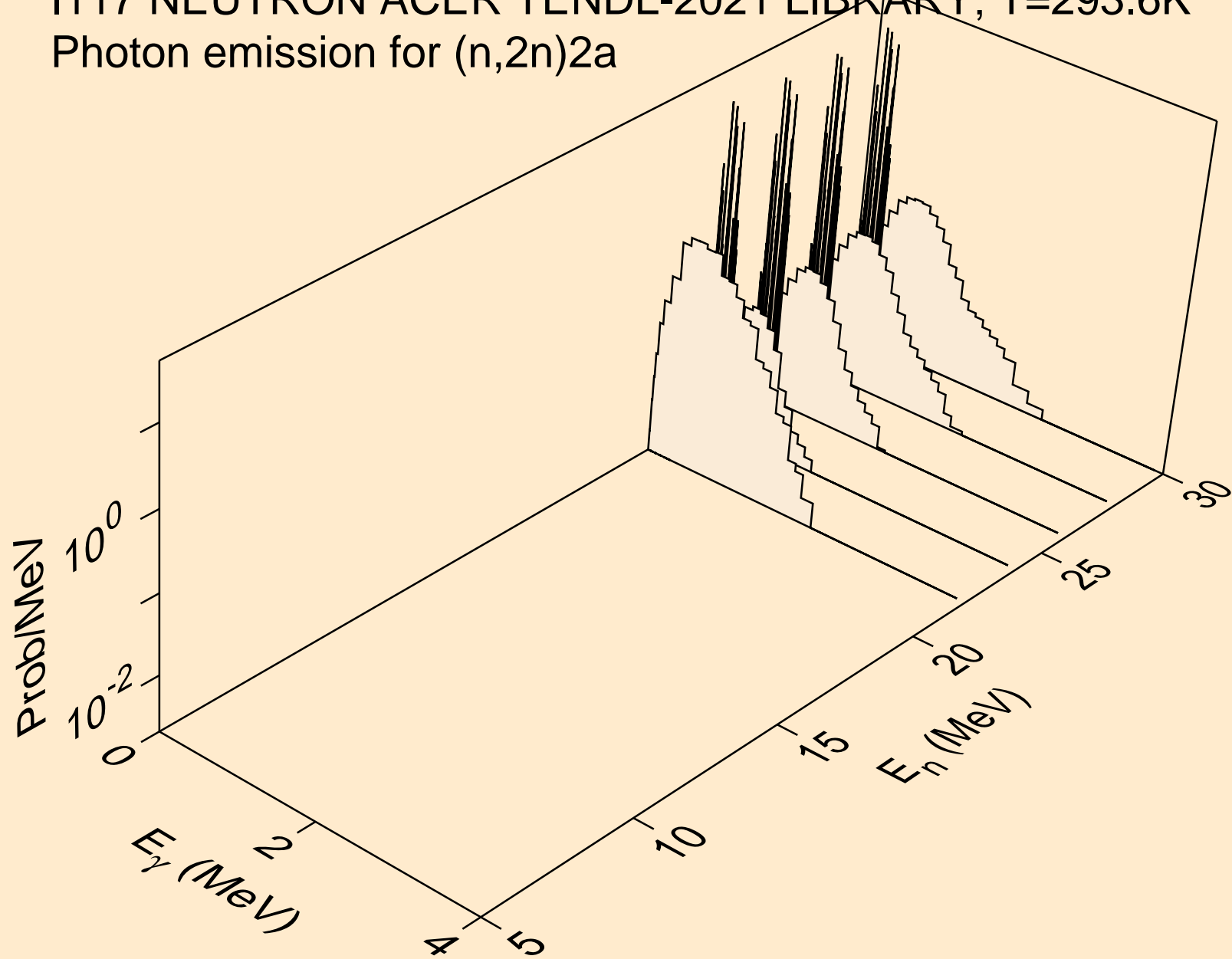

I117 NEUTRON ACER TENDL-2021 LIBRARY; T=293.6K  
Photon emission for (n,n\*)d

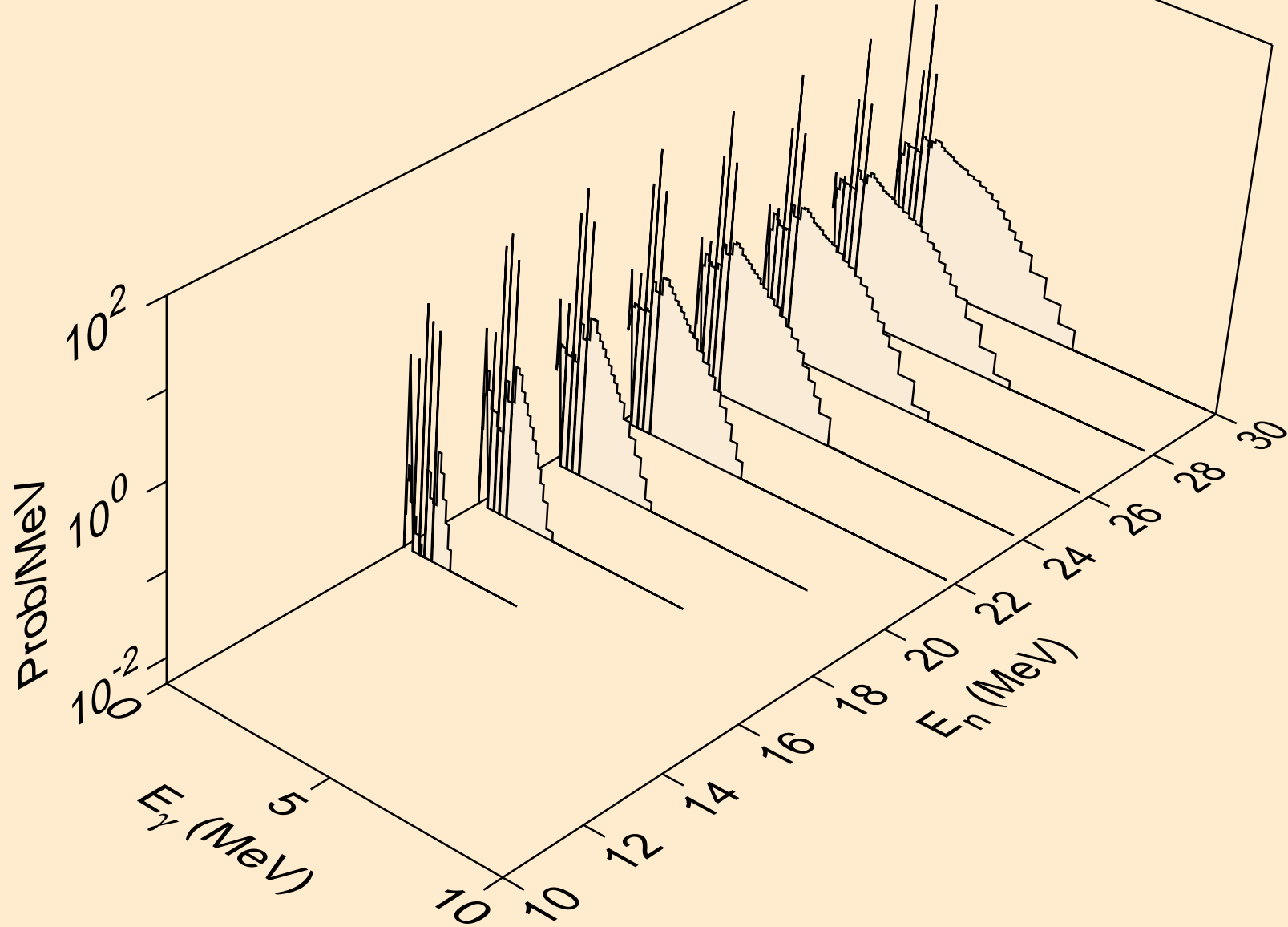

I117 NEUTRON ACER TENDL-2021 LIBRARY; T=293.6K  
Photon emission for (n,n\*)t

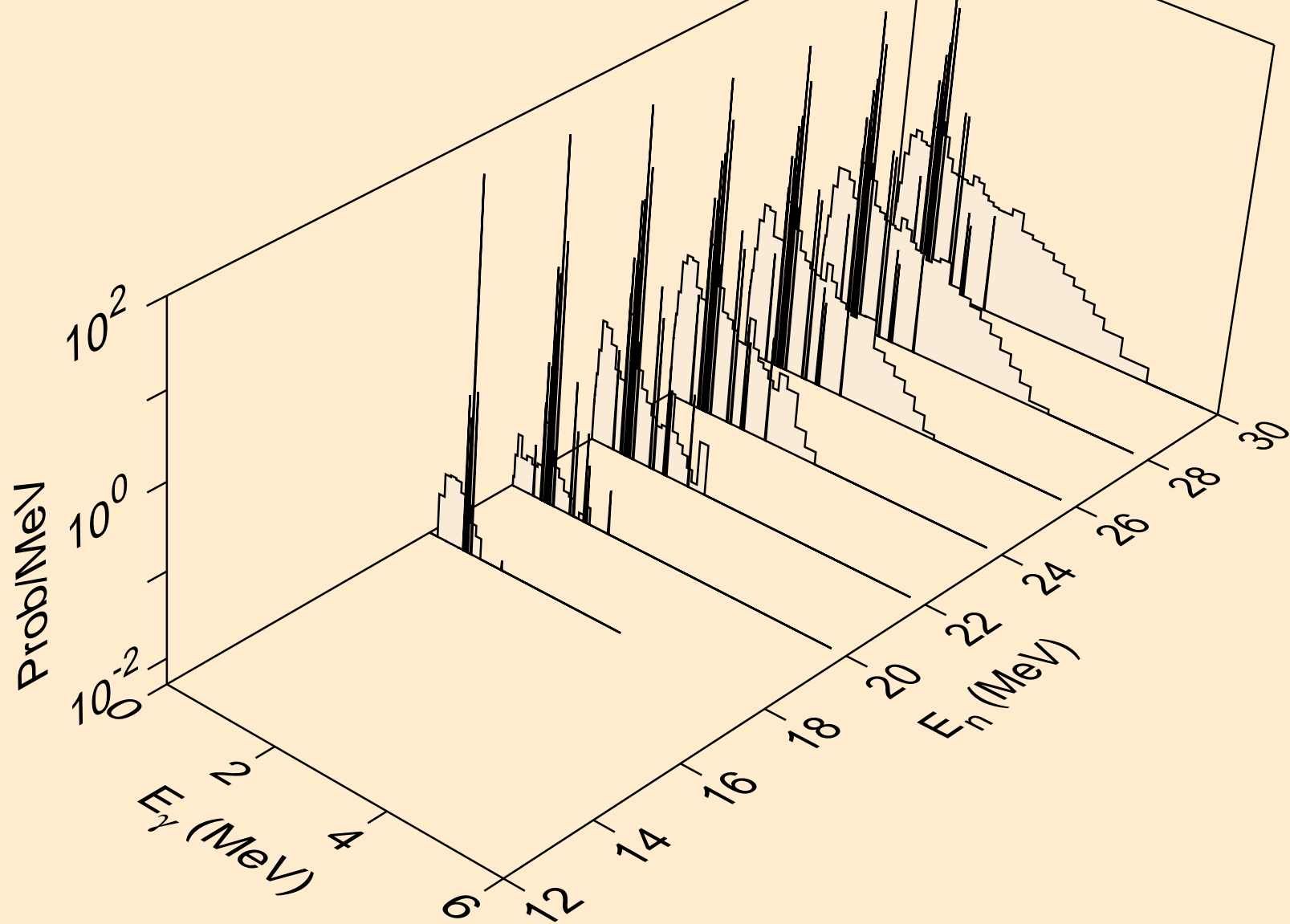

I117 NEUTRON ACER TENDL-2021 LIBRARY; T=293.6K  
Photon emission for (n,n\*)he3

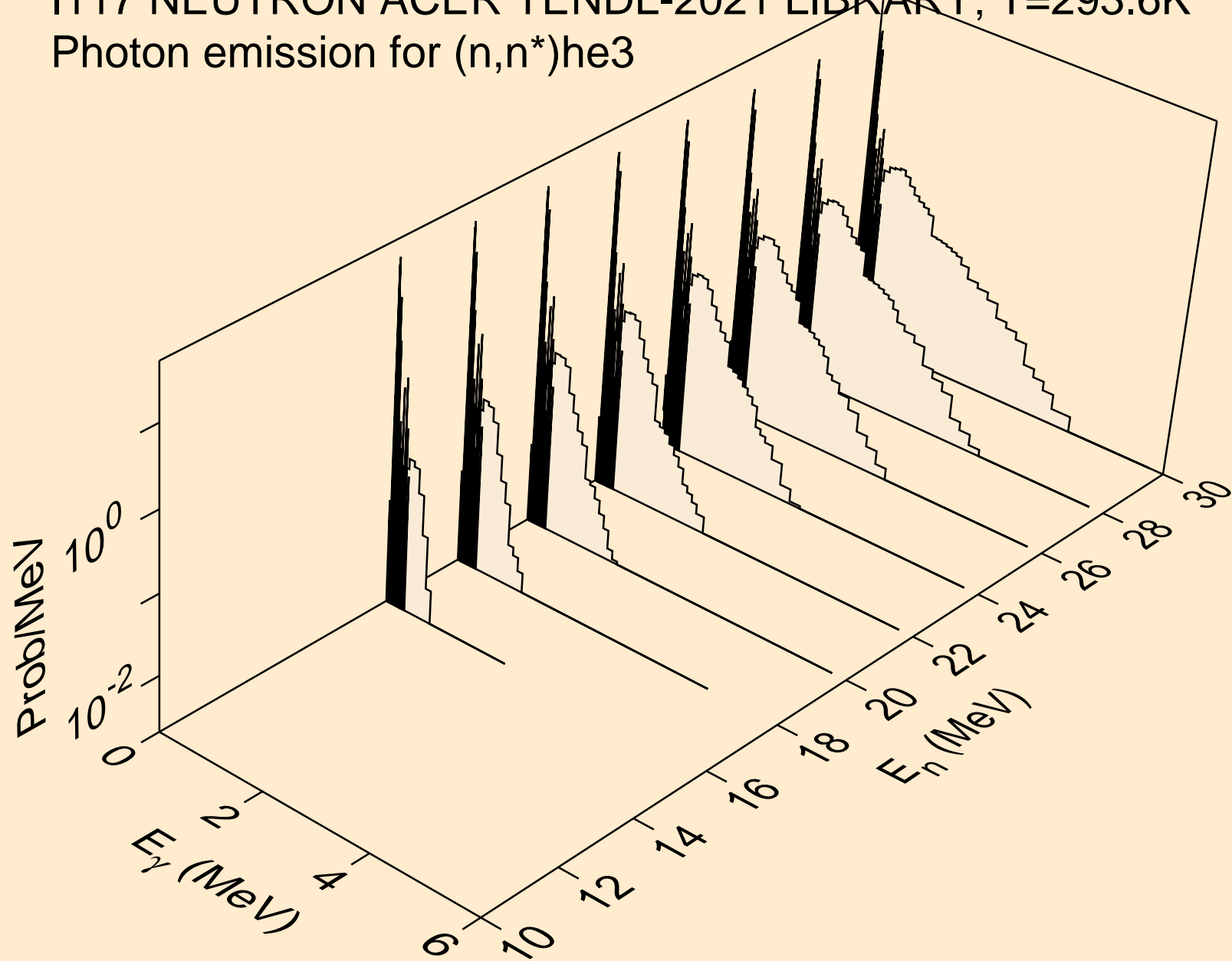

I117 NEUTRON ACER TENDL-2021 LIBRARY; T=293.6K  
Photon emission for (n,2np)

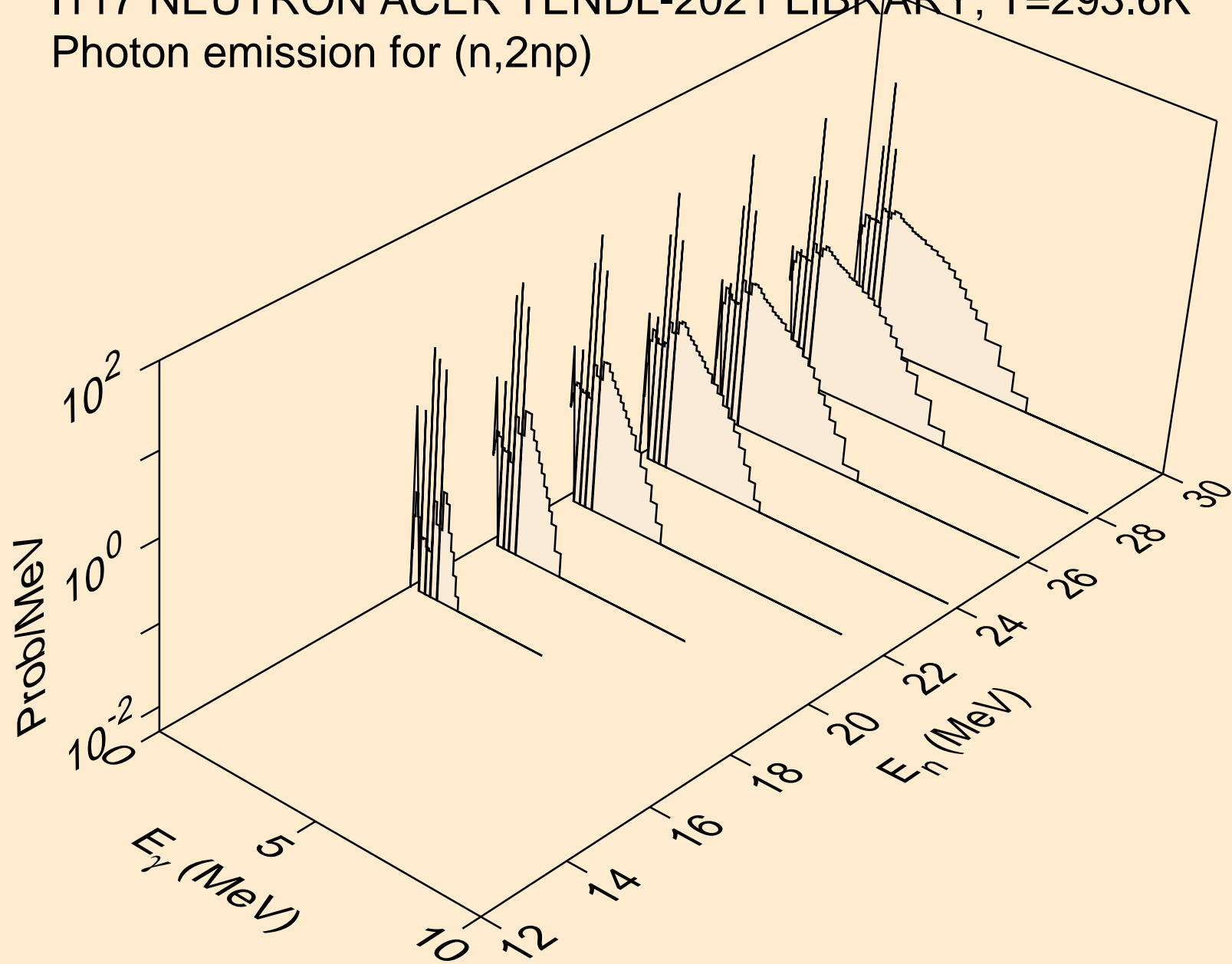

I117 NEUTRON ACER TENDL-2021 LIBRARY; T=293.6K  
Photon emission for (n,3np)

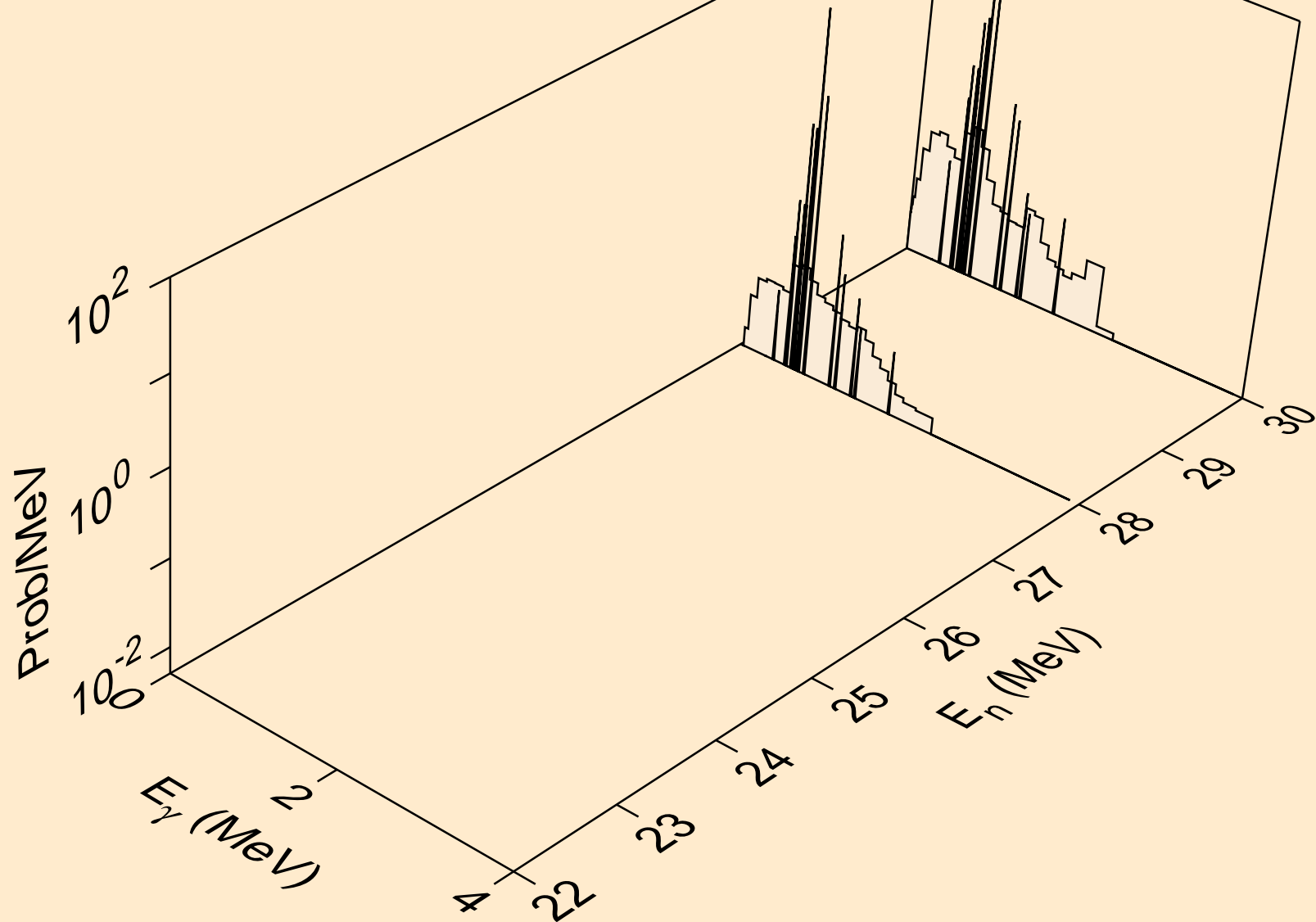

I117 NEUTRON ACER TENDL-2021 LIBRARY; T=293.6K  
Photon emission for (n,2np)

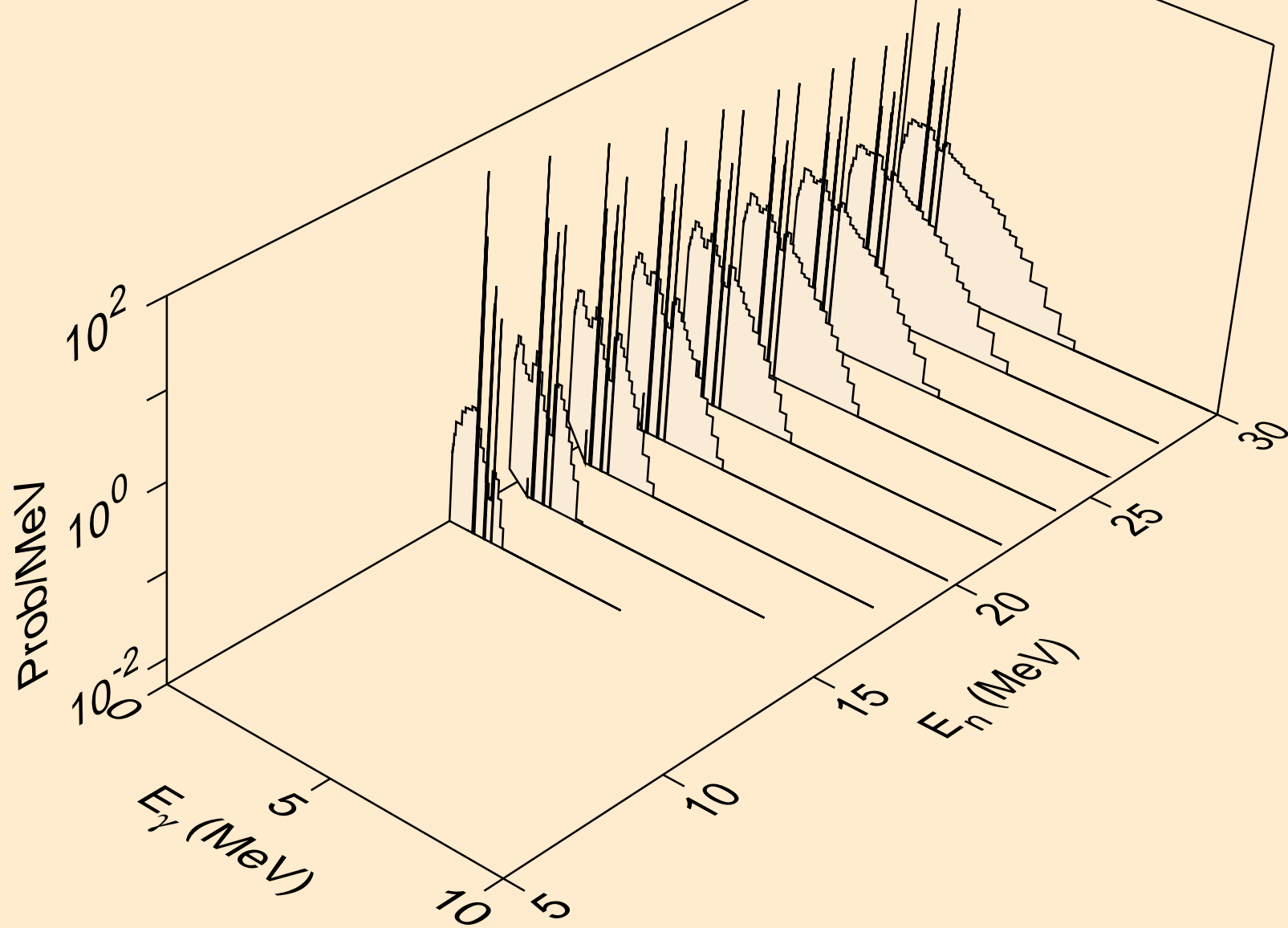



I117 NEUTRON ACER TENDL-2021 LIBRARY; T=293.6K  
Photon emission for (n,npa)

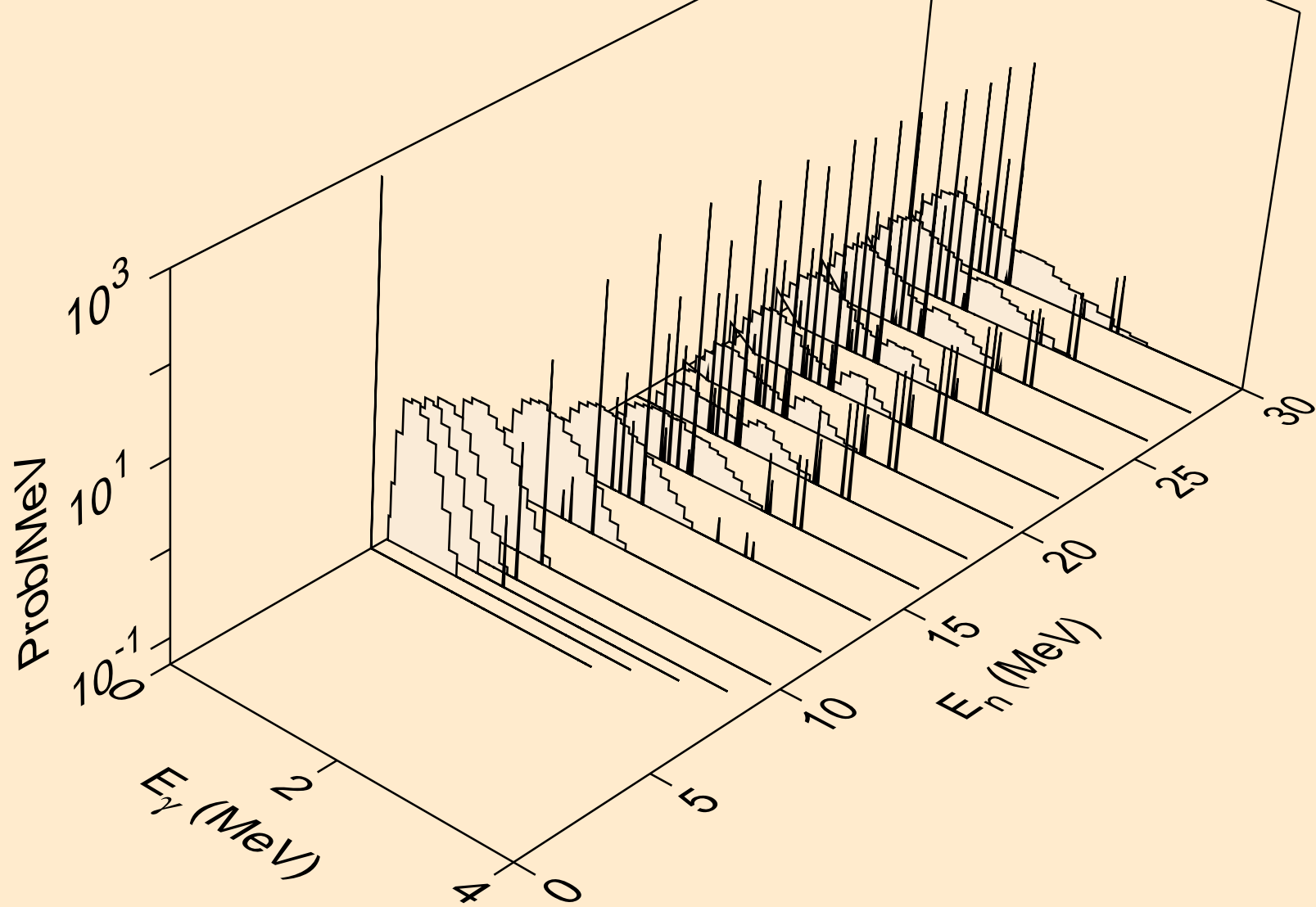

I117 NEUTRON ACER TENDL-2021 LIBRARY; T=293.6K  
Photon emission for (n,n\*c)

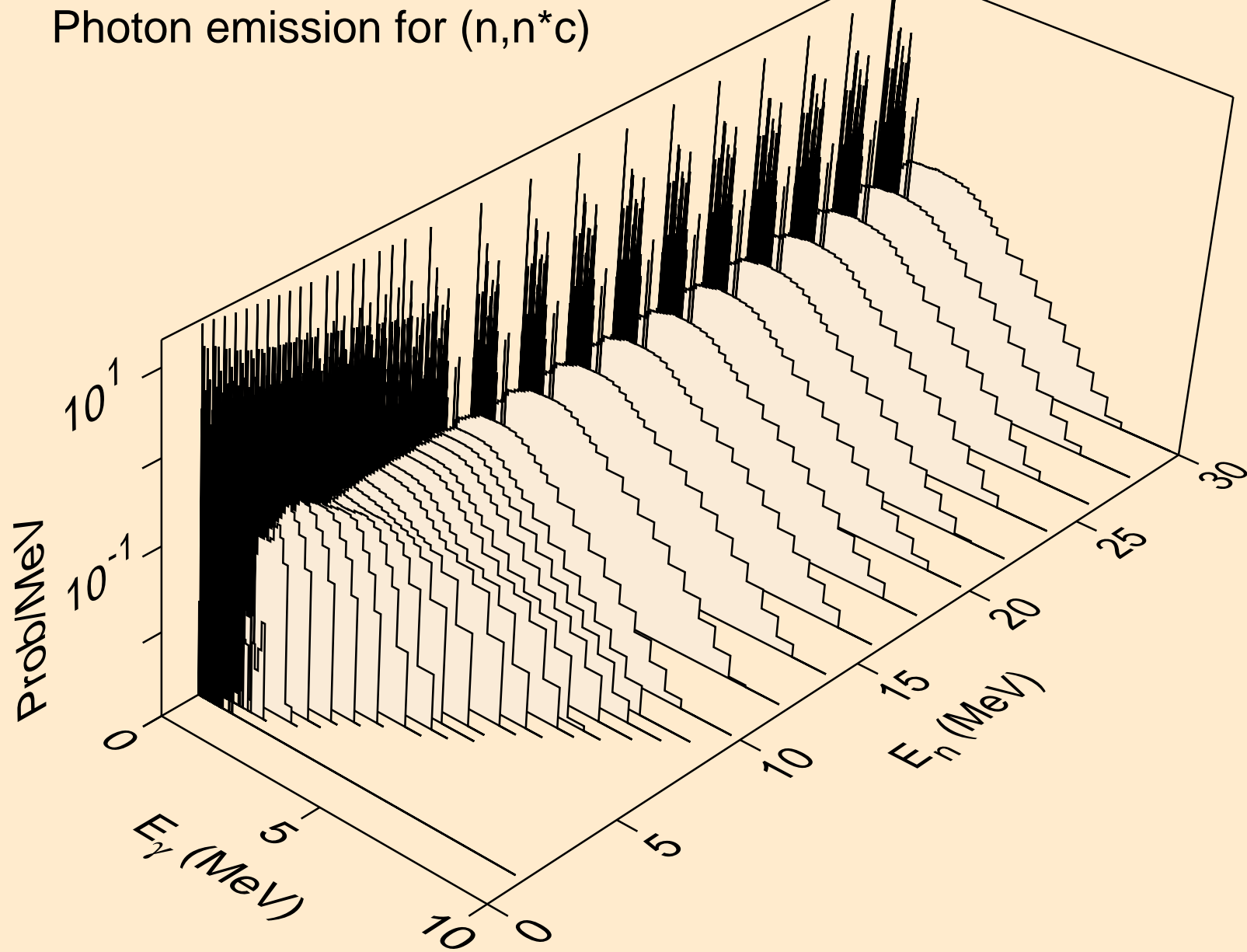

I117 NEUTRON ACER TENDL-2021 LIBRARY; T=293.6K  
Photon emission for (n,gma)

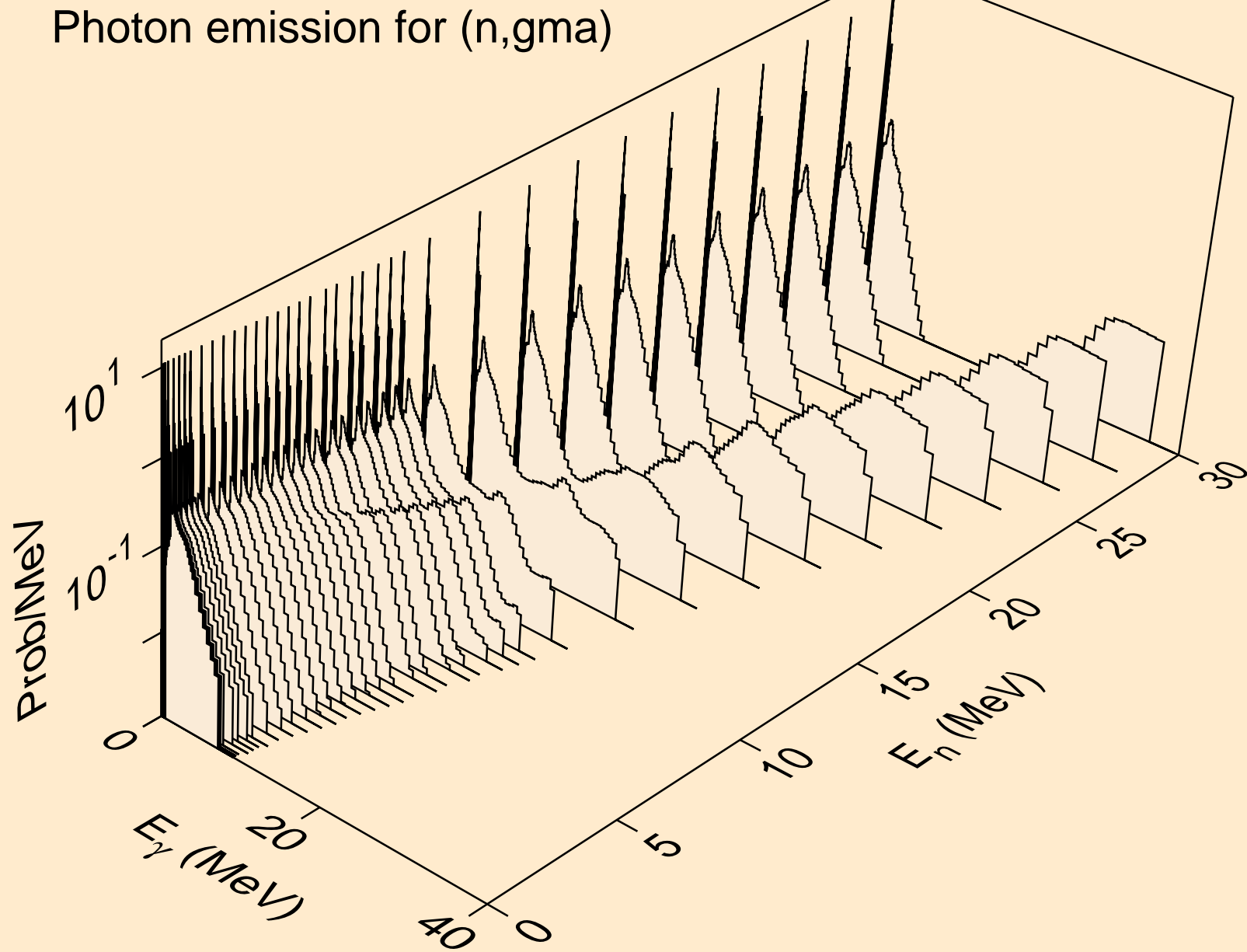

I117 NEUTRON ACER TENDL-2021 LIBRARY; T=293.6K  
Photon emission for (n,p)

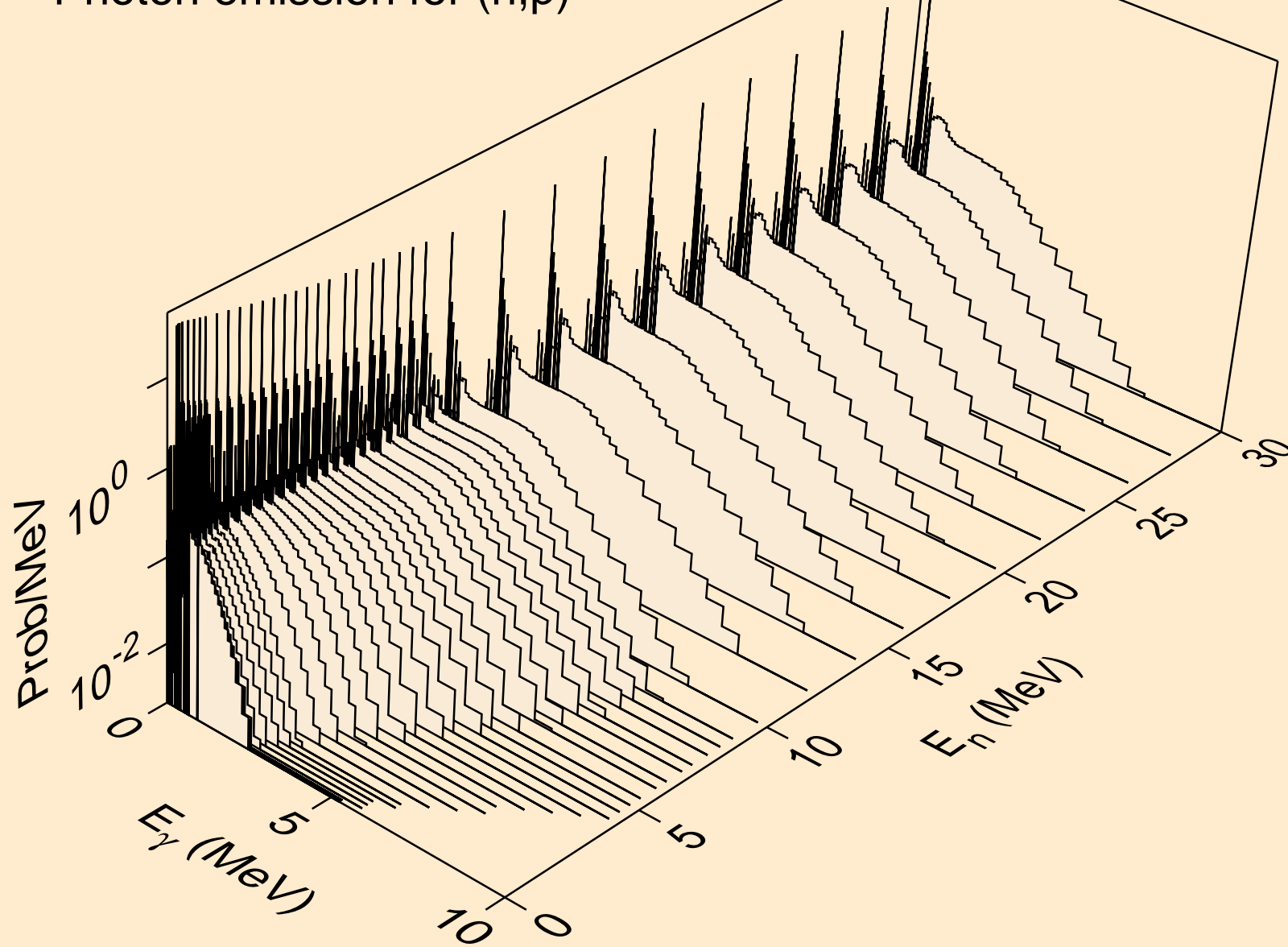

I117 NEUTRON ACER TENDL-2021 LIBRARY; T=293.6K  
Photon emission for (n,d)

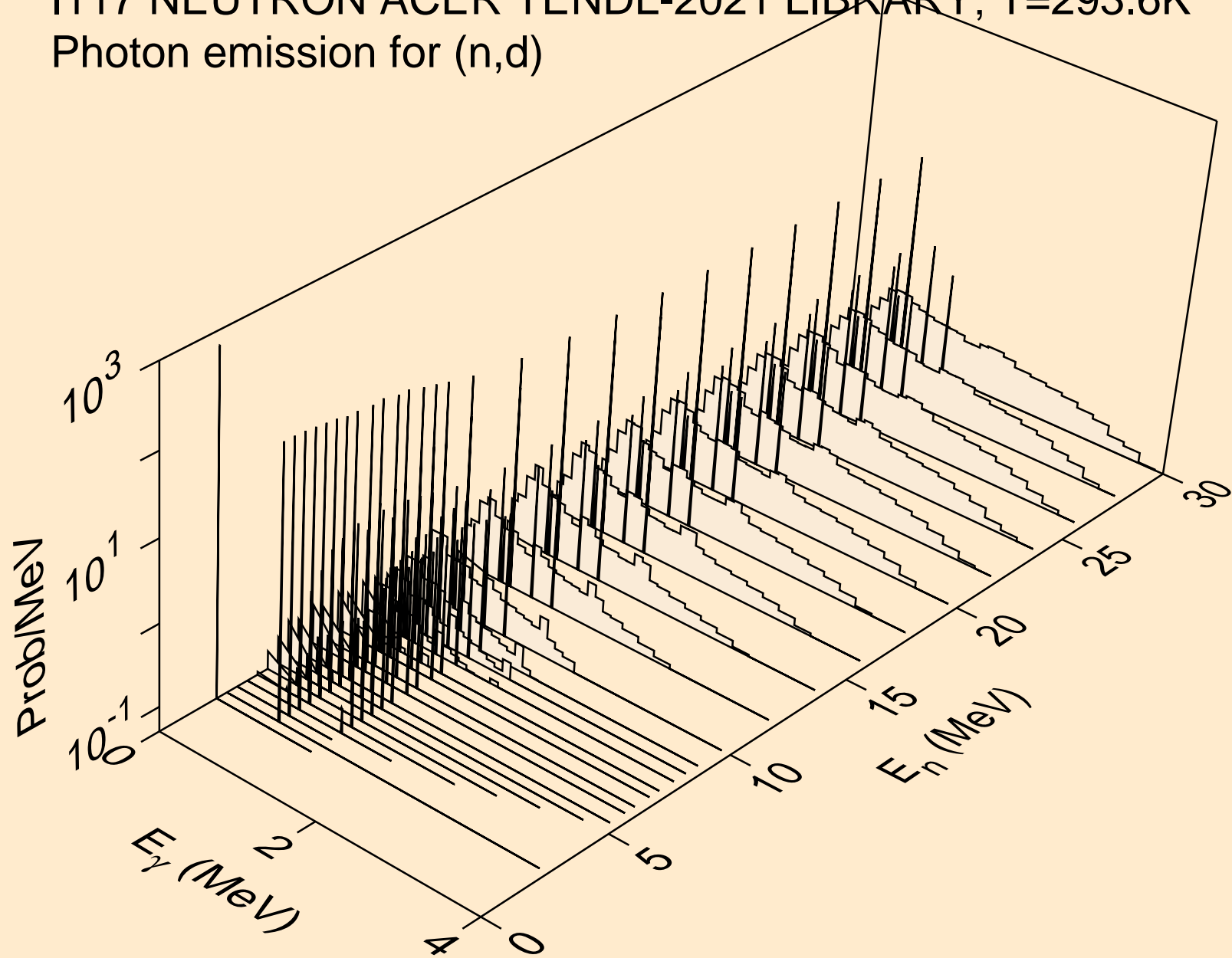

I117 NEUTRON ACER TENDL-2021 LIBRARY; T=293.6K  
Photon emission for (n,t)

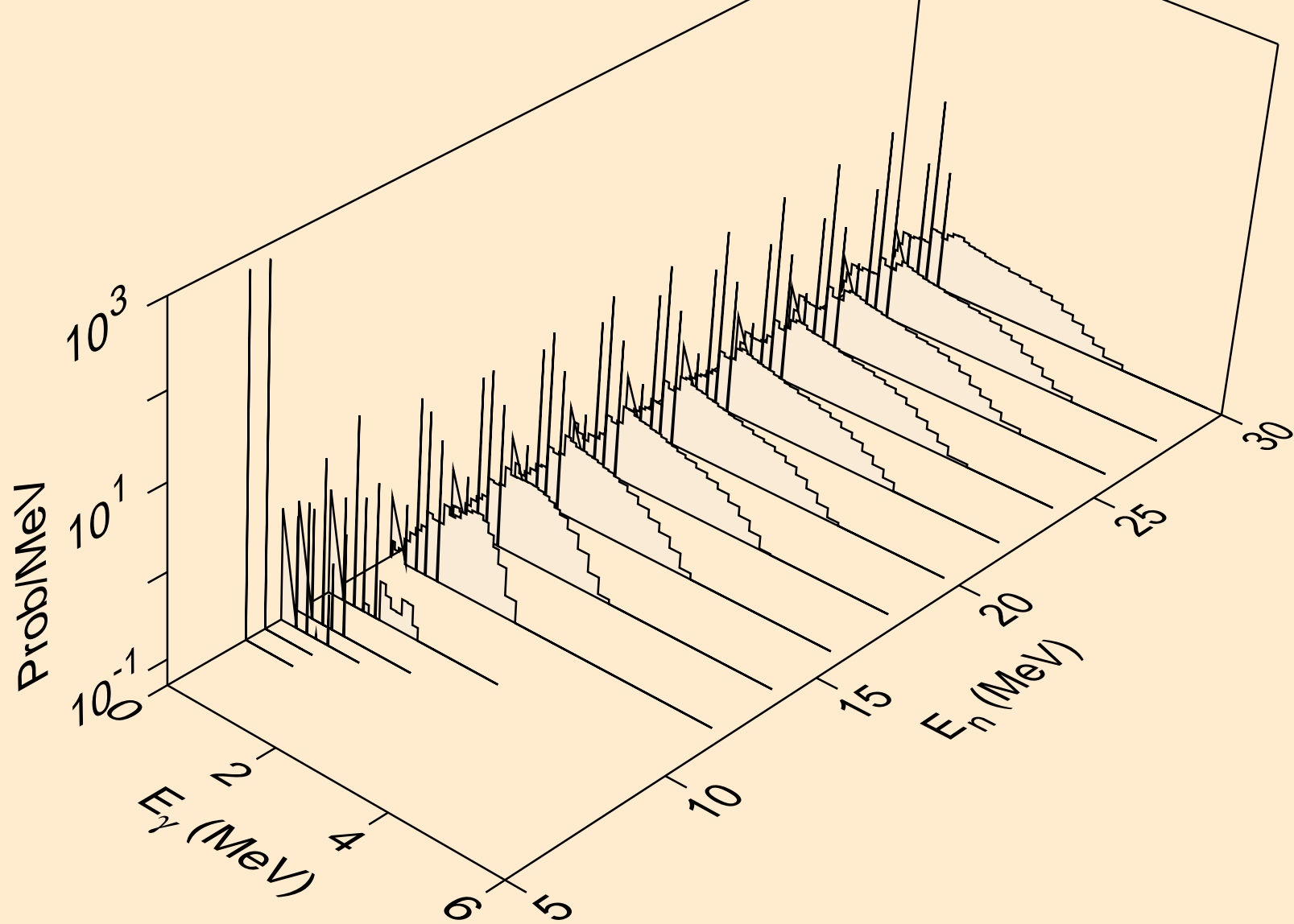

I117 NEUTRON ACER TENDL-2021 LIBRARY; T=293.6K  
Photon emission for (n,he3)

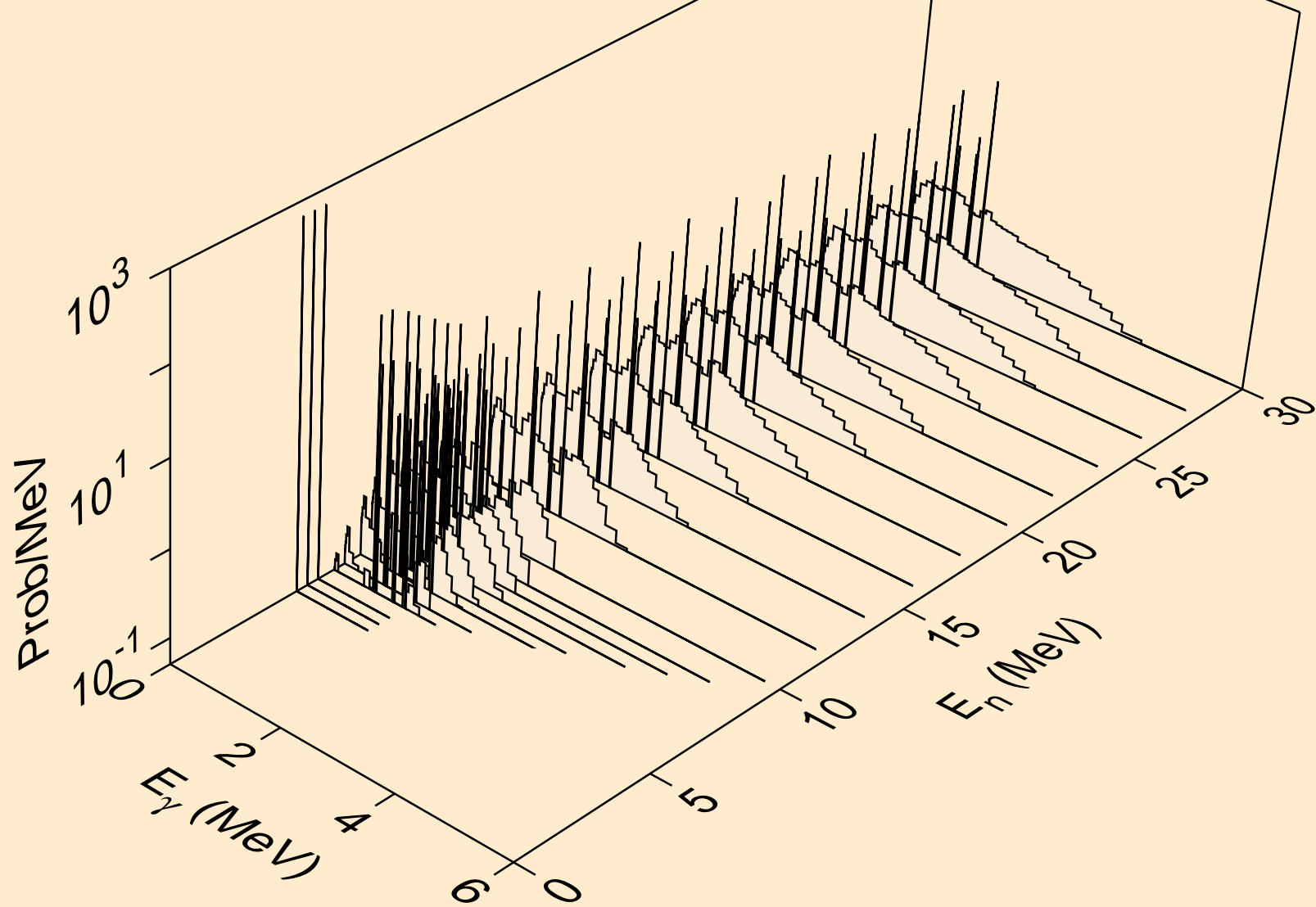

I117 NEUTRON ACER TENDL-2021 LIBRARY; T=293.6K  
Photon emission for (n,a)

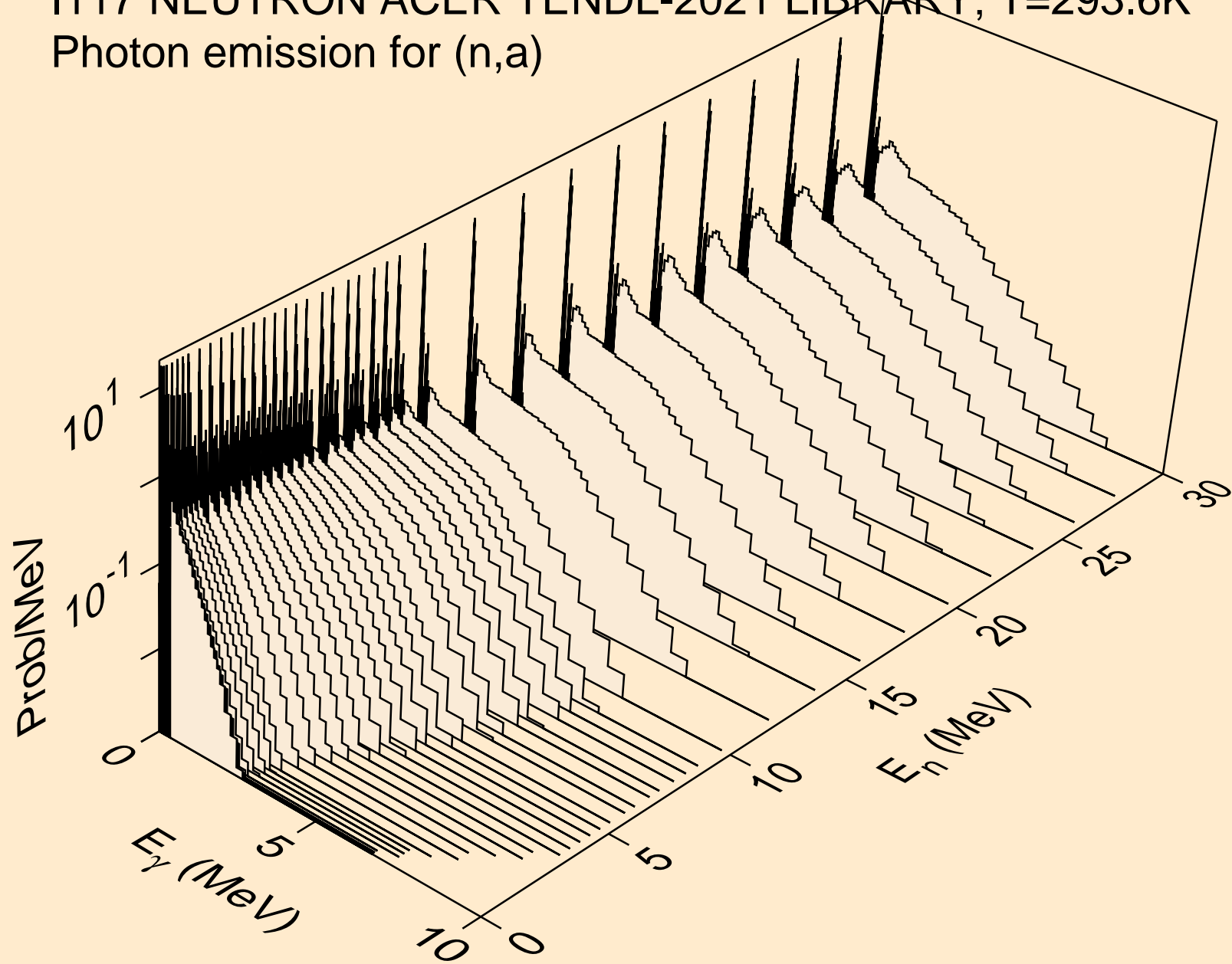



I117 NEUTRON ACER TENDL-2021 LIBRARY; T=293.6K  
Photon emission for (n,2a)

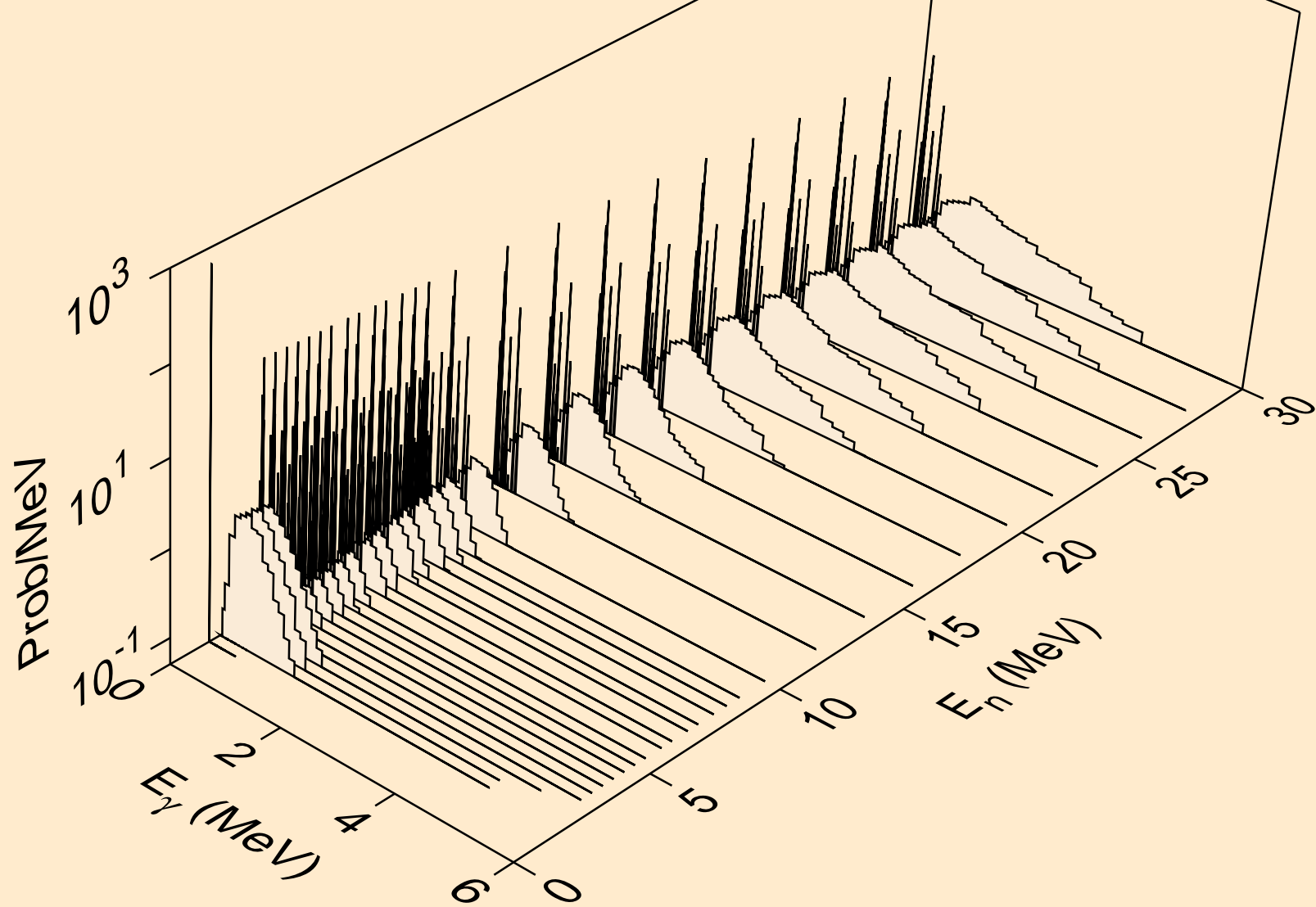

I117 NEUTRON ACER TENDL-2021 LIBRARY; T=293.6K  
Photon emission for (n,3a)

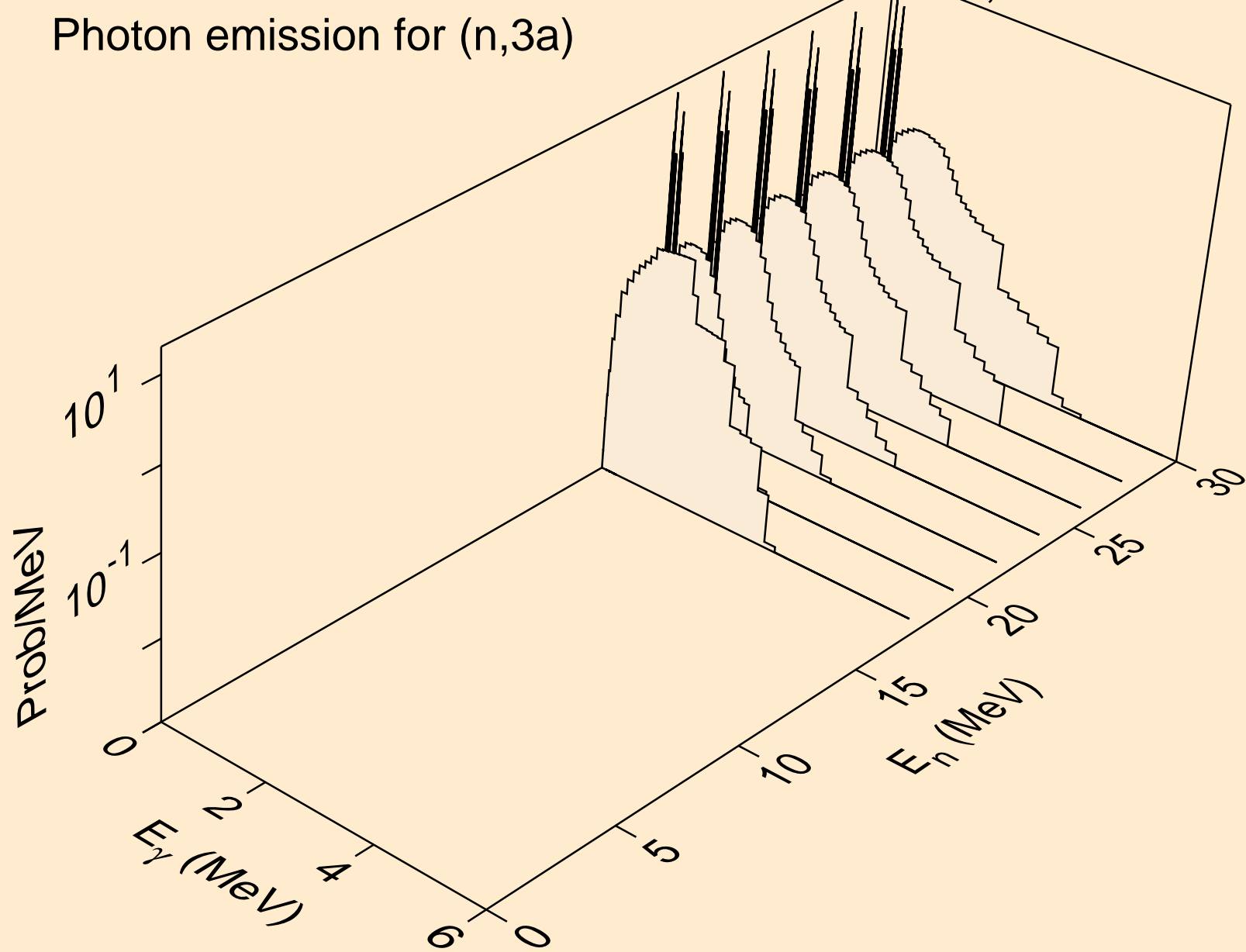

I117 NEUTRON ACER TENDL-2021 LIBRARY; T=293.6K  
Photon emission for (n,2p)

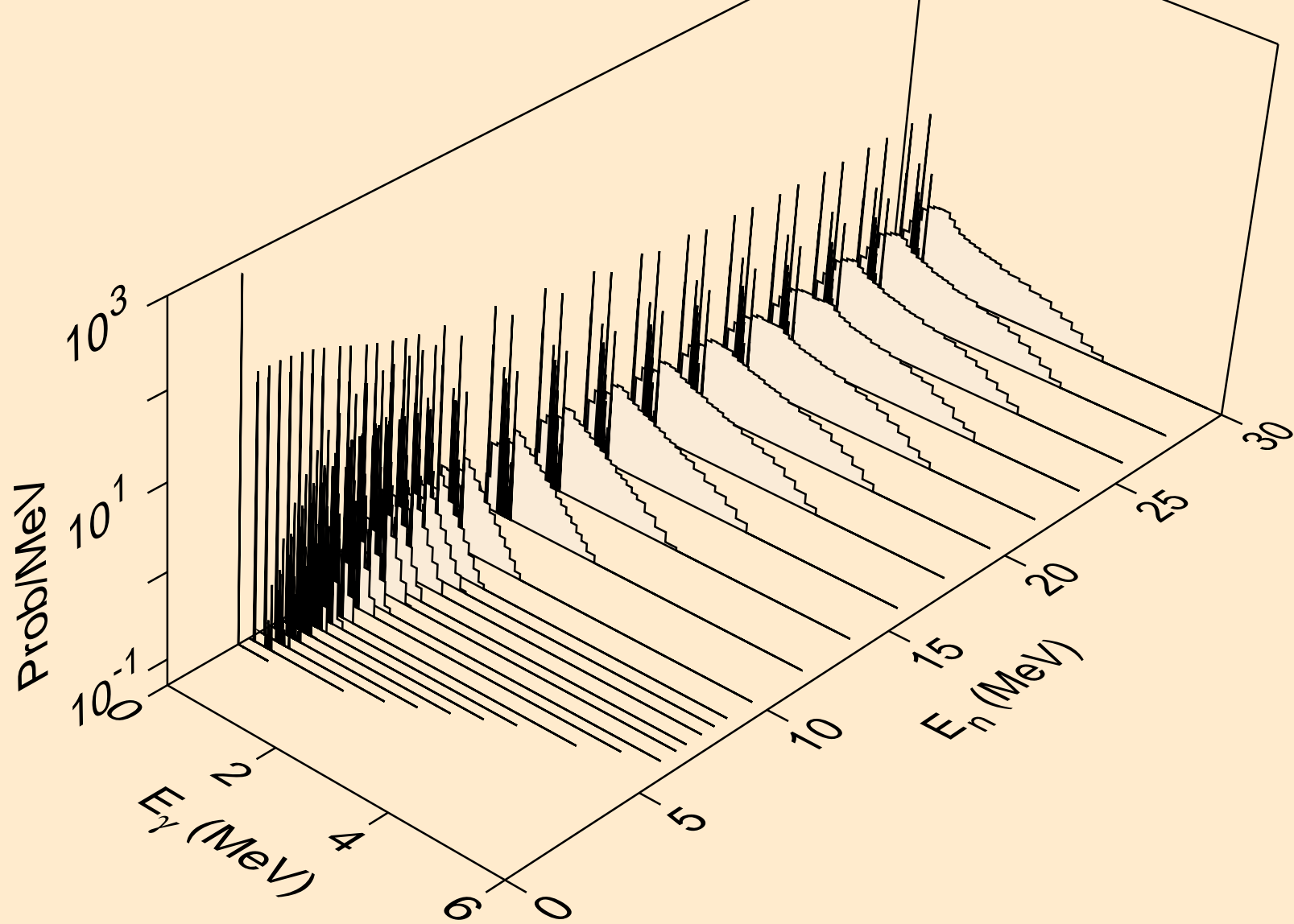

I117 NEUTRON ACER TENDL-2021 LIBRARY; T=293.6K  
Photon emission for (n,p)

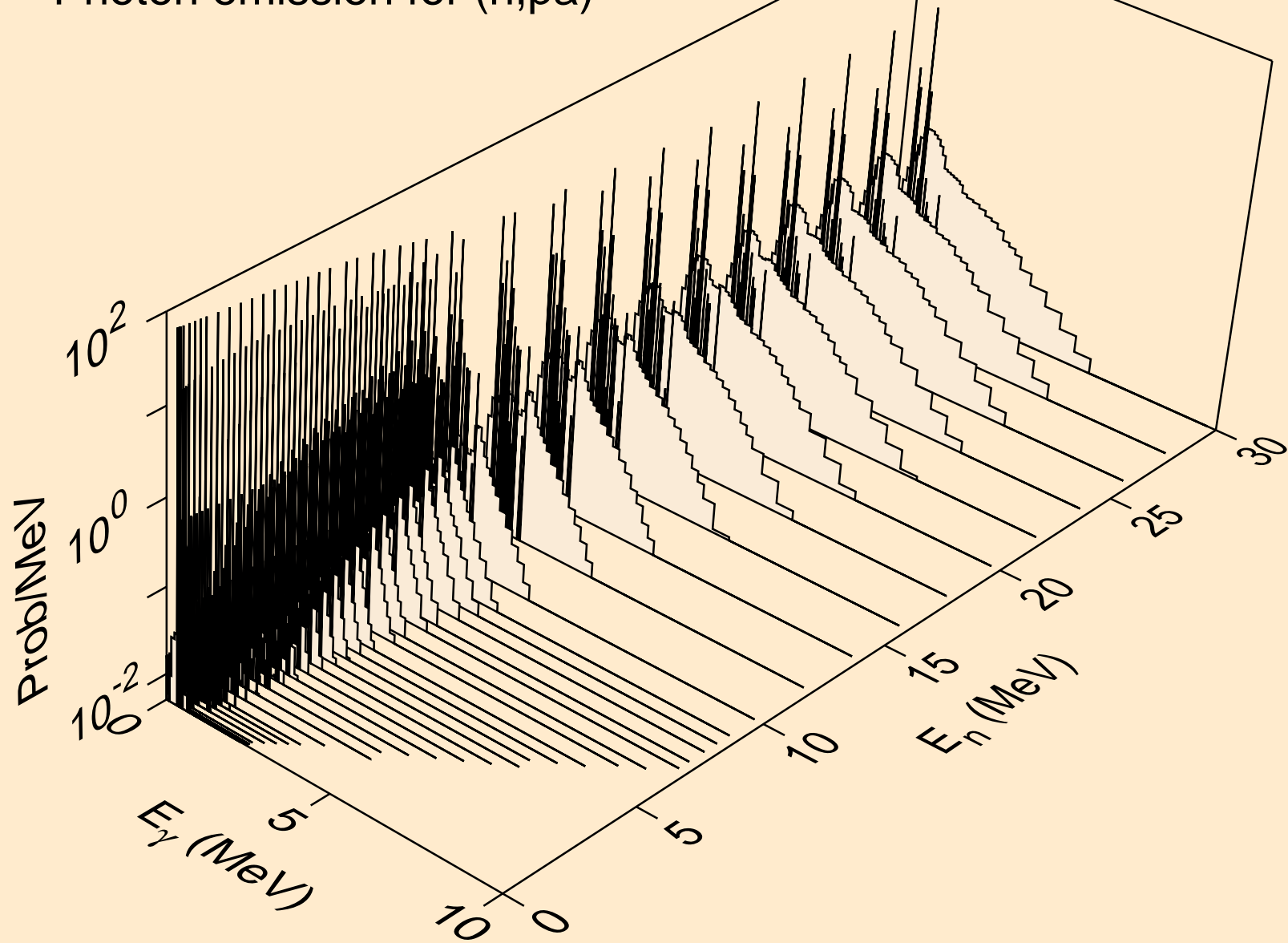

I117 NEUTRON ACER TENDL-2021 LIBRARY; T=293.6K  
Photon emission for (n,pd)

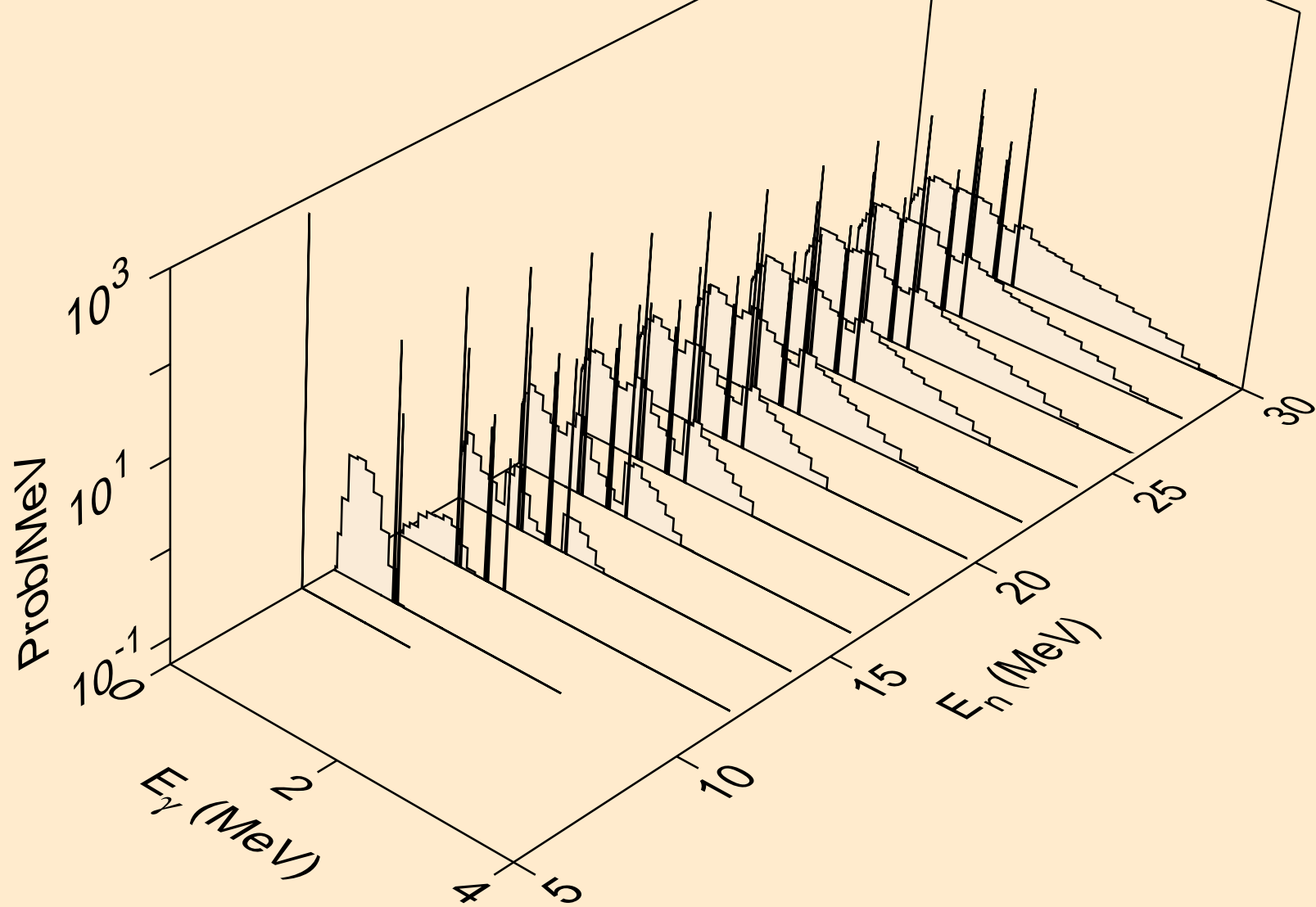

I117 NEUTRON ACER TENDL-2021 LIBRARY; T=293.6K  
Photon emission for (n,pt)

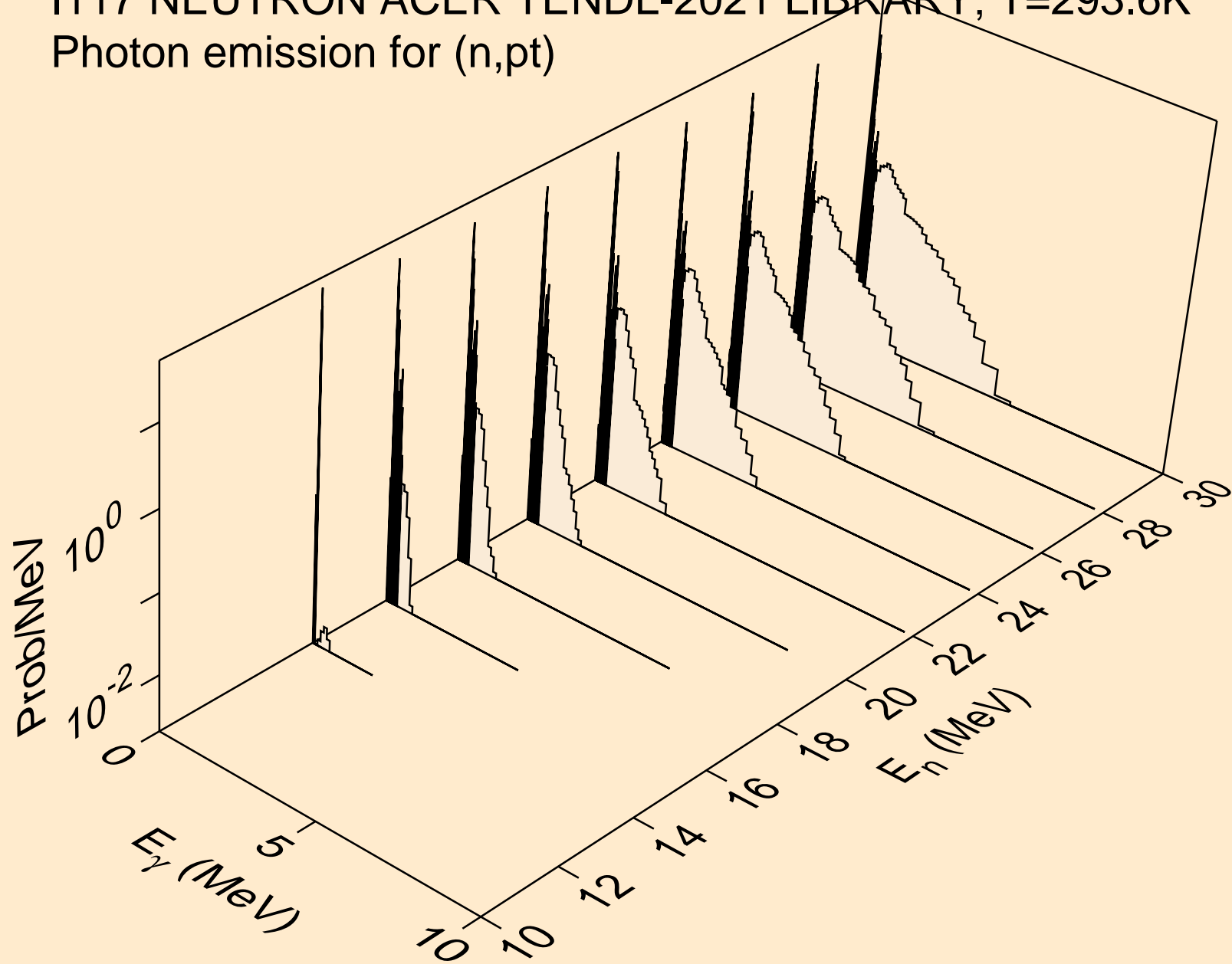

I117 NEUTRON ACER TENDL-2021 LIBRARY; T=293.6K  
Photon emission for (n,da)

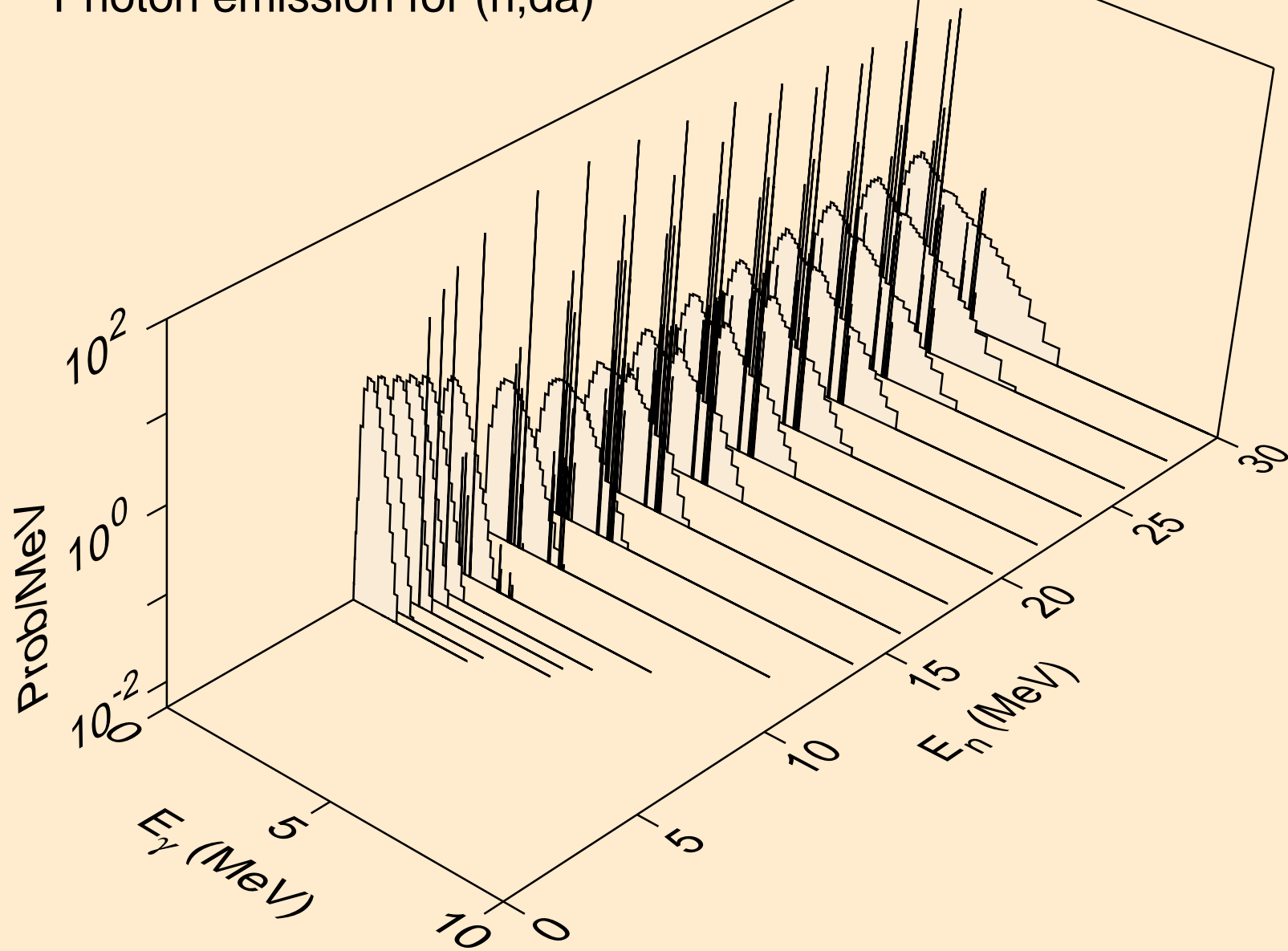

I117 NEUTRON ACER TENDL-2021 LIBRARY; T=293.6K  
thermal capture photon spectrum

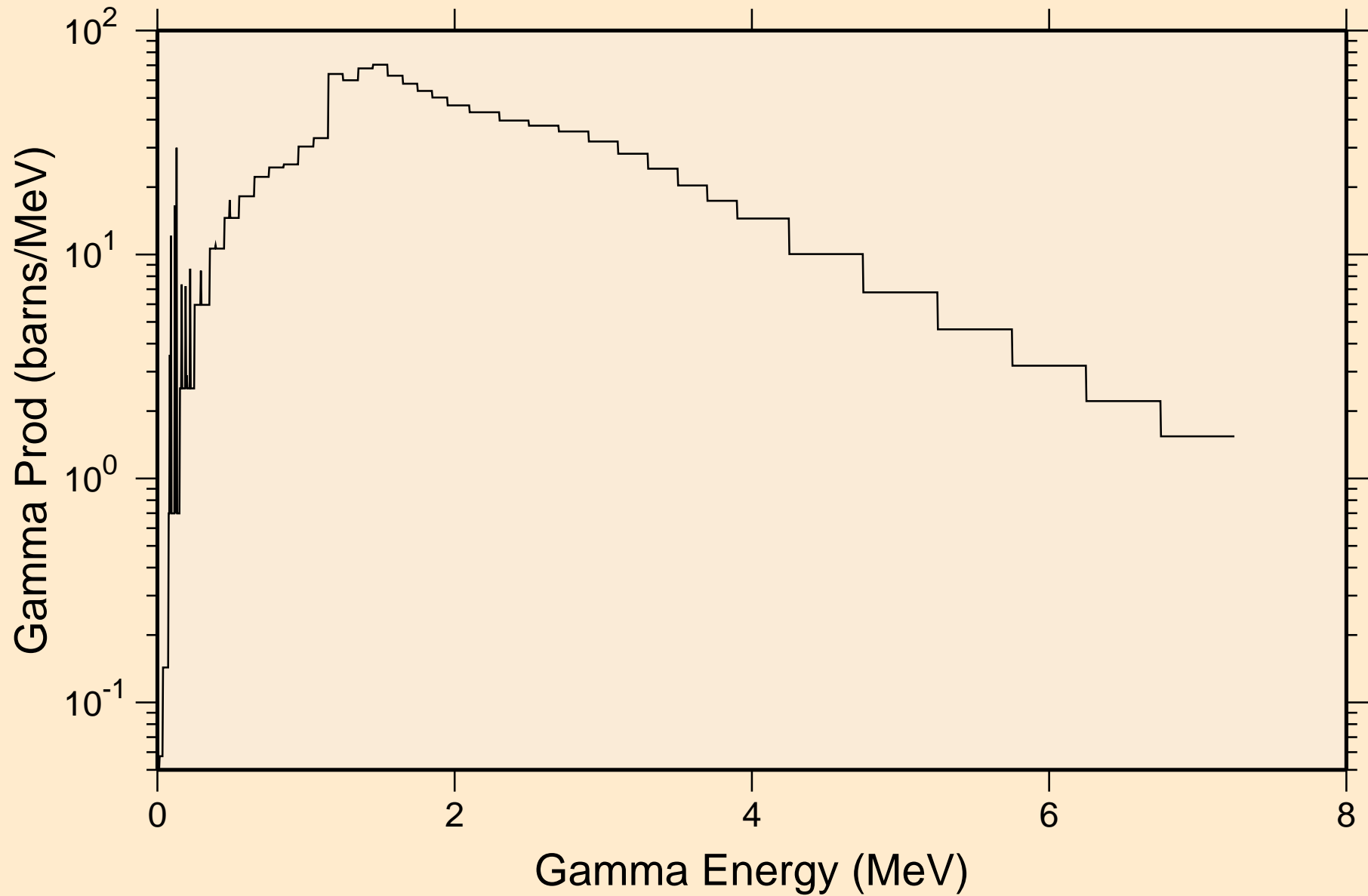



I117 NEUTRON ACER TENDL-2021 LIBRARY; T=293.6K  
14 MeV photon spectrum

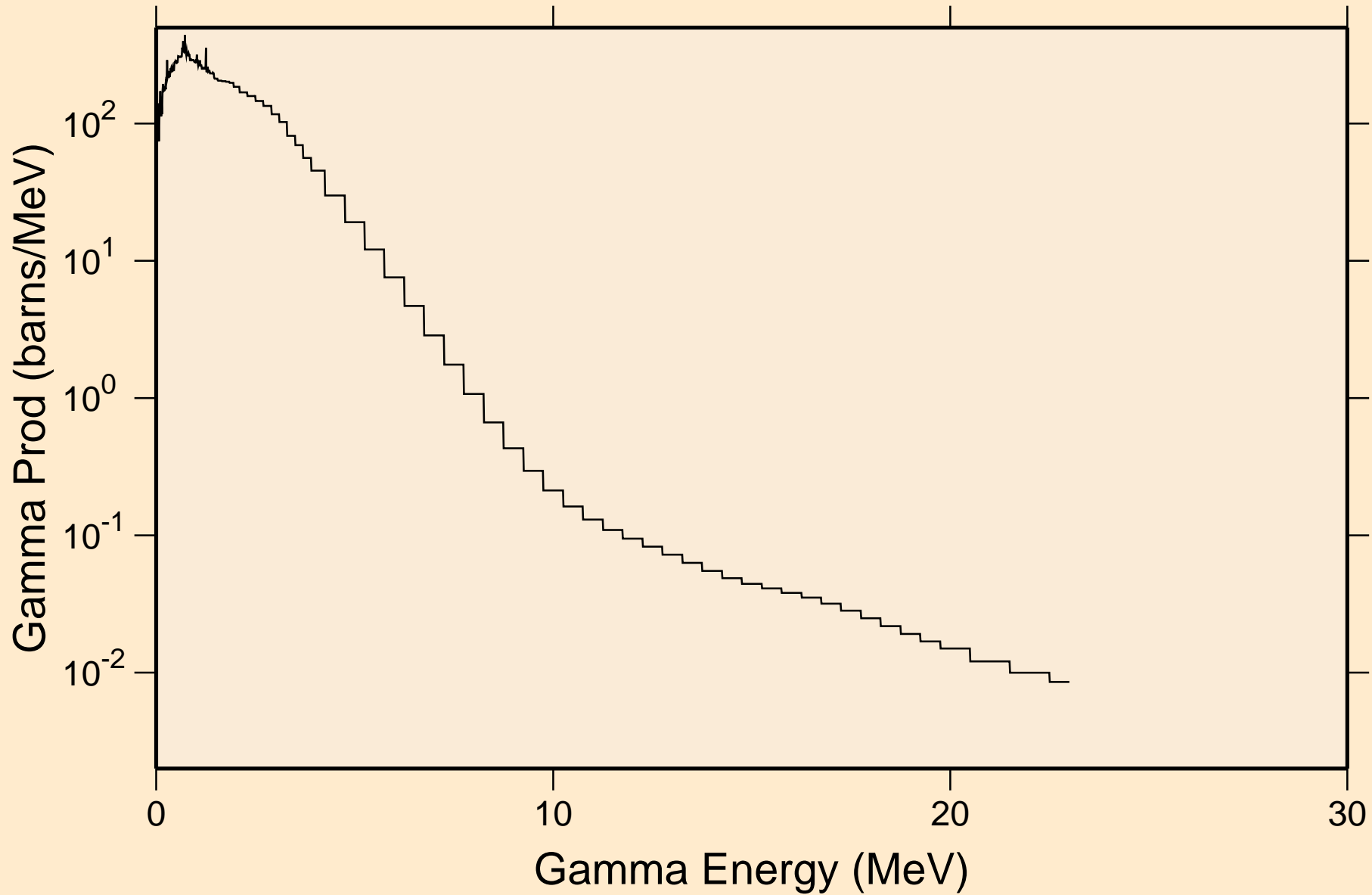

# I117 NEUTRON ACER TENDL-2021 LIBRARY; T=293.6K

## Particle heating contributions

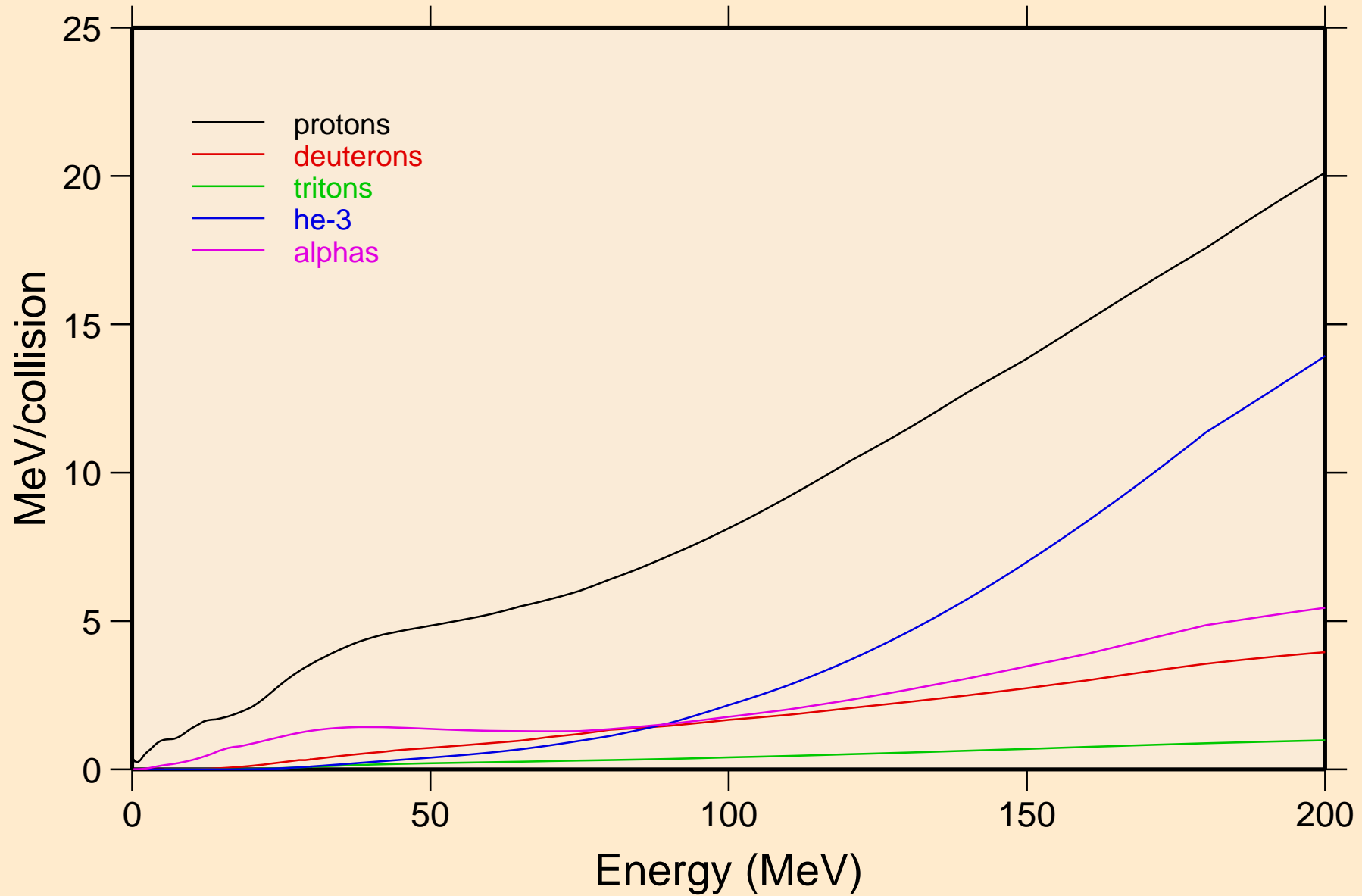

# I117 NEUTRON ACER TENDL-2021 LIBRARY; T=293.6K

## Recoil Heating

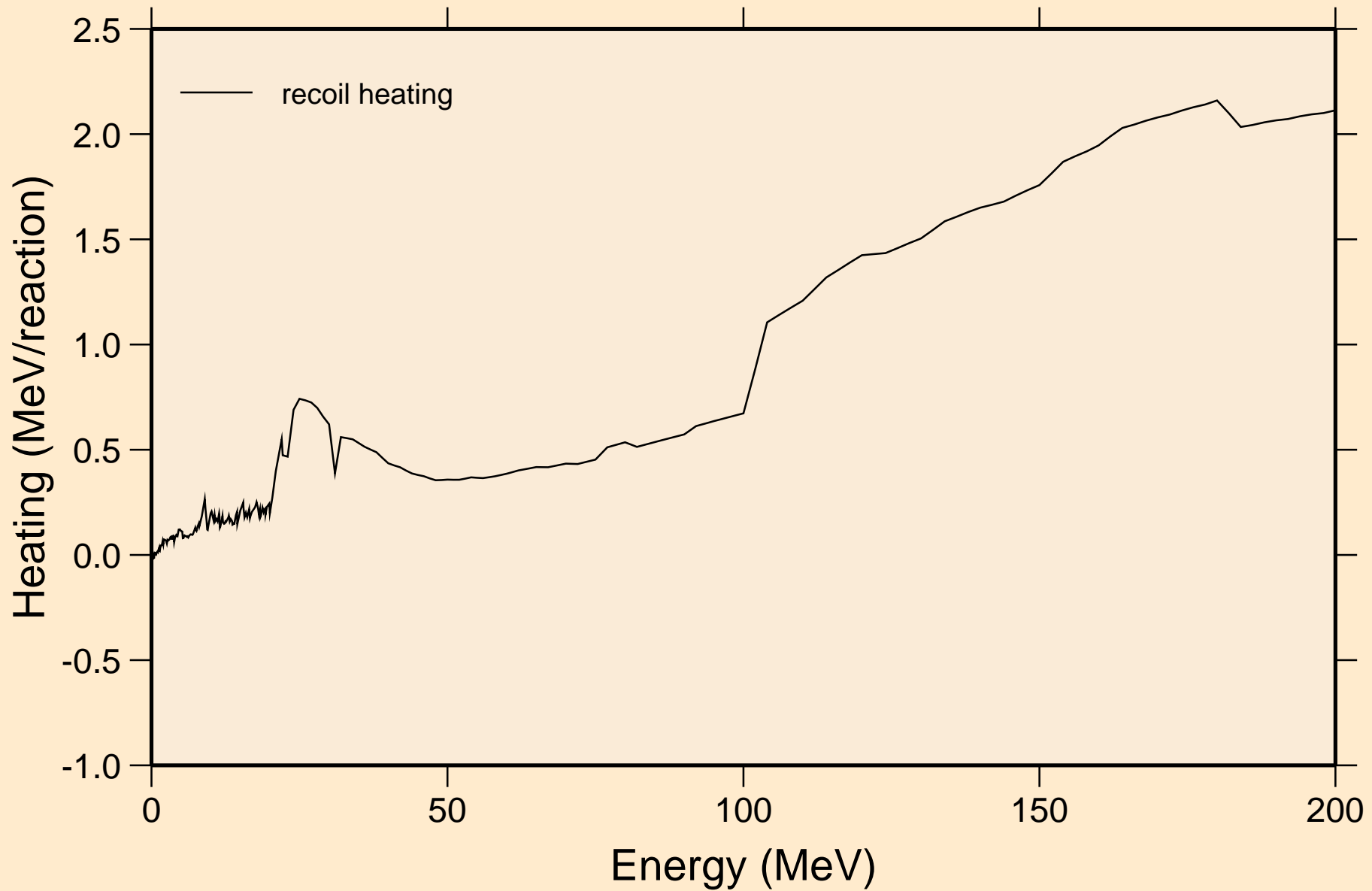

I117 NEUTRON ACER TENDL-2021 LIBRARY; T=293.6K  
Particle production cross sections

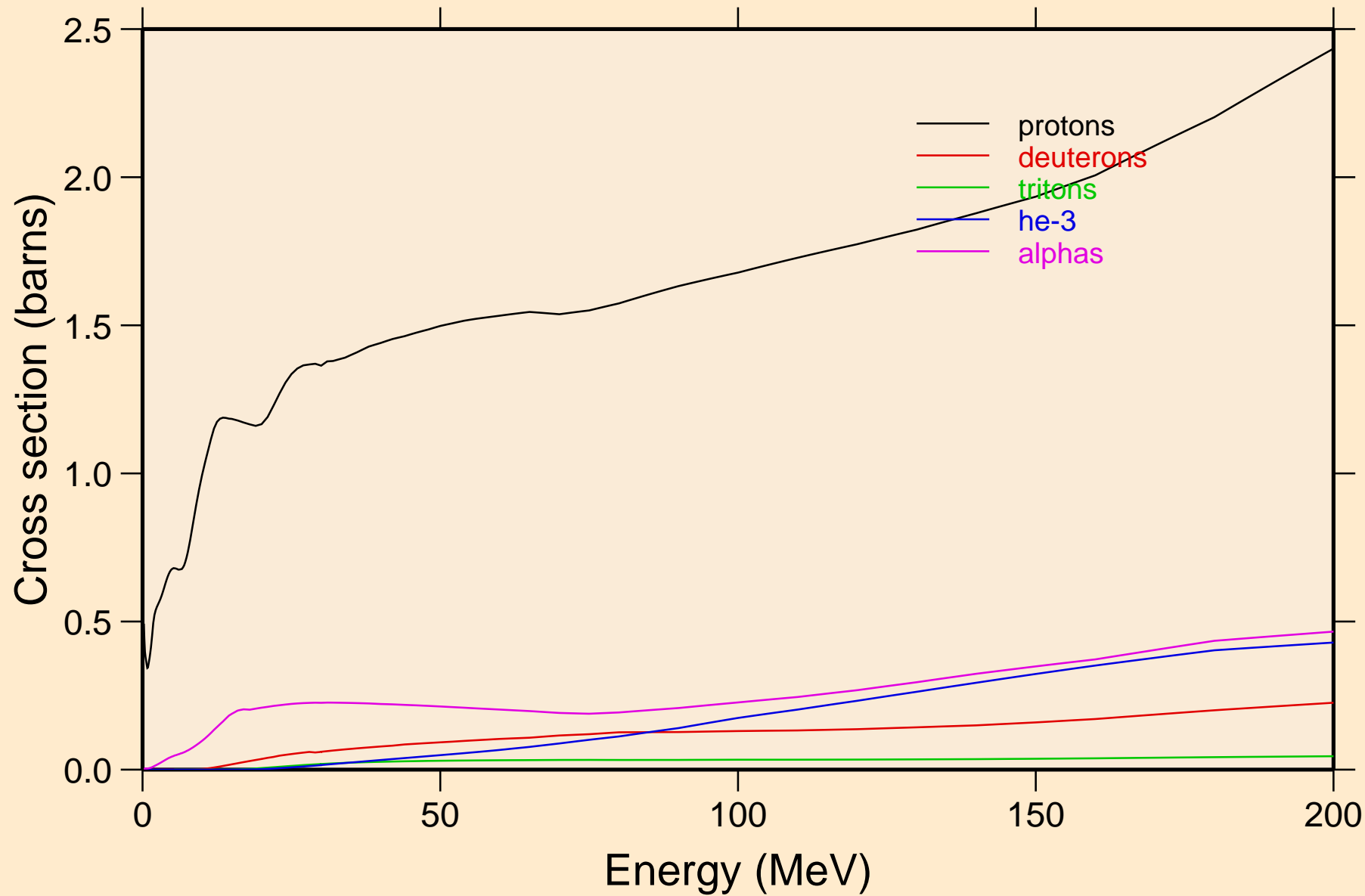

I117 NEUTRON ACER TENDL-2021 LIBRARY; T=293.6K  
protons from (n,x)

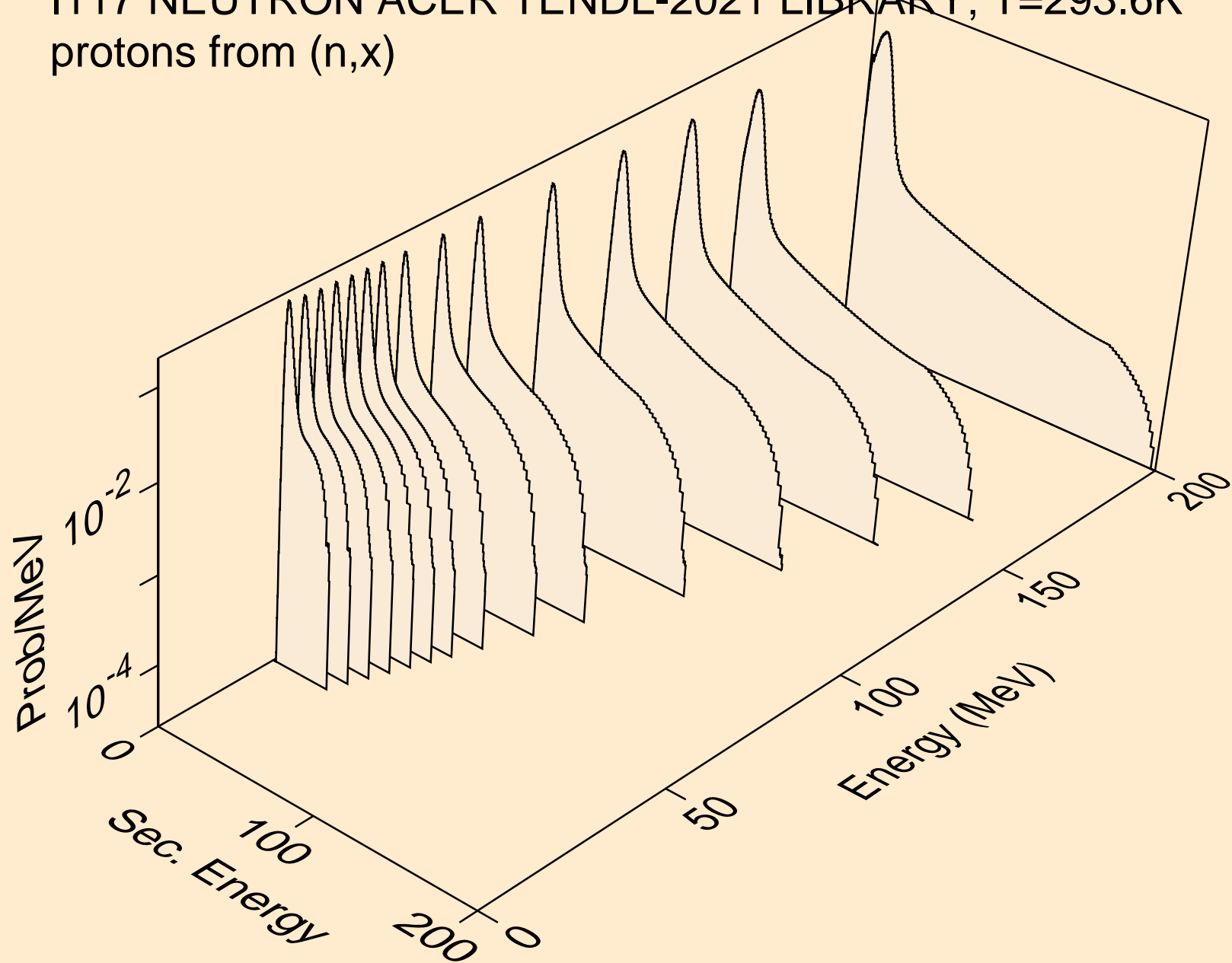

I117 NEUTRON ACER TENDL-2021 LIBRARY; T=293.6K  
protons from (n,n\*)p

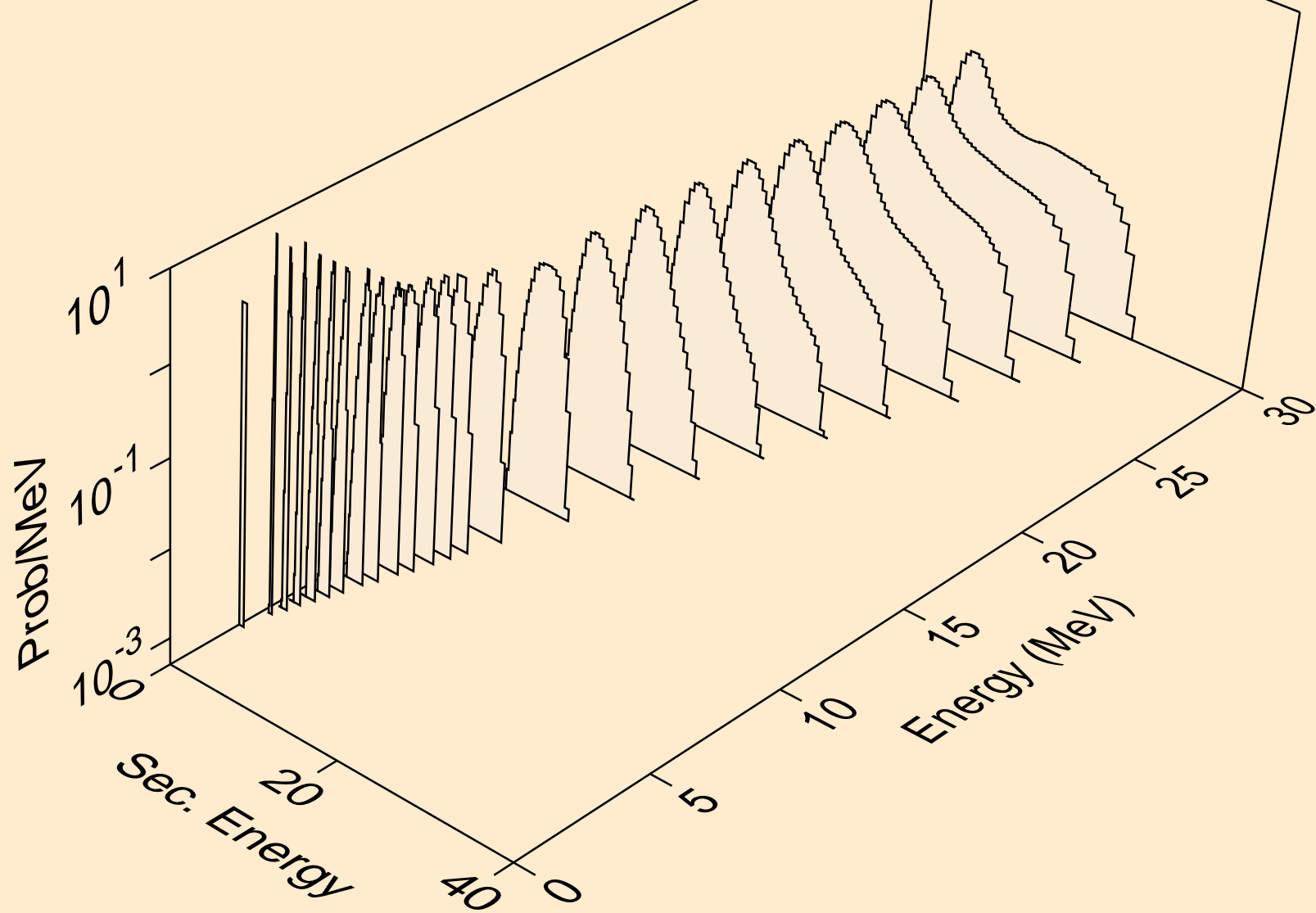

I117 NEUTRON ACER TENDL-2021 LIBRARY; T=293.6K  
protons from (n,2np)

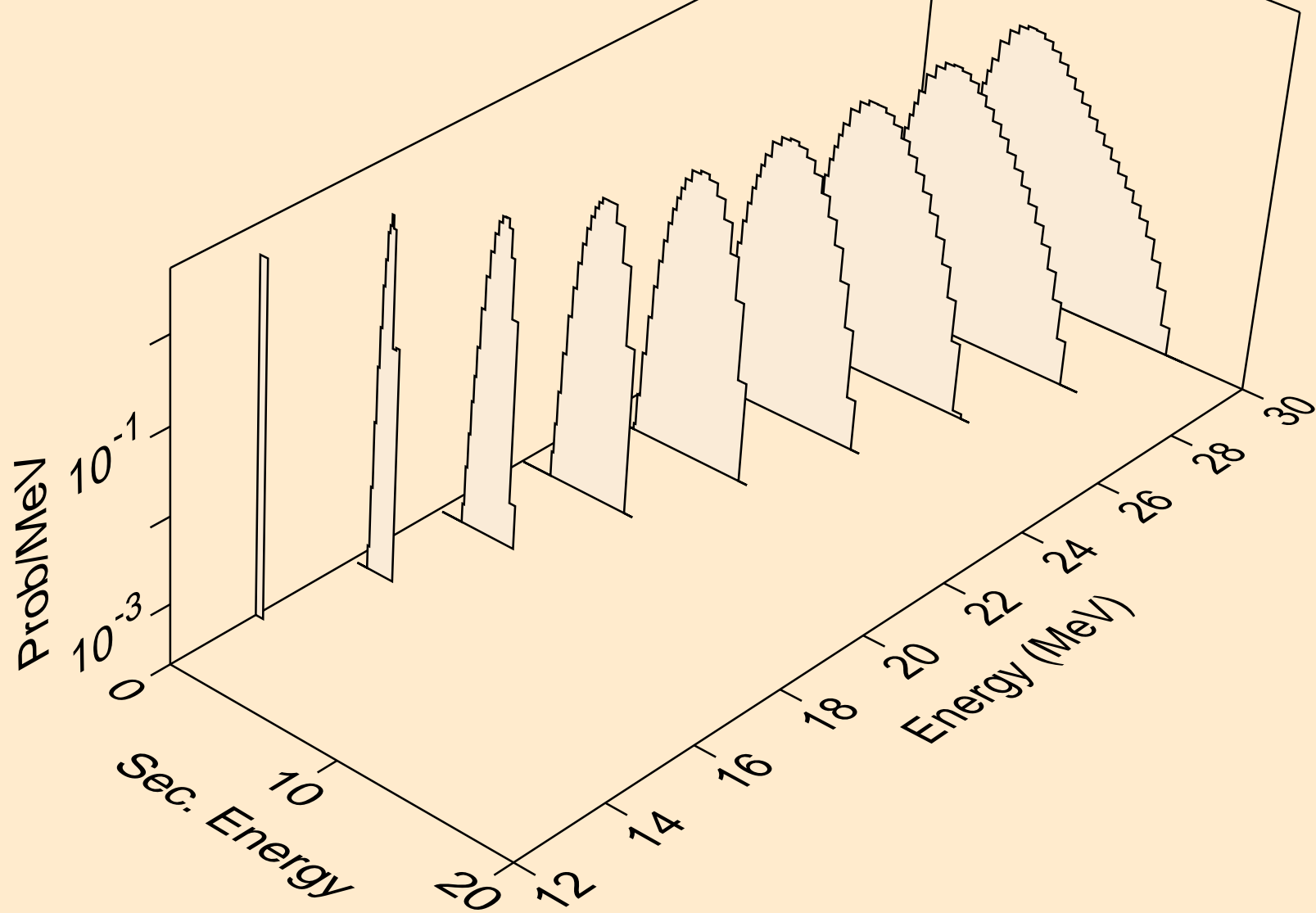

I117 NEUTRON ACER TENDL-2021 LIBRARY; T=293.6K  
protons from (n,3np)

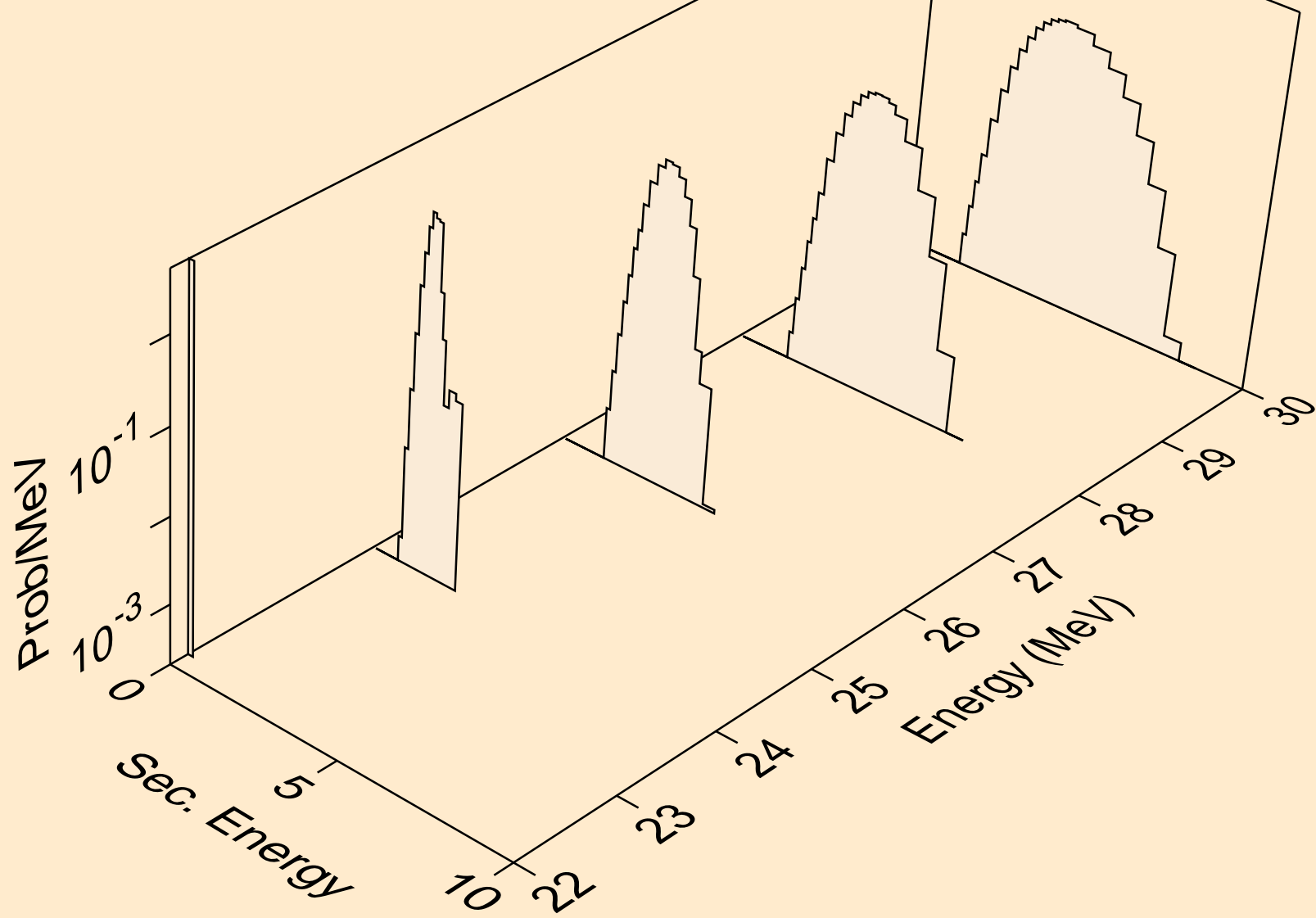



I117 NEUTRON ACER TENDL-2021 LIBRARY; T=293.6K  
protons from (n,2np)

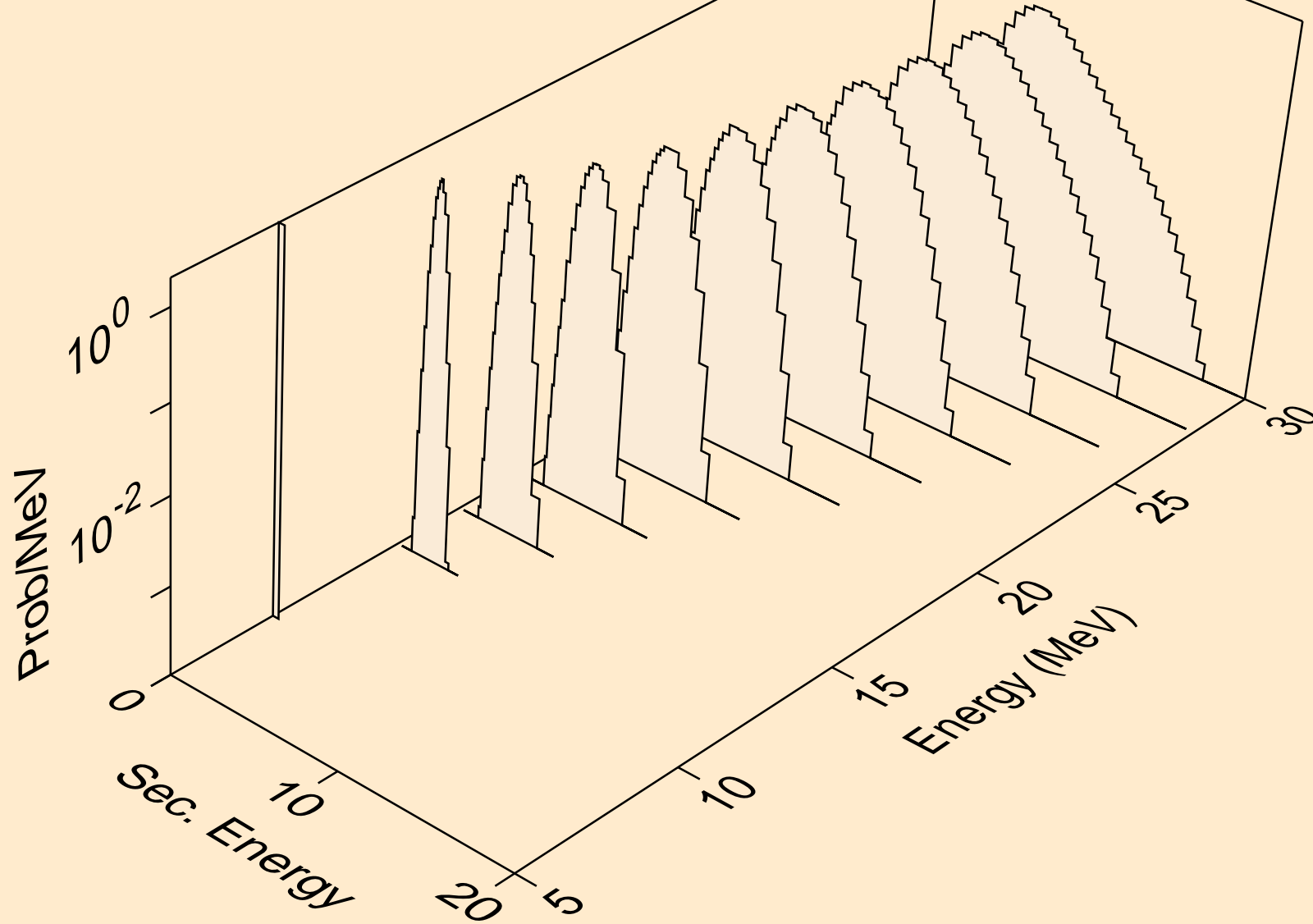

I117 NEUTRON ACER TENDL-2021 LIBRARY; T=293.6K  
protons from (n,npa)

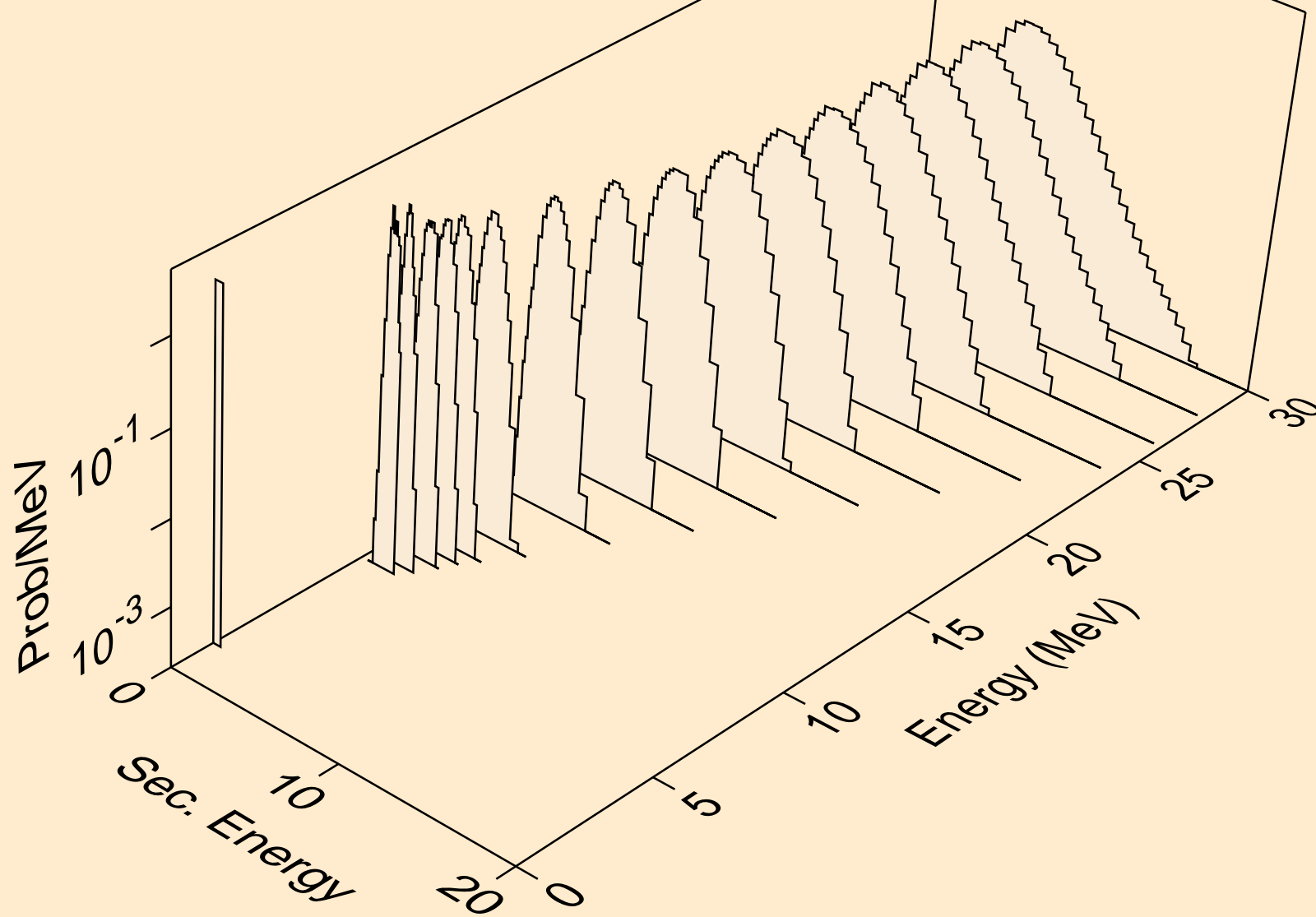

I117 NEUTRON ACER TENDL-2021 LIBRARY; T=293.6K  
protons from (n,p)

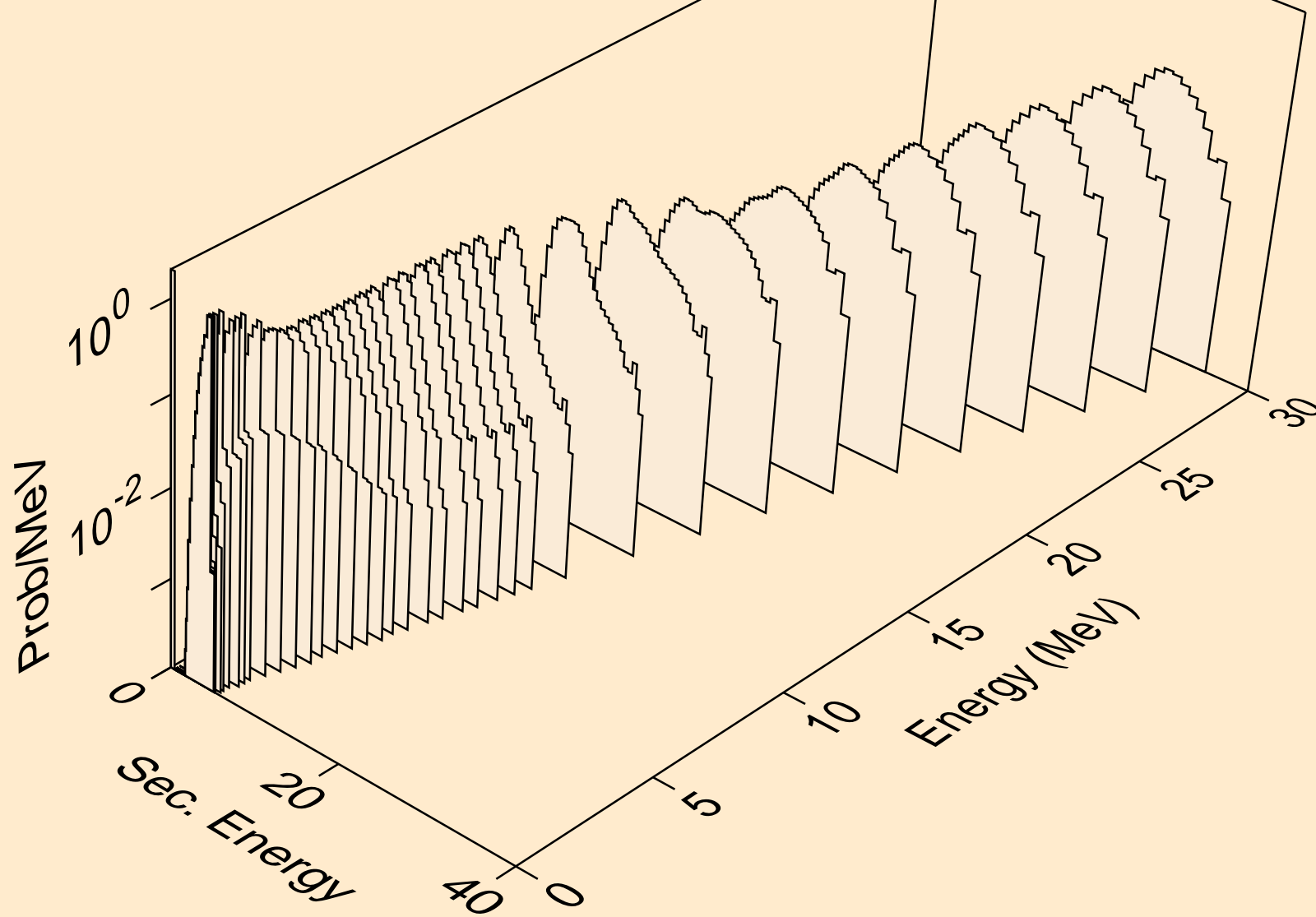

I117 NEUTRON ACER TENDL-2021 LIBRARY; T=293.6K  
protons from (n,2p)

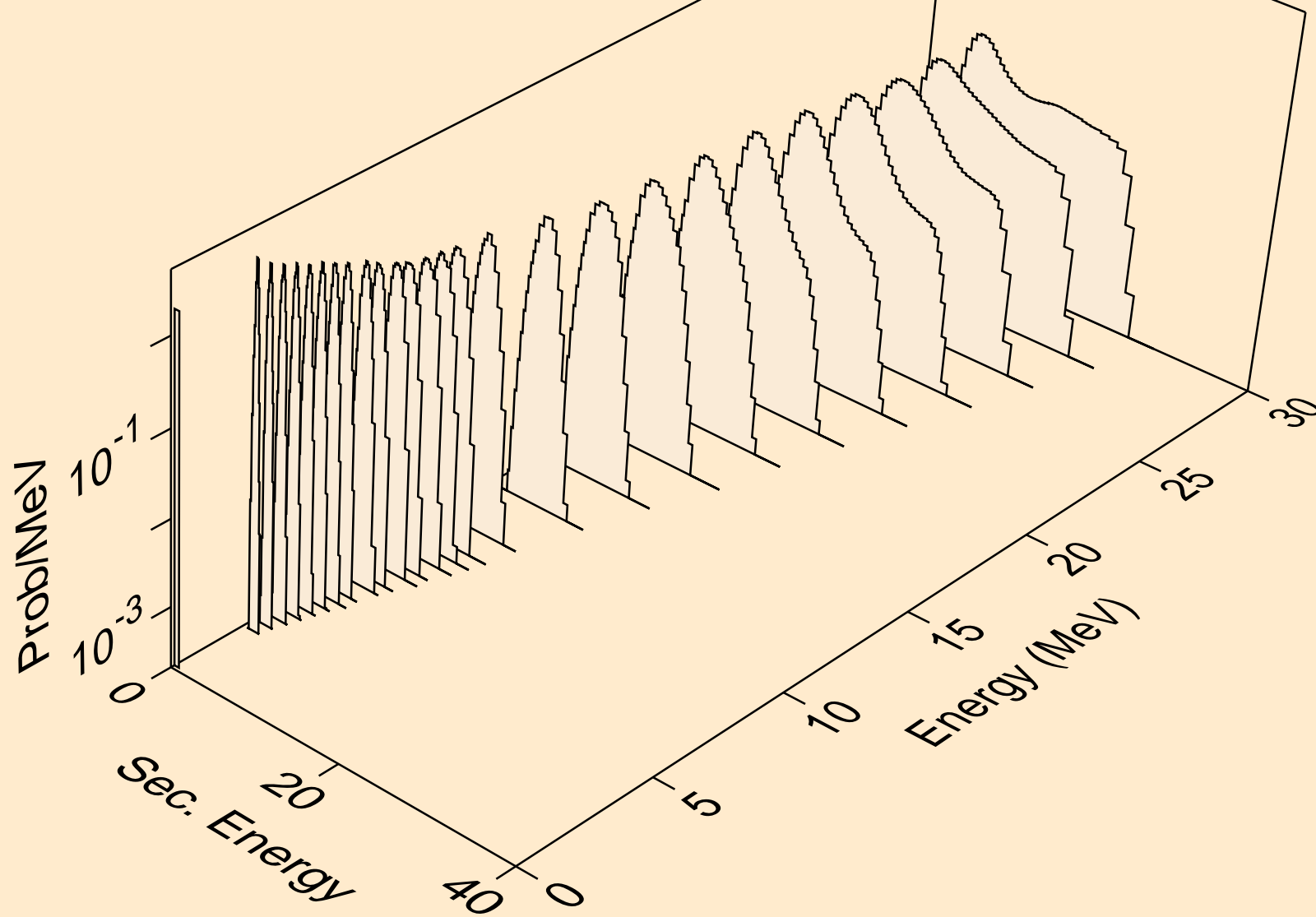

I117 NEUTRON ACER TENDL-2021 LIBRARY; T=293.6K  
protons from (n,p)

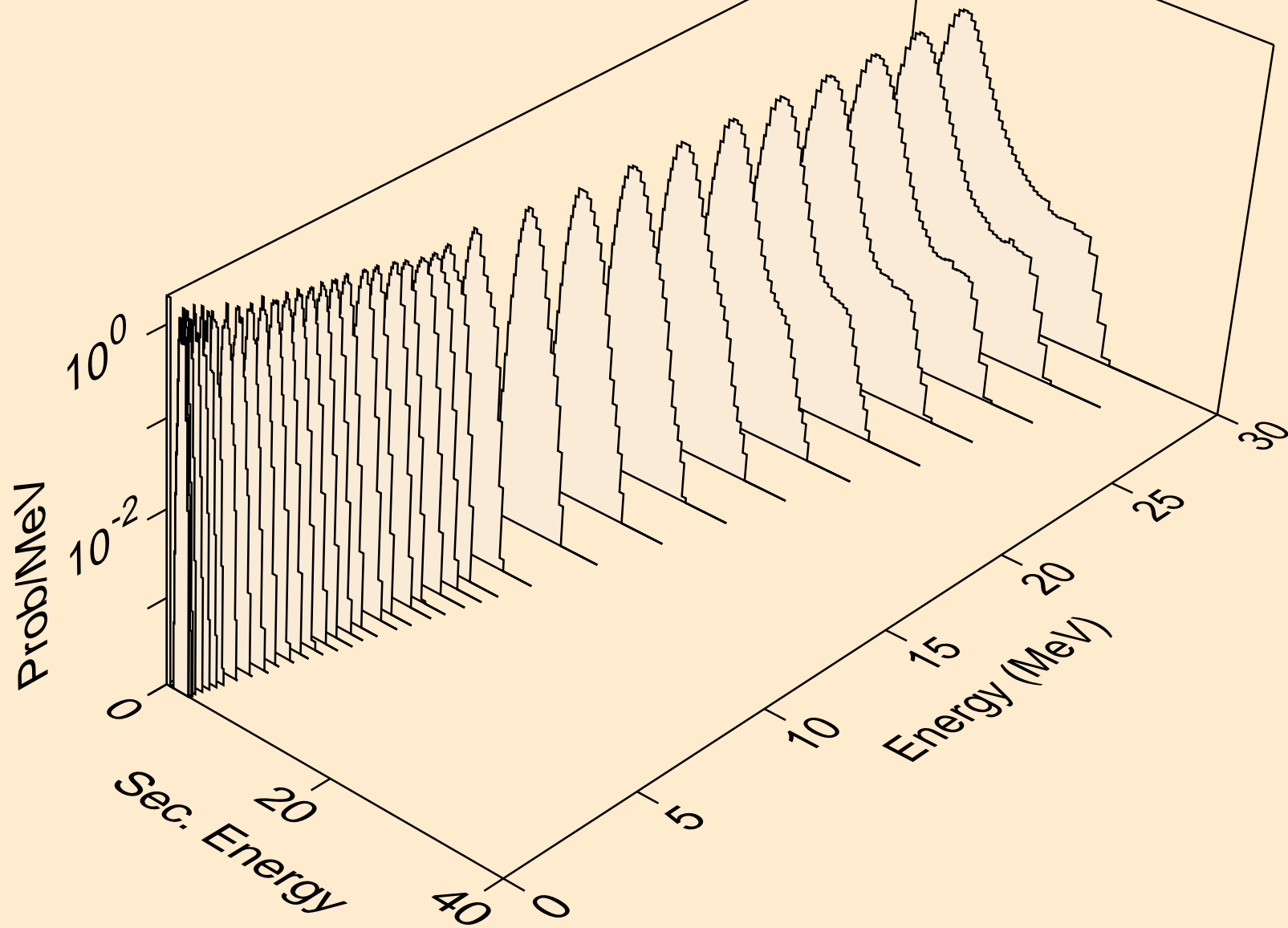

I117 NEUTRON ACER TENDL-2021 LIBRARY; T=293.6K  
protons from (n,pd)

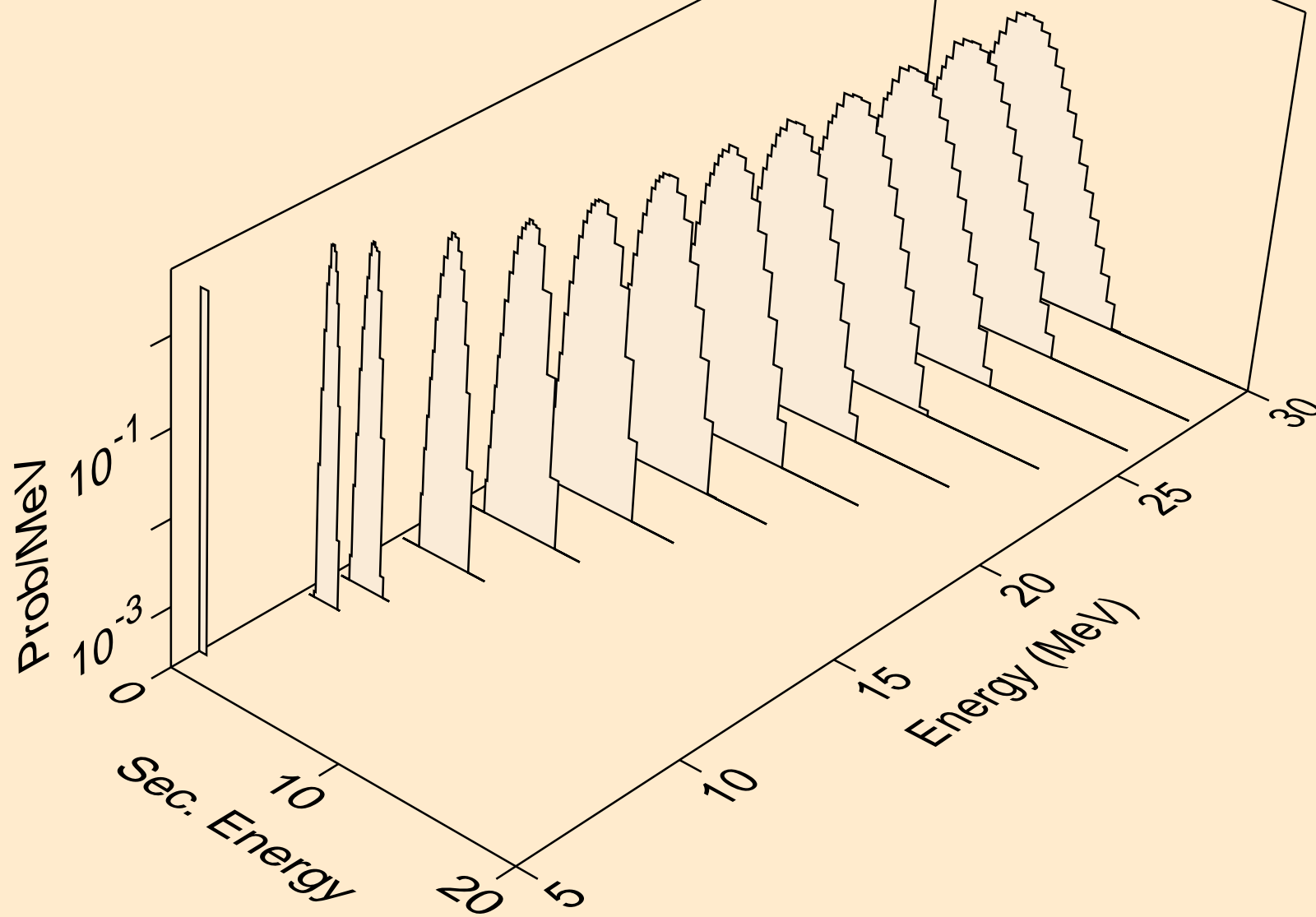

I117 NEUTRON ACER TENDL-2021 LIBRARY; T=293.6K  
protons from (n,pt)

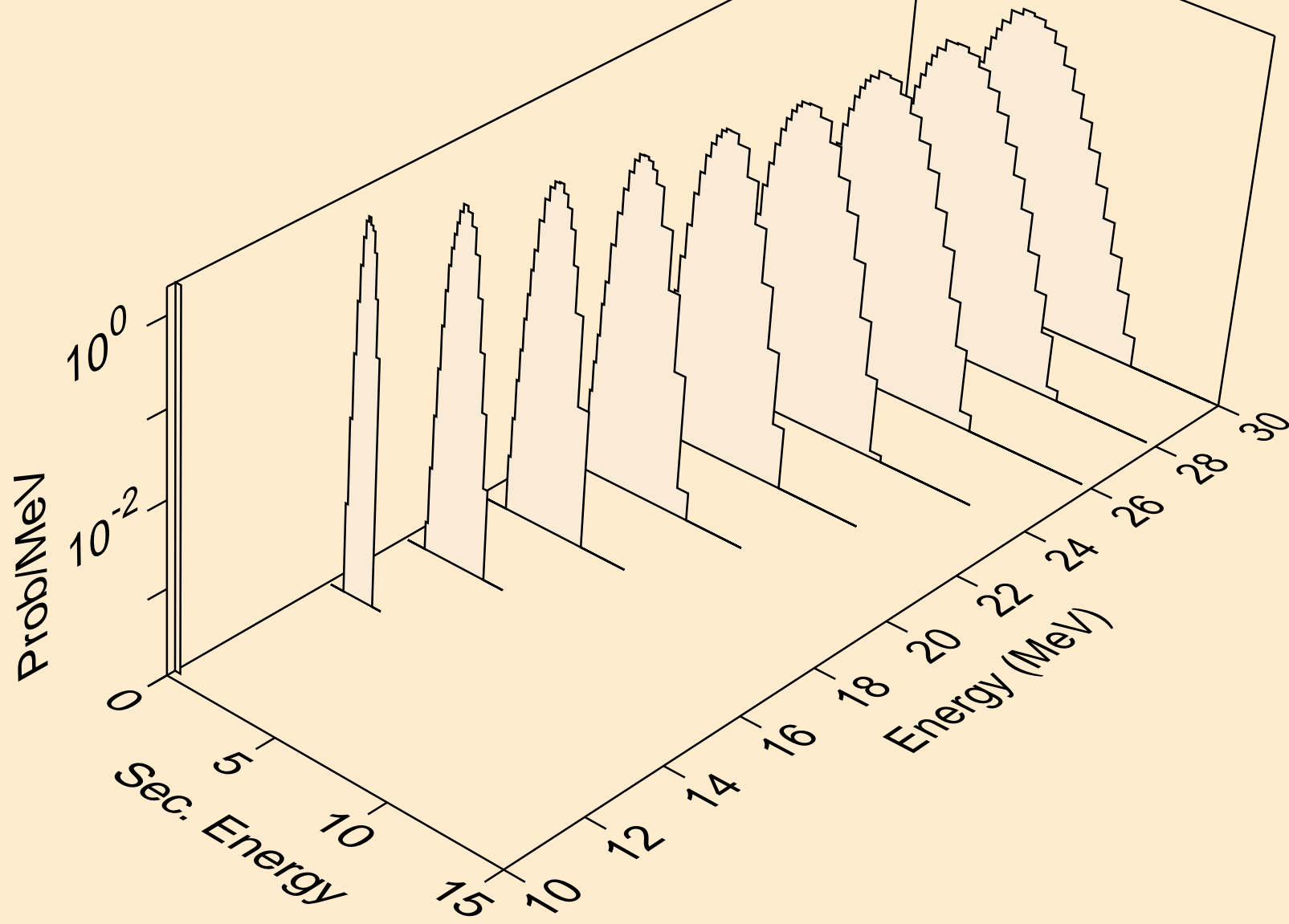

I117 NEUTRON ACER TENDL-2021 LIBRARY; T=293.6K  
deuterons from (n,x)

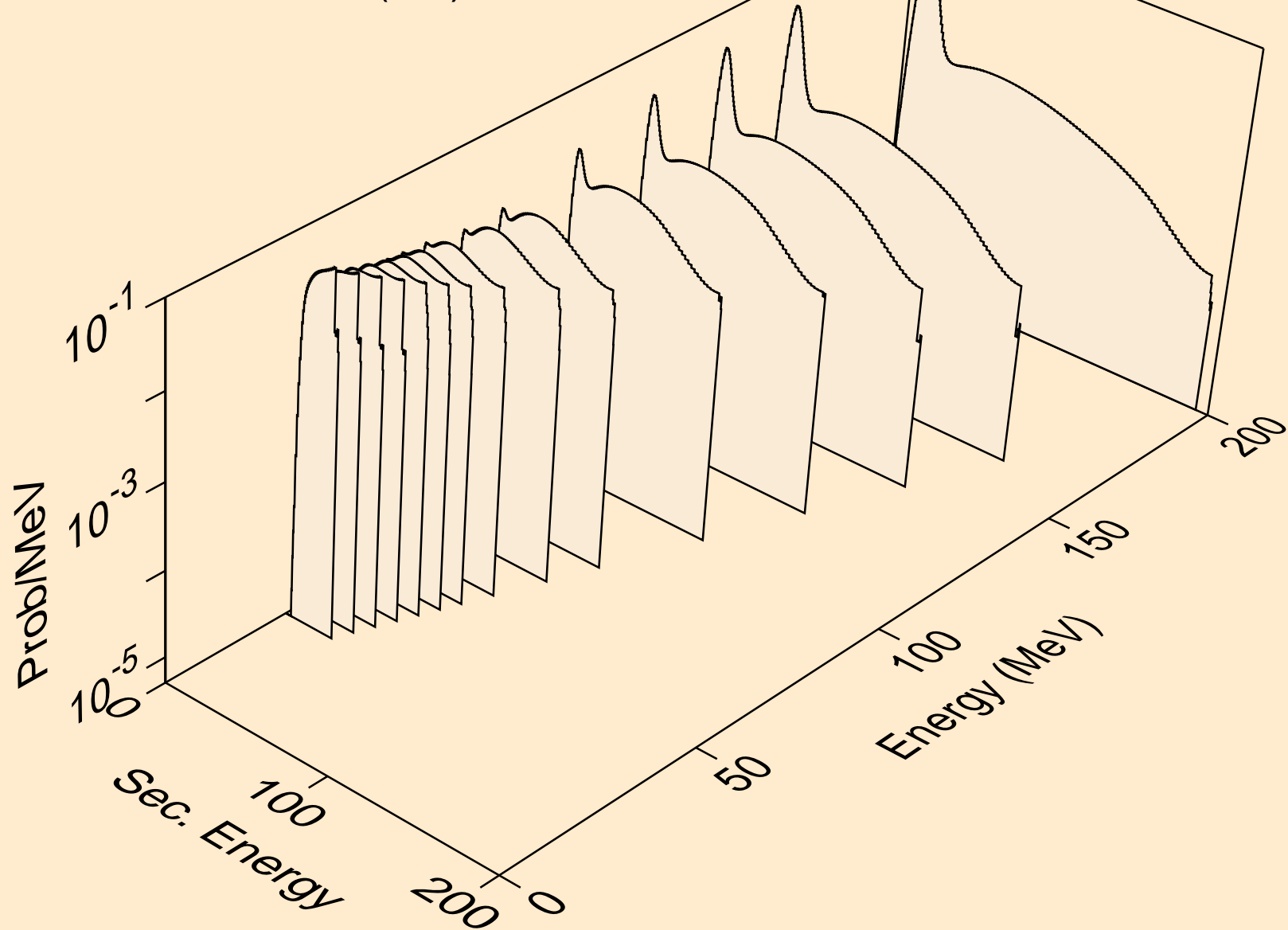



I117 NEUTRON ACER TENDL-2021 LIBRARY; T=293.6K  
deuterons from (n,2nd)

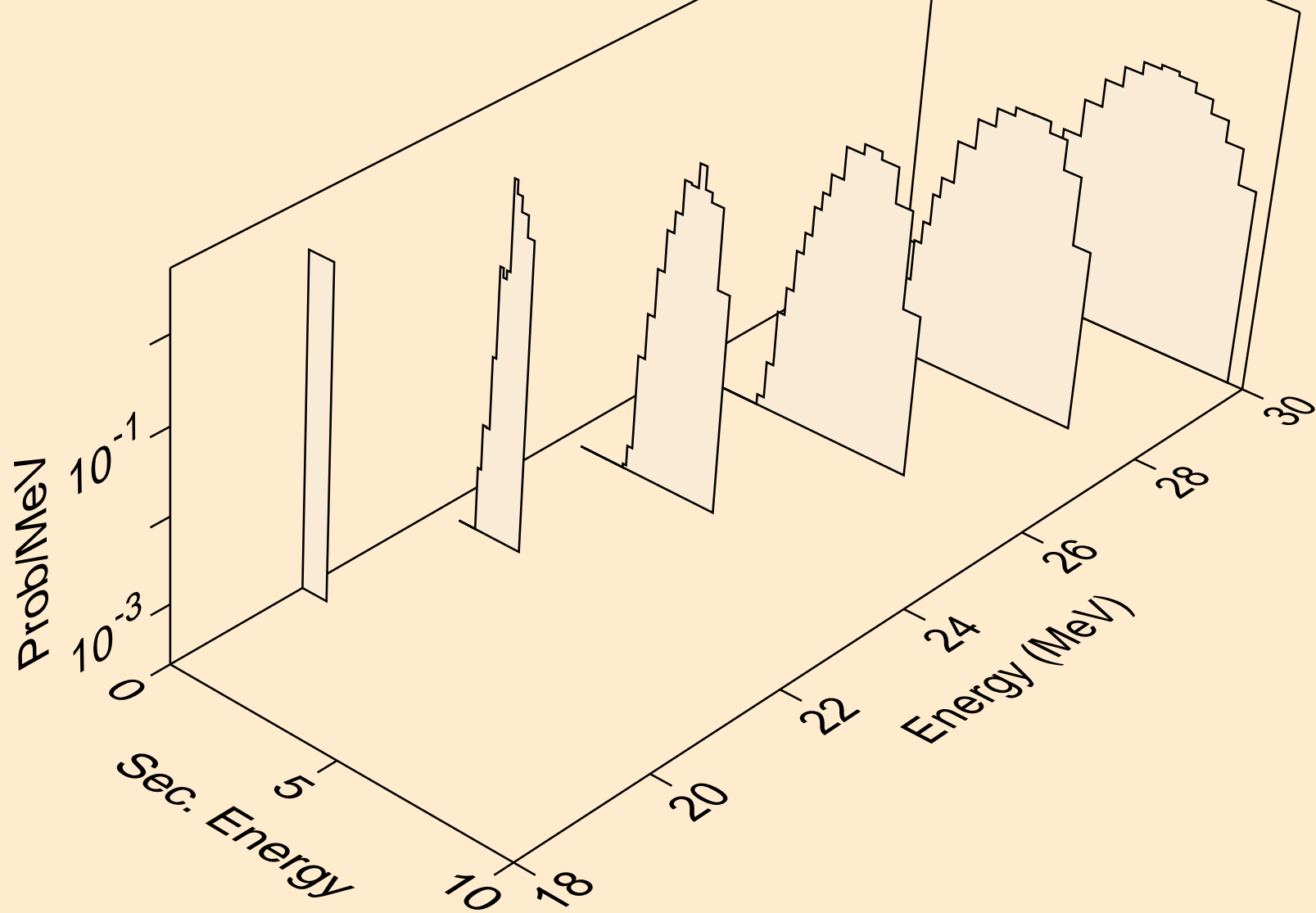

I117 NEUTRON ACER TENDL-2021 LIBRARY; T=293.6K  
deuterons from (n,n\*)d

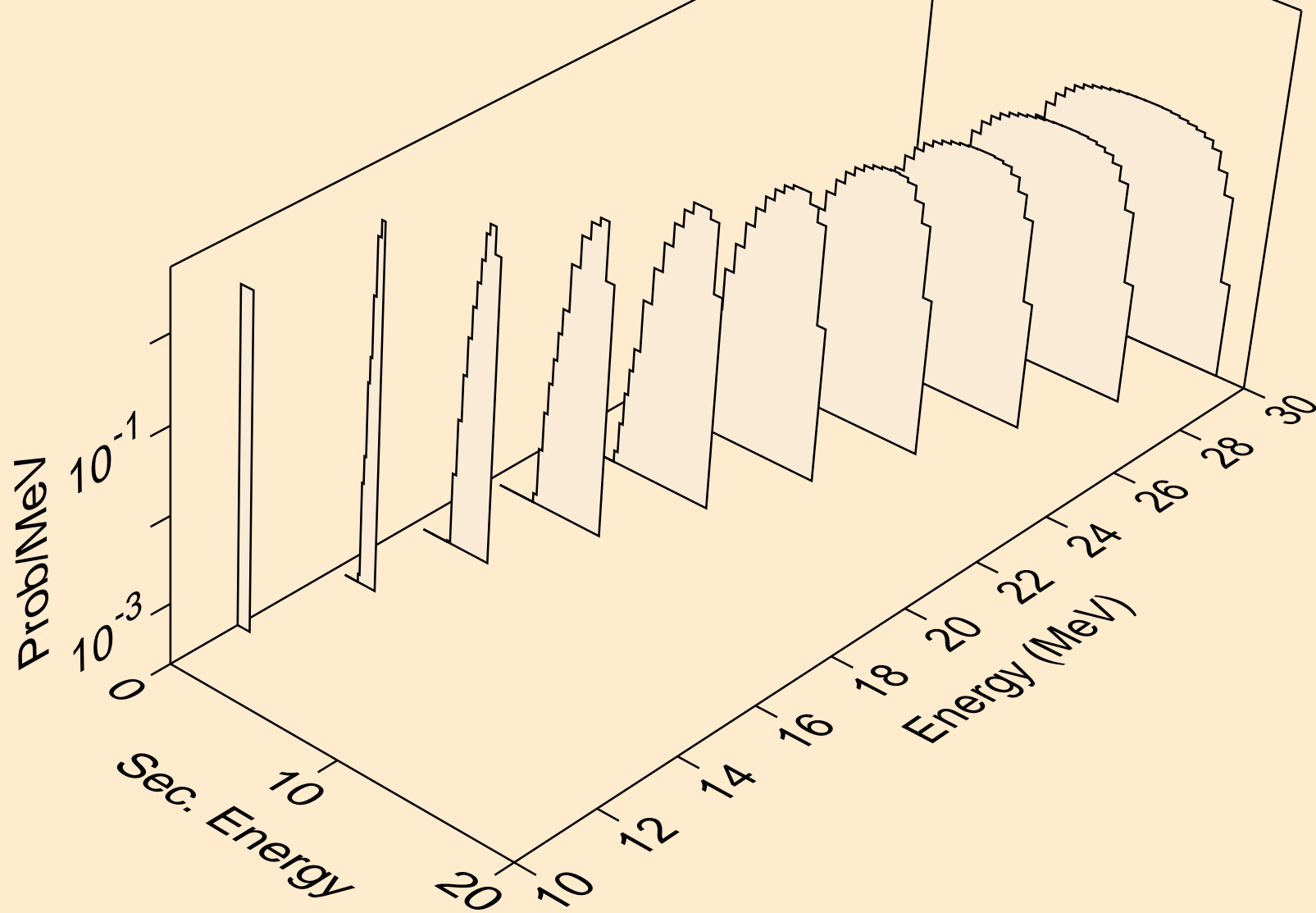

I117 NEUTRON ACER TENDL-2021 LIBRARY; T=293.6K  
deuterons from (n,d)

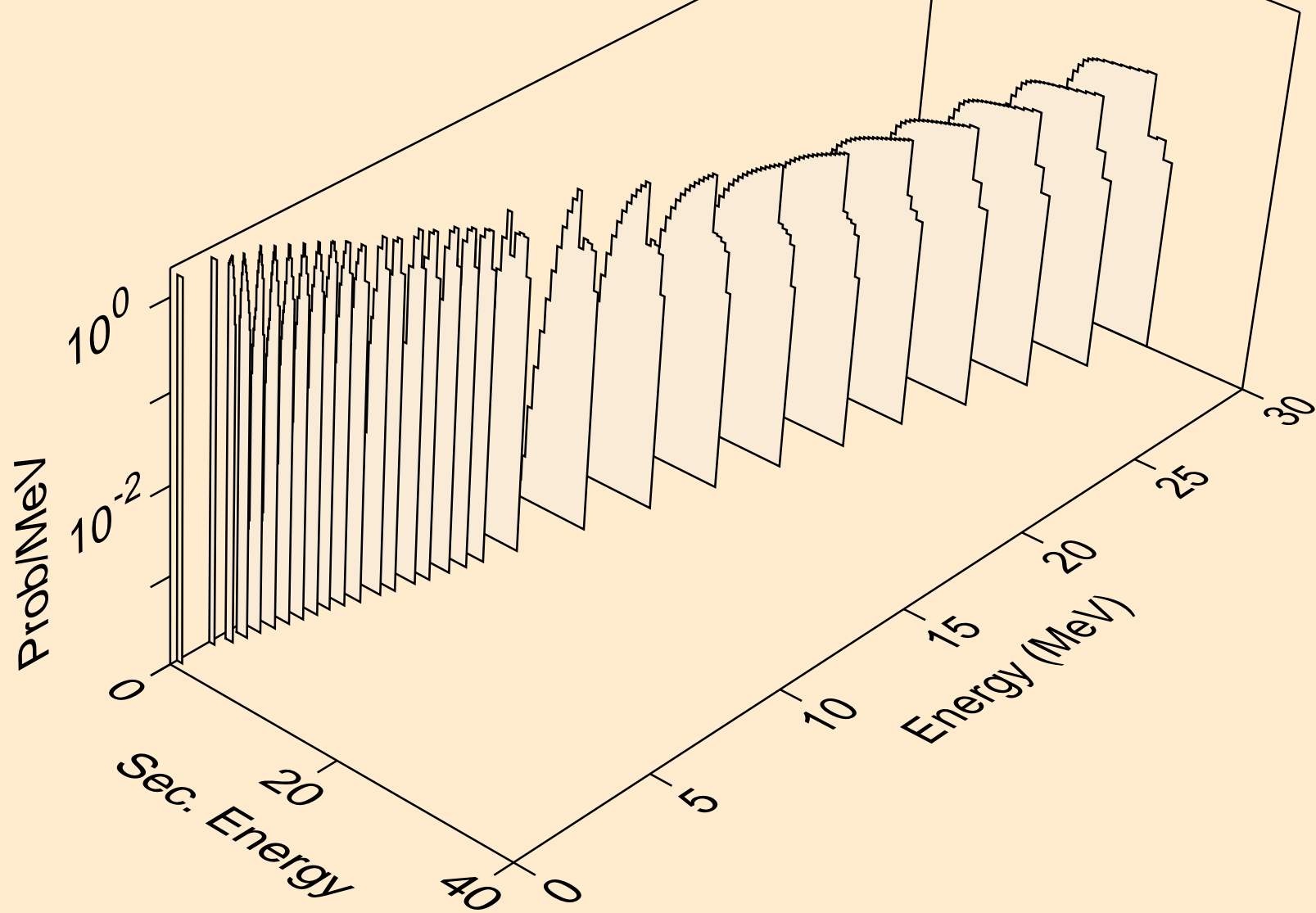

I117 NEUTRON ACER TENDL-2021 LIBRARY; T=293.6K  
deuterons from (n,pd)

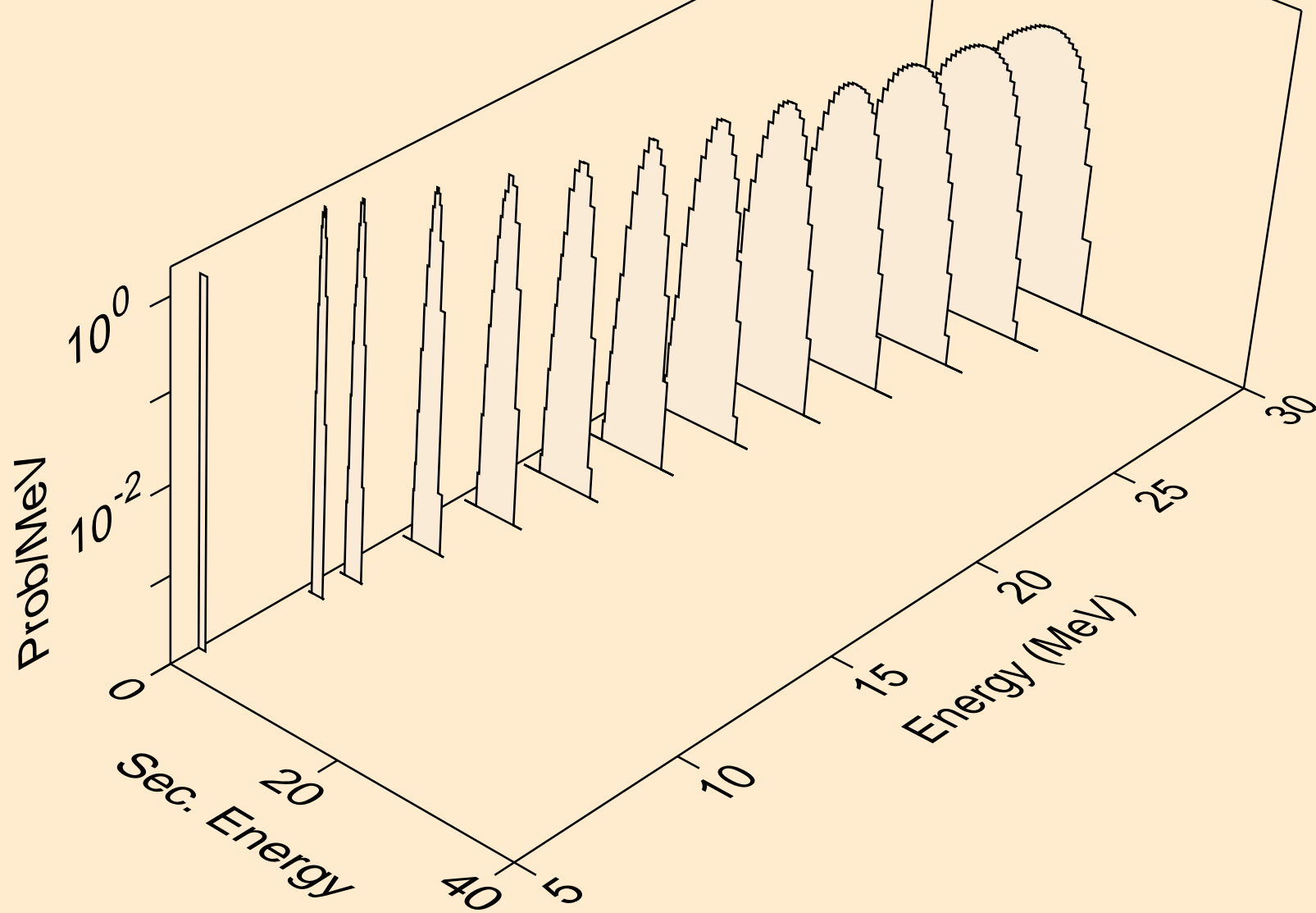

I117 NEUTRON ACER TENDL-2021 LIBRARY; T=293.6K  
deuterons from (n,da)

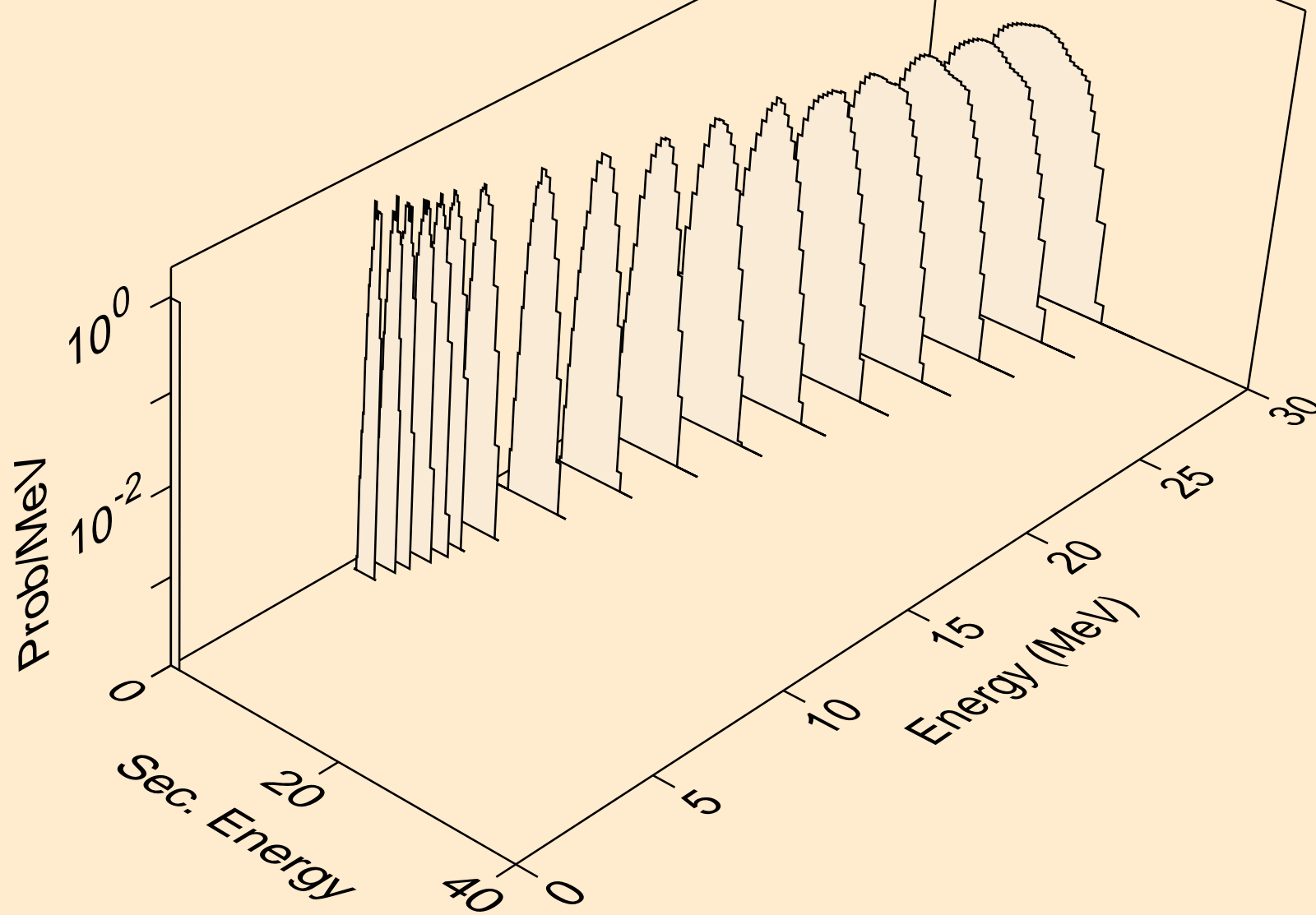

I117 NEUTRON ACER TENDL-2021 LIBRARY; T=293.6K  
tritons from (n,x)

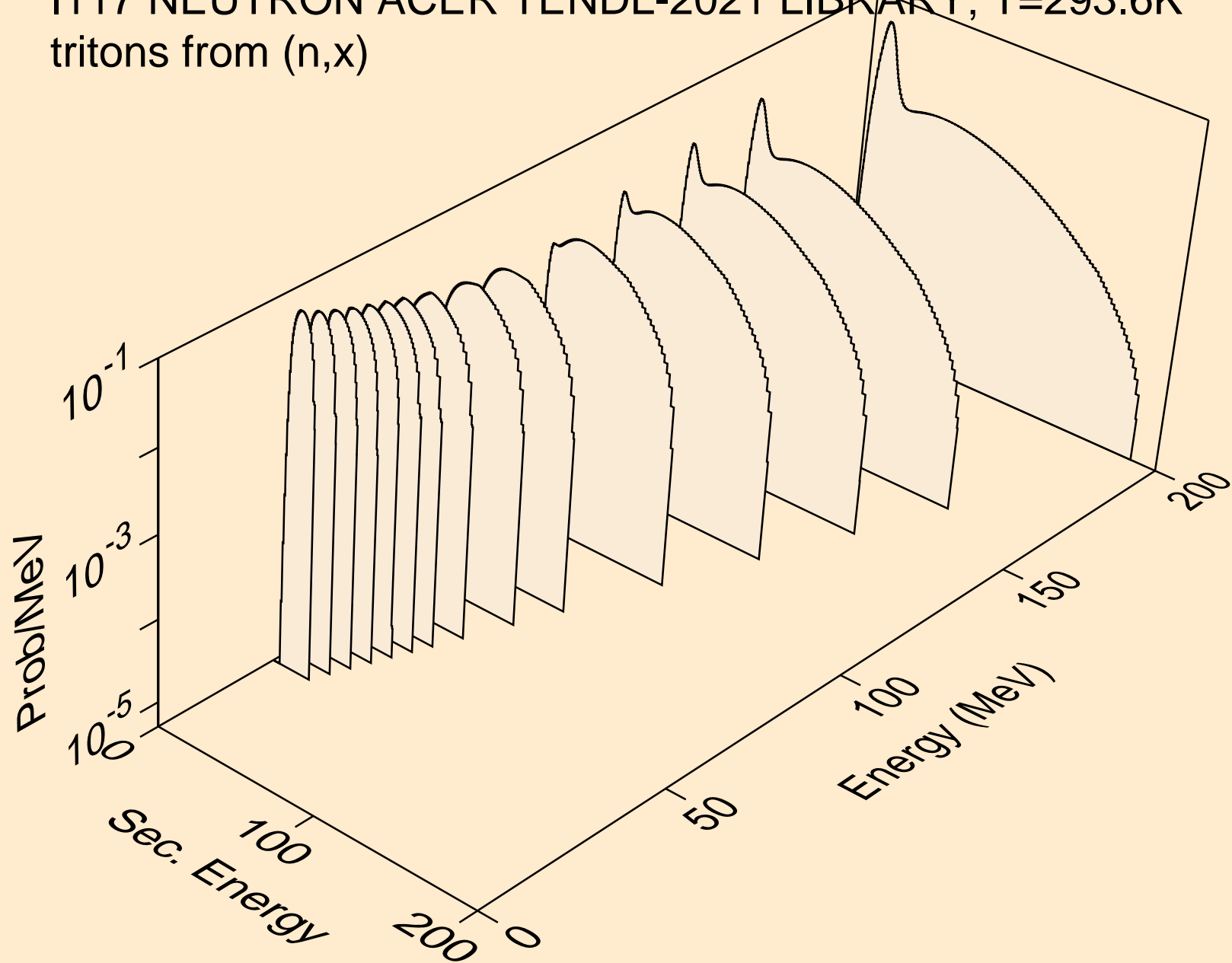

I117 NEUTRON ACER TENDL-2021 LIBRARY; T=293.6K  
tritons from (n,n\*)t

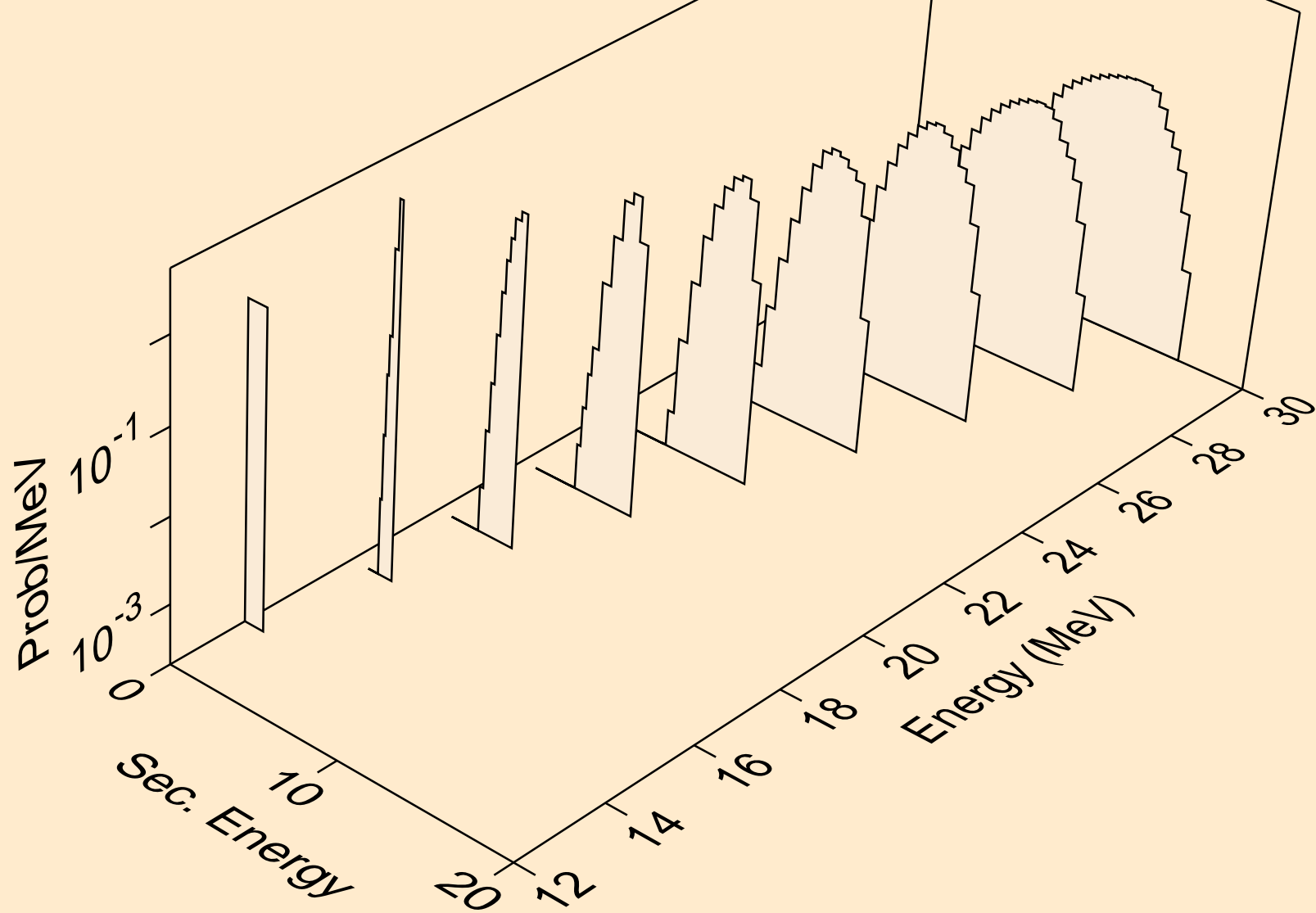

I117 NEUTRON ACER TENDL-2021 LIBRARY; T=293.6K  
tritons from (n,t)

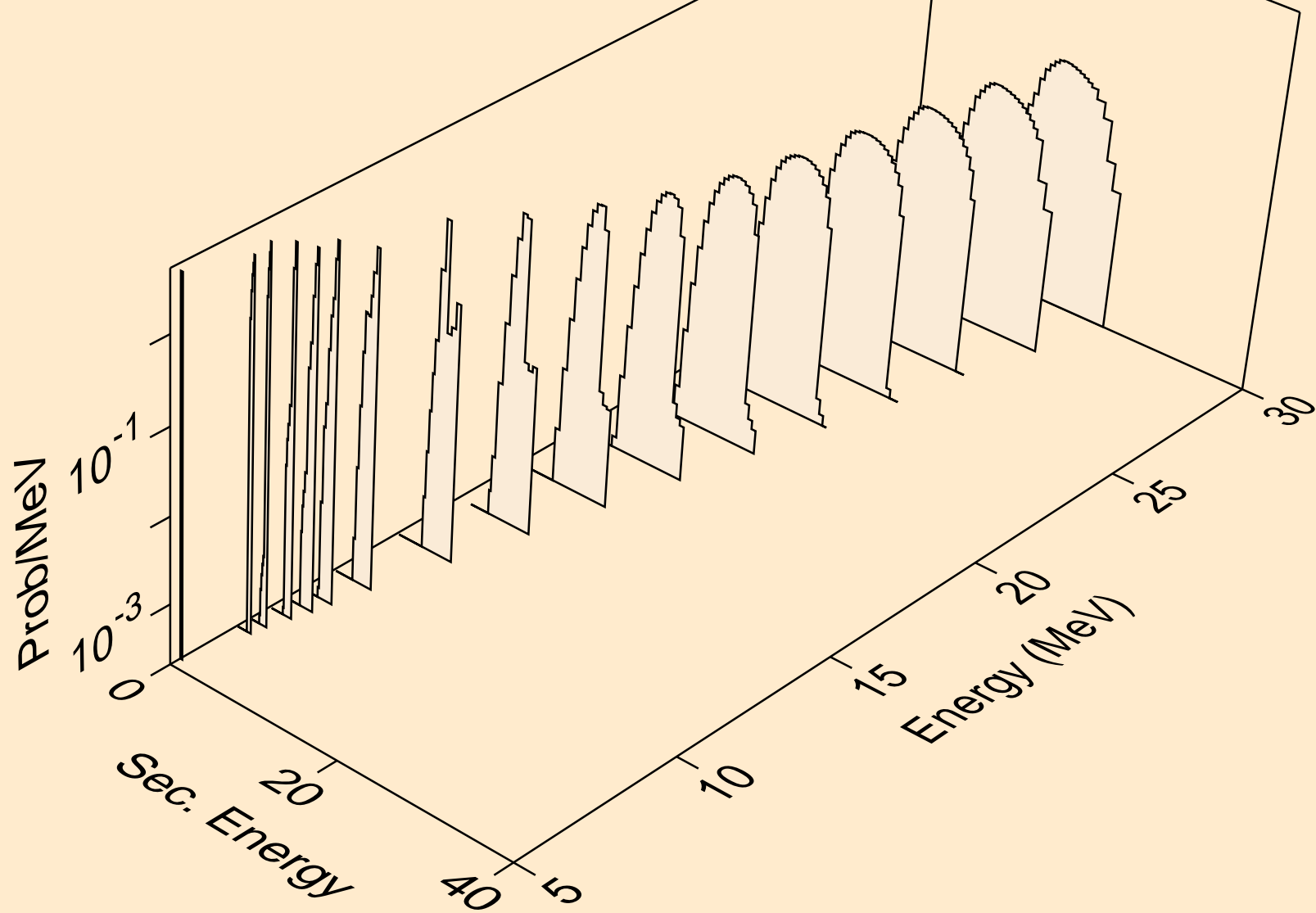



I117 NEUTRON ACER TENDL-2021 LIBRARY; T=293.6K  
tritons from (n,pt)

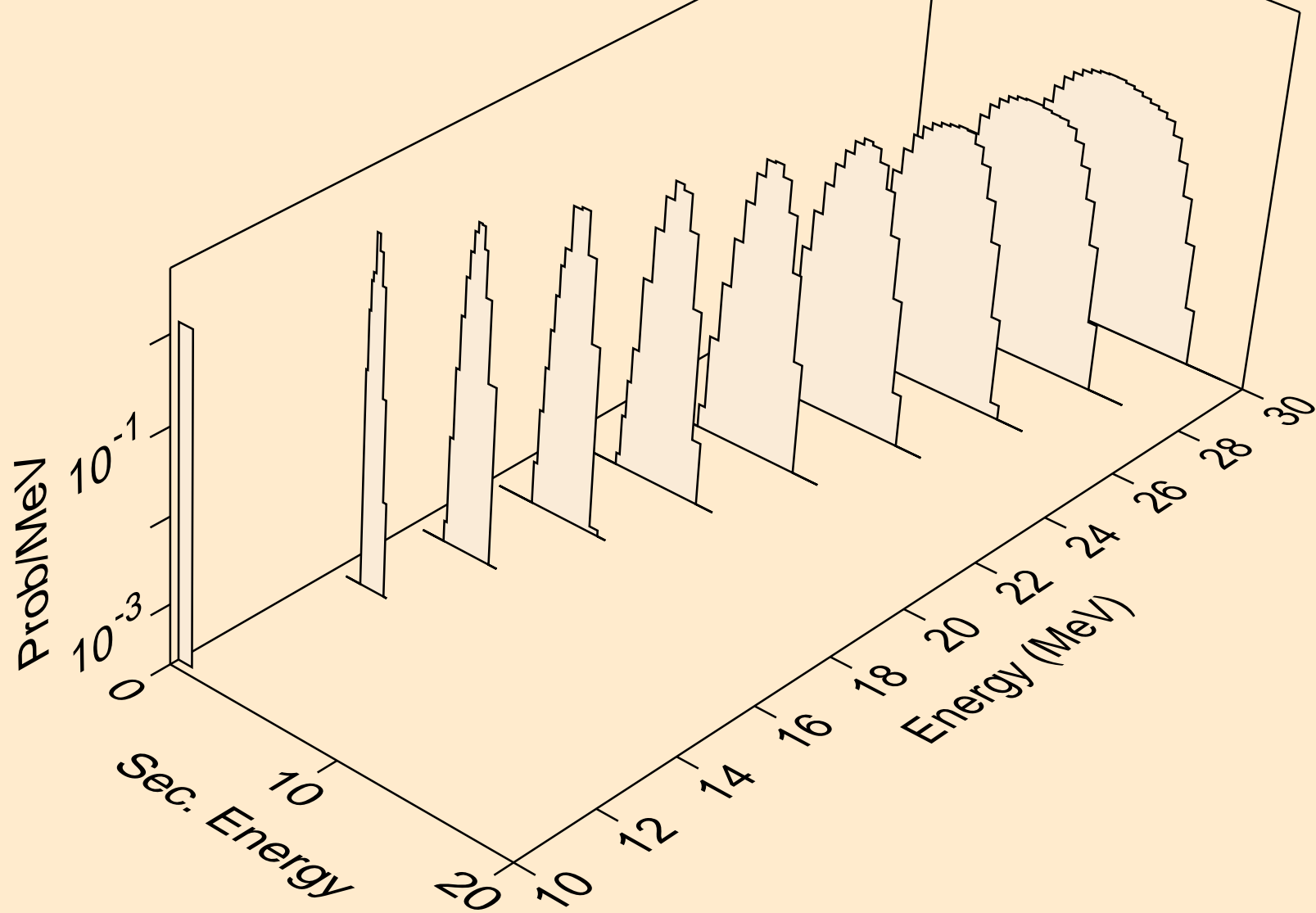

I117 NEUTRON ACER TENDL-2021 LIBRARY; T=293.6K  
he3s from (n,x)

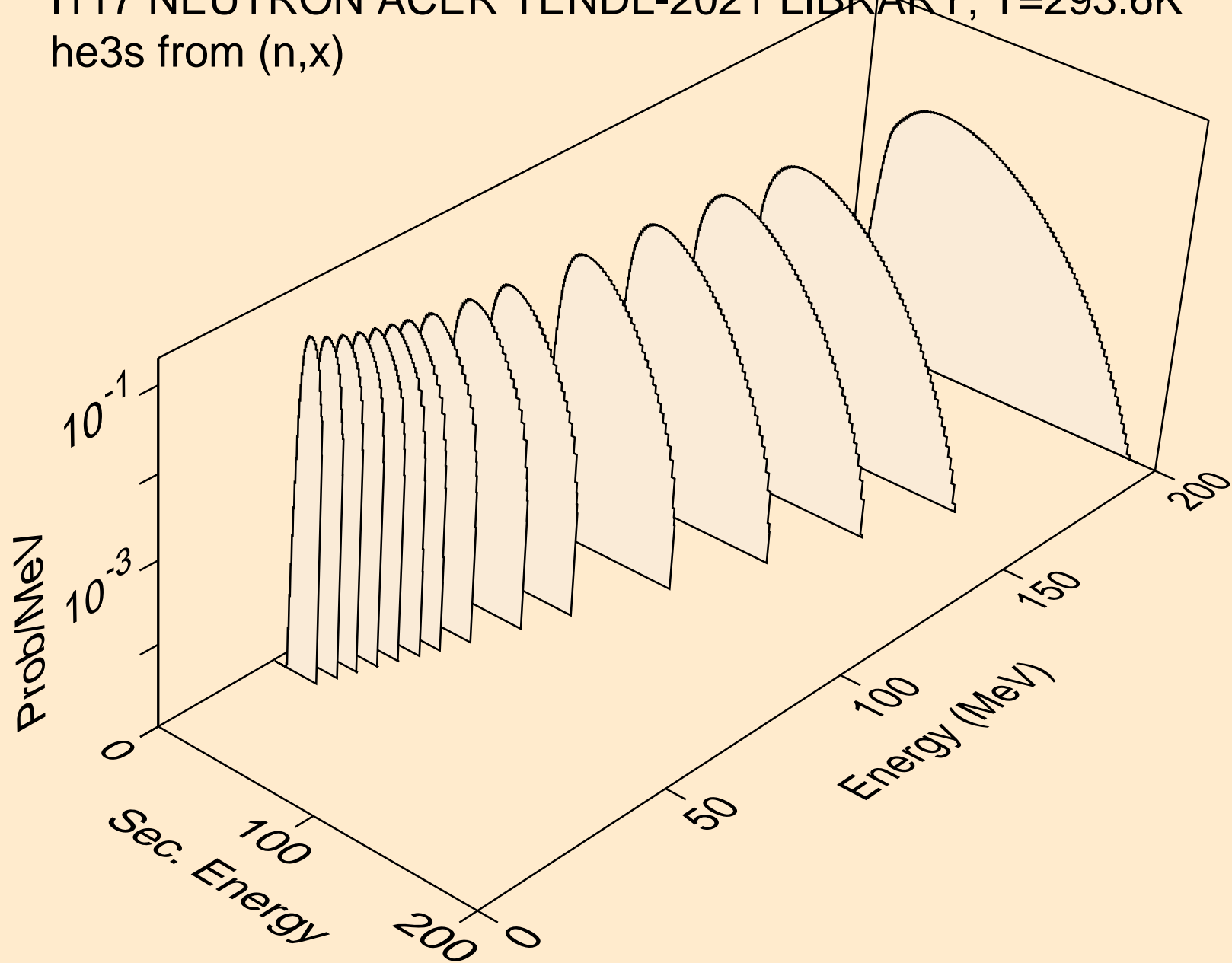

I117 NEUTRON ACER TENDL-2021 LIBRARY; T=293.6K  
he3s from (n,n\*)he3

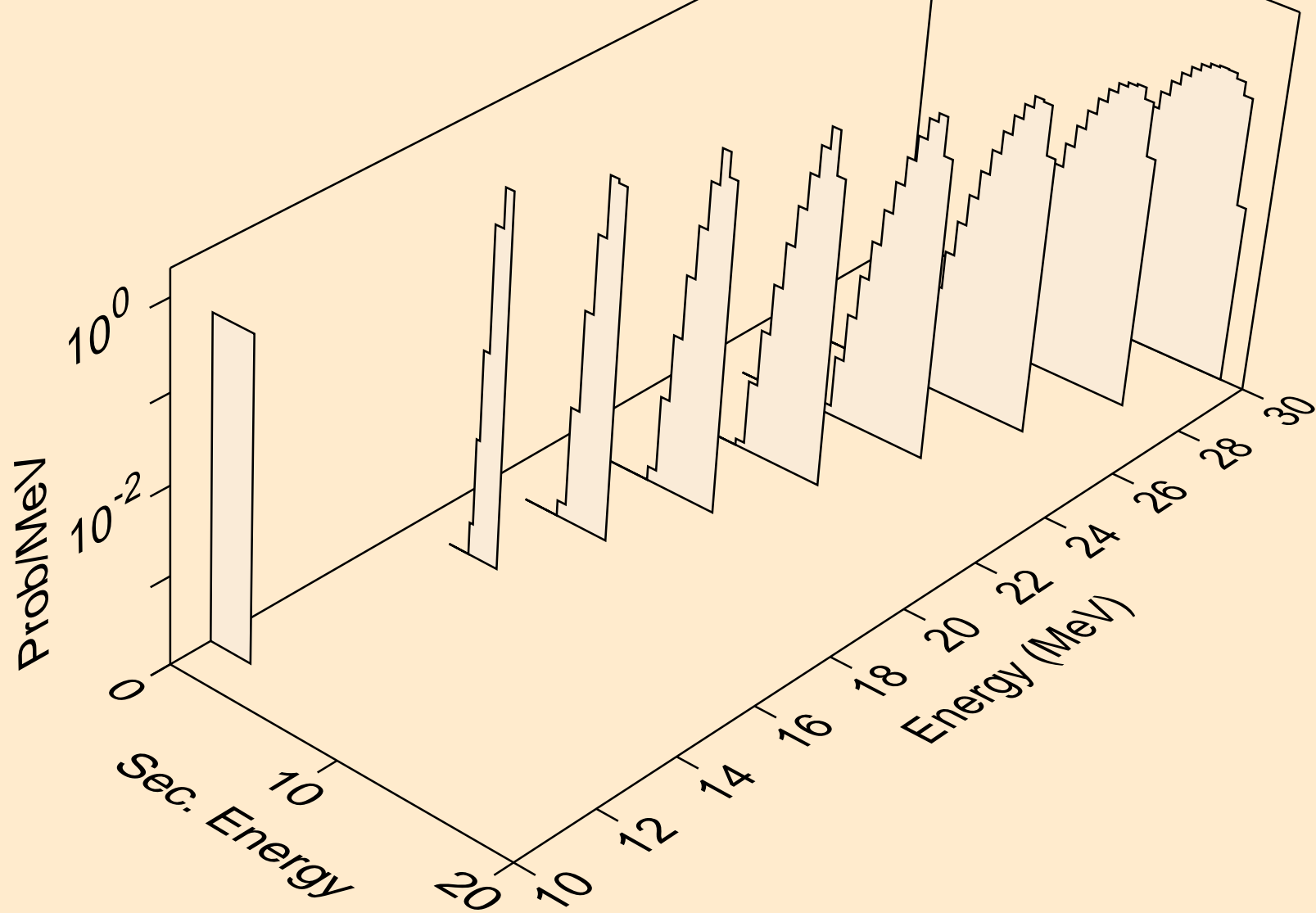

I117 NEUTRON ACER TENDL-2021 LIBRARY; T=293.6K  
he3s from (n,he3)

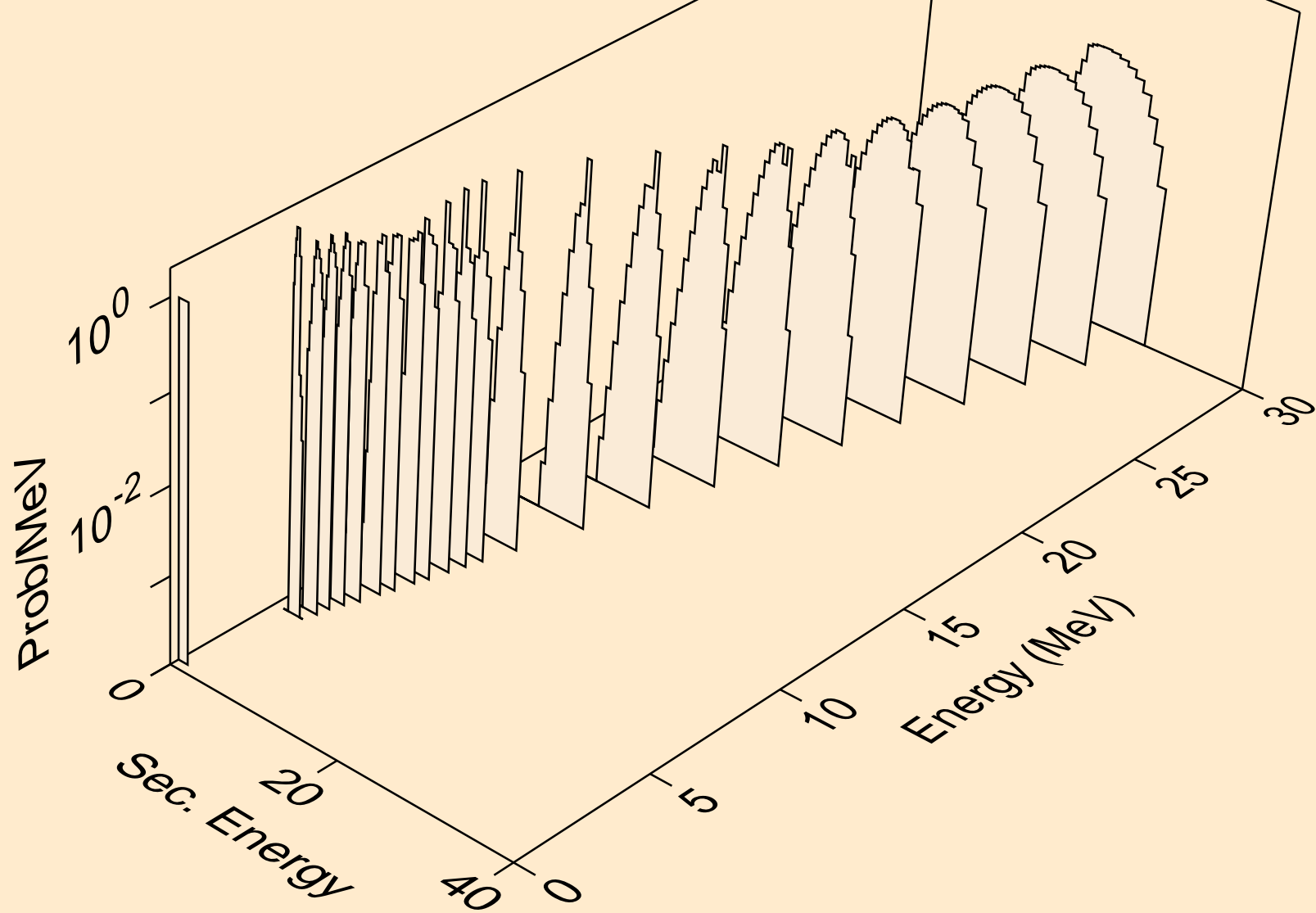

I117 NEUTRON ACER TENDL-2021 LIBRARY; T=293.6K  
alphas from (n,x)

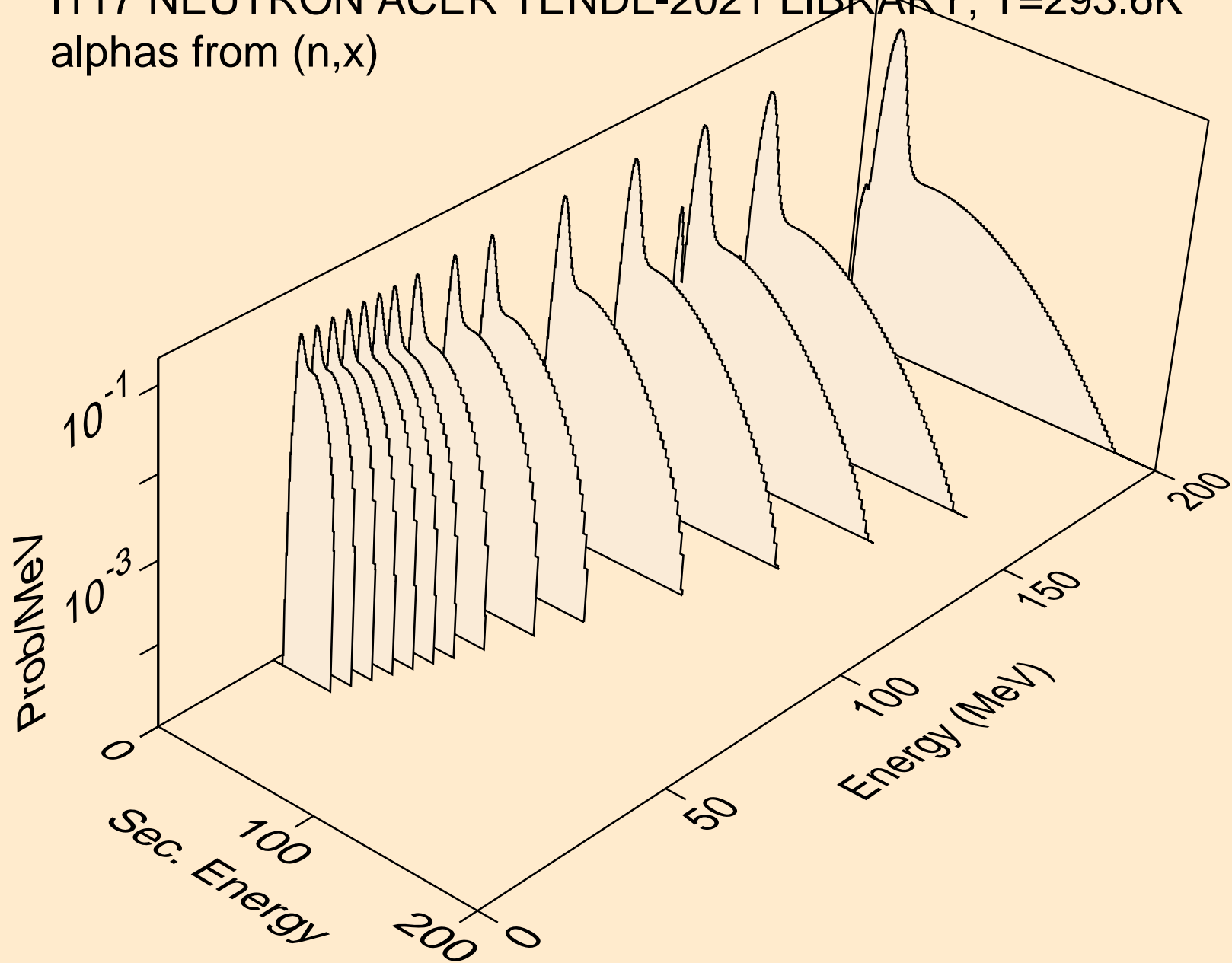

I117 NEUTRON ACER TENDL-2021 LIBRARY; T=293.6K  
alphas from (n,n\*)a

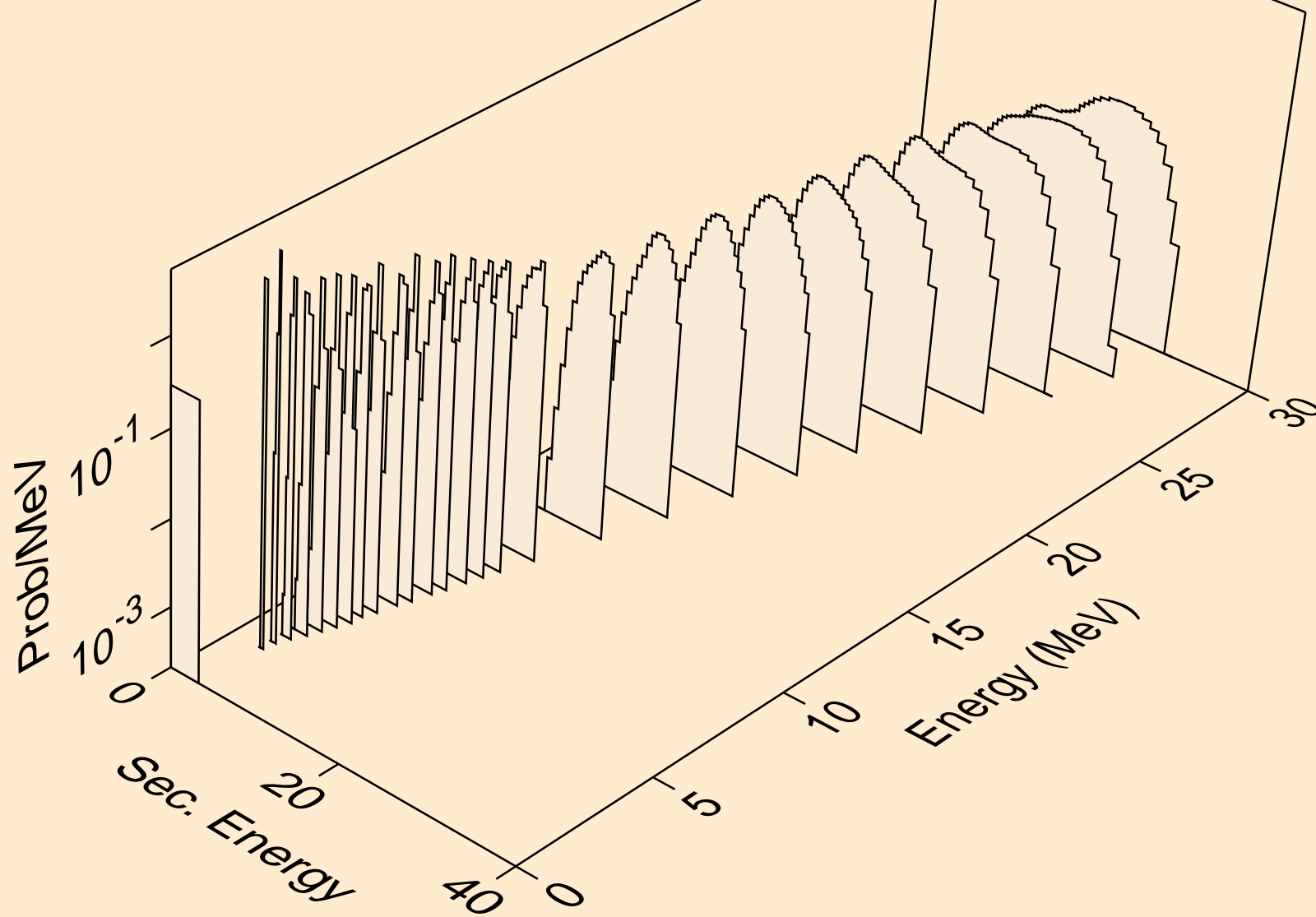

I117 NEUTRON ACER TENDL-2021 LIBRARY; T=293.6K  
alphas from (n,2n)a

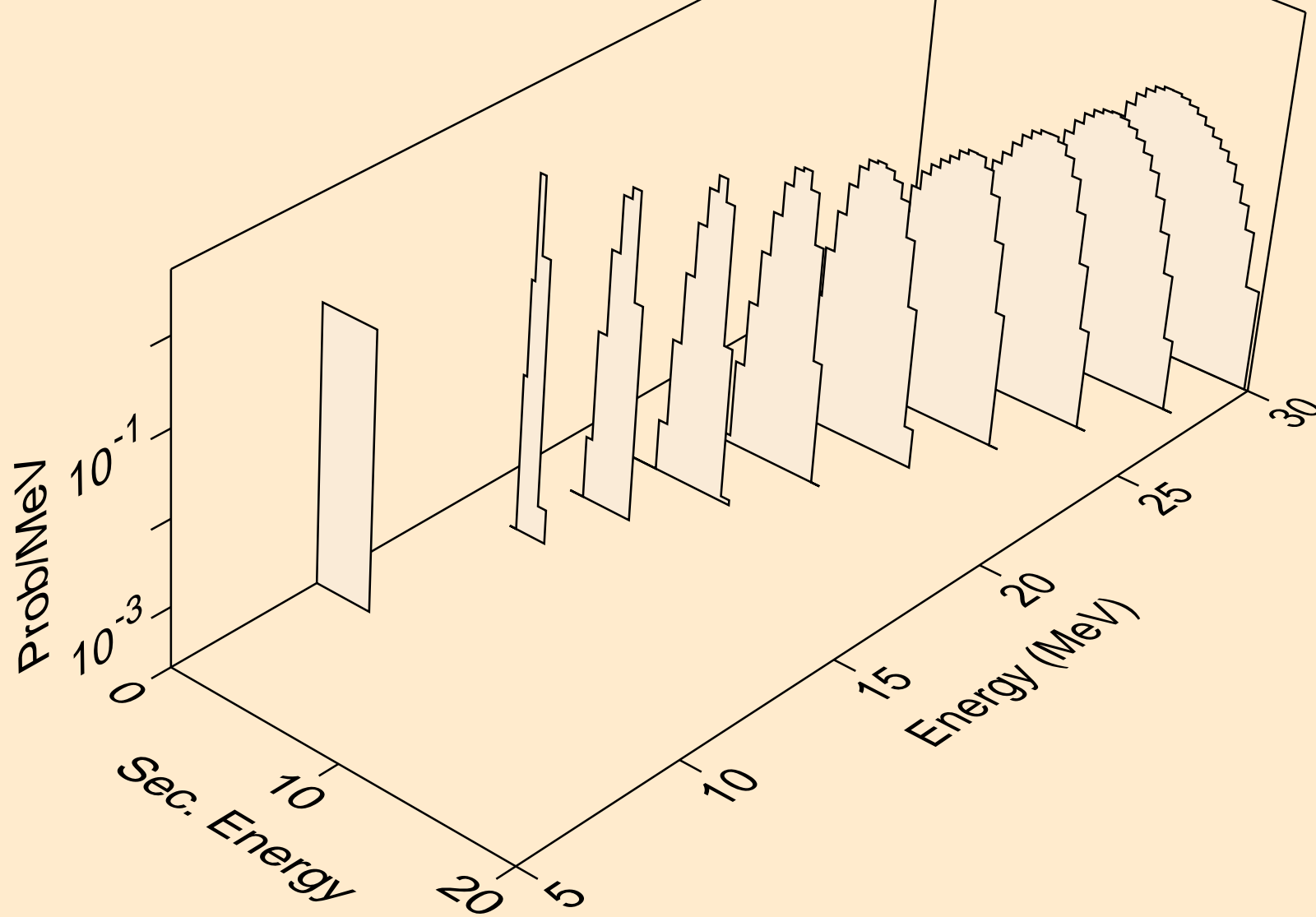

I117 NEUTRON ACER TENDL-2021 LIBRARY; T=293.6K  
alphas from (n,3n)a

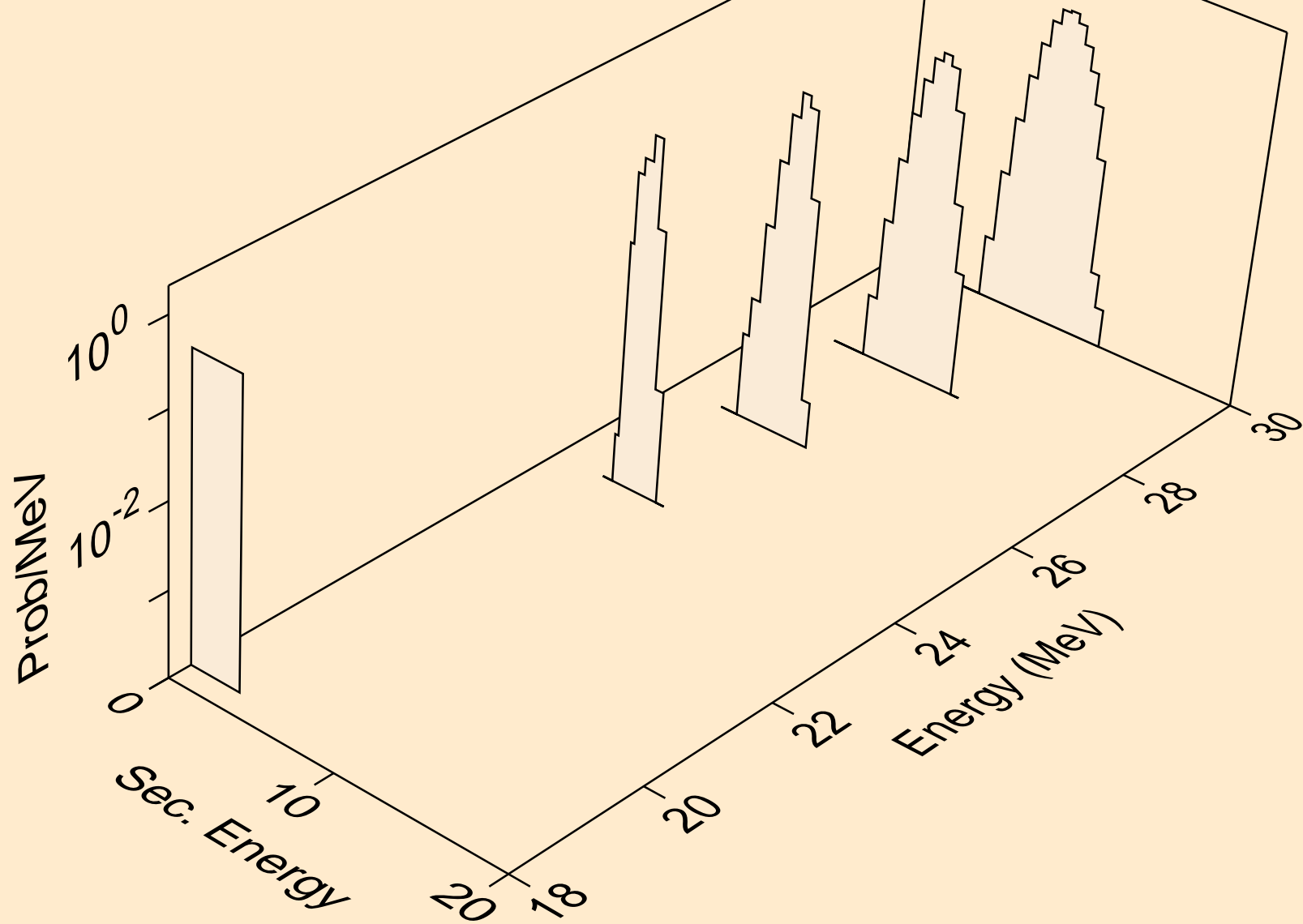



I117 NEUTRON ACER TENDL-2021 LIBRARY; T=293.6K  
alphas from (n,n\*)2a

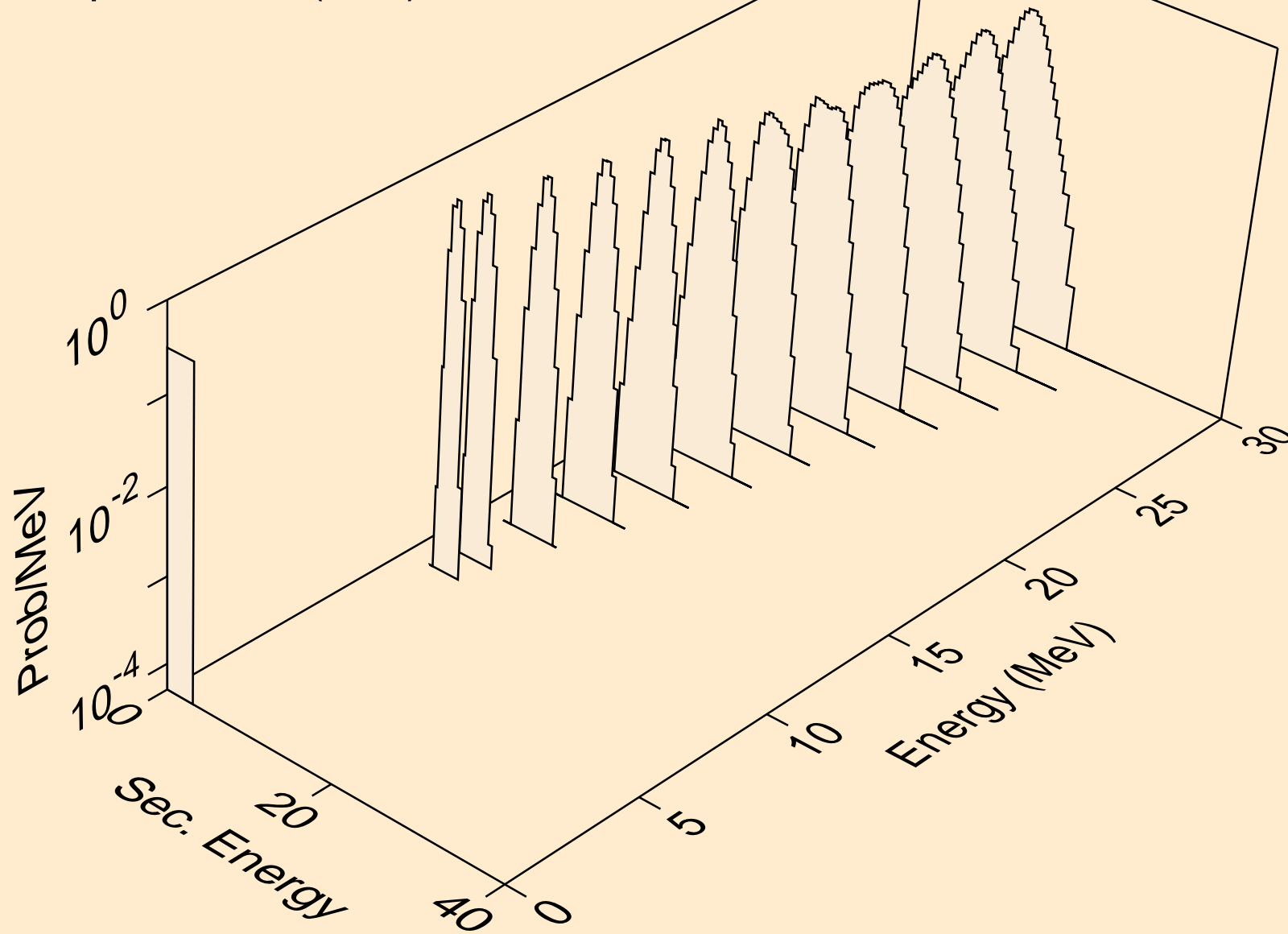

I117 NEUTRON ACER TENDL-2021 LIBRARY; T=293.6K  
alphas from (n,2n)2a

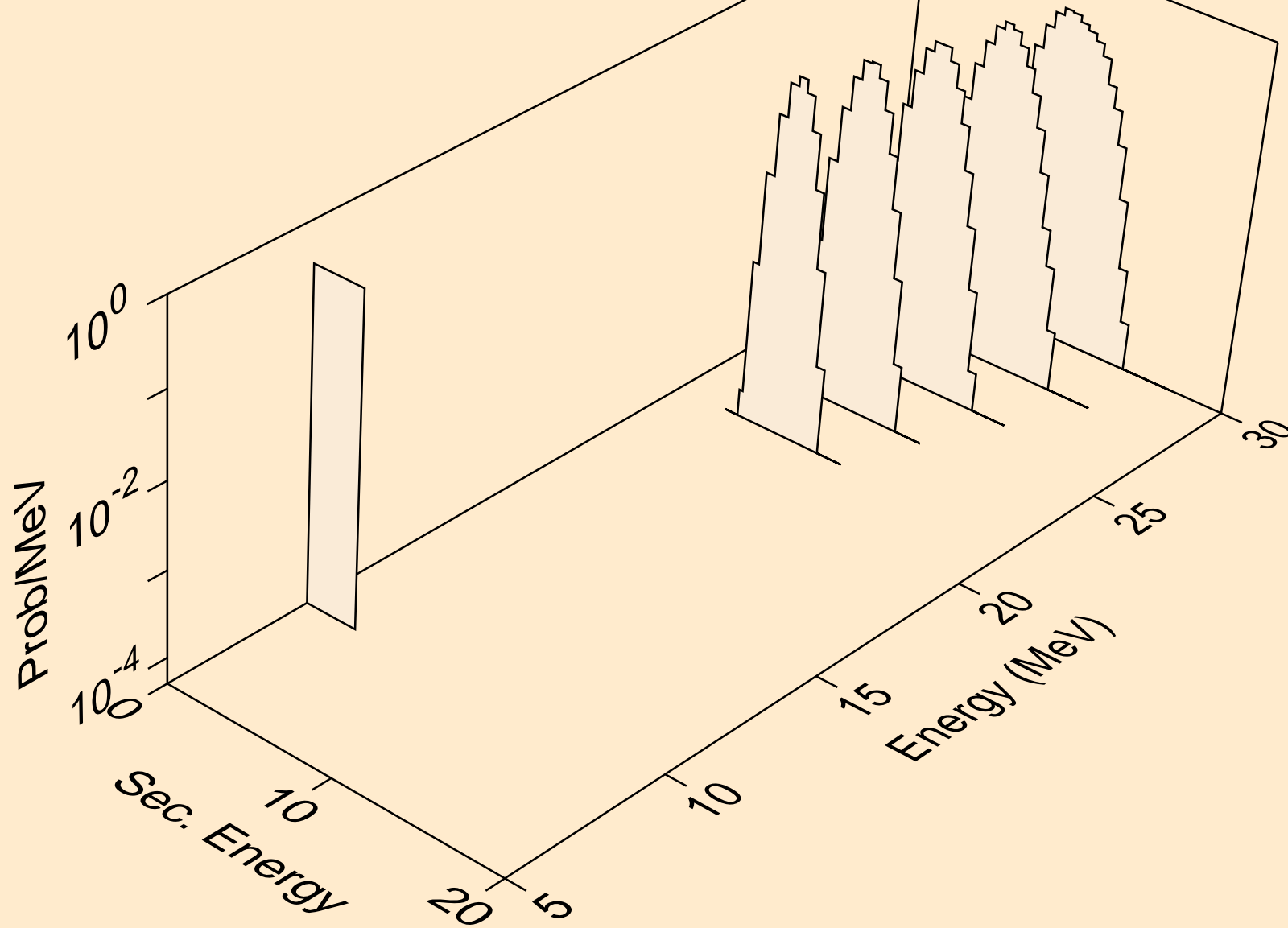

I117 NEUTRON ACER TENDL-2021 LIBRARY; T=293.6K  
alphas from (n,npa)

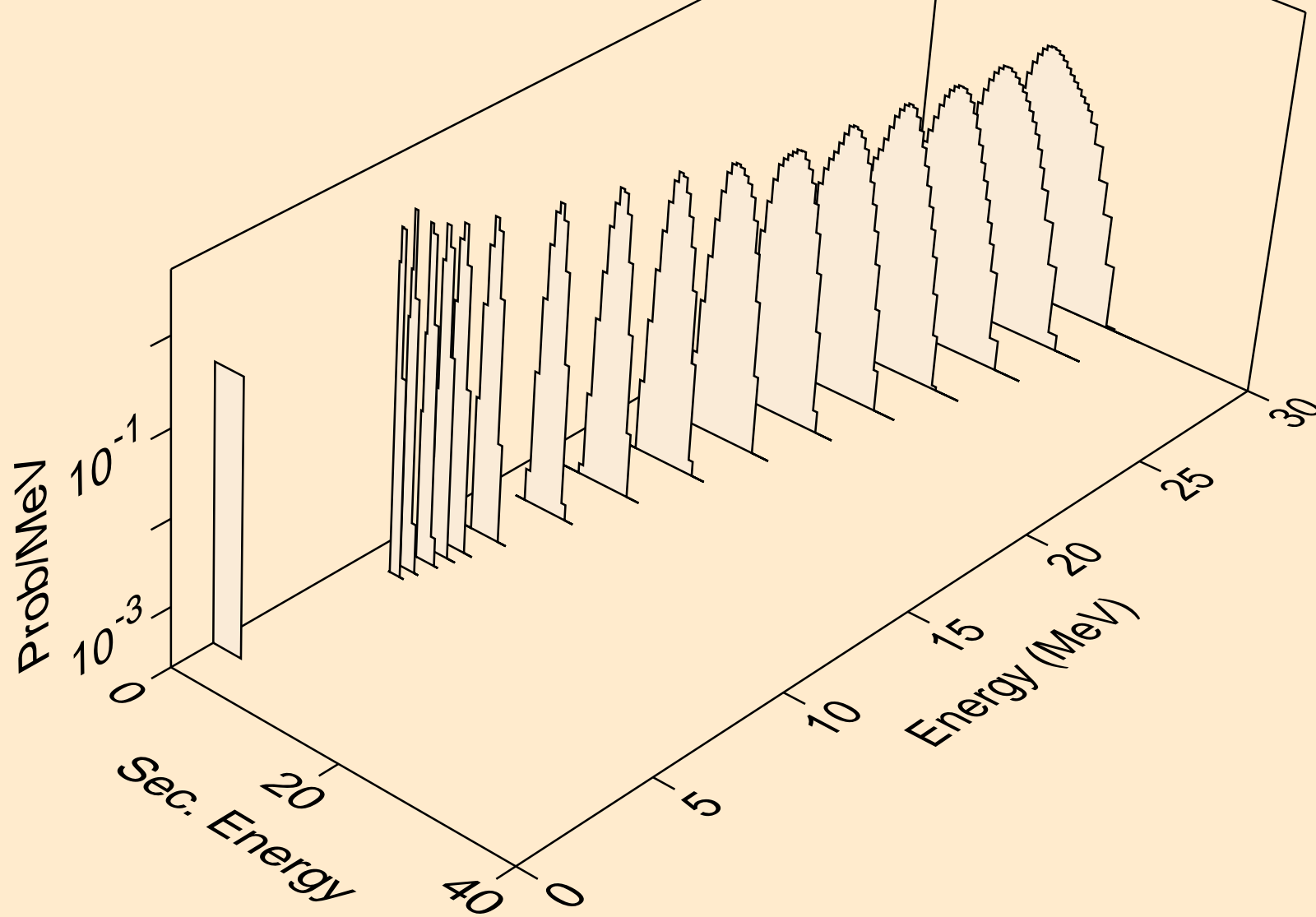

I117 NEUTRON ACER TENDL-2021 LIBRARY; T=293.6K  
alphas from (n,a)

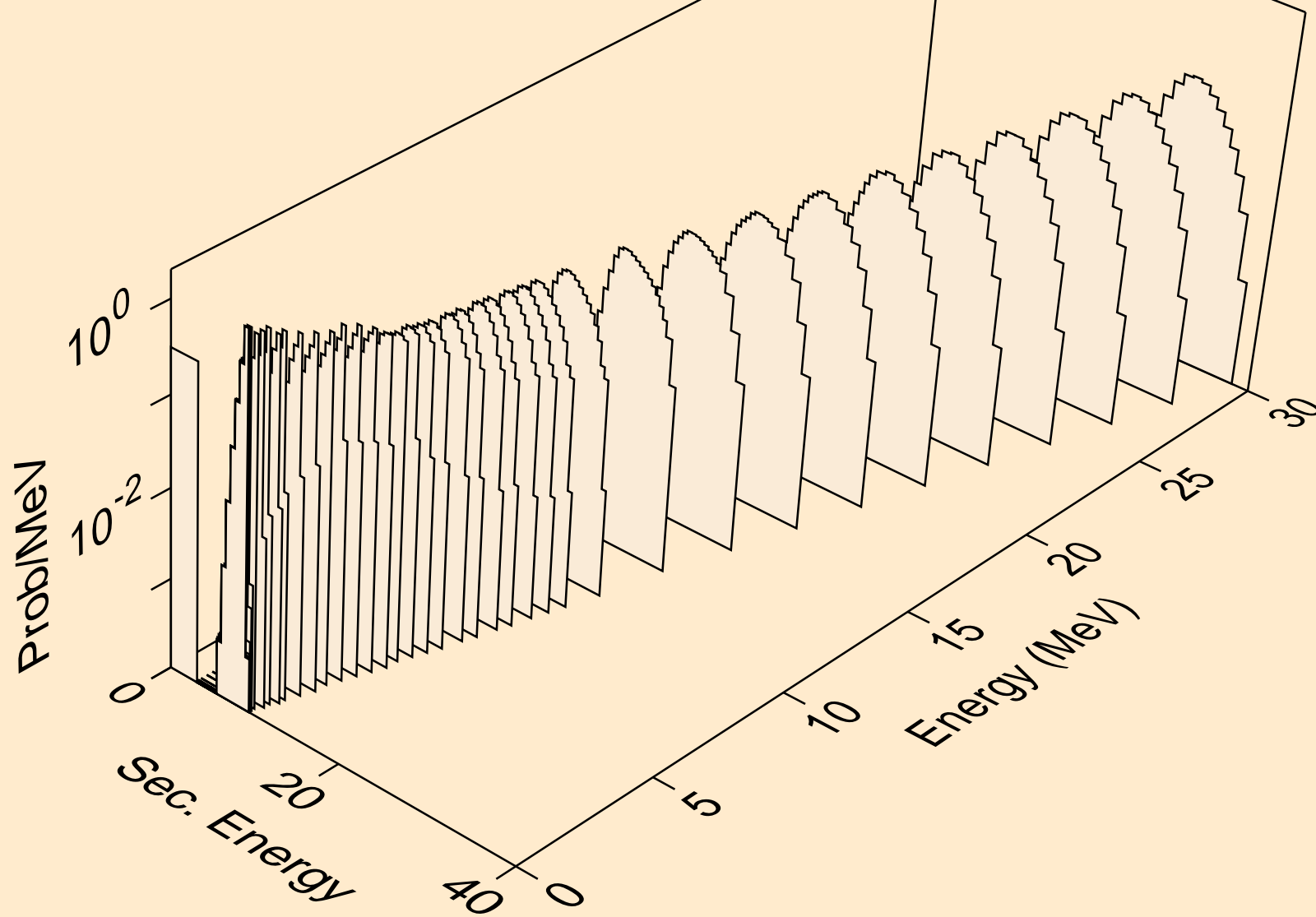

I117 NEUTRON ACER TENDL-2021 LIBRARY; T=293.6K  
alphas from (n,2a)

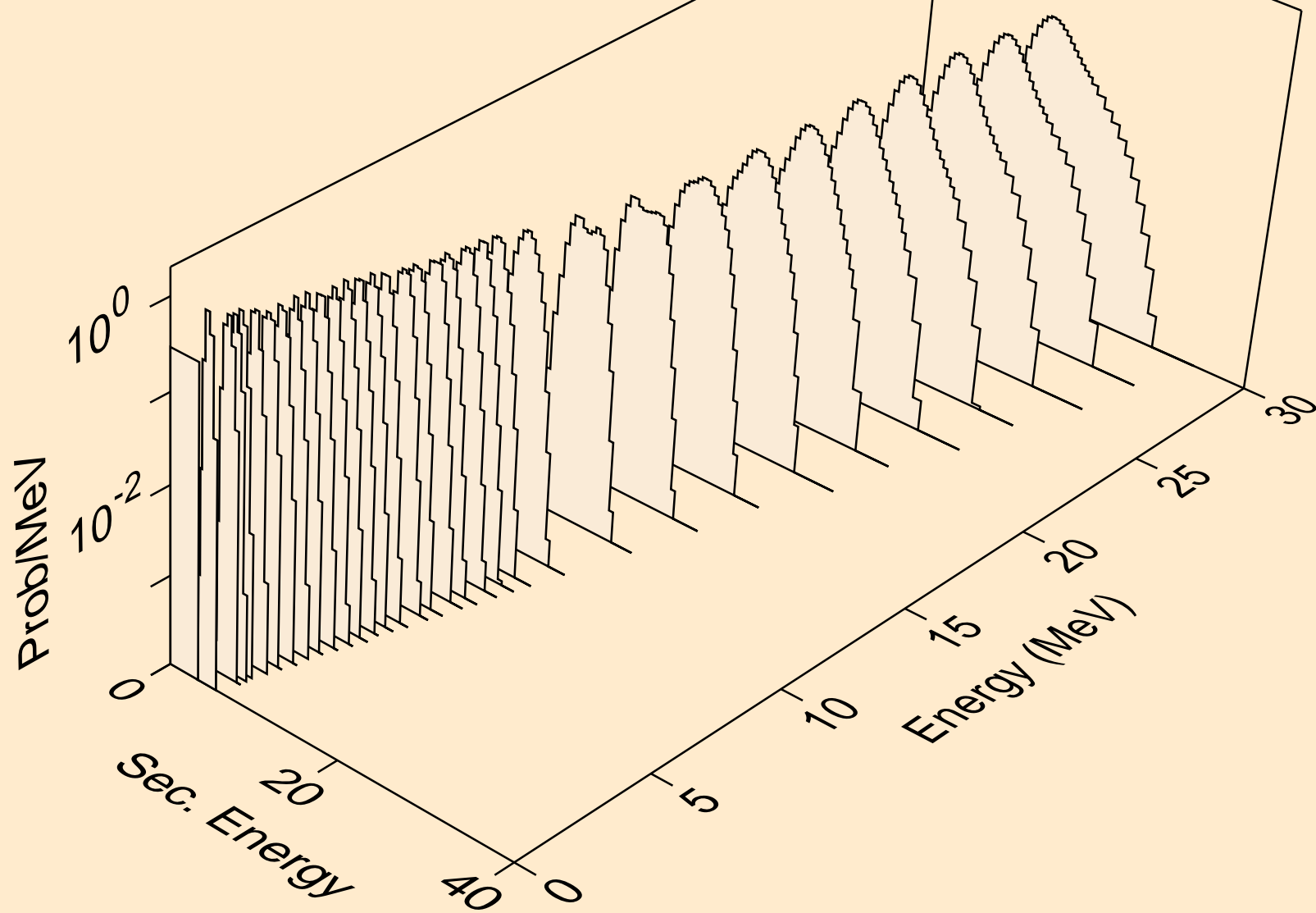

I117 NEUTRON ACER TENDL-2021 LIBRARY; T=293.6K  
alphas from (n,3a)

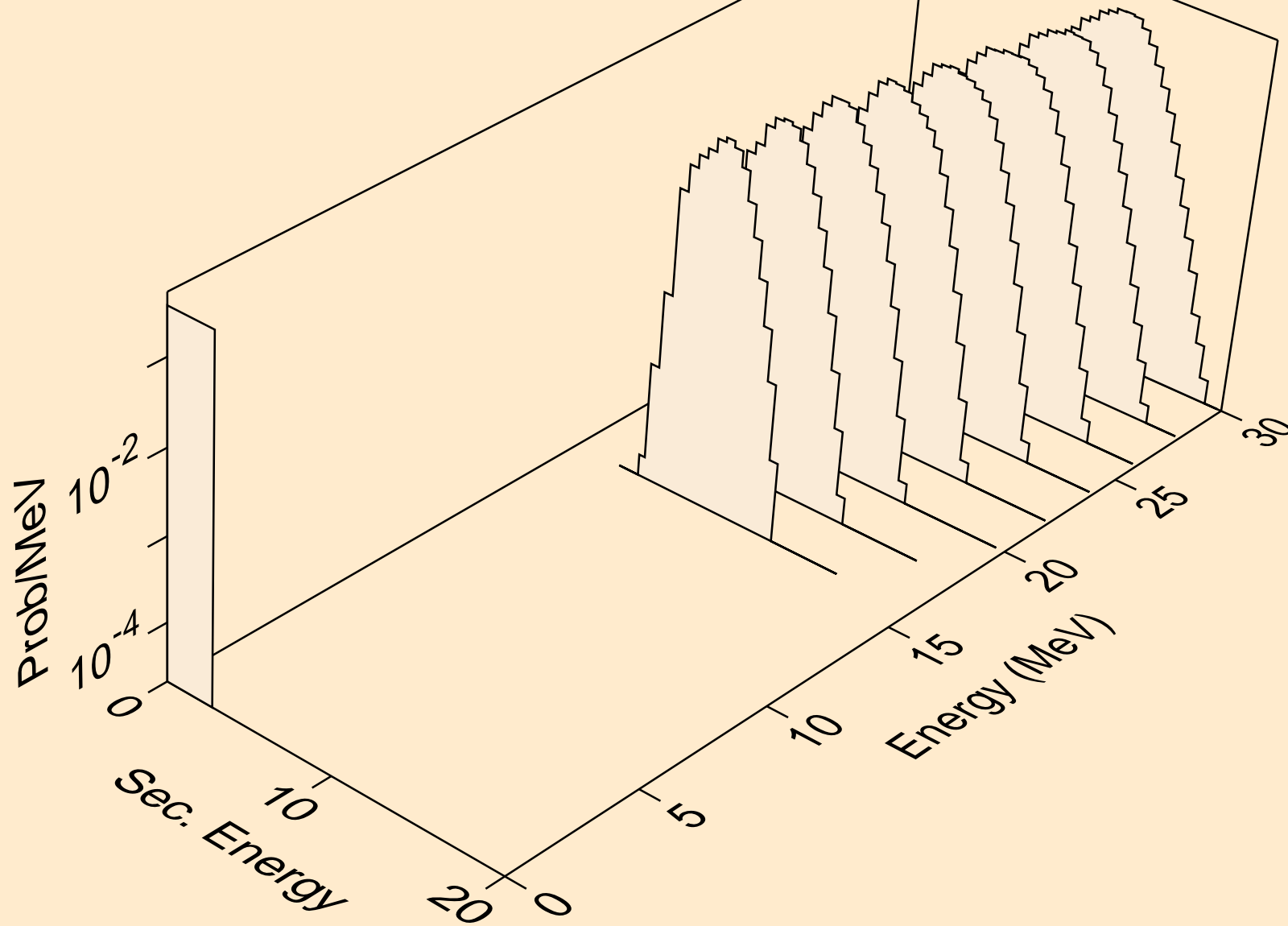

I117 NEUTRON ACER TENDL-2021 LIBRARY; T=293.6K  
alphas from (n,pa)

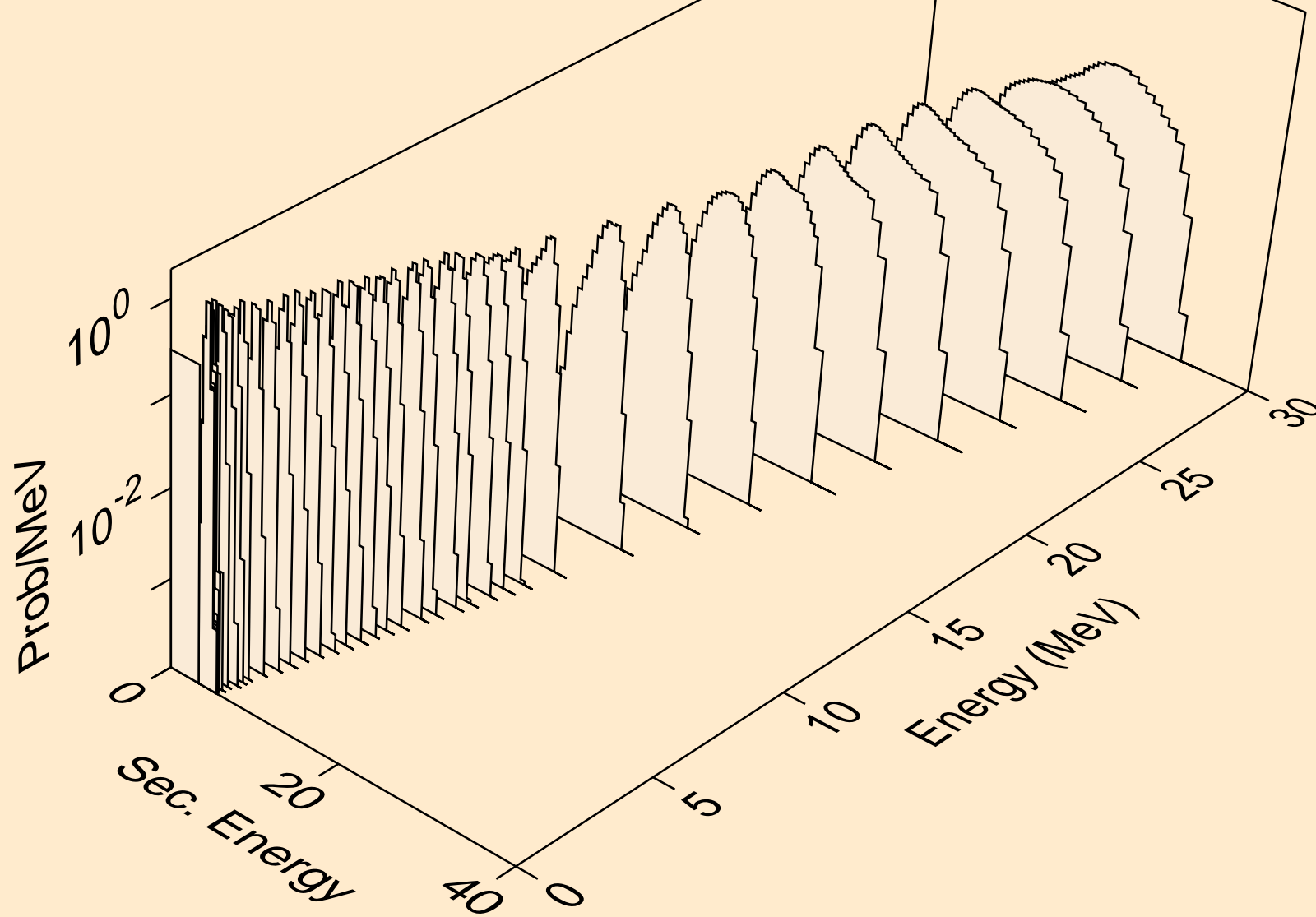

I117 NEUTRON ACER TENDL-2021 LIBRARY; T=293.6K  
alphas from (n,da)

