

IN099 NEUTRON ACER TENDL-2021 LIBRARY; T=293.6K

Principal cross sections

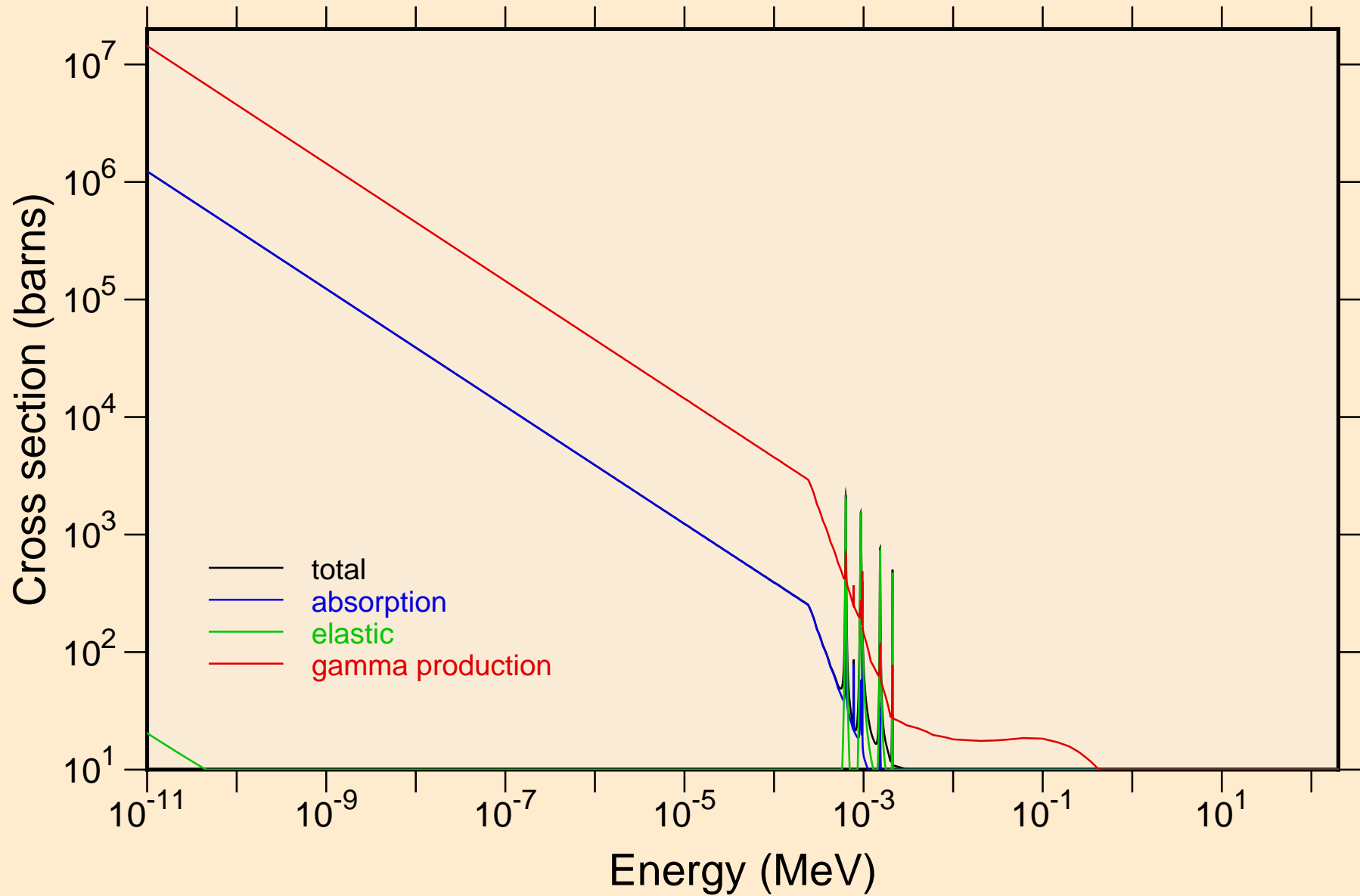

IN099 NEUTRON ACER TENDL-2021 LIBRARY; T=293.6K
resonance total cross section

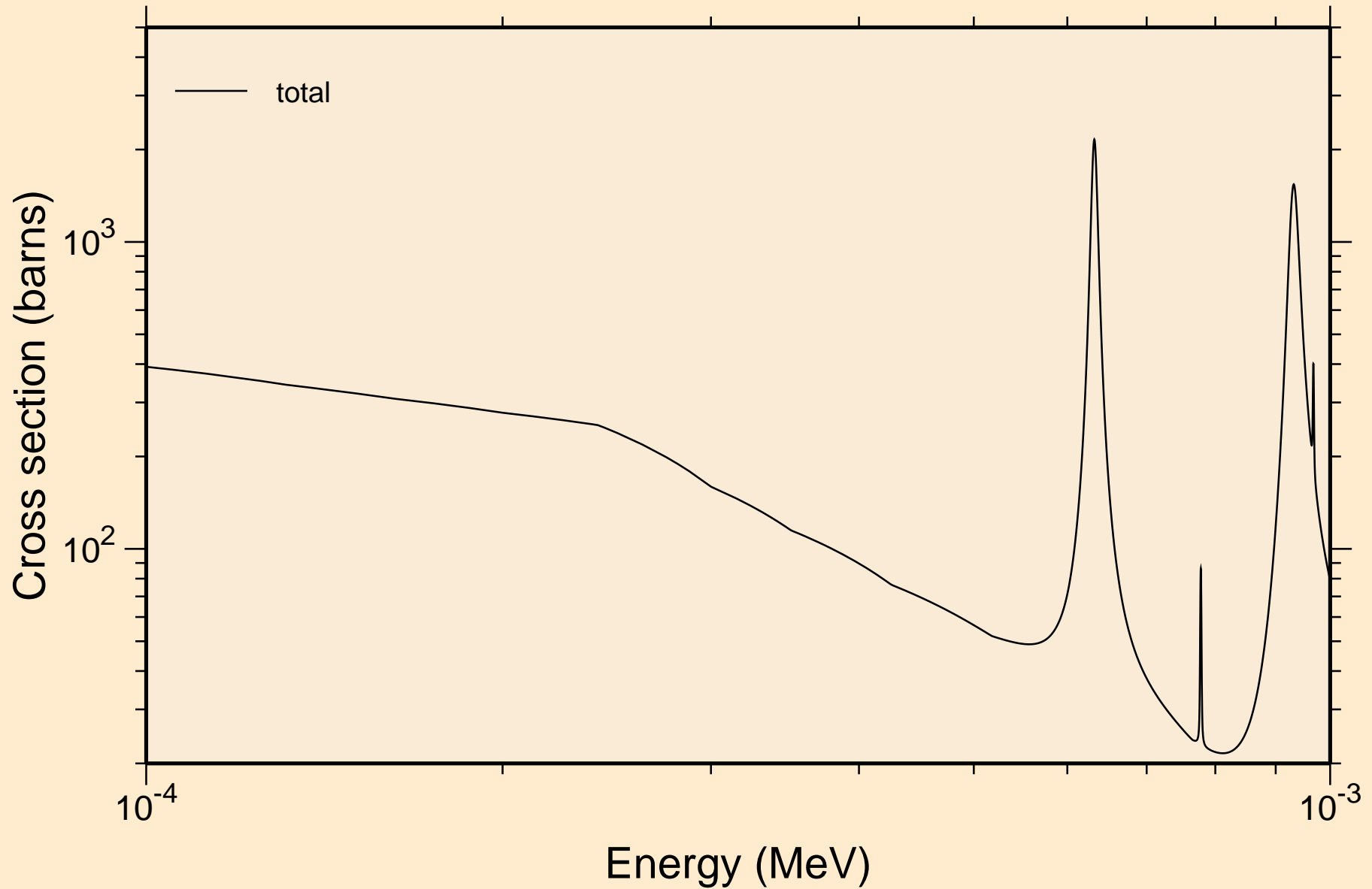

IN099 NEUTRON ACER TENDL-2021 LIBRARY; T=293.6K
resonance total cross section

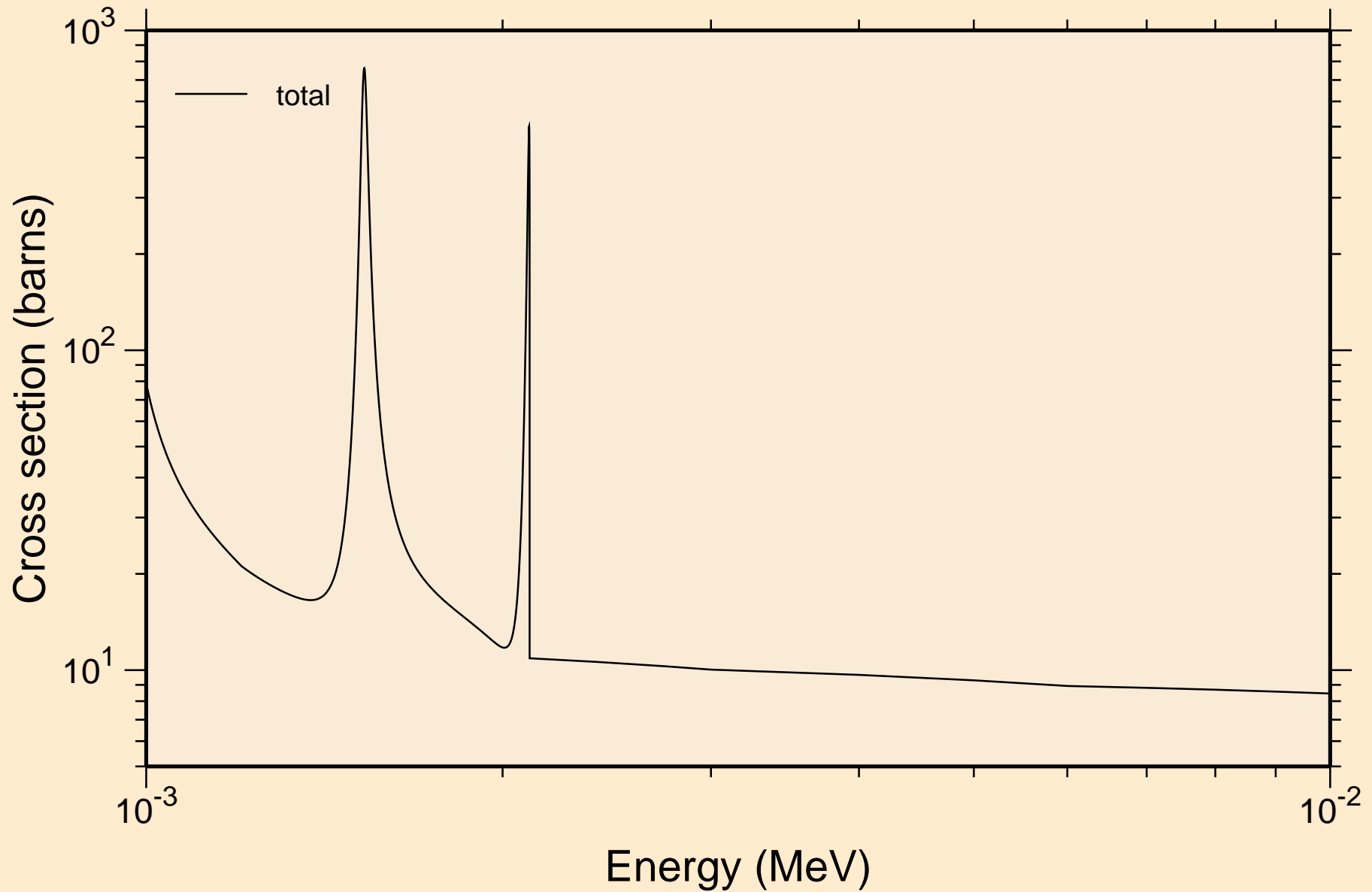

IN099 NEUTRON ACER TENDL-2021 LIBRARY; T=293.6K
resonance total cross section

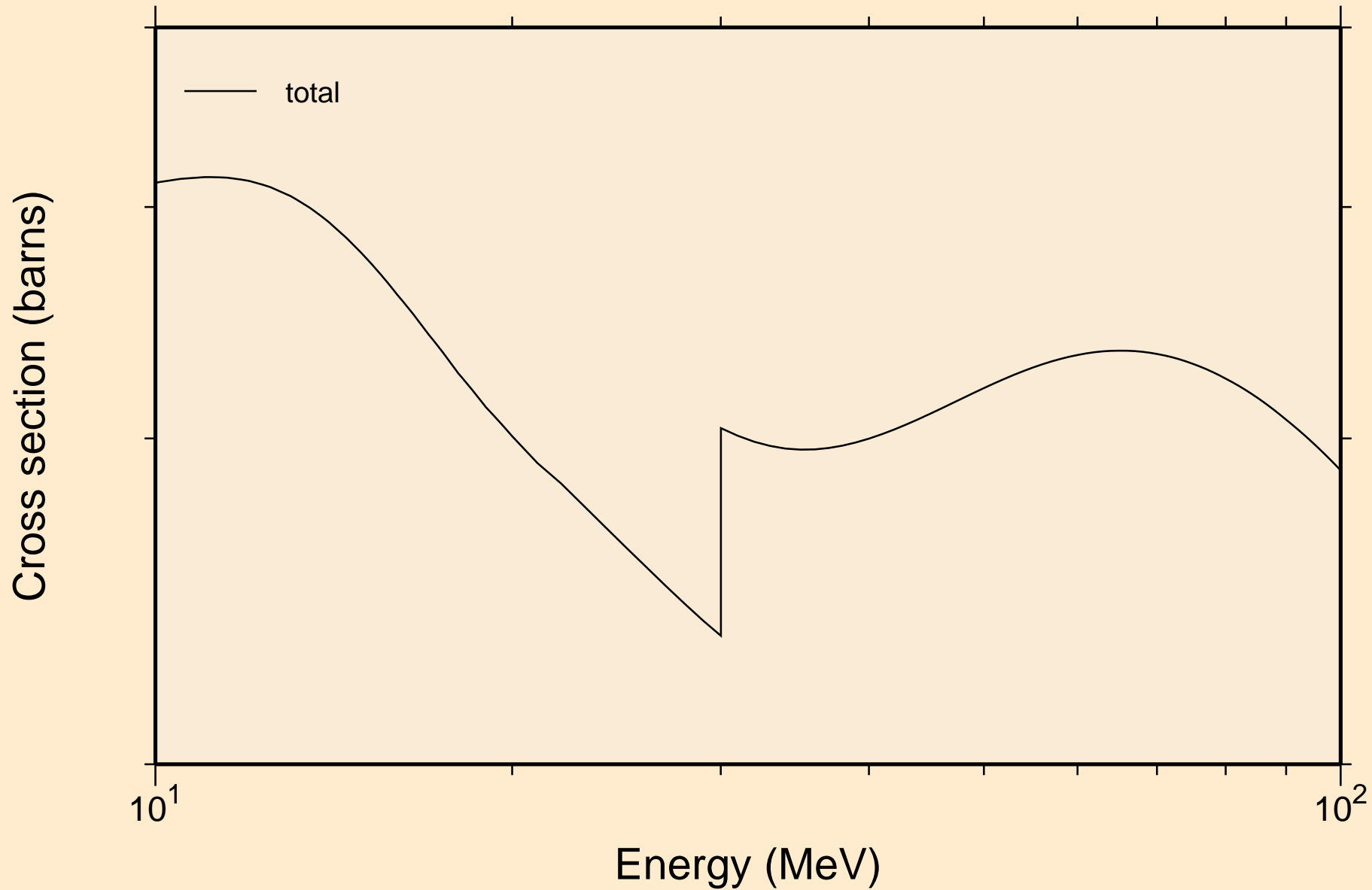

IN099 NEUTRON ACER TENDL-2021 LIBRARY; T=293.6K
resonance absorption cross sections

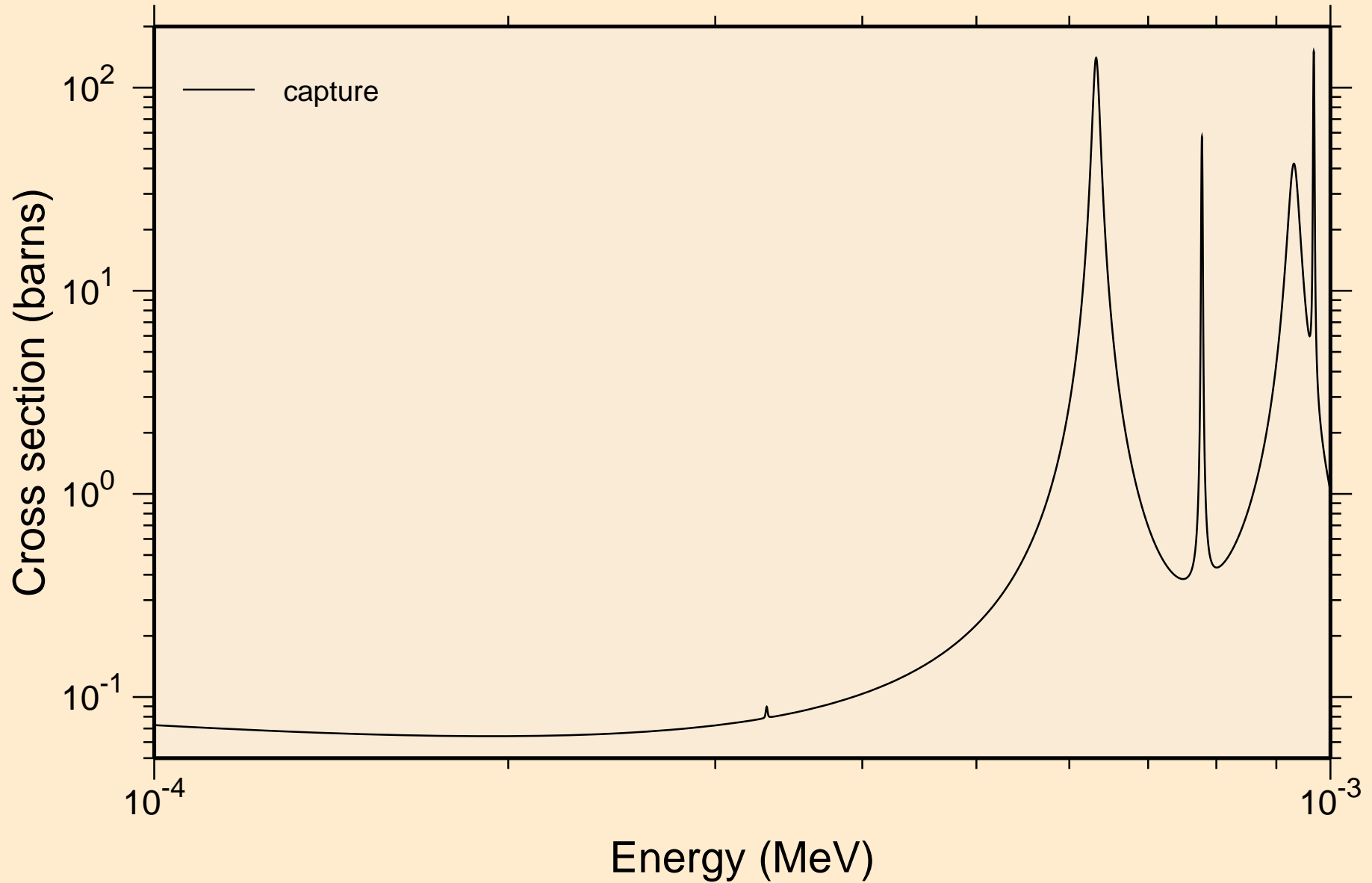

IN099 NEUTRON ACER TENDL-2021 LIBRARY; T=293.6K
resonance absorption cross sections

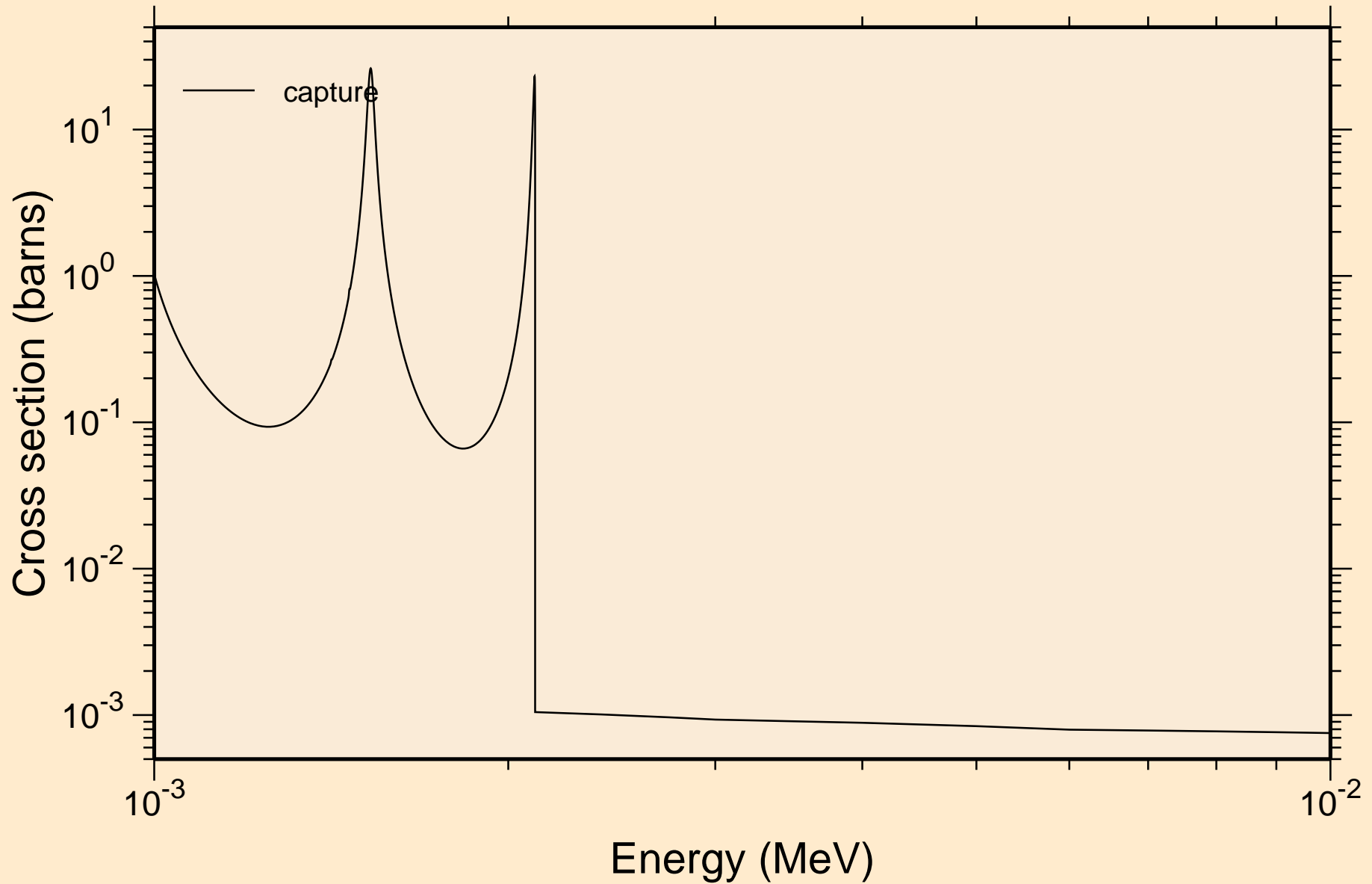

IN099 NEUTRON ACER TENDL-2021 LIBRARY; T=293.6K
resonance absorption cross sections

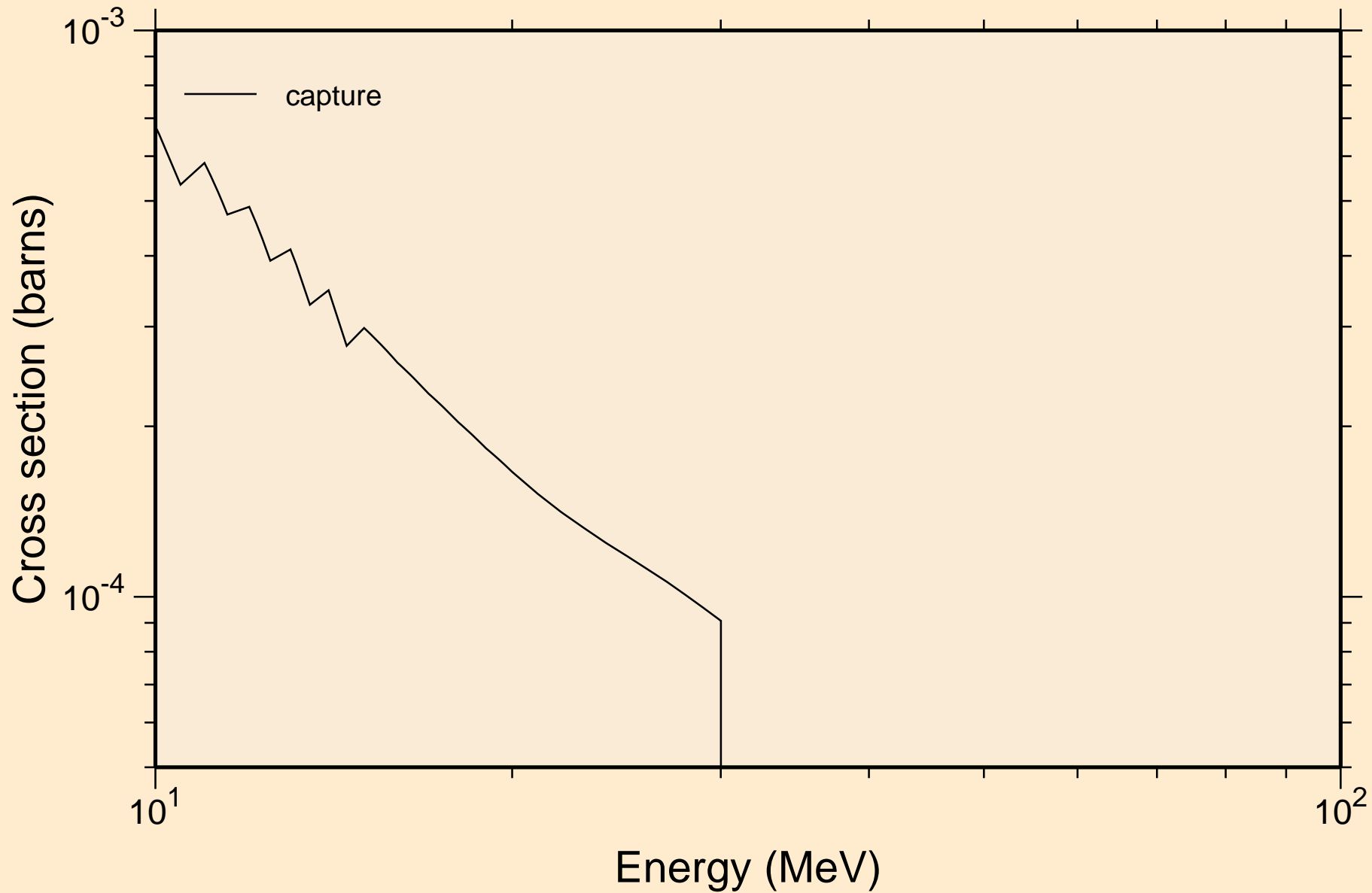

IN099 NEUTRON ACER TENDL-2021 LIBRARY; T=293.6K
Heating

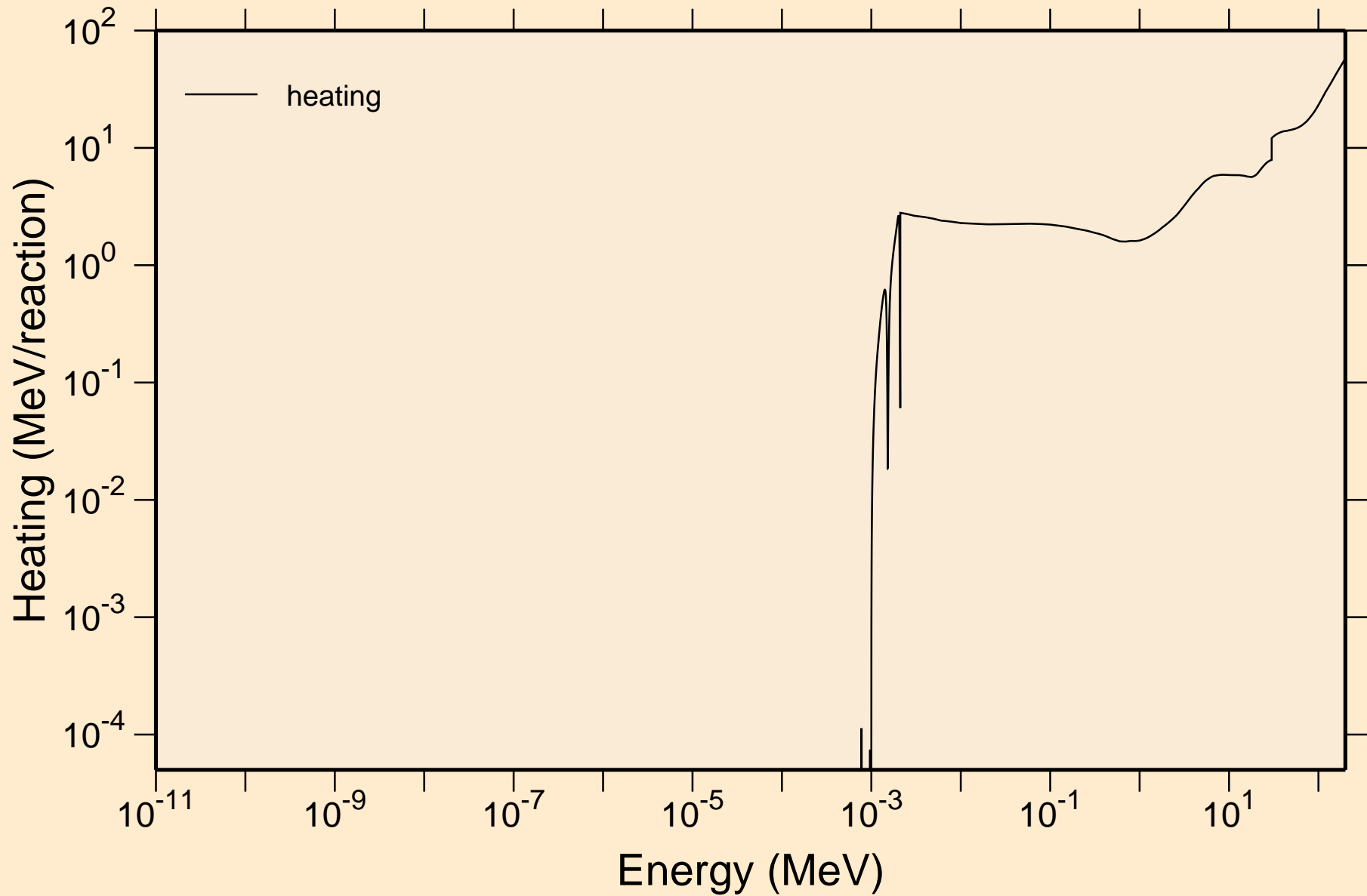

IN099 NEUTRON ACER TENDL-2021 LIBRARY; T=293.6K
Damage

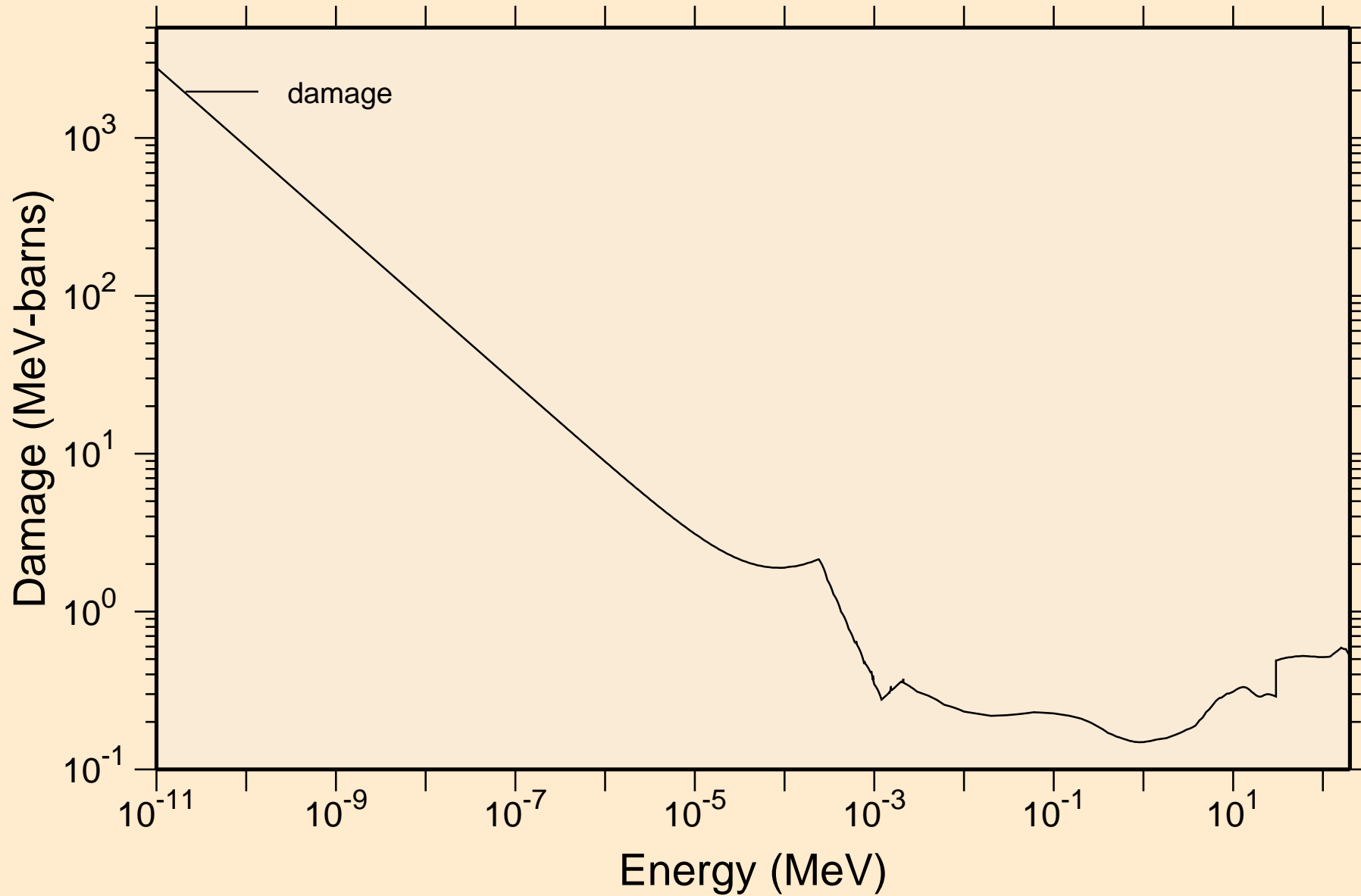

IN099 NEUTRON ACER TENDL-2021 LIBRARY; T=293.6K
Non-threshold reactions

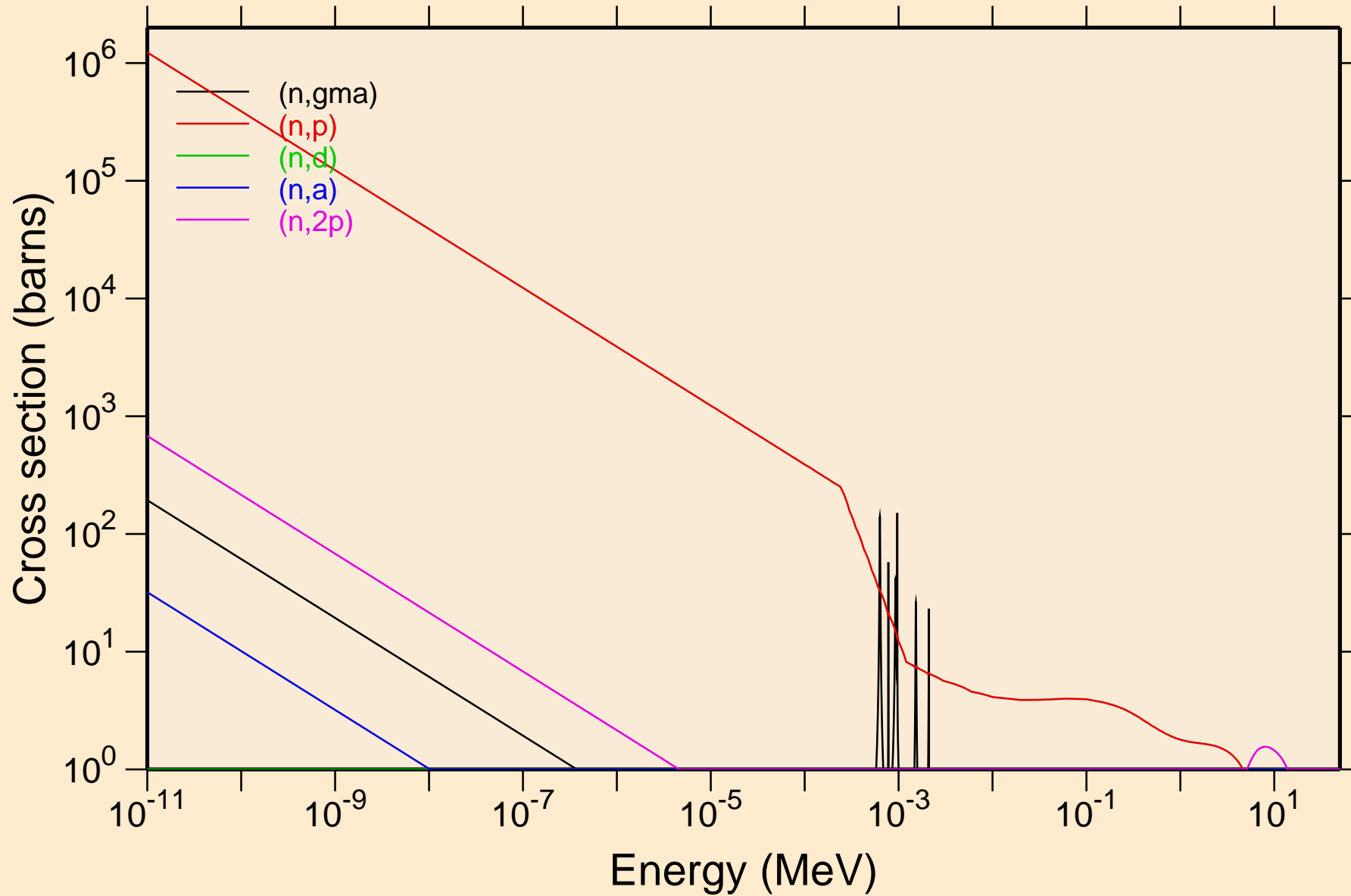

IN099 NEUTRON ACER TENDL-2021 LIBRARY; T=293.6K
Non-threshold reactions

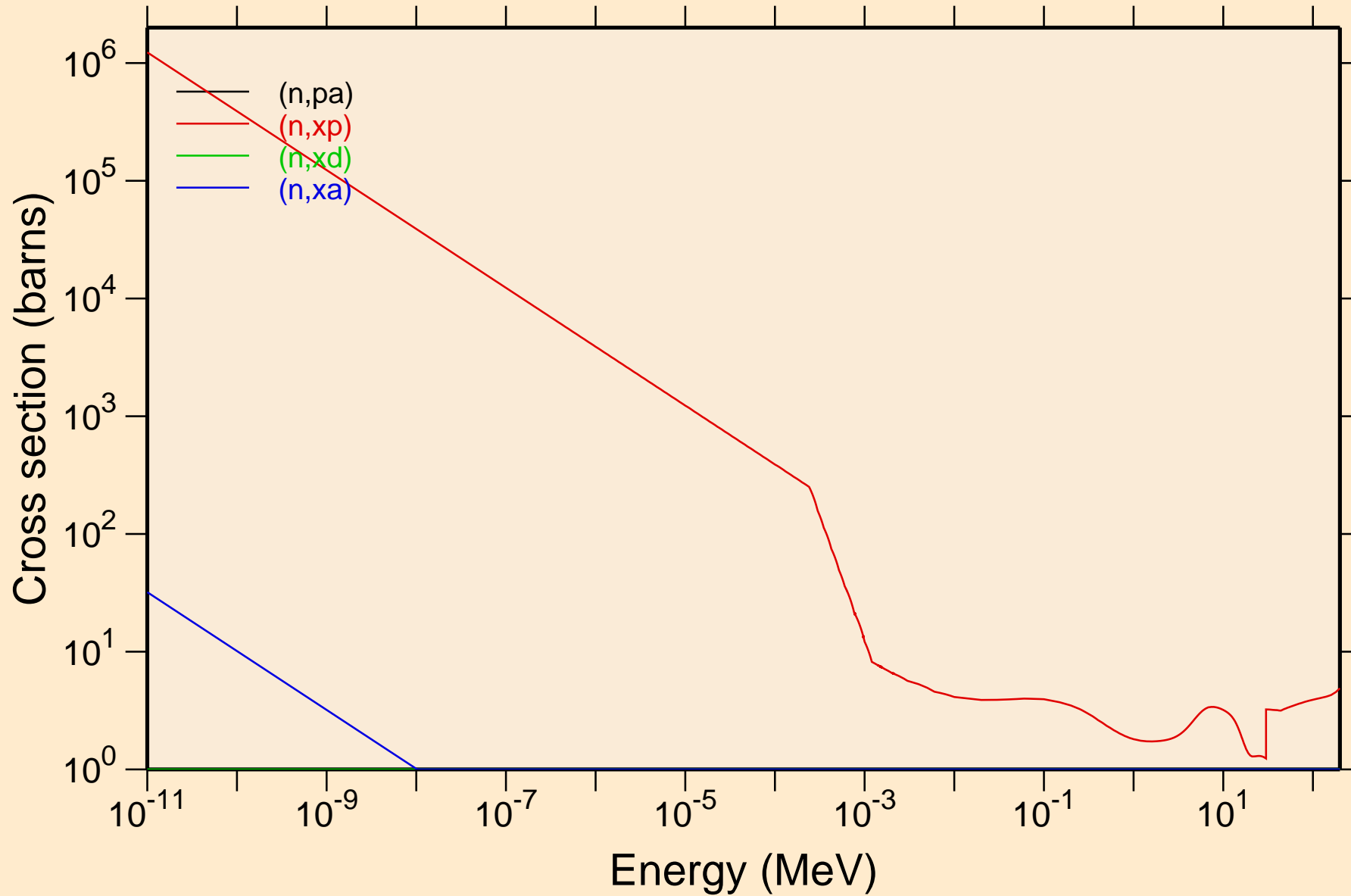

IN099 NEUTRON ACER TENDL-2021 LIBRARY; T=293.6K
Principal cross sections

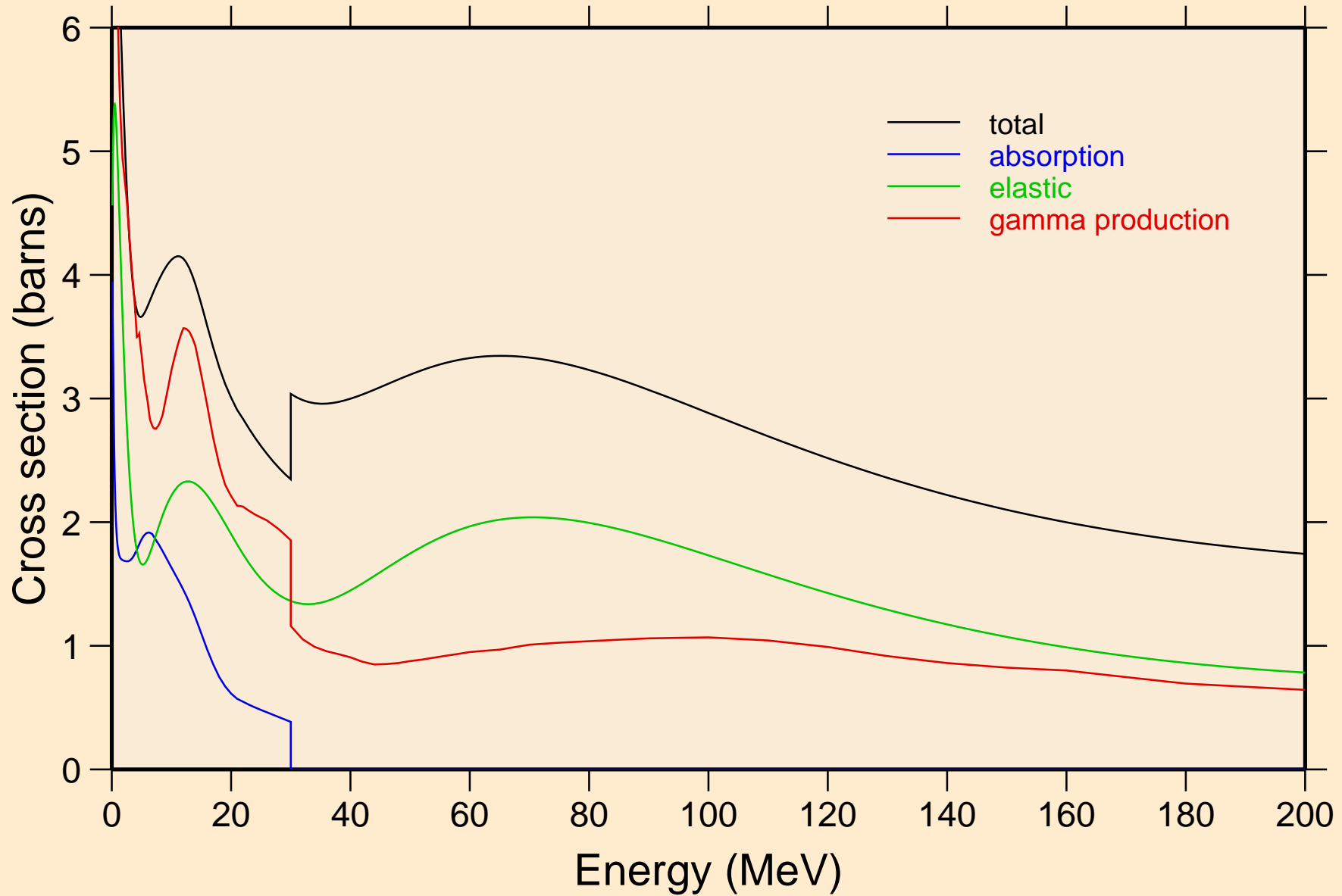

IN099 NEUTRON ACER TENDL-2021 LIBRARY; T=293.6K

Heating

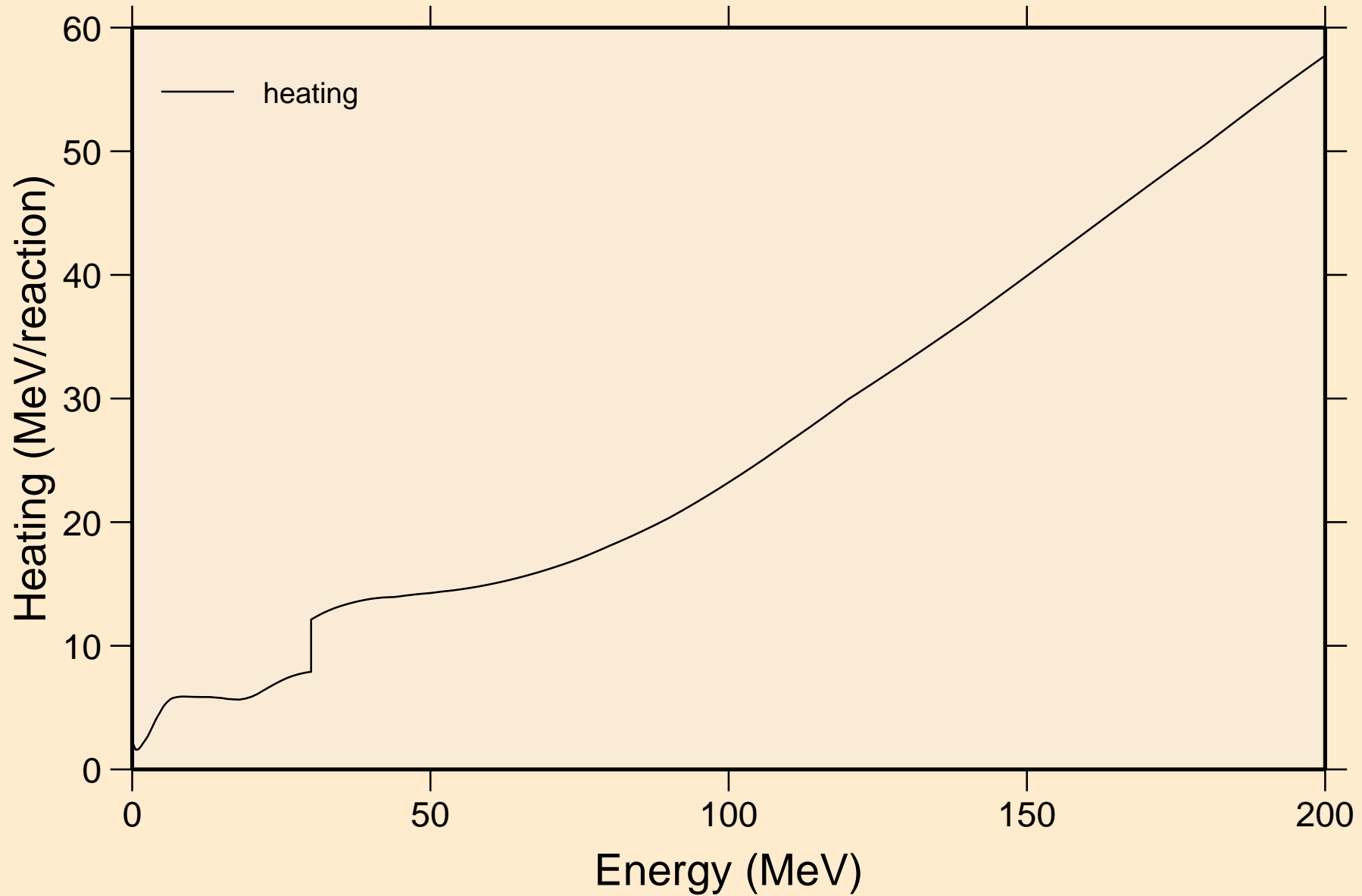

IN099 NEUTRON ACER TENDL-2021 LIBRARY; T=293.6K
Damage

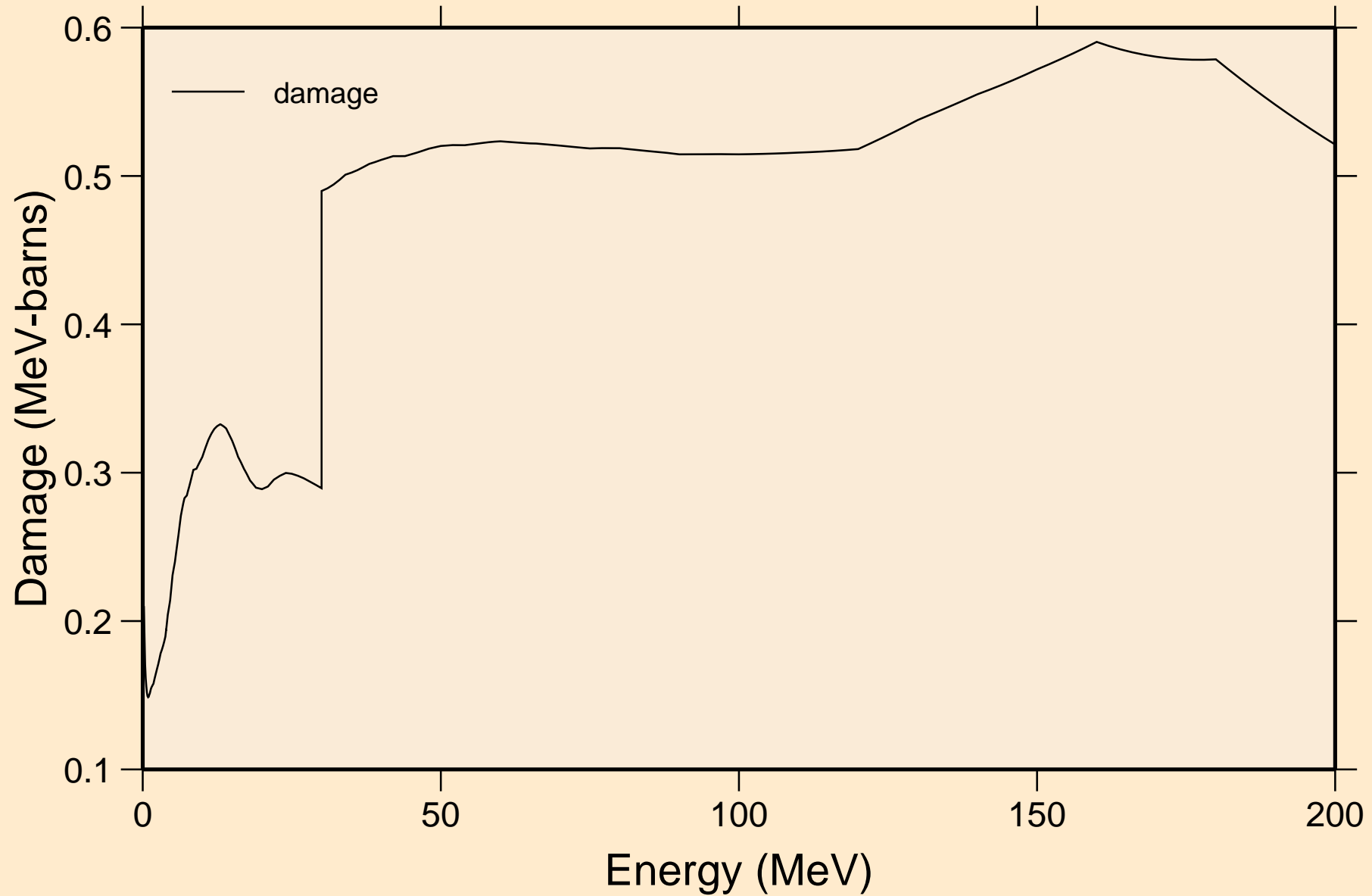

IN099 NEUTRON ACER TENDL-2021 LIBRARY; T=293.6K
Non-threshold reactions

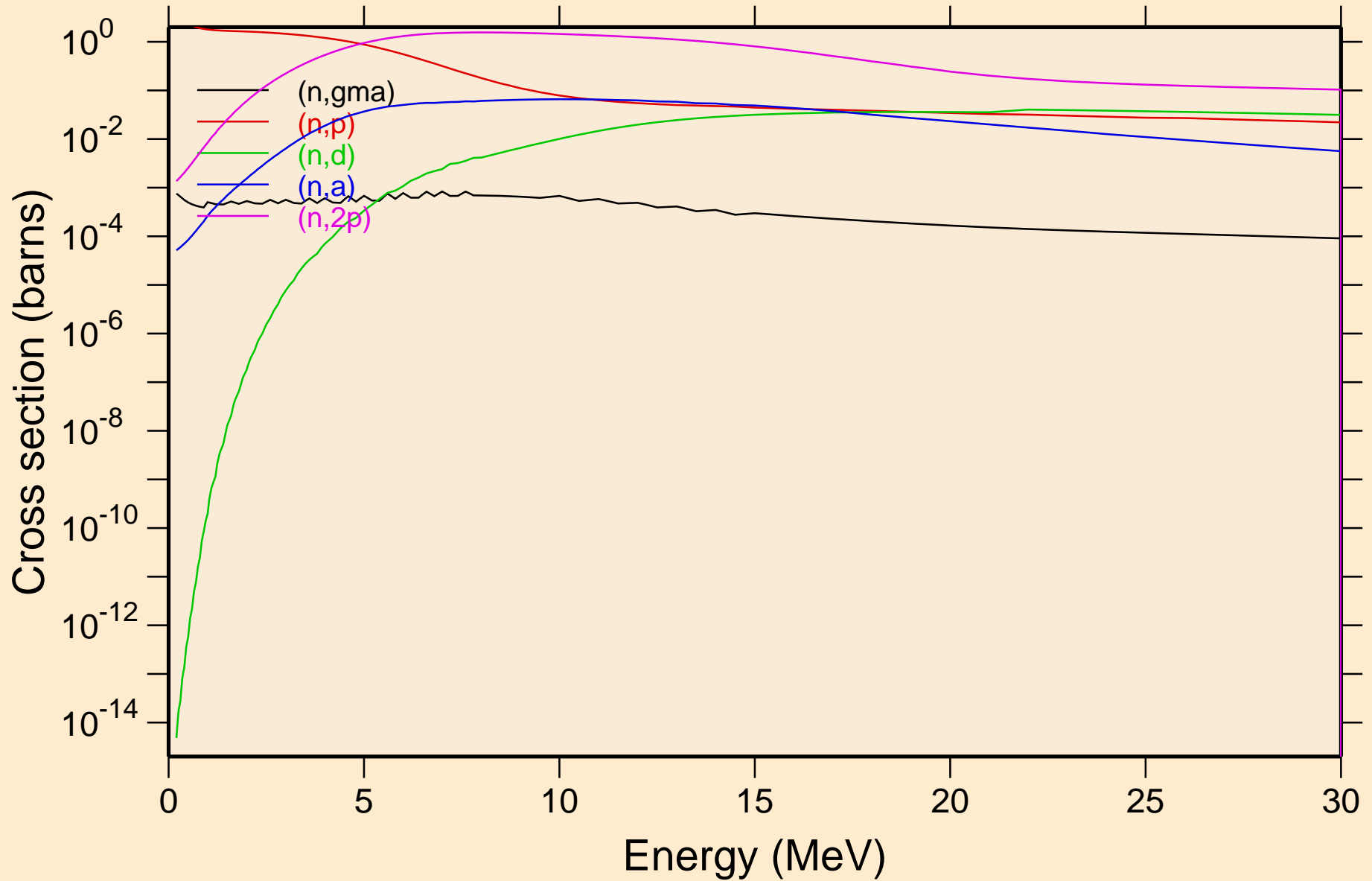

IN099 NEUTRON ACER TENDL-2021 LIBRARY; T=293.6K
Non-threshold reactions

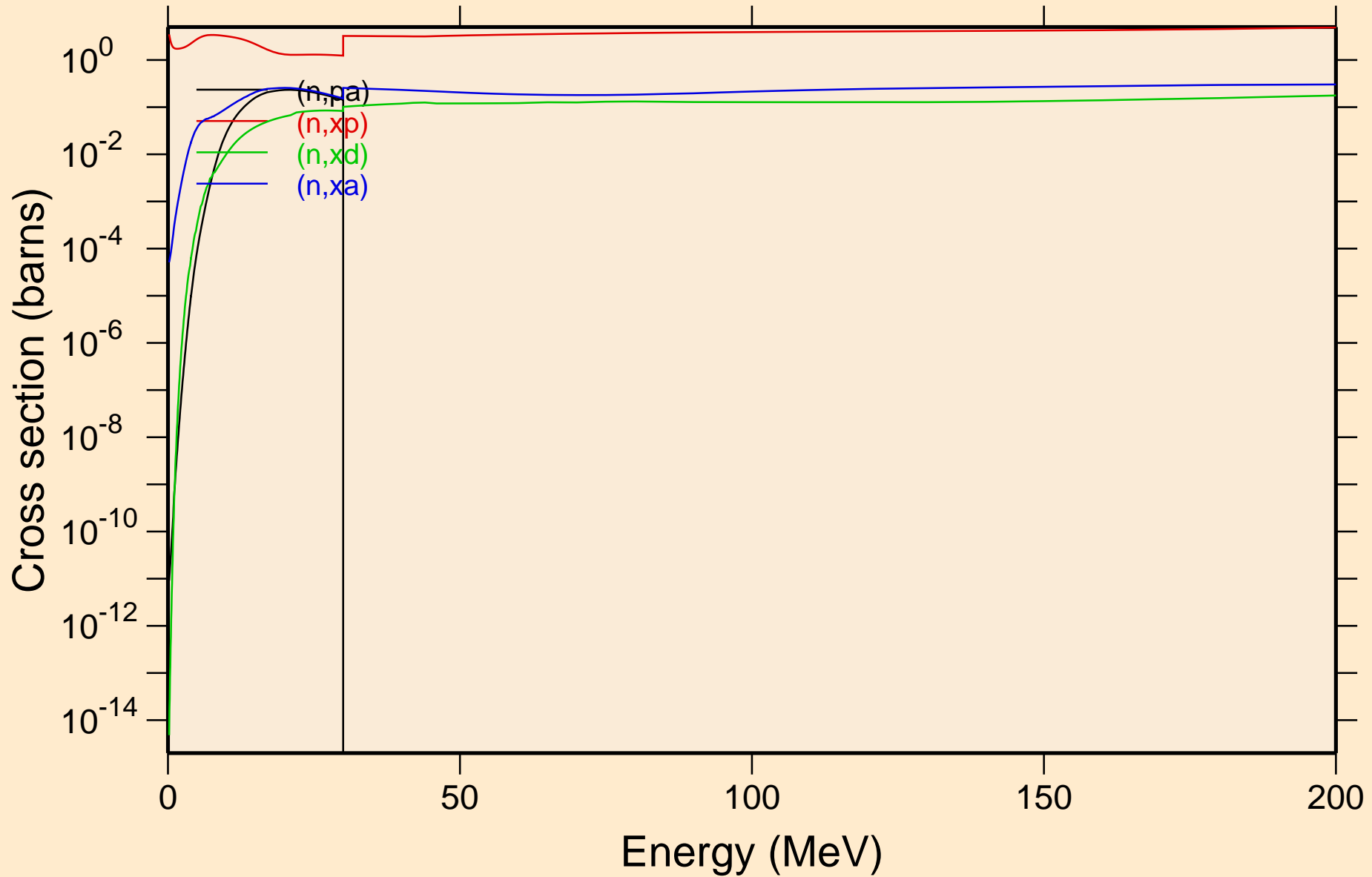

IN099 NEUTRON ACER TENDL-2021 LIBRARY; T=293.6K
Inelastic levels

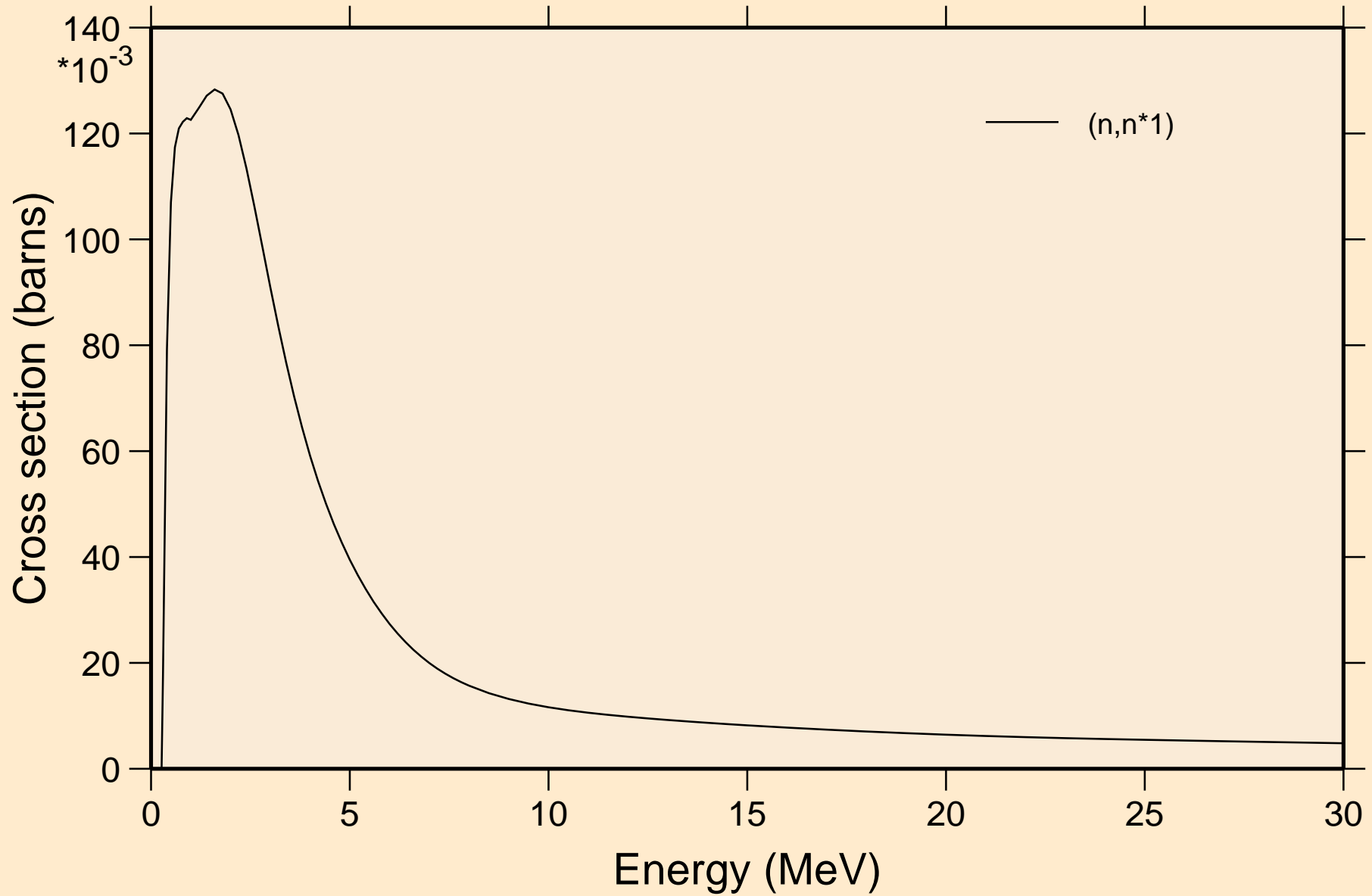

IN099 NEUTRON ACER TENDL-2021 LIBRARY; T=293.6K
Threshold reactions

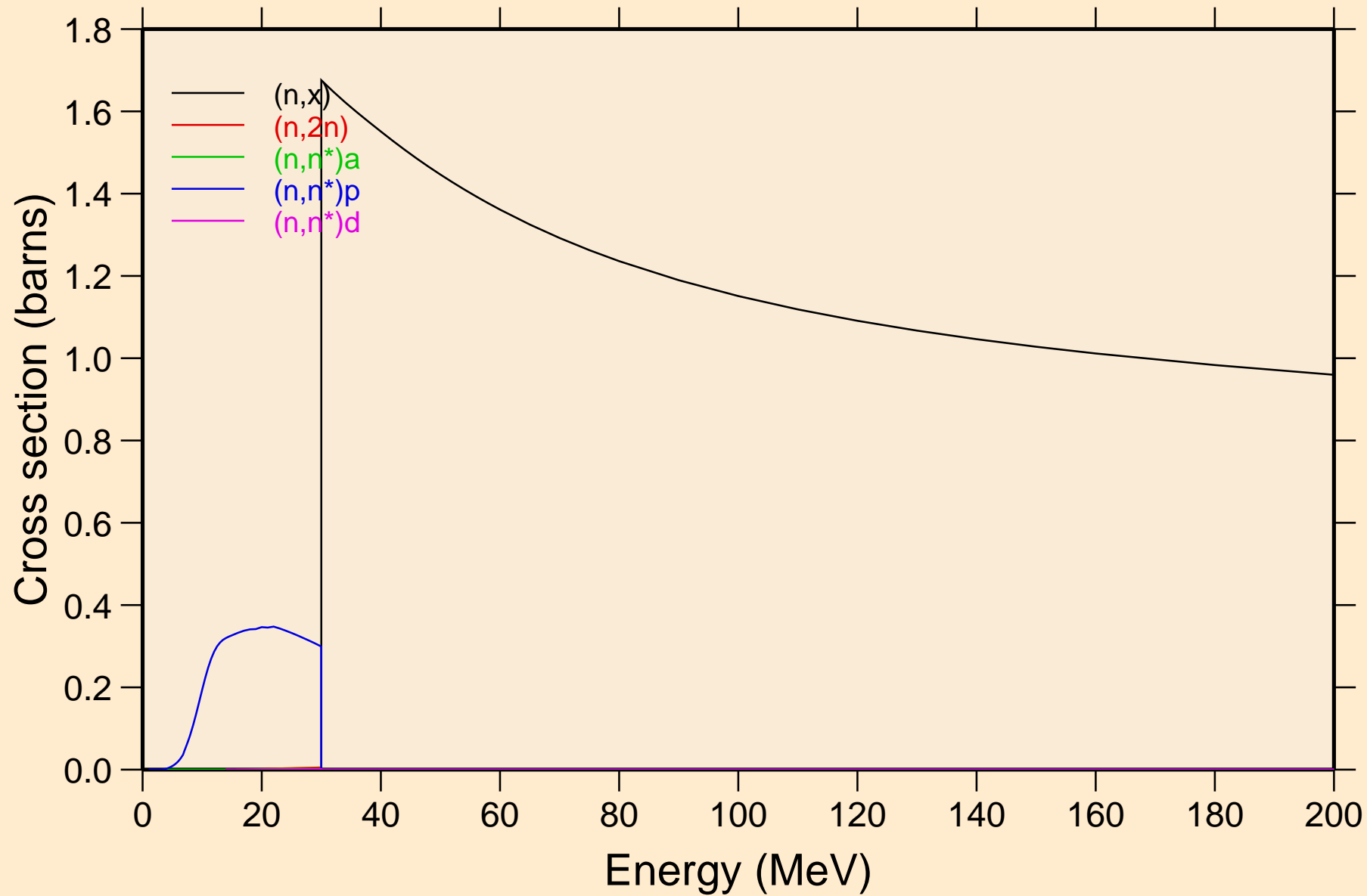

IN099 NEUTRON ACER TENDL-2021 LIBRARY; T=293.6K
Threshold reactions

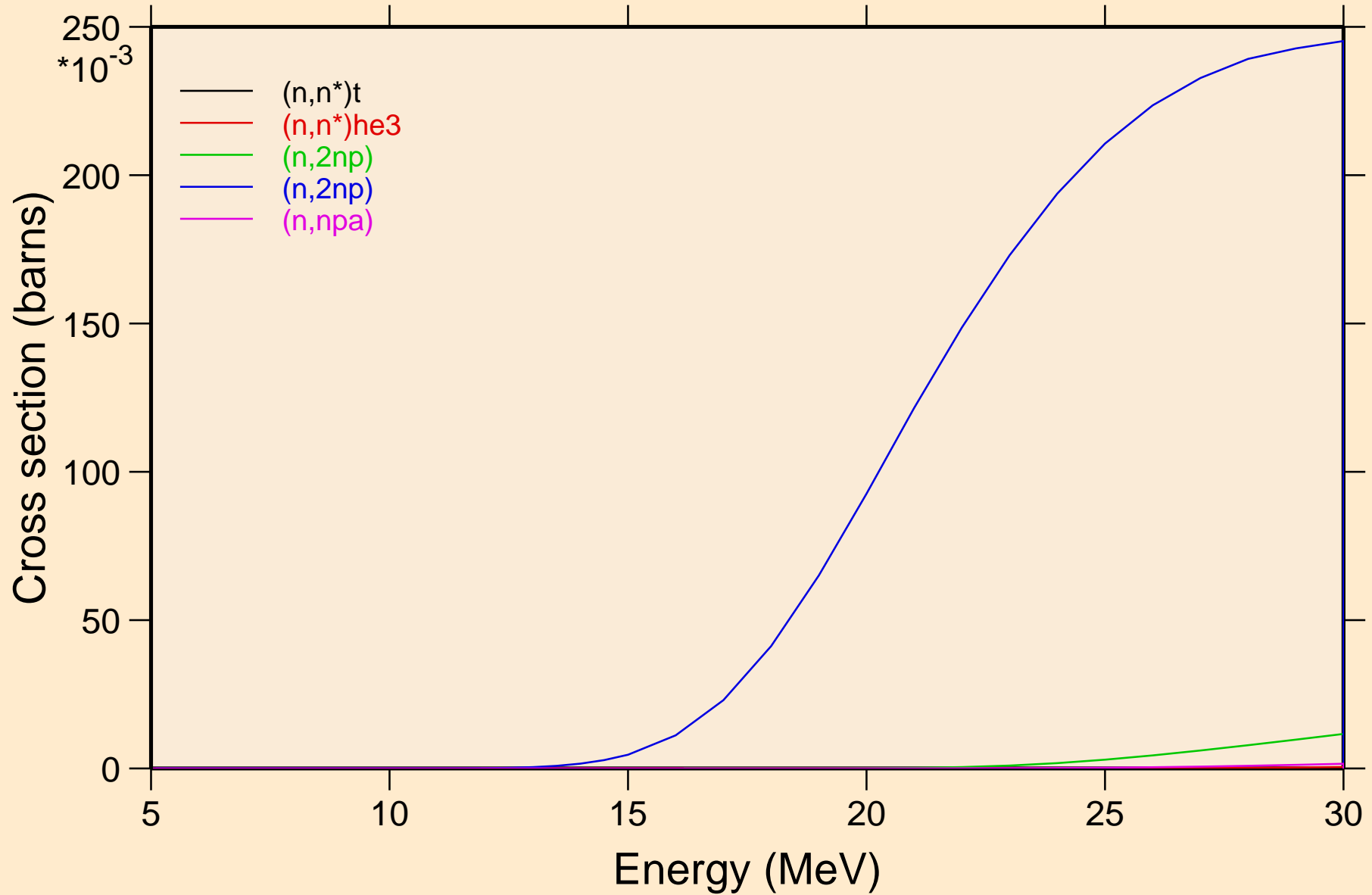

IN099 NEUTRON ACER TENDL-2021 LIBRARY; T=293.6K

Threshold reactions

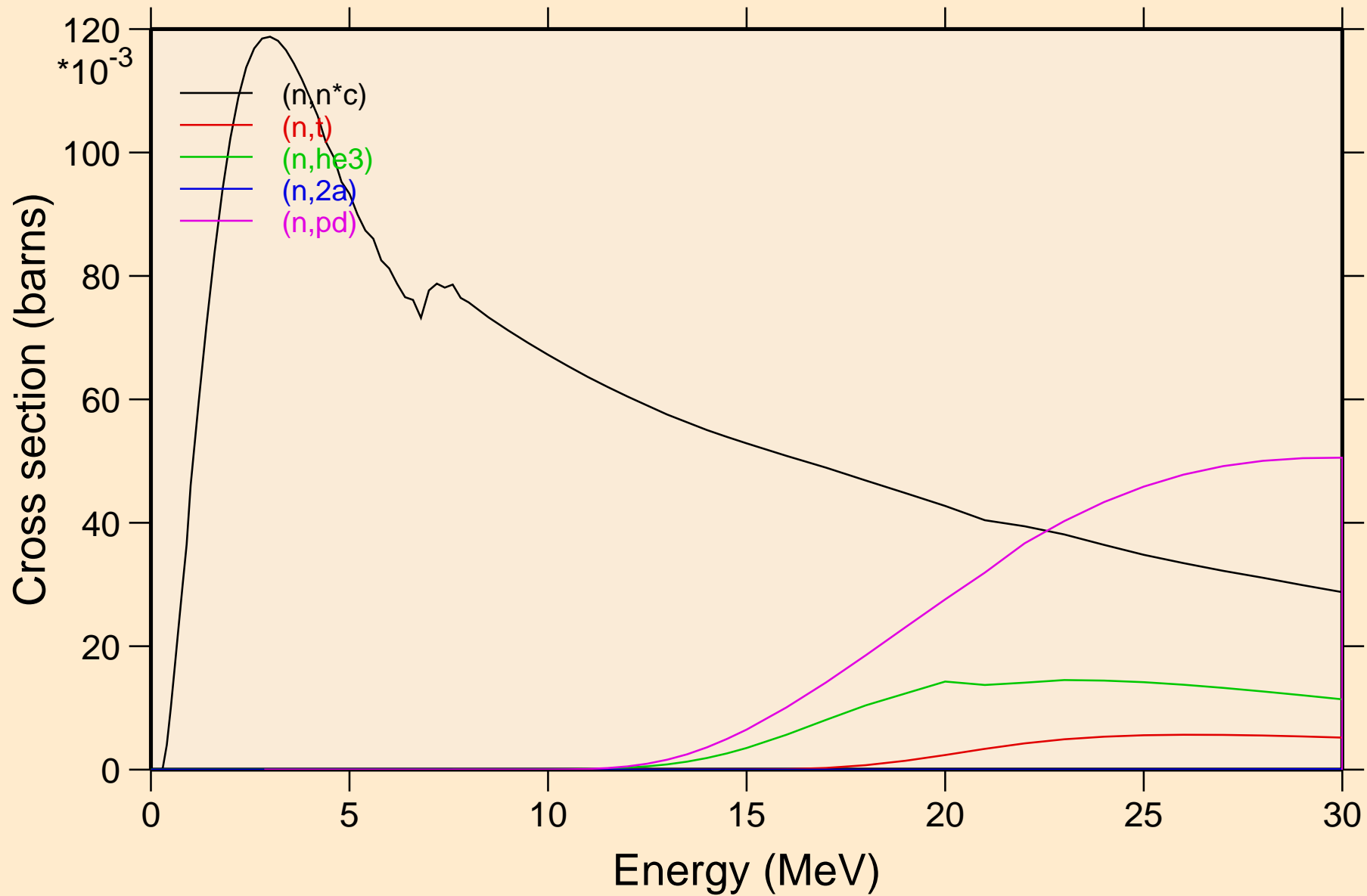

IN099 NEUTRON ACER TENDL-2021 LIBRARY; T=293.6K
Threshold reactions

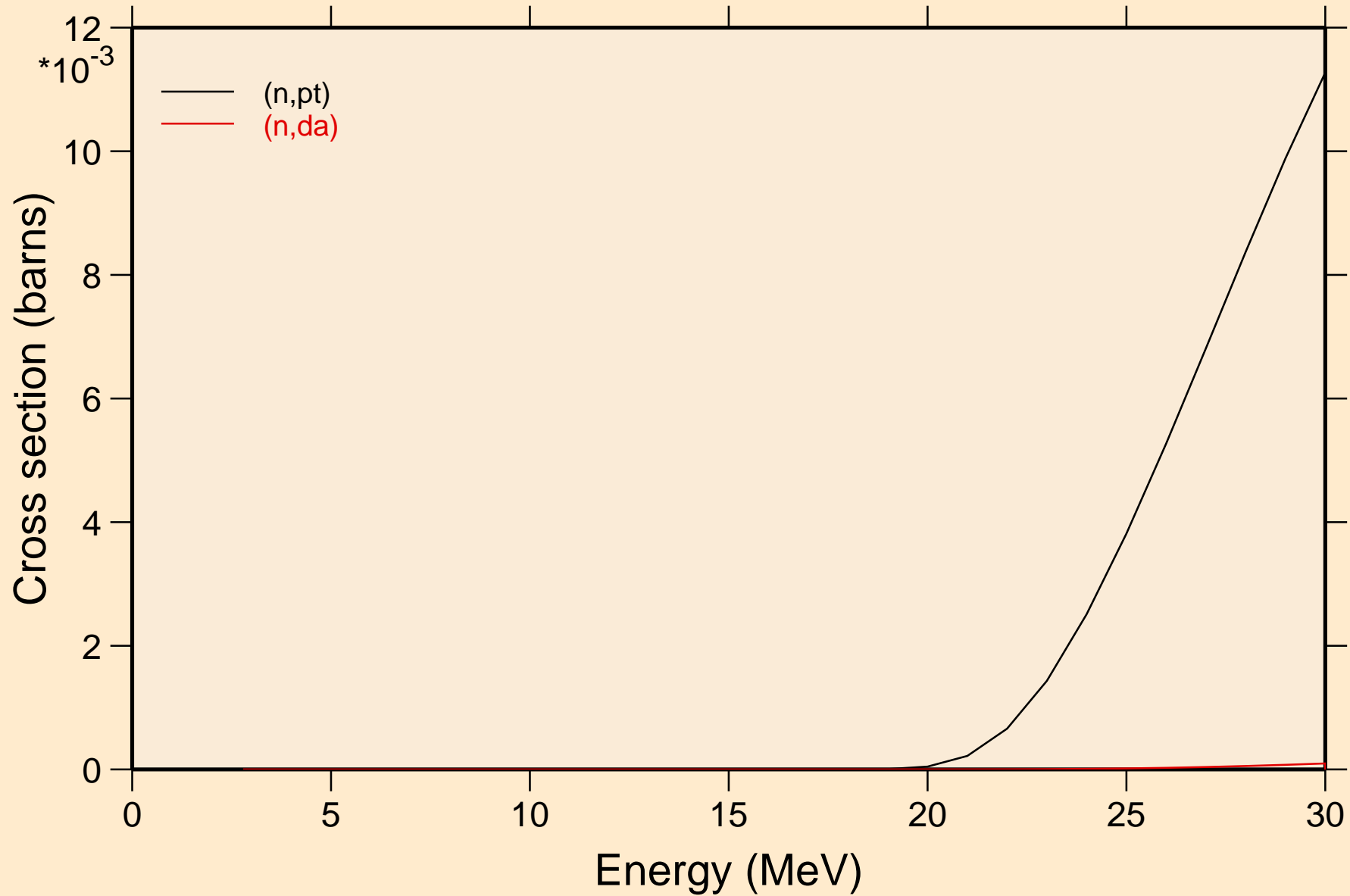

IN099 NEUTRON ACER TENDL-2021 LIBRARY; T=293.6K
Threshold reactions

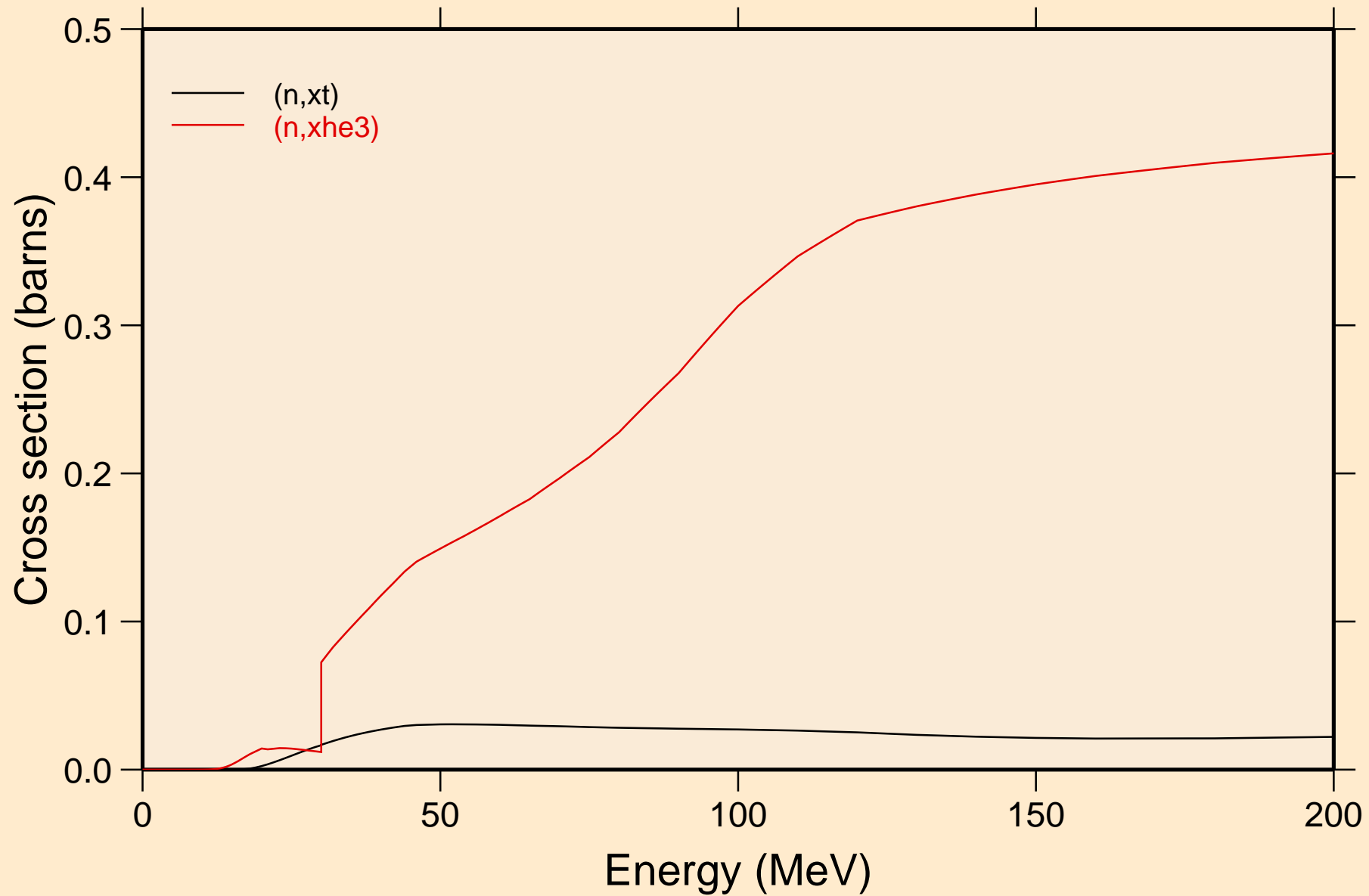

IN099 NEUTRON ACER TENDL-2021 LIBRARY; T=293.6K
angular distribution for elastic

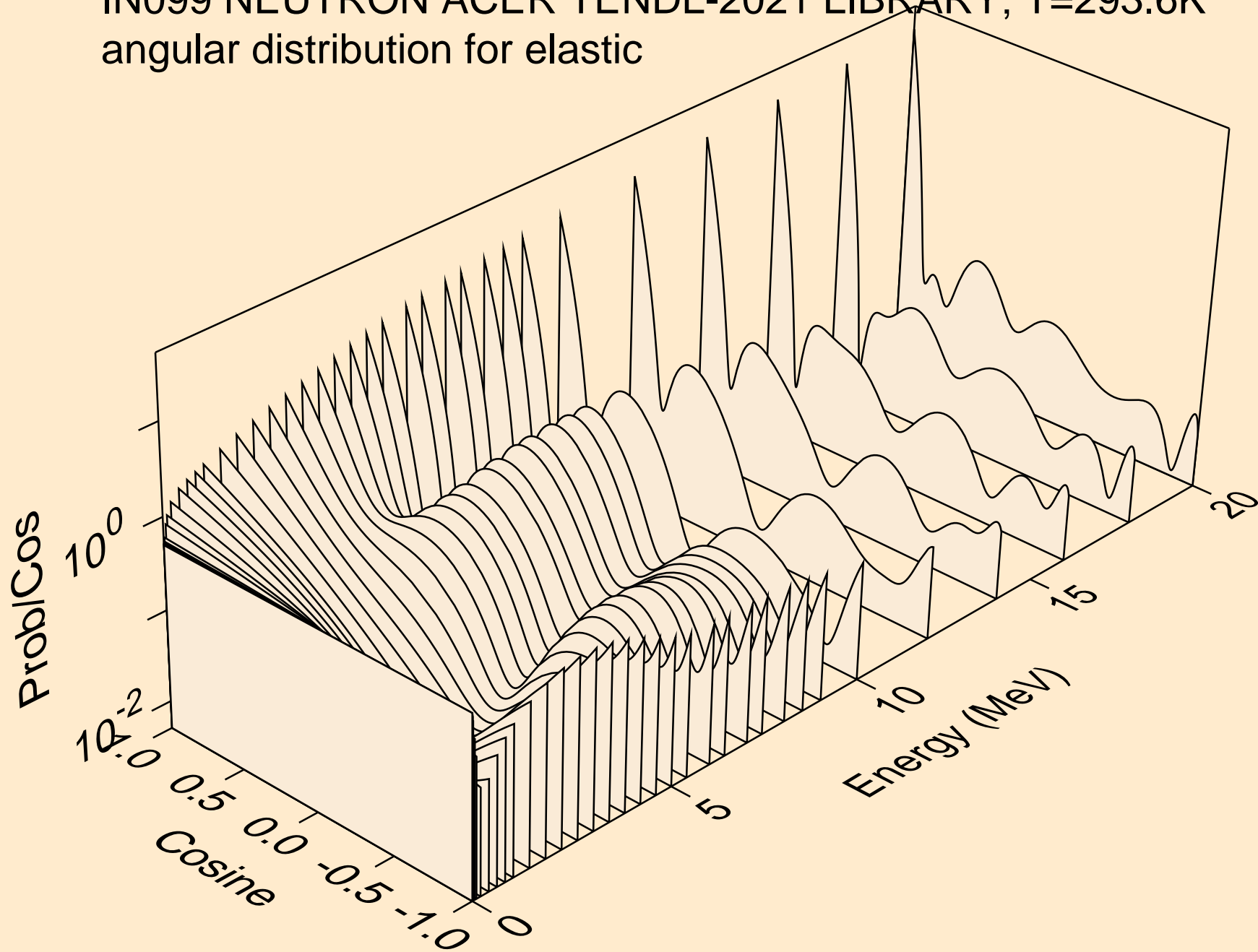

IN099 NEUTRON ACER TENDL-2021 LIBRARY; T=293.6K
angular distribution for elastic

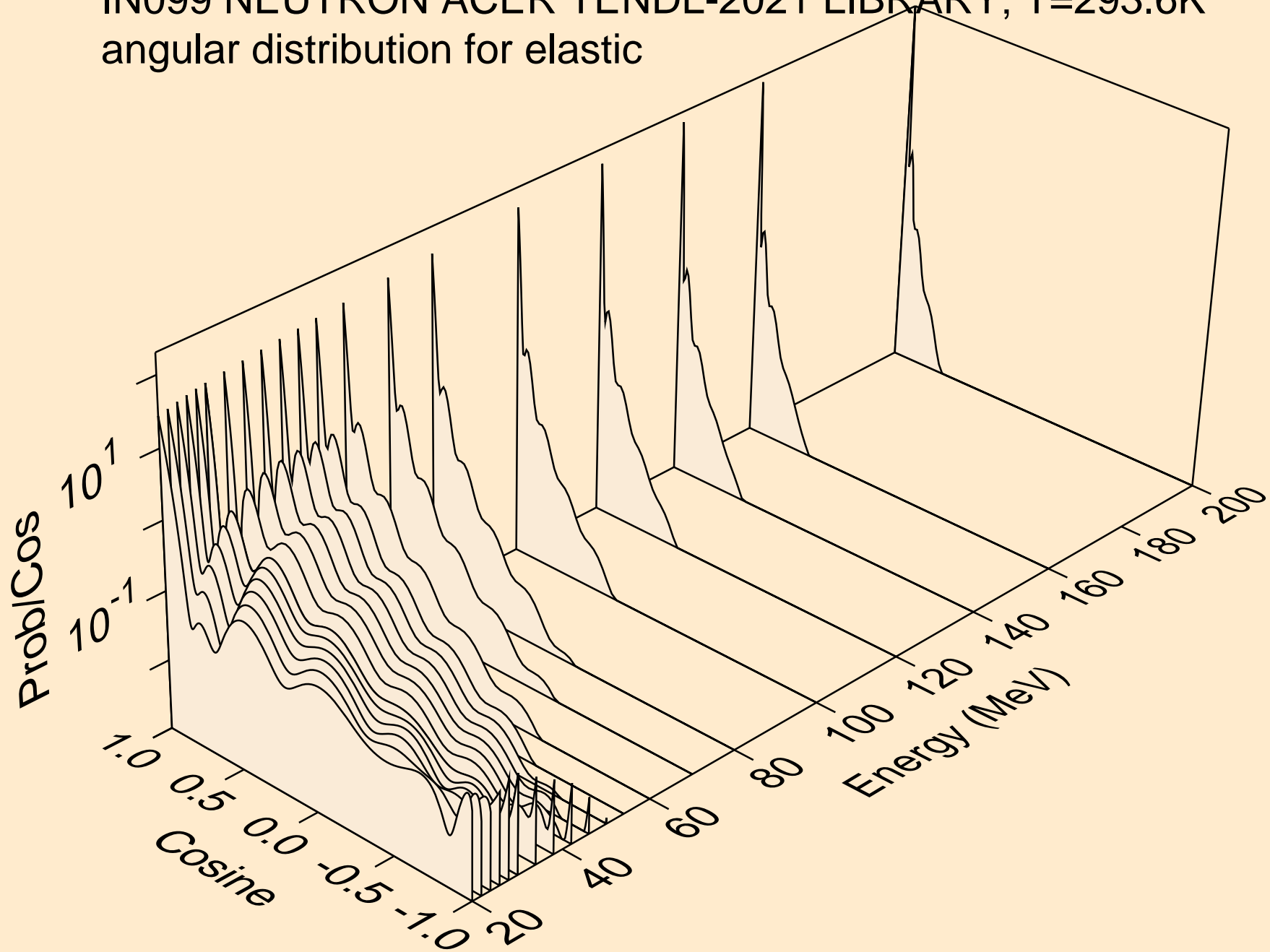

IN099 NEUTRON ACER TENDL-2021 LIBRARY; T=293.6K
angular distribution for (n,n*1)

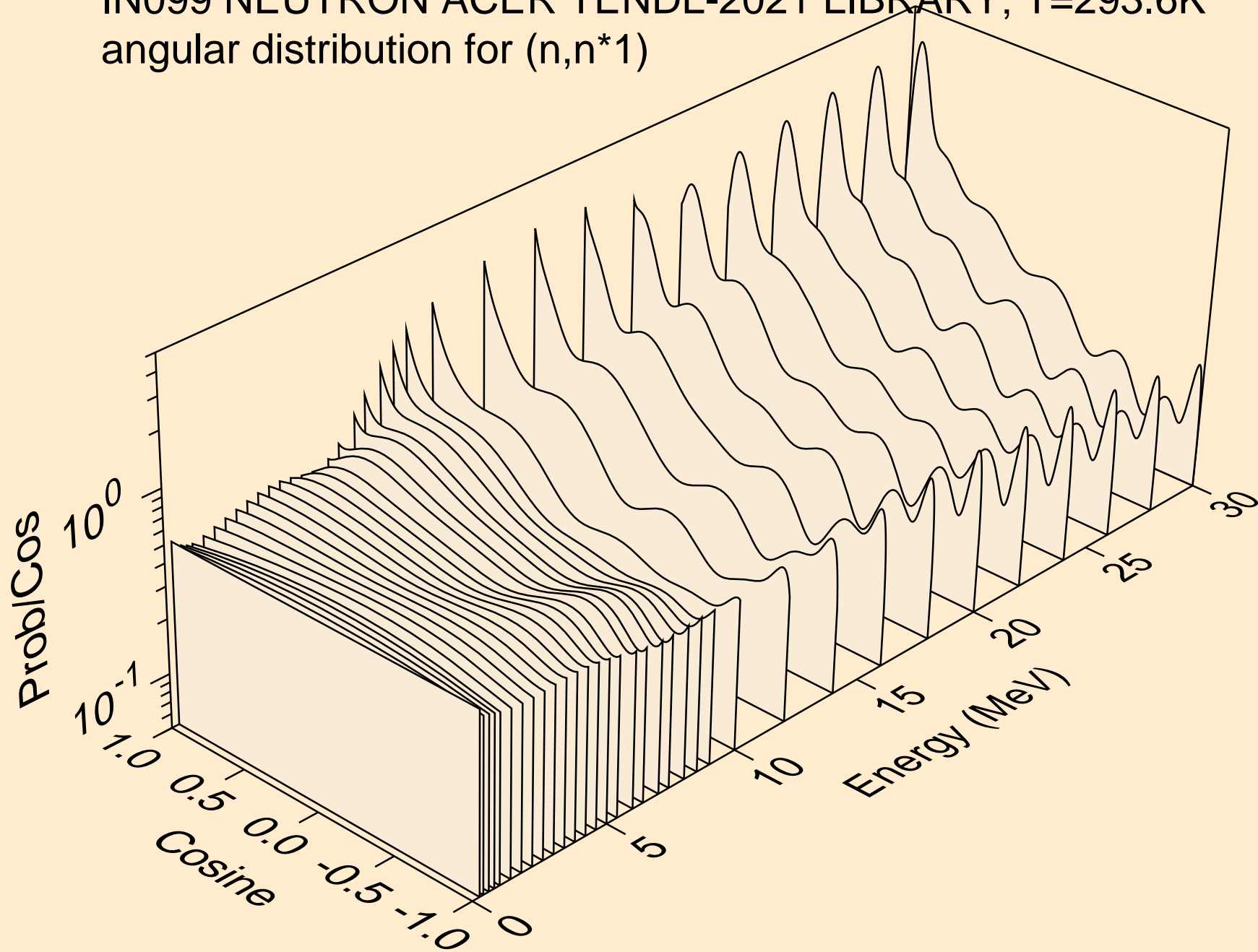

IN099 NEUTRON ACER TENDL-2021 LIBRARY; T=293.6K
Neutron emission for (n,x)

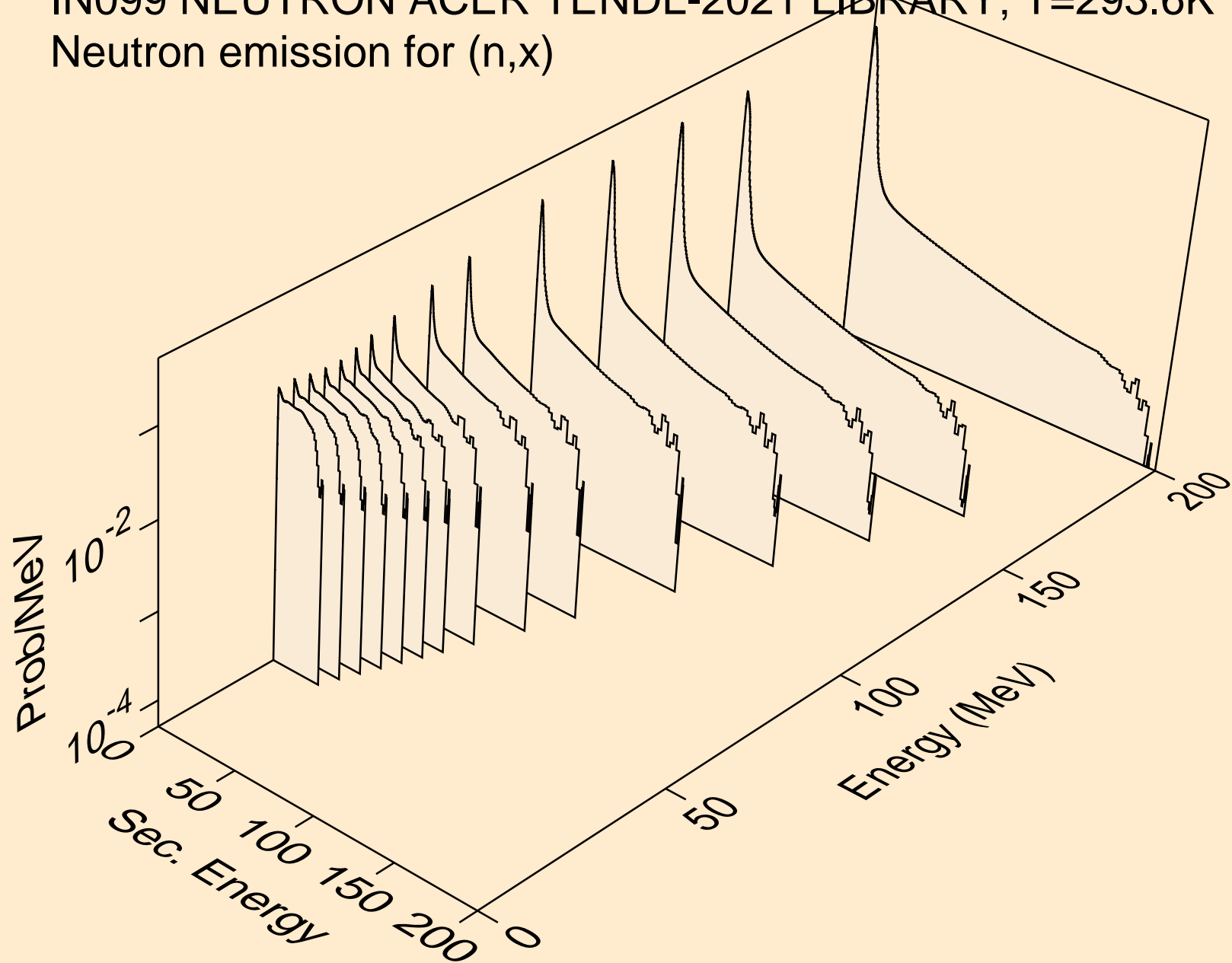

IN099 NEUTRON ACER TENDL-2021 LIBRARY; T=293.6K
Neutron emission for (n,2n)

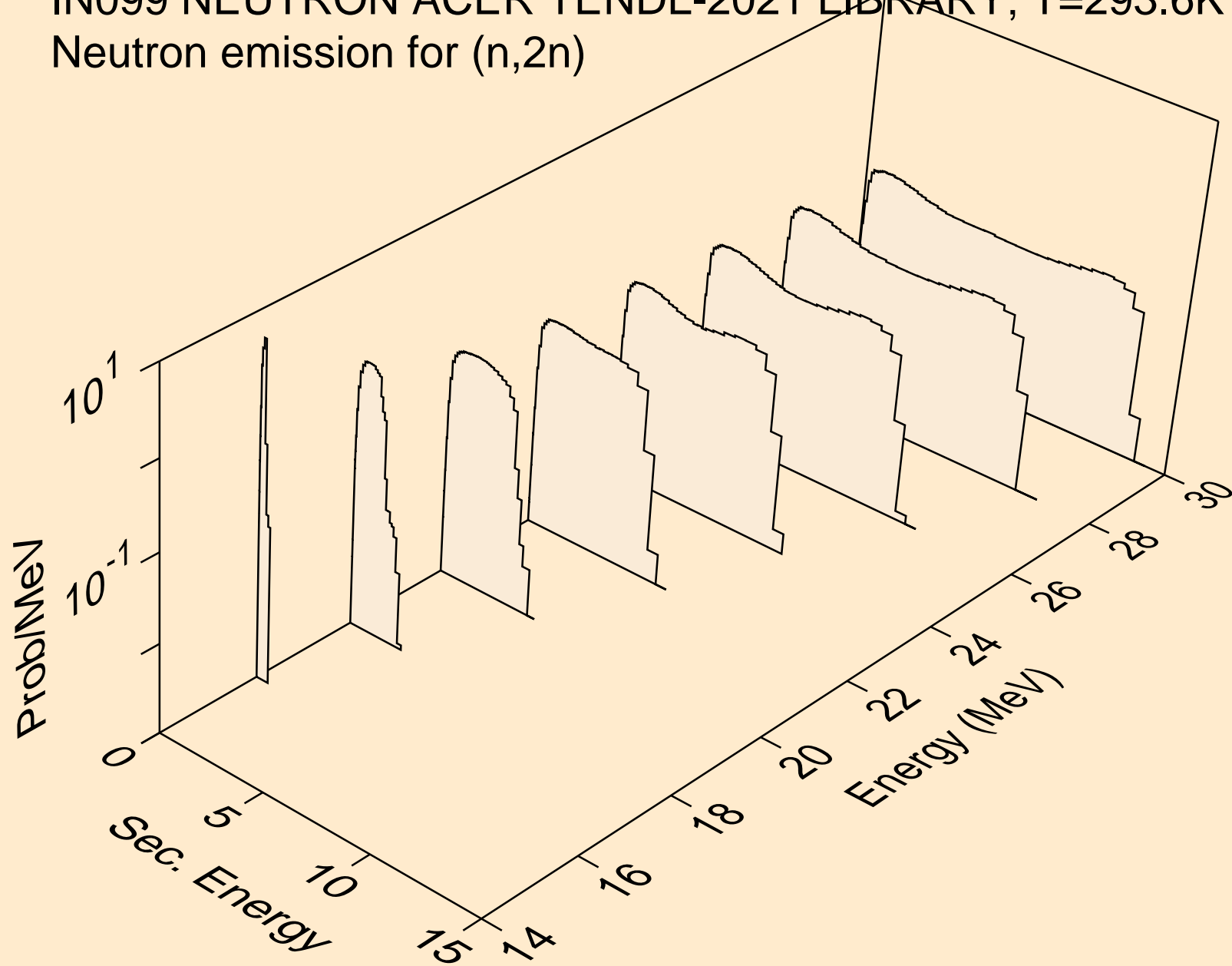

IN099 NEUTRON ACER TENDL-2021 LIBRARY; T=293.6K
Neutron emission for (n,n*)a

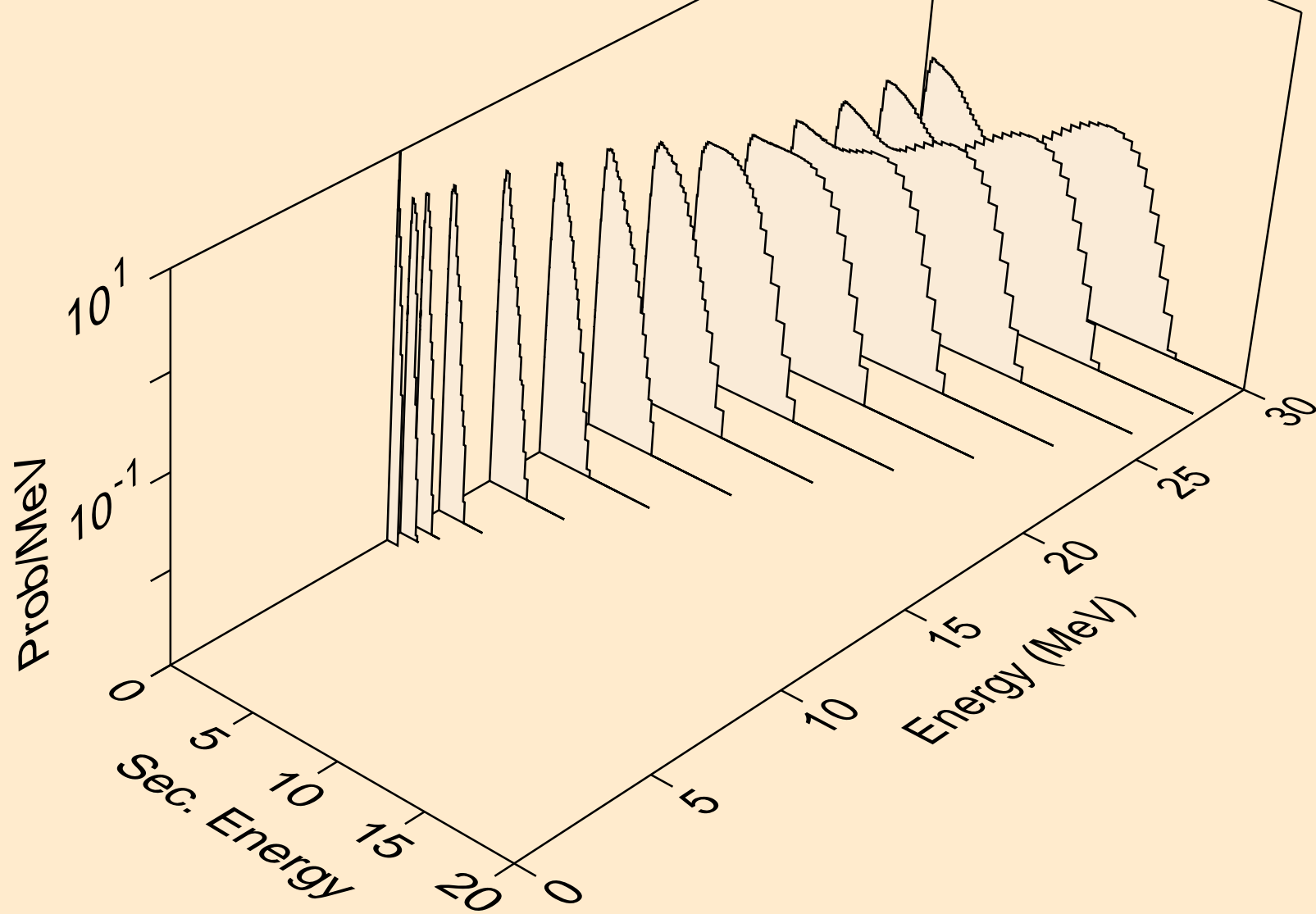

IN099 NEUTRON ACER TENDL-2021 LIBRARY; T=293.6K
Neutron emission for (n,n*)p

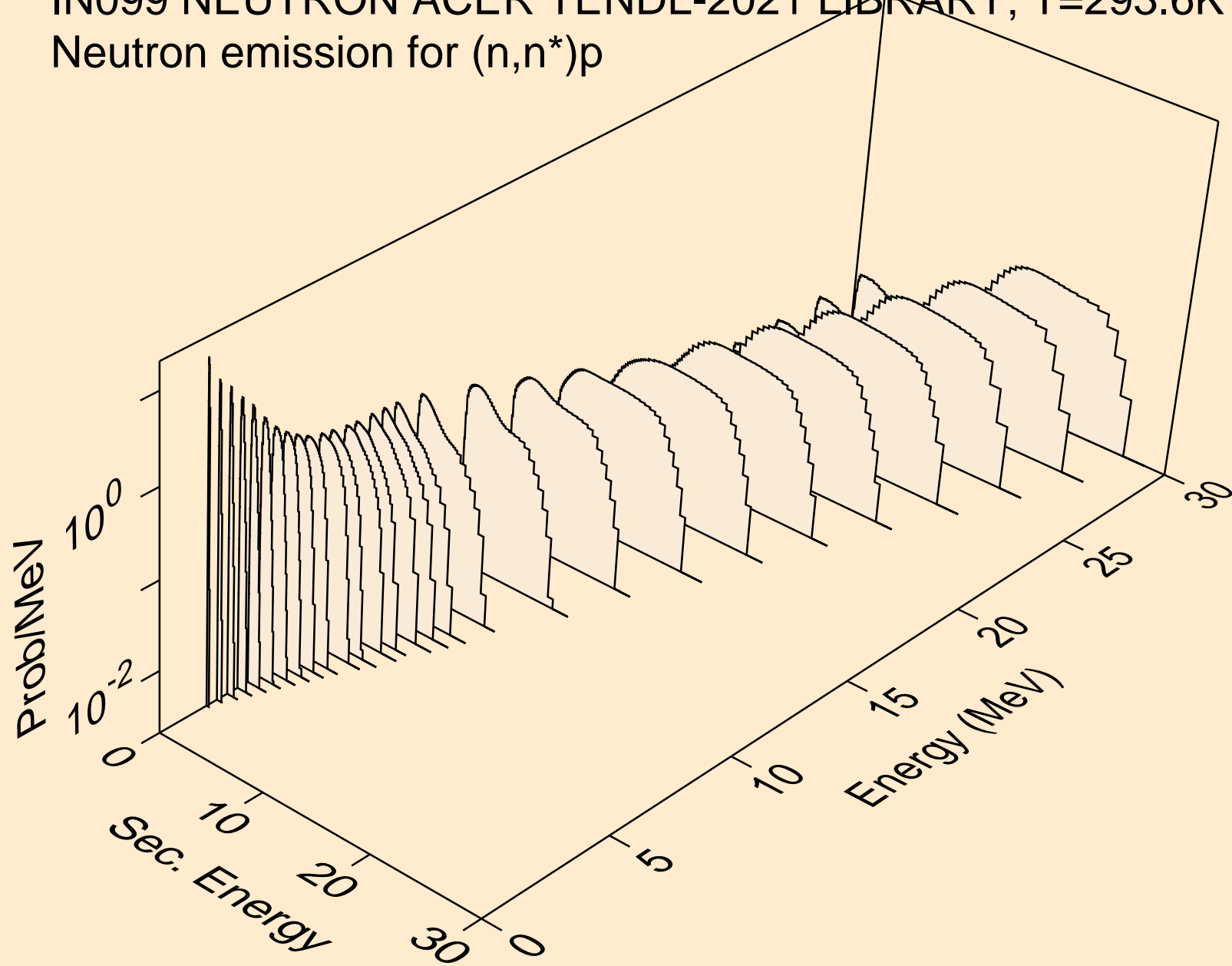

IN099 NEUTRON ACER TENDL-2021 LIBRARY; T=293.6K
Neutron emission for (n,n*)d

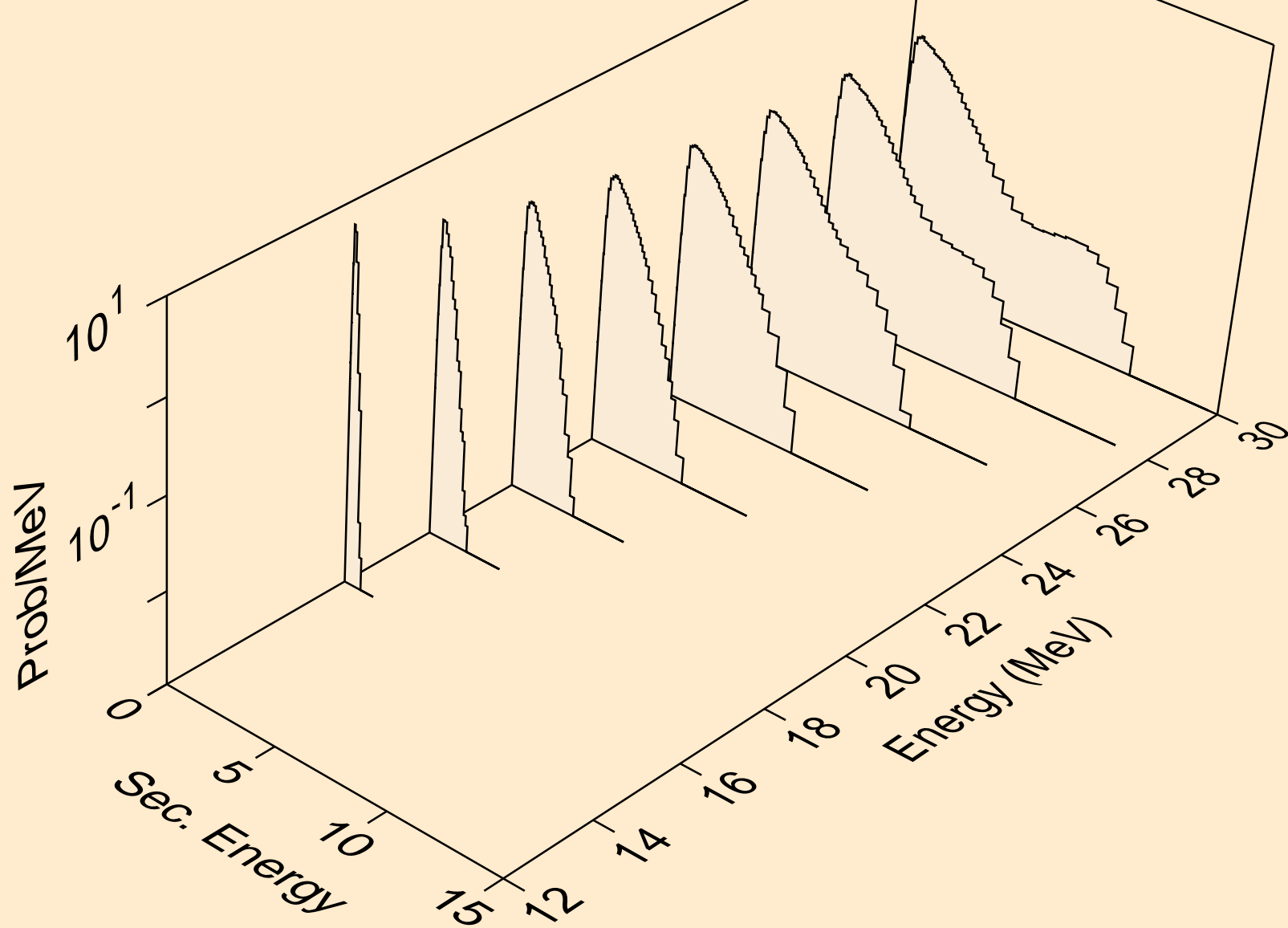

IN099 NEUTRON ACER TENDL-2021 LIBRARY; T=293.6K
Neutron emission for (n,n*)t

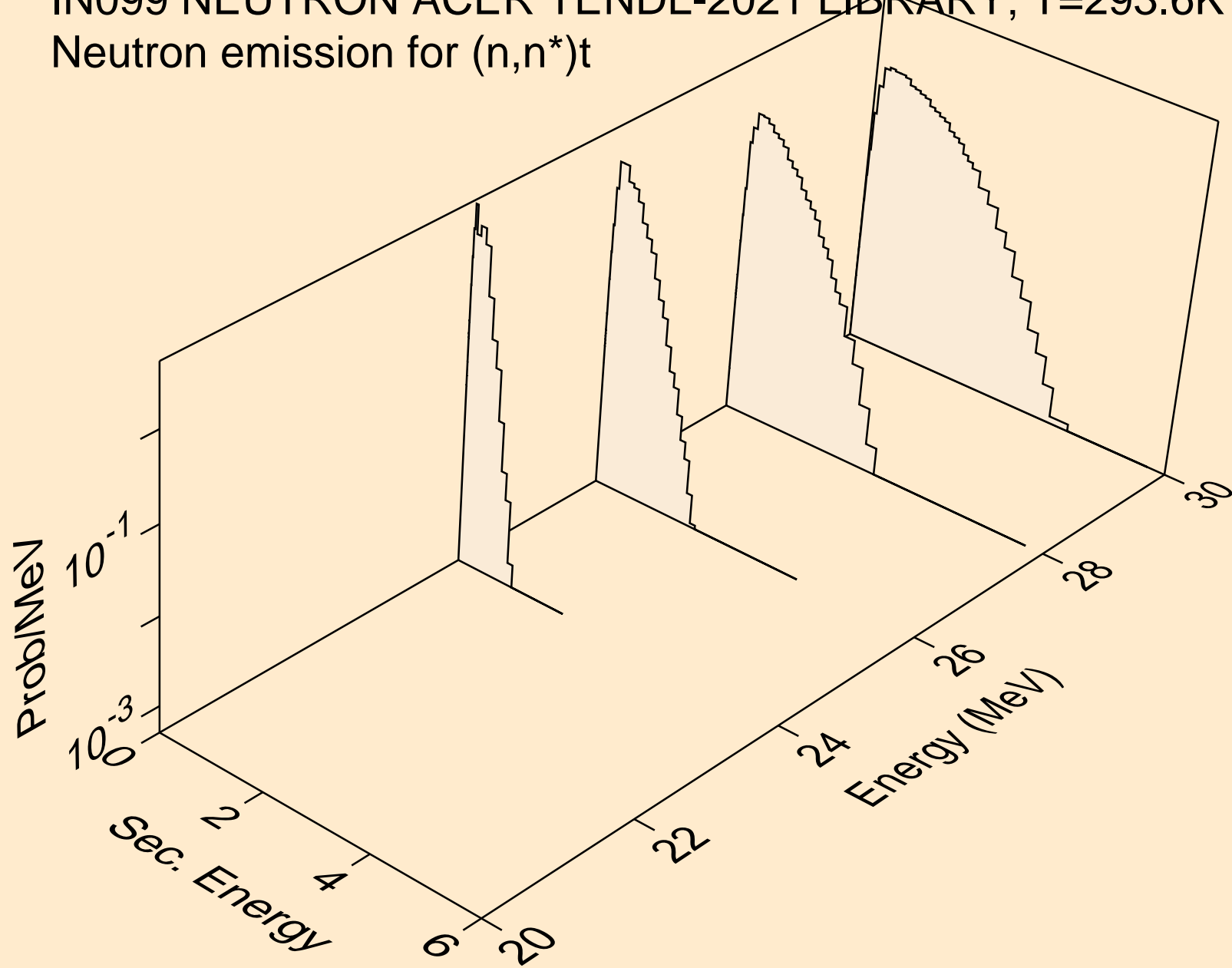

IN099 NEUTRON ACER TENDL-2021 LIBRARY; T=293.6K
Neutron emission for (n,n*)he3

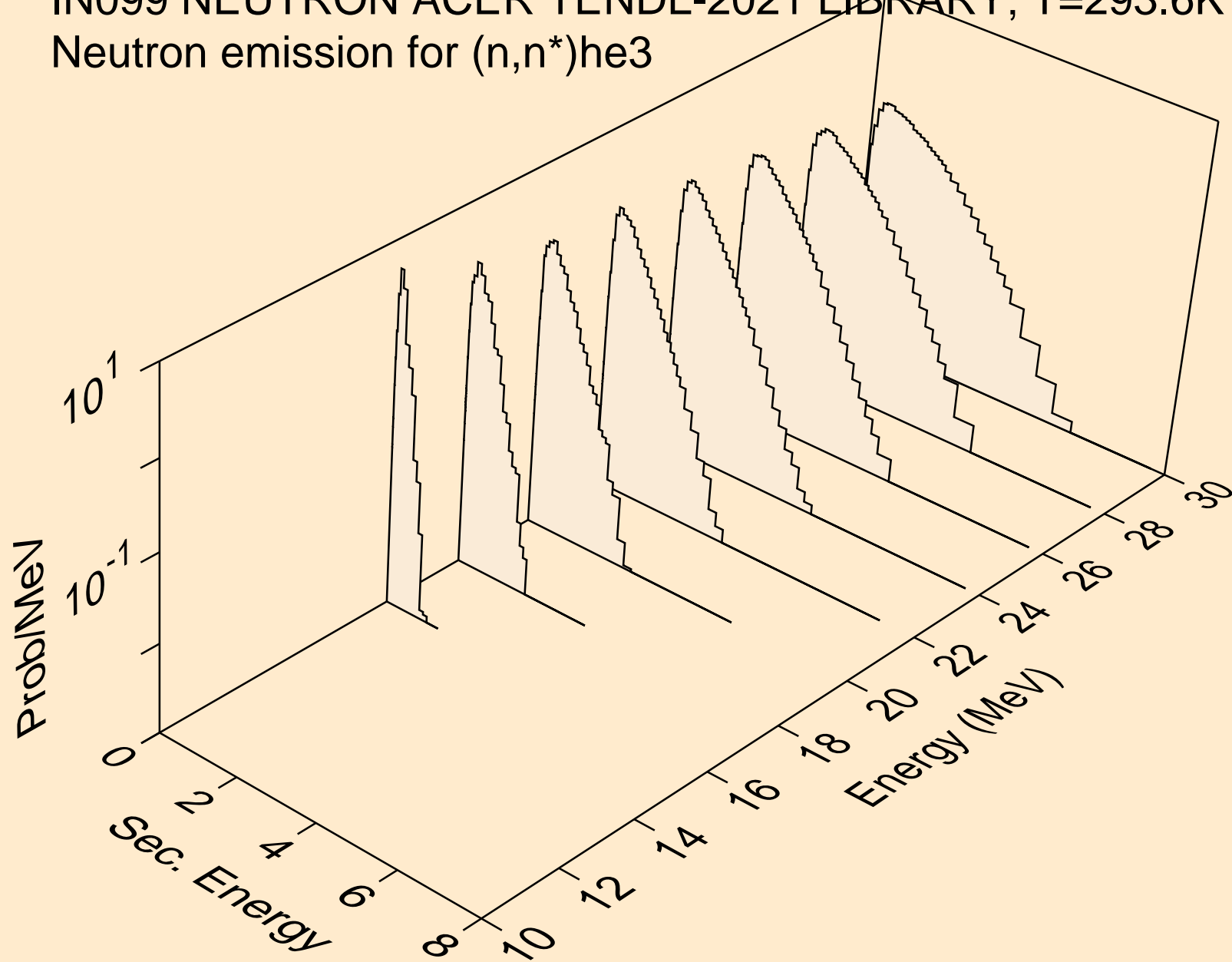

IN099 NEUTRON ACER TENDL-2021 LIBRARY; T=293.6K
Neutron emission for (n,2np)

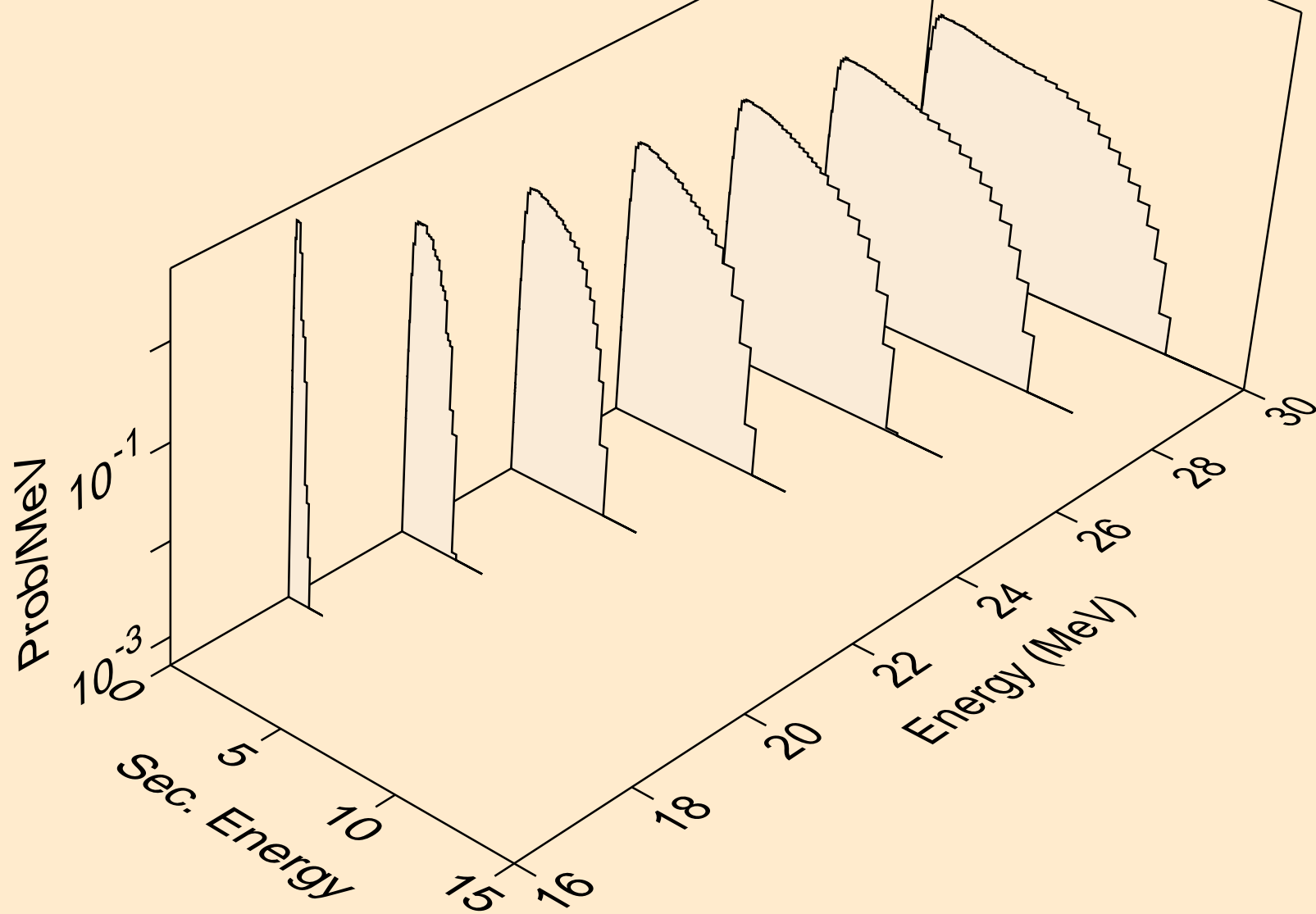

IN099 NEUTRON ACER TENDL-2021 LIBRARY; T=293.6K
Neutron emission for (n,2np)

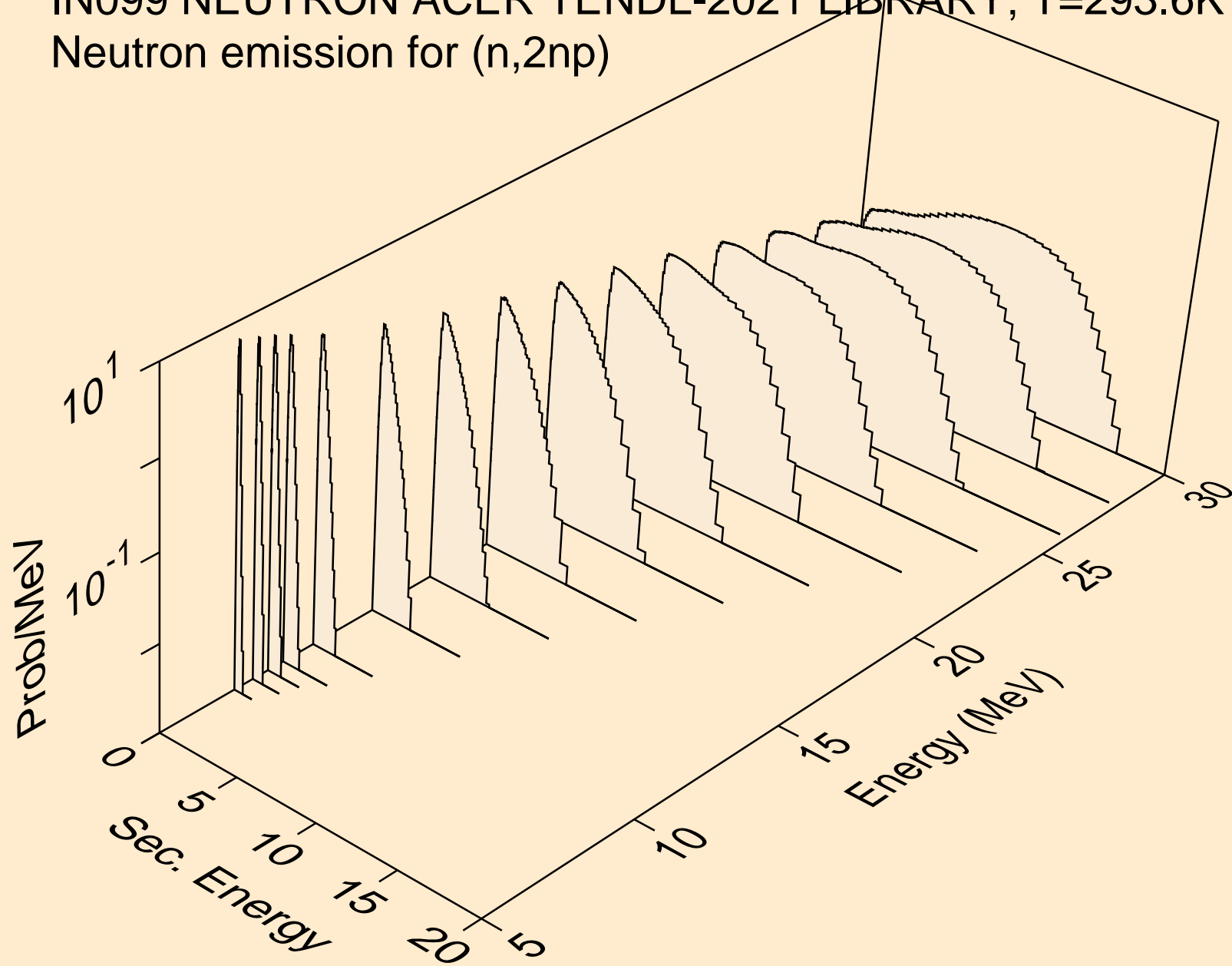

IN099 NEUTRON ACER TENDL-2021 LIBRARY; T=293.6K
Neutron emission for (n,npa)

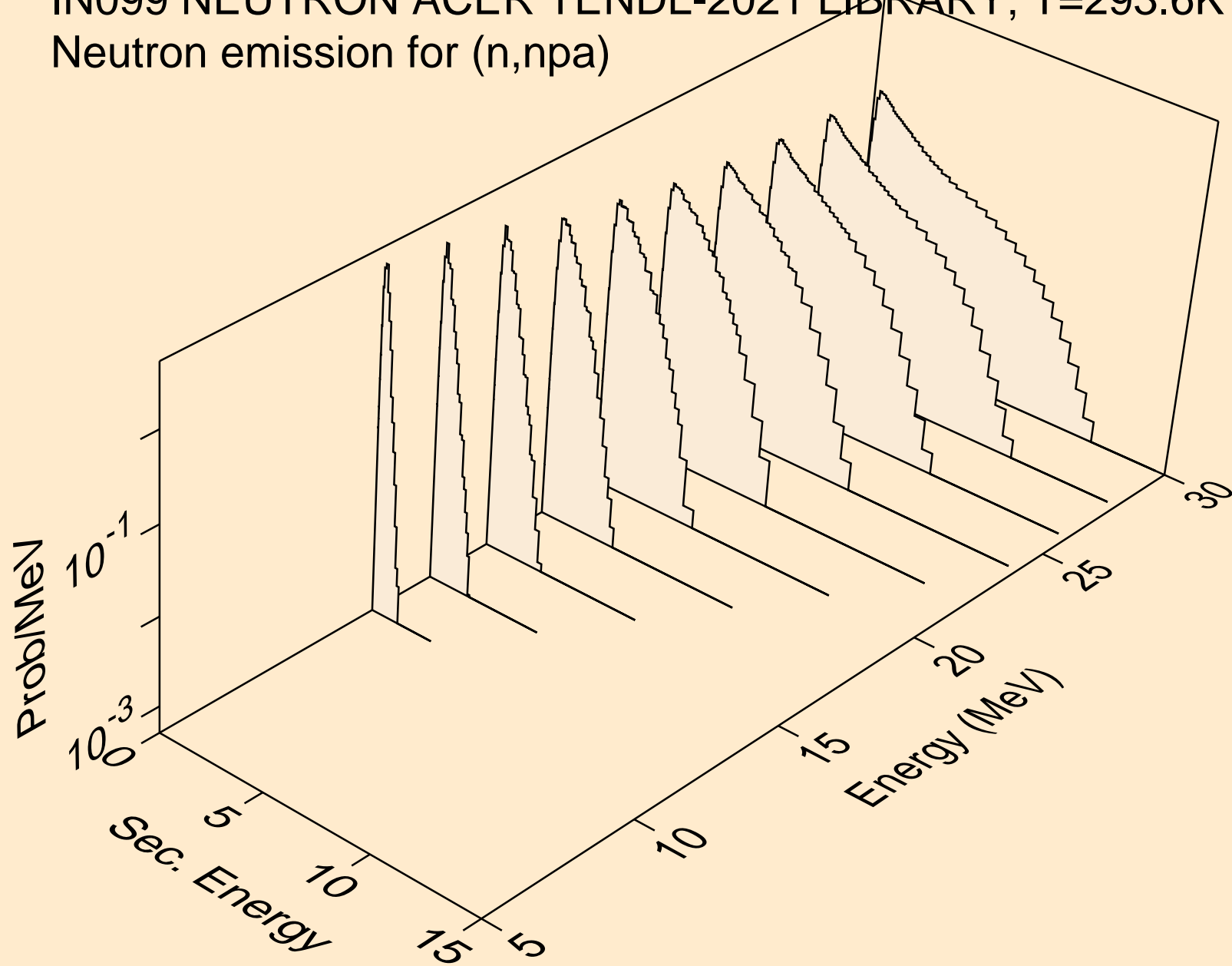

IN099 NEUTRON ACER TENDL-2021 LIBRARY; T=293.6K
Neutron emission for (n,n*c)

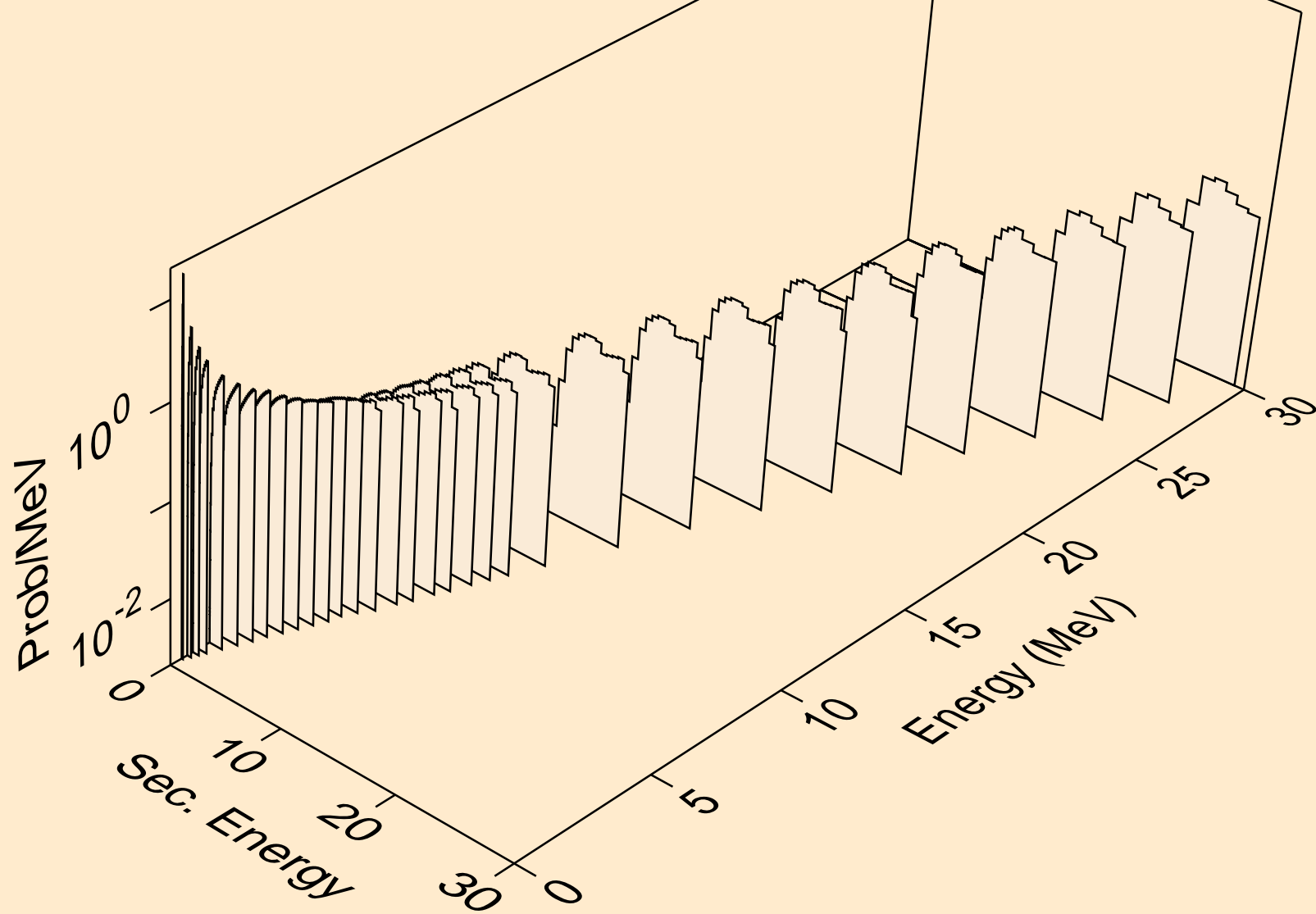

IN099 NEUTRON ACER TENDL-2021 LIBRARY; T=293.6K
Photon emission for (n,x)

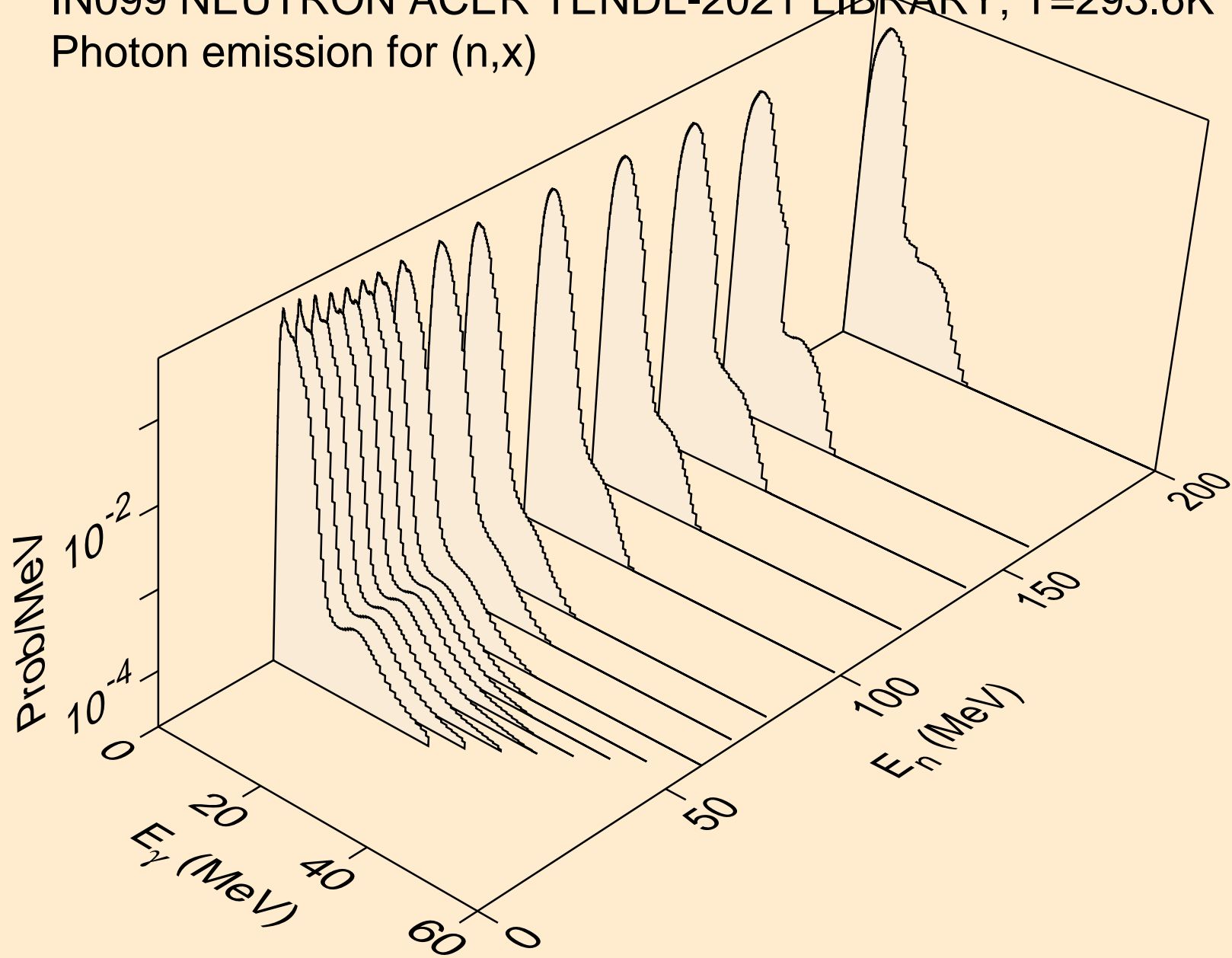

IN099 NEUTRON ACER TENDL-2021 LIBRARY; T=293.6K
Photon emission for (n,2n)

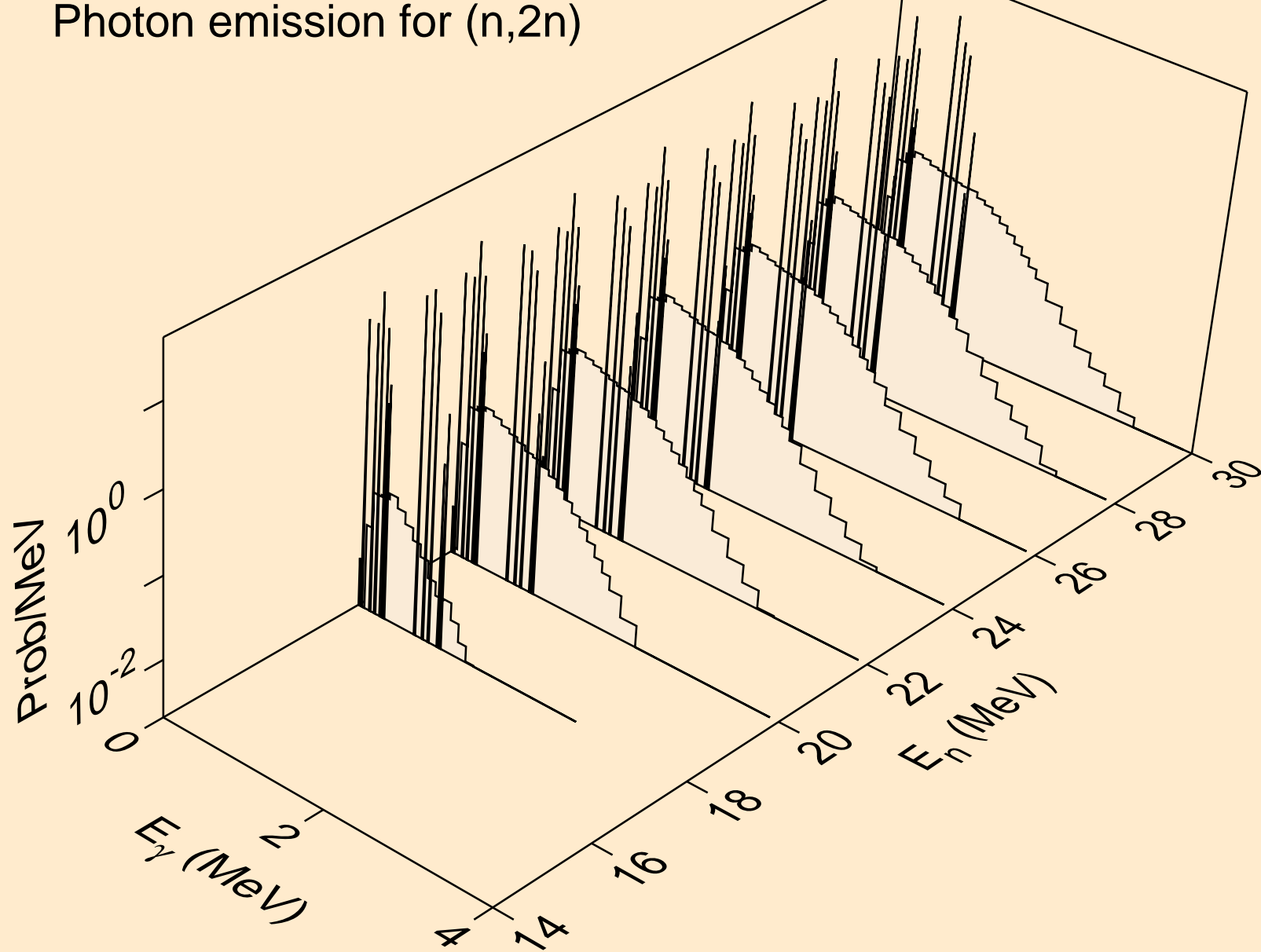

IN099 NEUTRON ACER TENDL-2021 LIBRARY; T=293.6K
Photon emission for (n,n*)a

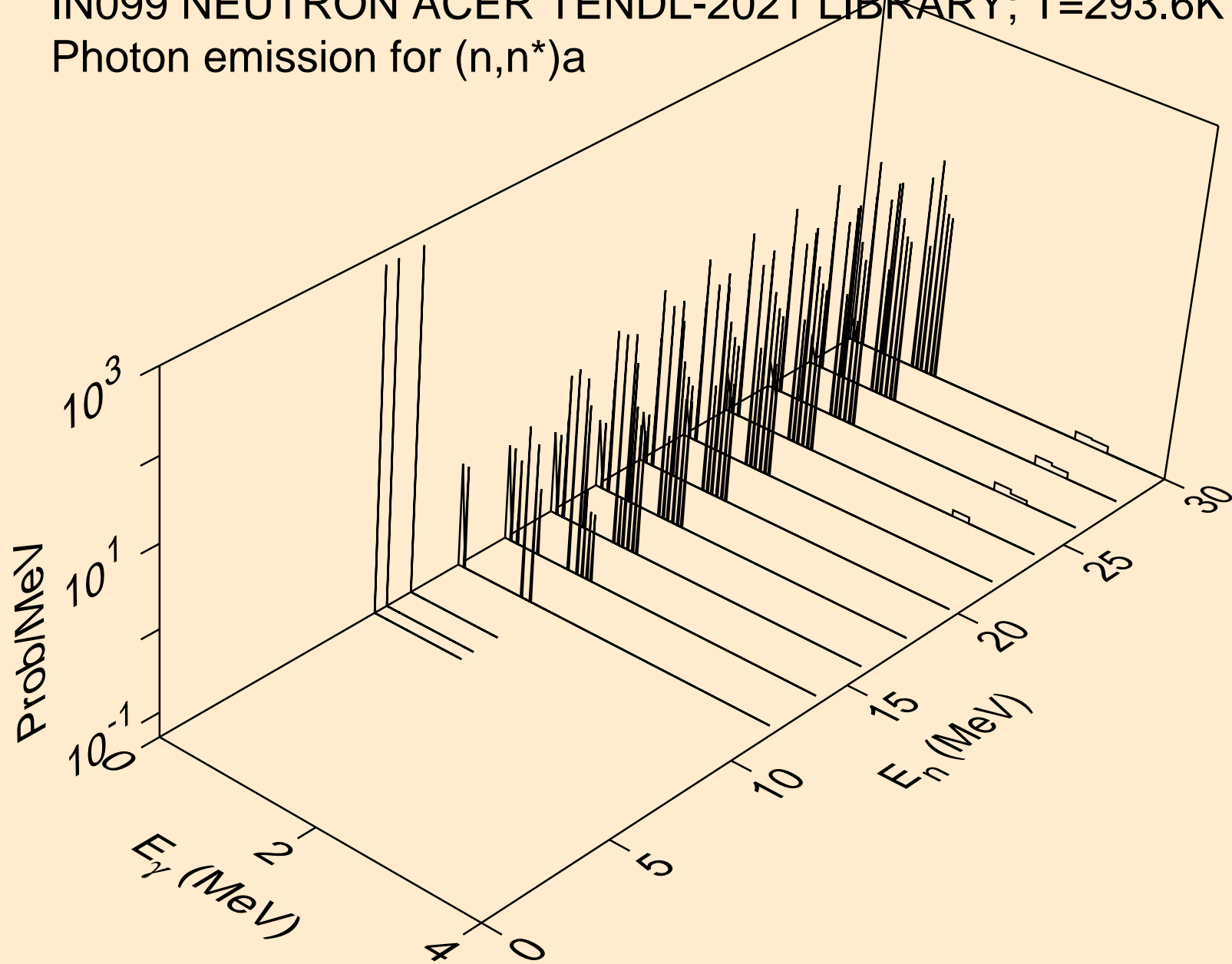

IN099 NEUTRON ACER TENDL-2021 LIBRARY; T=293.6K
Photon emission for (n,n*)p

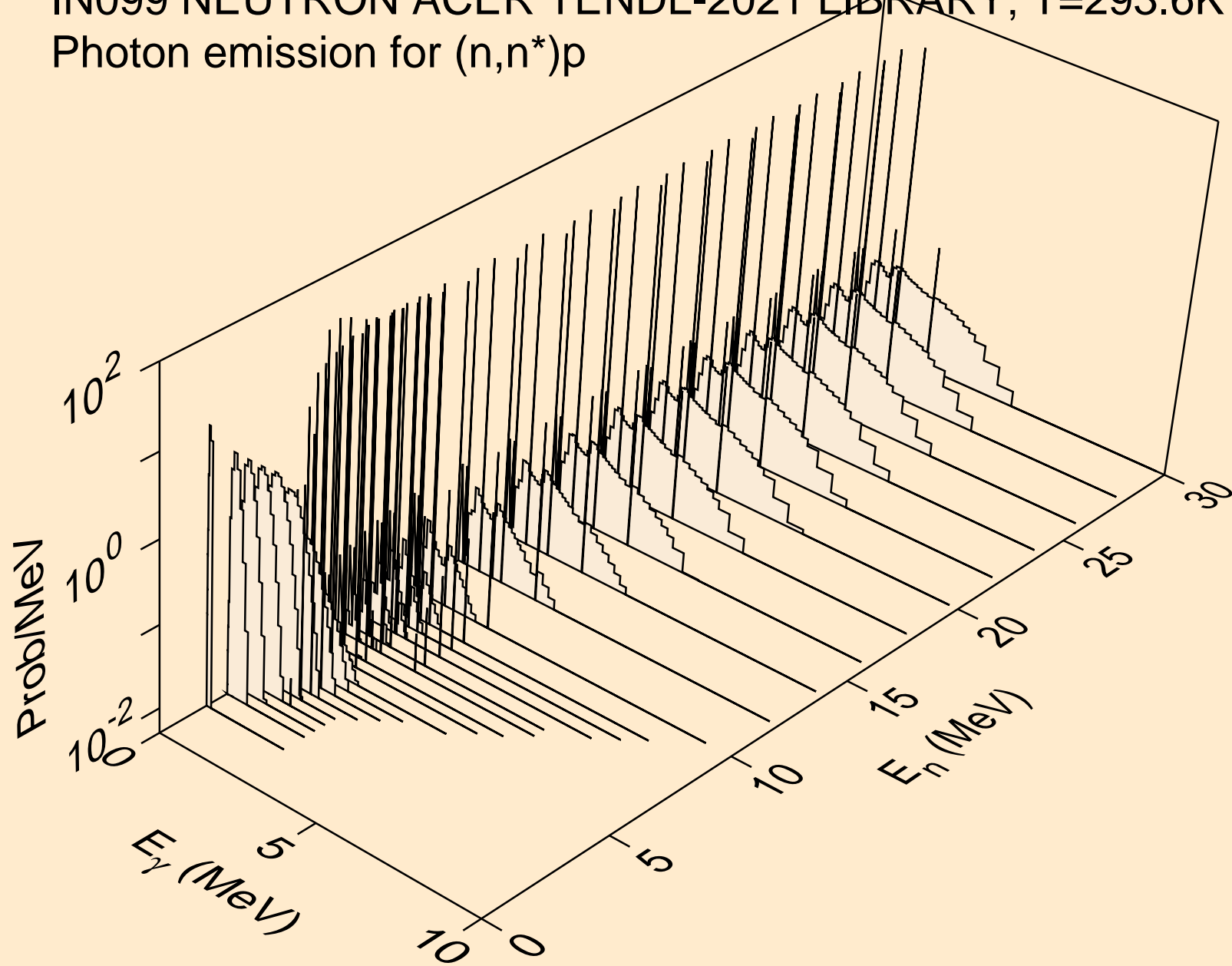

IN099 NEUTRON ACER TENDL-2021 LIBRARY; T=293.6K
Photon emission for (n,n*)d

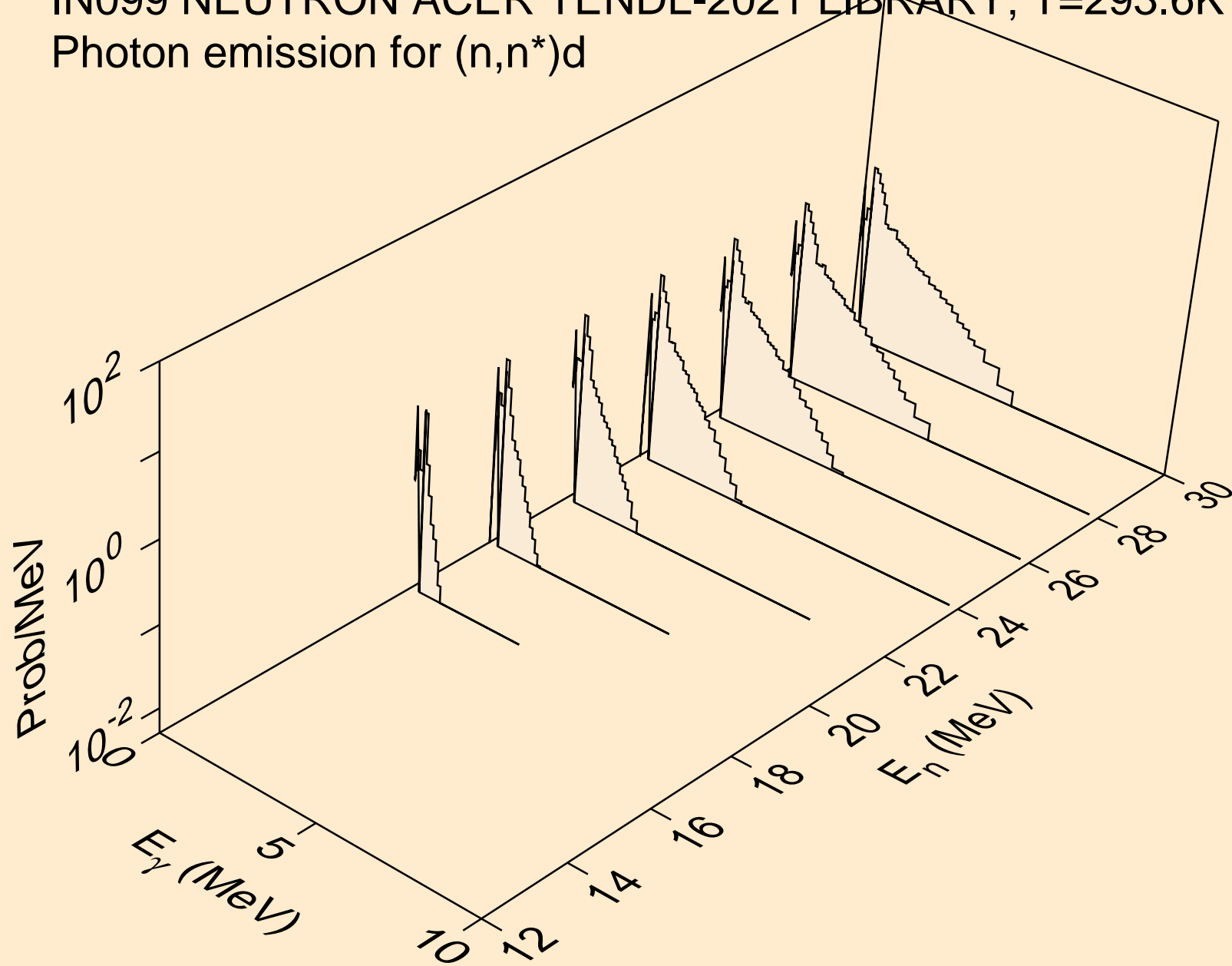

IN099 NEUTRON ACER TENDL-2021 LIBRARY; T=293.6K
Photon emission for (n,n*)t

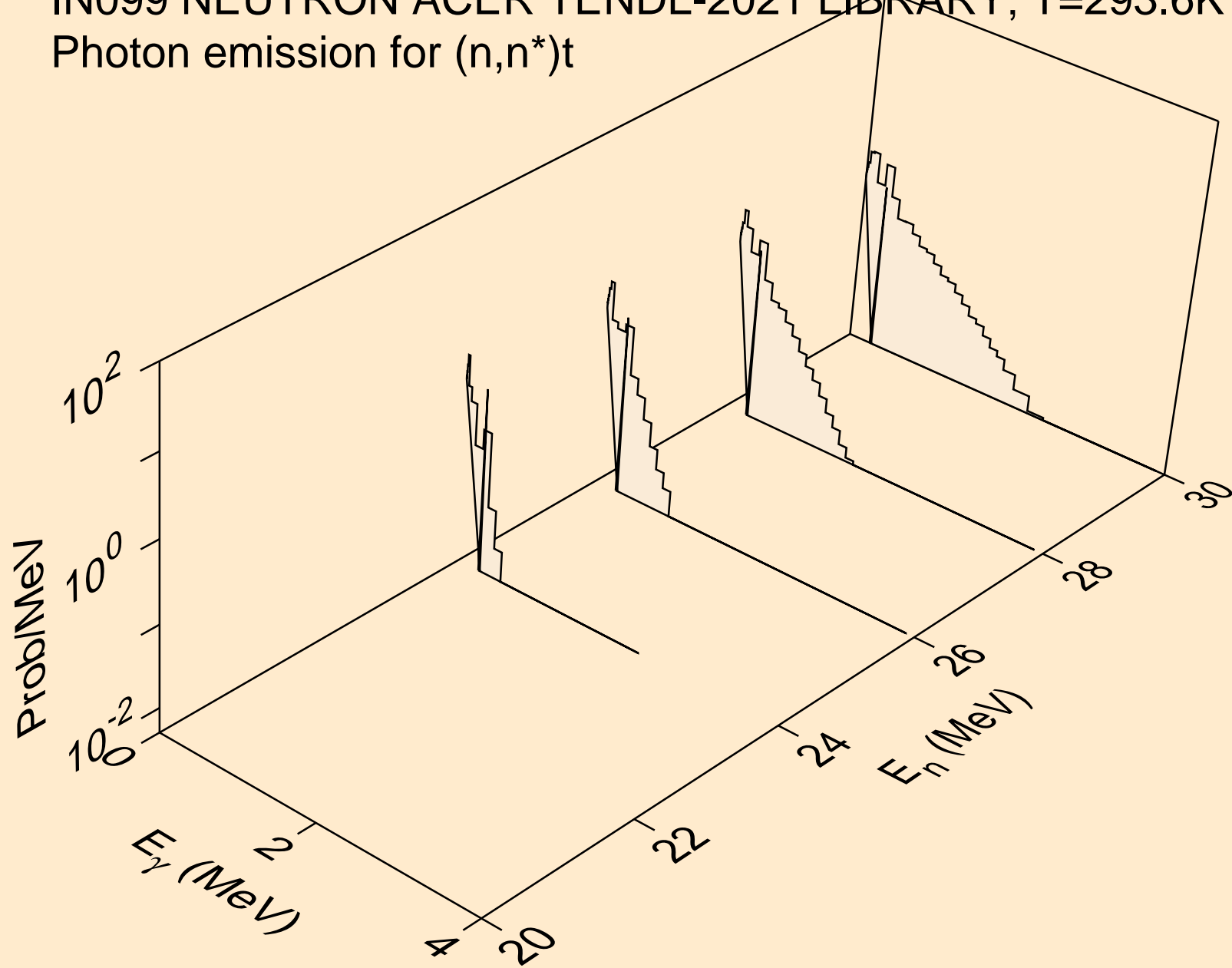

IN099 NEUTRON ACER TENDL-2021 LIBRARY; T=293.6K
Photon emission for (n,n*)he3

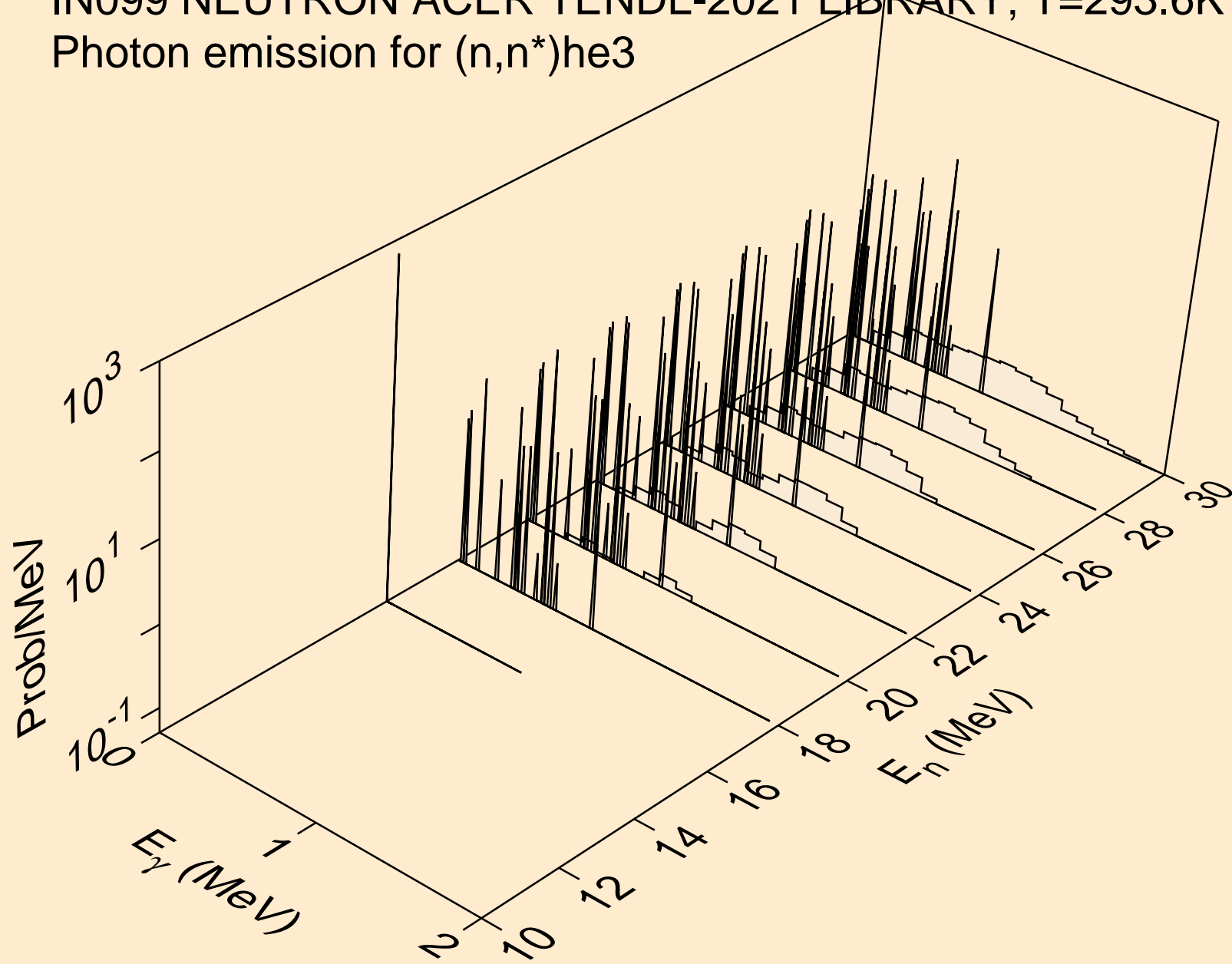

IN099 NEUTRON ACER TENDL-2021 LIBRARY; T=293.6K
Photon emission for (n,2np)

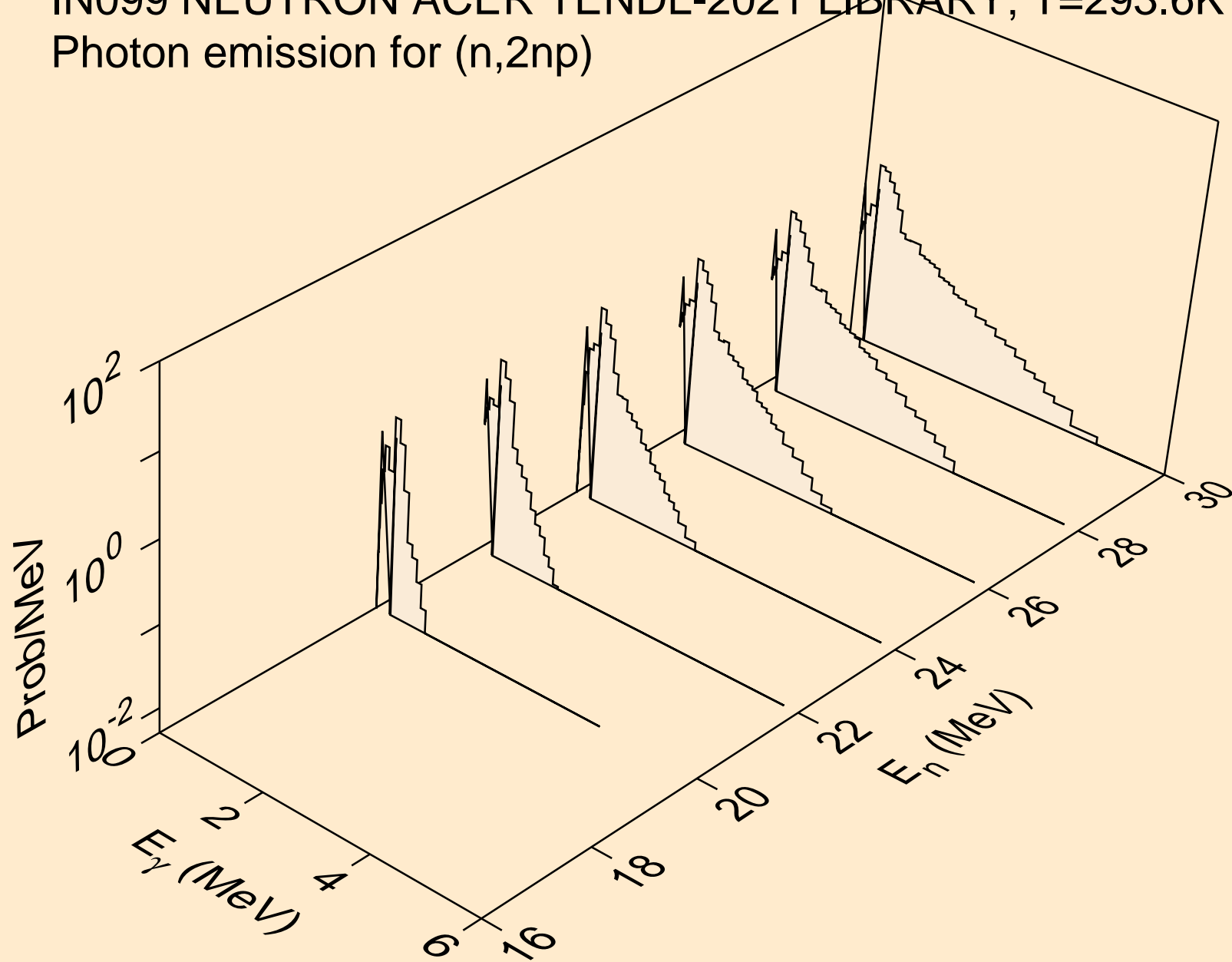

IN099 NEUTRON ACER TENDL-2021 LIBRARY; T=293.6K
Photon emission for (n,2np)

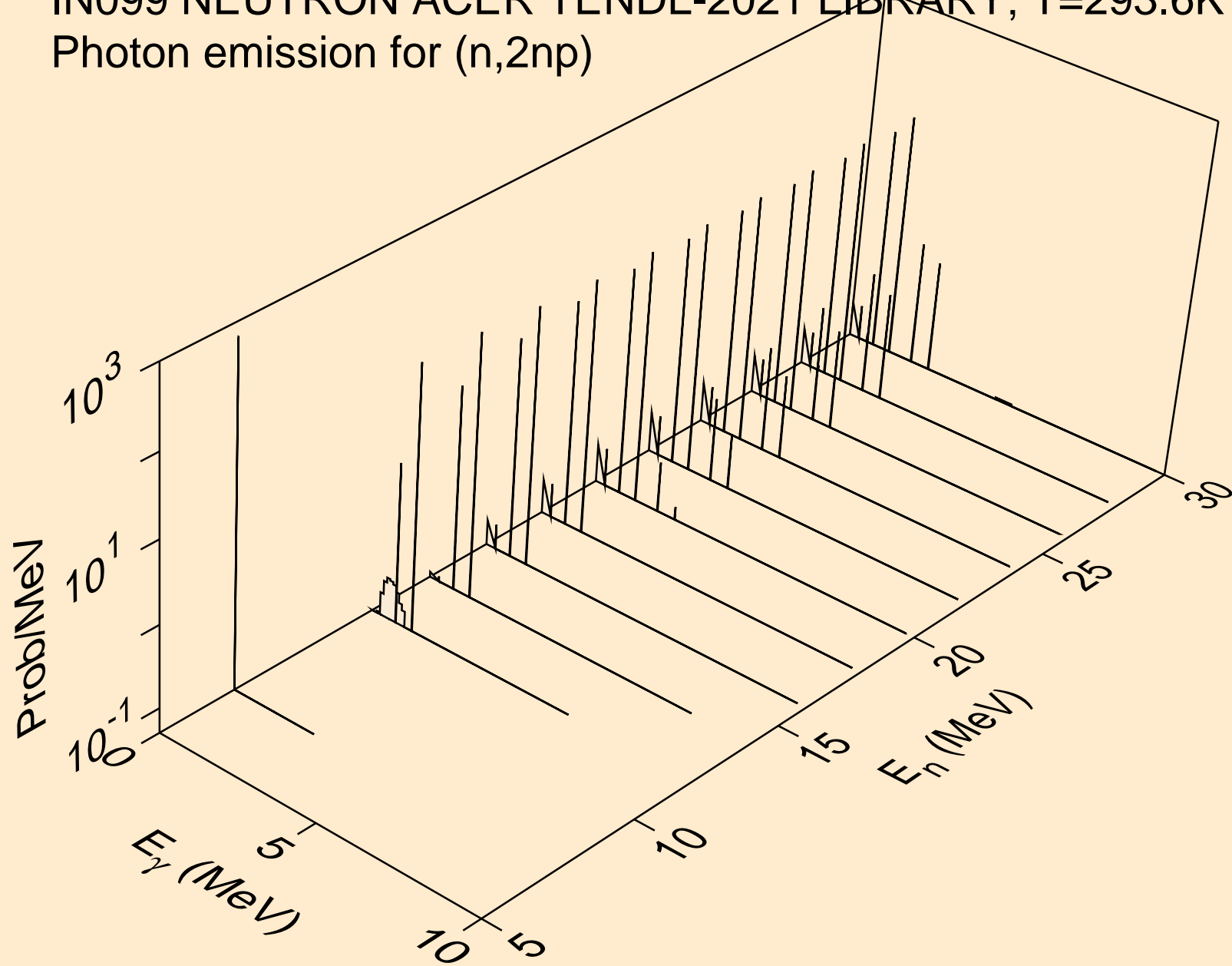

IN099 NEUTRON ACER TENDL-2021 LIBRARY; T=293.6K
Photon emission for (n,npa)

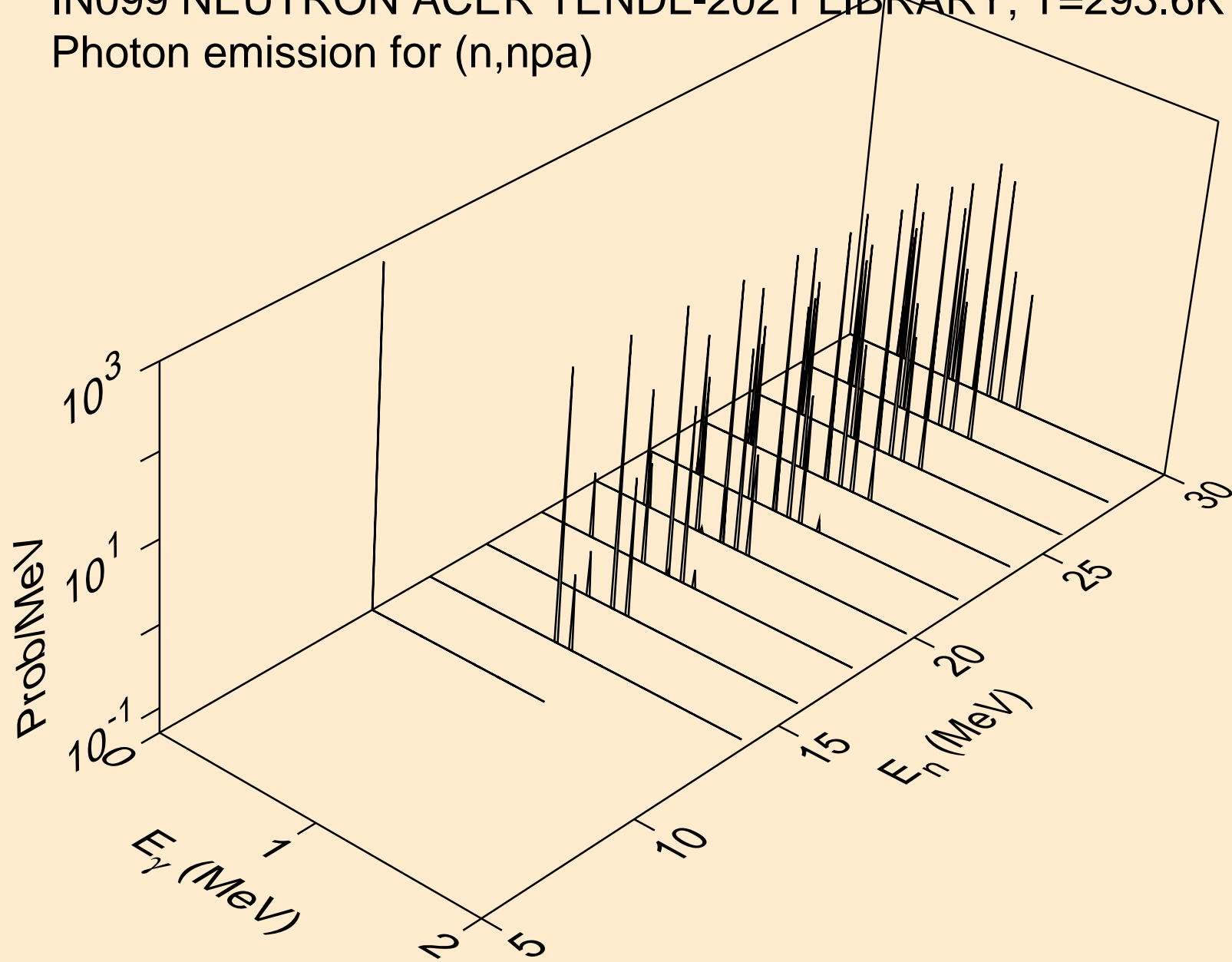

IN099 NEUTRON ACER TENDL-2021 LIBRARY; T=293.6K
Photon emission for (n,n*c)

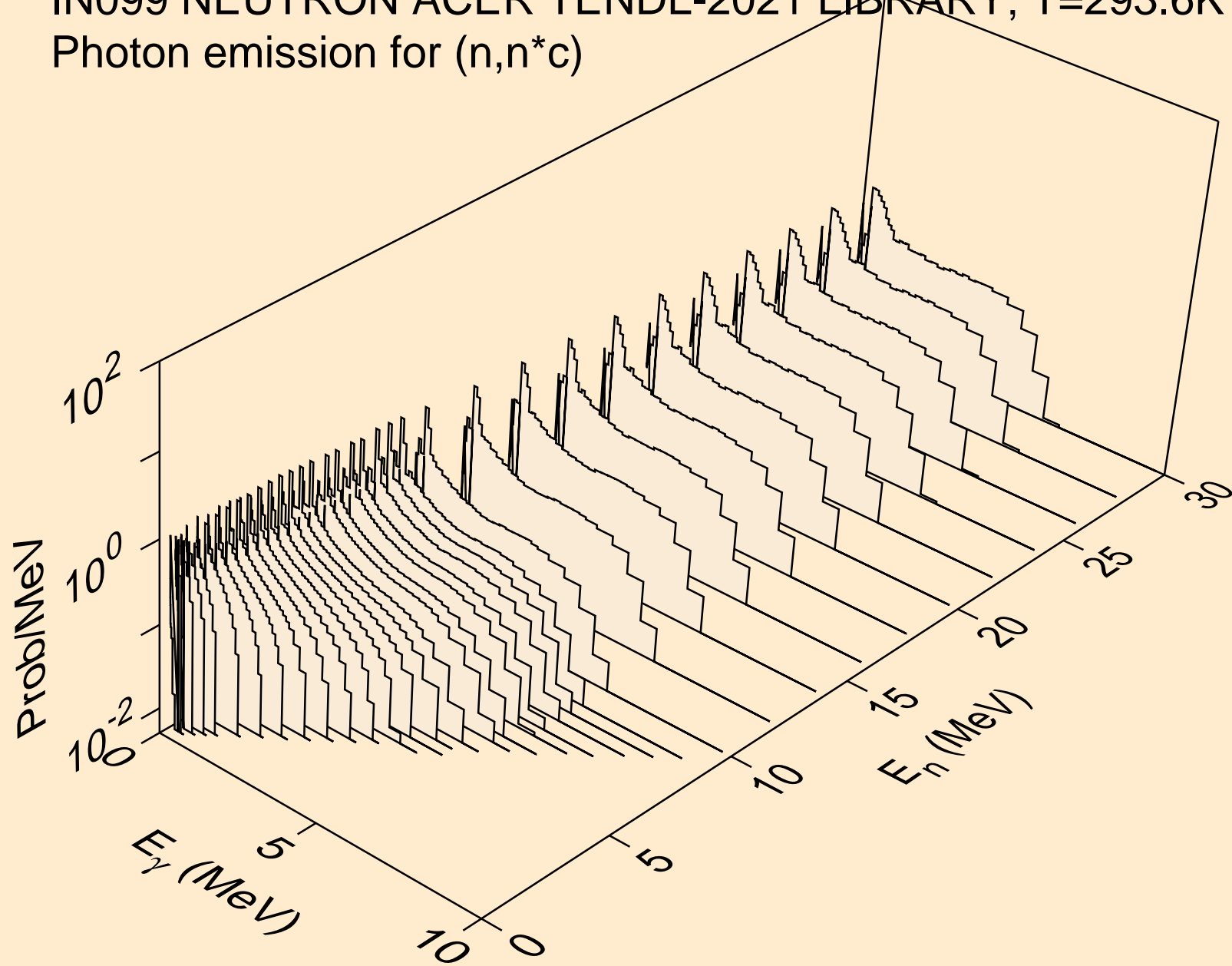

IN099 NEUTRON ACER TENDL-2021 LIBRARY; T=293.6K
Photon emission for (n,gma)

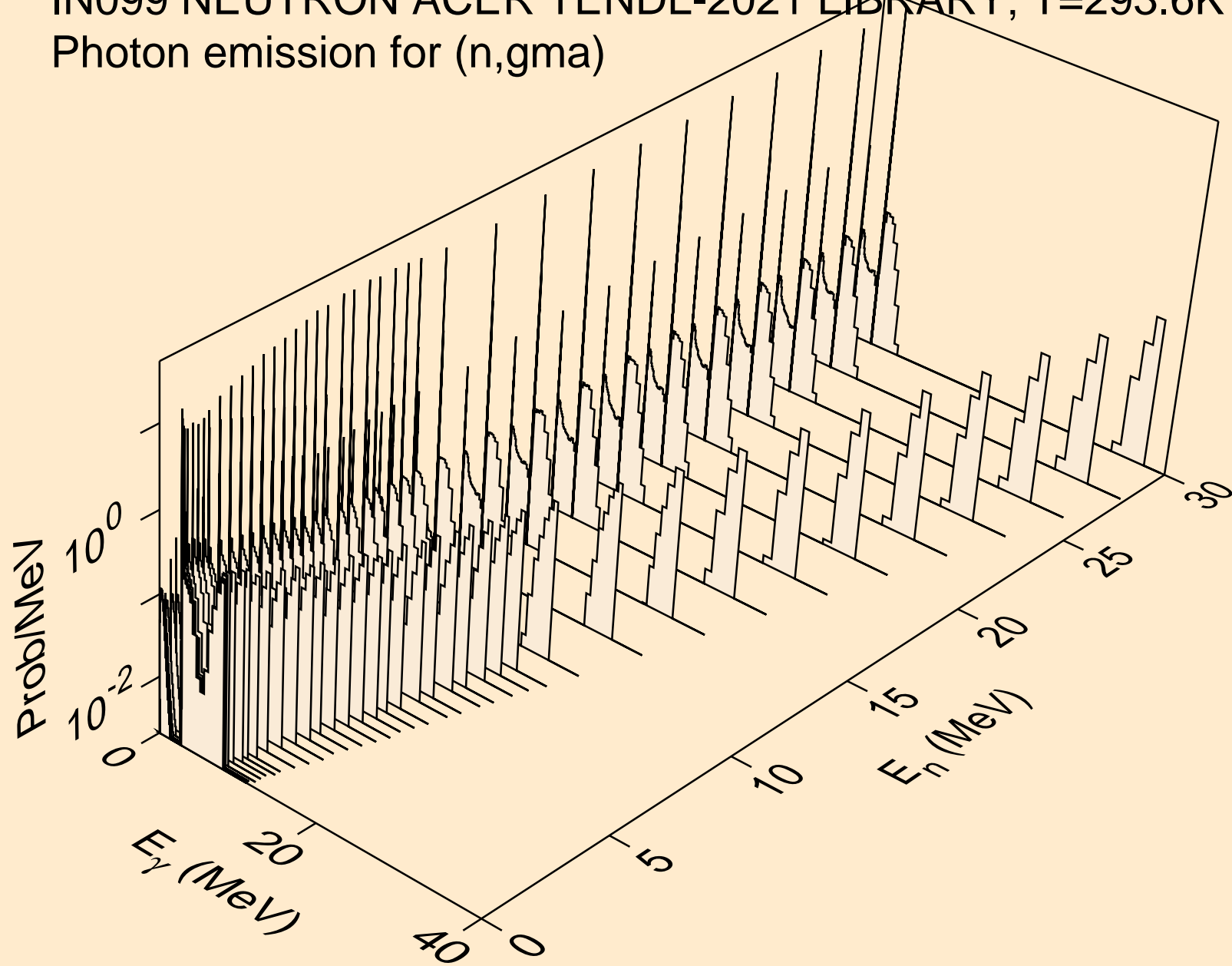

IN099 NEUTRON ACER TENDL-2021 LIBRARY; T=293.6K
Photon emission for (n,p)

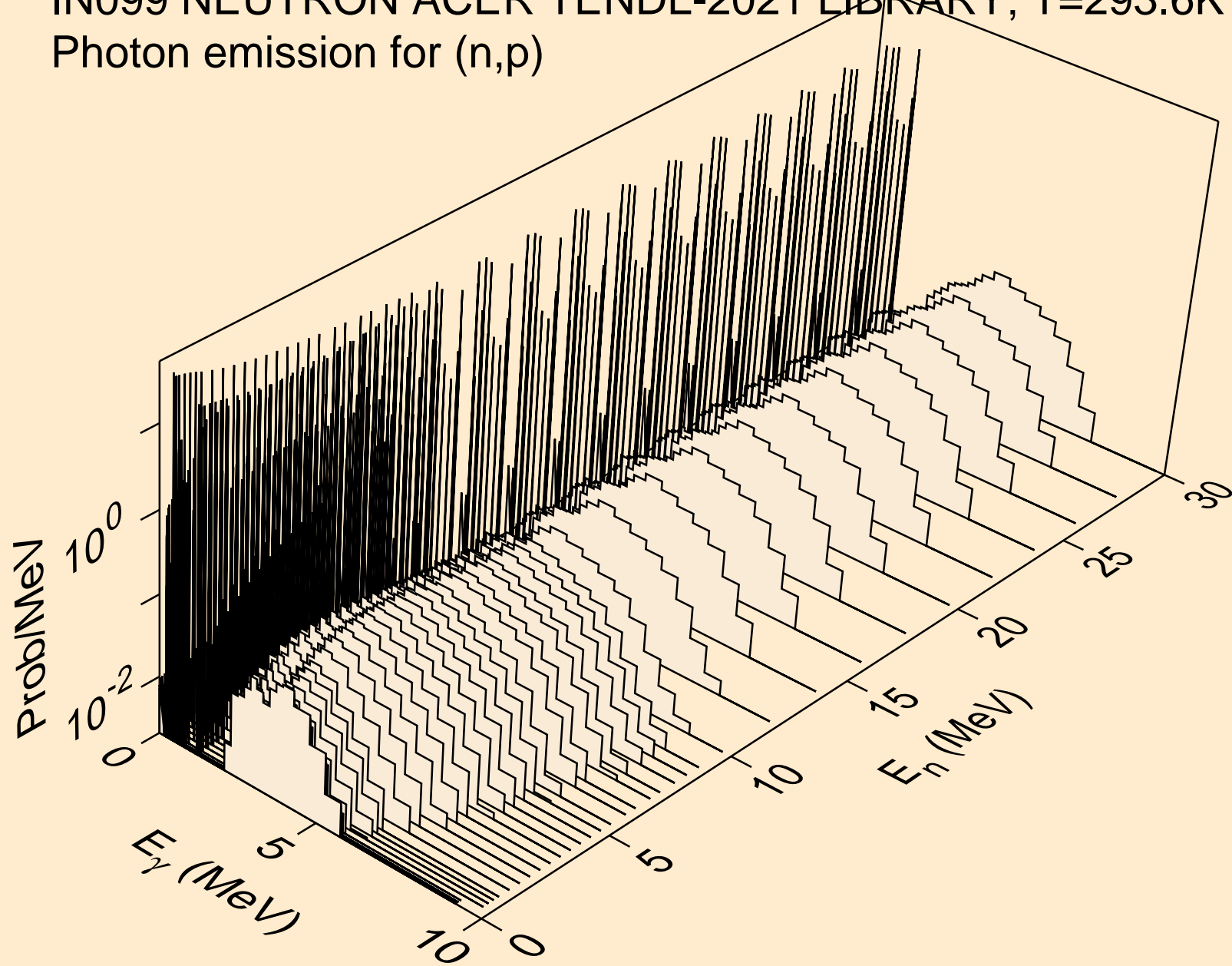

IN099 NEUTRON ACER TENDL-2021 LIBRARY; T=293.6K
Photon emission for (n,d)

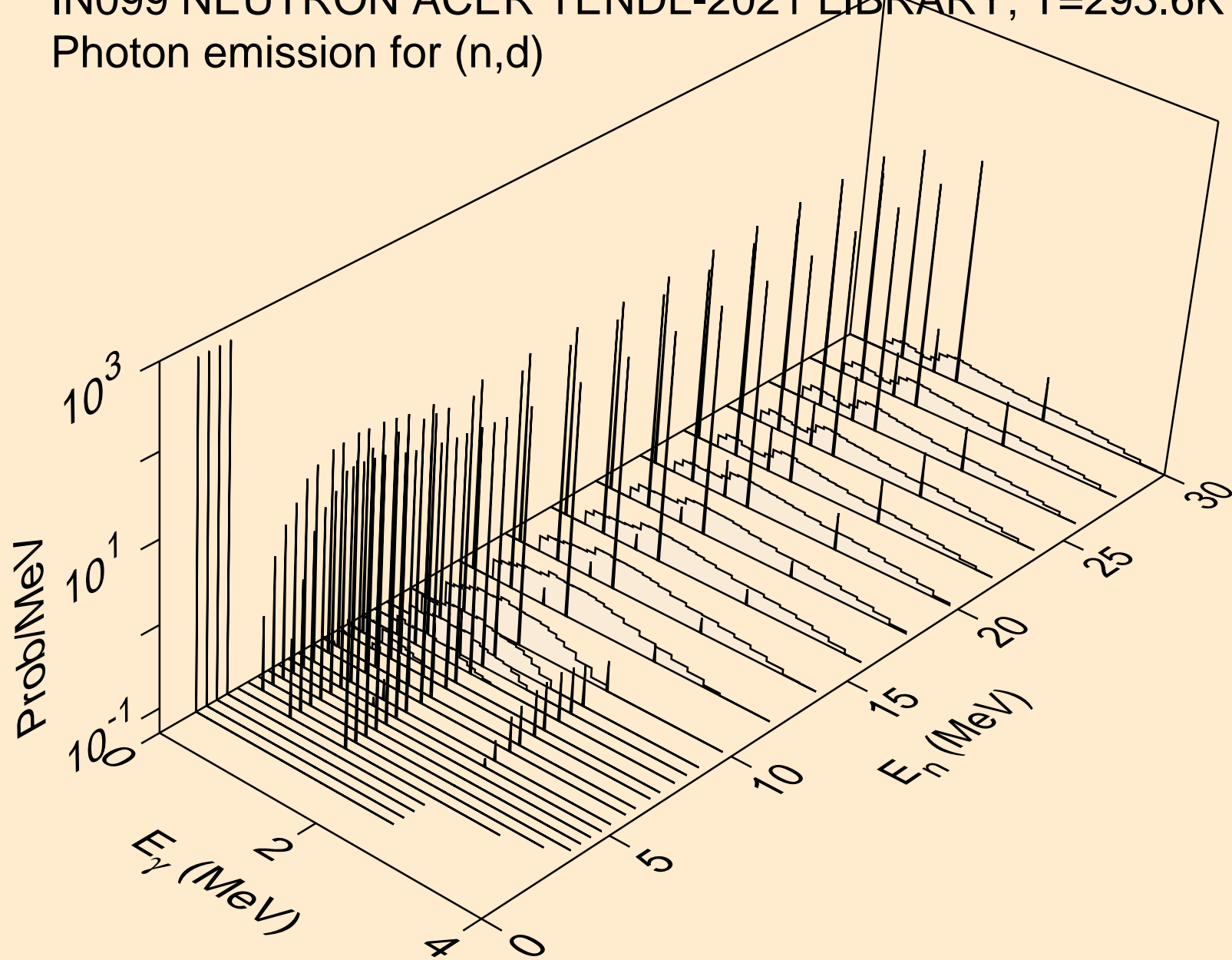

IN099 NEUTRON ACER TENDL-2021 LIBRARY; T=293.6K
Photon emission for (n,t)

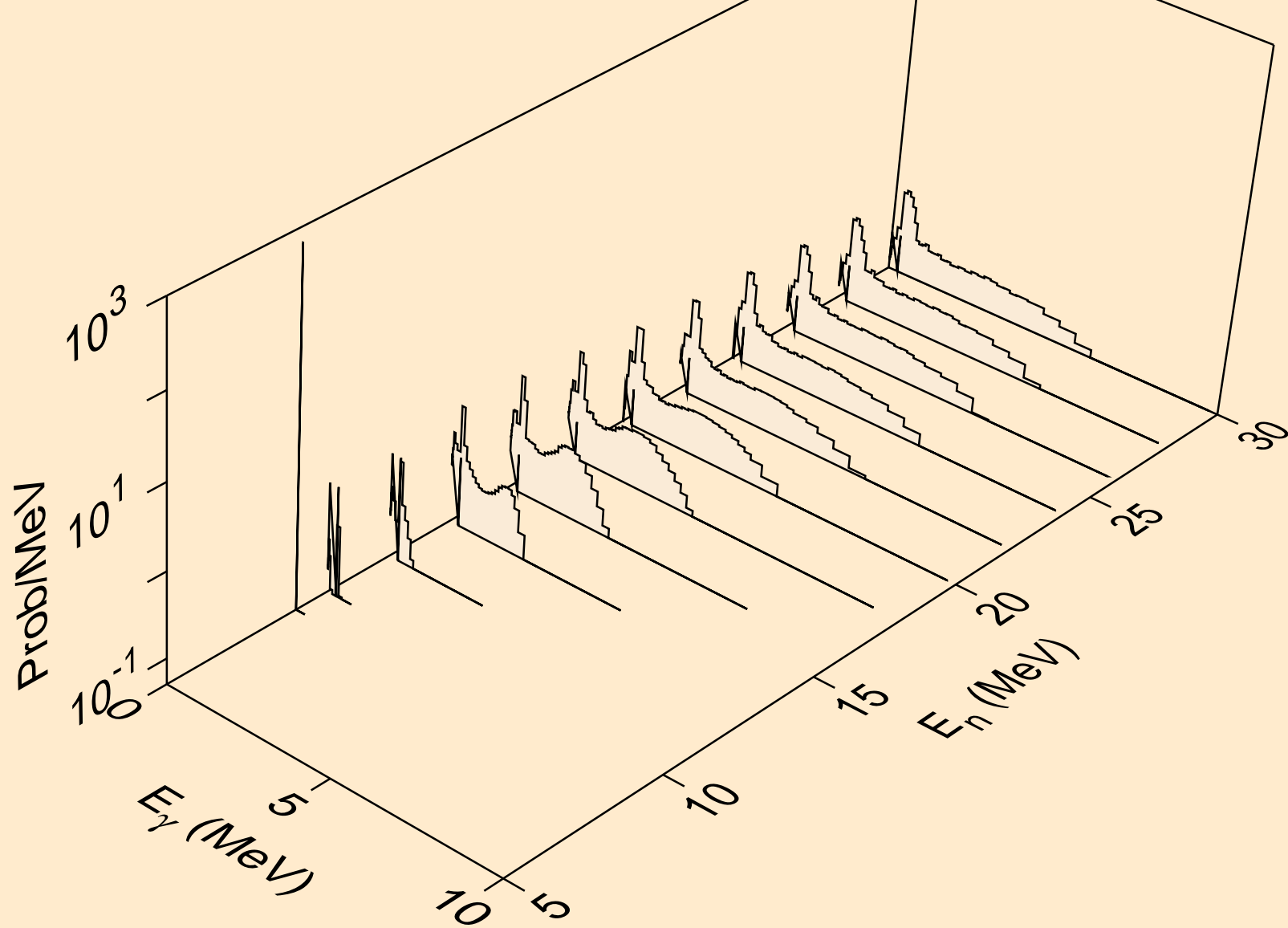

IN099 NEUTRON ACER TENDL-2021 LIBRARY; T=293.6K
Photon emission for (n,he3)

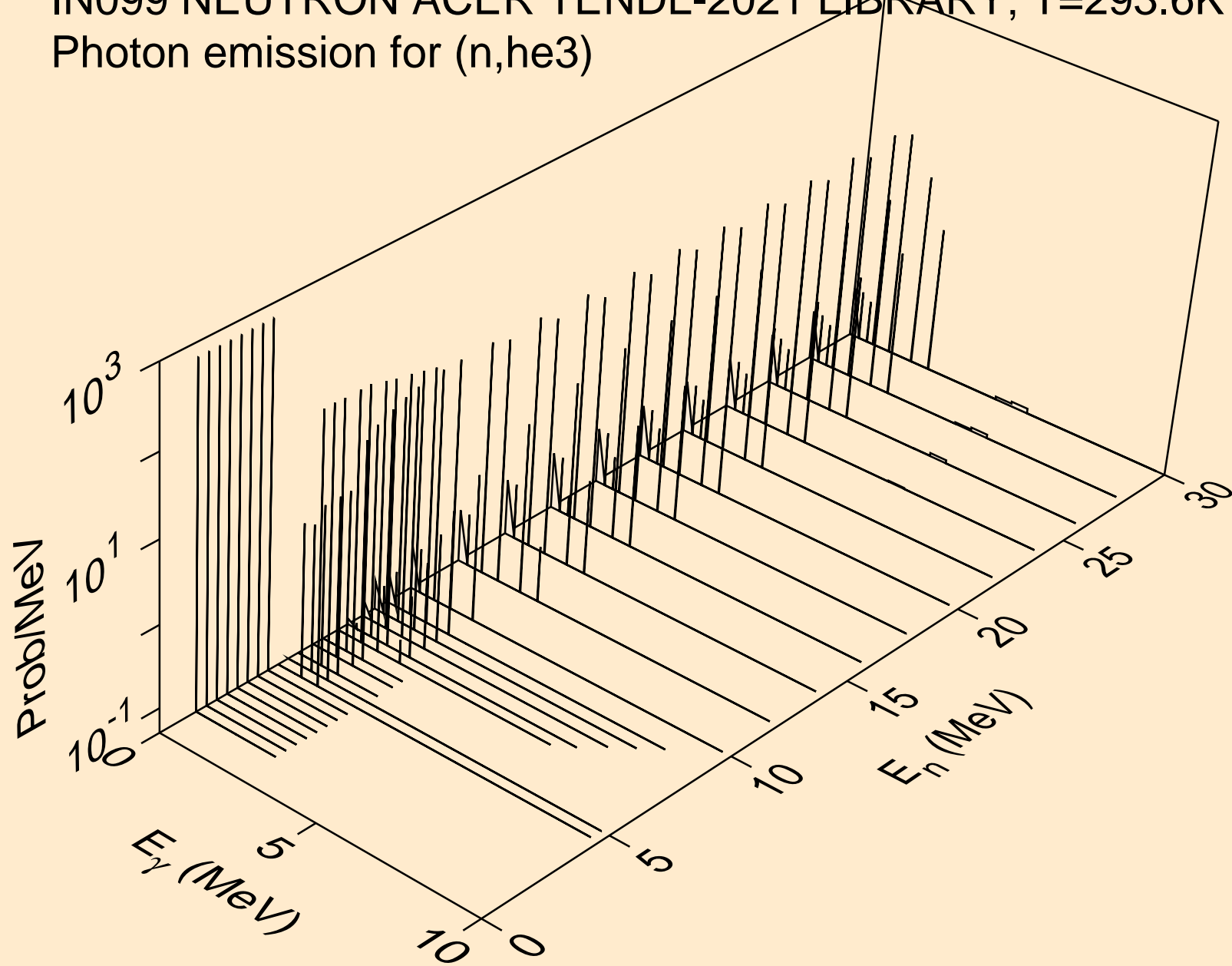

IN099 NEUTRON ACER TENDL-2021 LIBRARY; T=293.6K
Photon emission for (n,a)

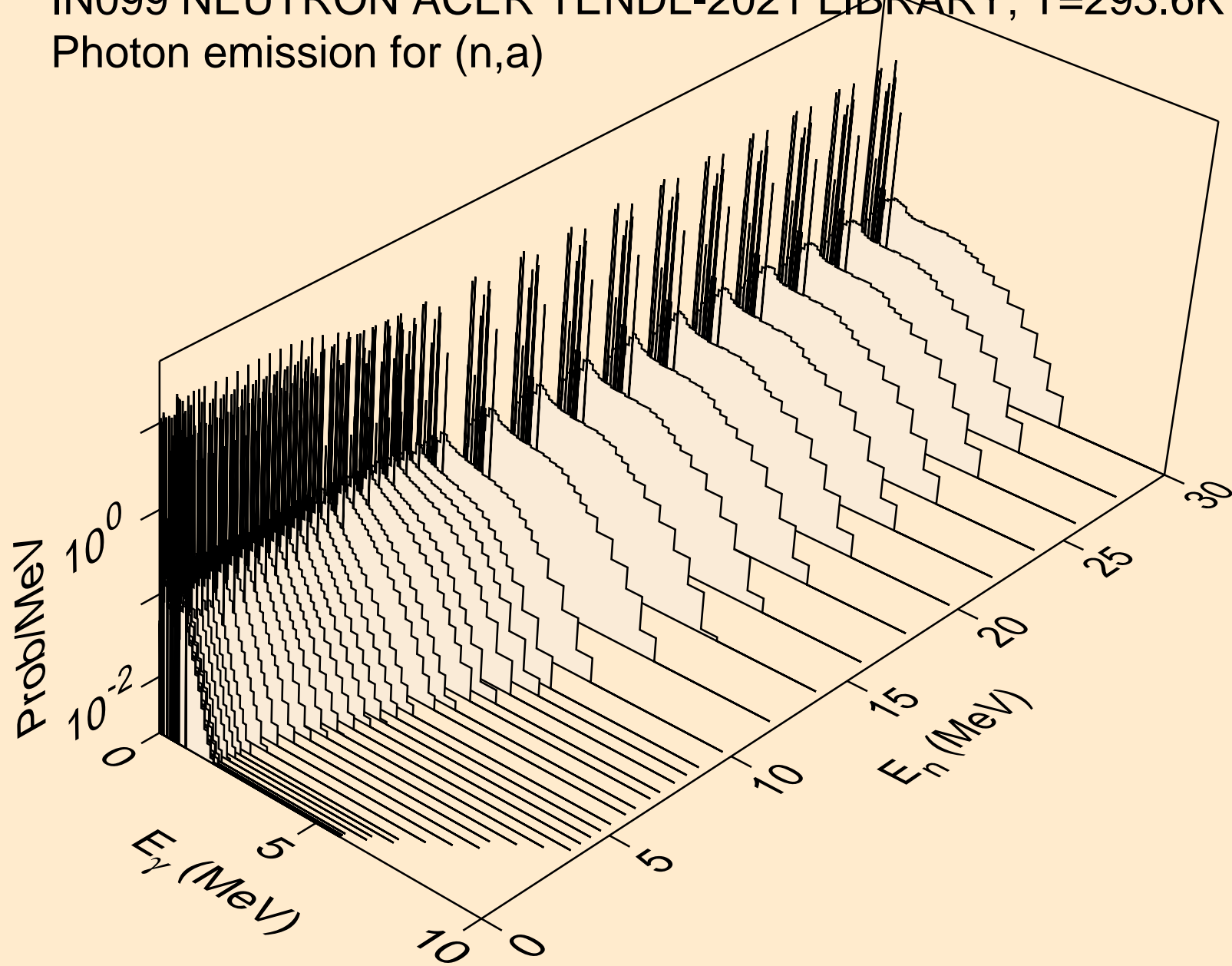

IN099 NEUTRON ACER TENDL-2021 LIBRARY; T=293.6K
Photon emission for (n,2a)

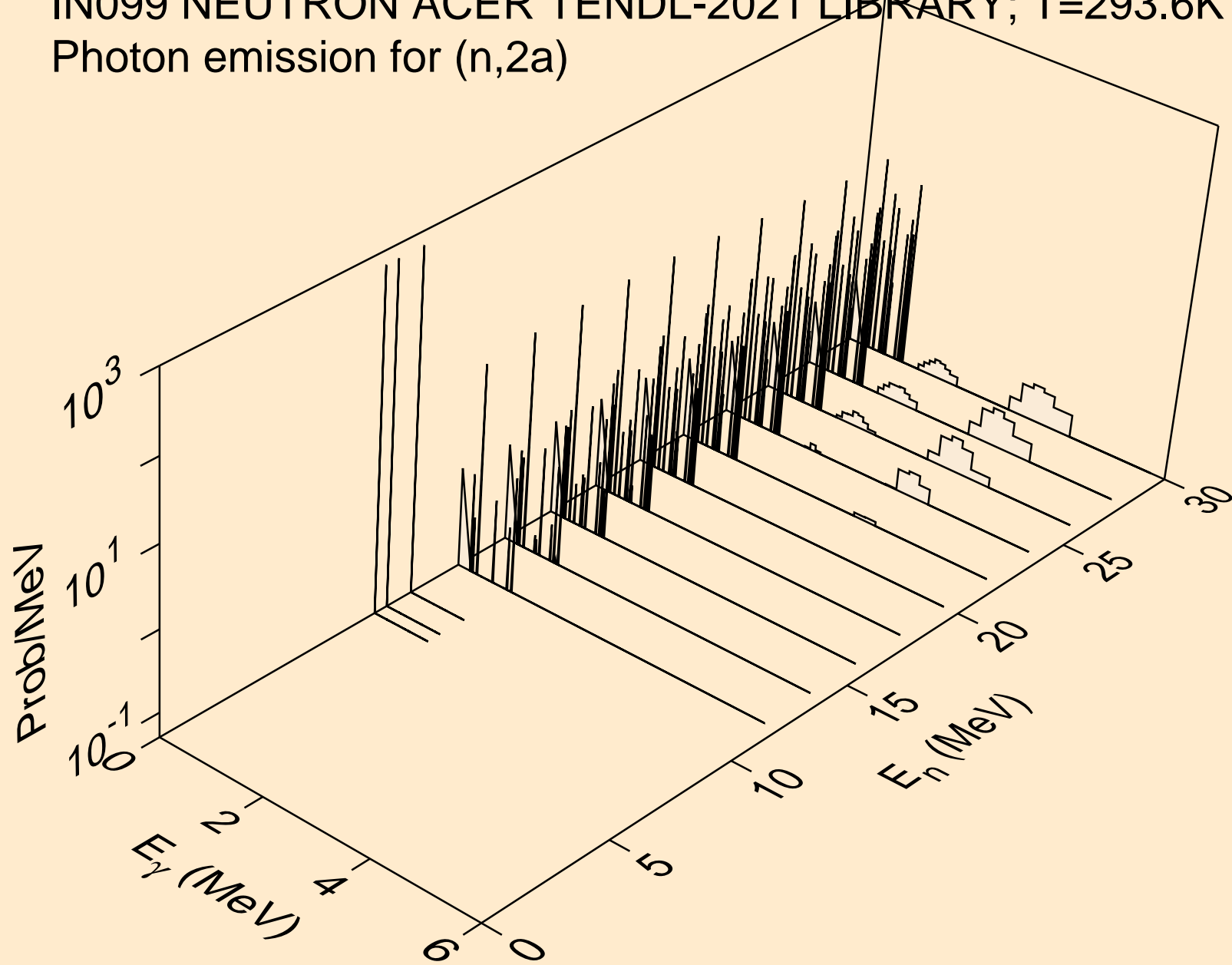

IN099 NEUTRON ACER TENDL-2021 LIBRARY; T=293.6K
Photon emission for (n,2p)

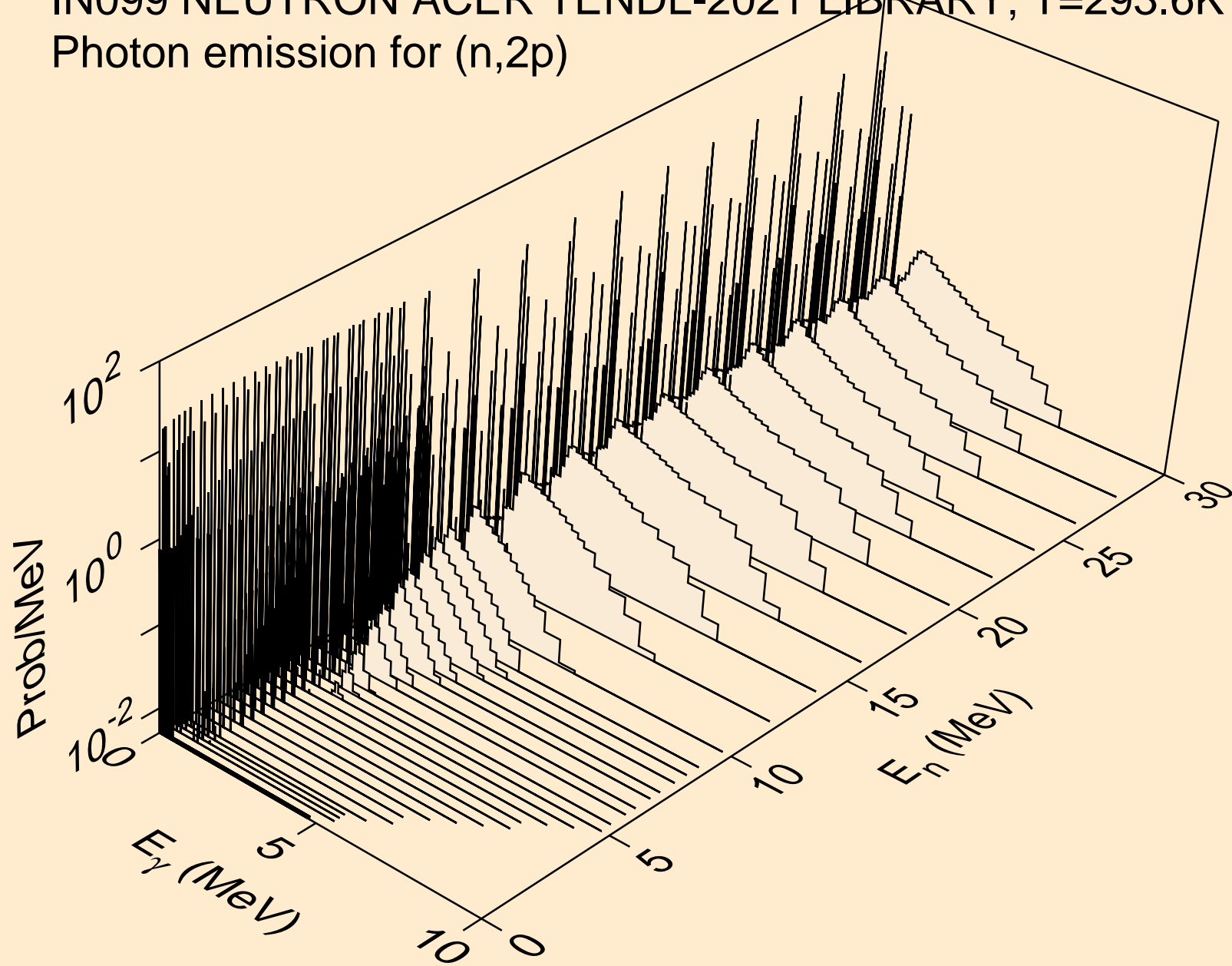

IN099 NEUTRON ACER TENDL-2021 LIBRARY; T=293.6K
Photon emission for (n,p α)

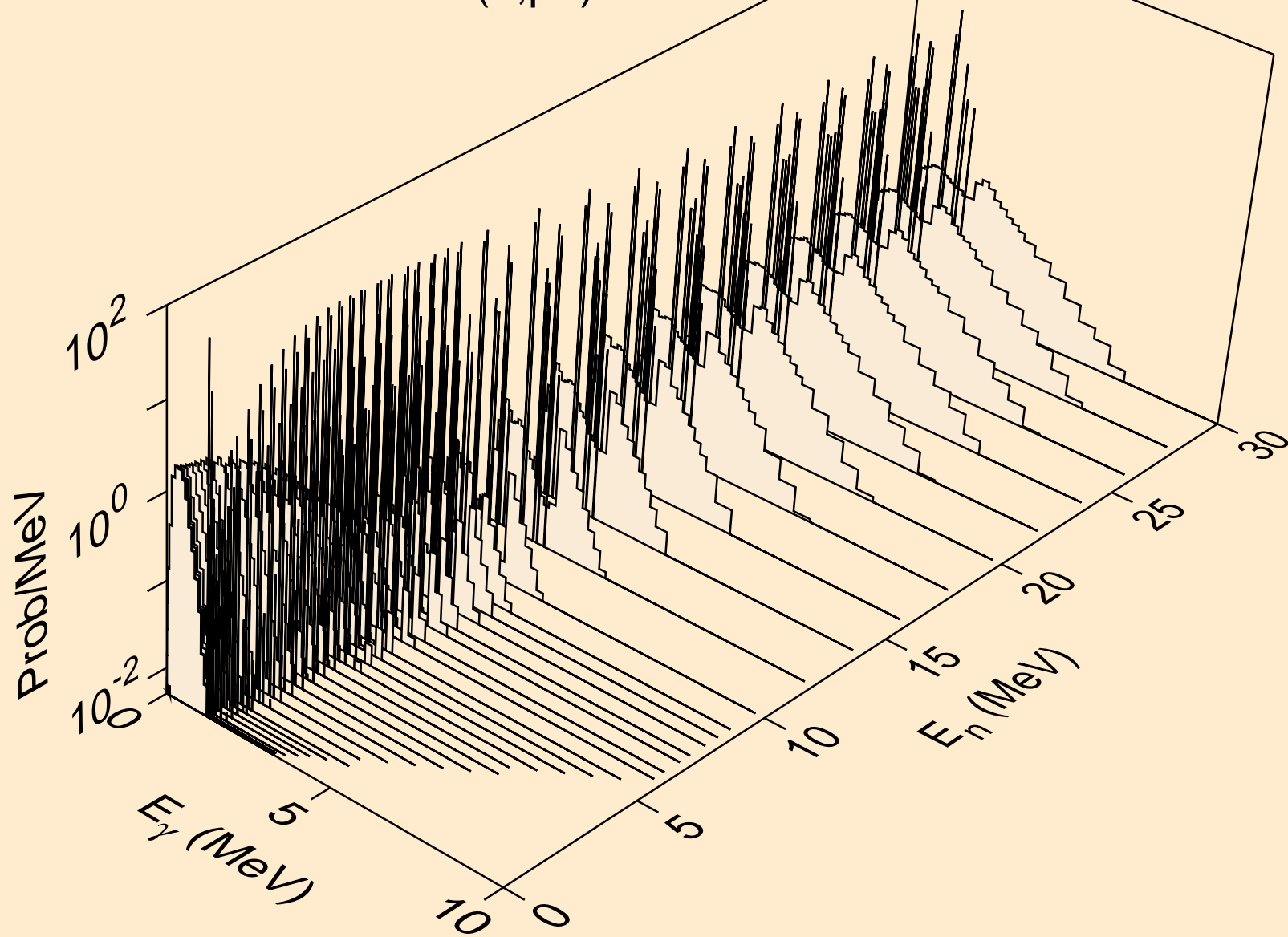

IN099 NEUTRON ACER TENDL-2021 LIBRARY; T=293.6K
Photon emission for (n,pd)

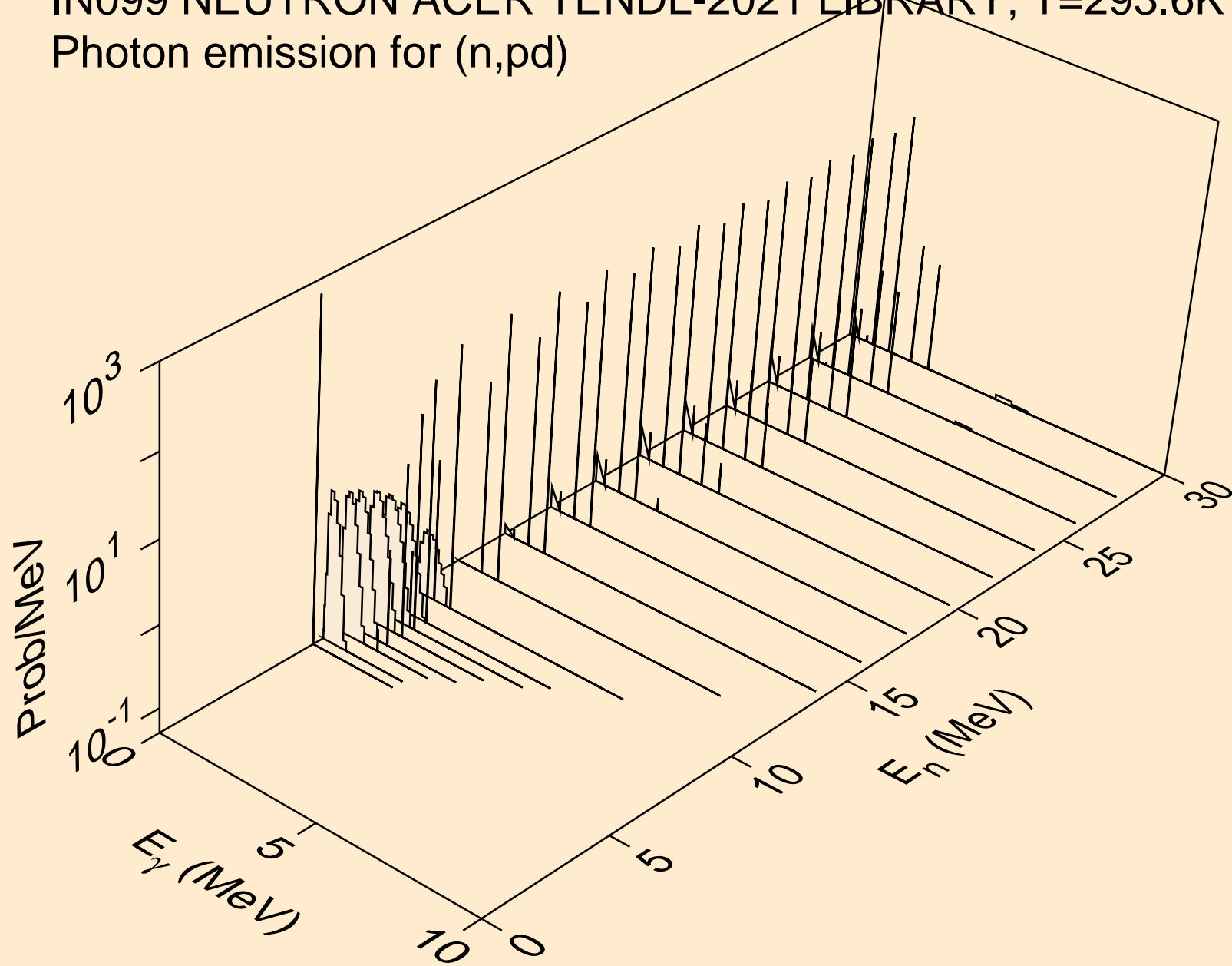

IN099 NEUTRON ACER TENDL-2021 LIBRARY; T=293.6K
Photon emission for (n,pt)

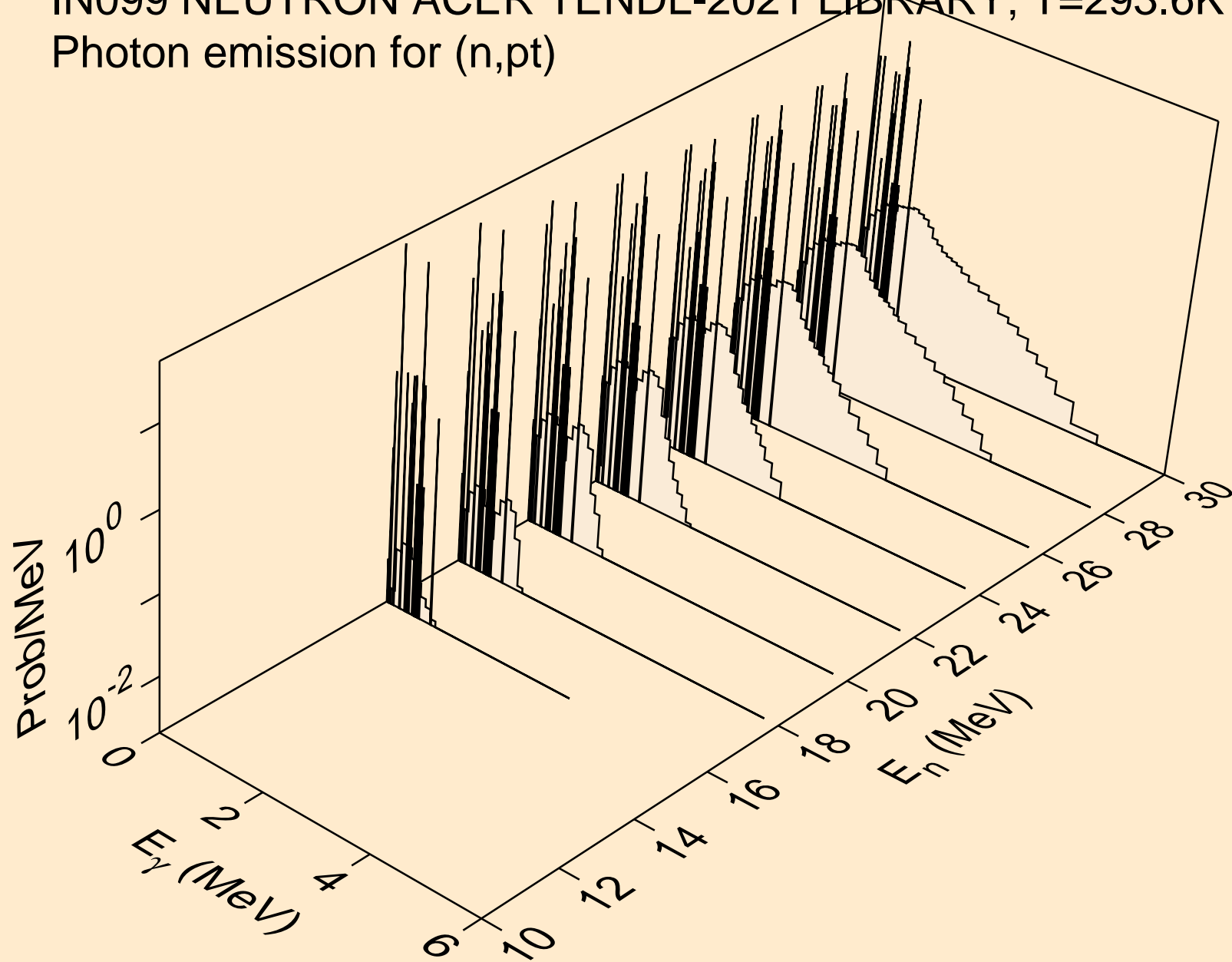

IN099 NEUTRON ACER TENDL-2021 LIBRARY; T=293.6K
Photon emission for (n,da)

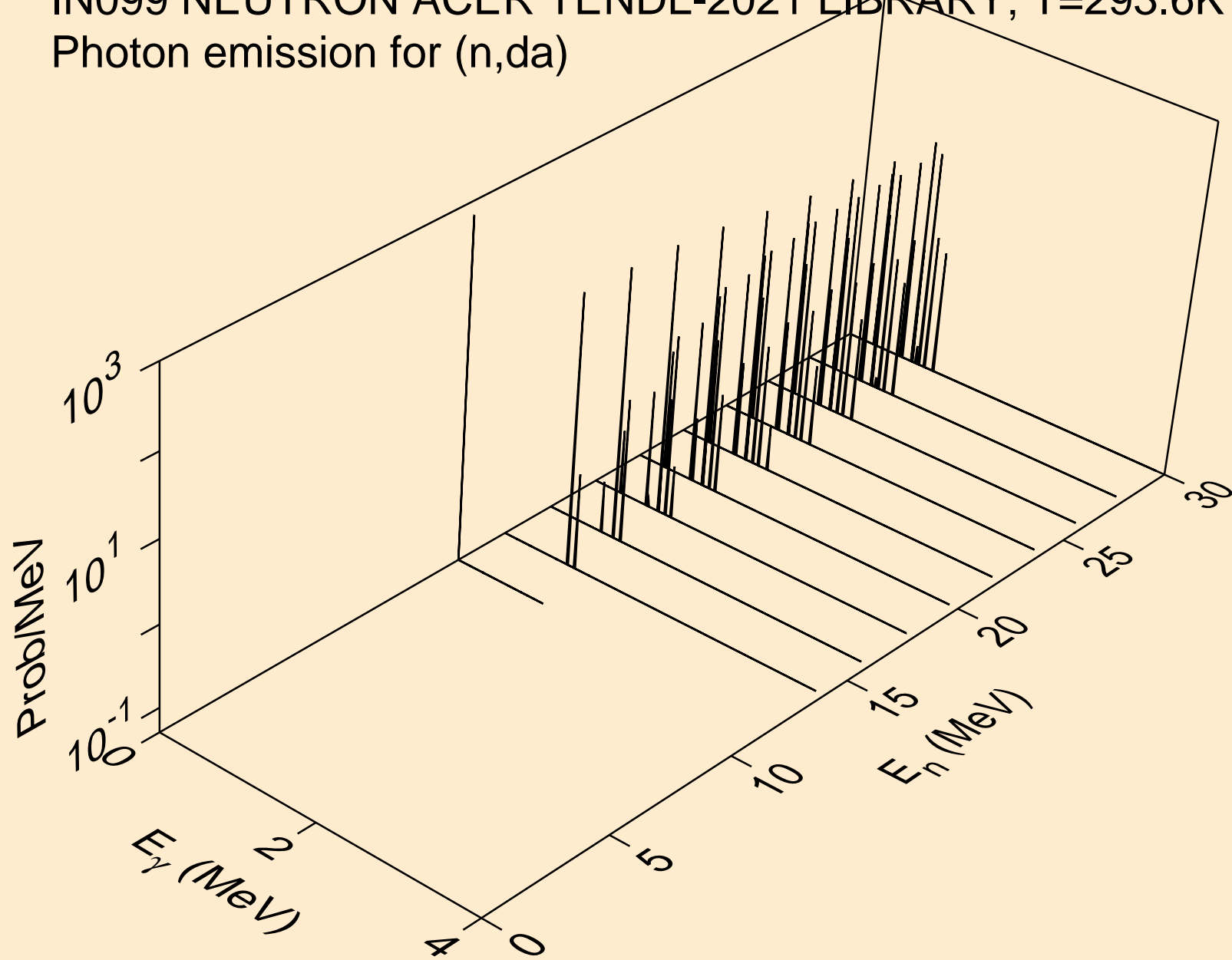

IN099 NEUTRON ACER TENDL-2021 LIBRARY; T=293.6K
thermal capture photon spectrum

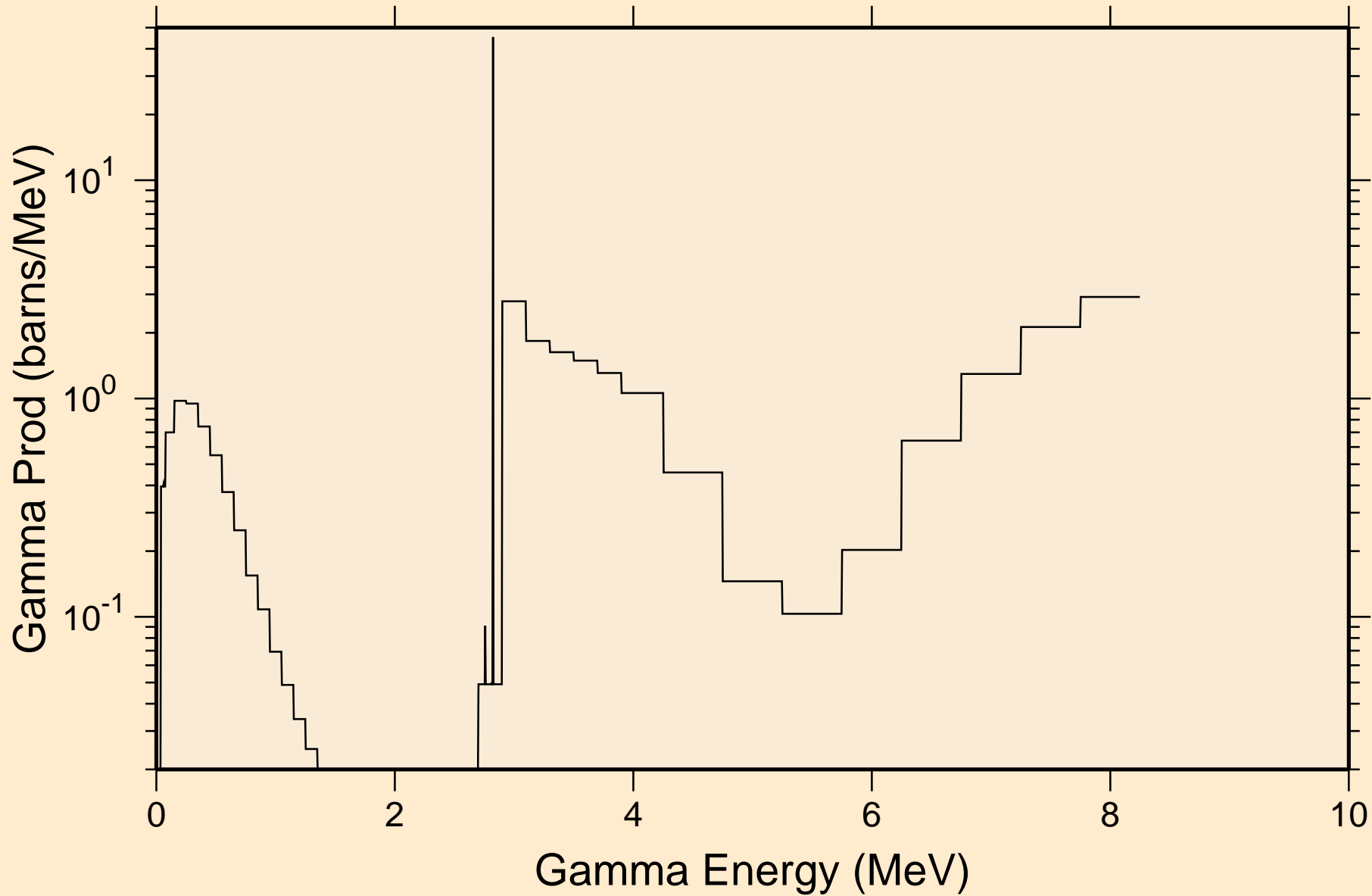

IN099 NEUTRON ACER TENDL-2021 LIBRARY; T=293.6K
14 MeV photon spectrum

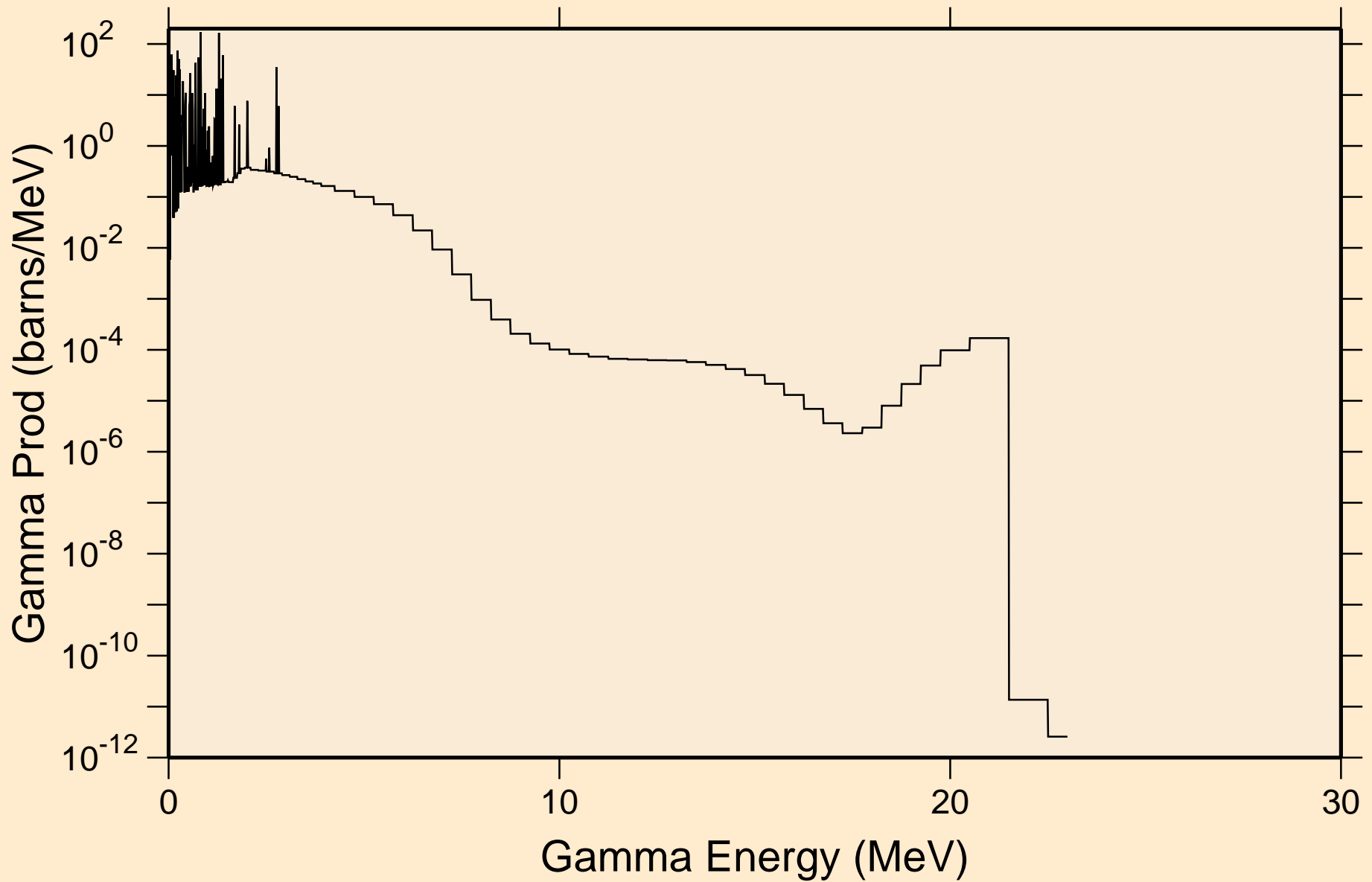

IN099 NEUTRON ACER TENDL-2021 LIBRARY; T=293.6K
Particle heating contributions

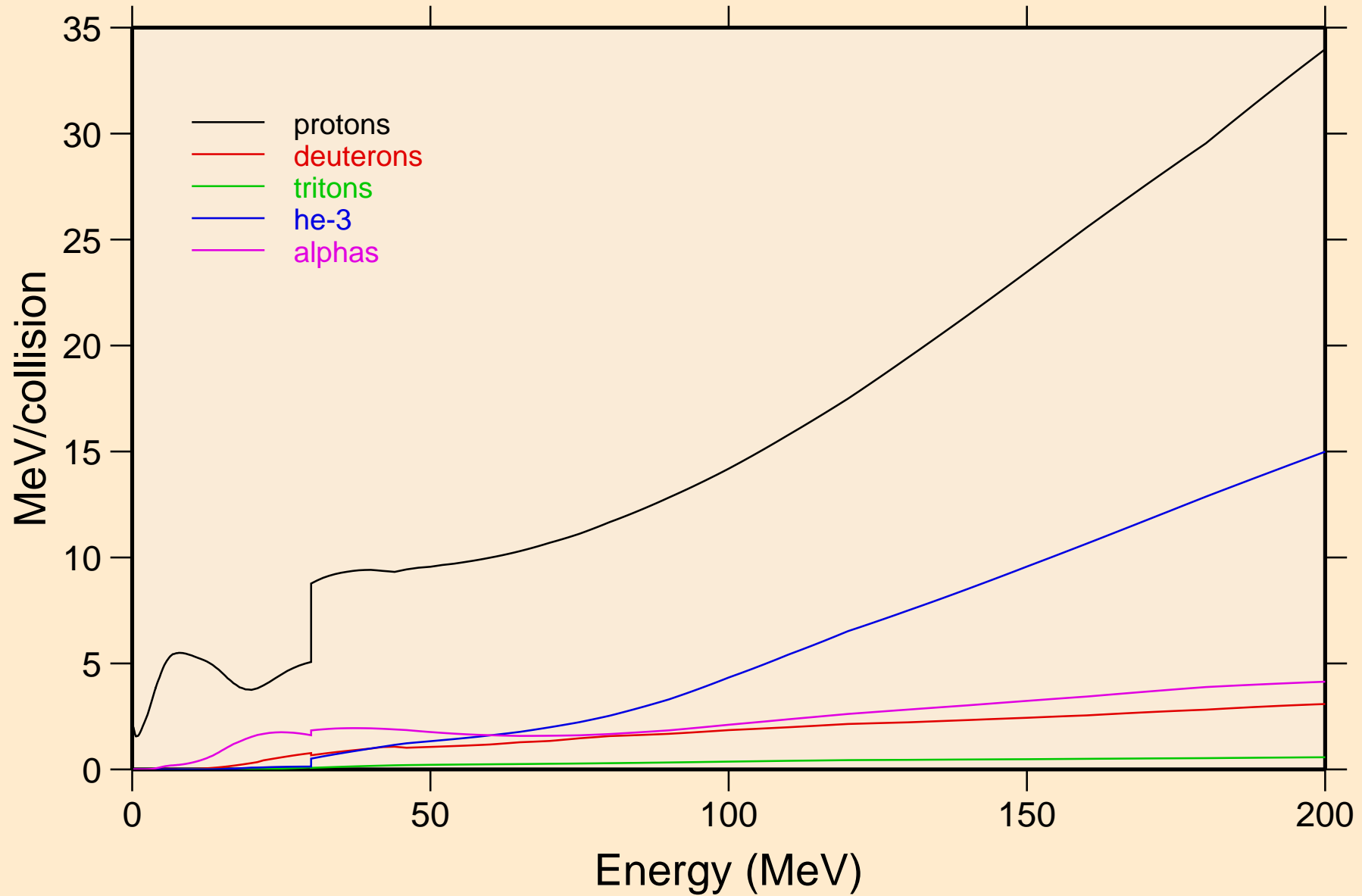

IN099 NEUTRON ACER TENDL-2021 LIBRARY; T=293.6K
Recoil Heating

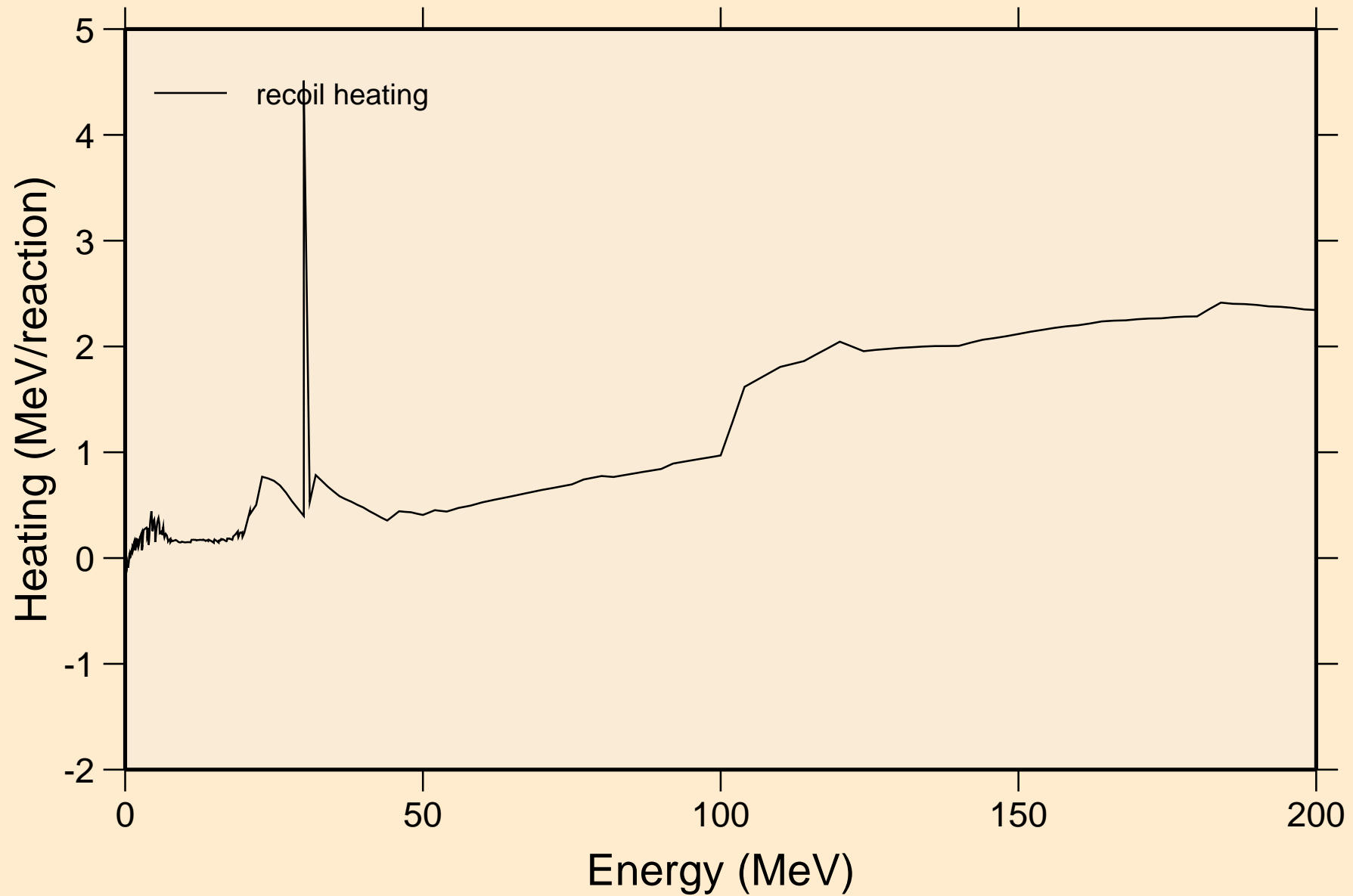

IN099 NEUTRON ACER TENDL-2021 LIBRARY; T=293.6K
Particle production cross sections

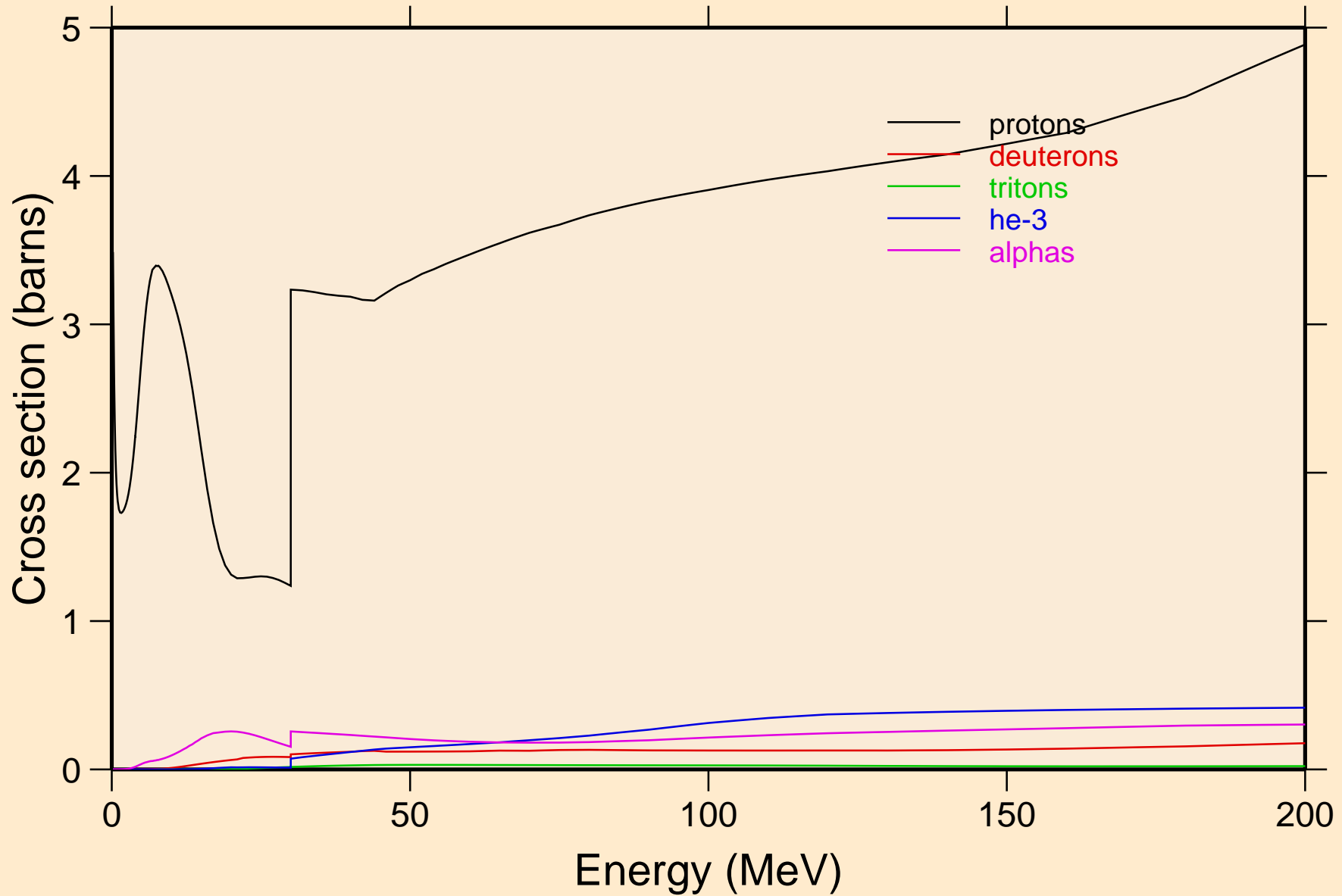

IN099 NEUTRON ACER TENDL-2021 LIBRARY; T=293.6K
protons from (n,x)

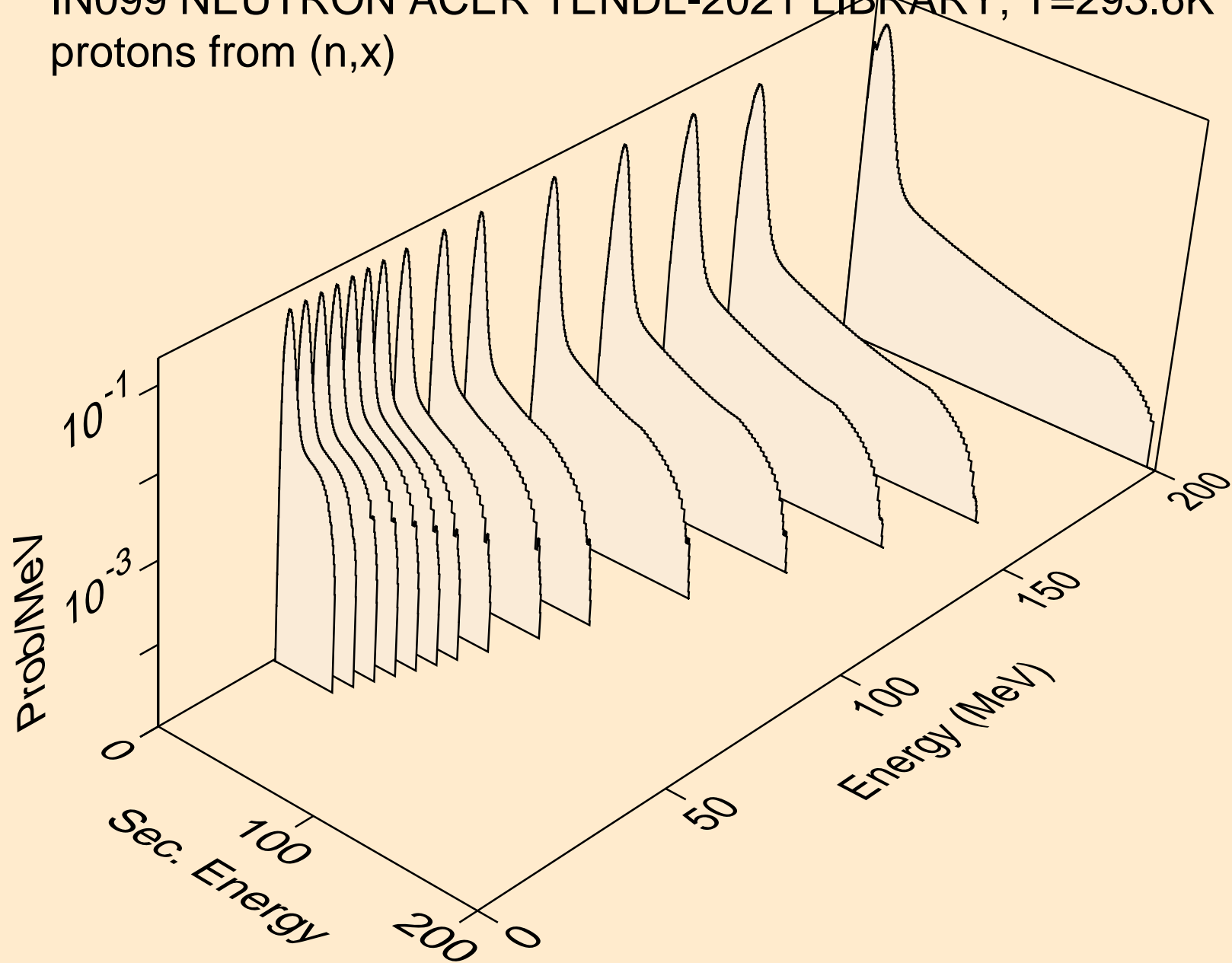

IN099 NEUTRON ACER TENDL-2021 LIBRARY; T=293.6K
protons from (n,n*)p

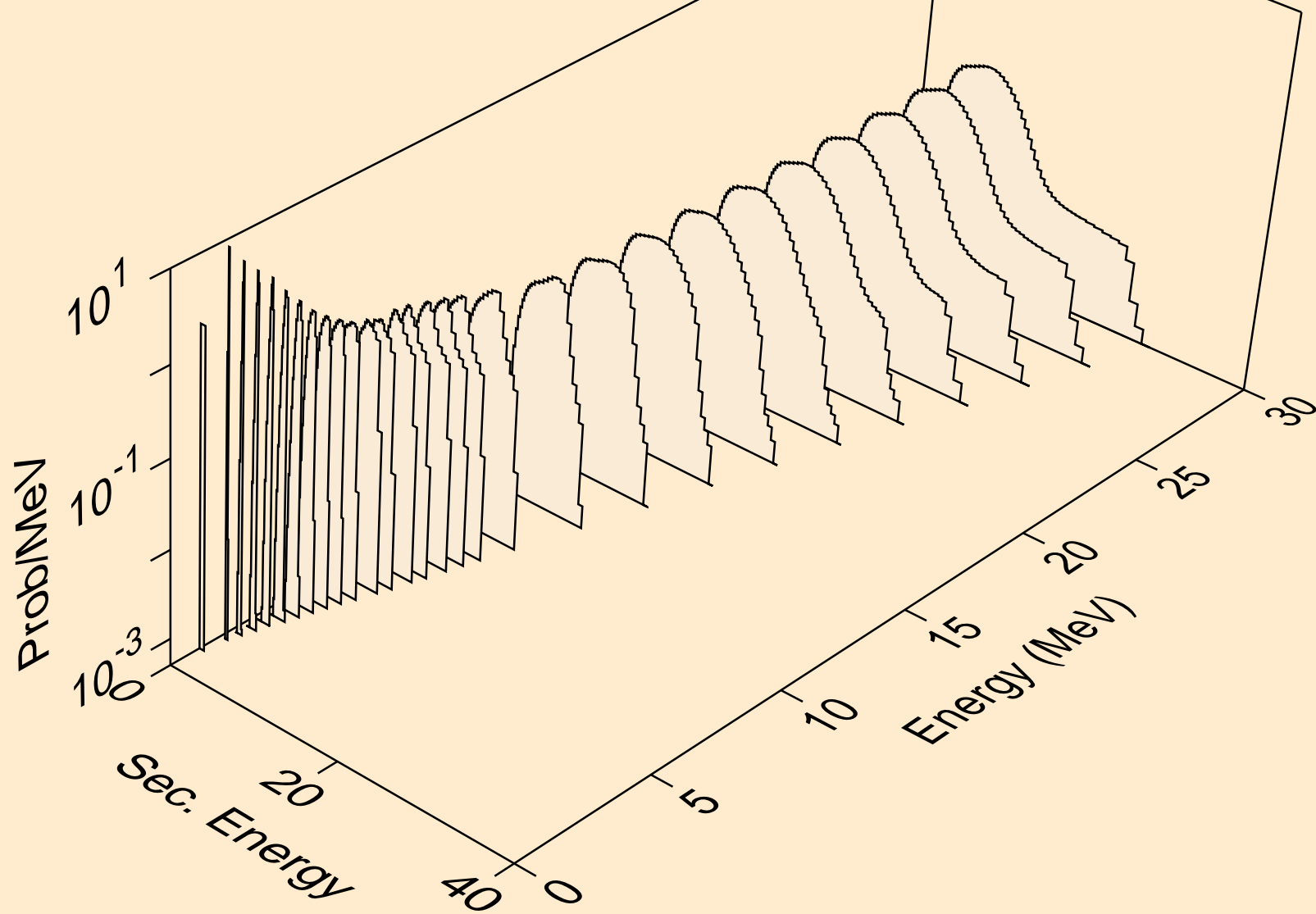

IN099 NEUTRON ACER TENDL-2021 LIBRARY; T=293.6K
protons from (n,2np)

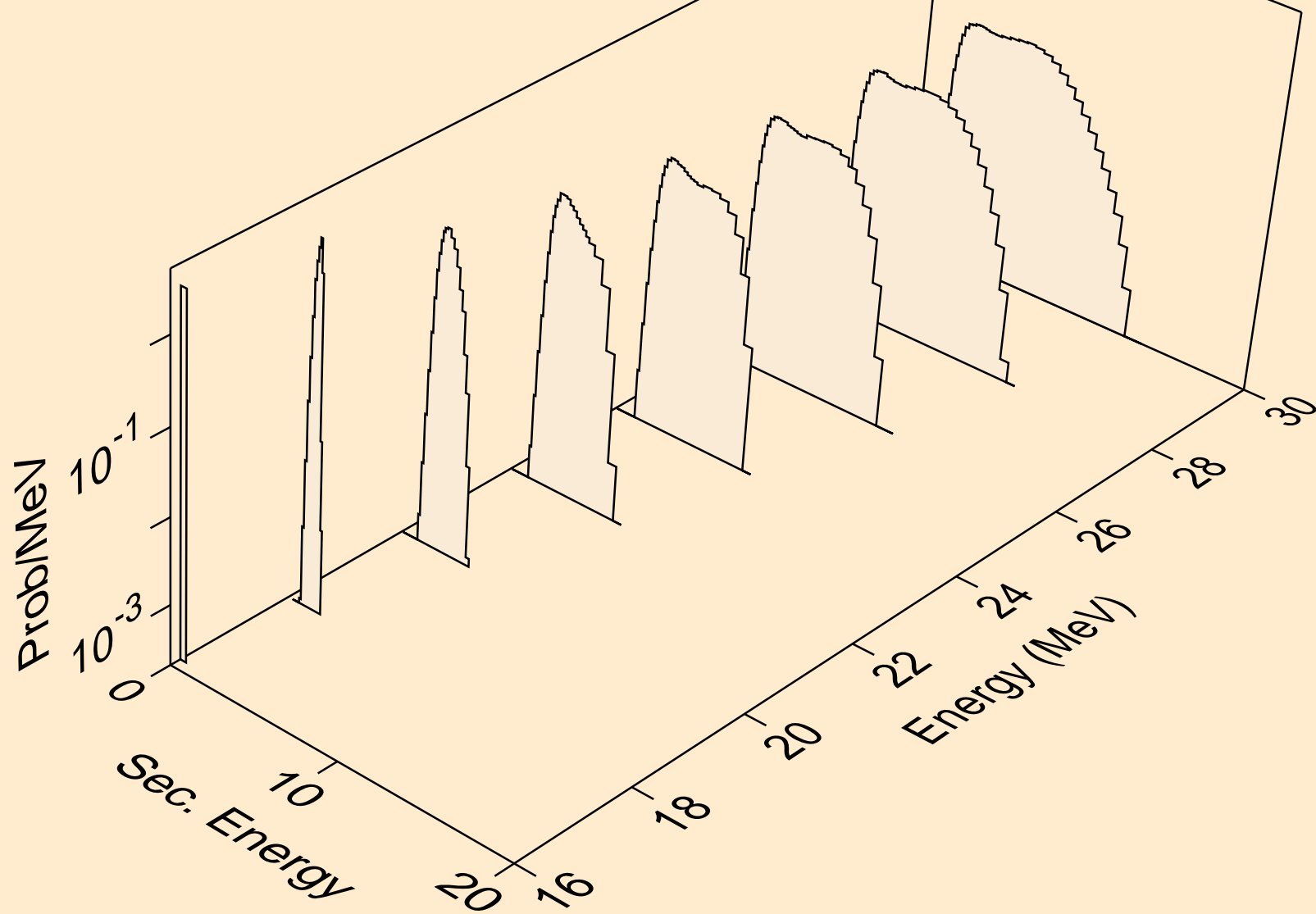

IN099 NEUTRON ACER TENDL-2021 LIBRARY; T=293.6K
protons from (n,2np)

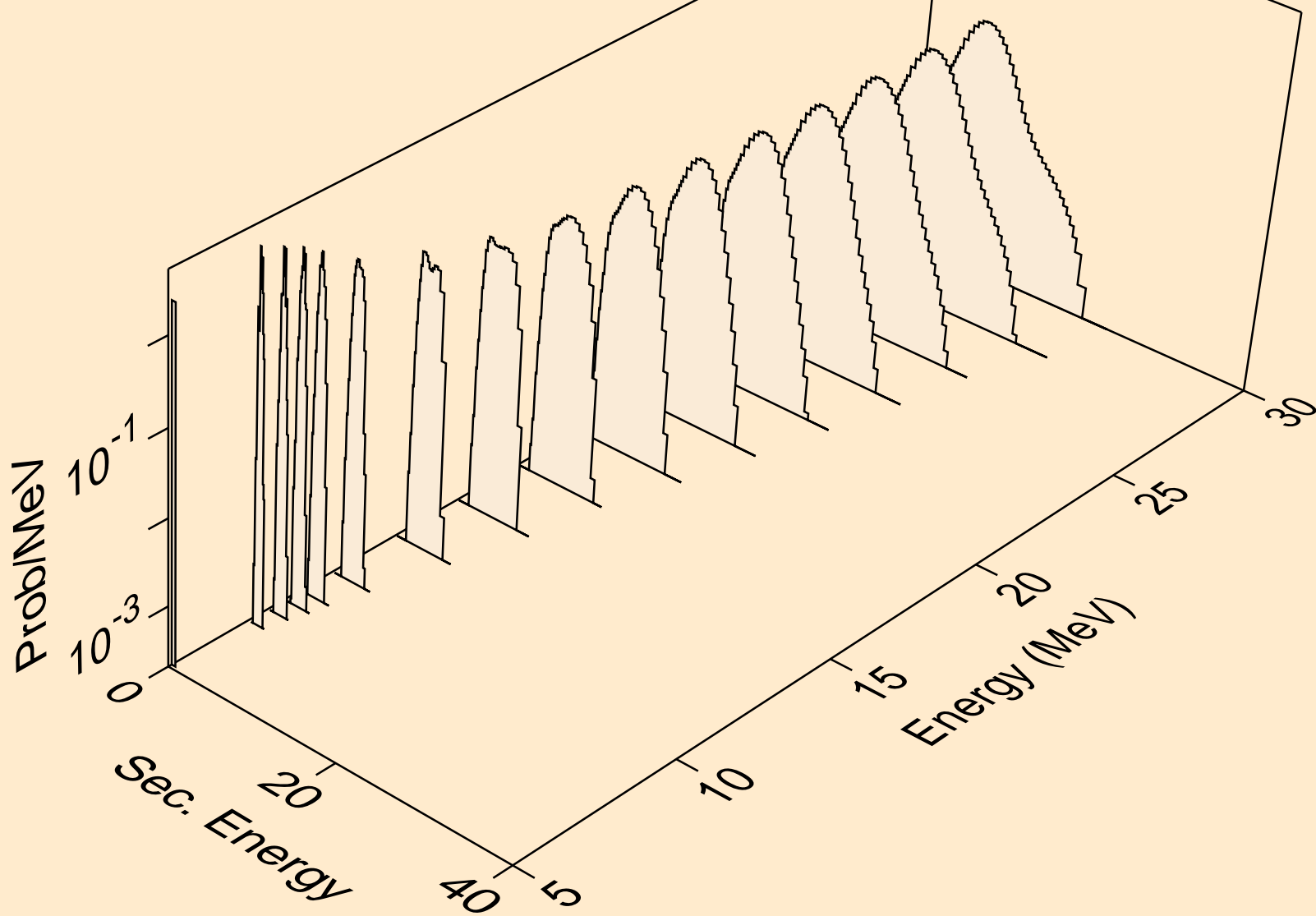

IN099 NEUTRON ACER TENDL-2021 LIBRARY; T=293.6K
protons from (n,npa)

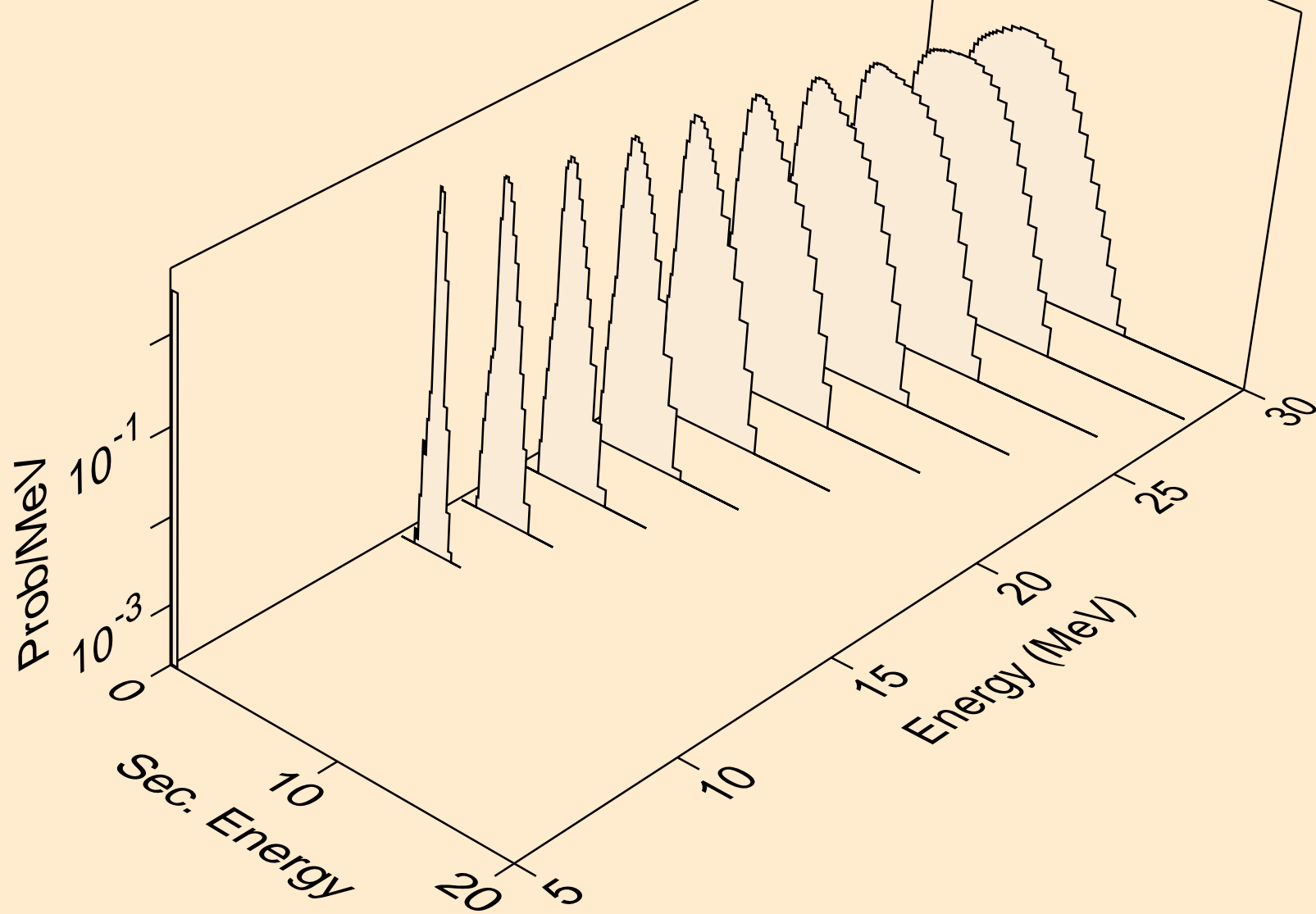

IN099 NEUTRON ACER TENDL-2021 LIBRARY; T=293.6K
protons from (n,p)

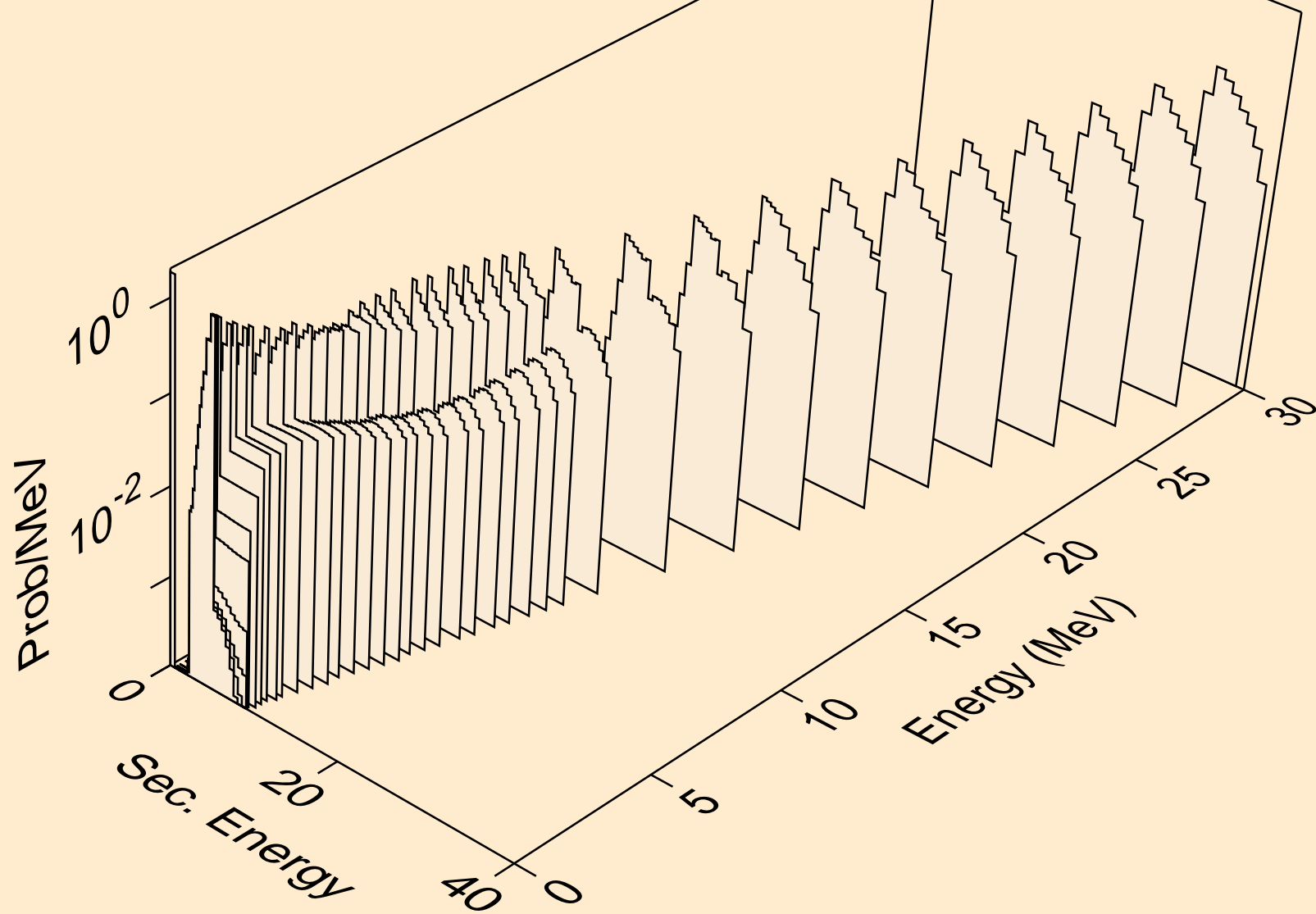

IN099 NEUTRON ACER TENDL-2021 LIBRARY; T=293.6K
protons from (n,2p)

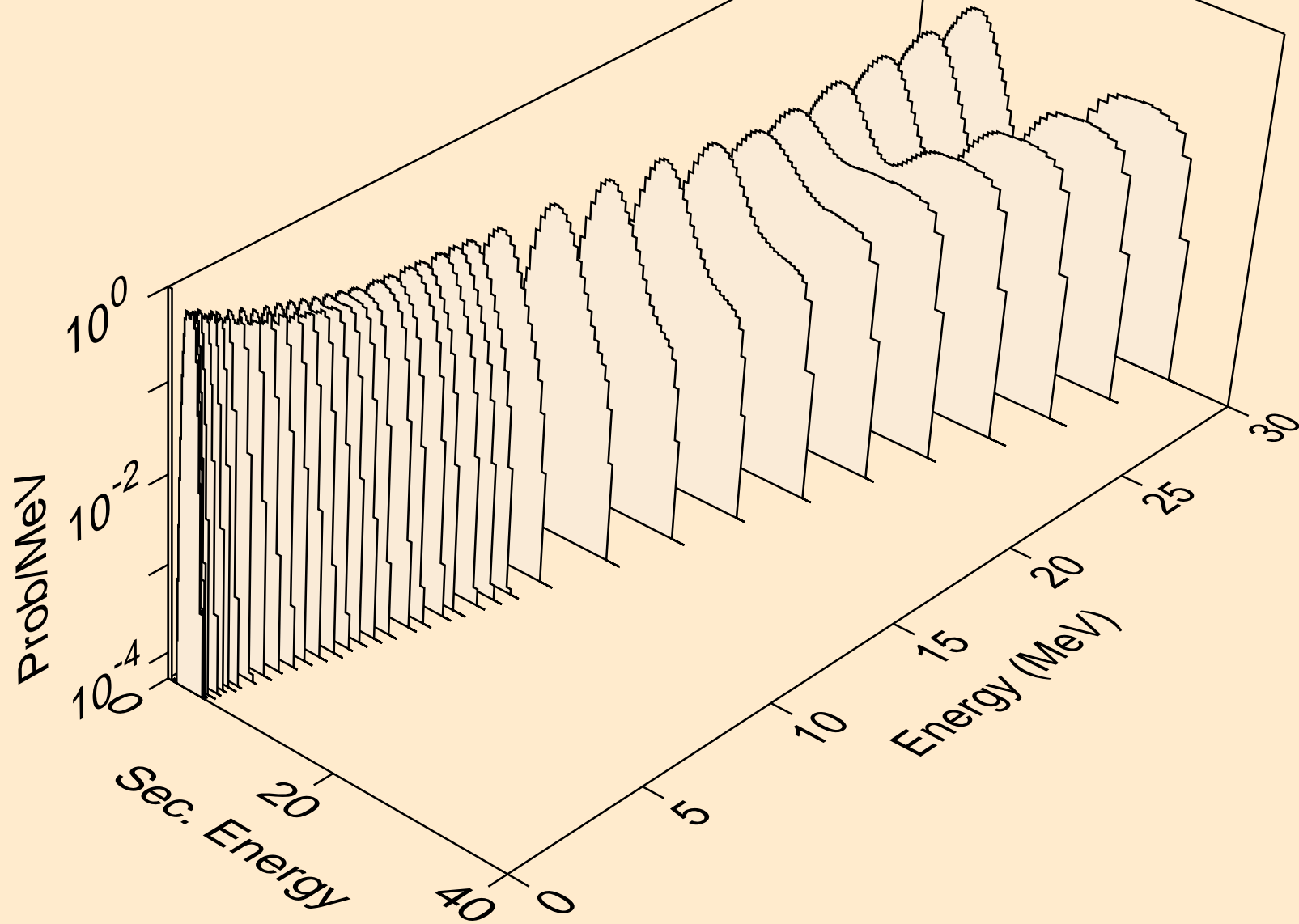

IN099 NEUTRON ACER TENDL-2021 LIBRARY; T=293.6K
protons from (n,p)

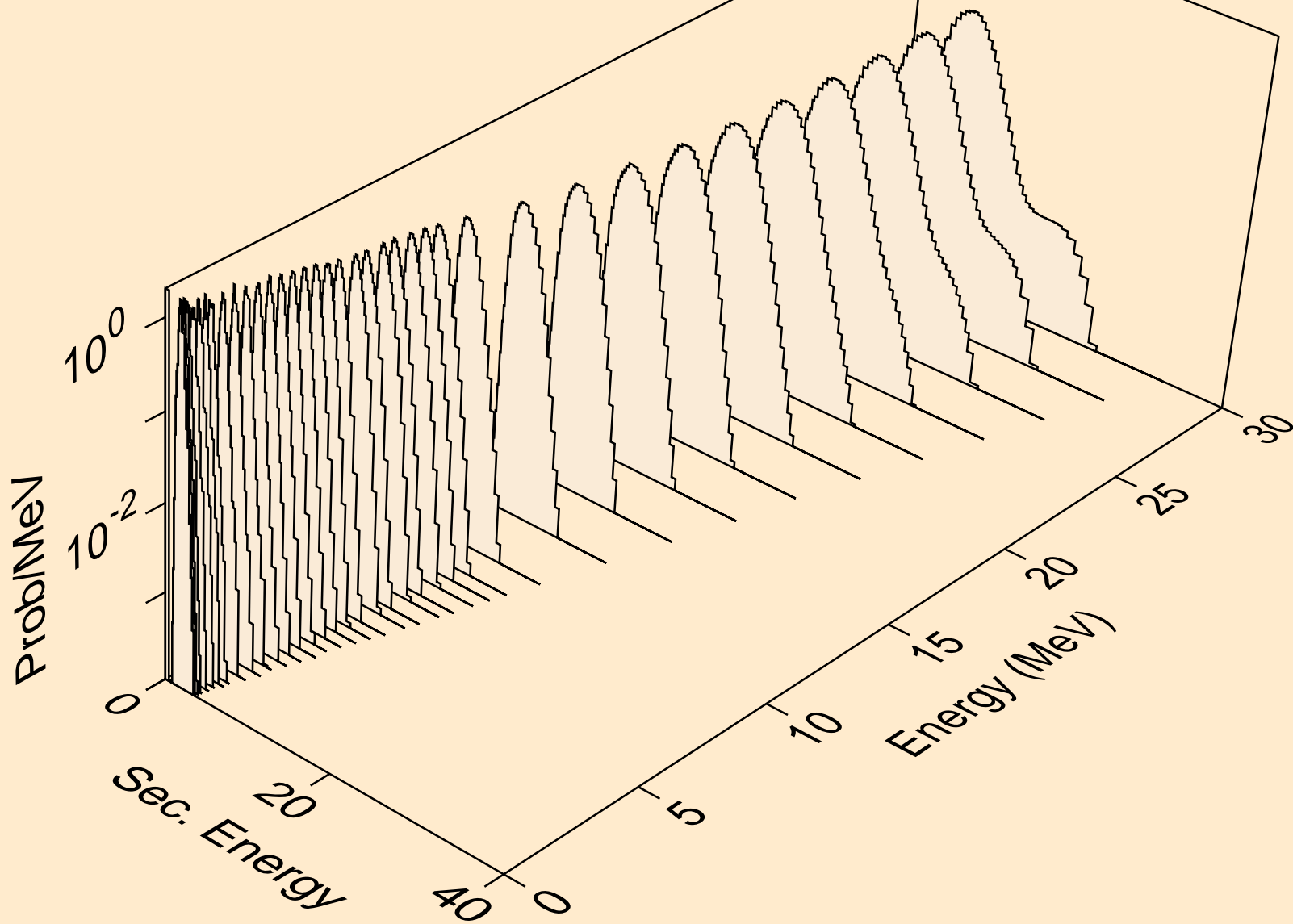

IN099 NEUTRON ACER TENDL-2021 LIBRARY; T=293.6K
protons from (n,pd)

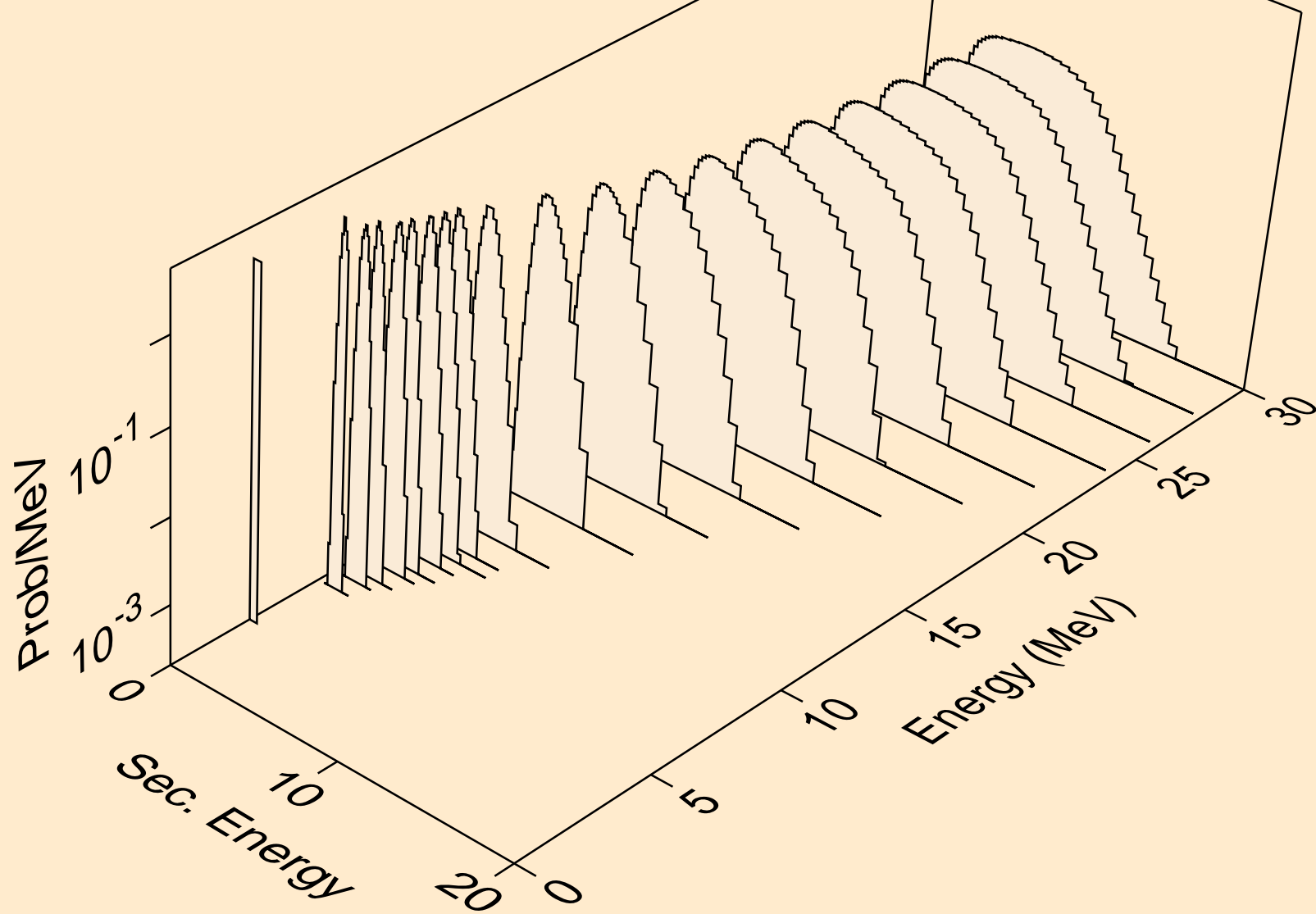

IN099 NEUTRON ACER TENDL-2021 LIBRARY; T=293.6K
protons from (n,pt)

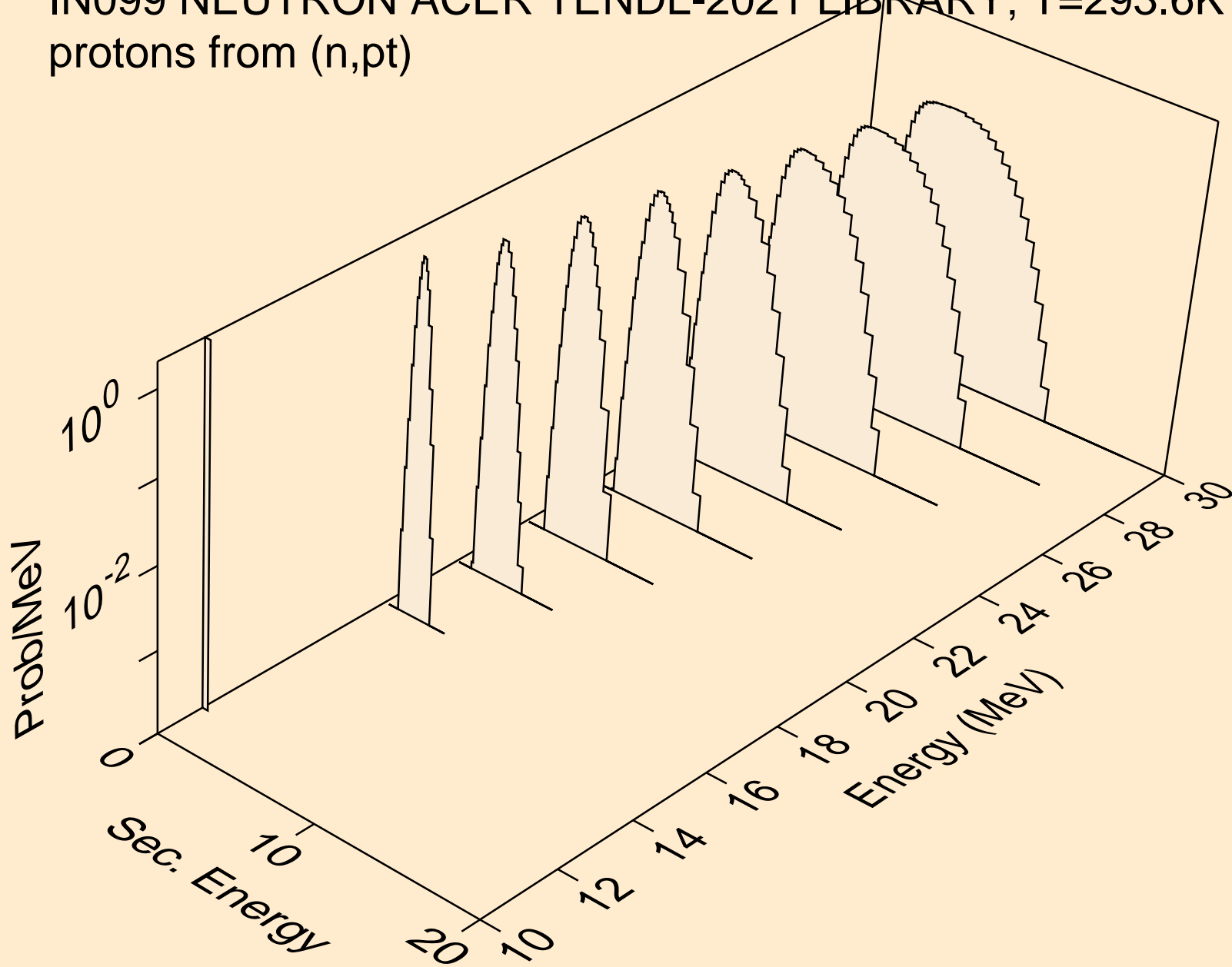

IN099 NEUTRON ACER TENDL-2021 LIBRARY; T=293.6K
deuterons from (n,x)

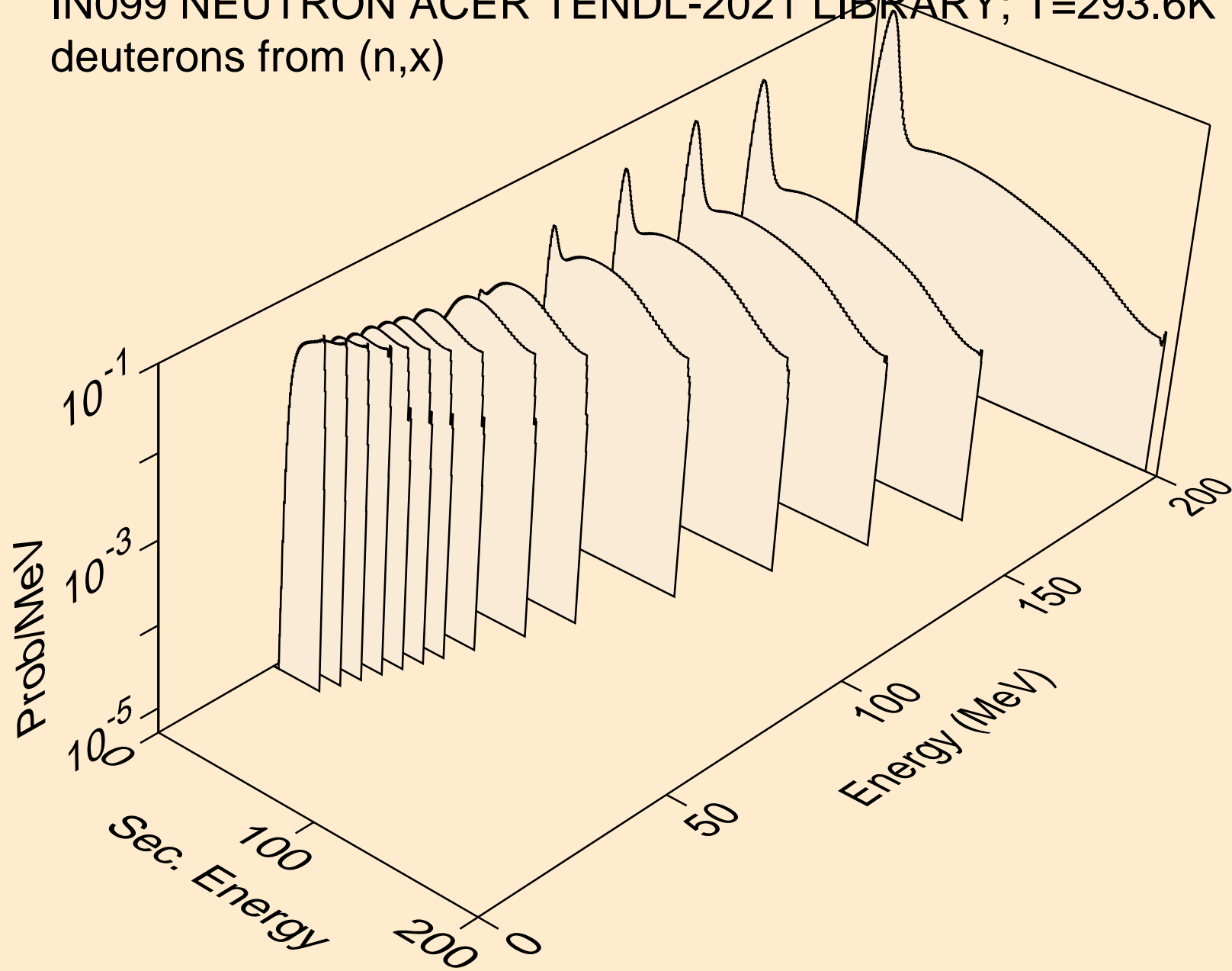

IN099 NEUTRON ACER TENDL-2021 LIBRARY; T=293.6K
deuterons from (n,n*)d

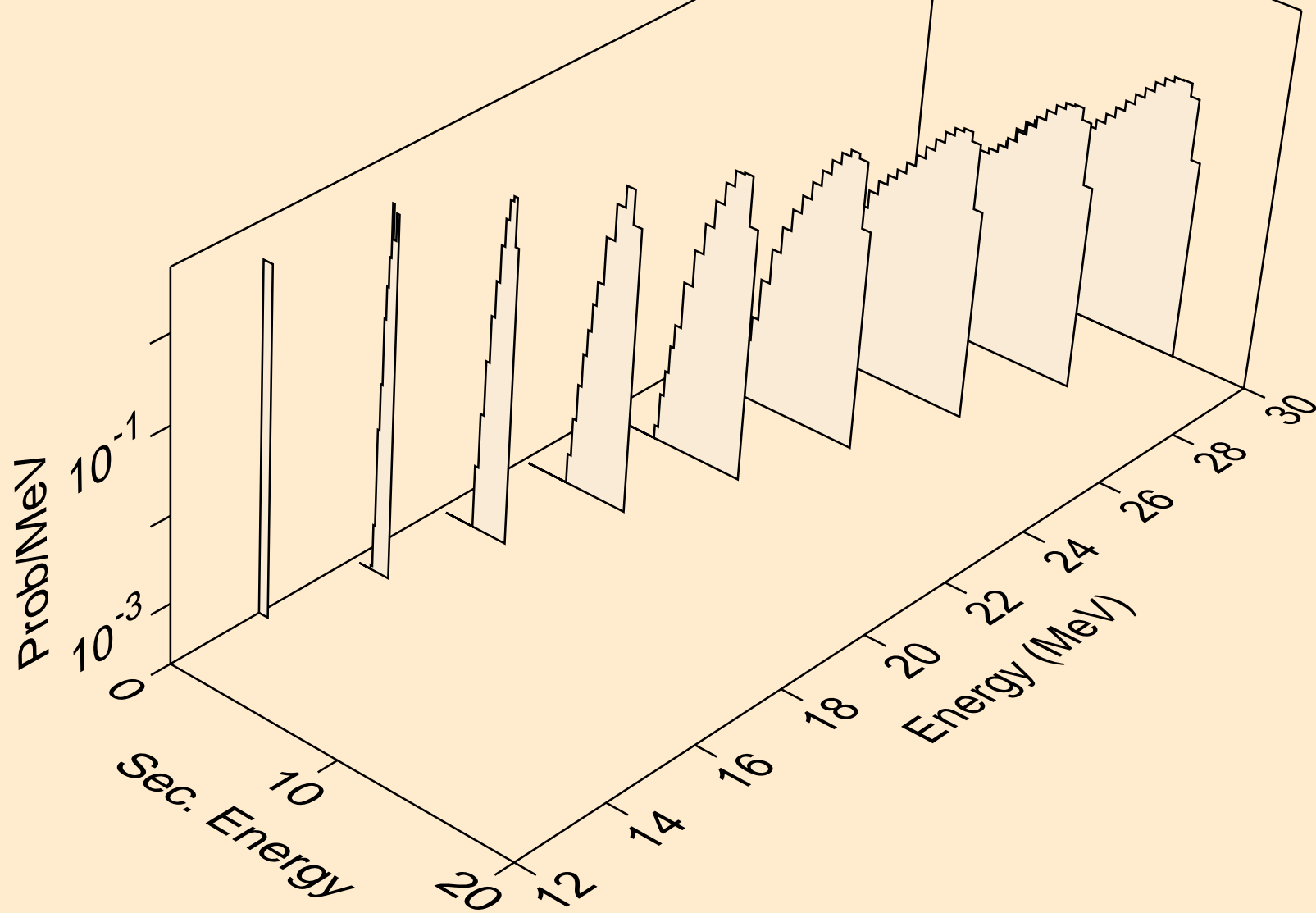

IN099 NEUTRON ACER TENDL-2021 LIBRARY; T=293.6K
deuterons from (n,d)

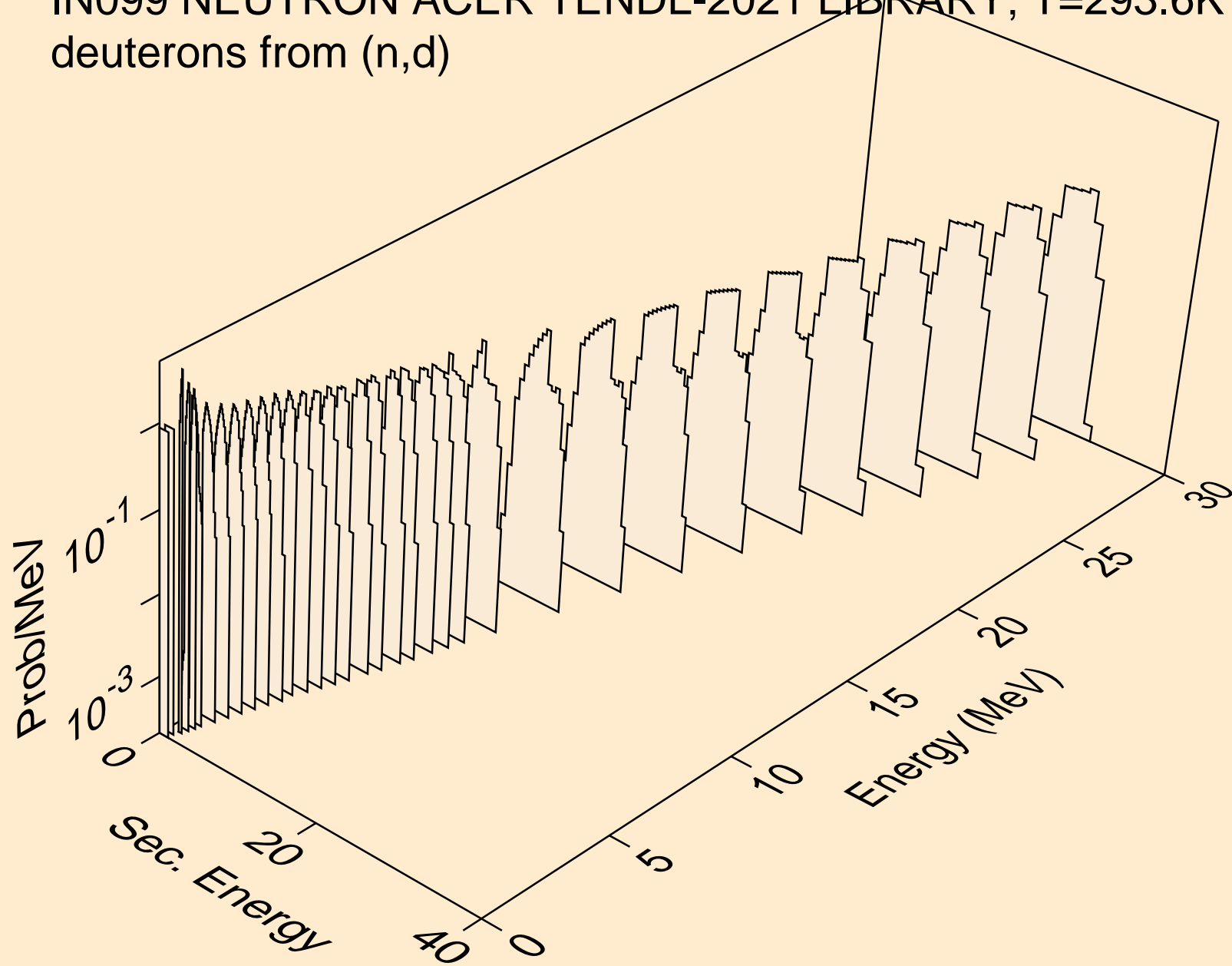

IN099 NEUTRON ACER TENDL-2021 LIBRARY; T=293.6K
deuterons from (n,pd)

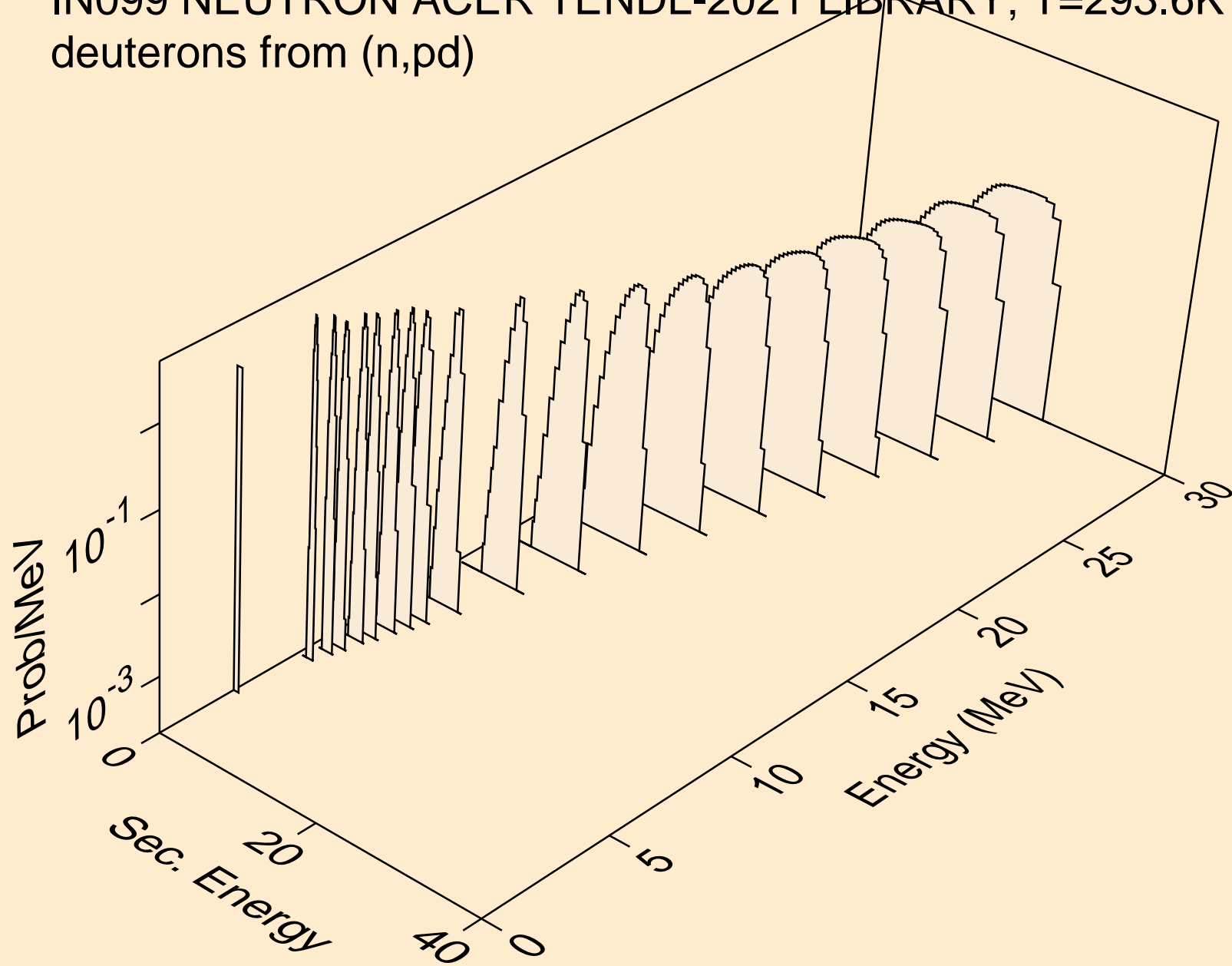

IN099 NEUTRON ACER TENDL-2021 LIBRARY; T=293.6K
deuterons from (n,da)

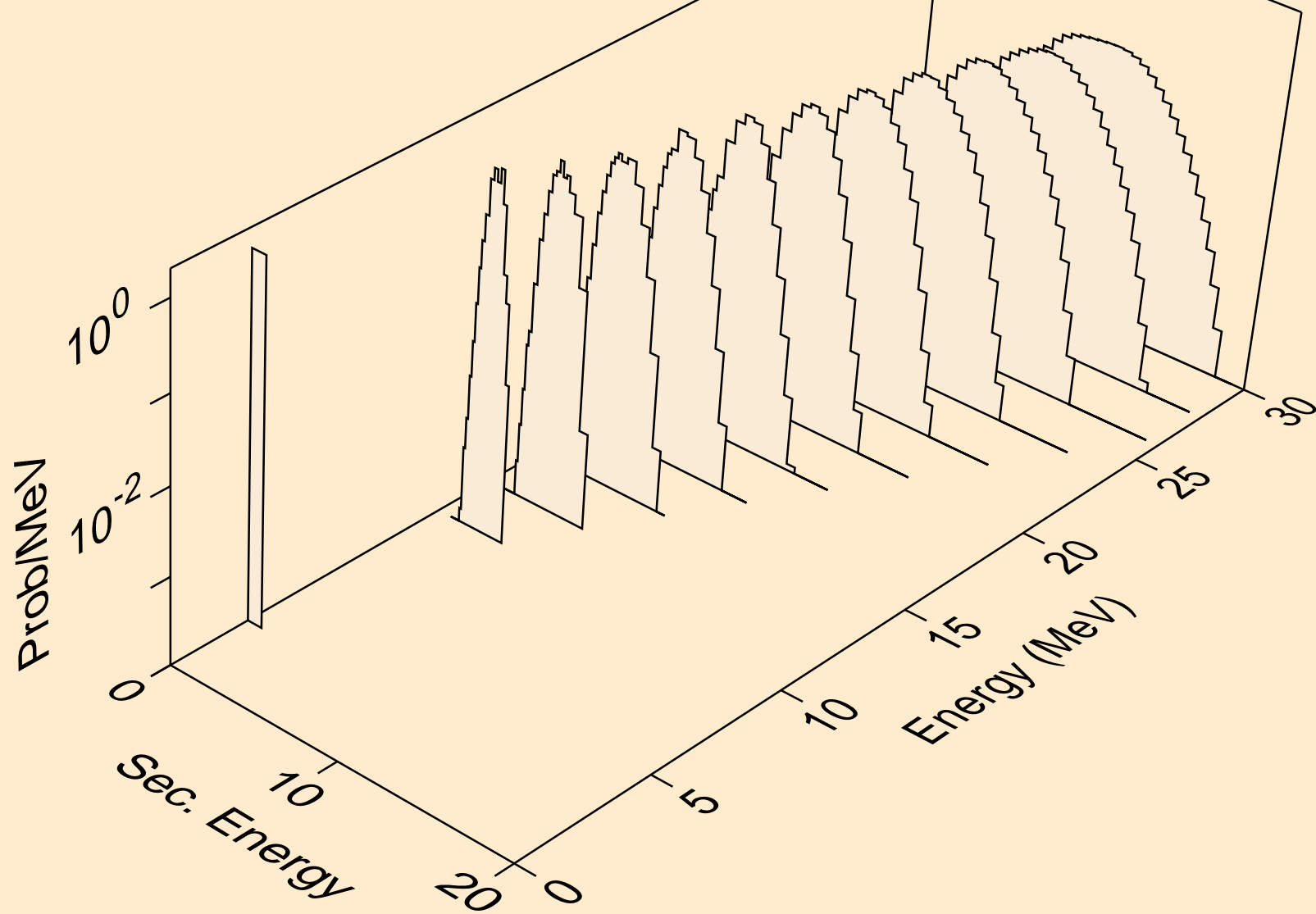

IN099 NEUTRON ACER TENDL-2021 LIBRARY; T=293.6K
tritons from (n,x)

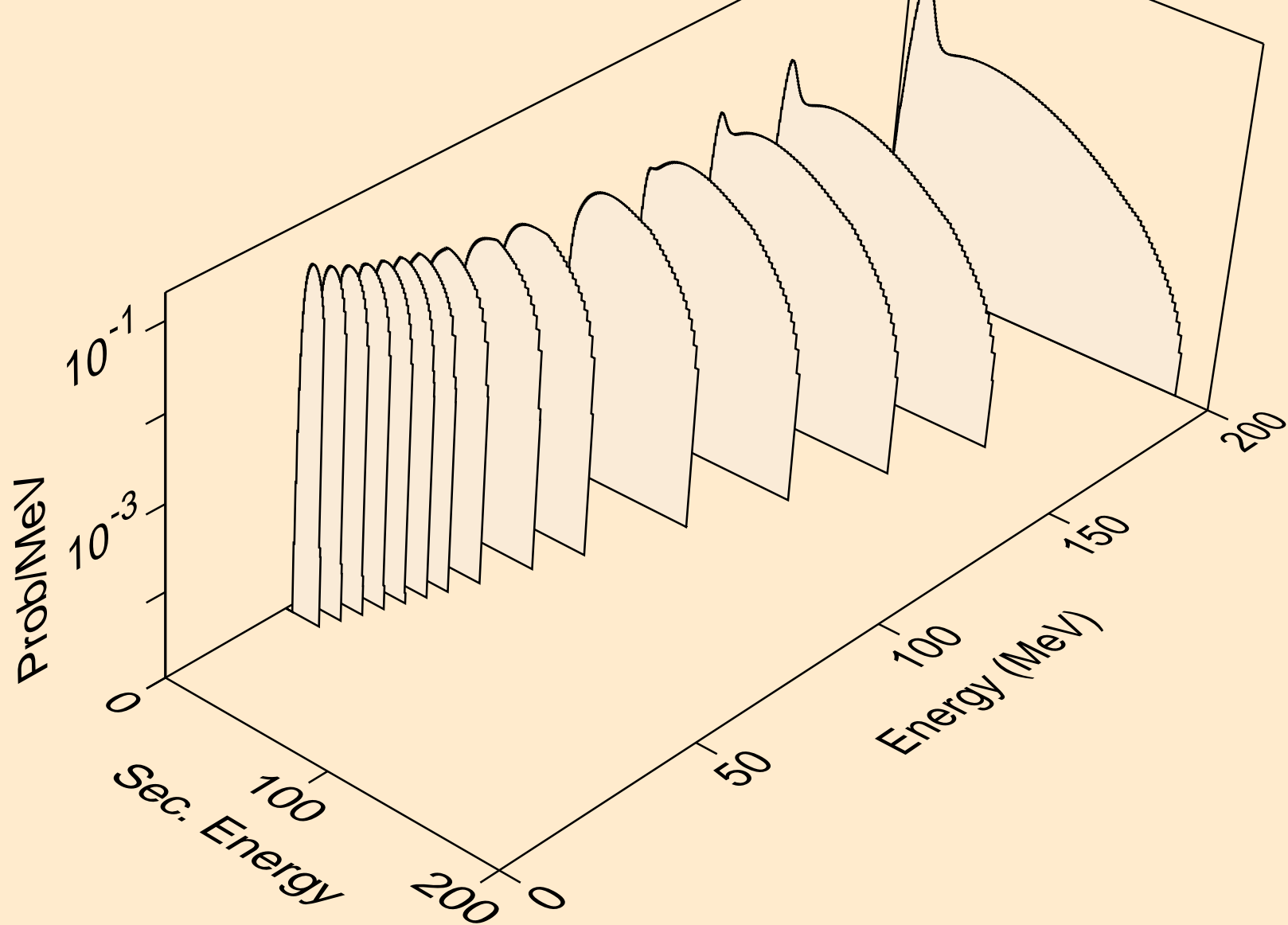

IN099 NEUTRON ACER TENDL-2021 LIBRARY; T=293.6K
tritons from (n,n*)t

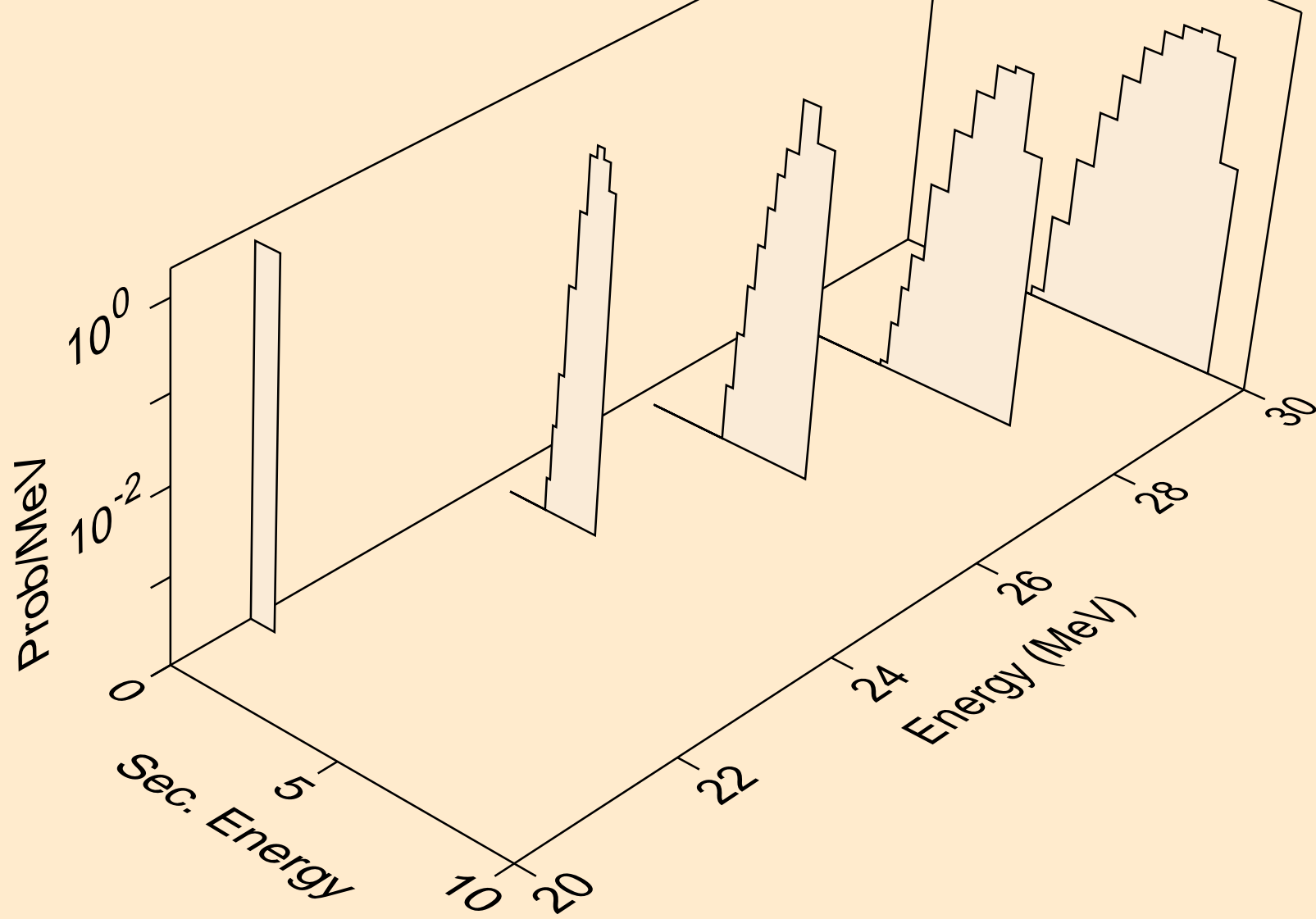

IN099 NEUTRON ACER TENDL-2021 LIBRARY; T=293.6K
tritons from (n,t)

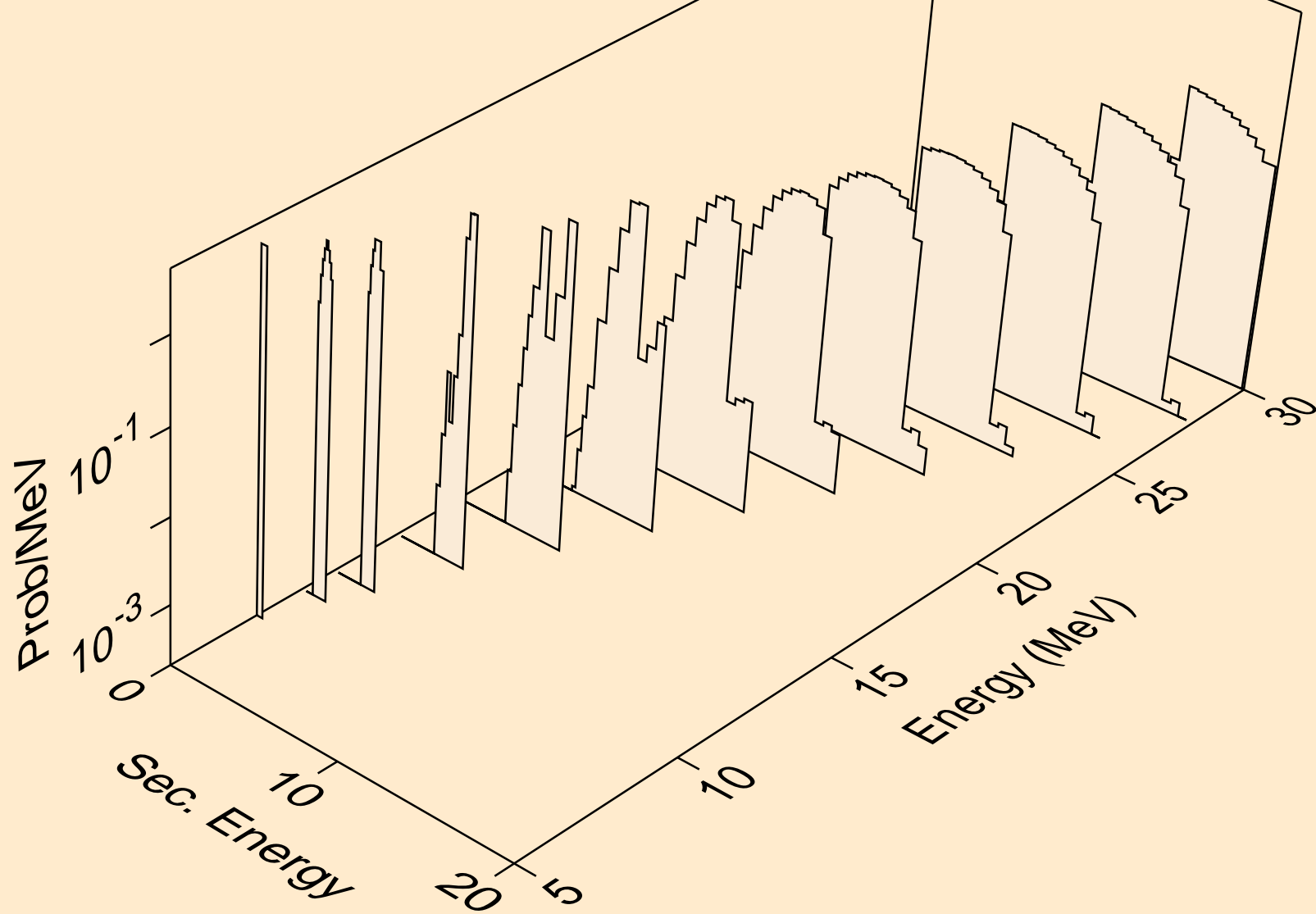

IN099 NEUTRON ACER TENDL-2021 LIBRARY; T=293.6K
tritons from (n,pt)

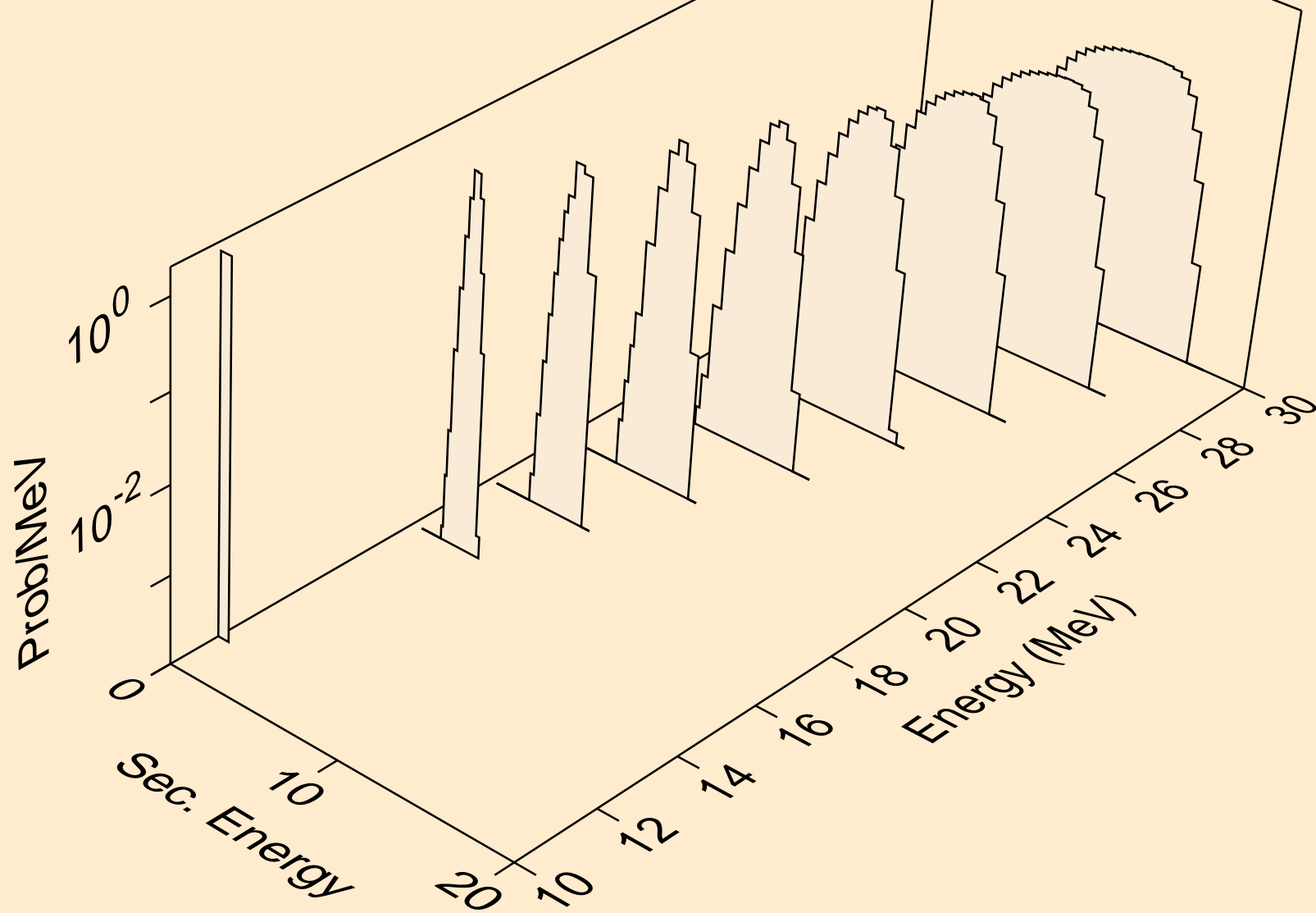

IN099 NEUTRON ACER TENDL-2021 LIBRARY; T=293.6K
he3s from (n,x)

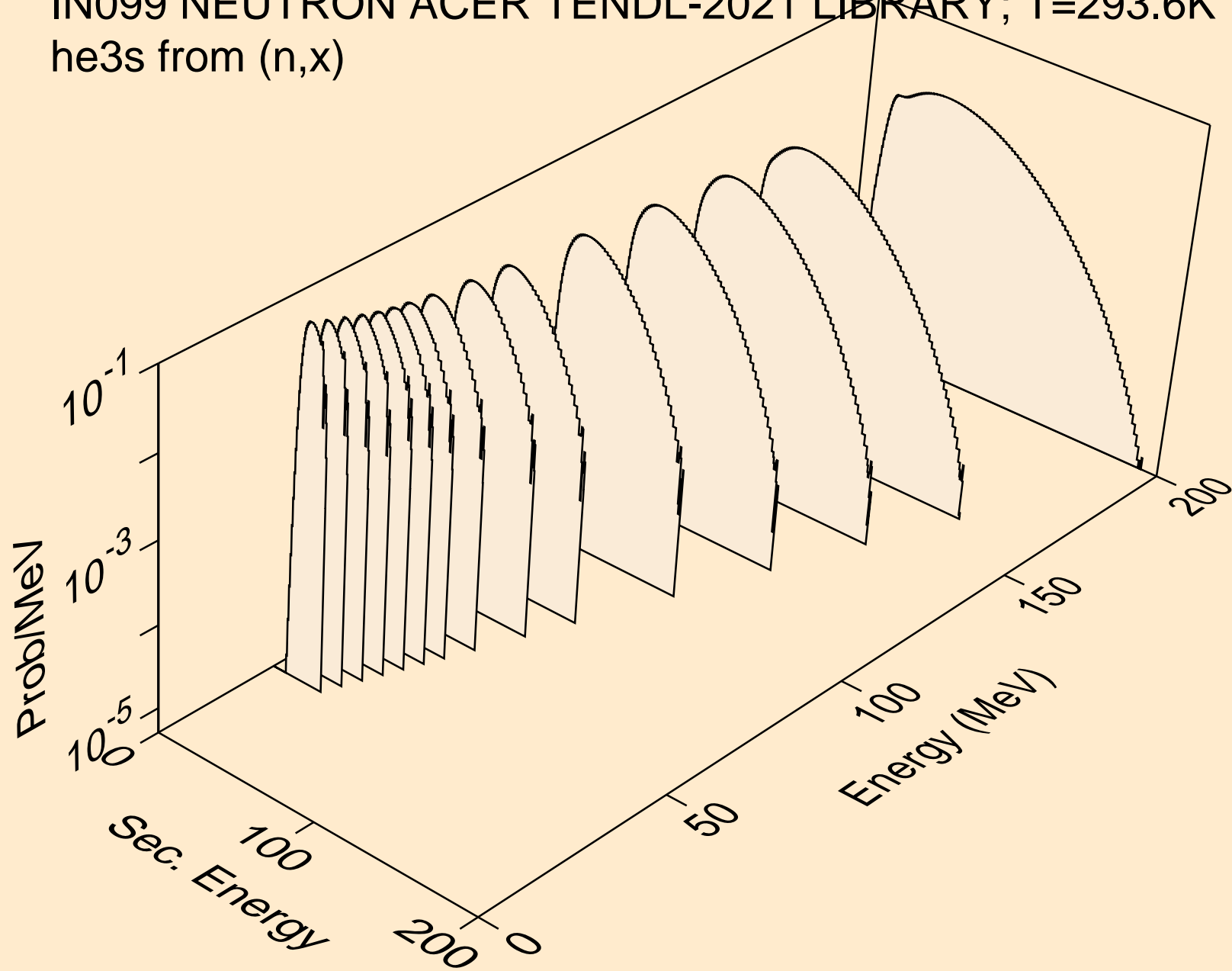

IN099 NEUTRON ACER TENDL-2021 LIBRARY; T=293.6K
he3s from (n,n*)he3

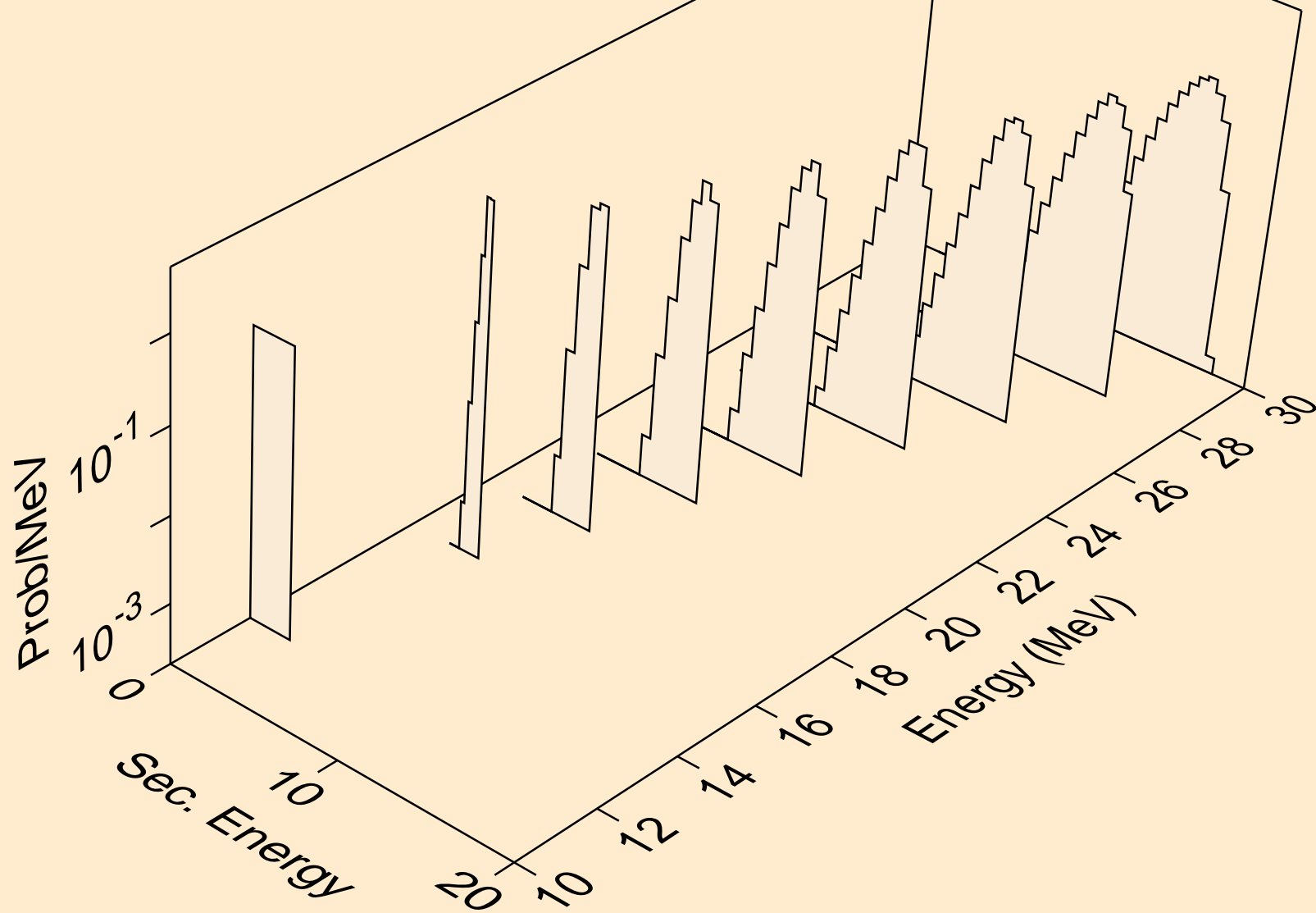

IN099 NEUTRON ACER TENDL-2021 LIBRARY; T=293.6K
he3s from (n,he3)

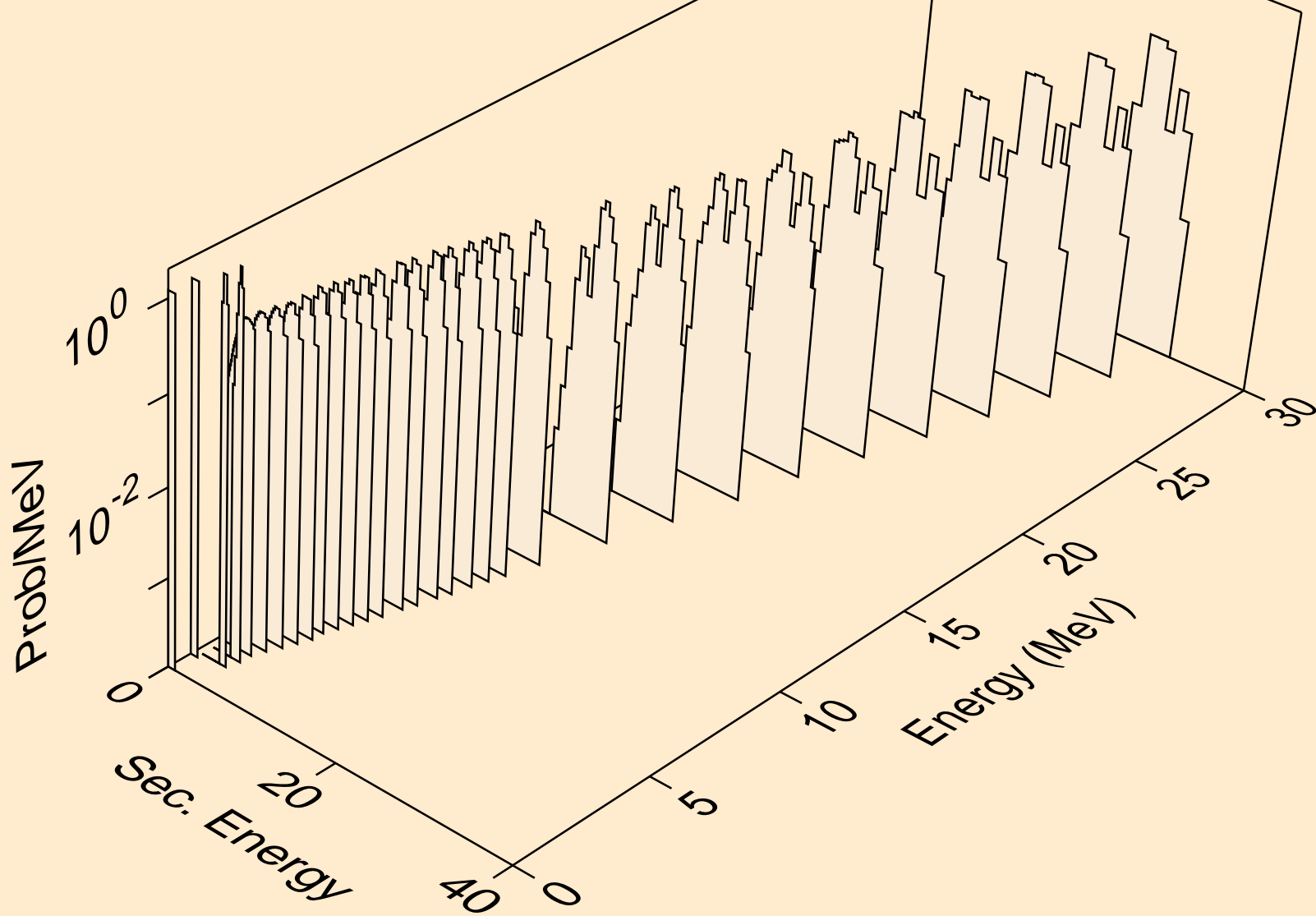

IN099 NEUTRON ACER TENDL-2021 LIBRARY; T=293.6K
alphas from (n,x)

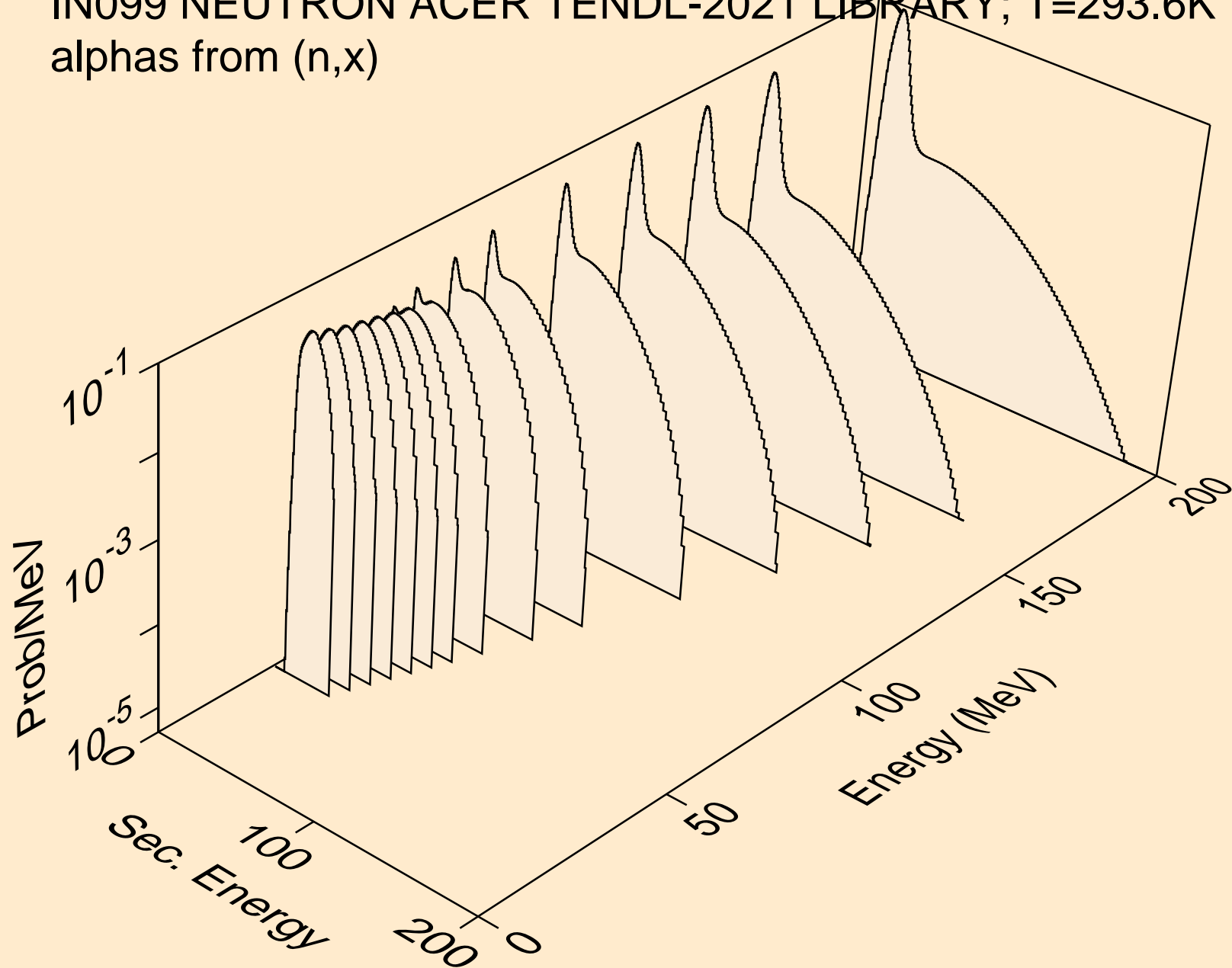

IN099 NEUTRON ACER TENDL-2021 LIBRARY; T=293.6K
alphas from (n,n*)a

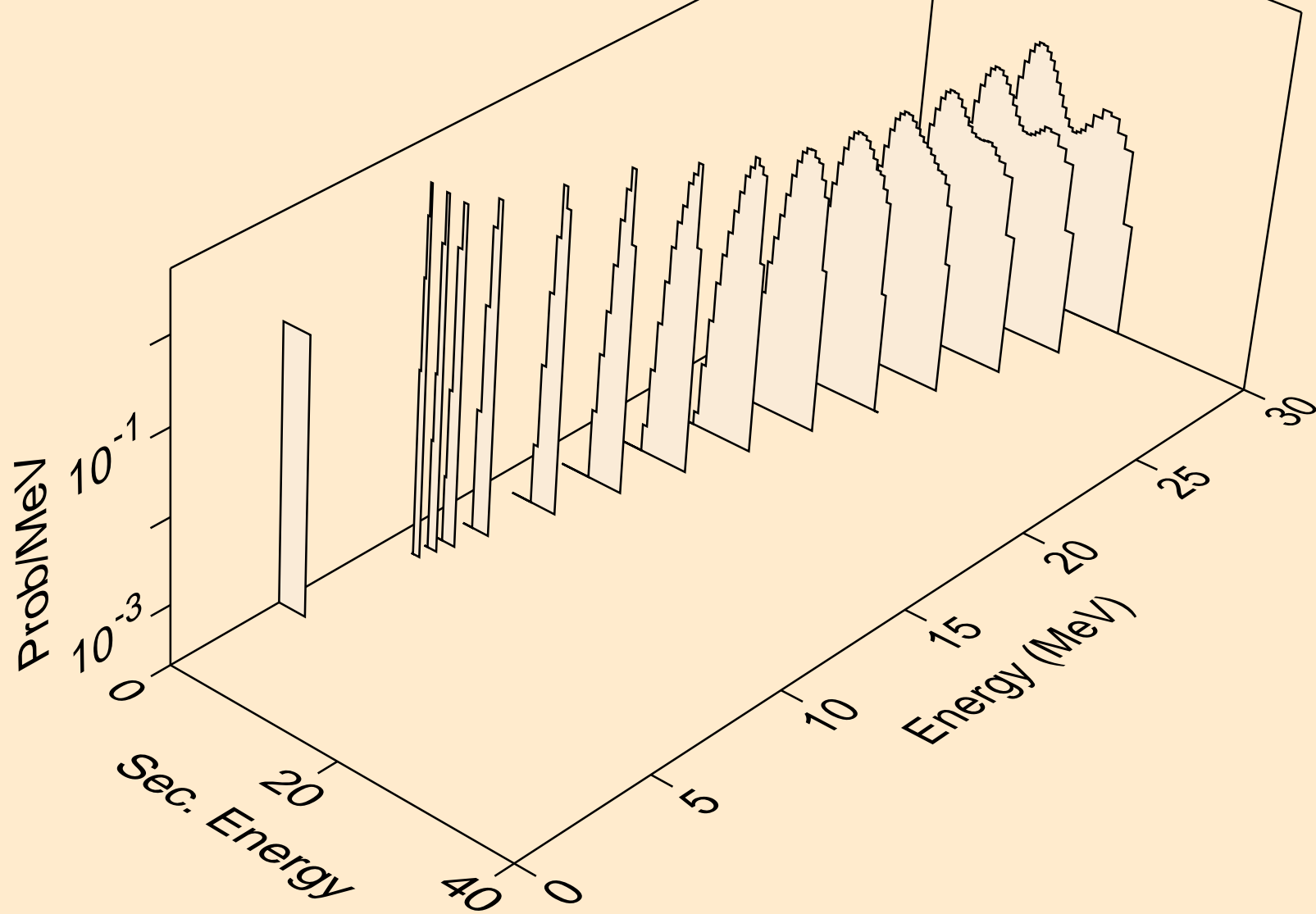

IN099 NEUTRON ACER TENDL-2021 LIBRARY; T=293.6K
alphas from (n,npa)

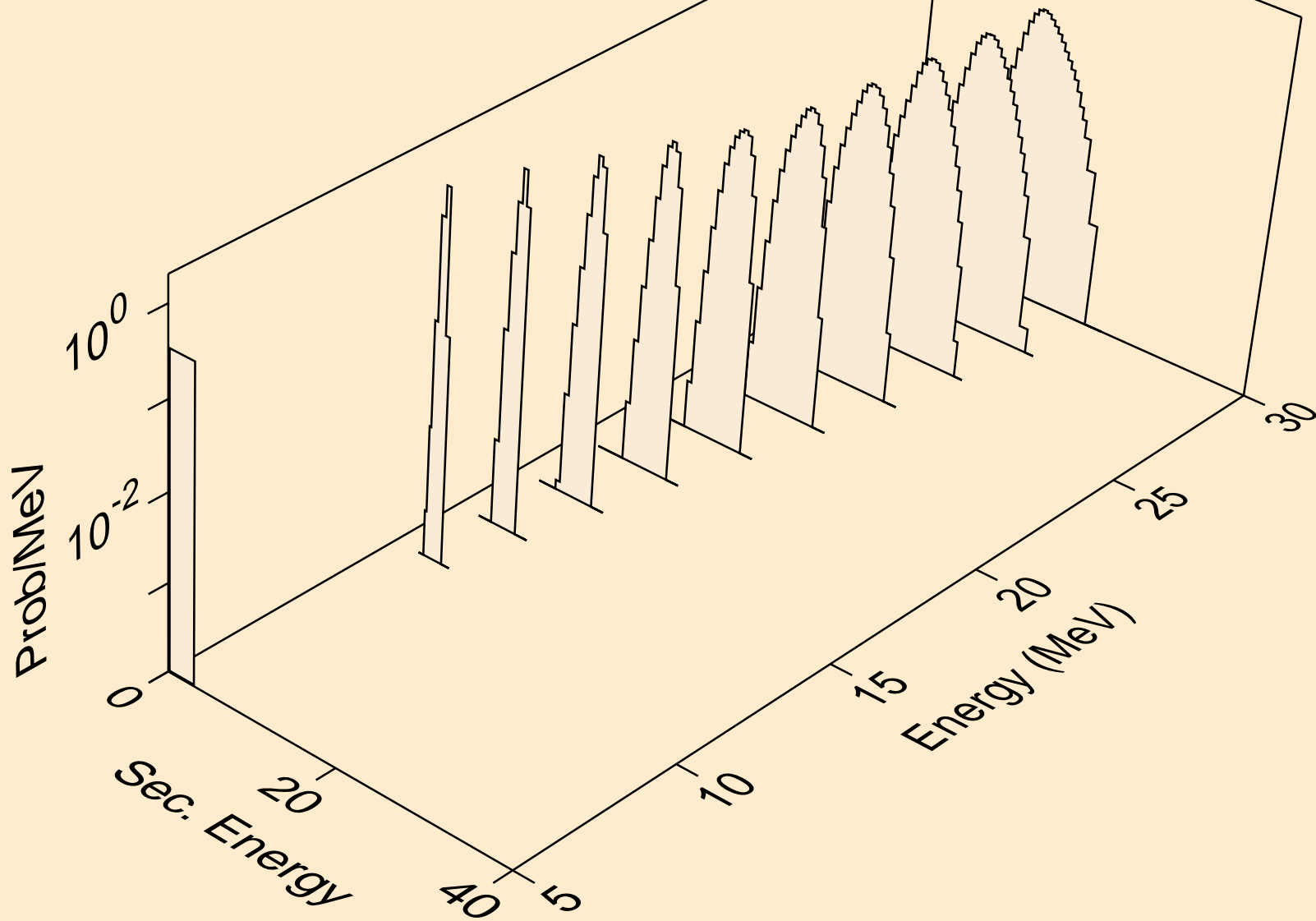

IN099 NEUTRON ACER TENDL-2021 LIBRARY; T=293.6K
alphas from (n,a)

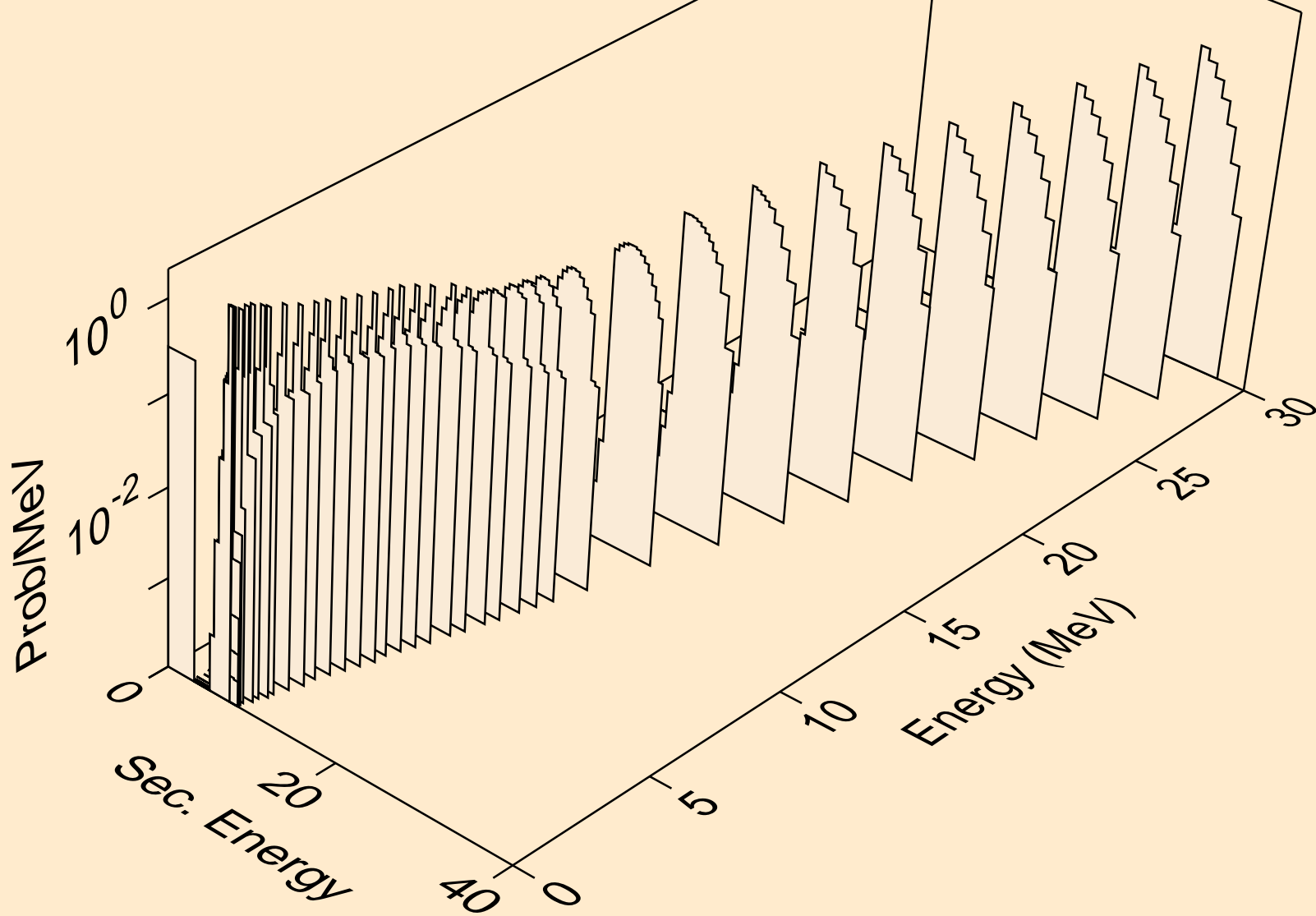

IN099 NEUTRON ACER TENDL-2021 LIBRARY; T=293.6K
alphas from (n,2a)

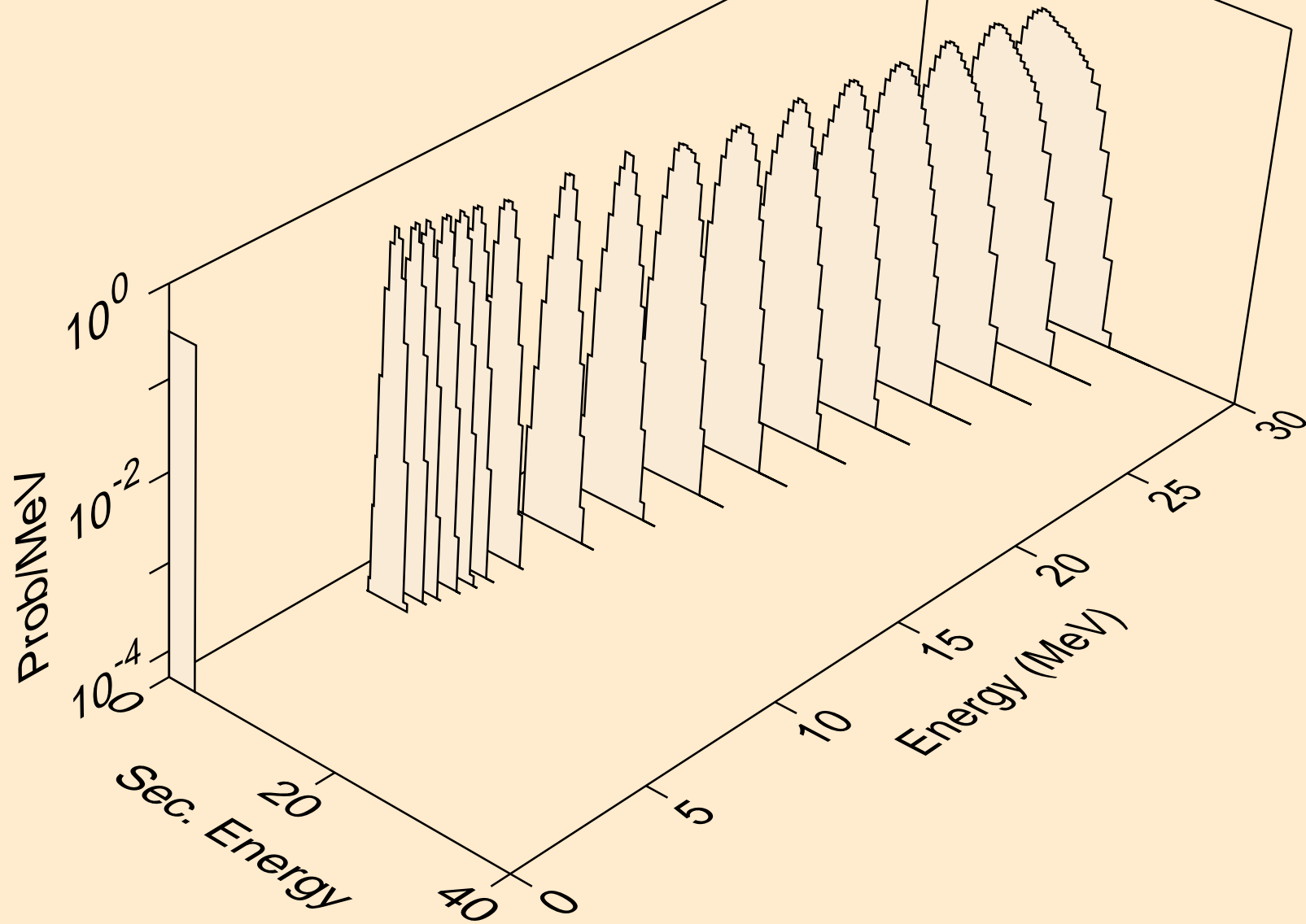

IN099 NEUTRON ACER TENDL-2021 LIBRARY; T=293.6K
alphas from (n,pa)

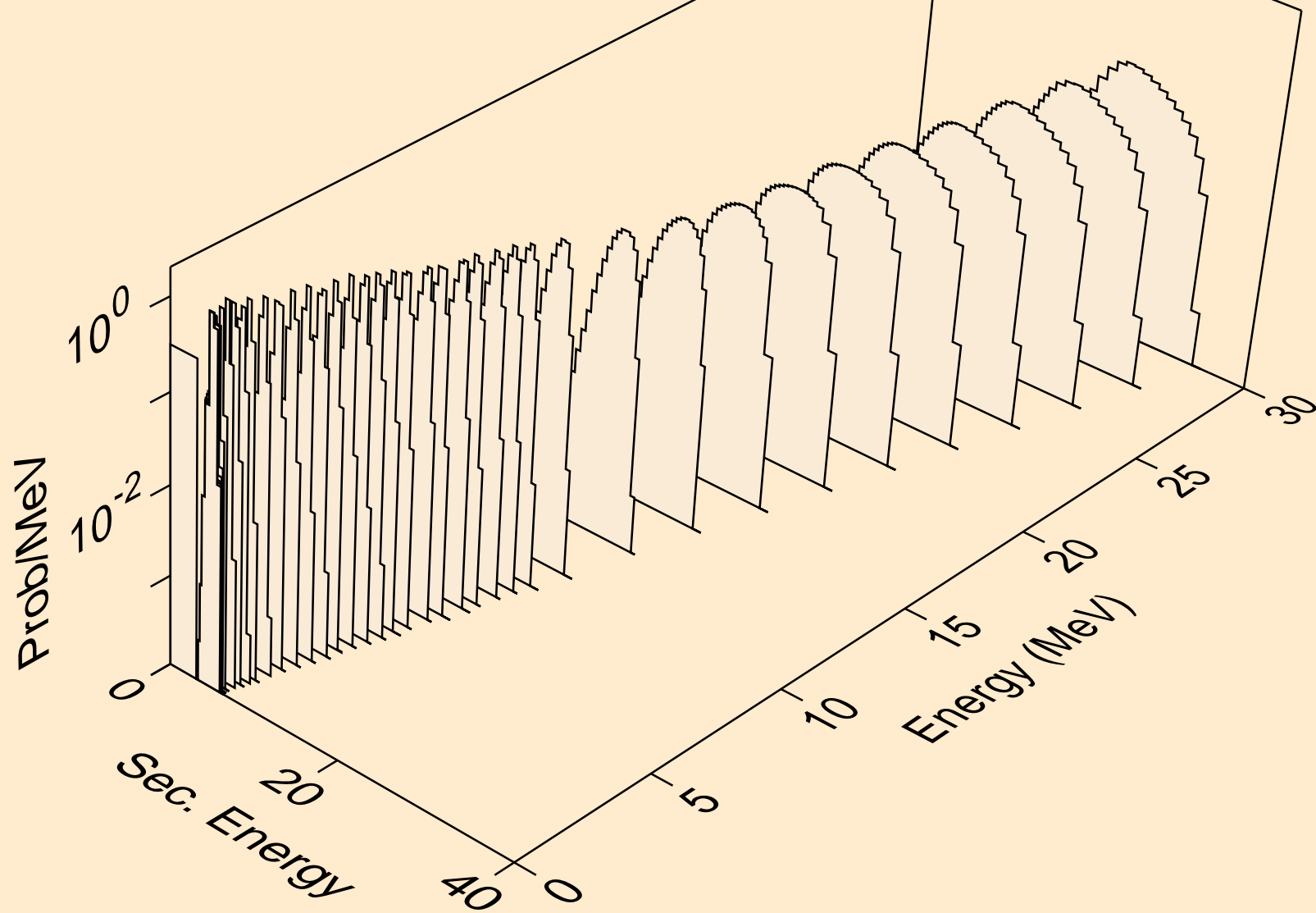

IN099 NEUTRON ACER TENDL-2021 LIBRARY; T=293.6K
alphas from (n,da)

