

IN101 NEUTRON ACER TENDL-2021 LIBRARY; T=293.6K
Principal cross sections

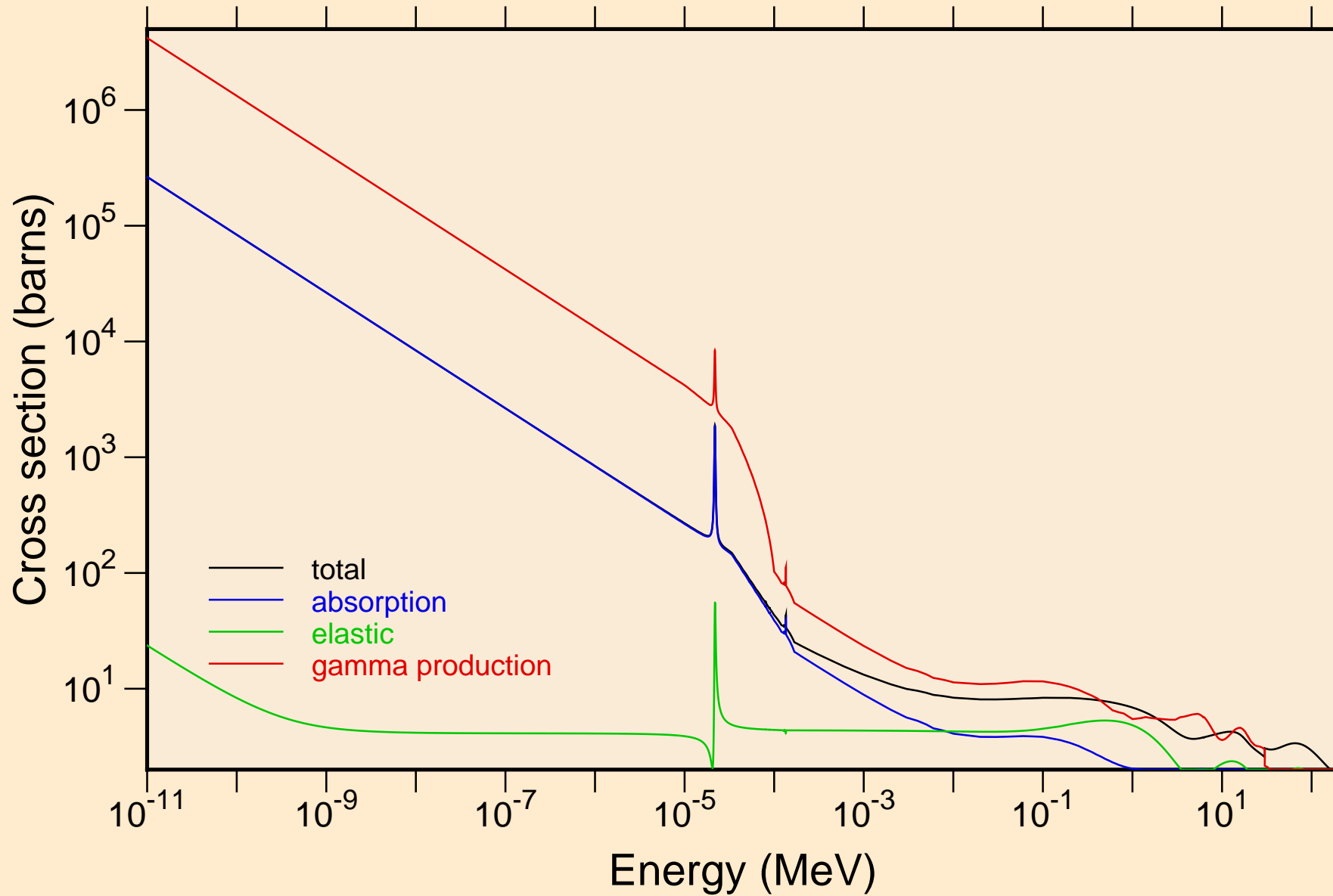

IN101 NEUTRON ACER TENDL-2021 LIBRARY; T=293.6K
resonance total cross section

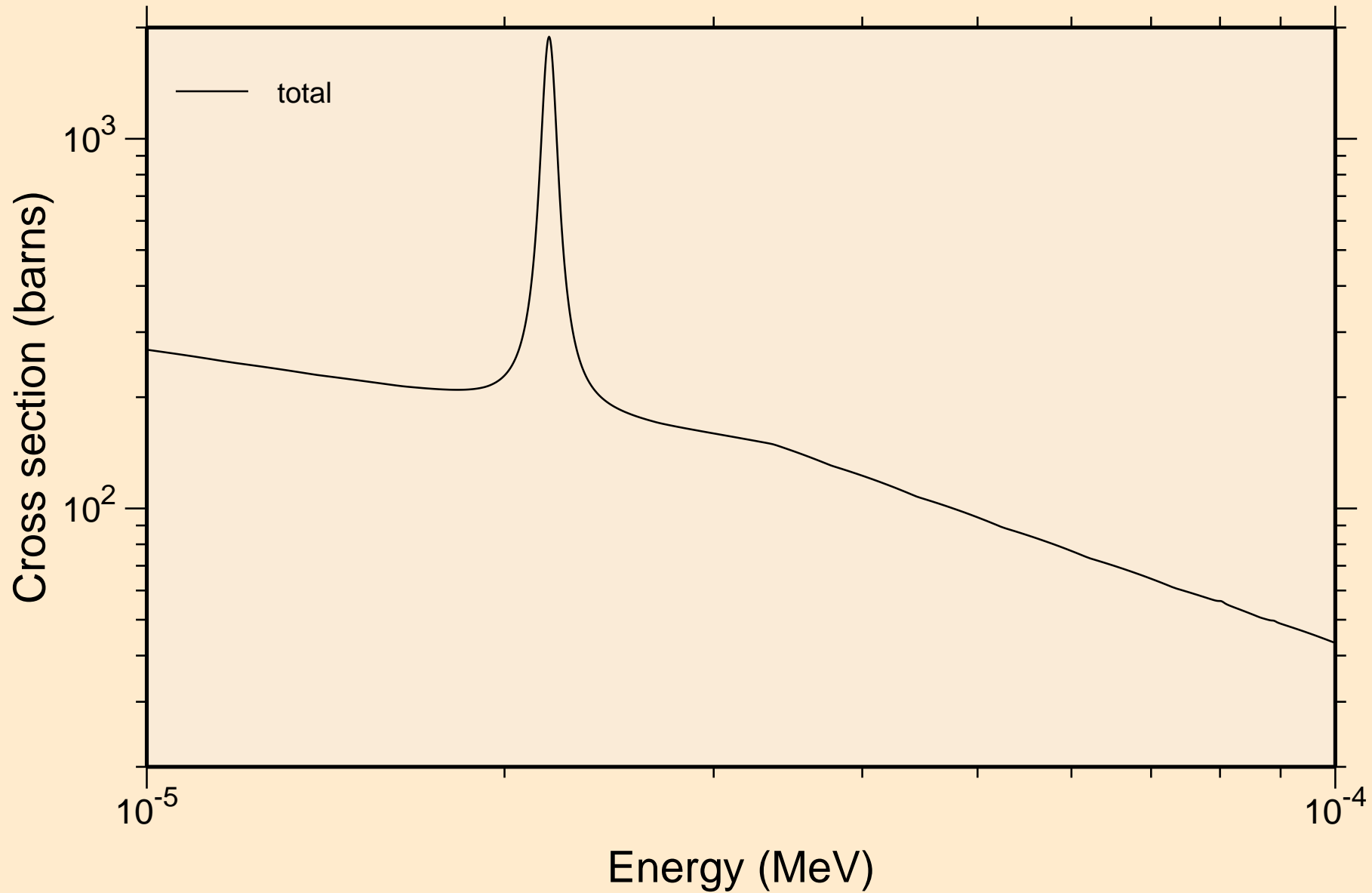

IN101 NEUTRON ACER TENDL-2021 LIBRARY; T=293.6K
resonance total cross section

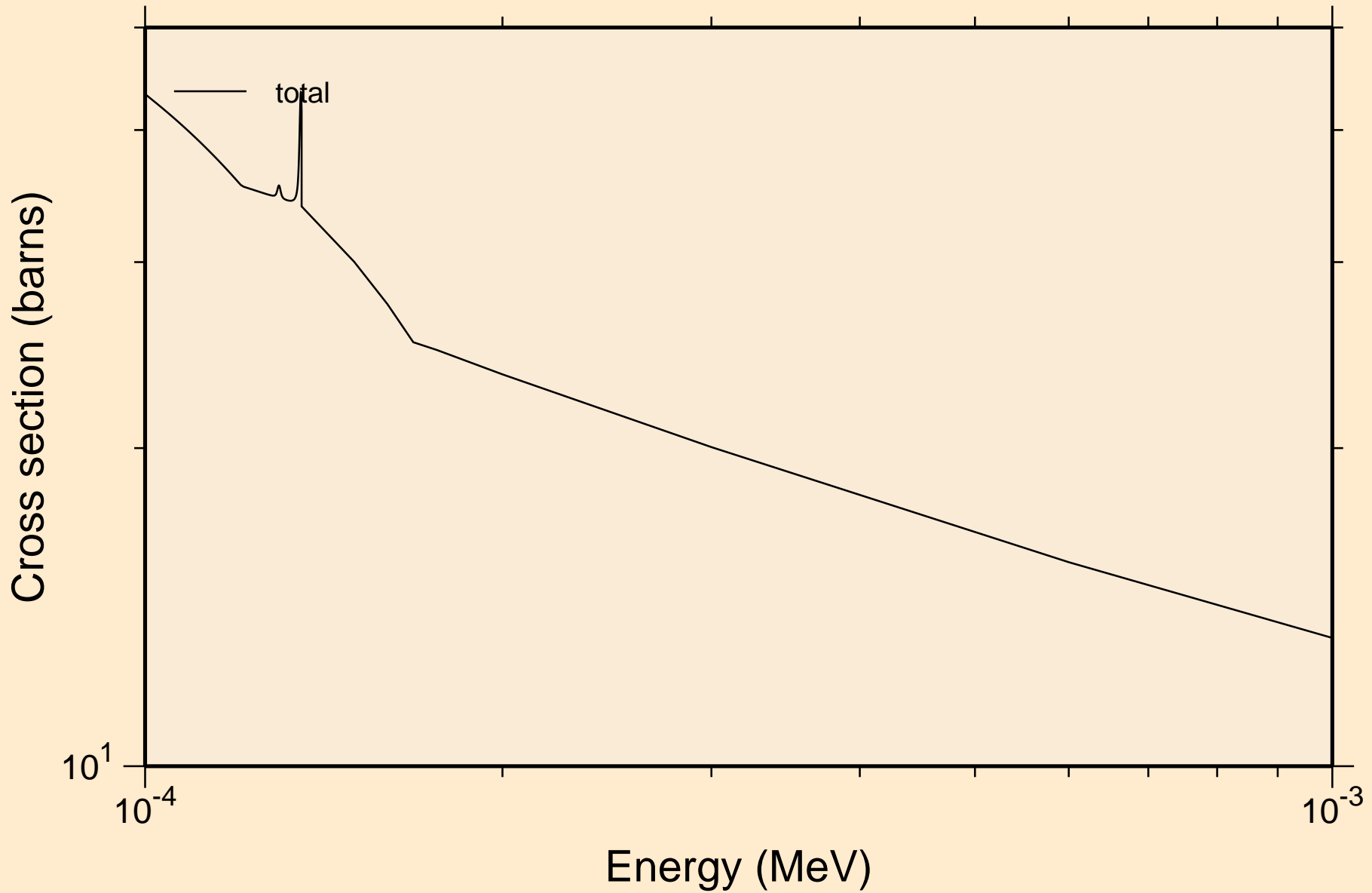

IN101 NEUTRON ACER TENDL-2021 LIBRARY; T=293.6K
resonance total cross section

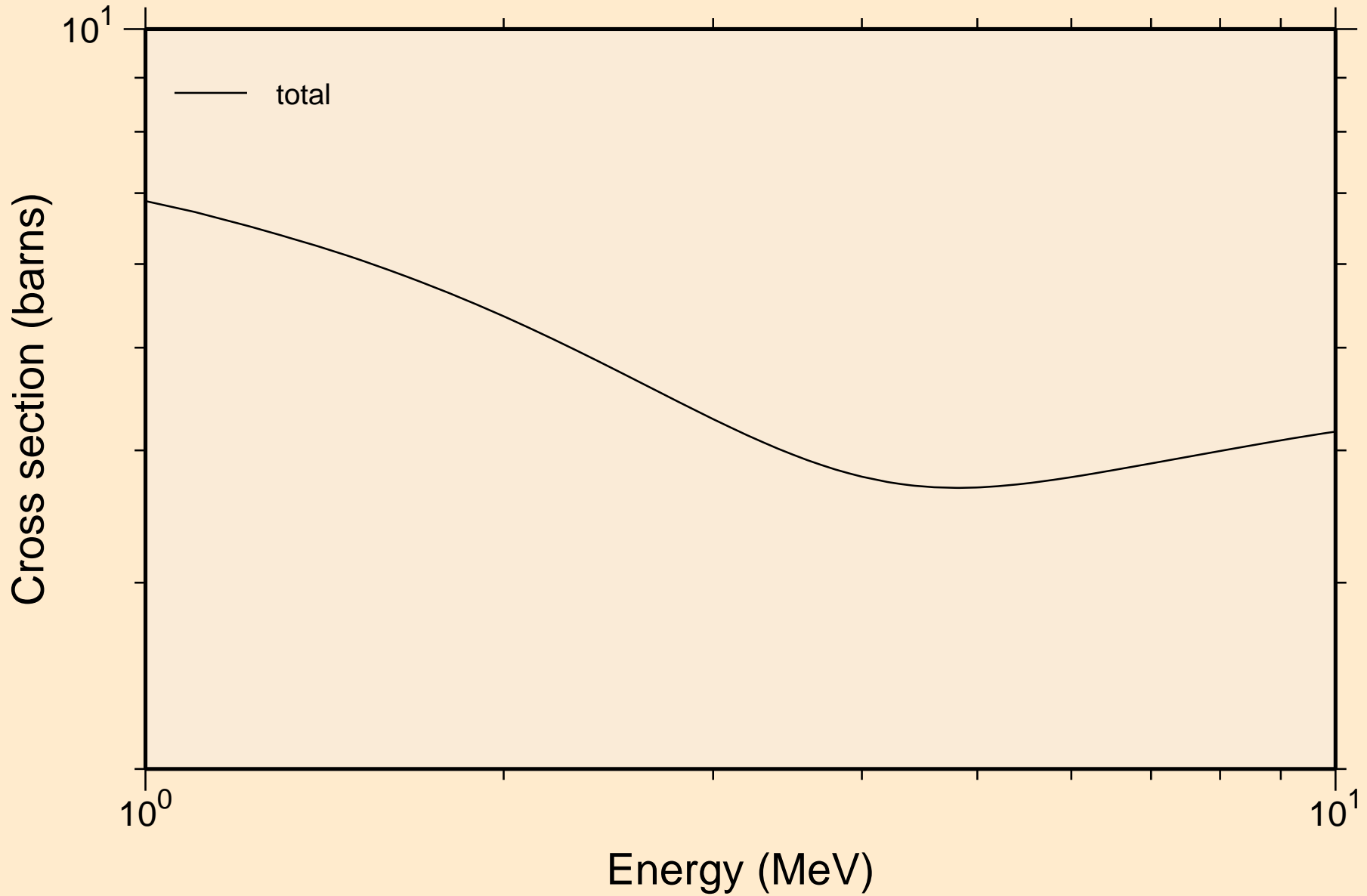

IN101 NEUTRON ACER TENDL-2021 LIBRARY; T=293.6K
resonance absorption cross sections

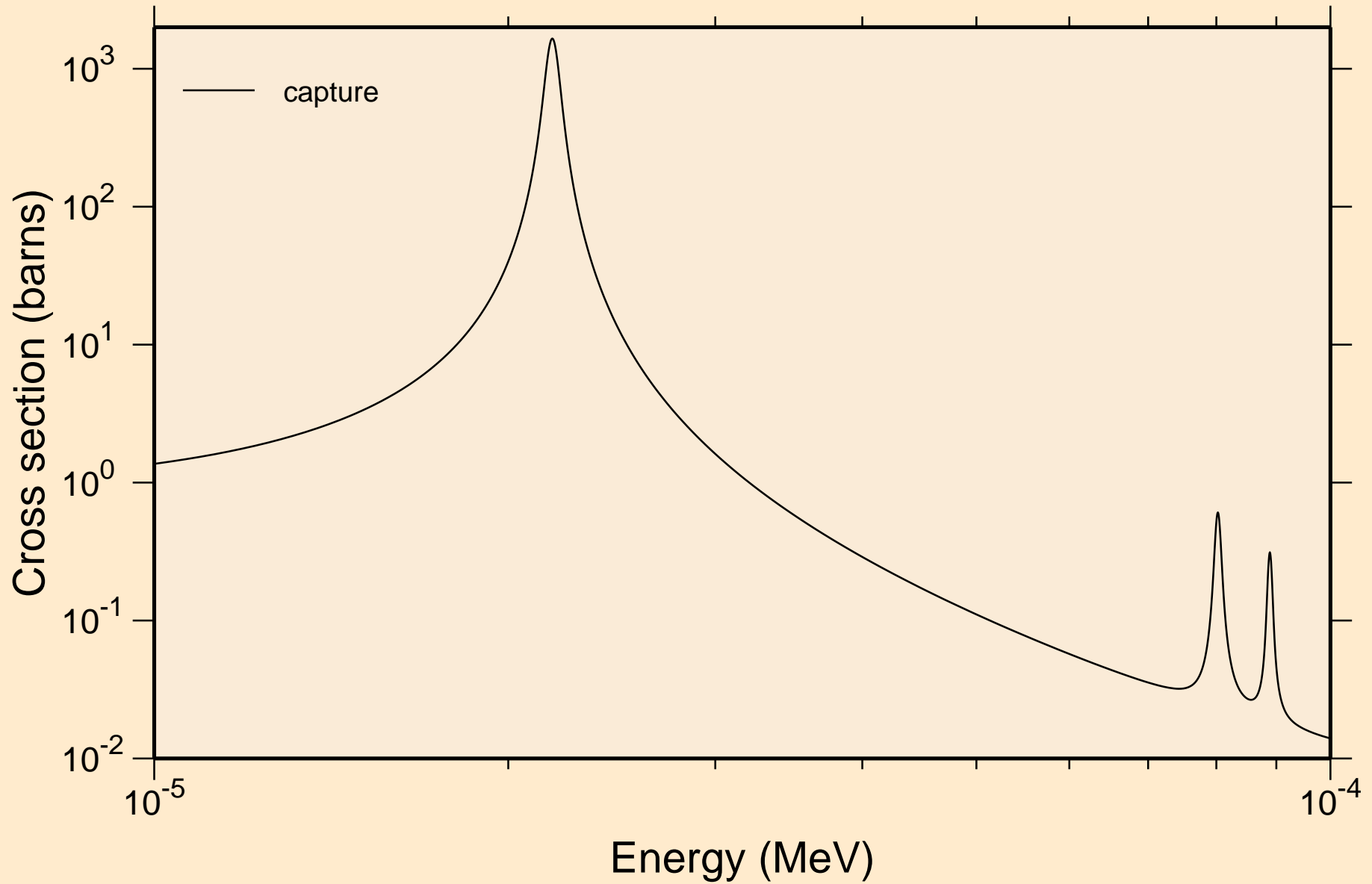

IN101 NEUTRON ACER TENDL-2021 LIBRARY; T=293.6K
resonance absorption cross sections

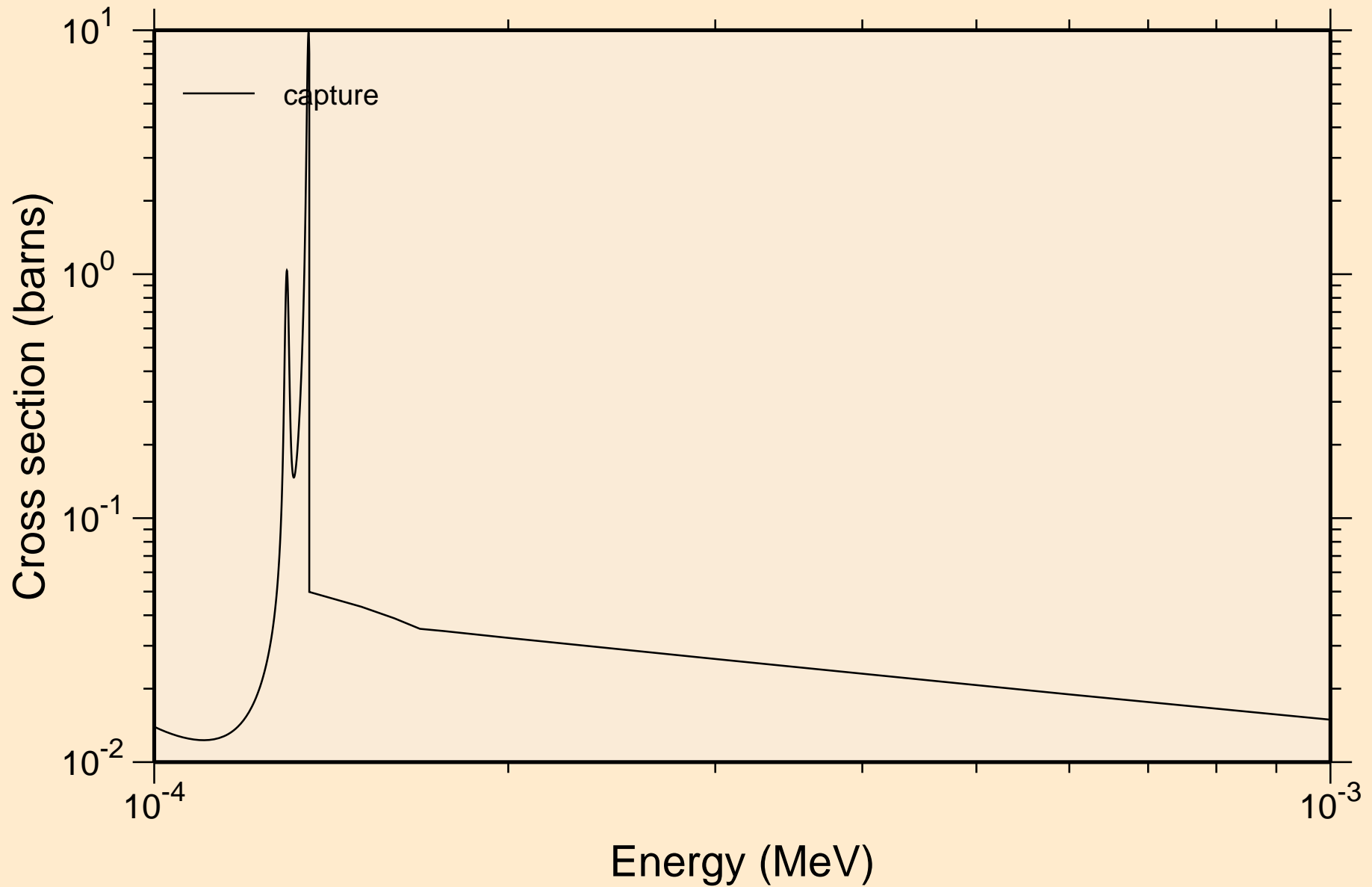

IN101 NEUTRON ACER TENDL-2021 LIBRARY; T=293.6K
resonance absorption cross sections

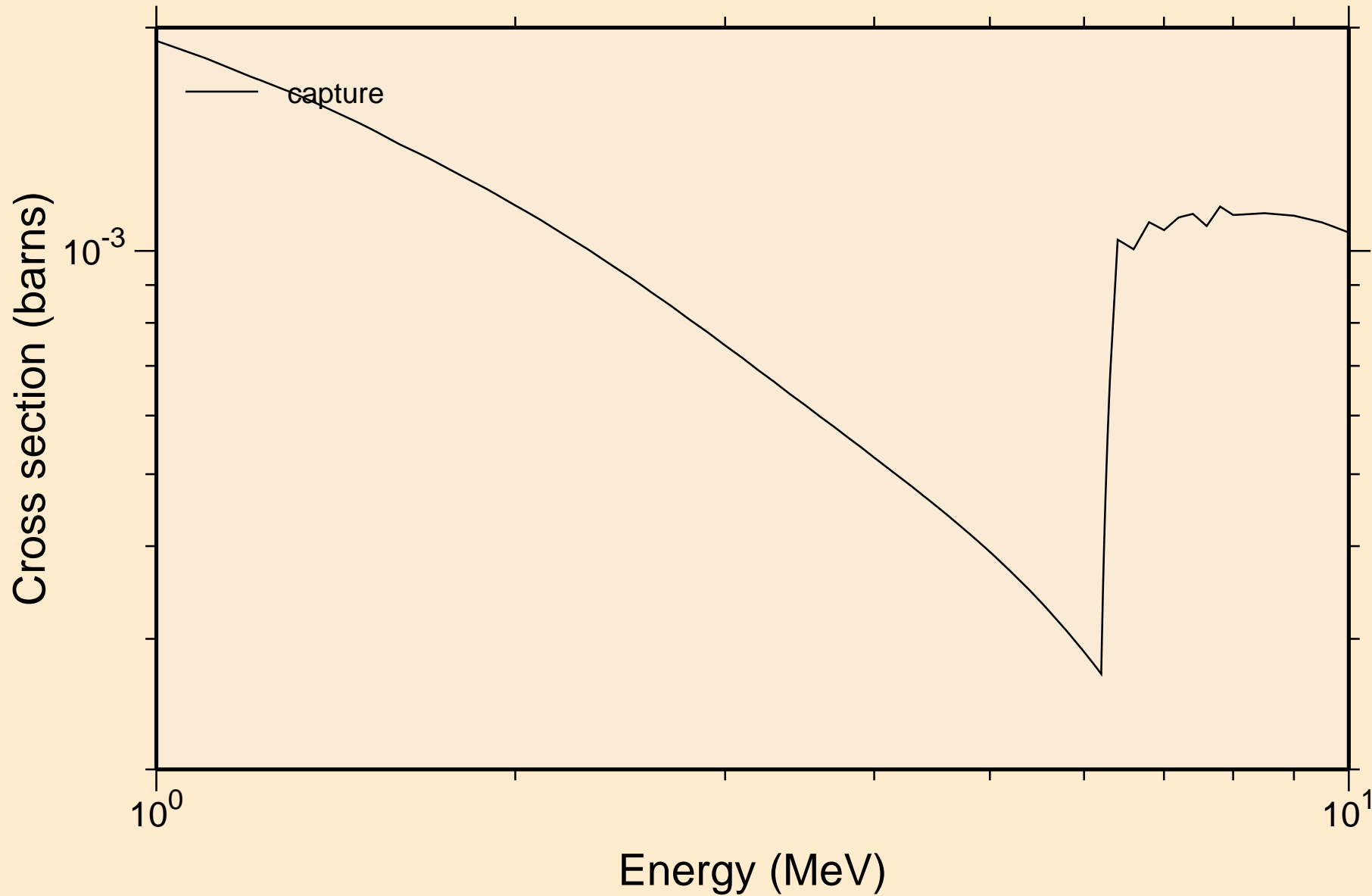

IN101 NEUTRON ACER TENDL-2021 LIBRARY; T=293.6K
Heating

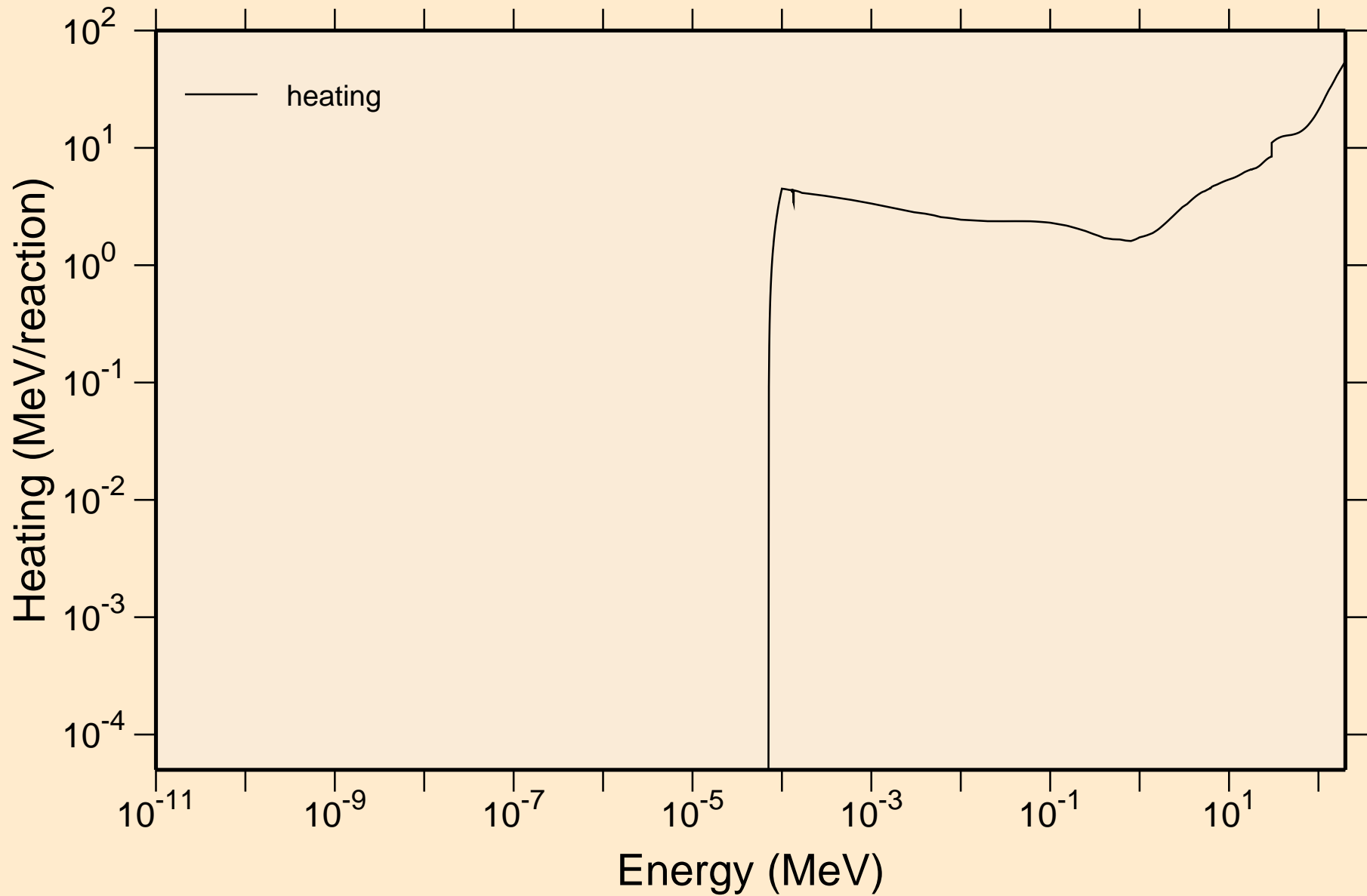

IN101 NEUTRON ACER TENDL-2021 LIBRARY; T=293.6K
Damage

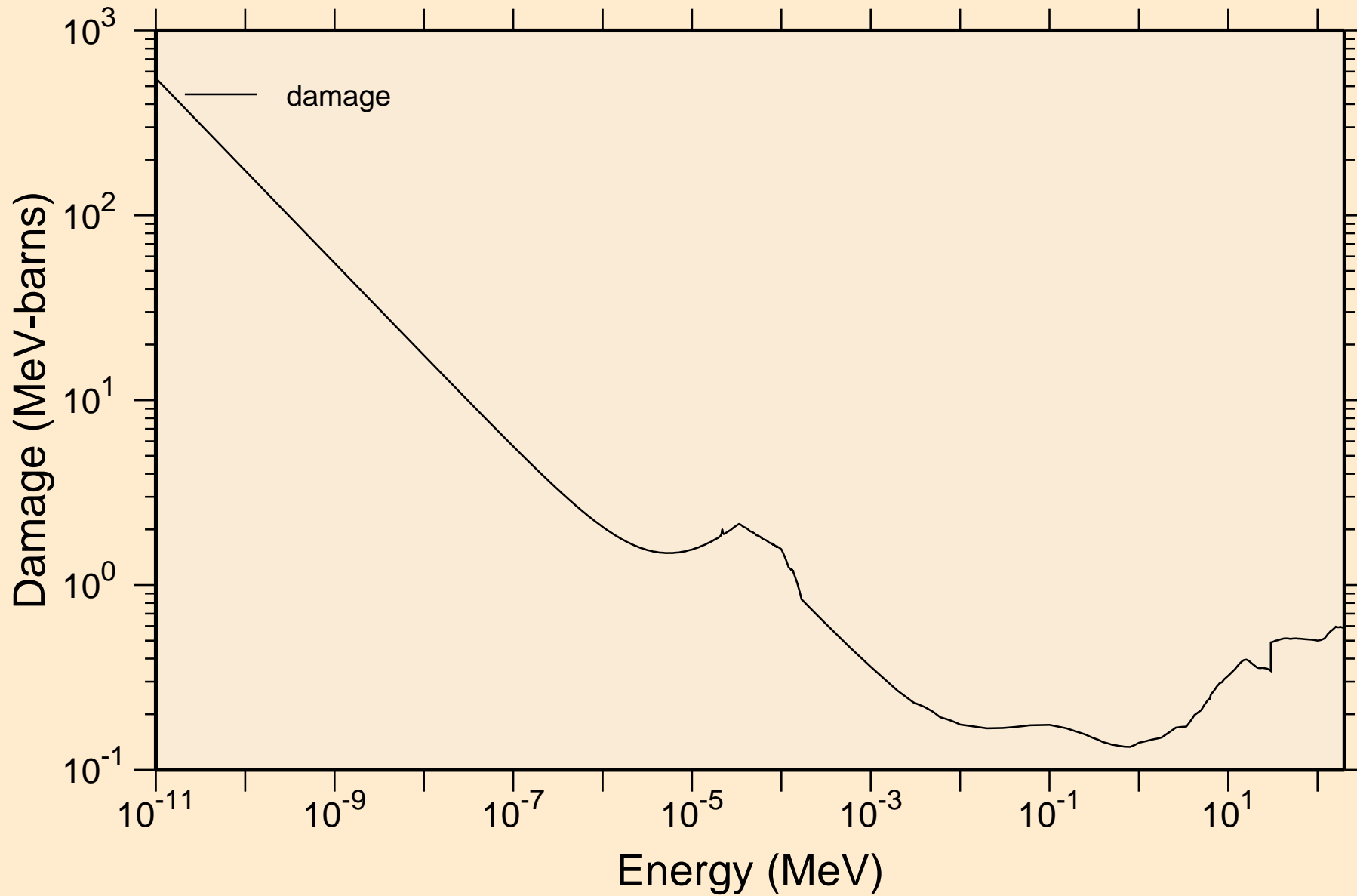

IN101 NEUTRON ACER TENDL-2021 LIBRARY; T=293.6K
Non-threshold reactions

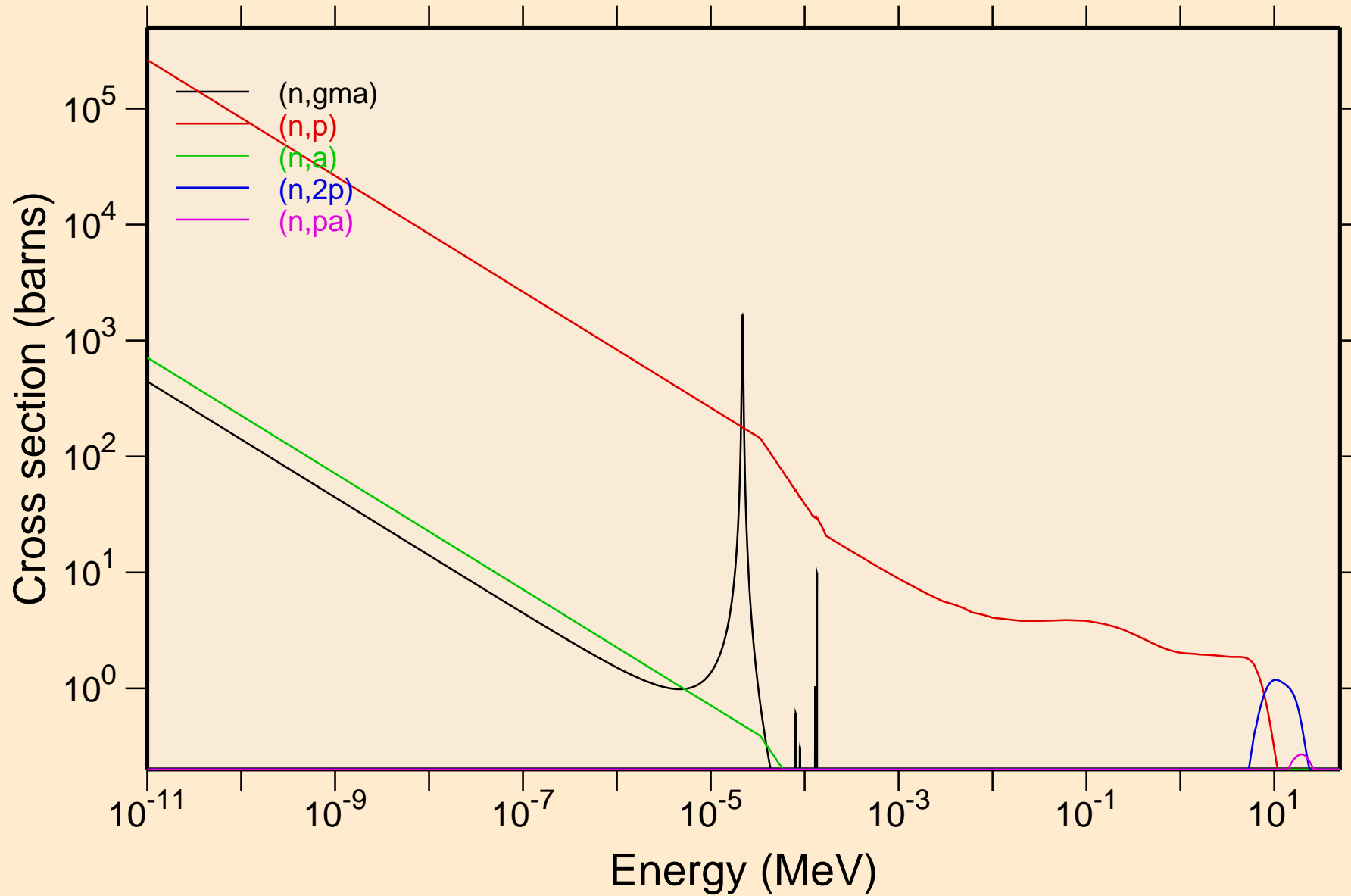

IN101 NEUTRON ACER TENDL-2021 LIBRARY; T=293.6K
Non-threshold reactions

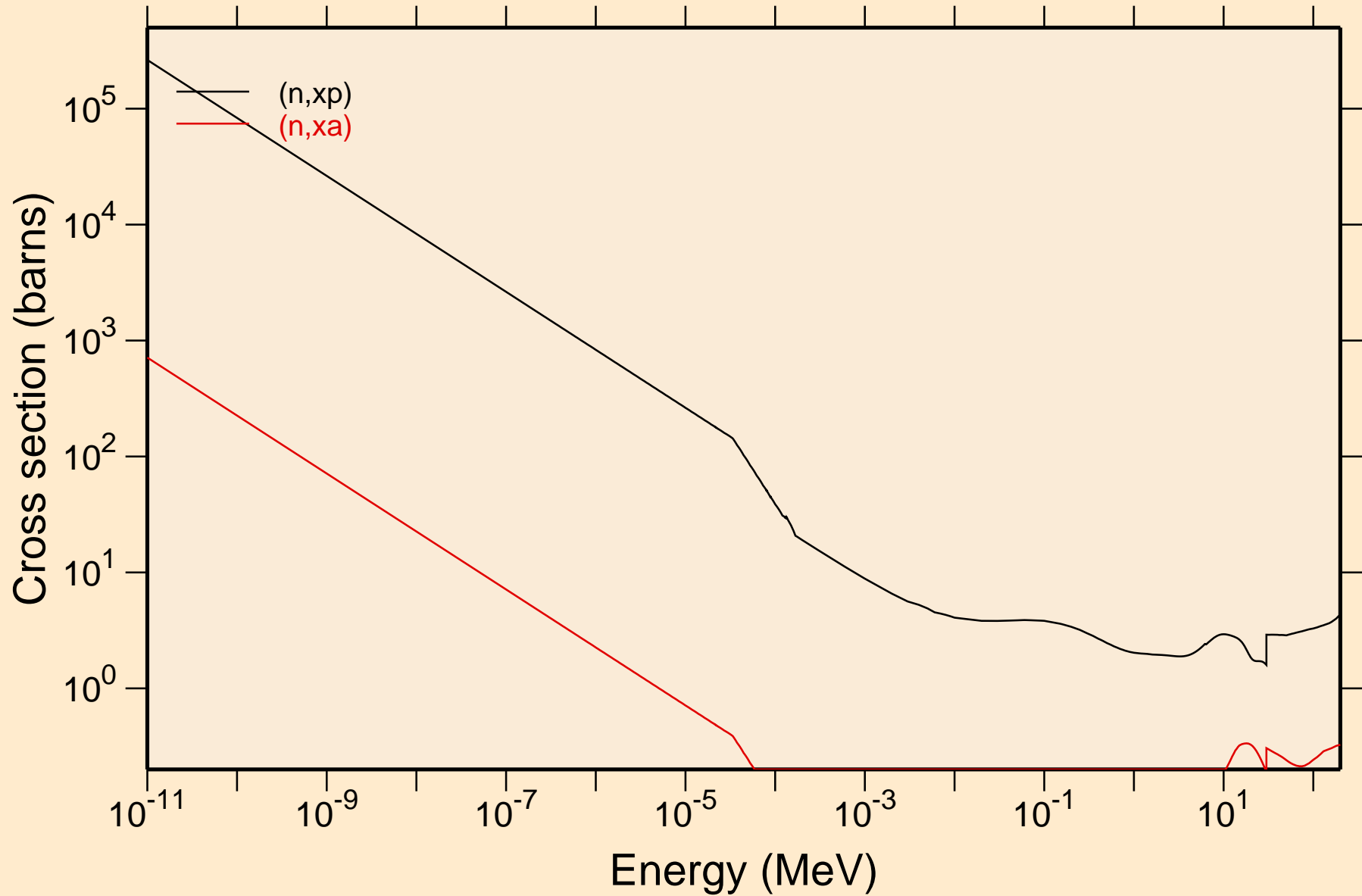

IN101 NEUTRON ACER TENDL-2021 LIBRARY; T=293.6K

Principal cross sections

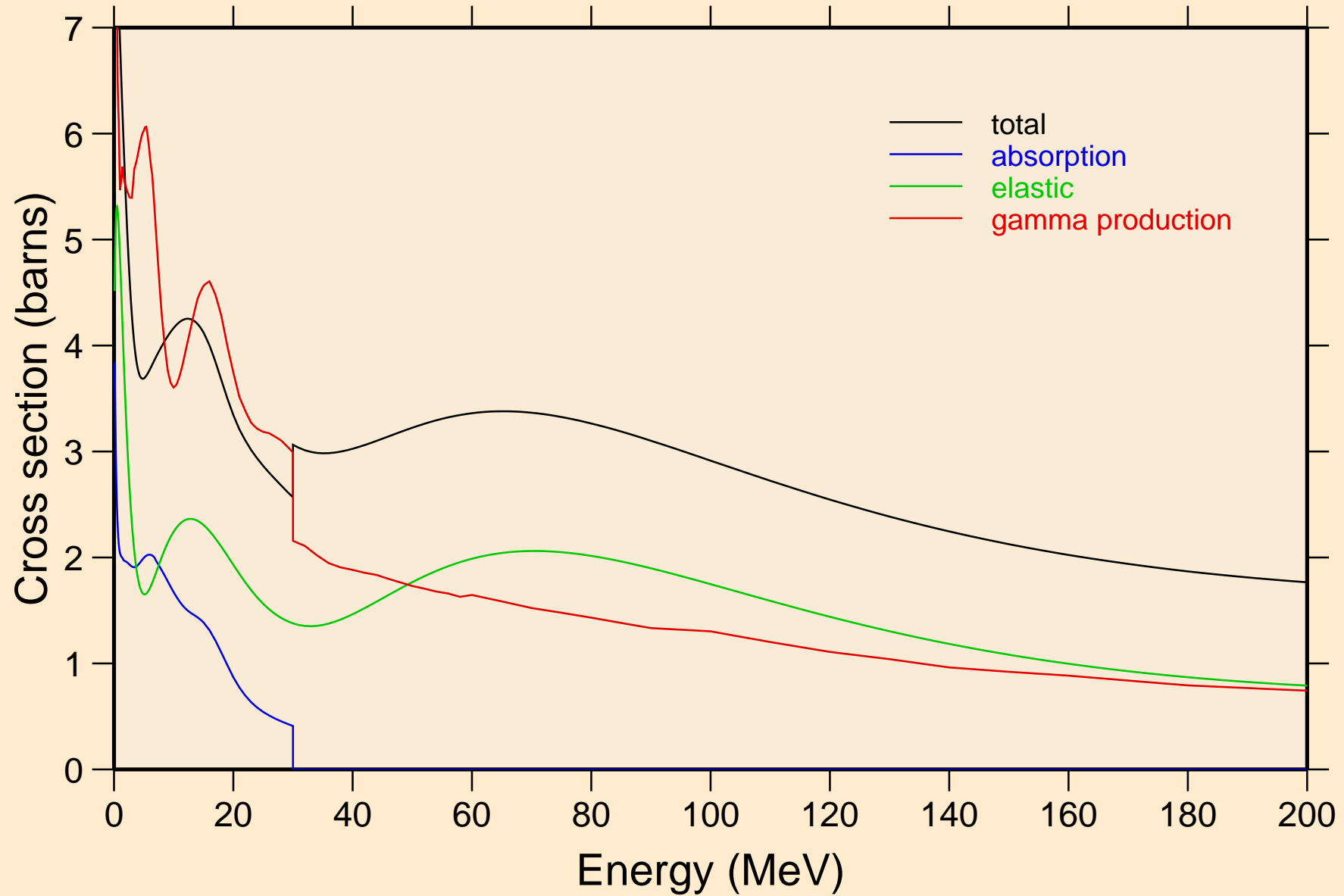

IN101 NEUTRON ACER TENDL-2021 LIBRARY; T=293.6K

Heating

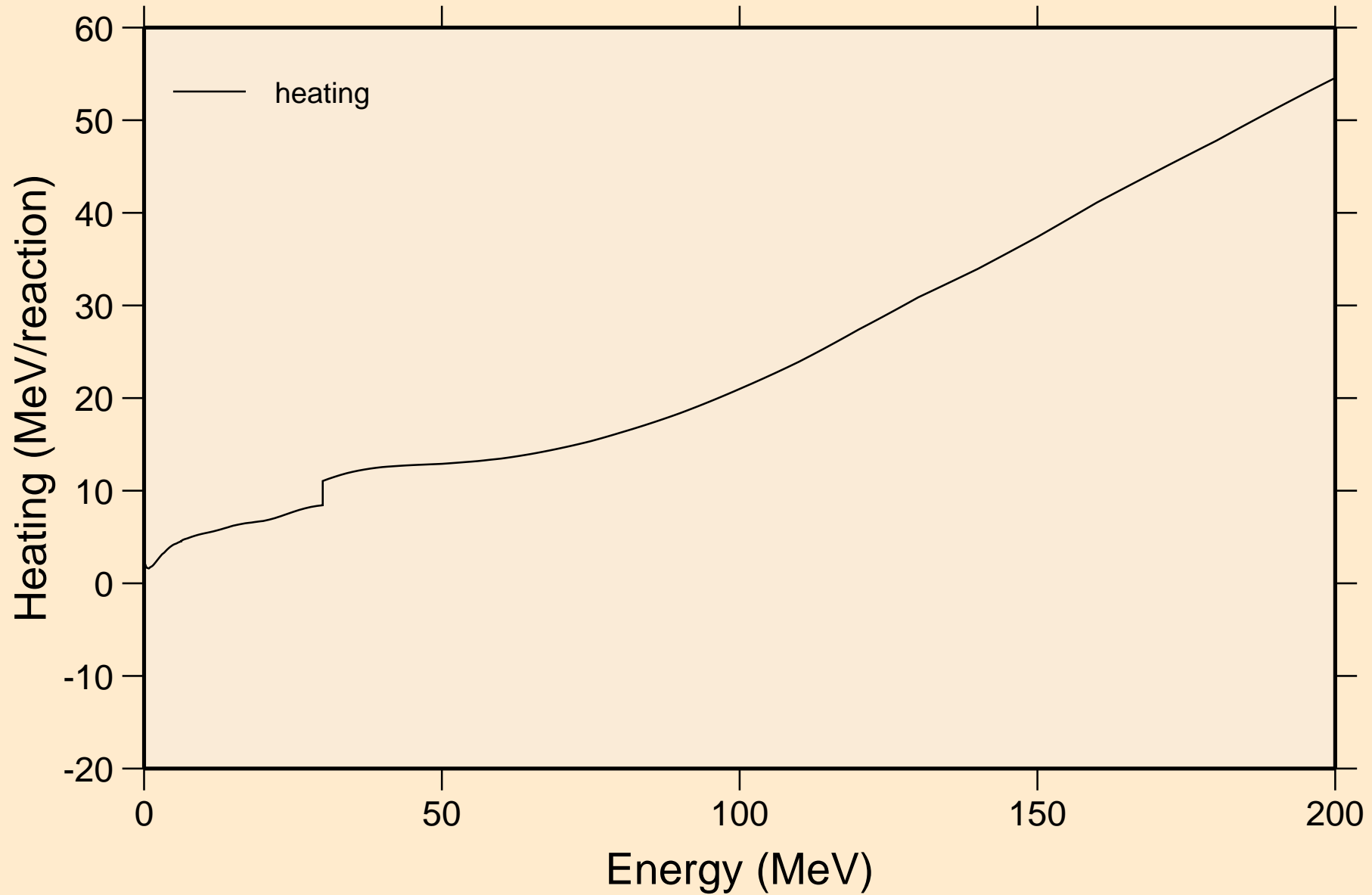

IN101 NEUTRON ACER TENDL-2021 LIBRARY; T=293.6K
Damage

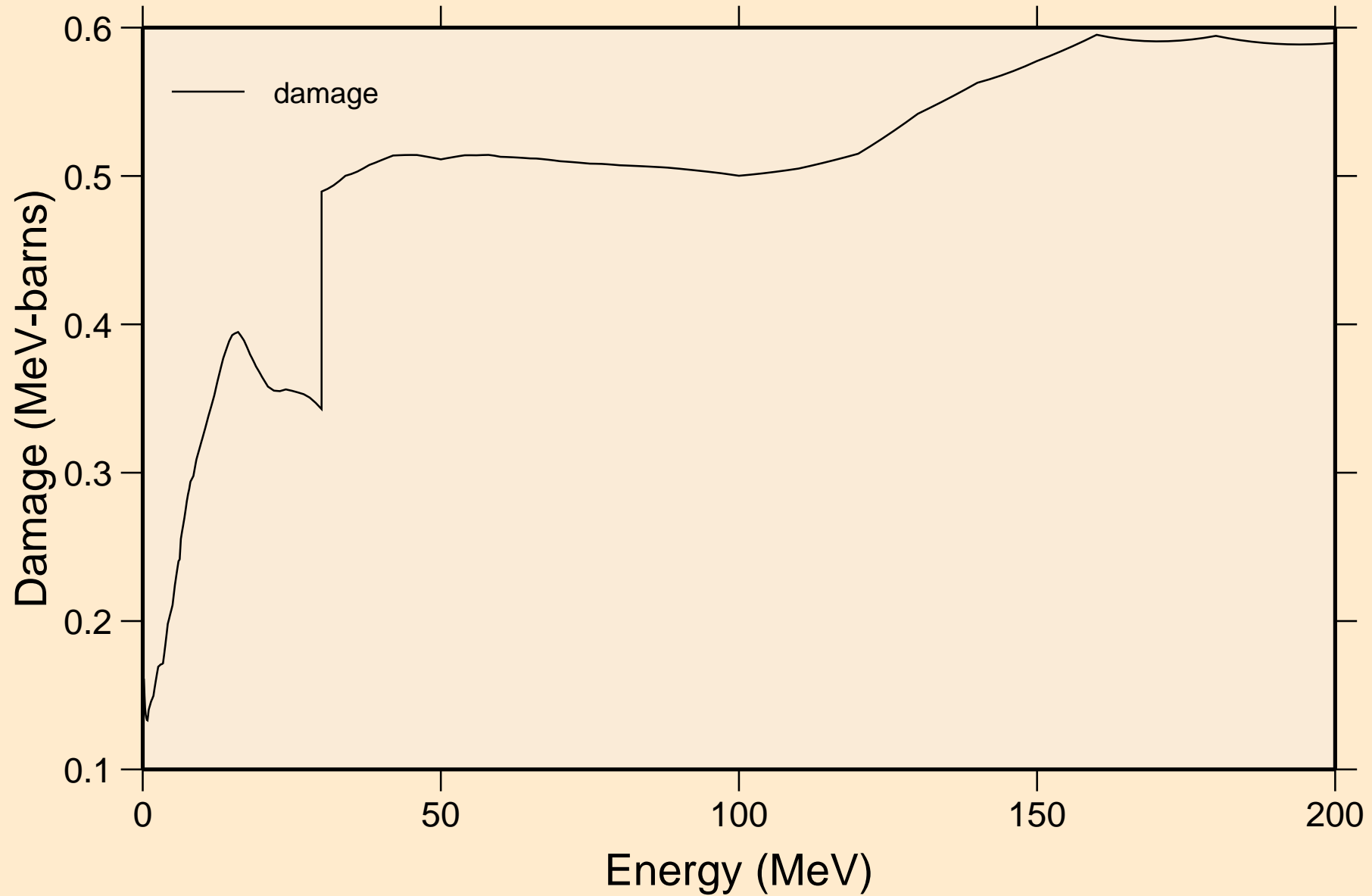

IN101 NEUTRON ACER TENDL-2021 LIBRARY; T=293.6K
Non-threshold reactions

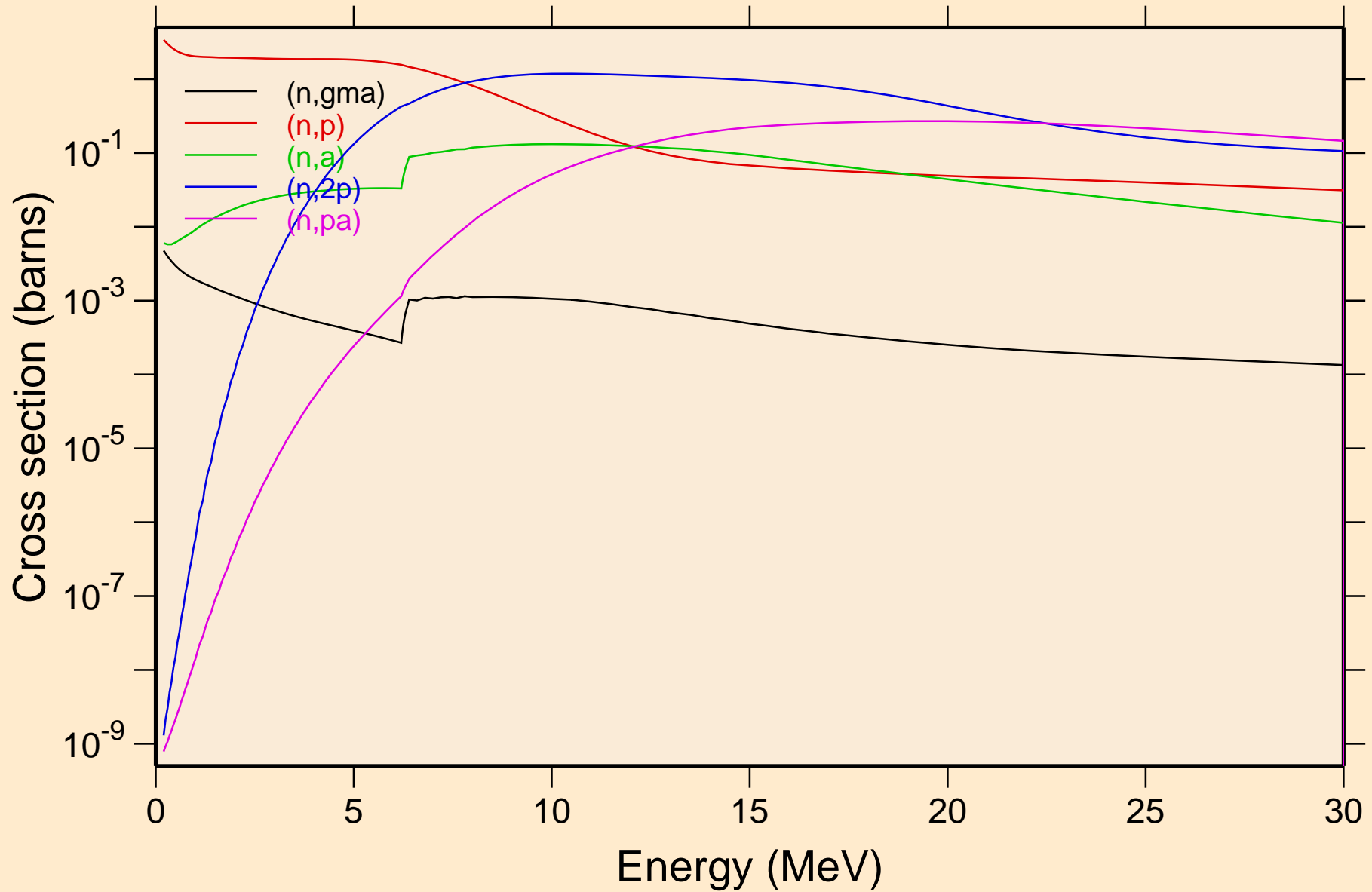

IN101 NEUTRON ACER TENDL-2021 LIBRARY; T=293.6K
Non-threshold reactions

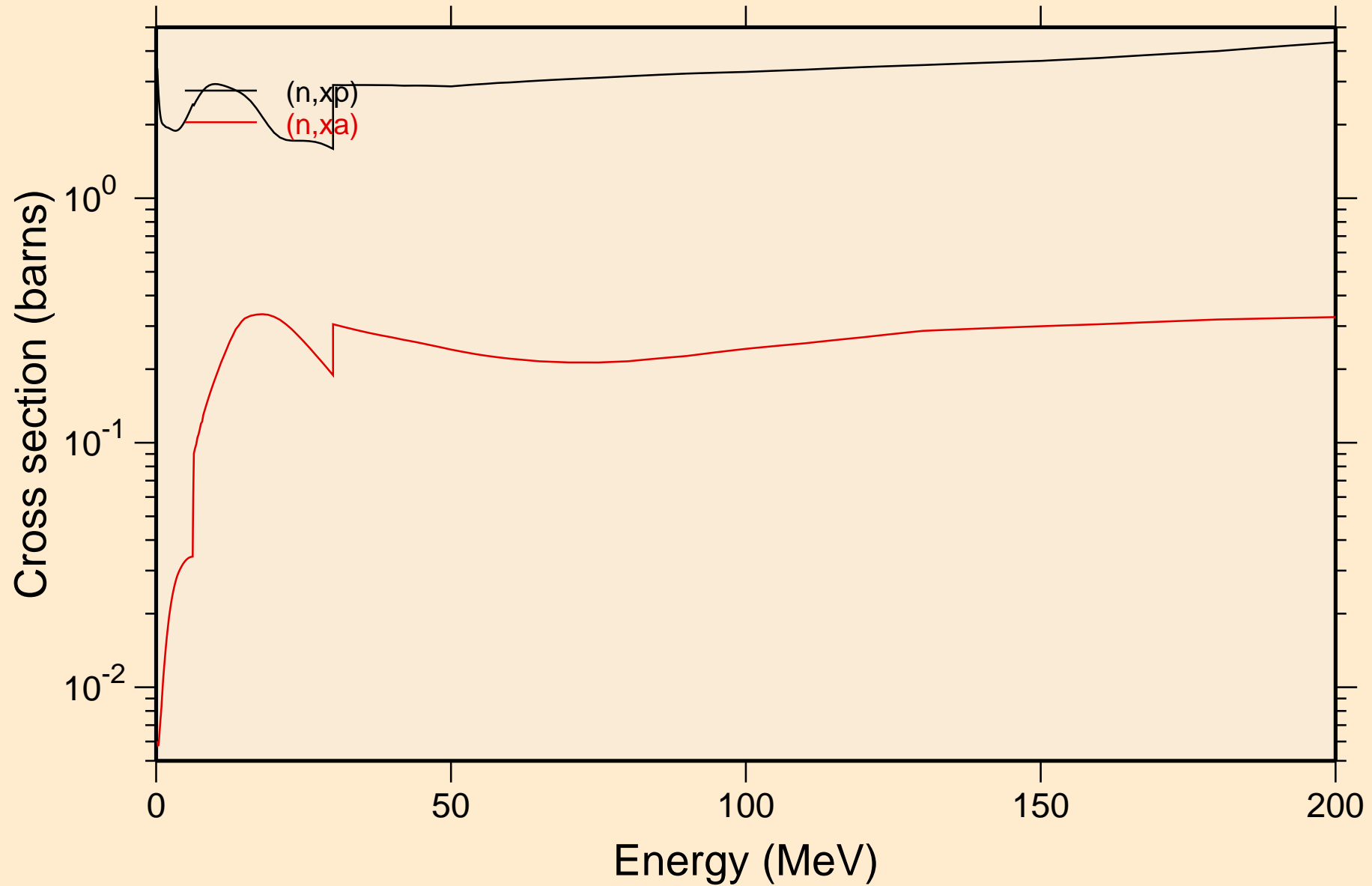

IN101 NEUTRON ACER TENDL-2021 LIBRARY; T=293.6K
Inelastic levels

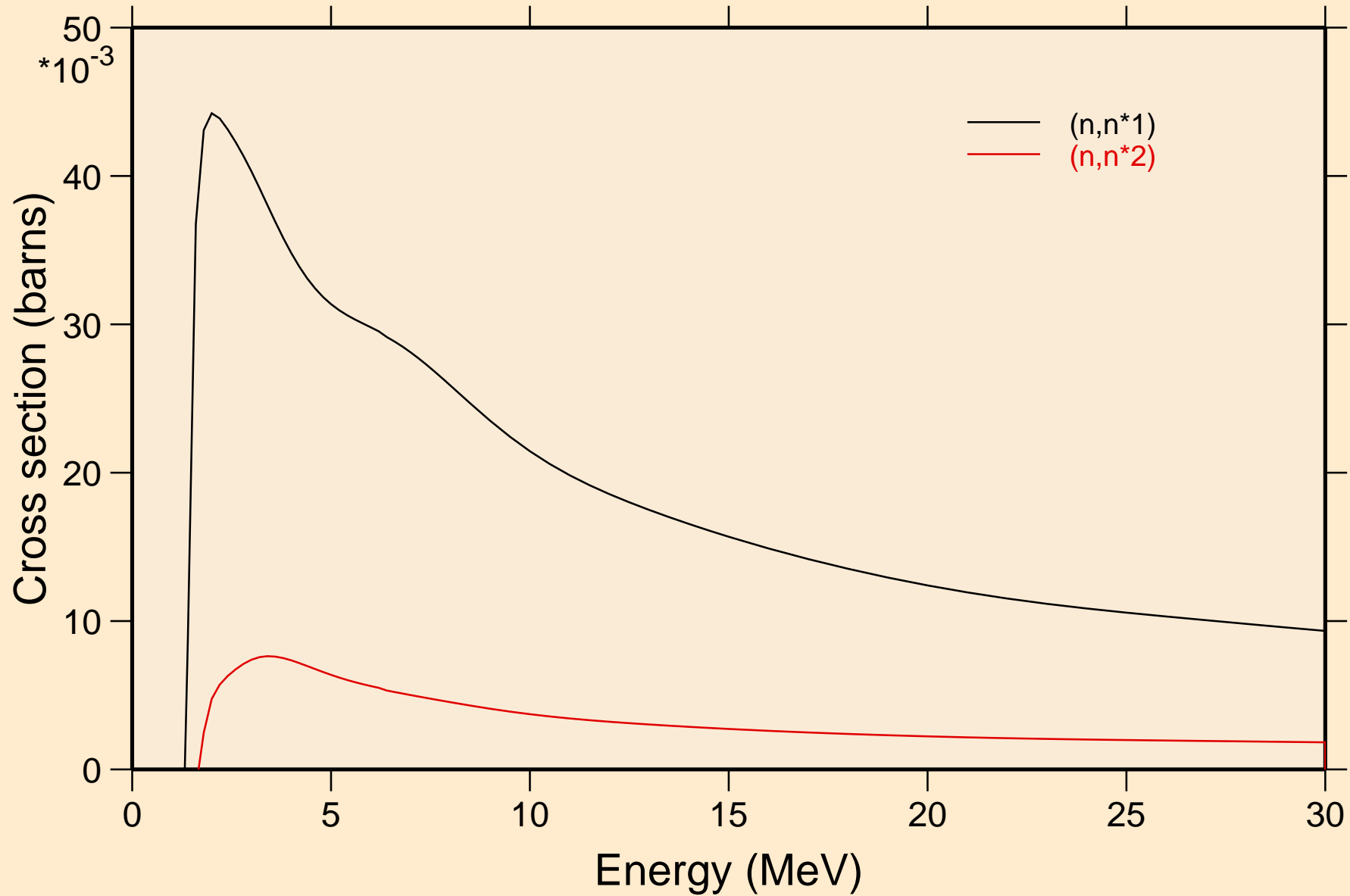

IN101 NEUTRON ACER TENDL-2021 LIBRARY; T=293.6K
Threshold reactions

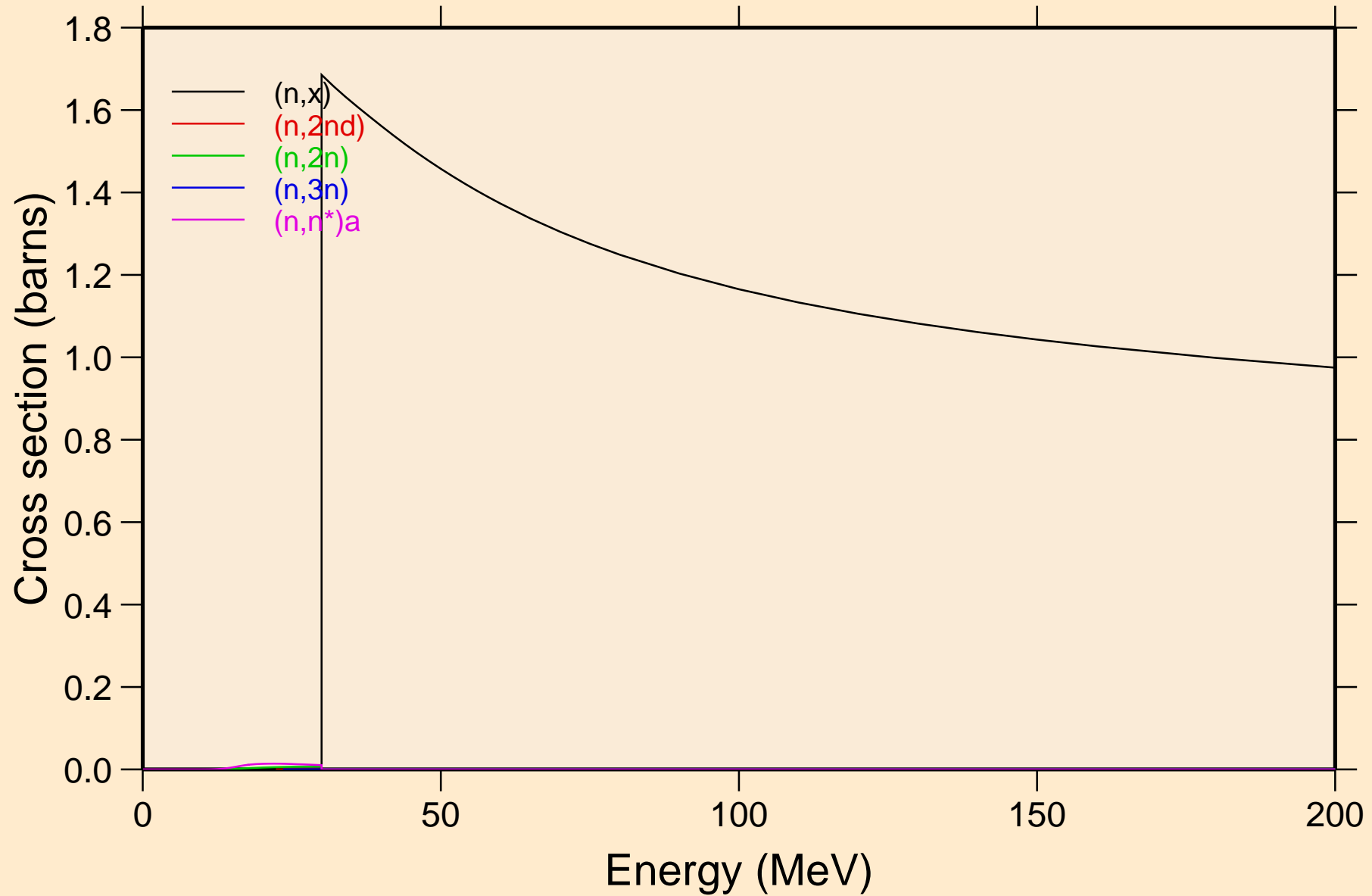

IN101 NEUTRON ACER TENDL-2021 LIBRARY; T=293.6K
Threshold reactions

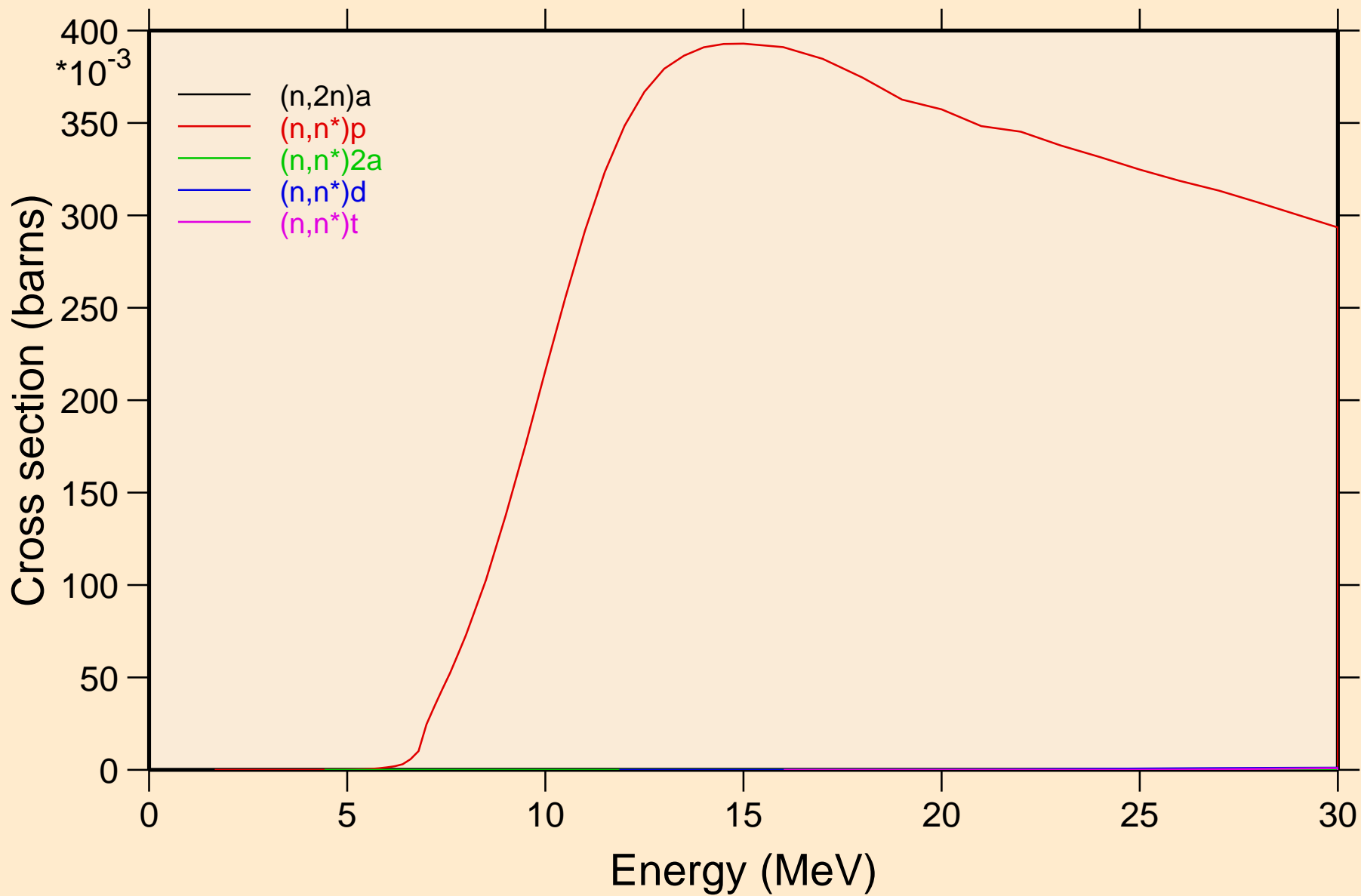

IN101 NEUTRON ACER TENDL-2021 LIBRARY; T=293.6K
Threshold reactions

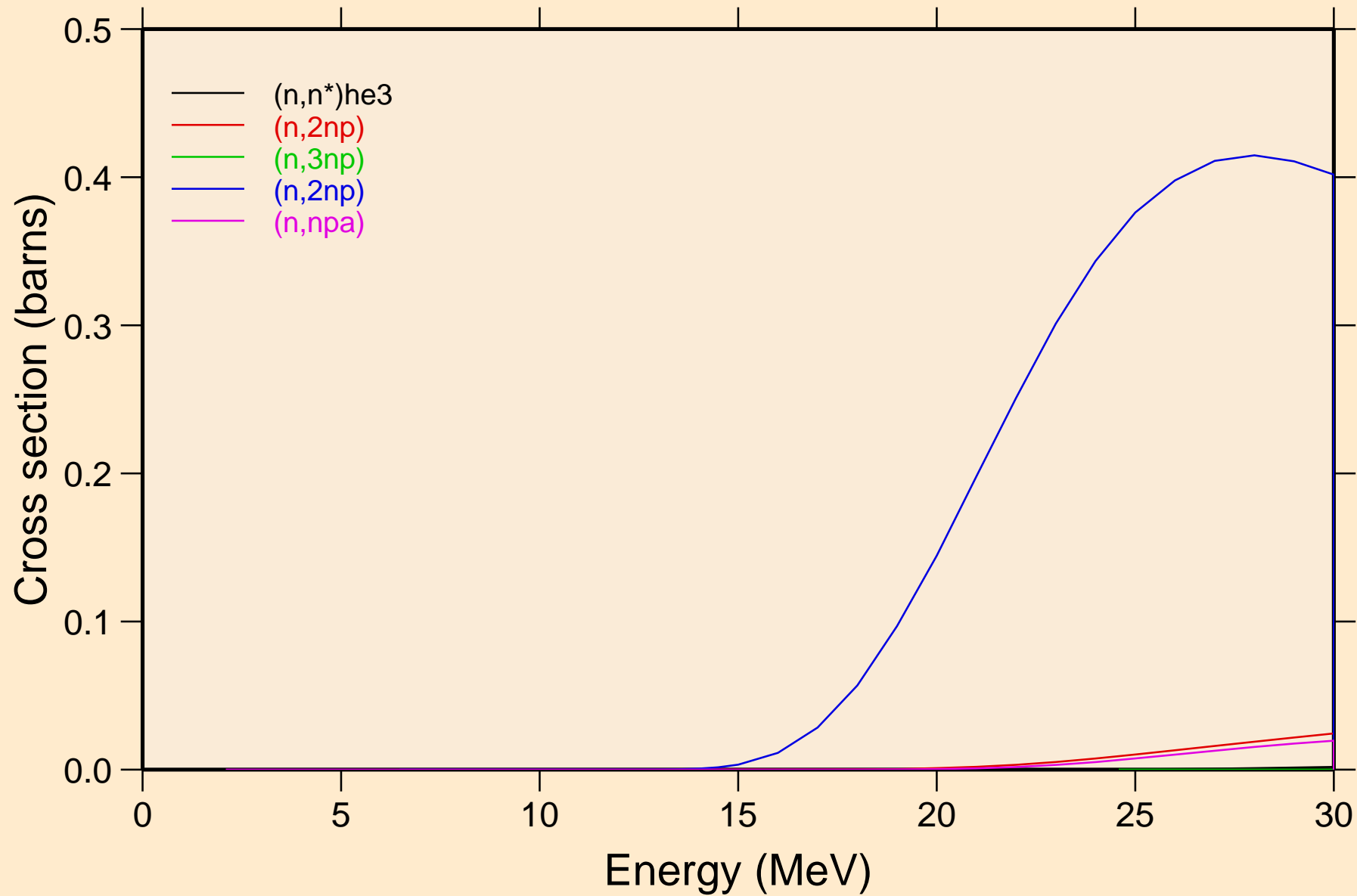

IN101 NEUTRON ACER TENDL-2021 LIBRARY; T=293.6K
Threshold reactions

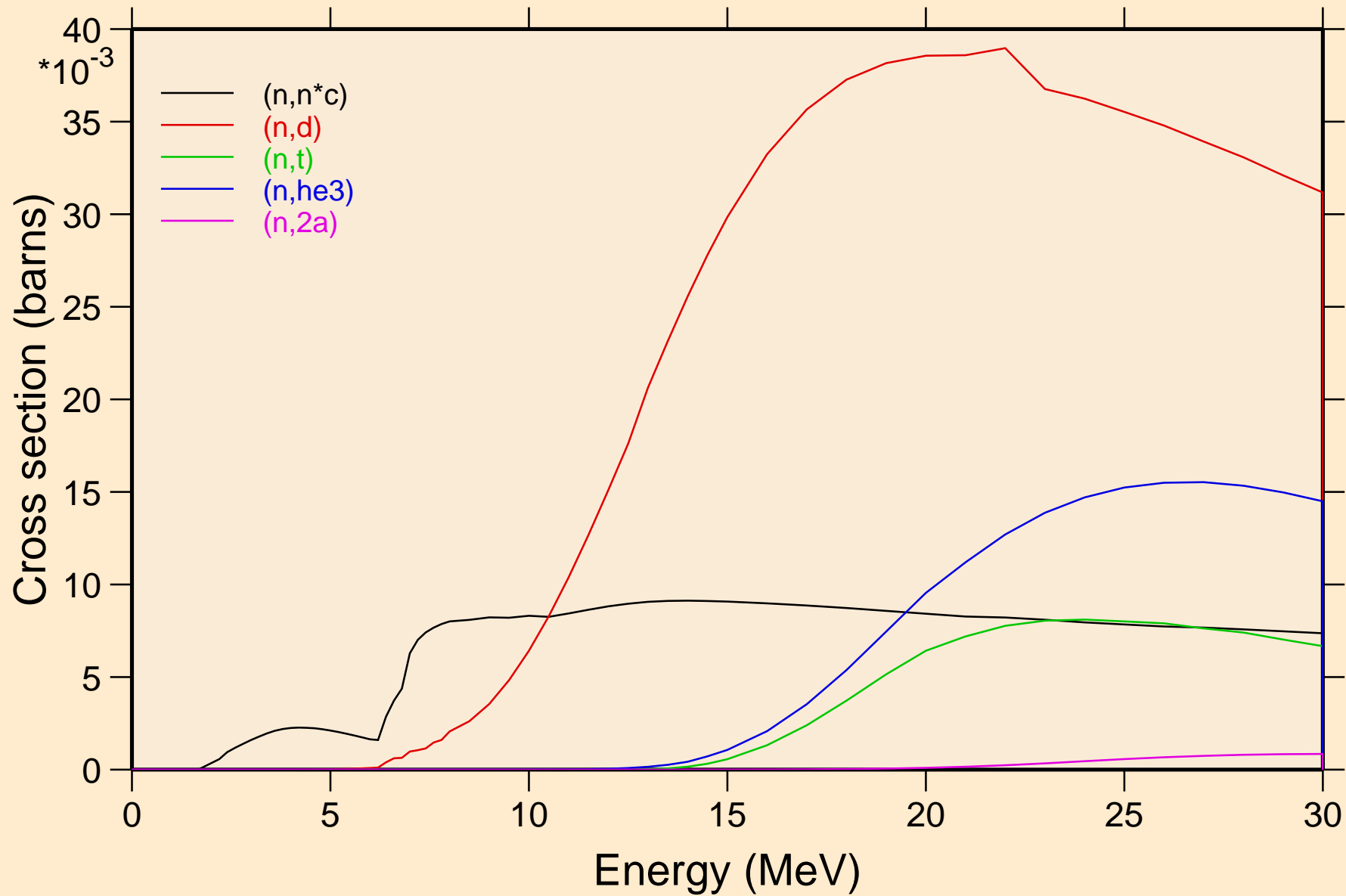

IN101 NEUTRON ACER TENDL-2021 LIBRARY; T=293.6K
Threshold reactions

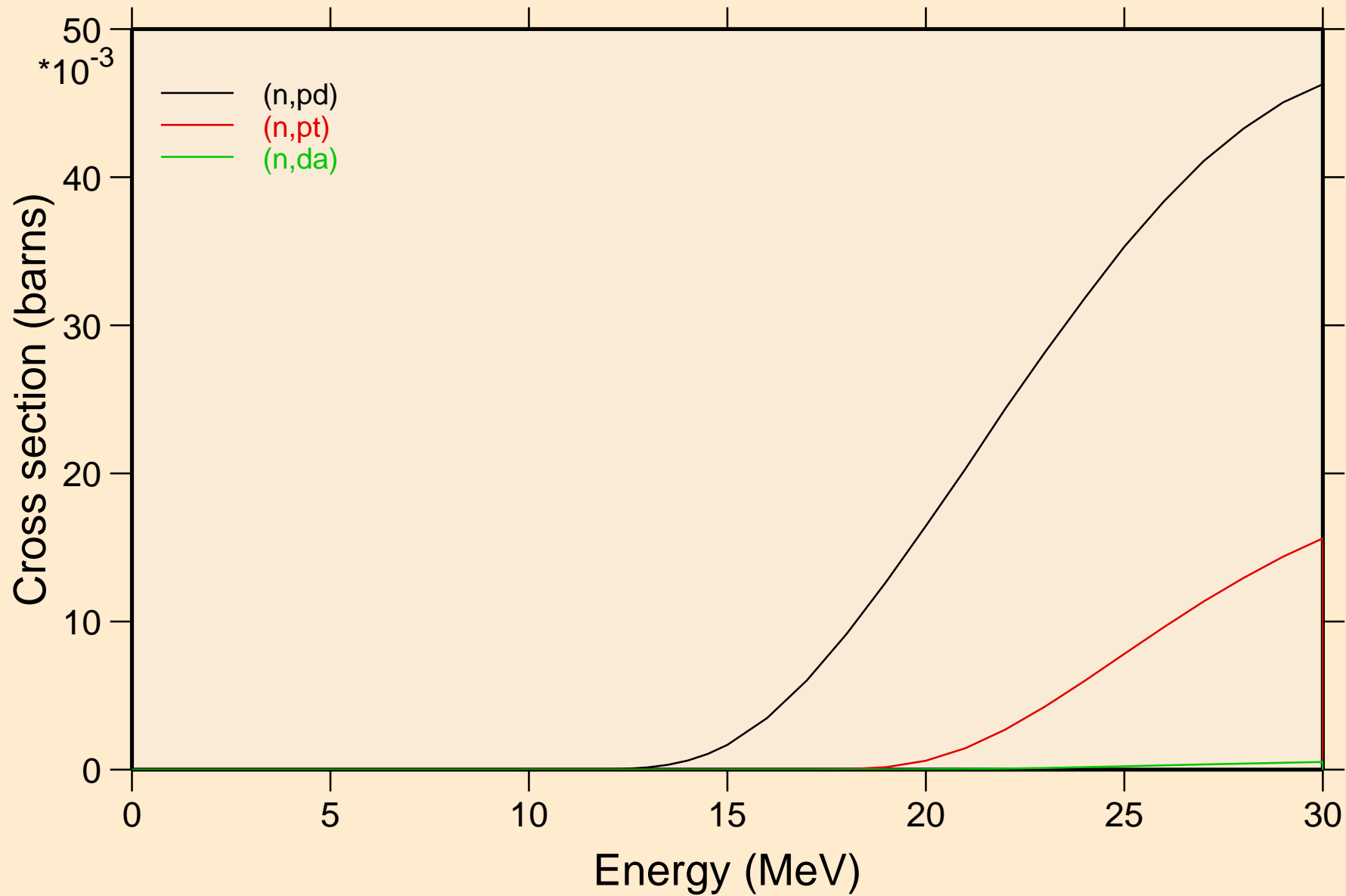

IN101 NEUTRON ACER TENDL-2021 LIBRARY; T=293.6K
Threshold reactions

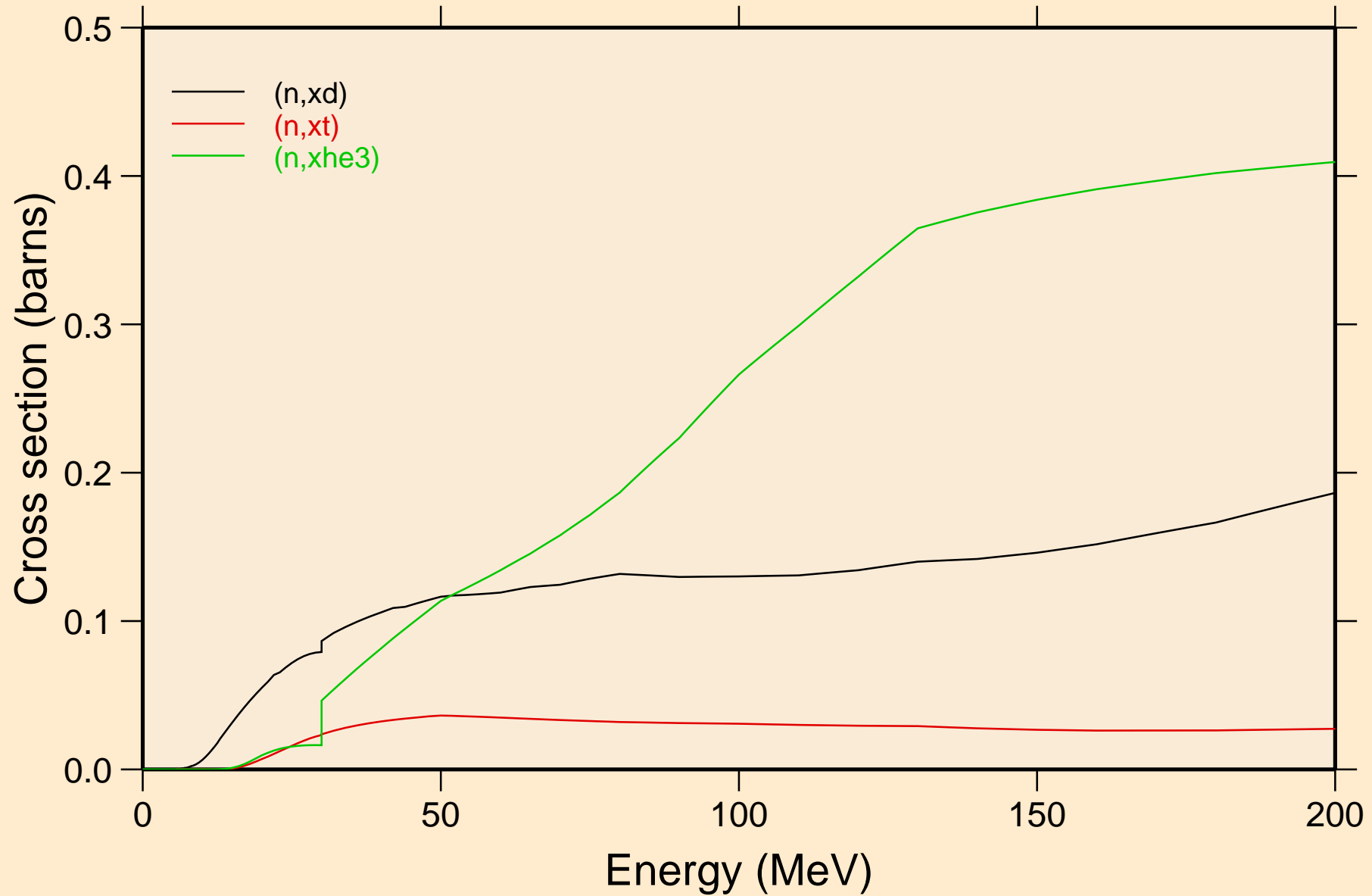

IN101 NEUTRON ACER TENDL-2021 LIBRARY; T=293.6K
angular distribution for elastic

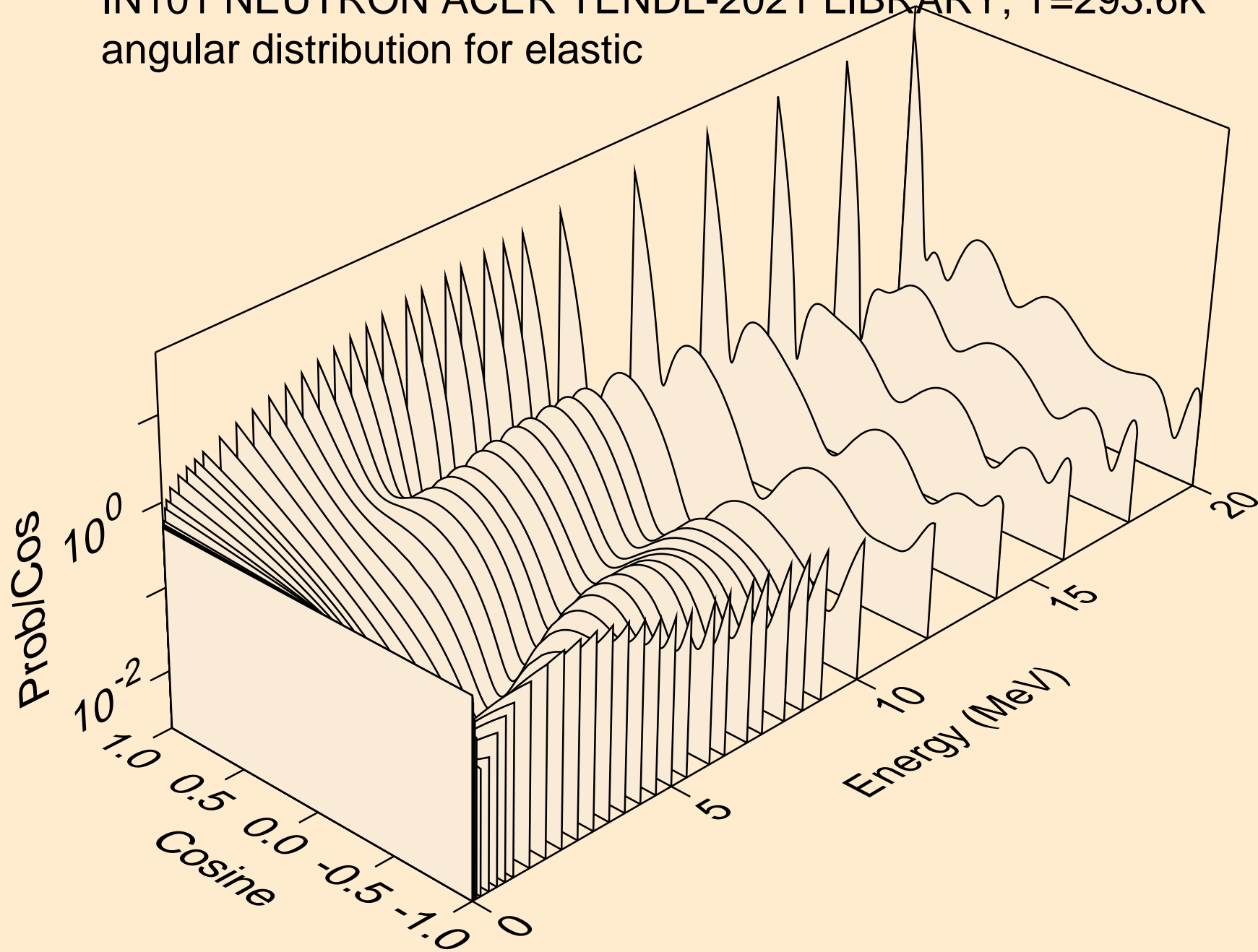

IN101 NEUTRON ACER TENDL-2021 LIBRARY; T=293.6K
angular distribution for elastic

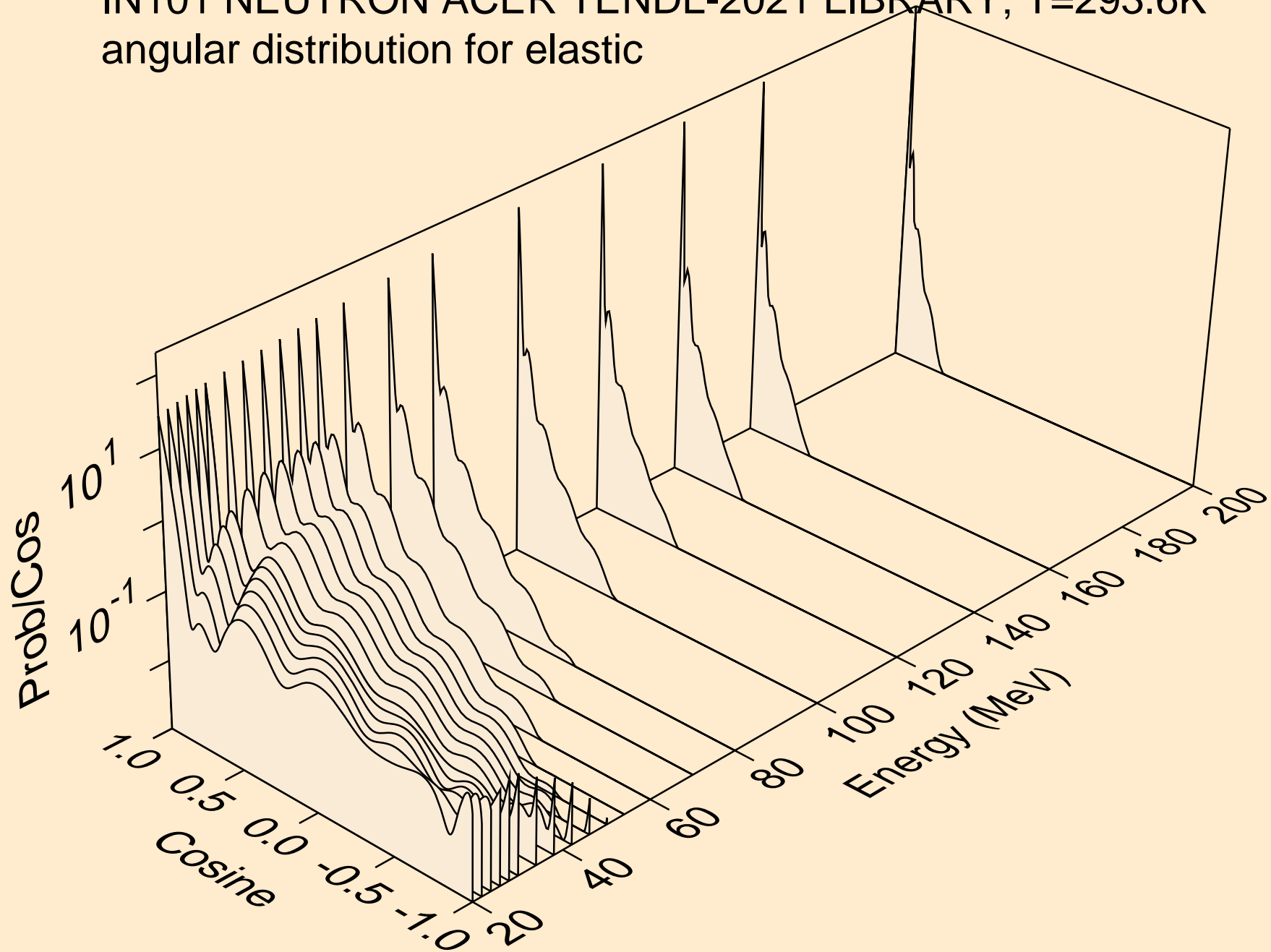

IN101 NEUTRON ACER TENDL-2021 LIBRARY; T=293.6K
angular distribution for (n,n*1)

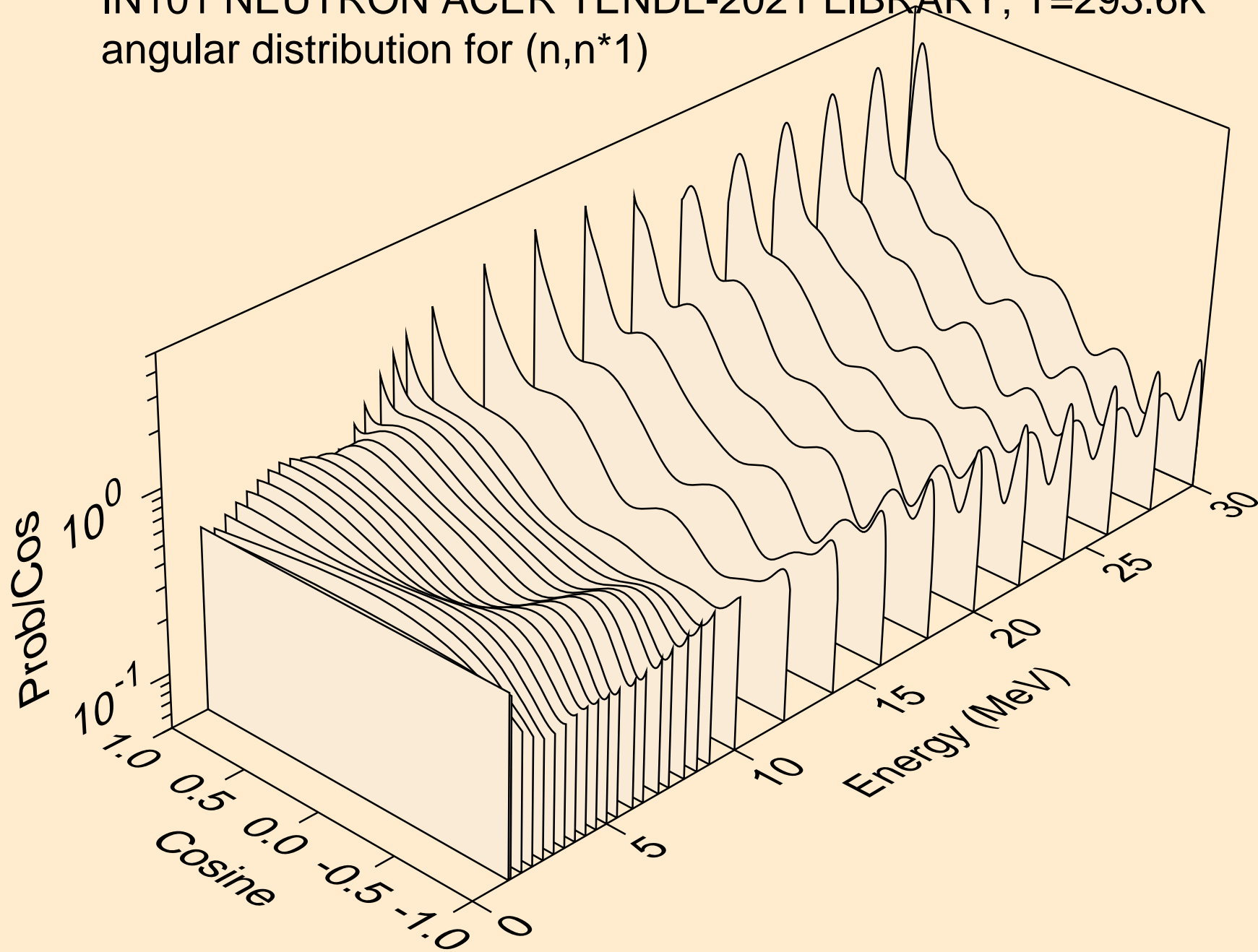

IN101 NEUTRON ACER TENDL-2021 LIBRARY; T=293.6K
angular distribution for (n,n*2)

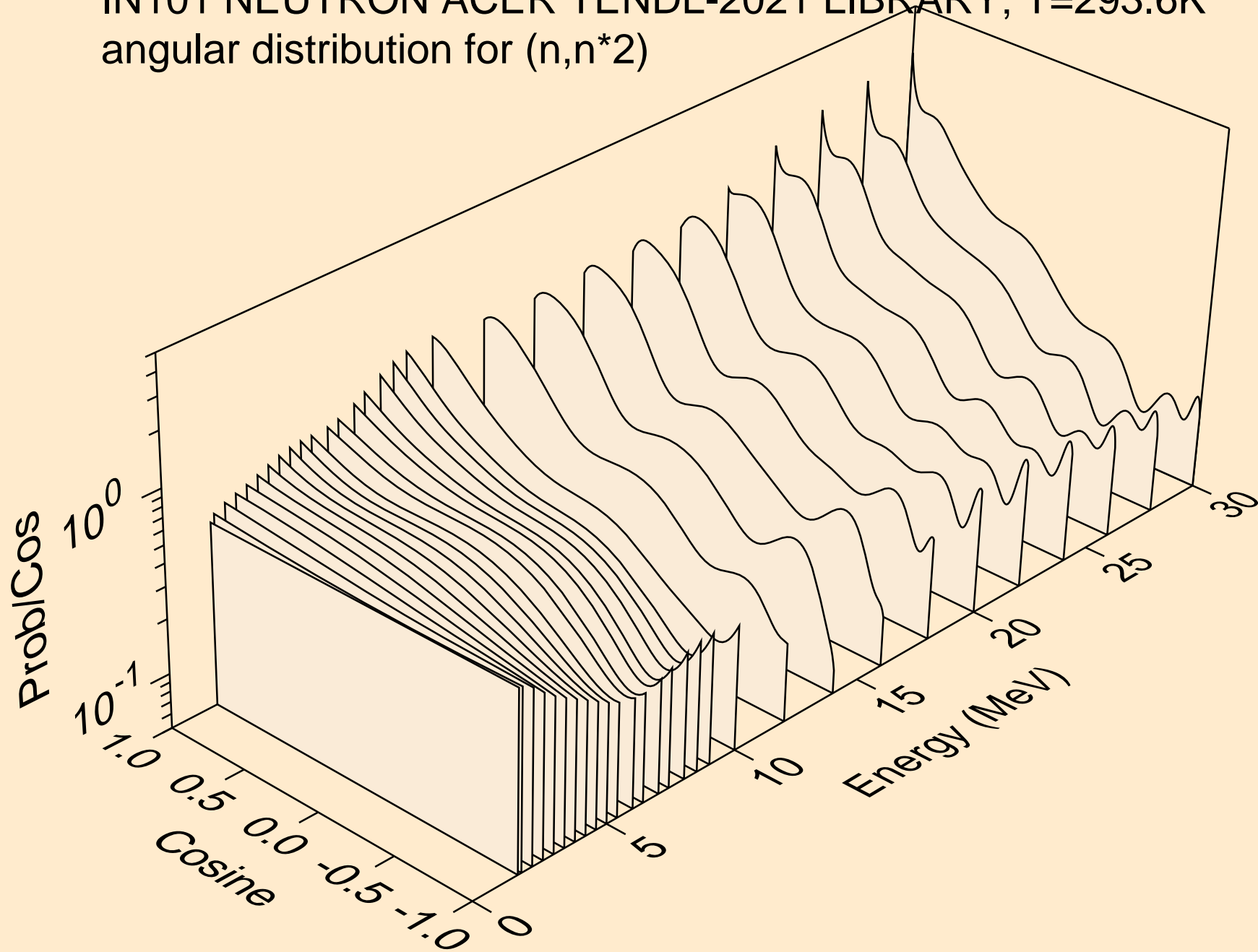

IN101 NEUTRON ACER TENDL-2021 LIBRARY; T=293.6K
Neutron emission for (n,x)

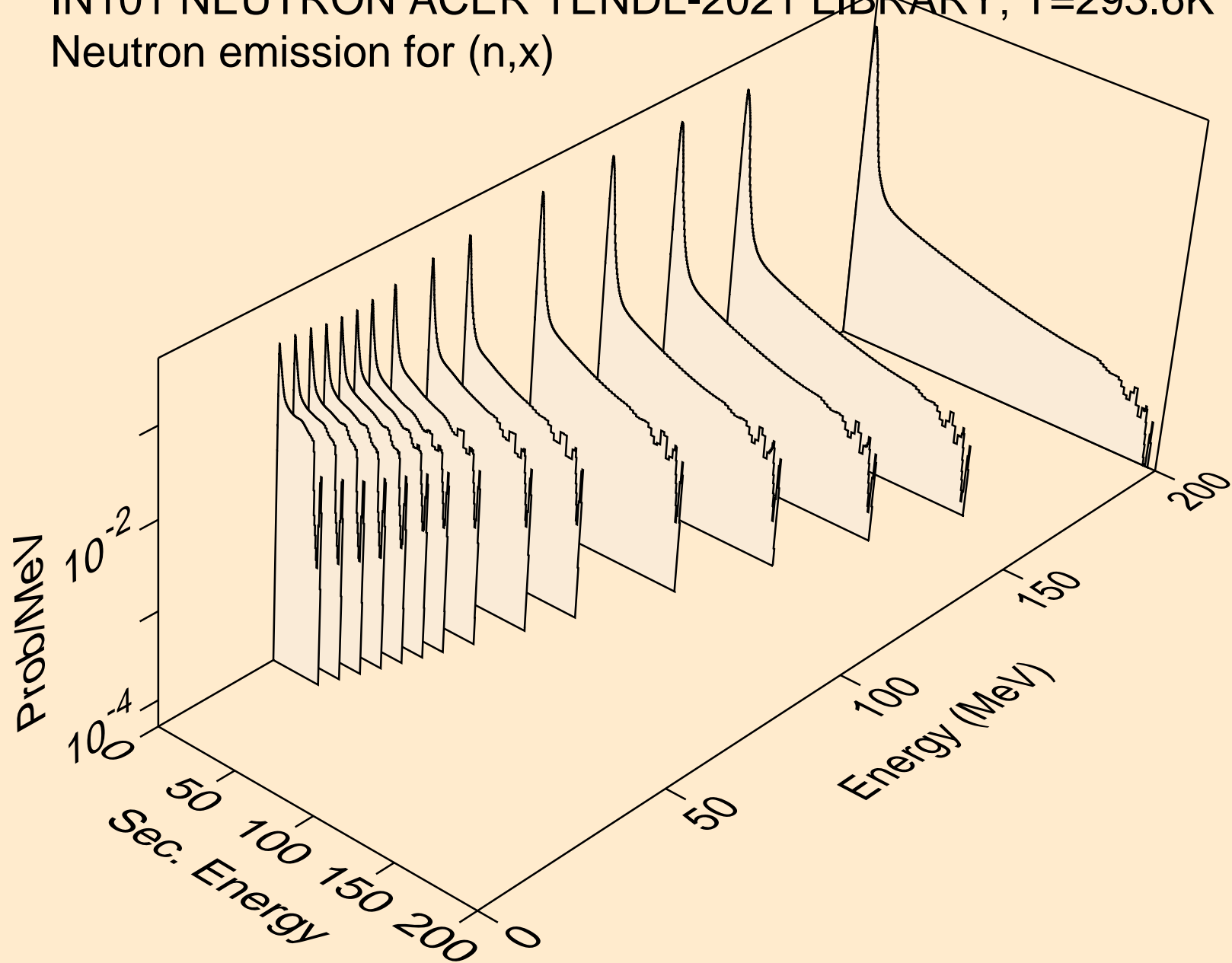

IN101 NEUTRON ACER TENDL-2021 LIBRARY; T=293.6K
Neutron emission for (n,2nd)

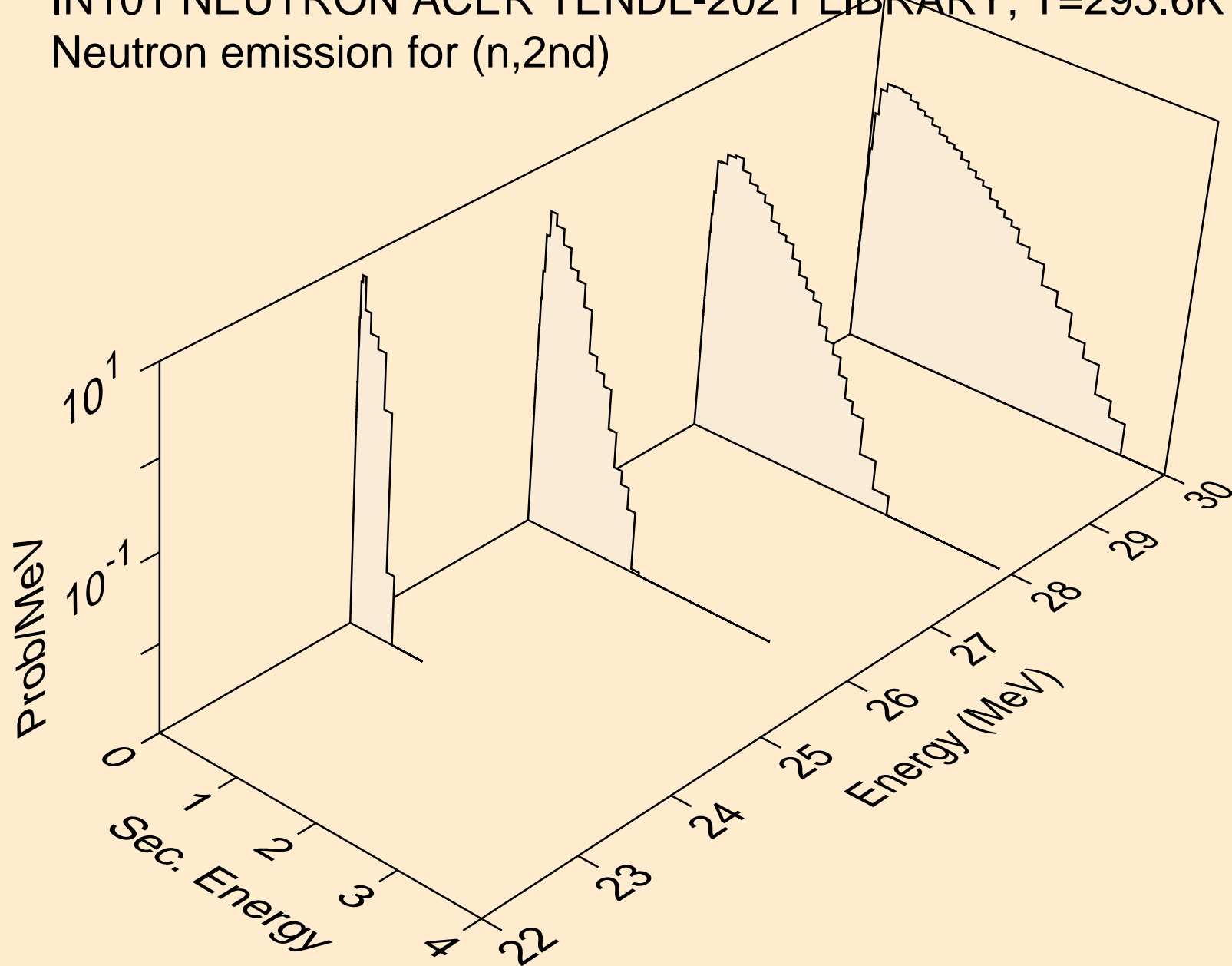

IN101 NEUTRON ACER TENDL-2021 LIBRARY; T=293.6K
Neutron emission for (n,2n)

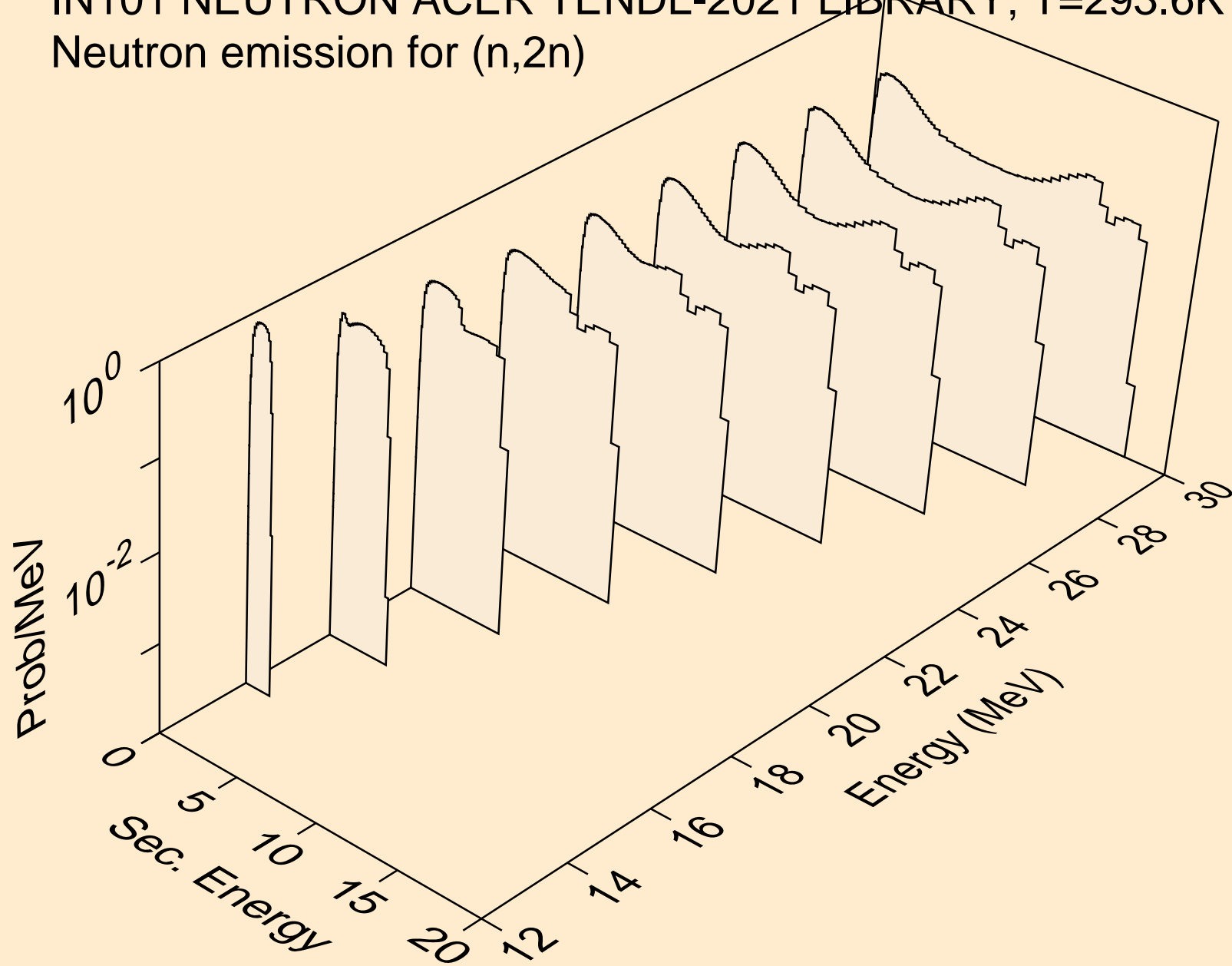

IN101 NEUTRON ACER TENDL-2021 LIBRARY; T=293.6K
Neutron emission for (n,3n)

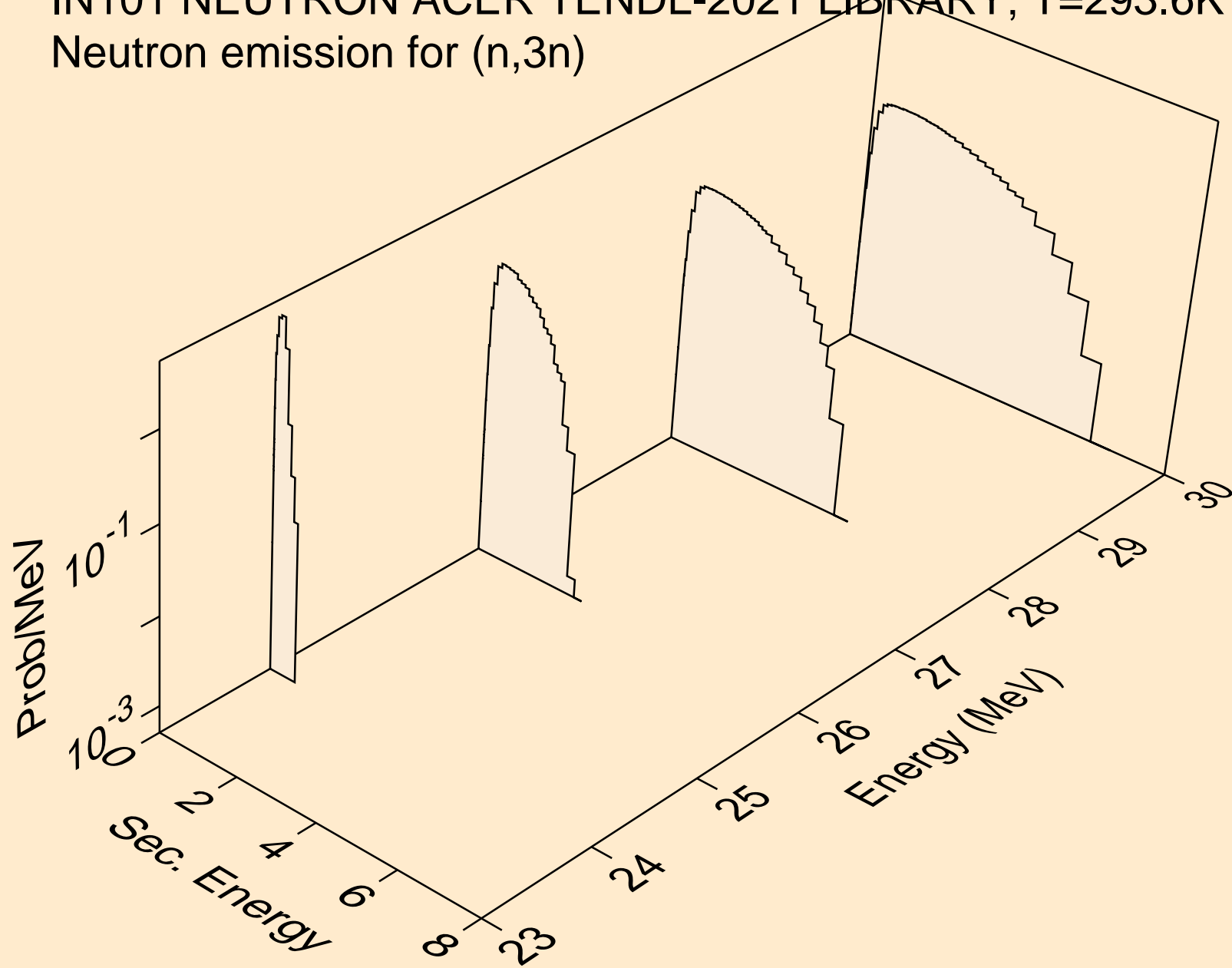

IN101 NEUTRON ACER TENDL-2021 LIBRARY; T=293.6K
Neutron emission for (n,n*)a

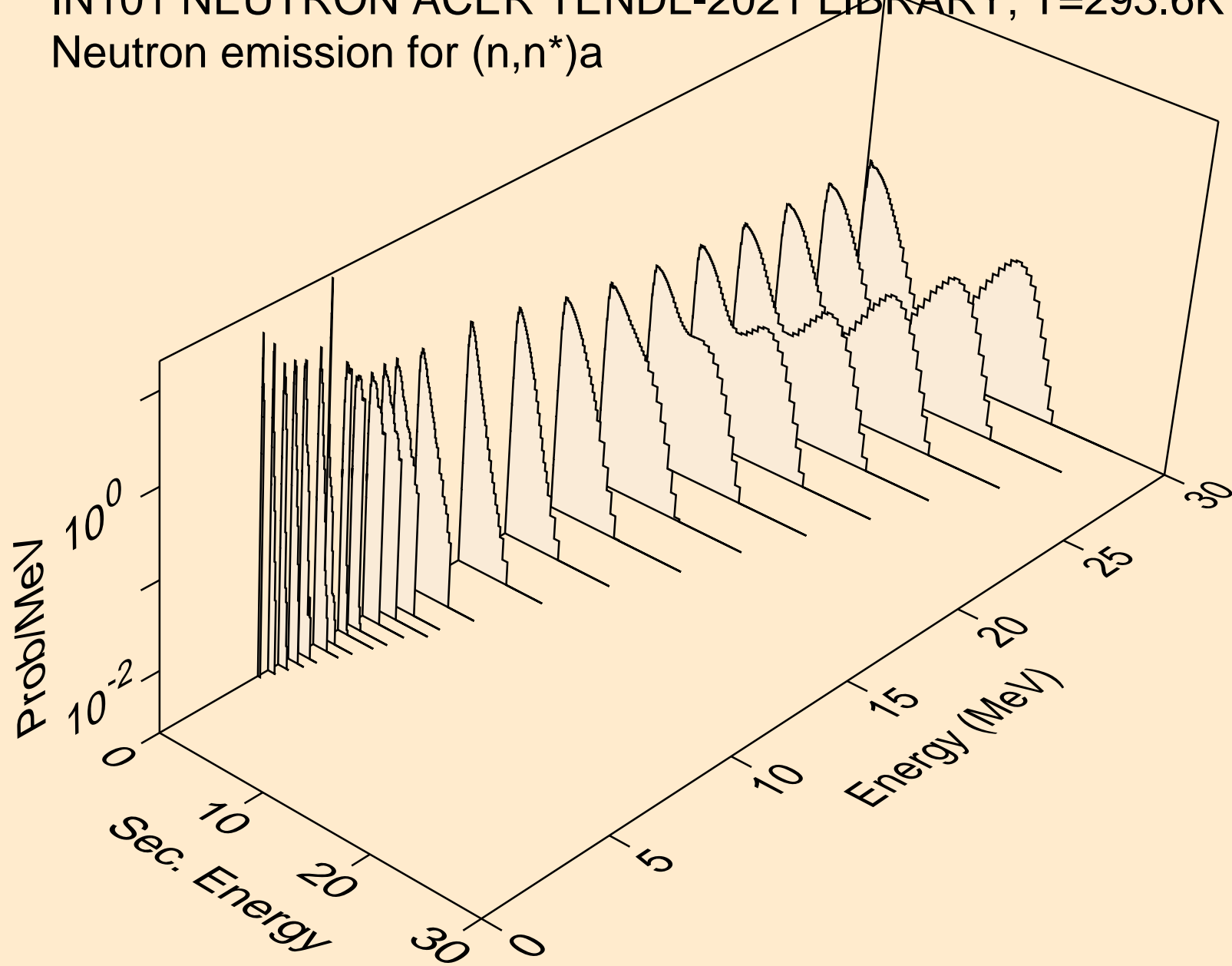

IN101 NEUTRON ACER TENDL-2021 LIBRARY; T=293.6K
Neutron emission for (n,2n)_a

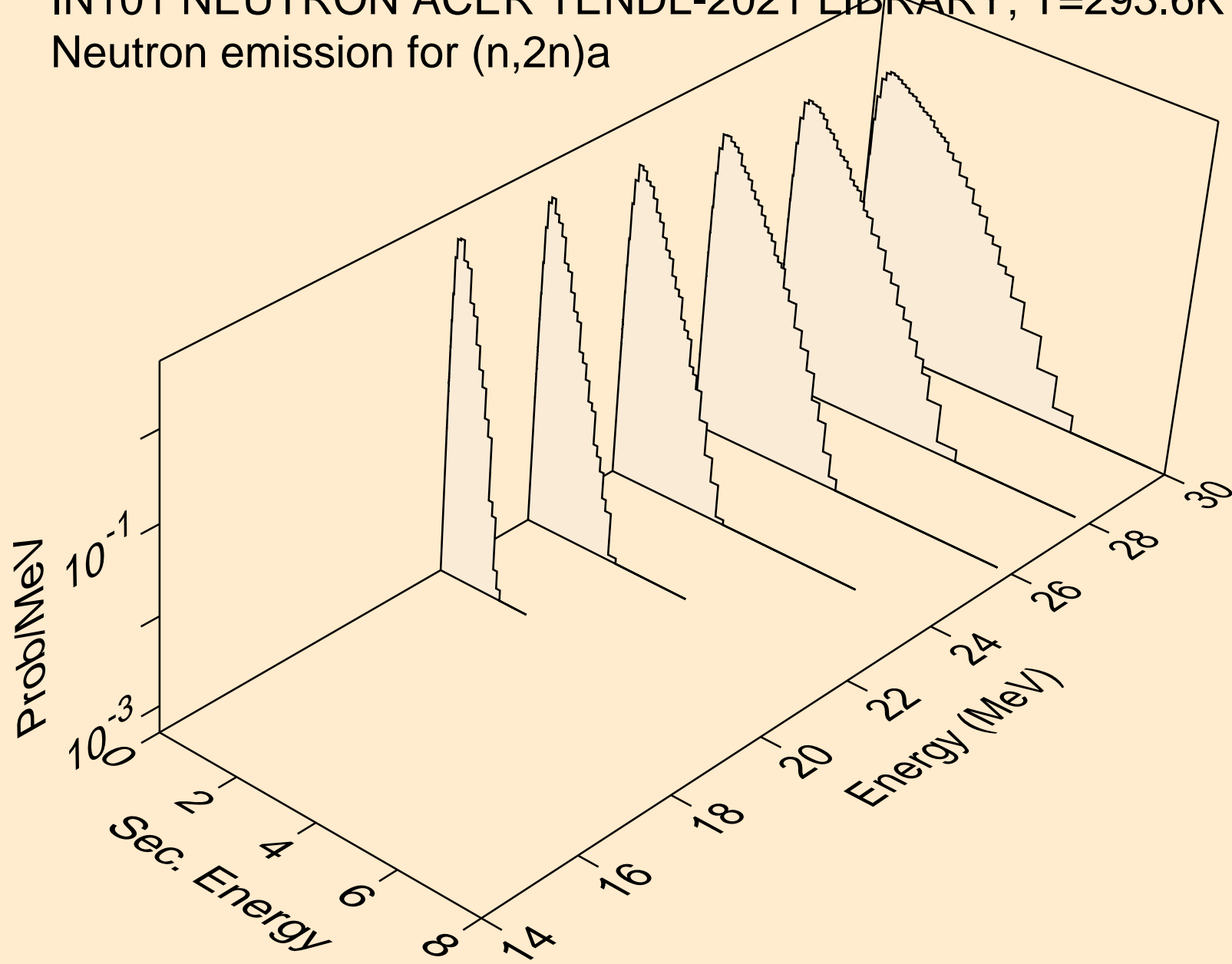

IN101 NEUTRON ACER TENDL-2021 LIBRARY; T=293.6K
Neutron emission for (n,n*)p

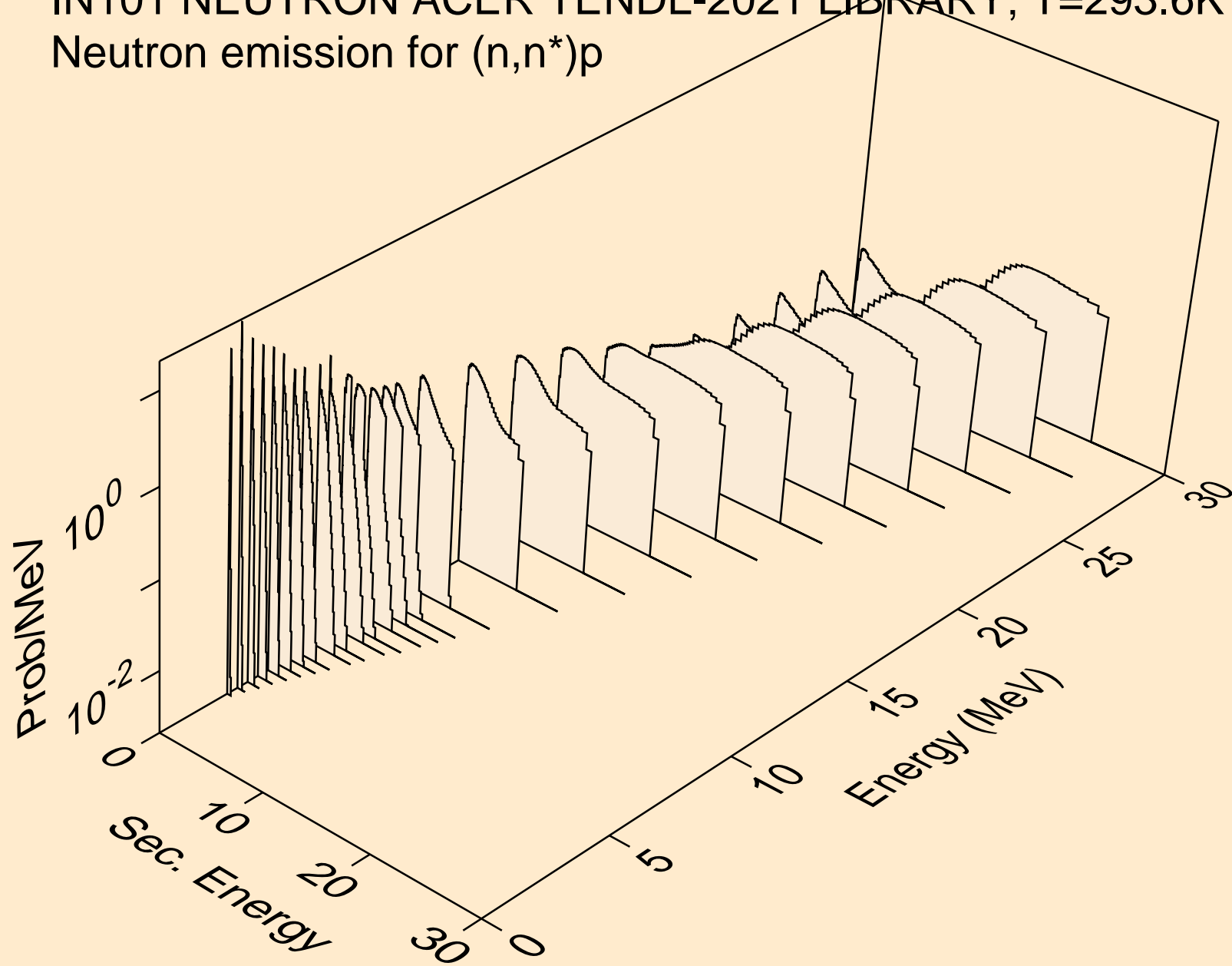

IN101 NEUTRON ACER TENDL-2021 LIBRARY; T=293.6K
Neutron emission for (n,n*)2a

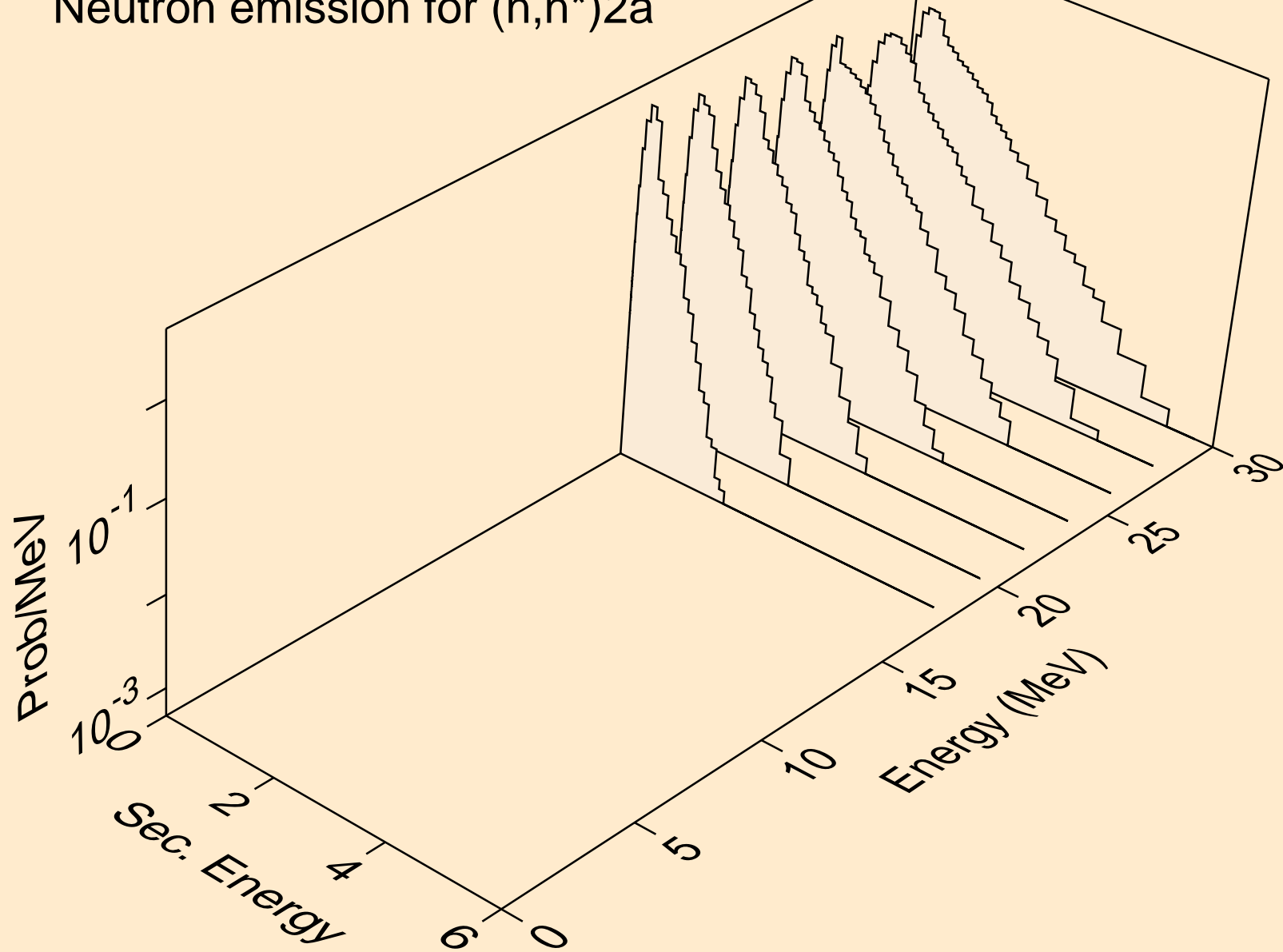

IN101 NEUTRON ACER TENDL-2021 LIBRARY; T=293.6K
Neutron emission for (n,n*)d

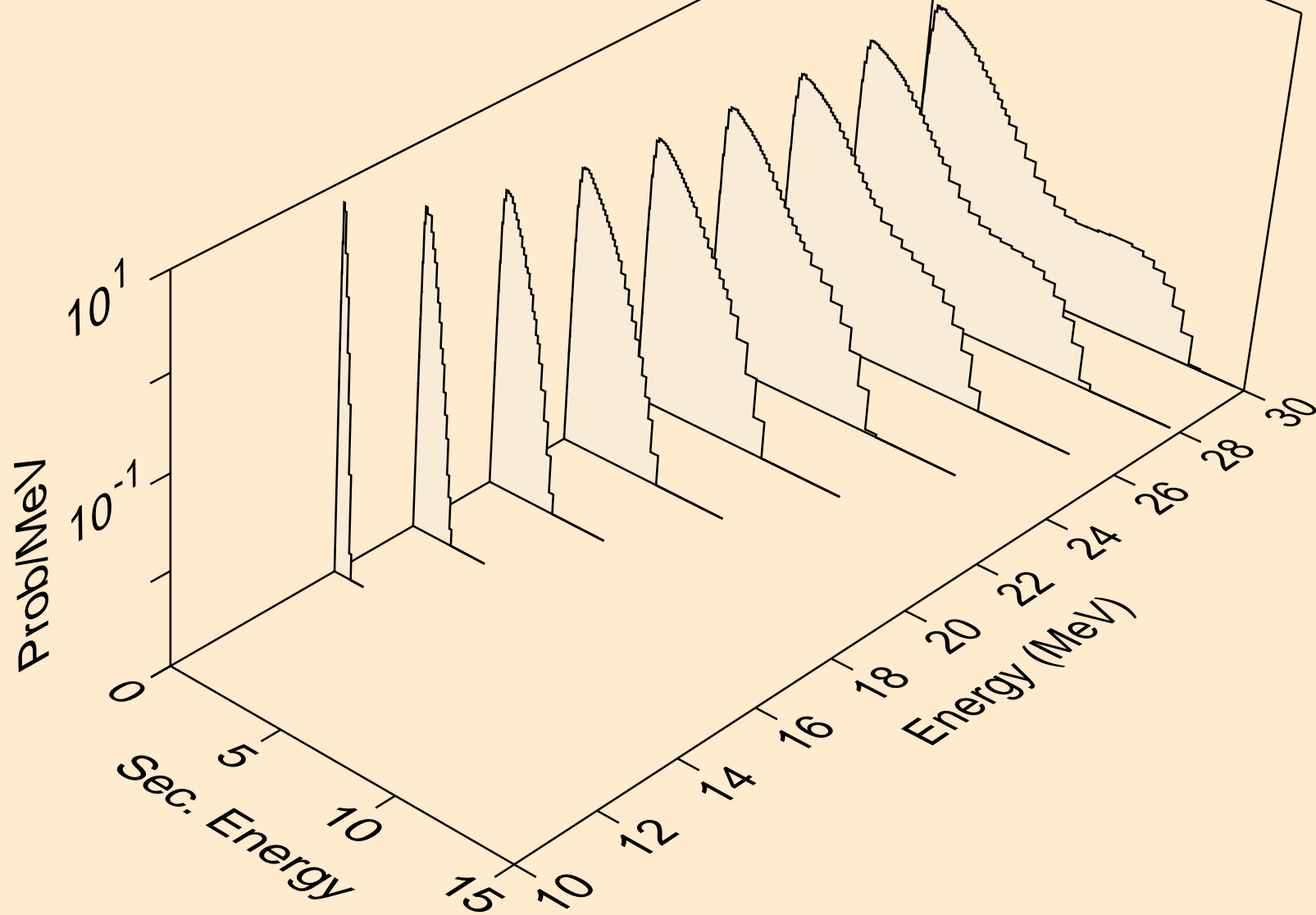

IN101 NEUTRON ACER TENDL-2021 LIBRARY; T=293.6K
Neutron emission for (n,n*)t

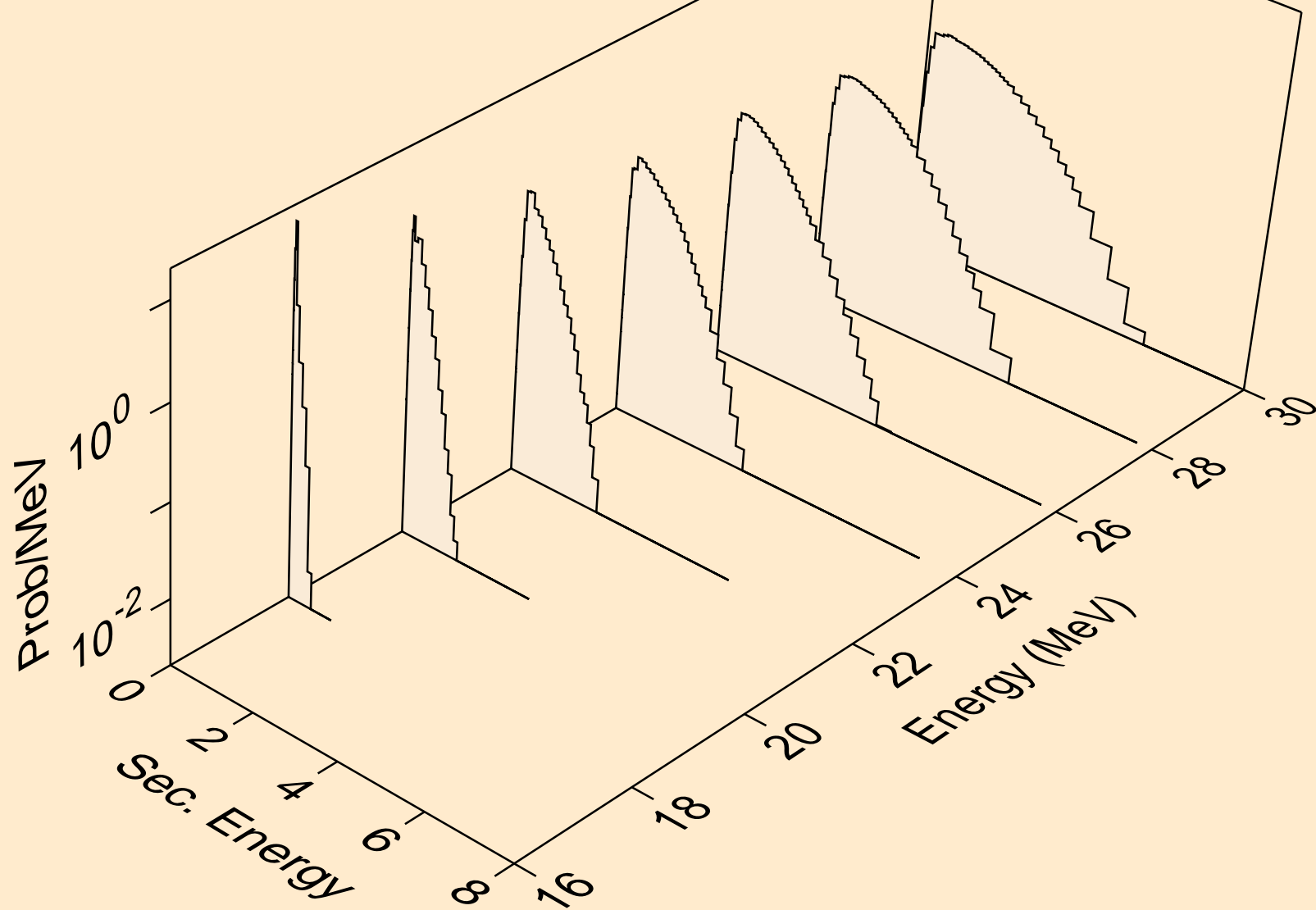

IN101 NEUTRON ACER TENDL-2021 LIBRARY; T=293.6K
Neutron emission for (n,n*)he3

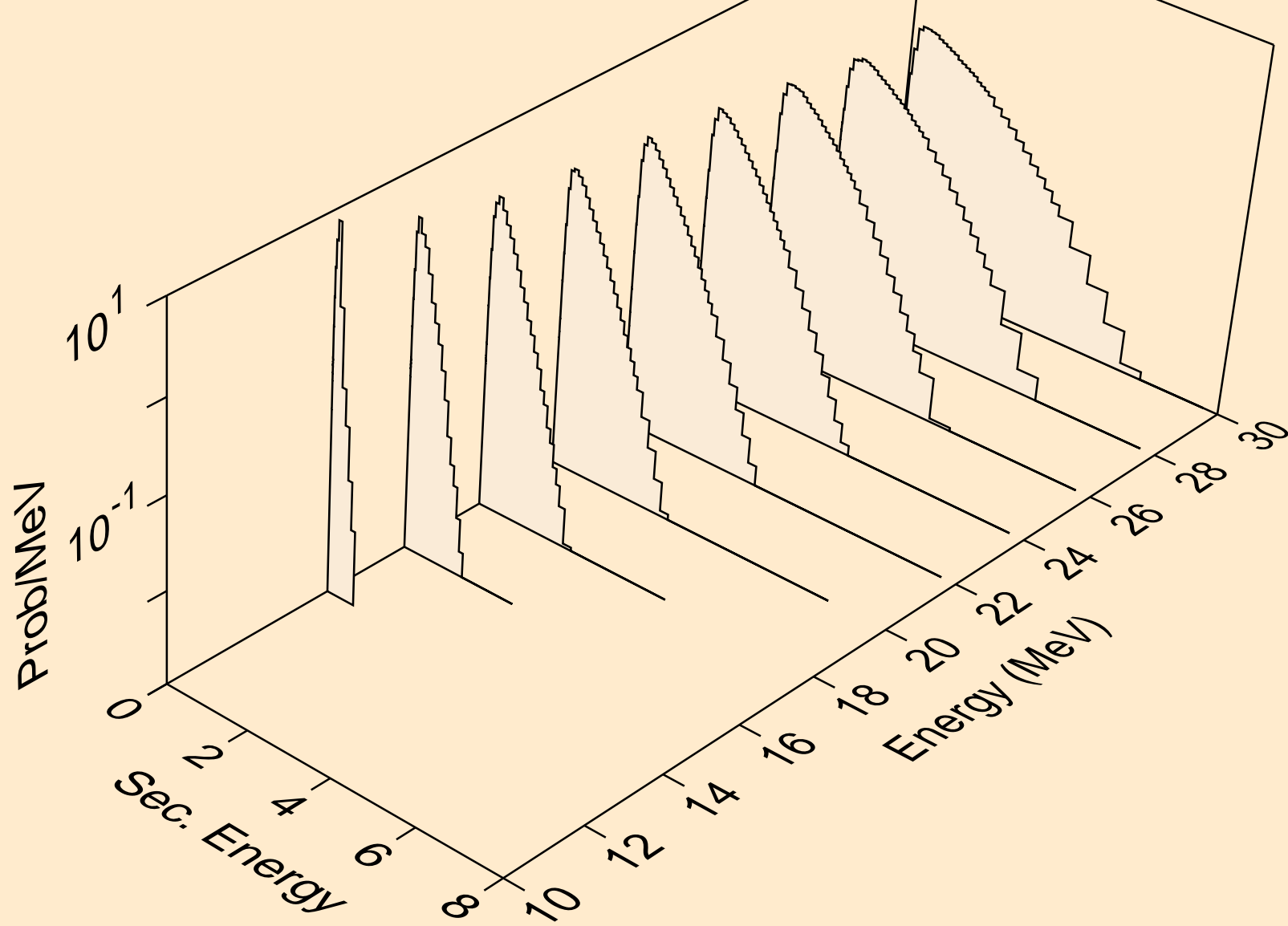

IN101 NEUTRON ACER TENDL-2021 LIBRARY; T=293.6K
Neutron emission for (n,2np)

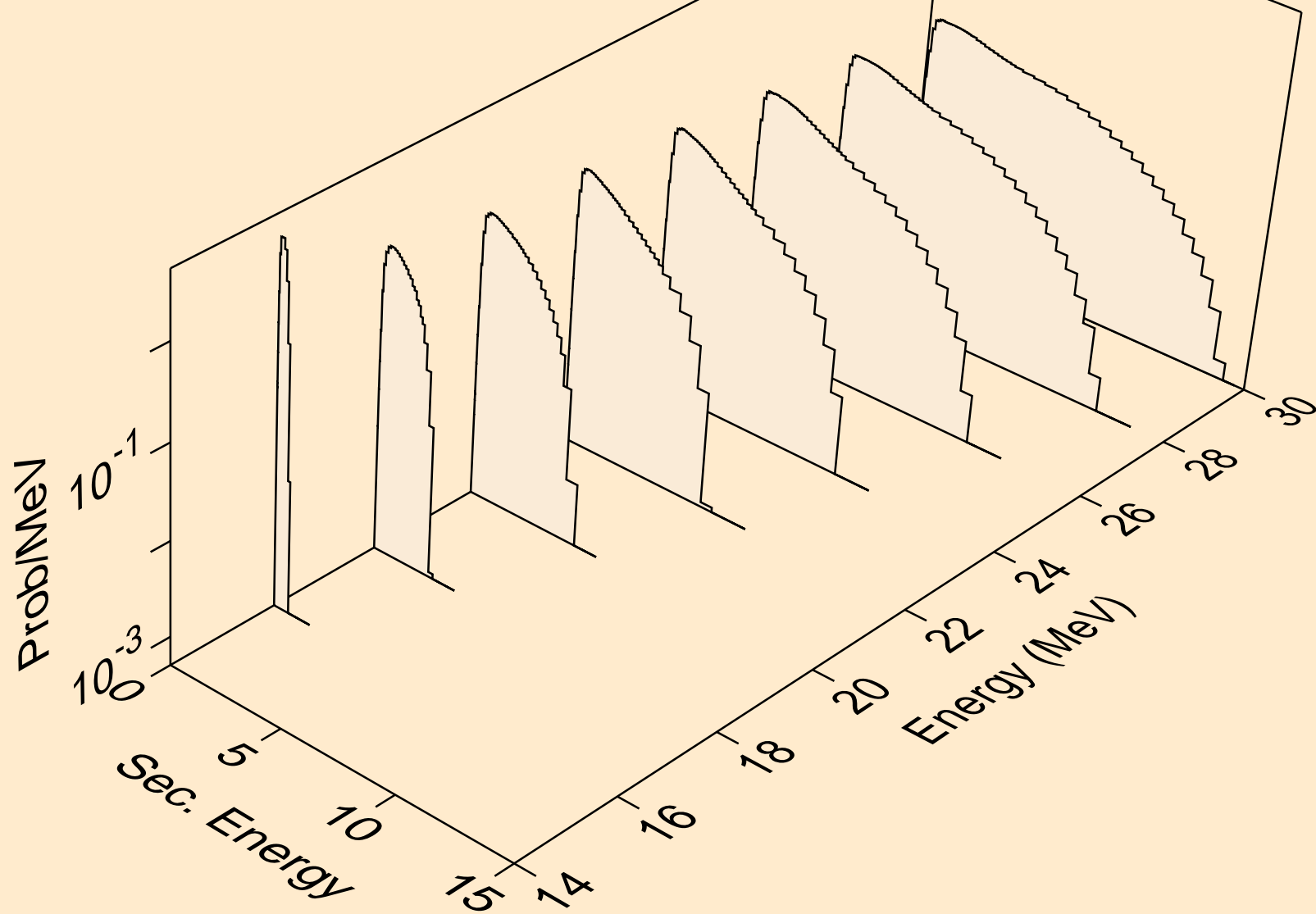

IN101 NEUTRON ACER TENDL-2021 LIBRARY; T=293.6K
Neutron emission for (n,3np)

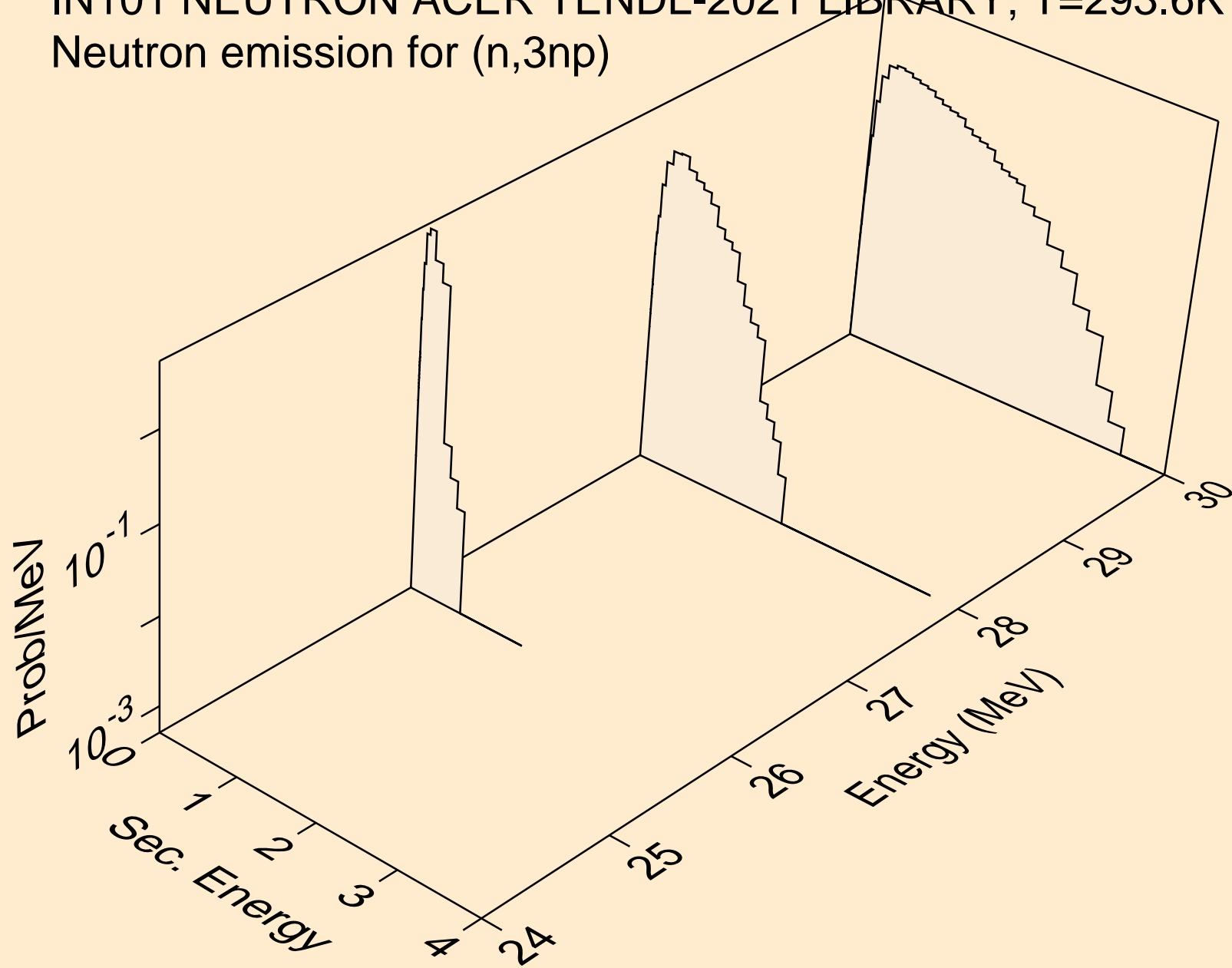

IN101 NEUTRON ACER TENDL-2021 LIBRARY; T=293.6K
Neutron emission for (n,2np)

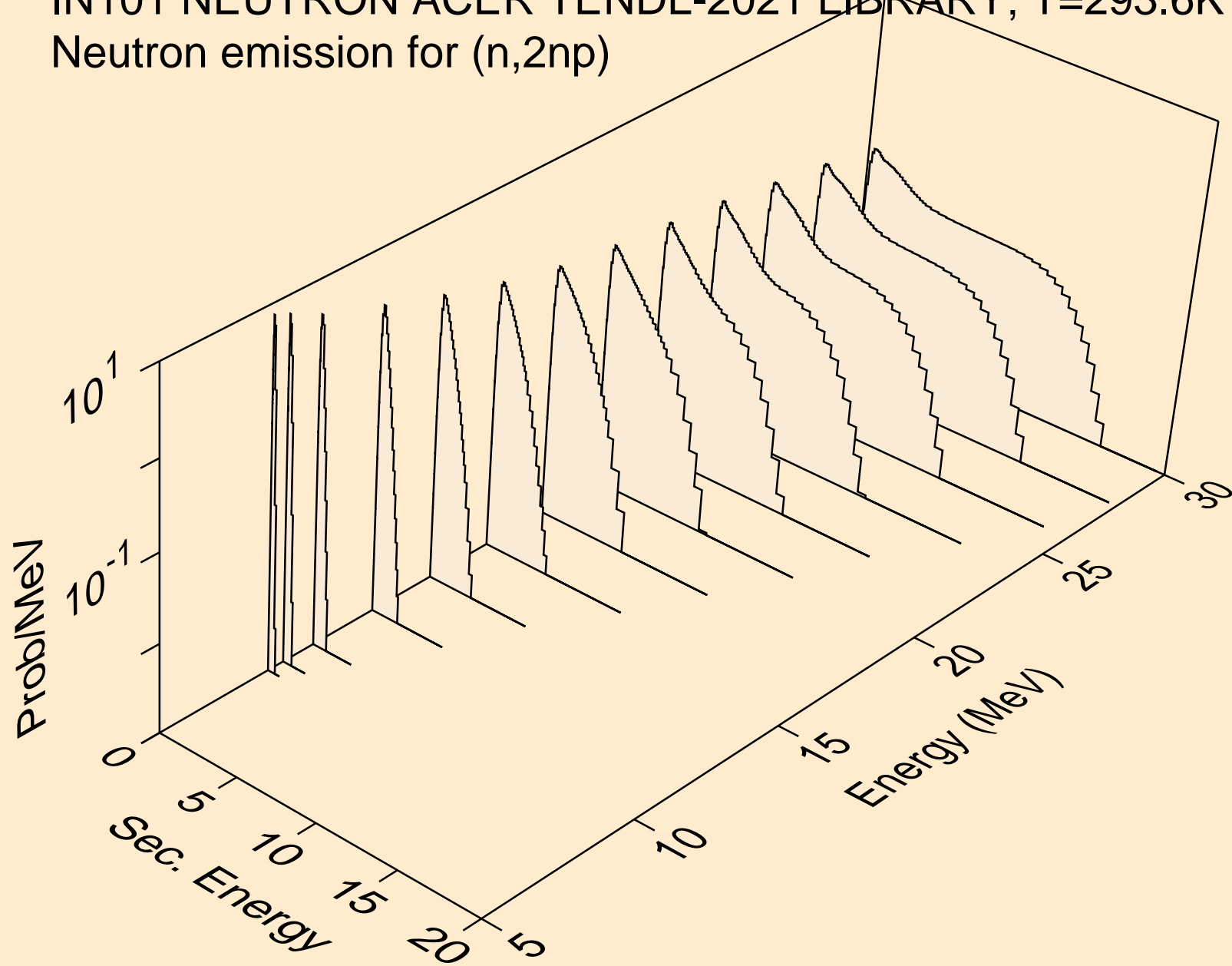

IN101 NEUTRON ACER TENDL-2021 LIBRARY; T=293.6K
Neutron emission for (n,npa)

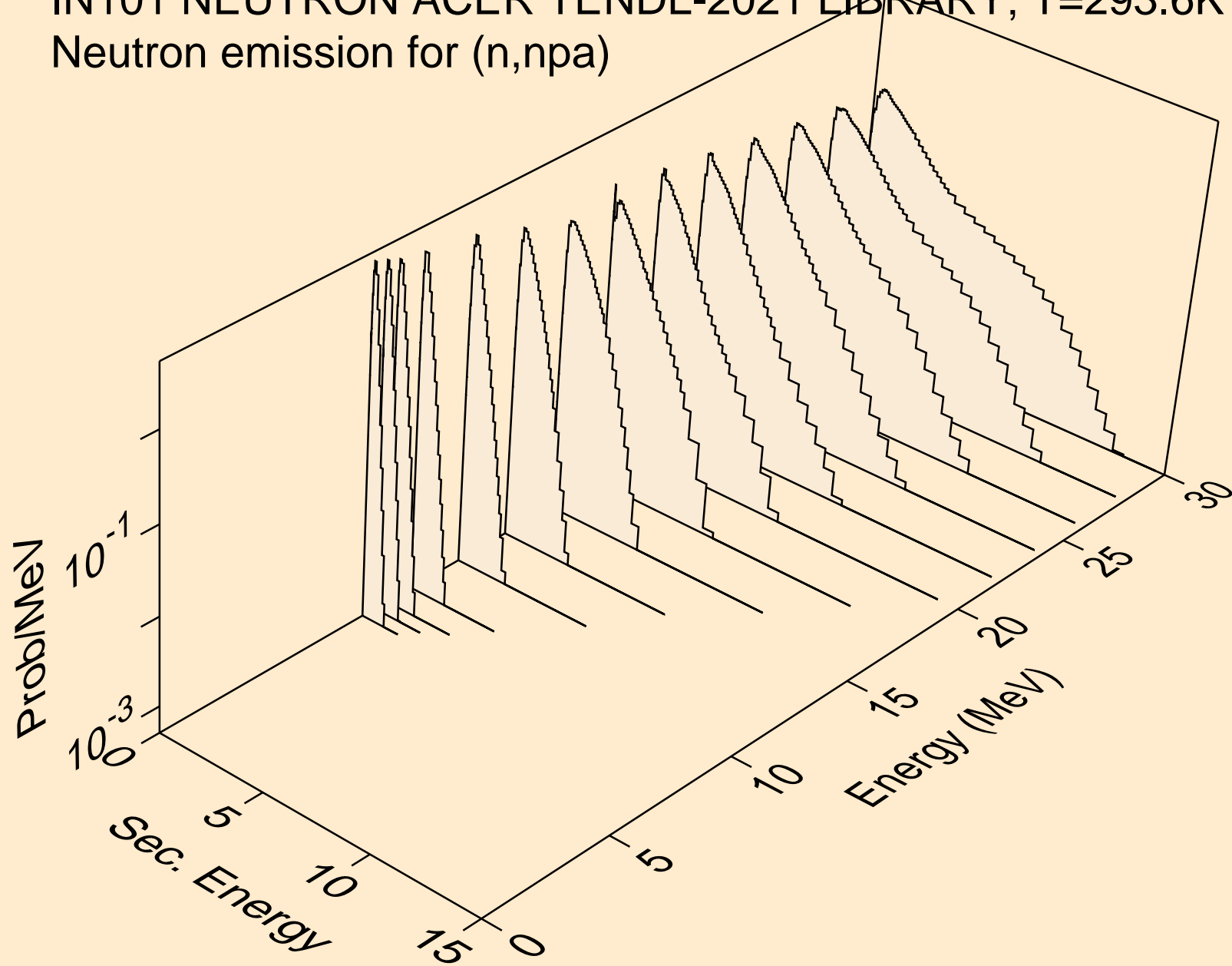

IN101 NEUTRON ACER TENDL-2021 LIBRARY; T=293.6K
Neutron emission for (n,n*c)

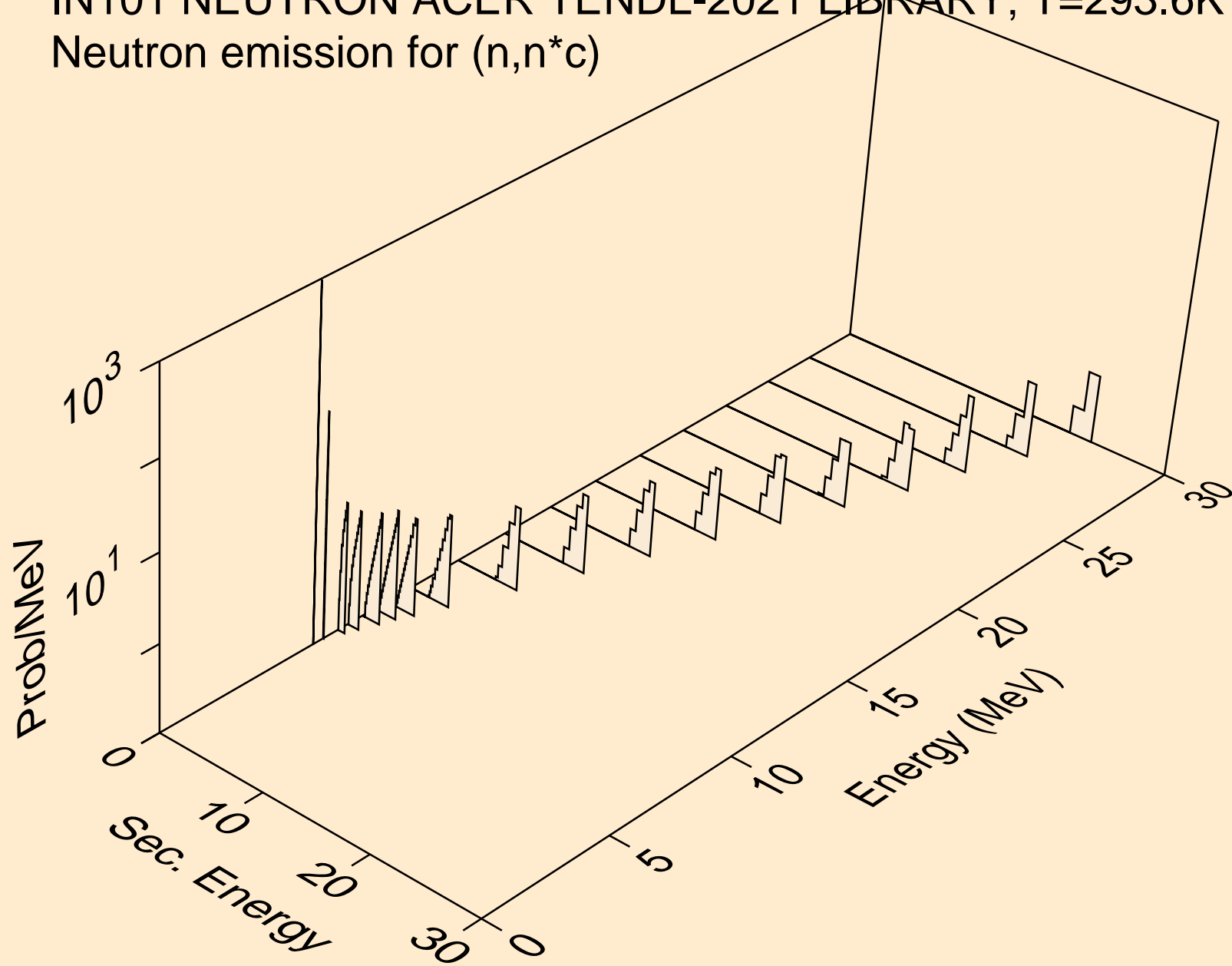

IN101 NEUTRON ACER TENDL-2021 LIBRARY; T=293.6K
Photon emission for (n,x)

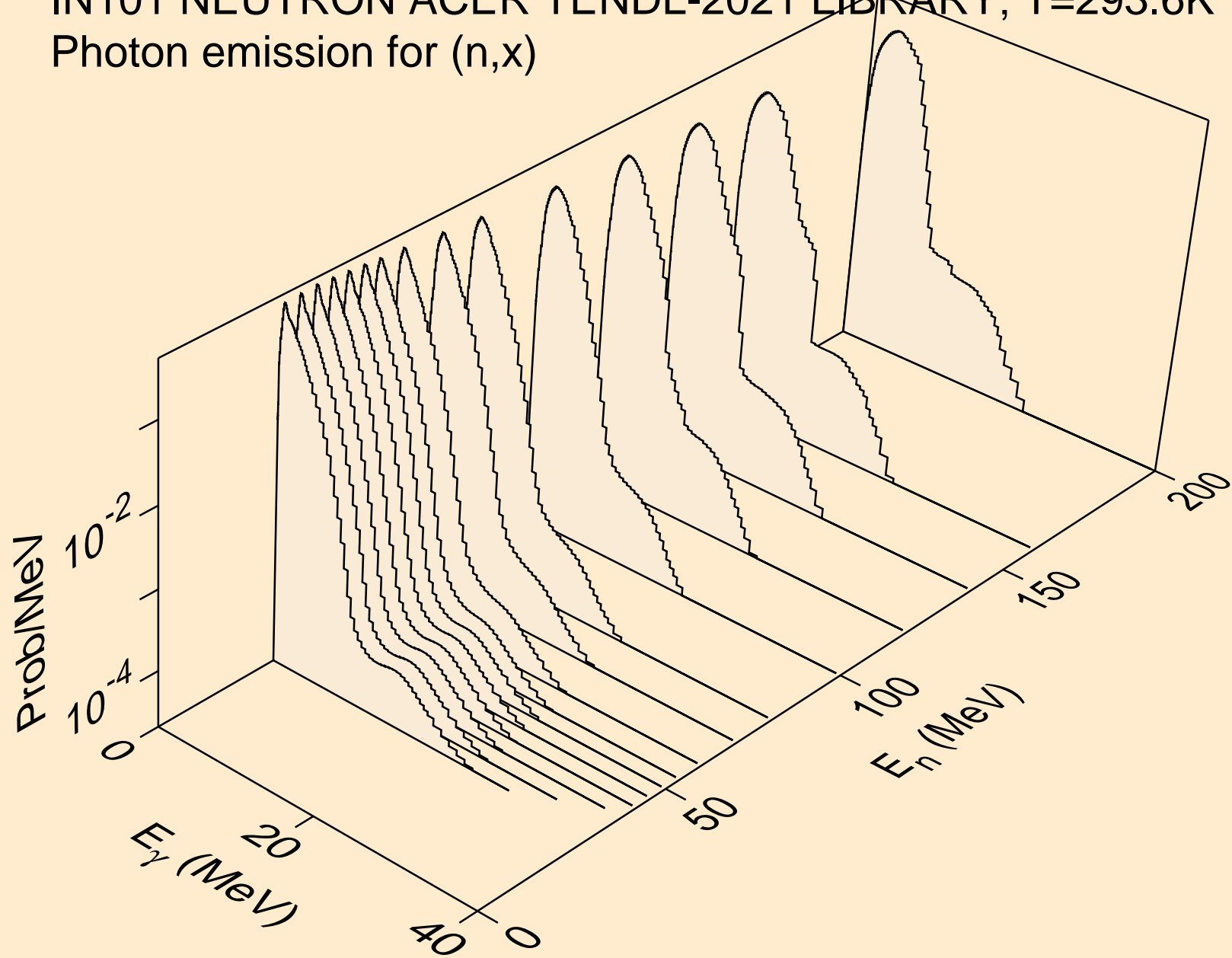

IN101 NEUTRON ACER TENDL-2021 LIBRARY; T=293.6K
Photon emission for (n,2nd)

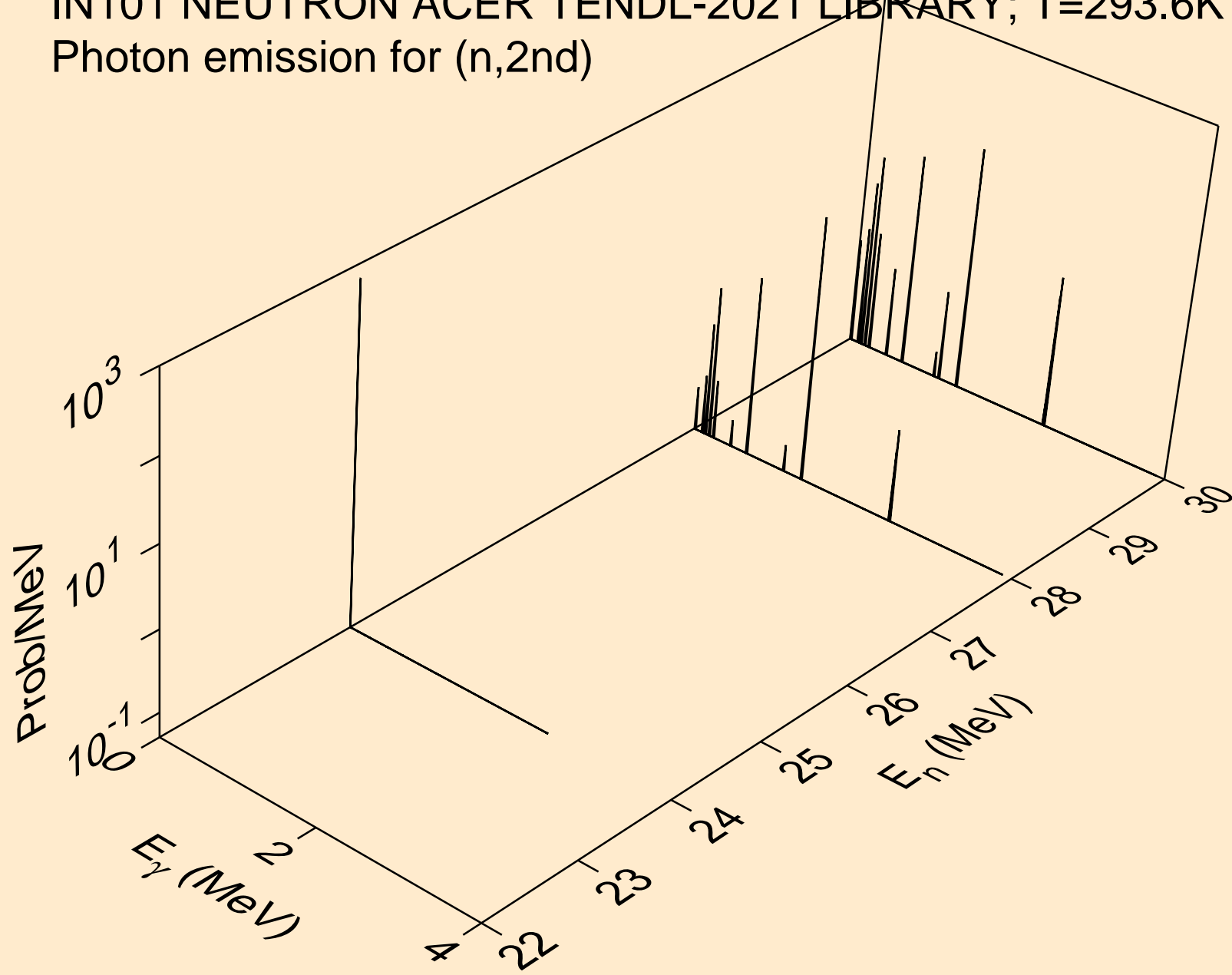

IN101 NEUTRON ACER TENDL-2021 LIBRARY; T=293.6K
Photon emission for (n,2n)

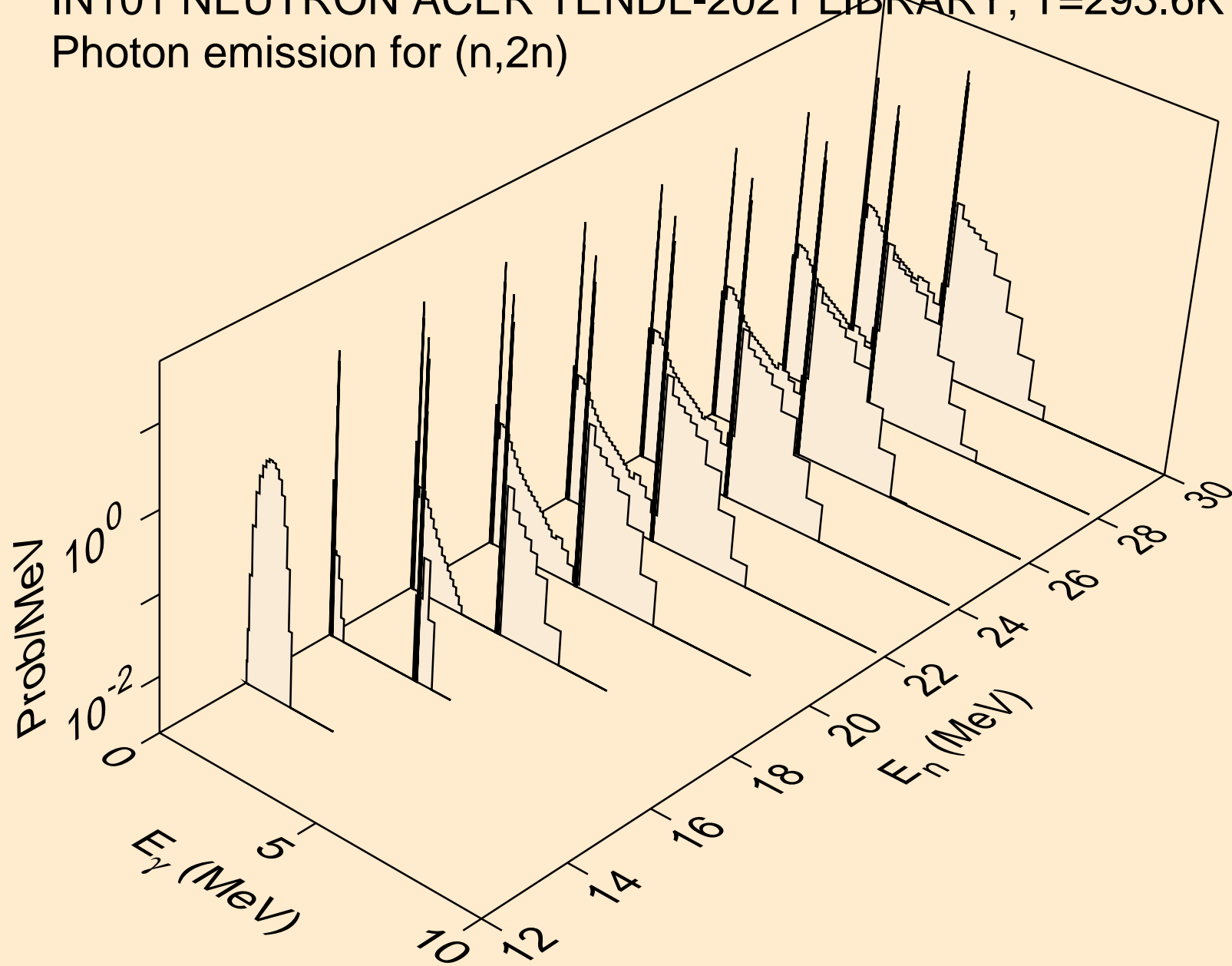

IN101 NEUTRON ACER TENDL-2021 LIBRARY; T=293.6K
Photon emission for (n,3n)

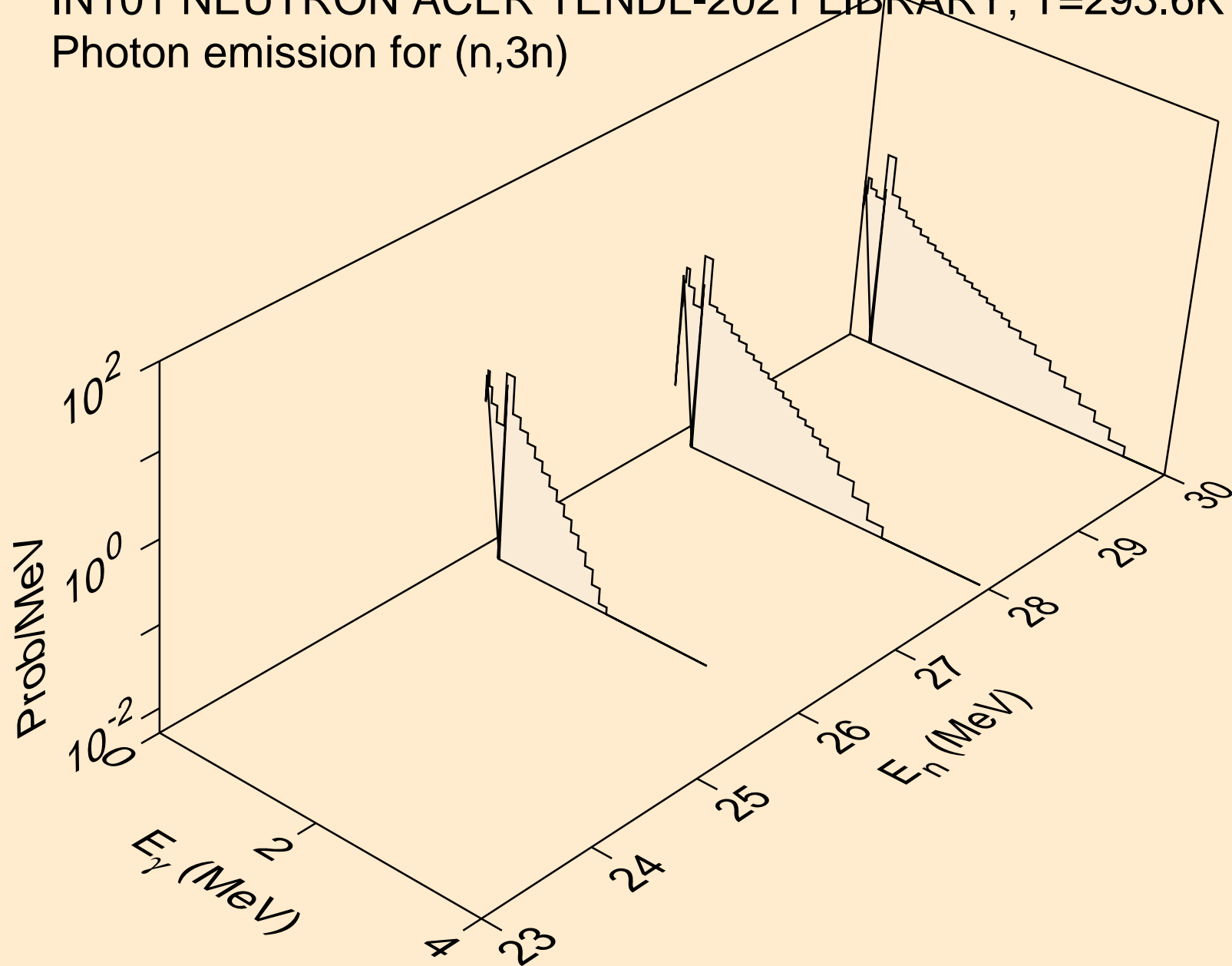

IN101 NEUTRON ACER TENDL-2021 LIBRARY; T=293.6K
Photon emission for (n,n*)a

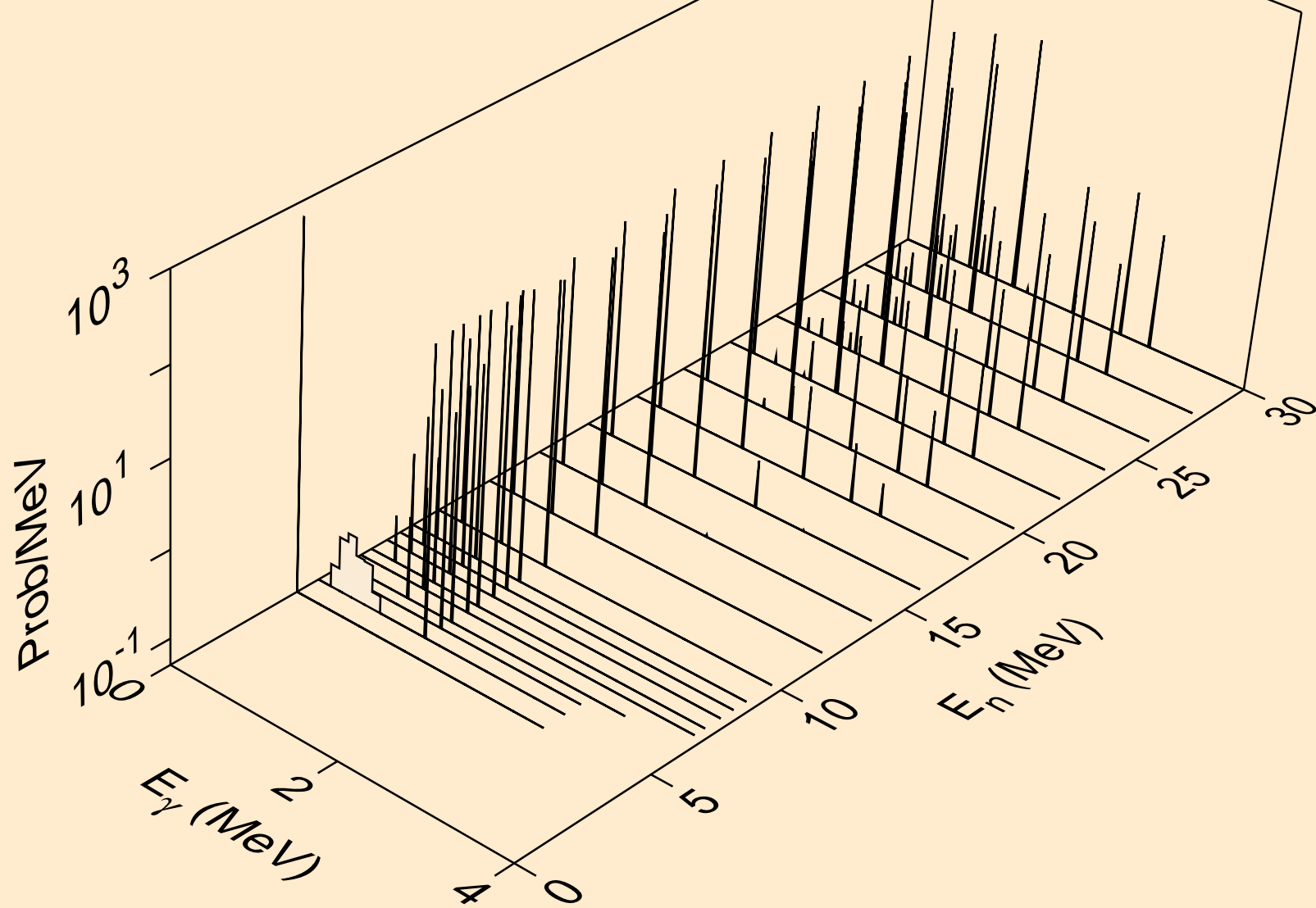

IN101 NEUTRON ACER TENDL-2021 LIBRARY; T=293.6K
Photon emission for (n,2n)a

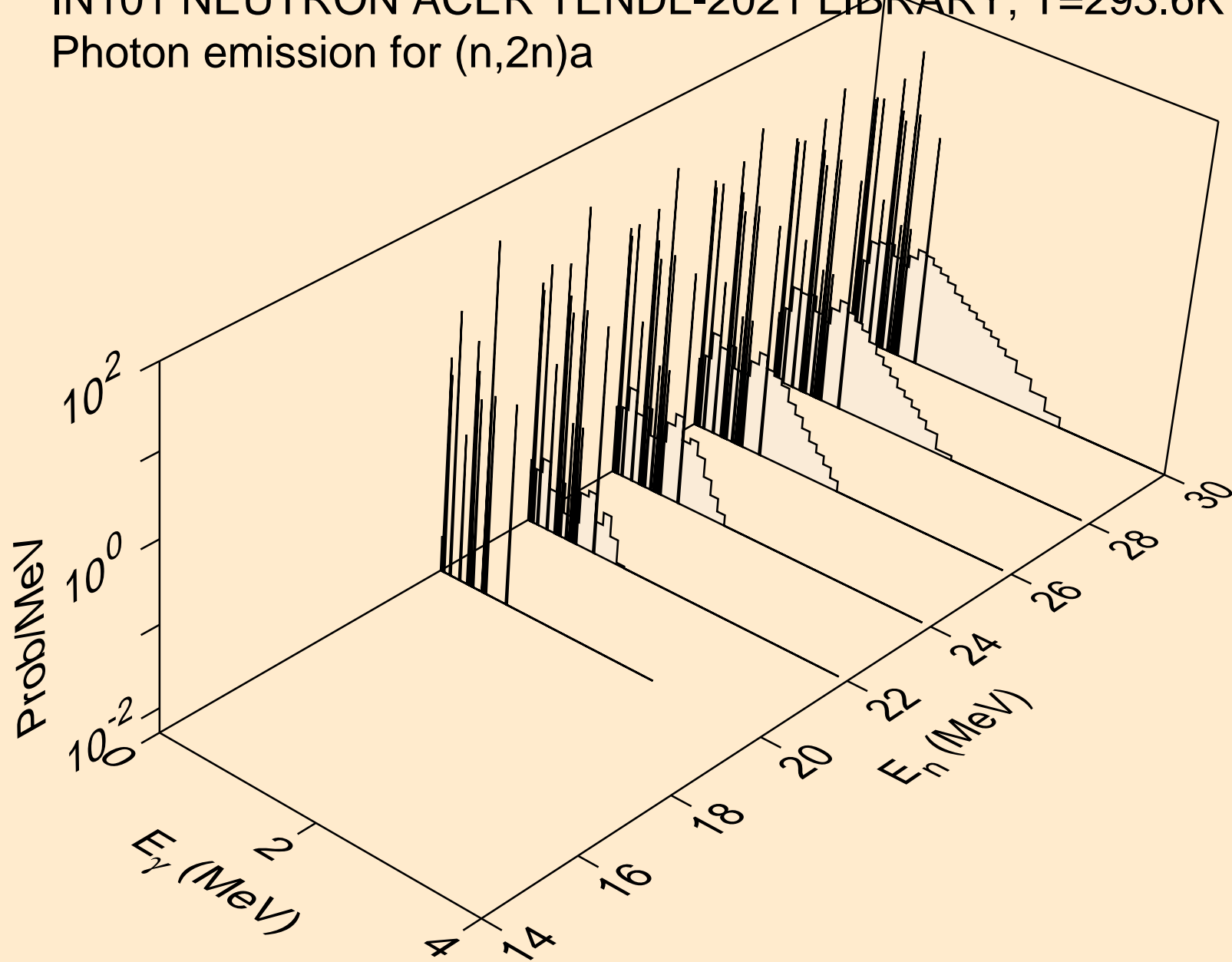

IN101 NEUTRON ACER TENDL-2021 LIBRARY; T=293.6K
Photon emission for (n,n*)p

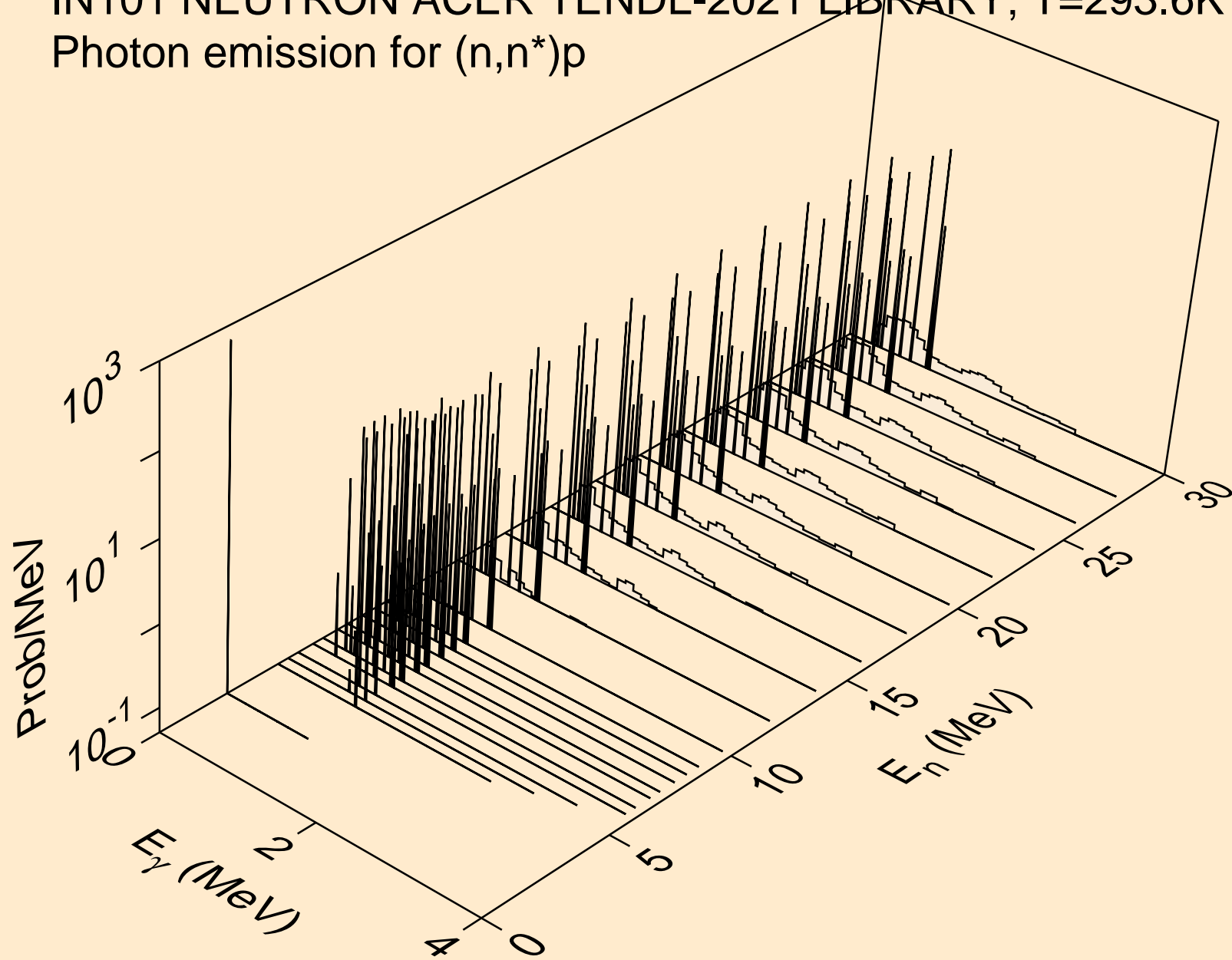

IN101 NEUTRON ACER TENDL-2021 LIBRARY; T=293.6K
Photon emission for (n,n*)2a

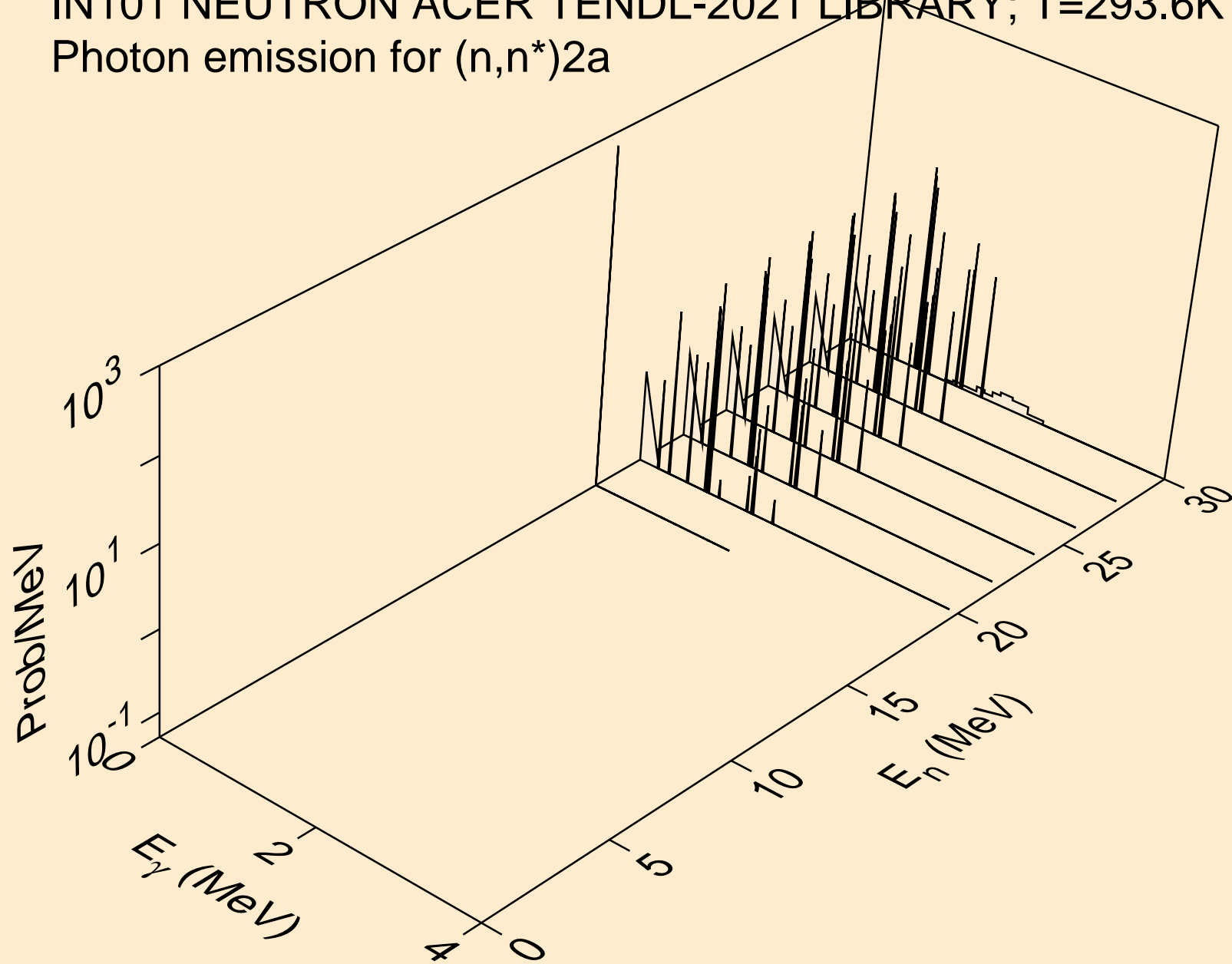

IN101 NEUTRON ACER TENDL-2021 LIBRARY; T=293.6K
Photon emission for (n,n*)d

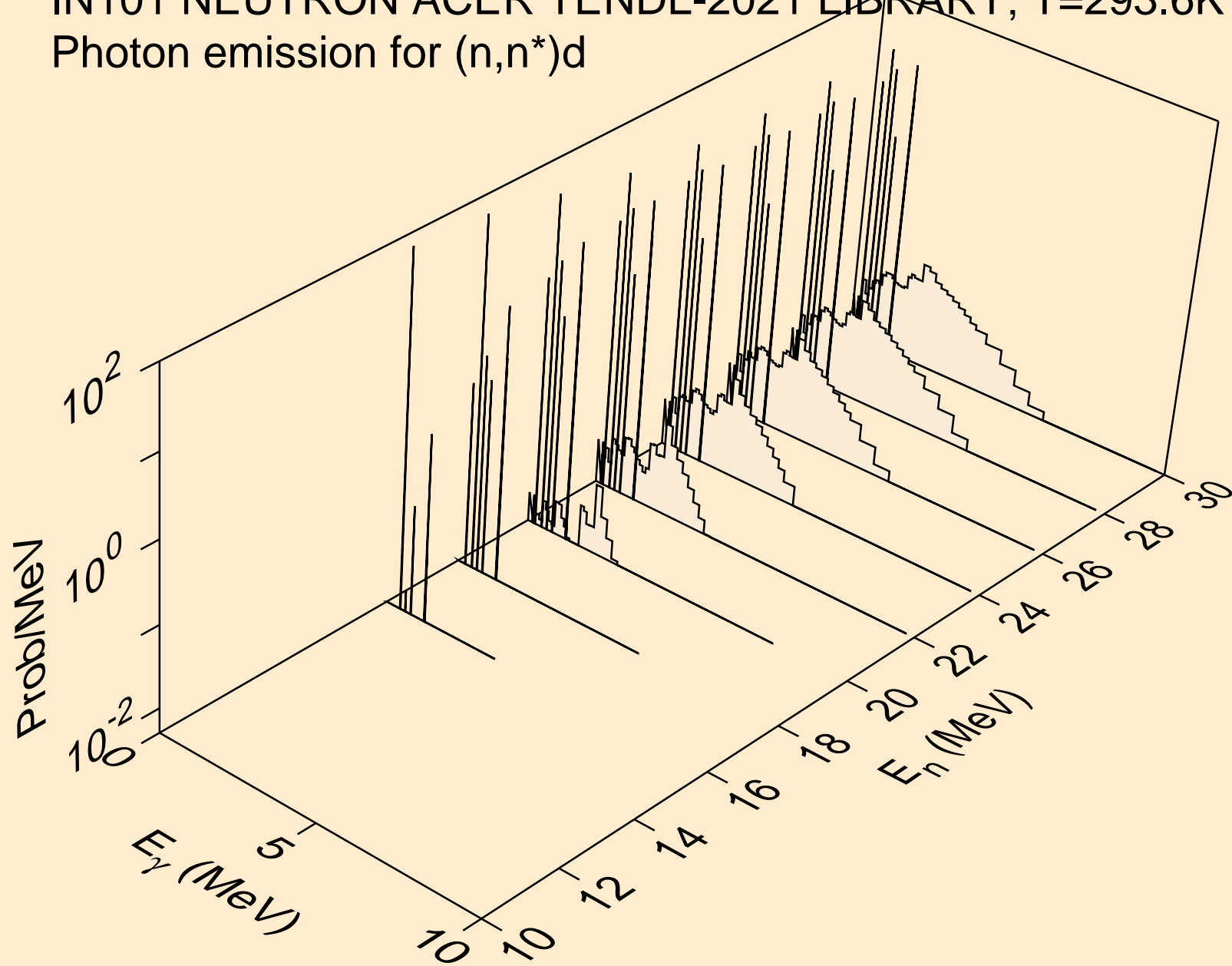

IN101 NEUTRON ACER TENDL-2021 LIBRARY; T=293.6K
Photon emission for (n,n*)t

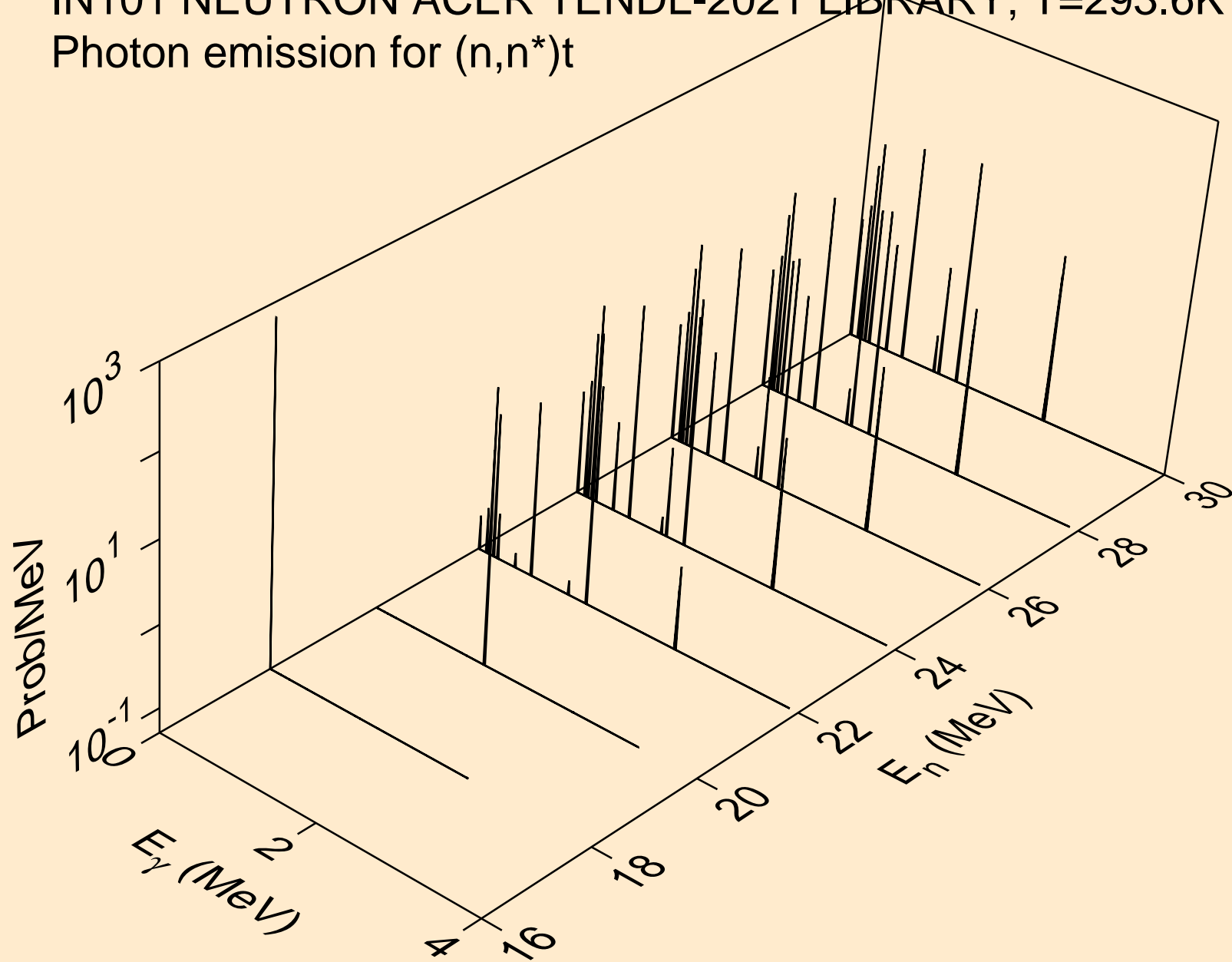

IN101 NEUTRON ACER TENDL-2021 LIBRARY; T=293.6K
Photon emission for (n,n*)he3

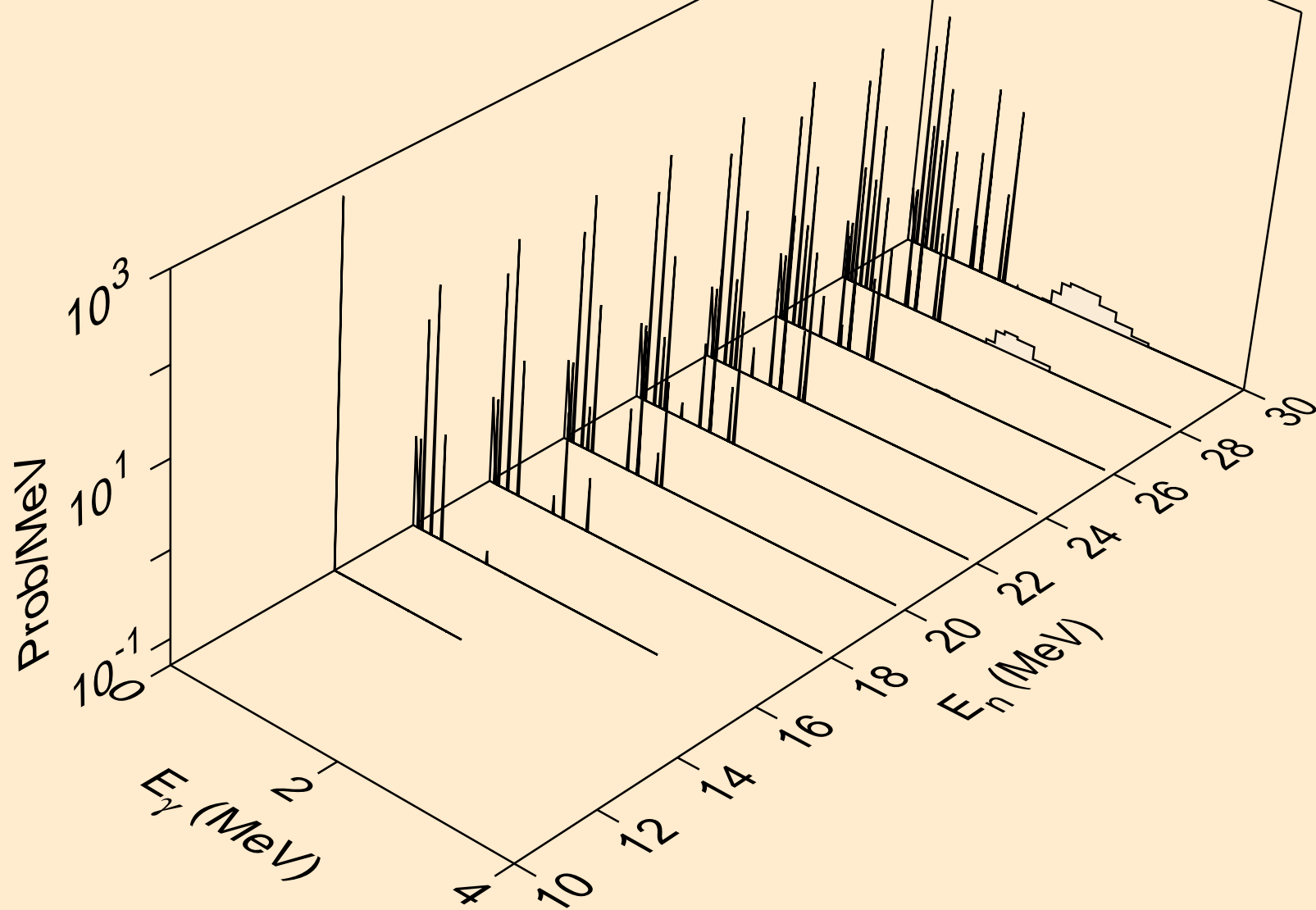

IN101 NEUTRON ACER TENDL-2021 LIBRARY; T=293.6K
Photon emission for (n,2np)

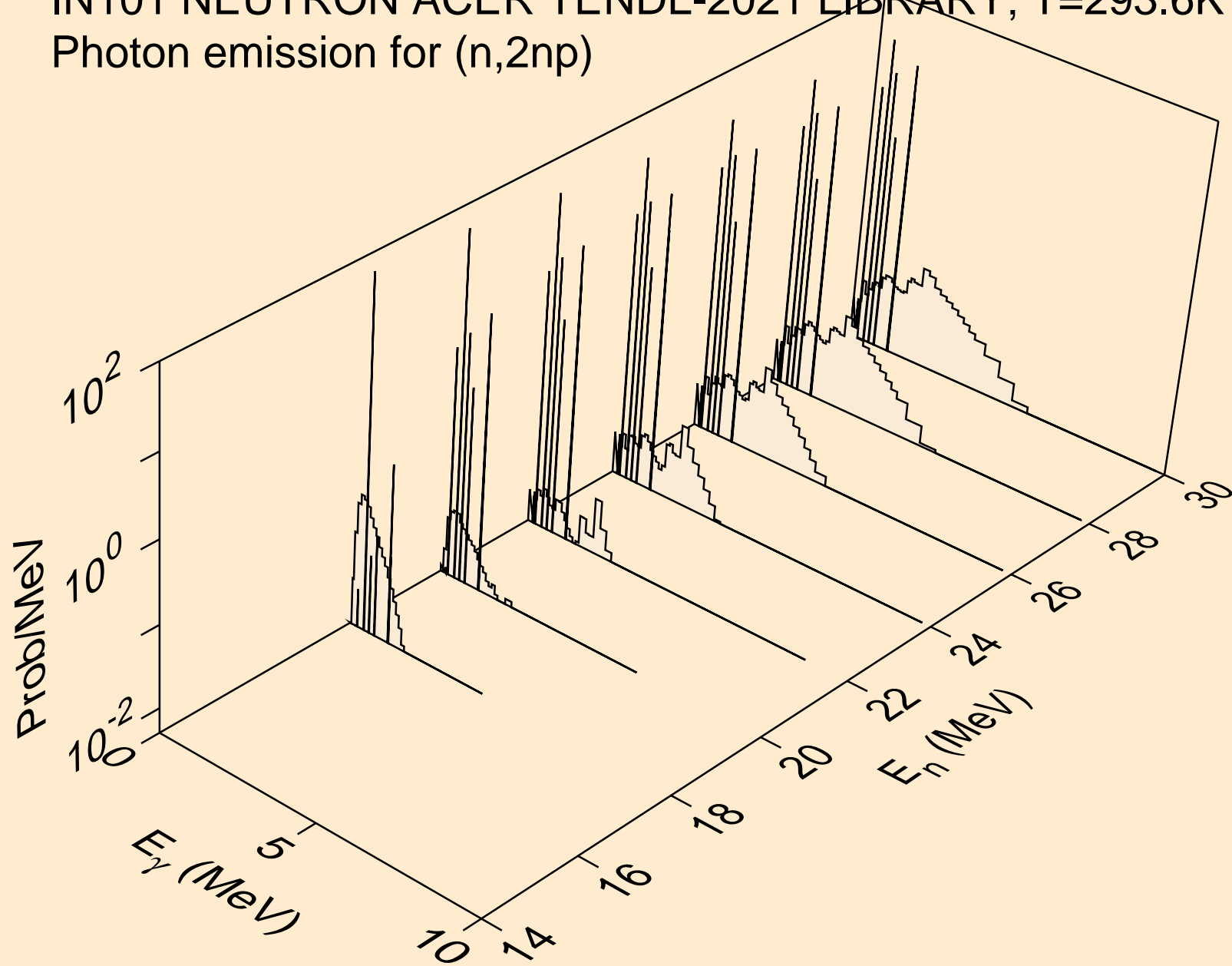

IN101 NEUTRON ACER TENDL-2021 LIBRARY; T=293.6K
Photon emission for (n,3np)

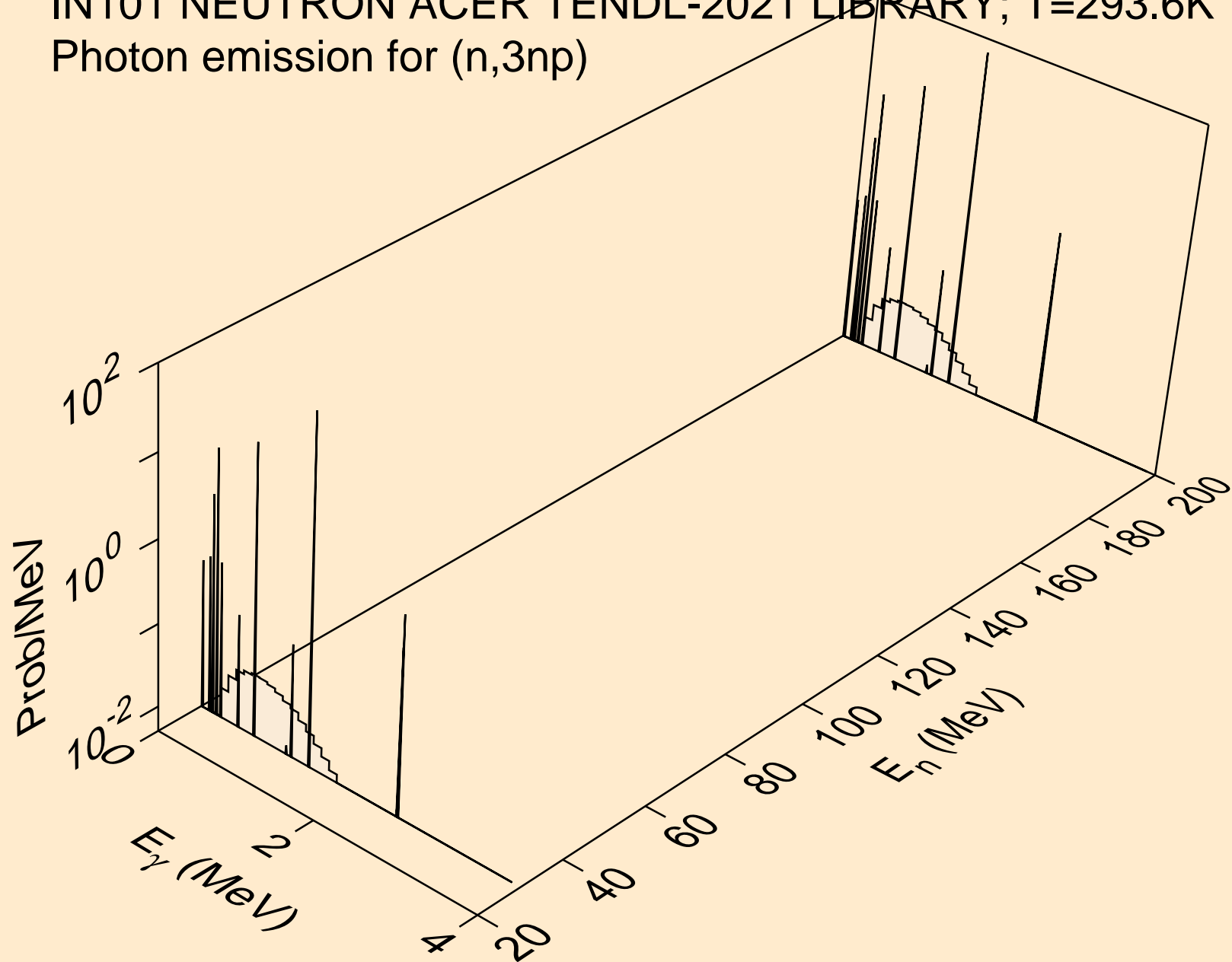

IN101 NEUTRON ACER TENDL-2021 LIBRARY; T=293.6K
Photon emission for (n,2np)

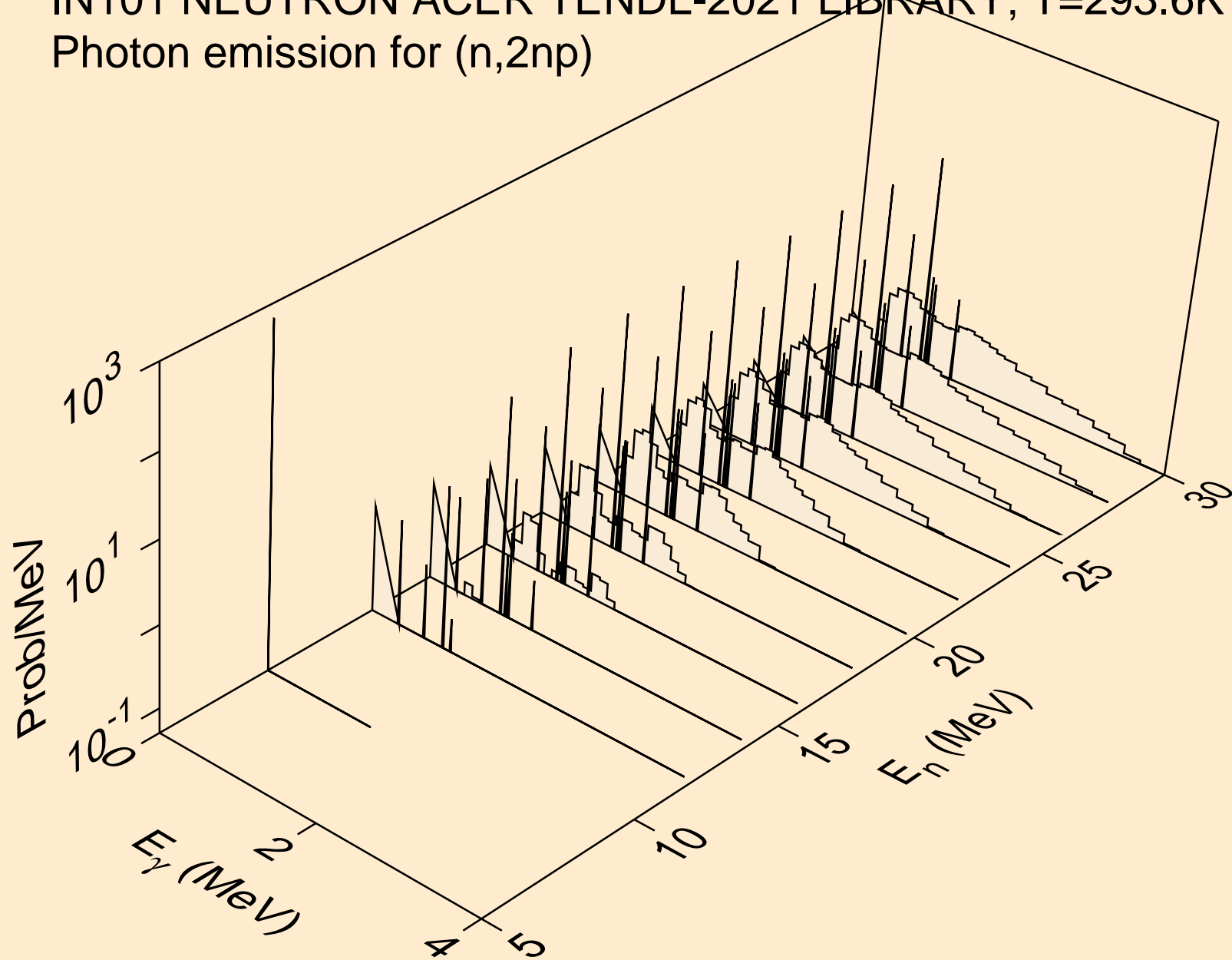

IN101 NEUTRON ACER TENDL-2021 LIBRARY; T=293.6K
Photon emission for (n,npa)

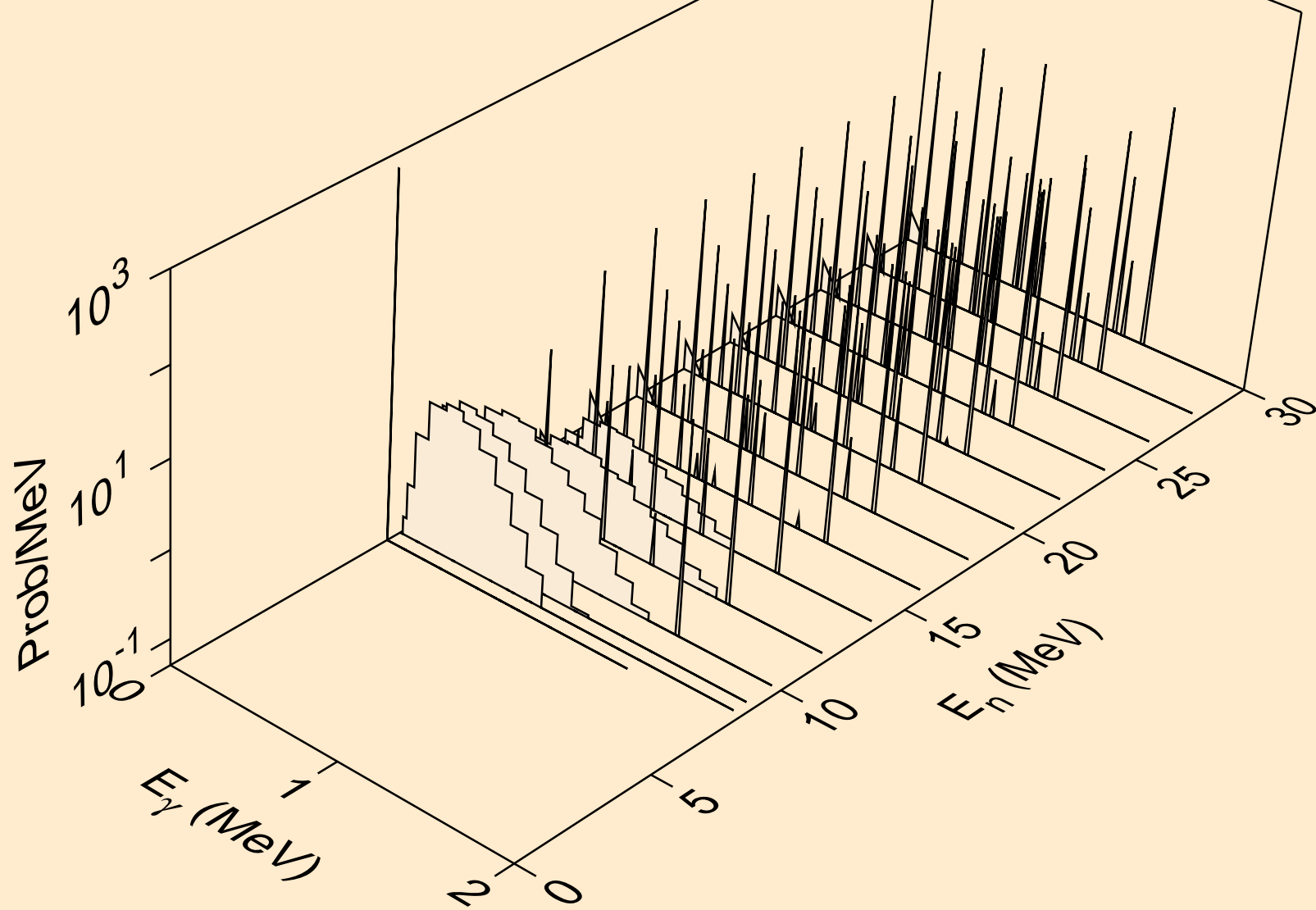

IN101 NEUTRON ACER TENDL-2021 LIBRARY; T=293.6K
Photon emission for (n,n*c)

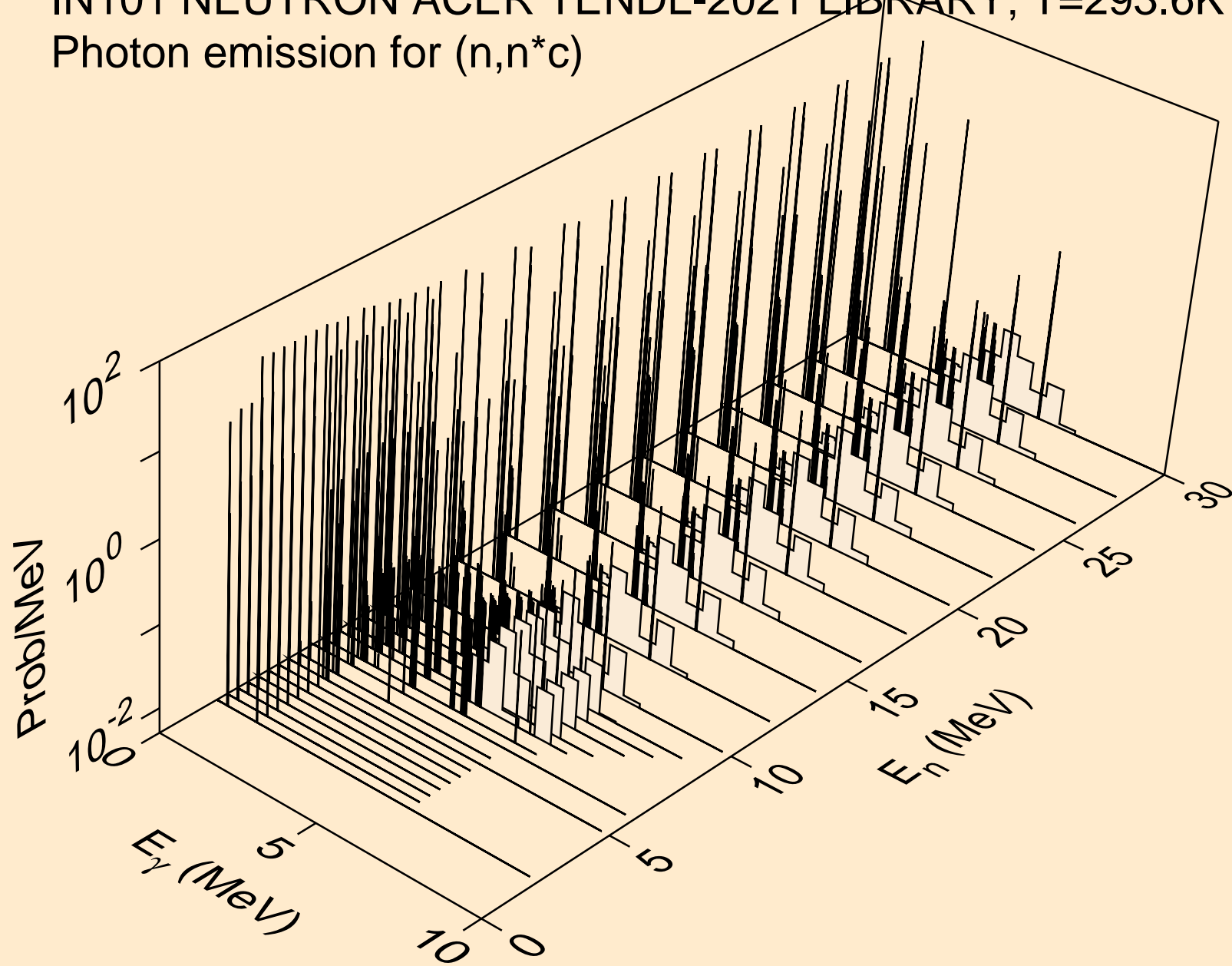

IN101 NEUTRON ACER TENDL-2021 LIBRARY; T=293.6K
Photon emission for (n,gma)

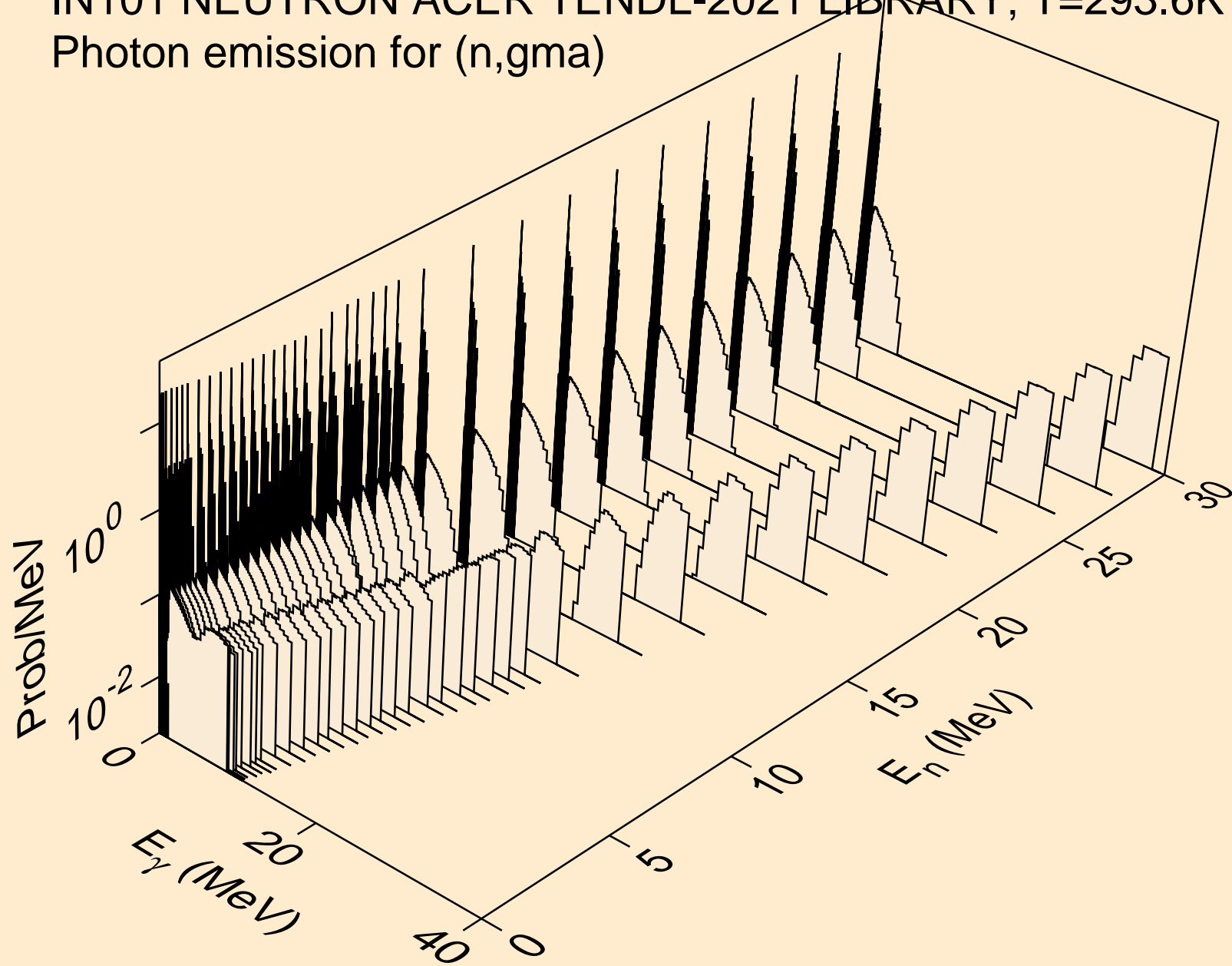

IN101 NEUTRON ACER TENDL-2021 LIBRARY; T=293.6K
Photon emission for (n,p)

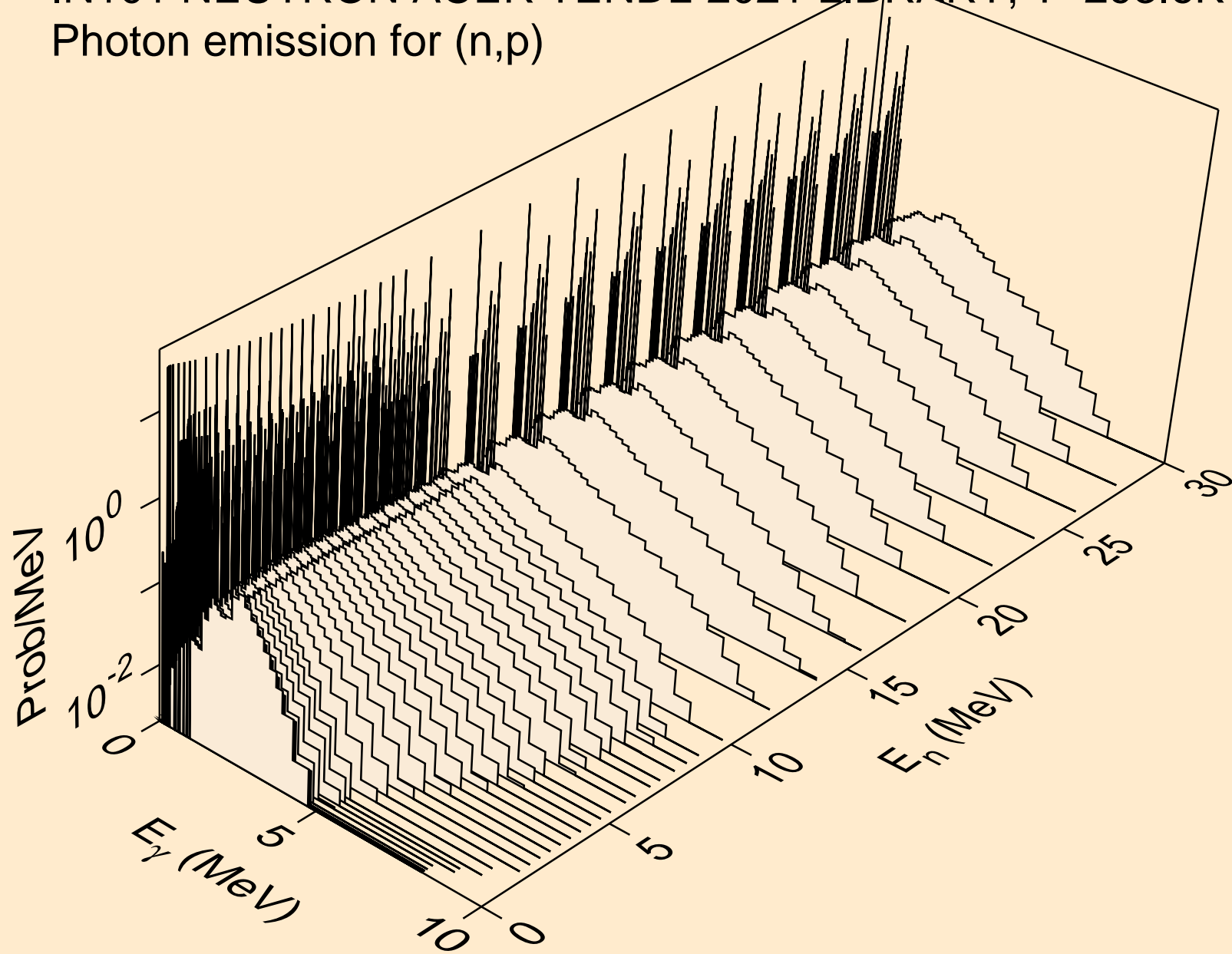

IN101 NEUTRON ACER TENDL-2021 LIBRARY; T=293.6K
Photon emission for (n,d)

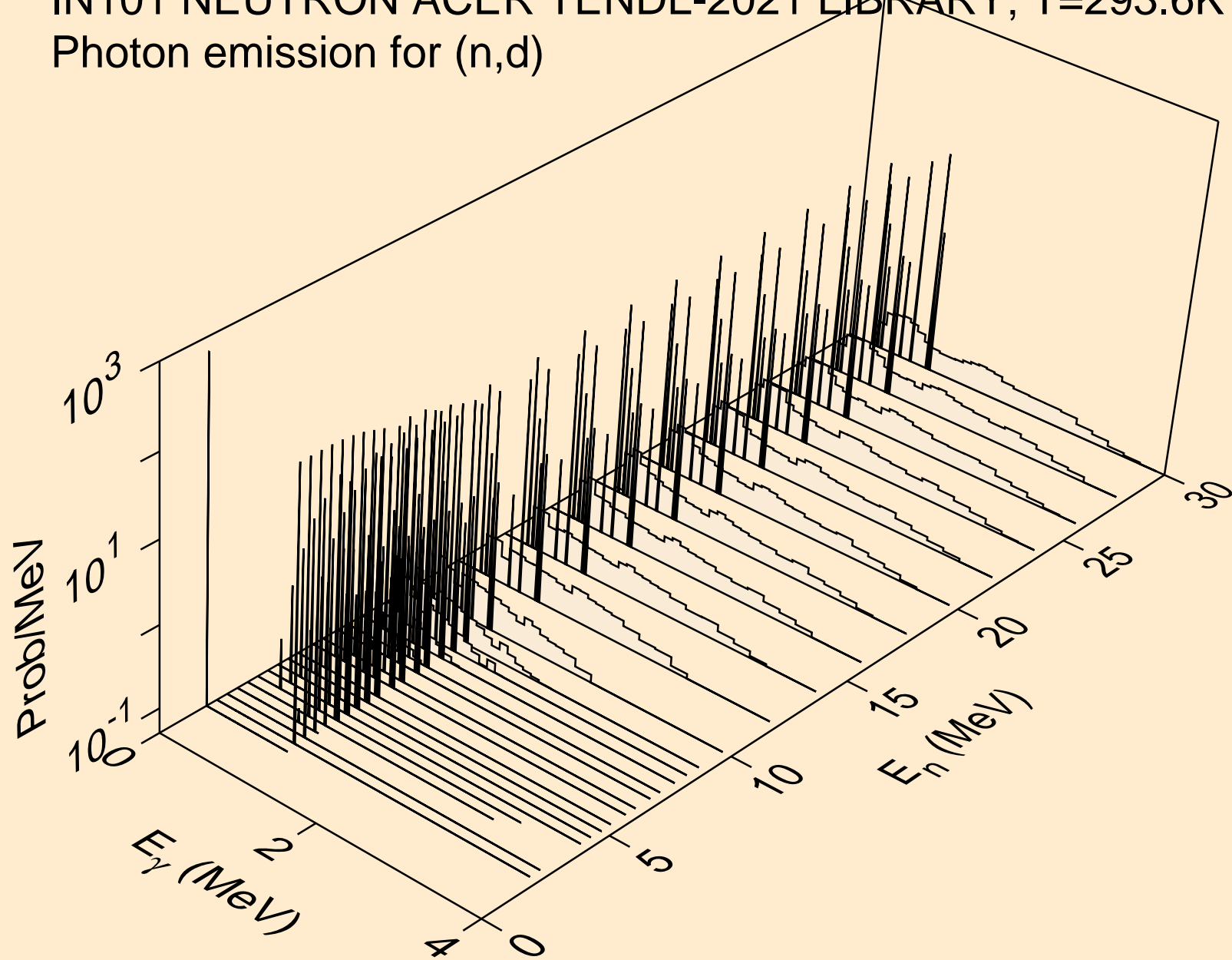

IN101 NEUTRON ACER TENDL-2021 LIBRARY; T=293.6K
Photon emission for (n,t)

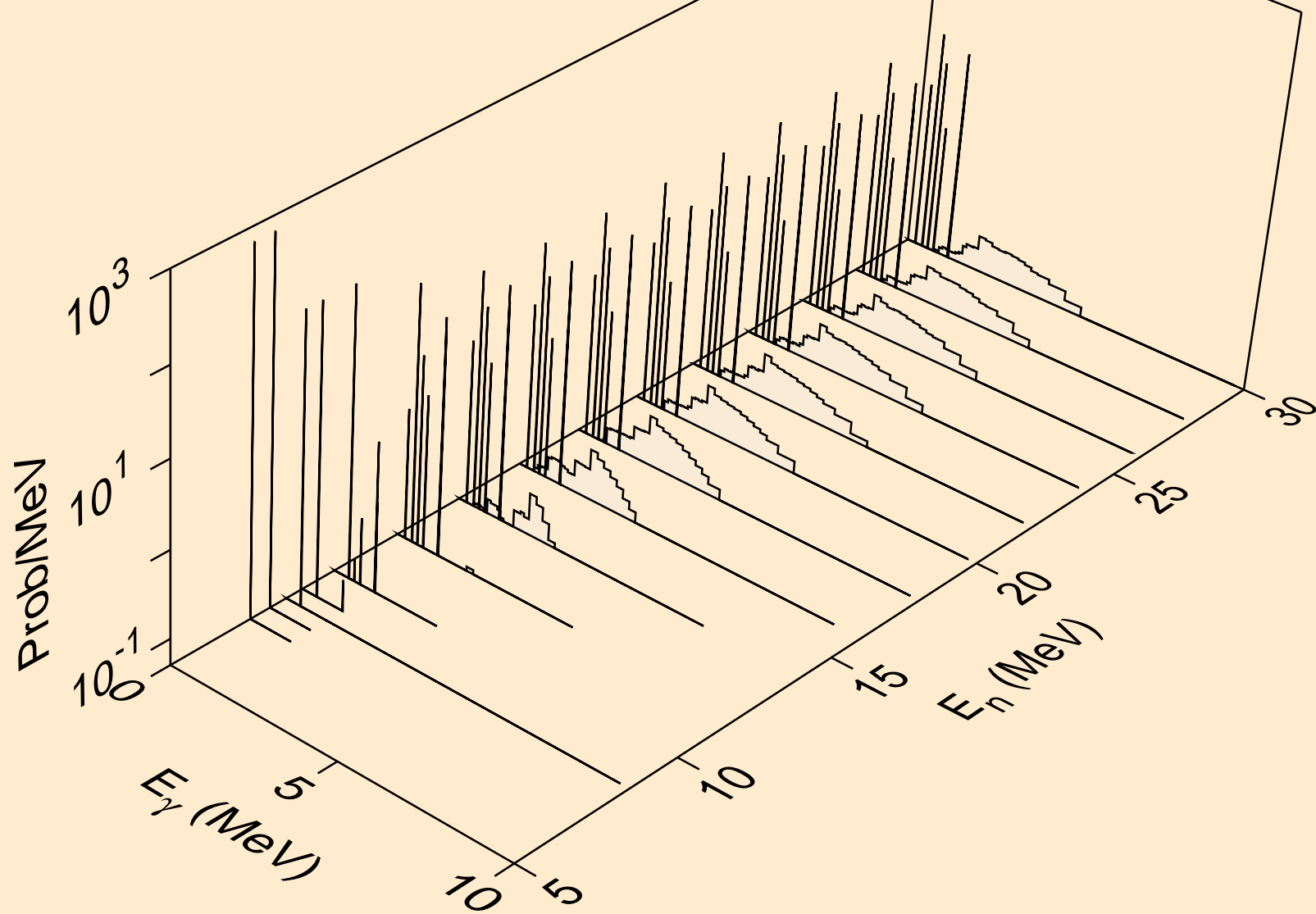

IN101 NEUTRON ACER TENDL-2021 LIBRARY; T=293.6K
Photon emission for (n,he3)

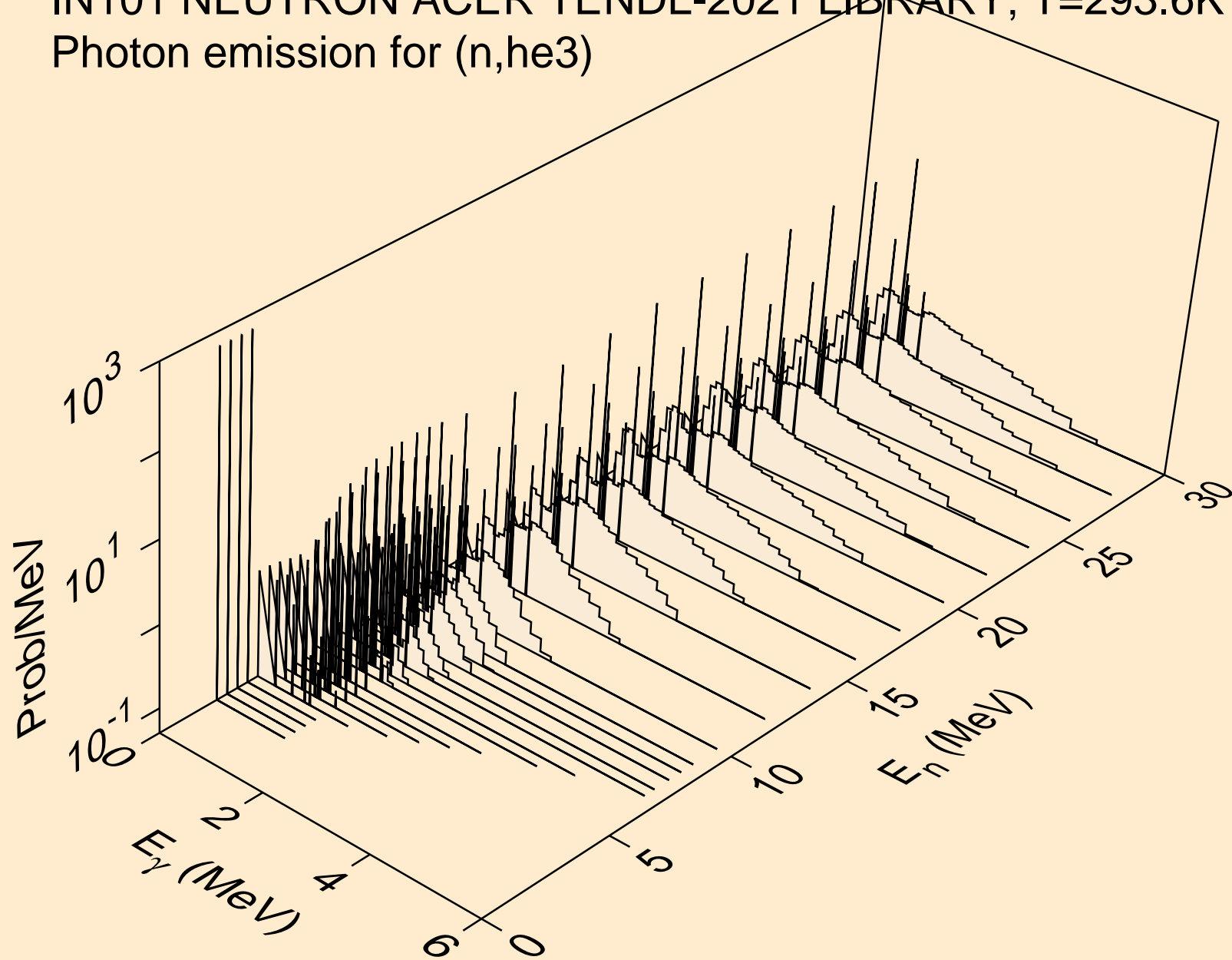

IN101 NEUTRON ACER TENDL-2021 LIBRARY; T=293.6K
Photon emission for (n,a)

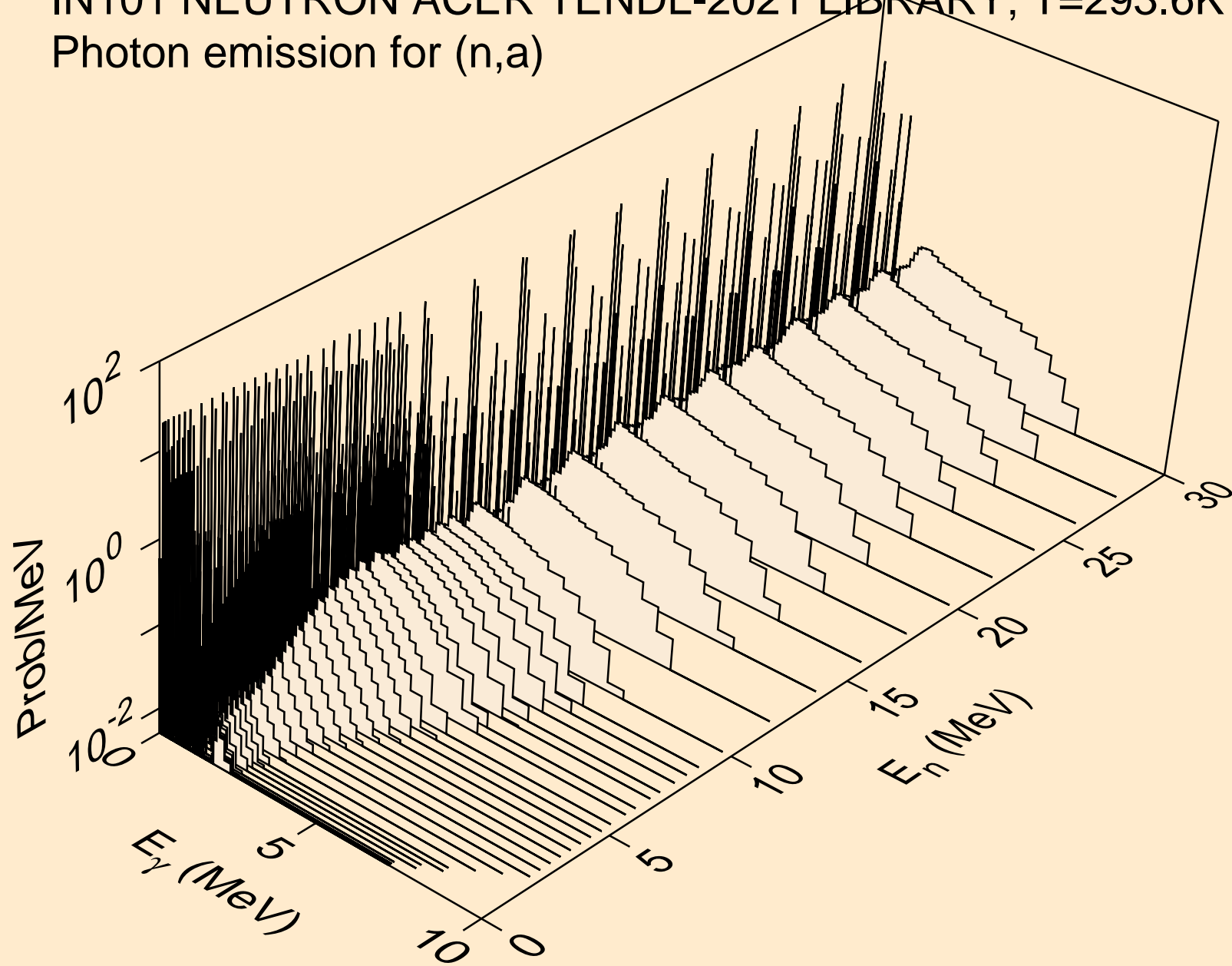

IN101 NEUTRON ACER TENDL-2021 LIBRARY; T=293.6K
Photon emission for (n,2a)

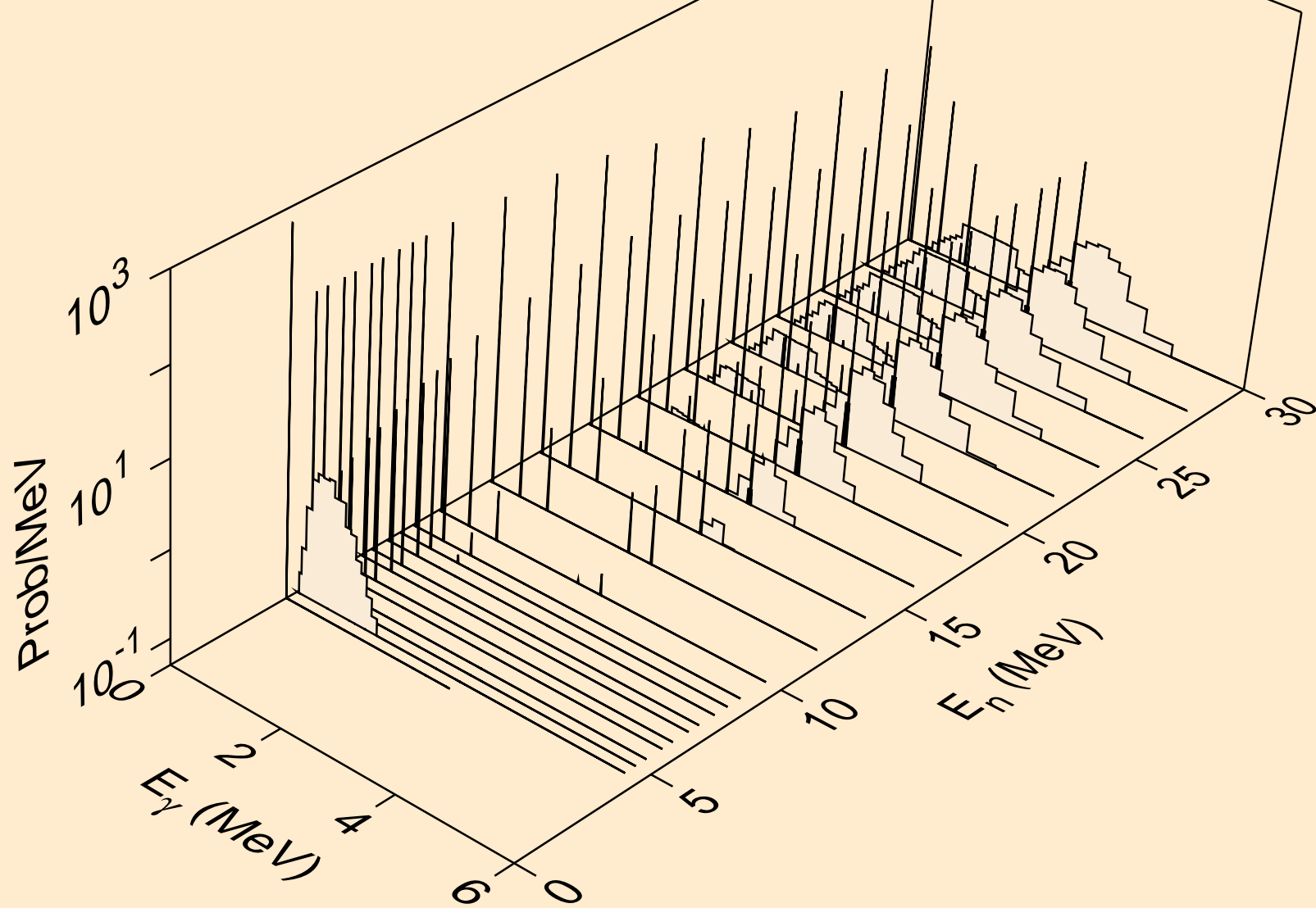

IN101 NEUTRON ACER TENDL-2021 LIBRARY; T=293.6K
Photon emission for (n,2p)

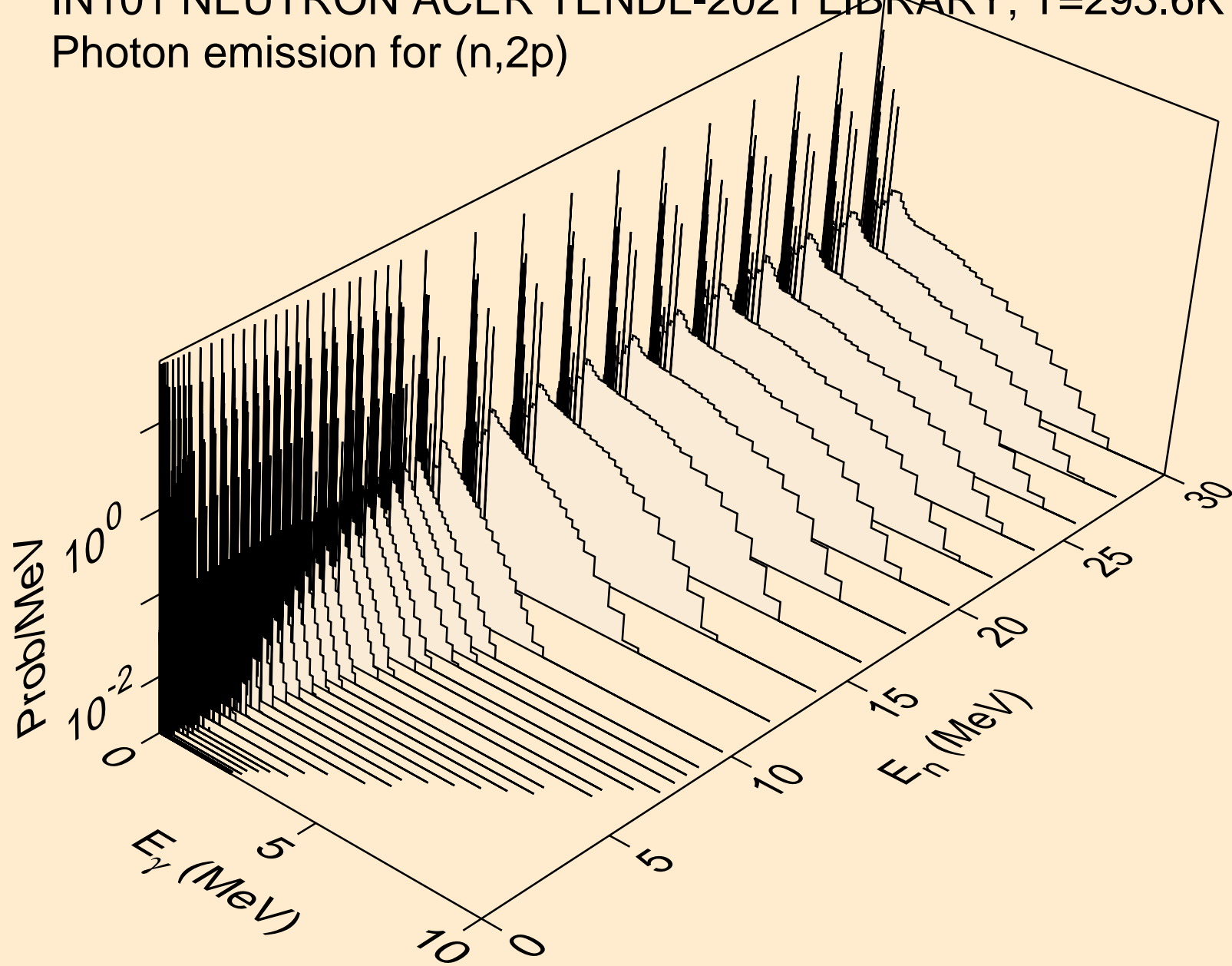

IN101 NEUTRON ACER TENDL-2021 LIBRARY; T=293.6K
Photon emission for (n,p α)

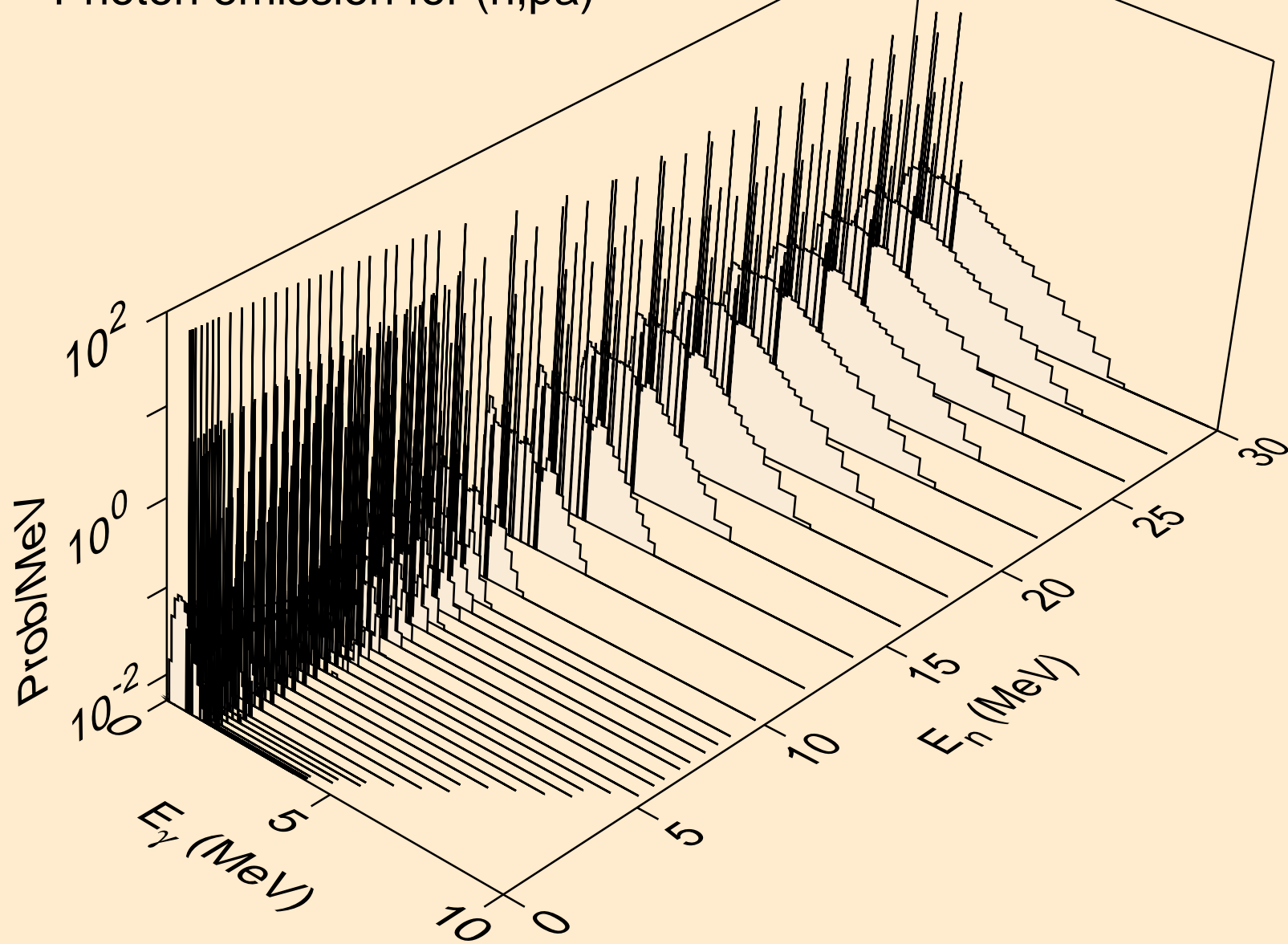

IN101 NEUTRON ACER TENDL-2021 LIBRARY; T=293.6K
Photon emission for (n,pd)

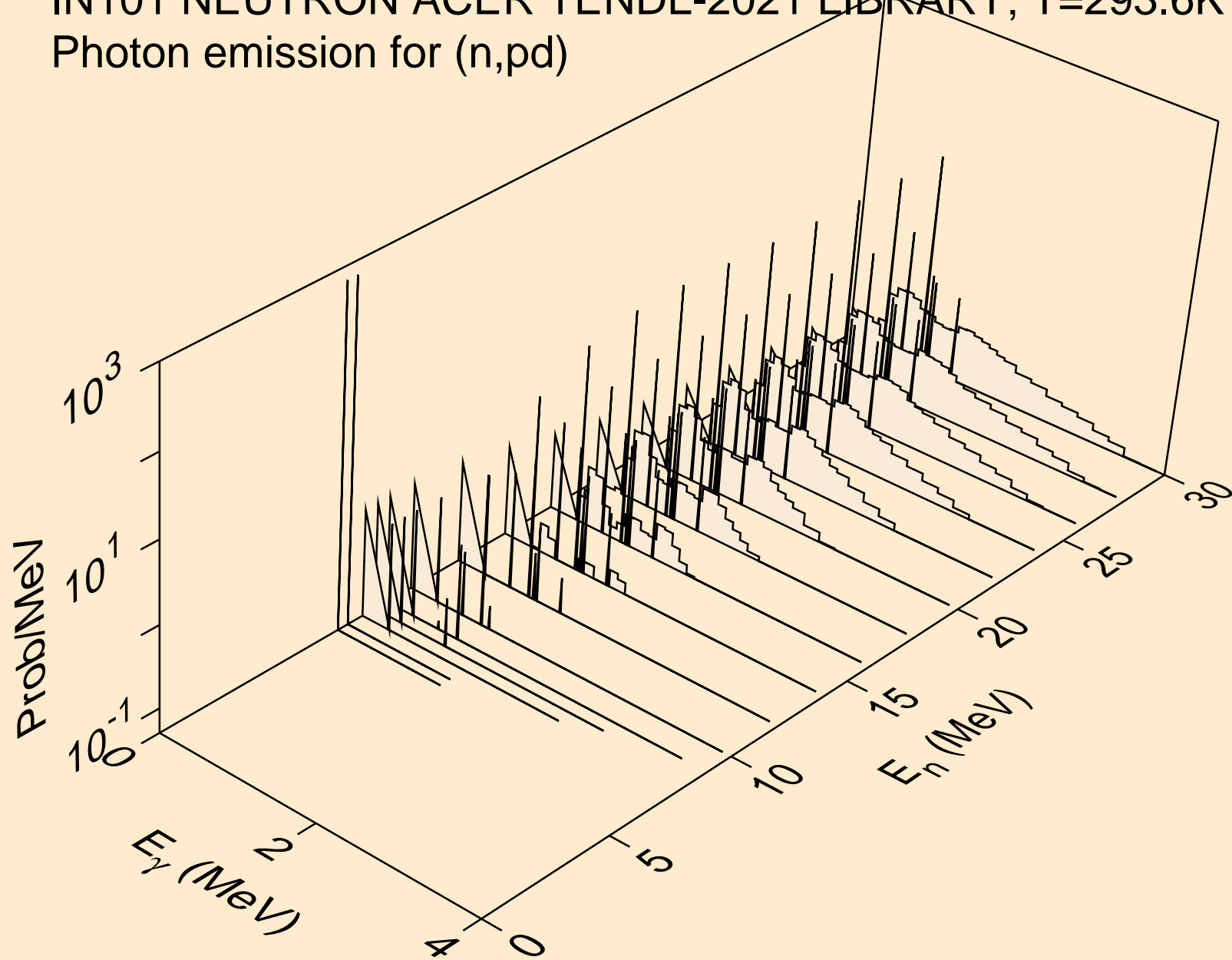

IN101 NEUTRON ACER TENDL-2021 LIBRARY; T=293.6K
Photon emission for (n,pt)

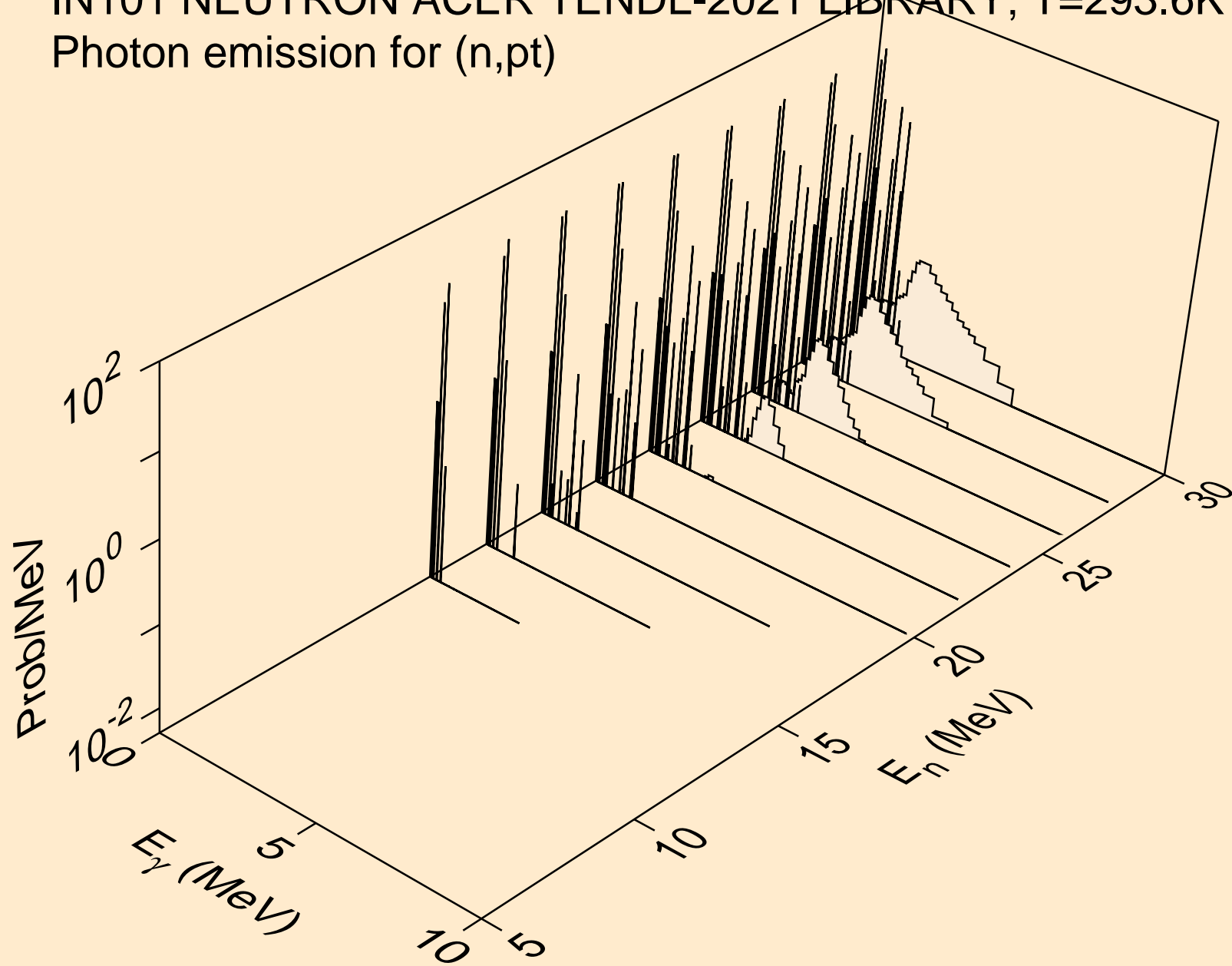

IN101 NEUTRON ACER TENDL-2021 LIBRARY; T=293.6K
Photon emission for (n,da)

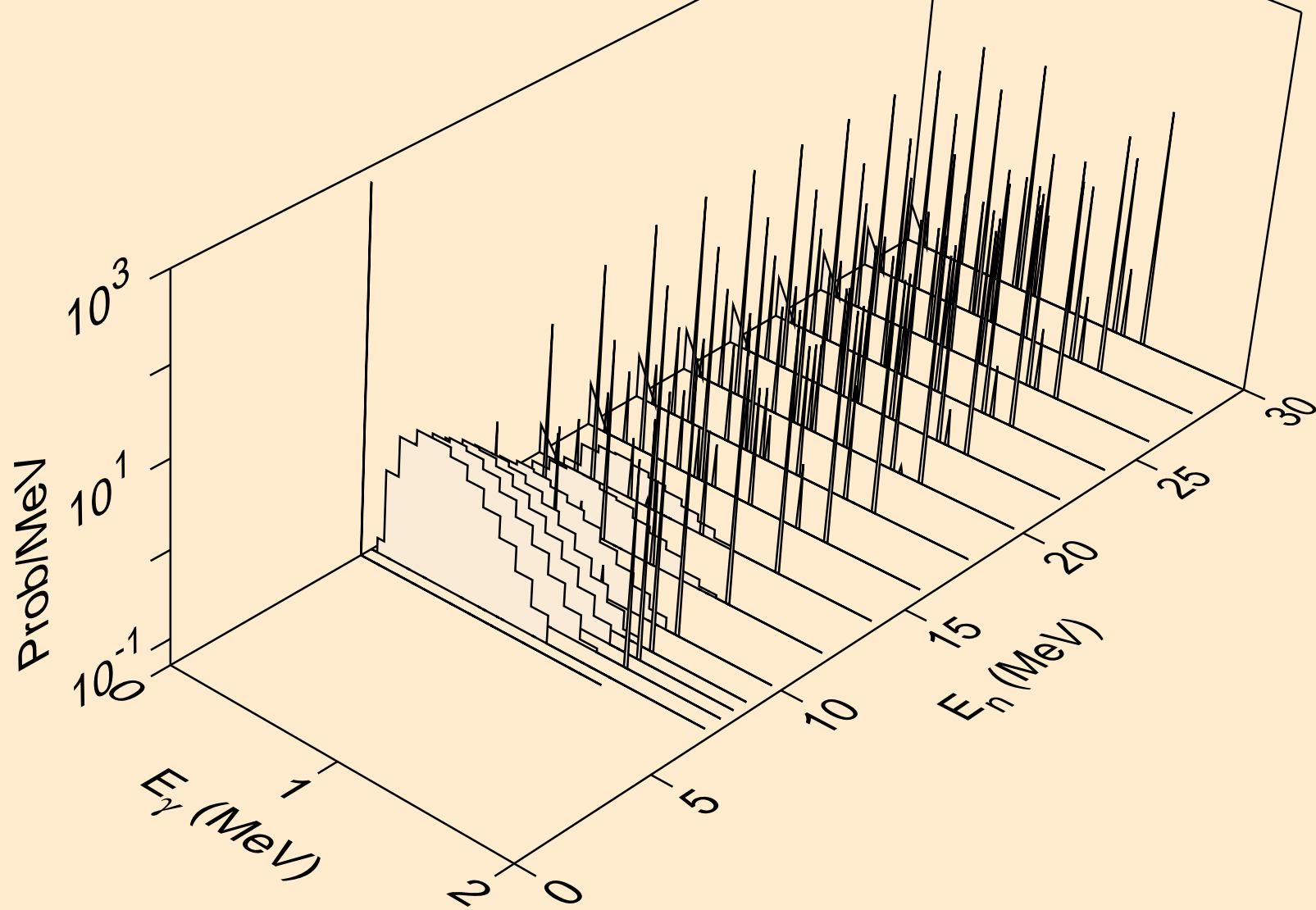

IN101 NEUTRON ACER TENDL-2021 LIBRARY; T=293.6K
thermal capture photon spectrum

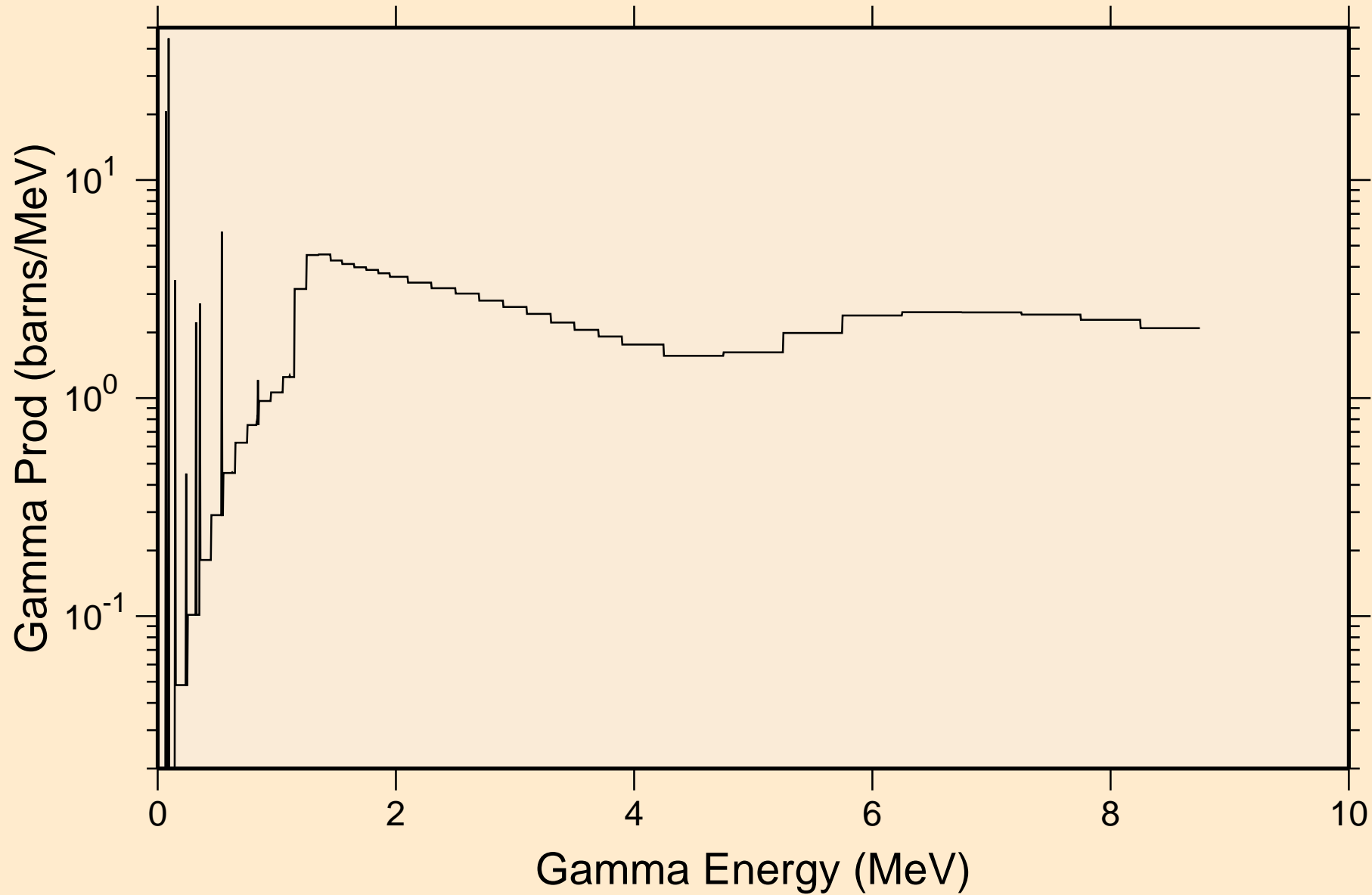

IN101 NEUTRON ACER TENDL-2021 LIBRARY; T=293.6K
14 MeV photon spectrum

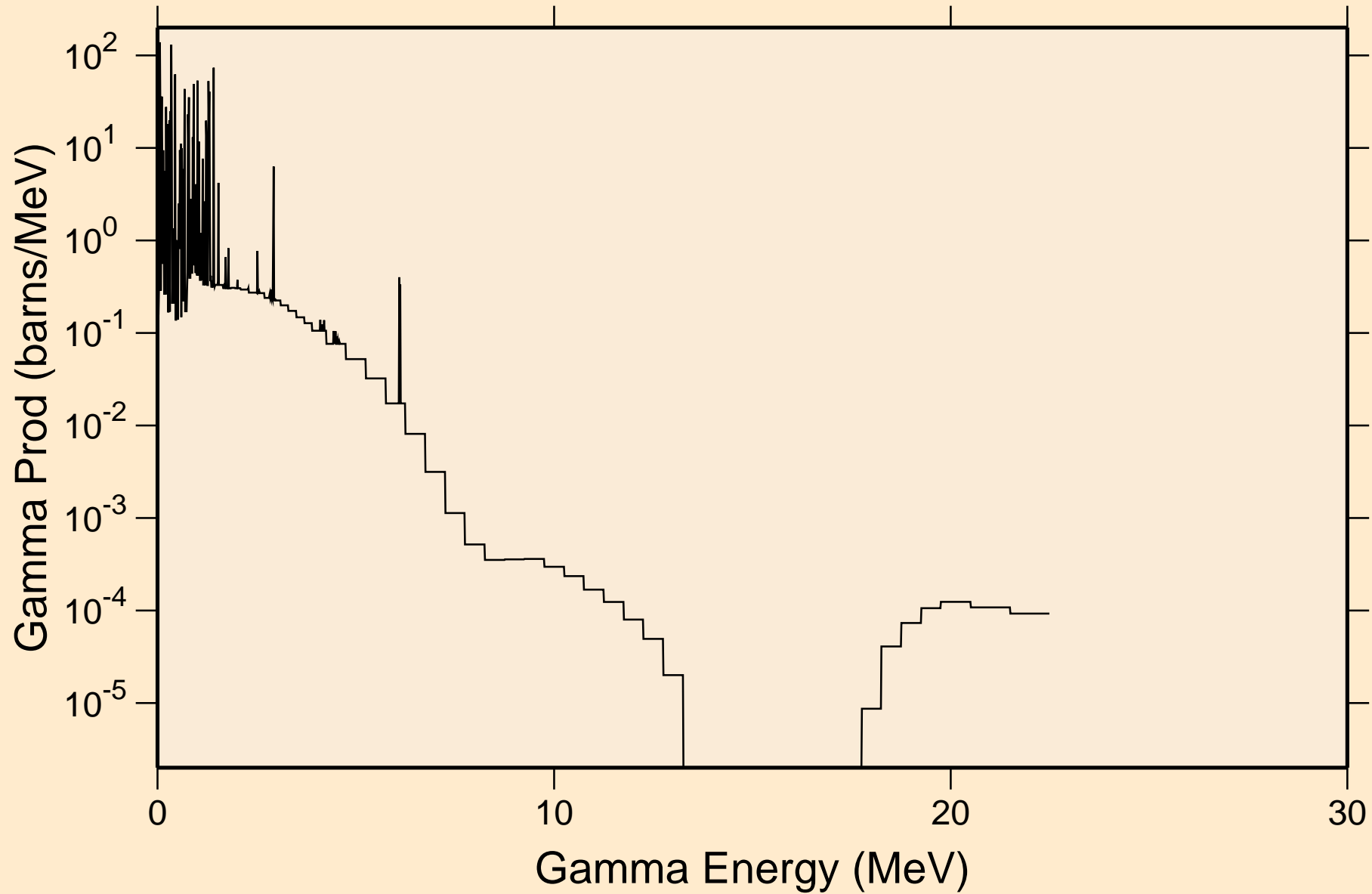

IN101 NEUTRON ACER TENDL-2021 LIBRARY; T=293.6K

Particle heating contributions

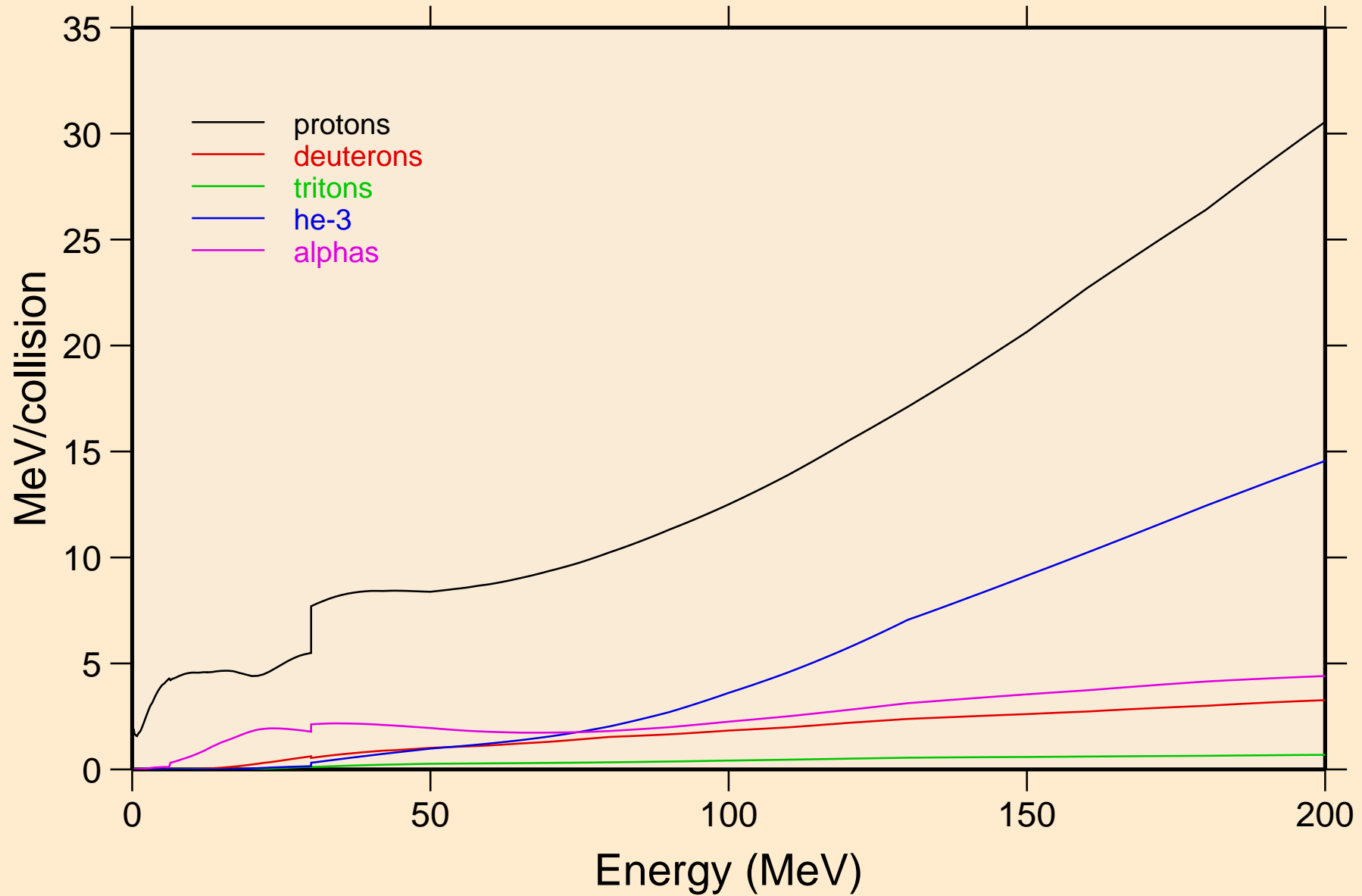

IN101 NEUTRON ACER TENDL-2021 LIBRARY; T=293.6K
Recoil Heating

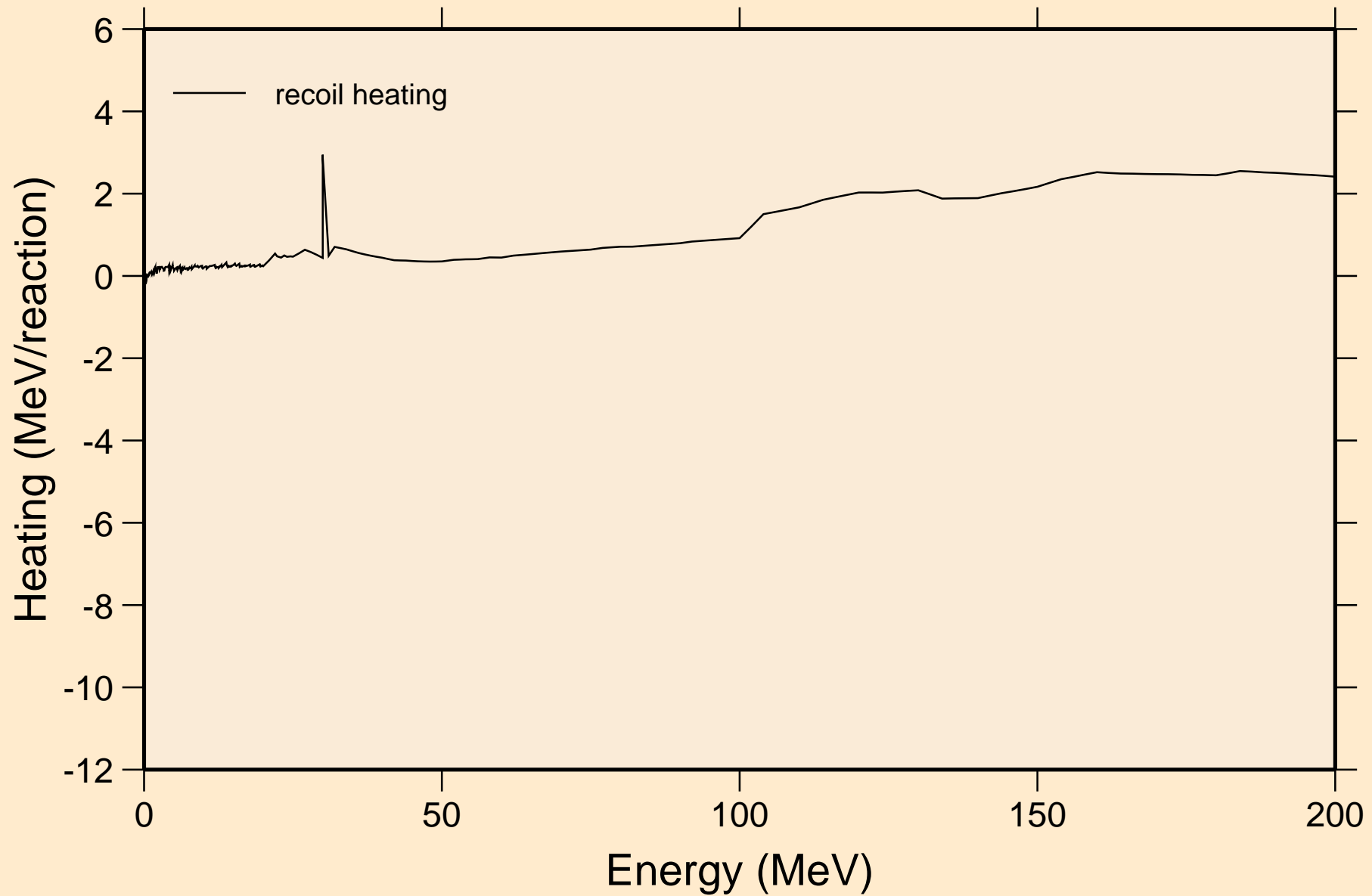

IN101 NEUTRON ACER TENDL-2021 LIBRARY; T=293.6K
Particle production cross sections

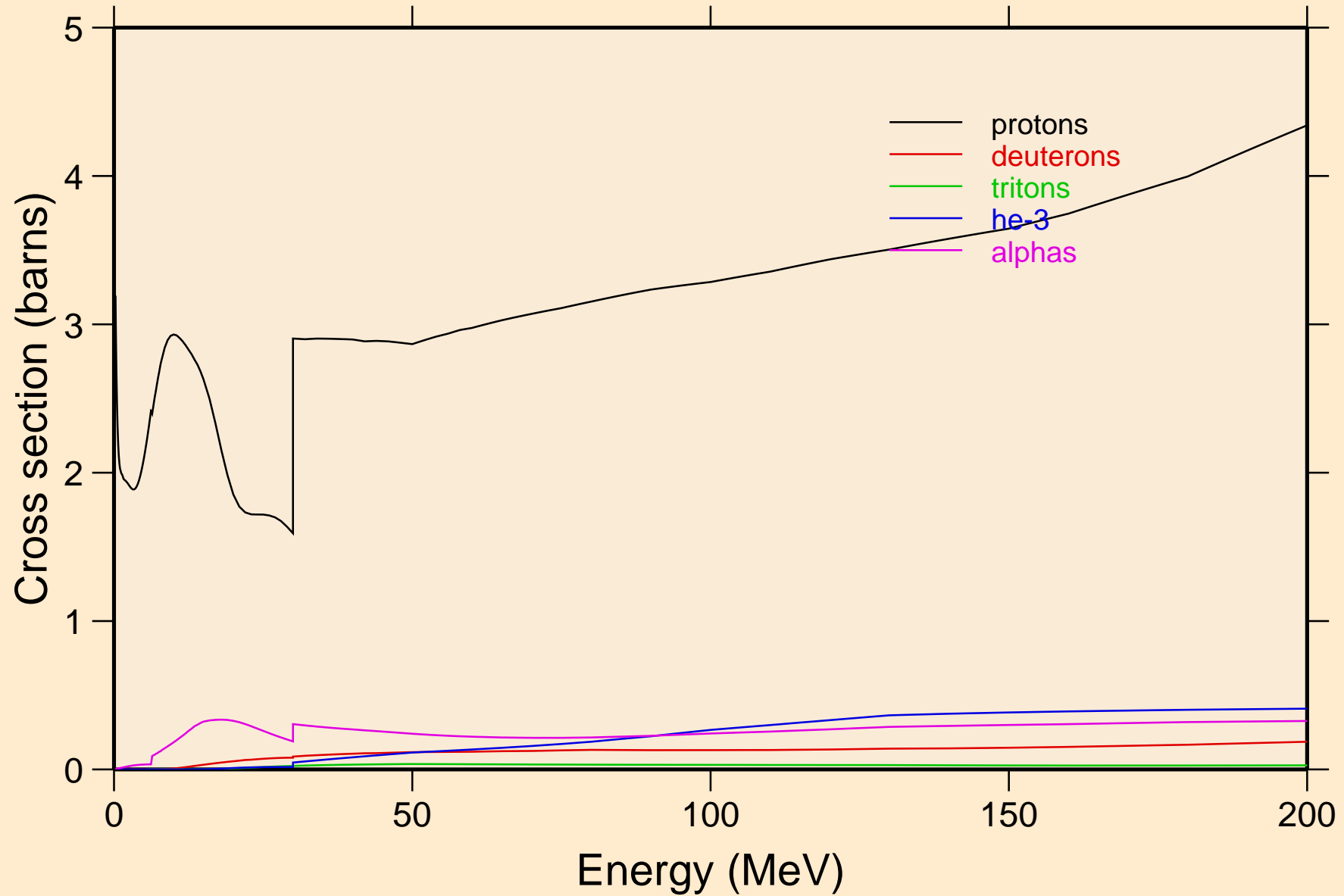

IN101 NEUTRON ACER TENDL-2021 LIBRARY; T=293.6K
protons from (n,x)

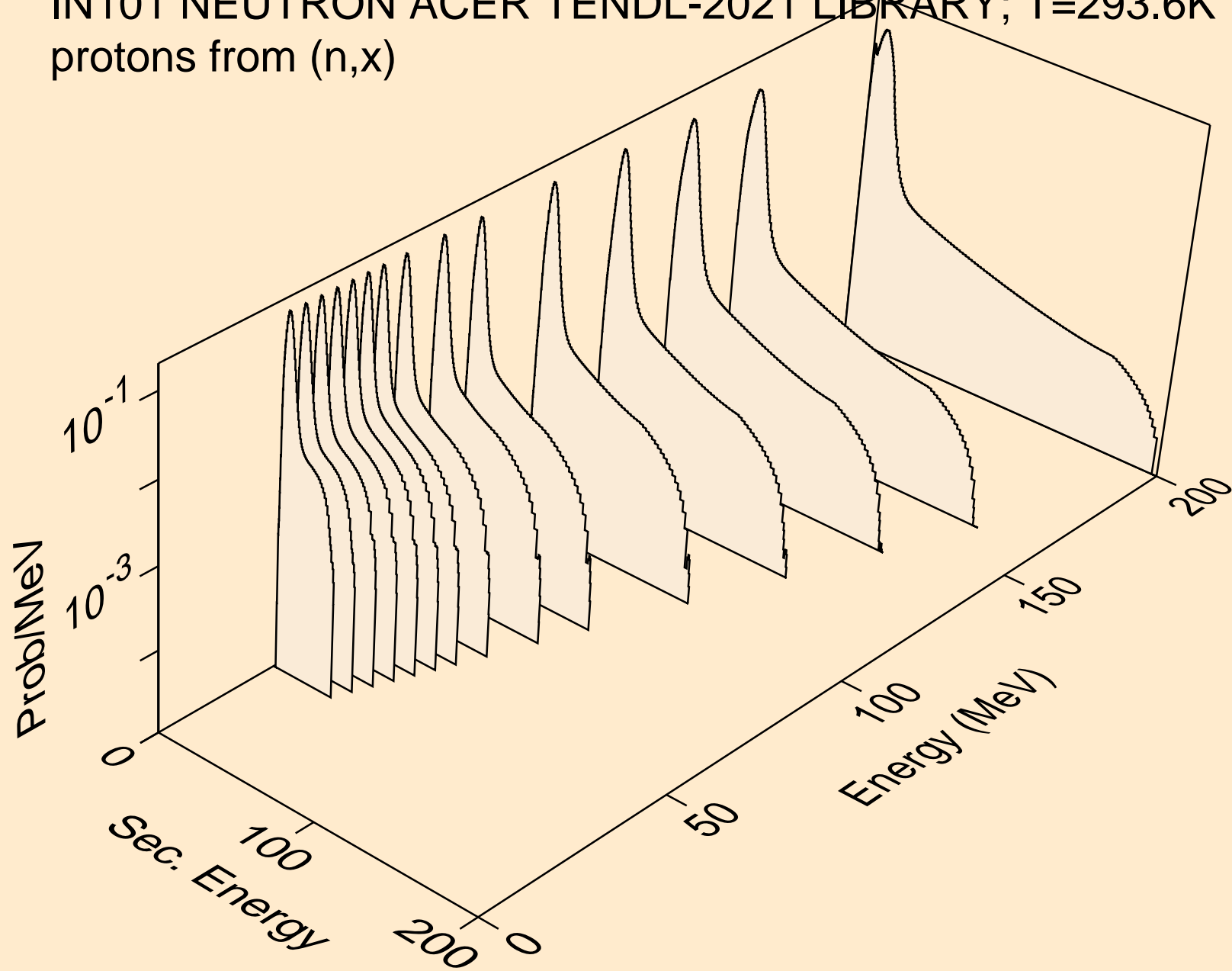

IN101 NEUTRON ACER TENDL-2021 LIBRARY; T=293.6K
protons from (n,n*)p

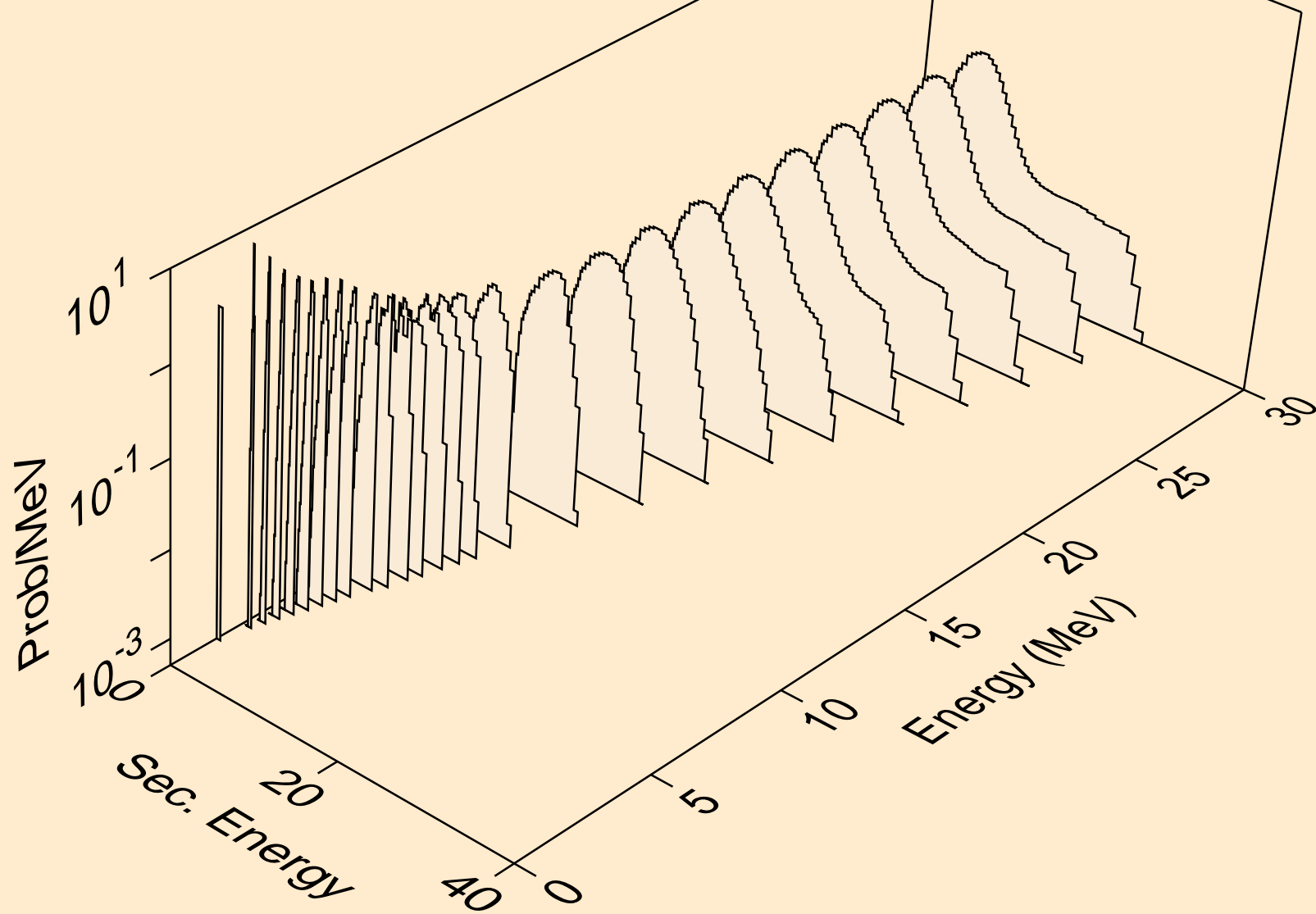

IN101 NEUTRON ACER TENDL-2021 LIBRARY; T=293.6K
protons from (n,2np)

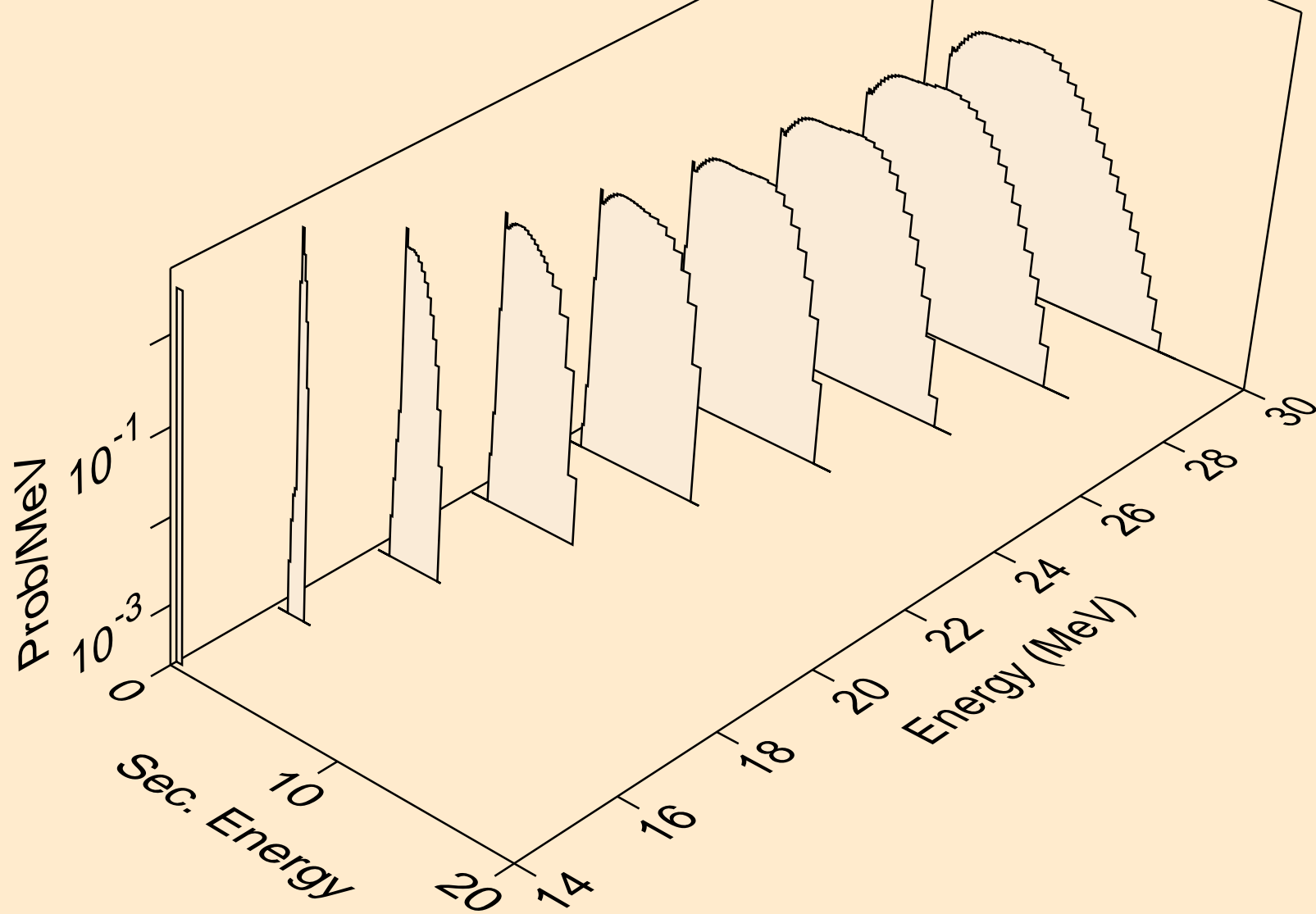

IN101 NEUTRON ACER TENDL-2021 LIBRARY; T=293.6K
protons from (n,3np)

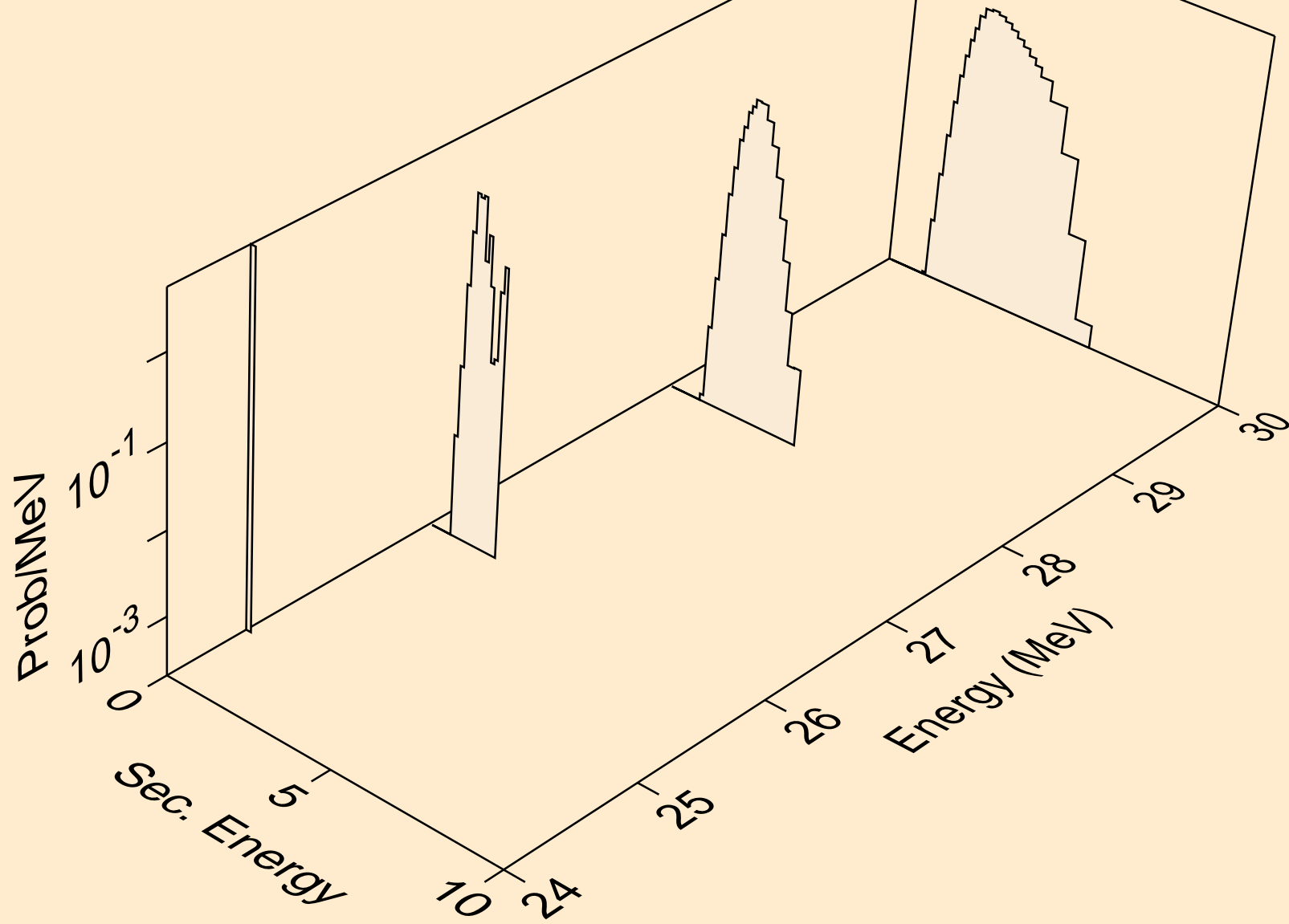

IN101 NEUTRON ACER TENDL-2021 LIBRARY; T=293.6K
protons from (n,2np)

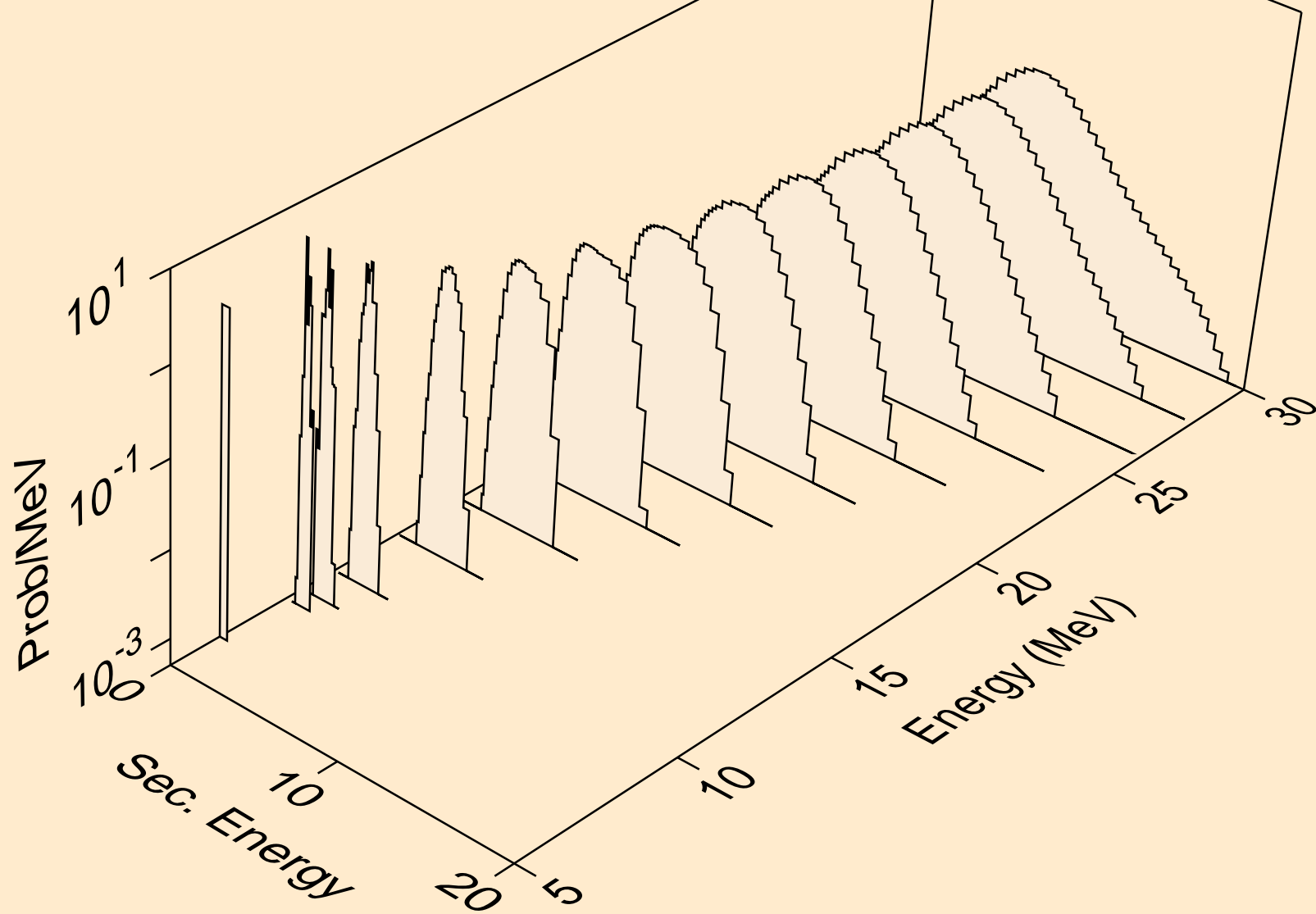

IN101 NEUTRON ACER TENDL-2021 LIBRARY; T=293.6K
protons from (n,npa)

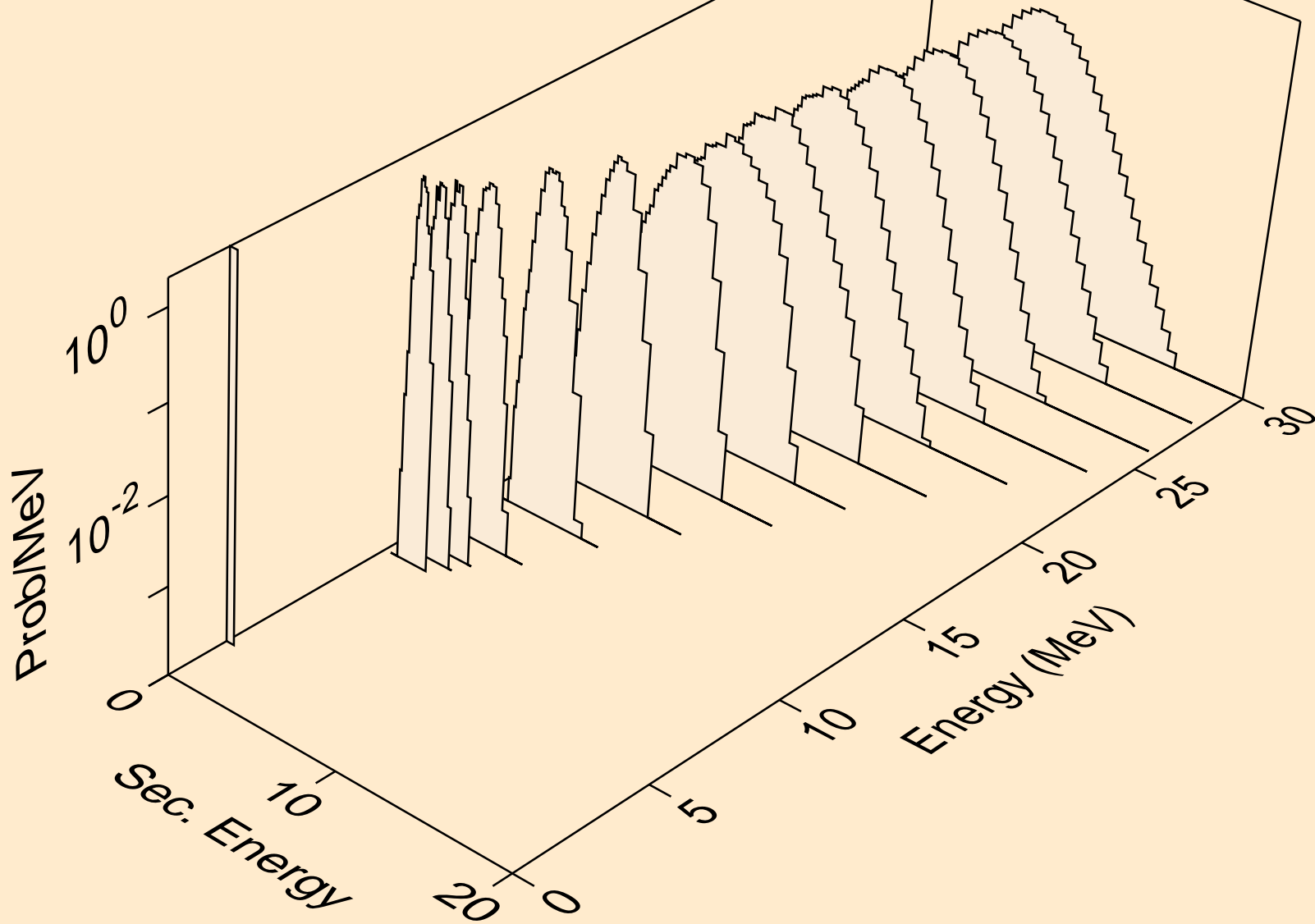

IN101 NEUTRON ACER TENDL-2021 LIBRARY; T=293.6K
protons from (n,p)

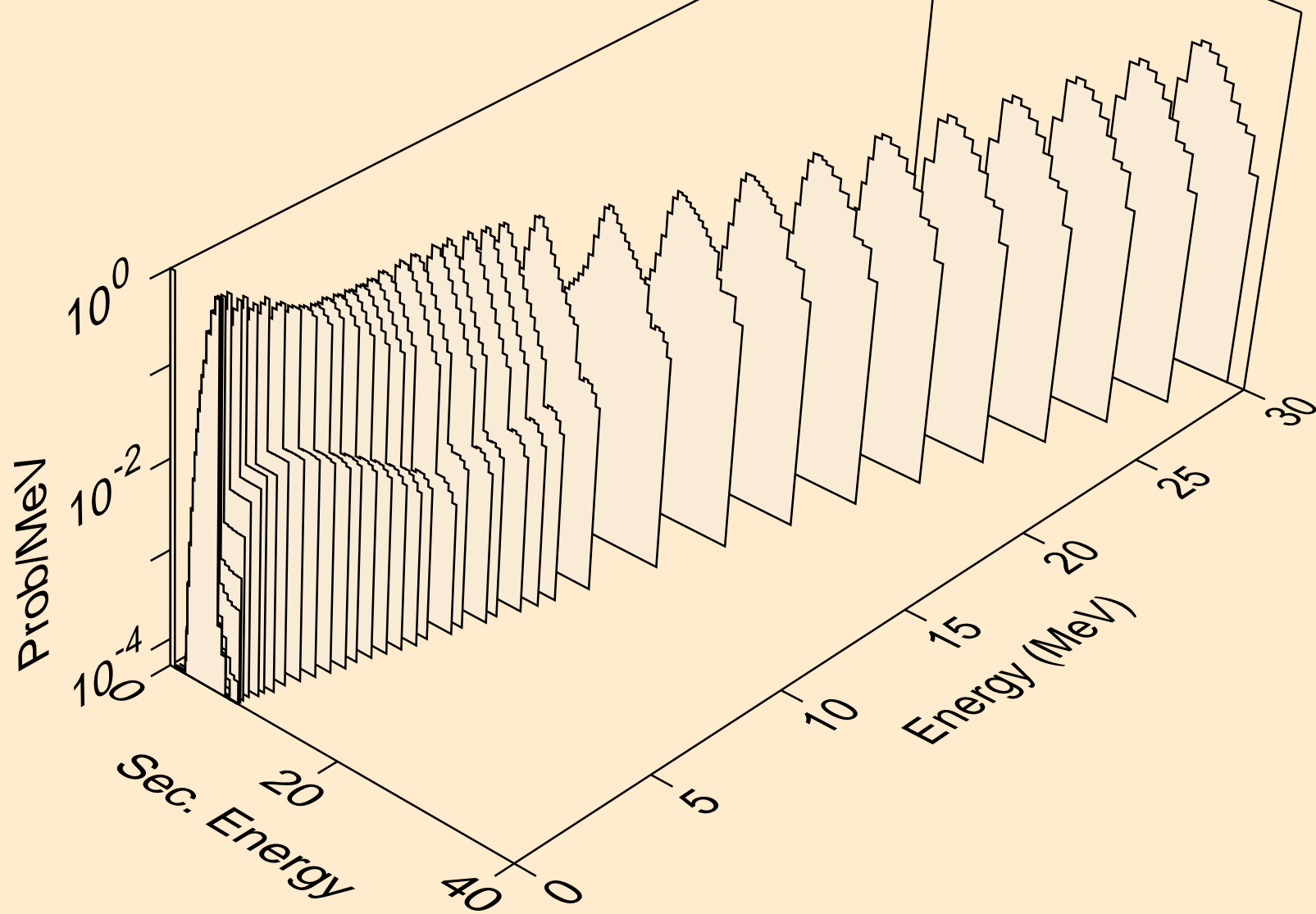

IN101 NEUTRON ACER TENDL-2021 LIBRARY; T=293.6K
protons from (n,2p)

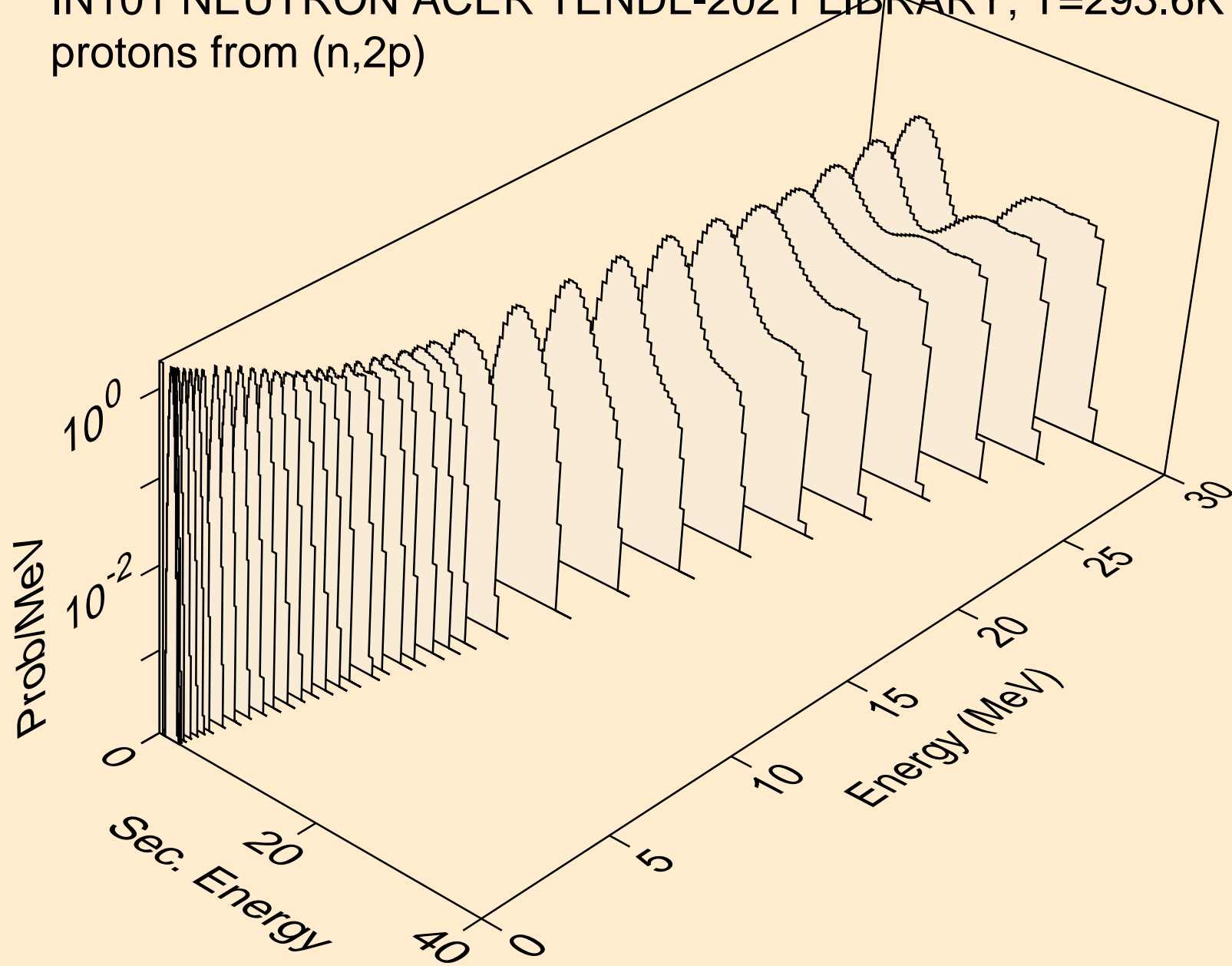

IN101 NEUTRON ACER TENDL-2021 LIBRARY; T=293.6K
protons from (n,p)

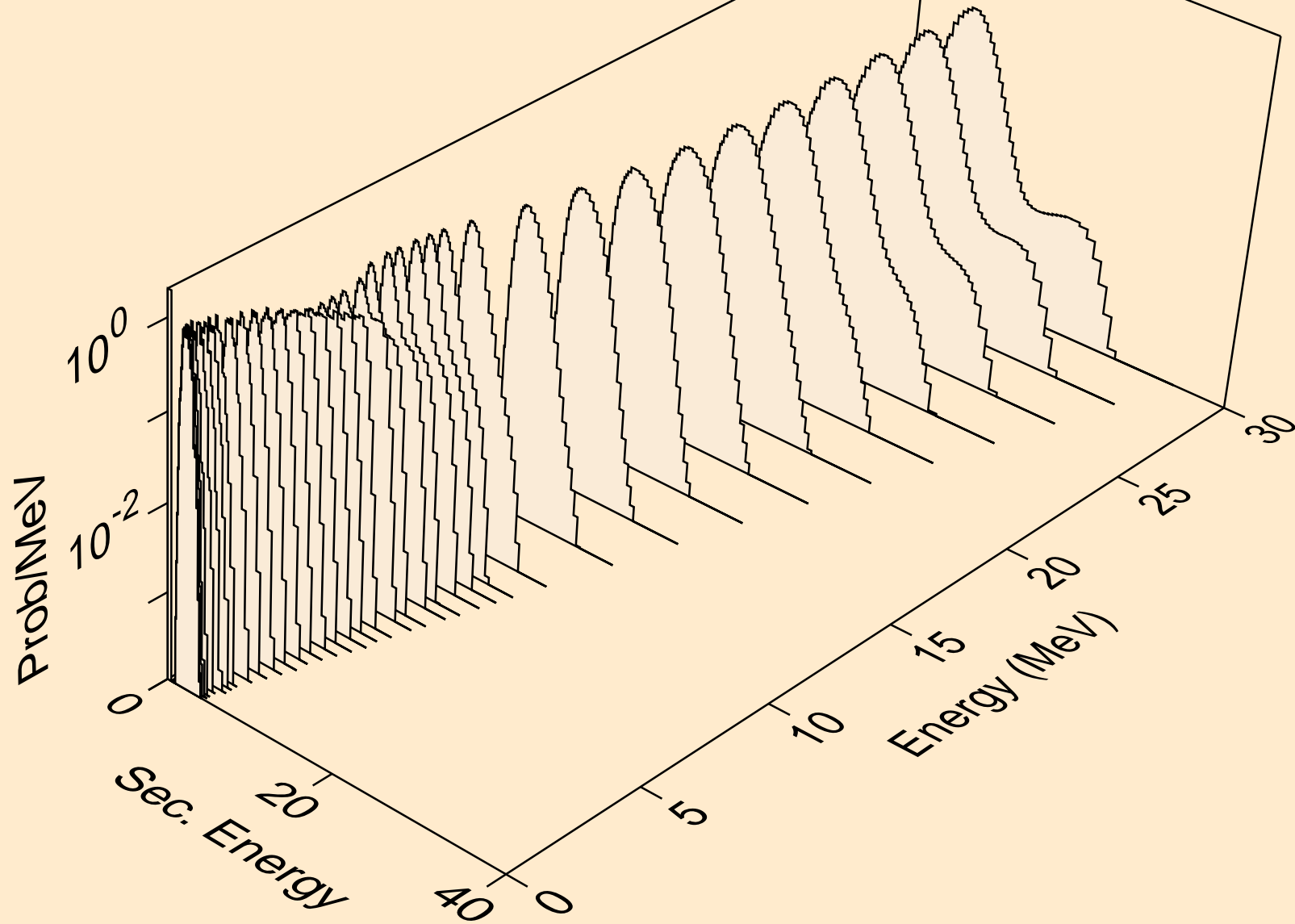

IN101 NEUTRON ACER TENDL-2021 LIBRARY; T=293.6K
protons from (n,pd)

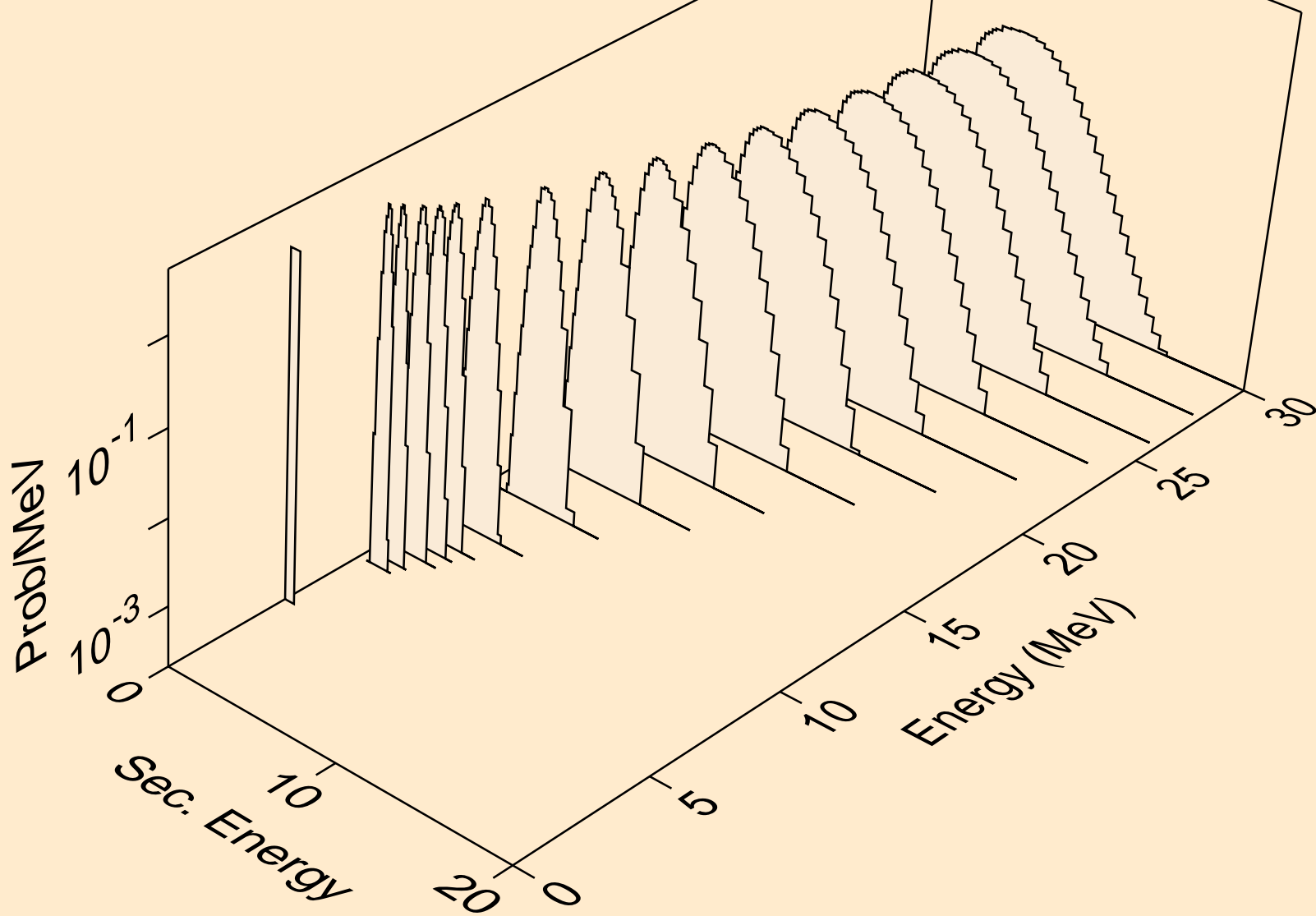

IN101 NEUTRON ACER TENDL-2021 LIBRARY; T=293.6K
protons from (n,pt)

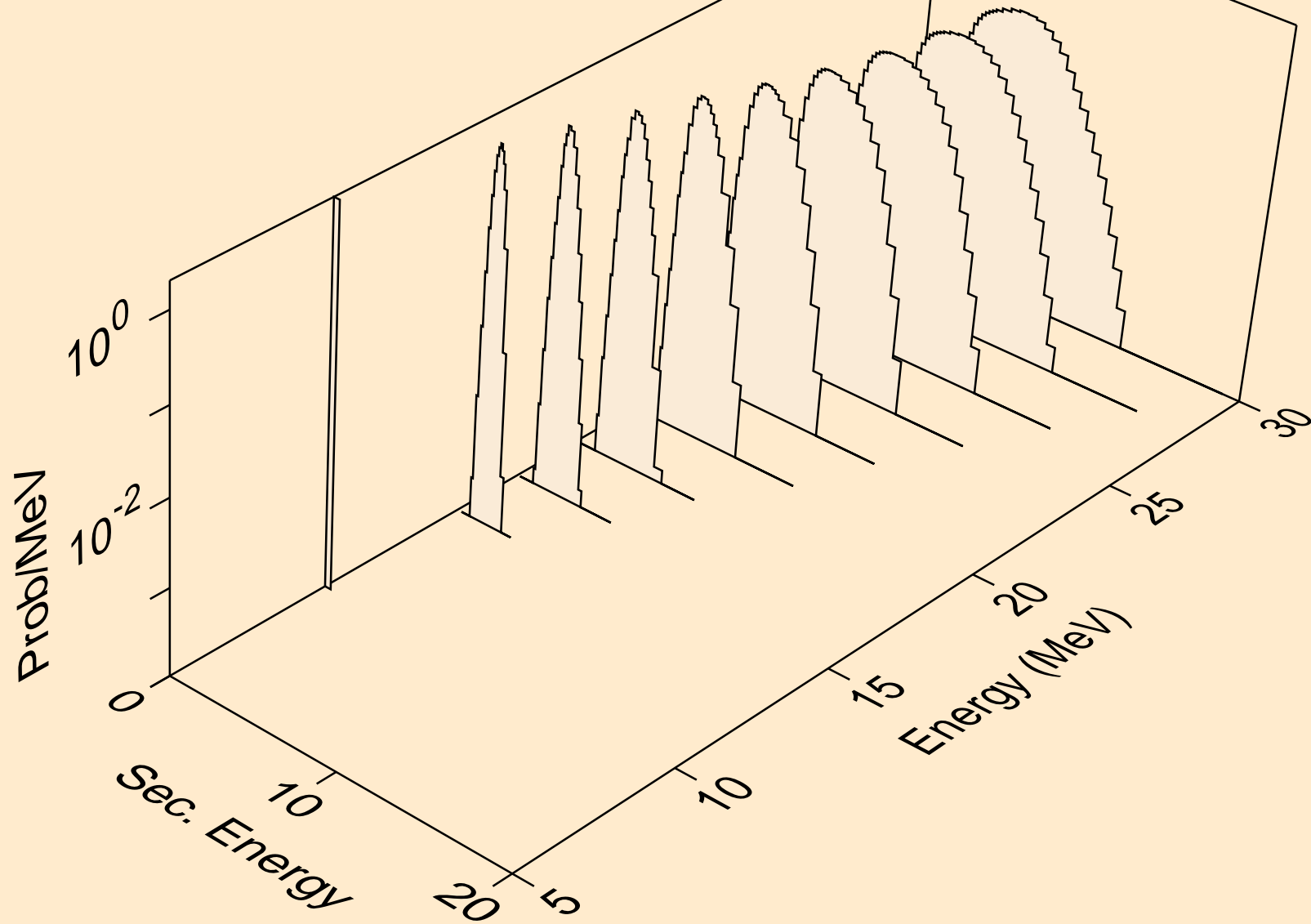

IN101 NEUTRON ACER TENDL-2021 LIBRARY; T=293.6K
deuterons from (n,x)

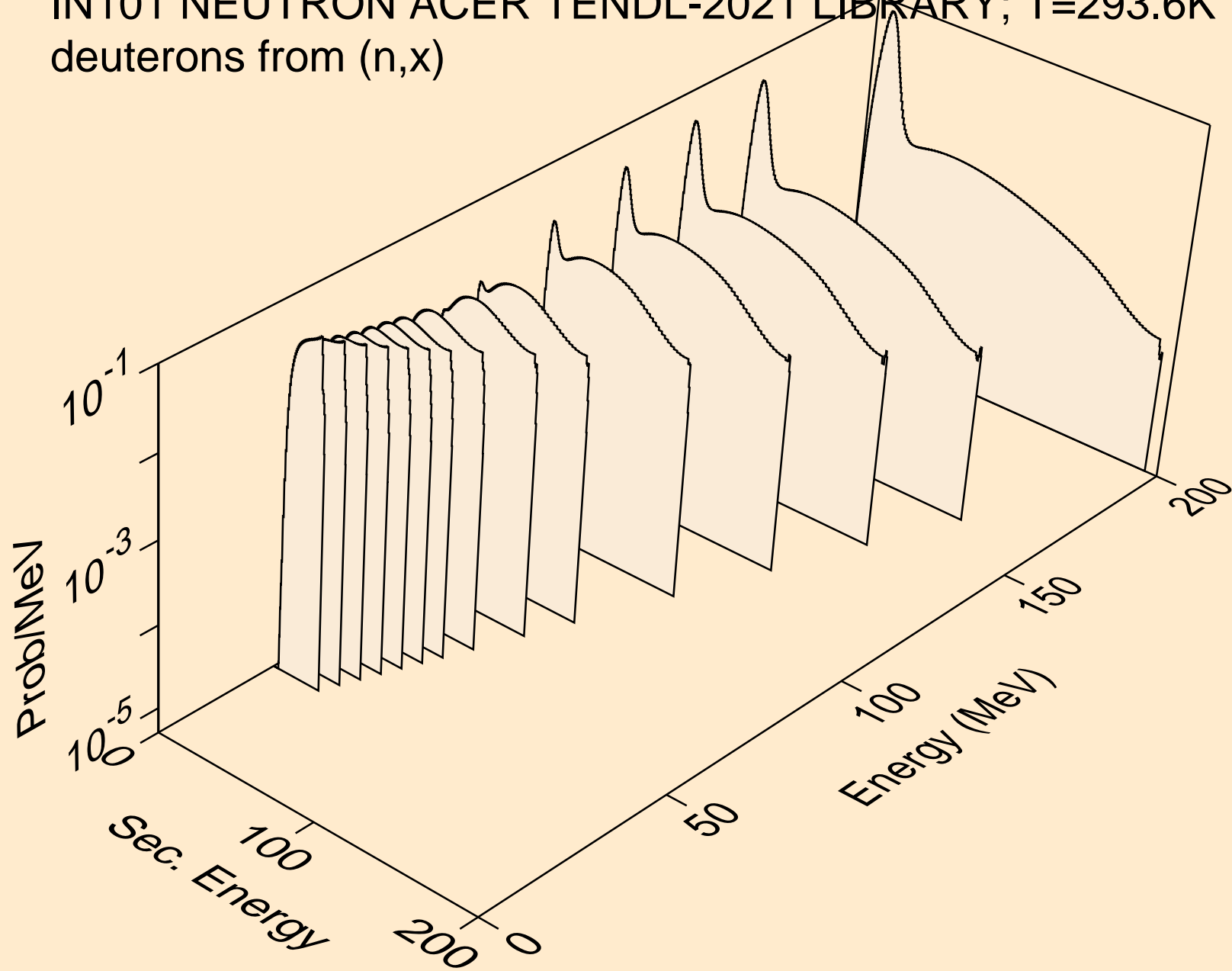

IN101 NEUTRON ACER TENDL-2021 LIBRARY; T=293.6K
deuterons from (n,2nd)

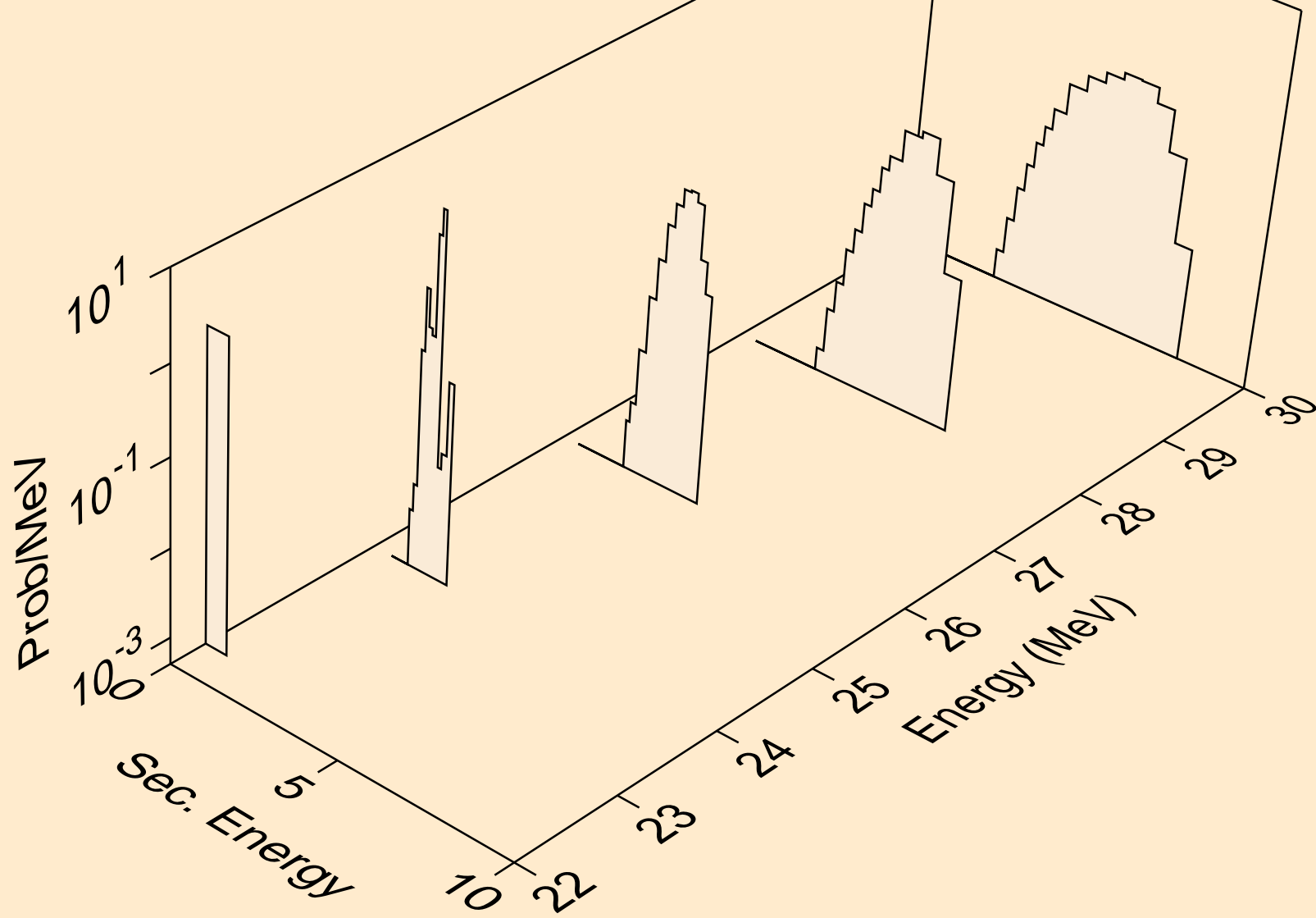

IN101 NEUTRON ACER TENDL-2021 LIBRARY; T=293.6K
deuterons from (n,n*)d

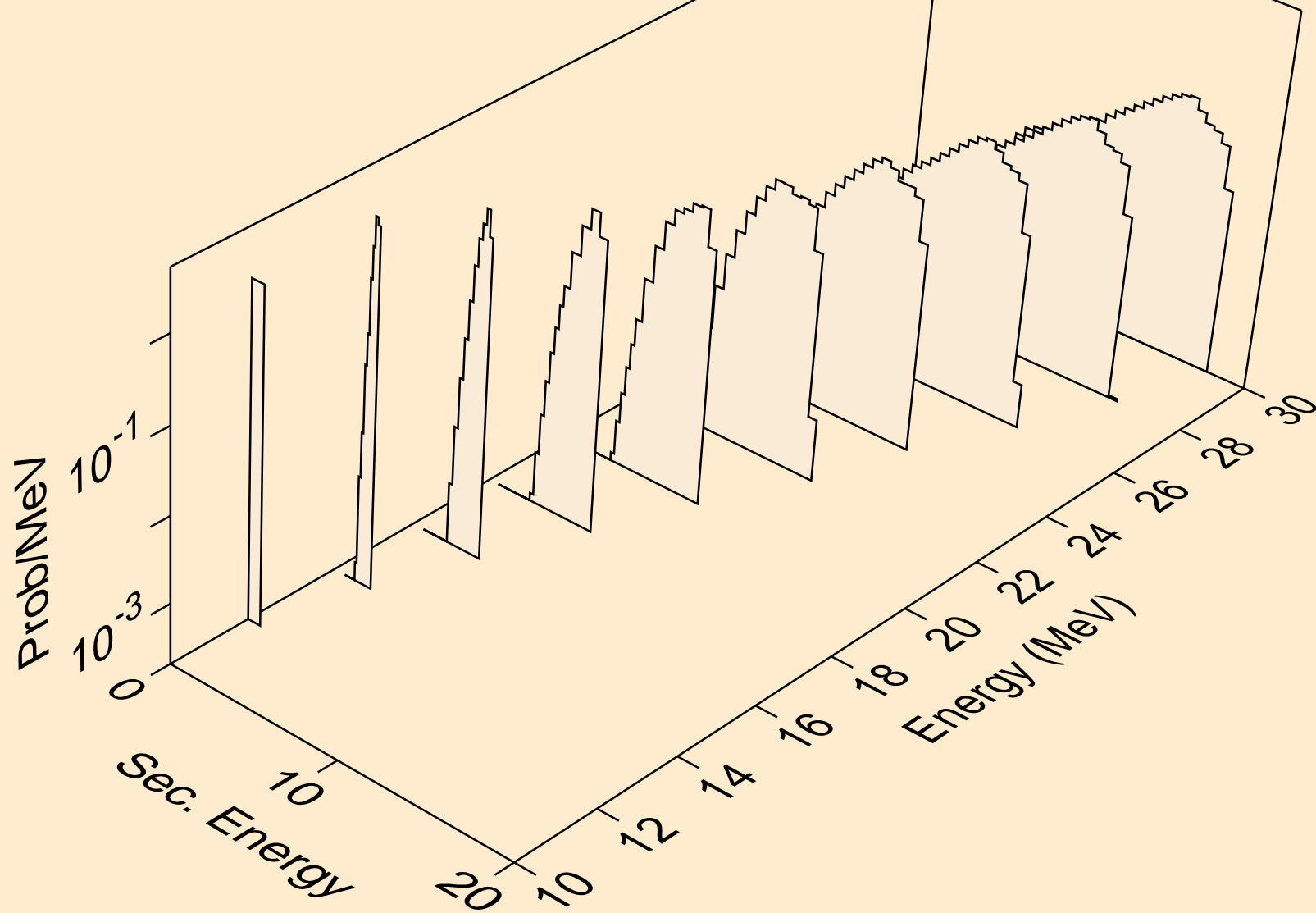

IN101 NEUTRON ACER TENDL-2021 LIBRARY; T=293.6K
deuterons from (n,d)

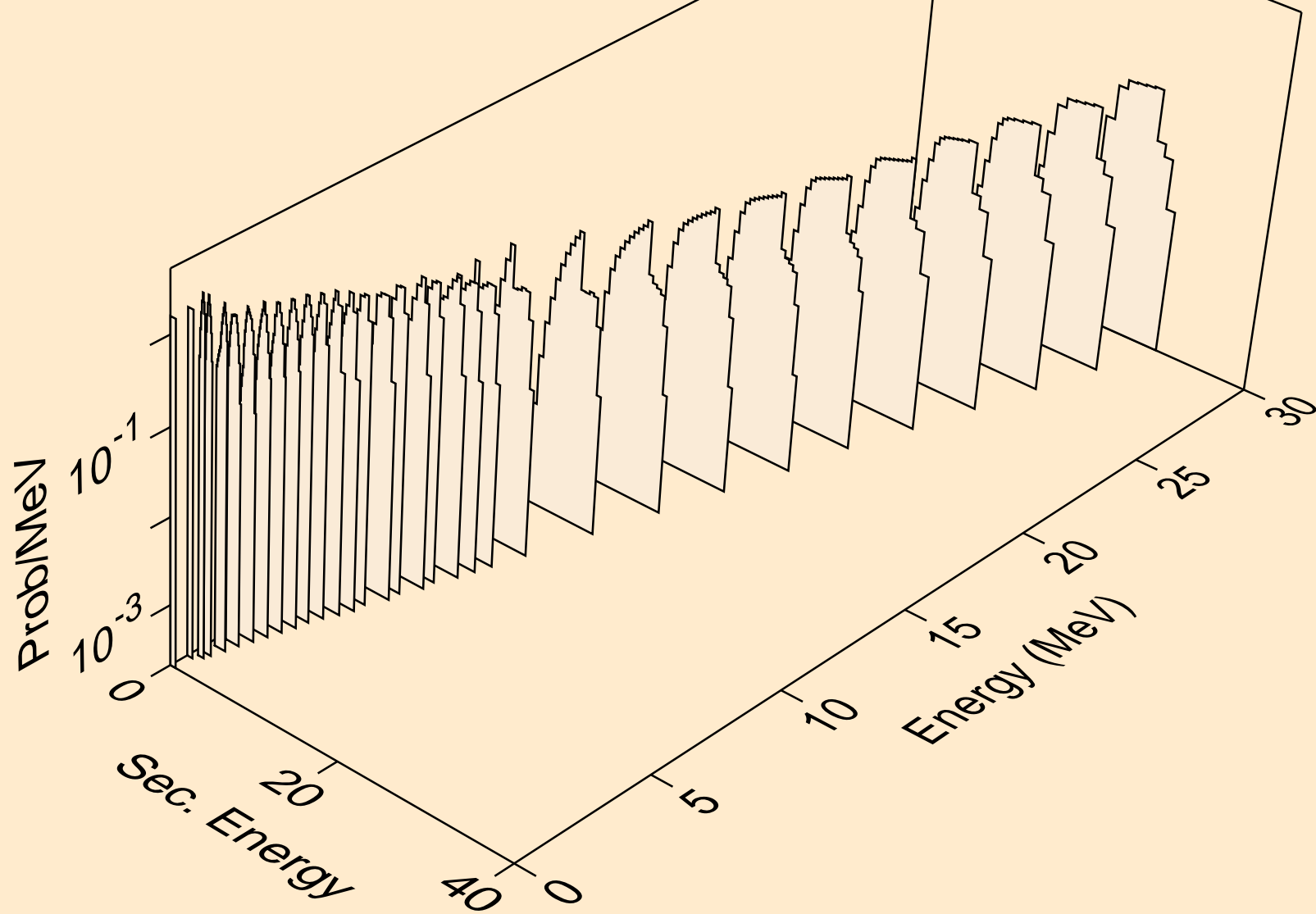

IN101 NEUTRON ACER TENDL-2021 LIBRARY; T=293.6K
deuterons from (n,pd)

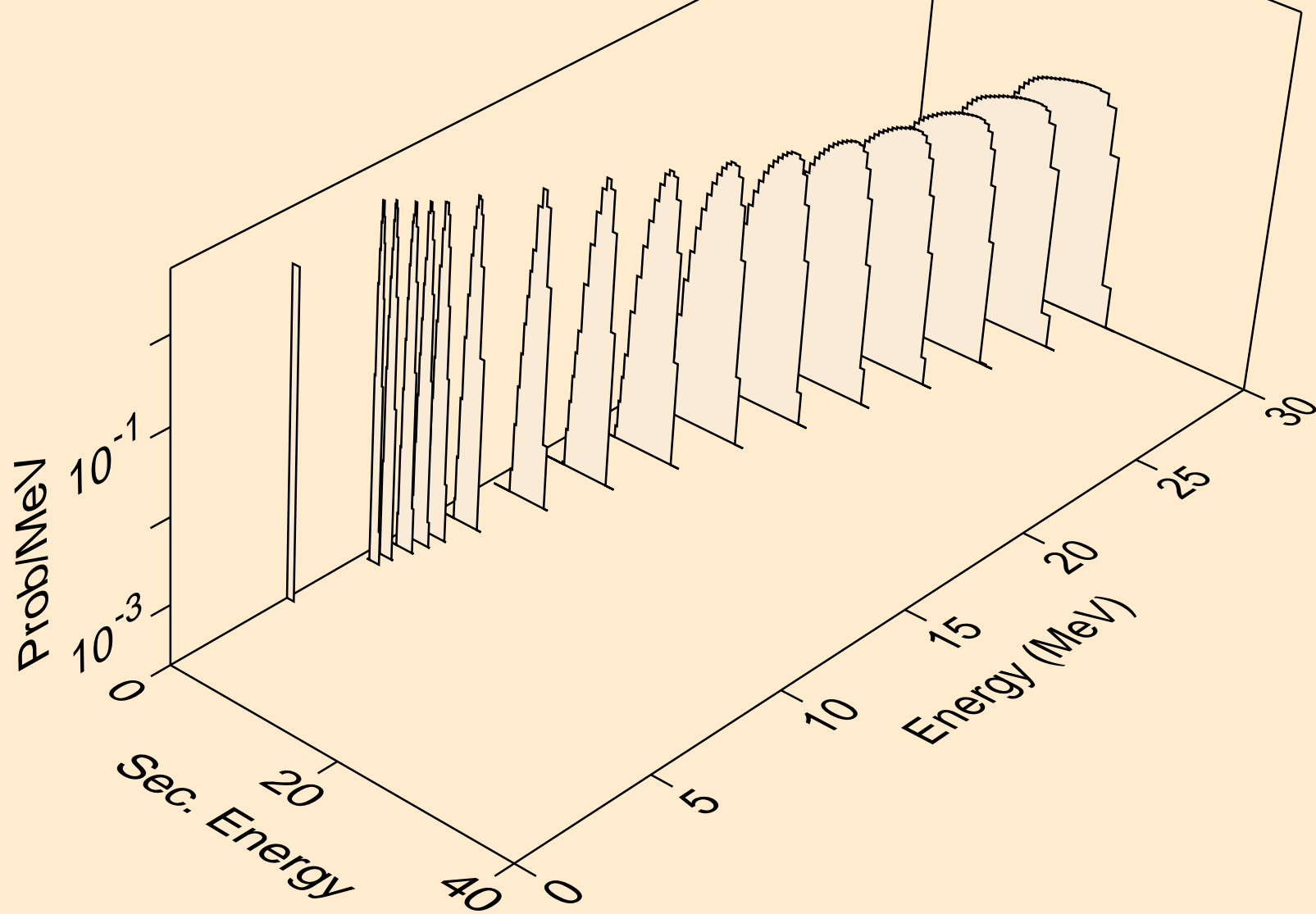

IN101 NEUTRON ACER TENDL-2021 LIBRARY; T=293.6K
deuterons from (n,da)

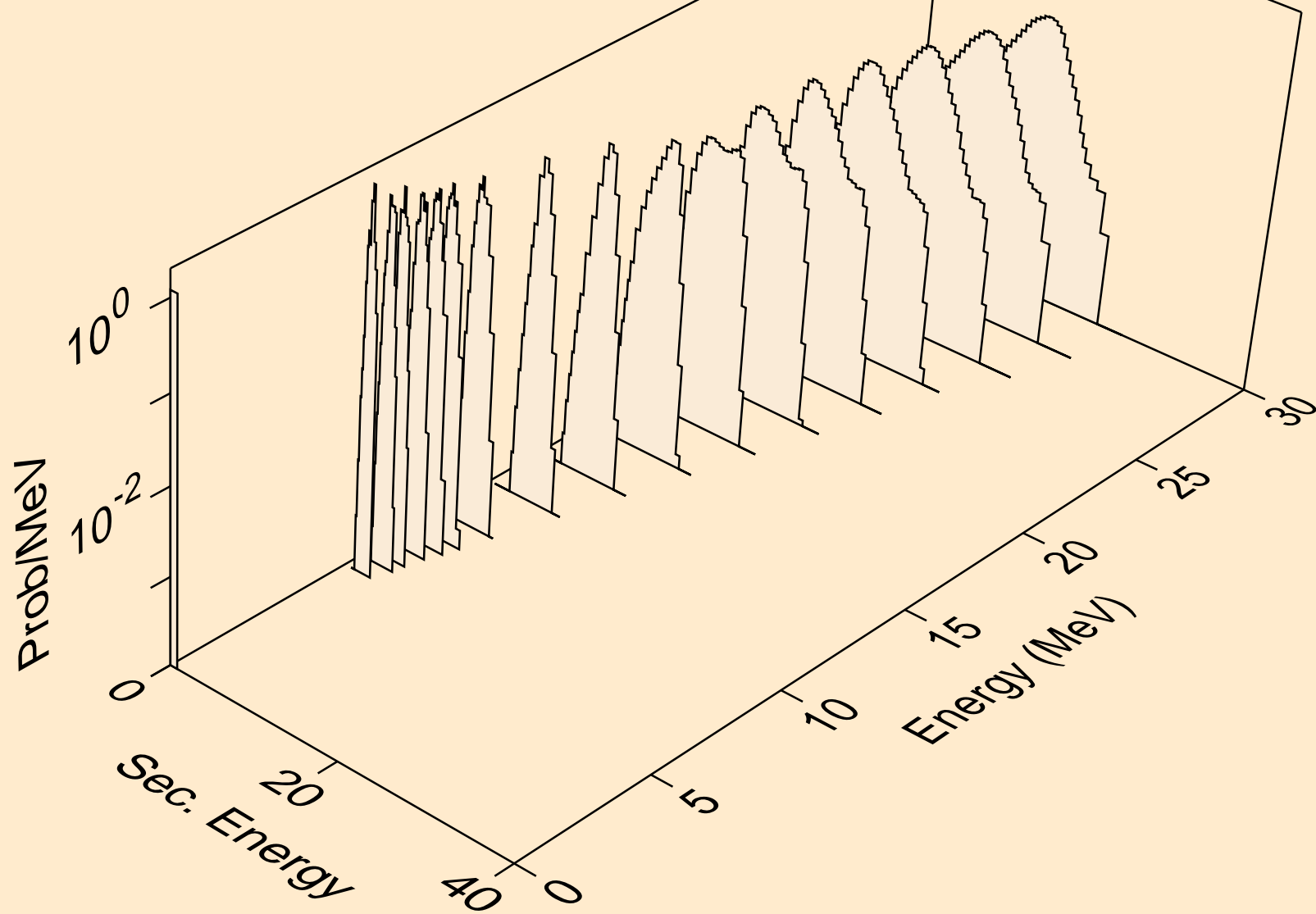

IN101 NEUTRON ACER TENDL-2021 LIBRARY; T=293.6K
tritons from (n,x)

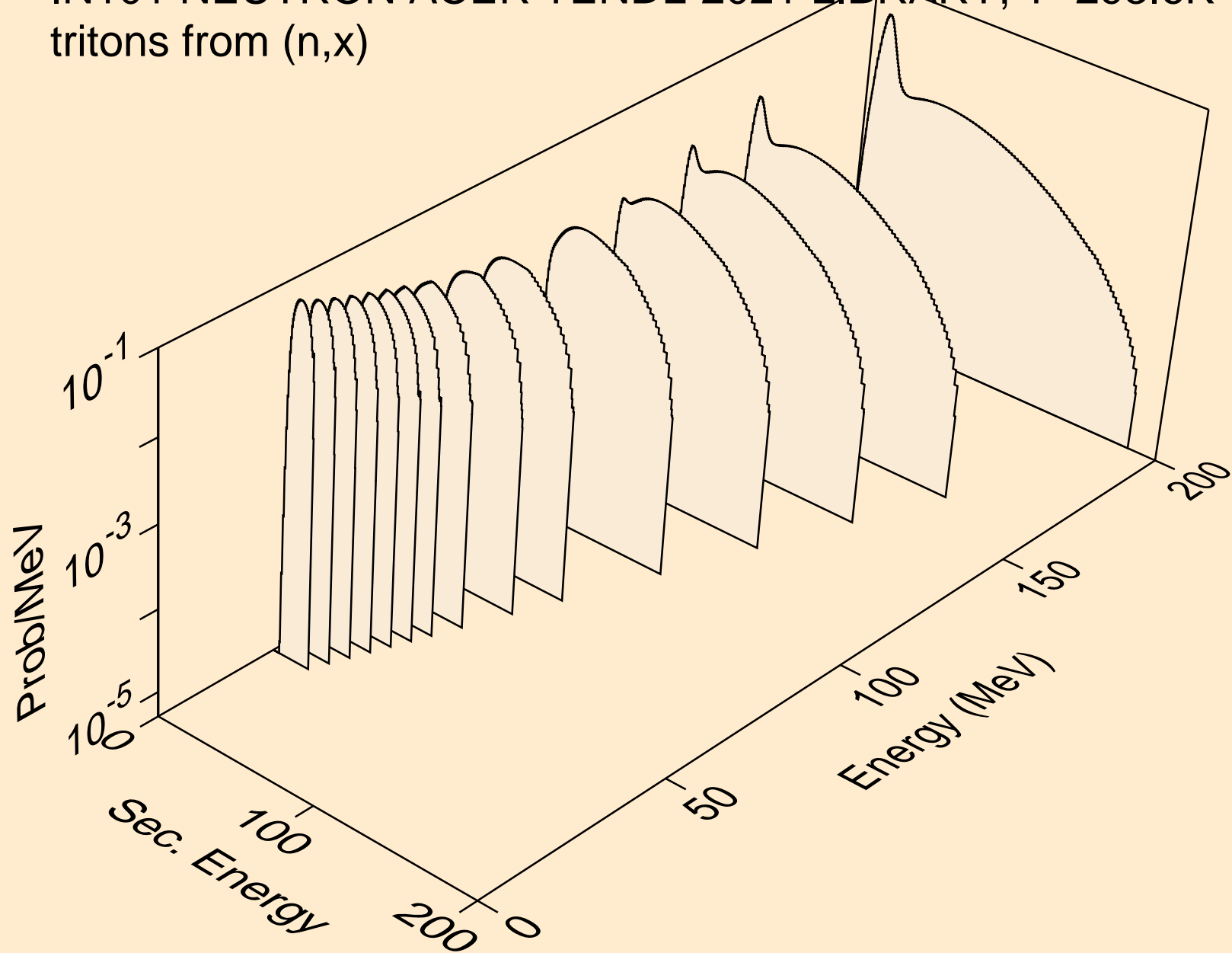

IN101 NEUTRON ACER TENDL-2021 LIBRARY; T=293.6K
tritons from (n,n*)t

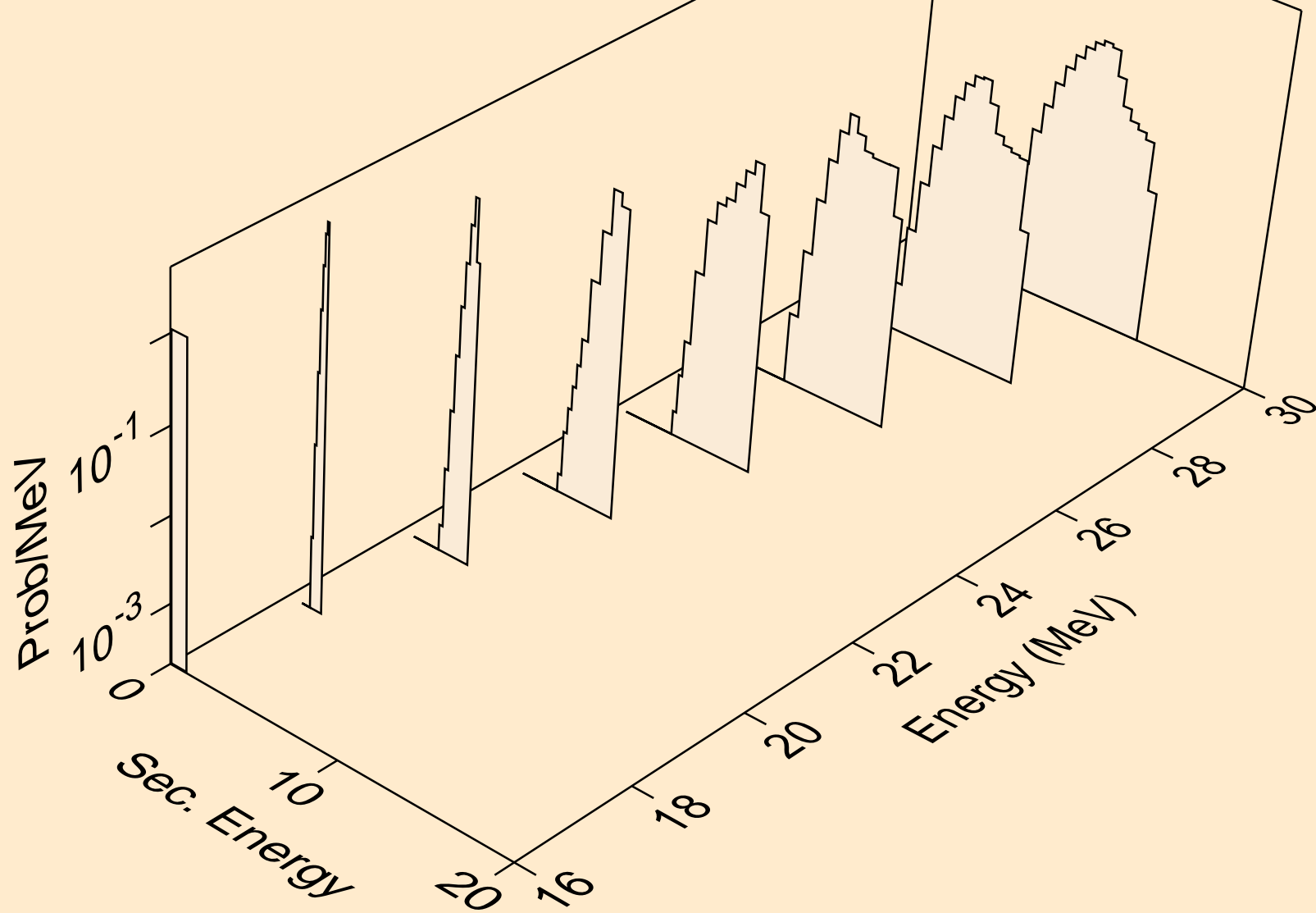

IN101 NEUTRON ACER TENDL-2021 LIBRARY; T=293.6K
tritons from (n,t)

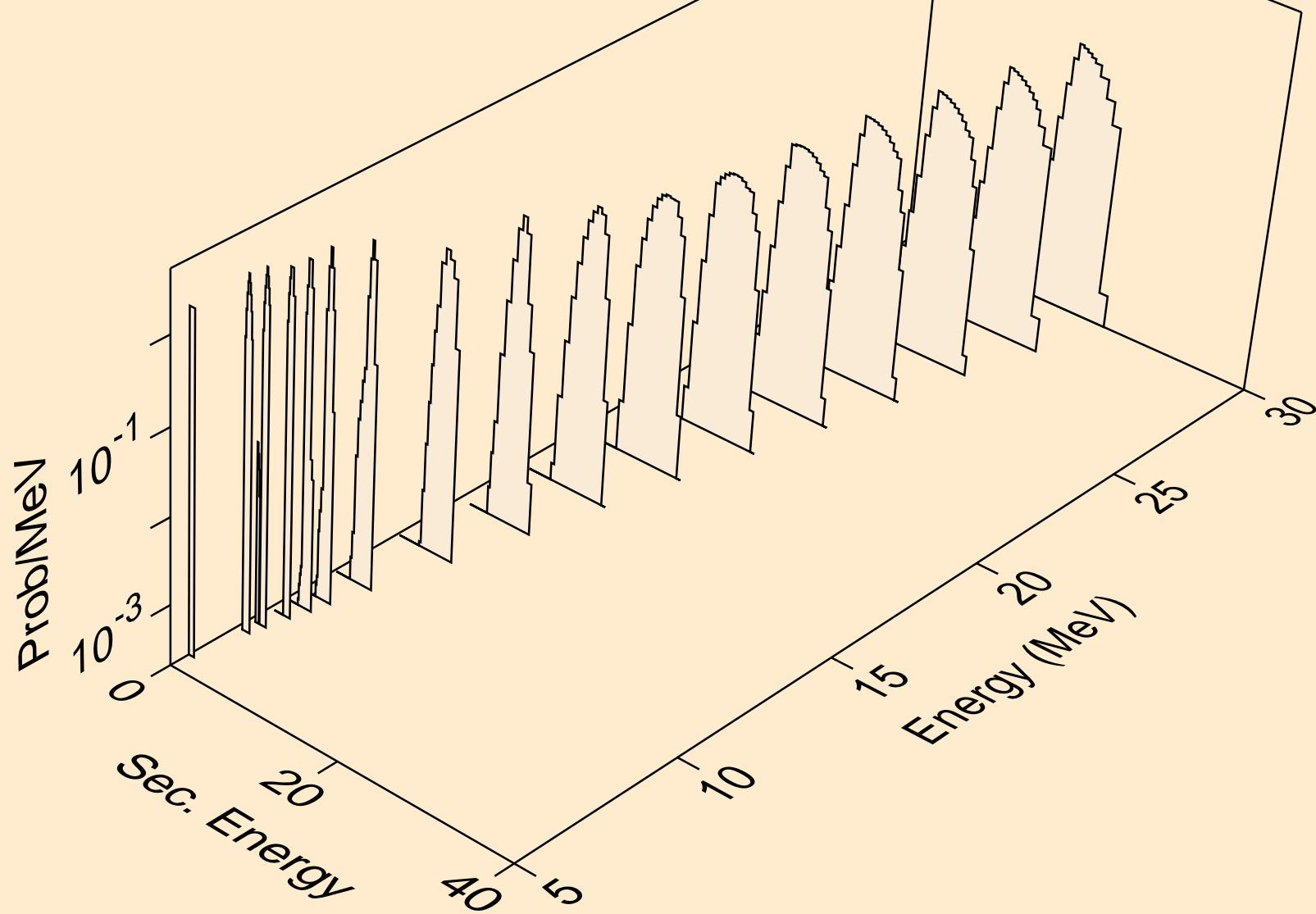

IN101 NEUTRON ACER TENDL-2021 LIBRARY; T=293.6K
tritons from (n,pt)

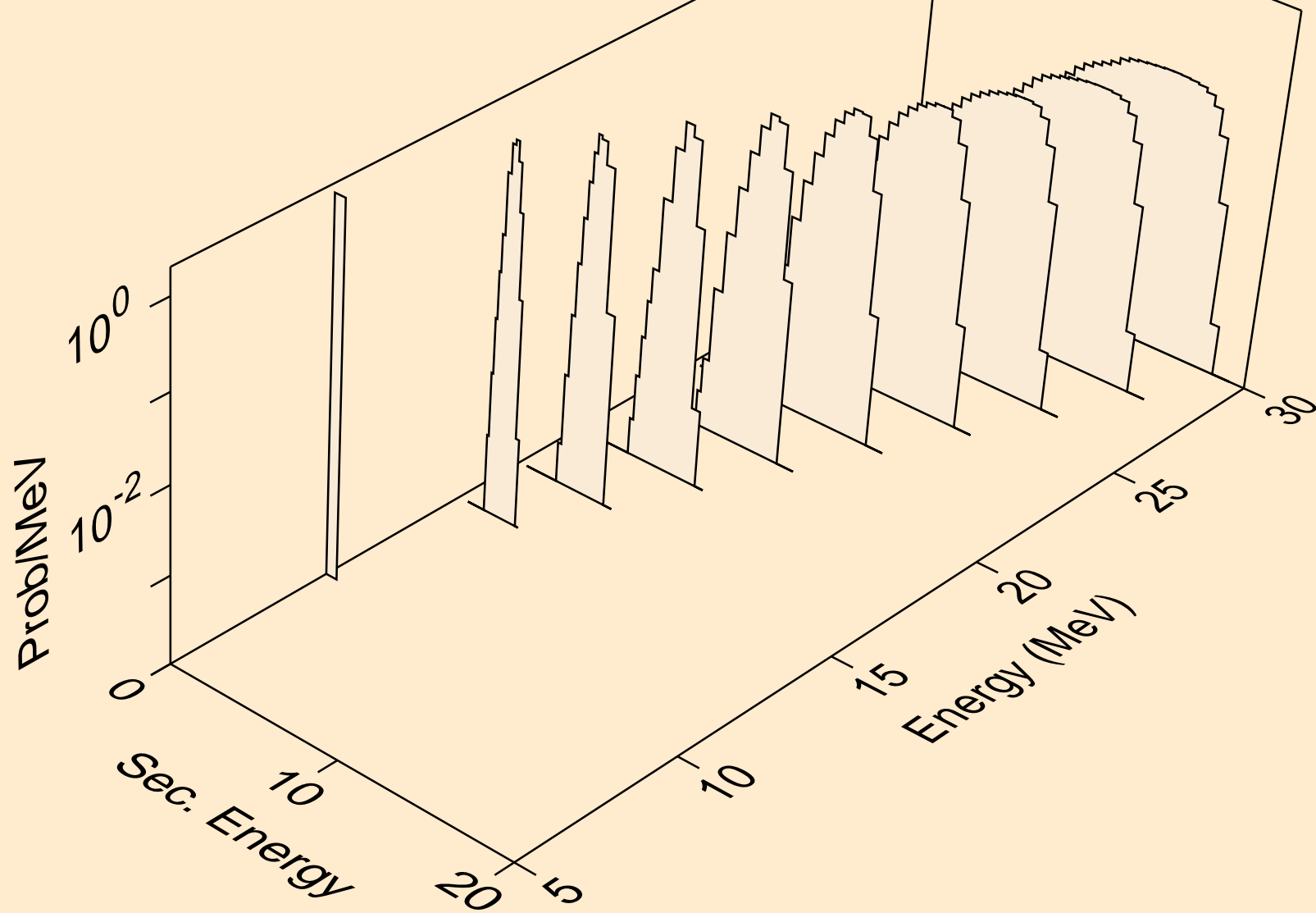

IN101 NEUTRON ACER TENDL-2021 LIBRARY; T=293.6K
he3s from (n,x)

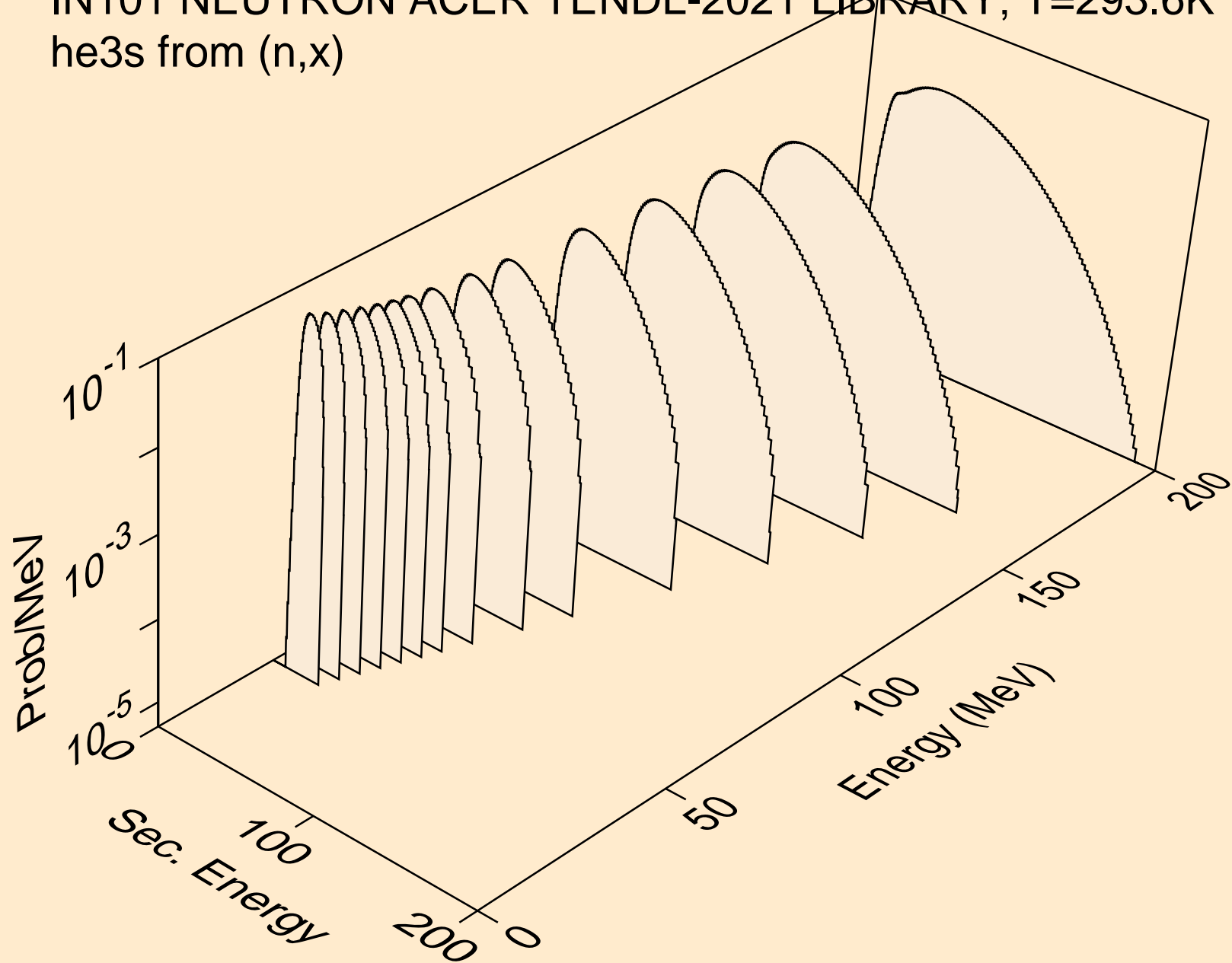

IN101 NEUTRON ACER TENDL-2021 LIBRARY; T=293.6K
he3s from (n,n*)he3

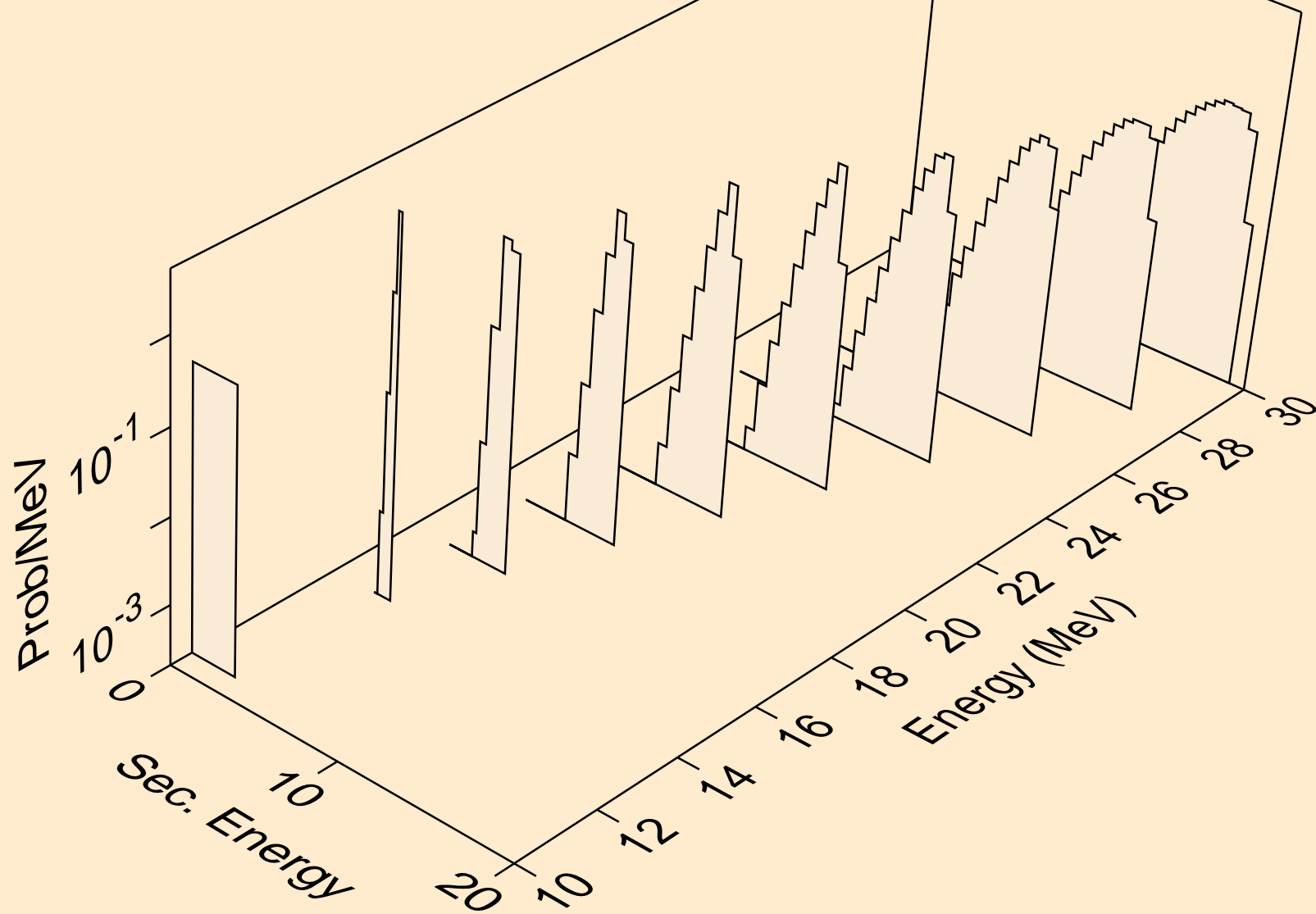

IN101 NEUTRON ACER TENDL-2021 LIBRARY; T=293.6K
he3s from (n,he3)

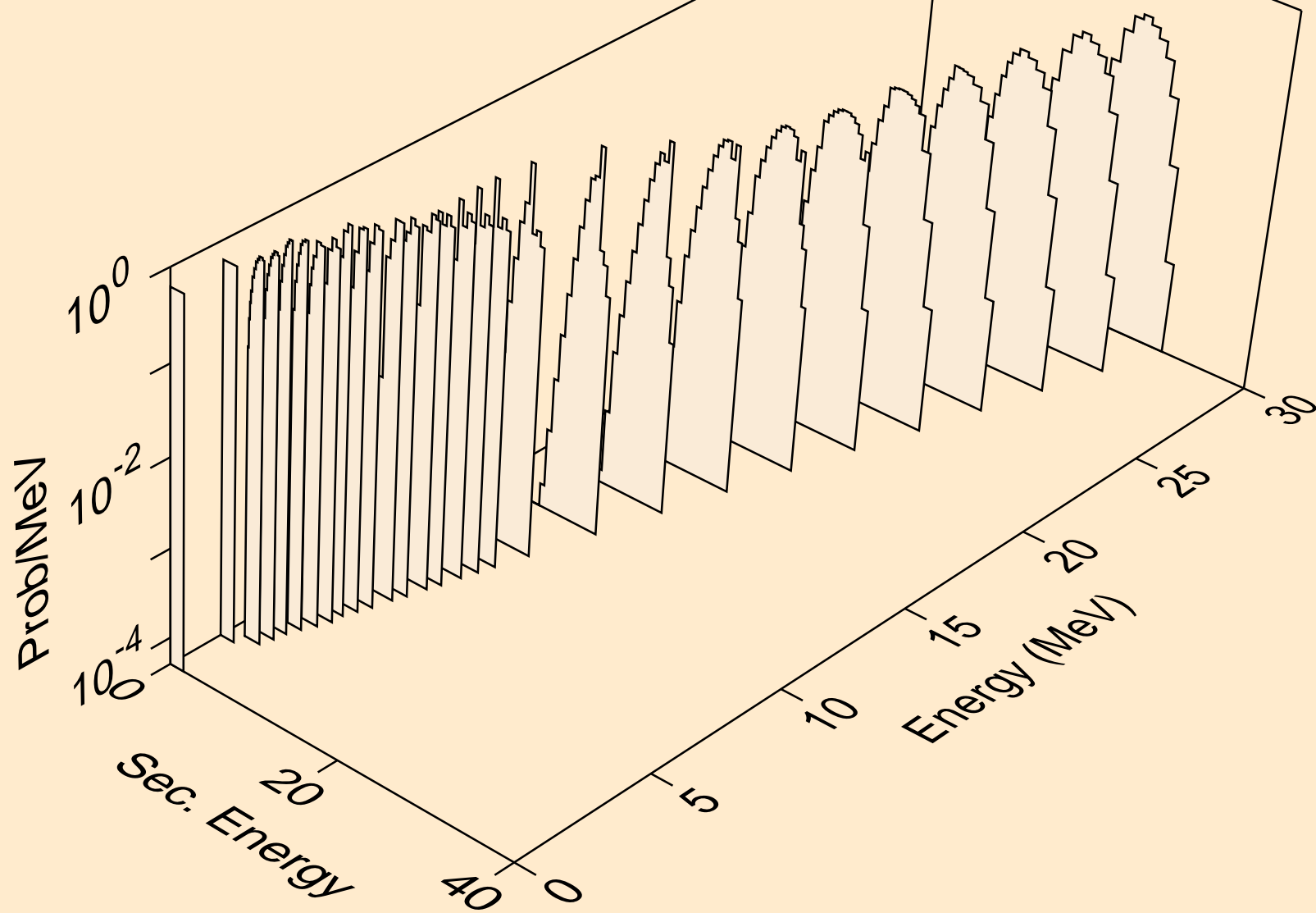

IN101 NEUTRON ACER TENDL-2021 LIBRARY; T=293.6K
alphas from (n,x)

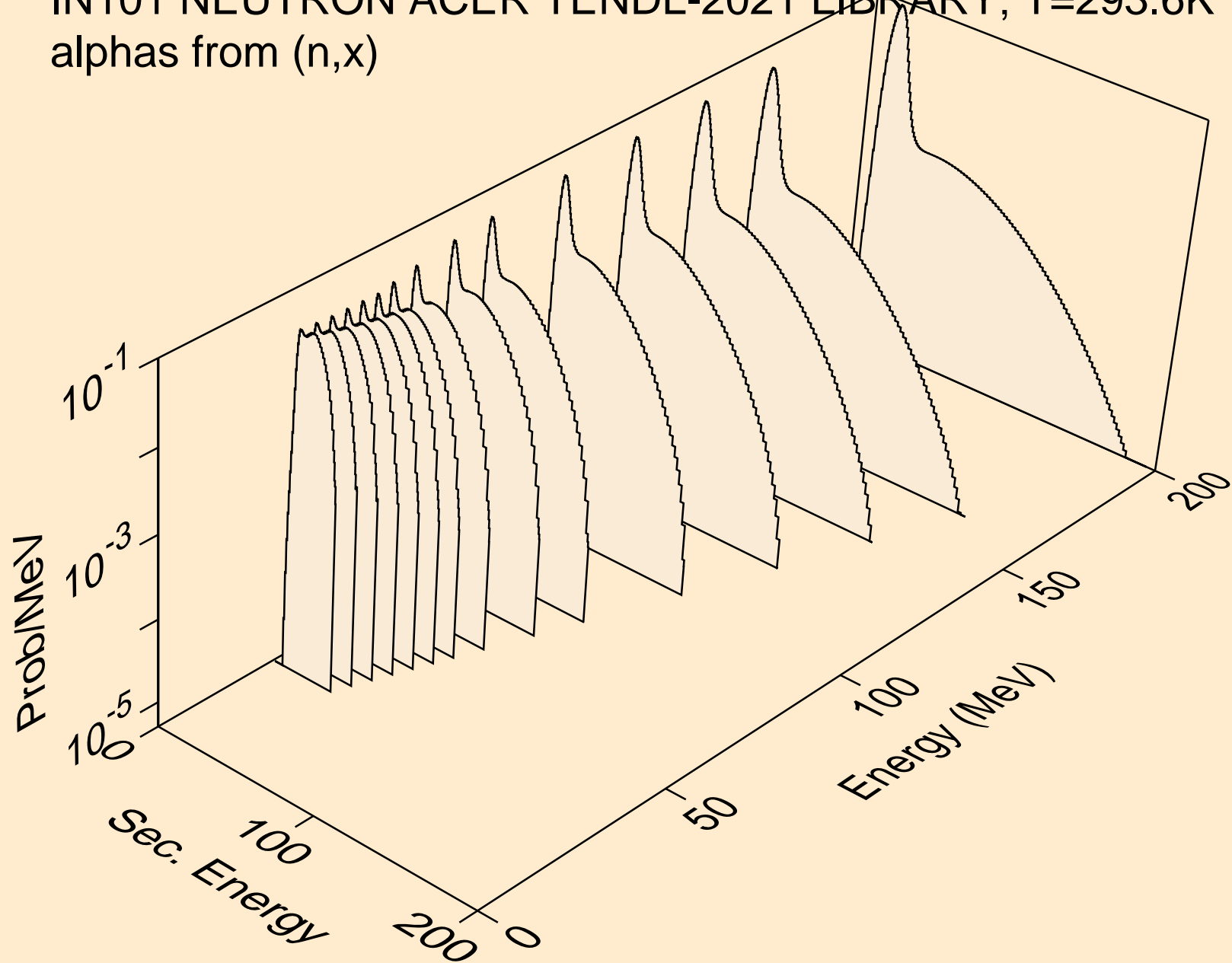

IN101 NEUTRON ACER TENDL-2021 LIBRARY; T=293.6K
alphas from (n,n*)a

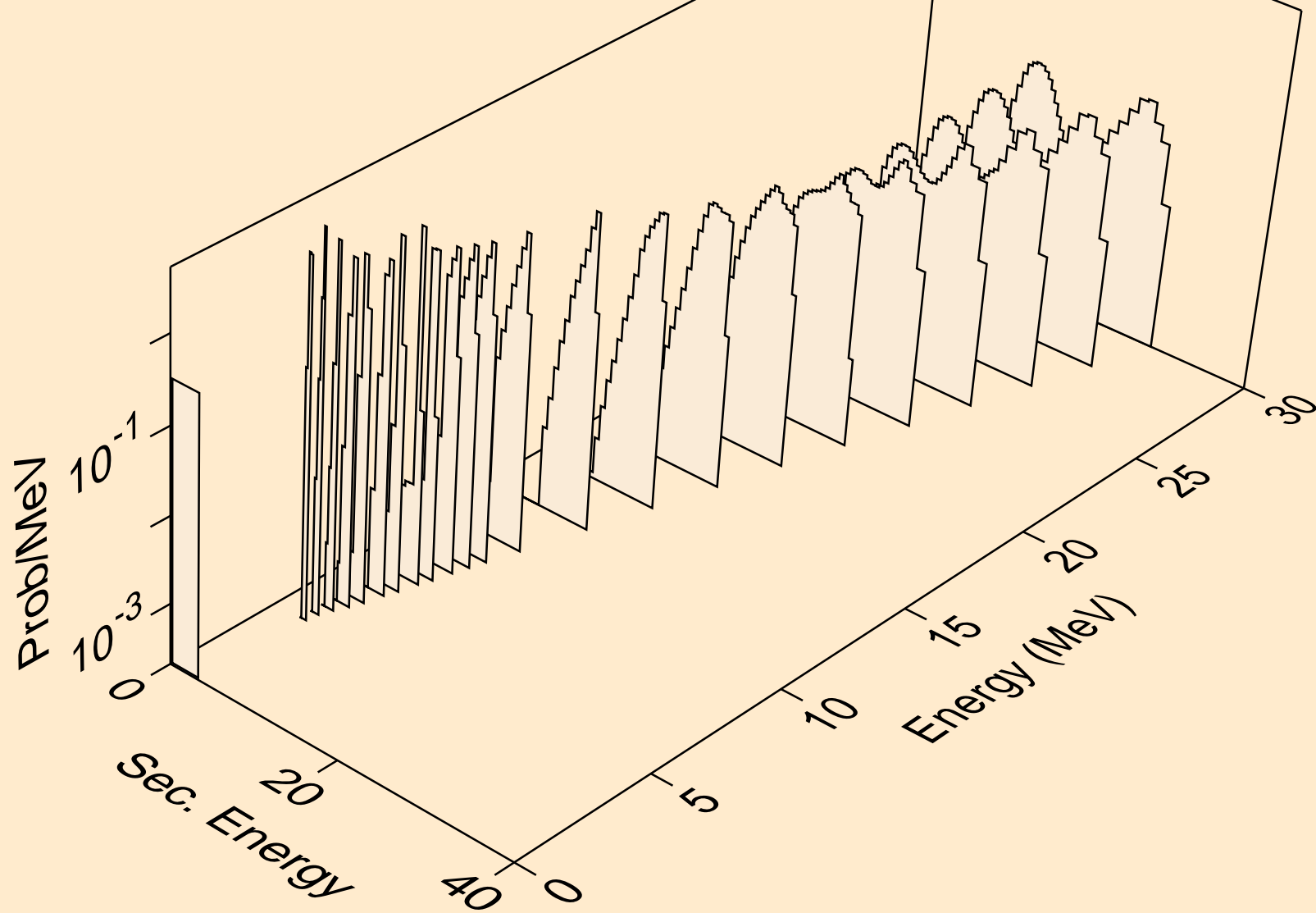

IN101 NEUTRON ACER TENDL-2021 LIBRARY; T=293.6K
alphas from (n,2n)a

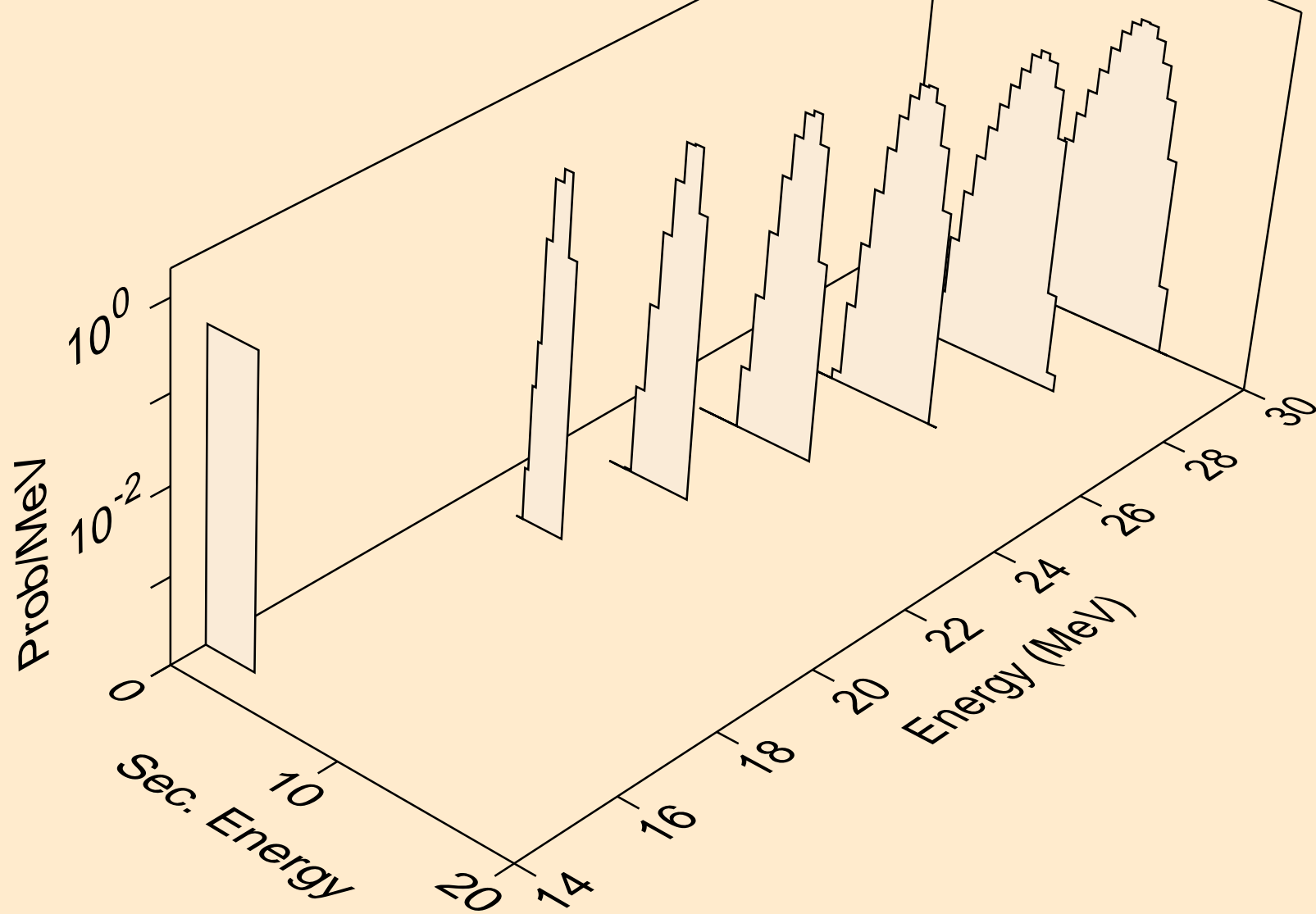

IN101 NEUTRON ACER TENDL-2021 LIBRARY; T=293.6K
alphas from (n,n*)2a

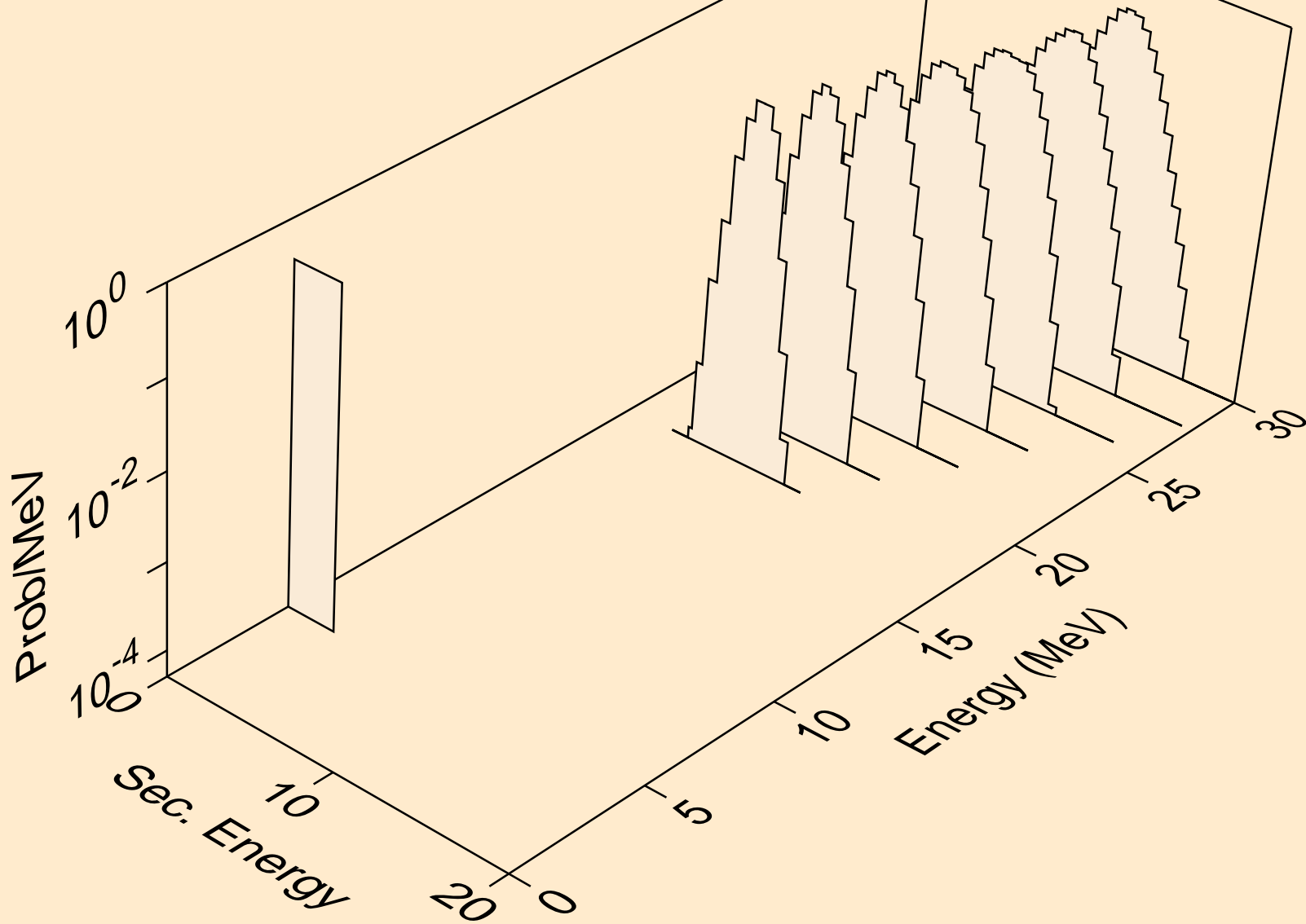

IN101 NEUTRON ACER TENDL-2021 LIBRARY; T=293.6K
alphas from (n,npa)

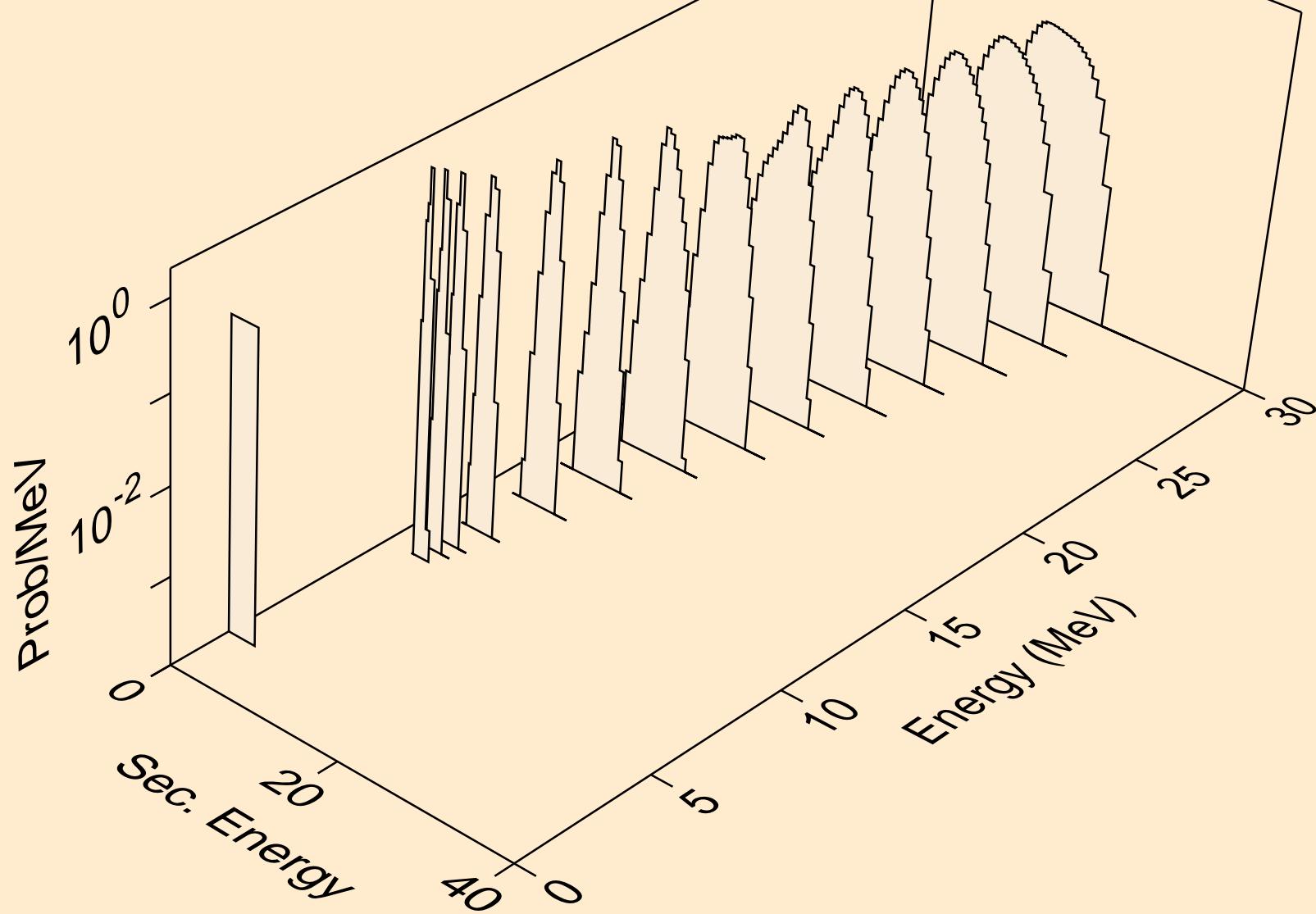

IN101 NEUTRON ACER TENDL-2021 LIBRARY; T=293.6K
alphas from (n,a)

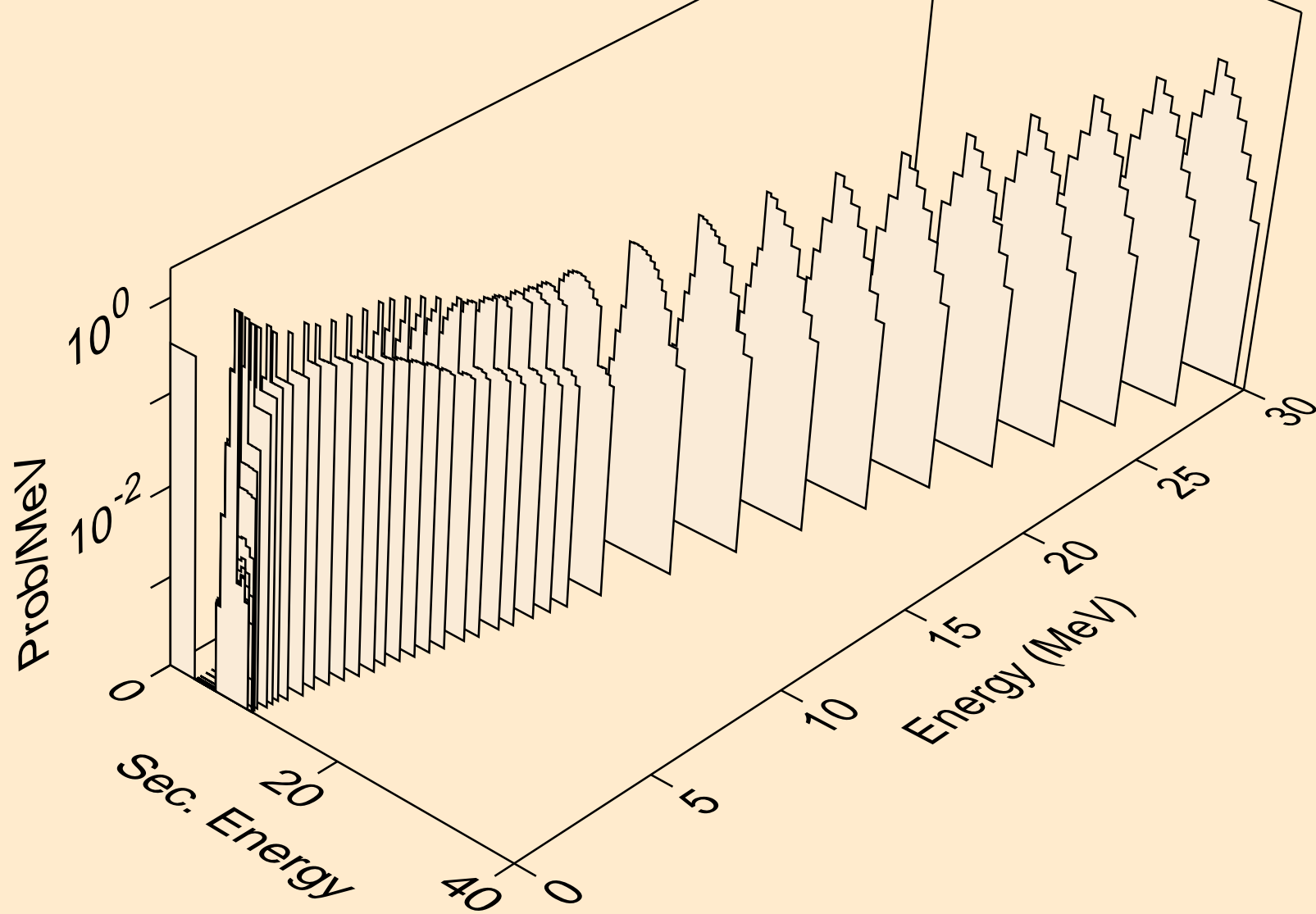

IN101 NEUTRON ACER TENDL-2021 LIBRARY; T=293.6K
alphas from (n,2a)

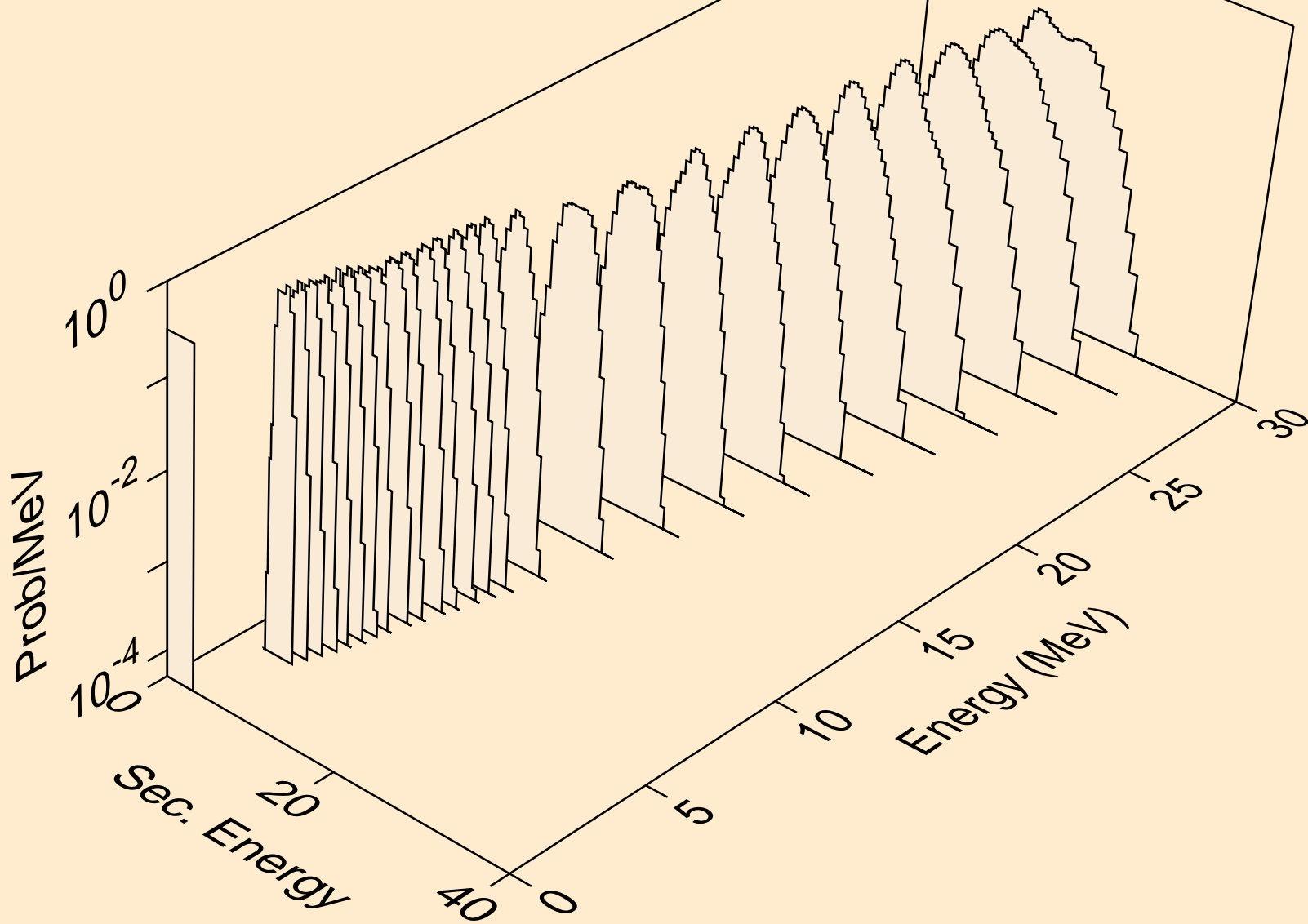

IN101 NEUTRON ACER TENDL-2021 LIBRARY; T=293.6K
alphas from (n,pa)

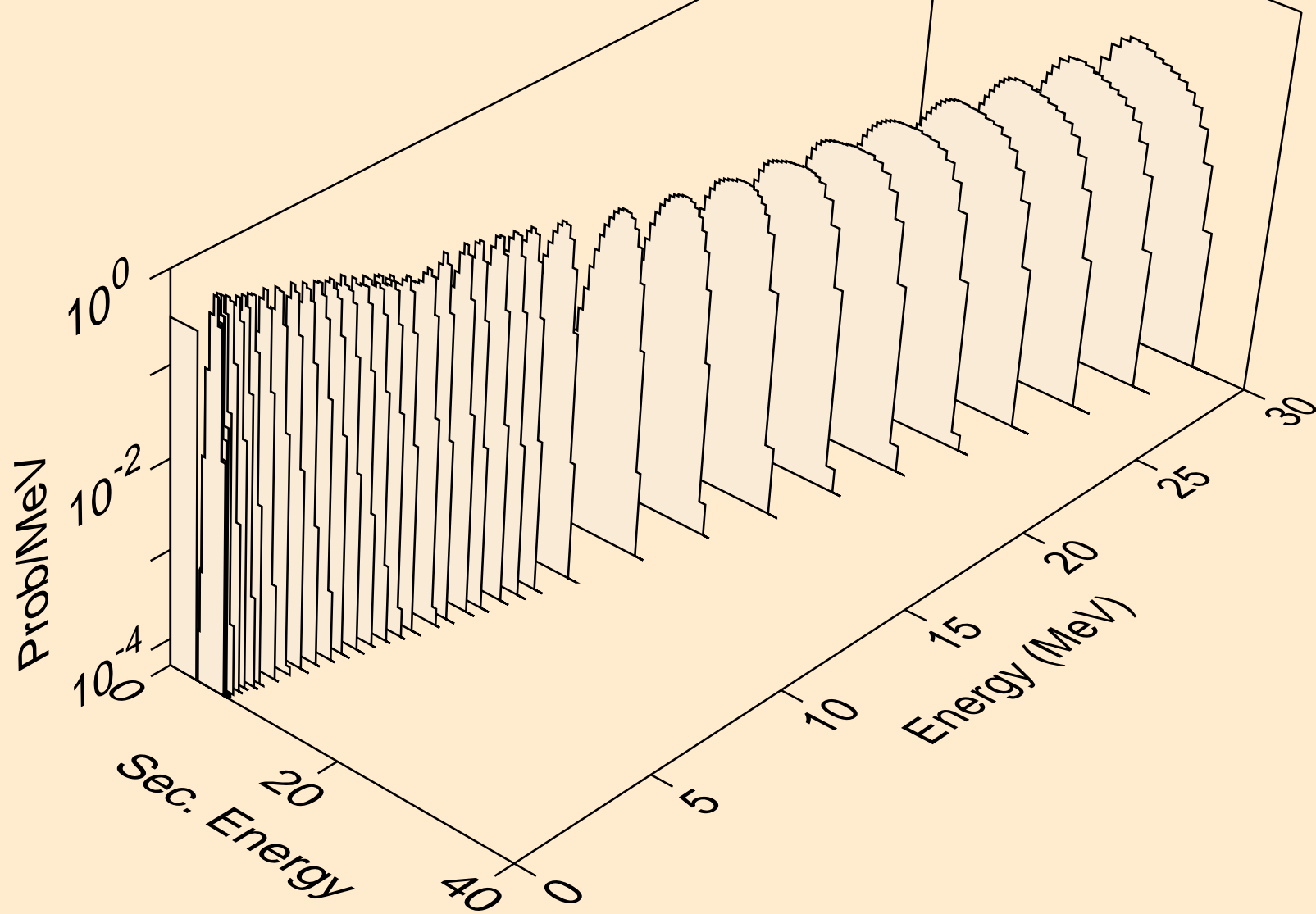

IN101 NEUTRON ACER TENDL-2021 LIBRARY; T=293.6K
alphas from (n,da)

