

IN111M NEUTRON ACER TENDL-2021 LIBRARY; T=293.6K  
Principal cross sections

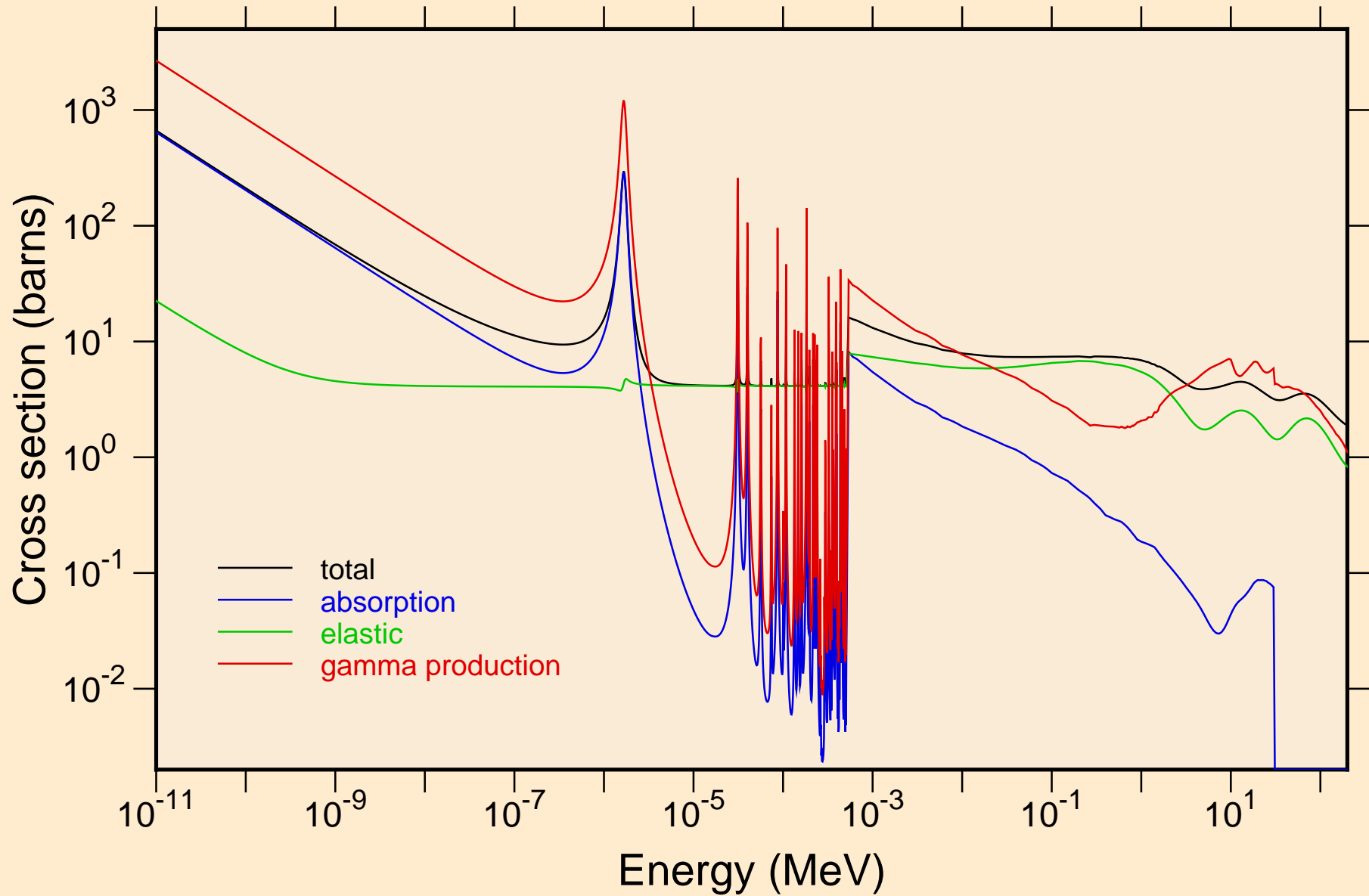

IN111M NEUTRON ACER TENDL-2021 LIBRARY; T=293.6K  
resonance total cross section

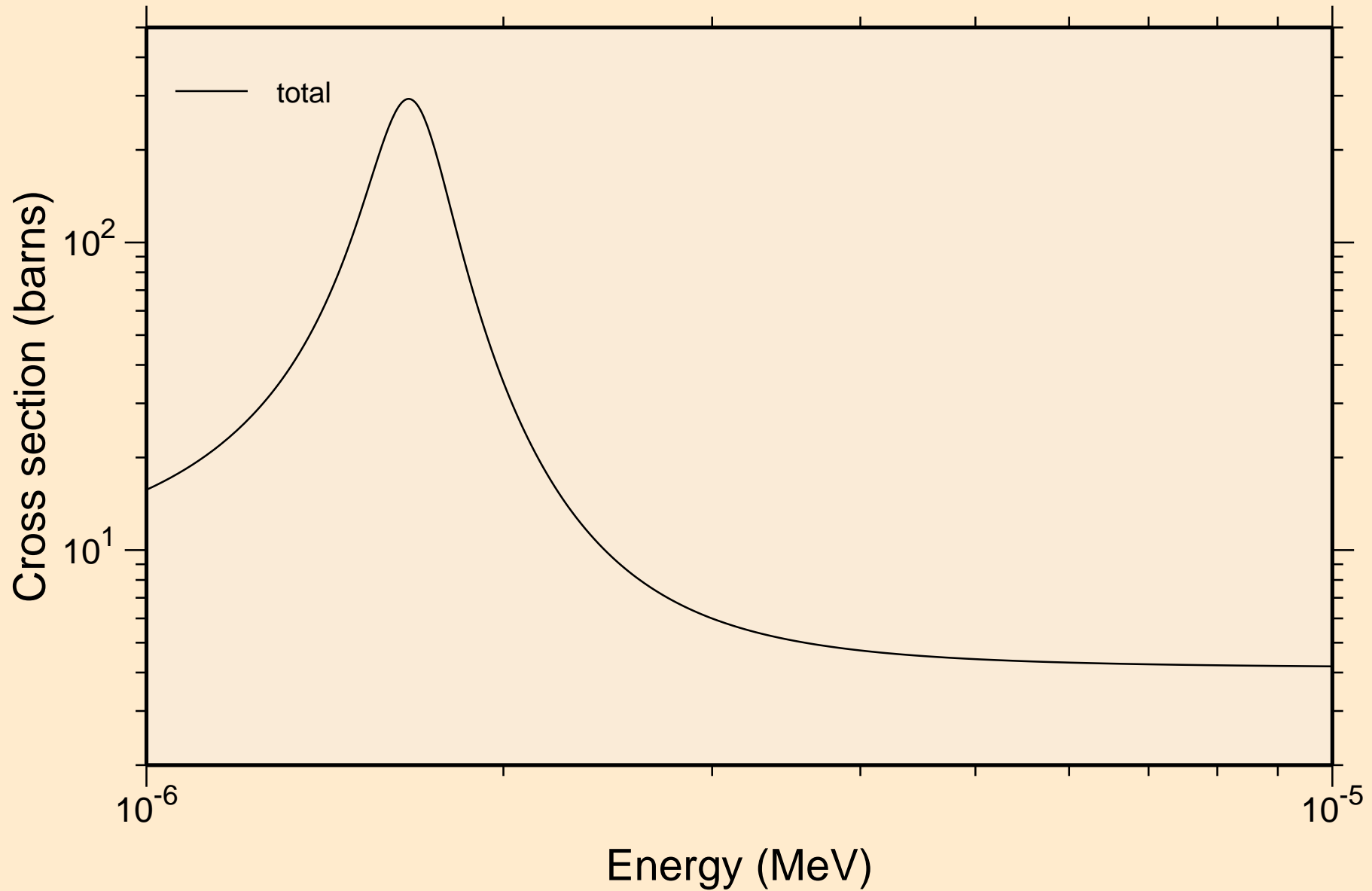

IN111M NEUTRON ACER TENDL-2021 LIBRARY; T=293.6K  
resonance total cross section

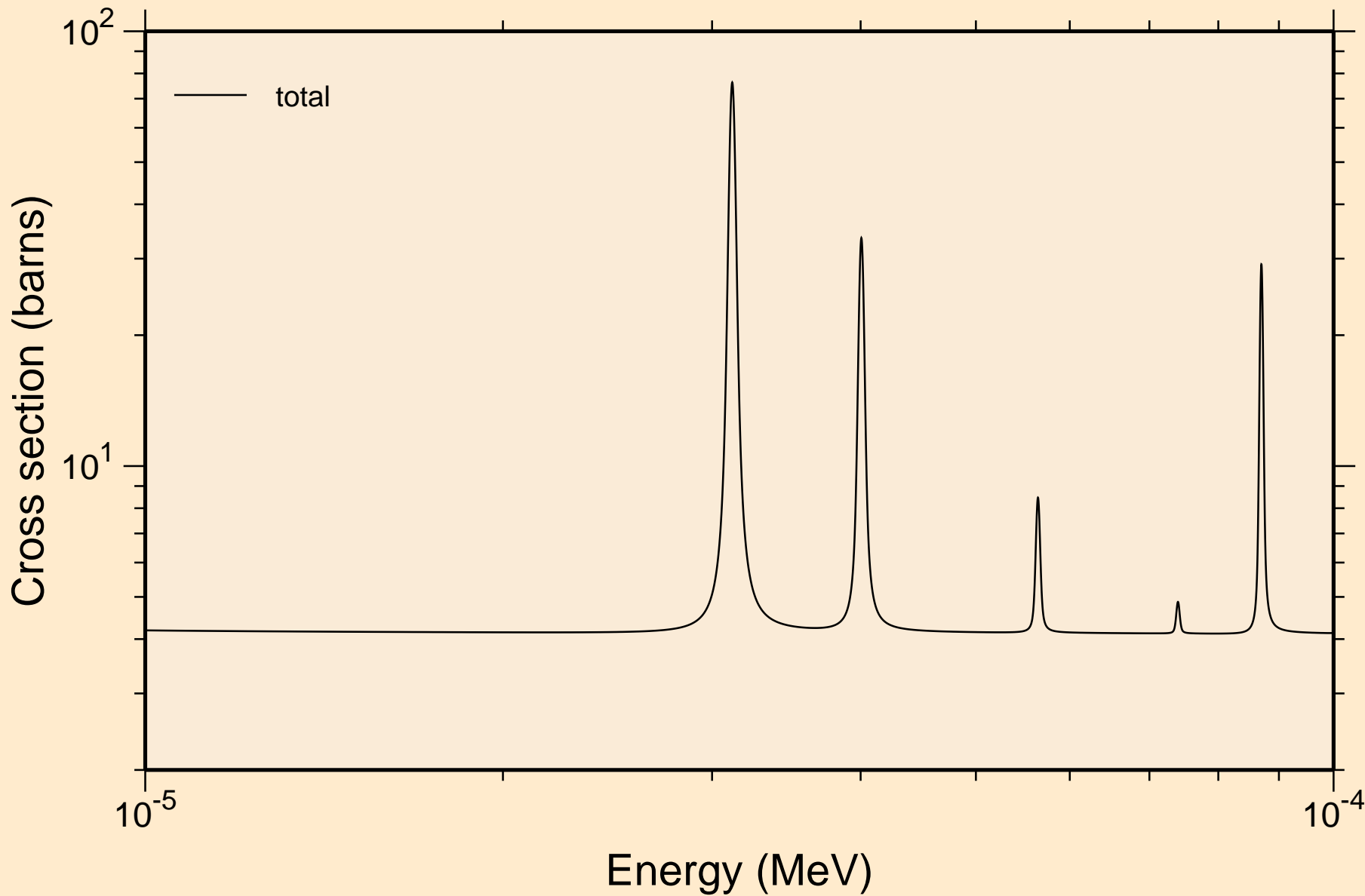

IN111M NEUTRON ACER TENDL-2021 LIBRARY; T=293.6K  
resonance total cross section

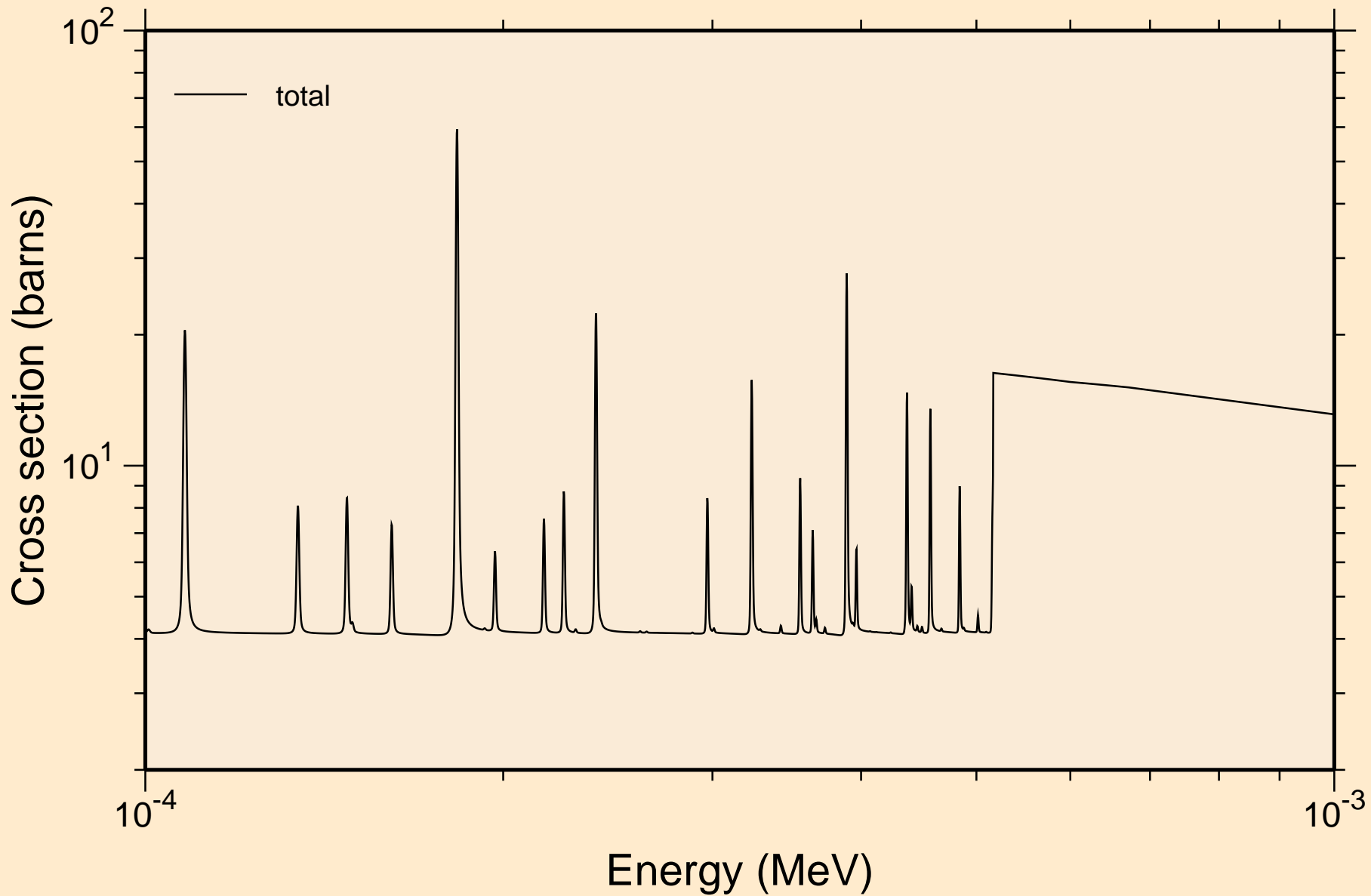

IN111M NEUTRON ACER TENDL-2021 LIBRARY; T=293.6K  
resonance total cross section

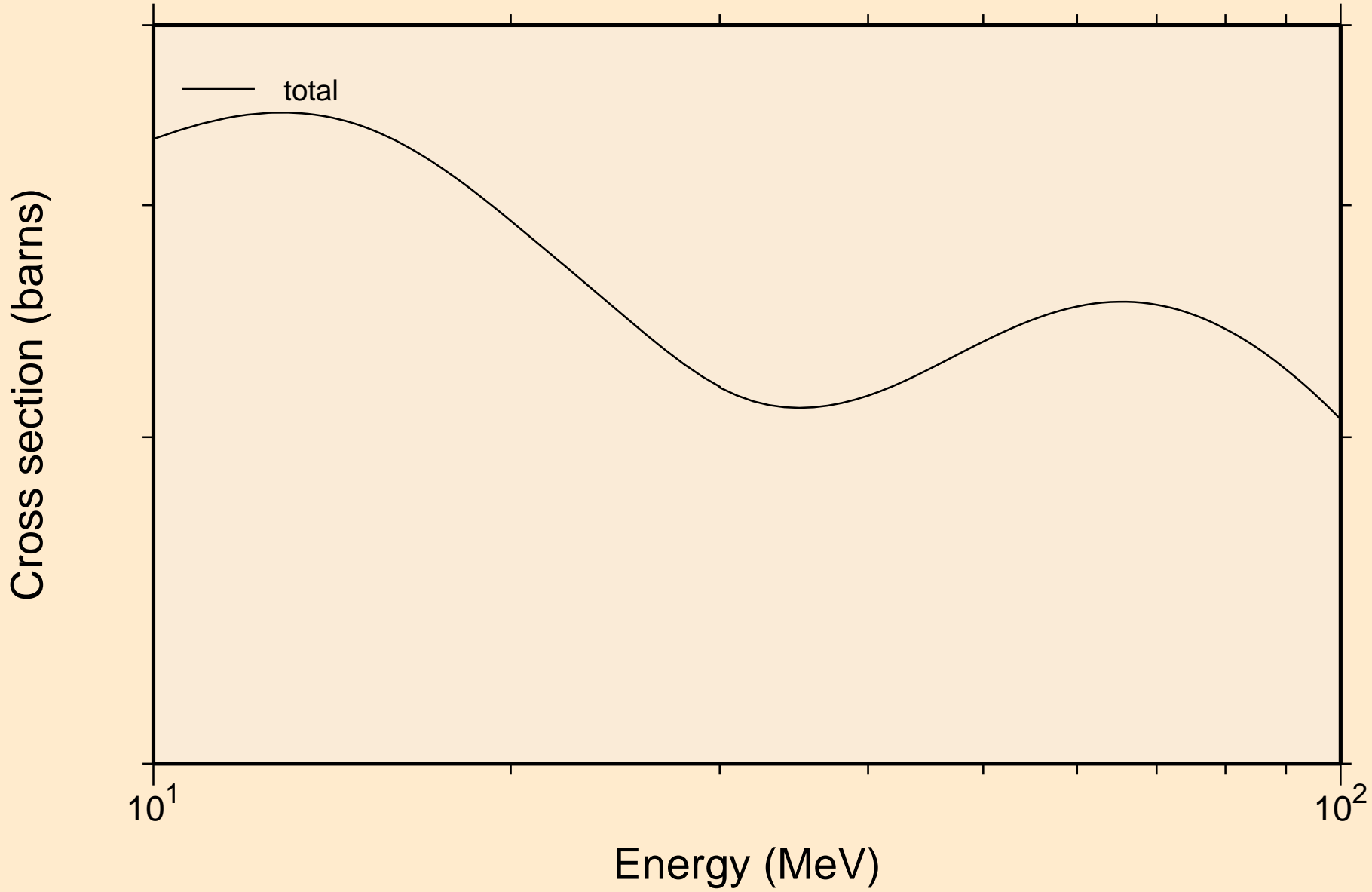

IN111M NEUTRON ACER TENDL-2021 LIBRARY; T=293.6K  
resonance absorption cross sections

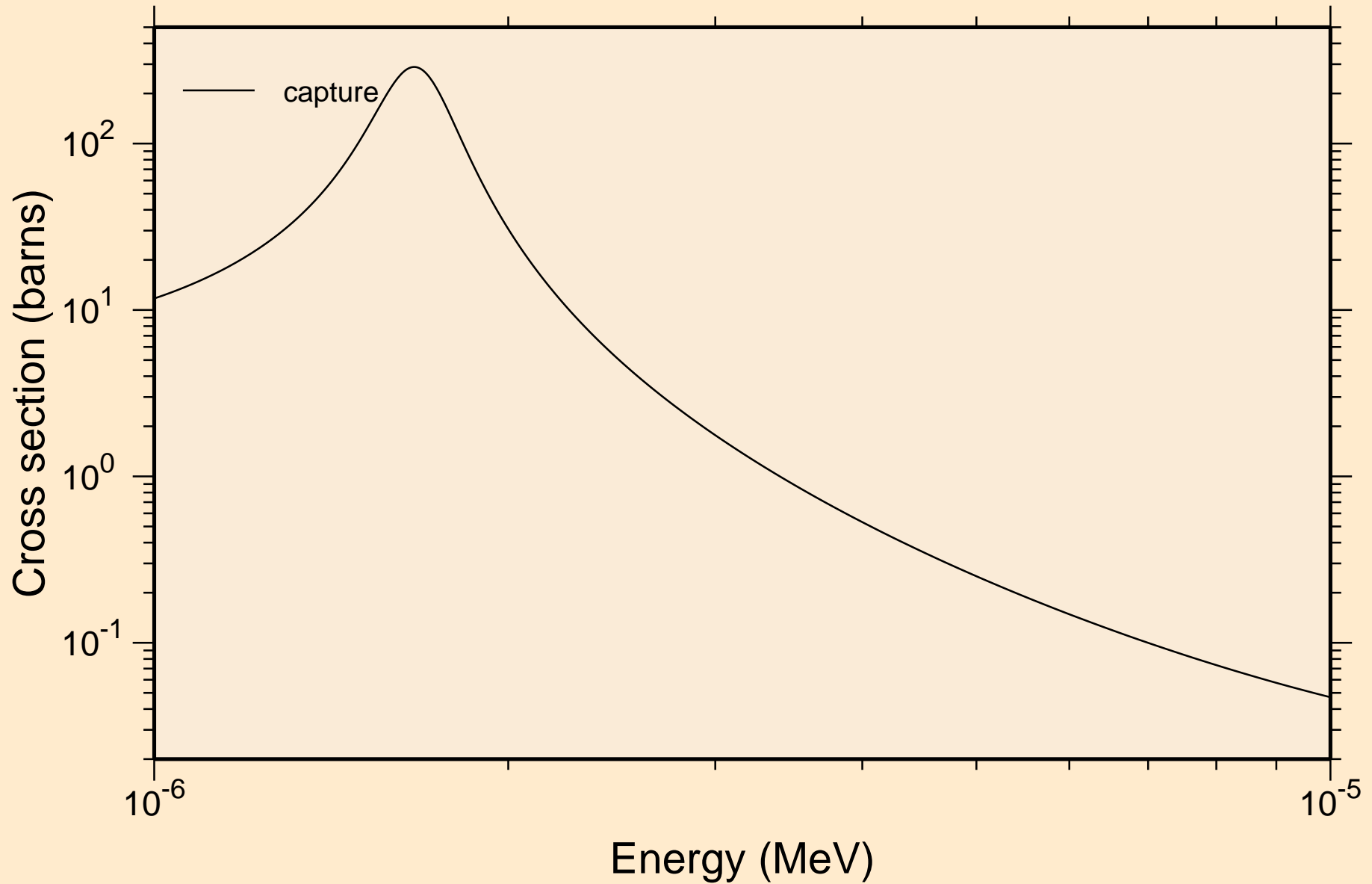

IN111M NEUTRON ACER TENDL-2021 LIBRARY; T=293.6K  
resonance absorption cross sections

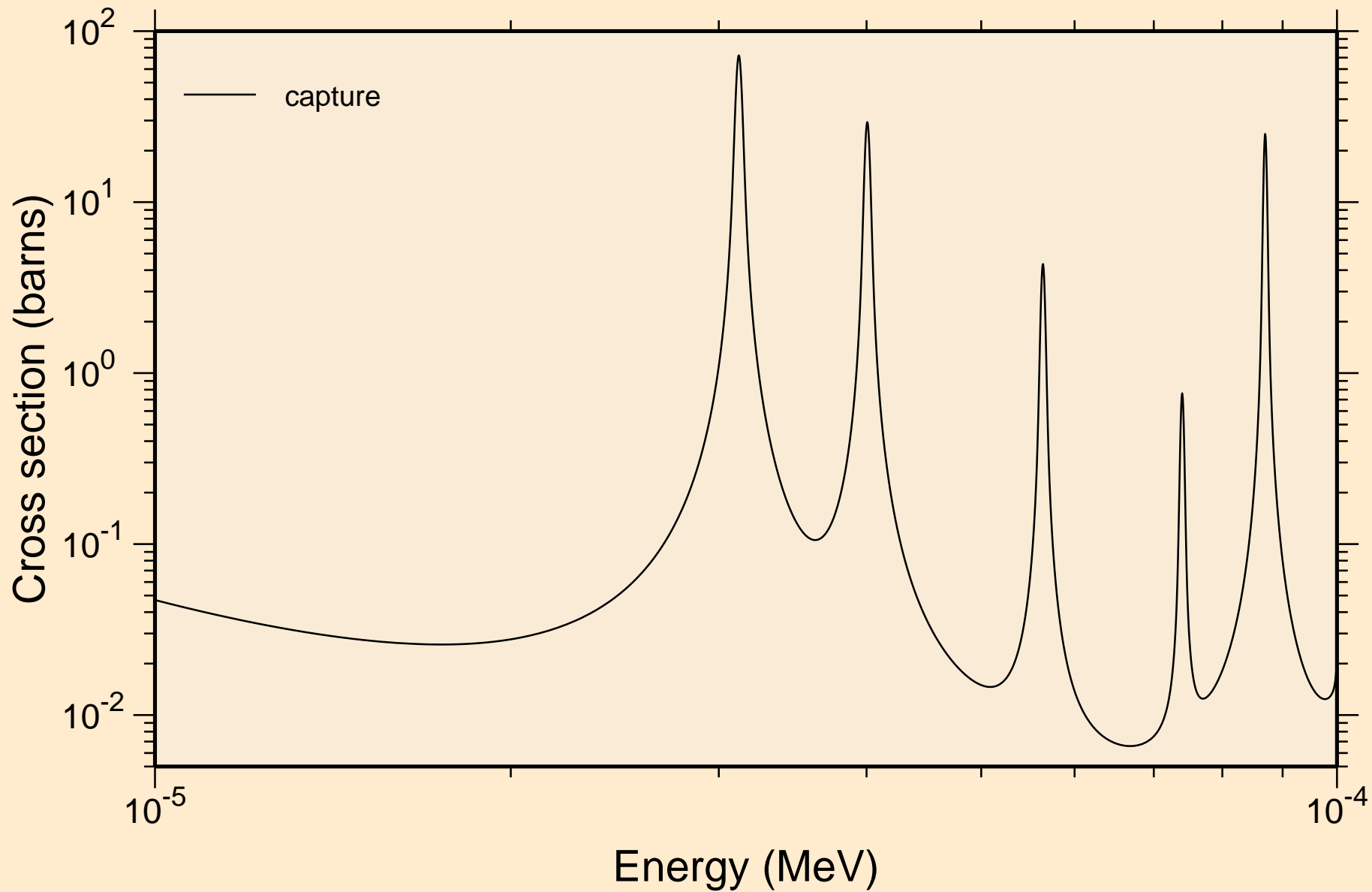

IN111M NEUTRON ACER TENDL-2021 LIBRARY; T=293.6K  
resonance absorption cross sections

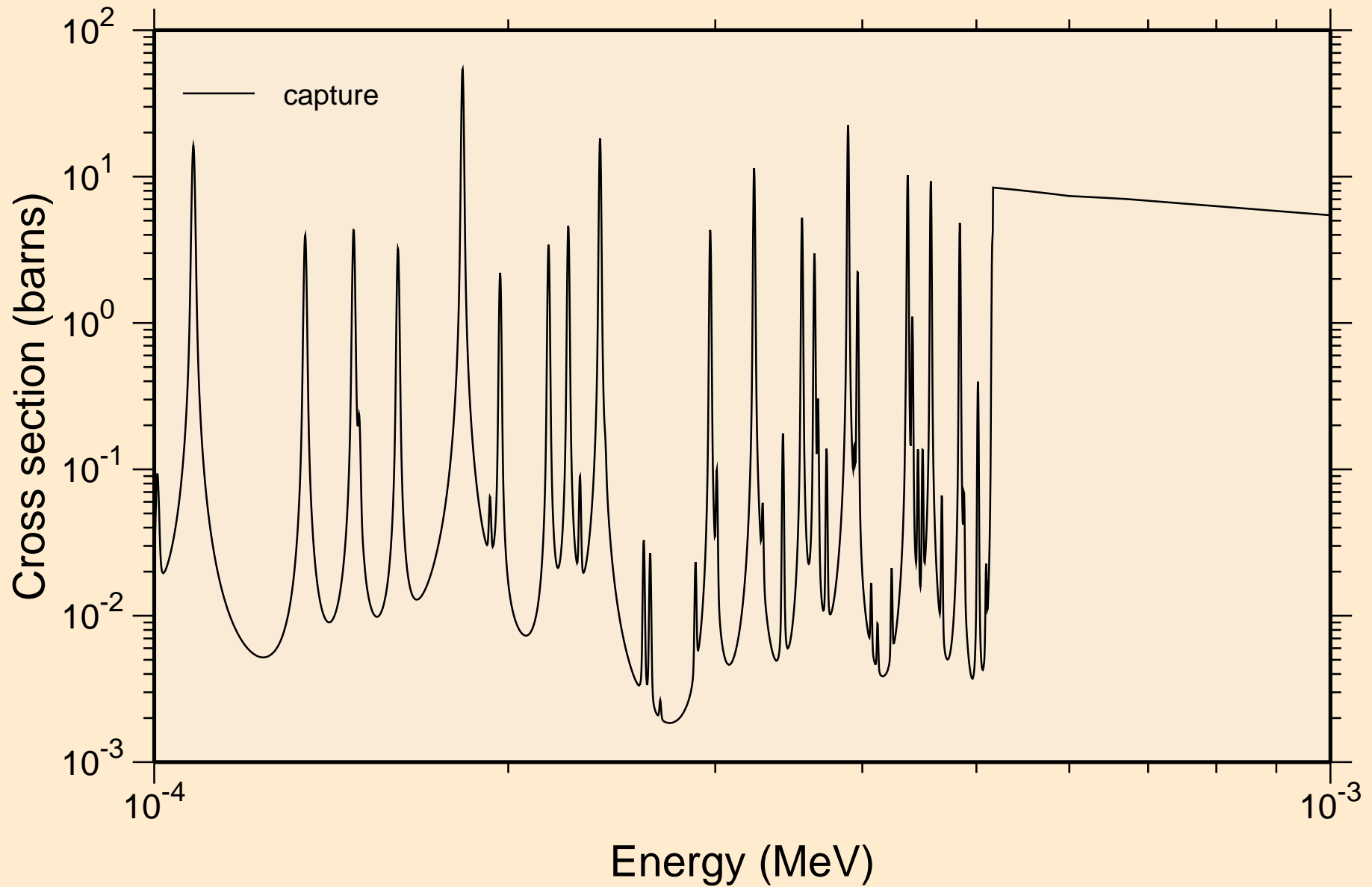



IN111M NEUTRON ACER TENDL-2021 LIBRARY; T=293.6K  
resonance absorption cross sections

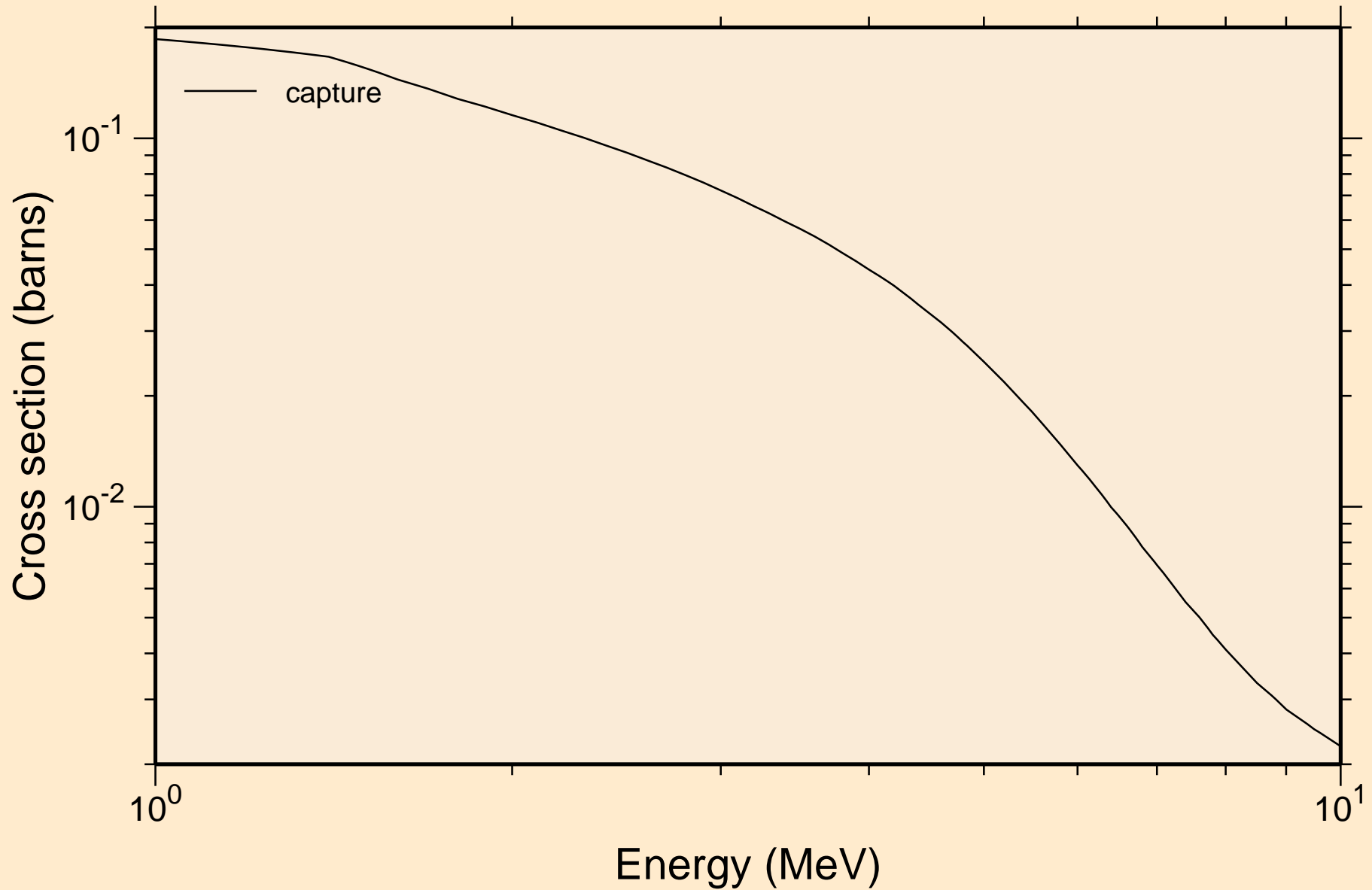

IN111M NEUTRON ACER TENDL-2021 LIBRARY; T=293.6K  
Heating

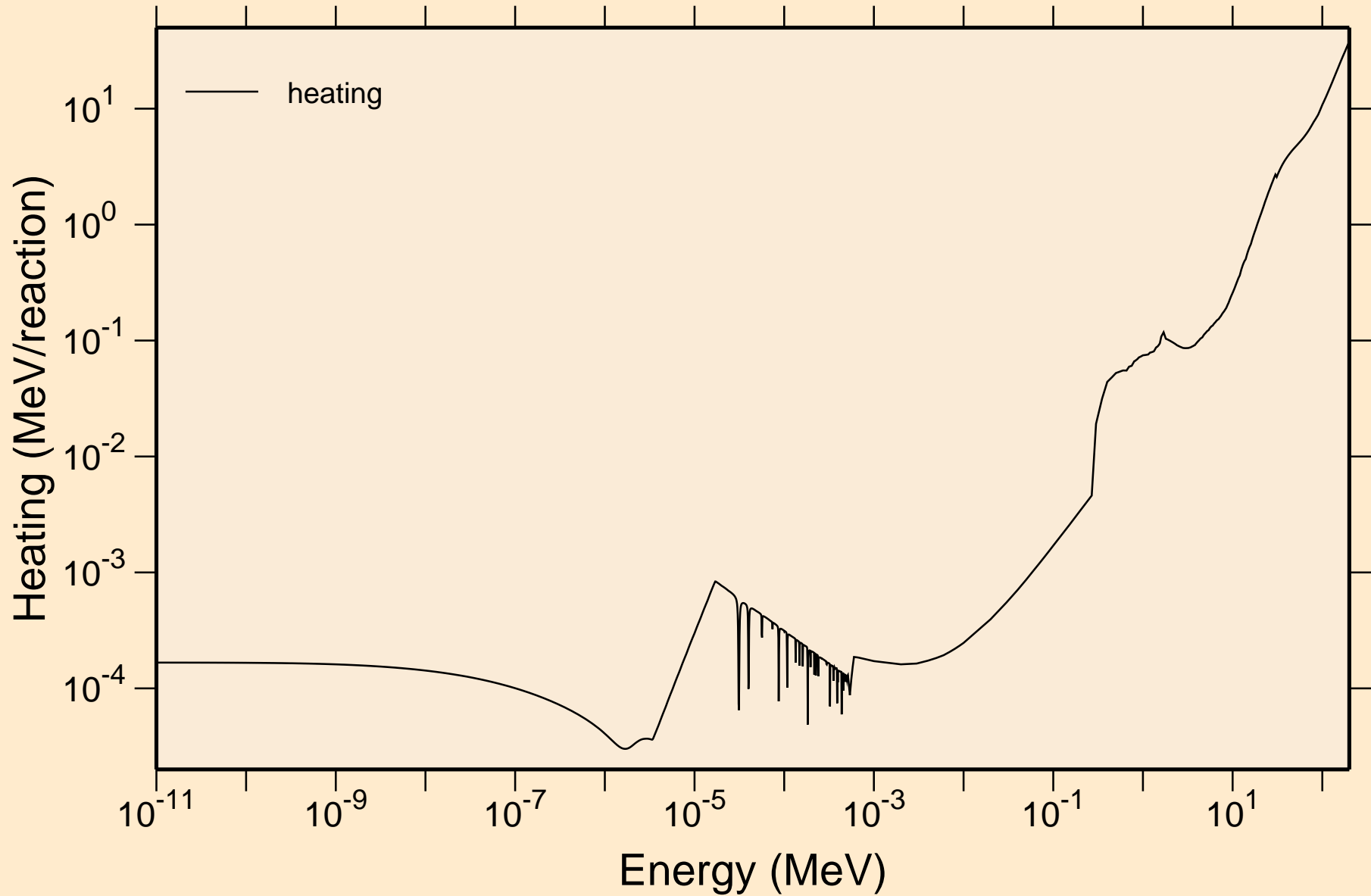

IN111M NEUTRON ACER TENDL-2021 LIBRARY; T=293.6K  
Damage

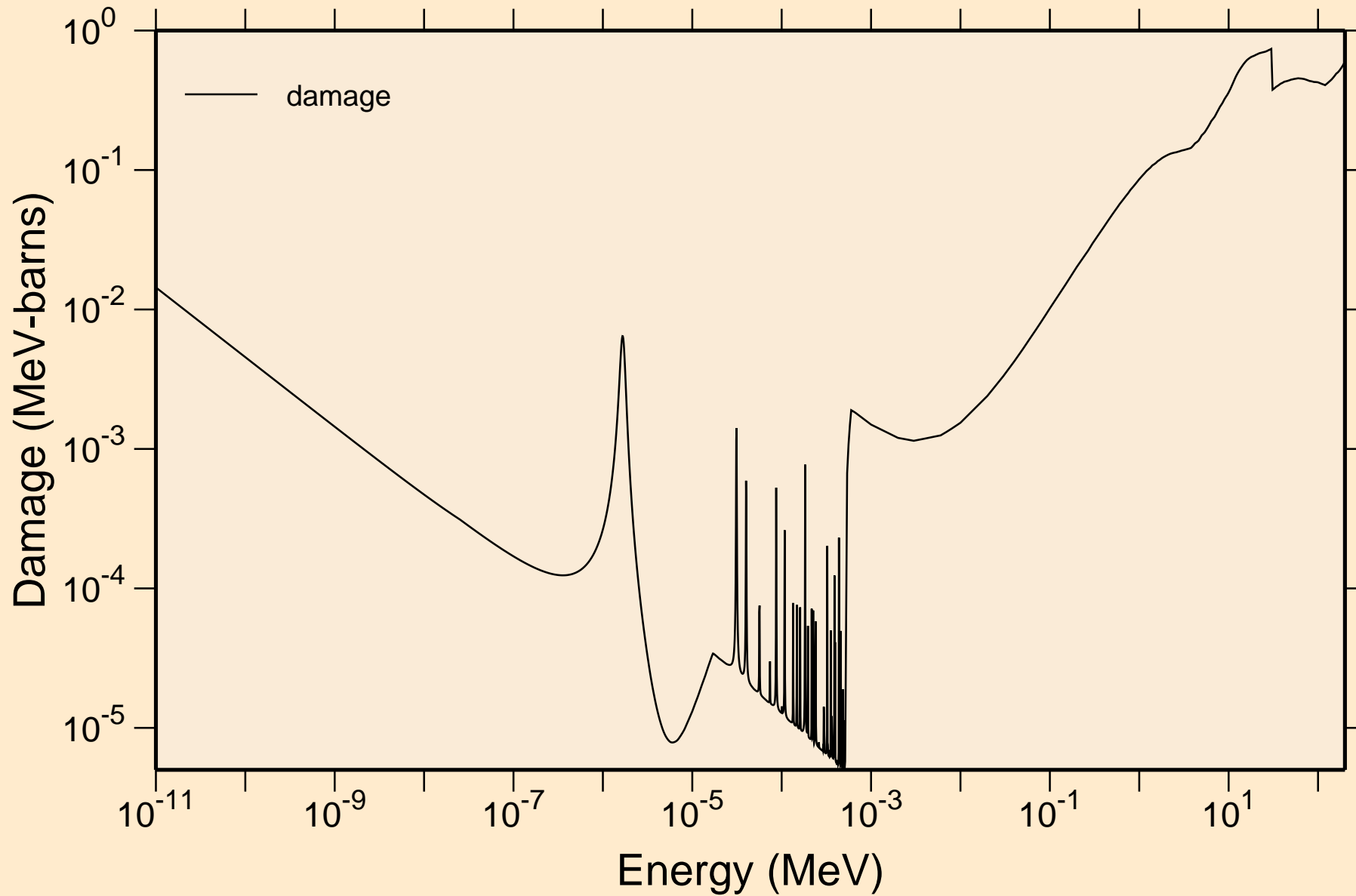

# IN111M NEUTRON ACER TENDL-2021 LIBRARY; T=293.6K

## Non-threshold reactions

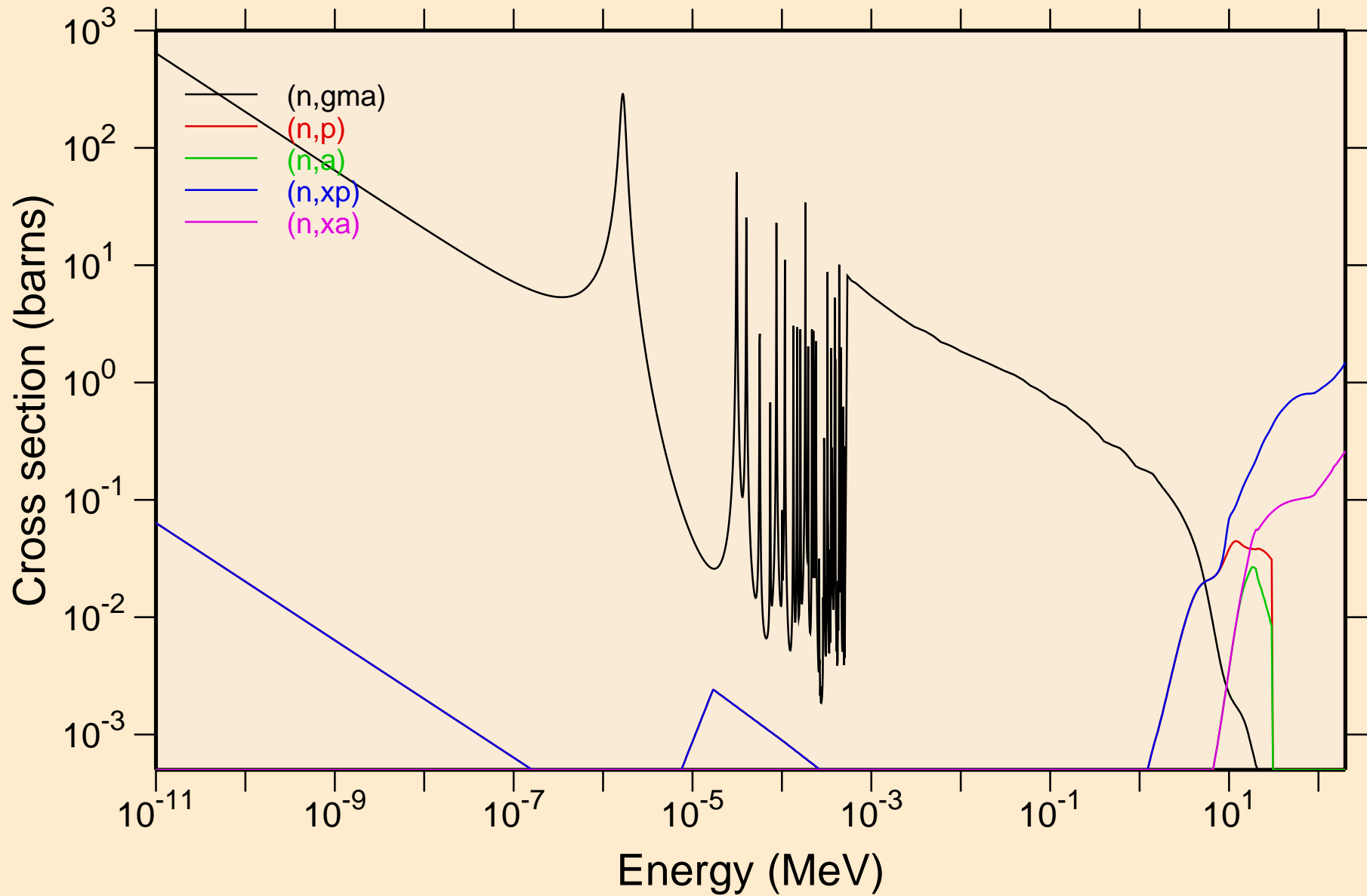

IN111M NEUTRON ACER TENDL-2021 LIBRARY; T=293.6K  
Principal cross sections

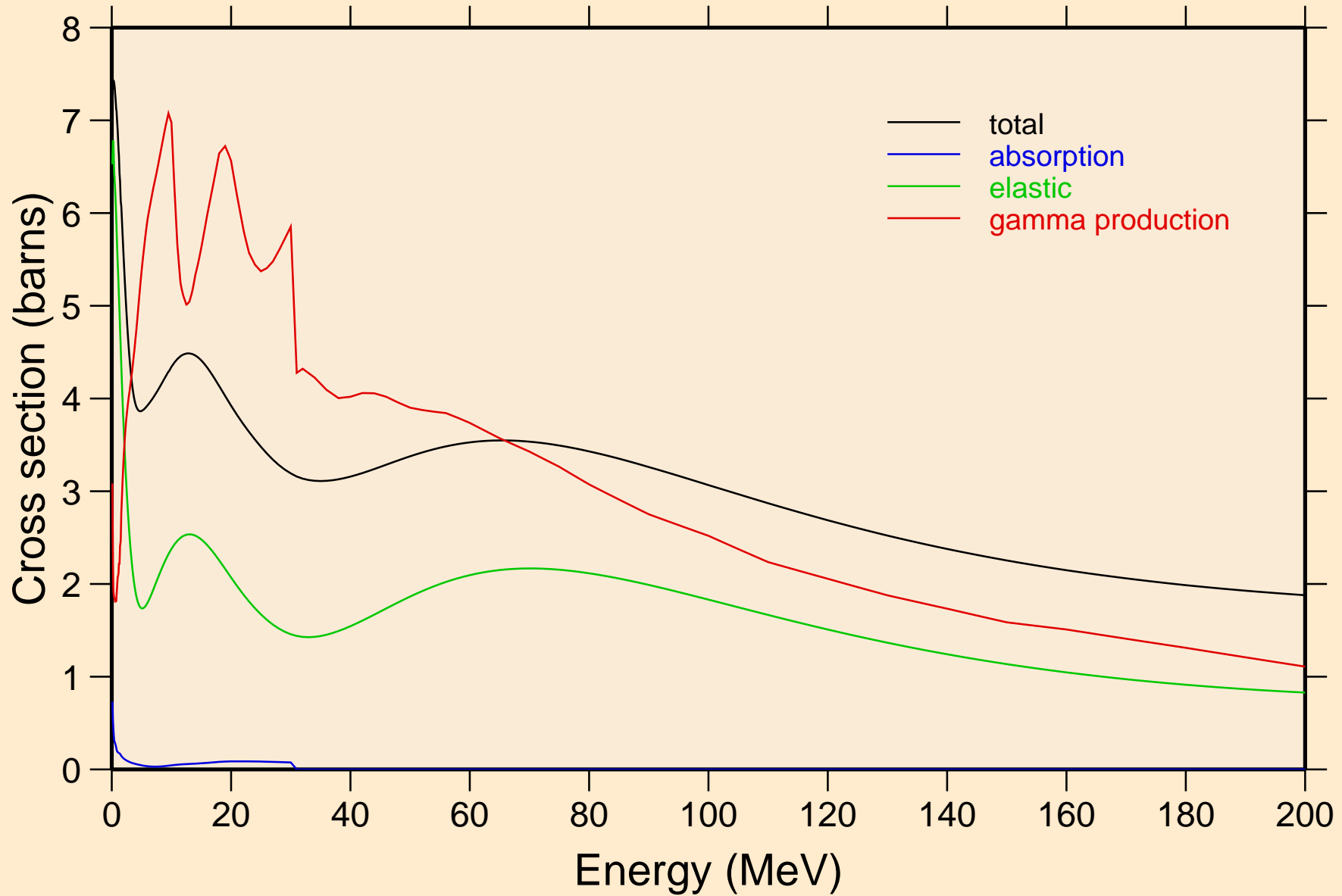

IN111M NEUTRON ACER TENDL-2021 LIBRARY; T=293.6K  
Heating

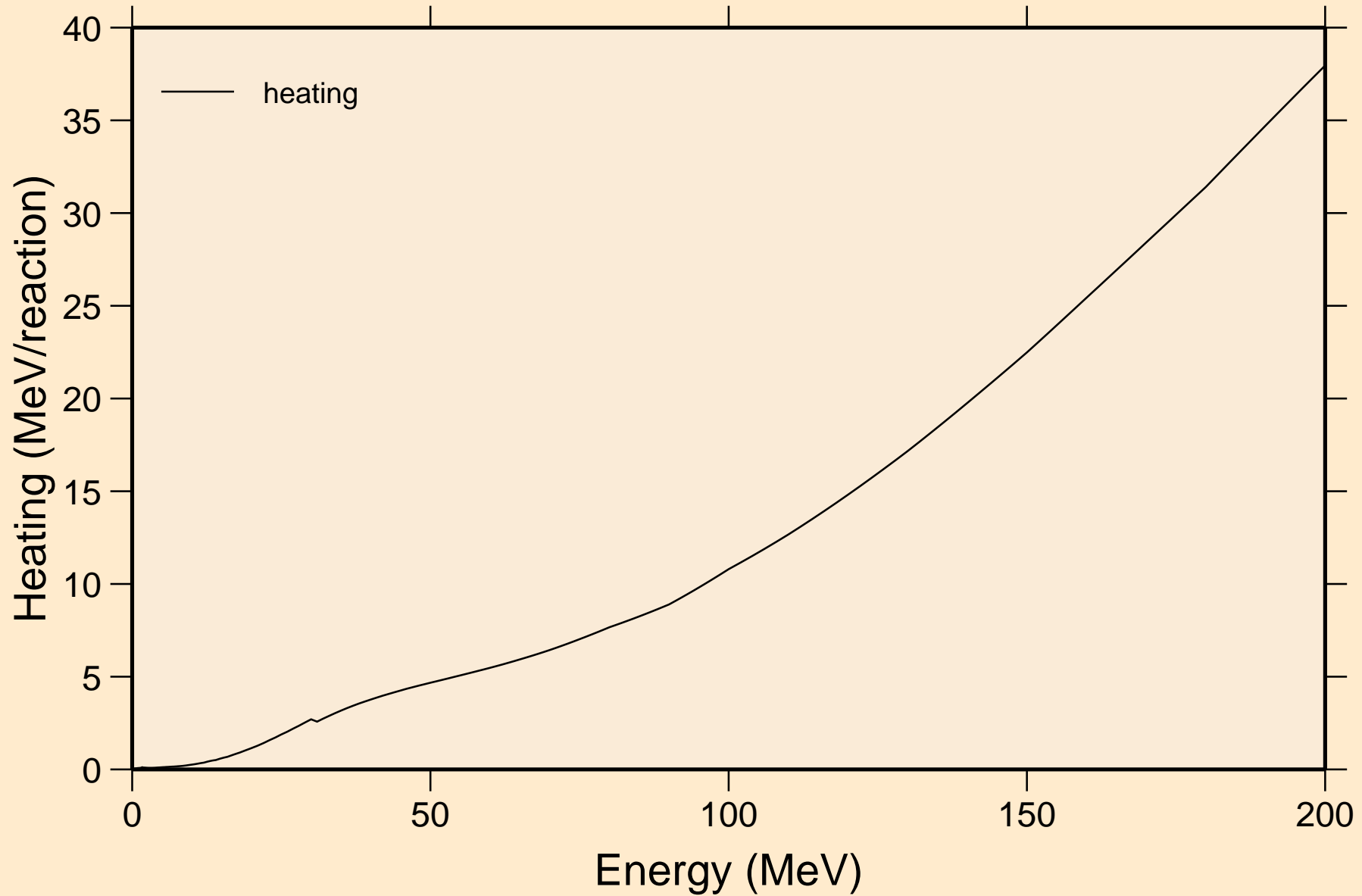

IN111M NEUTRON ACER TENDL-2021 LIBRARY; T=293.6K  
Damage

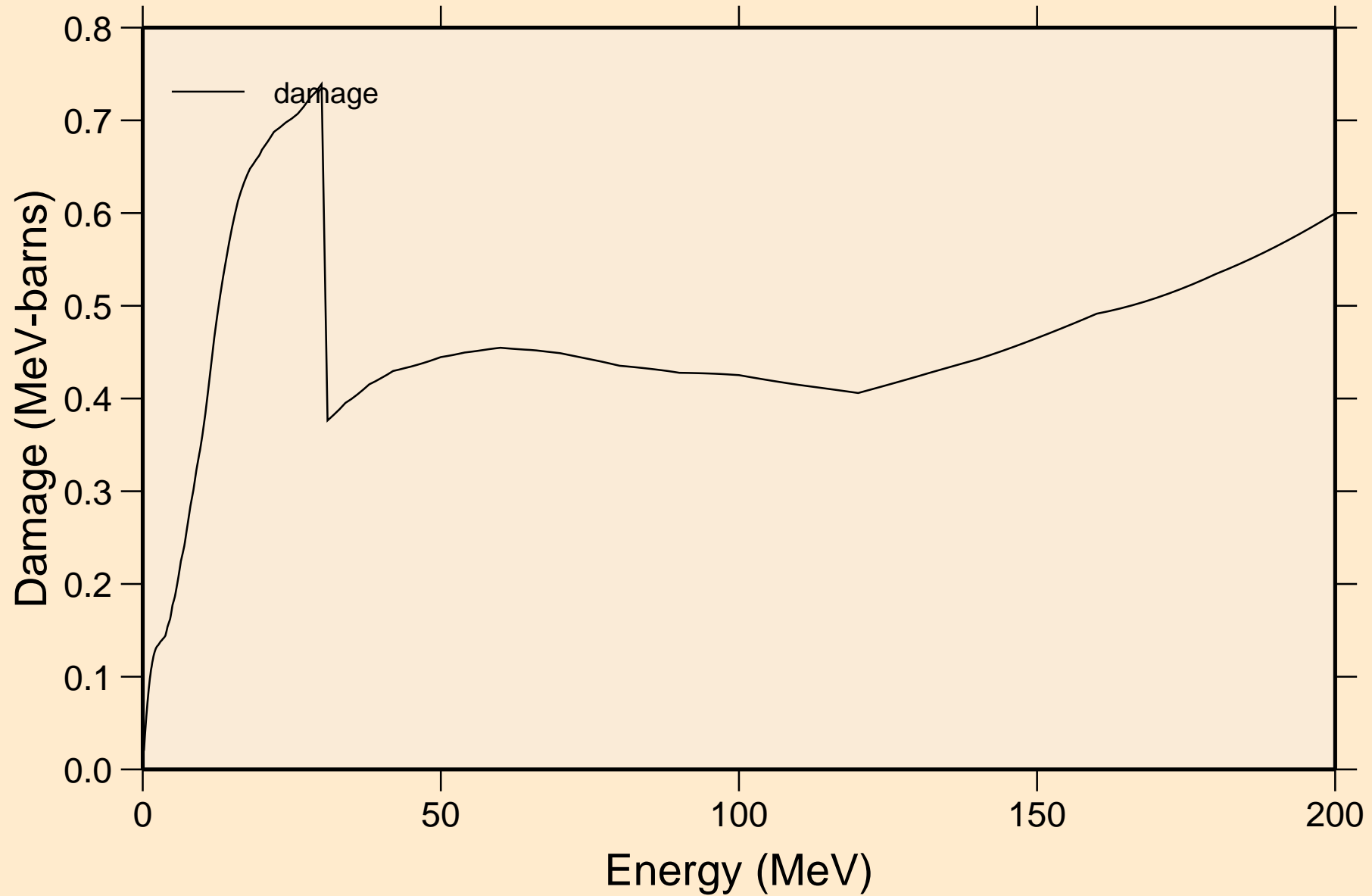

# IN111M NEUTRON ACER TENDL-2021 LIBRARY; T=293.6K

## Non-threshold reactions

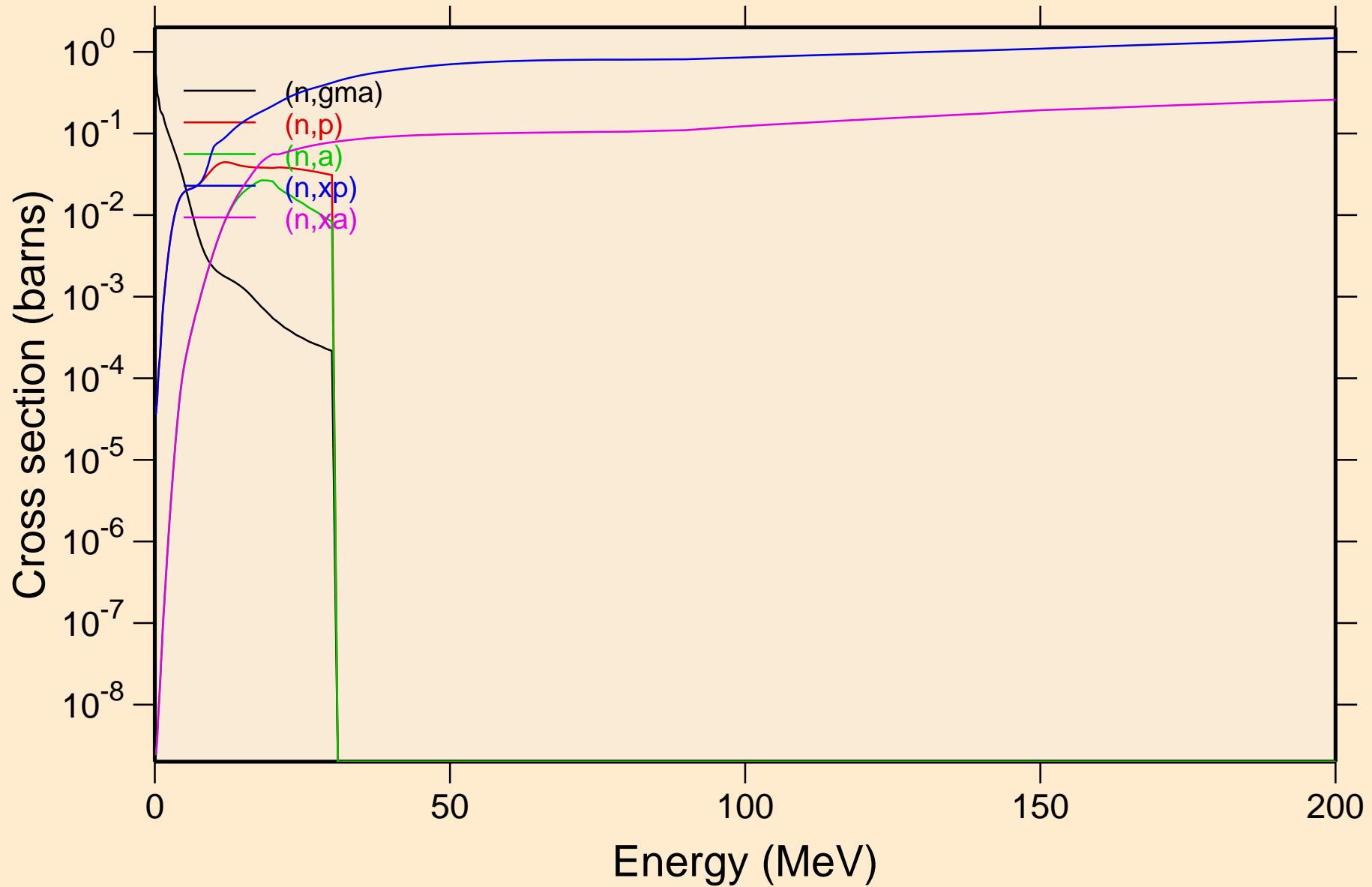



IN111M NEUTRON ACER TENDL-2021 LIBRARY; T=293.6K  
Inelastic levels

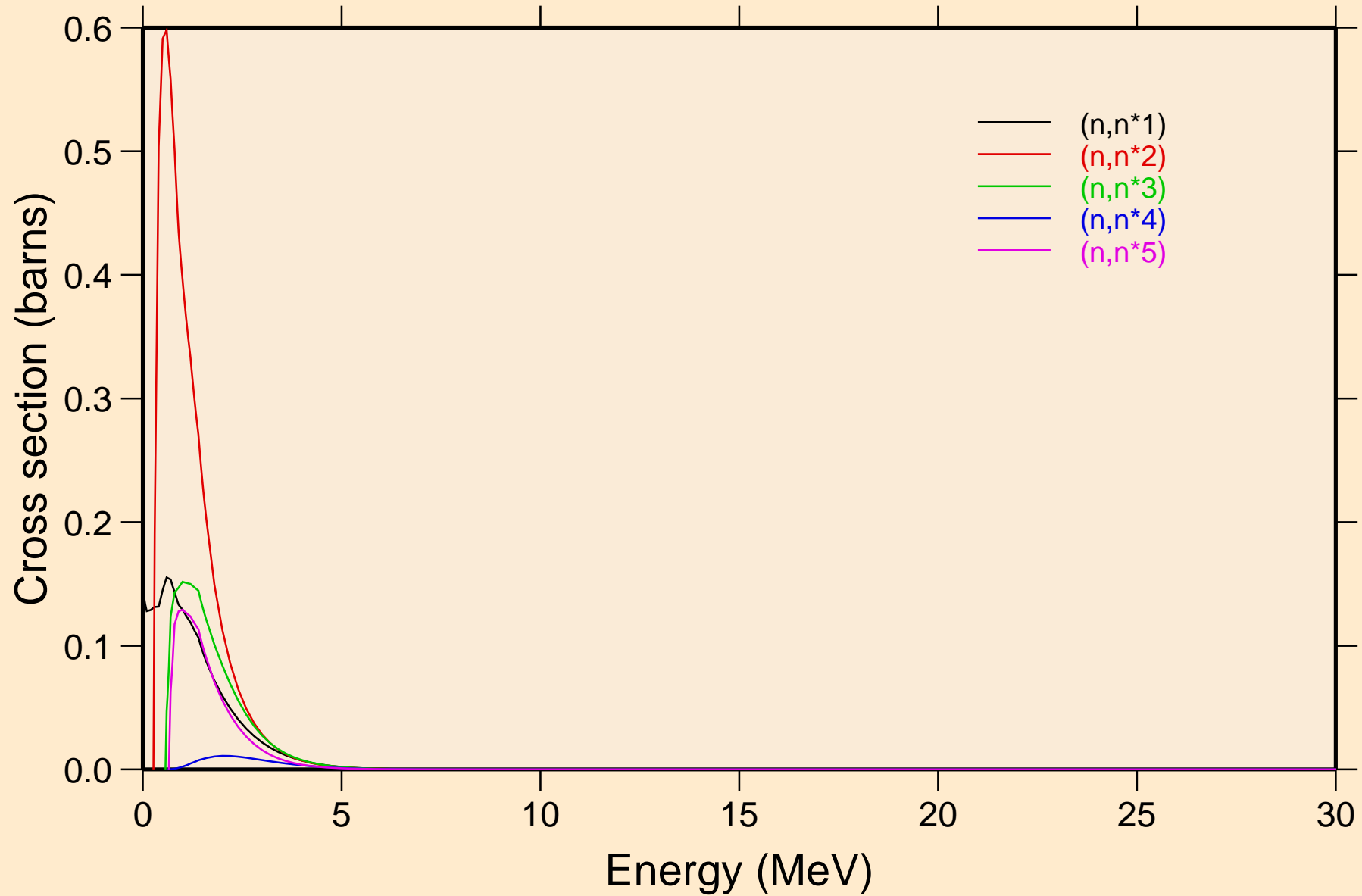

IN111M NEUTRON ACER TENDL-2021 LIBRARY; T=293.6K  
Inelastic levels

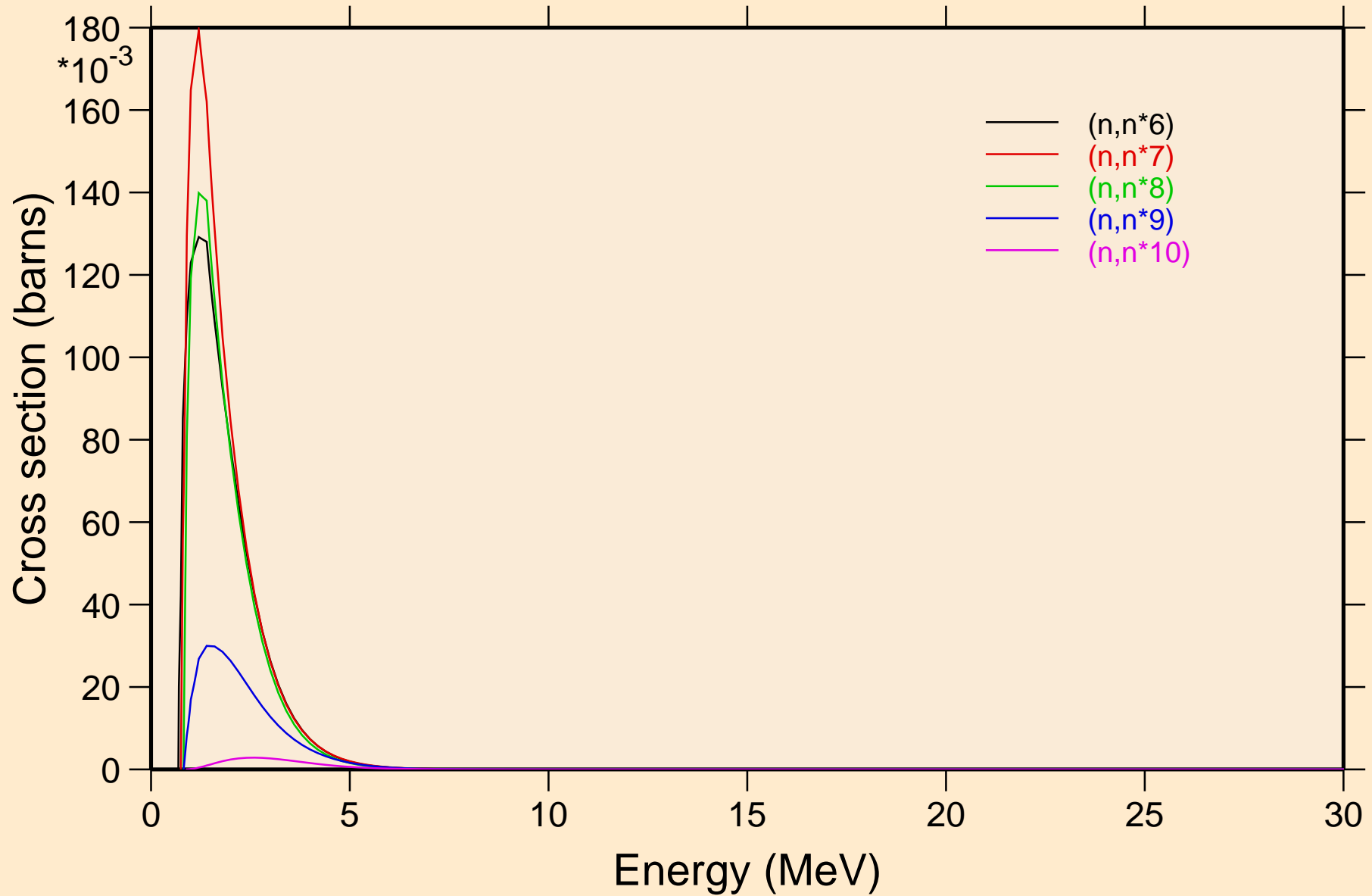

IN111M NEUTRON ACER TENDL-2021 LIBRARY; T=293.6K  
Inelastic levels

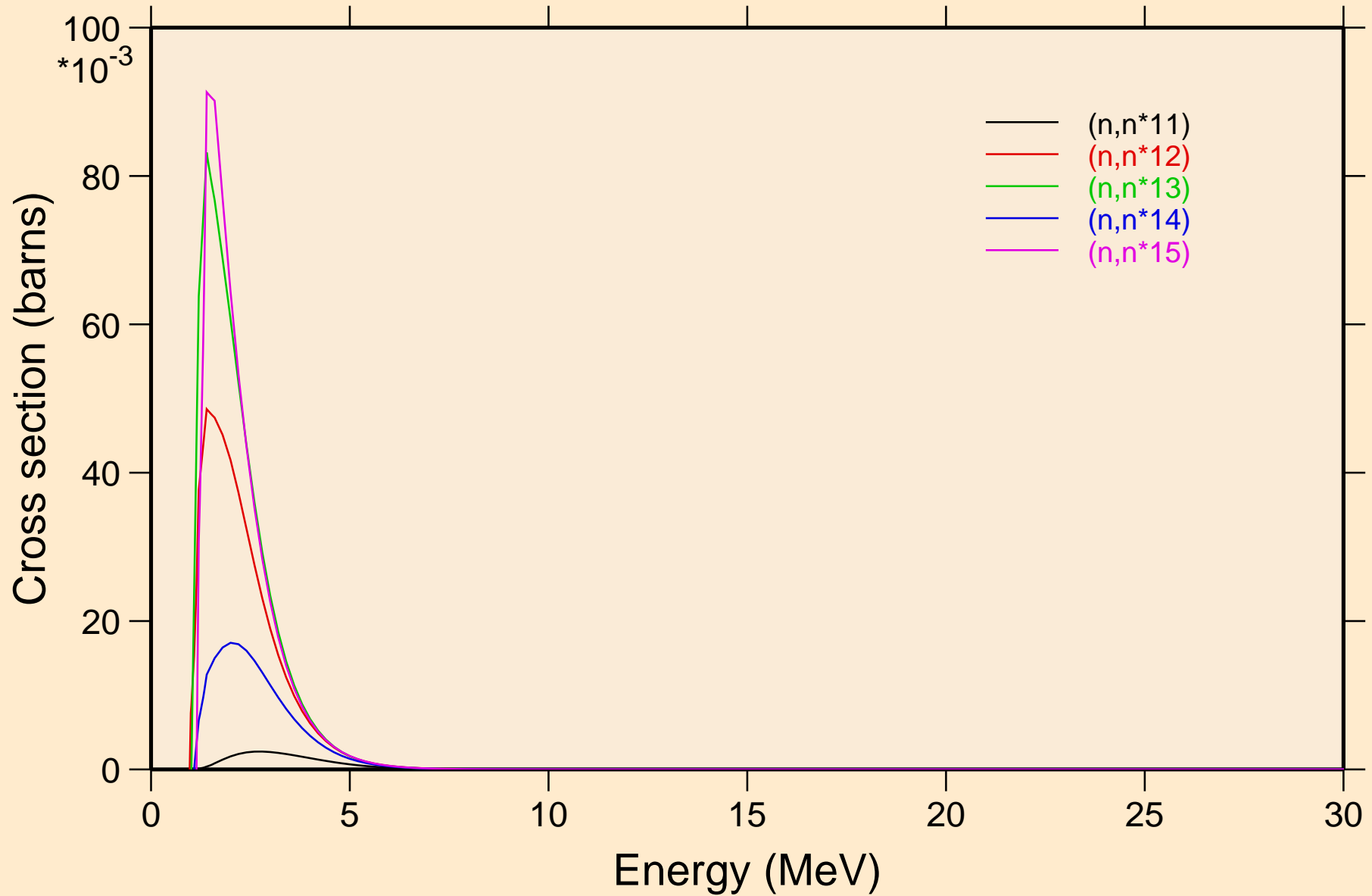

IN111M NEUTRON ACER TENDL-2021 LIBRARY; T=293.6K  
Inelastic levels

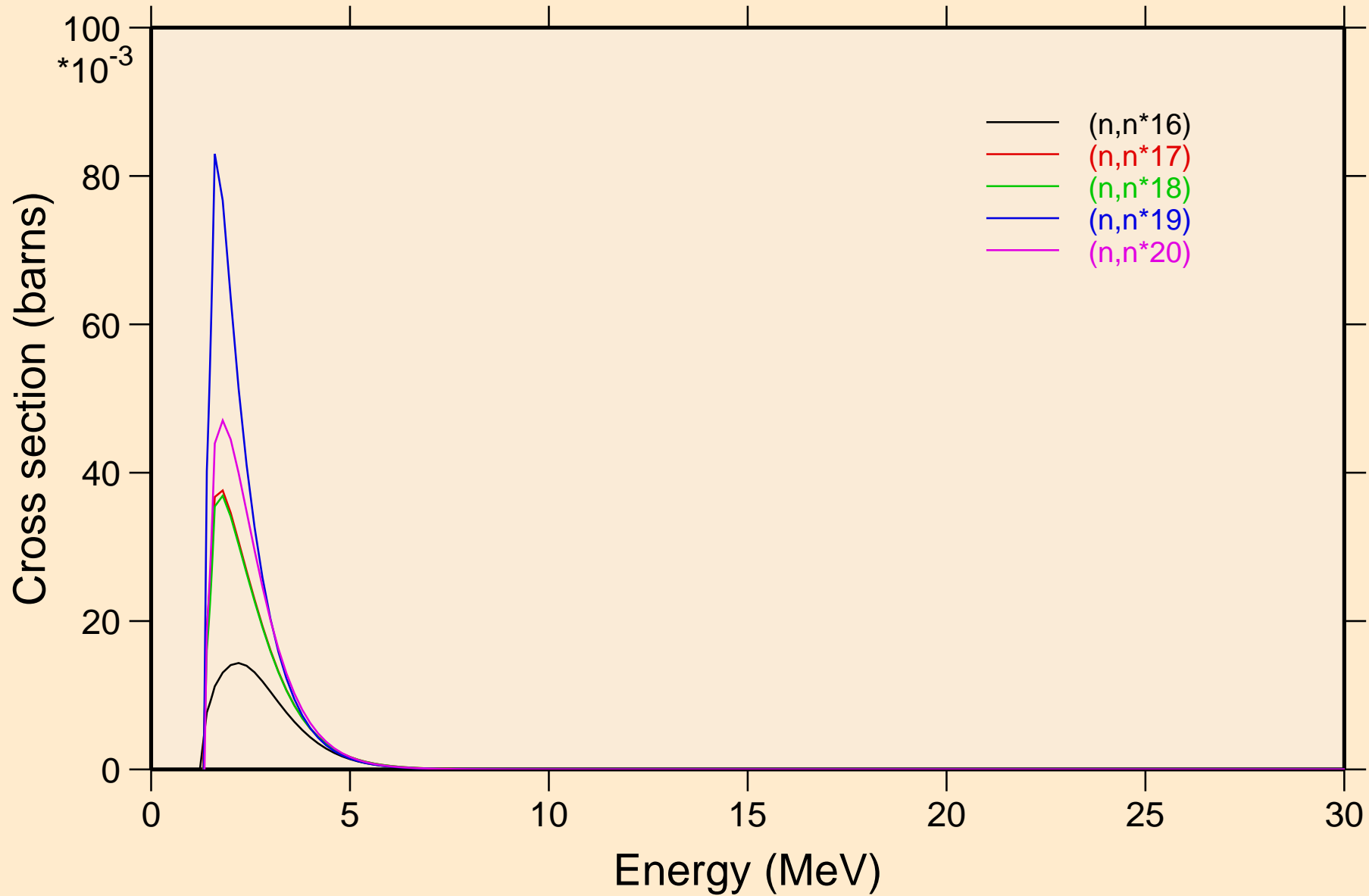

IN111M NEUTRON ACER TENDL-2021 LIBRARY; T=293.6K  
Inelastic levels

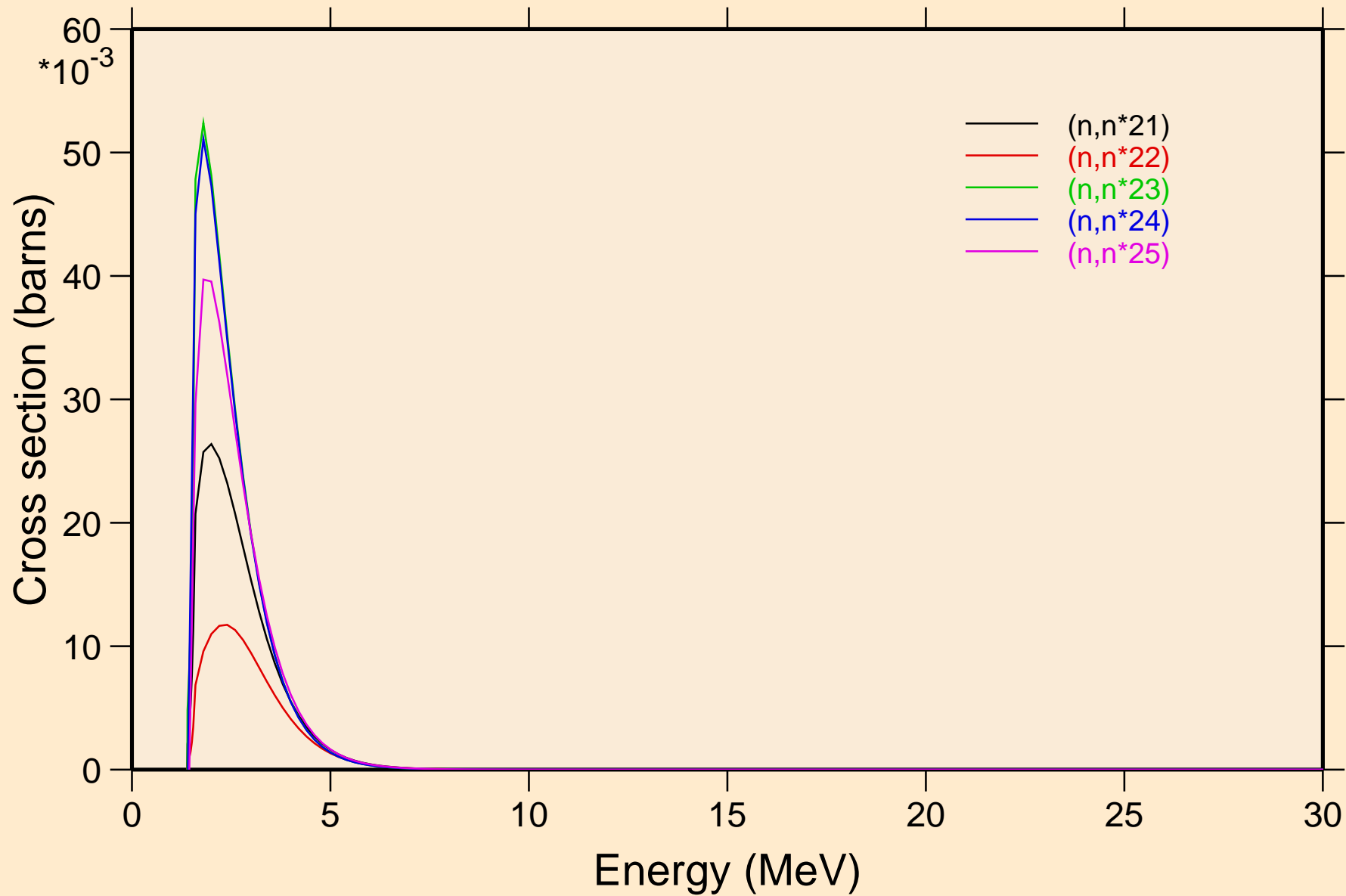

IN111M NEUTRON ACER TENDL-2021 LIBRARY; T=293.6K  
Inelastic levels

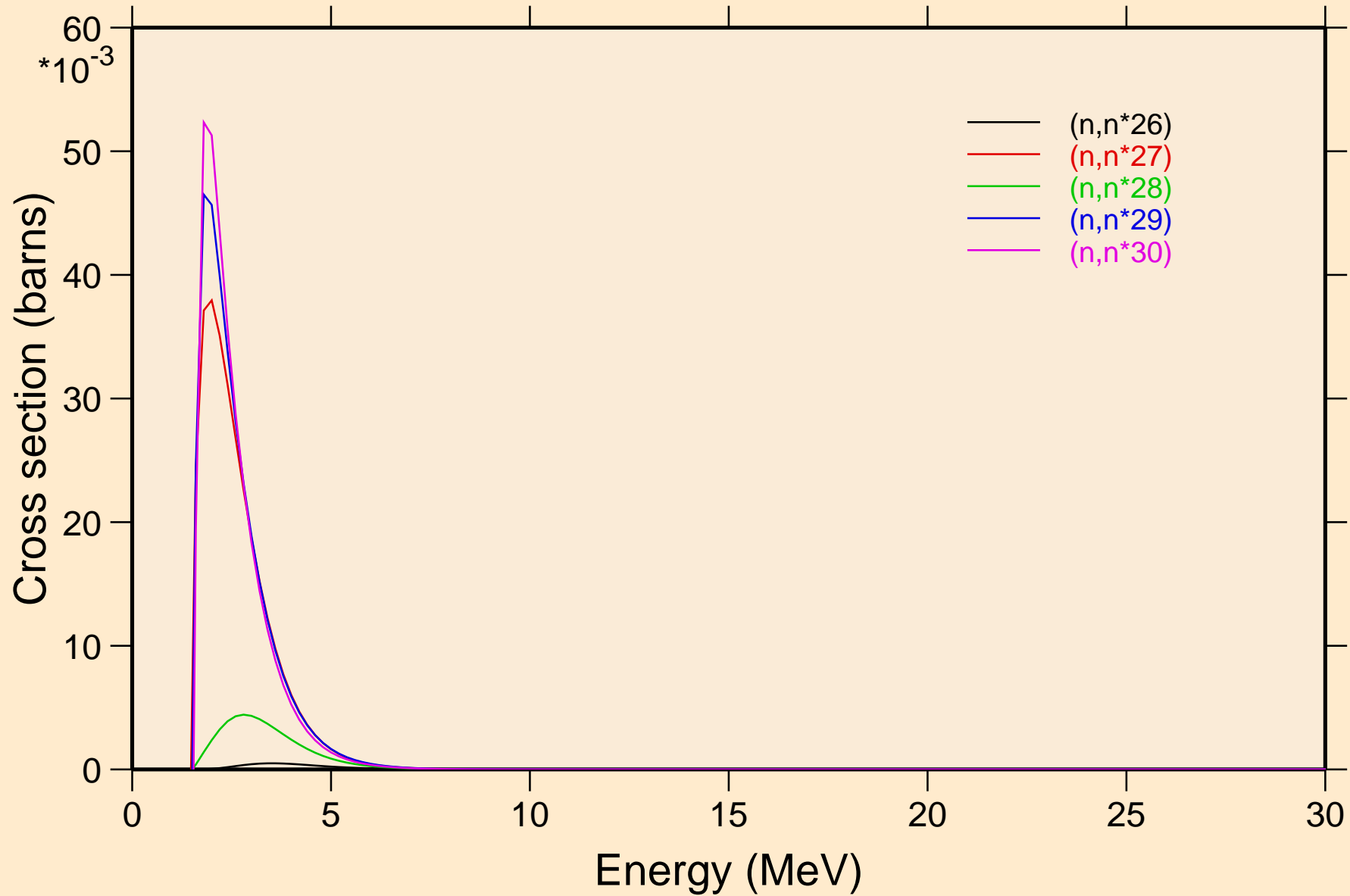

IN111M NEUTRON ACER TENDL-2021 LIBRARY; T=293.6K  
Threshold reactions

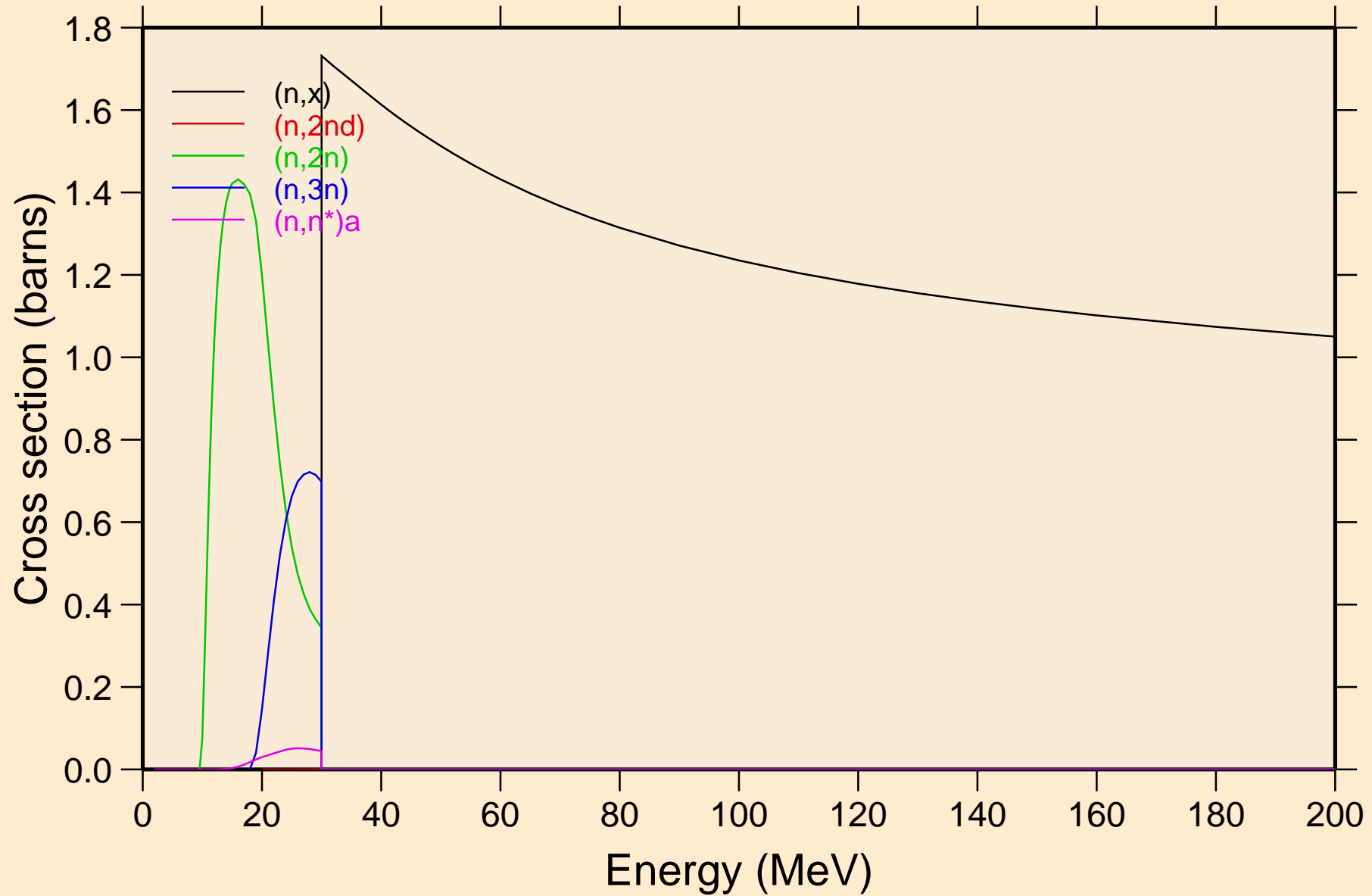

# IN111M NEUTRON ACER TENDL-2021 LIBRARY; T=293.6K

## Threshold reactions

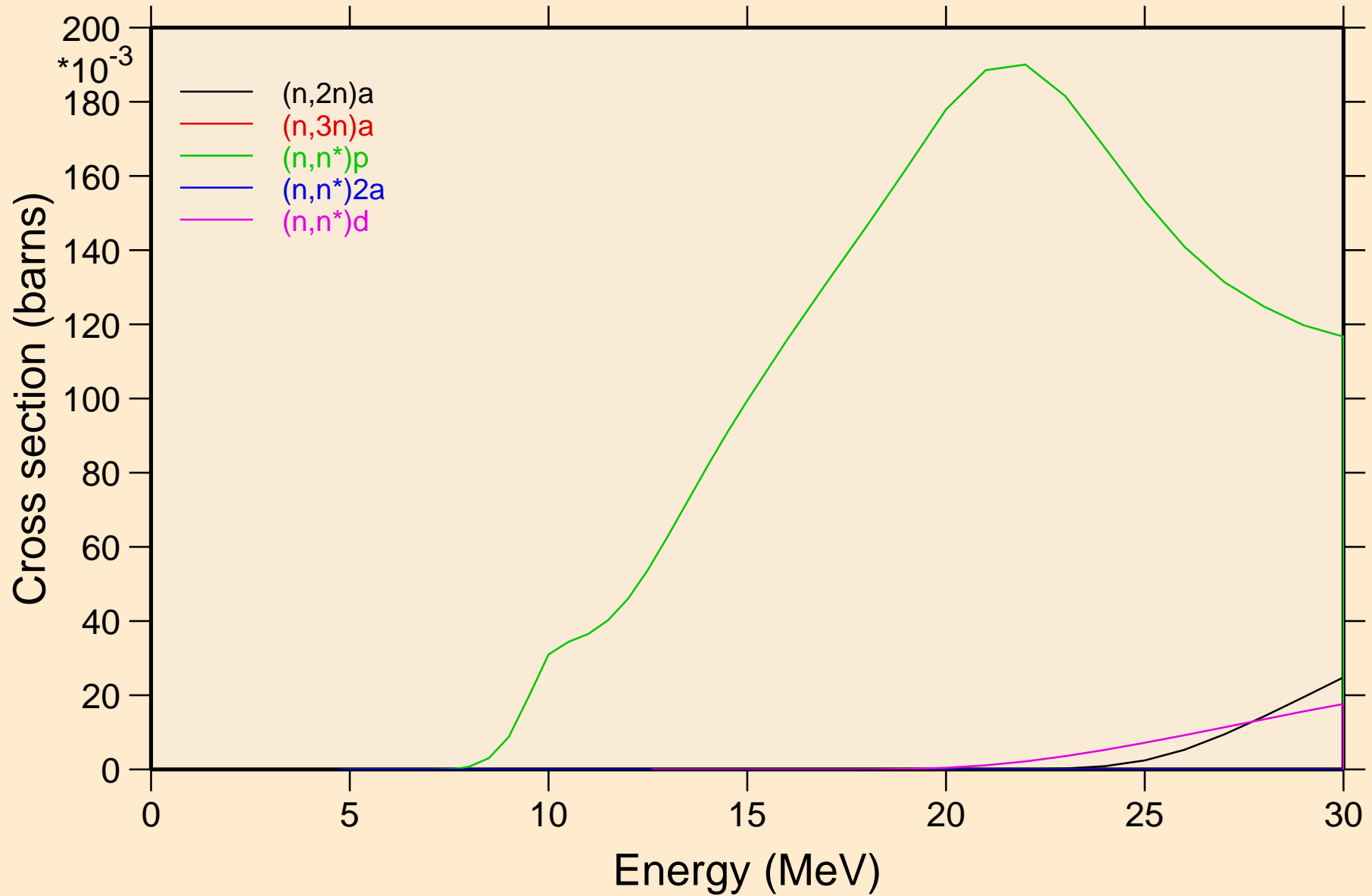



# IN111M NEUTRON ACER TENDL-2021 LIBRARY; T=293.6K

## Threshold reactions

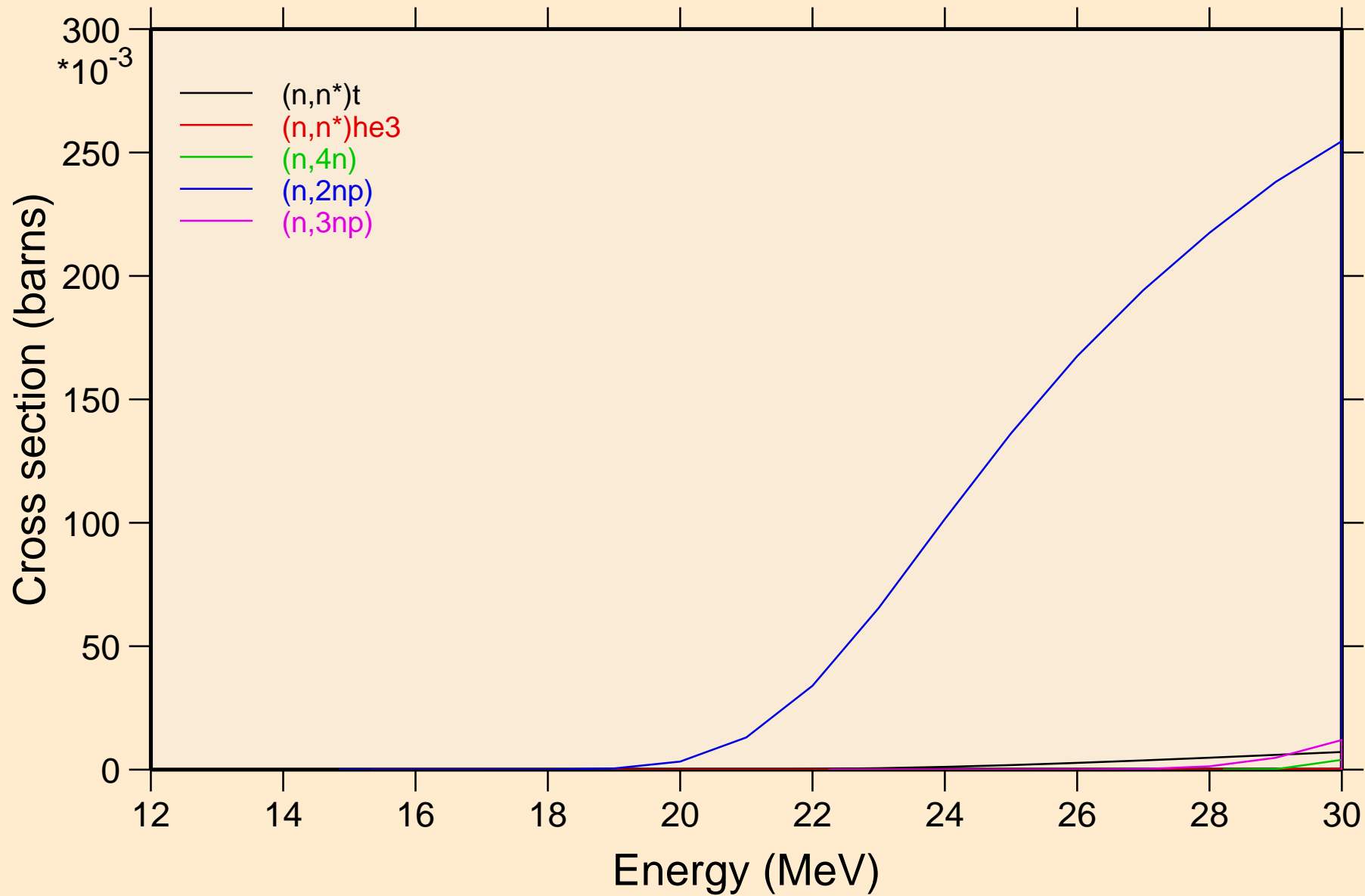

IN111M NEUTRON ACER TENDL-2021 LIBRARY; T=293.6K  
Threshold reactions

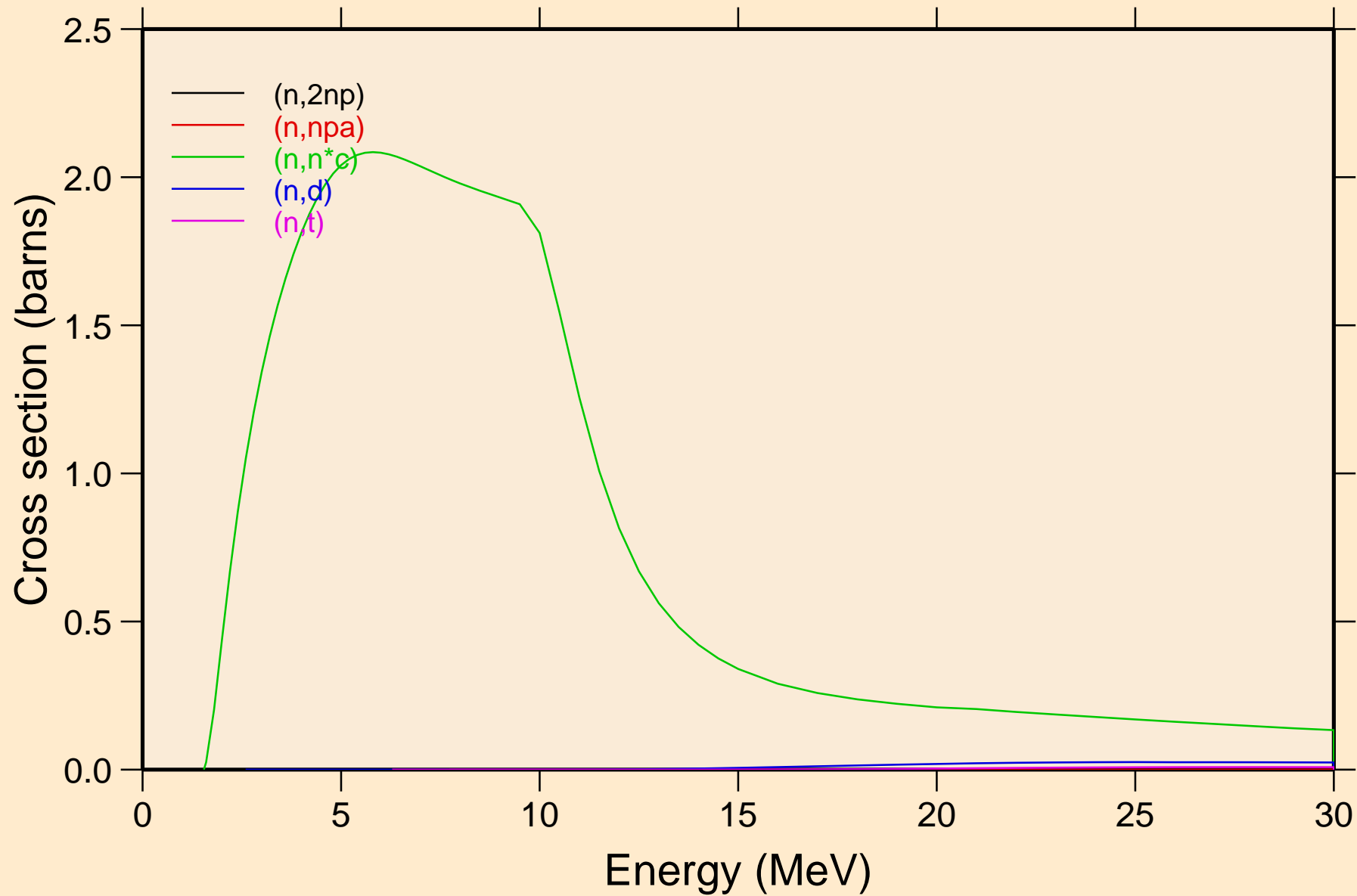

IN111M NEUTRON ACER TENDL-2021 LIBRARY; T=293.6K  
Threshold reactions

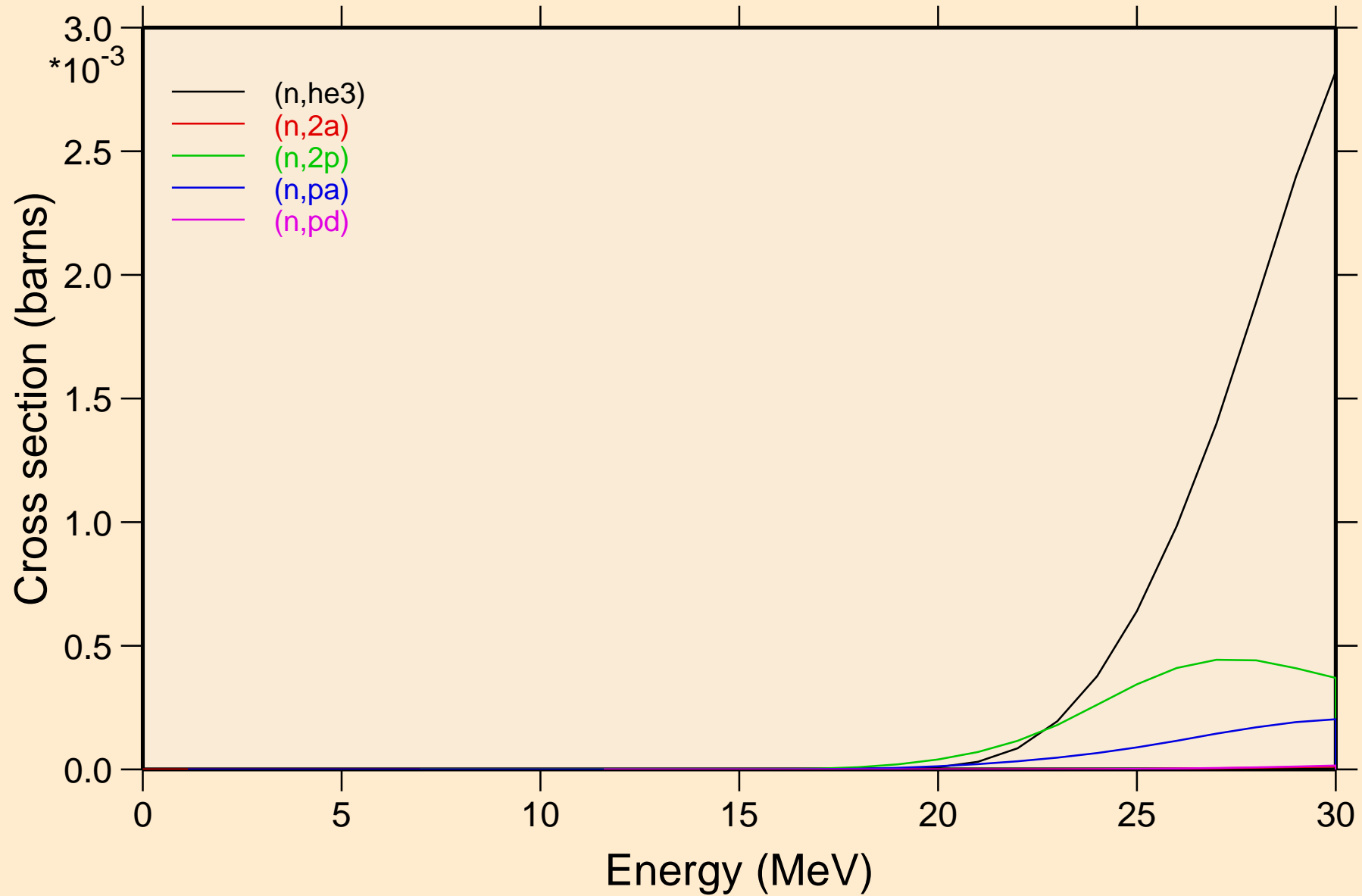

IN111M NEUTRON ACER TENDL-2021 LIBRARY; T=293.6K  
Threshold reactions

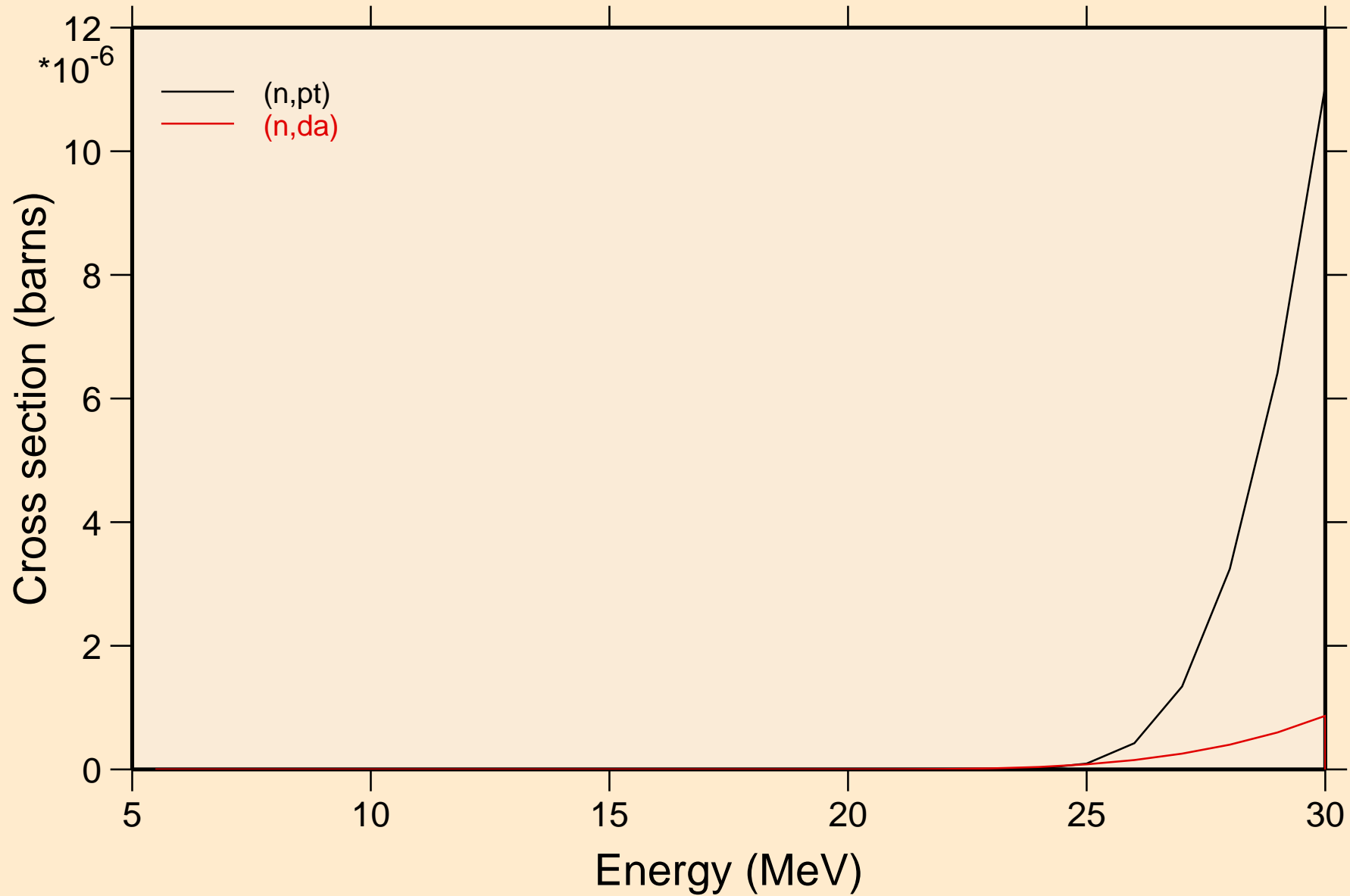

IN111M NEUTRON ACER TENDL-2021 LIBRARY; T=293.6K  
Threshold reactions

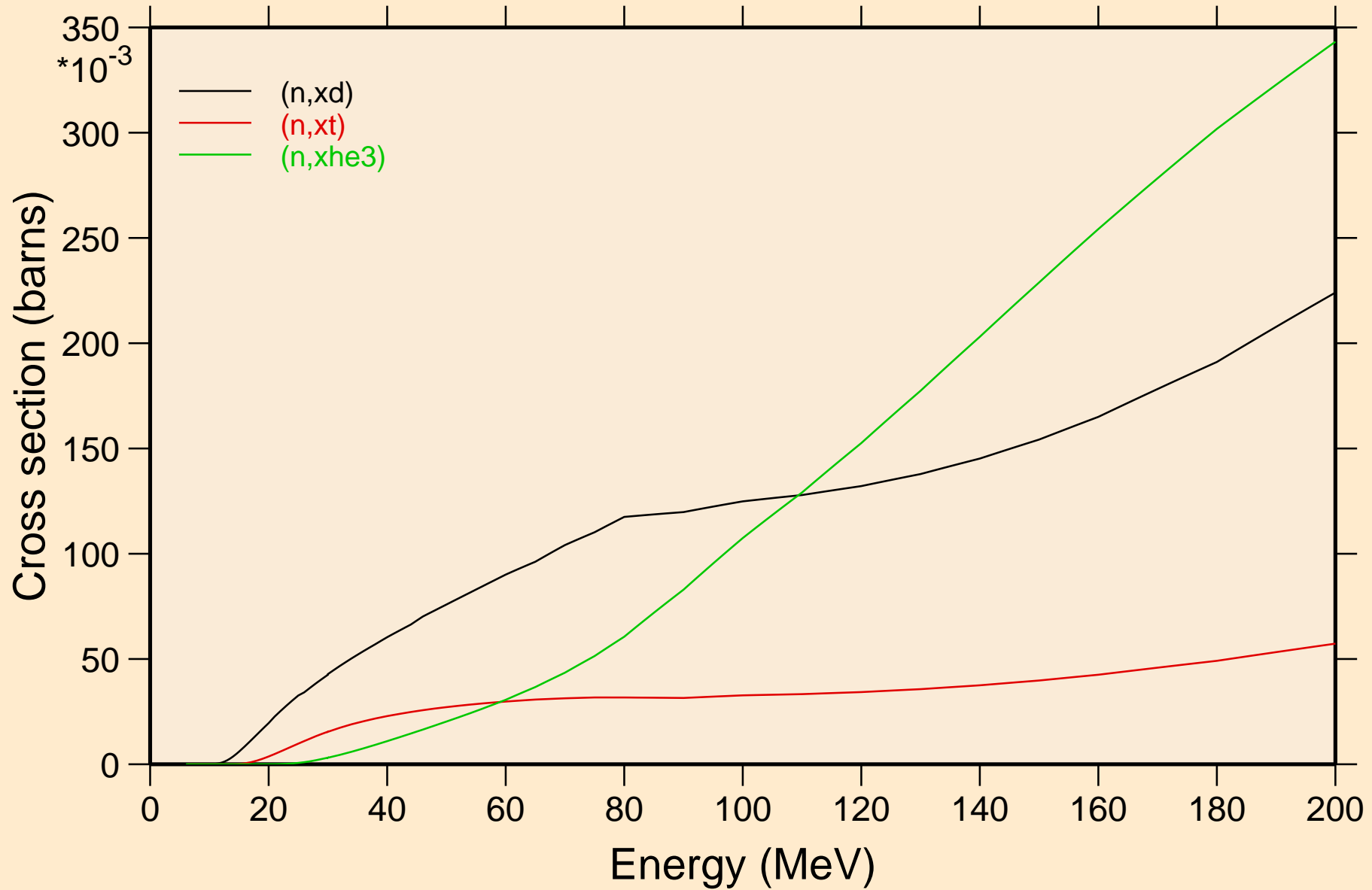

IN111M NEUTRON ACER TENDL-2021 LIBRARY; T=293.6K  
angular distribution for elastic

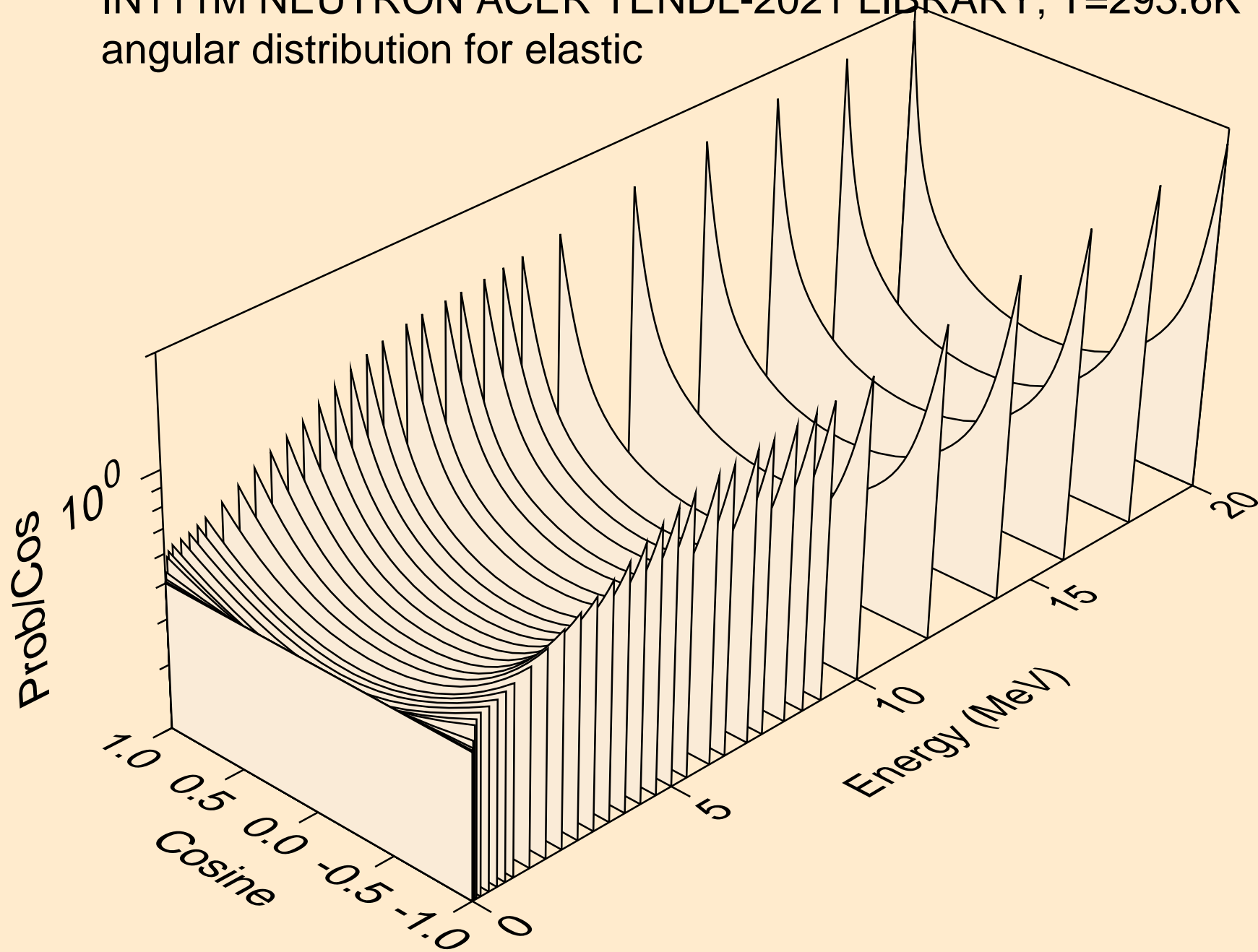

IN111M NEUTRON ACER TENDL-2021 LIBRARY; T=293.6K  
angular distribution for elastic

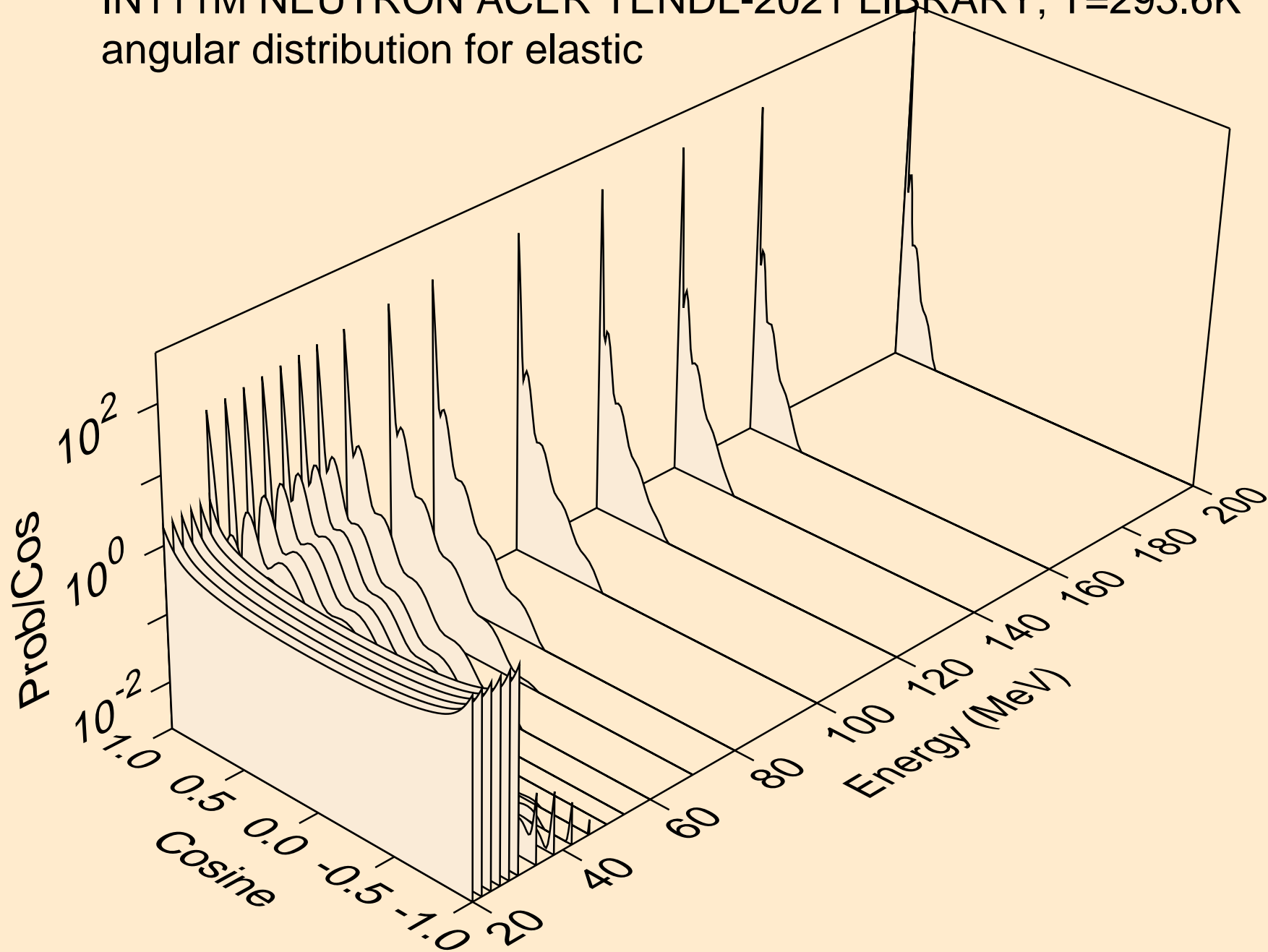

IN111M NEUTRON ACER TENDL-2021 LIBRARY; T=293.6K  
angular distribution for (n,n\*1)

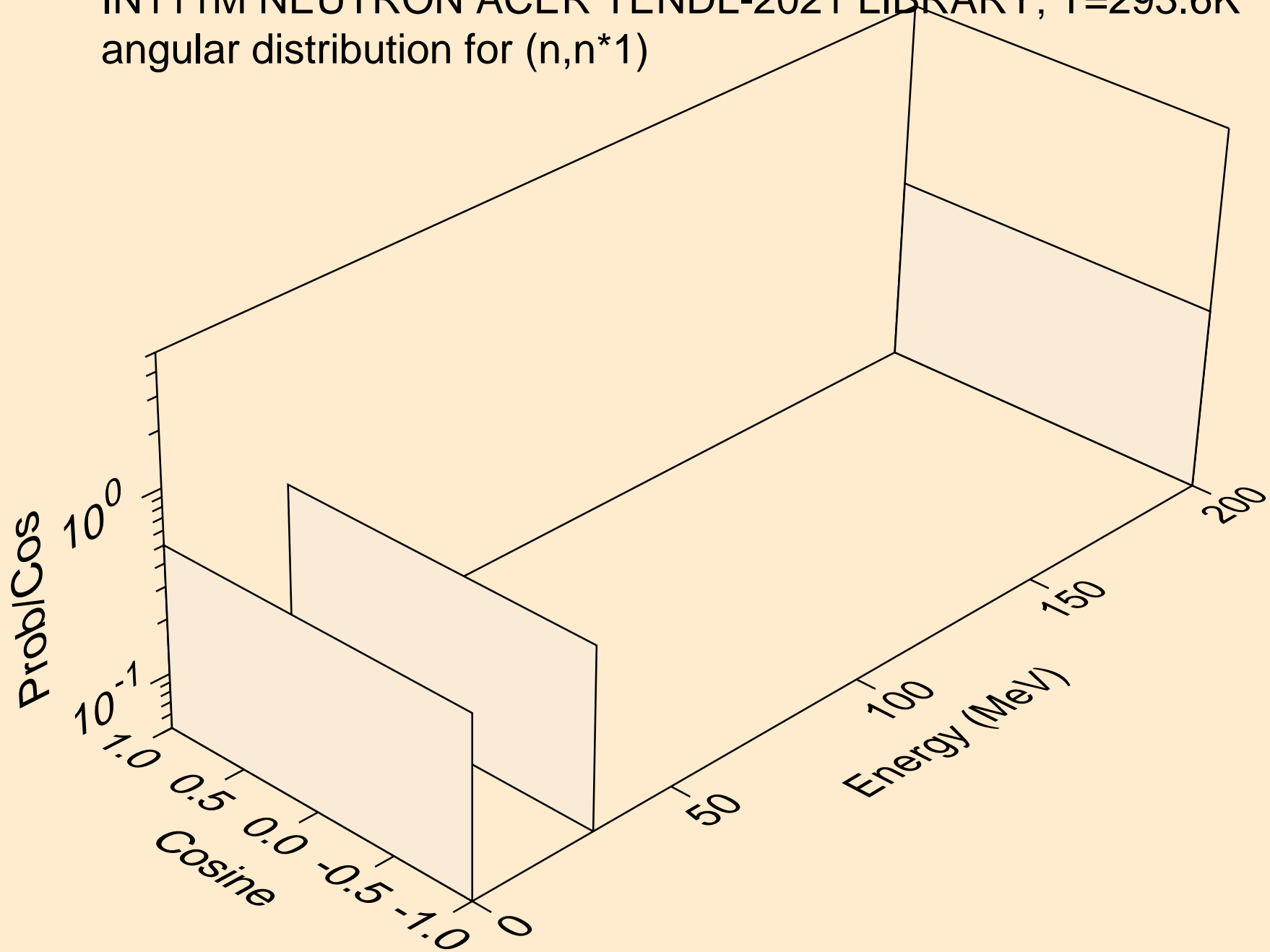



IN111M NEUTRON ACER TENDL-2021 LIBRARY; T=293.6K  
angular distribution for (n,n\*2)

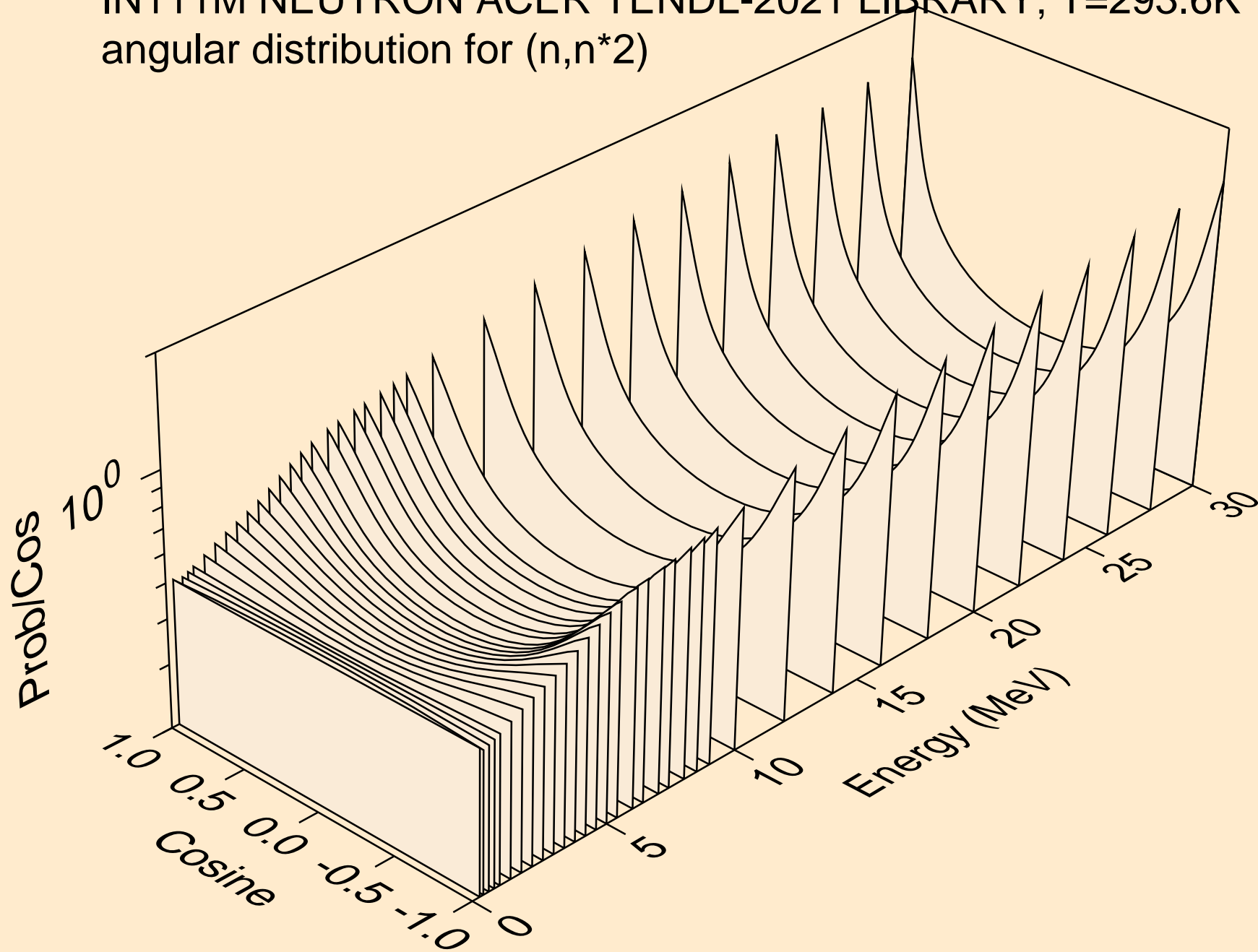

IN111M NEUTRON ACER TENDL-2021 LIBRARY; T=293.6K  
angular distribution for (n,n\*3)

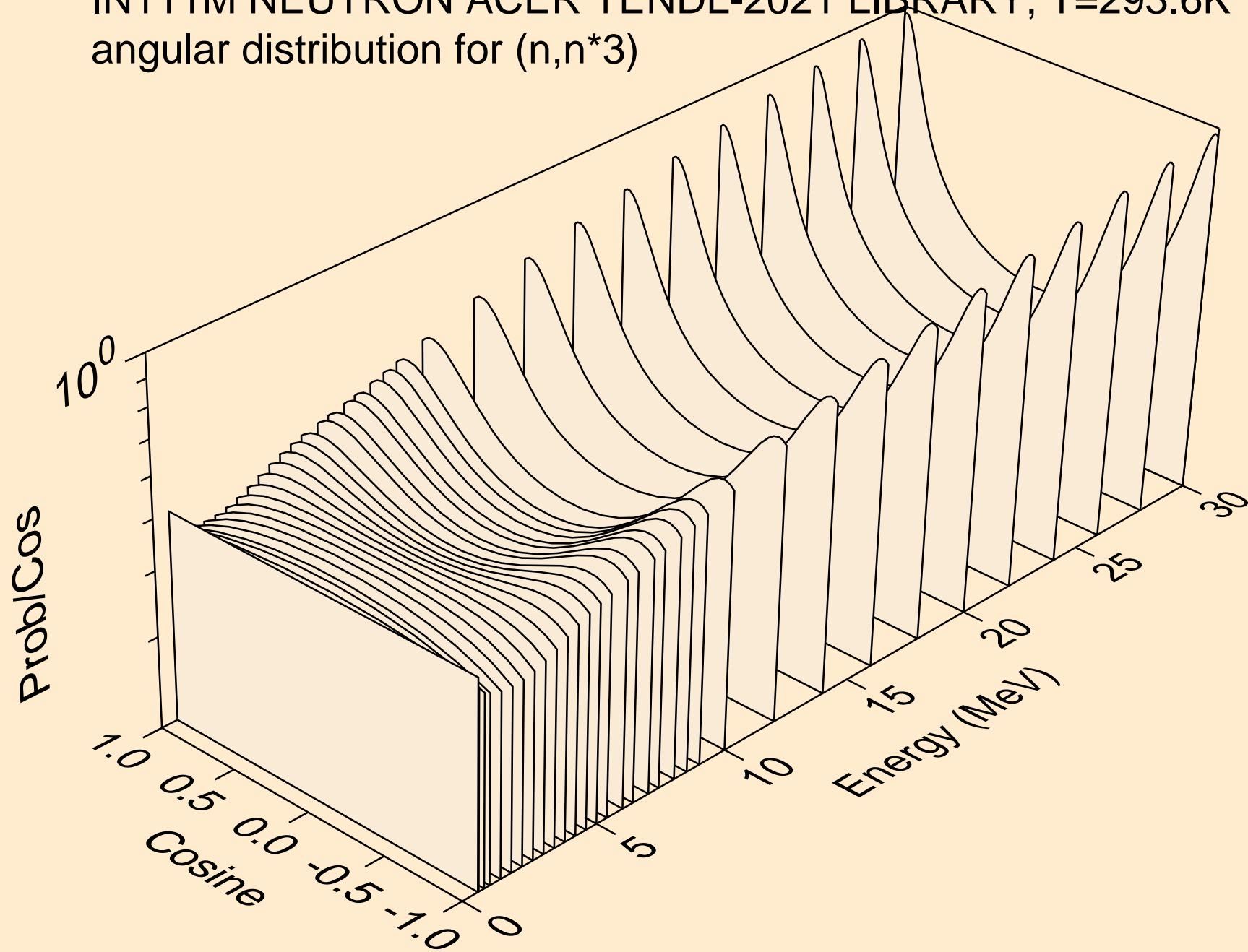

IN11M NEUTRON ACER TENDL-2021 LIBRARY; T=293.6K  
angular distribution for (n,n\*4)

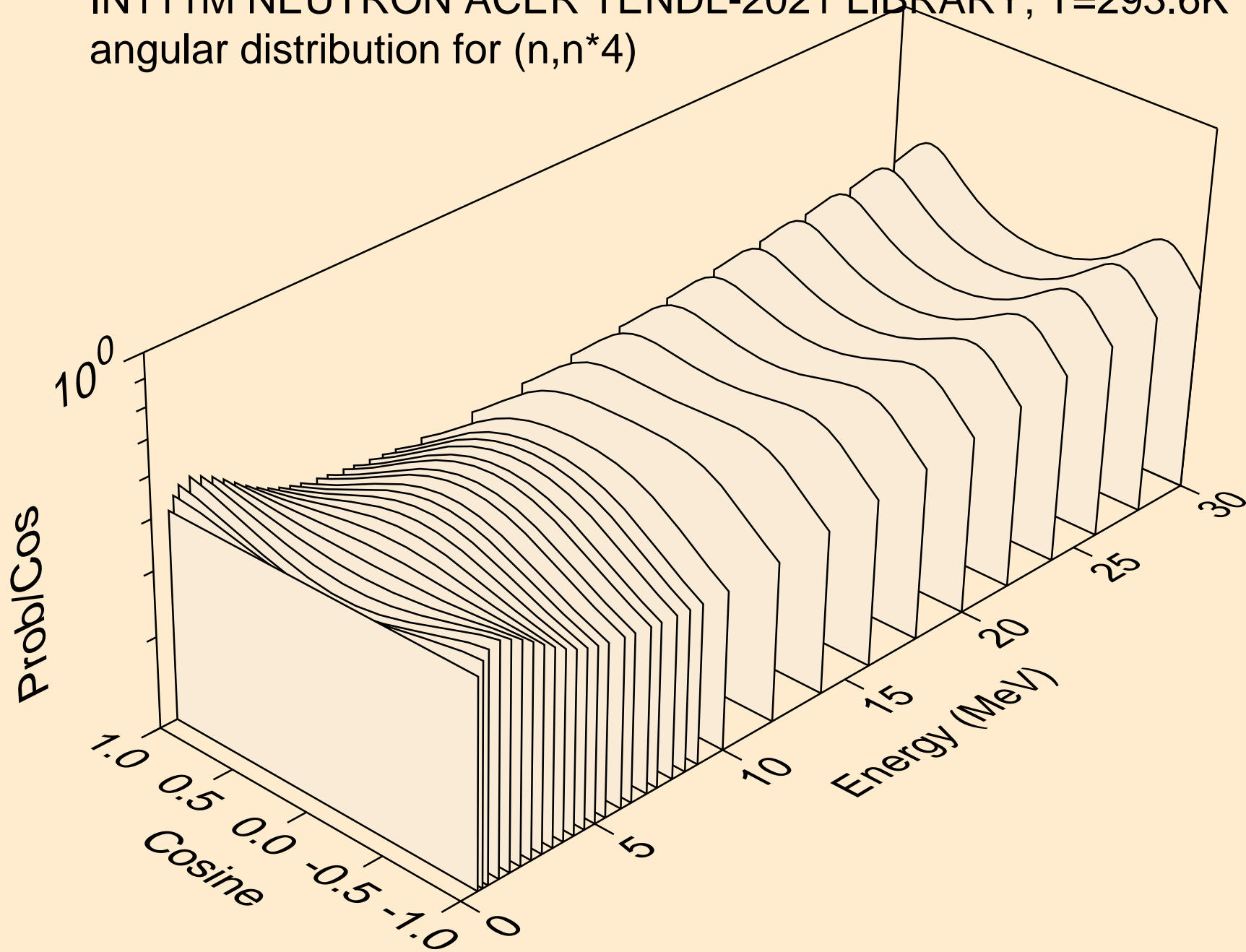

IN111M NEUTRON ACER TENDL-2021 LIBRARY; T=293.6K  
angular distribution for (n,n\*5)

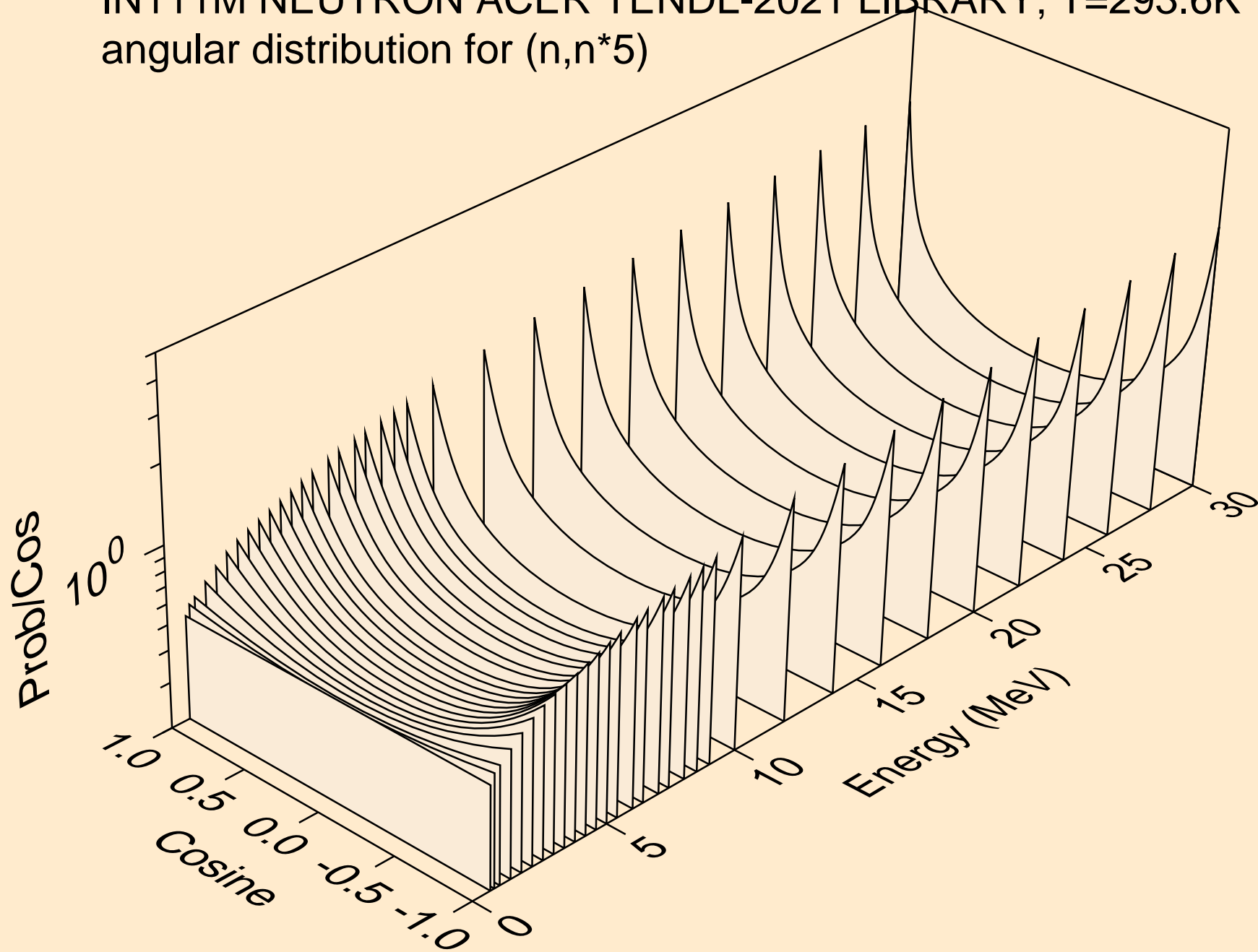

IN111M NEUTRON ACER TENDL-2021 LIBRARY; T=293.6K  
angular distribution for (n,n\*6)

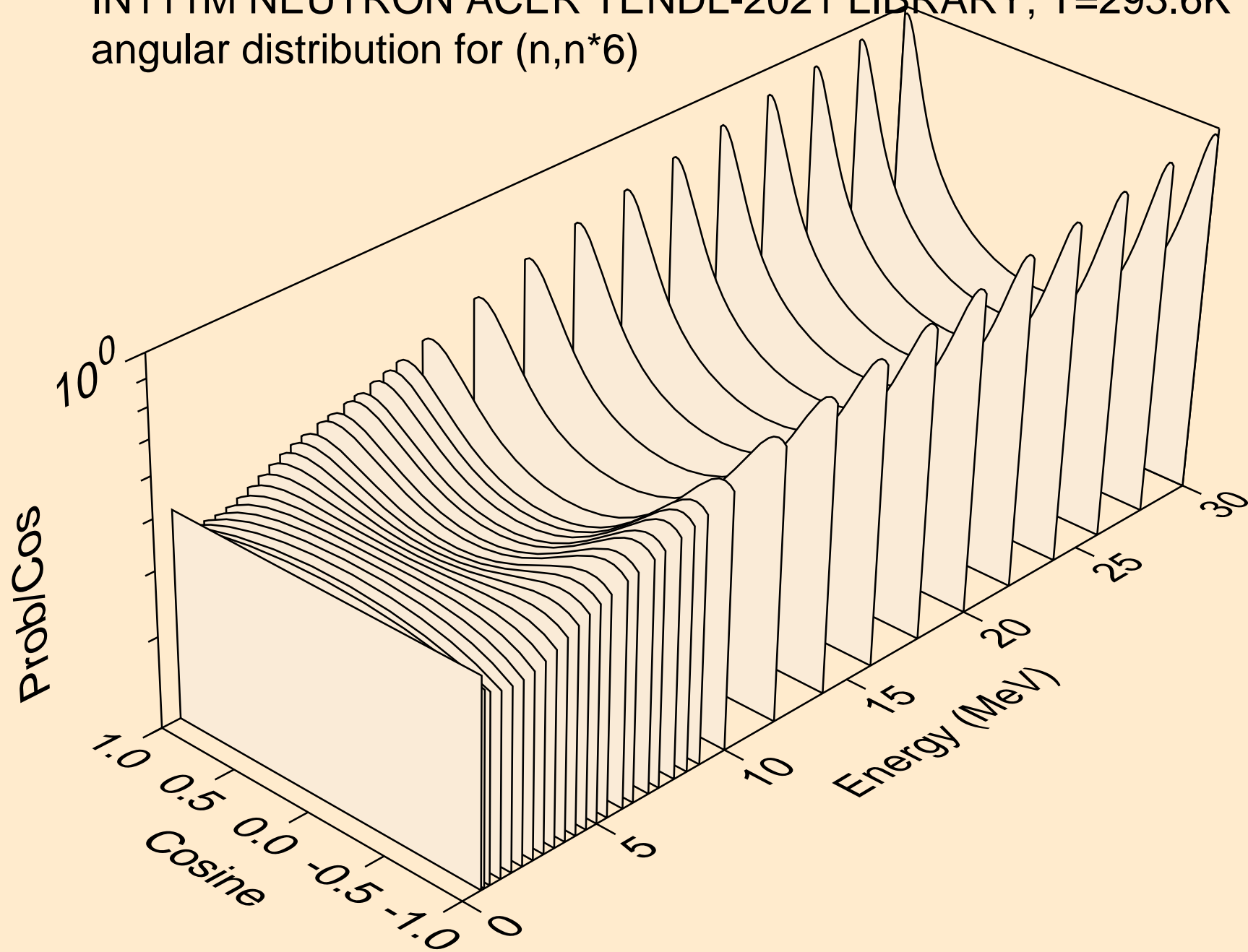

IN111M NEUTRON ACER TENDL-2021 LIBRARY; T=293.6K  
angular distribution for (n,n\*7)

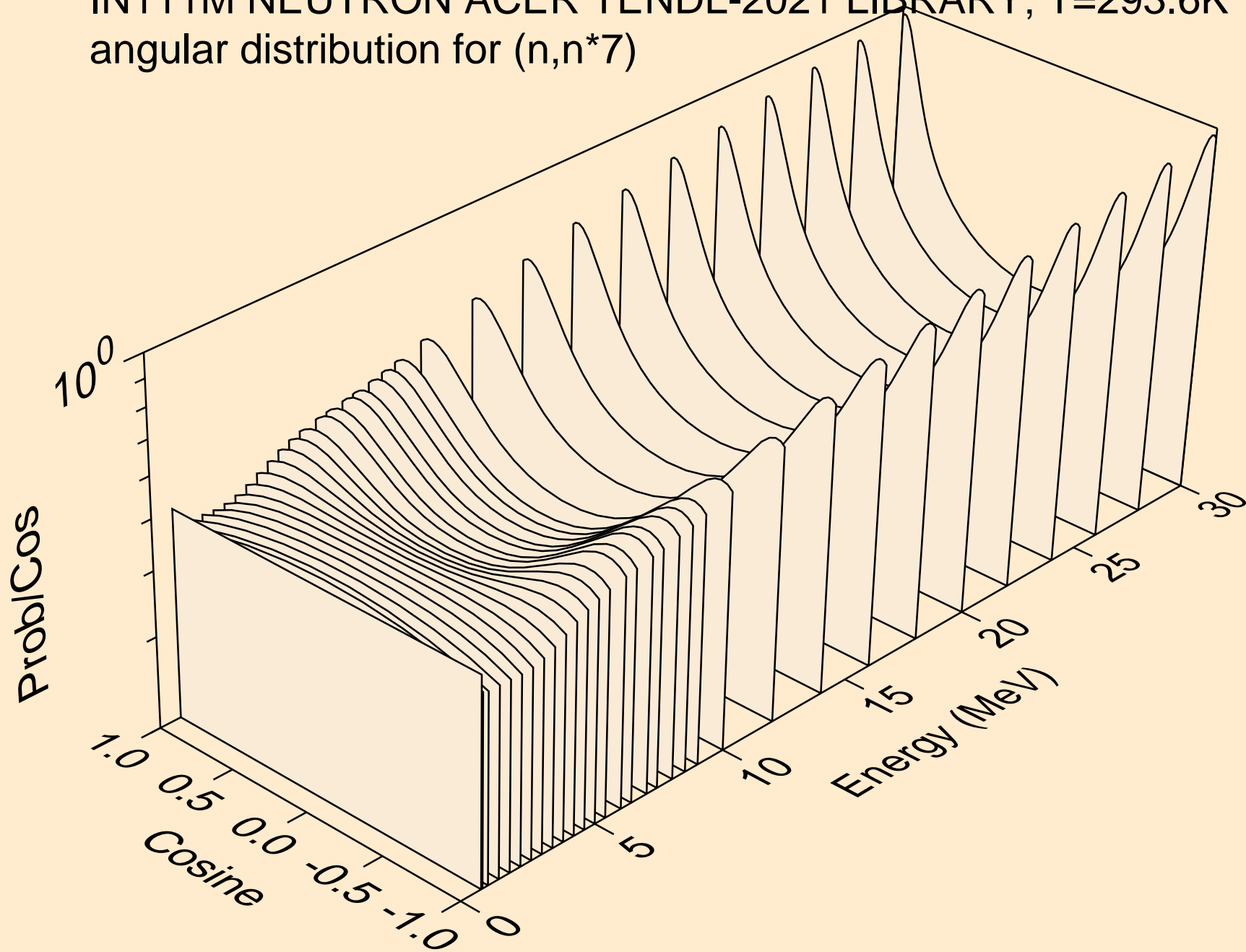

IN111M NEUTRON ACER TENDL-2021 LIBRARY; T=293.6K  
angular distribution for (n,n\*8)

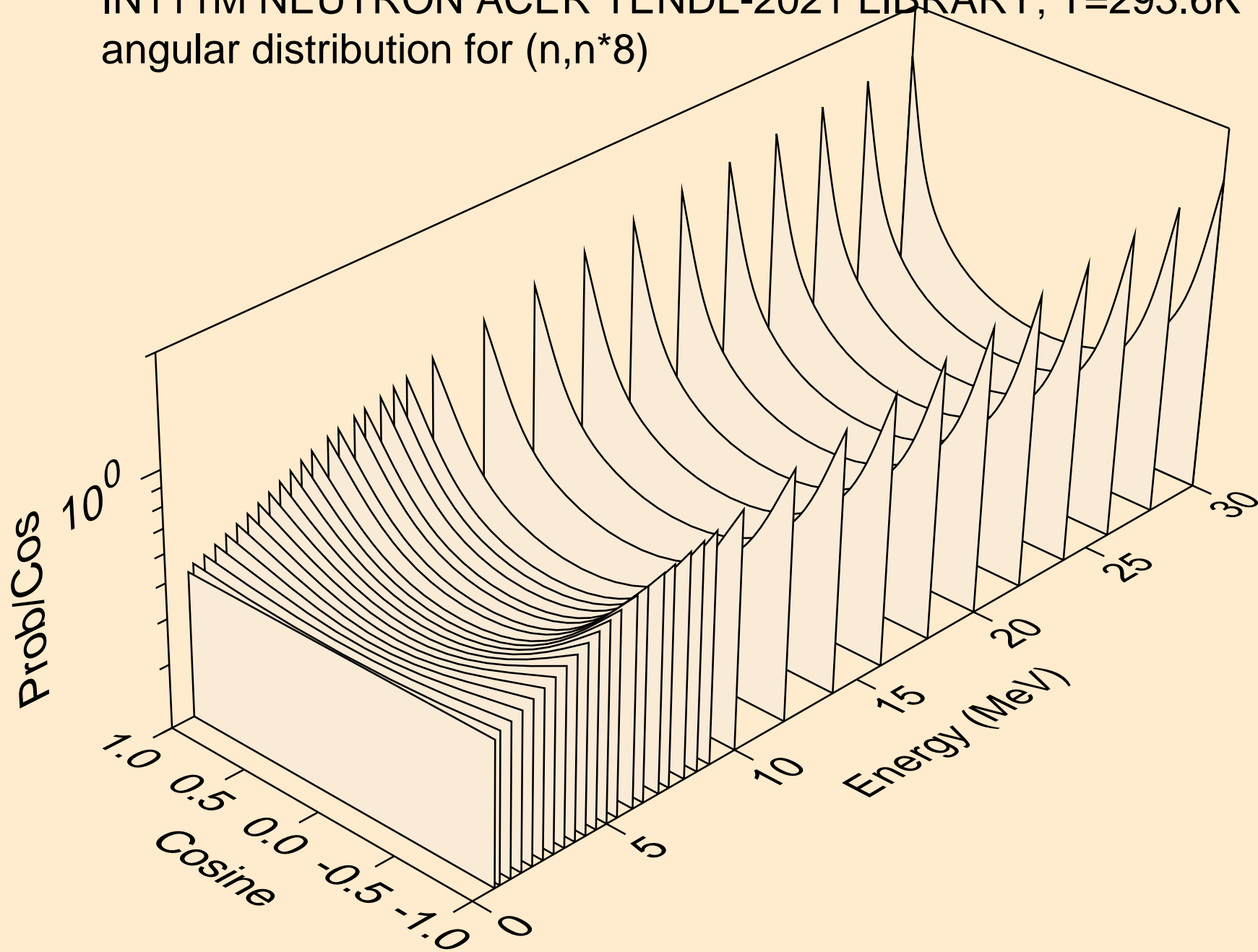

IN111M NEUTRON ACER TENDL-2021 LIBRARY; T=293.6K  
angular distribution for (n,n\*9)

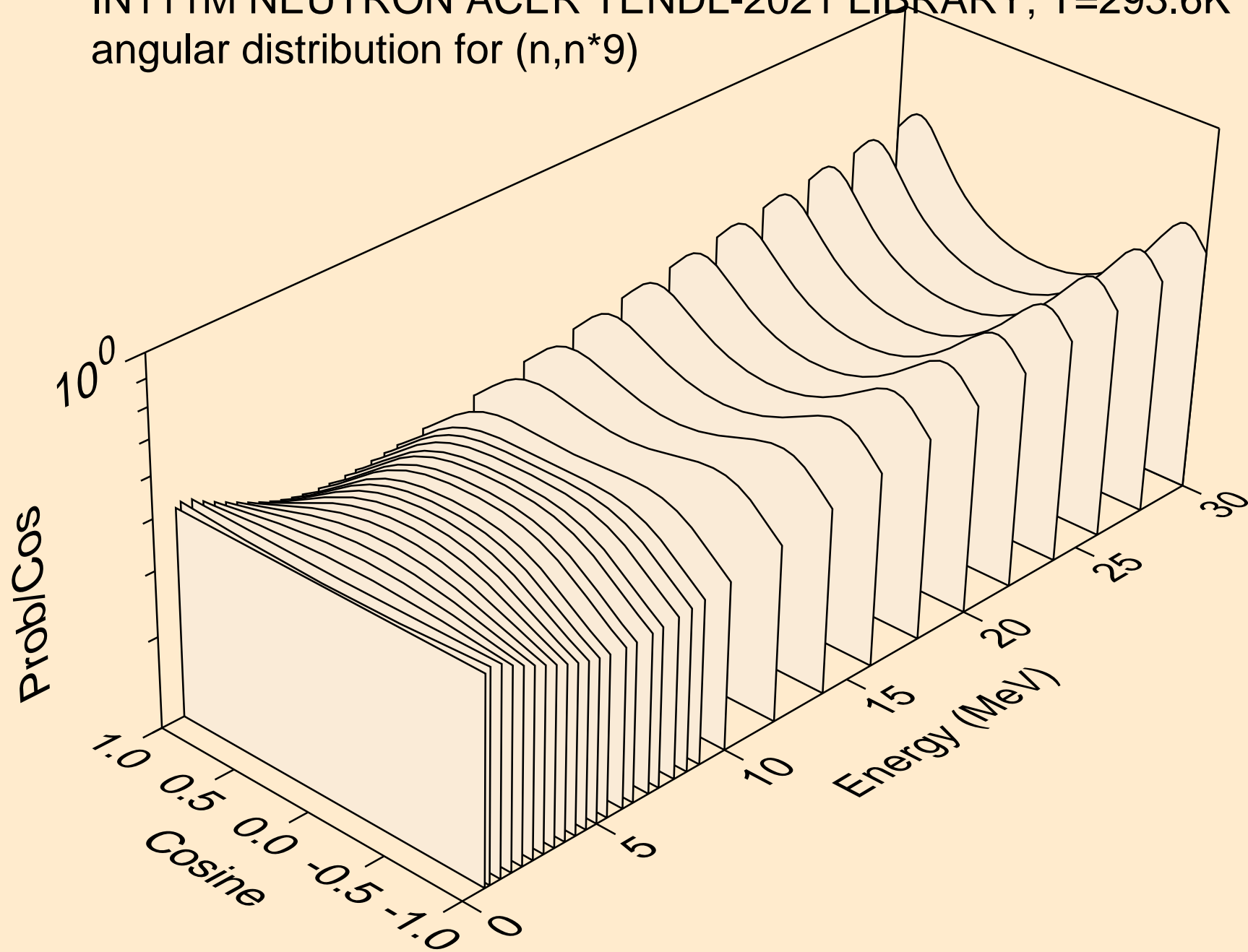



IN111M NEUTRON ACER TENDL-2021 LIBRARY; T=293.6K  
angular distribution for (n,n\*10)

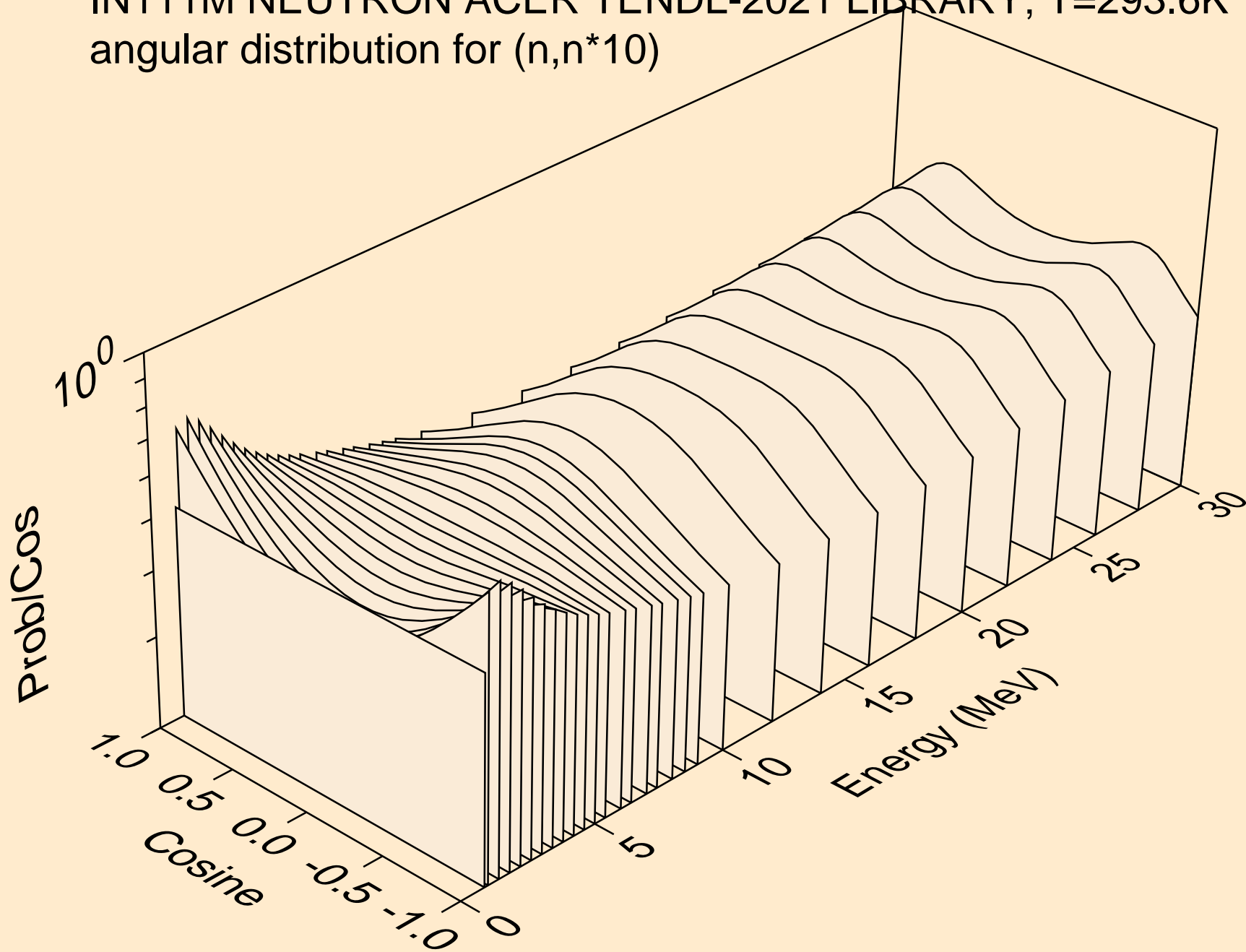

IN111M NEUTRON ACER TENDL-2021 LIBRARY; T=293.6K  
angular distribution for (n,n\*11)

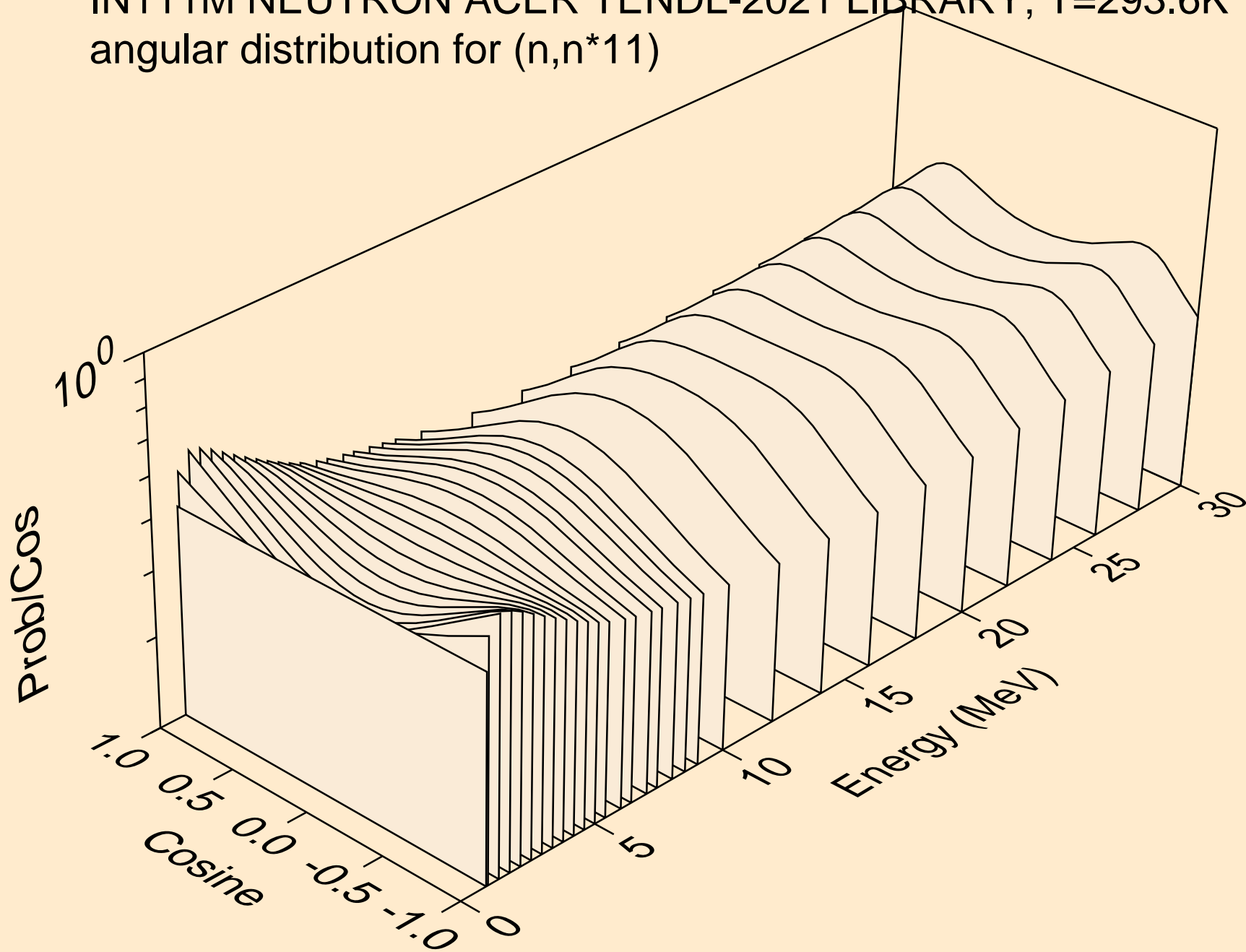

IN111M NEUTRON ACER TENDL-2021 LIBRARY; T=293.6K  
angular distribution for (n,n\*12)

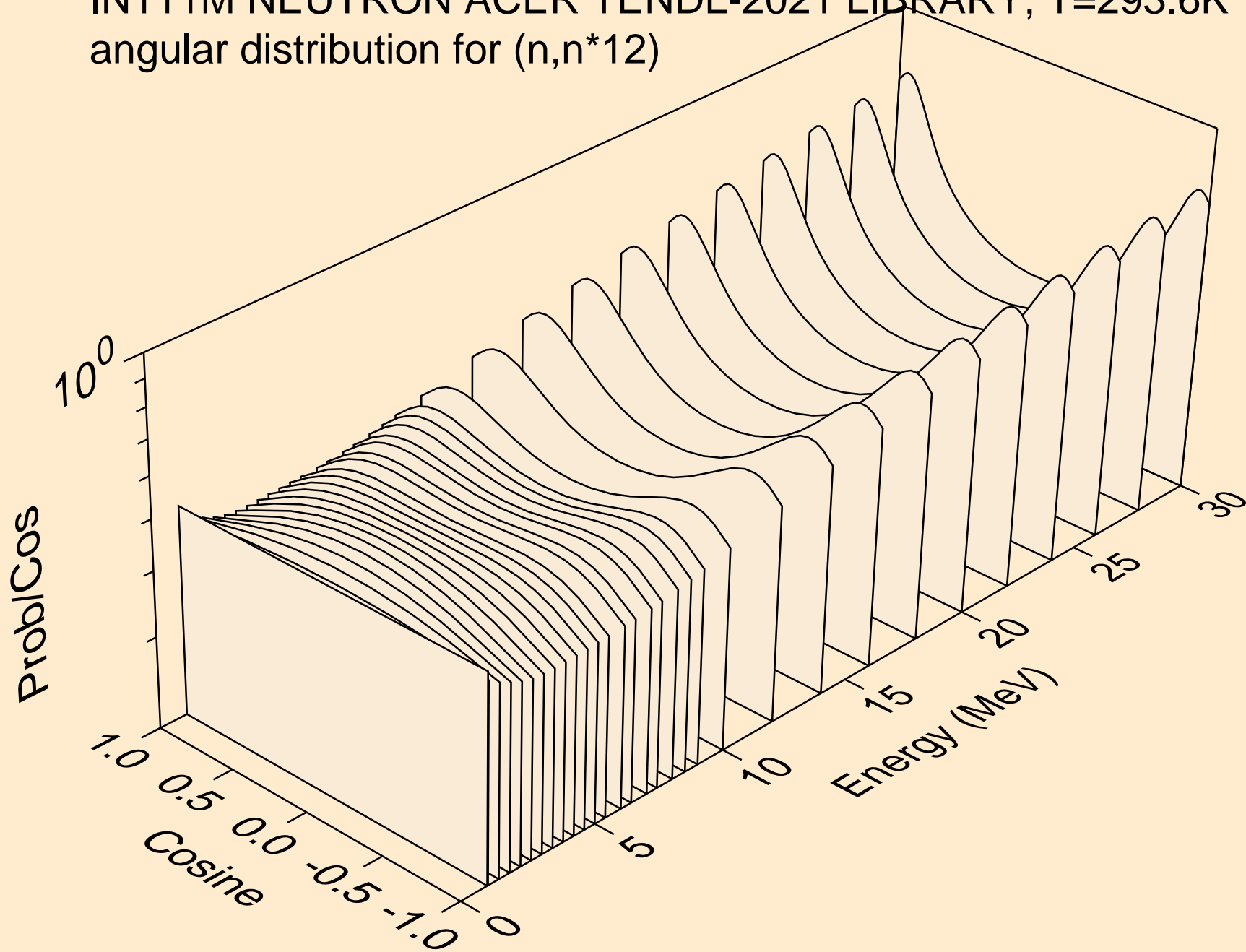

IN111M NEUTRON ACER TENDL-2021 LIBRARY; T=293.6K  
angular distribution for (n,n\*13)

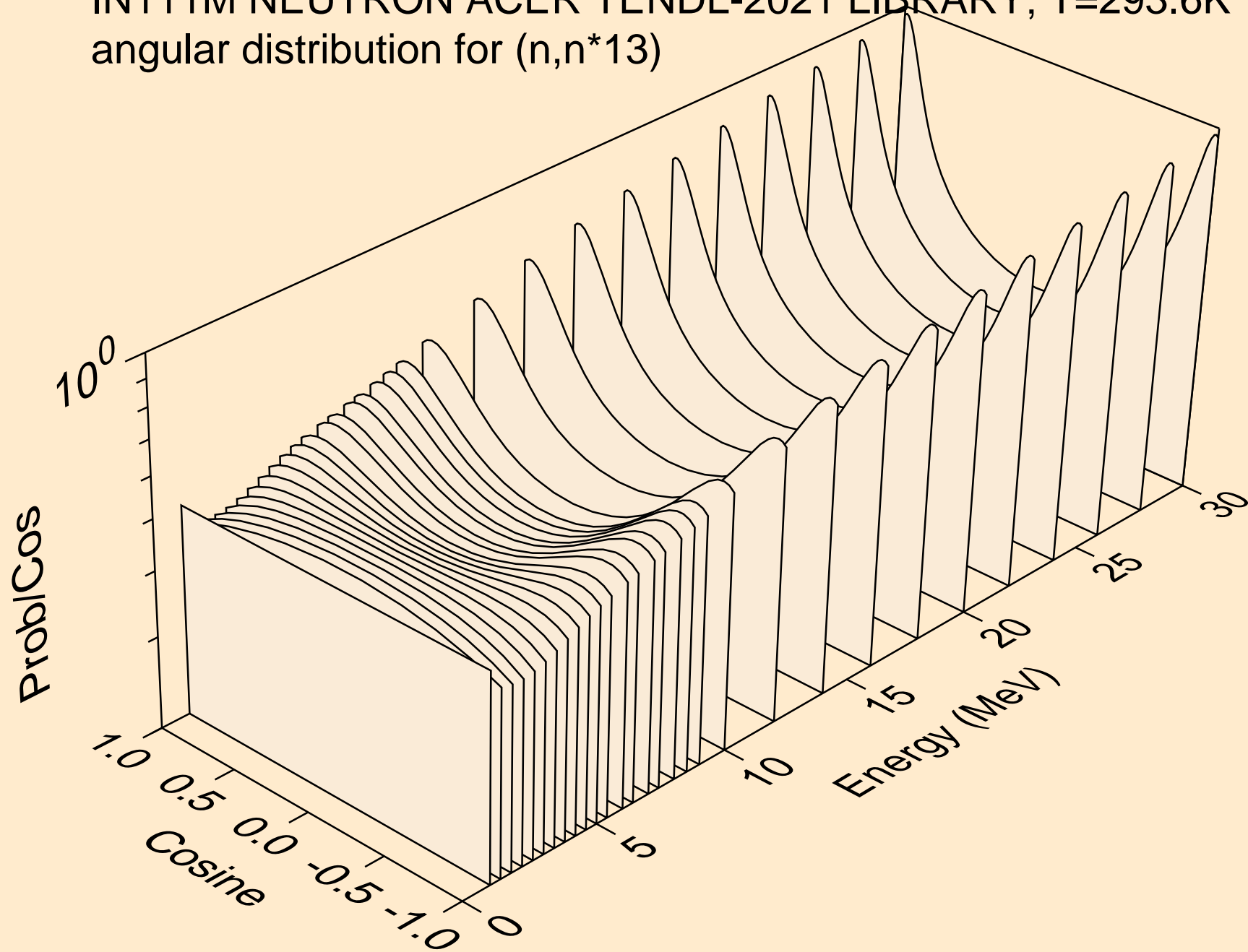

IN111M NEUTRON ACER TENDL-2021 LIBRARY; T=293.6K  
angular distribution for (n,n\*14)

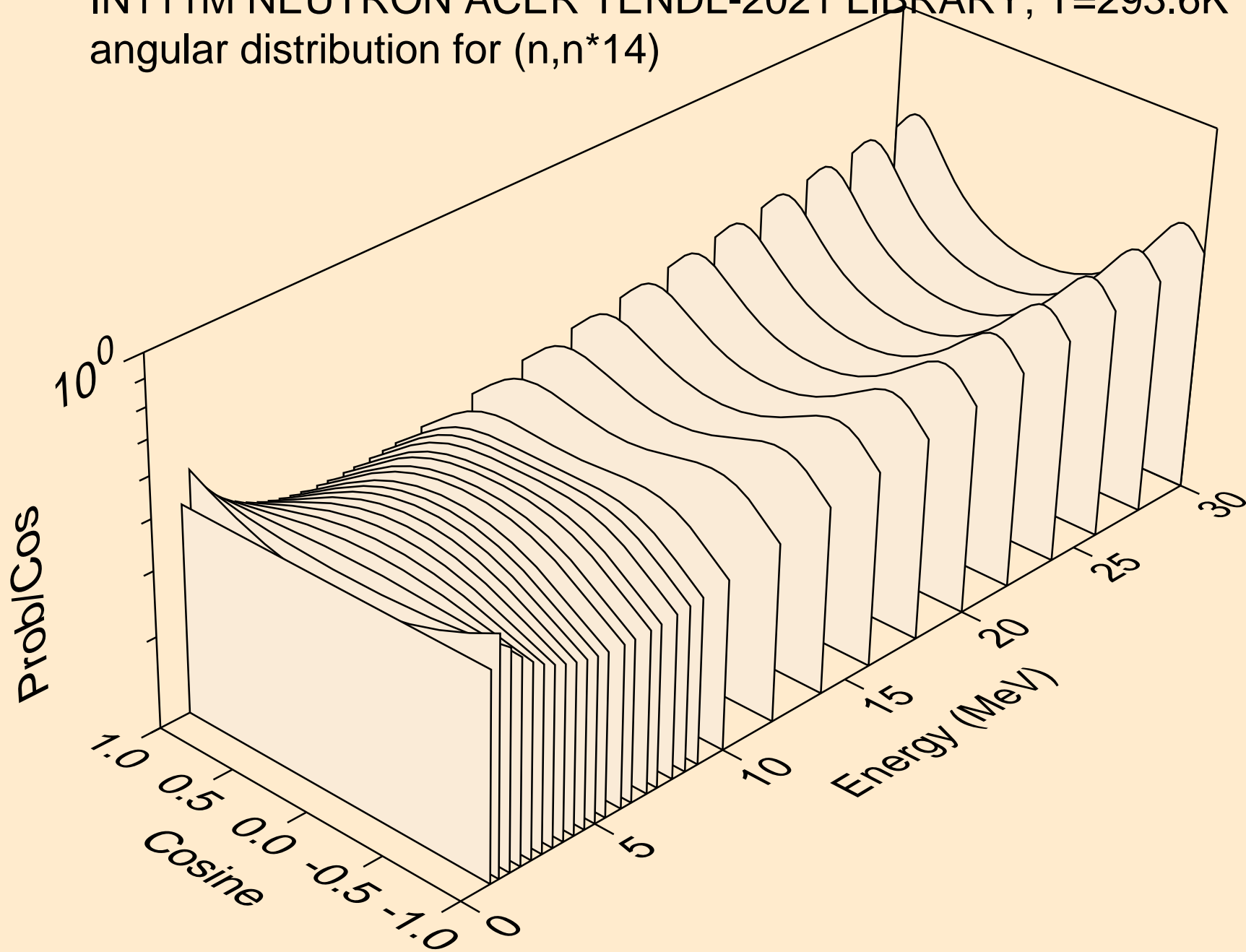

IN111M NEUTRON ACER TENDL-2021 LIBRARY; T=293.6K  
angular distribution for (n,n\*15)

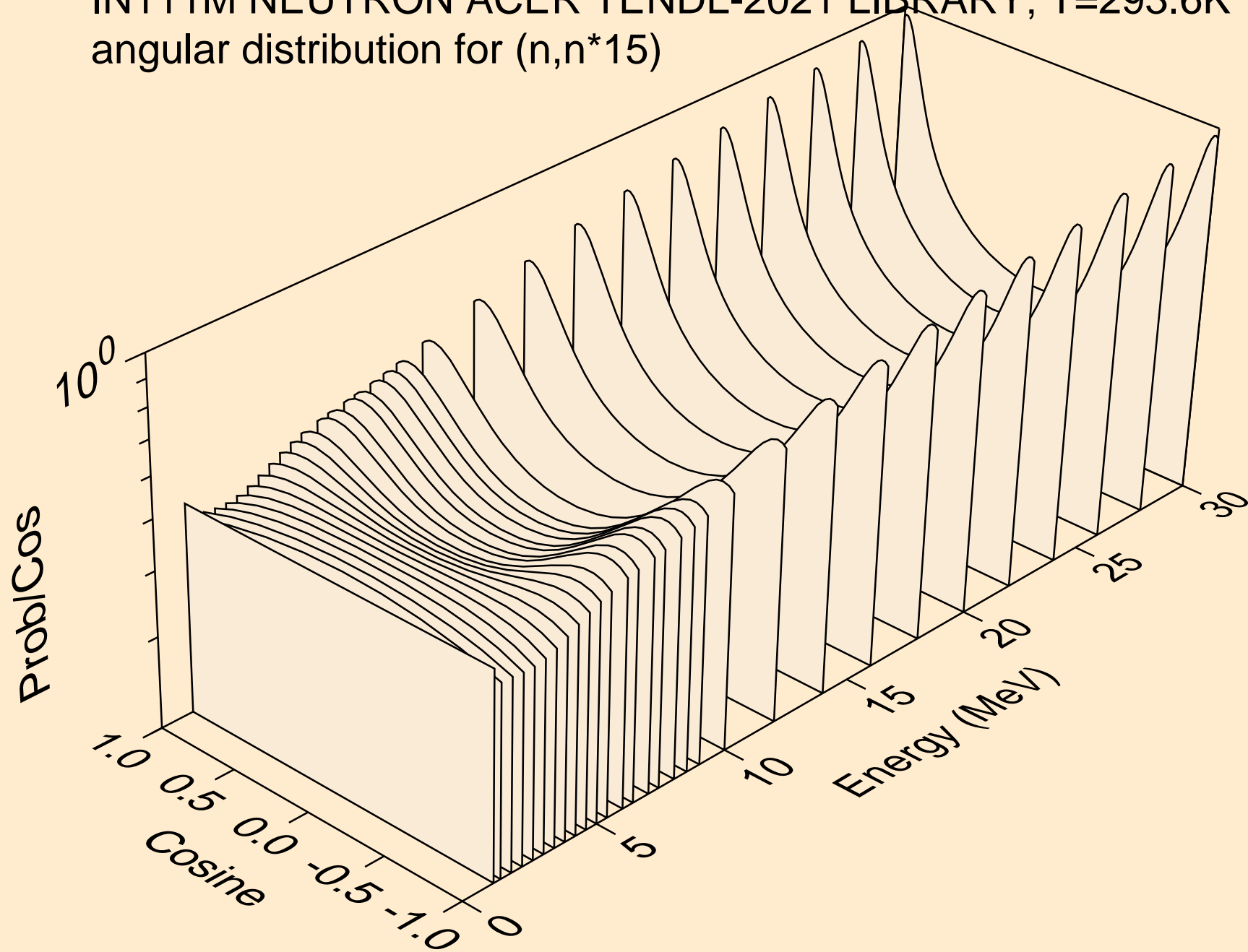

IN111M NEUTRON ACER TENDL-2021 LIBRARY; T=293.6K  
angular distribution for (n,n\*16)

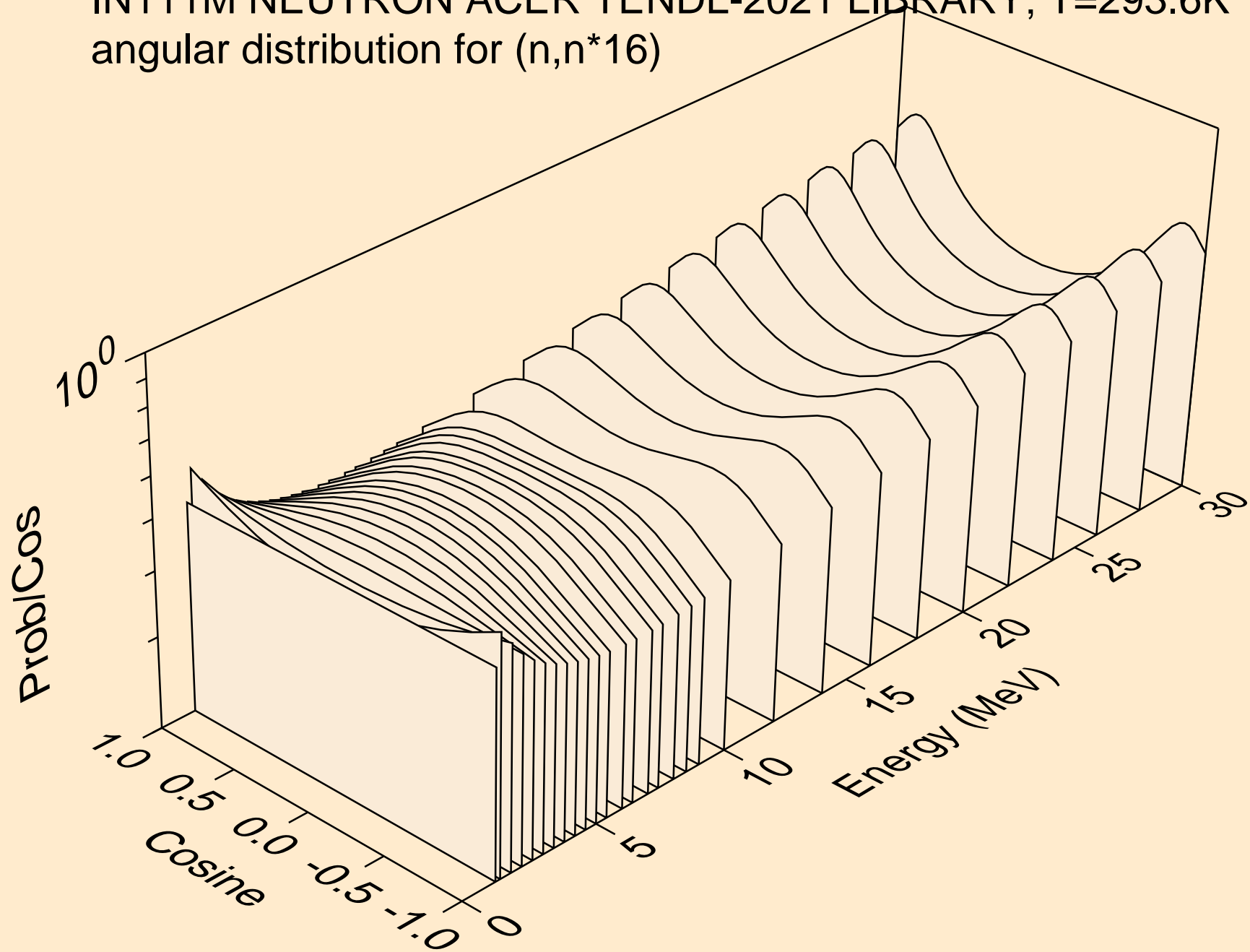

IN111M NEUTRON ACER TENDL-2021 LIBRARY; T=293.6K  
angular distribution for (n,n\*17)

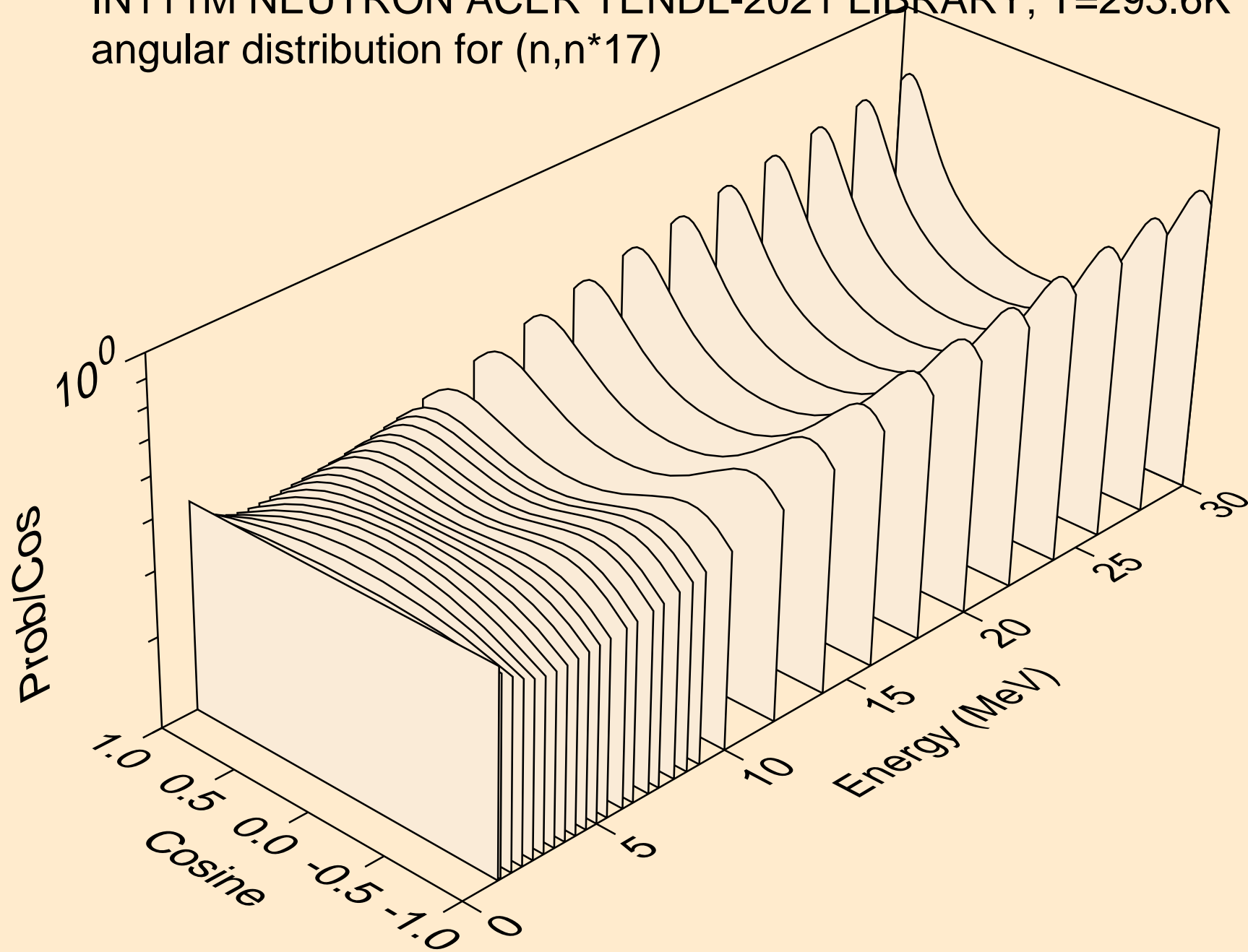



IN111M NEUTRON ACER TENDL-2021 LIBRARY; T=293.6K  
angular distribution for (n,n\*18)

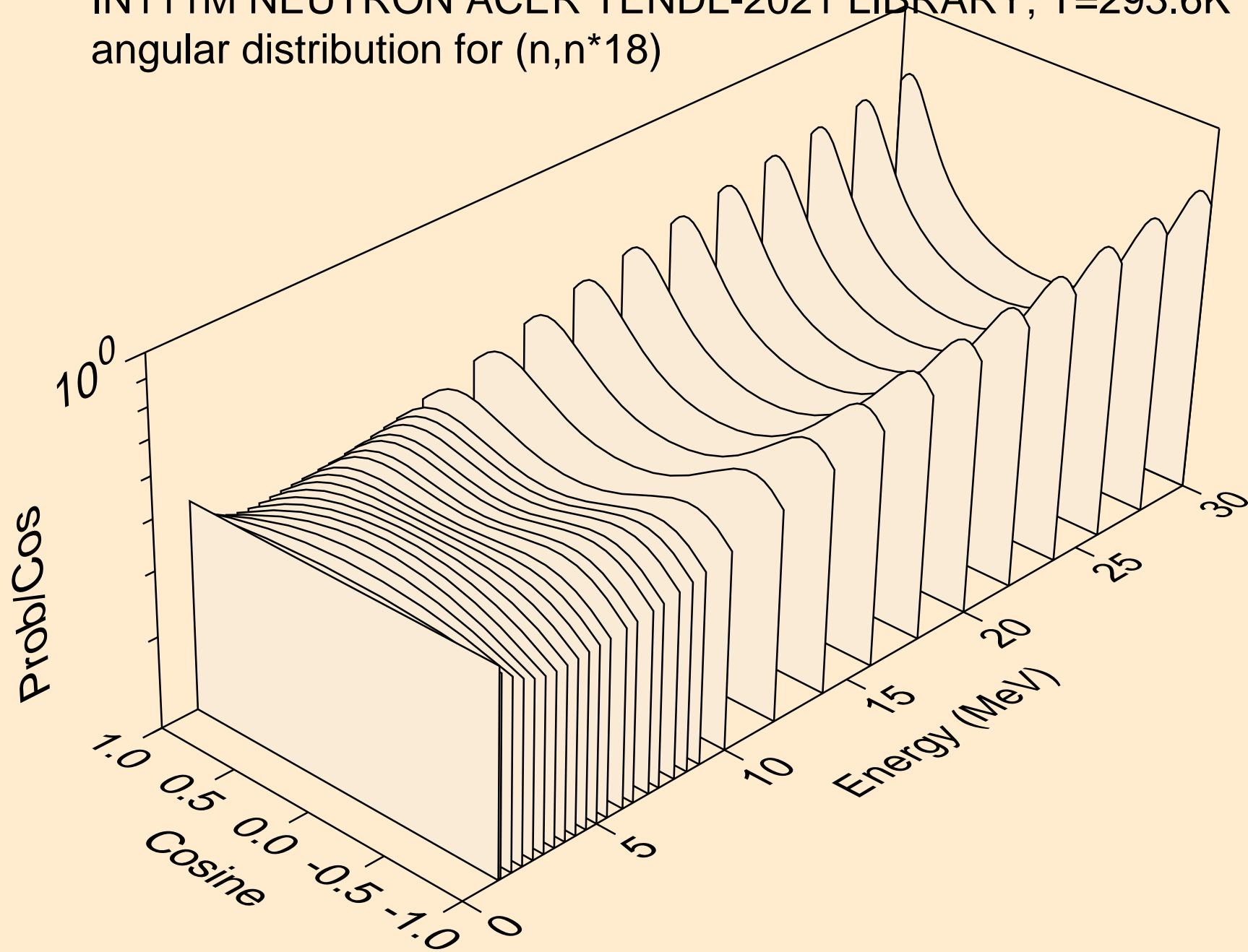

IN111M NEUTRON ACER TENDL-2021 LIBRARY; T=293.6K  
angular distribution for (n,n\*19)

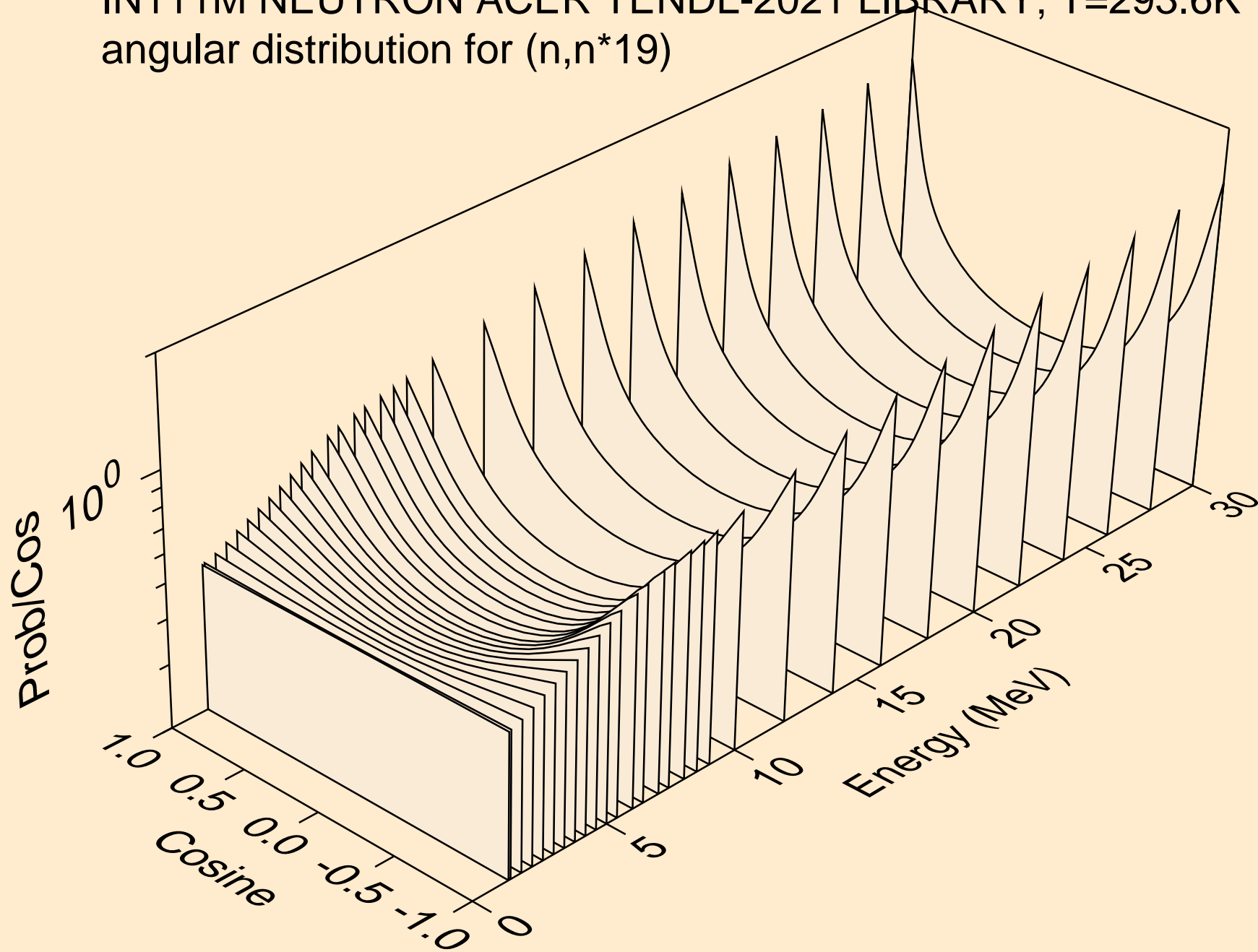

IN111M NEUTRON ACER TENDL-2021 LIBRARY; T=293.6K  
angular distribution for (n,n\*20)

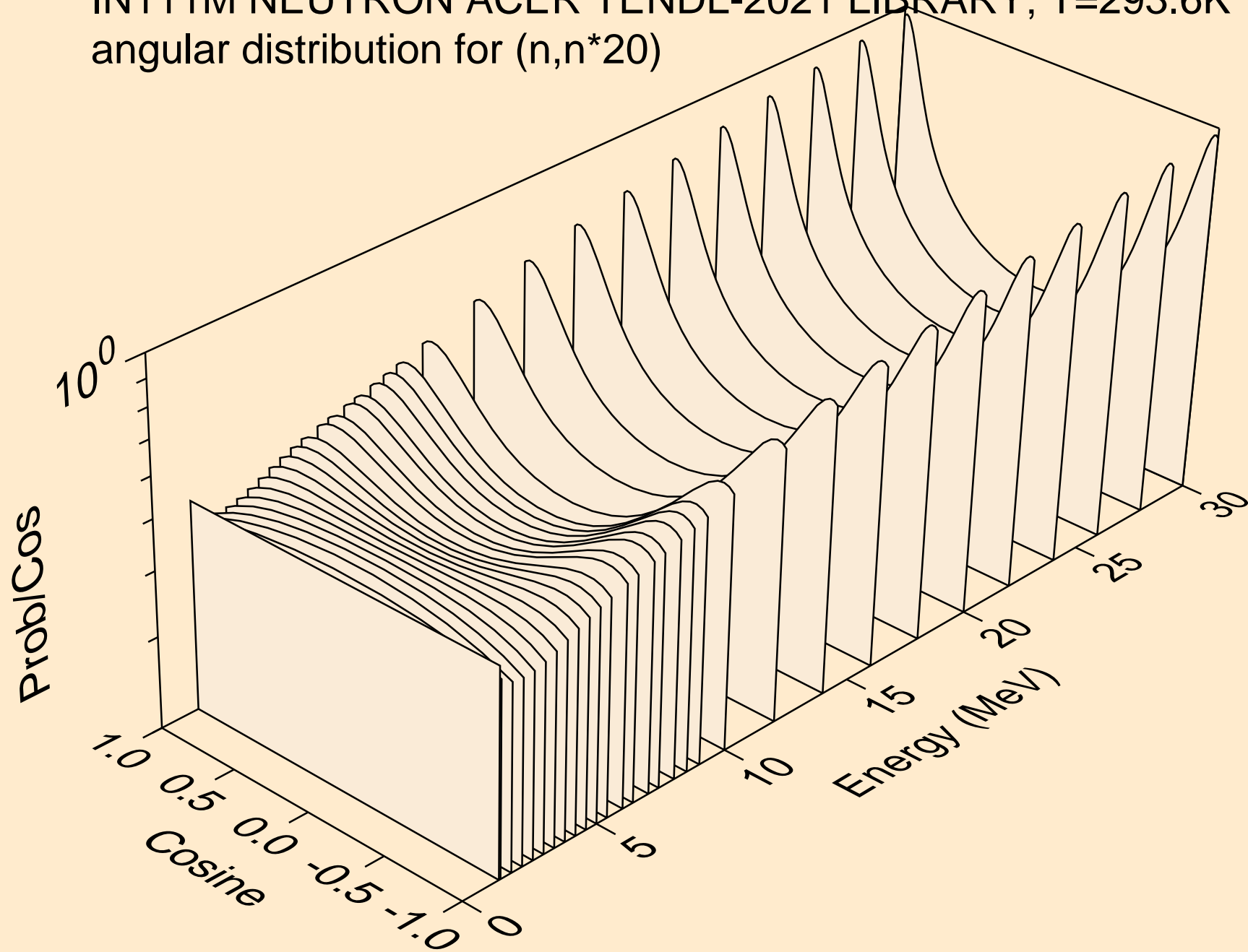

IN111M NEUTRON ACER TENDL-2021 LIBRARY; T=293.6K  
angular distribution for (n,n\*21)

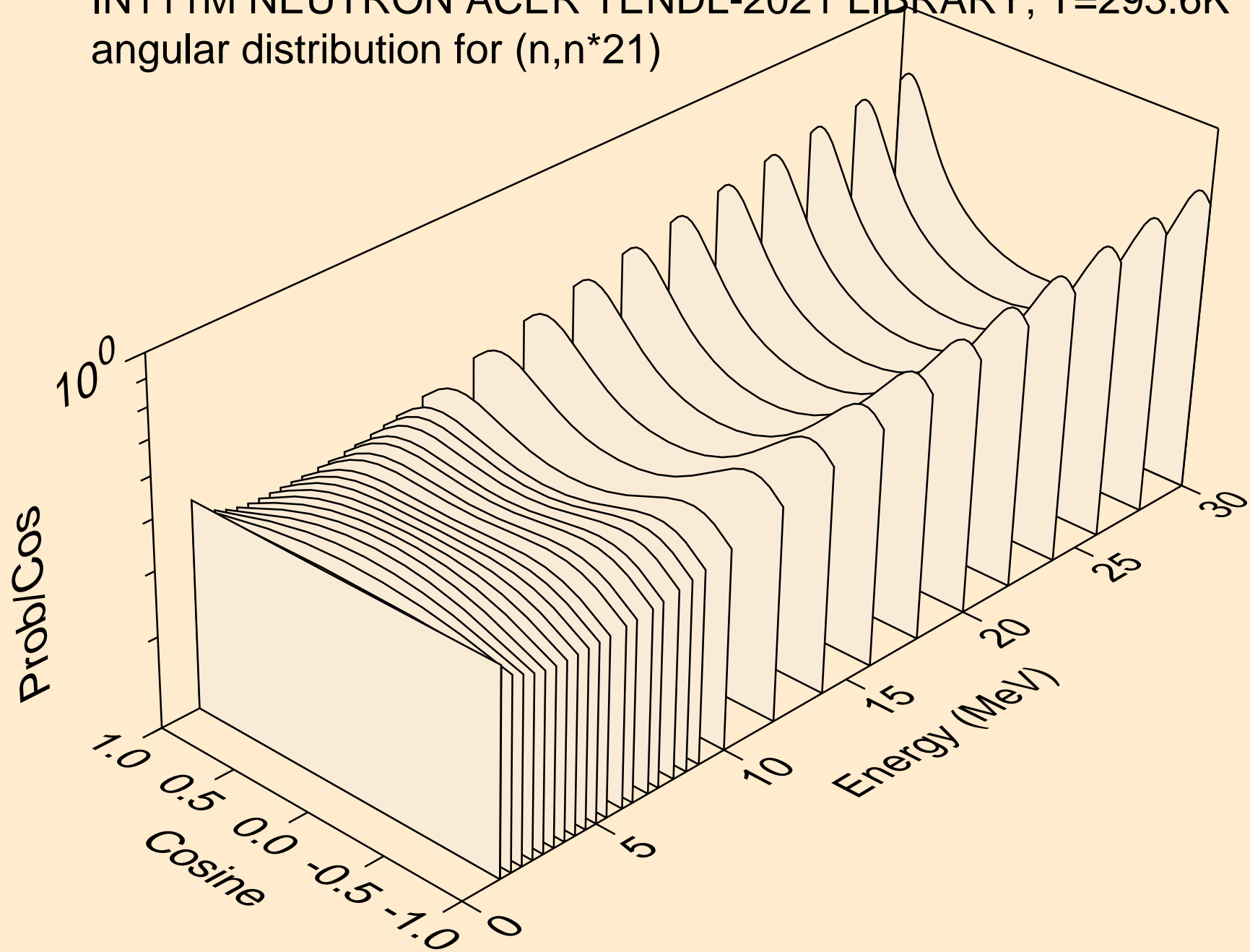

IN111M NEUTRON ACER TENDL-2021 LIBRARY; T=293.6K  
angular distribution for (n,n\*22)

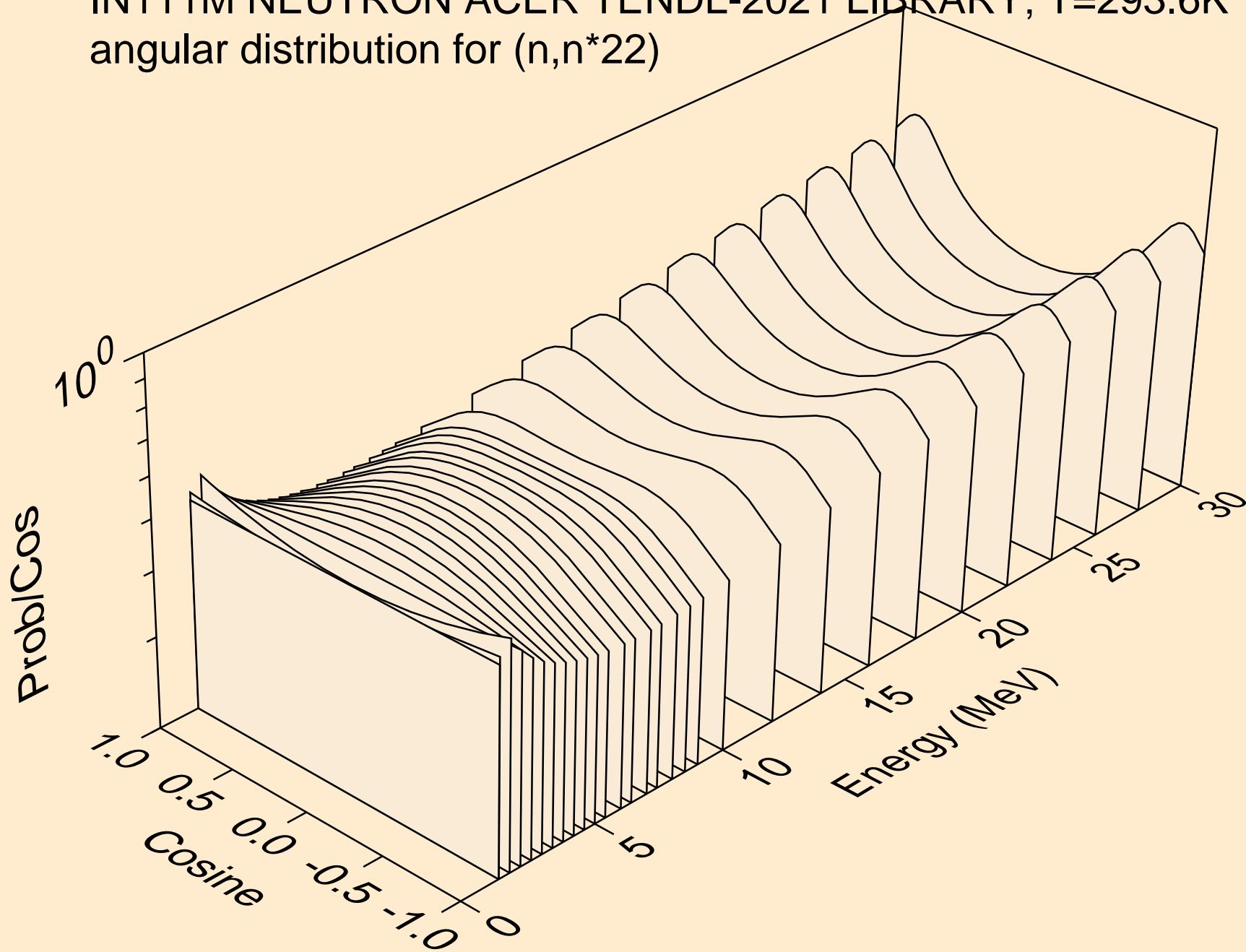

IN111M NEUTRON ACER TENDL-2021 LIBRARY; T=293.6K  
angular distribution for (n,n\*23)

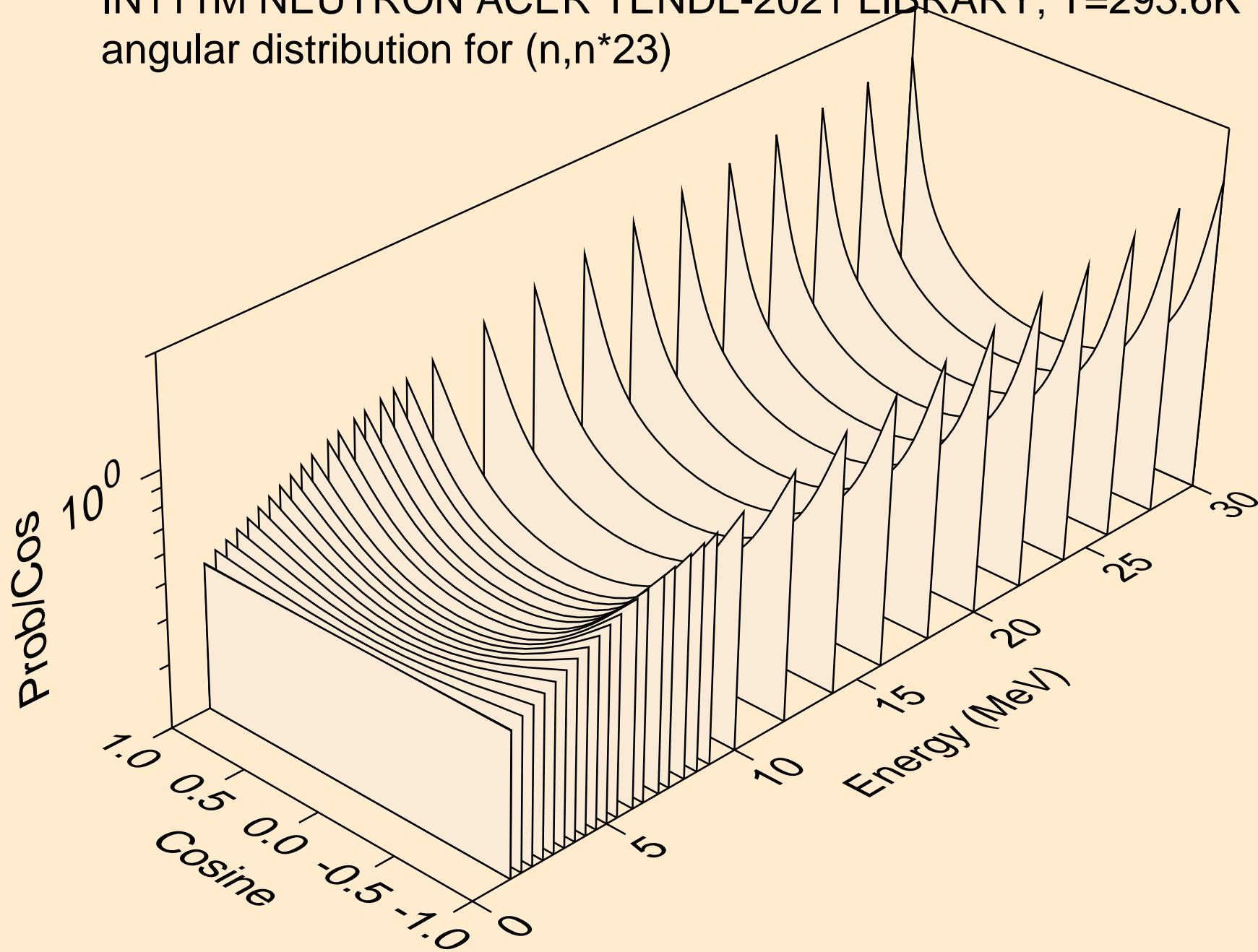

IN111M NEUTRON ACER TENDL-2021 LIBRARY; T=293.6K  
angular distribution for (n,n\*24)

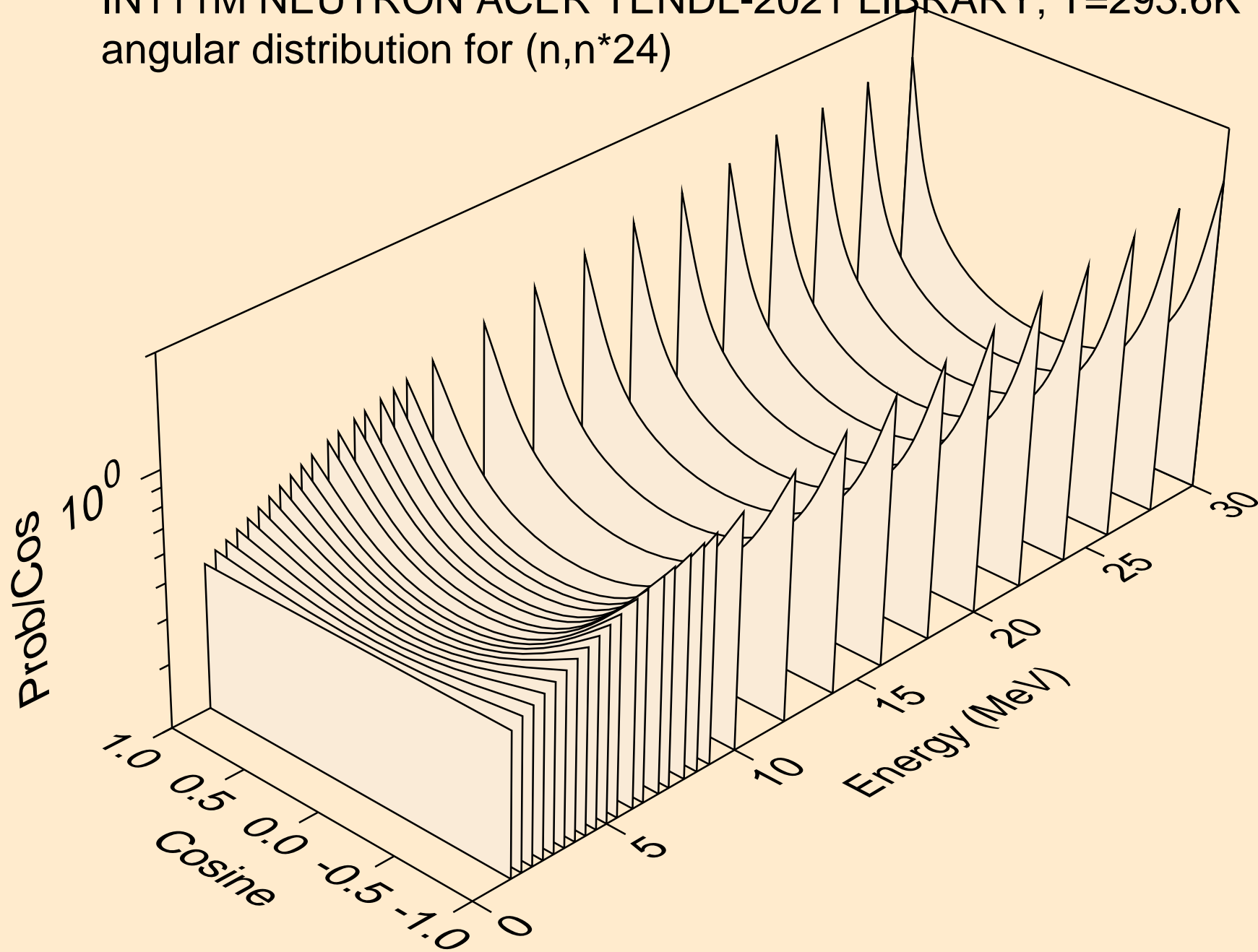

IN111M NEUTRON ACER TENDL-2021 LIBRARY; T=293.6K  
angular distribution for (n,n\*25)

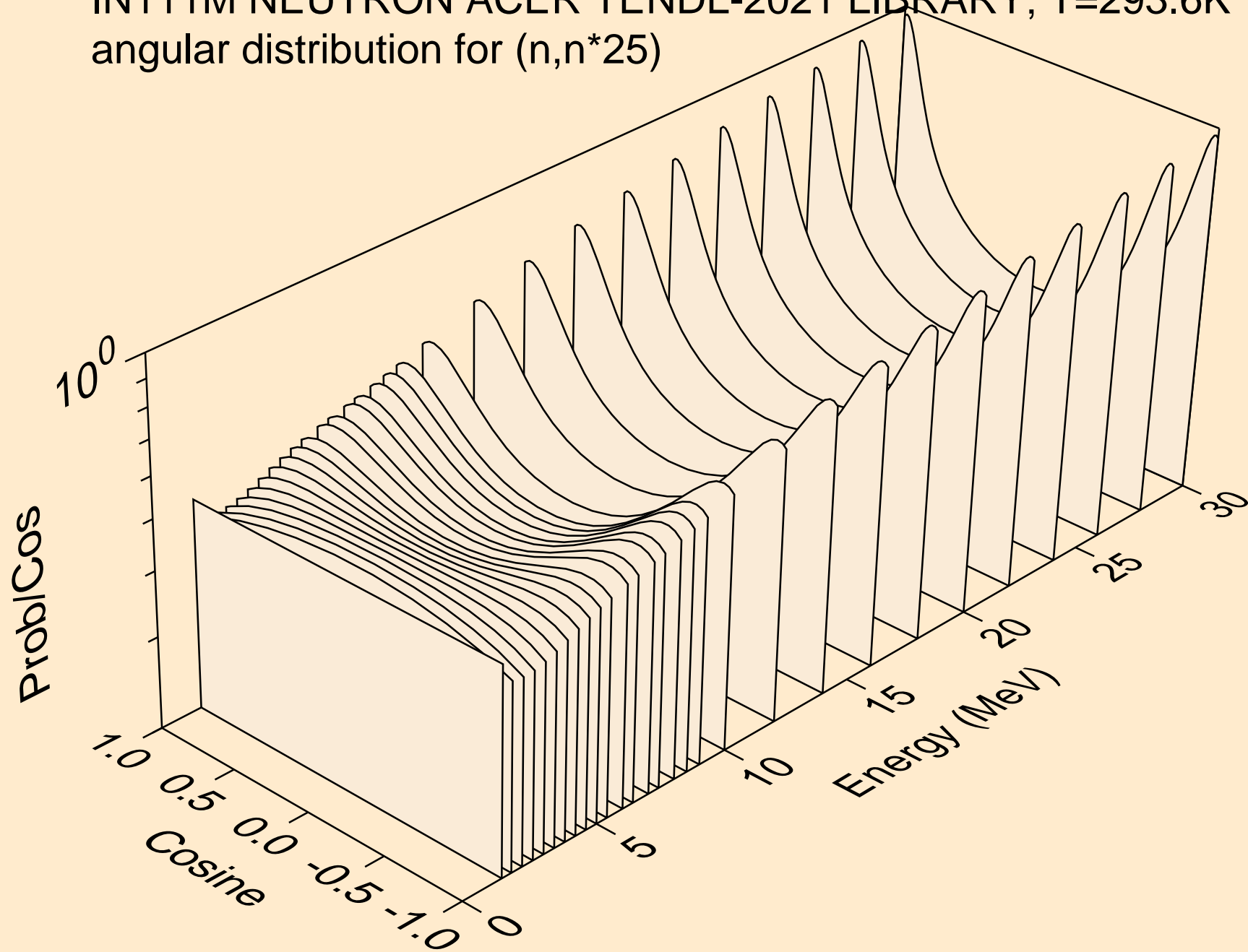



IN111M NEUTRON ACER TENDL-2021 LIBRARY; T=293.6K  
angular distribution for (n,n\*26)

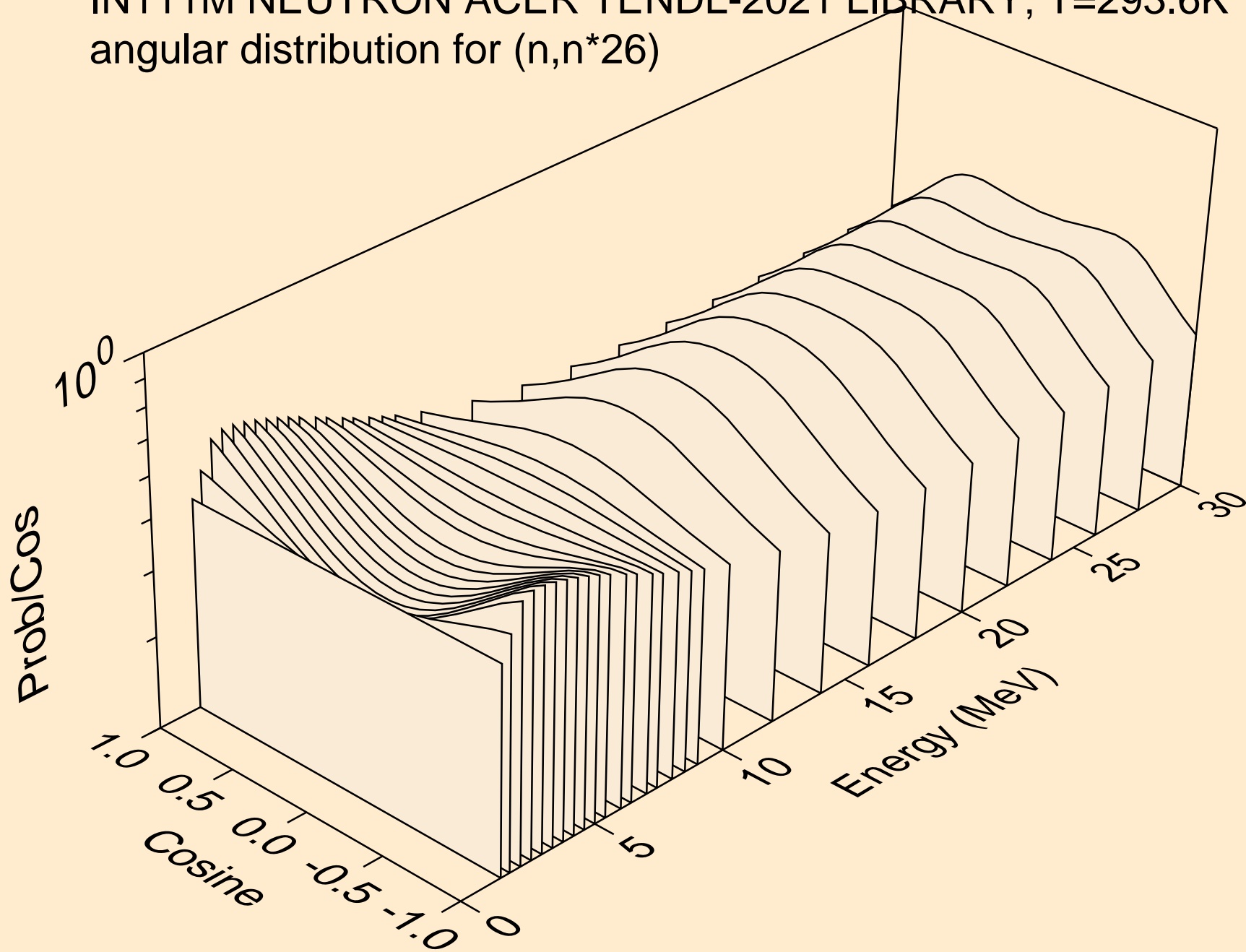

IN111M NEUTRON ACER TENDL-2021 LIBRARY; T=293.6K  
angular distribution for (n,n\*27)

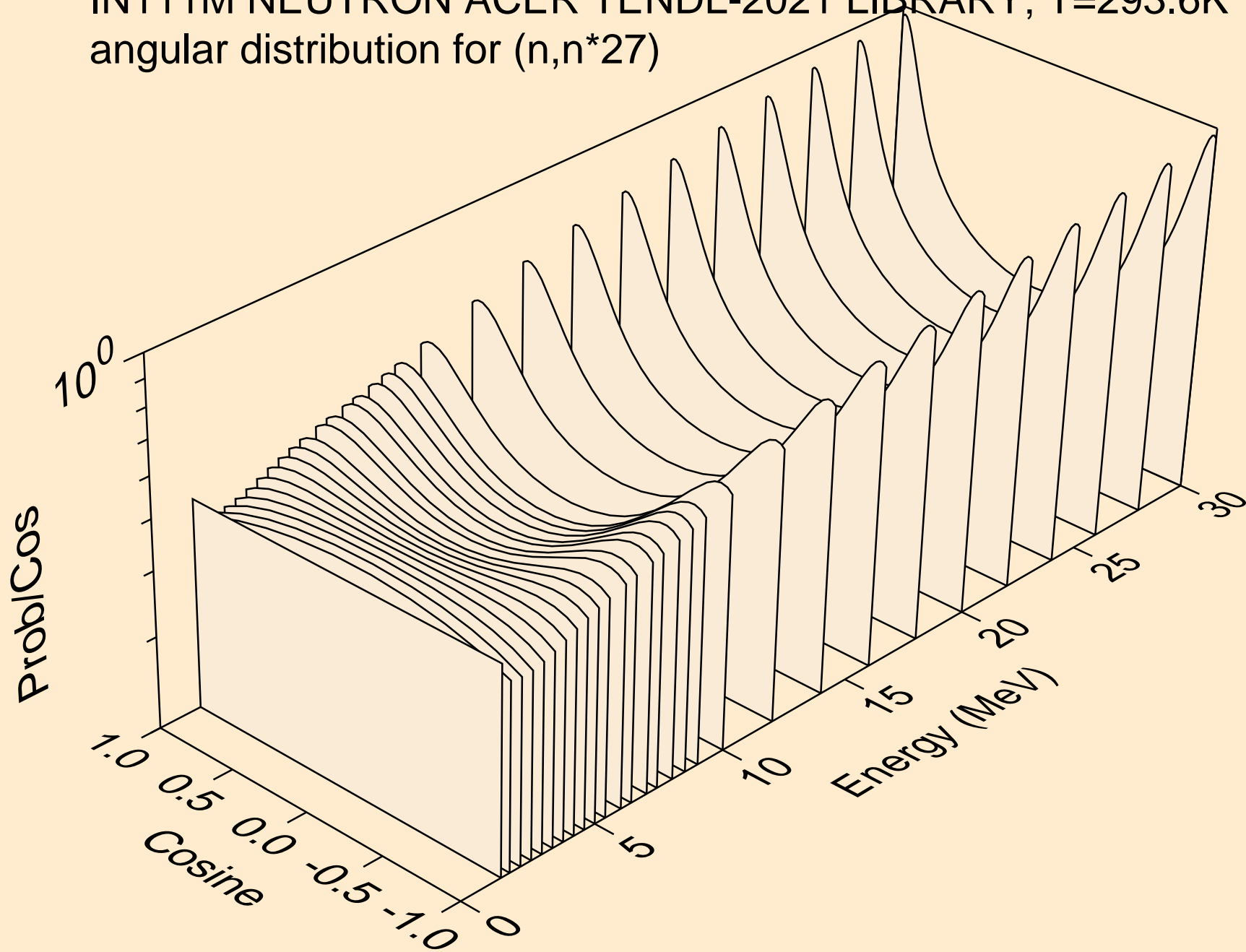

IN111M NEUTRON ACER TENDL-2021 LIBRARY; T=293.6K  
angular distribution for (n,n\*28)

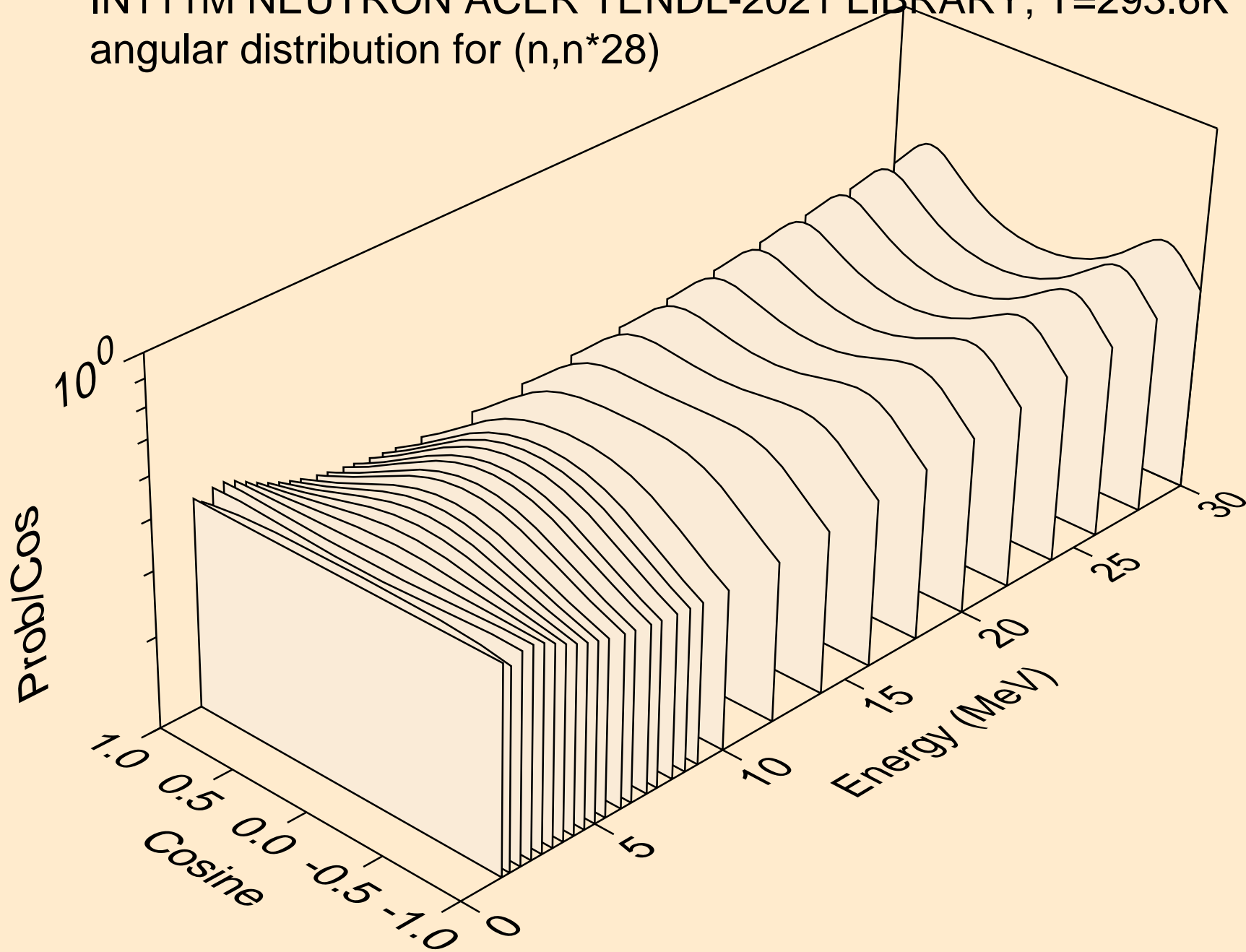

IN111M NEUTRON ACER TENDL-2021 LIBRARY; T=293.6K  
angular distribution for (n,n\*29)

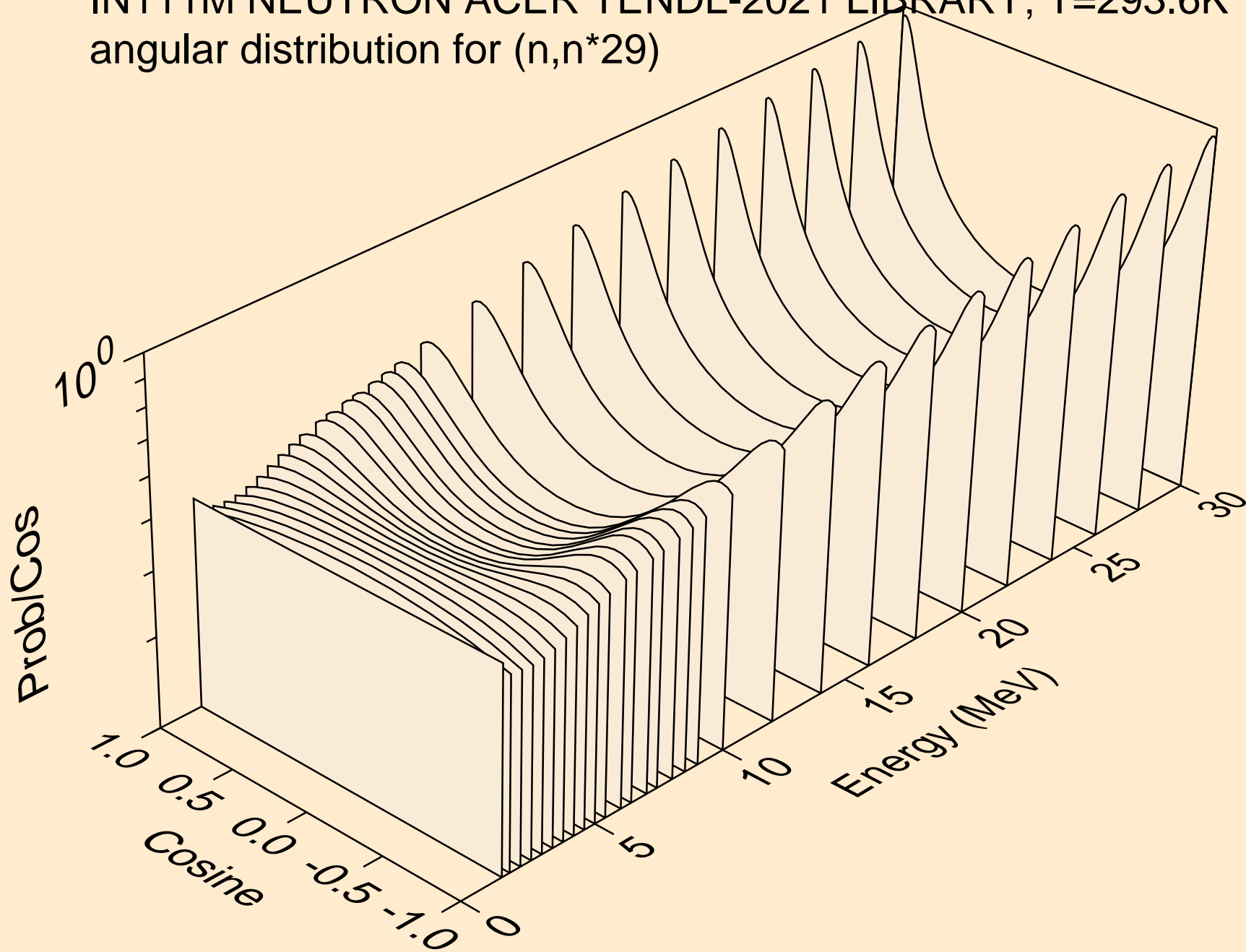

IN111M NEUTRON ACER TENDL-2021 LIBRARY; T=293.6K  
angular distribution for (n,n\*30)

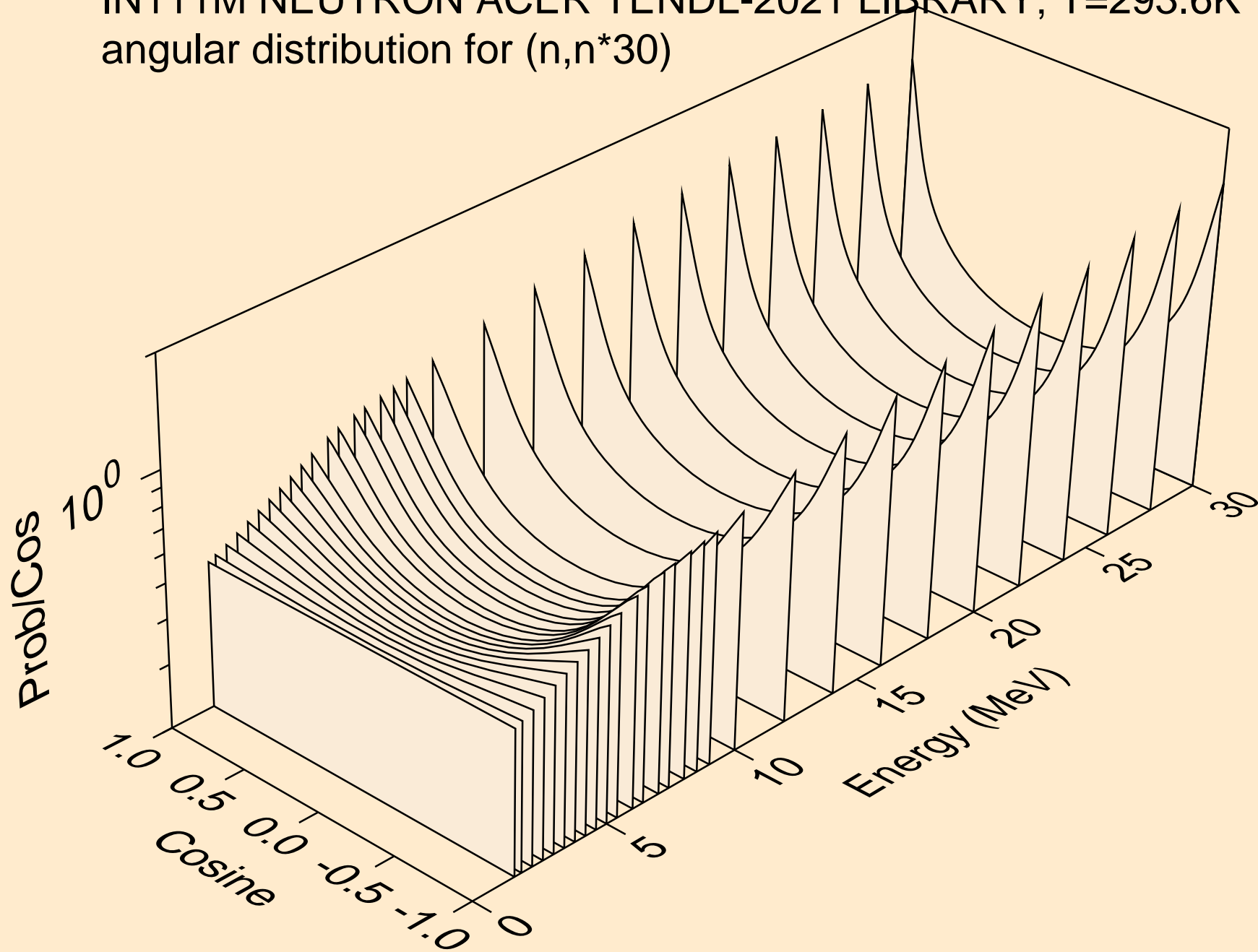

IN111M NEUTRON ACER TENDL-2021 LIBRARY; T=293.6K  
Neutron emission for (n,x)

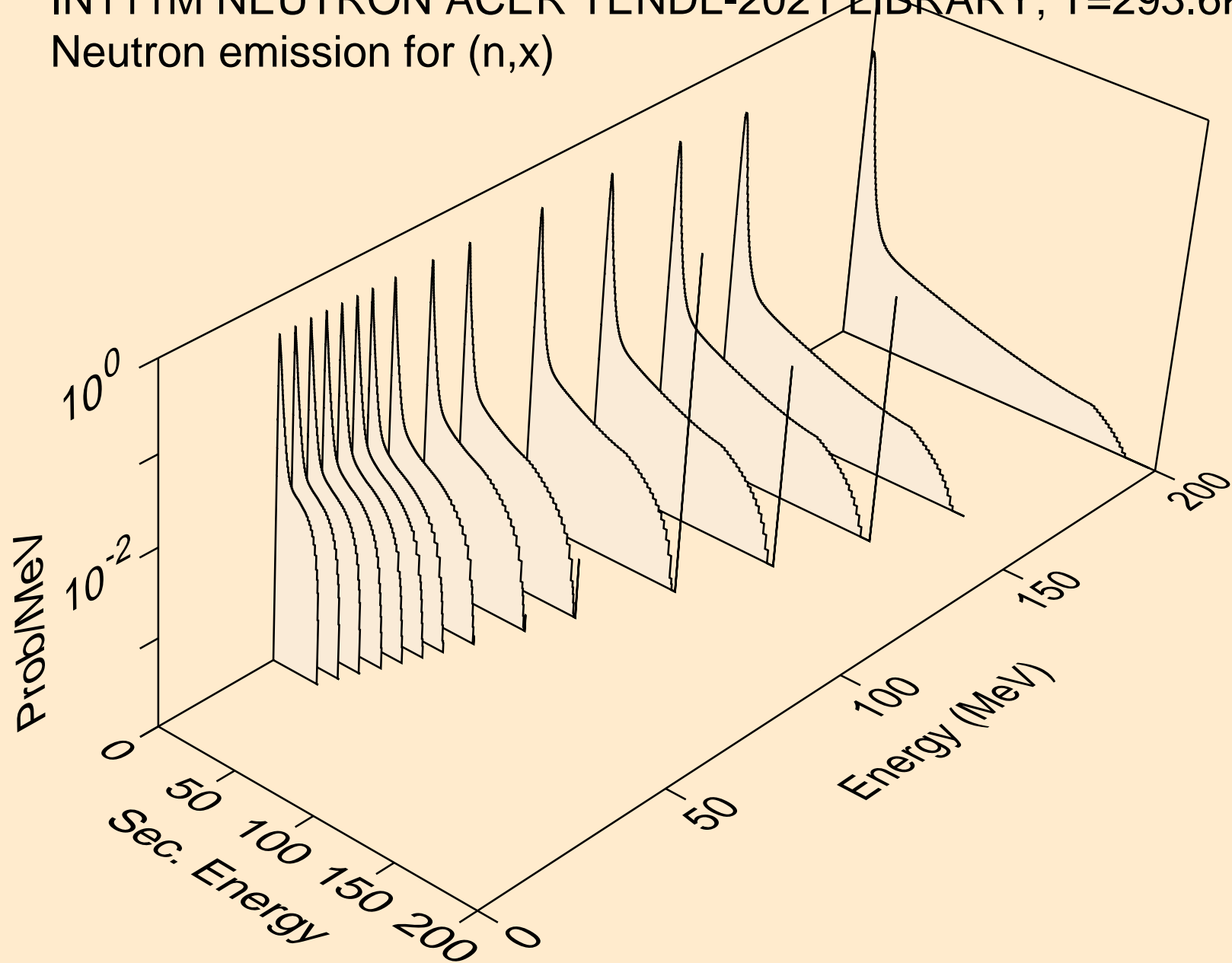

IN111M NEUTRON ACER TENDL-2021 LIBRARY; T=293.6K  
Neutron emission for (n,2nd)

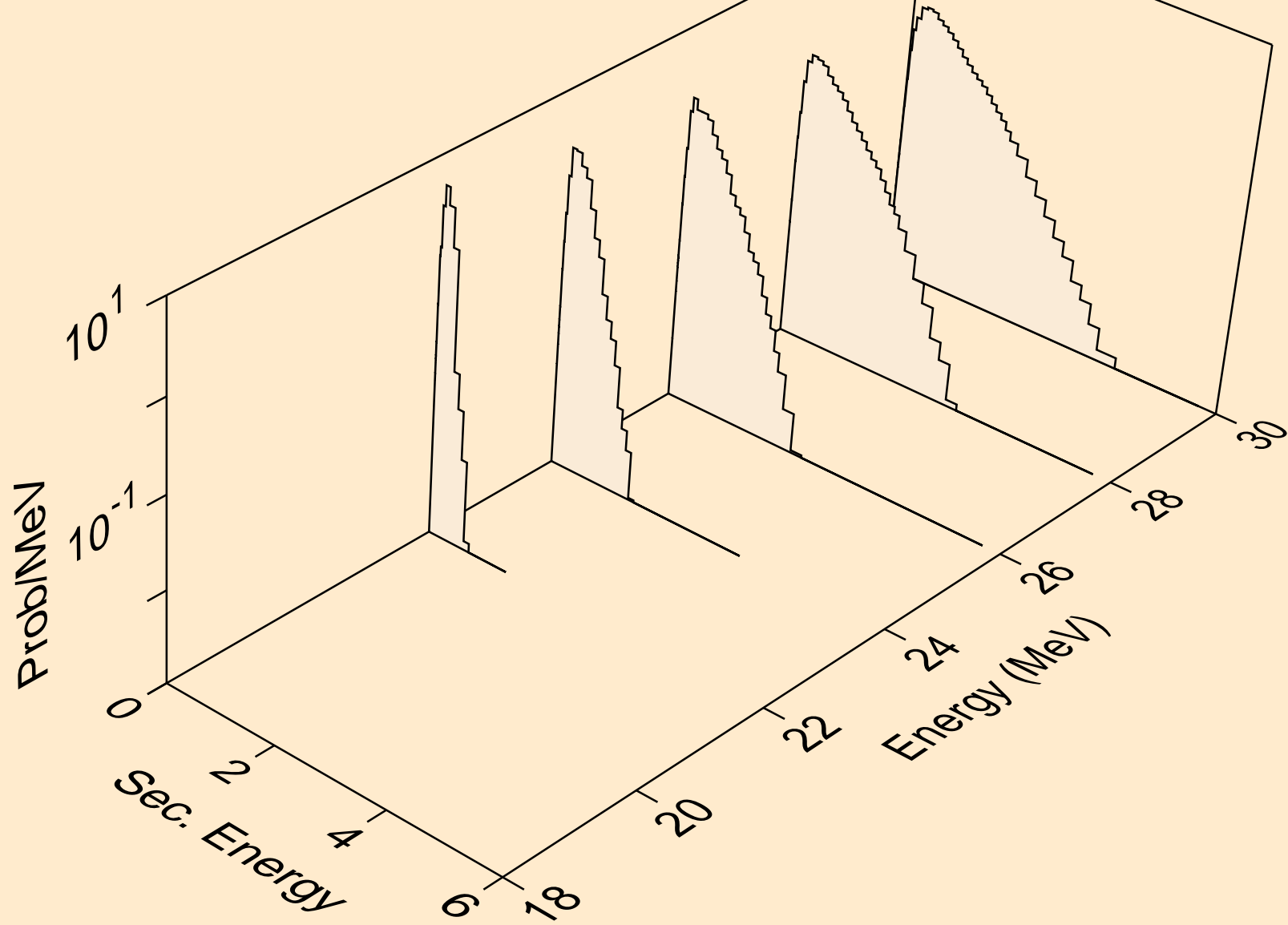

IN111M NEUTRON ACER TENDL-2021 LIBRARY; T=293.6K  
Neutron emission for (n,2n)

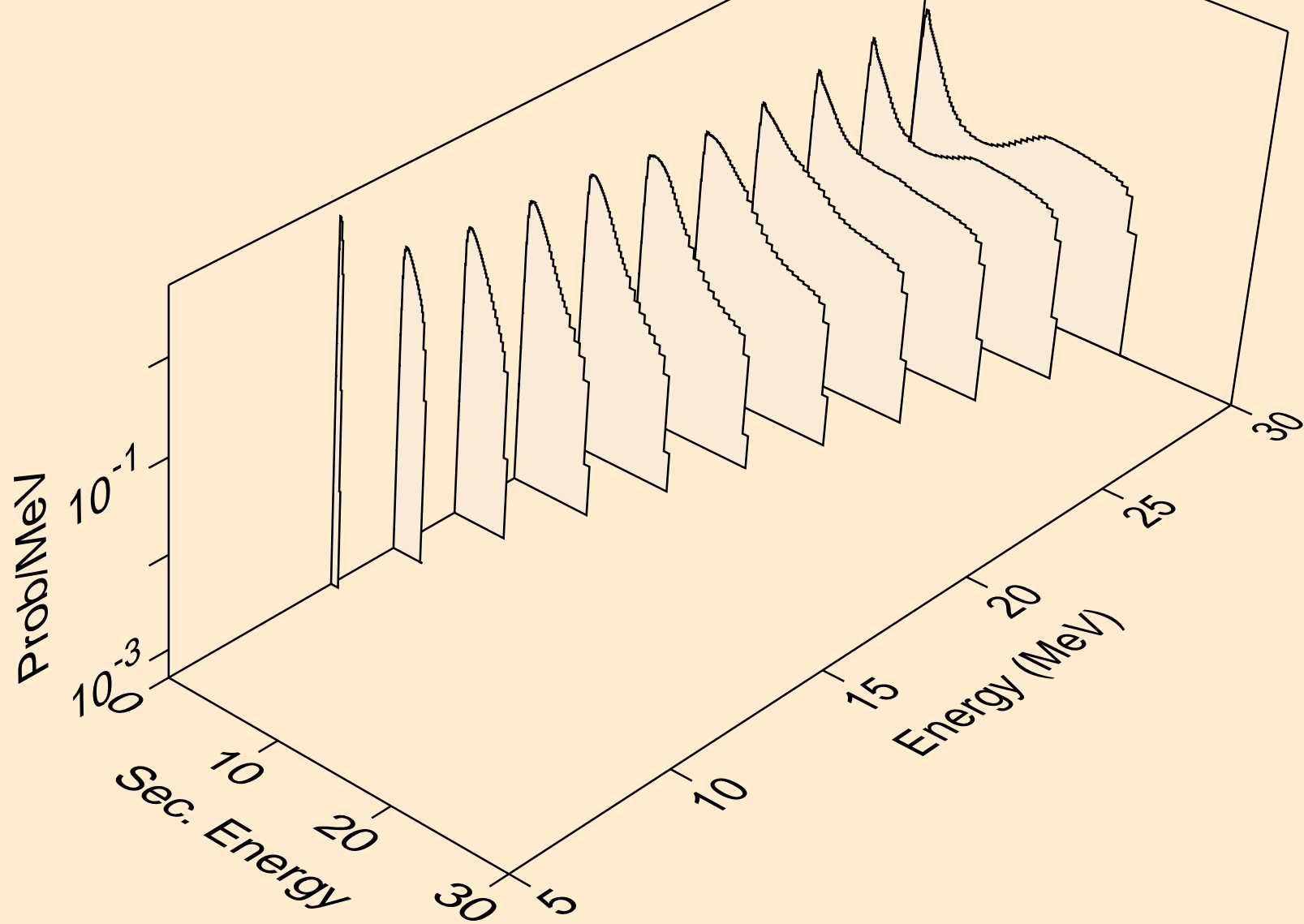



IN111M NEUTRON ACER TENDL-2021 LIBRARY; T=293.6K  
Neutron emission for (n,3n)

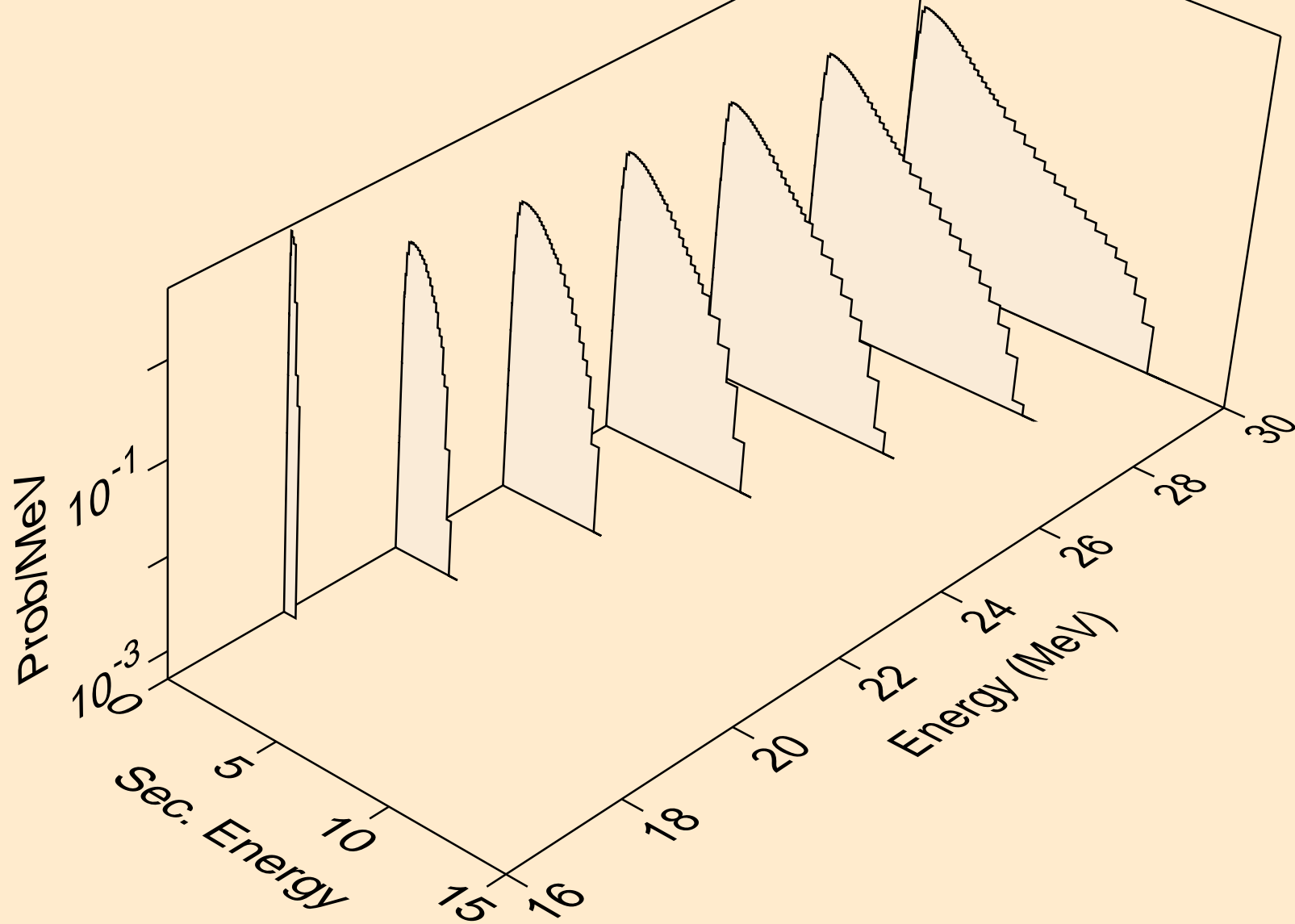

IN111M NEUTRON ACER TENDL-2021 LIBRARY; T=293.6K  
Neutron emission for (n,n\*)a

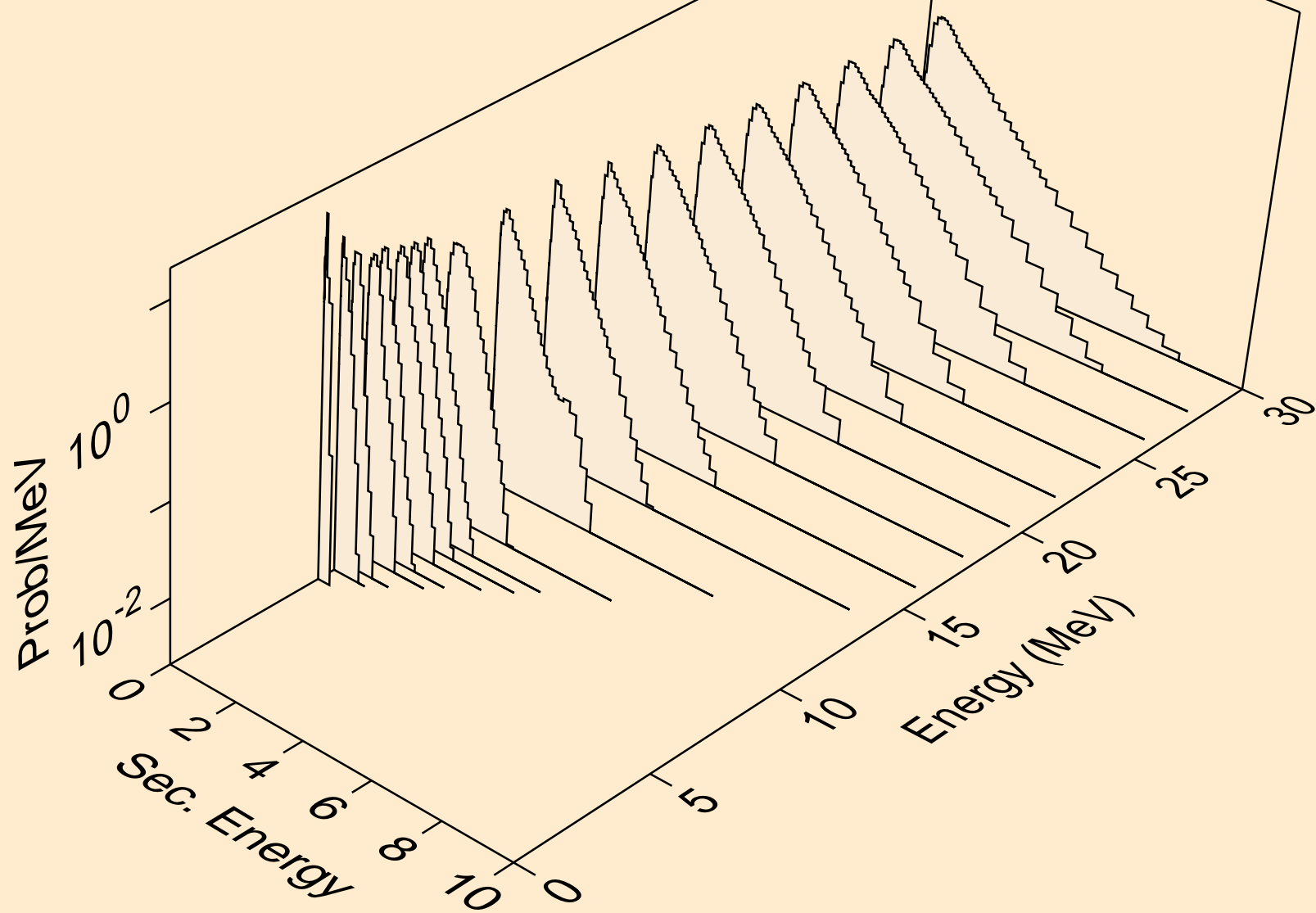

IN111M NEUTRON ACER TENDL-2021 LIBRARY; T=293.6K  
Neutron emission for (n,2n)<sub>a</sub>

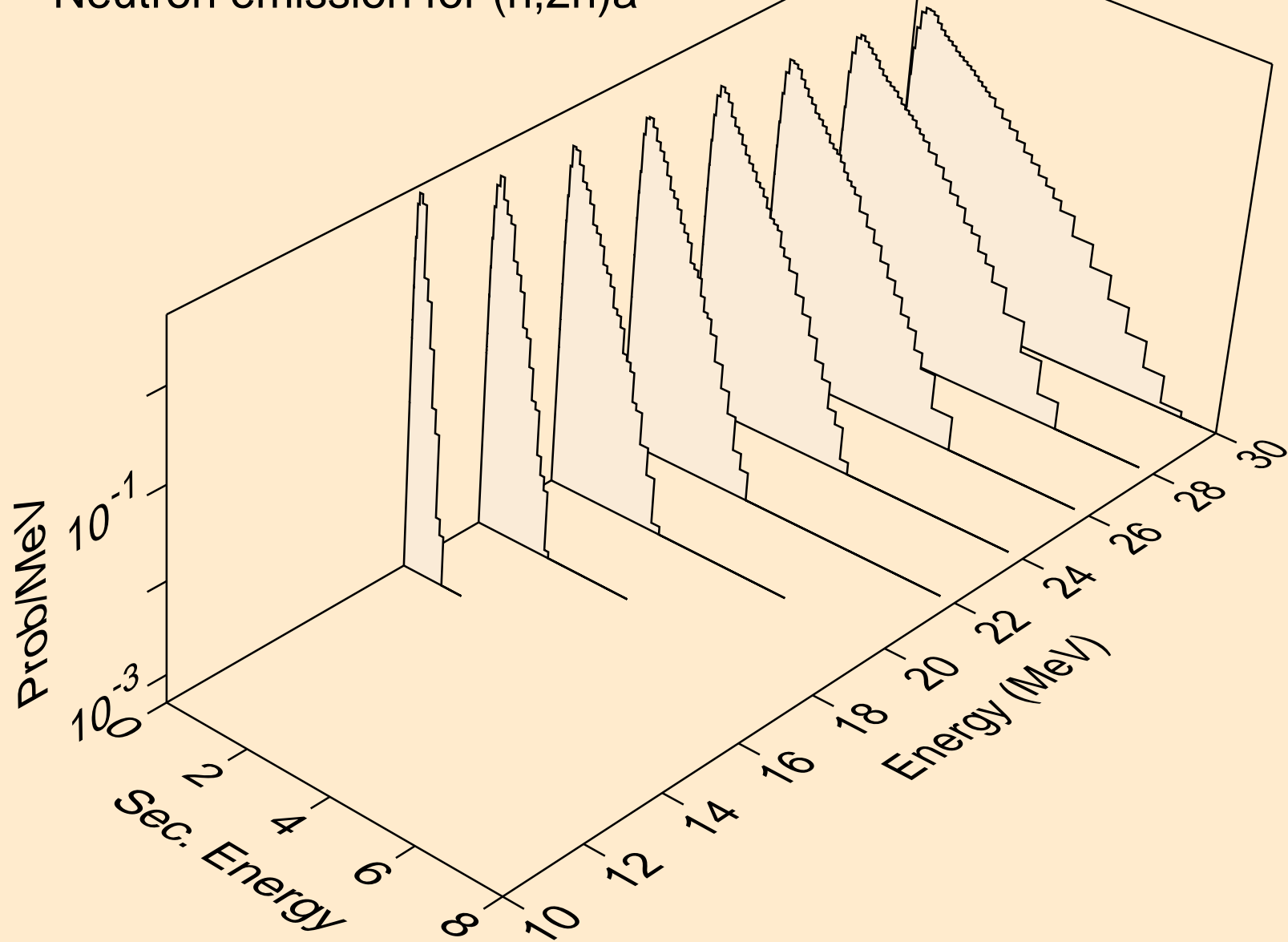

IN111M NEUTRON ACER TENDL-2021 LIBRARY; T=293.6K  
Neutron emission for (n,3n)a

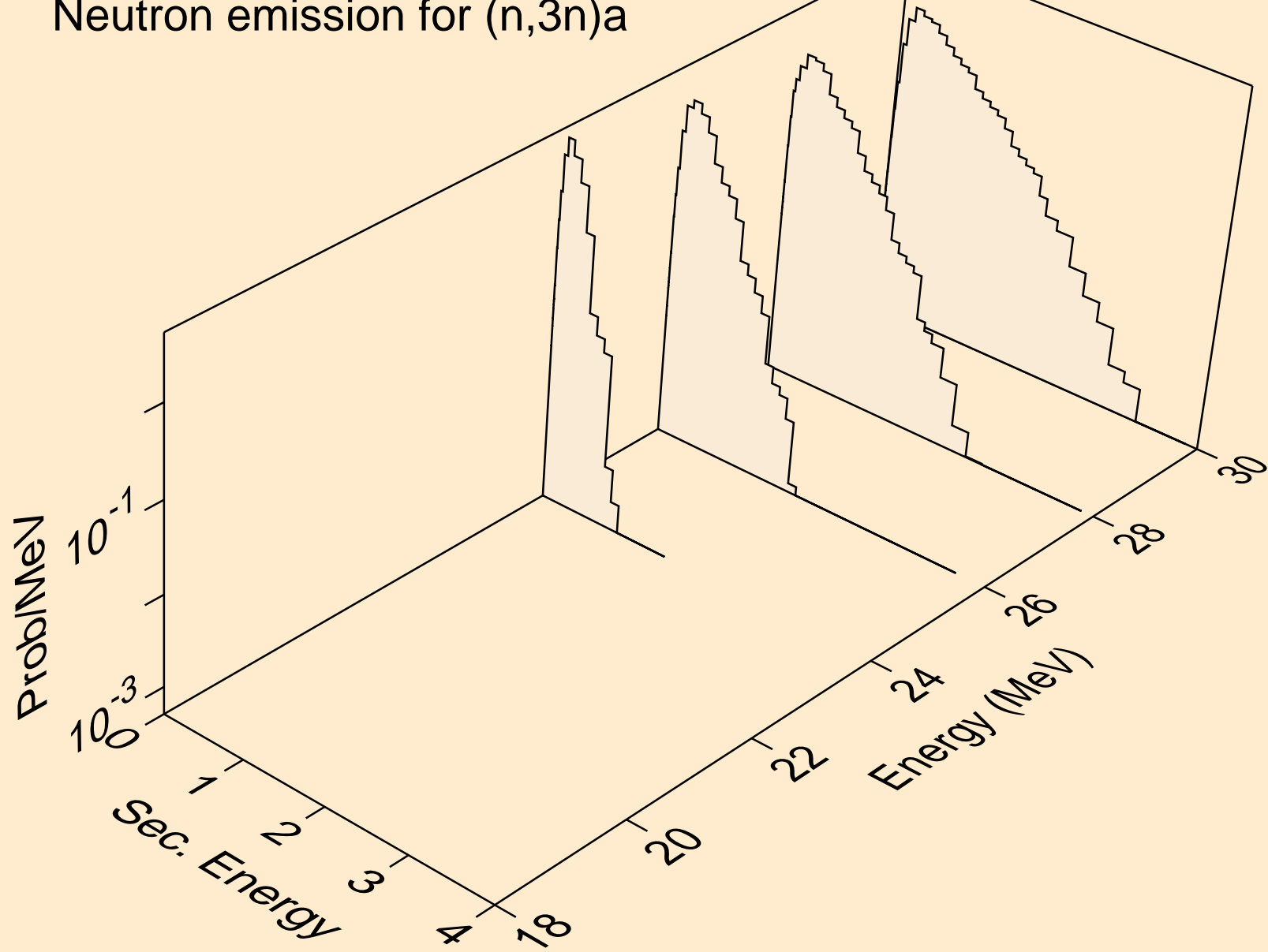

IN111M NEUTRON ACER TENDL-2021 LIBRARY; T=293.6K  
Neutron emission for (n,n\*)p

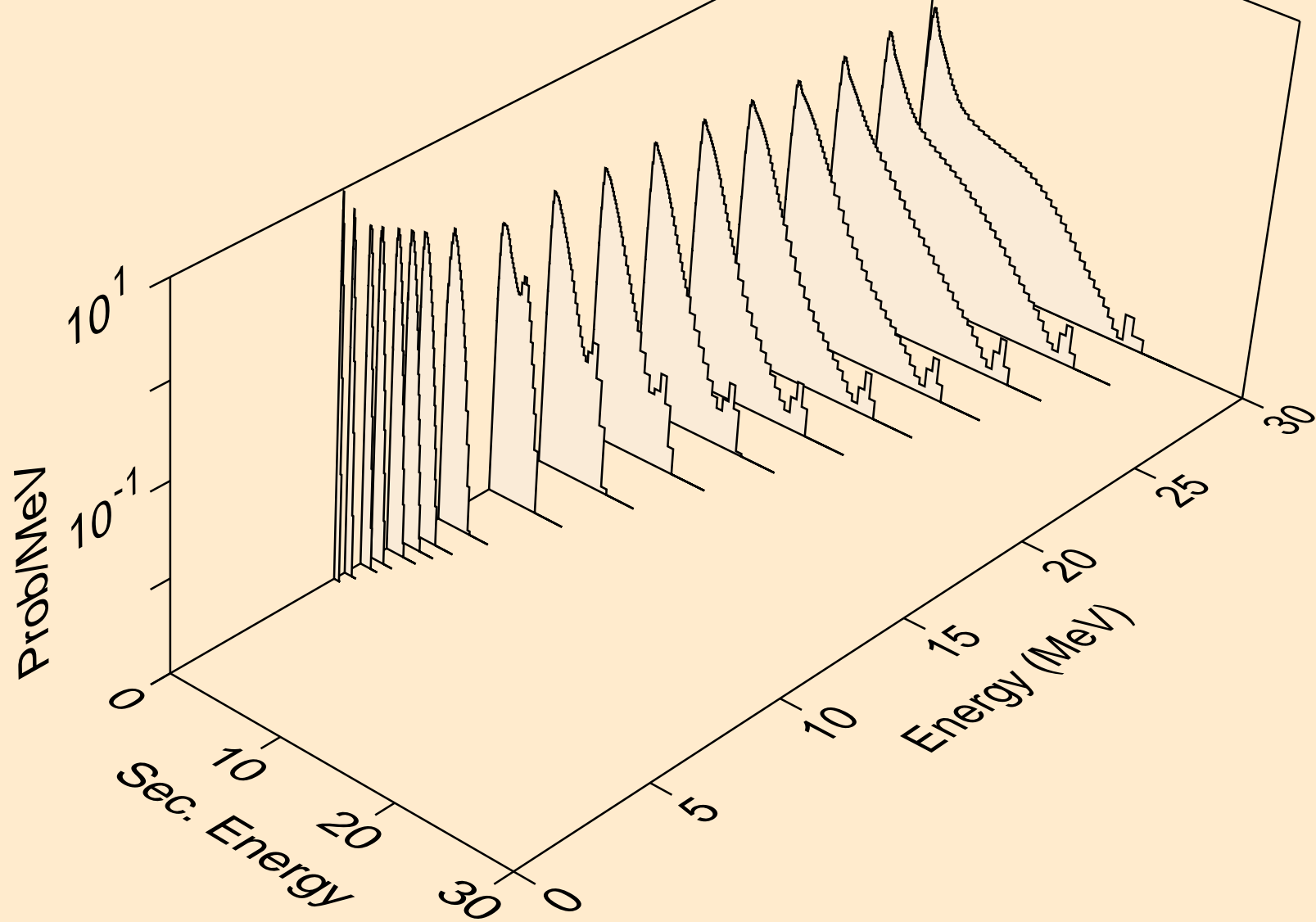

IN111M NEUTRON ACER TENDL-2021 LIBRARY; T=293.6K  
Neutron emission for (n,n\*)2a

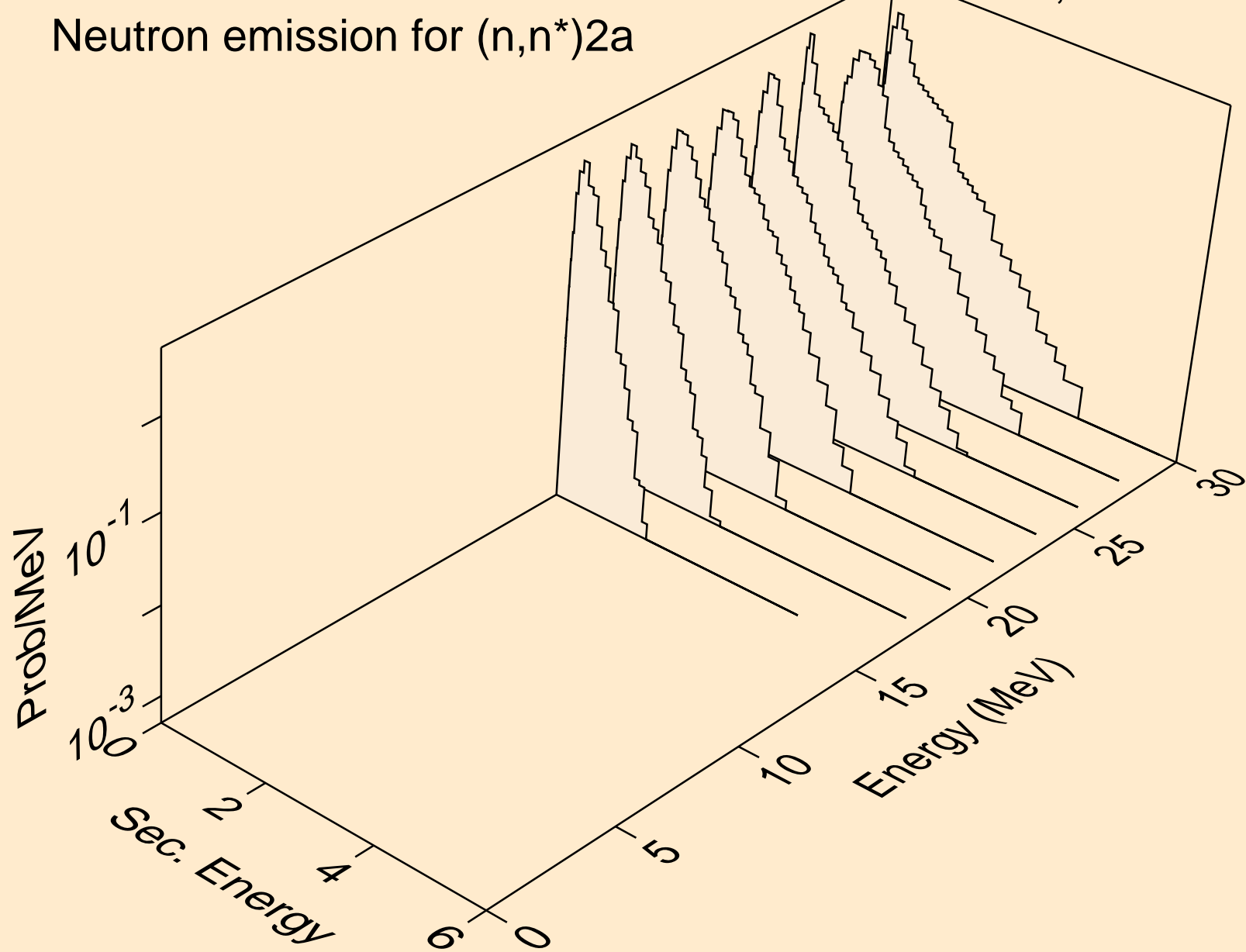

IN111M NEUTRON ACER TENDL-2021 LIBRARY; T=293.6K  
Neutron emission for (n,n\*)d

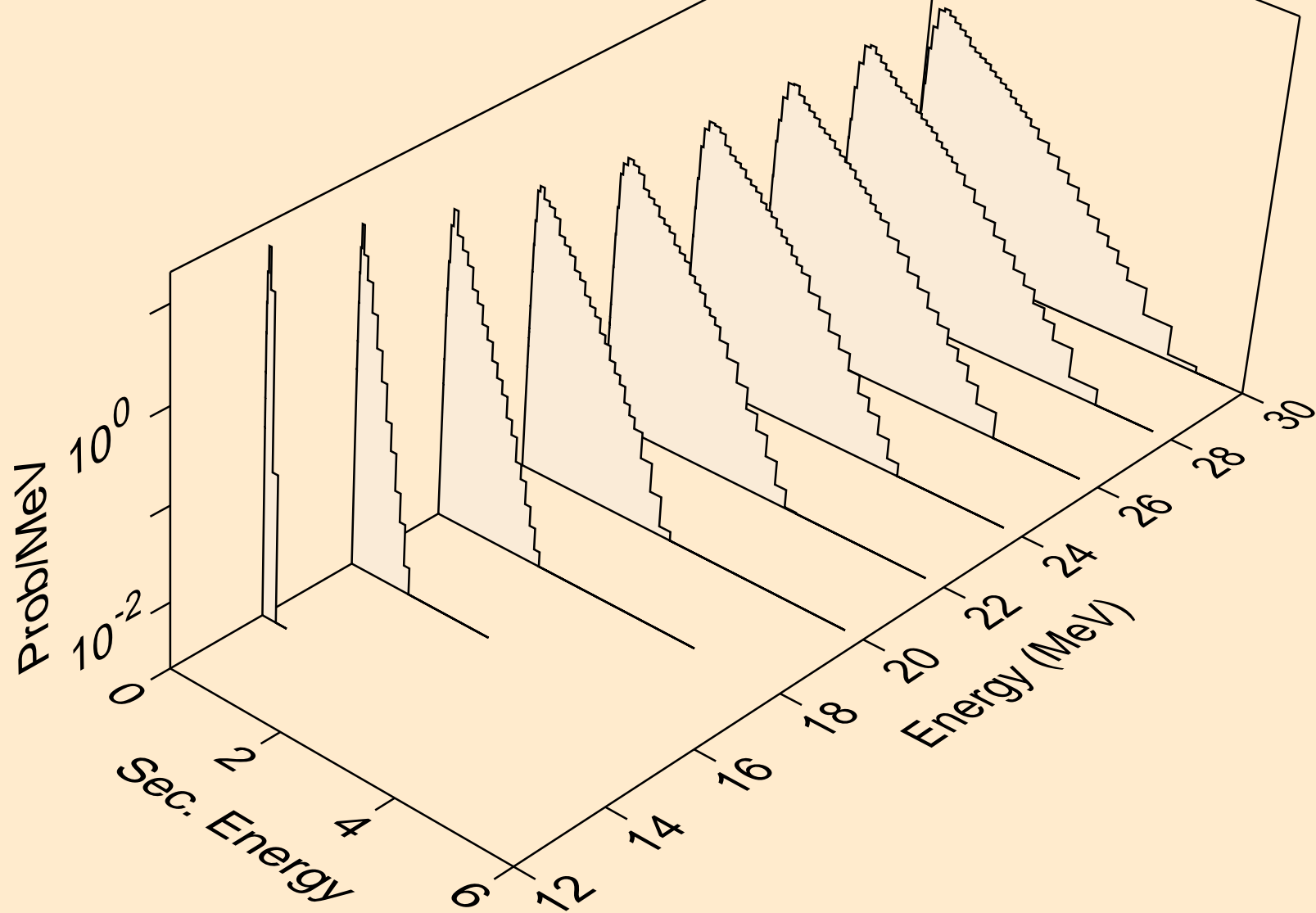

IN111M NEUTRON ACER TENDL-2021 LIBRARY; T=293.6K  
Neutron emission for (n,n\*)t

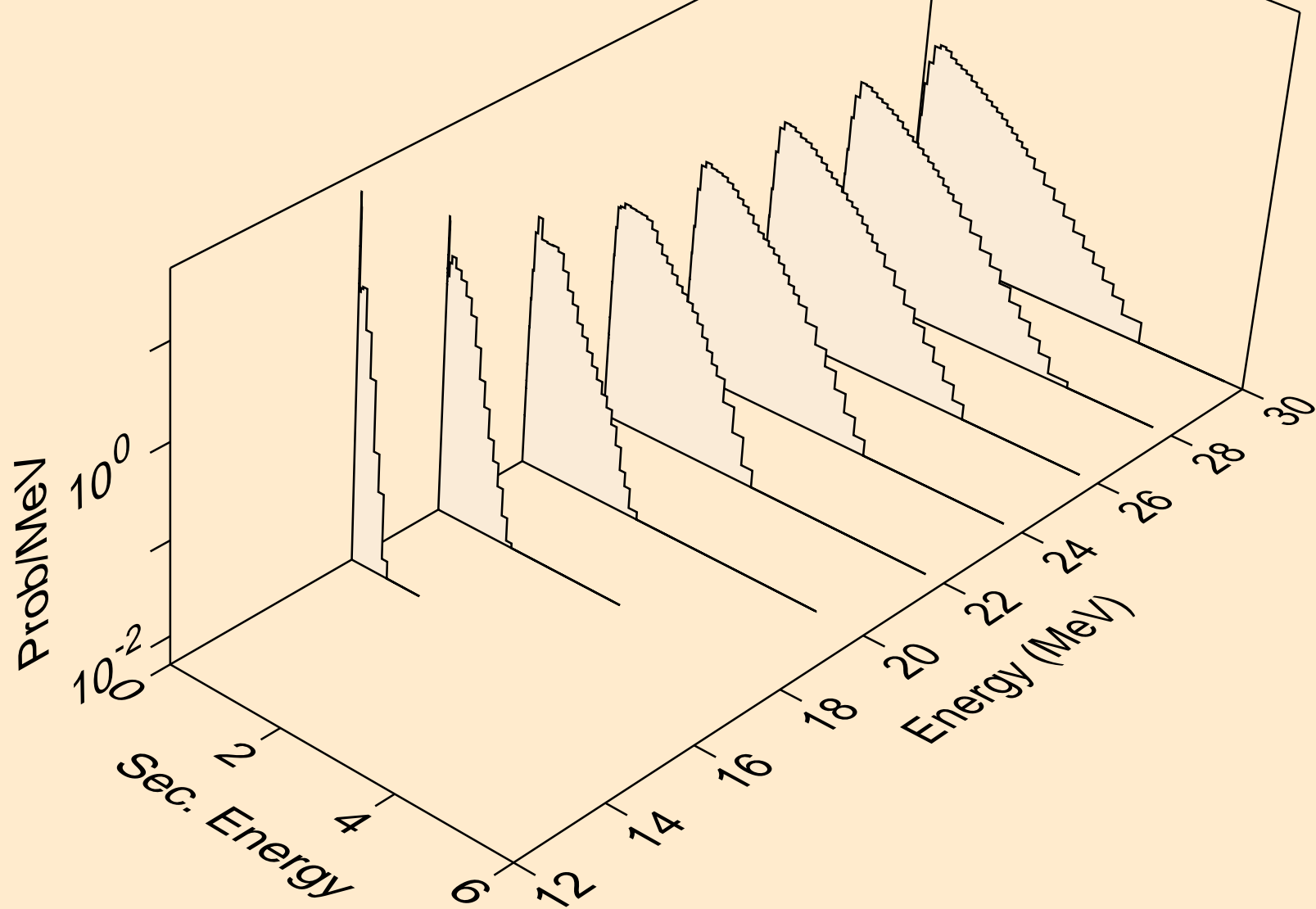



IN111M NEUTRON ACER TENDL-2021 LIBRARY; T=293.6K  
Neutron emission for (n,n\*)he3

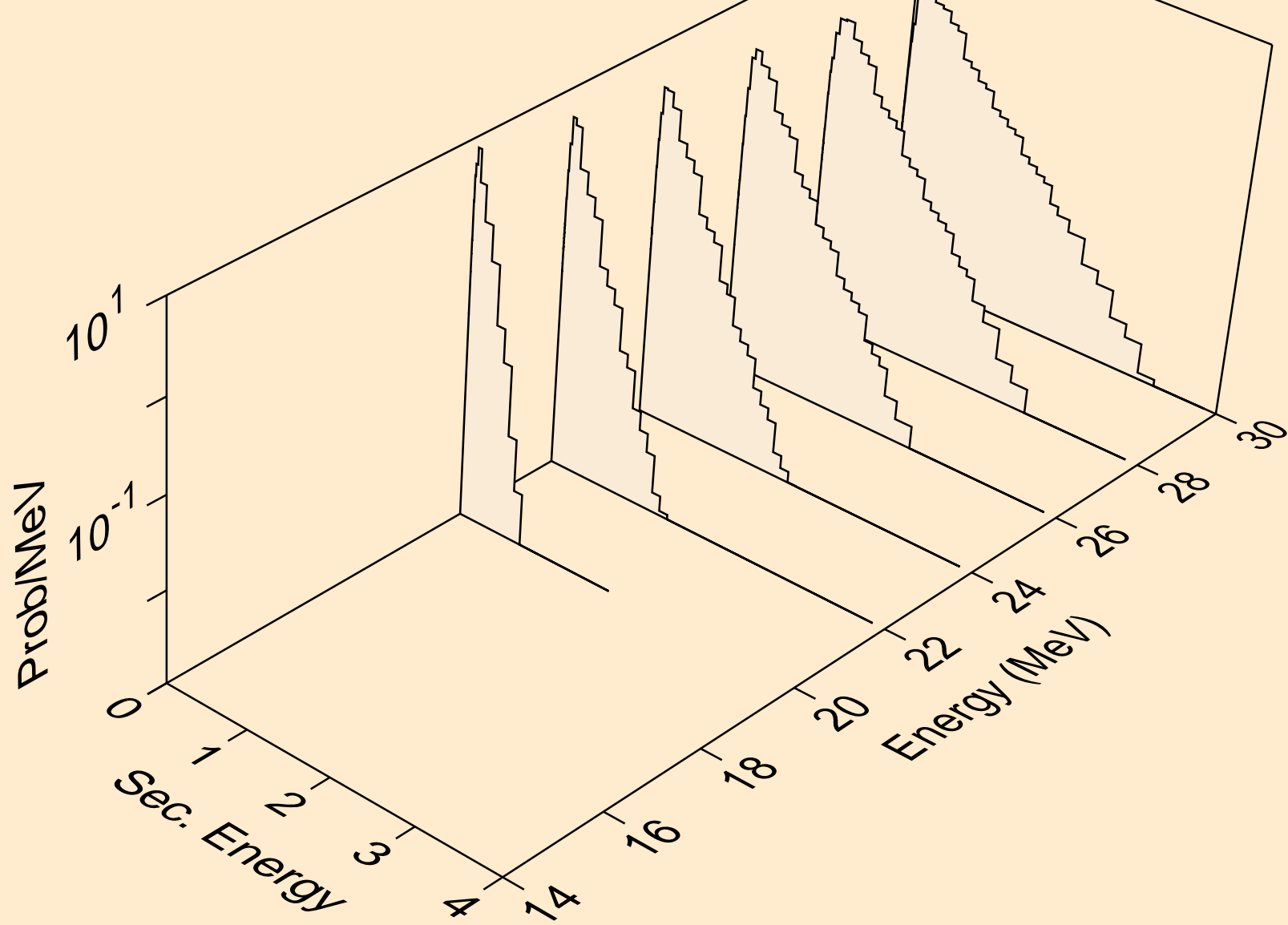

IN111M NEUTRON ACER TENDL-2021 LIBRARY; T=293.6K  
Neutron emission for (n,4n)

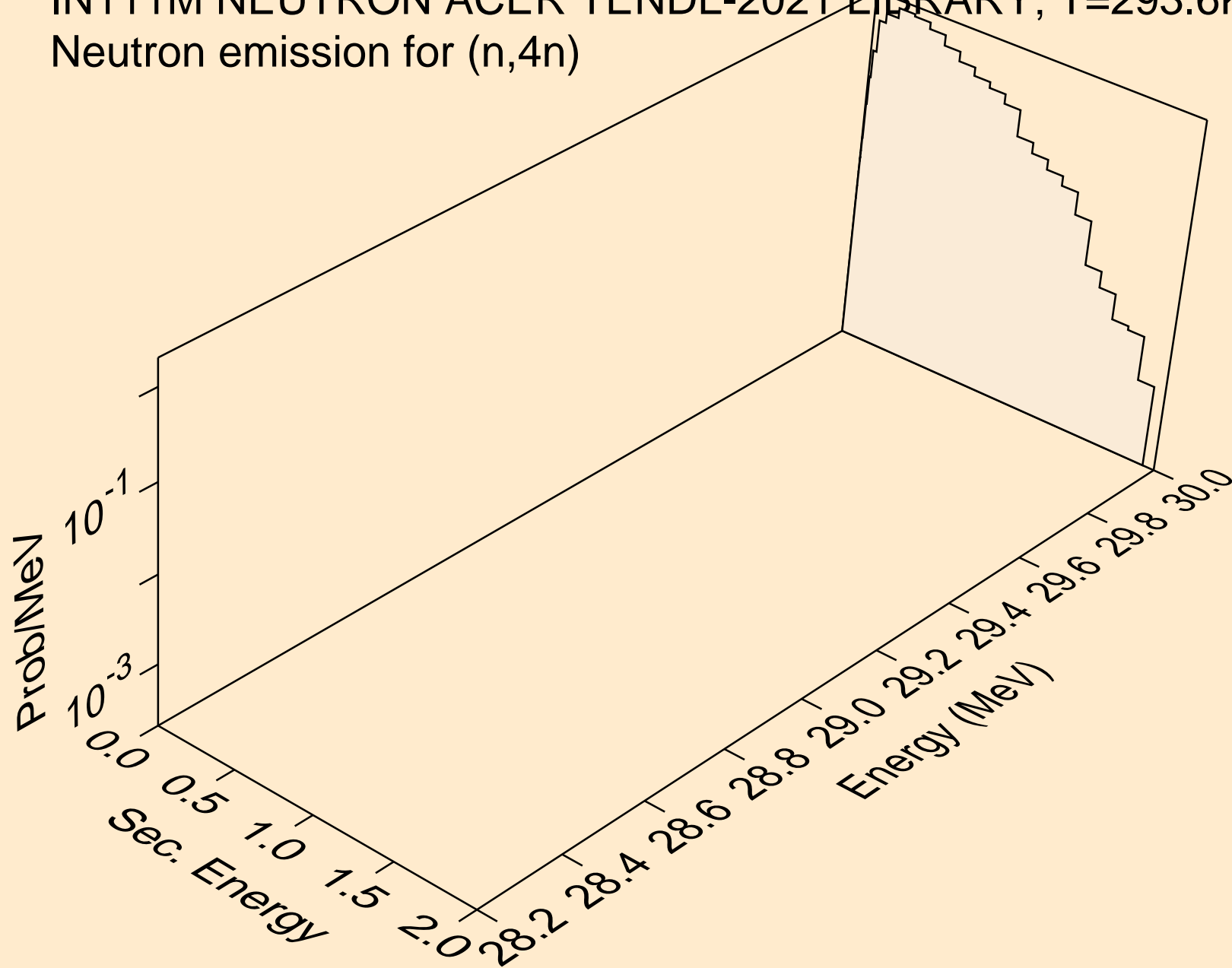

IN111M NEUTRON ACER TENDL-2021 LIBRARY; T=293.6K  
Neutron emission for (n,2np)

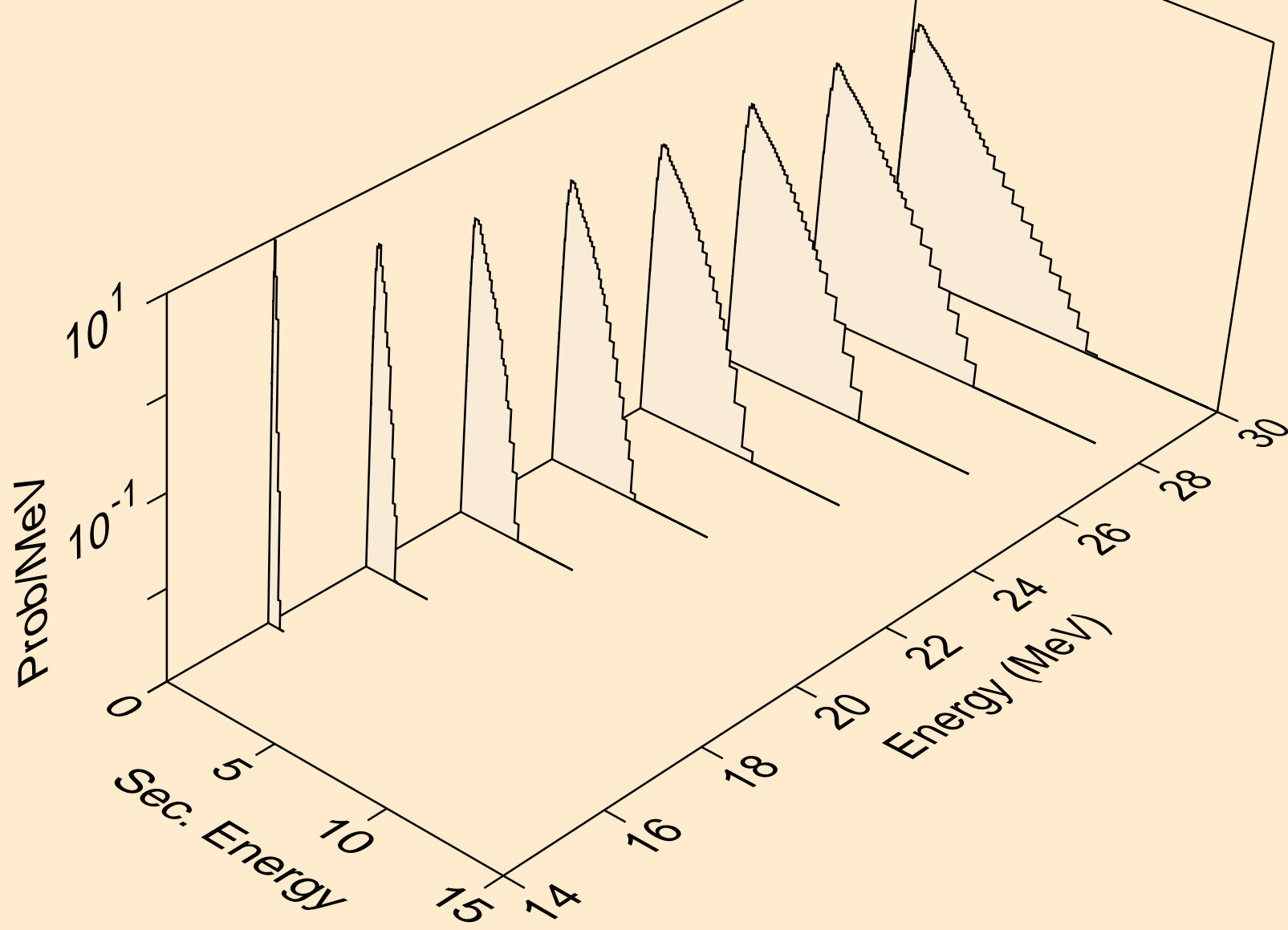

IN111M NEUTRON ACER TENDL-2021 LIBRARY; T=293.6K  
Neutron emission for (n,3np)

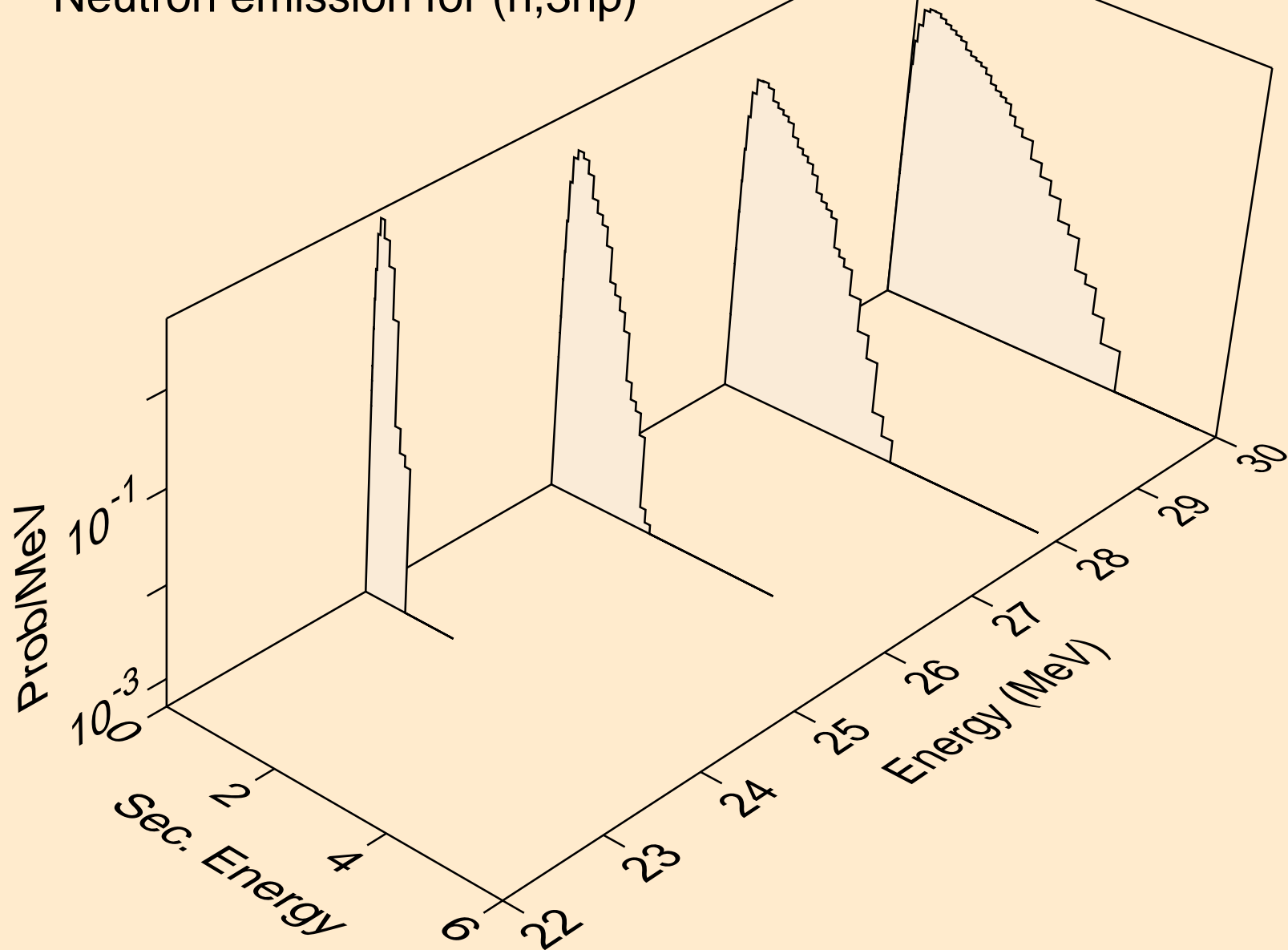

IN111M NEUTRON ACER TENDL-2021 LIBRARY; T=293.6K  
Neutron emission for (n,2np)

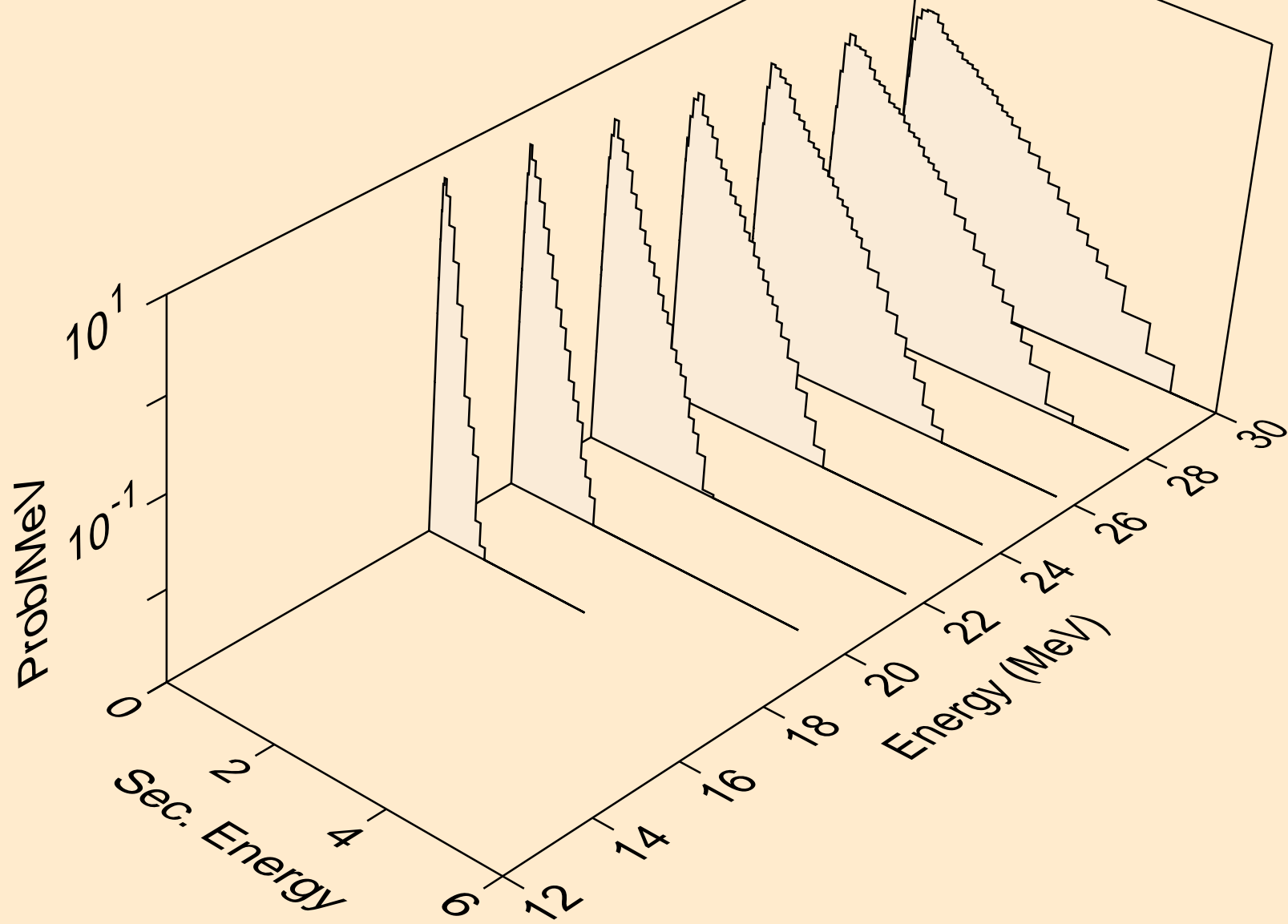

IN111M NEUTRON ACER TENDL-2021 LIBRARY; T=293.6K  
Neutron emission for (n,npa)

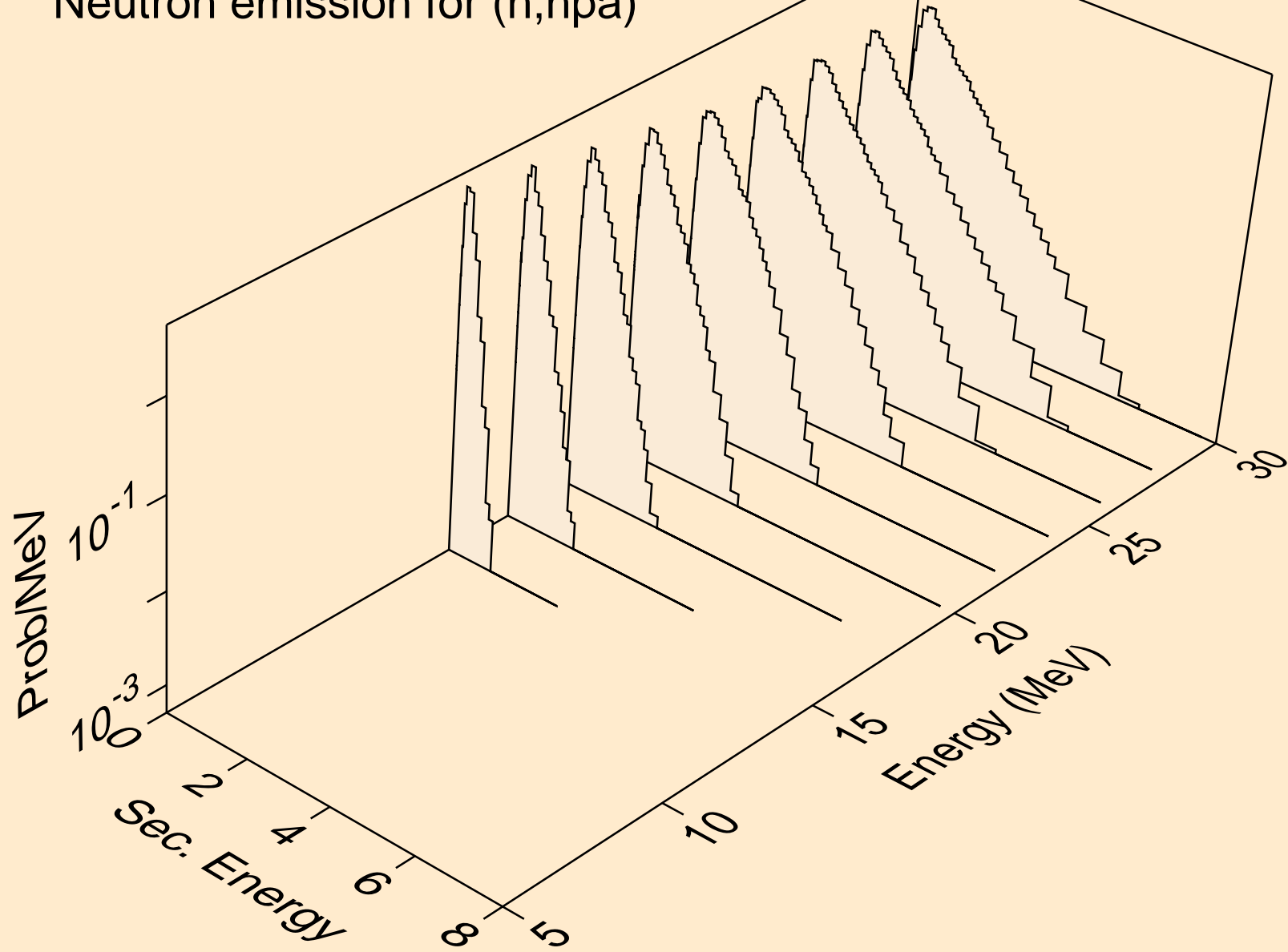

IN111M NEUTRON ACER TENDL-2021 LIBRARY; T=293.6K  
Neutron emission for (n,n\*c)

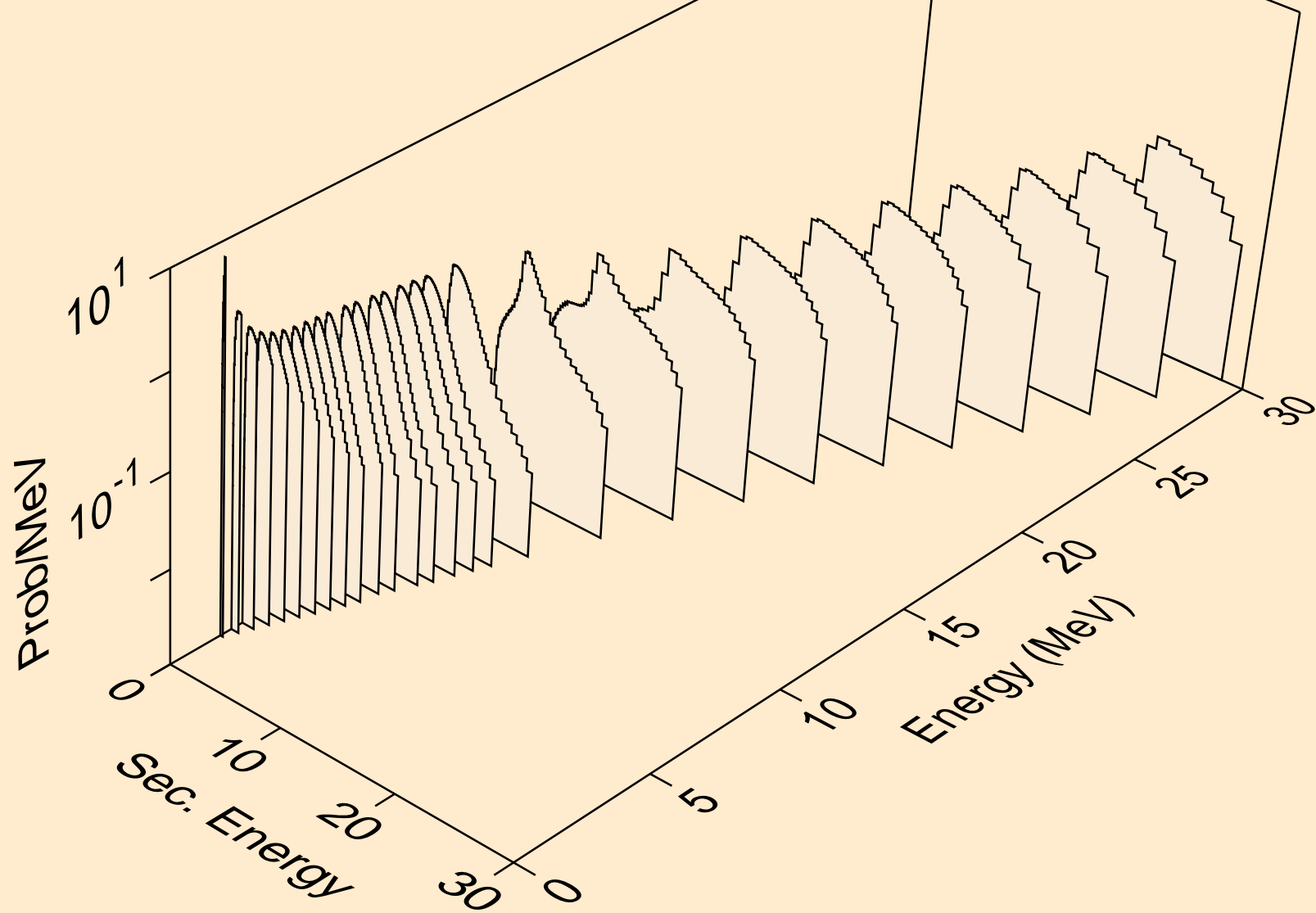

IN111M NEUTRON ACER TENDL-2021 LIBRARY; T=293.6K  
Photon emission for (n,x)

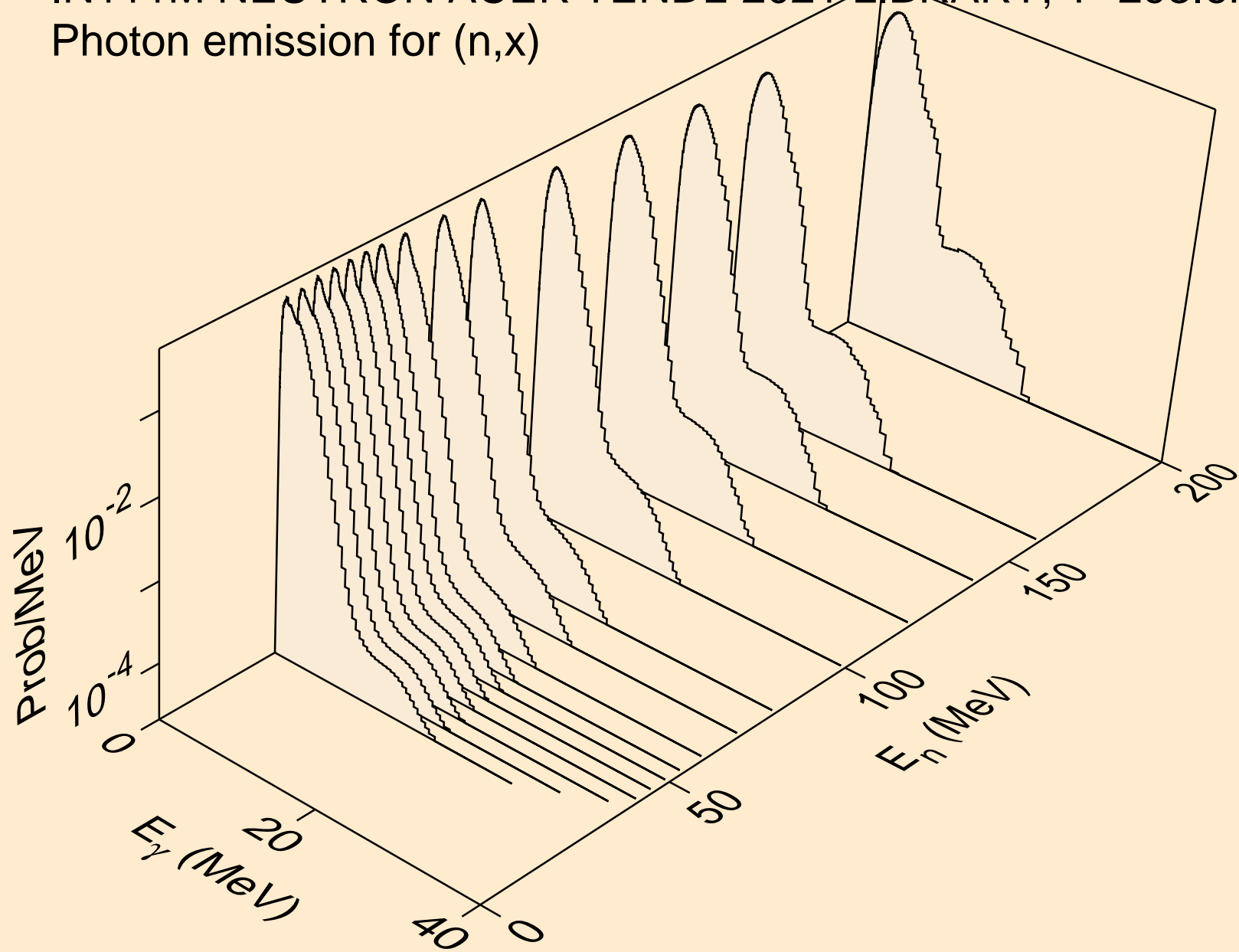



IN111M NEUTRON ACER TENDL-2021 LIBRARY; T=293.6K  
Photon emission for (n,2nd)

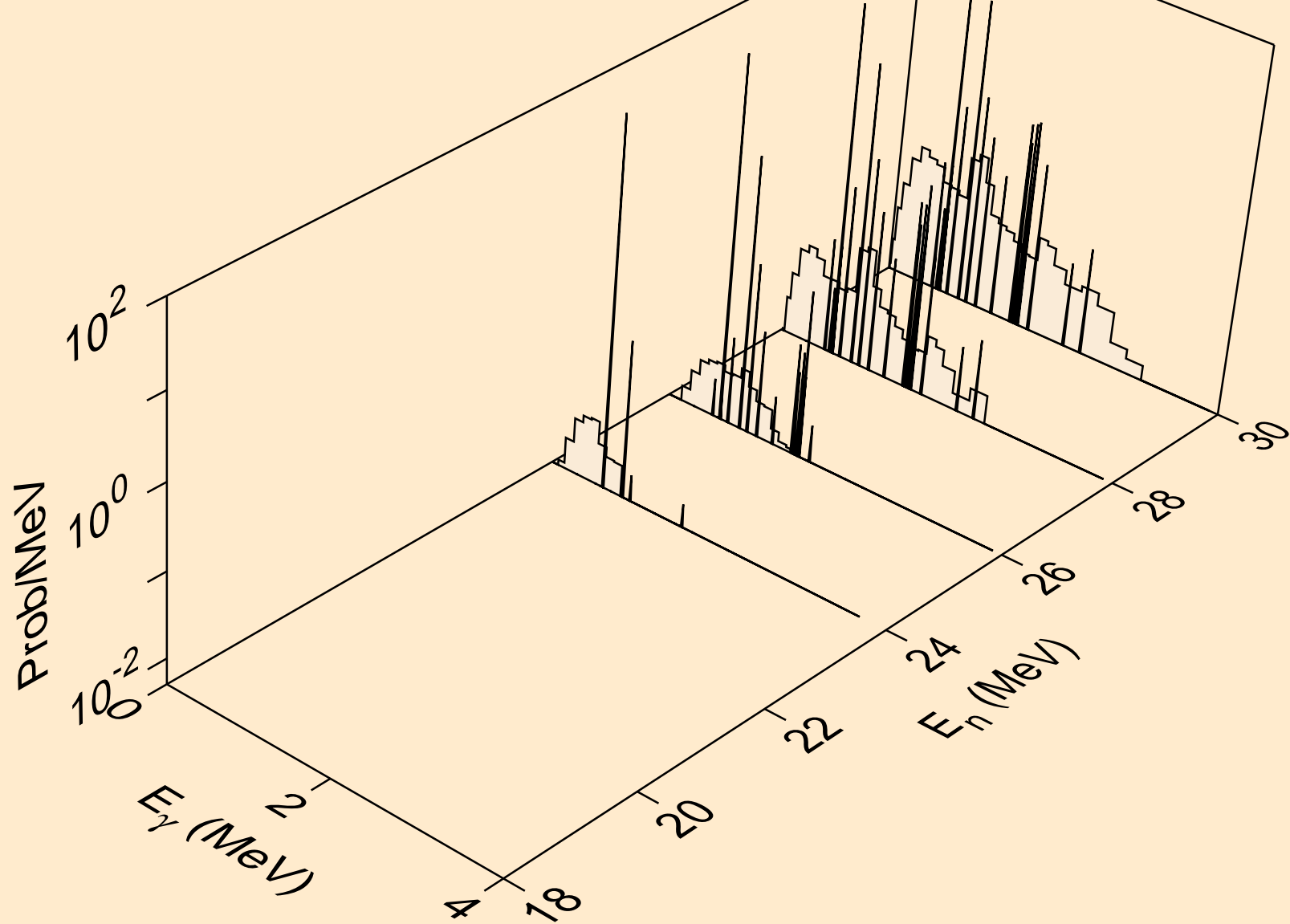

IN111M NEUTRON ACER TENDL-2021 LIBRARY; T=293.6K  
Photon emission for (n,2n)

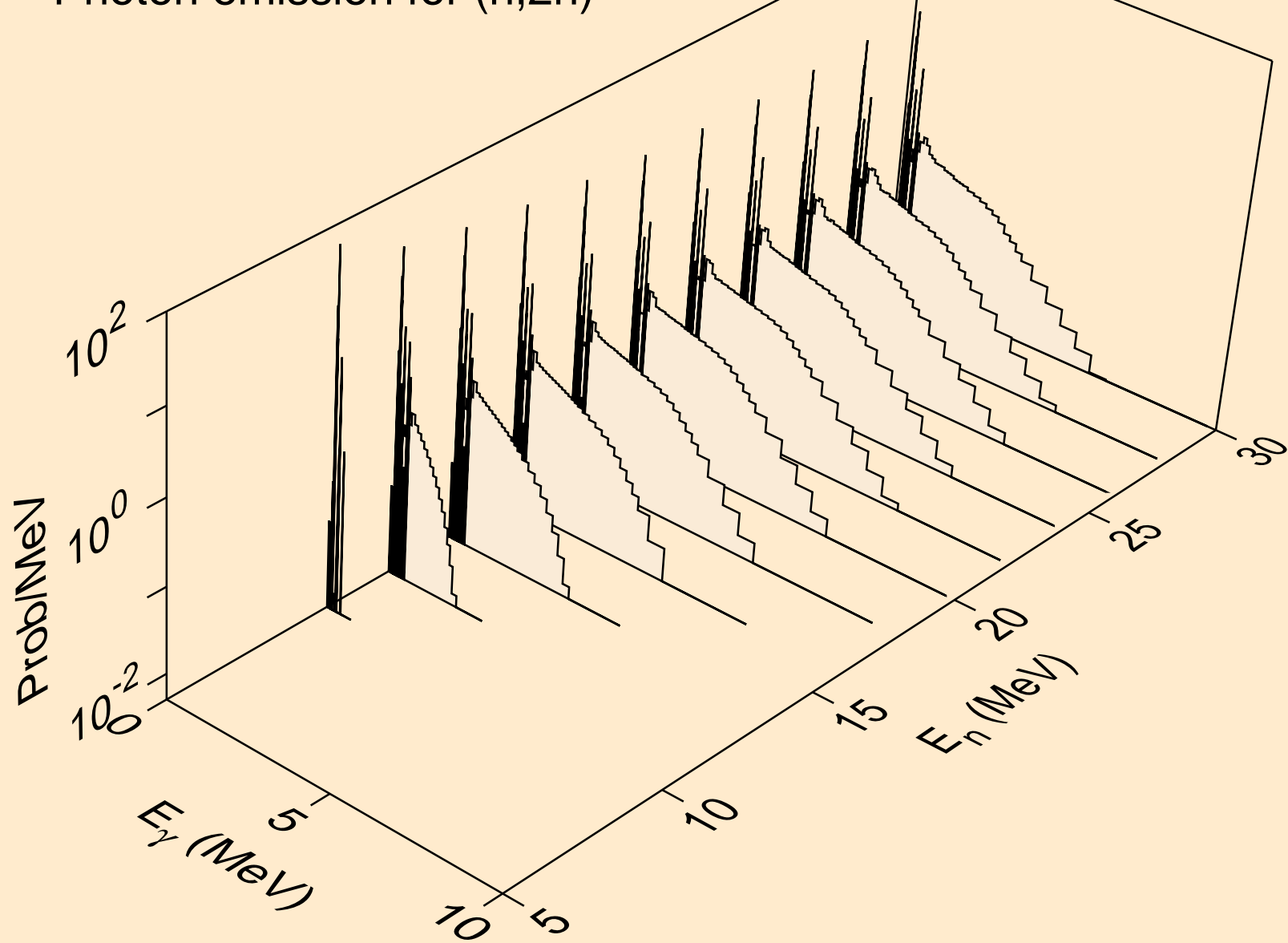

IN111M NEUTRON ACER TENDL-2021 LIBRARY; T=293.6K  
Photon emission for (n,3n)

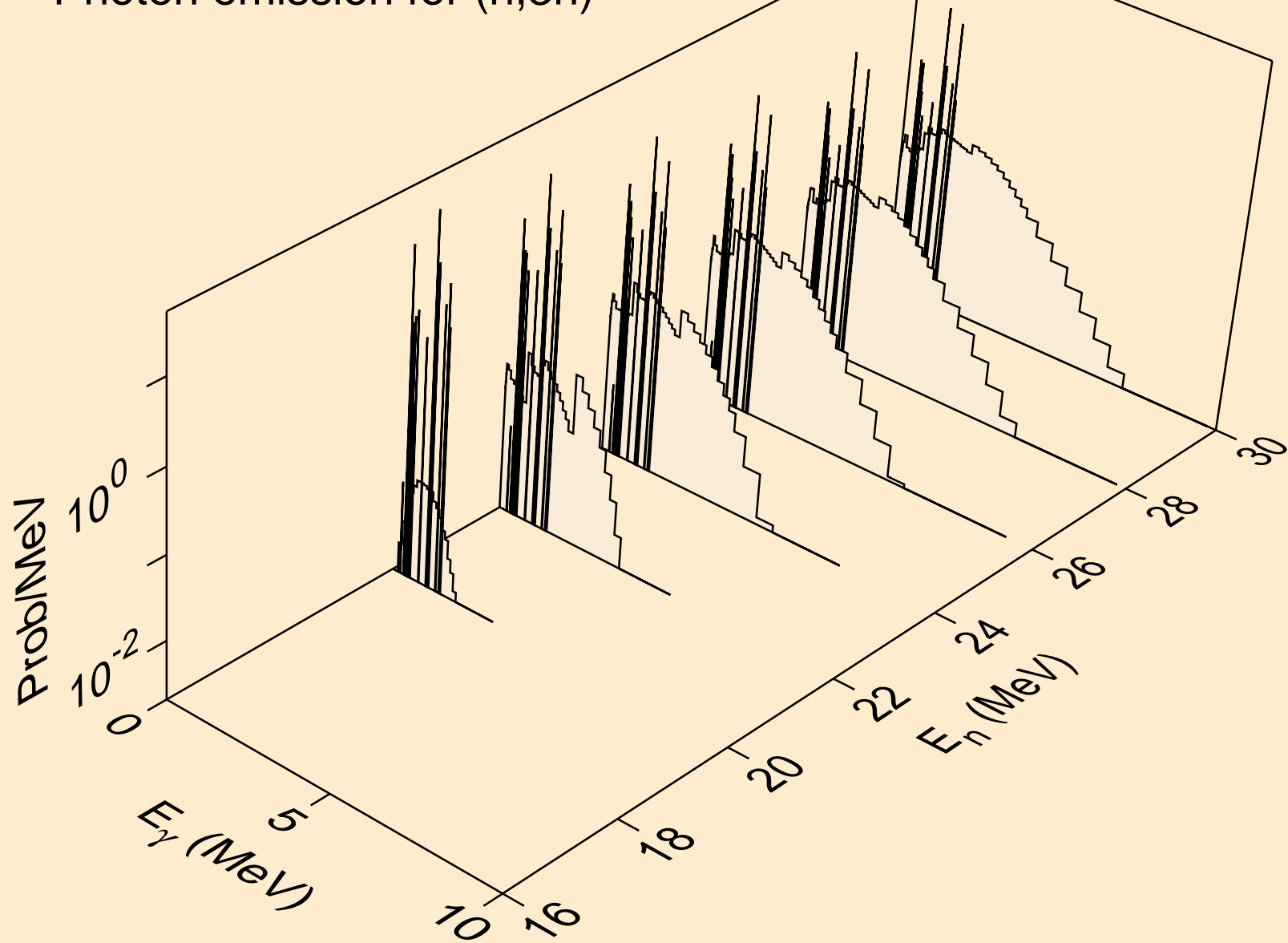

IN111M NEUTRON ACER TENDL-2021 LIBRARY; T=293.6K  
Photon emission for (n,n\*)a

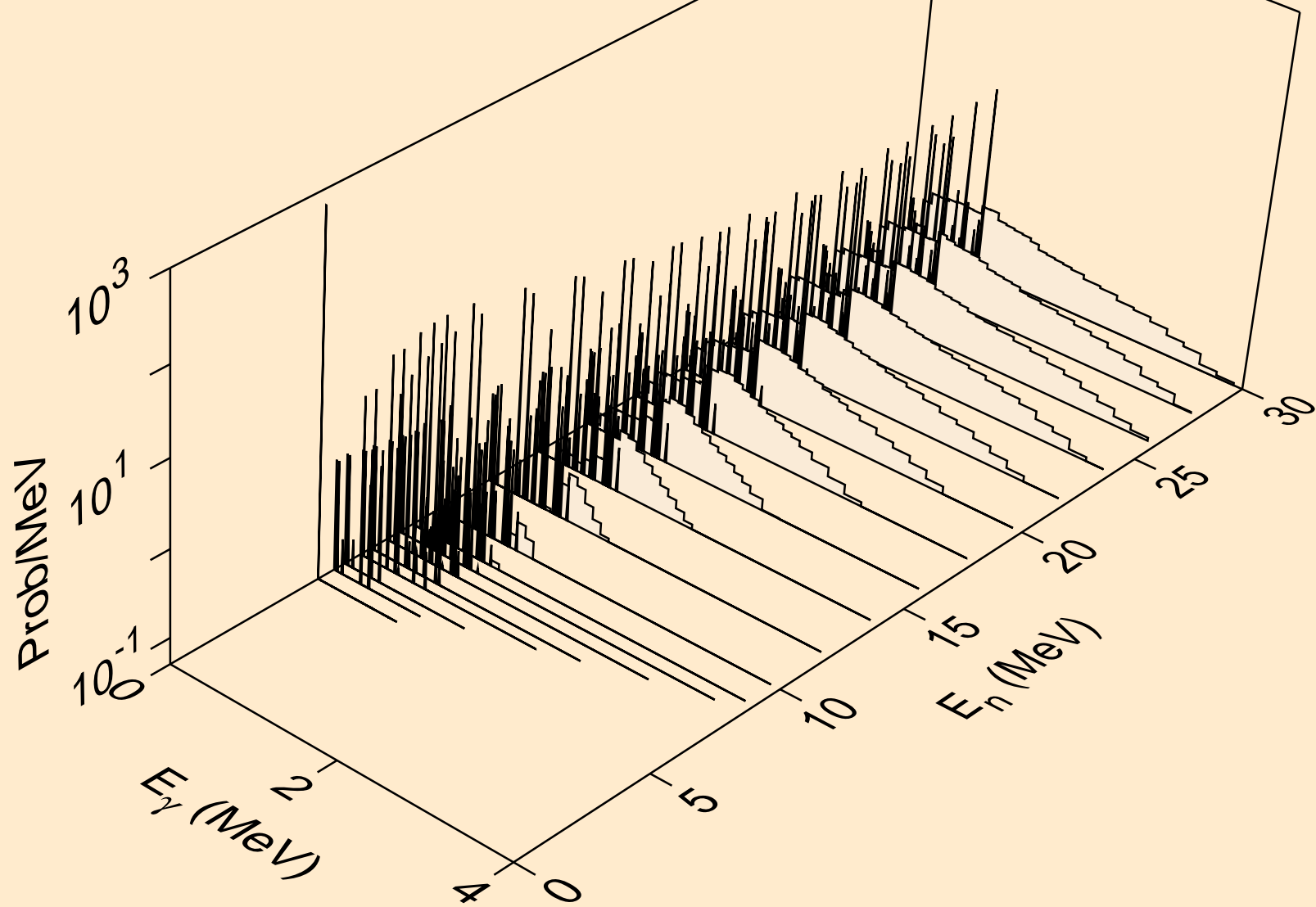

IN111M NEUTRON ACER TENDL-2021 LIBRARY; T=293.6K  
Photon emission for (n,2n)a

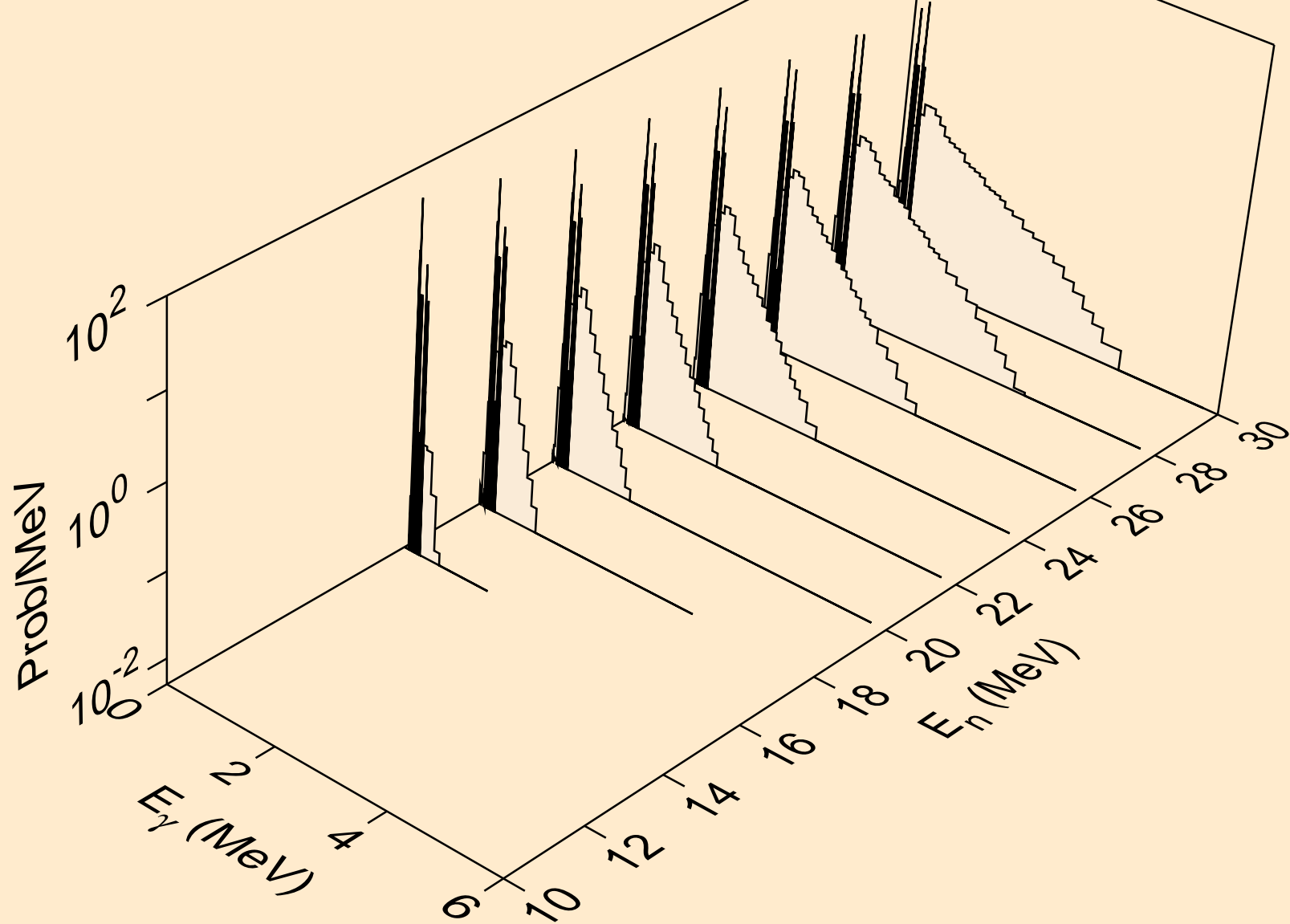

IN111M NEUTRON ACER TENDL-2021 LIBRARY; T=293.6K  
Photon emission for (n,3n)a

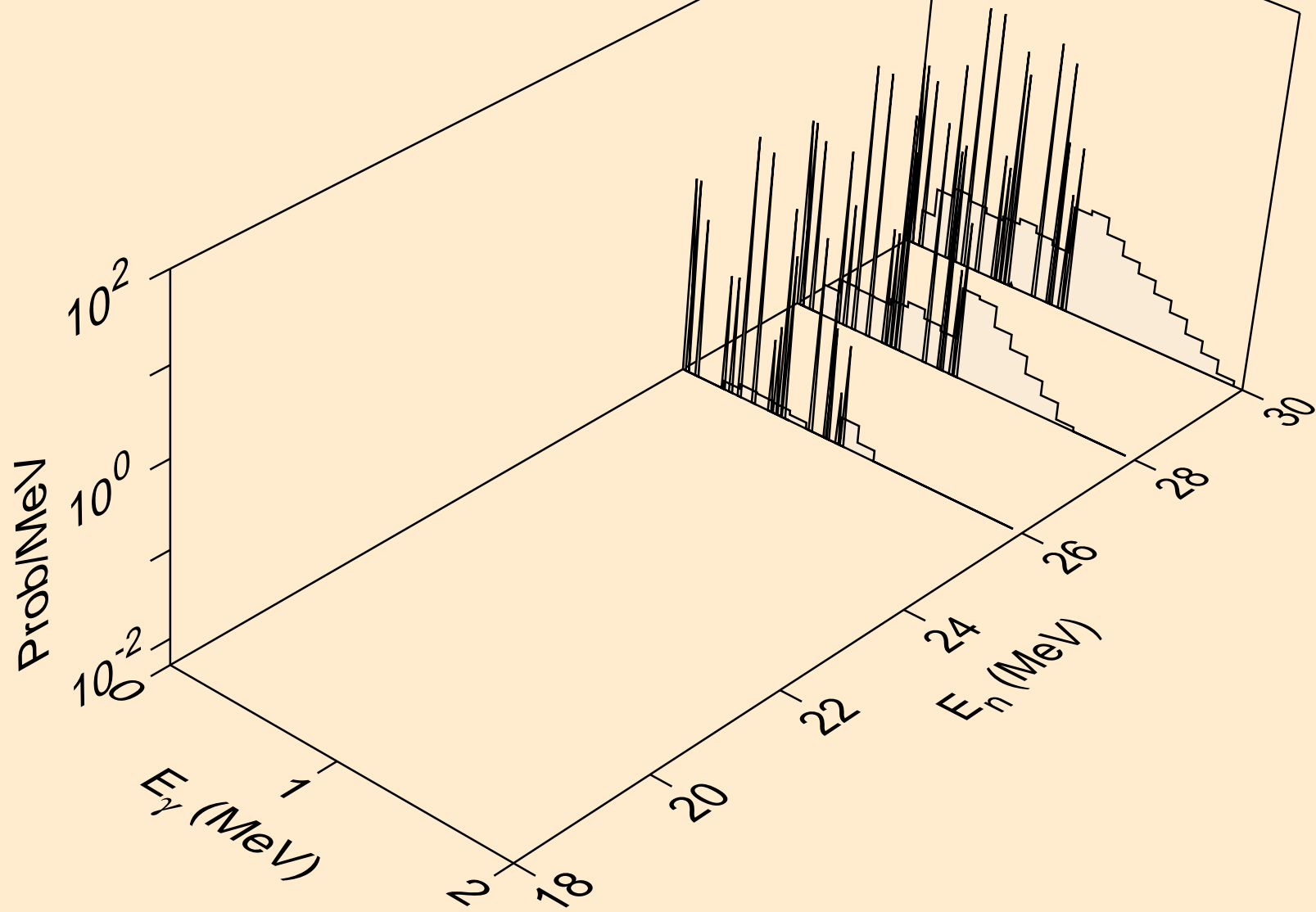

IN111M NEUTRON ACER TENDL-2021 LIBRARY; T=293.6K  
Photon emission for (n,n\*)p

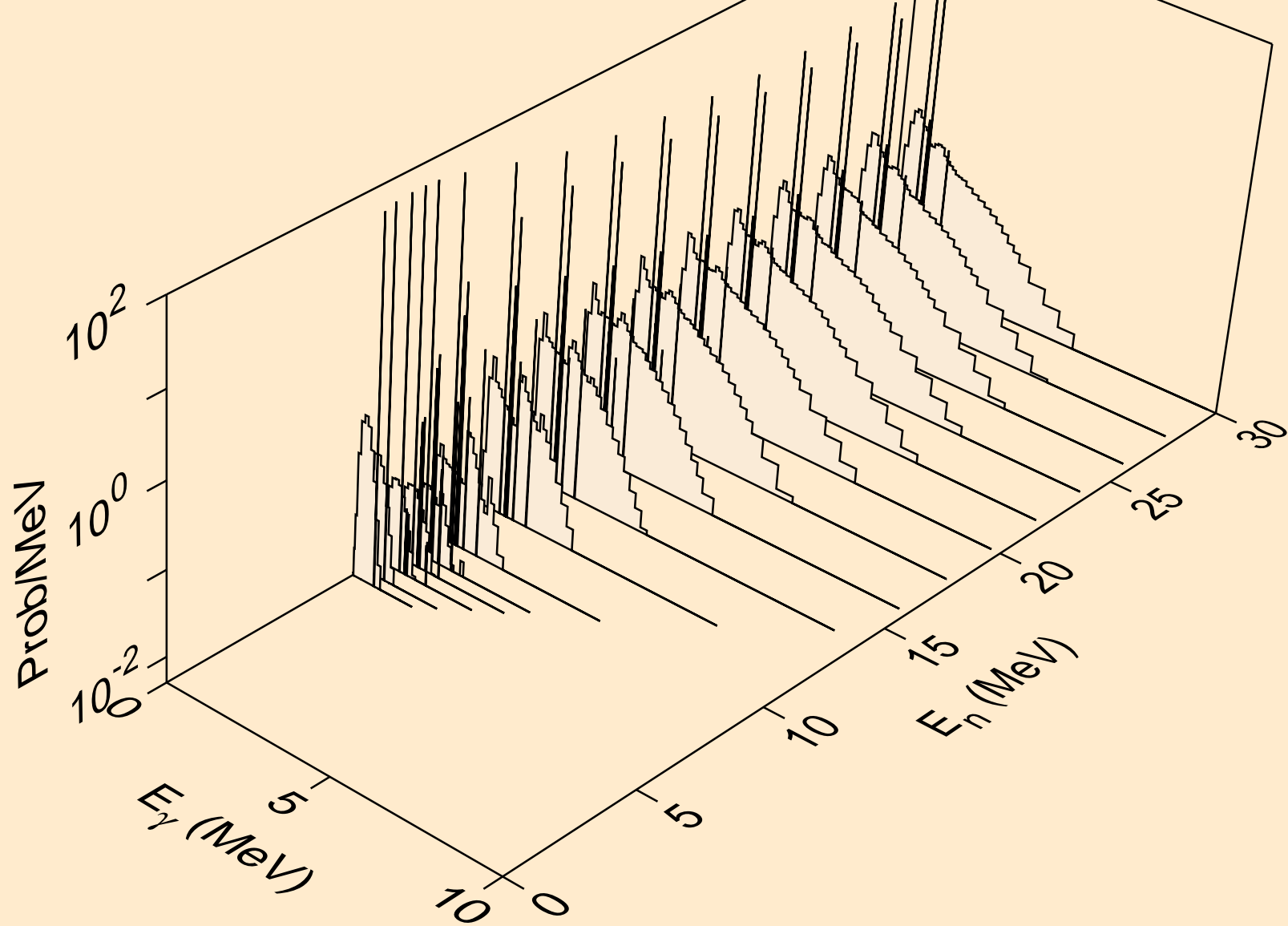

IN111M NEUTRON ACER TENDL-2021 LIBRARY; T=293.6K  
Photon emission for (n,n\*)2a

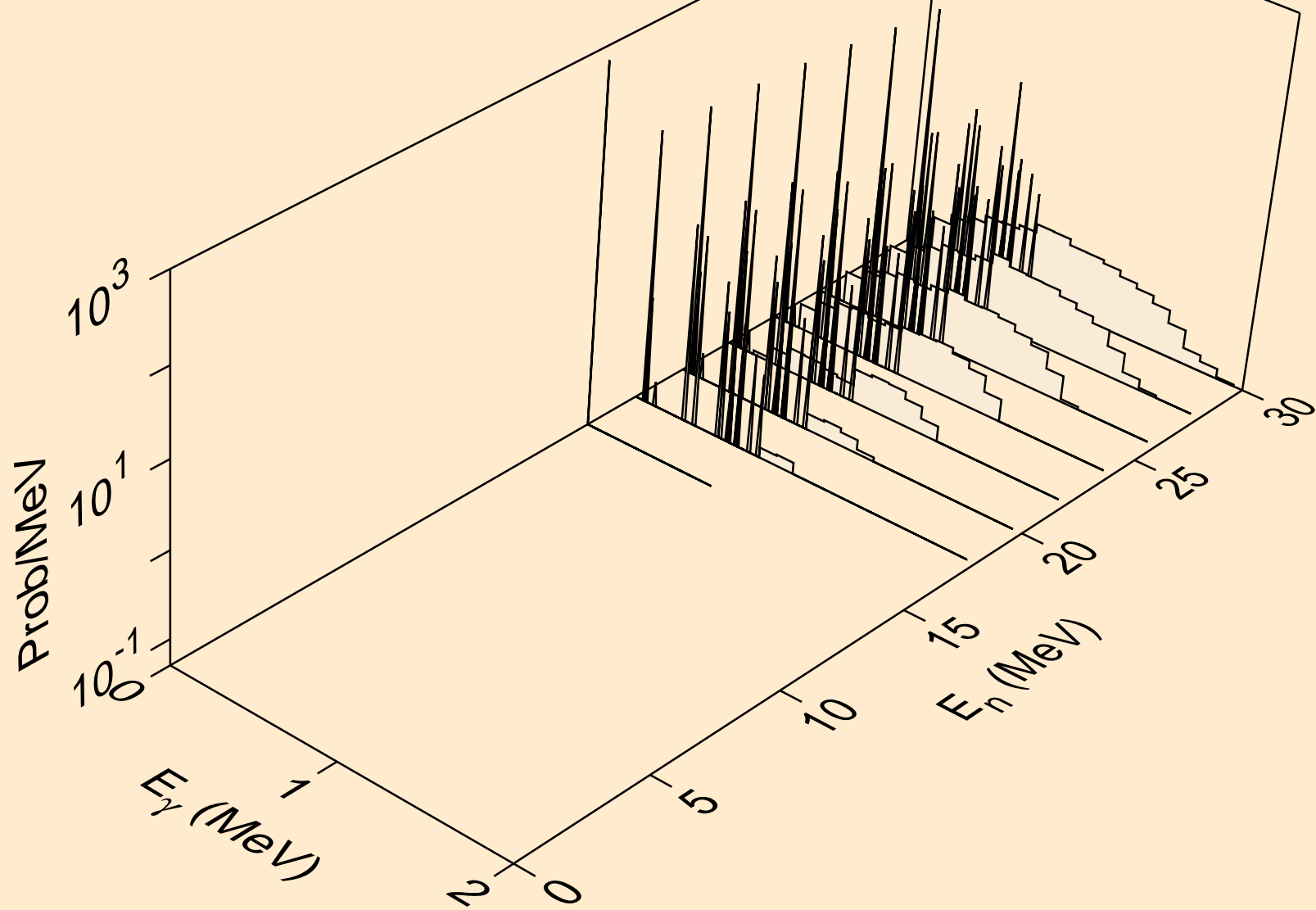



IN111M NEUTRON ACER TENDL-2021 LIBRARY; T=293.6K  
Photon emission for (n,n\*)d

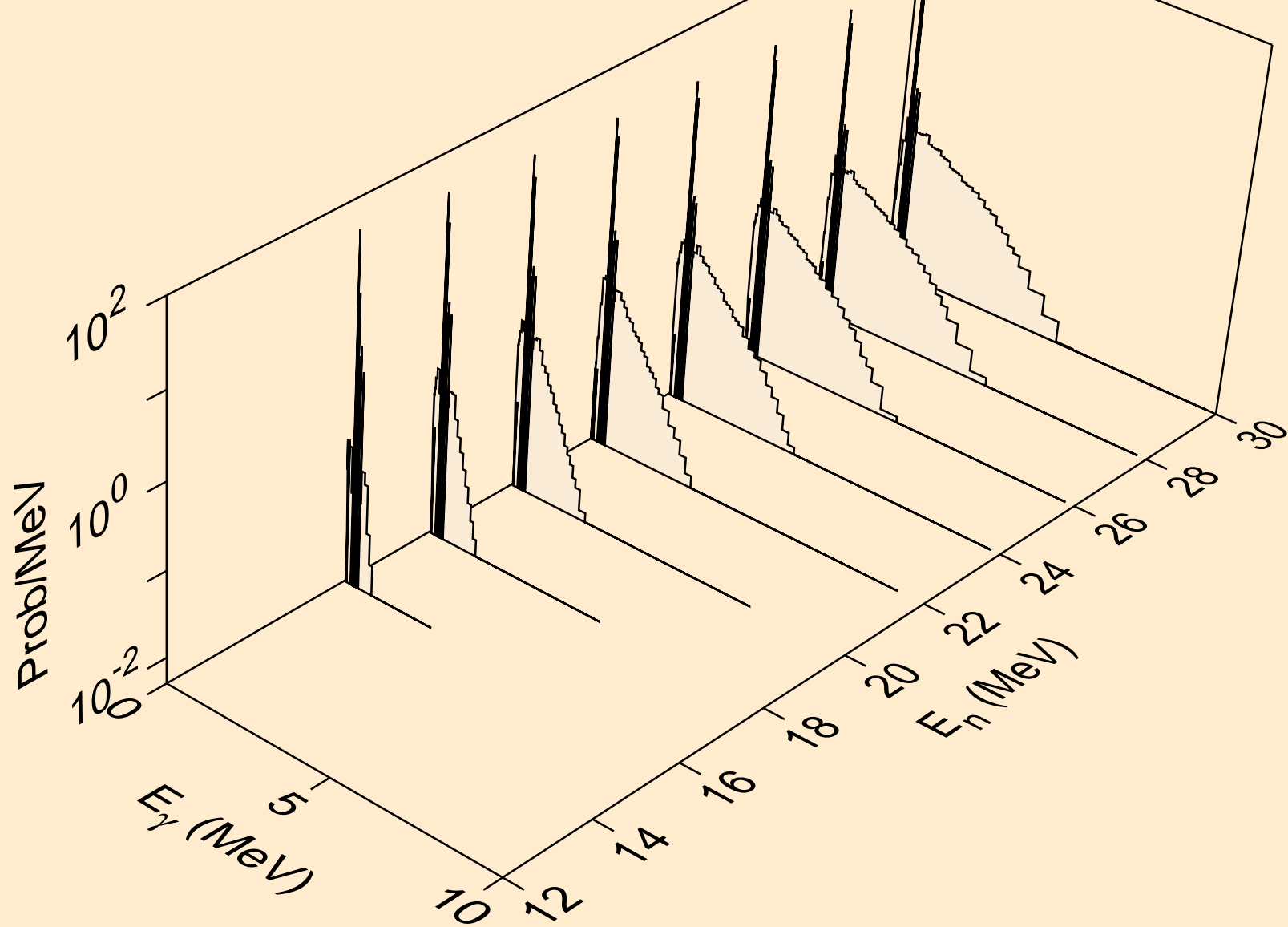

IN111M NEUTRON ACER TENDL-2021 LIBRARY; T=293.6K  
Photon emission for (n,n\*)t

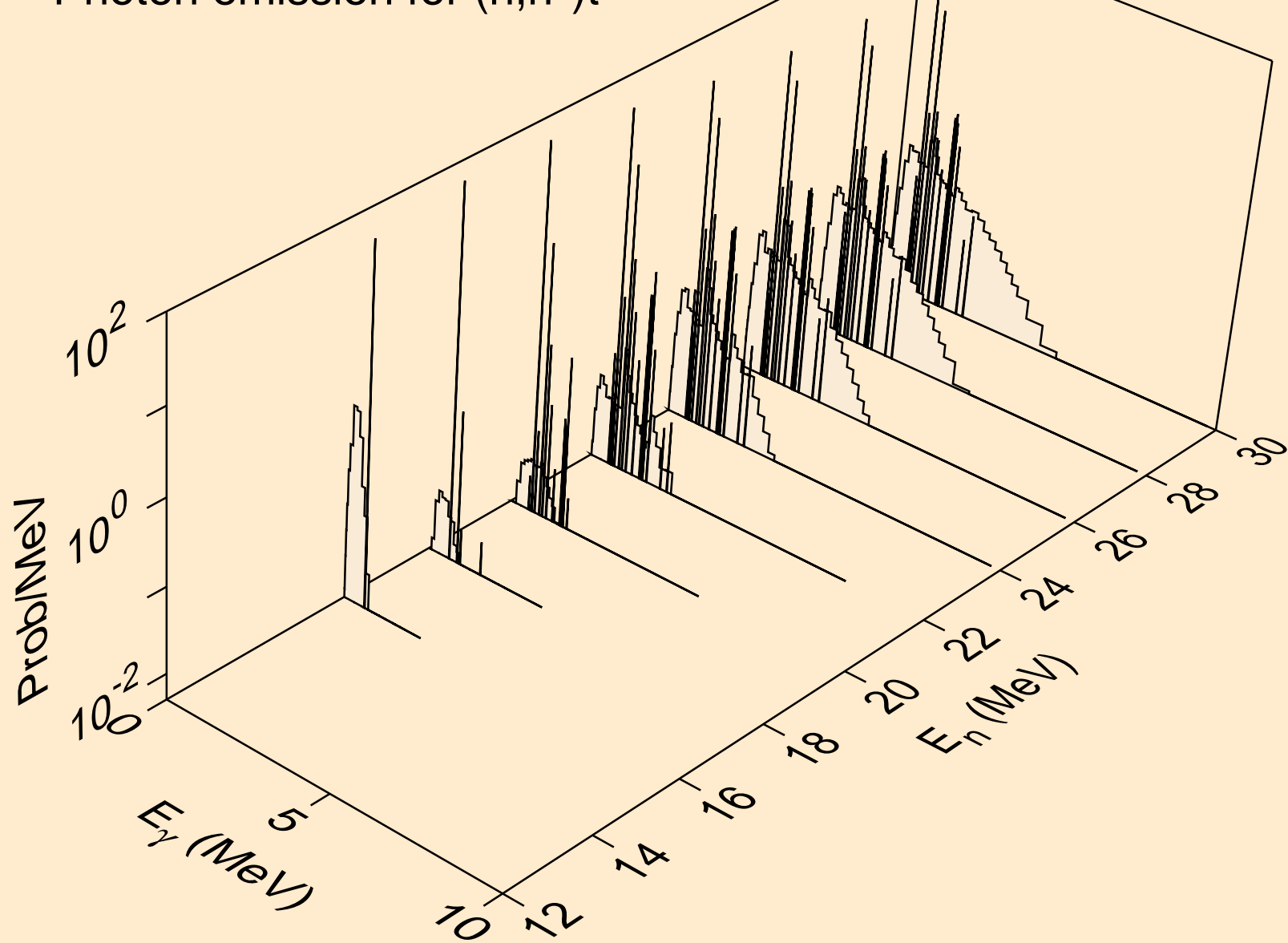

IN111M NEUTRON ACER TENDL-2021 LIBRARY; T=293.6K  
Photon emission for (n,n\*)he3

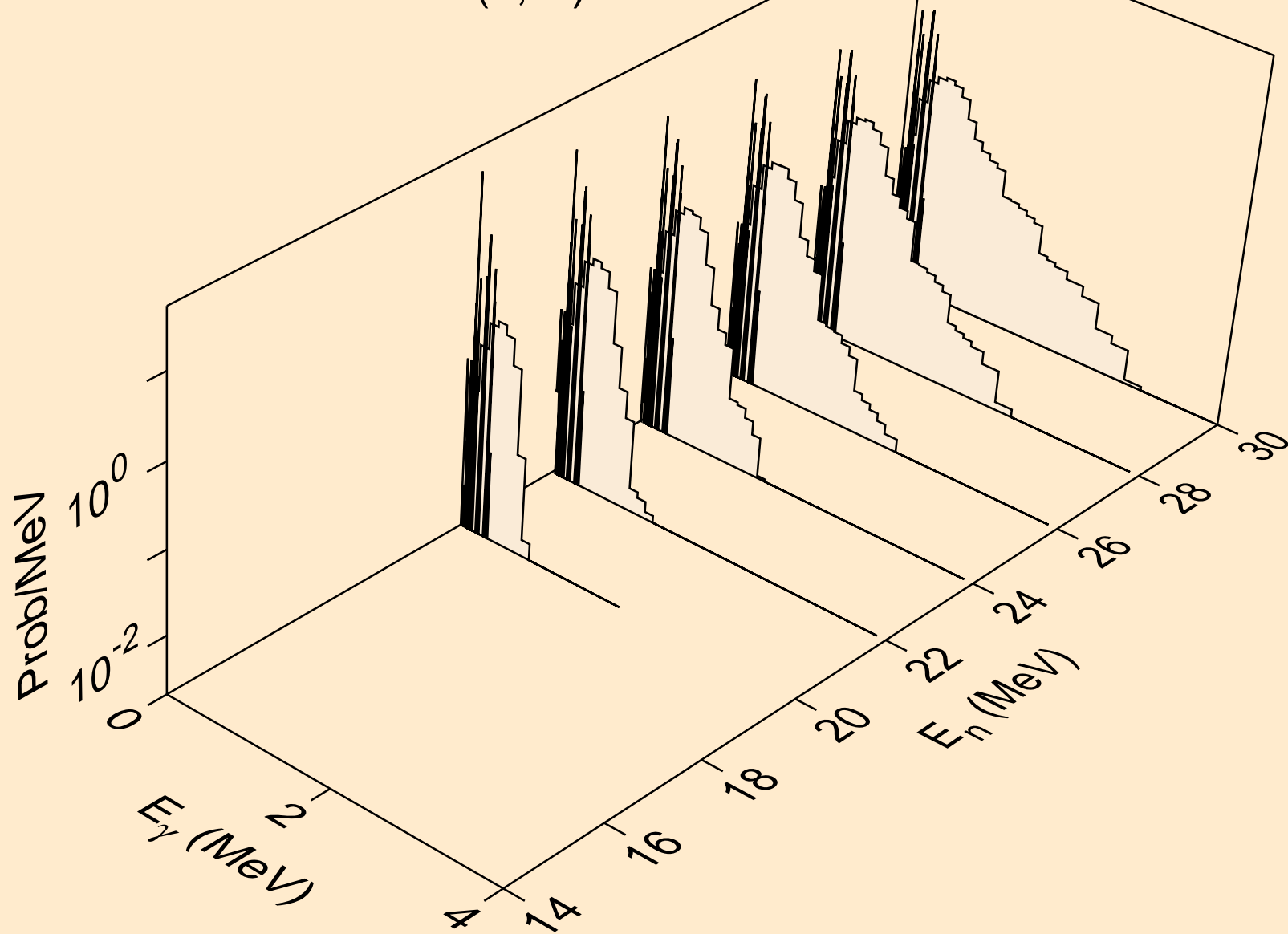

IN111M NEUTRON ACER TENDL-2021 LIBRARY; T=293.6K  
Photon emission for (n,4n)

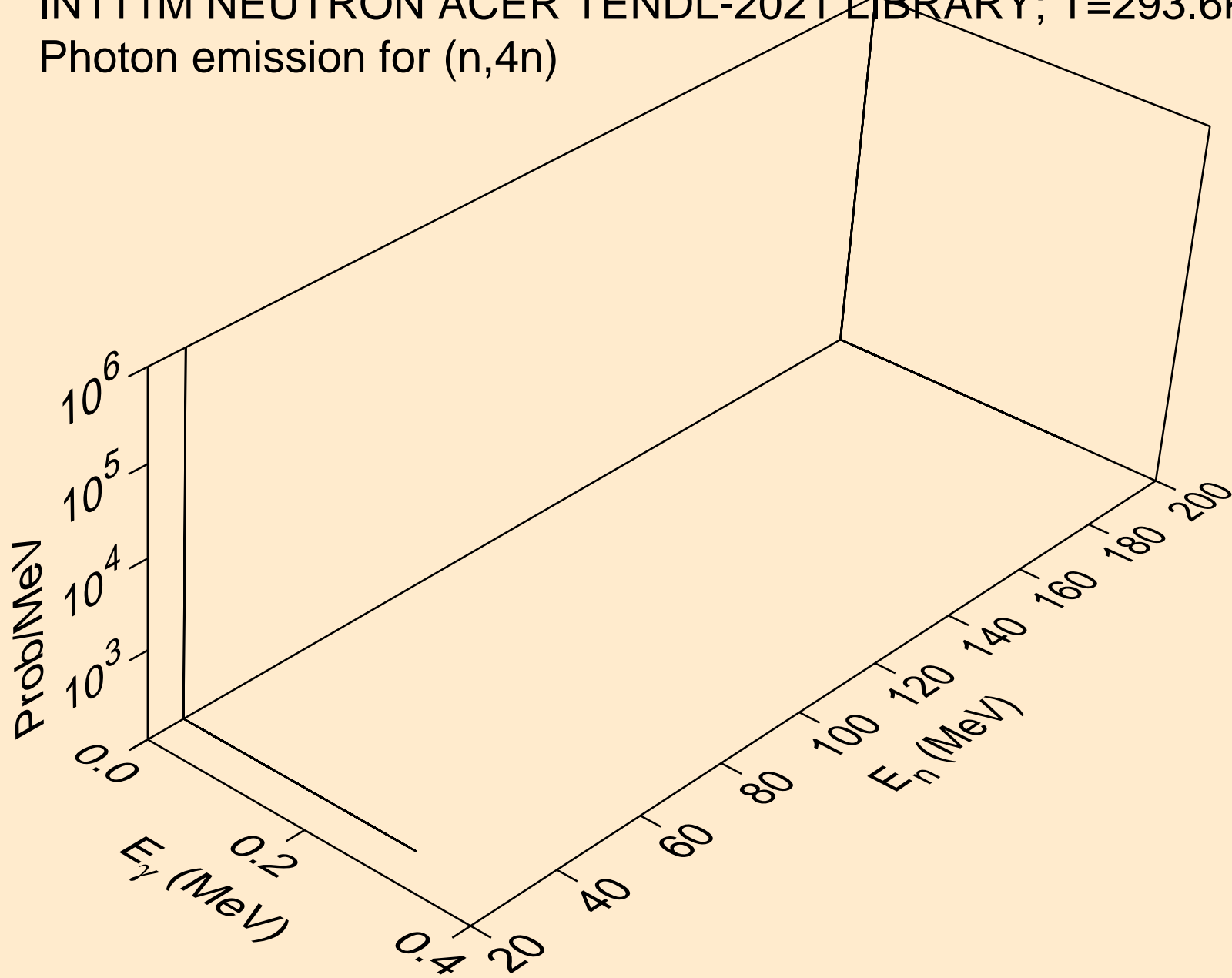

IN111M NEUTRON ACER TENDL-2021 LIBRARY; T=293.6K  
Photon emission for (n,2np)

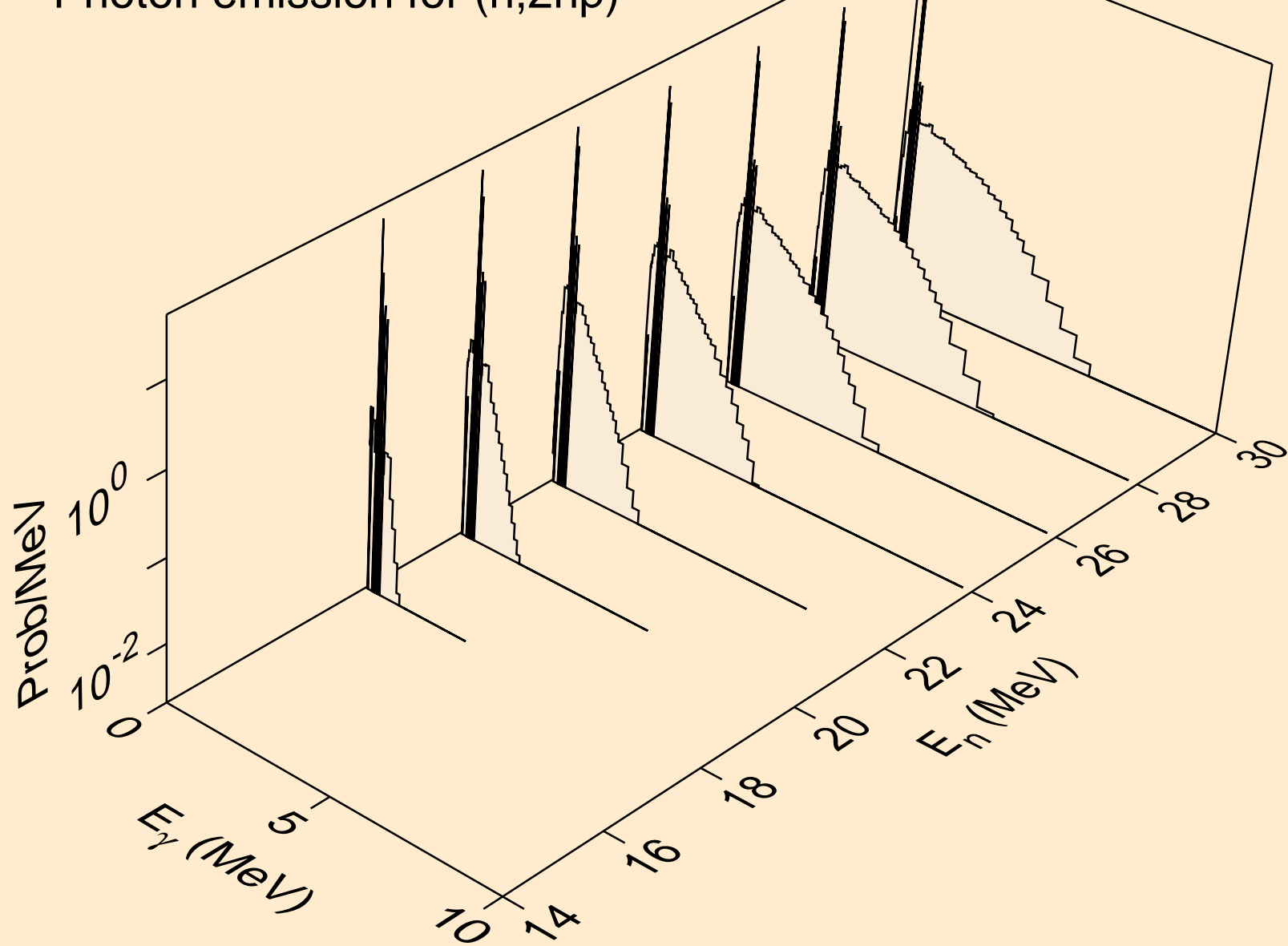

IN111M NEUTRON ACER TENDL-2021 LIBRARY; T=293.6K  
Photon emission for (n,3np)

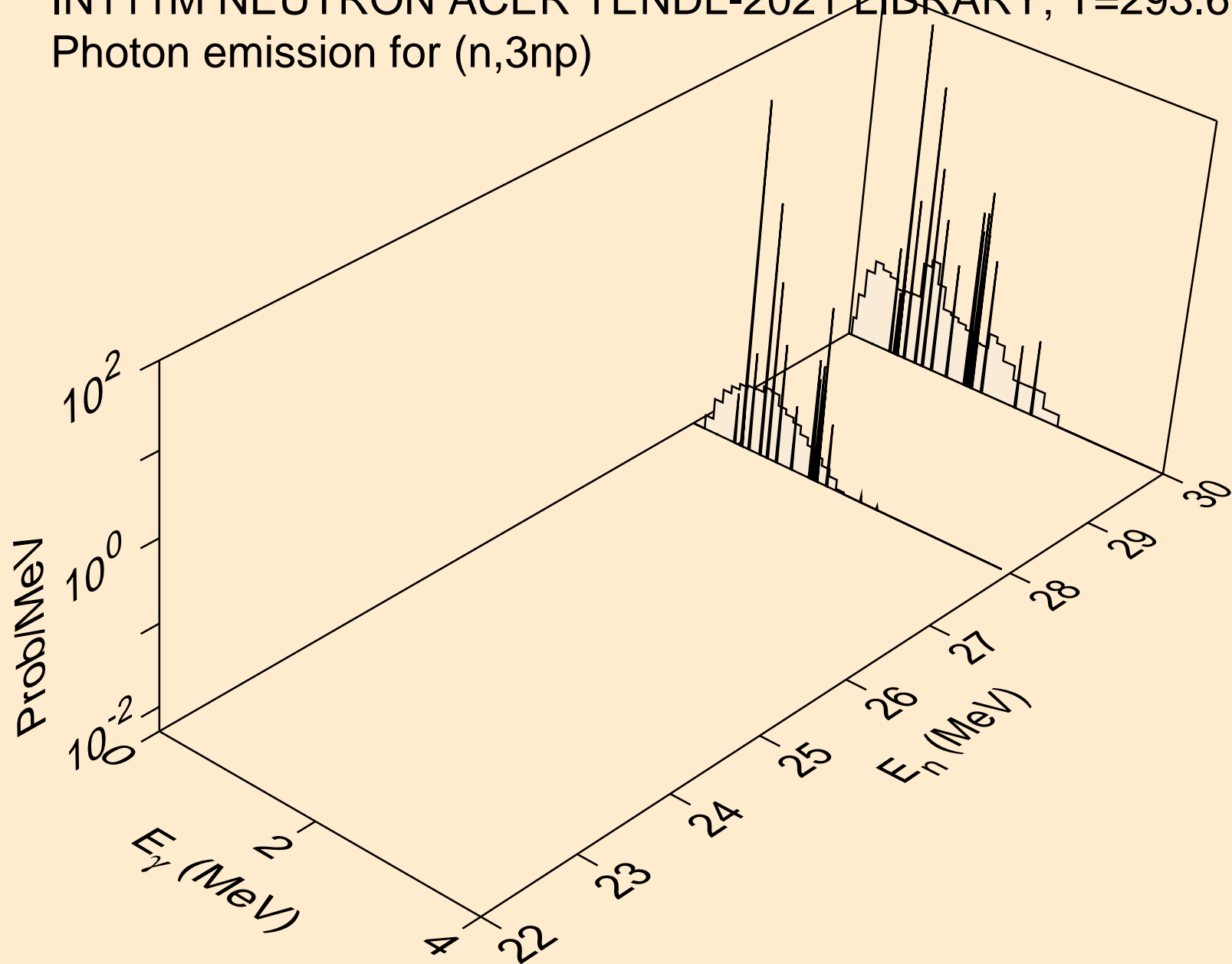

IN111M NEUTRON ACER TENDL-2021 LIBRARY; T=293.6K  
Photon emission for (n,2np)

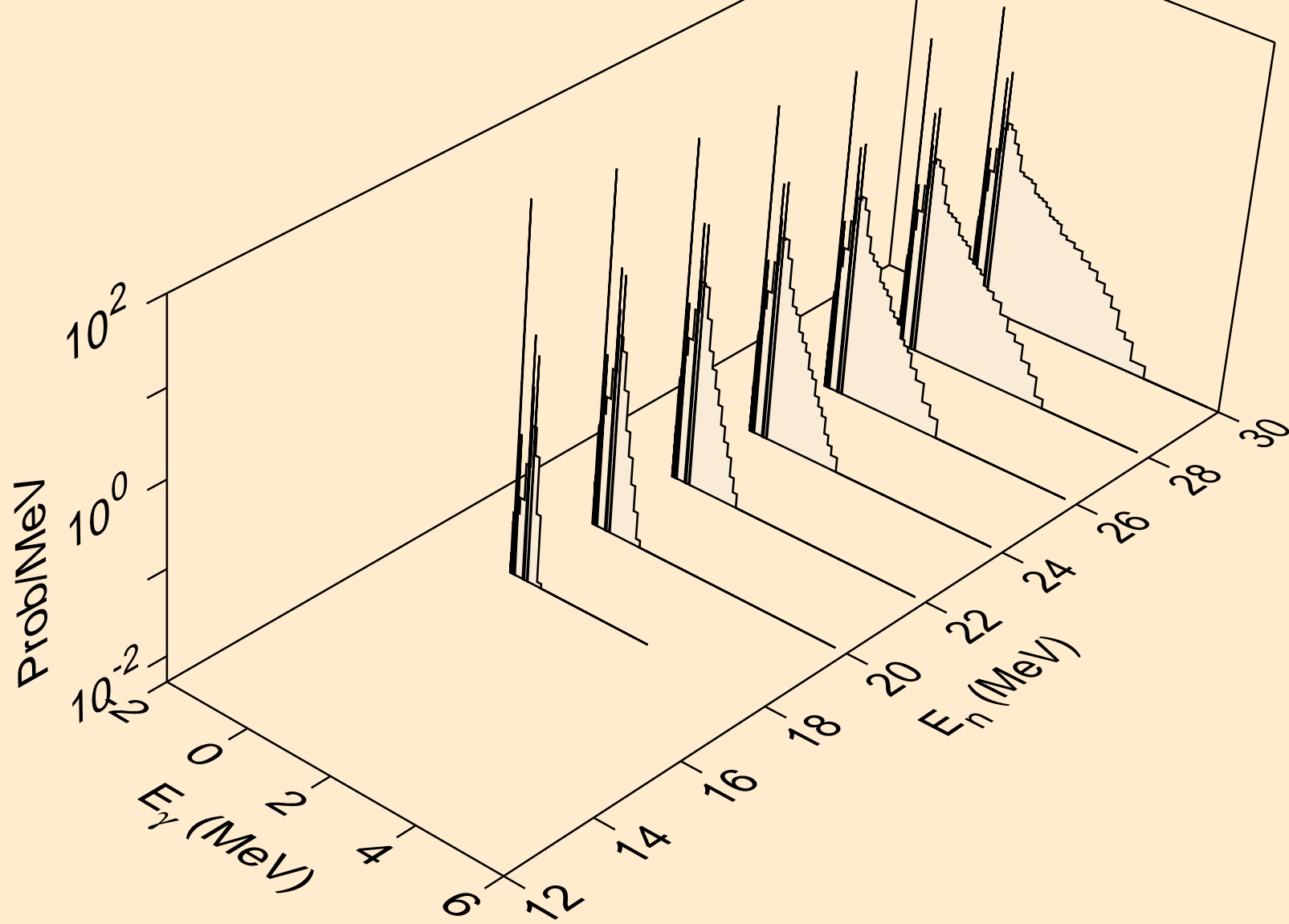

IN111M NEUTRON ACER TENDL-2021 LIBRARY; T=293.6K  
Photon emission for (n,npa)

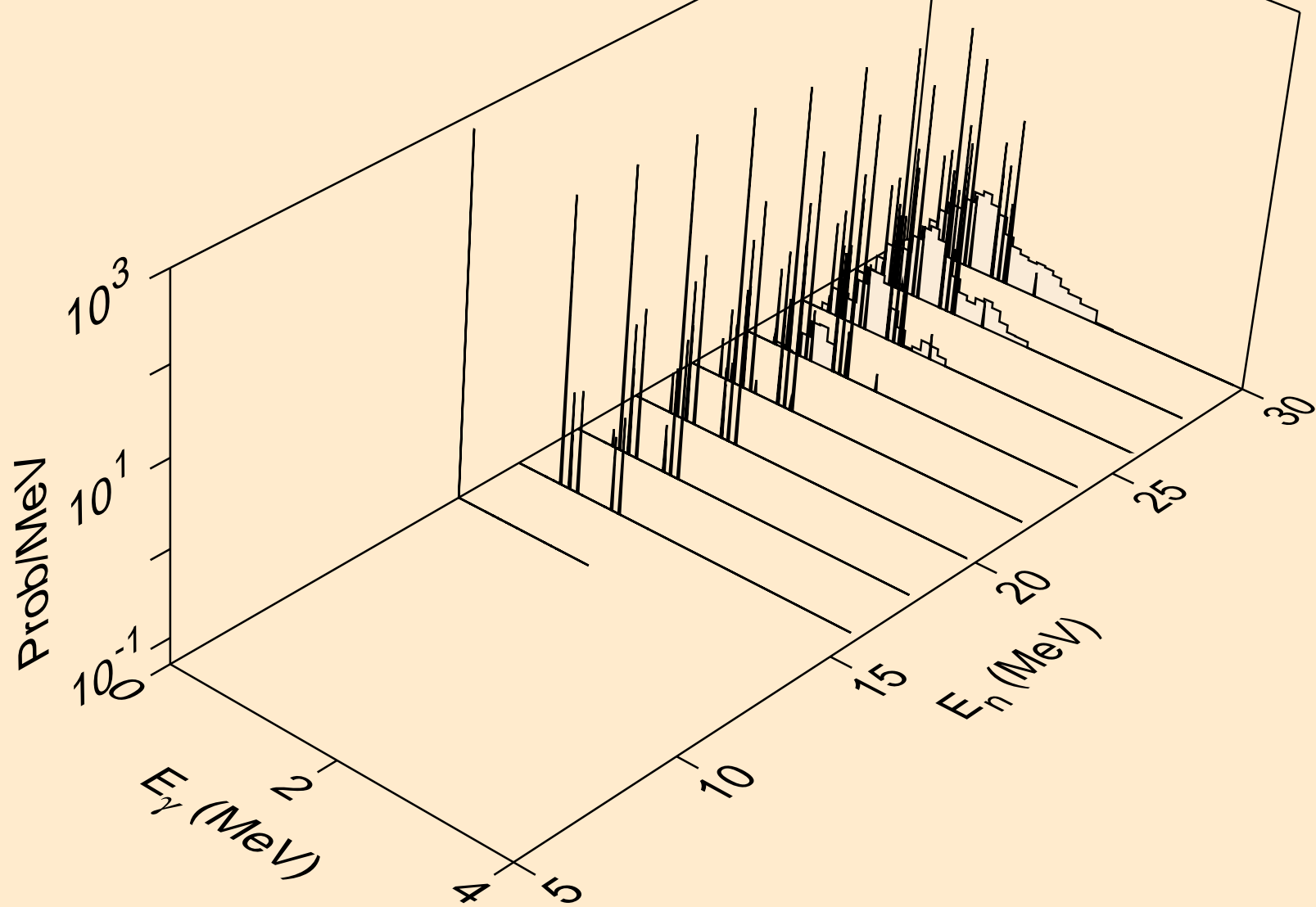



IN111M NEUTRON ACER TENDL-2021 LIBRARY; T=293.6K  
Photon emission for (n,n\*2)

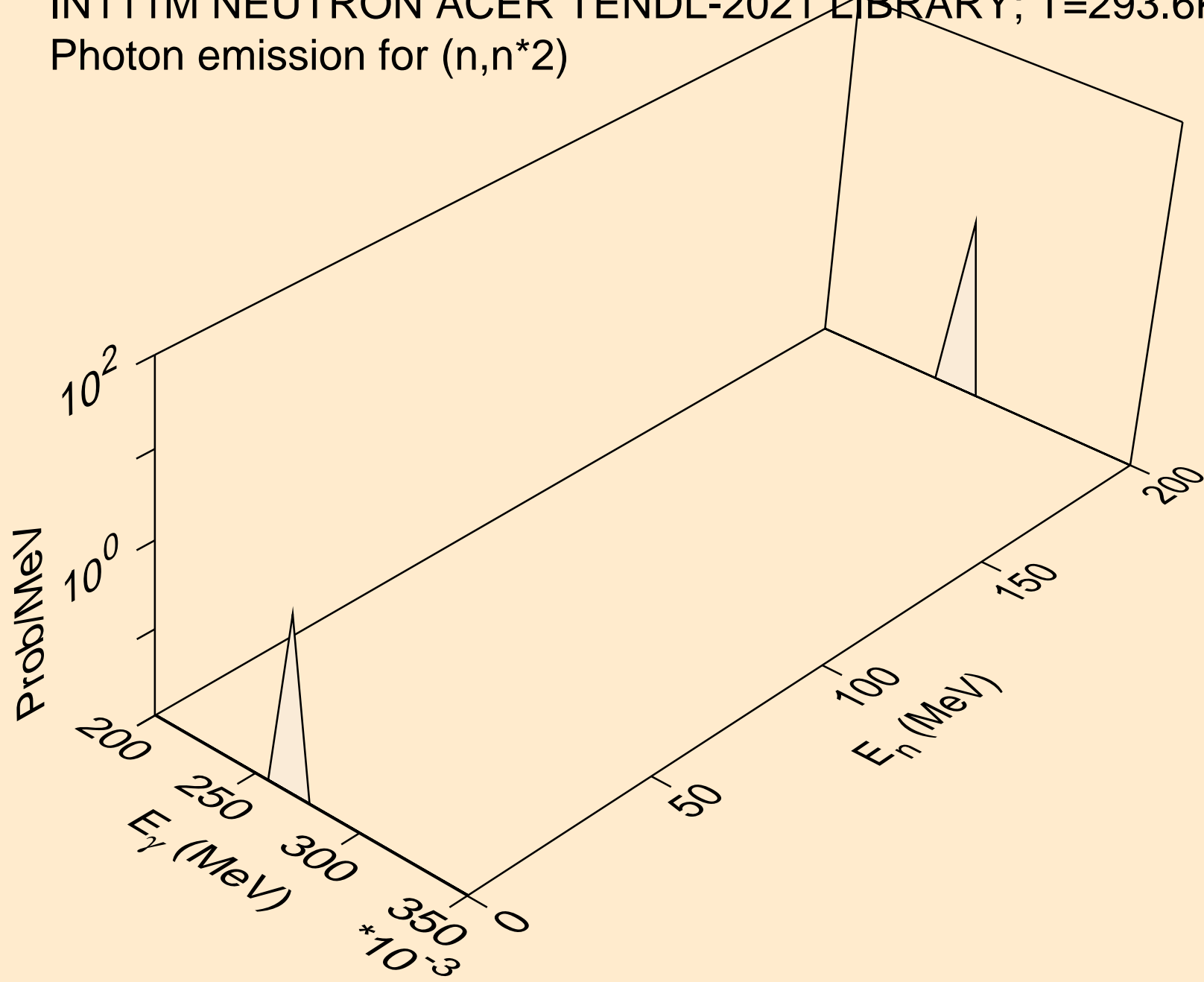

IN111M NEUTRON ACER TENDL-2021 LIBRARY; T=293.6K  
Photon emission for (n,n\*3)

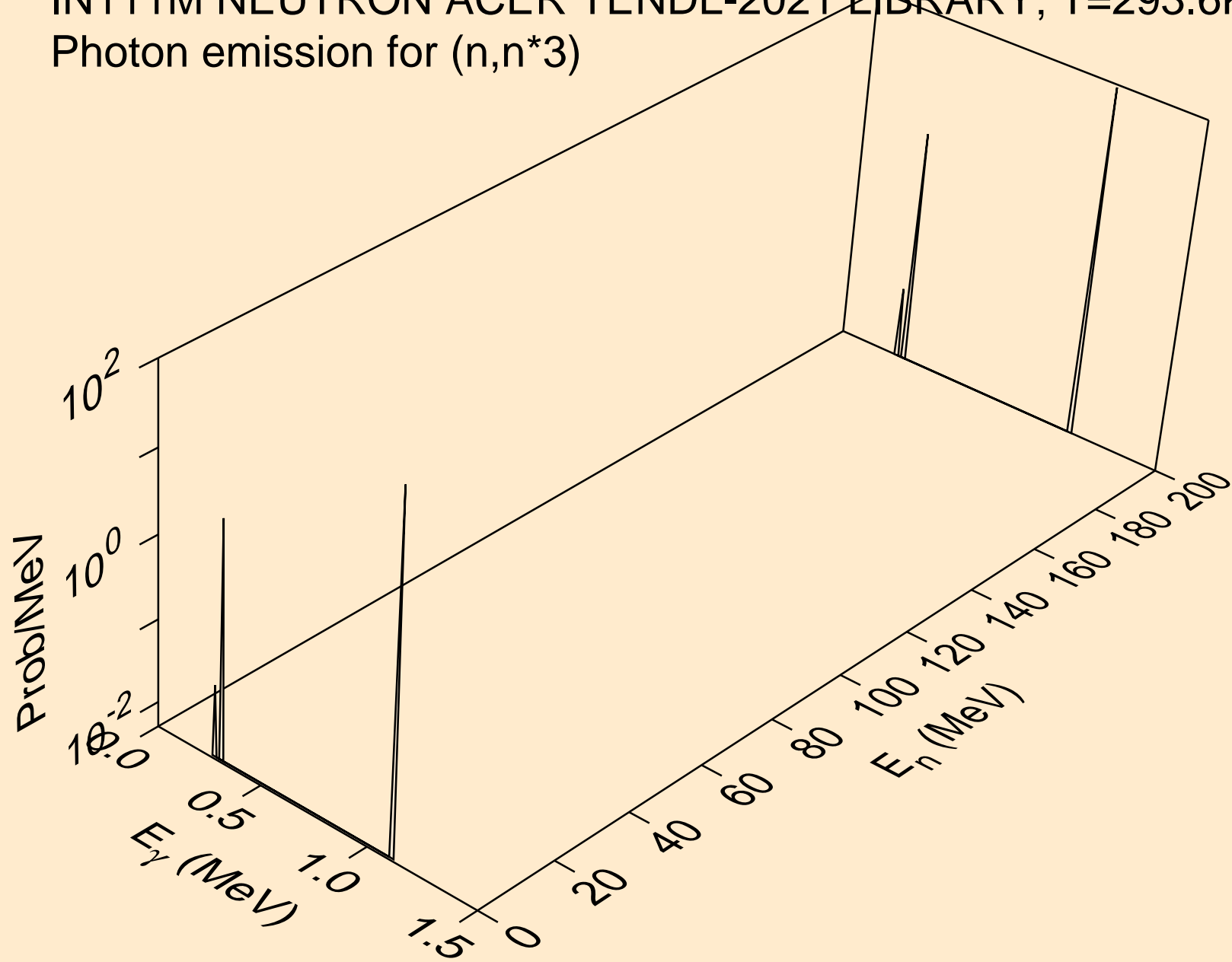

IN111M NEUTRON ACER TENDL-2021 LIBRARY; T=293.6K  
Photon emission for (n,n\*4)

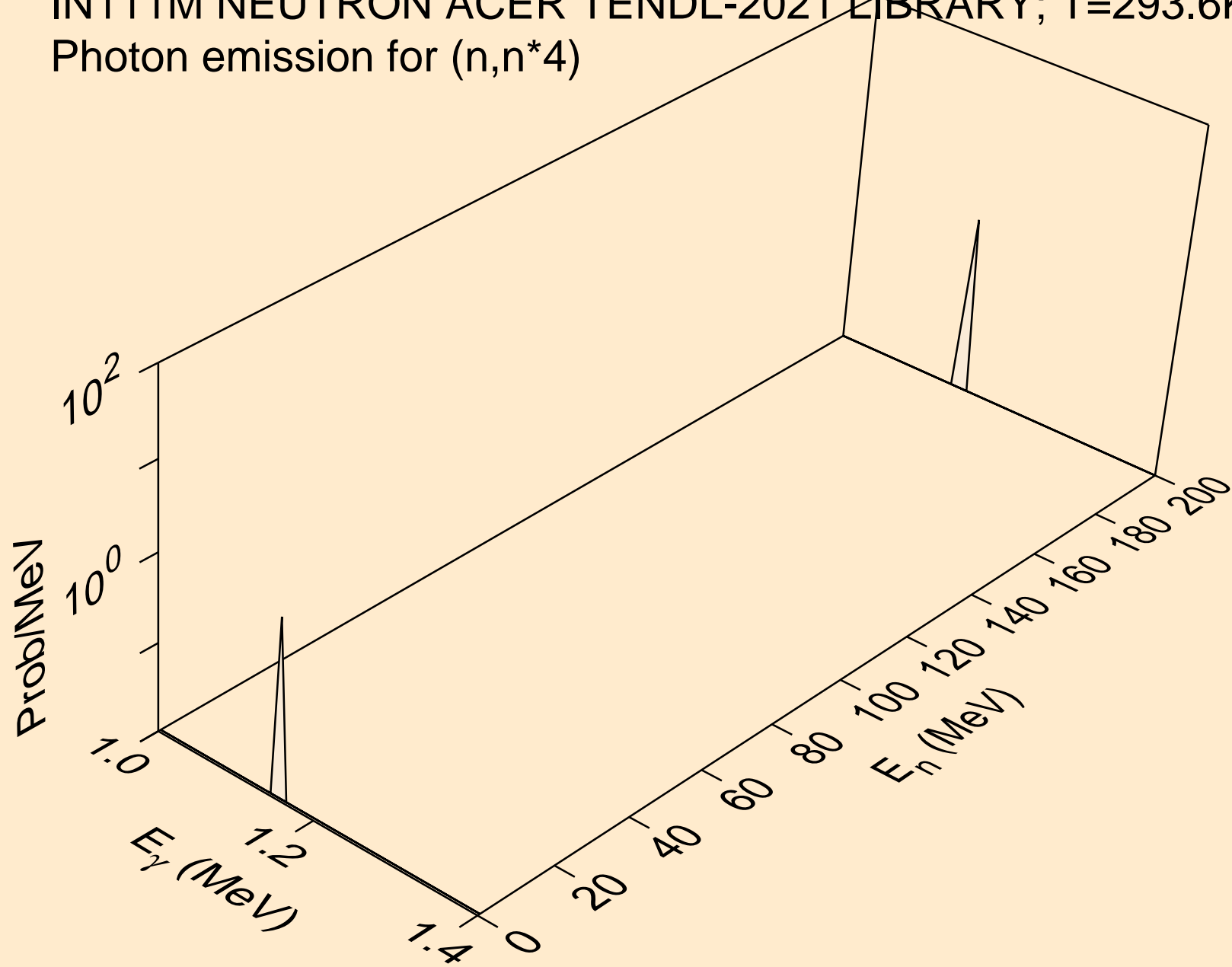

IN111M NEUTRON ACER TENDL-2021 LIBRARY; T=293.6K  
Photon emission for (n,n\*5)

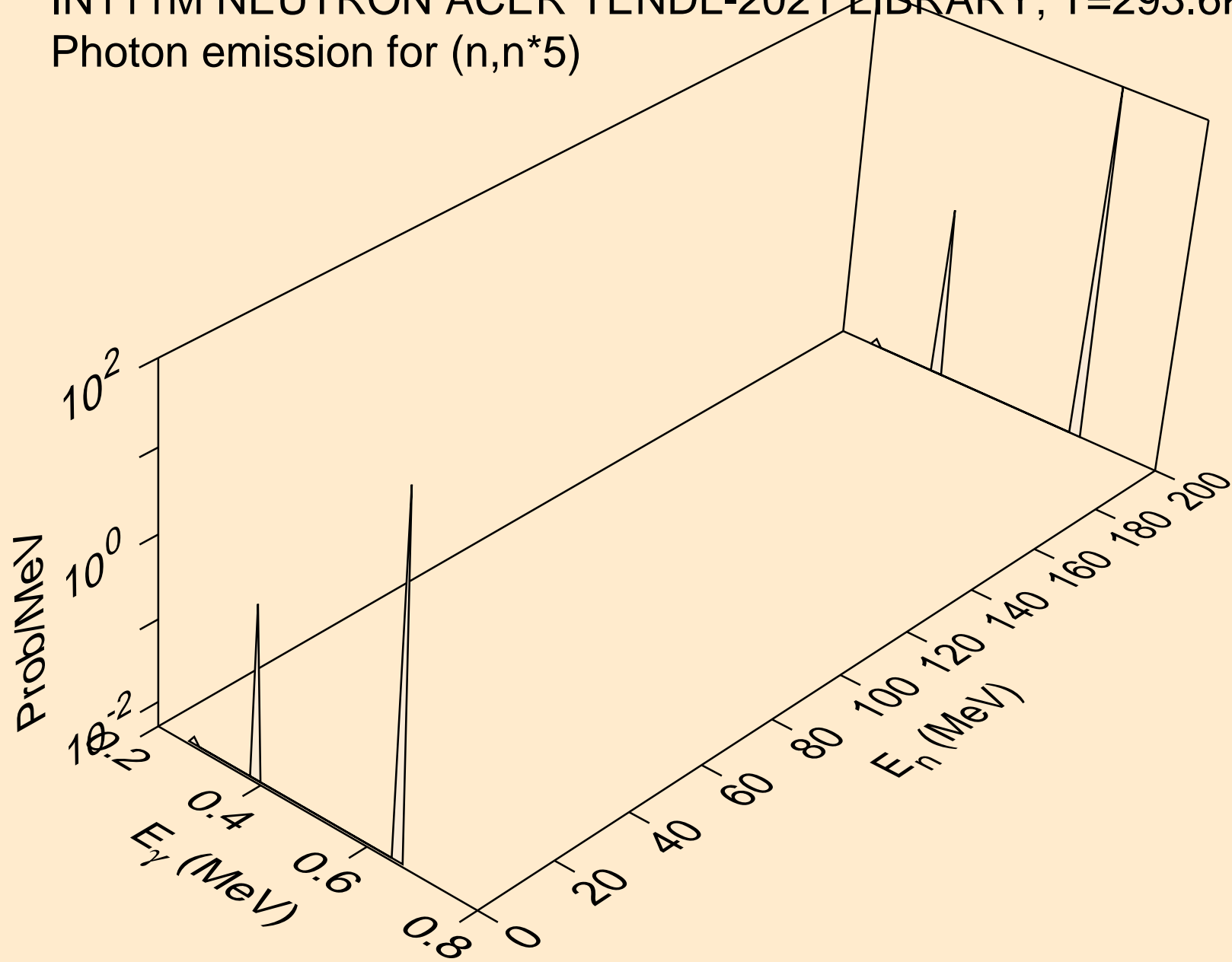

IN111M NEUTRON ACER TENDL-2021 LIBRARY; T=293.6K  
Photon emission for (n,n\*6)

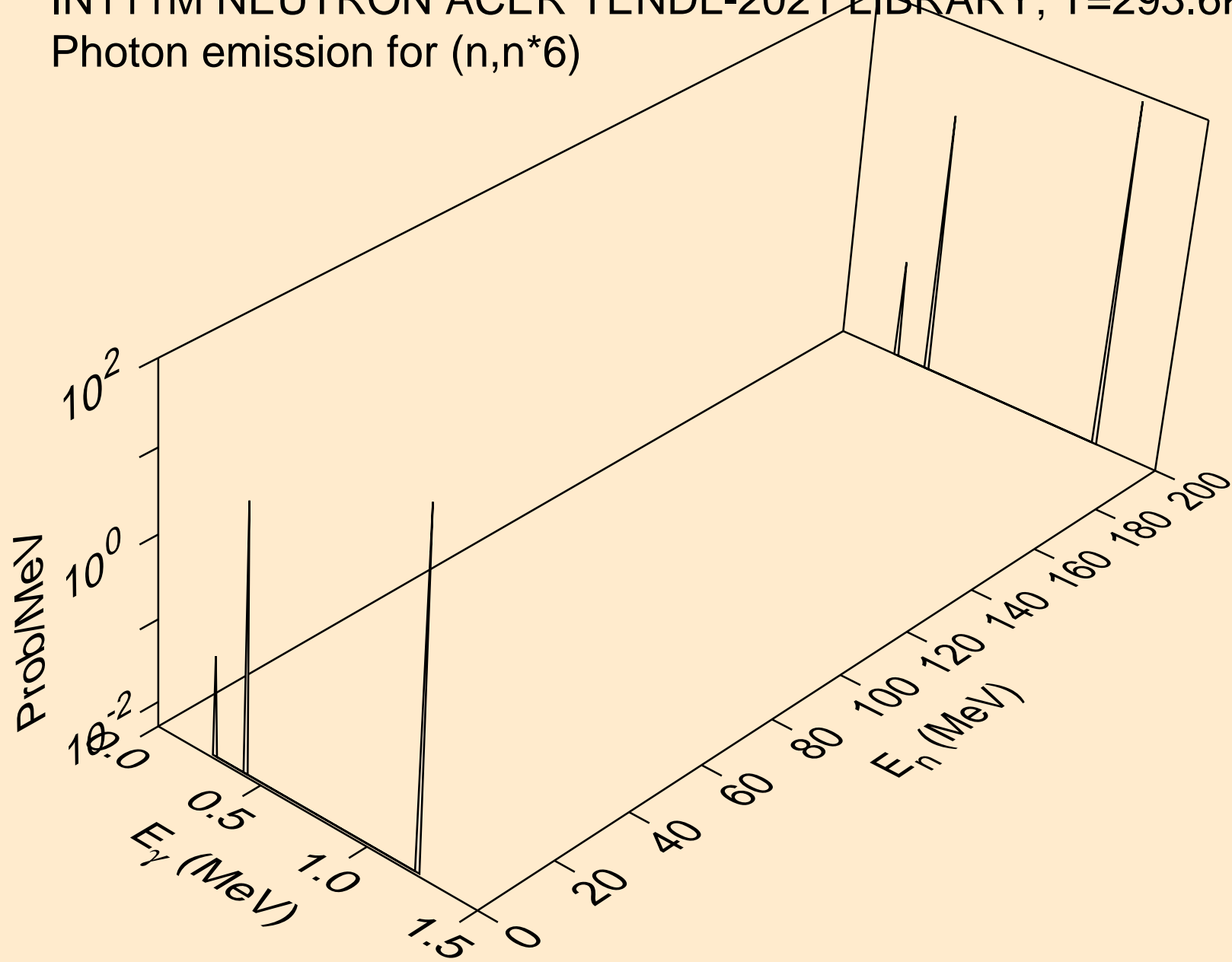

IN111M NEUTRON ACER TENDL-2021 LIBRARY; T=293.6K  
Photon emission for (n,n\*7)

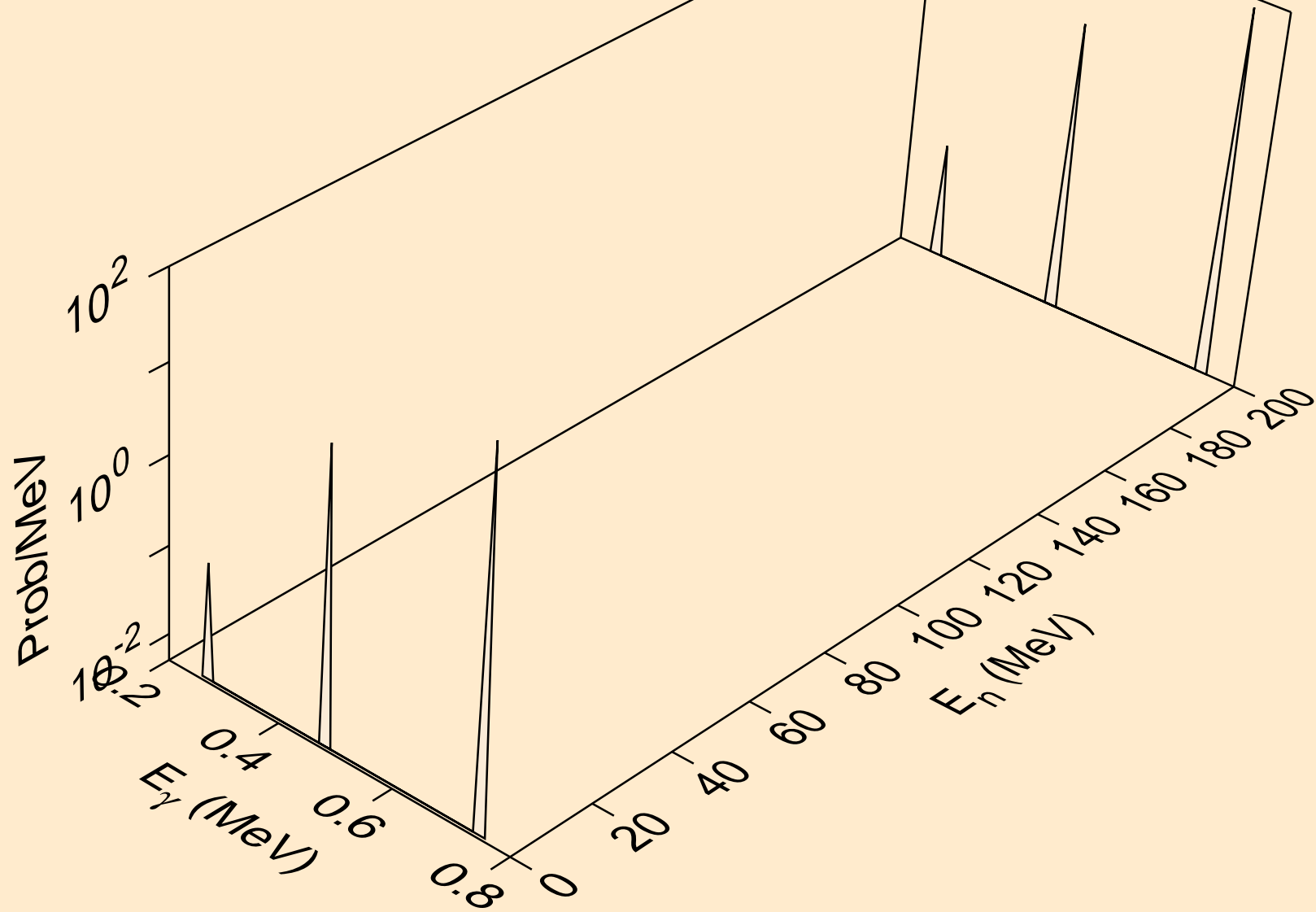

IN111M NEUTRON ACER TENDL-2021 LIBRARY; T=293.6K  
Photon emission for (n,n\*8)

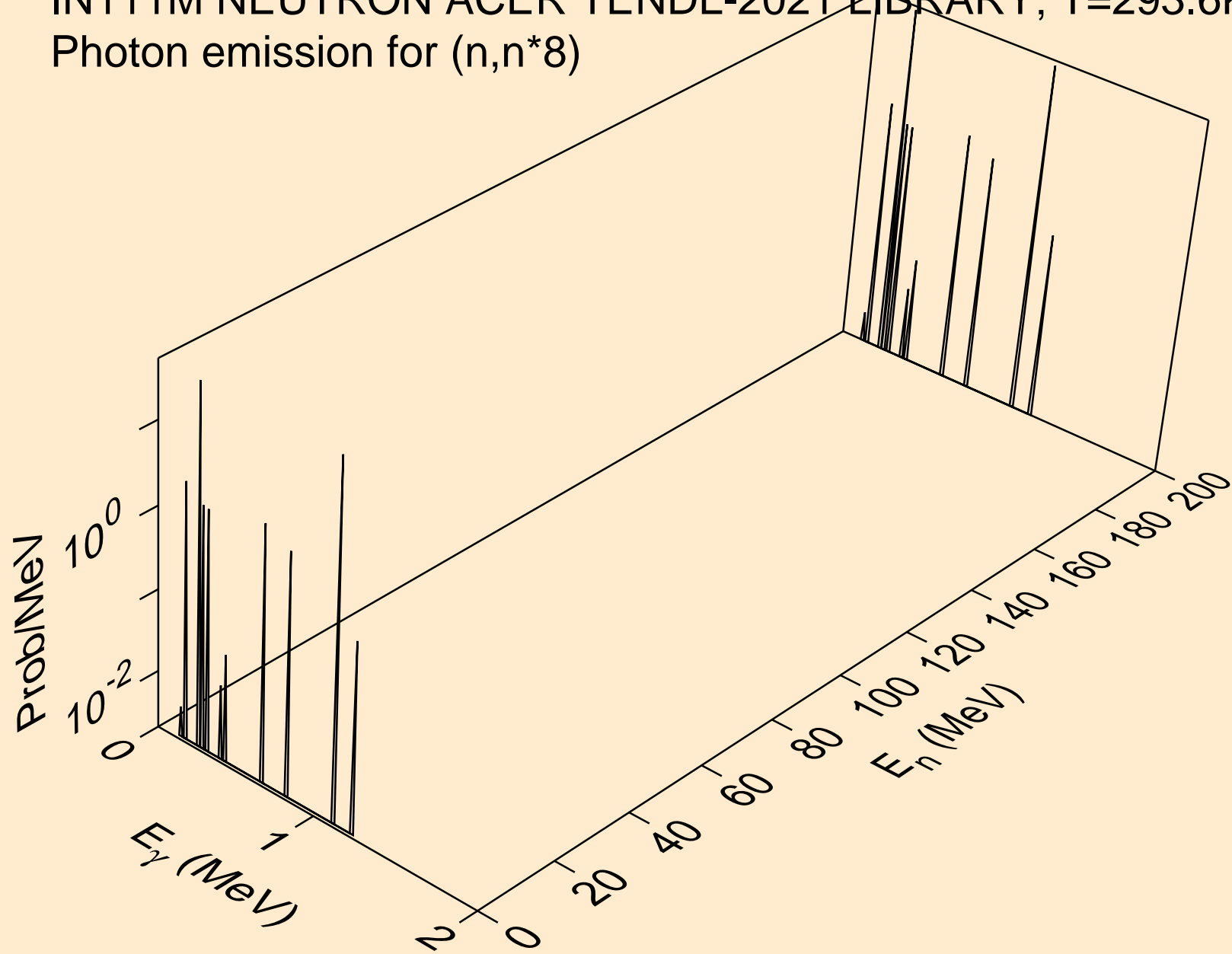

IN111M NEUTRON ACER TENDL-2021 LIBRARY; T=293.6K  
Photon emission for (n,n\*9)

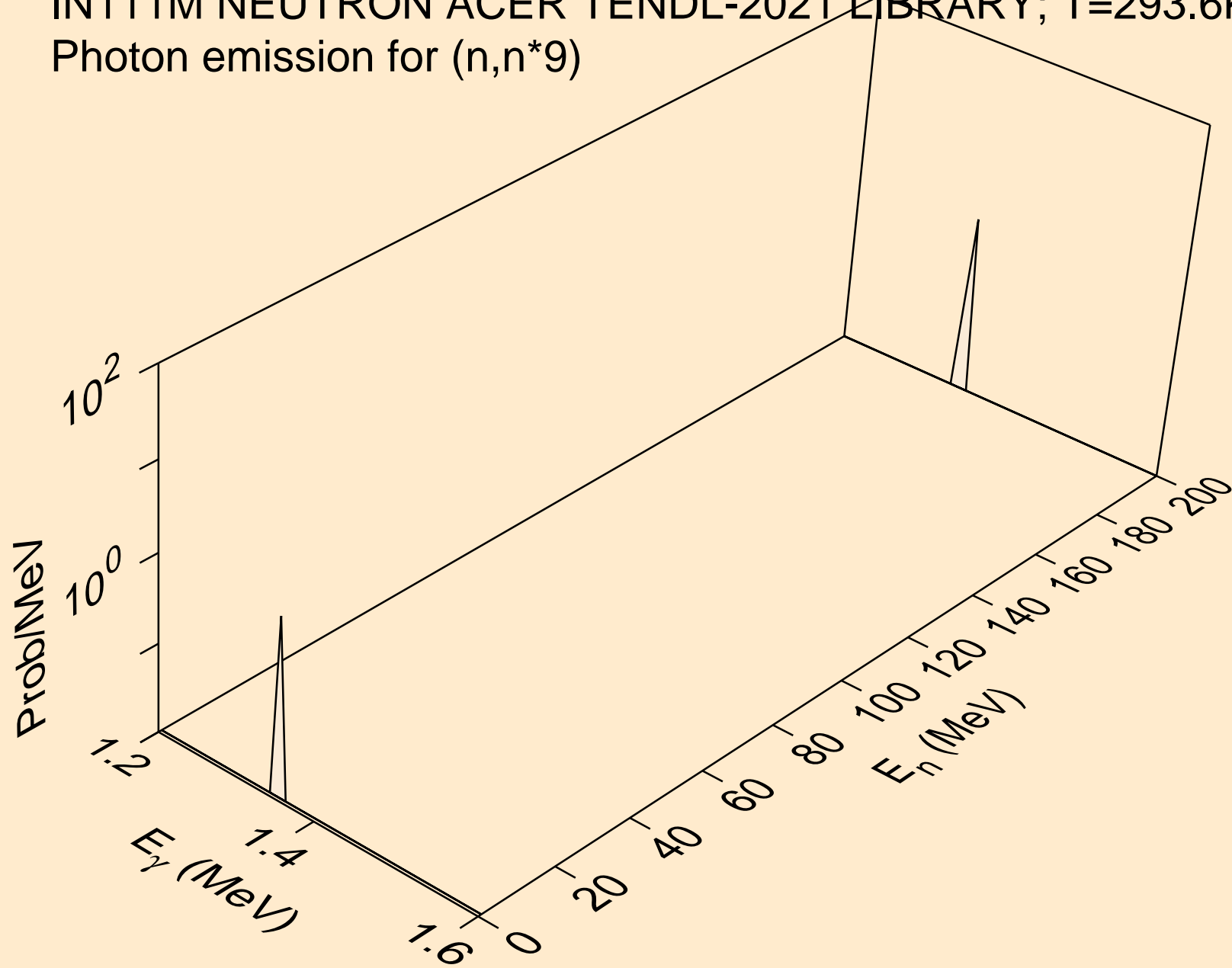



IN111M NEUTRON ACER TENDL-2021 LIBRARY; T=293.6K  
Photon emission for (n,n\*10)

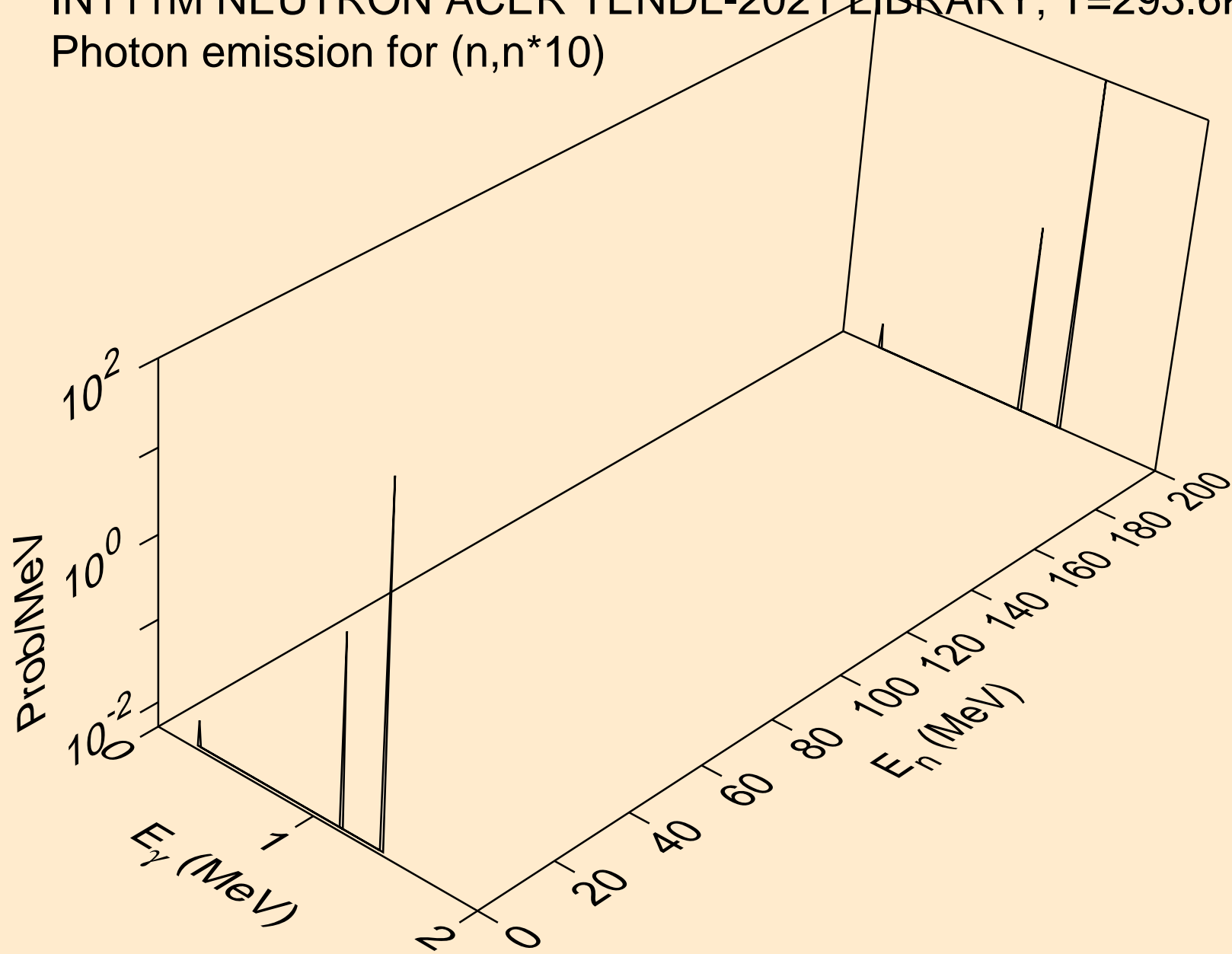

IN111M NEUTRON ACER TENDL-2021 LIBRARY; T=293.6K  
Photon emission for (n,n\*11)

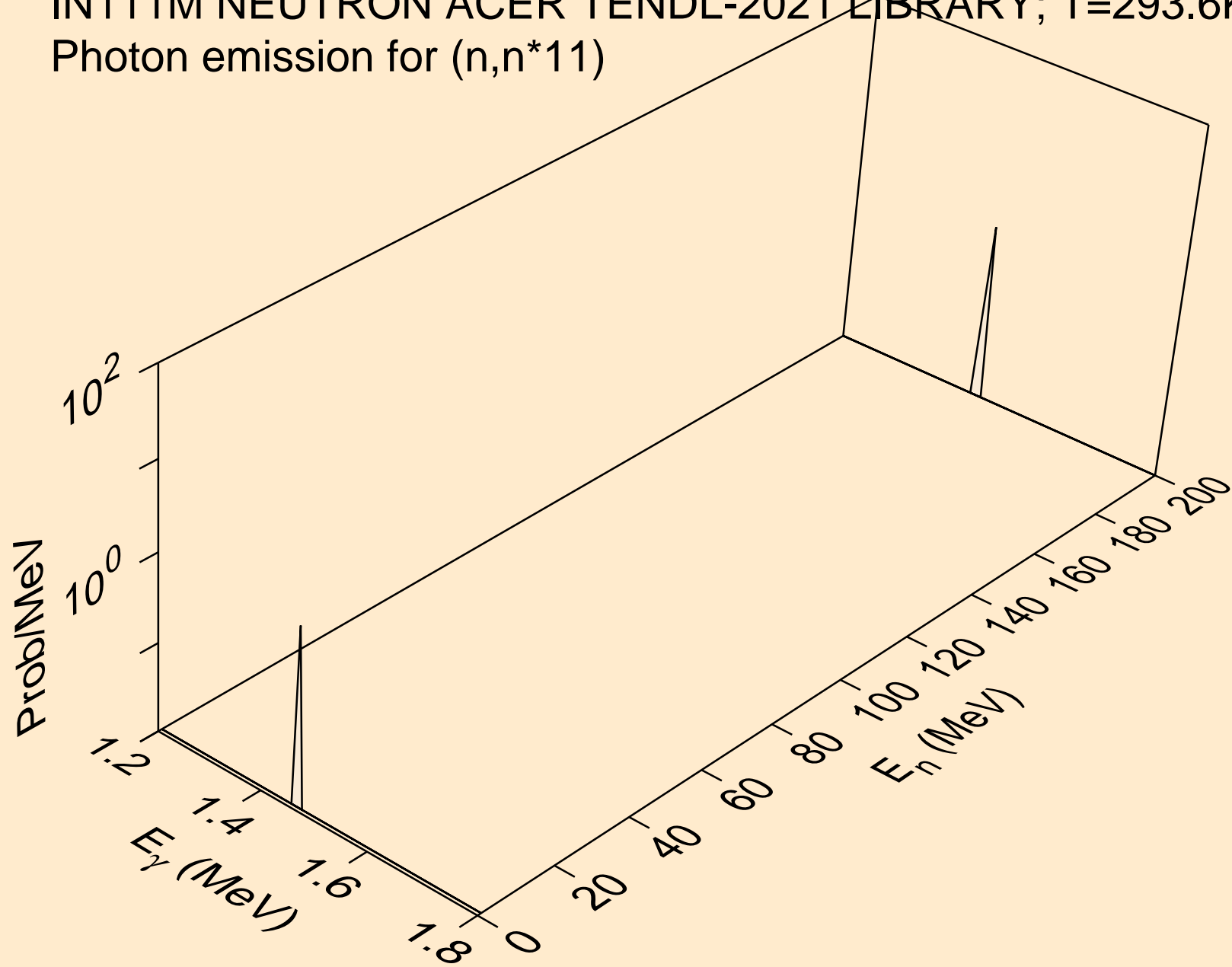

IN111M NEUTRON ACER TENDL-2021 LIBRARY; T=293.6K  
Photon emission for (n,n\*12)

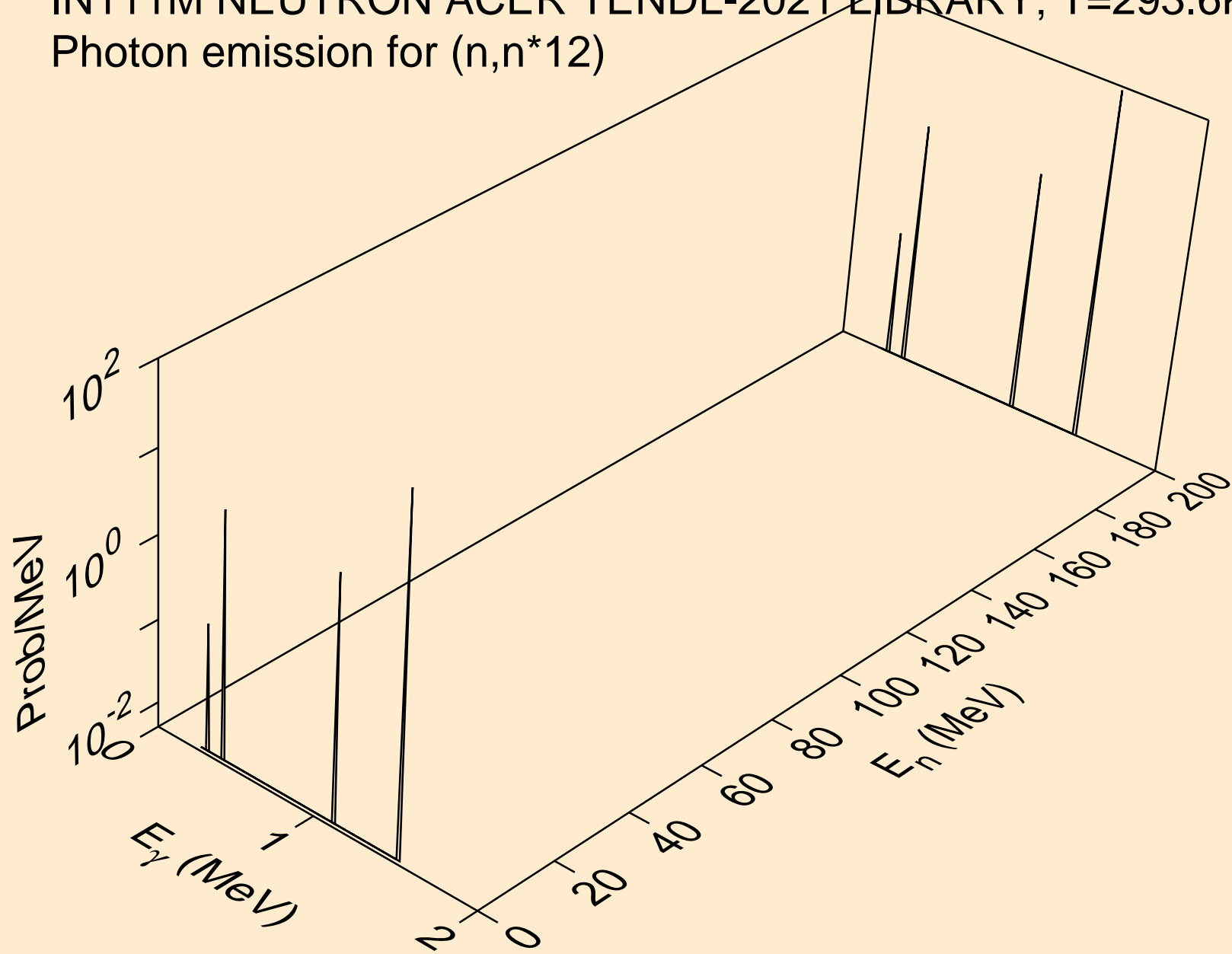

IN111M NEUTRON ACER TENDL-2021 LIBRARY; T=293.6K  
Photon emission for (n,n\*13)

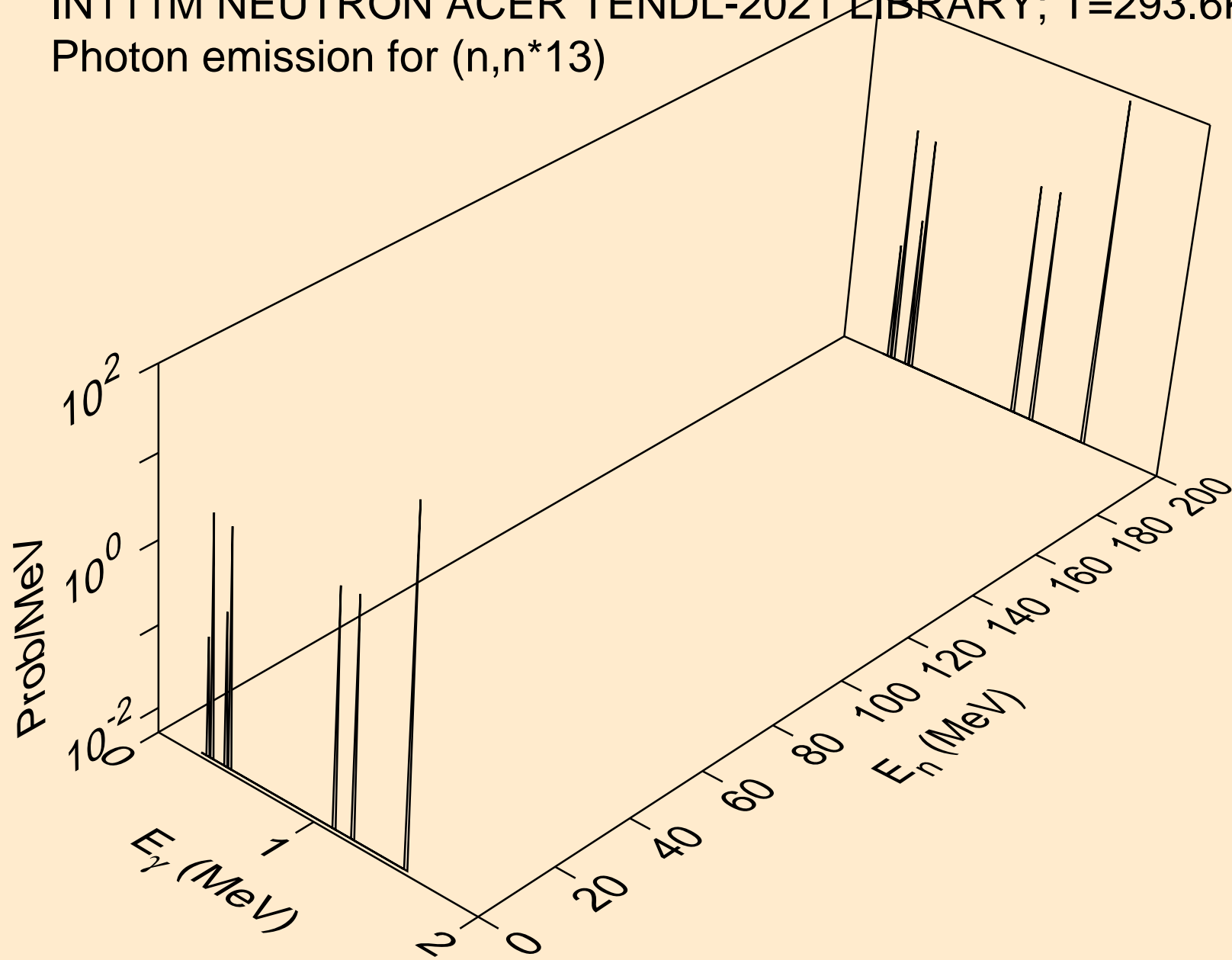

IN111M NEUTRON ACER TENDL-2021 LIBRARY; T=293.6K  
Photon emission for (n,n\*14)

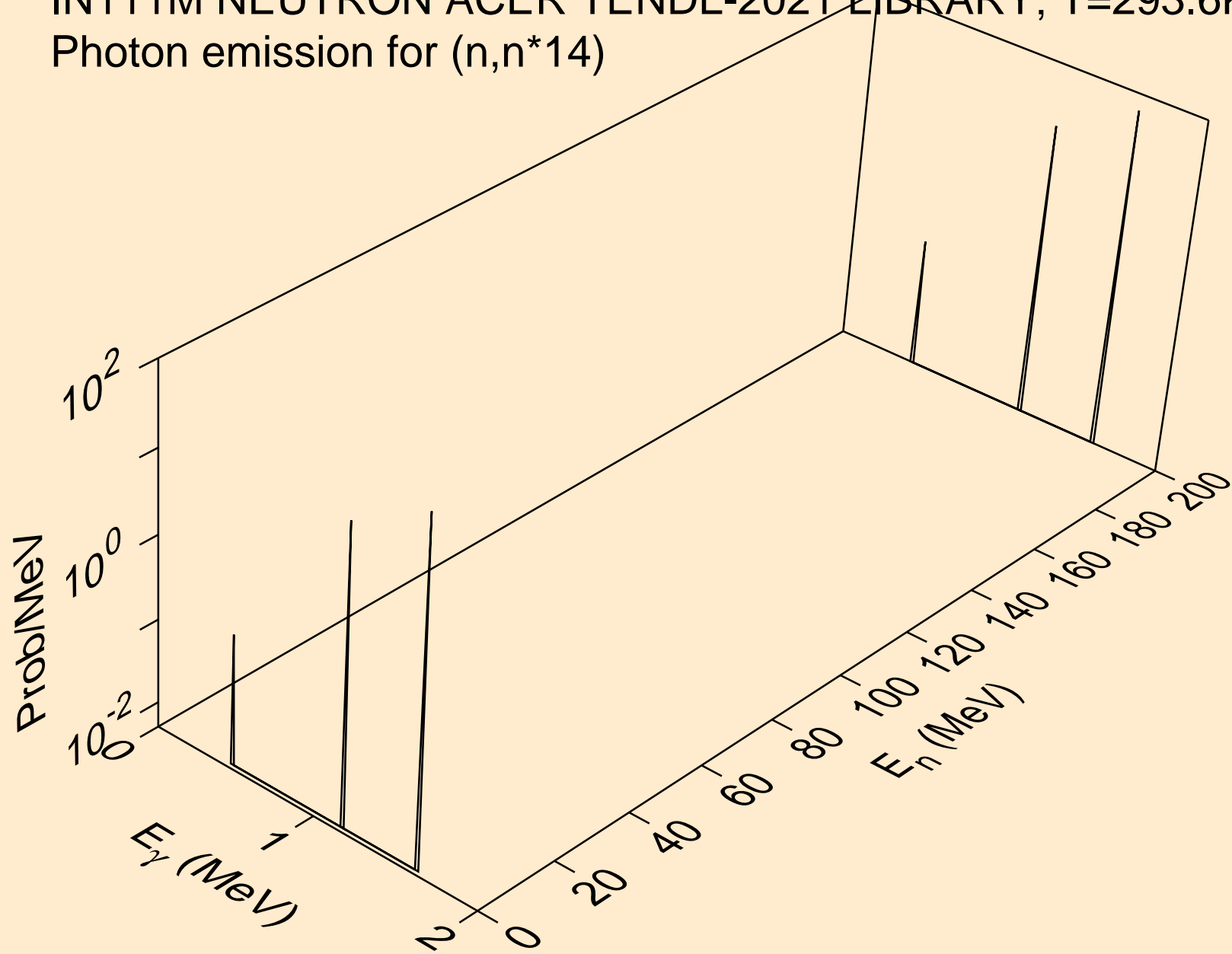

IN111M NEUTRON ACER TENDL-2021 LIBRARY; T=293.6K  
Photon emission for (n,n\*15)

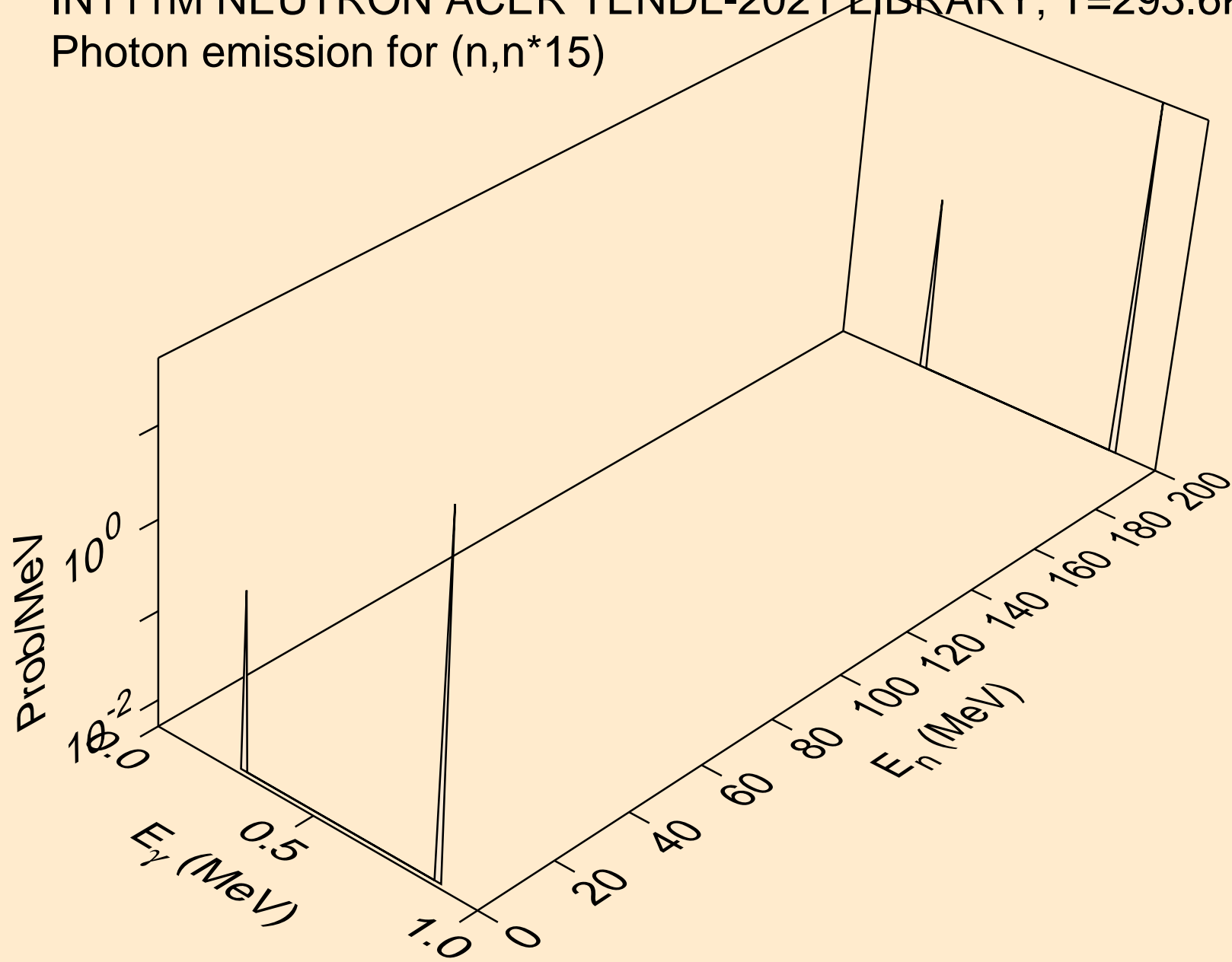

IN111M NEUTRON ACER TENDL-2021 LIBRARY; T=293.6K  
Photon emission for (n,n\*16)

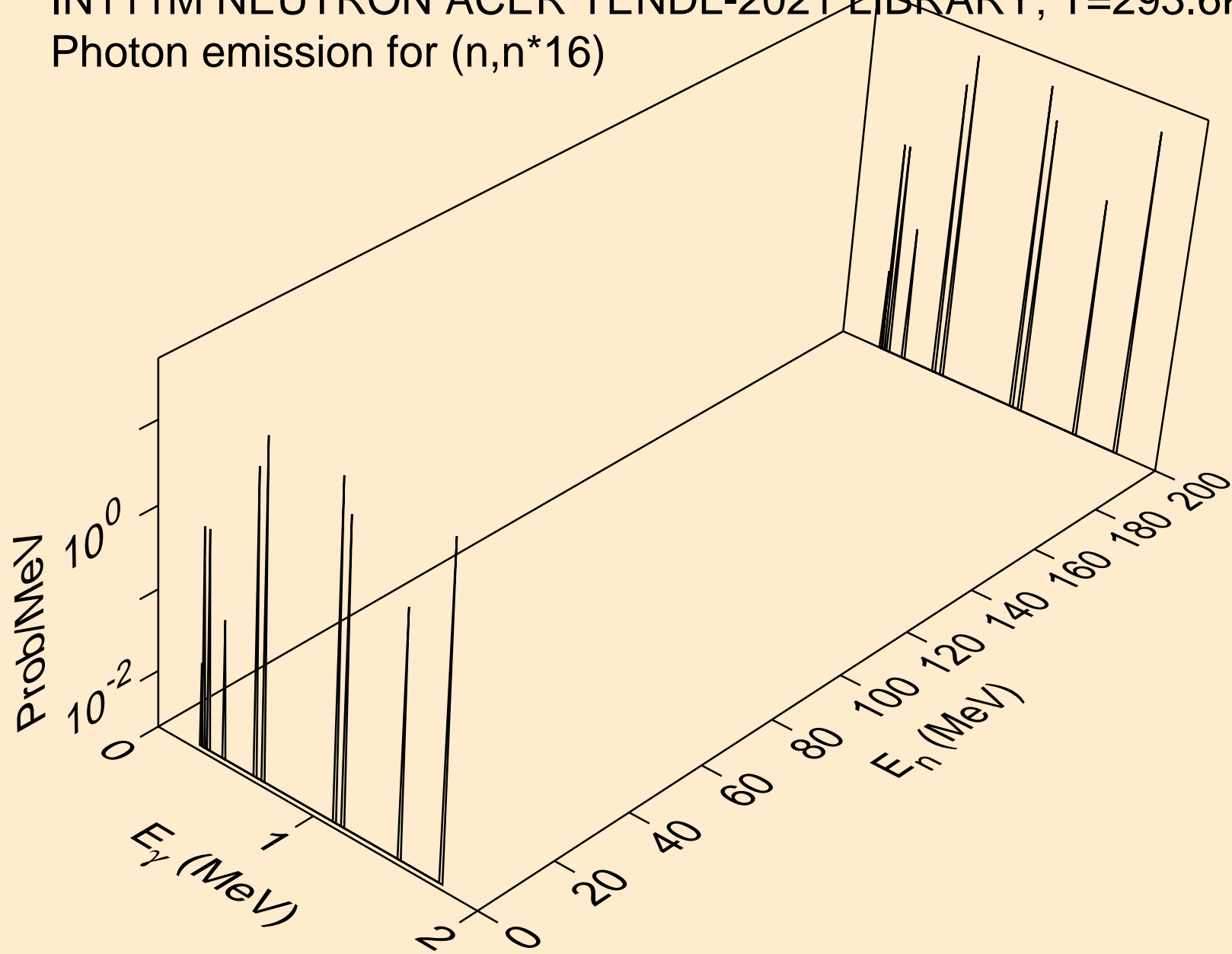

IN111M NEUTRON ACER TENDL-2021 LIBRARY; T=293.6K  
Photon emission for (n,n\*17)

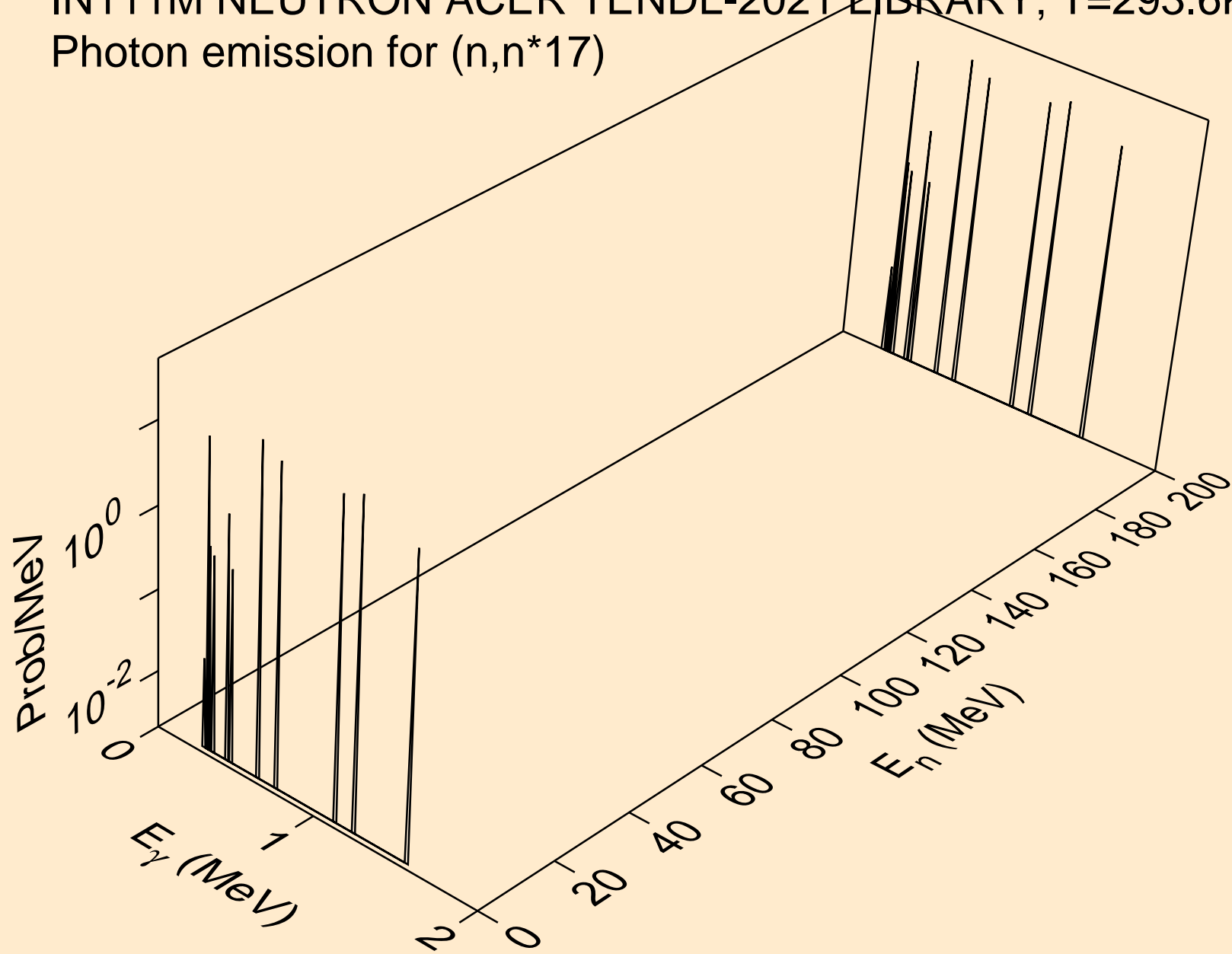



IN111M NEUTRON ACER TENDL-2021 LIBRARY; T=293.6K  
Photon emission for (n,n\*18)

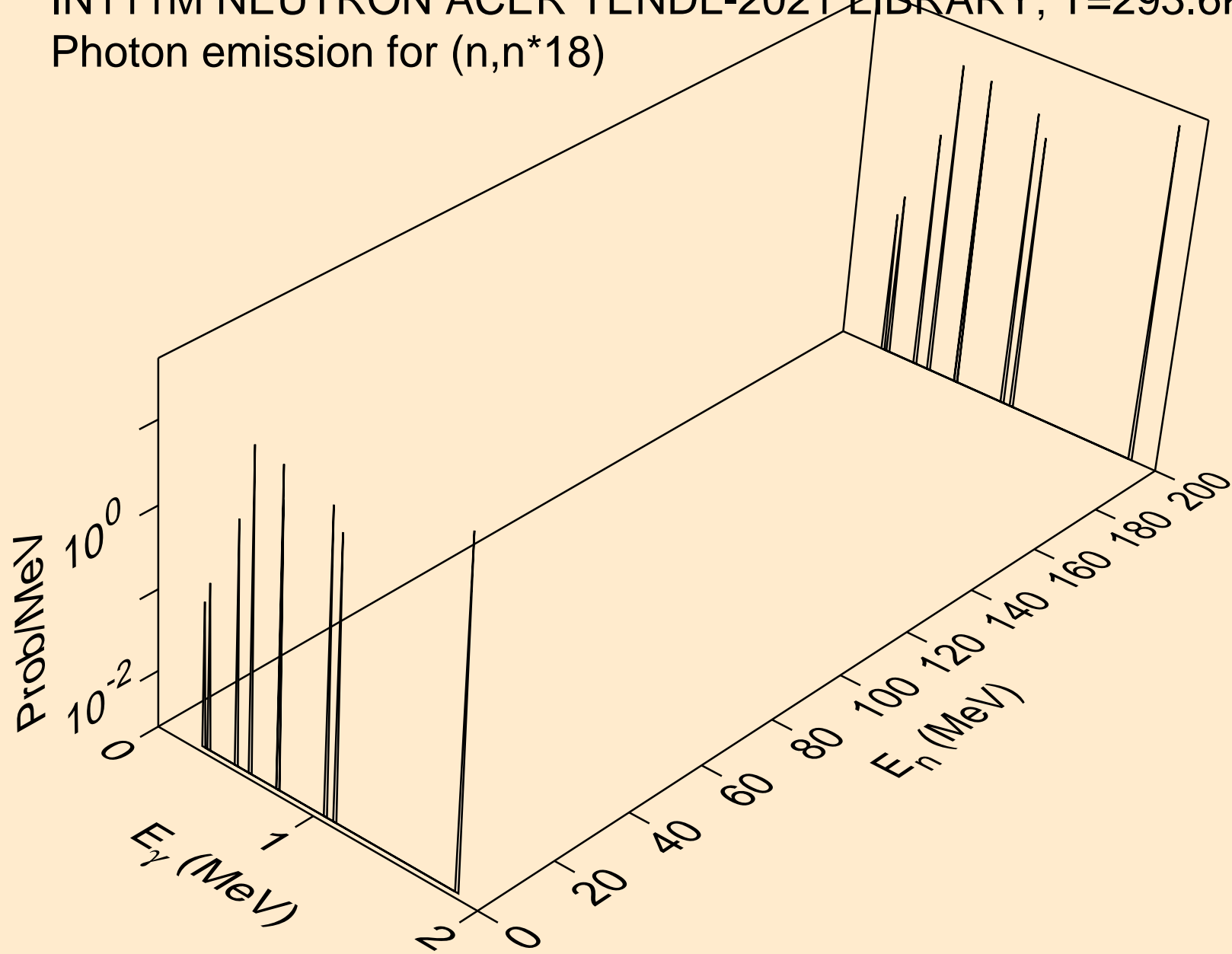

IN111M NEUTRON ACER TENDL-2021 LIBRARY; T=293.6K  
Photon emission for (n,n\*19)

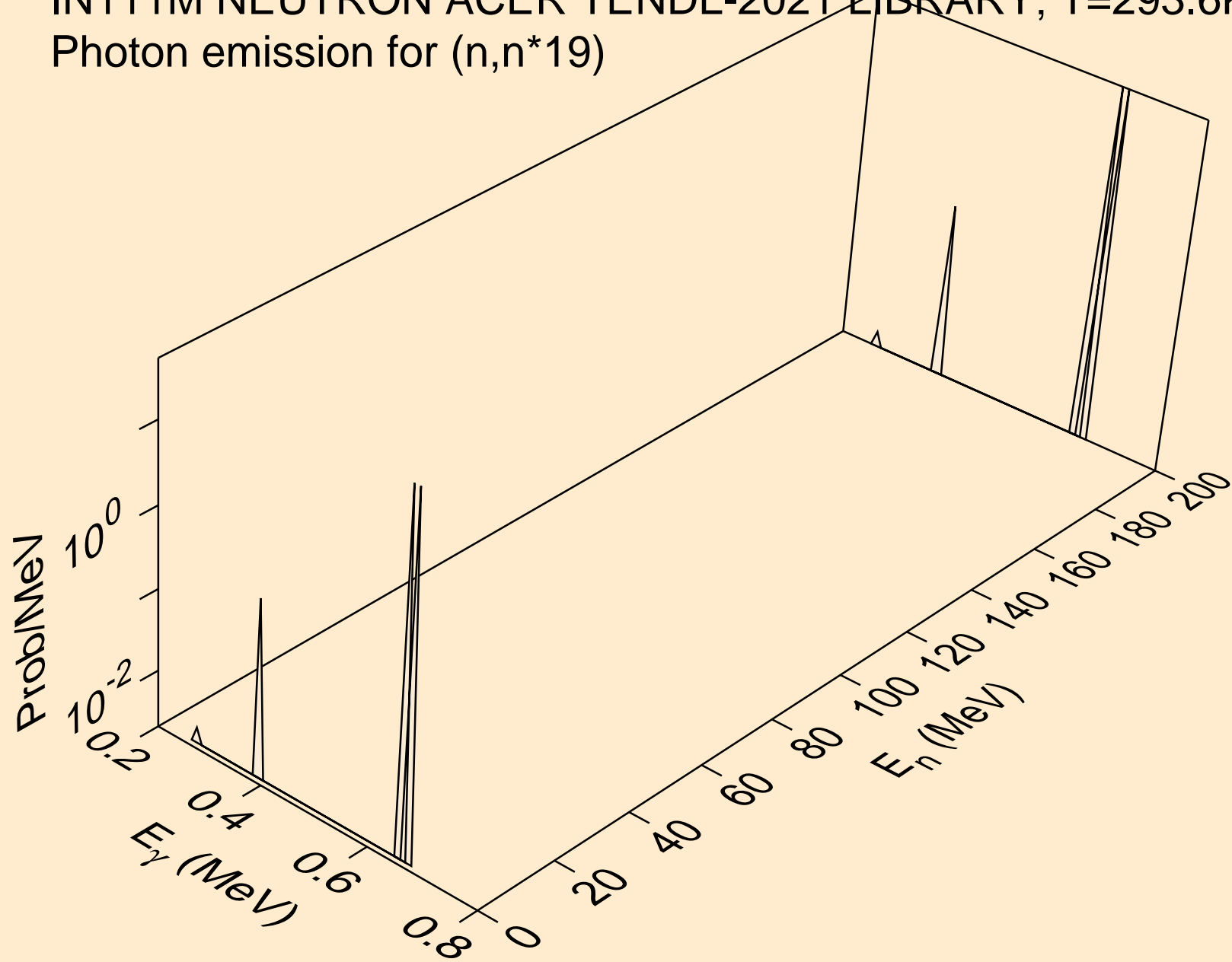

IN111M NEUTRON ACER TENDL-2021 LIBRARY; T=293.6K  
Photon emission for (n,n\*20)

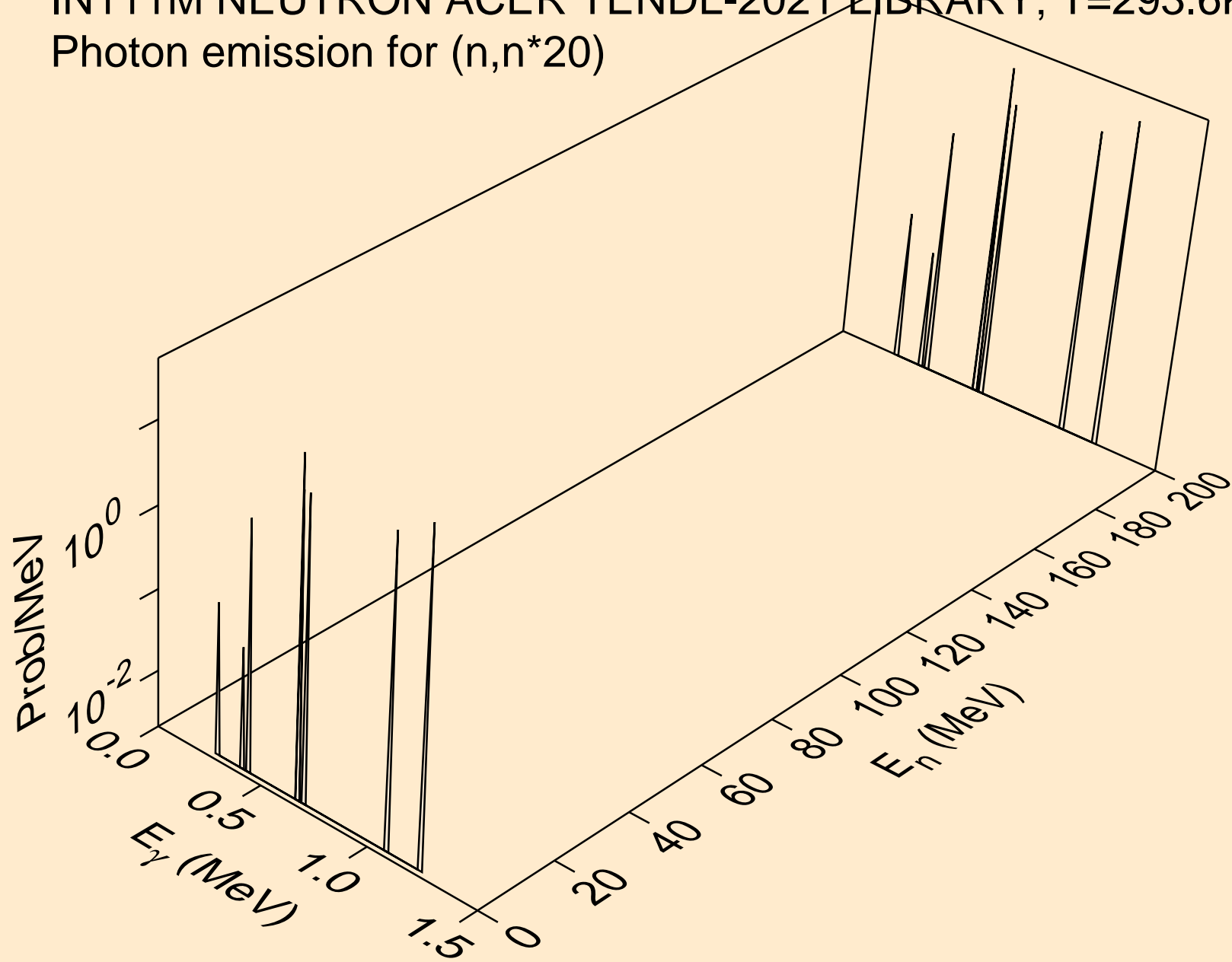

IN111M NEUTRON ACER TENDL-2021 LIBRARY; T=293.6K  
Photon emission for (n,n\*21)

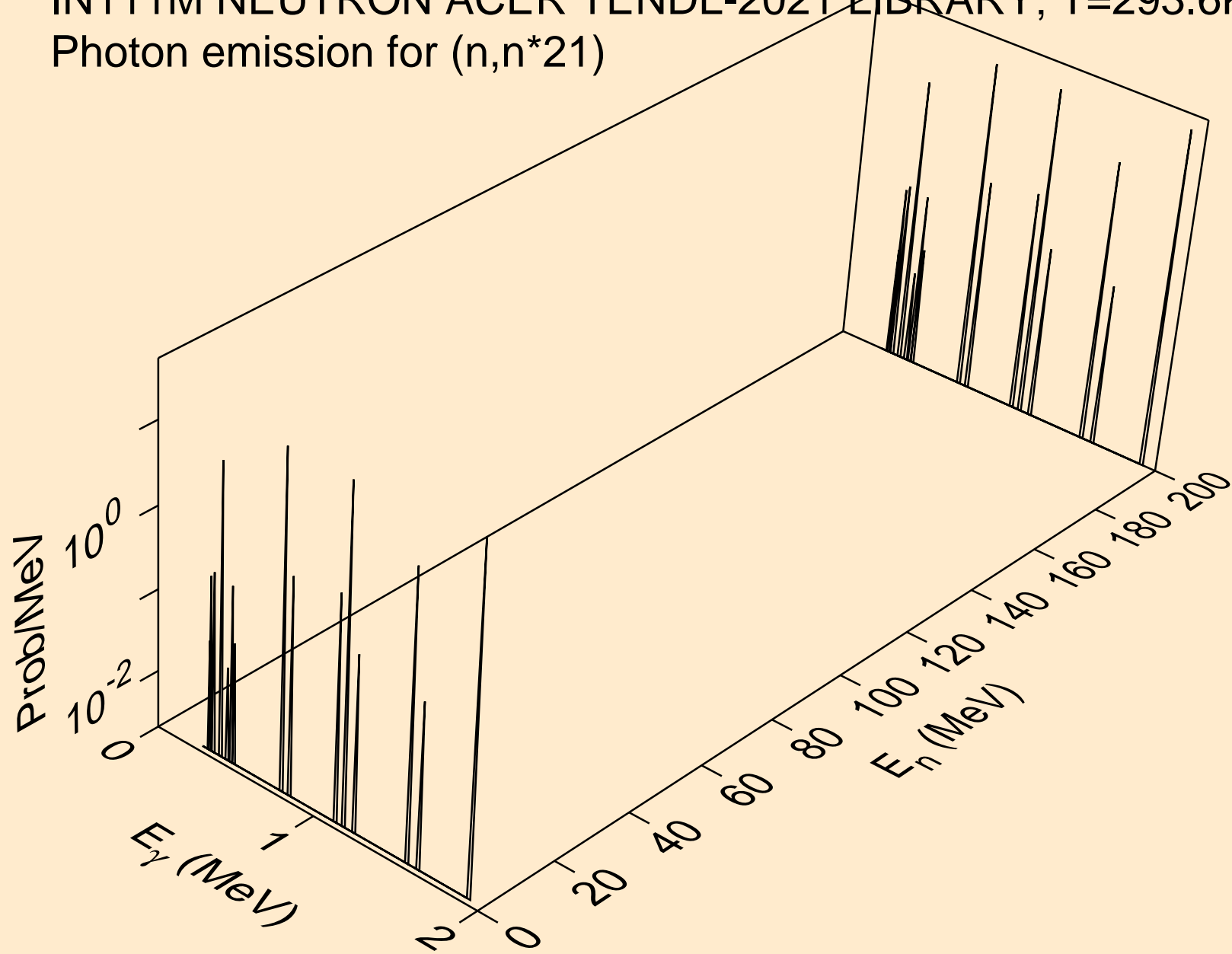

IN111M NEUTRON ACER TENDL-2021 LIBRARY; T=293.6K  
Photon emission for (n,n\*22)

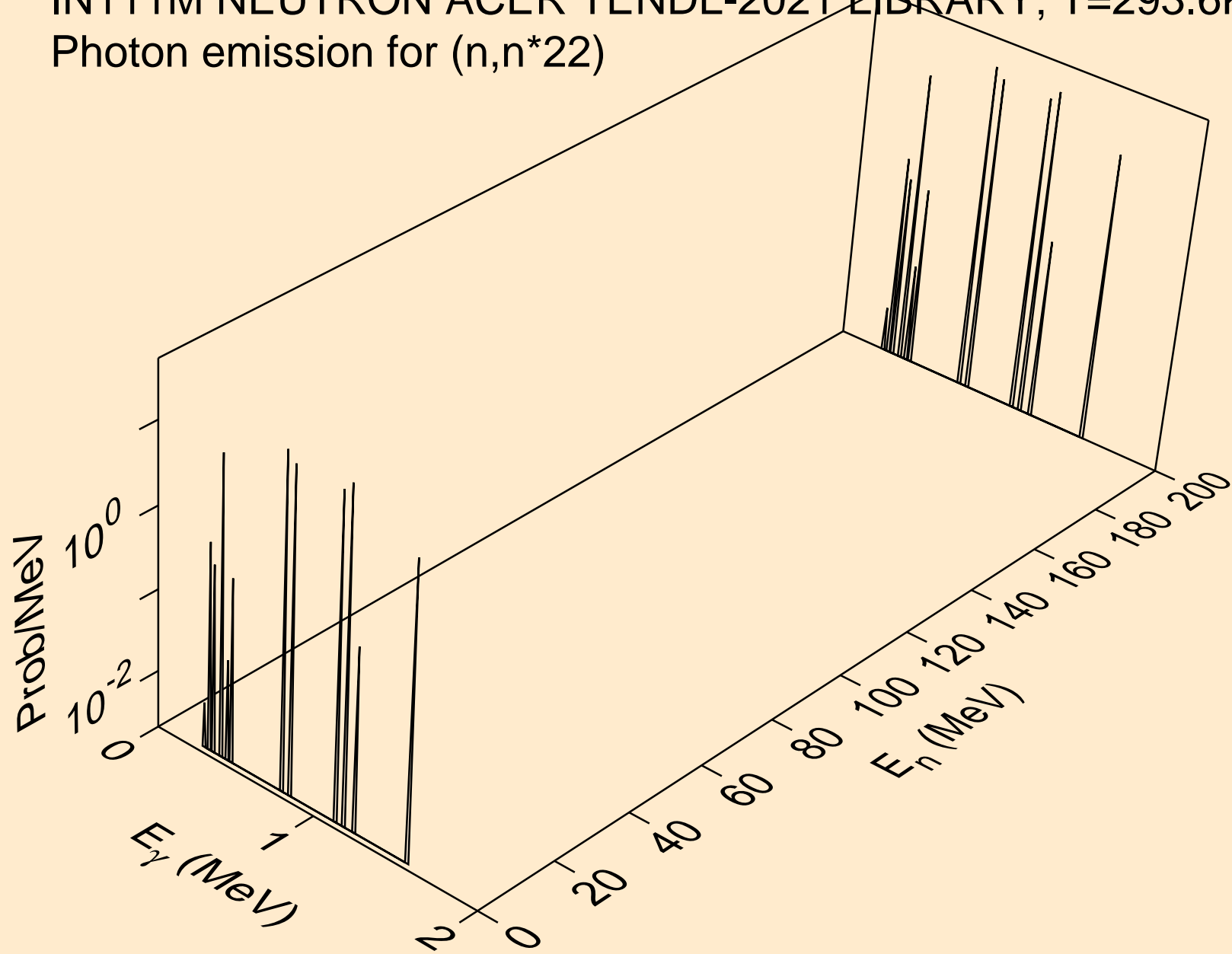

IN111M NEUTRON ACER TENDL-2021 LIBRARY; T=293.6K  
Photon emission for (n,n\*23)

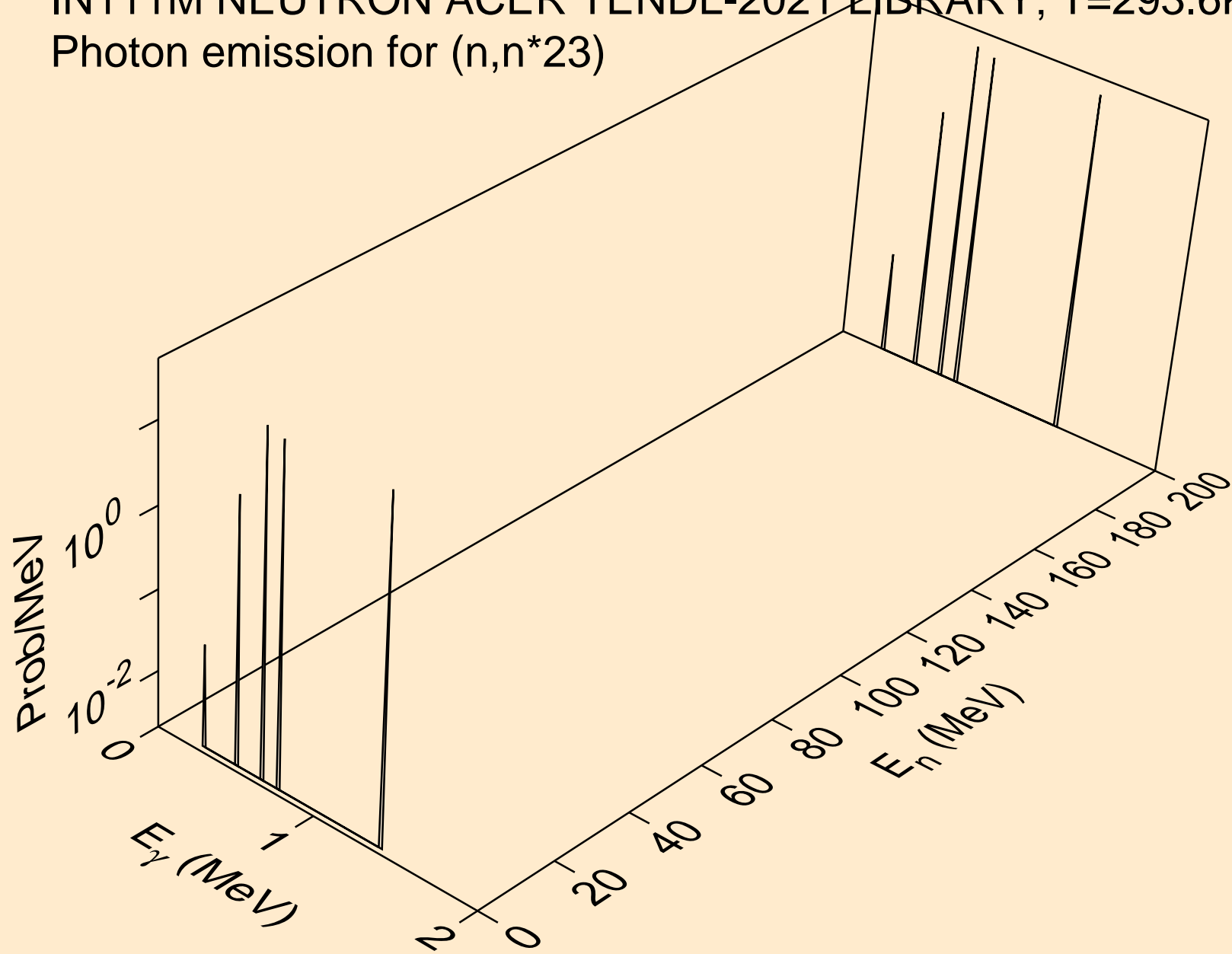

IN111M NEUTRON ACER TENDL-2021 LIBRARY; T=293.6K  
Photon emission for (n,n\*24)

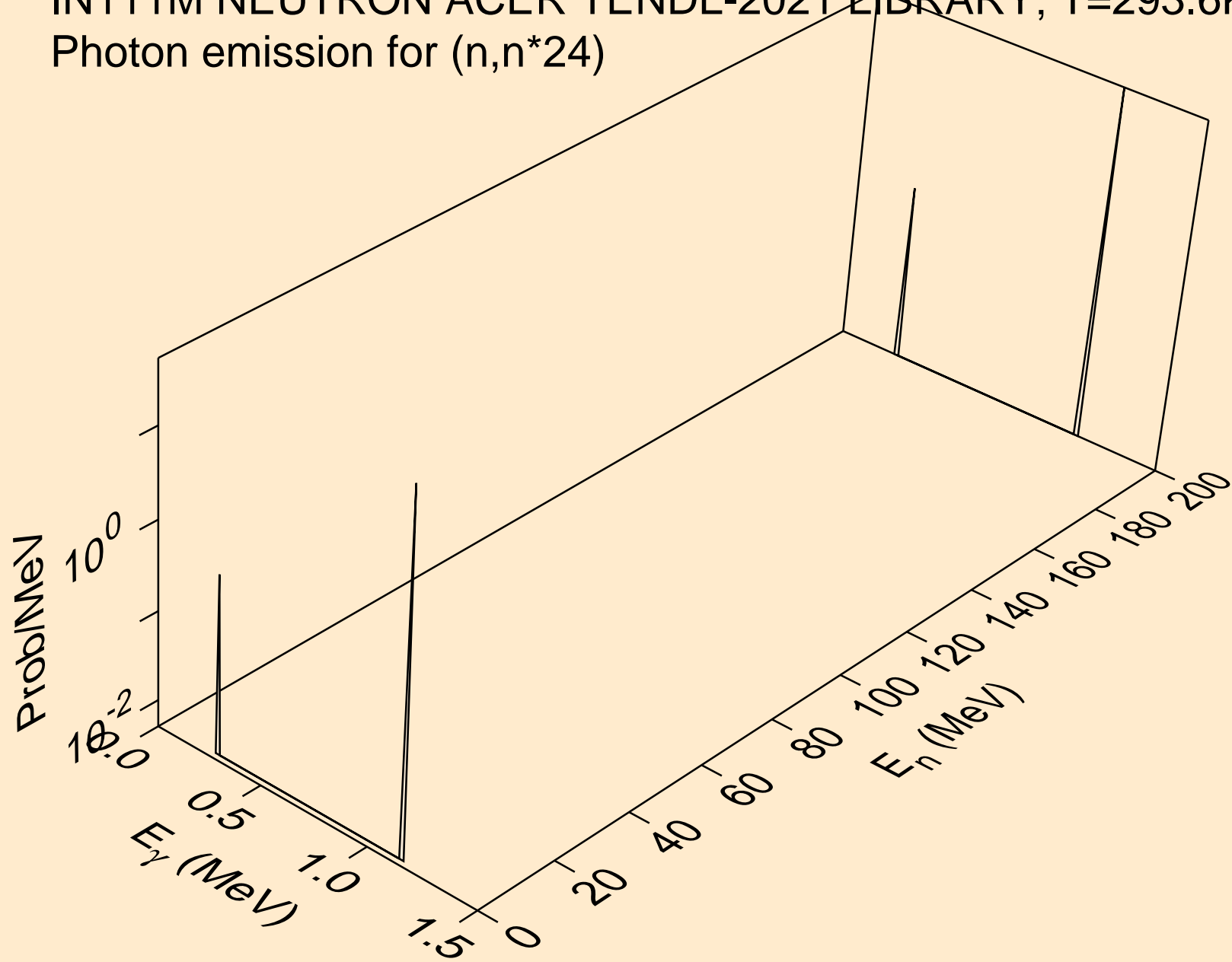

IN111M NEUTRON ACER TENDL-2021 LIBRARY; T=293.6K  
Photon emission for (n,n\*25)

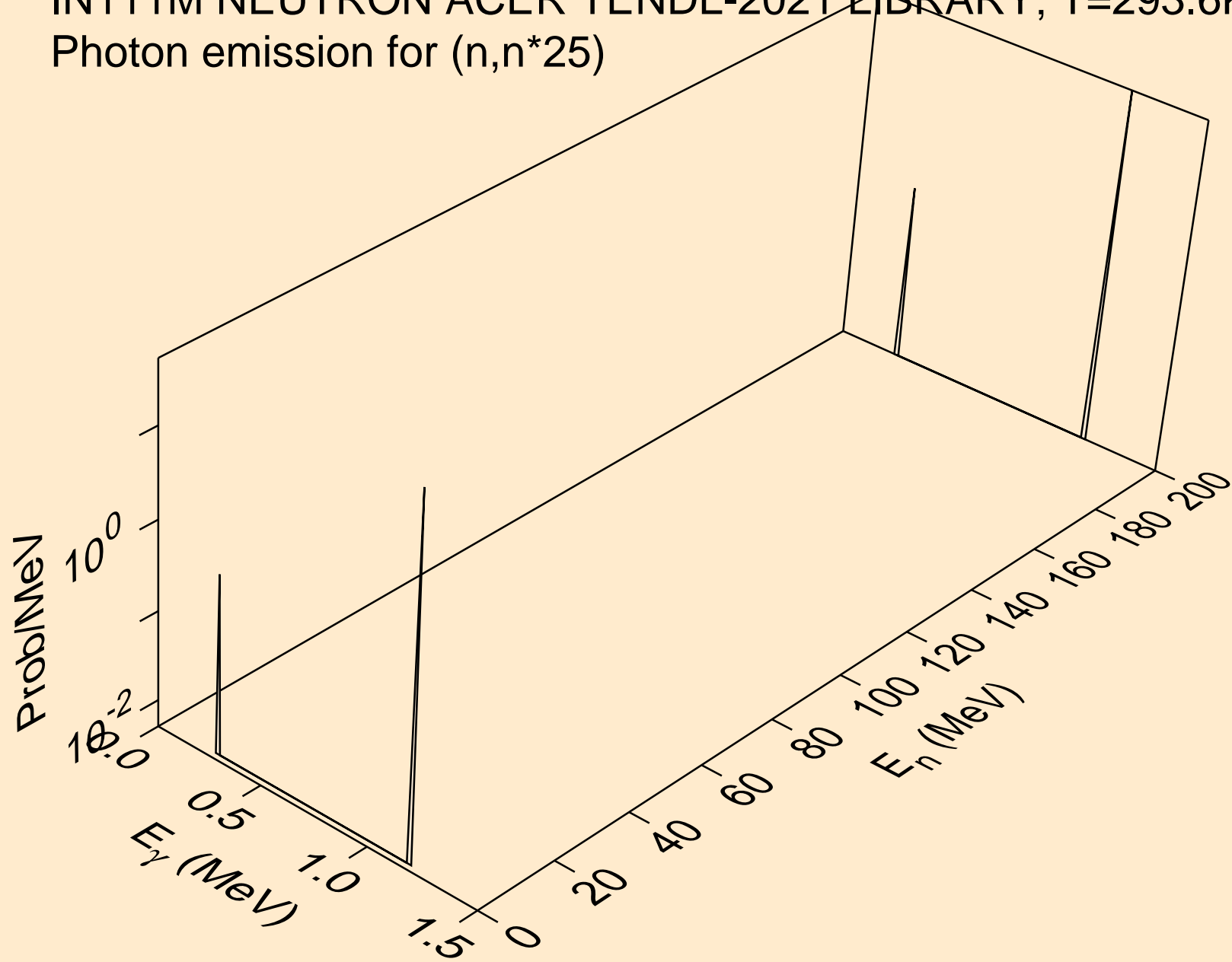



IN111M NEUTRON ACER TENDL-2021 LIBRARY; T=293.6K  
Photon emission for (n,n\*26)

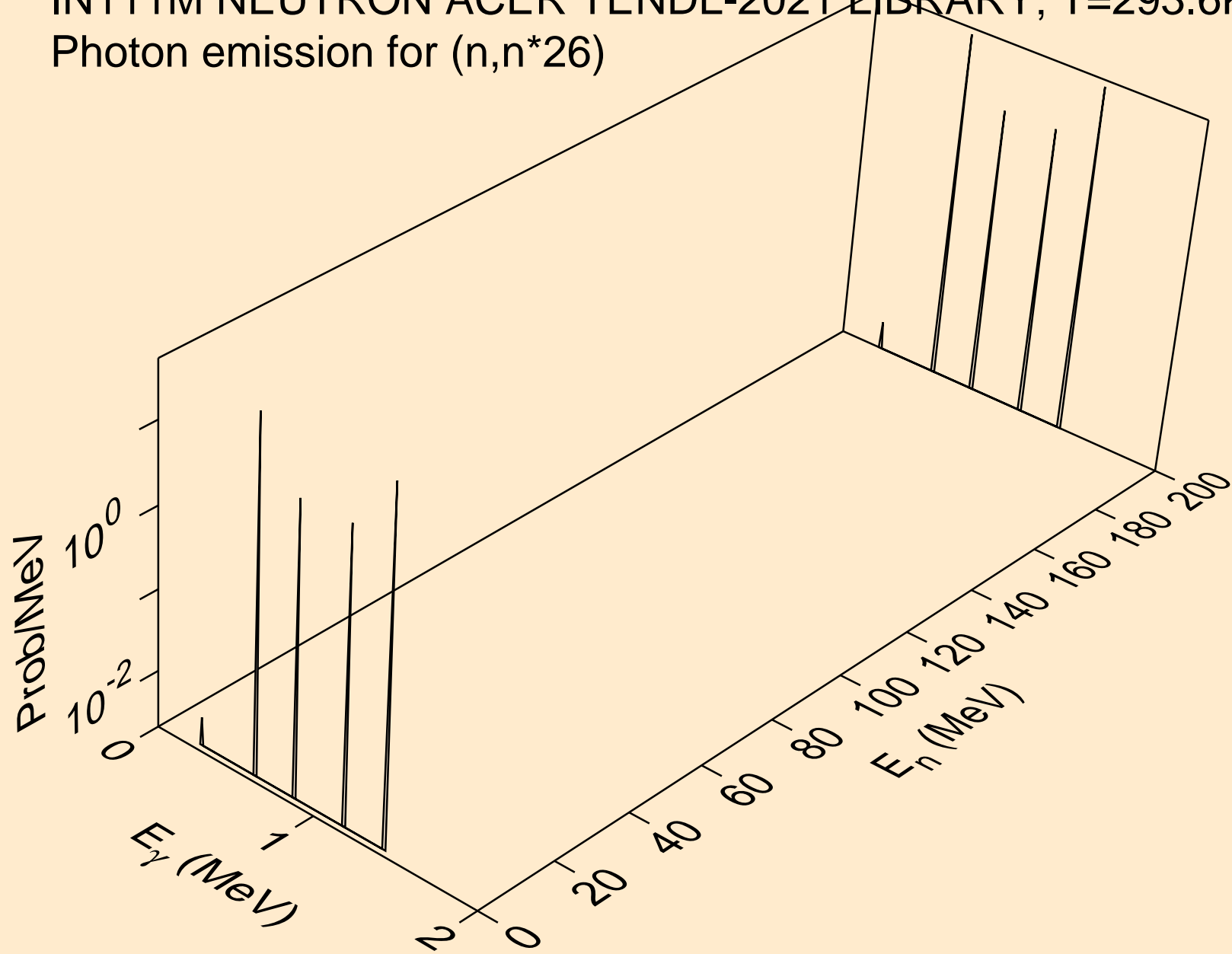

IN111M NEUTRON ACER TENDL-2021 LIBRARY; T=293.6K  
Photon emission for (n,n\*27)

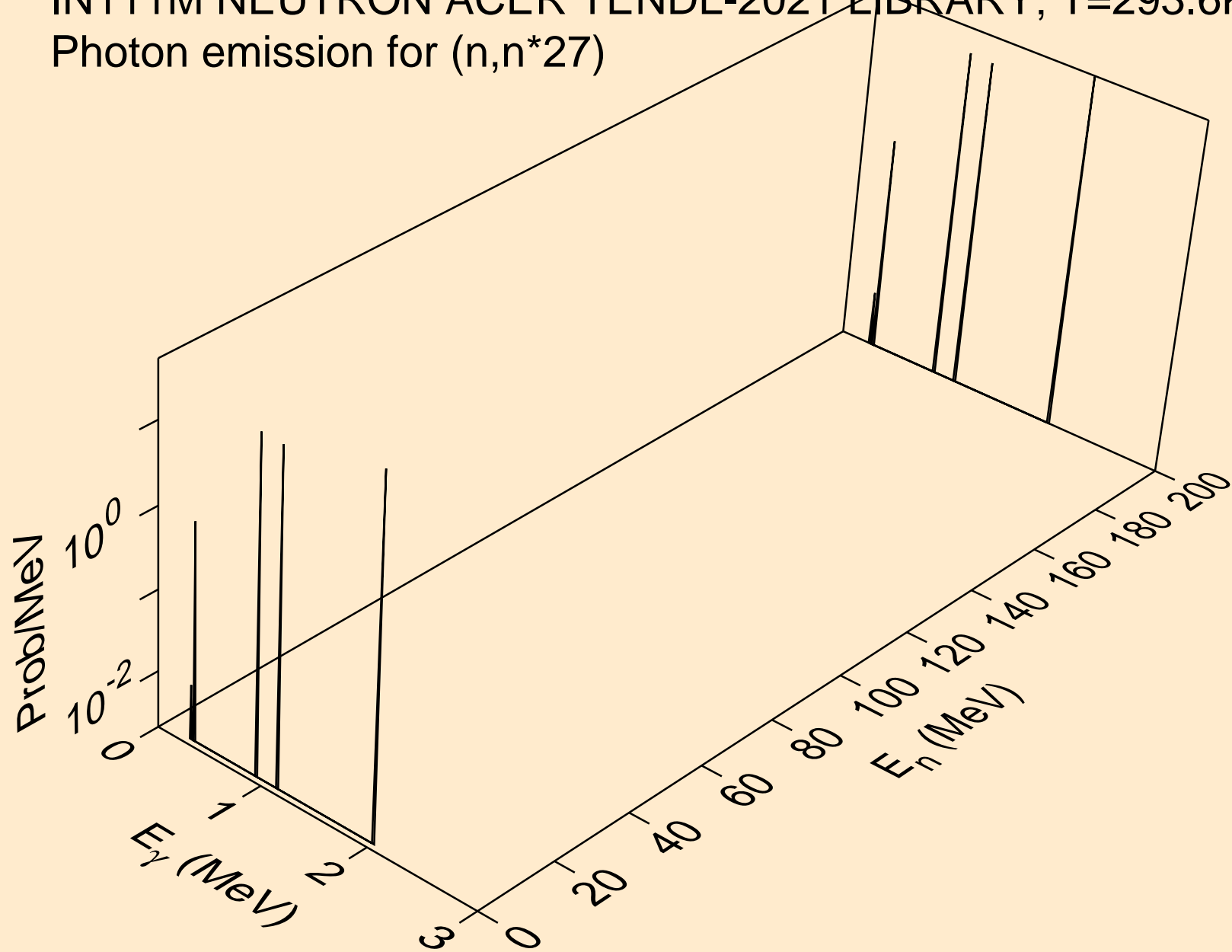

IN111M NEUTRON ACER TENDL-2021 LIBRARY; T=293.6K  
Photon emission for (n,n\*28)

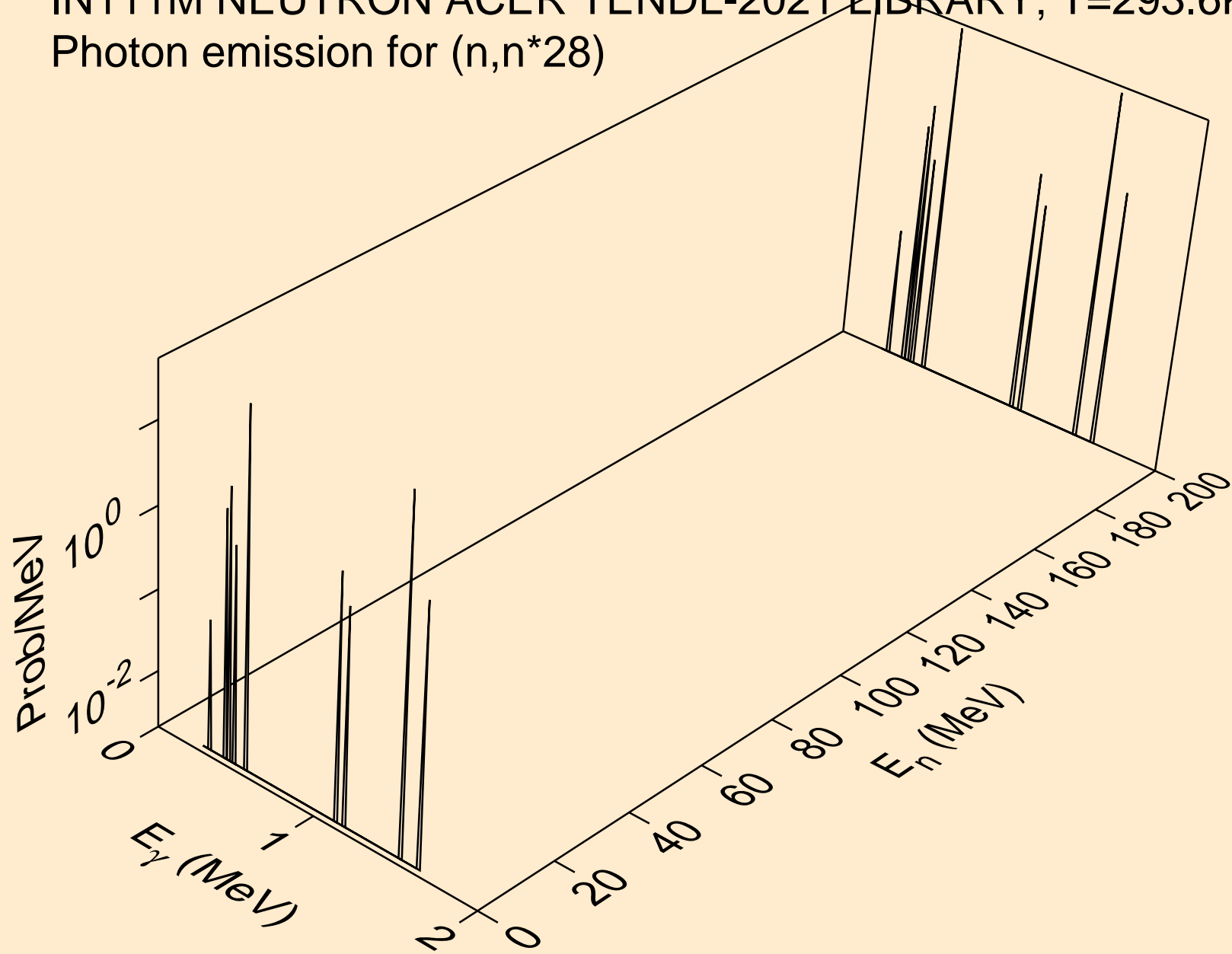

IN111M NEUTRON ACER TENDL-2021 LIBRARY; T=293.6K  
Photon emission for (n,n\*29)

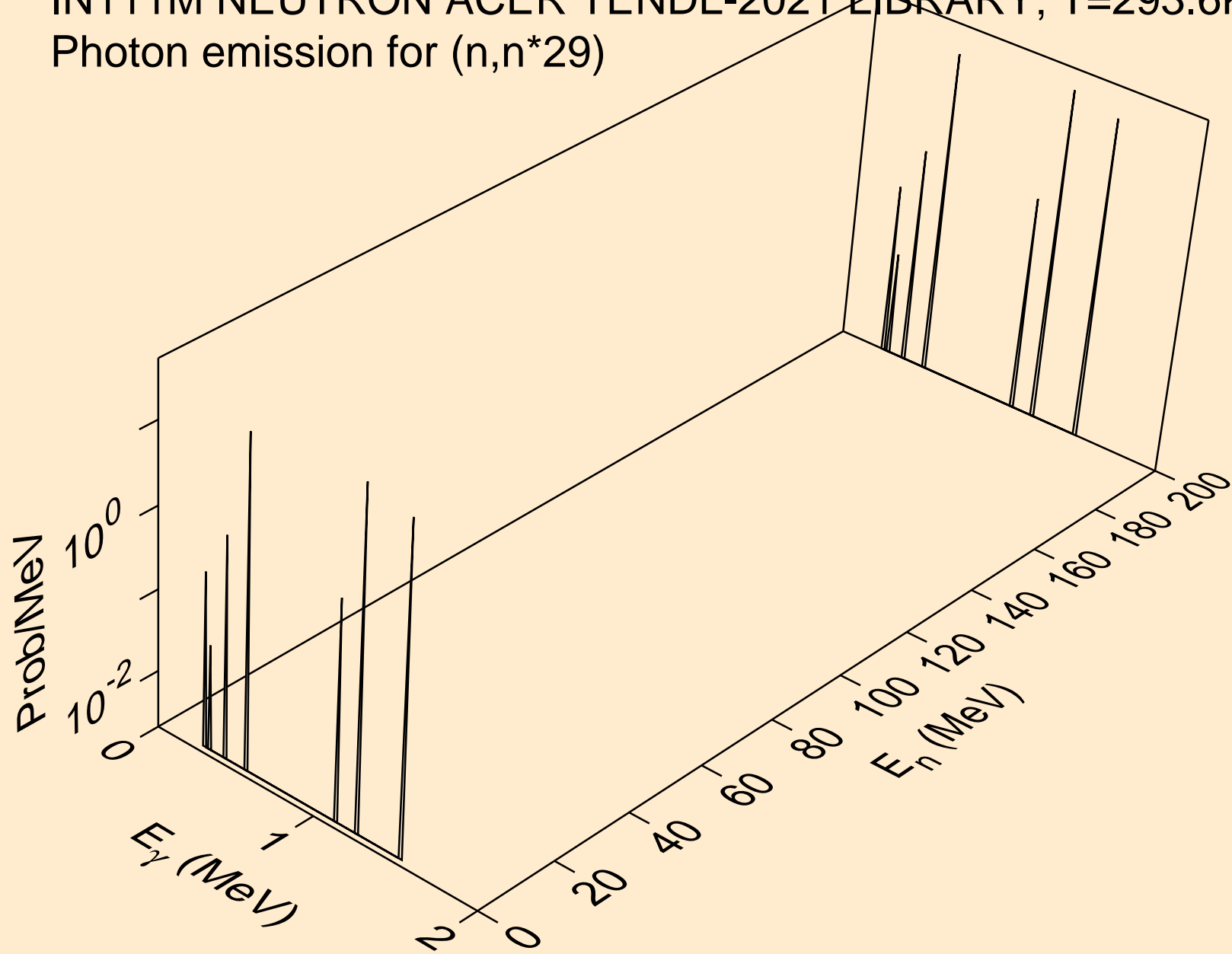

IN111M NEUTRON ACER TENDL-2021 LIBRARY; T=293.6K  
Photon emission for (n,n\*30)

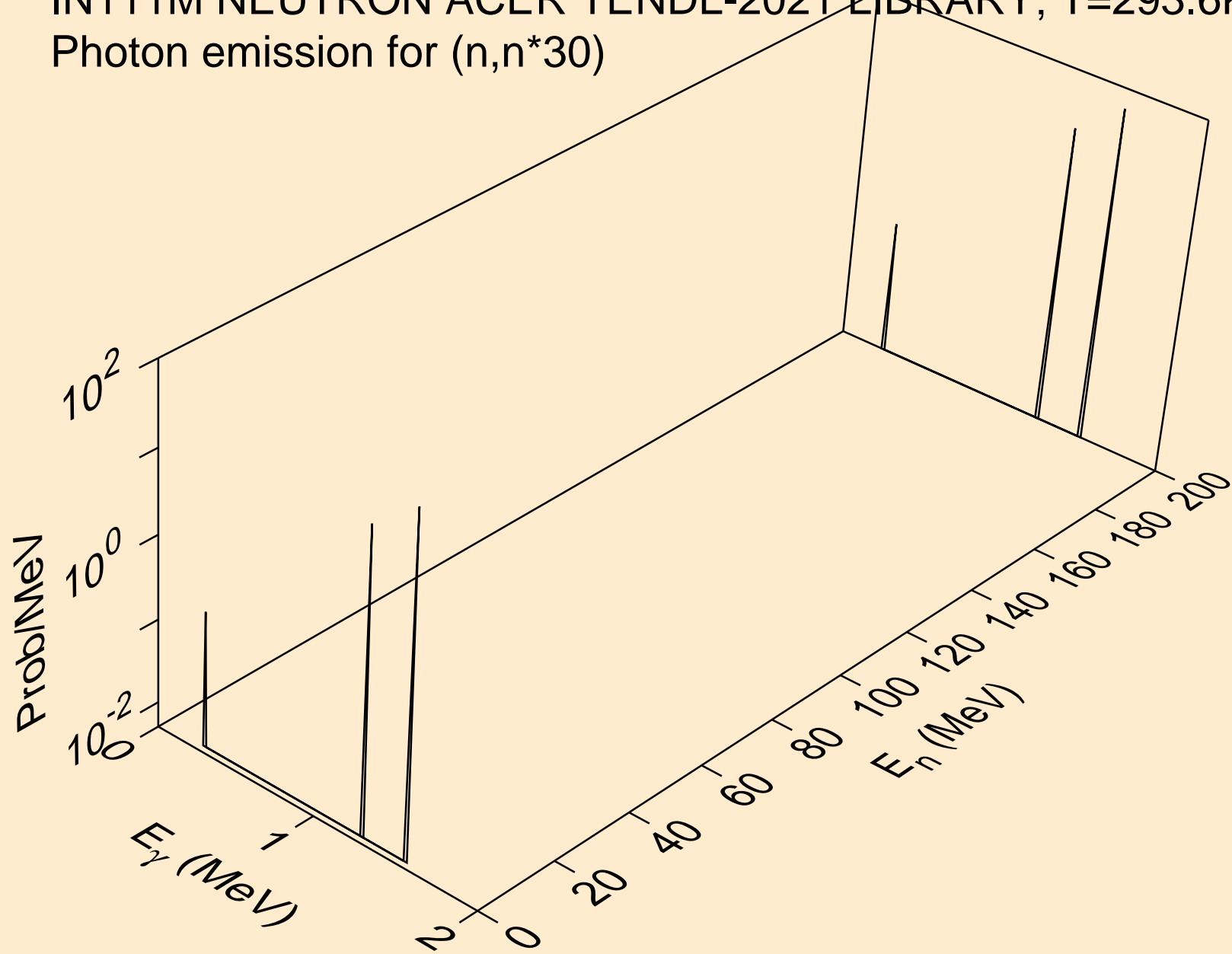

IN111M NEUTRON ACER TENDL-2021 LIBRARY; T=293.6K  
Photon emission for (n,n\*c)

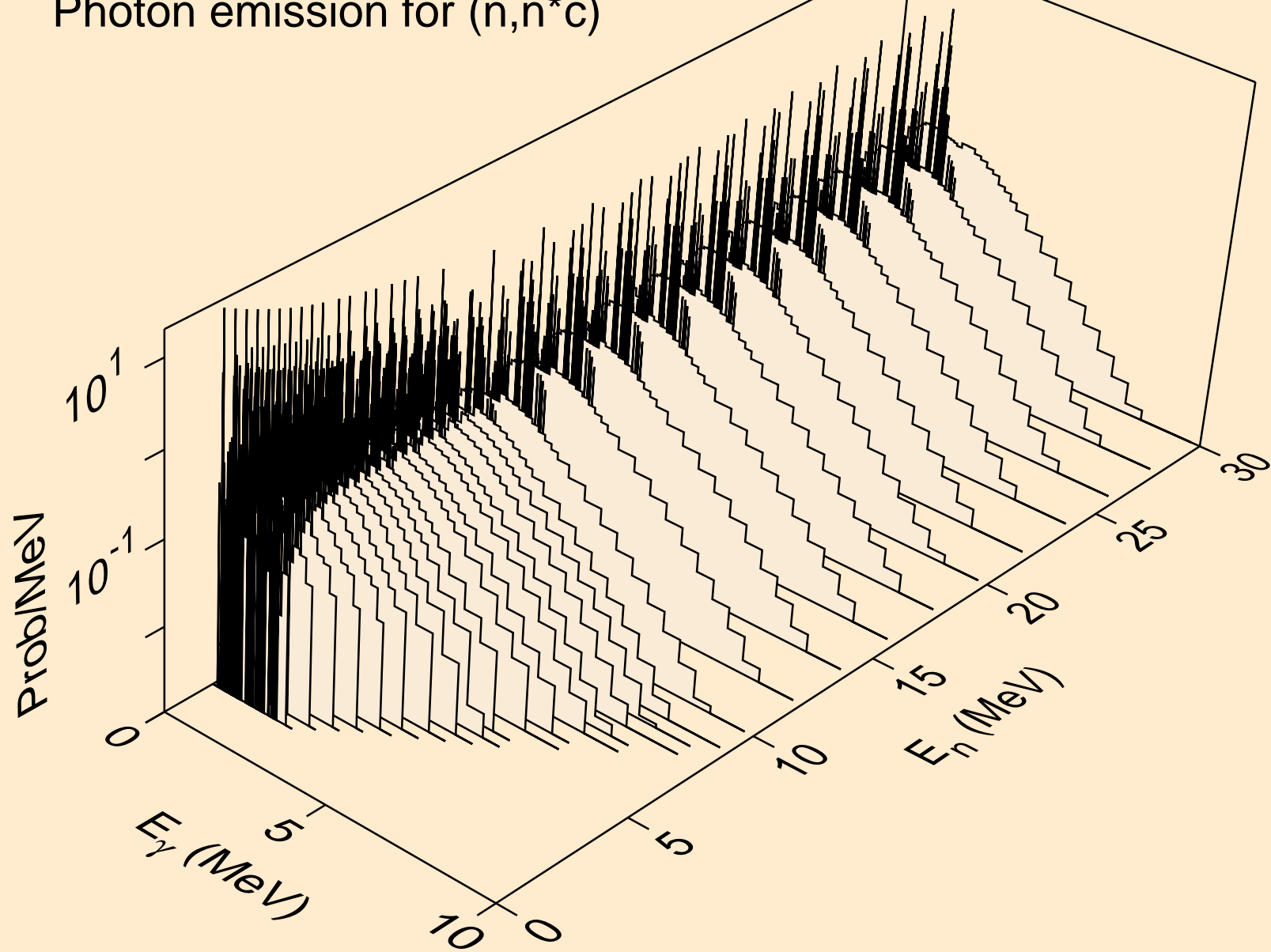

IN111M NEUTRON ACER TENDL-2021 LIBRARY; T=293.6K  
Photon emission for (n,gma)

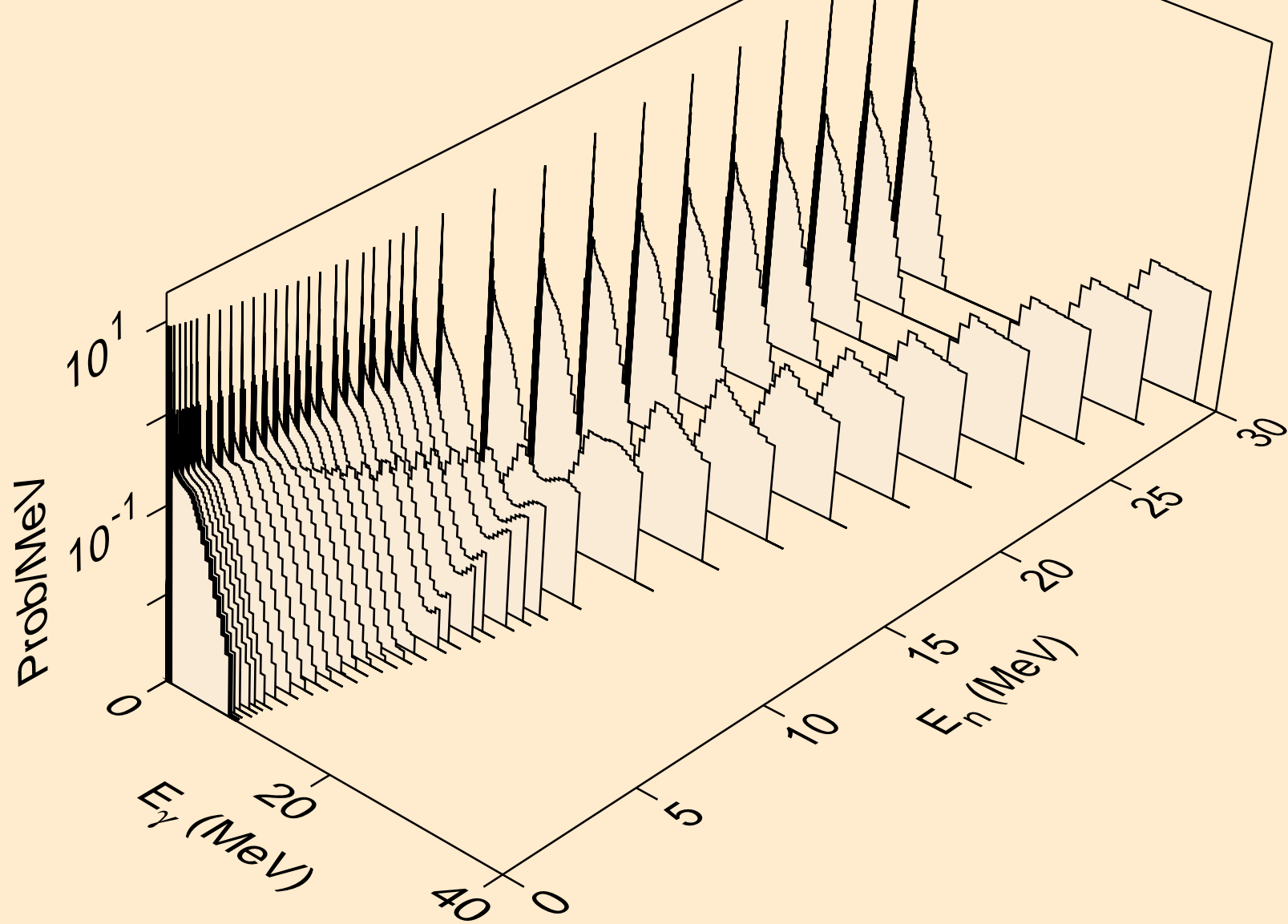

IN111M NEUTRON ACER TENDL-2021 LIBRARY; T=293.6K  
Photon emission for (n,p)

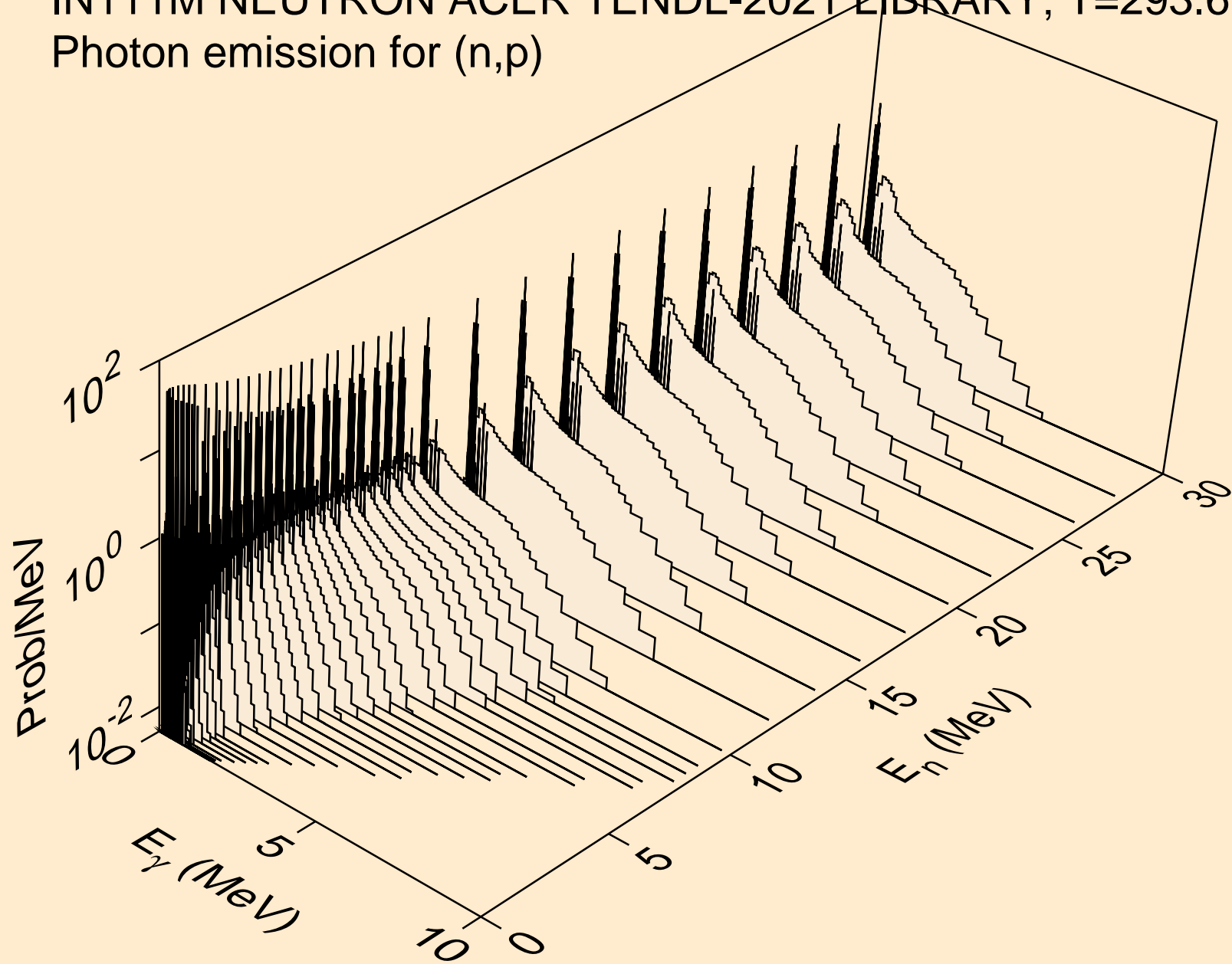



IN111M NEUTRON ACER TENDL-2021 LIBRARY; T=293.6K  
Photon emission for (n,d)

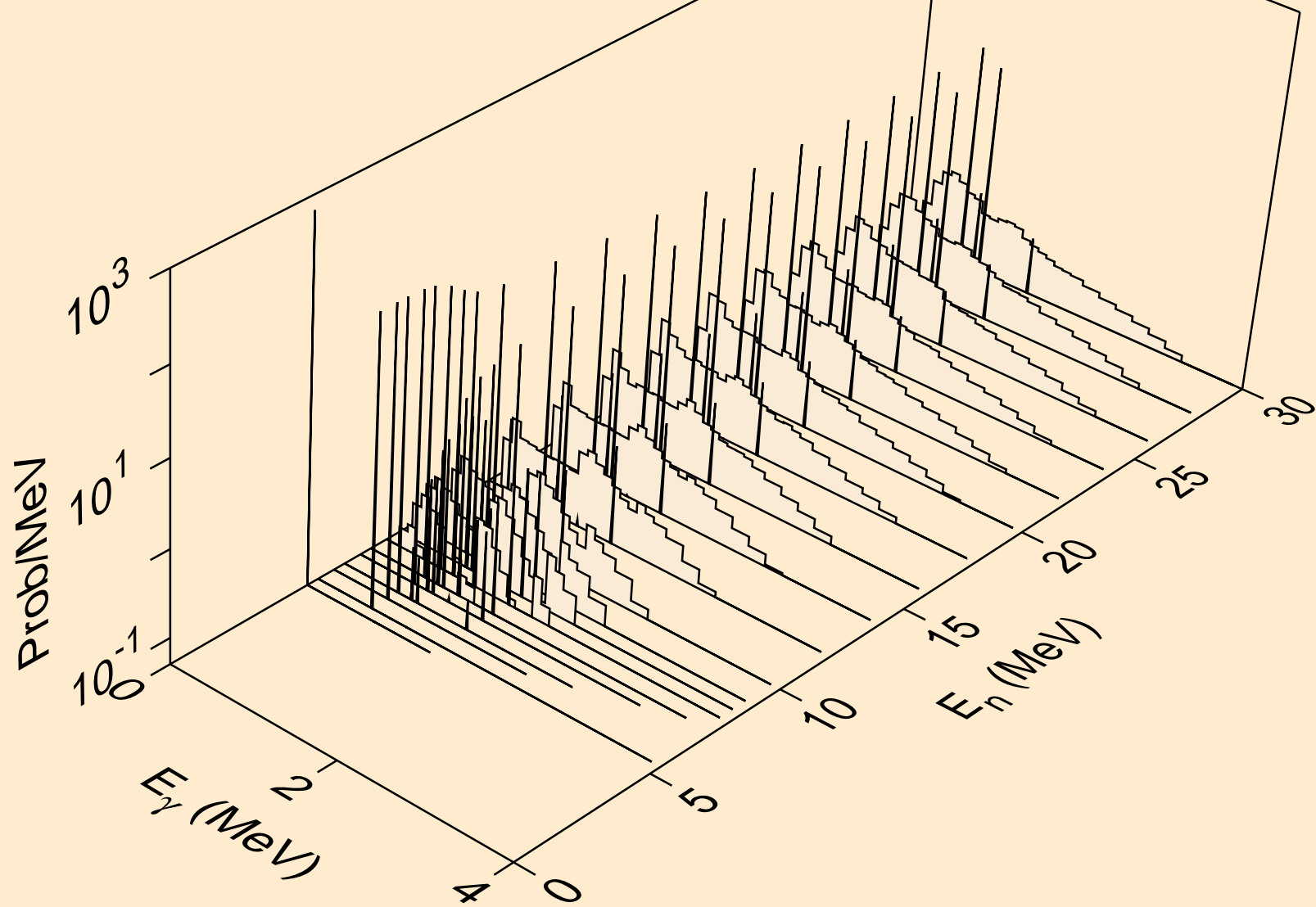

IN111M NEUTRON ACER TENDL-2021 LIBRARY; T=293.6K  
Photon emission for (n,t)

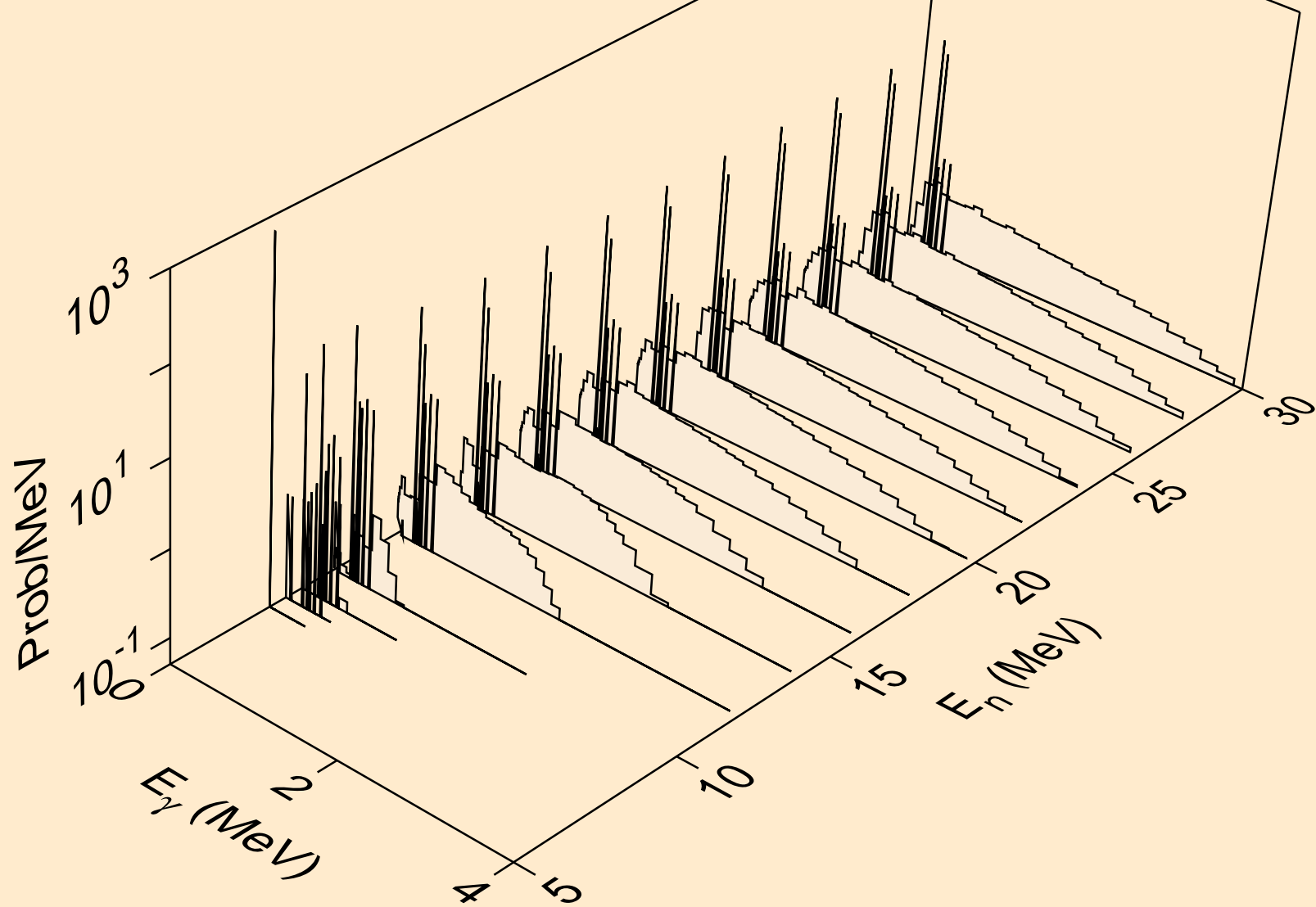

IN111M NEUTRON ACER TENDL-2021 LIBRARY; T=293.6K  
Photon emission for (n,he3)

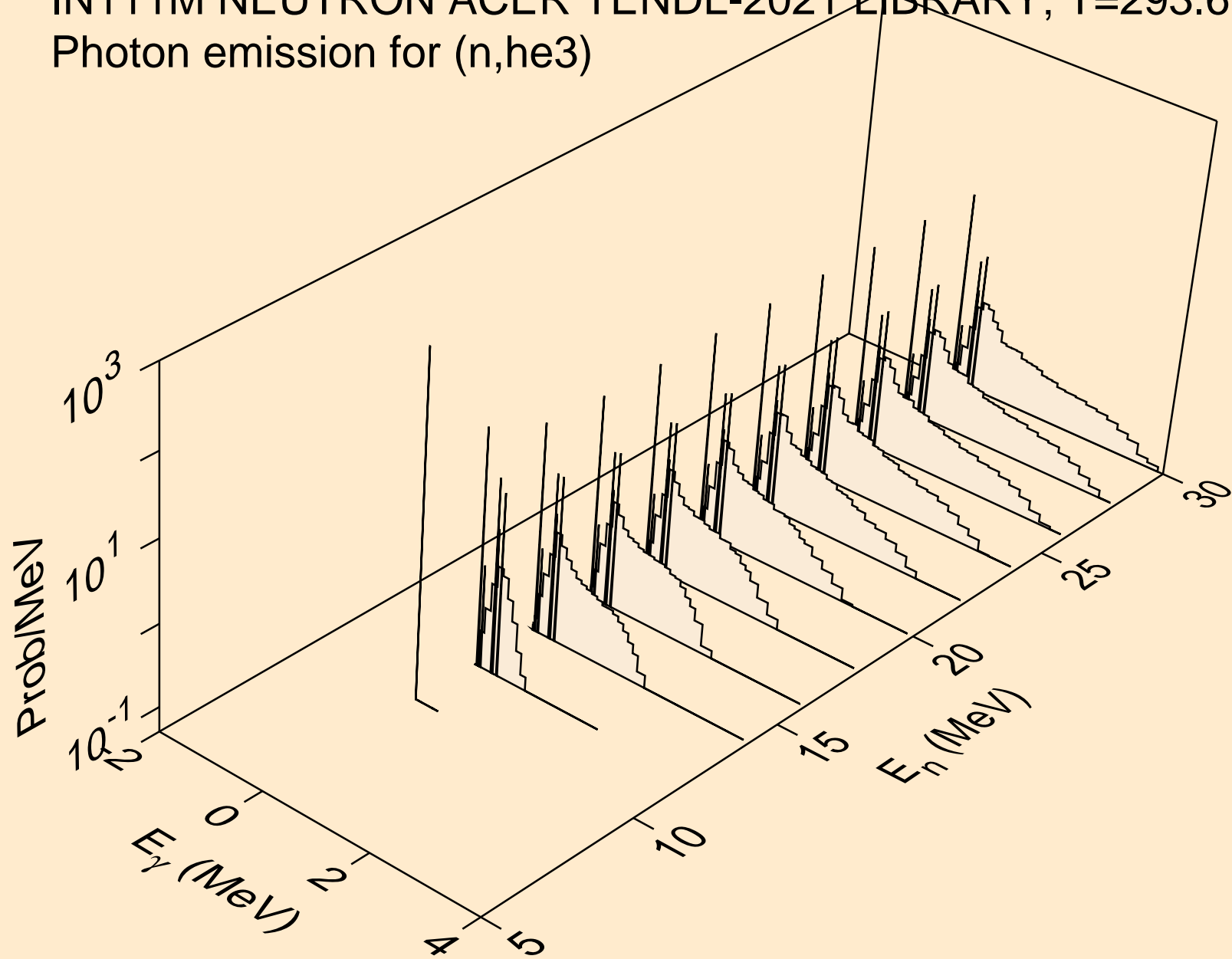

IN111M NEUTRON ACER TENDL-2021 LIBRARY; T=293.6K  
Photon emission for (n,a)

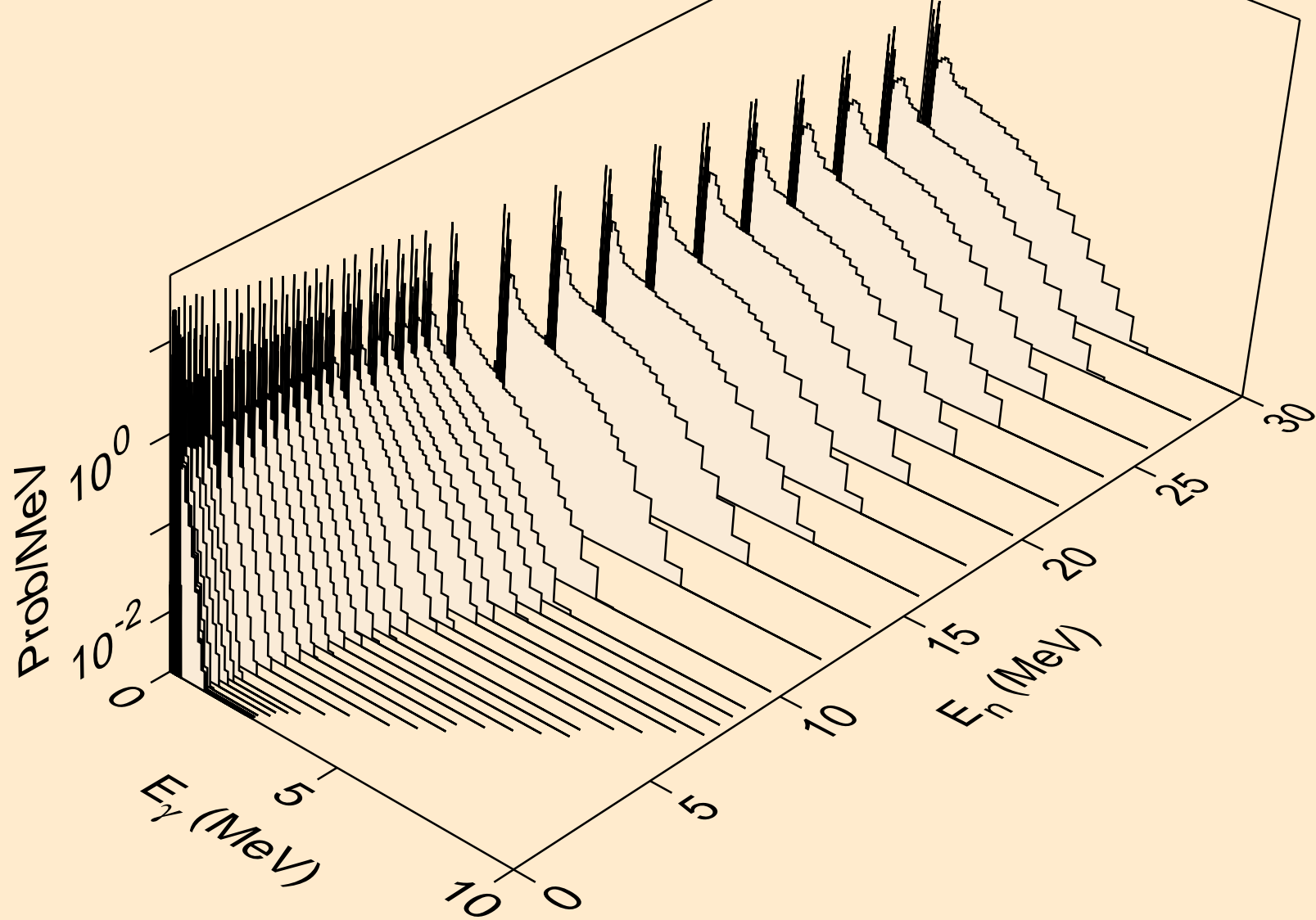

IN111M NEUTRON ACER TENDL-2021 LIBRARY; T=293.6K  
Photon emission for (n,2a)

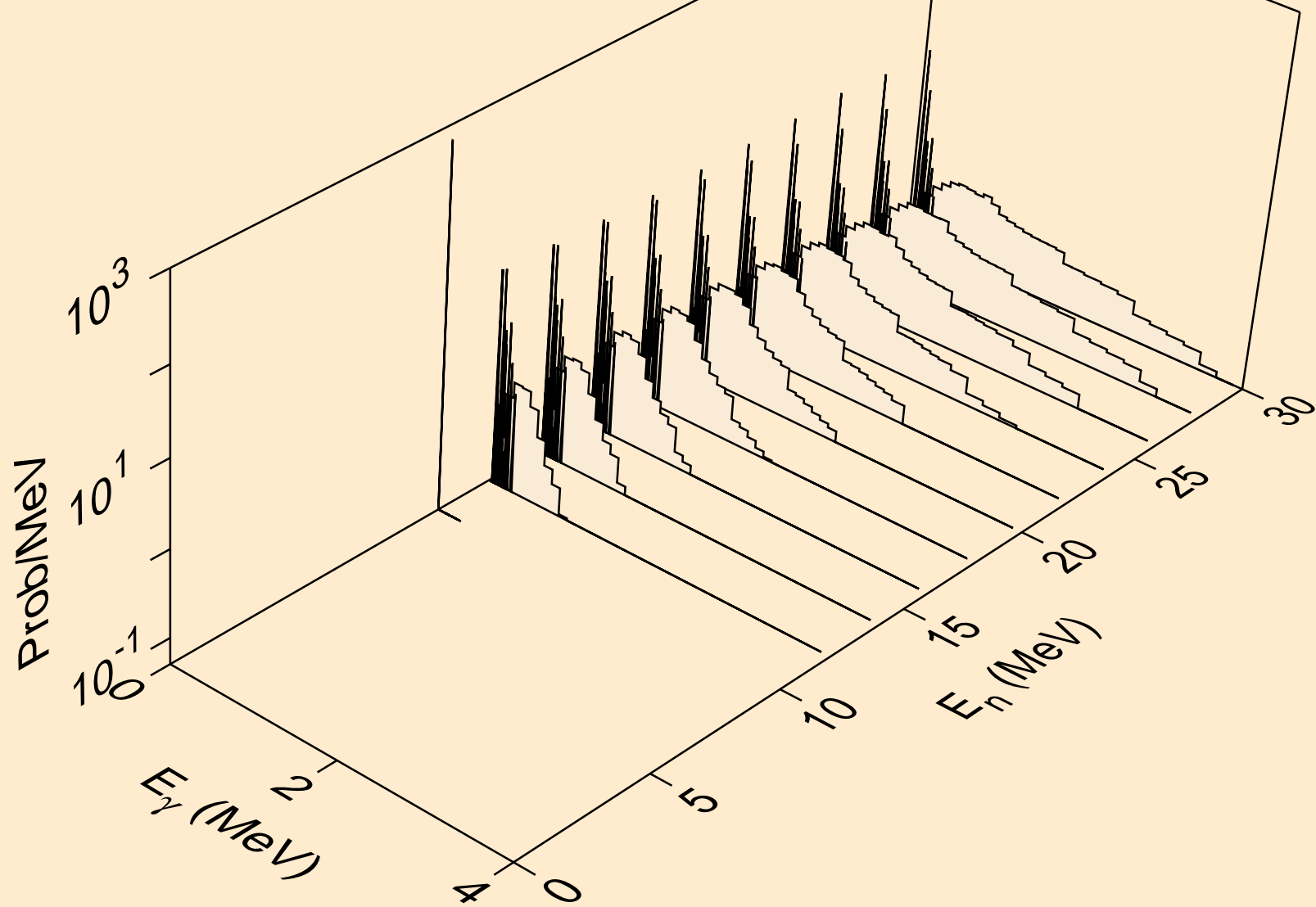

IN111M NEUTRON ACER TENDL-2021 LIBRARY; T=293.6K  
Photon emission for (n,2p)

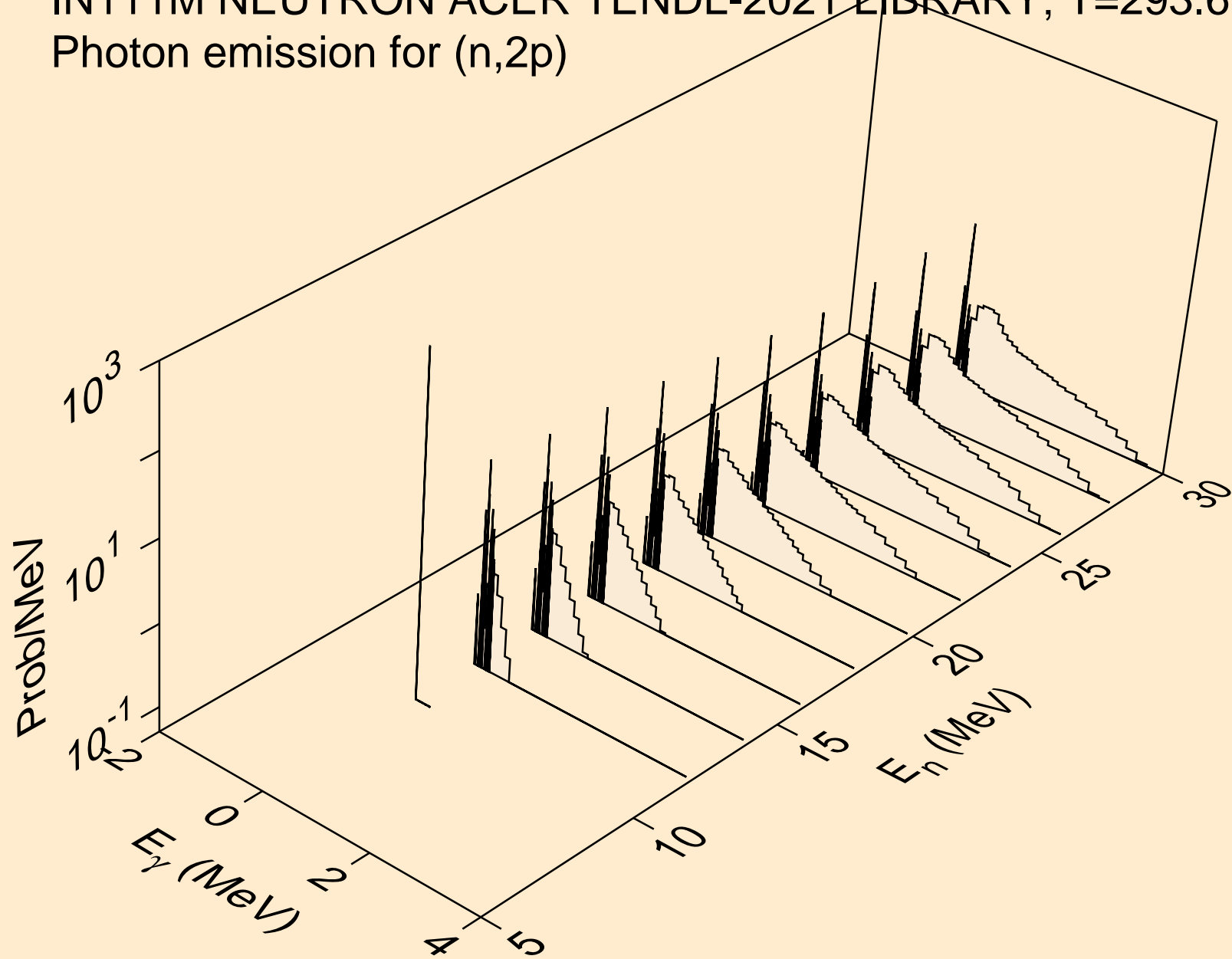

IN111M NEUTRON ACER TENDL-2021 LIBRARY; T=293.6K  
Photon emission for (n,p $\alpha$ )

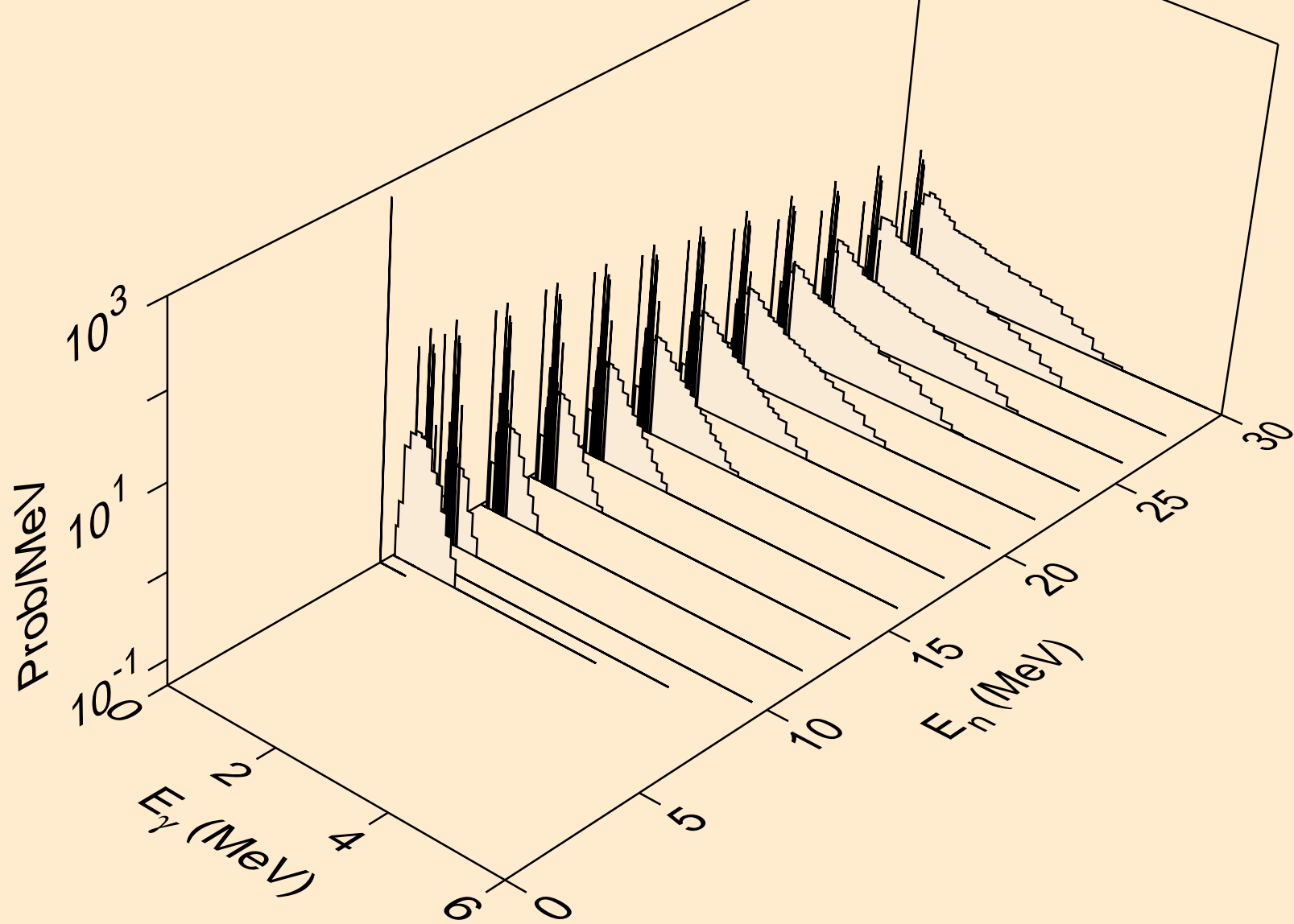

IN111M NEUTRON ACER TENDL-2021 LIBRARY; T=293.6K  
Photon emission for (n,pd)

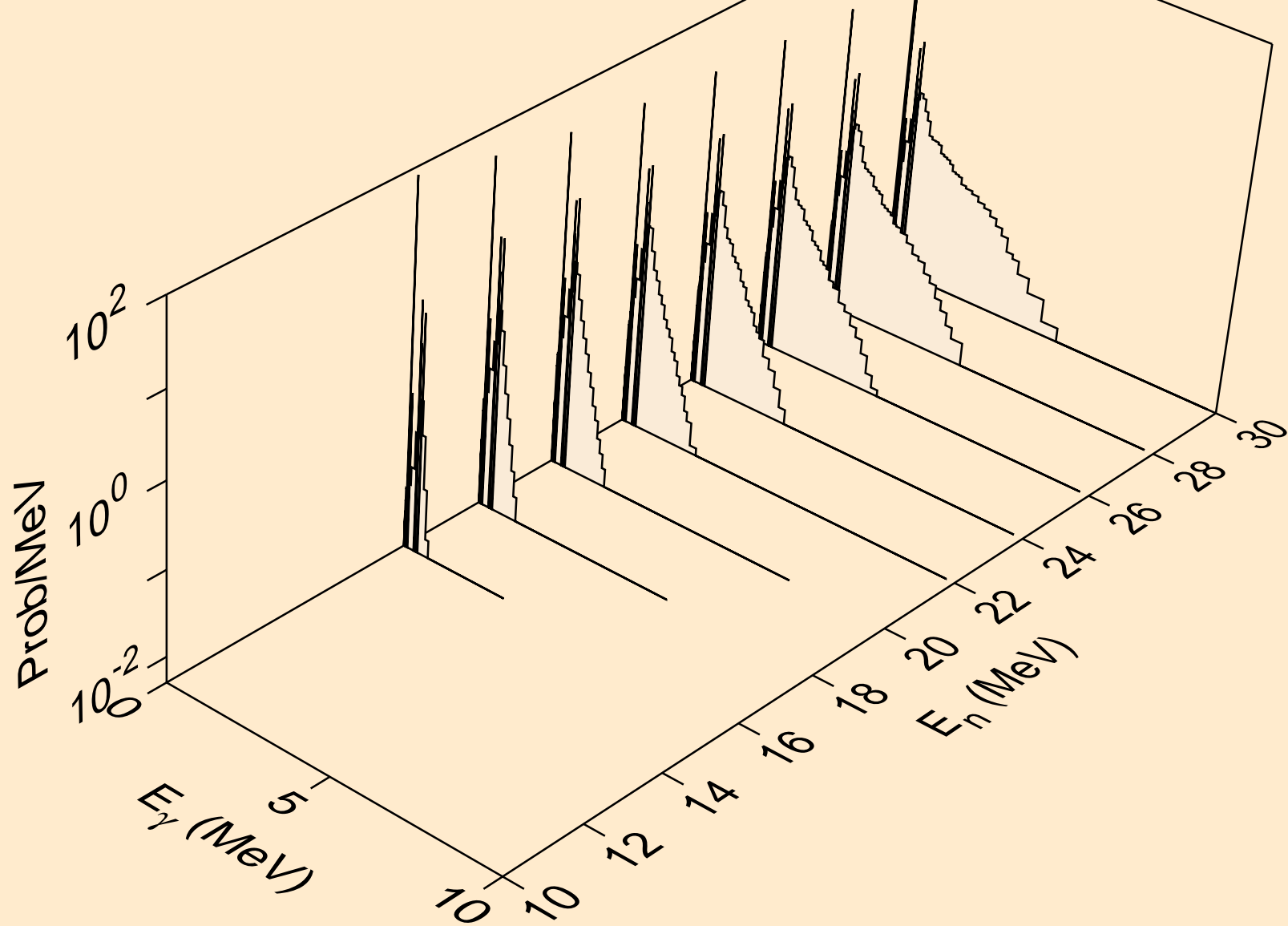



IN111M NEUTRON ACER TENDL-2021 LIBRARY; T=293.6K  
Photon emission for (n,pt)

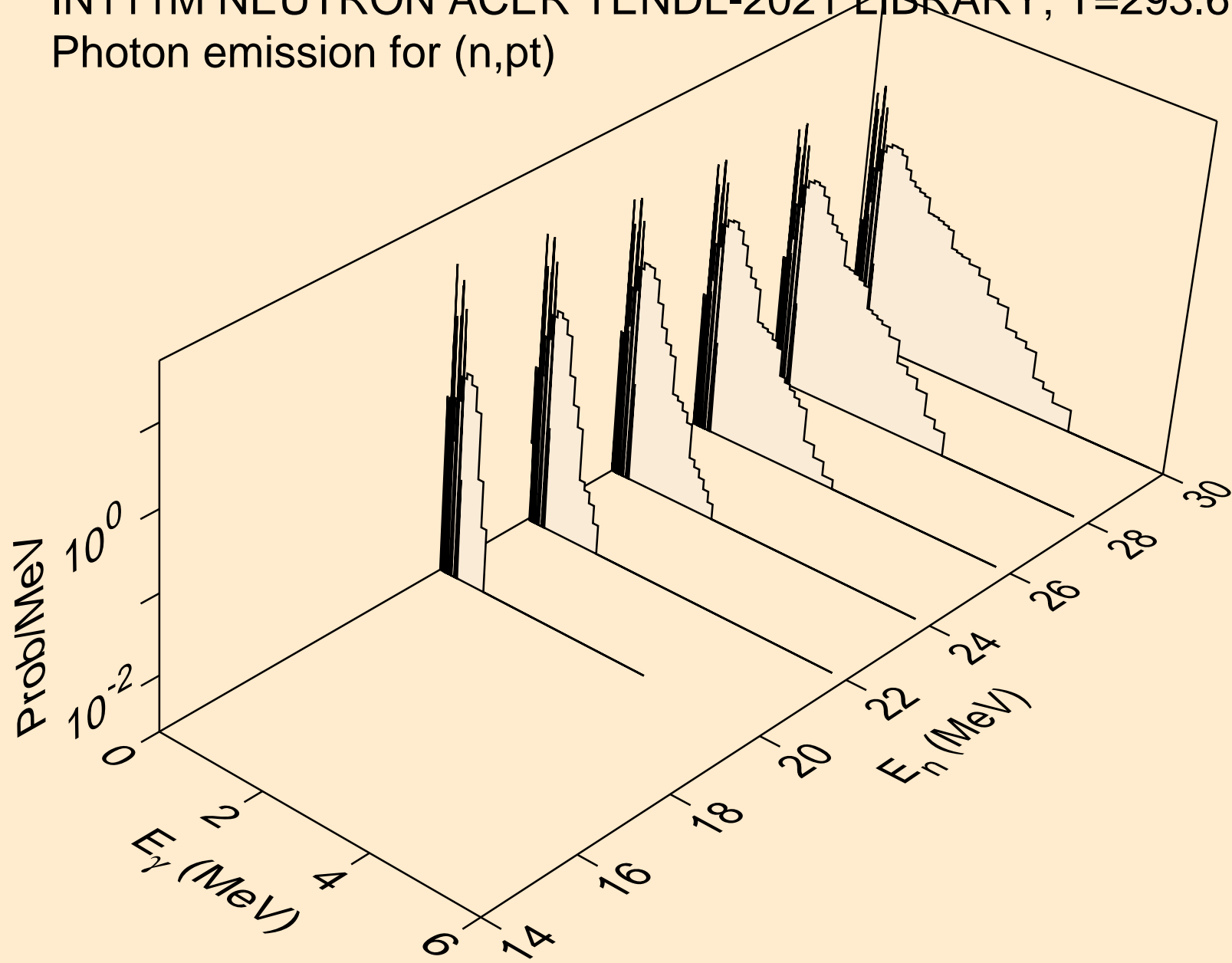

IN111M NEUTRON ACER TENDL-2021 LIBRARY; T=293.6K  
Photon emission for (n,da)

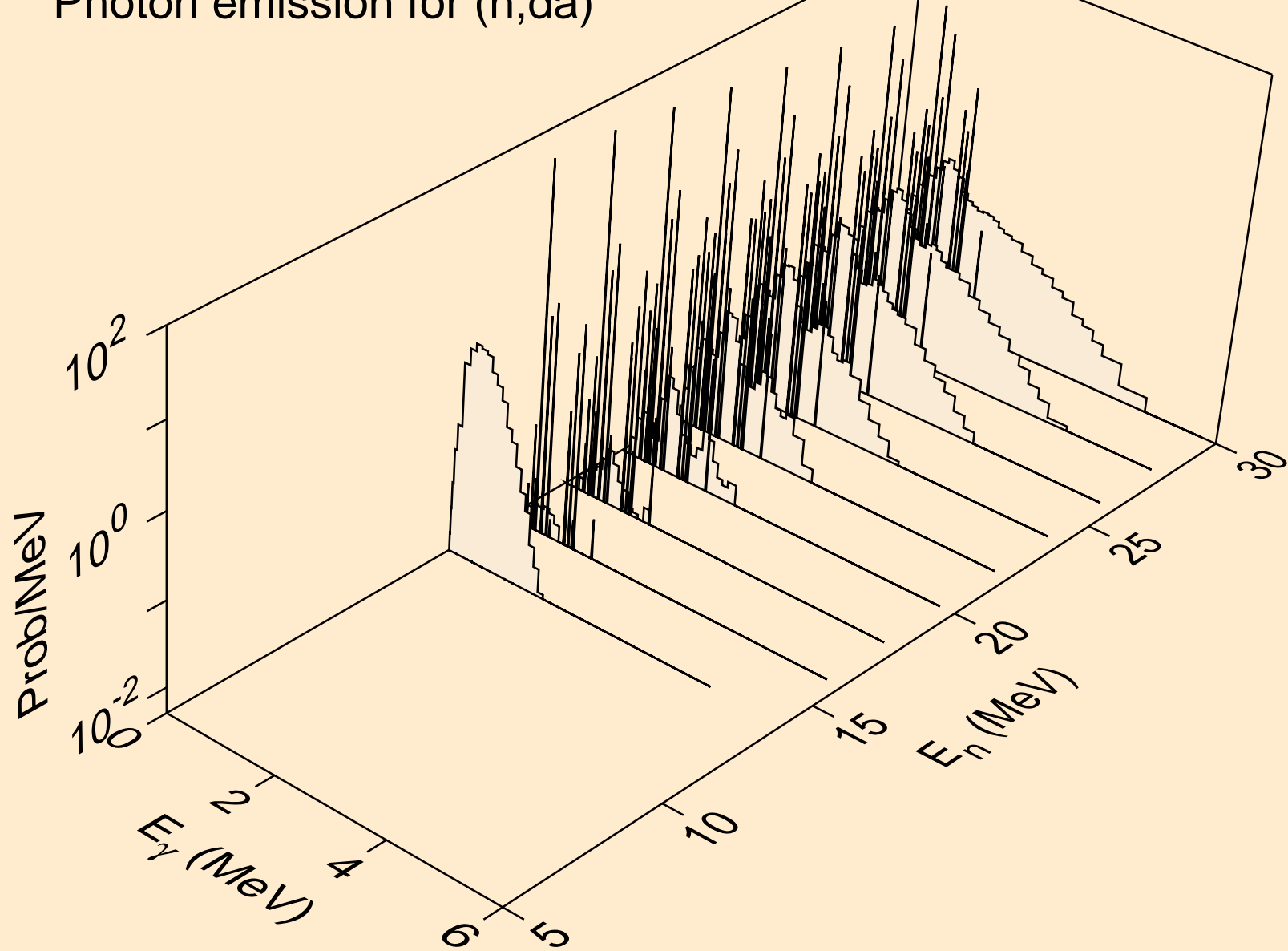

IN111M NEUTRON ACER TENDL-2021 LIBRARY; T=293.6K  
thermal capture photon spectrum

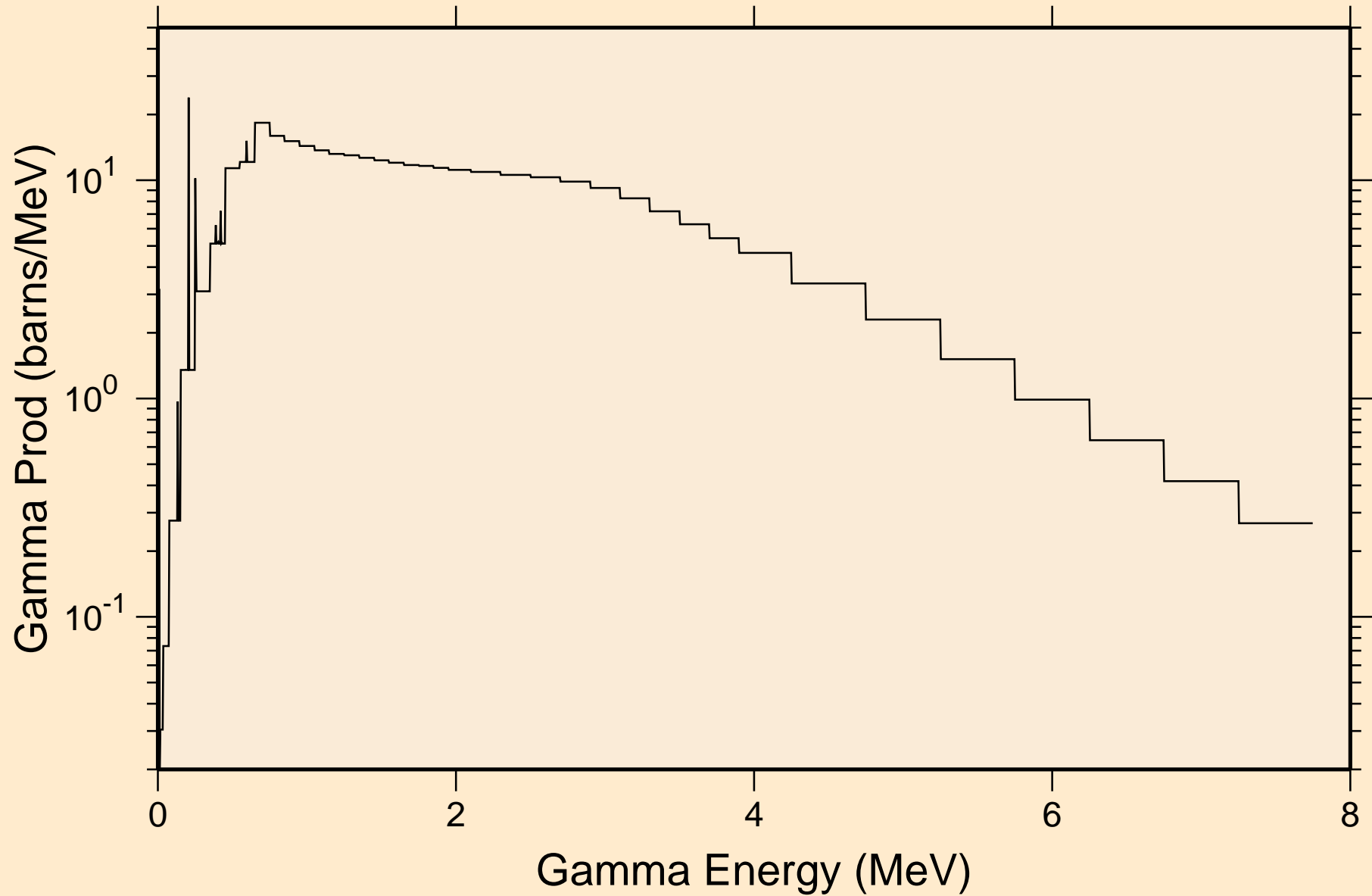

IN111M NEUTRON ACER TENDL-2021 LIBRARY; T=293.6K  
14 MeV photon spectrum

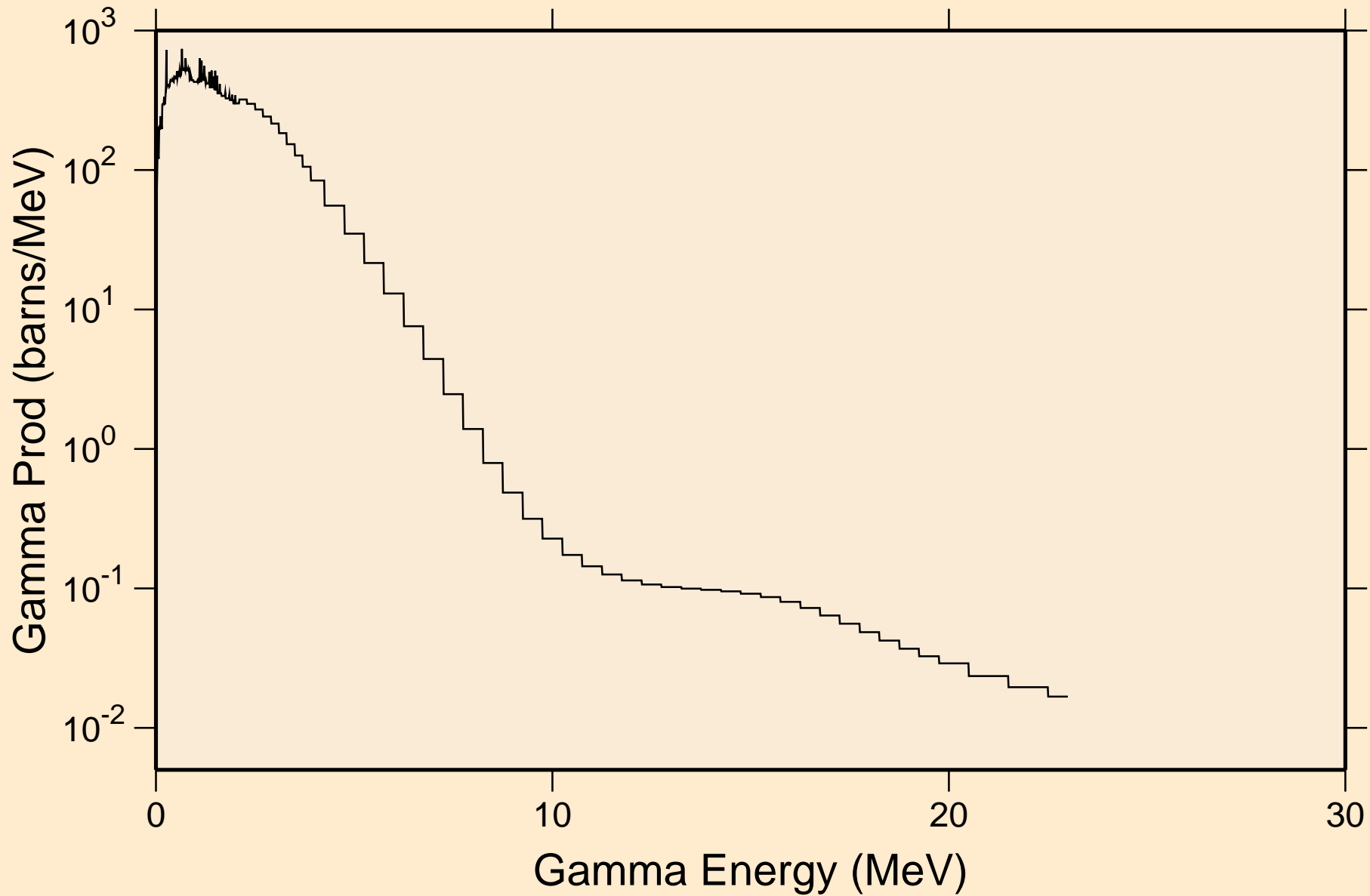

# IN111M NEUTRON ACER TENDL-2021 LIBRARY; T=293.6K

## Particle heating contributions

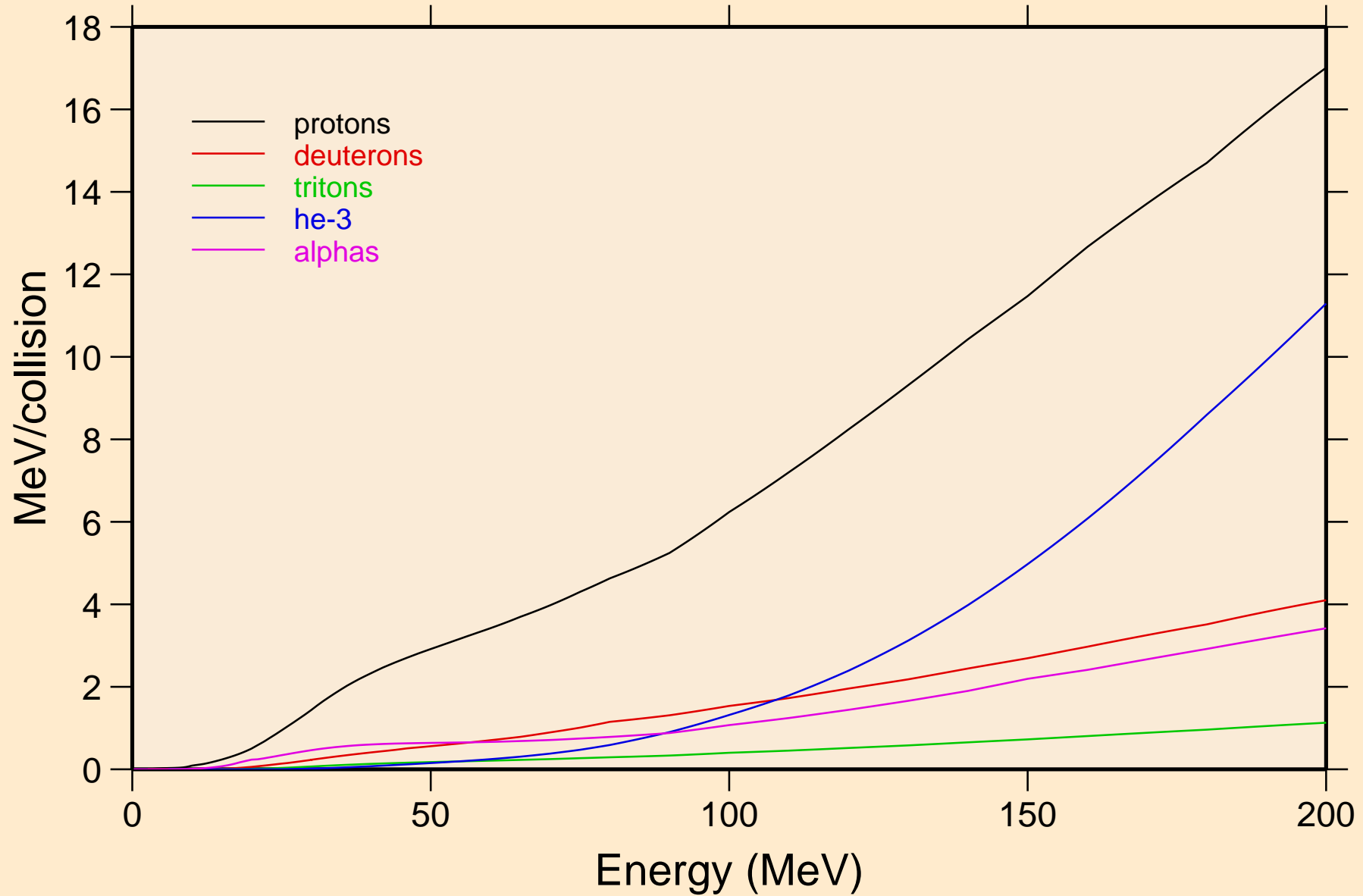

IN111M NEUTRON ACER TENDL-2021 LIBRARY; T=293.6K  
Recoil Heating

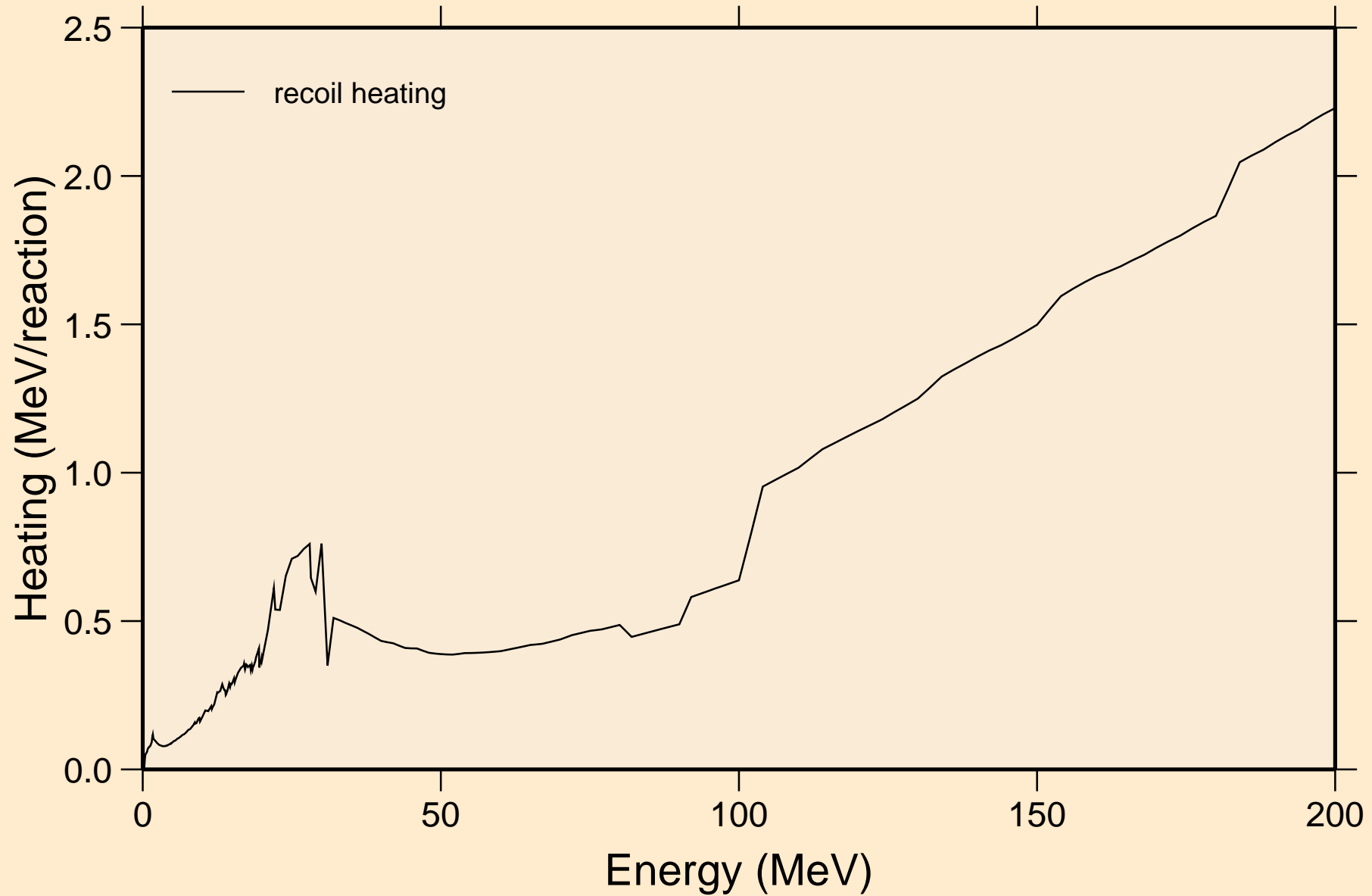

IN111M NEUTRON ACER TENDL-2021 LIBRARY; T=293.6K  
Particle production cross sections

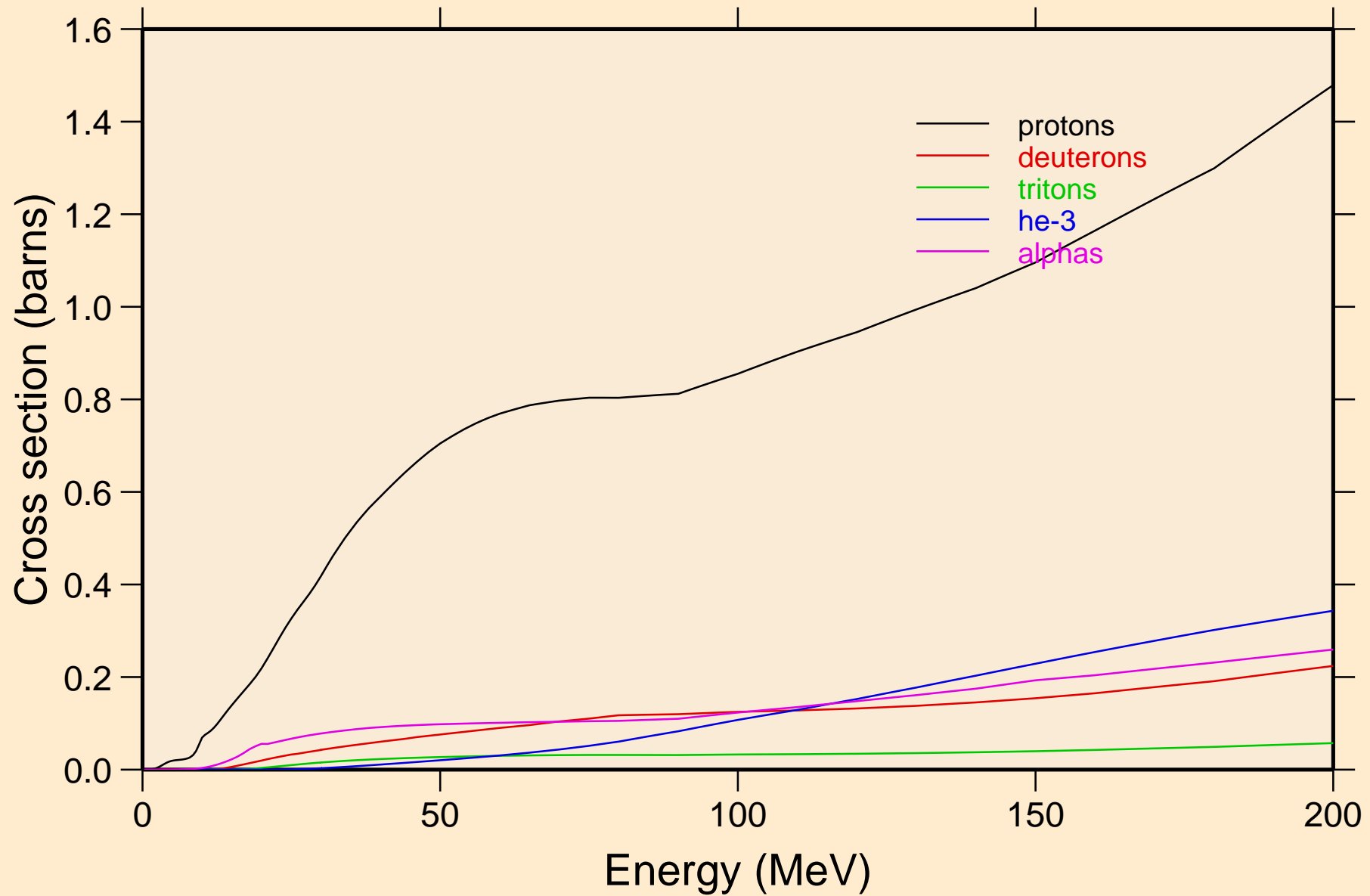

IN11M NEUTRON ACER TENDL-2021 LIBRARY; T=293.6K  
protons from (n,x)

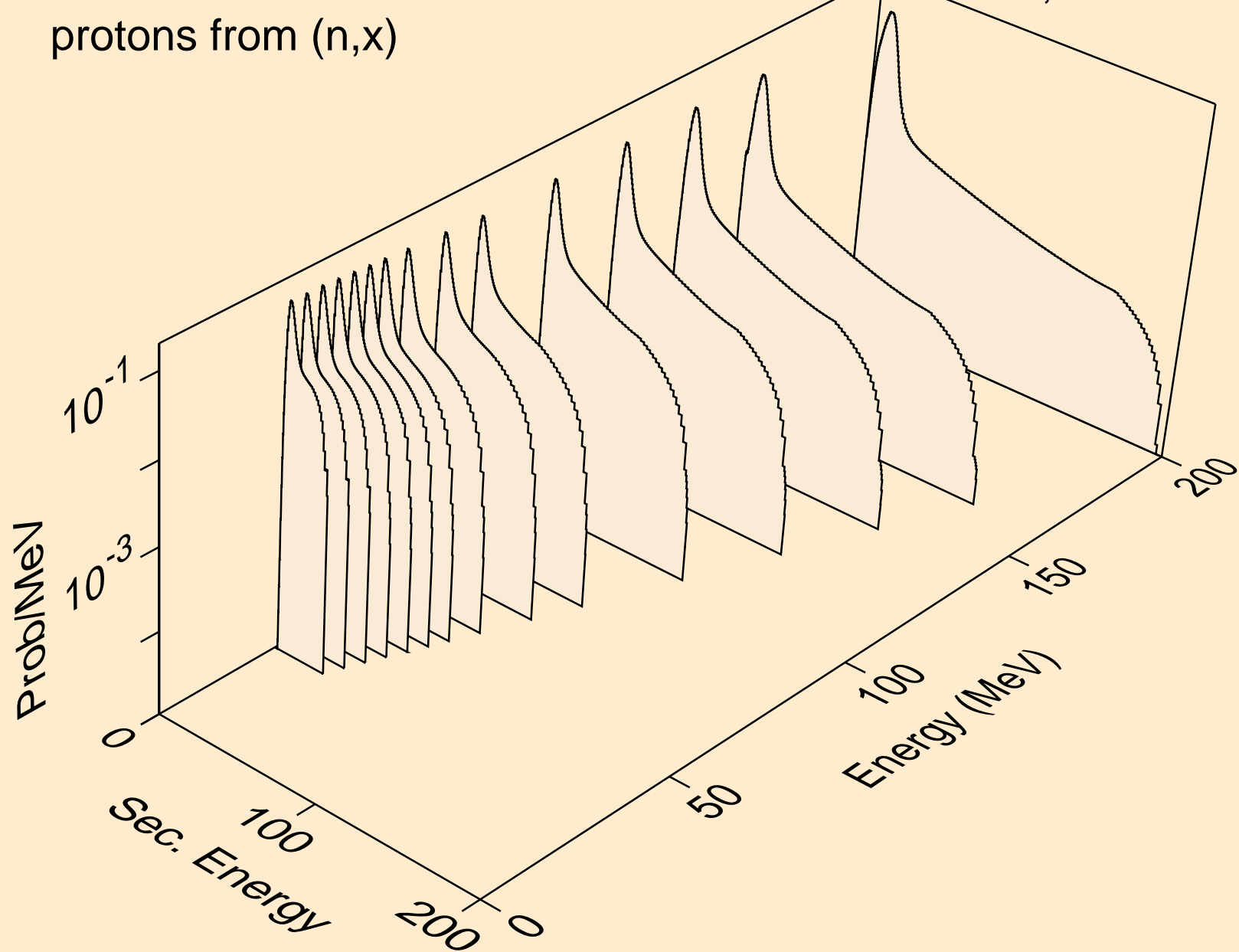



IN111M NEUTRON ACER TENDL-2021 LIBRARY; T=293.6K  
protons from (n,n\*)p

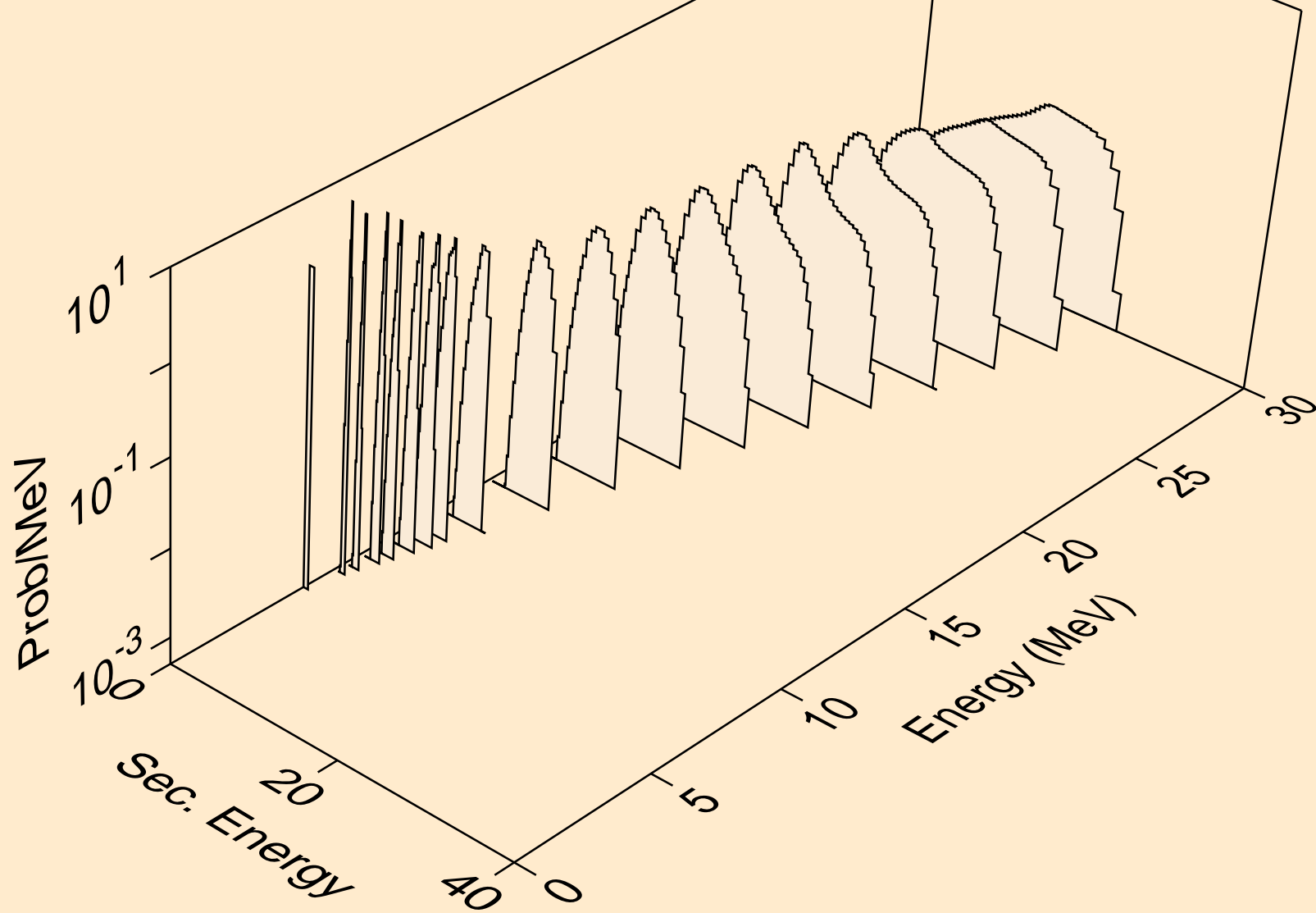

IN111M NEUTRON ACER TENDL-2021 LIBRARY; T=293.6K  
protons from (n,2np)

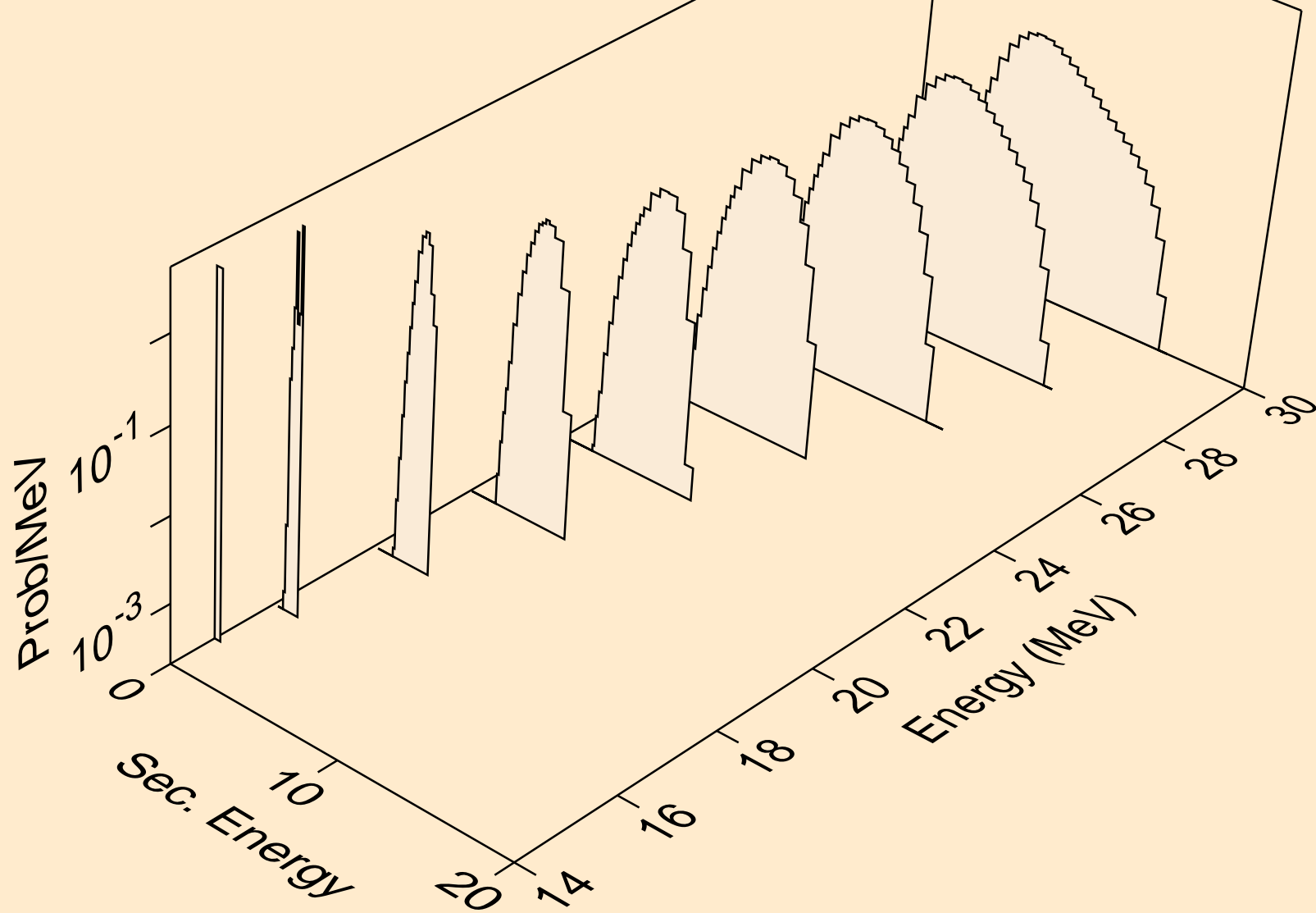

IN111M NEUTRON ACER TENDL-2021 LIBRARY; T=293.6K  
protons from (n,3np)

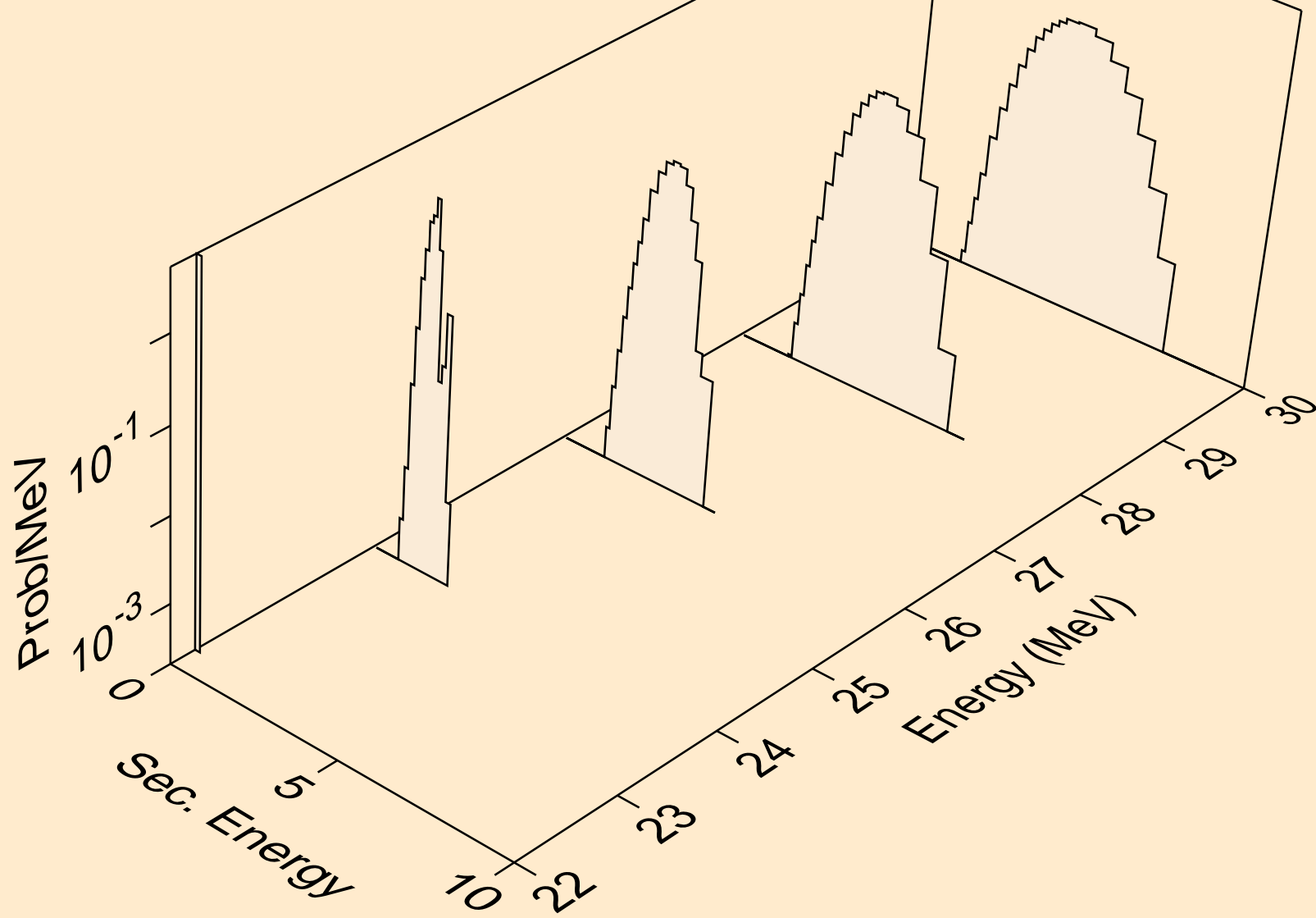

IN11M NEUTRON ACER TENDL-2021 LIBRARY; T=293.6K  
protons from (n,2np)

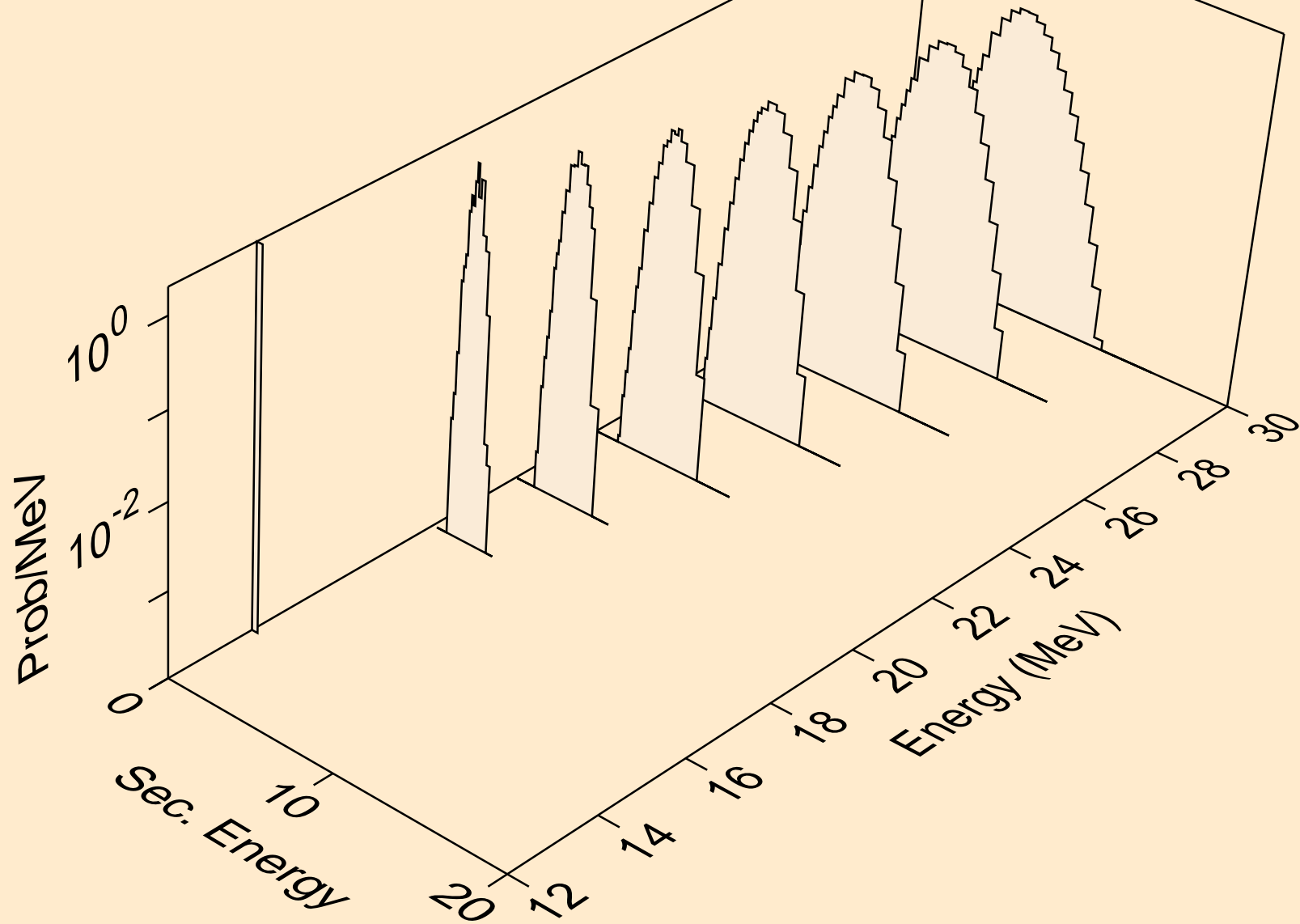

IN11M NEUTRON ACER TENDL-2021 LIBRARY; T=293.6K  
protons from (n,npa)

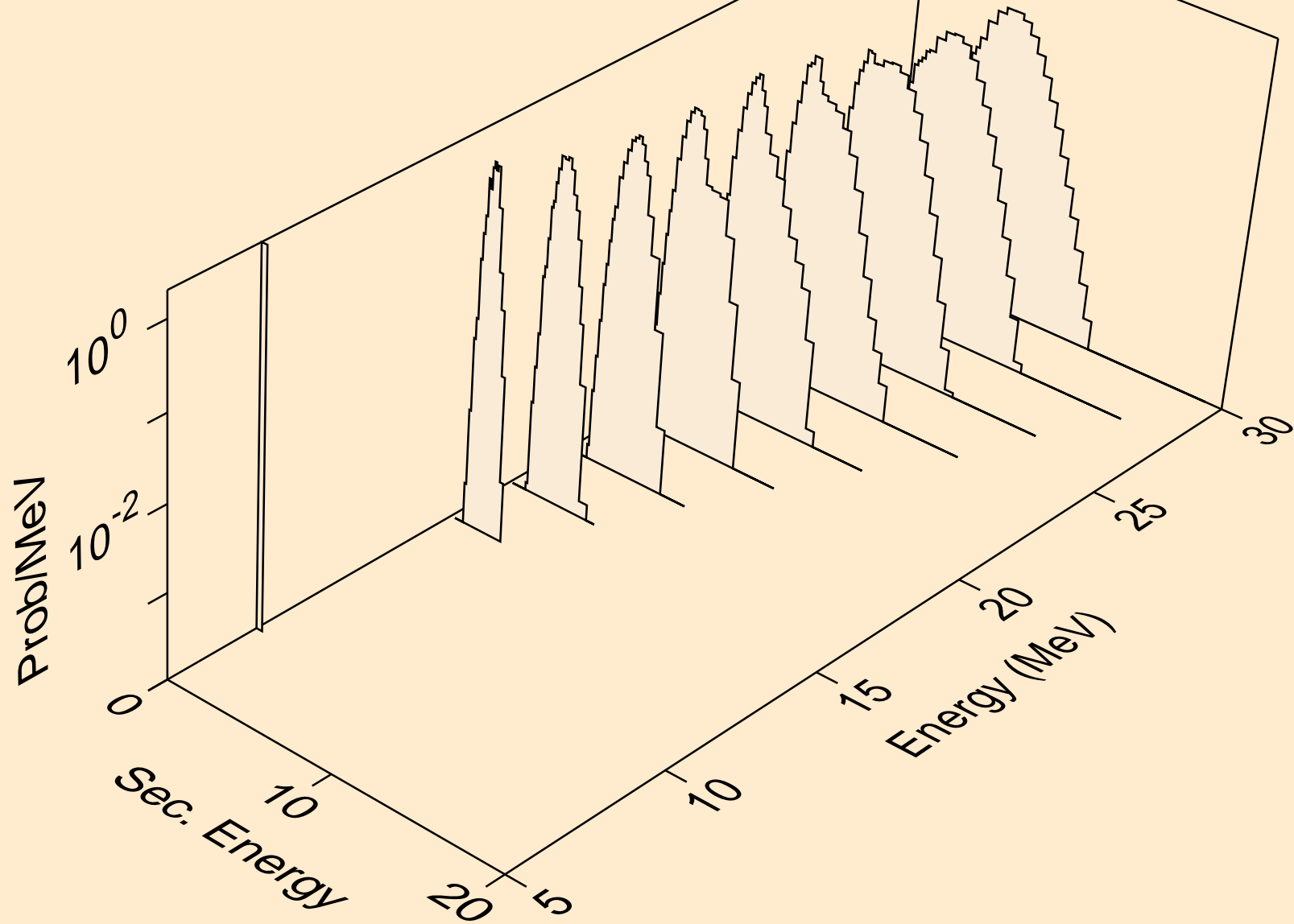

IN11M NEUTRON ACER TENDL-2021 LIBRARY; T=293.6K  
protons from (n,p)

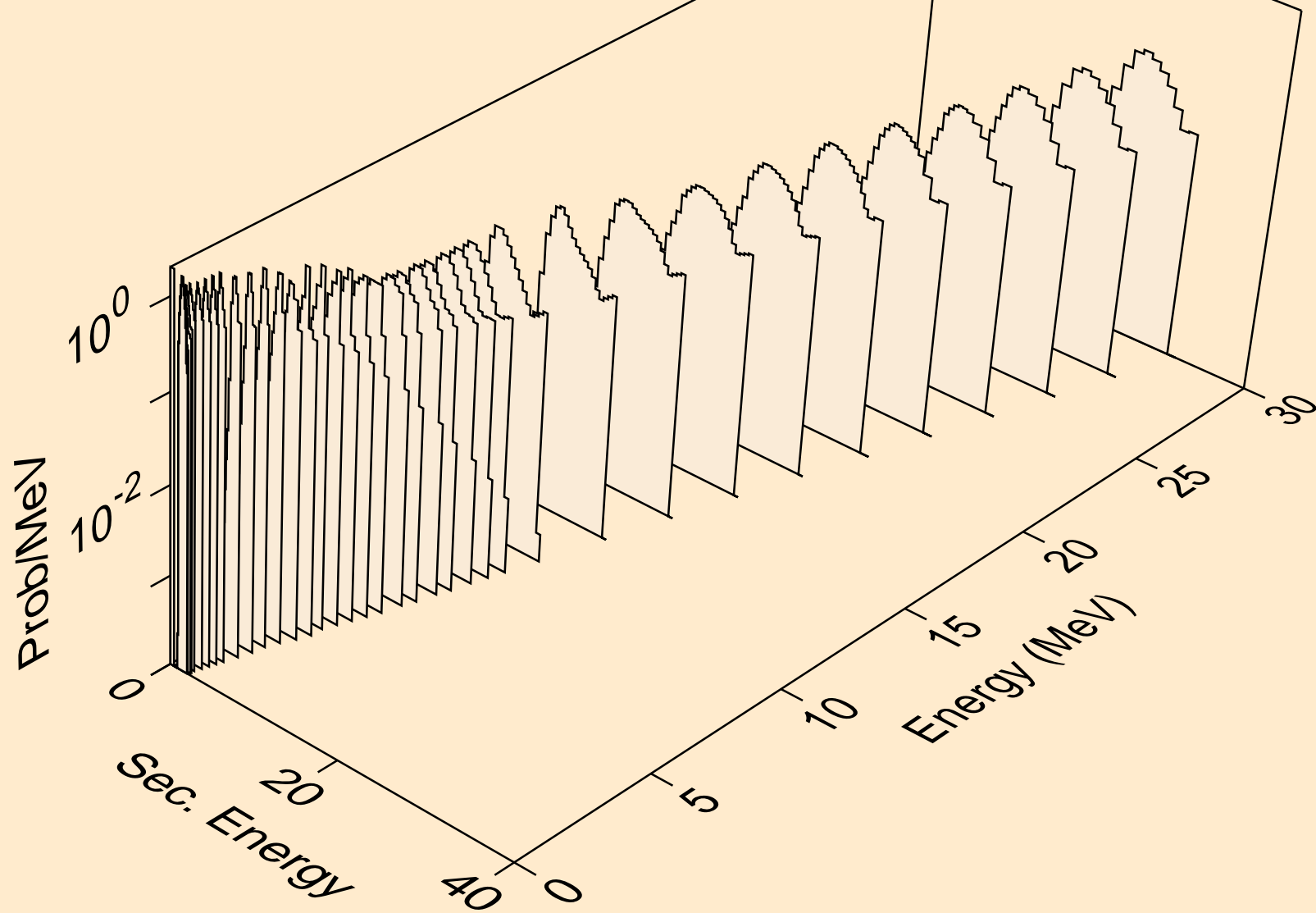

IN11M NEUTRON ACER TENDL-2021 LIBRARY; T=293.6K  
protons from (n,2p)

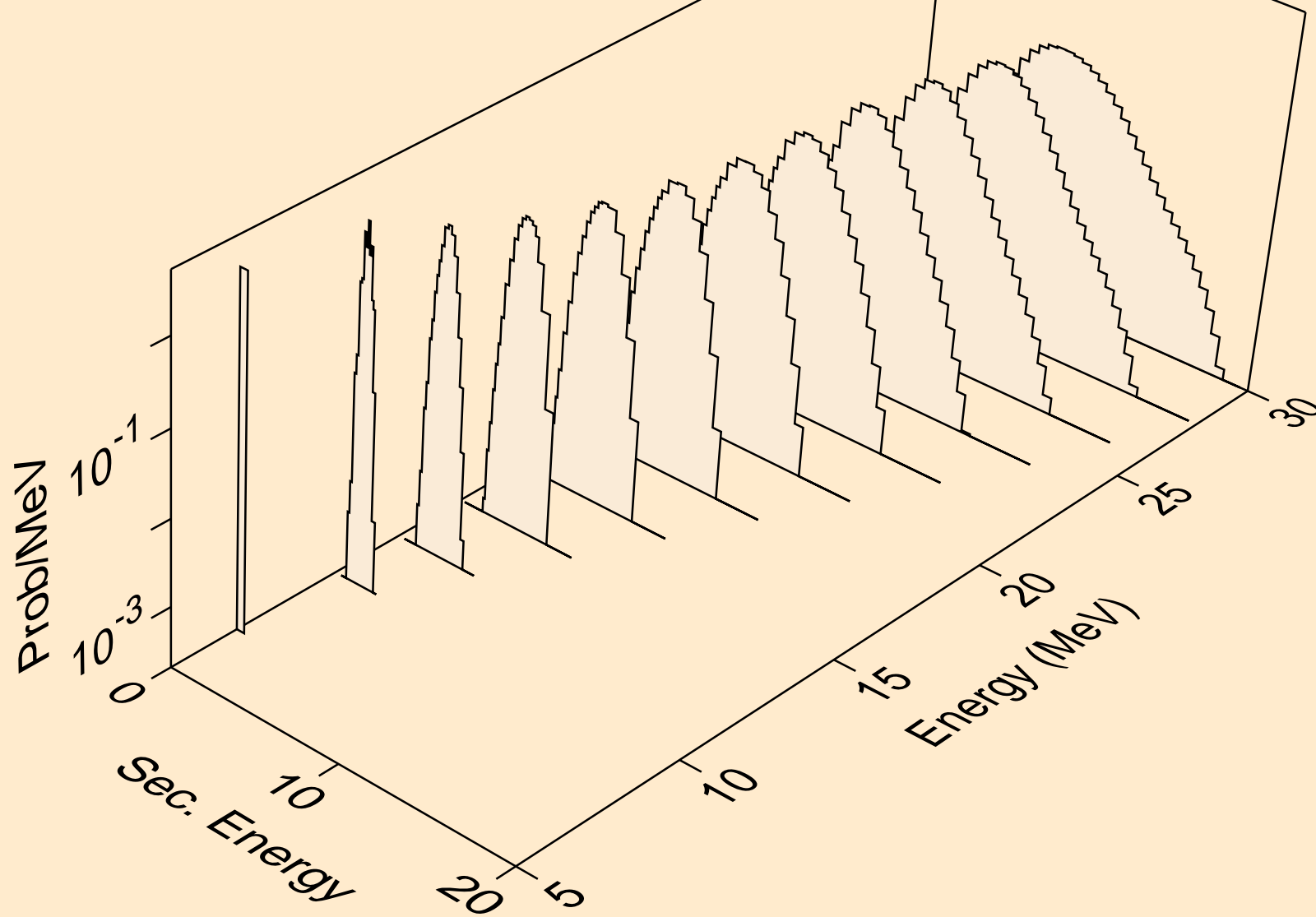

IN11M NEUTRON ACER TENDL-2021 LIBRARY; T=293.6K  
protons from (n,p)

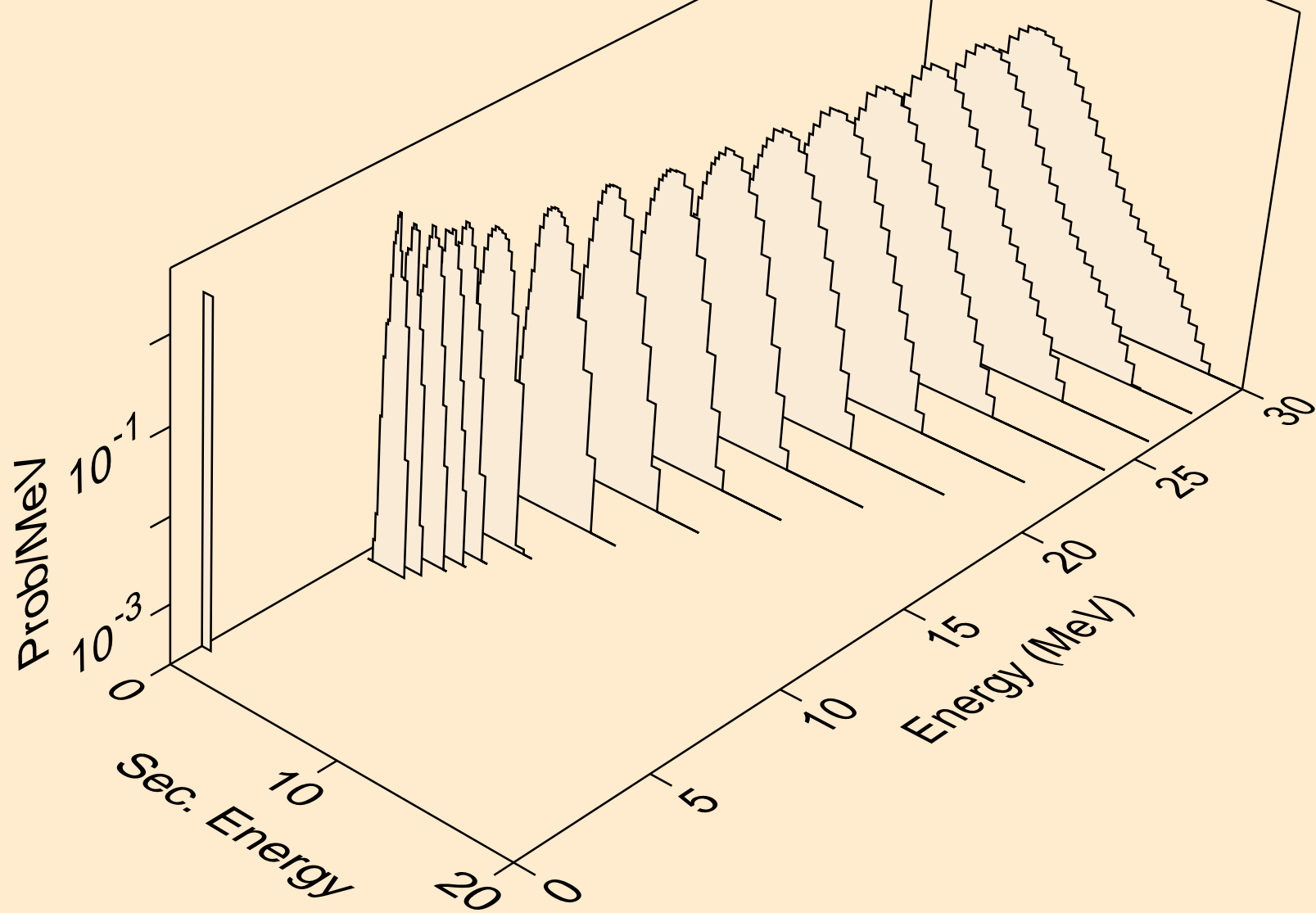



IN111M NEUTRON ACER TENDL-2021 LIBRARY; T=293.6K  
protons from (n,pd)

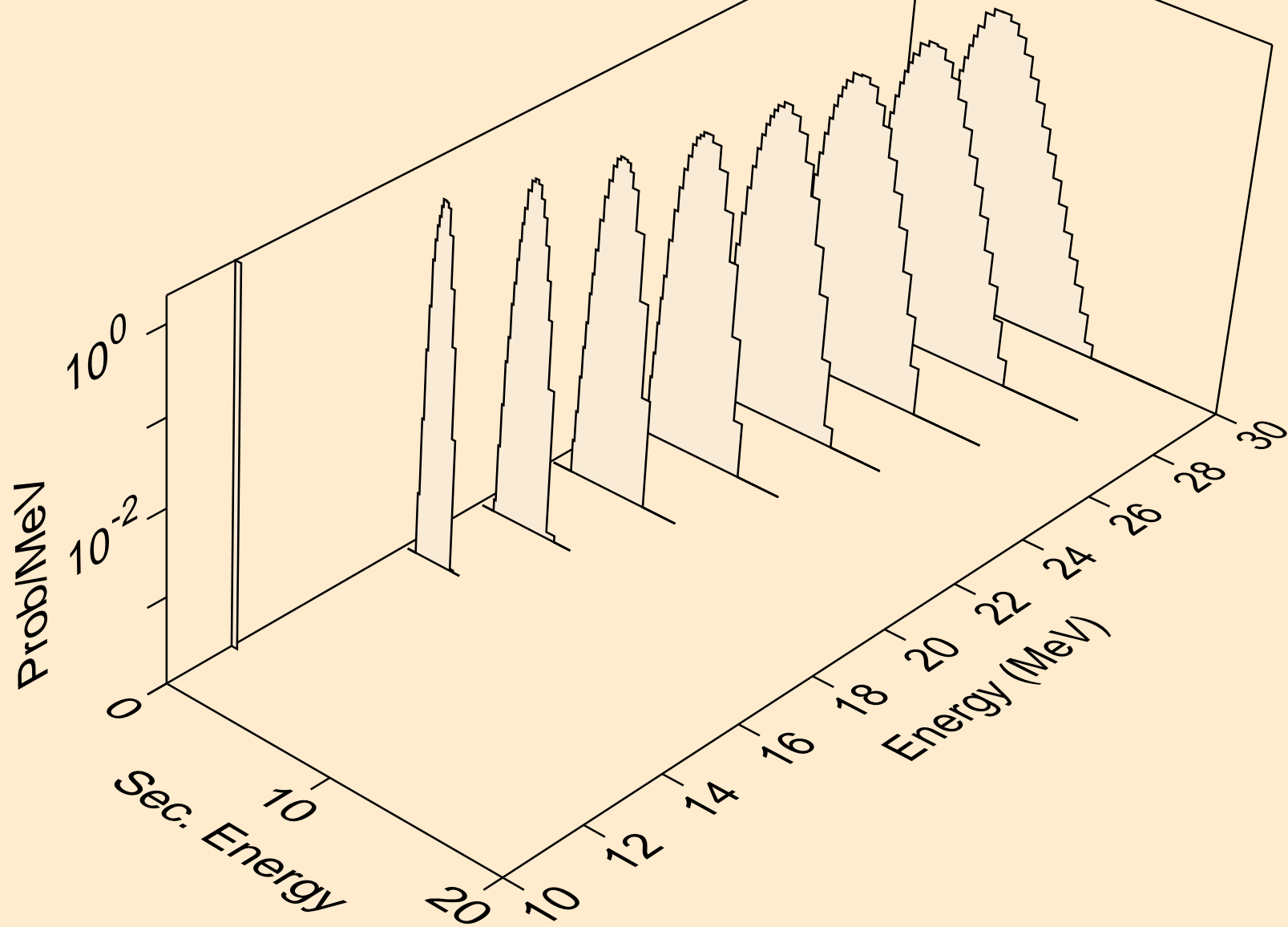

IN11M NEUTRON ACER TENDL-2021 LIBRARY; T=293.6K  
protons from (n,pt)

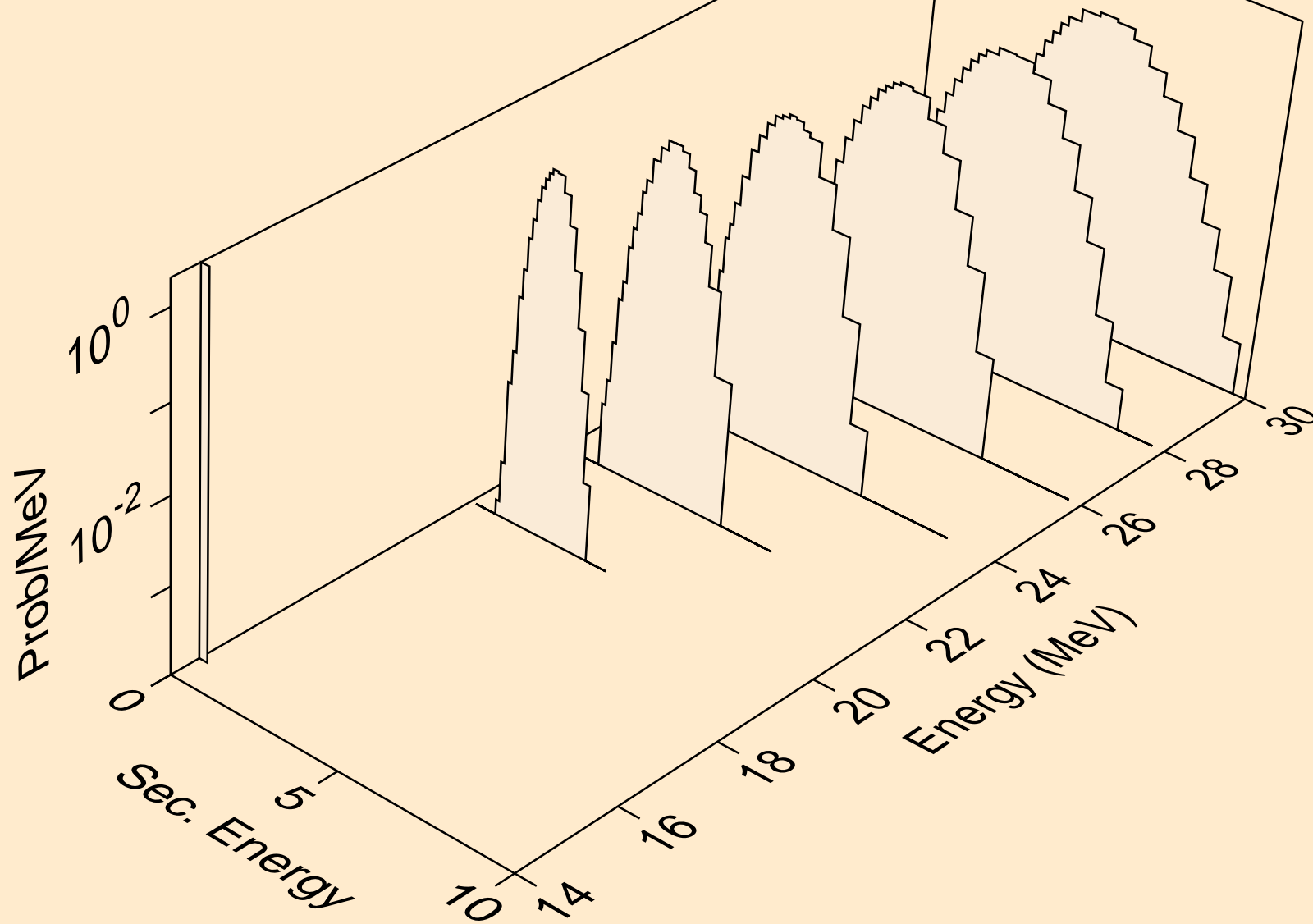

IN111M NEUTRON ACER TENDL-2021 LIBRARY; T=293.6K  
deuterons from (n,x)

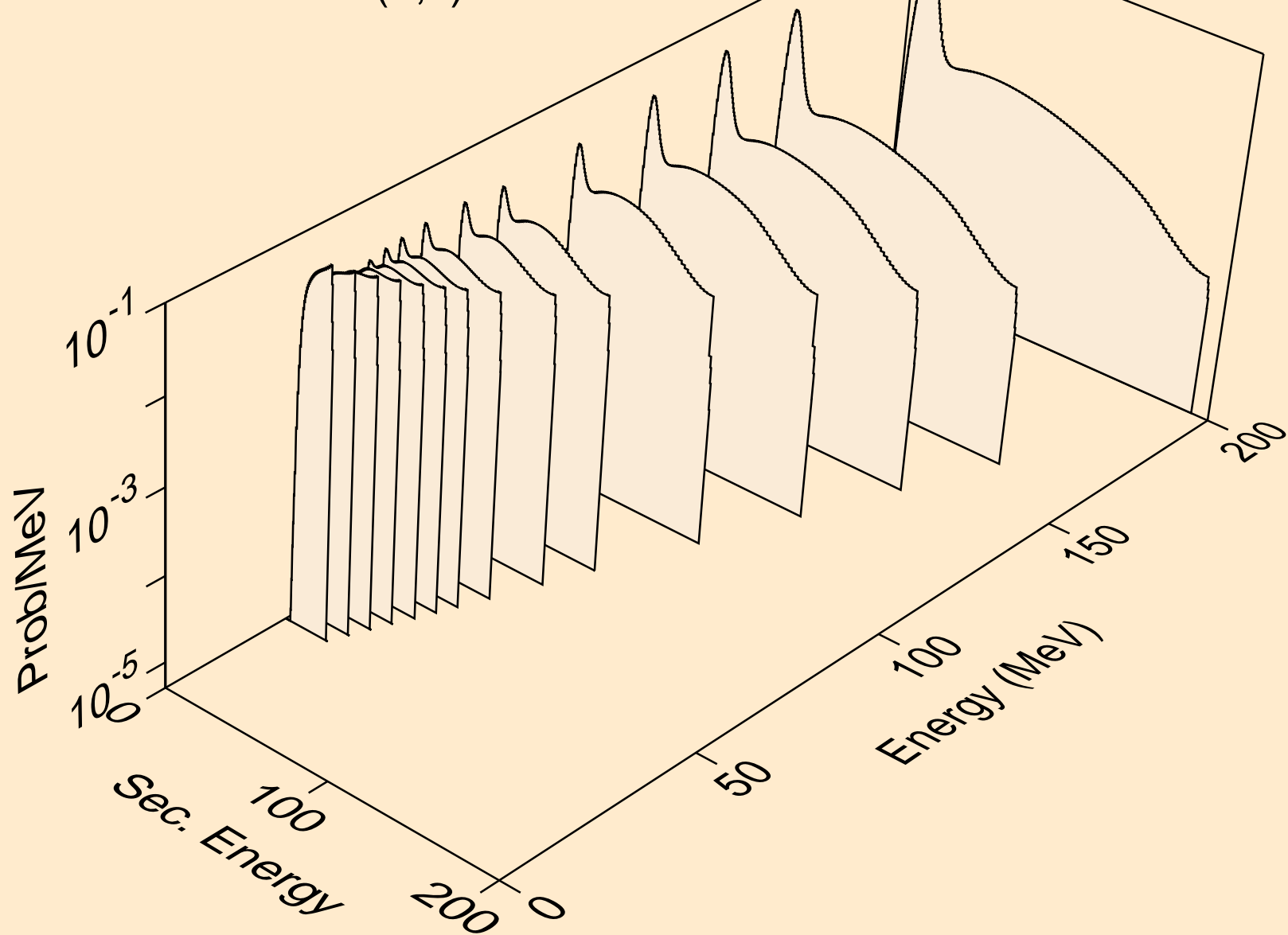

IN111M NEUTRON ACER TENDL-2021 LIBRARY; T=293.6K  
deuterons from (n,2nd)

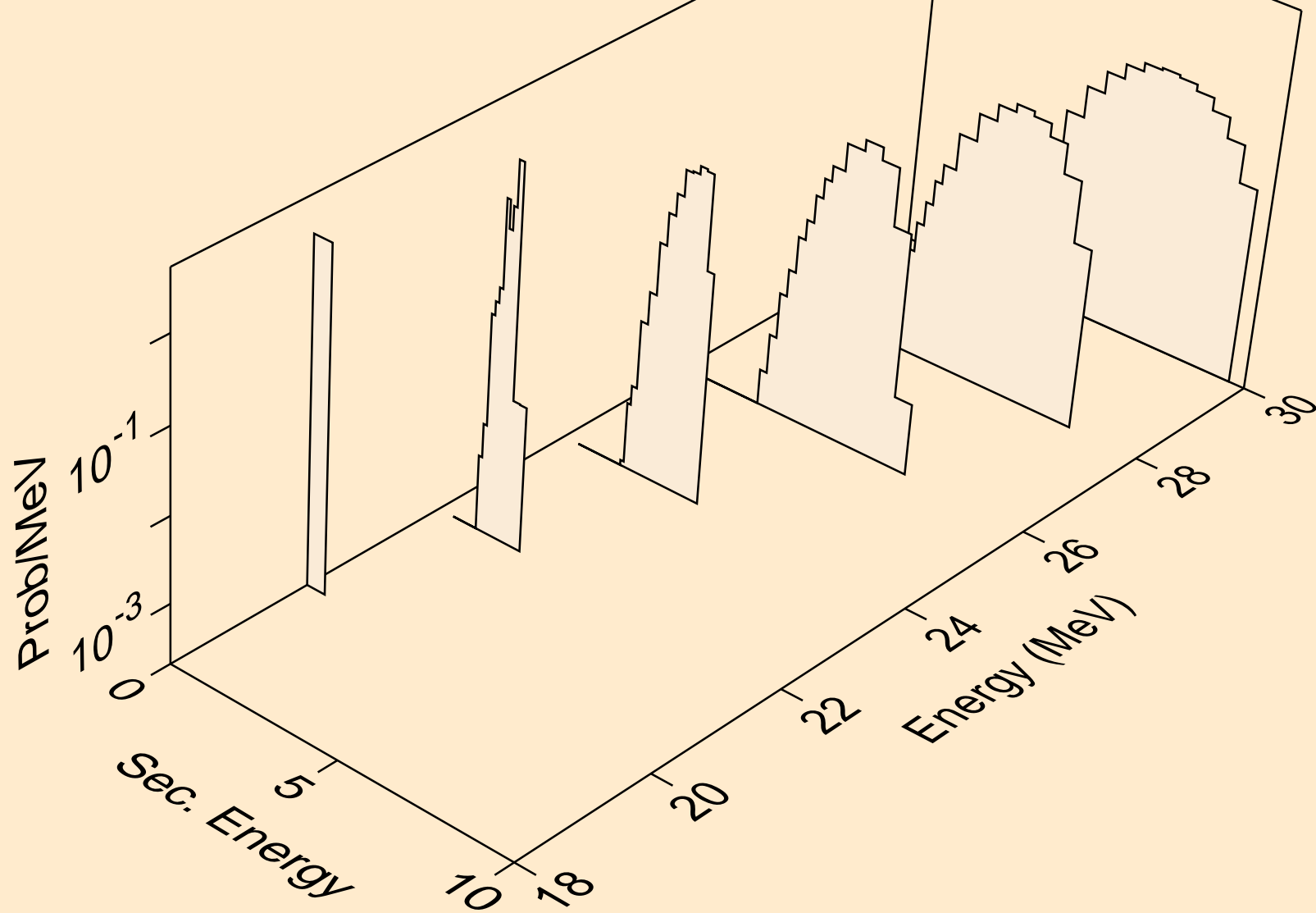

IN111M NEUTRON ACER TENDL-2021 LIBRARY; T=293.6K  
deuterons from (n,n\*)d

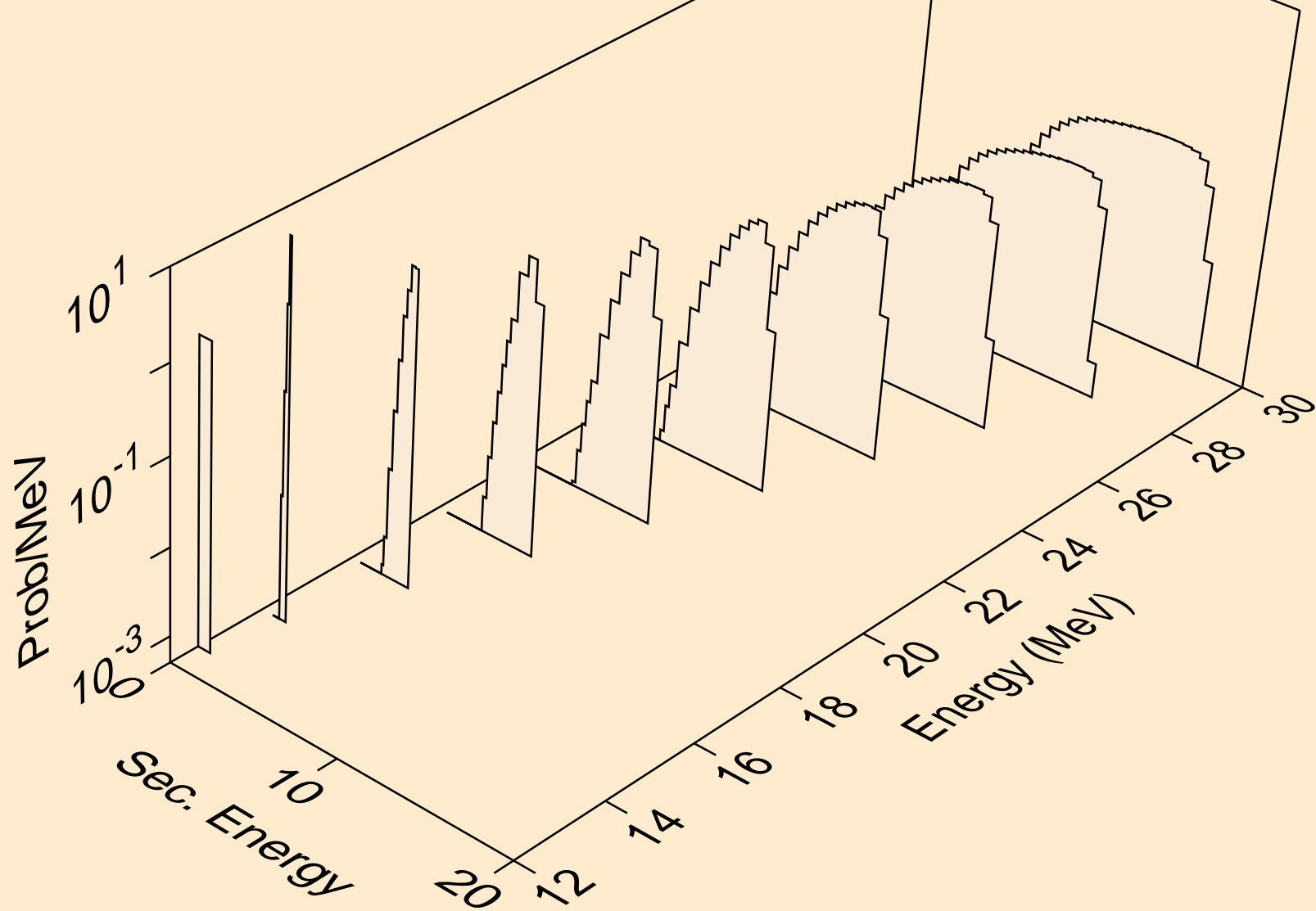

IN111M NEUTRON ACER TENDL-2021 LIBRARY; T=293.6K  
deuterons from (n,d)

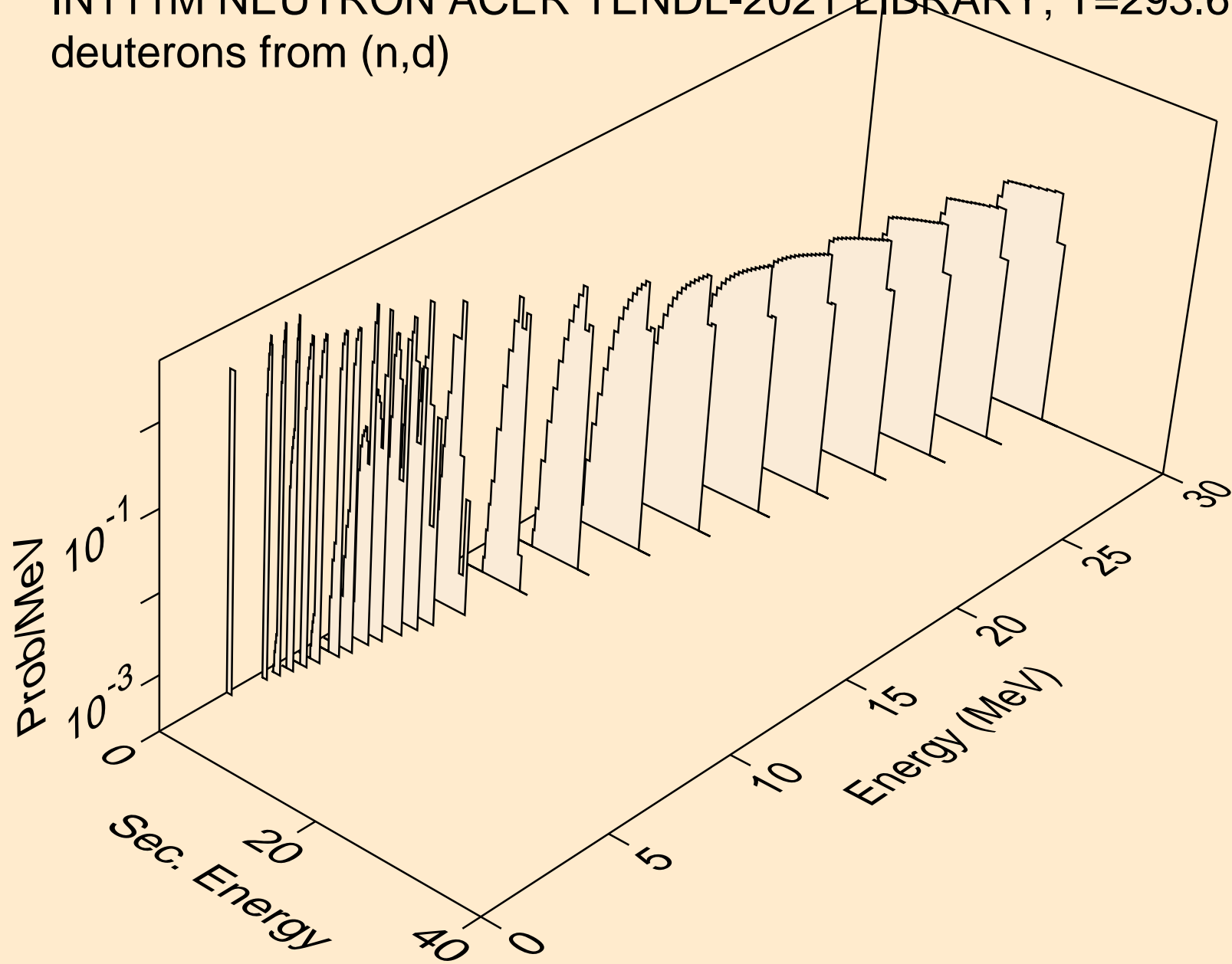

IN11M NEUTRON ACER TENDL-2021 LIBRARY; T=293.6K  
deuterons from (n,pd)

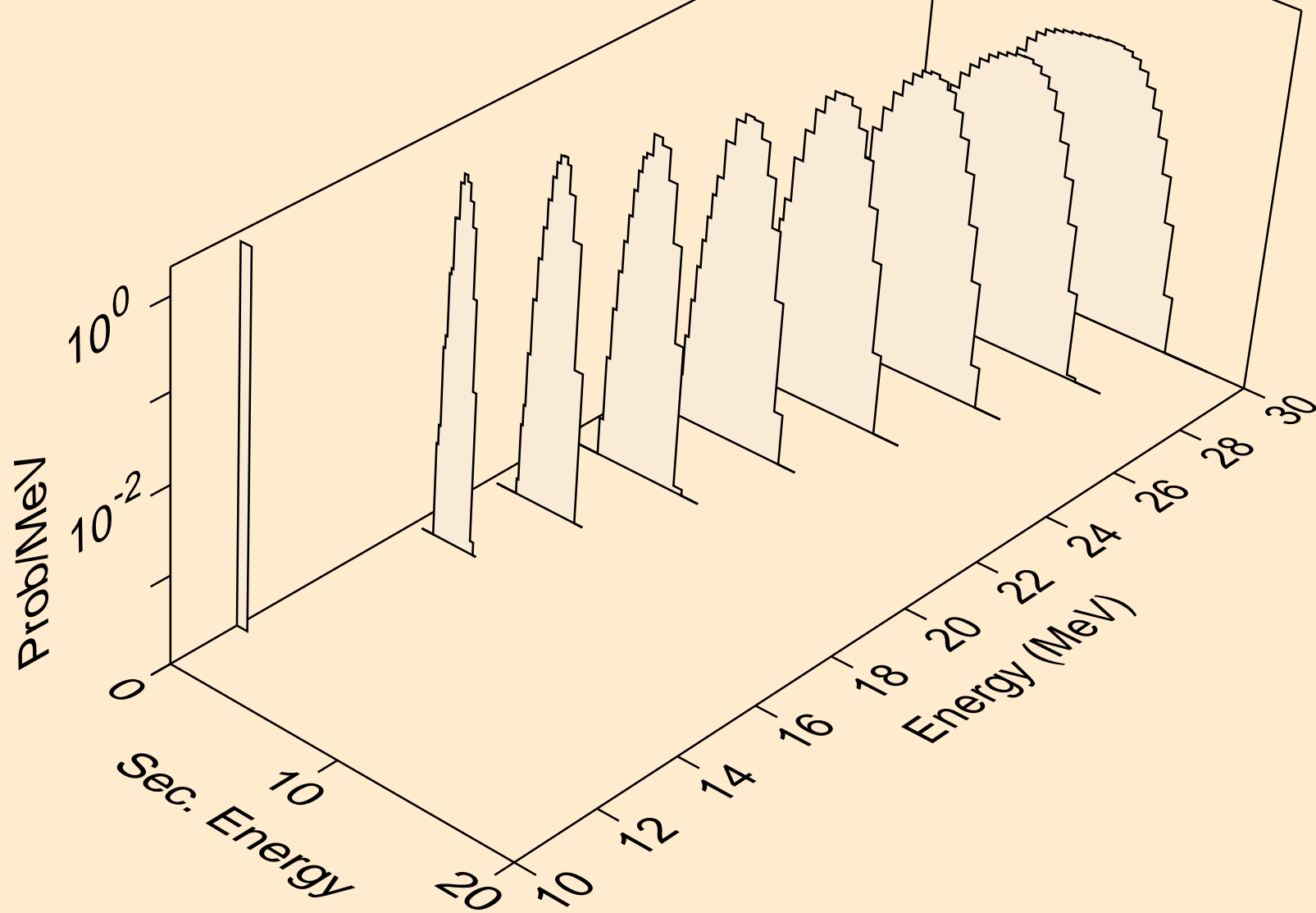

IN11M NEUTRON ACER TENDL-2021 LIBRARY; T=293.6K  
deuterons from (n,da)

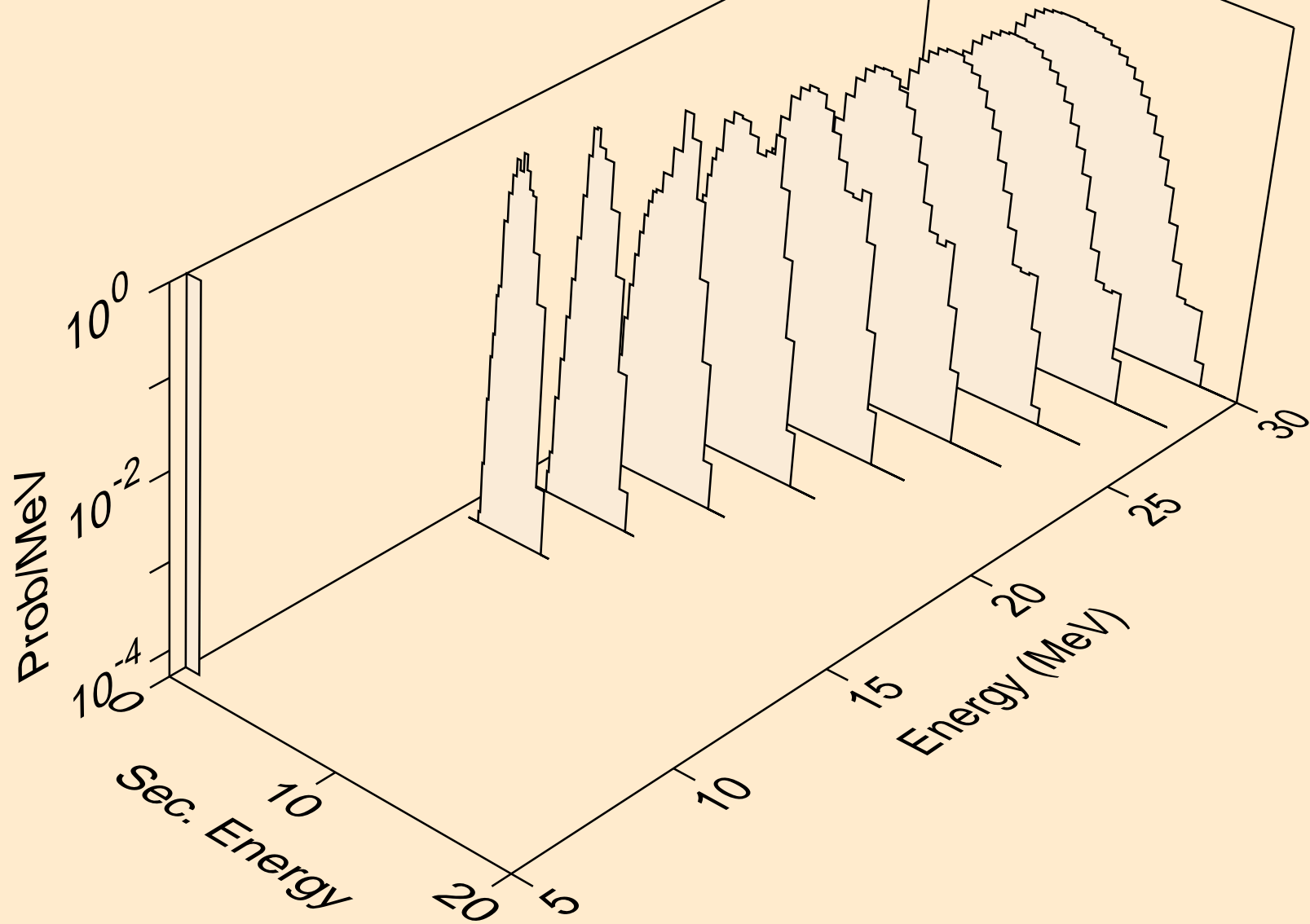



IN111M NEUTRON ACER TENDL-2021 LIBRARY; T=293.6K  
tritons from (n,x)

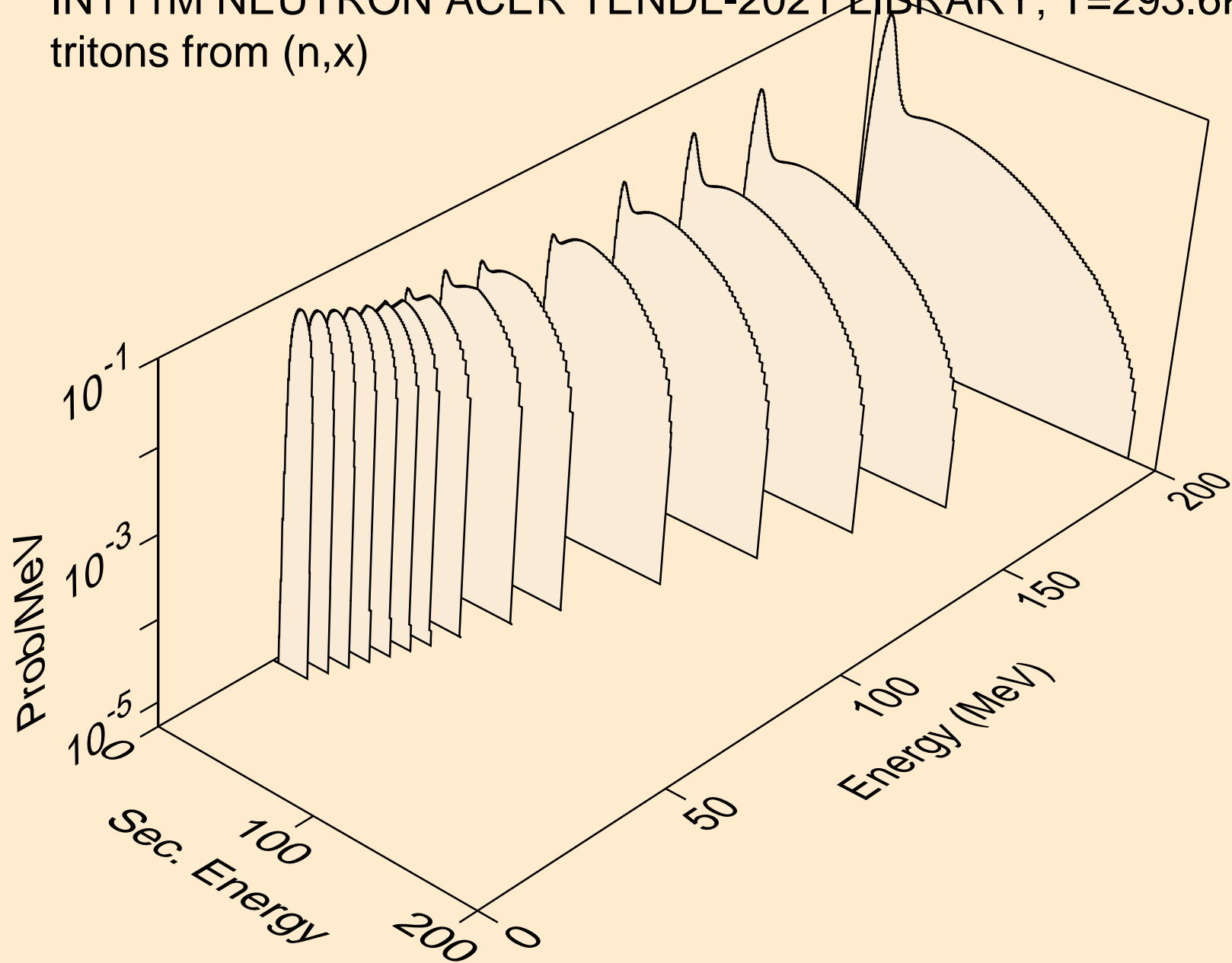

IN111M NEUTRON ACER TENDL-2021 LIBRARY; T=293.6K  
tritons from (n,n\*)t

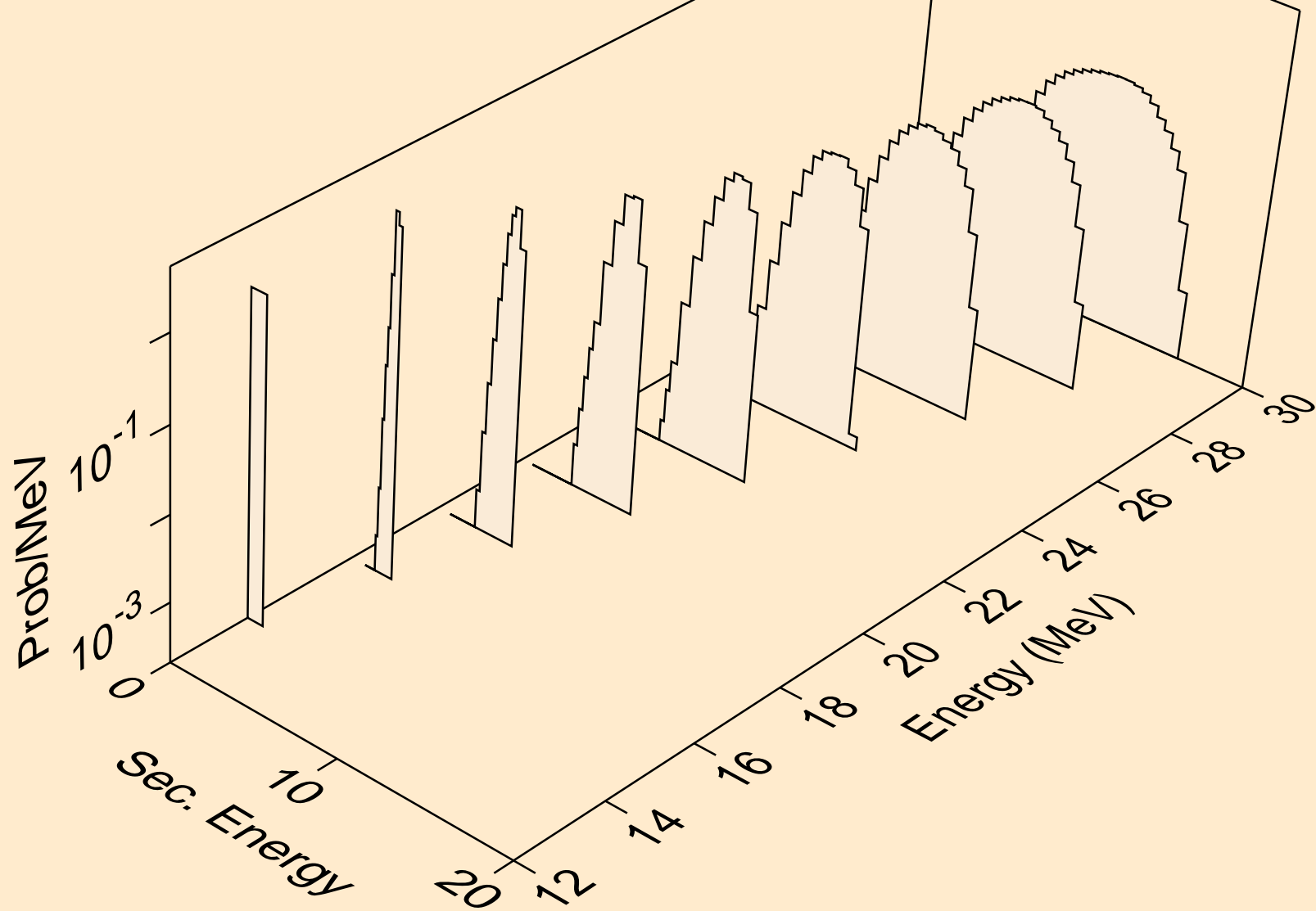

IN111M NEUTRON ACER TENDL-2021 LIBRARY; T=293.6K  
tritons from (n,t)

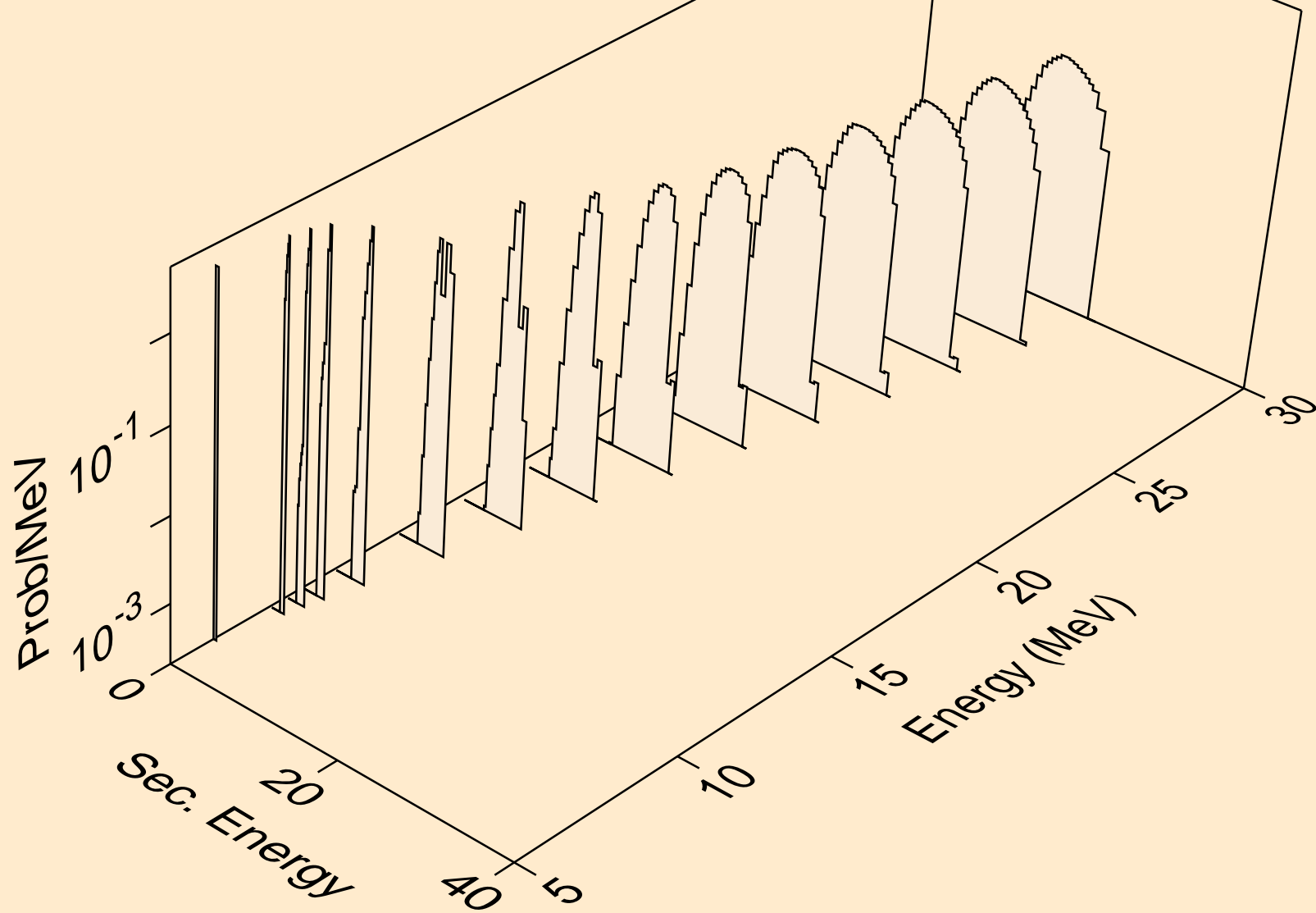

IN11M NEUTRON ACER TENDL-2021 LIBRARY; T=293.6K  
tritons from (n,pt)

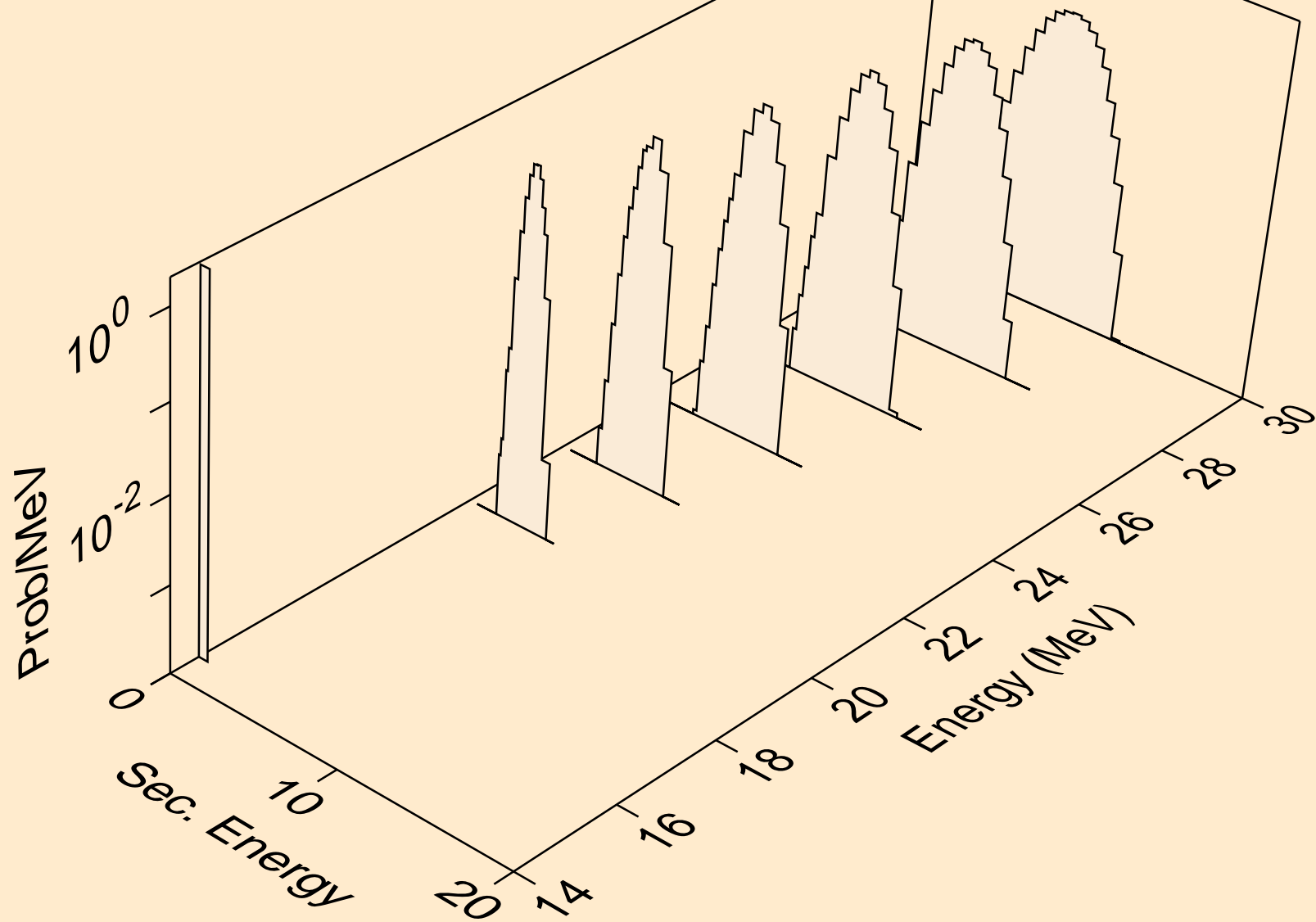

IN11M NEUTRON ACER TENDL-2021 LIBRARY; T=293.6K  
he3s from (n,x)

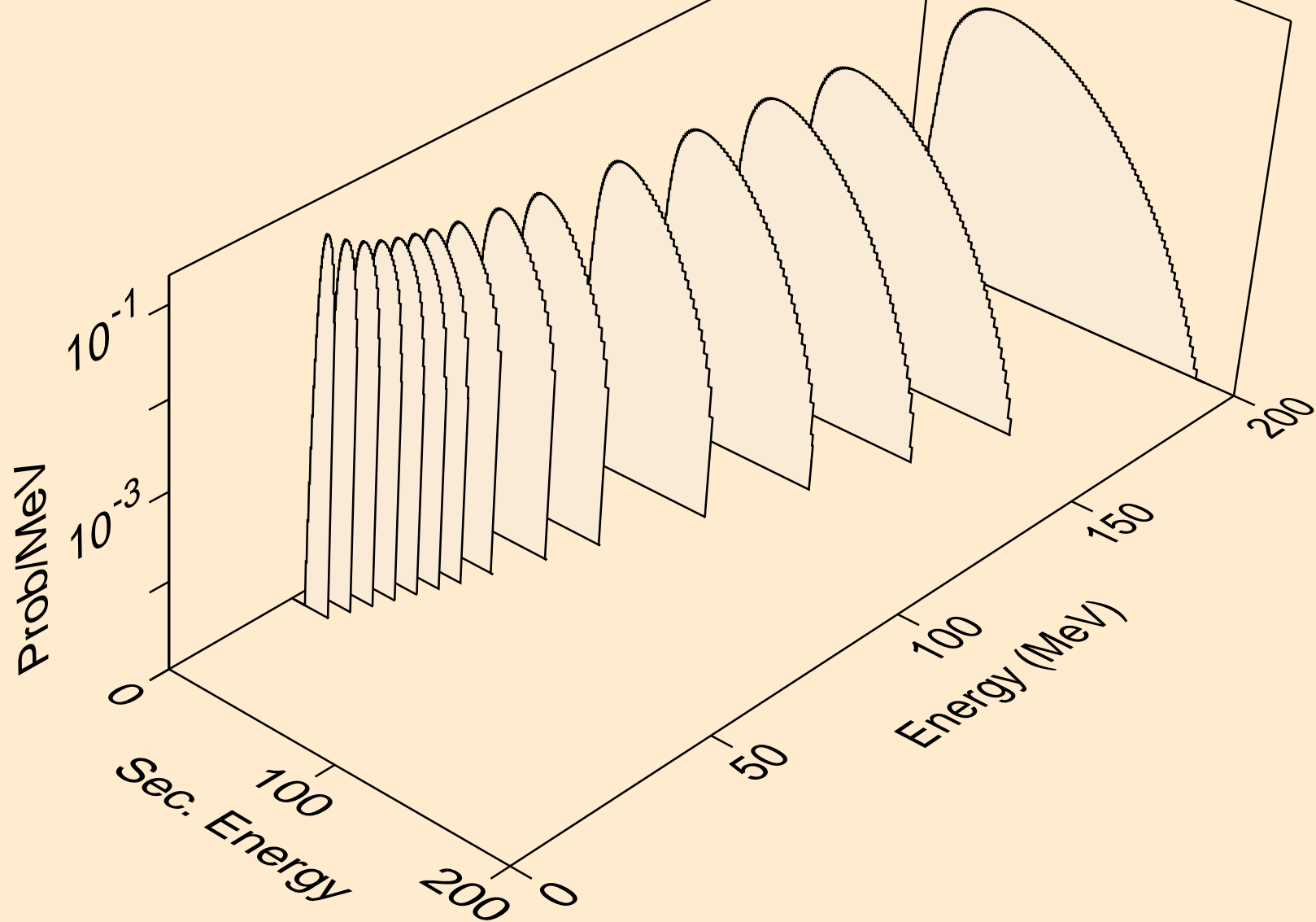

IN111M NEUTRON ACER TENDL-2021 LIBRARY; T=293.6K  
he3s from (n,n\*)he3

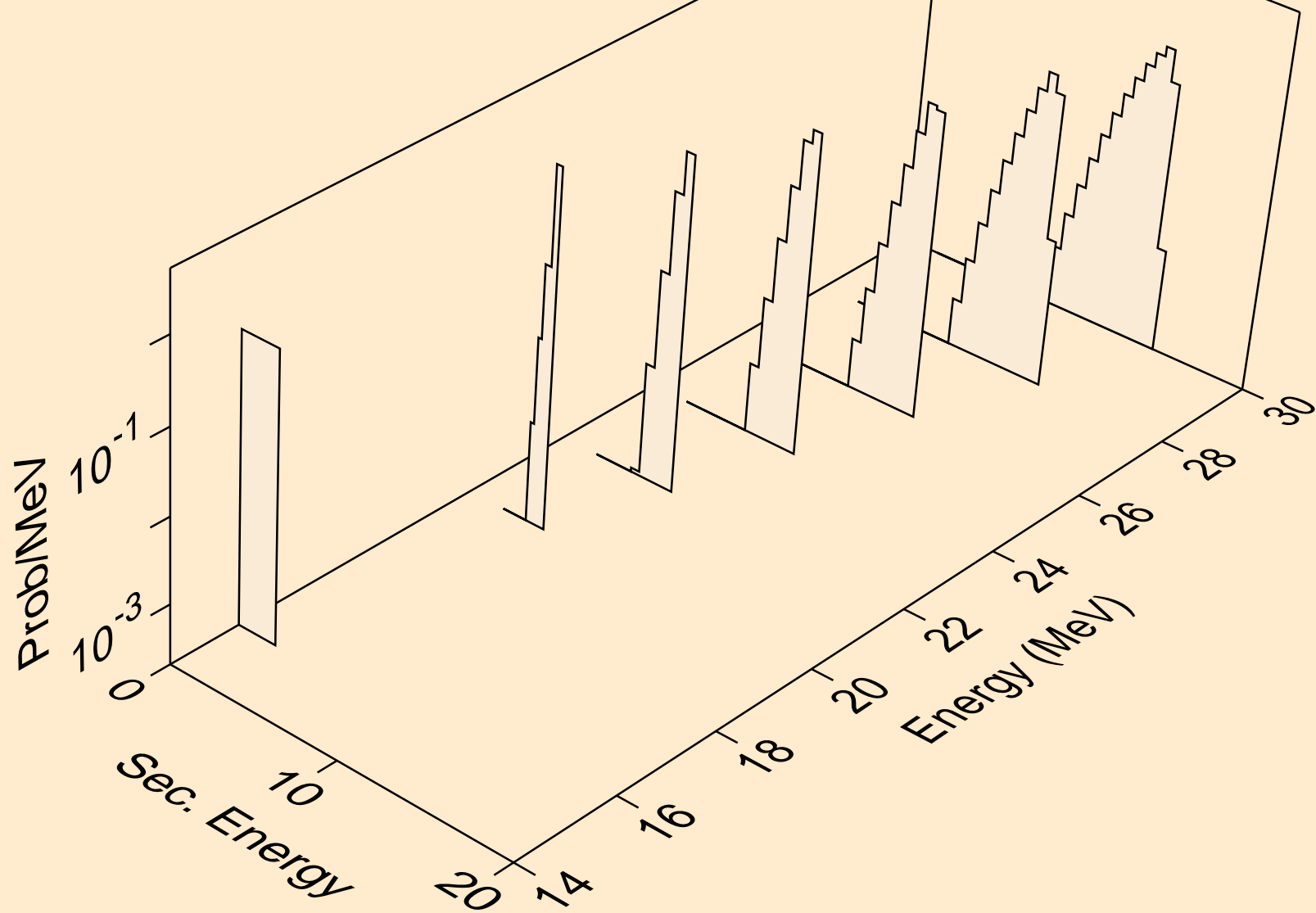

IN111M NEUTRON ACER TENDL-2021 LIBRARY; T=293.6K  
he3s from (n,he3)

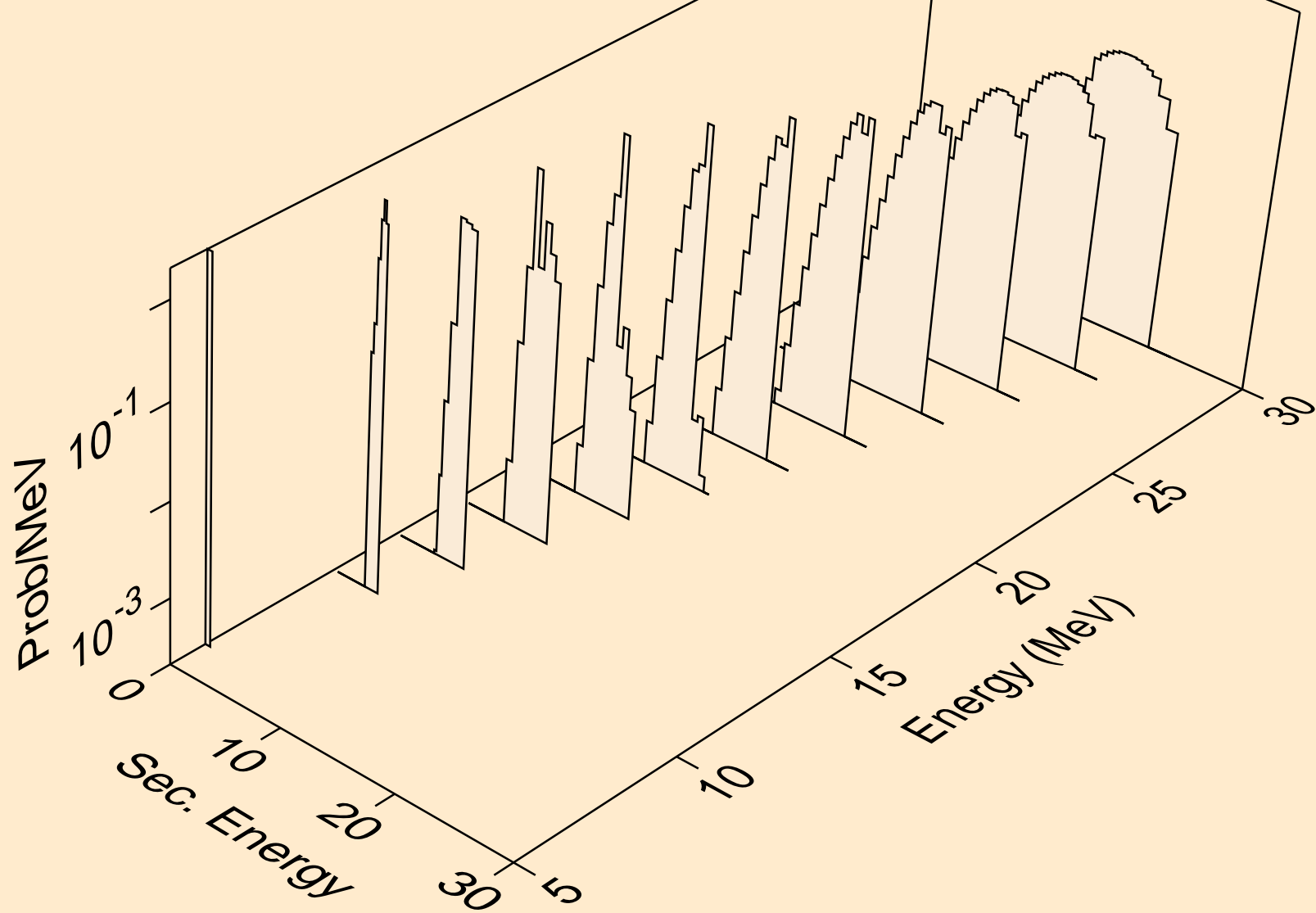

IN11M NEUTRON ACER TENDL-2021 LIBRARY; T=293.6K  
alphas from (n,x)

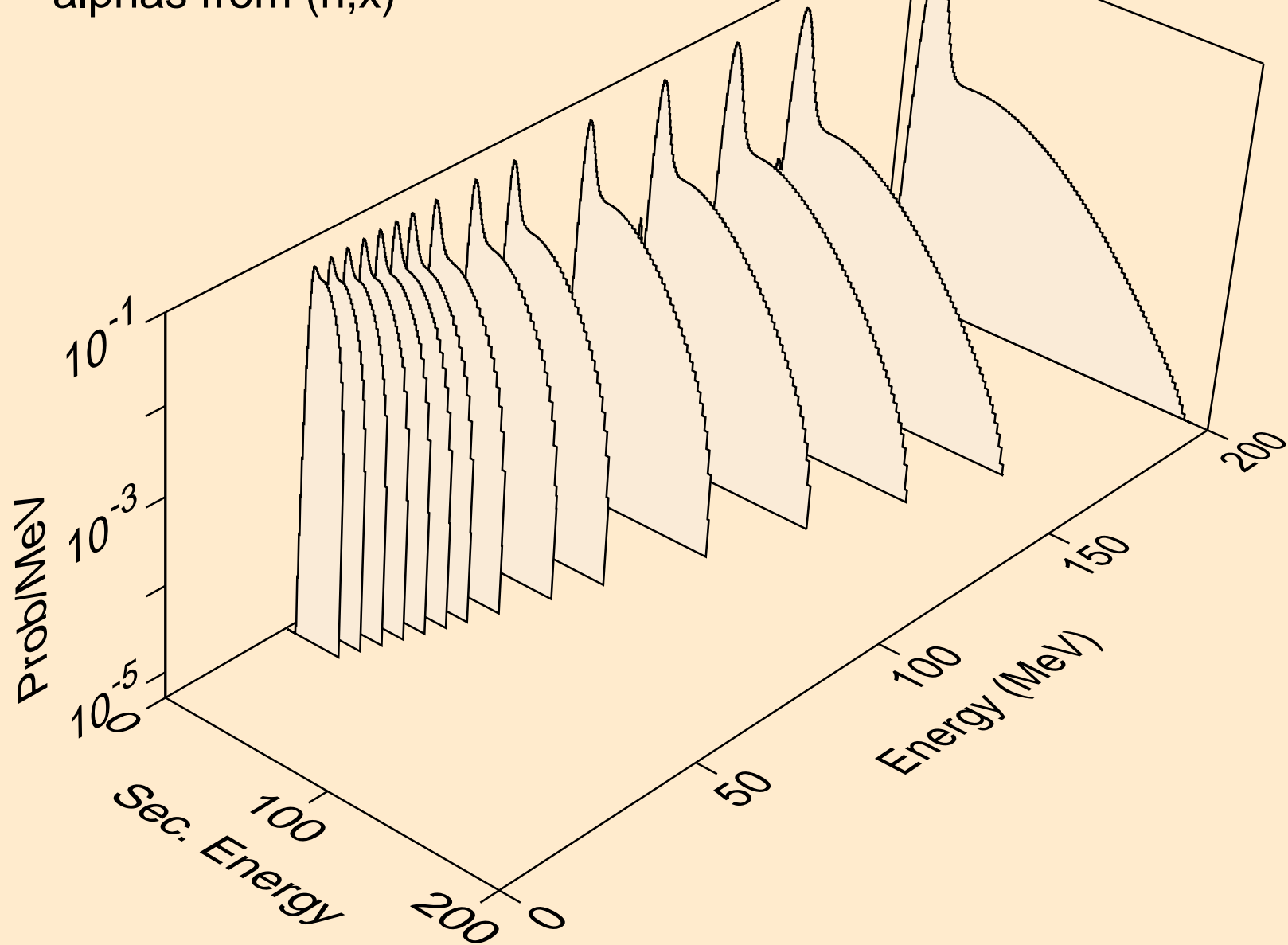



IN111M NEUTRON ACER TENDL-2021 LIBRARY; T=293.6K  
alphas from (n,n\*)a

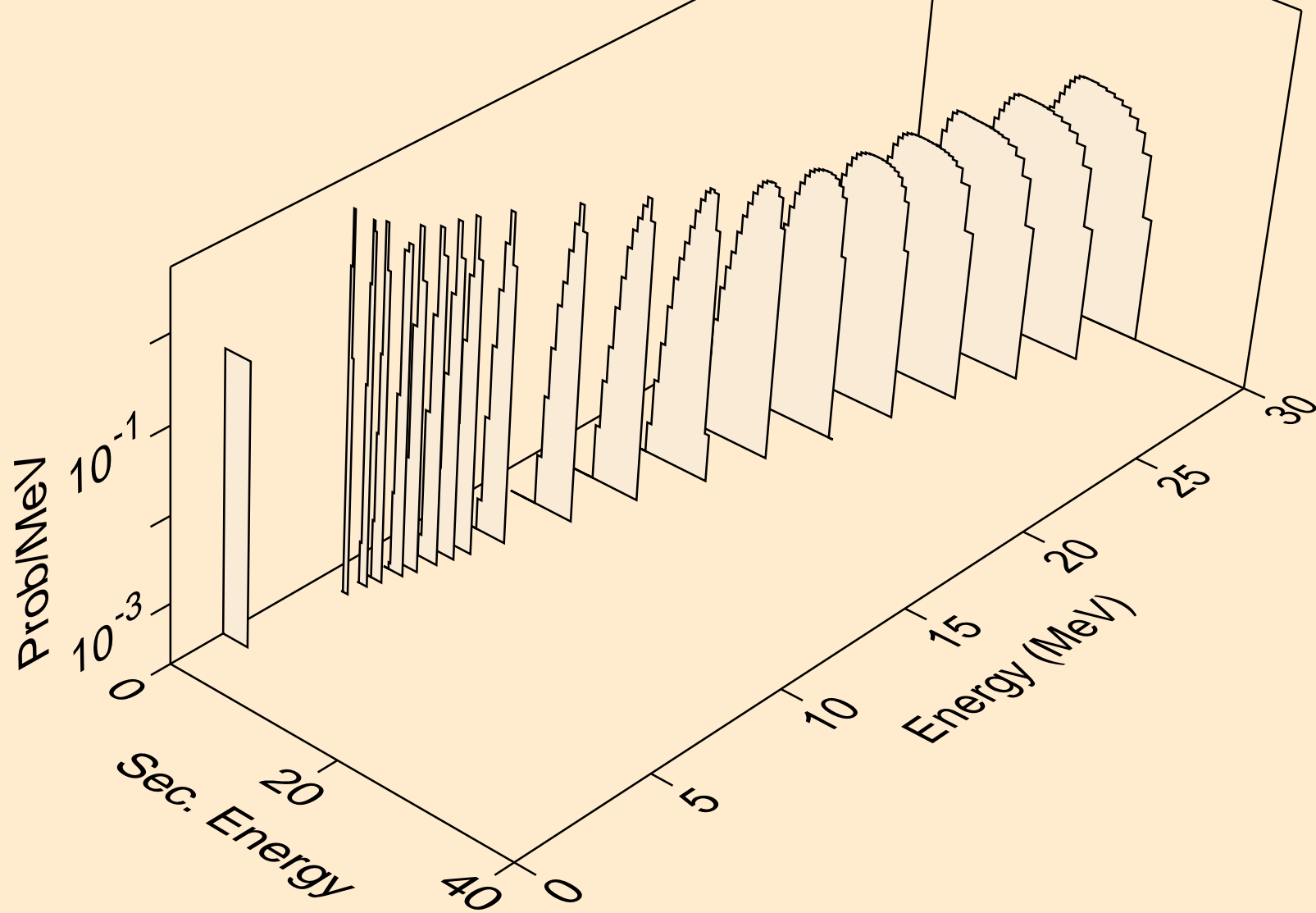

IN111M NEUTRON ACER TENDL-2021 LIBRARY; T=293.6K  
alphas from (n,2n)a

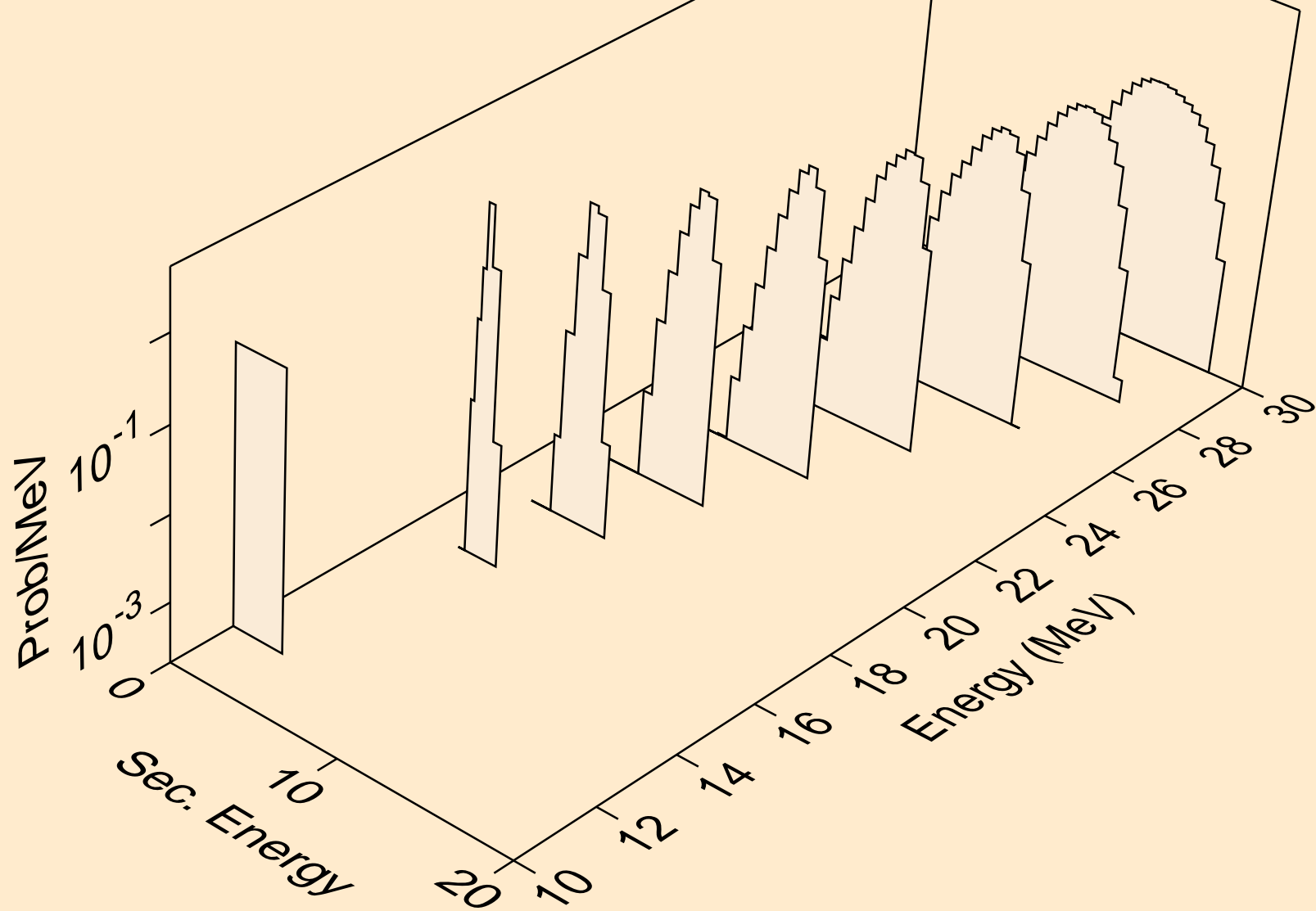

IN111M NEUTRON ACER TENDL-2021 LIBRARY; T=293.6K  
alphas from (n,3n)a

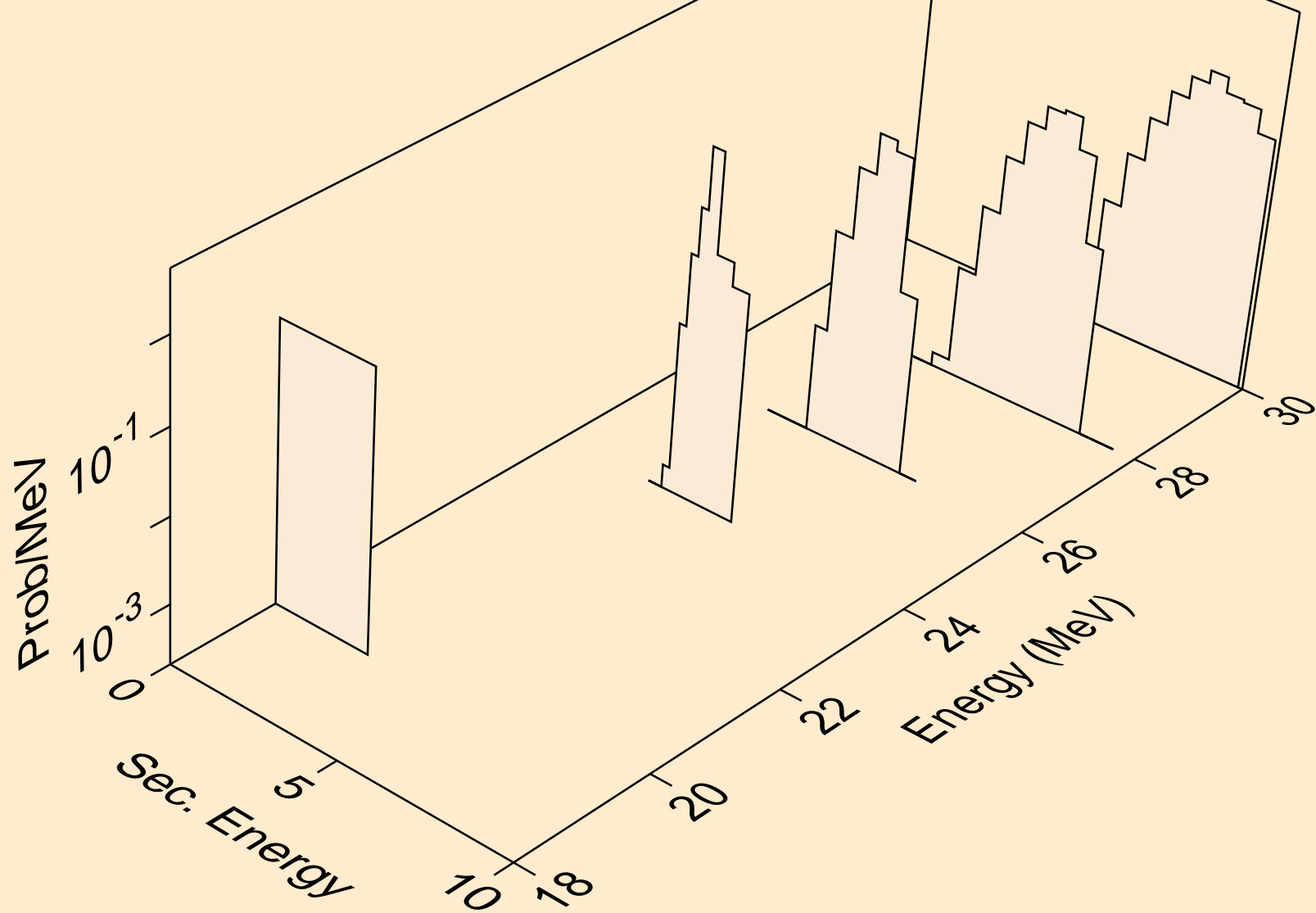

IN11M NEUTRON ACER TENDL-2021 LIBRARY; T=293.6K  
alphas from (n,n\*)2a

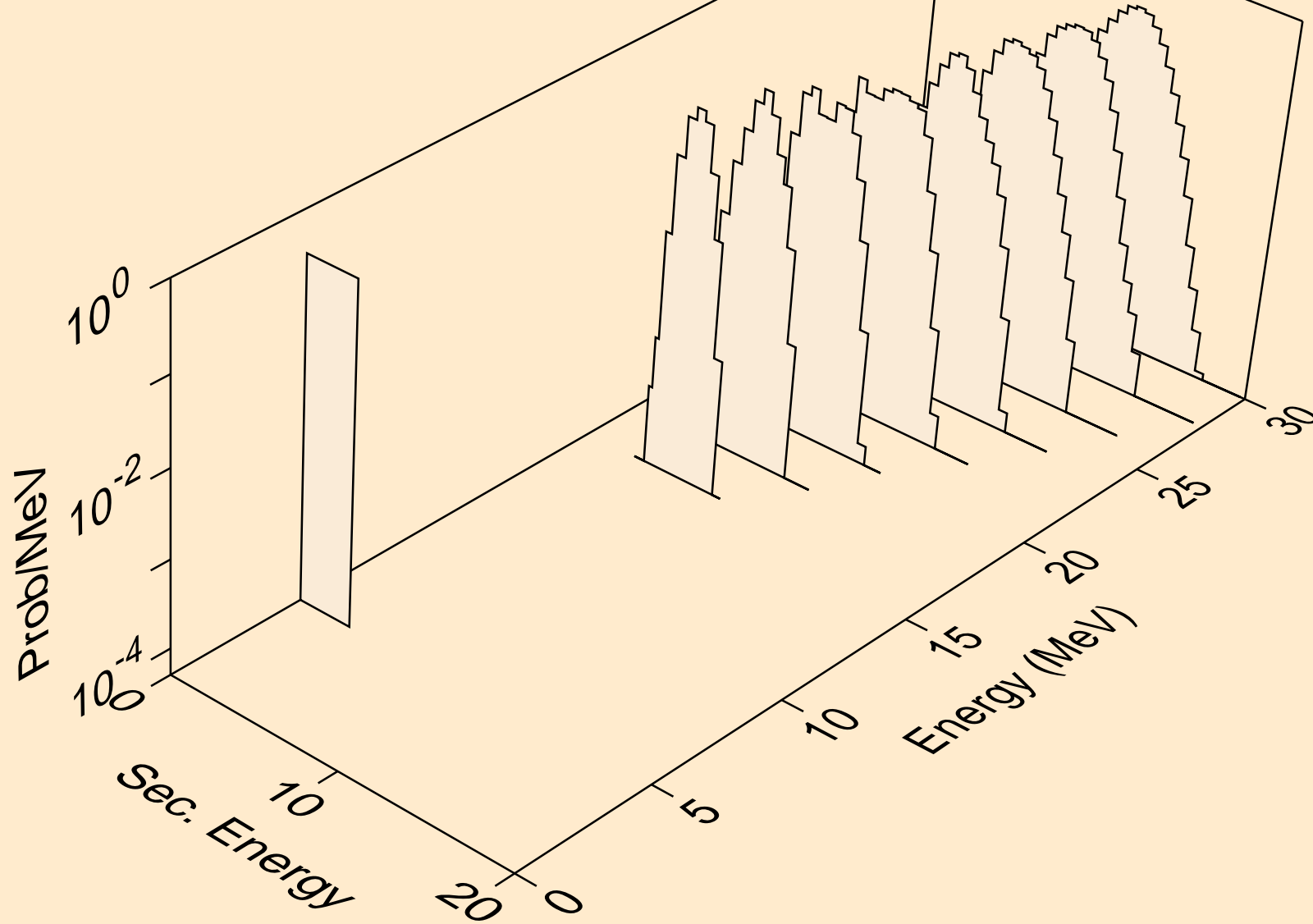

IN111M NEUTRON ACER TENDL-2021 LIBRARY; T=293.6K  
alphas from (n,npa)

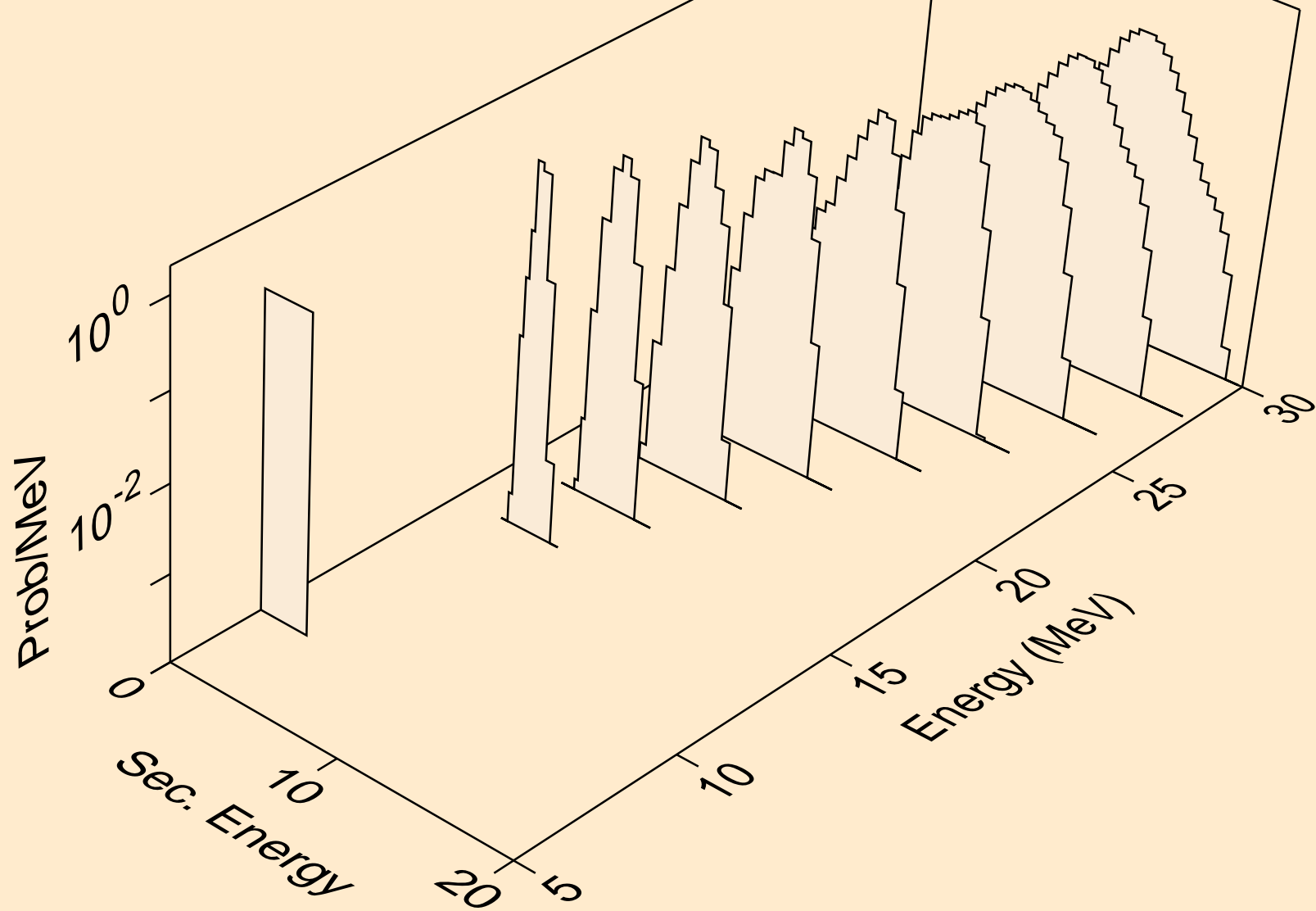

IN11M NEUTRON ACER TENDL-2021 LIBRARY; T=293.6K  
alphas from (n,a)

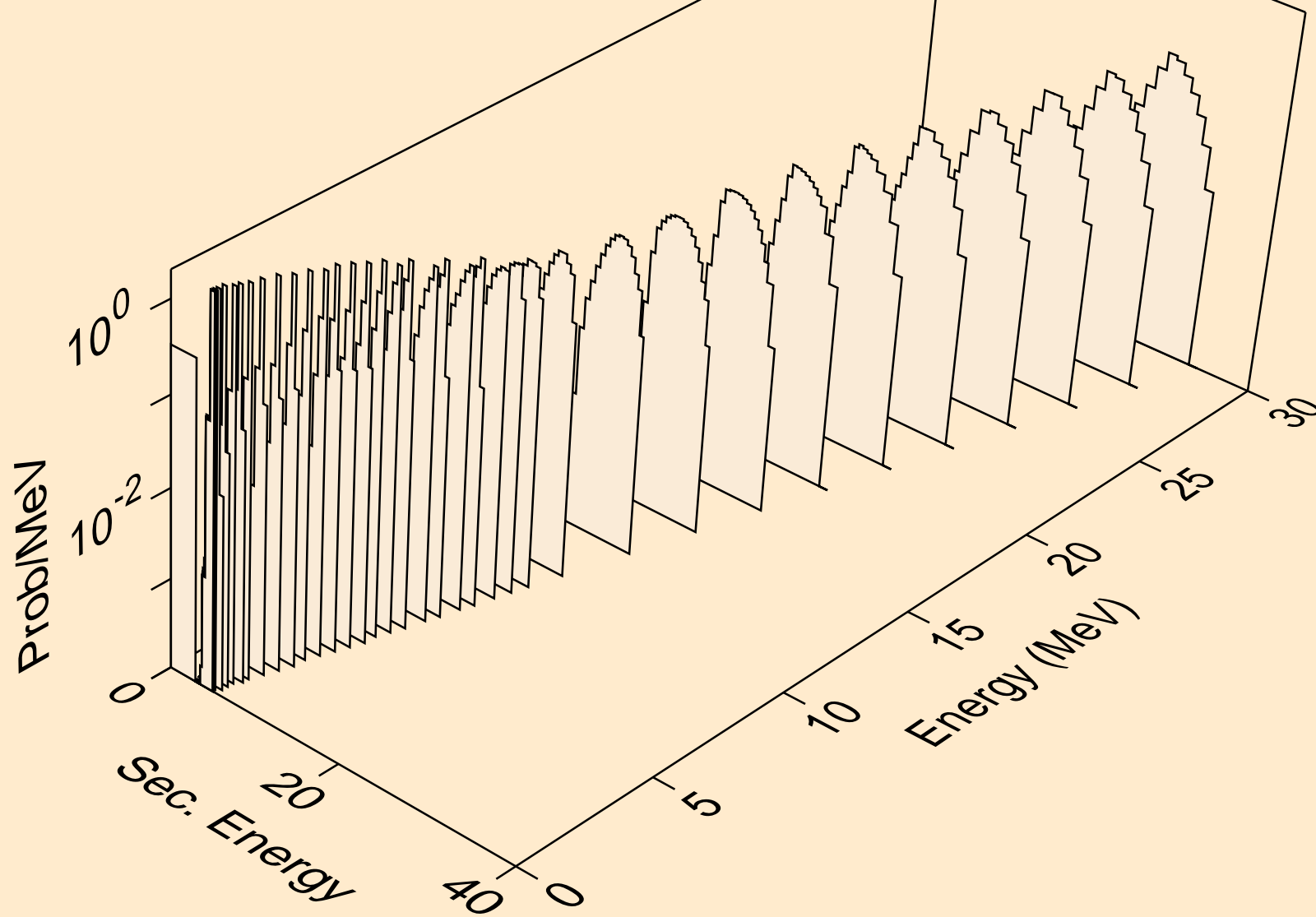

IN11M NEUTRON ACER TENDL-2021 LIBRARY; T=293.6K  
alphas from (n,2a)

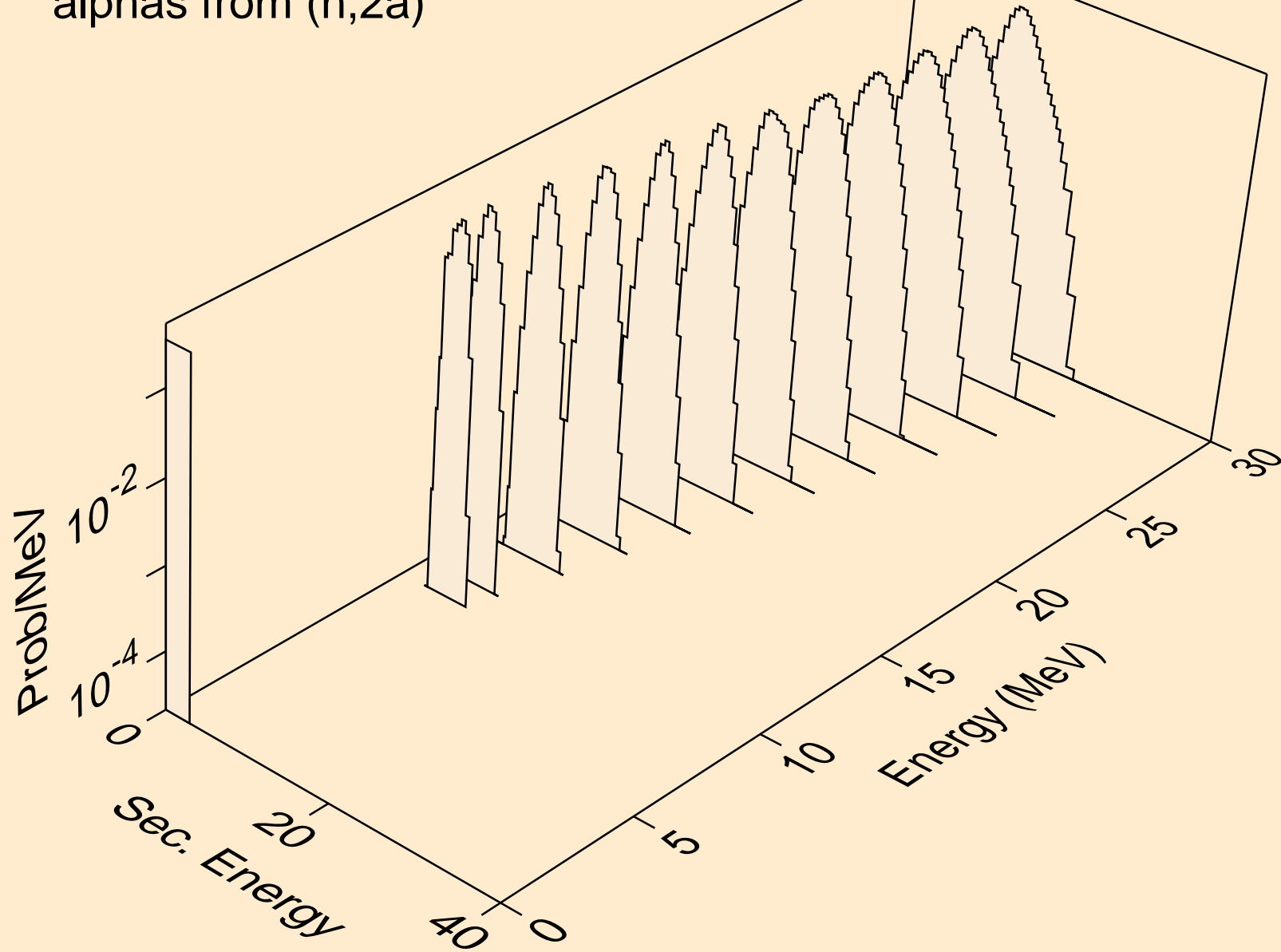

IN11M NEUTRON ACER TENDL-2021 LIBRARY; T=293.6K  
alphas from (n,pa)

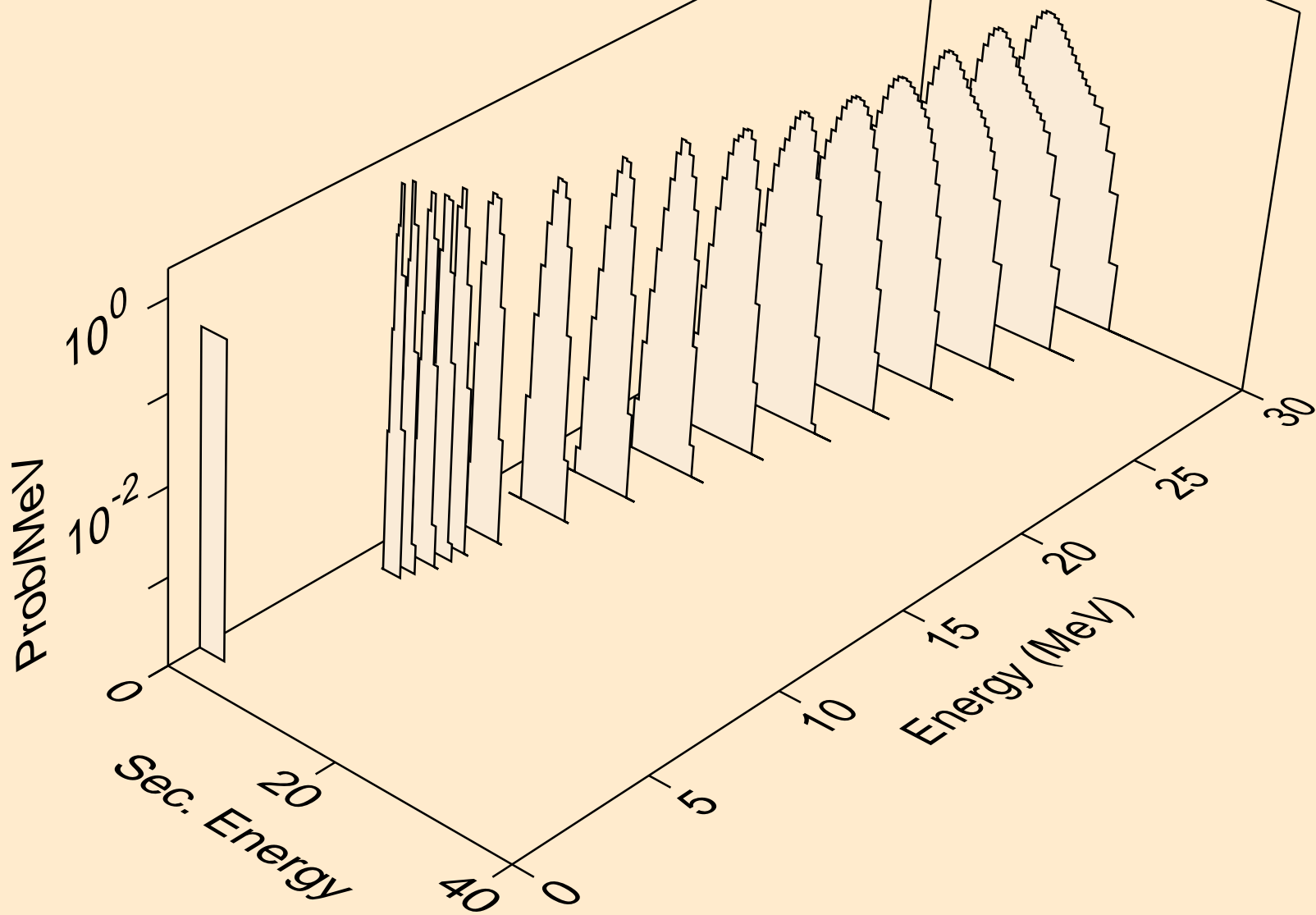



IN111M NEUTRON ACER TENDL-2021 LIBRARY; T=293.6K  
alphas from (n,da)

