

# IN122N NEUTRON ACER TENDL-2021 LIBRARY; T=293.6K

## Principal cross sections

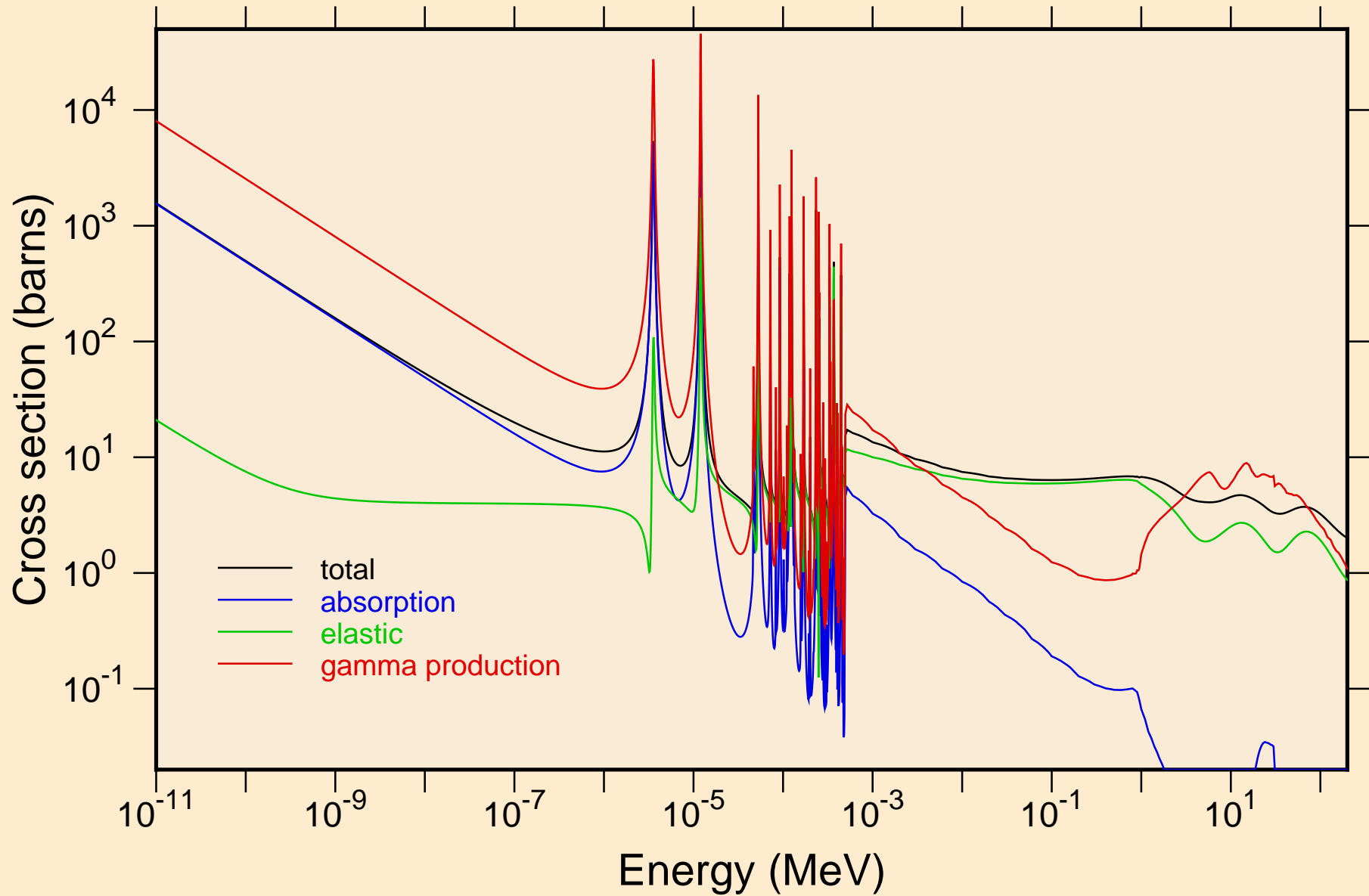

IN122N NEUTRON ACER TENDL-2021 LIBRARY; T=293.6K  
resonance total cross section

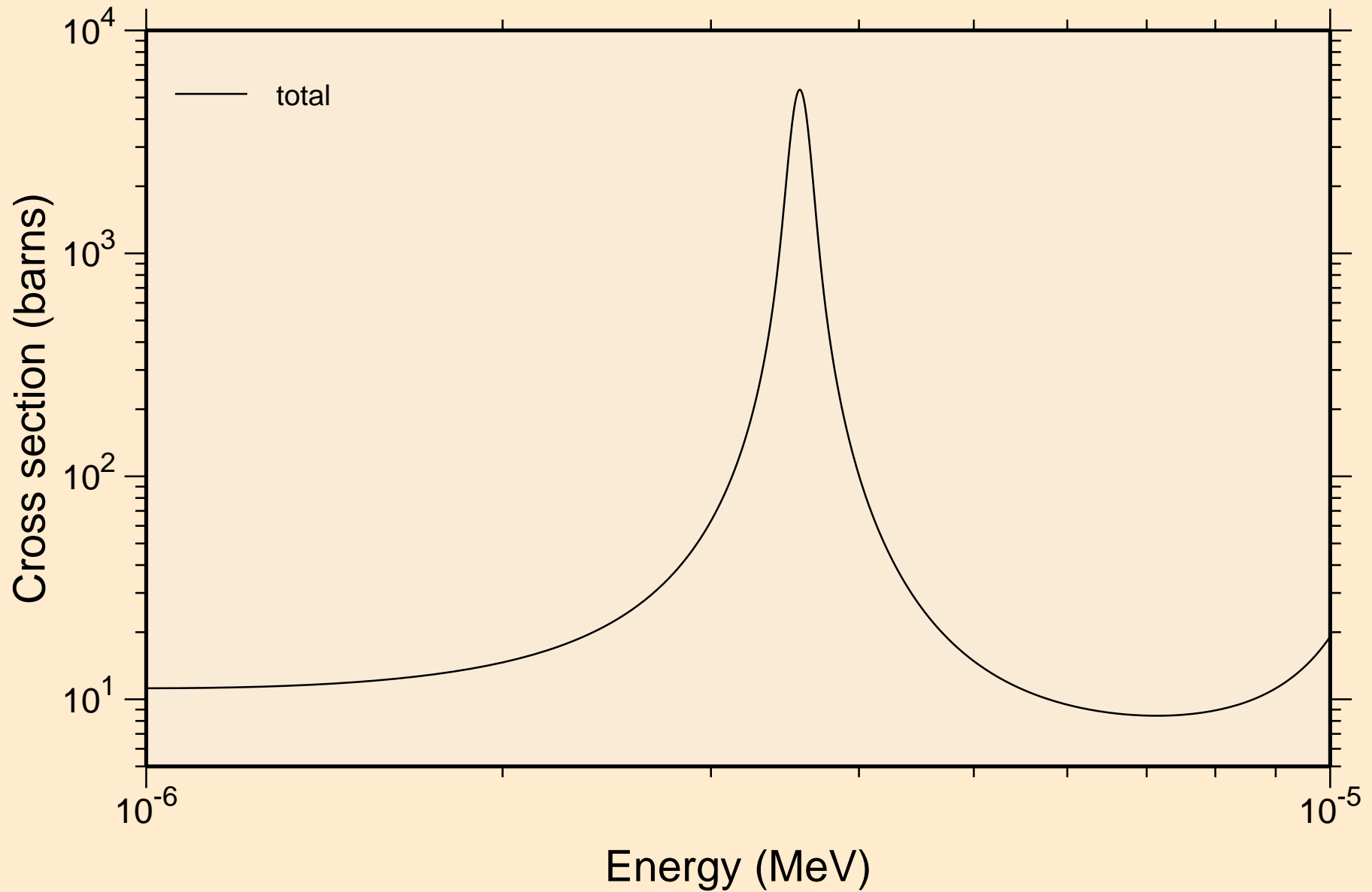

IN122N NEUTRON ACER TENDL-2021 LIBRARY; T=293.6K  
resonance total cross section

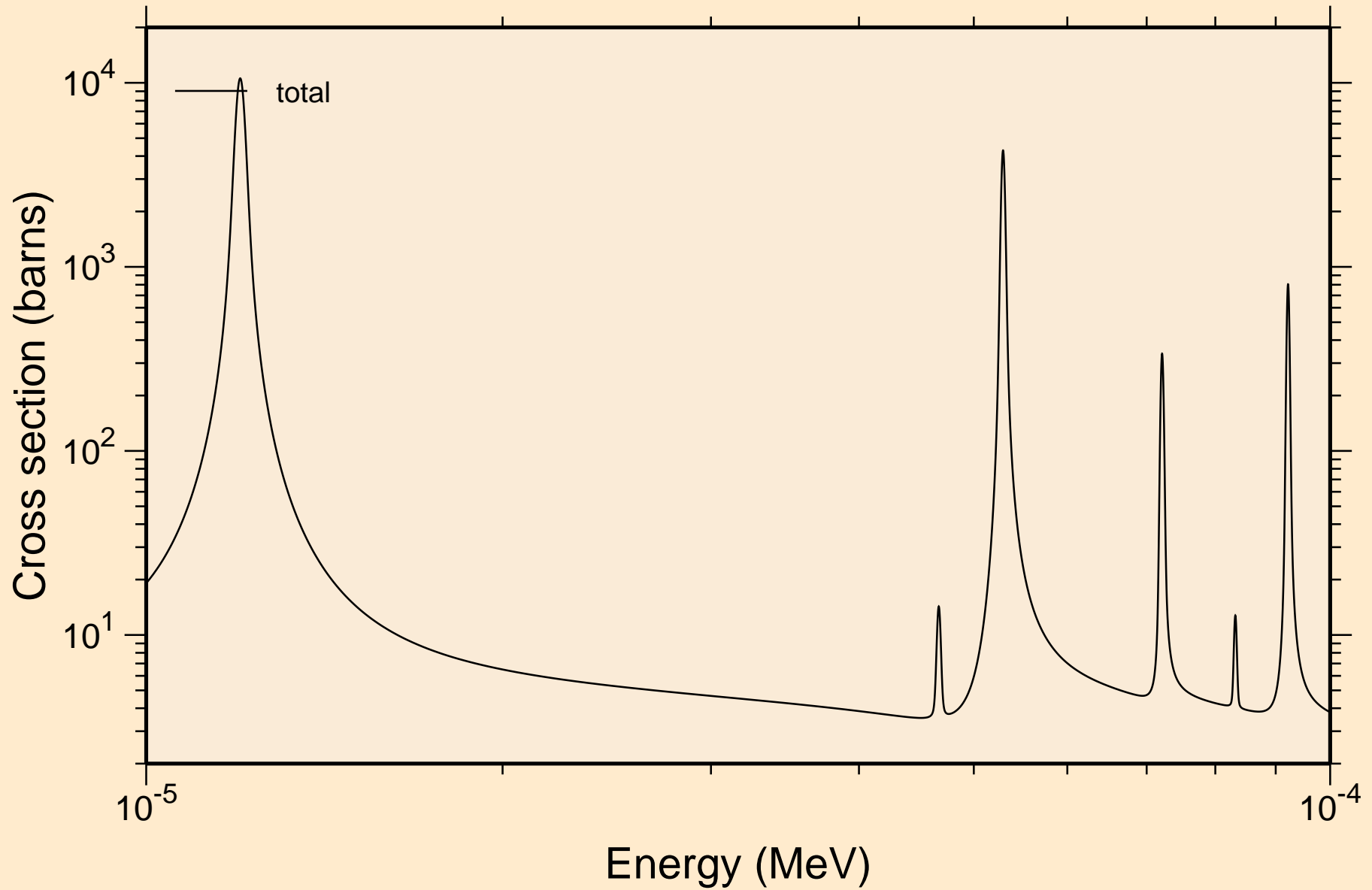

IN122N NEUTRON ACER TENDL-2021 LIBRARY; T=293.6K  
resonance total cross section

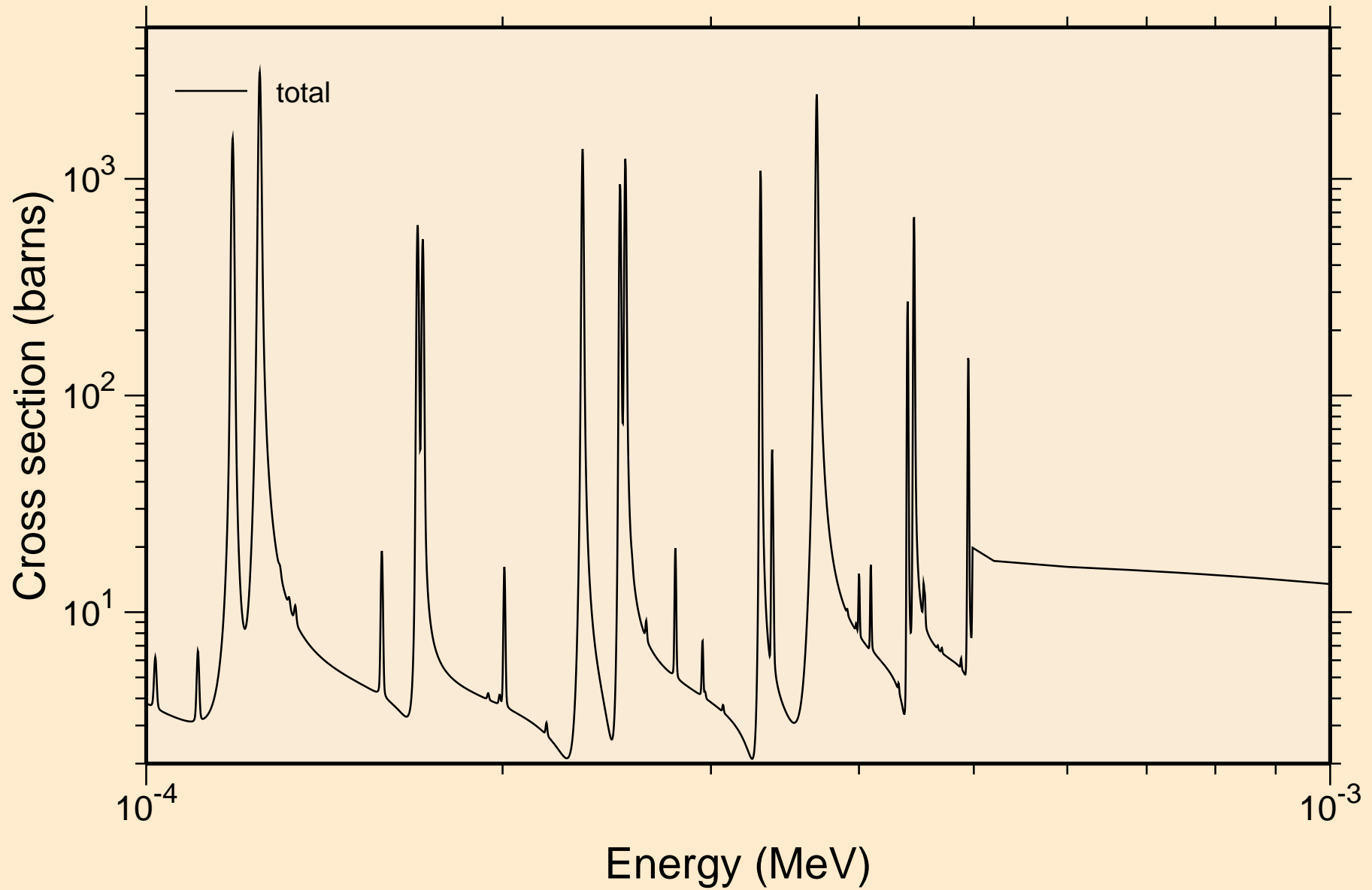

IN122N NEUTRON ACER TENDL-2021 LIBRARY; T=293.6K  
resonance total cross section

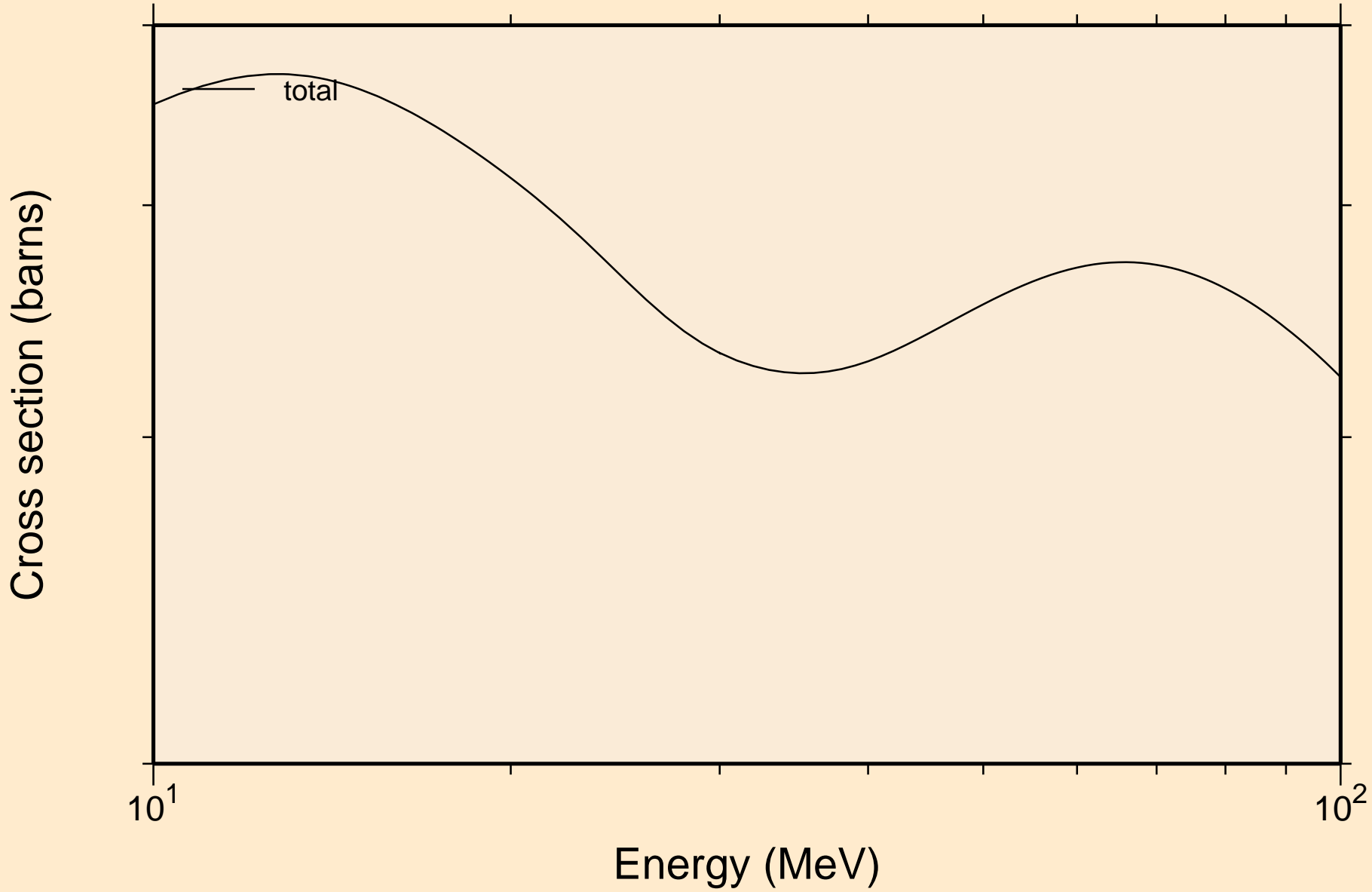

IN122N NEUTRON ACER TENDL-2021 LIBRARY; T=293.6K  
resonance absorption cross sections

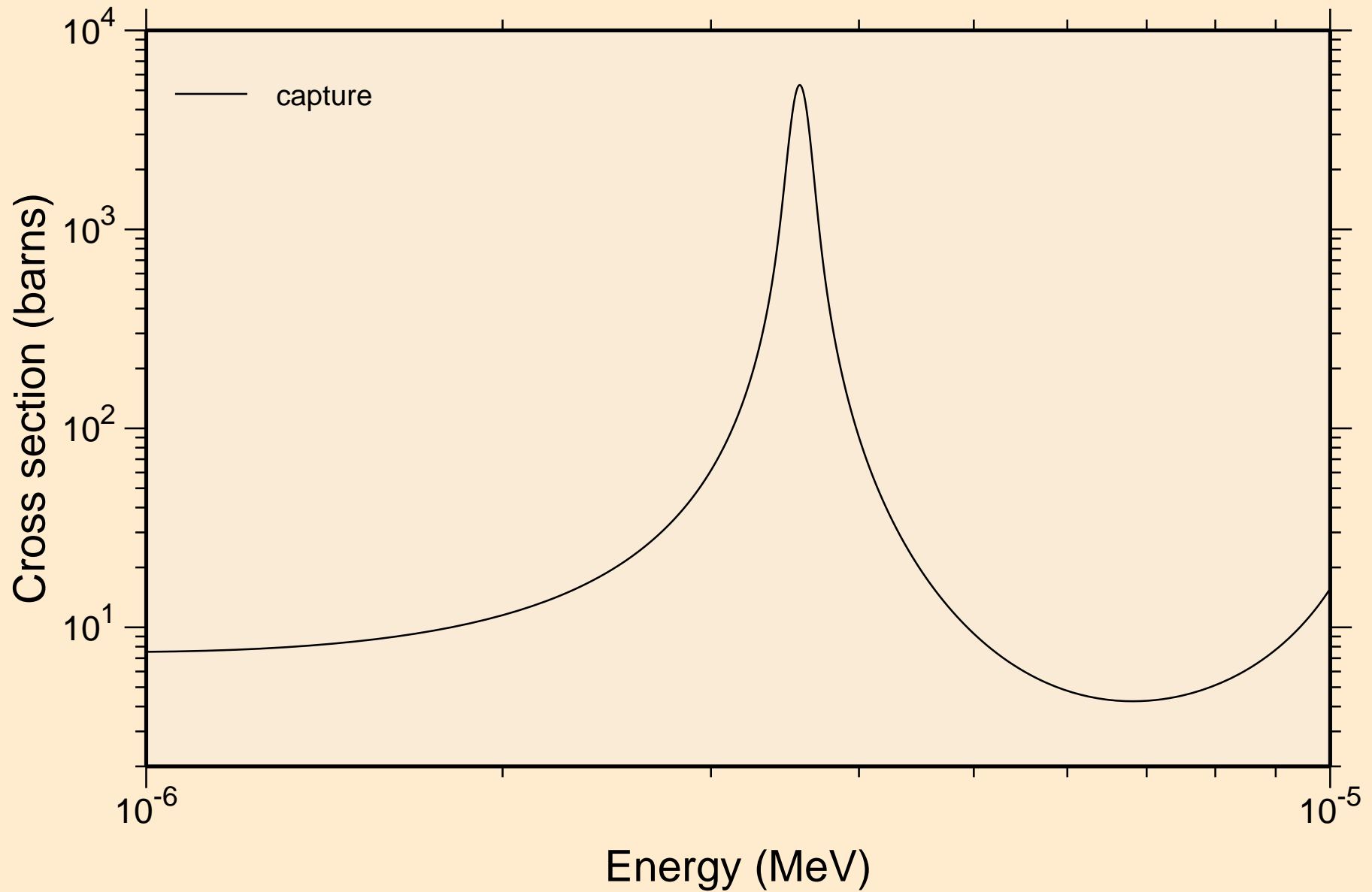

IN122N NEUTRON ACER TENDL-2021 LIBRARY; T=293.6K  
resonance absorption cross sections

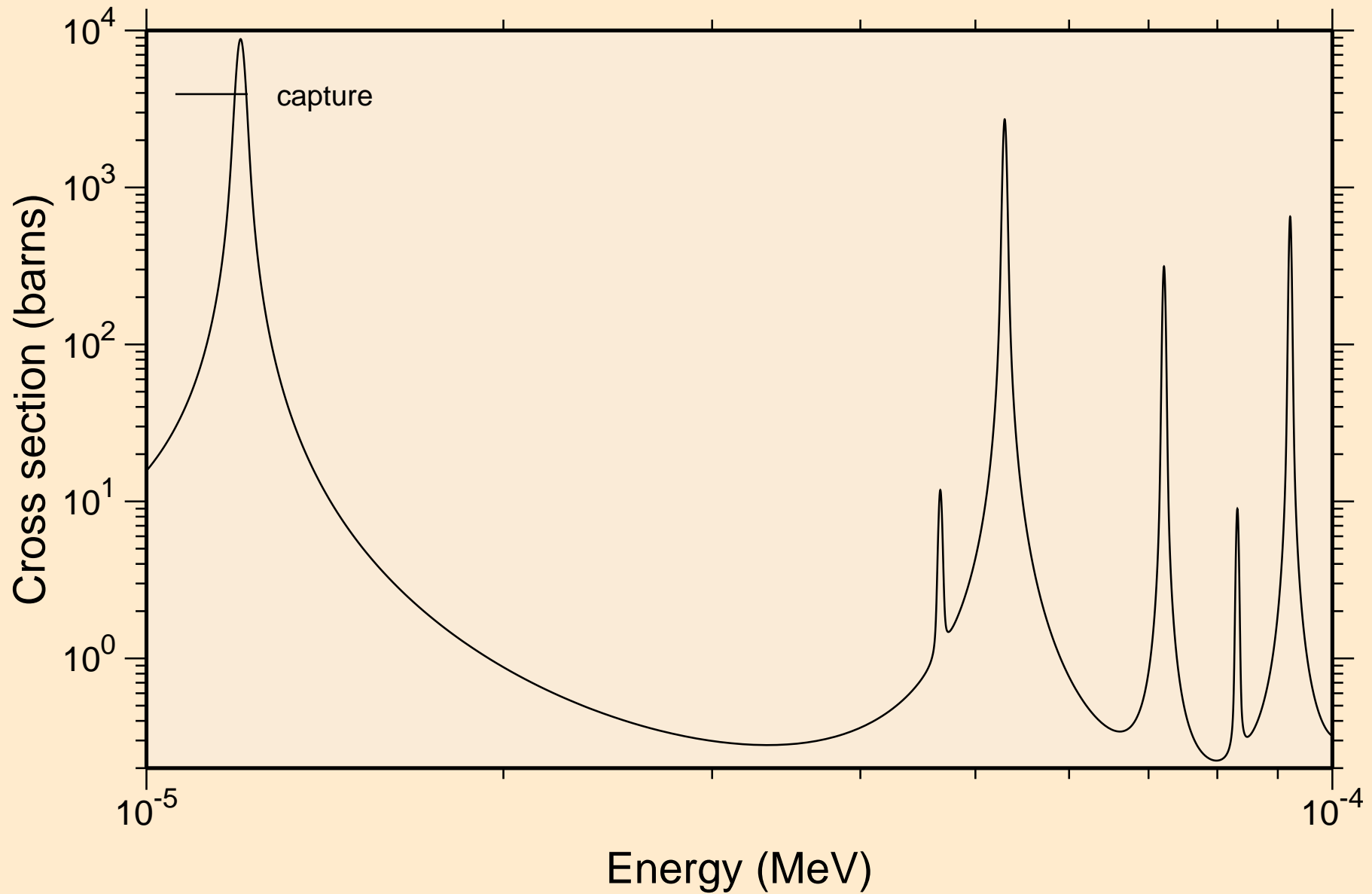

IN122N NEUTRON ACER TENDL-2021 LIBRARY; T=293.6K  
resonance absorption cross sections

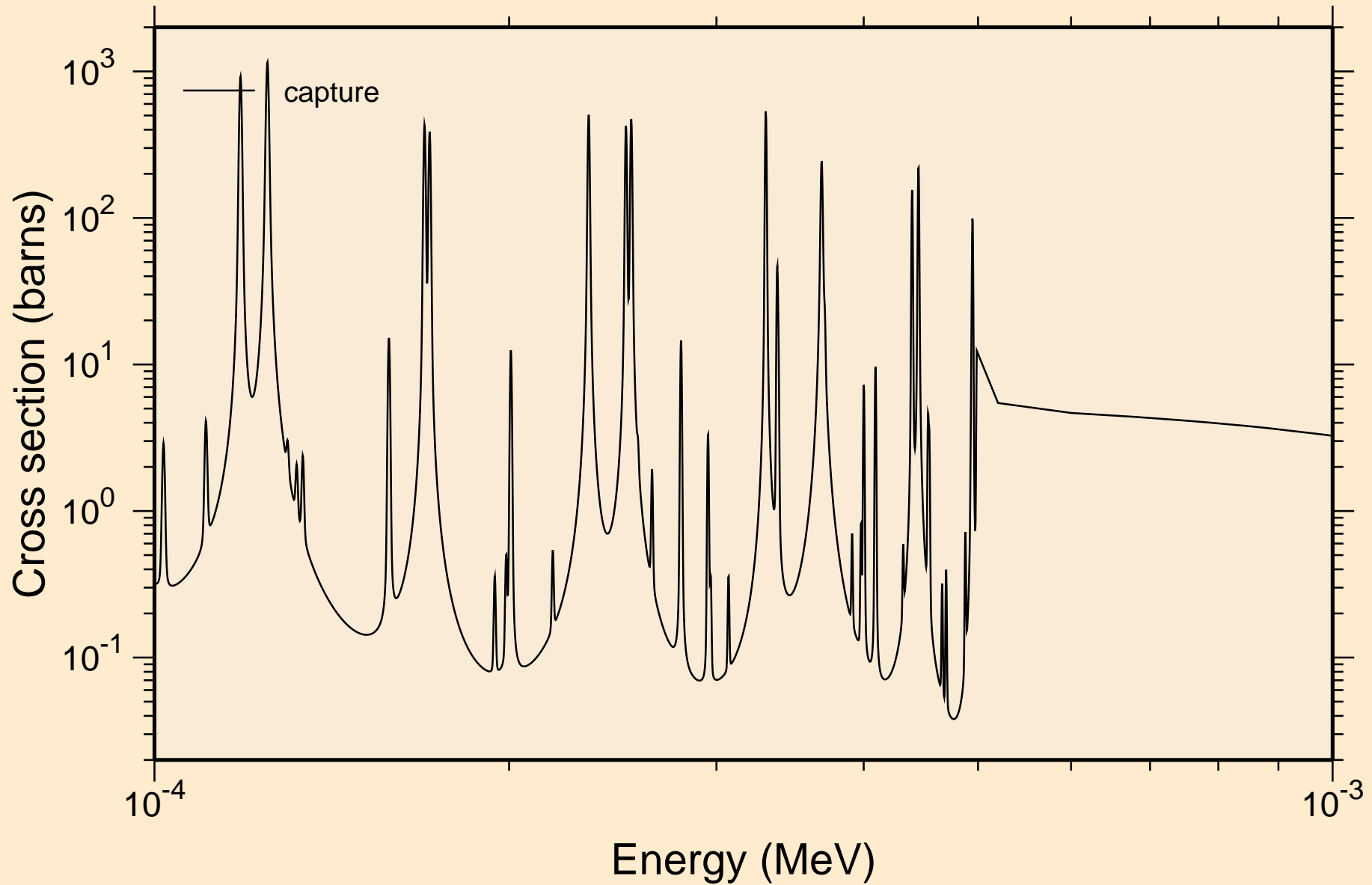



IN122N NEUTRON ACER TENDL-2021 LIBRARY; T=293.6K  
resonance absorption cross sections

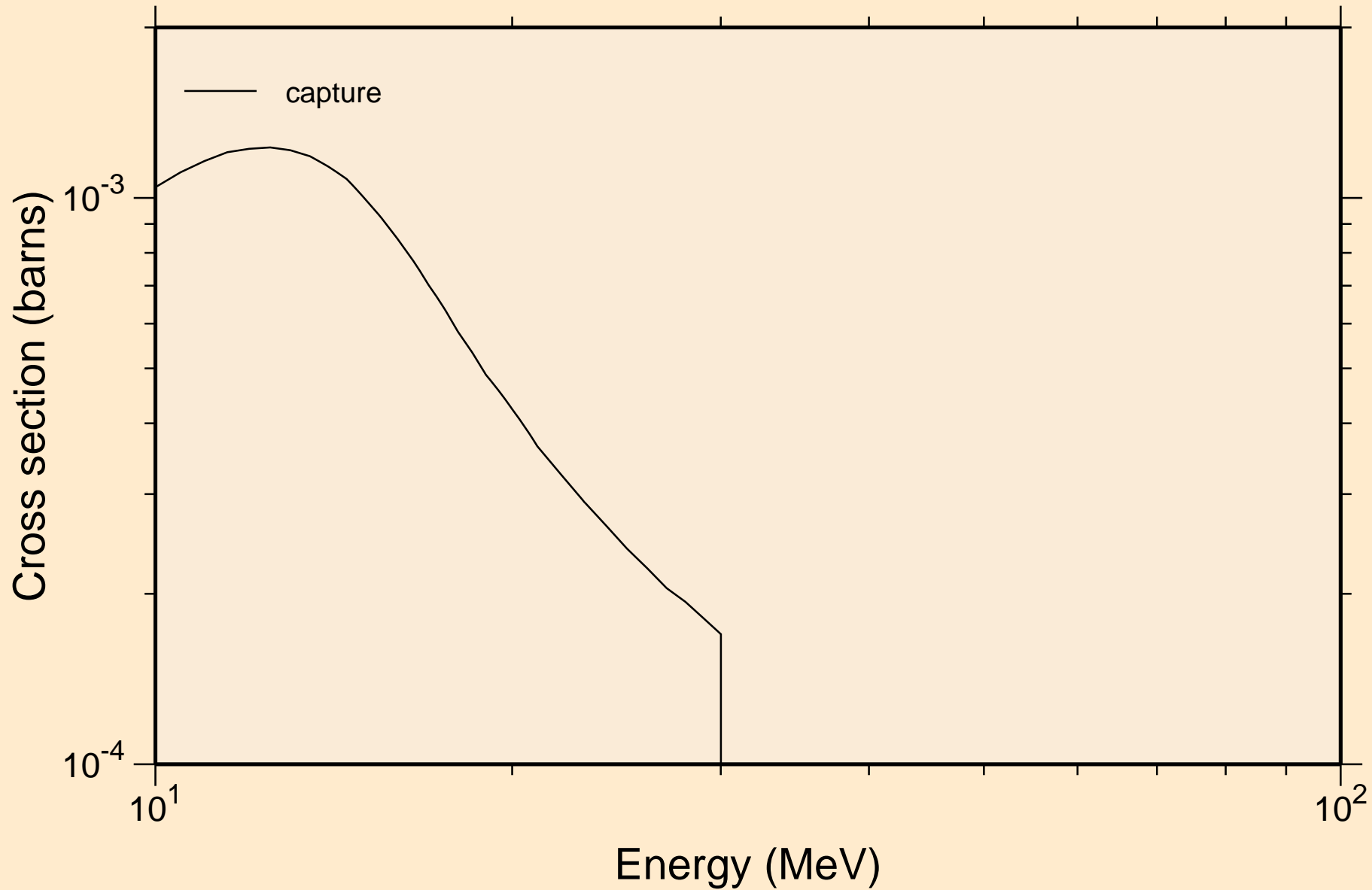

IN122N NEUTRON ACER TENDL-2021 LIBRARY; T=293.6K  
Heating

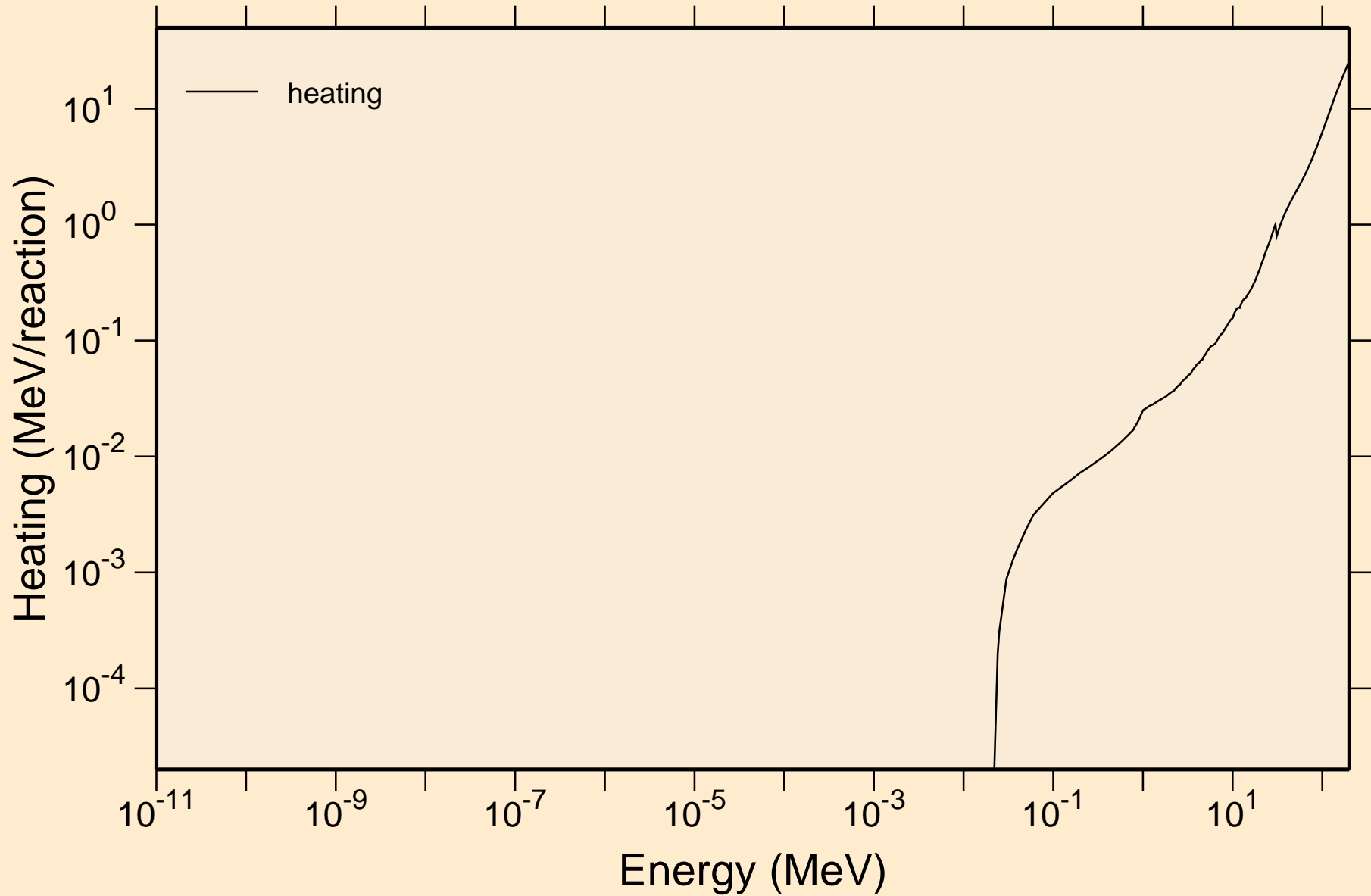

IN122N NEUTRON ACER TENDL-2021 LIBRARY; T=293.6K  
Damage

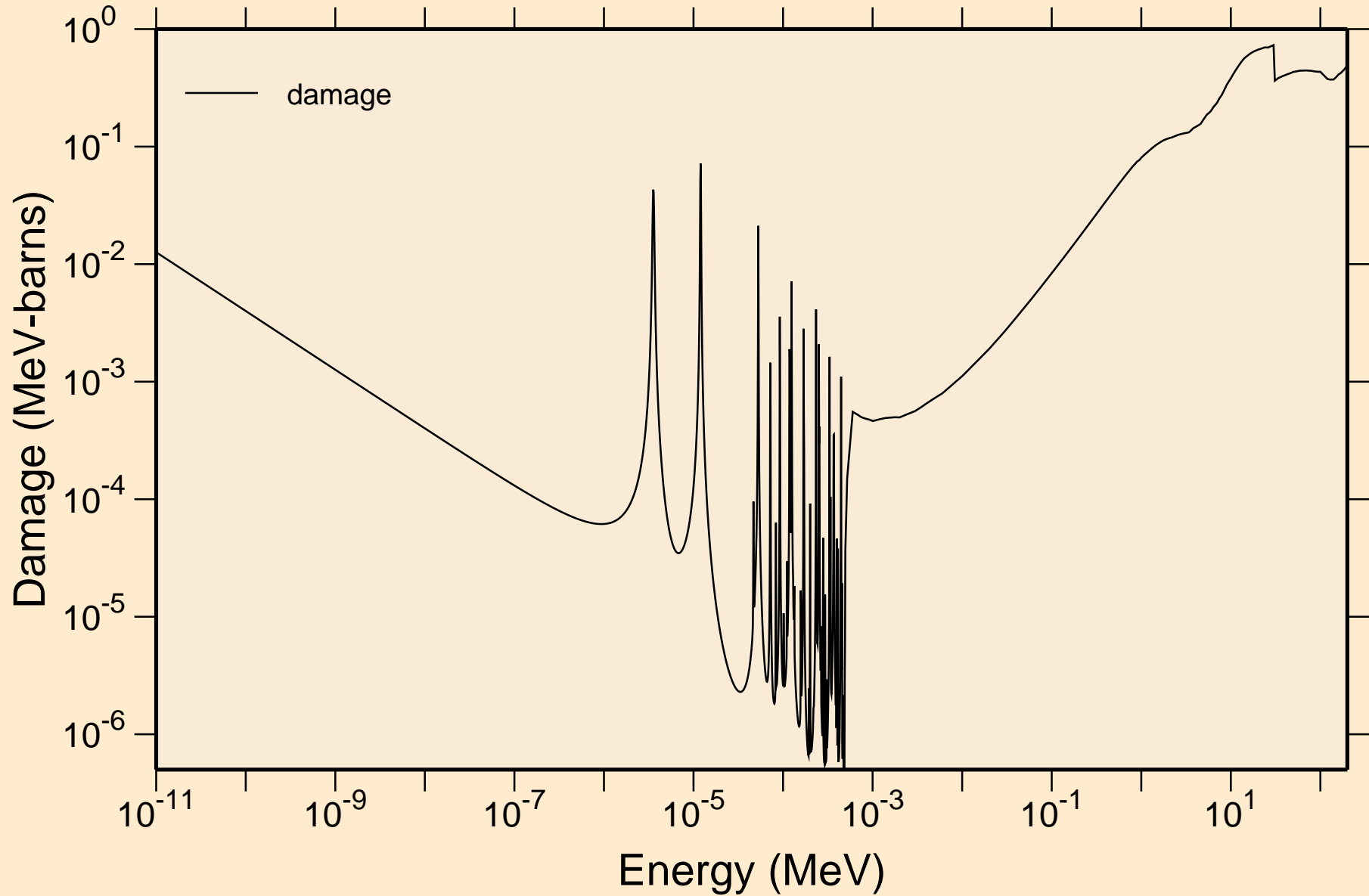

IN122N NEUTRON ACER TENDL-2021 LIBRARY; T=293.6K  
Non-threshold reactions

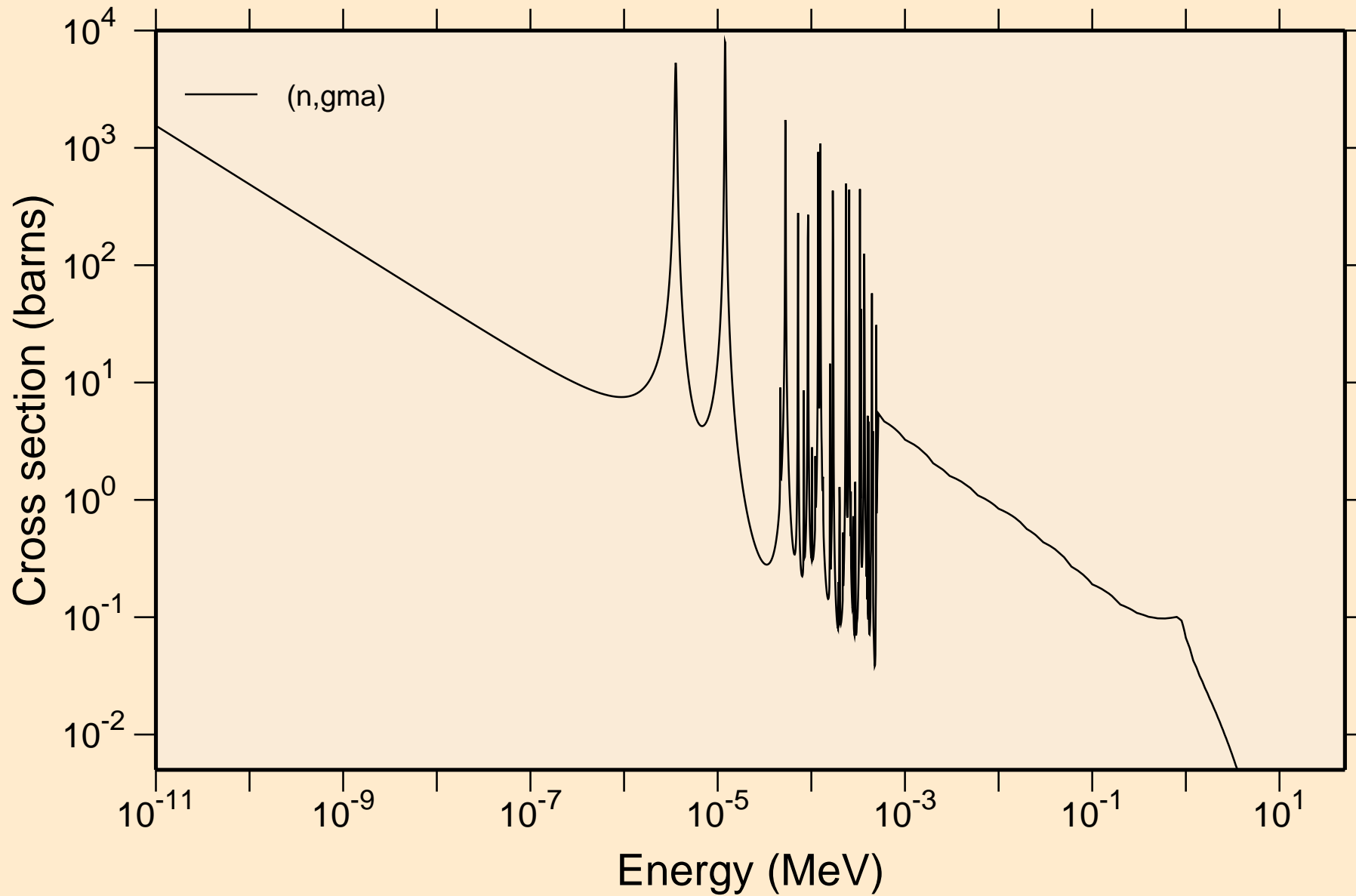

IN122N NEUTRON ACER TENDL-2021 LIBRARY; T=293.6K  
Principal cross sections

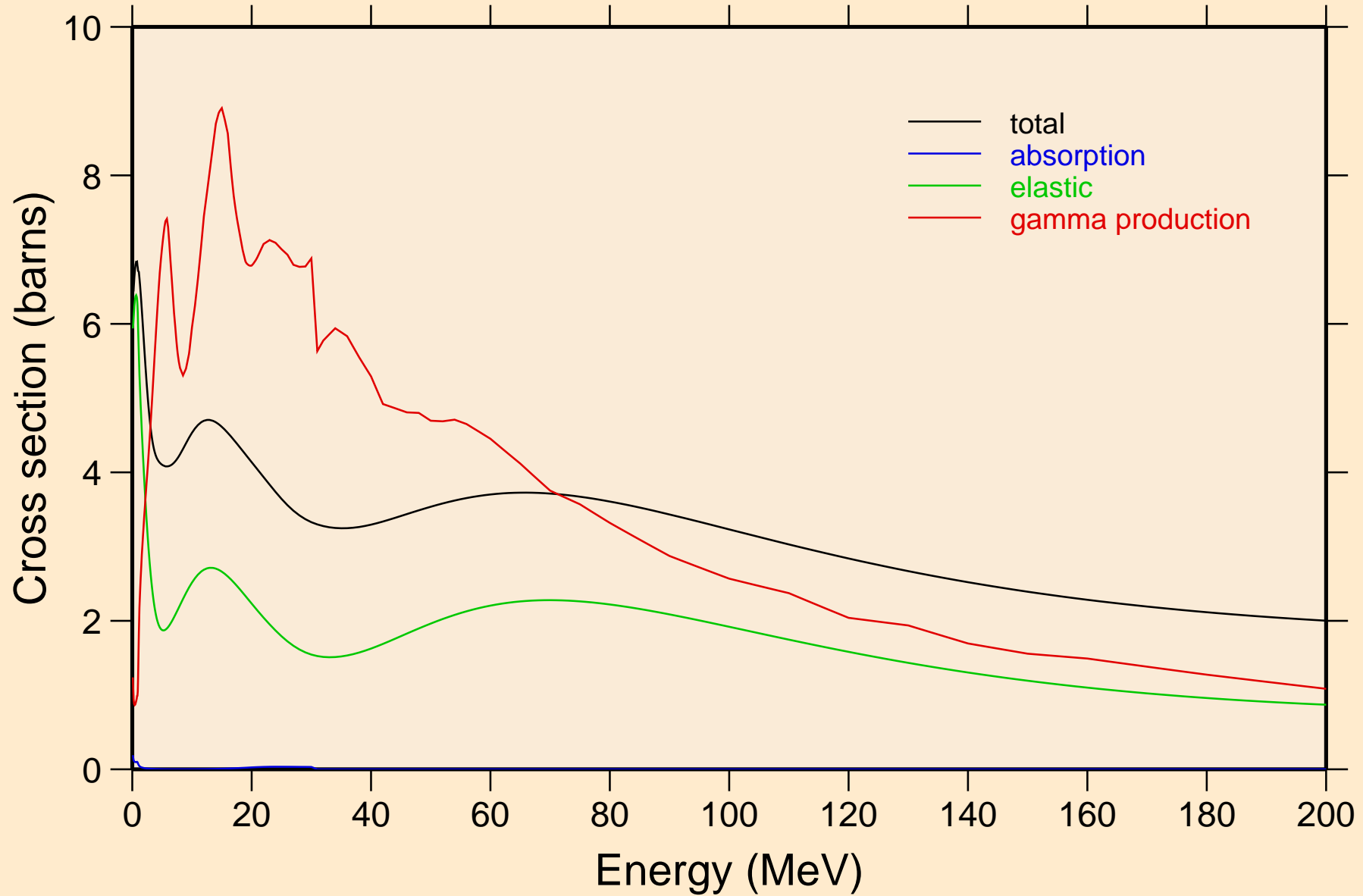

IN122N NEUTRON ACER TENDL-2021 LIBRARY; T=293.6K  
Heating

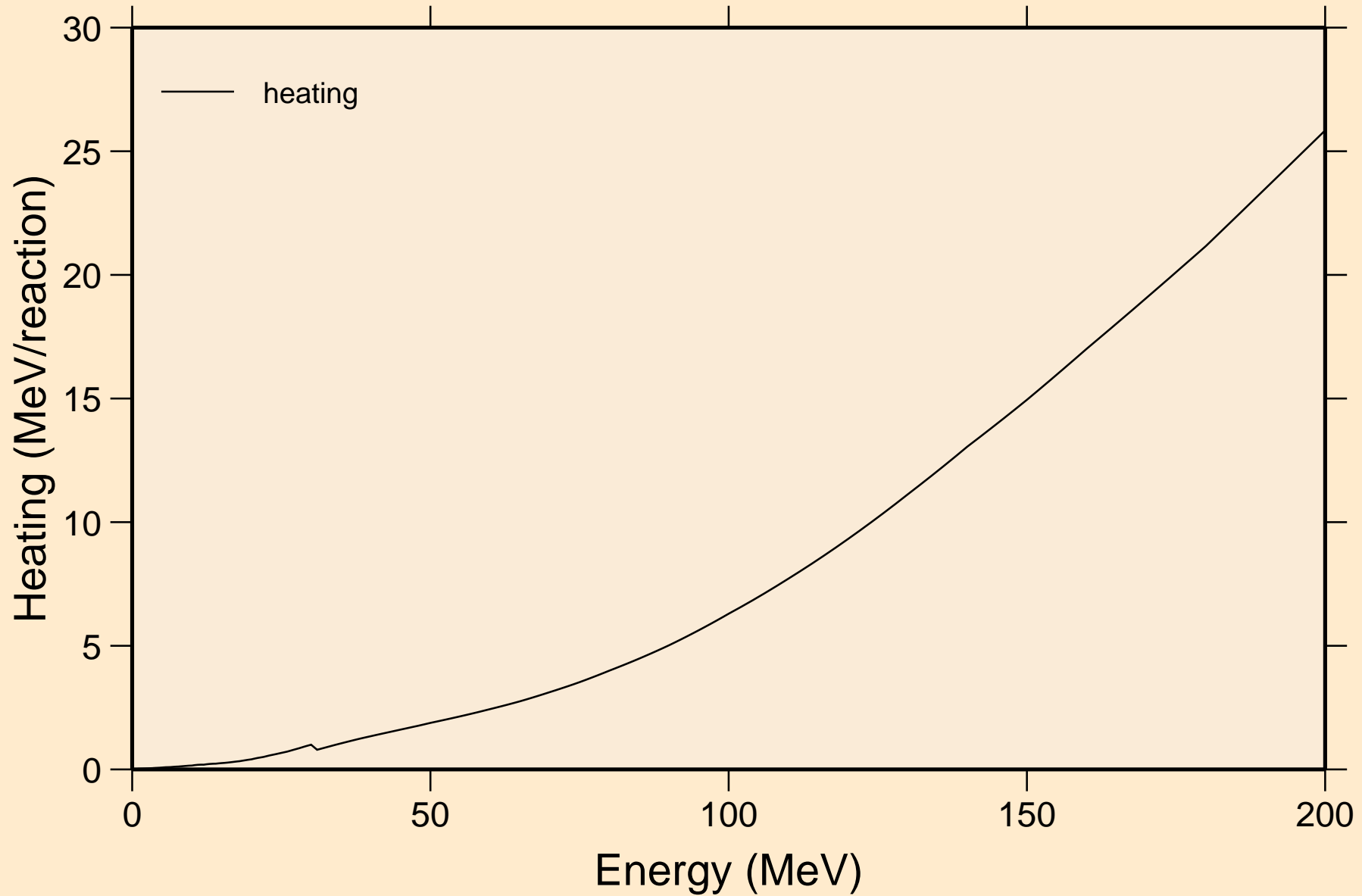

IN122N NEUTRON ACER TENDL-2021 LIBRARY; T=293.6K  
Damage

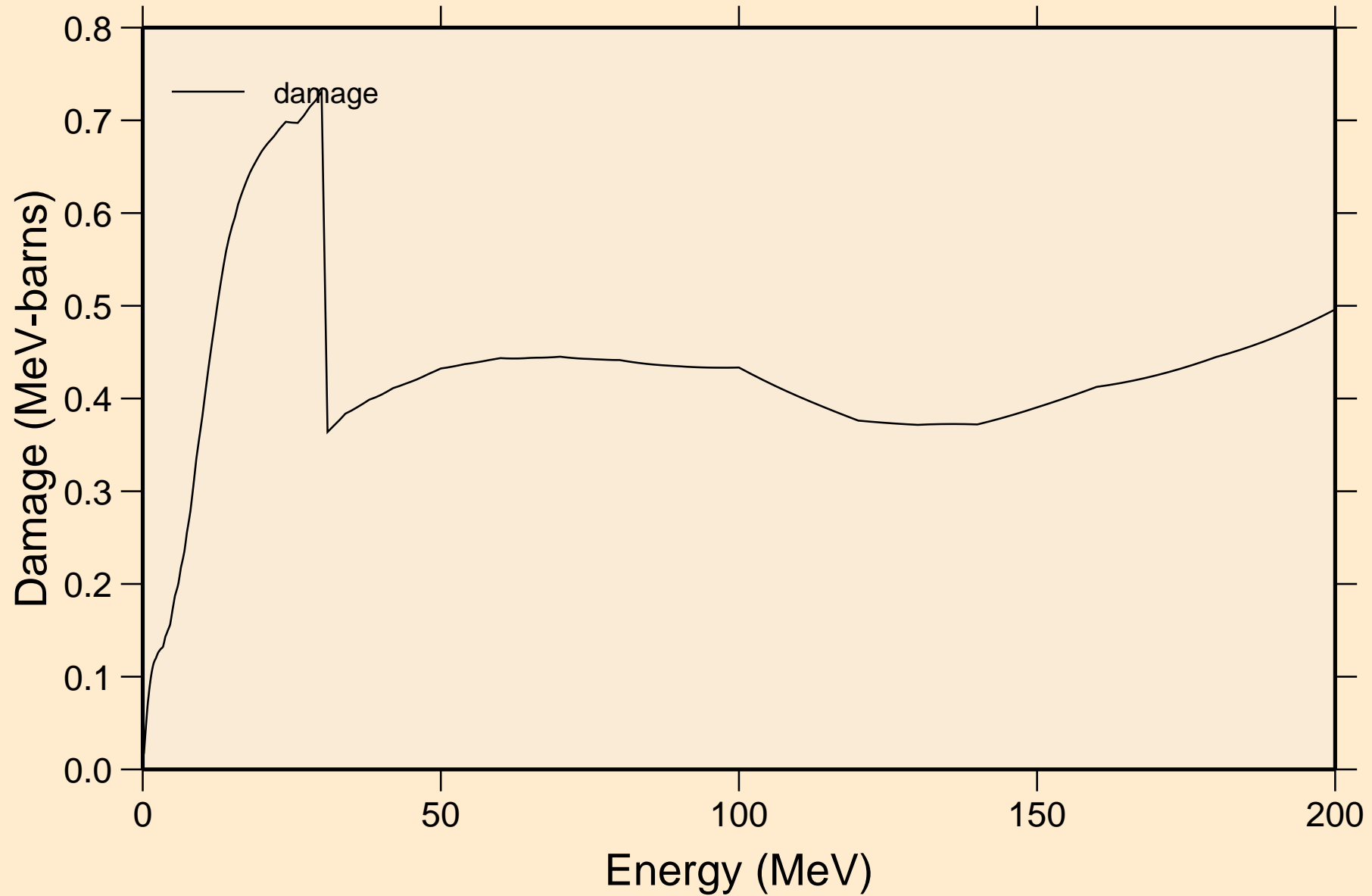

IN122N NEUTRON ACER TENDL-2021 LIBRARY; T=293.6K  
Non-threshold reactions

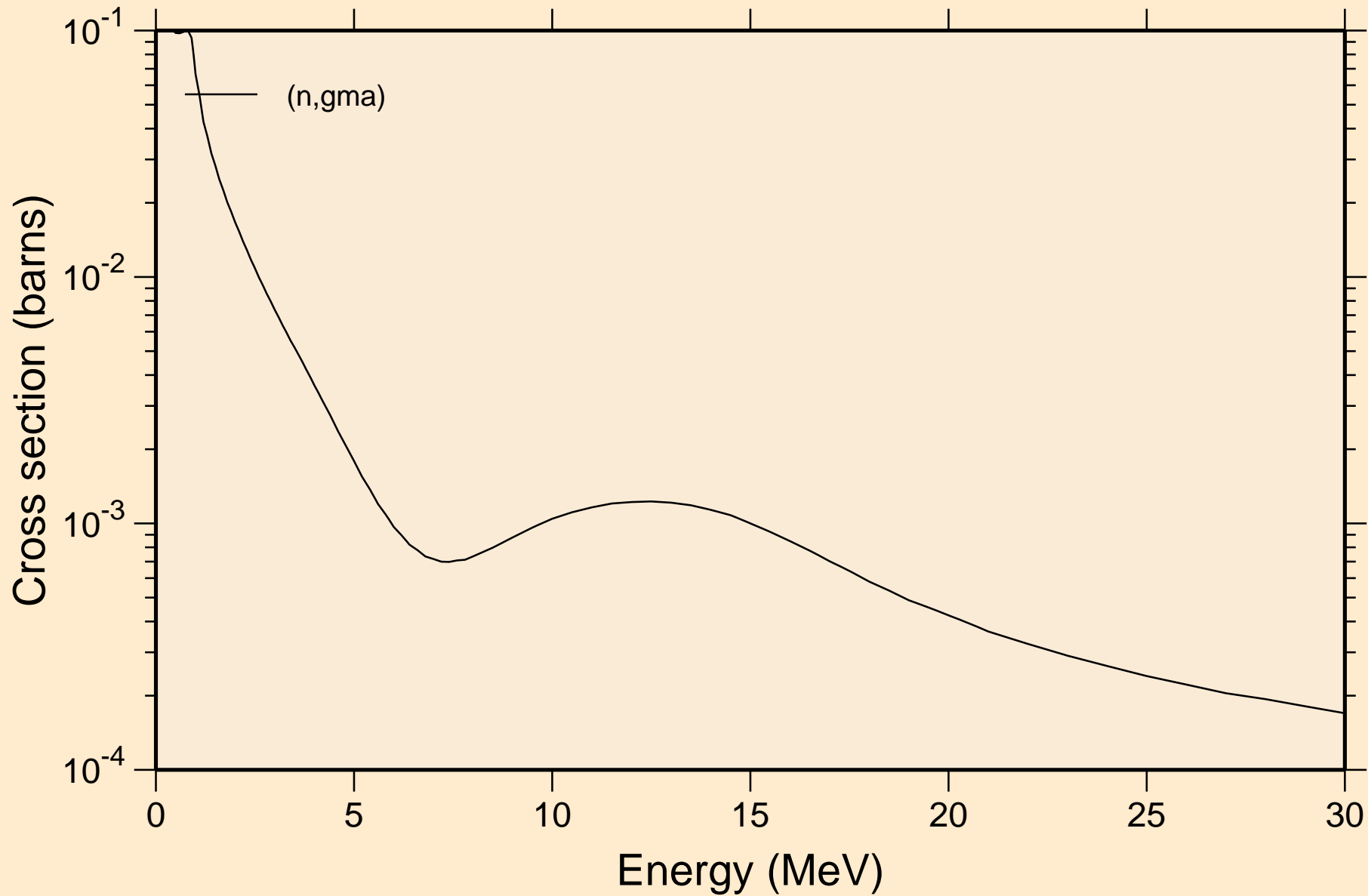



IN122N NEUTRON ACER TENDL-2021 LIBRARY; T=293.6K  
Inelastic levels

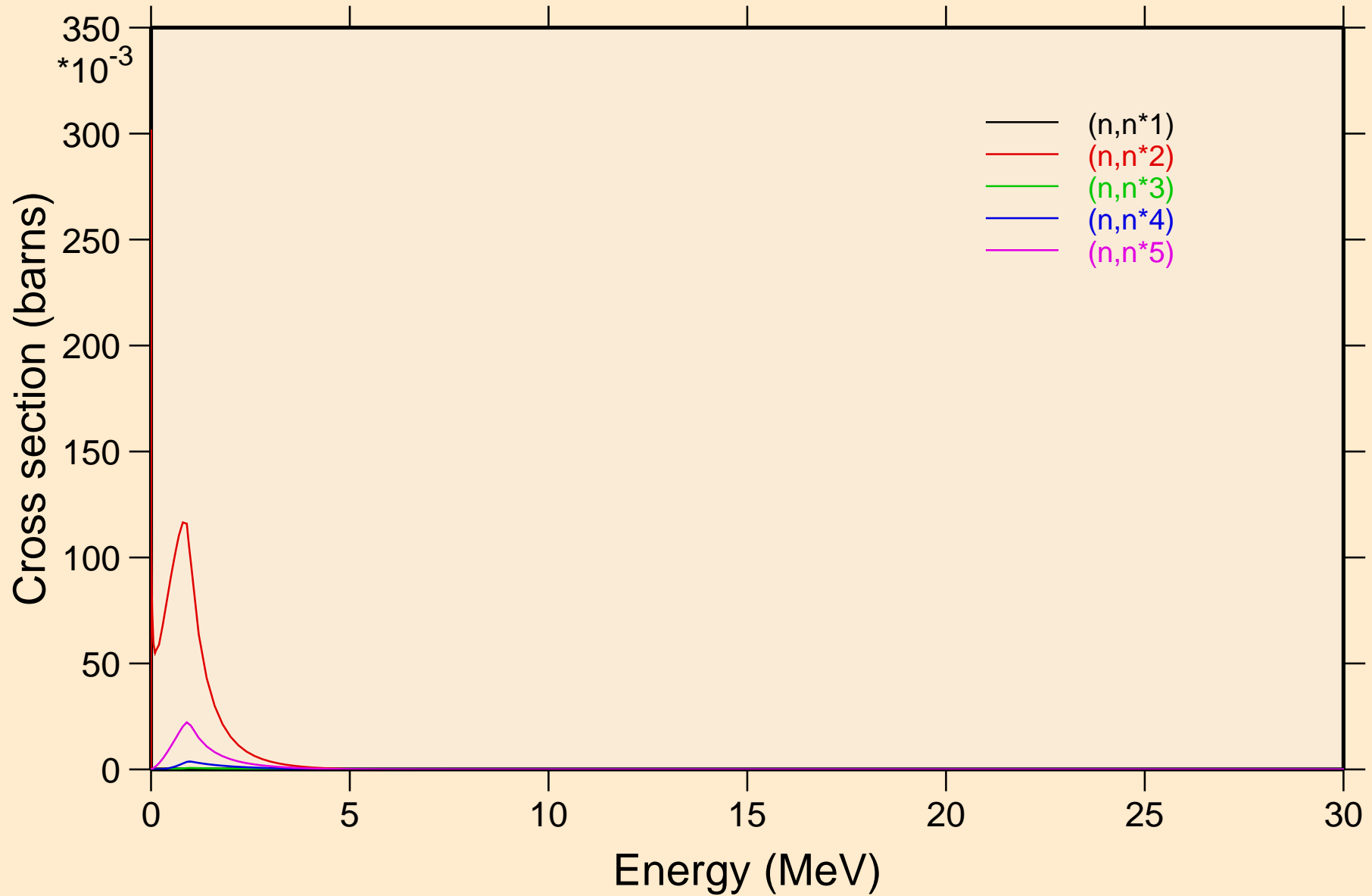

IN122N NEUTRON ACER TENDL-2021 LIBRARY; T=293.6K  
Inelastic levels

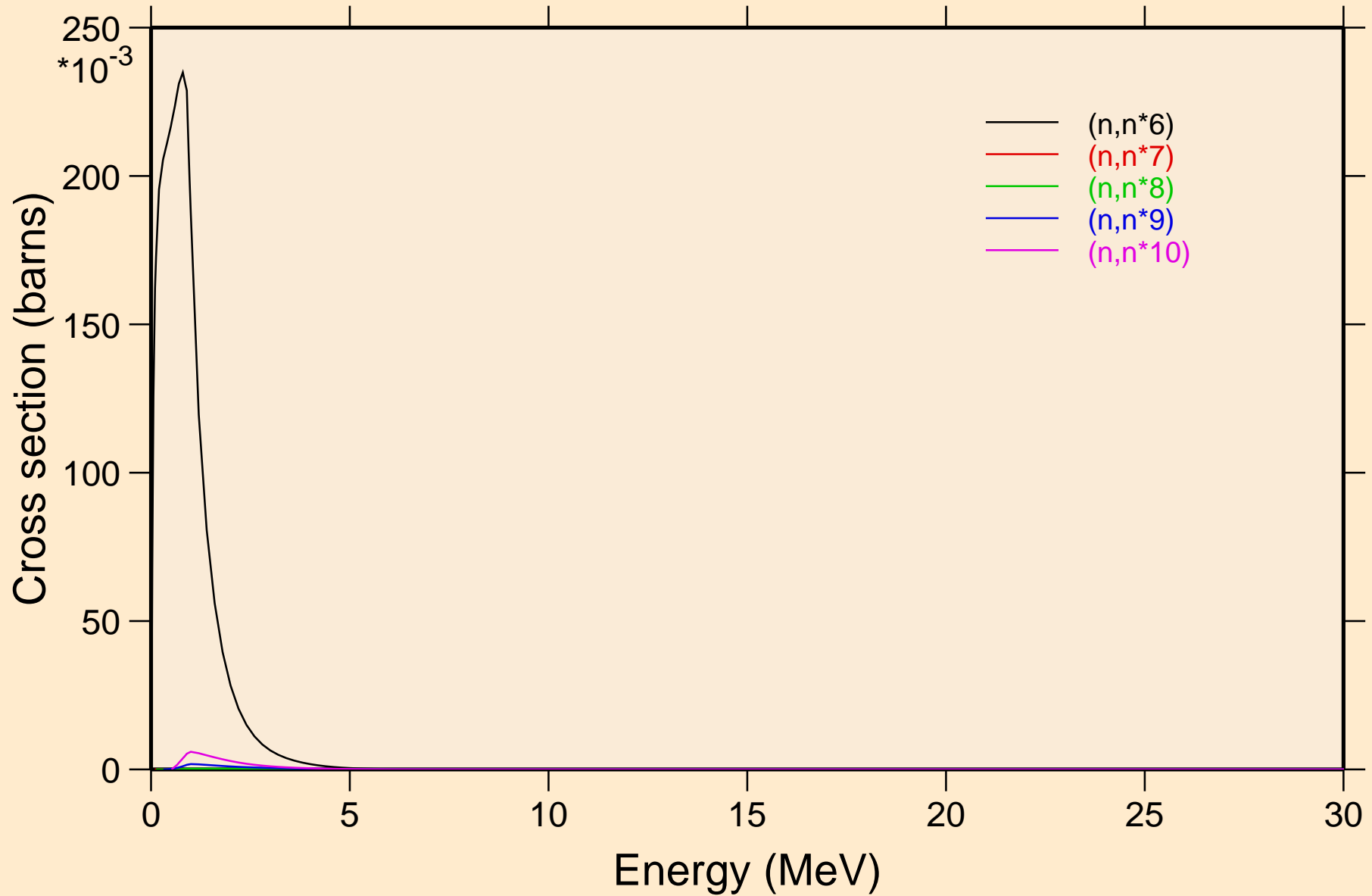

IN122N NEUTRON ACER TENDL-2021 LIBRARY; T=293.6K  
Inelastic levels

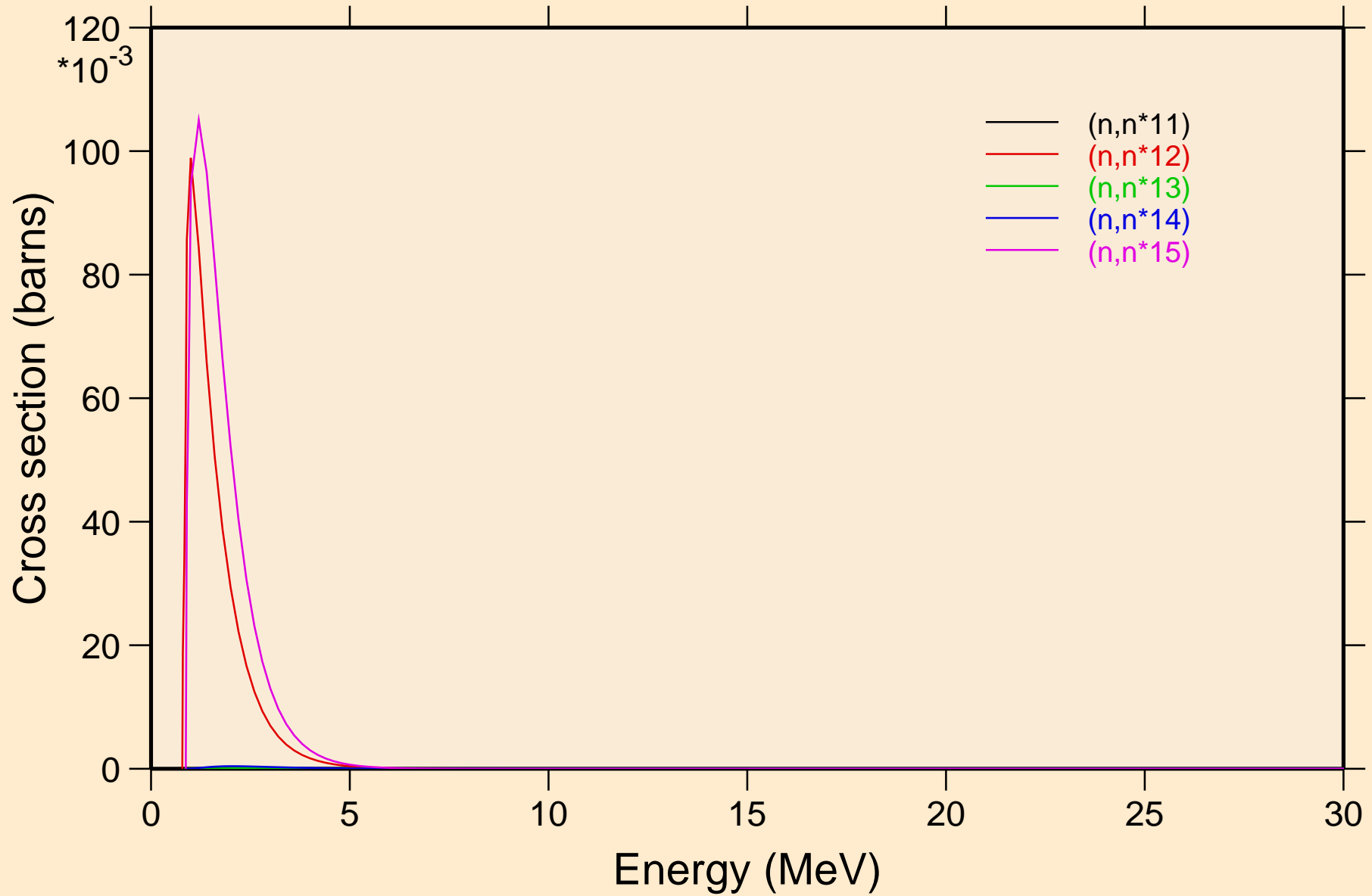

IN122N NEUTRON ACER TENDL-2021 LIBRARY; T=293.6K  
Inelastic levels

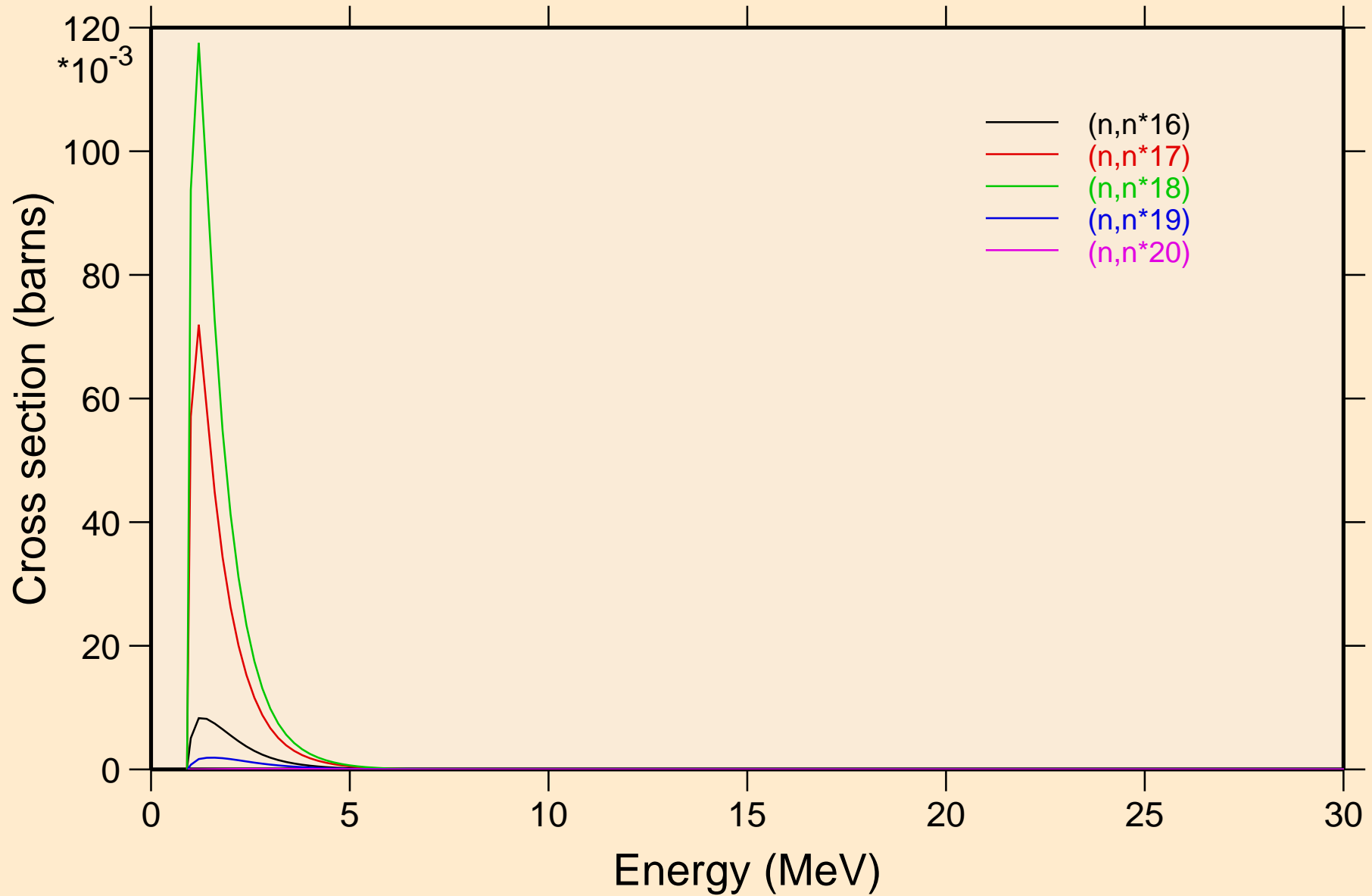

IN122N NEUTRON ACER TENDL-2021 LIBRARY; T=293.6K  
Inelastic levels

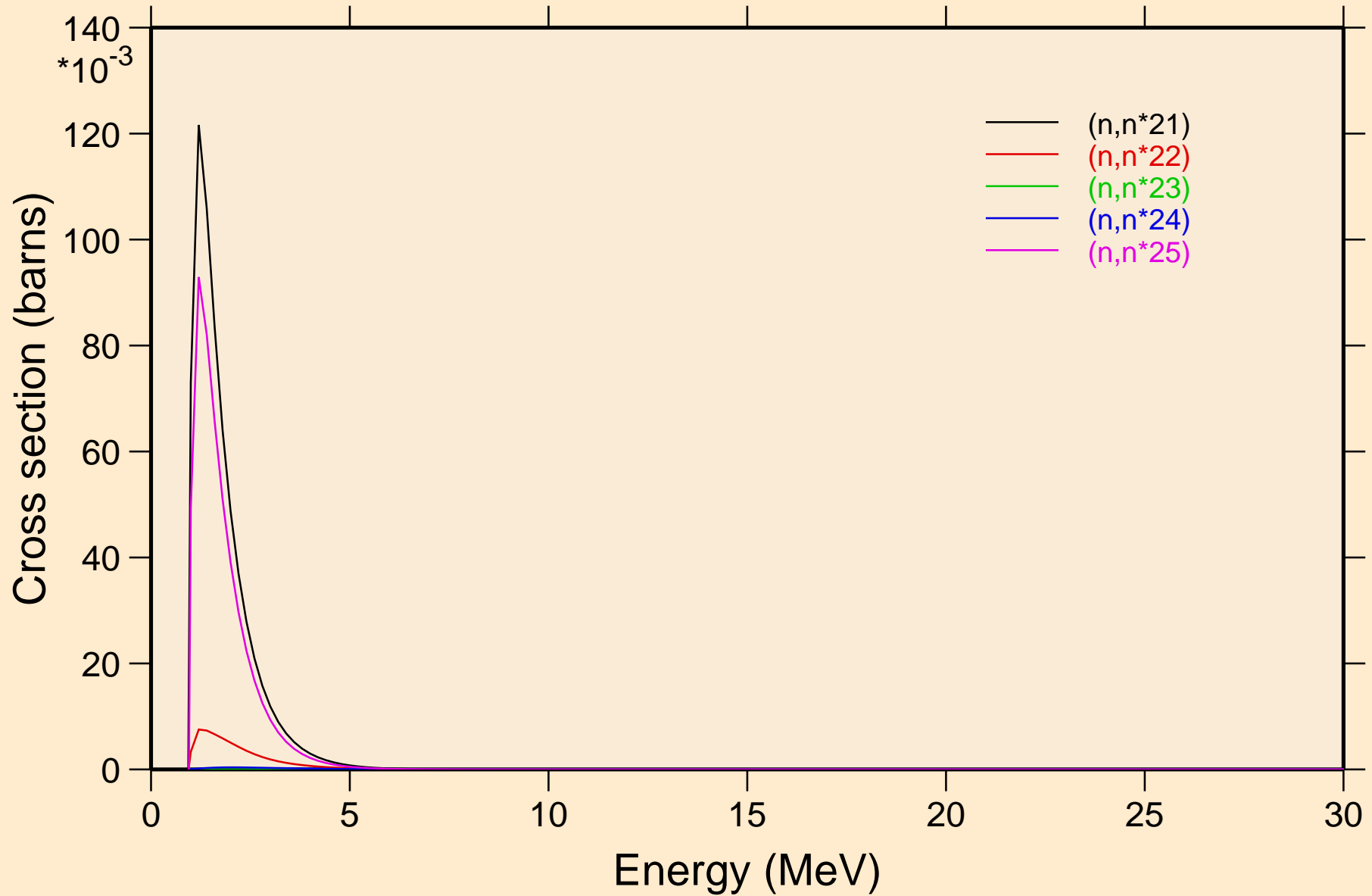

IN122N NEUTRON ACER TENDL-2021 LIBRARY; T=293.6K  
Inelastic levels

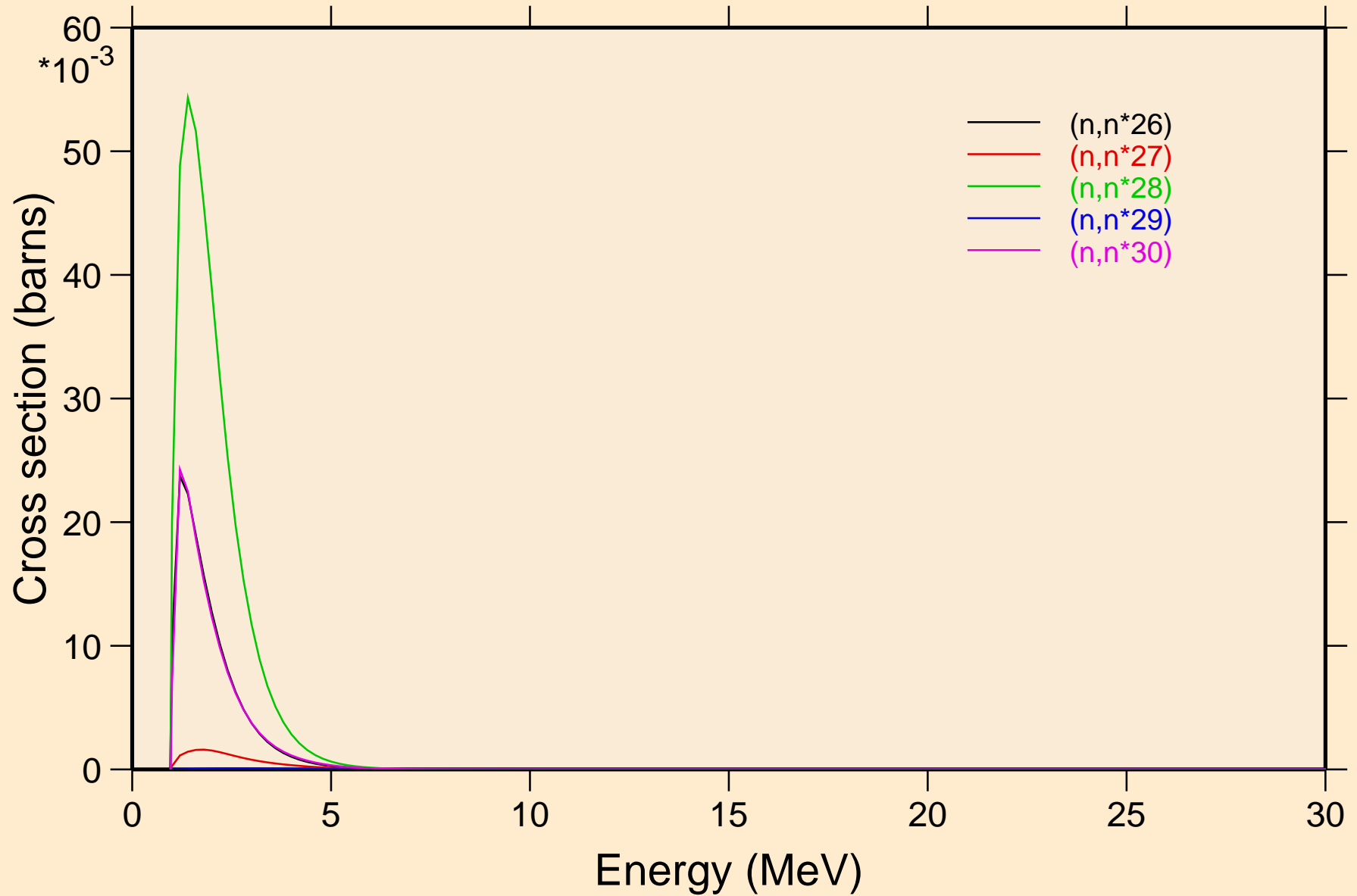

IN122N NEUTRON ACER TENDL-2021 LIBRARY; T=293.6K  
Threshold reactions

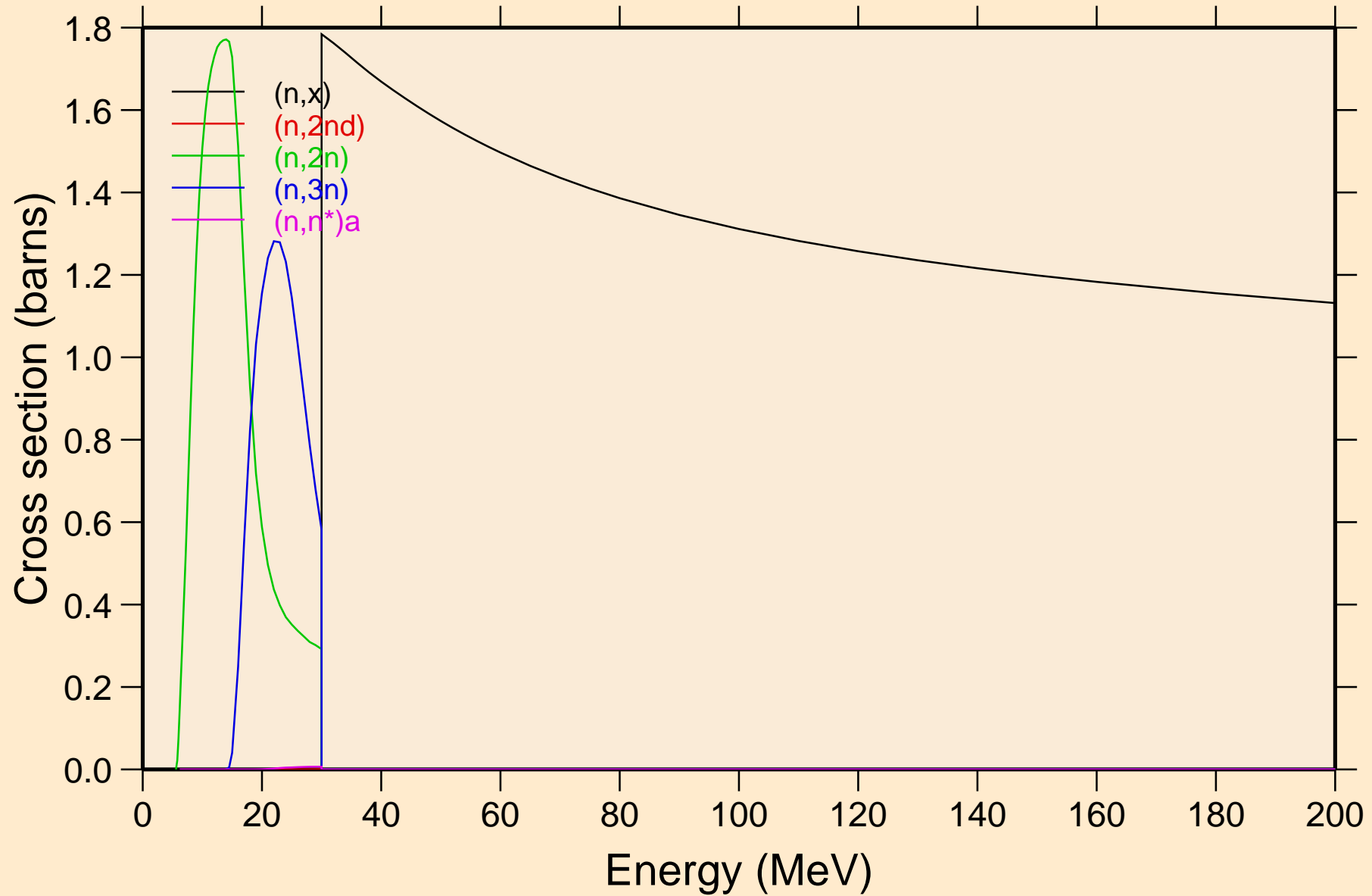

IN122N NEUTRON ACER TENDL-2021 LIBRARY; T=293.6K  
Threshold reactions

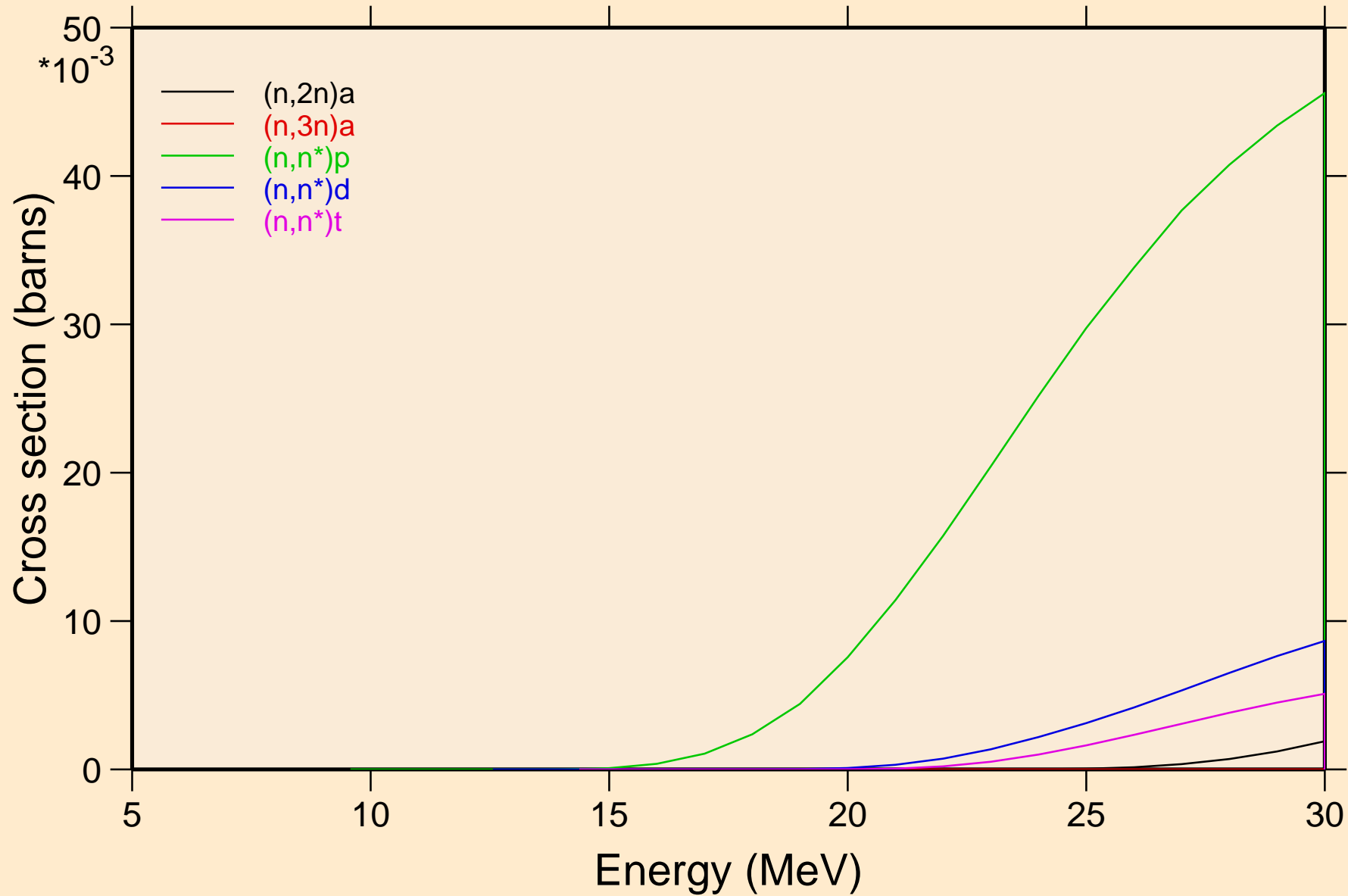



IN122N NEUTRON ACER TENDL-2021 LIBRARY; T=293.6K  
Threshold reactions

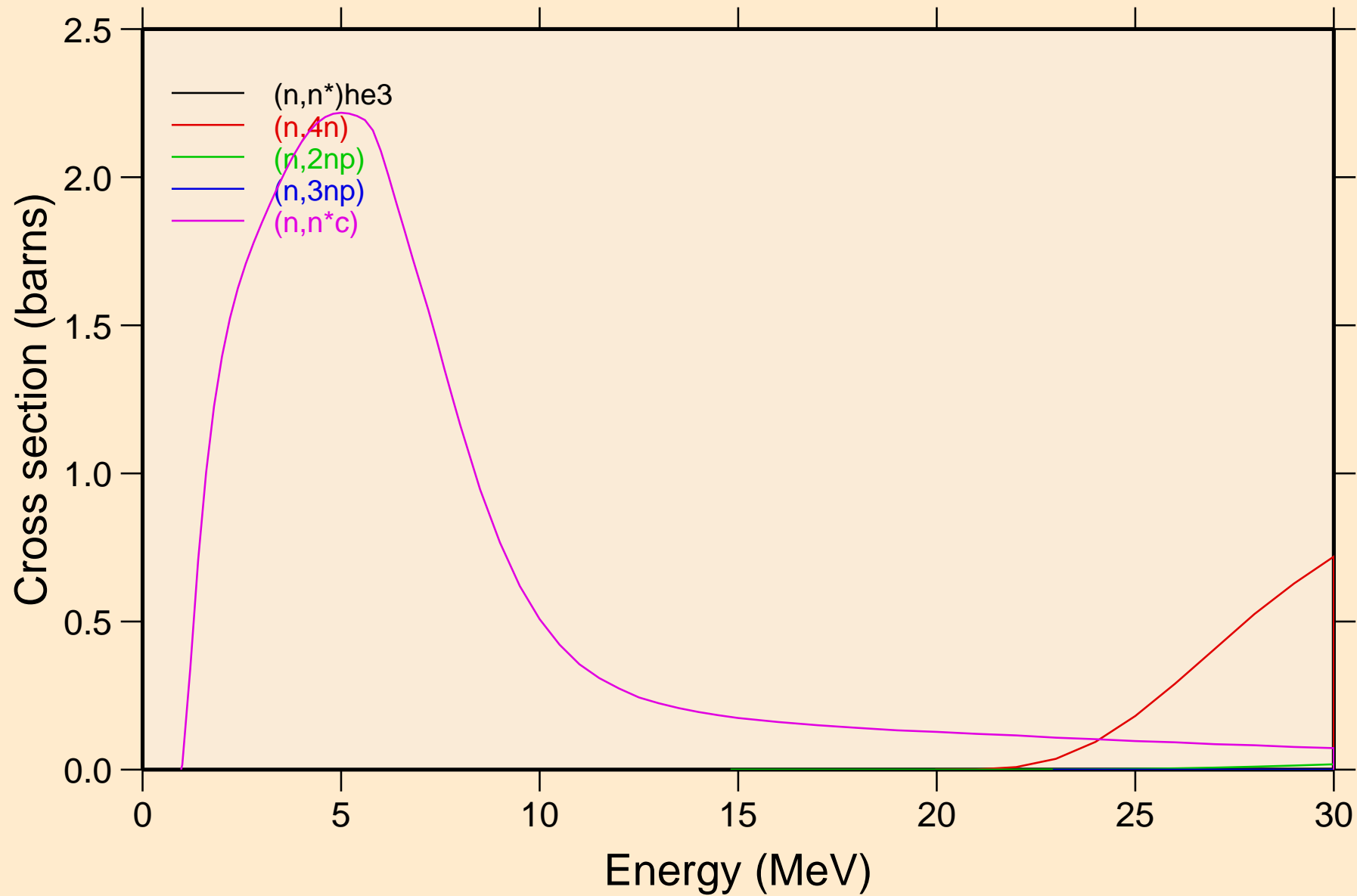

IN122N NEUTRON ACER TENDL-2021 LIBRARY; T=293.6K  
Threshold reactions

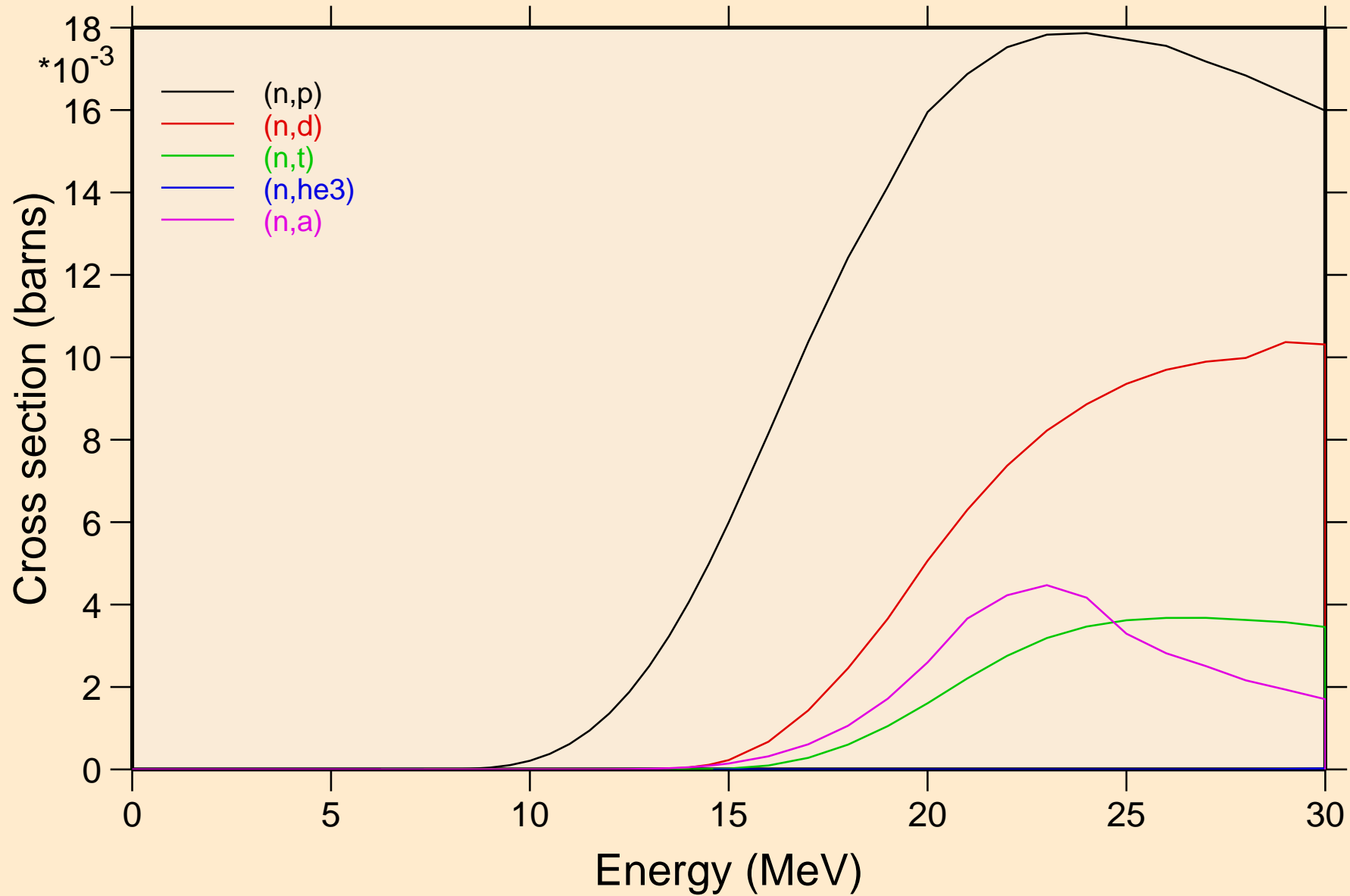

IN122N NEUTRON ACER TENDL-2021 LIBRARY; T=293.6K  
Threshold reactions

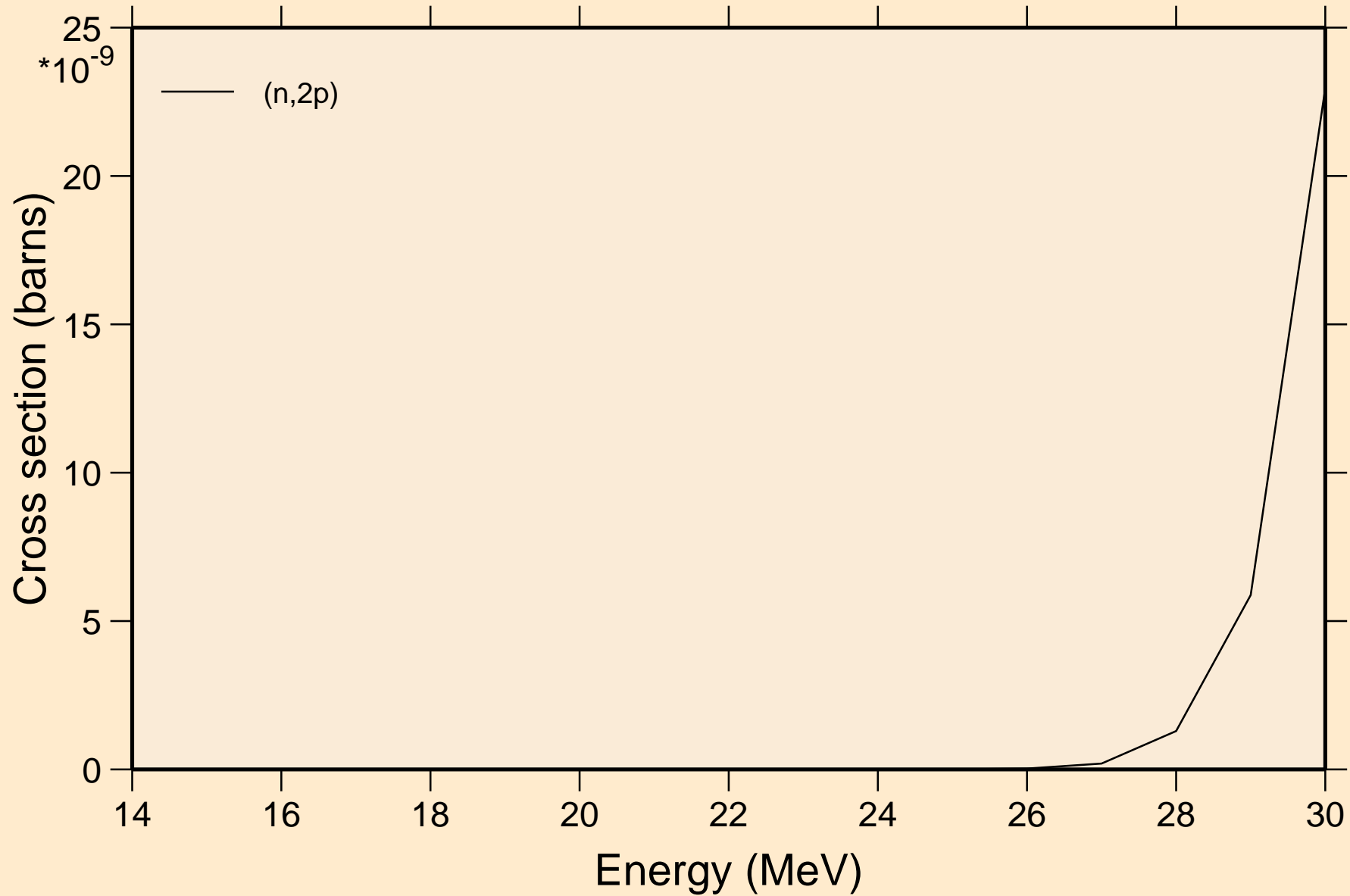

IN122N NEUTRON ACER TENDL-2021 LIBRARY; T=293.6K  
Threshold reactions

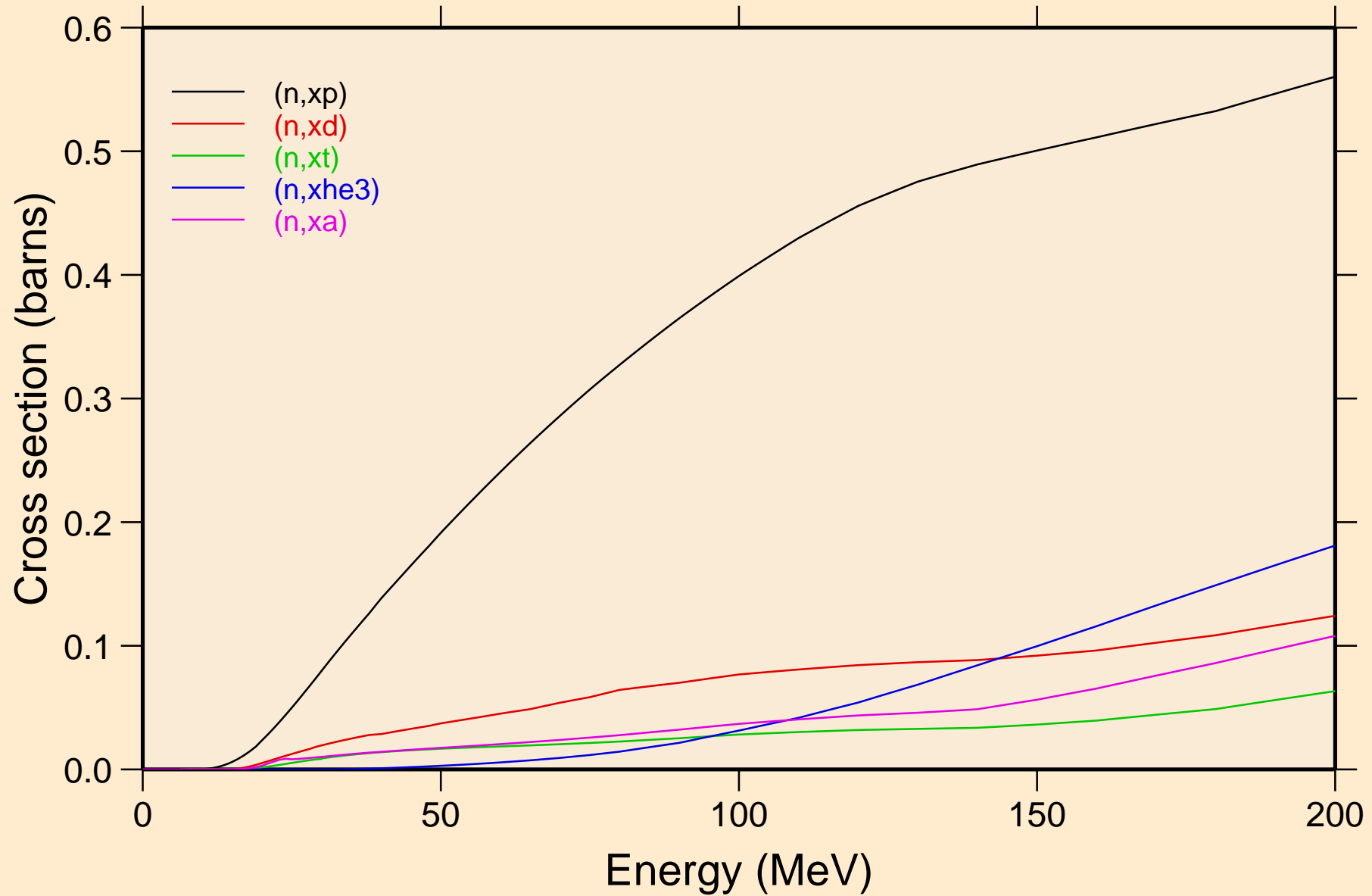

IN122N NEUTRON ACER TENDL-2021 LIBRARY; T=293.6K  
angular distribution for elastic

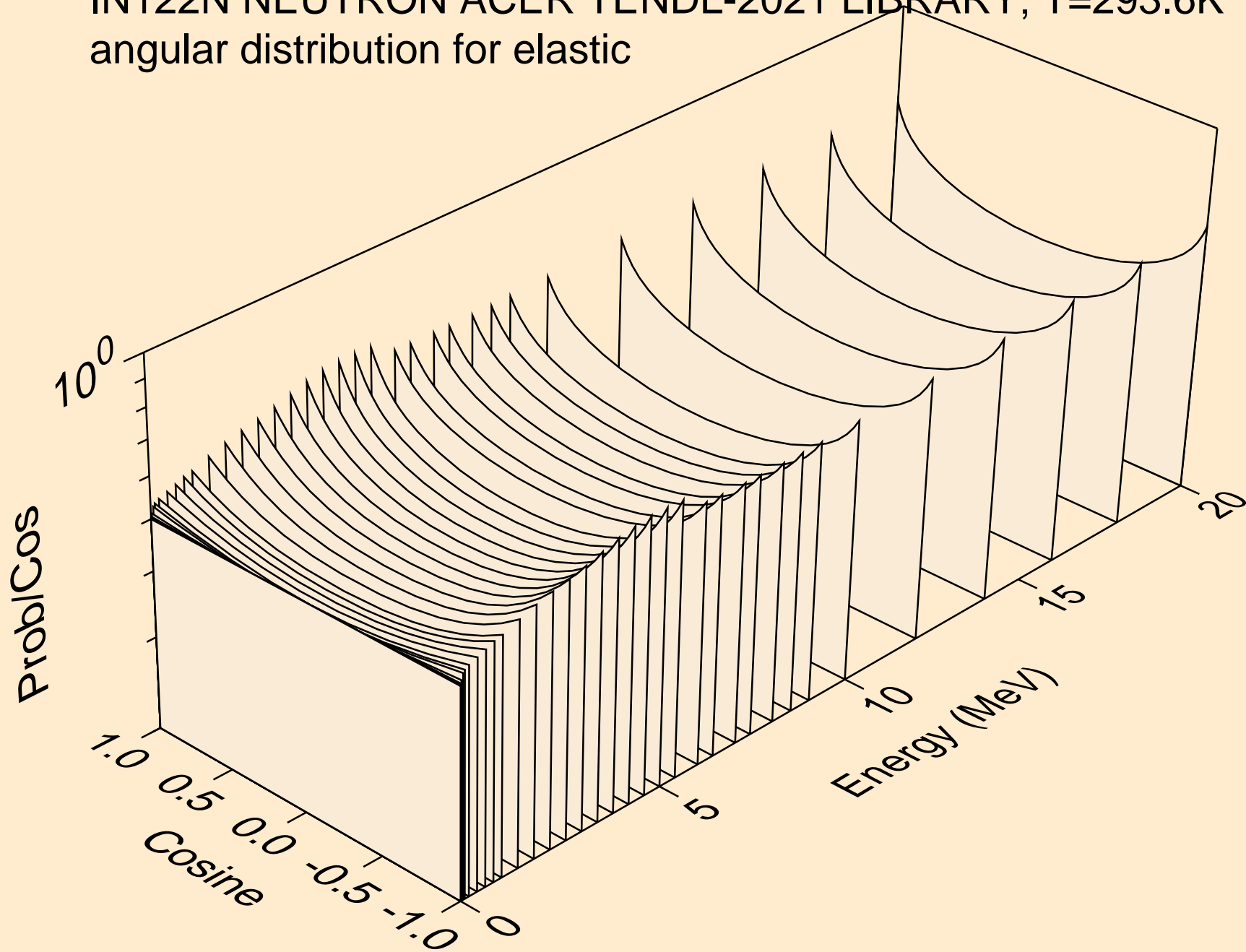

IN122N NEUTRON ACER TENDL-2021 LIBRARY; T=293.6K  
angular distribution for elastic

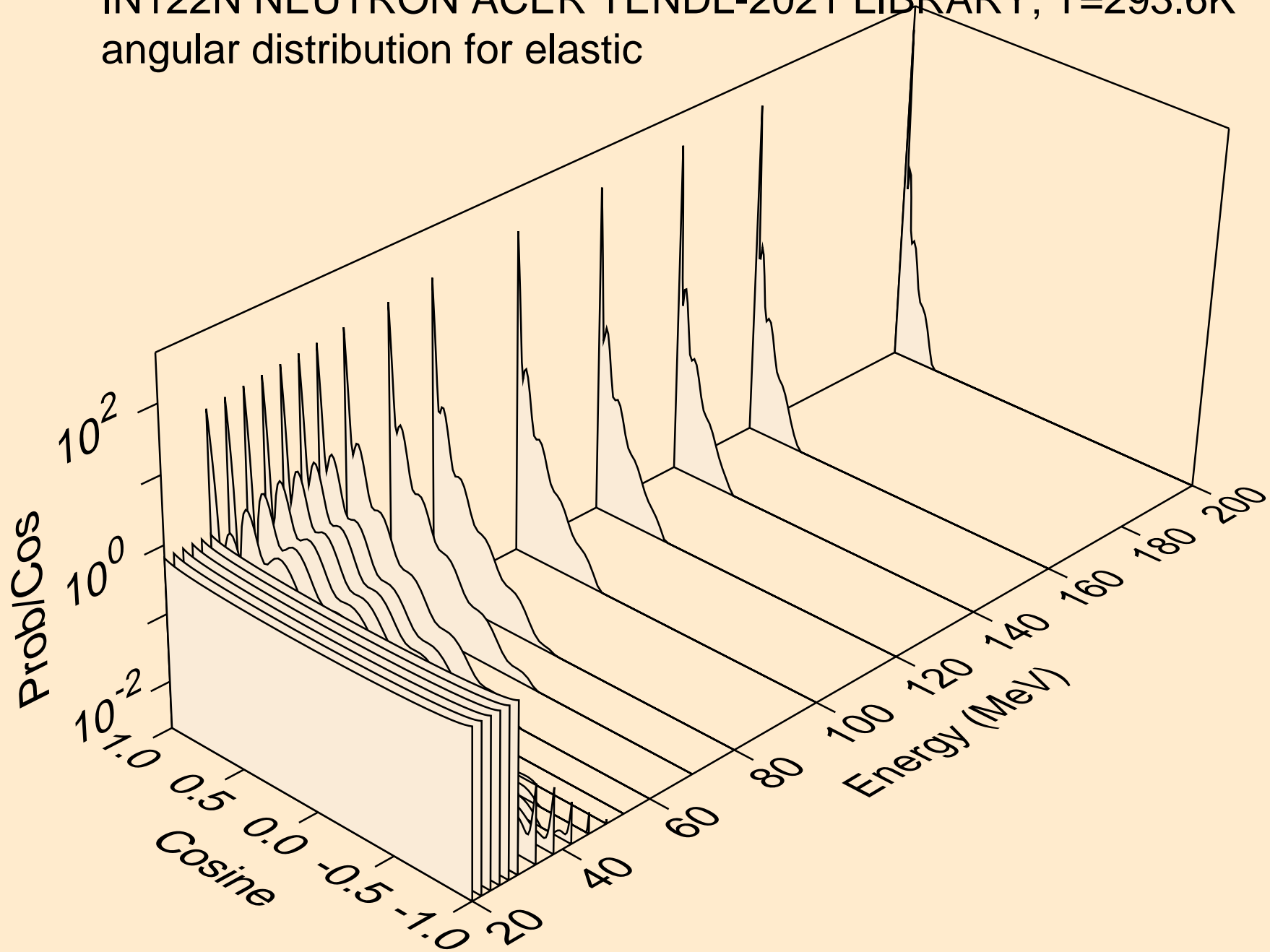

IN122N NEUTRON ACER TENDL-2021 LIBRARY; T=293.6K  
angular distribution for (n,n\*1)

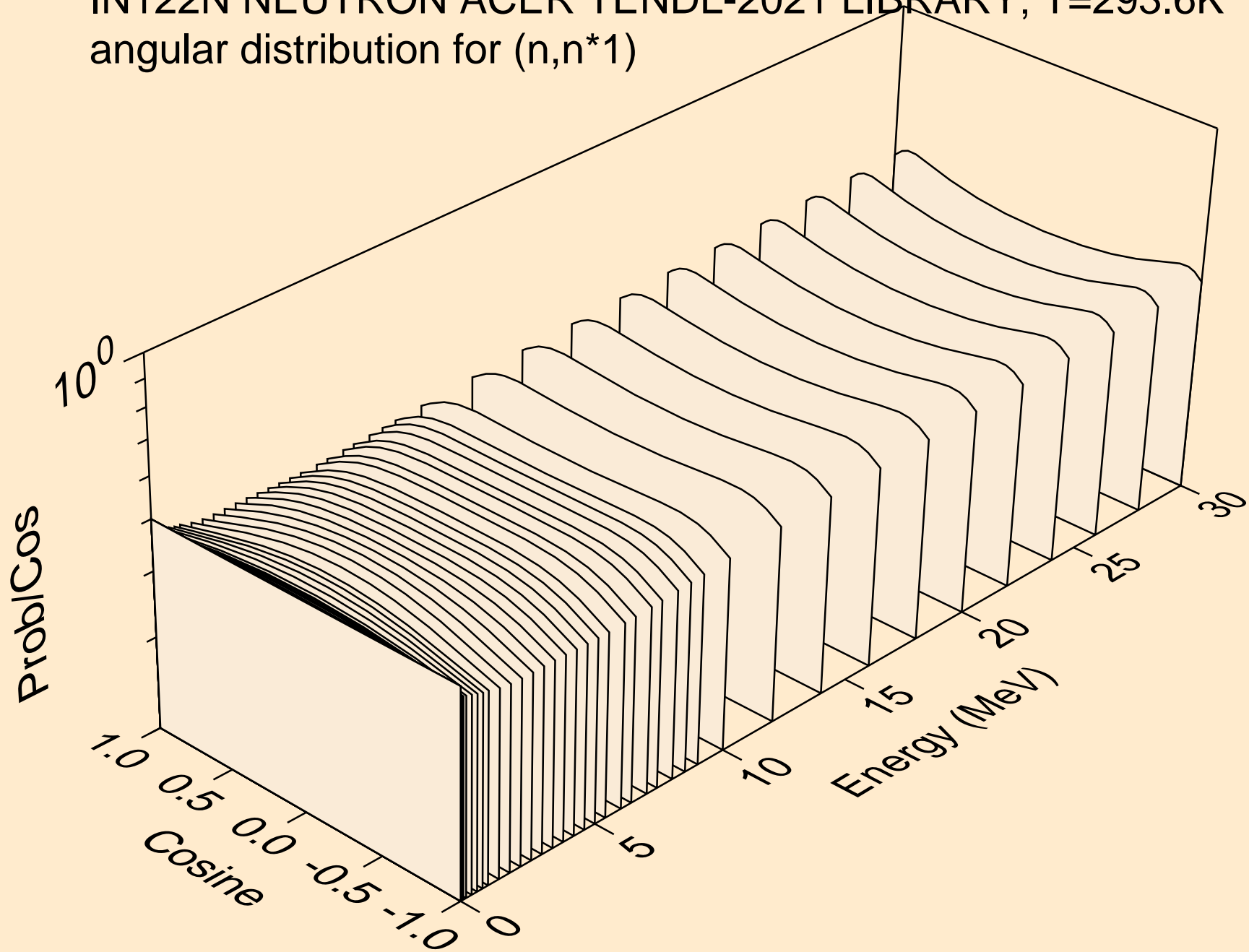

IN122N NEUTRON ACER TENDL-2021 LIBRARY; T=293.6K  
angular distribution for (n,n\*2)

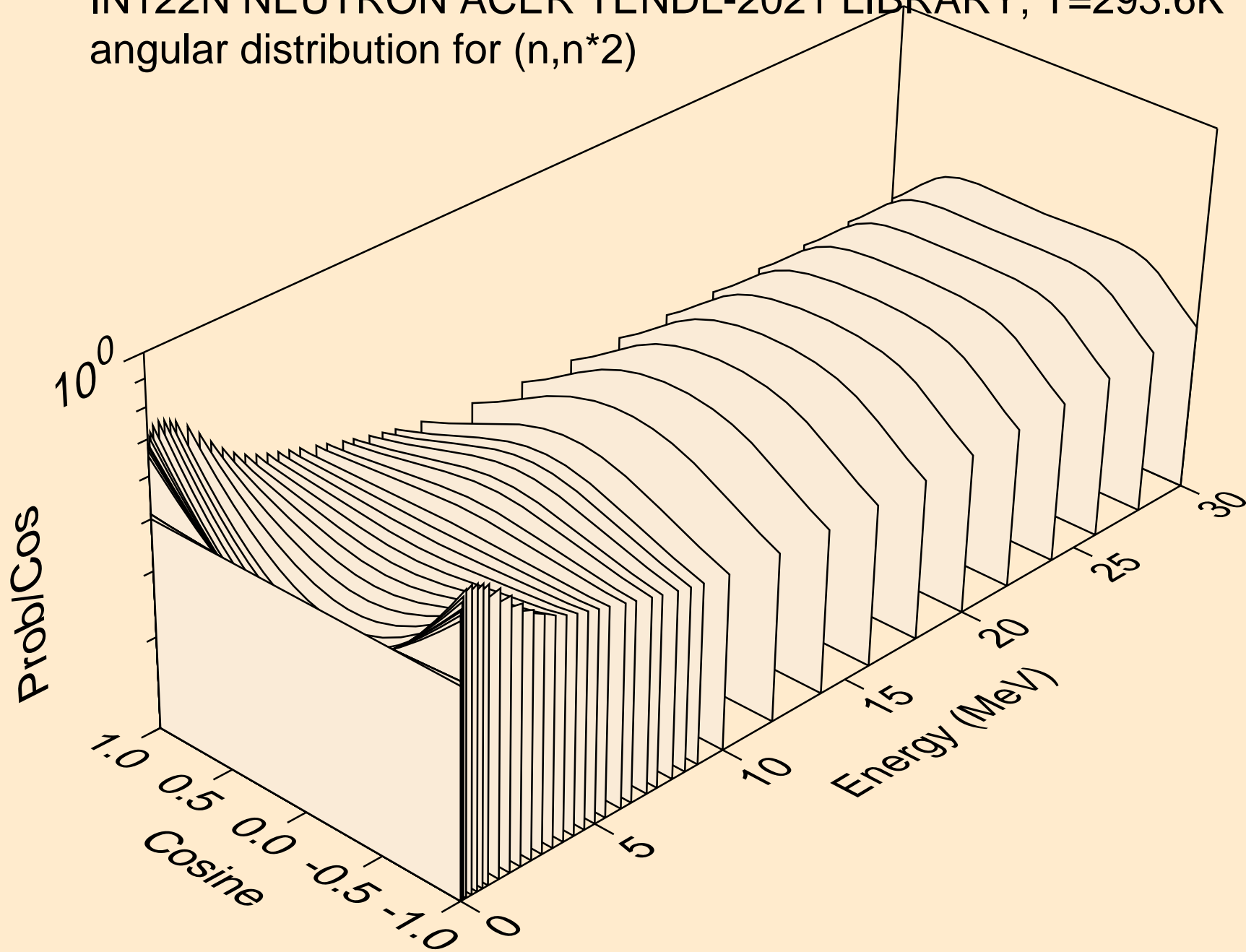



IN122N NEUTRON ACER TENDL-2021 LIBRARY; T=293.6K  
angular distribution for (n,n\*3)

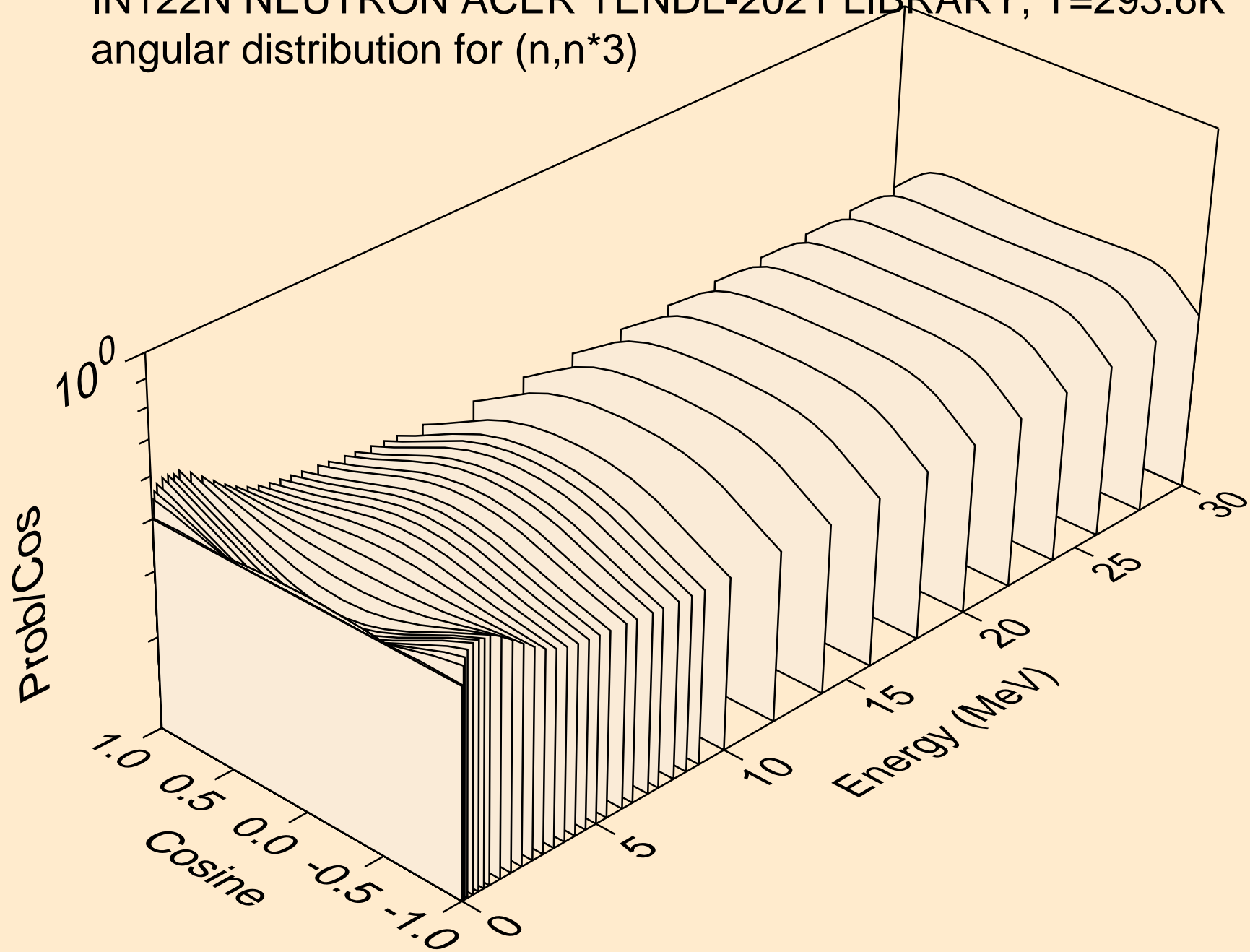

IN122N NEUTRON ACER TENDL-2021 LIBRARY; T=293.6K  
angular distribution for (n,n\*4)

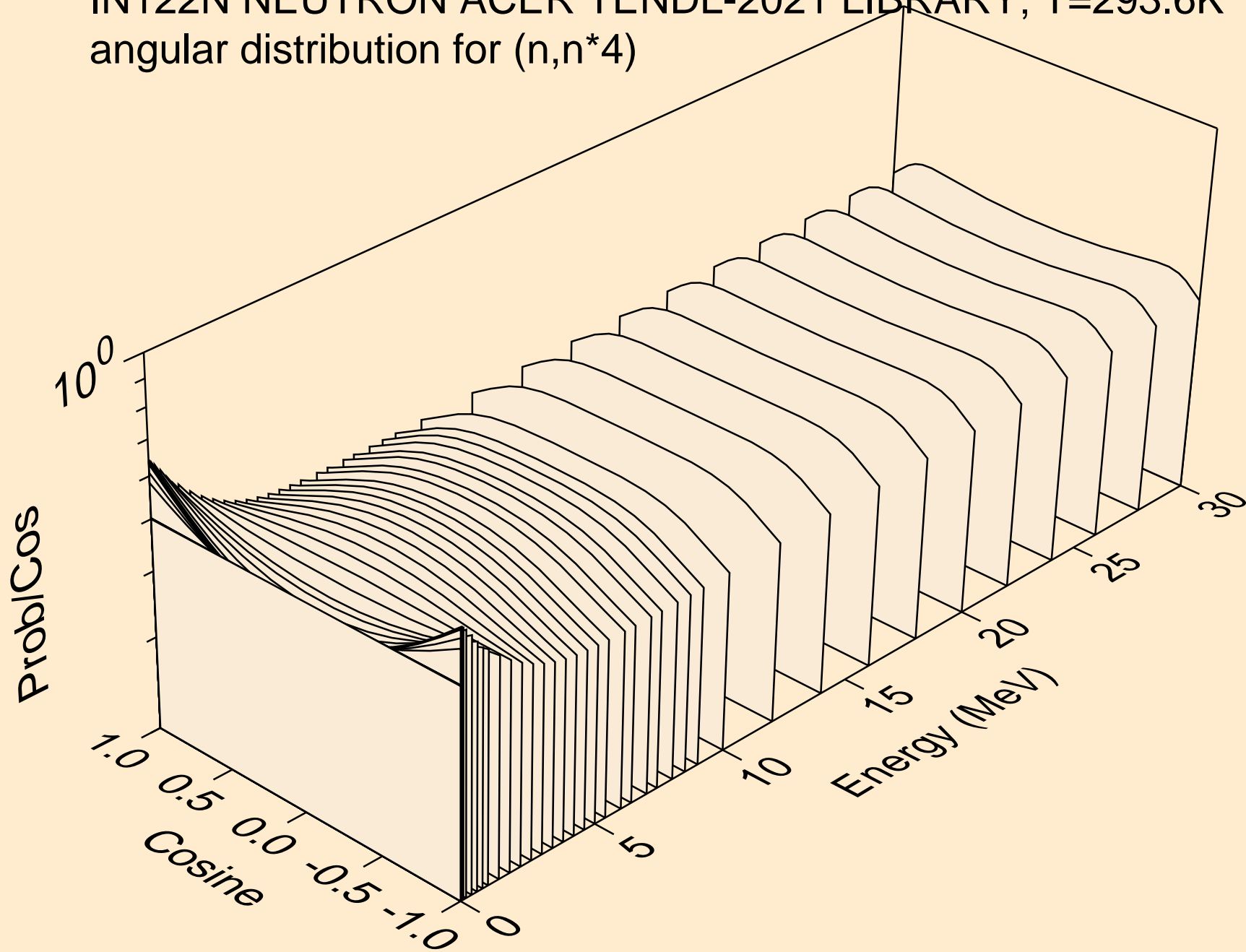

IN122N NEUTRON ACER TENDL-2021 LIBRARY; T=293.6K  
angular distribution for (n,n\*5)

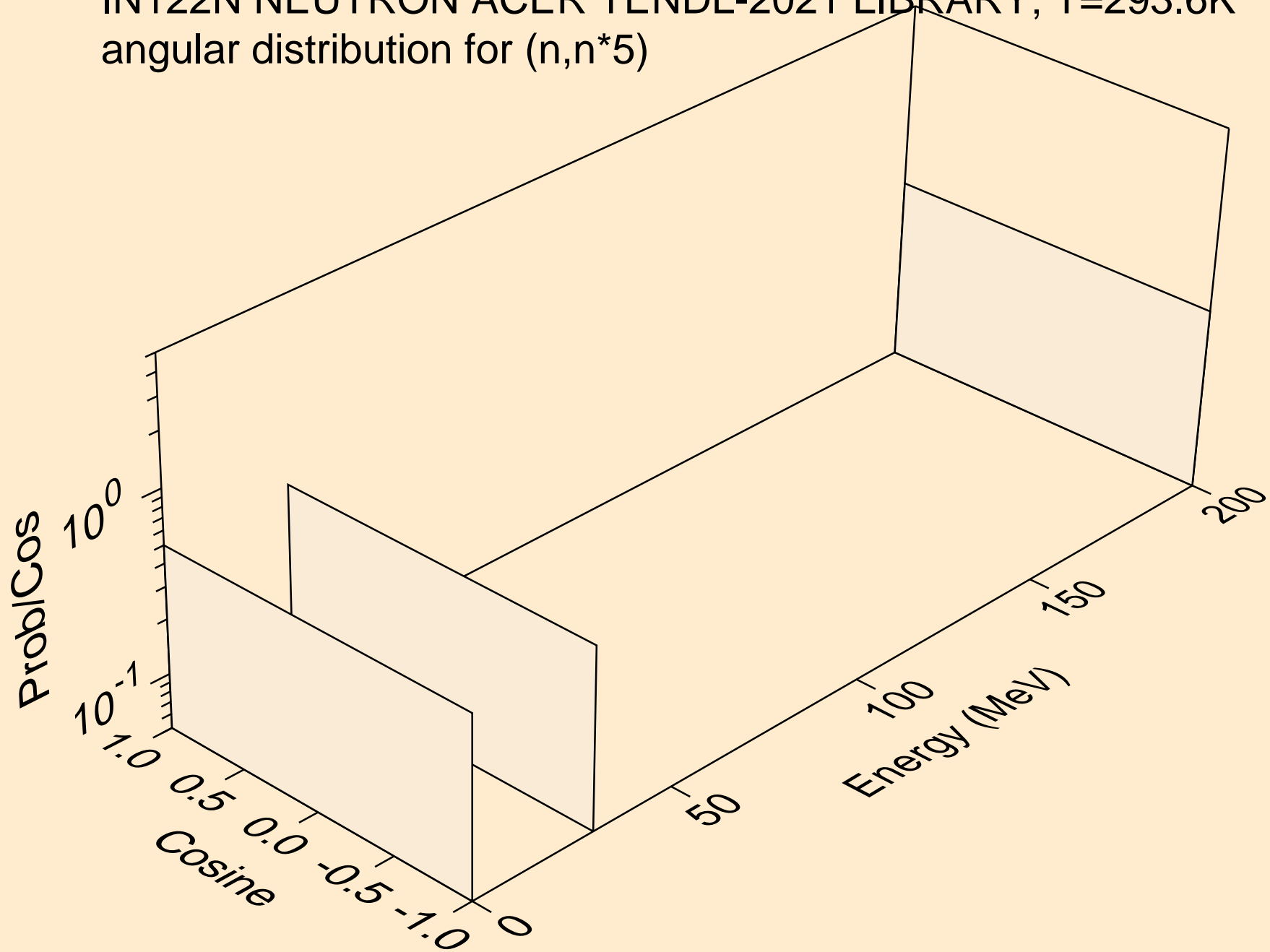

IN122N NEUTRON ACER TENDL-2021 LIBRARY; T=293.6K  
angular distribution for (n,n\*6)

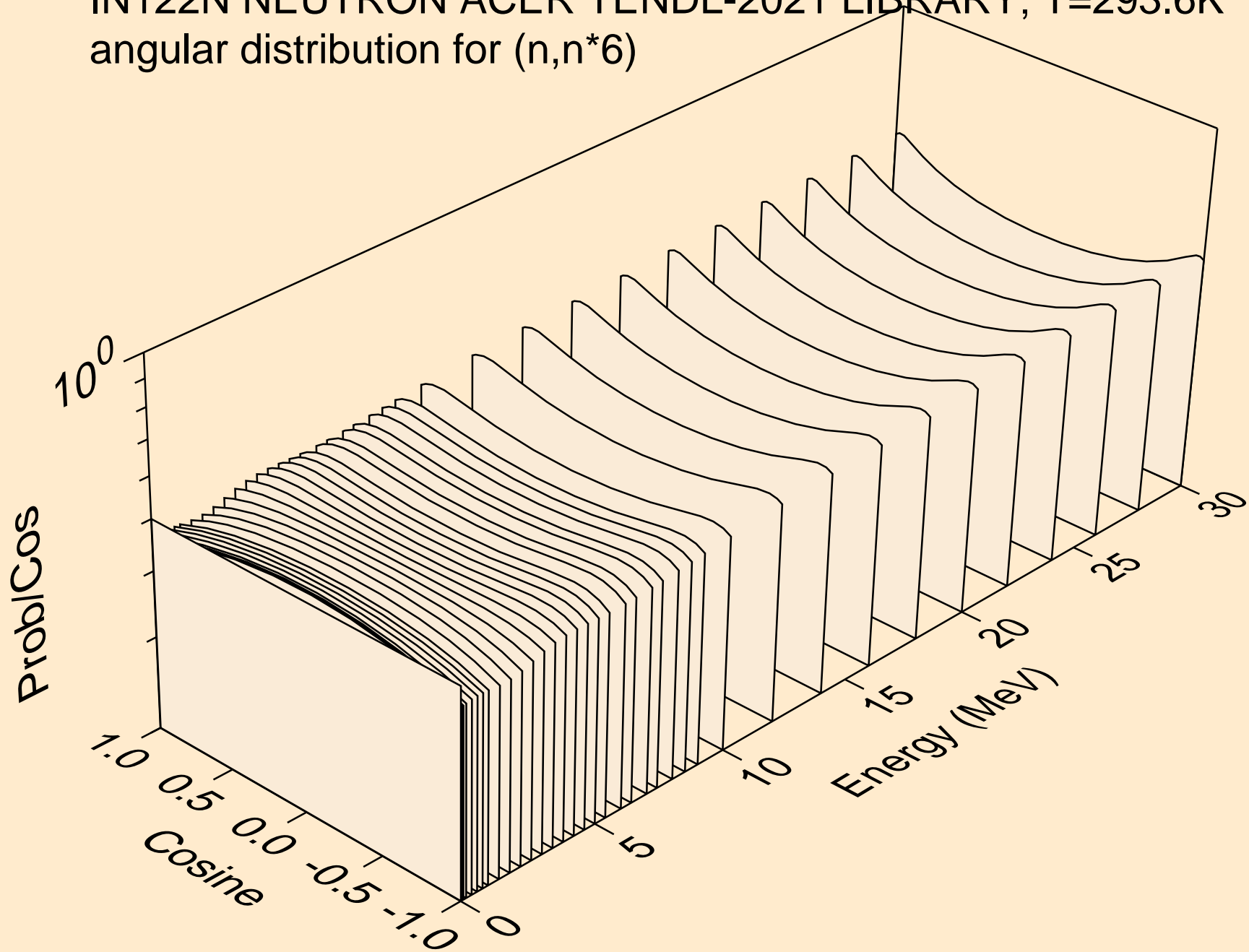

IN122N NEUTRON ACER TENDL-2021 LIBRARY; T=293.6K  
angular distribution for (n,n\*7)

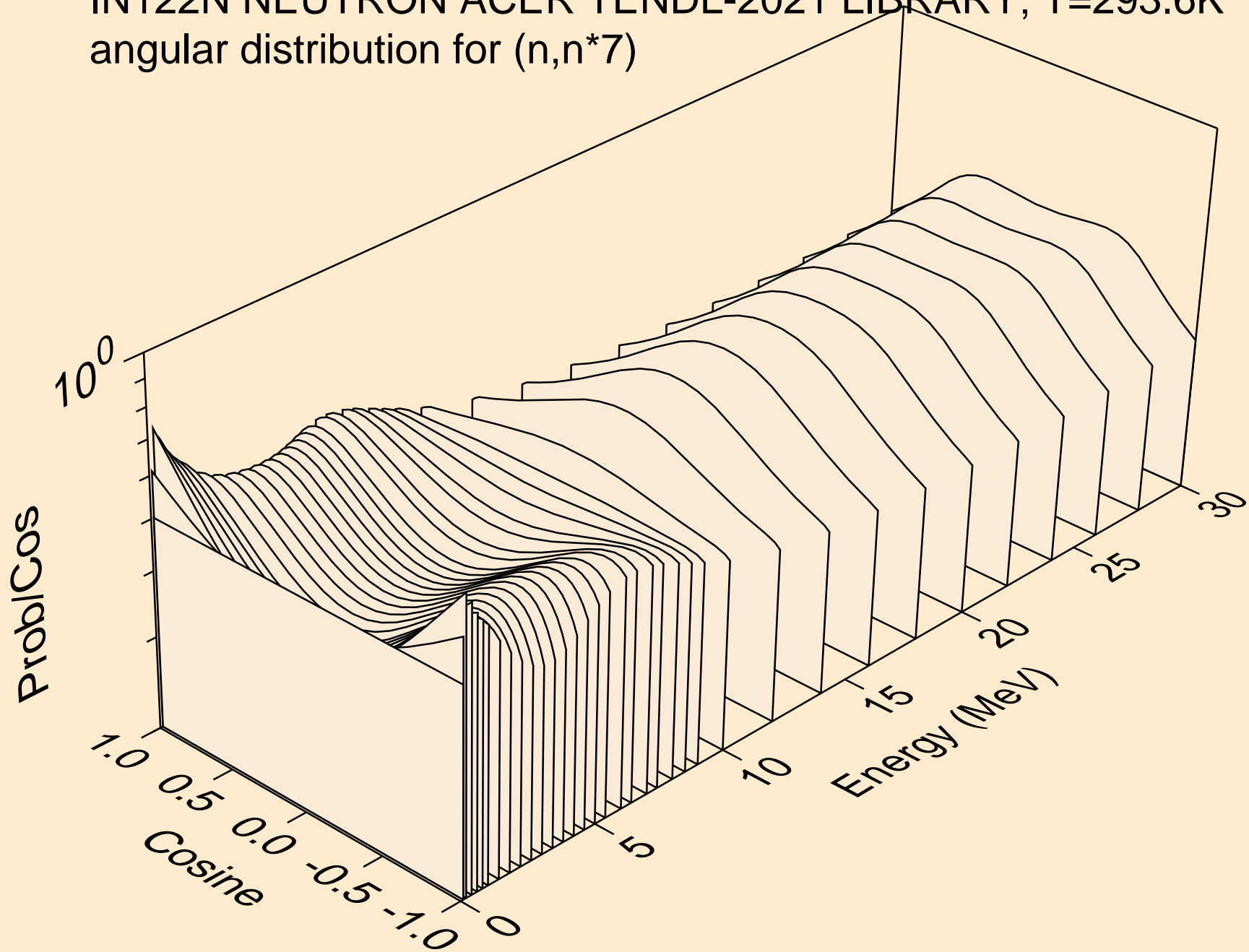

IN122N NEUTRON ACER TENDL-2021 LIBRARY; T=293.6K  
angular distribution for (n,n\*8)

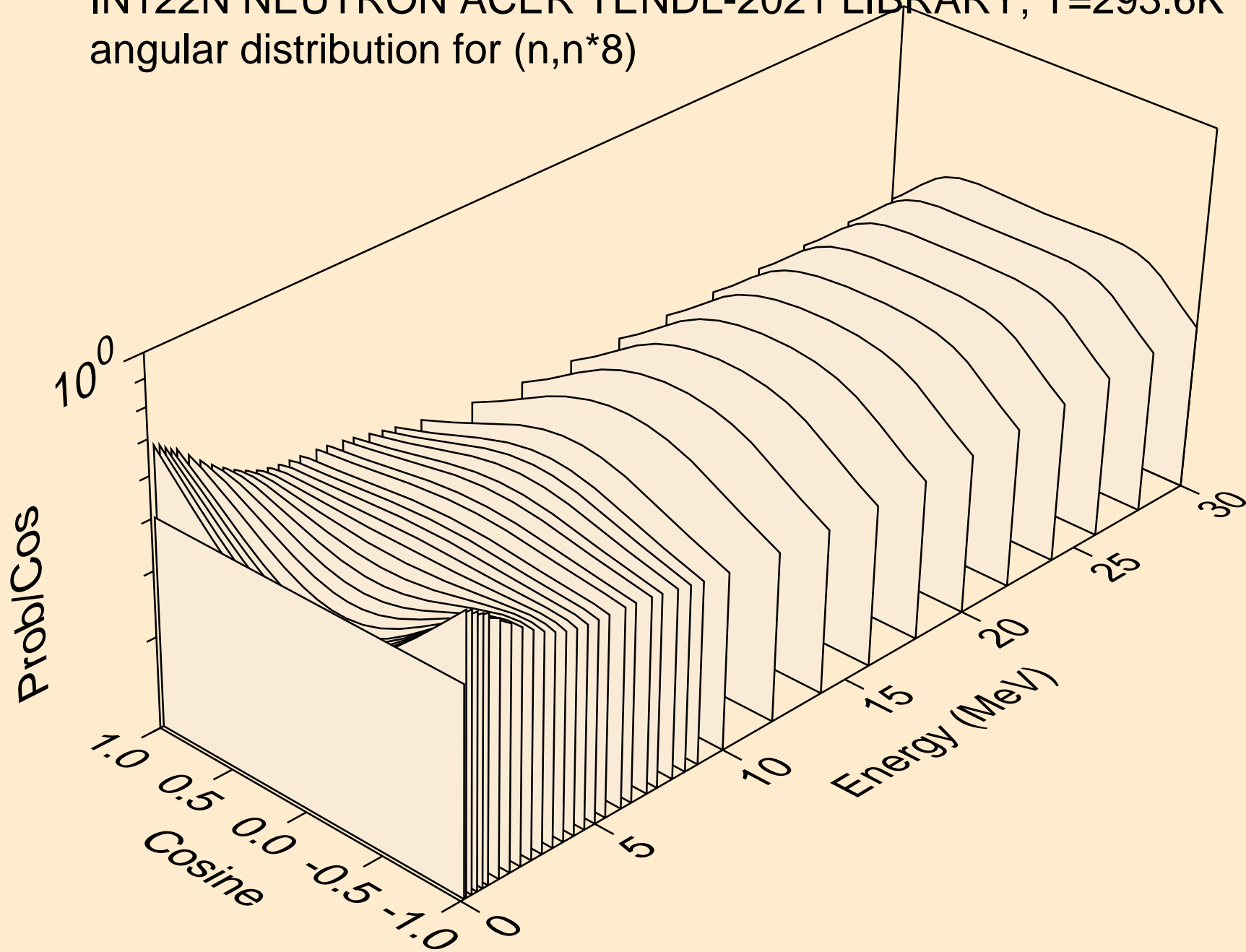

IN122N NEUTRON ACER TENDL-2021 LIBRARY; T=293.6K  
angular distribution for (n,n\*9)

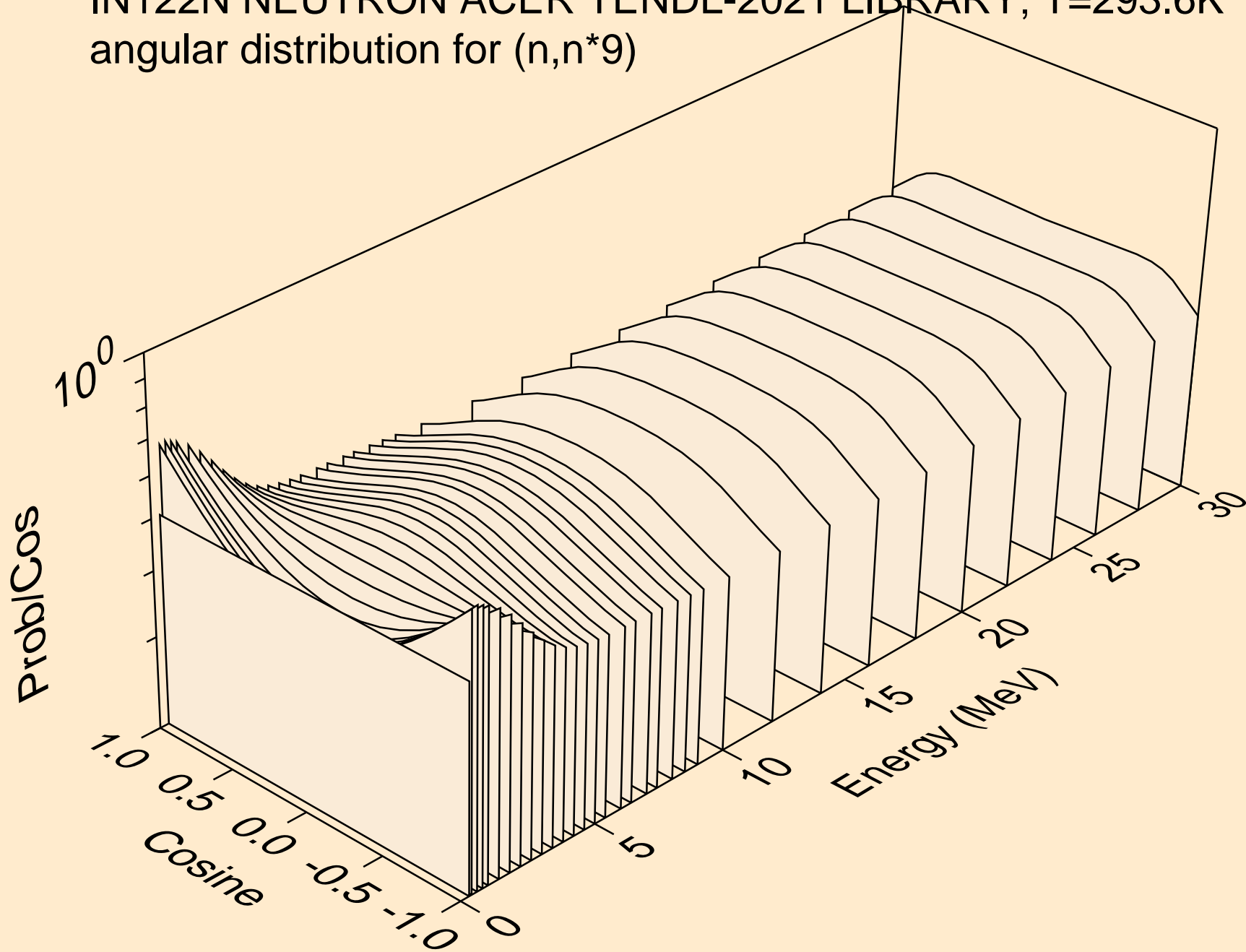

IN122N NEUTRON ACER TENDL-2021 LIBRARY; T=293.6K  
angular distribution for (n,n\*10)

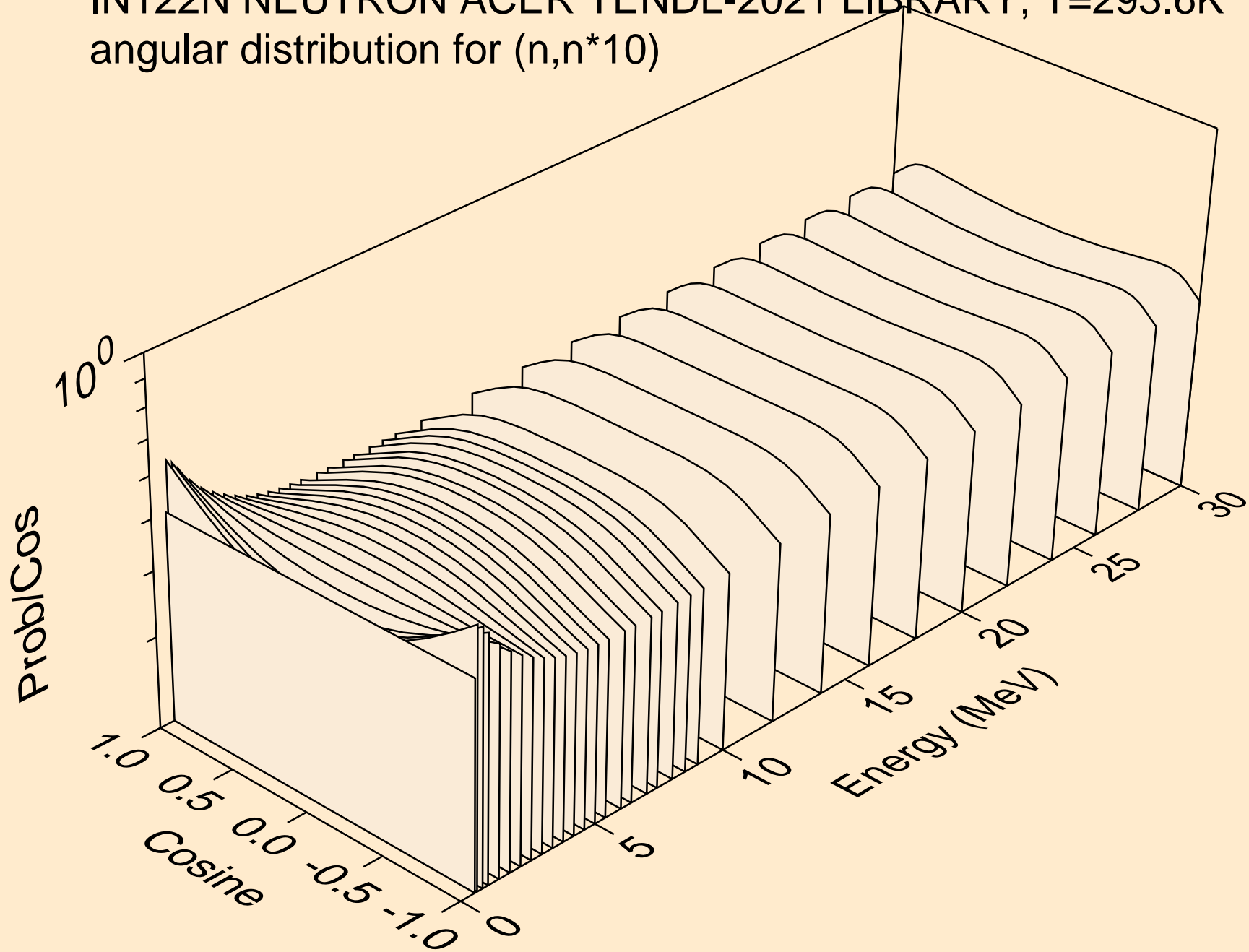



IN122N NEUTRON ACER TENDL-2021 LIBRARY; T=293.6K  
angular distribution for (n,n\*11)

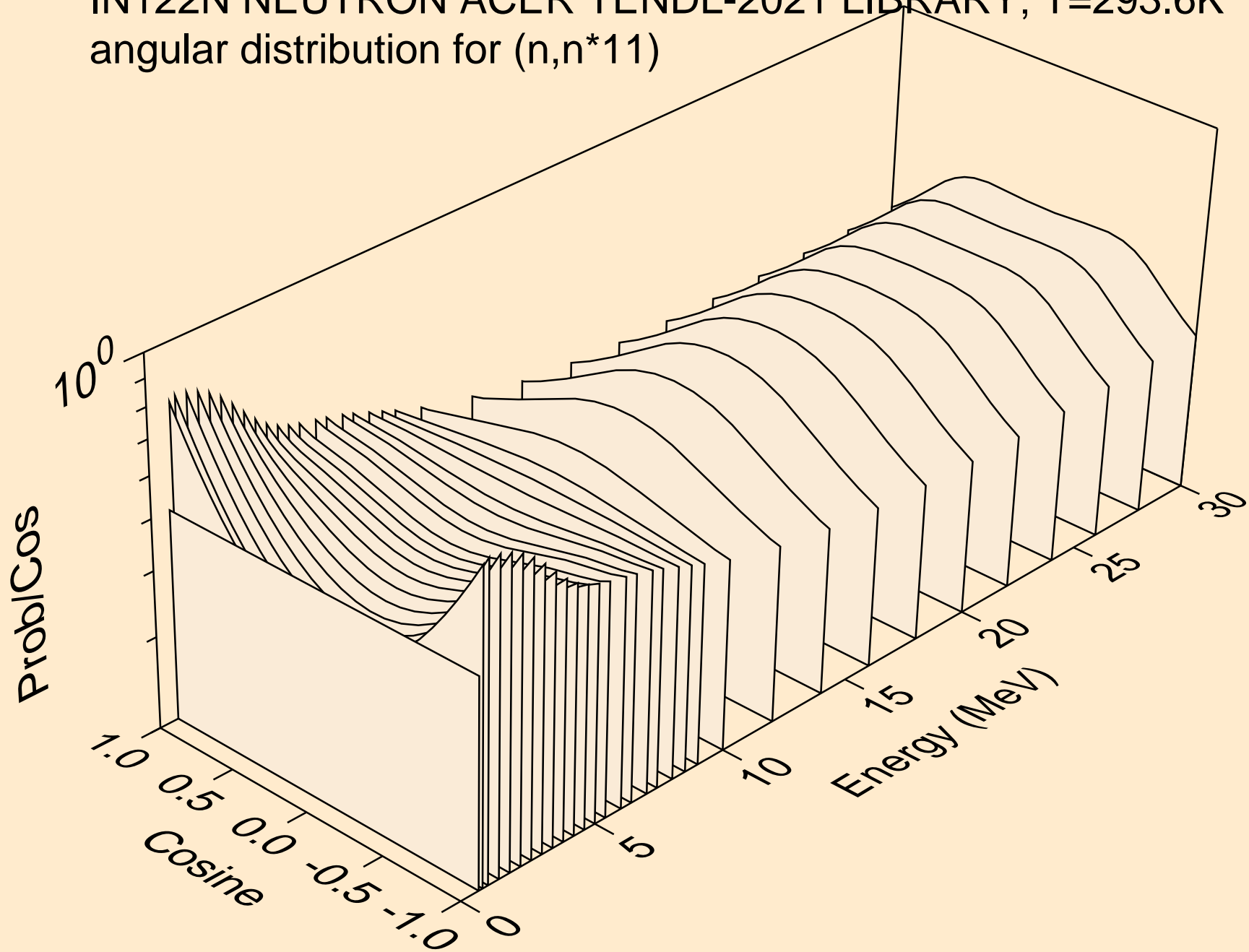

IN122N NEUTRON ACER TENDL-2021 LIBRARY; T=293.6K  
angular distribution for (n,n\*12)

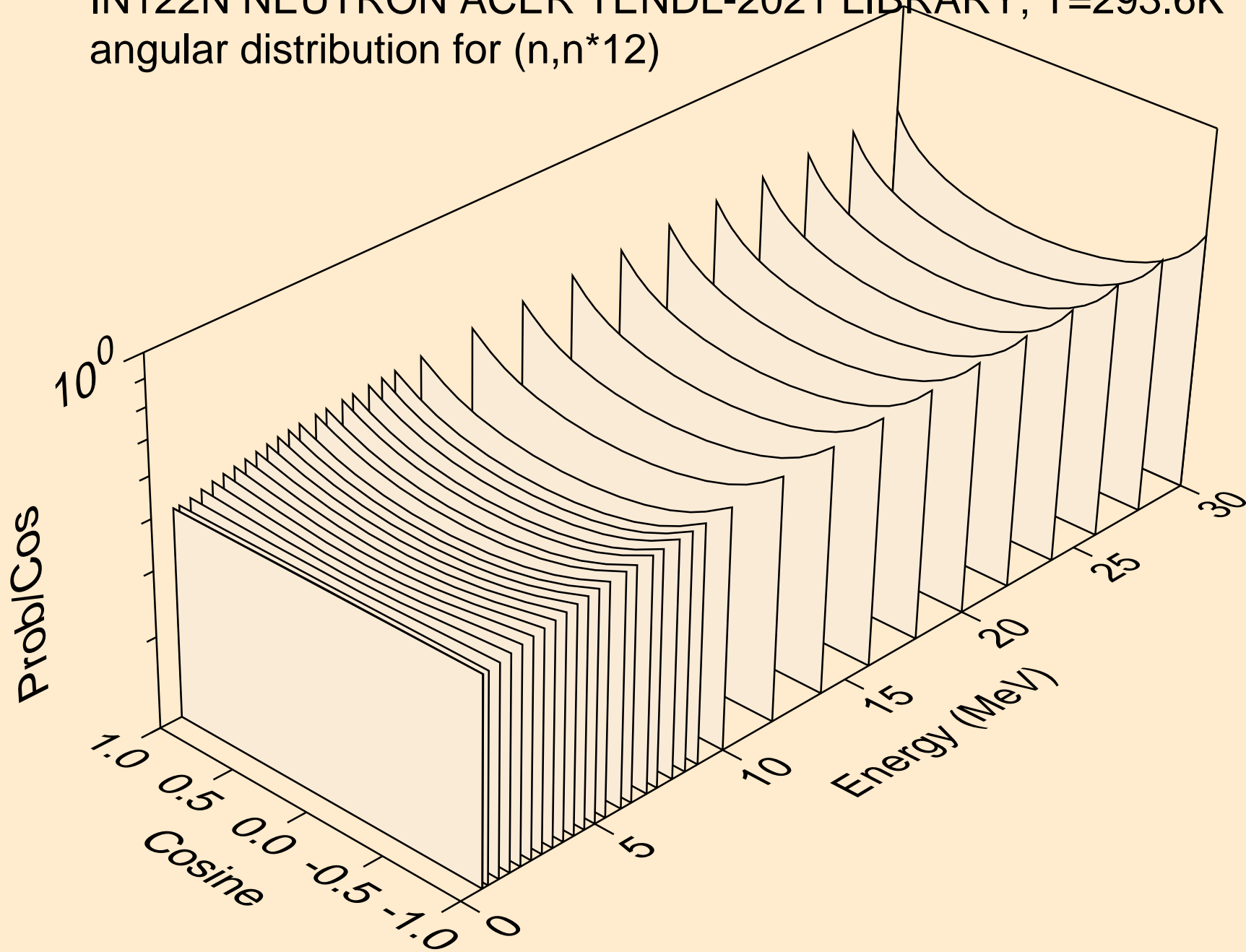

IN122N NEUTRON ACER TENDL-2021 LIBRARY; T=293.6K  
angular distribution for (n,n\*13)

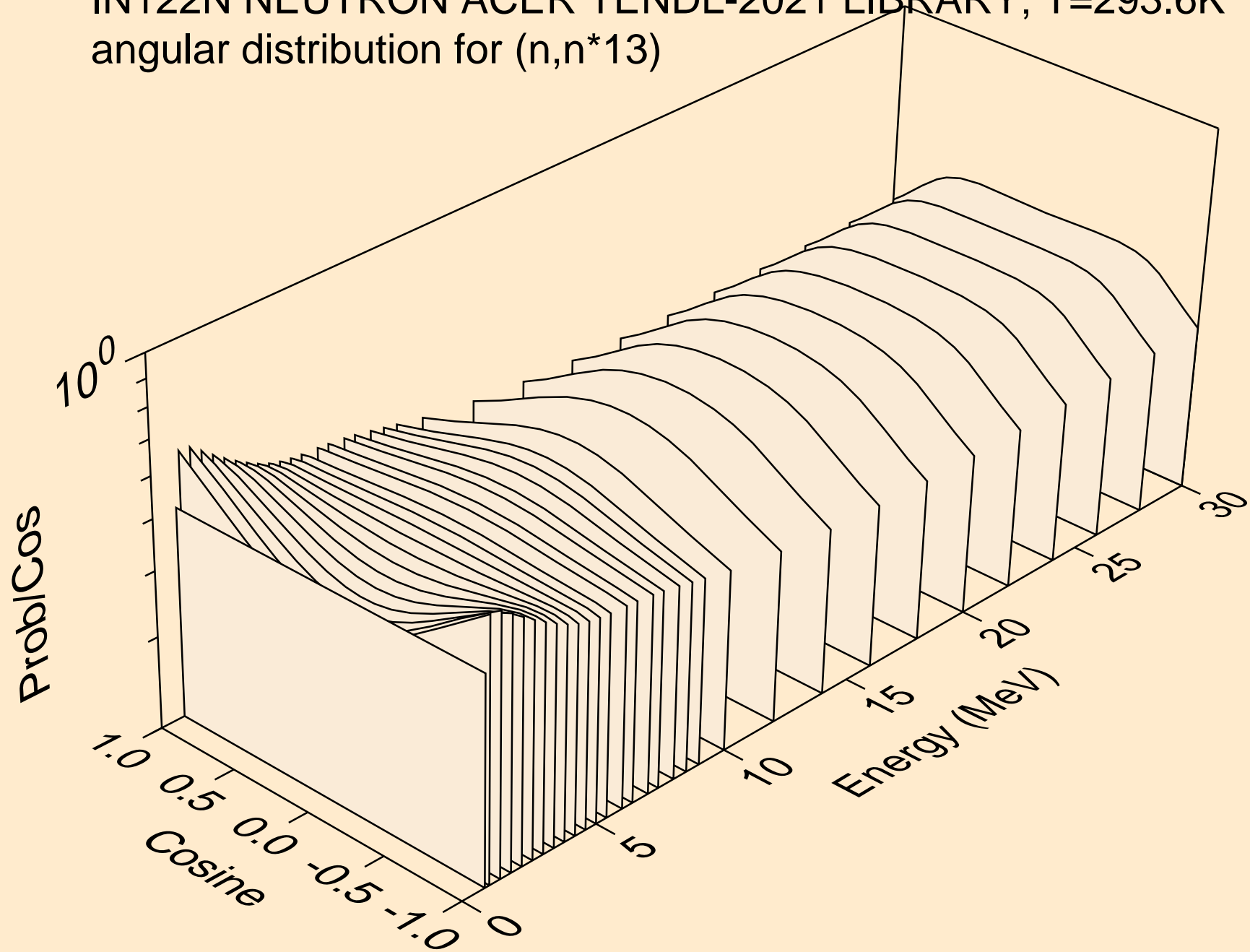

IN122N NEUTRON ACER TENDL-2021 LIBRARY; T=293.6K  
angular distribution for (n,n\*14)

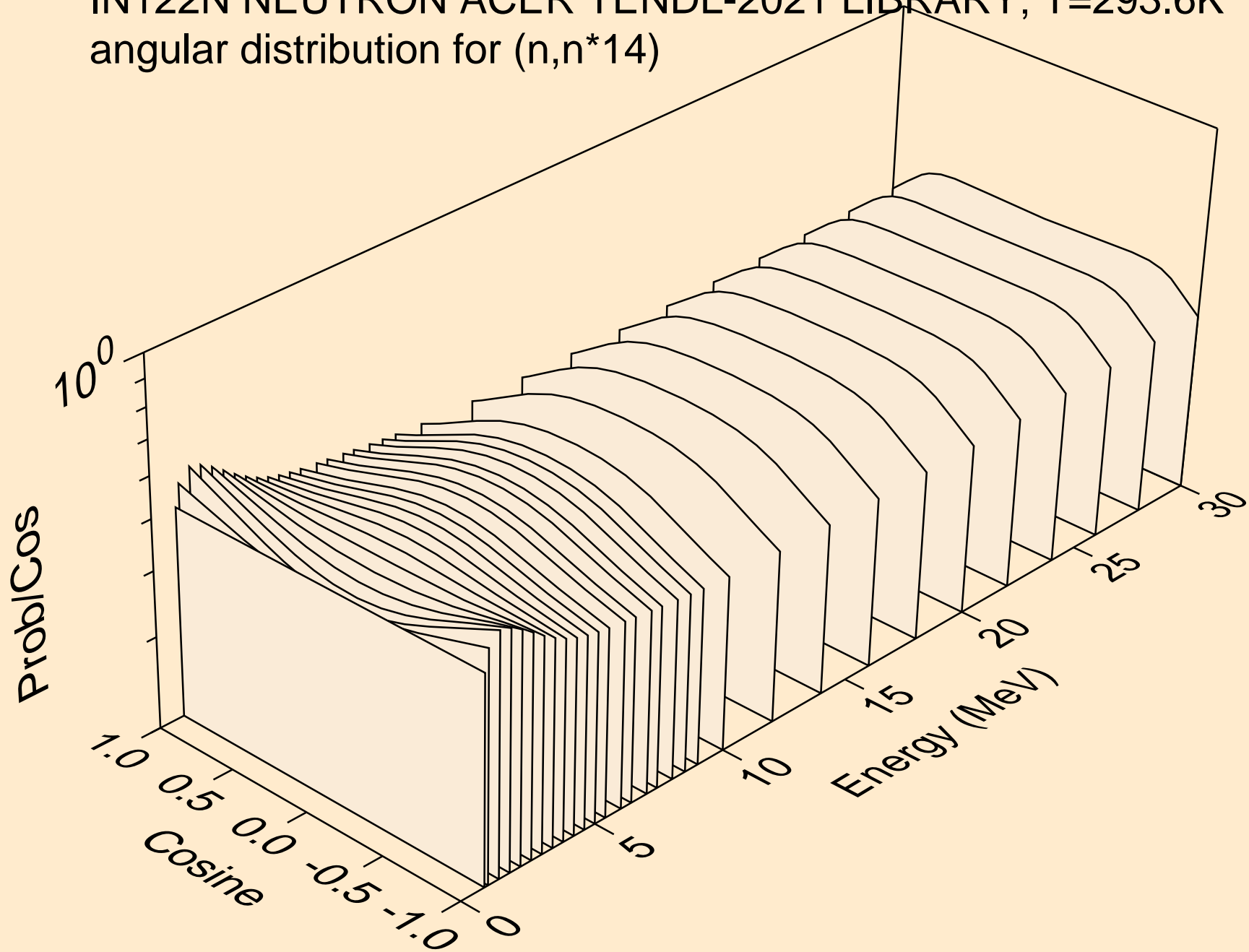

IN122N NEUTRON ACER TENDL-2021 LIBRARY; T=293.6K  
angular distribution for (n,n\*15)

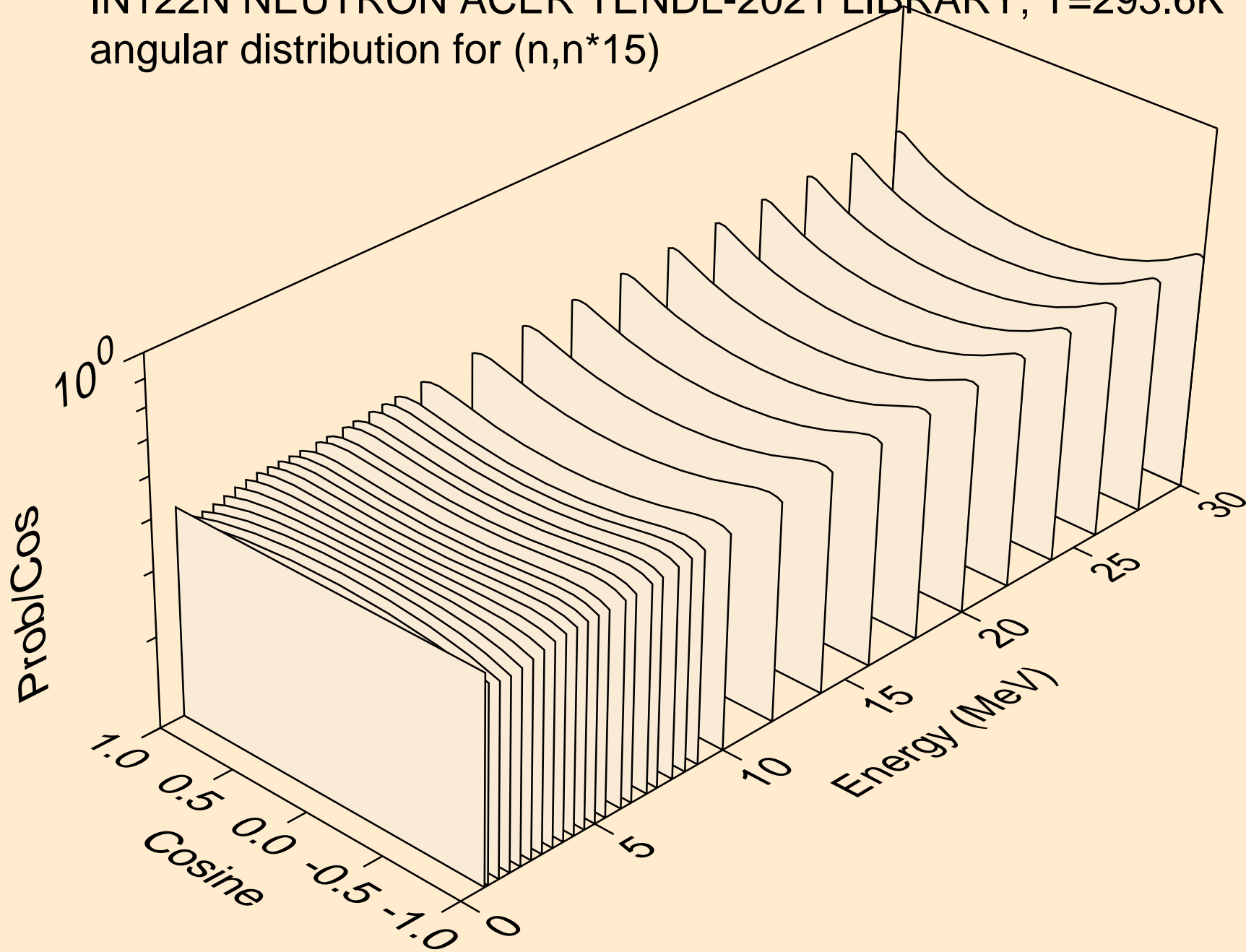

IN122N NEUTRON ACER TENDL-2021 LIBRARY; T=293.6K  
angular distribution for (n,n\*16)

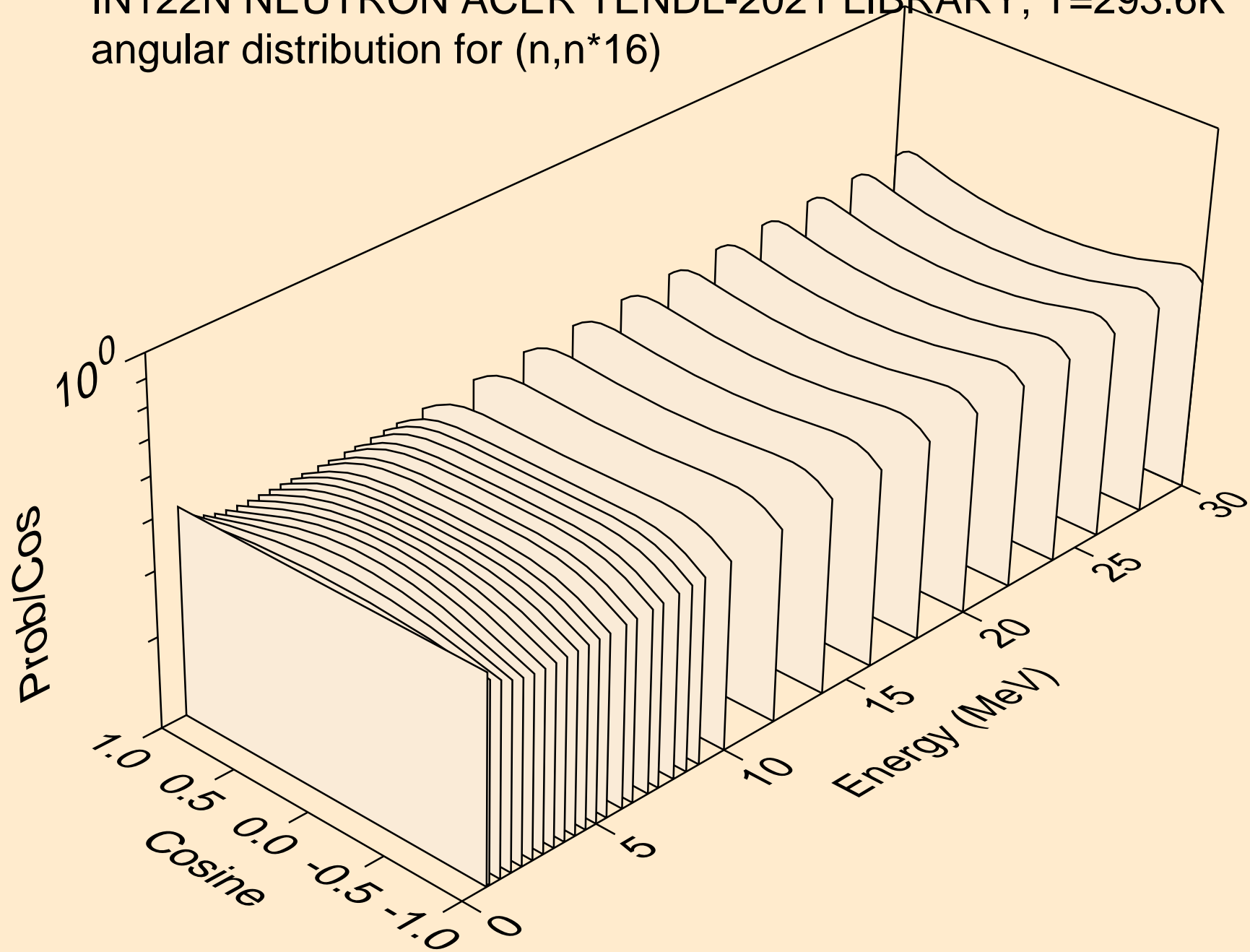

IN122N NEUTRON ACER TENDL-2021 LIBRARY; T=293.6K  
angular distribution for (n,n\*17)

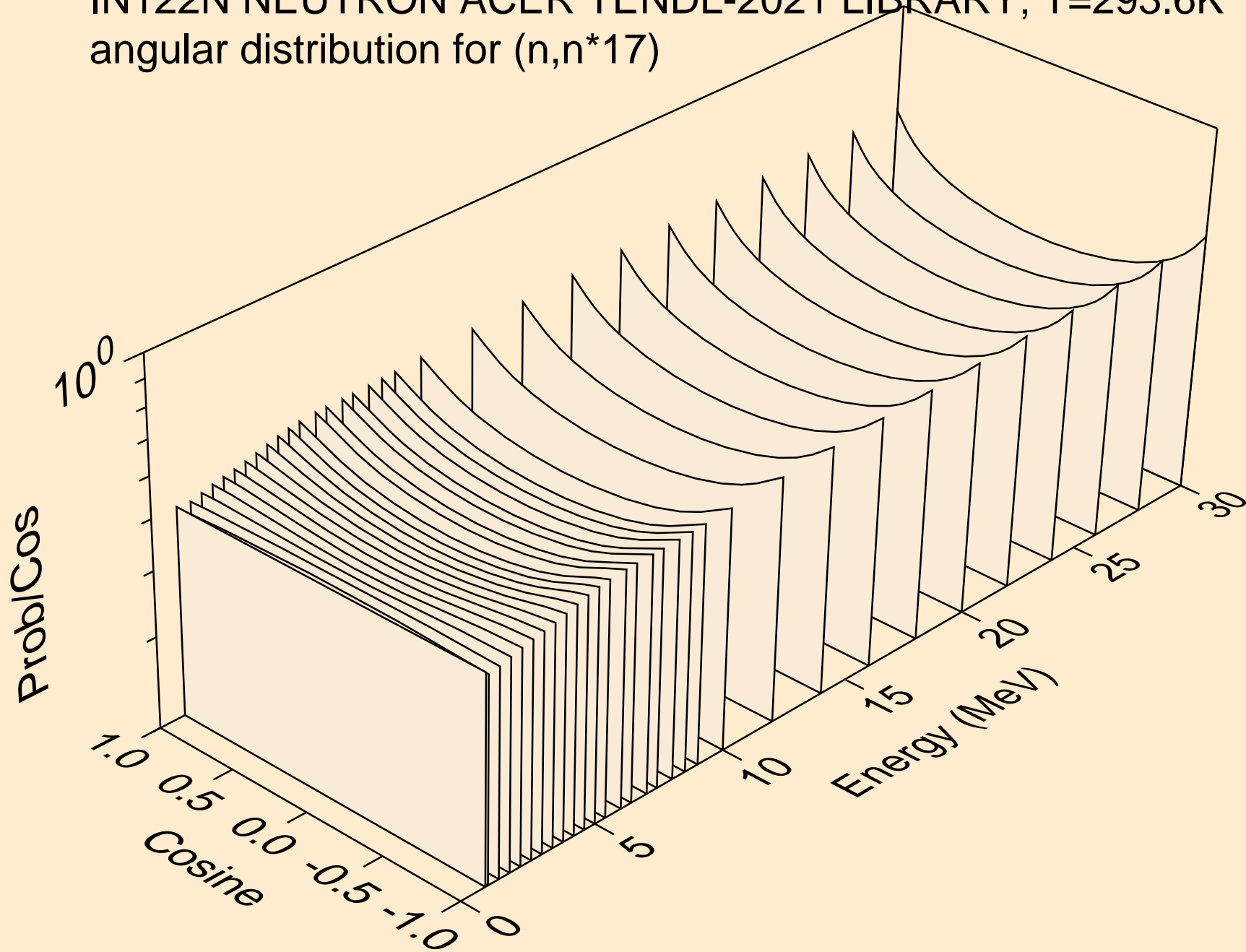

IN122N NEUTRON ACER TENDL-2021 LIBRARY; T=293.6K  
angular distribution for (n,n\*18)

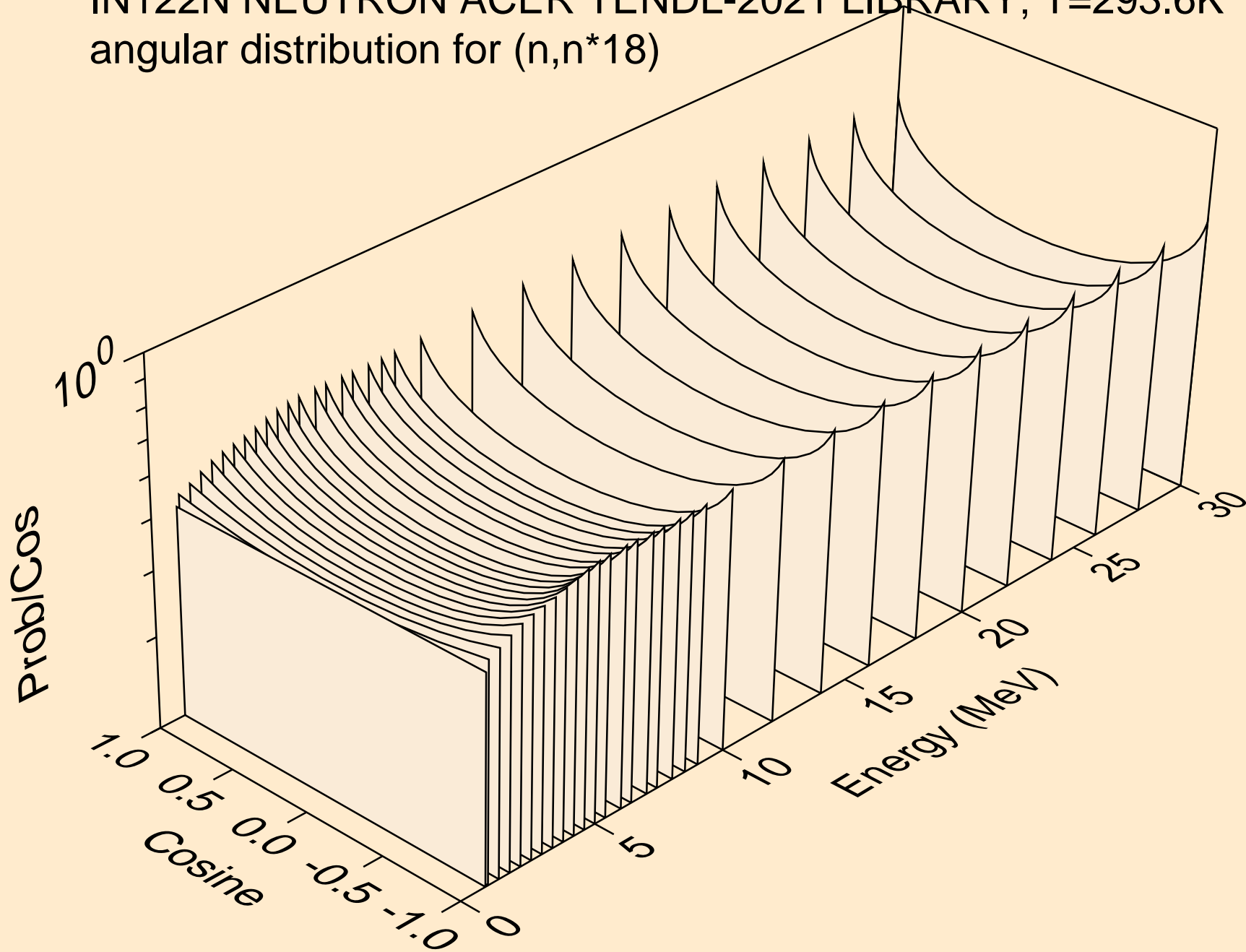



IN122N NEUTRON ACER TENDL-2021 LIBRARY; T=293.6K  
angular distribution for (n,n\*19)

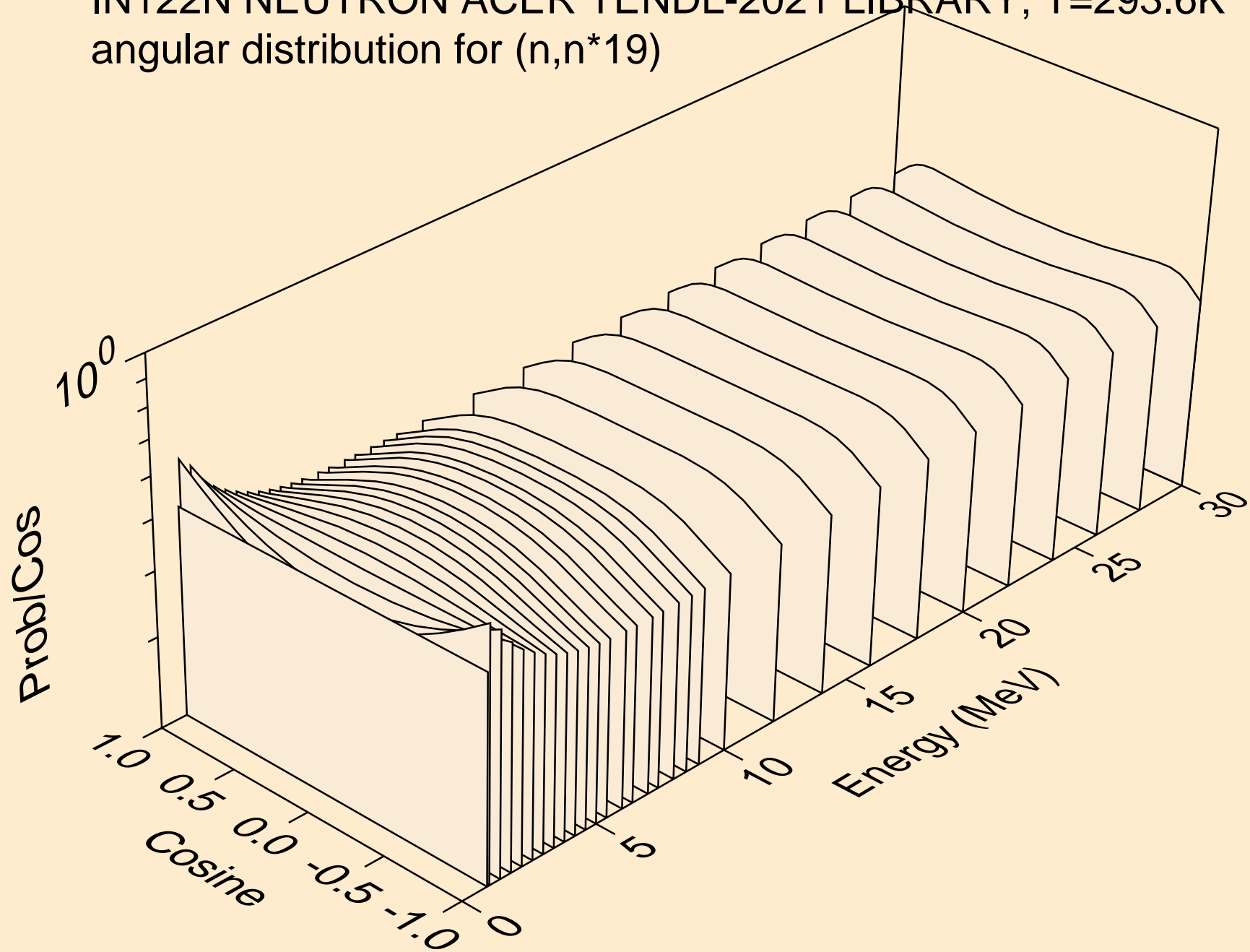

IN122N NEUTRON ACER TENDL-2021 LIBRARY; T=293.6K  
angular distribution for (n,n\*20)

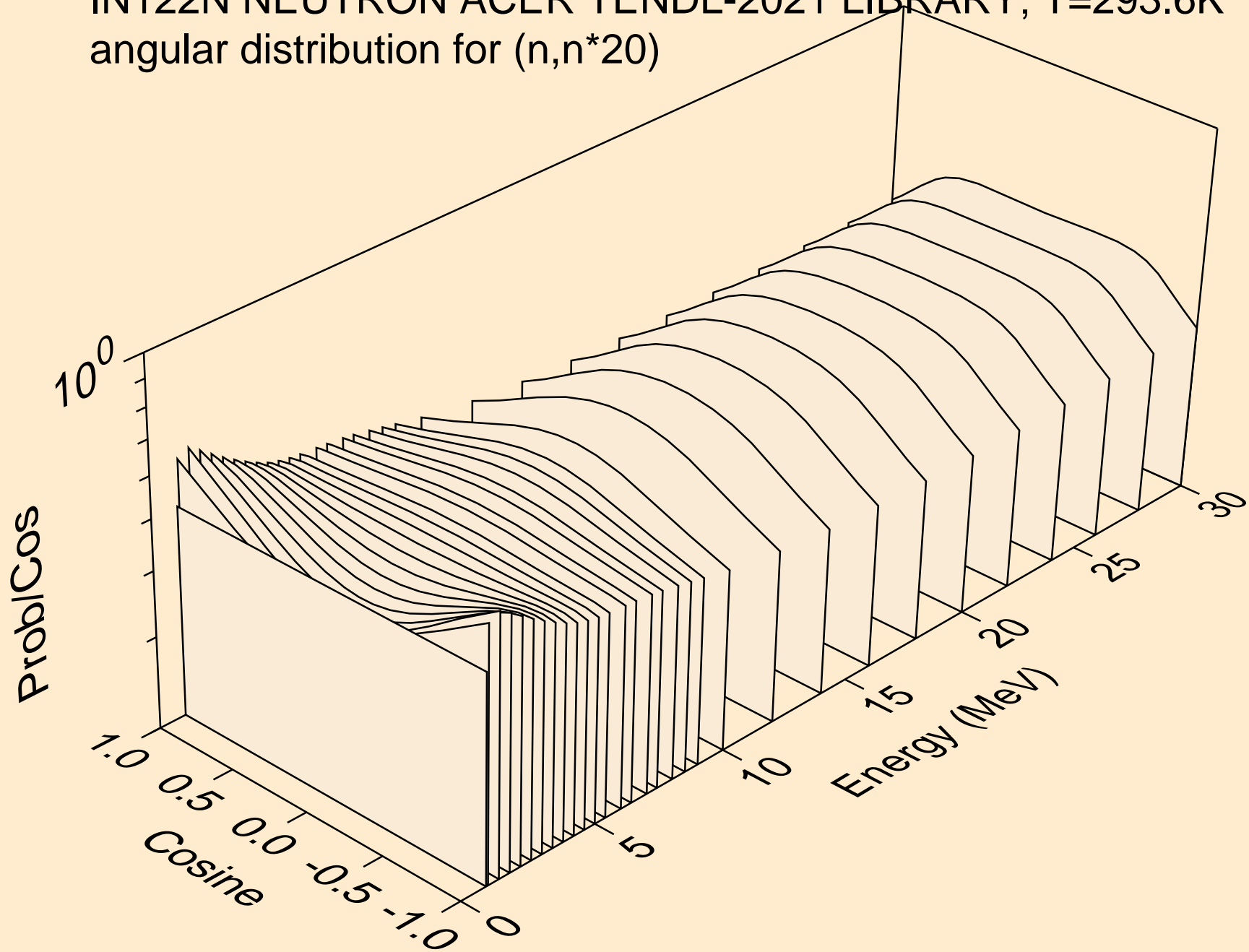

IN122N NEUTRON ACER TENDL-2021 LIBRARY; T=293.6K  
angular distribution for (n,n\*21)

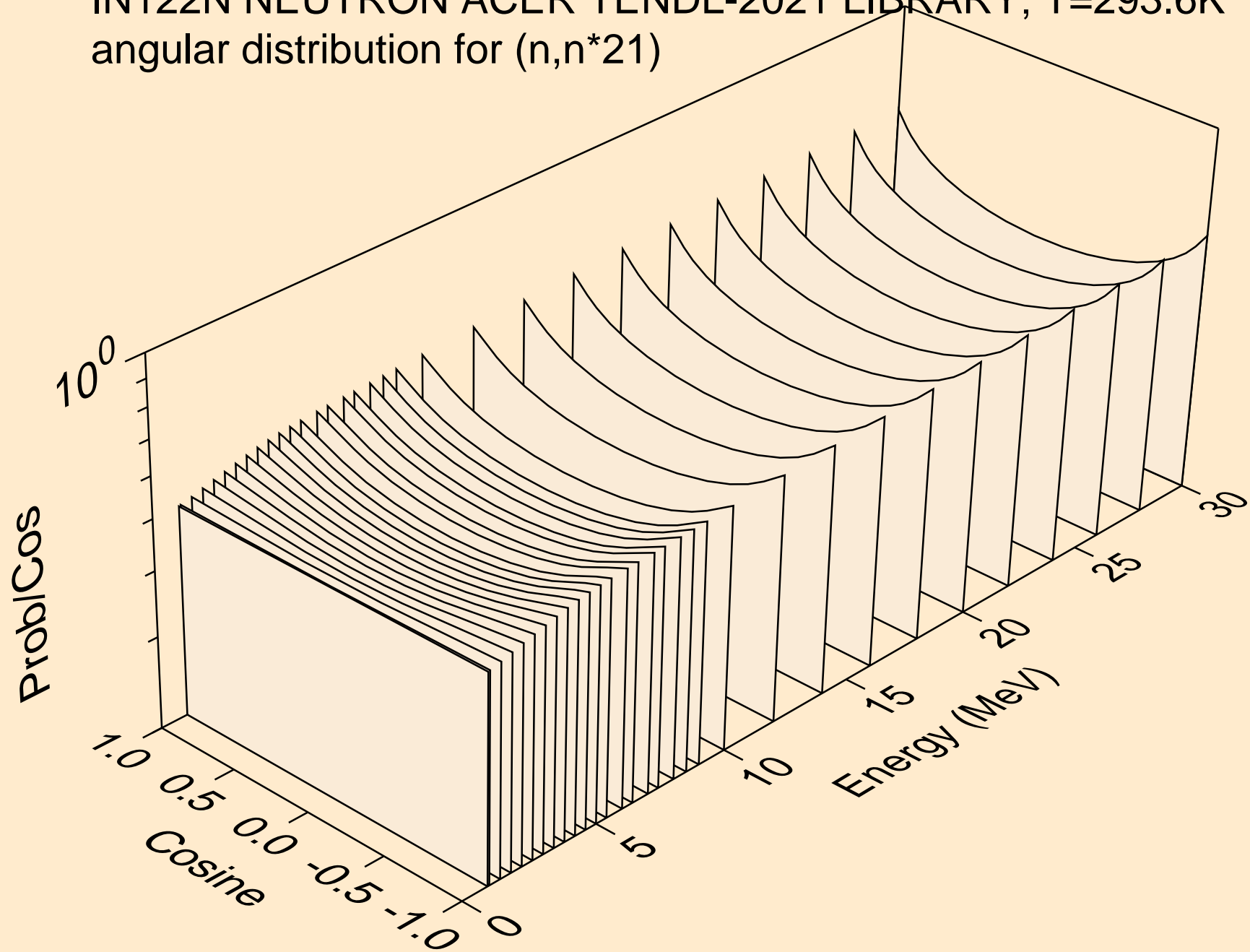

IN122N NEUTRON ACER TENDL-2021 LIBRARY; T=293.6K  
angular distribution for (n,n\*22)

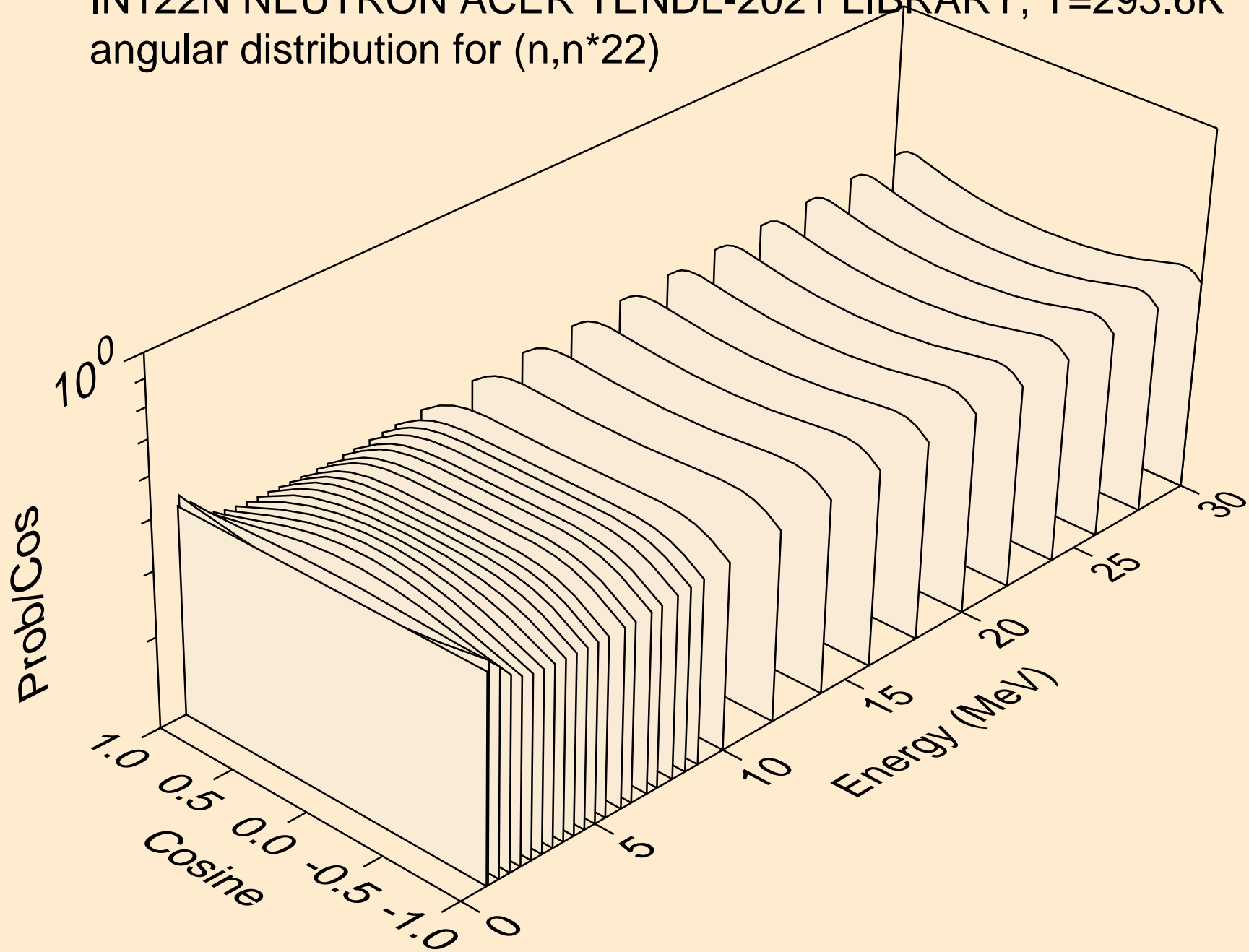

IN122N NEUTRON ACER TENDL-2021 LIBRARY; T=293.6K  
angular distribution for (n,n\*23)

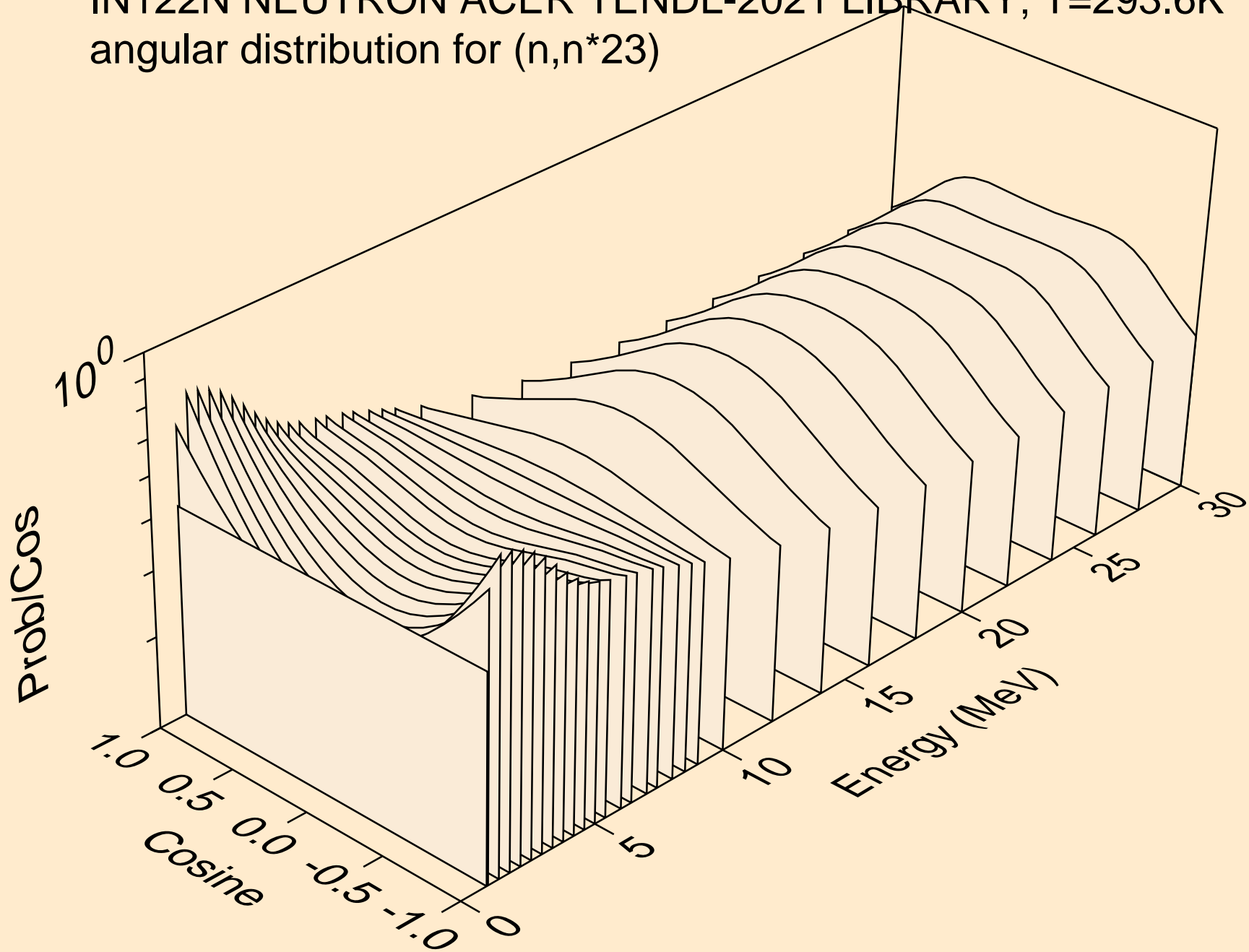

IN122N NEUTRON ACER TENDL-2021 LIBRARY; T=293.6K  
angular distribution for (n,n\*24)

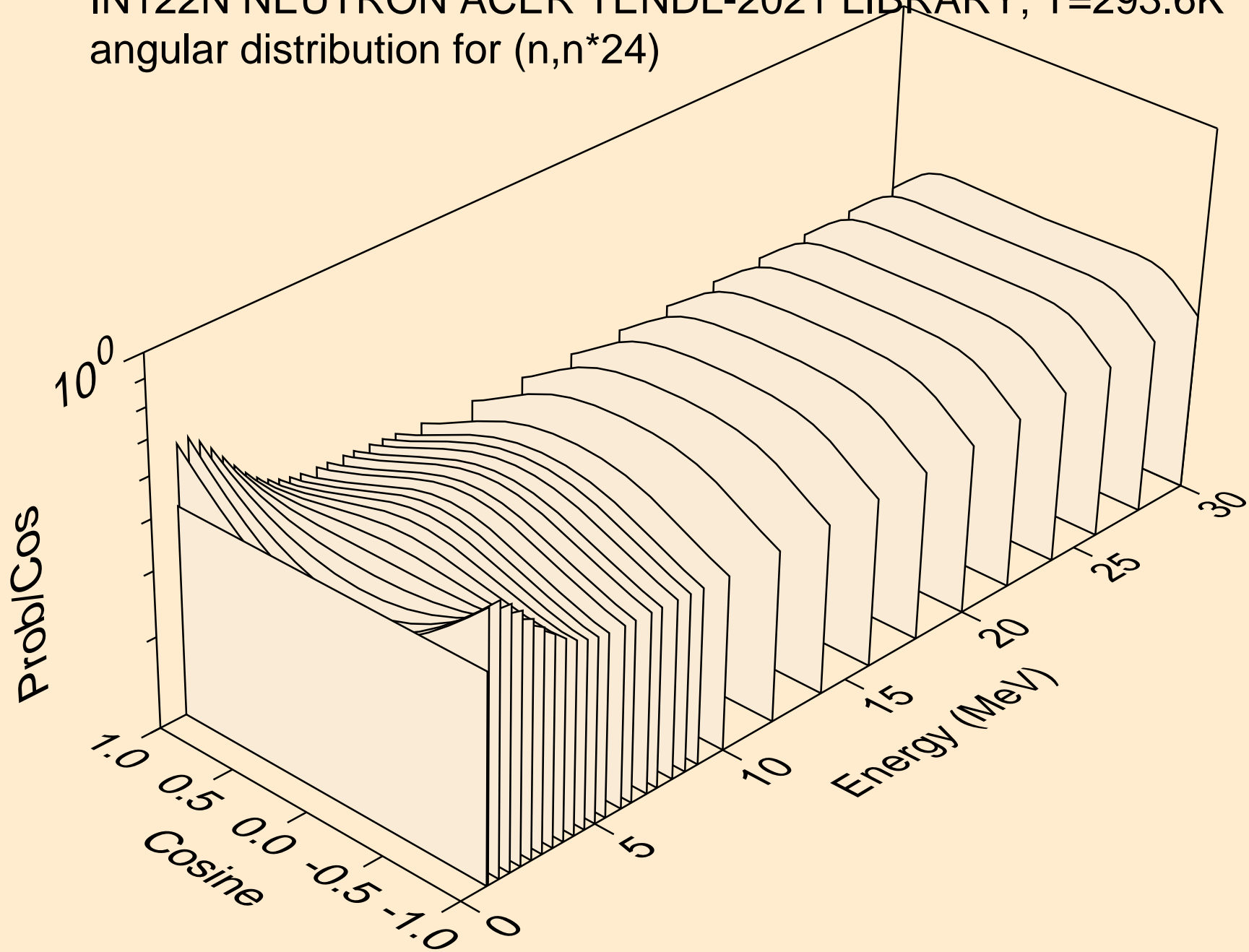

IN122N NEUTRON ACER TENDL-2021 LIBRARY; T=293.6K  
angular distribution for (n,n\*25)

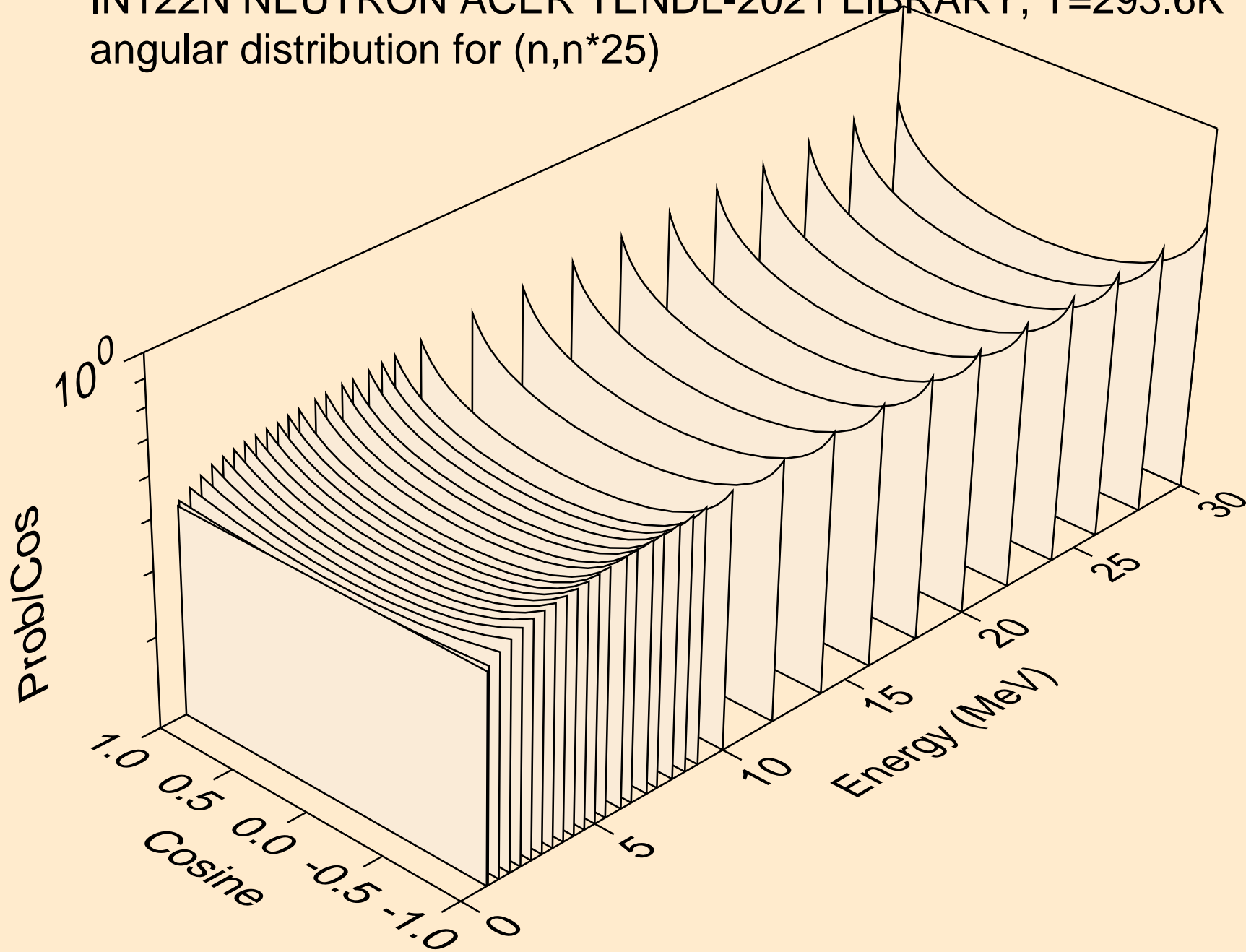

IN122N NEUTRON ACER TENDL-2021 LIBRARY; T=293.6K  
angular distribution for (n,n\*26)

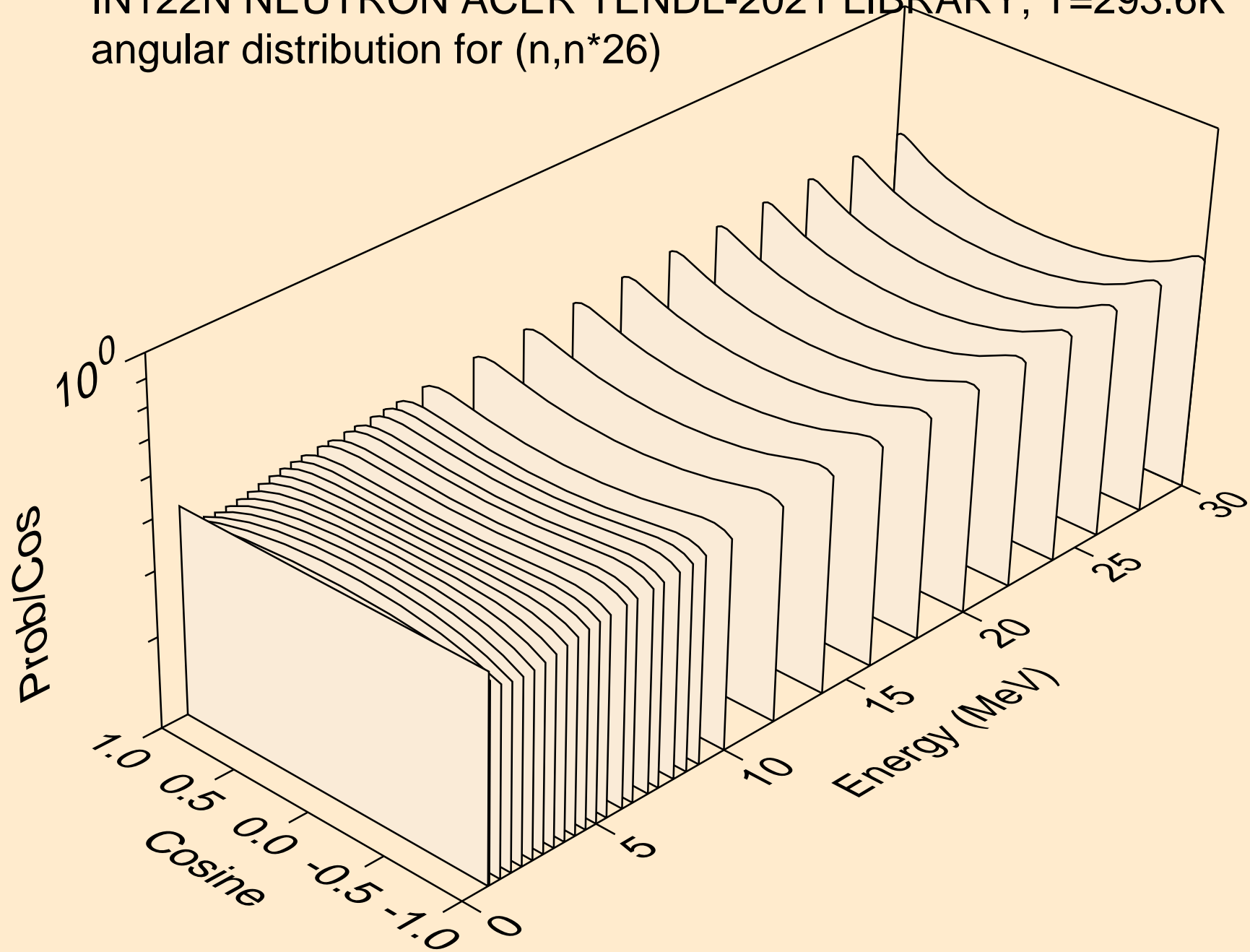



IN122N NEUTRON ACER TENDL-2021 LIBRARY; T=293.6K  
angular distribution for (n,n\*27)

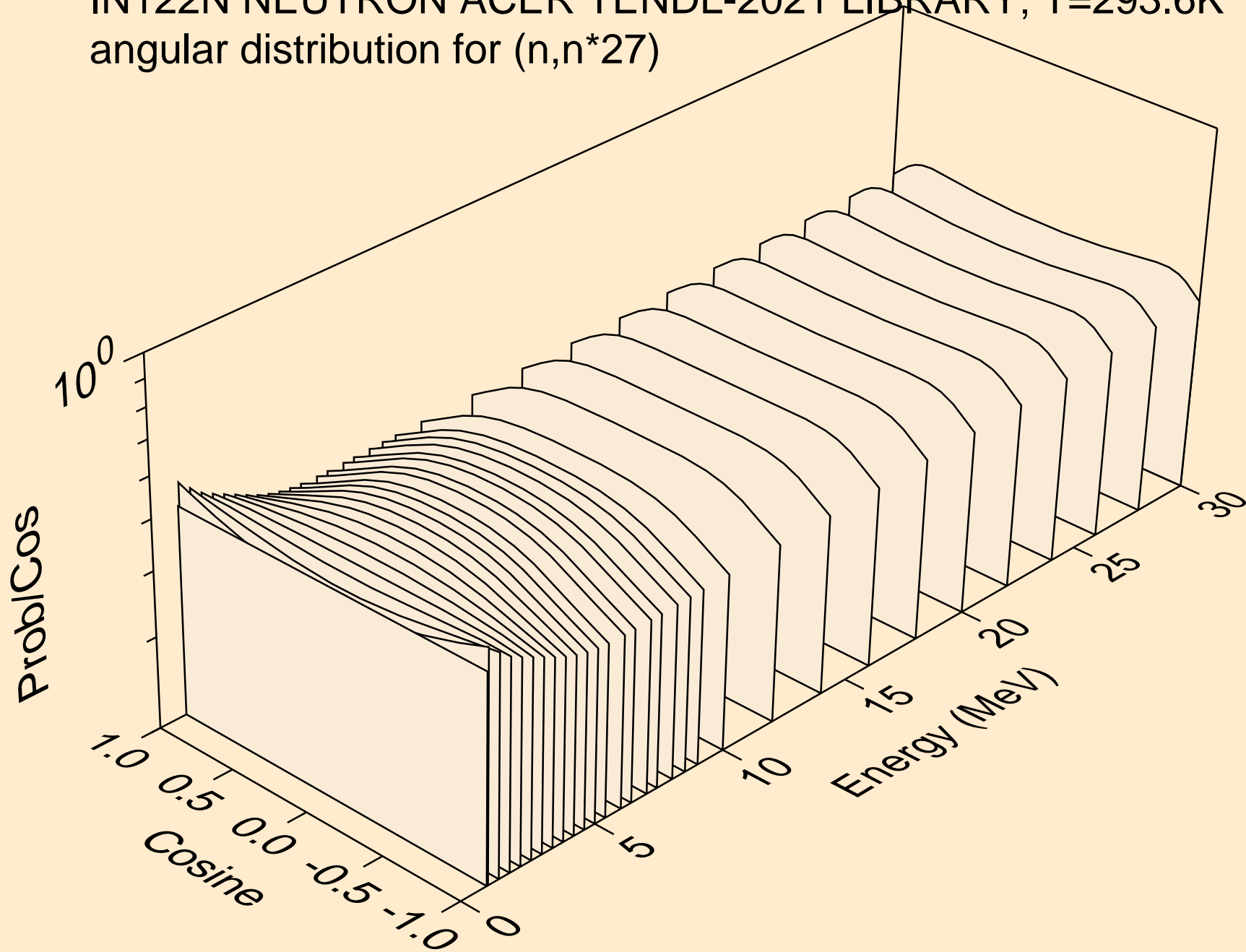

IN122N NEUTRON ACER TENDL-2021 LIBRARY; T=293.6K  
angular distribution for (n,n\*28)

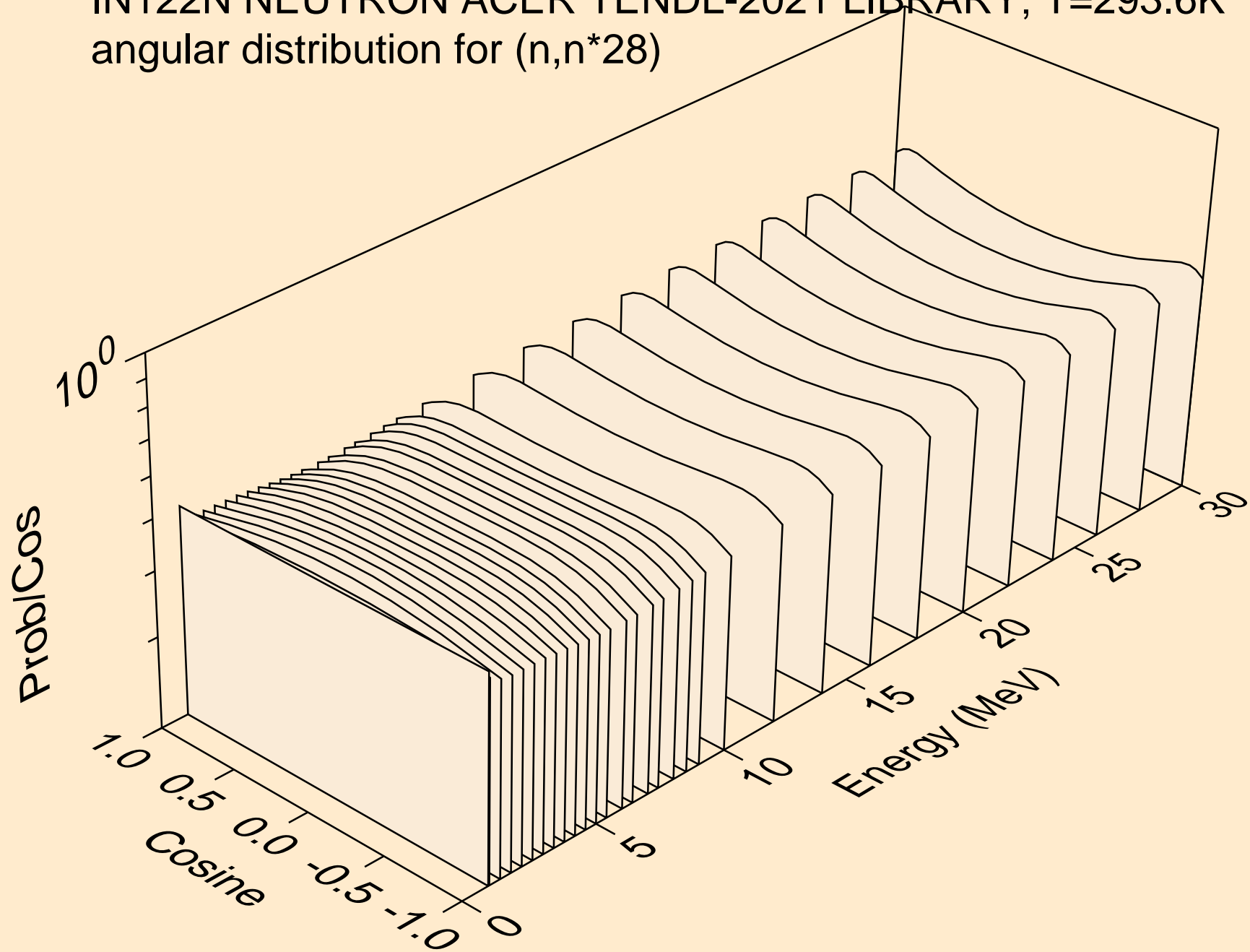

IN122N NEUTRON ACER TENDL-2021 LIBRARY; T=293.6K  
angular distribution for (n,n\*29)

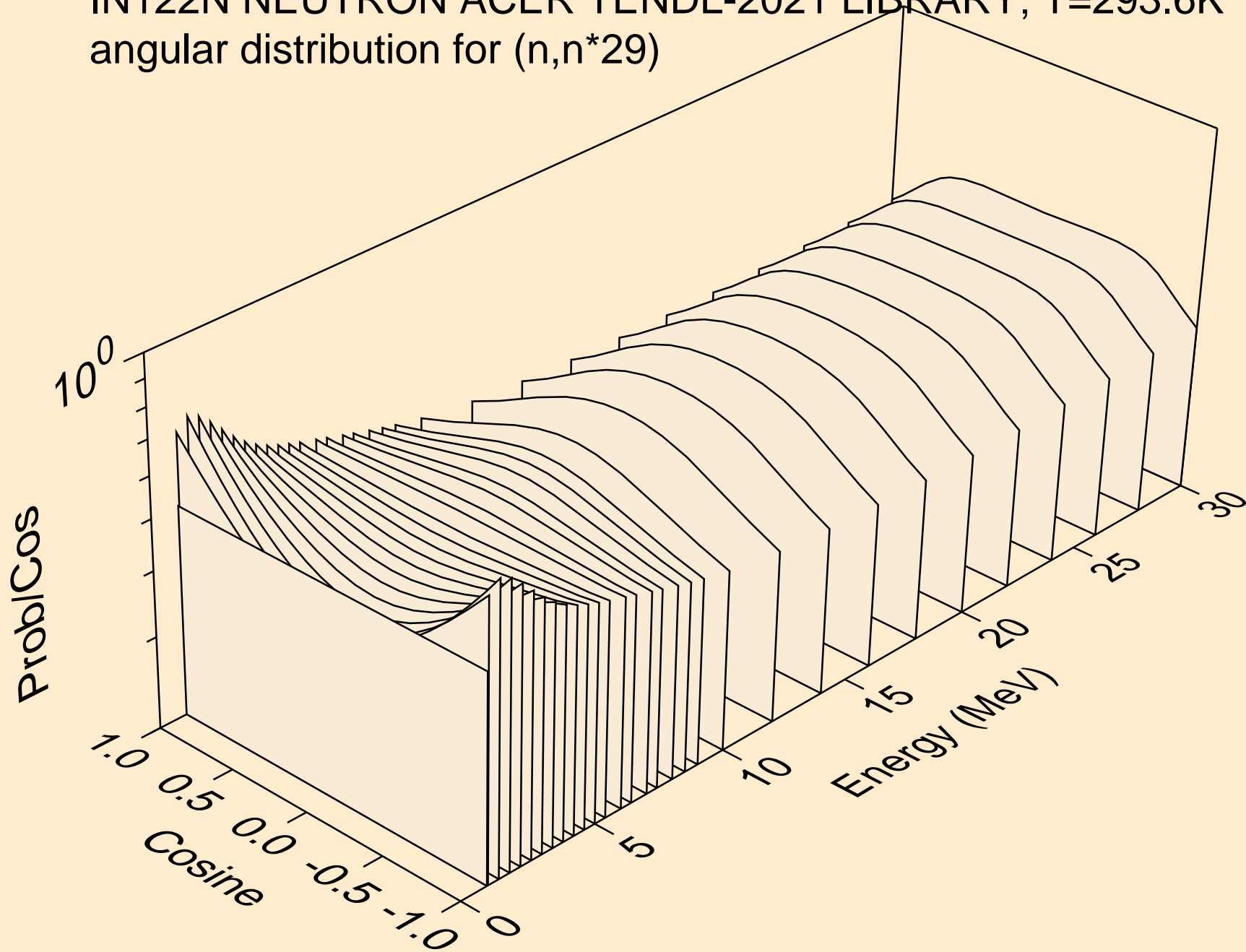

IN122N NEUTRON ACER TENDL-2021 LIBRARY; T=293.6K  
angular distribution for (n,n\*30)

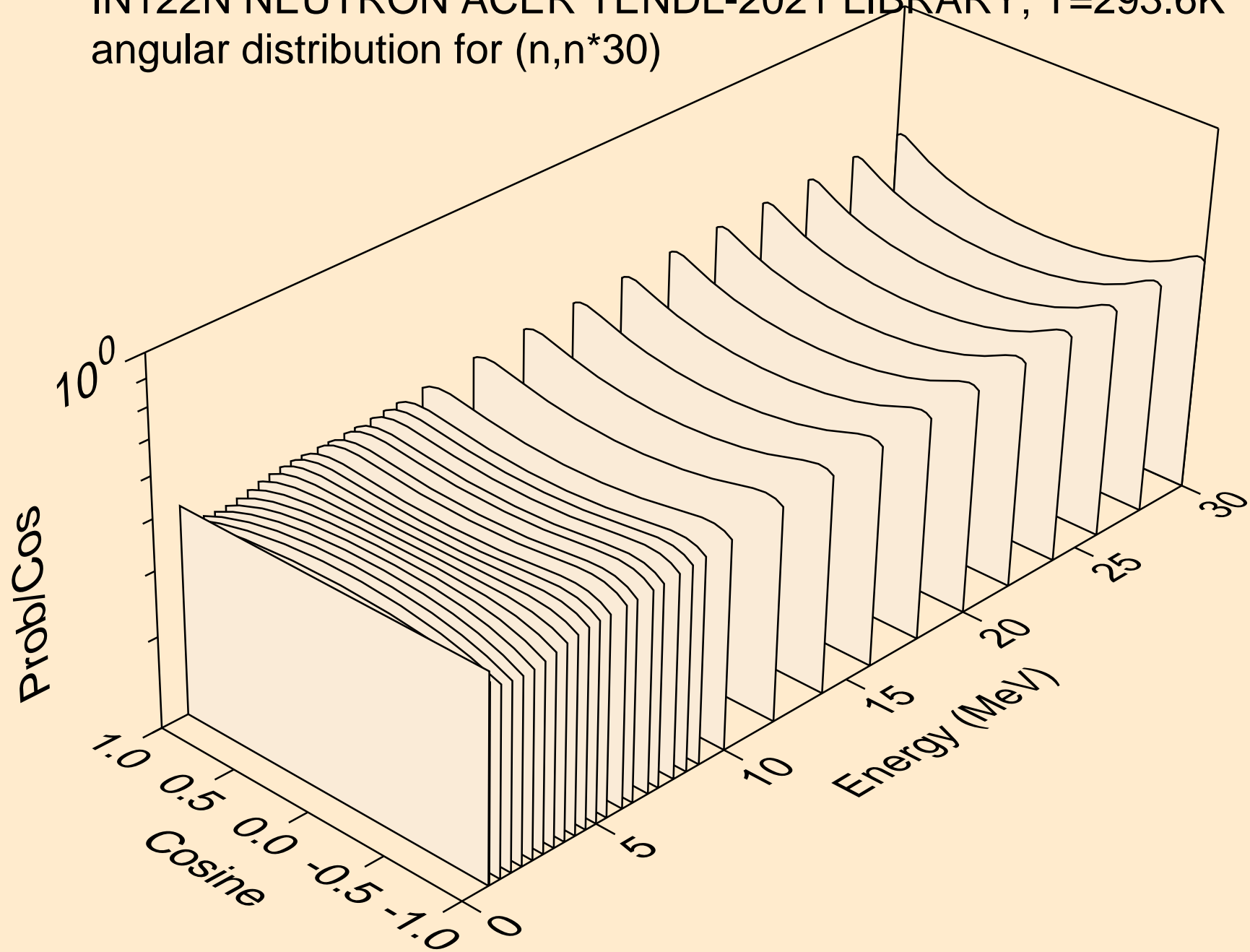

IN122N NEUTRON ACER TENDL-2021 LIBRARY; T=293.6K  
Neutron emission for (n,x)

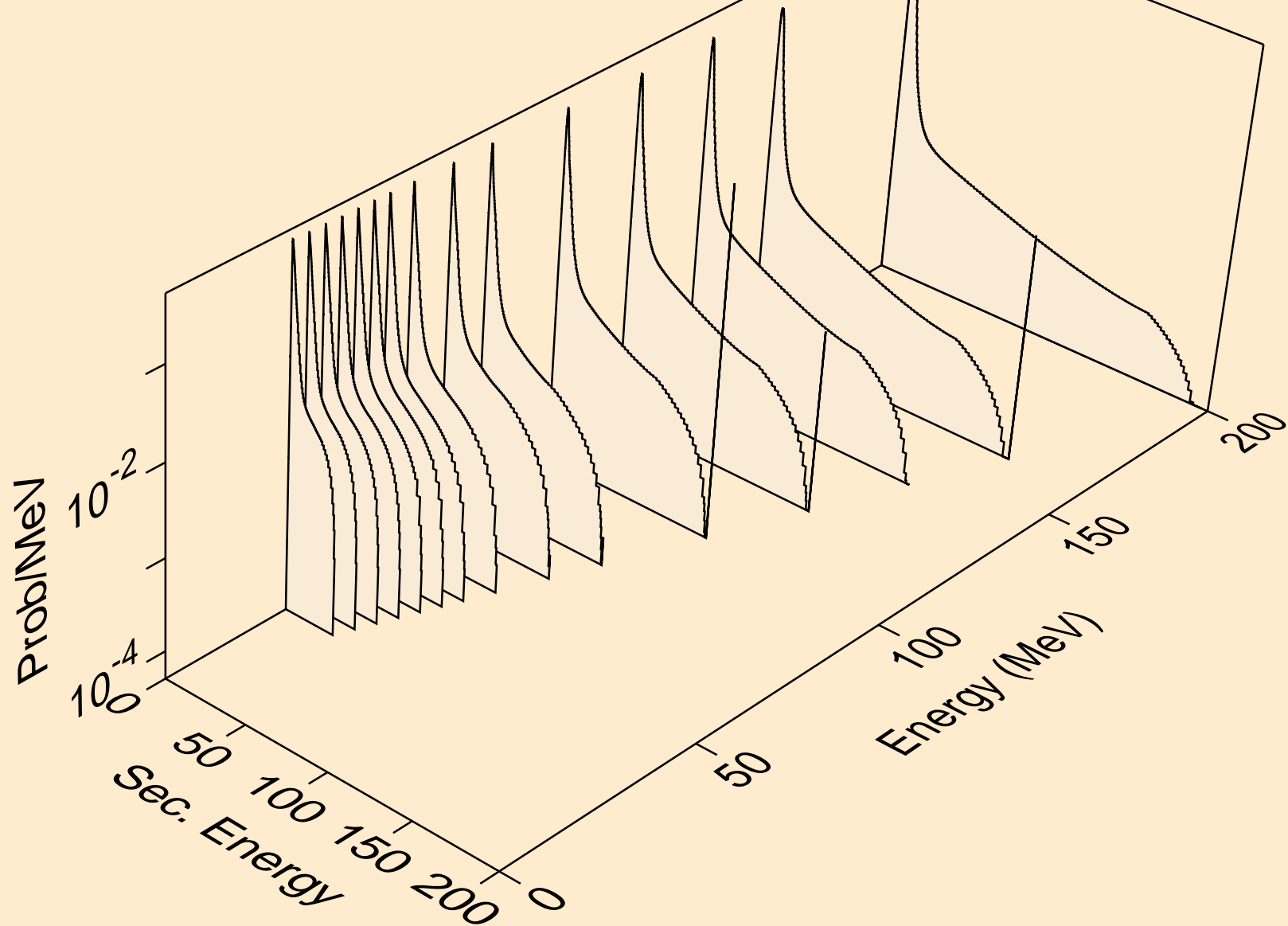

IN122N NEUTRON ACER TENDL-2021 LIBRARY; T=293.6K  
Neutron emission for (n,2nd)

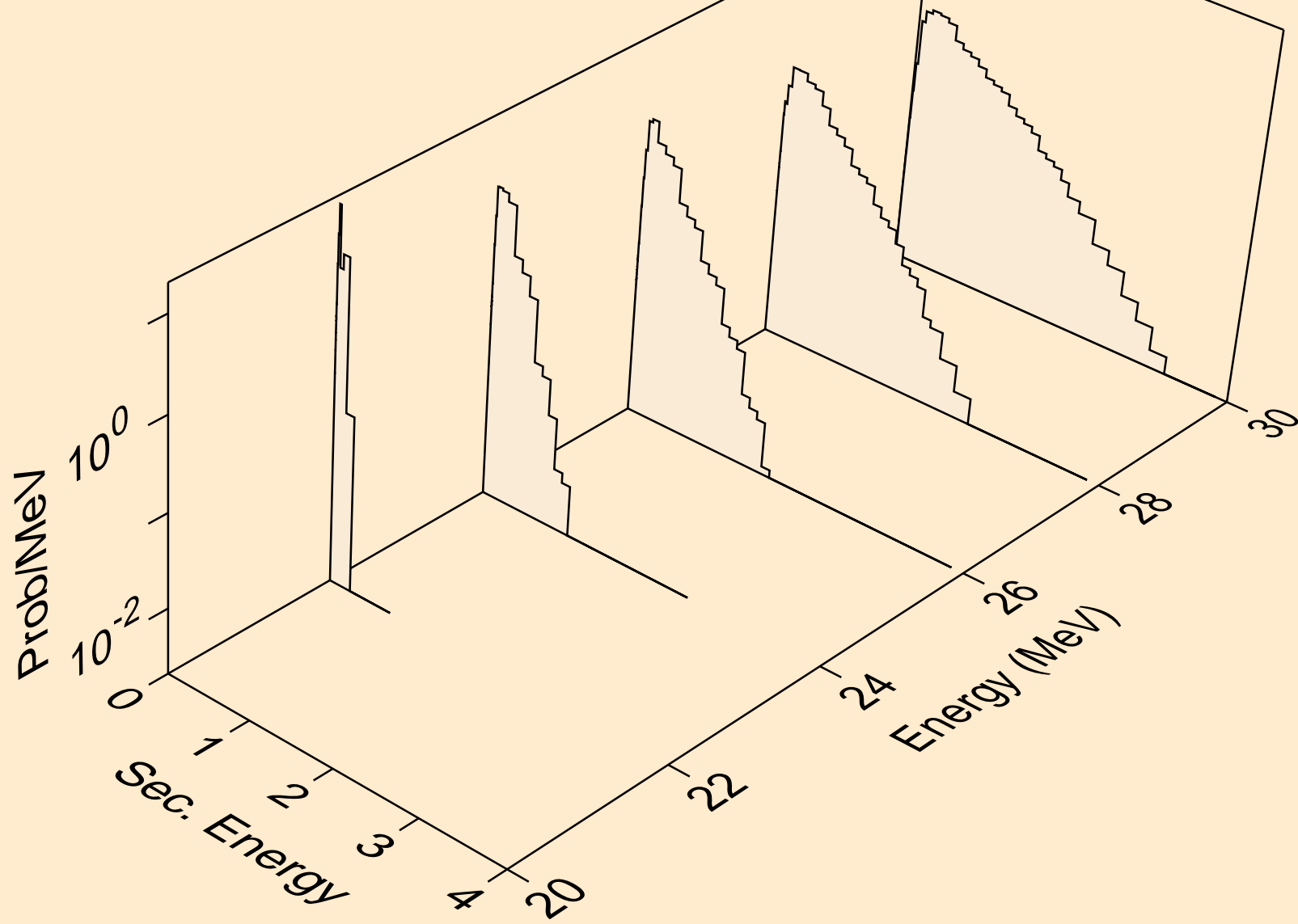

IN122N NEUTRON ACER TENDL-2021 LIBRARY; T=293.6K  
Neutron emission for (n,2n)

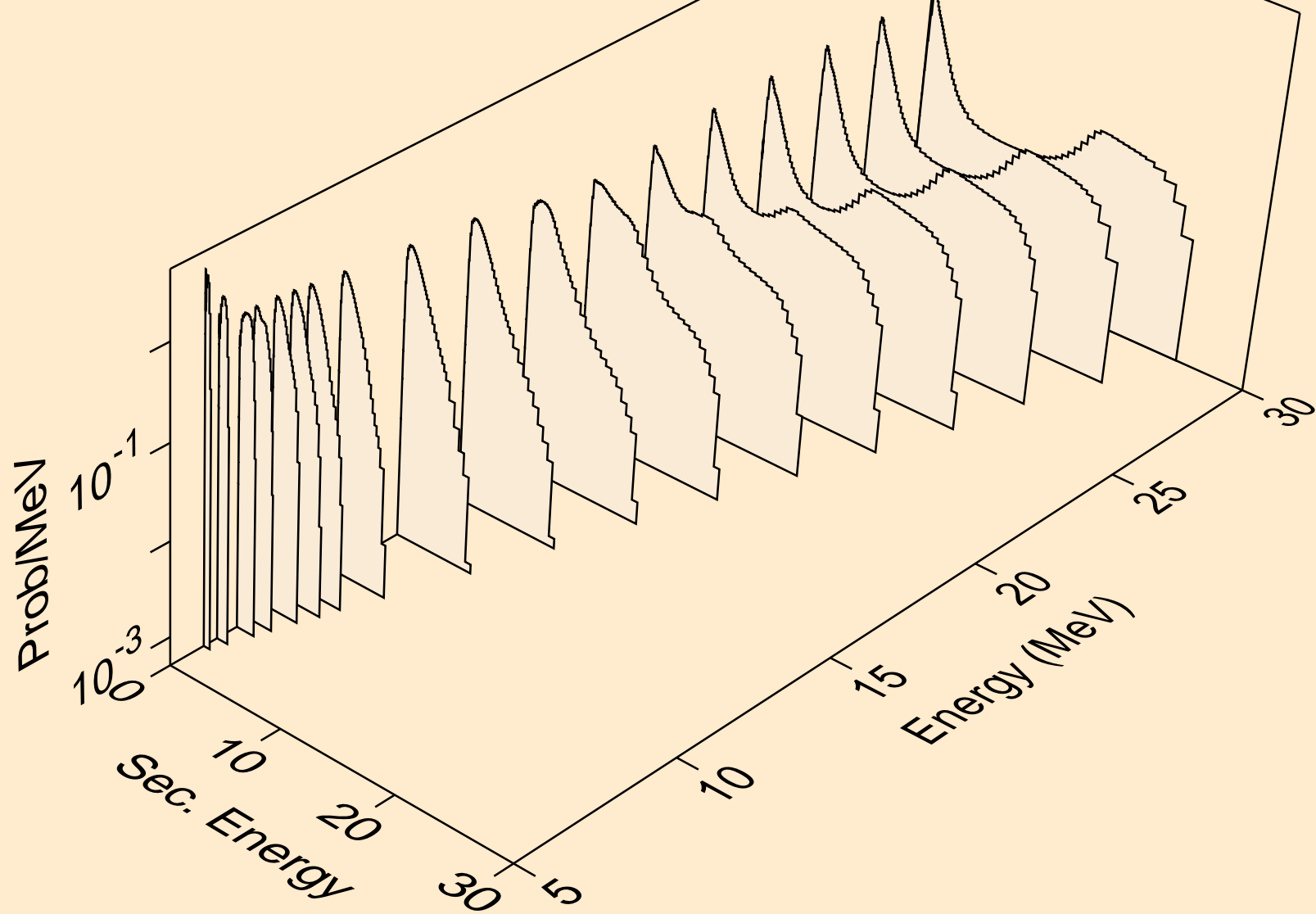

IN122N NEUTRON ACER TENDL-2021 LIBRARY; T=293.6K  
Neutron emission for (n,3n)

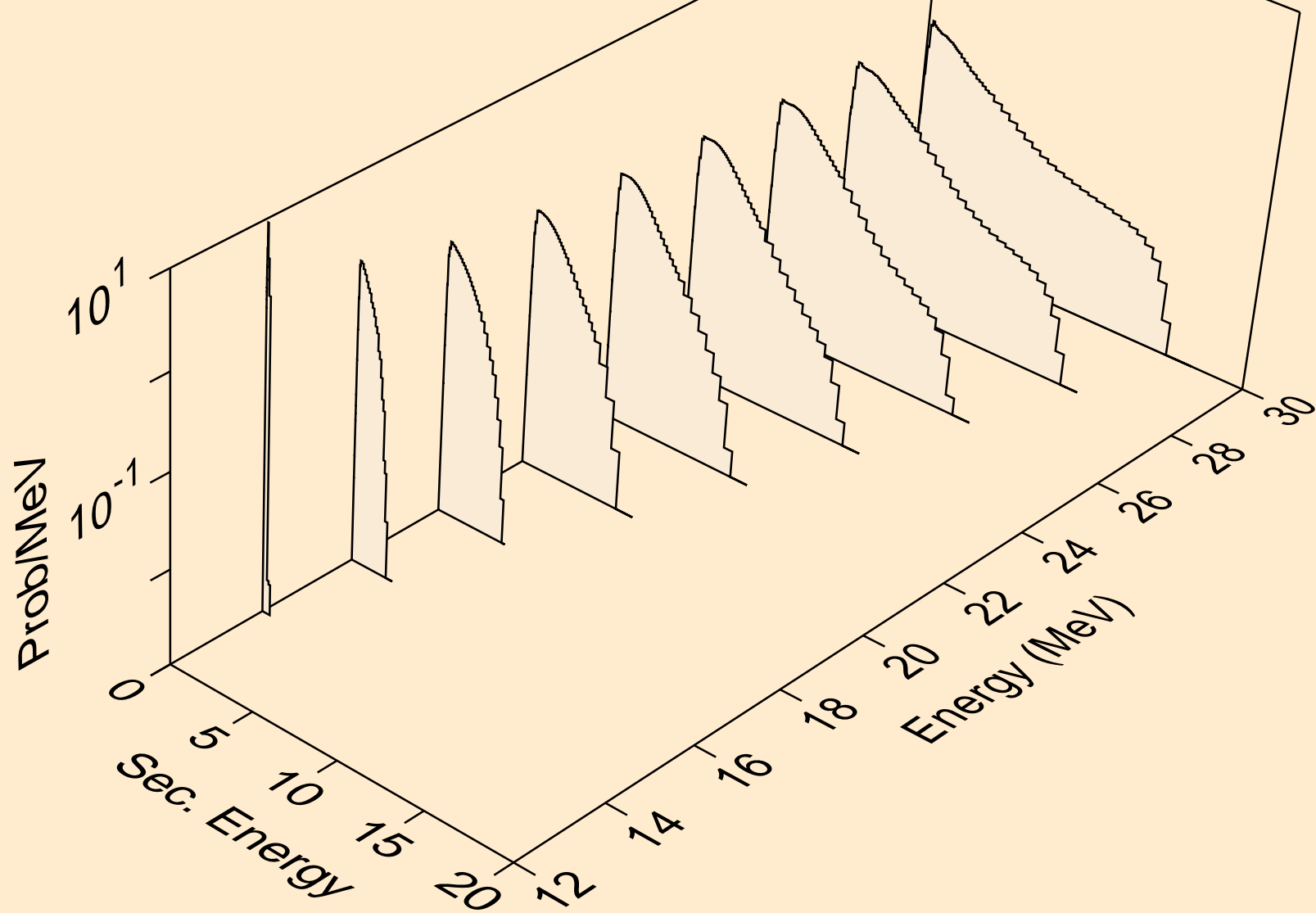



IN122N NEUTRON ACER TENDL-2021 LIBRARY; T=293.6K  
Neutron emission for (n,n\*)a

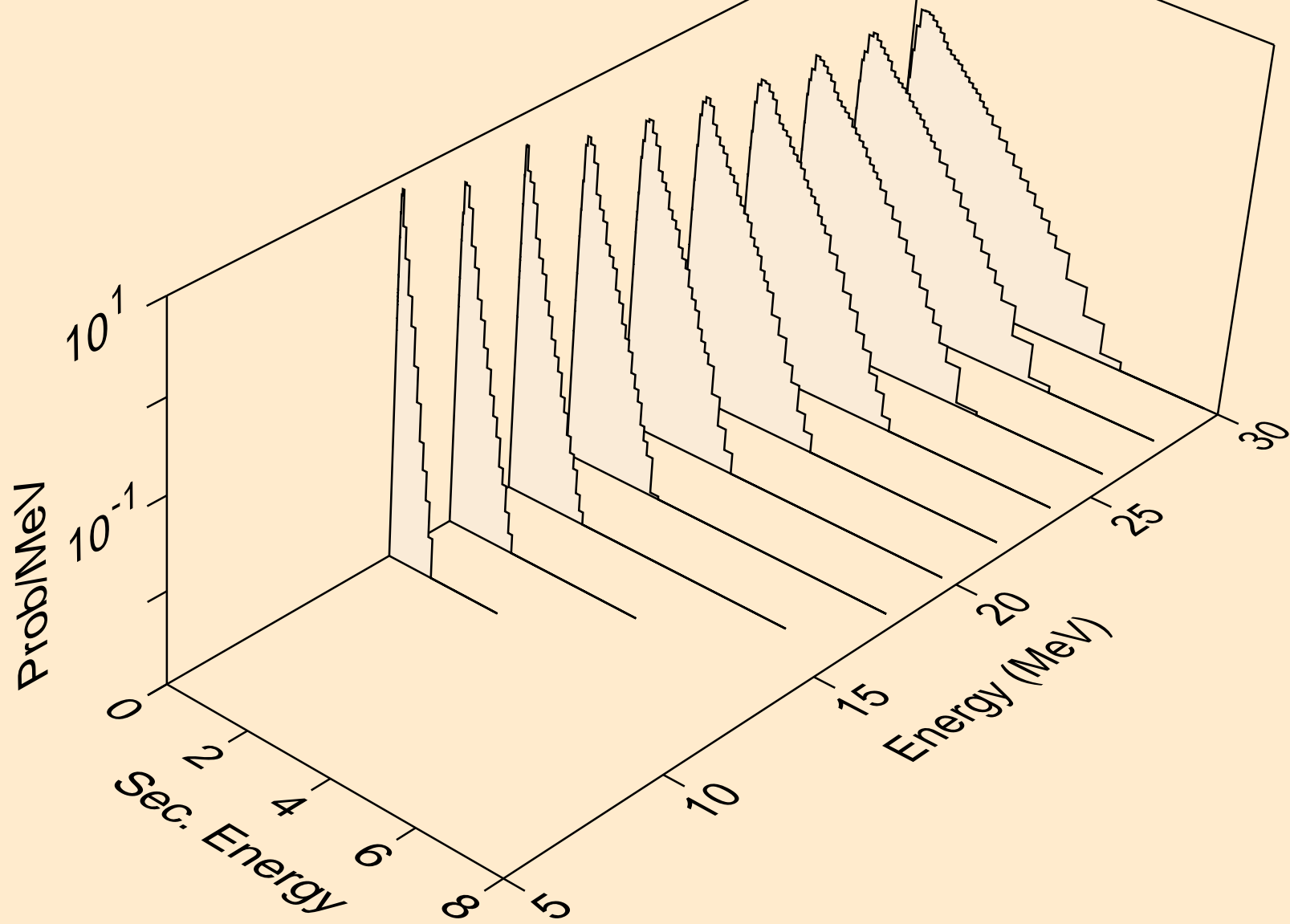

IN122N NEUTRON ACER TENDL-2021 LIBRARY; T=293.6K  
Neutron emission for (n,2n)<sub>a</sub>

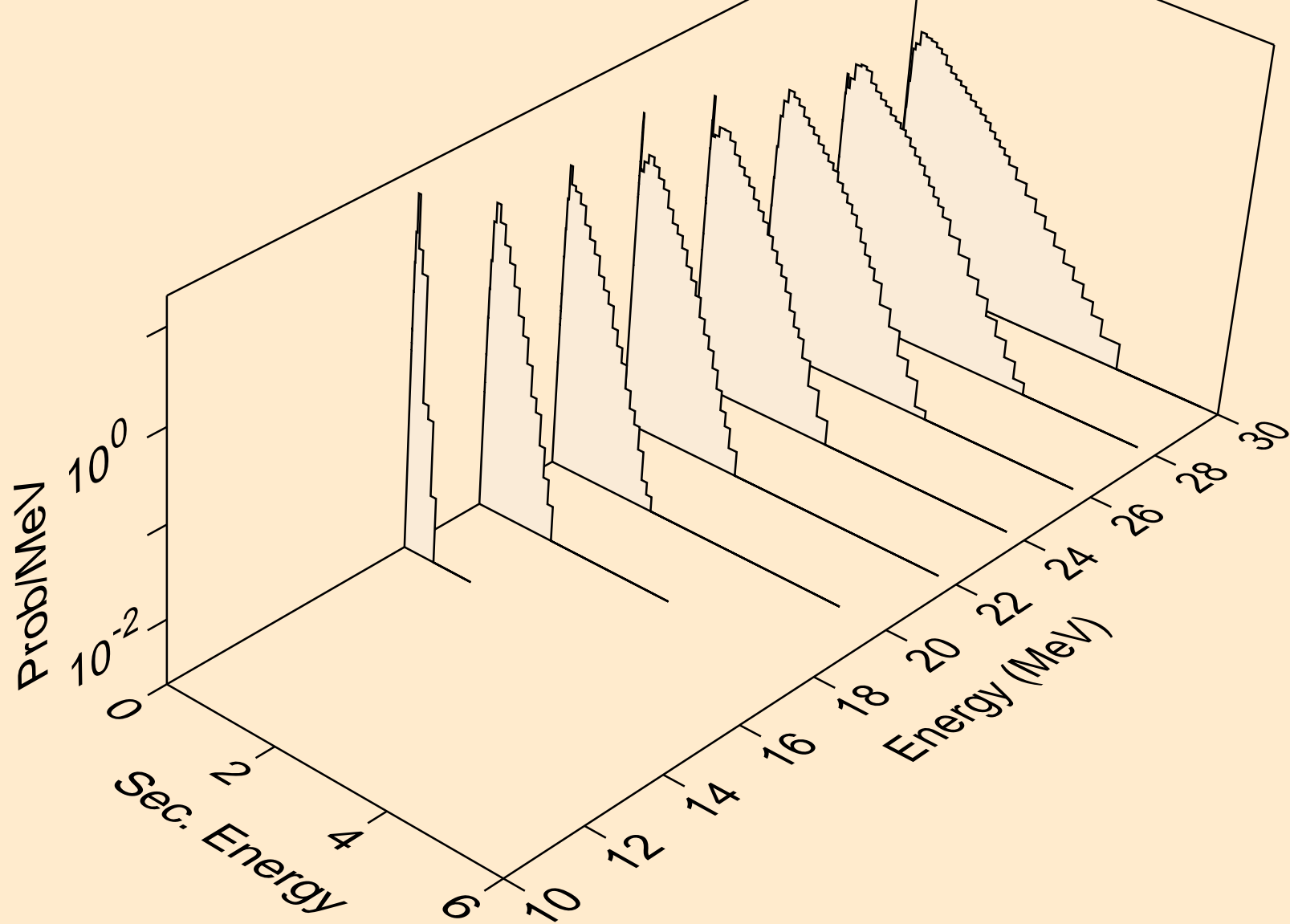

IN122N NEUTRON ACER TENDL-2021 LIBRARY; T=293.6K  
Neutron emission for (n,3n)a

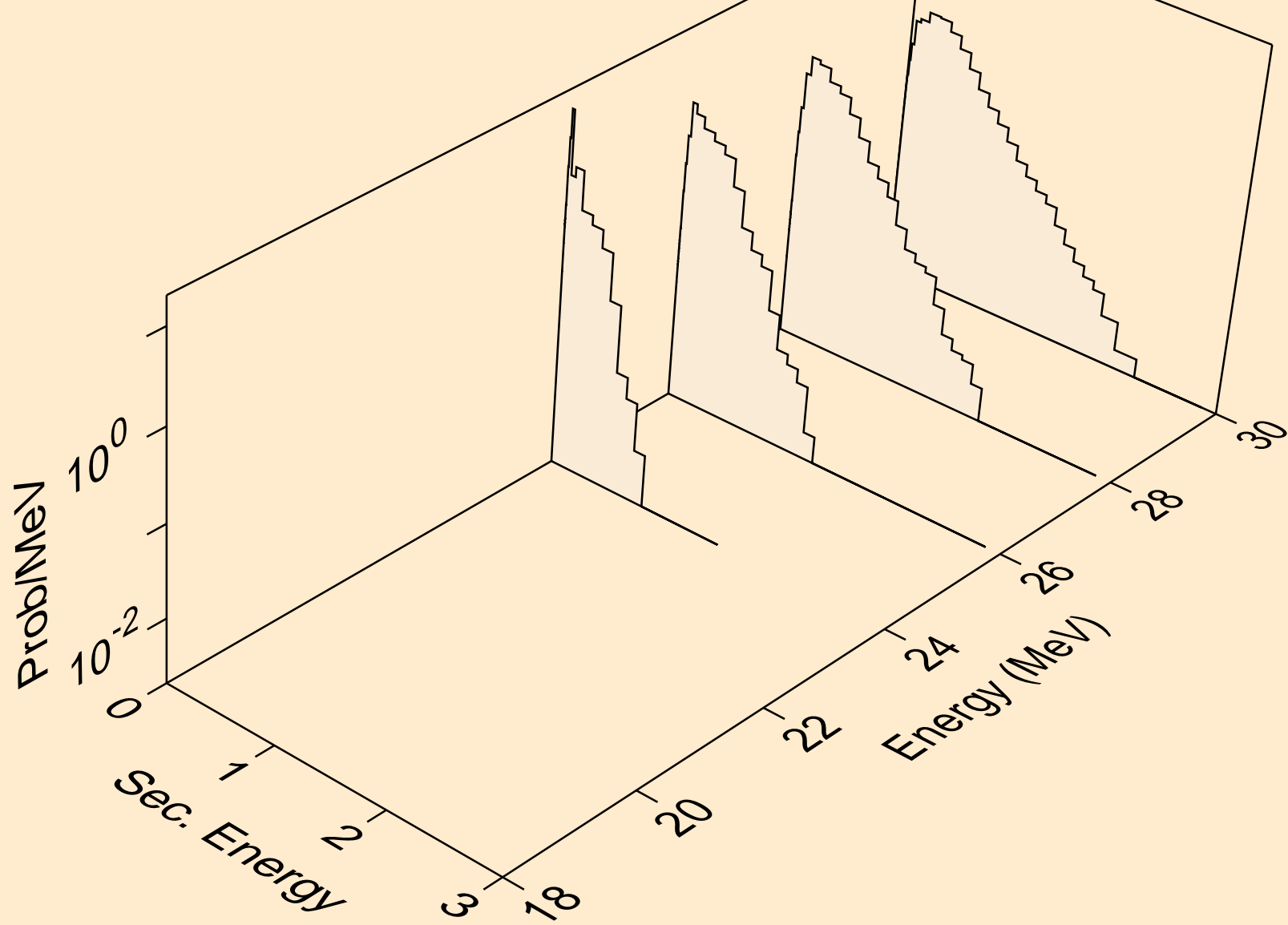

IN122N NEUTRON ACER TENDL-2021 LIBRARY; T=293.6K  
Neutron emission for (n,n\*)p

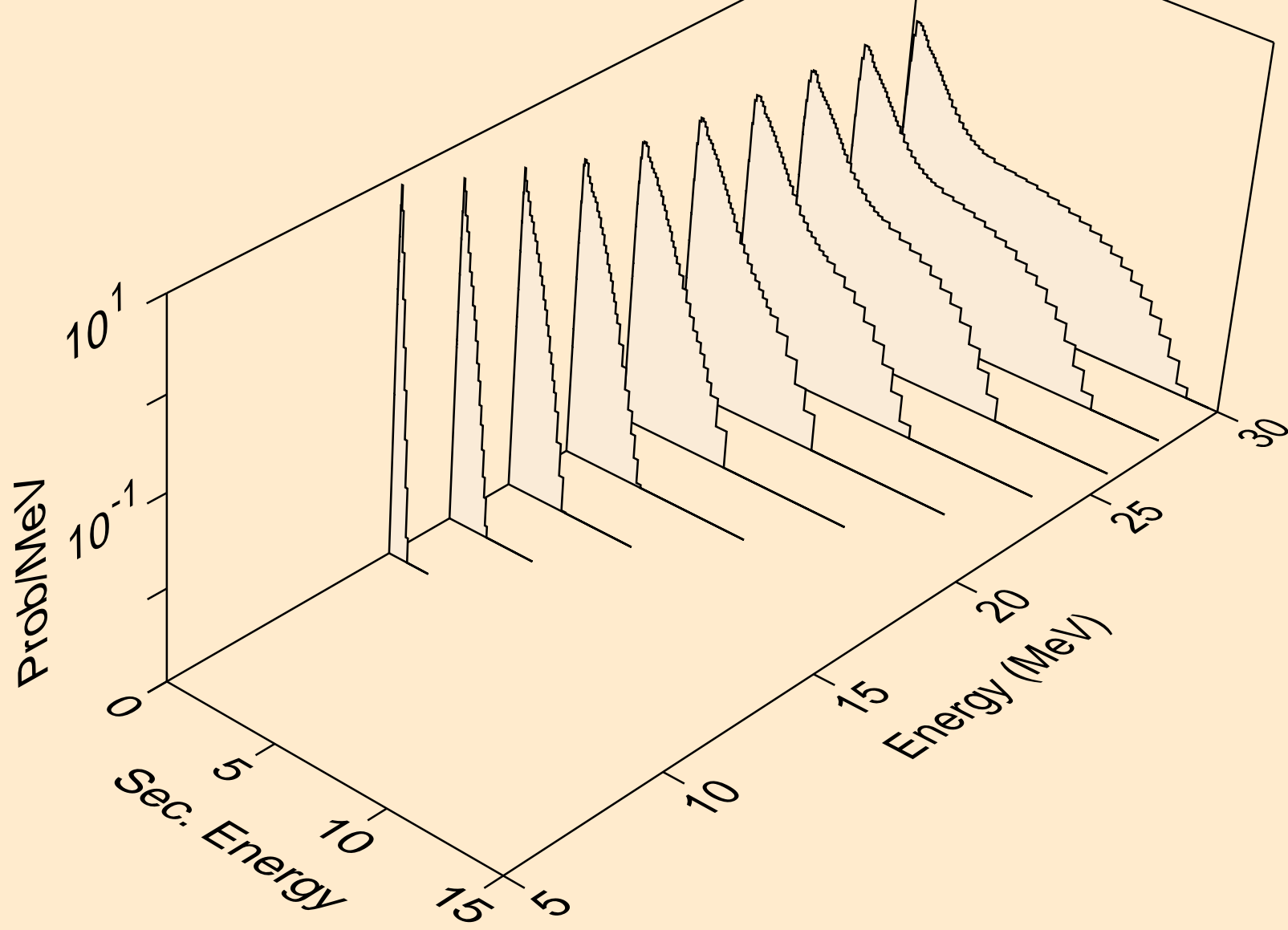

IN122N NEUTRON ACER TENDL-2021 LIBRARY; T=293.6K  
Neutron emission for (n,n\*)d

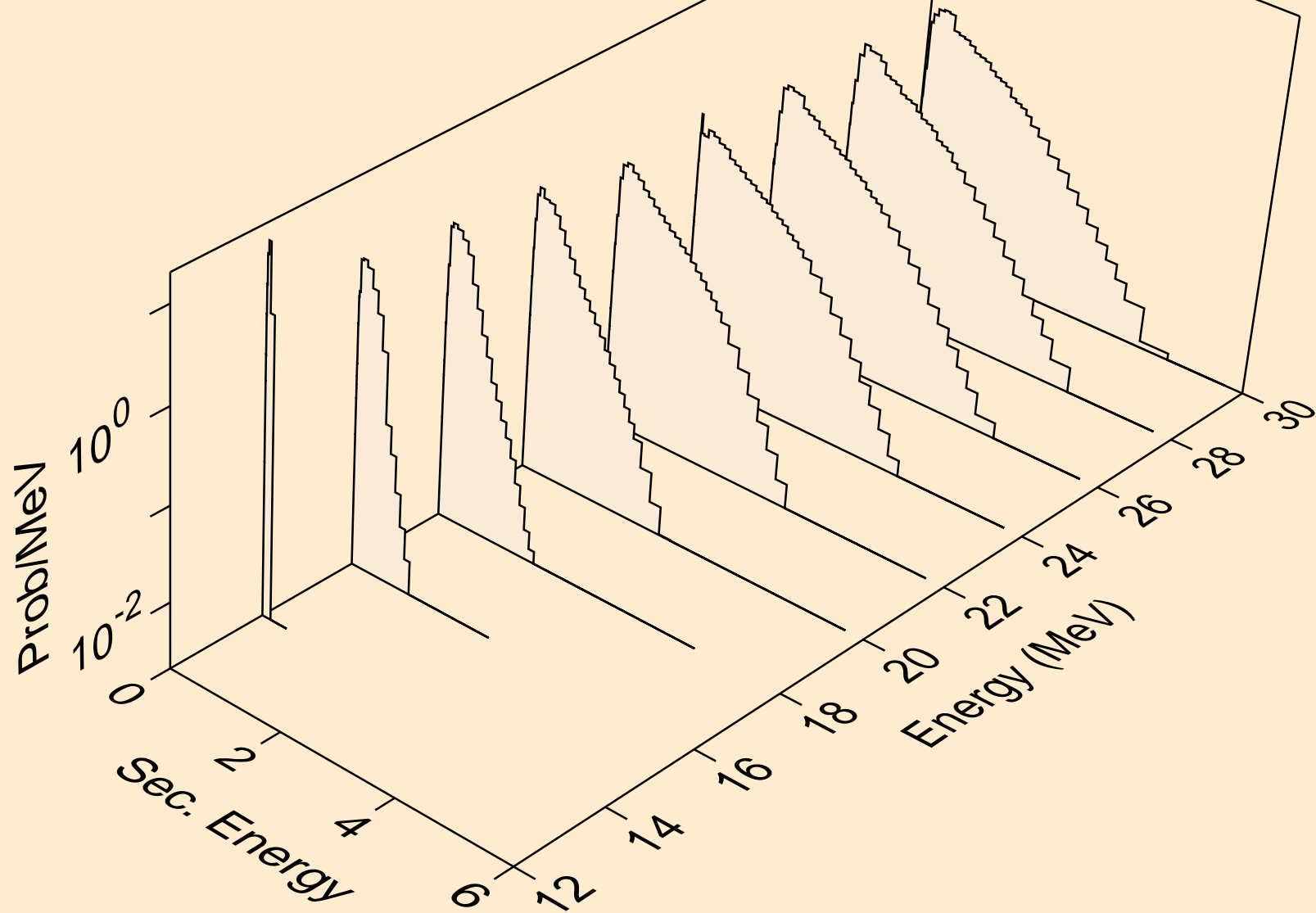

IN122N NEUTRON ACER TENDL-2021 LIBRARY; T=293.6K  
Neutron emission for (n,n\*)t

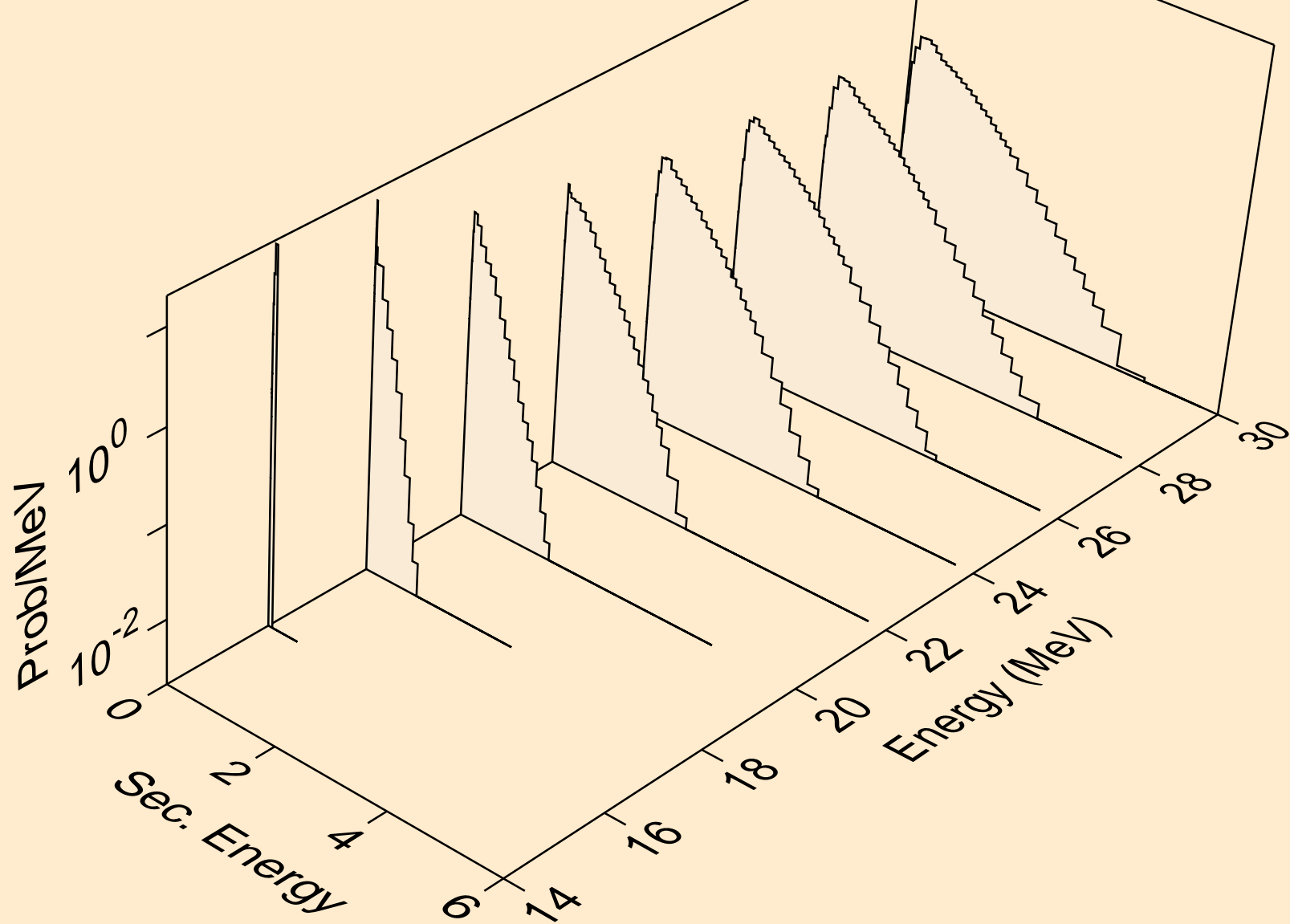

IN122N NEUTRON ACER TENDL-2021 LIBRARY; T=293.6K  
Neutron emission for (n,n\*)he3

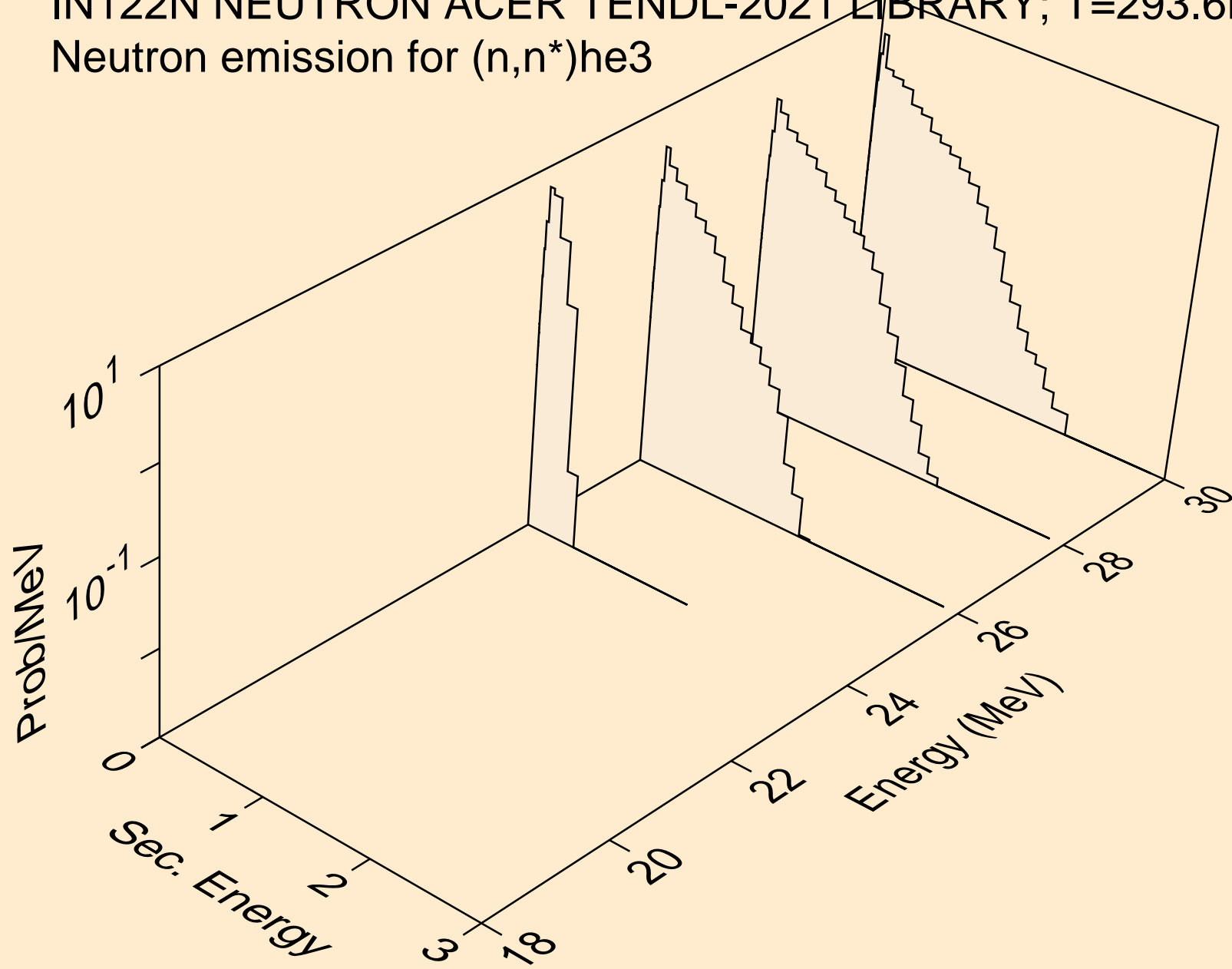

IN122N NEUTRON ACER TENDL-2021 LIBRARY; T=293.6K  
Neutron emission for (n,4n)

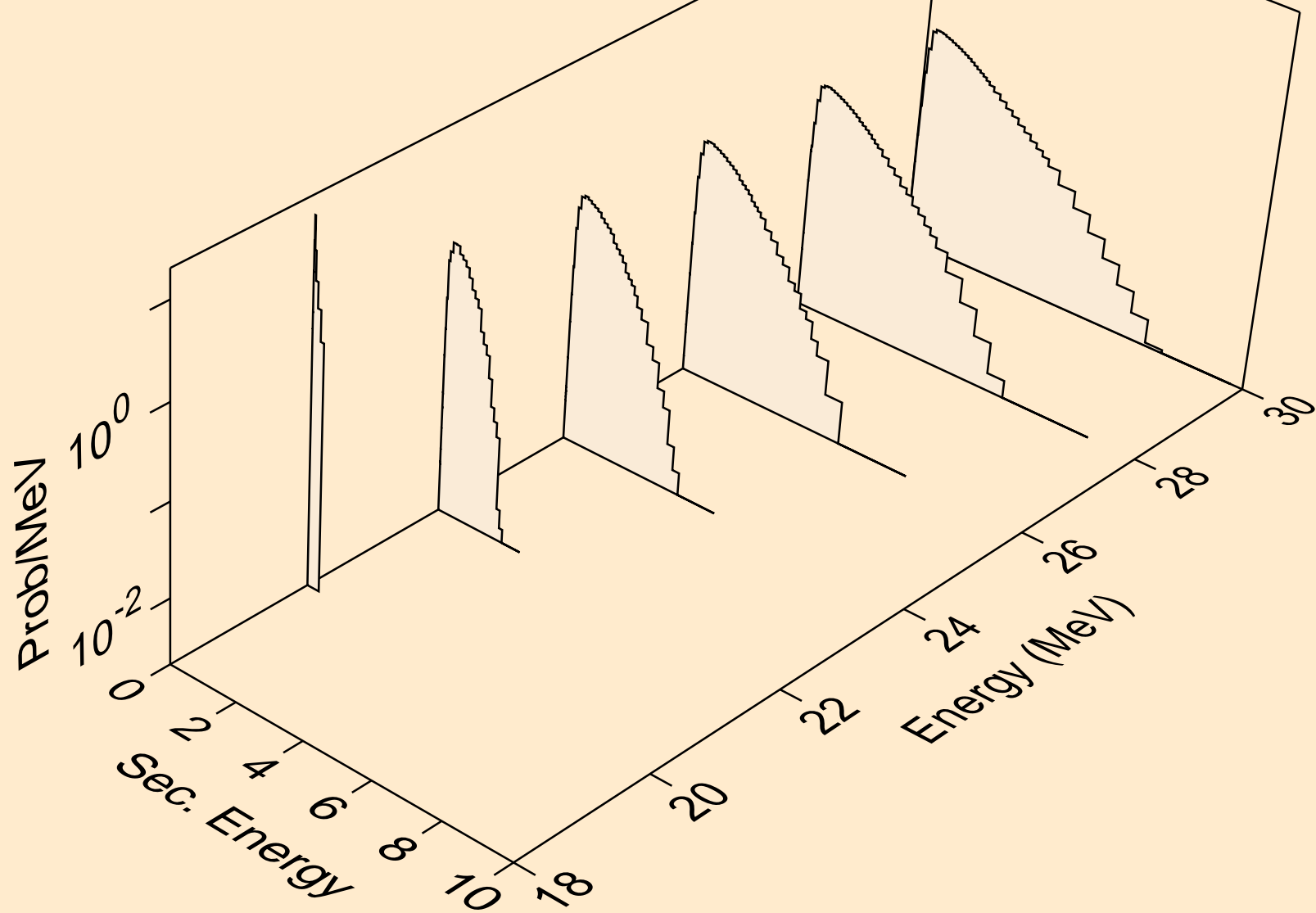



IN122N NEUTRON ACER TENDL-2021 LIBRARY; T=293.6K  
Neutron emission for (n,2np)

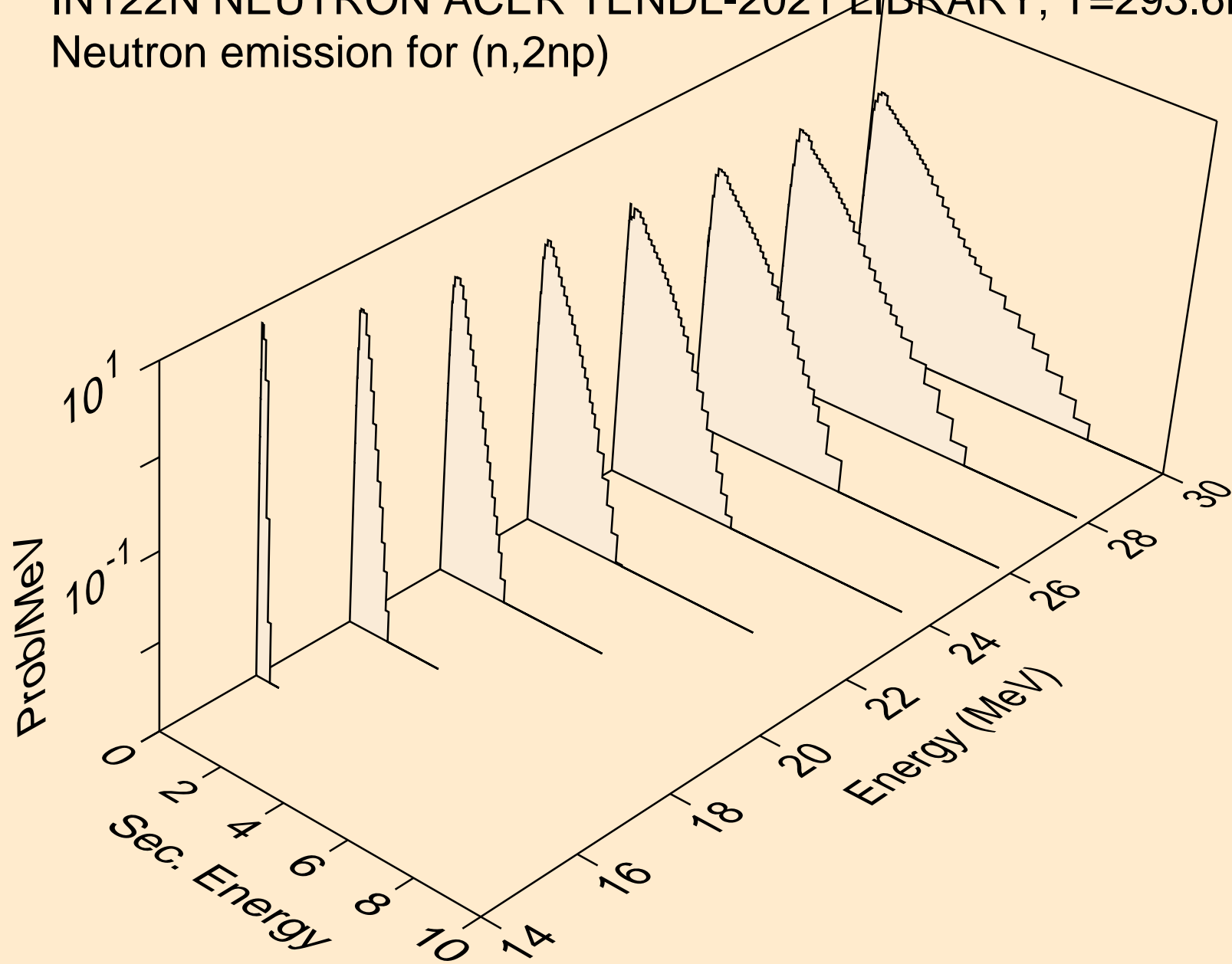

IN122N NEUTRON ACER TENDL-2021 LIBRARY; T=293.6K  
Neutron emission for (n,3np)

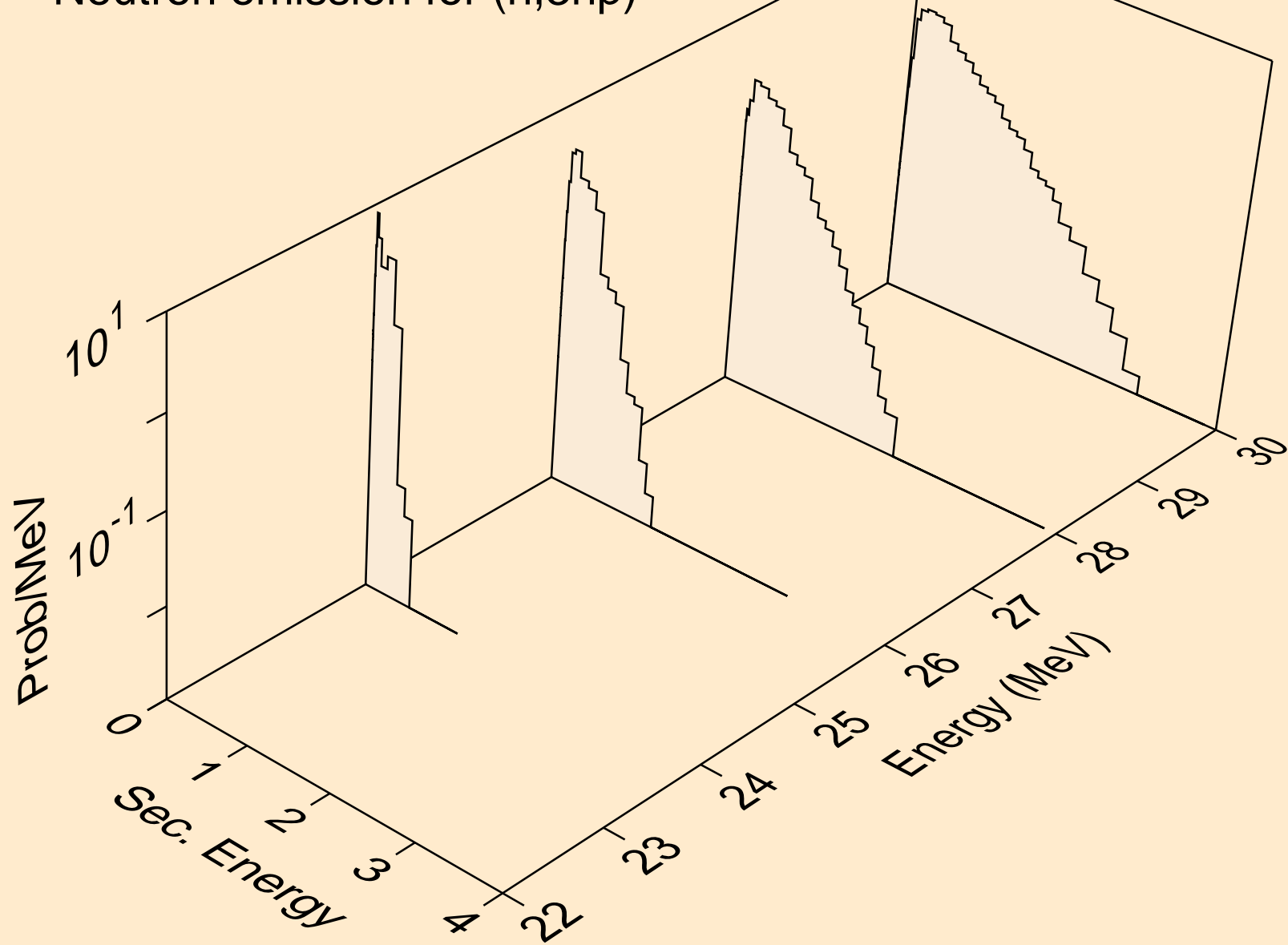

IN122N NEUTRON ACER TENDL-2021 LIBRARY; T=293.6K  
Neutron emission for (n,n\*c)

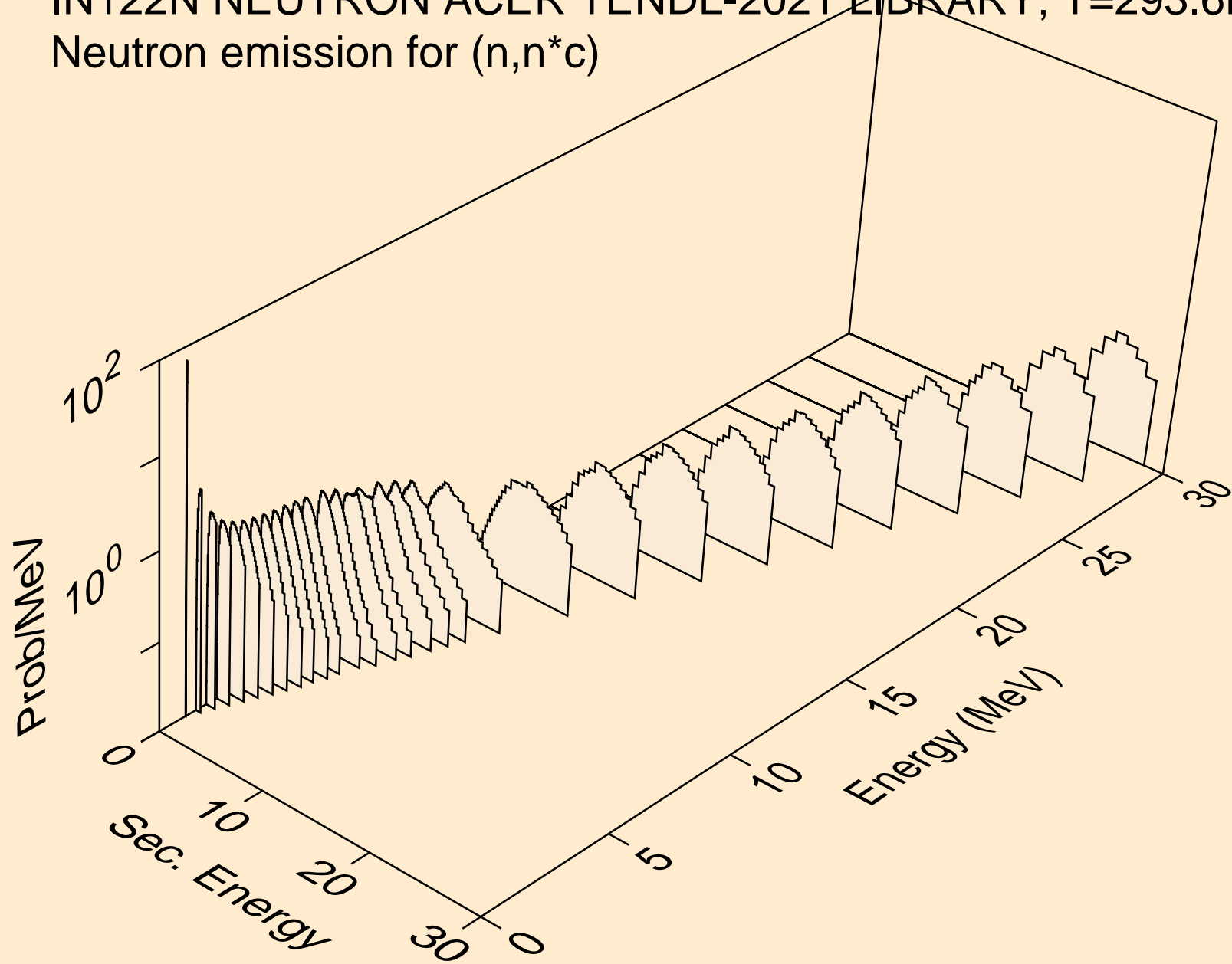

IN122N NEUTRON ACER TENDL-2021 LIBRARY; T=293.6K  
Photon emission for (n,x)

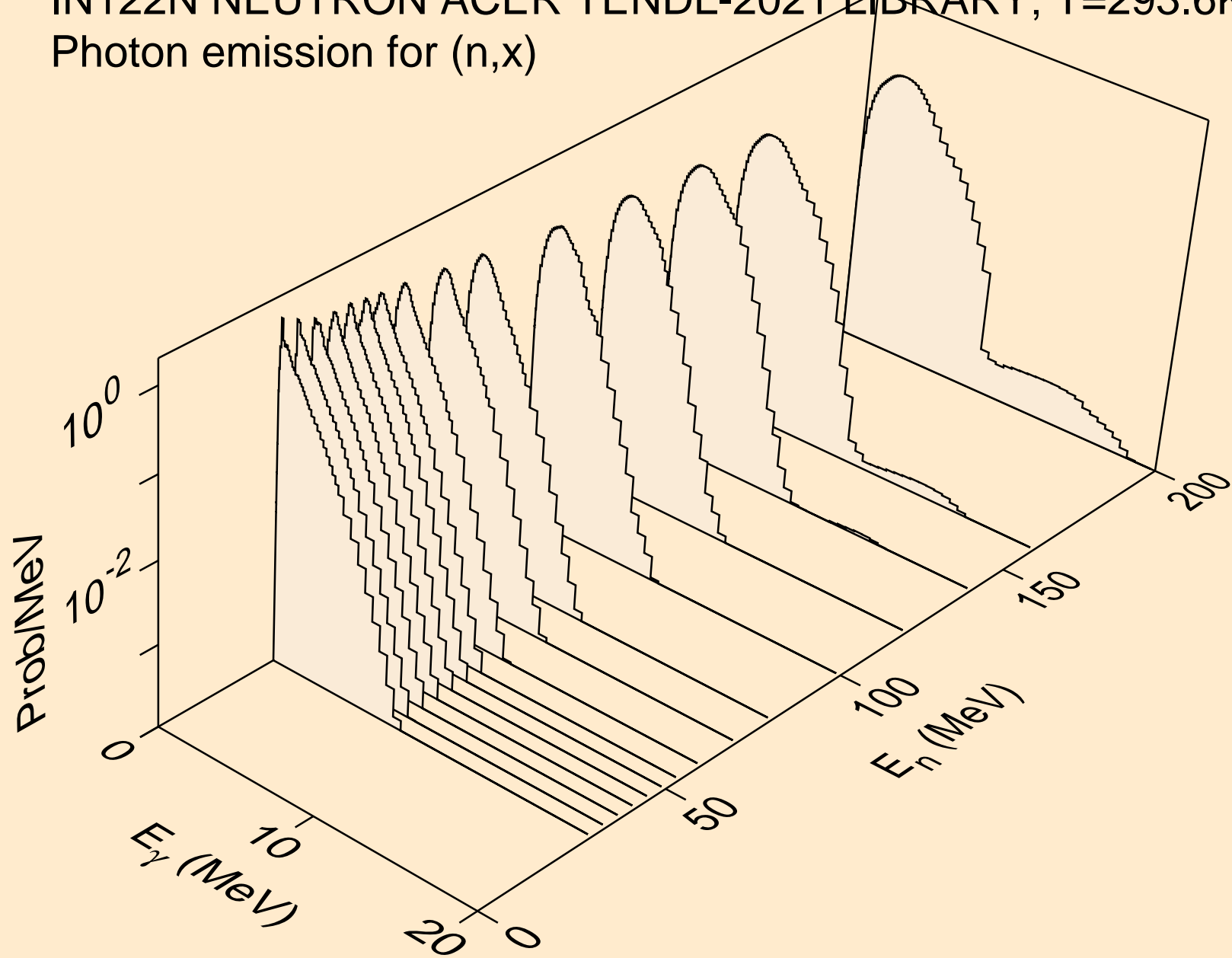

IN122N NEUTRON ACER TENDL-2021 LIBRARY; T=293.6K  
Photon emission for (n,2nd)

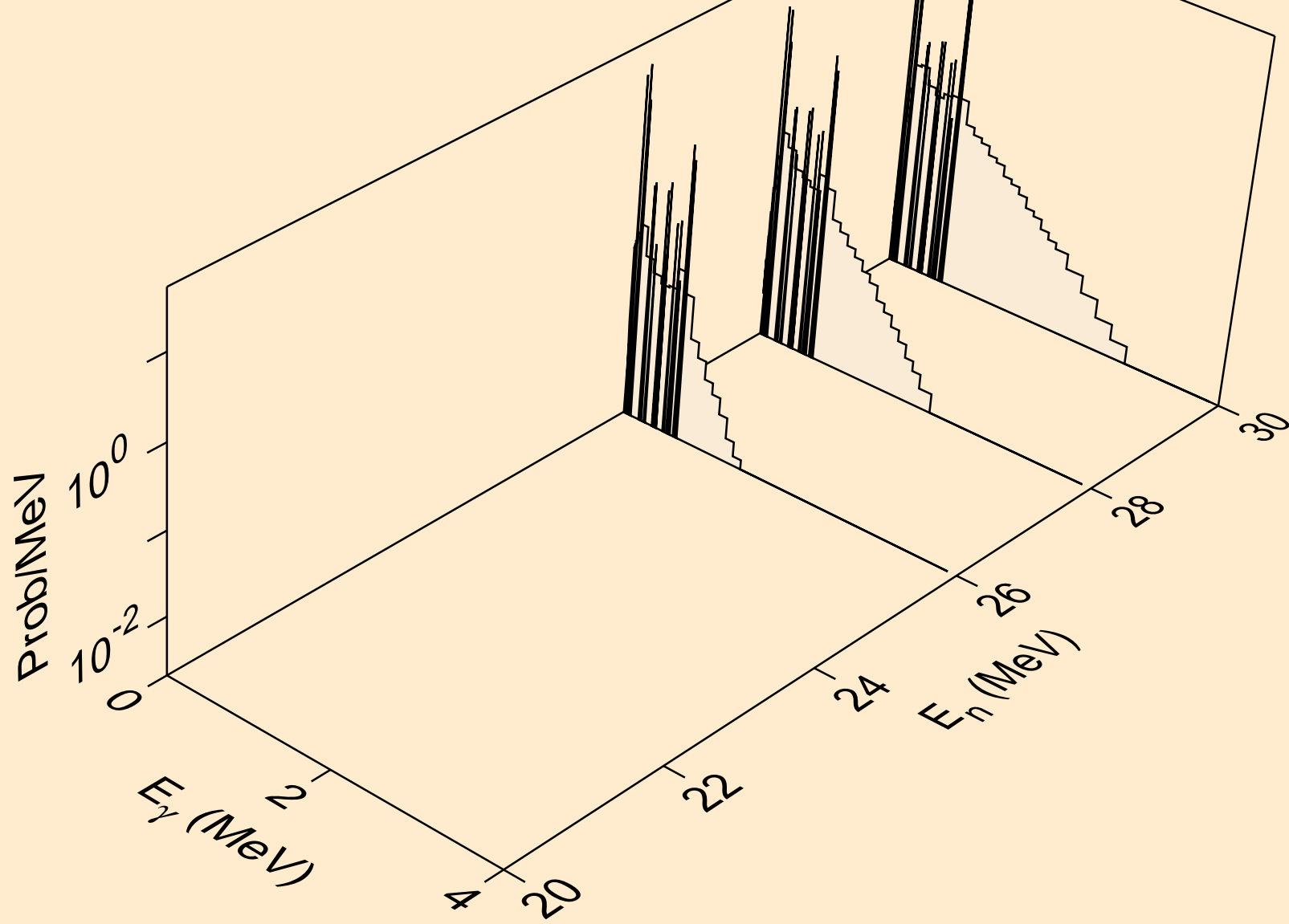

IN122N NEUTRON ACER TENDL-2021 LIBRARY; T=293.6K  
Photon emission for (n,2n)

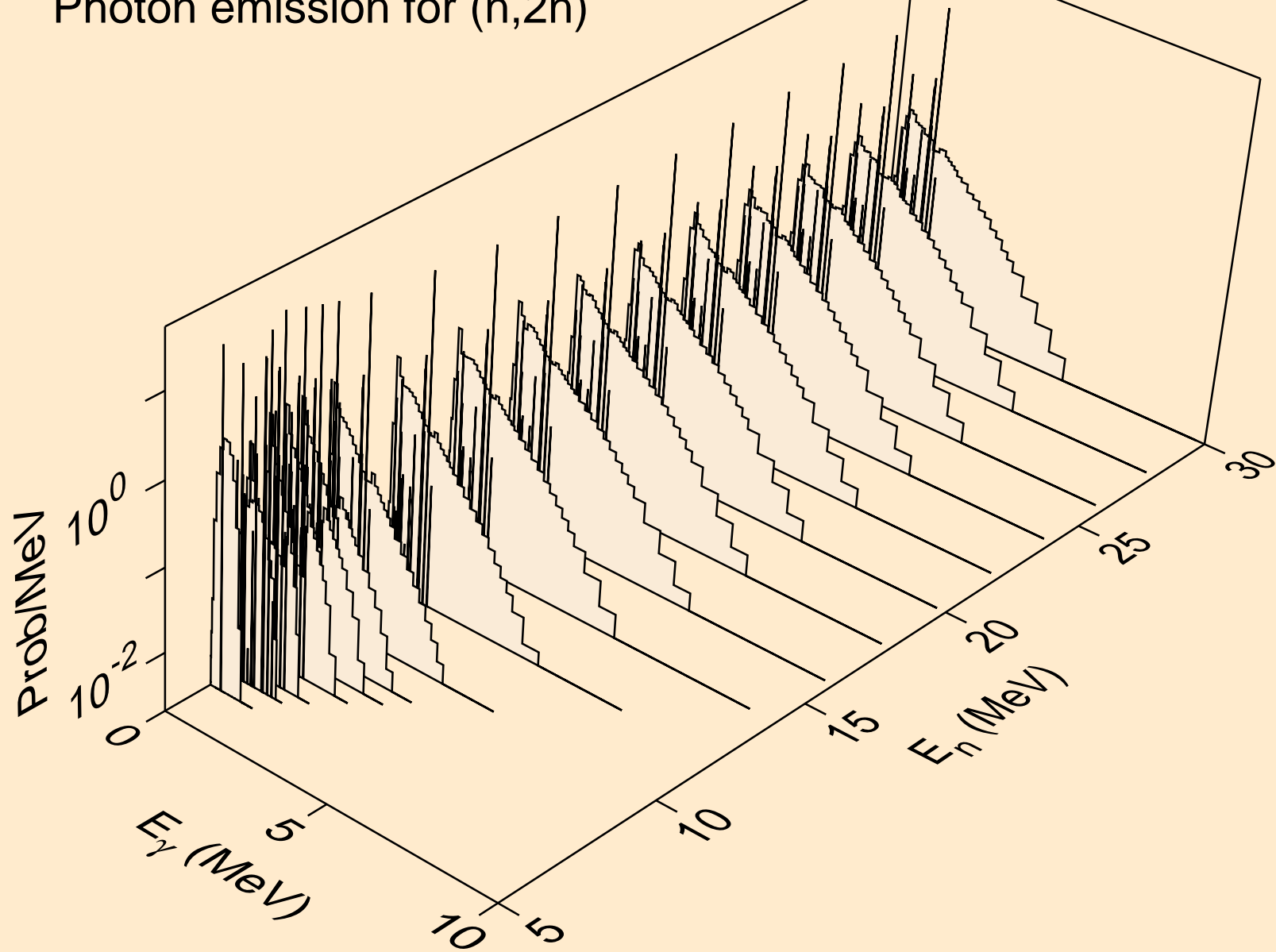

IN122N NEUTRON ACER TENDL-2021 LIBRARY; T=293.6K  
Photon emission for (n,3n)

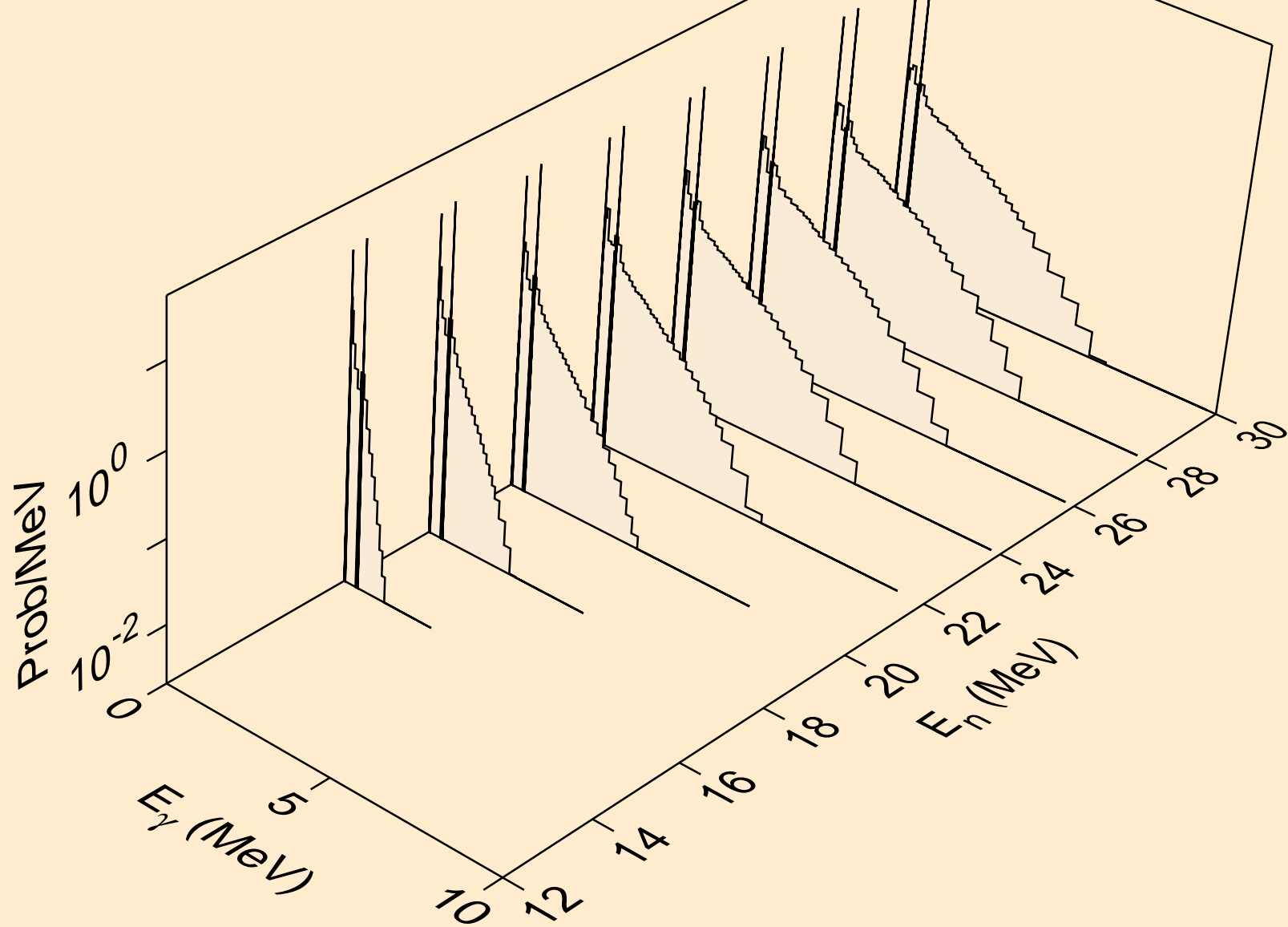

IN122N NEUTRON ACER TENDL-2021 LIBRARY; T=293.6K  
Photon emission for (n,n\*)a

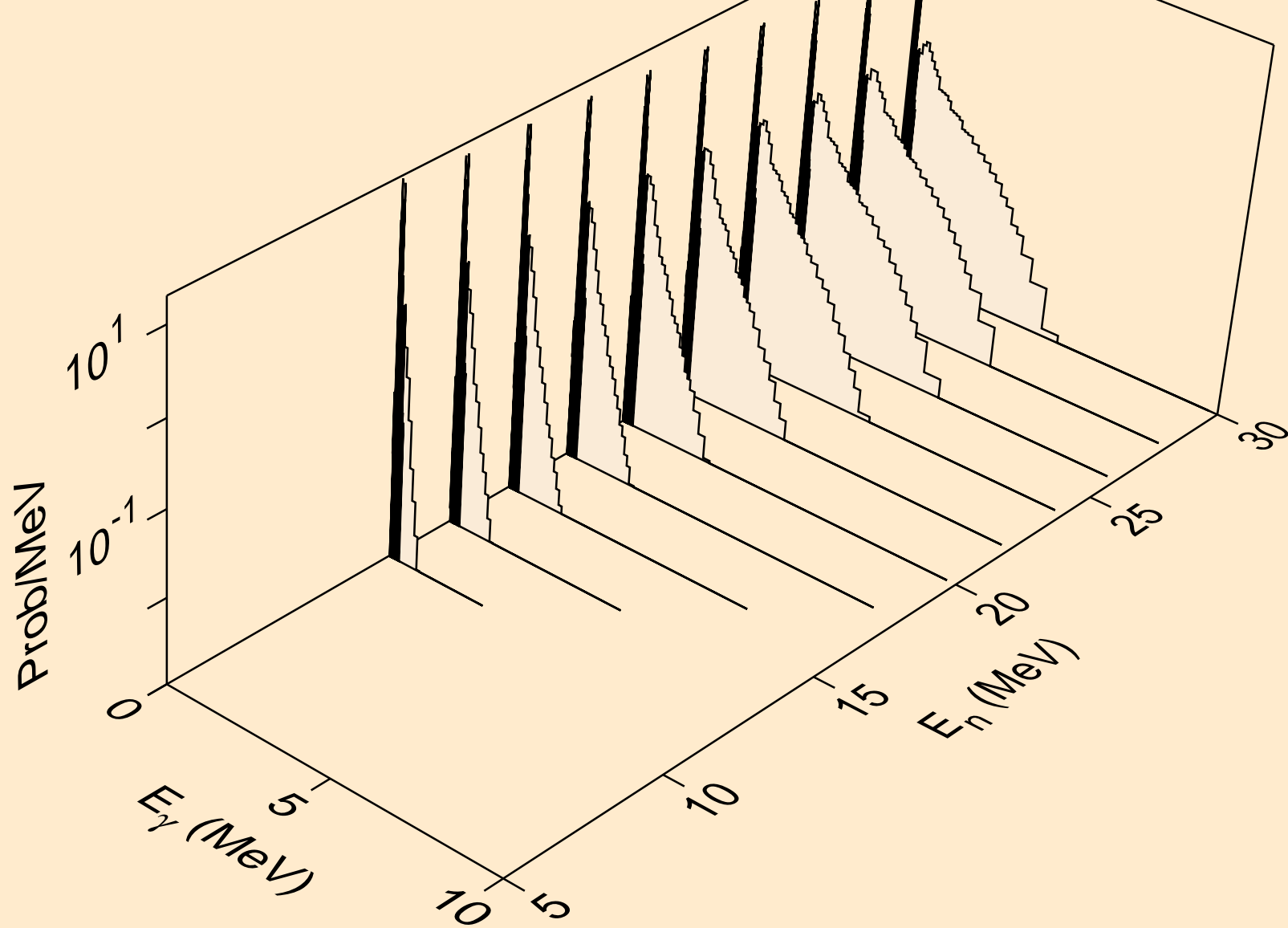



IN122N NEUTRON ACER TENDL-2021 LIBRARY; T=293.6K  
Photon emission for (n,2n)a

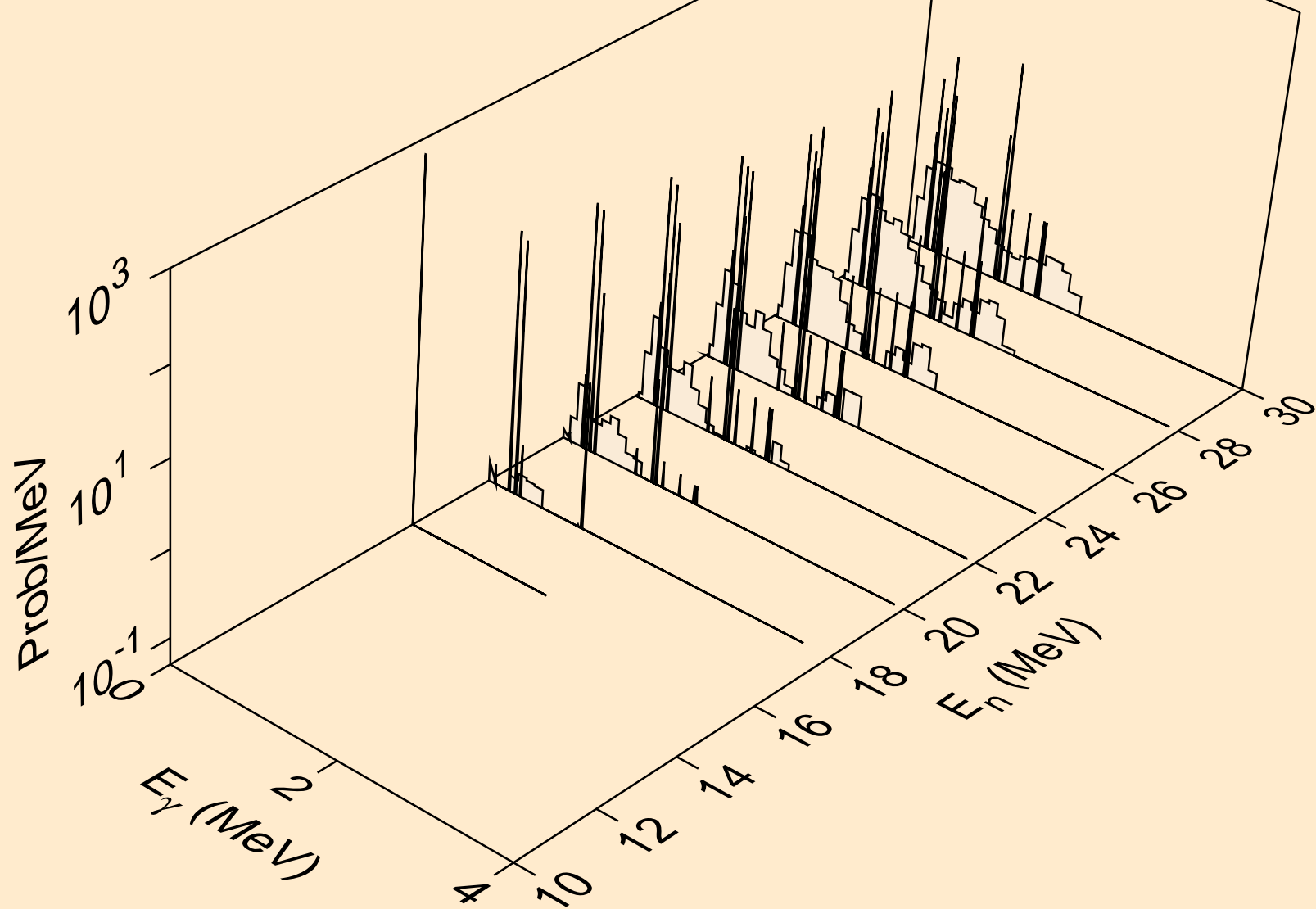

IN122N NEUTRON ACER TENDL-2021 LIBRARY; T=293.6K  
Photon emission for (n,3n)a

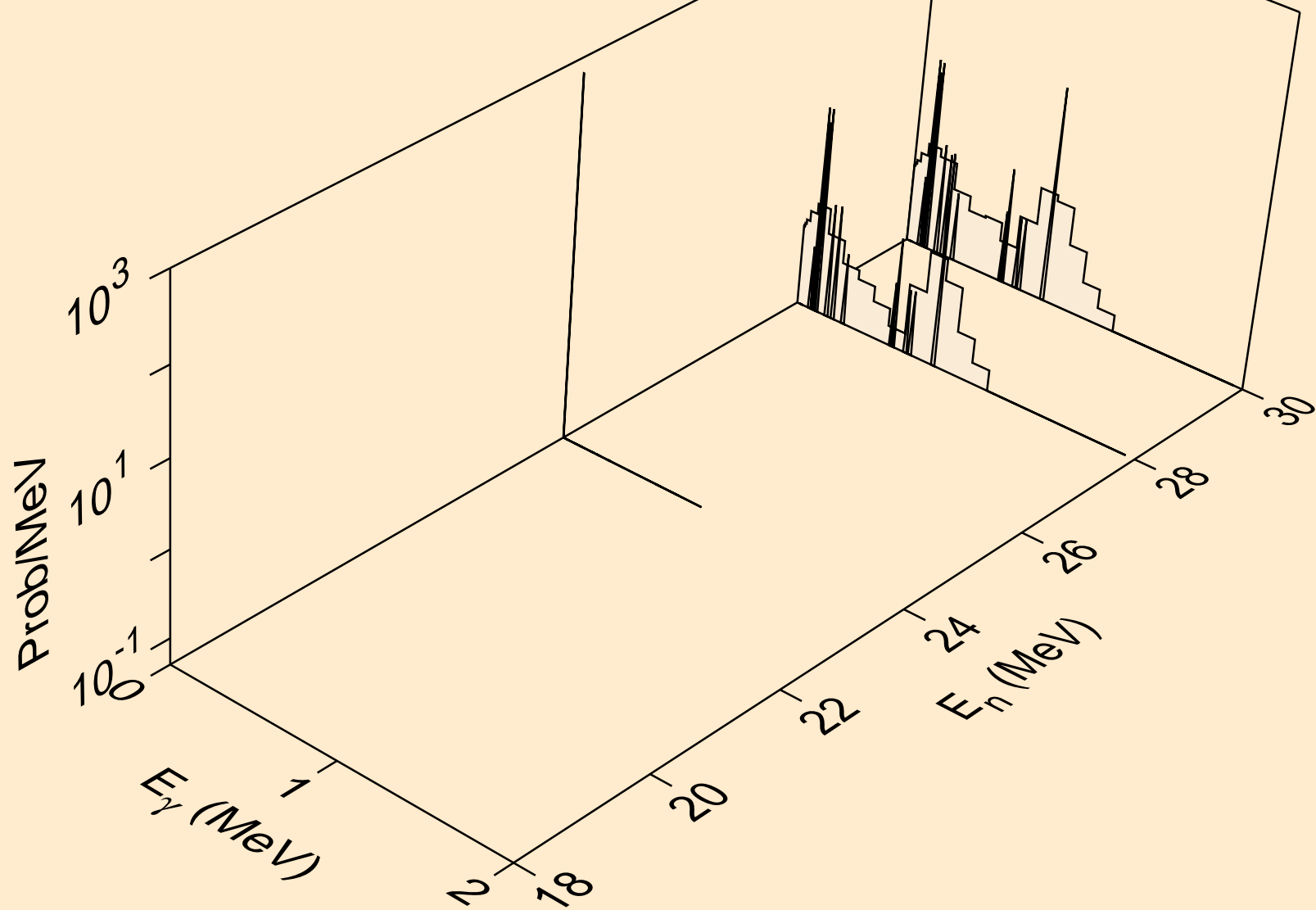

IN122N NEUTRON ACER TENDL-2021 LIBRARY; T=293.6K  
Photon emission for (n,n\*)p

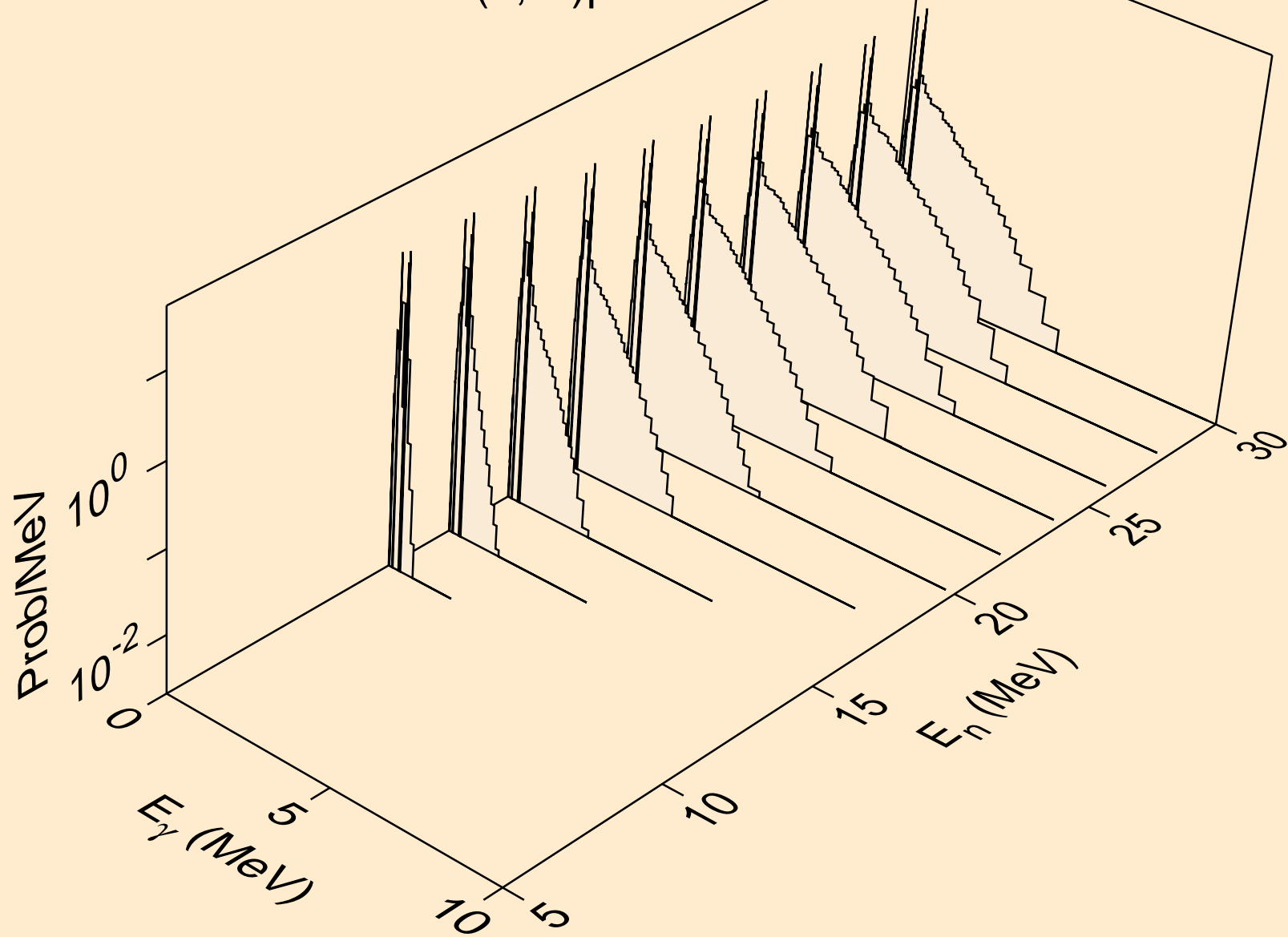

IN122N NEUTRON ACER TENDL-2021 LIBRARY; T=293.6K  
Photon emission for (n,n\*)d

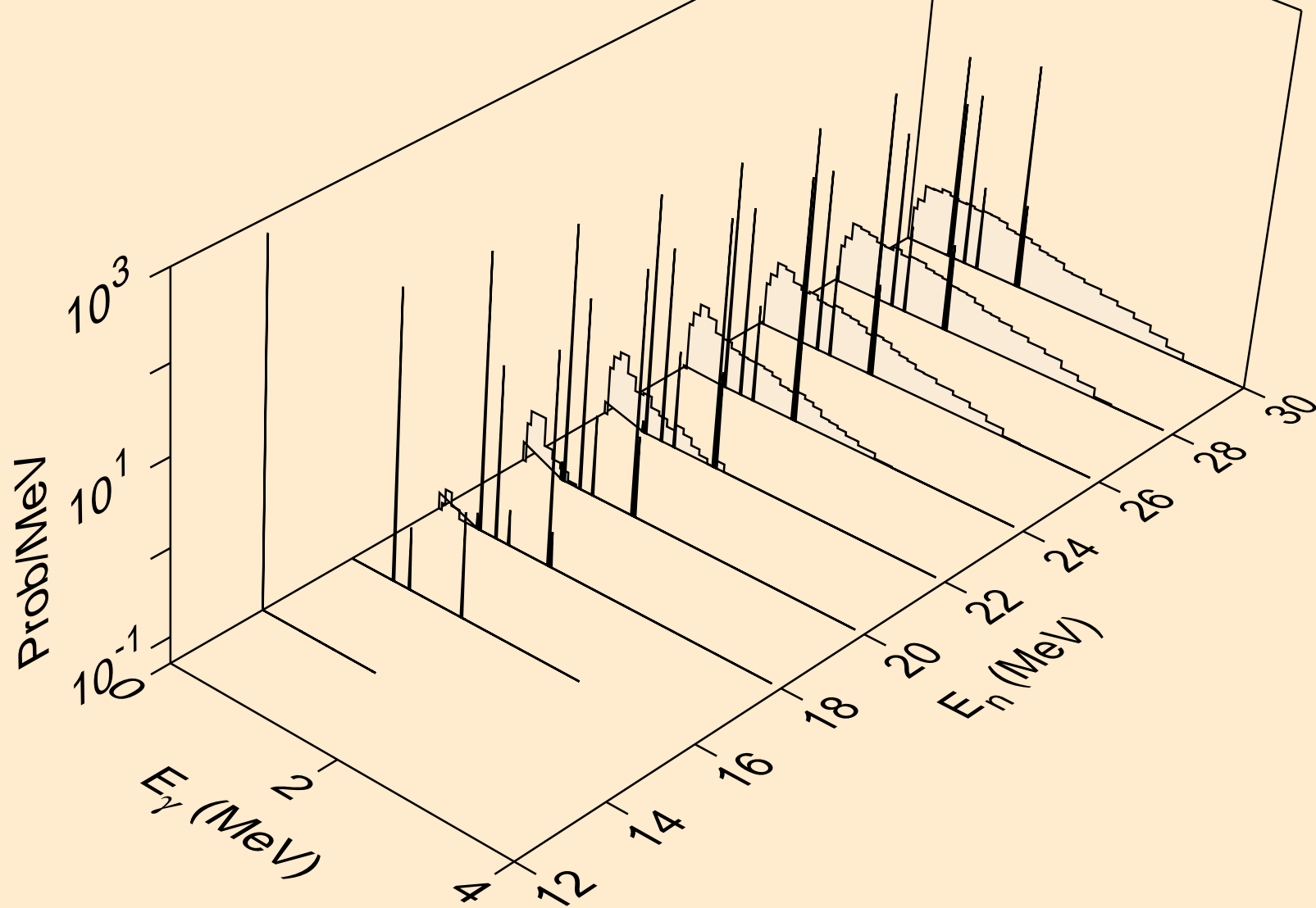

IN122N NEUTRON ACER TENDL-2021 LIBRARY; T=293.6K  
Photon emission for (n,n\*)t

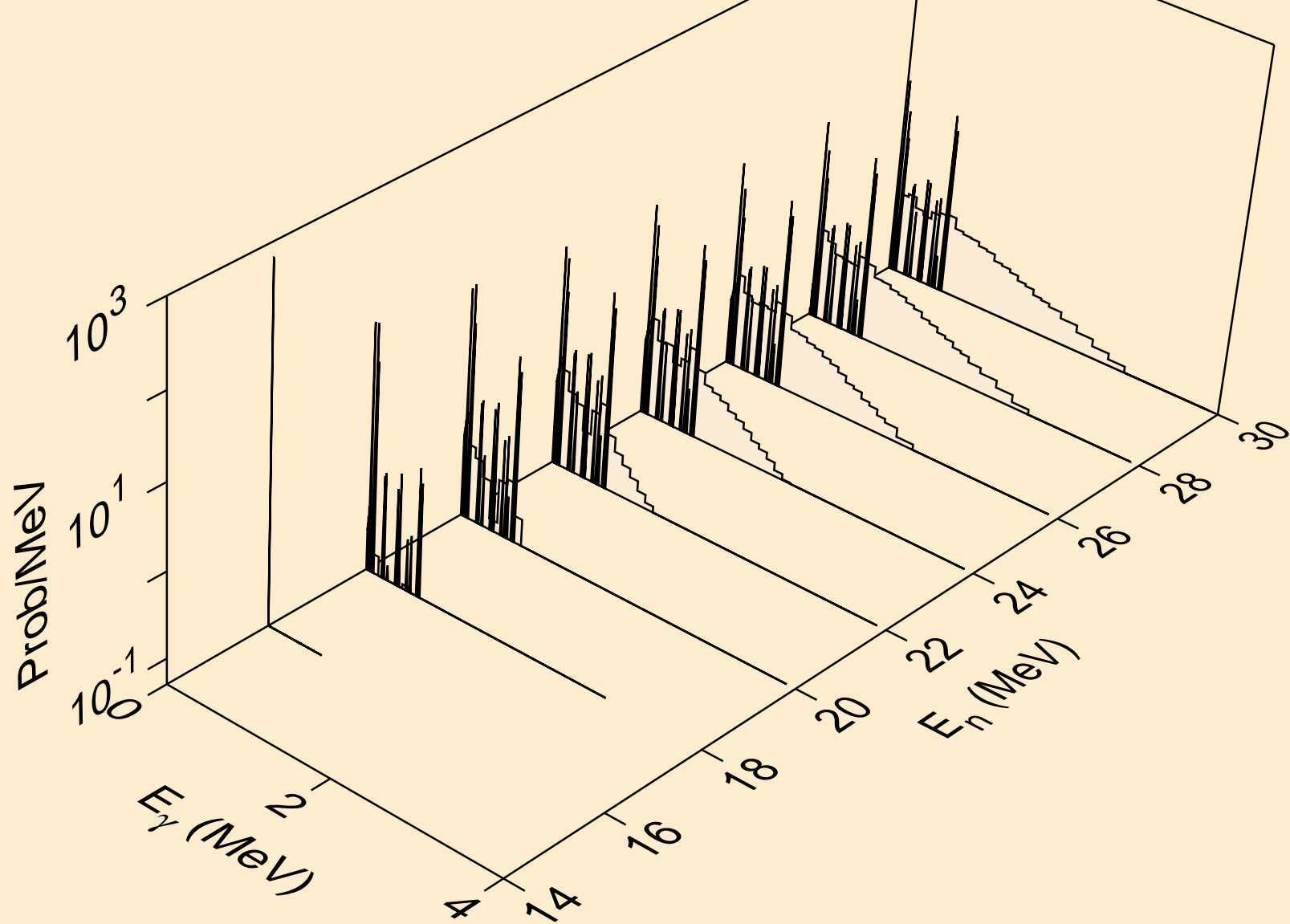

IN122N NEUTRON ACER TENDL-2021 LIBRARY; T=293.6K  
Photon emission for (n,n\*)he3

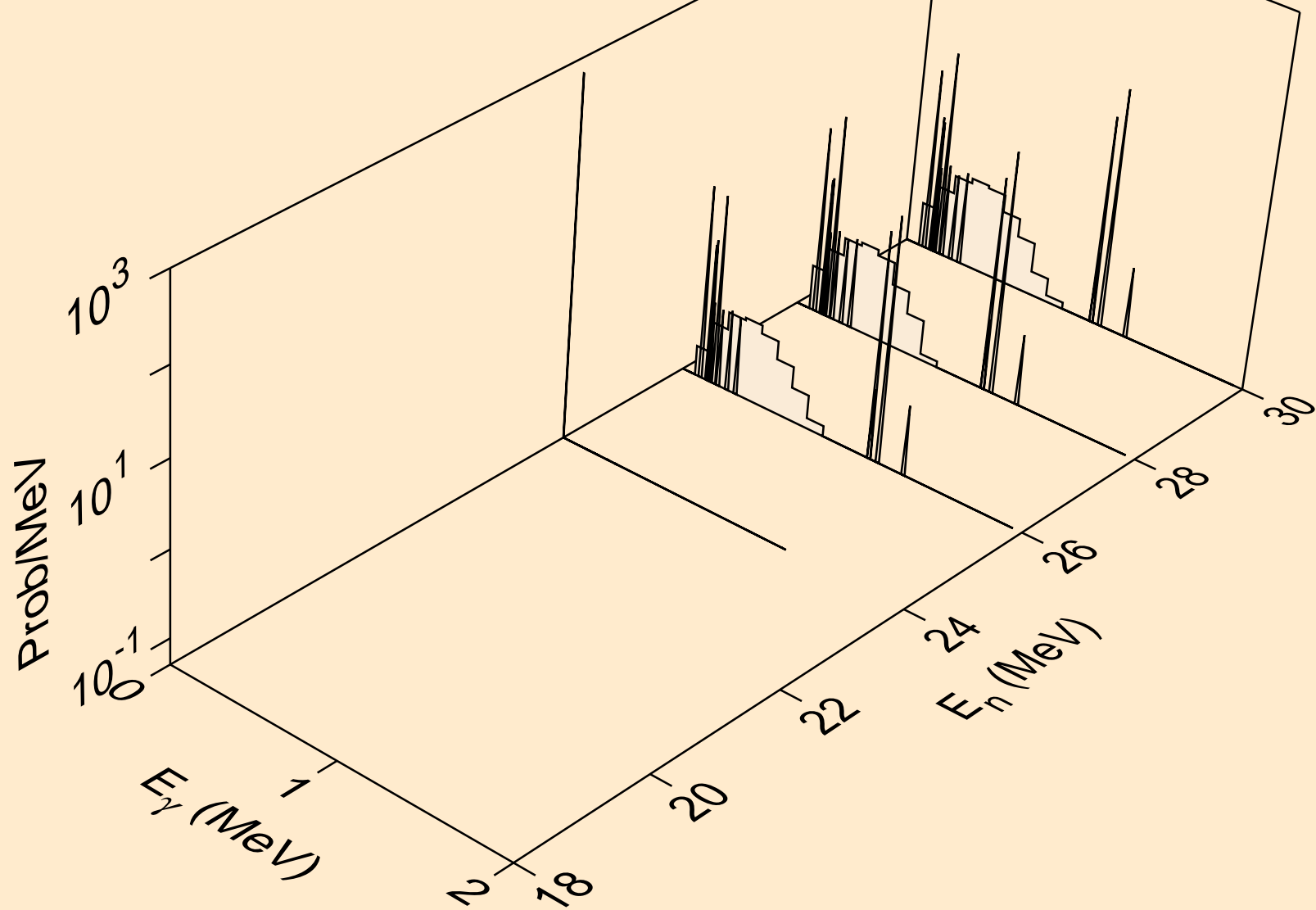

IN122N NEUTRON ACER TENDL-2021 LIBRARY; T=293.6K  
Photon emission for (n,4n)

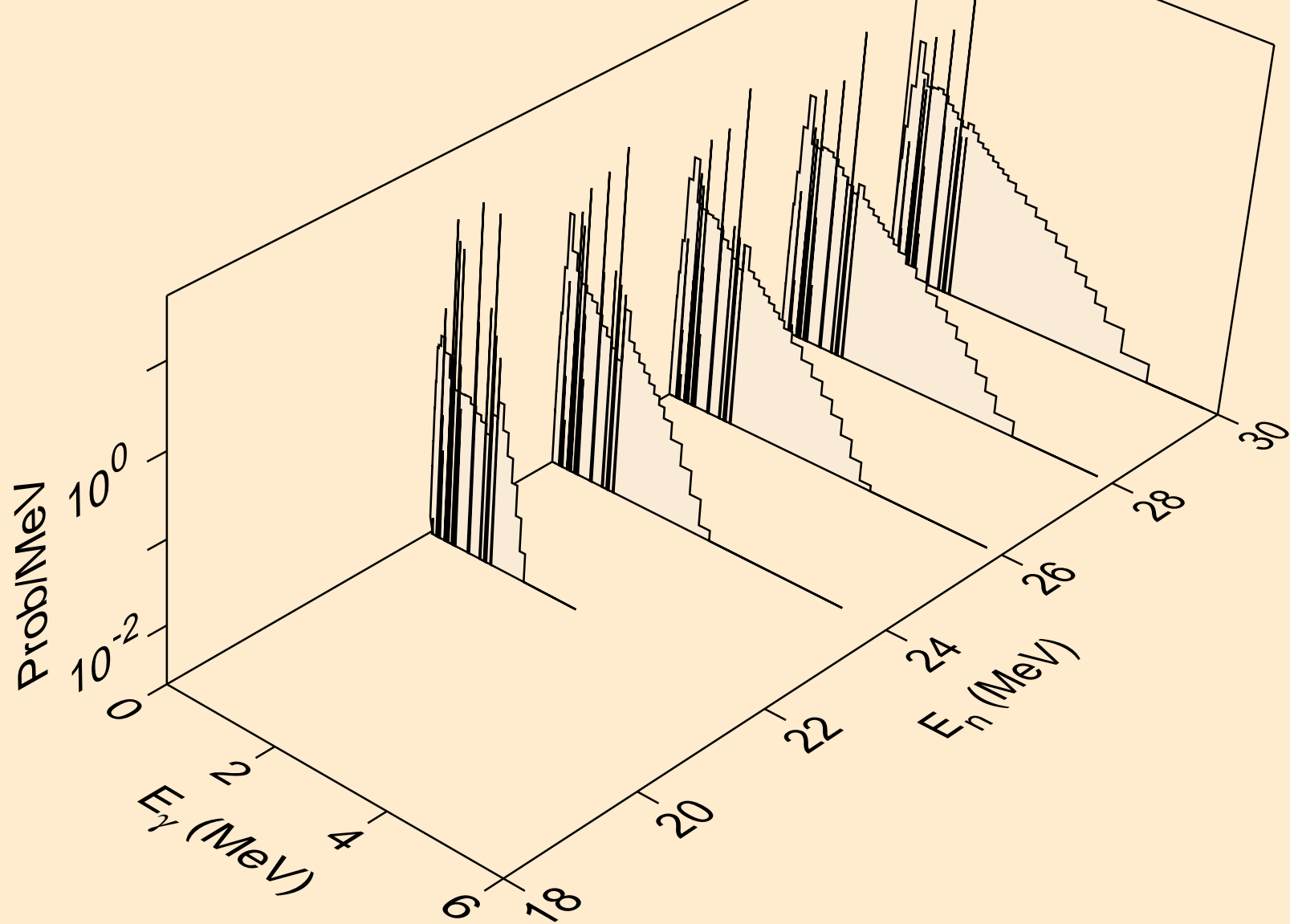

IN122N NEUTRON ACER TENDL-2021 LIBRARY; T=293.6K  
Photon emission for (n,2np)

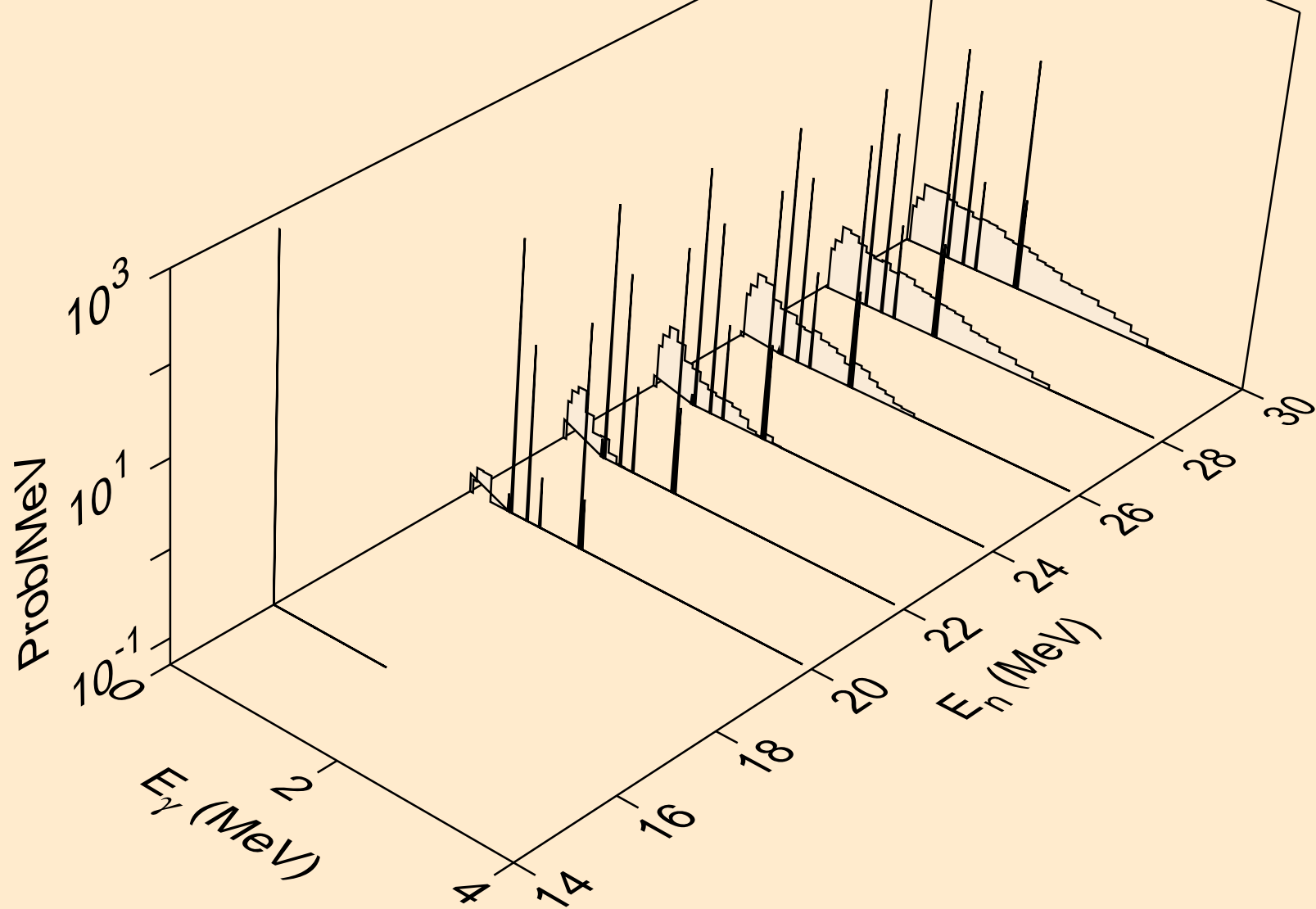



IN122N NEUTRON ACER TENDL-2021 LIBRARY; T=293.6K  
Photon emission for (n,3np)

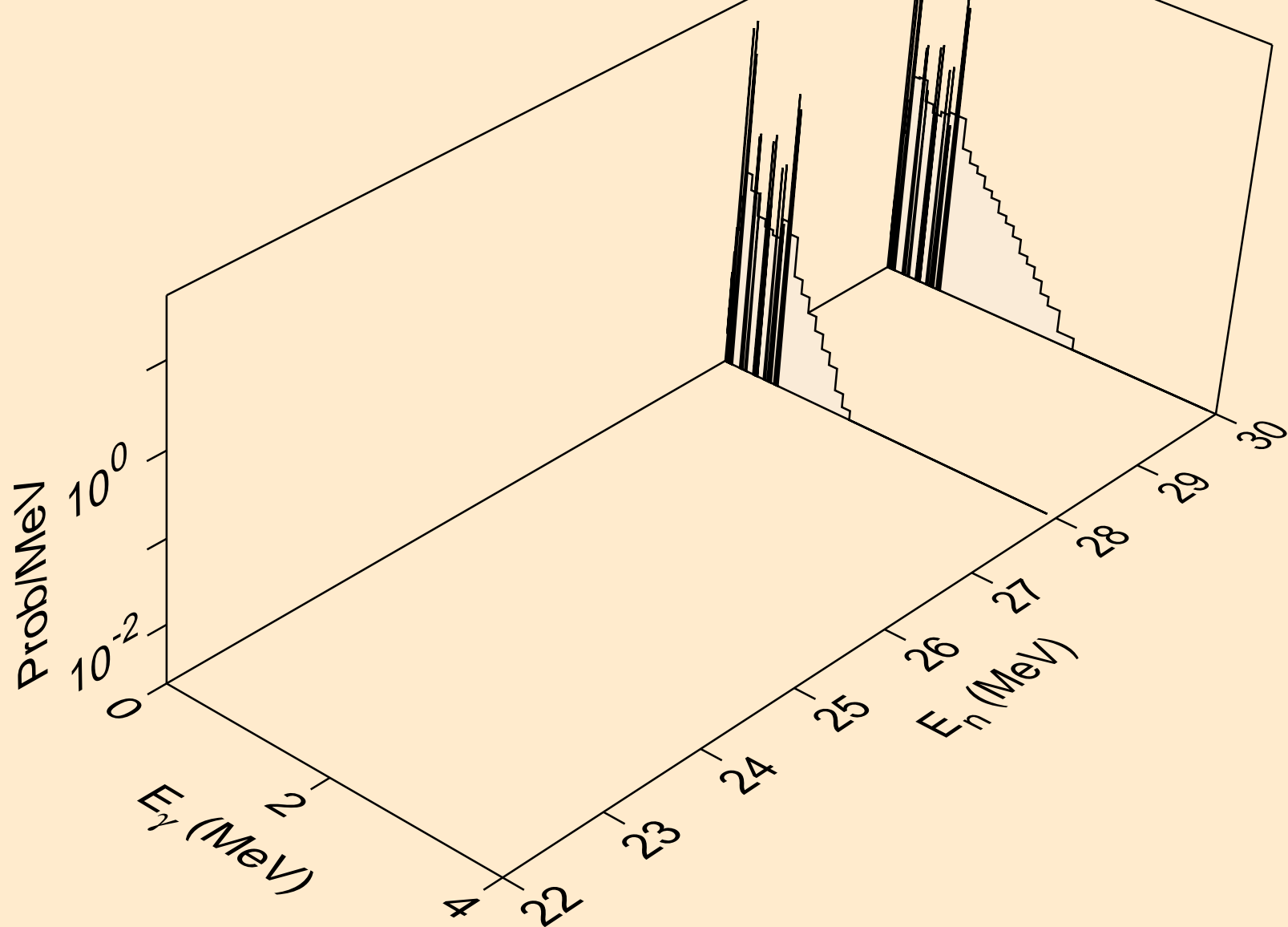

IN122N NEUTRON ACER TENDL-2021 LIBRARY; T=293.6K  
Photon emission for (n,n\*2)

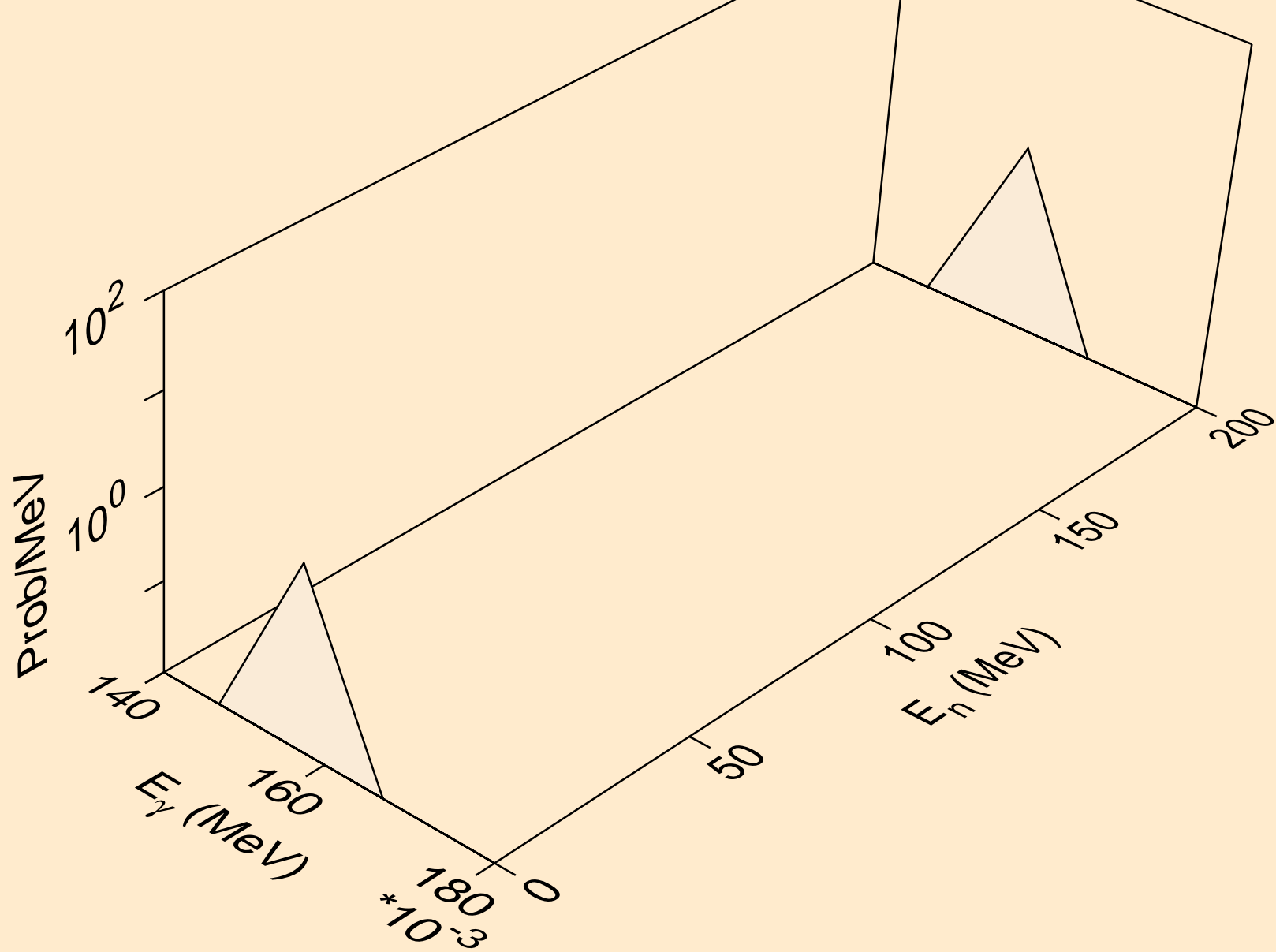

IN122N NEUTRON ACER TENDL-2021 LIBRARY; T=293.6K  
Photon emission for (n,n\*3)

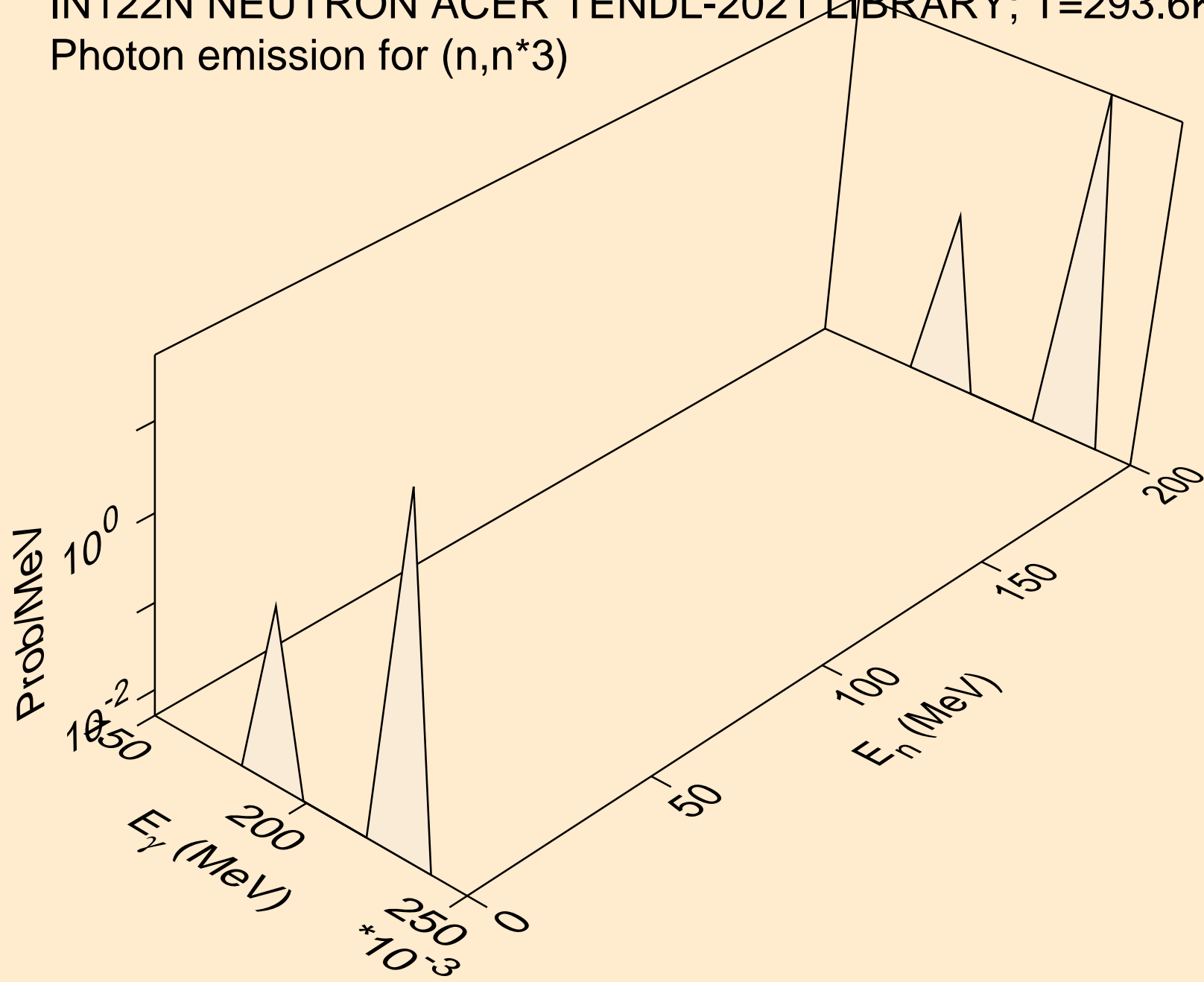

IN122N NEUTRON ACER TENDL-2021 LIBRARY; T=293.6K  
Photon emission for (n,n\*4)

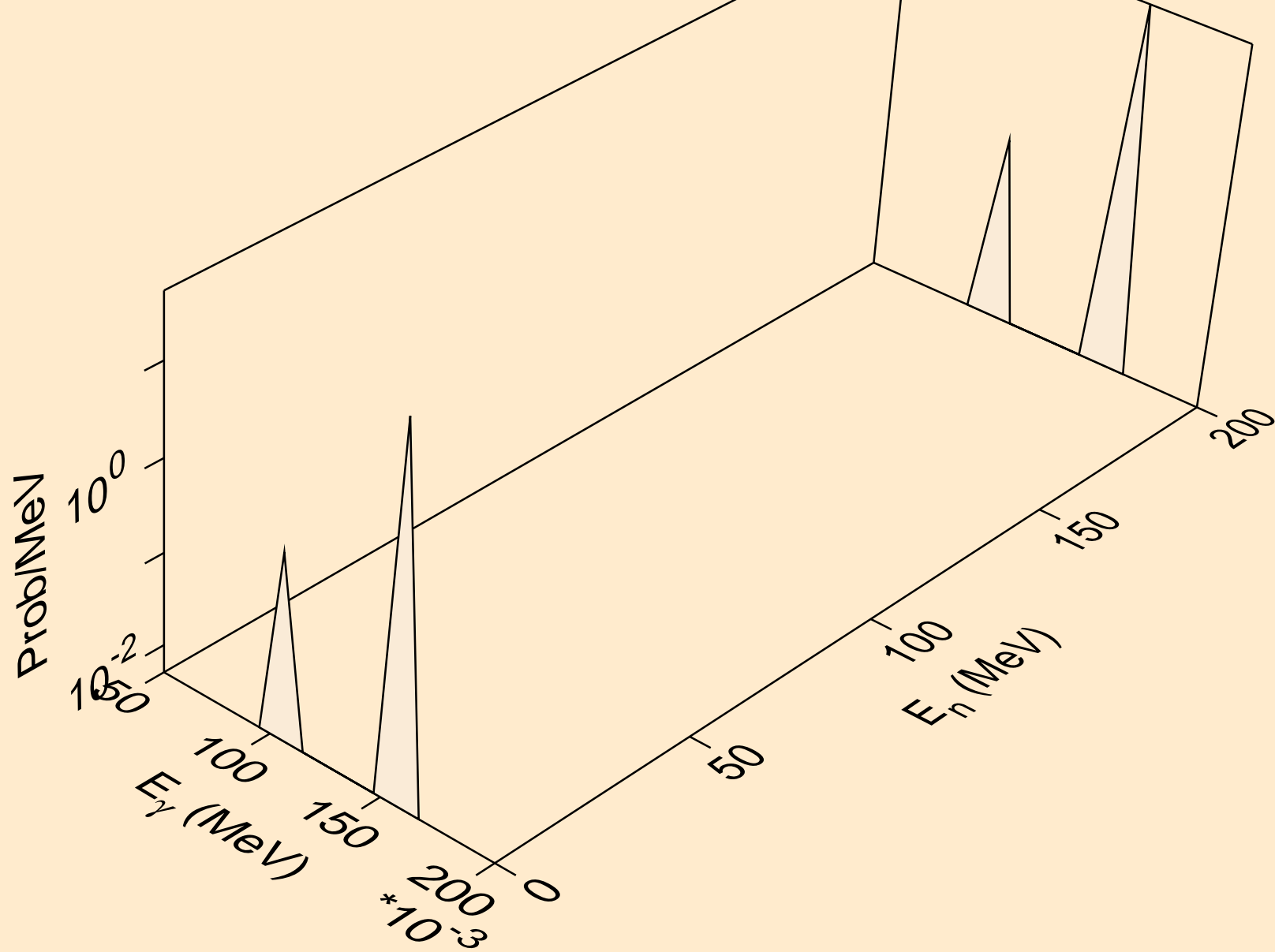

IN122N NEUTRON ACER TENDL-2021 LIBRARY; T=293.6K  
Photon emission for (n,n\*6)

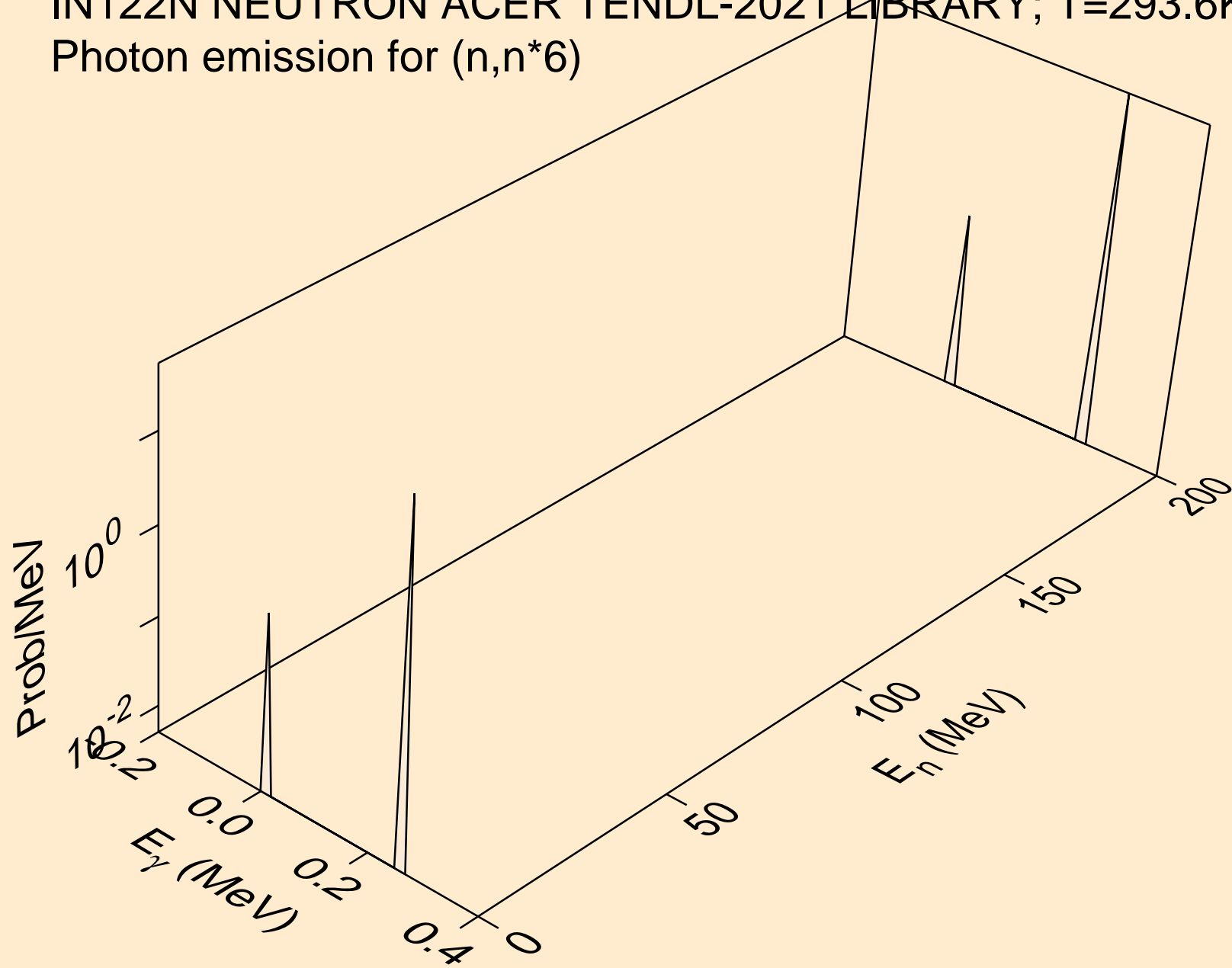

IN122N NEUTRON ACER TENDL-2021 LIBRARY; T=293.6K  
Photon emission for (n,n\*7)

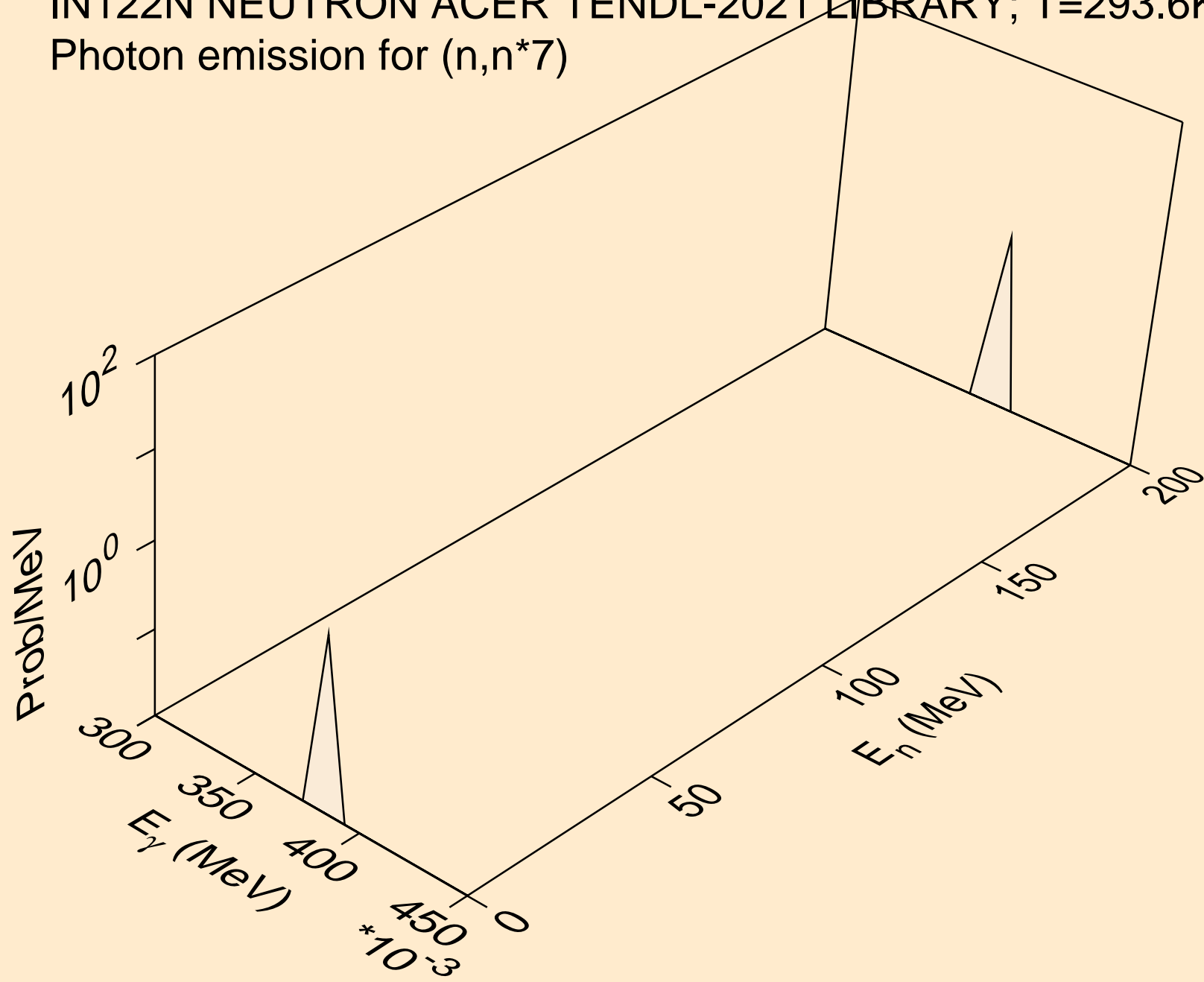

IN122N NEUTRON ACER TENDL-2021 LIBRARY; T=293.6K  
Photon emission for (n,n\*8)

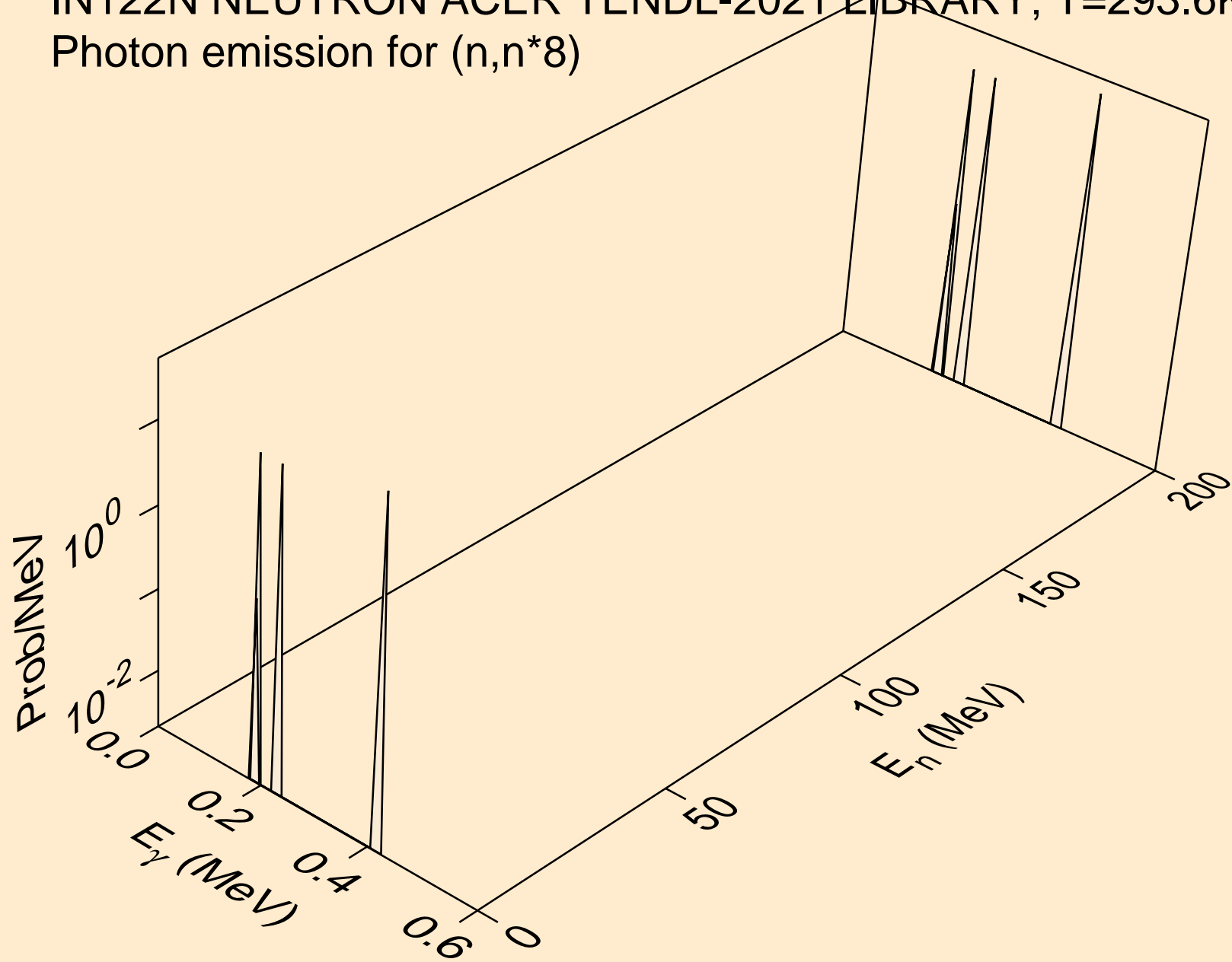

IN122N NEUTRON ACER TENDL-2021 LIBRARY; T=293.6K  
Photon emission for (n,n\*9)

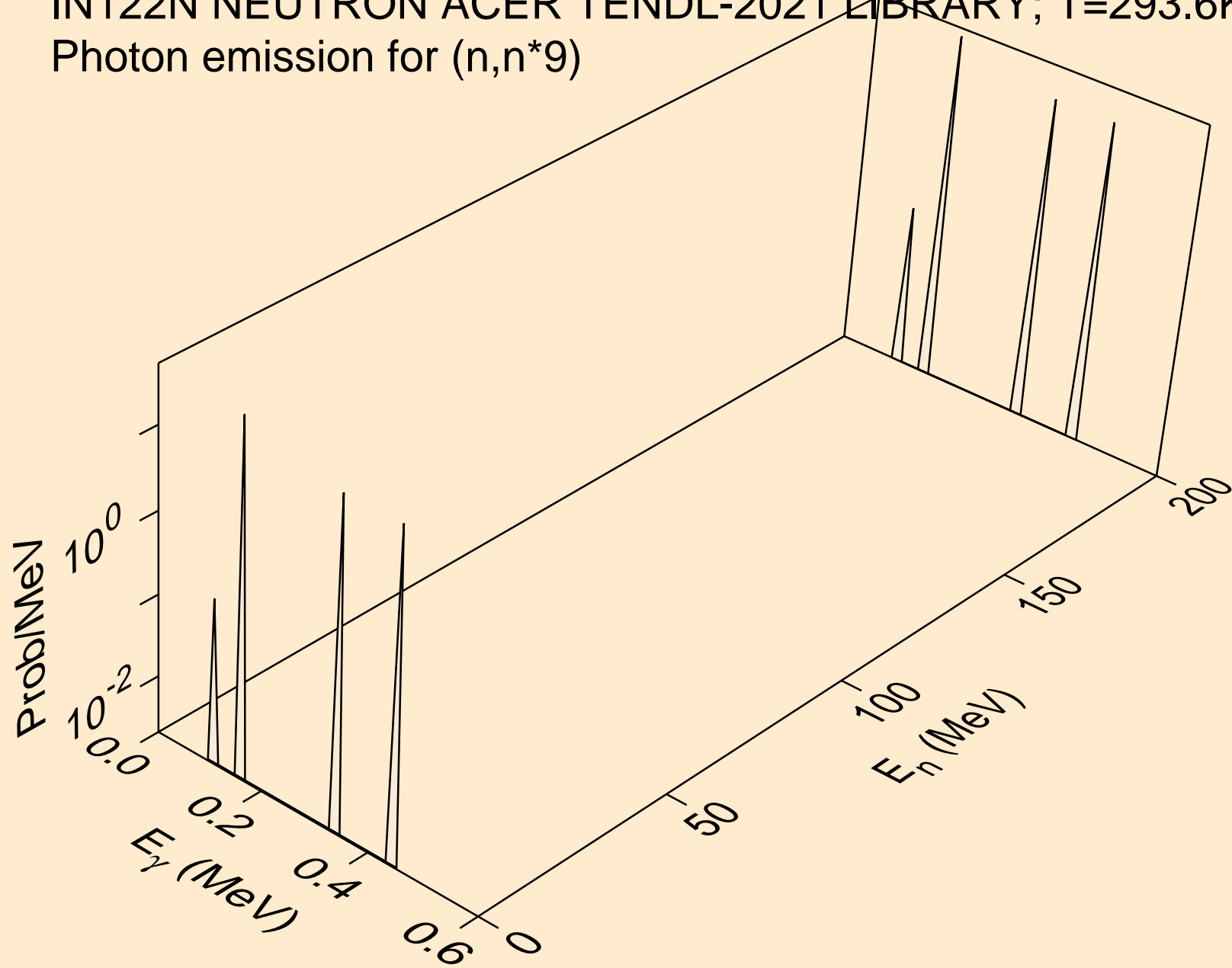



IN122N NEUTRON ACER TENDL-2021 LIBRARY; T=293.6K  
Photon emission for (n,n\*10)

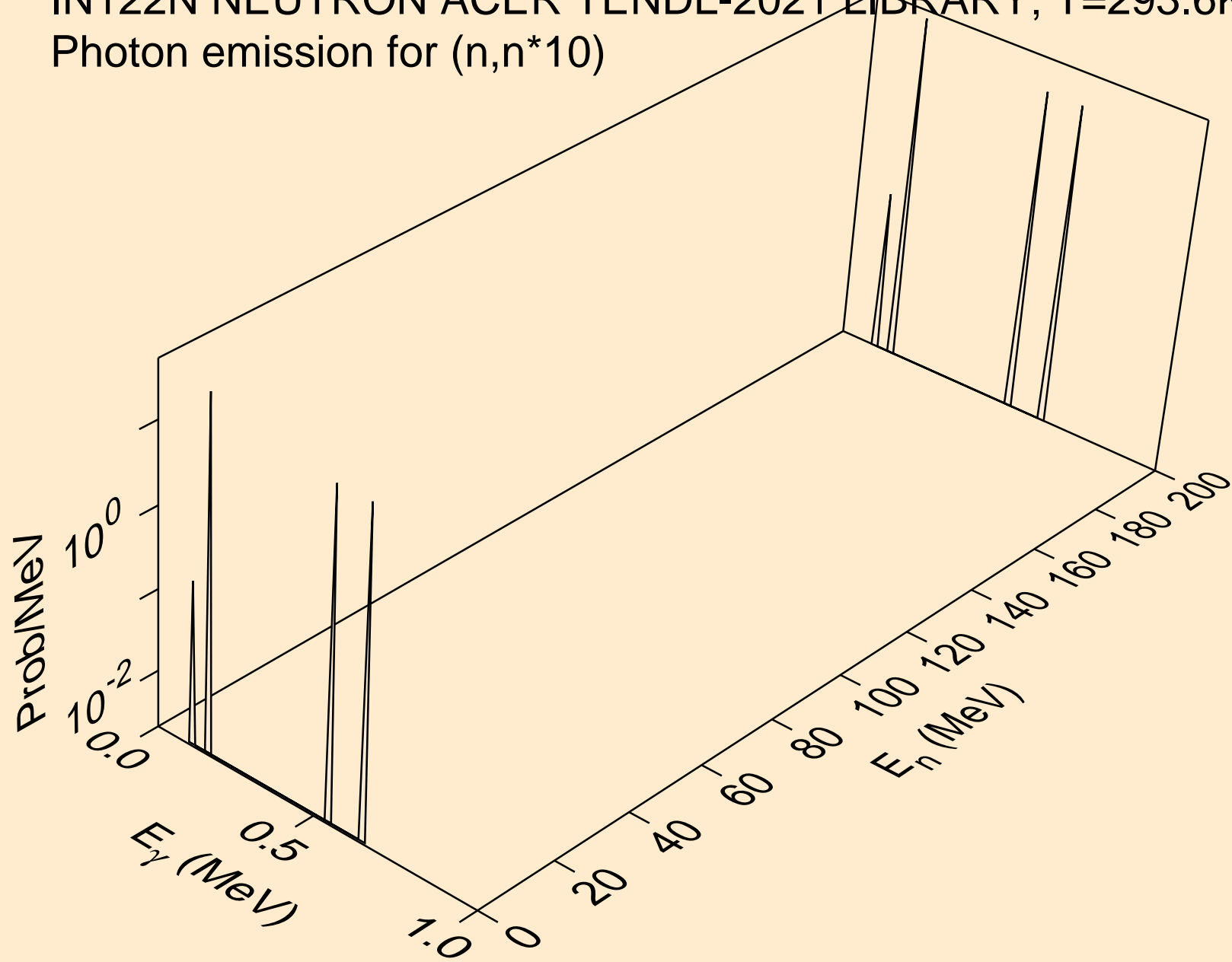

IN122N NEUTRON ACER TENDL-2021 LIBRARY; T=293.6K  
Photon emission for (n,n\*11)

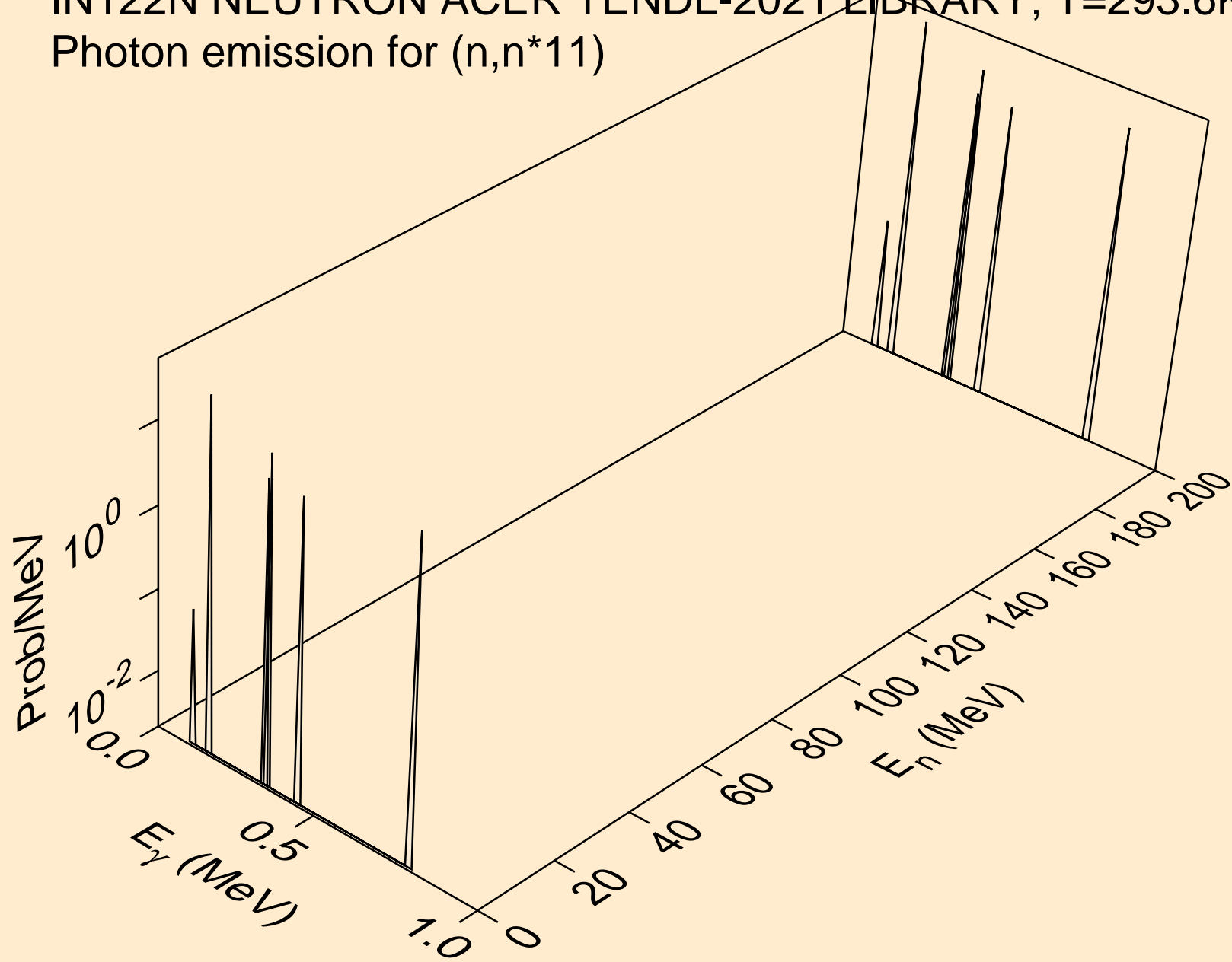

IN122N NEUTRON ACER TENDL-2021 LIBRARY; T=293.6K  
Photon emission for (n,n\*12)

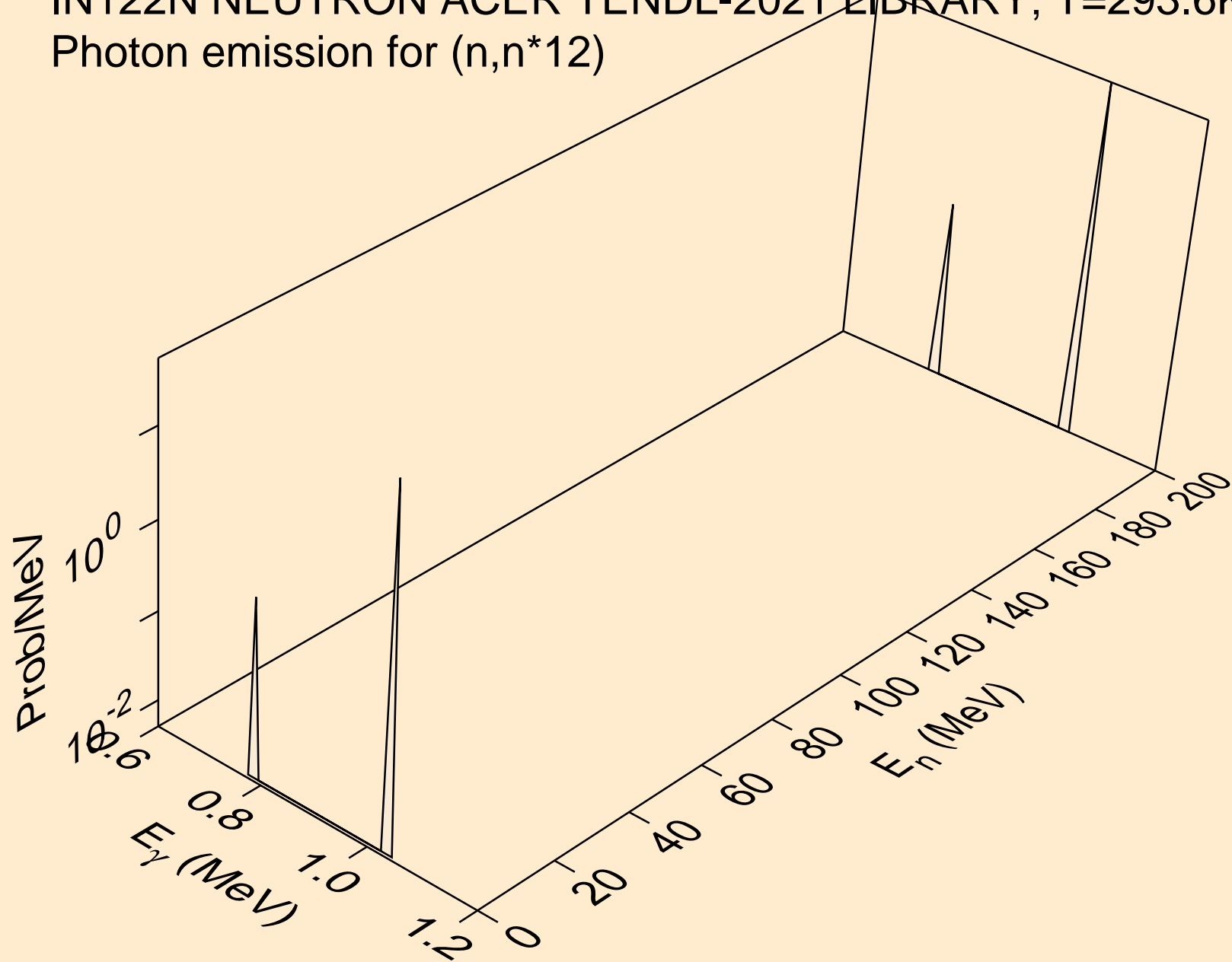

IN122N NEUTRON ACER TENDL-2021 LIBRARY; T=293.6K  
Photon emission for (n,n\*13)

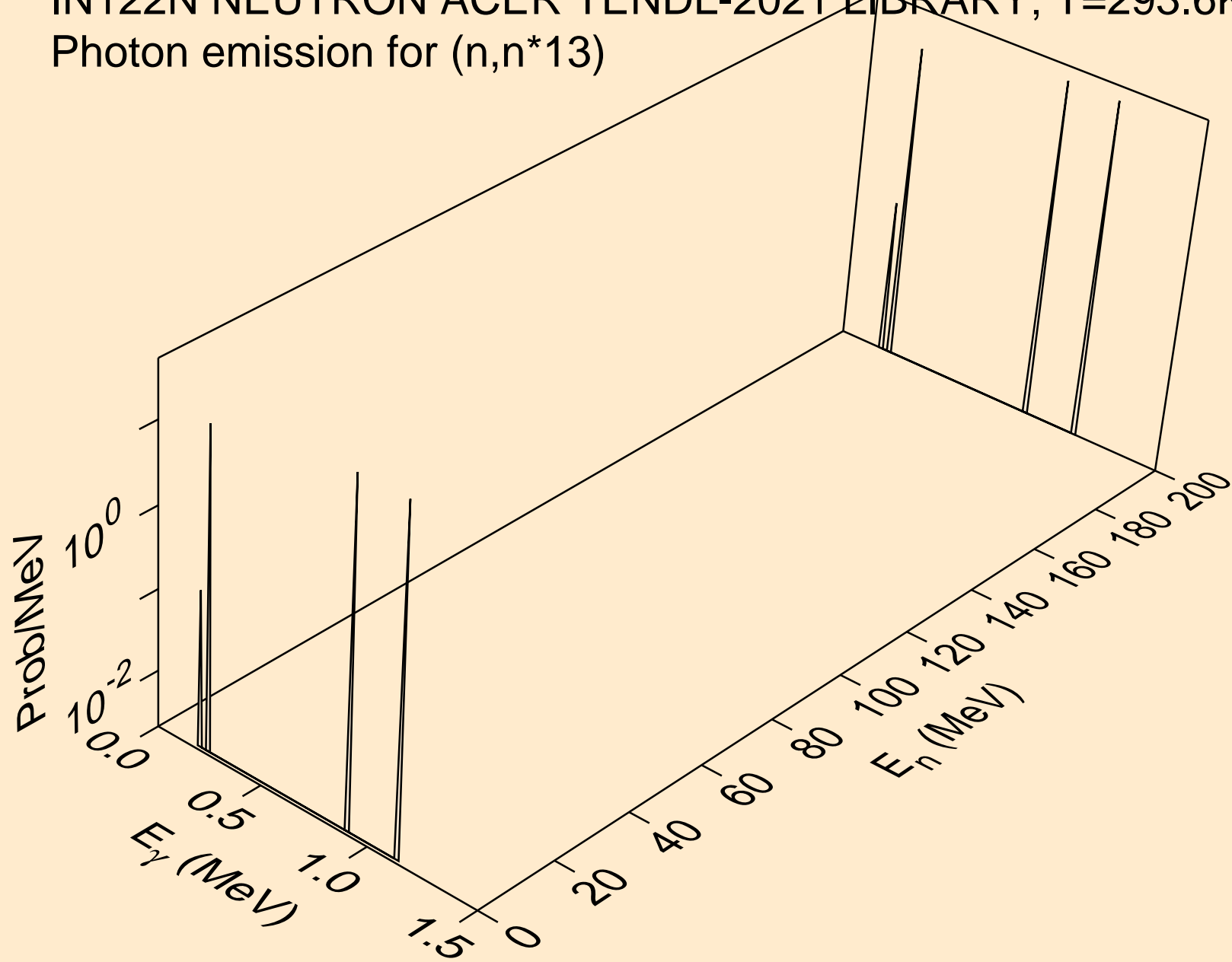

IN122N NEUTRON ACER TENDL-2021 LIBRARY; T=293.6K  
Photon emission for (n,n\*14)

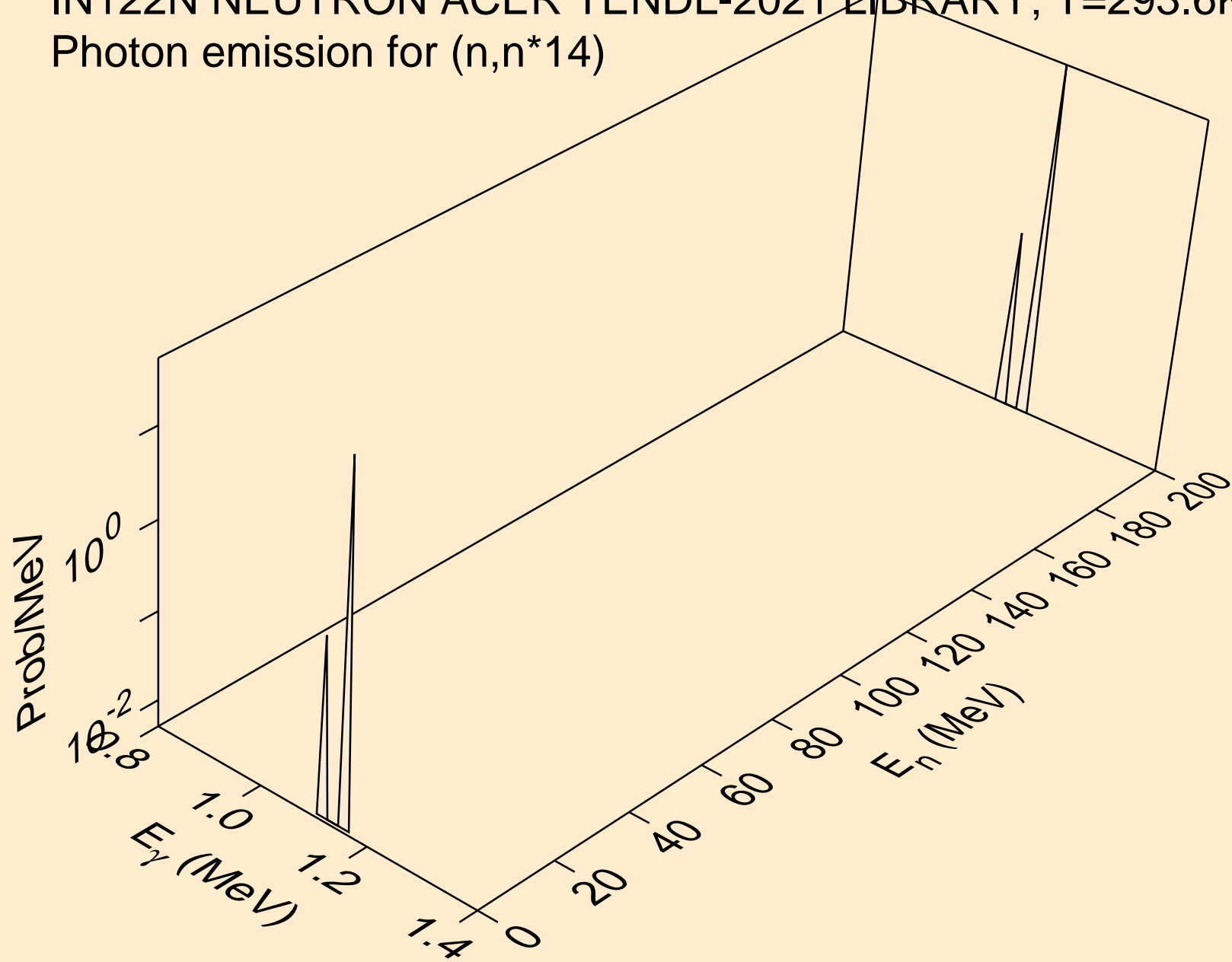

IN122N NEUTRON ACER TENDL-2021 LIBRARY; T=293.6K  
Photon emission for (n,n\*15)

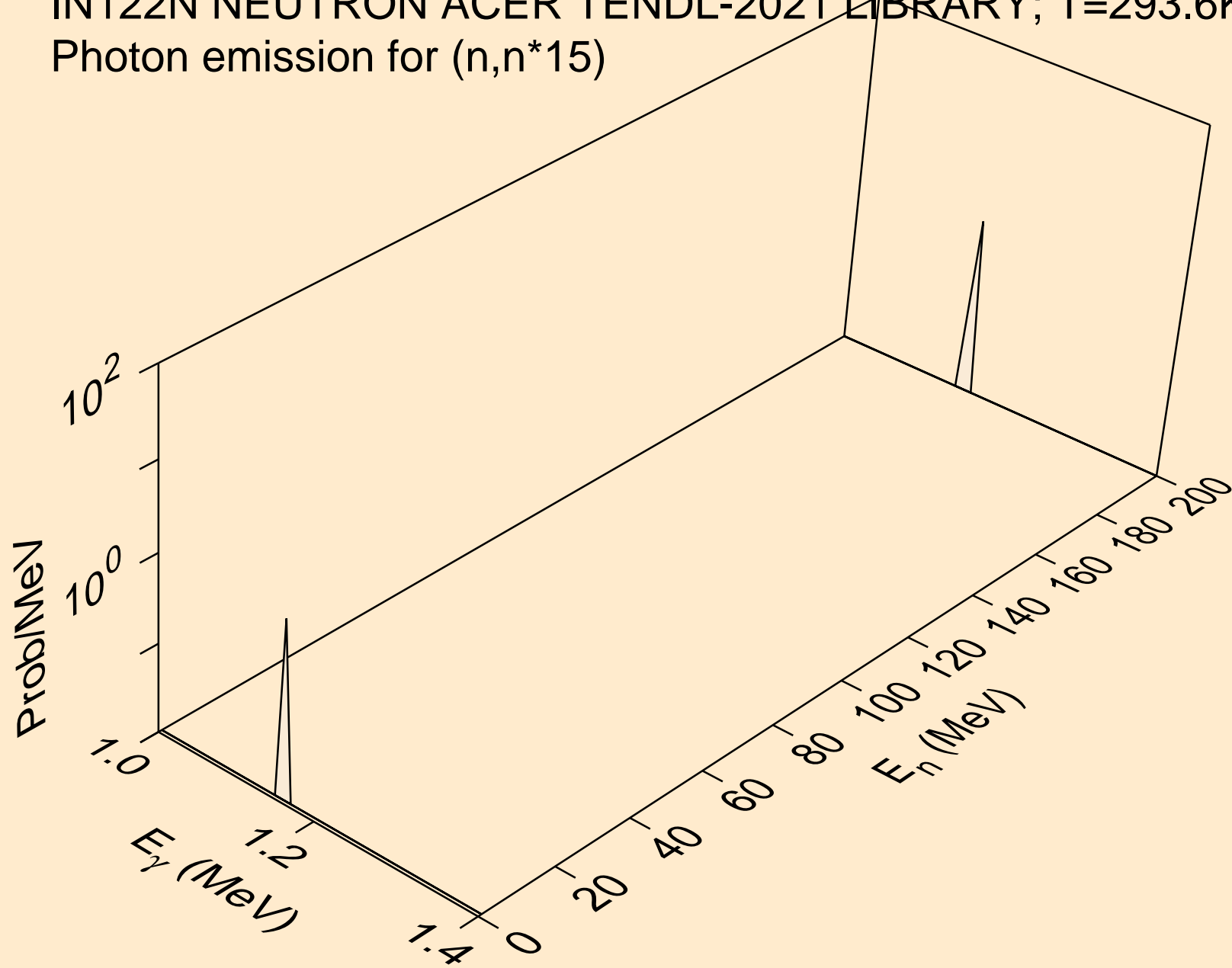

IN122N NEUTRON ACER TENDL-2021 LIBRARY; T=293.6K  
Photon emission for (n,n\*16)

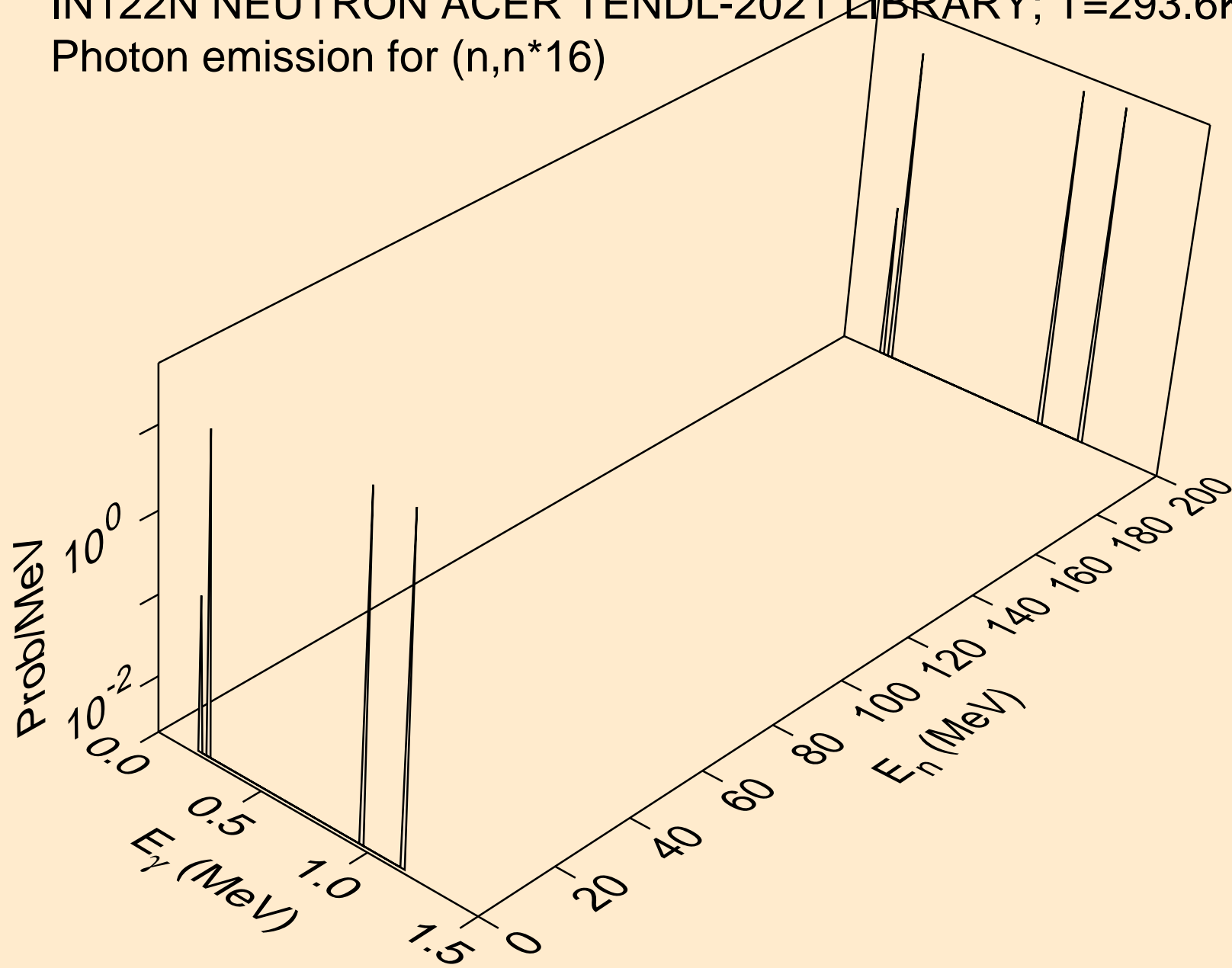

IN122N NEUTRON ACER TENDL-2021 LIBRARY; T=293.6K  
Photon emission for (n,n\*17)

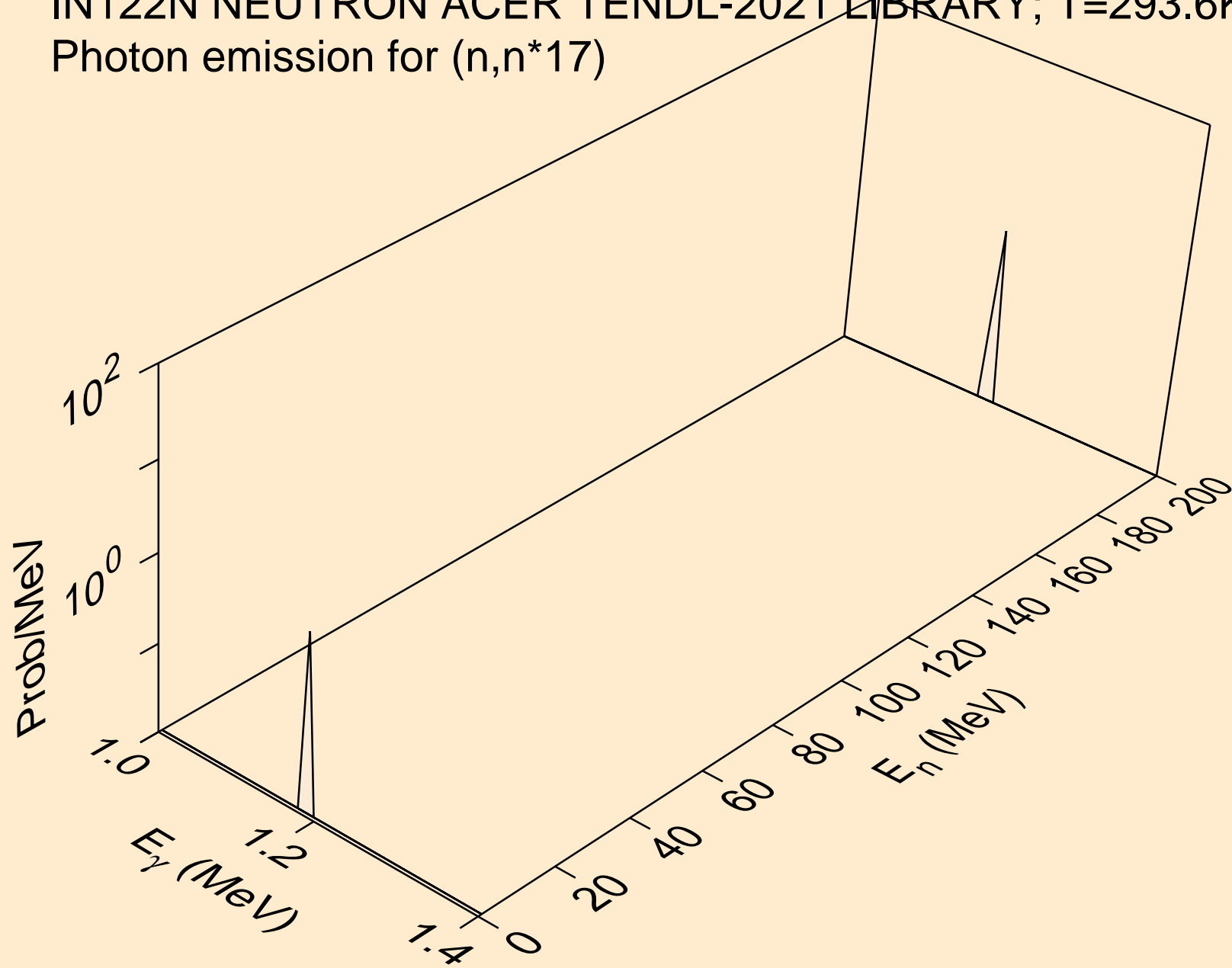



IN122N NEUTRON ACER TENDL-2021 LIBRARY; T=293.6K  
Photon emission for (n,n\*18)

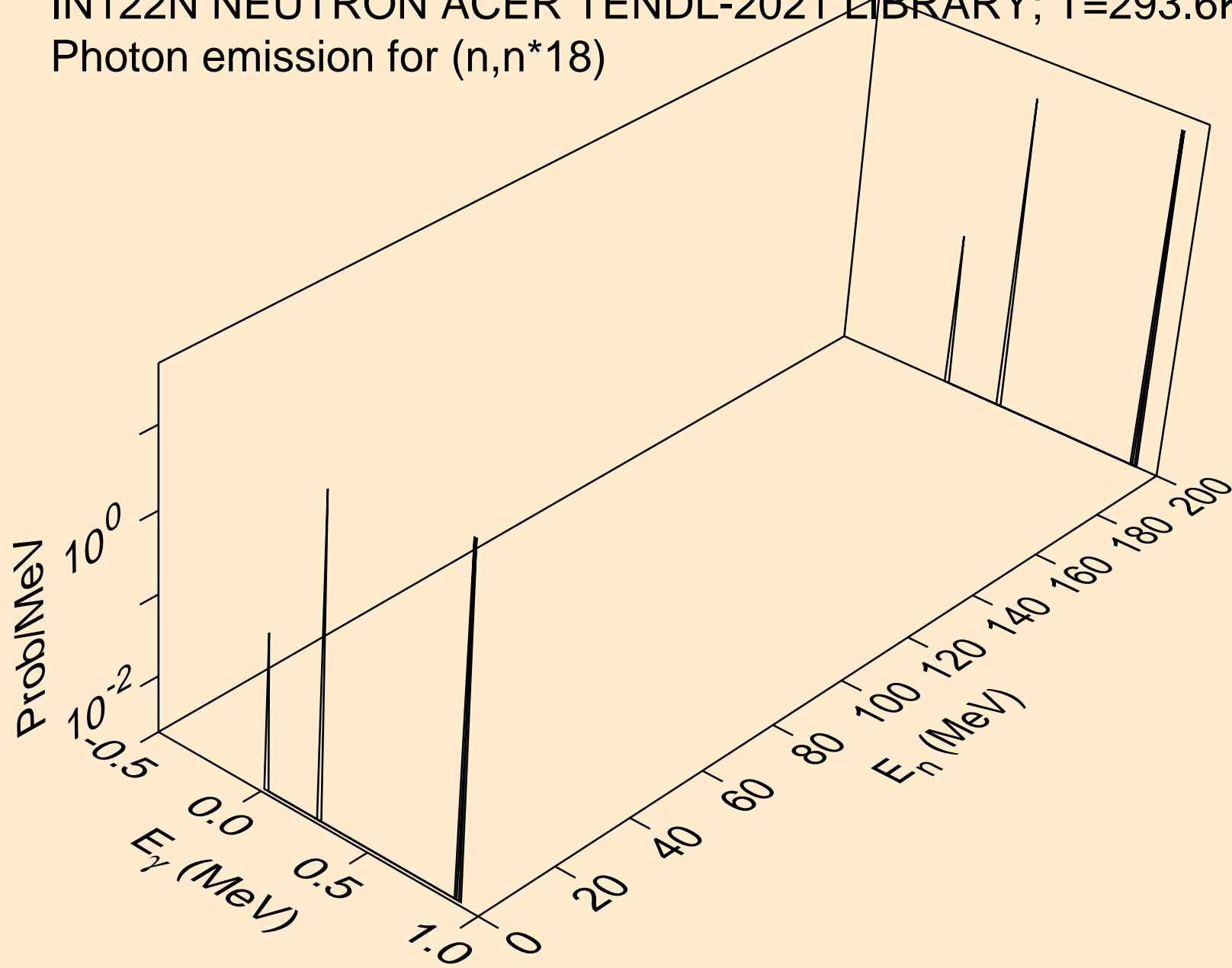

IN122N NEUTRON ACER TENDL-2021 LIBRARY; T=293.6K  
Photon emission for (n,n\*19)

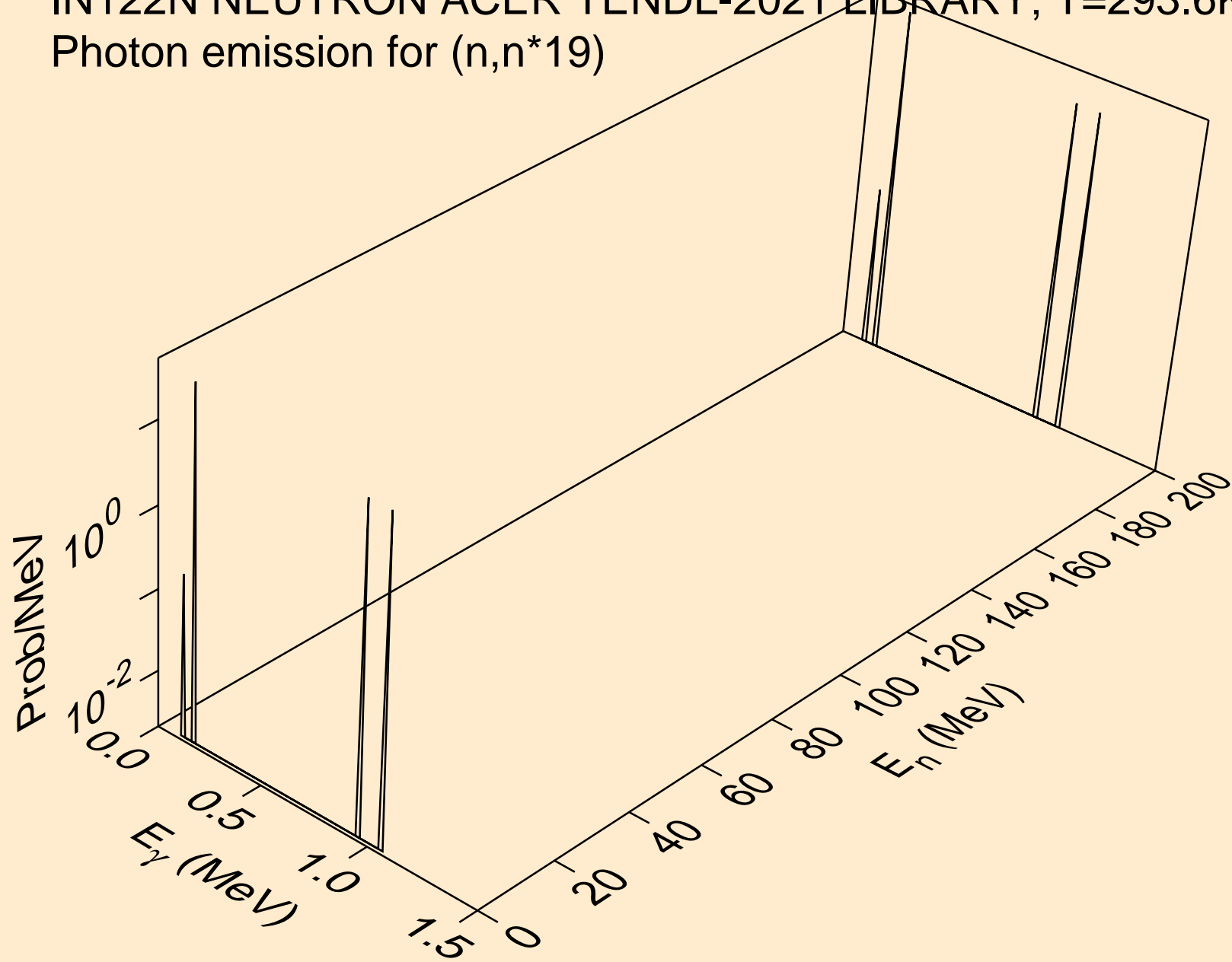

IN122N NEUTRON ACER TENDL-2021 LIBRARY; T=293.6K  
Photon emission for (n,n\*20)

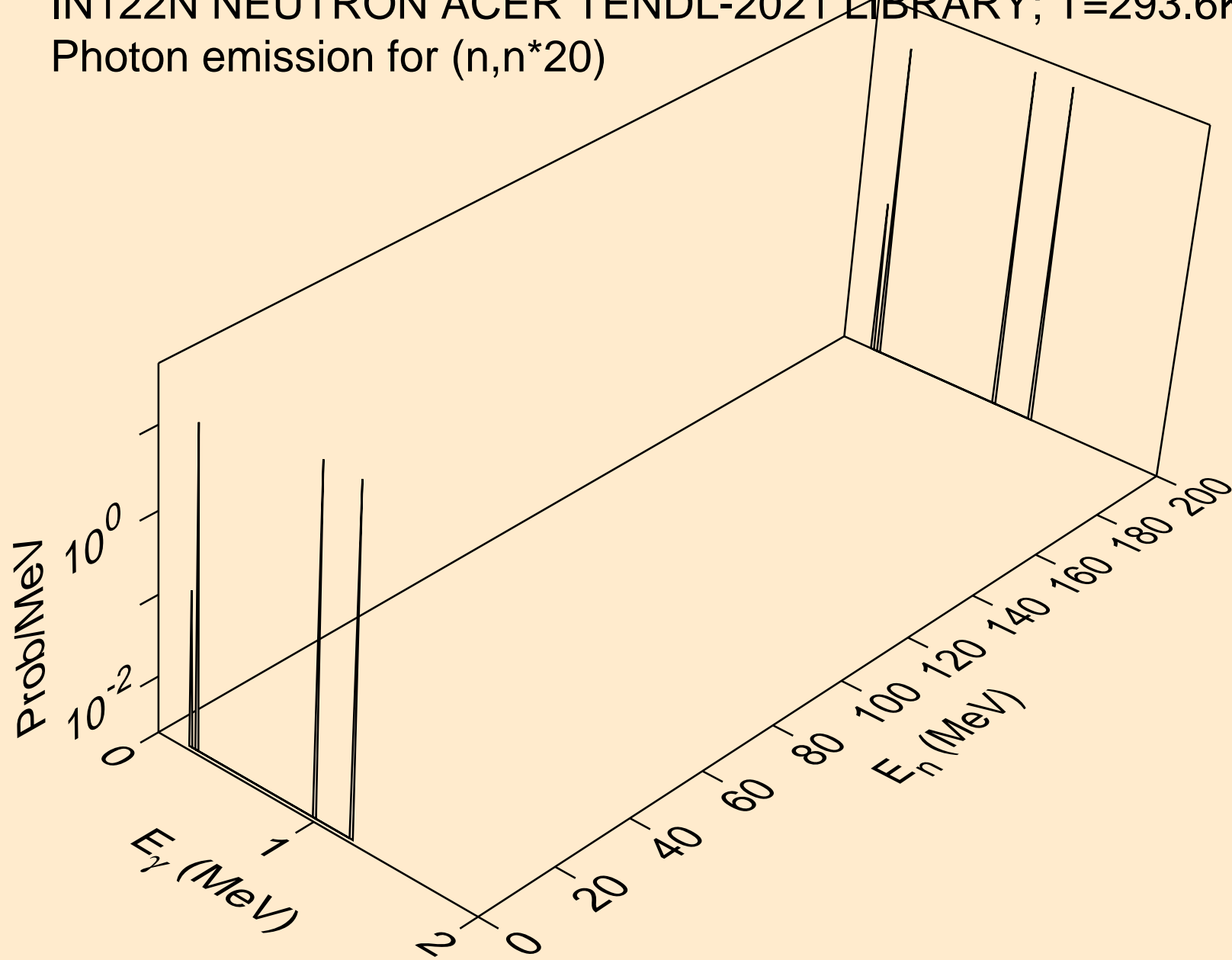

IN122N NEUTRON ACER TENDL-2021 LIBRARY; T=293.6K  
Photon emission for (n,n\*21)

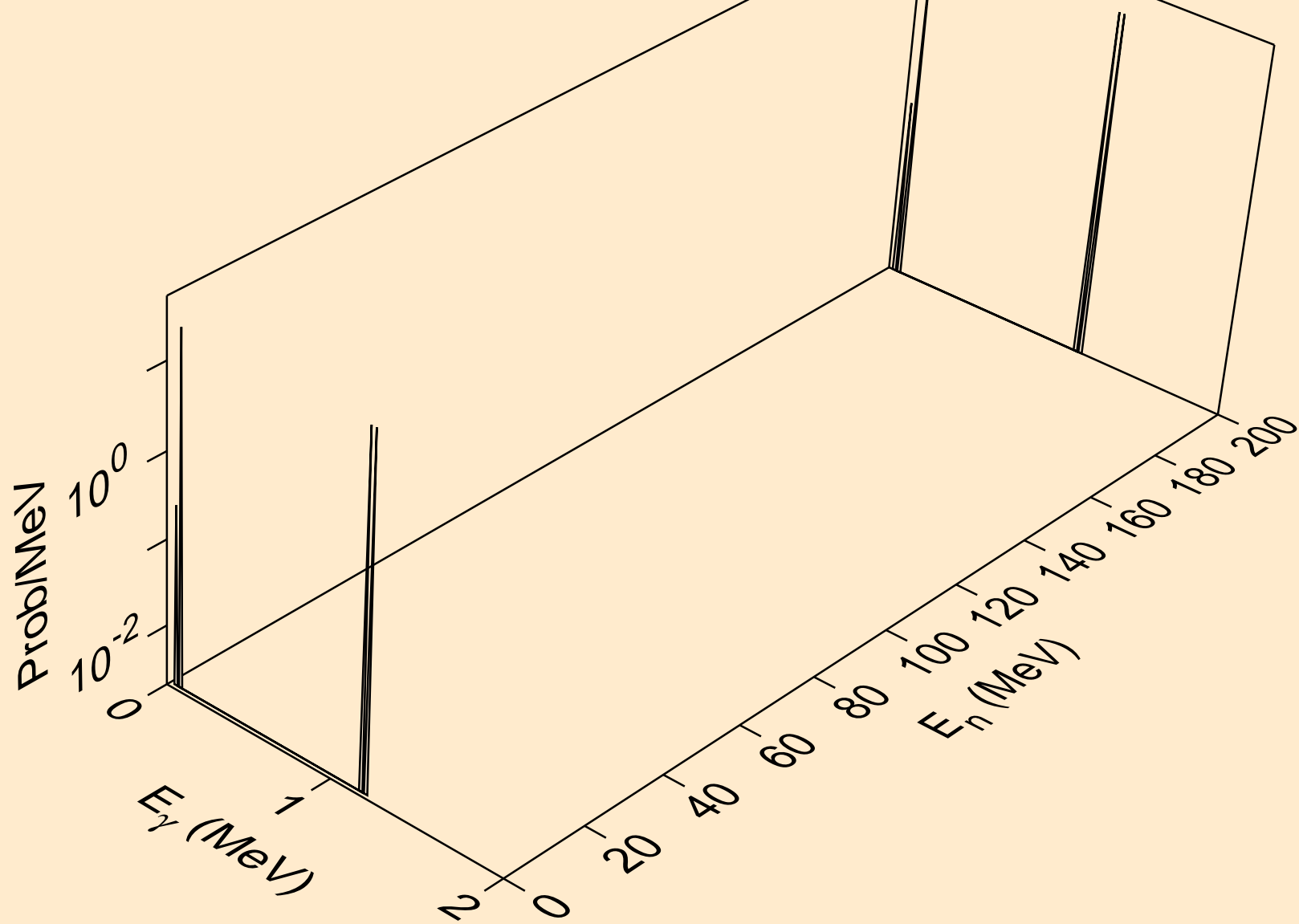

IN122N NEUTRON ACER TENDL-2021 LIBRARY; T=293.6K  
Photon emission for (n,n\*22)

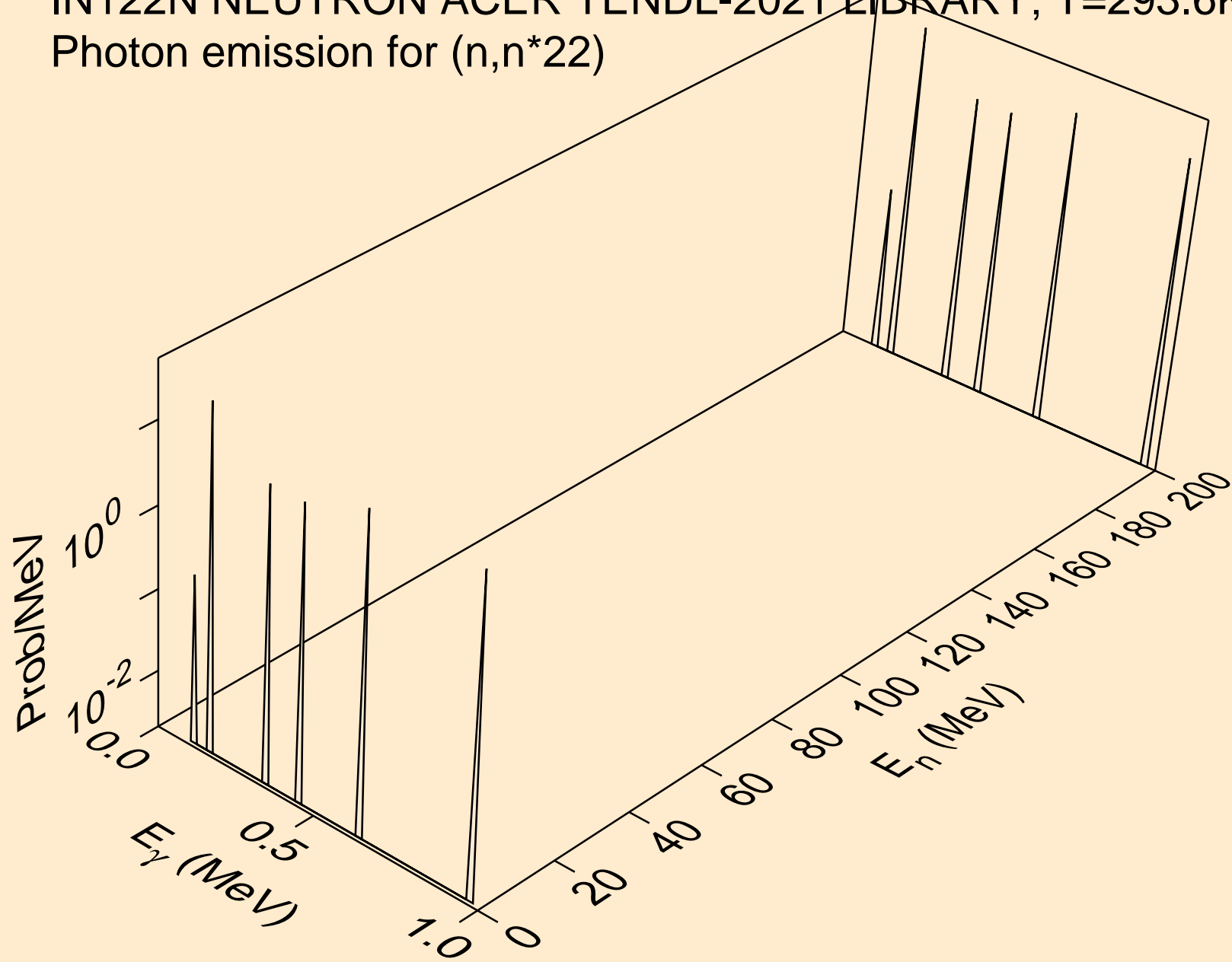

IN122N NEUTRON ACER TENDL-2021 LIBRARY; T=293.6K  
Photon emission for (n,n\*23)

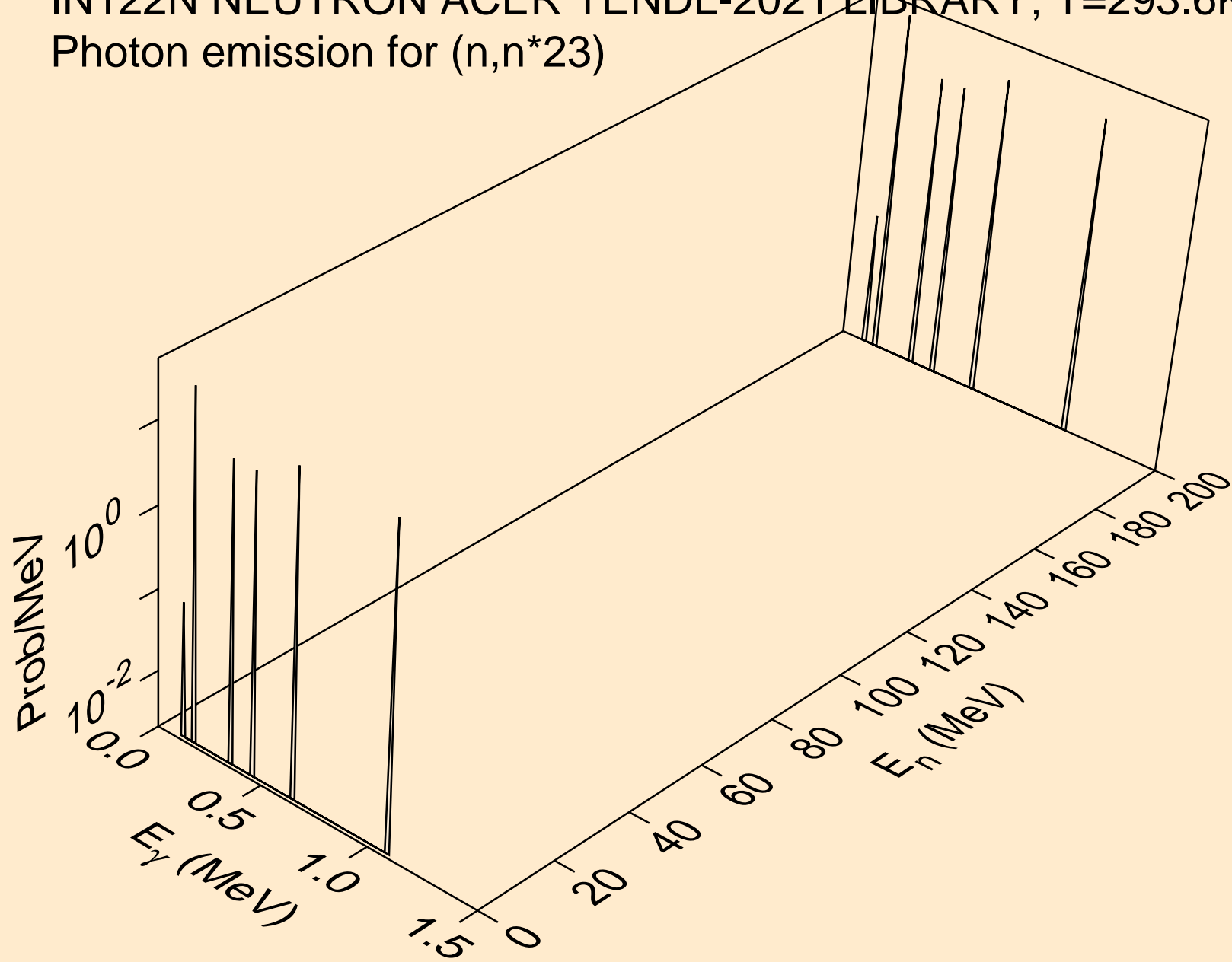

IN122N NEUTRON ACER TENDL-2021 LIBRARY; T=293.6K  
Photon emission for (n,n\*24)

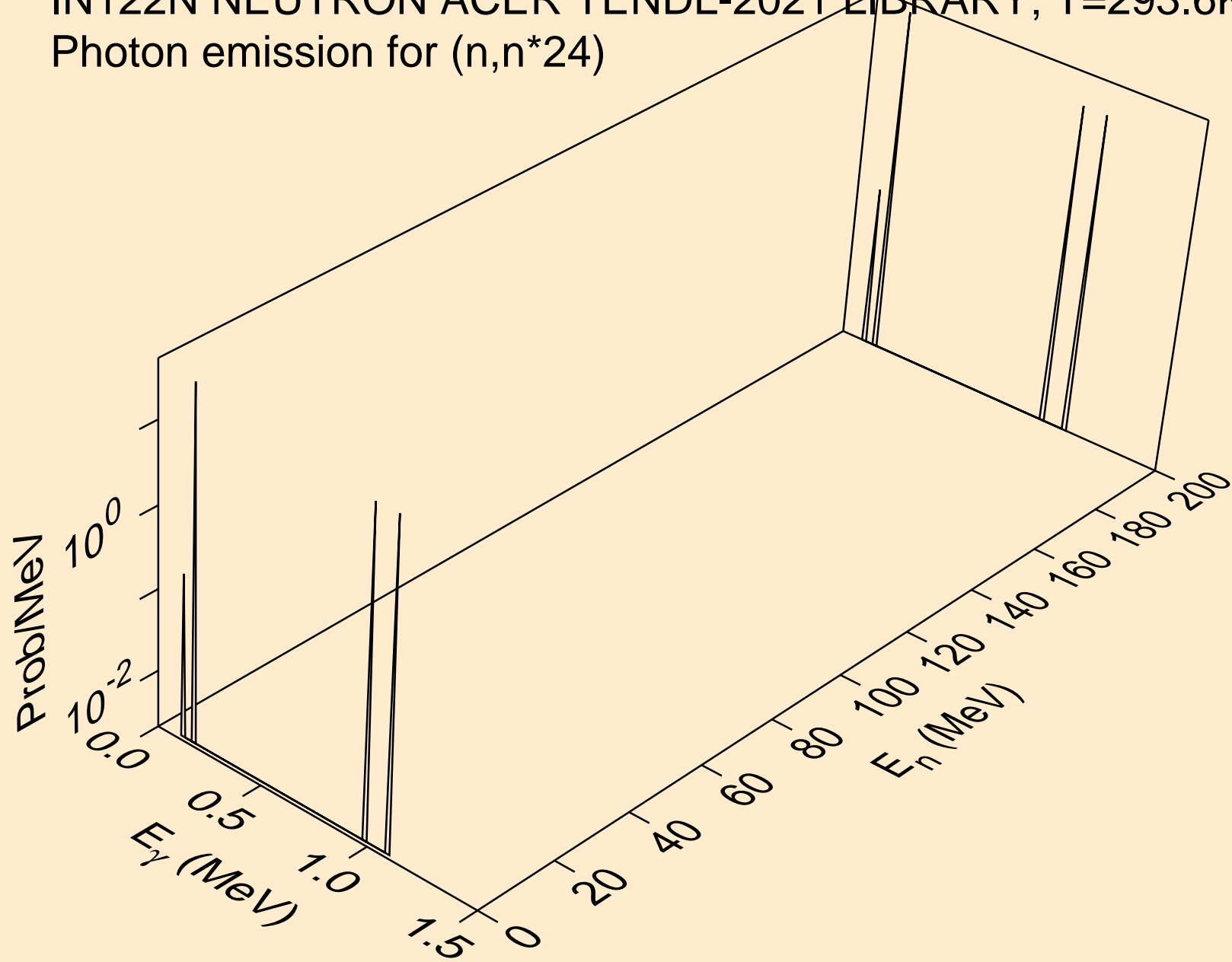

IN122N NEUTRON ACER TENDL-2021 LIBRARY; T=293.6K  
Photon emission for (n,n\*25)

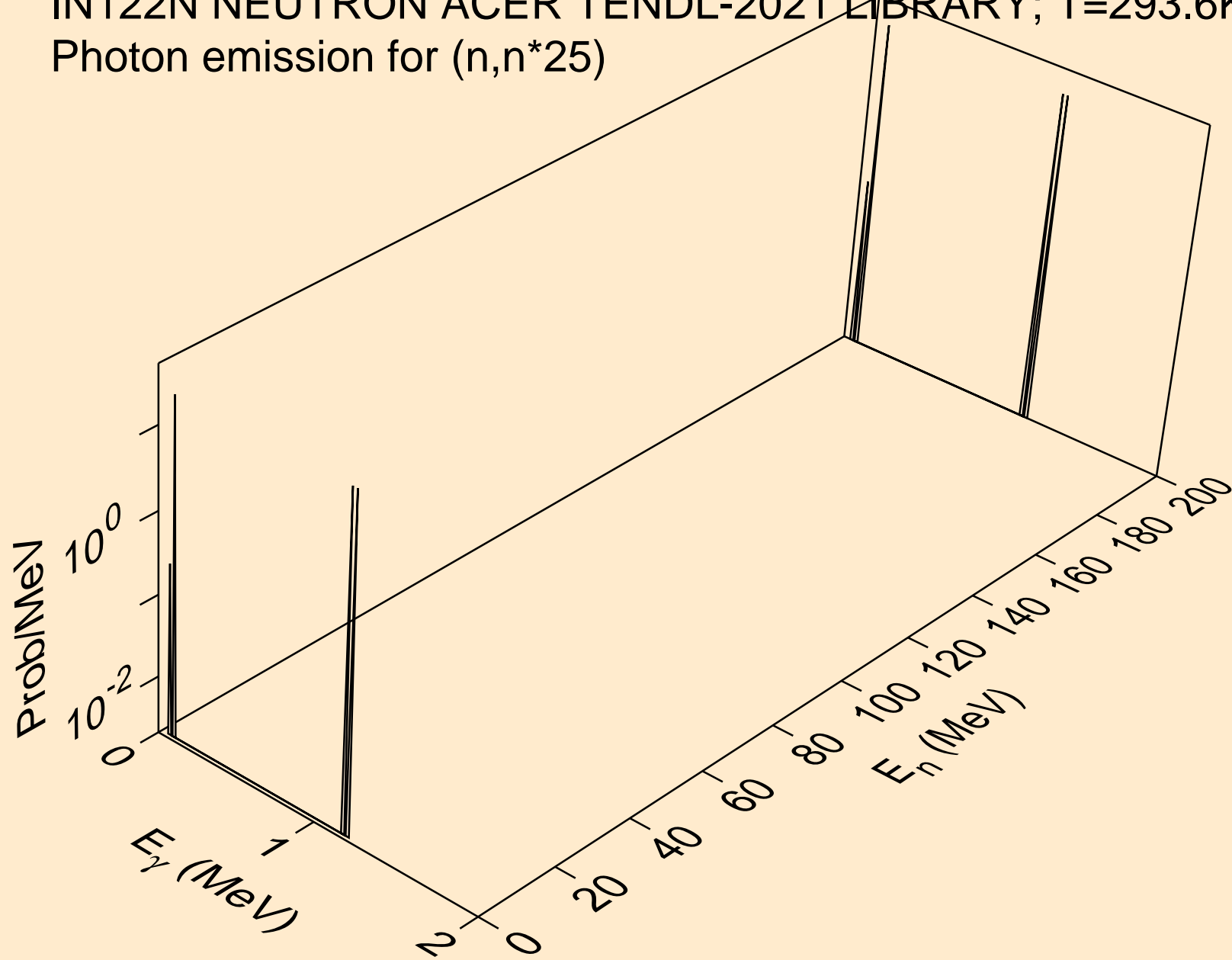



IN122N NEUTRON ACER TENDL-2021 LIBRARY; T=293.6K  
Photon emission for (n,n\*26)

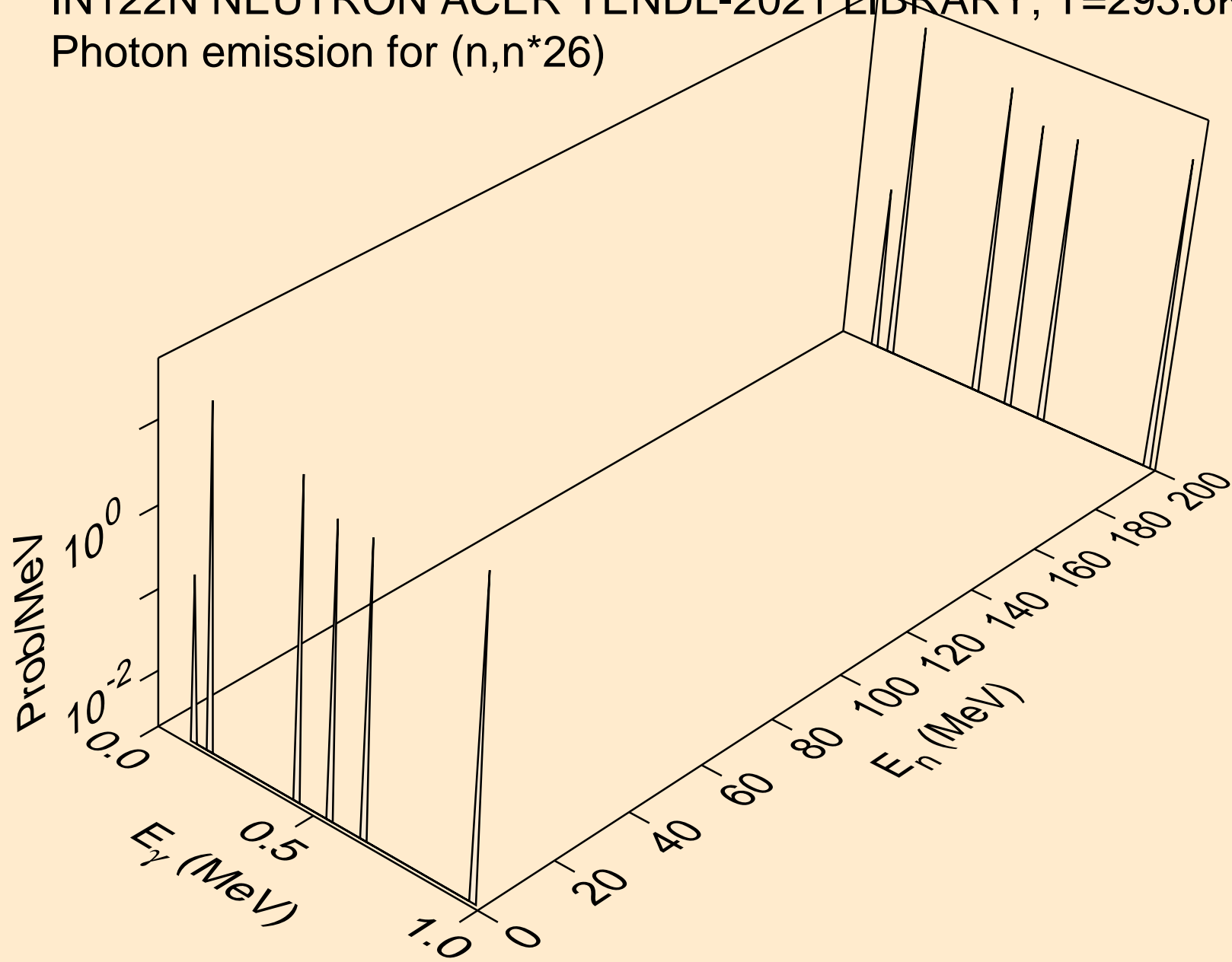

IN122N NEUTRON ACER TENDL-2021 LIBRARY; T=293.6K  
Photon emission for (n,n\*27)

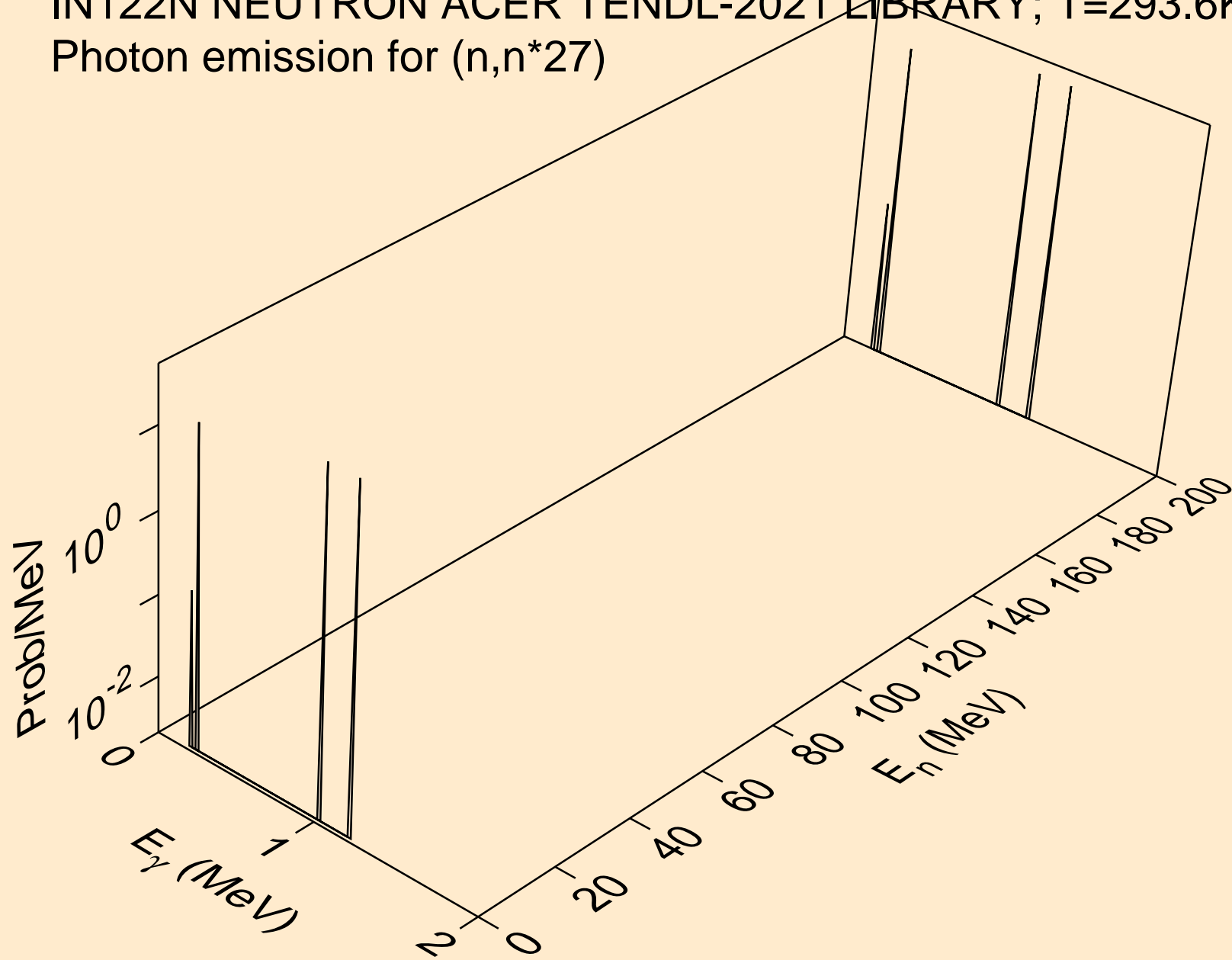

IN122N NEUTRON ACER TENDL-2021 LIBRARY; T=293.6K  
Photon emission for (n,n\*28)

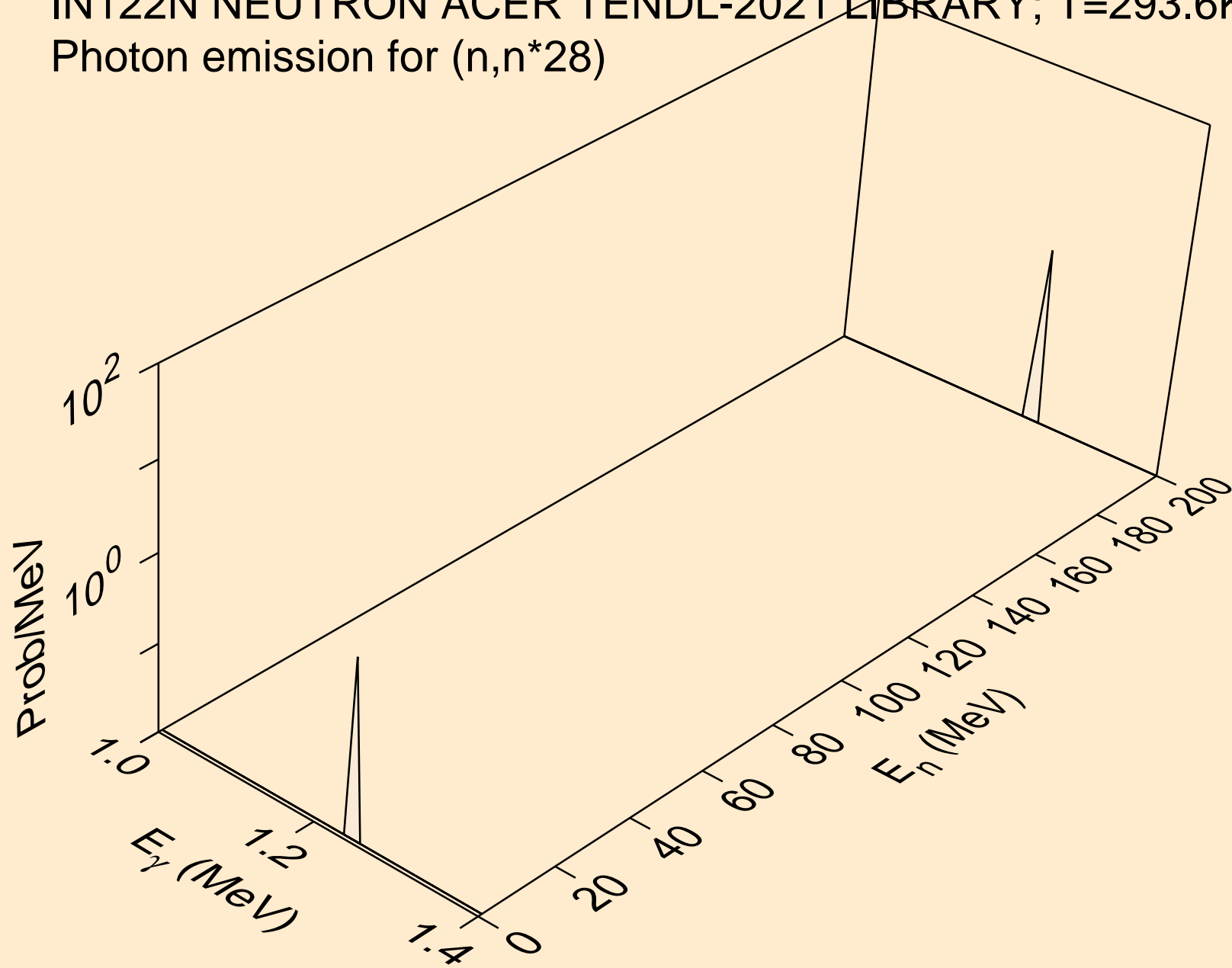

IN122N NEUTRON ACER TENDL-2021 LIBRARY; T=293.6K  
Photon emission for (n,n\*29)

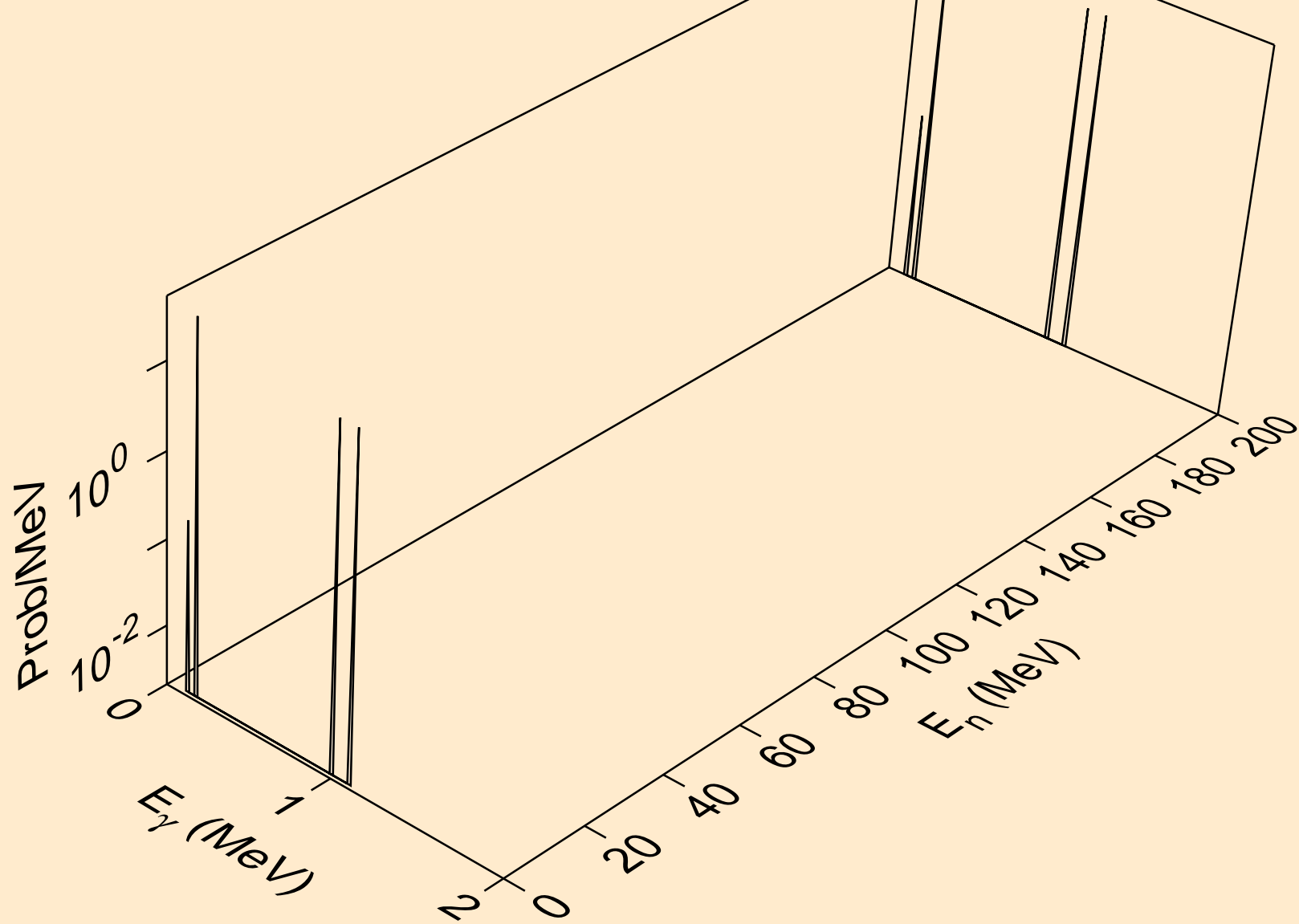

IN122N NEUTRON ACER TENDL-2021 LIBRARY; T=293.6K  
Photon emission for (n,n\*30)

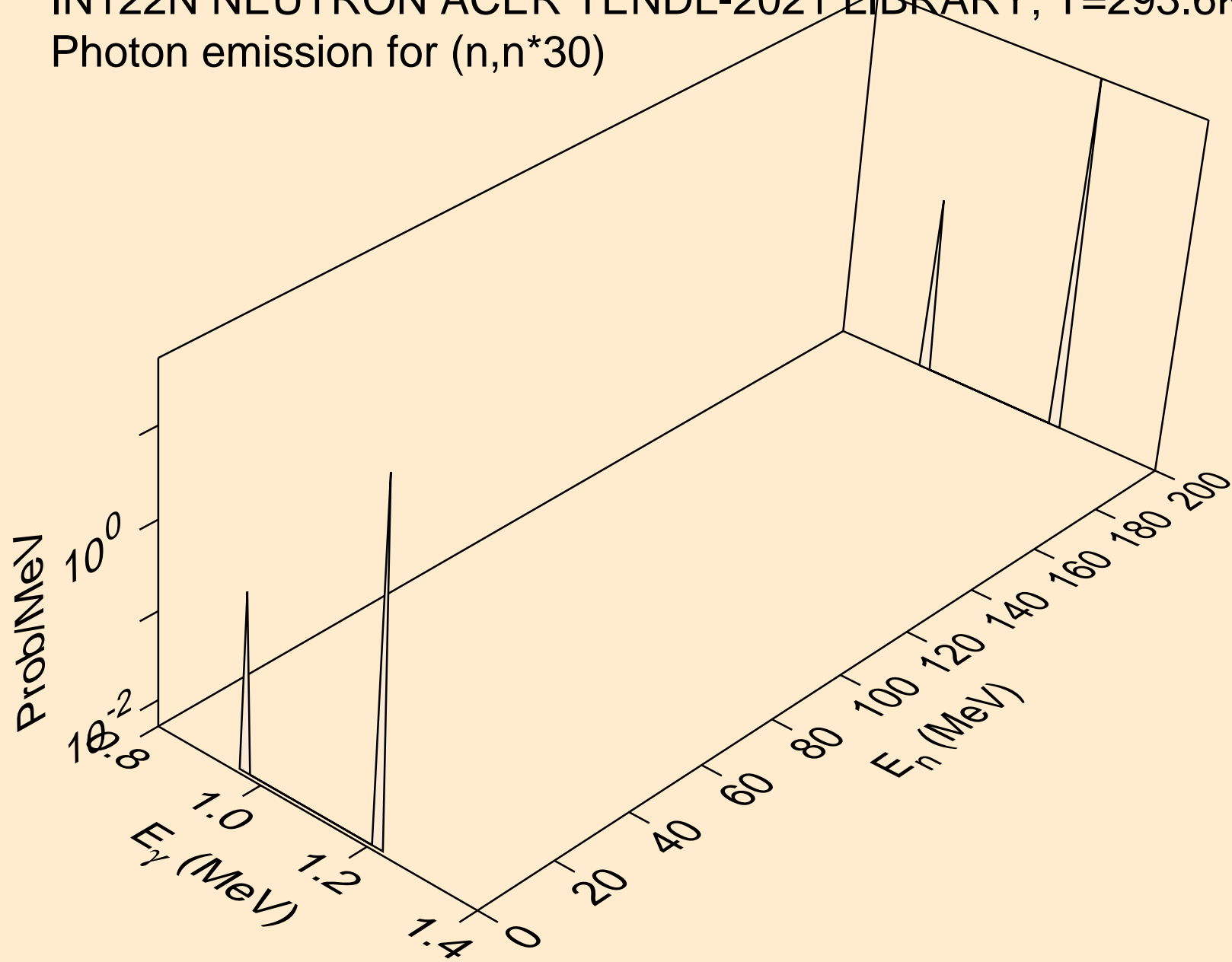

IN122N NEUTRON ACER TENDL-2021 LIBRARY; T=293.6K  
Photon emission for (n,n\*c)

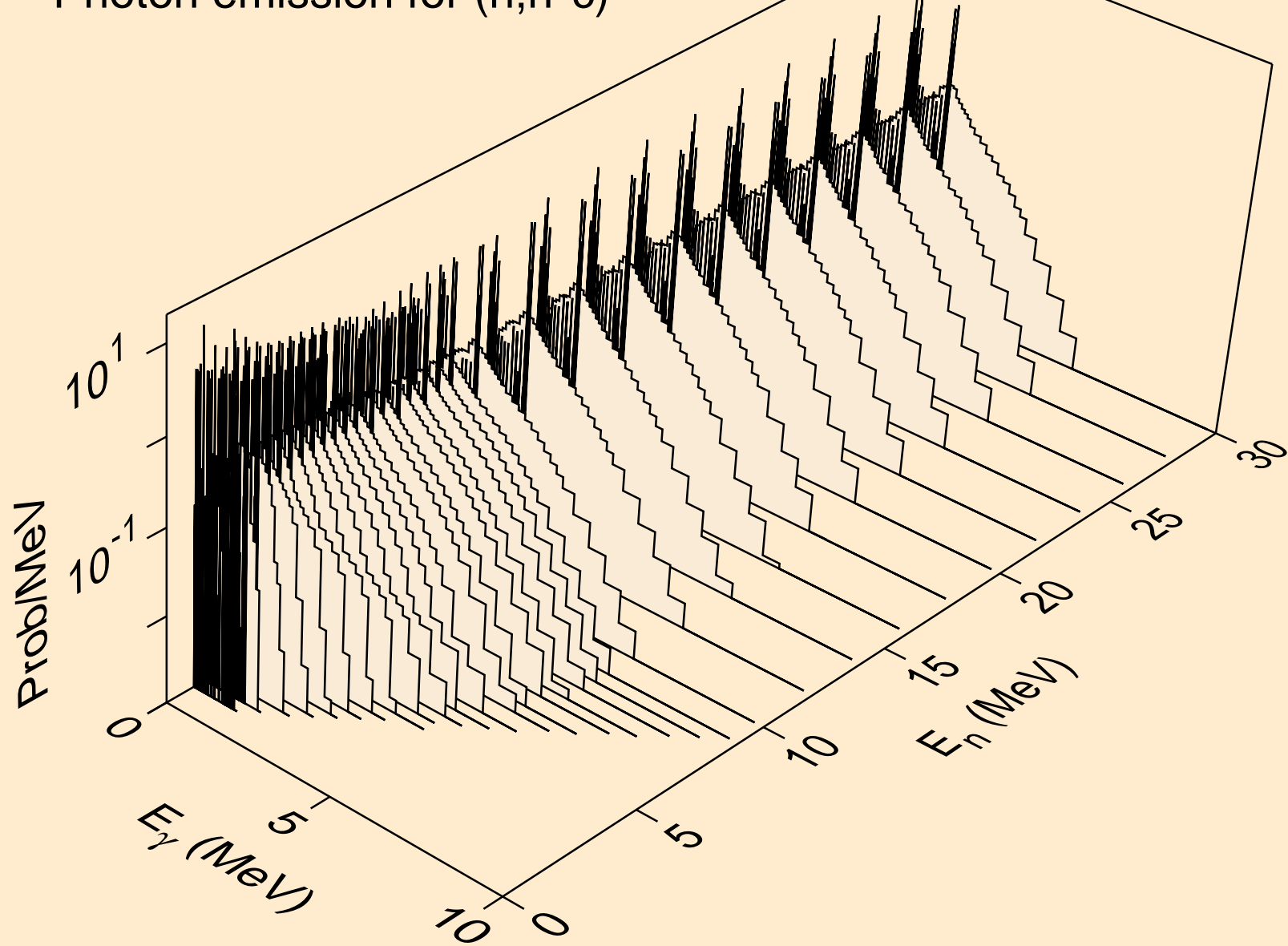

IN122N NEUTRON ACER TENDL-2021 LIBRARY; T=293.6K  
Photon emission for (n,gma)

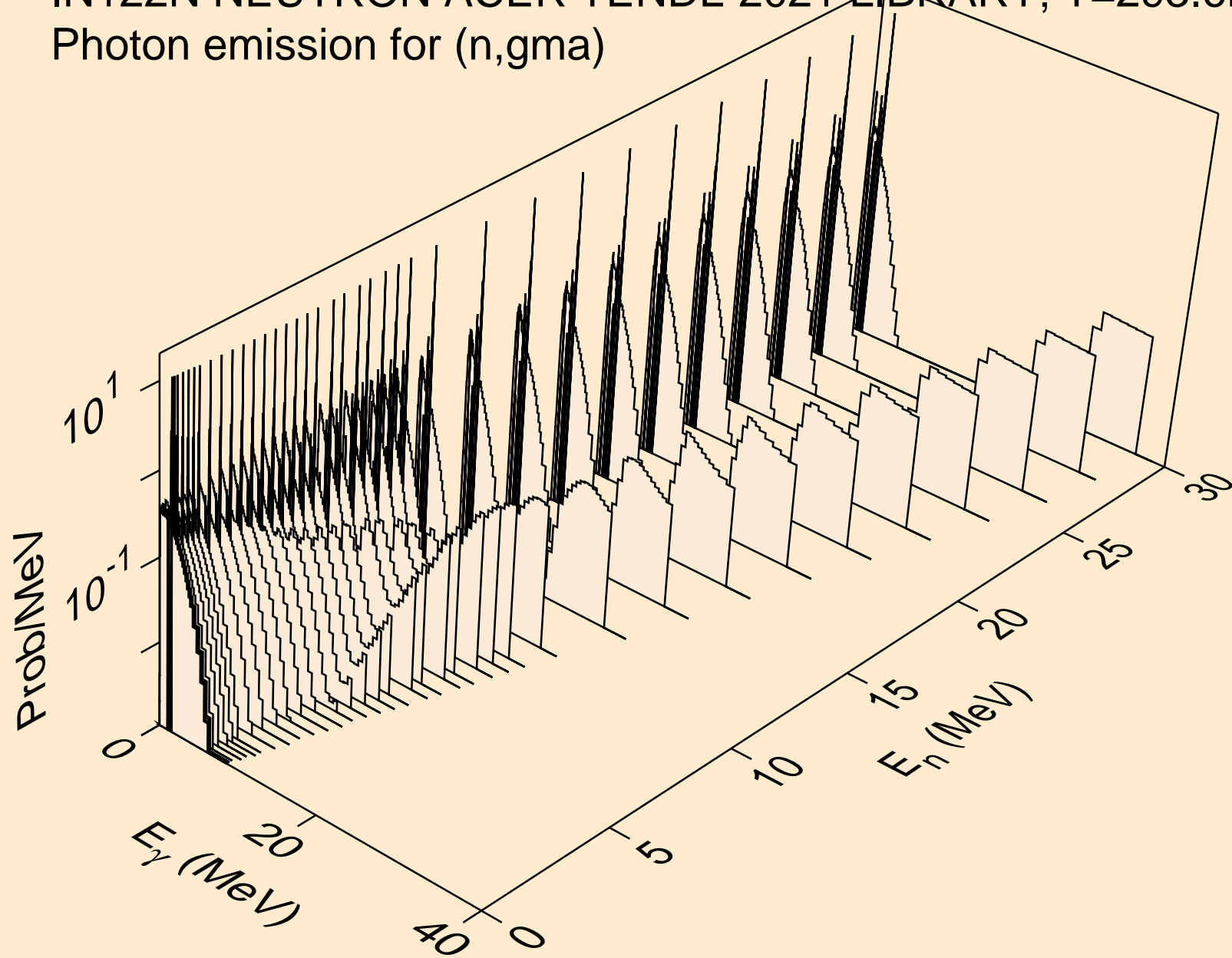

IN122N NEUTRON ACER TENDL-2021 LIBRARY; T=293.6K  
Photon emission for (n,p)

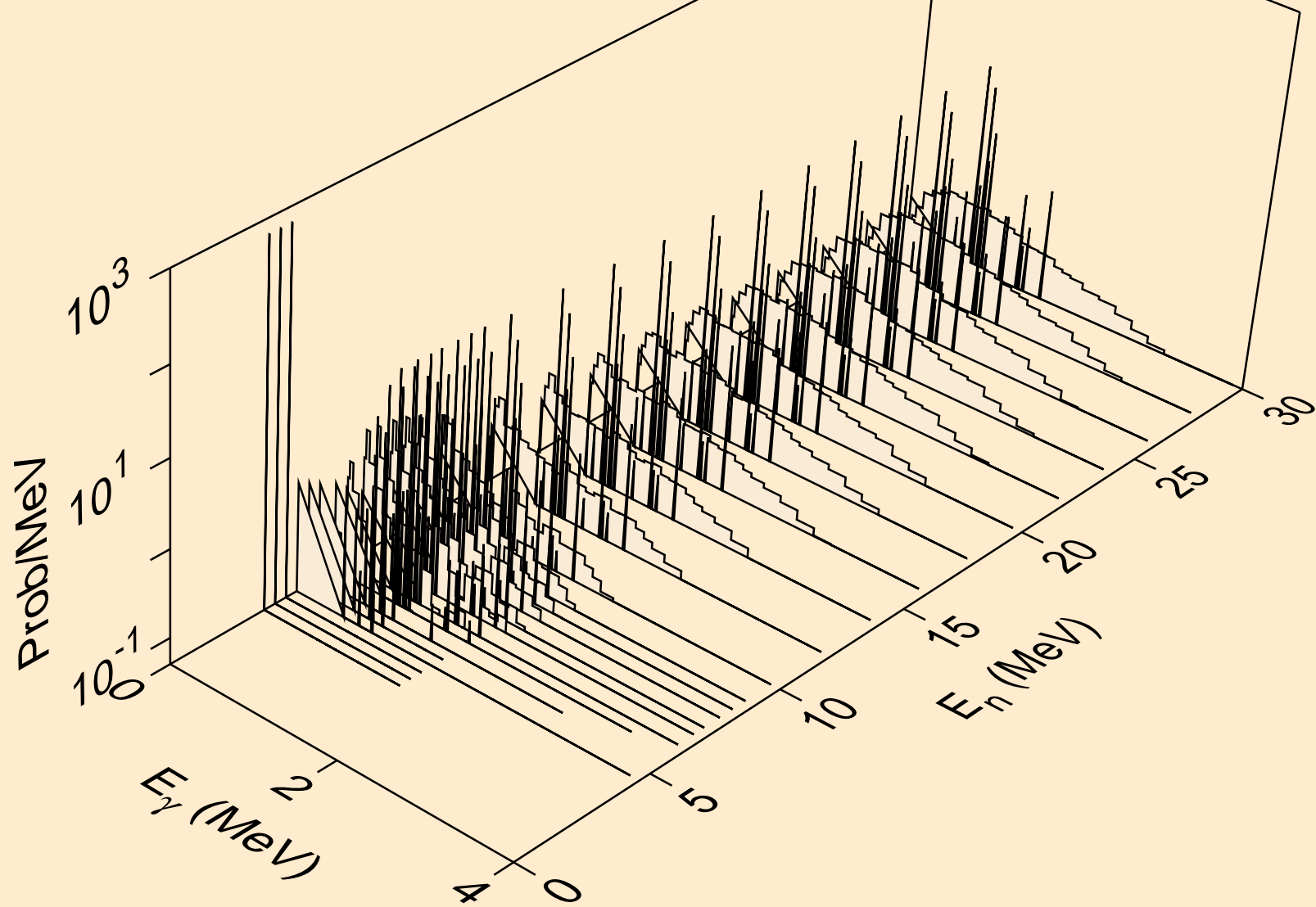



IN122N NEUTRON ACER TENDL-2021 LIBRARY; T=293.6K  
Photon emission for (n,d)

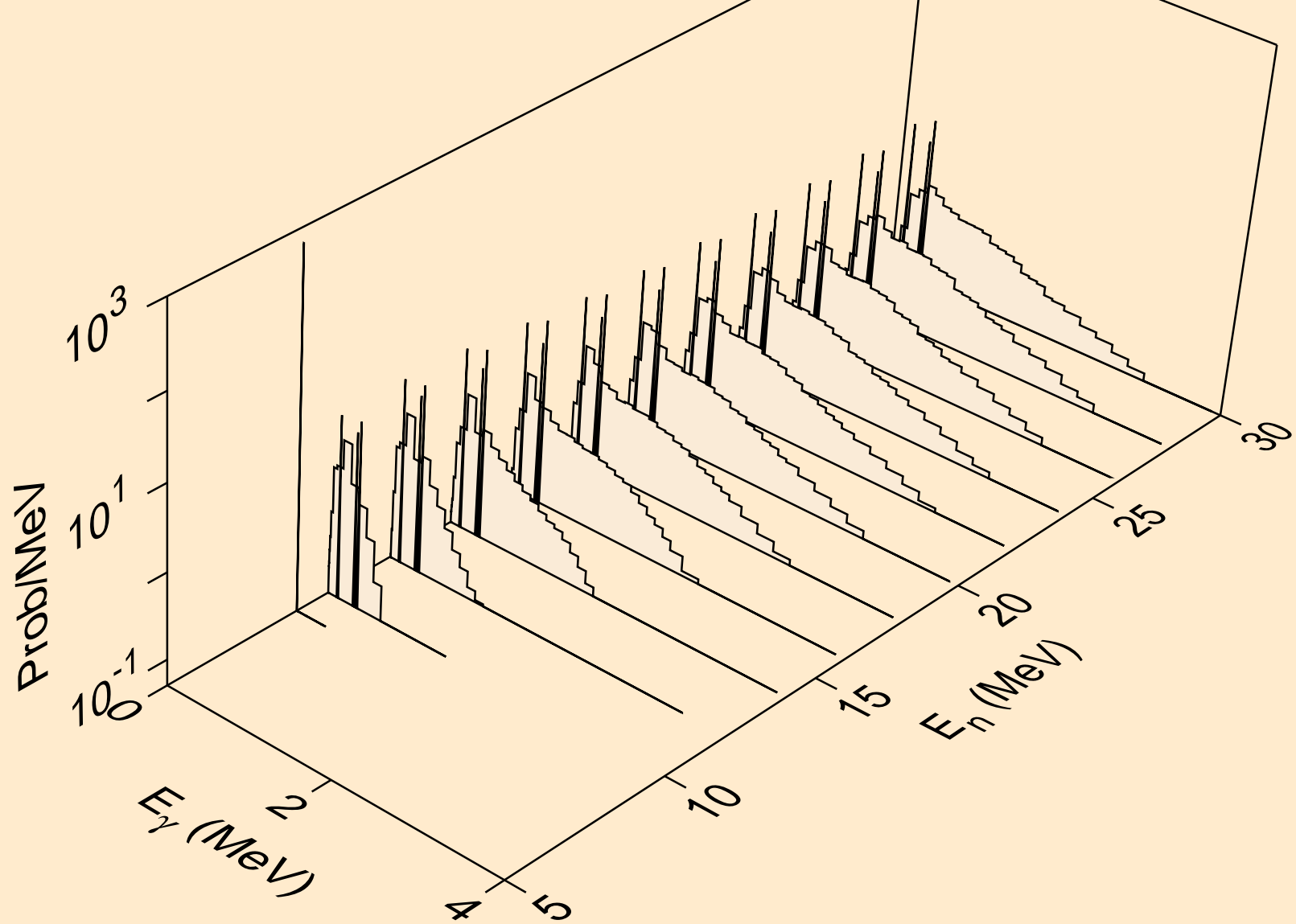

IN122N NEUTRON ACER TENDL-2021 LIBRARY; T=293.6K  
Photon emission for (n,t)

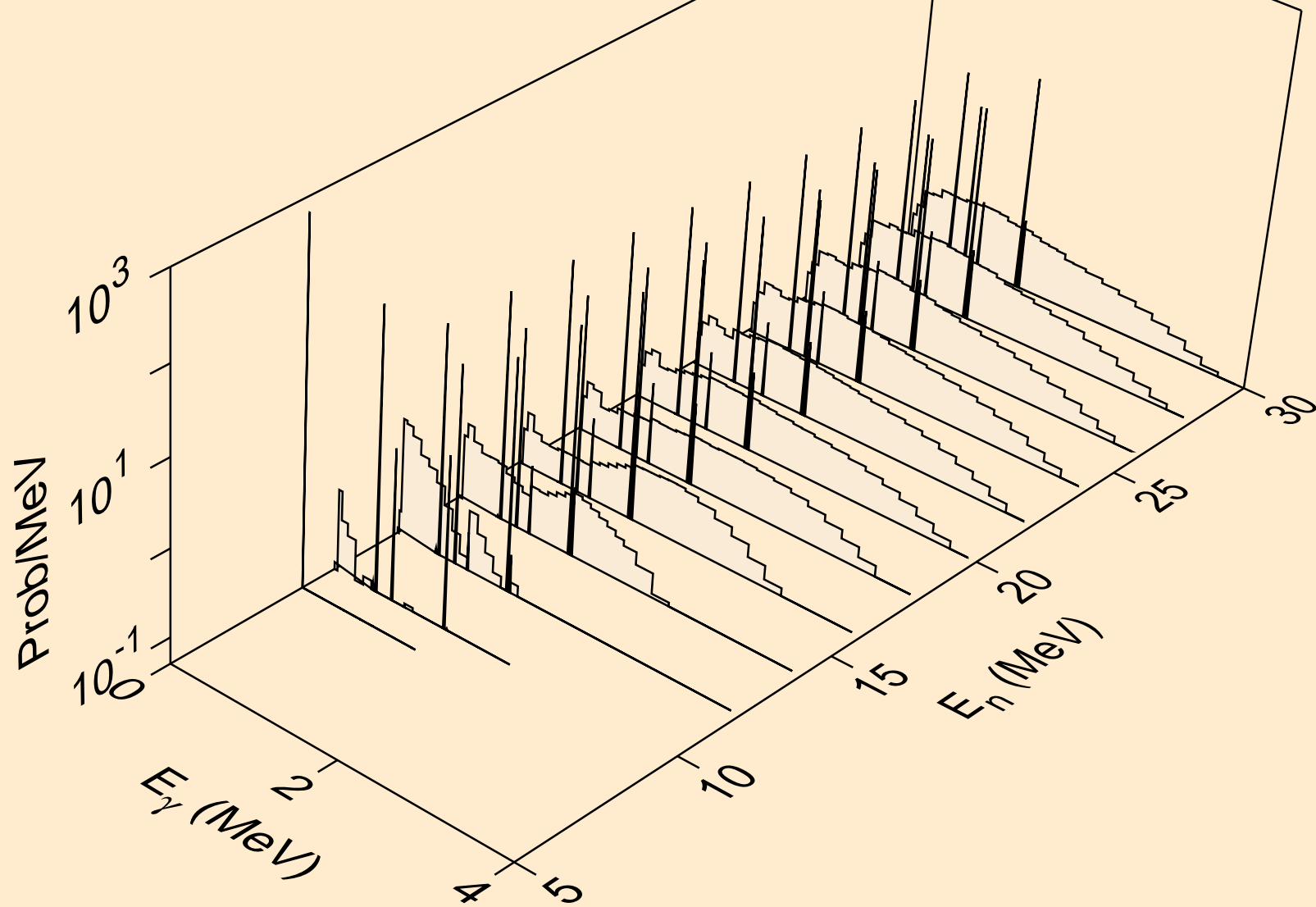

IN122N NEUTRON ACER TENDL-2021 LIBRARY; T=293.6K  
Photon emission for (n,he3)

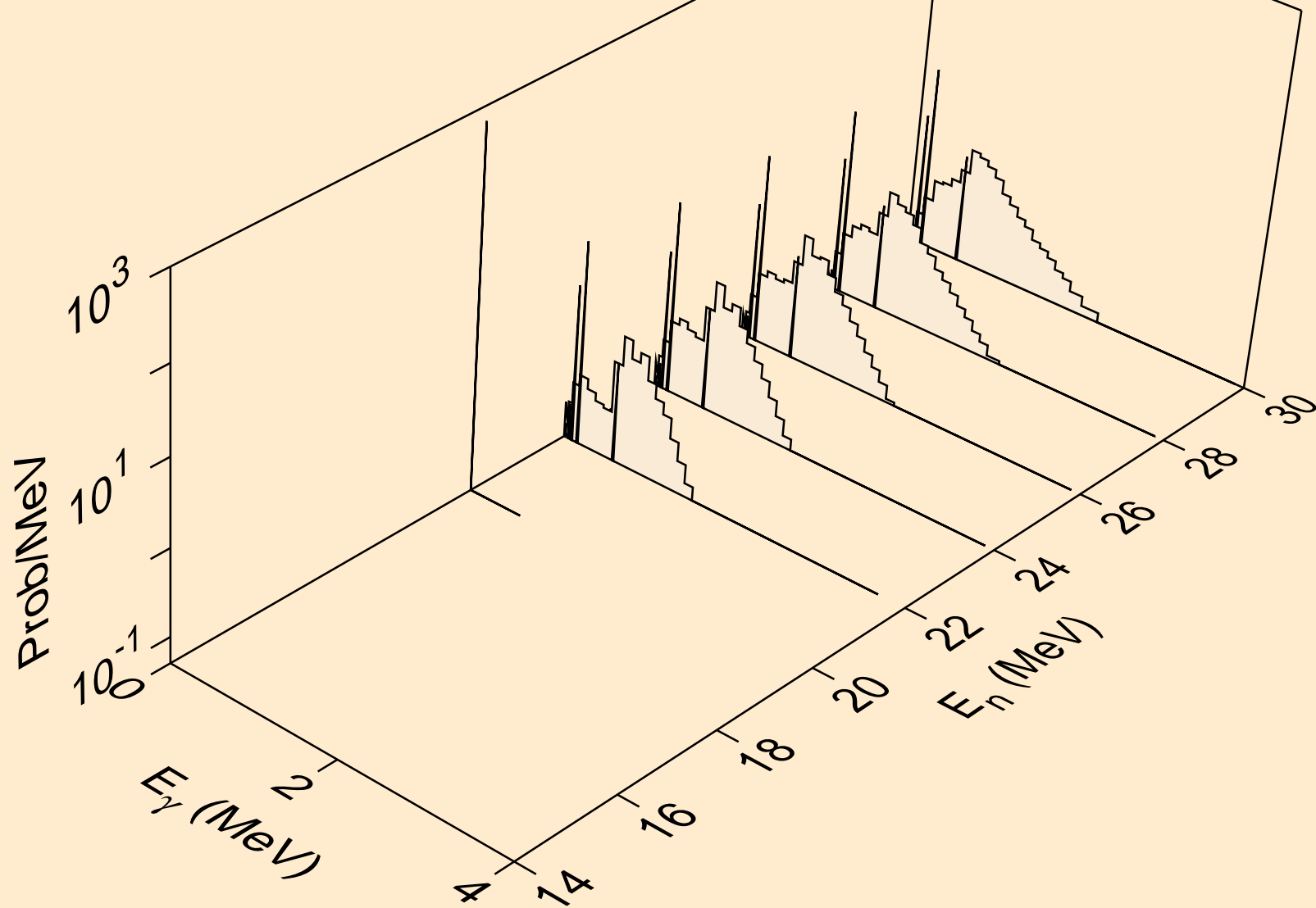

IN122N NEUTRON ACER TENDL-2021 LIBRARY; T=293.6K  
Photon emission for (n,a)

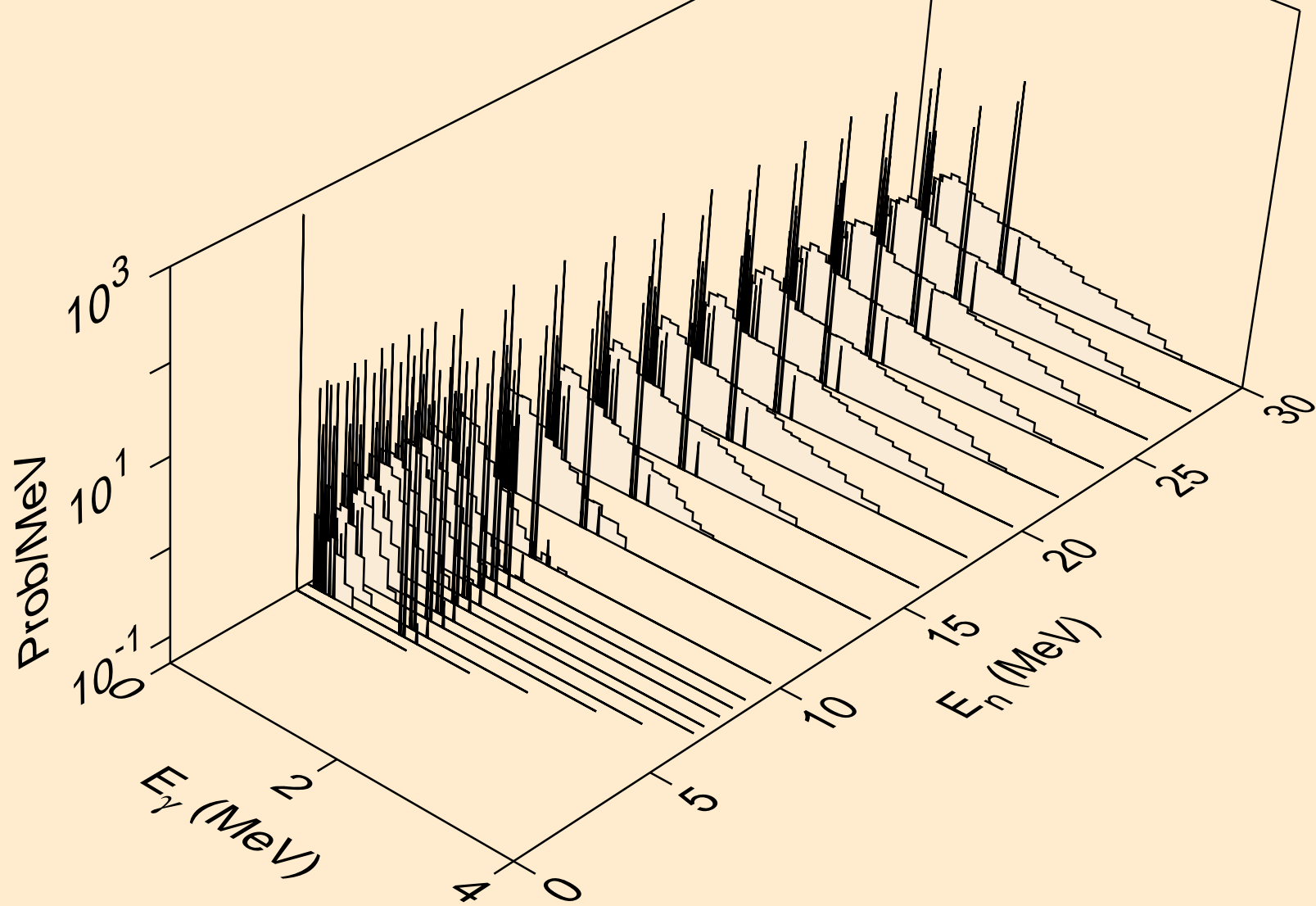

IN122N NEUTRON ACER TENDL-2021 LIBRARY; T=293.6K  
Photon emission for (n,2p)

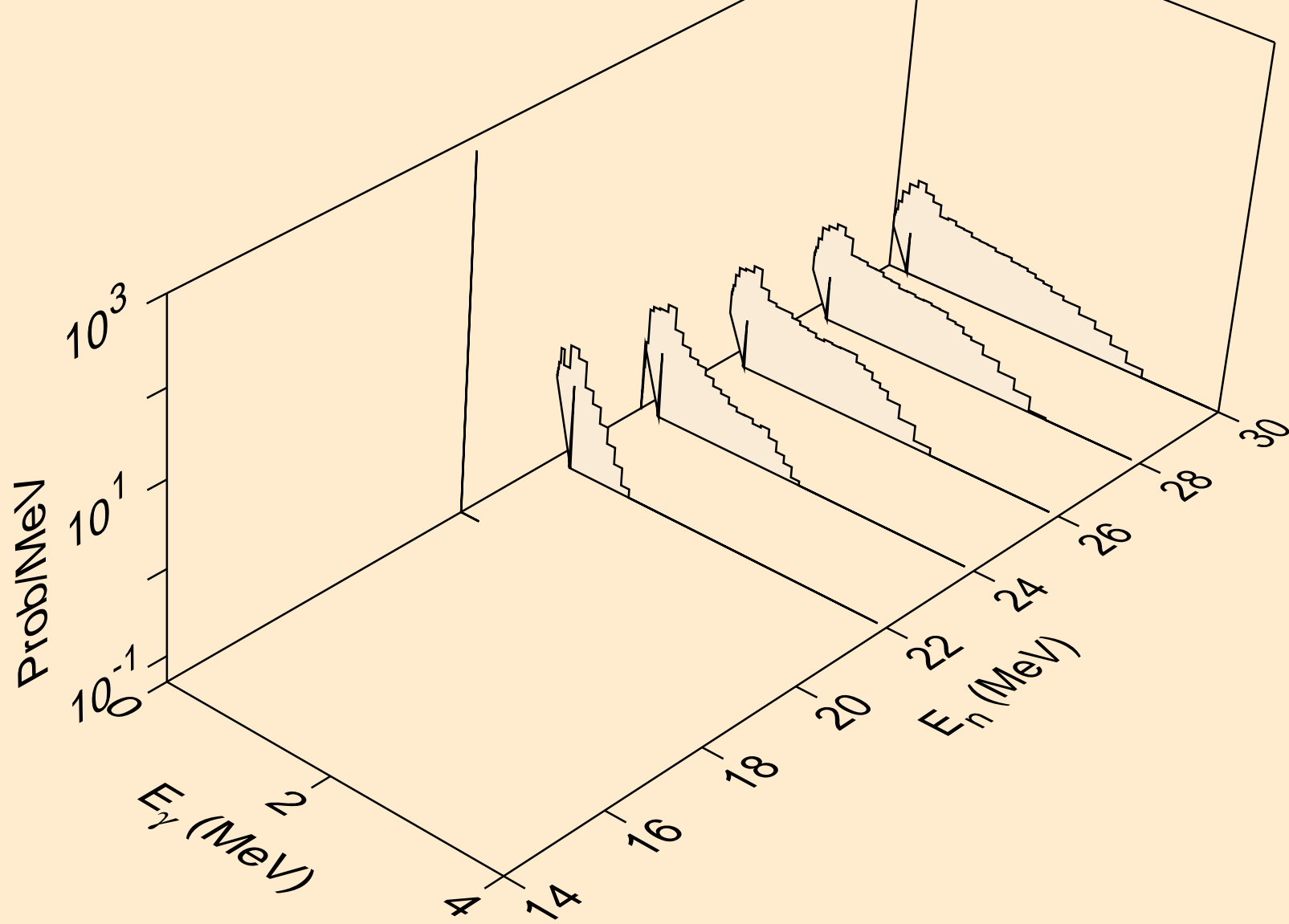

IN122N NEUTRON ACER TENDL-2021 LIBRARY; T=293.6K  
thermal capture photon spectrum

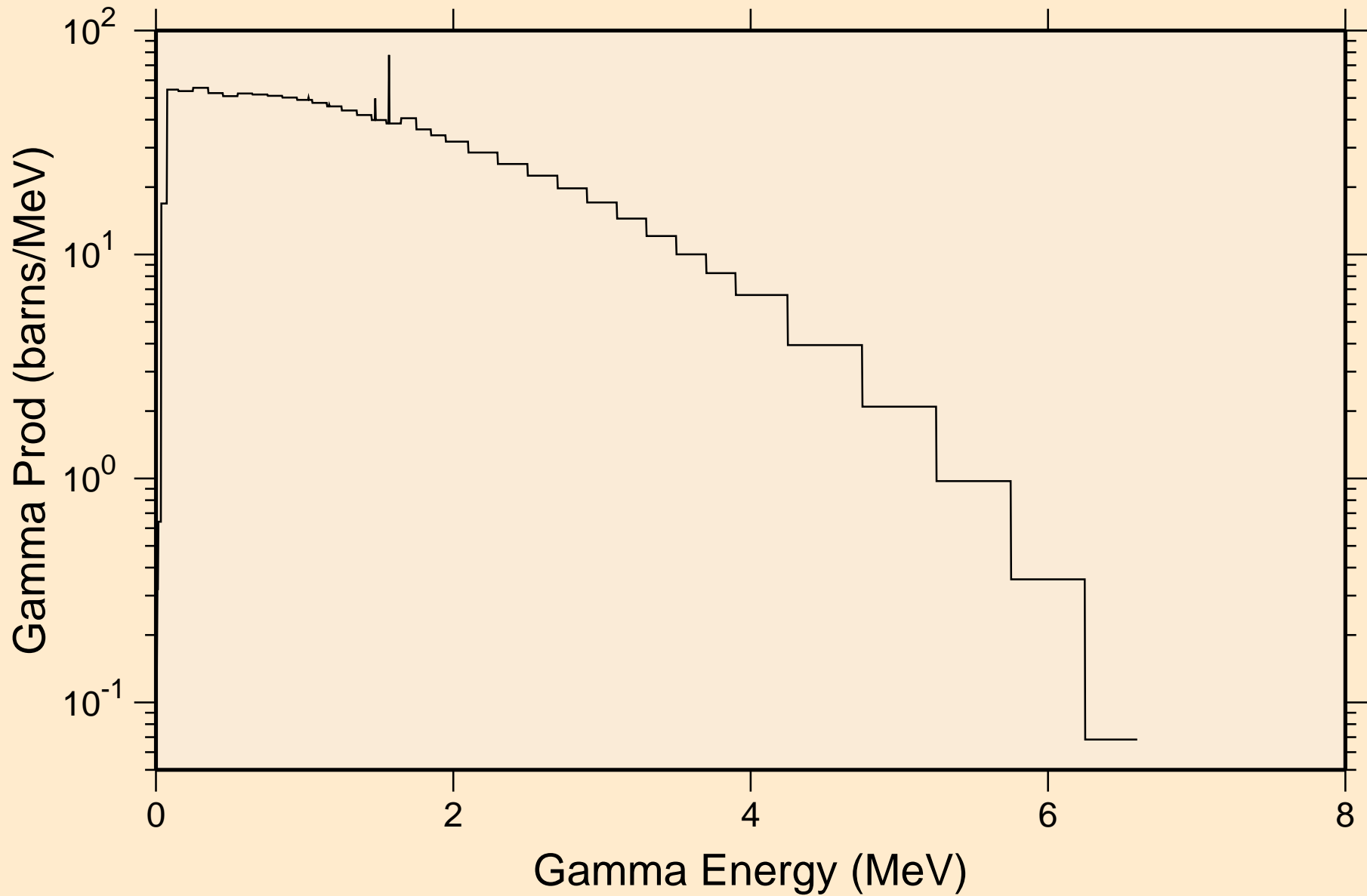

IN122N NEUTRON ACER TENDL-2021 LIBRARY; T=293.6K  
14 MeV photon spectrum

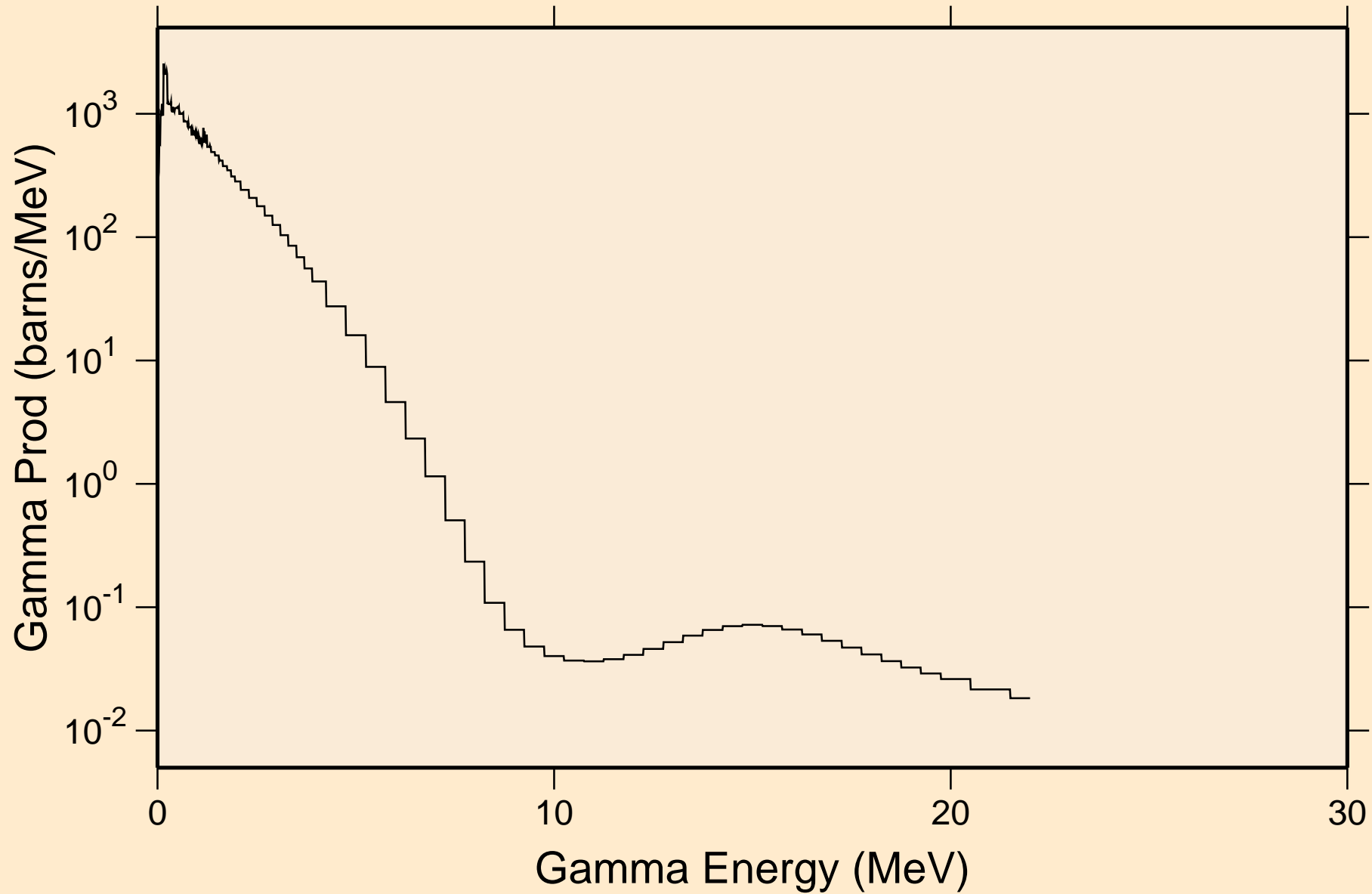

IN122N NEUTRON ACER TENDL-2021 LIBRARY; T=293.6K  
Particle heating contributions

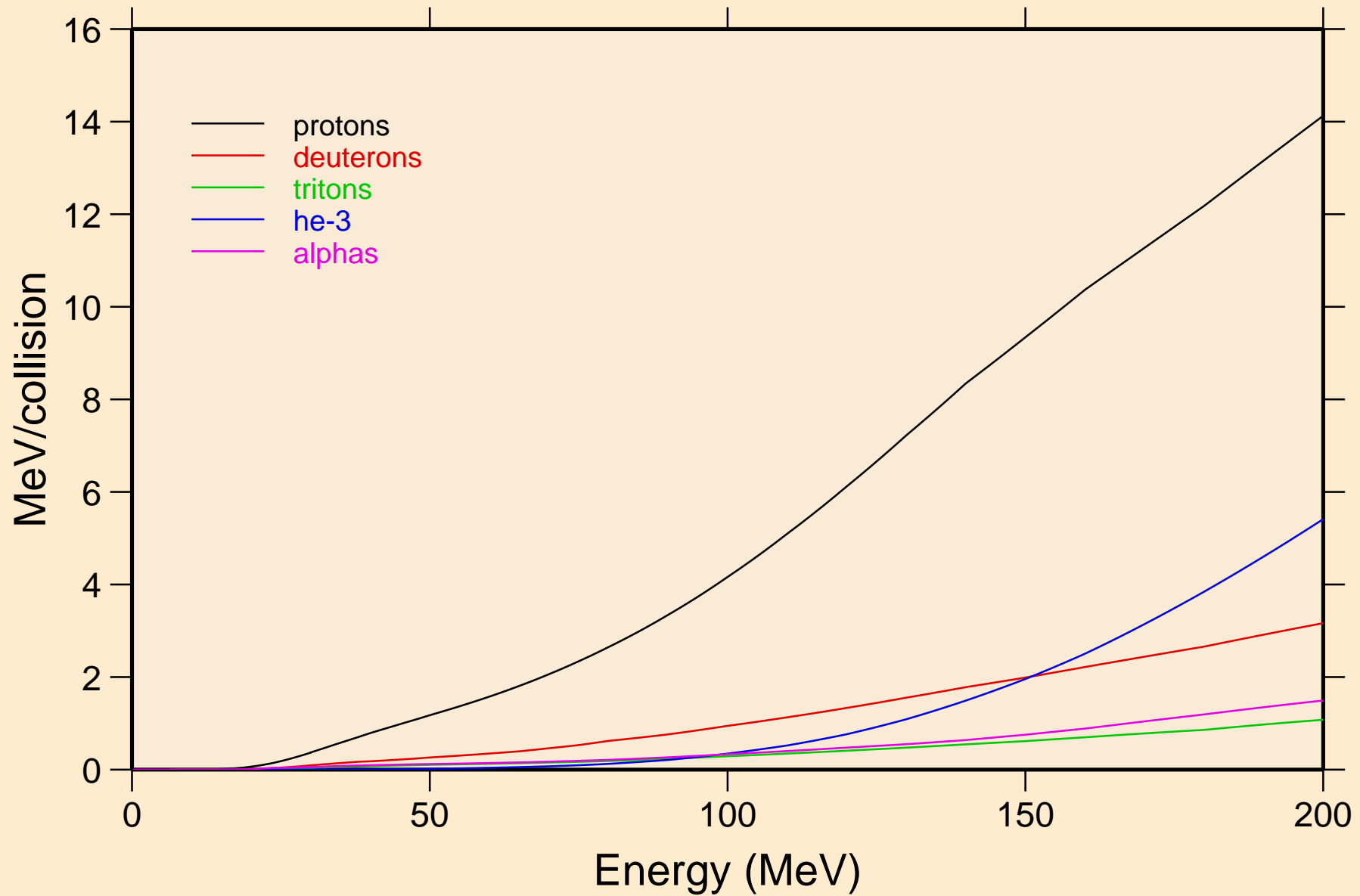



IN122N NEUTRON ACER TENDL-2021 LIBRARY; T=293.6K  
Recoil Heating

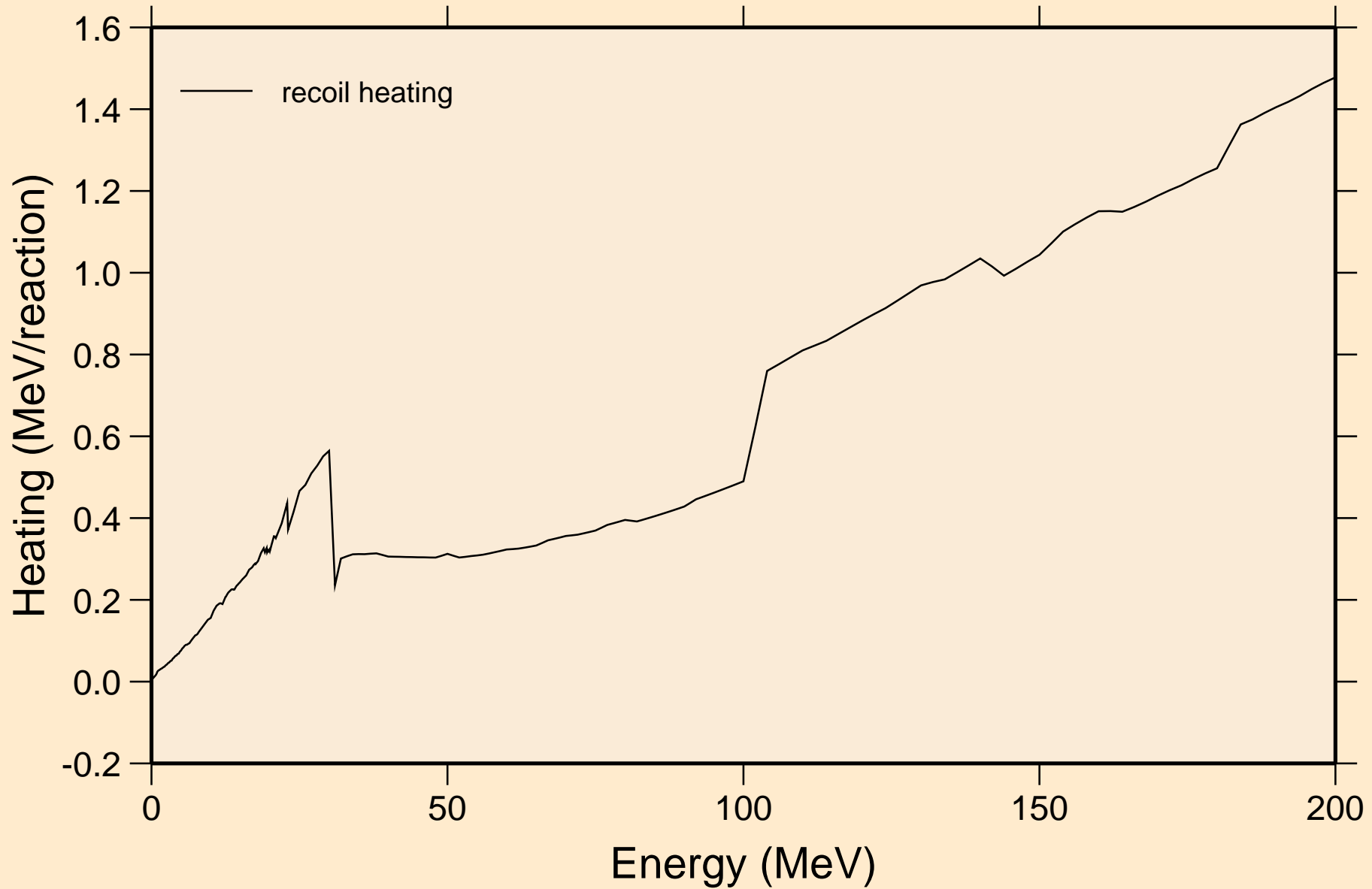

IN122N NEUTRON ACER TENDL-2021 LIBRARY; T=293.6K  
Particle production cross sections

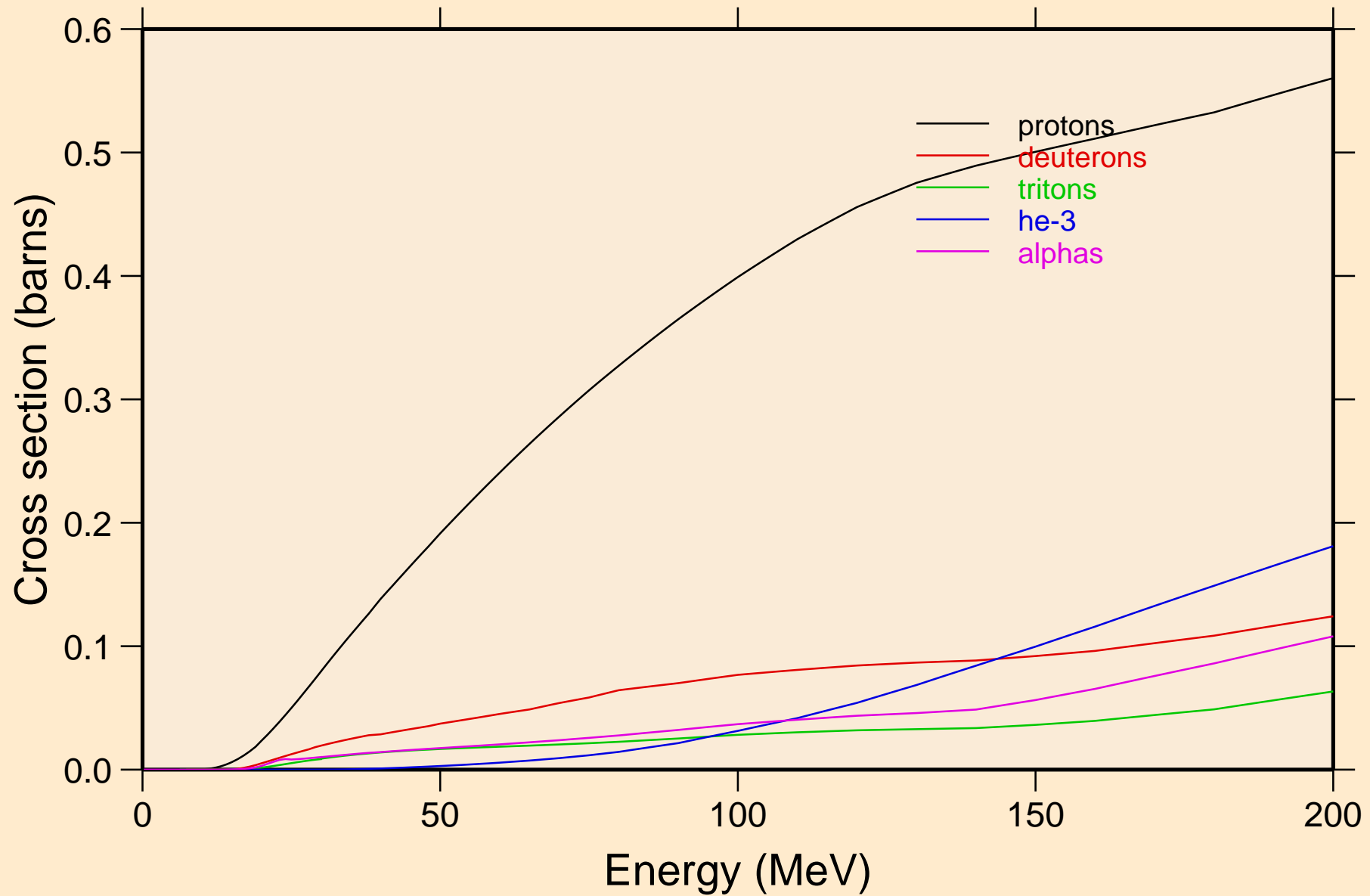

IN122N NEUTRON ACER TENDL-2021 LIBRARY; T=293.6K  
protons from (n,x)

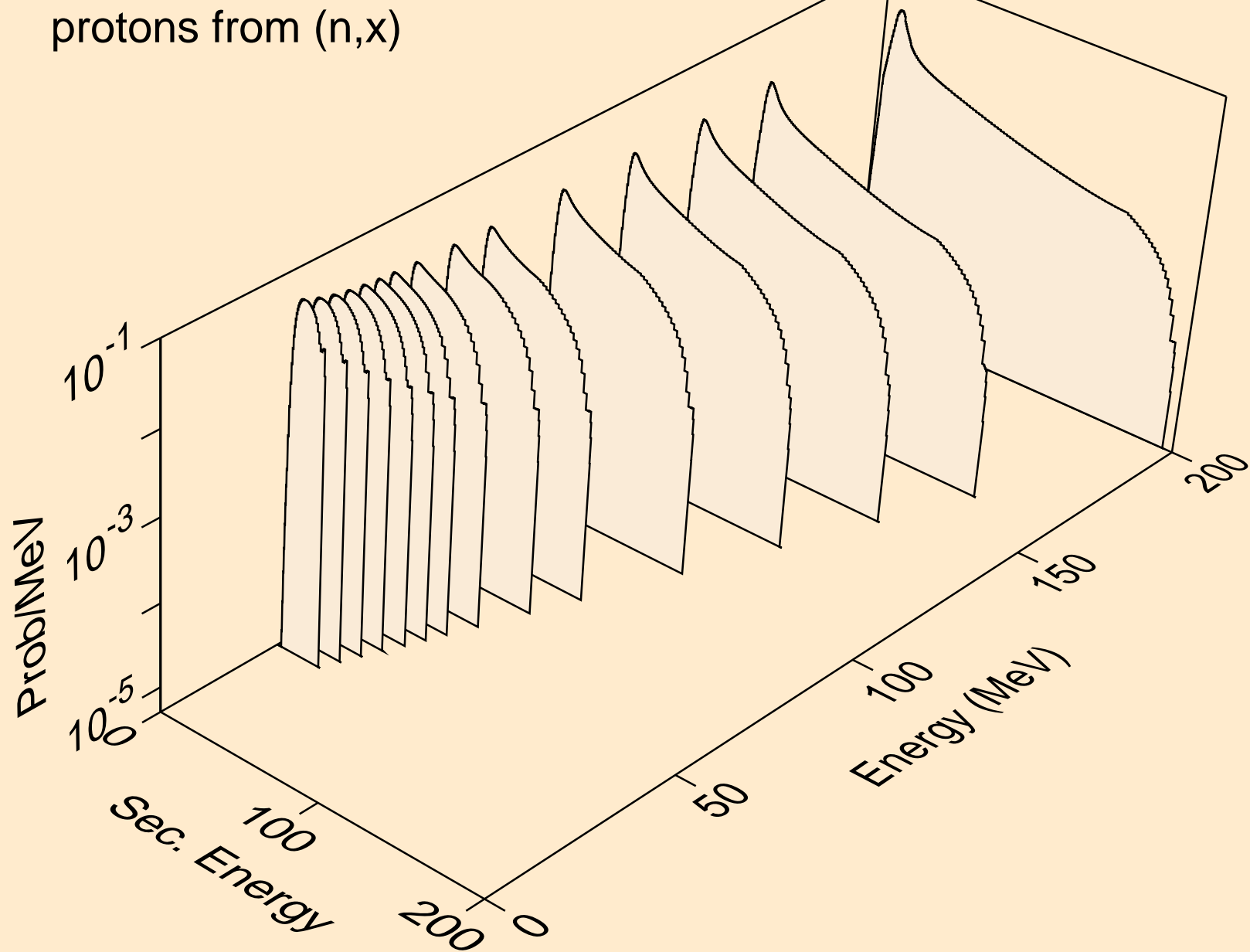

IN122N NEUTRON ACER TENDL-2021 LIBRARY; T=293.6K  
protons from (n,n\*)p

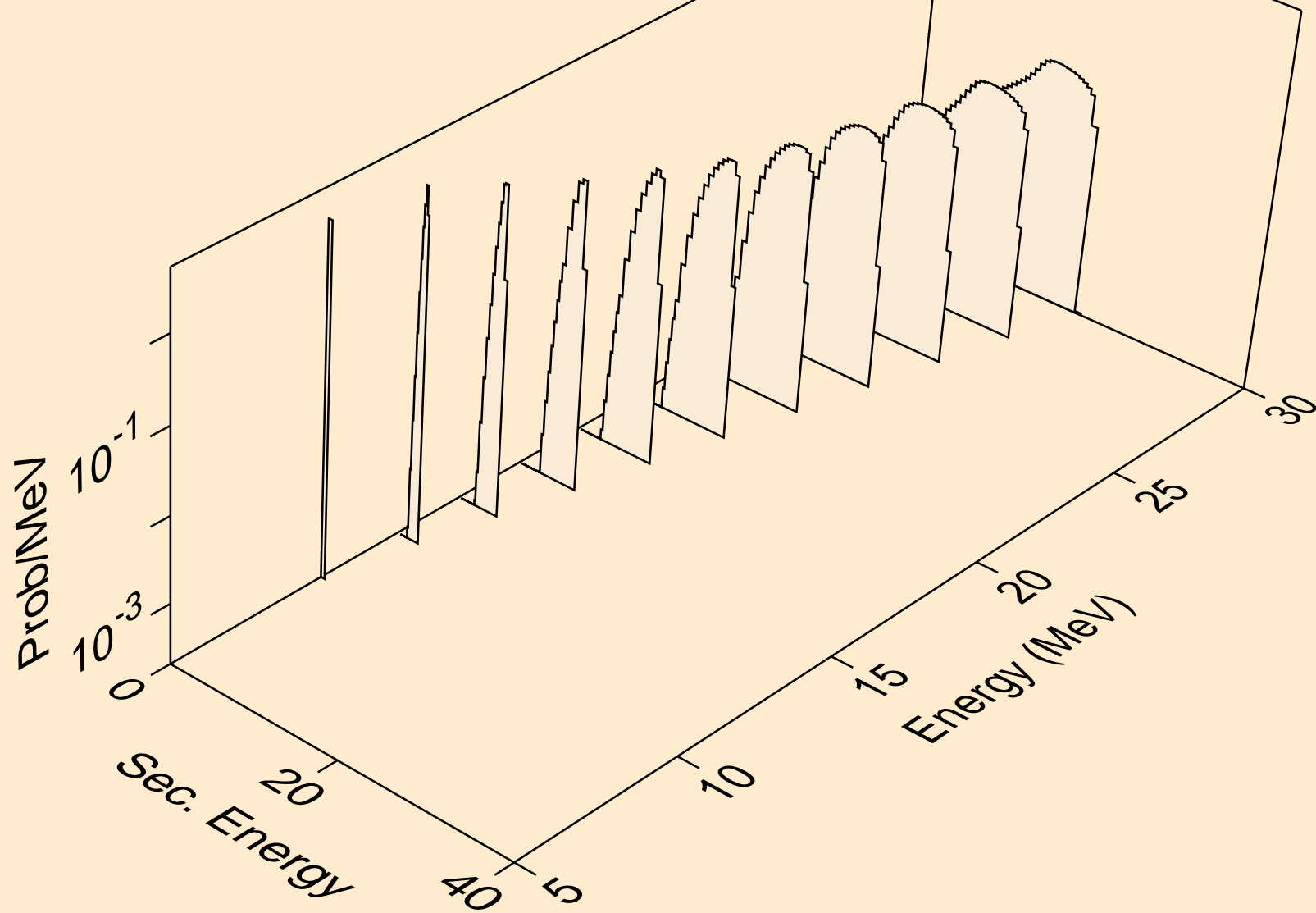

IN122N NEUTRON ACER TENDL-2021 LIBRARY; T=293.6K  
protons from (n,2np)

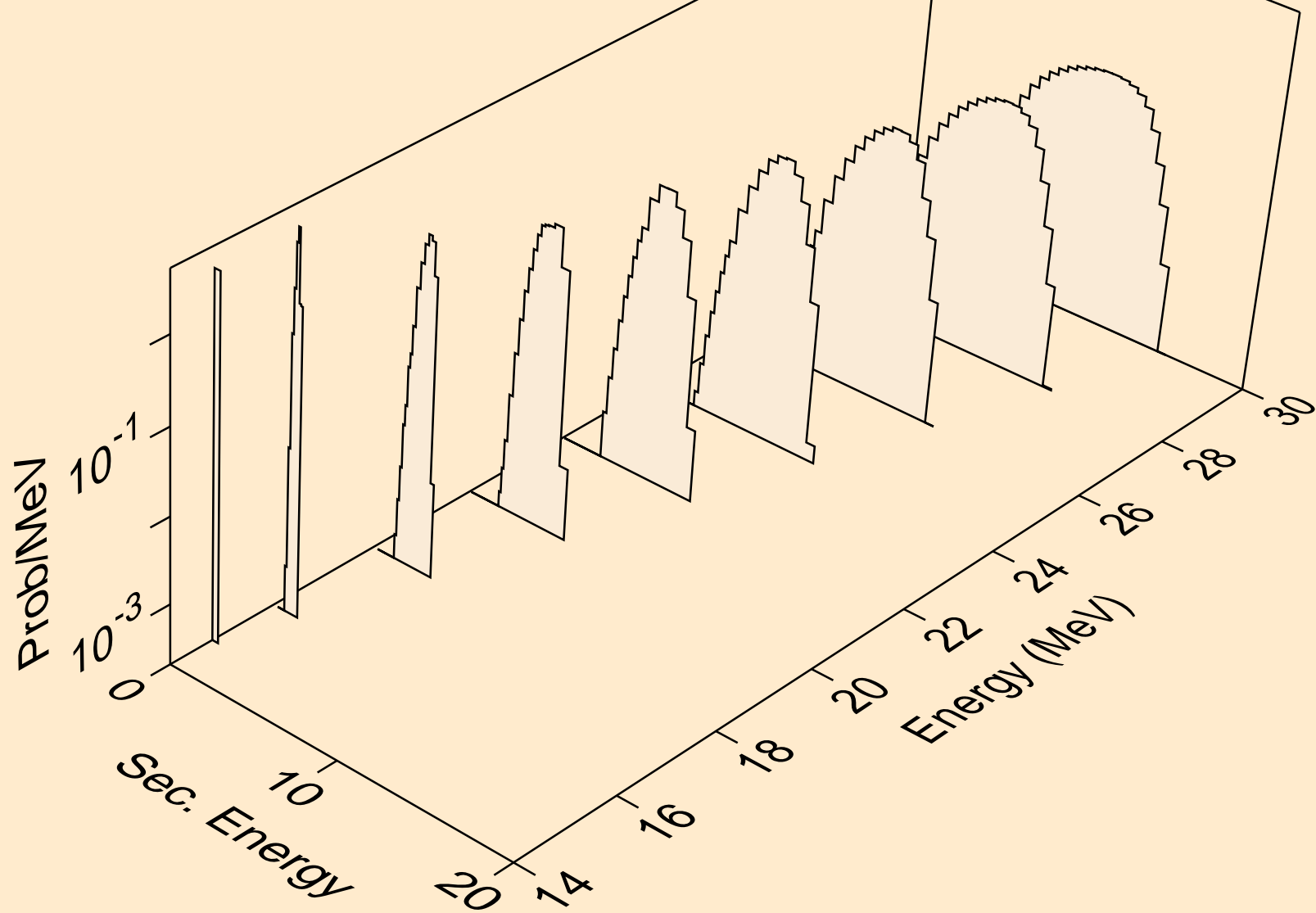

IN122N NEUTRON ACER TENDL-2021 LIBRARY; T=293.6K  
protons from (n,3np)

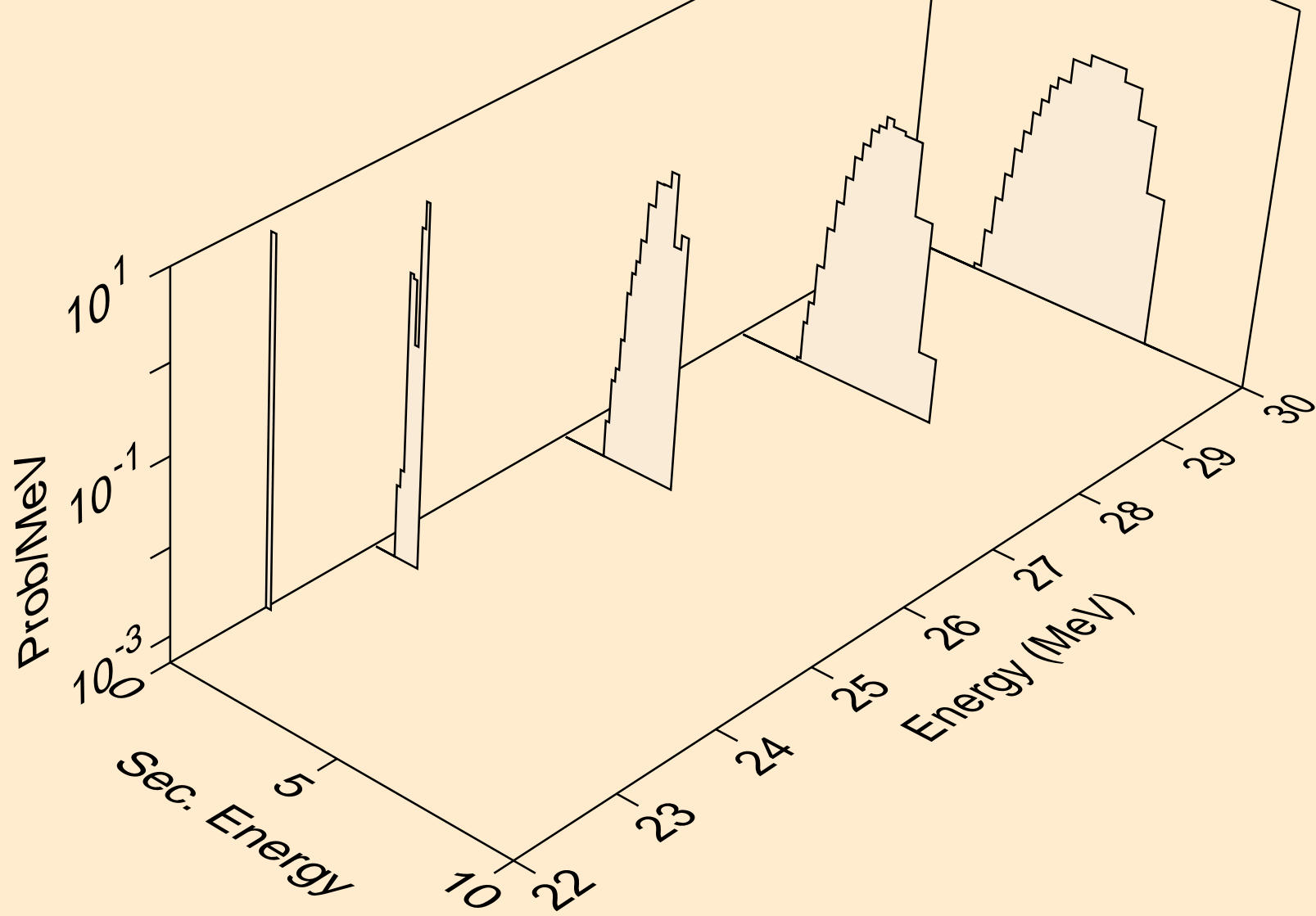

IN122N NEUTRON ACER TENDL-2021 LIBRARY; T=293.6K  
protons from (n,p)

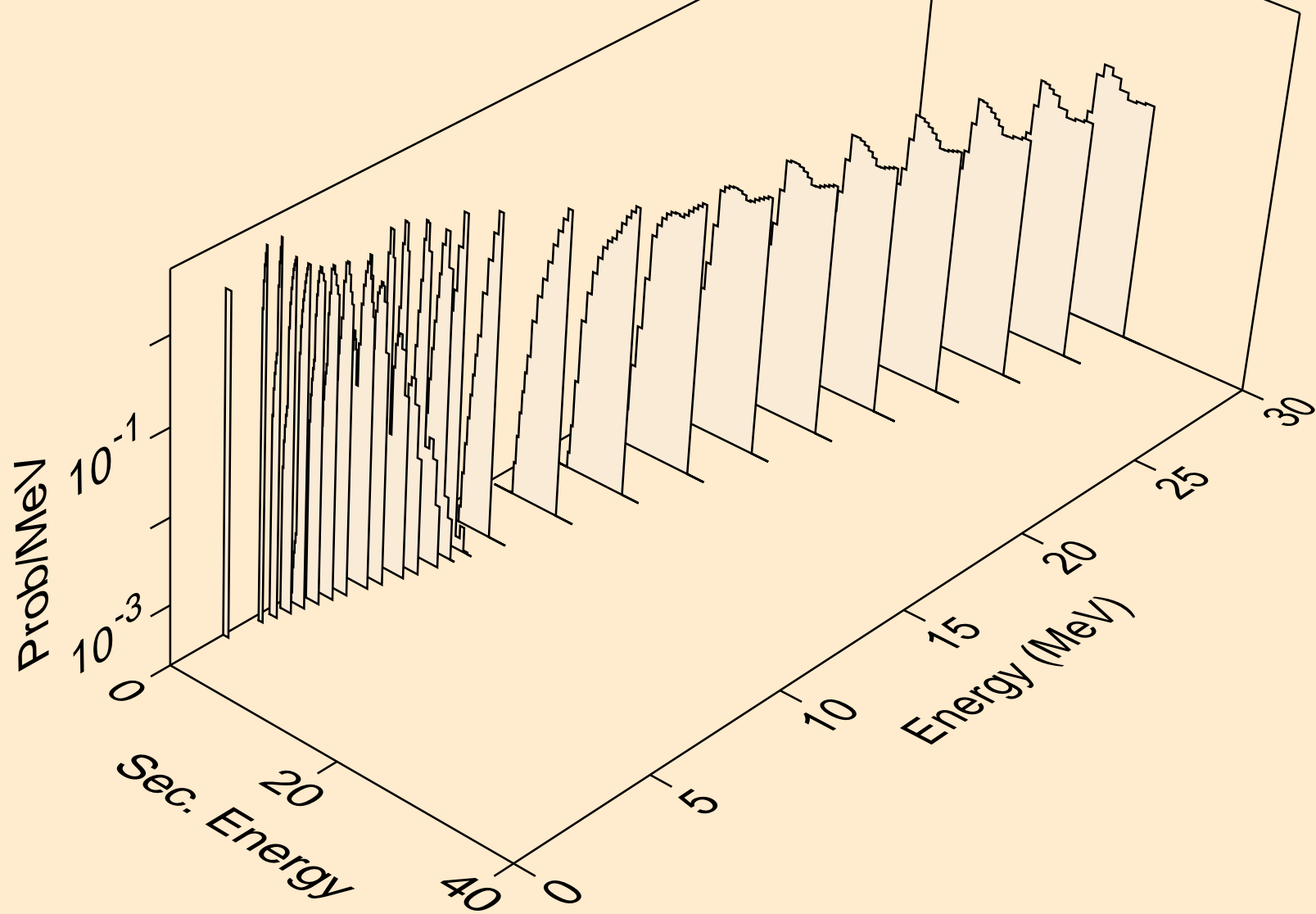

IN122N NEUTRON ACER TENDL-2021 LIBRARY; T=293.6K  
protons from (n,2p)

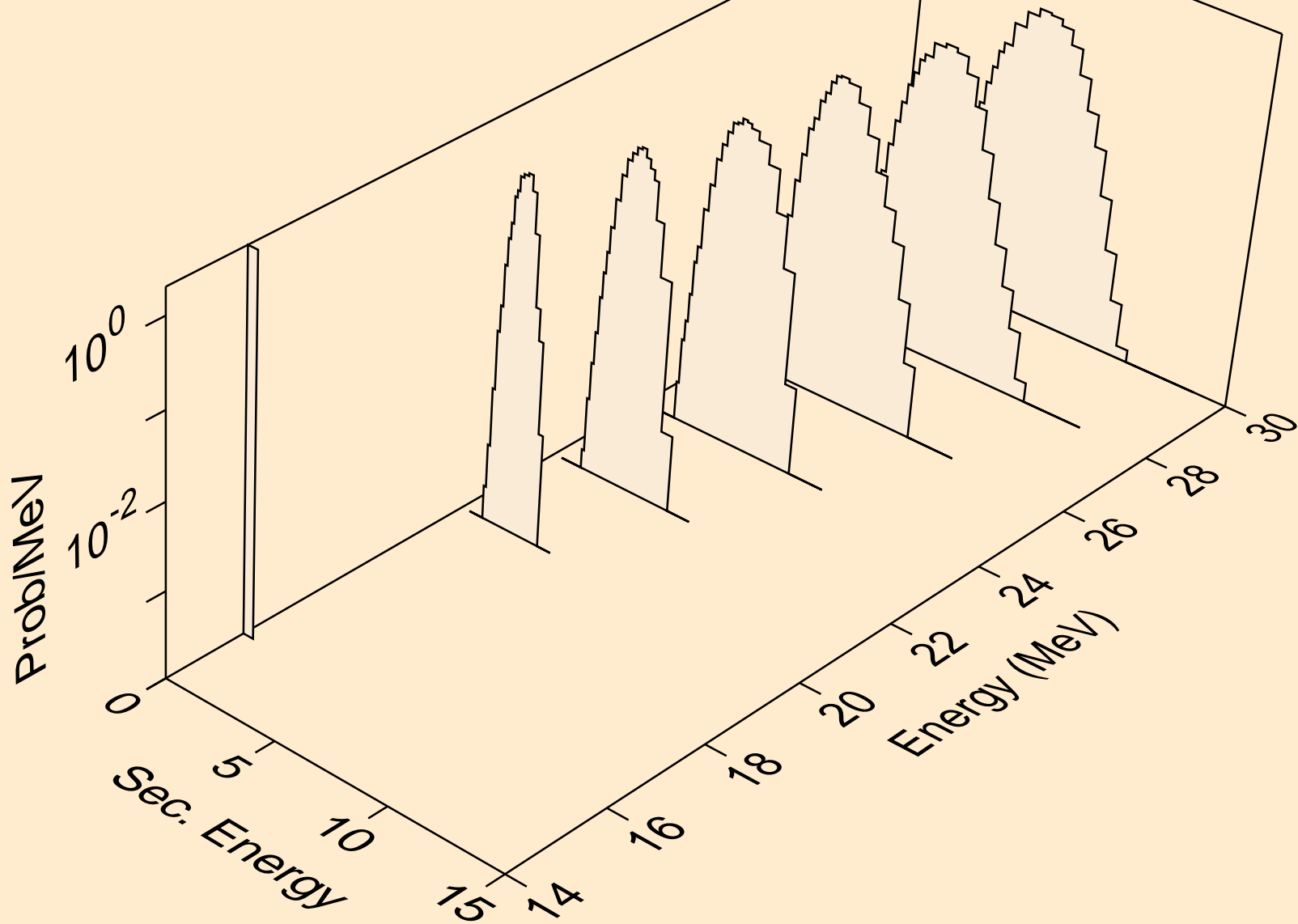



IN122N NEUTRON ACER TENDL-2021 LIBRARY; T=293.6K  
deuterons from (n,x)

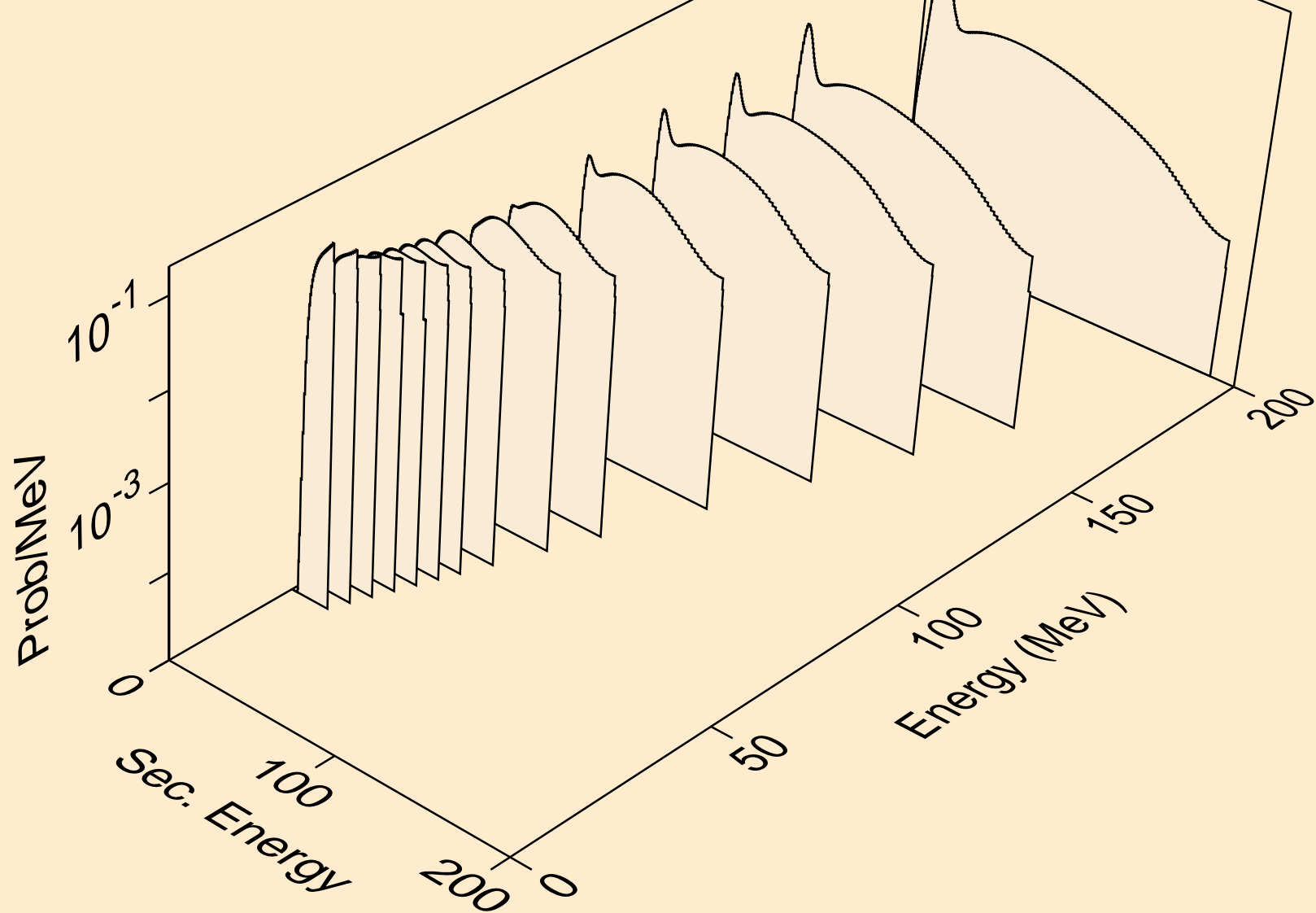

IN122N NEUTRON ACER TENDL-2021 LIBRARY; T=293.6K  
deuterons from (n,2nd)

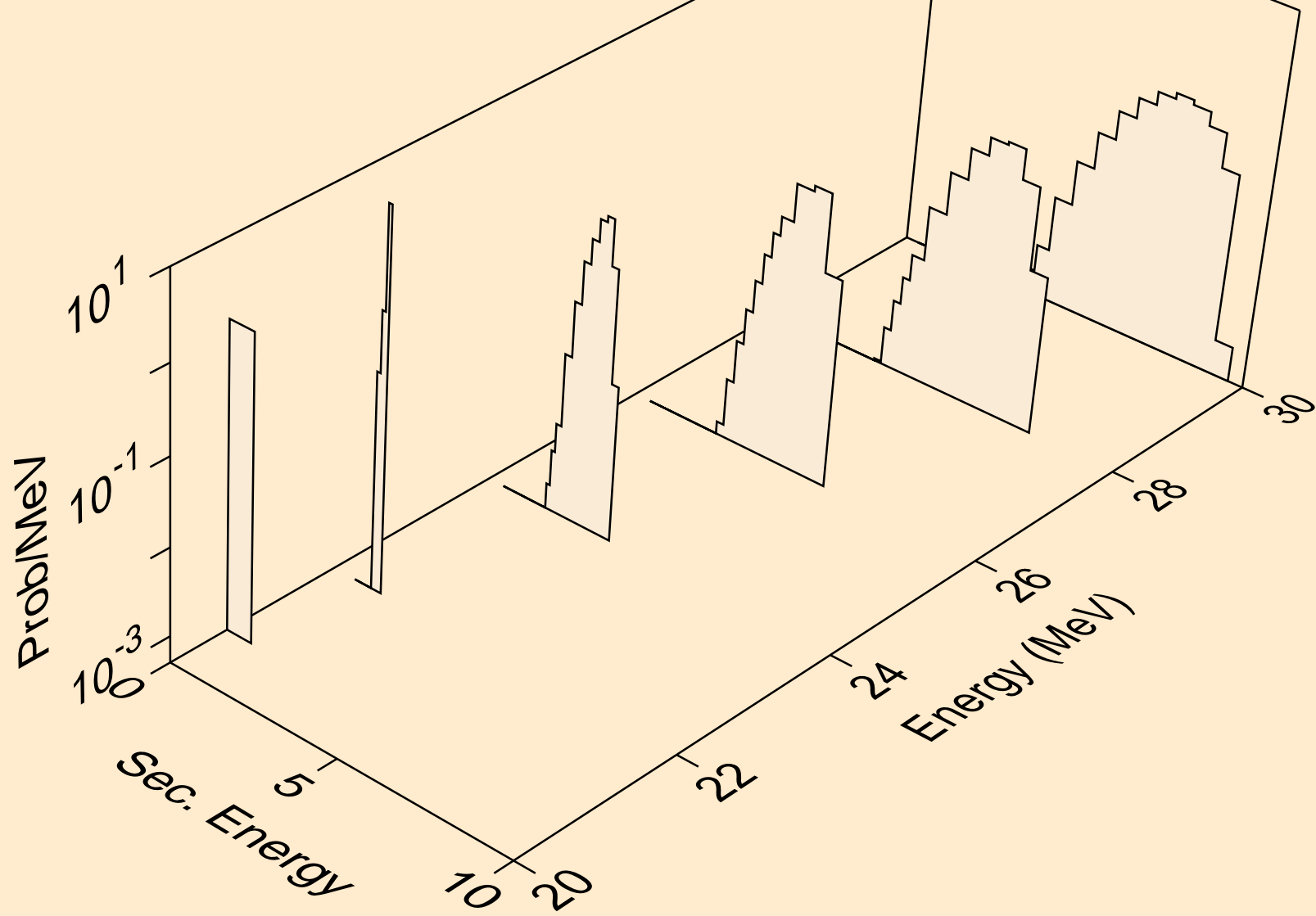

IN122N NEUTRON ACER TENDL-2021 LIBRARY; T=293.6K  
deuterons from (n,n\*)d

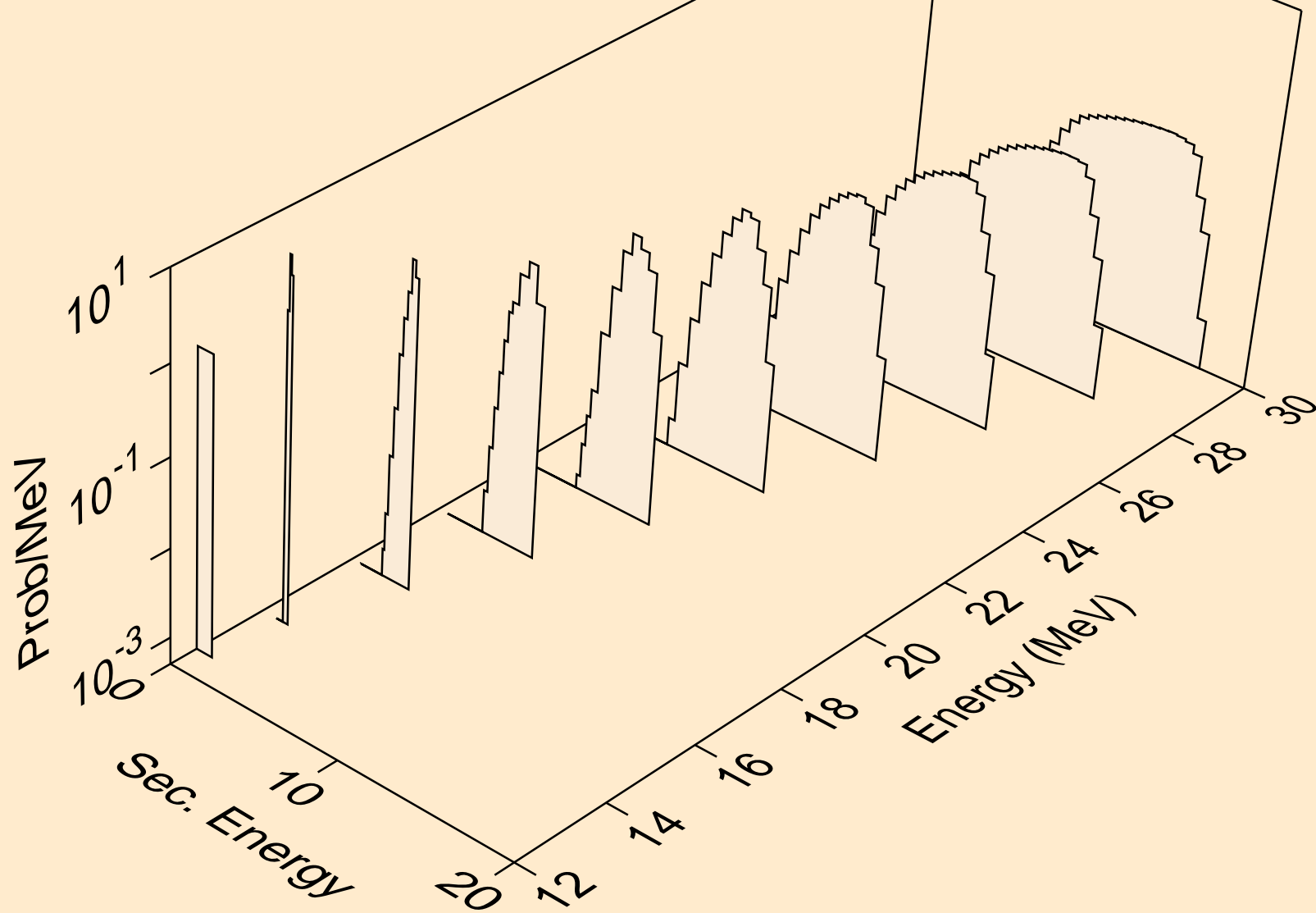

IN122N NEUTRON ACER TENDL-2021 LIBRARY; T=293.6K  
deuterons from (n,d)

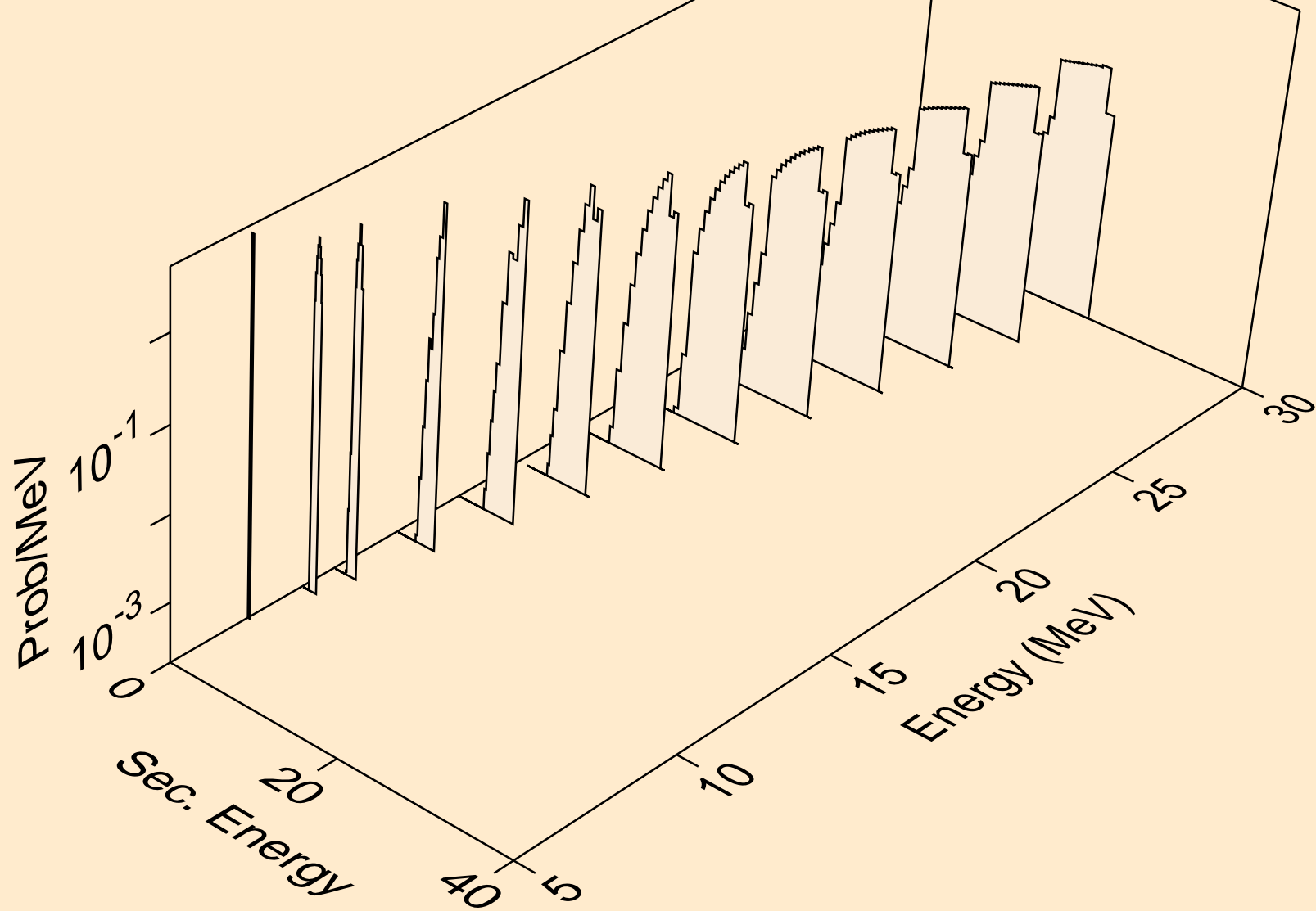

IN122N NEUTRON ACER TENDL-2021 LIBRARY; T=293.6K  
tritons from (n,x)

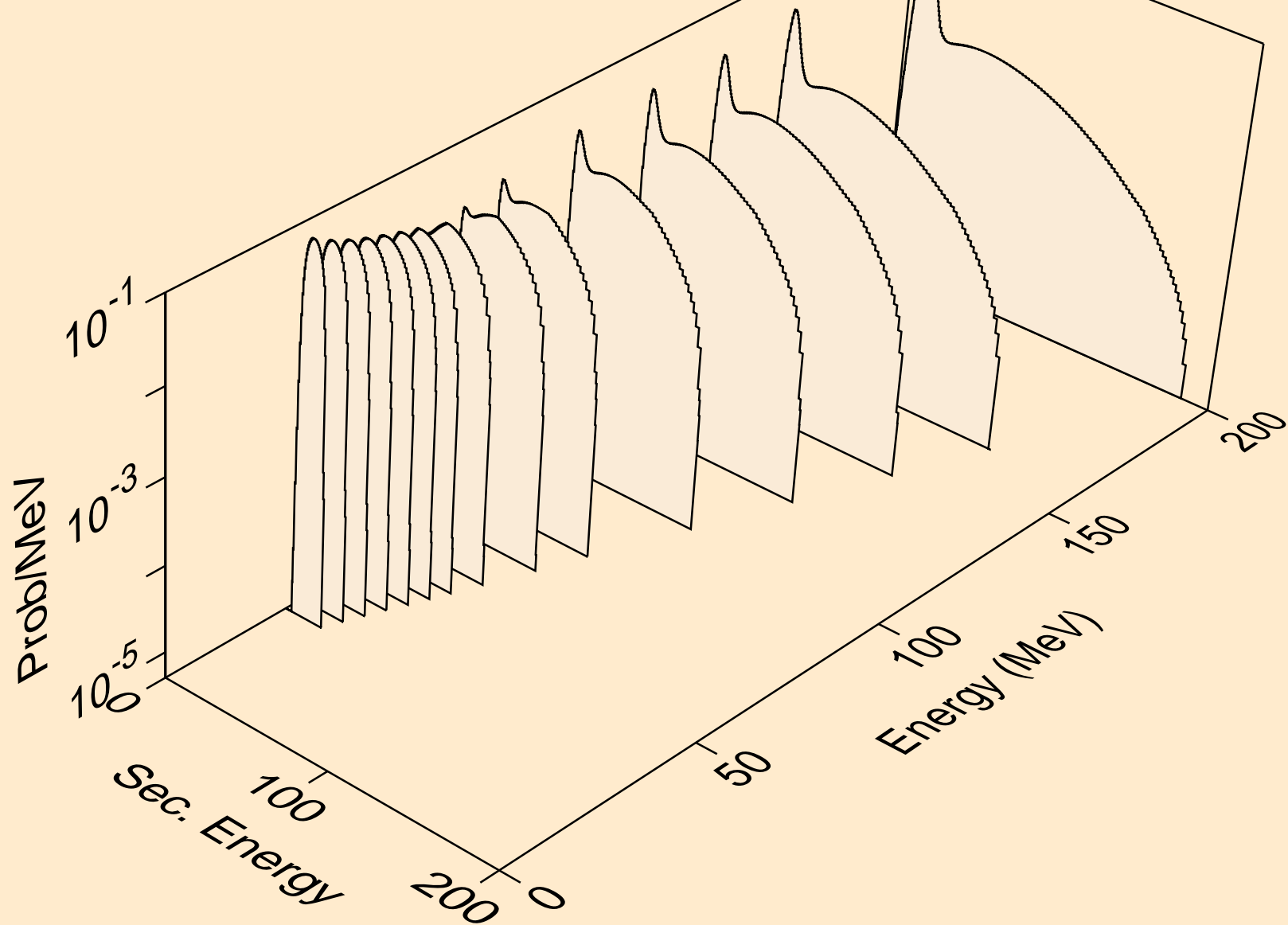

IN122N NEUTRON ACER TENDL-2021 LIBRARY; T=293.6K  
tritons from (n,n\*)t

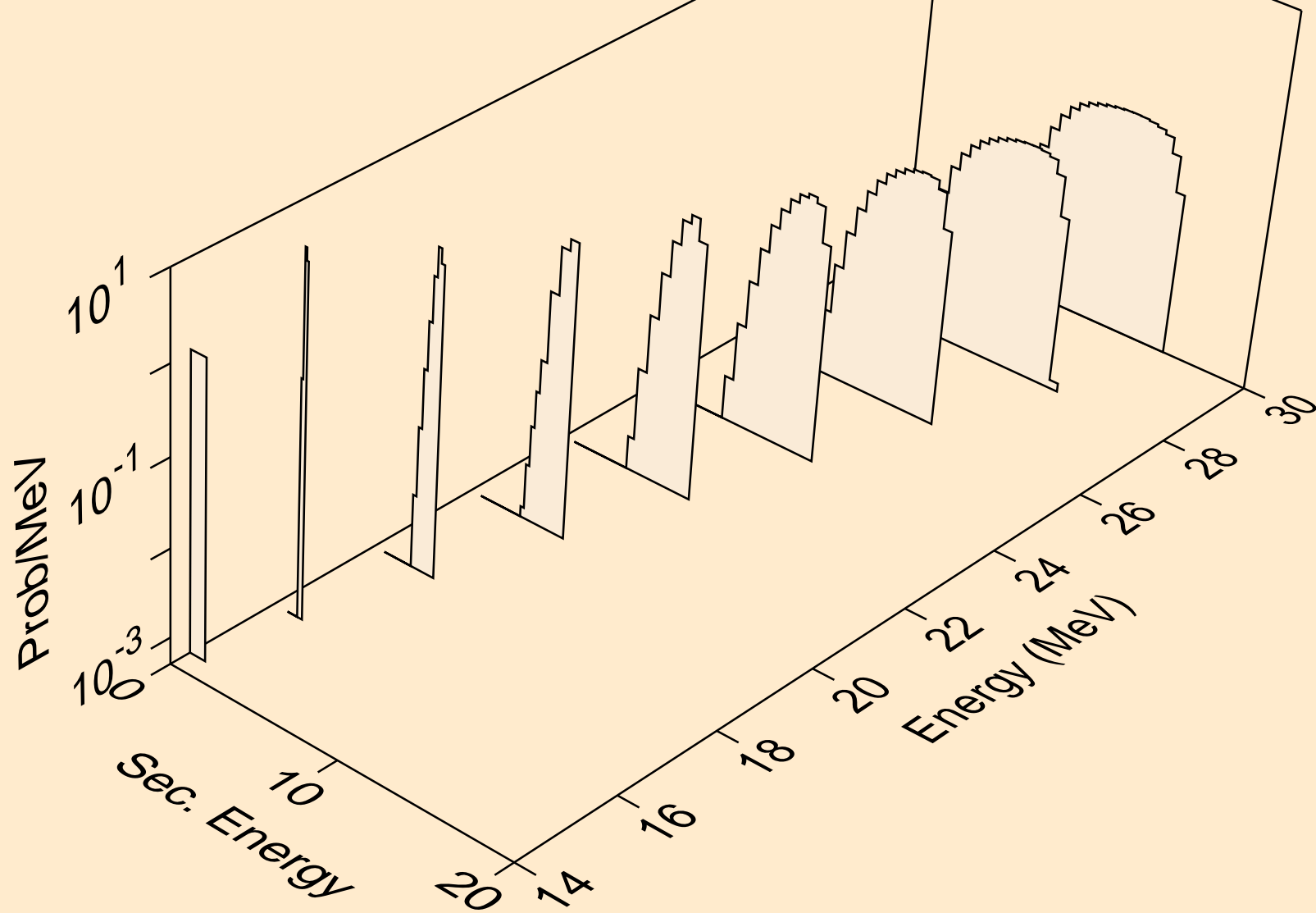

IN122N NEUTRON ACER TENDL-2021 LIBRARY; T=293.6K  
tritons from (n,t)

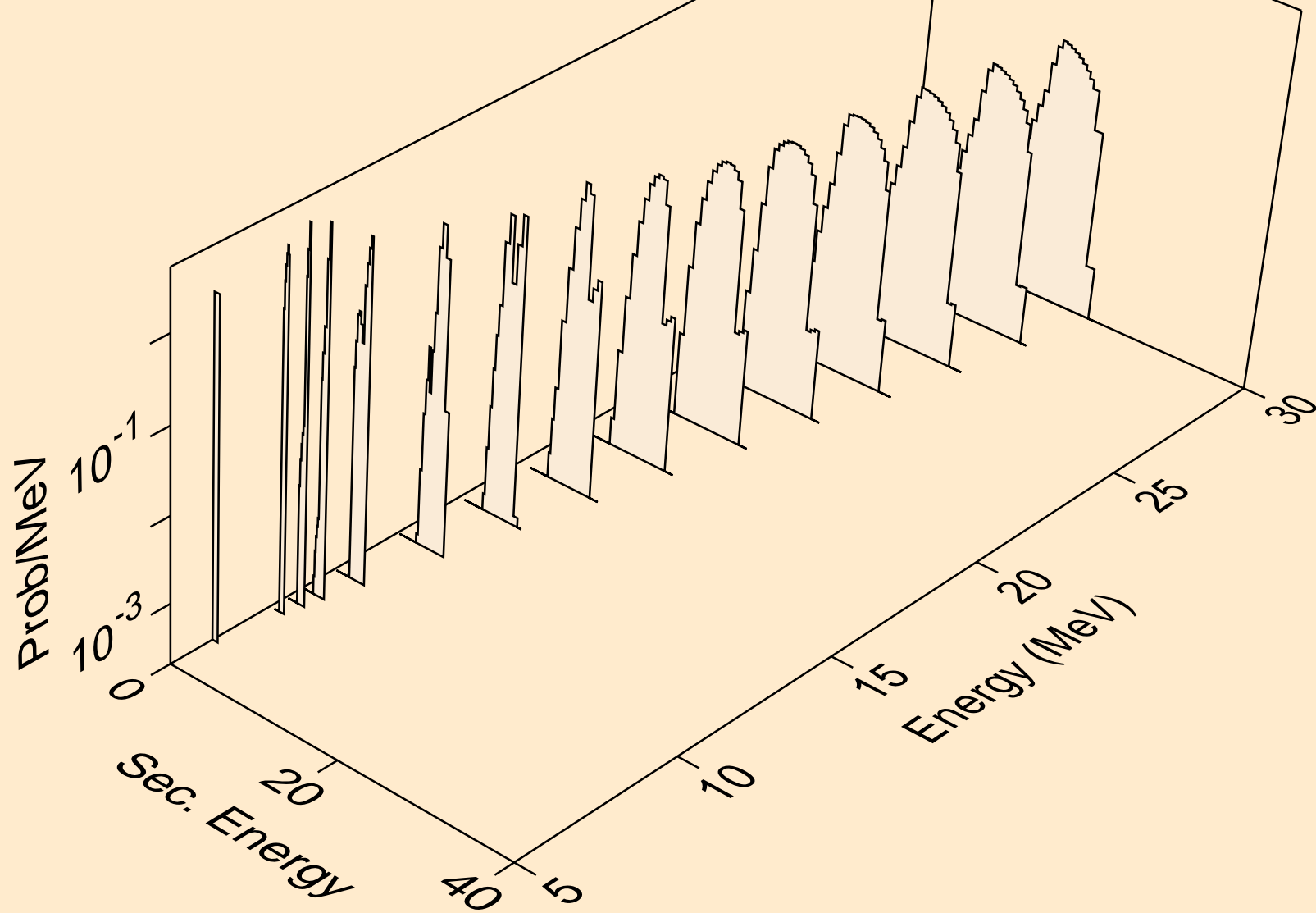

IN122N NEUTRON ACER TENDL-2021 LIBRARY; T=293.6K  
he3s from (n,x)

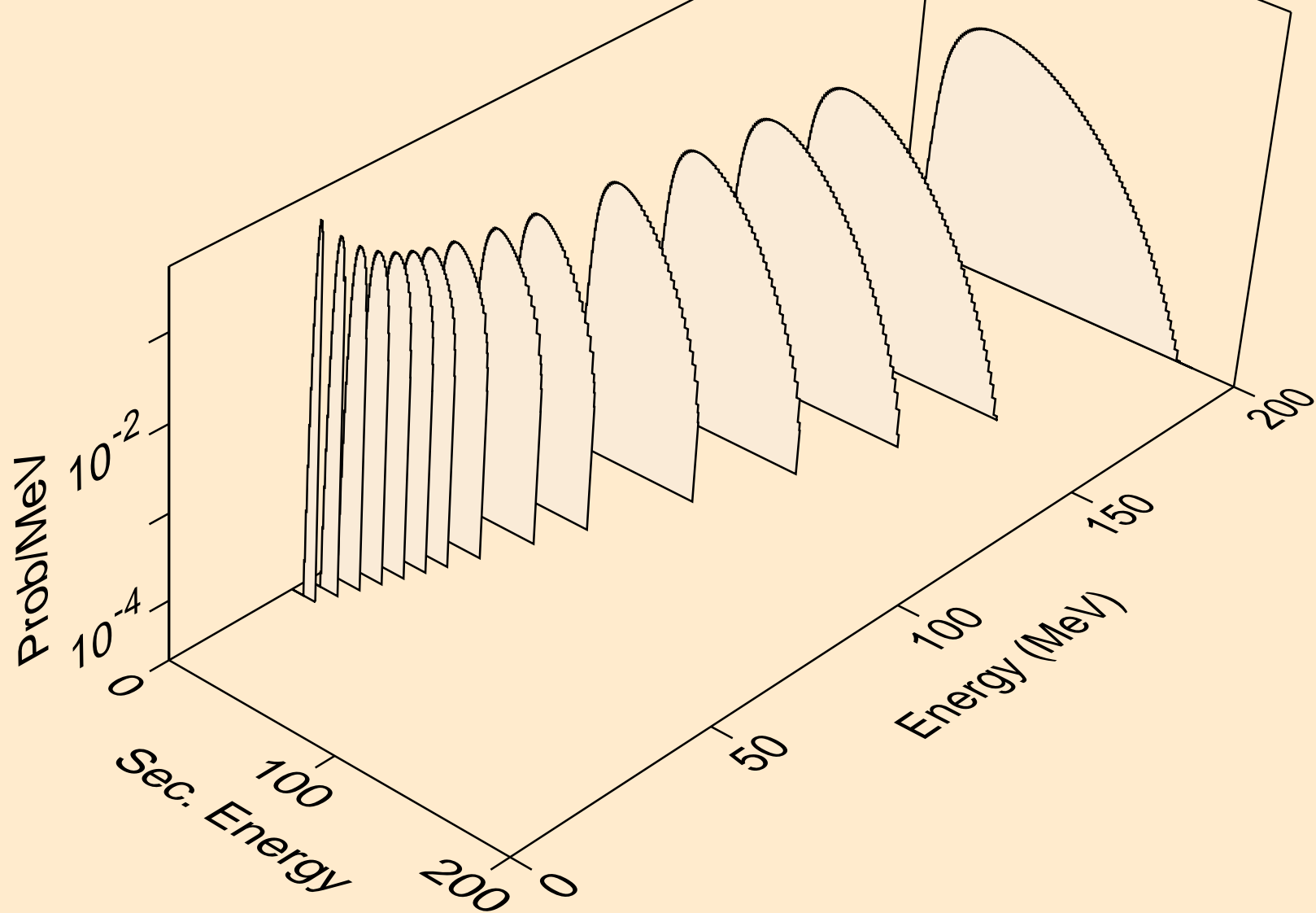



IN122N NEUTRON ACER TENDL-2021 LIBRARY; T=293.6K  
he3s from (n,n\*)he3

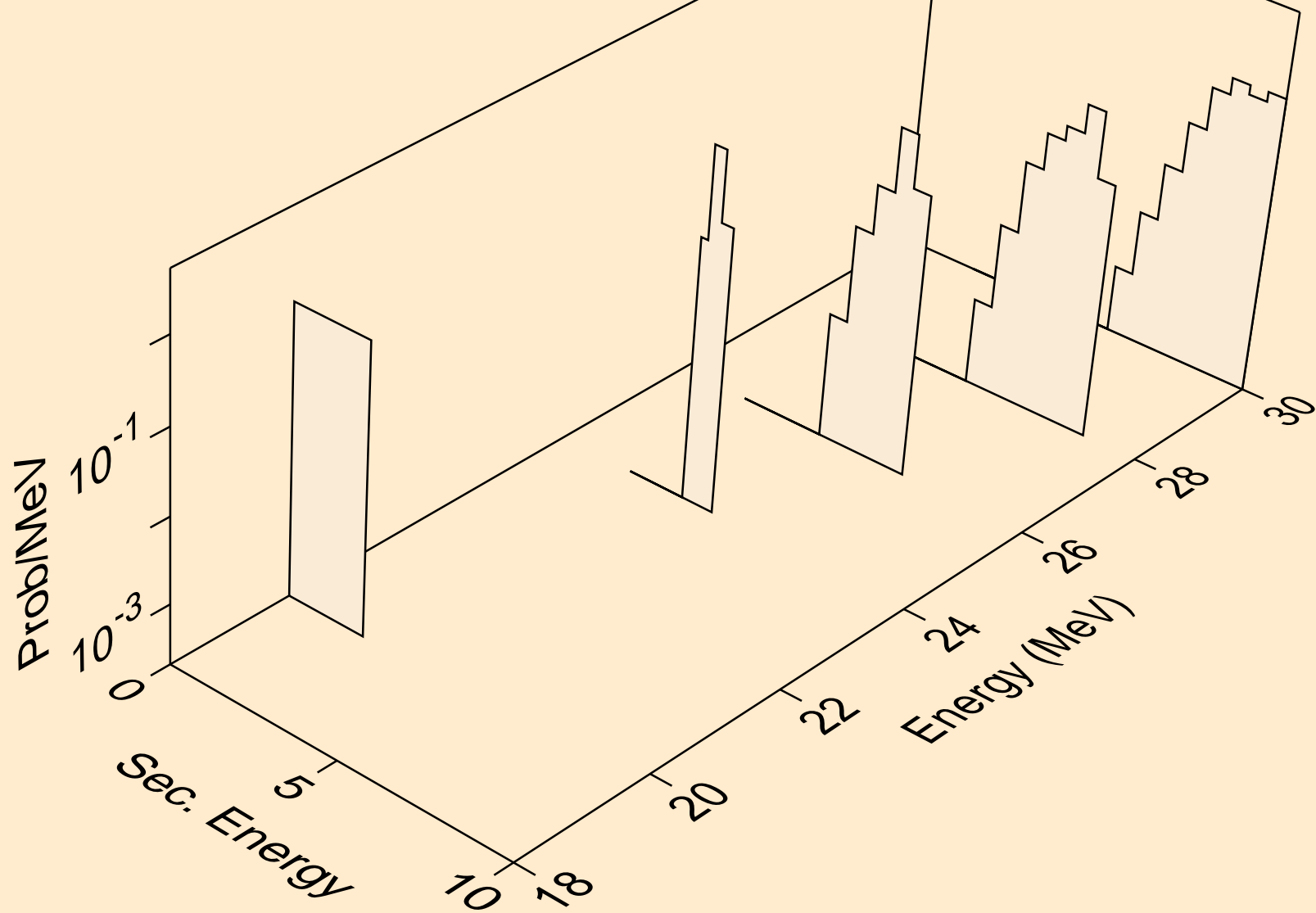

IN122N NEUTRON ACER TENDL-2021 LIBRARY; T=293.6K  
he3s from (n,he3)

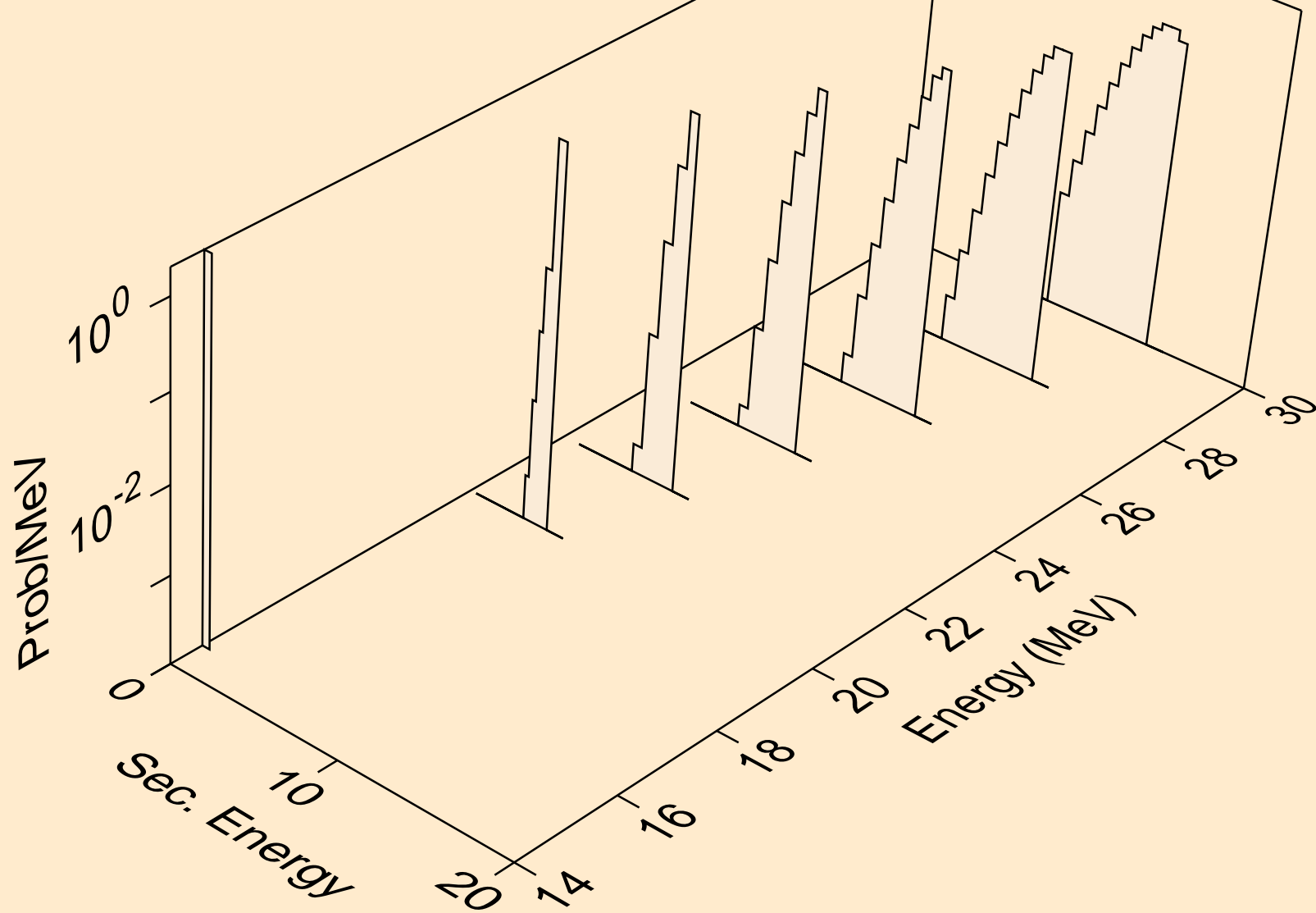

IN122N NEUTRON ACER TENDL-2021 LIBRARY; T=293.6K  
alphas from (n,x)

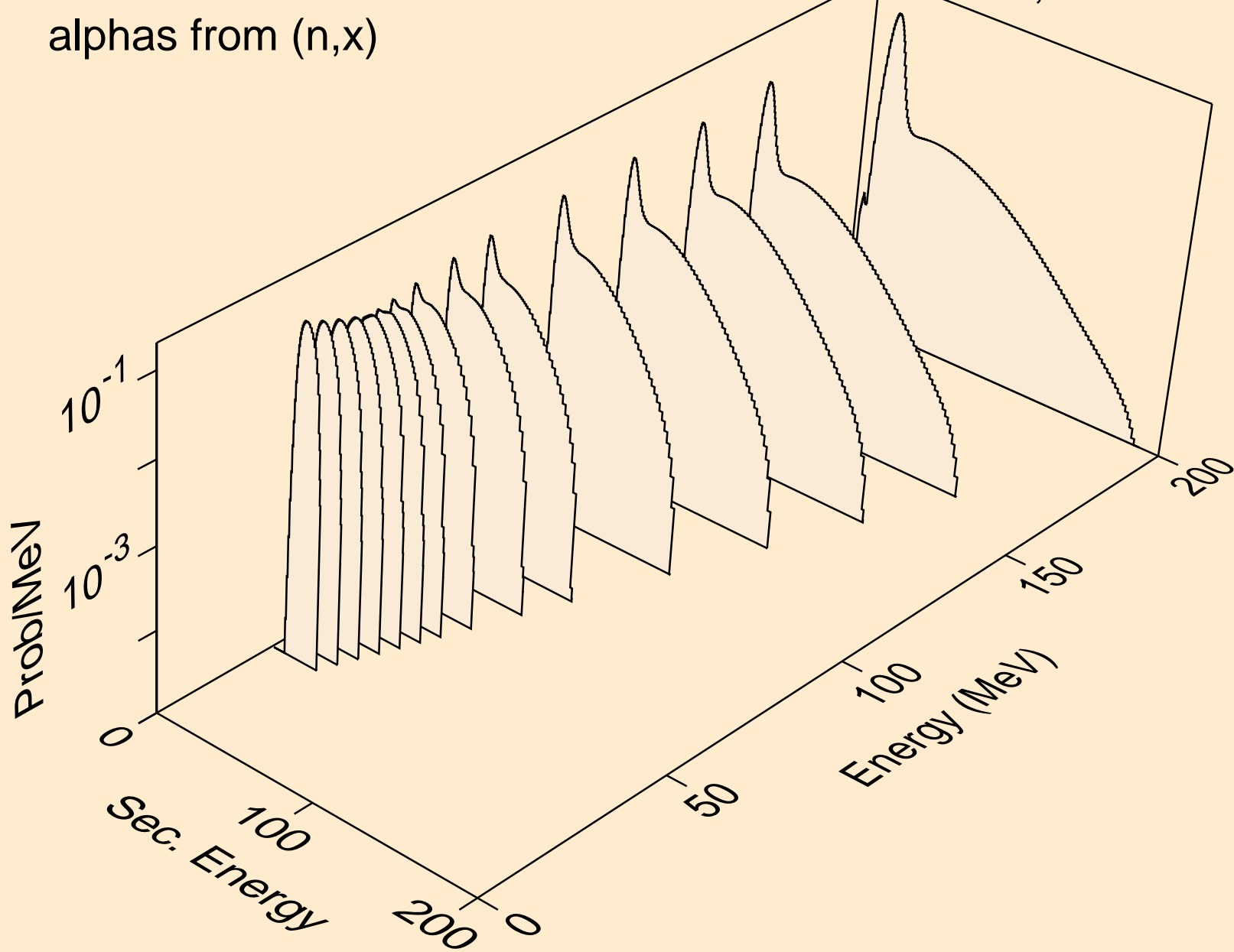

IN122N NEUTRON ACER TENDL-2021 LIBRARY; T=293.6K  
alphas from (n,n\*)a

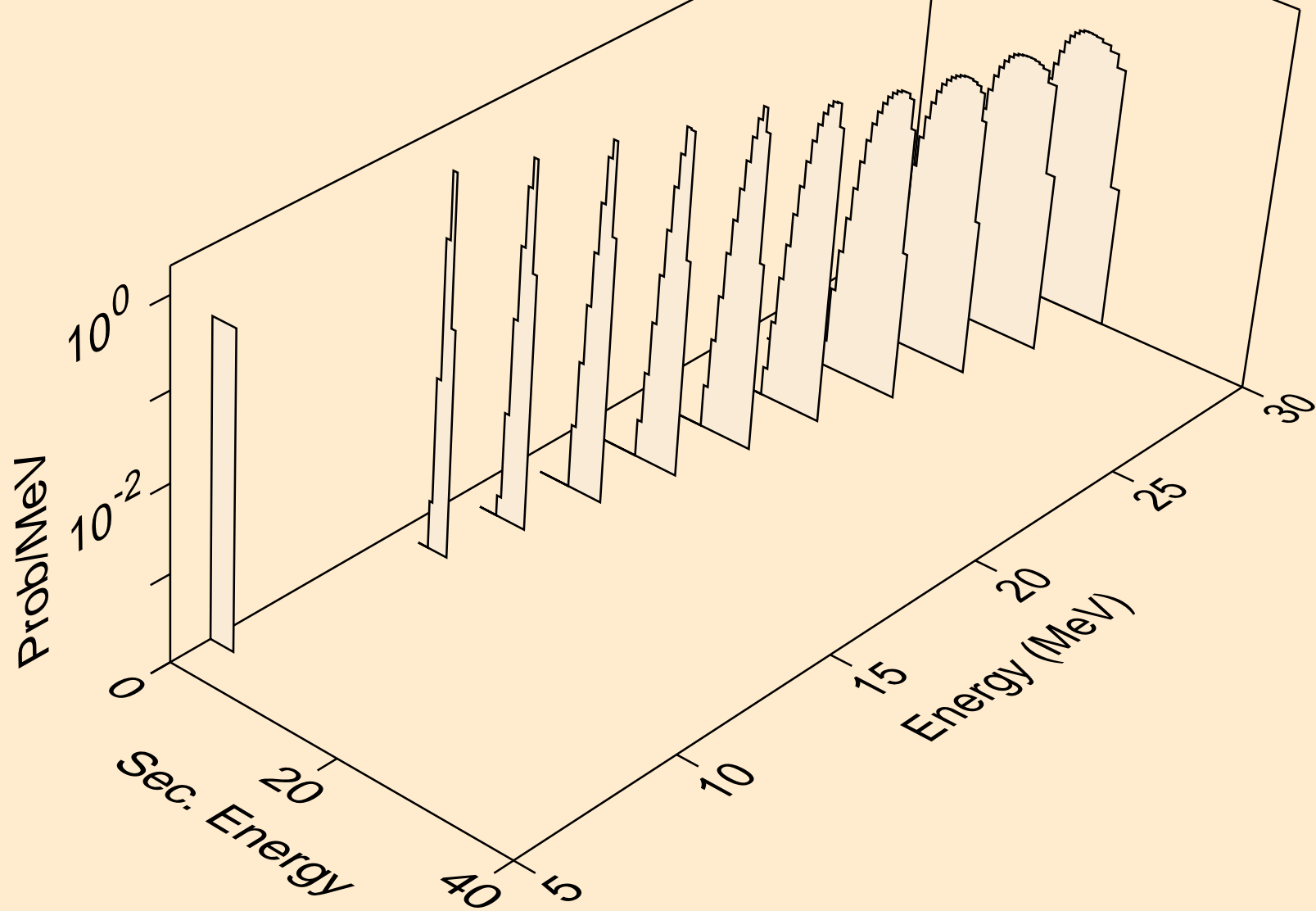

IN122N NEUTRON ACER TENDL-2021 LIBRARY; T=293.6K  
alphas from (n,2n)a

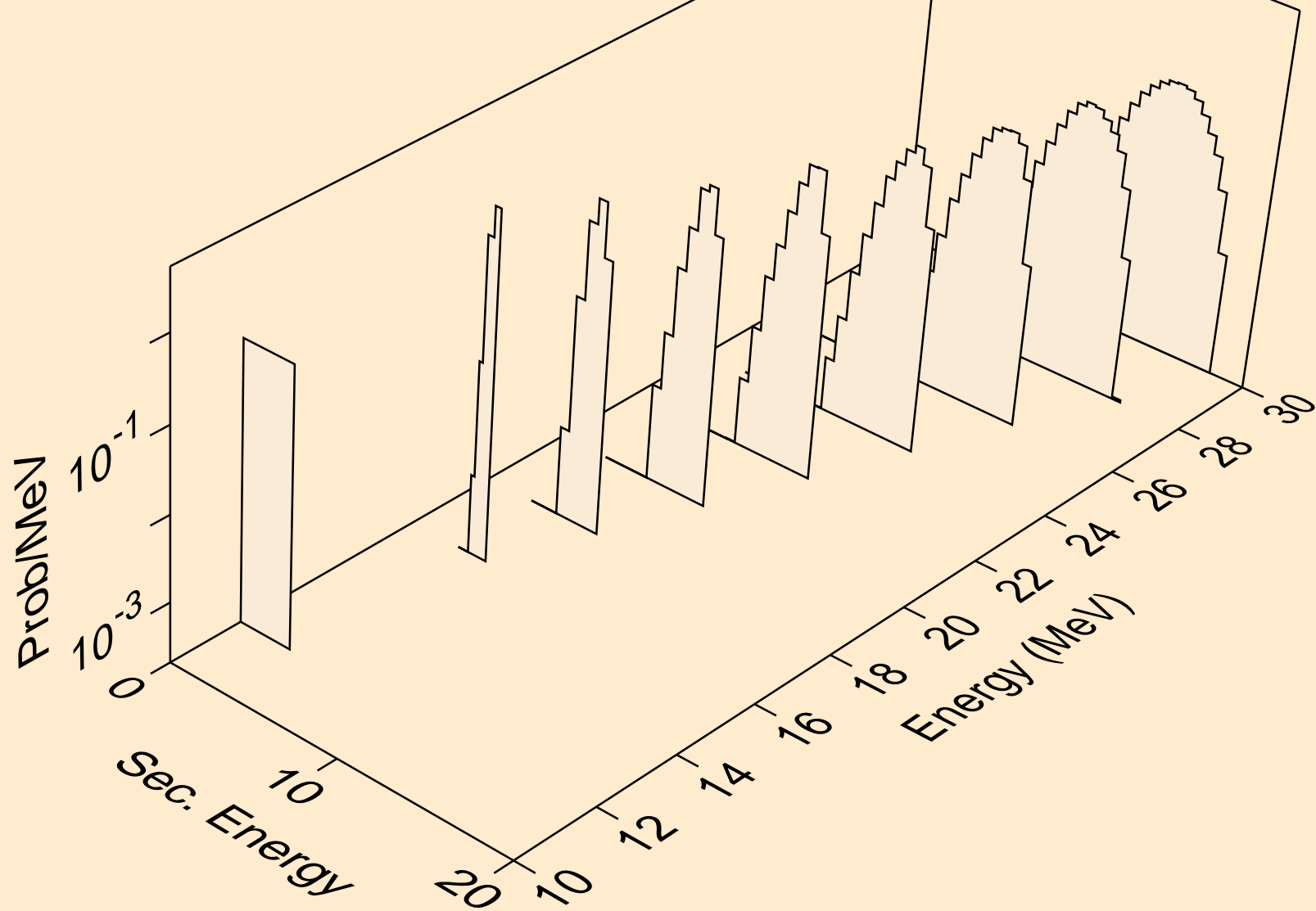

IN122N NEUTRON ACER TENDL-2021 LIBRARY; T=293.6K  
alphas from (n,3n)a

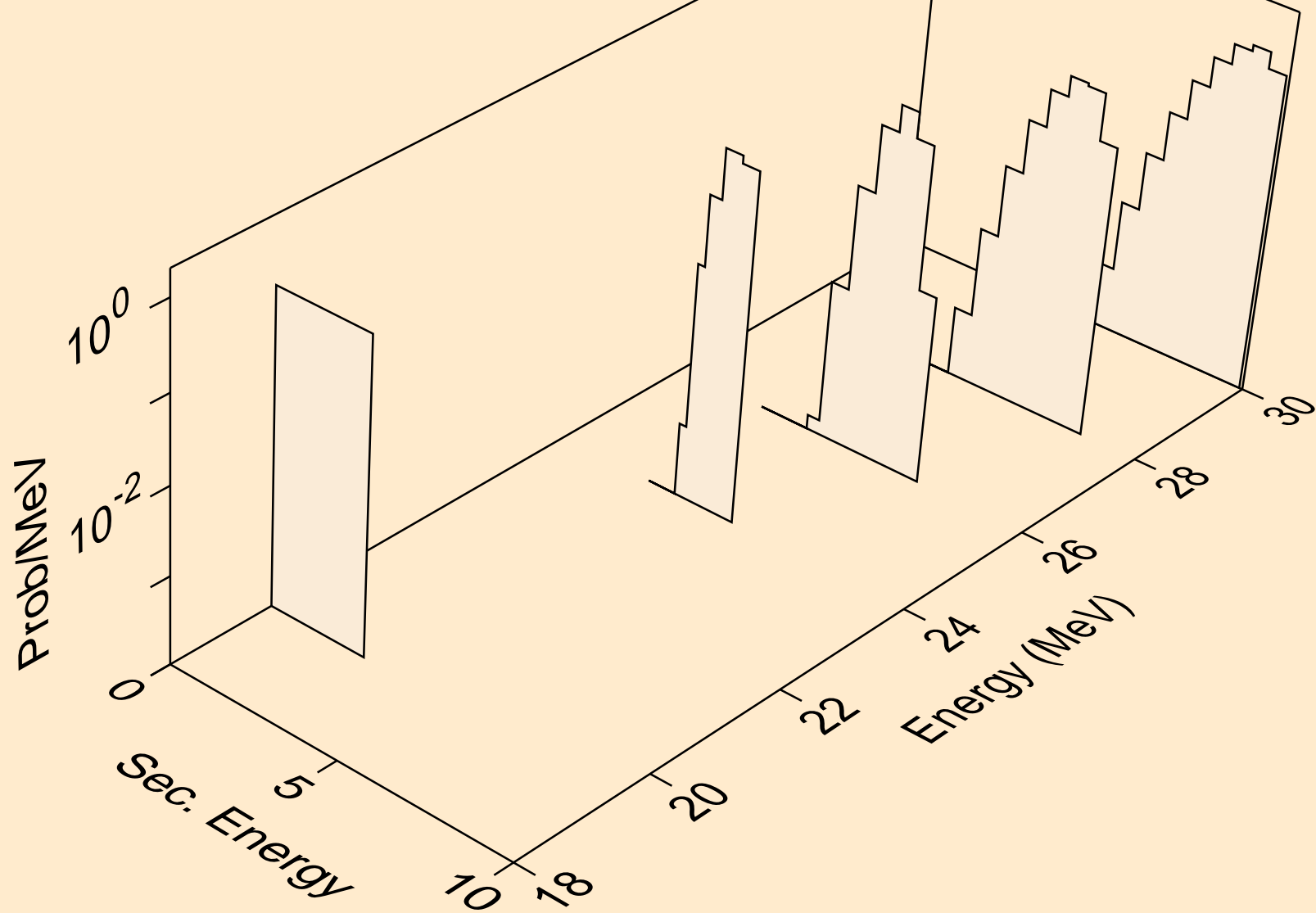

IN122N NEUTRON ACER TENDL-2021 LIBRARY; T=293.6K  
alphas from (n,a)

