

IR172M NEUTRON ACER TENDL-2021 LIBRARY; T=293.6K

Principal cross sections

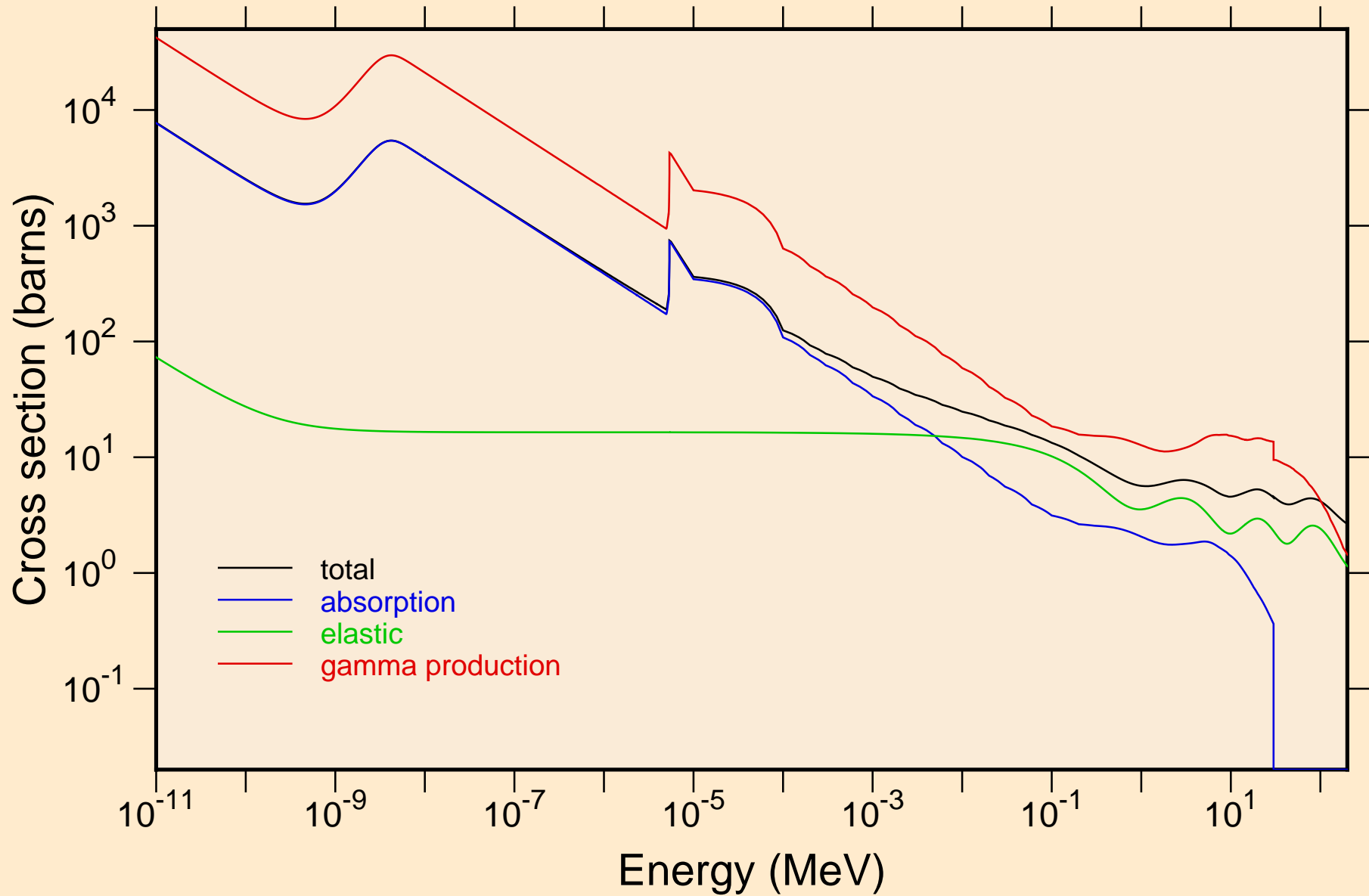

IR172M NEUTRON ACER TENDL-2021 LIBRARY; T=293.6K
Heating

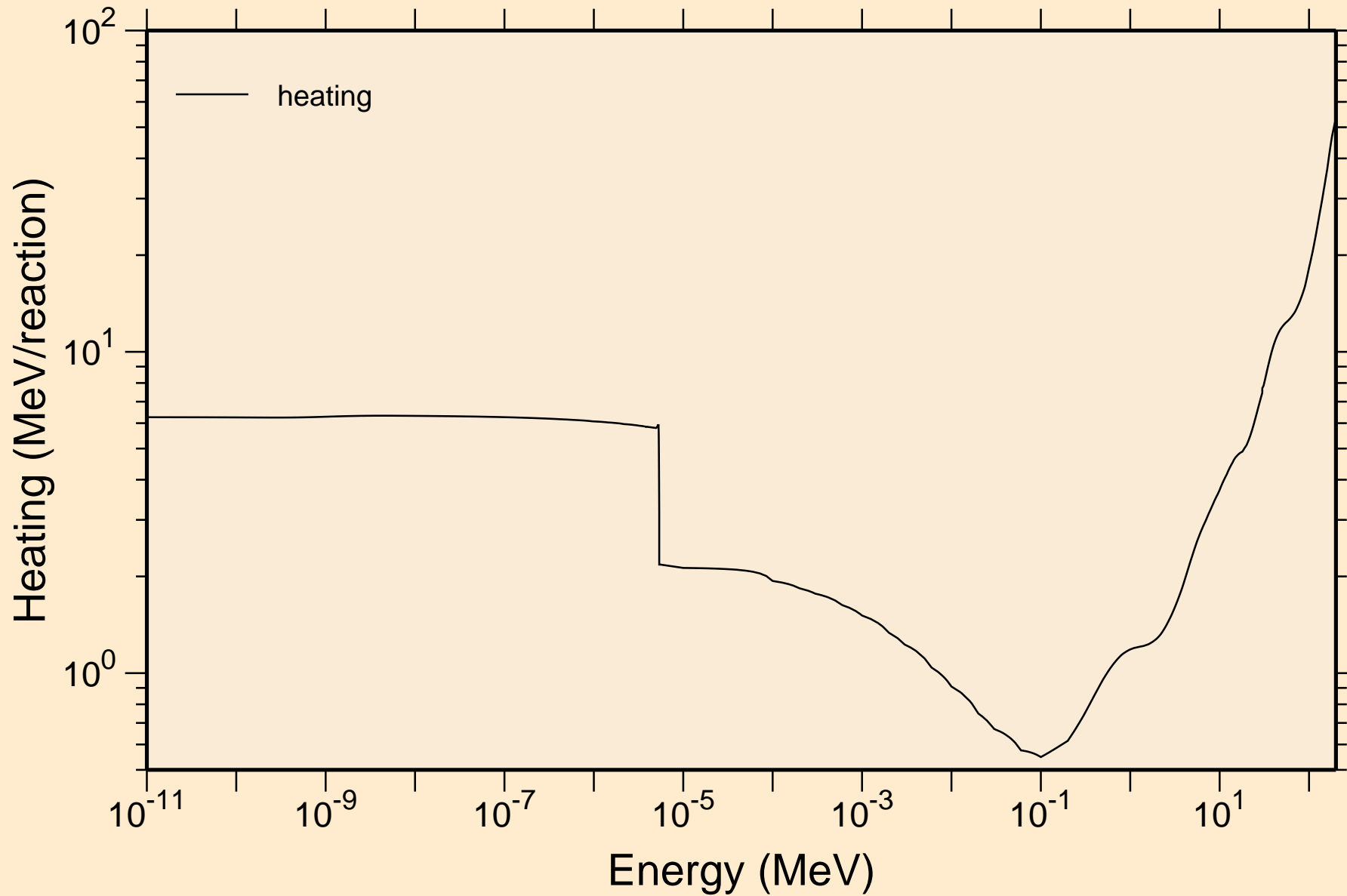

IR172M NEUTRON ACER TENDL-2021 LIBRARY; T=293.6K
Damage

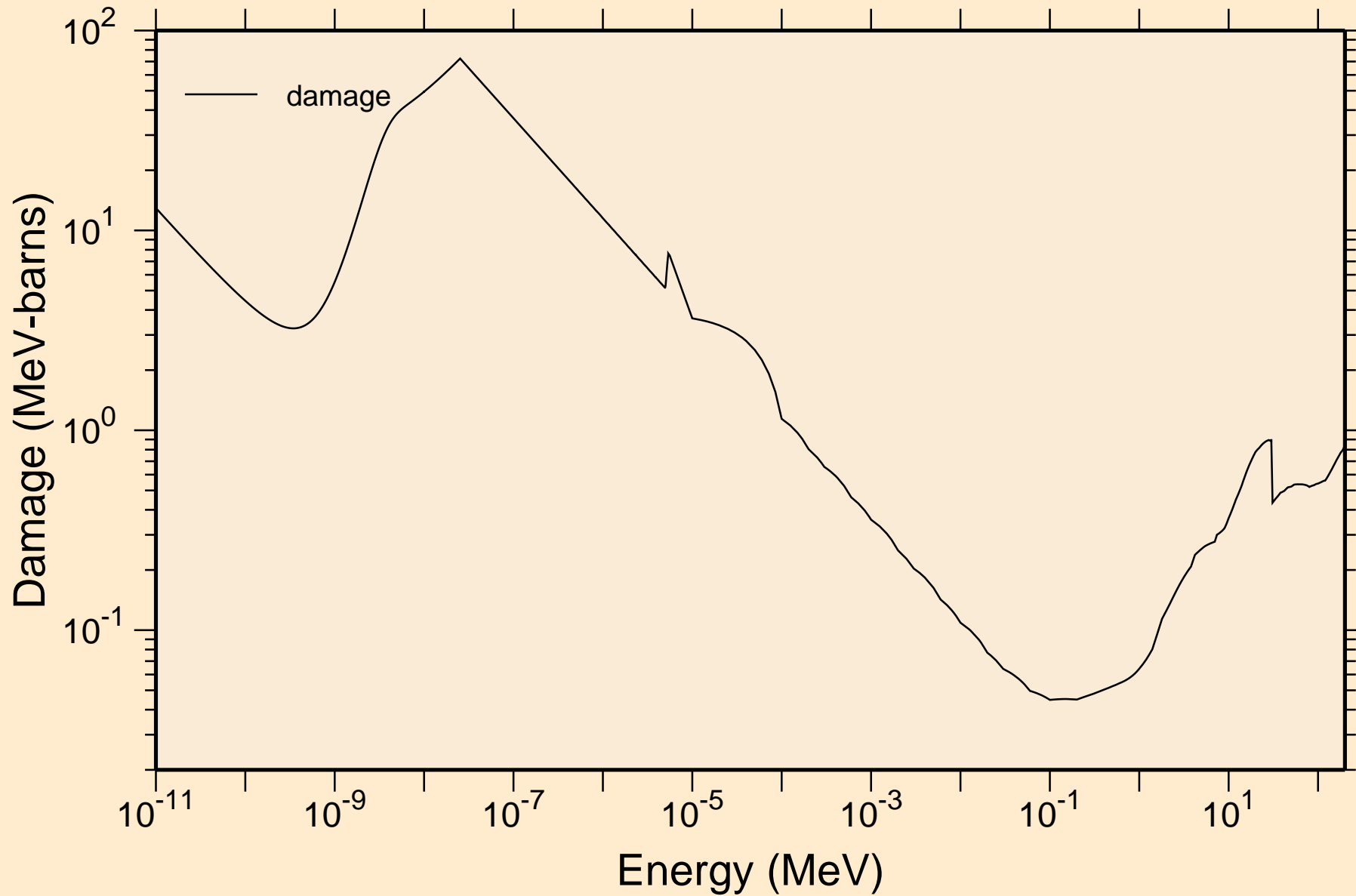

IR172M NEUTRON ACER TENDL-2021 LIBRARY; T=293.6K
Non-threshold reactions

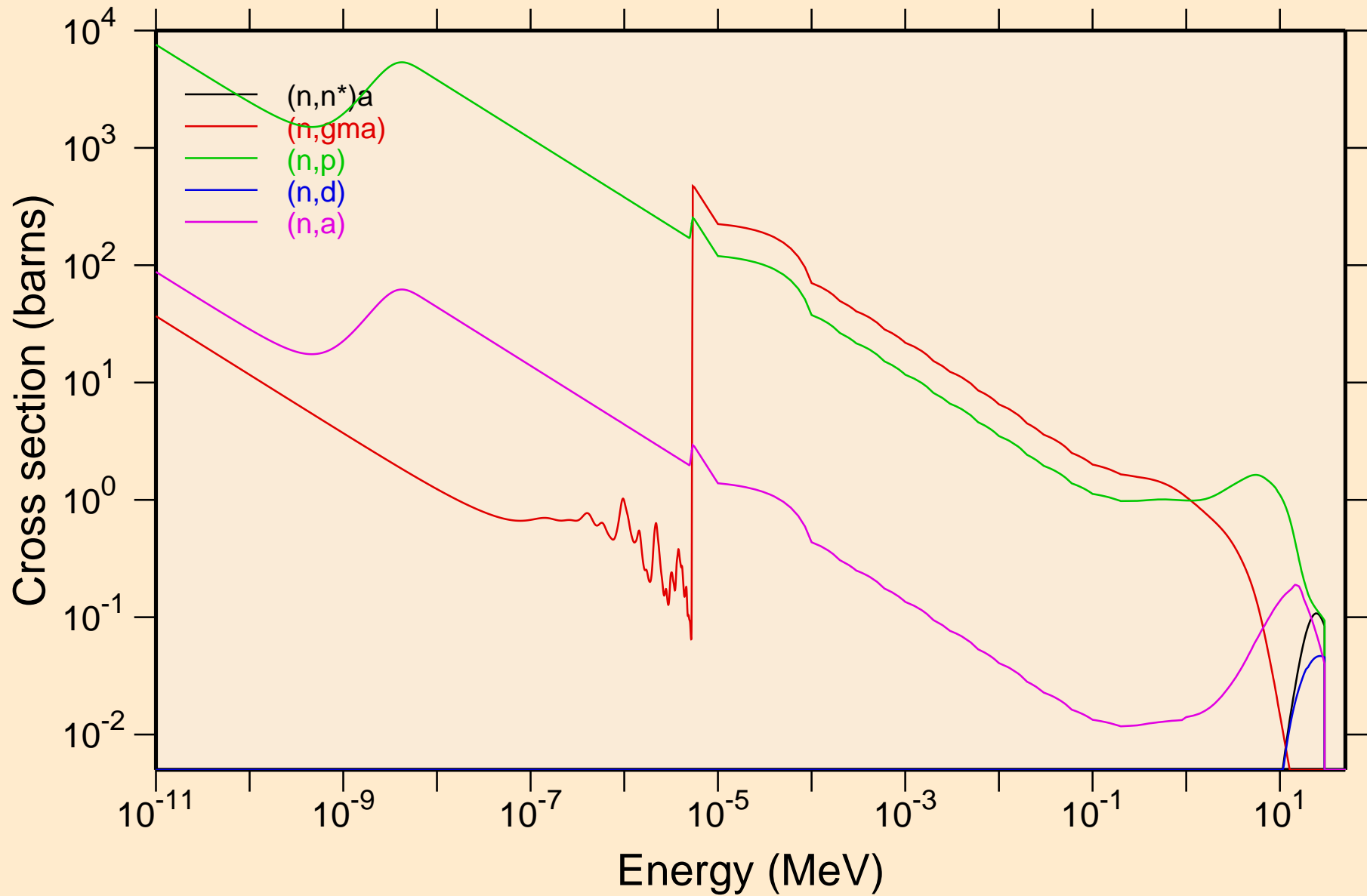

IR172M NEUTRON ACER TENDL-2021 LIBRARY; T=293.6K
Non-threshold reactions

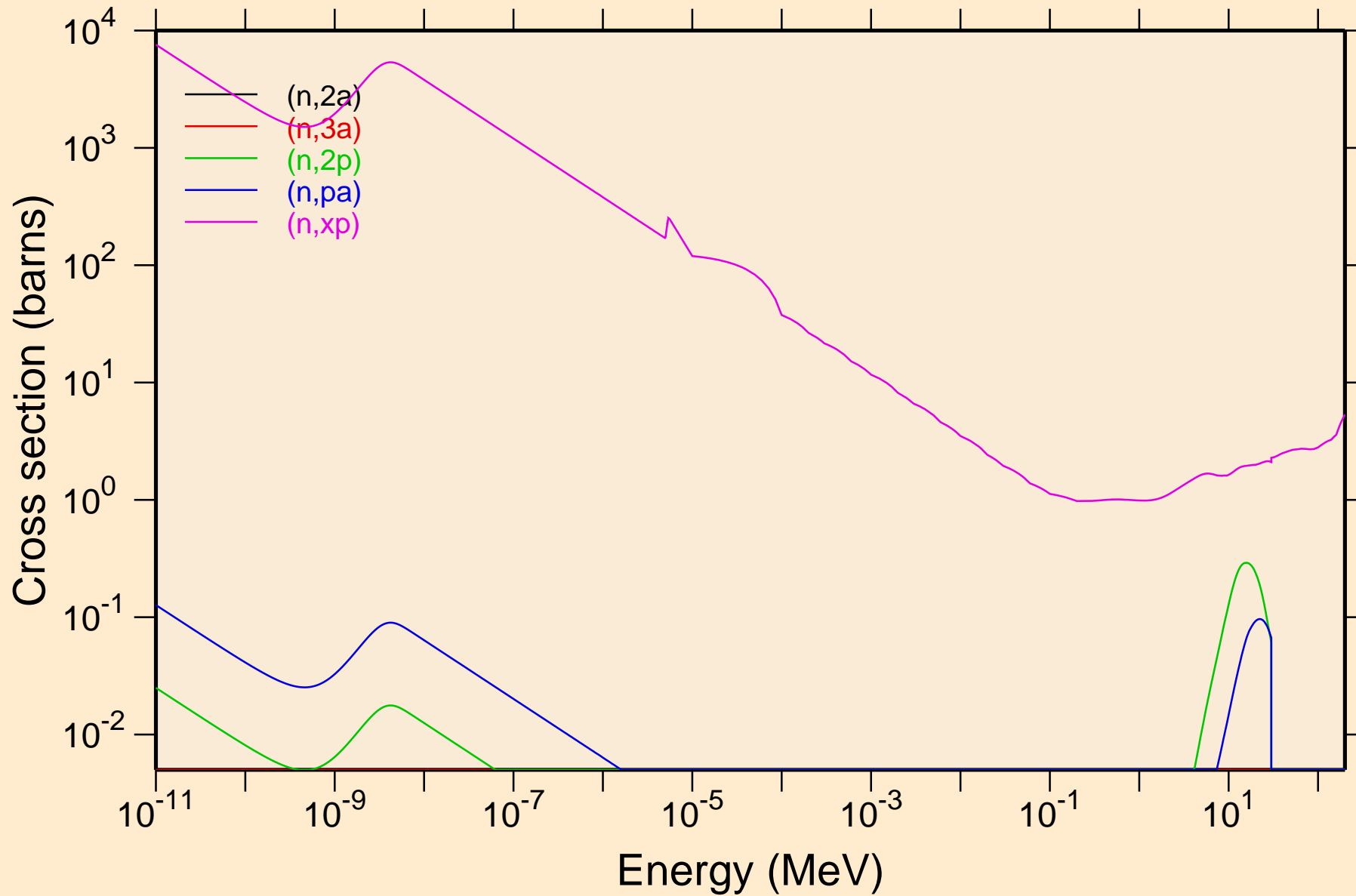

IR172M NEUTRON ACER TENDL-2021 LIBRARY; T=293.6K
Non-threshold reactions

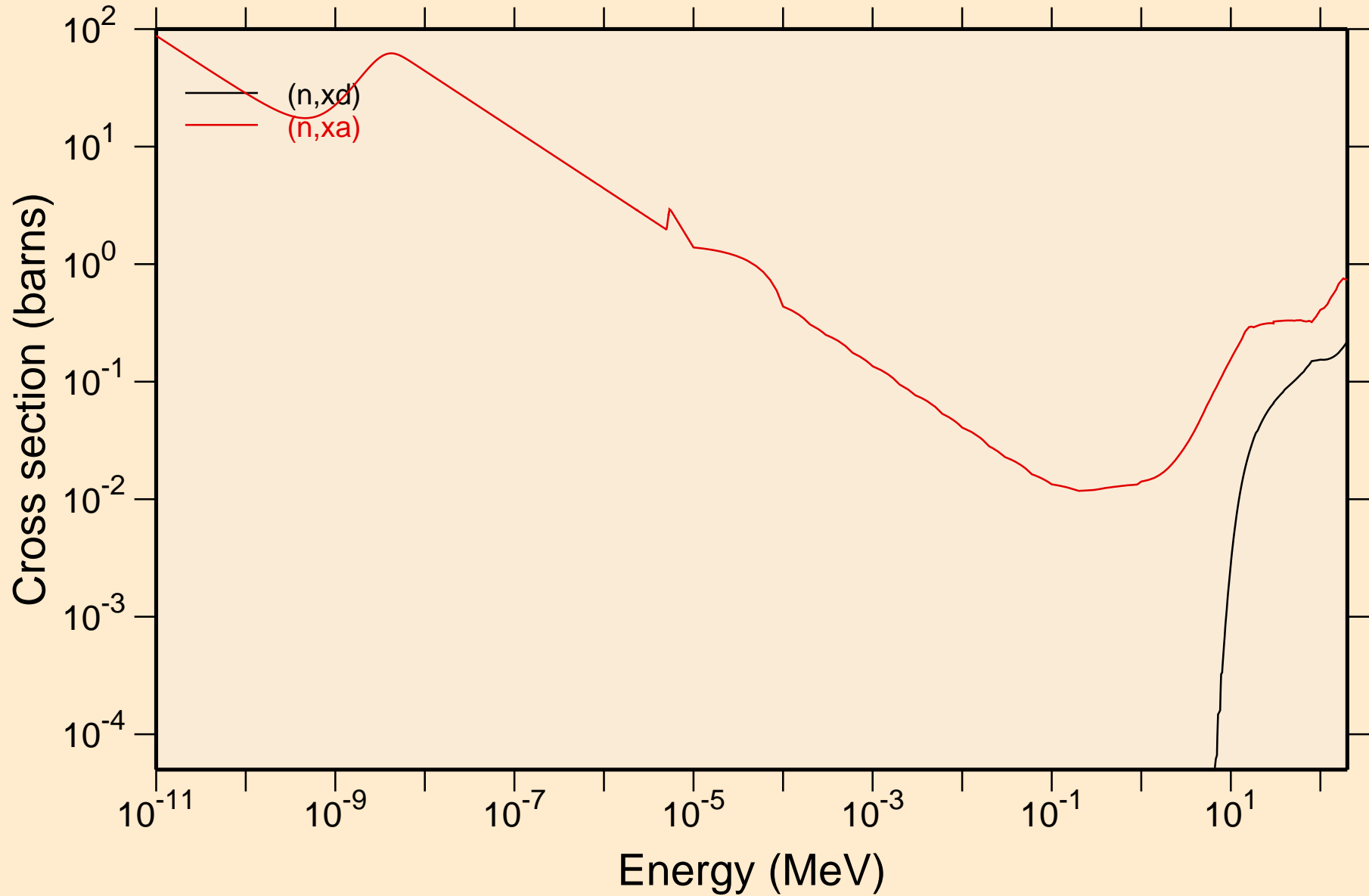

IR172M NEUTRON ACER TENDL-2021 LIBRARY; T=293.6K
Principal cross sections

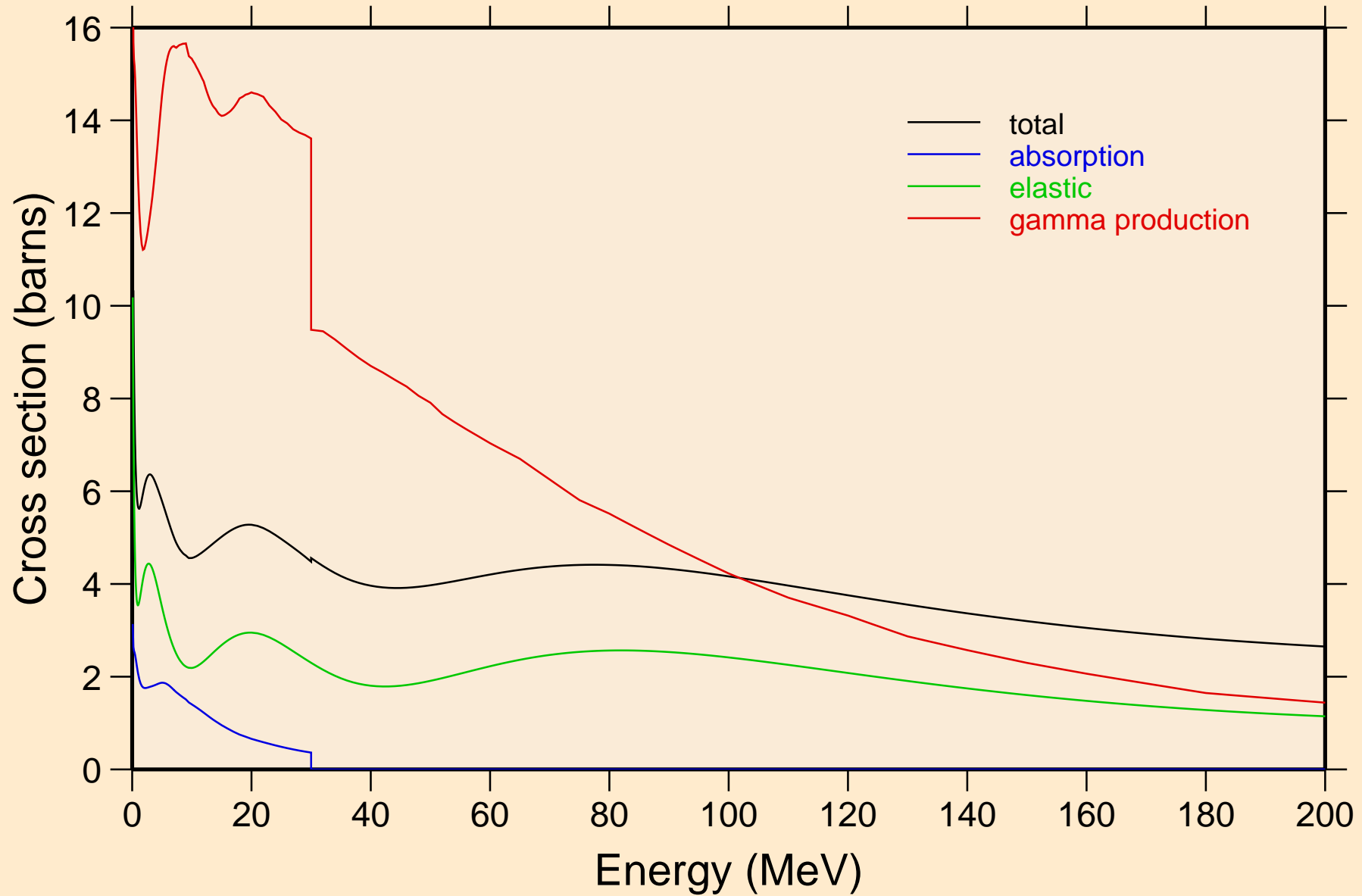

IR172M NEUTRON ACER TENDL-2021 LIBRARY; T=293.6K
Heating

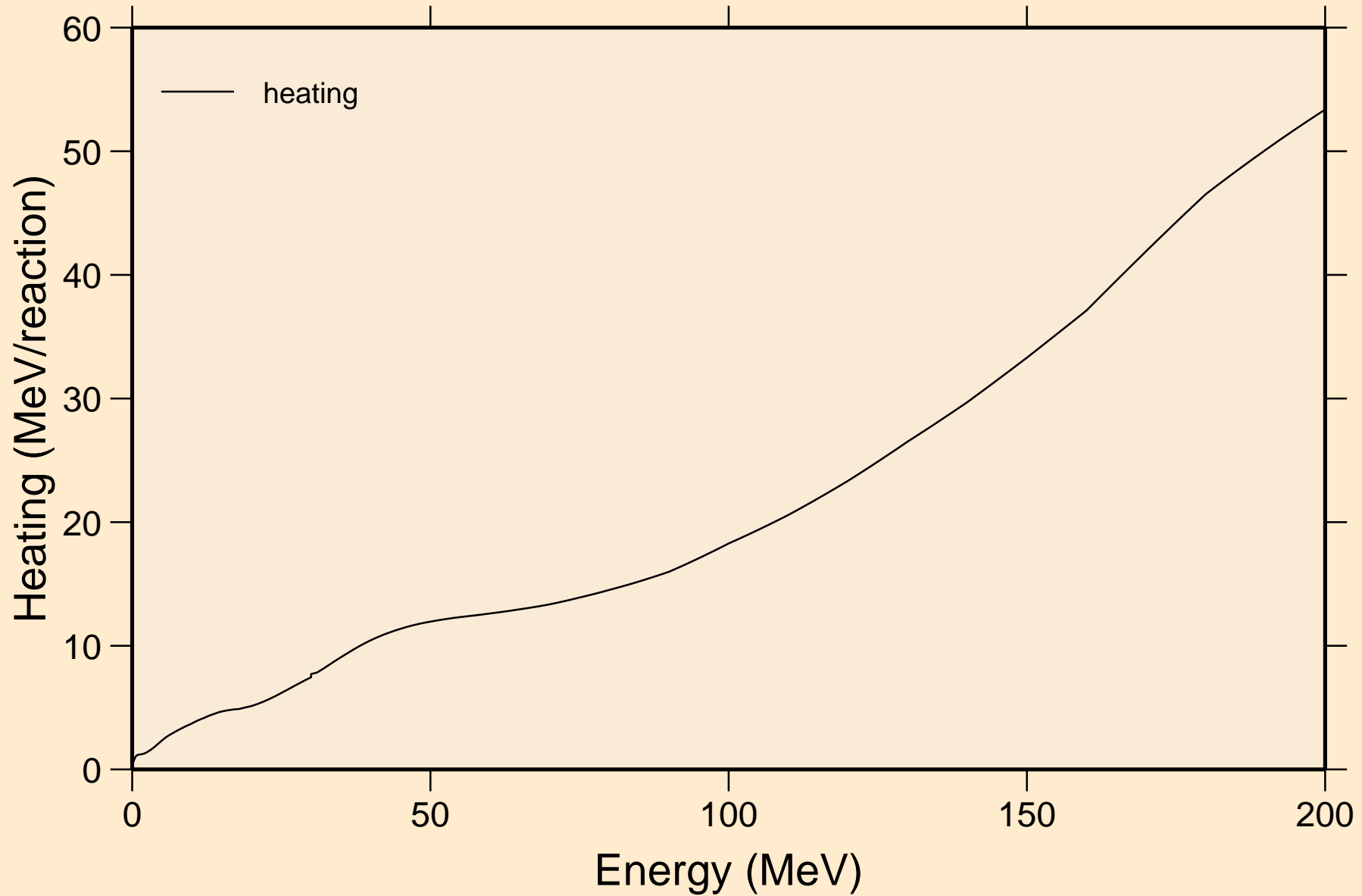

IR172M NEUTRON ACER TENDL-2021 LIBRARY; T=293.6K
Damage

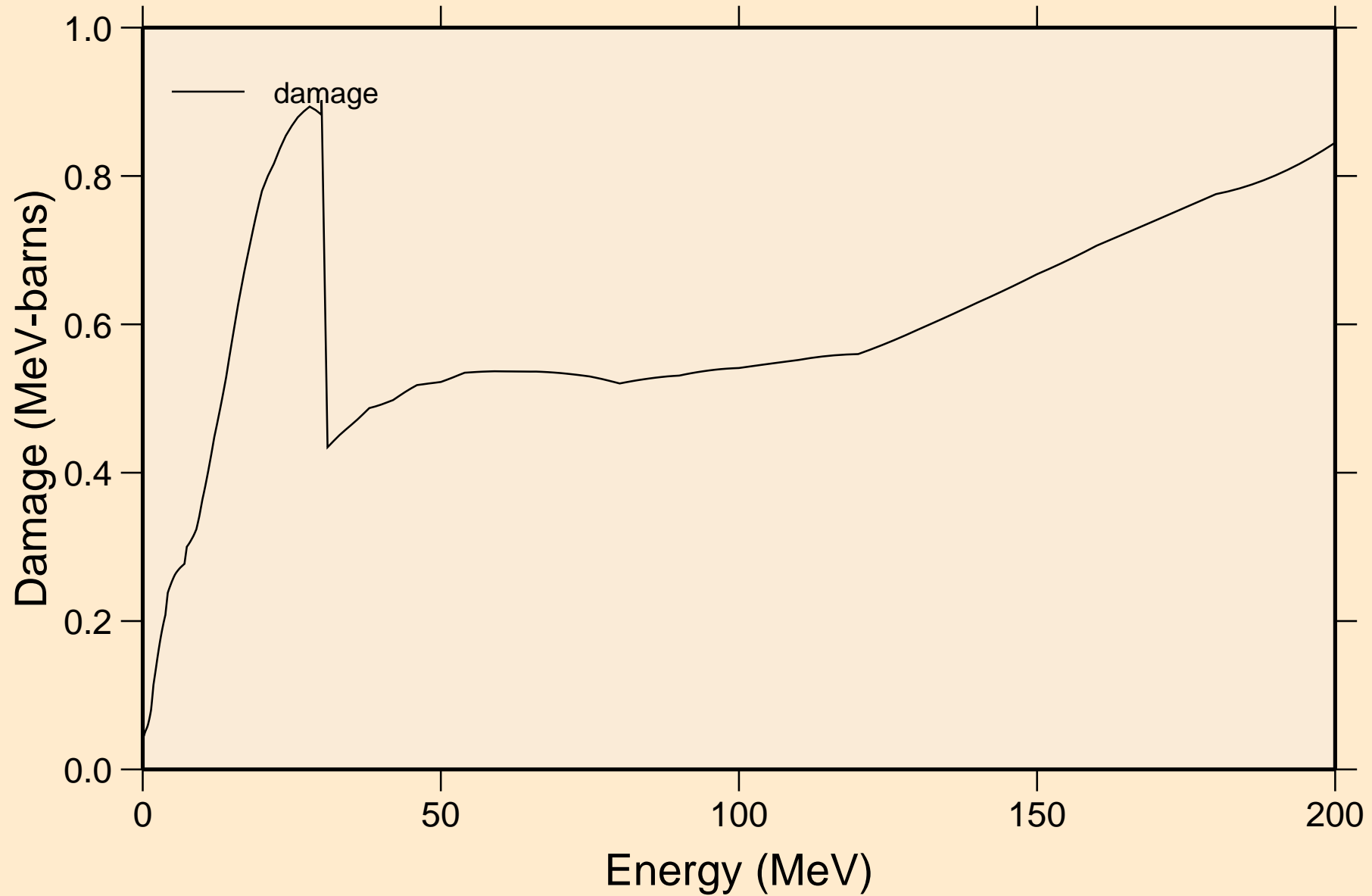

IR172M NEUTRON ACER TENDL-2021 LIBRARY; T=293.6K
Non-threshold reactions

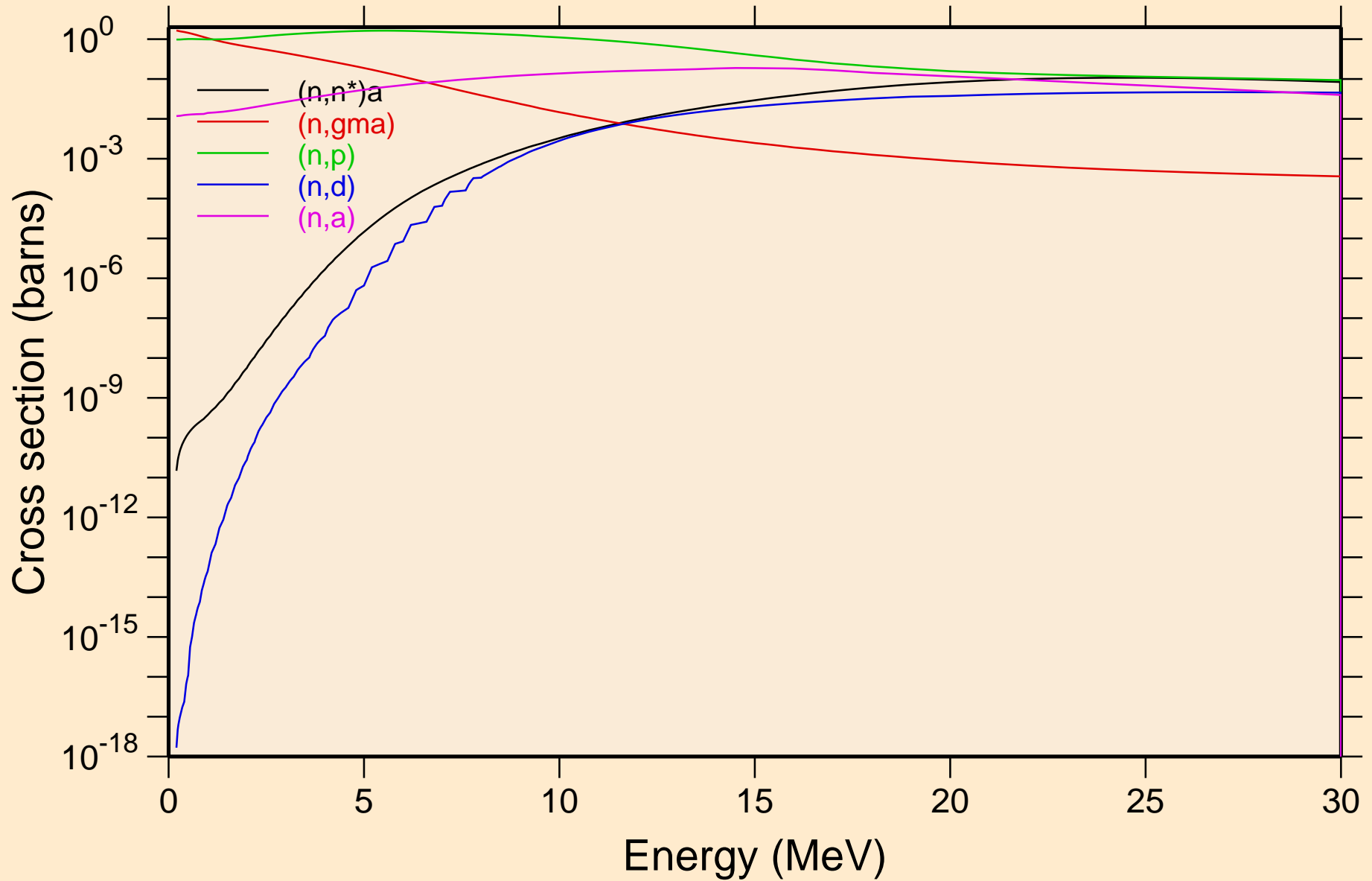

IR172M NEUTRON ACER TENDL-2021 LIBRARY; T=293.6K
Non-threshold reactions

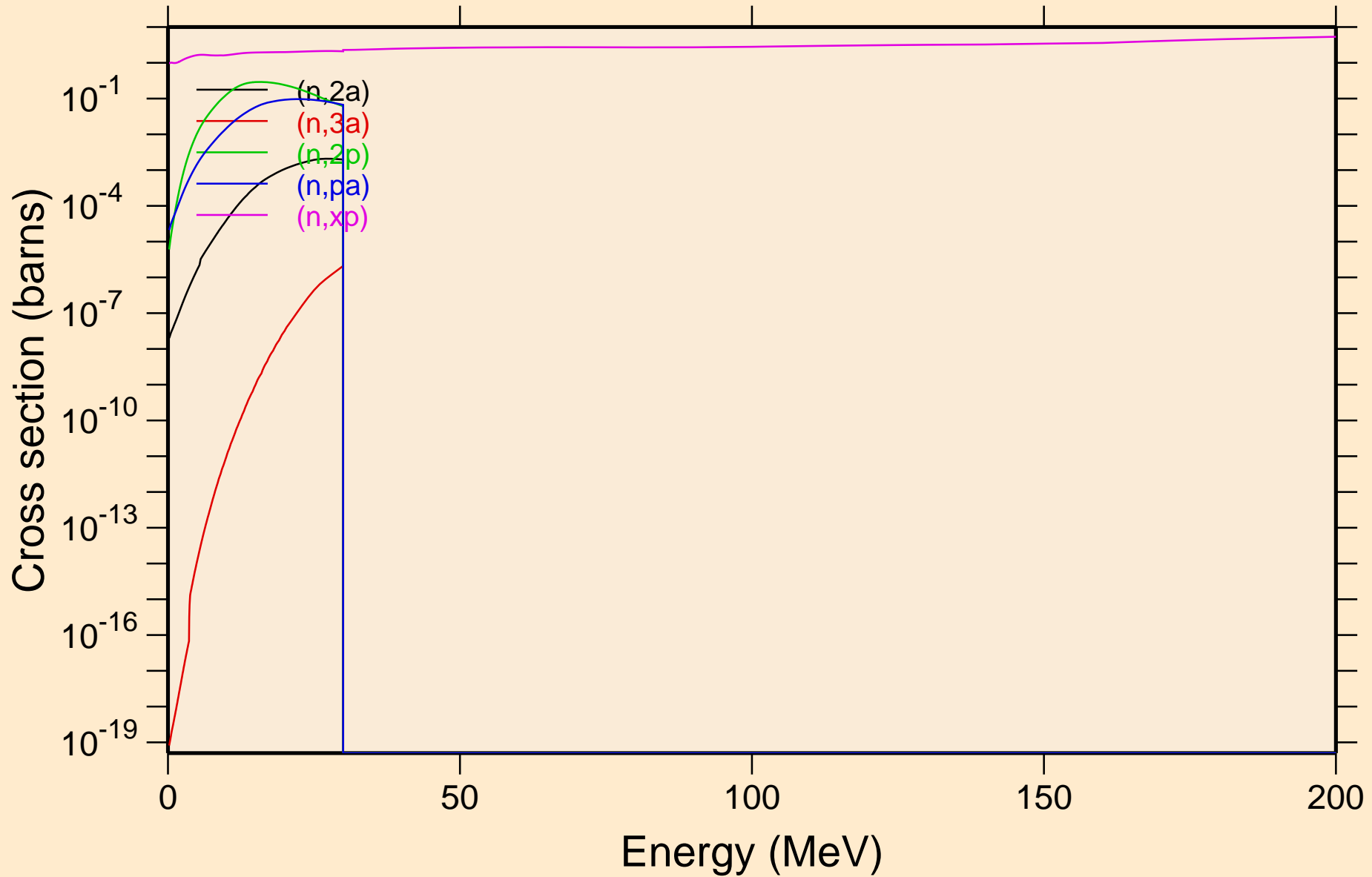

IR172M NEUTRON ACER TENDL-2021 LIBRARY; T=293.6K
Non-threshold reactions

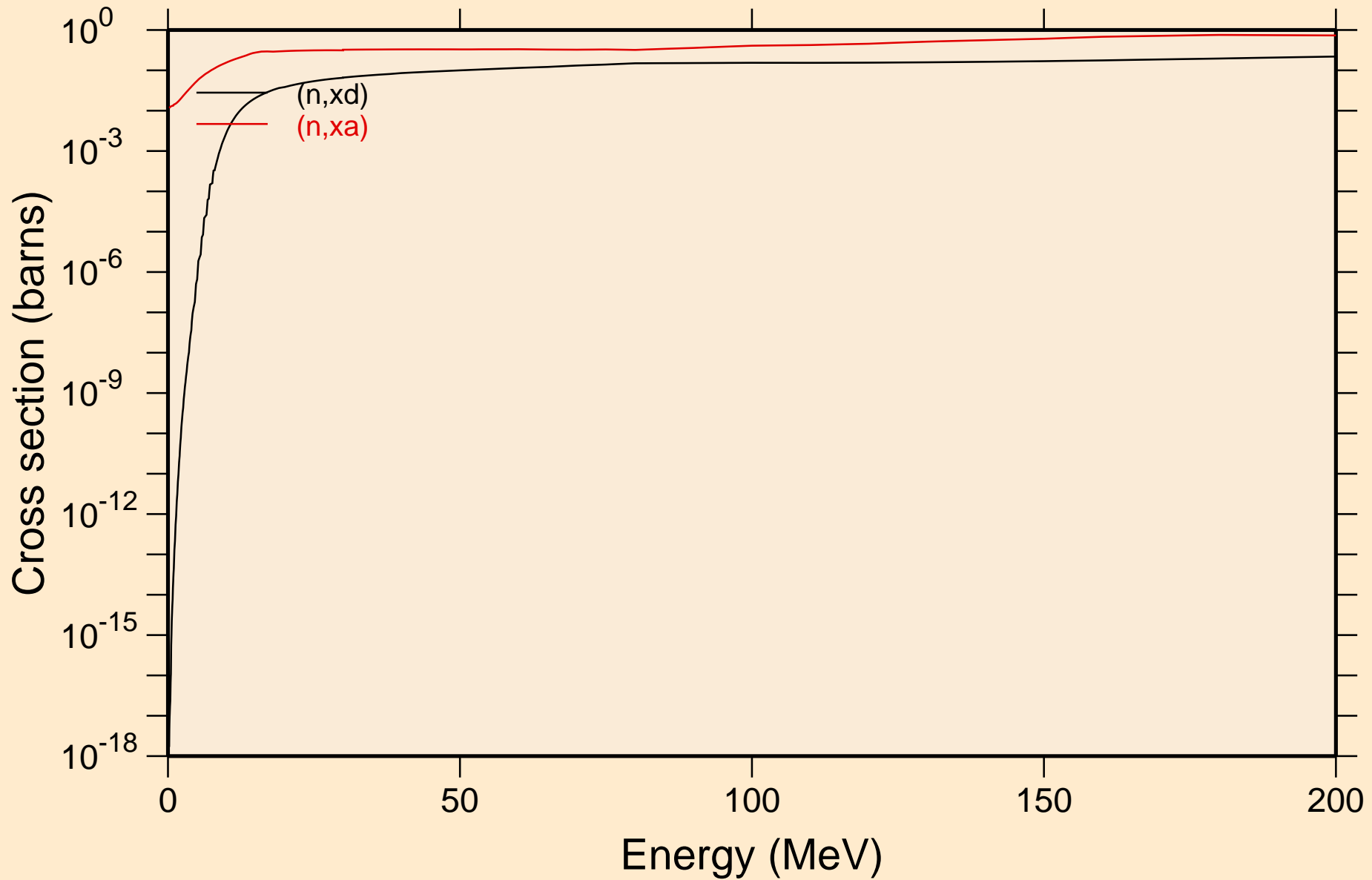

IR172M NEUTRON ACER TENDL-2021 LIBRARY; T=293.6K
Inelastic levels

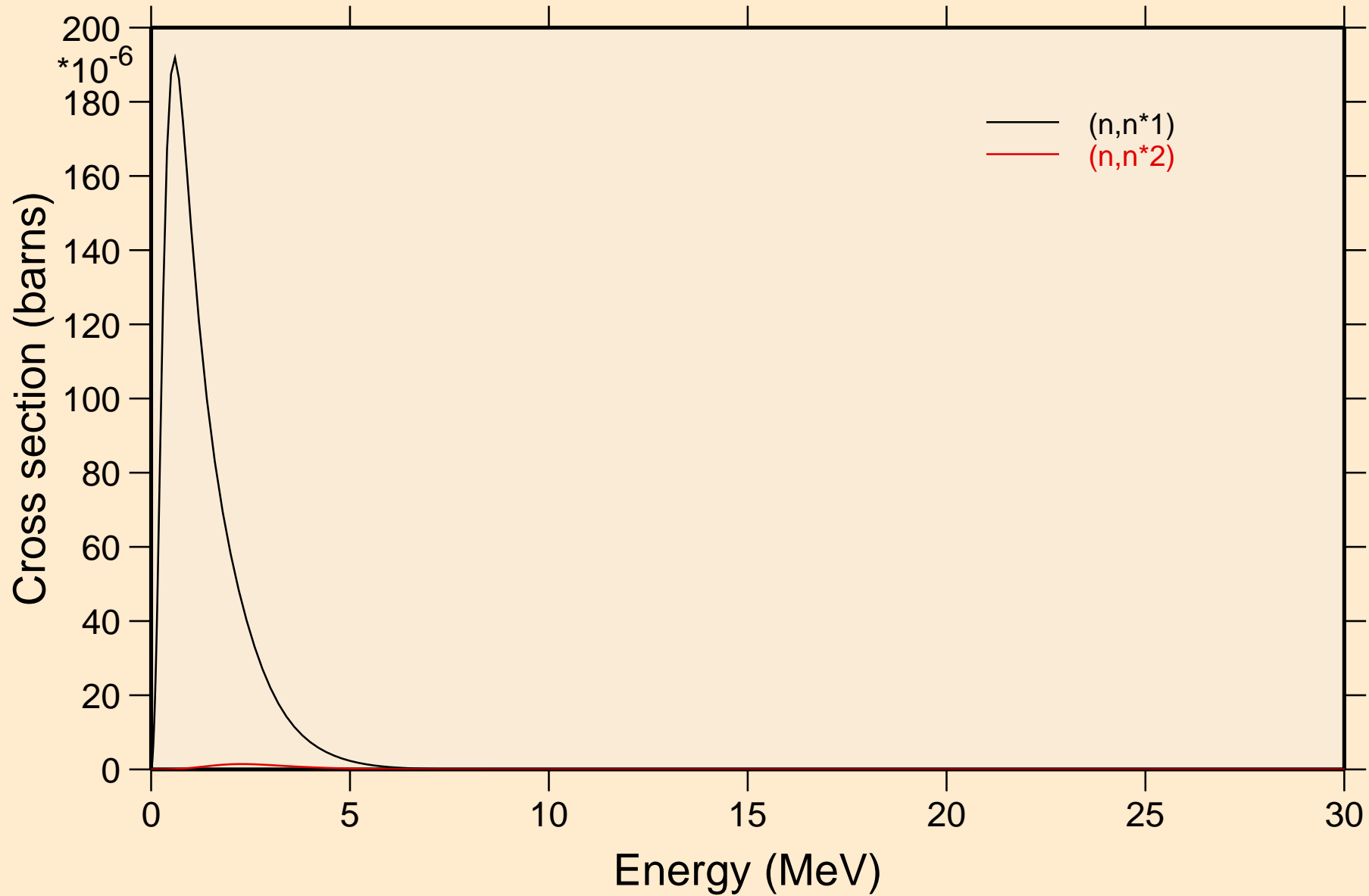

IR172M NEUTRON ACER TENDL-2021 LIBRARY; T=293.6K
Threshold reactions

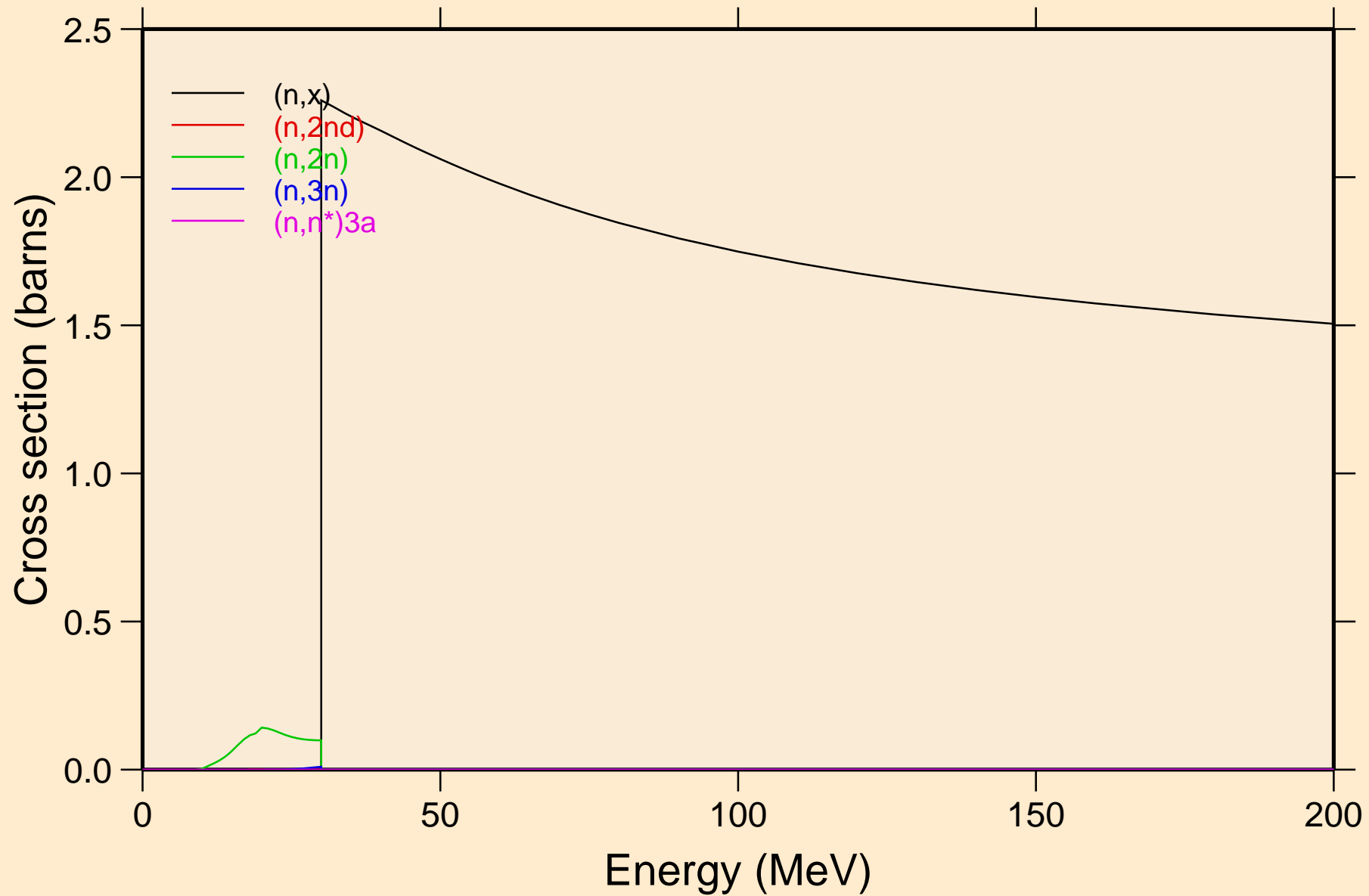

IR172M NEUTRON ACER TENDL-2021 LIBRARY; T=293.6K
Threshold reactions

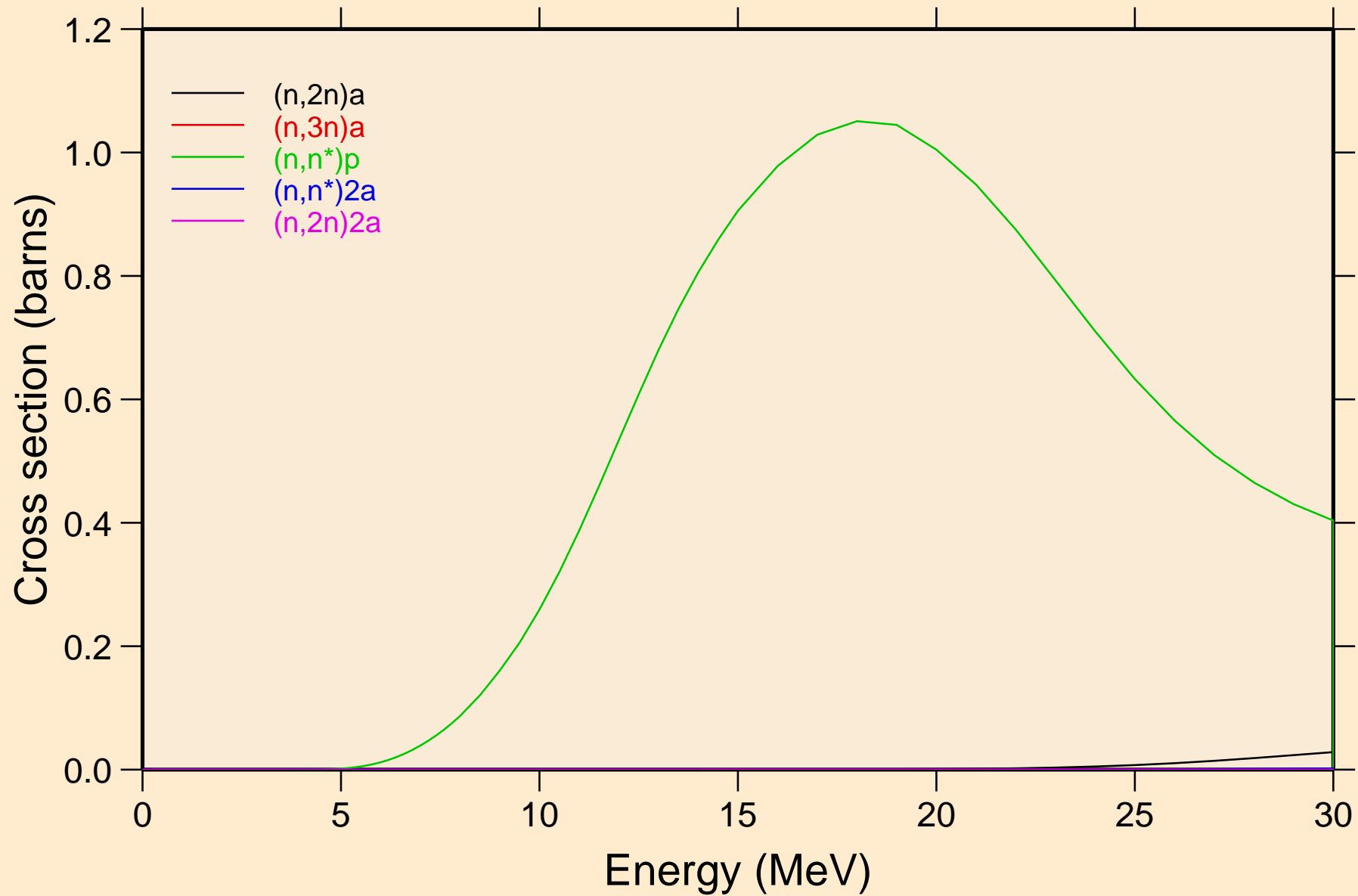

IR172M NEUTRON ACER TENDL-2021 LIBRARY; T=293.6K
Threshold reactions

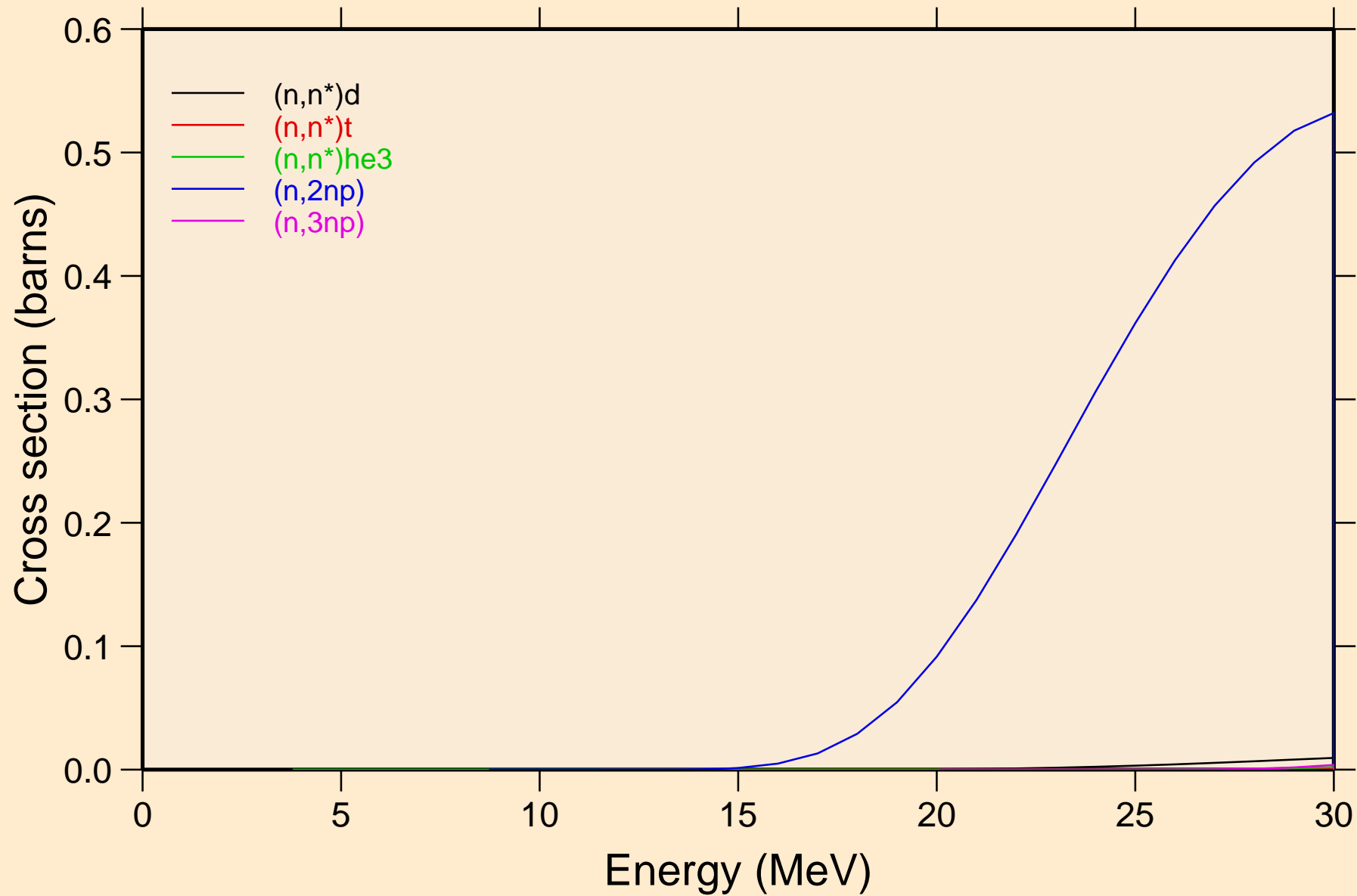

IR172M NEUTRON ACER TENDL-2021 LIBRARY; T=293.6K
Threshold reactions

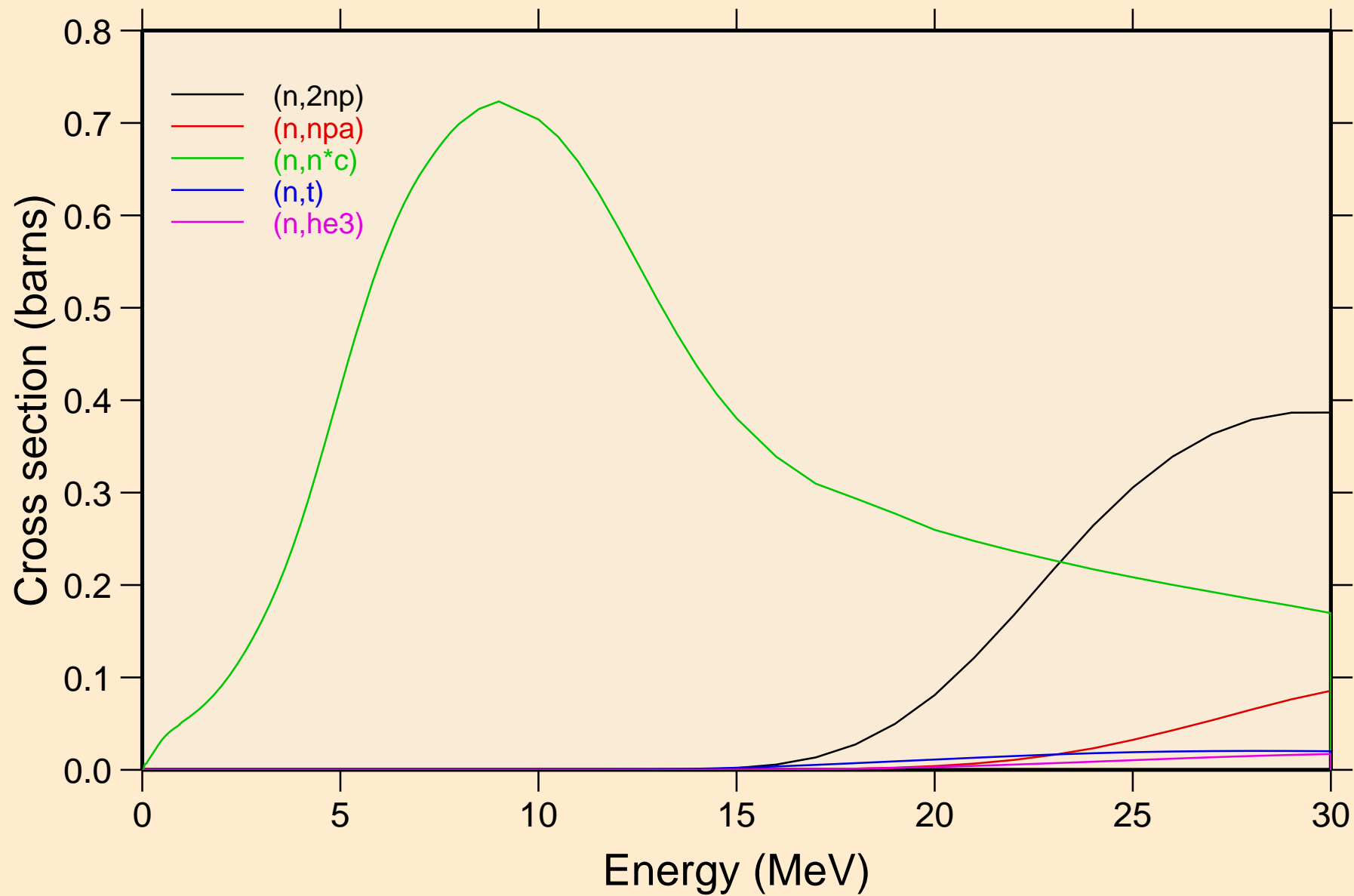

IR172M NEUTRON ACER TENDL-2021 LIBRARY; T=293.6K
Threshold reactions

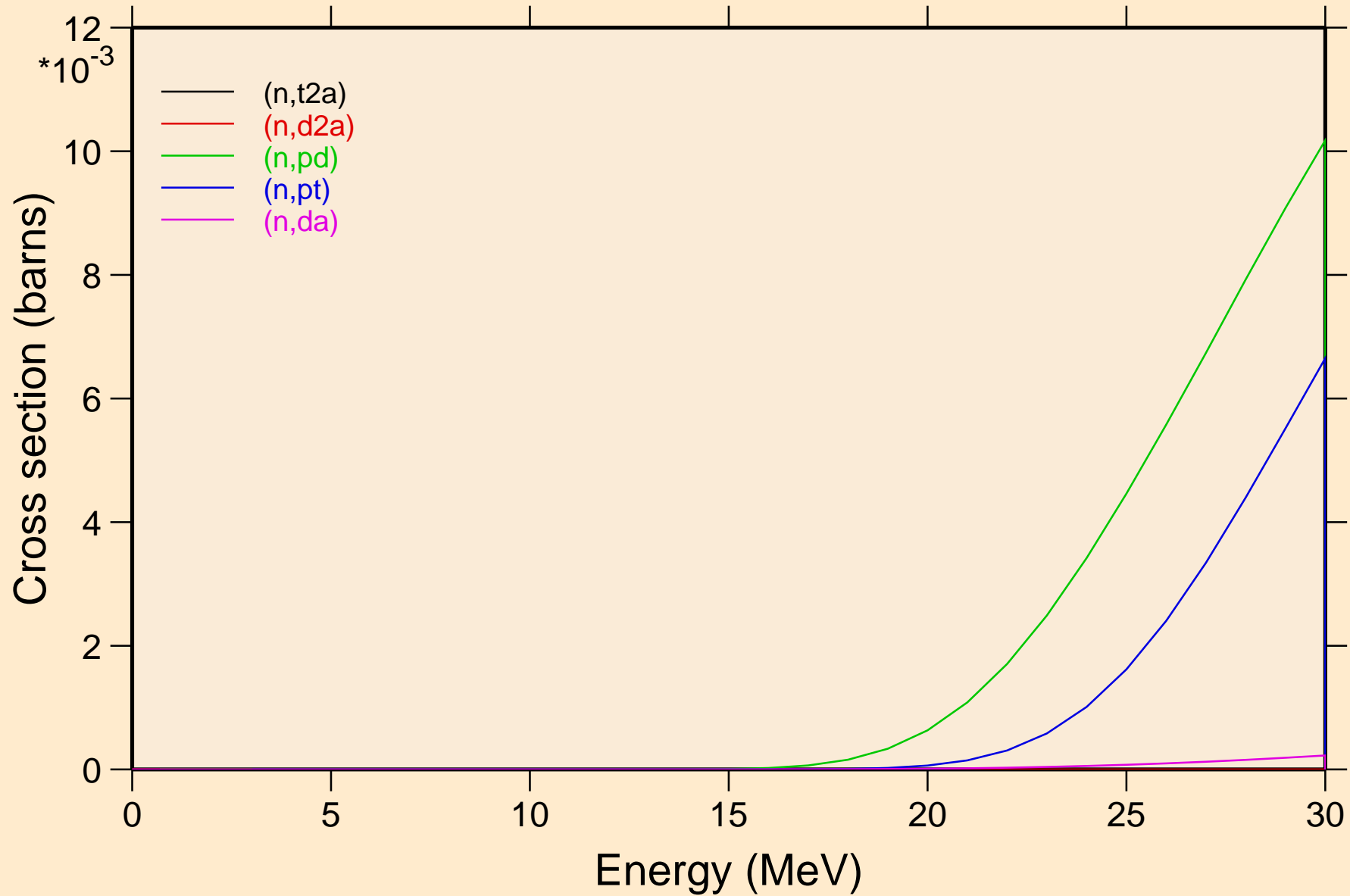

IR172M NEUTRON ACER TENDL-2021 LIBRARY; T=293.6K
Threshold reactions

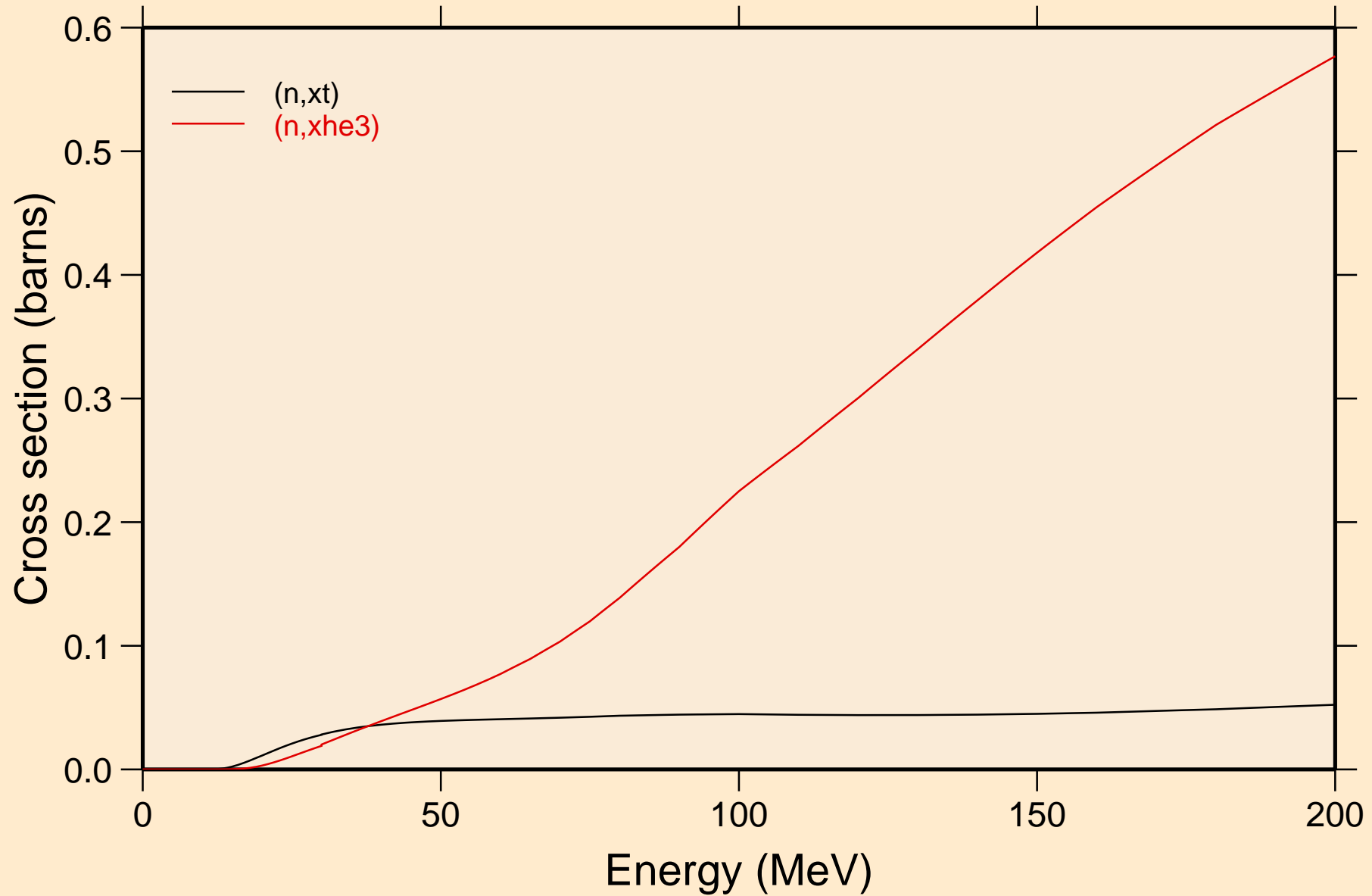

IR172M NEUTRON ACER TENDL-2021 LIBRARY; T=293.6K
angular distribution for elastic

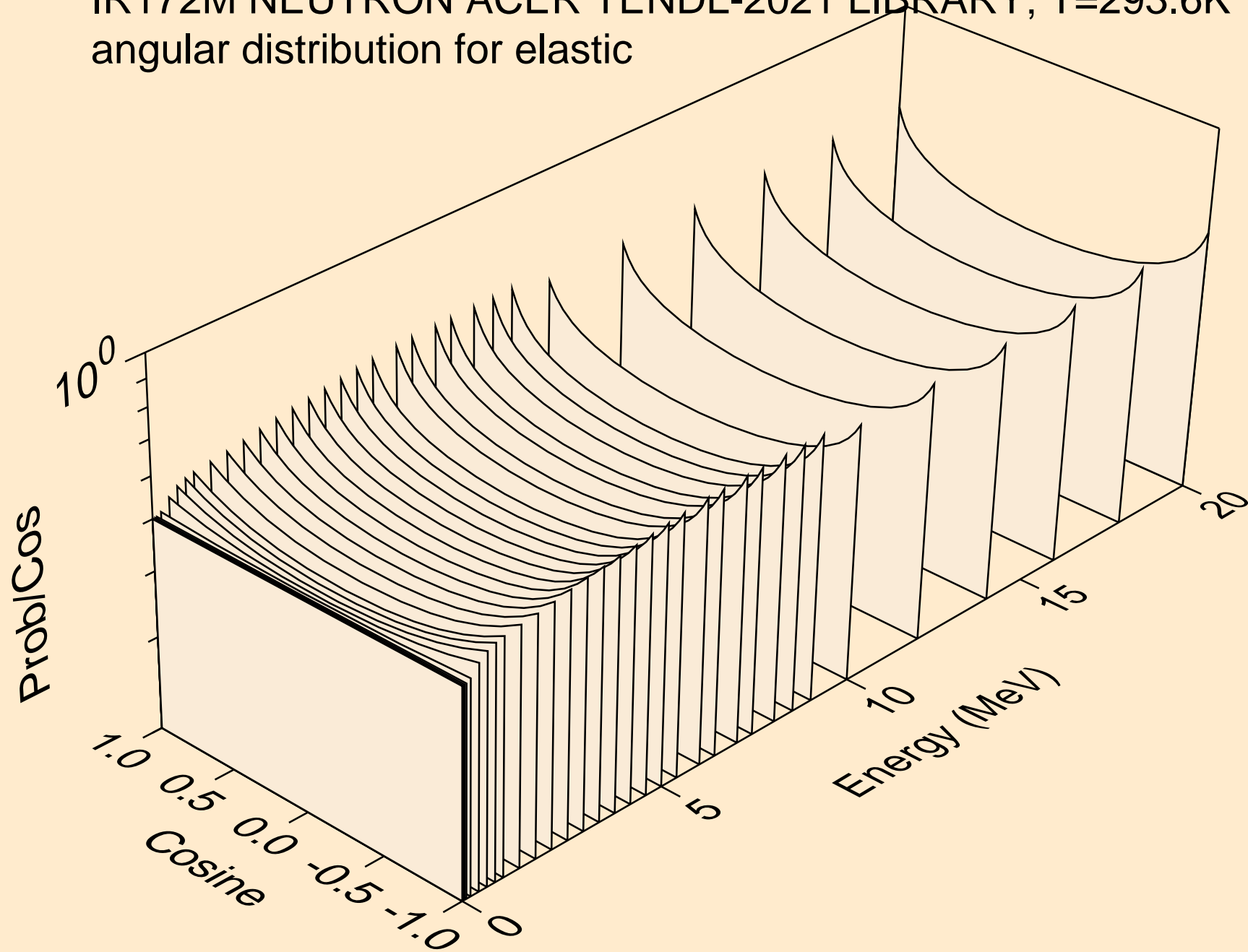

IR172M NEUTRON ACER TENDL-2021 LIBRARY; T=293.6K
angular distribution for elastic

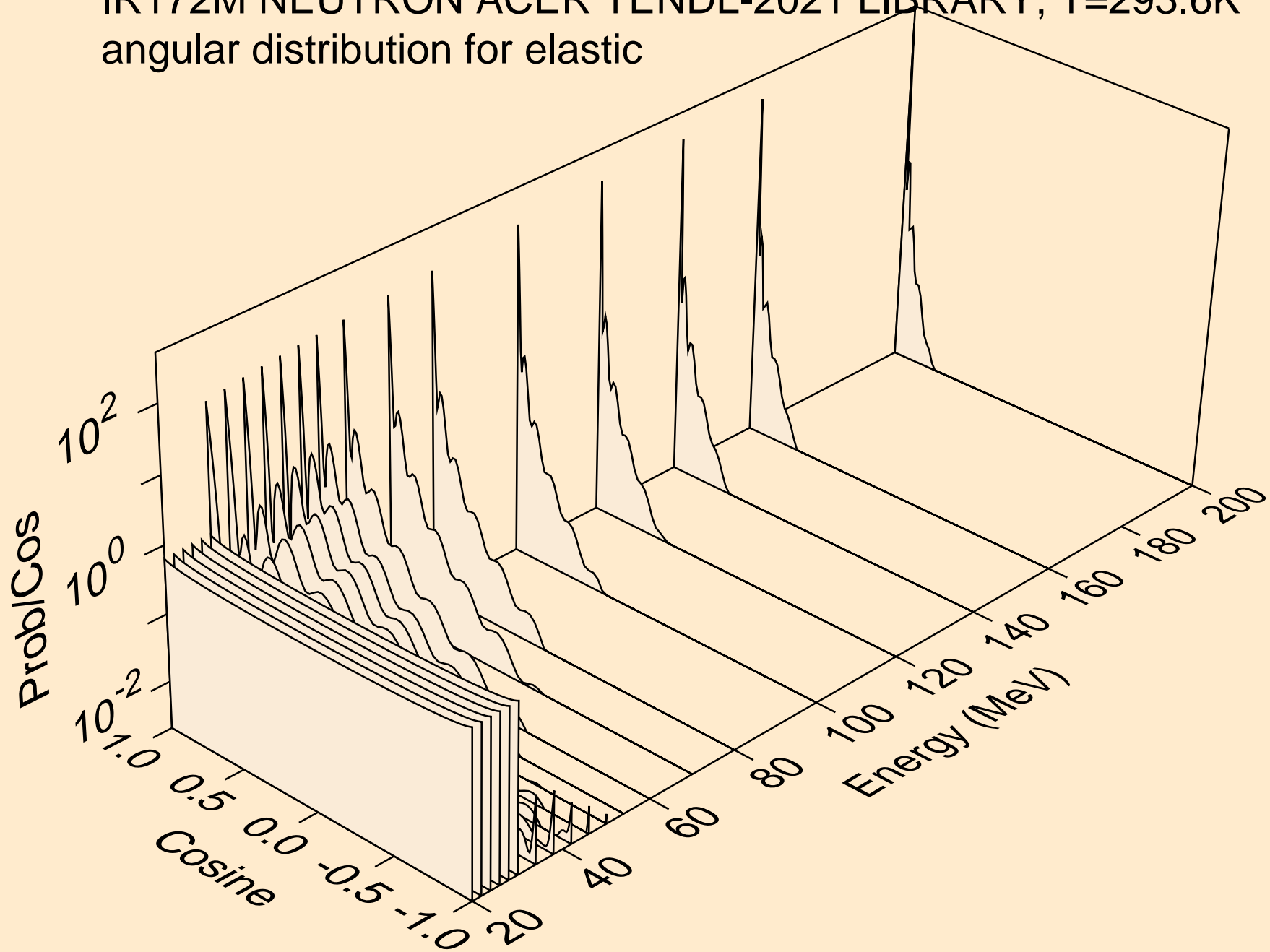

IR172M NEUTRON ACER TENDL-2021 LIBRARY; T=293.6K
angular distribution for (n,n*1)

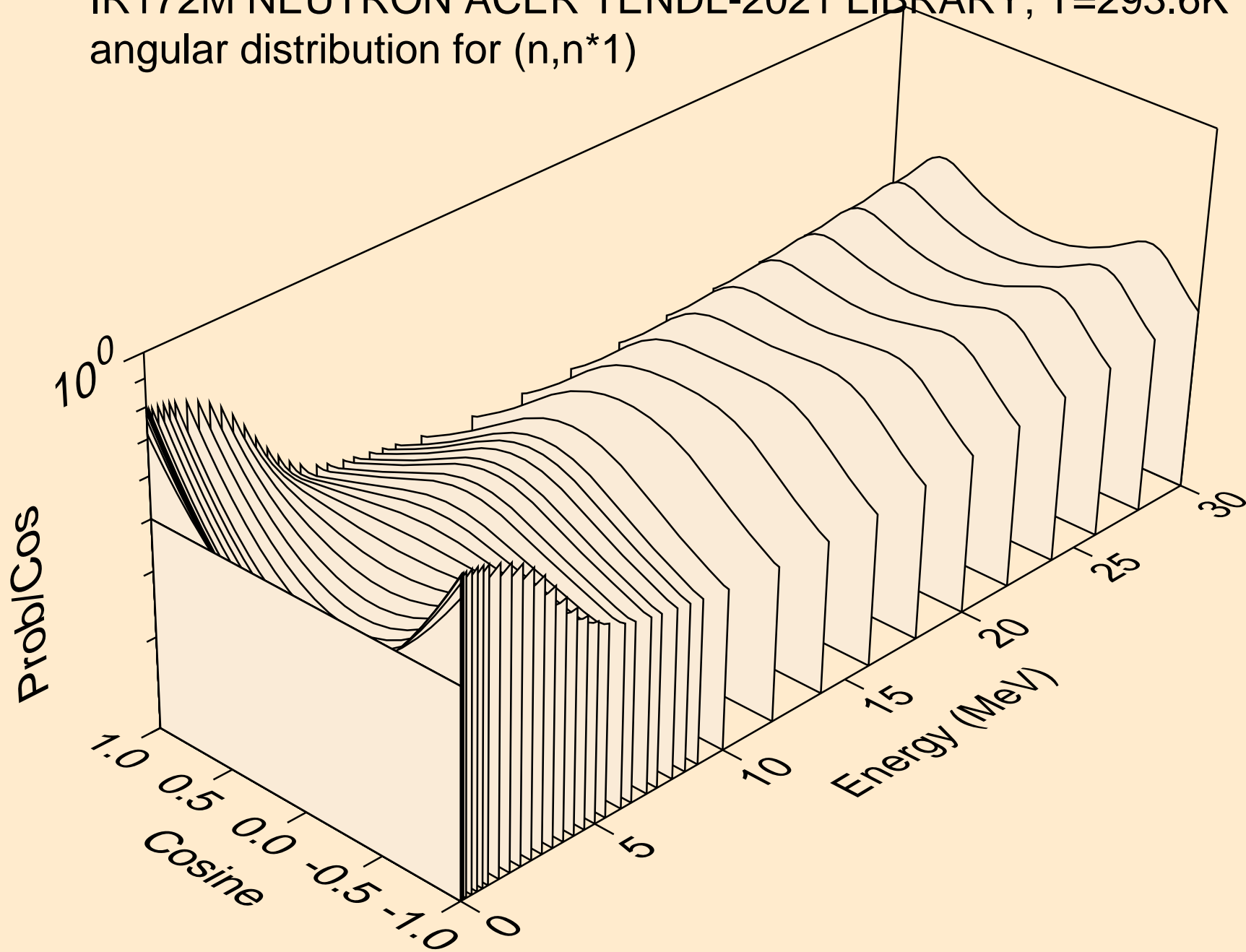

IR172M NEUTRON ACER TENDL-2021 LIBRARY; T=293.6K
angular distribution for (n,n*2)

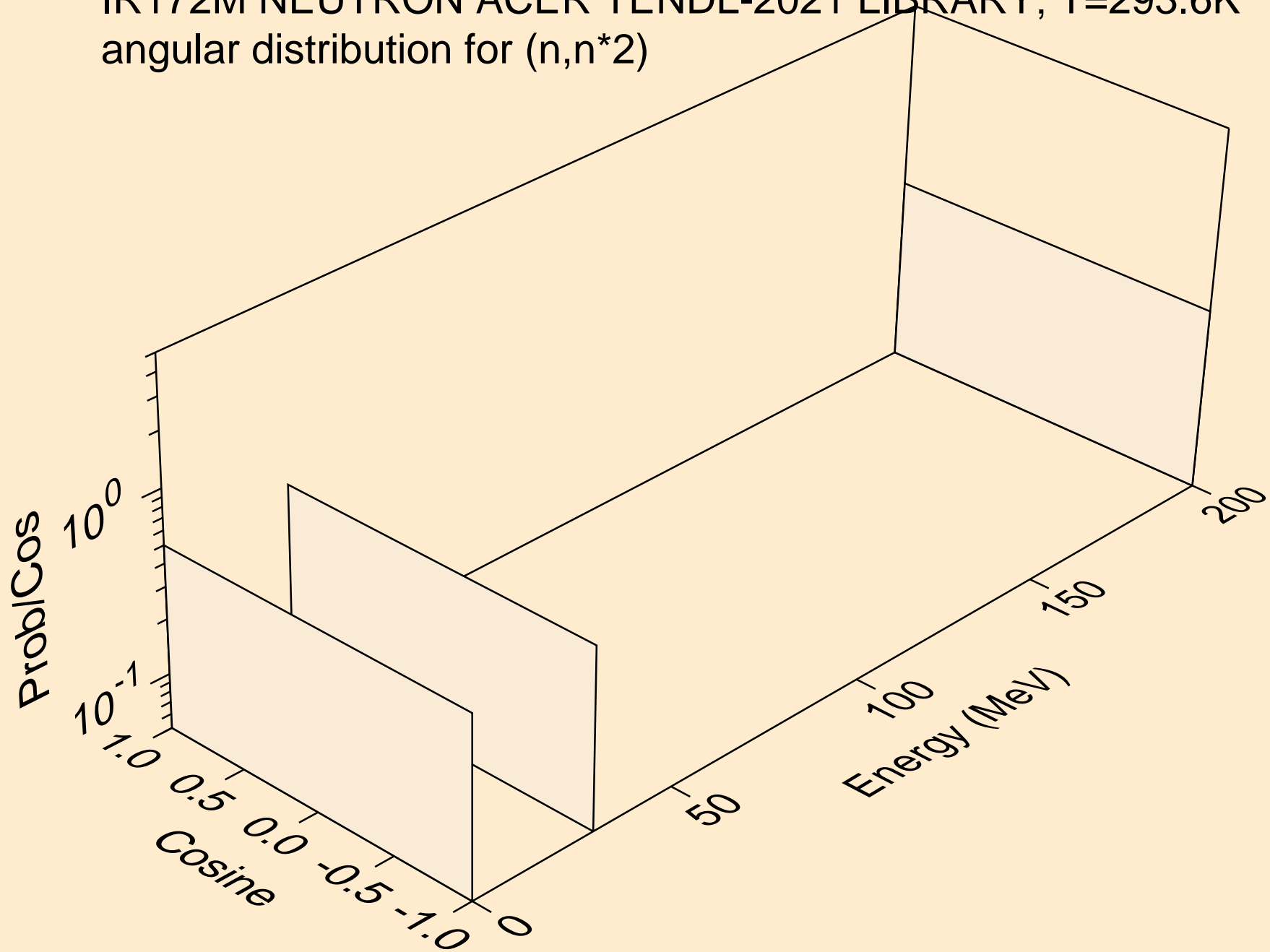

IR172M NEUTRON ACER TENDL-2021 LIBRARY; T=293.6K
Neutron emission for (n,x)

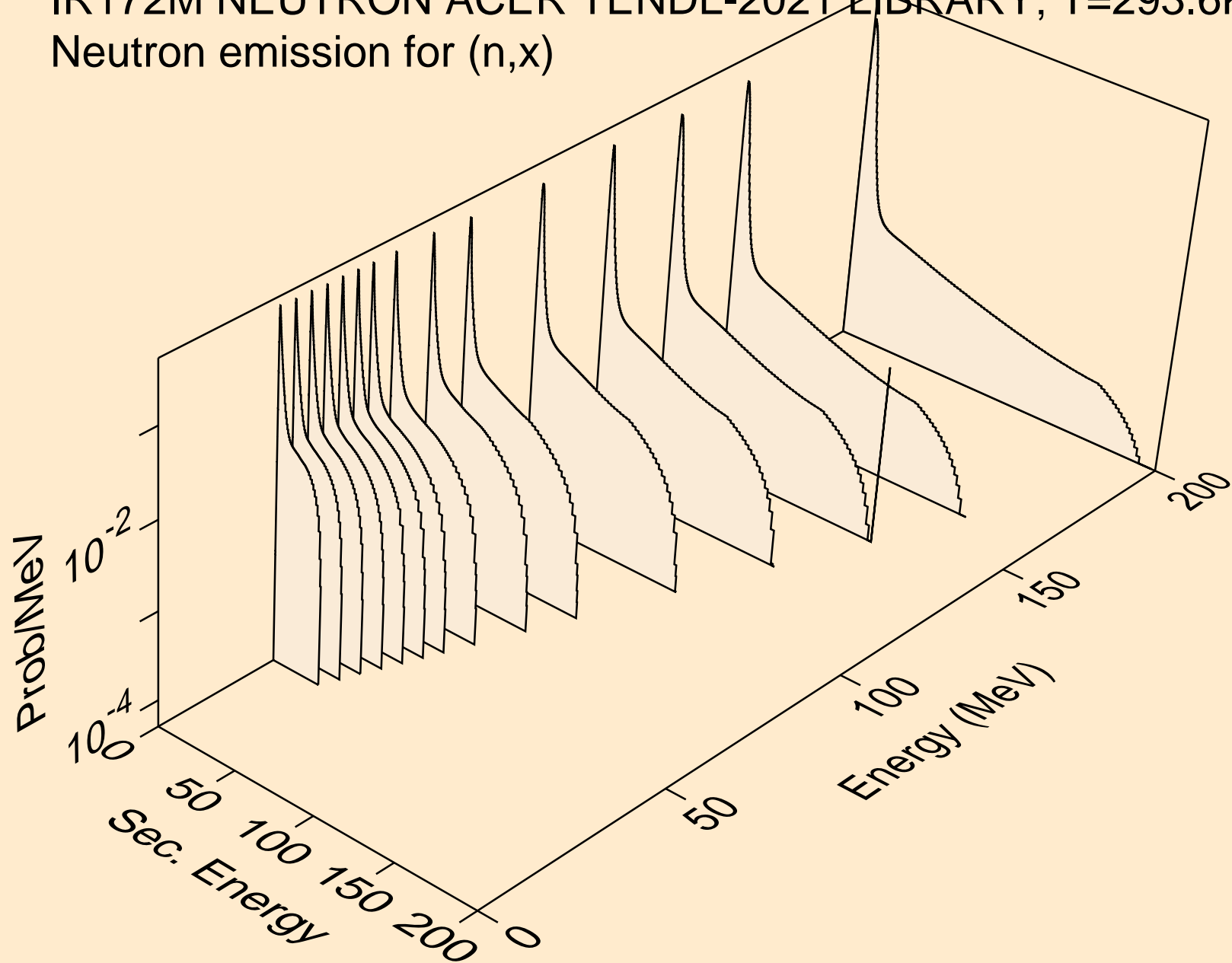

IR172M NEUTRON ACER TENDL-2021 LIBRARY; T=293.6K
Neutron emission for (n,2nd)

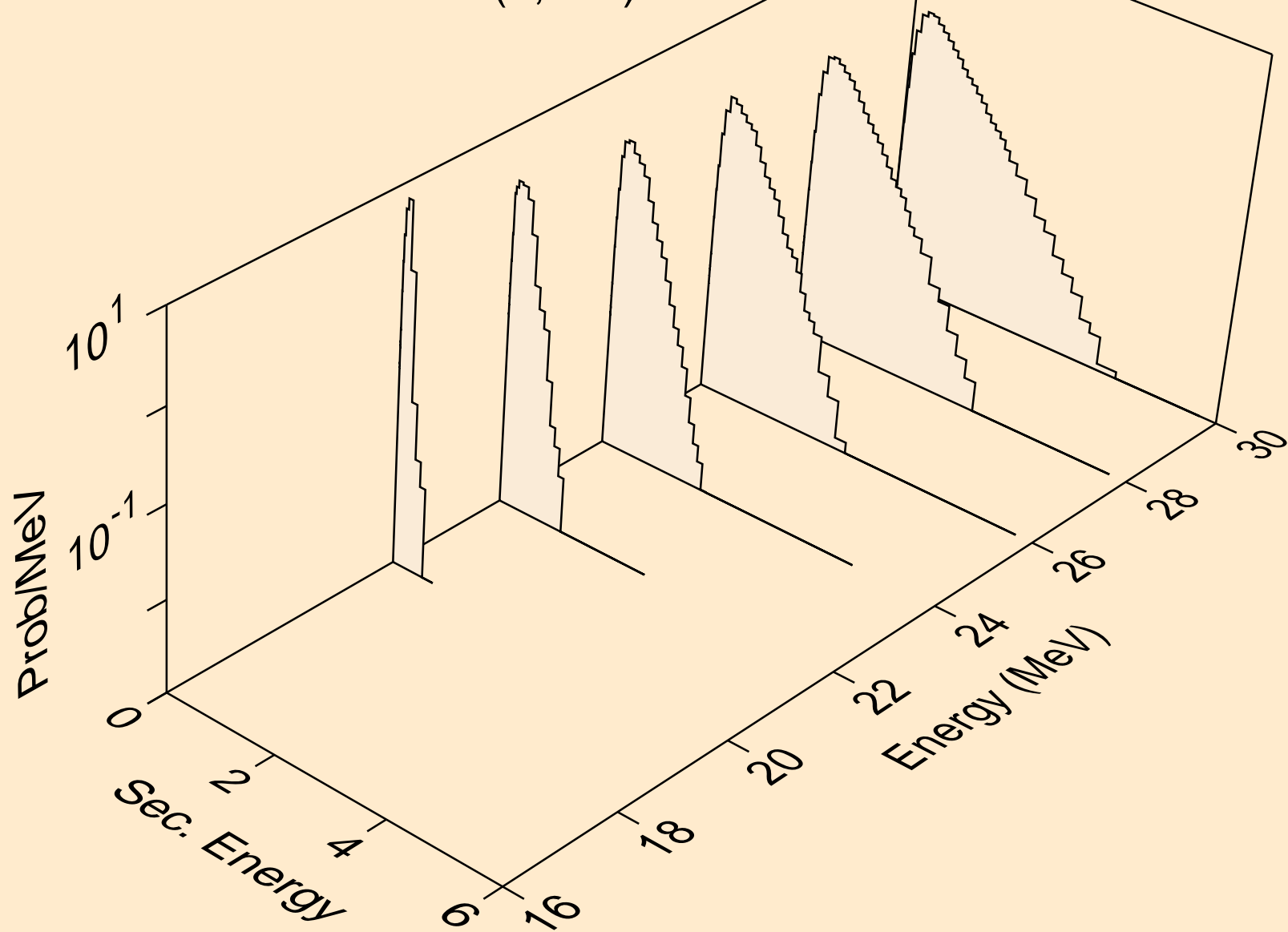

IR172M NEUTRON ACER TENDL-2021 LIBRARY; T=293.6K
Neutron emission for (n,2n)

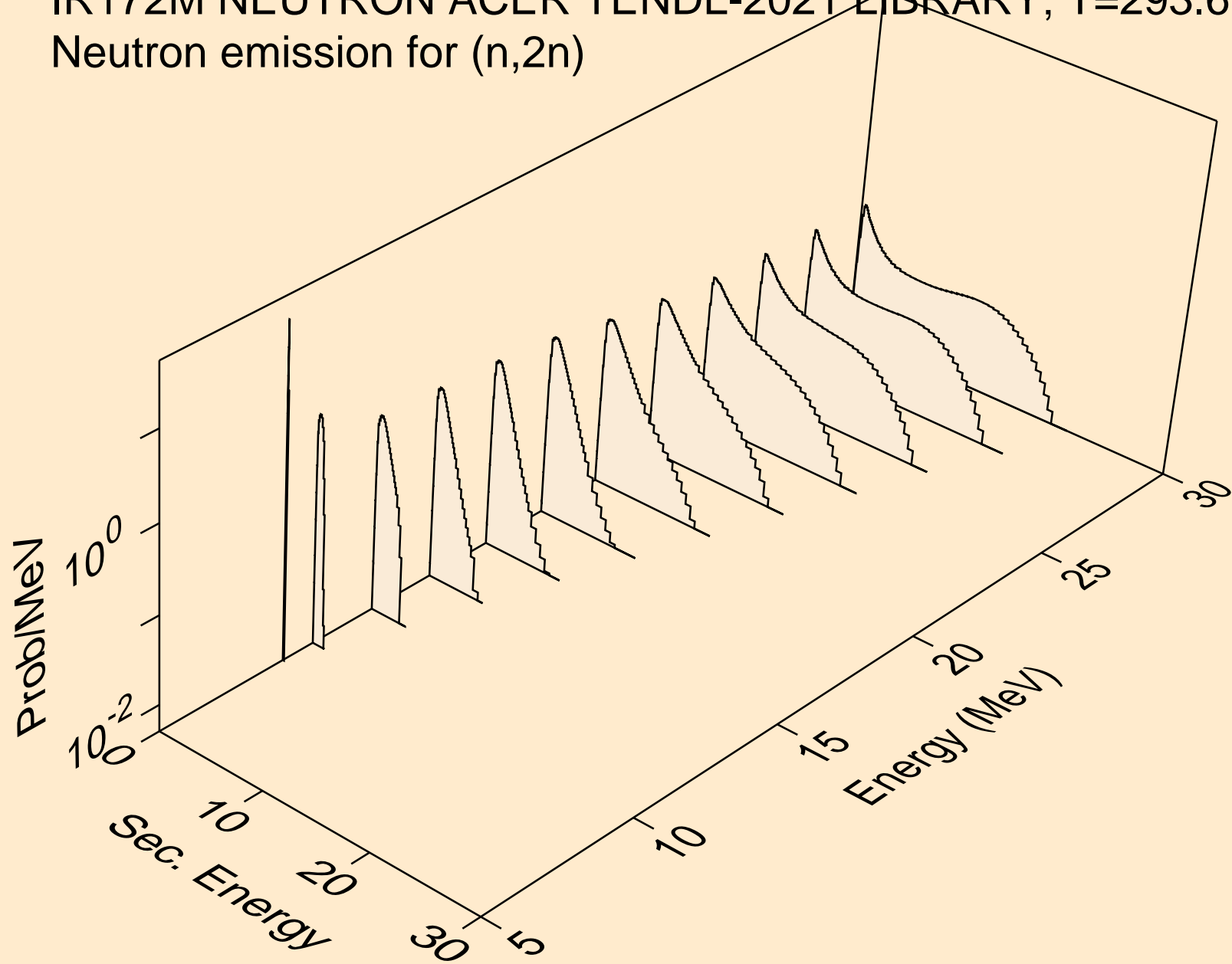

IR172M NEUTRON ACER TENDL-2021 LIBRARY; T=293.6K
Neutron emission for (n,3n)

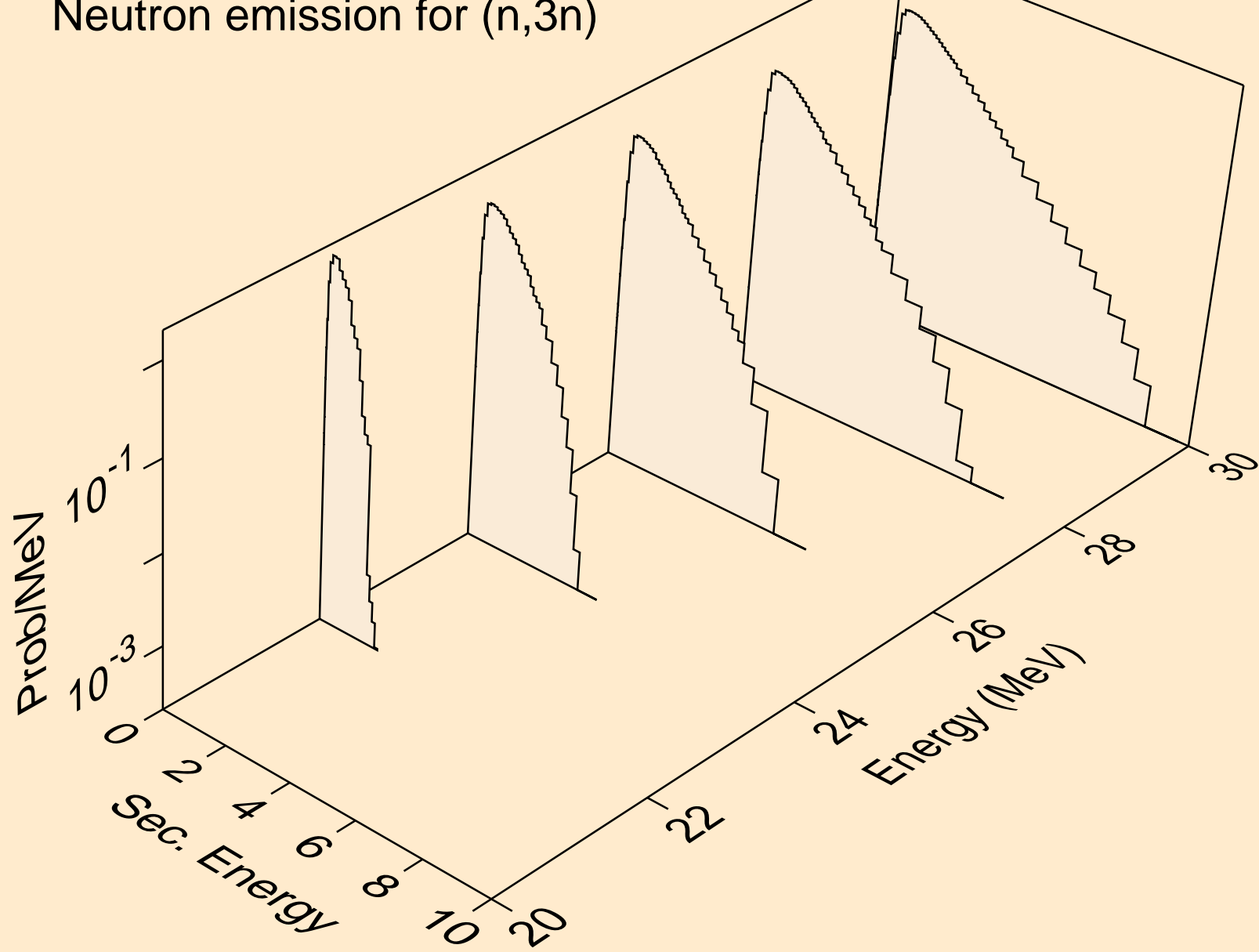

IR172M NEUTRON ACER TENDL-2021 LIBRARY; T=293.6K
Neutron emission for (n,n*)a

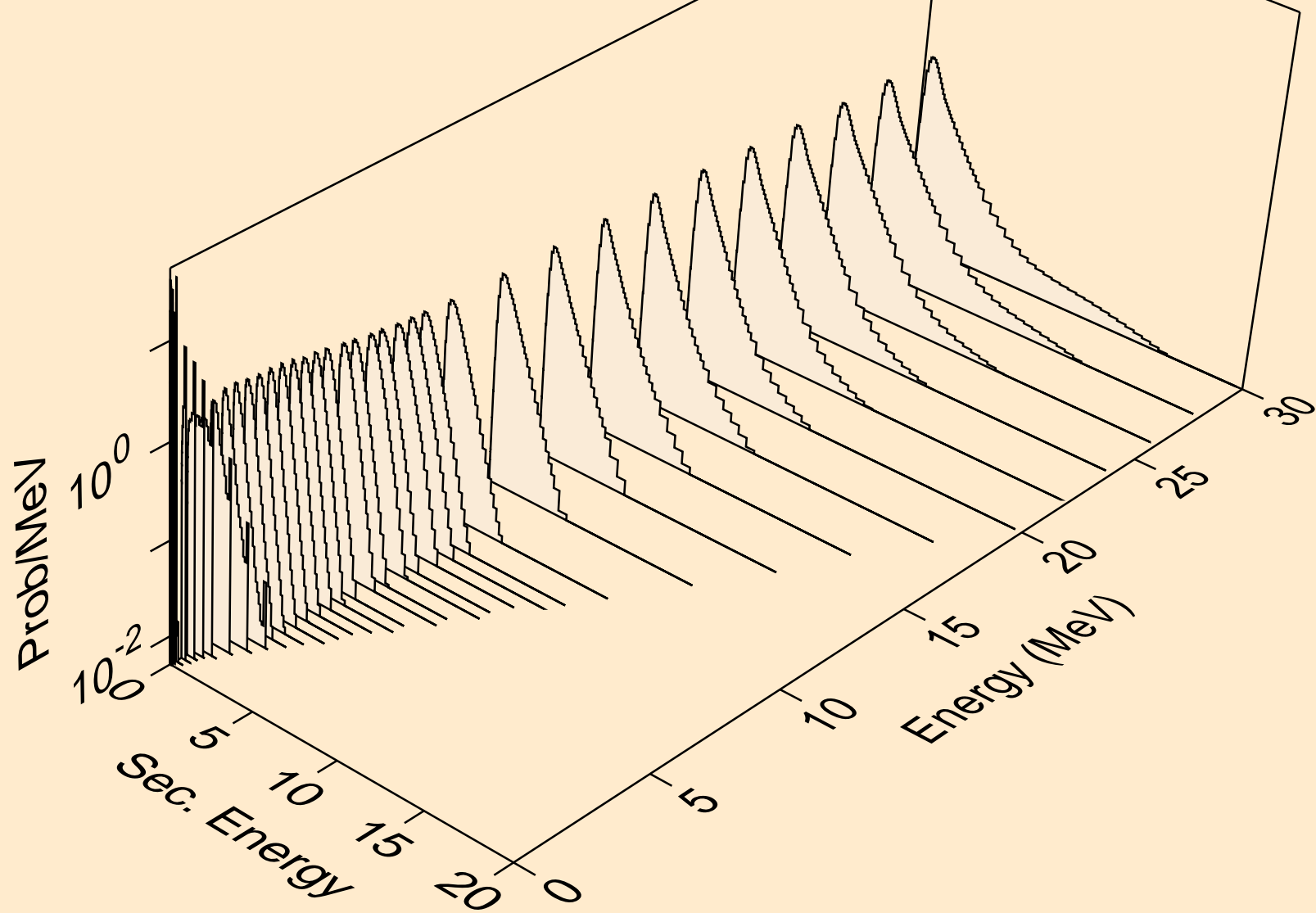

IR172M NEUTRON ACER TENDL-2021 LIBRARY; T=293.6K
Neutron emission for (n,n*)3a

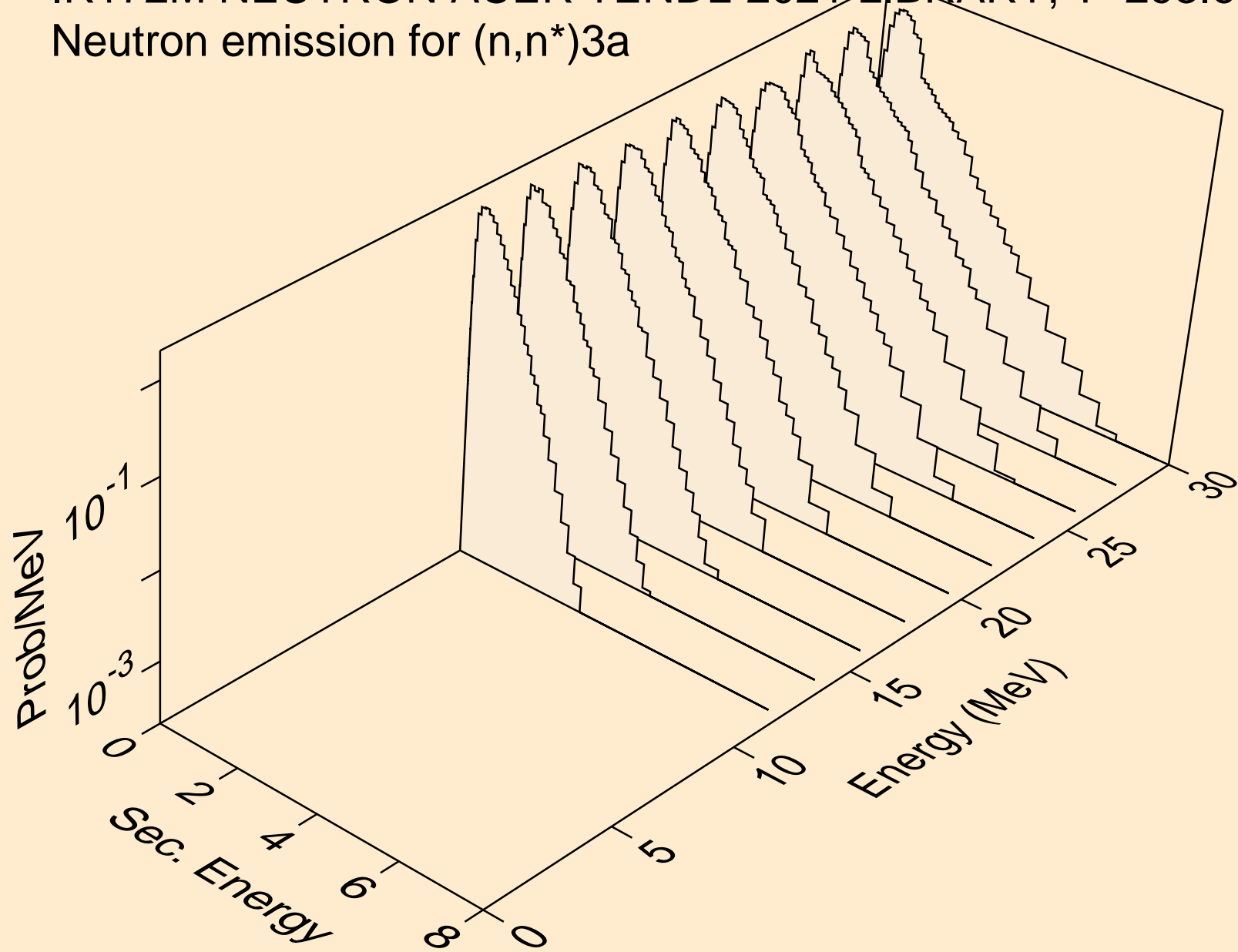

IR172M NEUTRON ACER TENDL-2021 LIBRARY; T=293.6K
Neutron emission for (n,2n)a

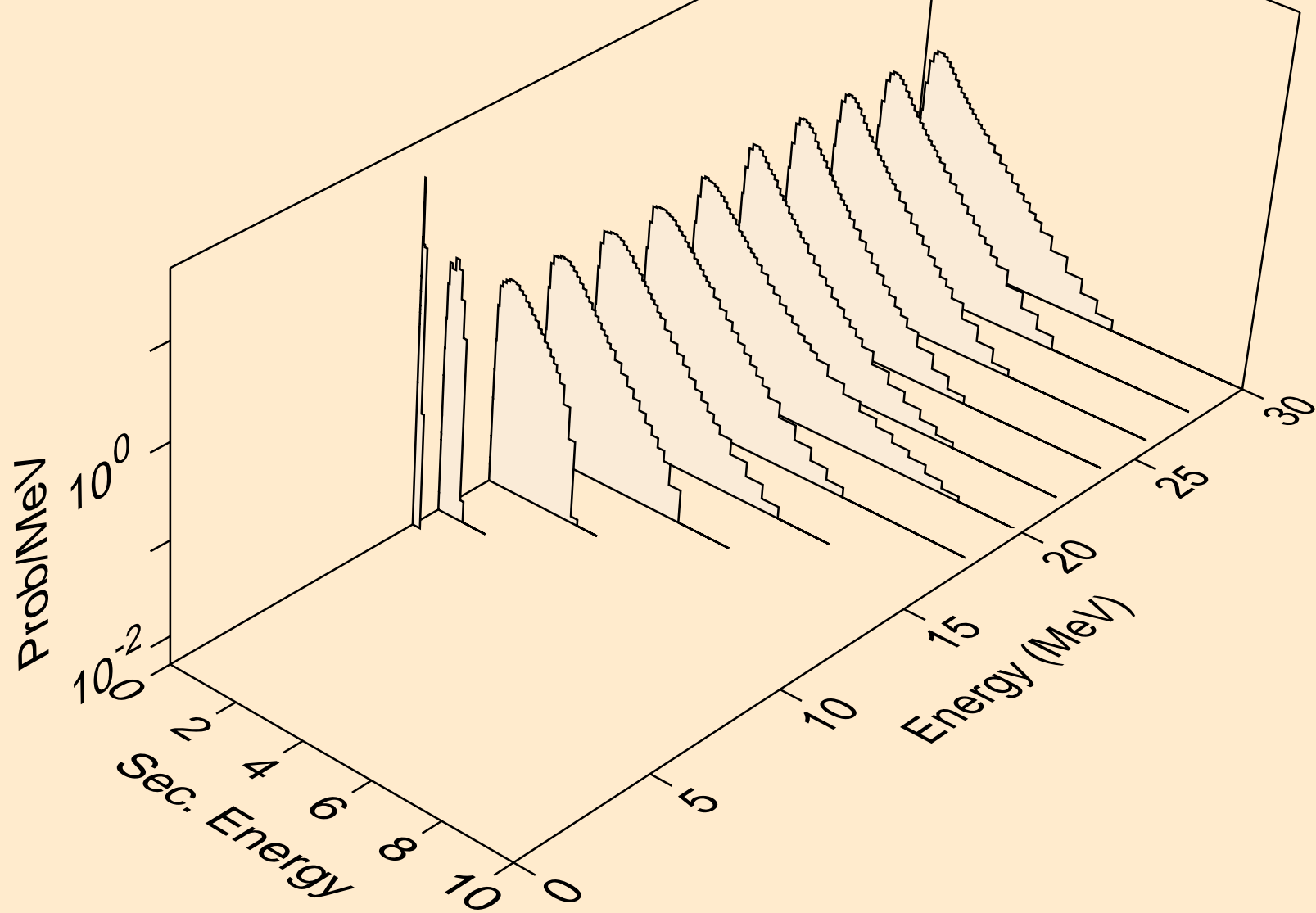

IR172M NEUTRON ACER TENDL-2021 LIBRARY; T=293.6K
Neutron emission for (n,3n)a

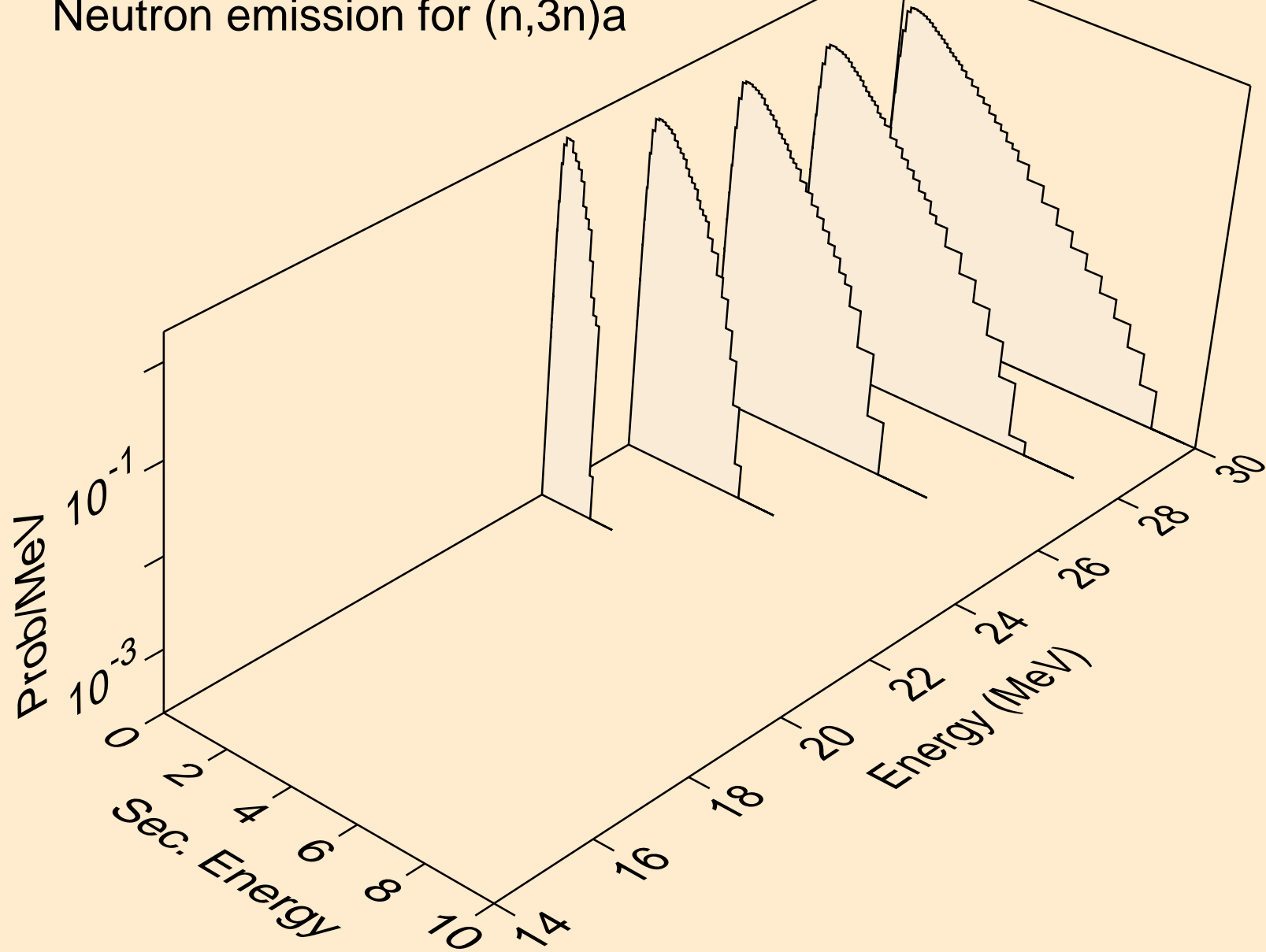

IR172M NEUTRON ACER TENDL-2021 LIBRARY; T=293.6K
Neutron emission for (n,n*)p

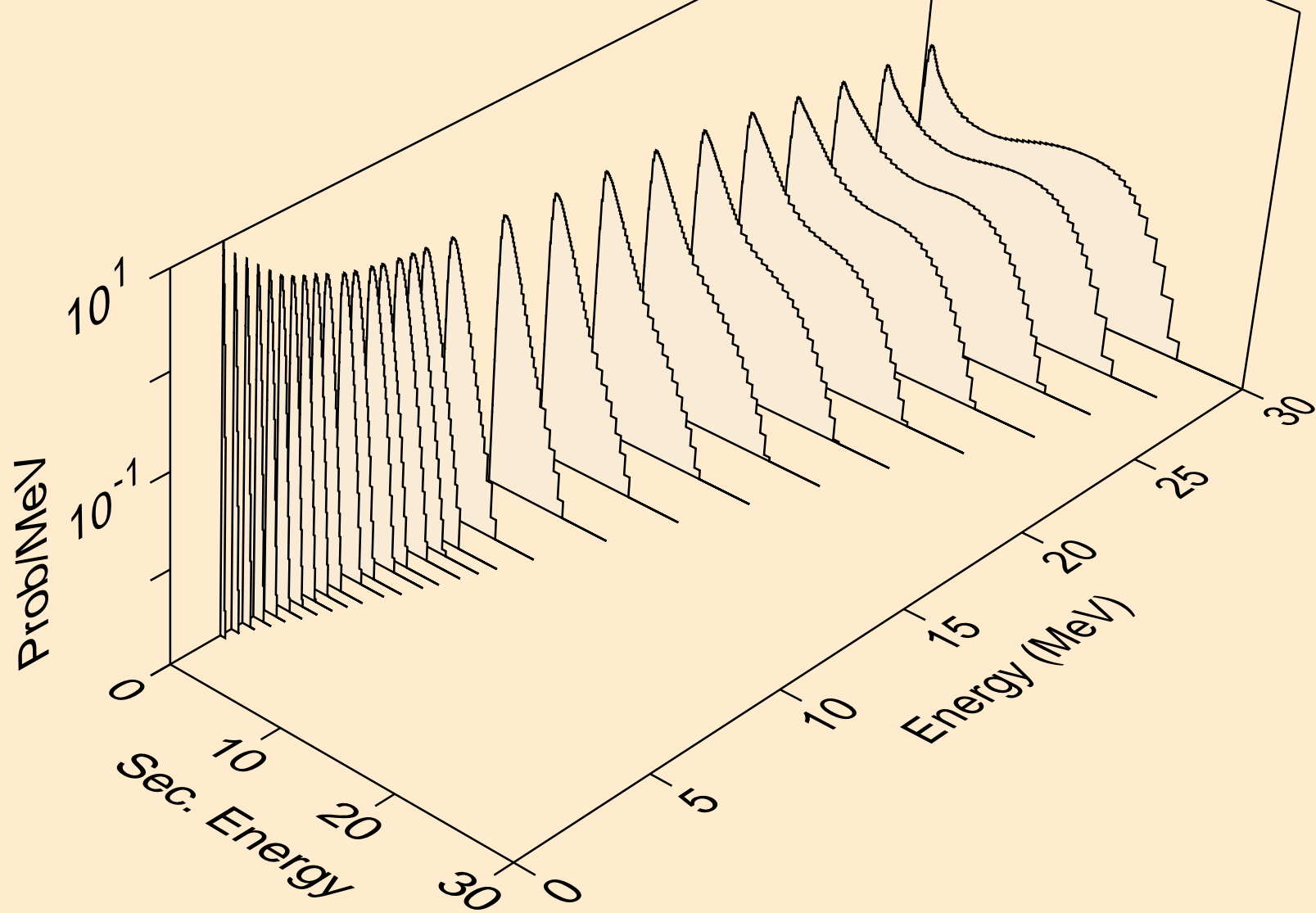

IR172M NEUTRON ACER TENDL-2021 LIBRARY; T=293.6K
Neutron emission for (n,n*)2a

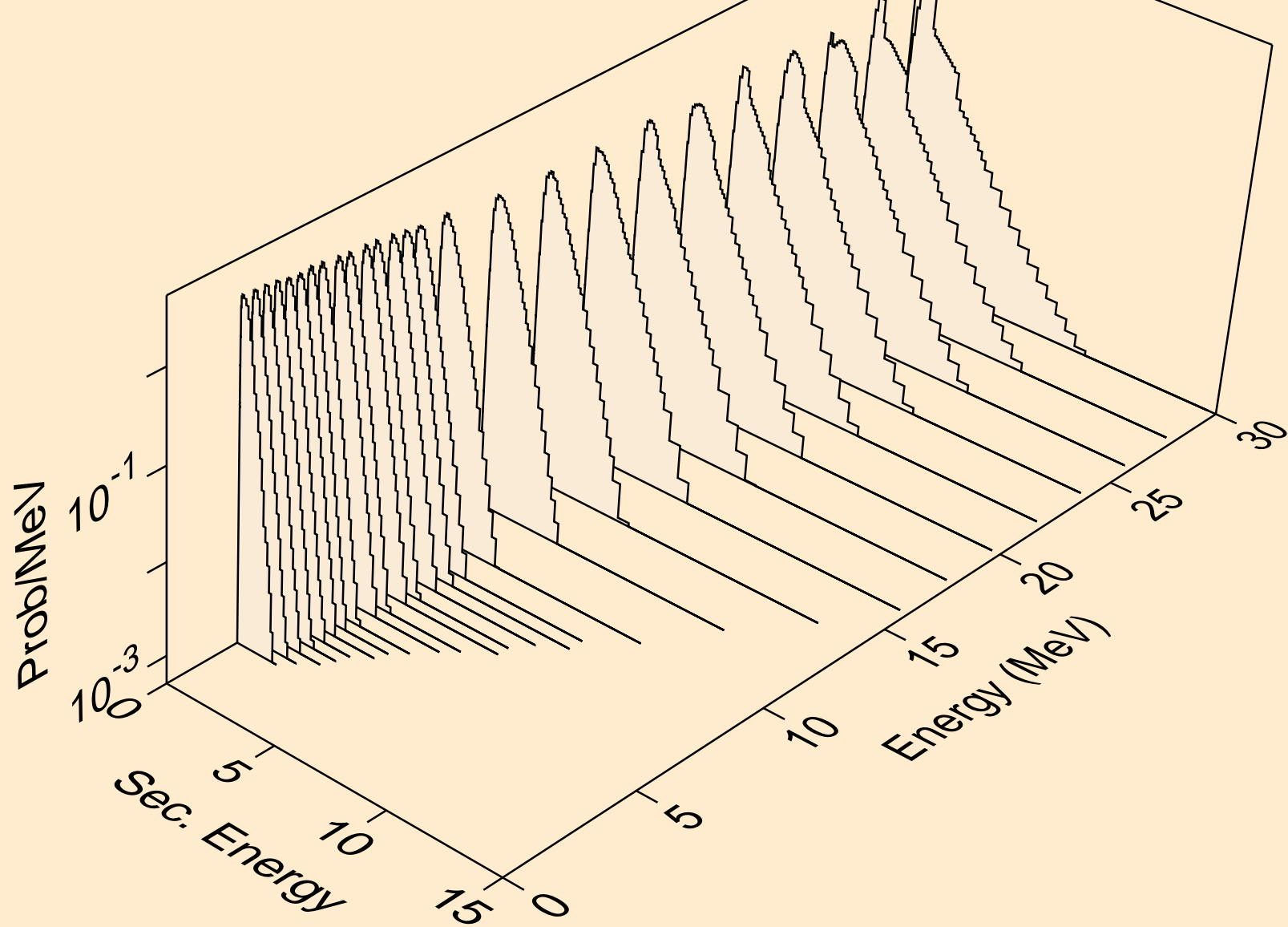

IR172M NEUTRON ACER TENDL-2021 LIBRARY; T=293.6K
Neutron emission for (n,2n)2a

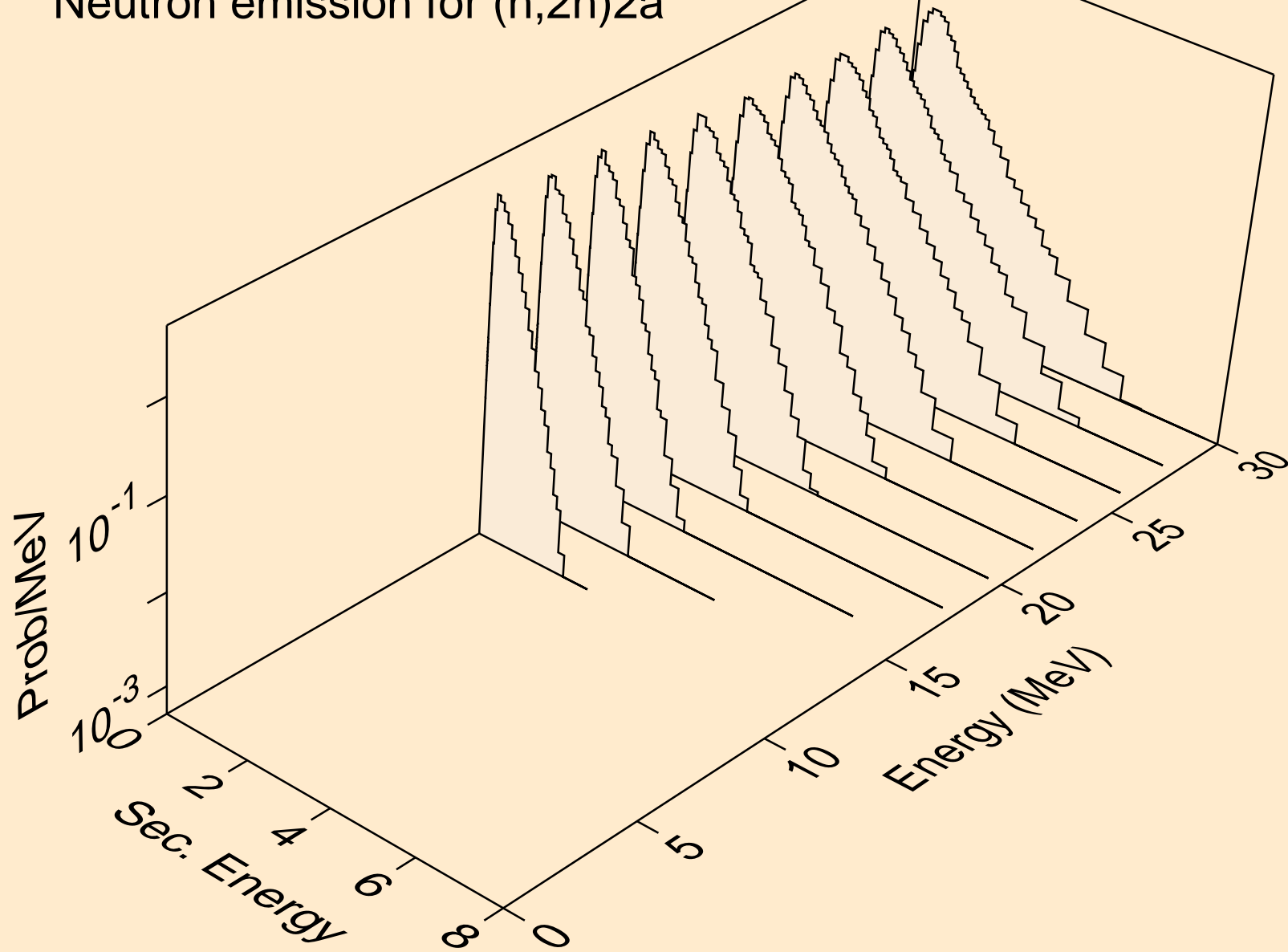

IR172M NEUTRON ACER TENDL-2021 LIBRARY; T=293.6K
Neutron emission for (n,n*)d

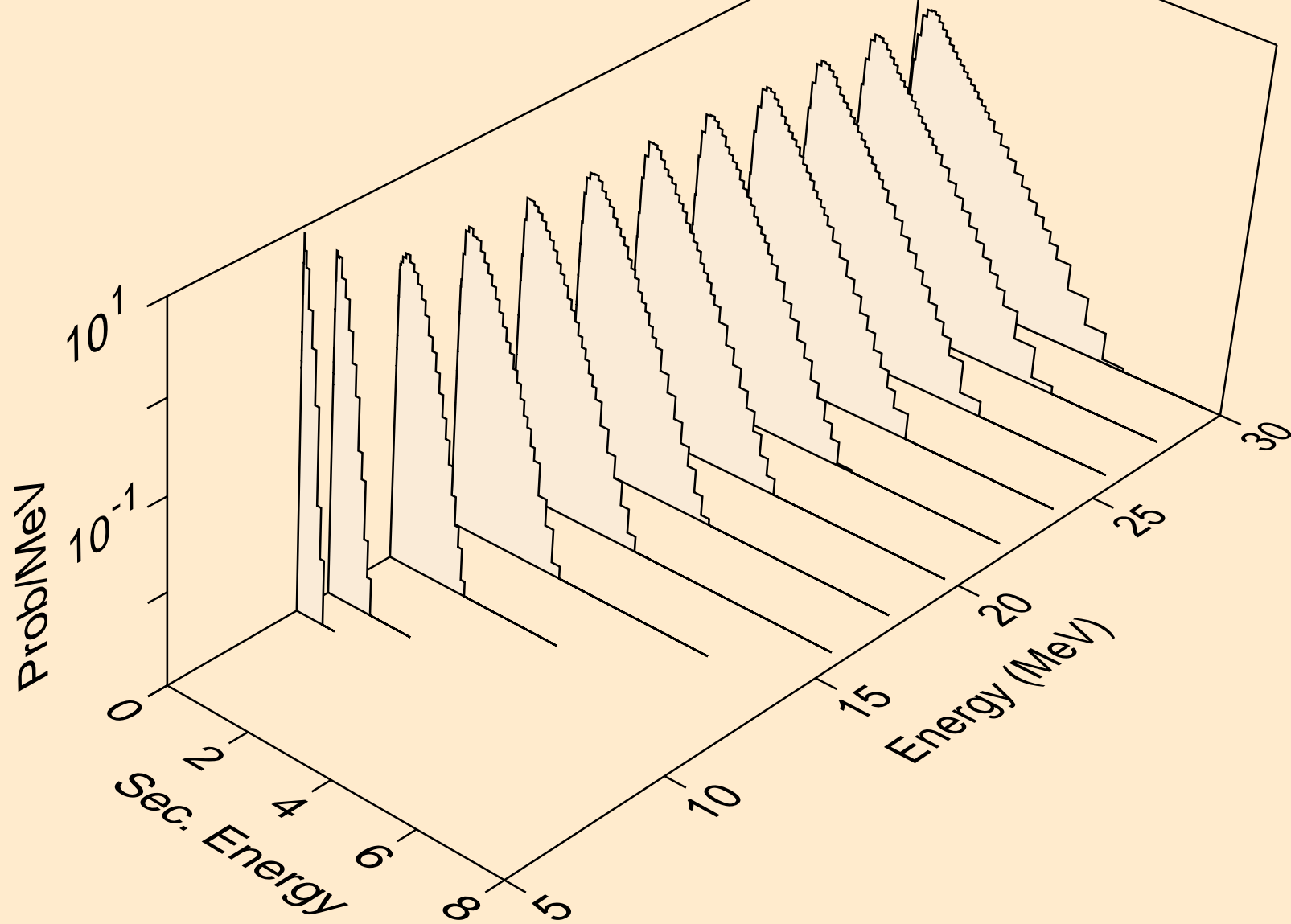

IR172M NEUTRON ACER TENDL-2021 LIBRARY; T=293.6K
Neutron emission for (n,n*)t

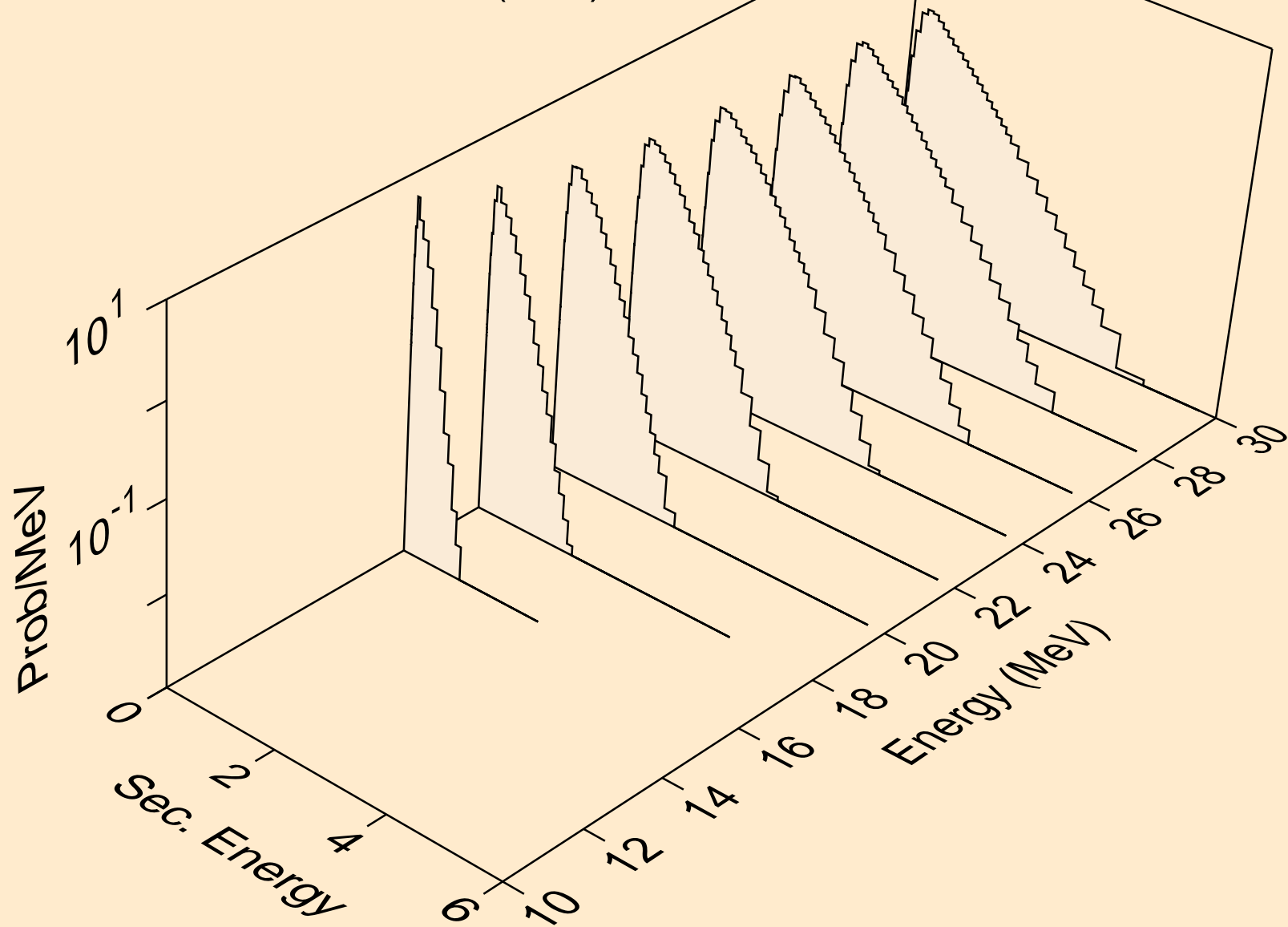

IR172M NEUTRON ACER TENDL-2021 LIBRARY; T=293.6K
Neutron emission for (n,n*)he3

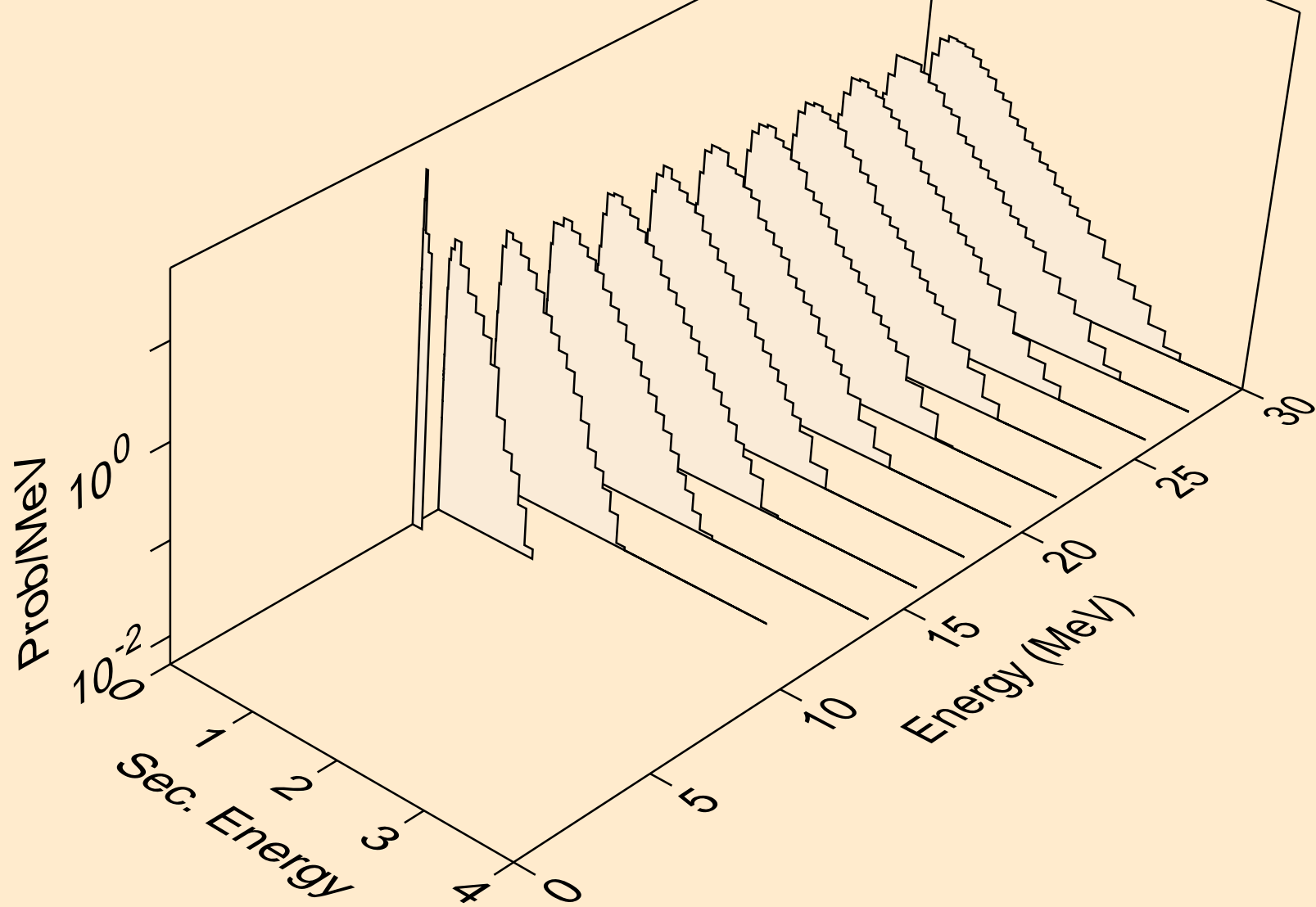

IR172M NEUTRON ACER TENDL-2021 LIBRARY; T=293.6K
Neutron emission for (n,2np)

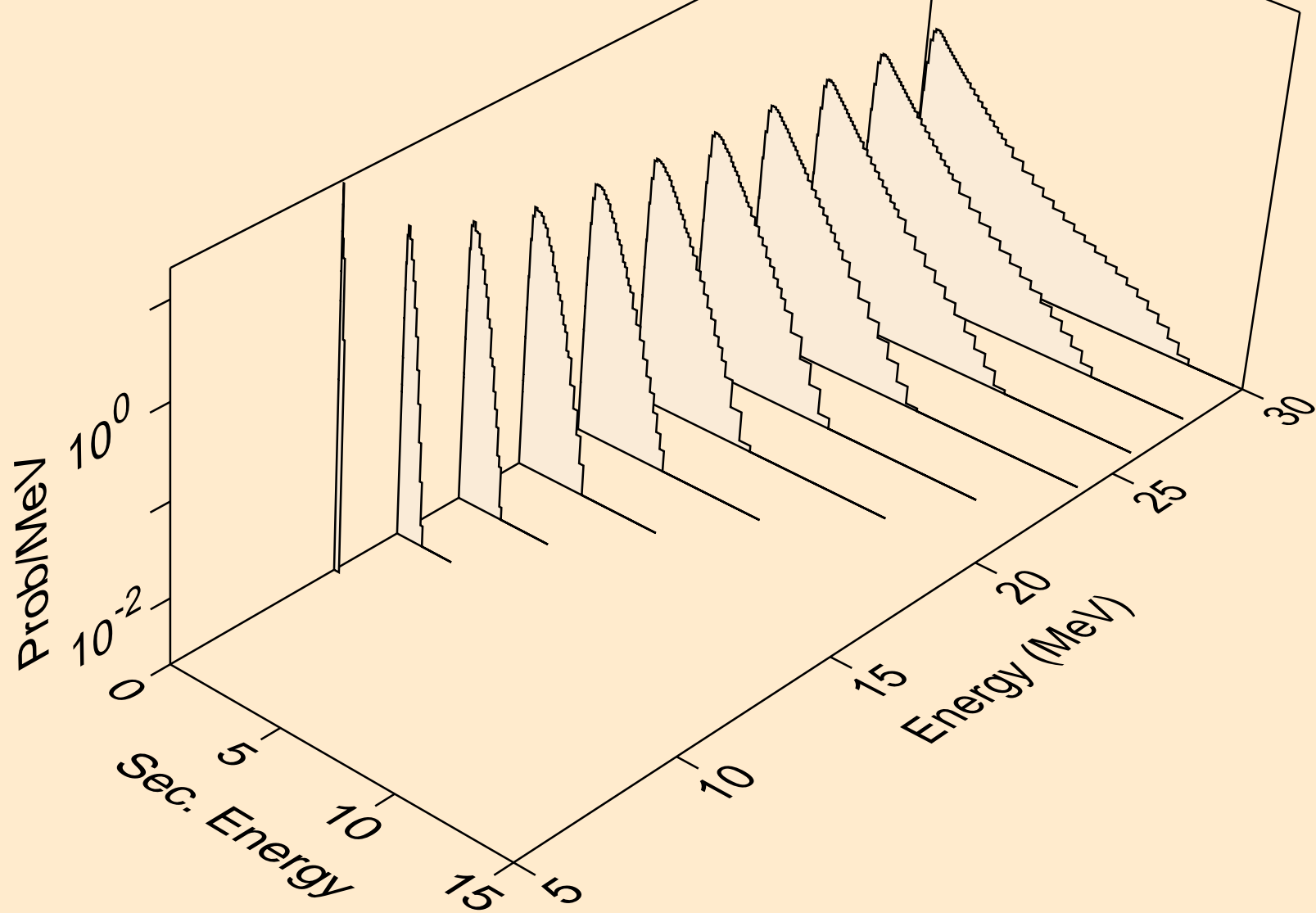

IR172M NEUTRON ACER TENDL-2021 LIBRARY; T=293.6K
Neutron emission for (n,3np)

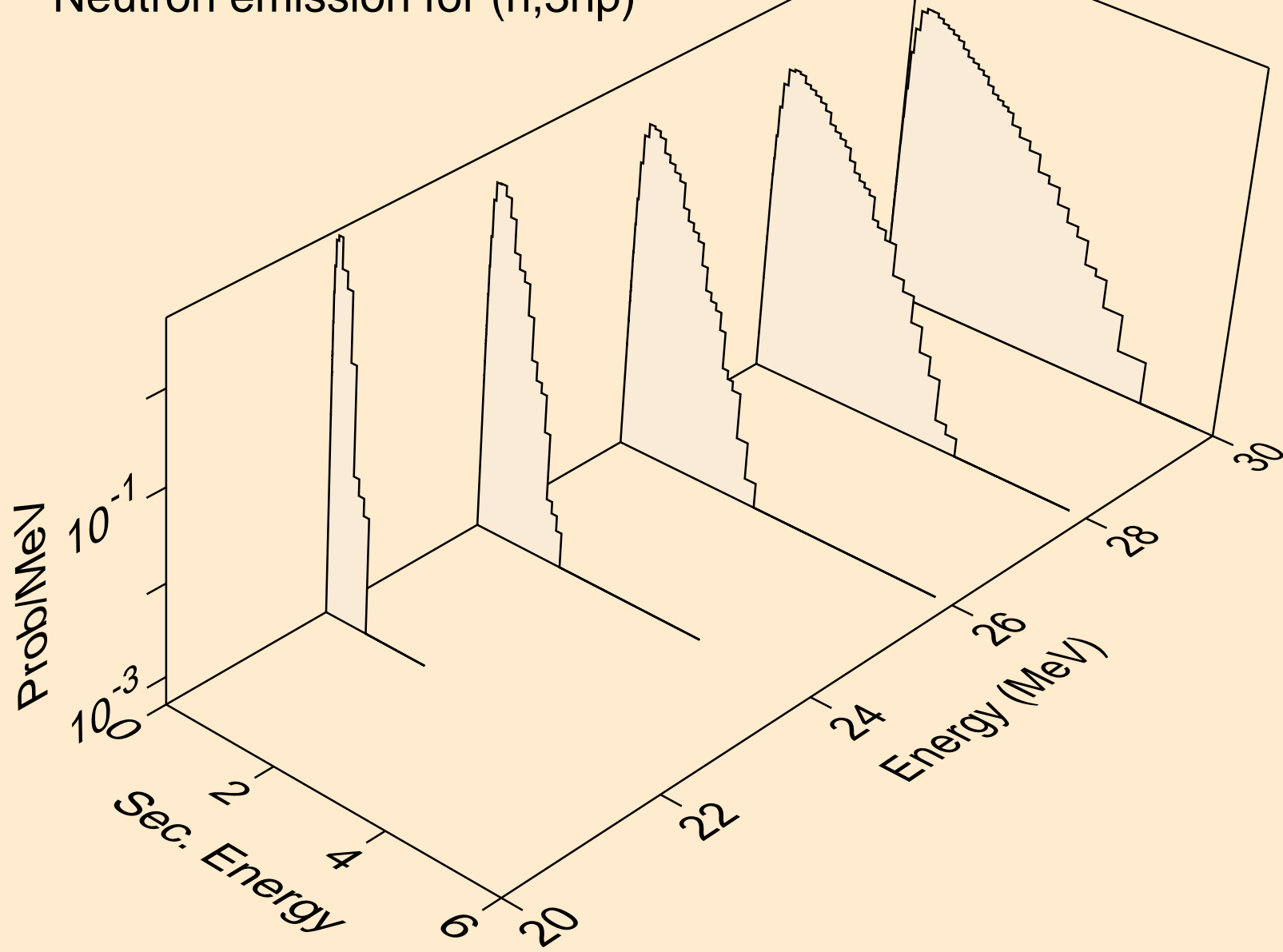

IR172M NEUTRON ACER TENDL-2021 LIBRARY; T=293.6K
Neutron emission for (n,2np)

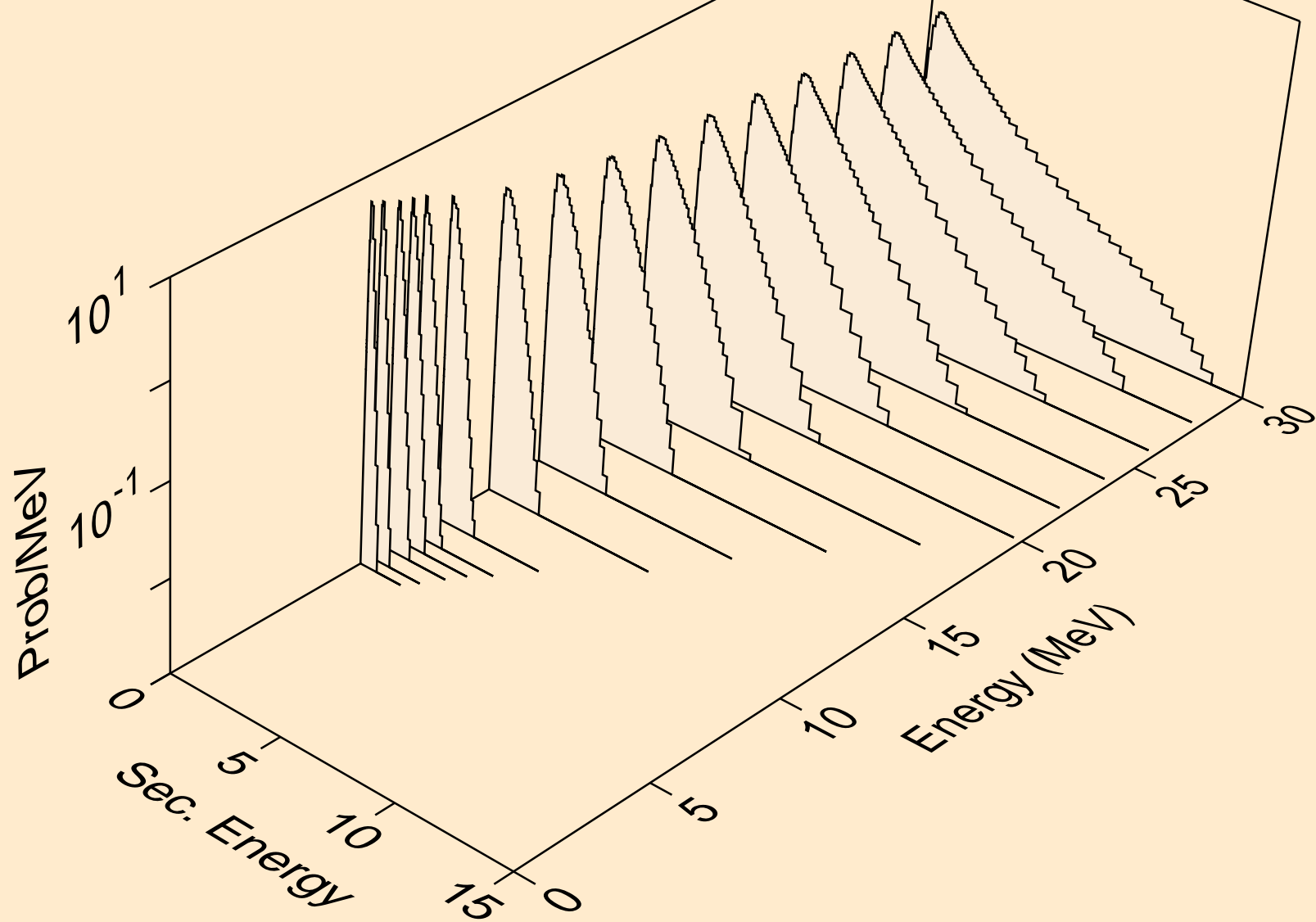

IR172M NEUTRON ACER TENDL-2021 LIBRARY; T=293.6K
Neutron emission for (n,npa)

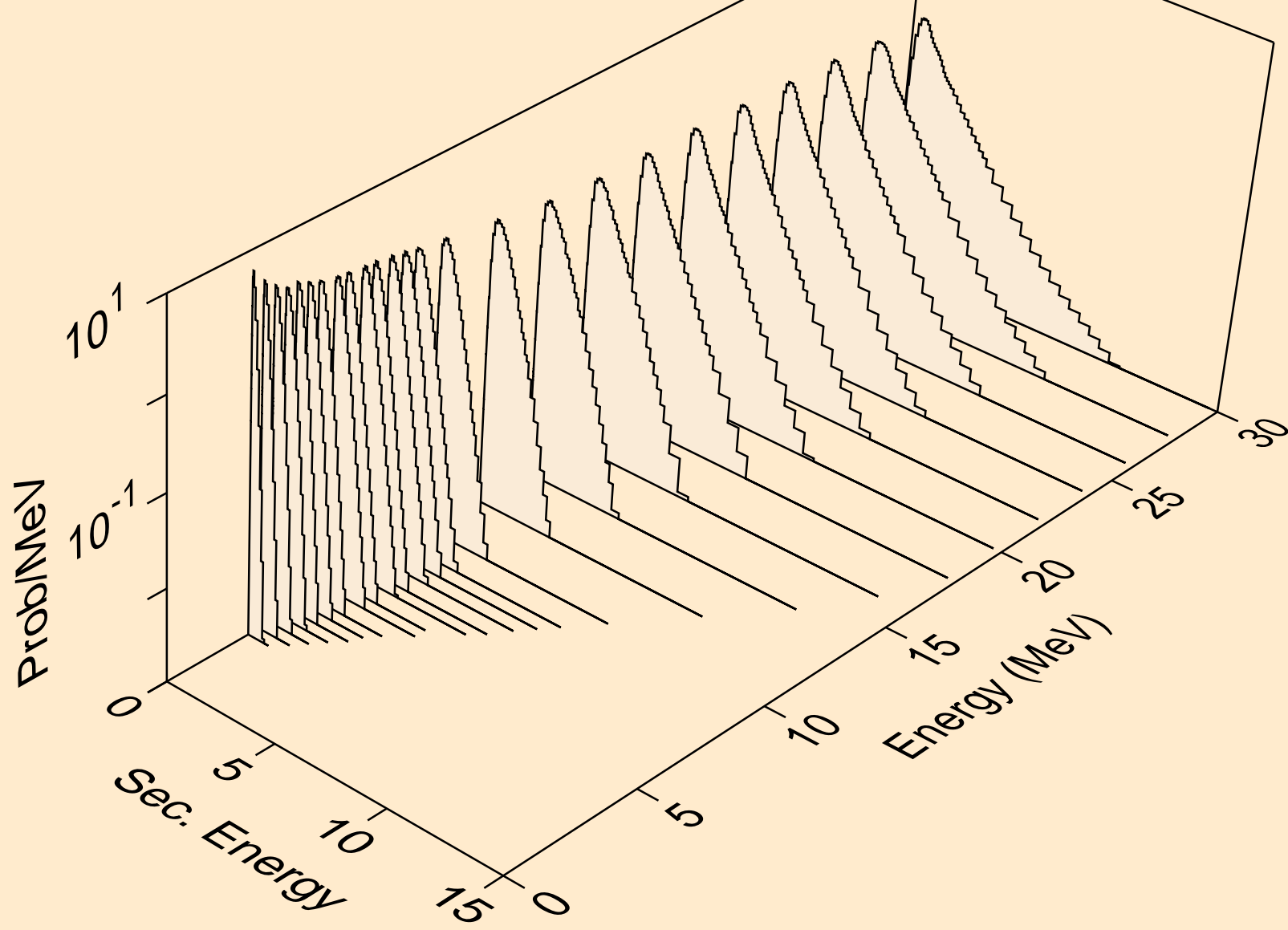

IR172M NEUTRON ACER TENDL-2021 LIBRARY; T=293.6K
Neutron emission for (n,n*c)

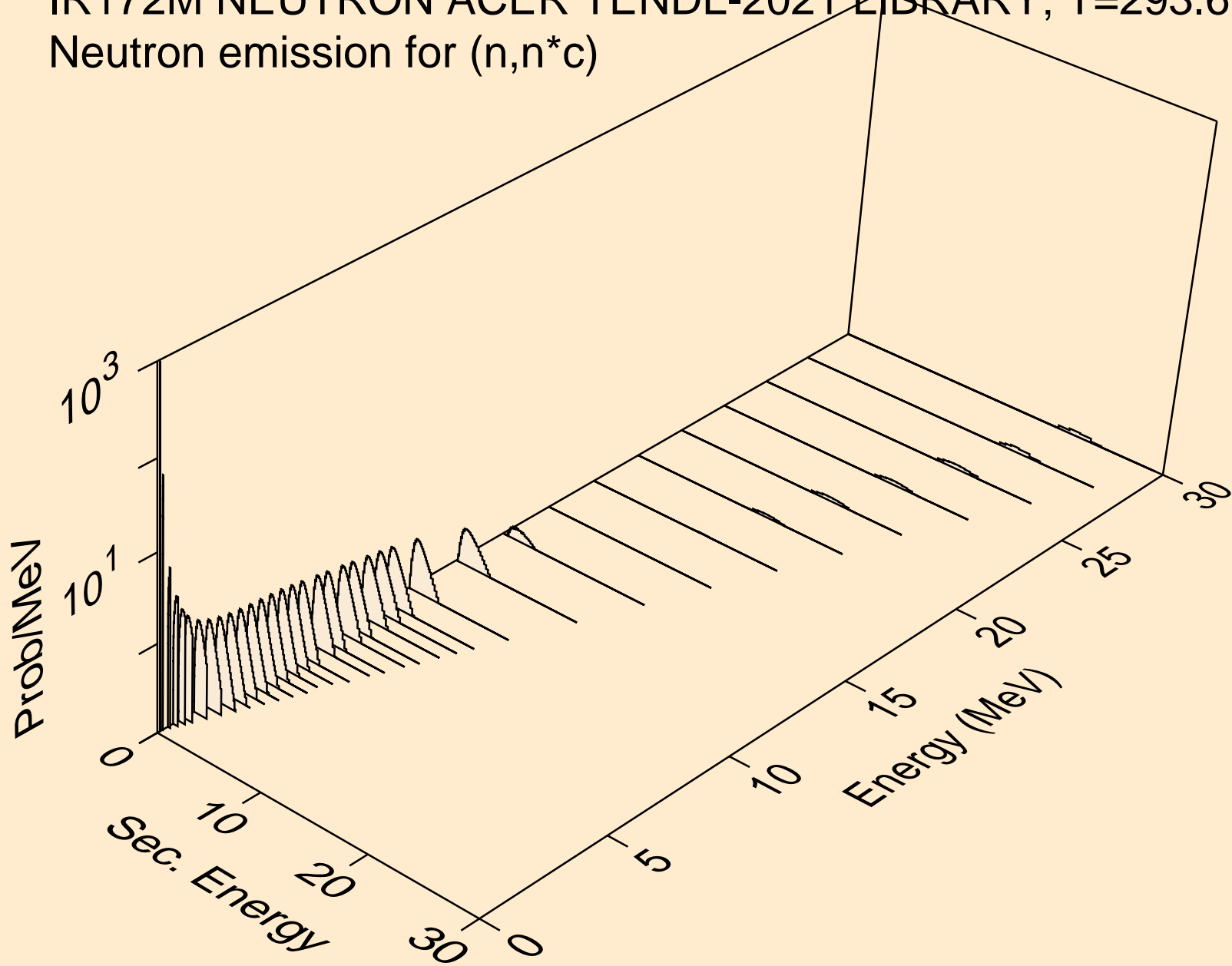

IR172M NEUTRON ACER TENDL-2021 LIBRARY; T=293.6K
Photon emission for (n,x)

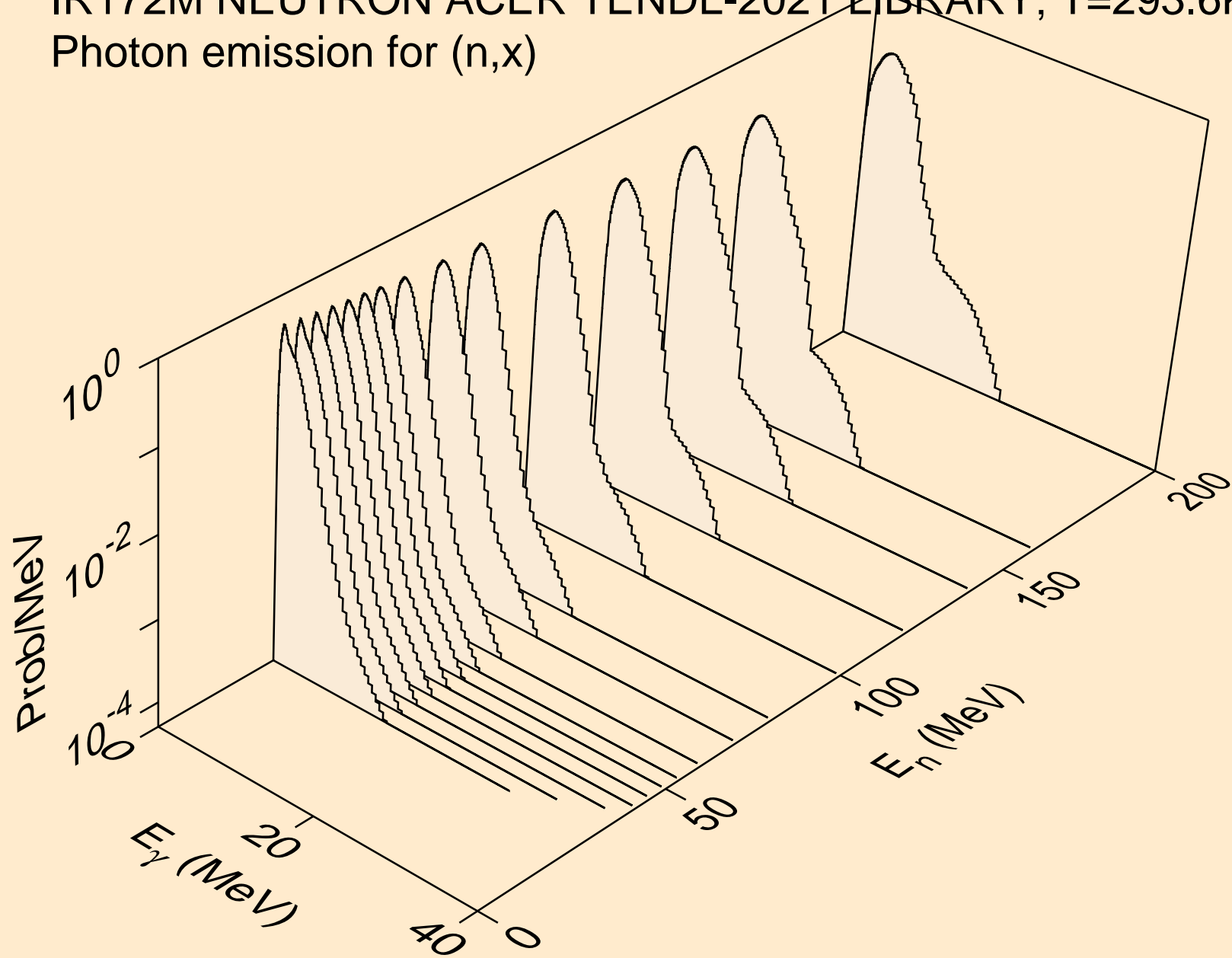

IR172M NEUTRON ACER TENDL-2021 LIBRARY; T=293.6K
Photon emission for (n,2nd)

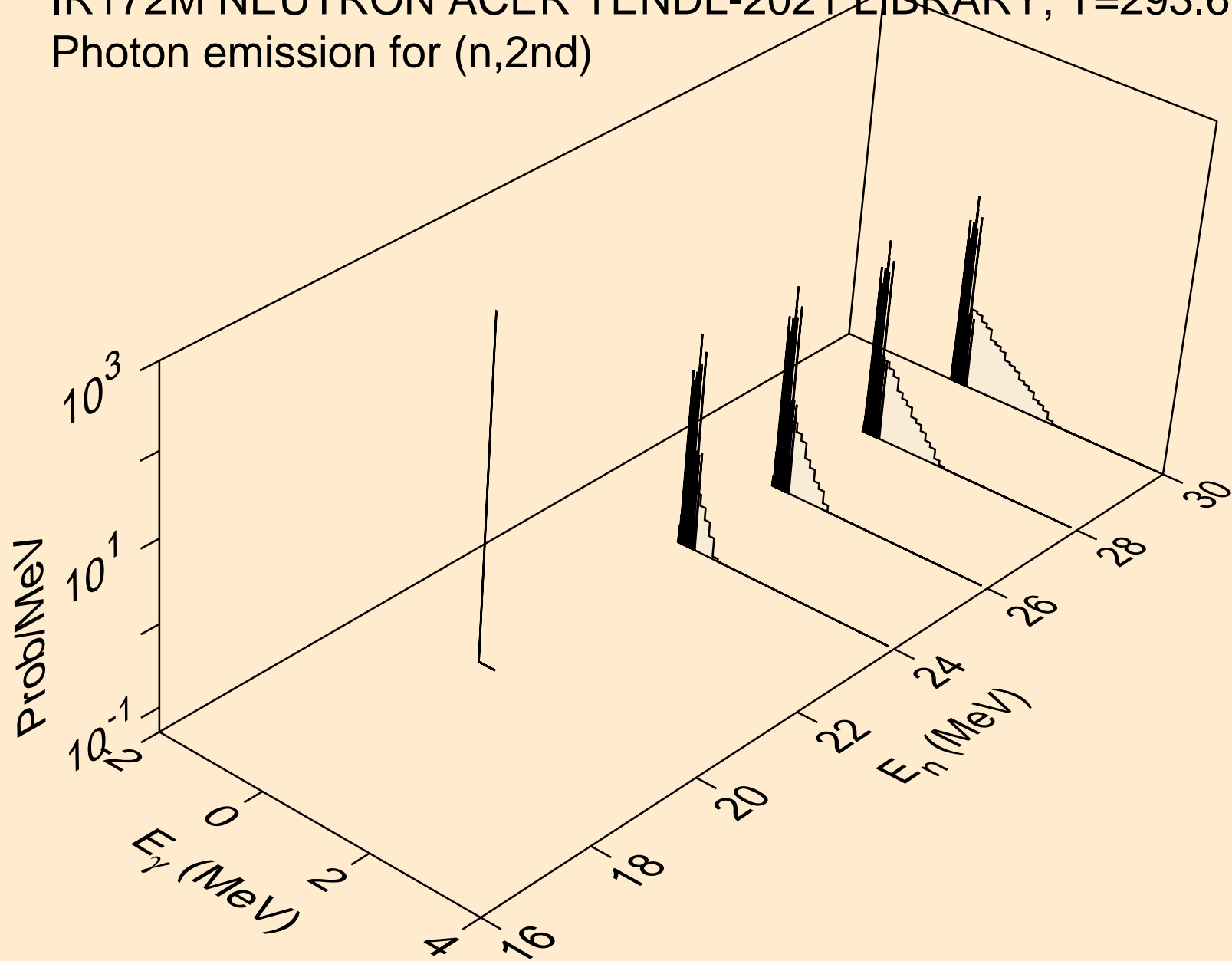

IR172M NEUTRON ACER TENDL-2021 LIBRARY; T=293.6K
Photon emission for (n,2n)

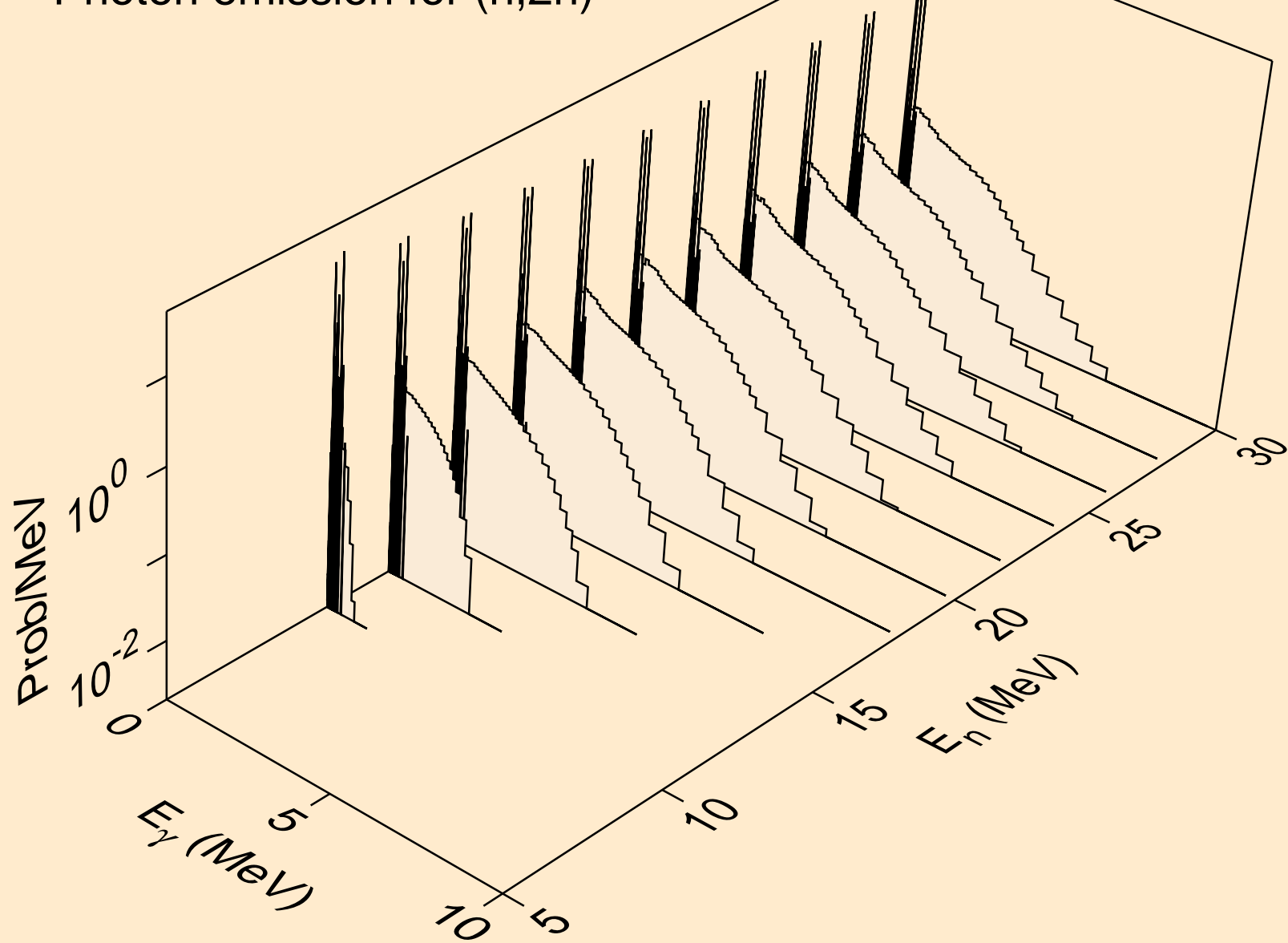

IR172M NEUTRON ACER TENDL-2021 LIBRARY; T=293.6K
Photon emission for (n,3n)

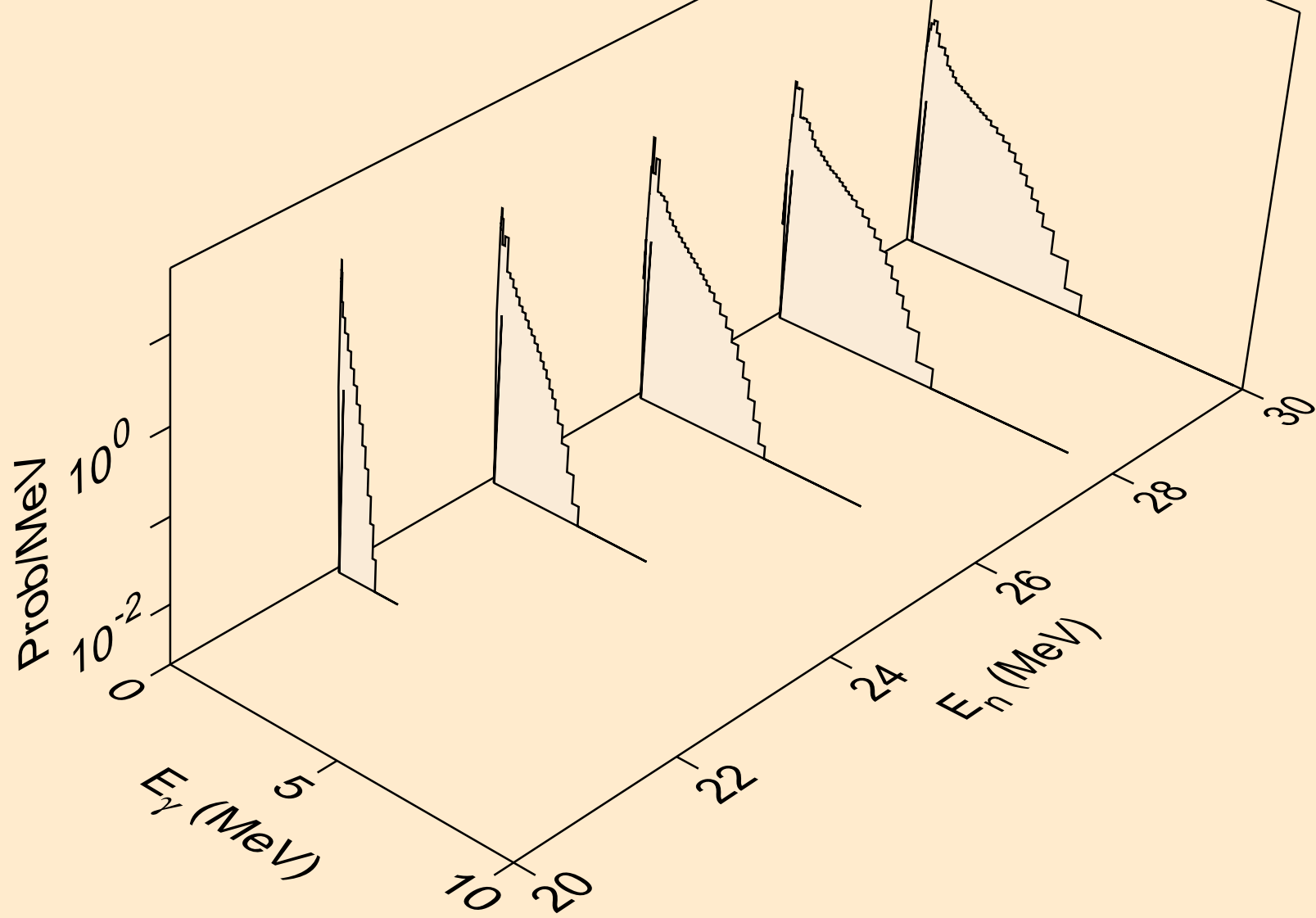

IR172M NEUTRON ACER TENDL-2021 LIBRARY; T=293.6K
Photon emission for (n,n*)a

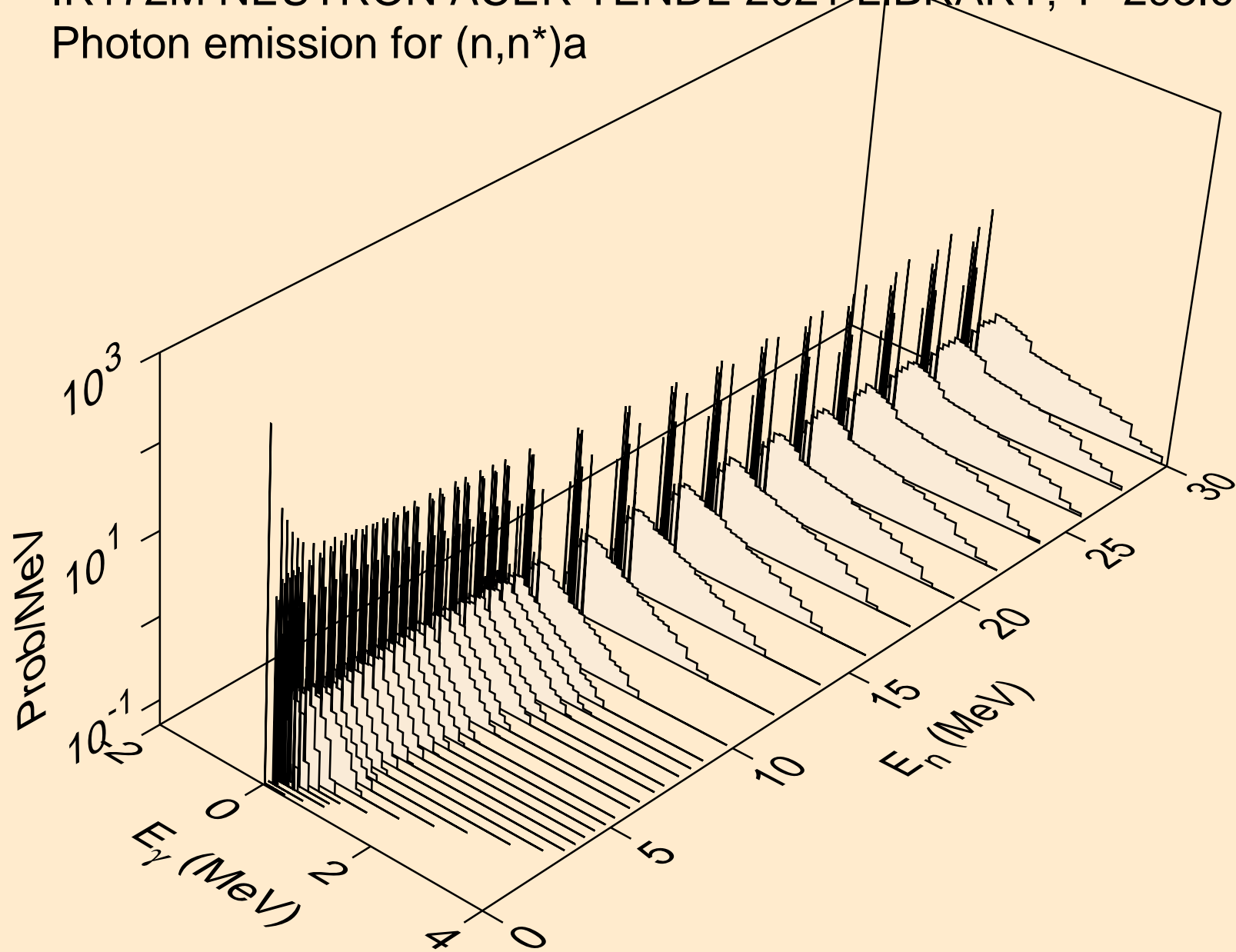

IR172M NEUTRON ACER TENDL-2021 LIBRARY; T=293.6K
Photon emission for (n,n*)3a

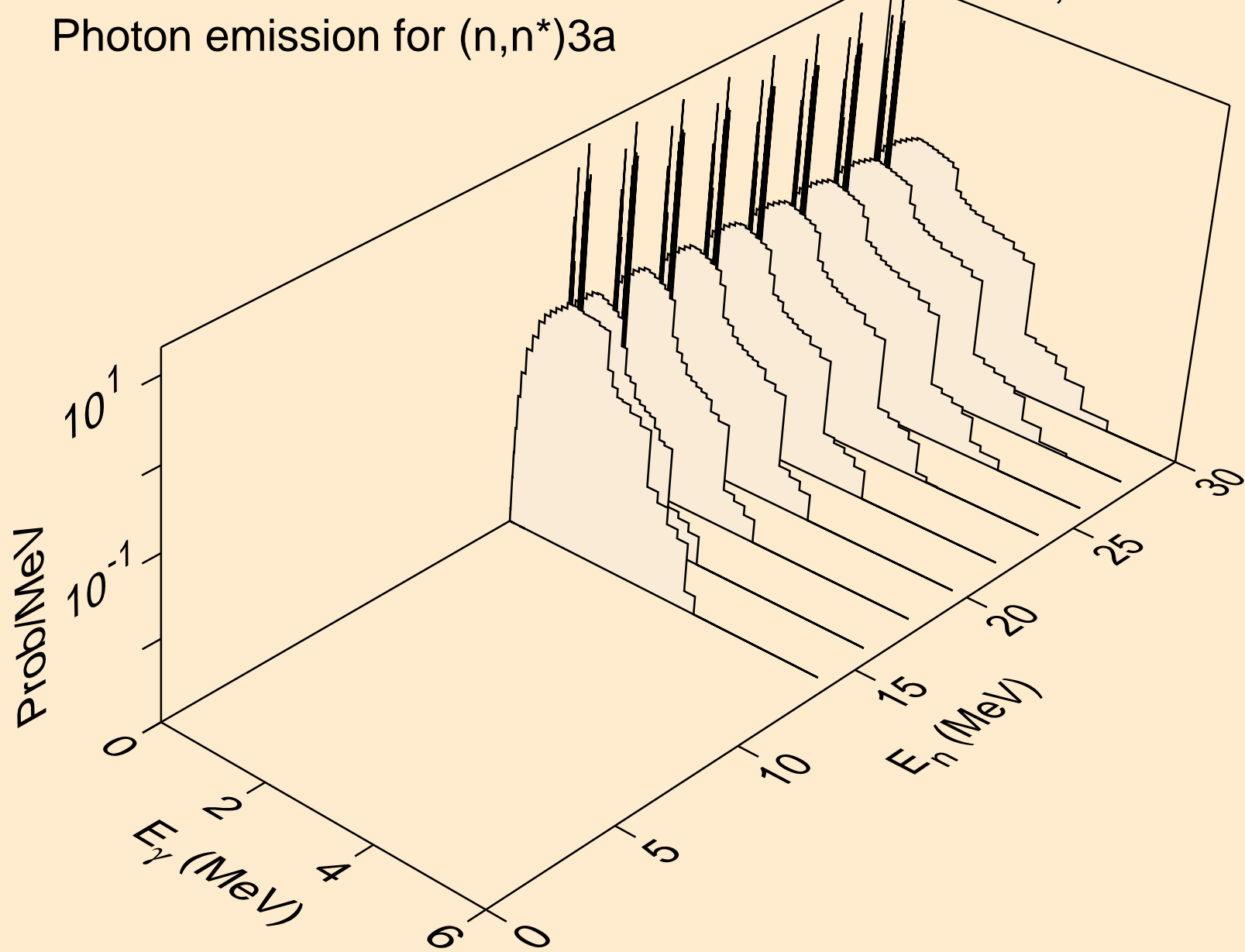

IR172M NEUTRON ACER TENDL-2021 LIBRARY; T=293.6K
Photon emission for (n,2n)a

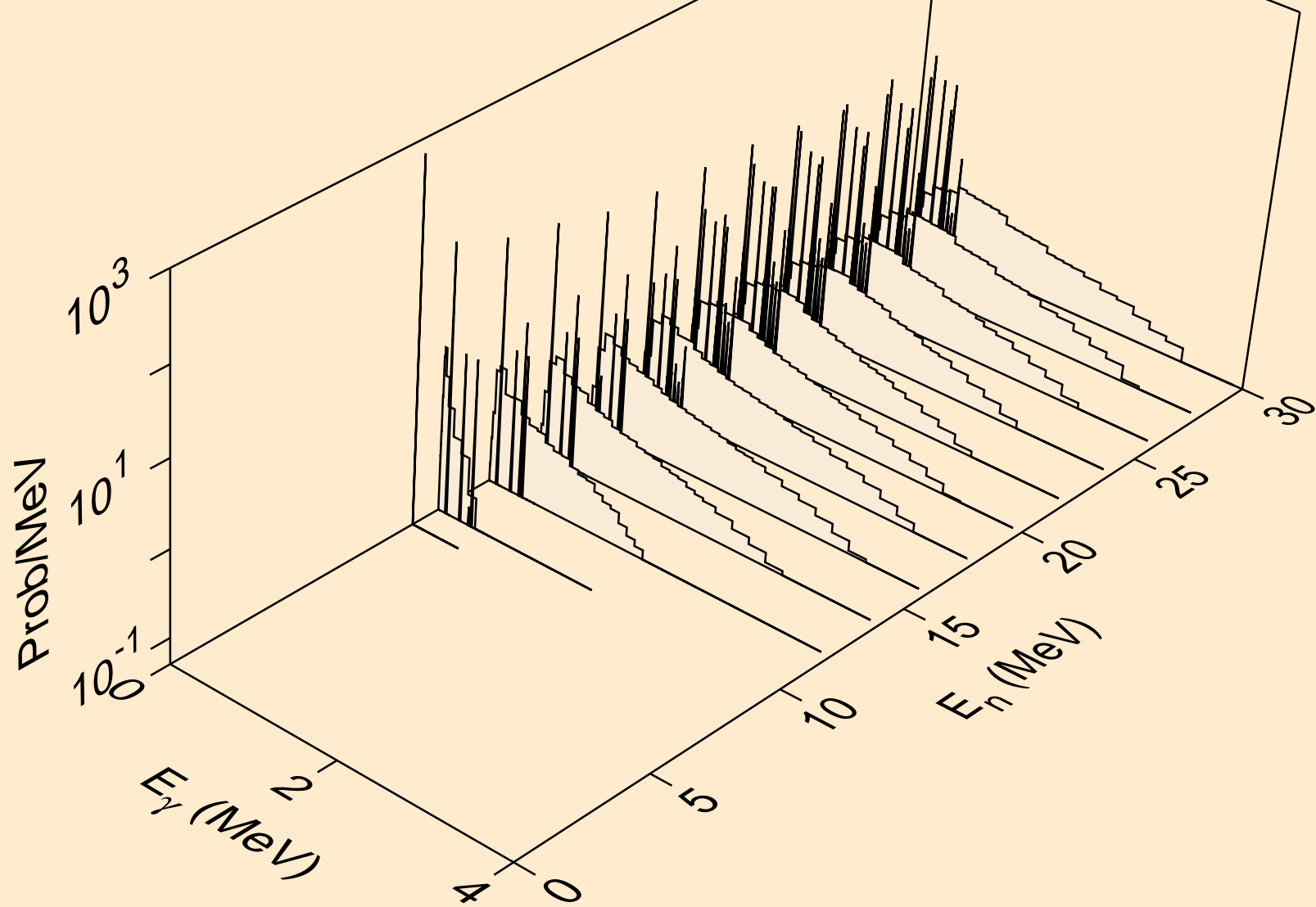

IR172M NEUTRON ACER TENDL-2021 LIBRARY; T=293.6K
Photon emission for (n,3n)a

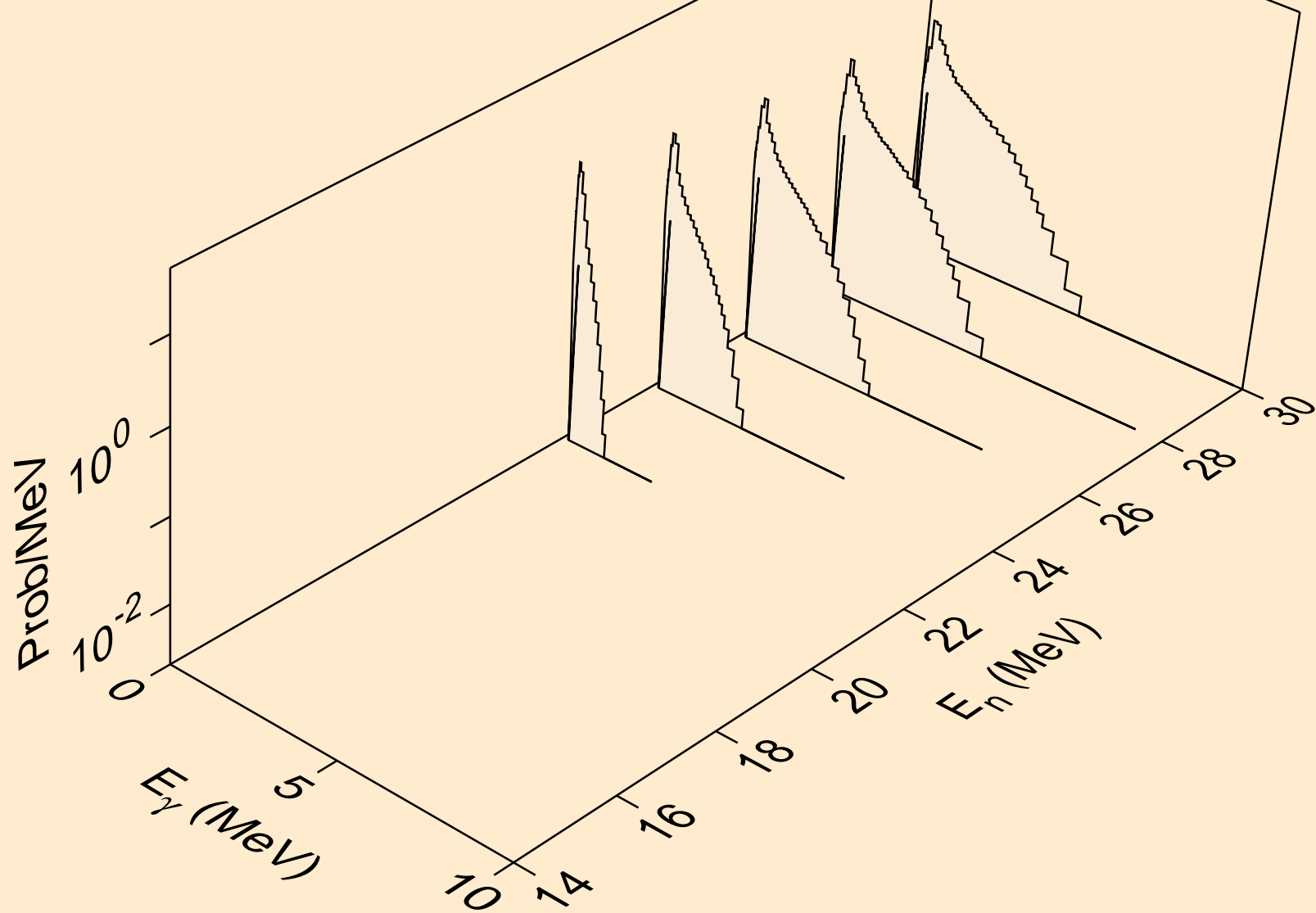

IR172M NEUTRON ACER TENDL-2021 LIBRARY; T=293.6K
Photon emission for (n,n*)p

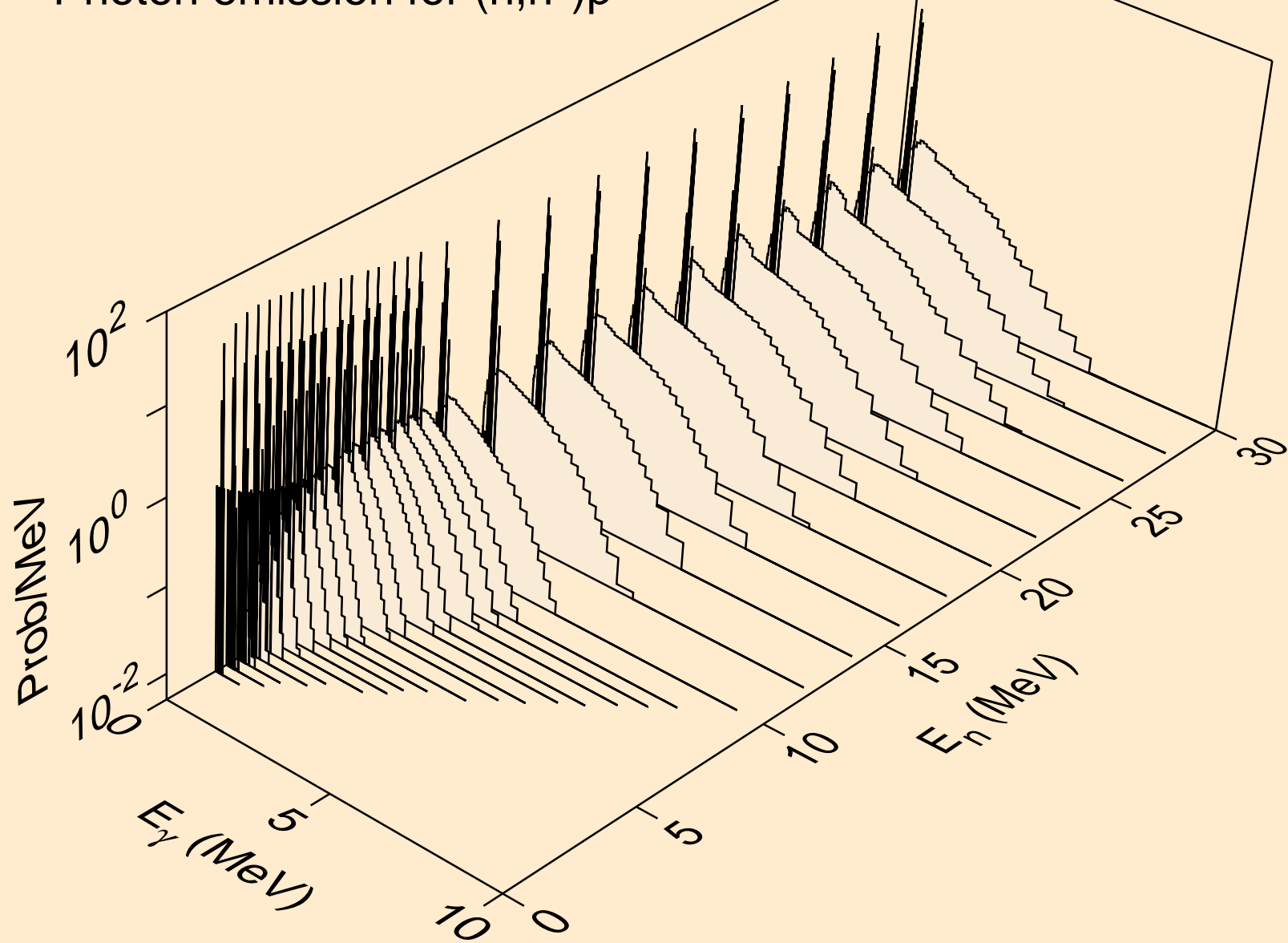

IR172M NEUTRON ACER TENDL-2021 LIBRARY; T=293.6K
Photon emission for (n,n*)2a

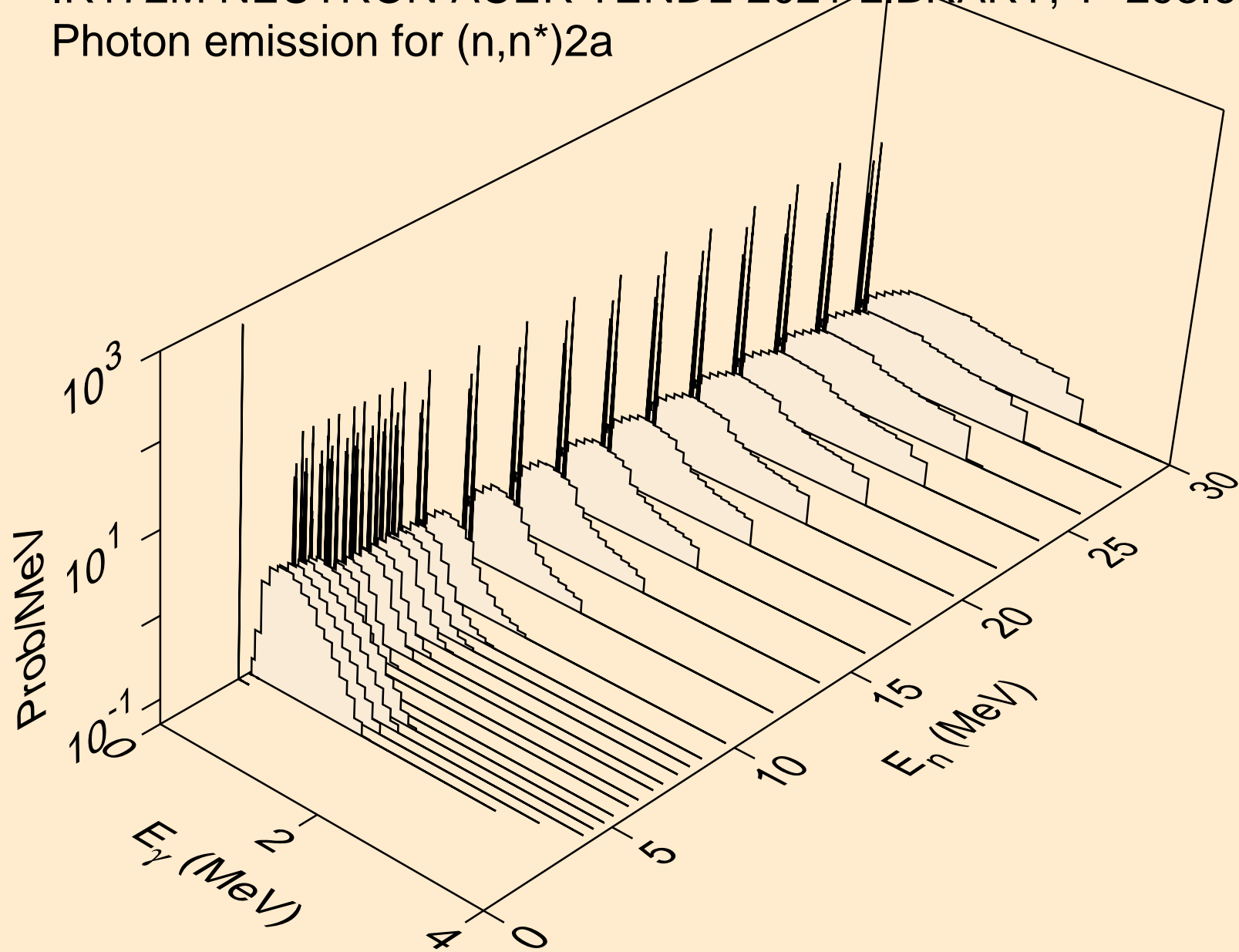

IR172M NEUTRON ACER TENDL-2021 LIBRARY; T=293.6K
Photon emission for (n,2n)2a

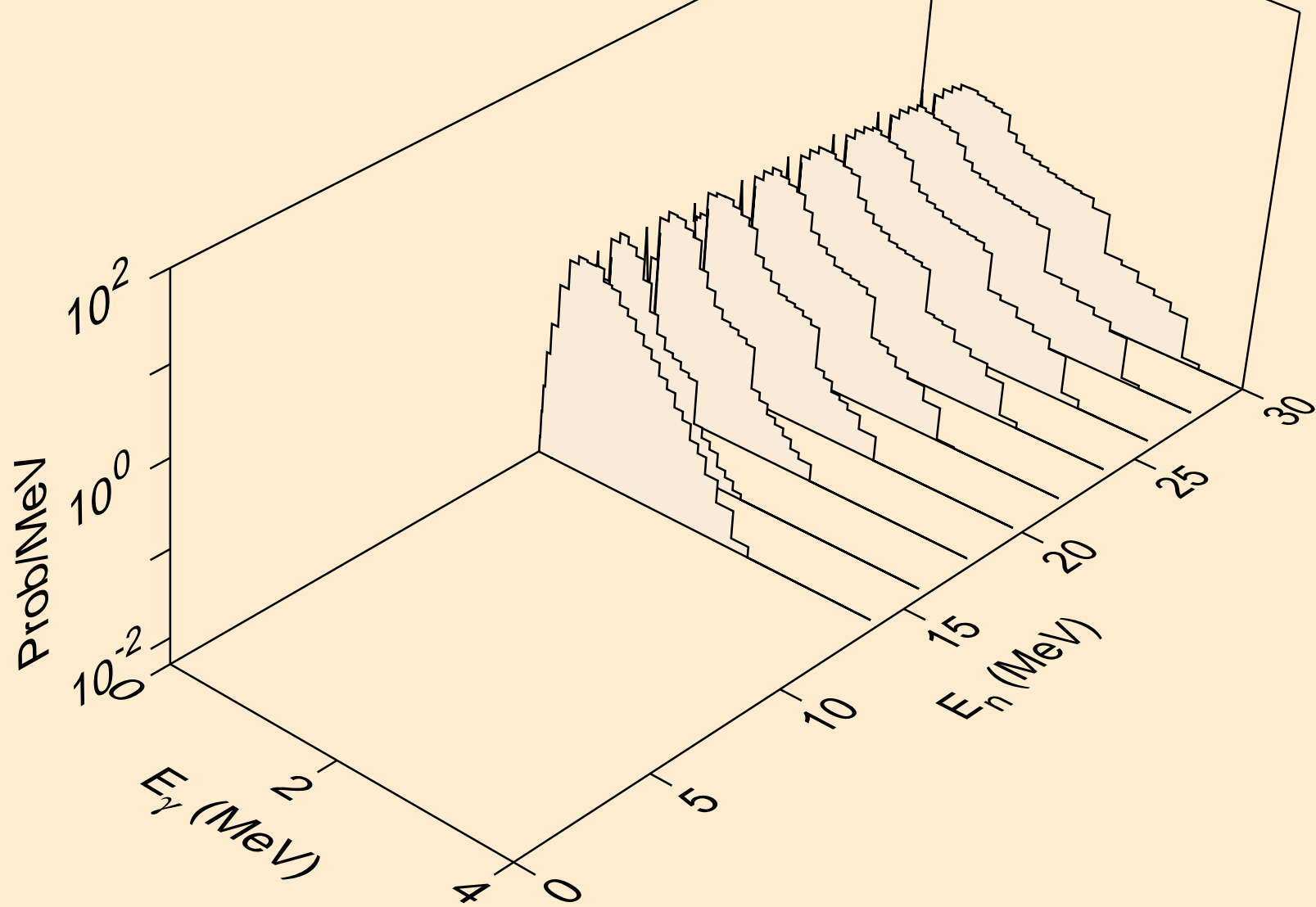

IR172M NEUTRON ACER TENDL-2021 LIBRARY; T=293.6K
Photon emission for (n,n*)d

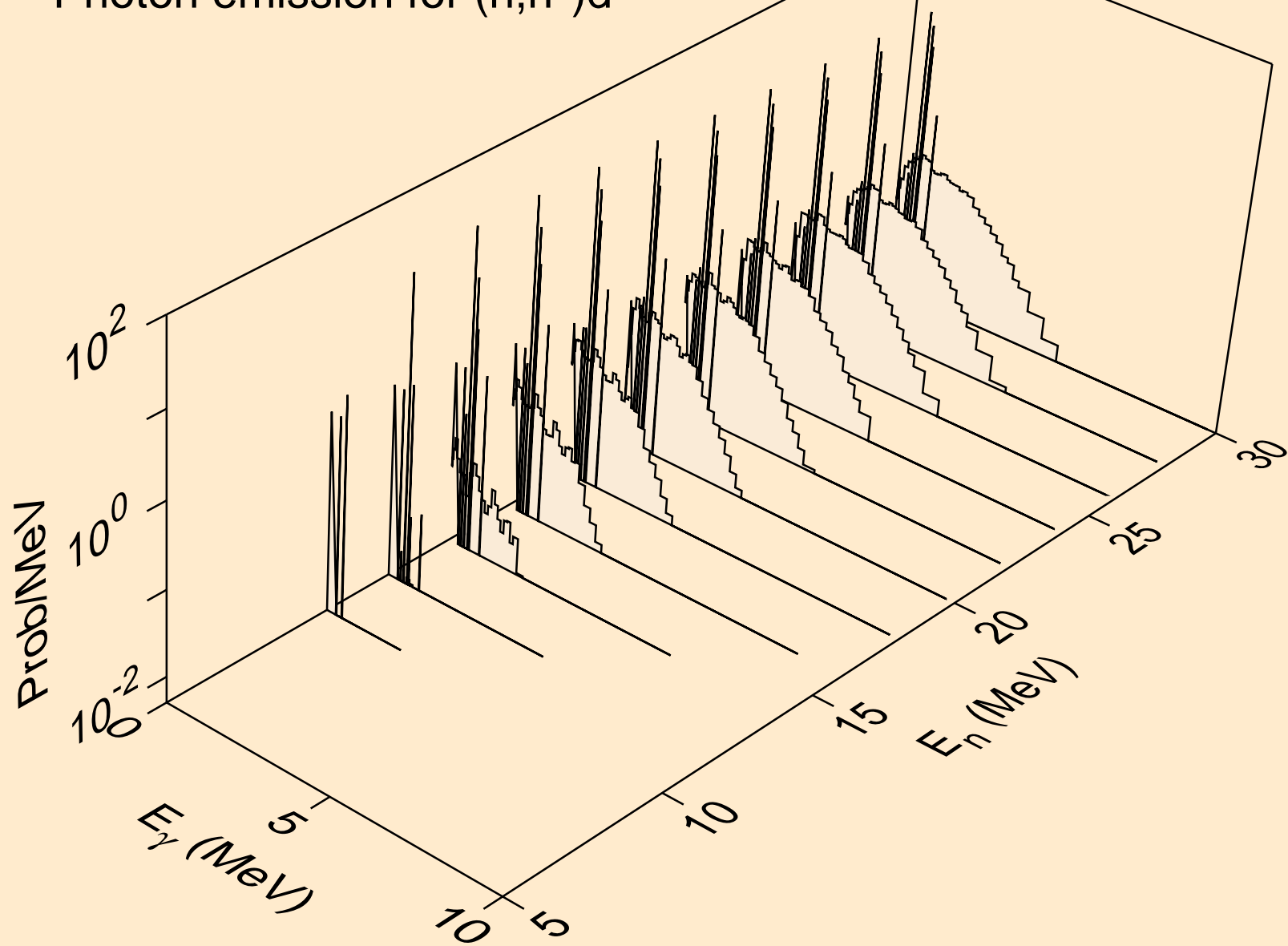

IR172M NEUTRON ACER TENDL-2021 LIBRARY; T=293.6K
Photon emission for (n,n*)t

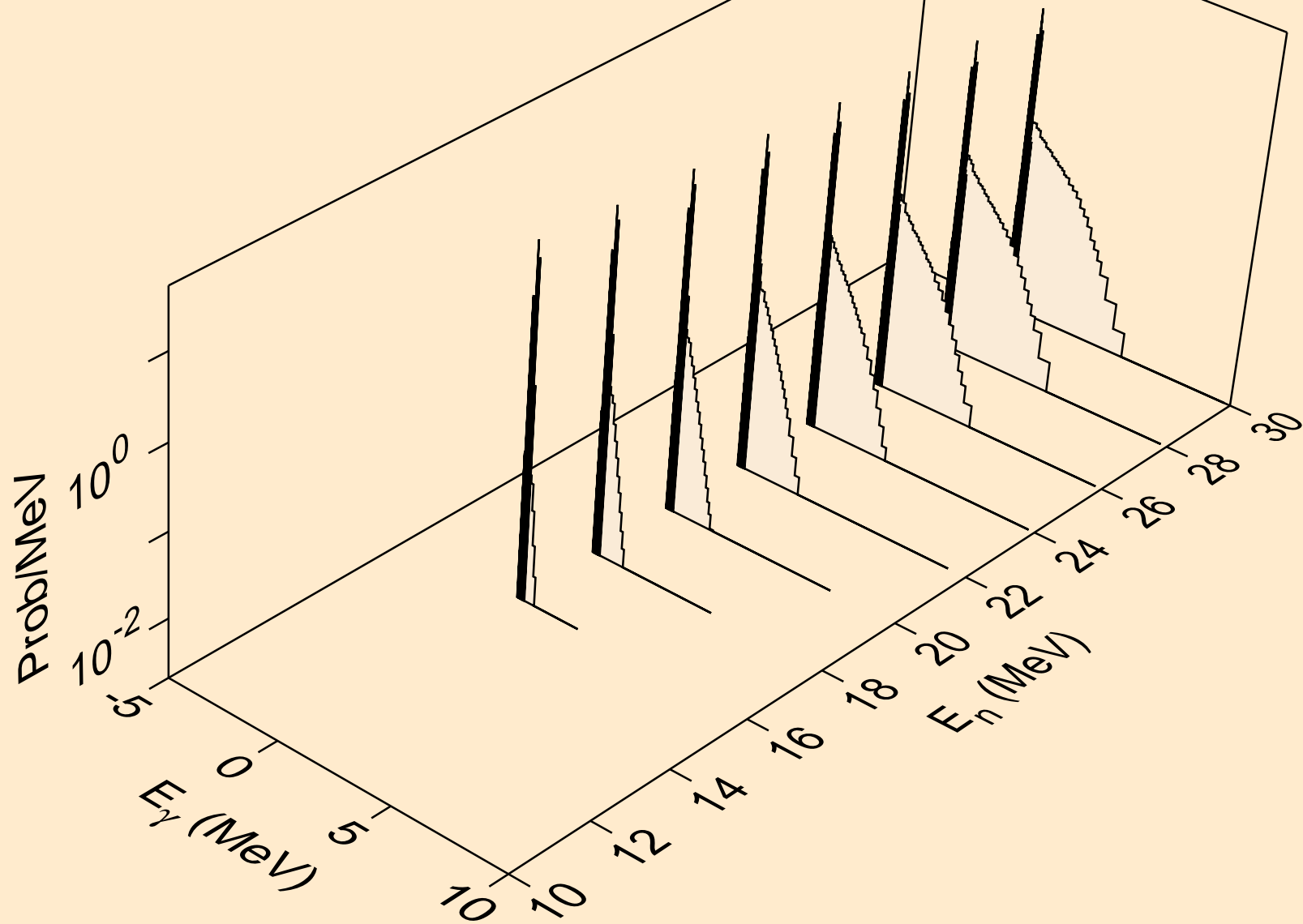

IR172M NEUTRON ACER TENDL-2021 LIBRARY; T=293.6K
Photon emission for (n,n*)he3

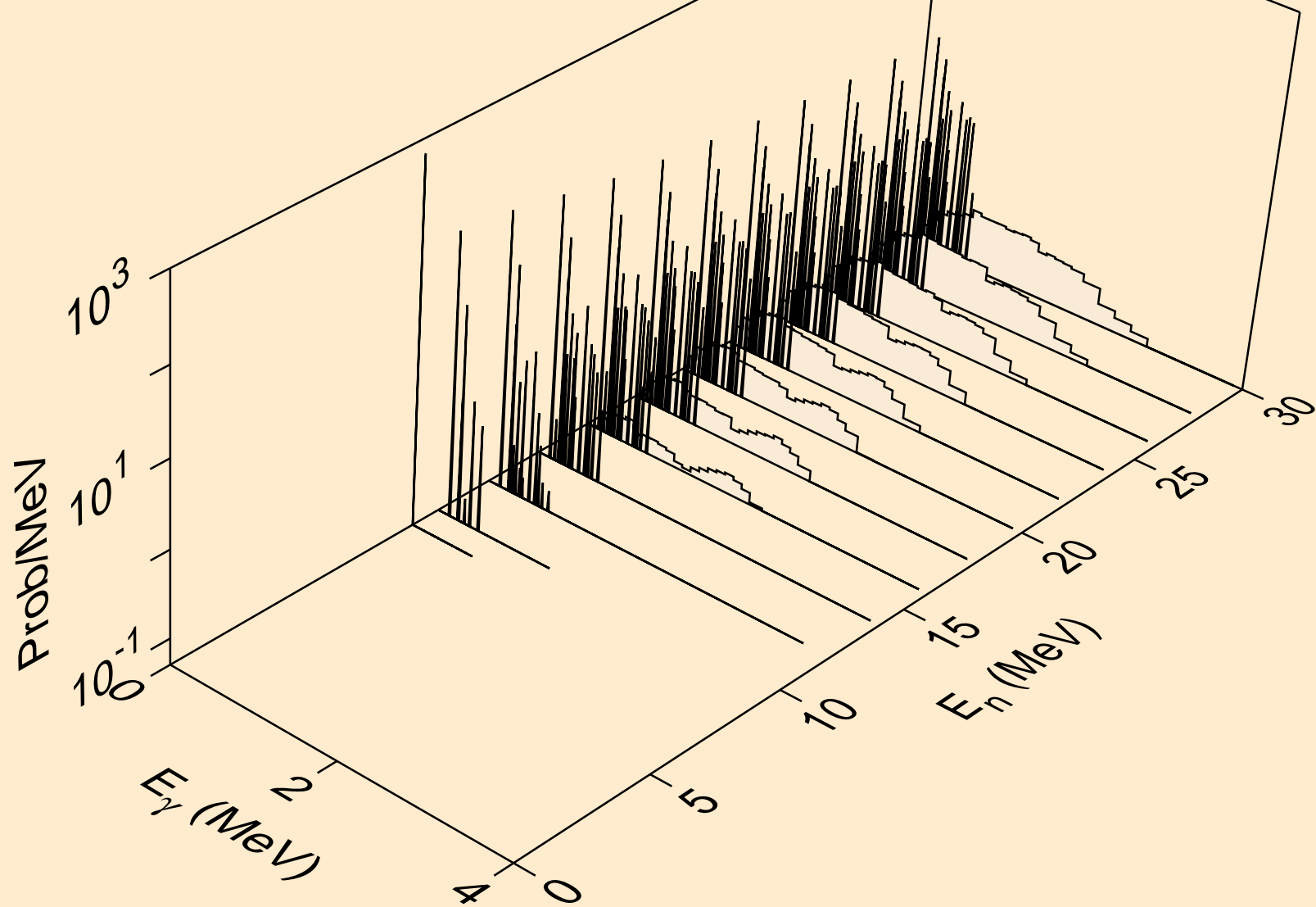

IR172M NEUTRON ACER TENDL-2021 LIBRARY; T=293.6K
Photon emission for (n,2np)

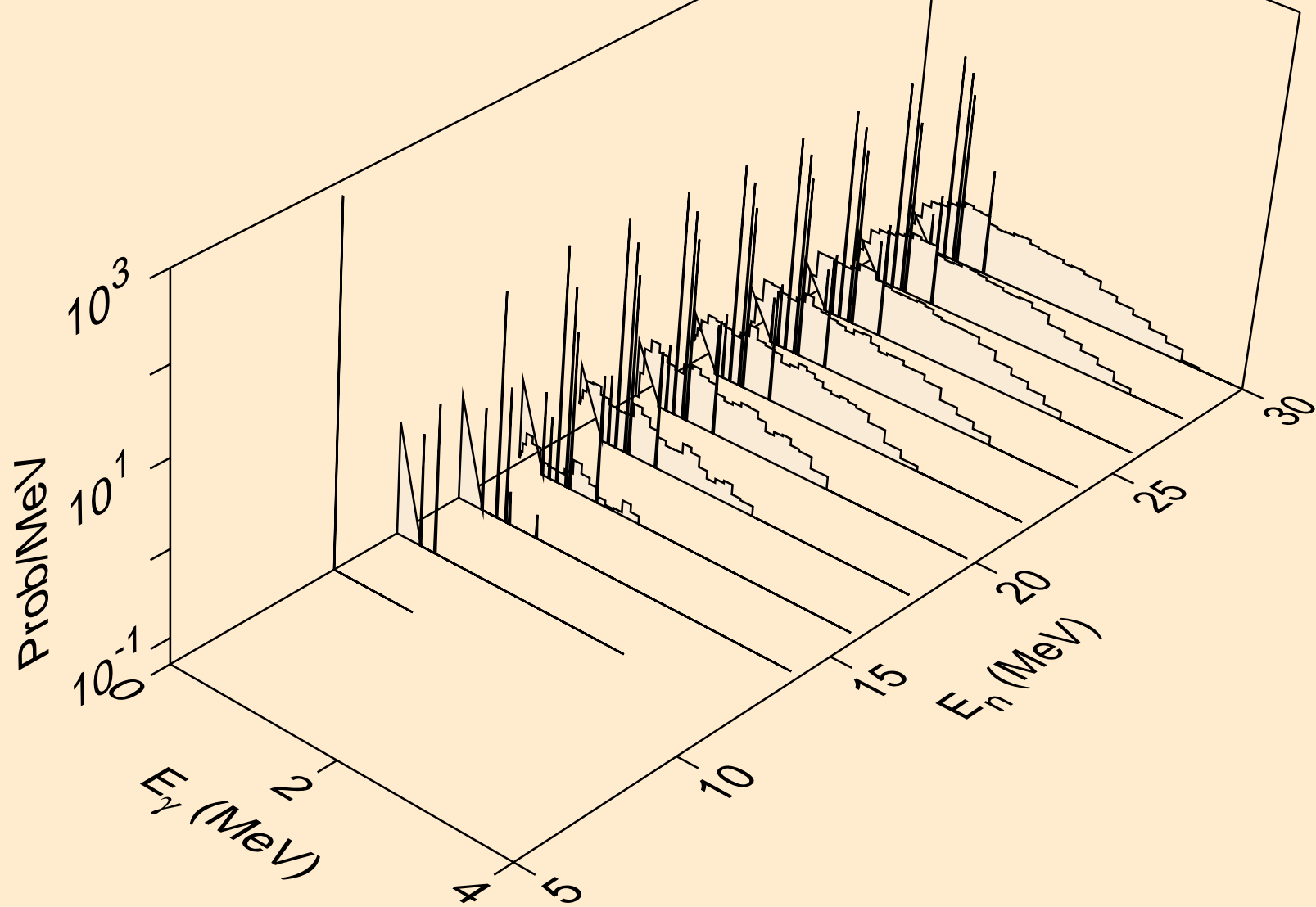

IR172M NEUTRON ACER TENDL-2021 LIBRARY; T=293.6K
Photon emission for (n,3np)

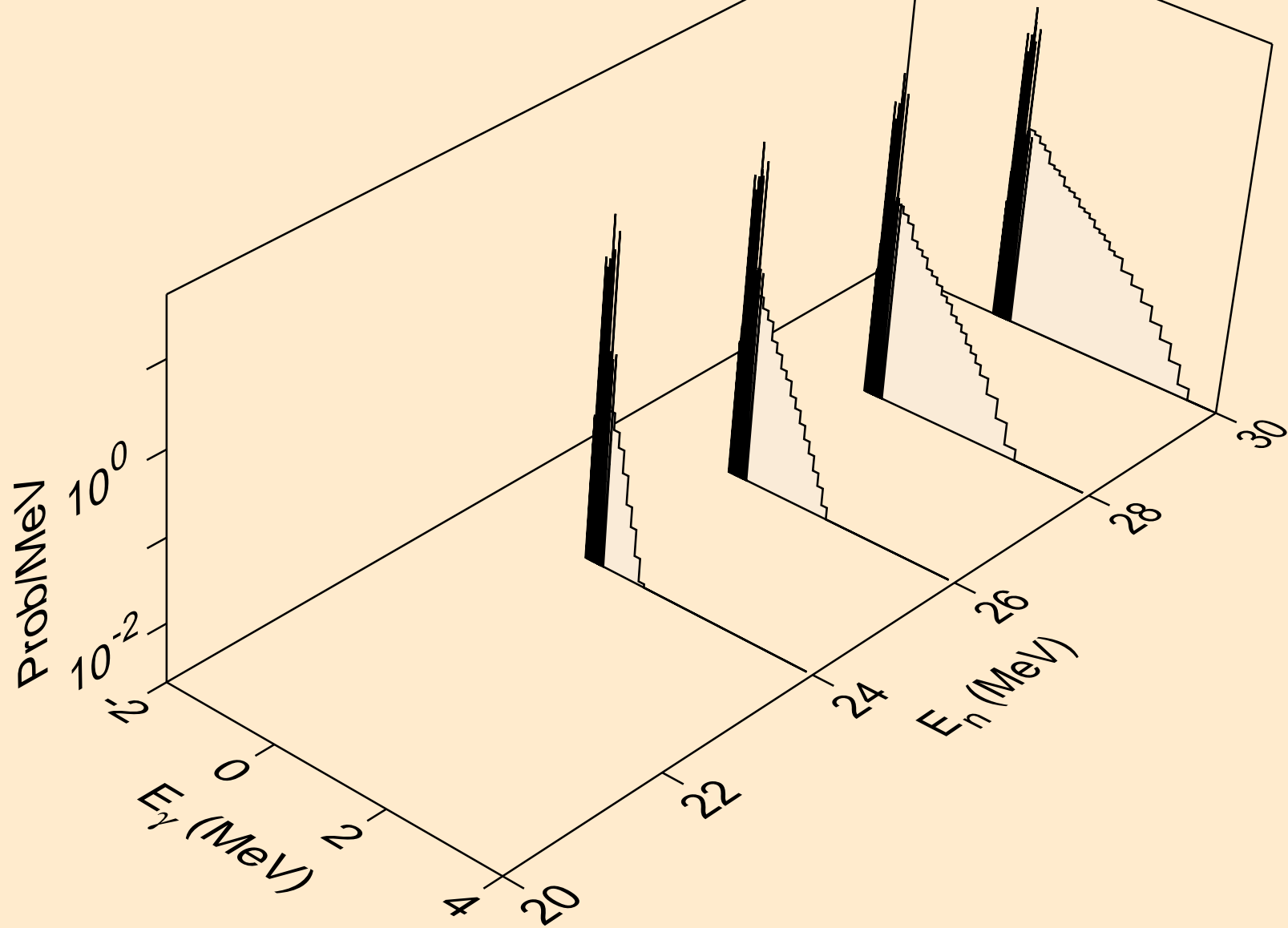

IR172M NEUTRON ACER TENDL-2021 LIBRARY; T=293.6K
Photon emission for (n,2np)

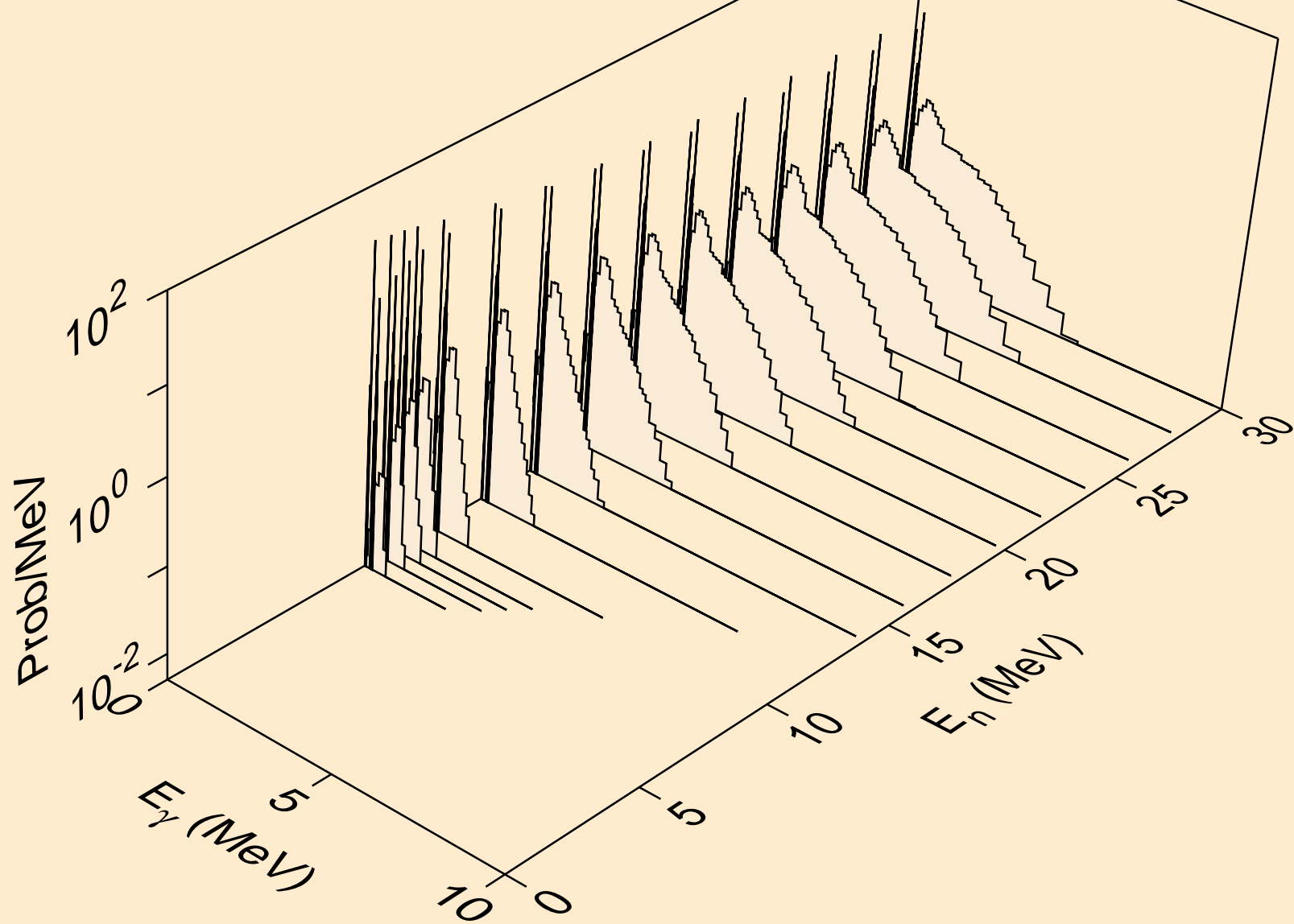

IR172M NEUTRON ACER TENDL-2021 LIBRARY; T=293.6K
Photon emission for (n,npa)

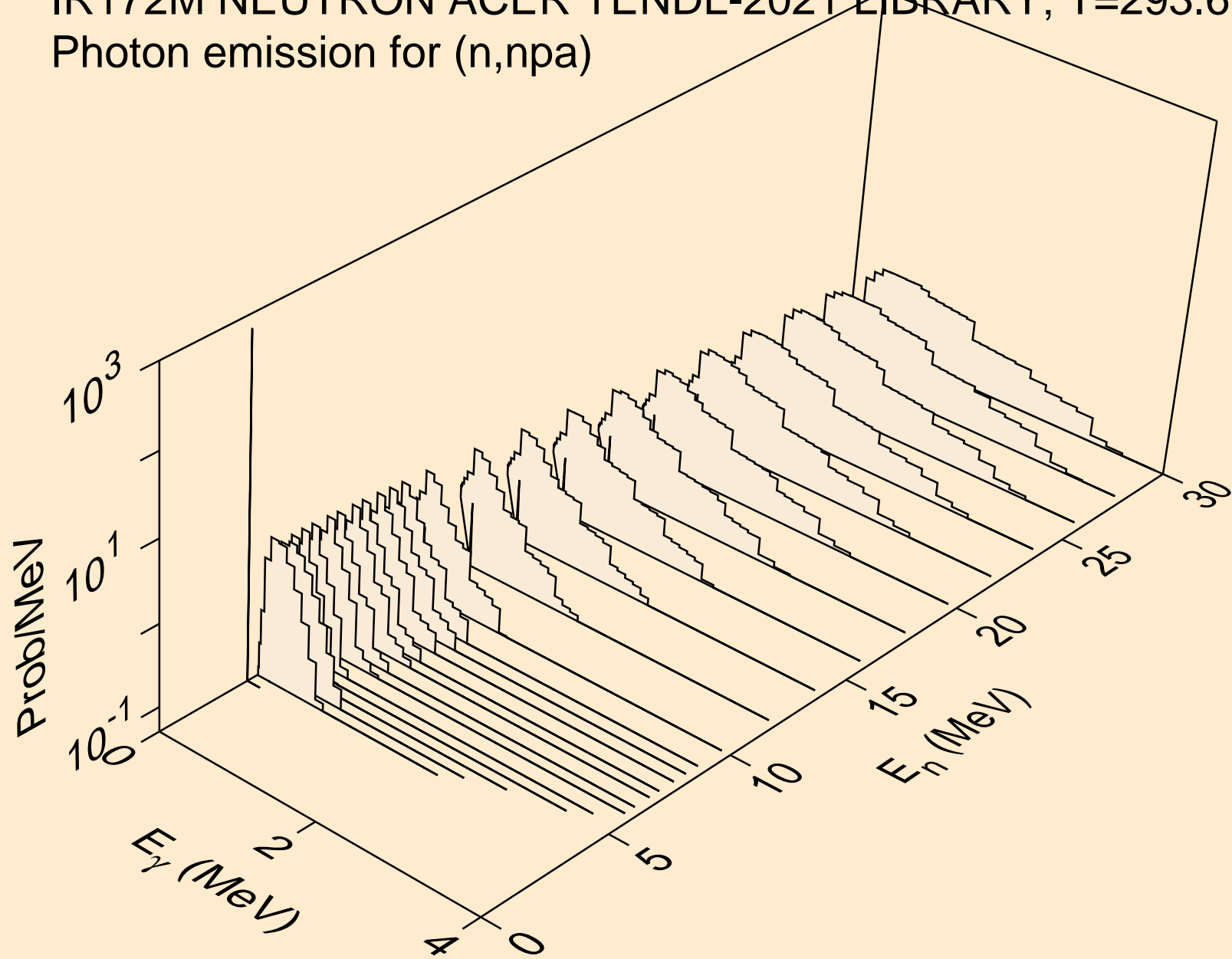

IR172M NEUTRON ACER TENDL-2021 LIBRARY; T=293.6K
Photon emission for (n,n*1)

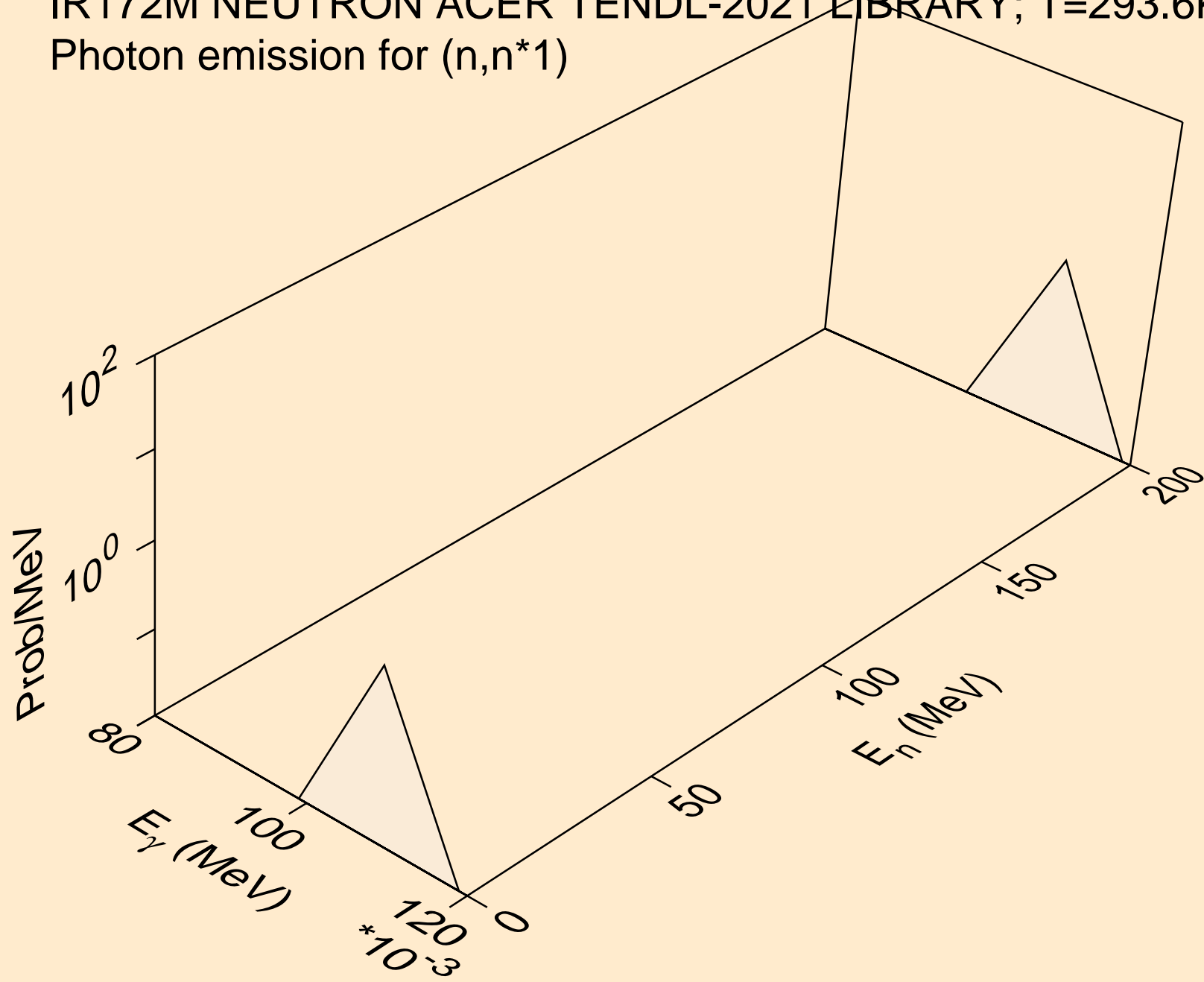

IR172M NEUTRON ACER TENDL-2021 LIBRARY; T=293.6K
Photon emission for (n,n*c)

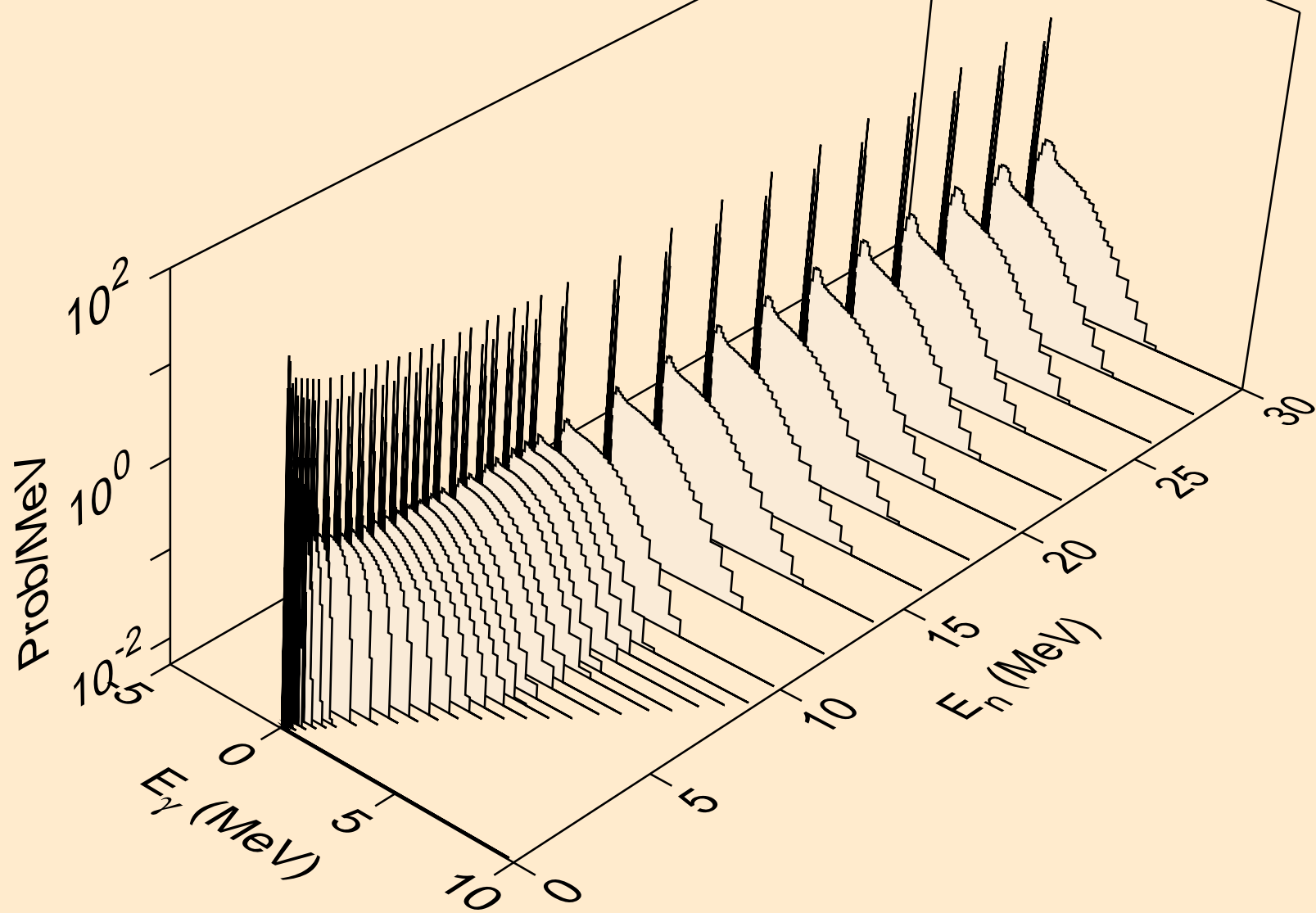

IR172M NEUTRON ACER TENDL-2021 LIBRARY; T=293.6K
Photon emission for (n,gma)

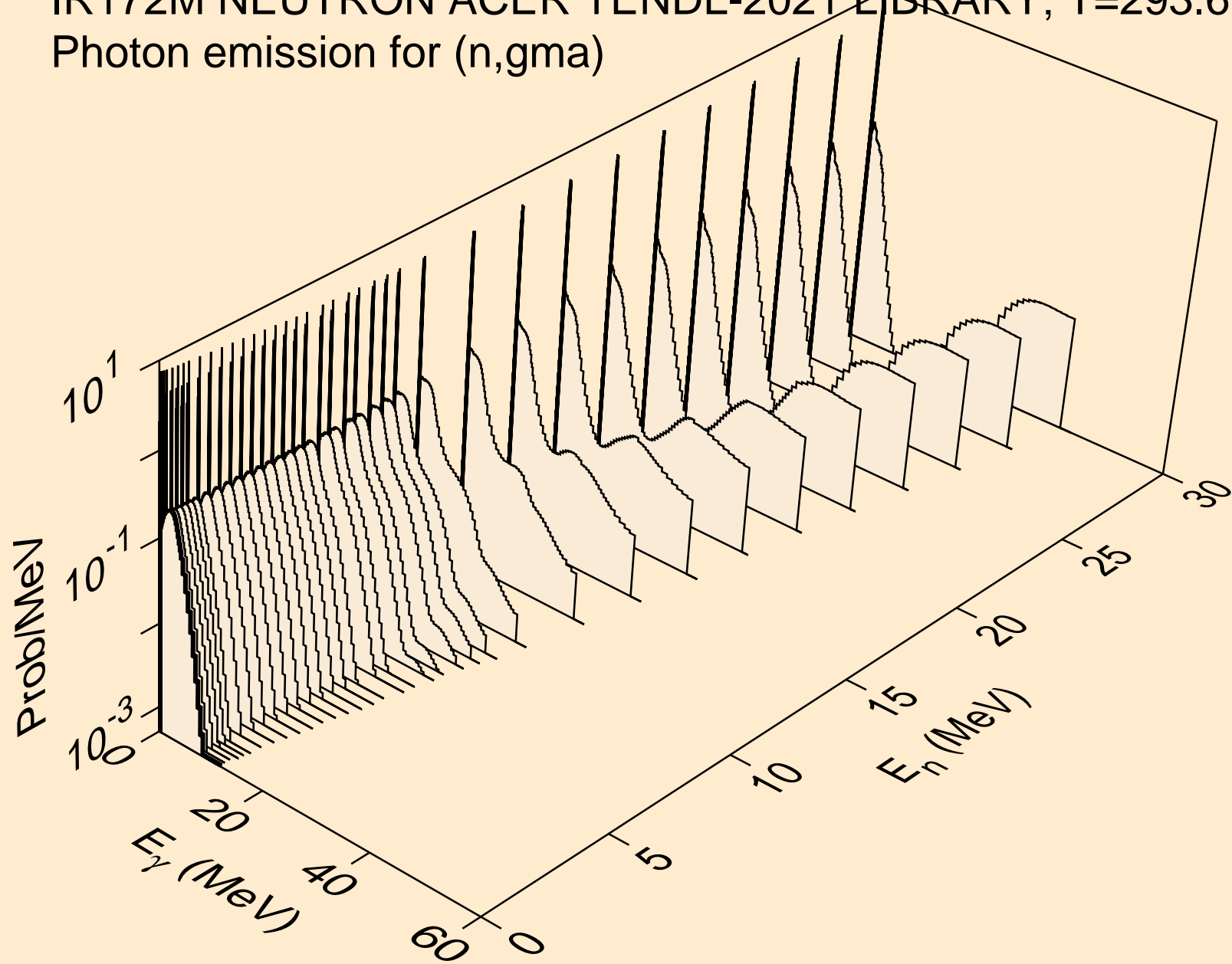

IR172M NEUTRON ACER TENDL-2021 LIBRARY; T=293.6K
Photon emission for (n,p)

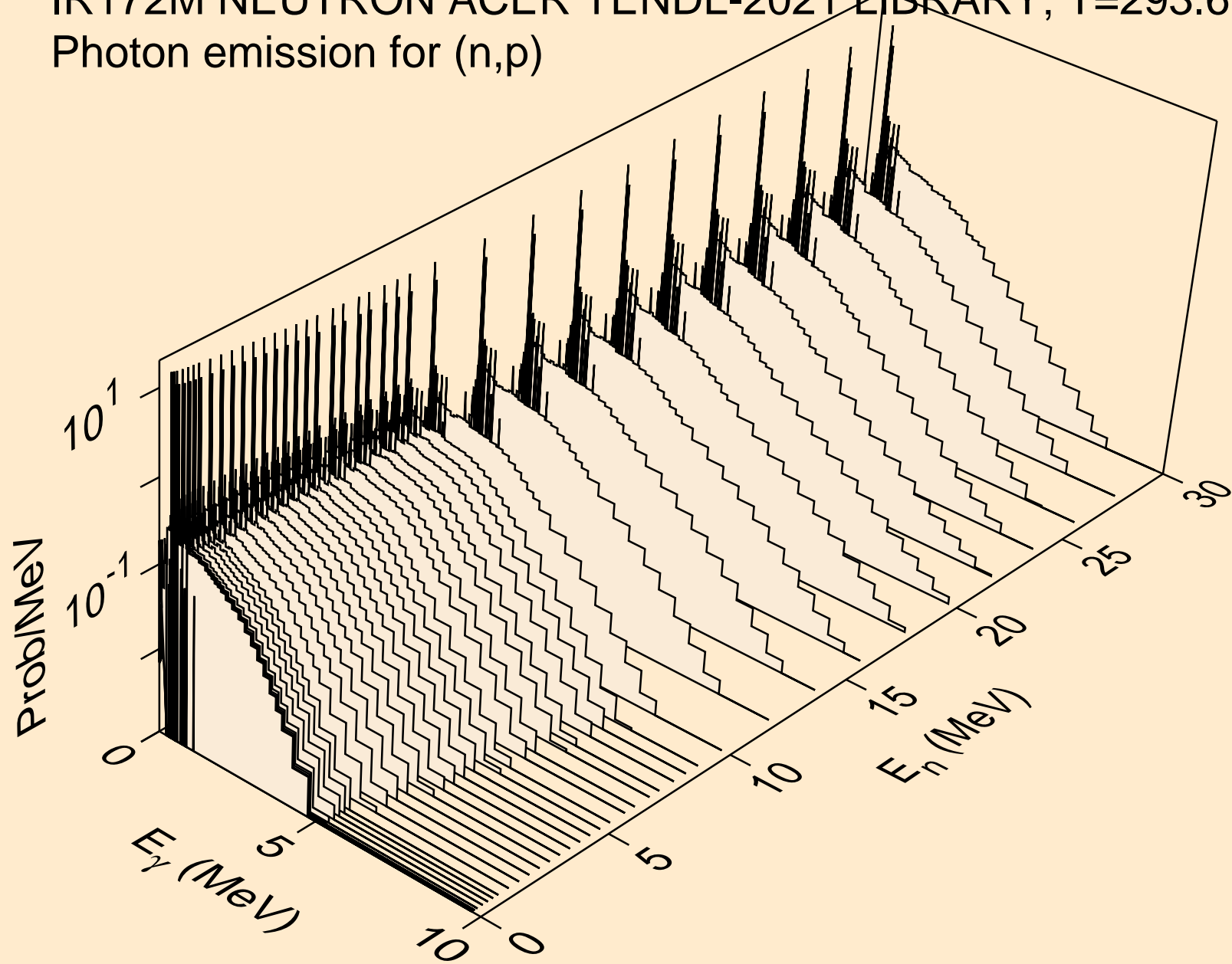

IR172M NEUTRON ACER TENDL-2021 LIBRARY; T=293.6K
Photon emission for (n,d)

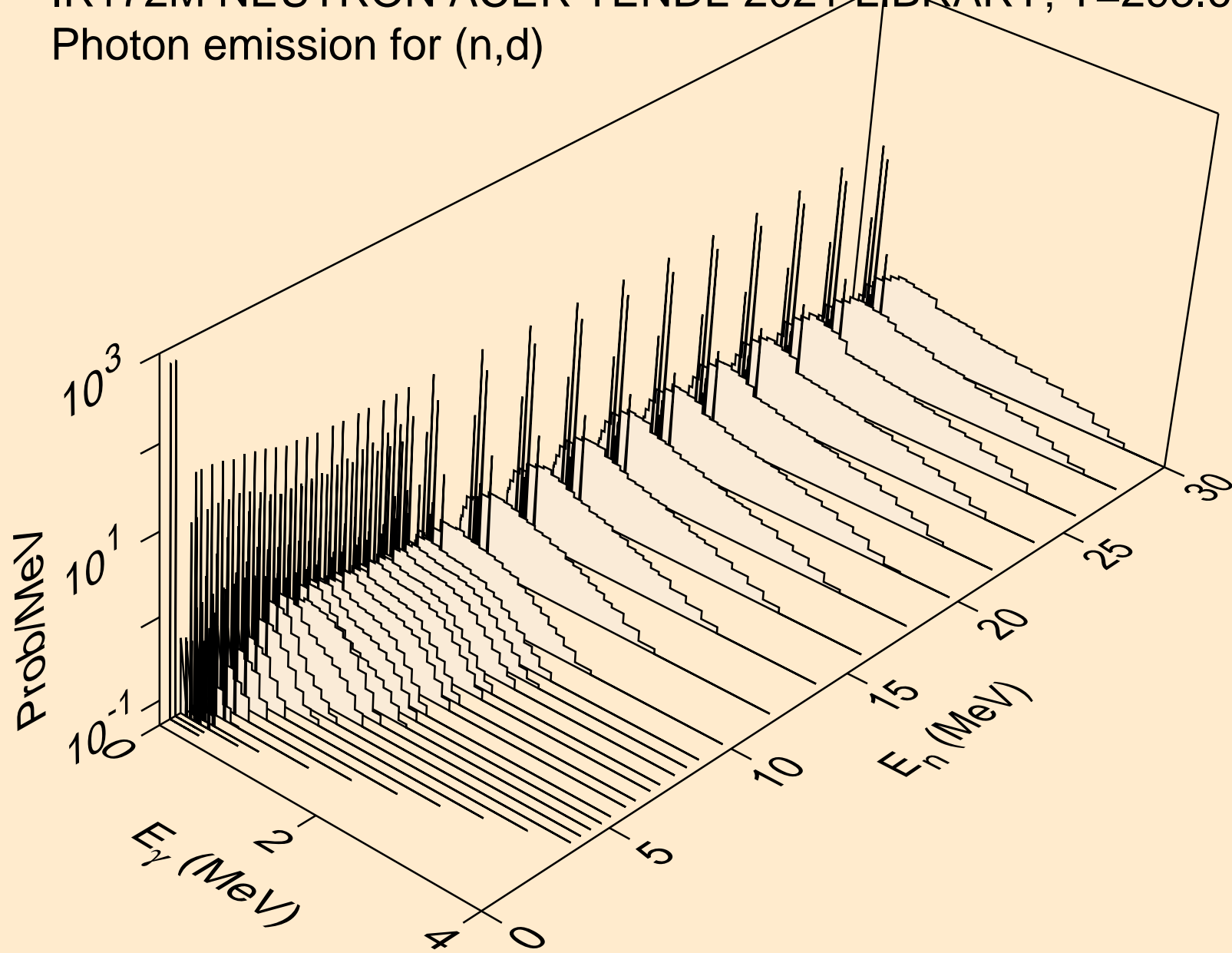

IR172M NEUTRON ACER TENDL-2021 LIBRARY; T=293.6K
Photon emission for (n,t)

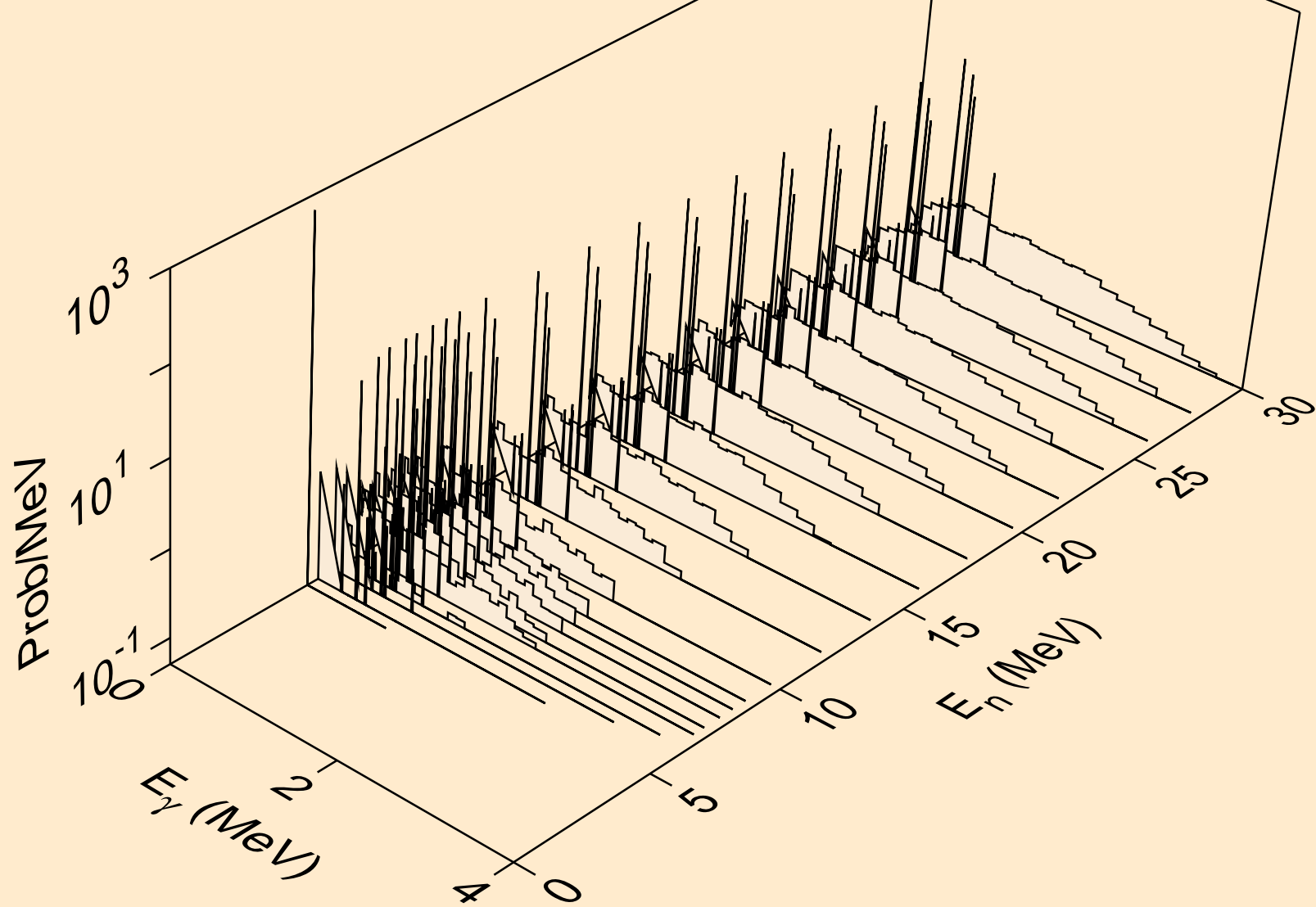

IR172M NEUTRON ACER TENDL-2021 LIBRARY; T=293.6K
Photon emission for (n,he3)

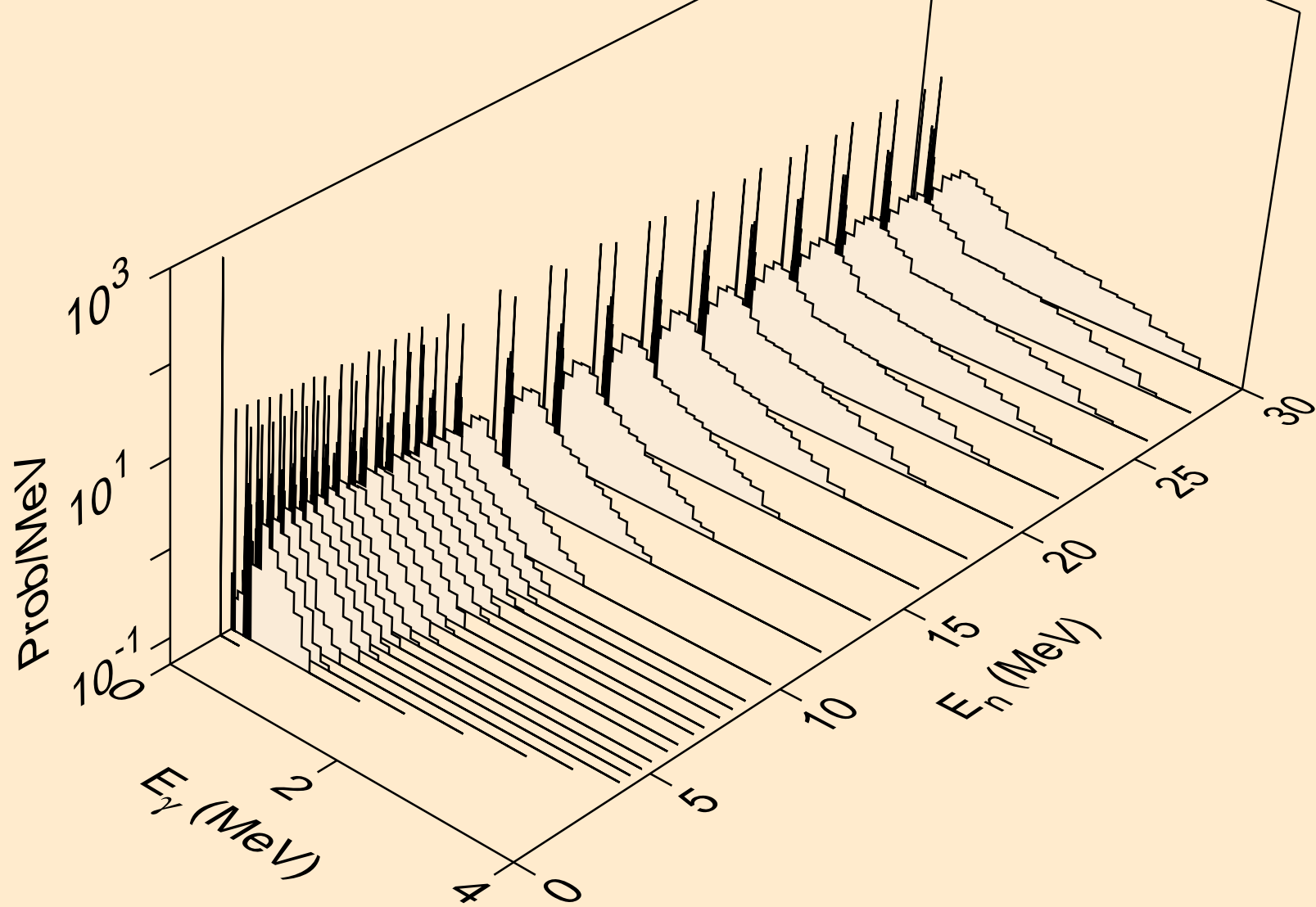

IR172M NEUTRON ACER TENDL-2021 LIBRARY; T=293.6K
Photon emission for (n,a)

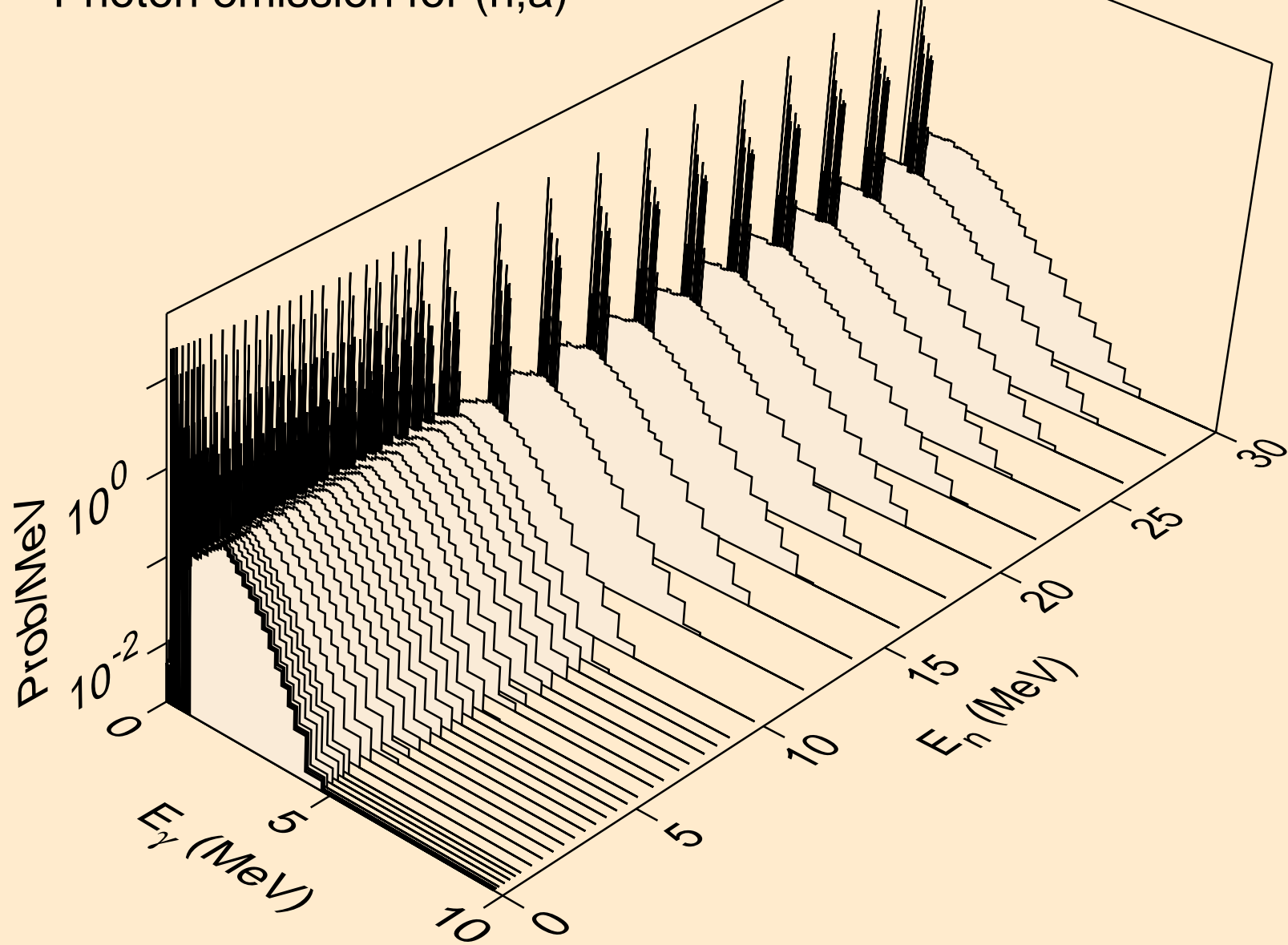

IR172M NEUTRON ACER TENDL-2021 LIBRARY; T=293.6K
Photon emission for (n,2a)

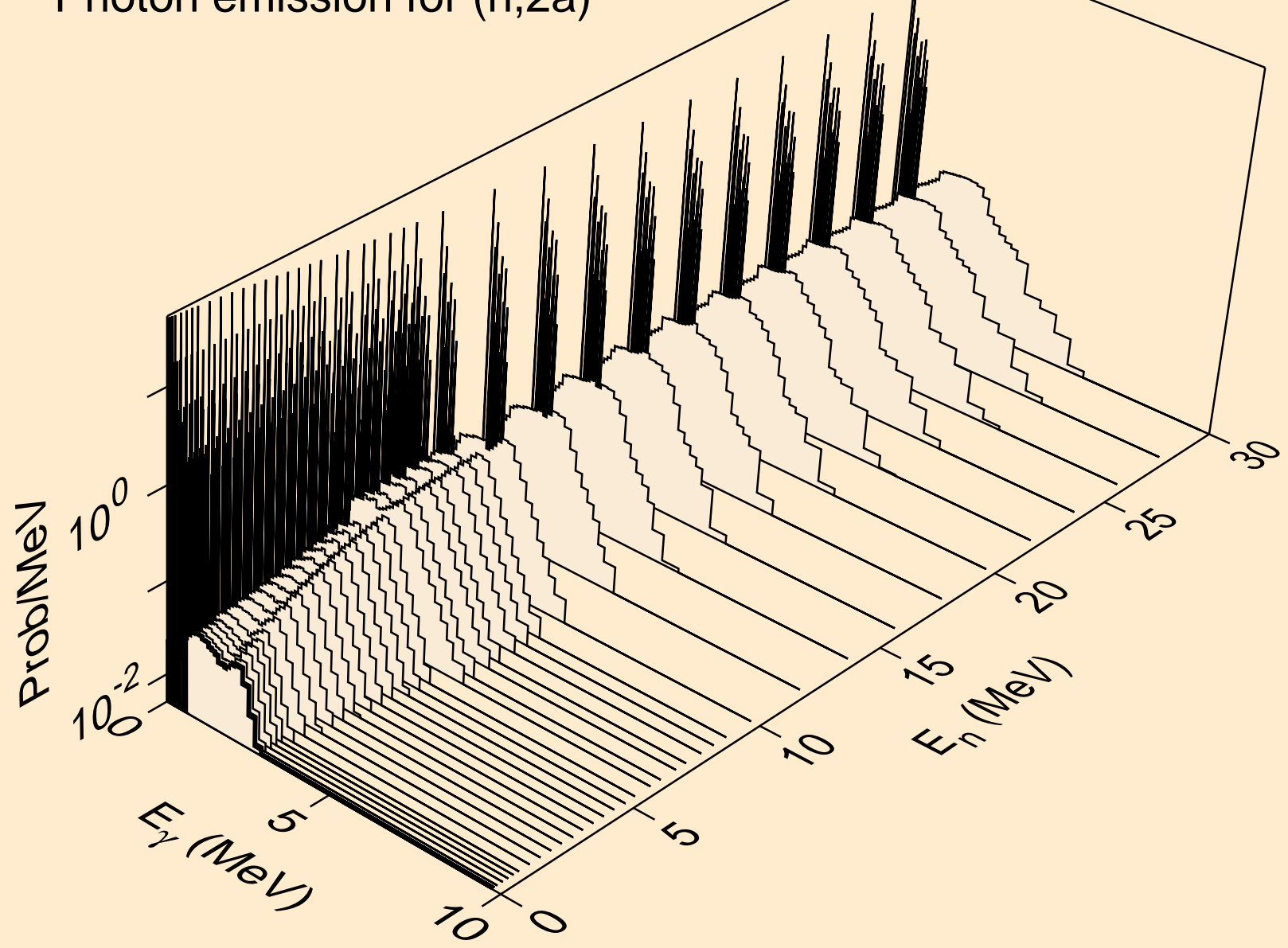

IR172M NEUTRON ACER TENDL-2021 LIBRARY; T=293.6K
Photon emission for (n,3a)

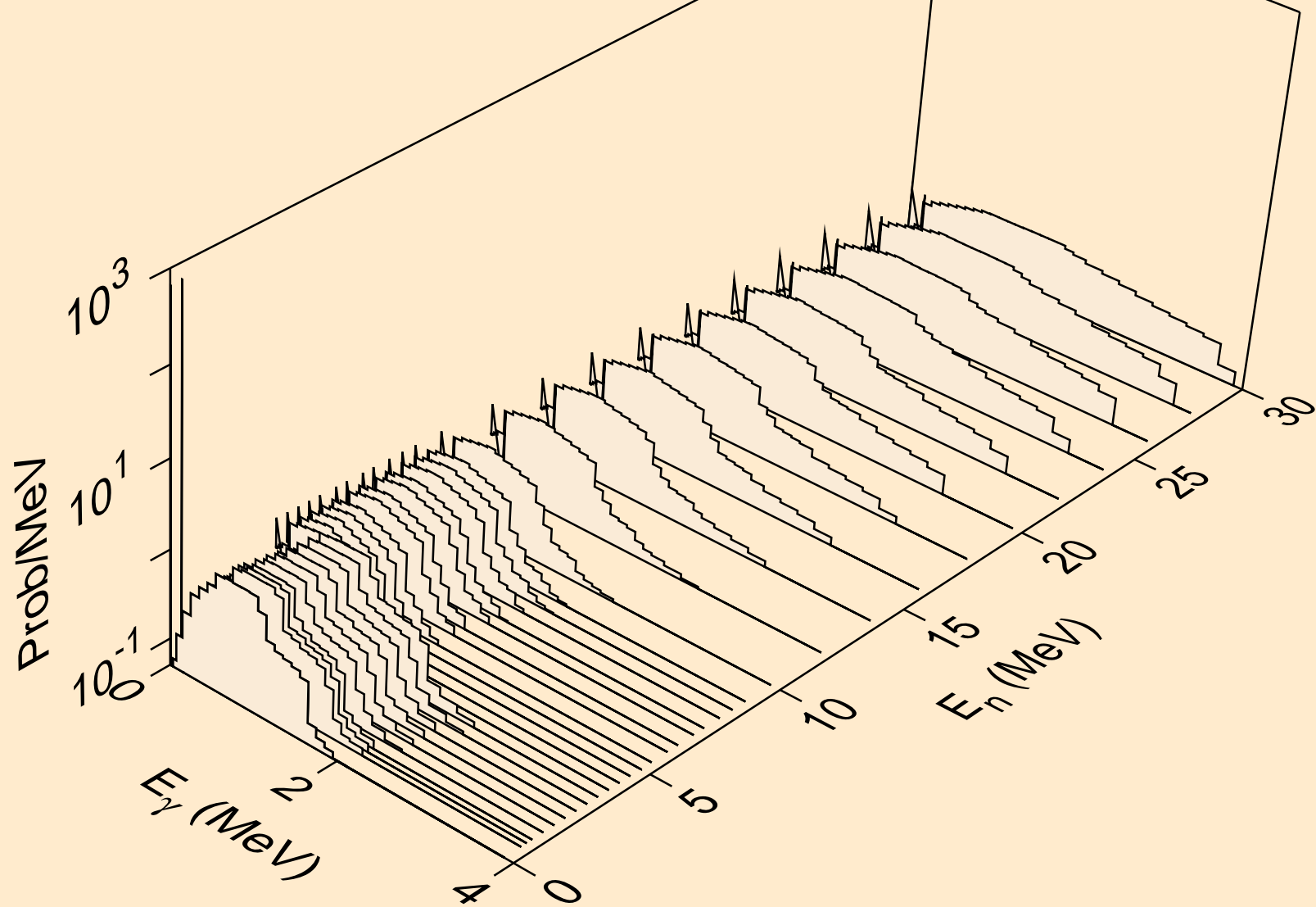

IR172M NEUTRON ACER TENDL-2021 LIBRARY; T=293.6K
Photon emission for (n,2p)

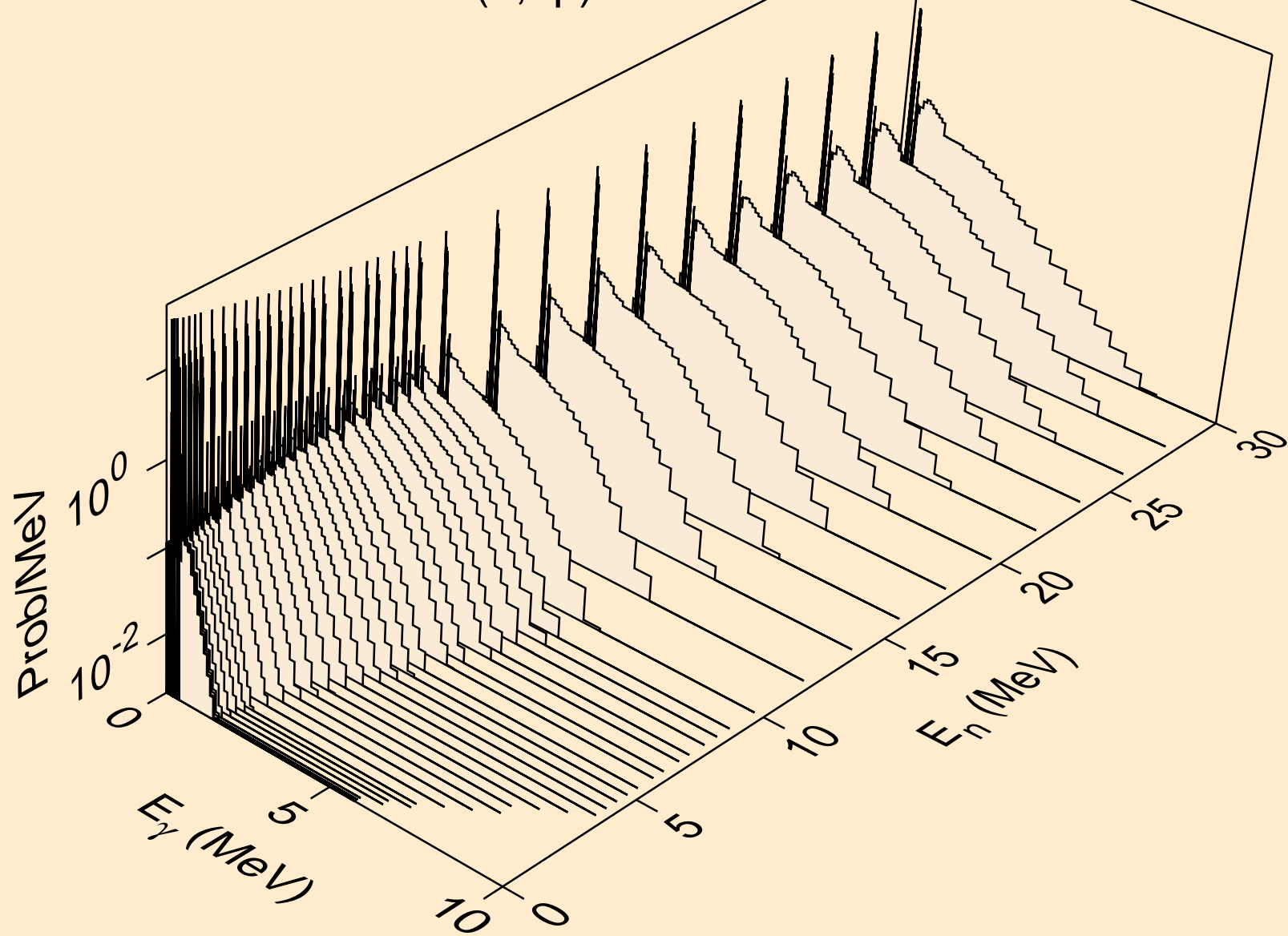

IR172M NEUTRON ACER TENDL-2021 LIBRARY; T=293.6K
Photon emission for (n,p α)

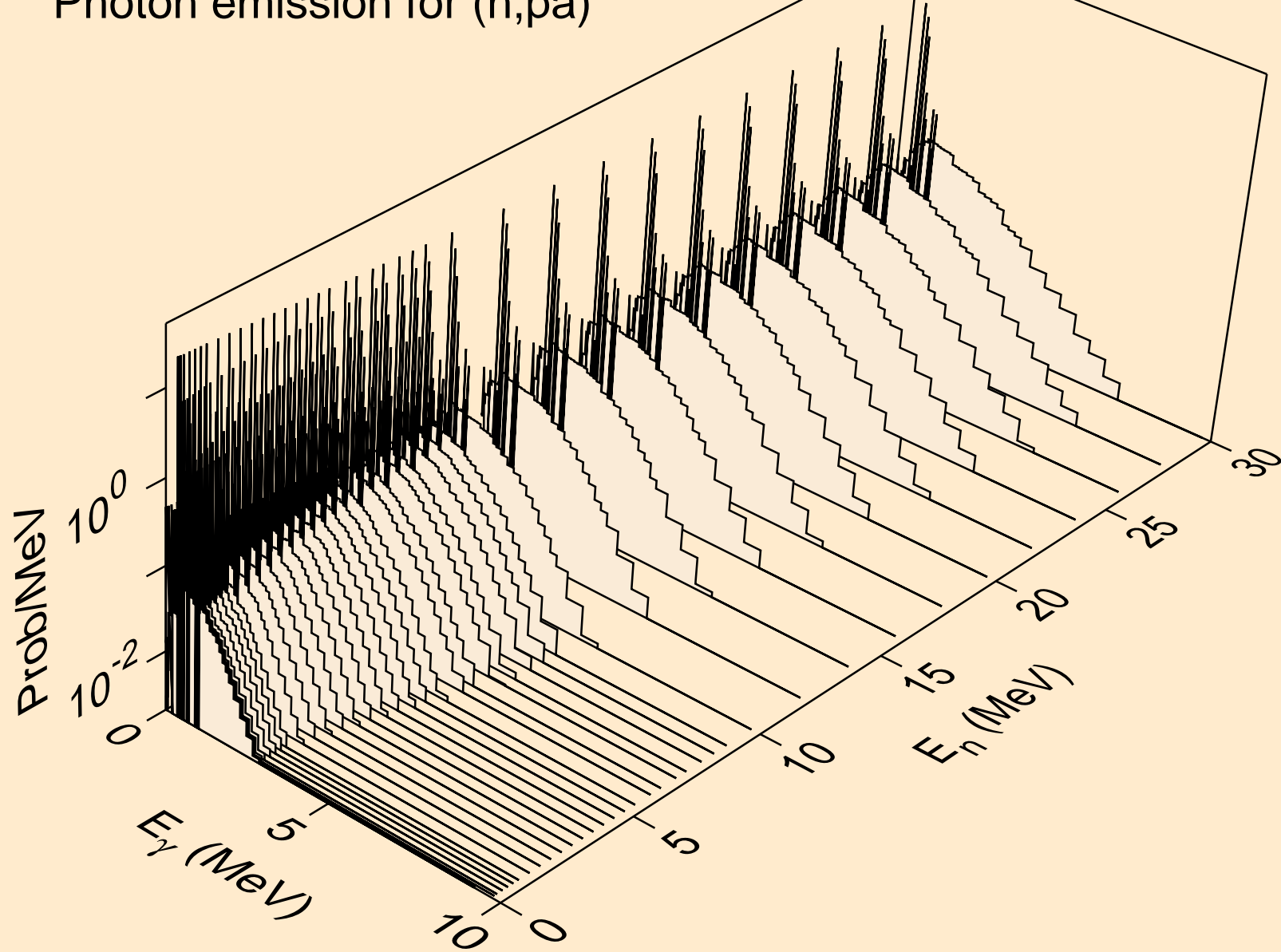

IR172M NEUTRON ACER TENDL-2021 LIBRARY; T=293.6K
Photon emission for (n,t2a)

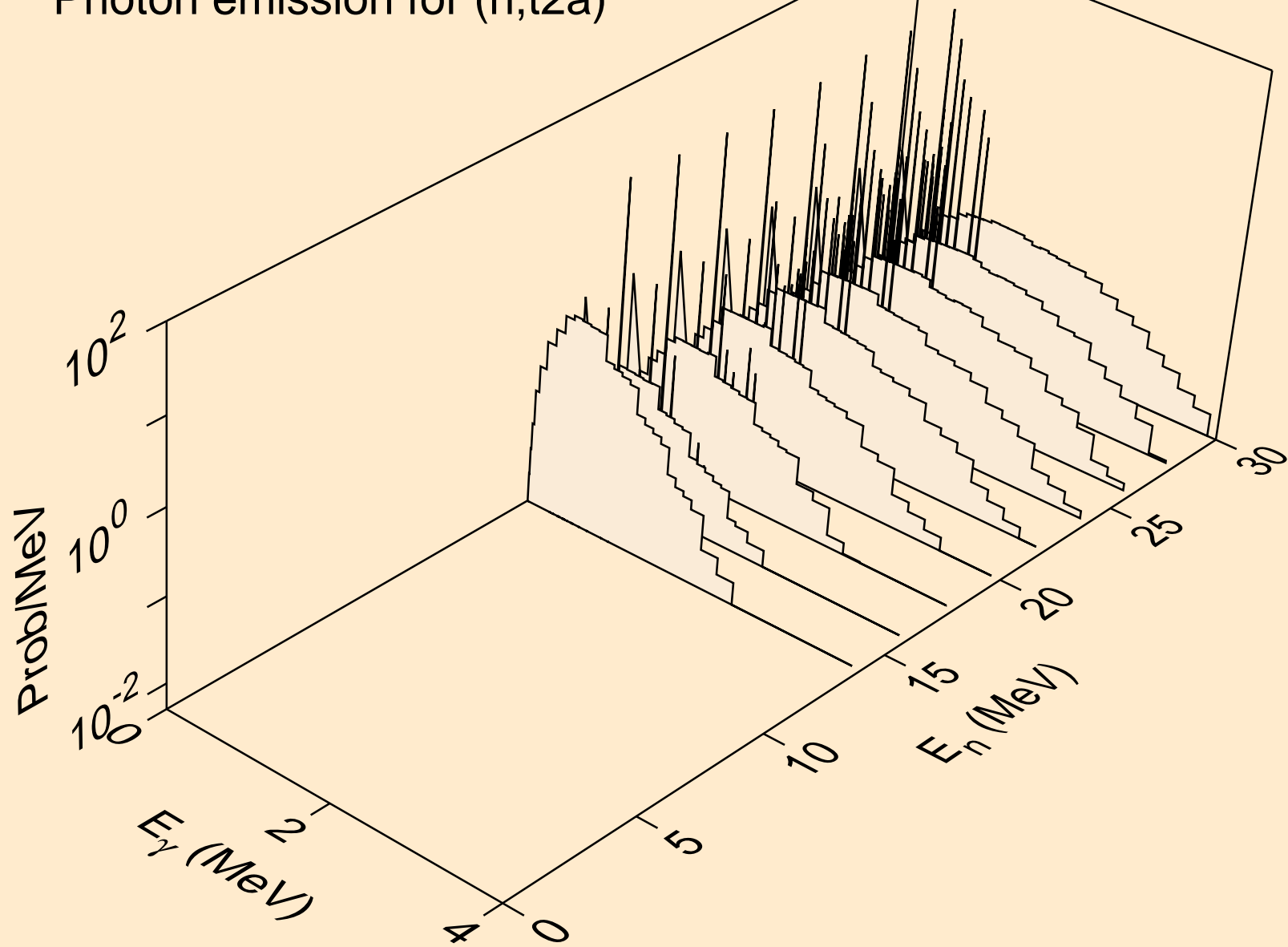

IR172M NEUTRON ACER TENDL-2021 LIBRARY; T=293.6K
Photon emission for (n,d2a)

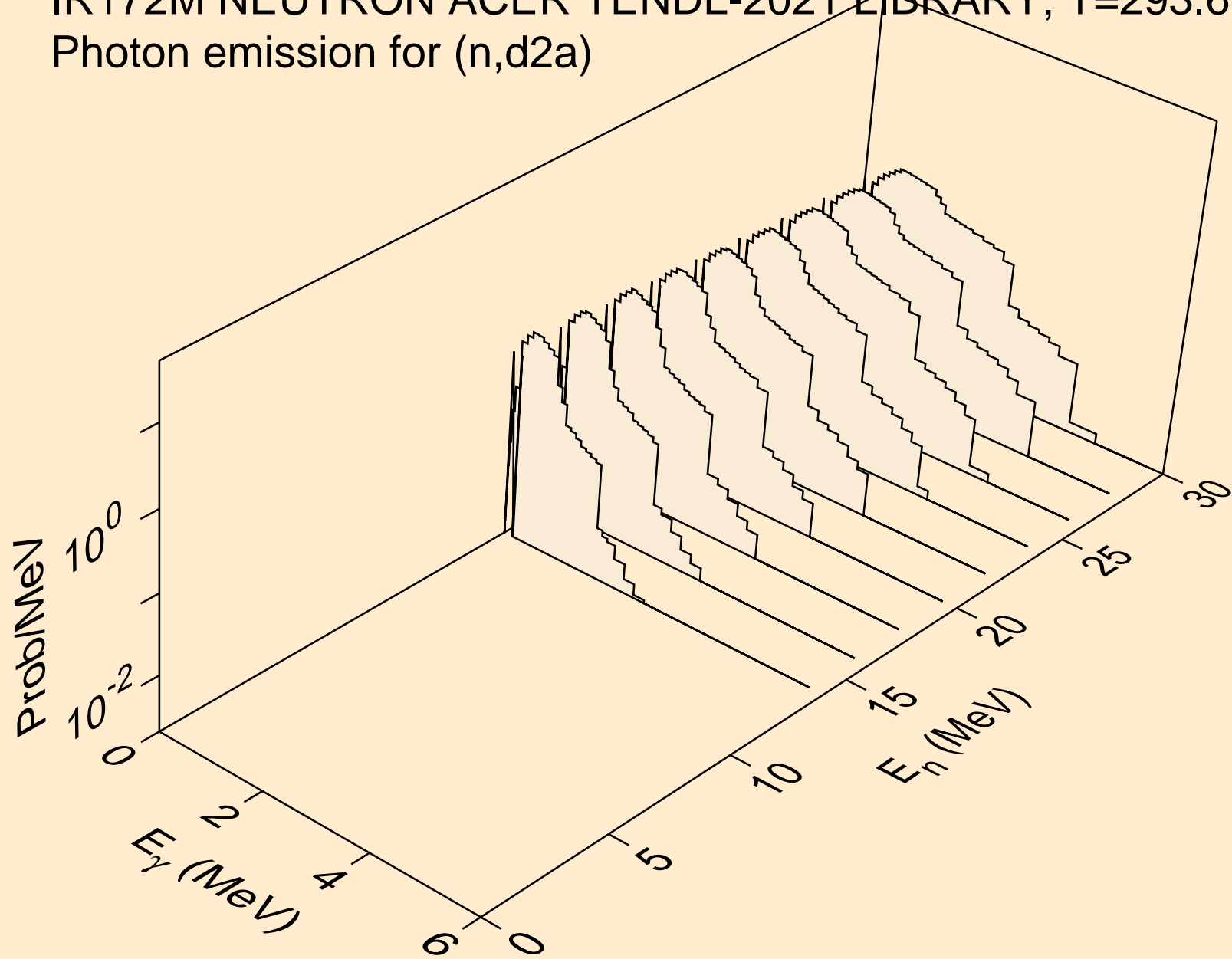

IR172M NEUTRON ACER TENDL-2021 LIBRARY; T=293.6K
Photon emission for (n,pd)

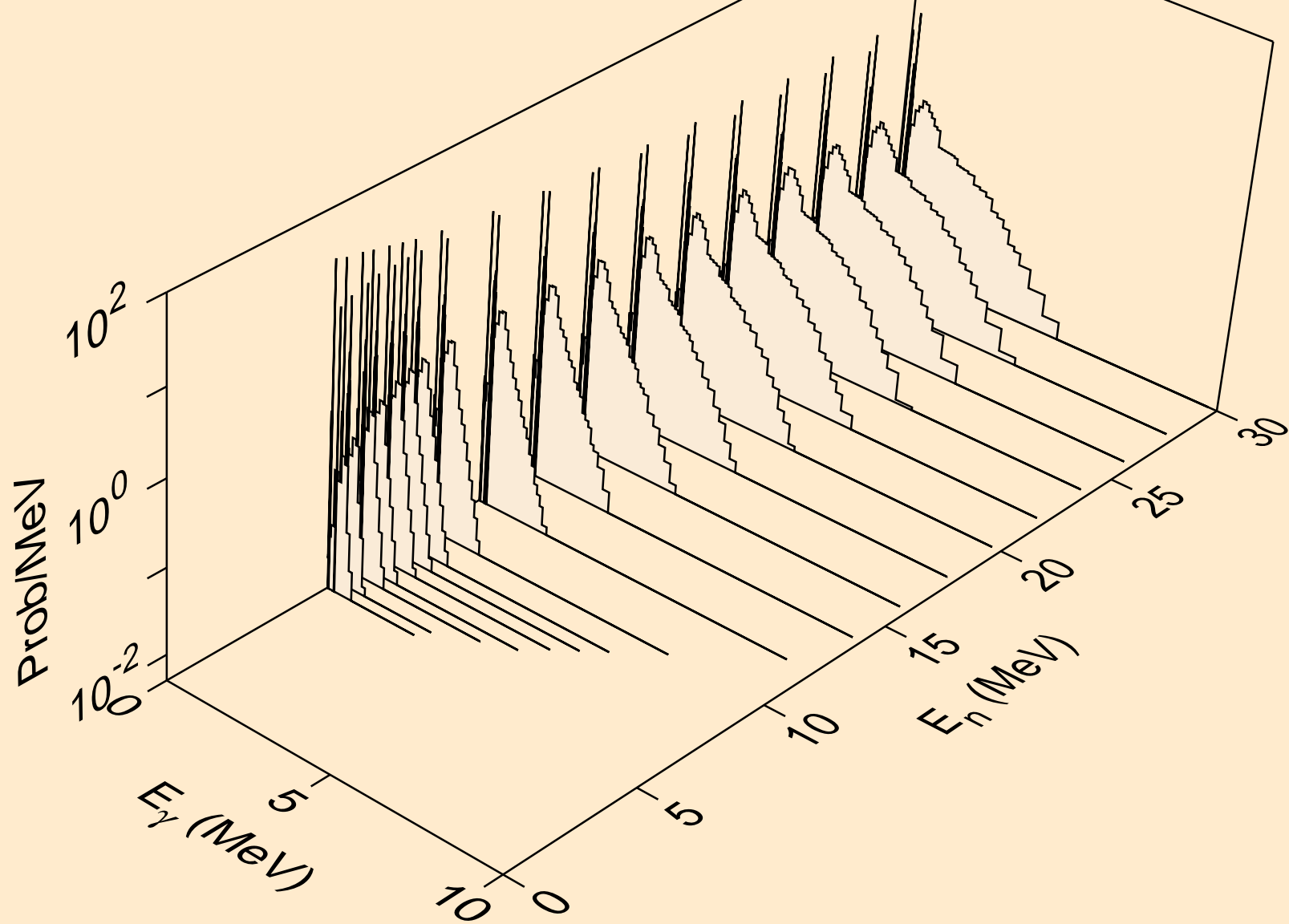

IR172M NEUTRON ACER TENDL-2021 LIBRARY; T=293.6K
Photon emission for (n,pt)

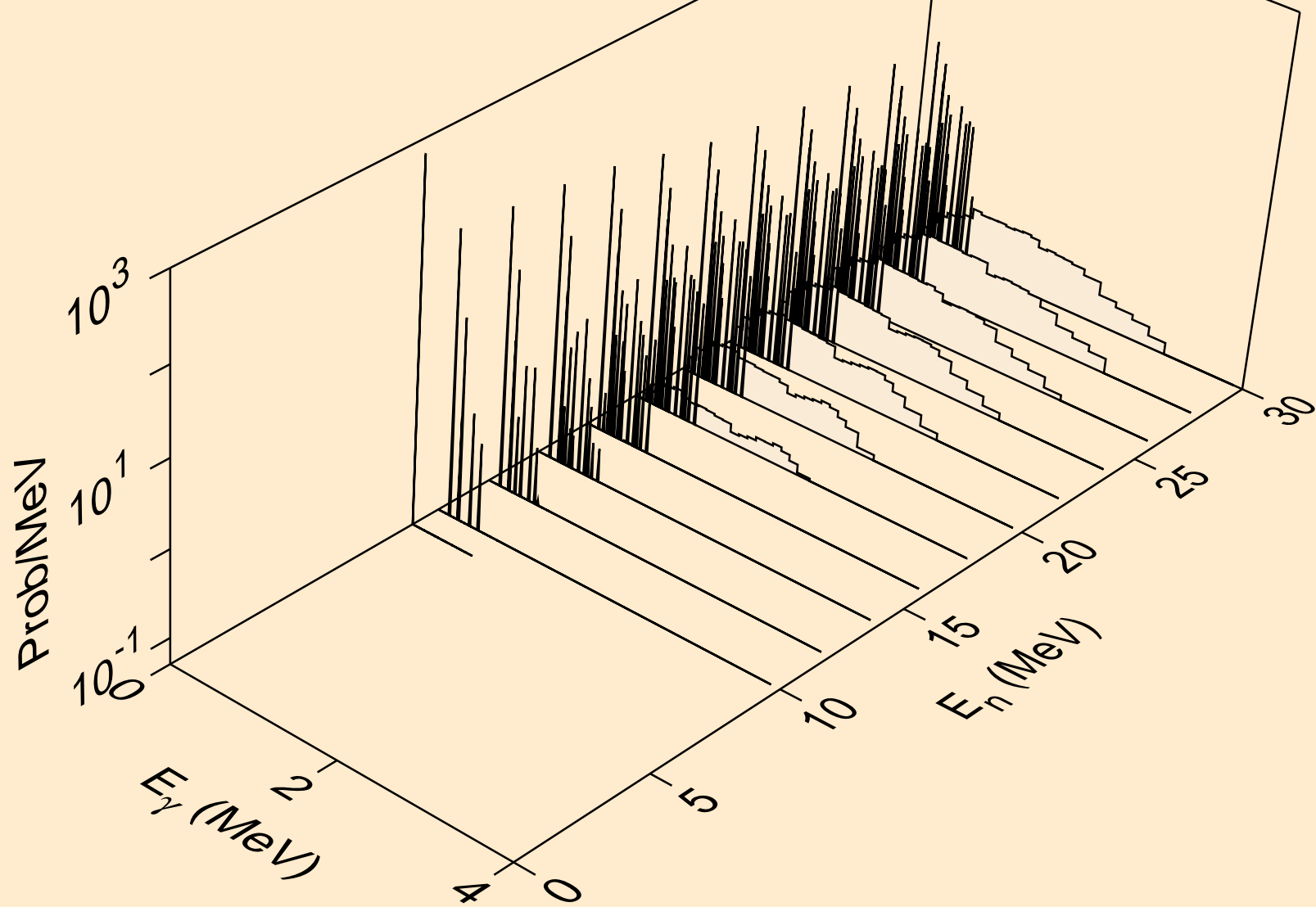

IR172M NEUTRON ACER TENDL-2021 LIBRARY; T=293.6K
Photon emission for (n,da)

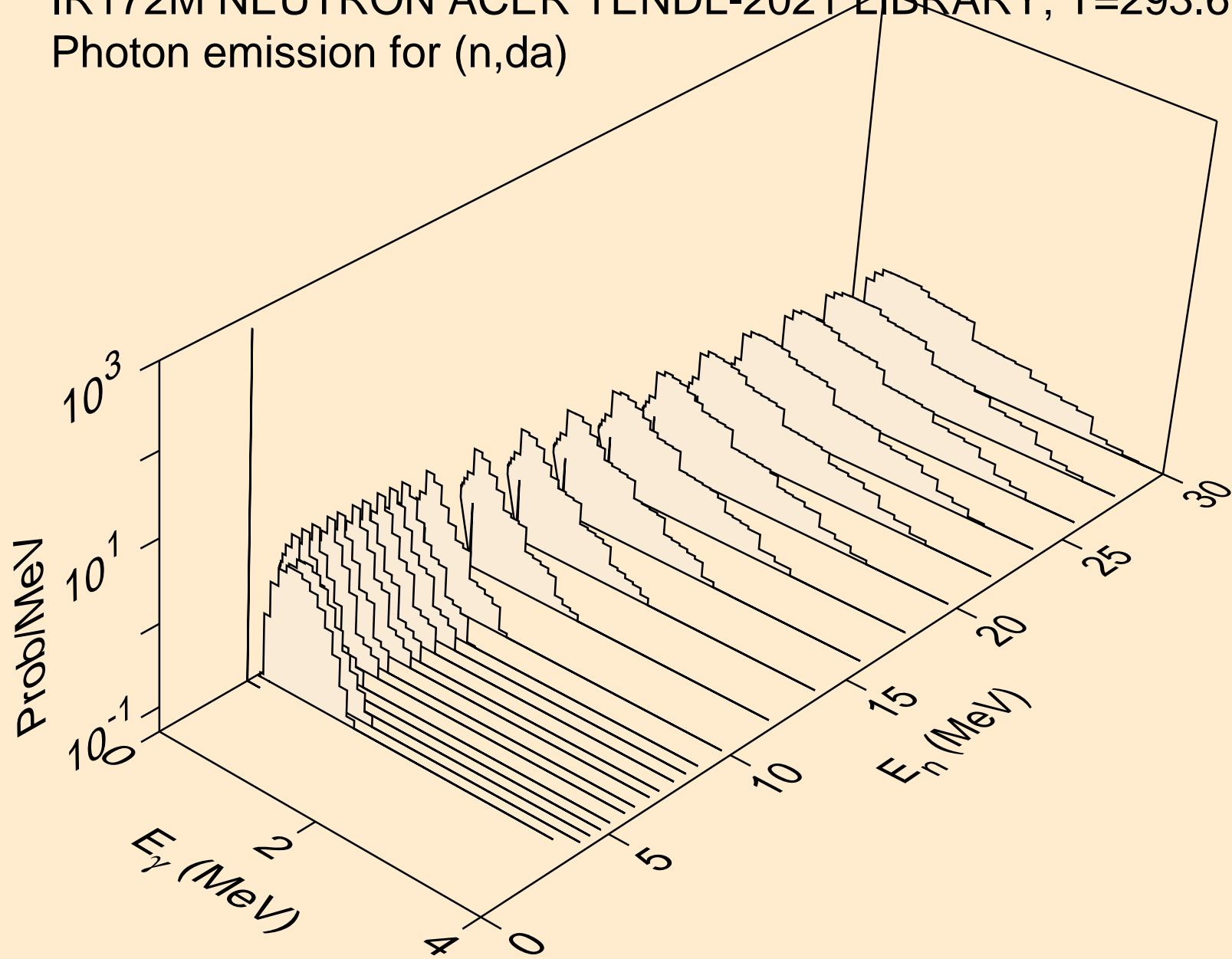

IR172M NEUTRON ACER TENDL-2021 LIBRARY; T=293.6K
thermal capture photon spectrum

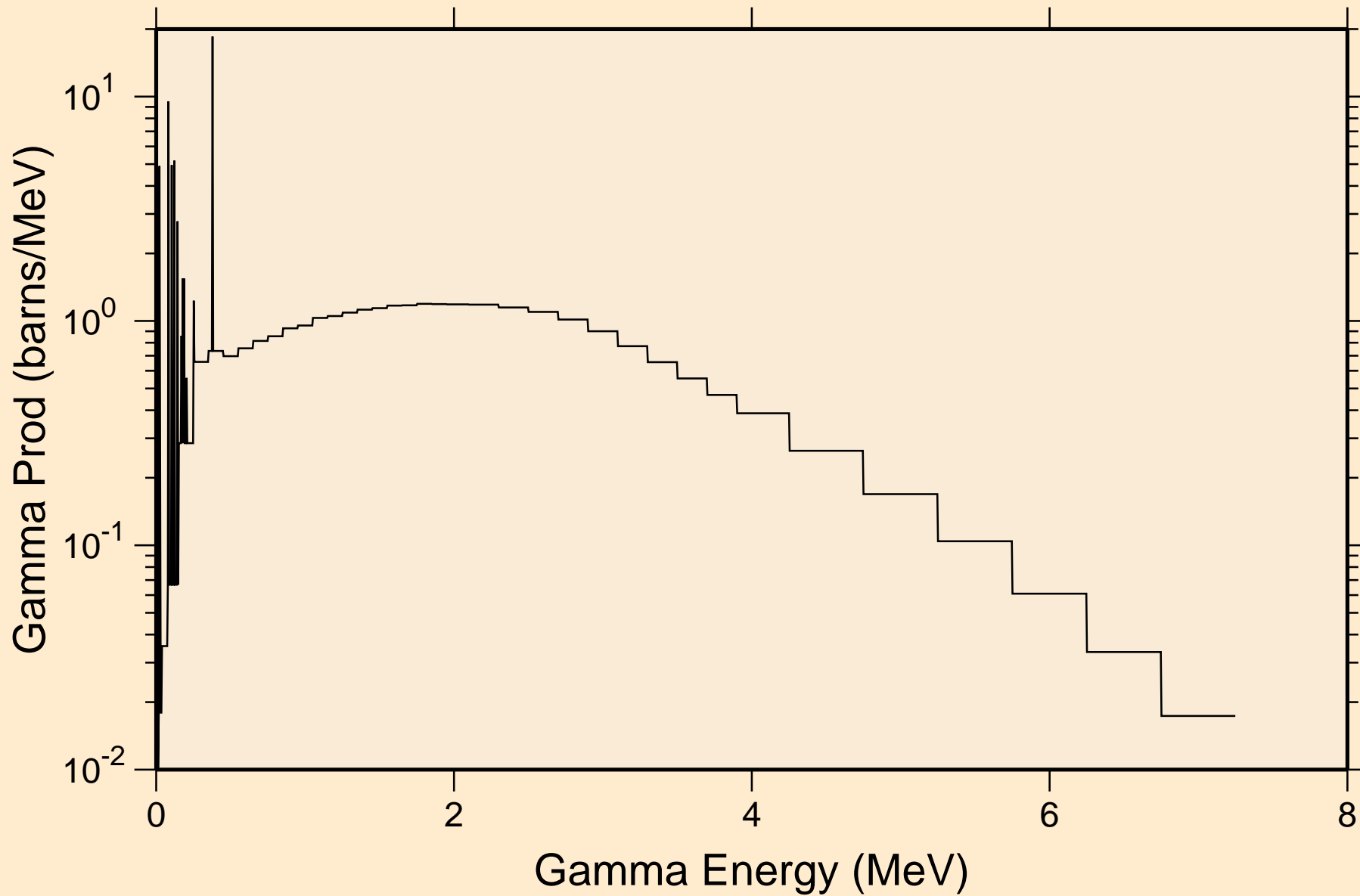

IR172M NEUTRON ACER TENDL-2021 LIBRARY; T=293.6K
14 MeV photon spectrum

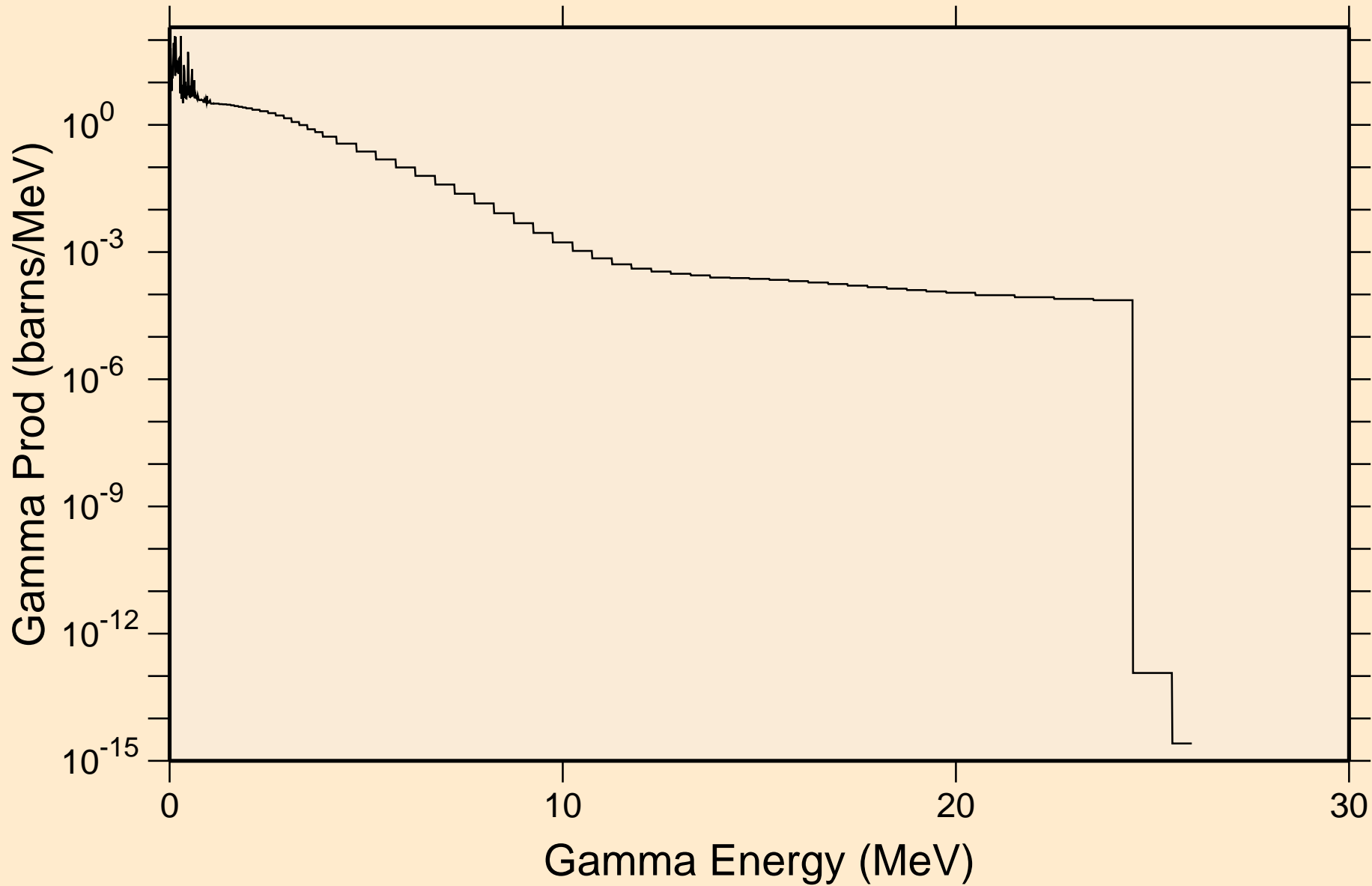

IR172M NEUTRON ACER TENDL-2021 LIBRARY; T=293.6K
Particle heating contributions

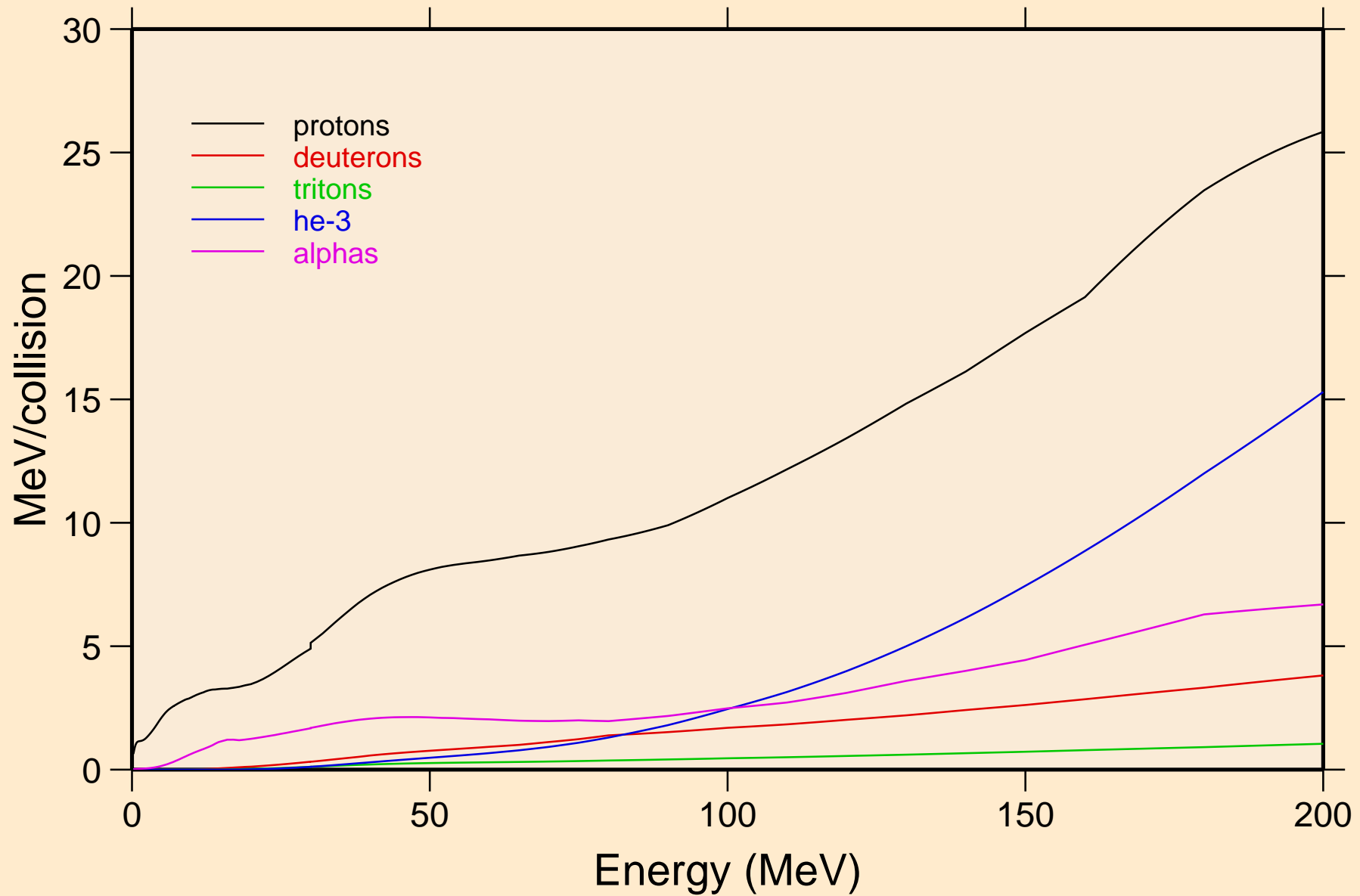

IR172M NEUTRON ACER TENDL-2021 LIBRARY; T=293.6K
Recoil Heating

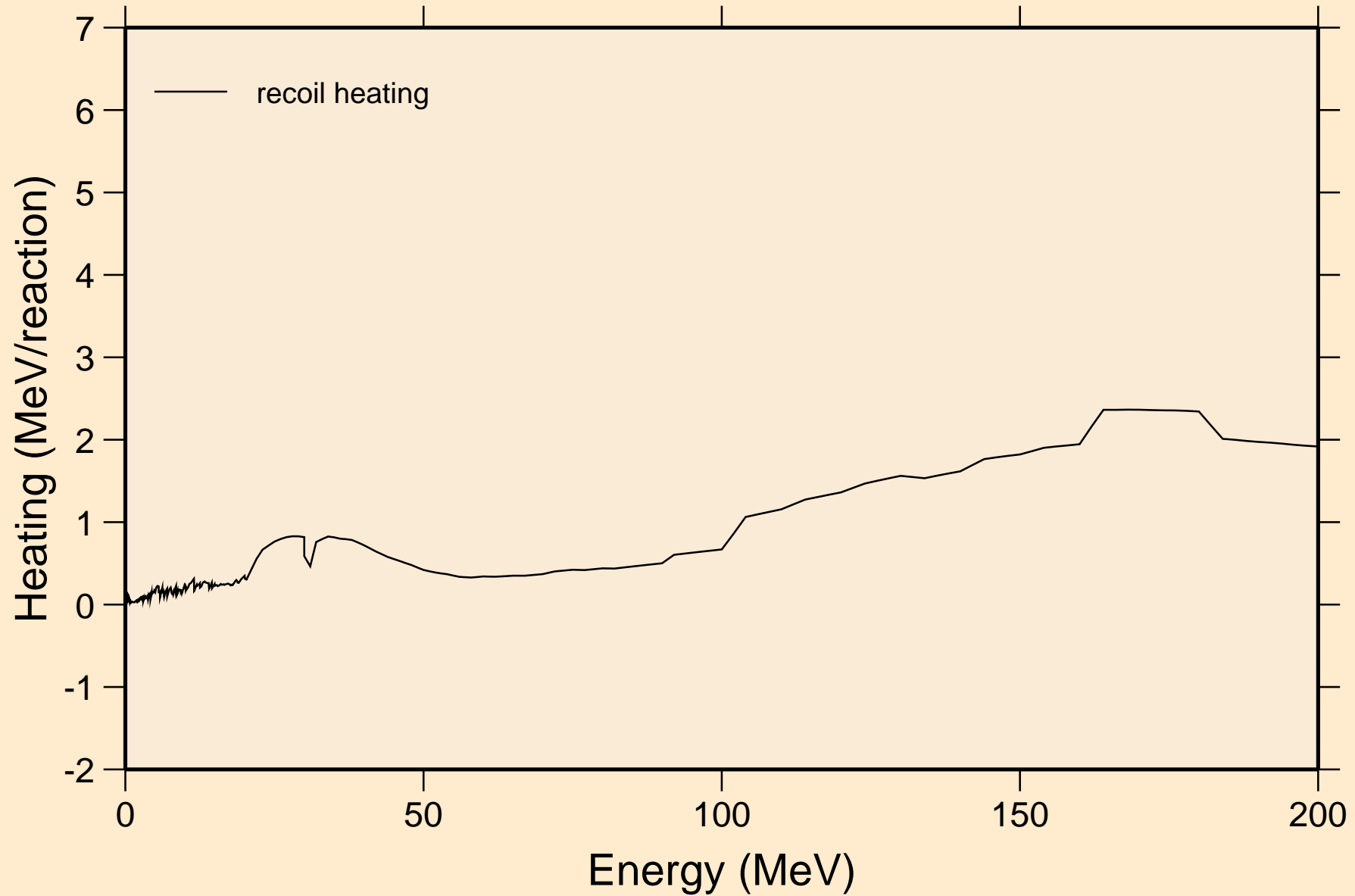

IR172M NEUTRON ACER TENDL-2021 LIBRARY; T=293.6K
Particle production cross sections

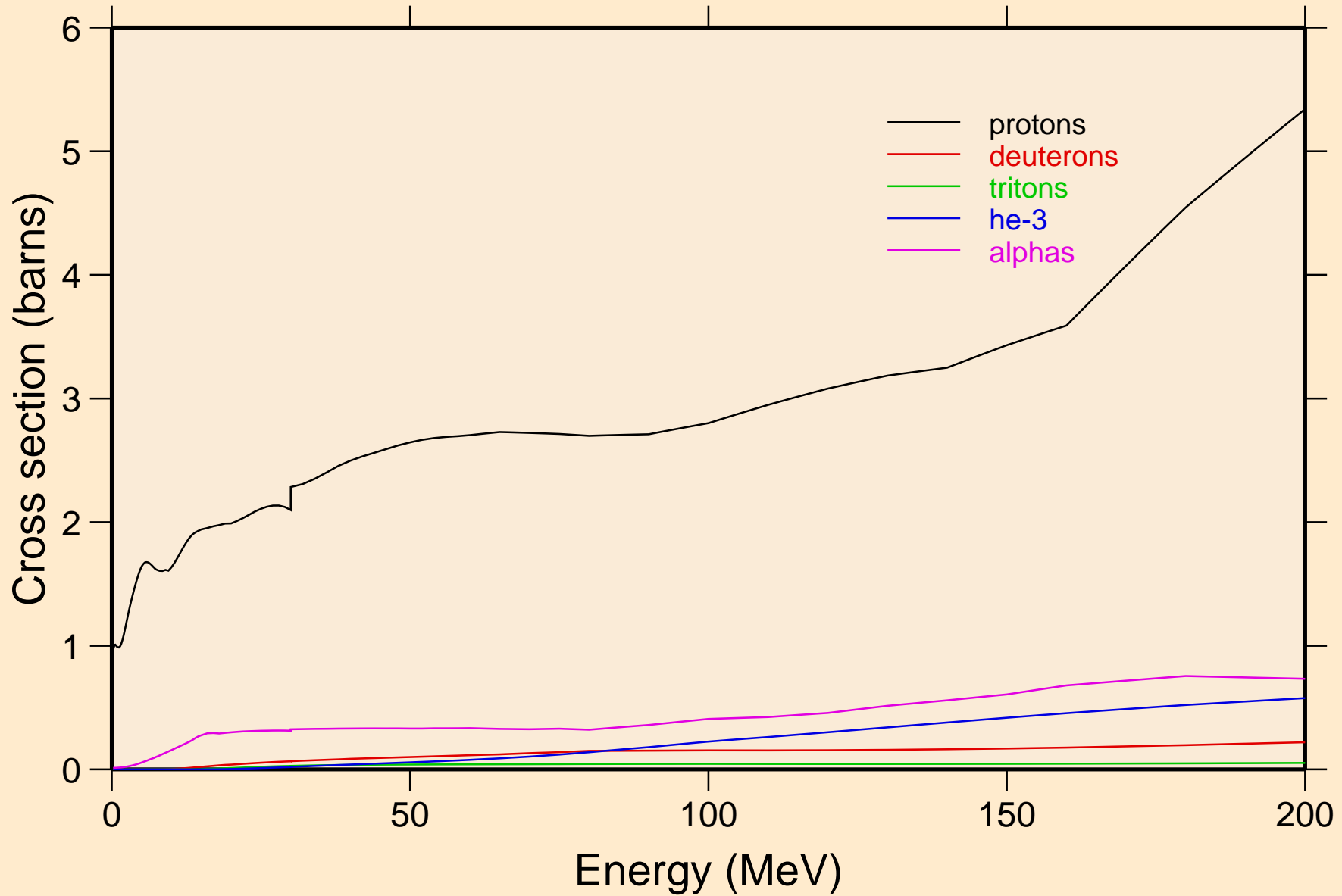

IR172M NEUTRON ACER TENDL-2021 LIBRARY; T=293.6K
protons from (n,x)

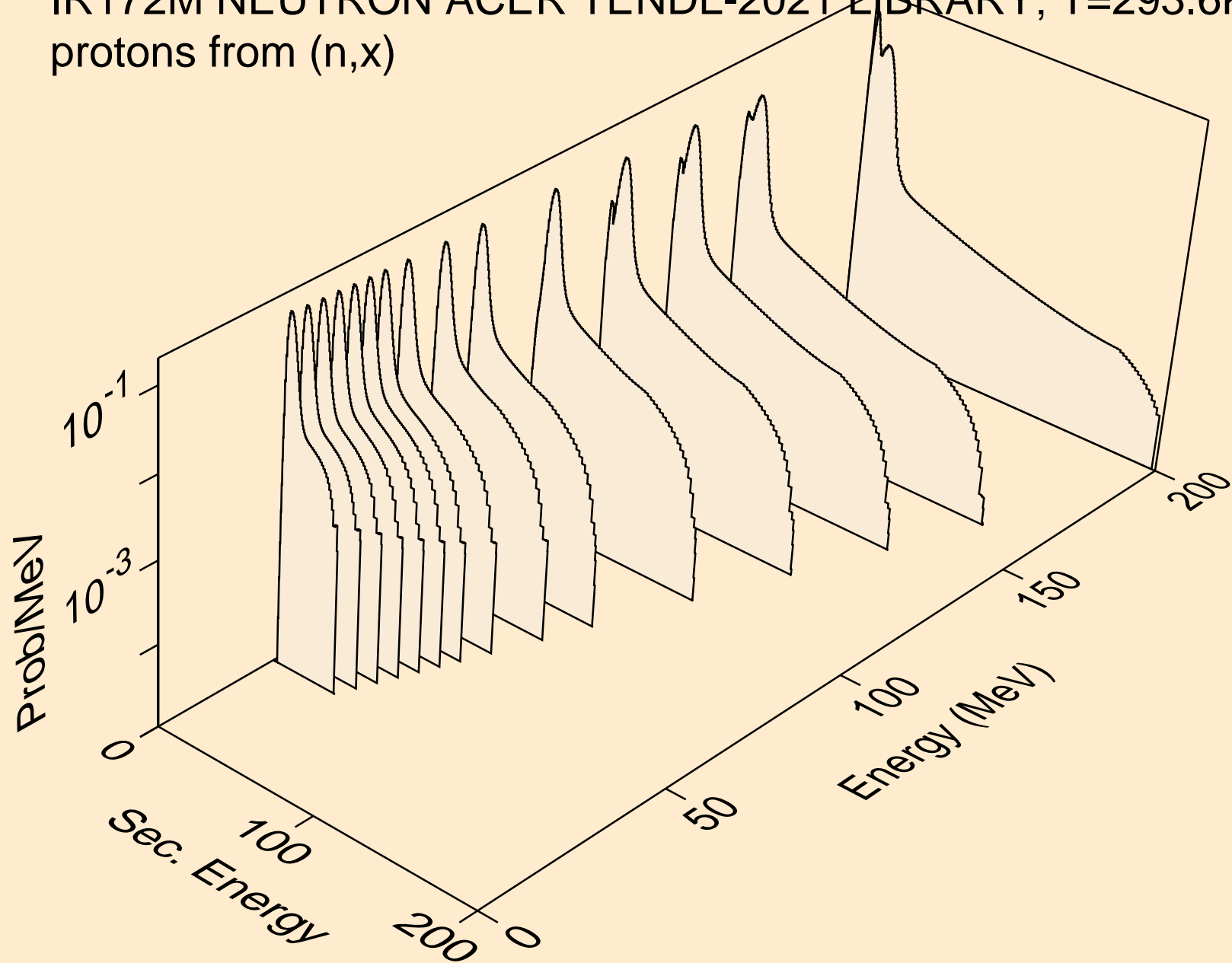

IR172M NEUTRON ACER TENDL-2021 LIBRARY; T=293.6K
protons from (n,n*)p

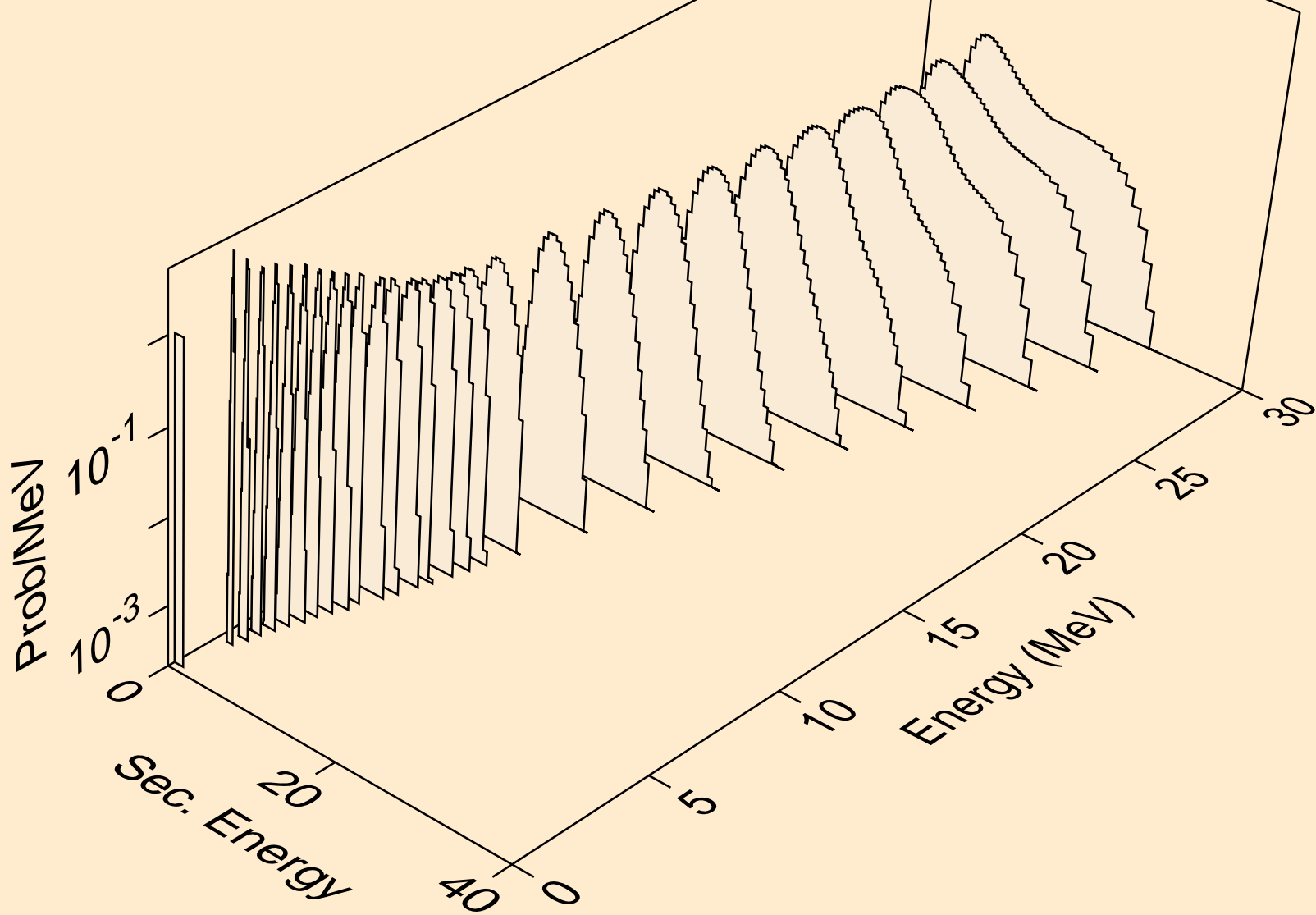

IR172M NEUTRON ACER TENDL-2021 LIBRARY; T=293.6K
protons from (n,2np)

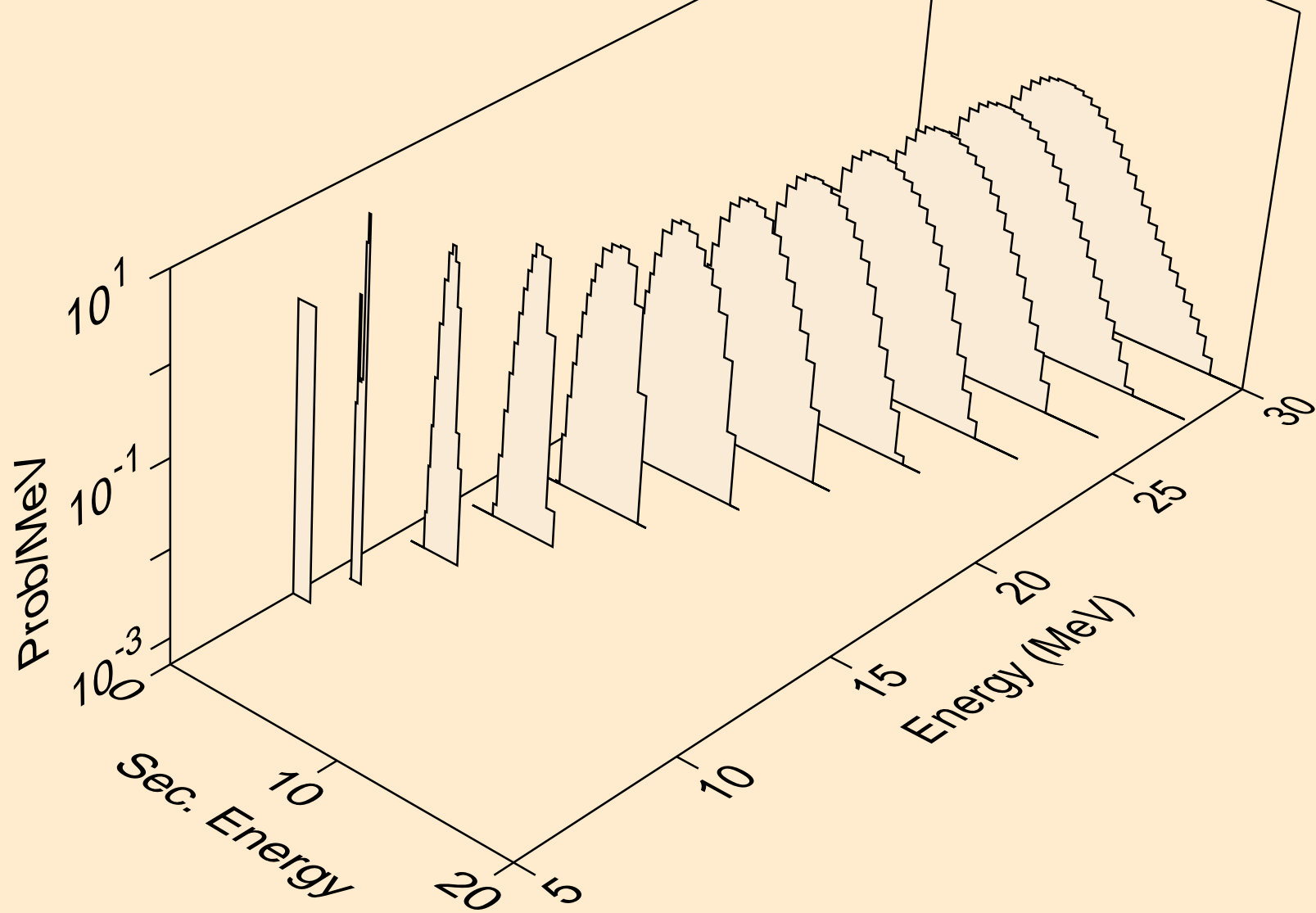

IR172M NEUTRON ACER TENDL-2021 LIBRARY; T=293.6K
protons from (n,3np)

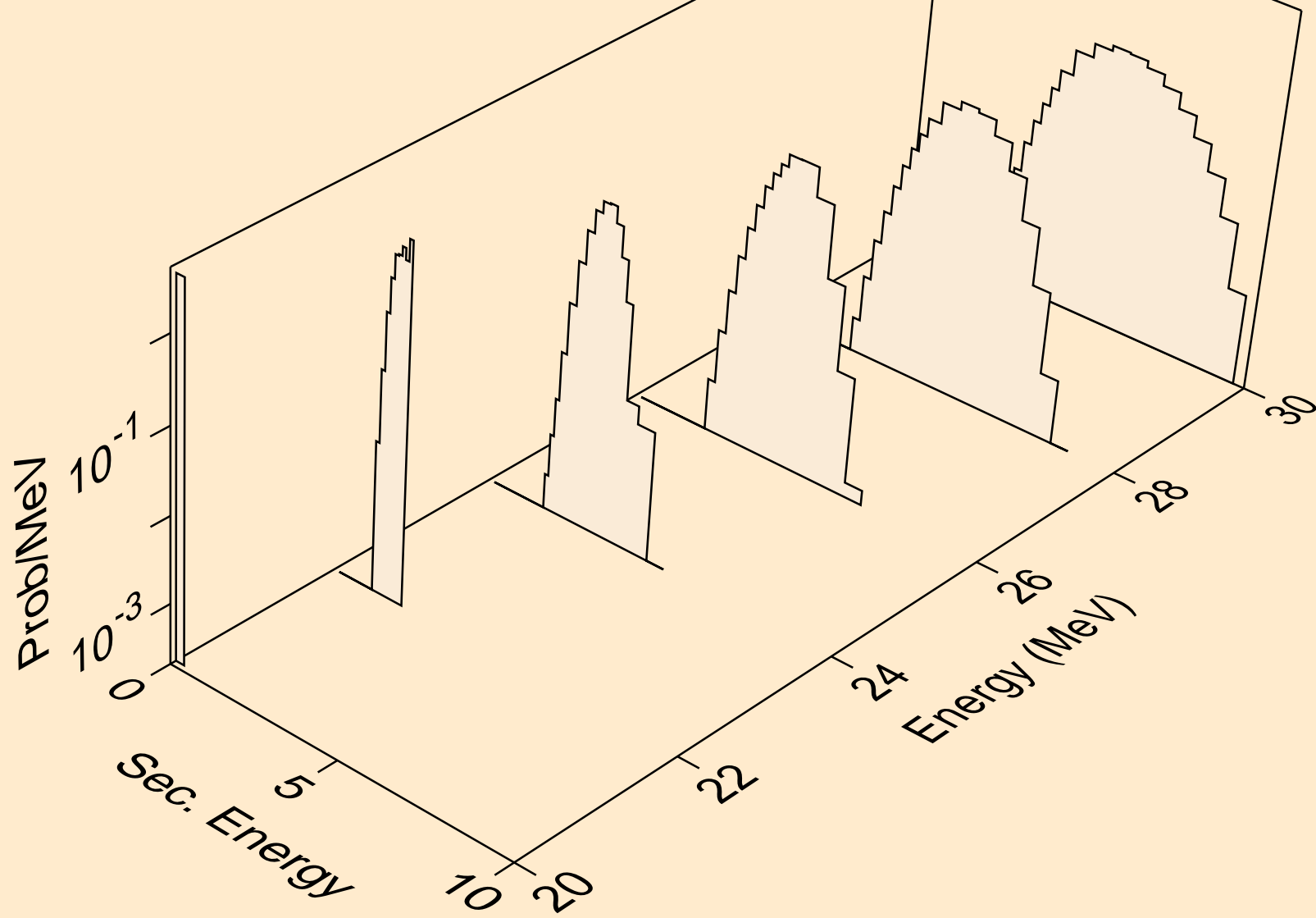

IR172M NEUTRON ACER TENDL-2021 LIBRARY; T=293.6K
protons from (n,2np)

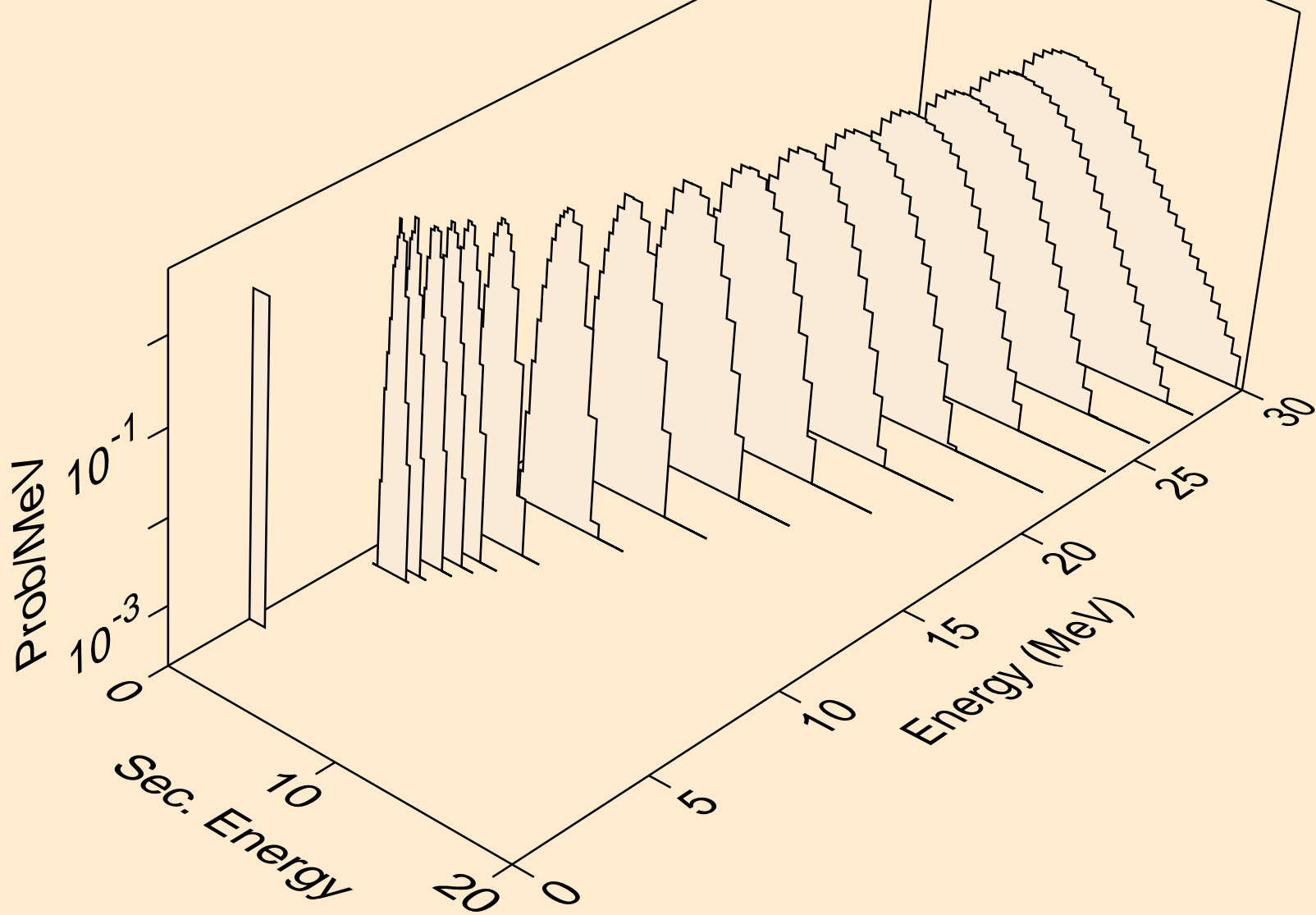

IR172M NEUTRON ACER TENDL-2021 LIBRARY; T=293.6K
protons from (n,npa)

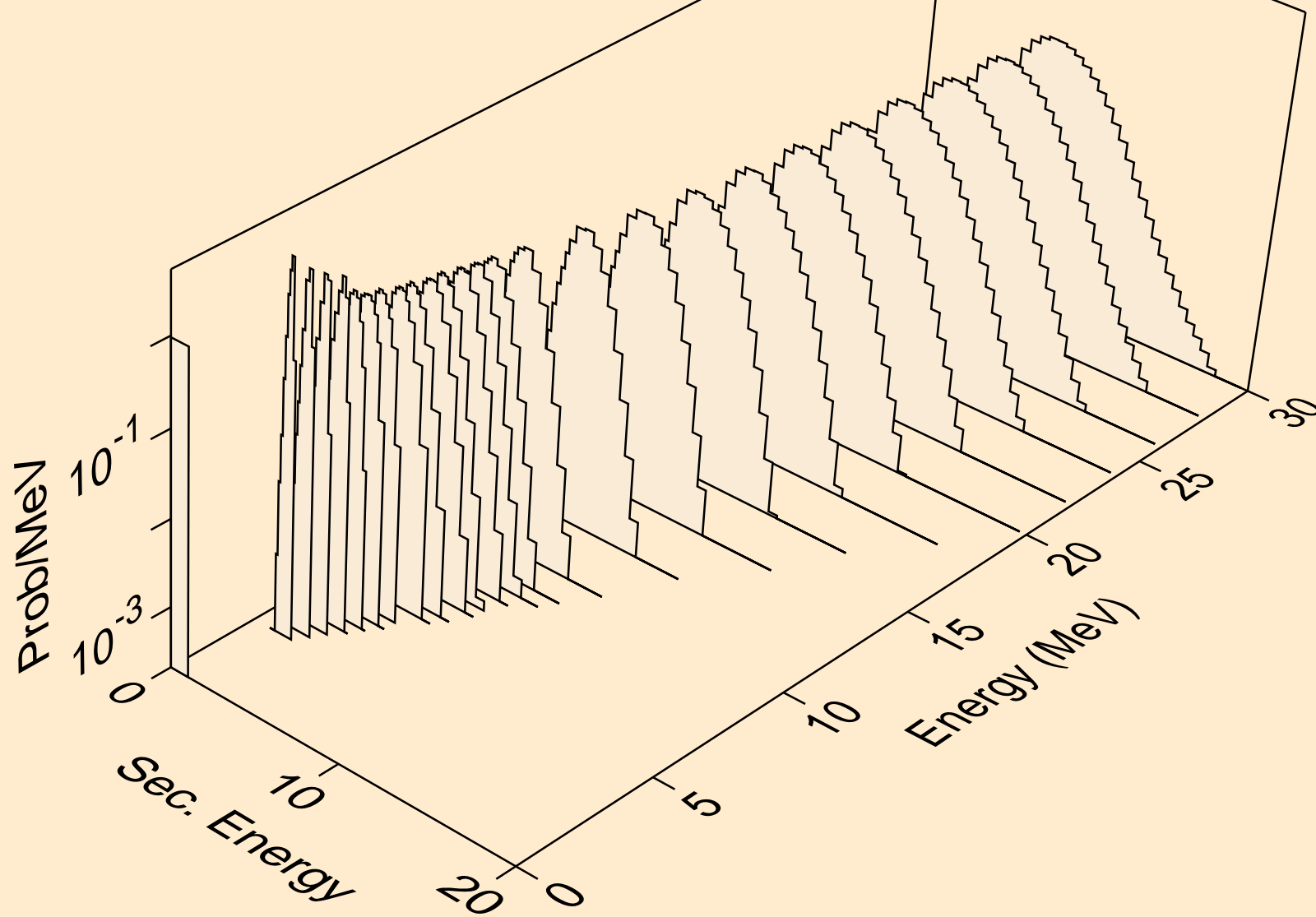

IR172M NEUTRON ACER TENDL-2021 LIBRARY; T=293.6K
protons from (n,p)

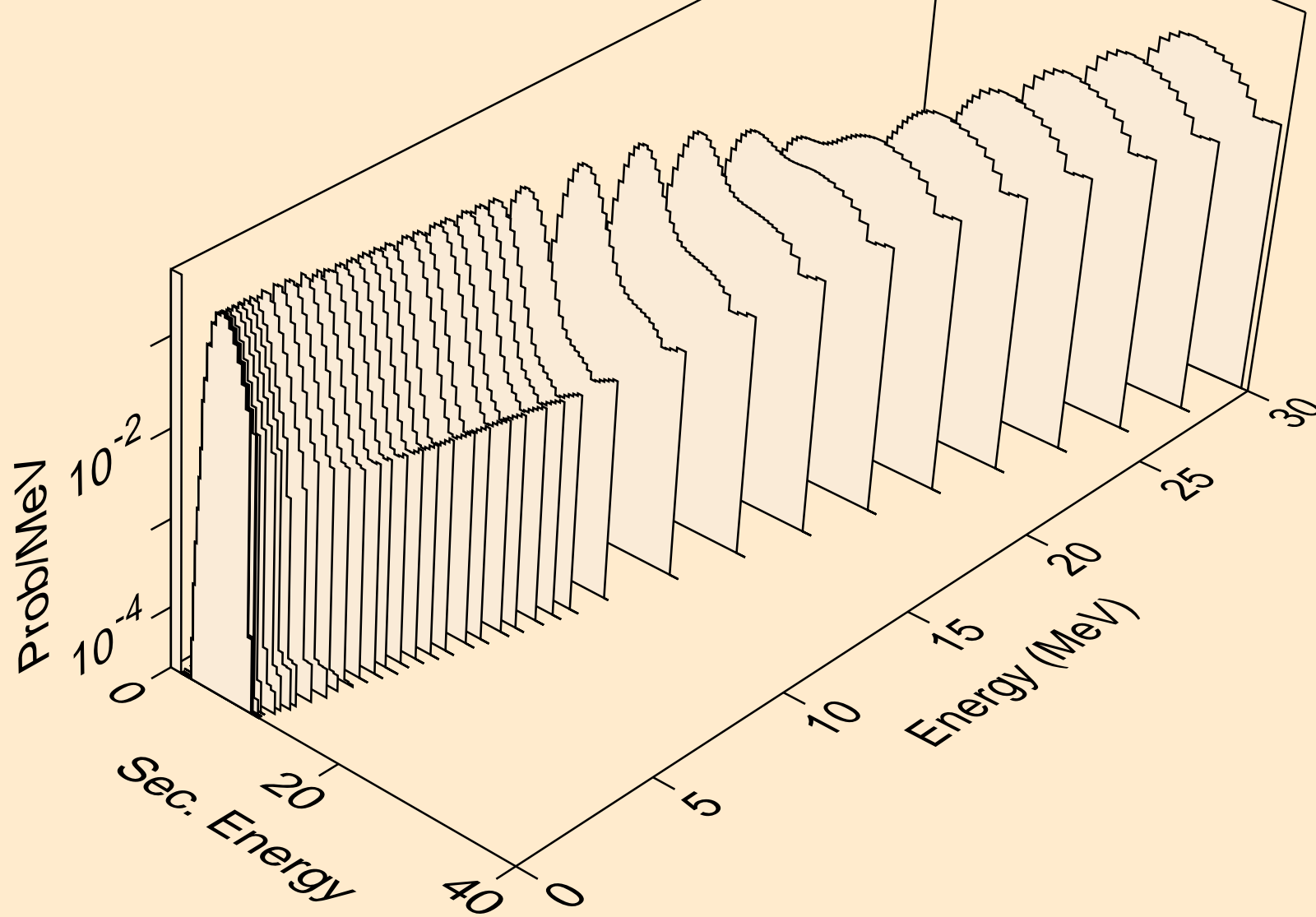

IR172M NEUTRON ACER TENDL-2021 LIBRARY; T=293.6K
protons from (n,2p)

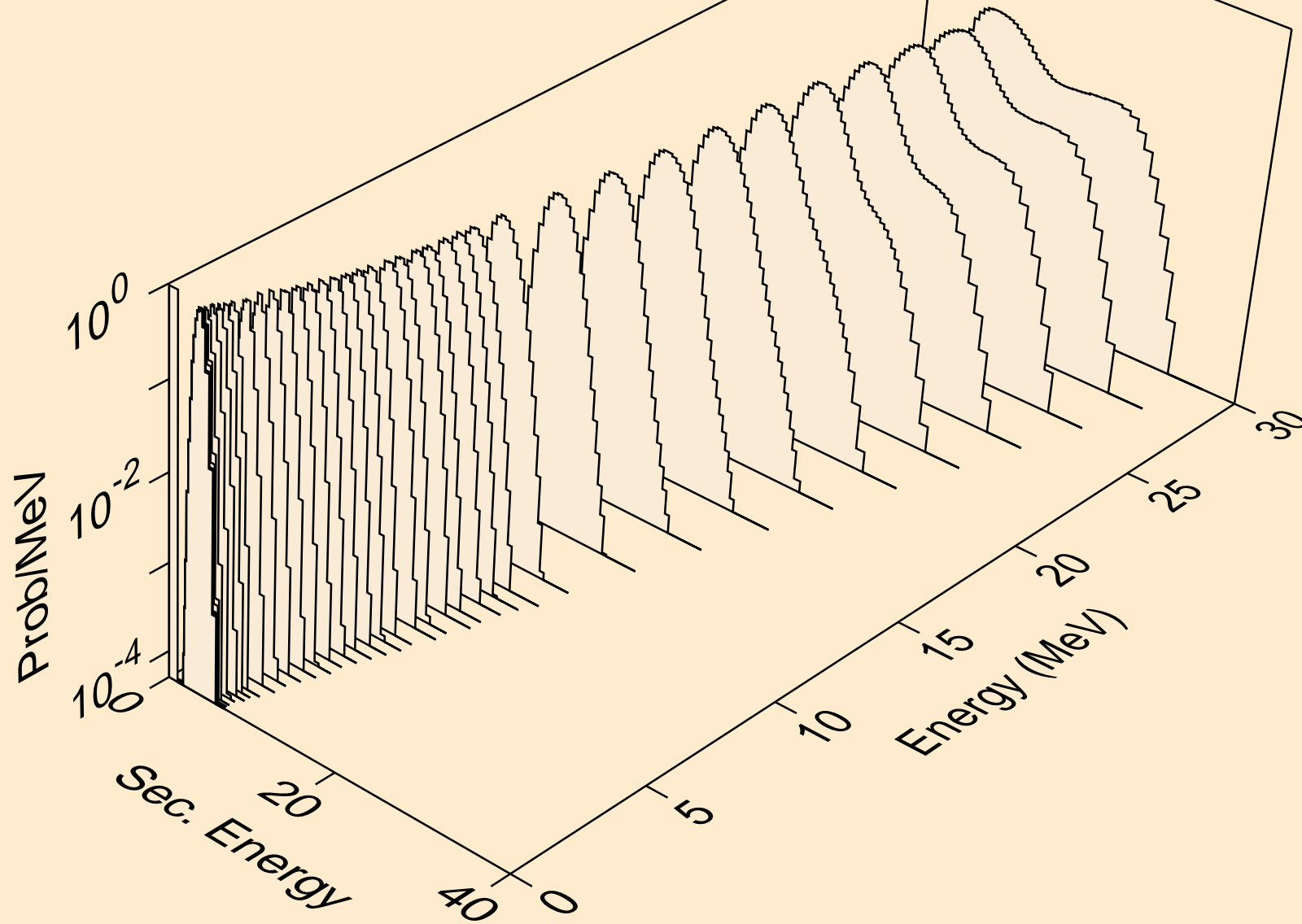

IR172M NEUTRON ACER TENDL-2021 LIBRARY; T=293.6K
protons from (n,p)

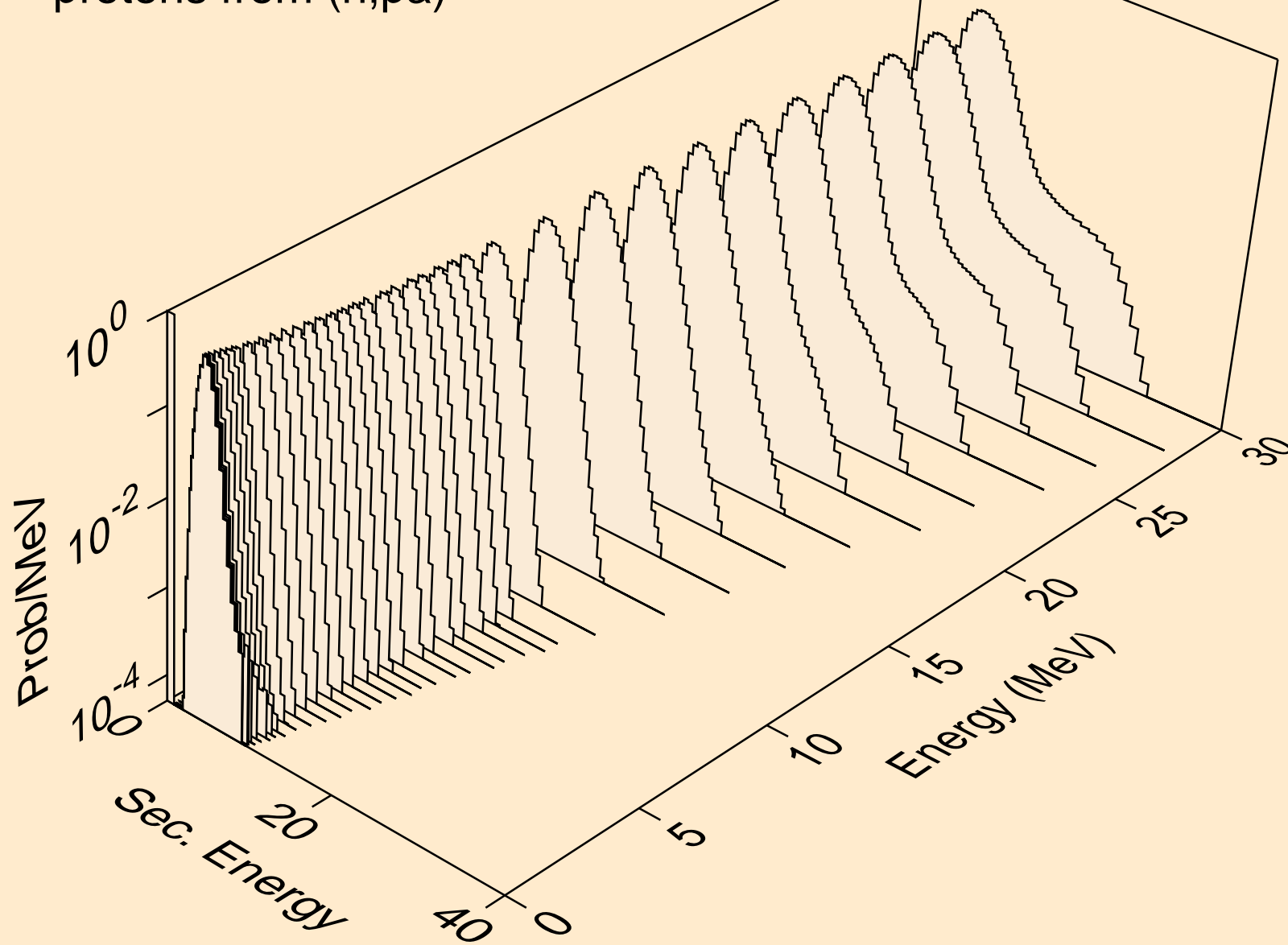

IR172M NEUTRON ACER TENDL-2021 LIBRARY; T=293.6K
protons from (n,pd)

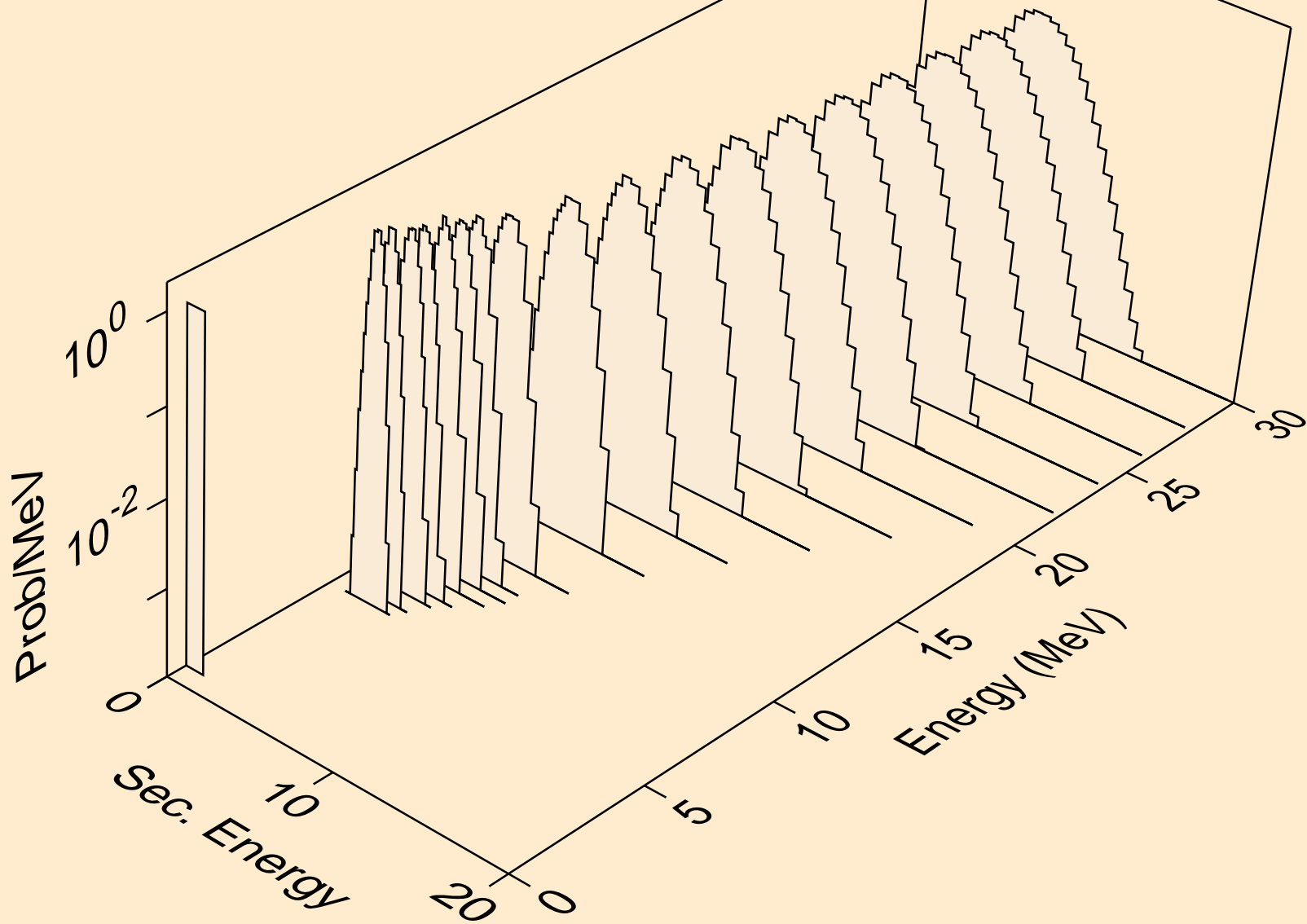

IR172M NEUTRON ACER TENDL-2021 LIBRARY; T=293.6K
protons from (n,pt)

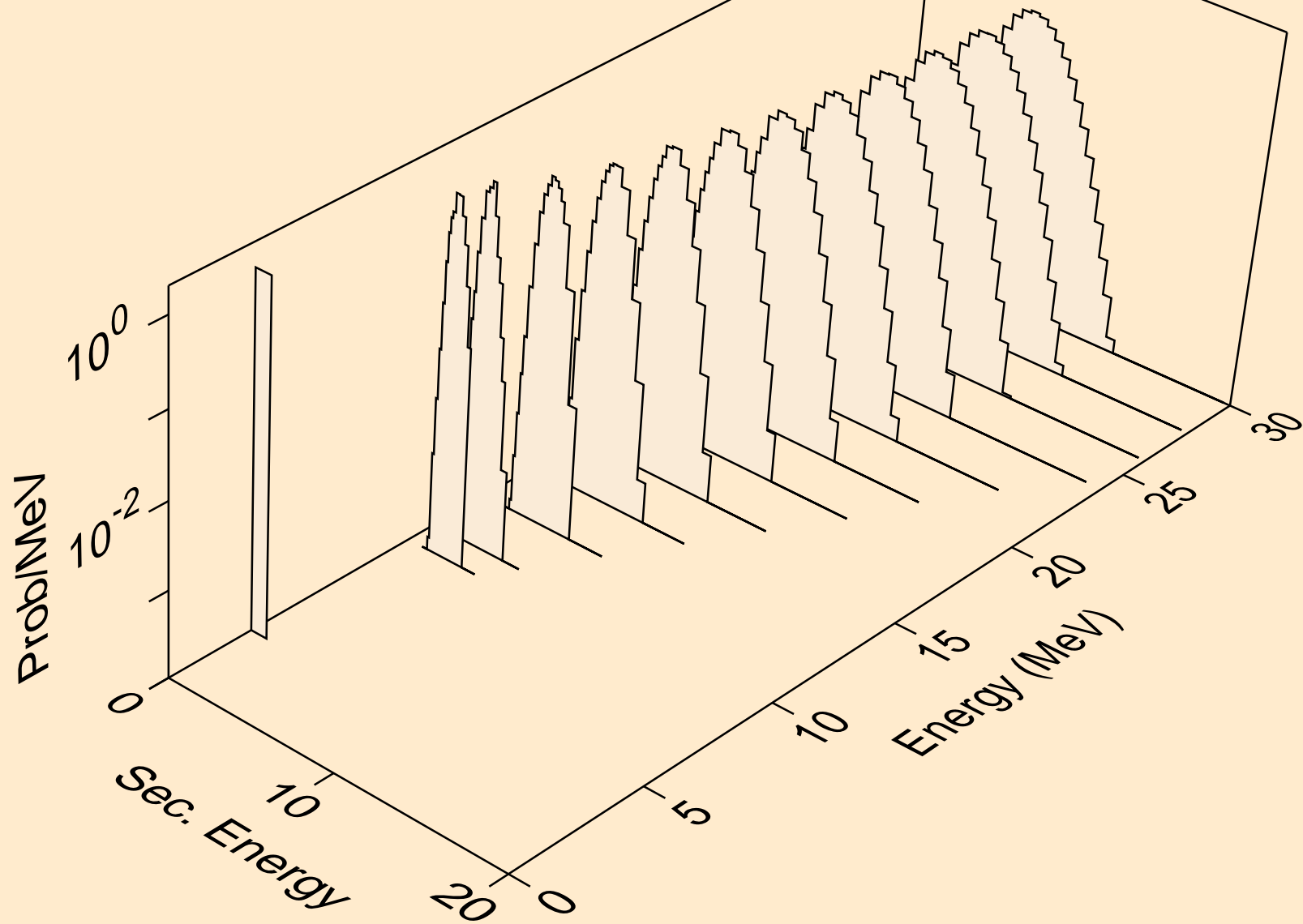

IR172M NEUTRON ACER TENDL-2021 LIBRARY; T=293.6K
deuterons from (n,x)

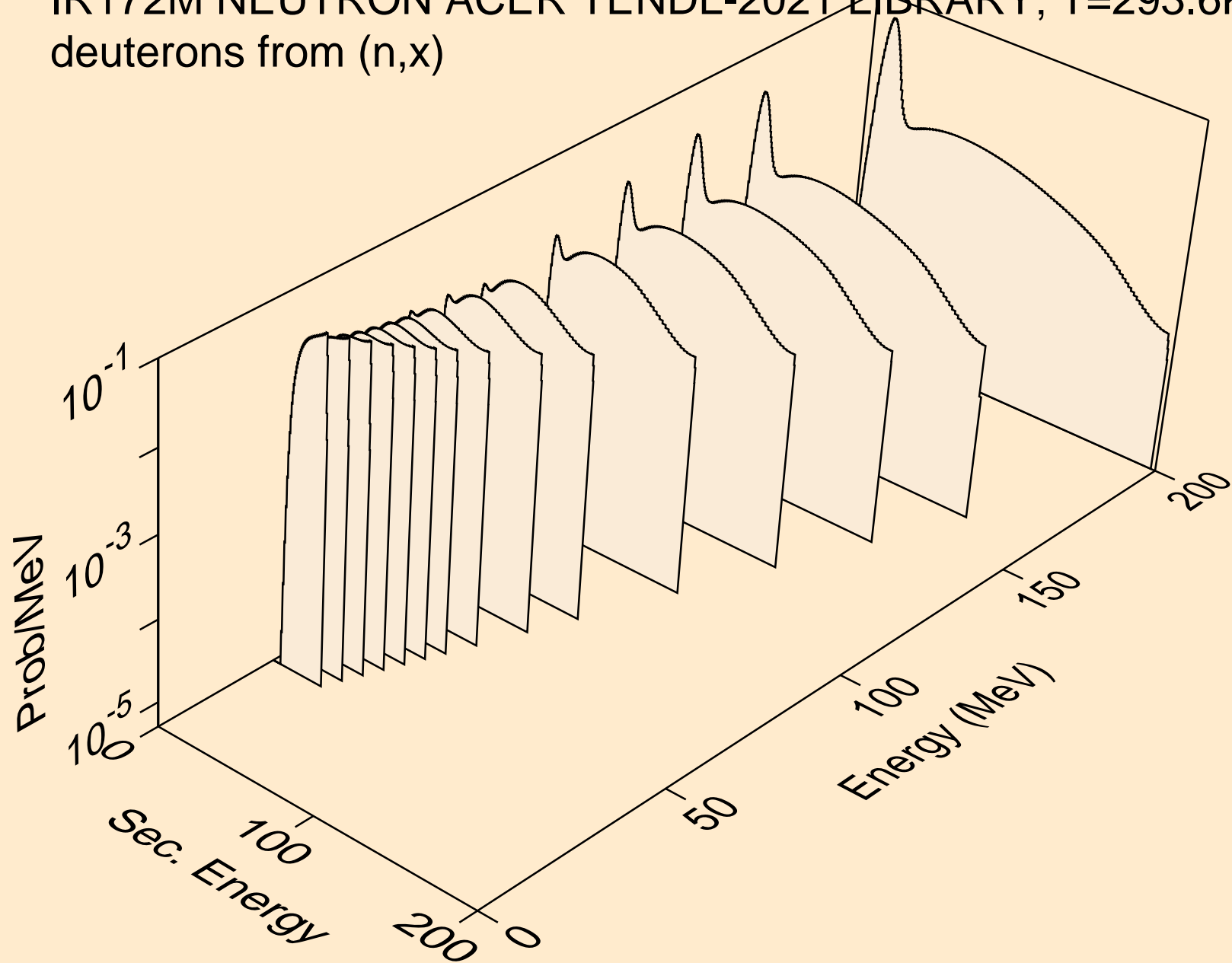

IR172M NEUTRON ACER TENDL-2021 LIBRARY; T=293.6K
deuterons from (n,2nd)

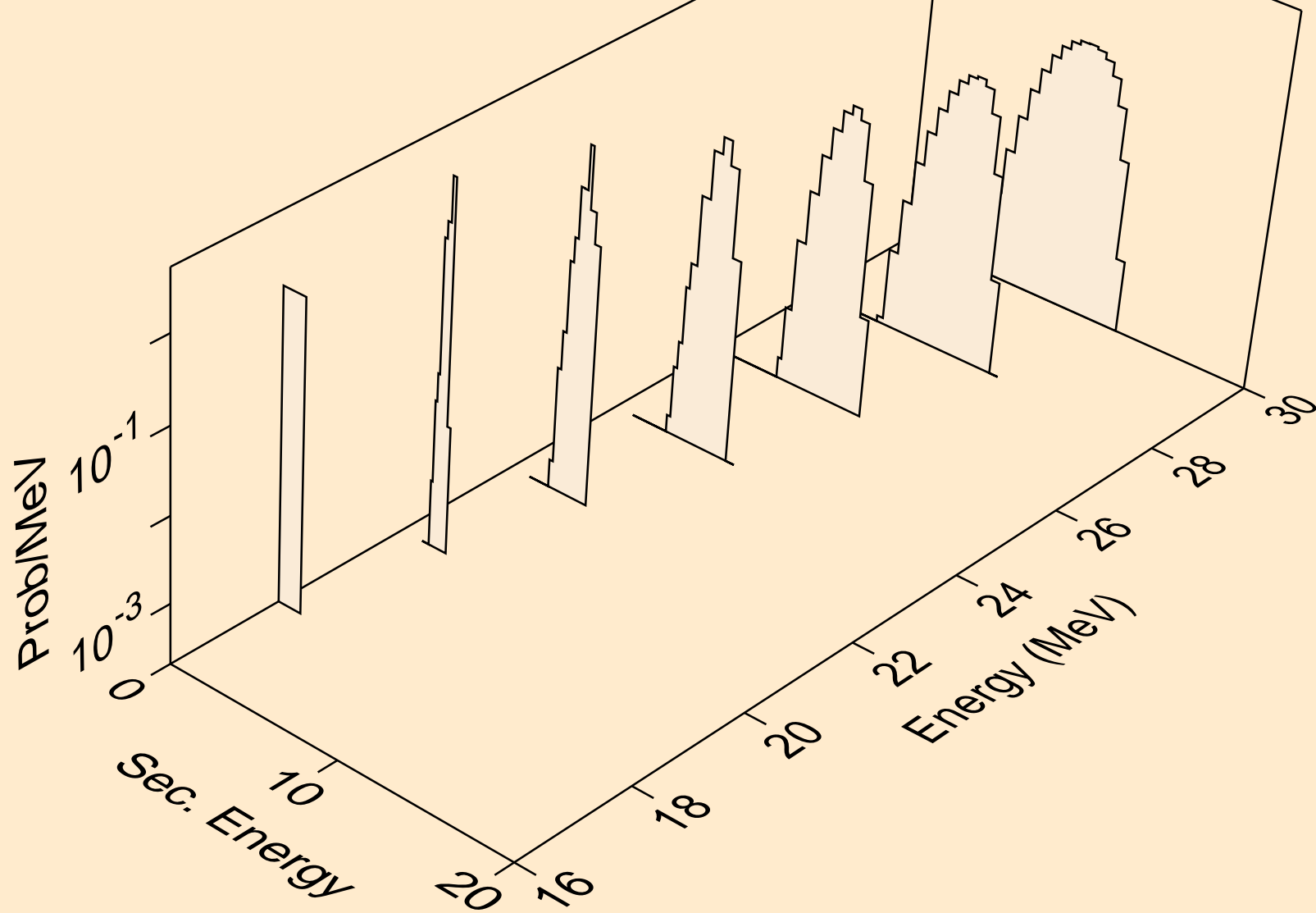

IR172M NEUTRON ACER TENDL-2021 LIBRARY; T=293.6K
deuterons from (n,n*)d

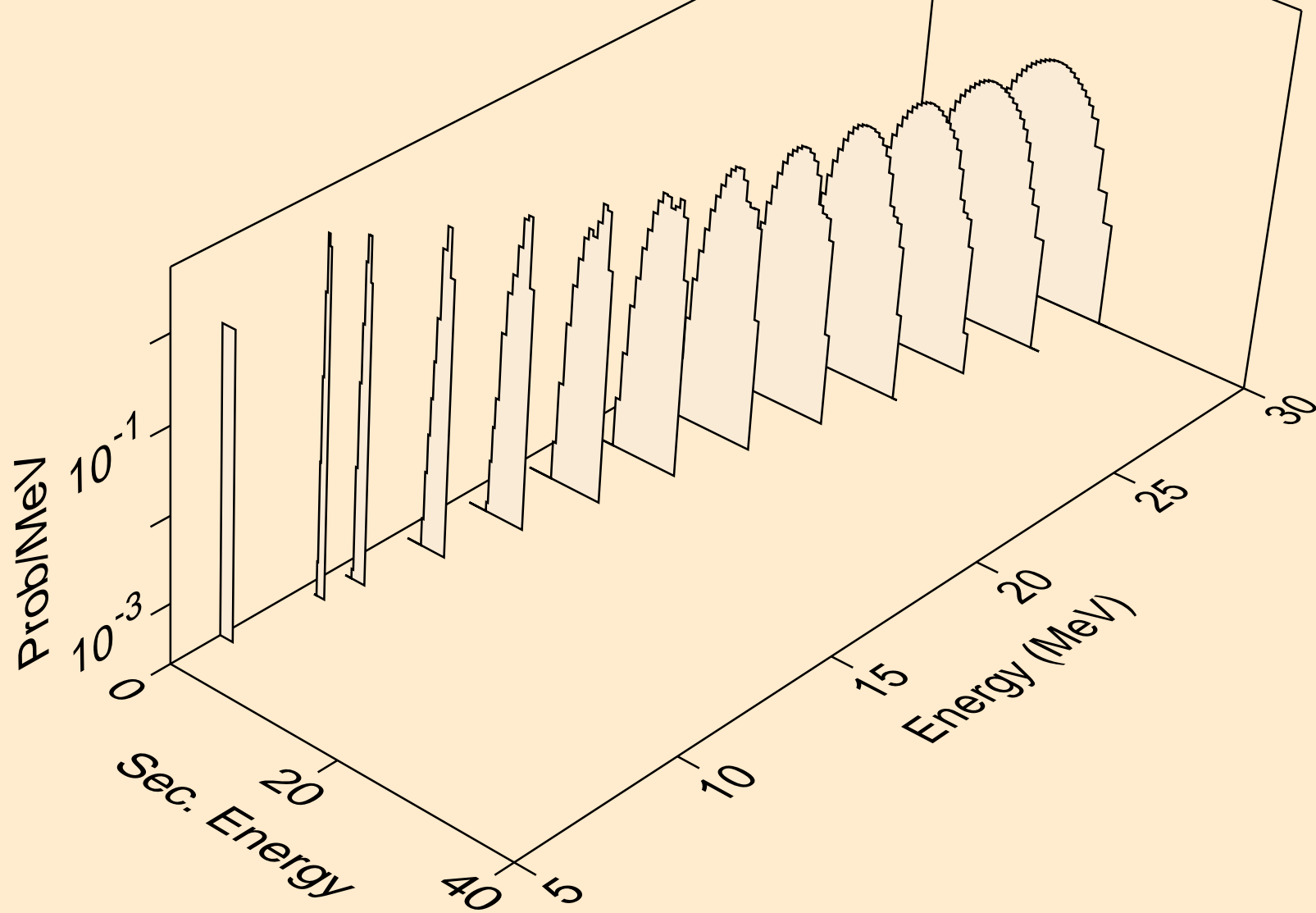

IR172M NEUTRON ACER TENDL-2021 LIBRARY; T=293.6K
deuterons from (n,d)

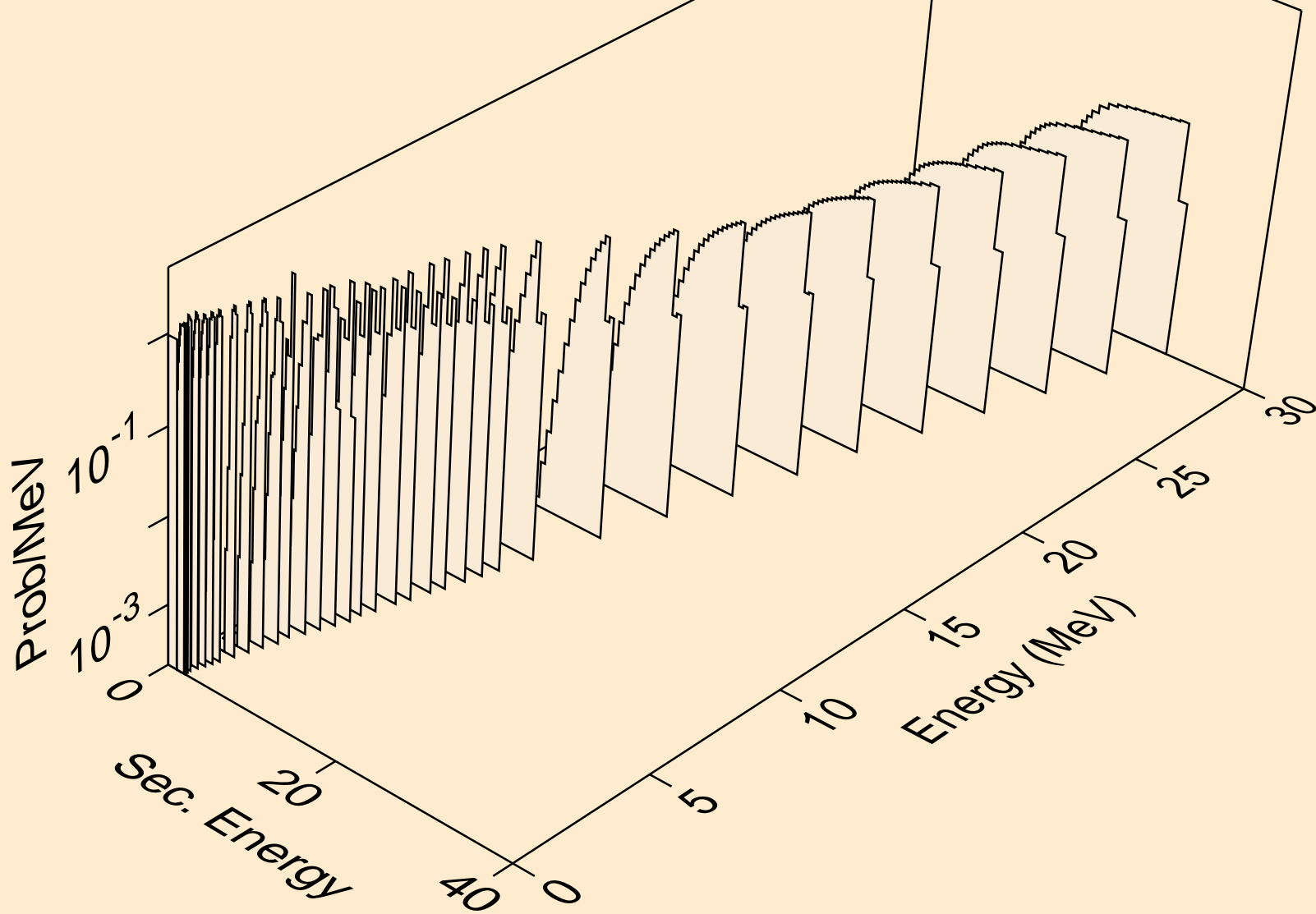

IR172M NEUTRON ACER TENDL-2021 LIBRARY; T=293.6K
deuterons from (n,d2a)

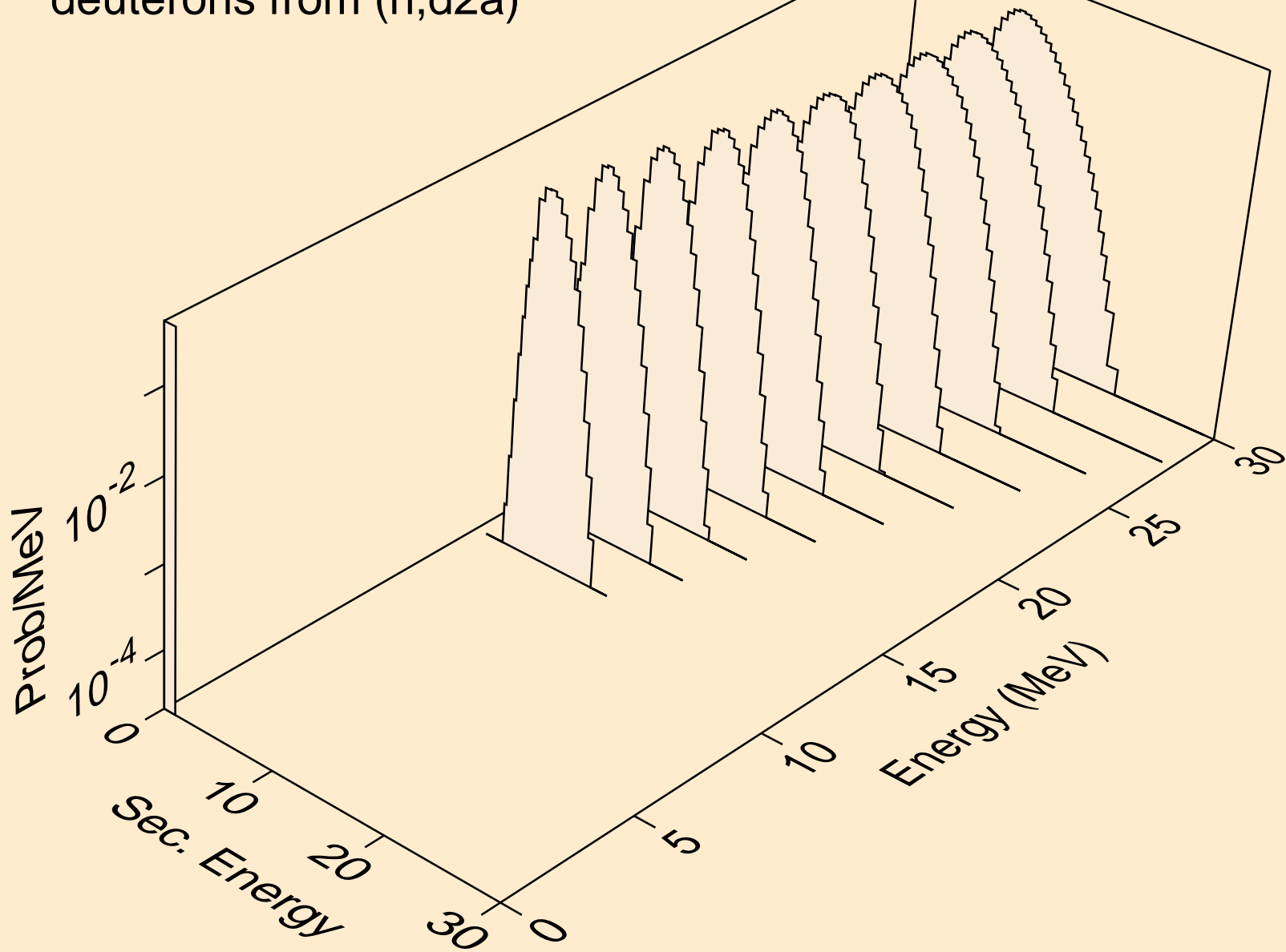

IR172M NEUTRON ACER TENDL-2021 LIBRARY; T=293.6K
deuterons from (n,pd)

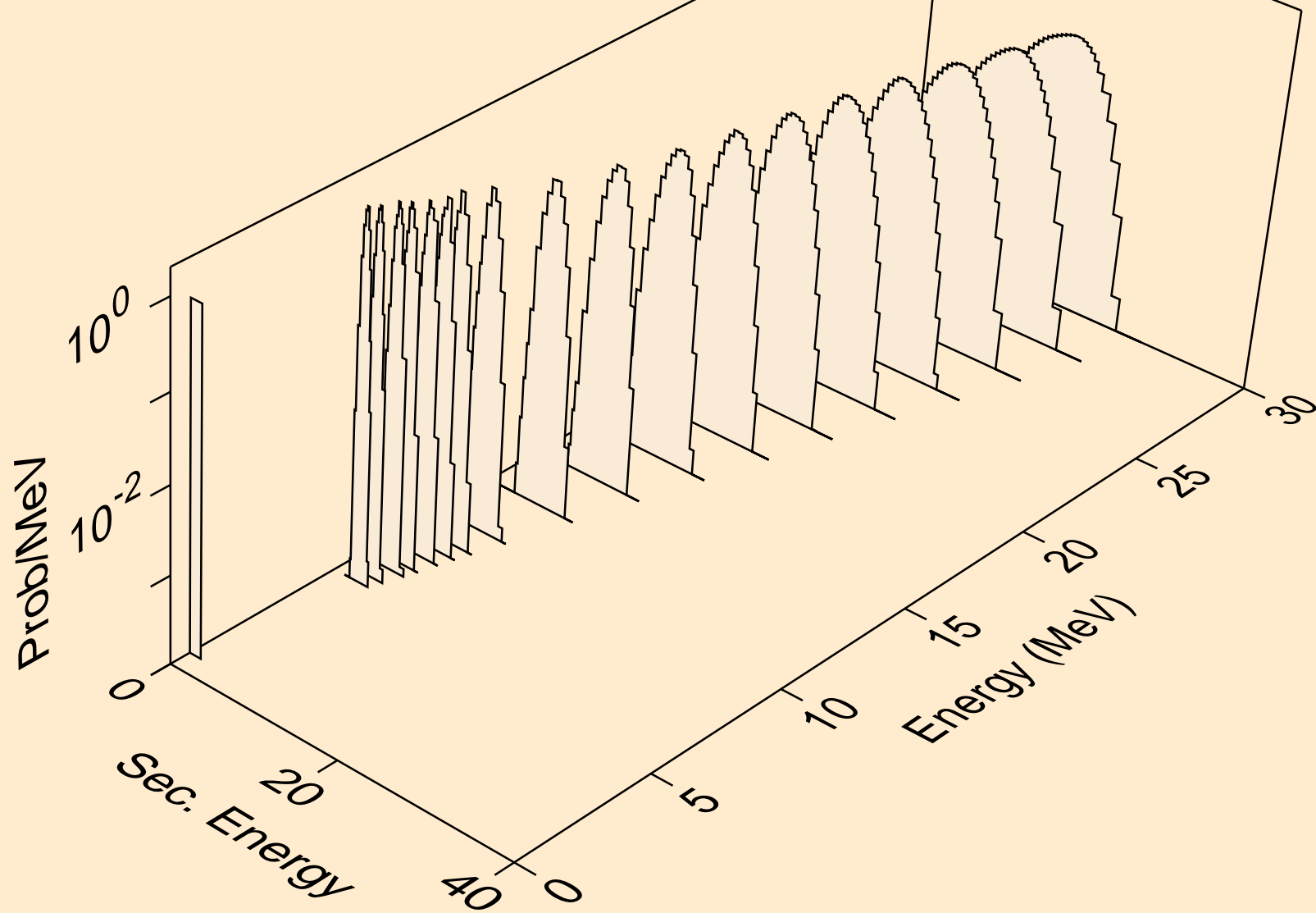

IR172M NEUTRON ACER TENDL-2021 LIBRARY; T=293.6K
deuterons from (n,da)

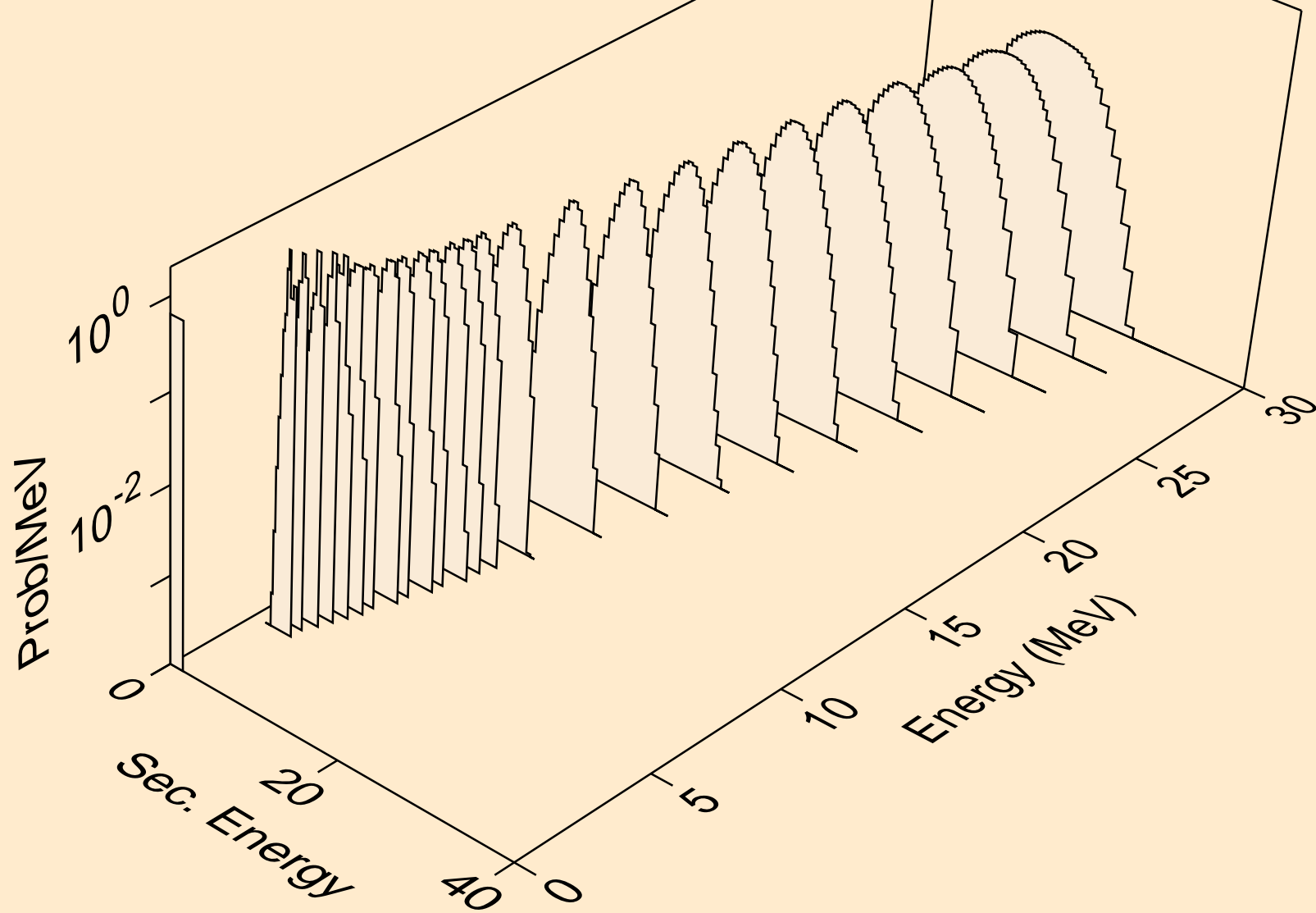

IR172M NEUTRON ACER TENDL-2021 LIBRARY; T=293.6K
tritons from (n,x)

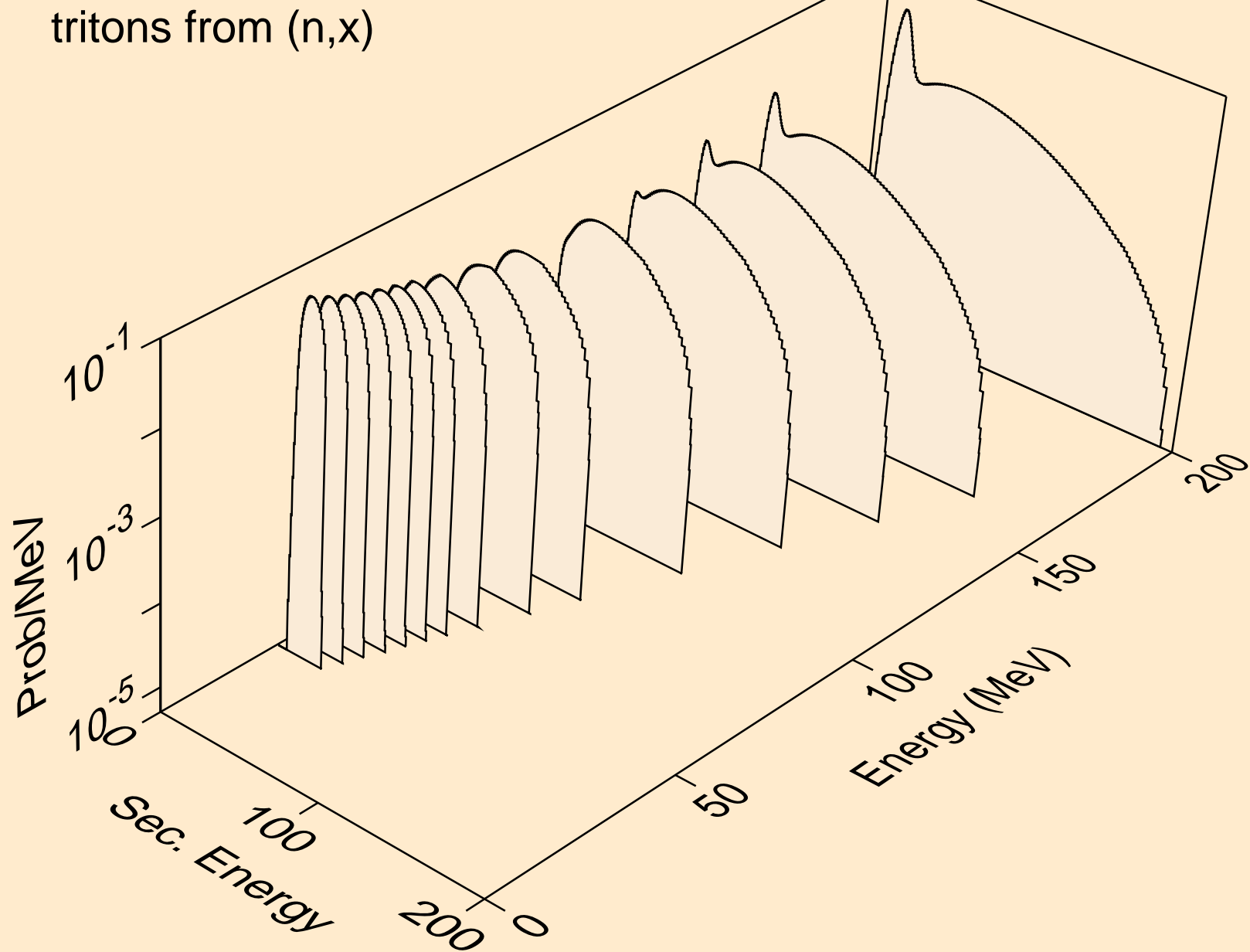

IR172M NEUTRON ACER TENDL-2021 LIBRARY; T=293.6K
tritons from (n,n*)t

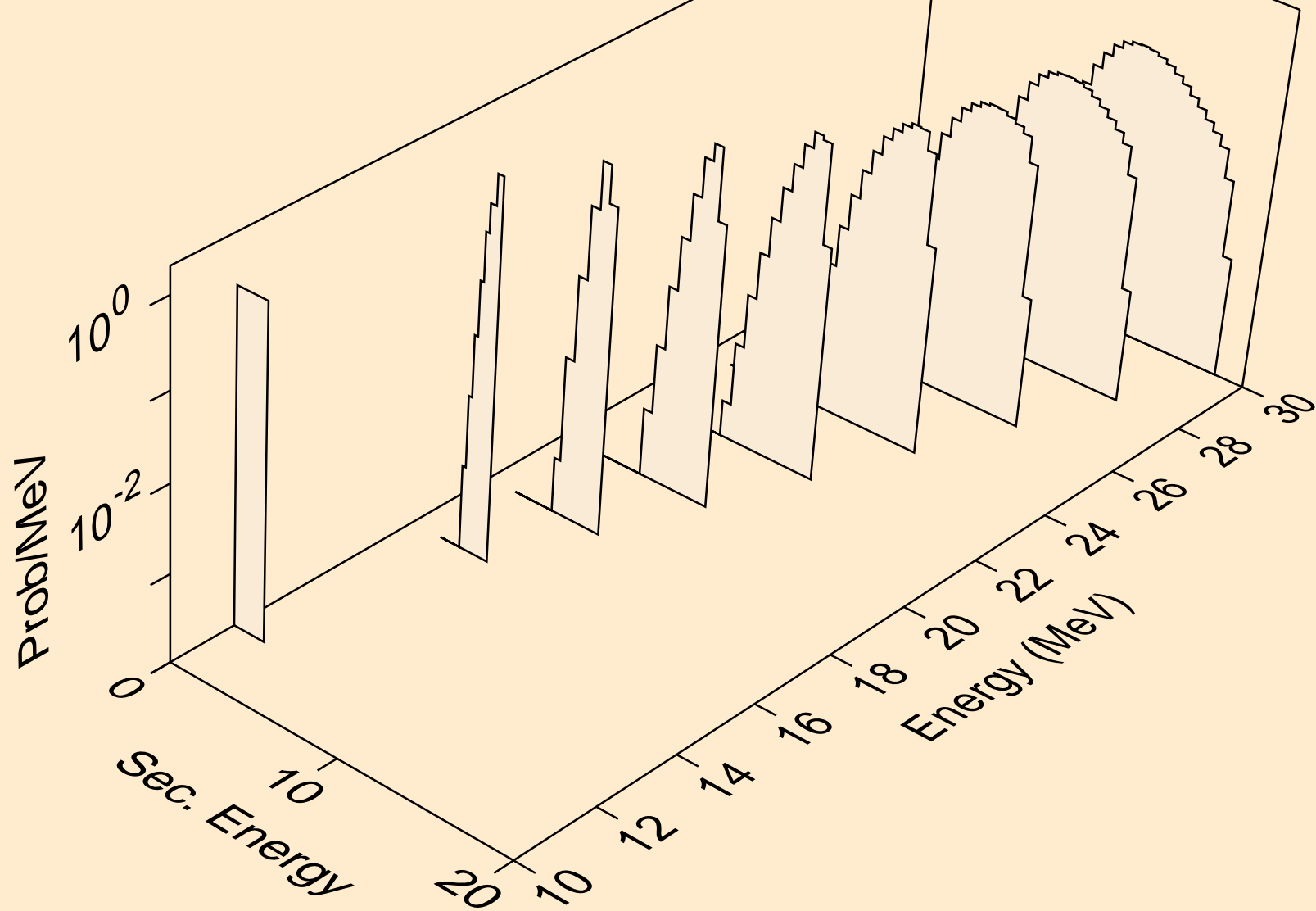

IR172M NEUTRON ACER TENDL-2021 LIBRARY; T=293.6K
tritons from (n,t)

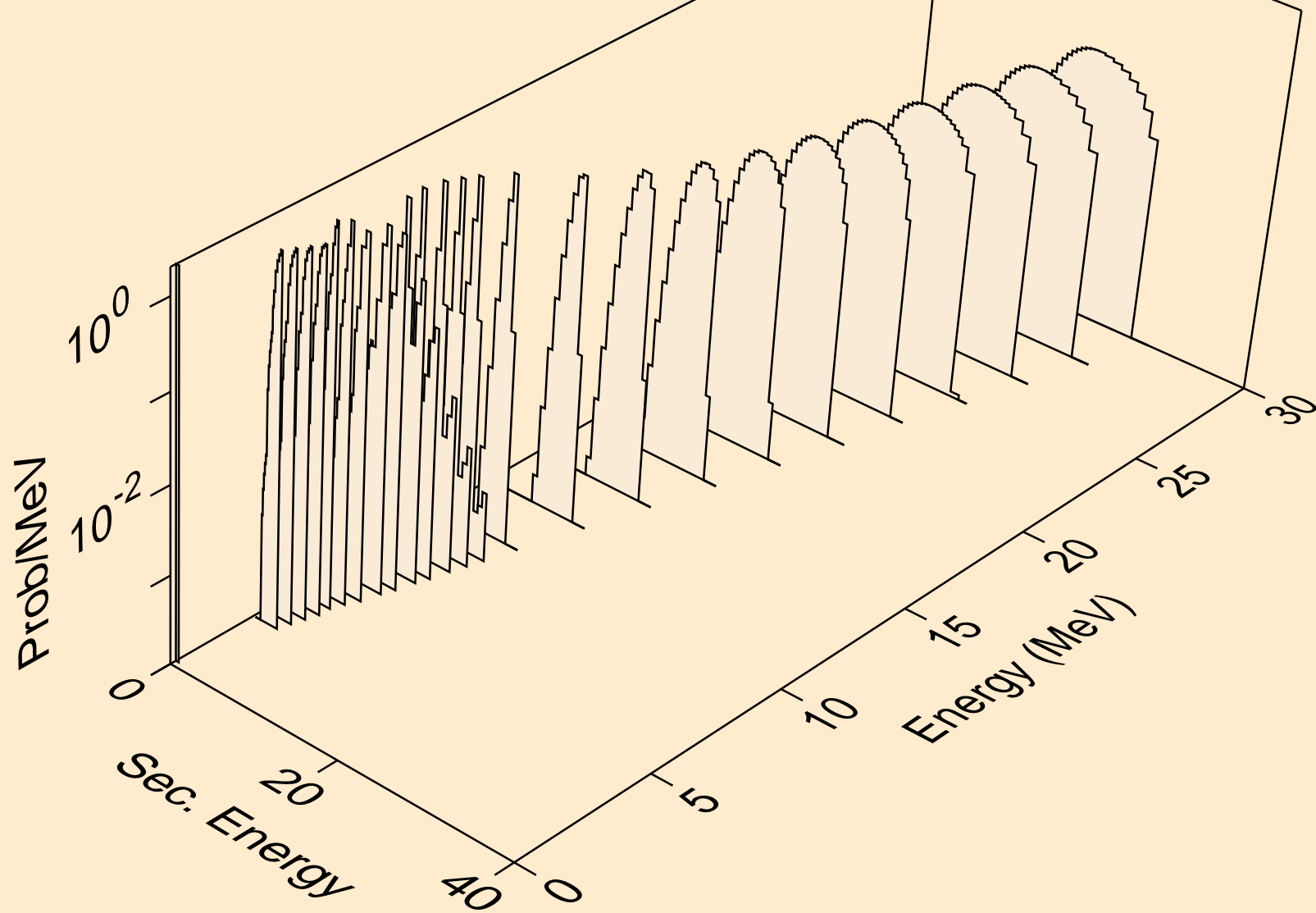

IR172M NEUTRON ACER TENDL-2021 LIBRARY; T=293.6K
tritons from (n,t2a)

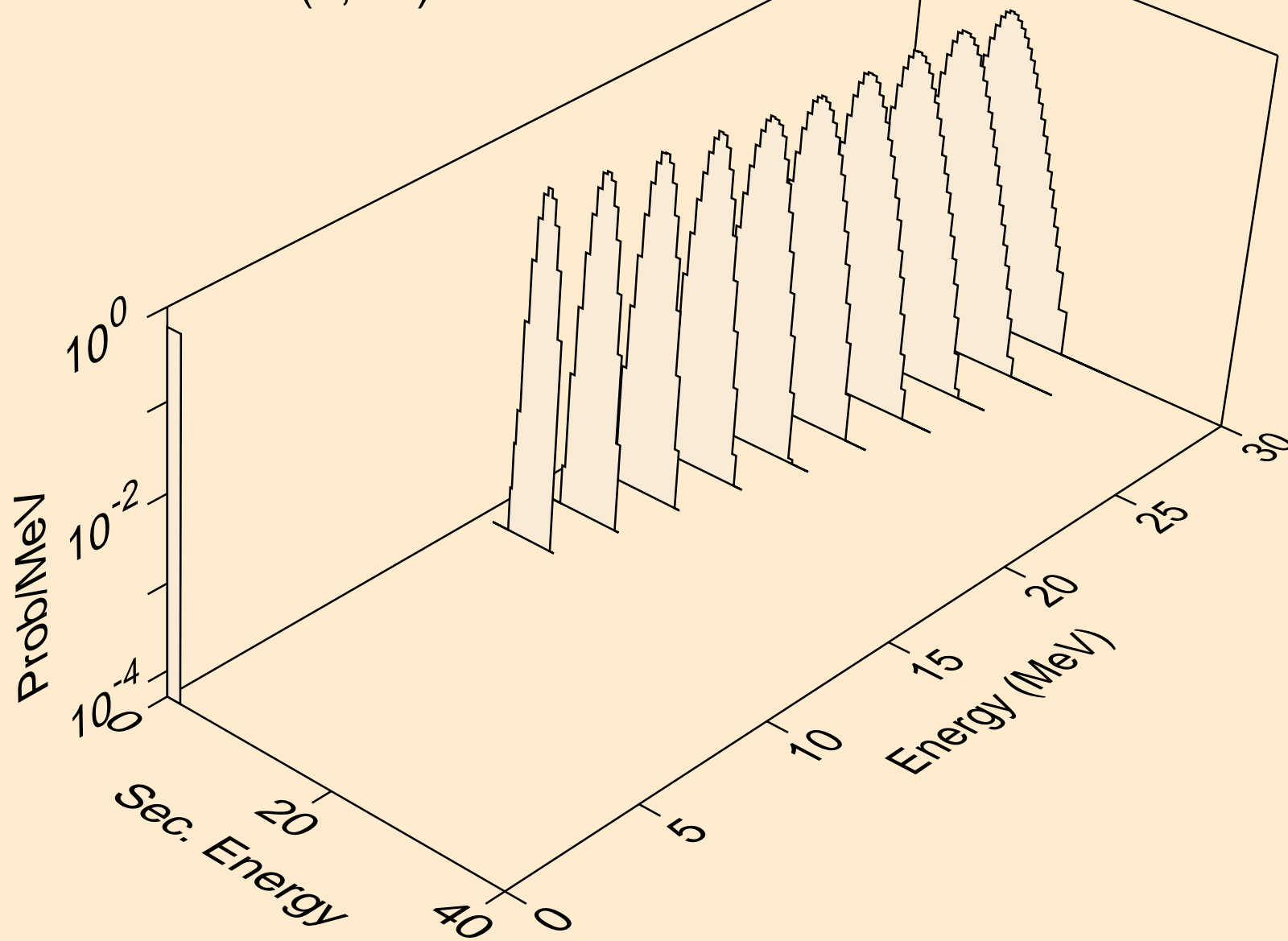

IR172M NEUTRON ACER TENDL-2021 LIBRARY; T=293.6K
tritons from (n,pt)

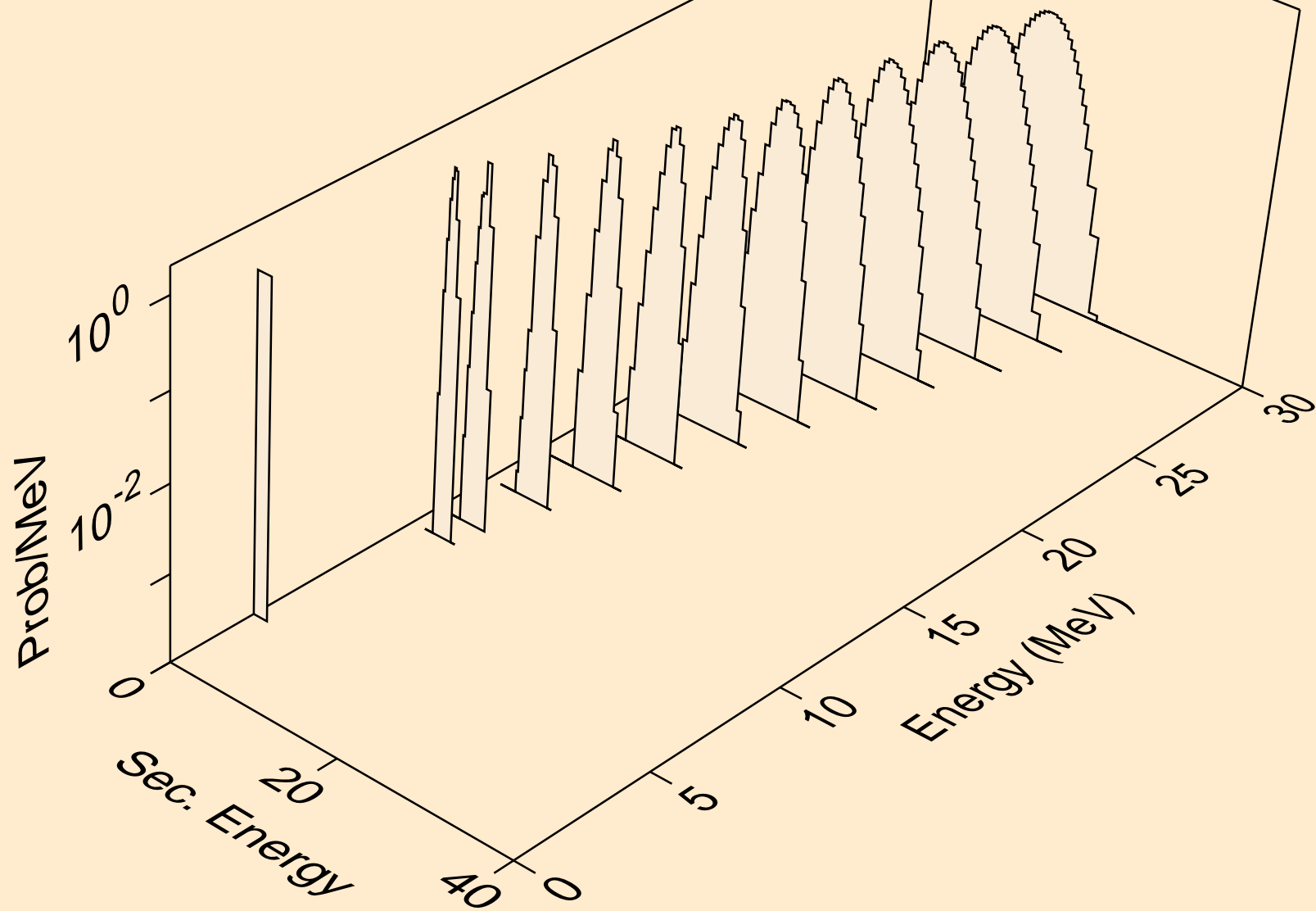

IR172M NEUTRON ACER TENDL-2021 LIBRARY; T=293.6K
he3s from (n,x)

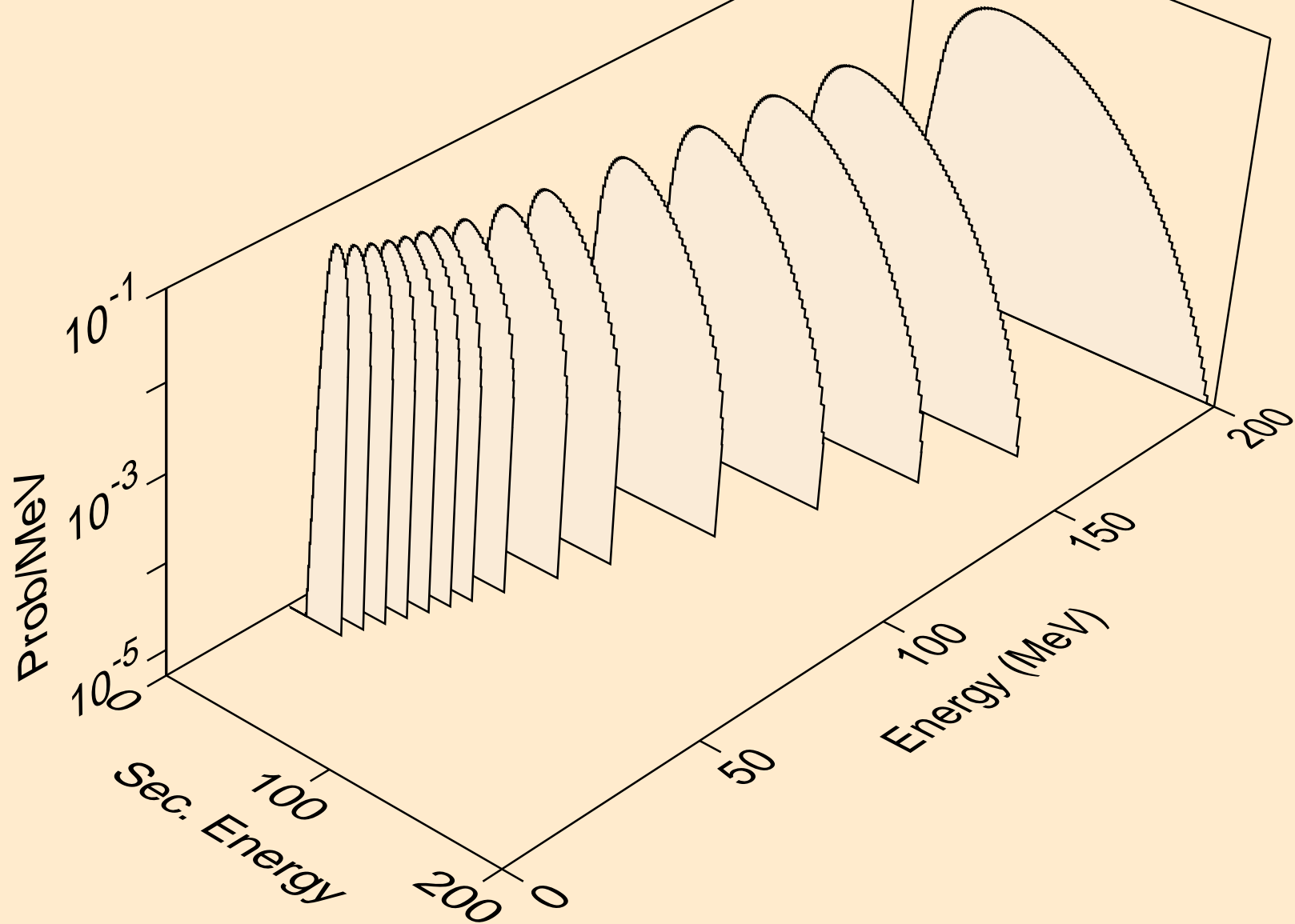

IR172M NEUTRON ACER TENDL-2021 LIBRARY; T=293.6K
he3s from (n,n*)he3

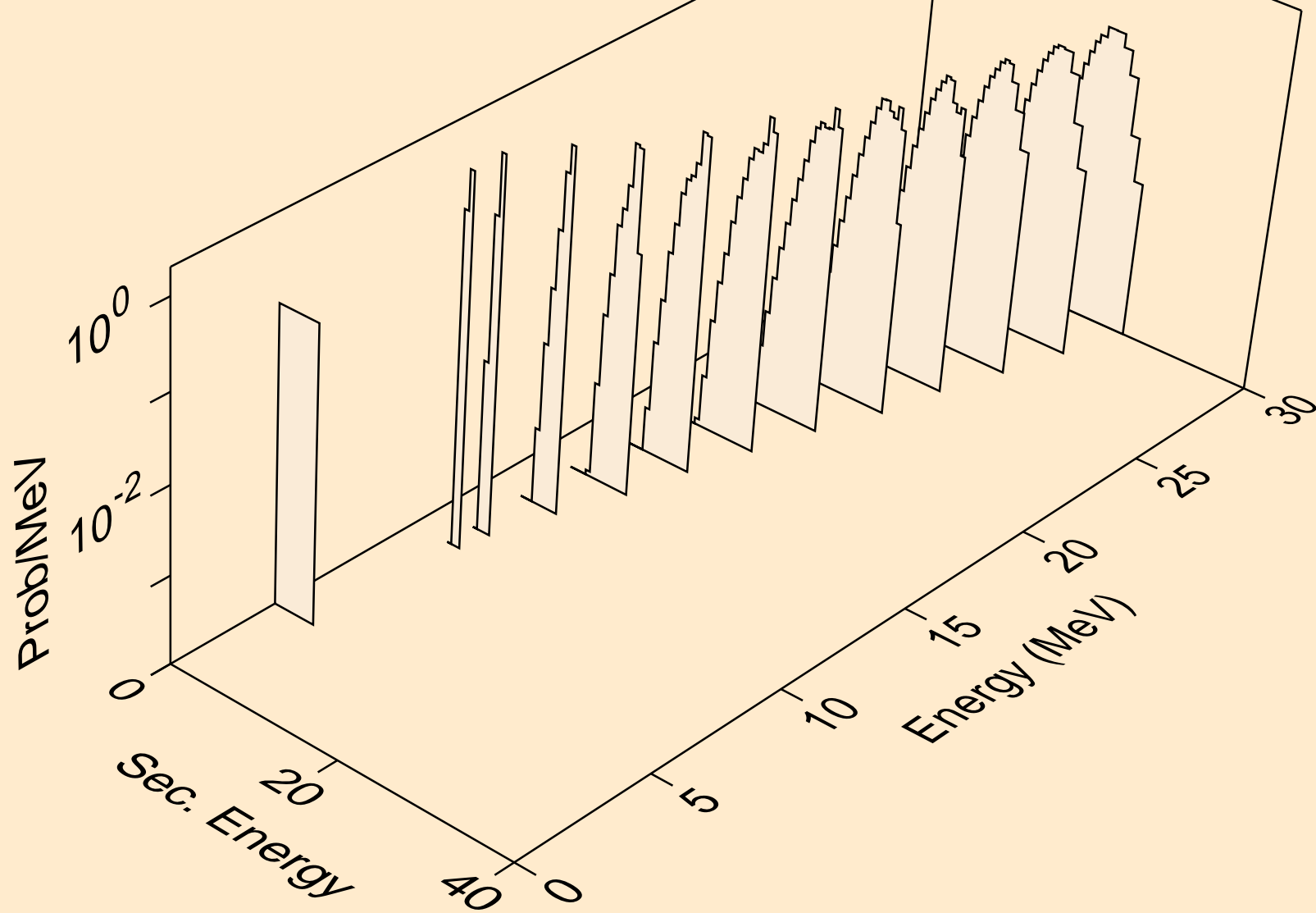

IR172M NEUTRON ACER TENDL-2021 LIBRARY; T=293.6K
he3s from (n,he3)

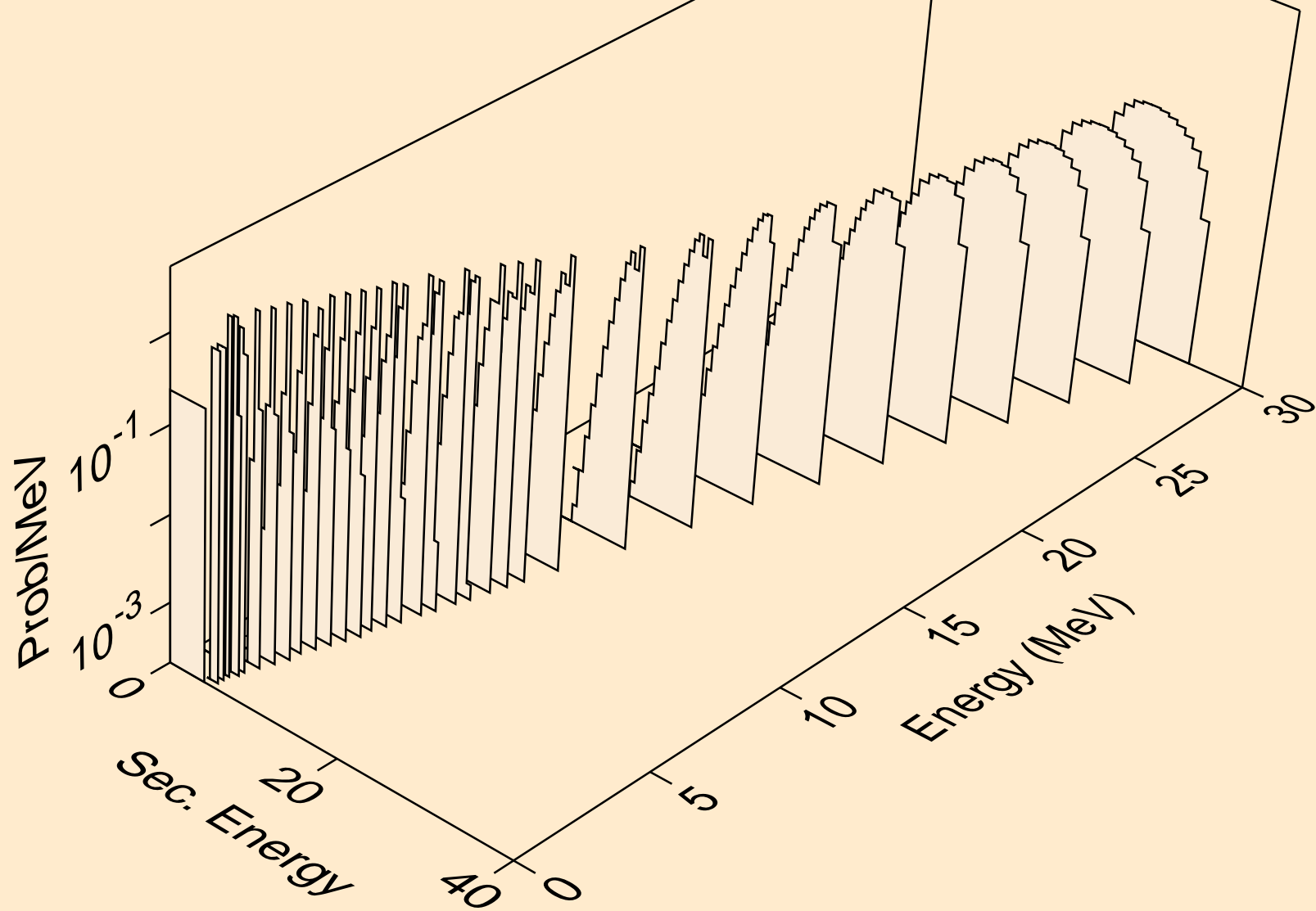

IR172M NEUTRON ACER TENDL-2021 LIBRARY; T=293.6K
alphas from (n,x)

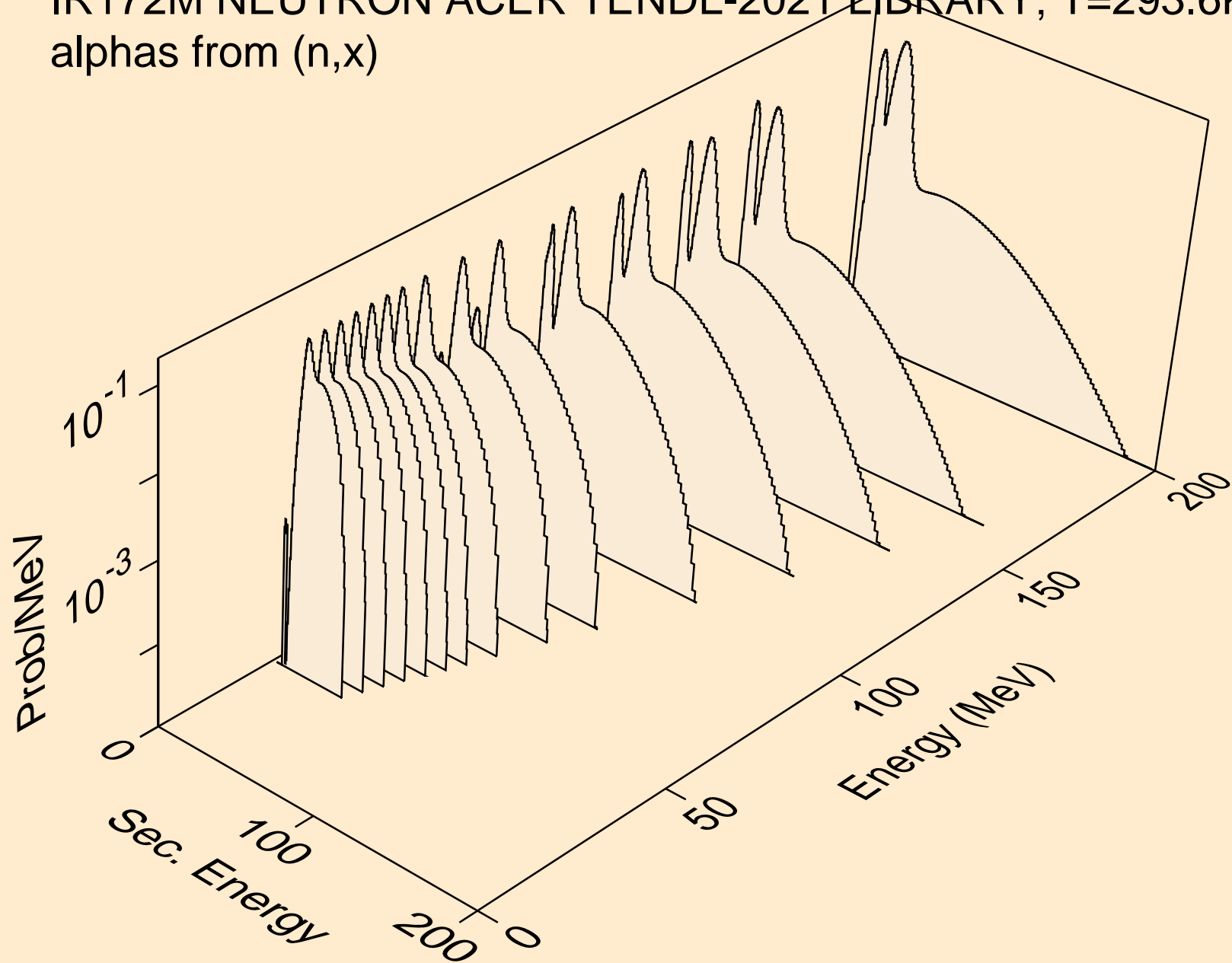

IR172M NEUTRON ACER TENDL-2021 LIBRARY; T=293.6K
alphas from (n,n*)a

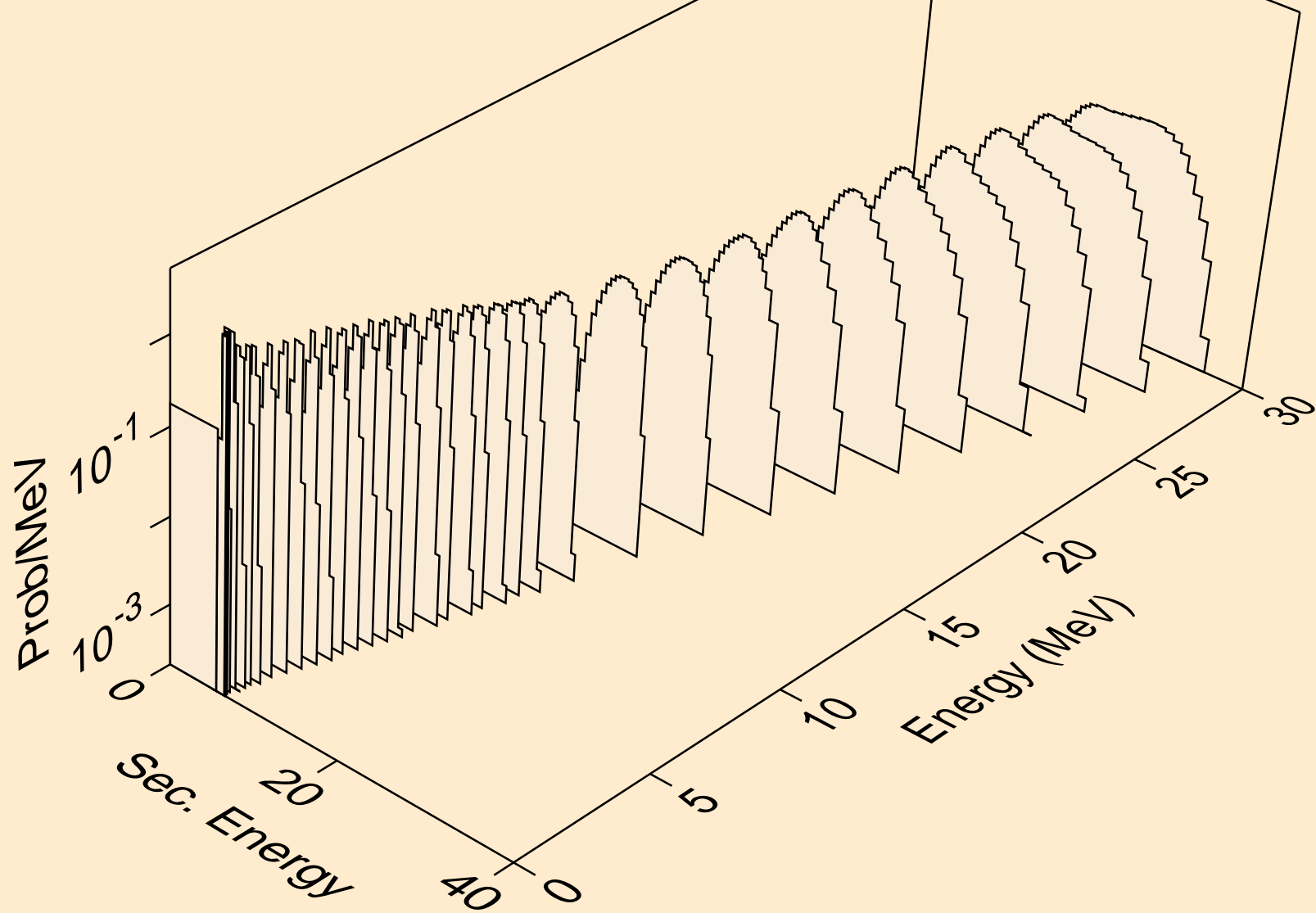

IR172M NEUTRON ACER TENDL-2021 LIBRARY; T=293.6K
alphas from (n,n*)3a

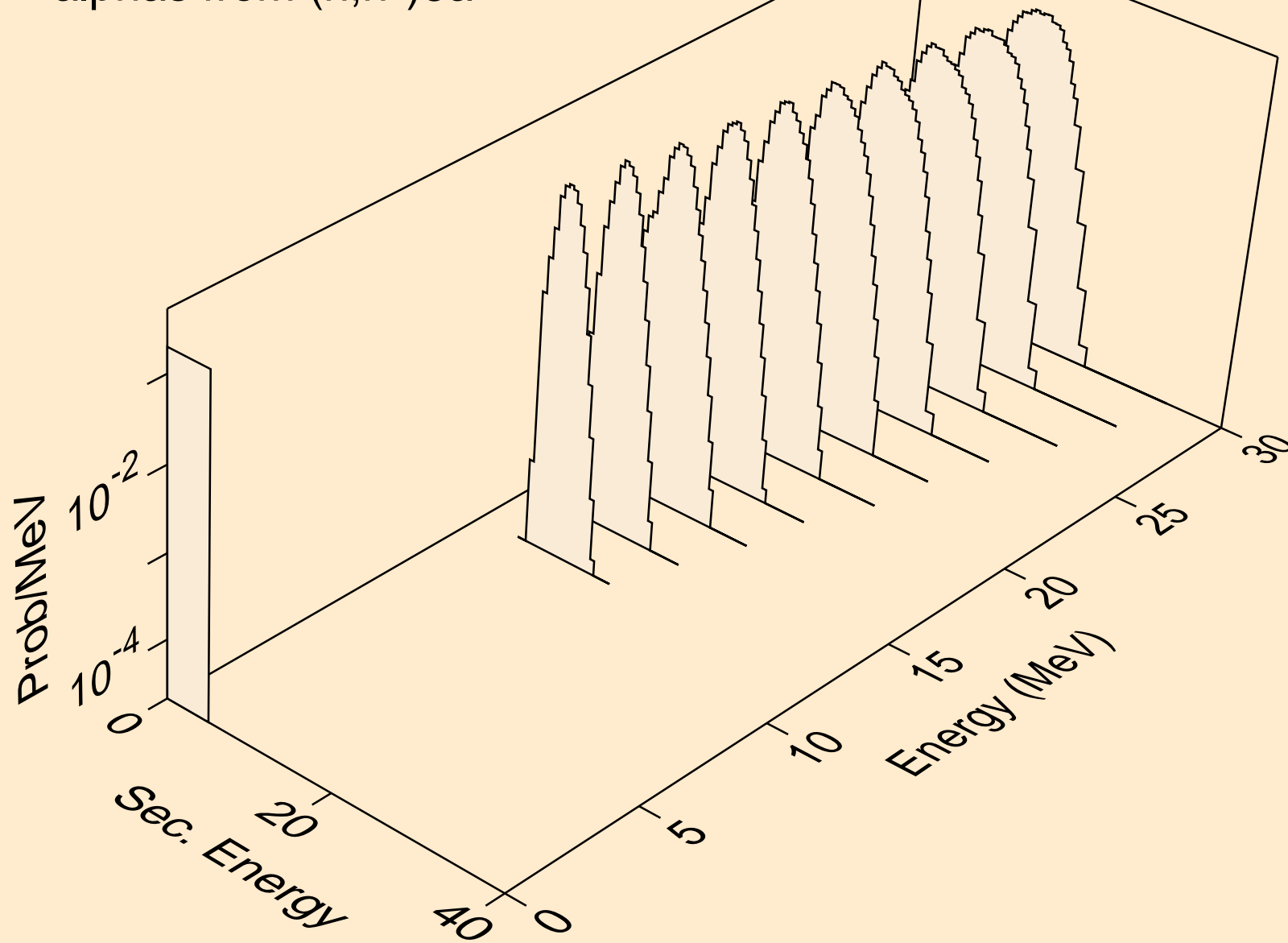

IR172M NEUTRON ACER TENDL-2021 LIBRARY; T=293.6K
alphas from (n,2n)a

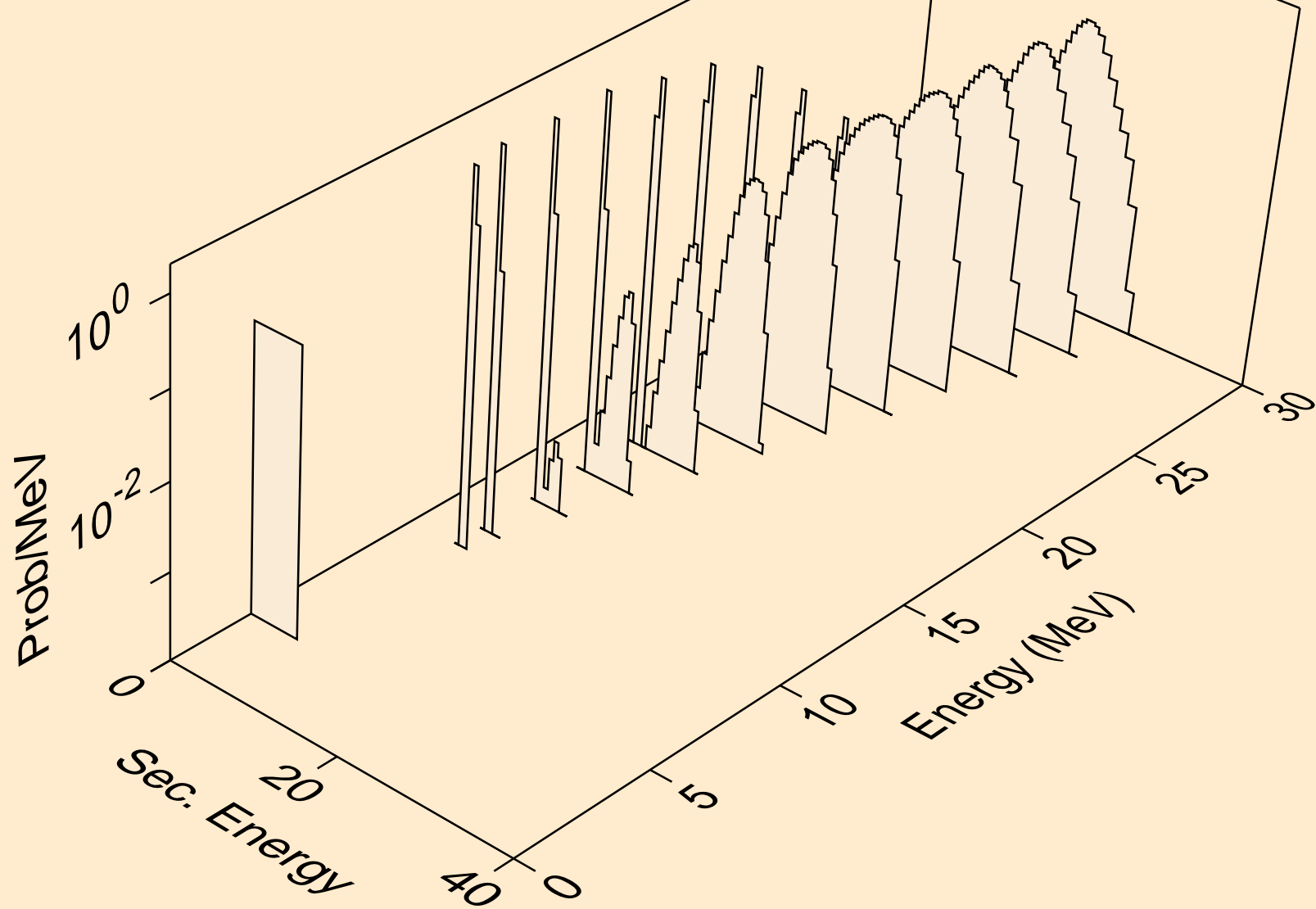

IR172M NEUTRON ACER TENDL-2021 LIBRARY; T=293.6K
alphas from (n,3n)a

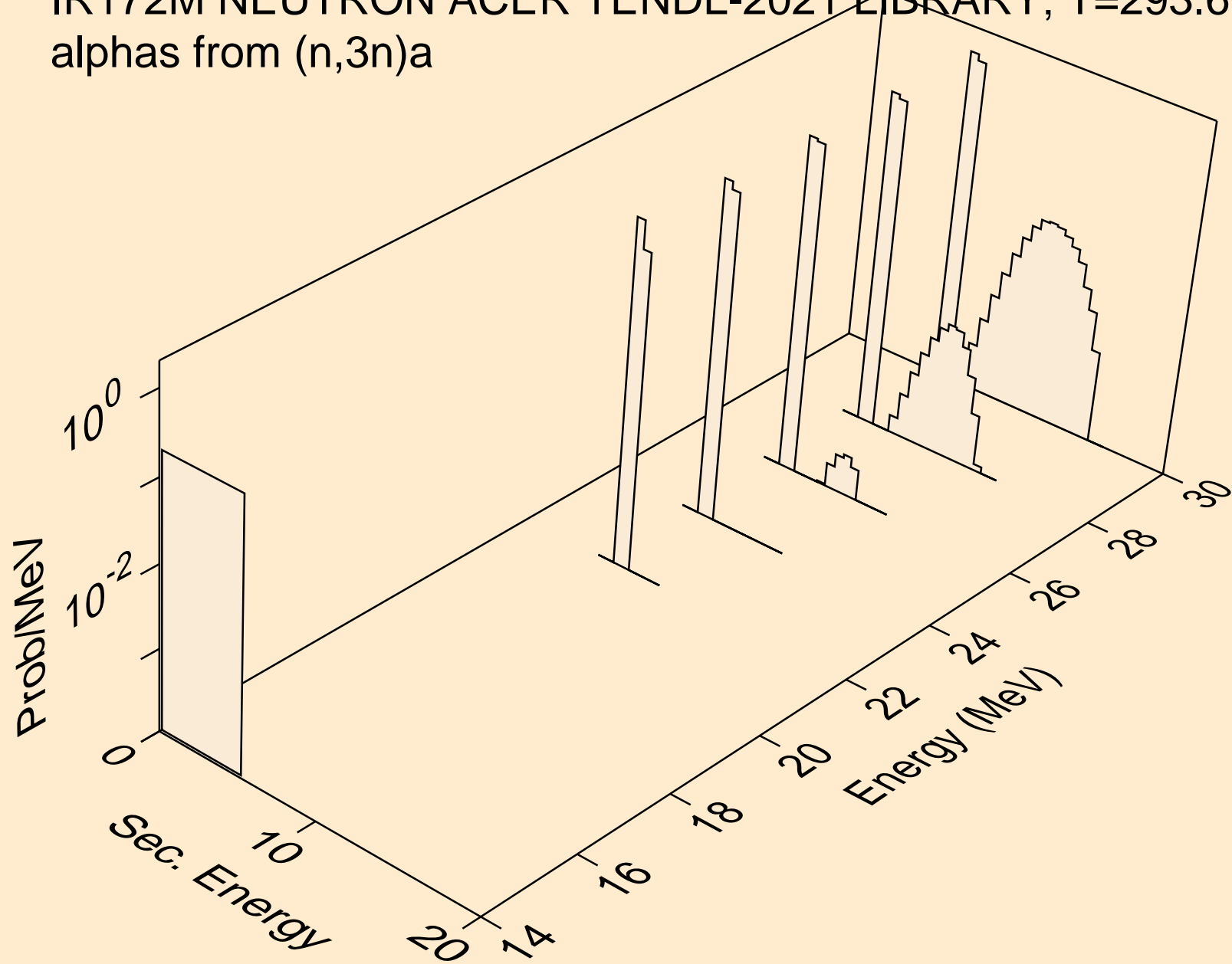

IR172M NEUTRON ACER TENDL-2021 LIBRARY; T=293.6K
alphas from (n,n*)2a

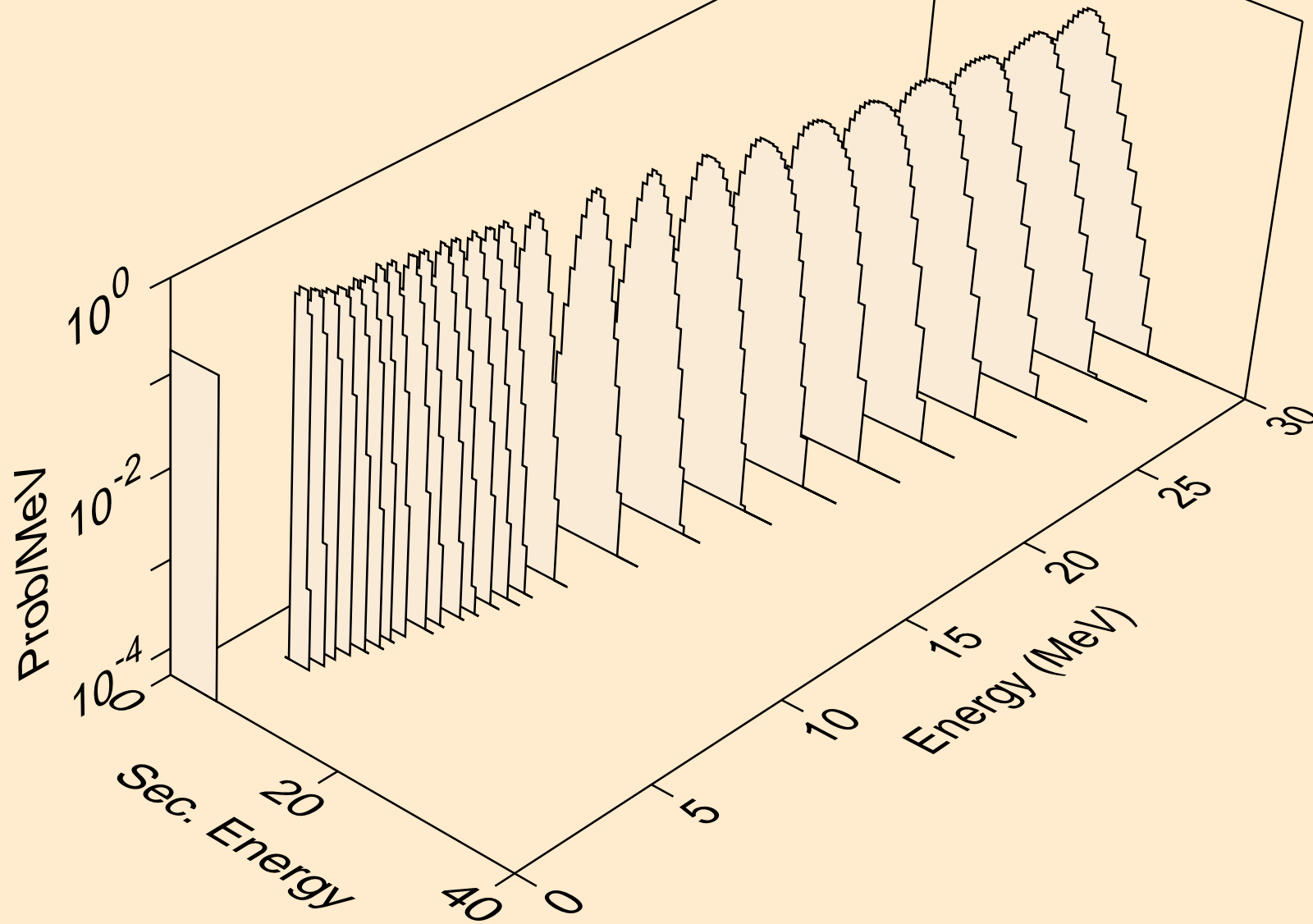

IR172M NEUTRON ACER TENDL-2021 LIBRARY; T=293.6K
alphas from (n,2n)2a

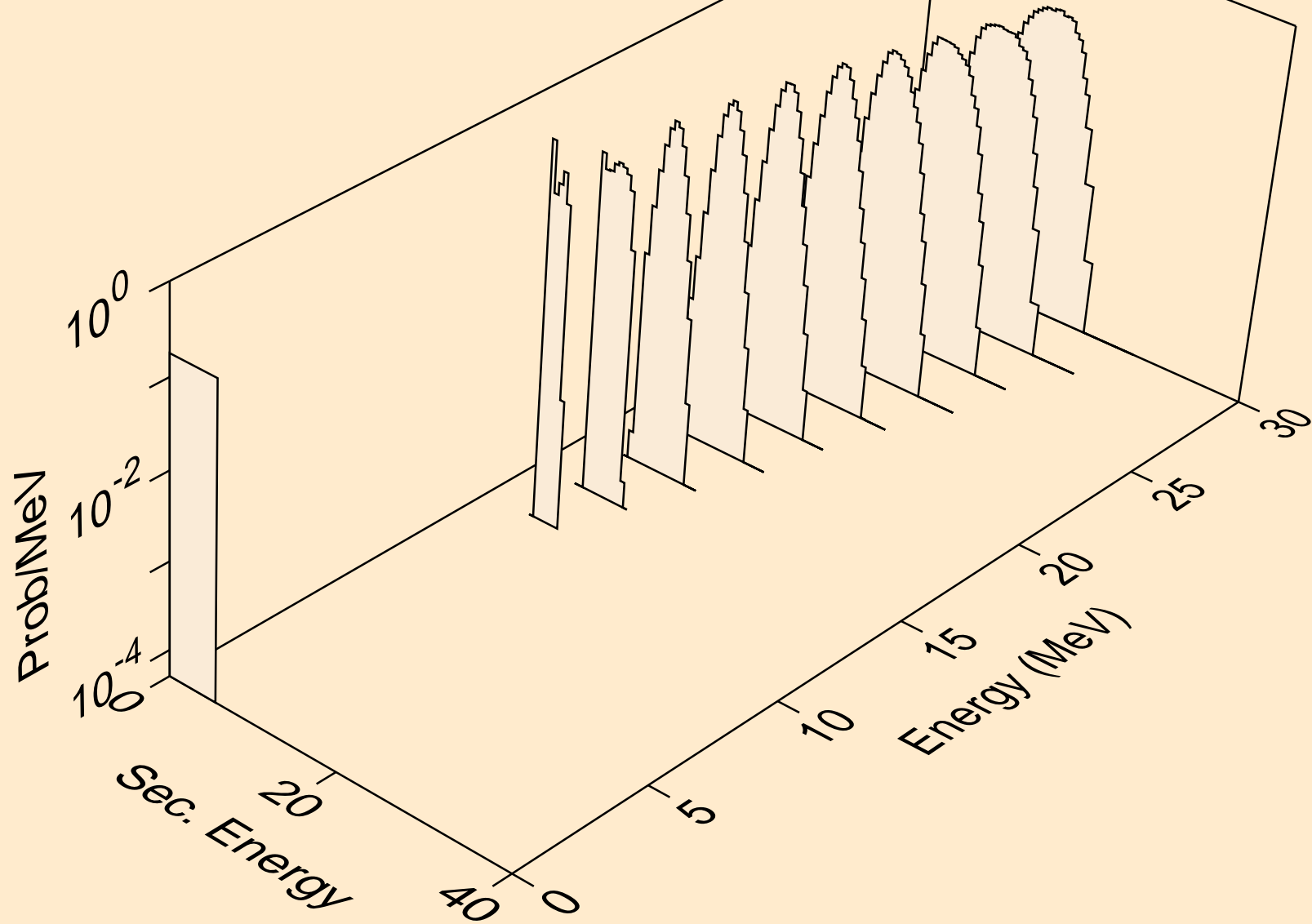

IR172M NEUTRON ACER TENDL-2021 LIBRARY; T=293.6K
alphas from (n,npa)

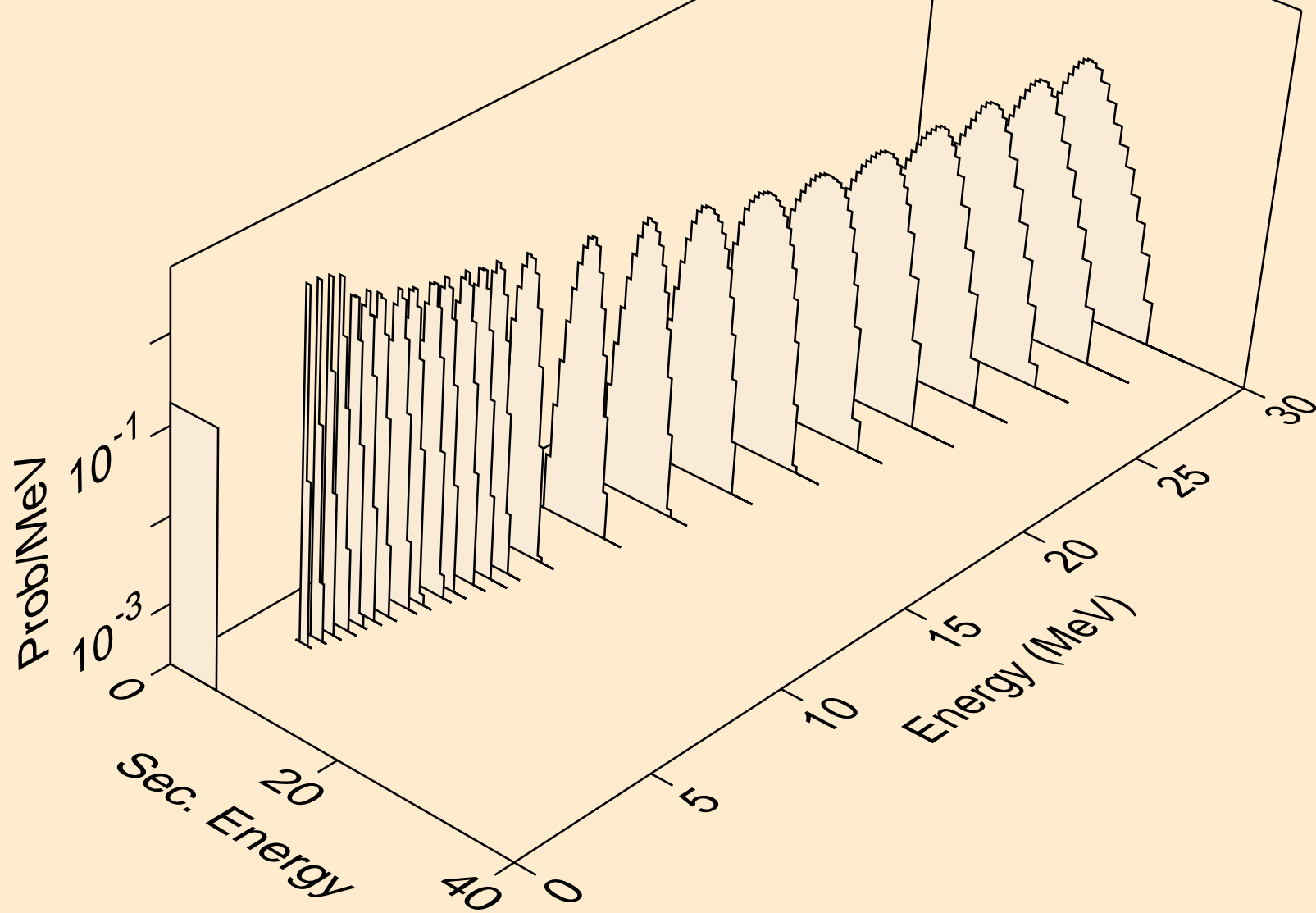

IR172M NEUTRON ACER TENDL-2021 LIBRARY; T=293.6K
alphas from (n,a)

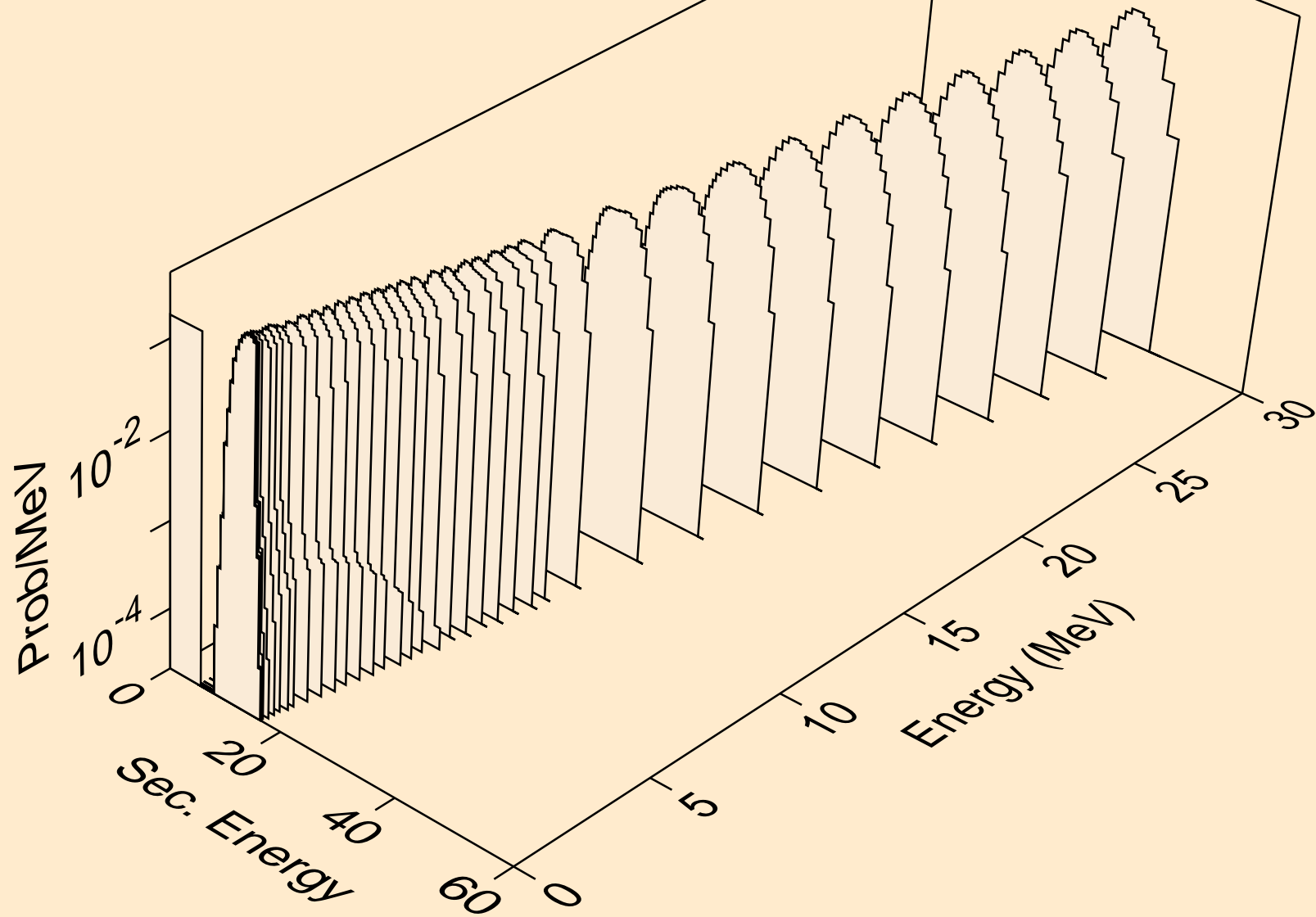

IR172M NEUTRON ACER TENDL-2021 LIBRARY; T=293.6K
alphas from (n,2a)

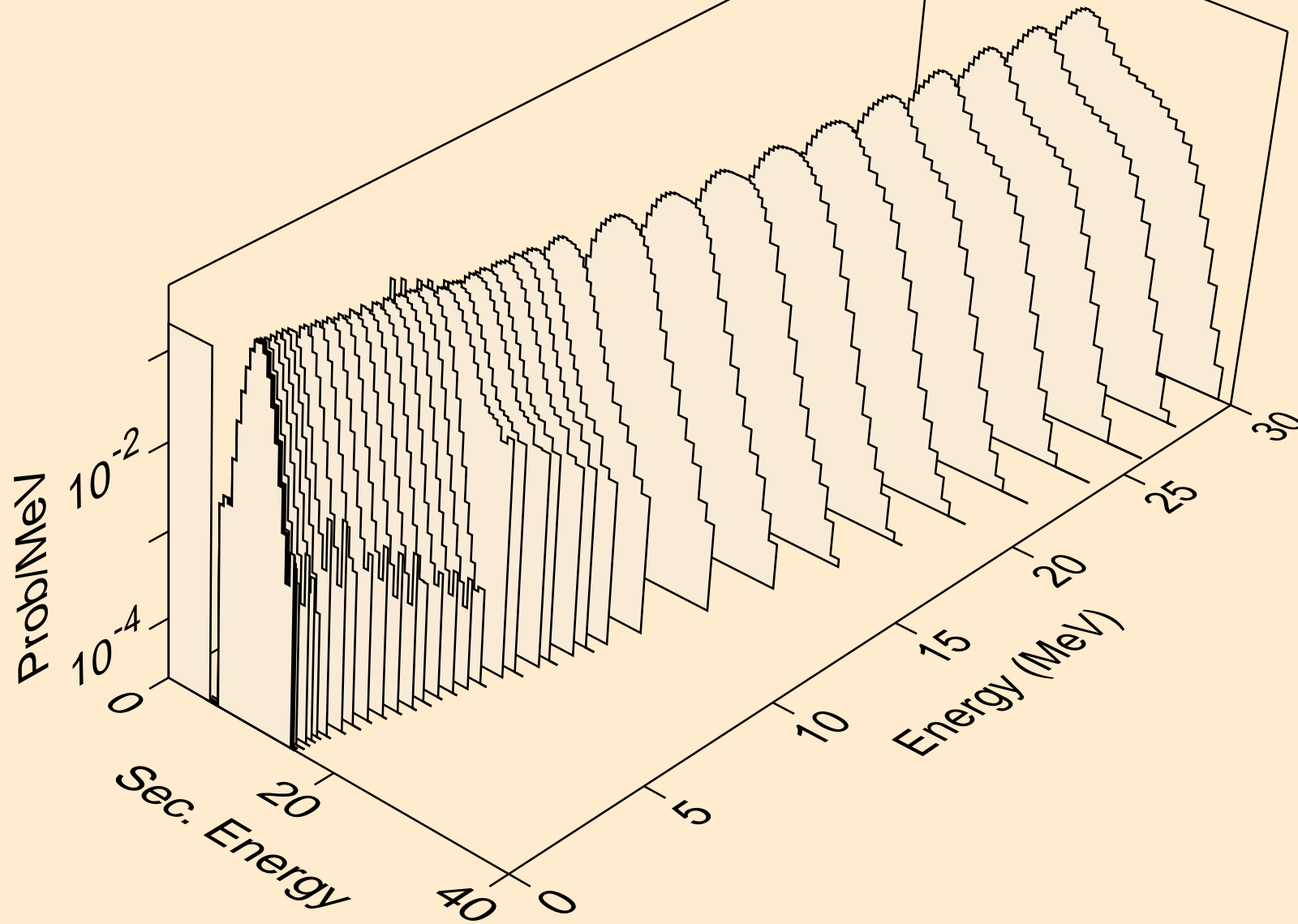

IR172M NEUTRON ACER TENDL-2021 LIBRARY; T=293.6K
alphas from (n,3a)

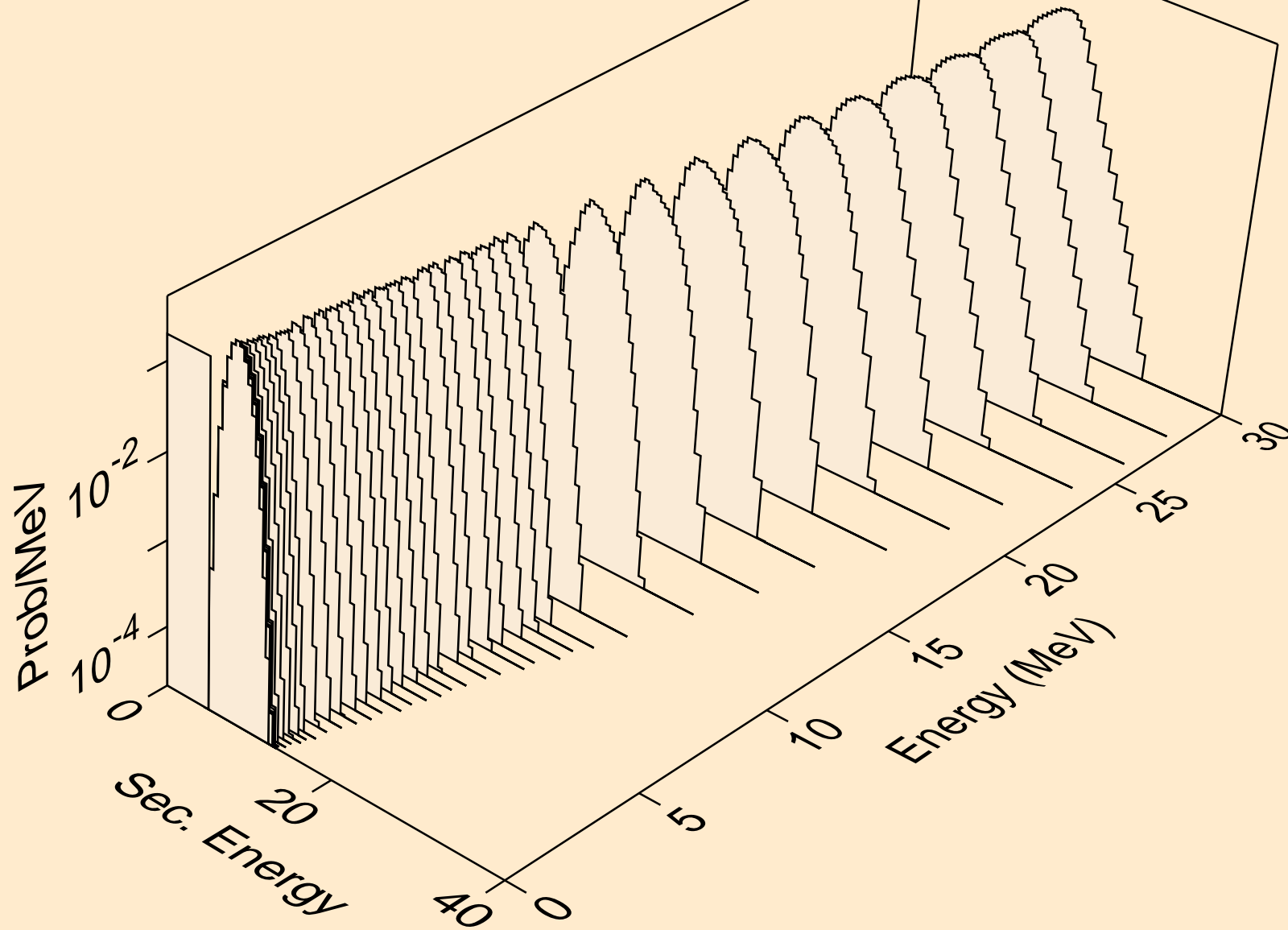

IR172M NEUTRON ACER TENDL-2021 LIBRARY; T=293.6K
alphas from (n,pa)

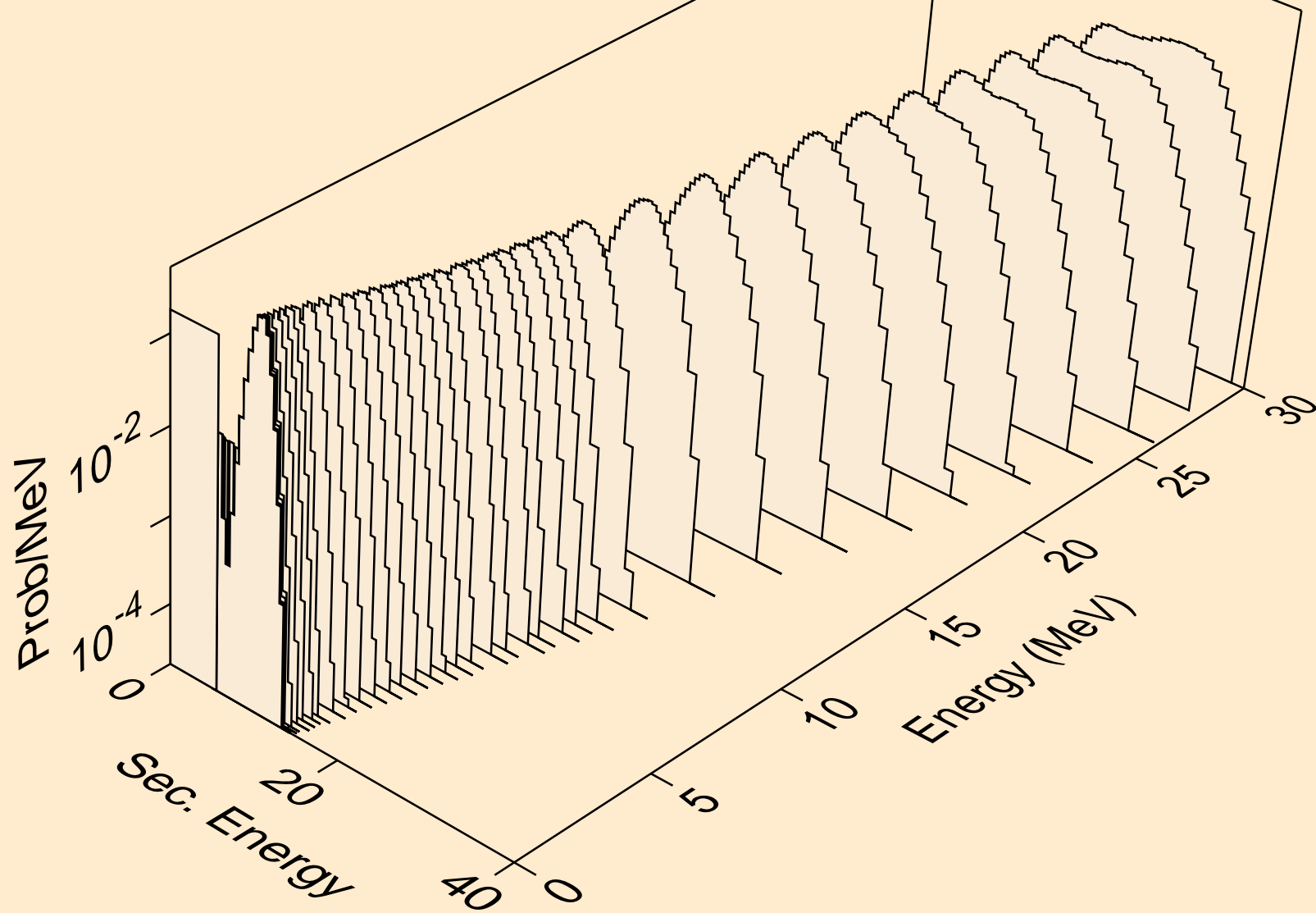

IR172M NEUTRON ACER TENDL-2021 LIBRARY; T=293.6K
alphas from (n,t2a)

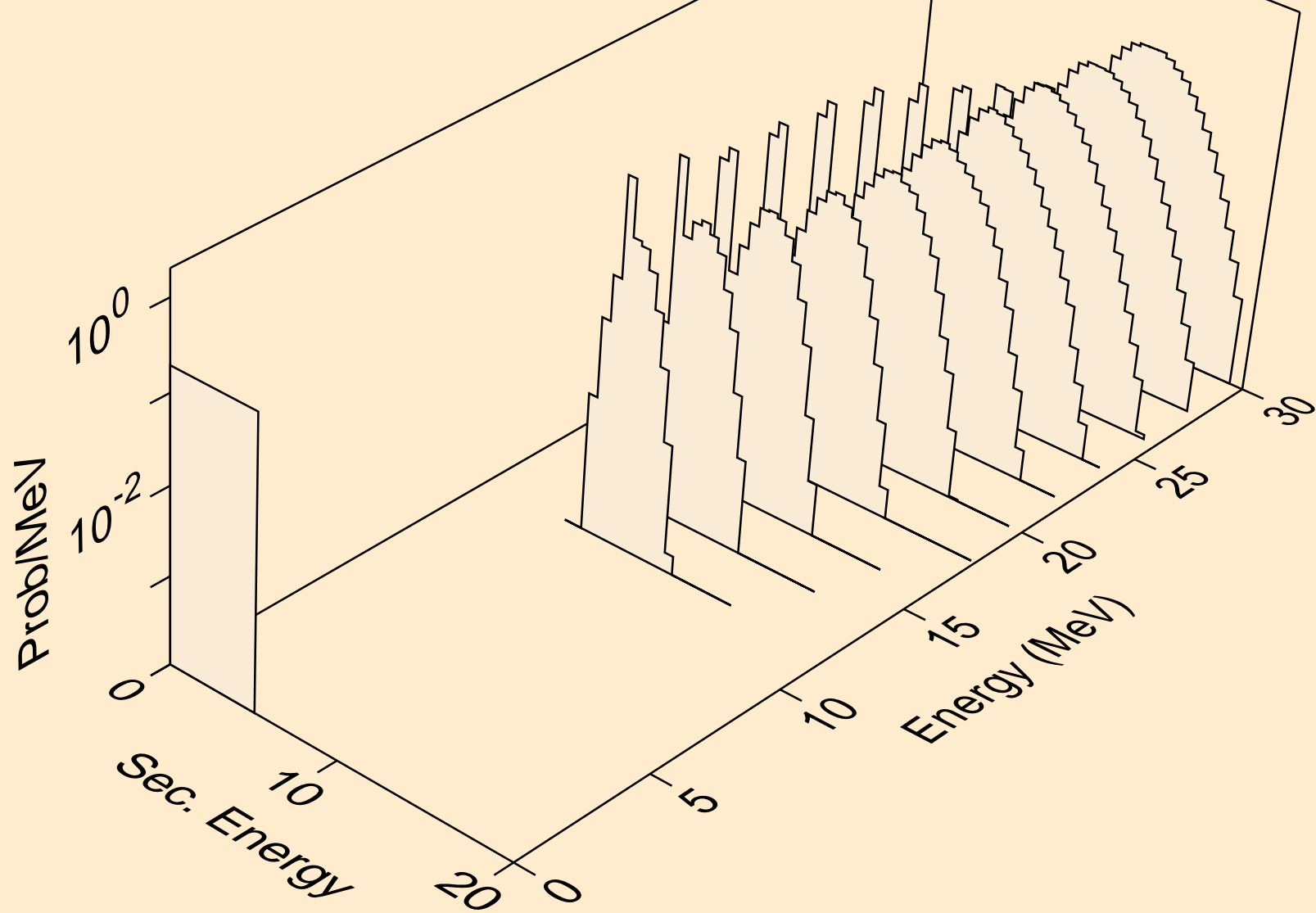

IR172M NEUTRON ACER TENDL-2021 LIBRARY; T=293.6K
alphas from (n,d2a)

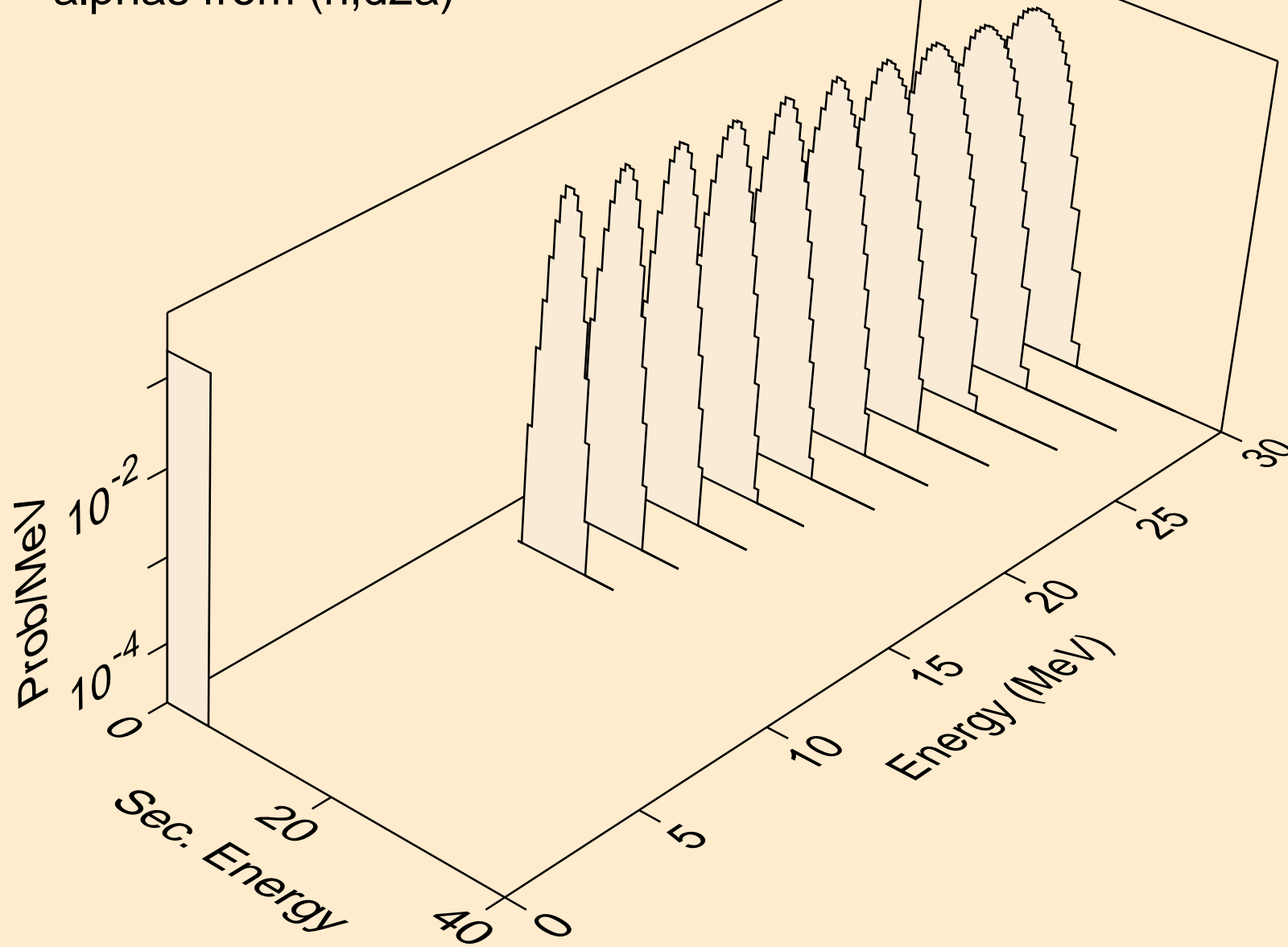

IR172M NEUTRON ACER TENDL-2021 LIBRARY; T=293.6K
alphas from (n,da)

