

IR180 NEUTRON ACER TENDL-2021 LIBRARY; T=293.6K

Principal cross sections

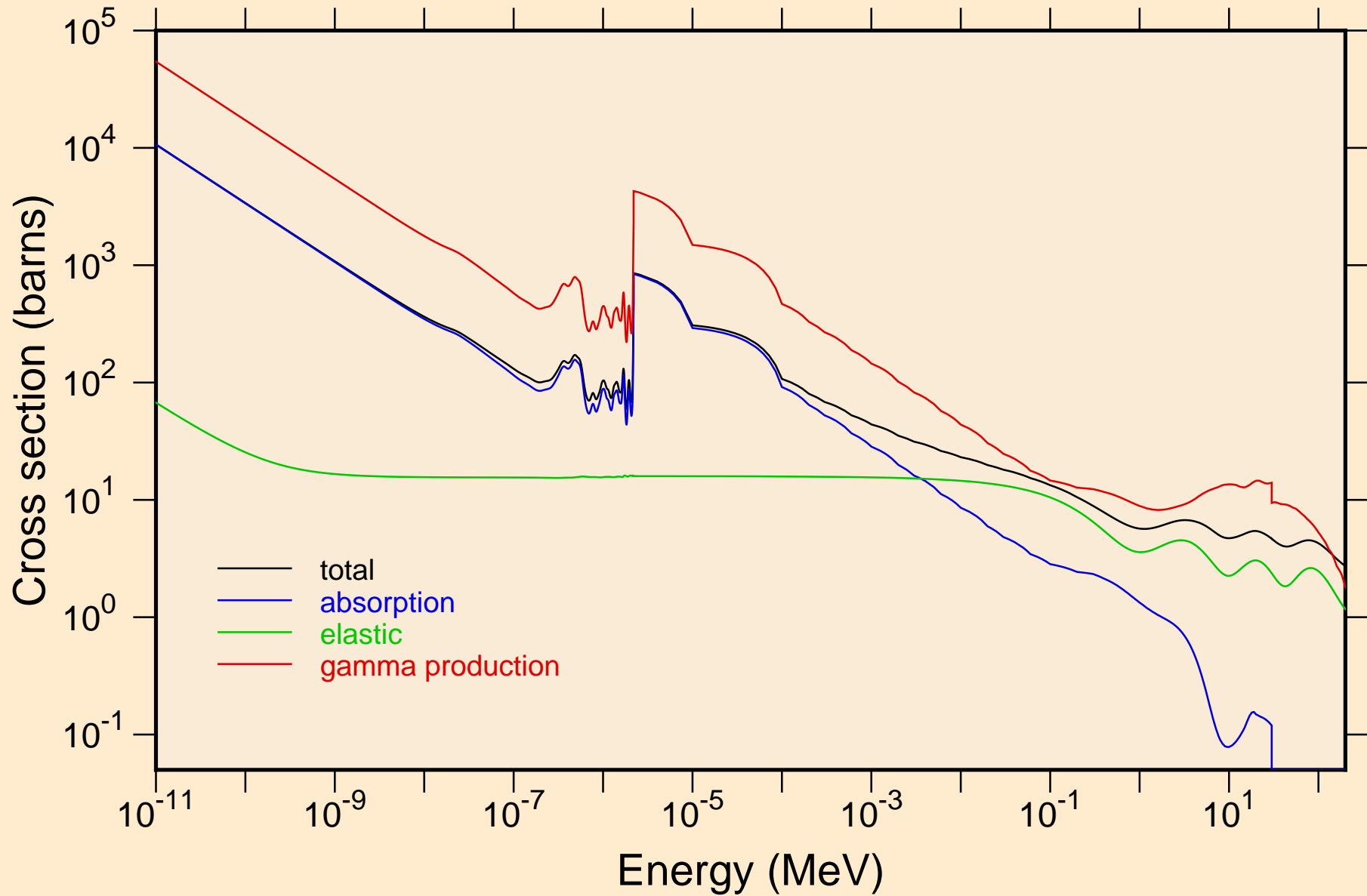

IR180 NEUTRON ACER TENDL-2021 LIBRARY; T=293.6K
Heating

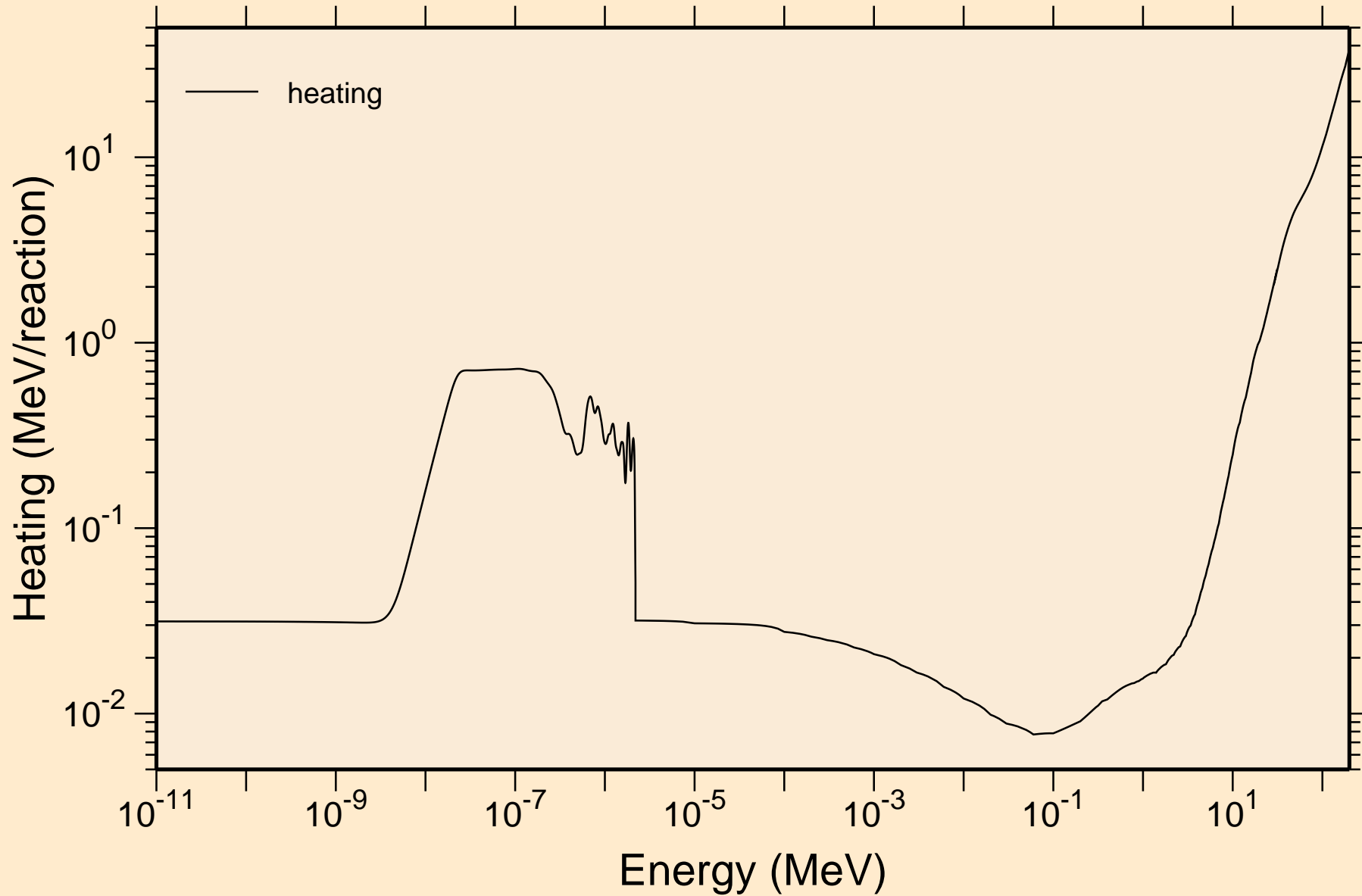

IR180 NEUTRON ACER TENDL-2021 LIBRARY; T=293.6K
Damage

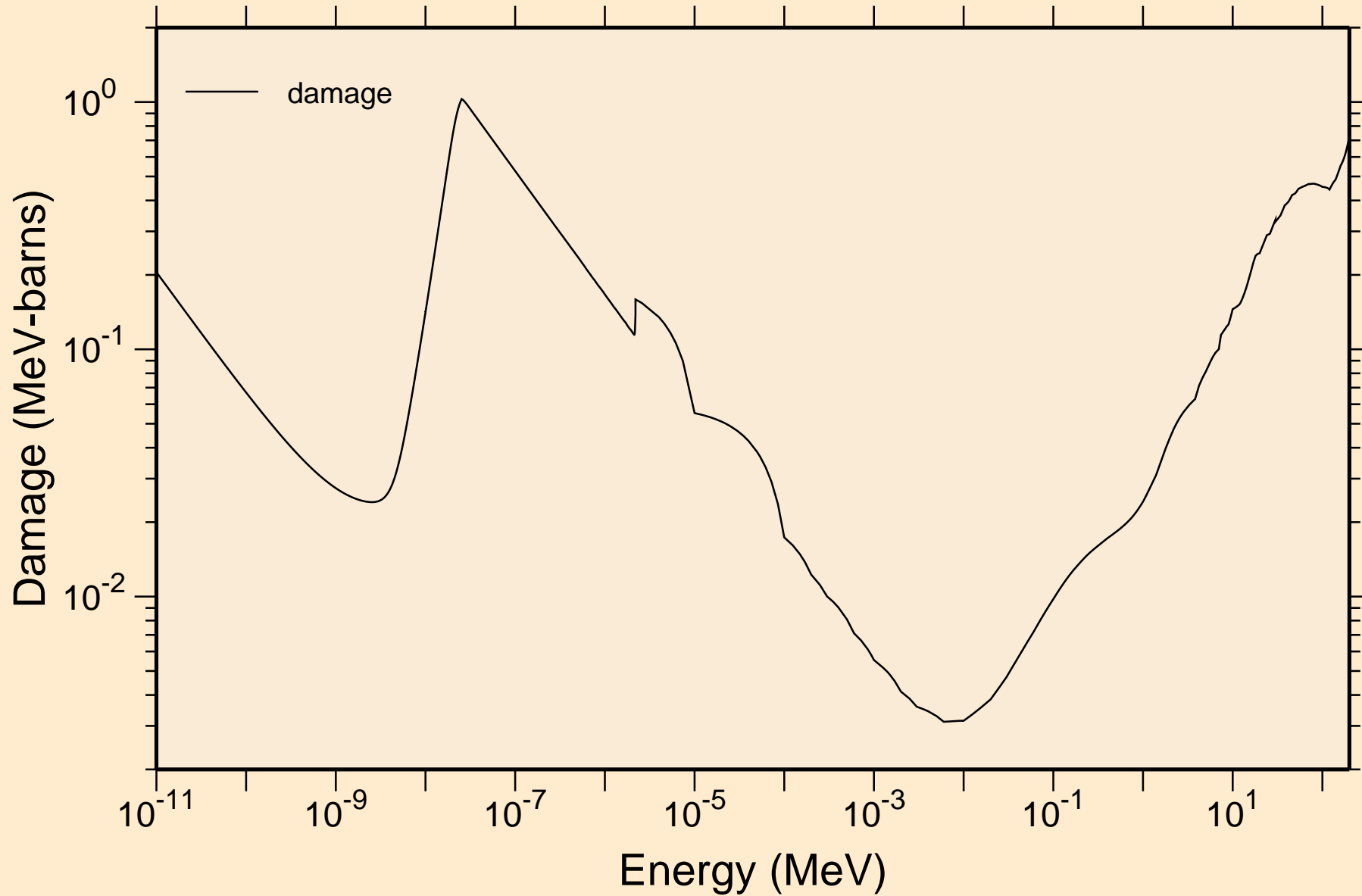

IR180 NEUTRON ACER TENDL-2021 LIBRARY; T=293.6K
Non-threshold reactions

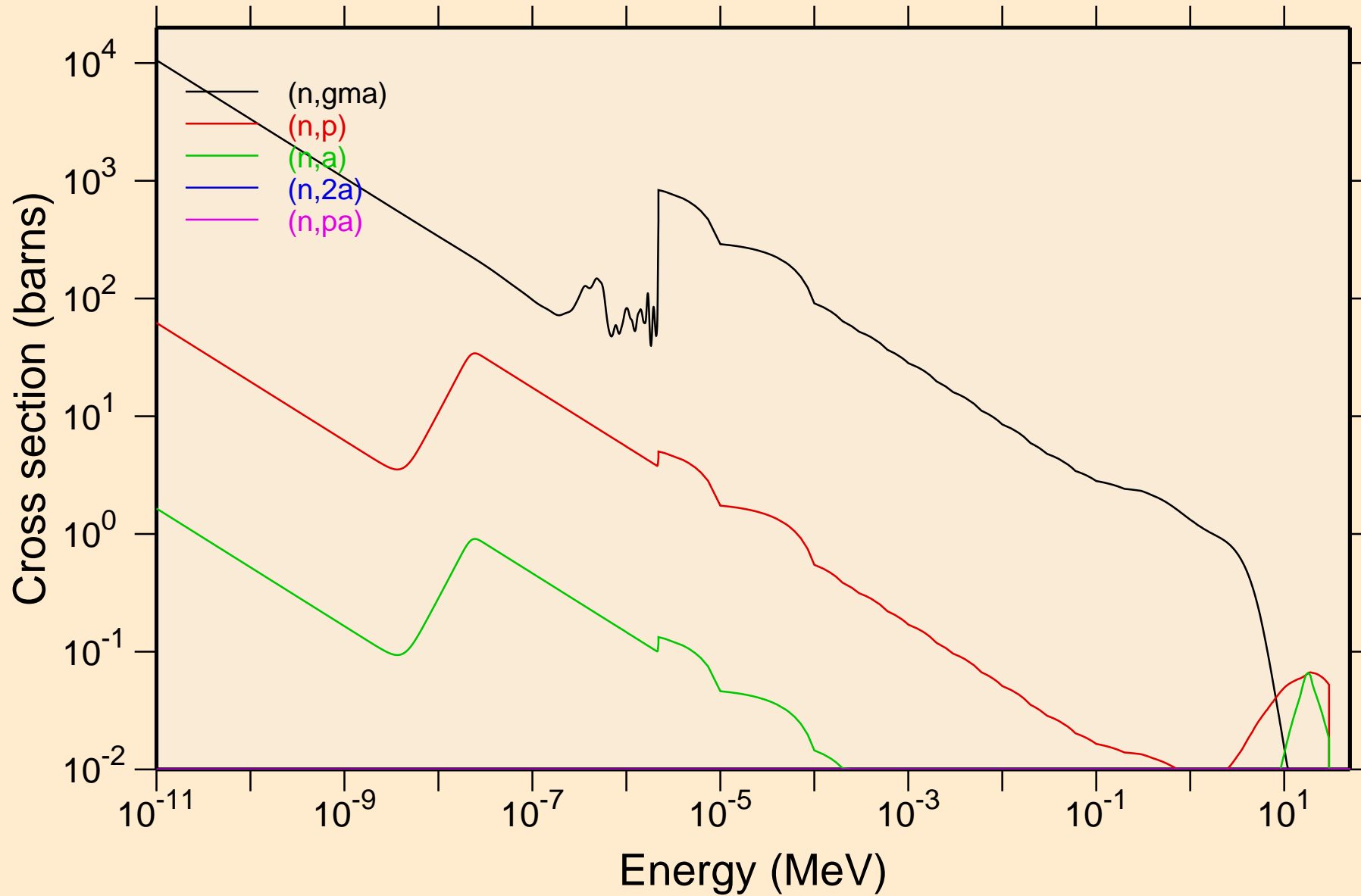

IR180 NEUTRON ACER TENDL-2021 LIBRARY; T=293.6K
Non-threshold reactions

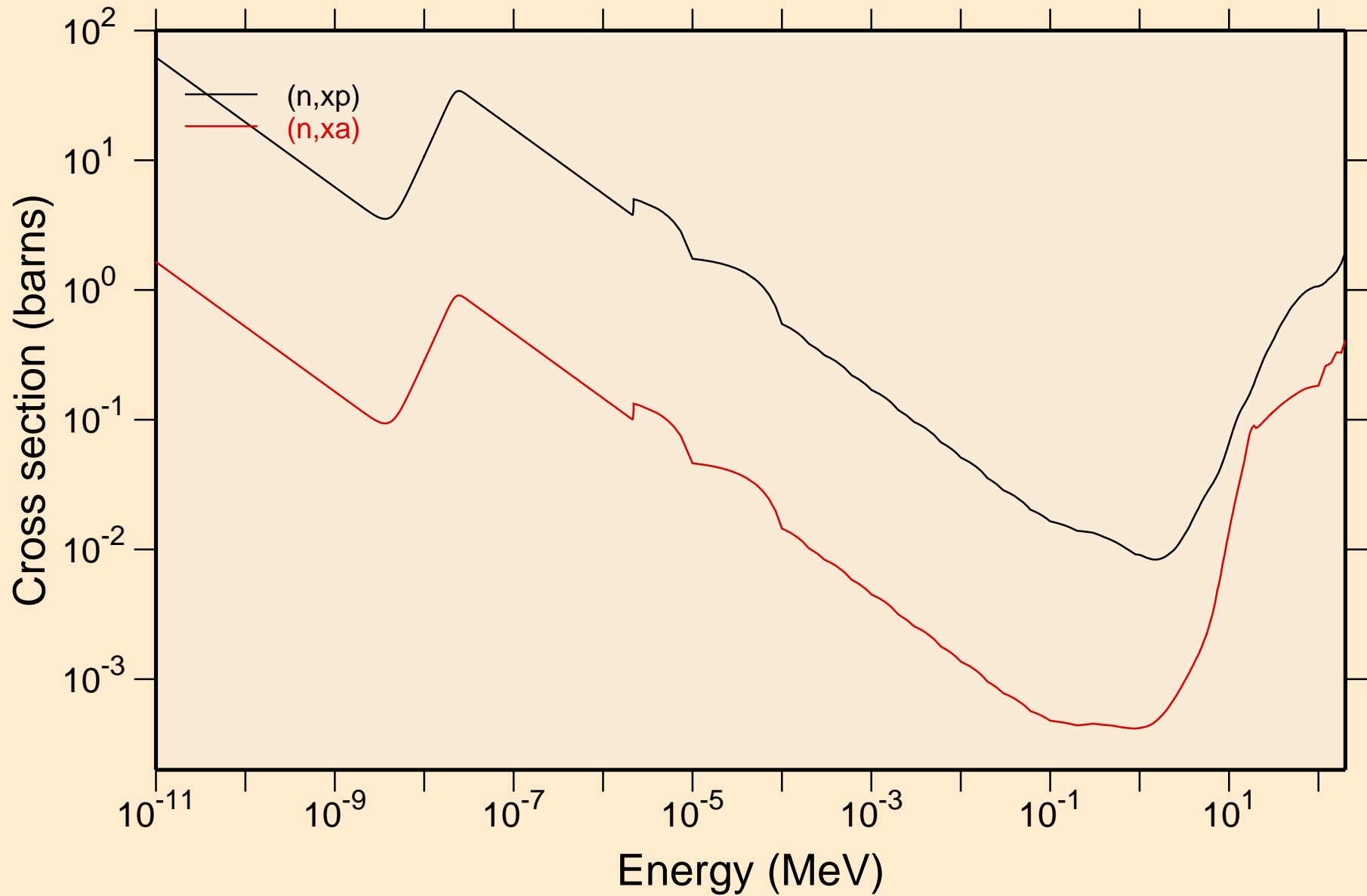

IR180 NEUTRON ACER TENDL-2021 LIBRARY; T=293.6K

Principal cross sections

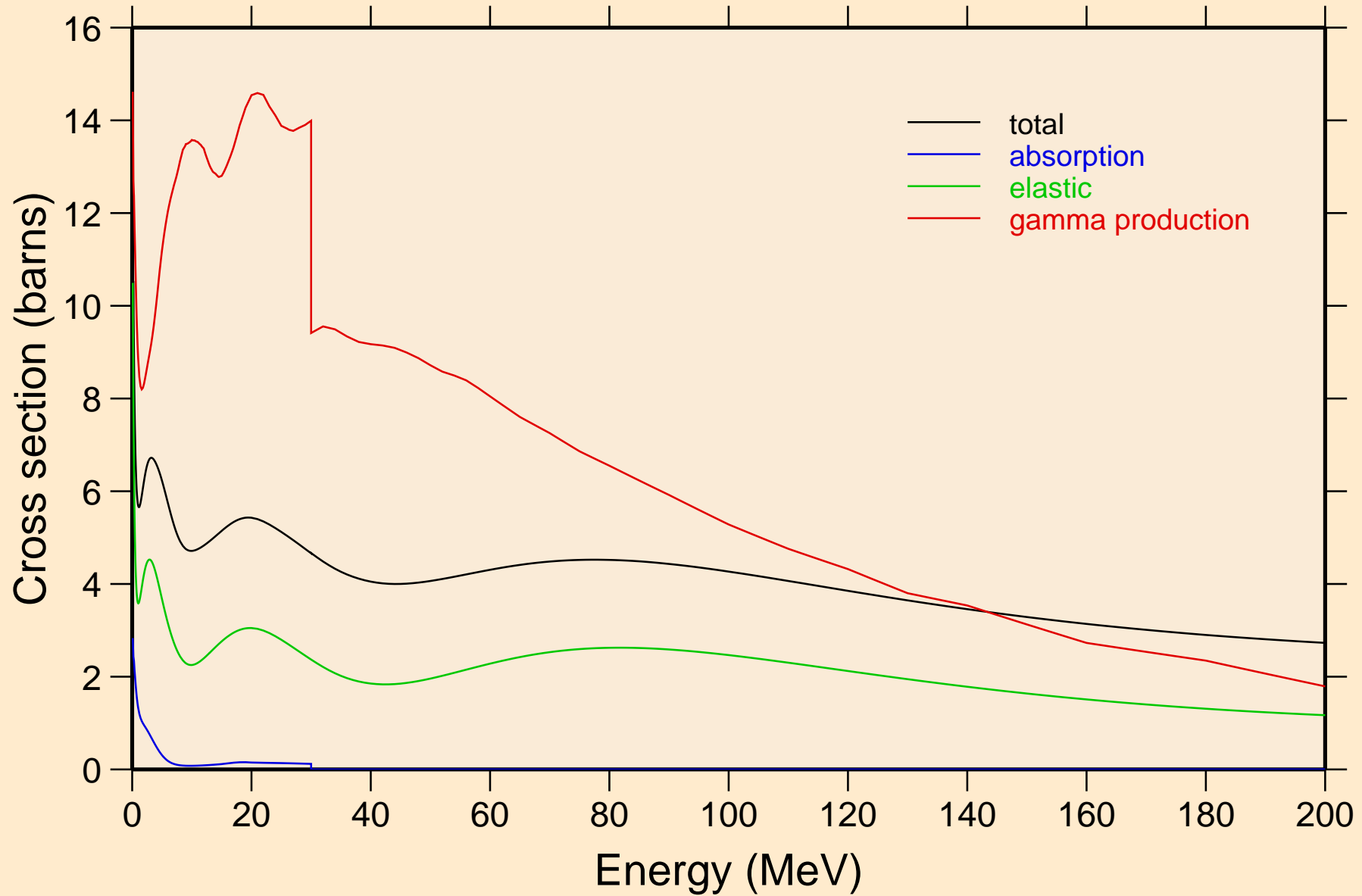

IR180 NEUTRON ACER TENDL-2021 LIBRARY; T=293.6K

Heating

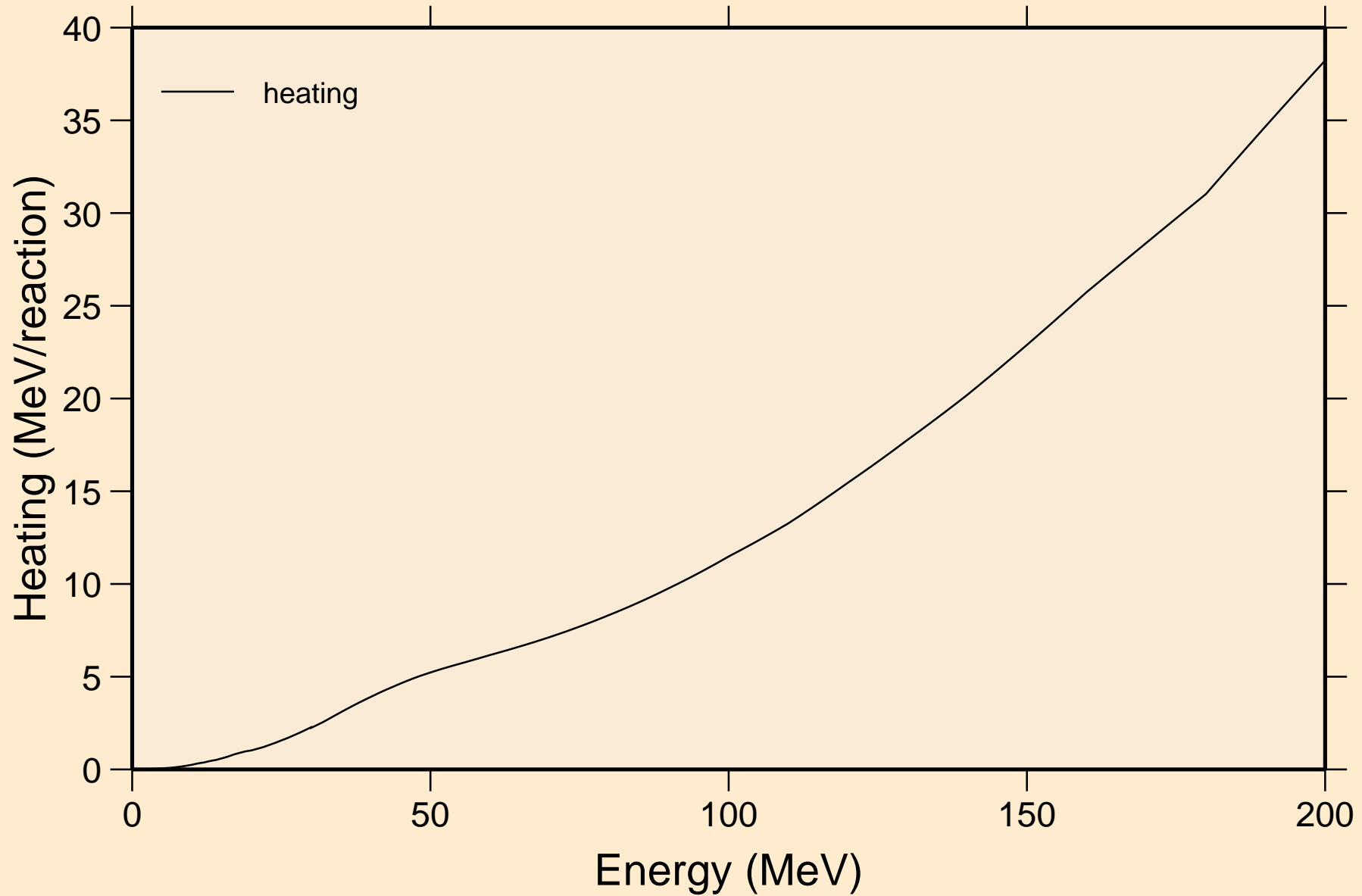

IR180 NEUTRON ACER TENDL-2021 LIBRARY; T=293.6K
Damage

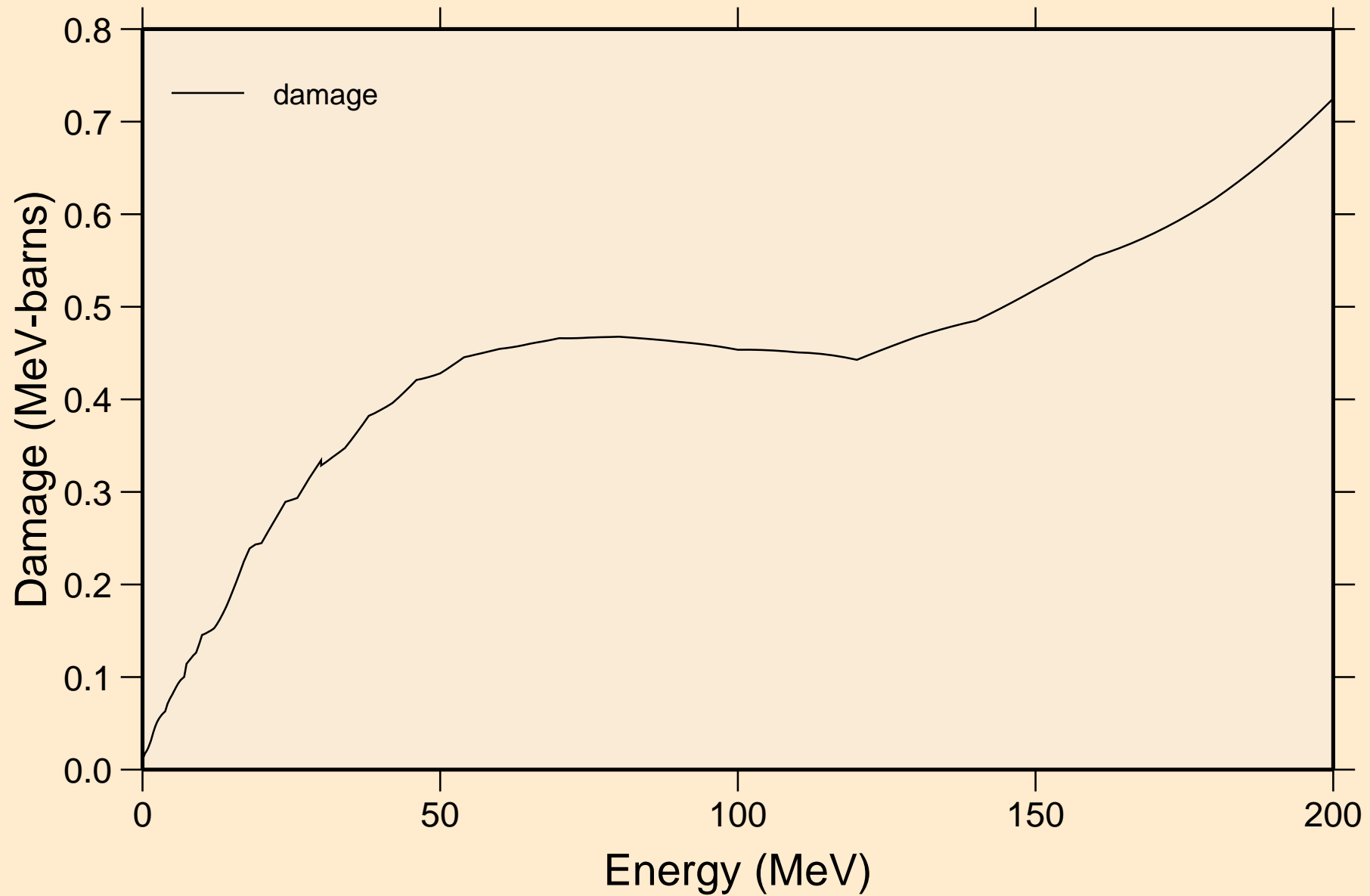

IR180 NEUTRON ACER TENDL-2021 LIBRARY; T=293.6K
Non-threshold reactions

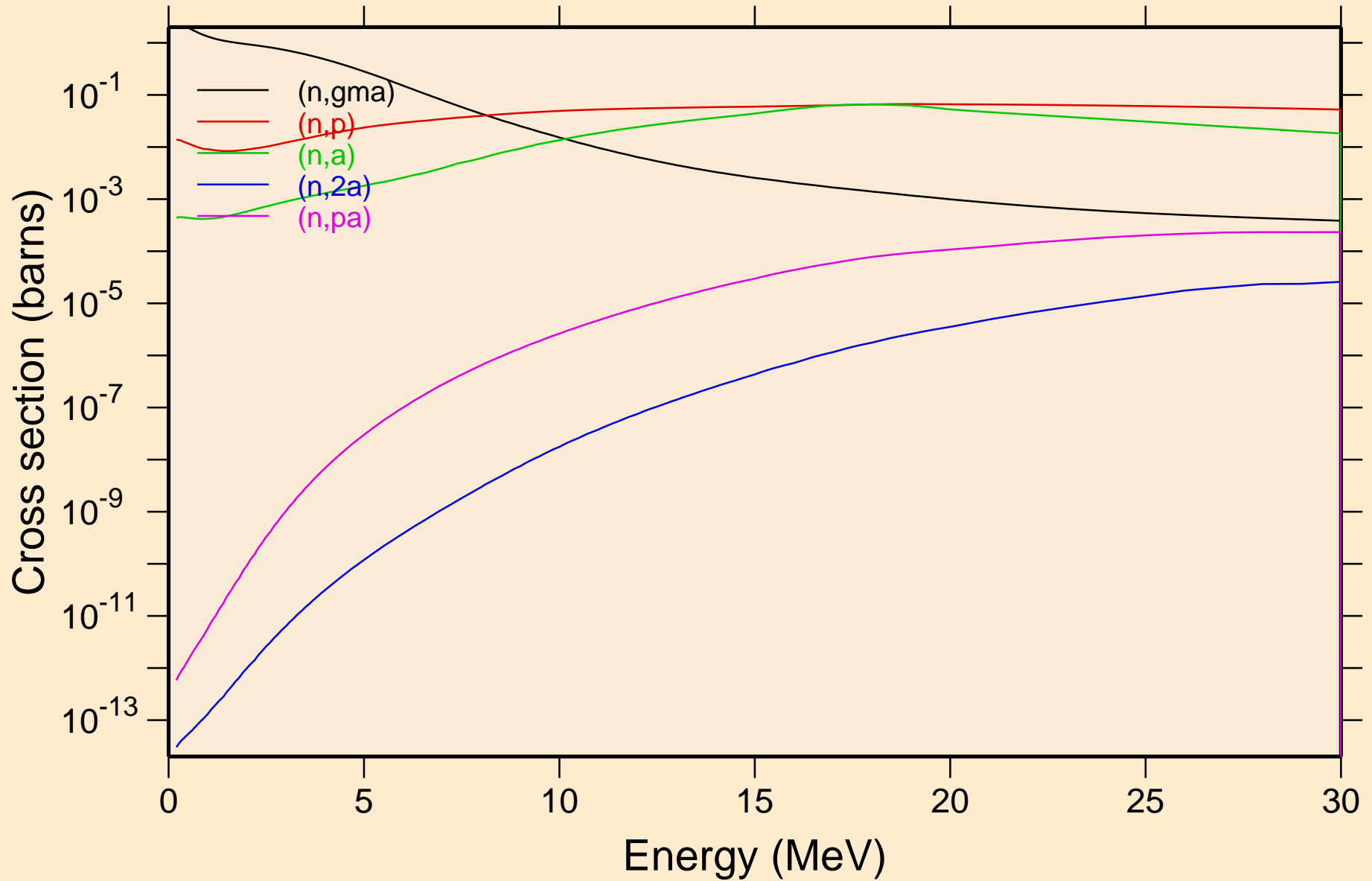

IR180 NEUTRON ACER TENDL-2021 LIBRARY; T=293.6K
Non-threshold reactions

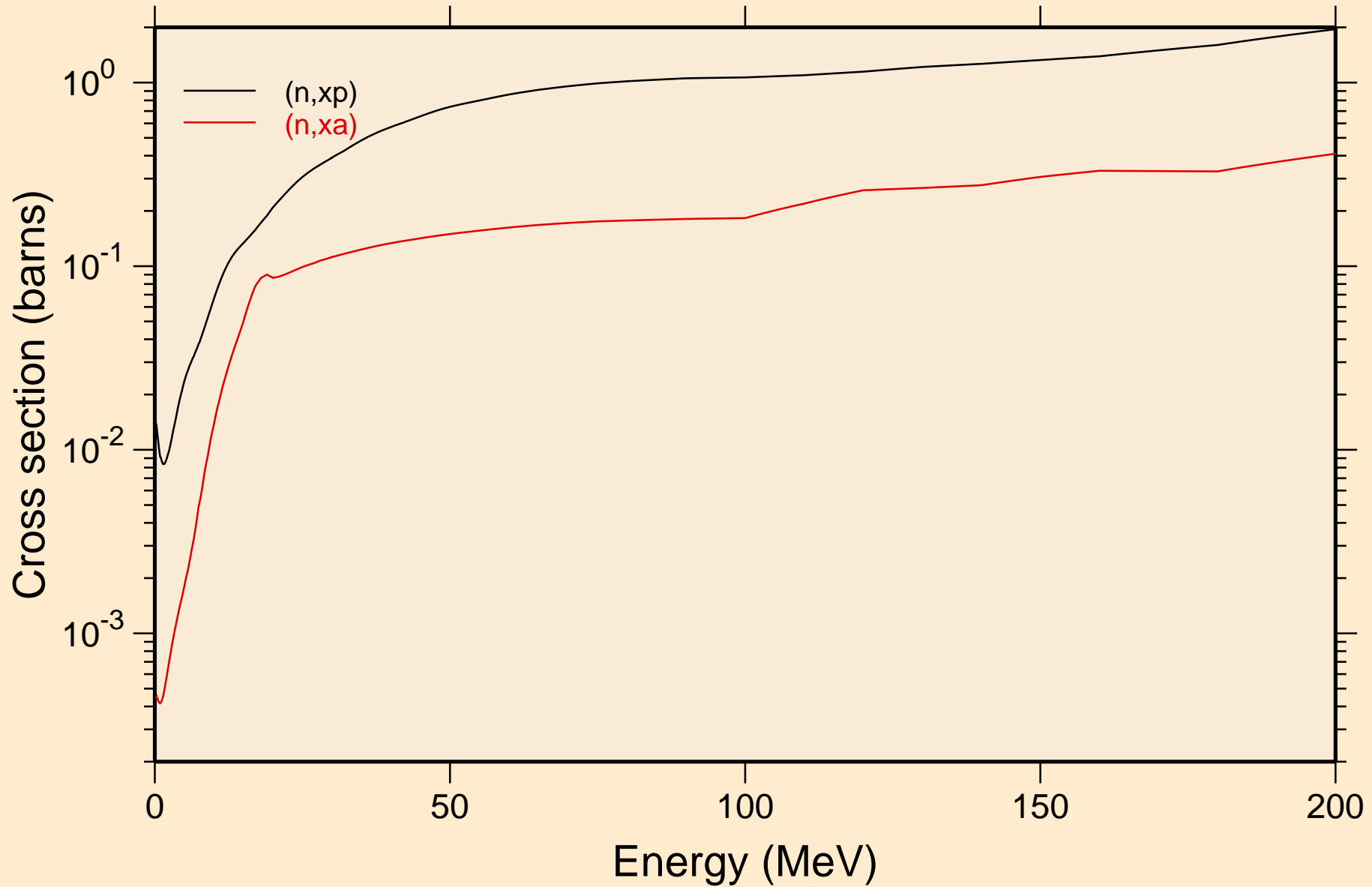

IR180 NEUTRON ACER TENDL-2021 LIBRARY; T=293.6K
Inelastic levels

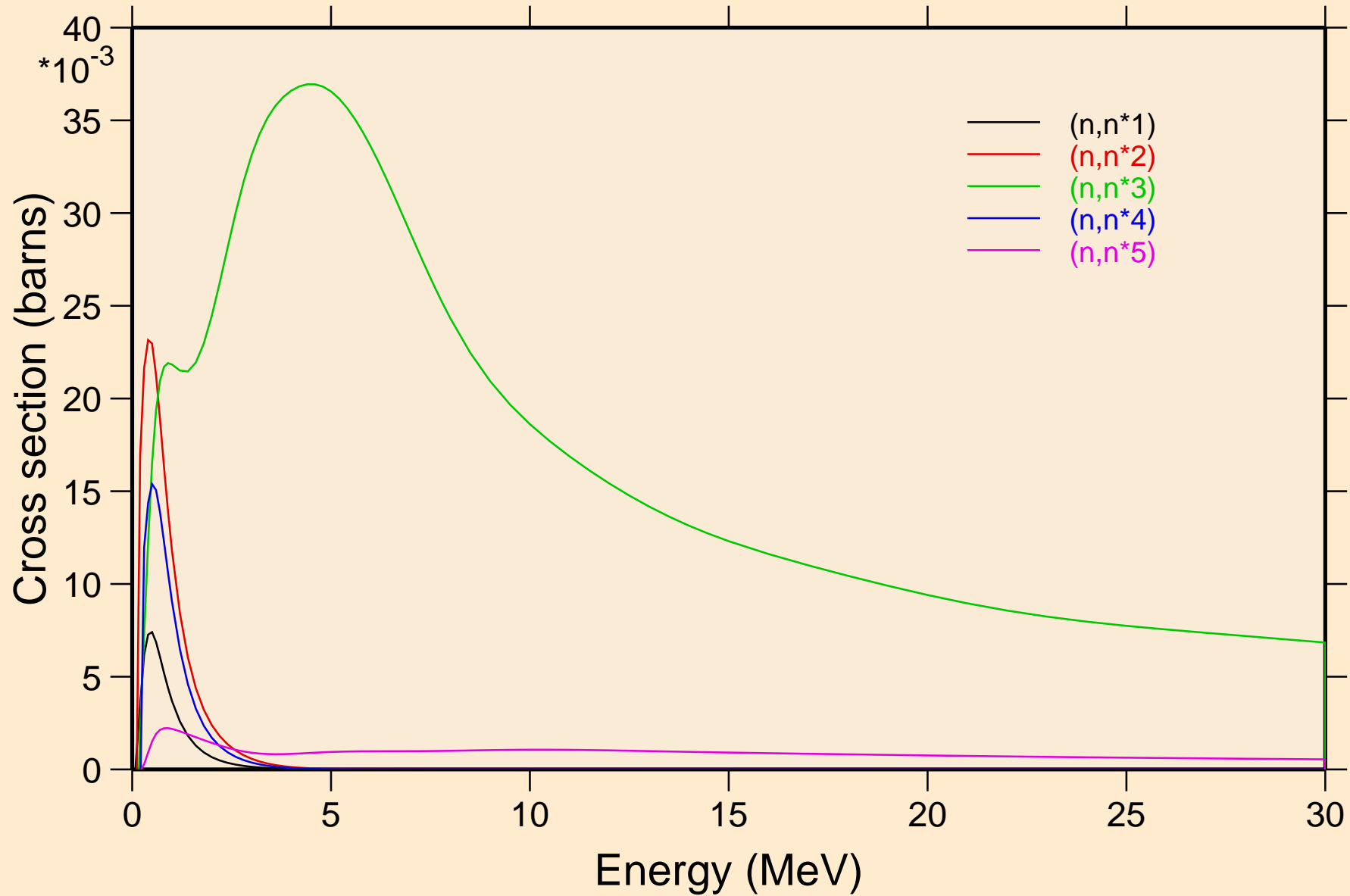

IR180 NEUTRON ACER TENDL-2021 LIBRARY; T=293.6K
Inelastic levels

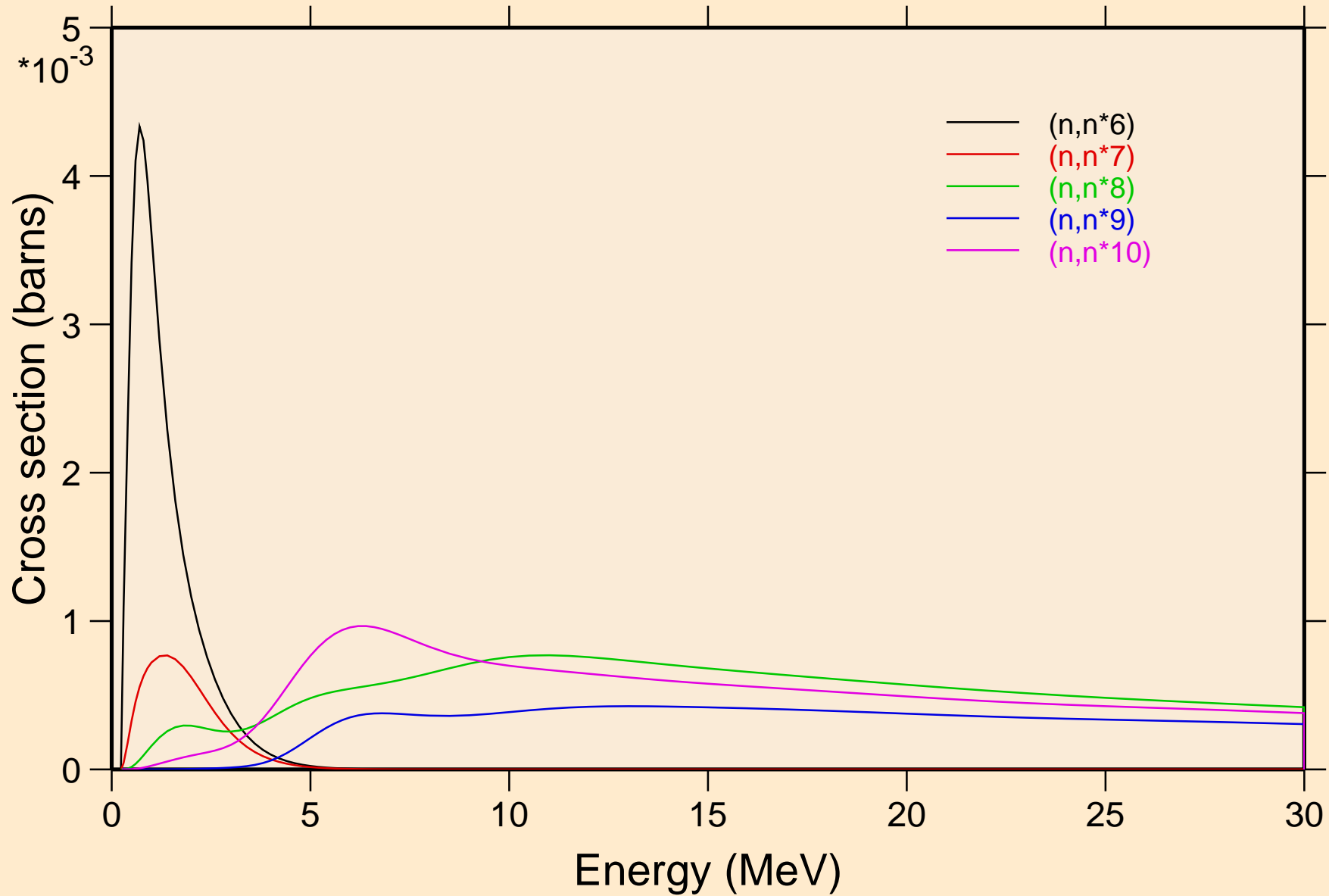

IR180 NEUTRON ACER TENDL-2021 LIBRARY; T=293.6K
Inelastic levels

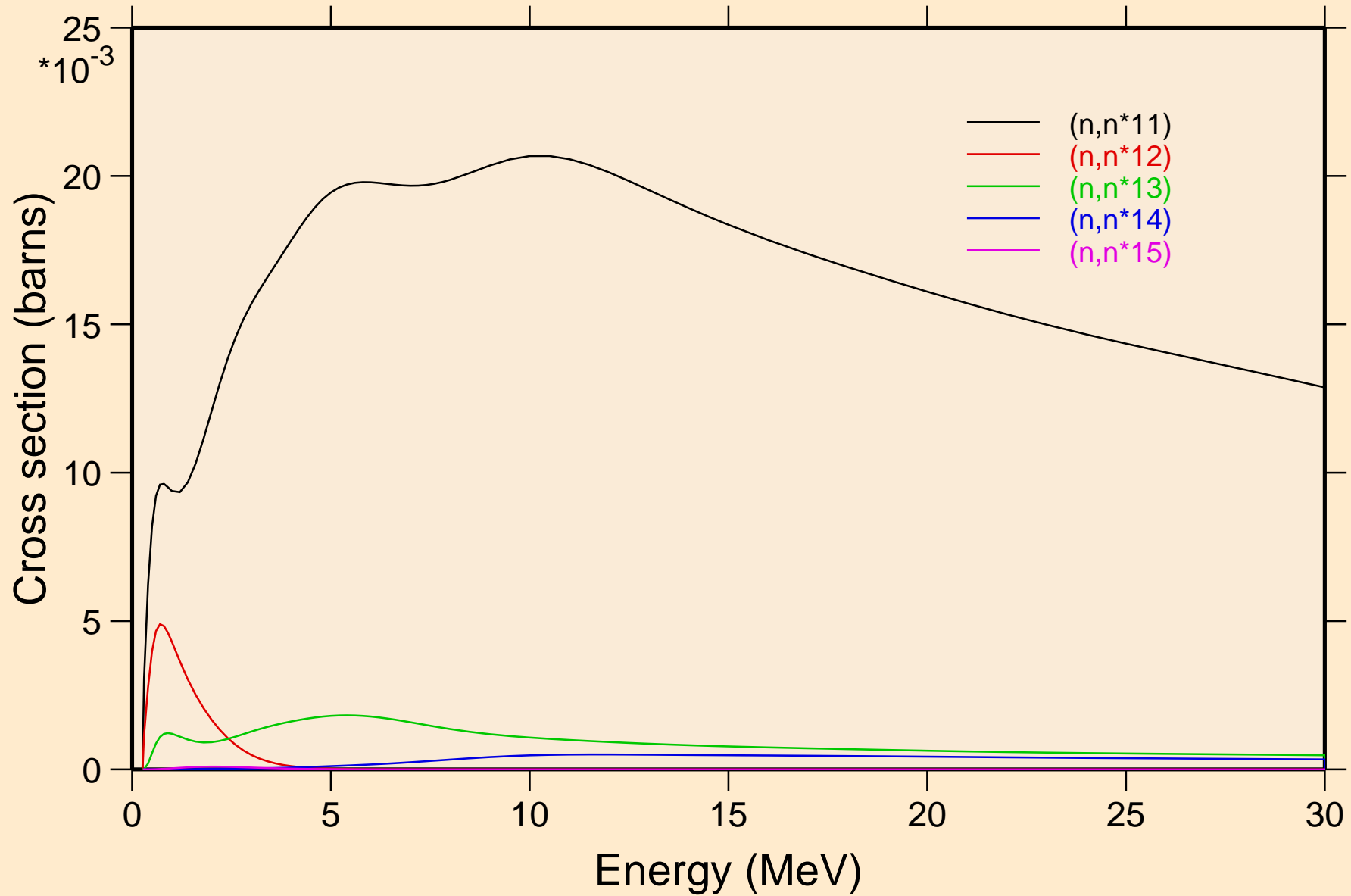

IR180 NEUTRON ACER TENDL-2021 LIBRARY; T=293.6K
Inelastic levels

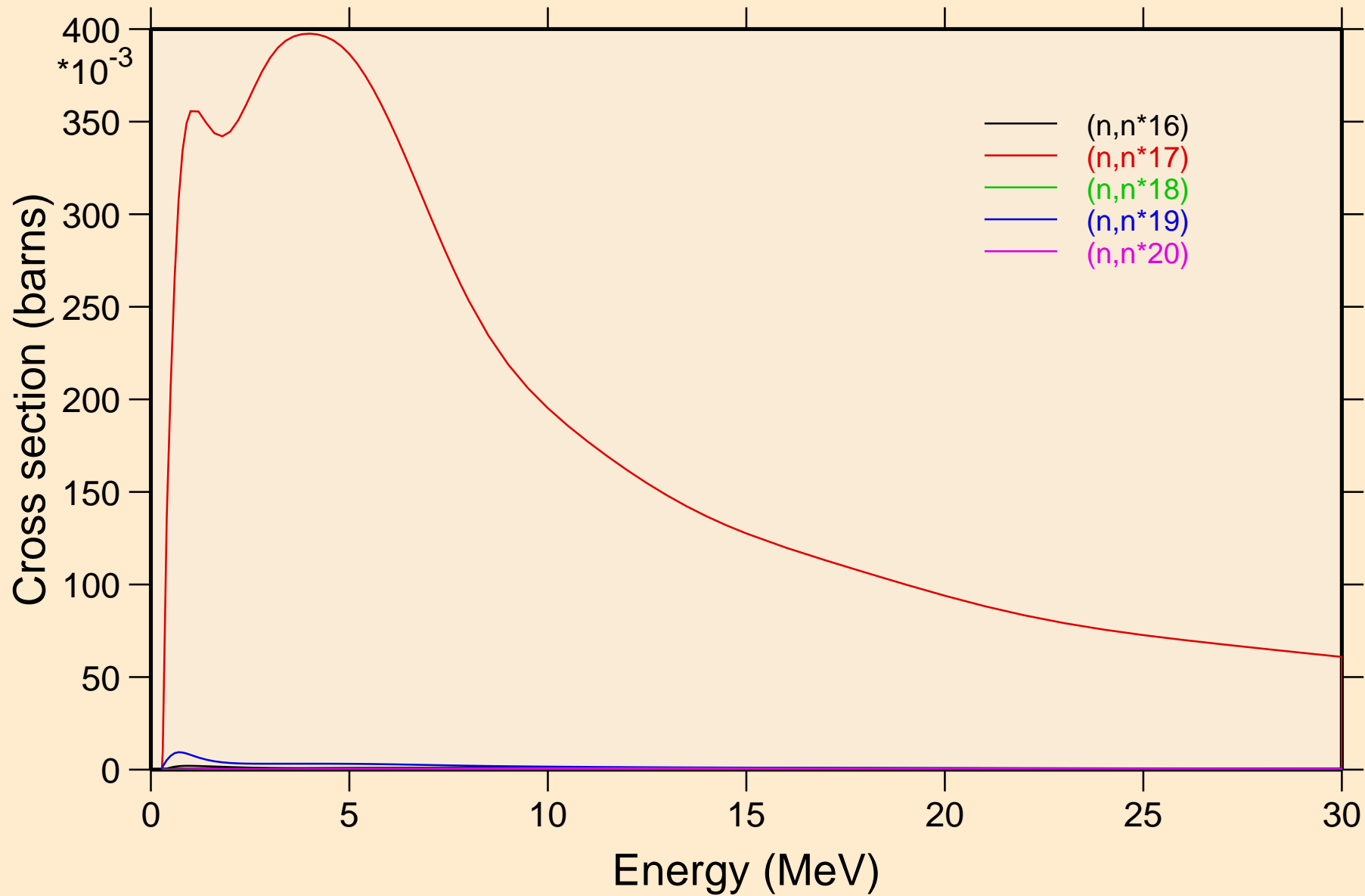

IR180 NEUTRON ACER TENDL-2021 LIBRARY; T=293.6K
Inelastic levels

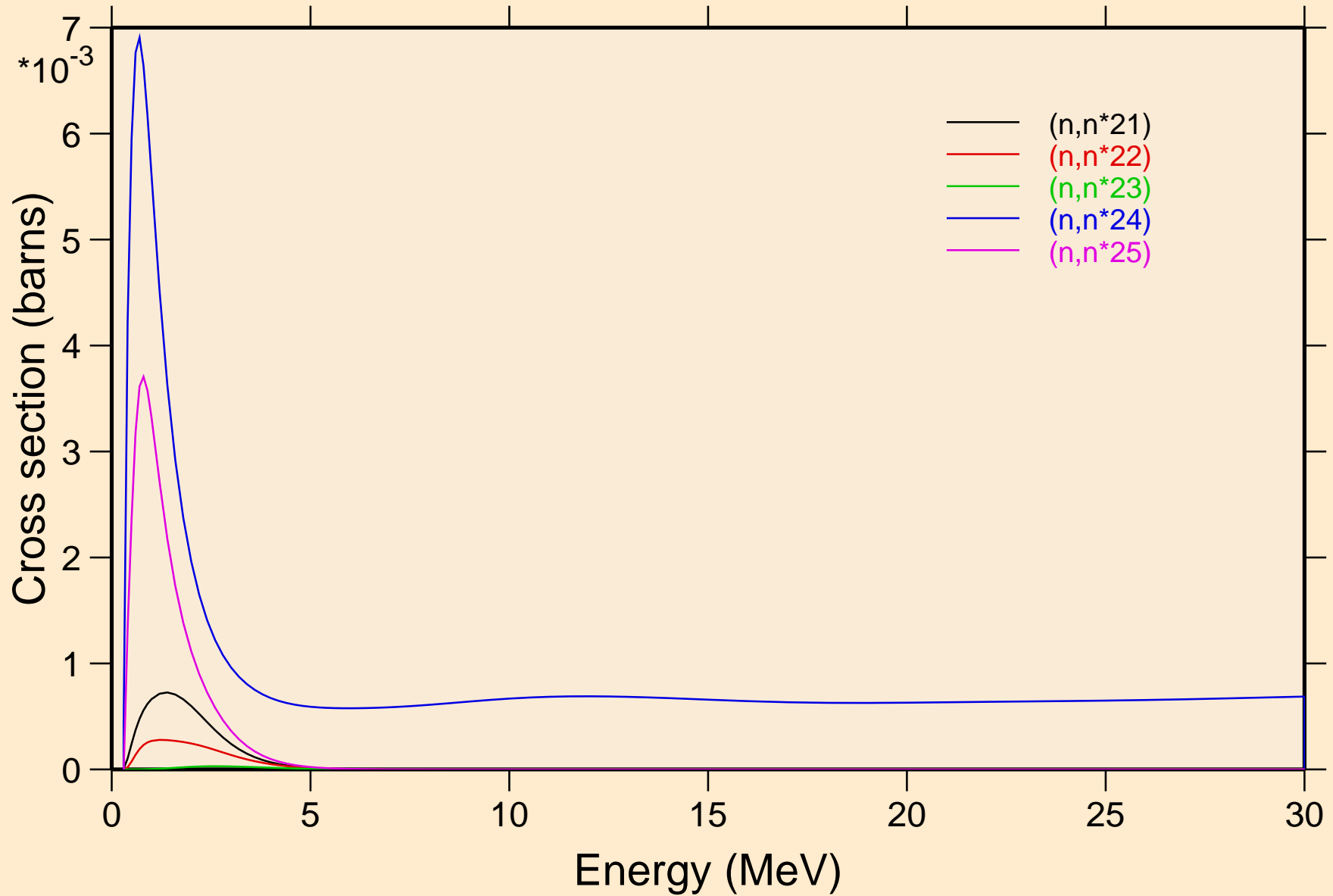

IR180 NEUTRON ACER TENDL-2021 LIBRARY; T=293.6K
Inelastic levels

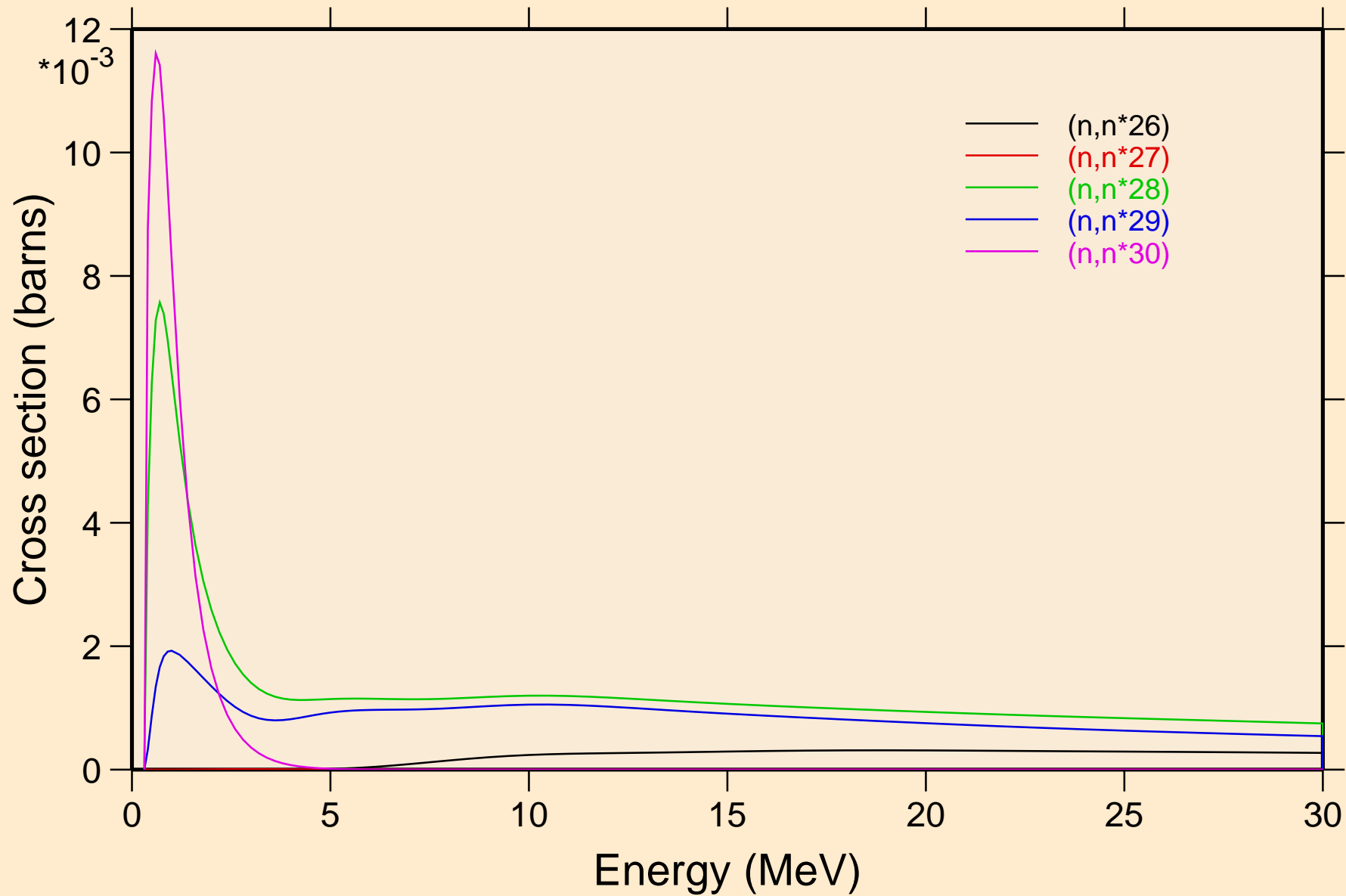

IR180 NEUTRON ACER TENDL-2021 LIBRARY; T=293.6K
Threshold reactions

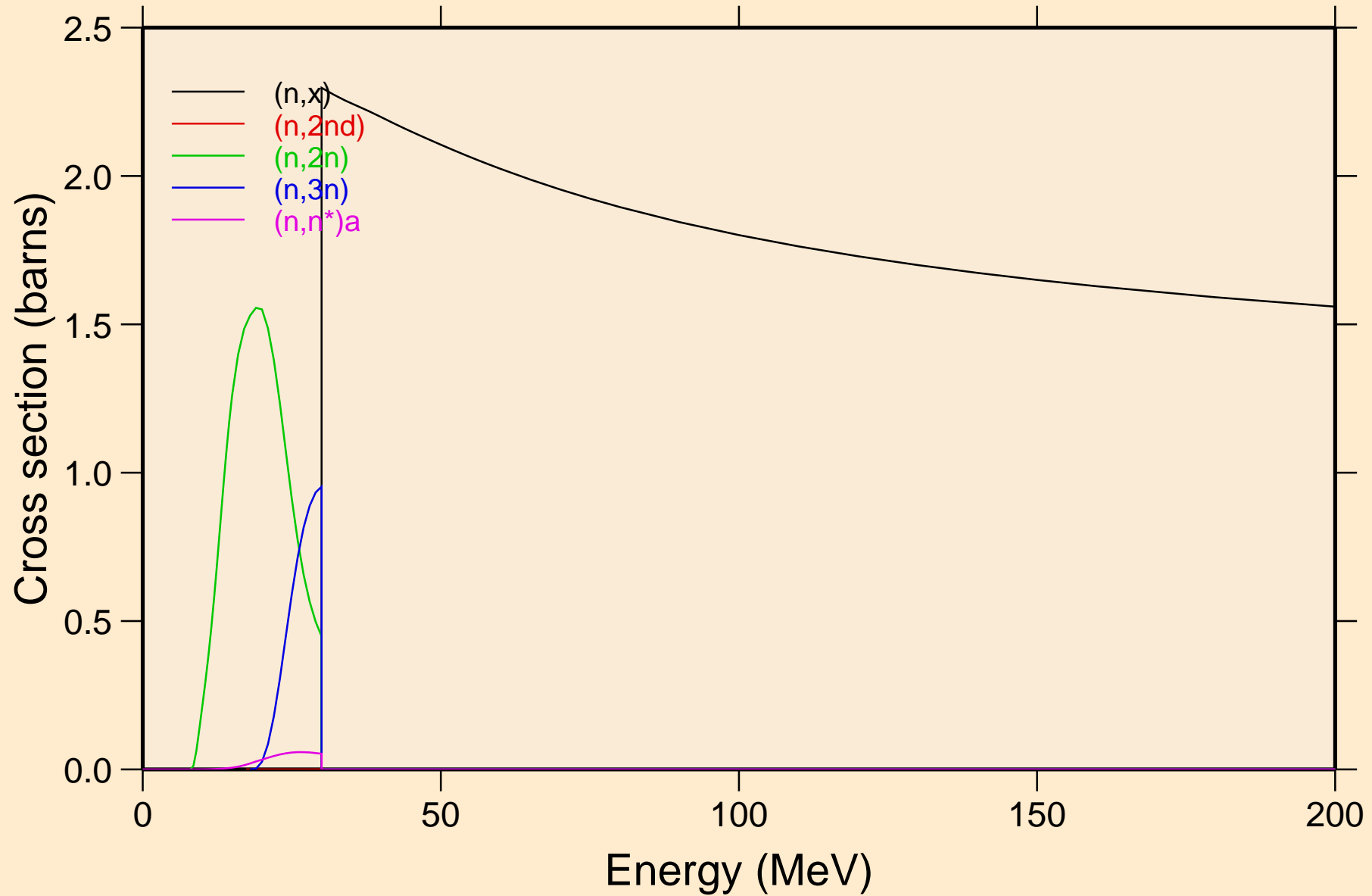

IR180 NEUTRON ACER TENDL-2021 LIBRARY; T=293.6K
Threshold reactions

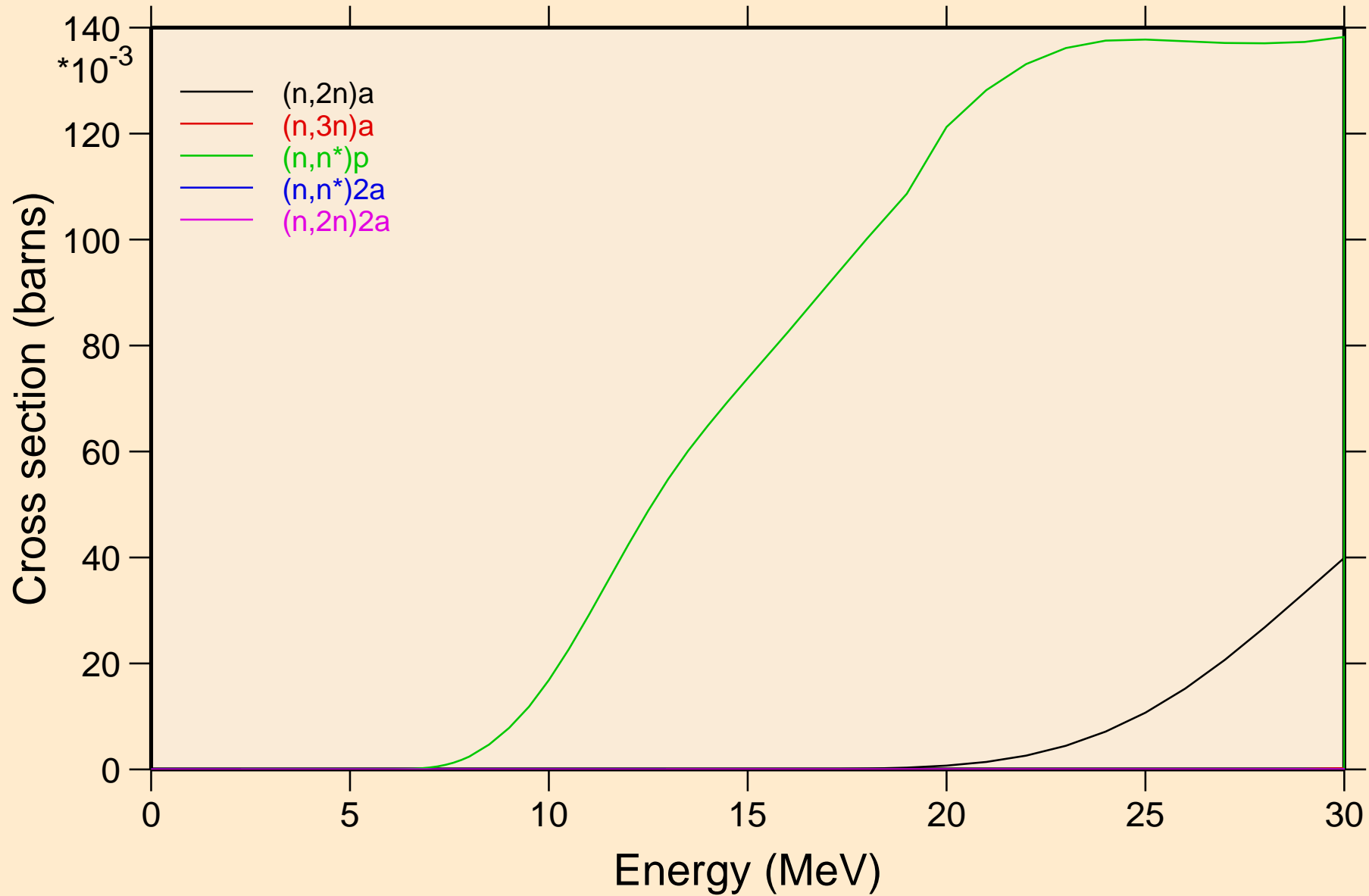

IR180 NEUTRON ACER TENDL-2021 LIBRARY; T=293.6K

Threshold reactions

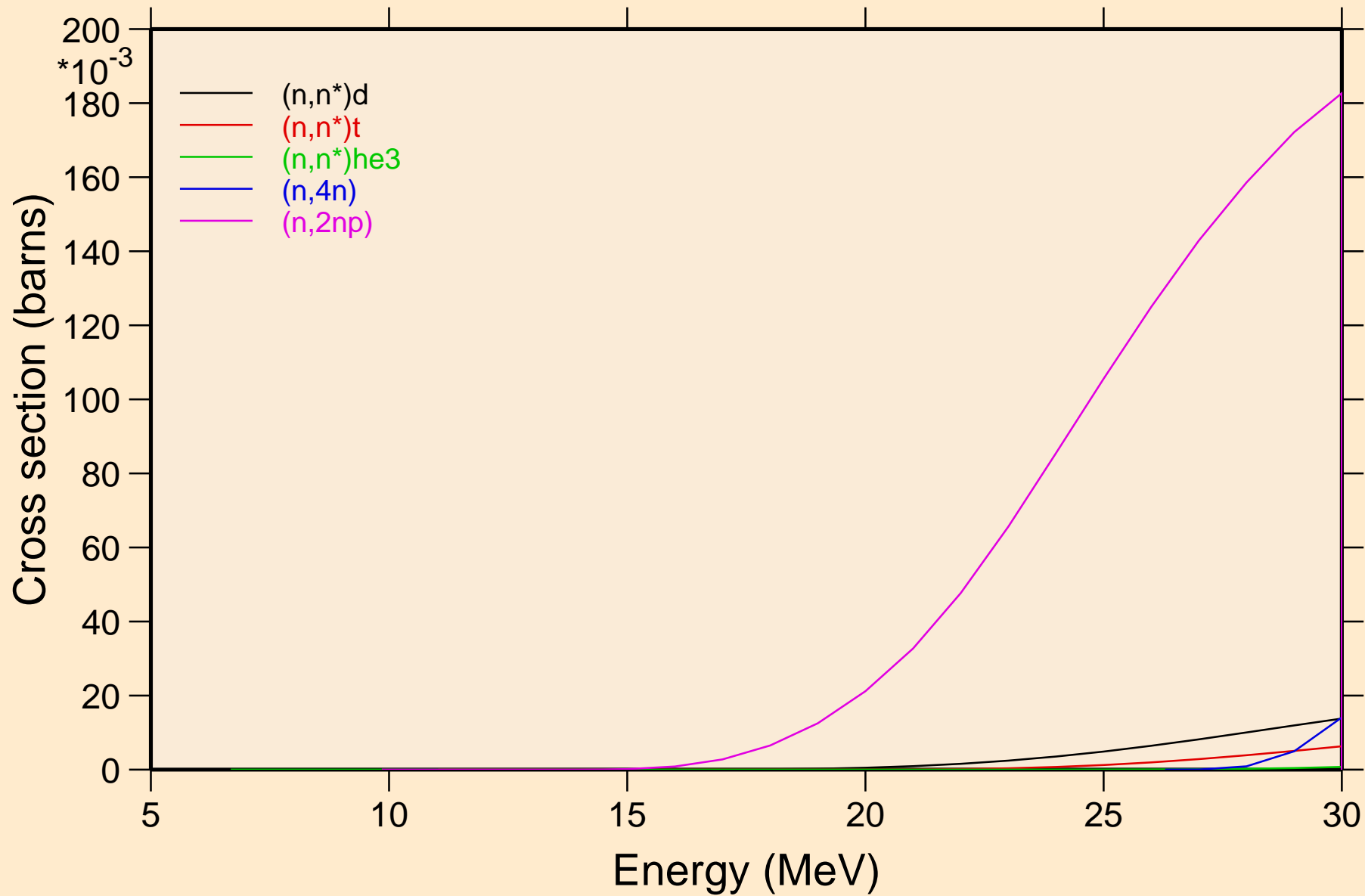

IR180 NEUTRON ACER TENDL-2021 LIBRARY; T=293.6K
Threshold reactions

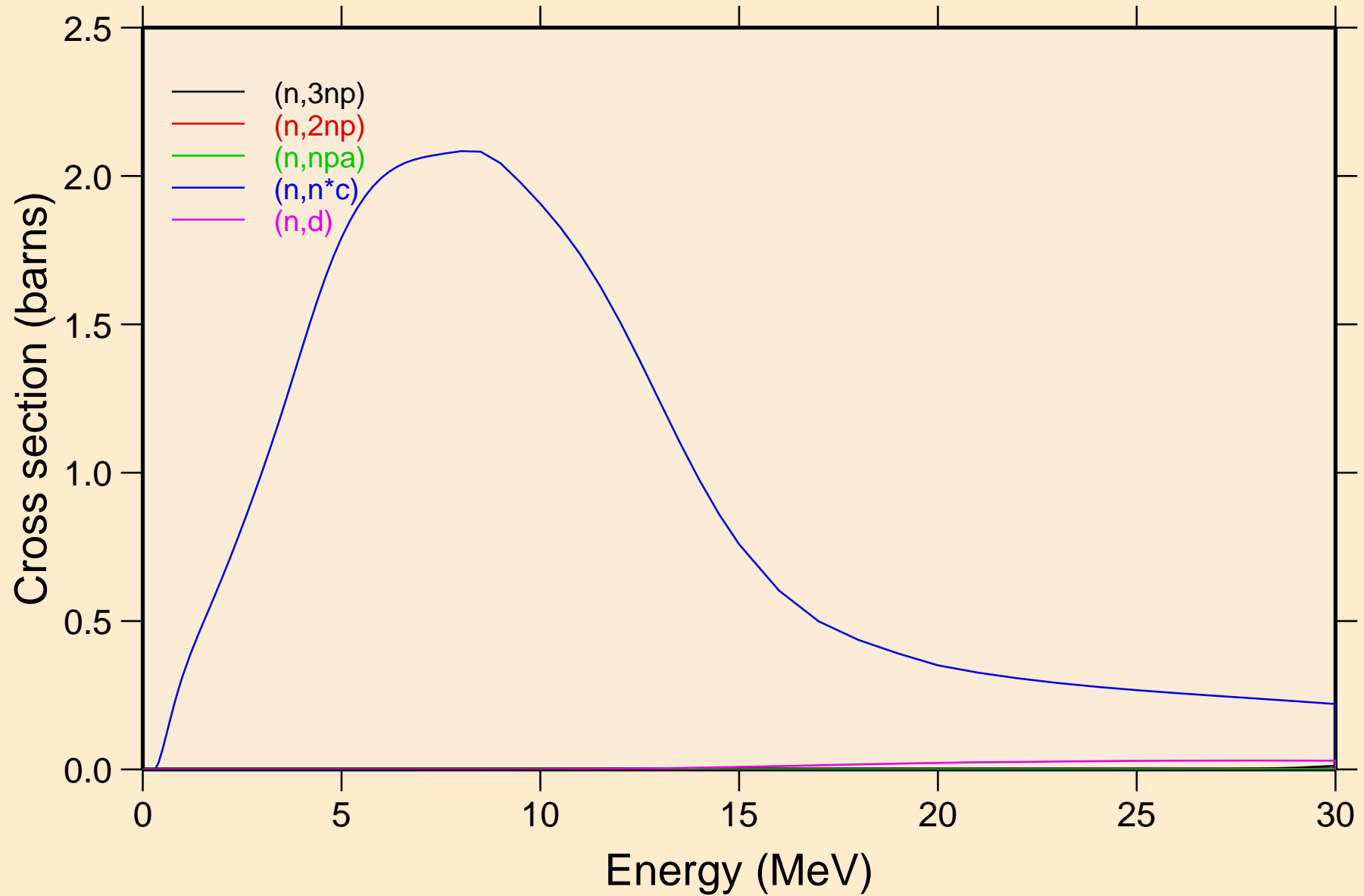

IR180 NEUTRON ACER TENDL-2021 LIBRARY; T=293.6K
Threshold reactions

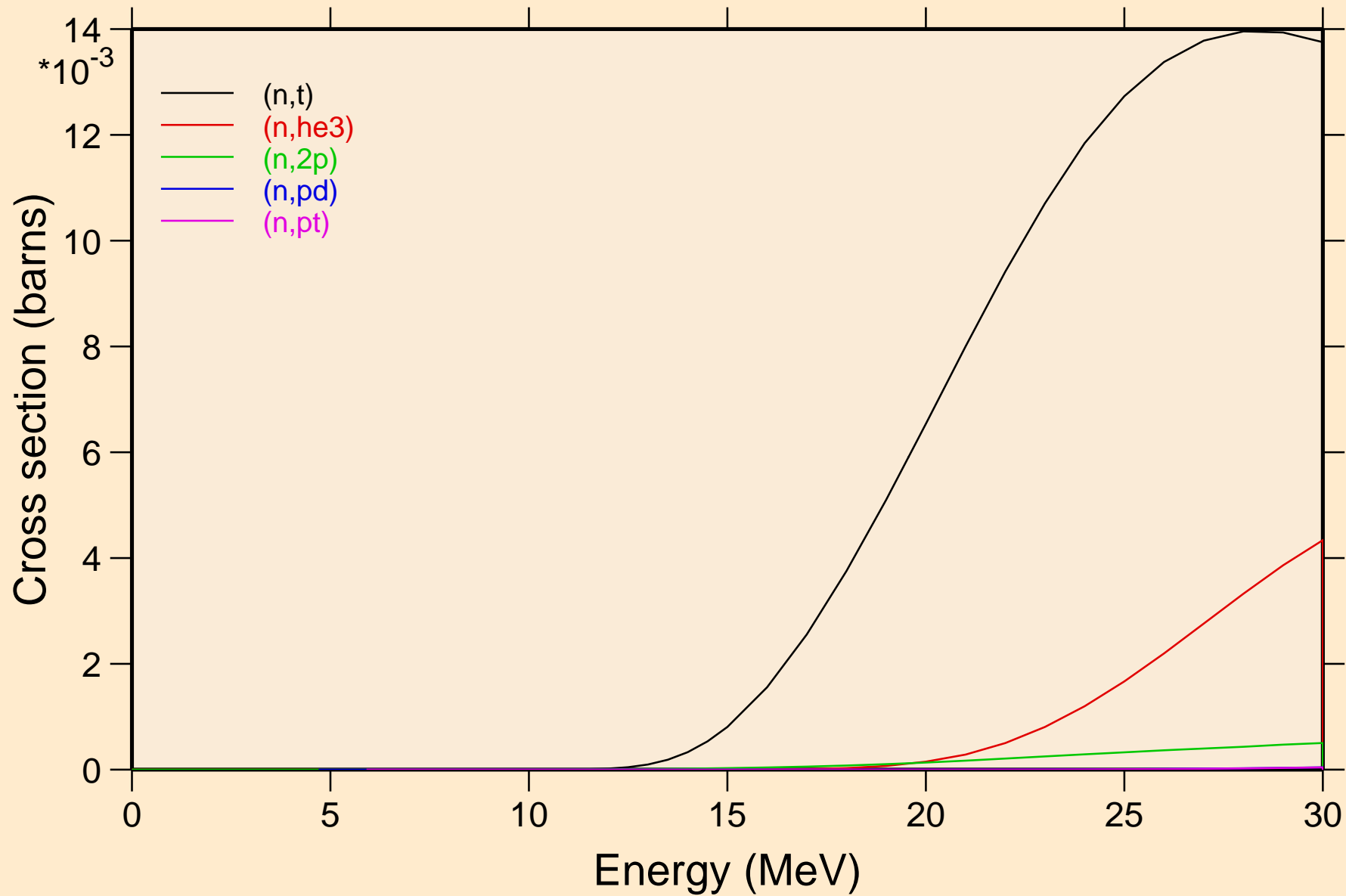

IR180 NEUTRON ACER TENDL-2021 LIBRARY; T=293.6K
Threshold reactions

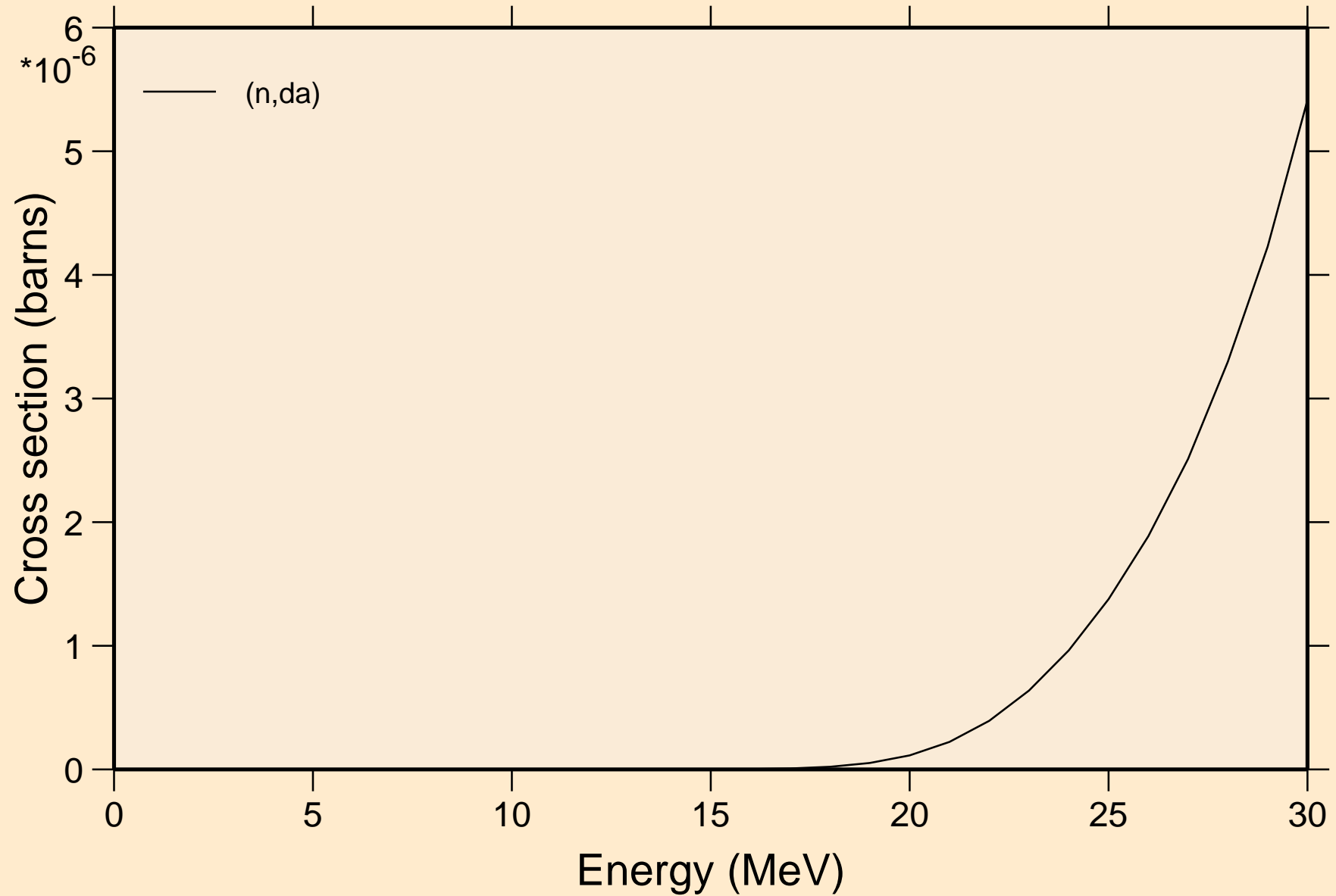

IR180 NEUTRON ACER TENDL-2021 LIBRARY; T=293.6K
Threshold reactions

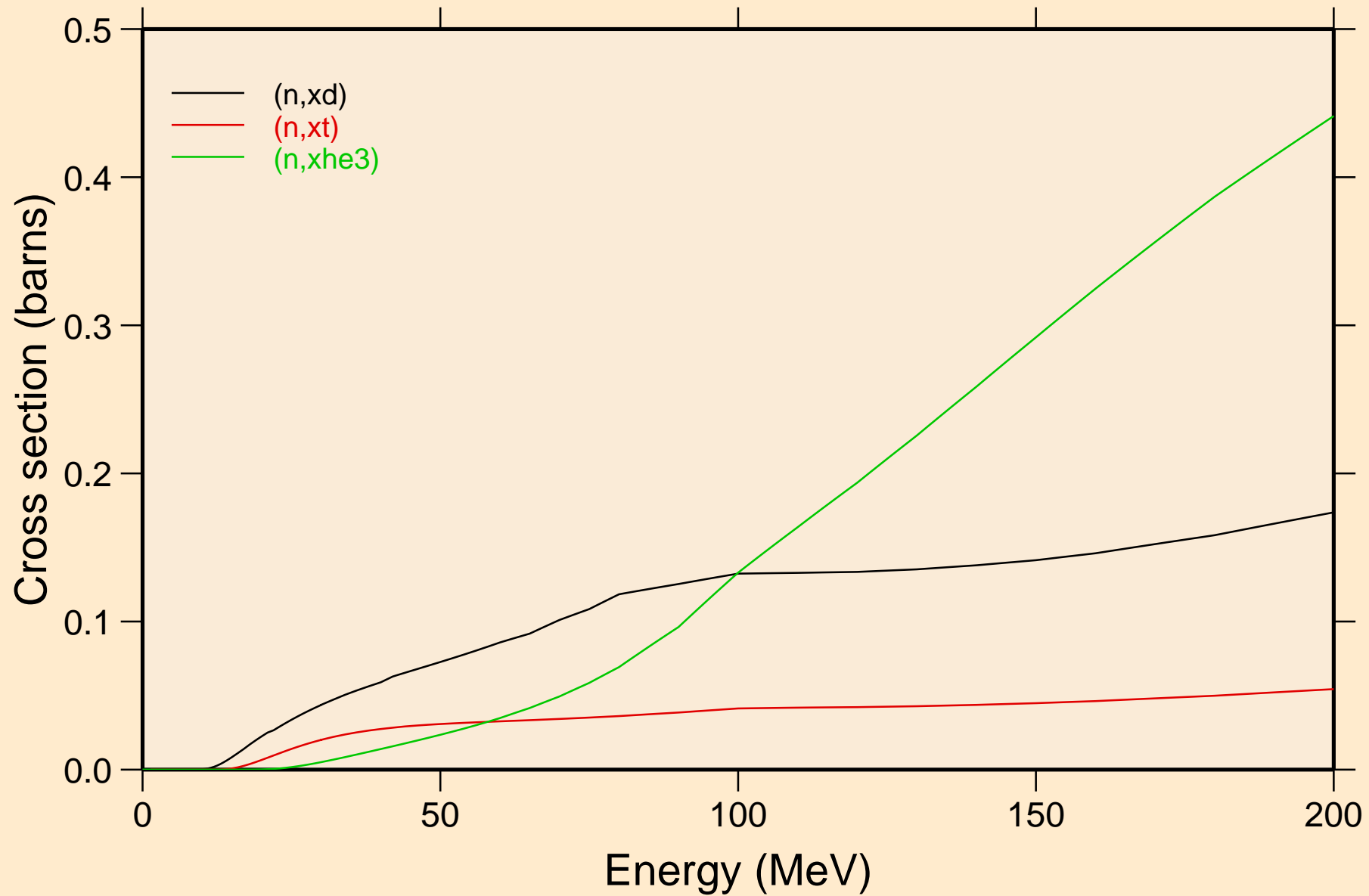

IR180 NEUTRON ACER TENDL-2021 LIBRARY; T=293.6K
angular distribution for elastic

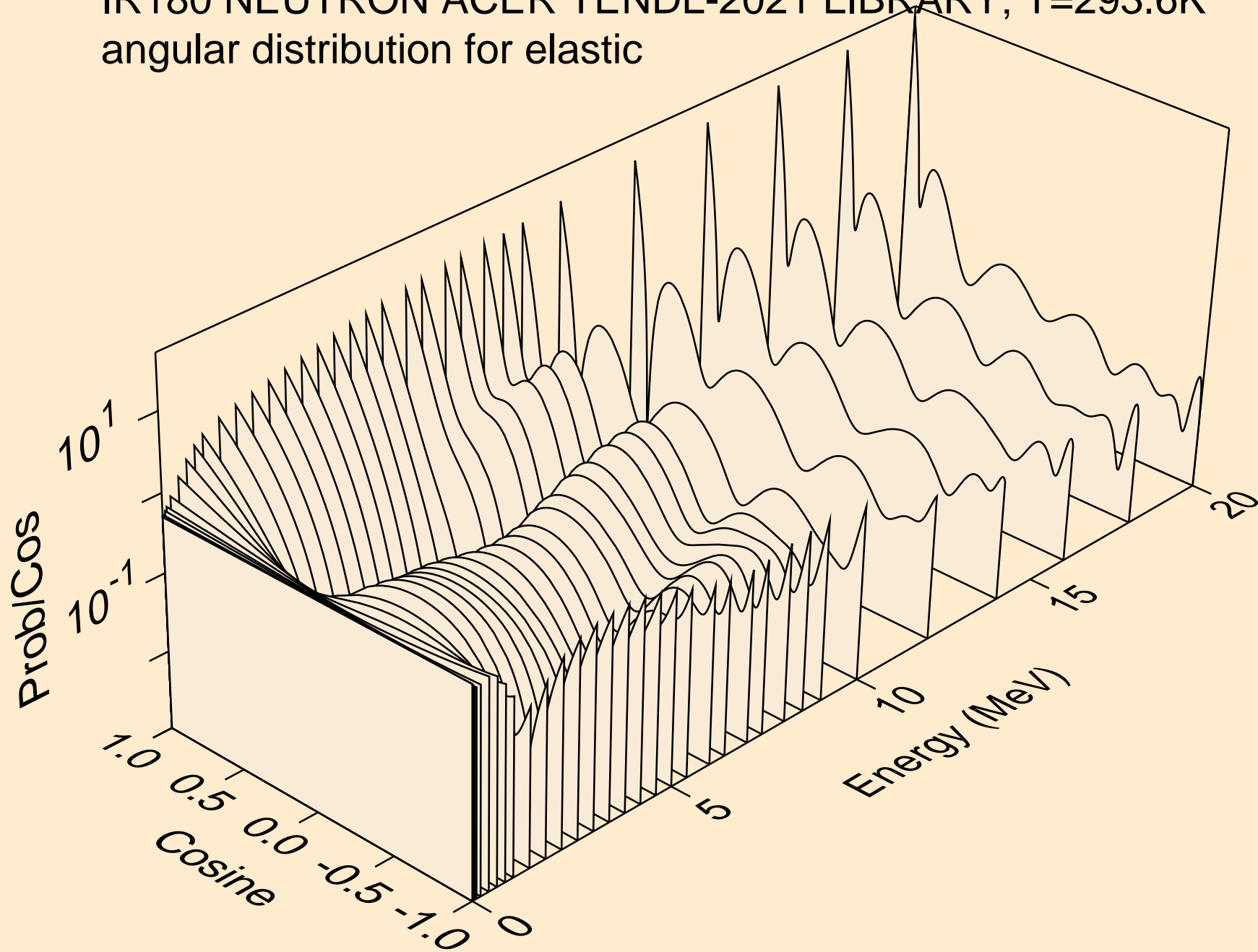

IR180 NEUTRON ACER TENDL-2021 LIBRARY; T=293.6K
angular distribution for elastic

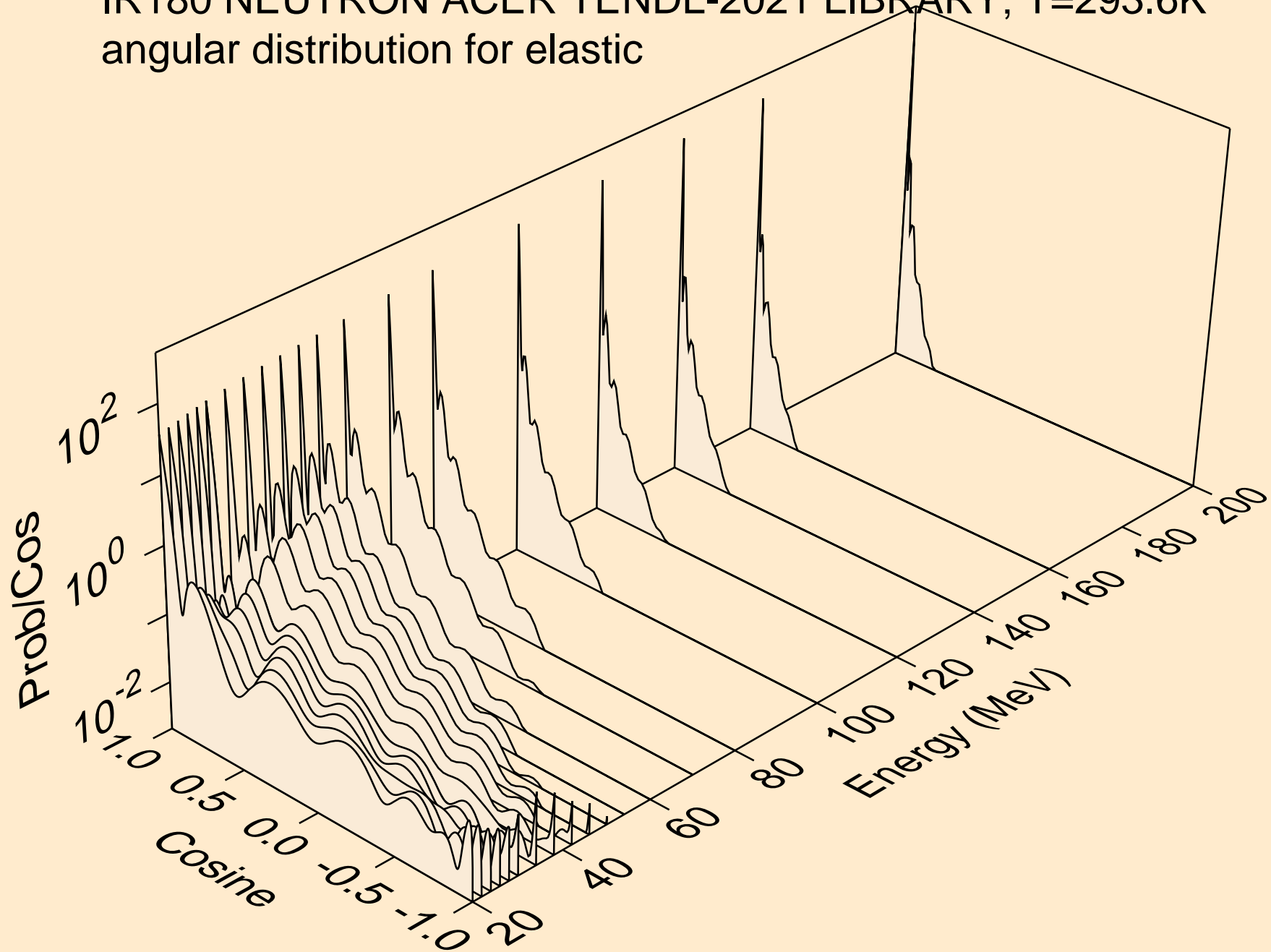

IR180 NEUTRON ACER TENDL-2021 LIBRARY; T=293.6K
angular distribution for (n,n*1)

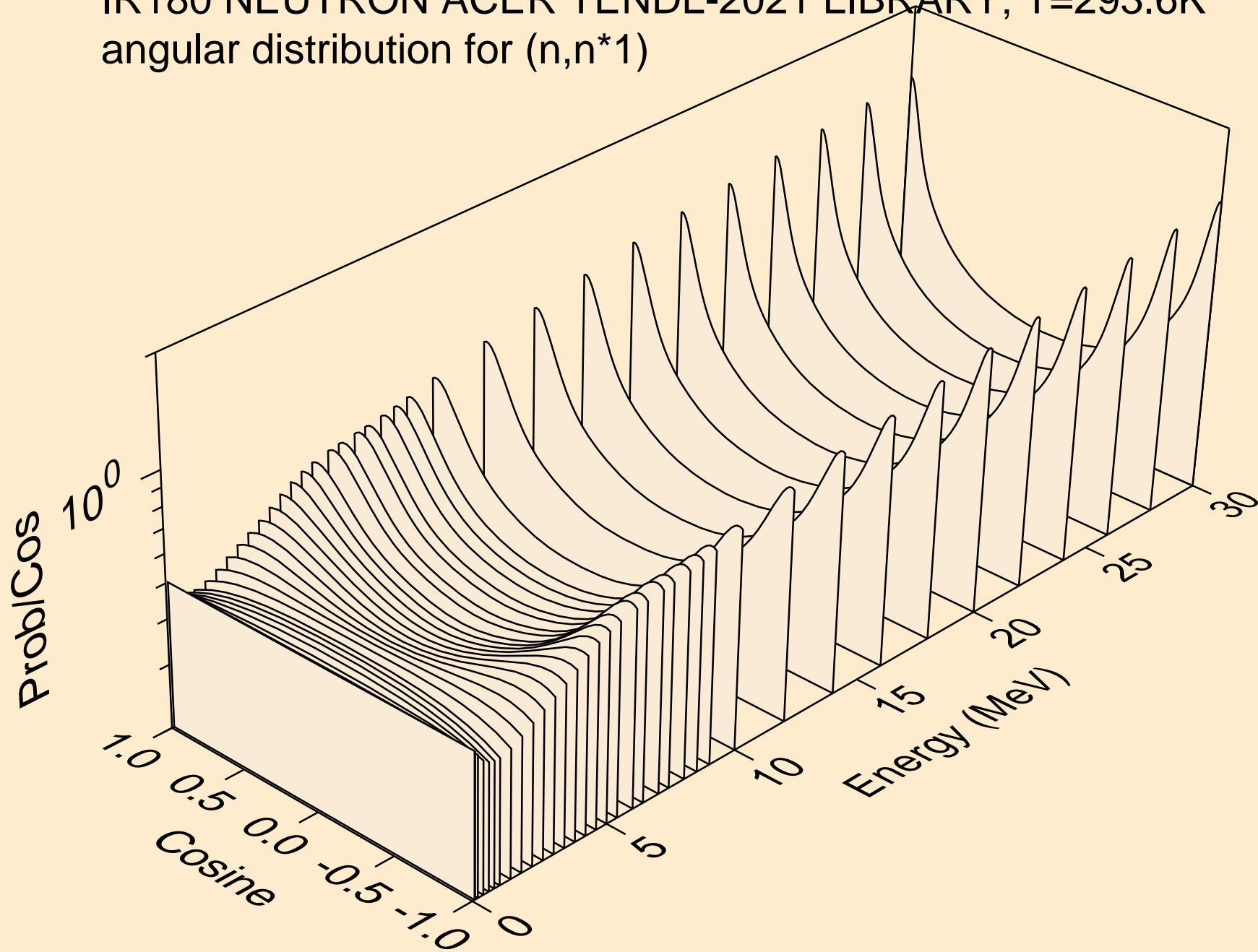

IR180 NEUTRON ACER TENDL-2021 LIBRARY; T=293.6K
angular distribution for (n,n*2)

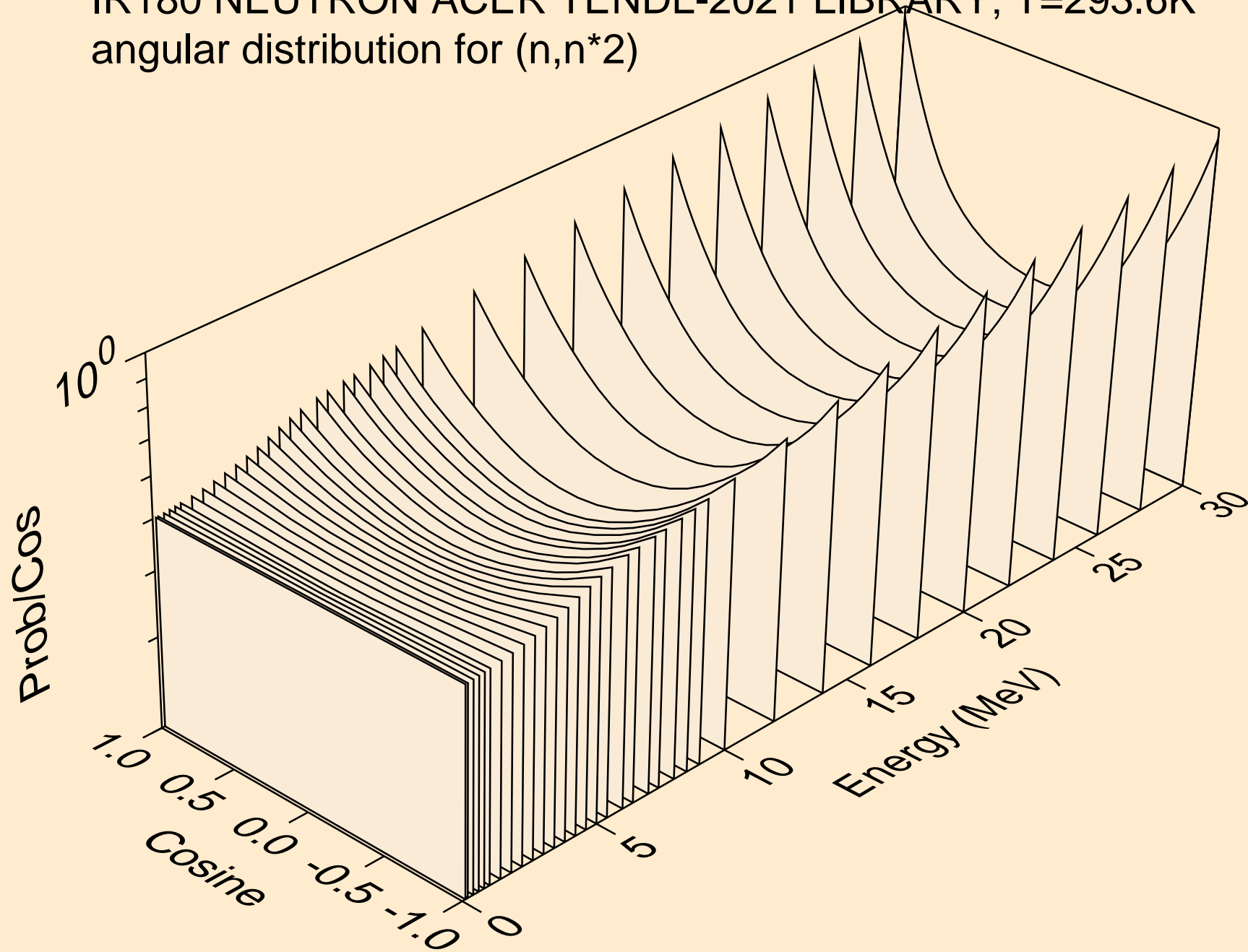

IR180 NEUTRON ACER TENDL-2021 LIBRARY; T=293.6K
angular distribution for (n,n*3)

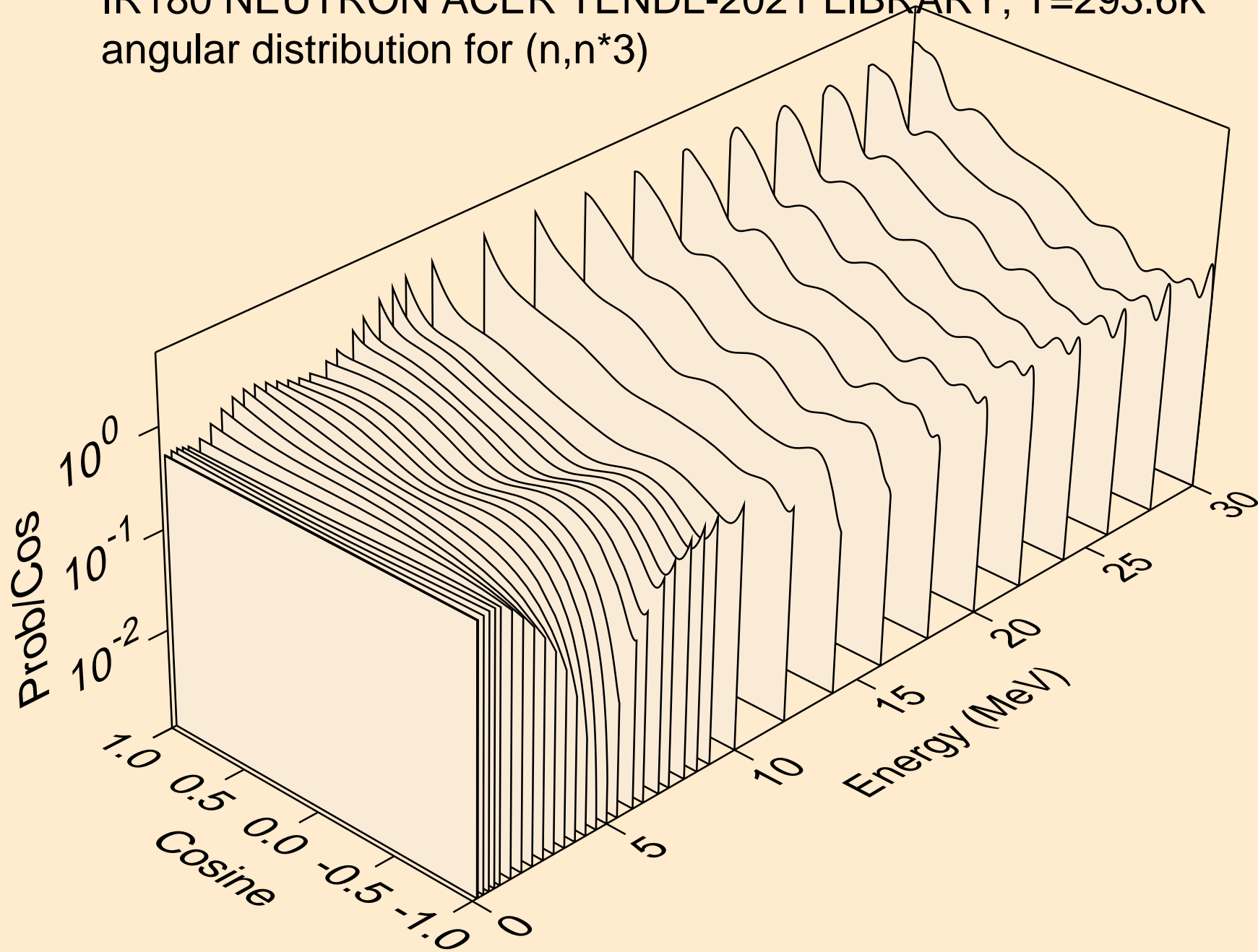

IR180 NEUTRON ACER TENDL-2021 LIBRARY; T=293.6K
angular distribution for (n,n*4)

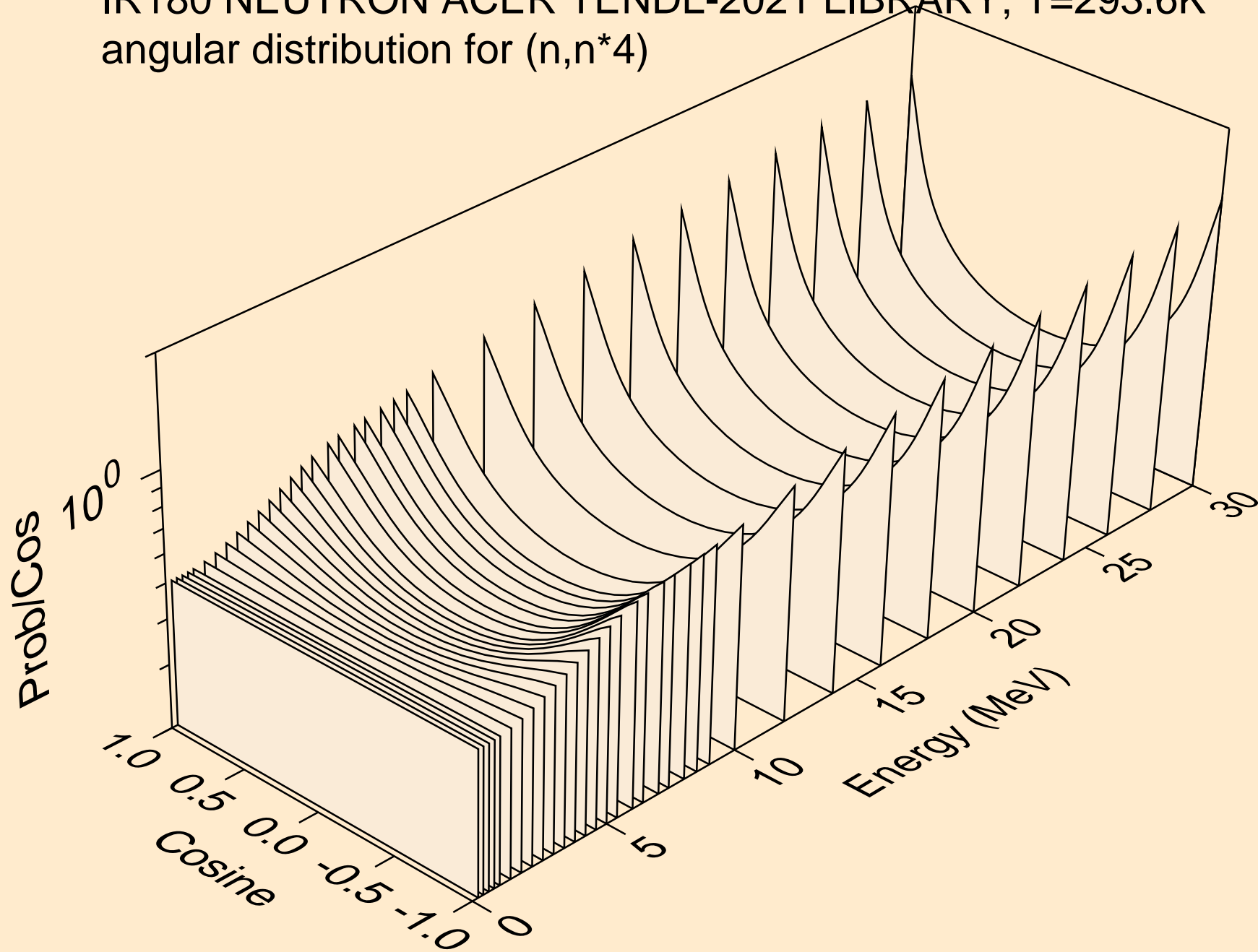

IR180 NEUTRON ACER TENDL-2021 LIBRARY; T=293.6K
angular distribution for (n,n*5)

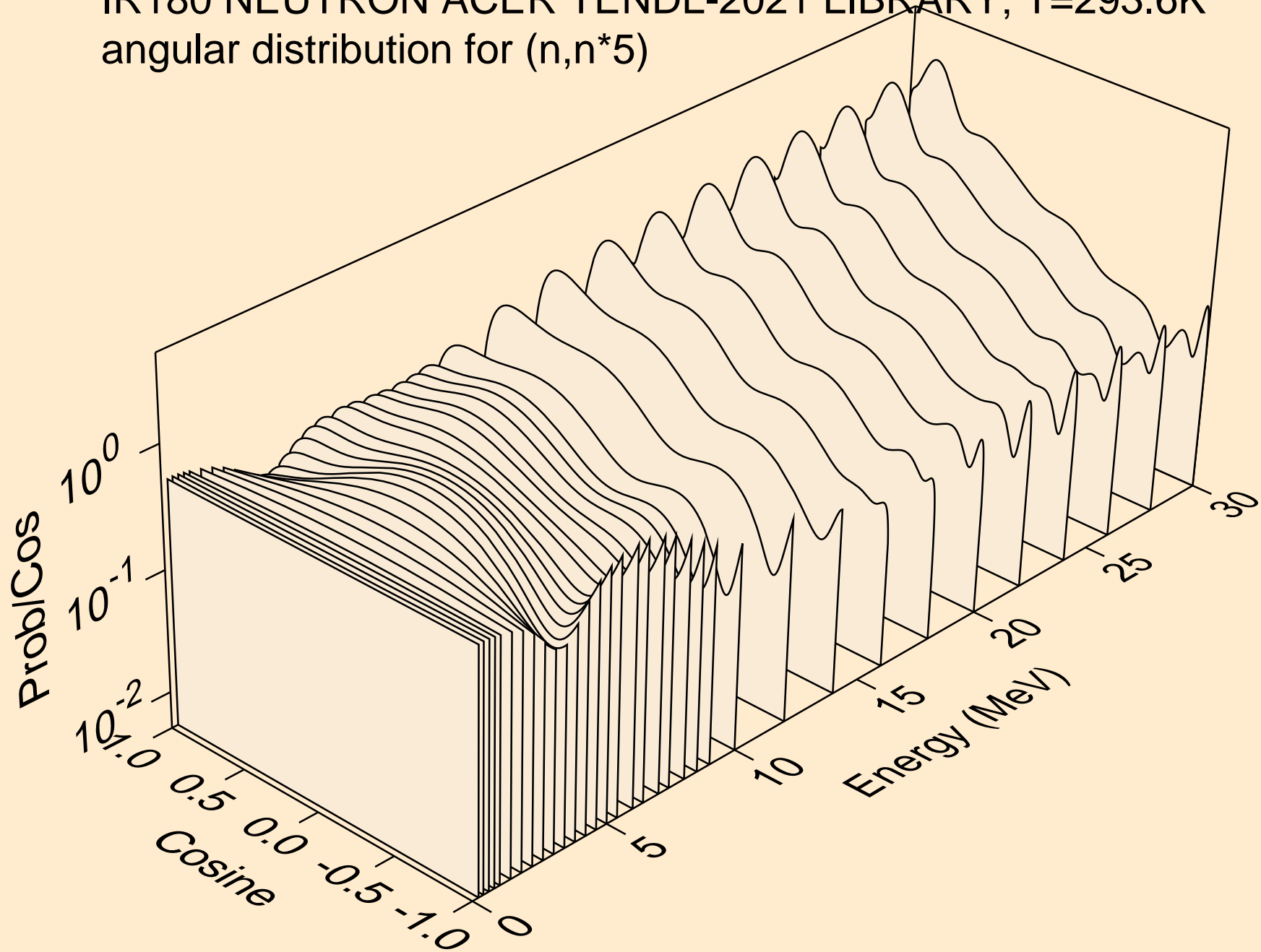

IR180 NEUTRON ACER TENDL-2021 LIBRARY; T=293.6K
angular distribution for (n,n*6)

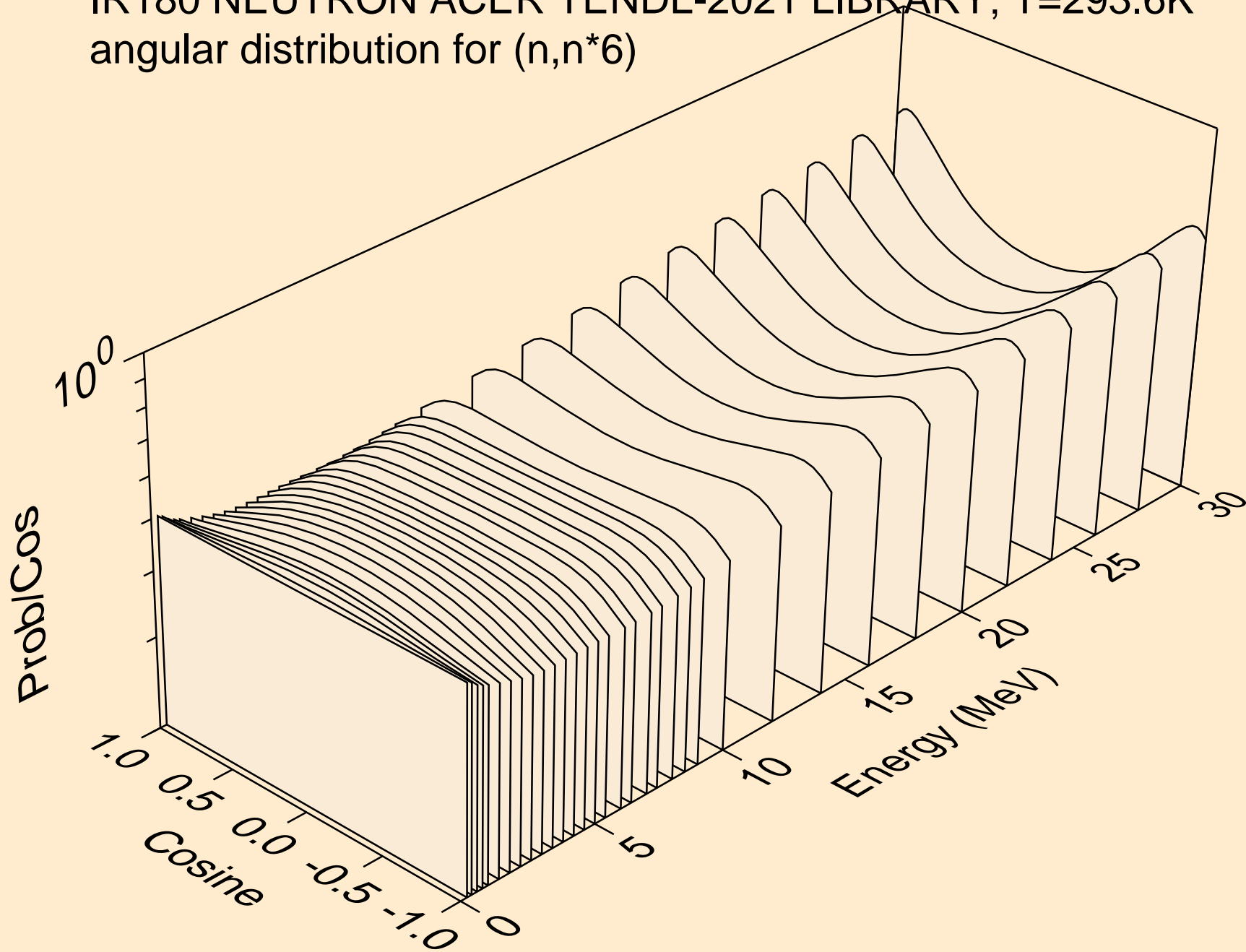

IR180 NEUTRON ACER TENDL-2021 LIBRARY; T=293.6K
angular distribution for (n,n*7)

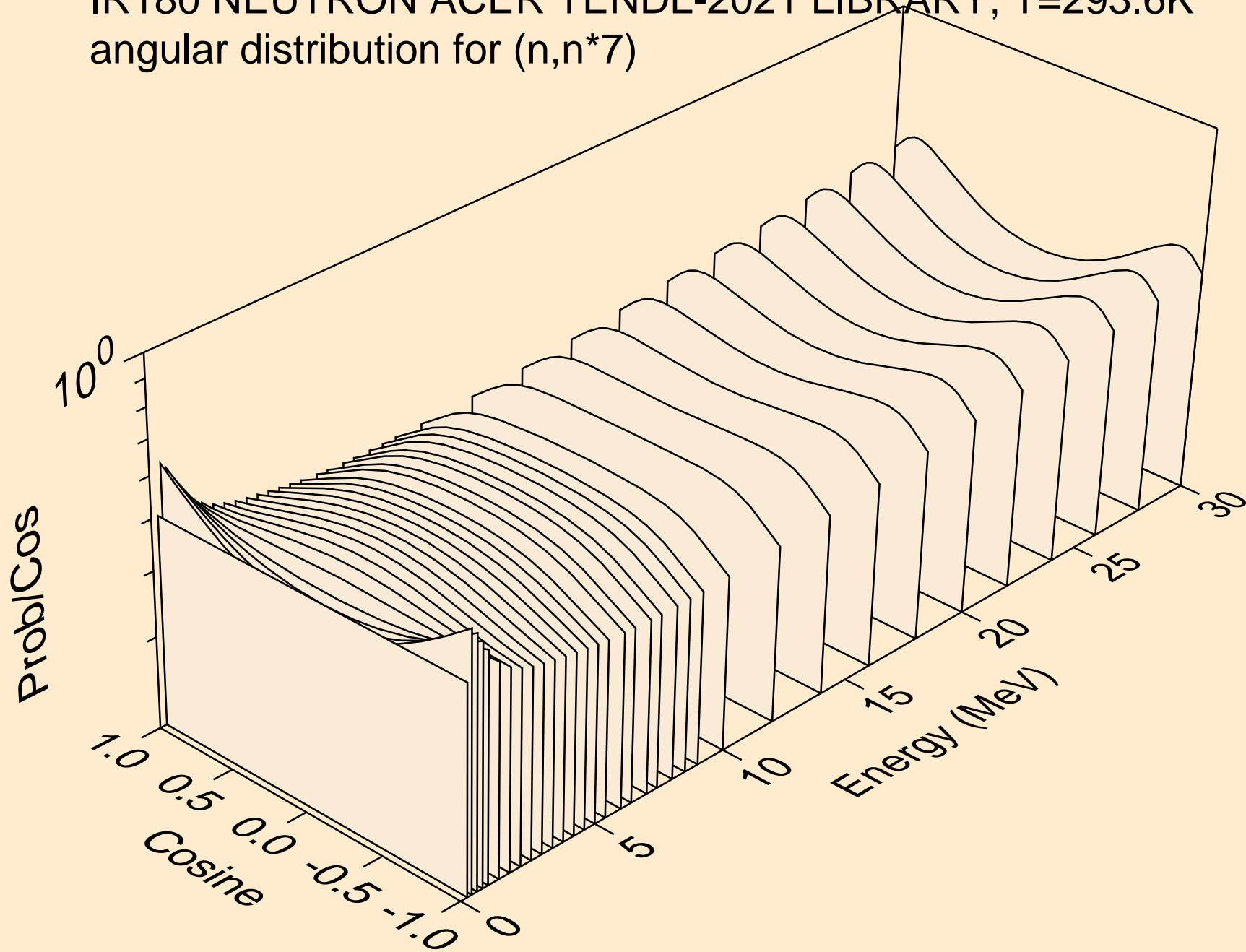

IR180 NEUTRON ACER TENDL-2021 LIBRARY; T=293.6K
angular distribution for (n,n*8)

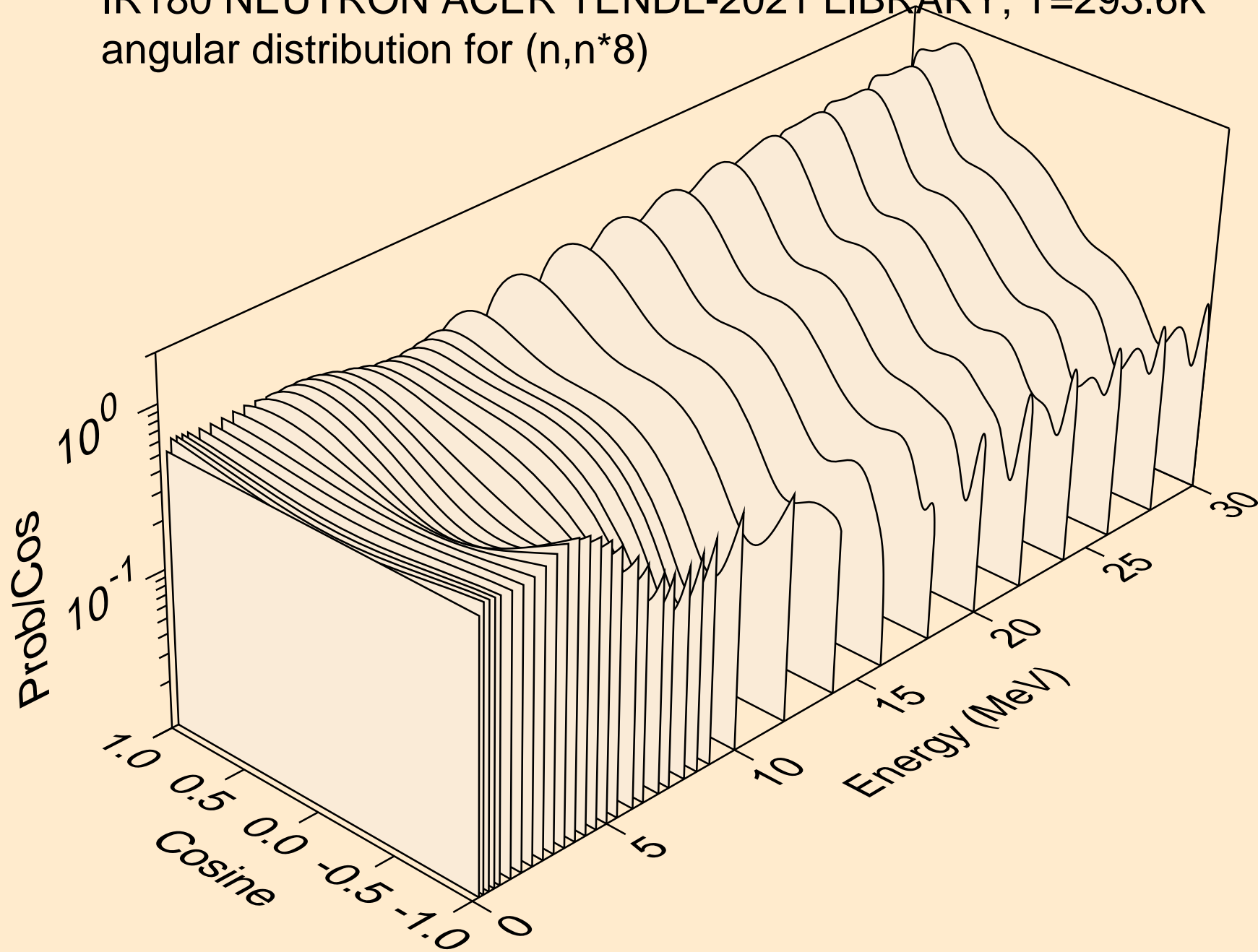

IR180 NEUTRON ACER TENDL-2021 LIBRARY; T=293.6K
angular distribution for (n,n*9)

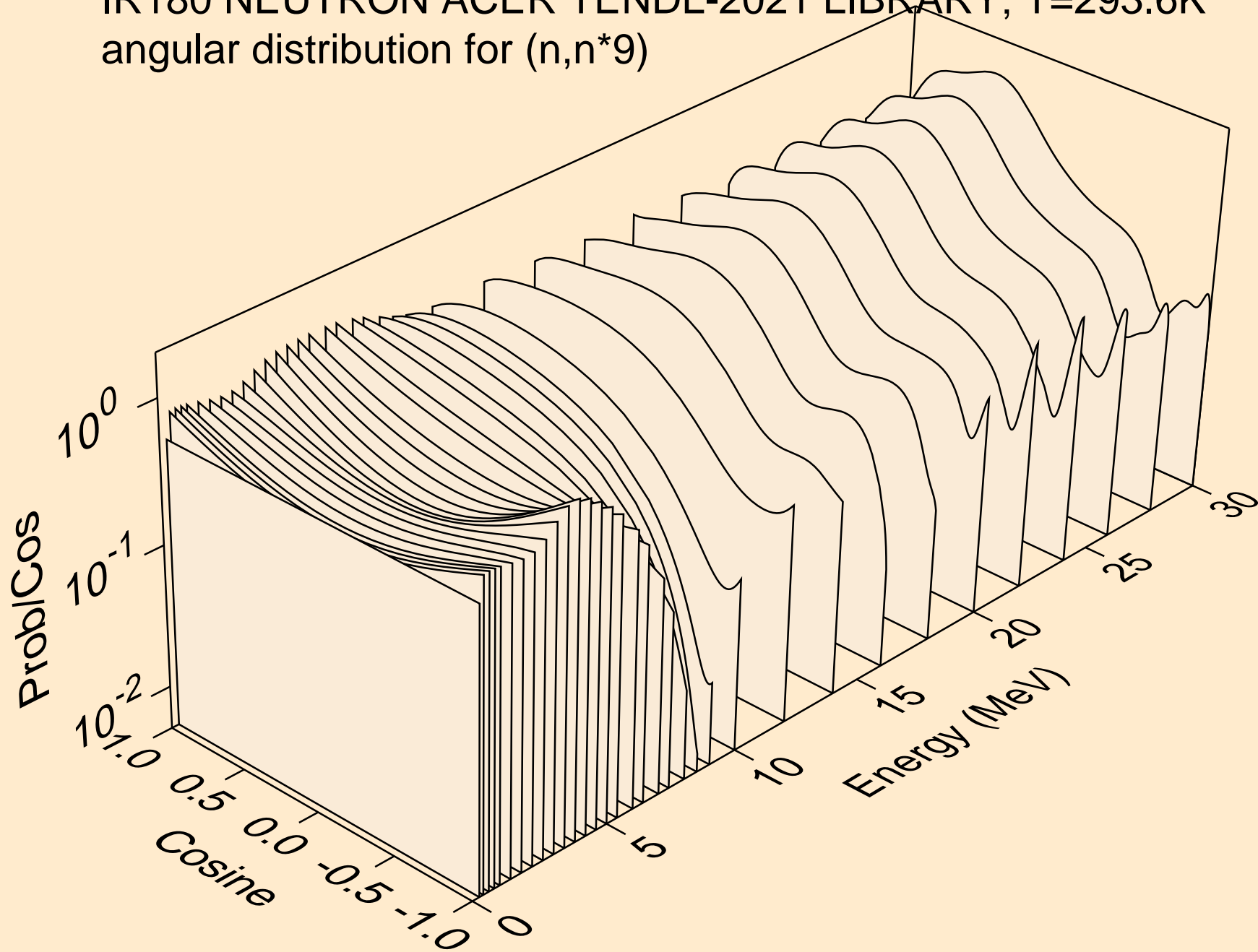

IR180 NEUTRON ACER TENDL-2021 LIBRARY; T=293.6K
angular distribution for (n,n*10)

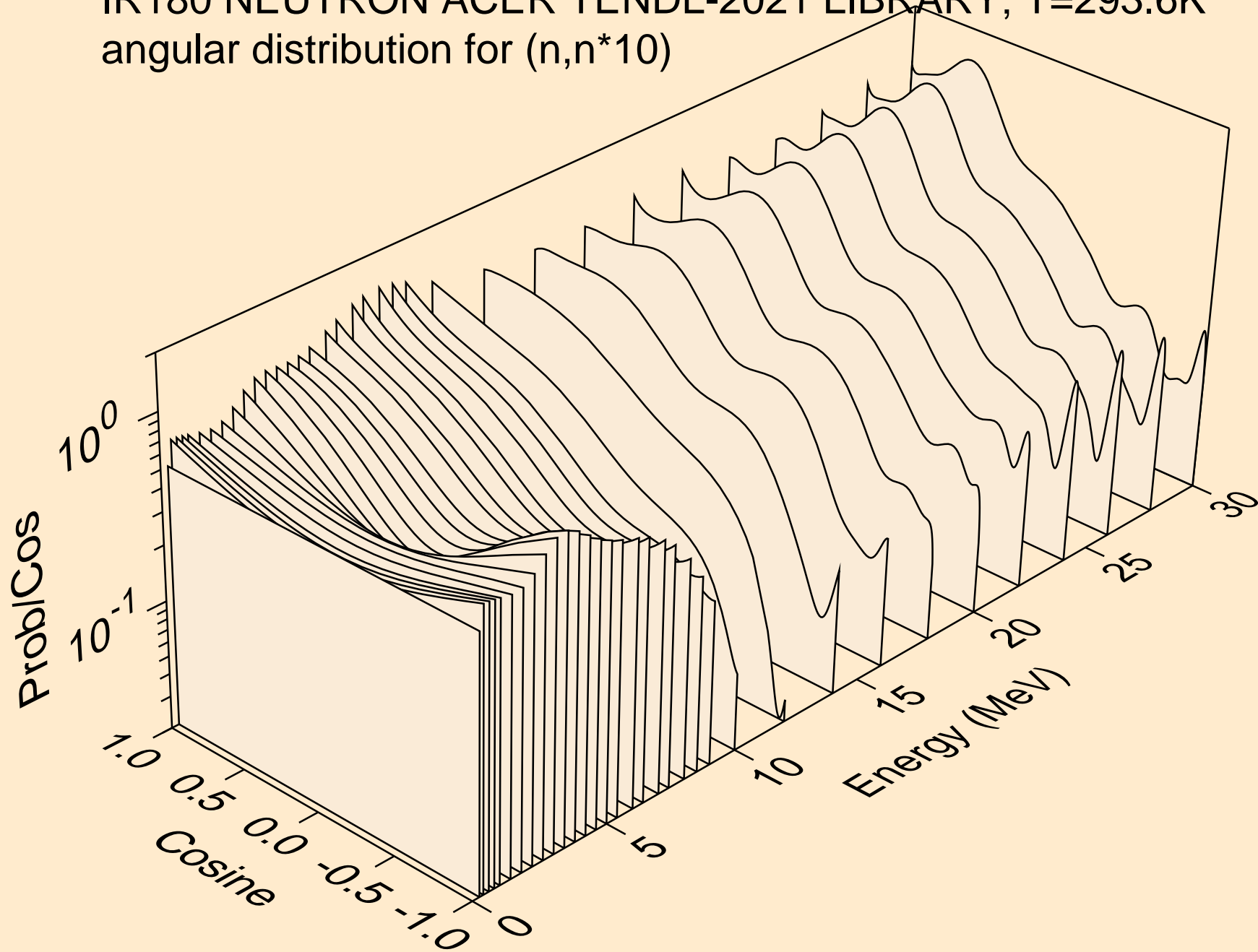

IR180 NEUTRON ACER TENDL-2021 LIBRARY; T=293.6K
angular distribution for (n,n*11)

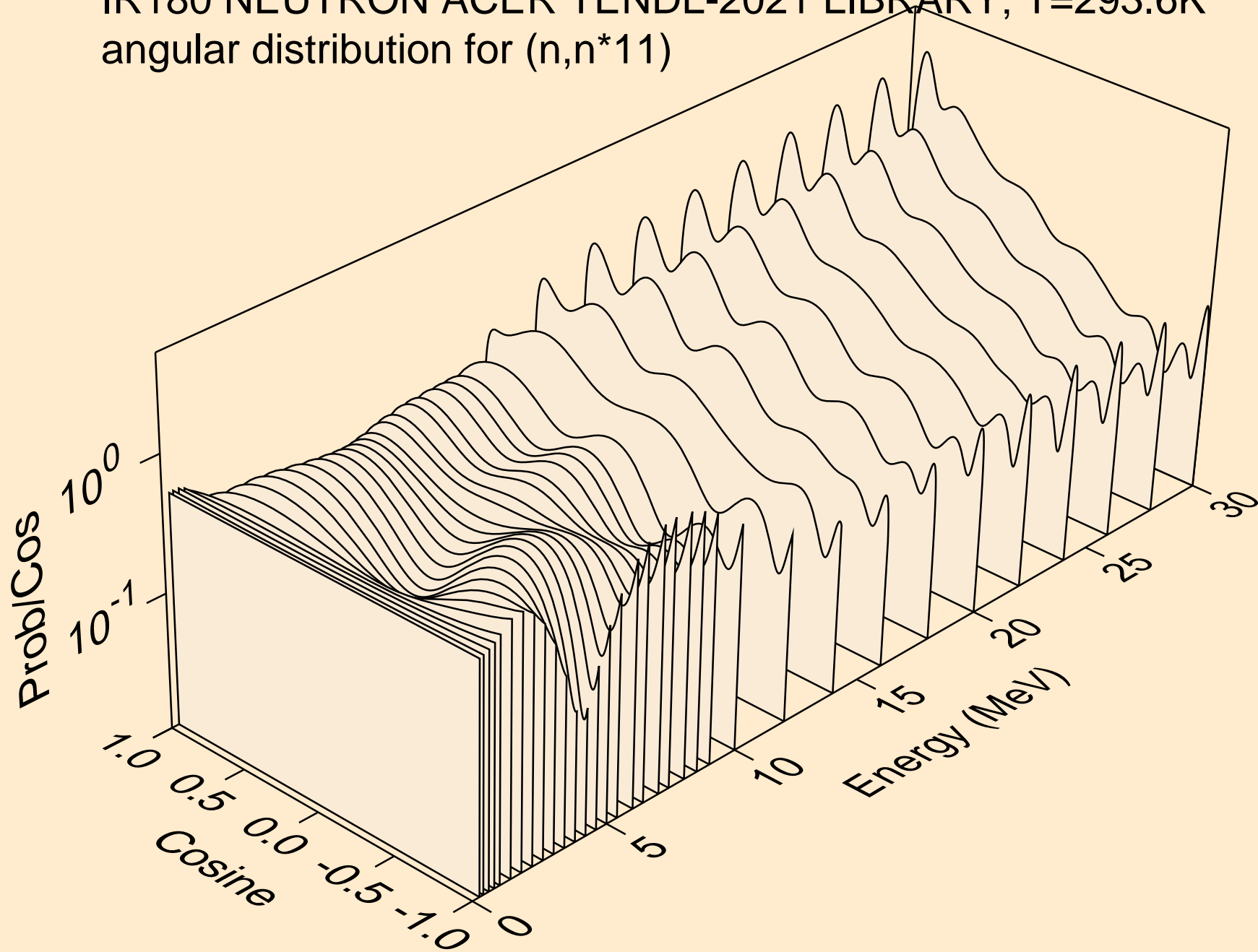

IR180 NEUTRON ACER TENDL-2021 LIBRARY; T=293.6K
angular distribution for (n,n*12)

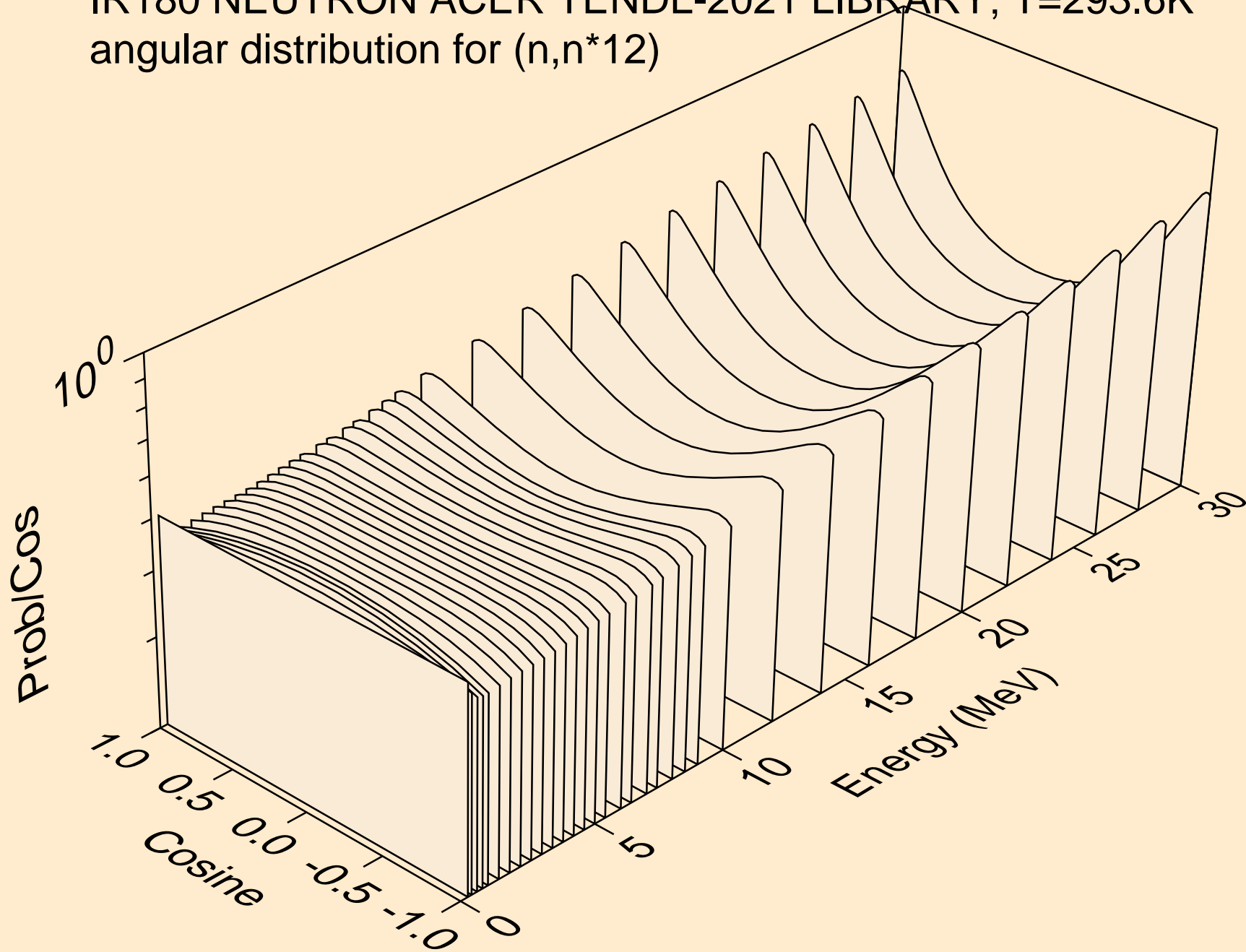

IR180 NEUTRON ACER TENDL-2021 LIBRARY; T=293.6K
angular distribution for (n,n*13)

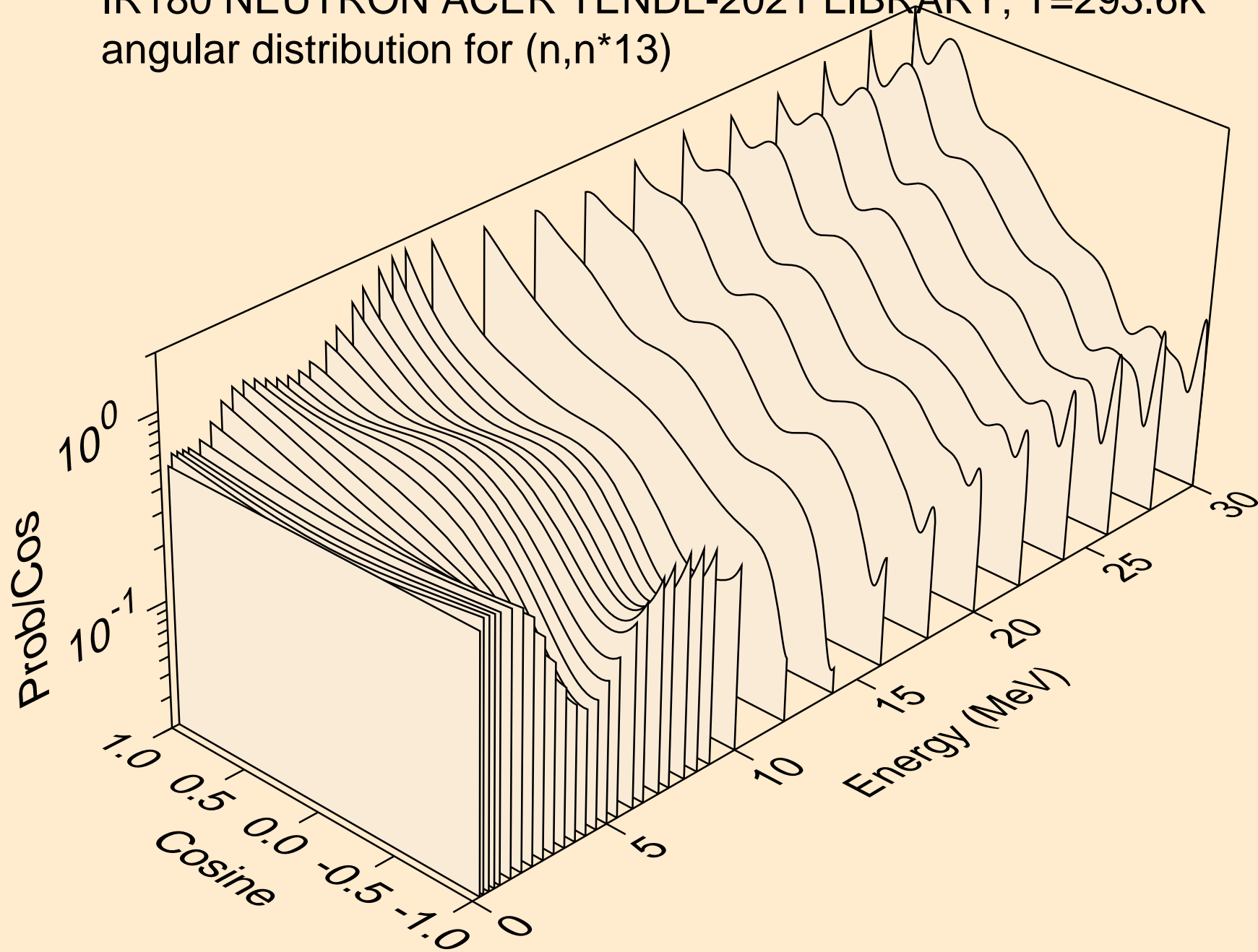

IR180 NEUTRON ACER TENDL-2021 LIBRARY; T=293.6K
angular distribution for (n,n*14)

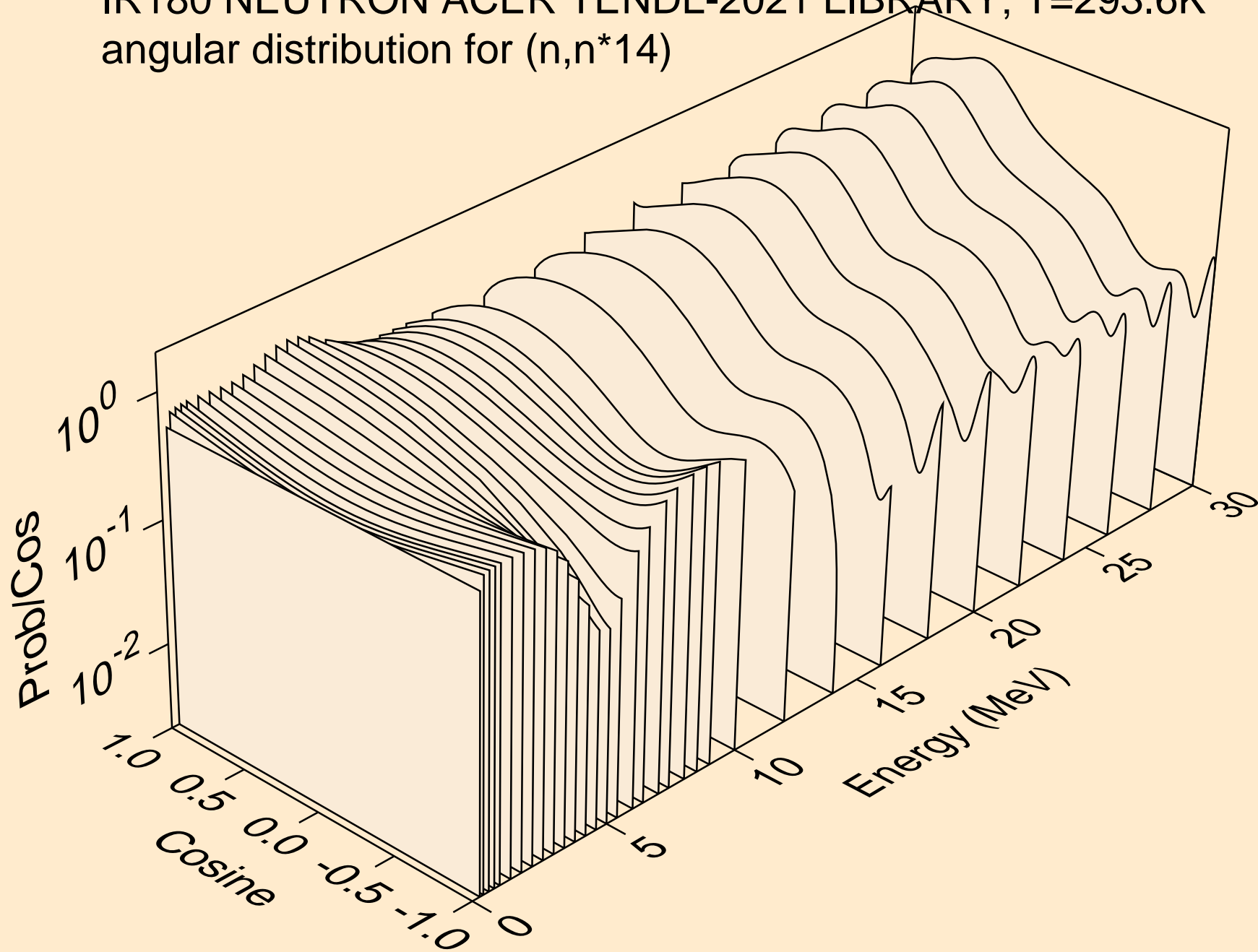

IR180 NEUTRON ACER TENDL-2021 LIBRARY; T=293.6K
angular distribution for (n,n*15)

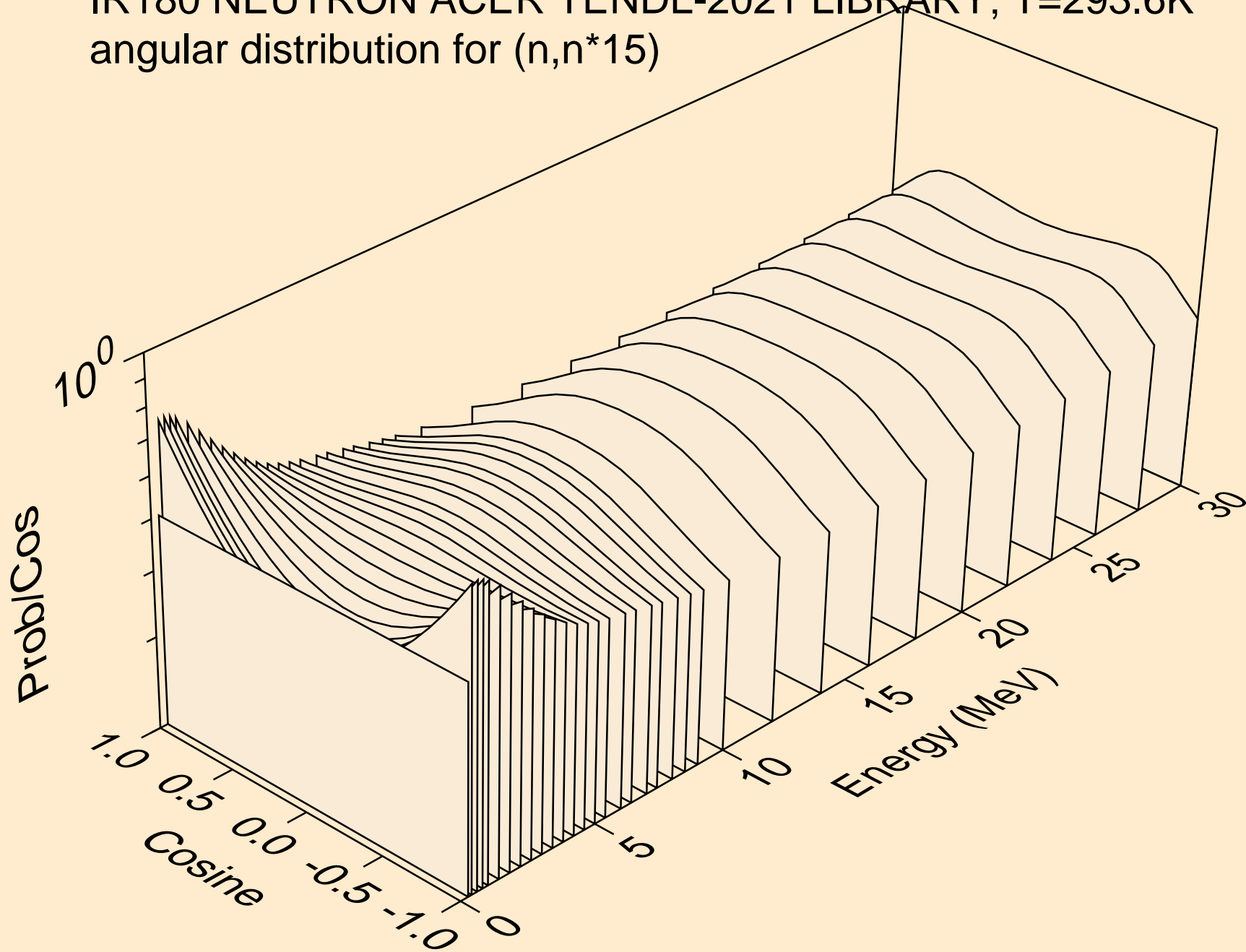

IR180 NEUTRON ACER TENDL-2021 LIBRARY; T=293.6K
angular distribution for (n,n*16)

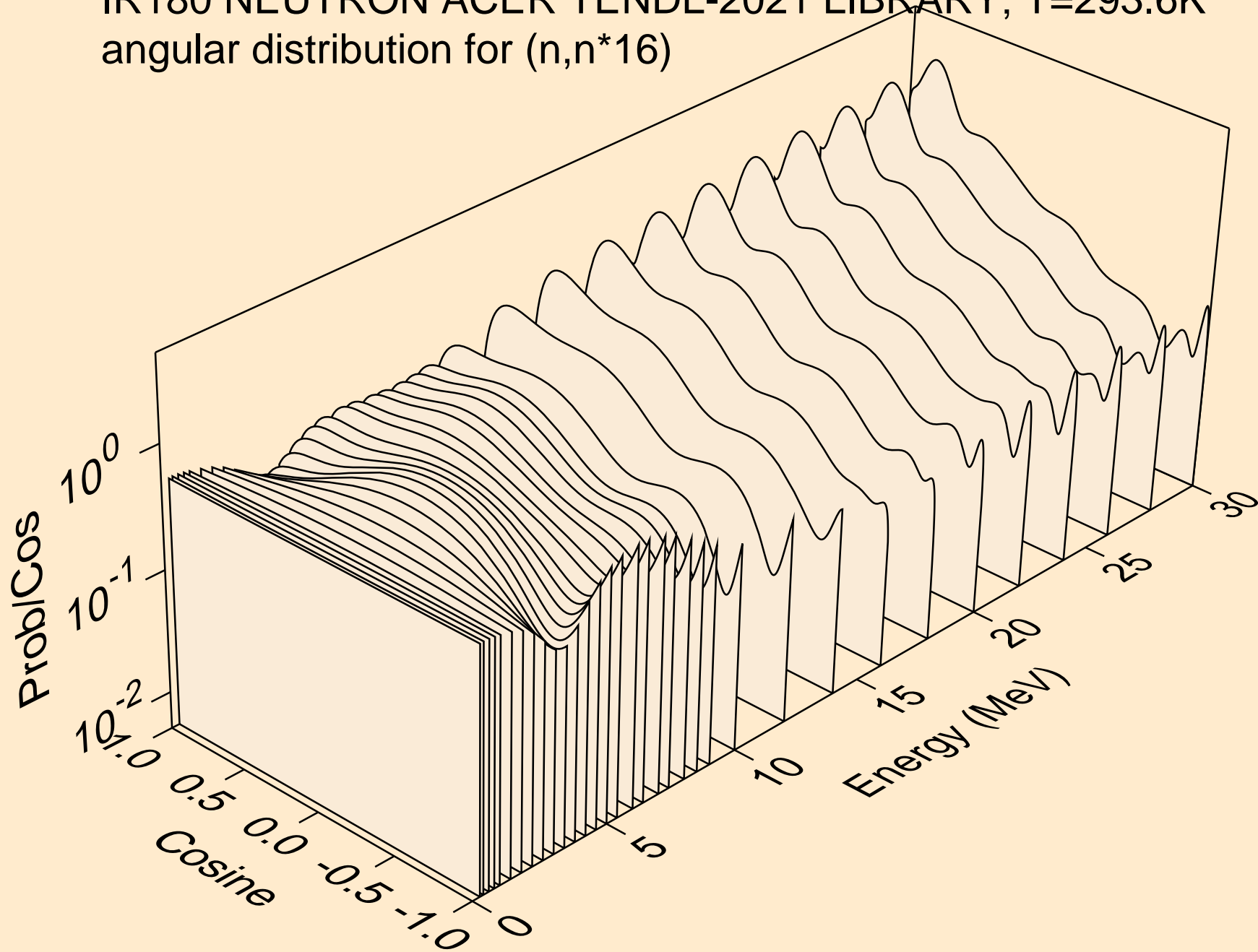

IR180 NEUTRON ACER TENDL-2021 LIBRARY; T=293.6K
angular distribution for (n,n*17)

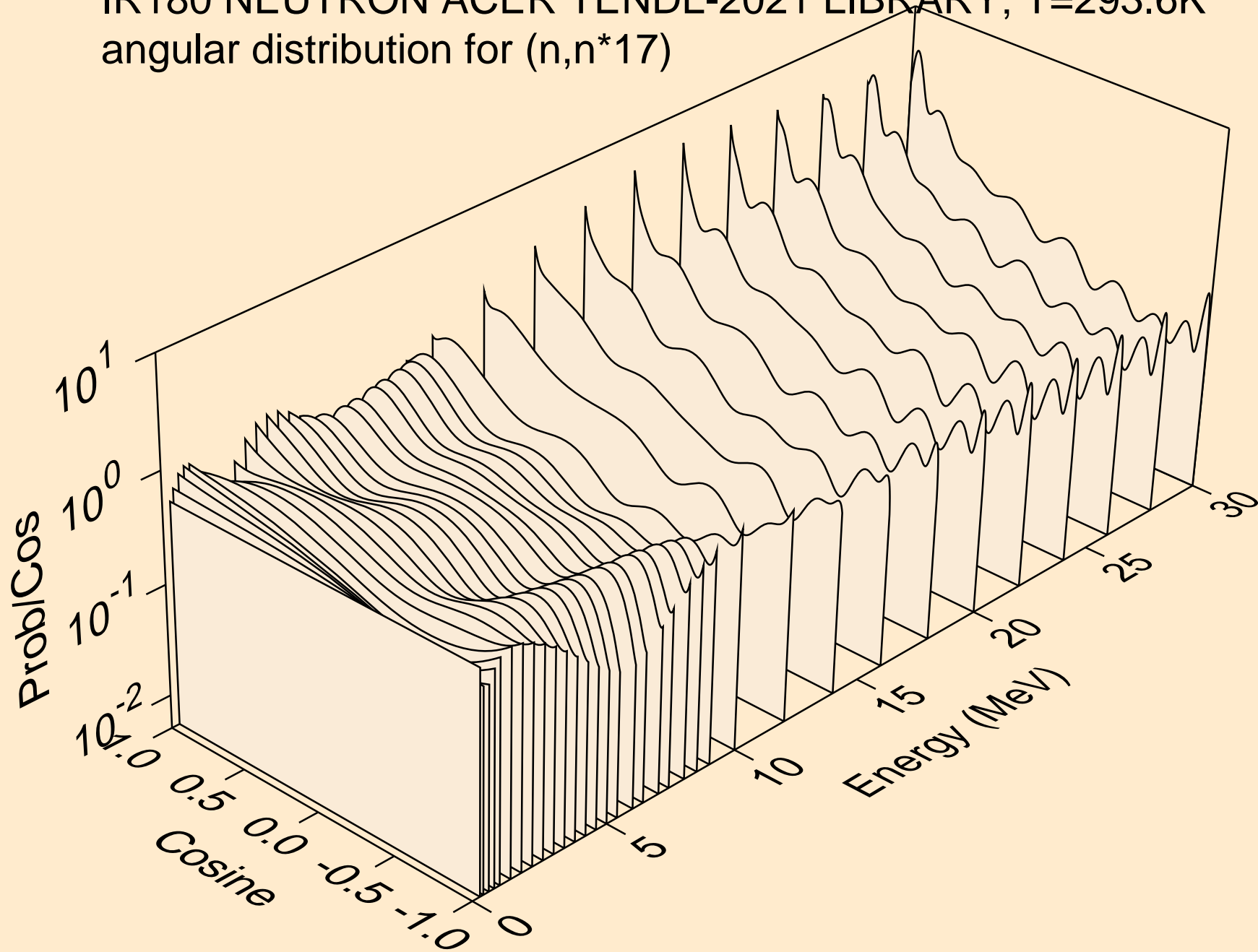

IR180 NEUTRON ACER TENDL-2021 LIBRARY; T=293.6K
angular distribution for (n,n*18)

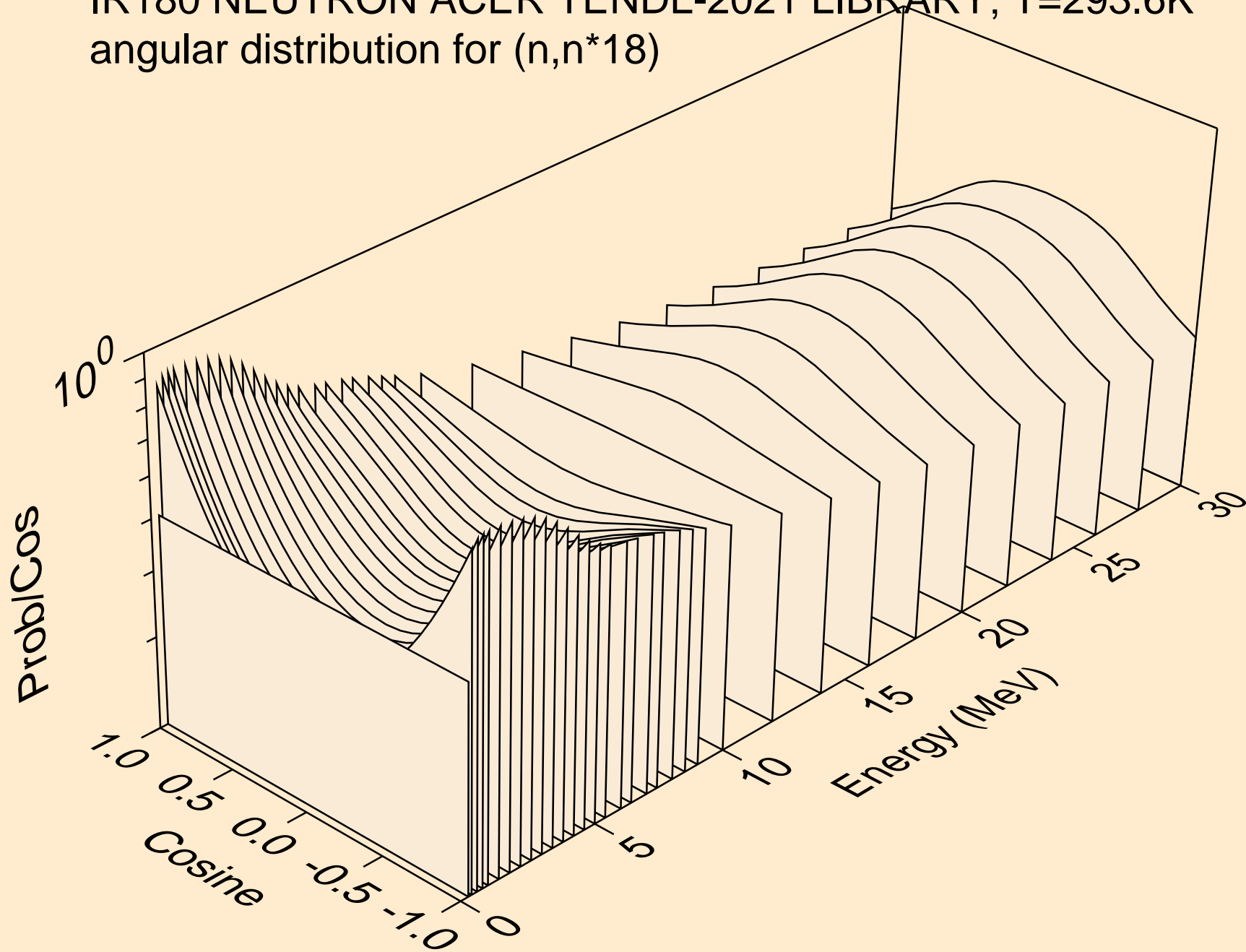

IR180 NEUTRON ACER TENDL-2021 LIBRARY; T=293.6K
angular distribution for (n,n*19)

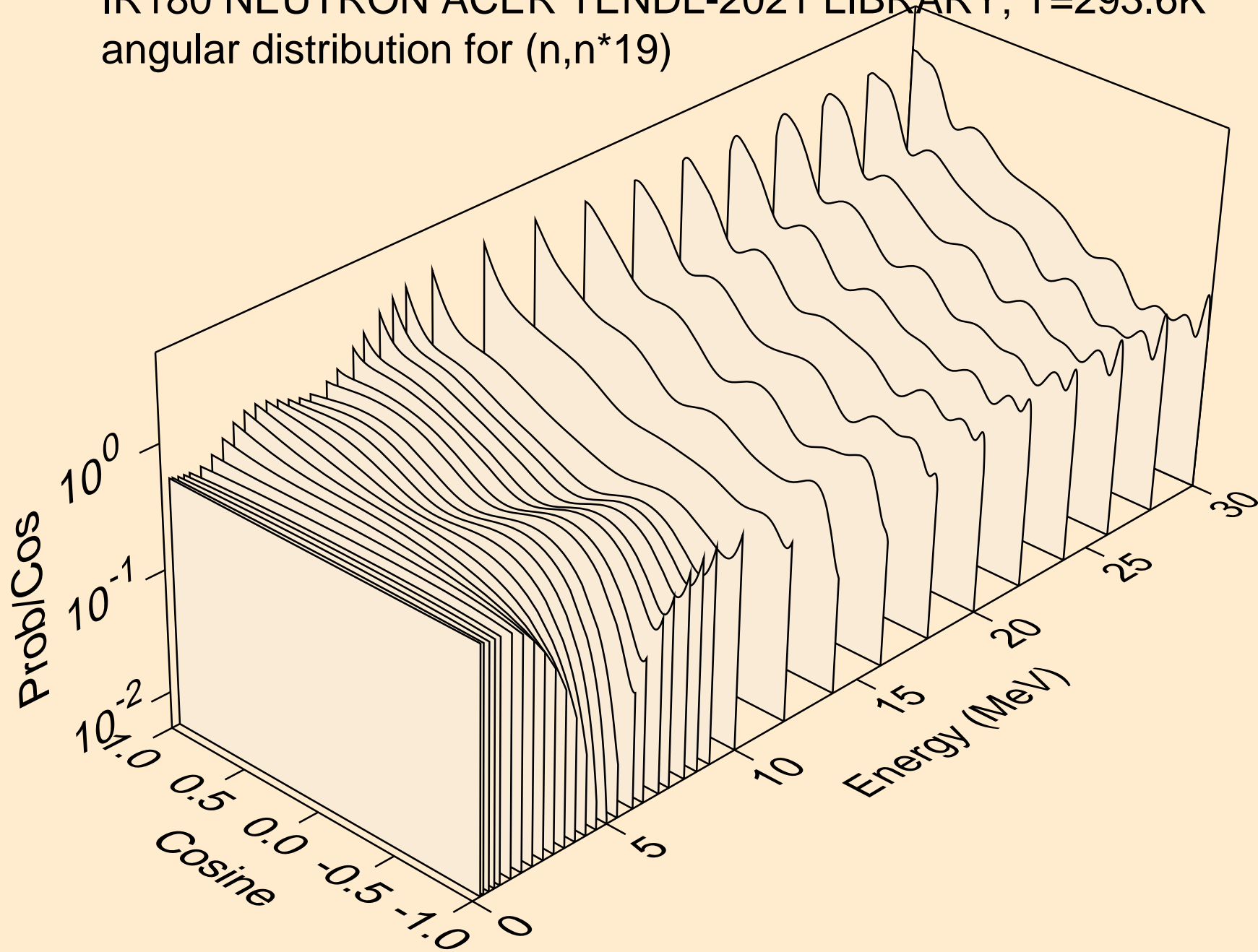

IR180 NEUTRON ACER TENDL-2021 LIBRARY; T=293.6K
angular distribution for (n,n*20)

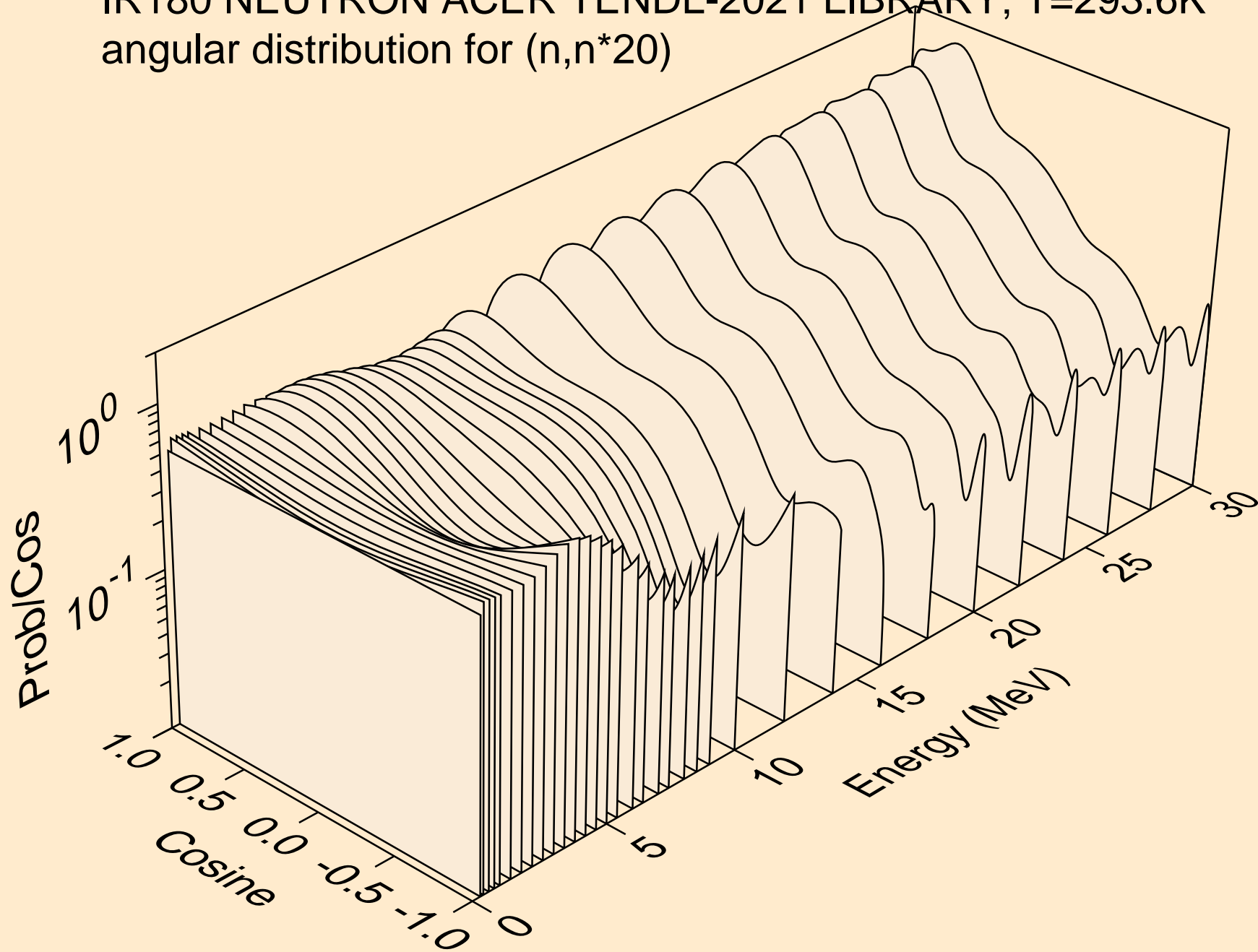

IR180 NEUTRON ACER TENDL-2021 LIBRARY; T=293.6K
angular distribution for (n,n*21)

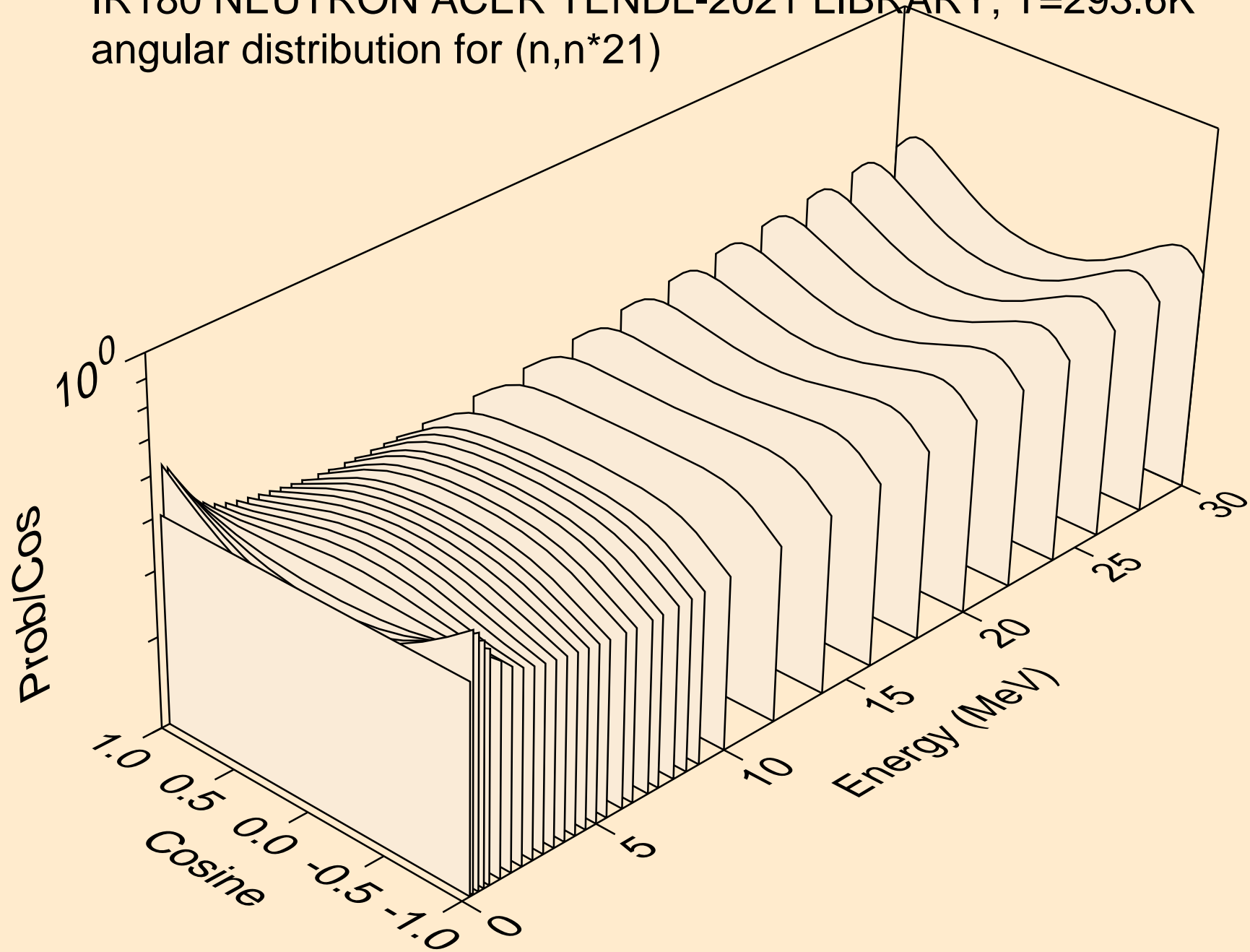

IR180 NEUTRON ACER TENDL-2021 LIBRARY; T=293.6K
angular distribution for (n,n*22)

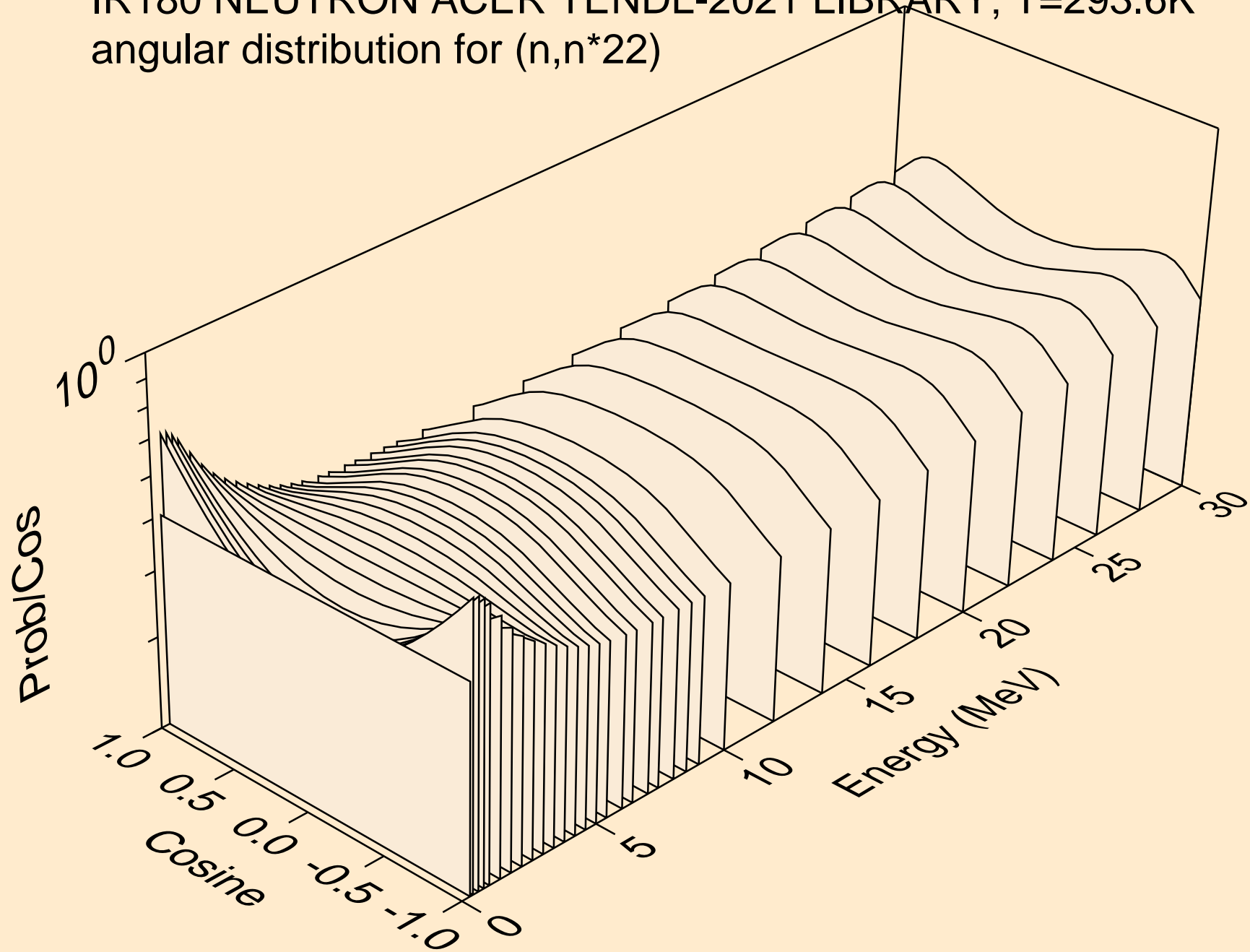

IR180 NEUTRON ACER TENDL-2021 LIBRARY; T=293.6K
angular distribution for (n,n*23)

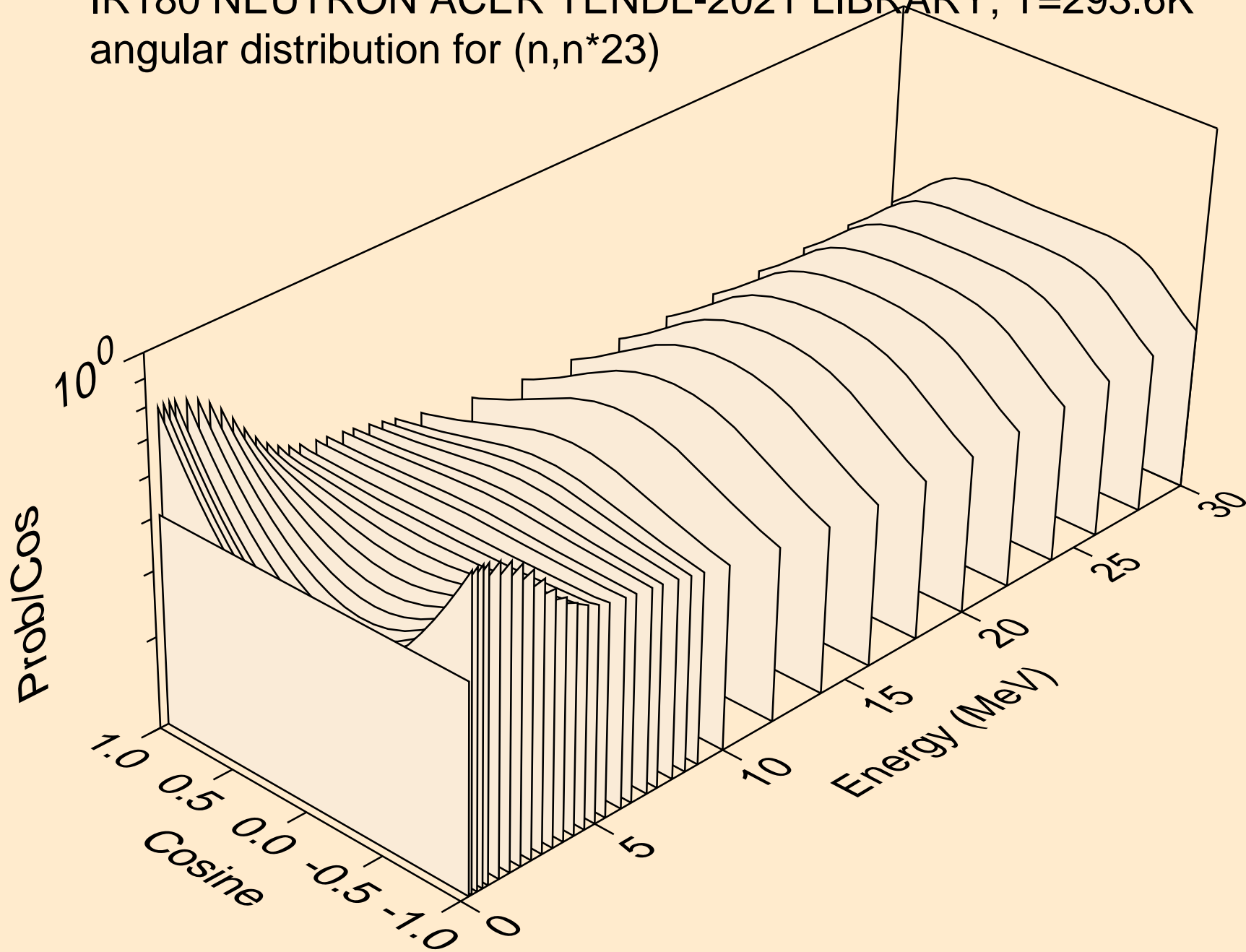

IR180 NEUTRON ACER TENDL-2021 LIBRARY; T=293.6K
angular distribution for (n,n*24)

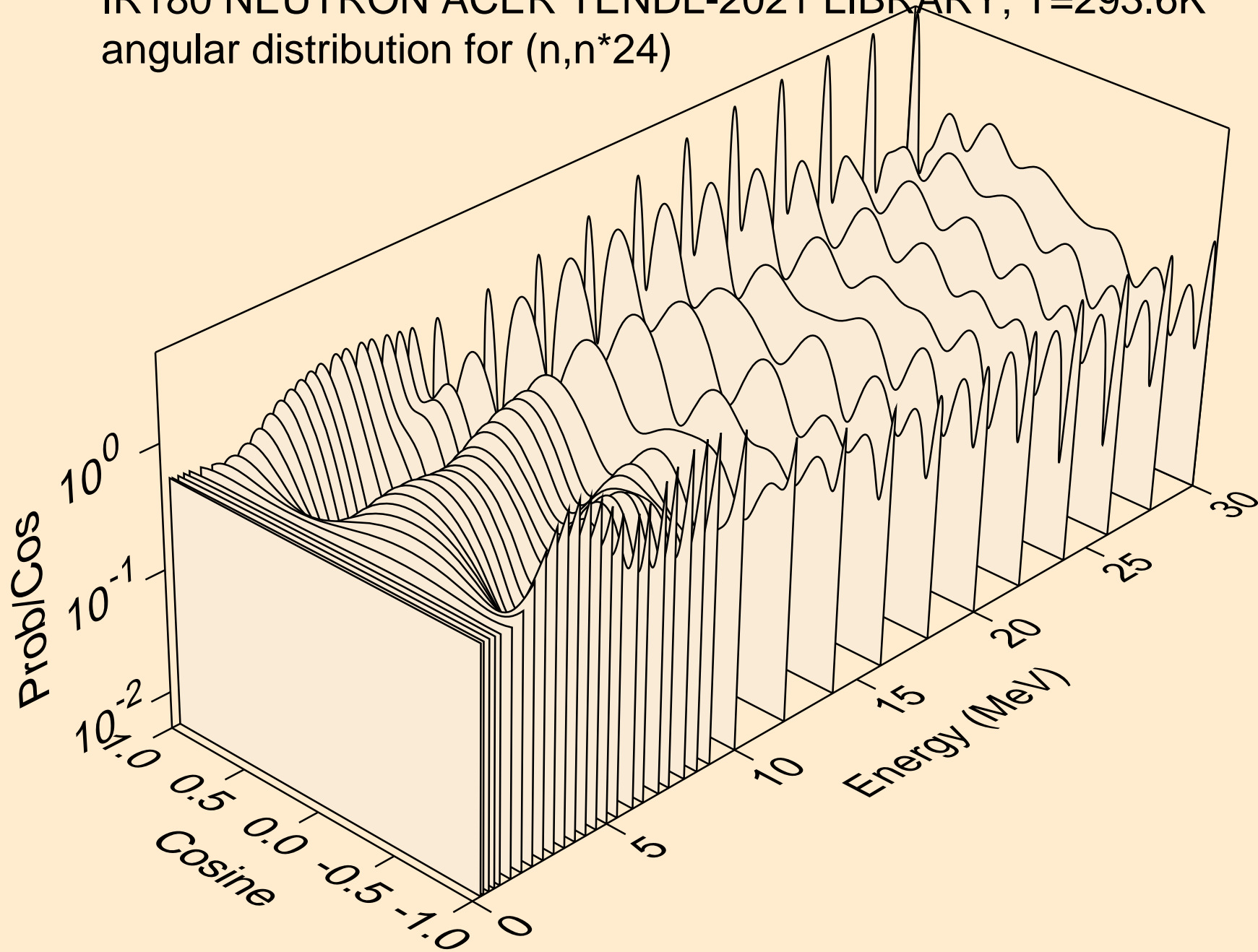

IR180 NEUTRON ACER TENDL-2021 LIBRARY; T=293.6K
angular distribution for (n,n*25)

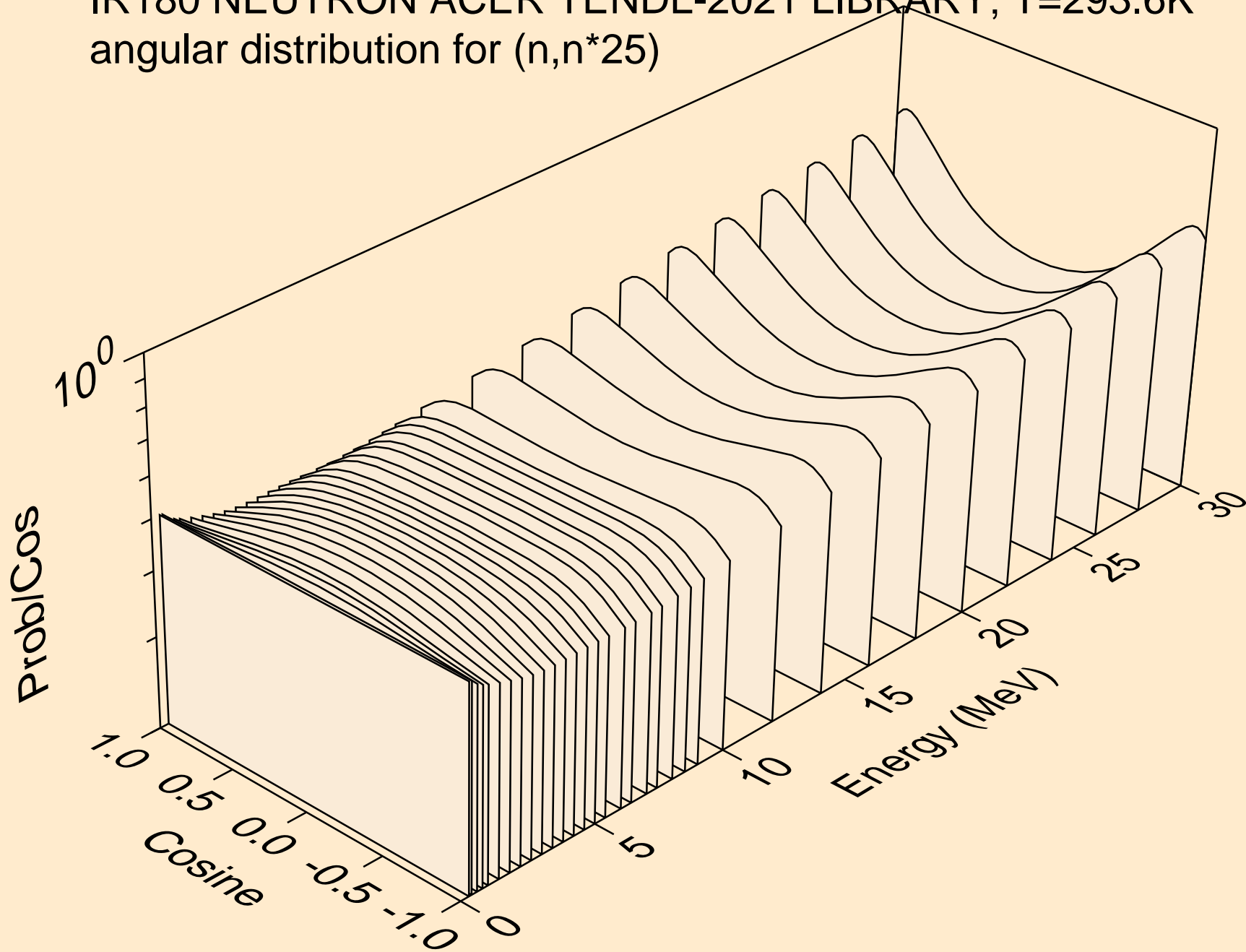

IR180 NEUTRON ACER TENDL-2021 LIBRARY; T=293.6K
angular distribution for (n,n*26)

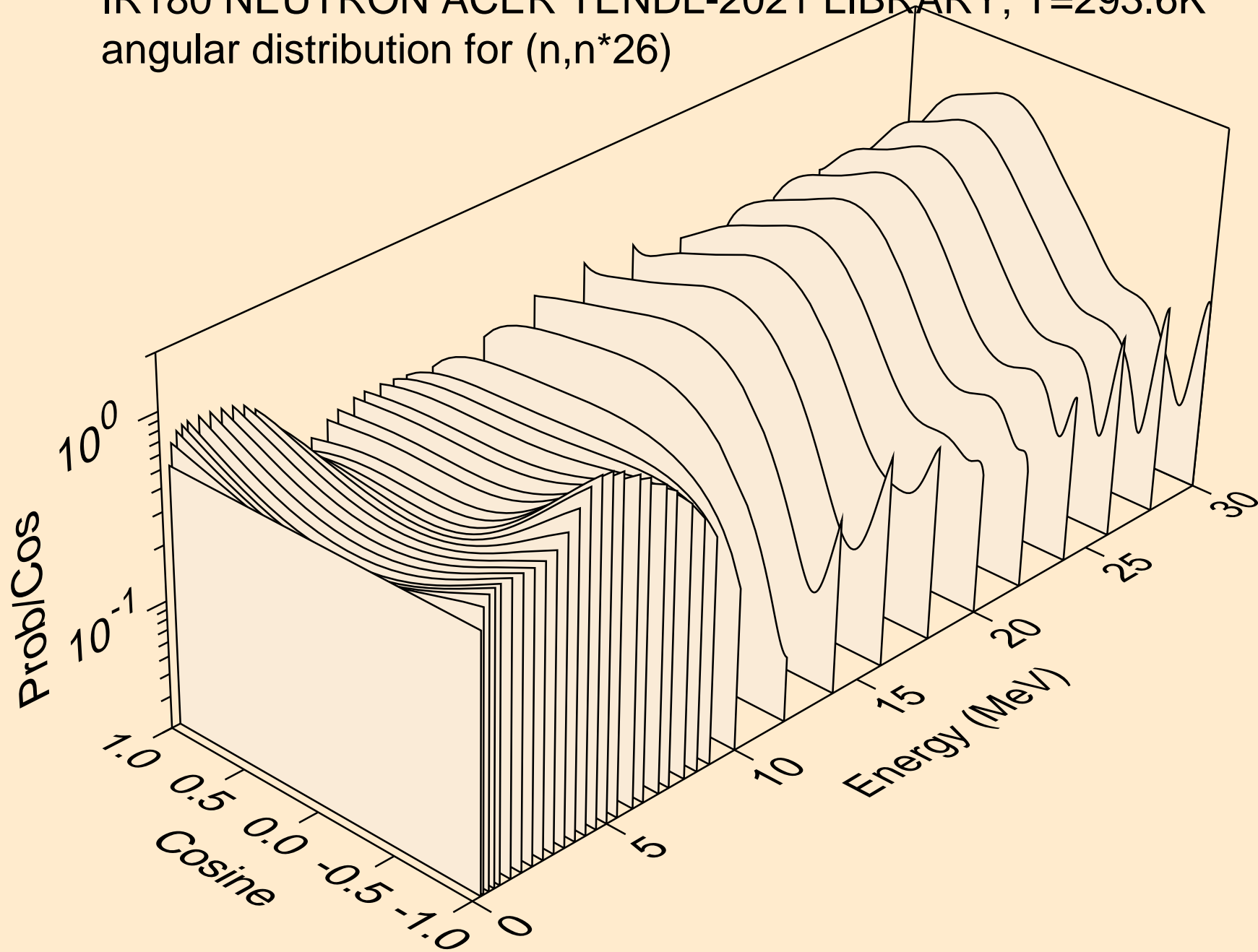

IR180 NEUTRON ACER TENDL-2021 LIBRARY; T=293.6K
angular distribution for (n,n*27)

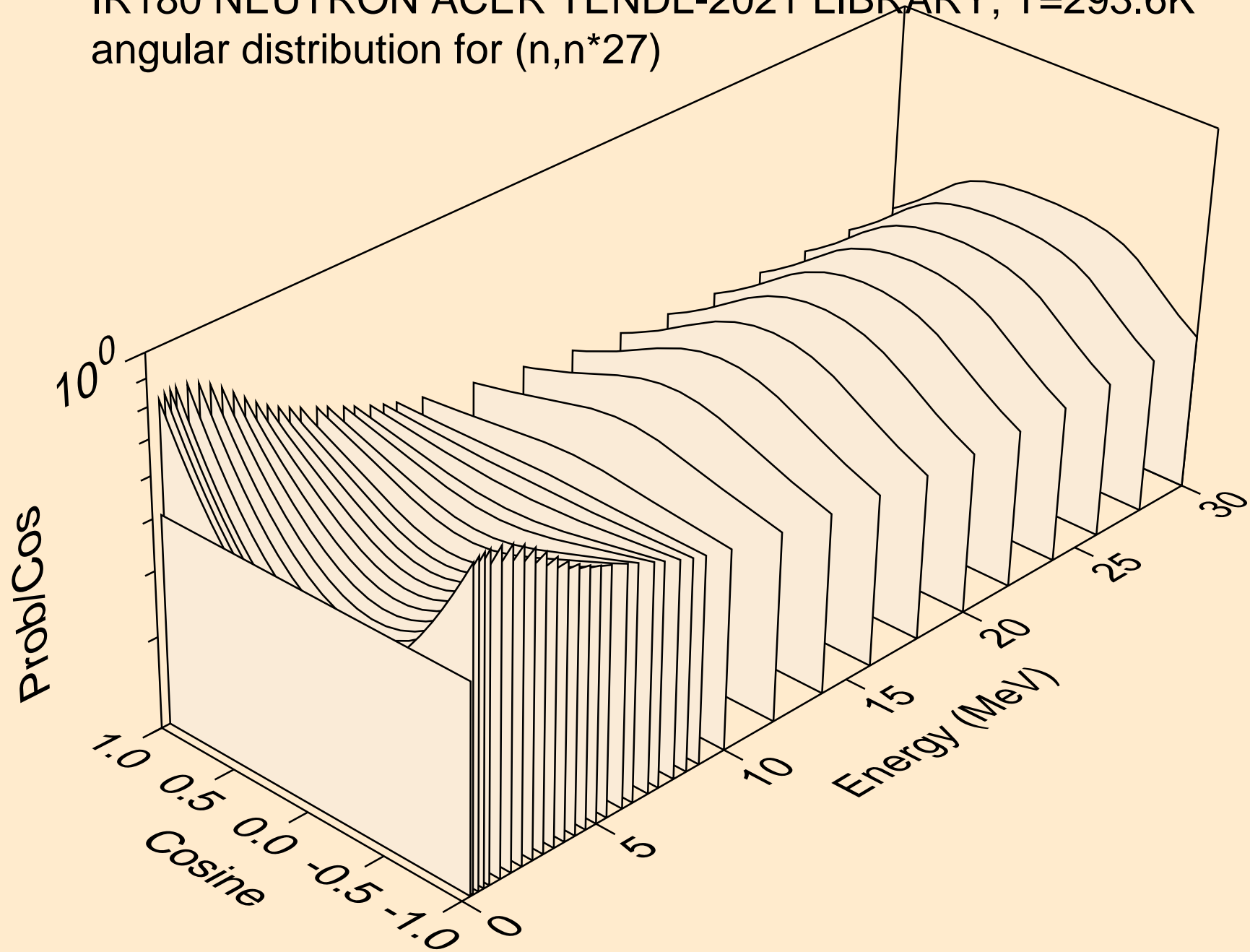

IR180 NEUTRON ACER TENDL-2021 LIBRARY; T=293.6K
angular distribution for (n,n*28)

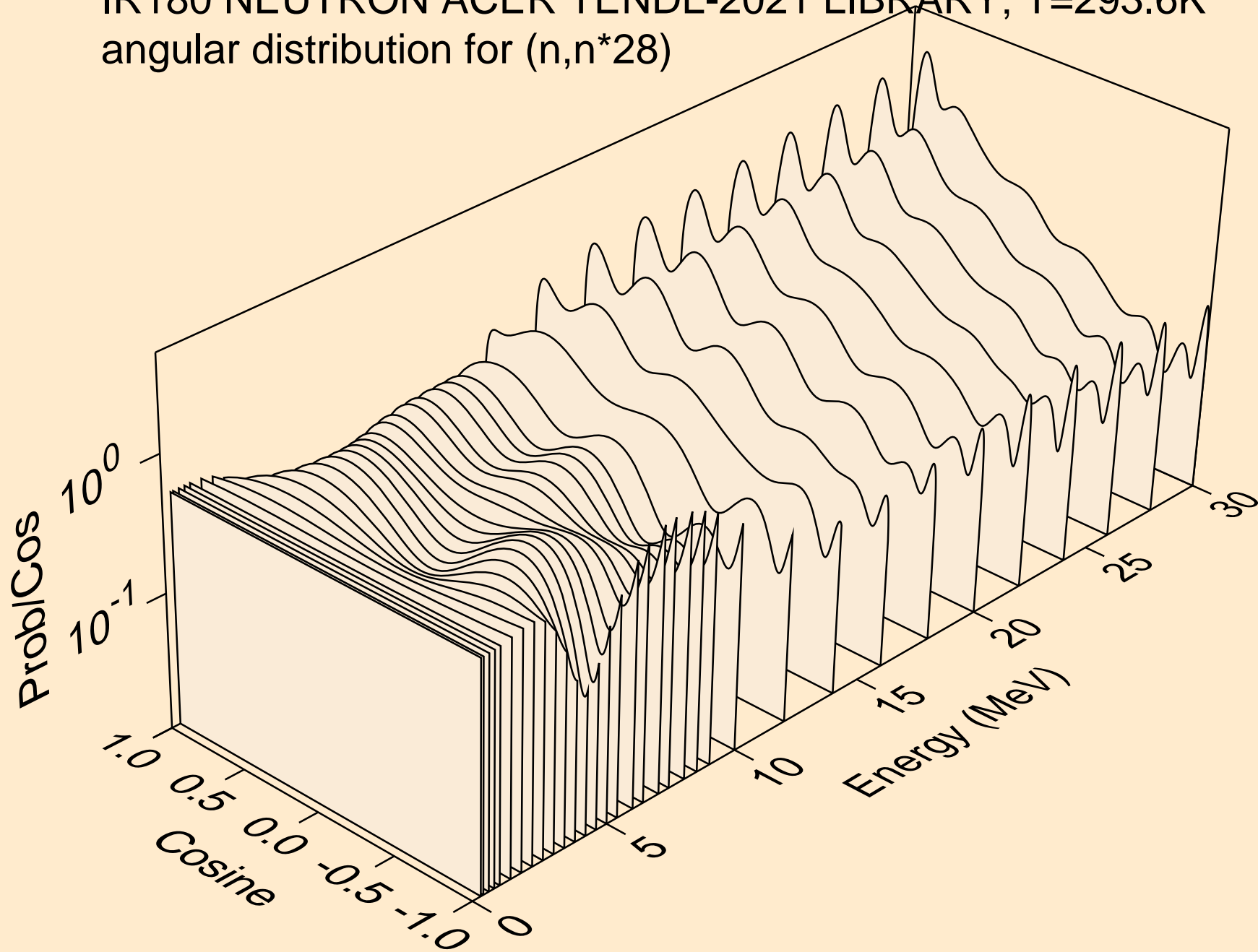

IR180 NEUTRON ACER TENDL-2021 LIBRARY; T=293.6K
angular distribution for (n,n*29)

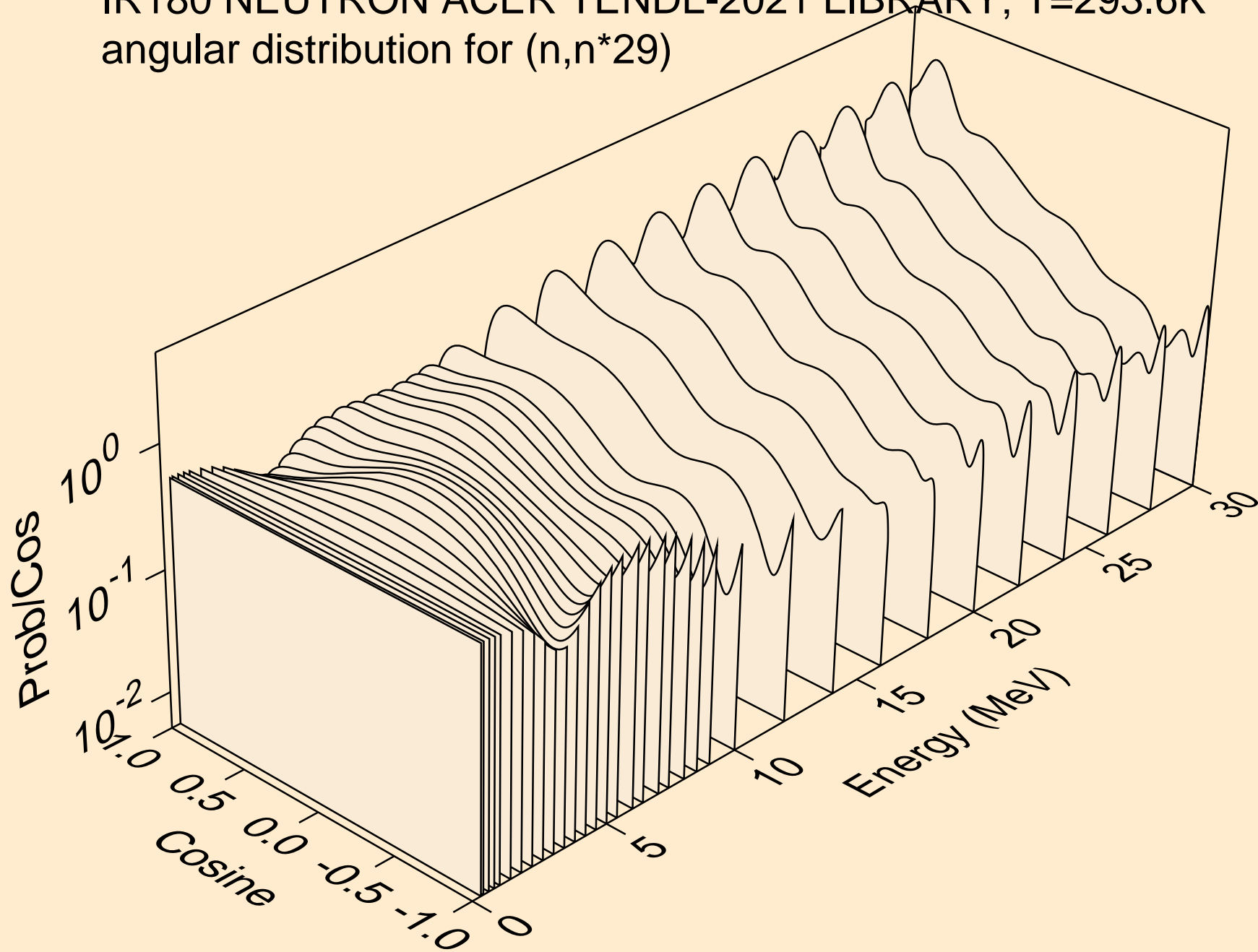

IR180 NEUTRON ACER TENDL-2021 LIBRARY; T=293.6K
angular distribution for (n,n*30)

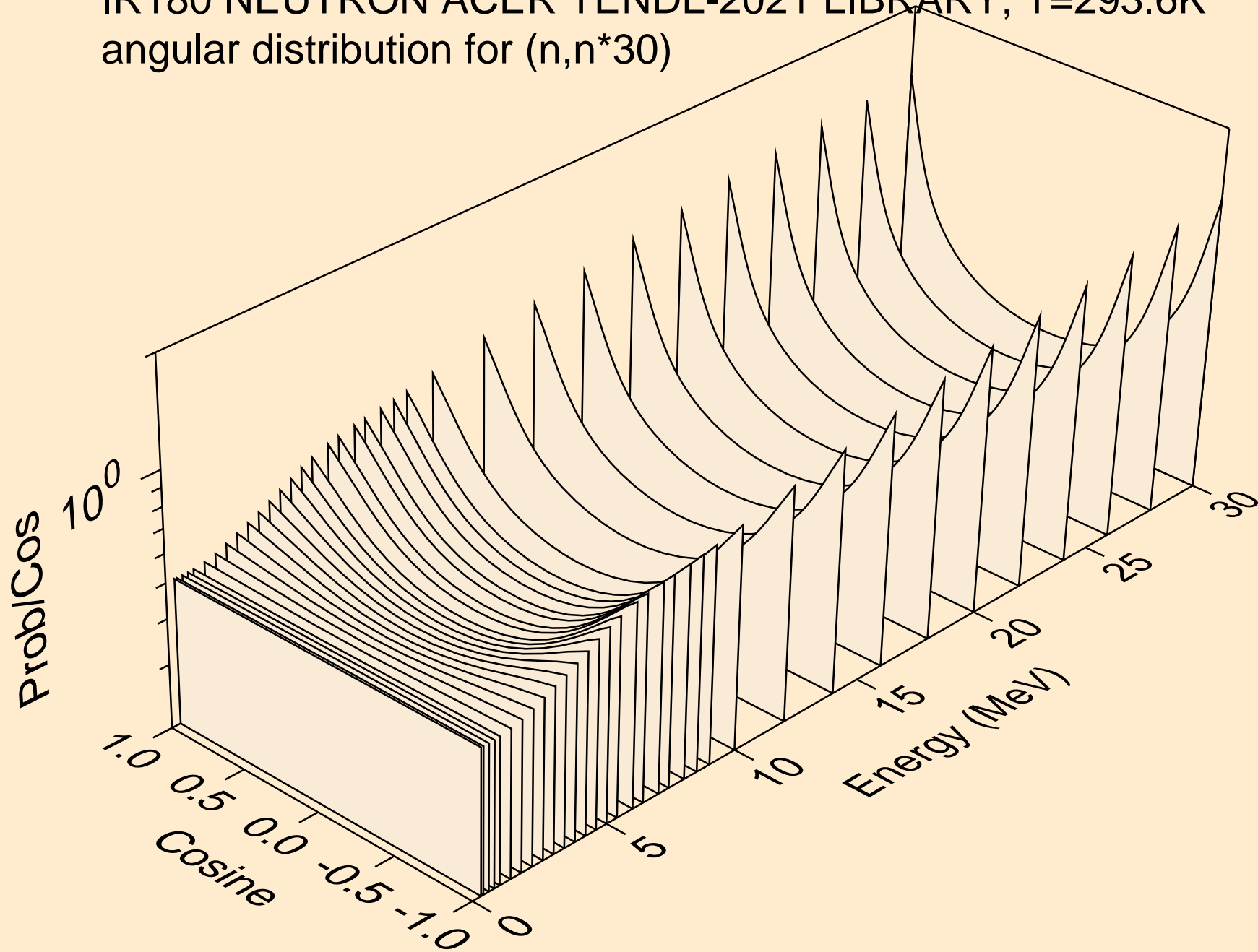

IR180 NEUTRON ACER TENDL-2021 LIBRARY; T=293.6K
Neutron emission for (n,x)

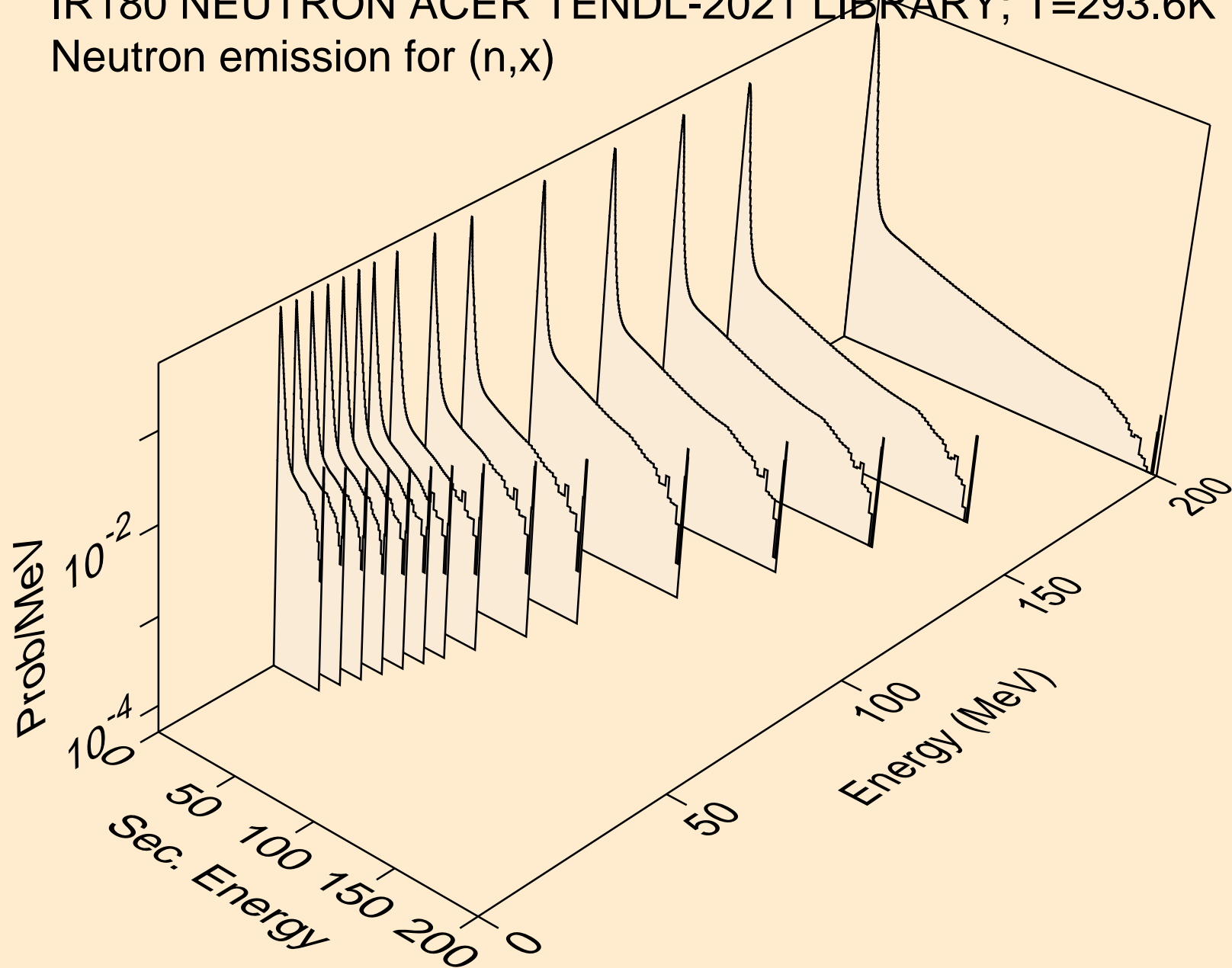

IR180 NEUTRON ACER TENDL-2021 LIBRARY; T=293.6K
Neutron emission for (n,2nd)

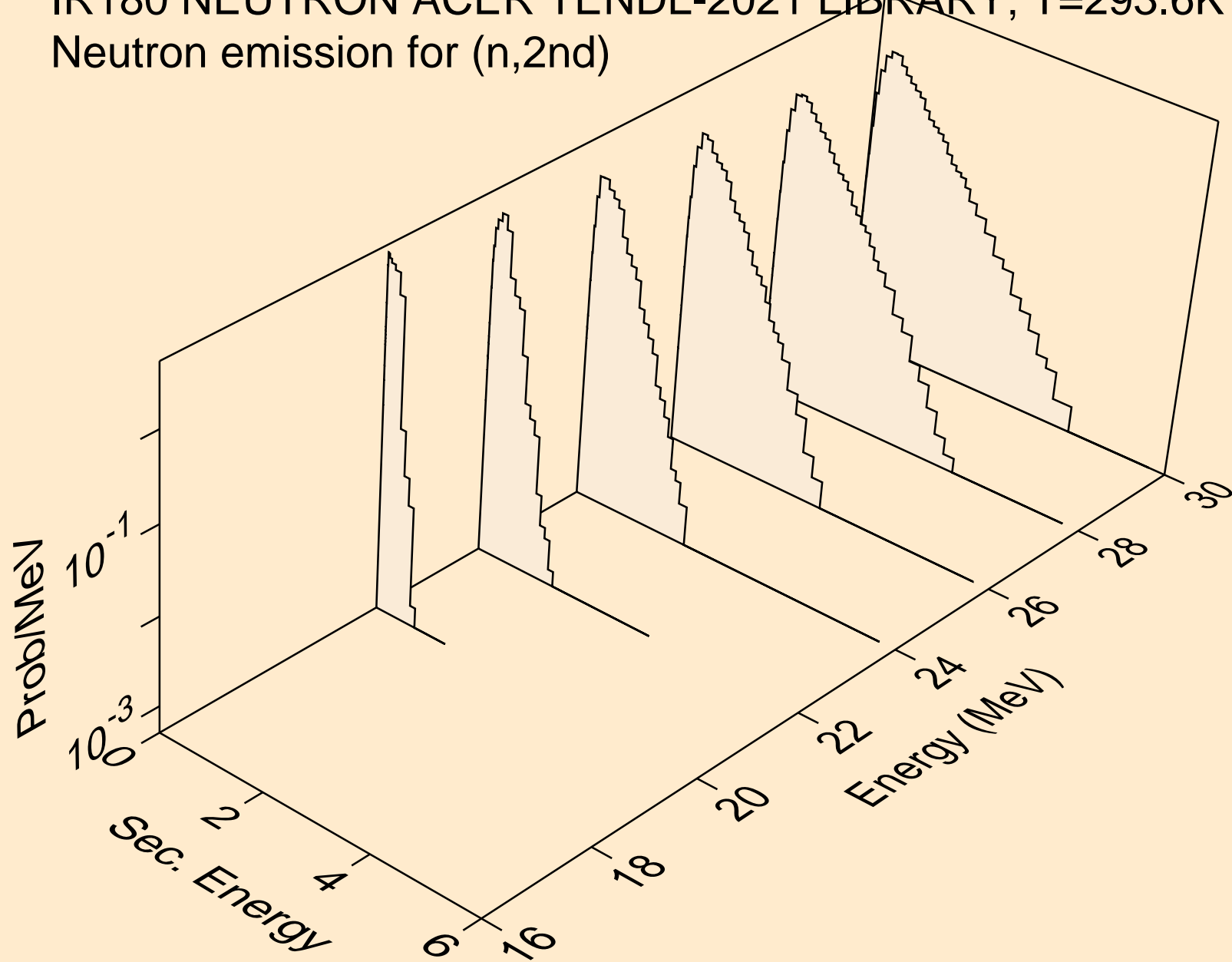

IR180 NEUTRON ACER TENDL-2021 LIBRARY; T=293.6K
Neutron emission for (n,2n)

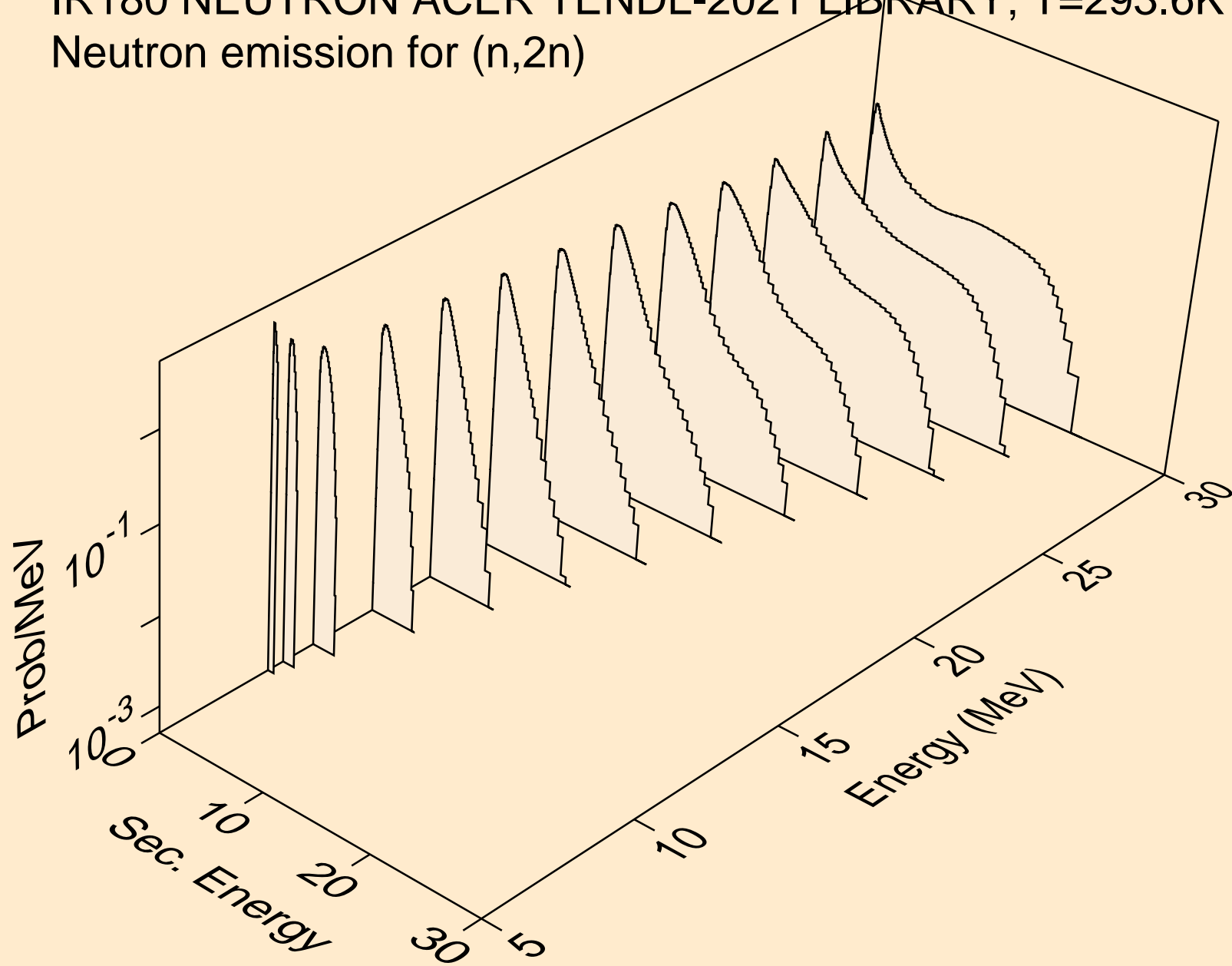

IR180 NEUTRON ACER TENDL-2021 LIBRARY; T=293.6K
Neutron emission for (n,3n)

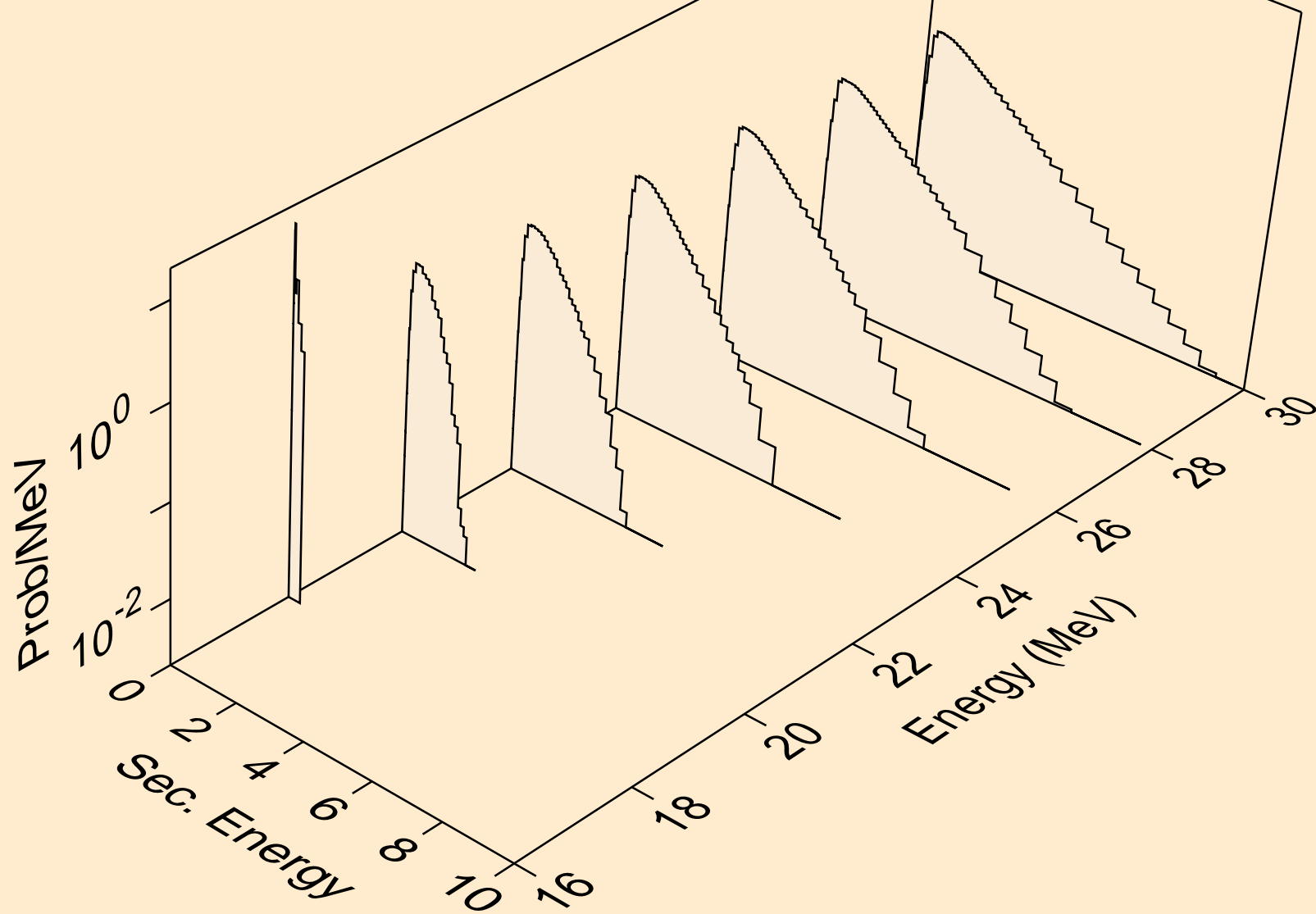

IR180 NEUTRON ACER TENDL-2021 LIBRARY; T=293.6K
Neutron emission for (n,n*)a

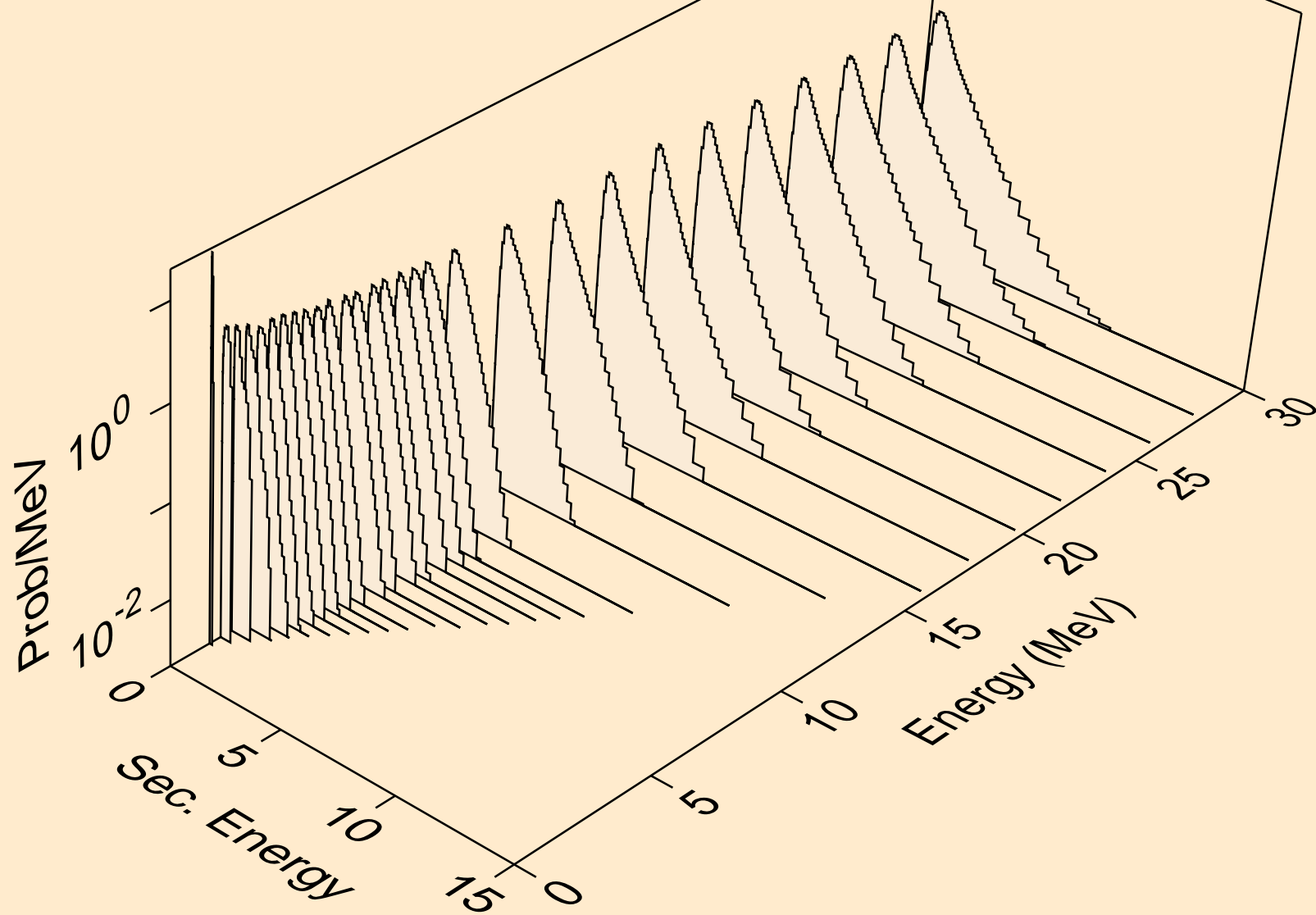

IR180 NEUTRON ACER TENDL-2021 LIBRARY; T=293.6K
Neutron emission for (n,2n)_a

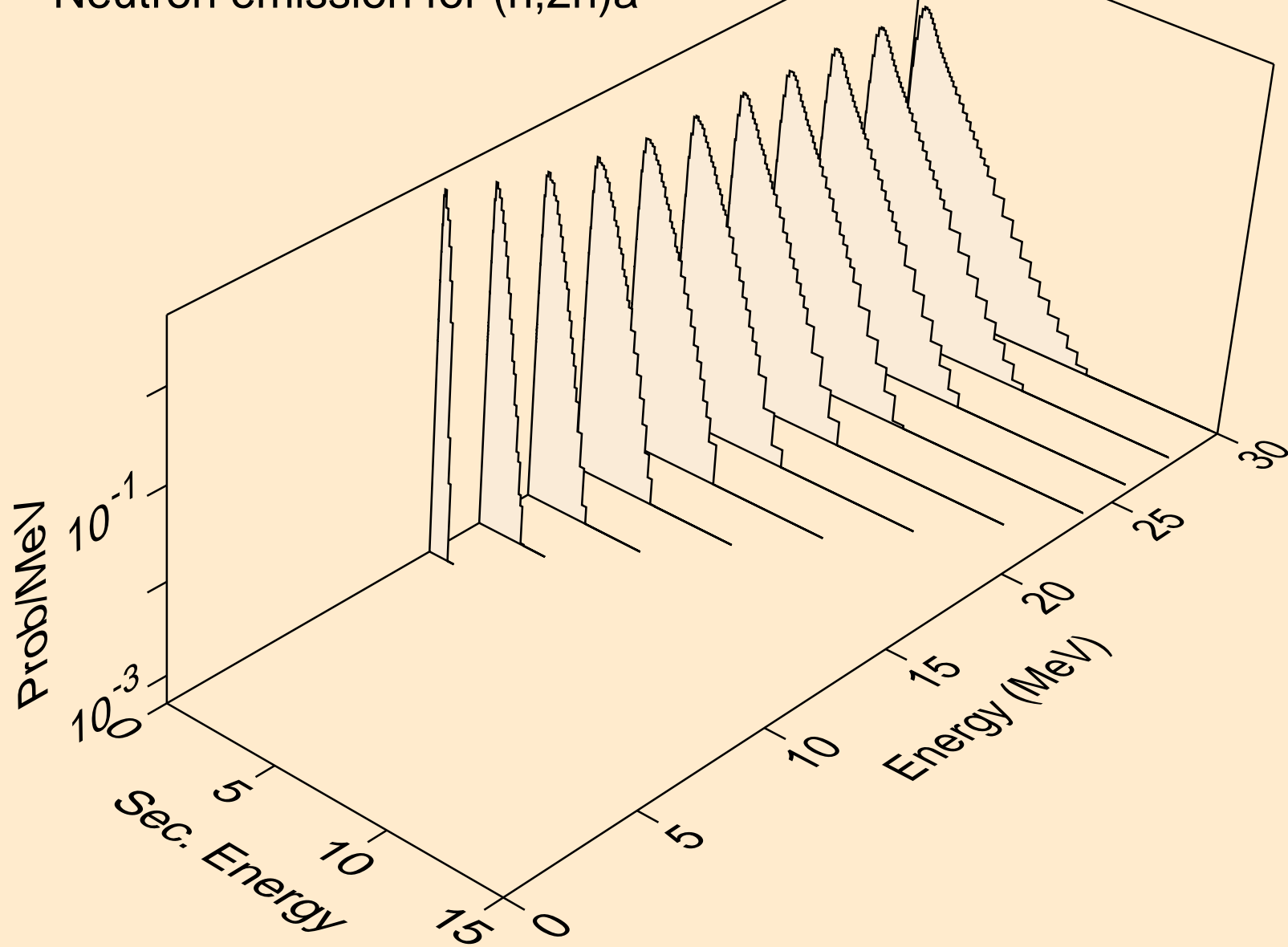

IR180 NEUTRON ACER TENDL-2021 LIBRARY; T=293.6K
Neutron emission for (n,3n)a

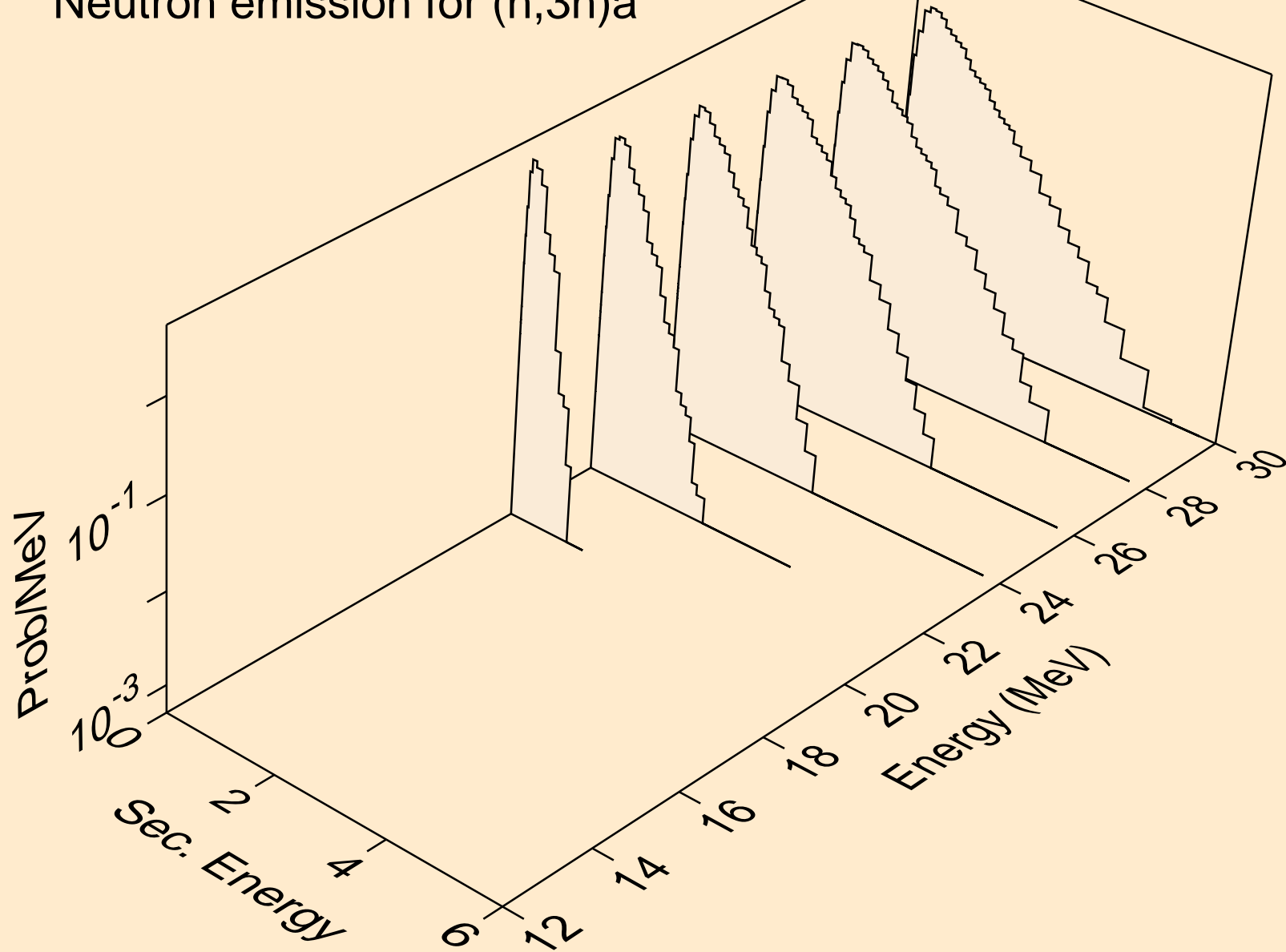

IR180 NEUTRON ACER TENDL-2021 LIBRARY; T=293.6K
Neutron emission for (n,n*)p

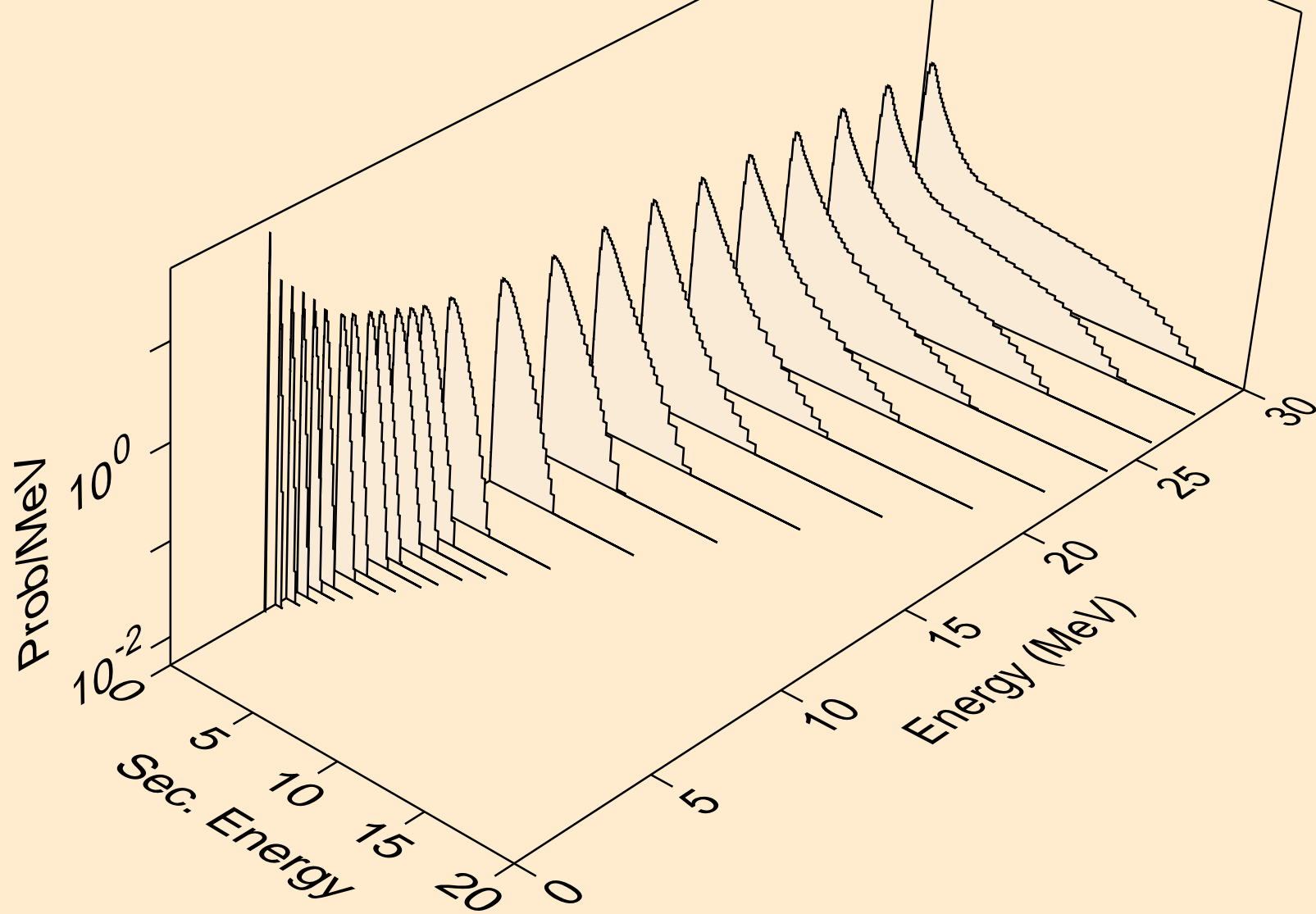

IR180 NEUTRON ACER TENDL-2021 LIBRARY; T=293.6K
Neutron emission for (n,n*)2a

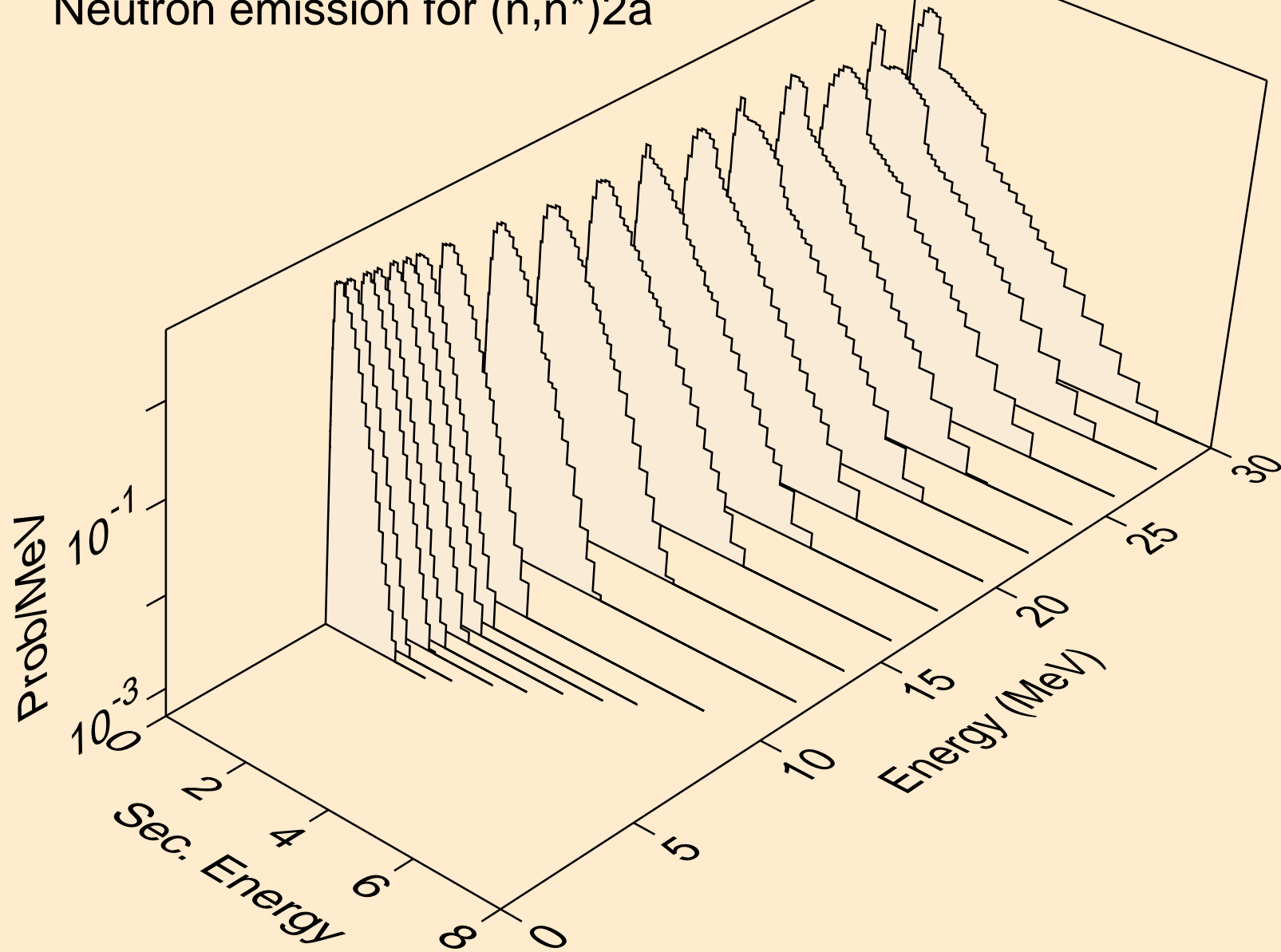

IR180 NEUTRON ACER TENDL-2021 LIBRARY; T=293.6K
Neutron emission for (n,2n)2a

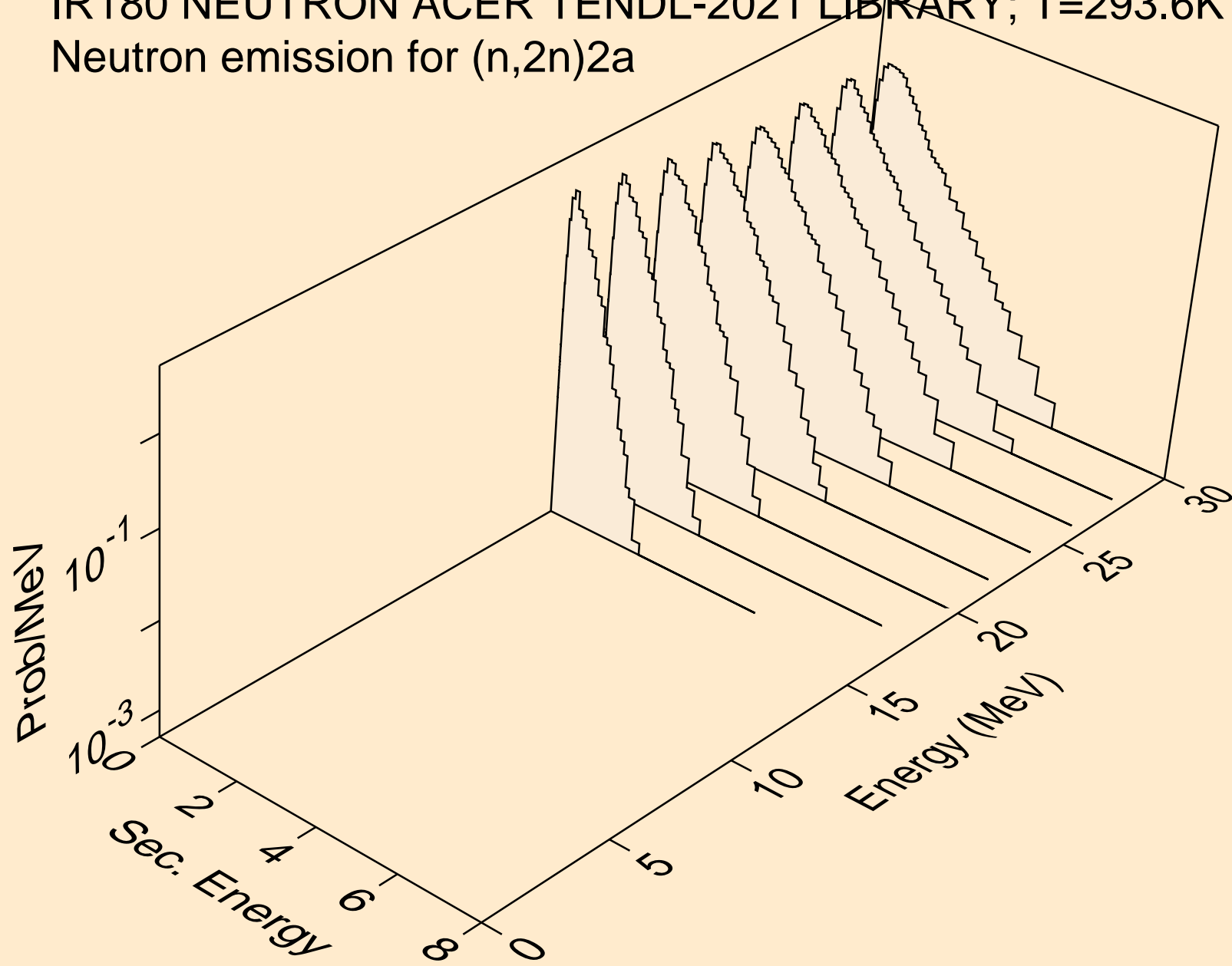

IR180 NEUTRON ACER TENDL-2021 LIBRARY; T=293.6K
Neutron emission for (n,n*)d

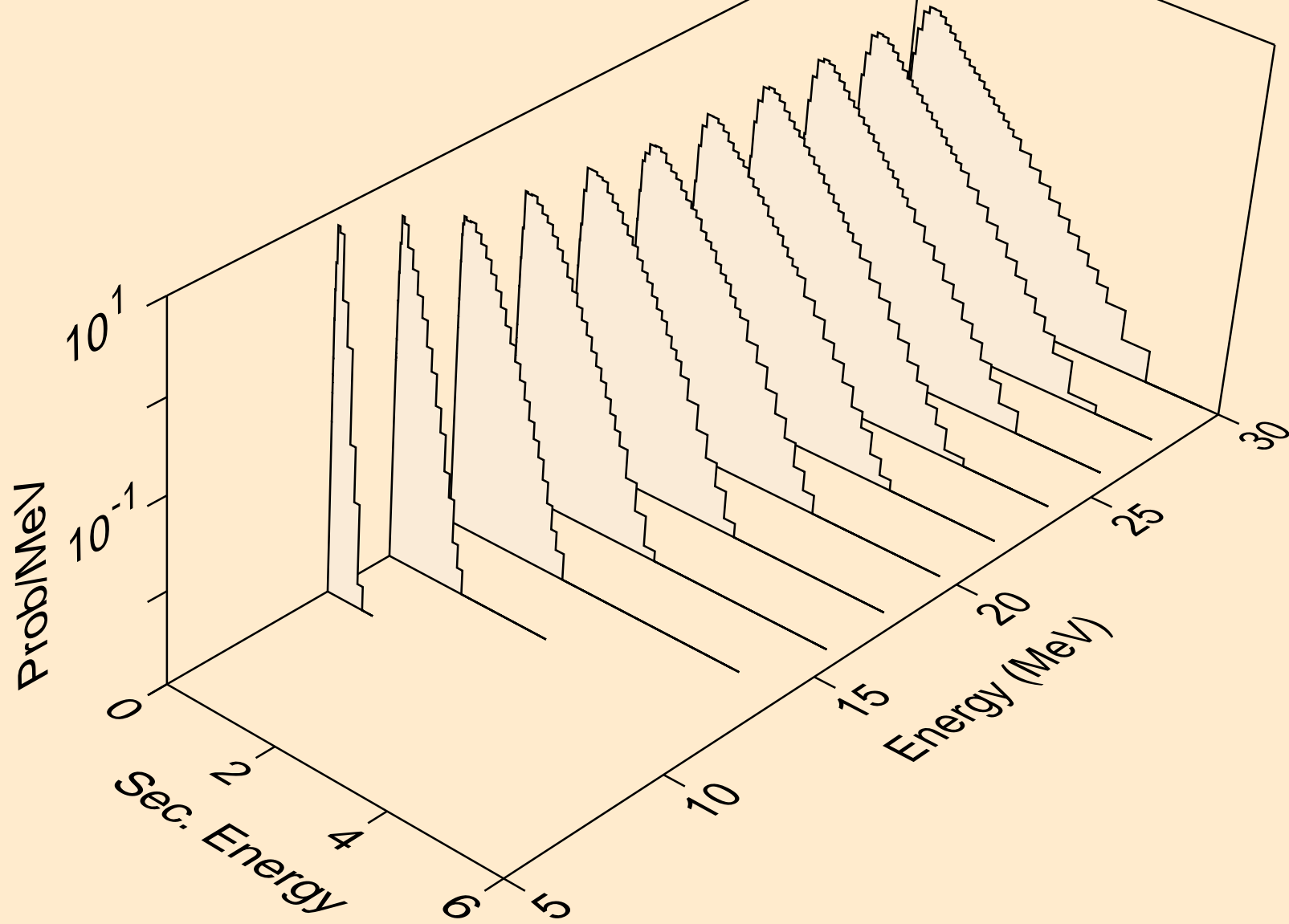

IR180 NEUTRON ACER TENDL-2021 LIBRARY; T=293.6K
Neutron emission for (n,n*)t

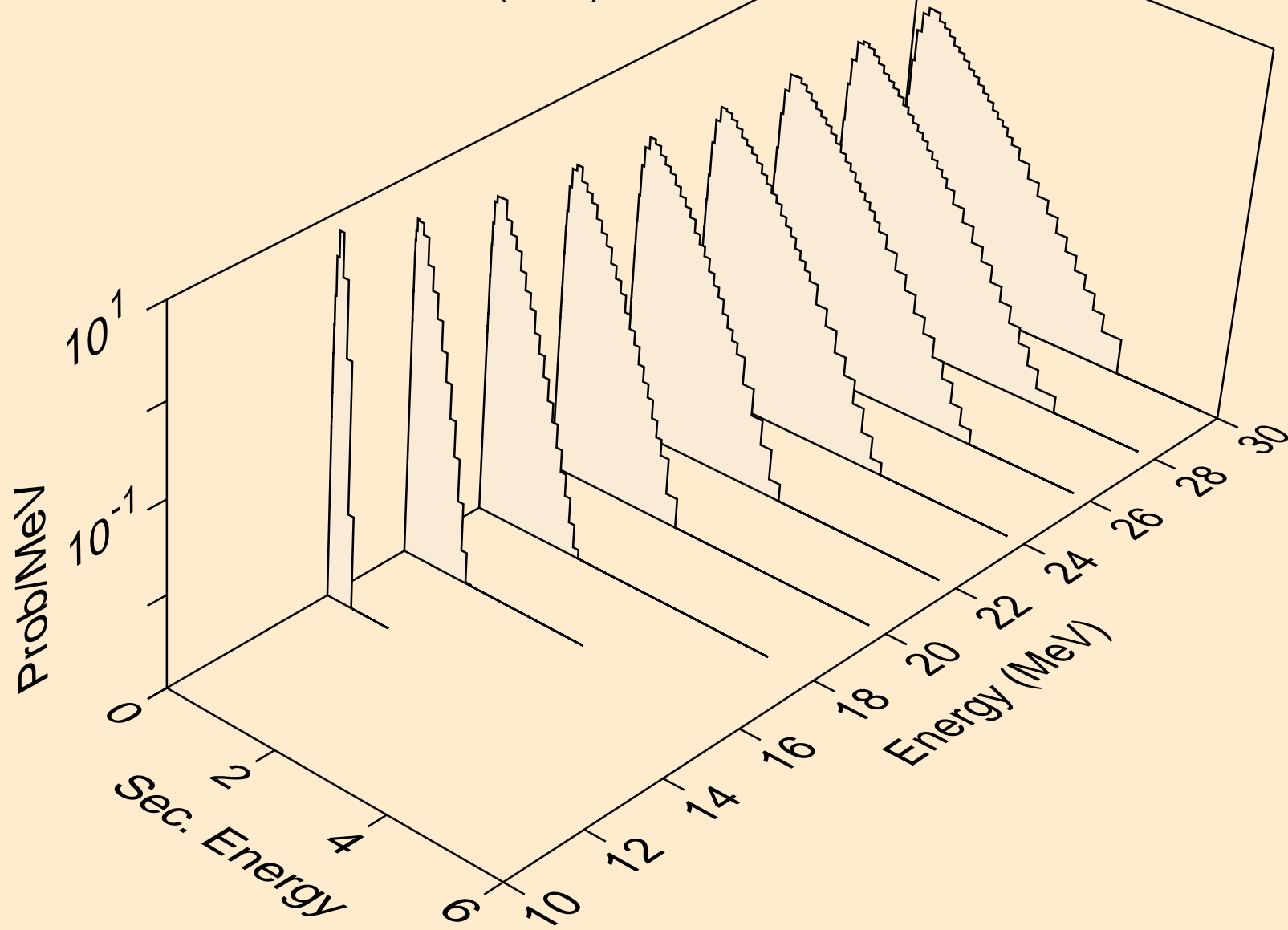

IR180 NEUTRON ACER TENDL-2021 LIBRARY; T=293.6K
Neutron emission for (n,n*)he3

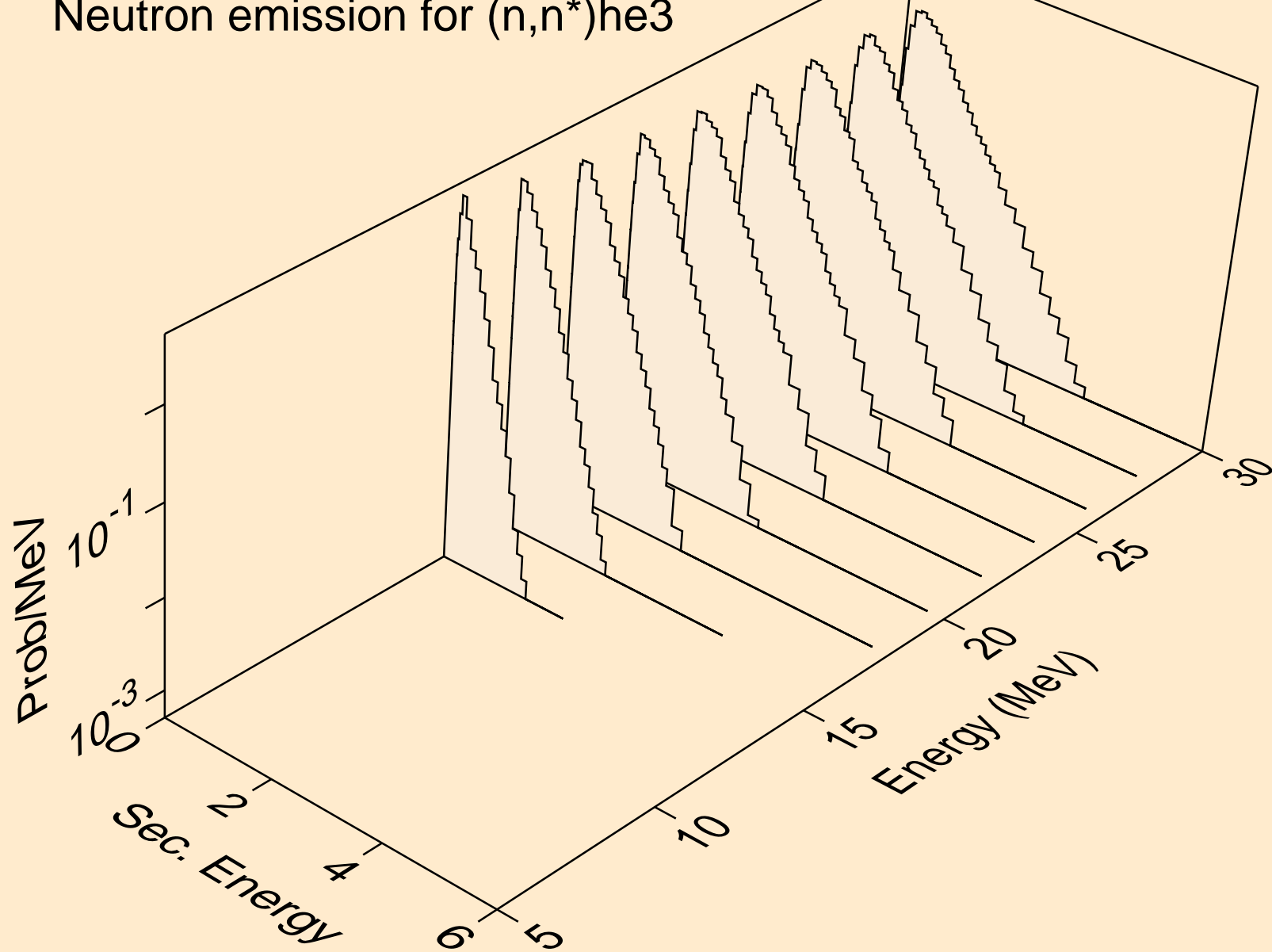

IR180 NEUTRON ACER TENDL-2021 LIBRARY; T=293.6K
Neutron emission for (n,4n)

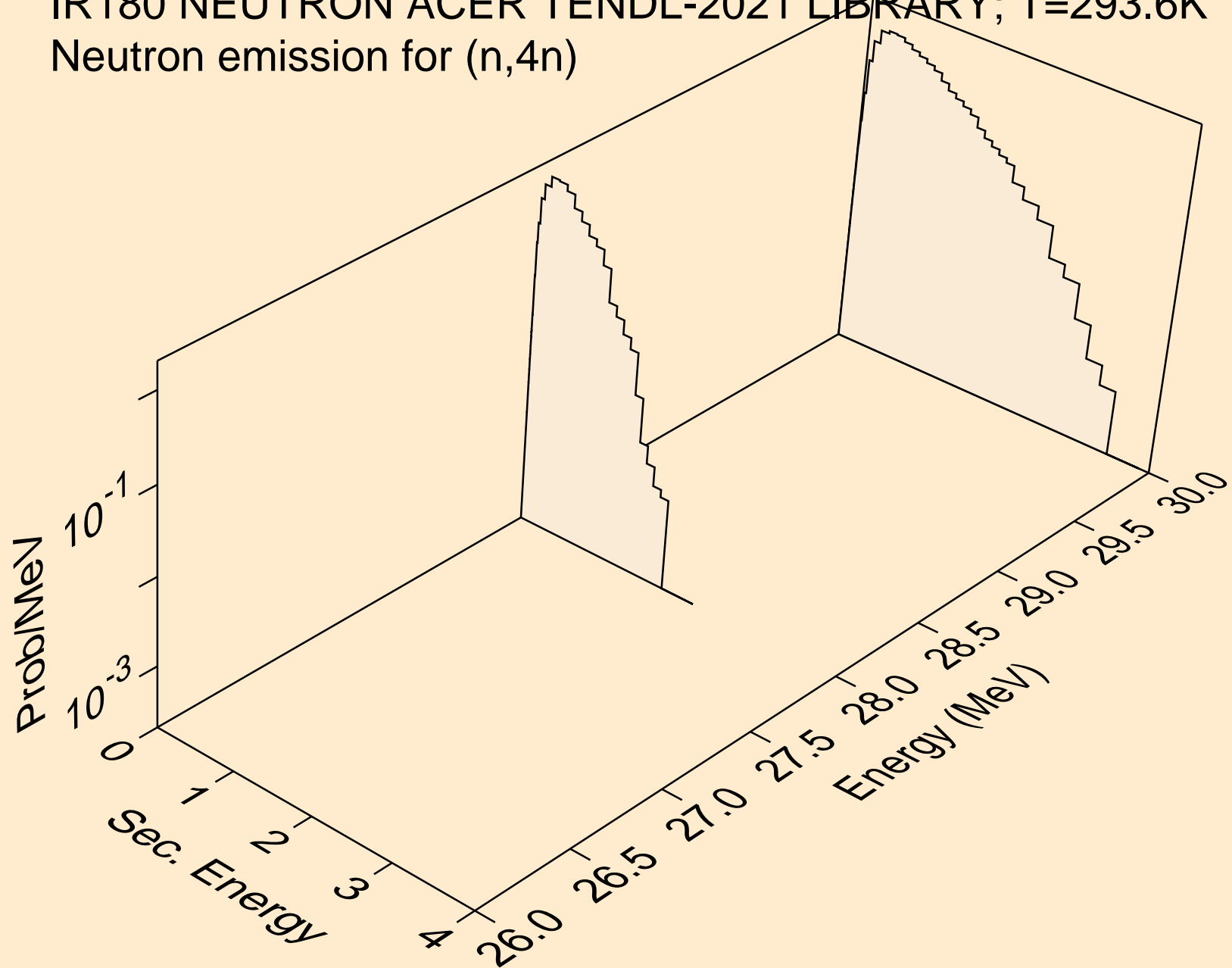

IR180 NEUTRON ACER TENDL-2021 LIBRARY; T=293.6K
Neutron emission for (n,2np)

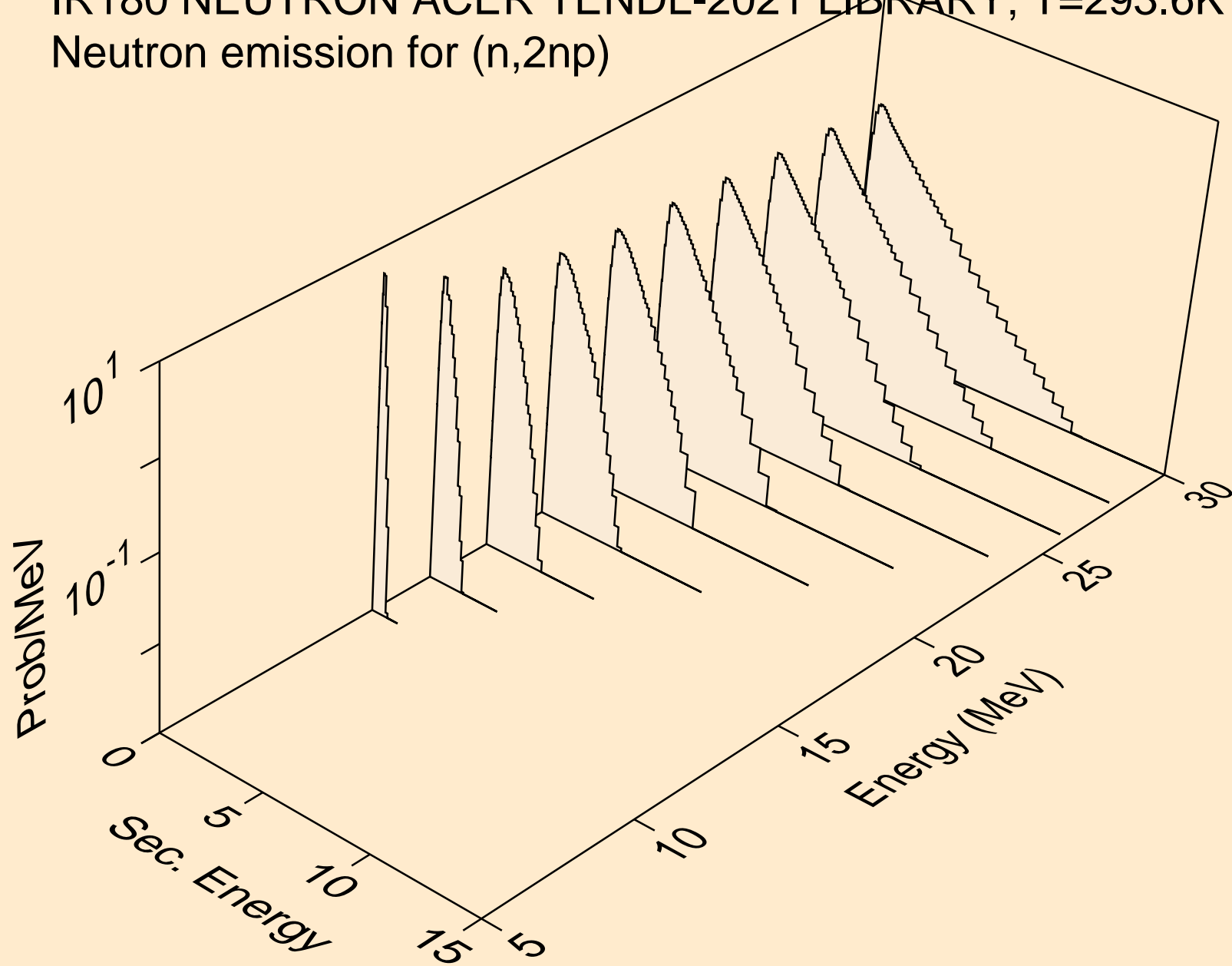

IR180 NEUTRON ACER TENDL-2021 LIBRARY; T=293.6K
Neutron emission for (n,3np)

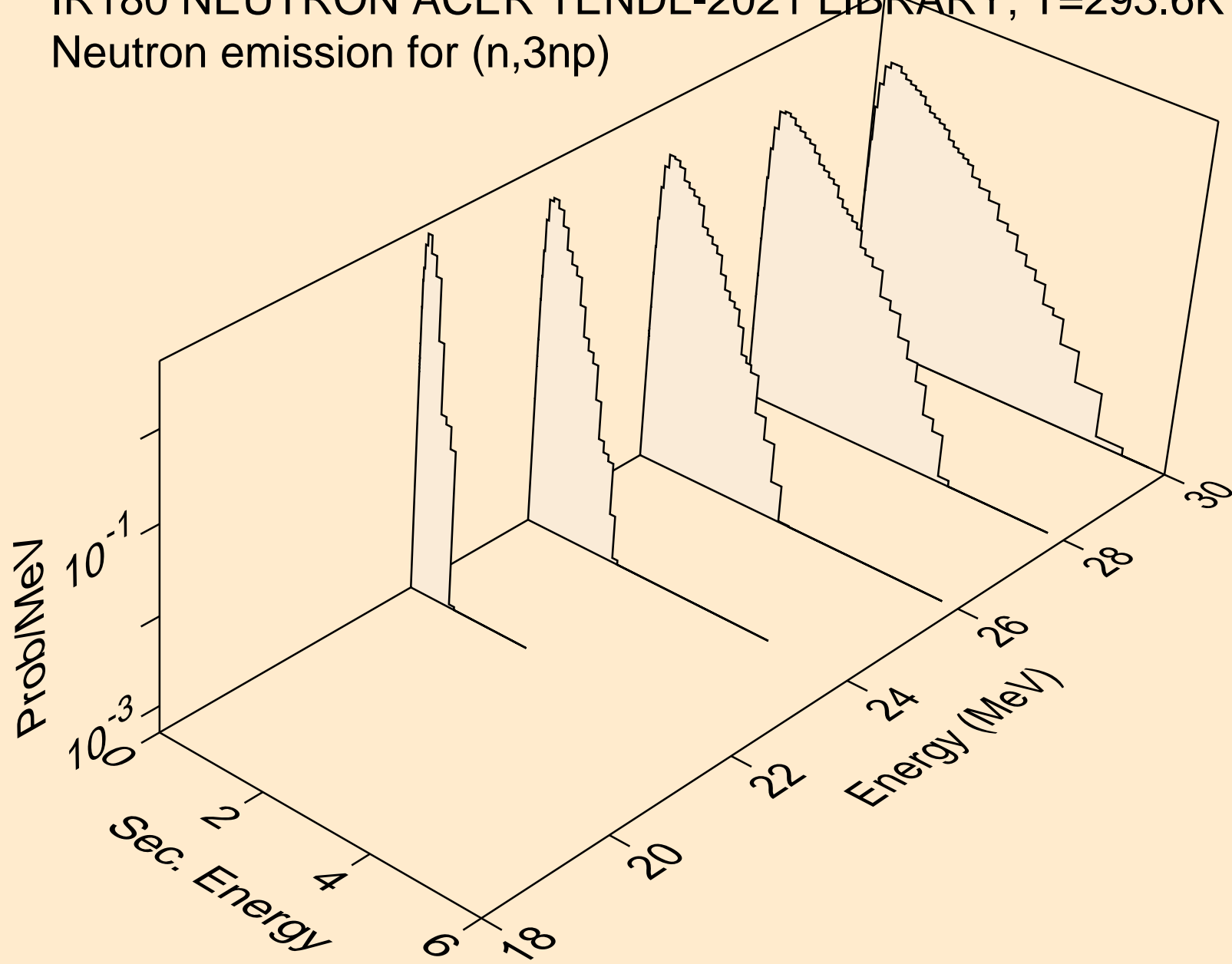

IR180 NEUTRON ACER TENDL-2021 LIBRARY; T=293.6K
Neutron emission for (n,2np)

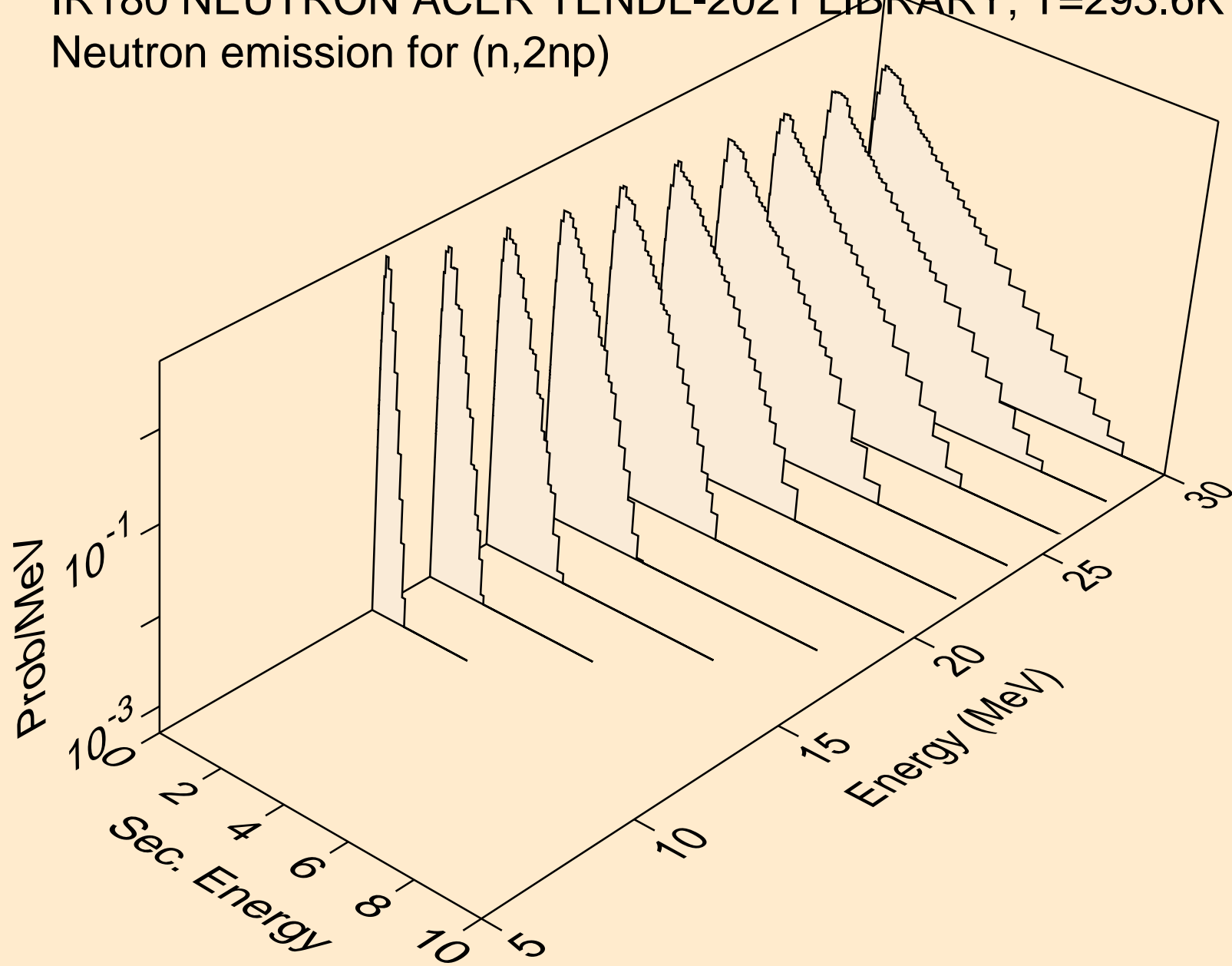

IR180 NEUTRON ACER TENDL-2021 LIBRARY; T=293.6K
Neutron emission for (n,npa)

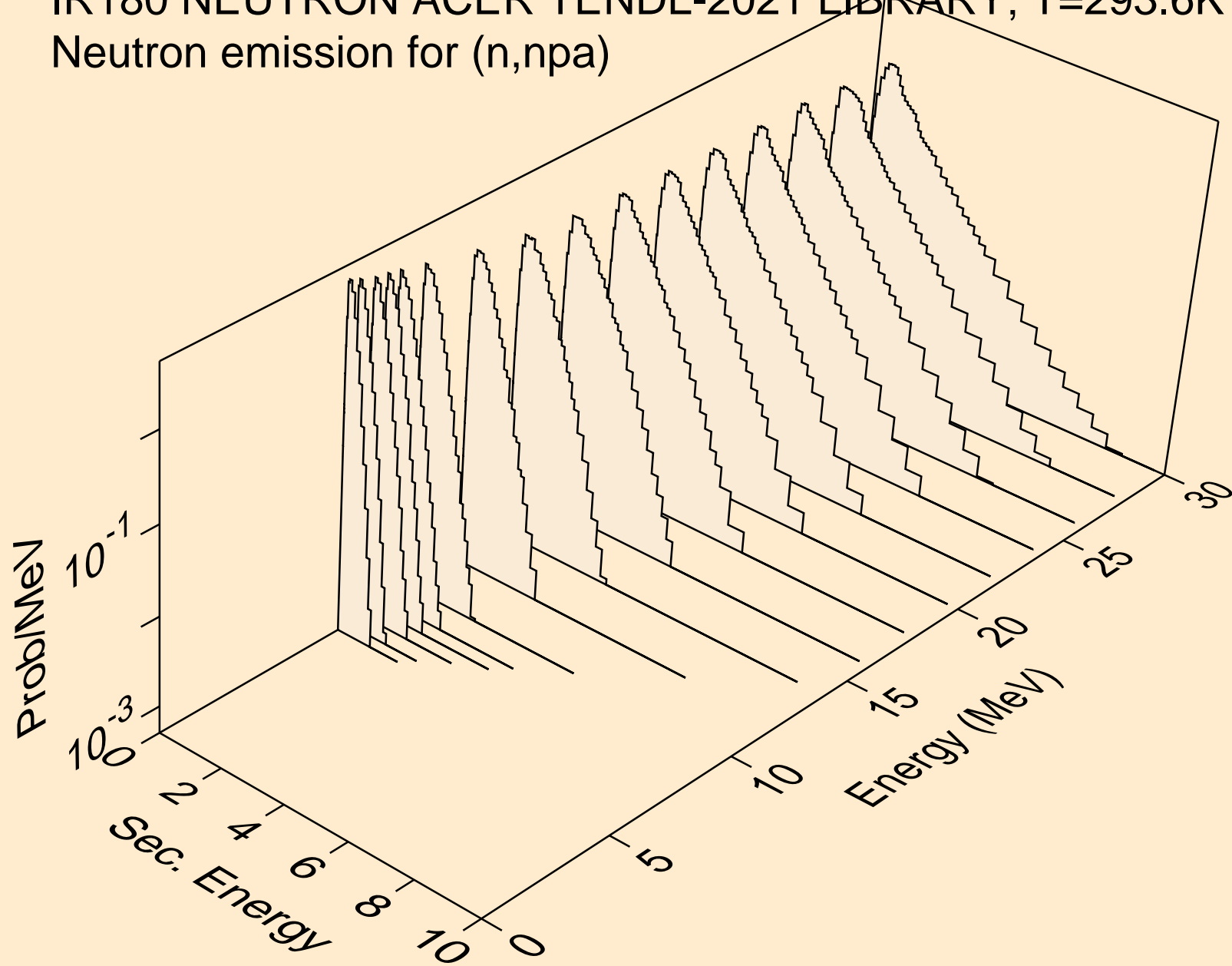

IR180 NEUTRON ACER TENDL-2021 LIBRARY; T=293.6K
Neutron emission for (n,n*c)

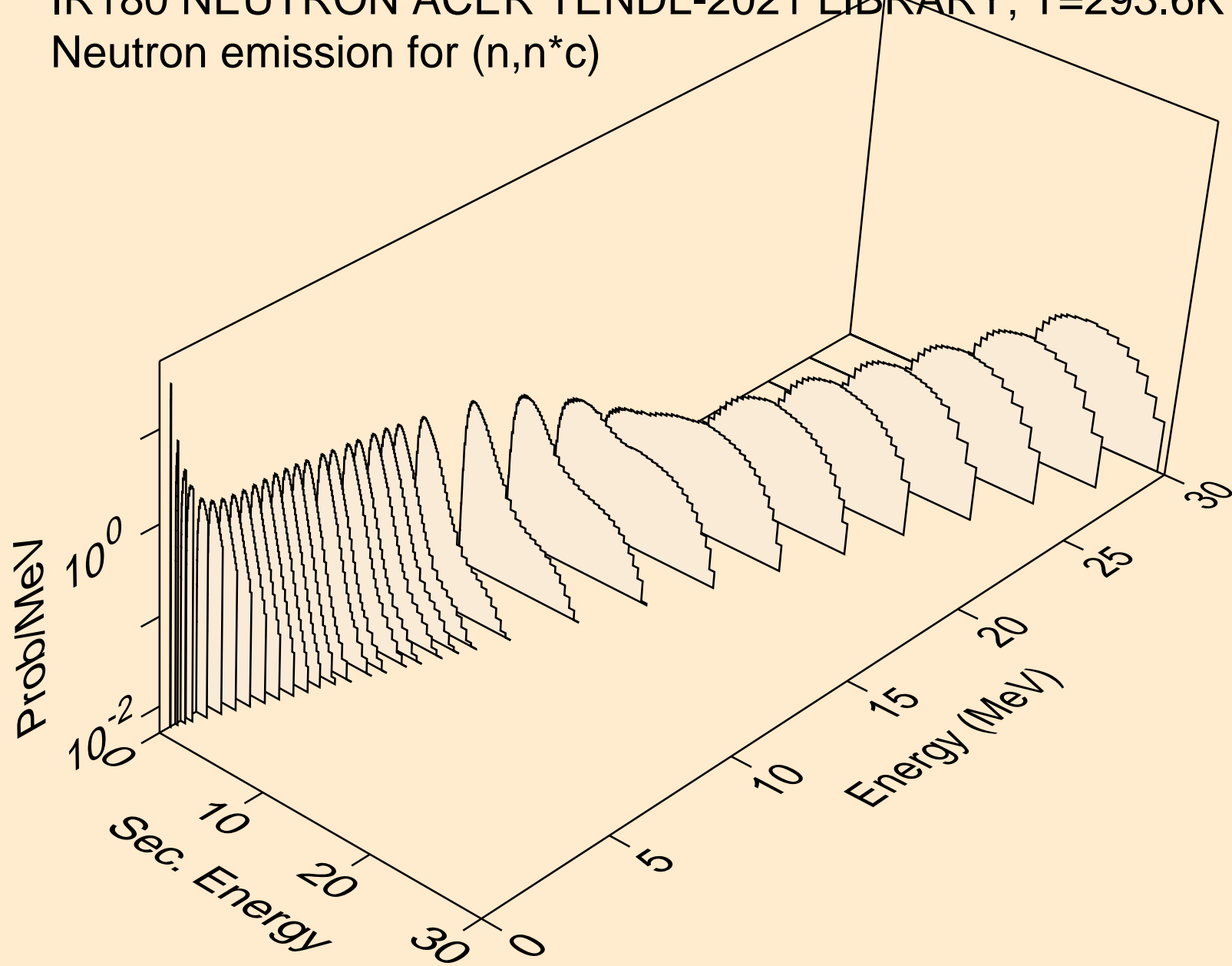

IR180 NEUTRON ACER TENDL-2021 LIBRARY; T=293.6K
Photon emission for (n,x)

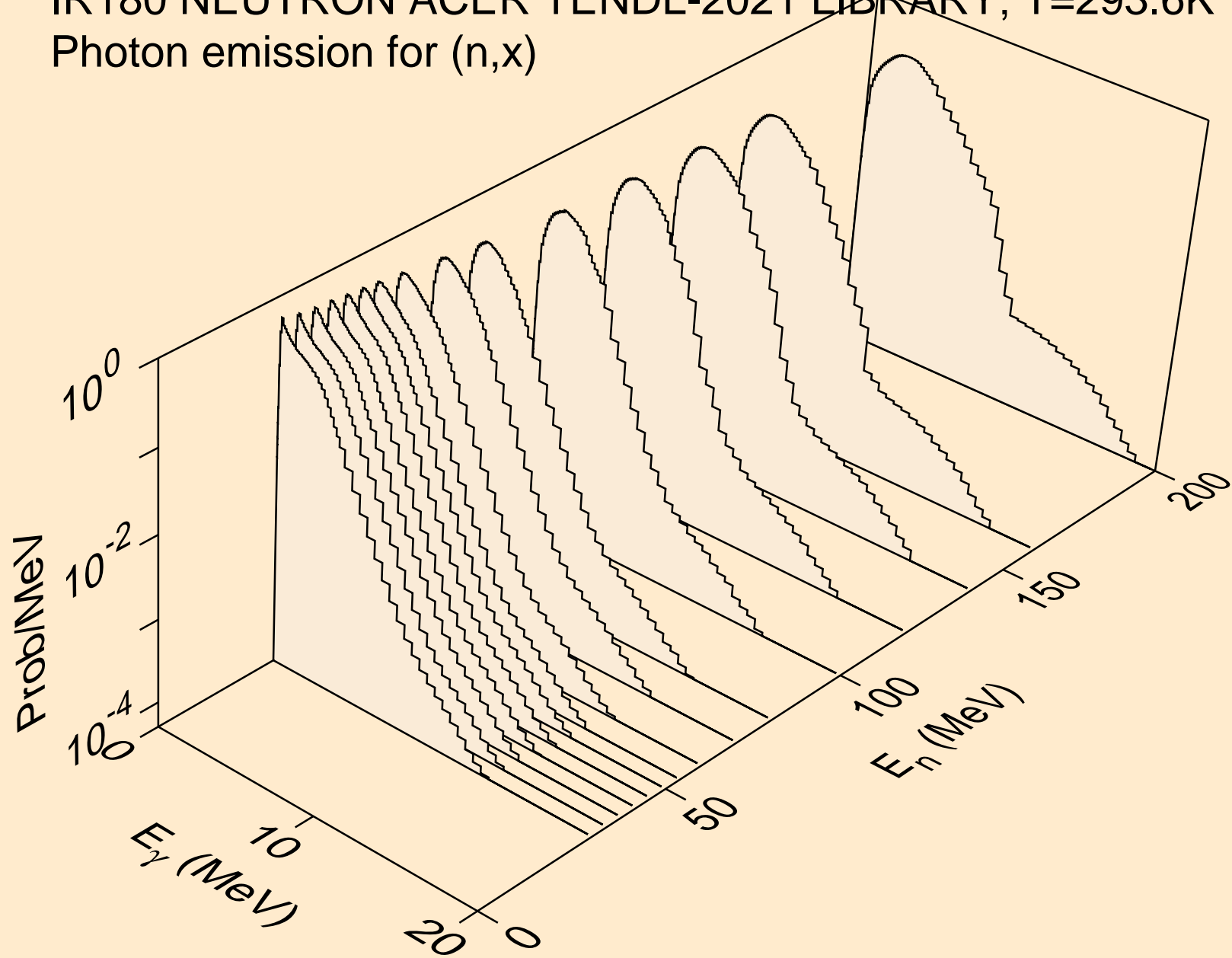

IR180 NEUTRON ACER TENDL-2021 LIBRARY; T=293.6K
Photon emission for (n,2nd)

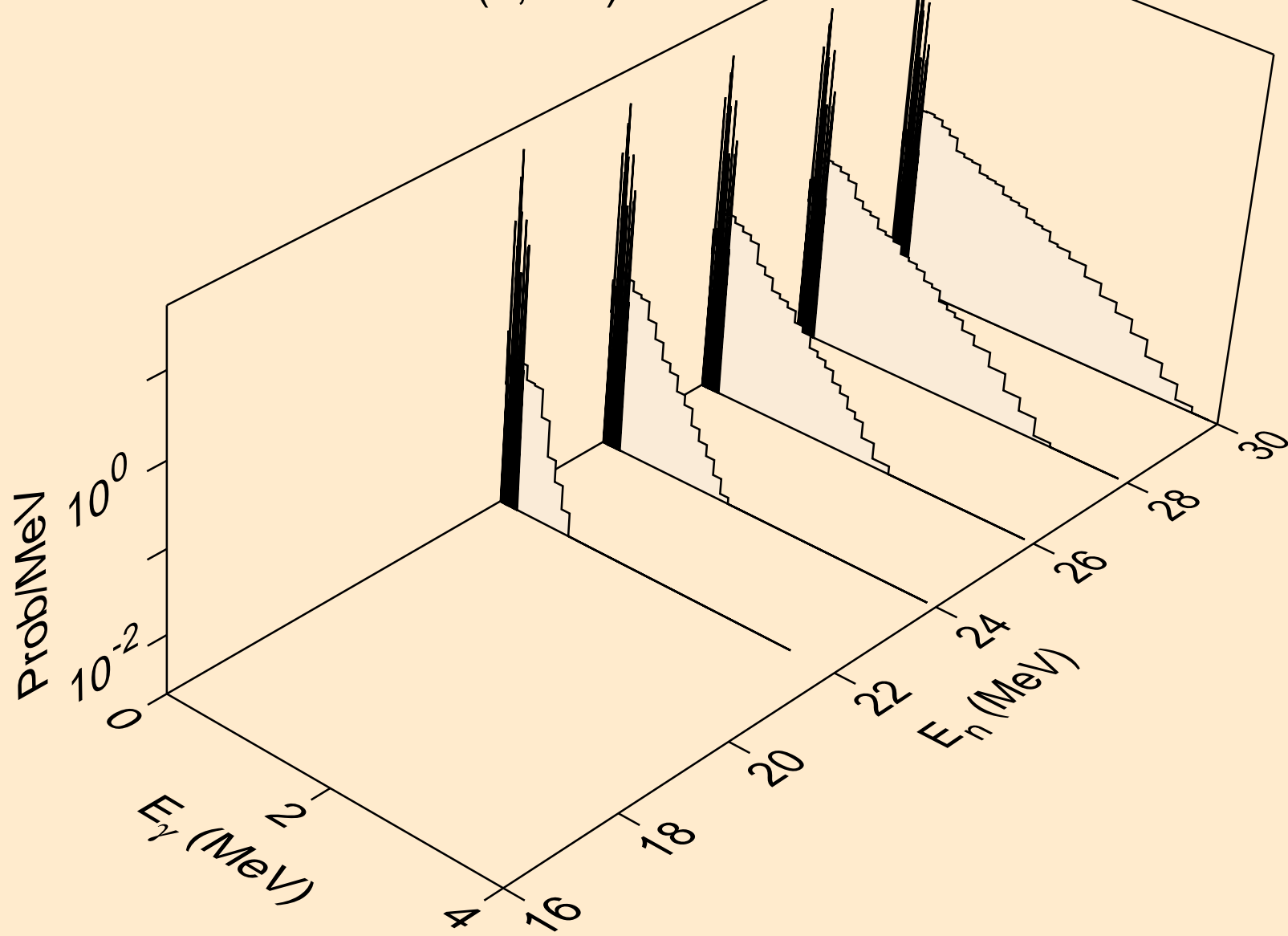

IR180 NEUTRON ACER TENDL-2021 LIBRARY; T=293.6K
Photon emission for (n,2n)

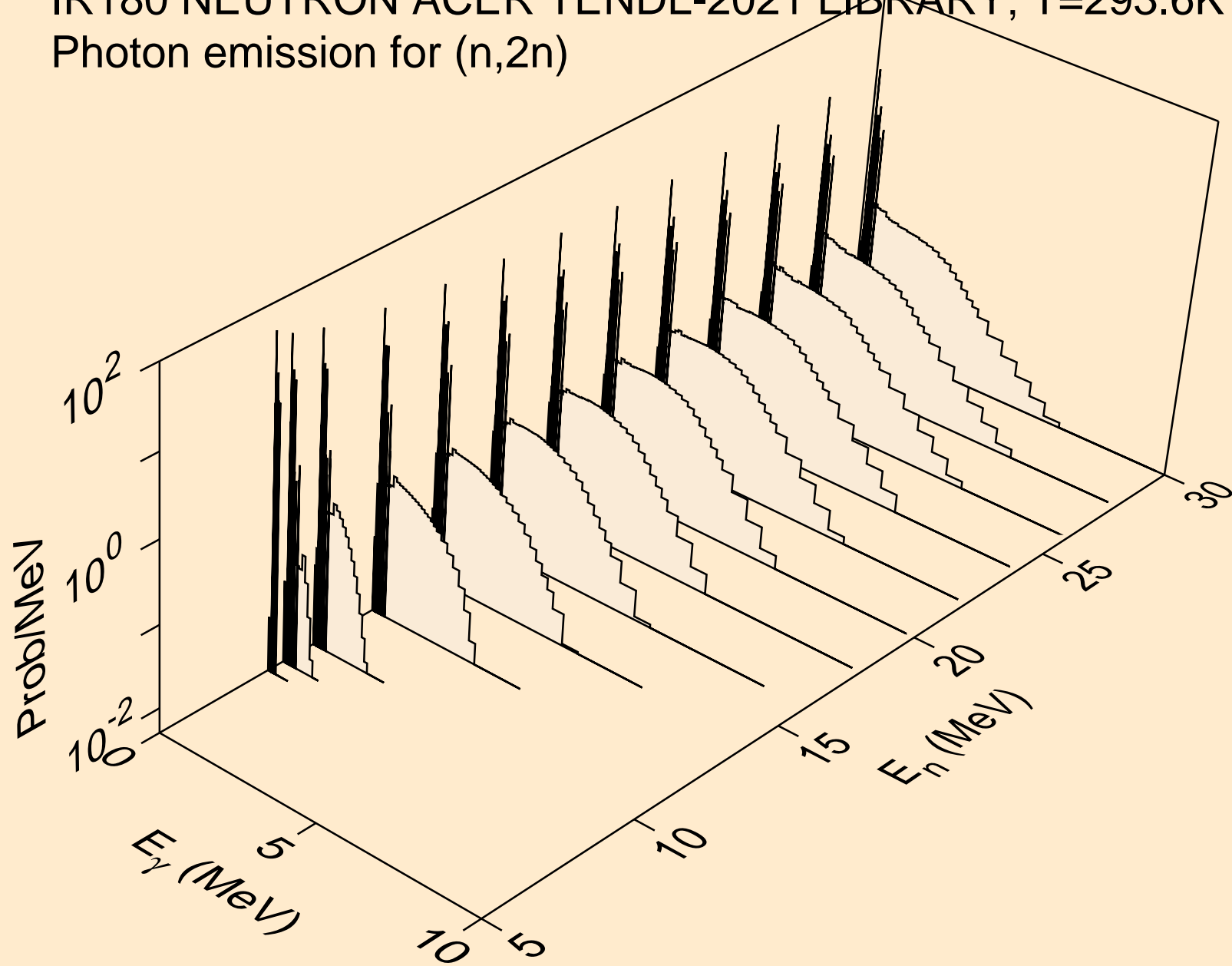

IR180 NEUTRON ACER TENDL-2021 LIBRARY; T=293.6K
Photon emission for (n,3n)

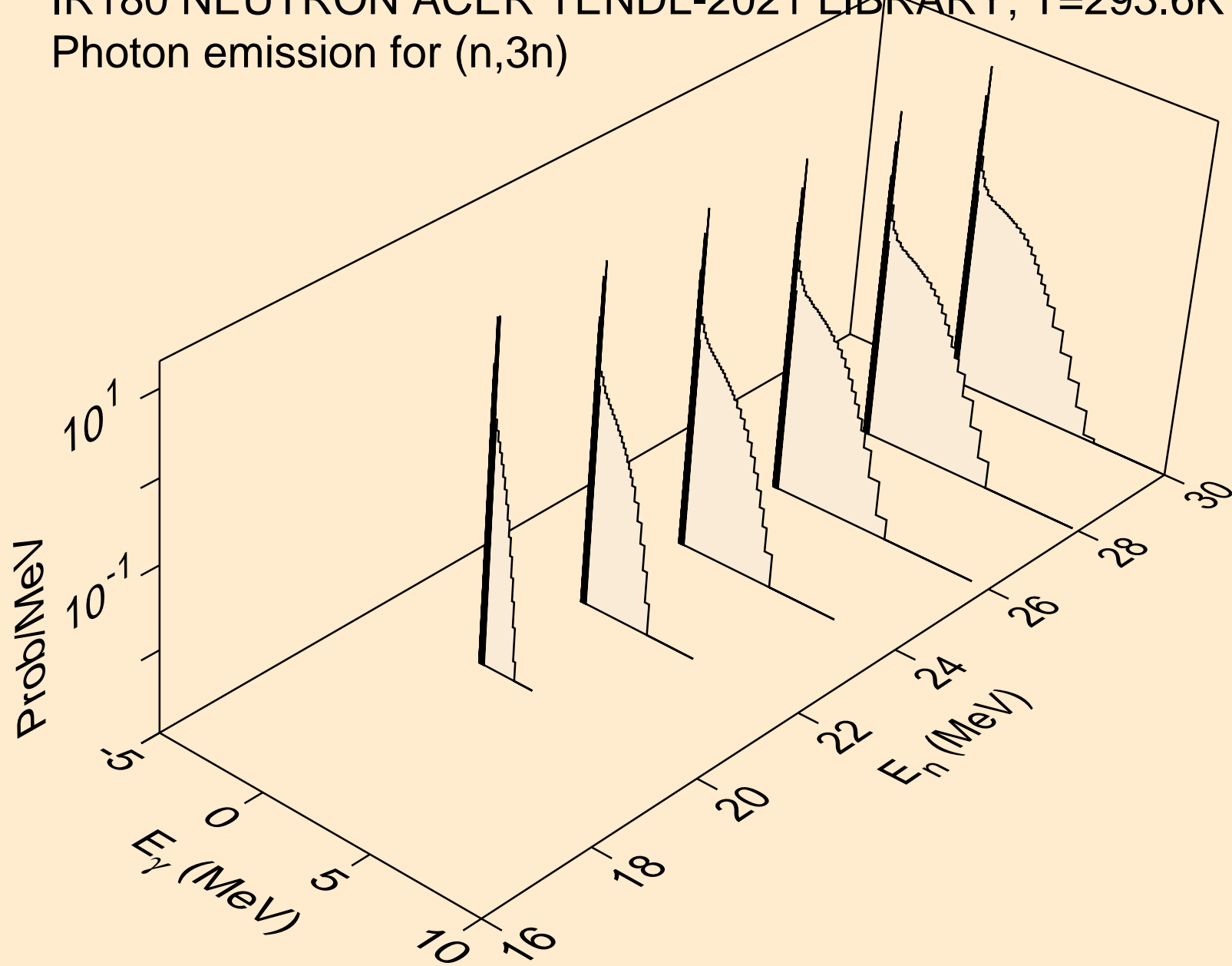

IR180 NEUTRON ACER TENDL-2021 LIBRARY; T=293.6K
Photon emission for (n,n*)a

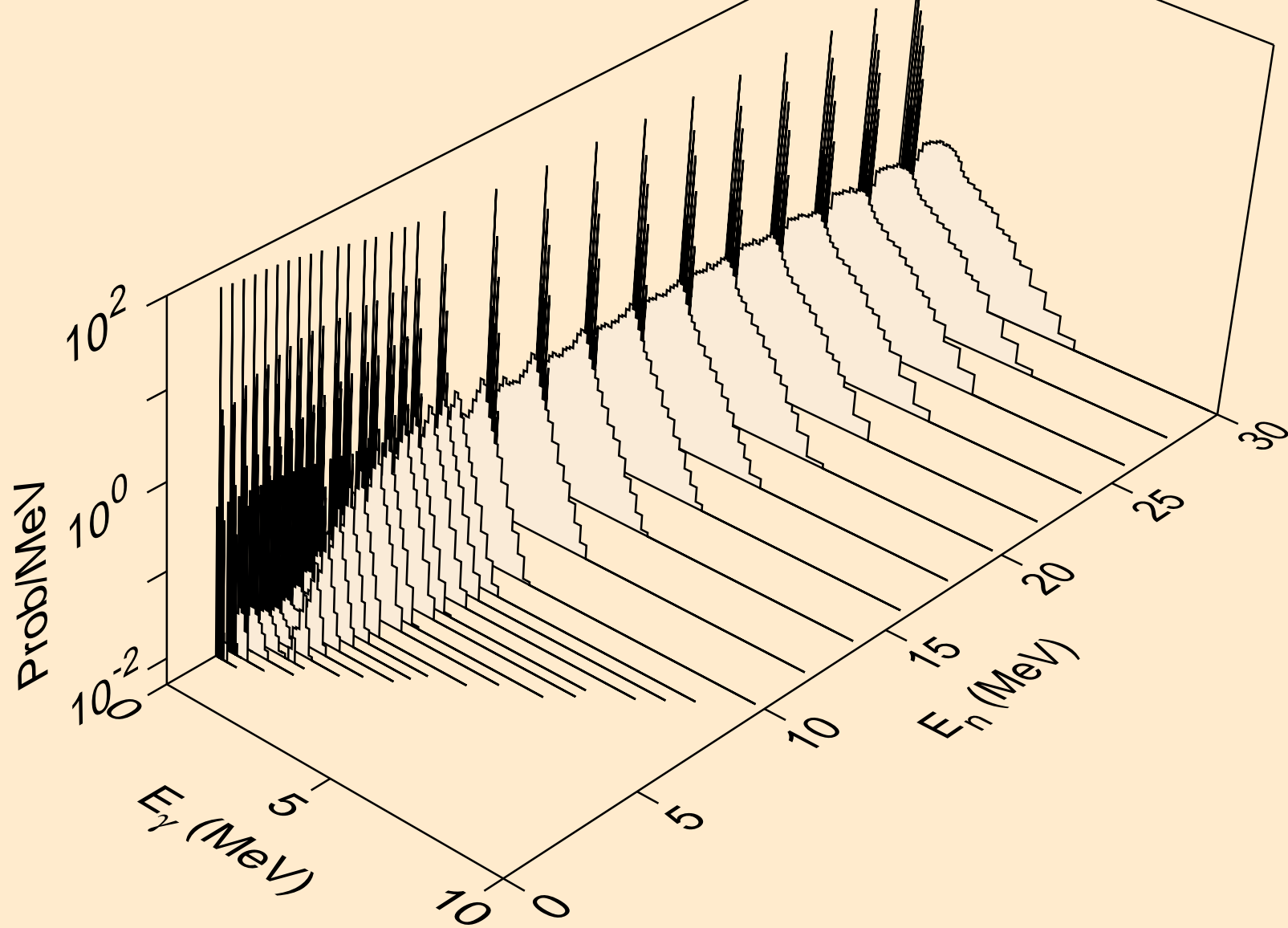

IR180 NEUTRON ACER TENDL-2021 LIBRARY; T=293.6K
Photon emission for (n,2n)a

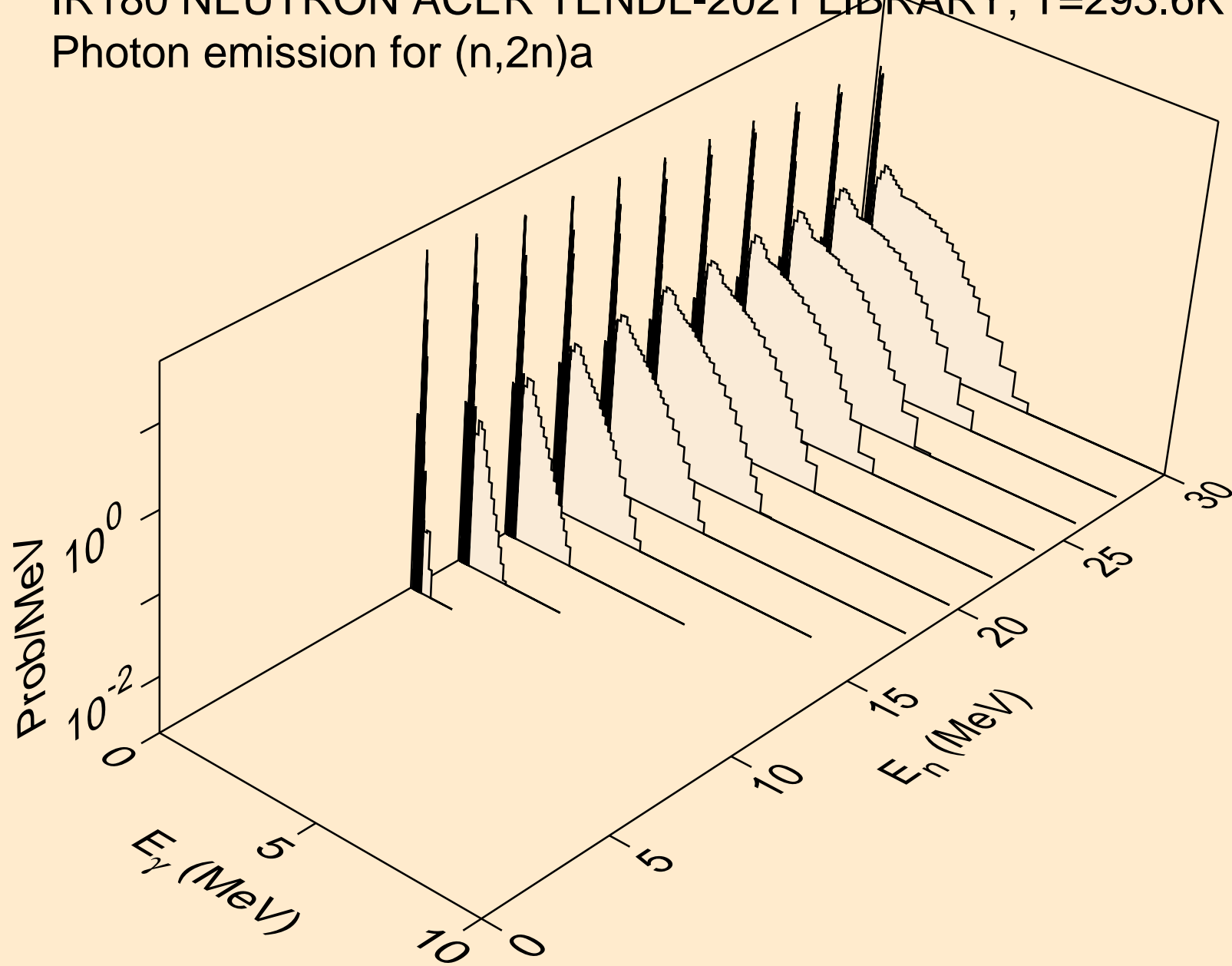

IR180 NEUTRON ACER TENDL-2021 LIBRARY; T=293.6K
Photon emission for (n,3n)a

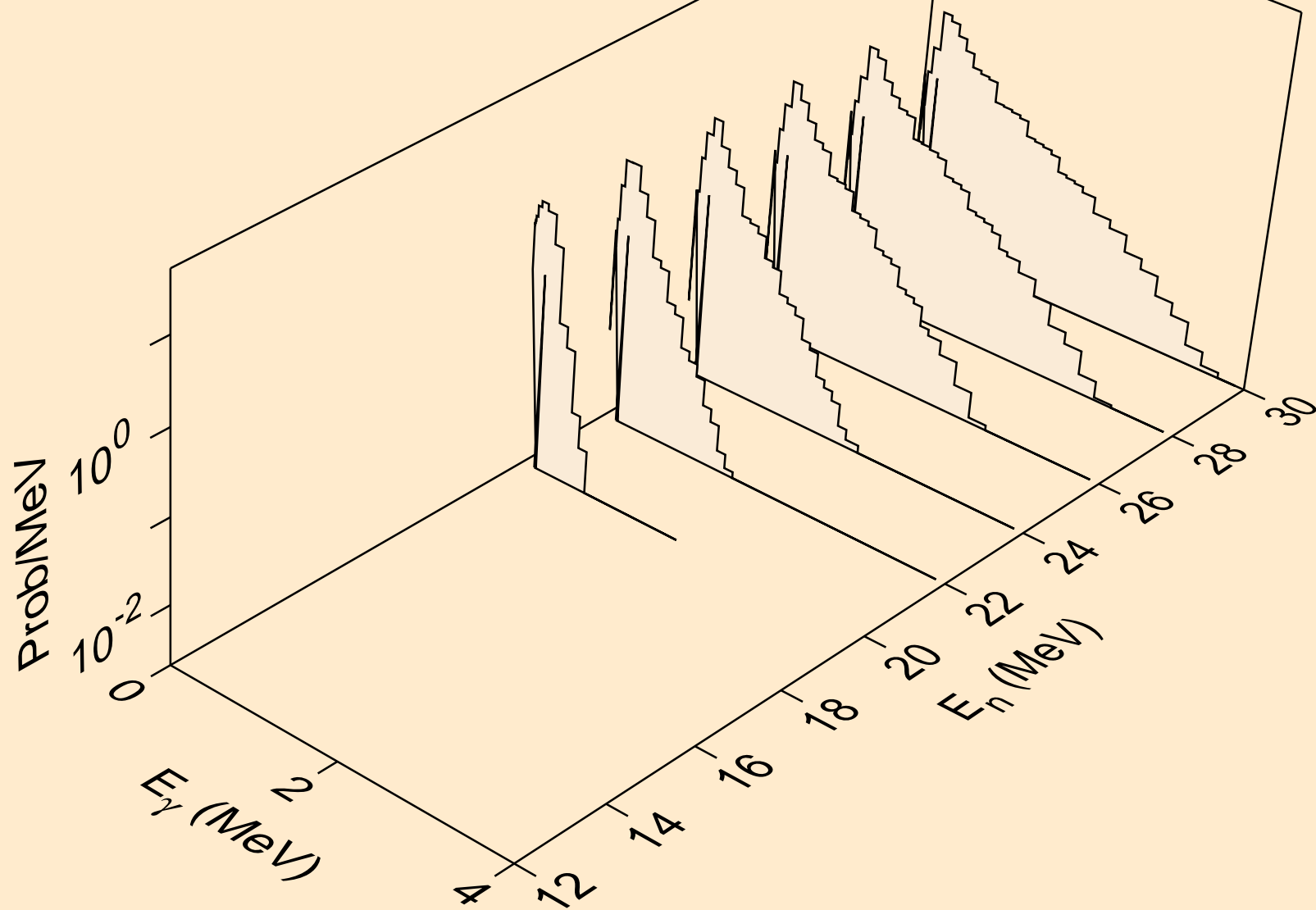

IR180 NEUTRON ACER TENDL-2021 LIBRARY; T=293.6K
Photon emission for (n,n*)p

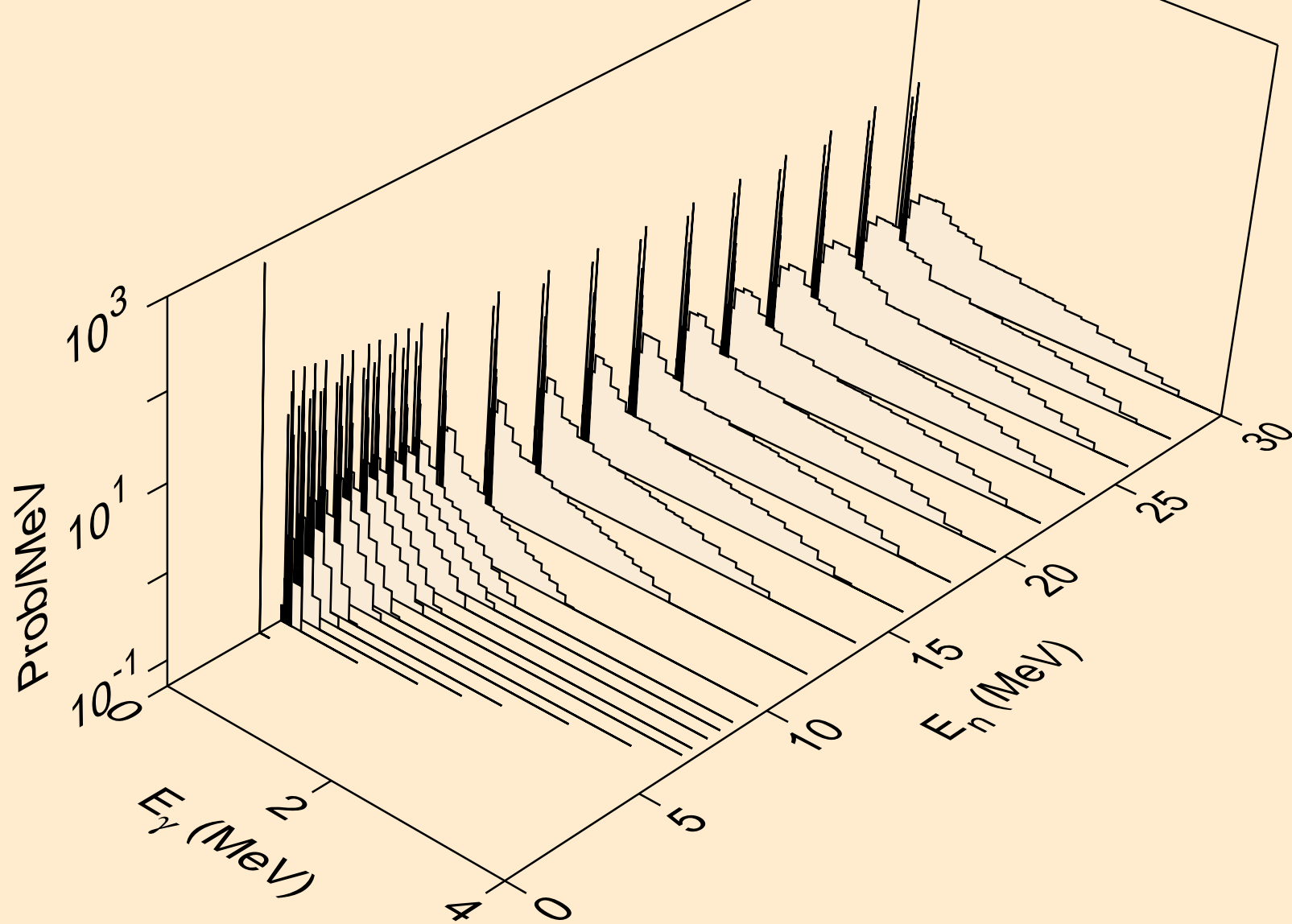

IR180 NEUTRON ACER TENDL-2021 LIBRARY; T=293.6K
Photon emission for (n,n*)2a

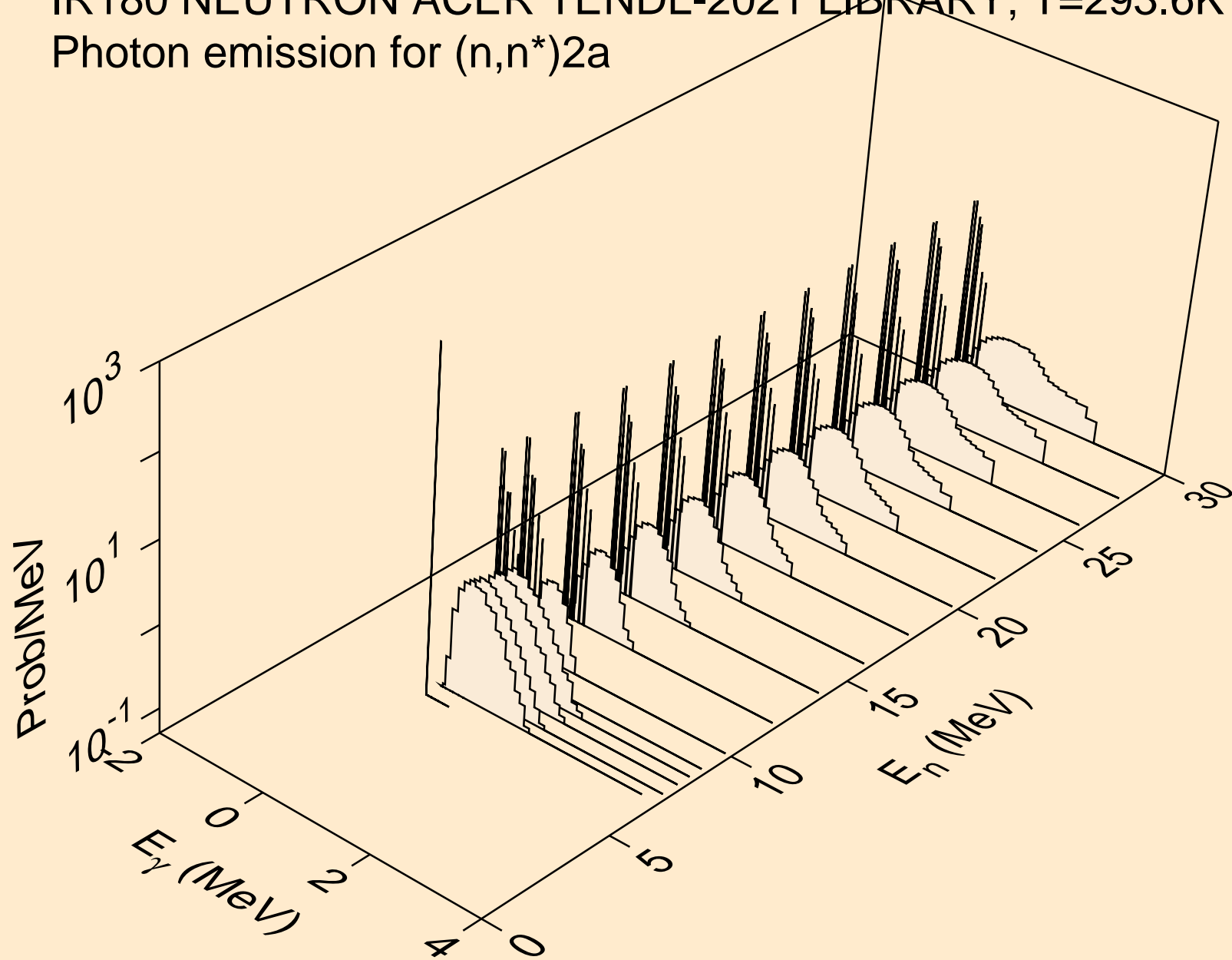

IR180 NEUTRON ACER TENDL-2021 LIBRARY; T=293.6K
Photon emission for (n,2n)2a

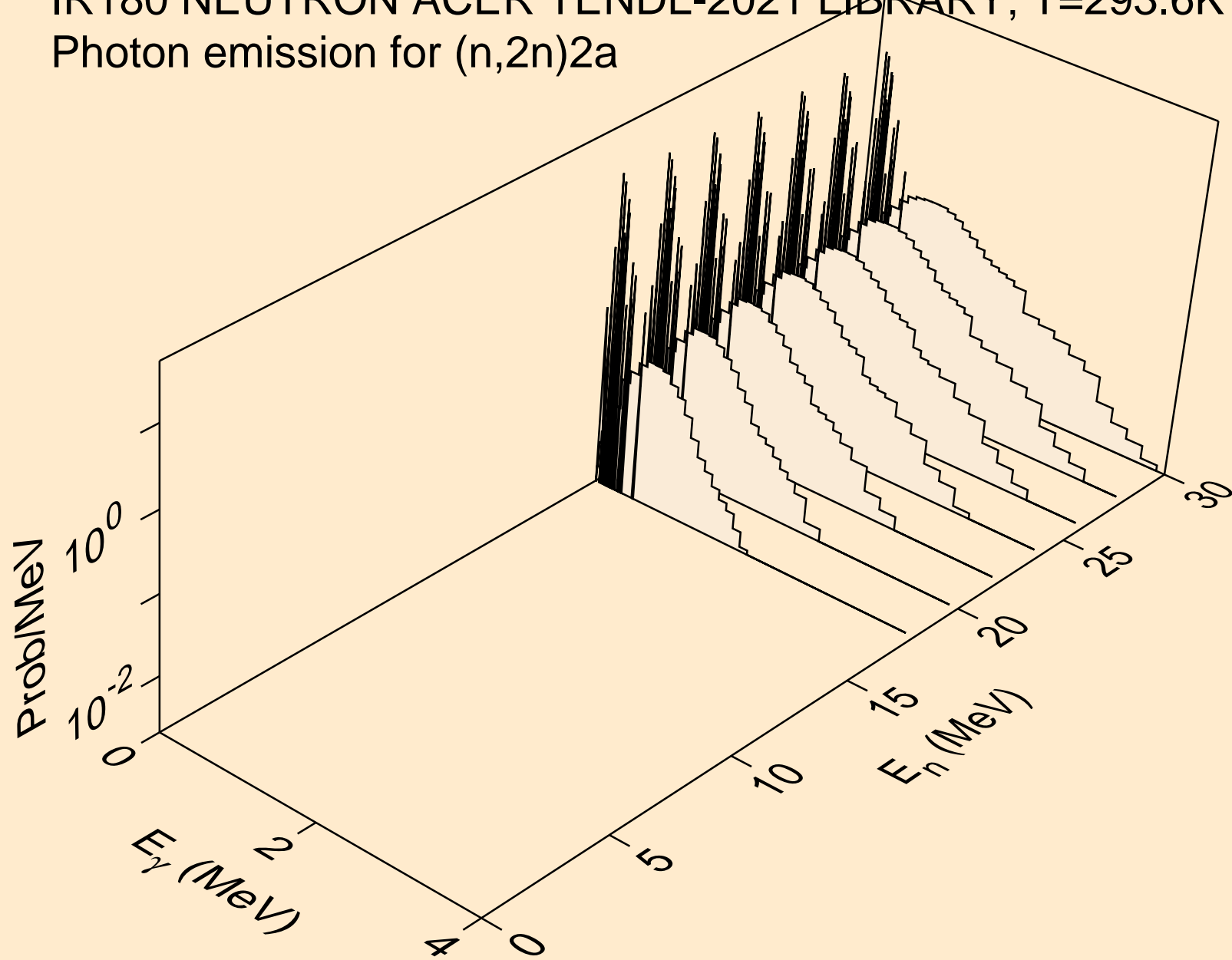

IR180 NEUTRON ACER TENDL-2021 LIBRARY; T=293.6K
Photon emission for (n,n*)d

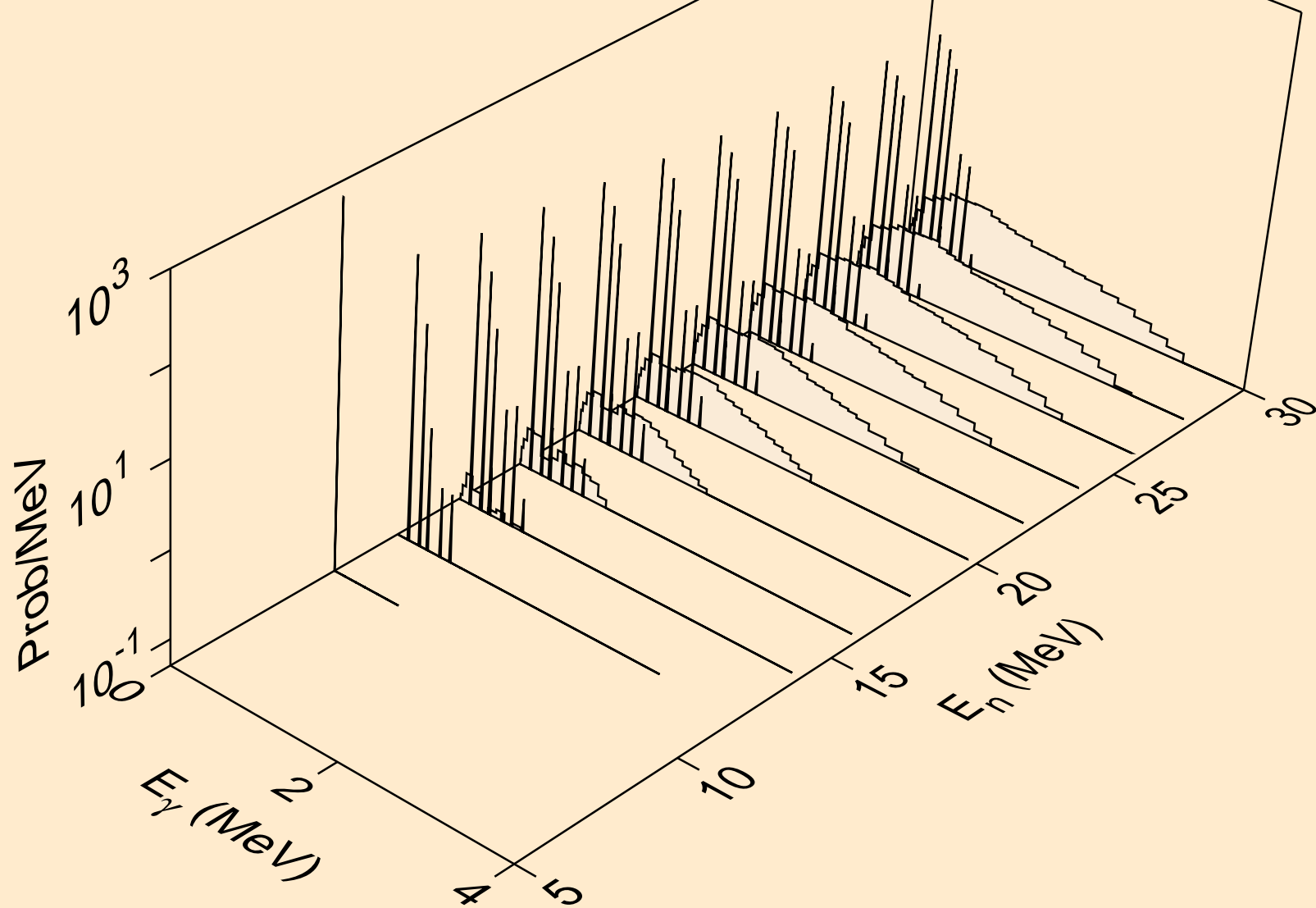

IR180 NEUTRON ACER TENDL-2021 LIBRARY; T=293.6K
Photon emission for (n,n*)t

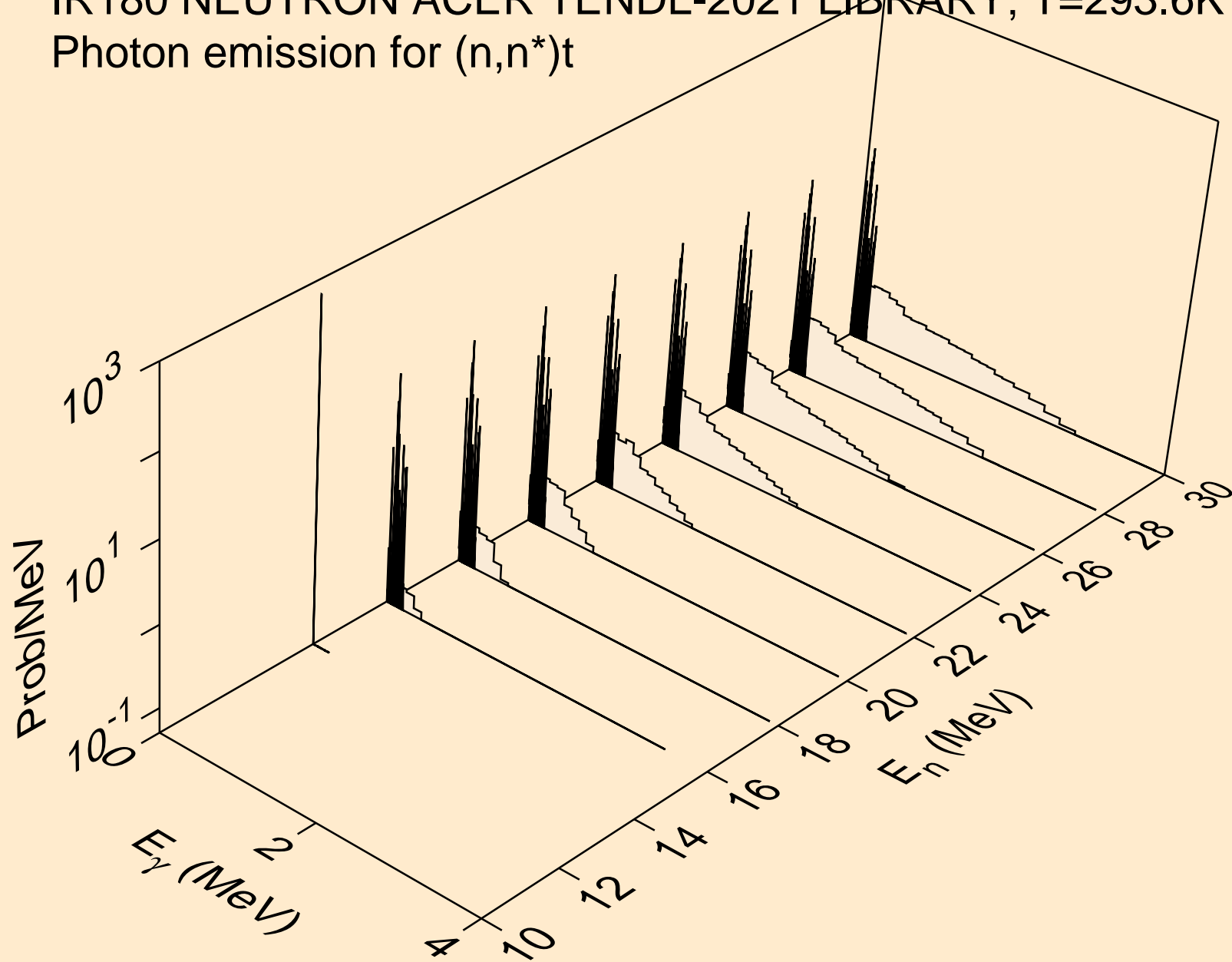

IR180 NEUTRON ACER TENDL-2021 LIBRARY; T=293.6K
Photon emission for (n,n*)he3

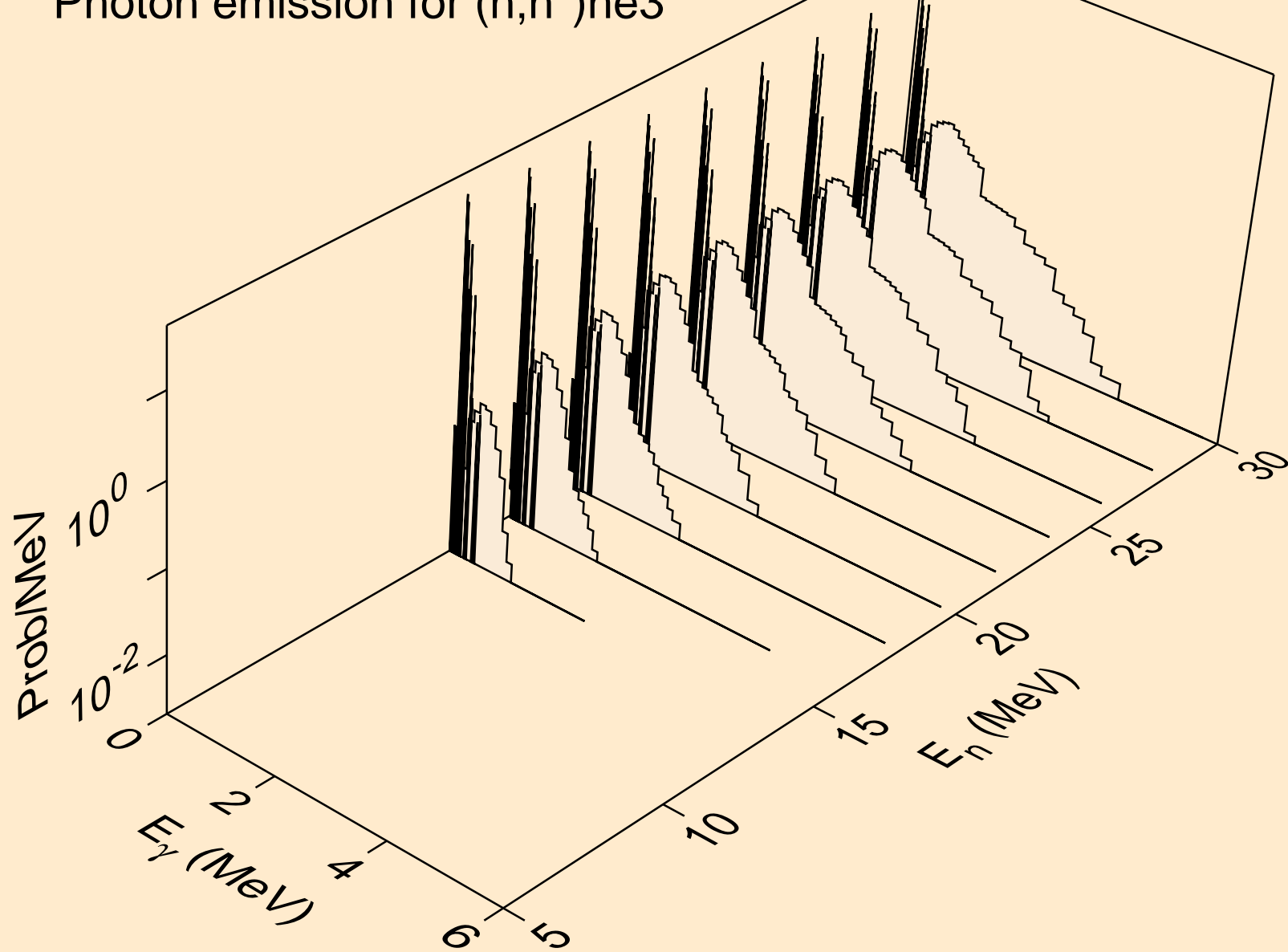

IR180 NEUTRON ACER TENDL-2021 LIBRARY; T=293.6K
Photon emission for (n,4n)

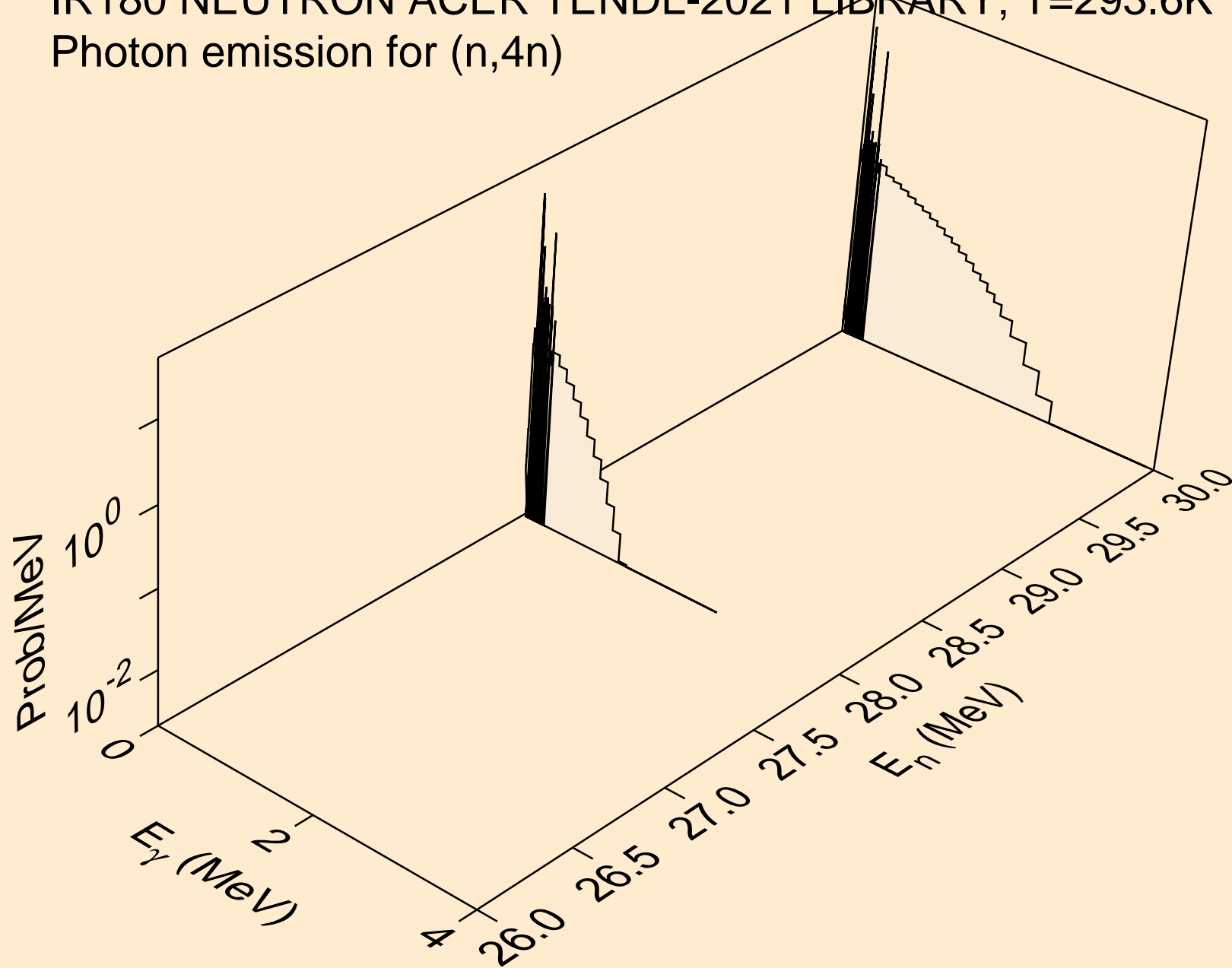

IR180 NEUTRON ACER TENDL-2021 LIBRARY; T=293.6K
Photon emission for (n,2np)

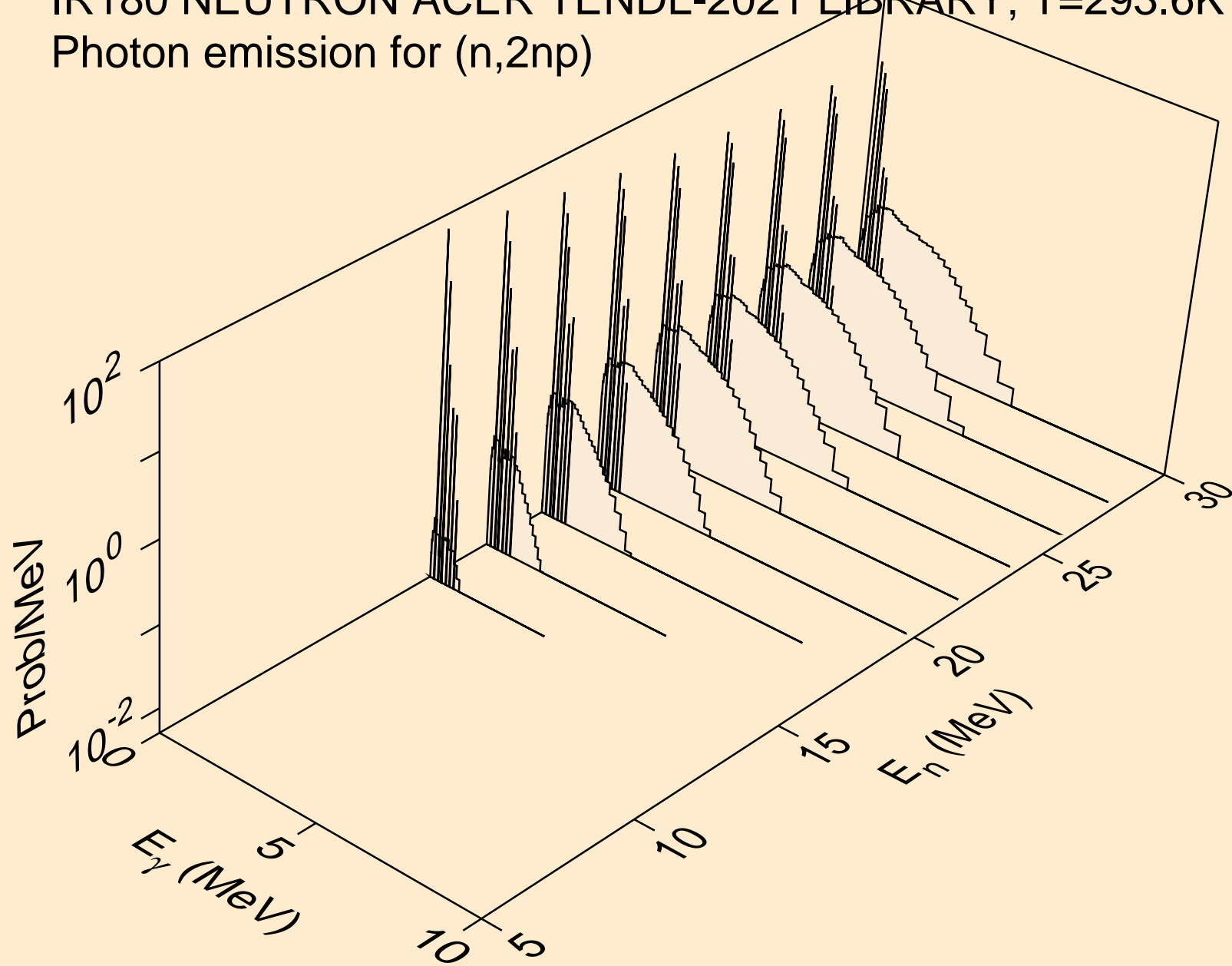

IR180 NEUTRON ACER TENDL-2021 LIBRARY; T=293.6K
Photon emission for (n,3np)

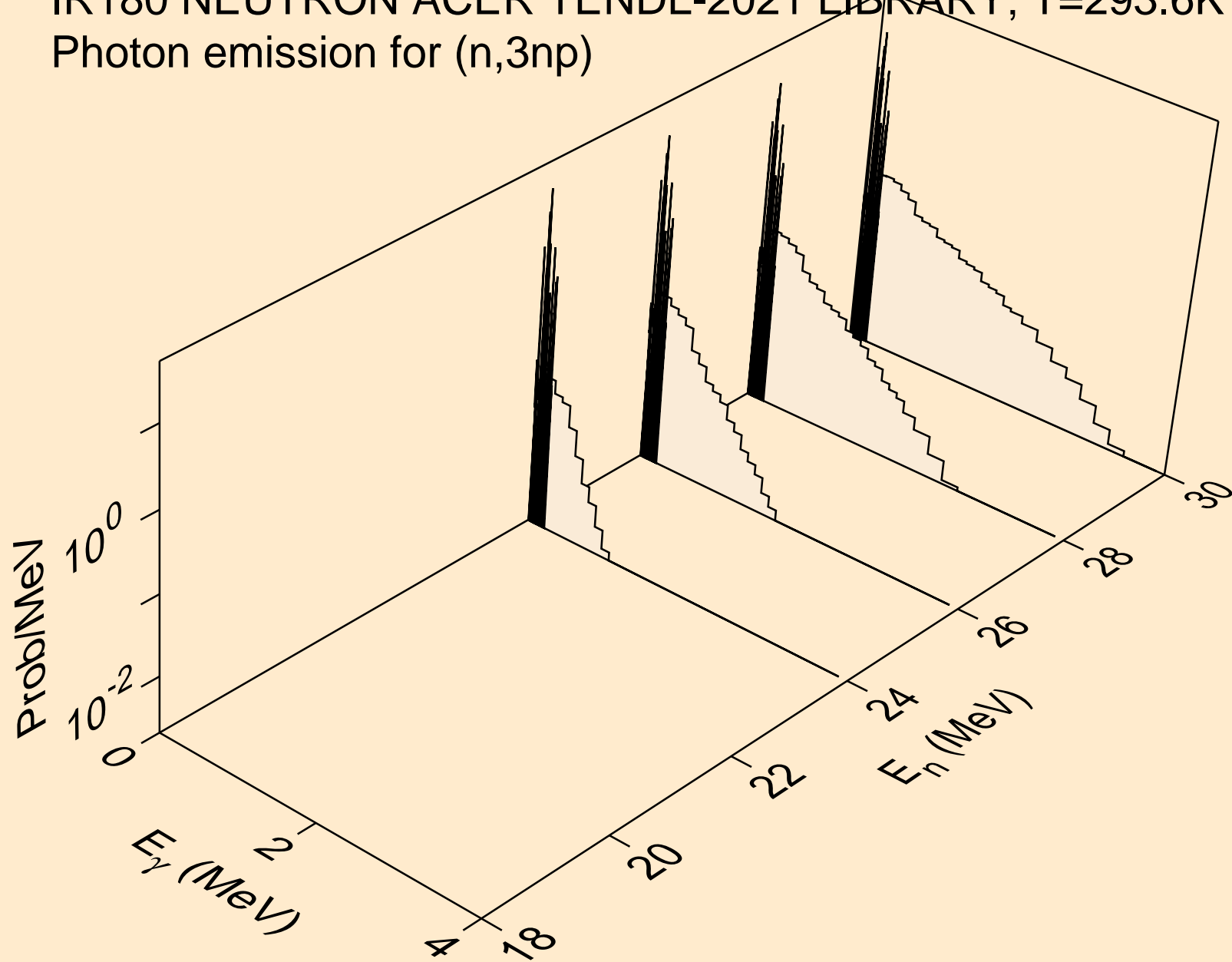

IR180 NEUTRON ACER TENDL-2021 LIBRARY; T=293.6K
Photon emission for (n,2np)

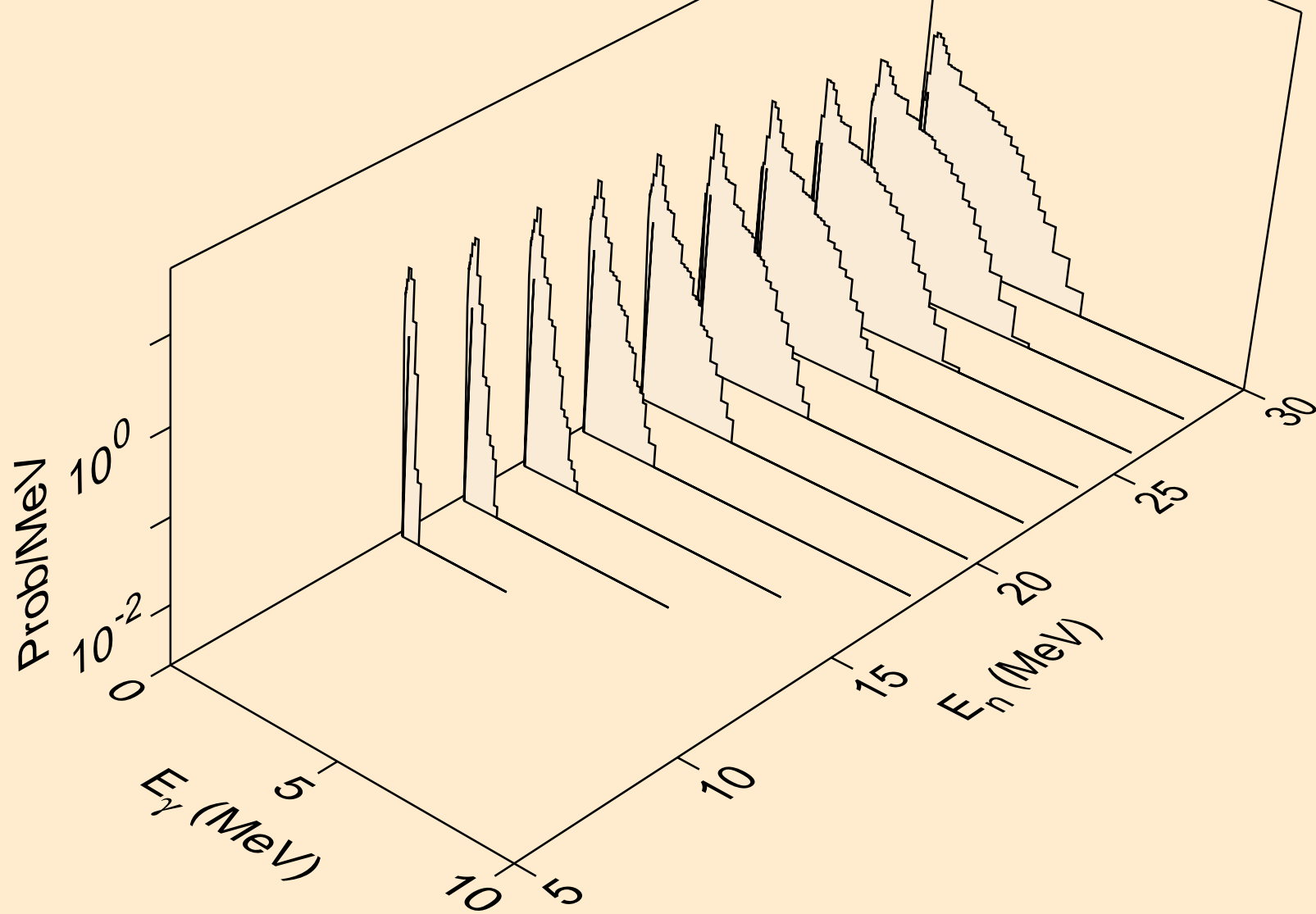

IR180 NEUTRON ACER TENDL-2021 LIBRARY; T=293.6K
Photon emission for (n,npa)

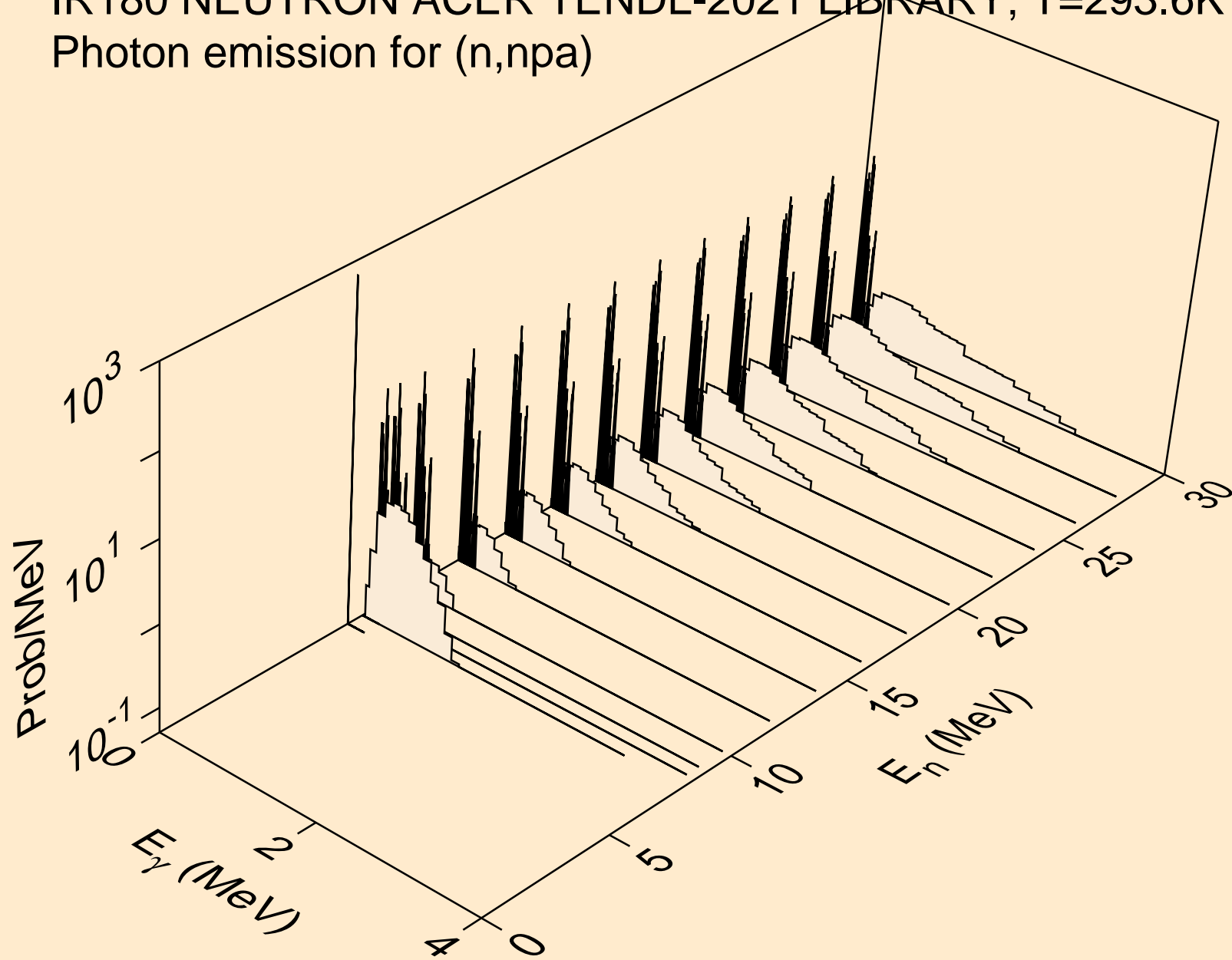

IR180 NEUTRON ACER TENDL-2021 LIBRARY; T=293.6K
Photon emission for (n,n*c)

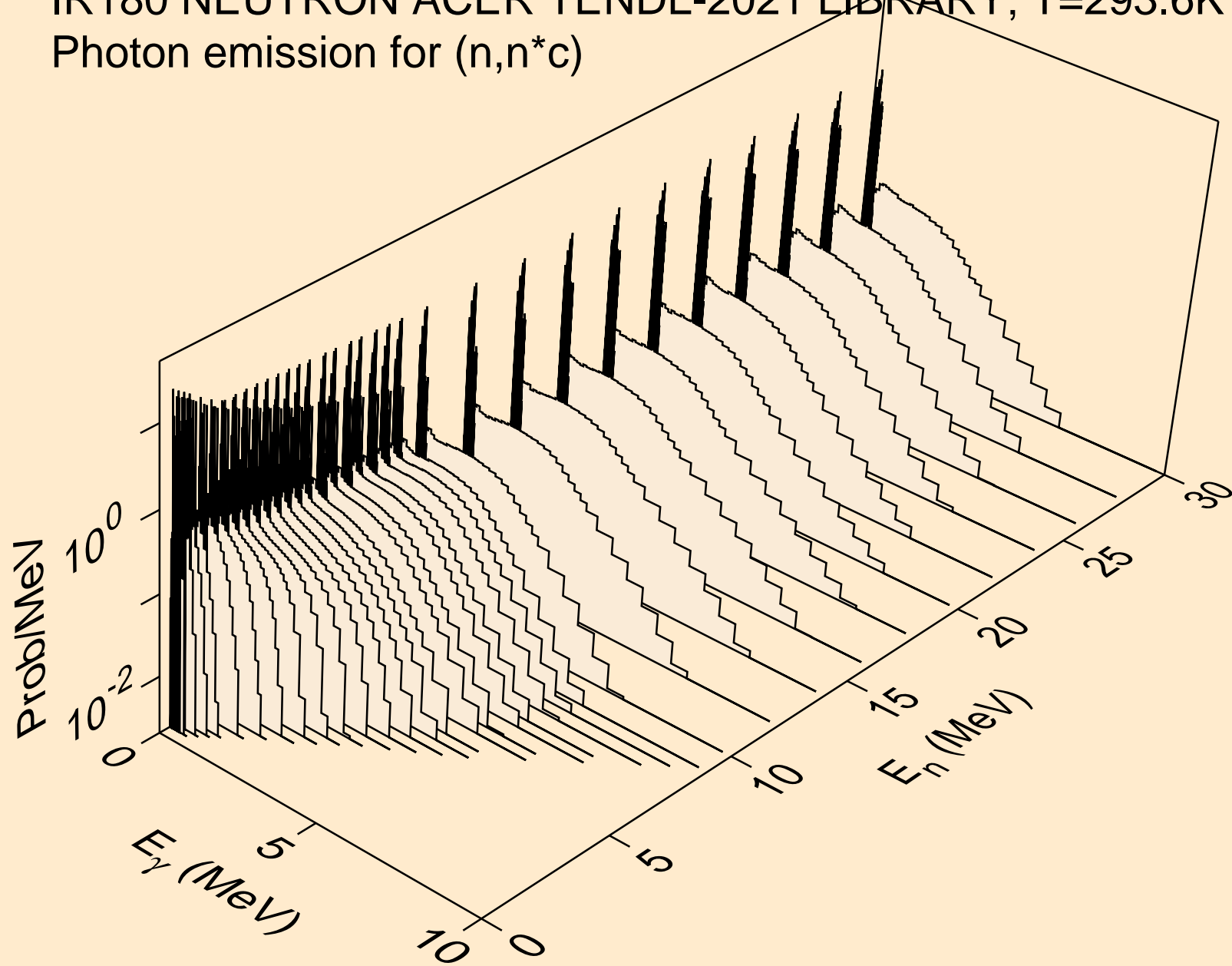

IR180 NEUTRON ACER TENDL-2021 LIBRARY; T=293.6K
Photon emission for (n,gma)

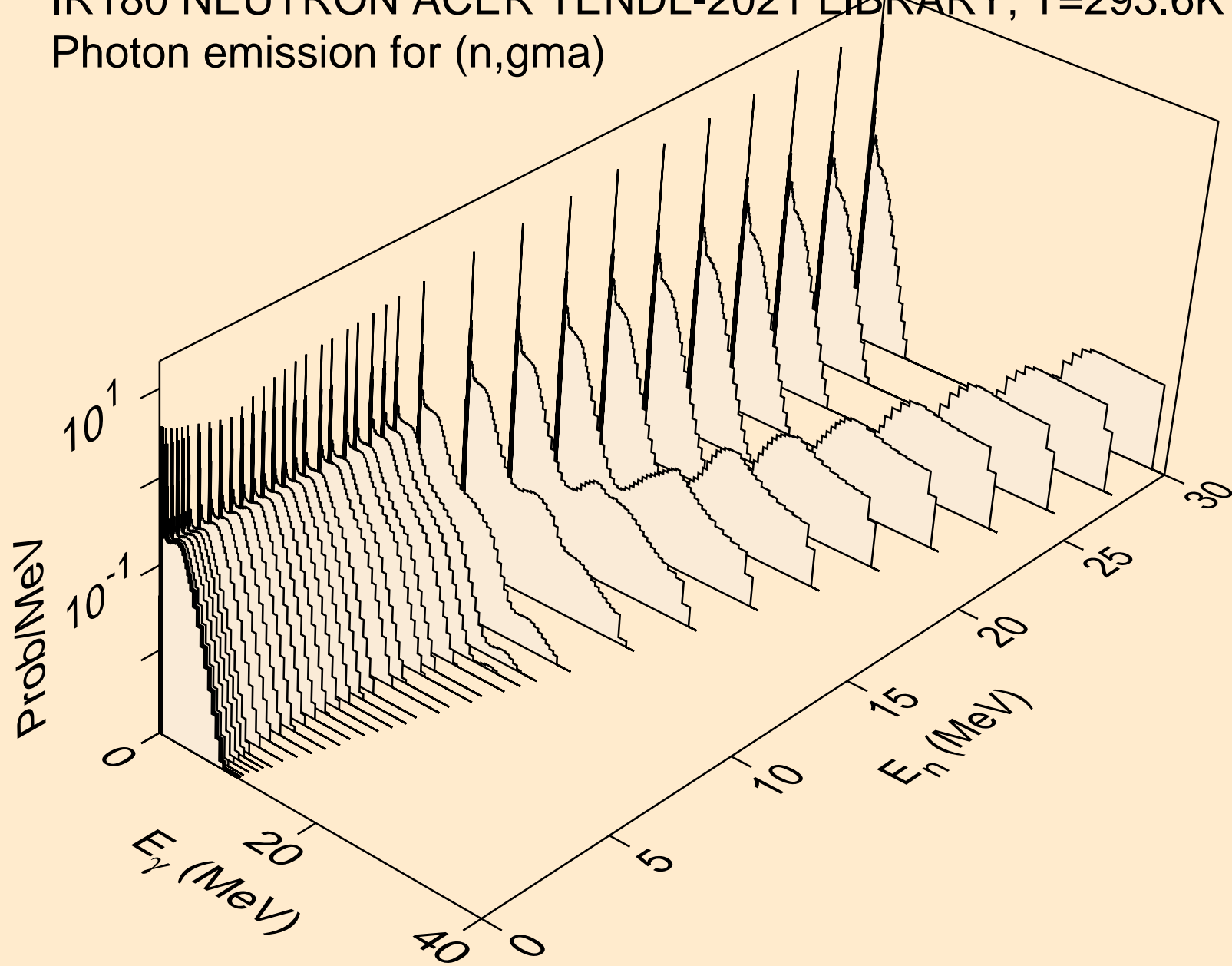

IR180 NEUTRON ACER TENDL-2021 LIBRARY; T=293.6K
Photon emission for (n,p)

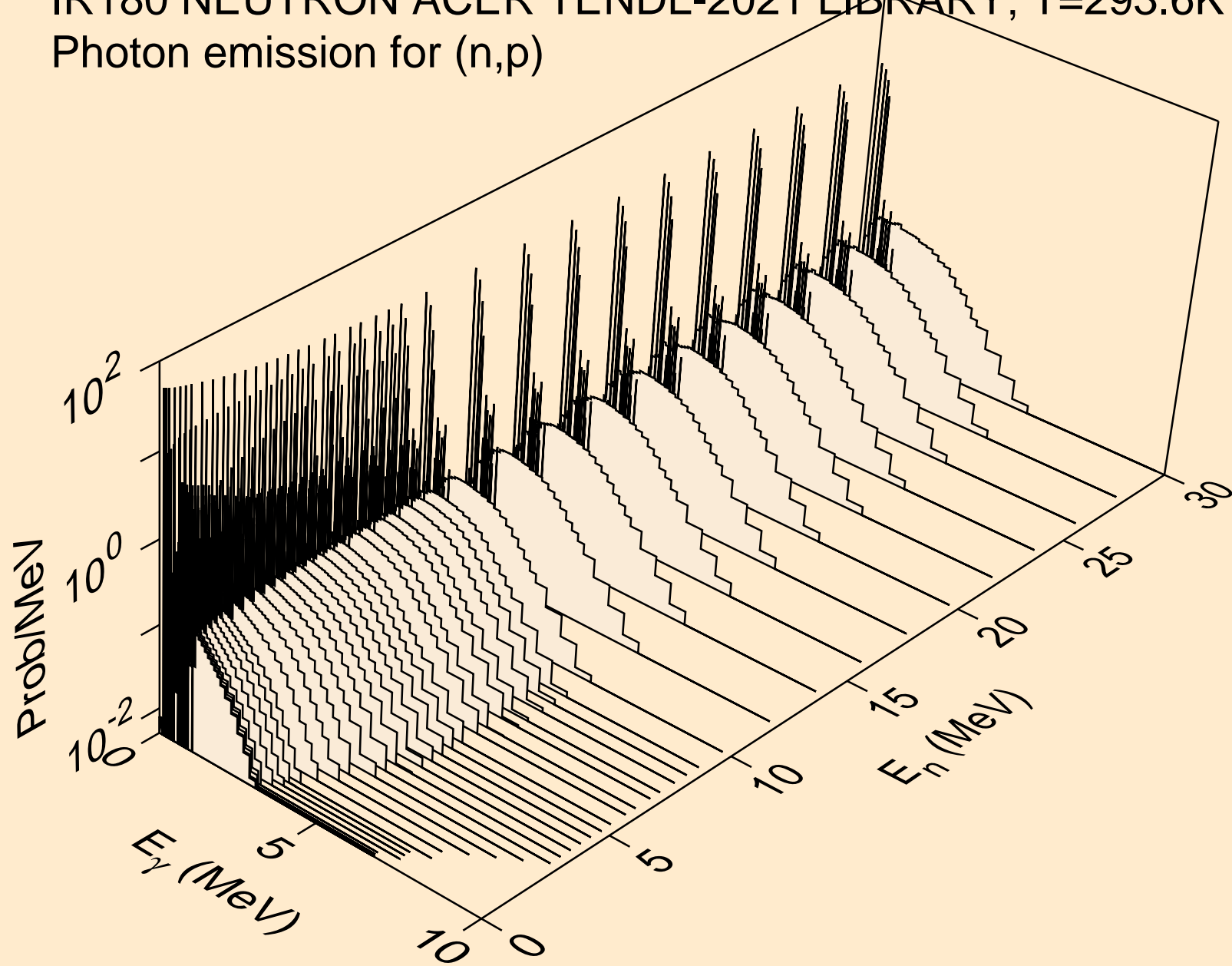

IR180 NEUTRON ACER TENDL-2021 LIBRARY; T=293.6K
Photon emission for (n,d)

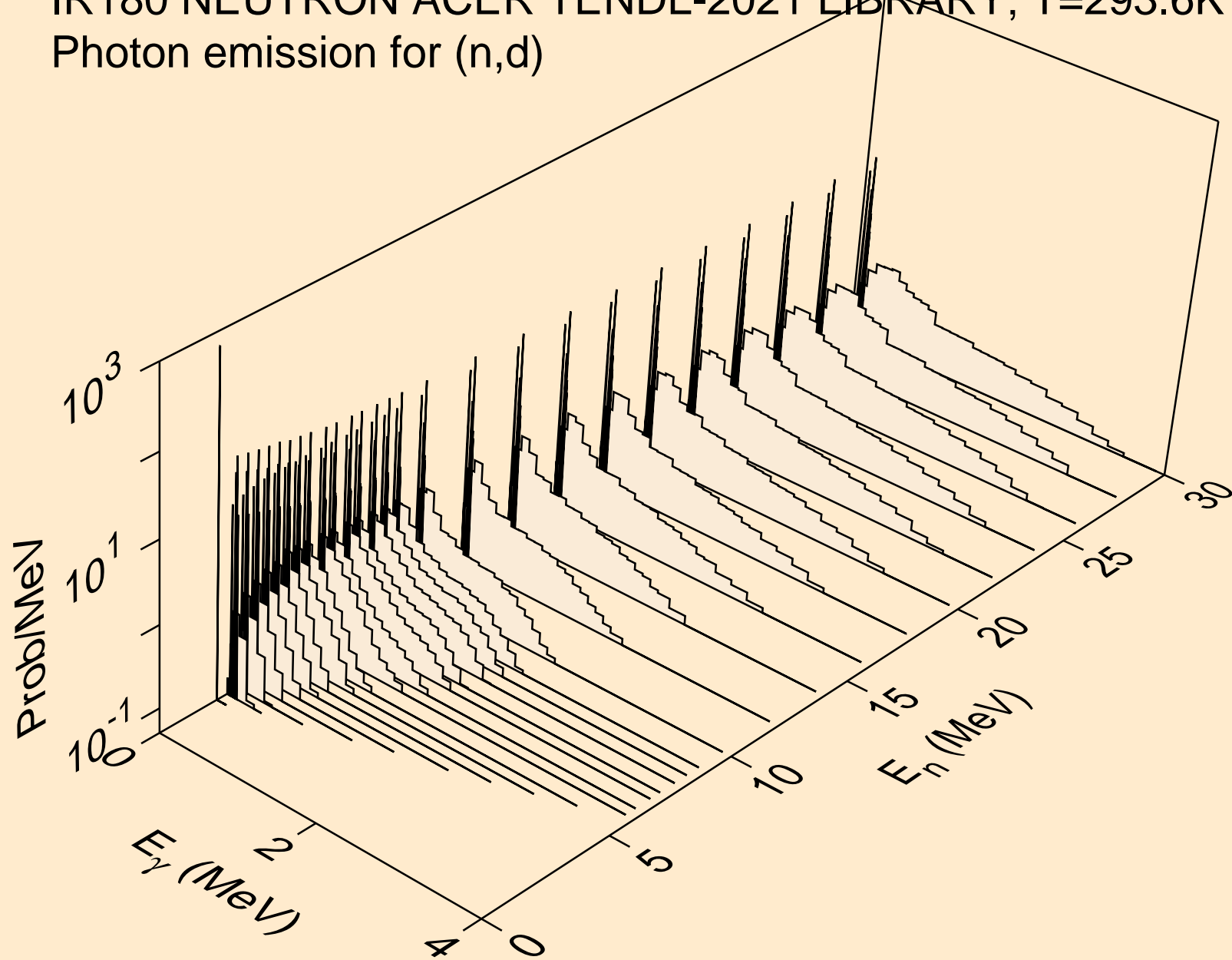

IR180 NEUTRON ACER TENDL-2021 LIBRARY; T=293.6K
Photon emission for (n,t)

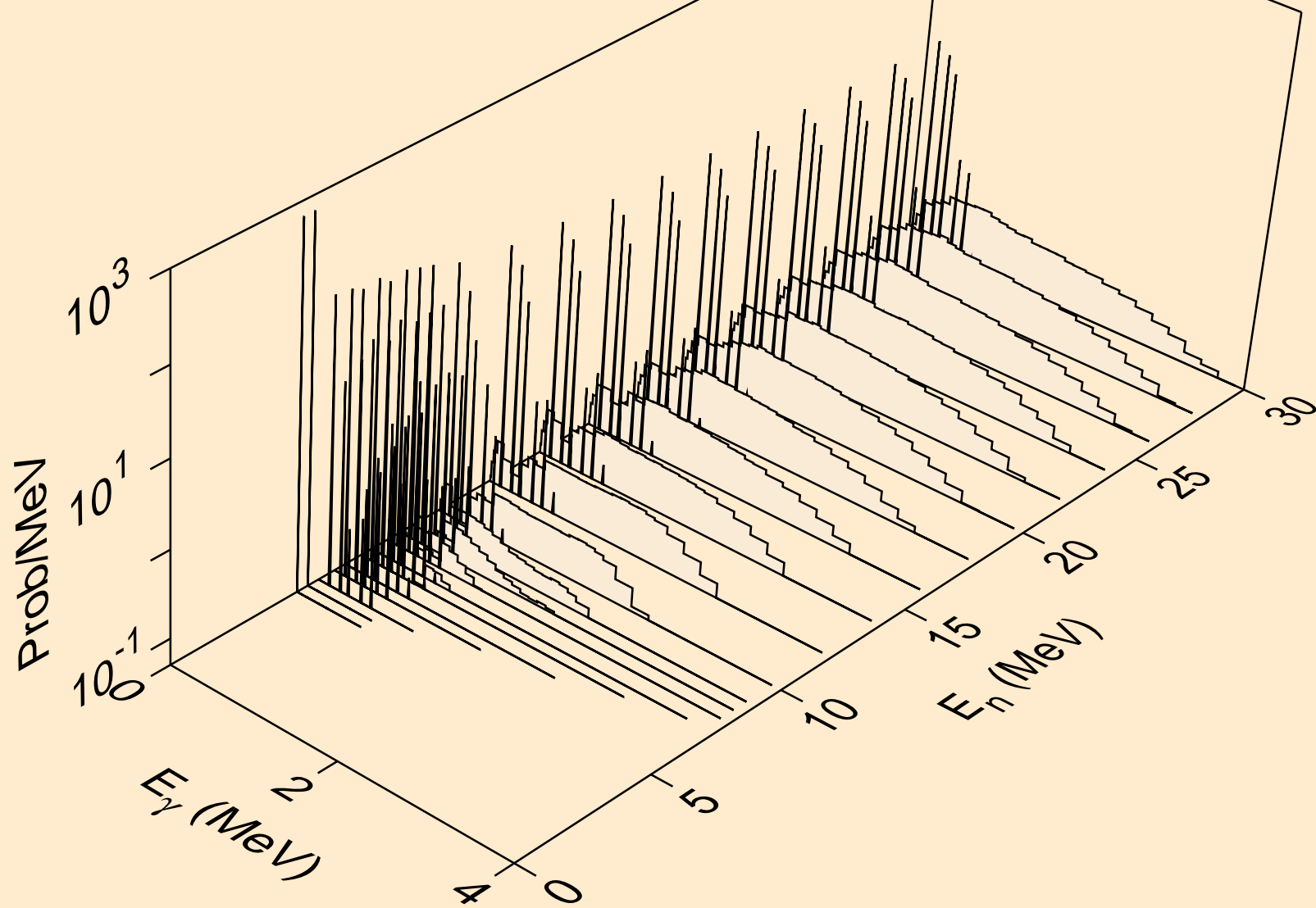

IR180 NEUTRON ACER TENDL-2021 LIBRARY; T=293.6K
Photon emission for (n,he3)

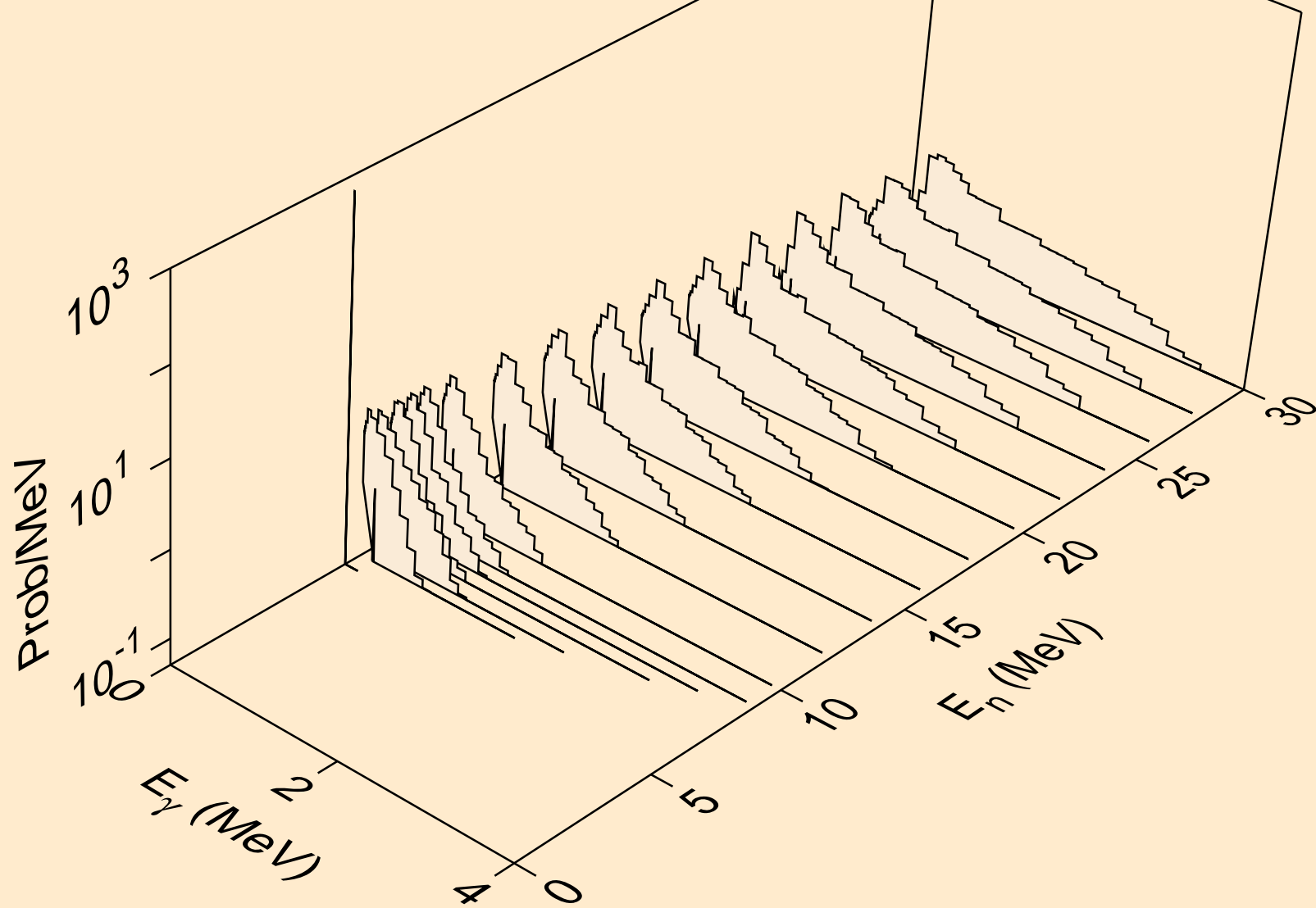

IR180 NEUTRON ACER TENDL-2021 LIBRARY; T=293.6K
Photon emission for (n,a)

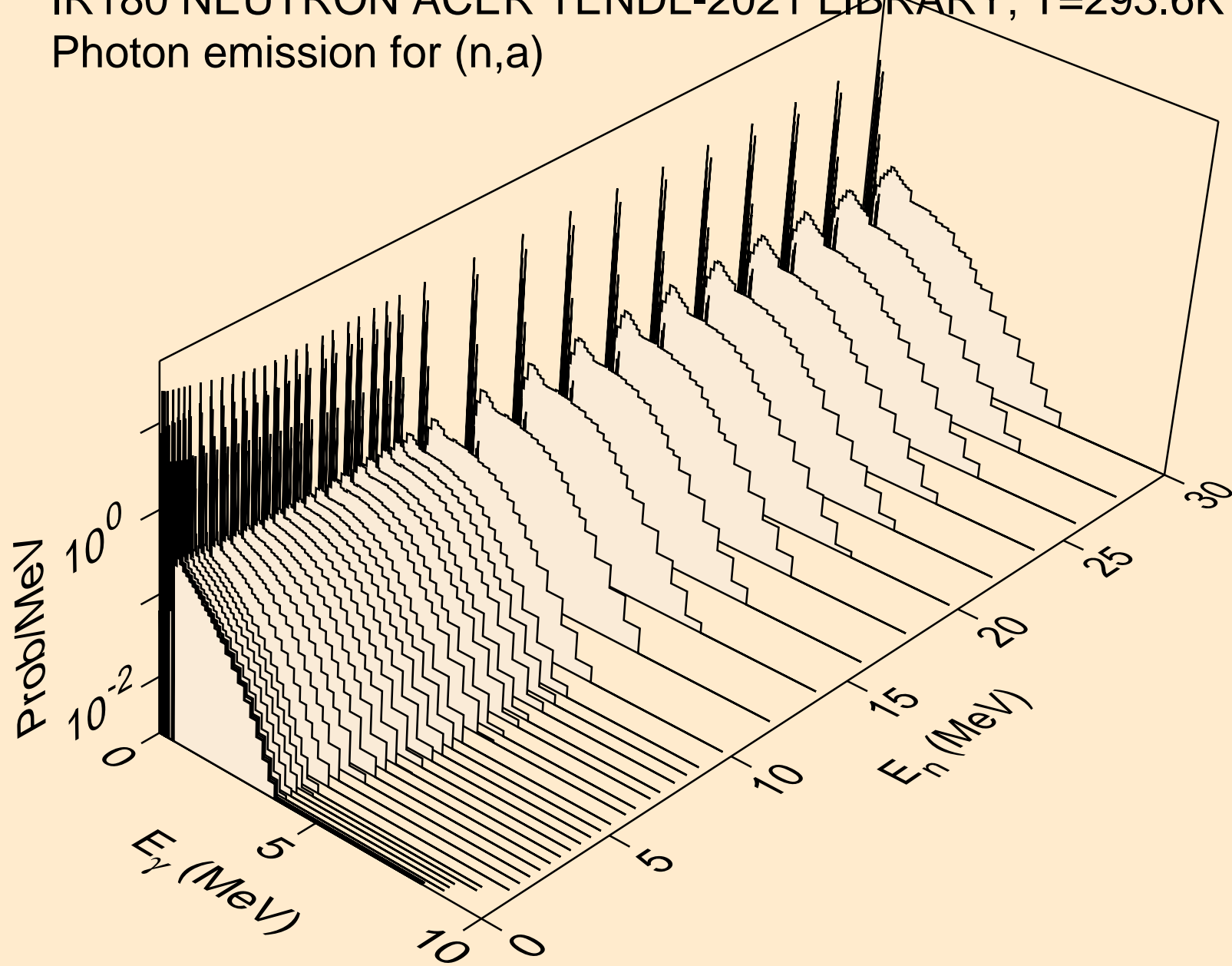

IR180 NEUTRON ACER TENDL-2021 LIBRARY; T=293.6K
Photon emission for (n,2a)

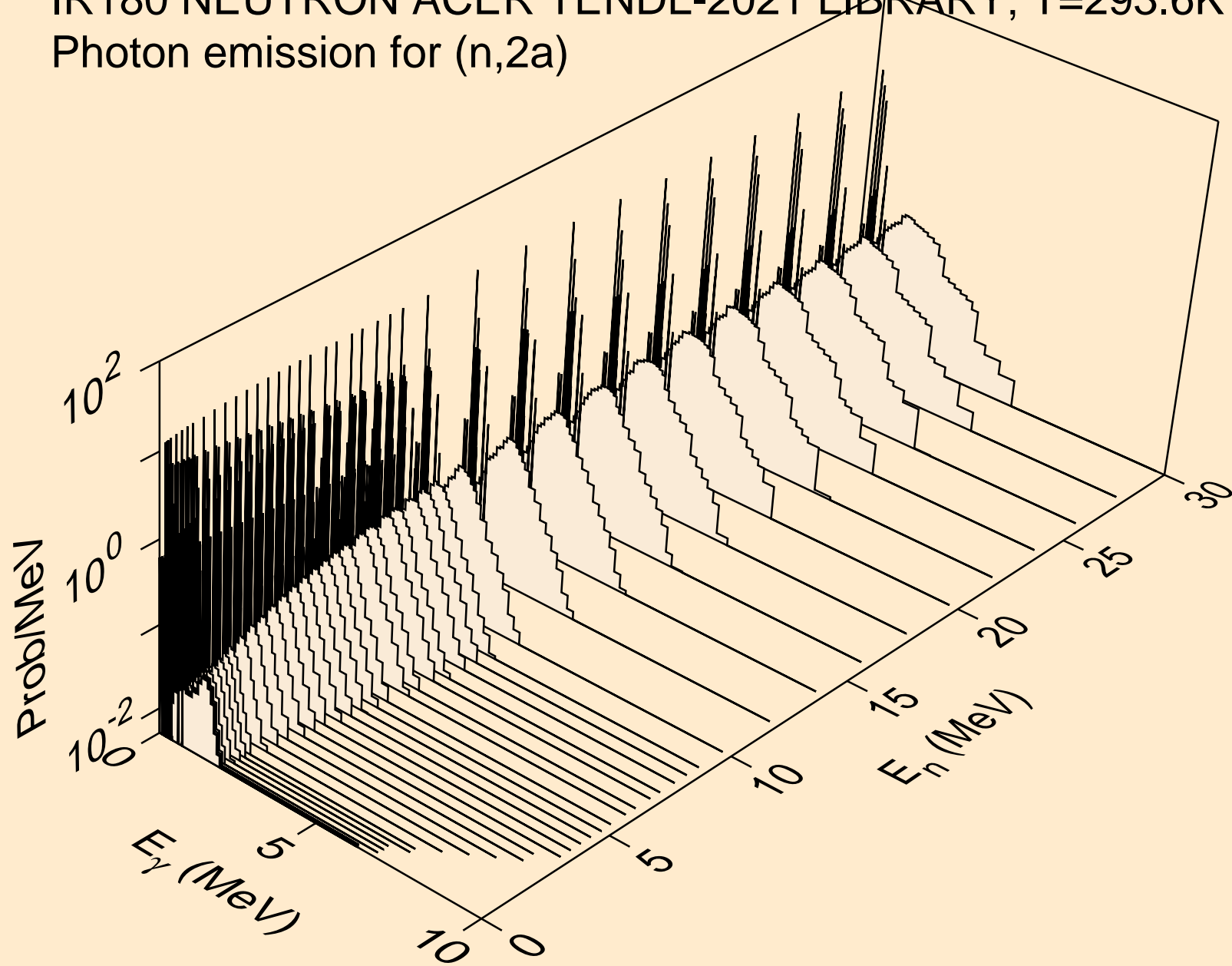

IR180 NEUTRON ACER TENDL-2021 LIBRARY; T=293.6K
Photon emission for (n,2p)

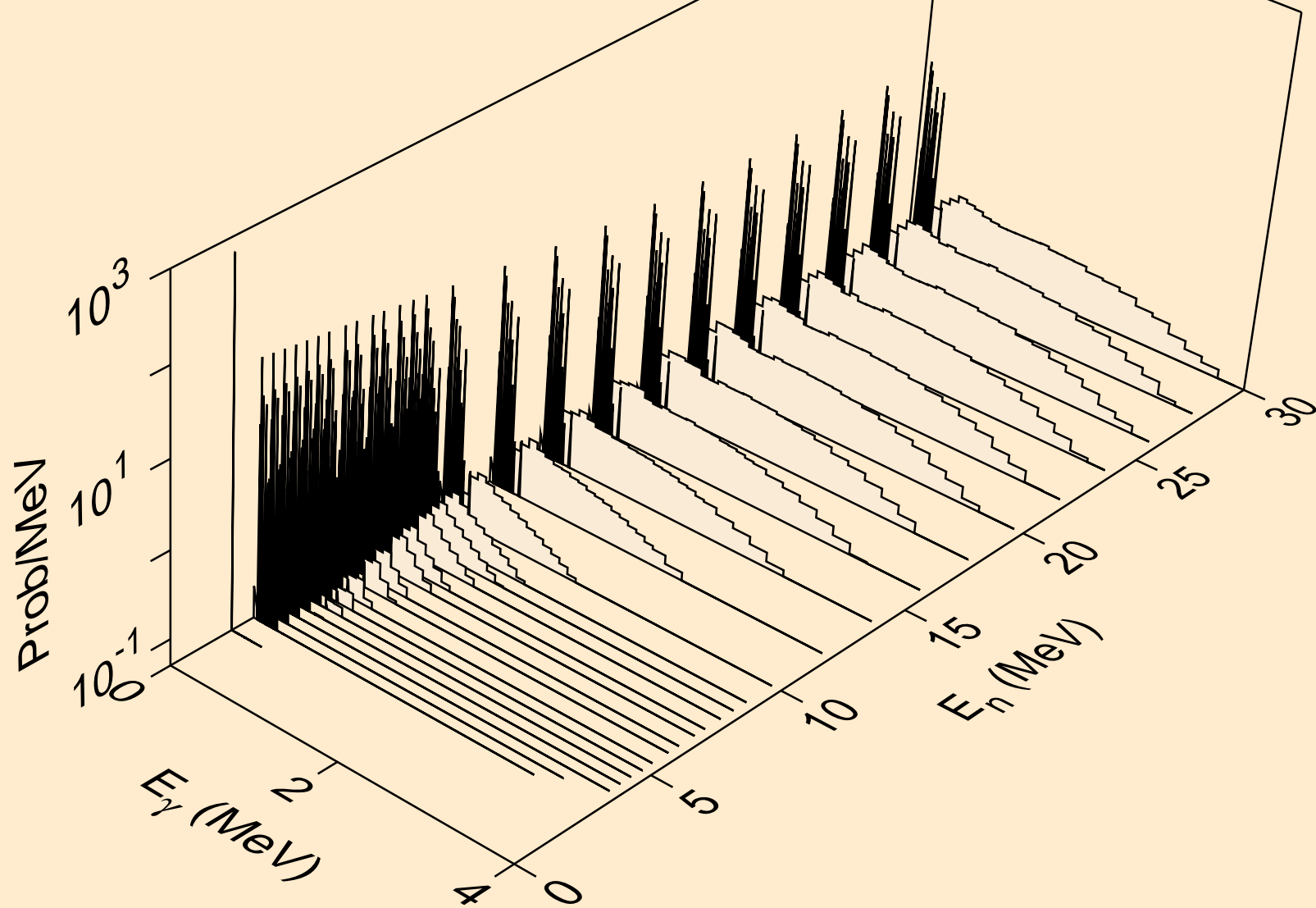

IR180 NEUTRON ACER TENDL-2021 LIBRARY; T=293.6K
Photon emission for (n,p α)

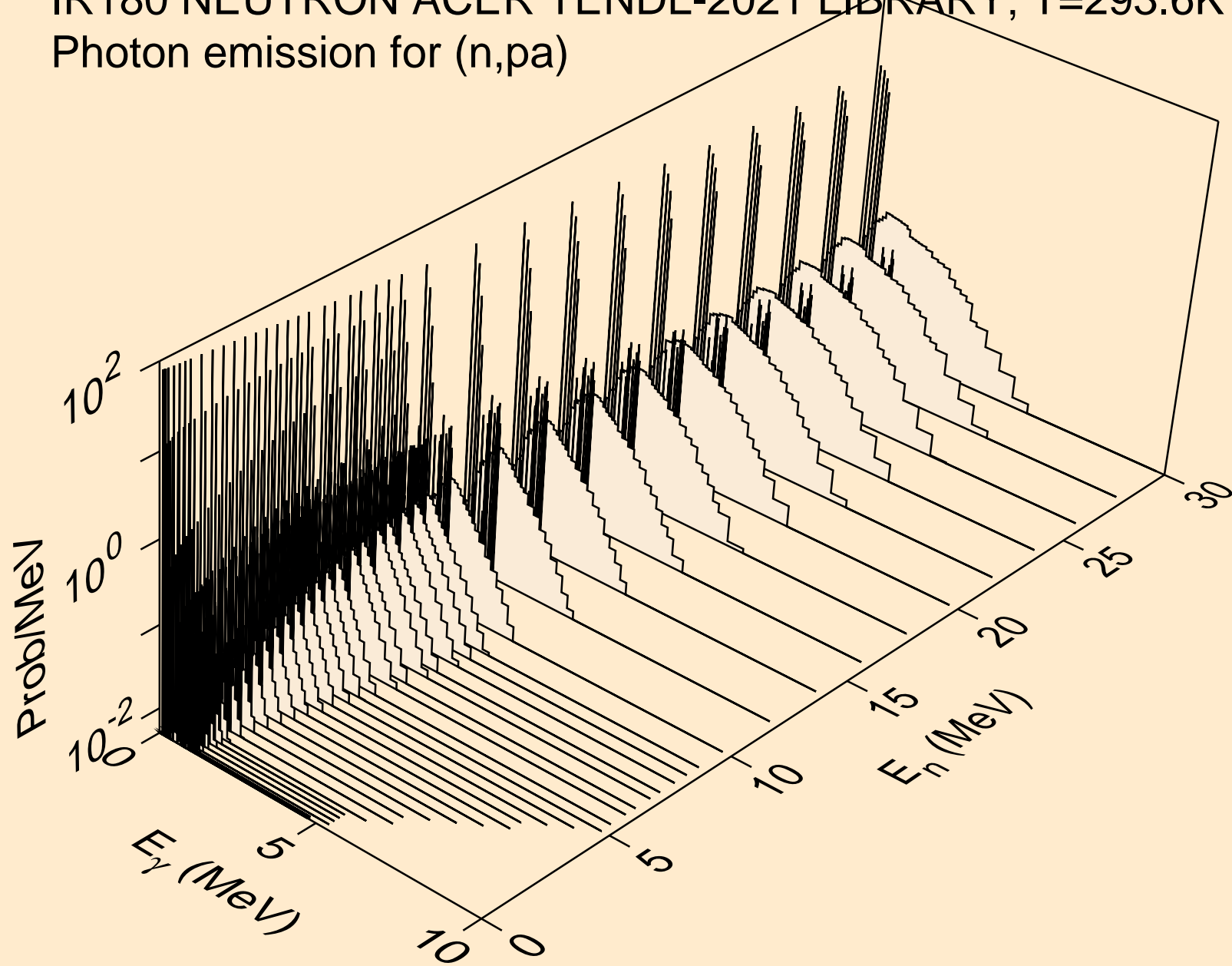

IR180 NEUTRON ACER TENDL-2021 LIBRARY; T=293.6K
Photon emission for (n,pd)

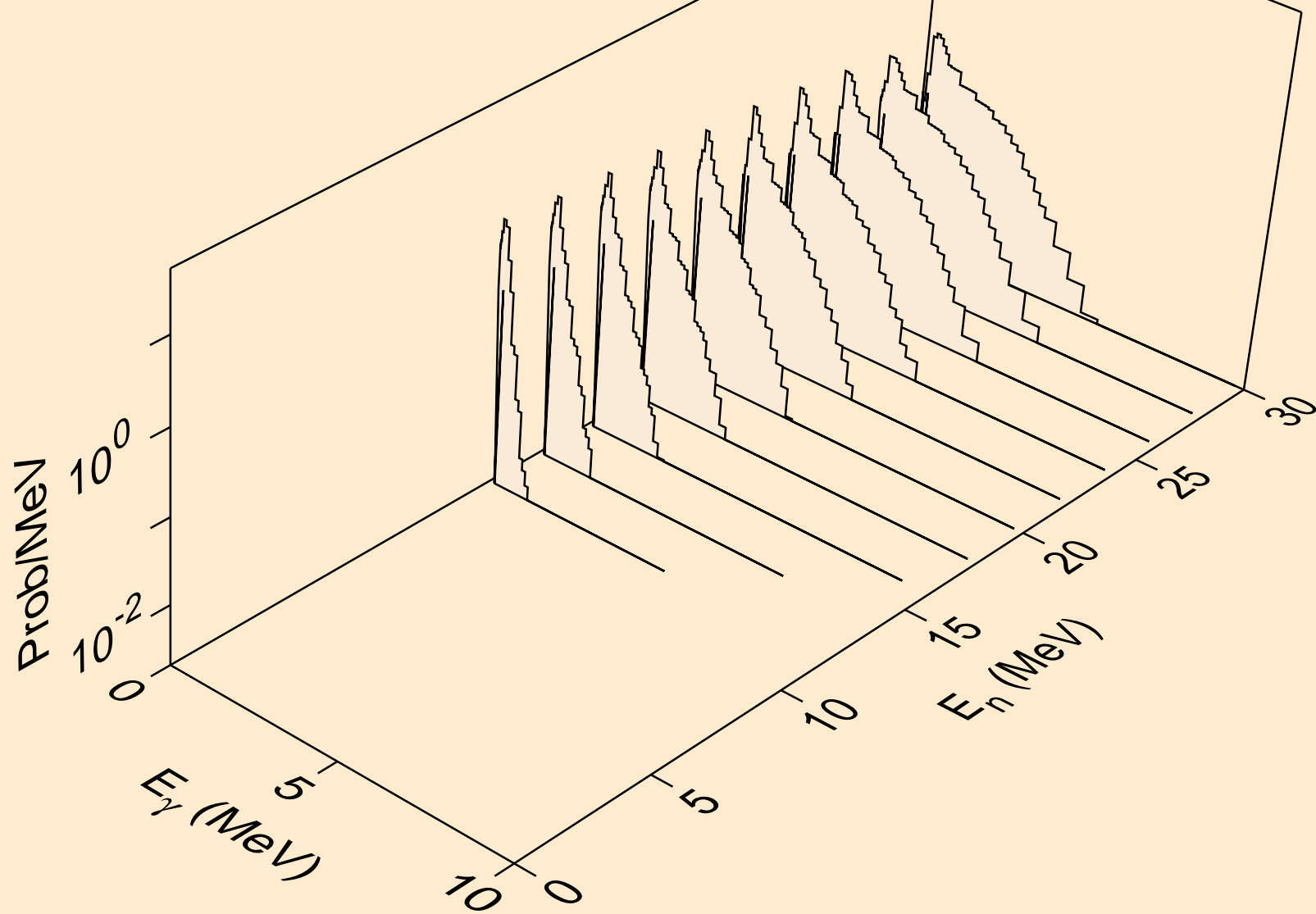

IR180 NEUTRON ACER TENDL-2021 LIBRARY; T=293.6K
Photon emission for (n,pt)

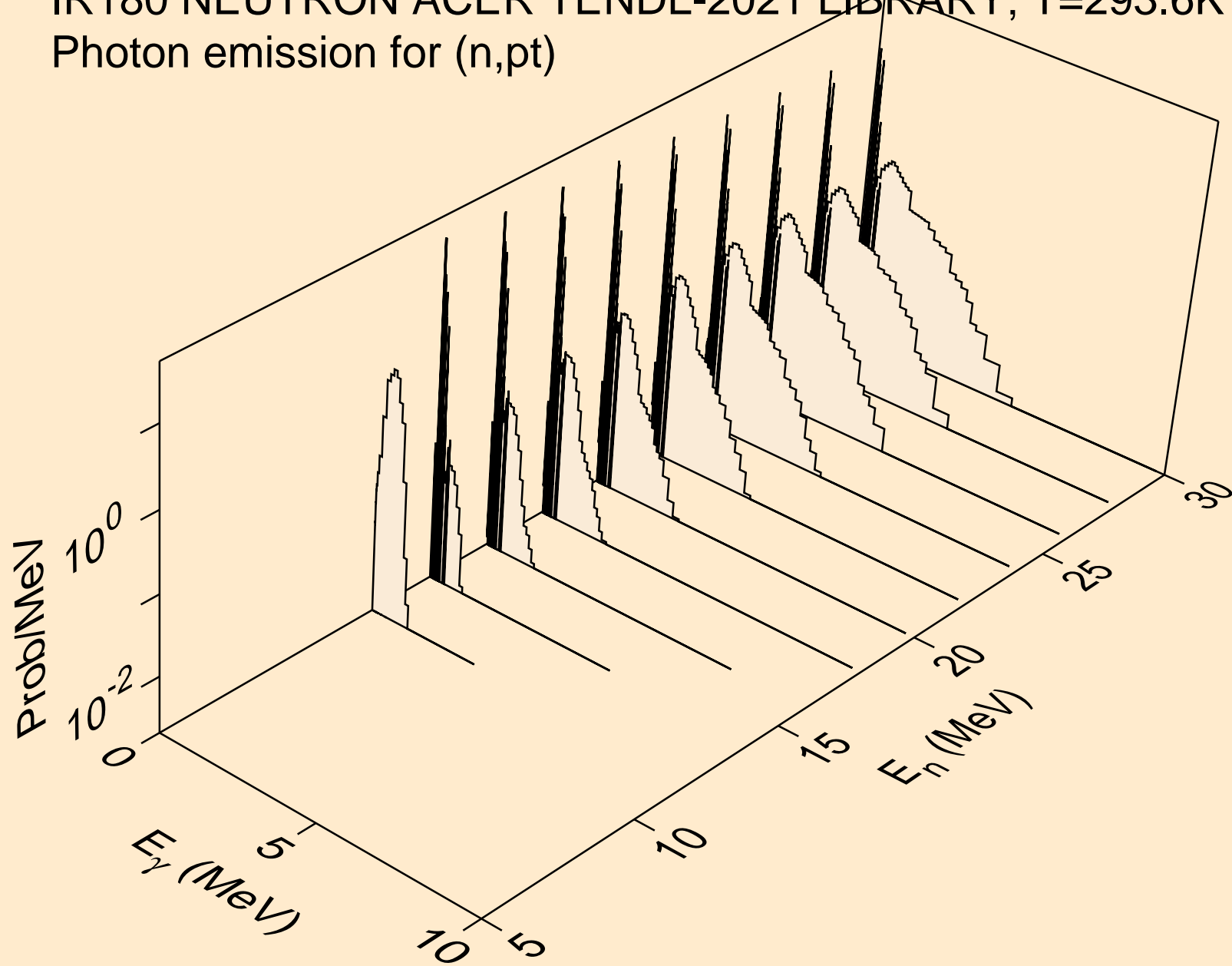

IR180 NEUTRON ACER TENDL-2021 LIBRARY; T=293.6K
Photon emission for (n,da)

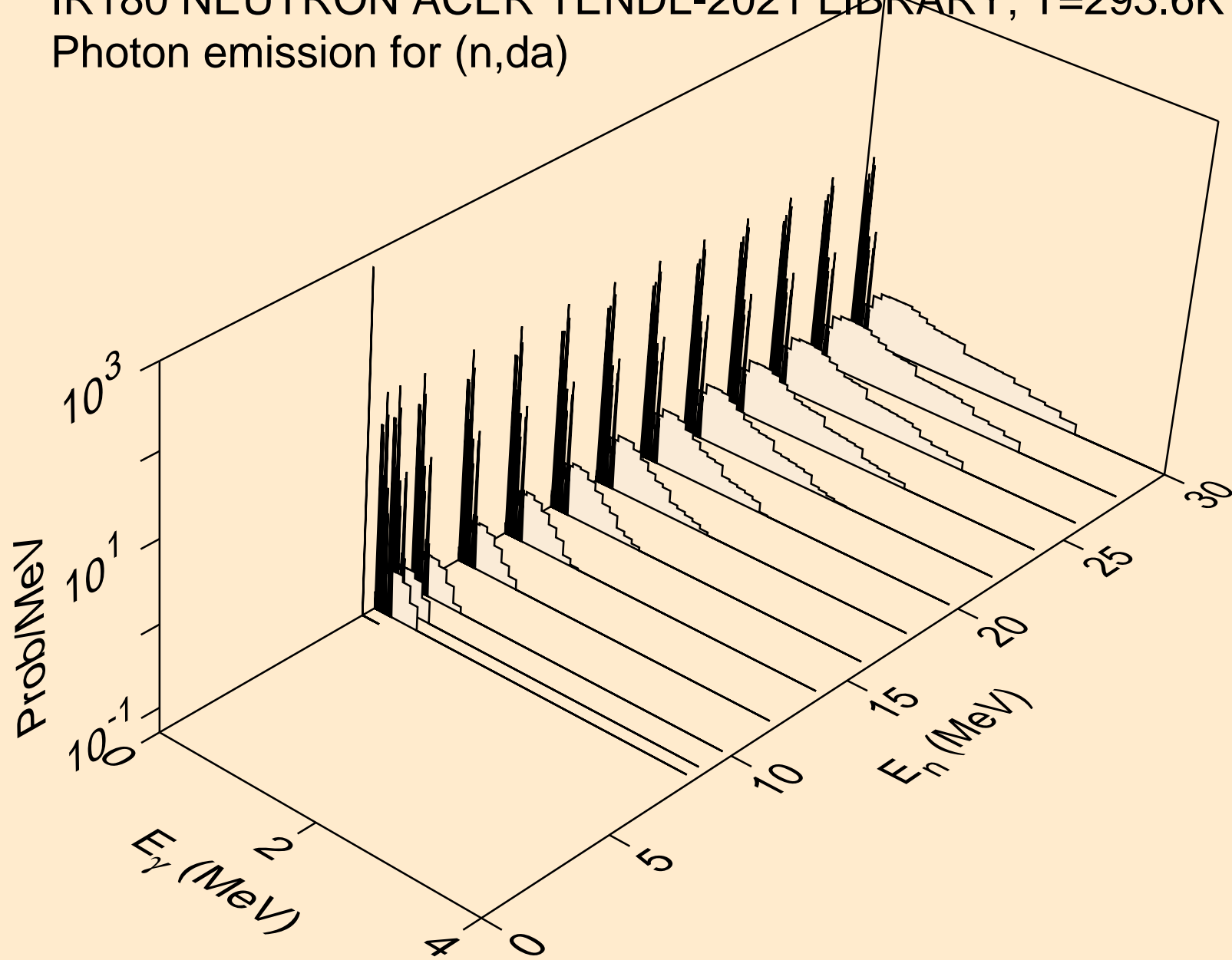

IR180 NEUTRON ACER TENDL-2021 LIBRARY; T=293.6K
thermal capture photon spectrum

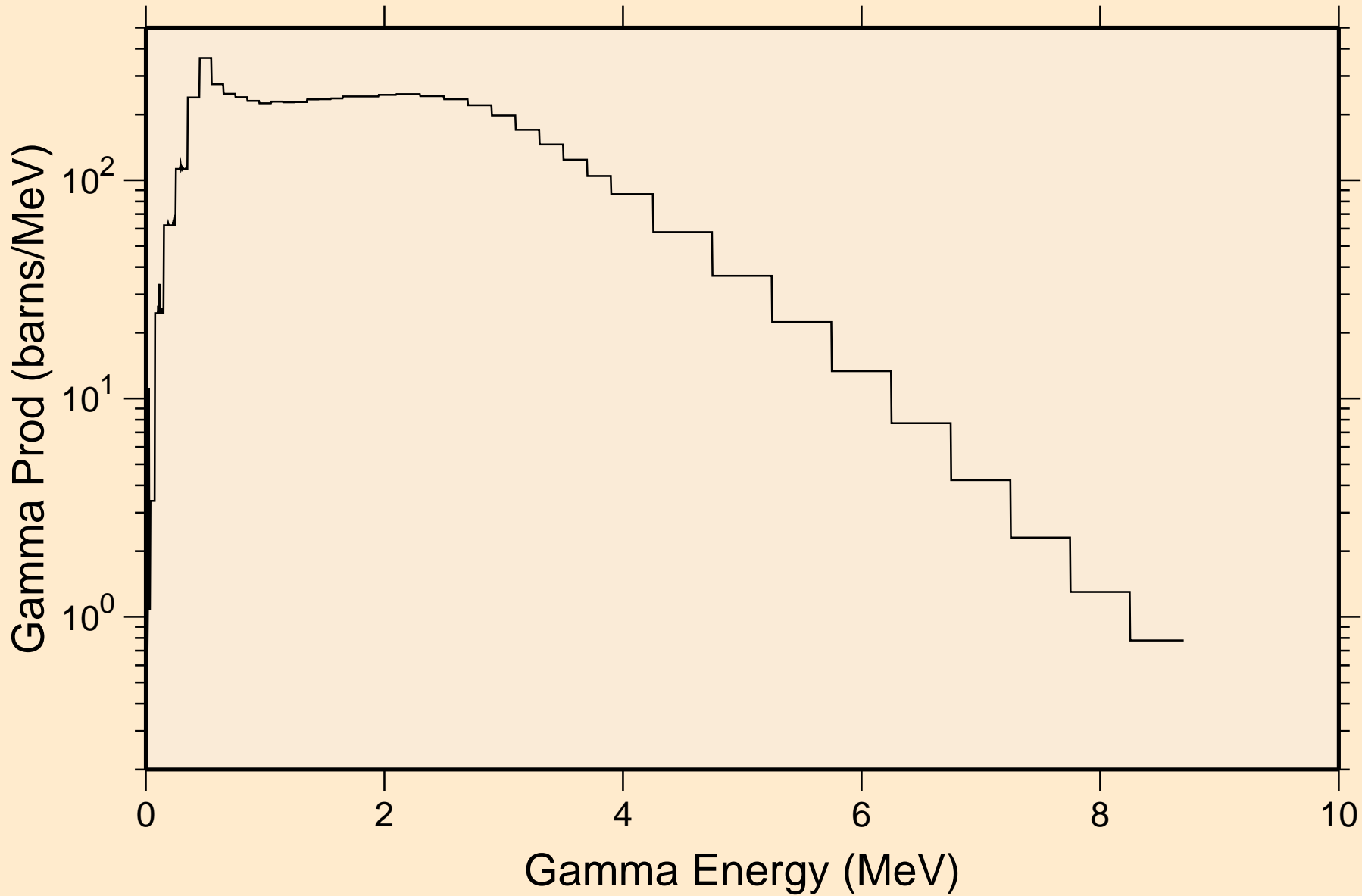

IR180 NEUTRON ACER TENDL-2021 LIBRARY; T=293.6K
14 MeV photon spectrum

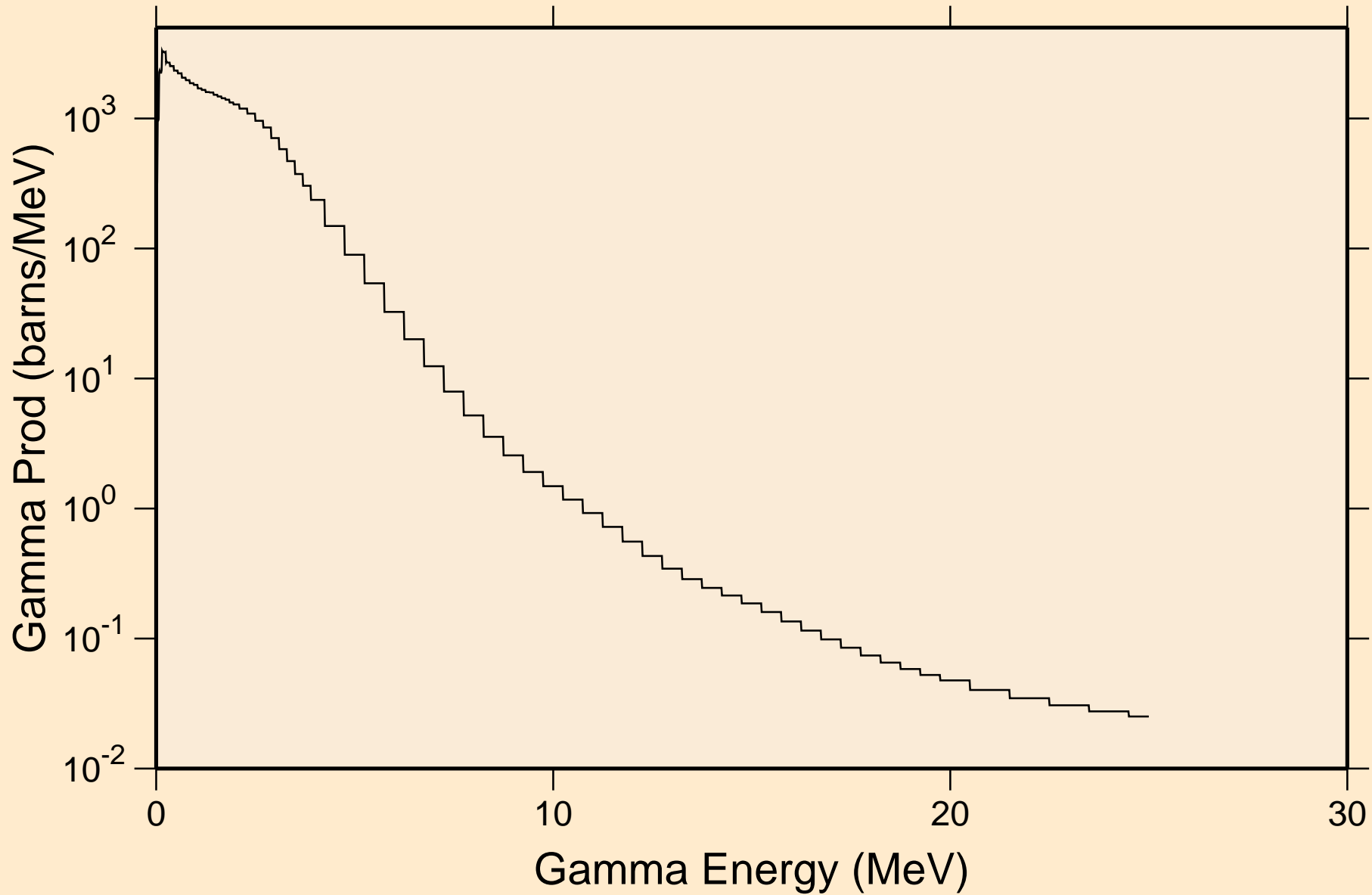

IR180 NEUTRON ACER TENDL-2021 LIBRARY; T=293.6K
Particle heating contributions

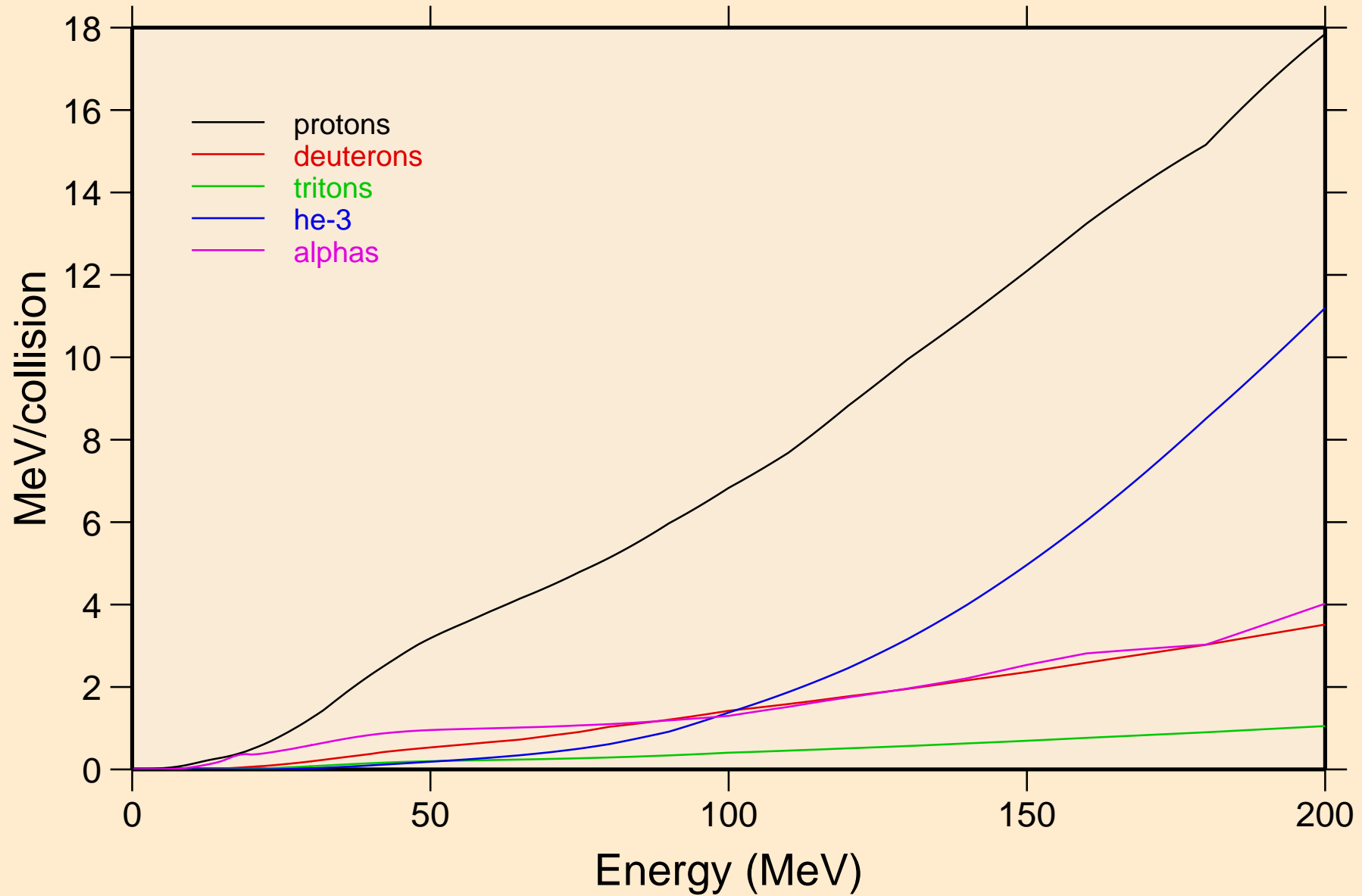

IR180 NEUTRON ACER TENDL-2021 LIBRARY; T=293.6K
Recoil Heating

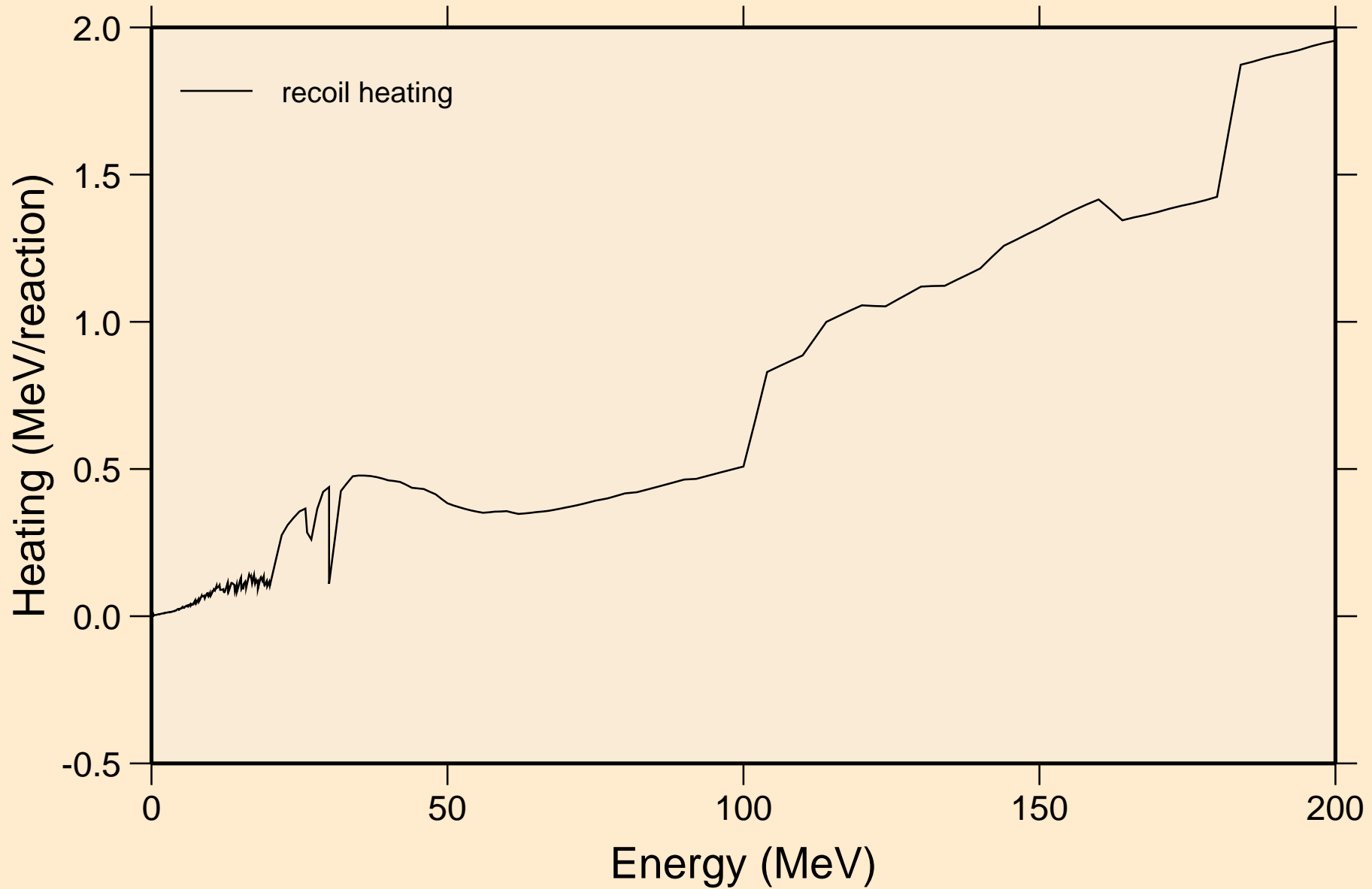

IR180 NEUTRON ACER TENDL-2021 LIBRARY; T=293.6K
Particle production cross sections

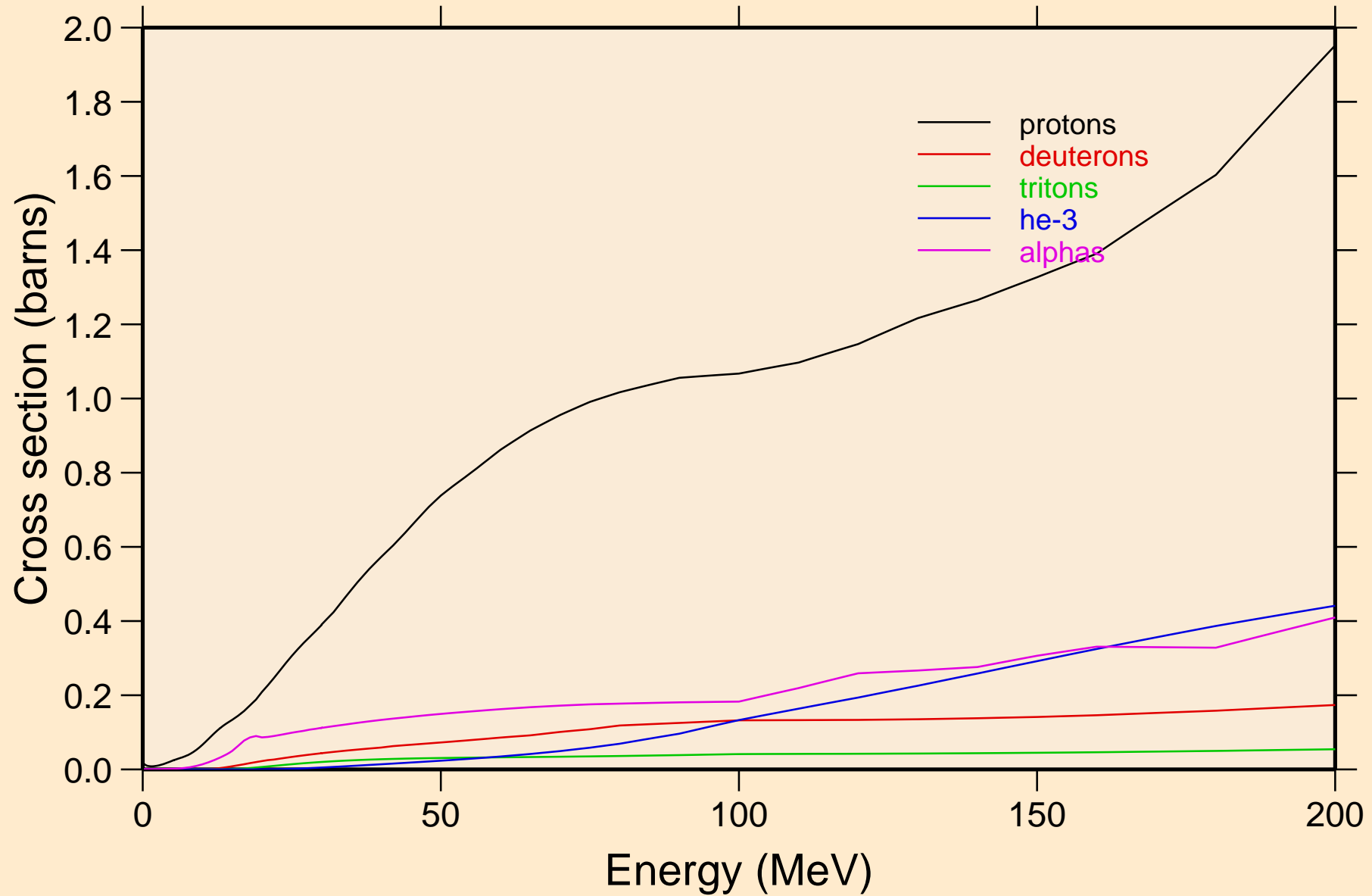

IR180 NEUTRON ACER TENDL-2021 LIBRARY; T=293.6K
protons from (n,x)

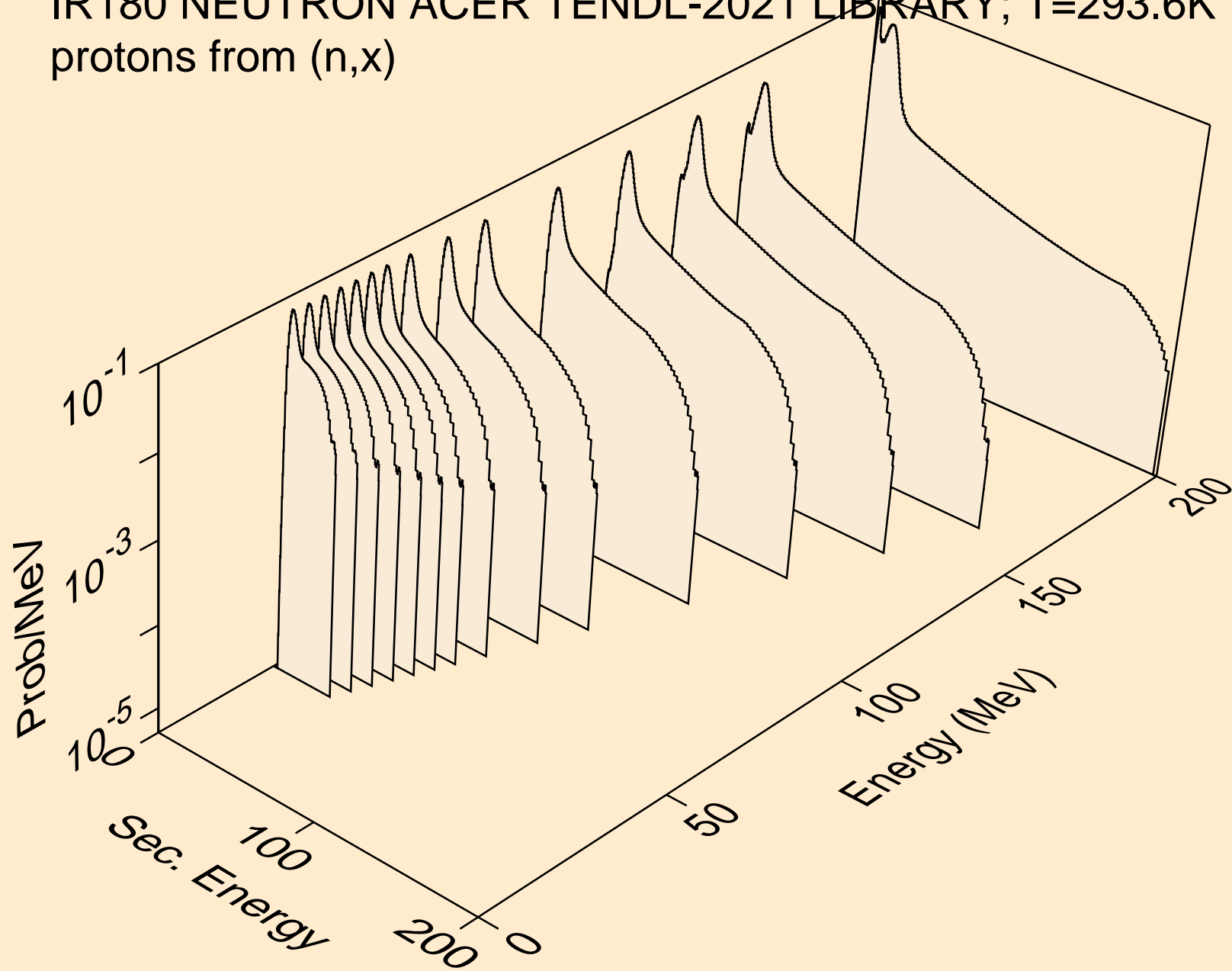

IR180 NEUTRON ACER TENDL-2021 LIBRARY; T=293.6K
protons from (n,n*)p

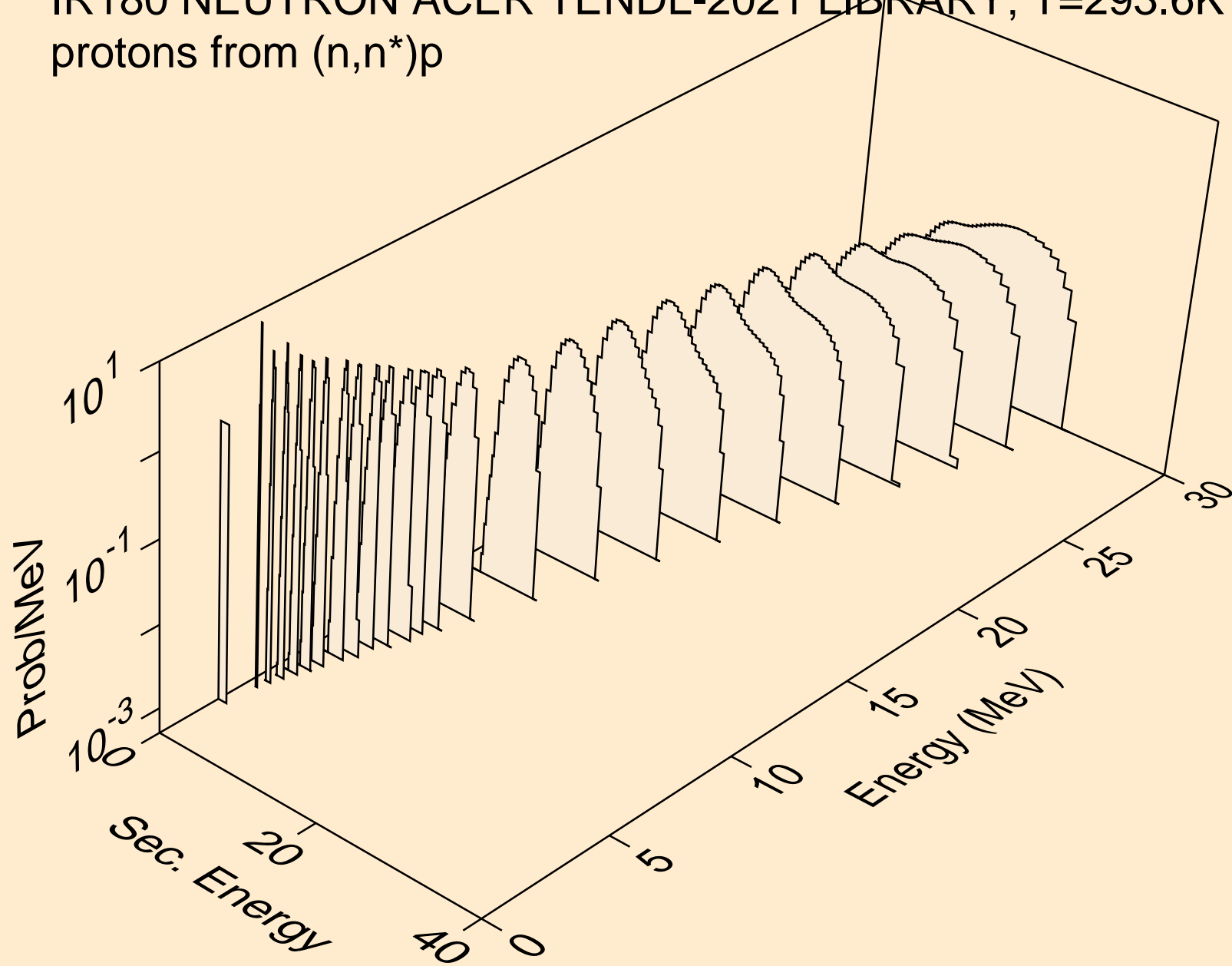

IR180 NEUTRON ACER TENDL-2021 LIBRARY; T=293.6K
protons from (n,2np)

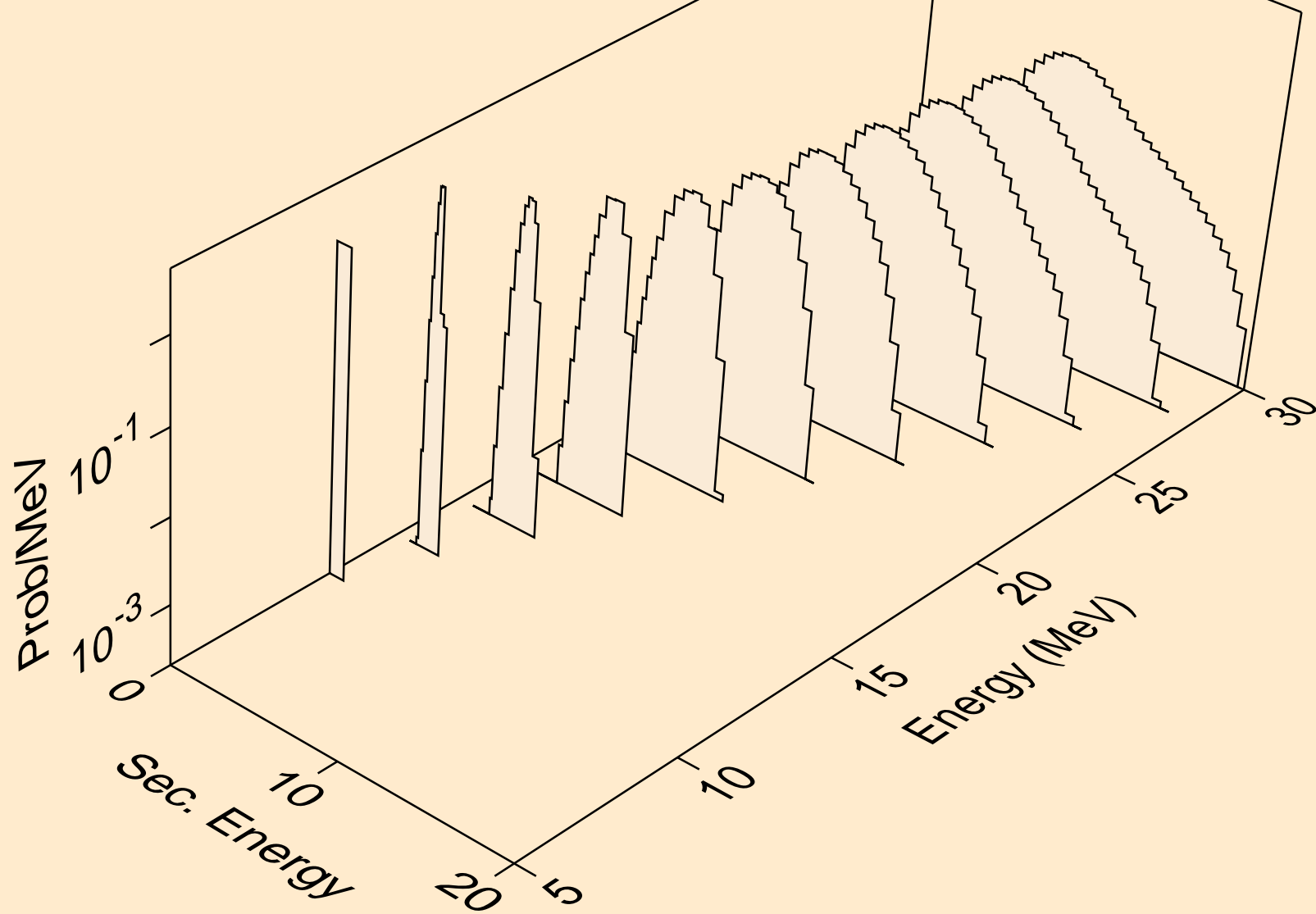

IR180 NEUTRON ACER TENDL-2021 LIBRARY; T=293.6K
protons from (n,3np)

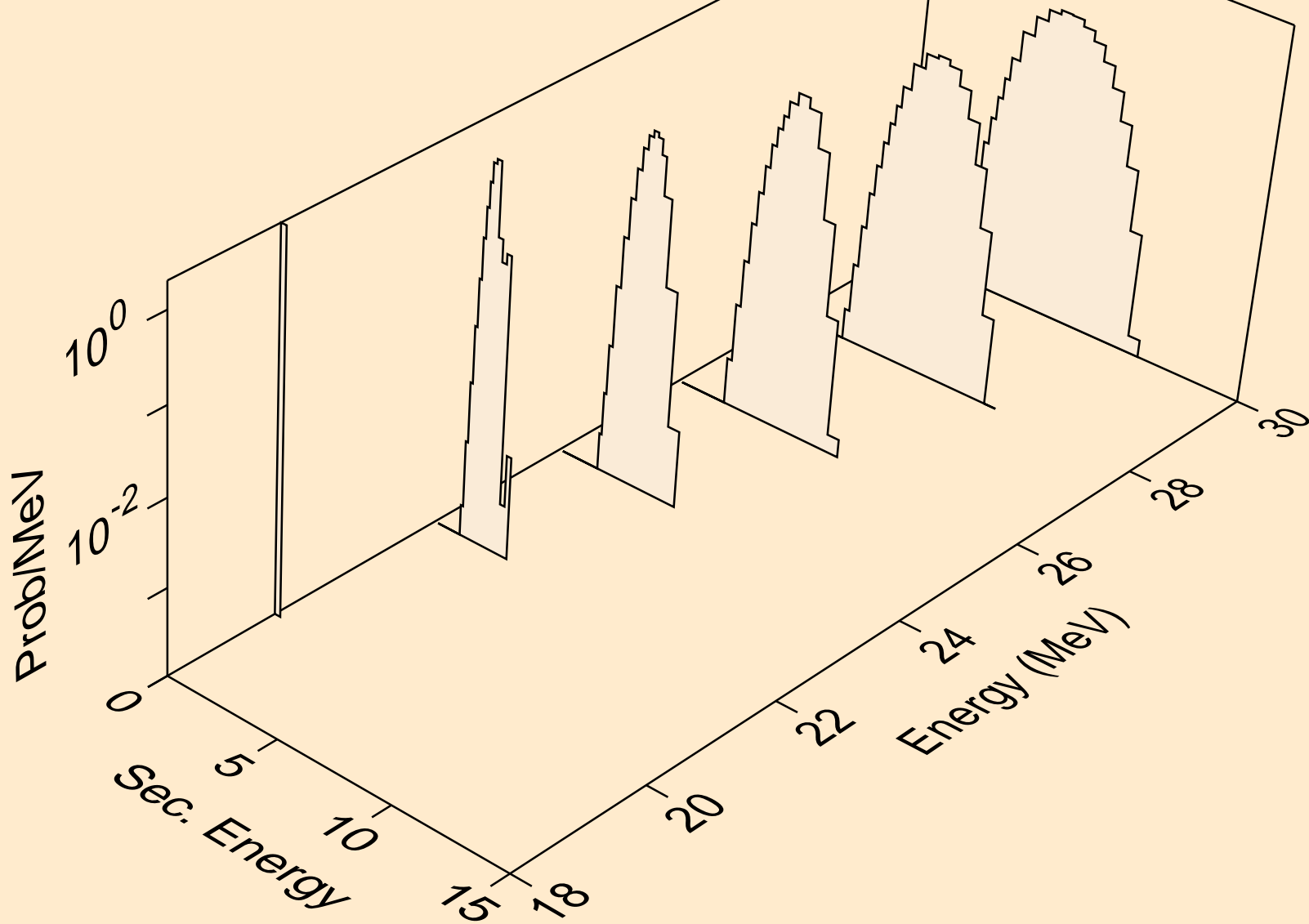

IR180 NEUTRON ACER TENDL-2021 LIBRARY; T=293.6K
protons from (n,2np)

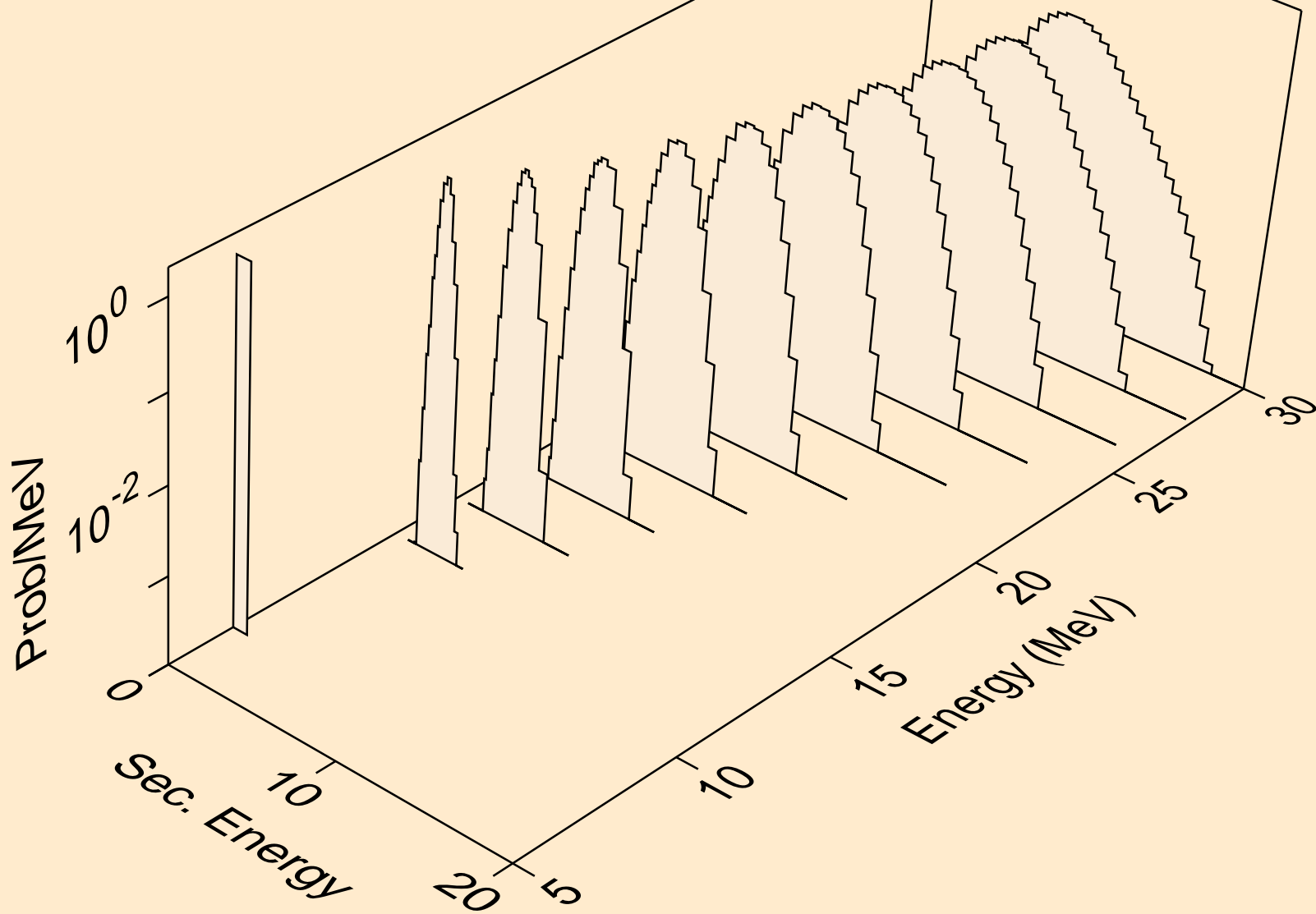

IR180 NEUTRON ACER TENDL-2021 LIBRARY; T=293.6K
protons from (n,npa)

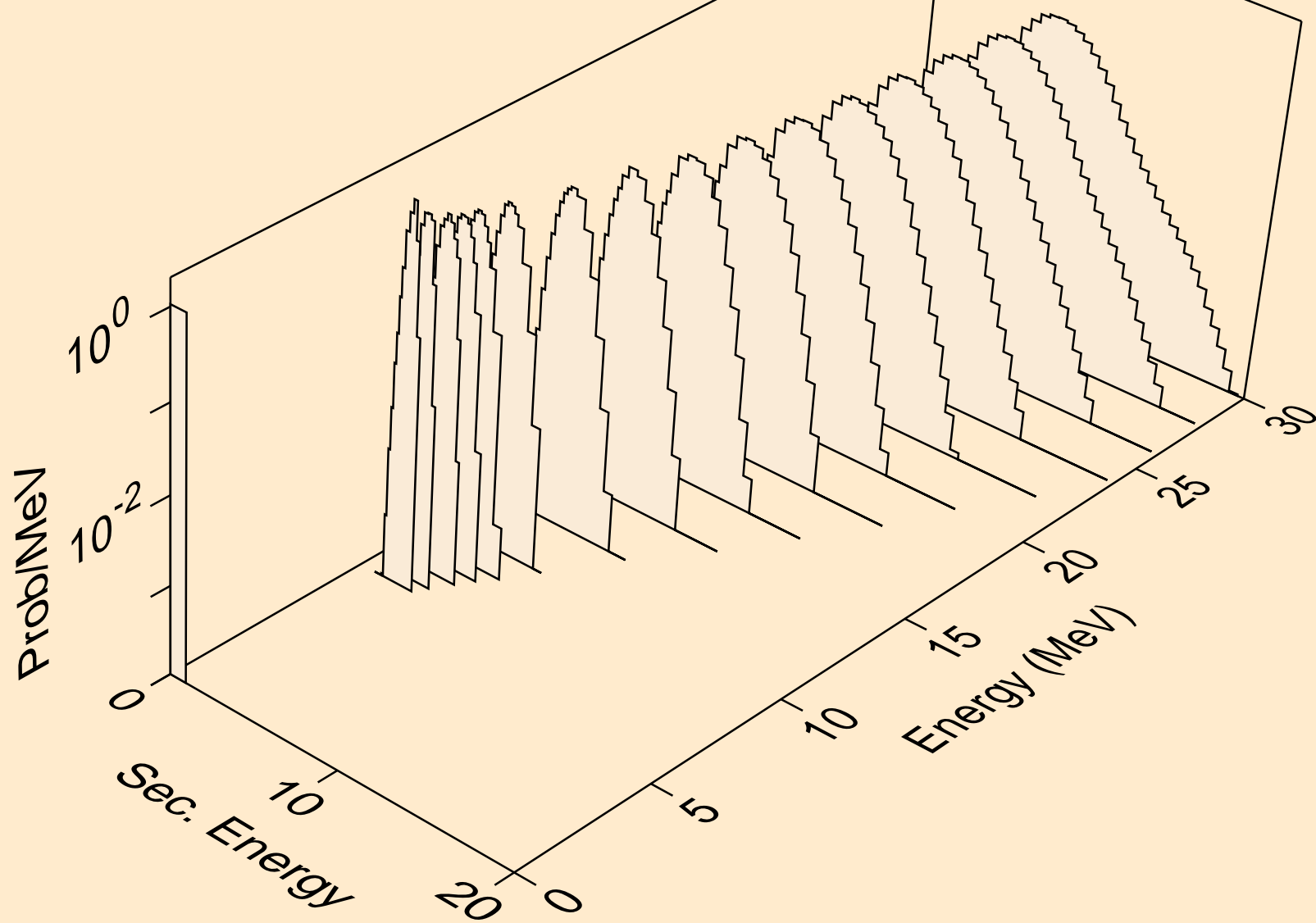

IR180 NEUTRON ACER TENDL-2021 LIBRARY; T=293.6K
protons from (n,p)

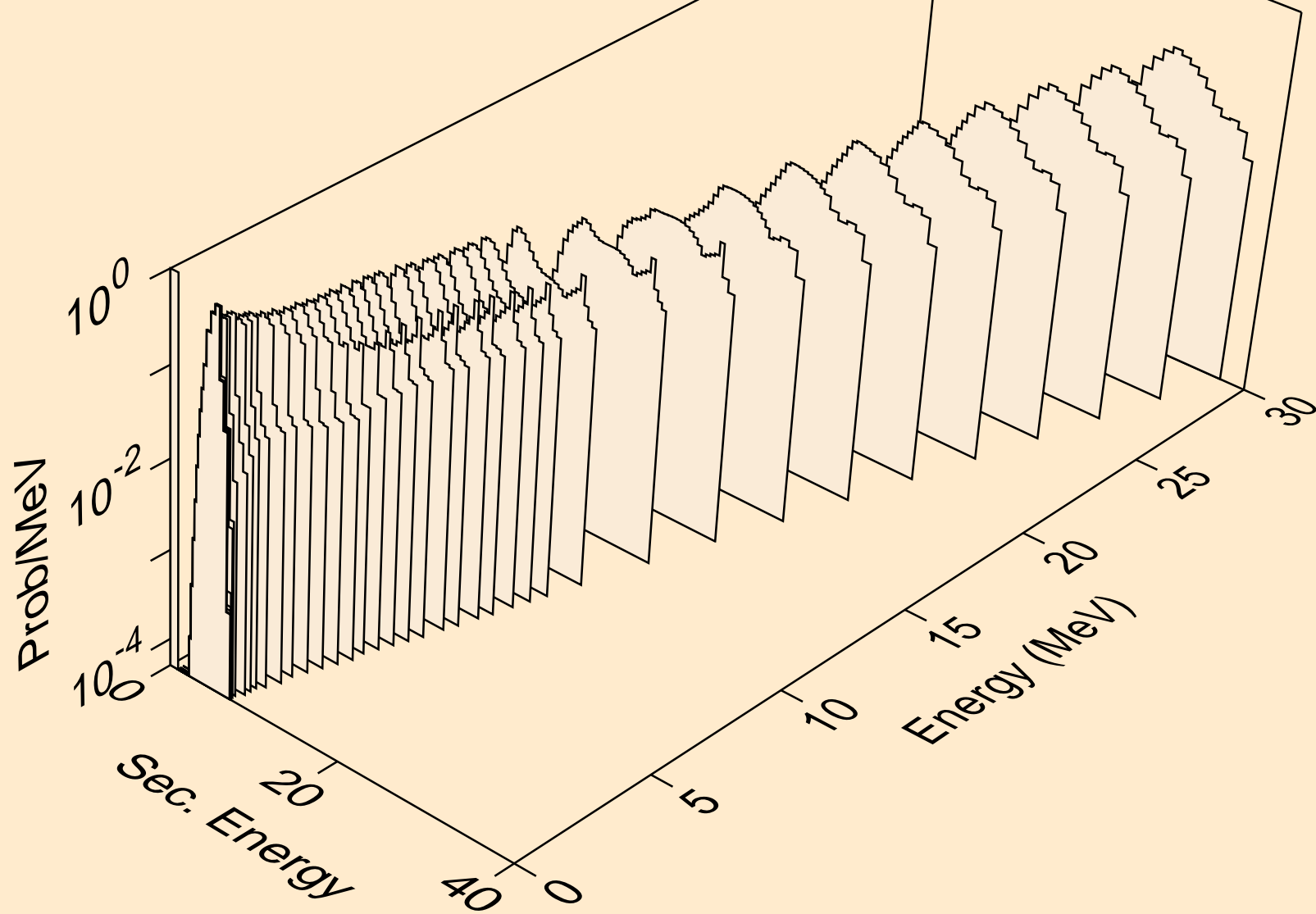

IR180 NEUTRON ACER TENDL-2021 LIBRARY; T=293.6K
protons from (n,2p)

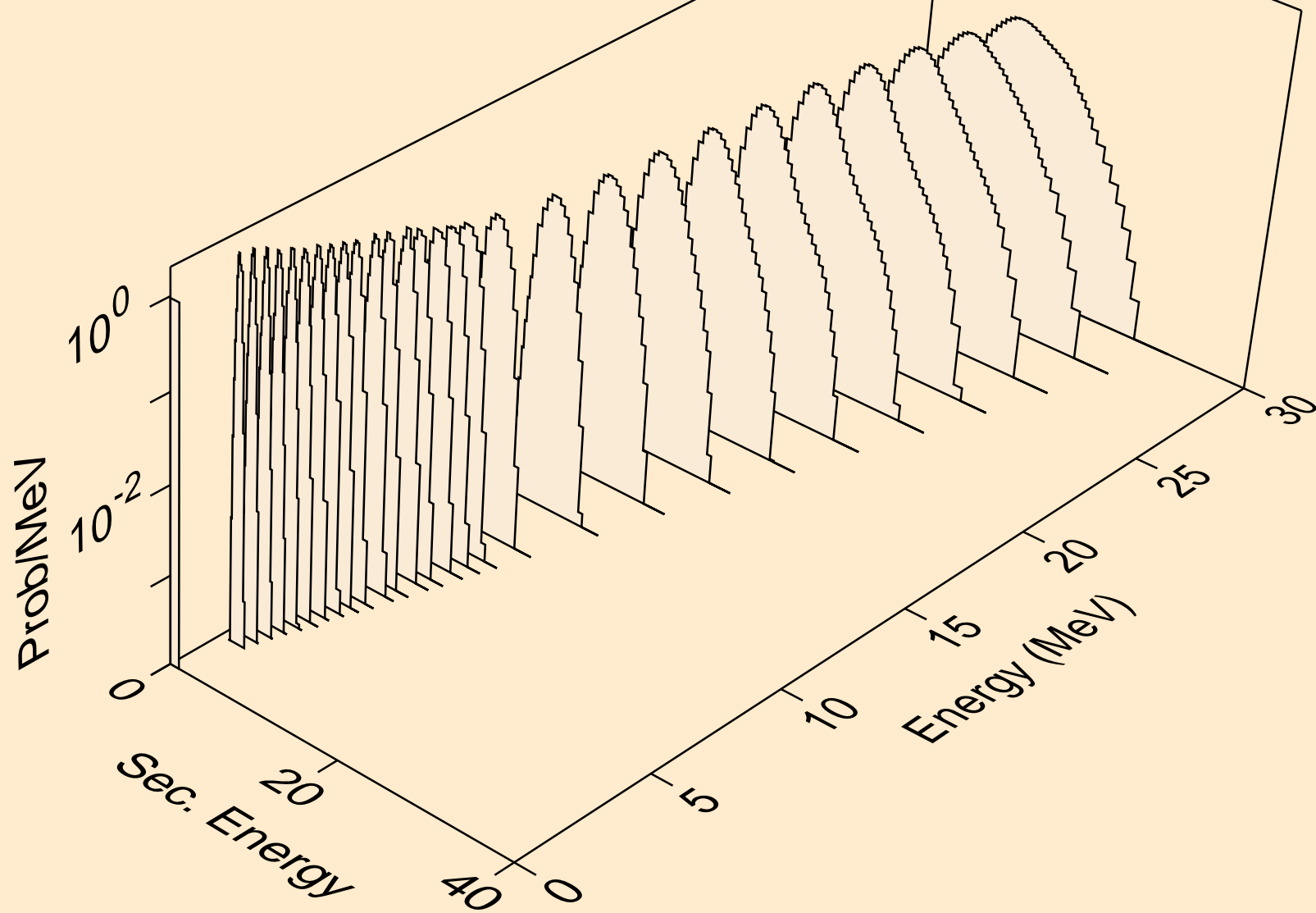

IR180 NEUTRON ACER TENDL-2021 LIBRARY; T=293.6K
protons from (n,p)

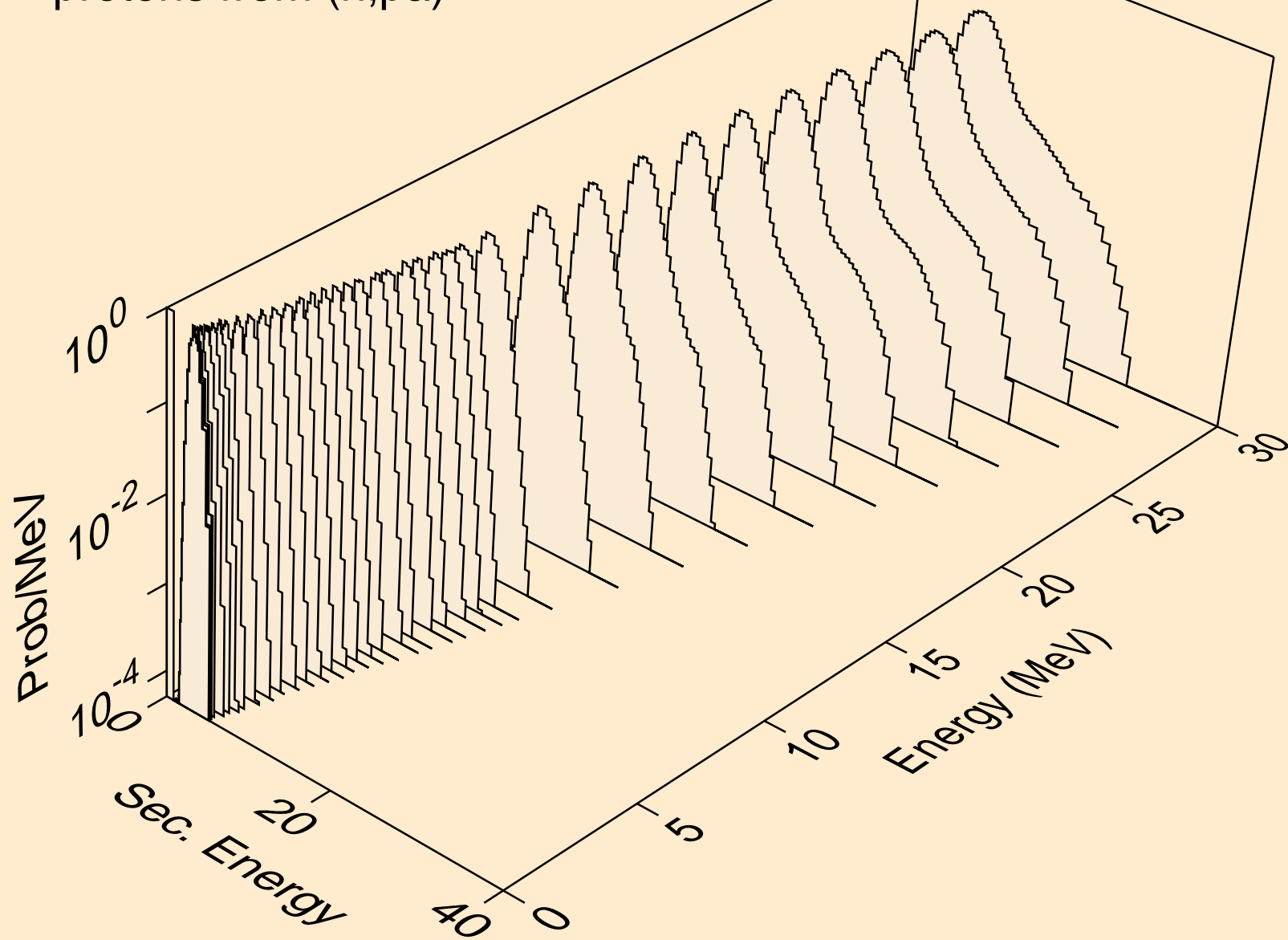

IR180 NEUTRON ACER TENDL-2021 LIBRARY; T=293.6K
protons from (n,pd)

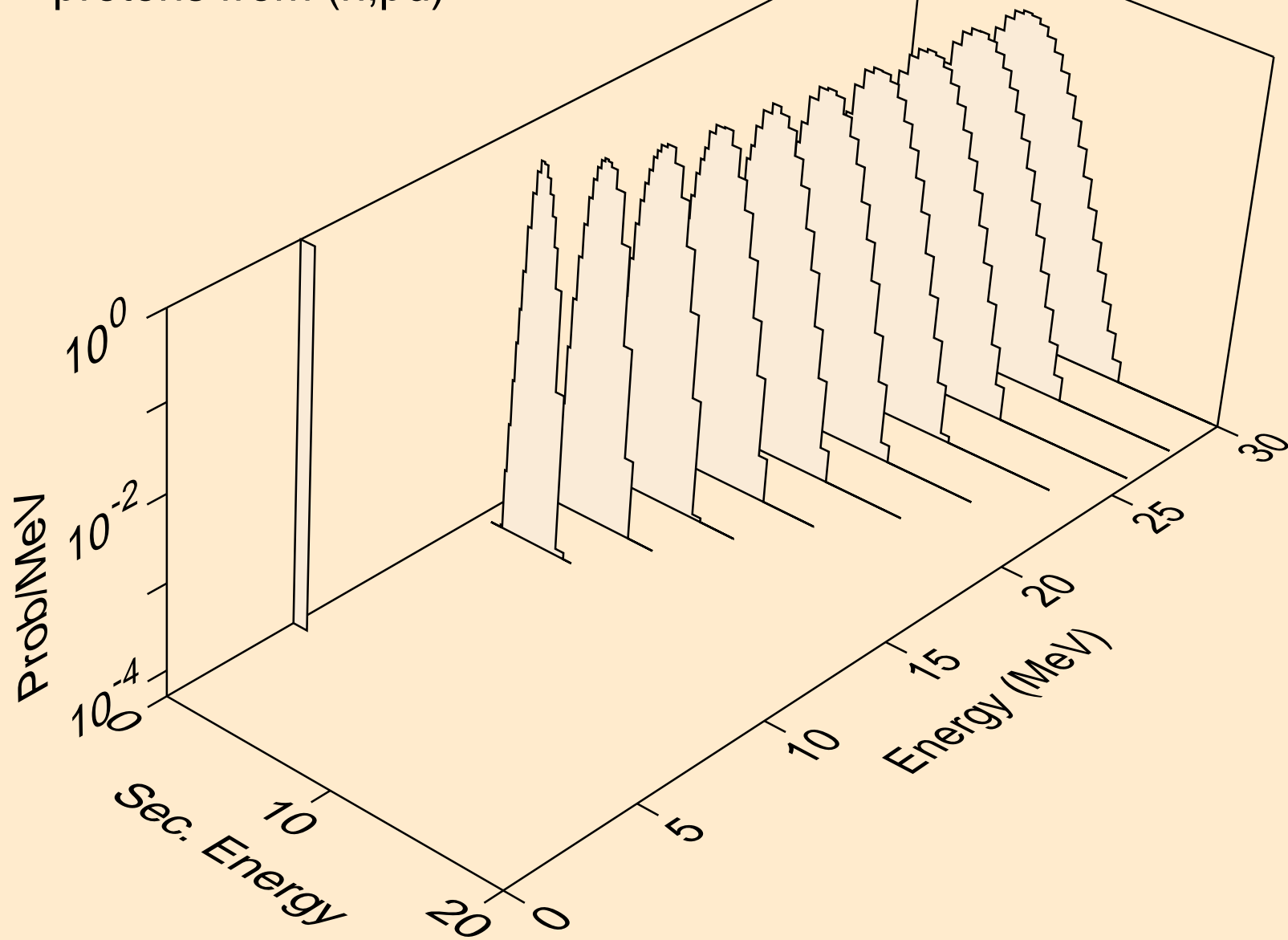

IR180 NEUTRON ACER TENDL-2021 LIBRARY; T=293.6K
protons from (n,pt)

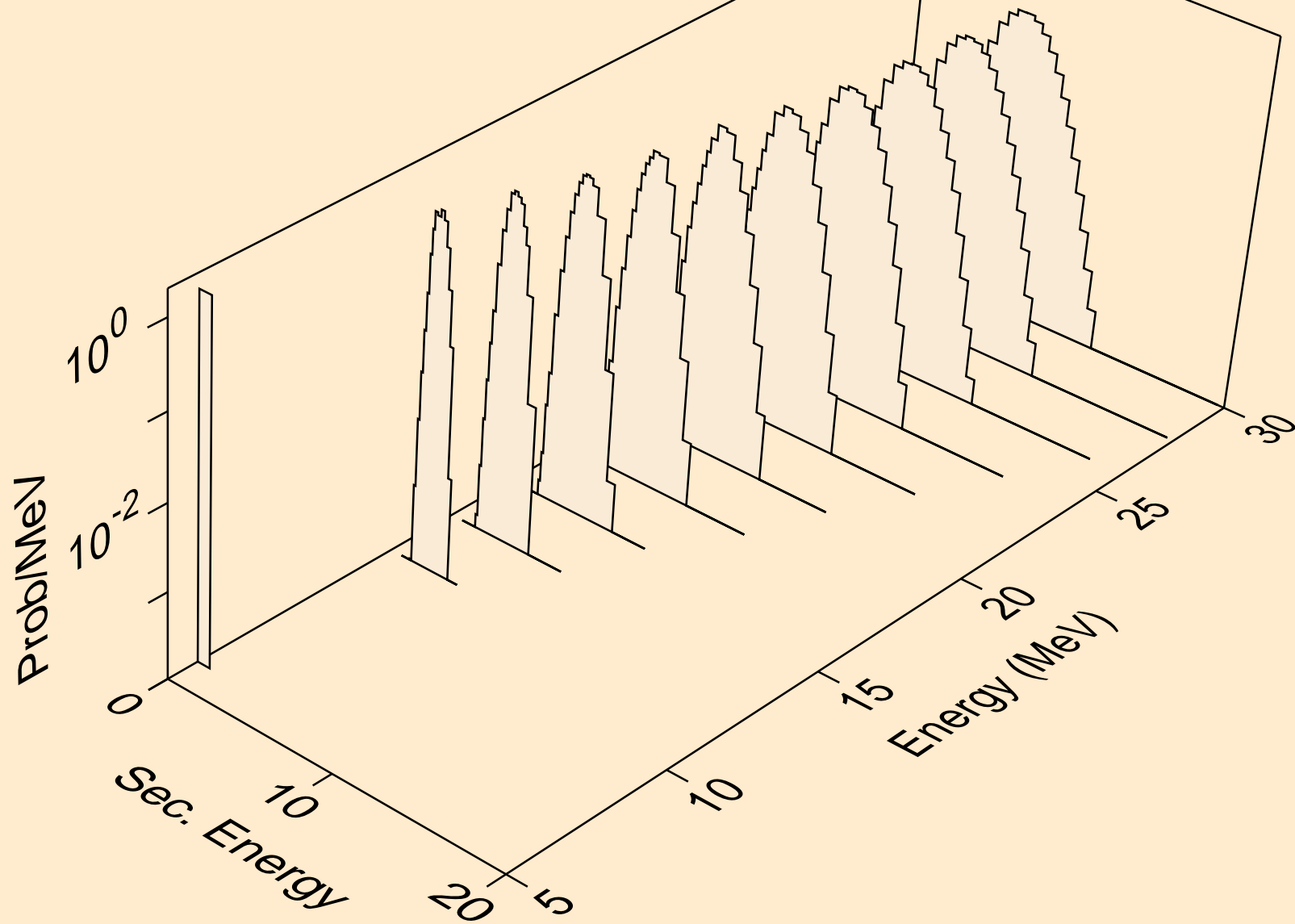

IR180 NEUTRON ACER TENDL-2021 LIBRARY; T=293.6K
deuterons from (n,x)

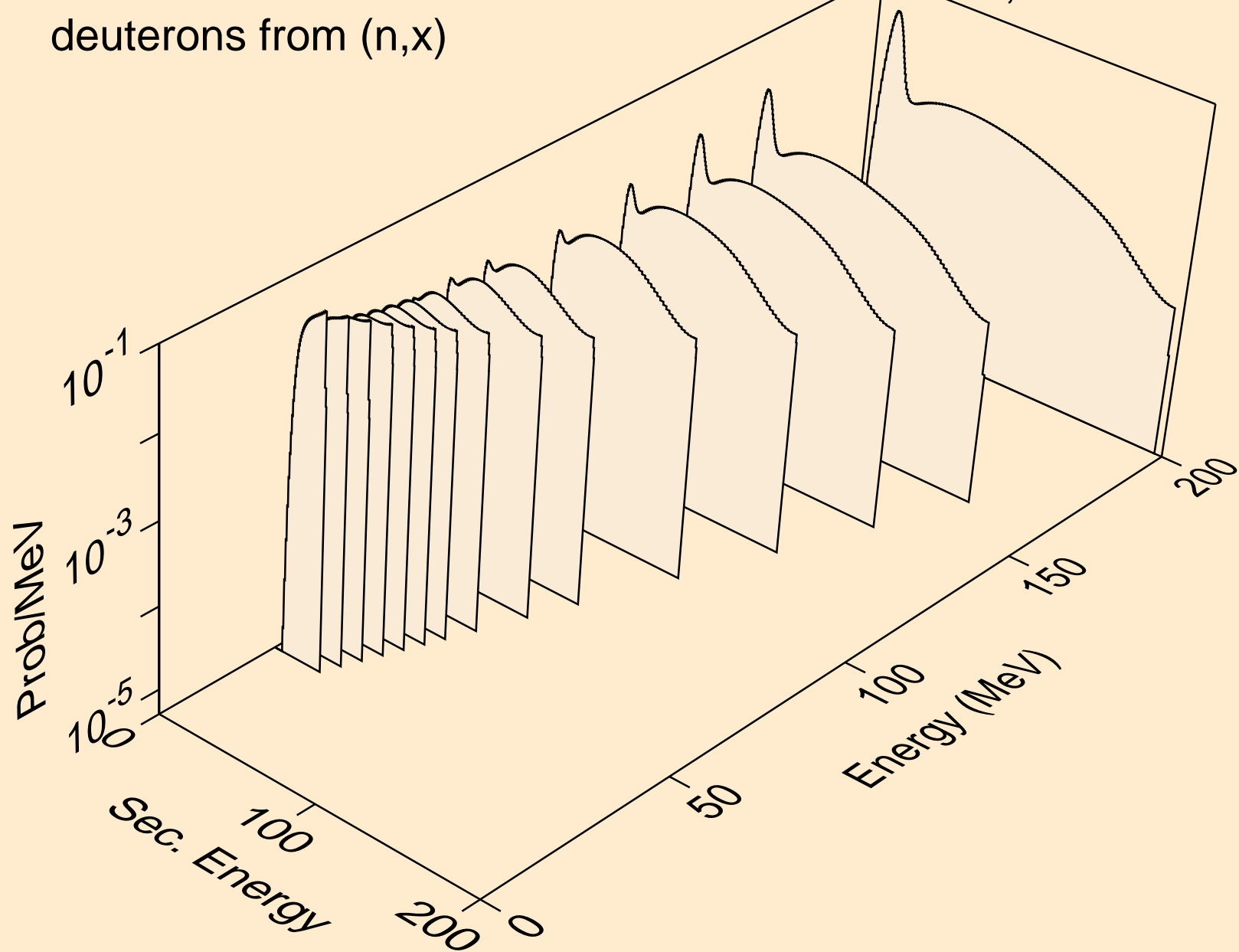

IR180 NEUTRON ACER TENDL-2021 LIBRARY; T=293.6K
deuterons from (n,2nd)

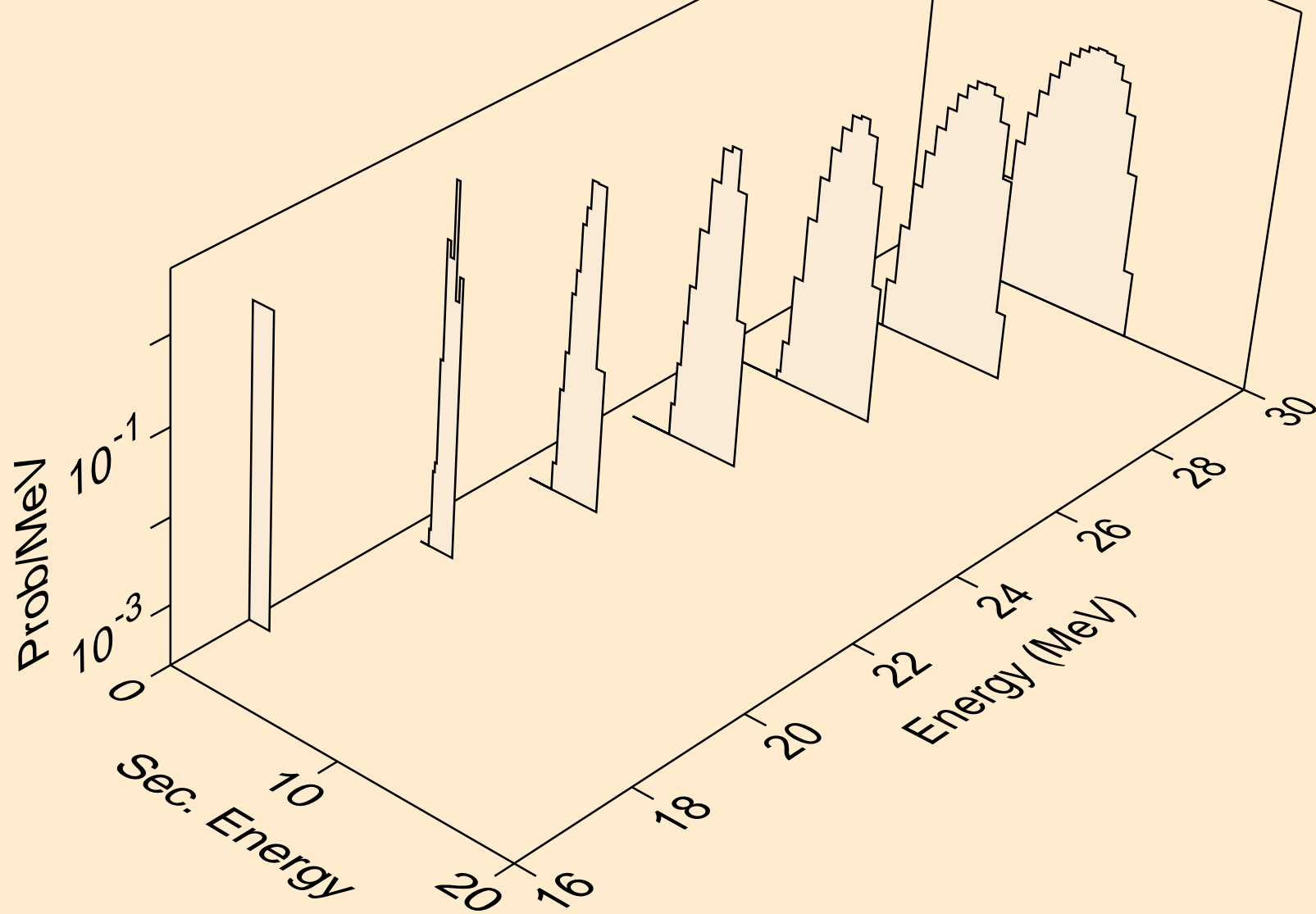

IR180 NEUTRON ACER TENDL-2021 LIBRARY; T=293.6K
deuterons from (n,n*)d

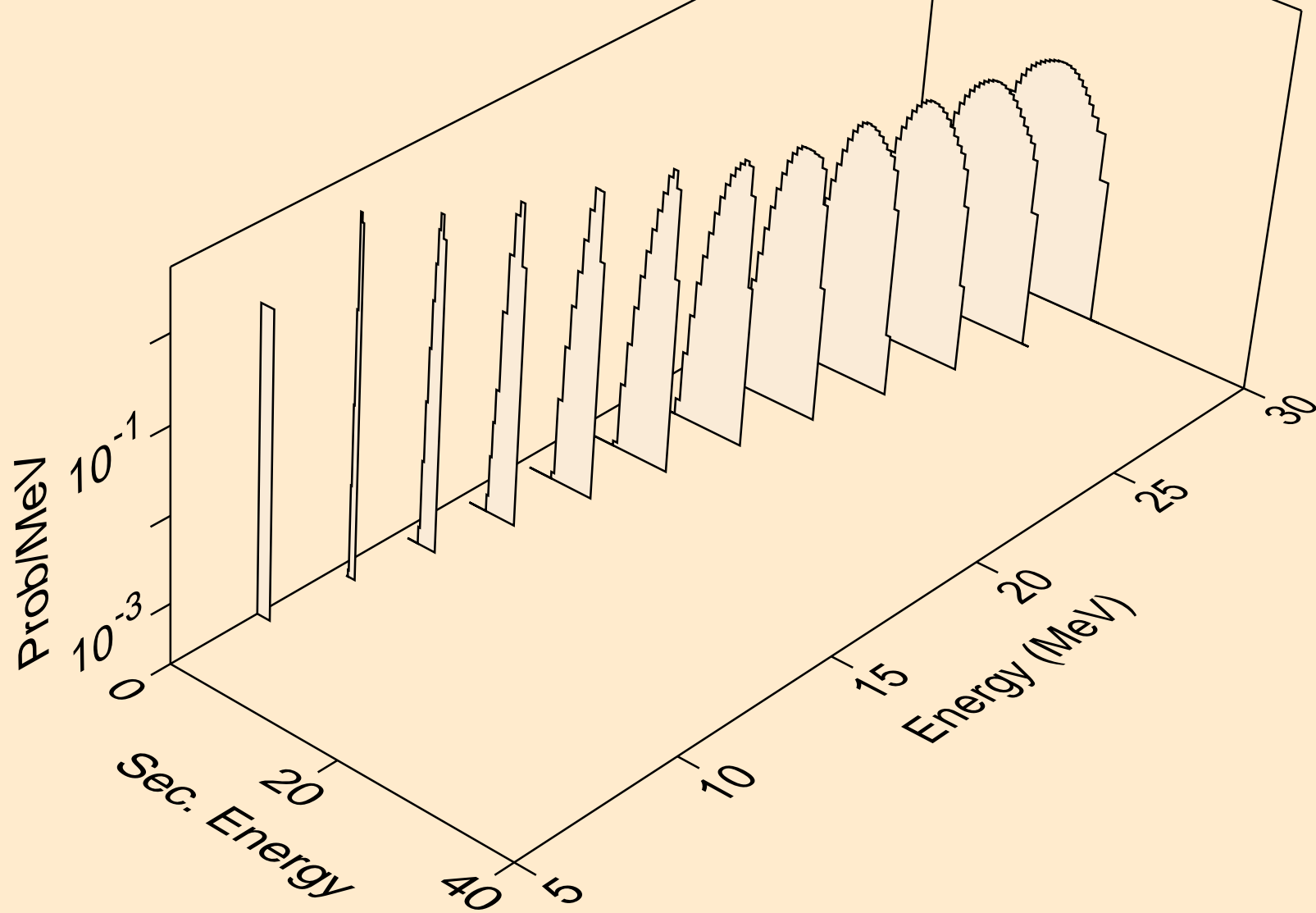

IR180 NEUTRON ACER TENDL-2021 LIBRARY; T=293.6K
deuterons from (n,d)

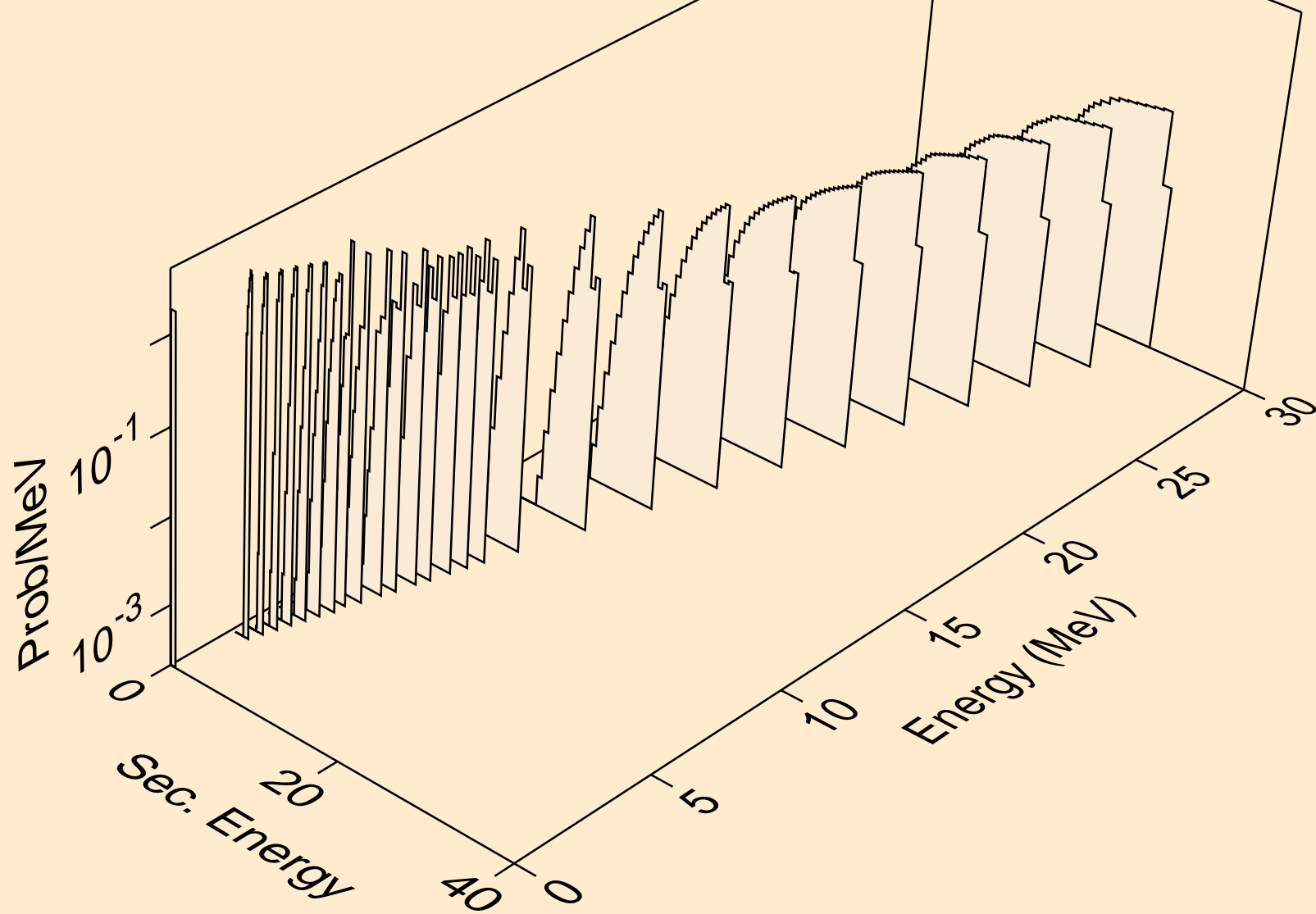

IR180 NEUTRON ACER TENDL-2021 LIBRARY; T=293.6K
deuterons from (n,pd)

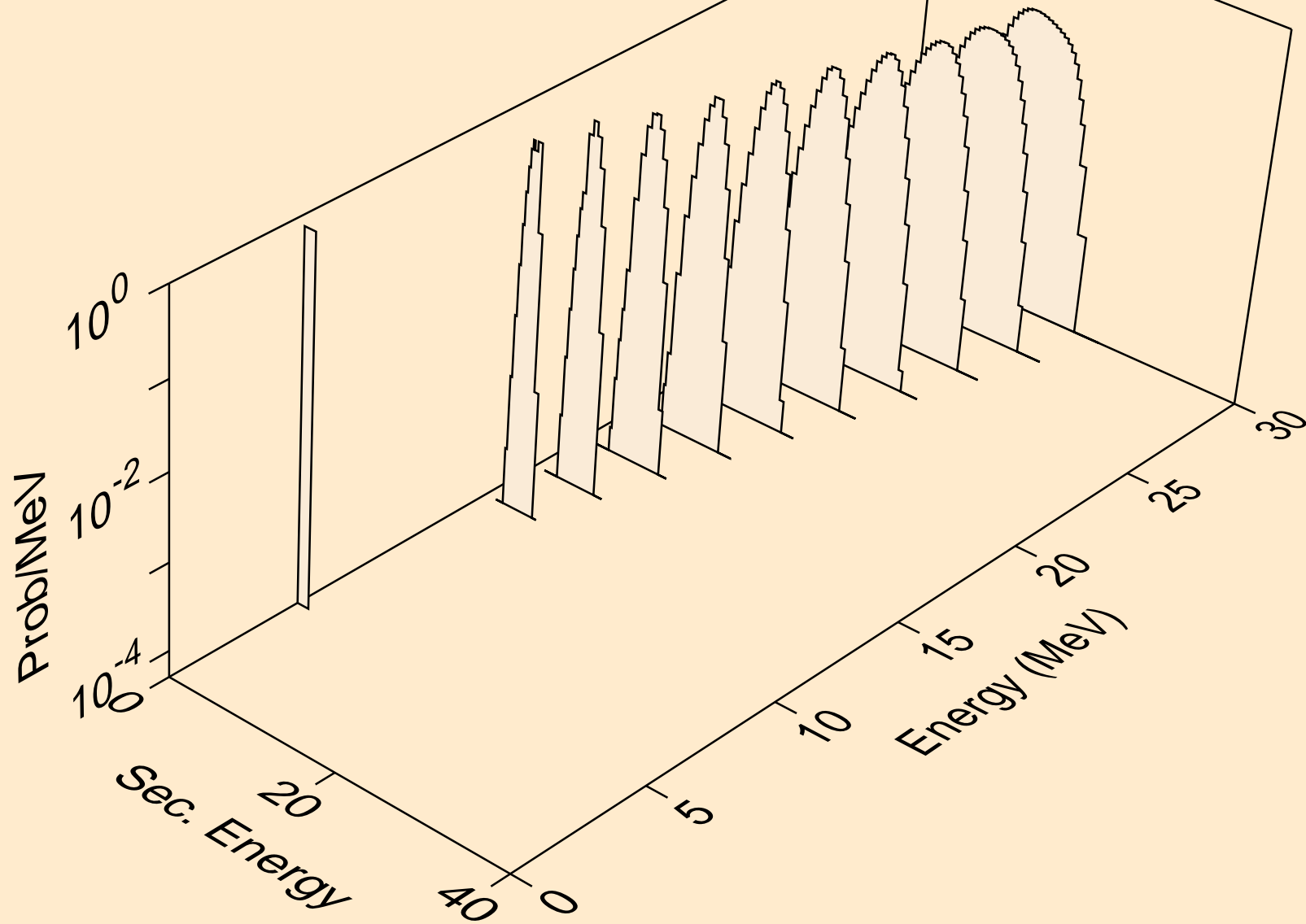

IR180 NEUTRON ACER TENDL-2021 LIBRARY; T=293.6K
deuterons from (n,da)

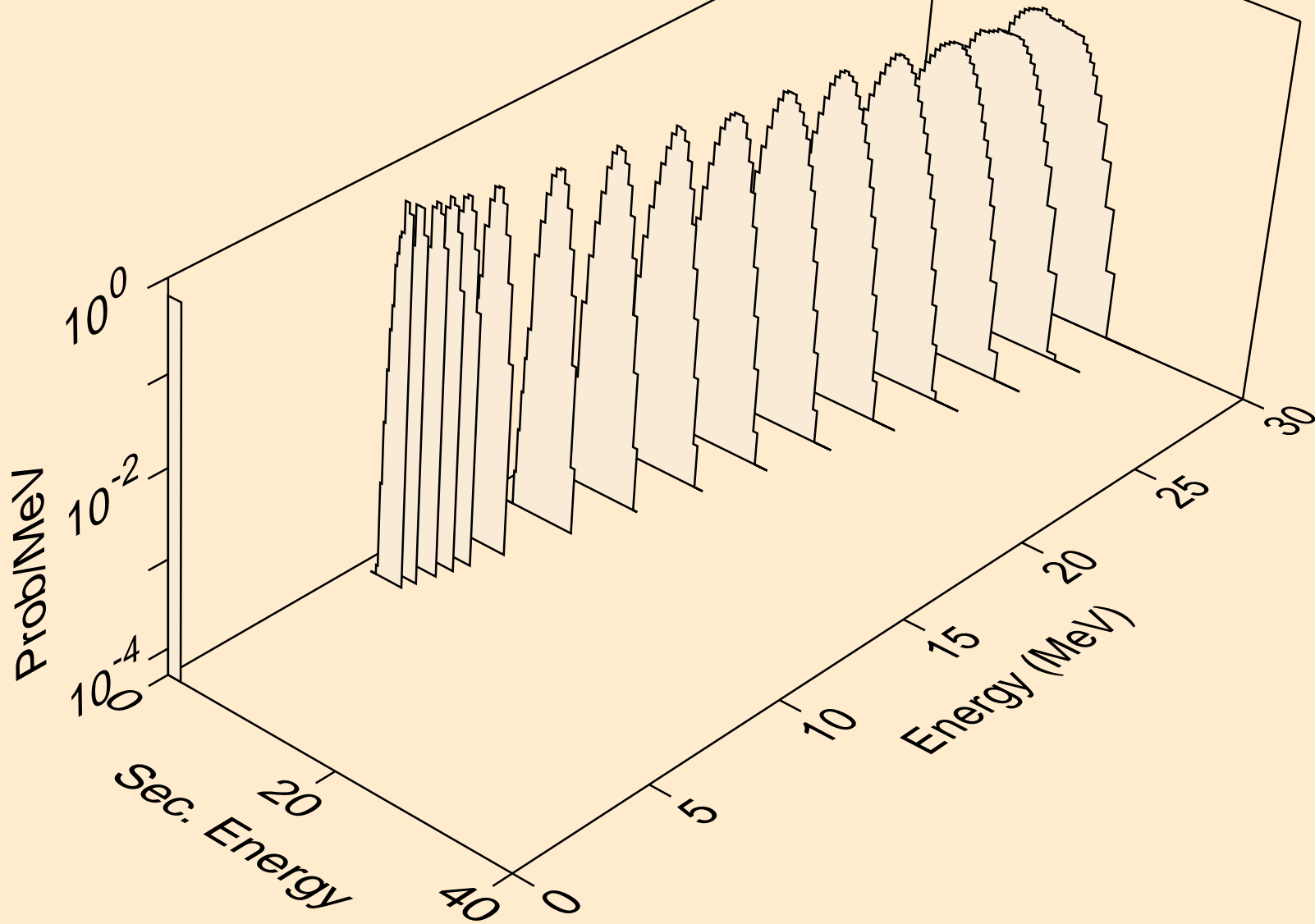

IR180 NEUTRON ACER TENDL-2021 LIBRARY; T=293.6K
tritons from (n,x)

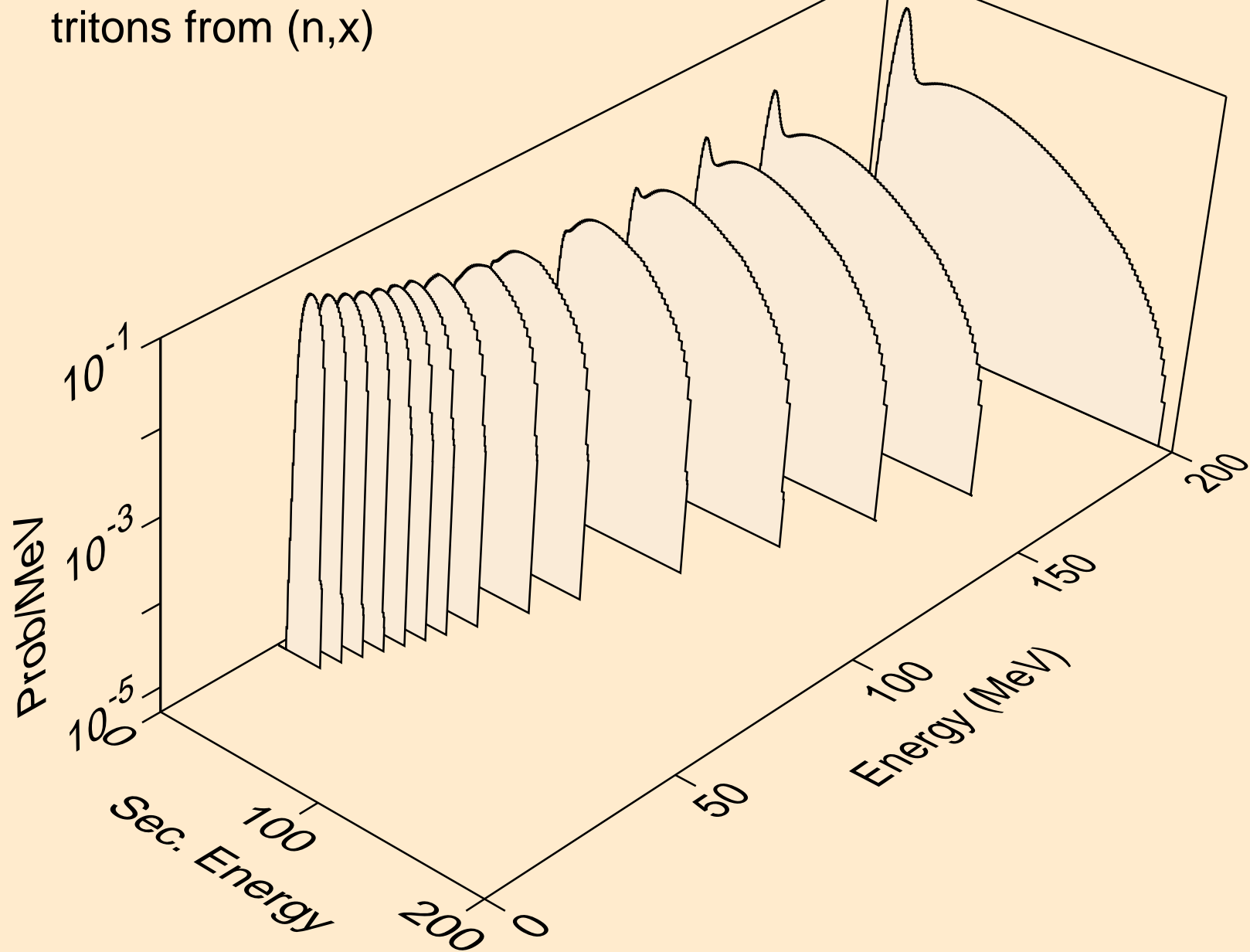

IR180 NEUTRON ACER TENDL-2021 LIBRARY; T=293.6K
tritons from (n,n*)t

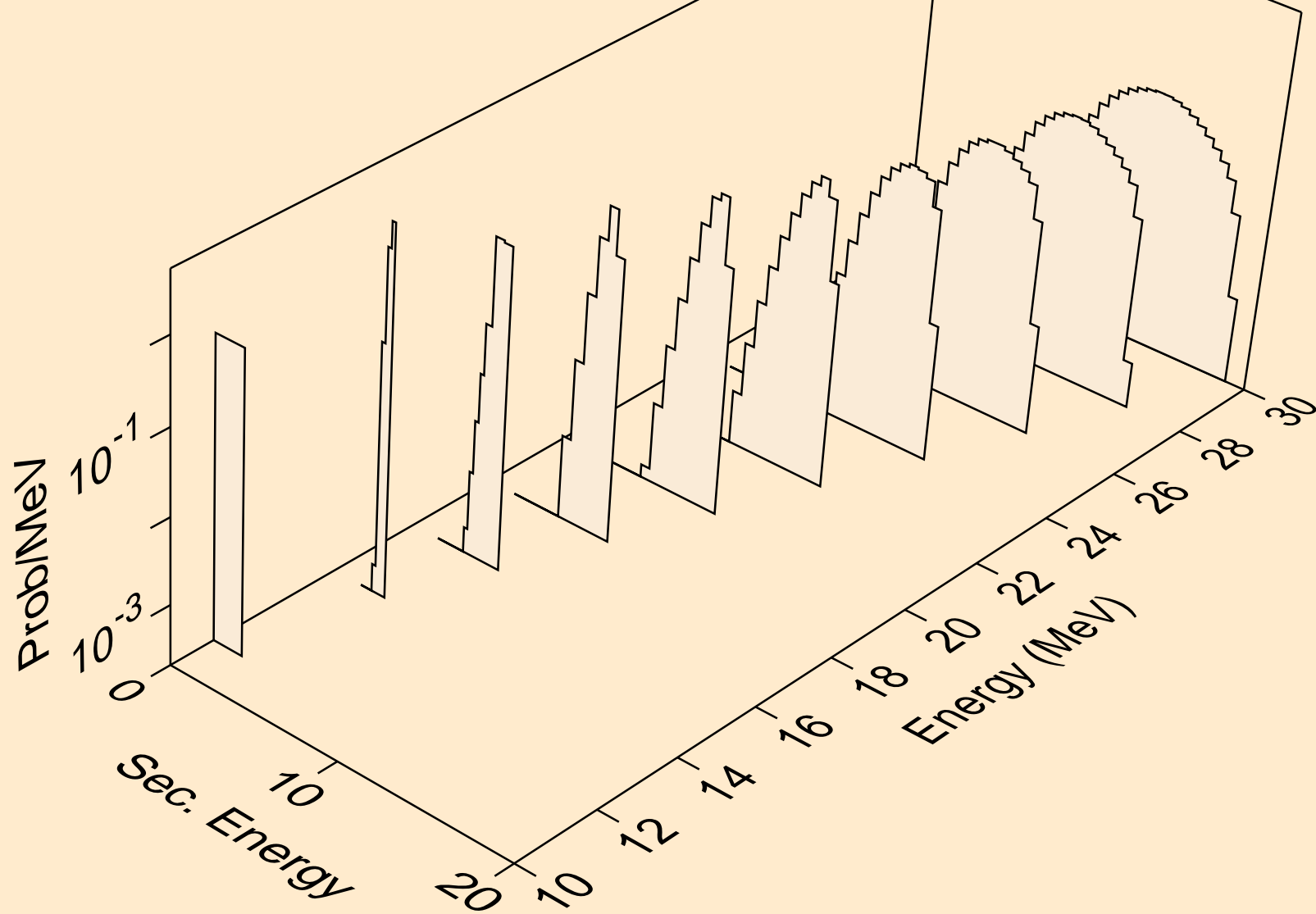

IR180 NEUTRON ACER TENDL-2021 LIBRARY; T=293.6K
tritons from (n,t)

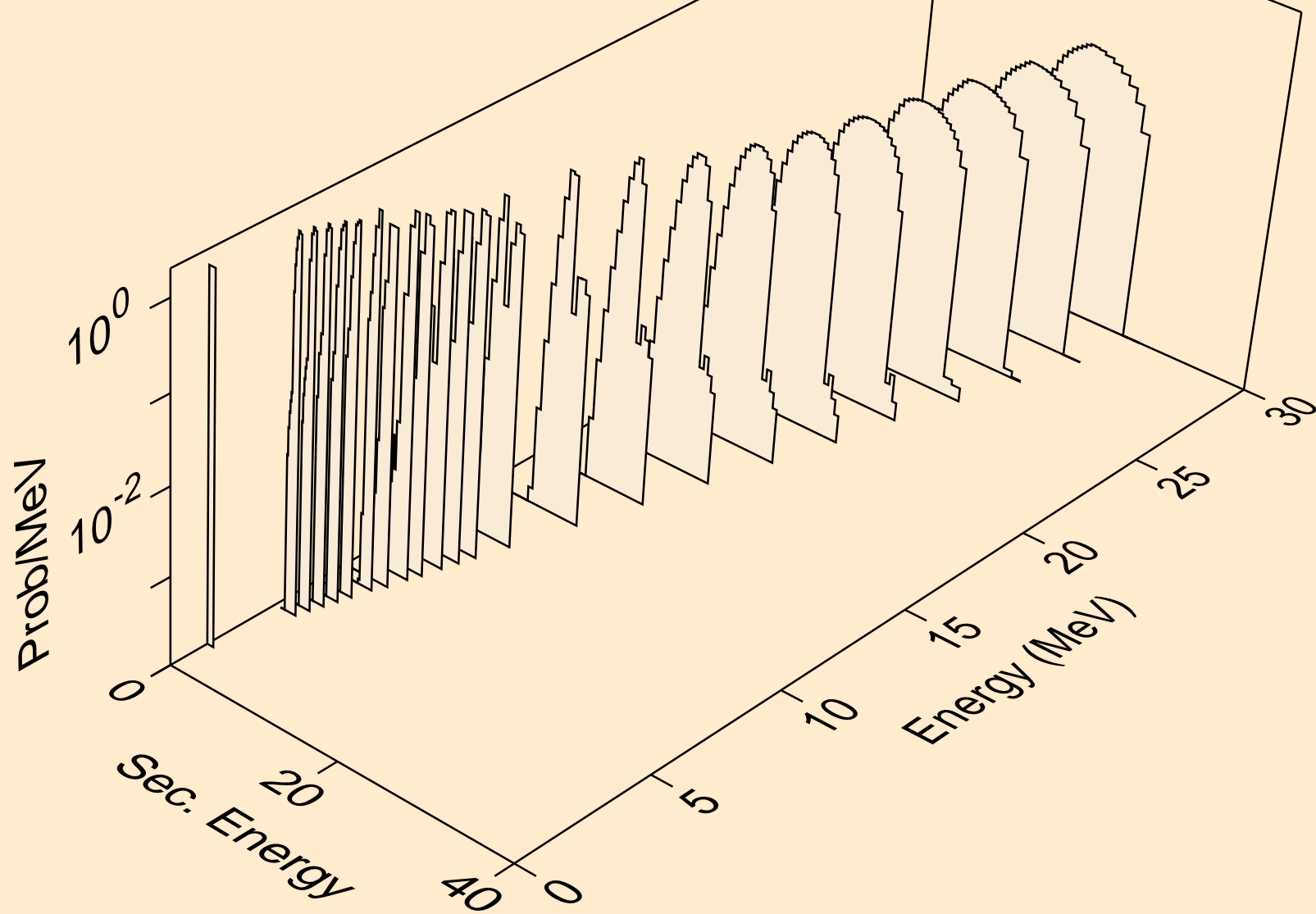

IR180 NEUTRON ACER TENDL-2021 LIBRARY; T=293.6K
tritons from (n,pt)

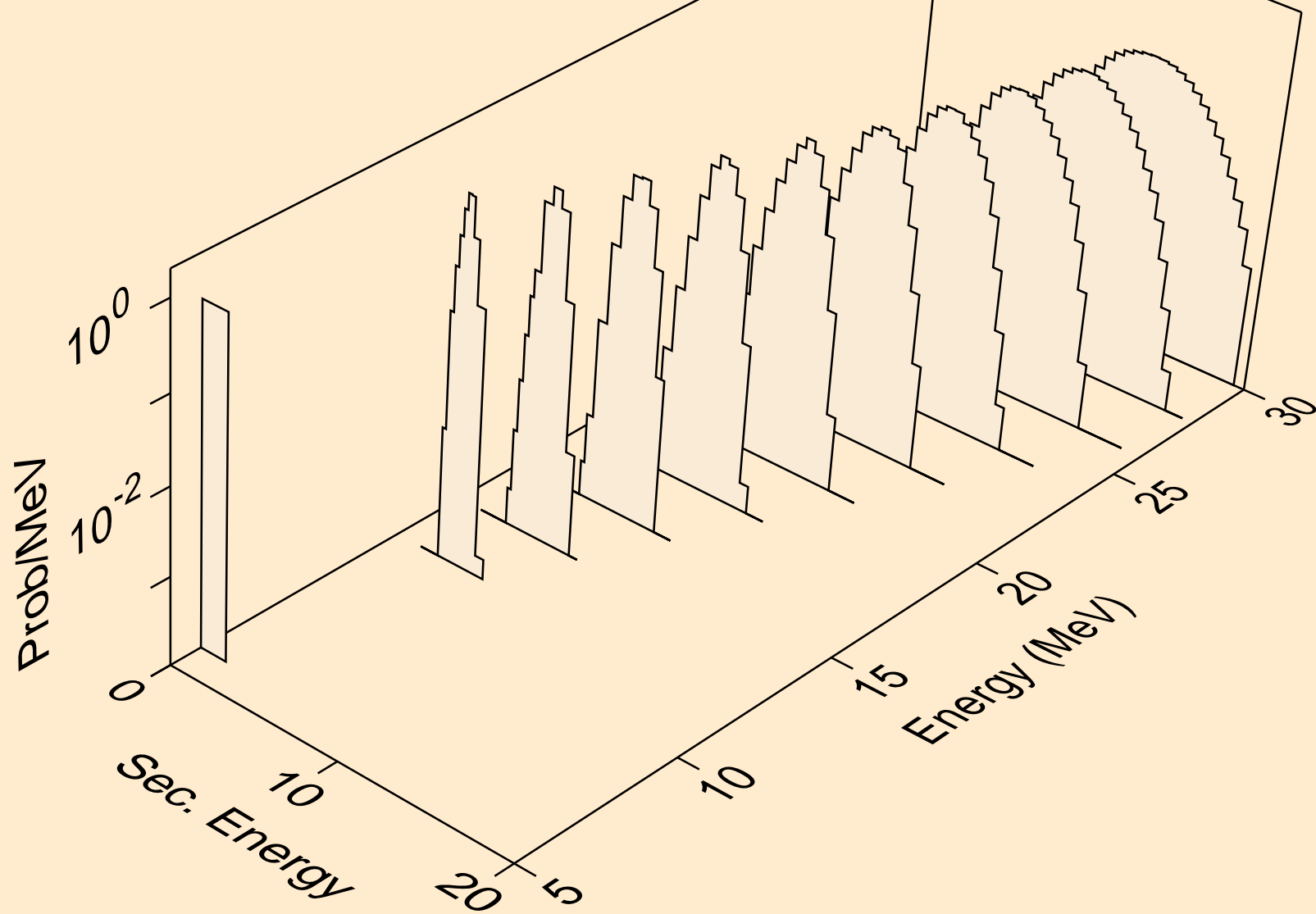

IR180 NEUTRON ACER TENDL-2021 LIBRARY; T=293.6K
he3s from (n,x)

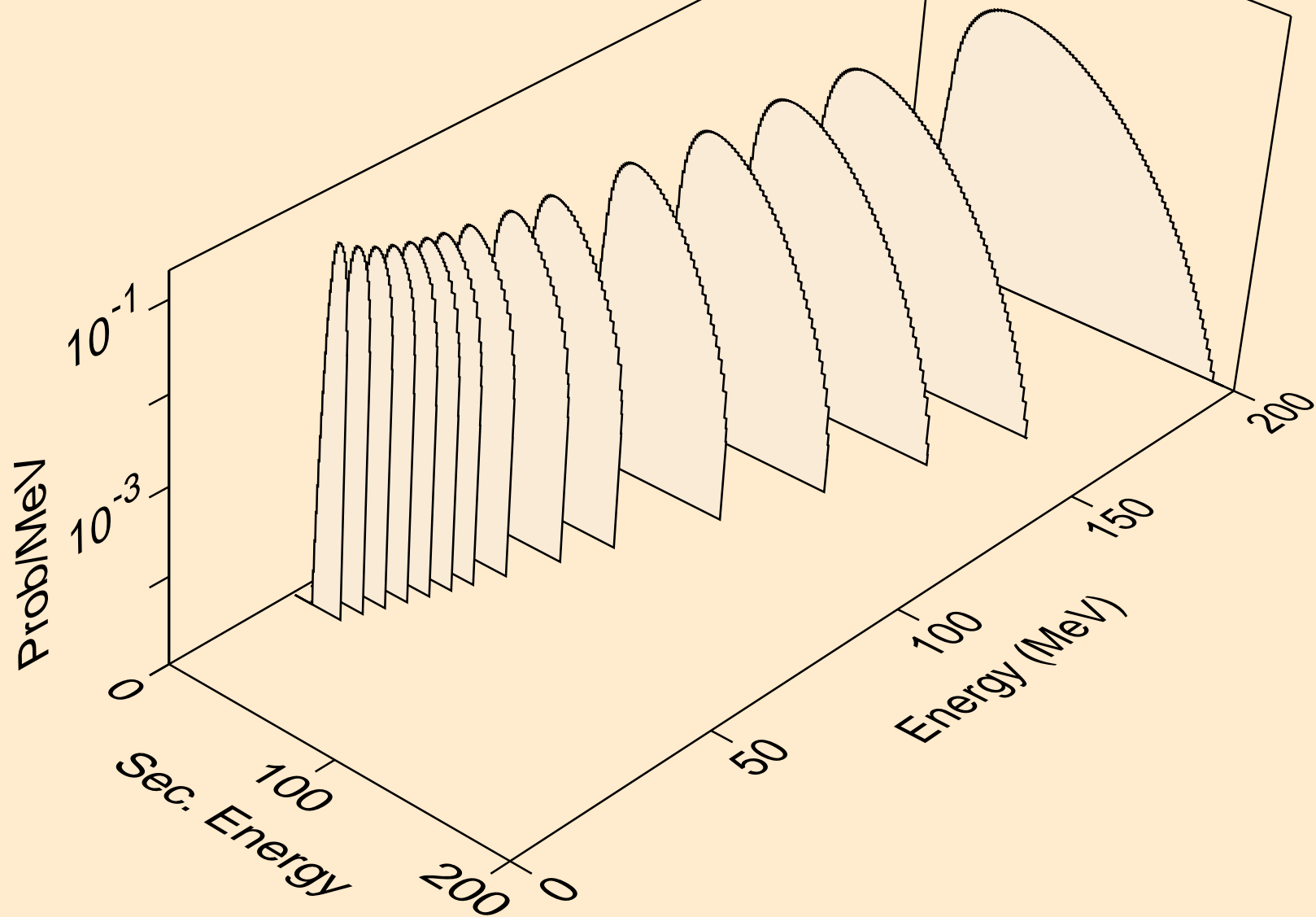

IR180 NEUTRON ACER TENDL-2021 LIBRARY; T=293.6K
he3s from (n,n*)he3

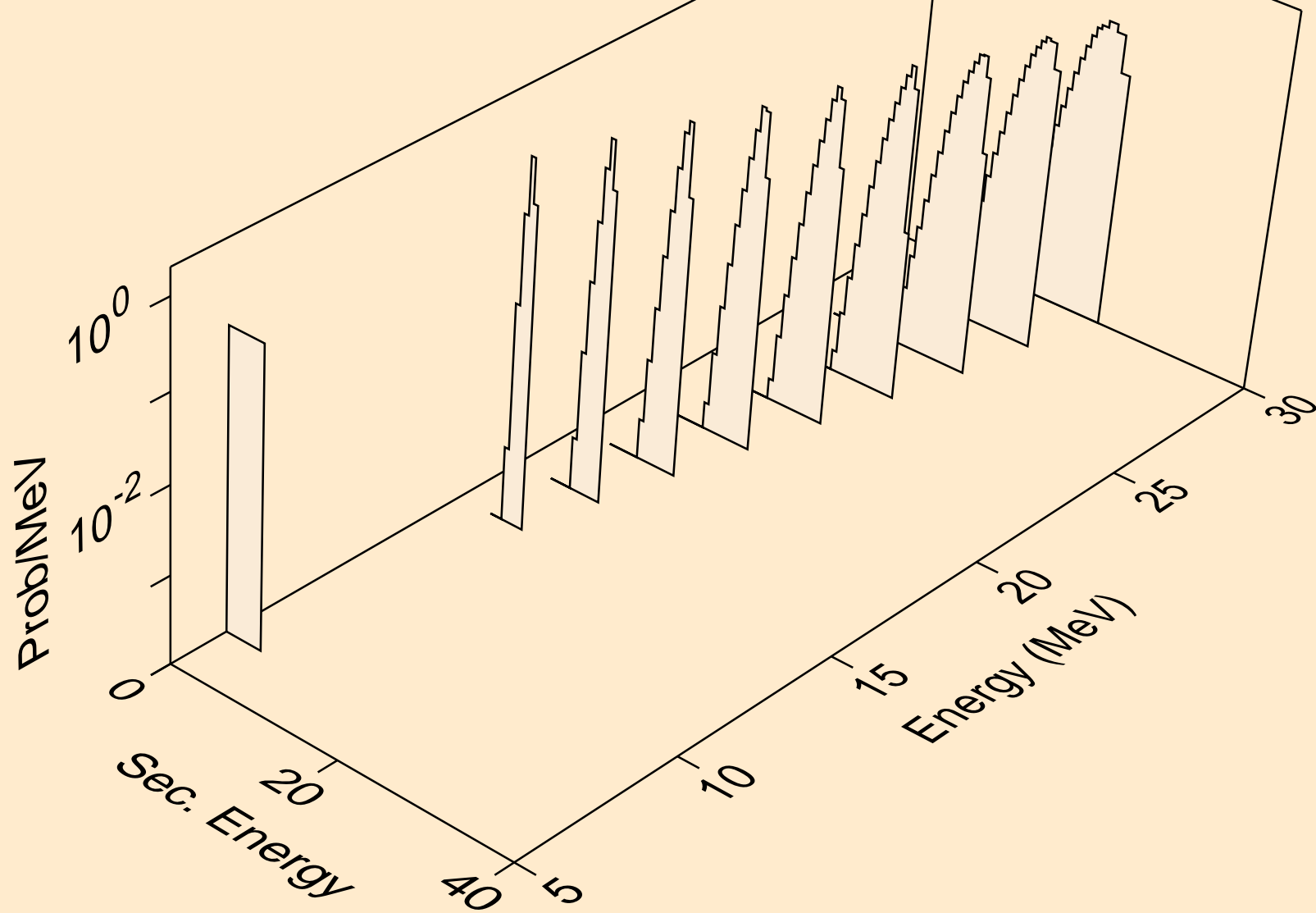

IR180 NEUTRON ACER TENDL-2021 LIBRARY; T=293.6K
he3s from (n,he3)

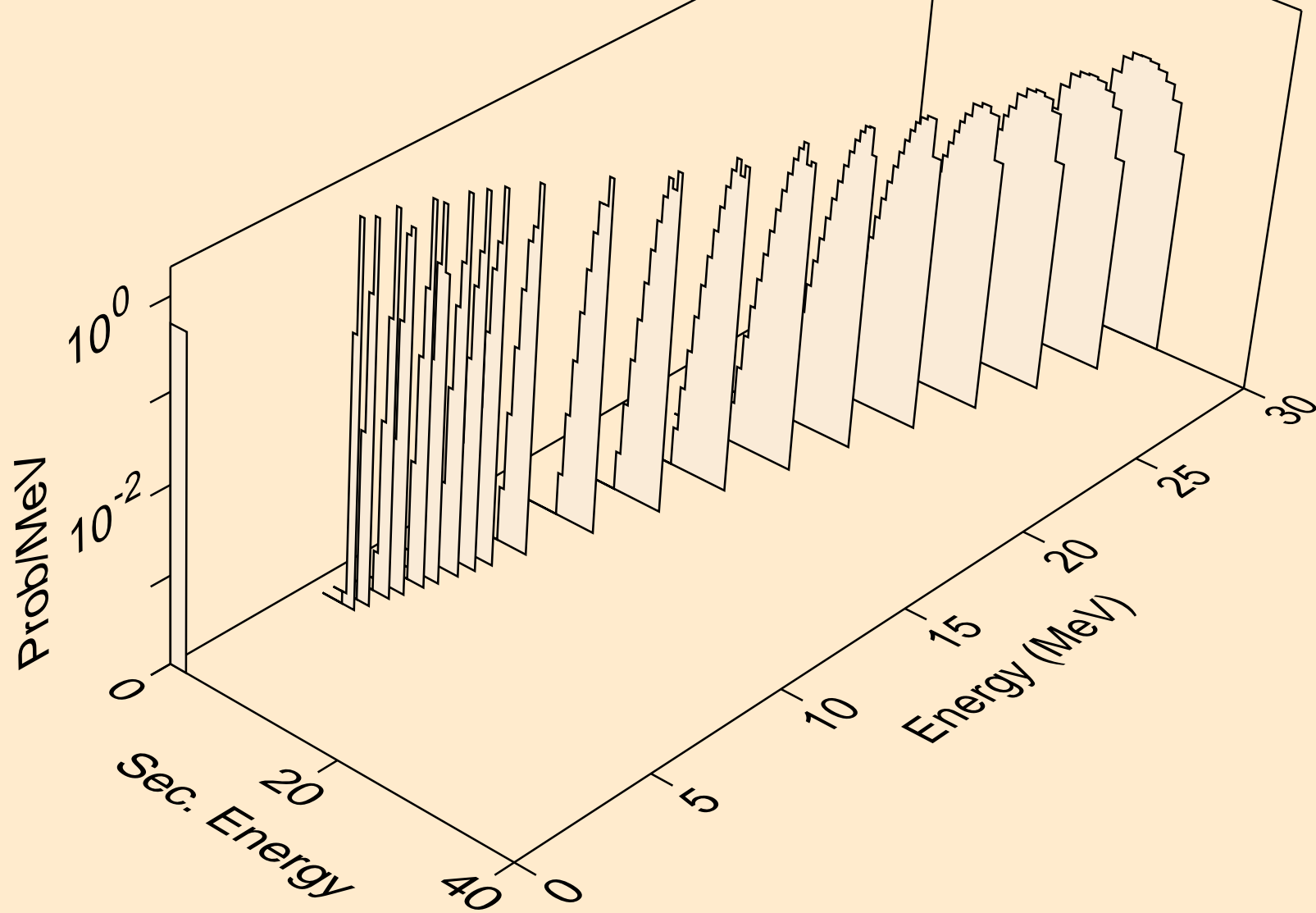

IR180 NEUTRON ACER TENDL-2021 LIBRARY; T=293.6K
alphas from (n,x)

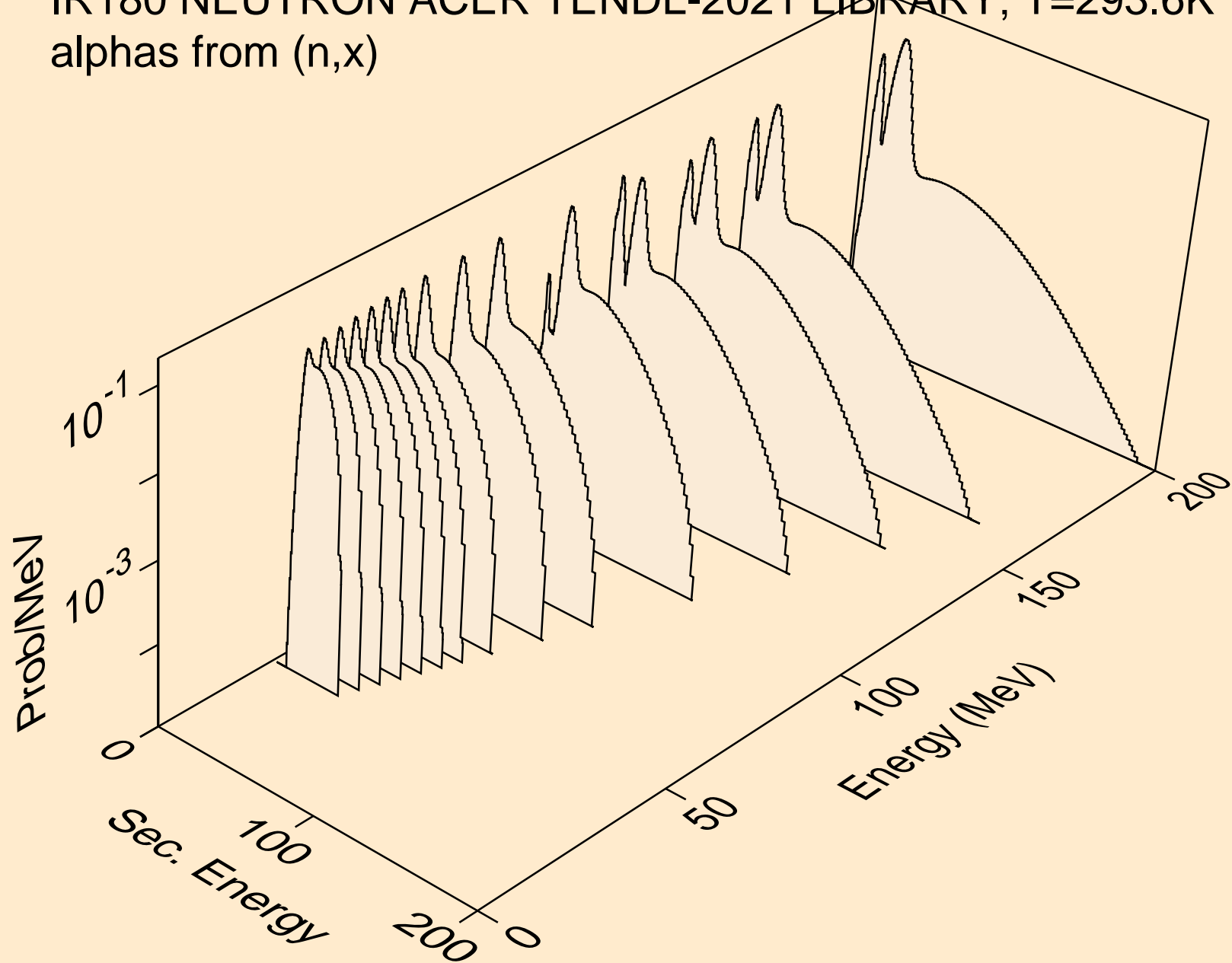

IR180 NEUTRON ACER TENDL-2021 LIBRARY; T=293.6K
alphas from (n,n*)a

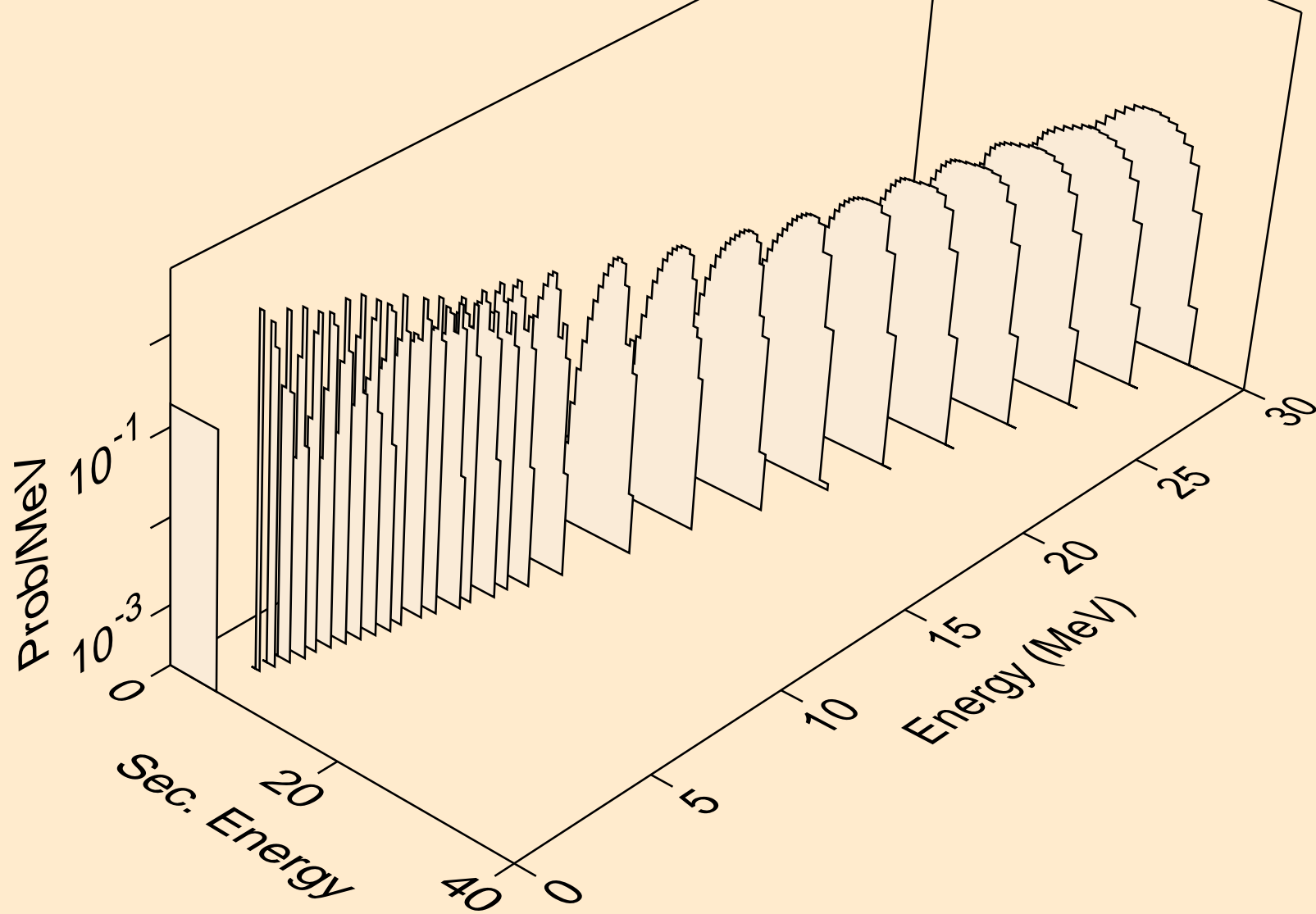

IR180 NEUTRON ACER TENDL-2021 LIBRARY; T=293.6K
alphas from (n,2n)a

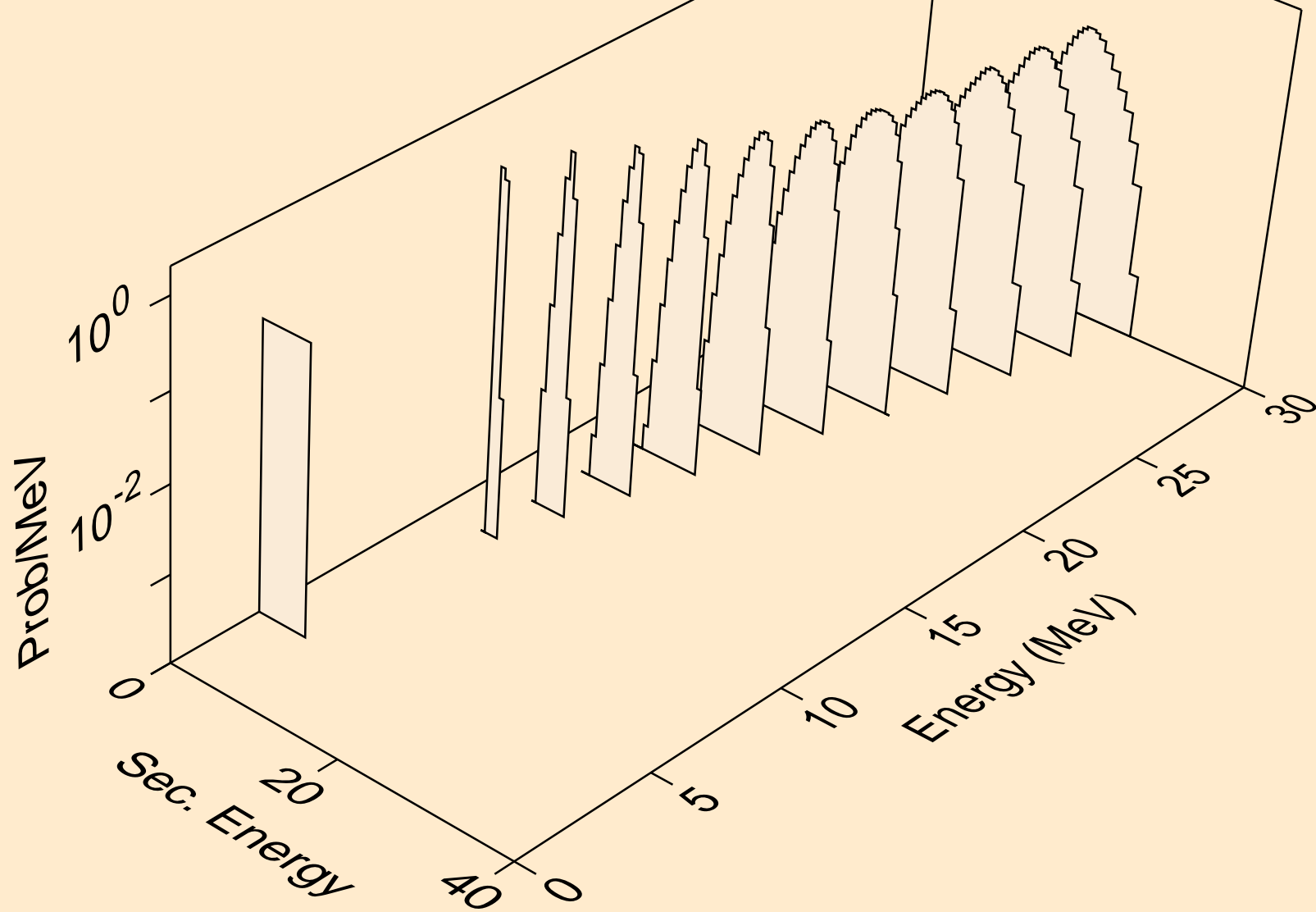

IR180 NEUTRON ACER TENDL-2021 LIBRARY; T=293.6K
alphas from (n,3n)a

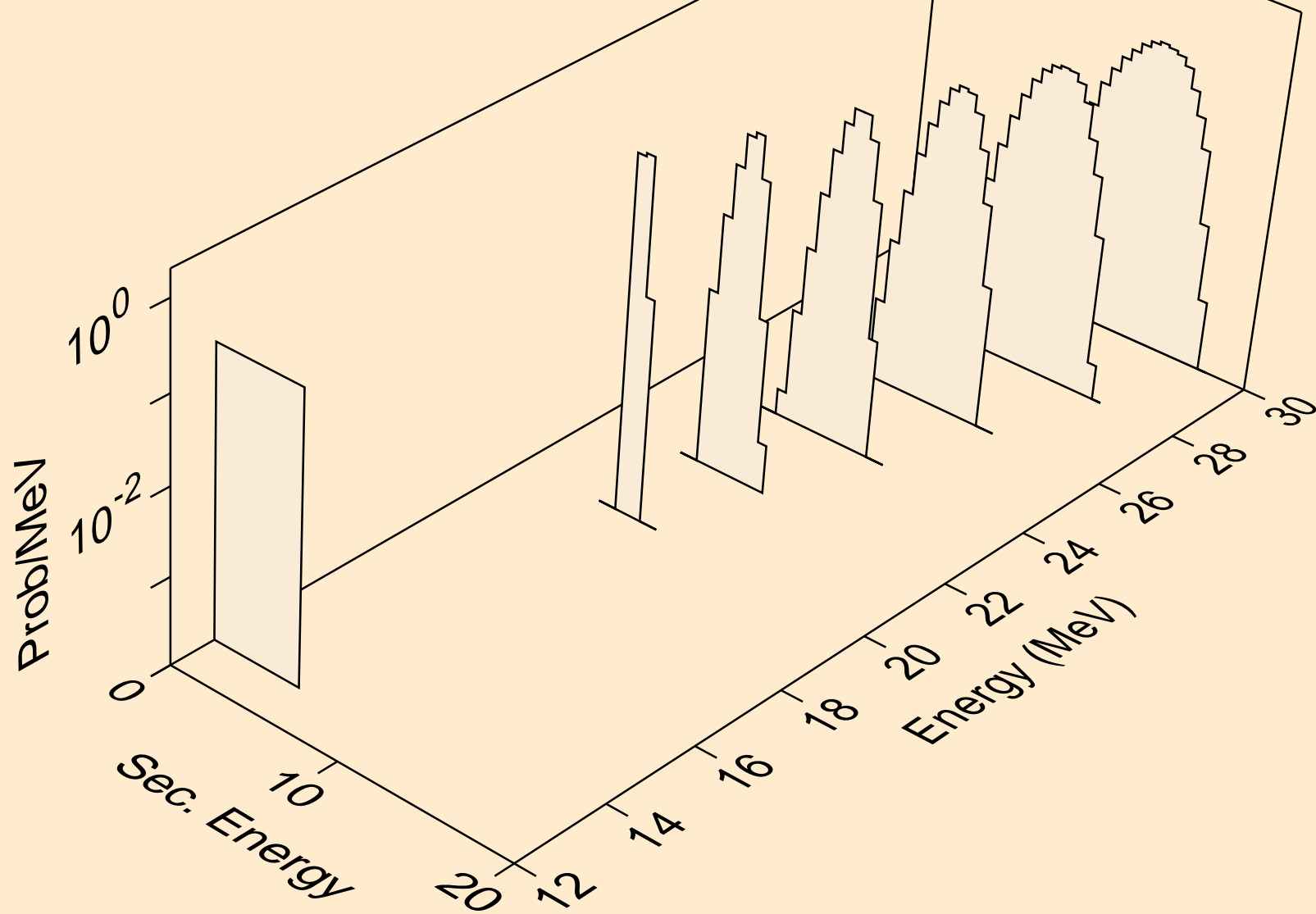

IR180 NEUTRON ACER TENDL-2021 LIBRARY; T=293.6K
alphas from (n,n*)2a

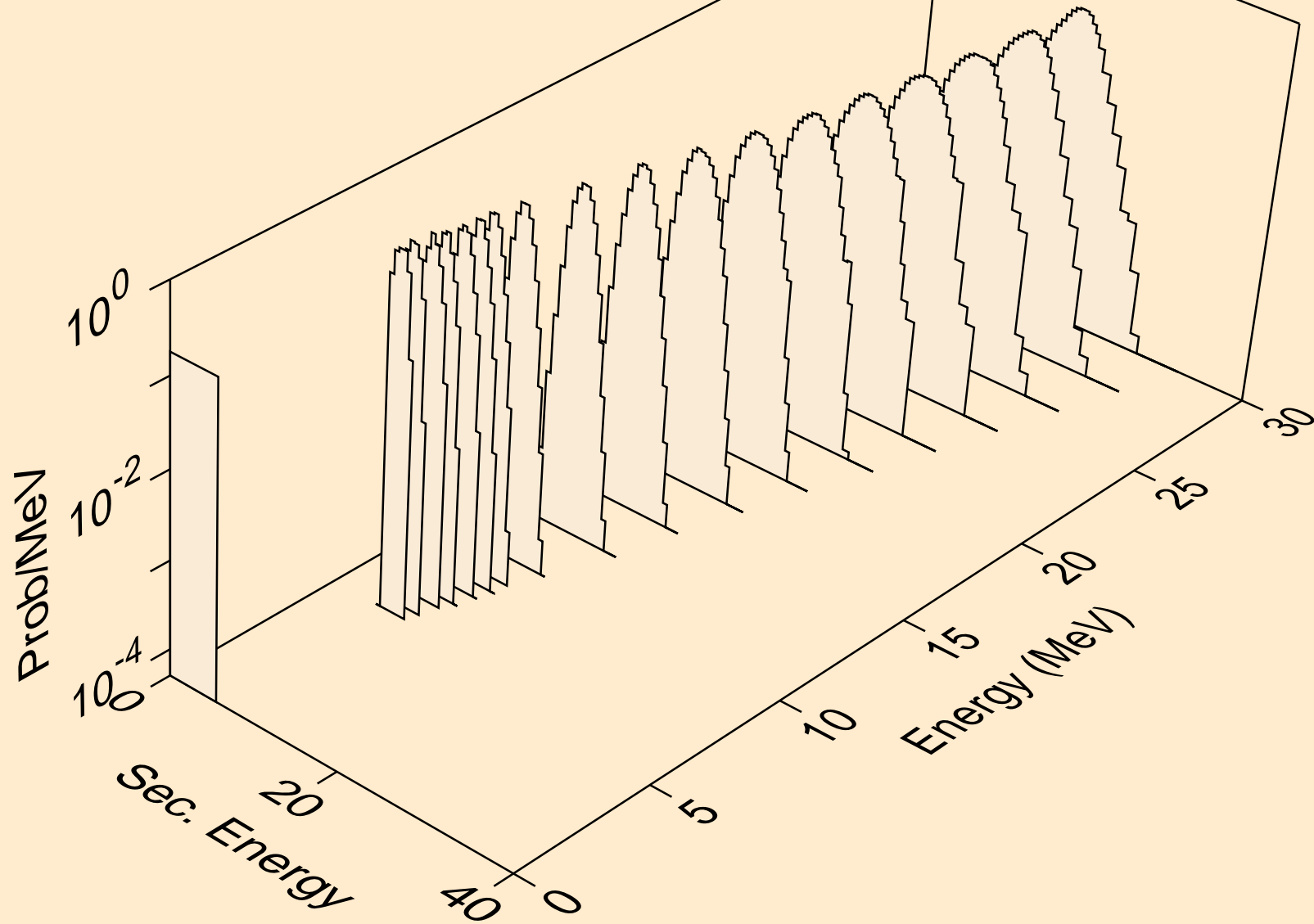

IR180 NEUTRON ACER TENDL-2021 LIBRARY; T=293.6K
alphas from (n,2n)2a

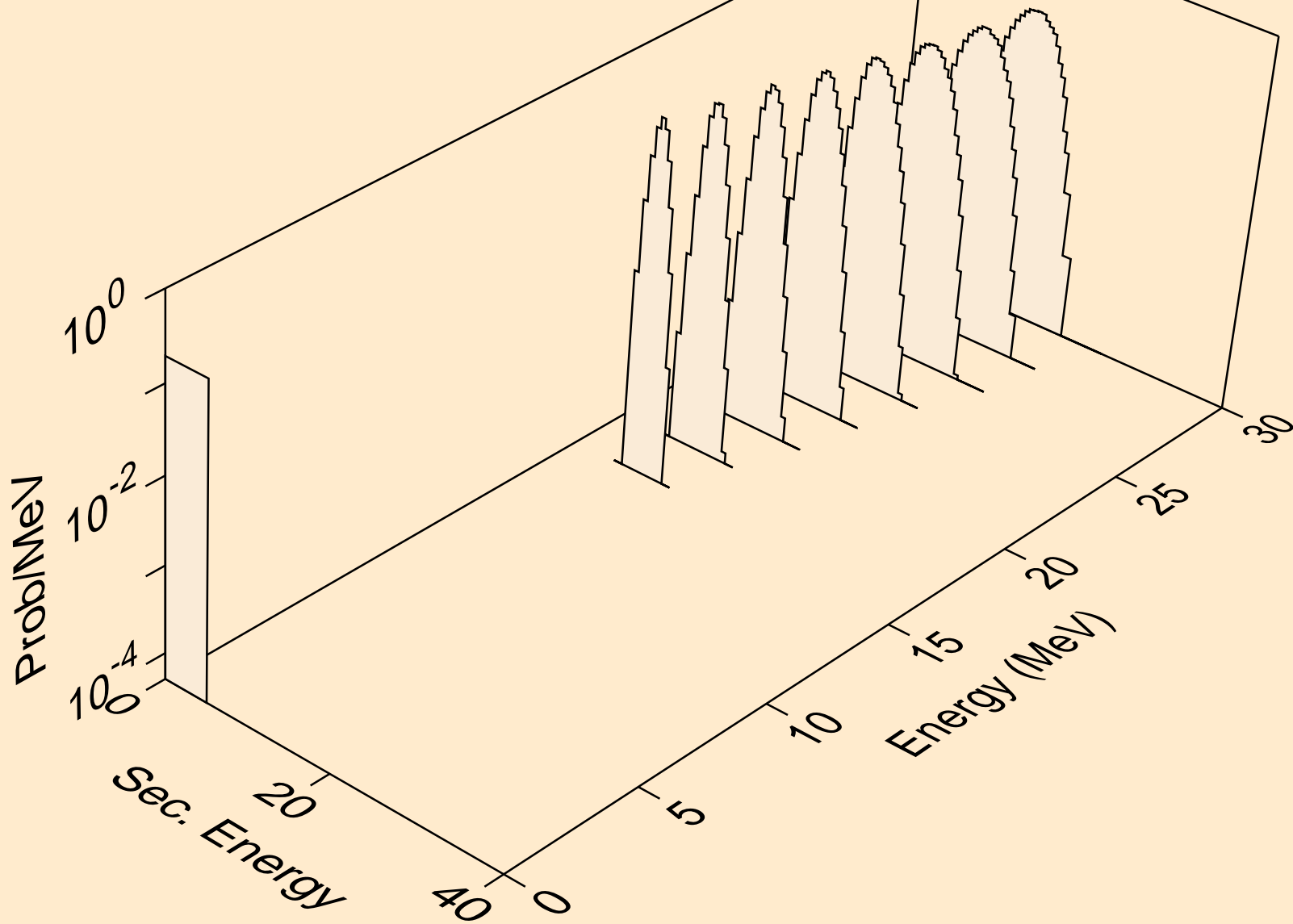

IR180 NEUTRON ACER TENDL-2021 LIBRARY; T=293.6K
alphas from (n,npa)

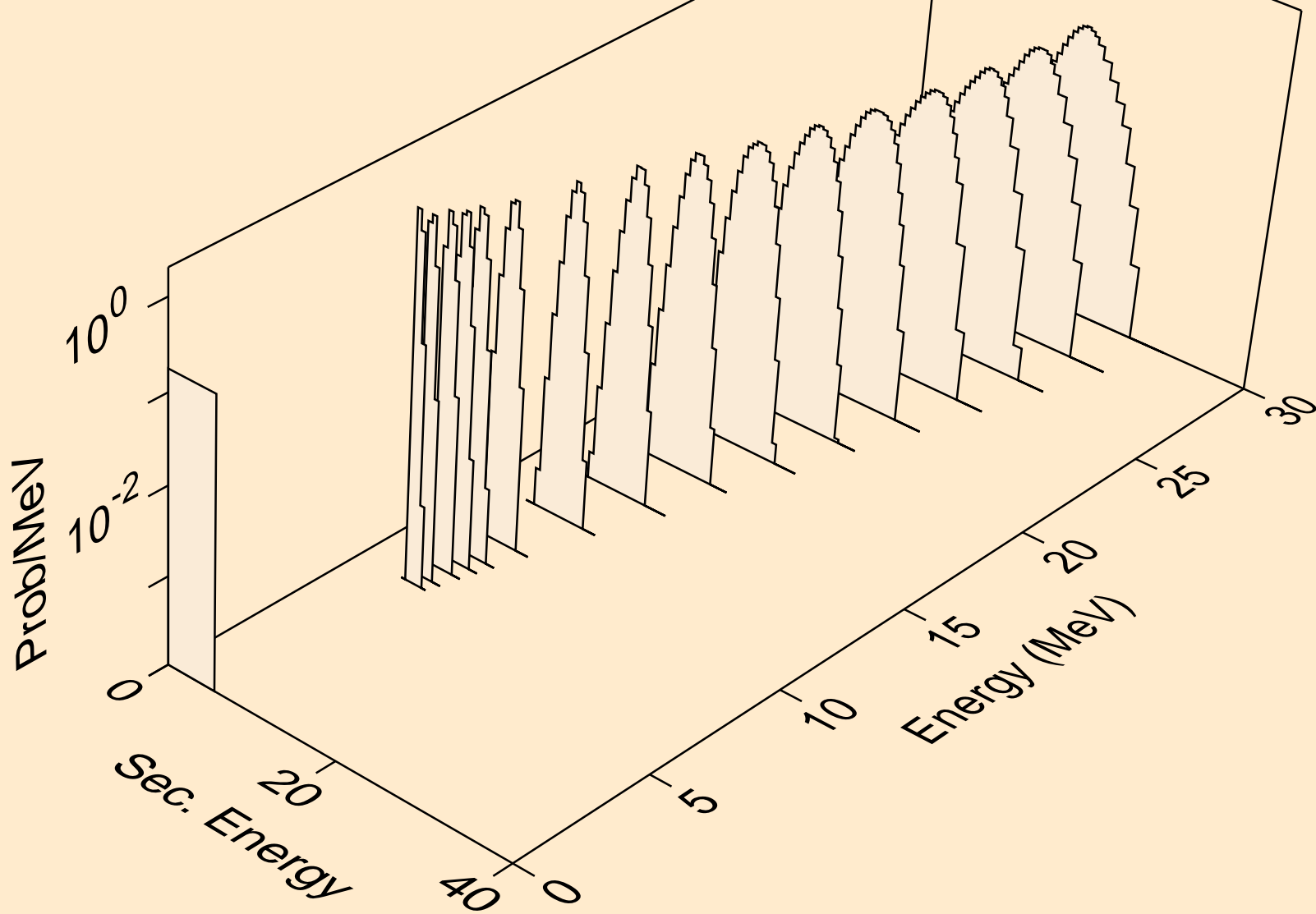

IR180 NEUTRON ACER TENDL-2021 LIBRARY; T=293.6K
alphas from (n,a)

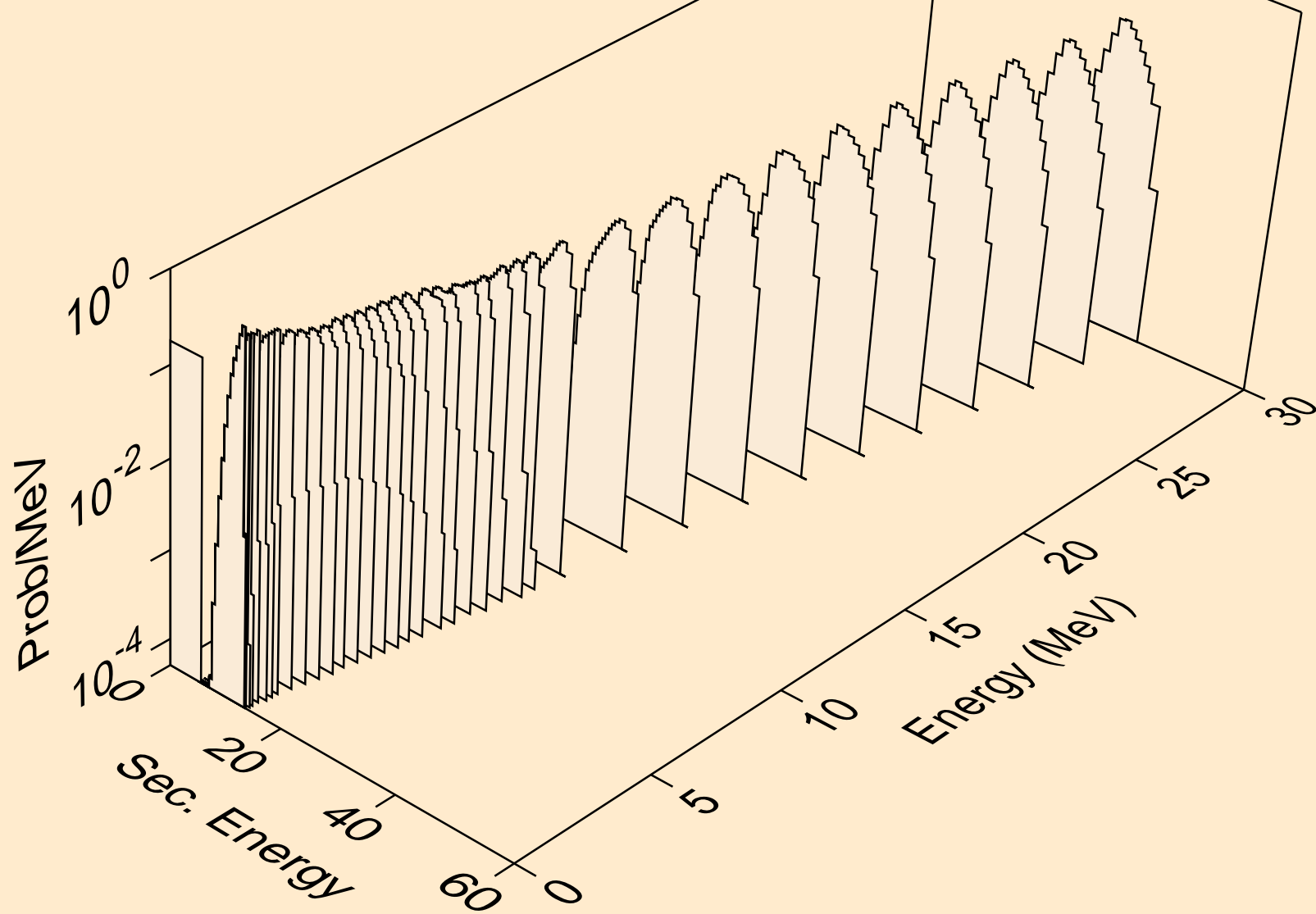

IR180 NEUTRON ACER TENDL-2021 LIBRARY; T=293.6K
alphas from (n,2a)

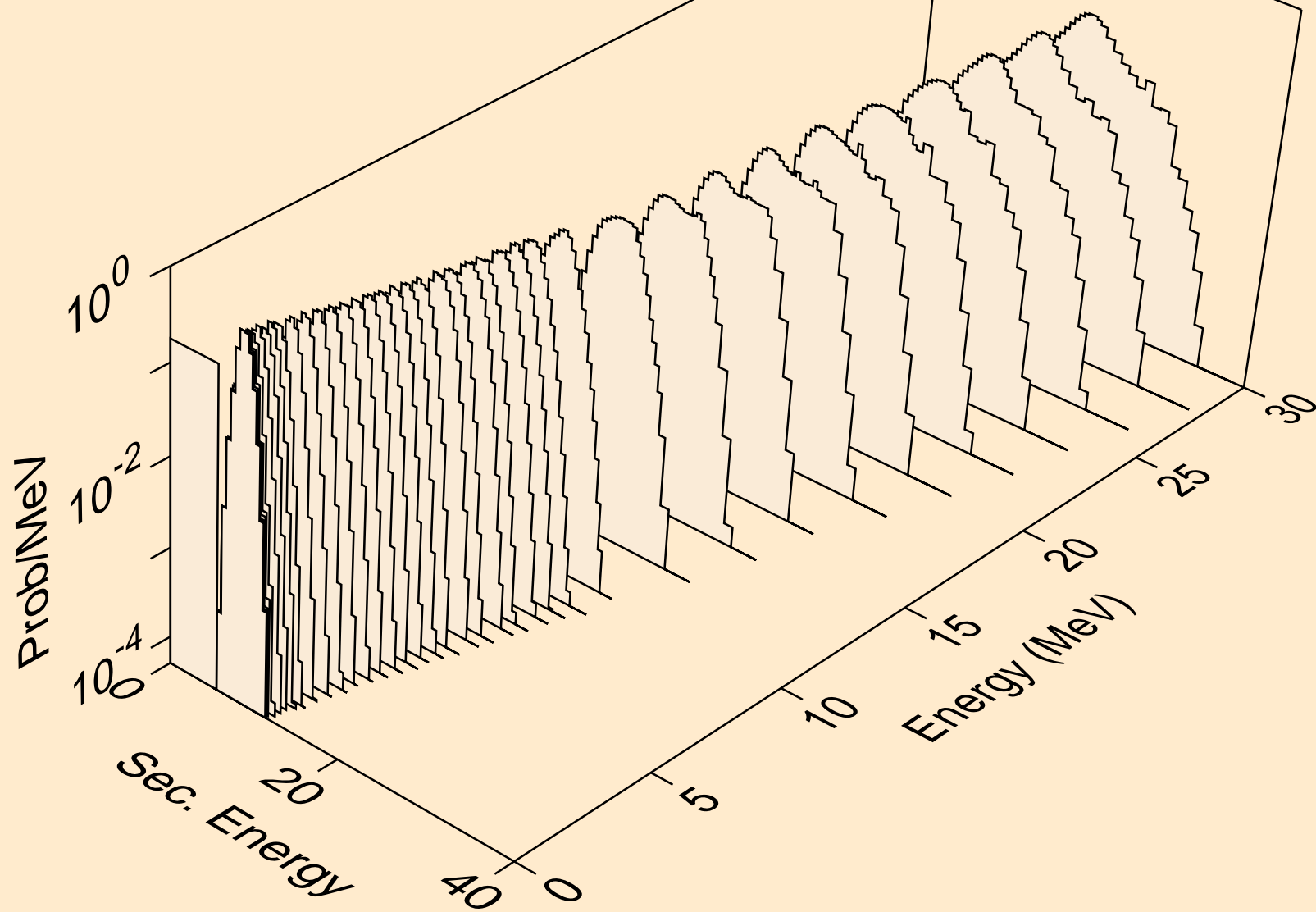

IR180 NEUTRON ACER TENDL-2021 LIBRARY; T=293.6K
alphas from (n,p)

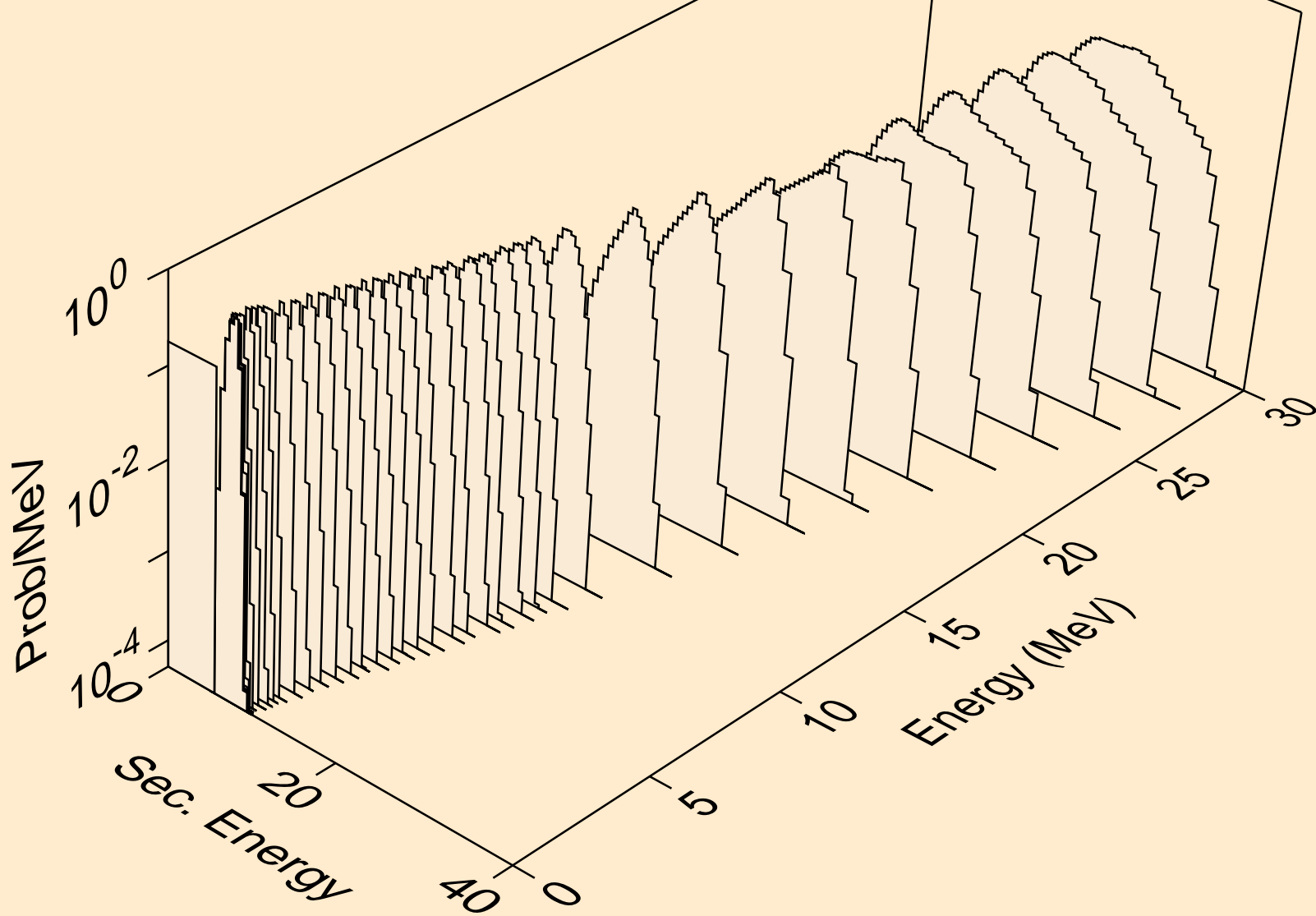

IR180 NEUTRON ACER TENDL-2021 LIBRARY; T=293.6K
alphas from (n,da)

