

# IR184 NEUTRON ACER TENDL-2021 LIBRARY; T=293.6K

## Principal cross sections

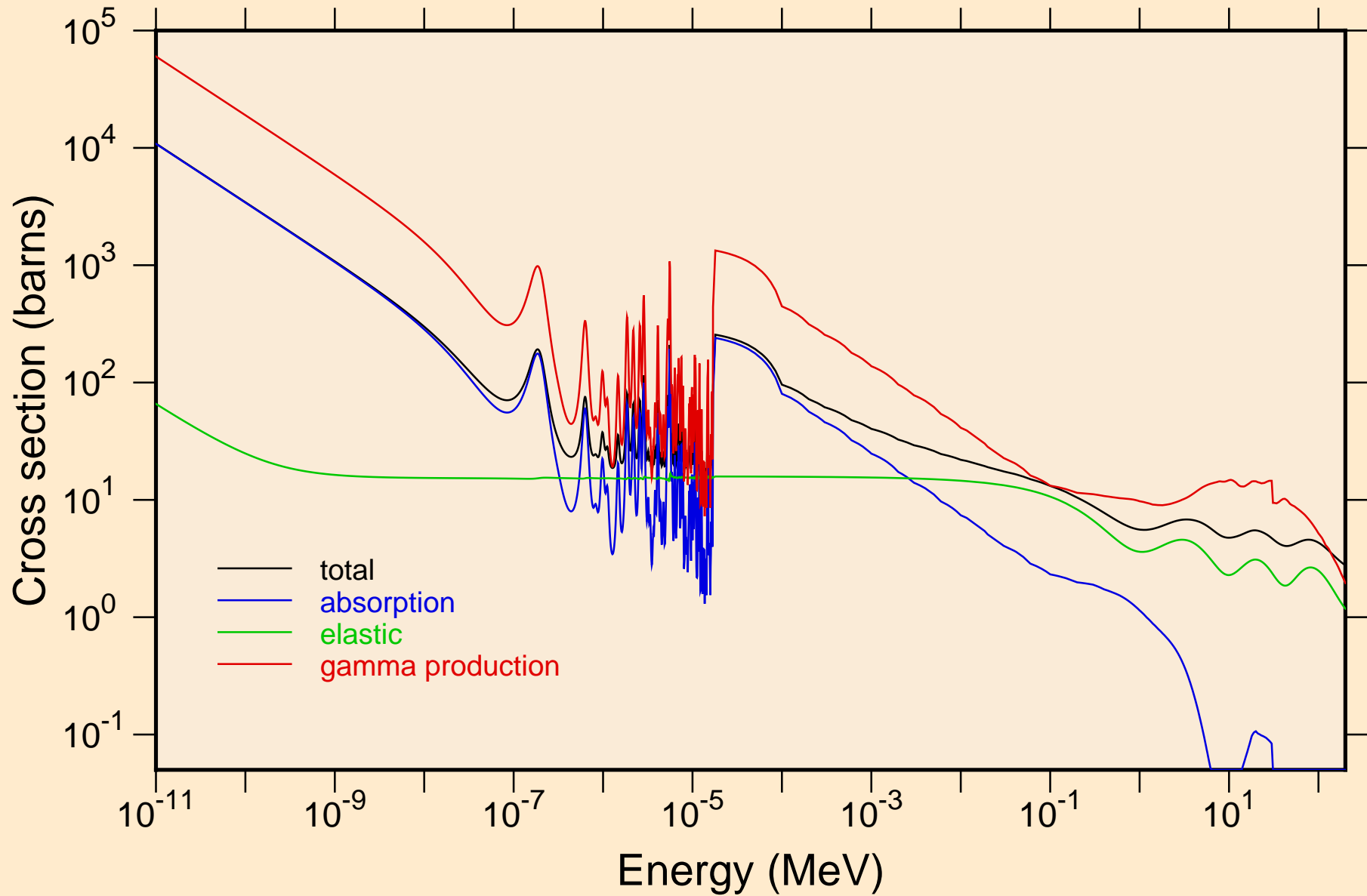

IR184 NEUTRON ACER TENDL-2021 LIBRARY; T=293.6K  
resonance total cross section

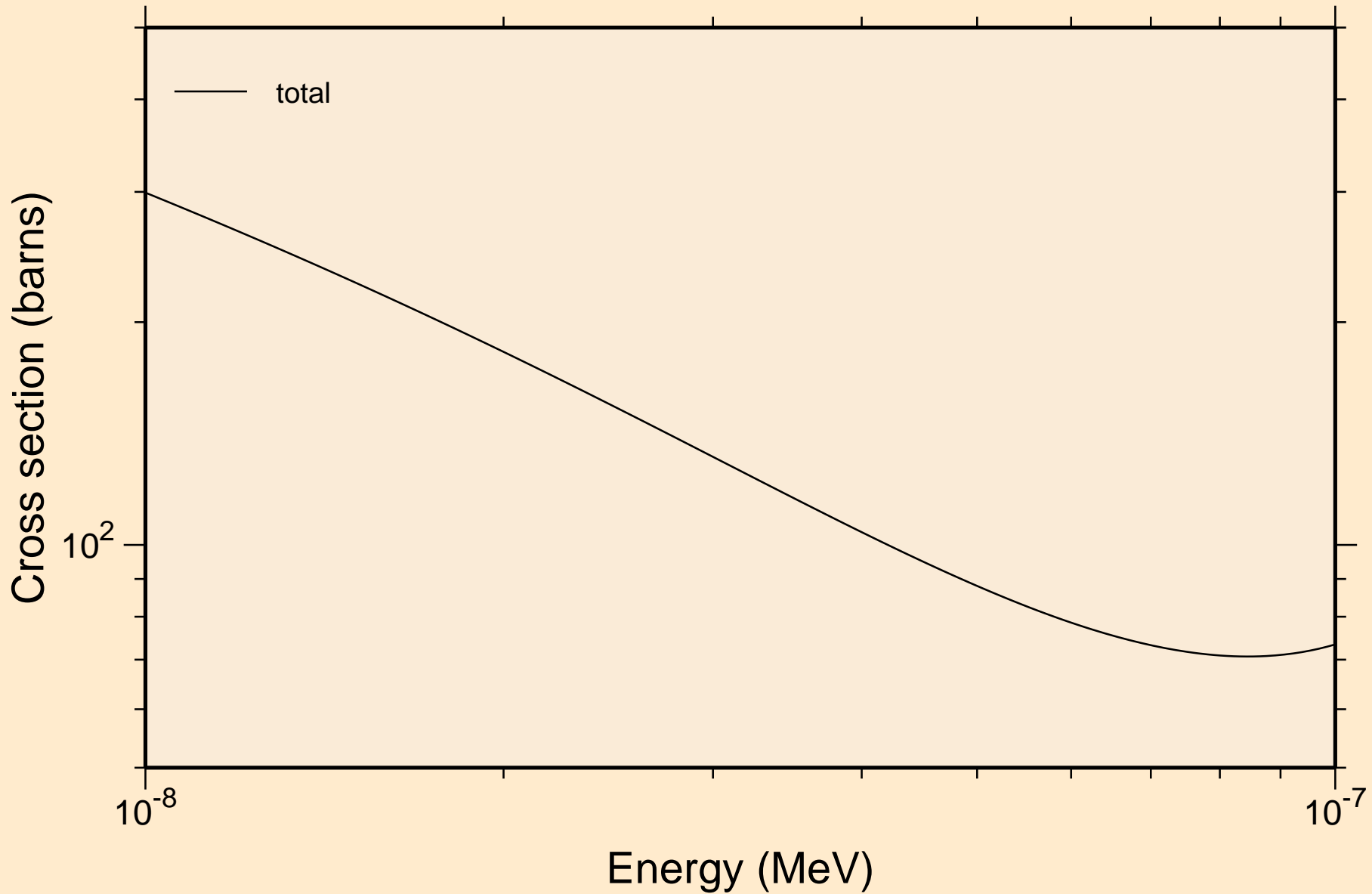

IR184 NEUTRON ACER TENDL-2021 LIBRARY; T=293.6K  
resonance total cross section

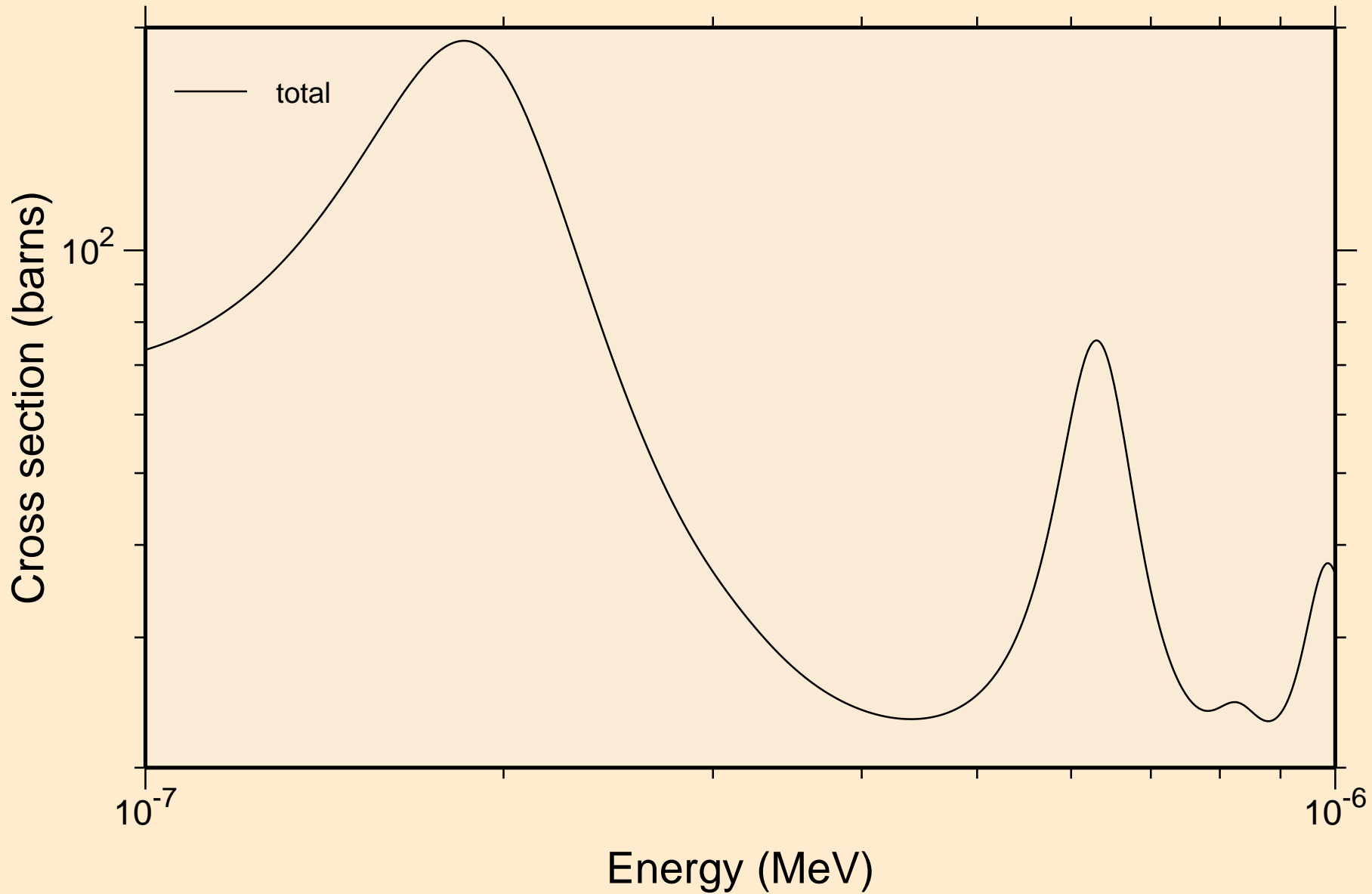

IR184 NEUTRON ACER TENDL-2021 LIBRARY; T=293.6K  
resonance total cross section

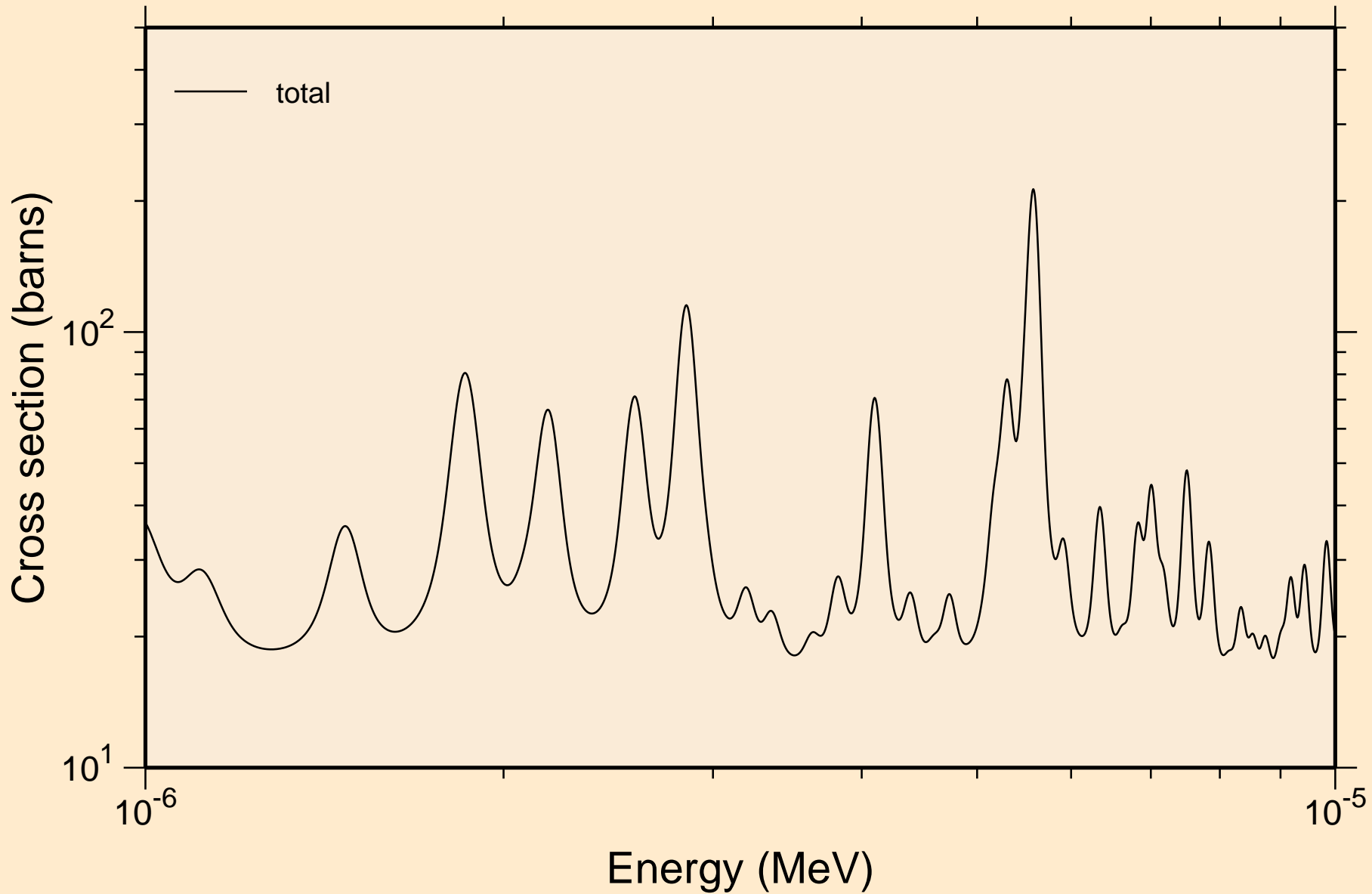

IR184 NEUTRON ACER TENDL-2021 LIBRARY; T=293.6K  
resonance total cross section

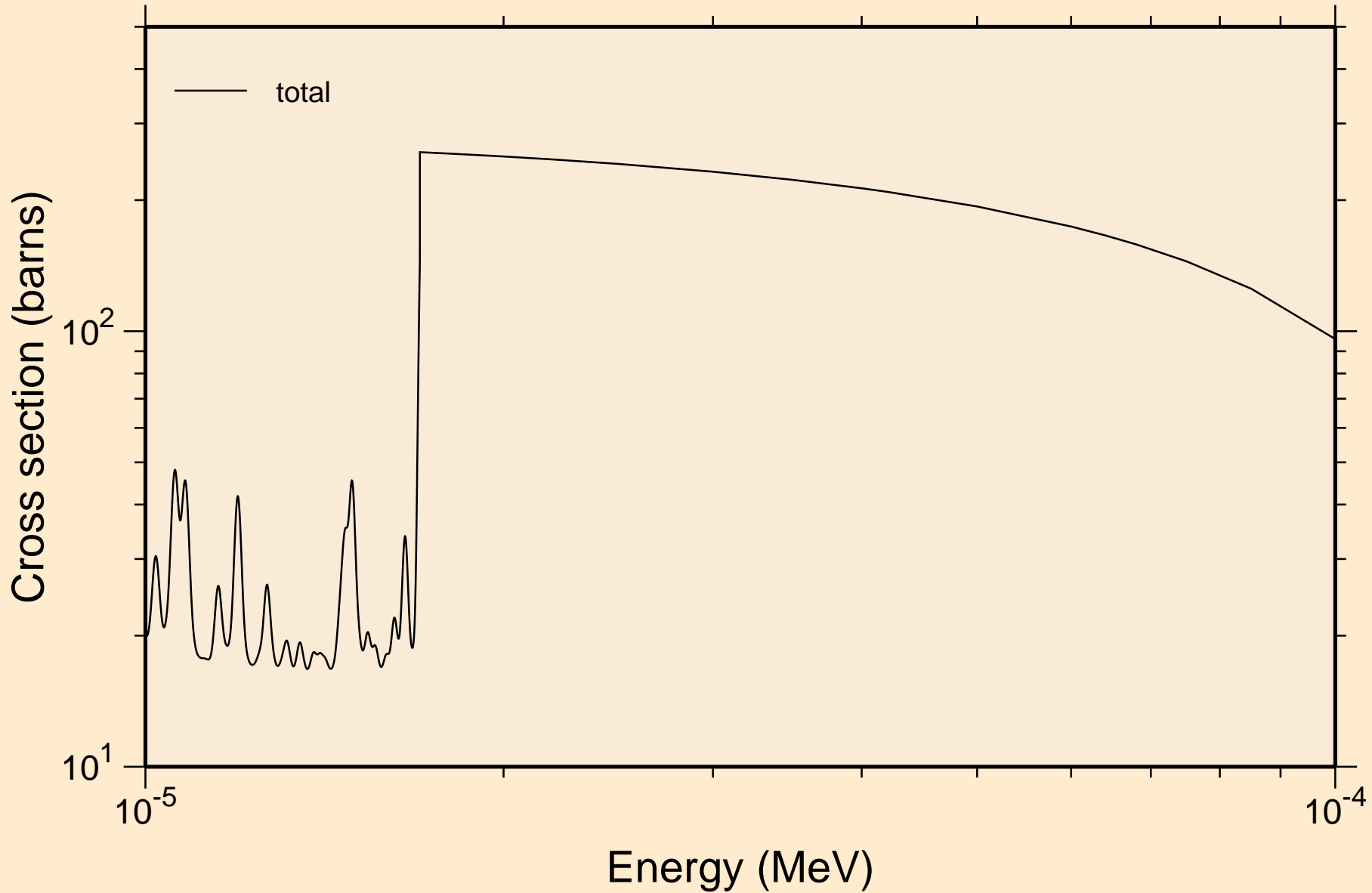

IR184 NEUTRON ACER TENDL-2021 LIBRARY; T=293.6K  
resonance total cross section

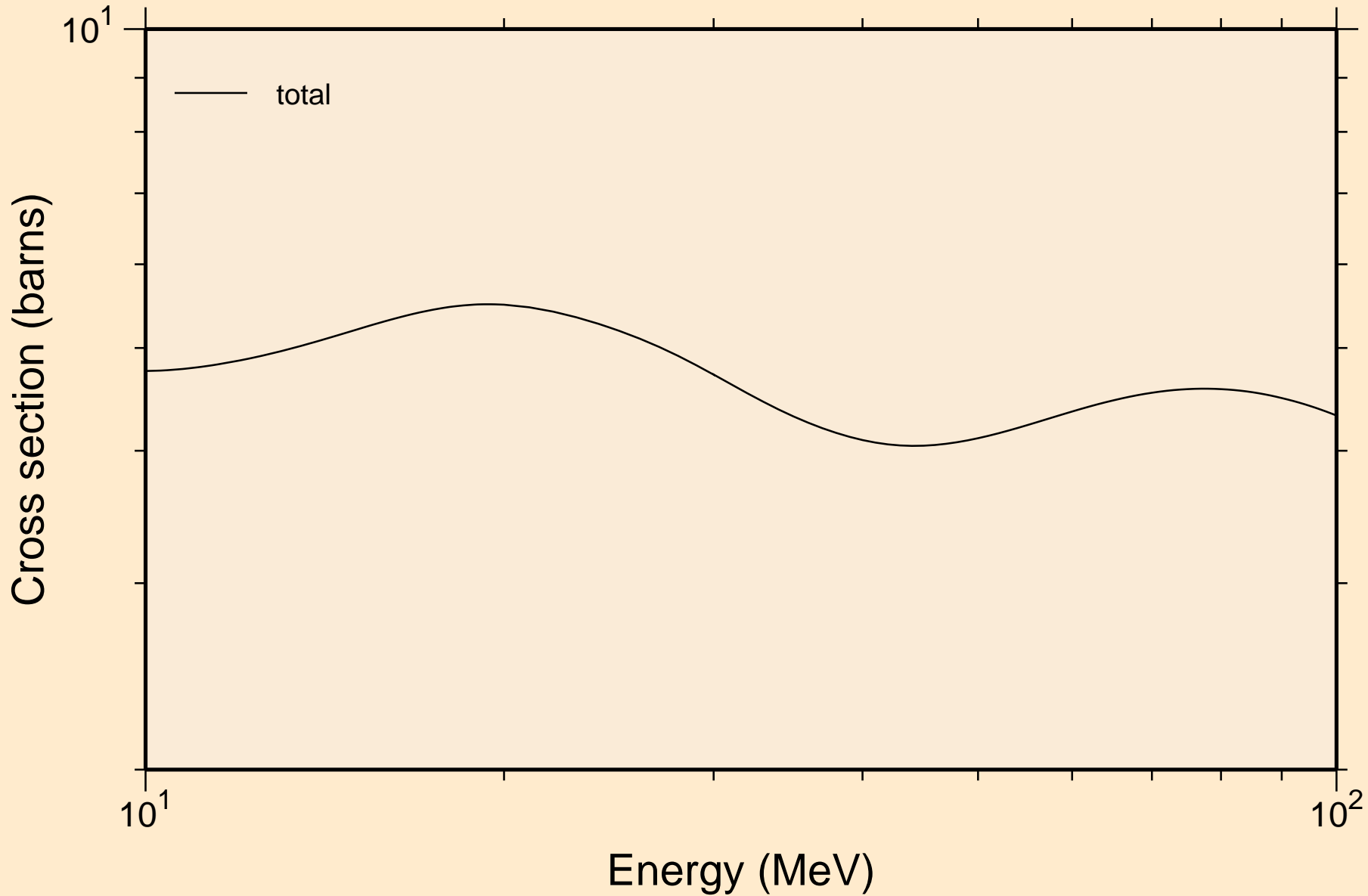

IR184 NEUTRON ACER TENDL-2021 LIBRARY; T=293.6K  
resonance absorption cross sections

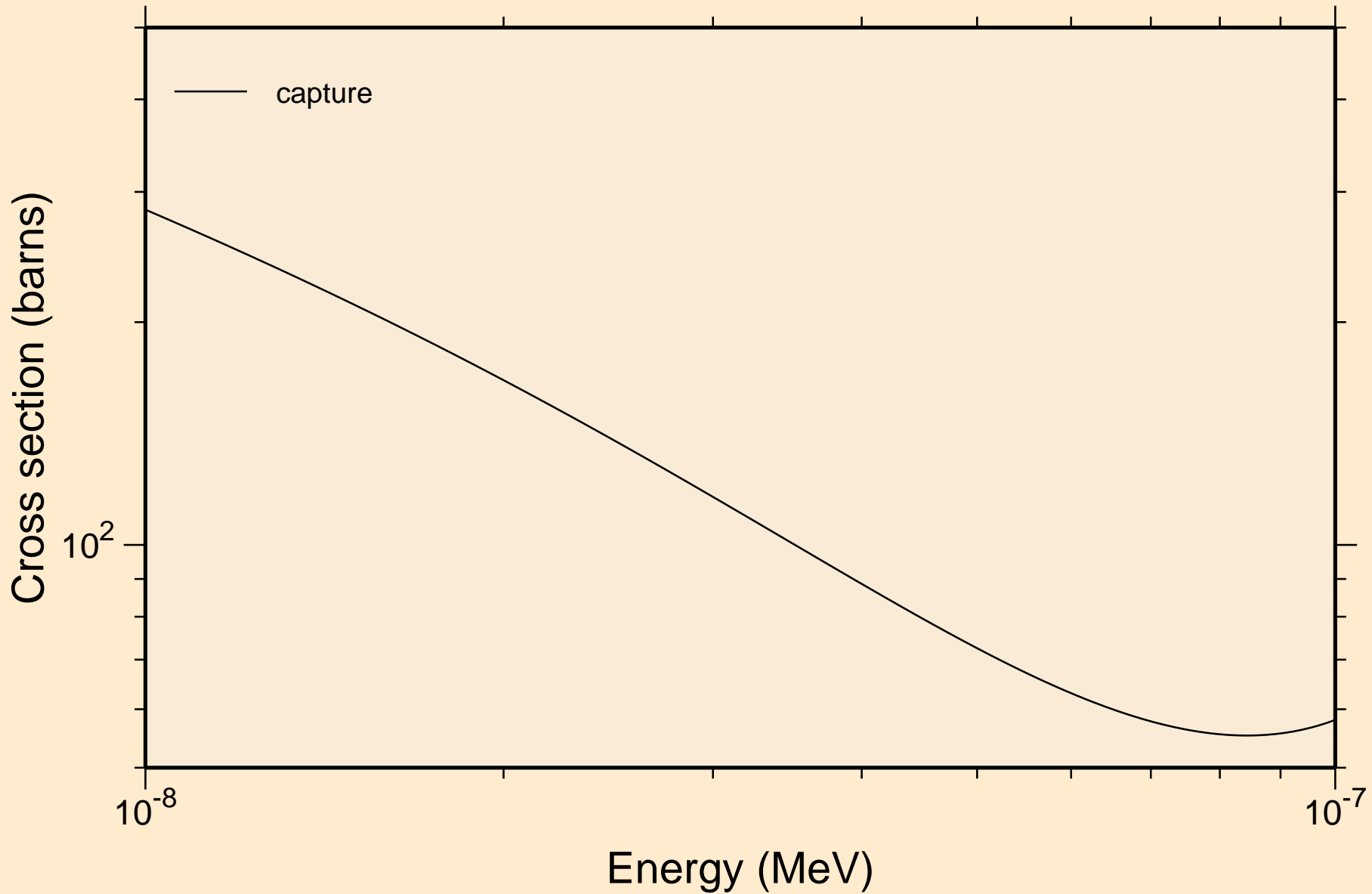

IR184 NEUTRON ACER TENDL-2021 LIBRARY; T=293.6K  
resonance absorption cross sections

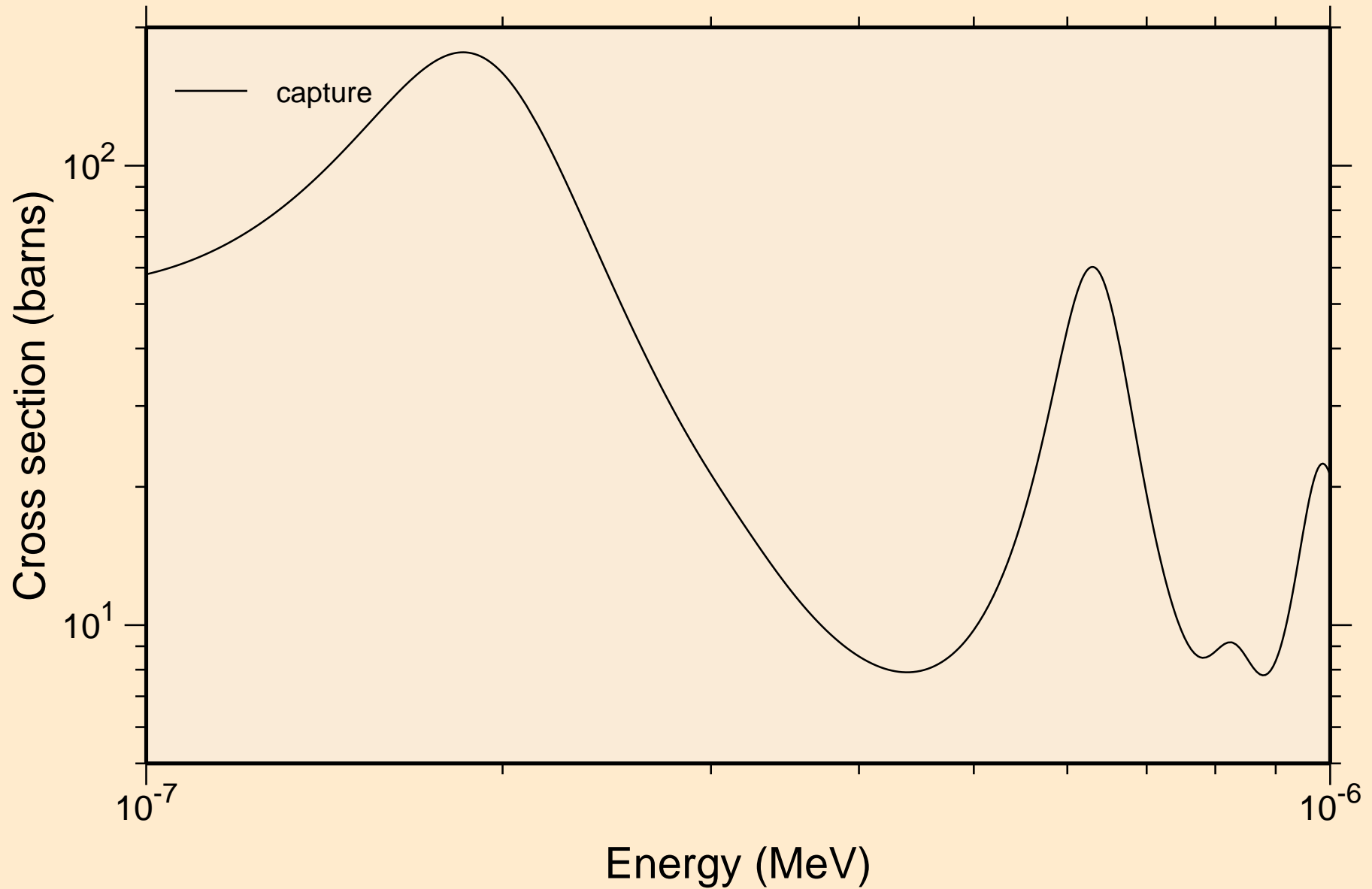



IR184 NEUTRON ACER TENDL-2021 LIBRARY; T=293.6K  
resonance absorption cross sections

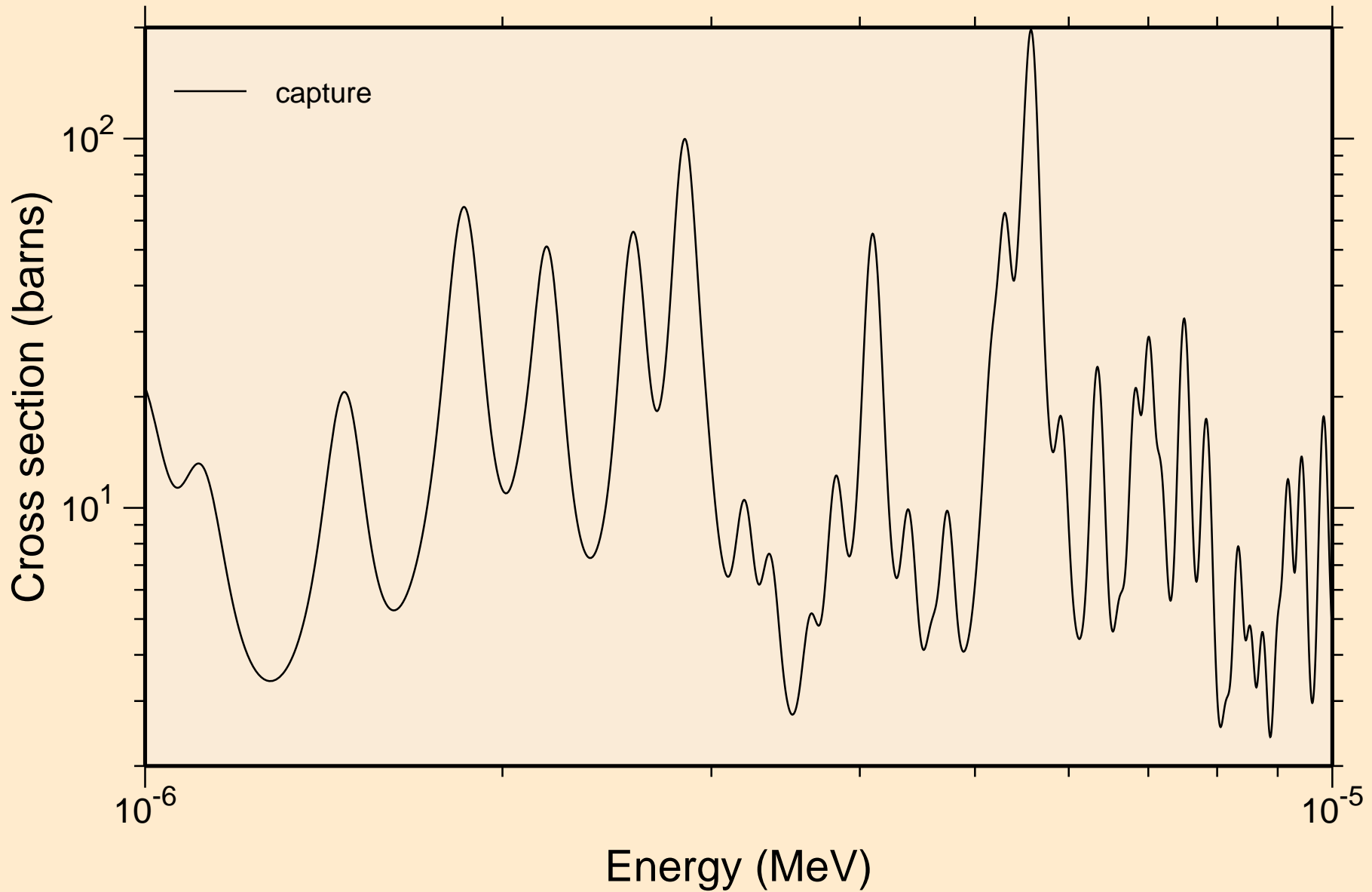

IR184 NEUTRON ACER TENDL-2021 LIBRARY; T=293.6K  
resonance absorption cross sections

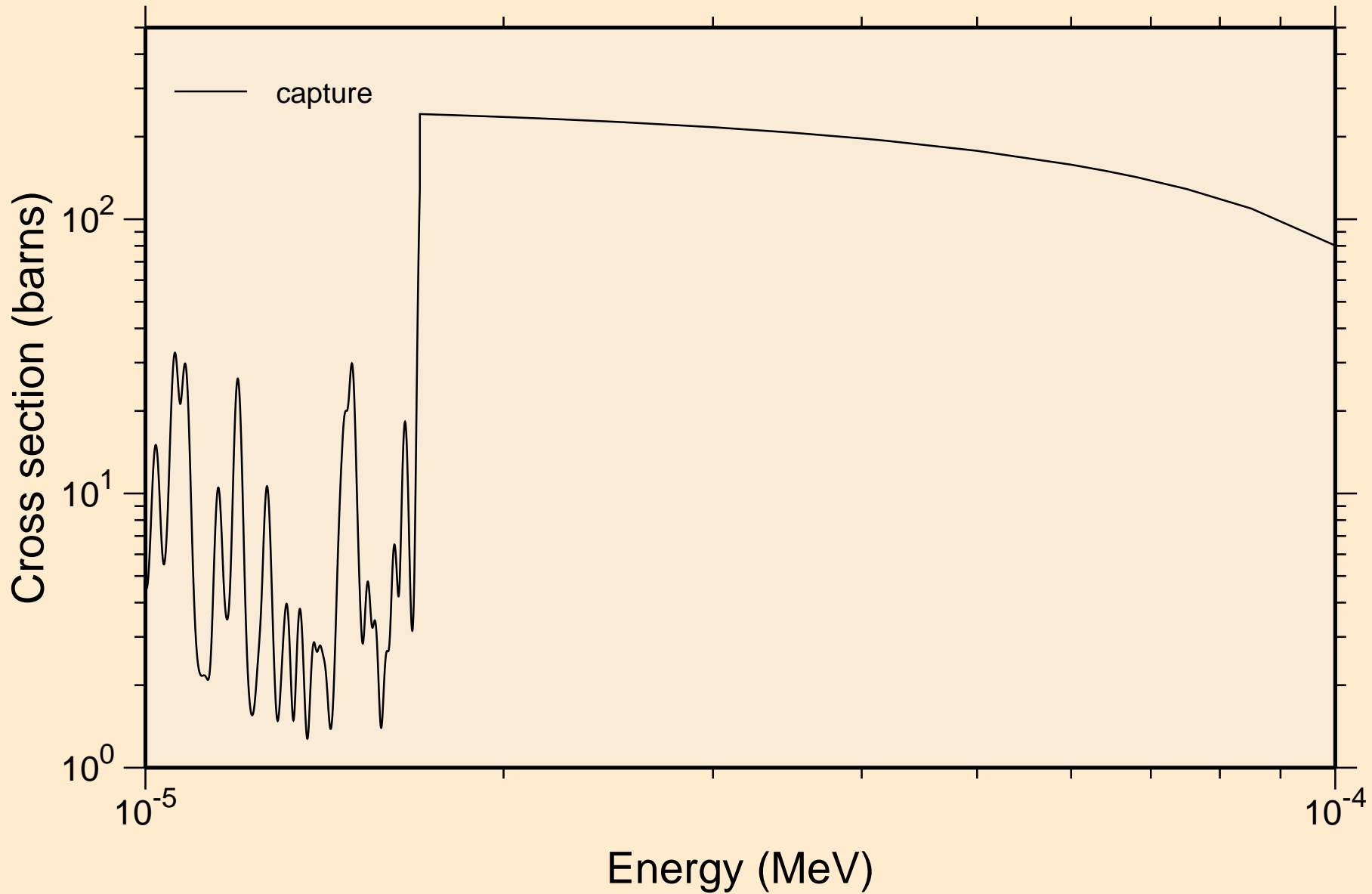

IR184 NEUTRON ACER TENDL-2021 LIBRARY; T=293.6K  
resonance absorption cross sections

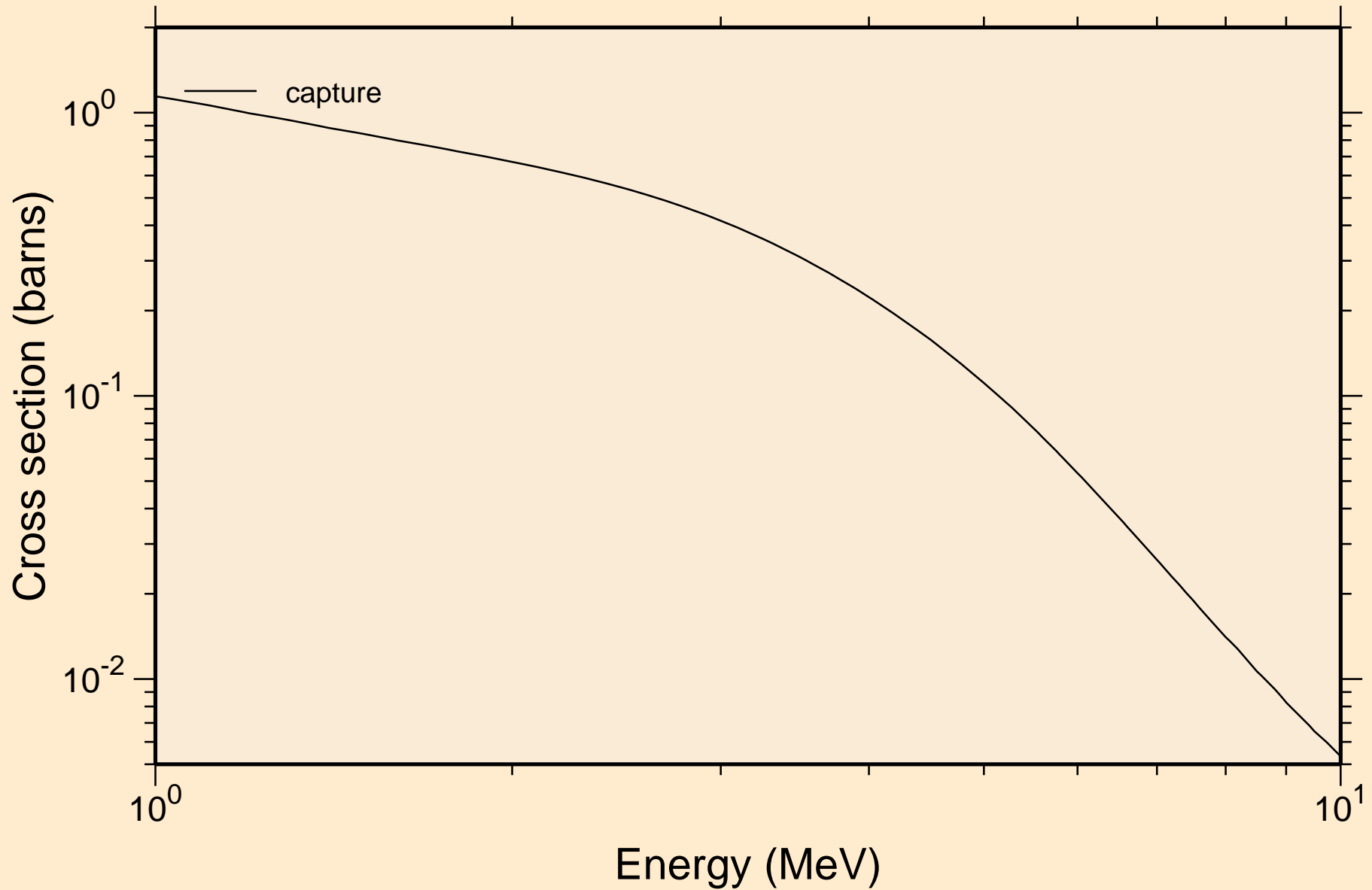

IR184 NEUTRON ACER TENDL-2021 LIBRARY; T=293.6K  
Heating

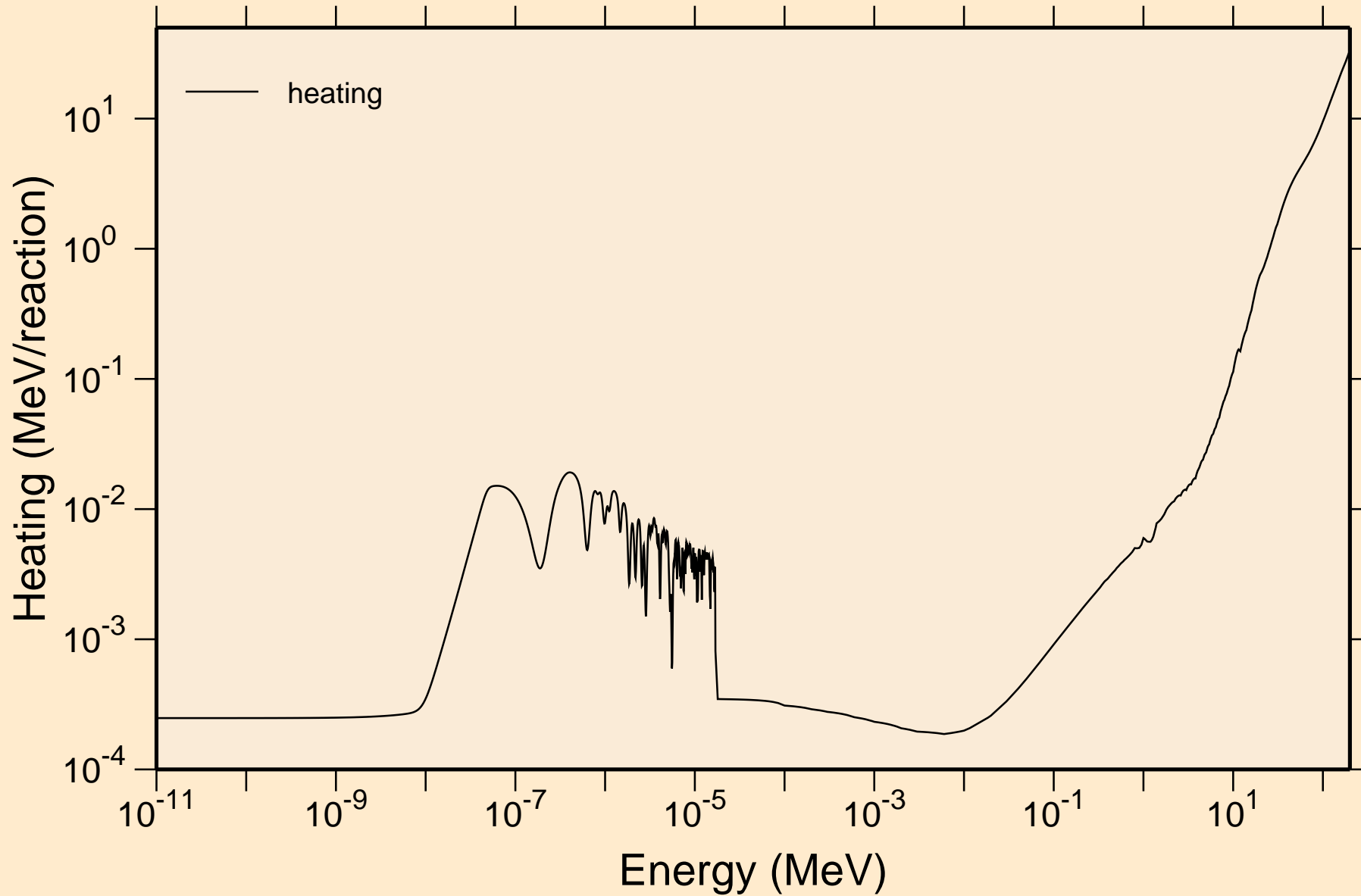

IR184 NEUTRON ACER TENDL-2021 LIBRARY; T=293.6K  
Damage

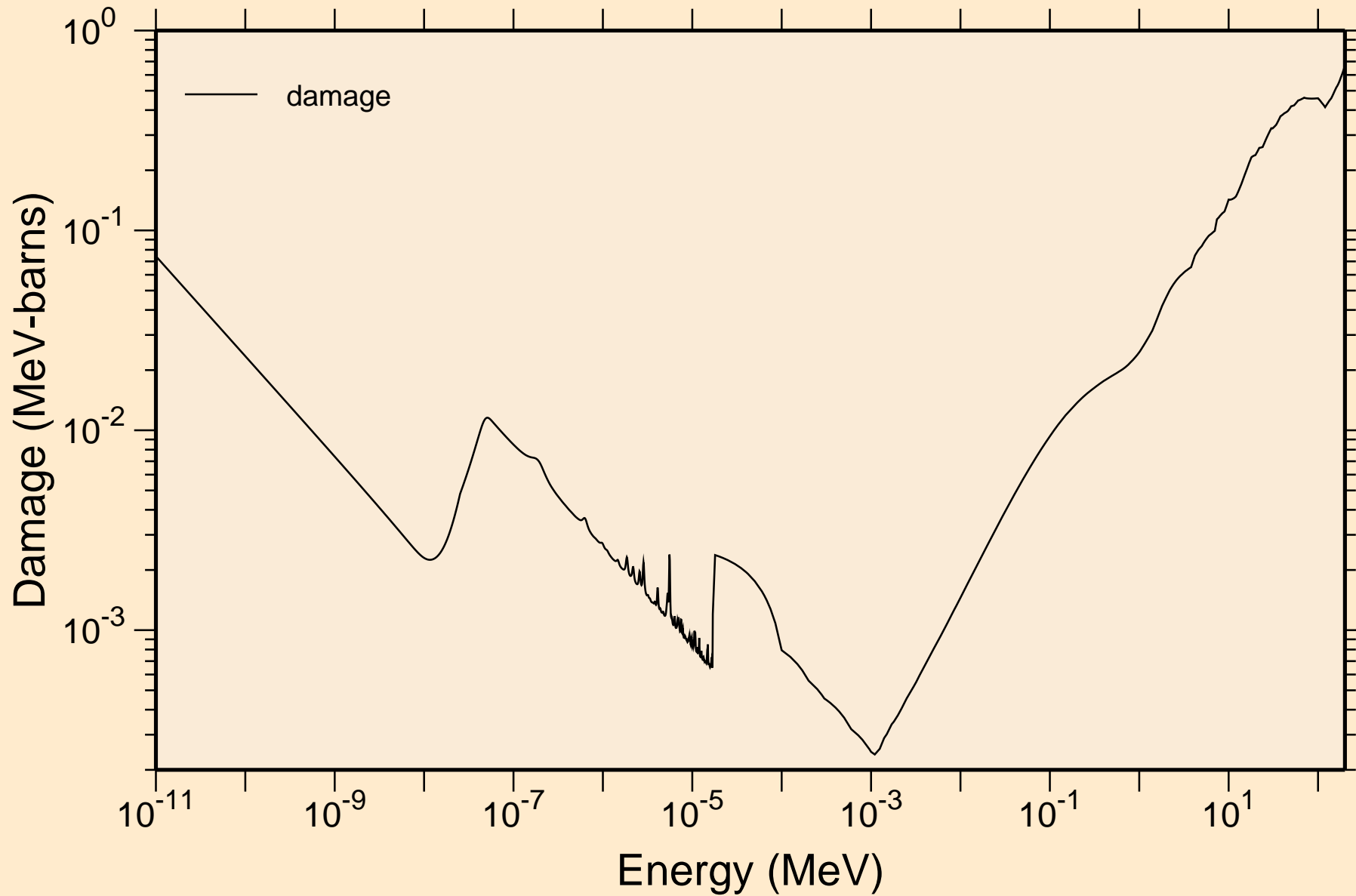

# IR184 NEUTRON ACER TENDL-2021 LIBRARY; T=293.6K

## Non-threshold reactions

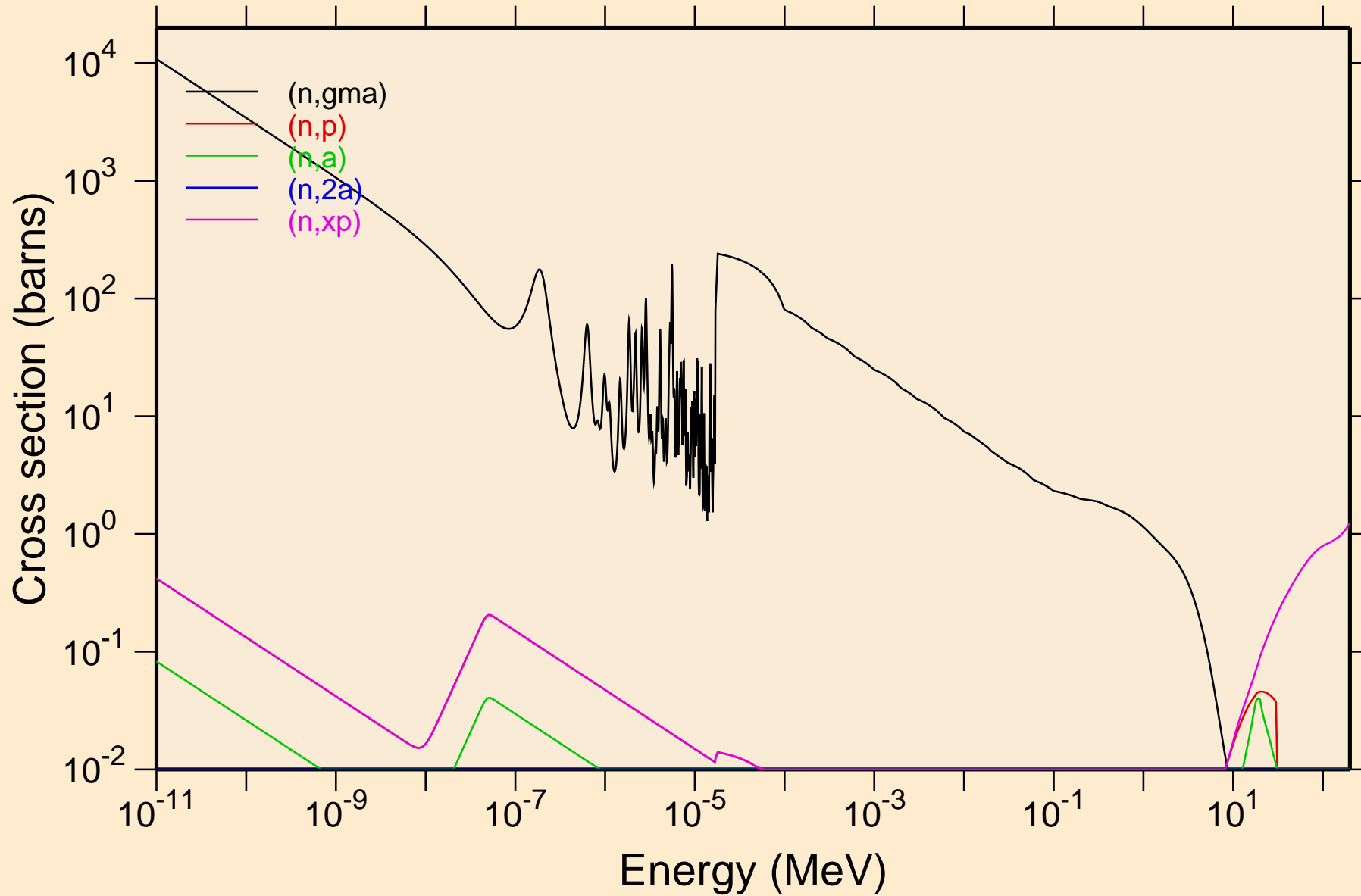

IR184 NEUTRON ACER TENDL-2021 LIBRARY; T=293.6K  
Non-threshold reactions

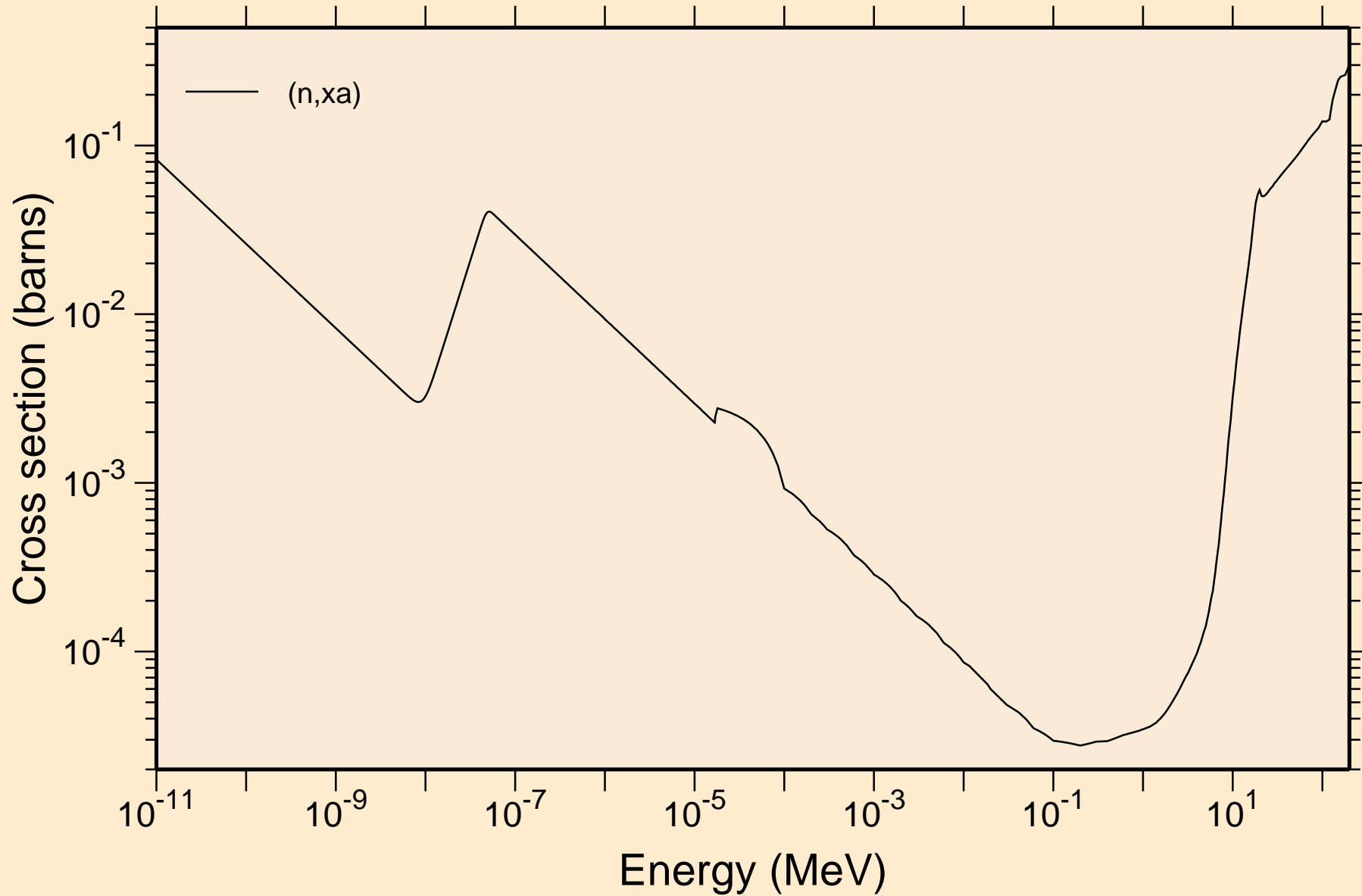

IR184 NEUTRON ACER TENDL-2021 LIBRARY; T=293.6K  
Principal cross sections

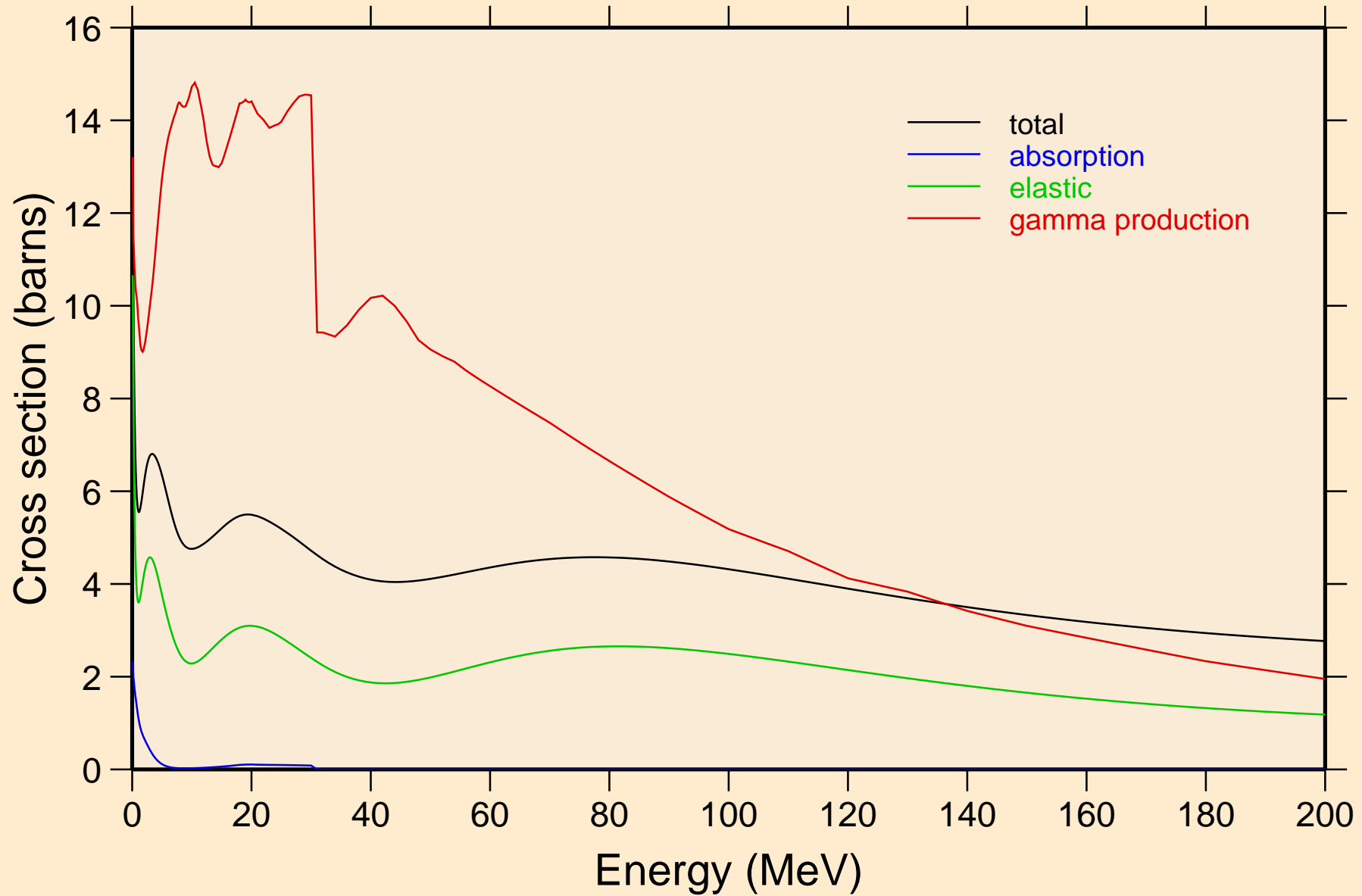



IR184 NEUTRON ACER TENDL-2021 LIBRARY; T=293.6K

Heating

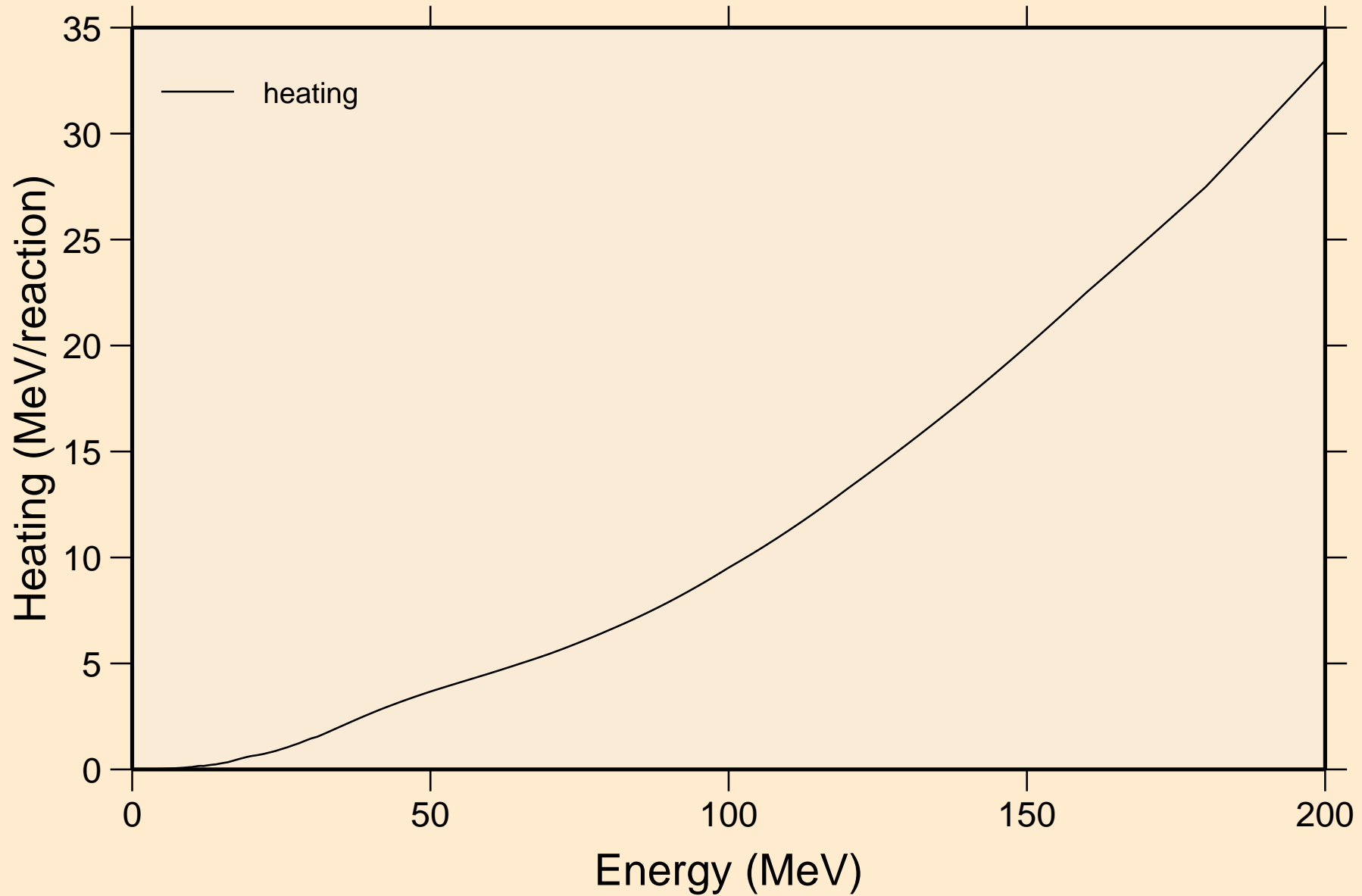

IR184 NEUTRON ACER TENDL-2021 LIBRARY; T=293.6K  
Damage

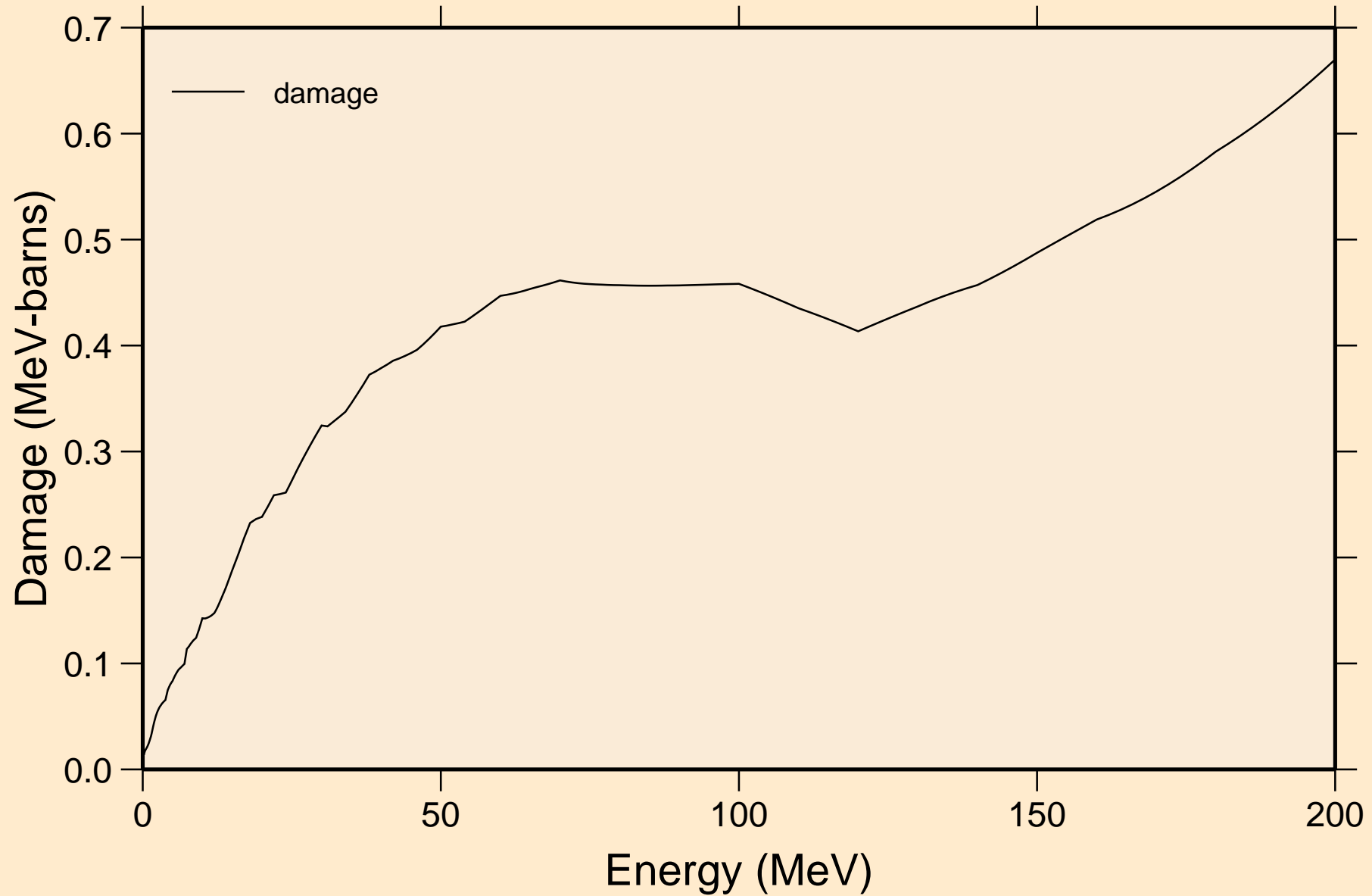

IR184 NEUTRON ACER TENDL-2021 LIBRARY; T=293.6K  
Non-threshold reactions

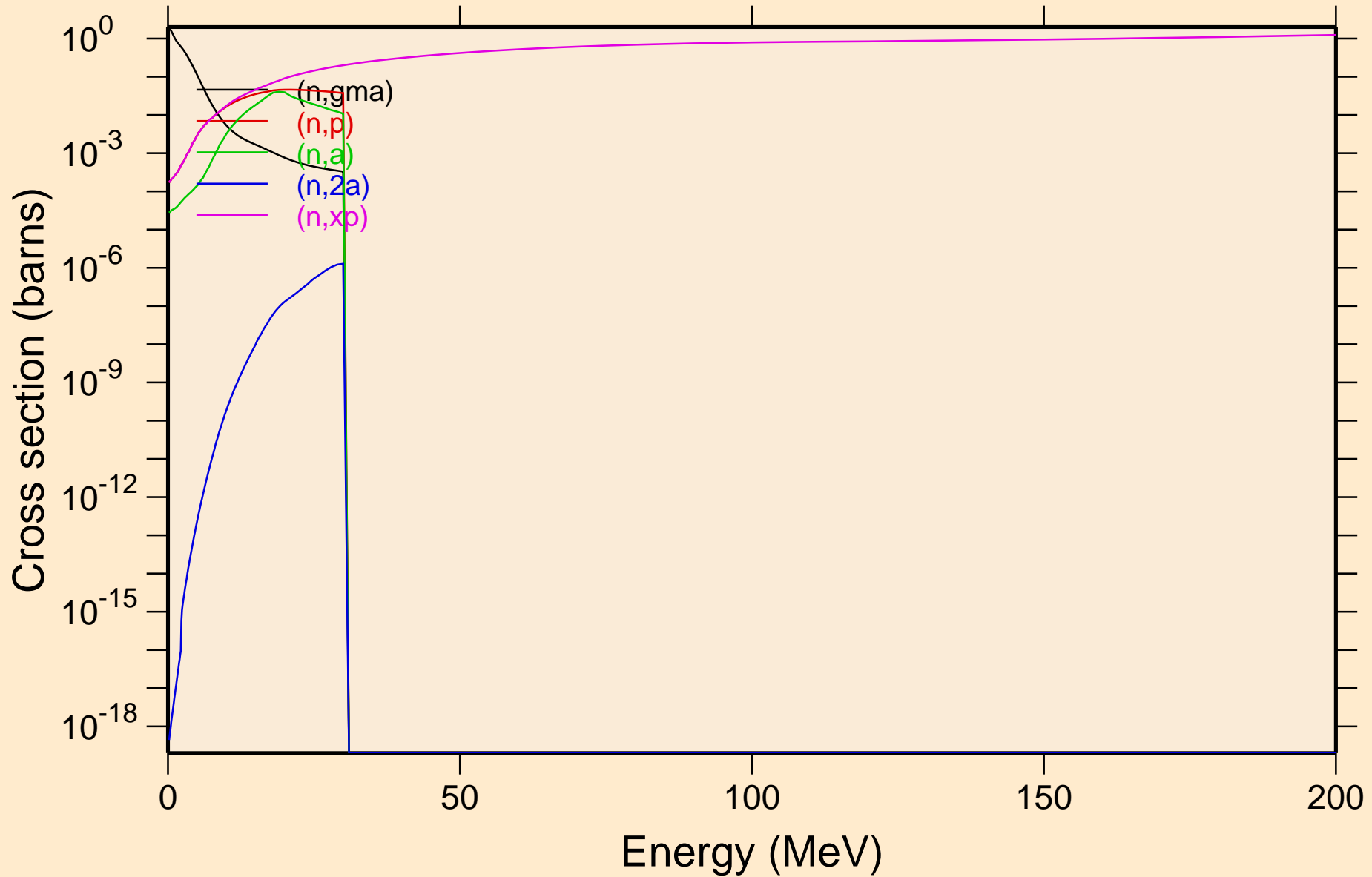

IR184 NEUTRON ACER TENDL-2021 LIBRARY; T=293.6K  
Non-threshold reactions

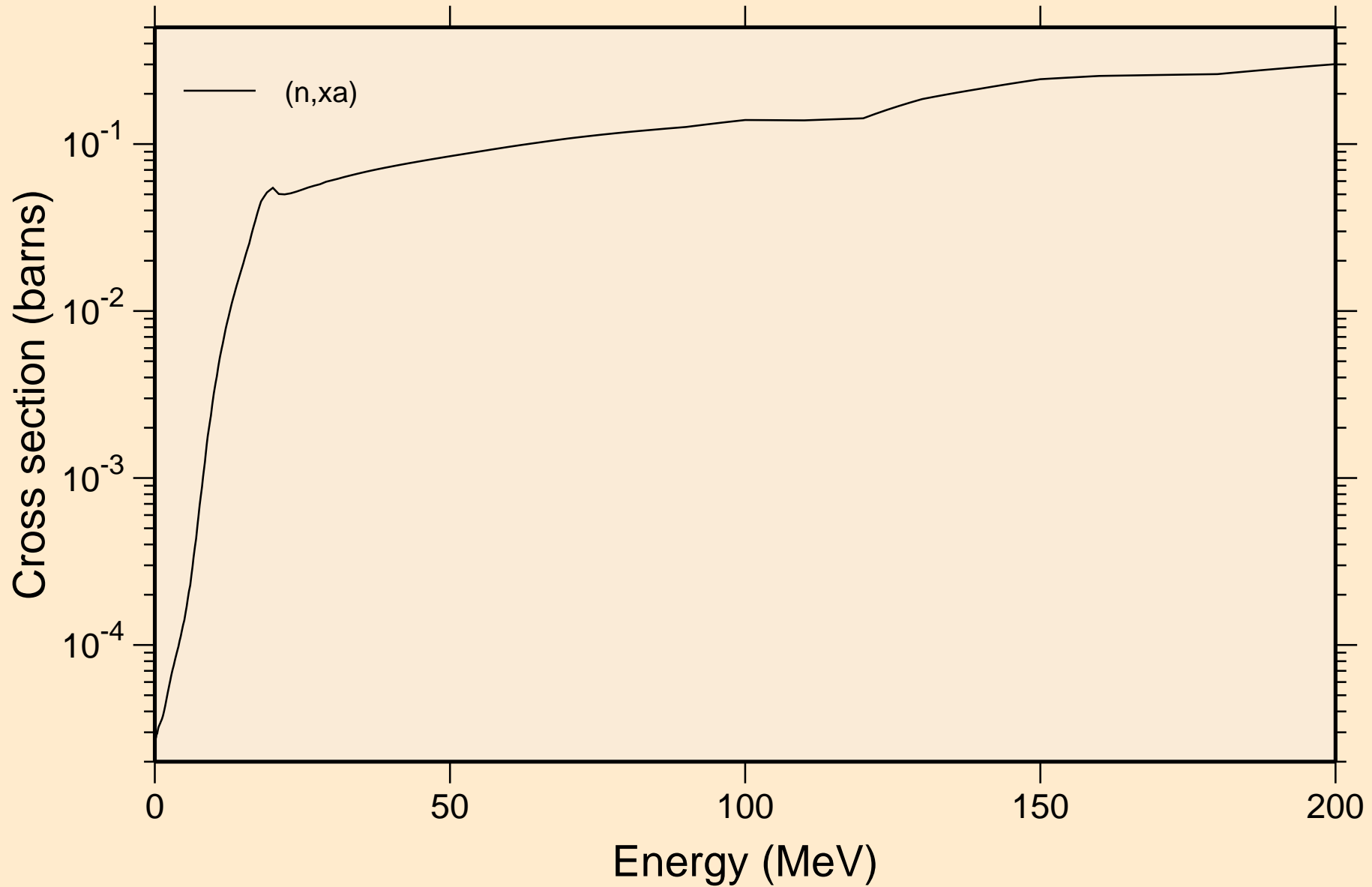

IR184 NEUTRON ACER TENDL-2021 LIBRARY; T=293.6K  
Inelastic levels

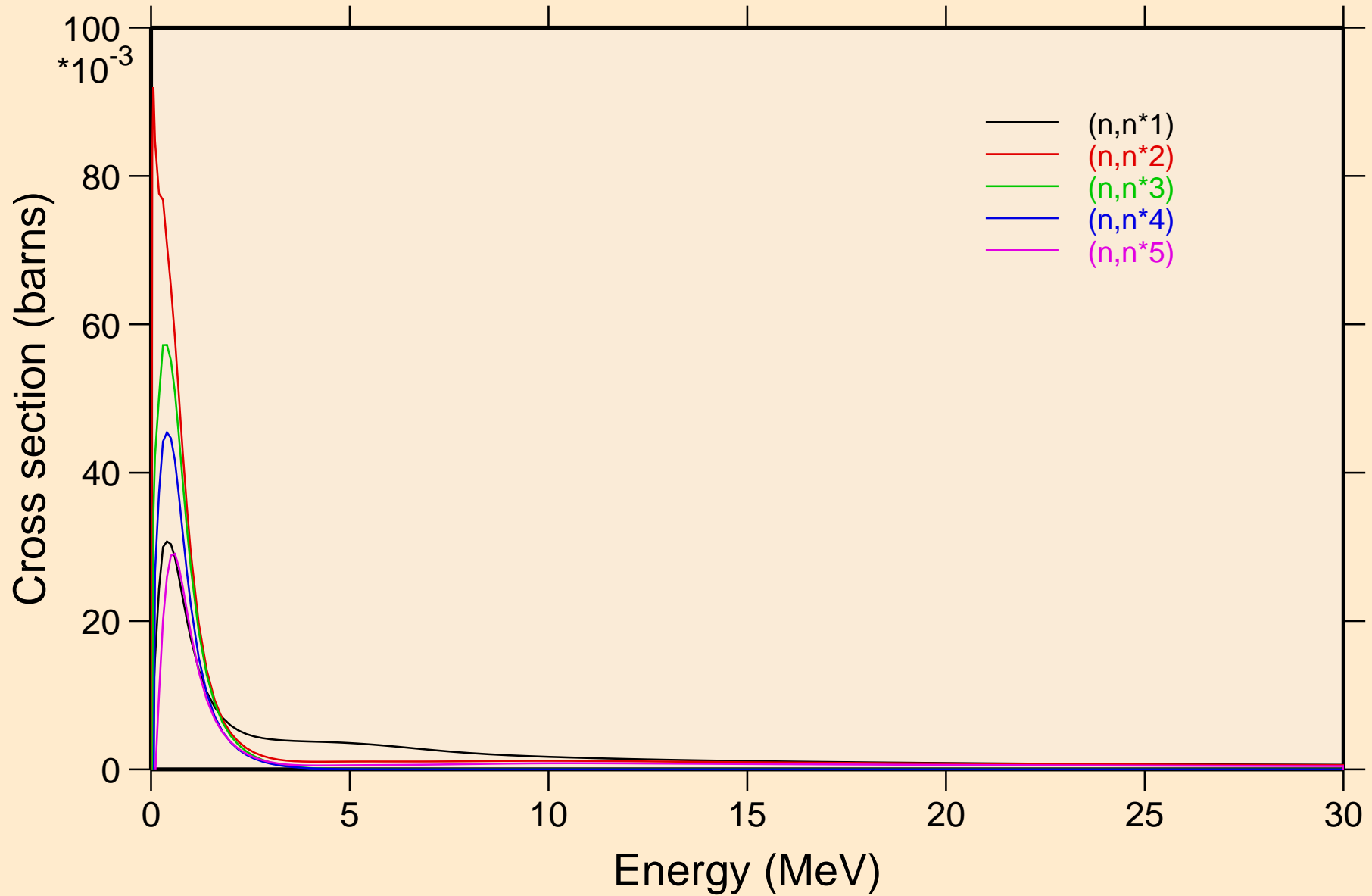

IR184 NEUTRON ACER TENDL-2021 LIBRARY; T=293.6K  
Inelastic levels

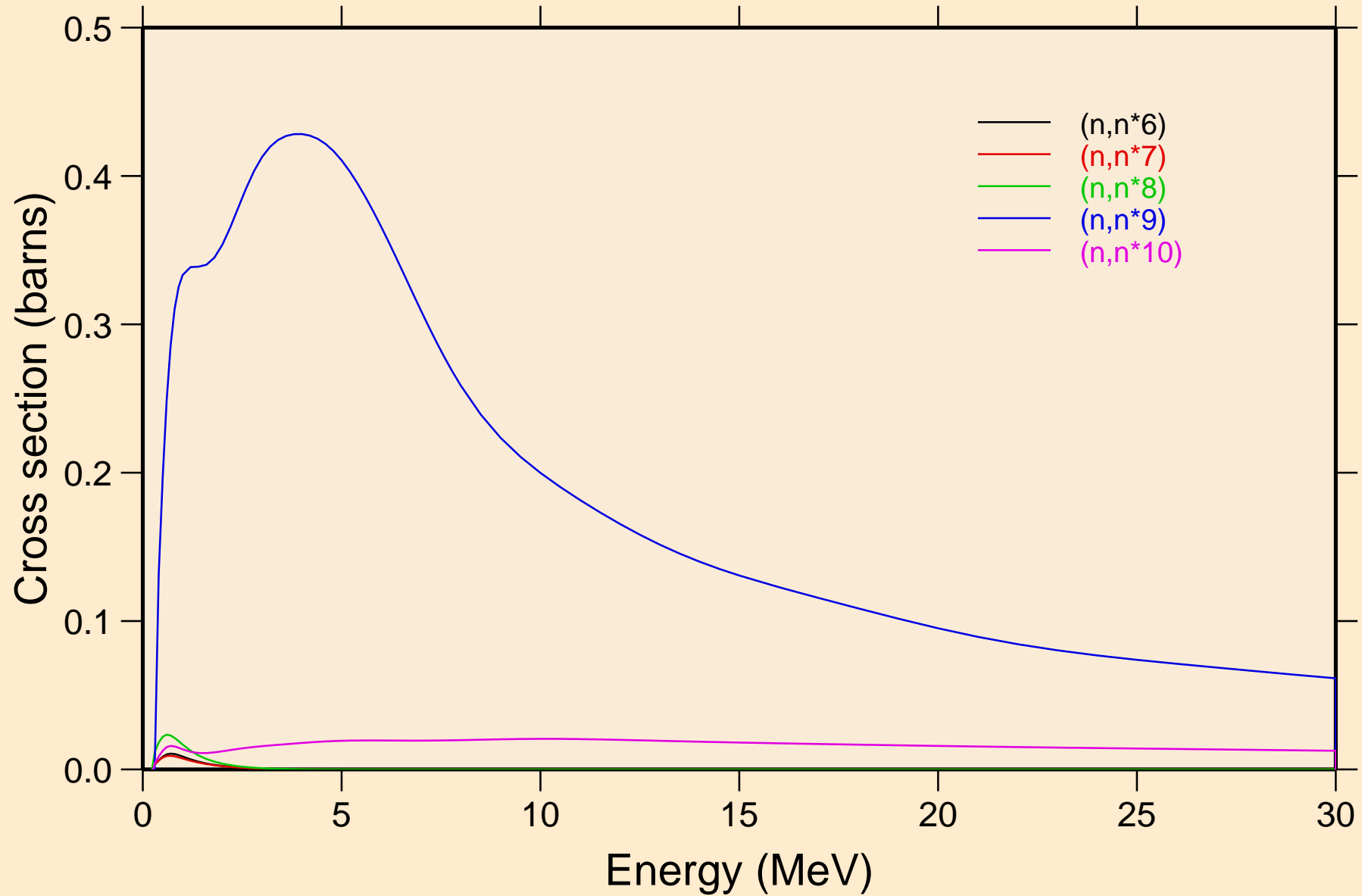

IR184 NEUTRON ACER TENDL-2021 LIBRARY; T=293.6K  
Inelastic levels

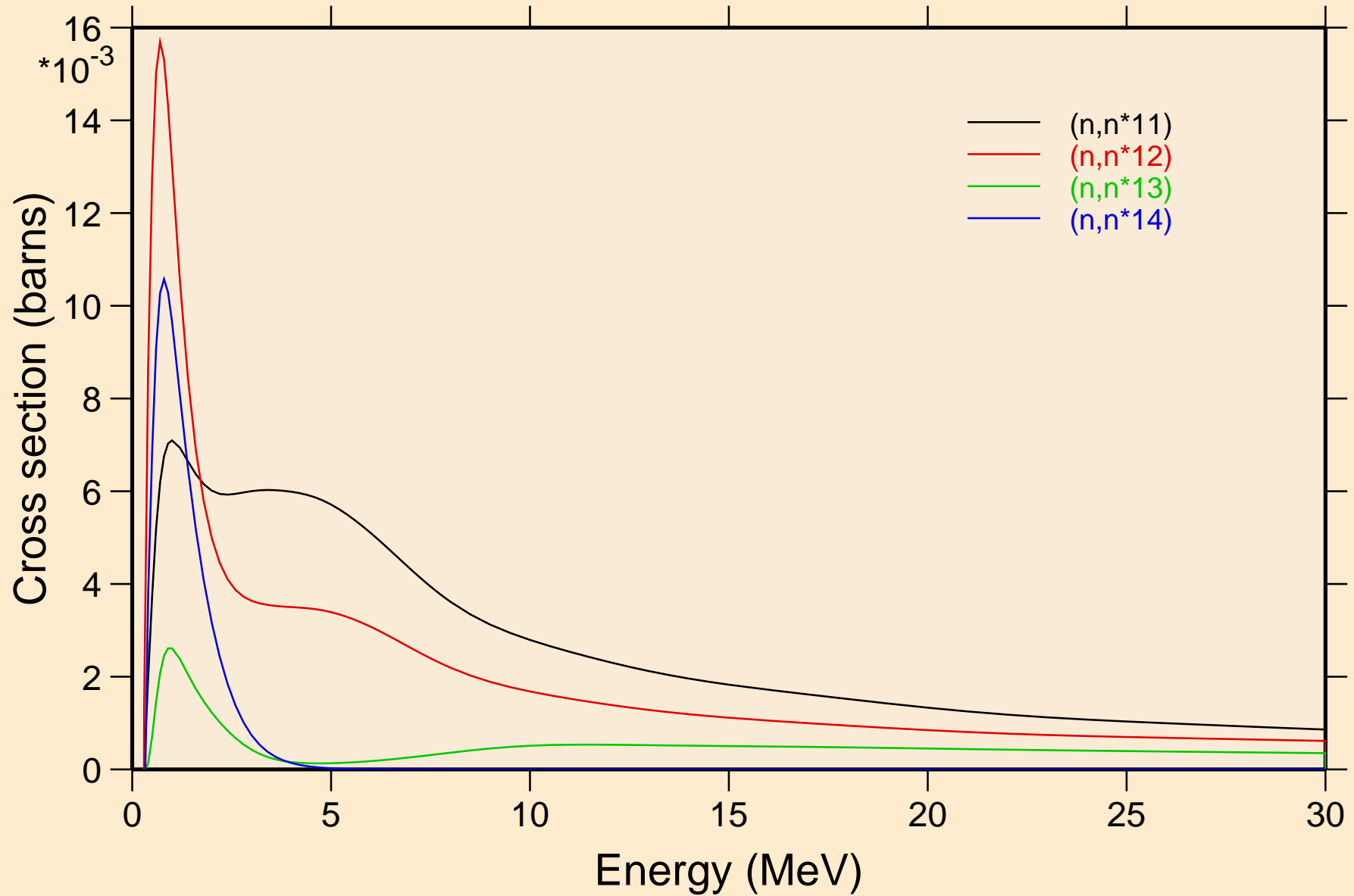

IR184 NEUTRON ACER TENDL-2021 LIBRARY; T=293.6K  
Threshold reactions

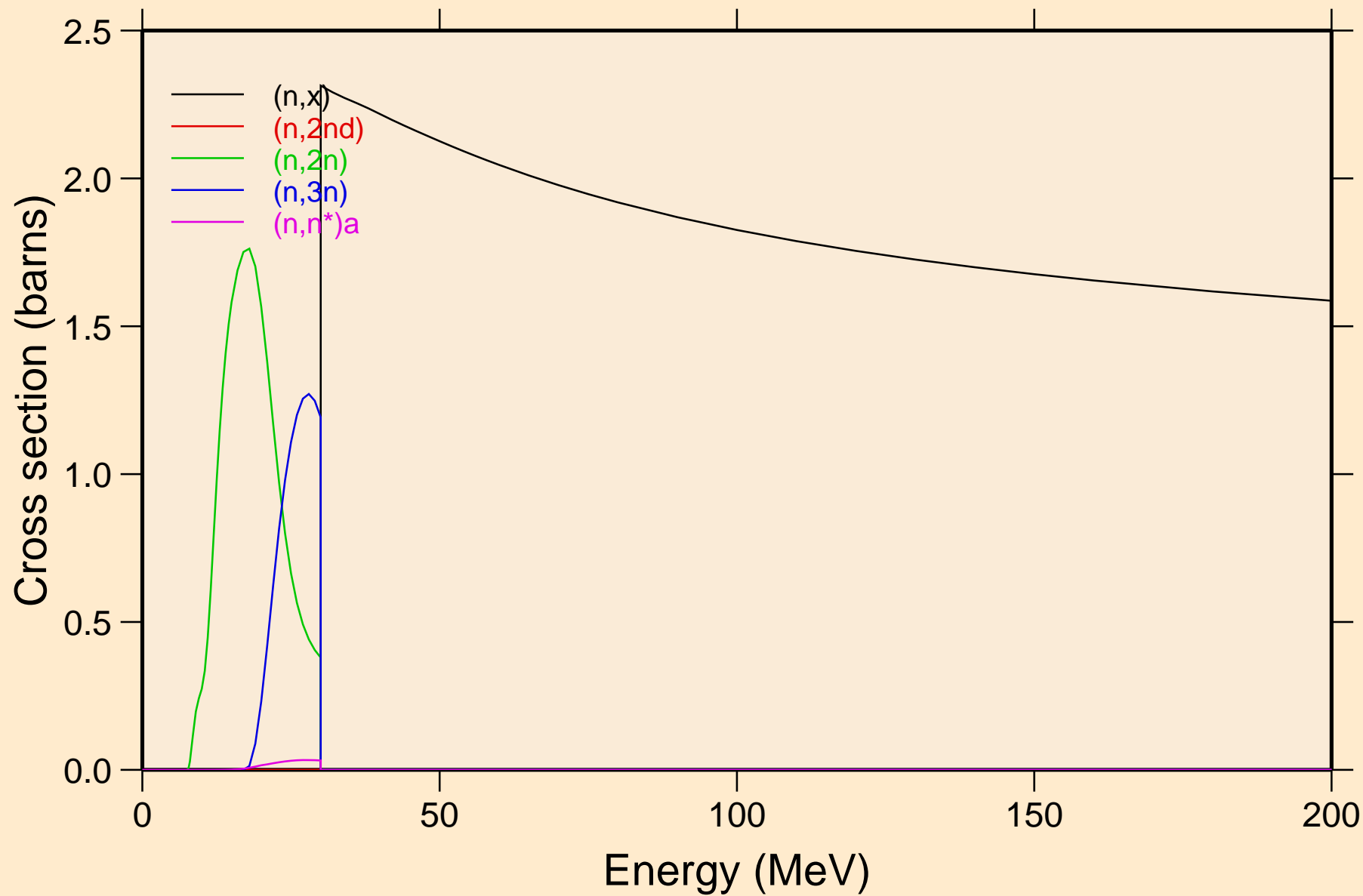



IR184 NEUTRON ACER TENDL-2021 LIBRARY; T=293.6K  
Threshold reactions

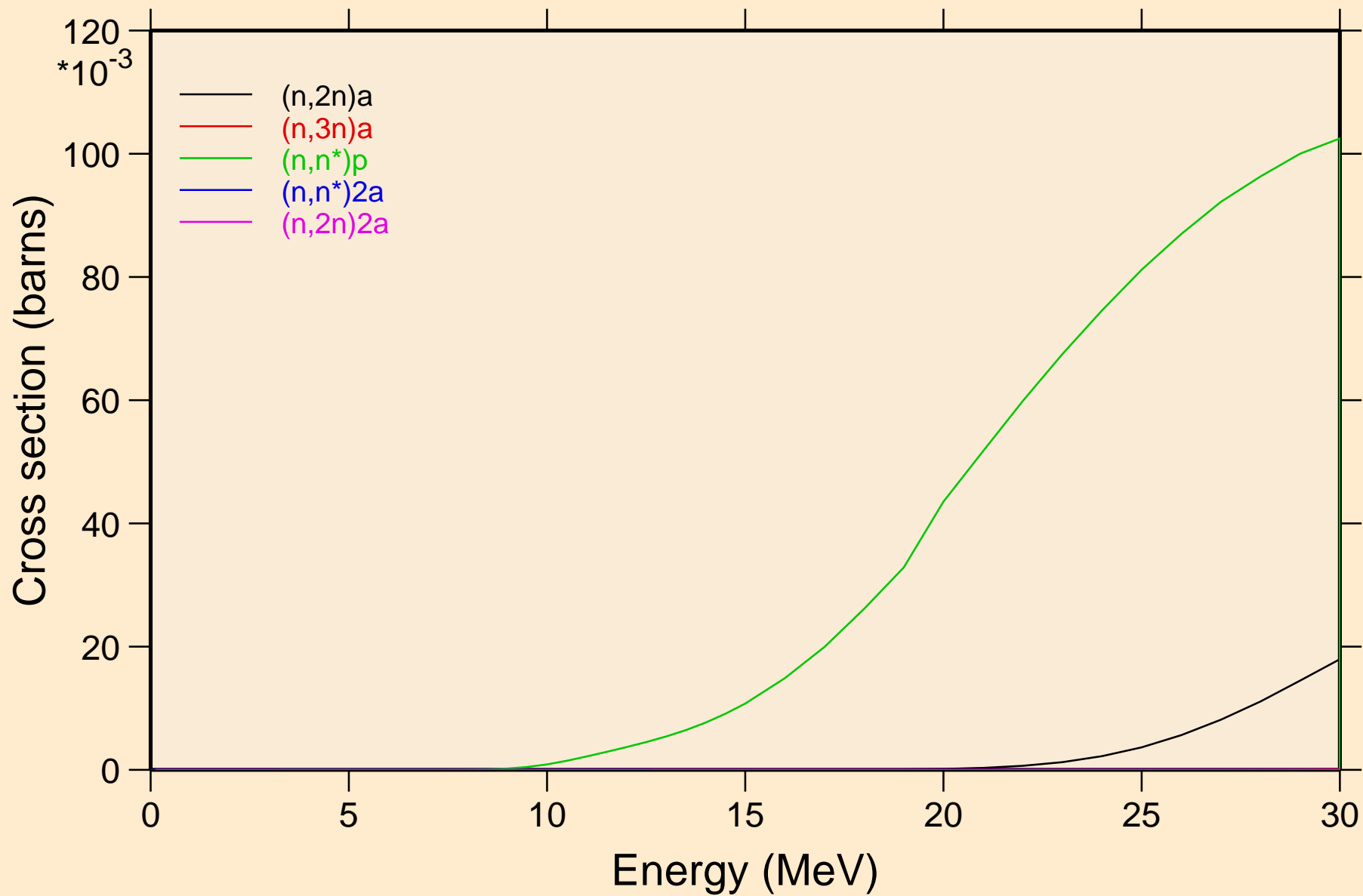

# IR184 NEUTRON ACER TENDL-2021 LIBRARY; T=293.6K

## Threshold reactions

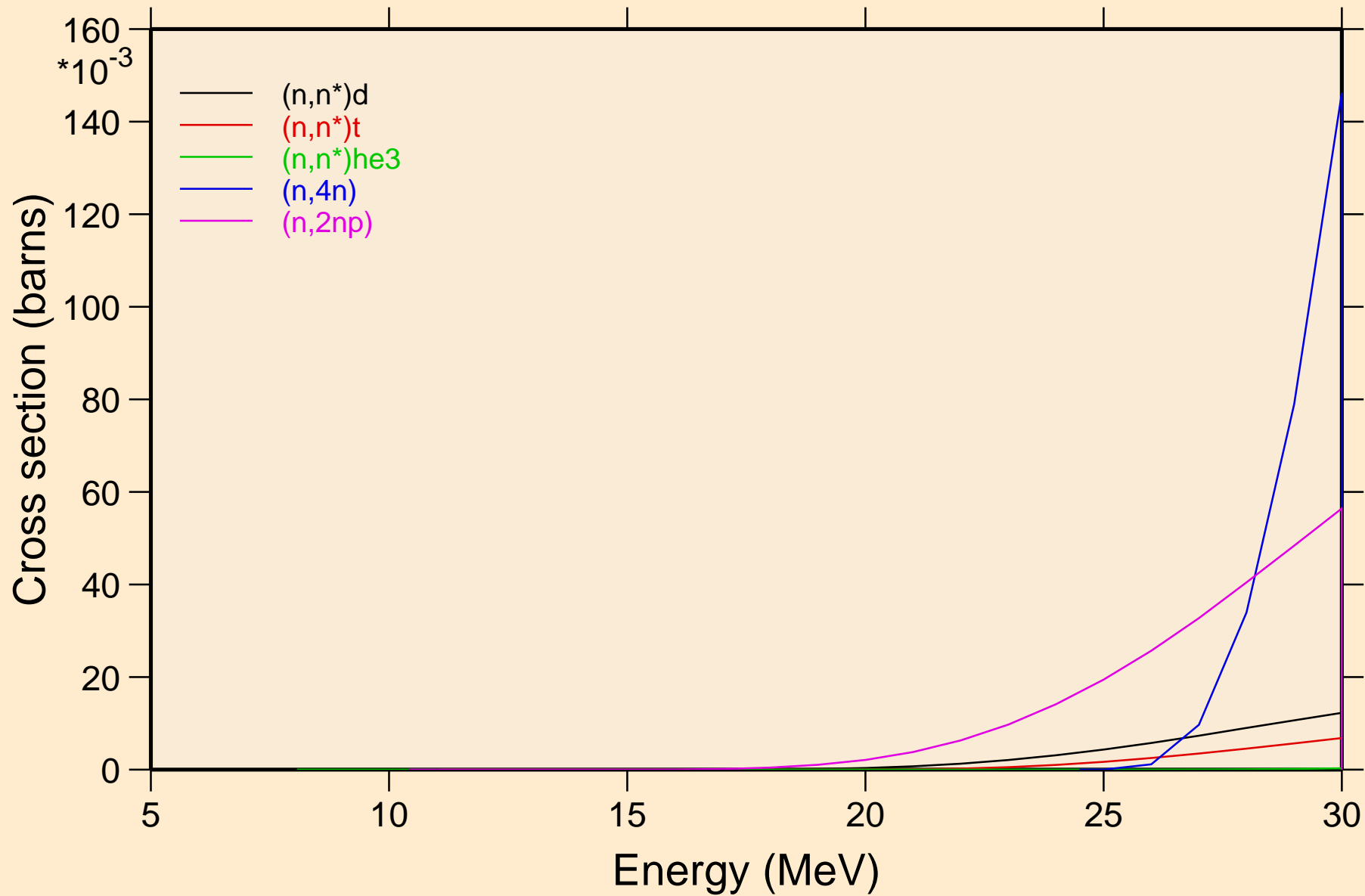

IR184 NEUTRON ACER TENDL-2021 LIBRARY; T=293.6K  
Threshold reactions

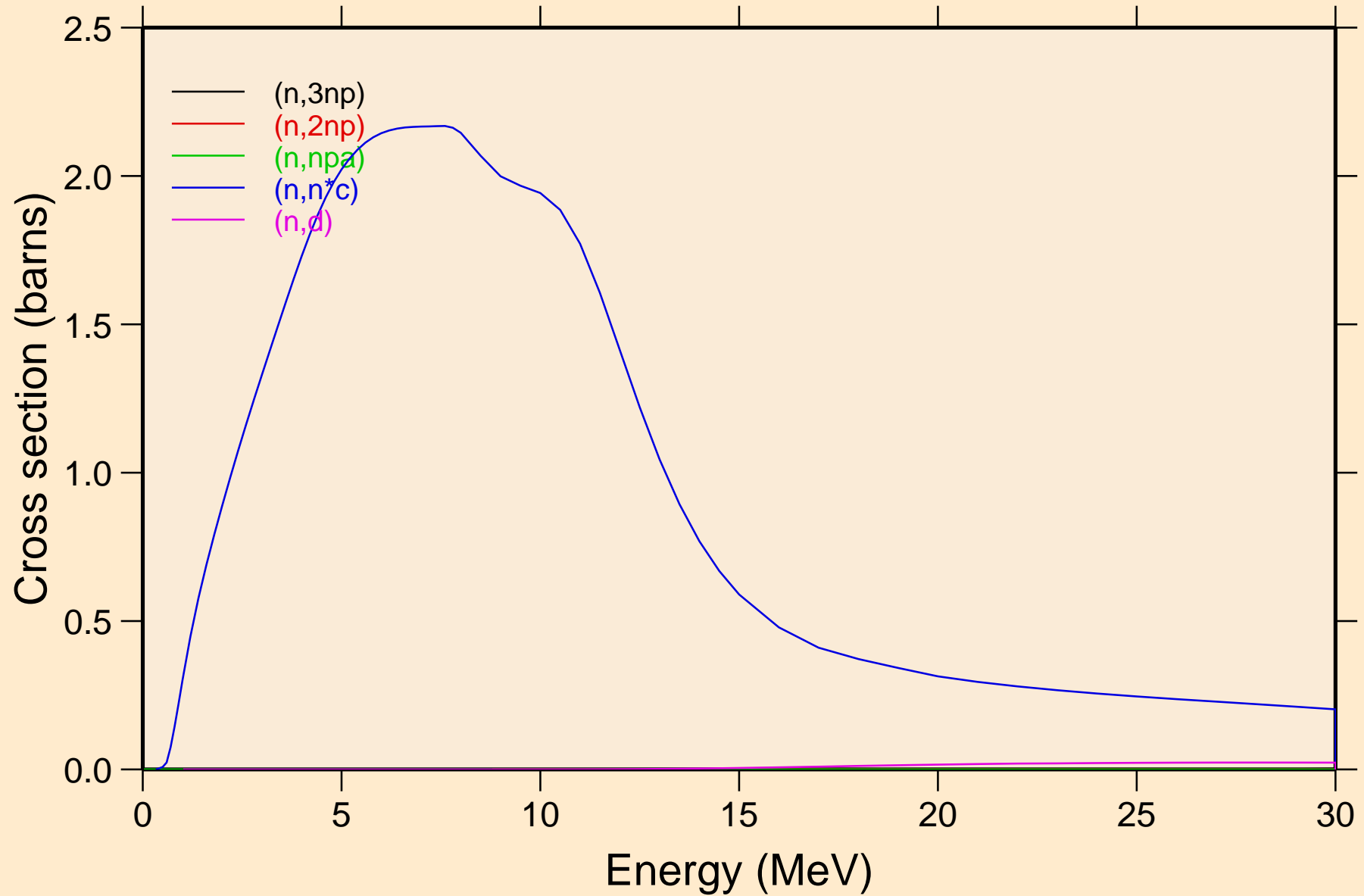

IR184 NEUTRON ACER TENDL-2021 LIBRARY; T=293.6K  
Threshold reactions

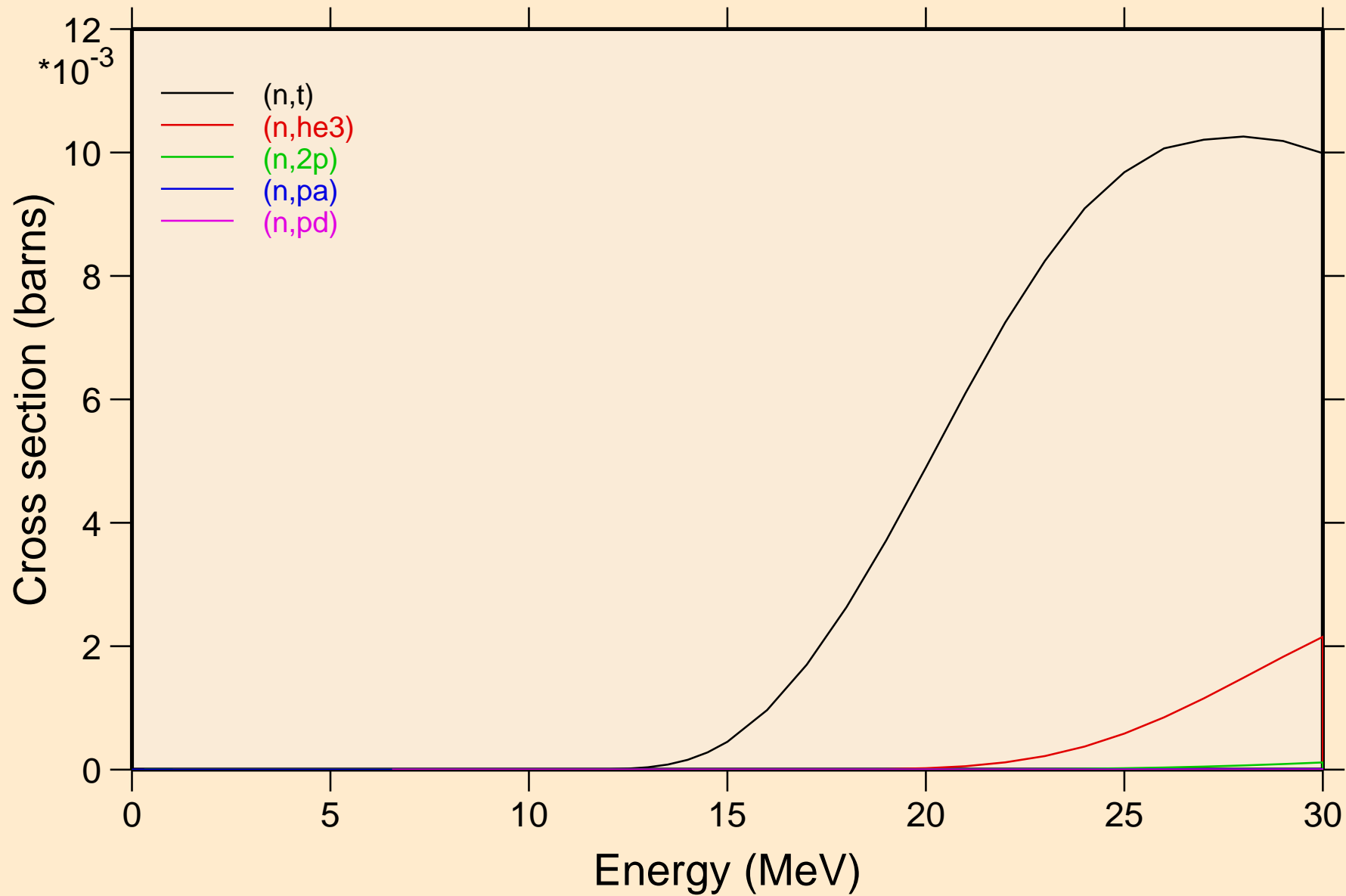

IR184 NEUTRON ACER TENDL-2021 LIBRARY; T=293.6K  
Threshold reactions

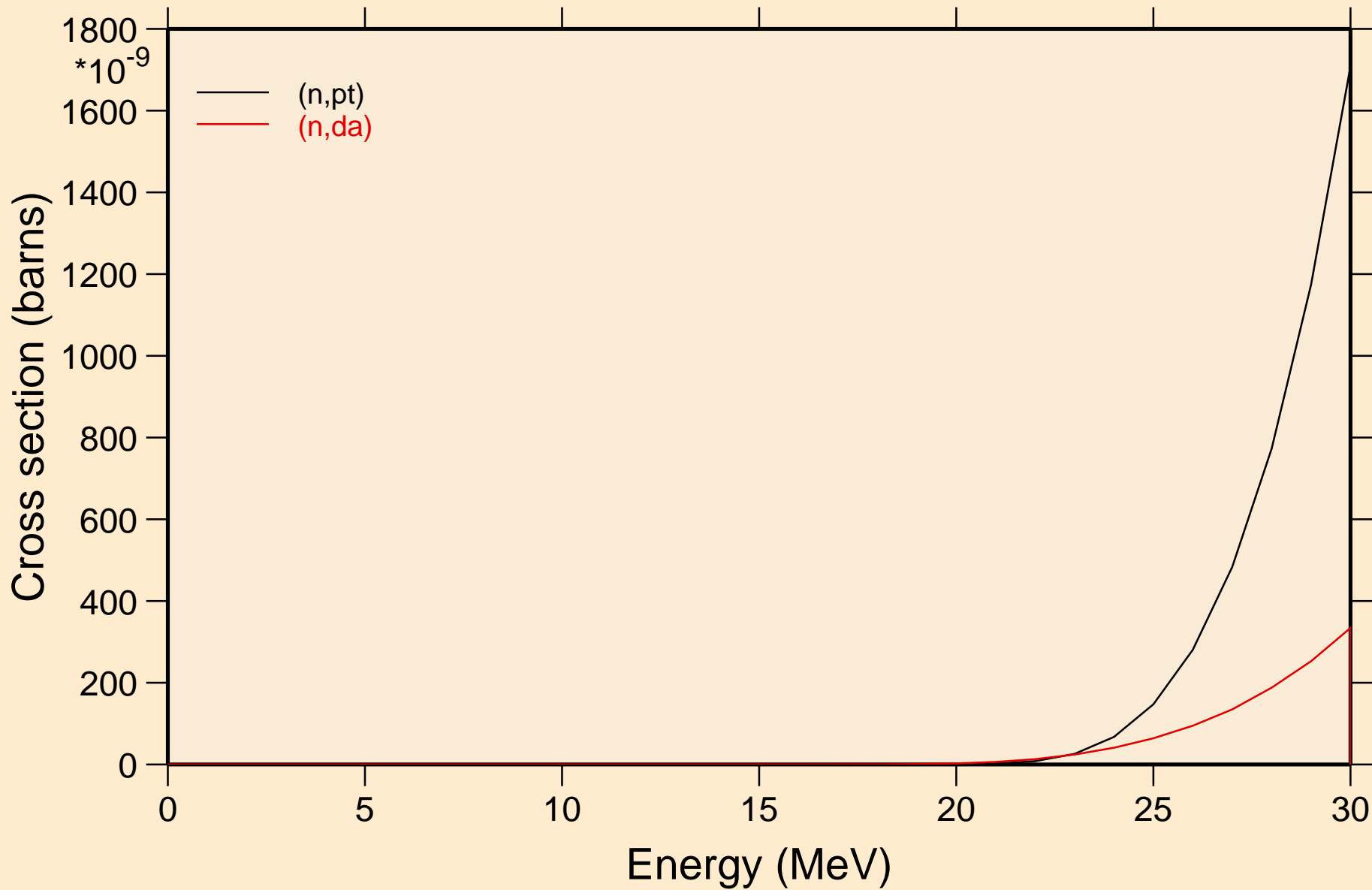

IR184 NEUTRON ACER TENDL-2021 LIBRARY; T=293.6K  
Threshold reactions

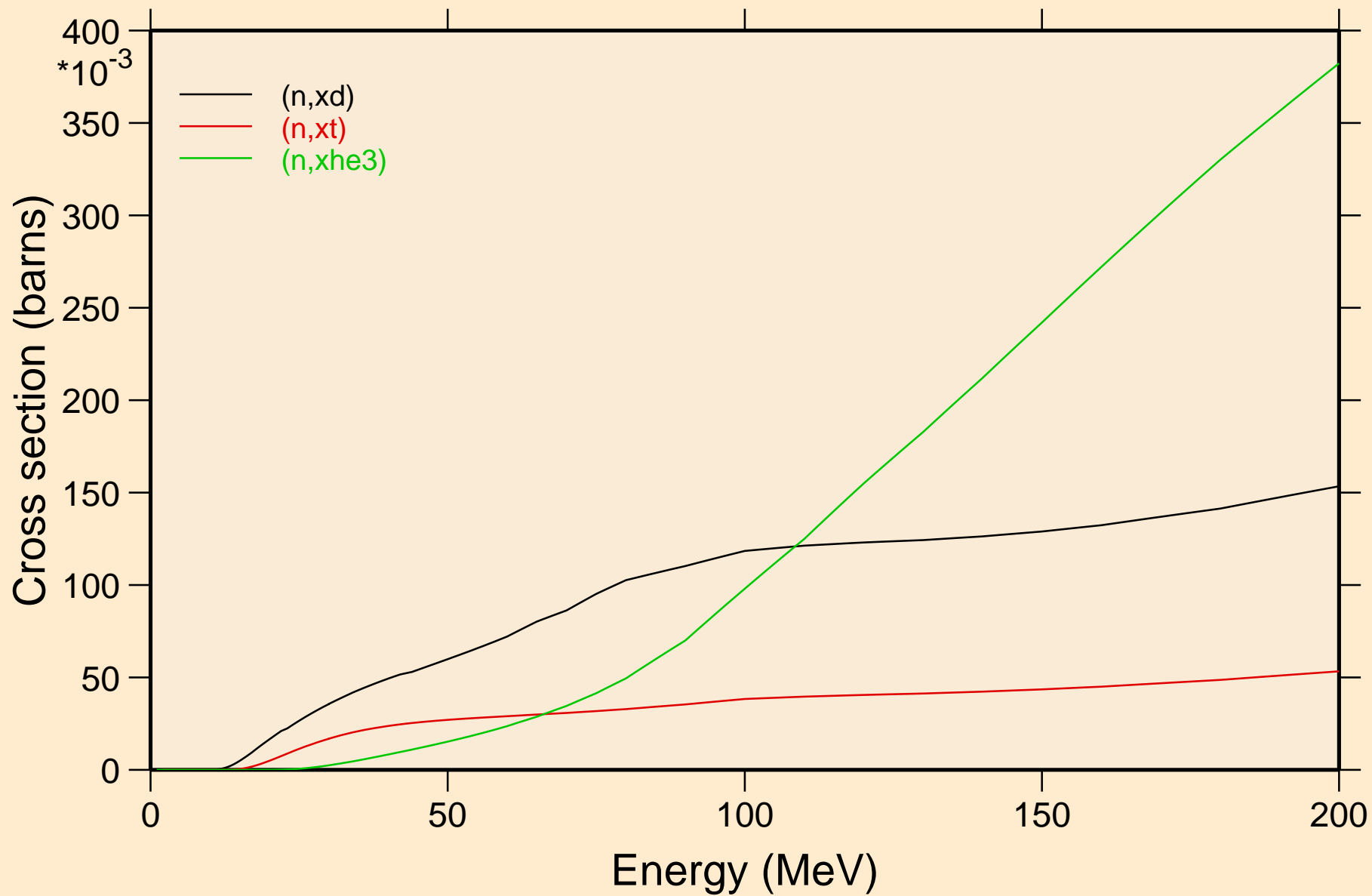

IR184 NEUTRON ACER TENDL-2021 LIBRARY; T=293.6K  
angular distribution for elastic

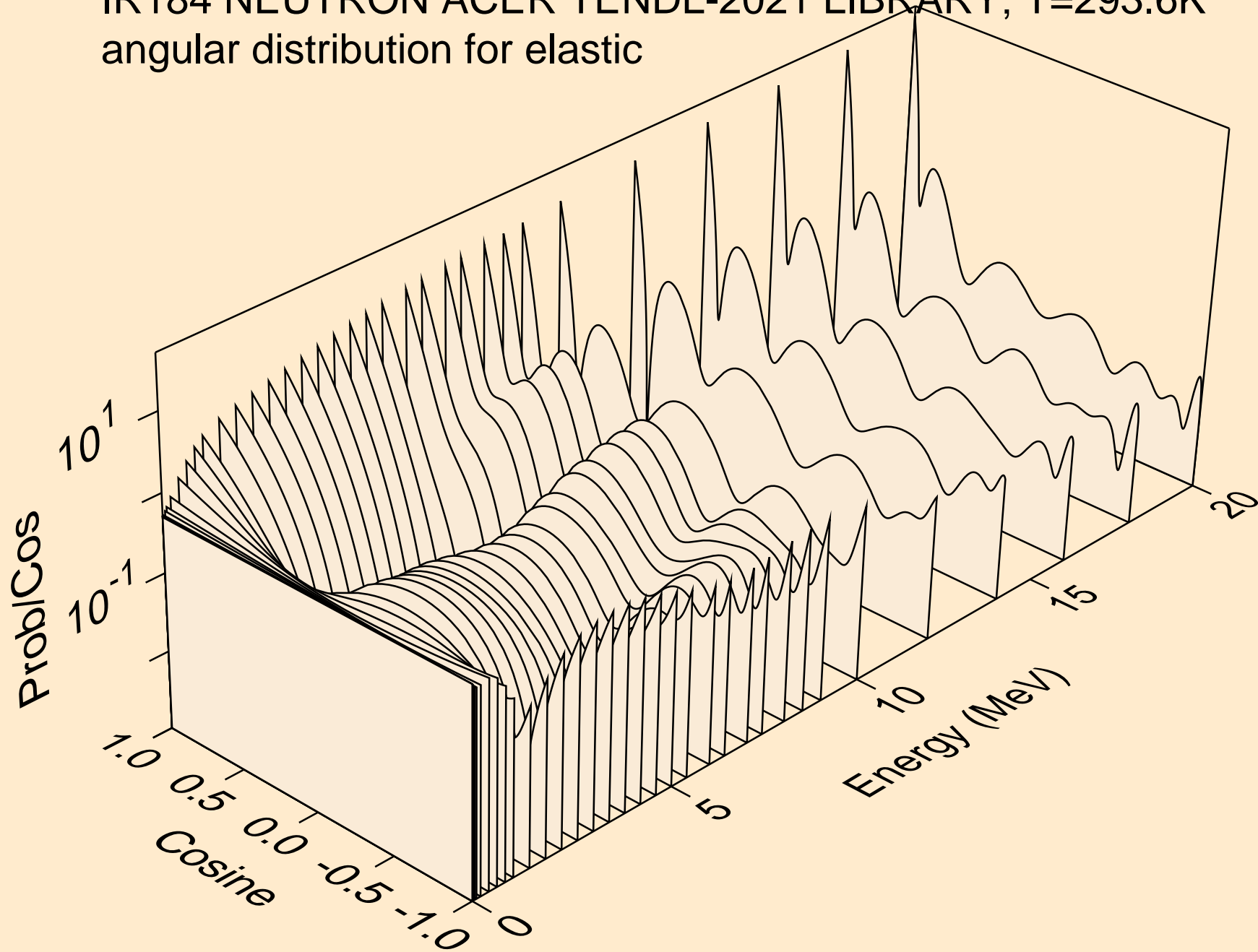

IR184 NEUTRON ACER TENDL-2021 LIBRARY; T=293.6K  
angular distribution for elastic

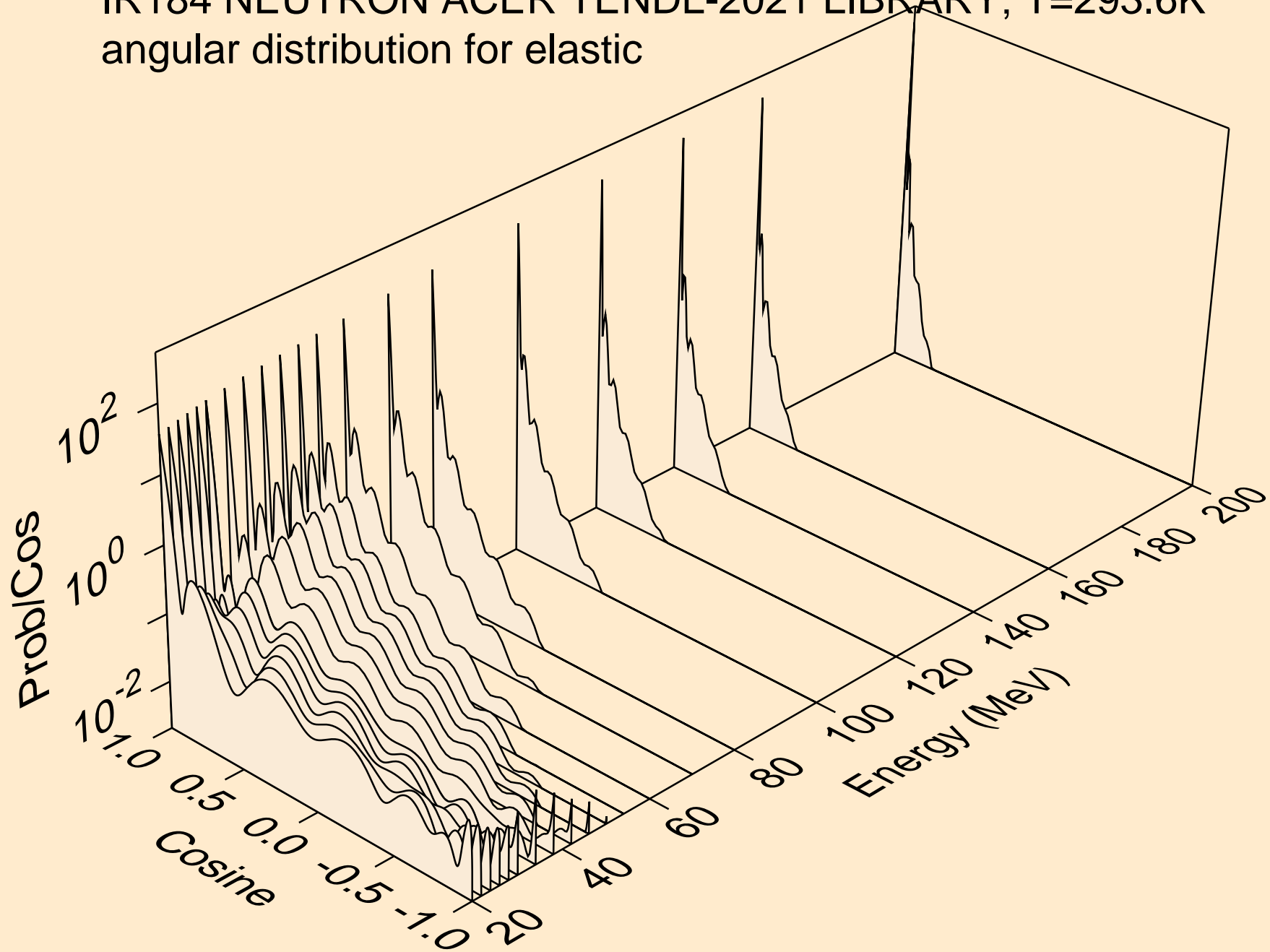



IR184 NEUTRON ACER TENDL-2021 LIBRARY; T=293.6K  
angular distribution for (n,n\*1)

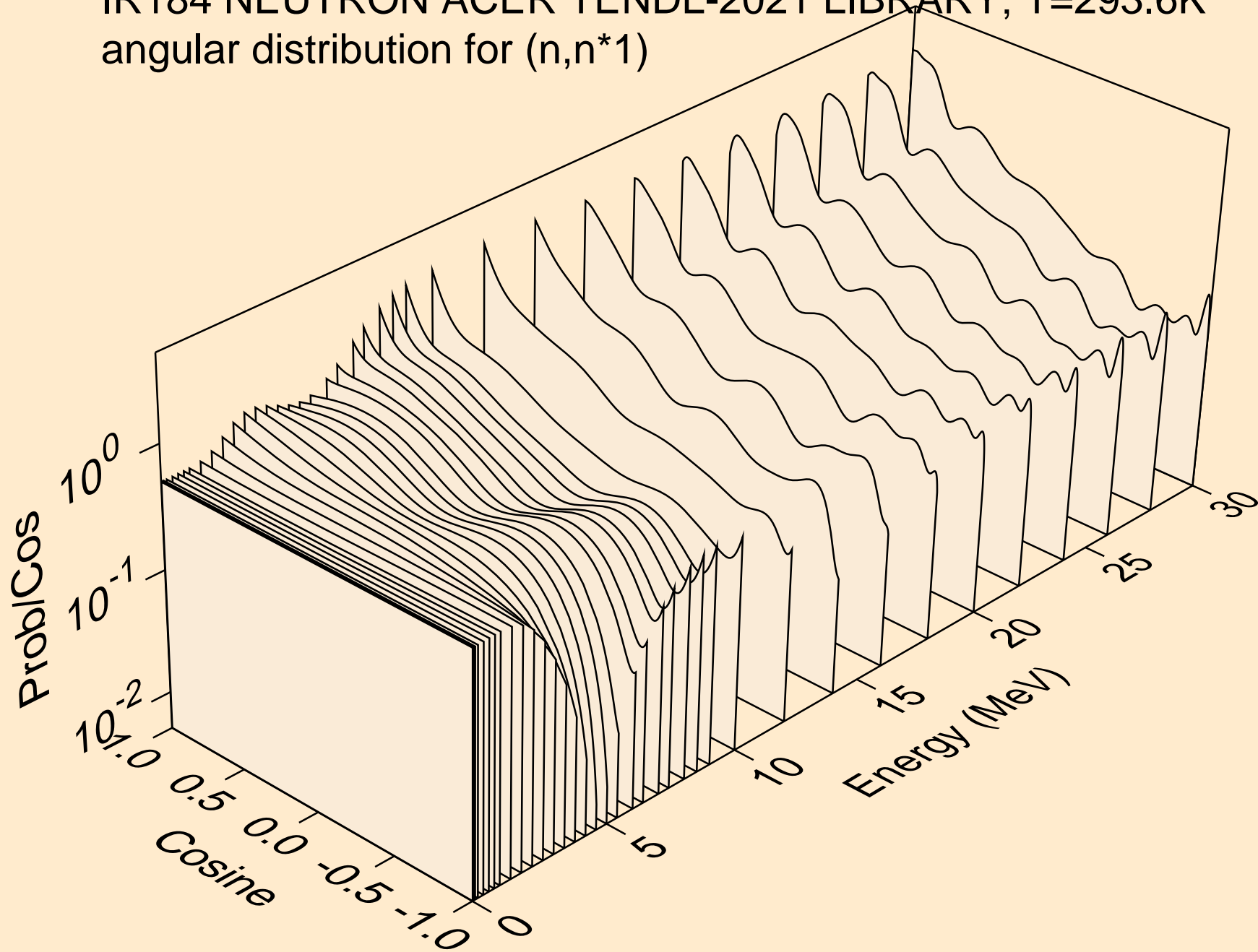

IR184 NEUTRON ACER TENDL-2021 LIBRARY; T=293.6K  
angular distribution for (n,n\*2)

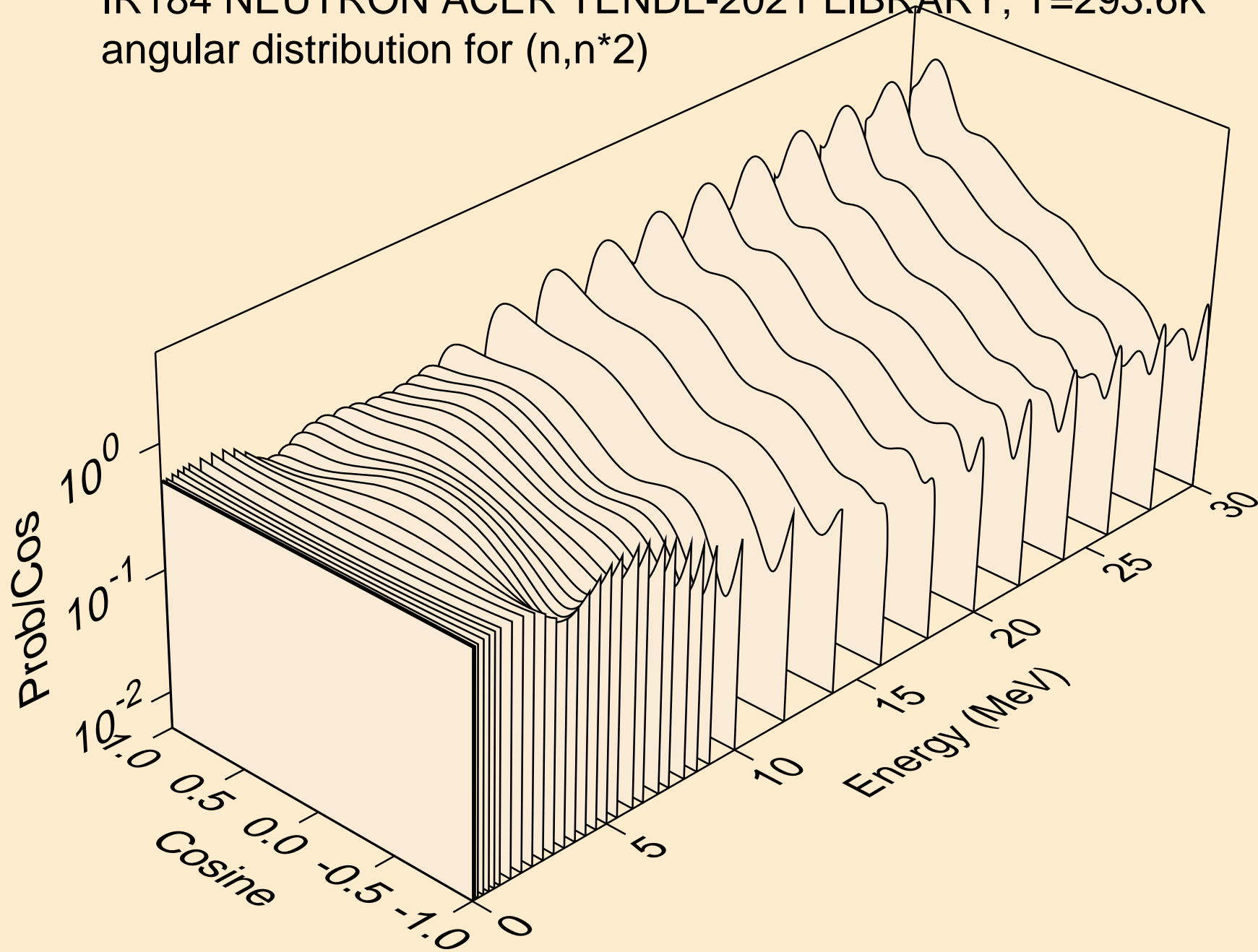

IR184 NEUTRON ACER TENDL-2021 LIBRARY; T=293.6K  
angular distribution for (n,n\*3)

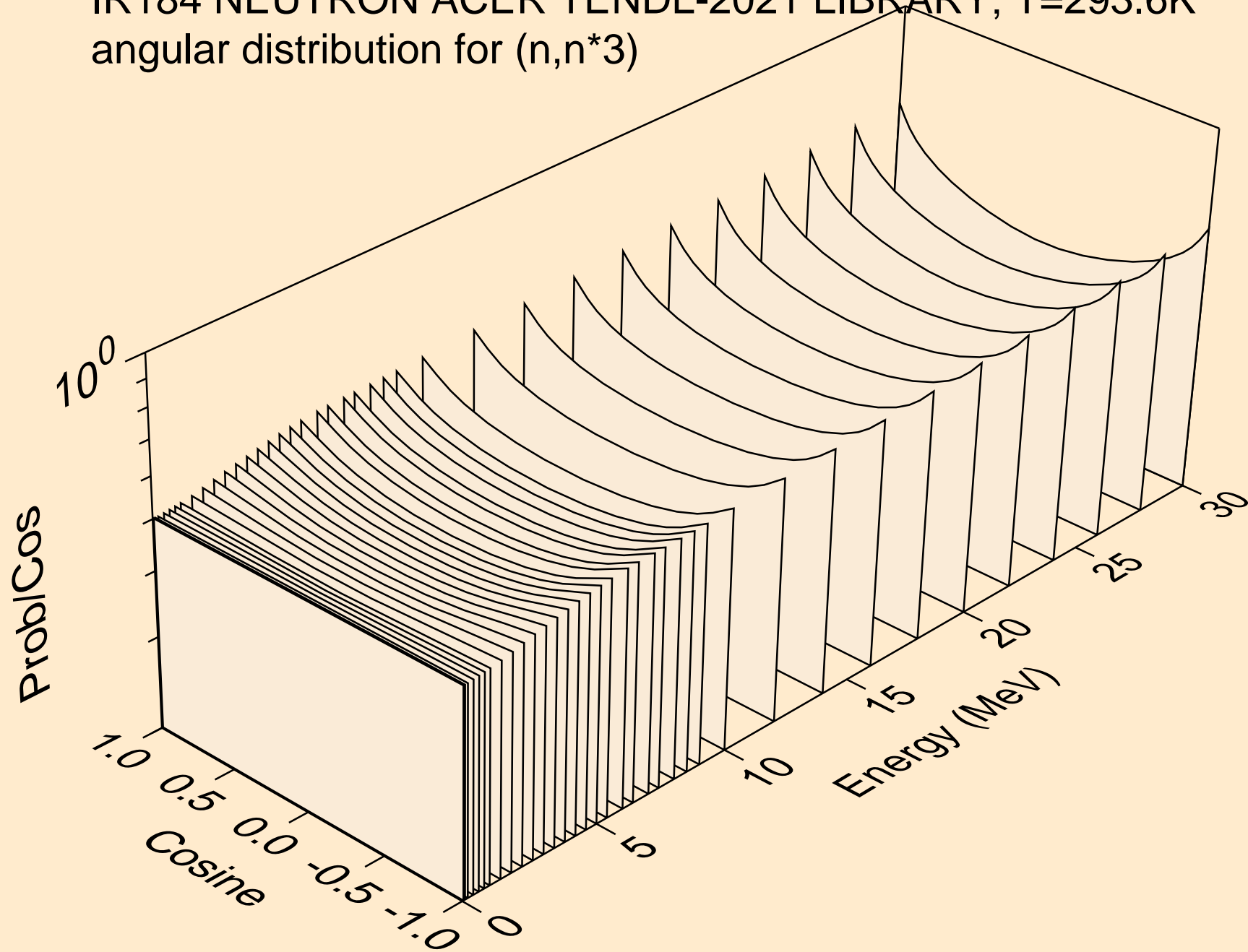

IR184 NEUTRON ACER TENDL-2021 LIBRARY; T=293.6K  
angular distribution for (n,n\*4)

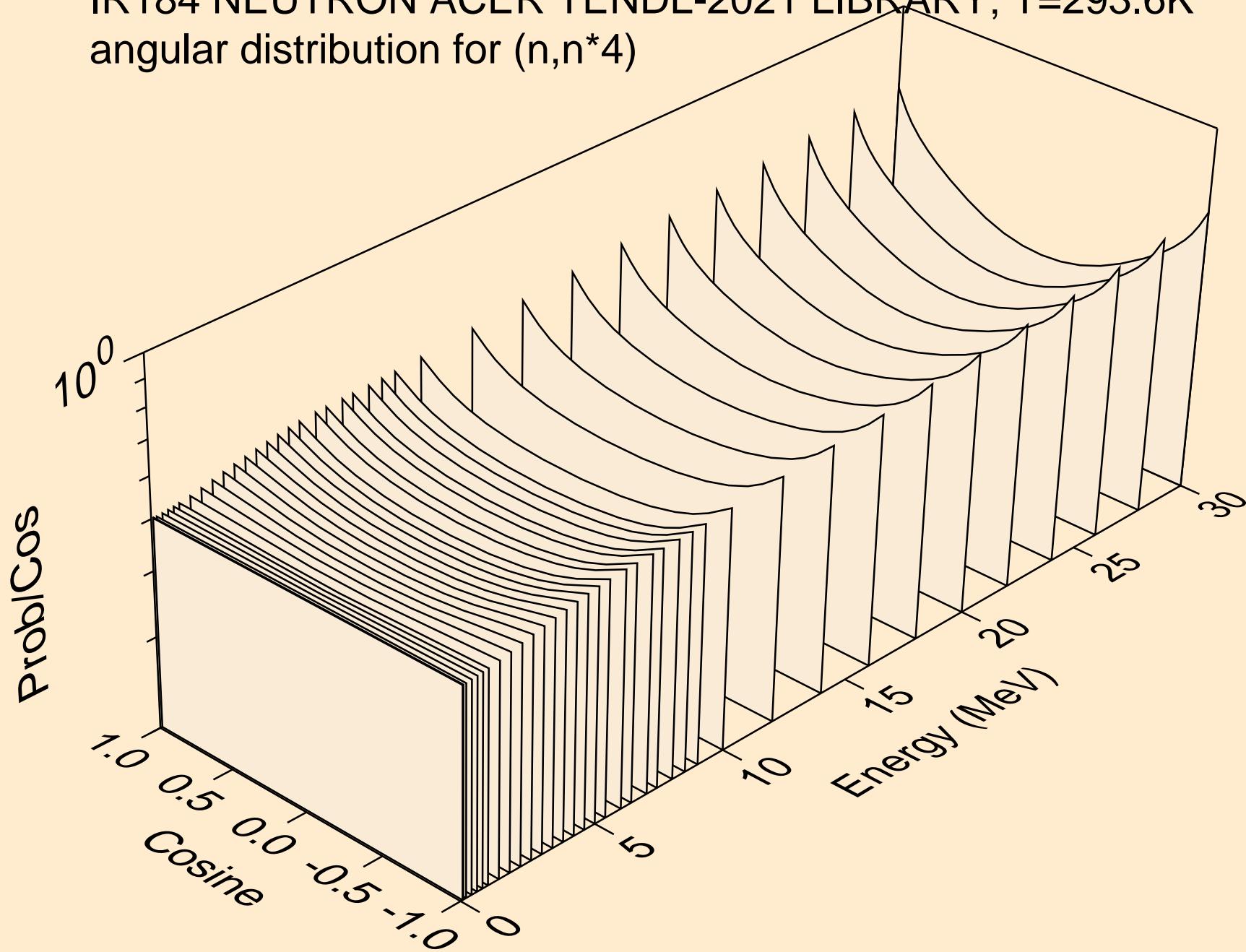

IR184 NEUTRON ACER TENDL-2021 LIBRARY; T=293.6K  
angular distribution for (n,n\*5)

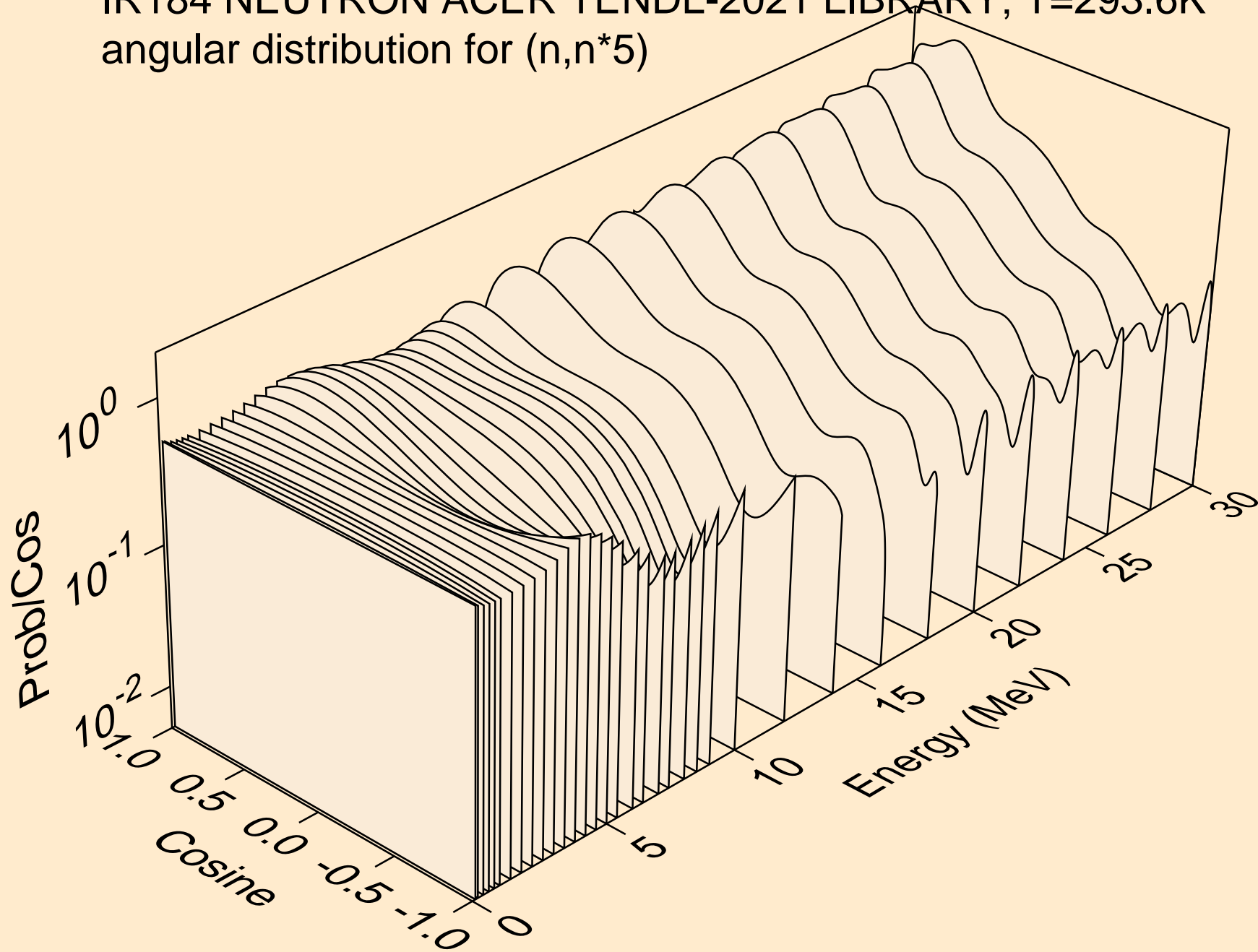

IR184 NEUTRON ACER TENDL-2021 LIBRARY; T=293.6K  
angular distribution for (n,n\*6)

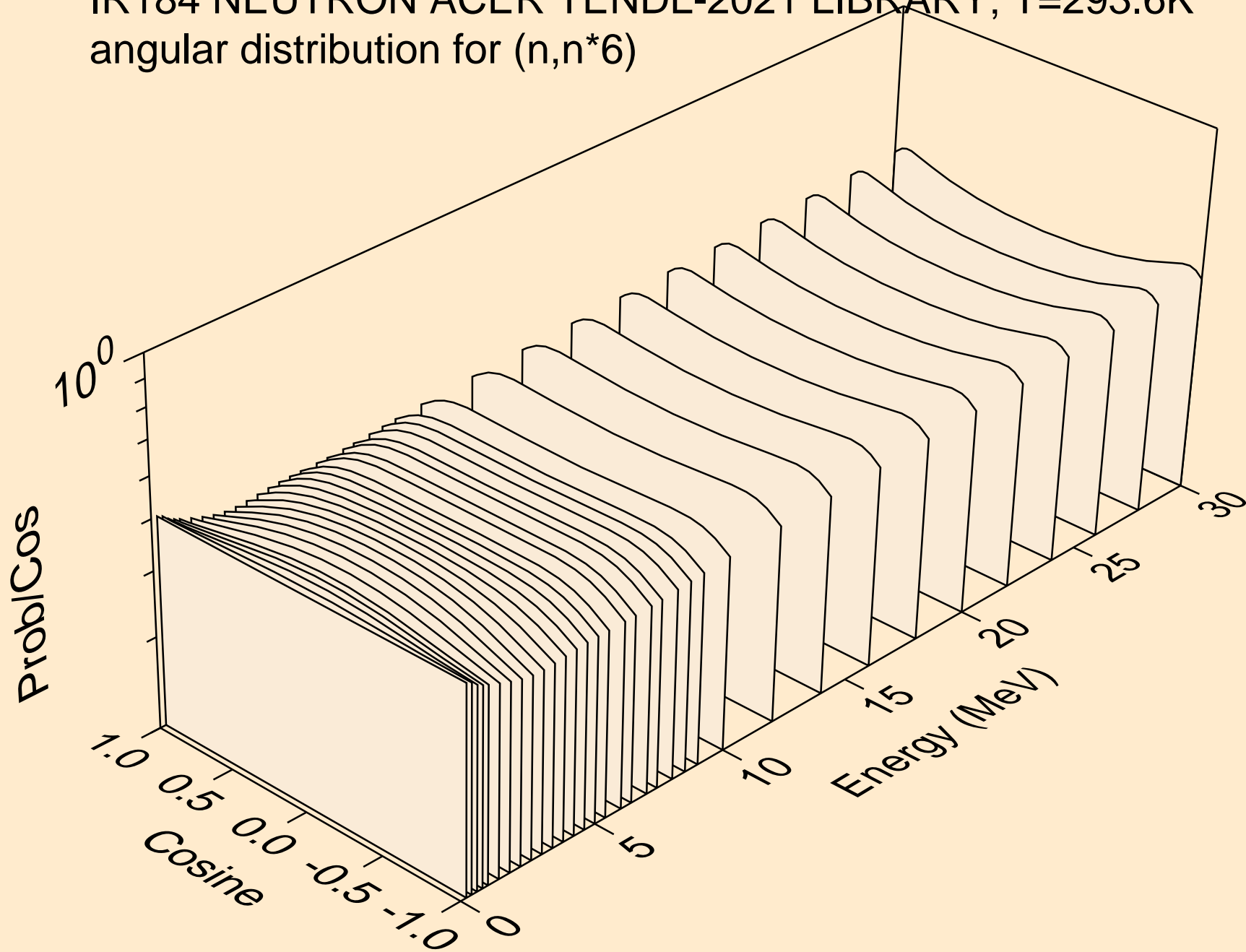

IR184 NEUTRON ACER TENDL-2021 LIBRARY; T=293.6K  
angular distribution for (n,n\*7)

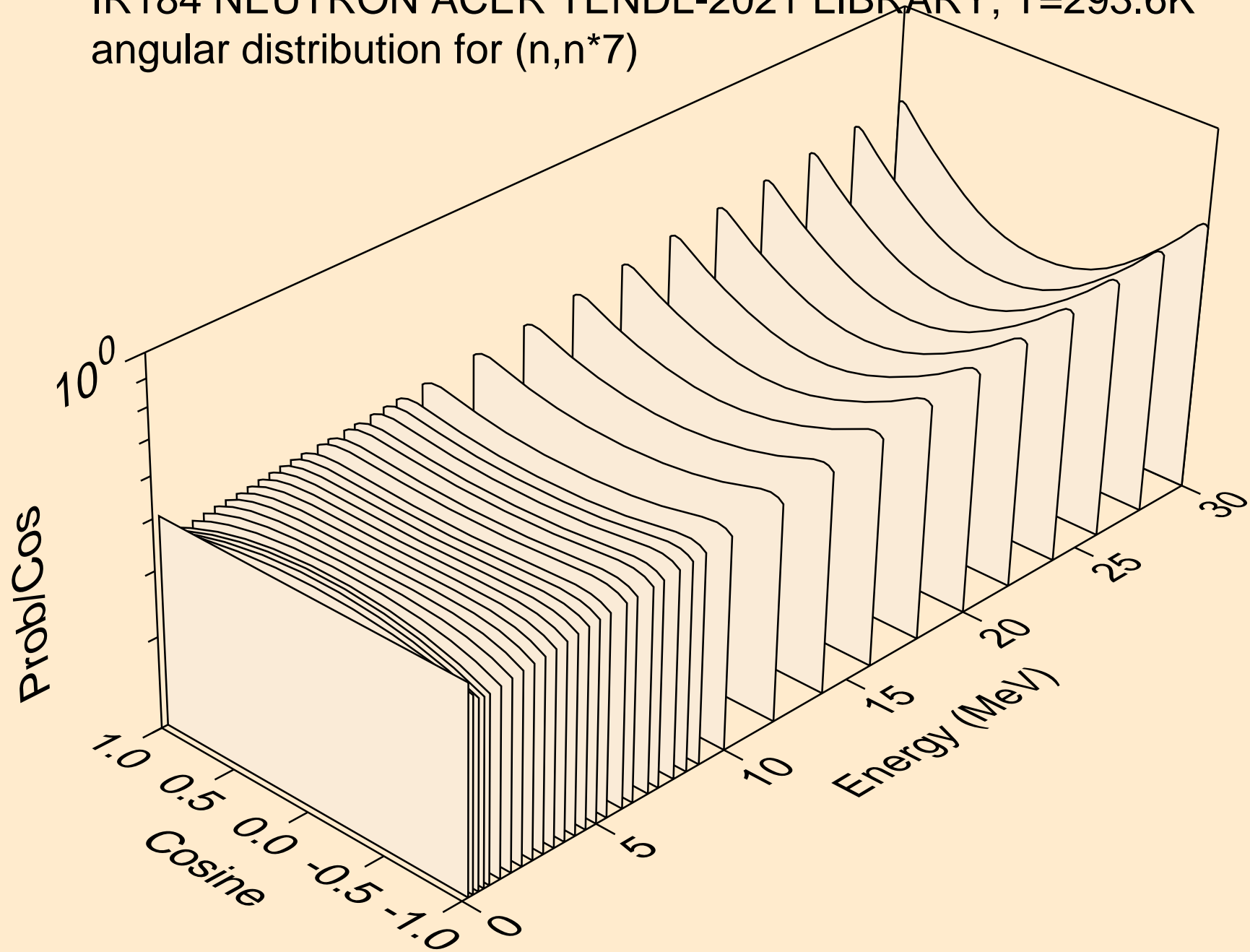

IR184 NEUTRON ACER TENDL-2021 LIBRARY; T=293.6K  
angular distribution for (n,n\*8)

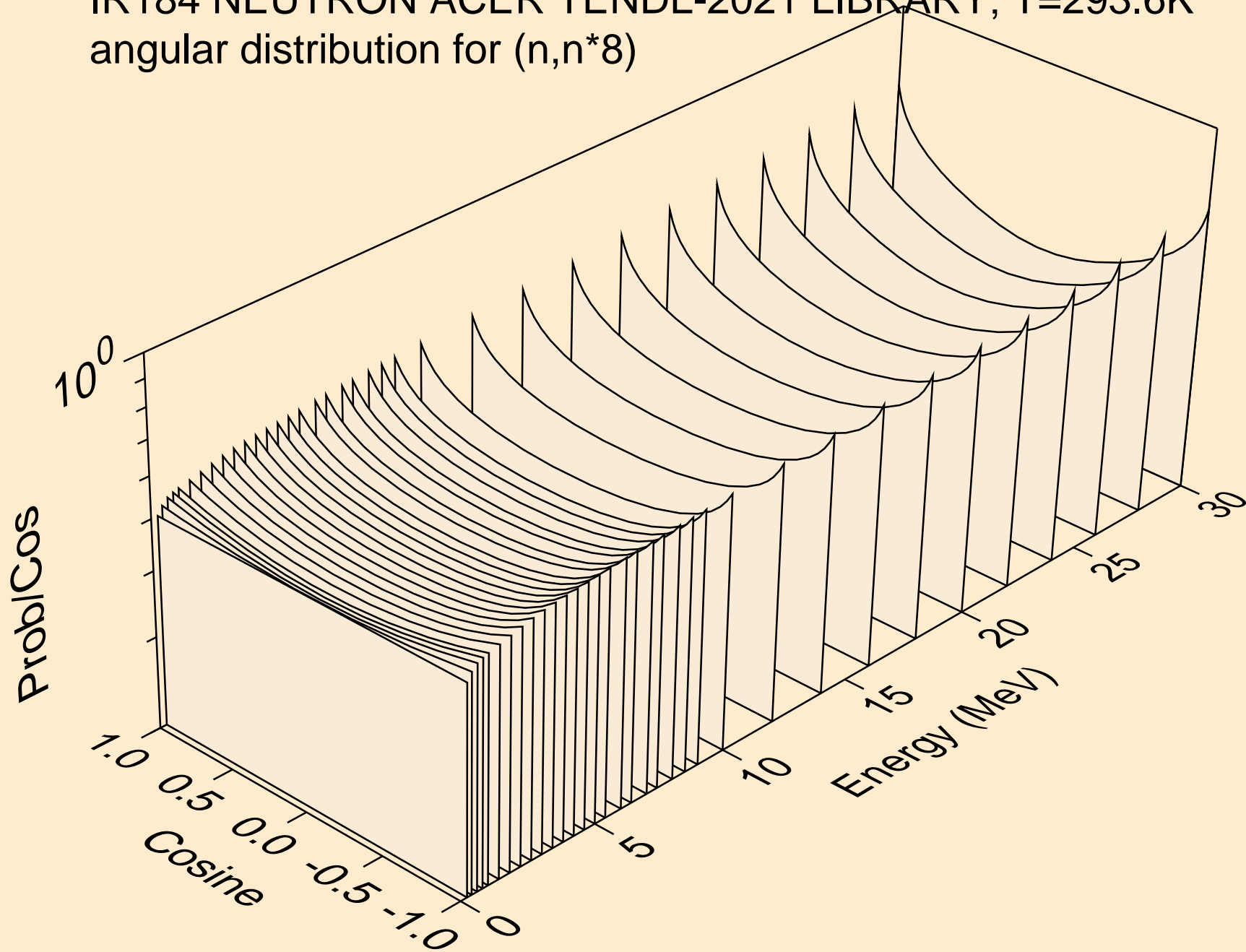



IR184 NEUTRON ACER TENDL-2021 LIBRARY; T=293.6K  
angular distribution for (n,n\*9)

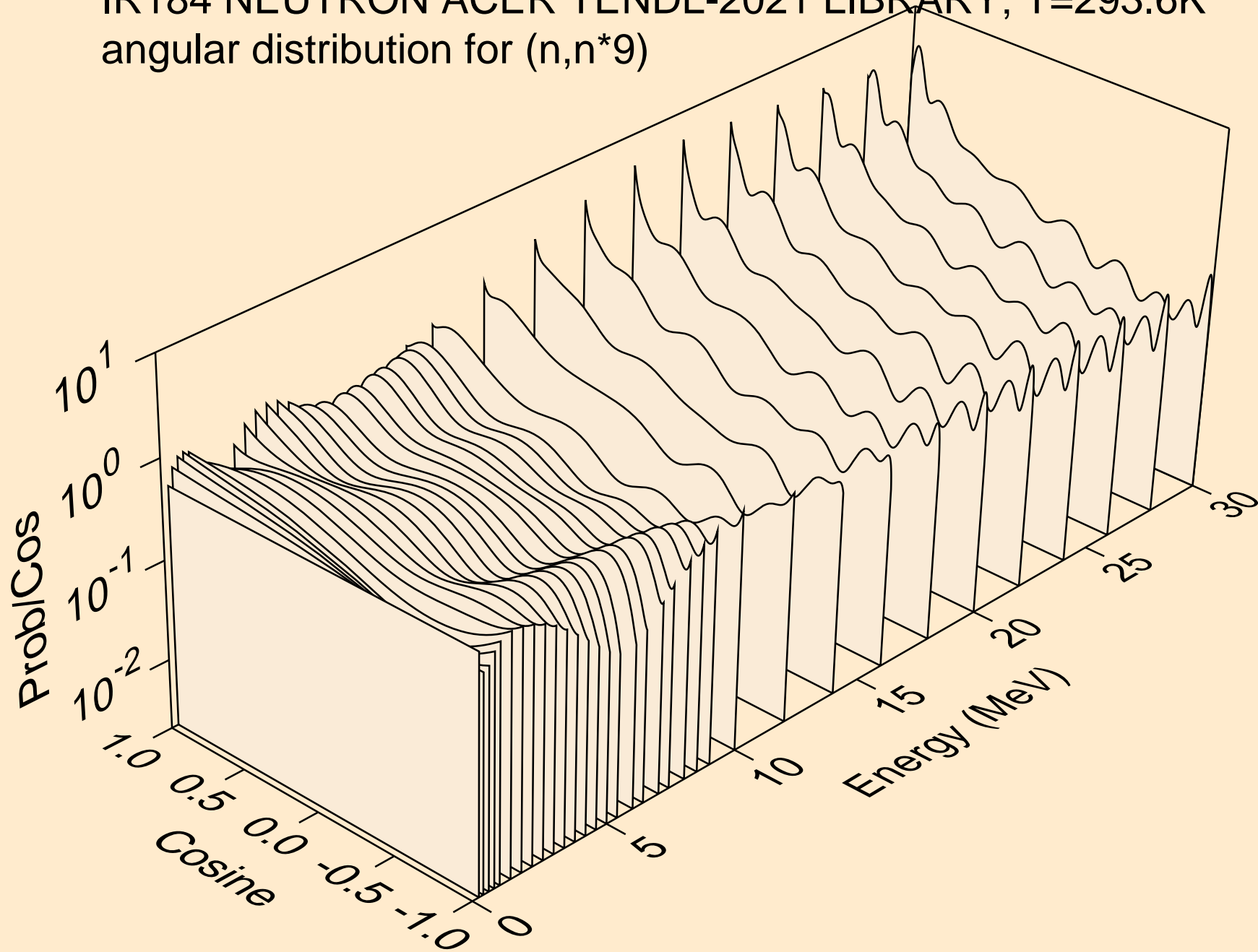

IR184 NEUTRON ACER TENDL-2021 LIBRARY; T=293.6K  
angular distribution for (n,n\*10)

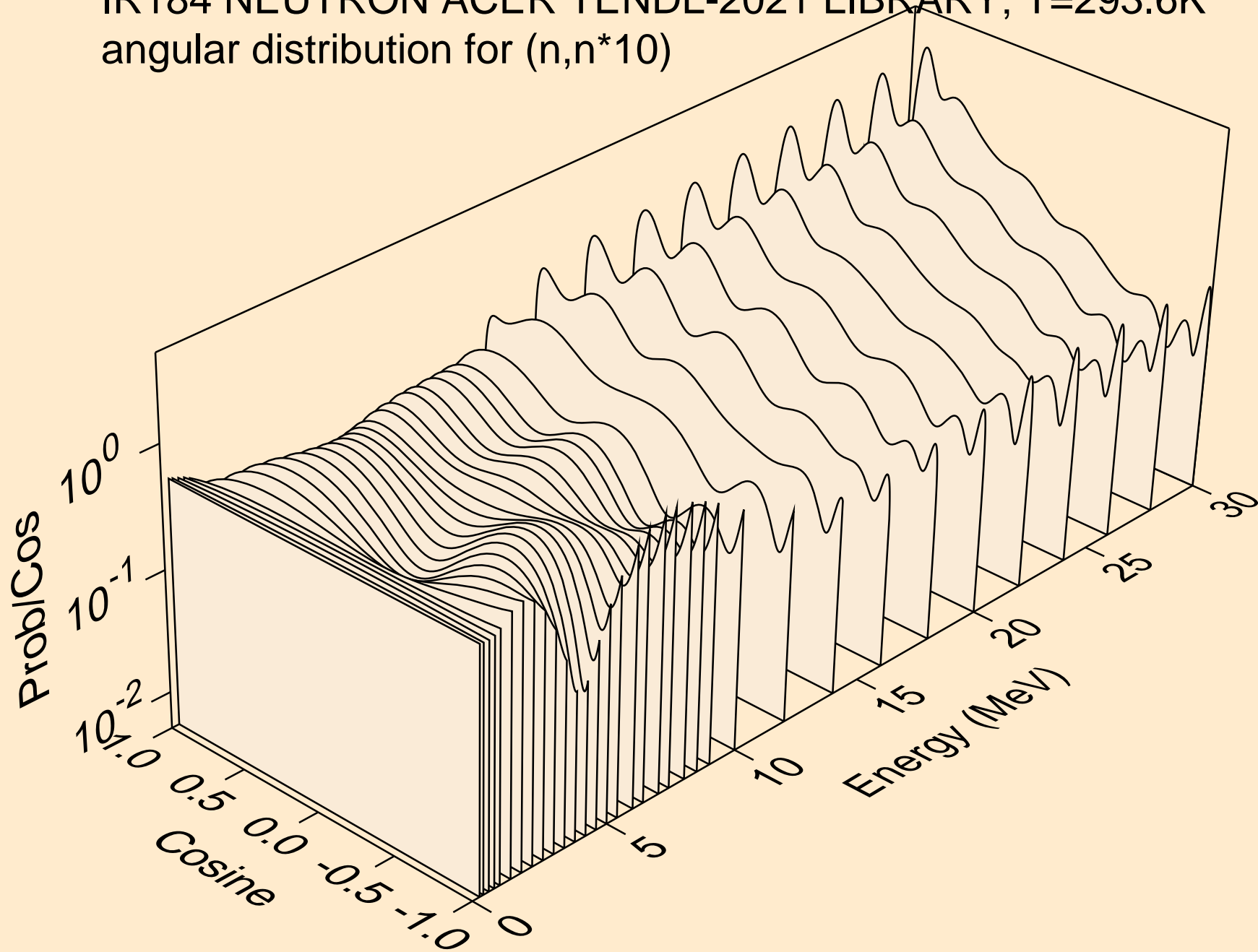

IR184 NEUTRON ACER TENDL-2021 LIBRARY; T=293.6K  
angular distribution for (n,n\*11)

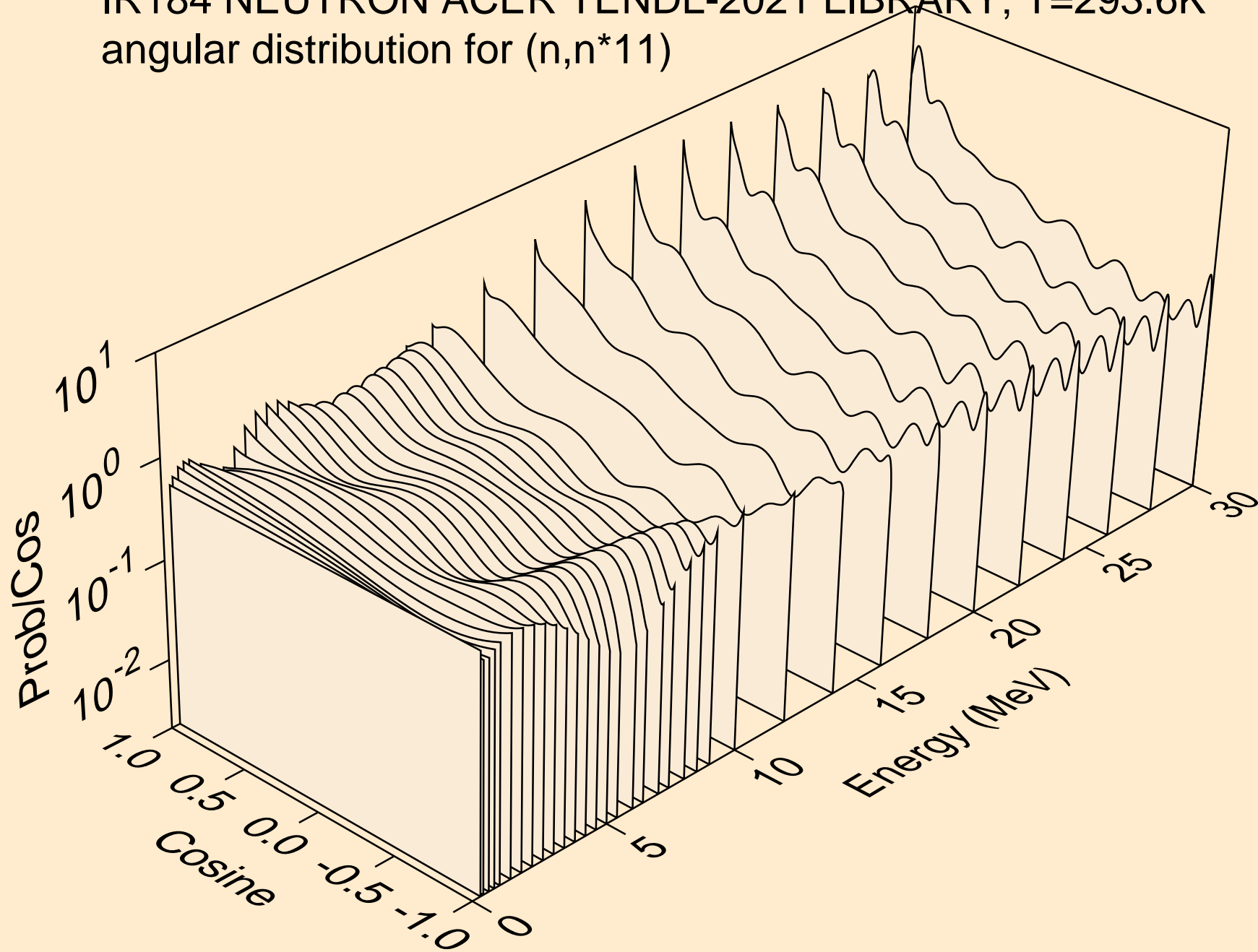

IR184 NEUTRON ACER TENDL-2021 LIBRARY; T=293.6K  
angular distribution for (n,n\*12)

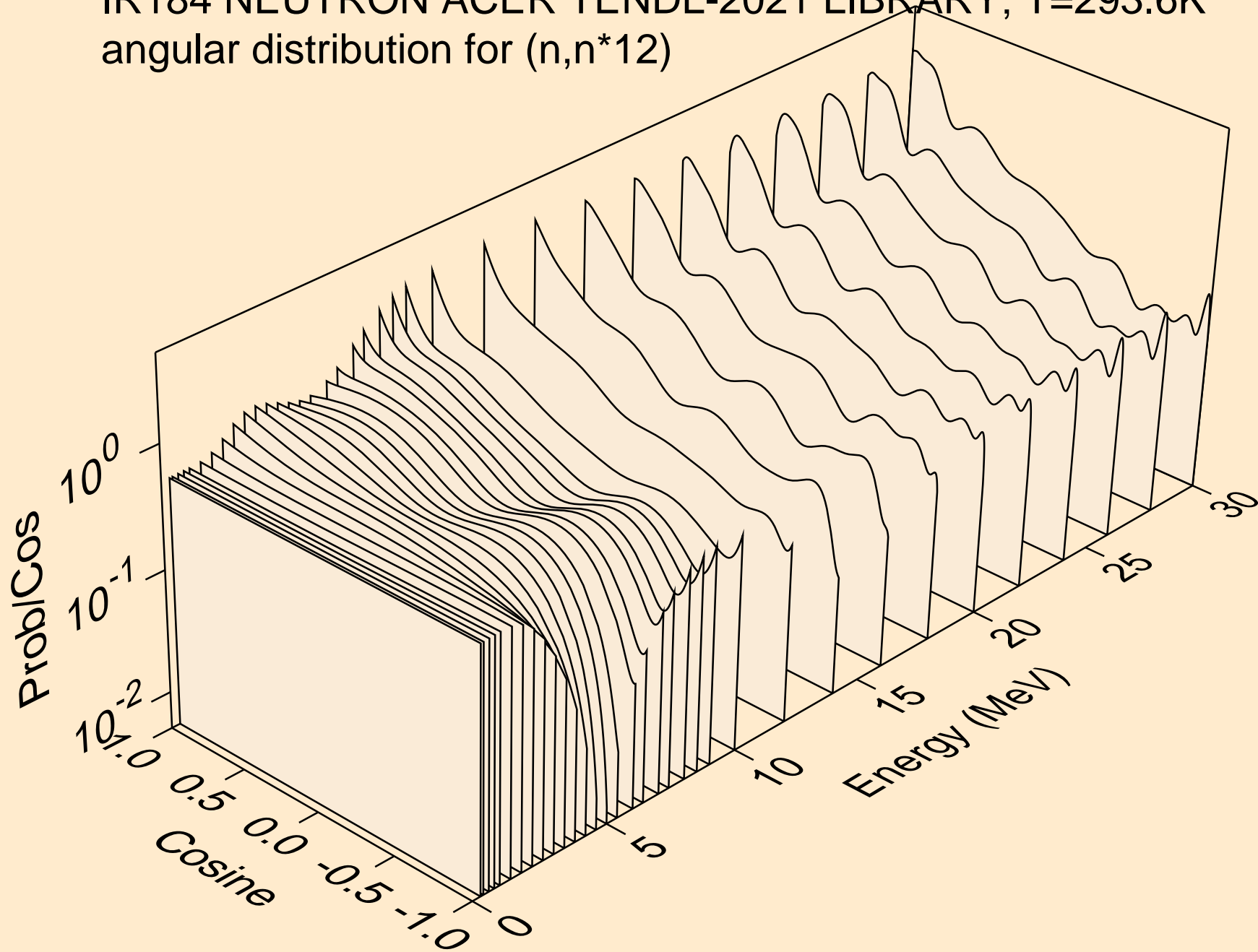

IR184 NEUTRON ACER TENDL-2021 LIBRARY; T=293.6K  
angular distribution for (n,n\*13)

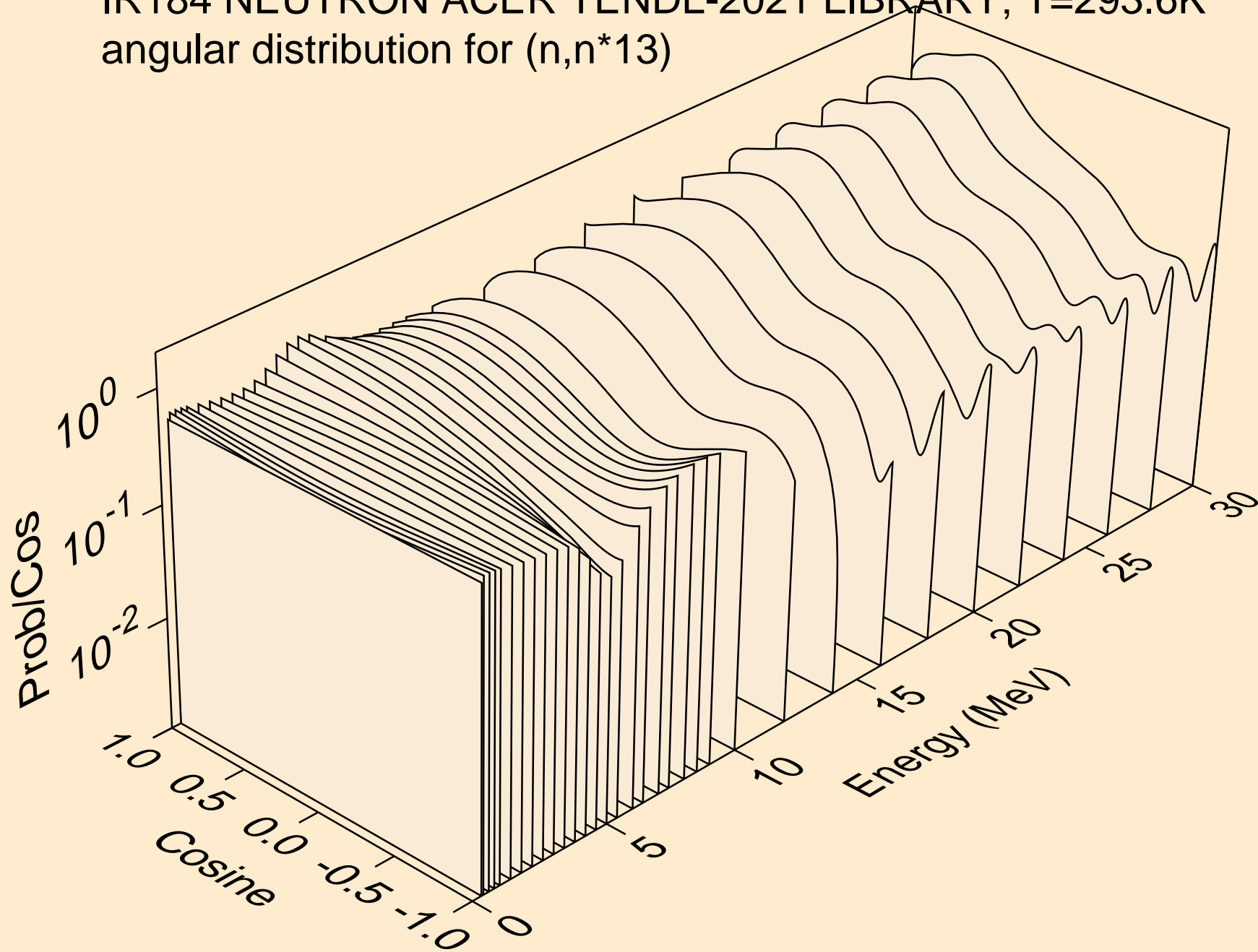

IR184 NEUTRON ACER TENDL-2021 LIBRARY; T=293.6K  
angular distribution for (n,n\*14)

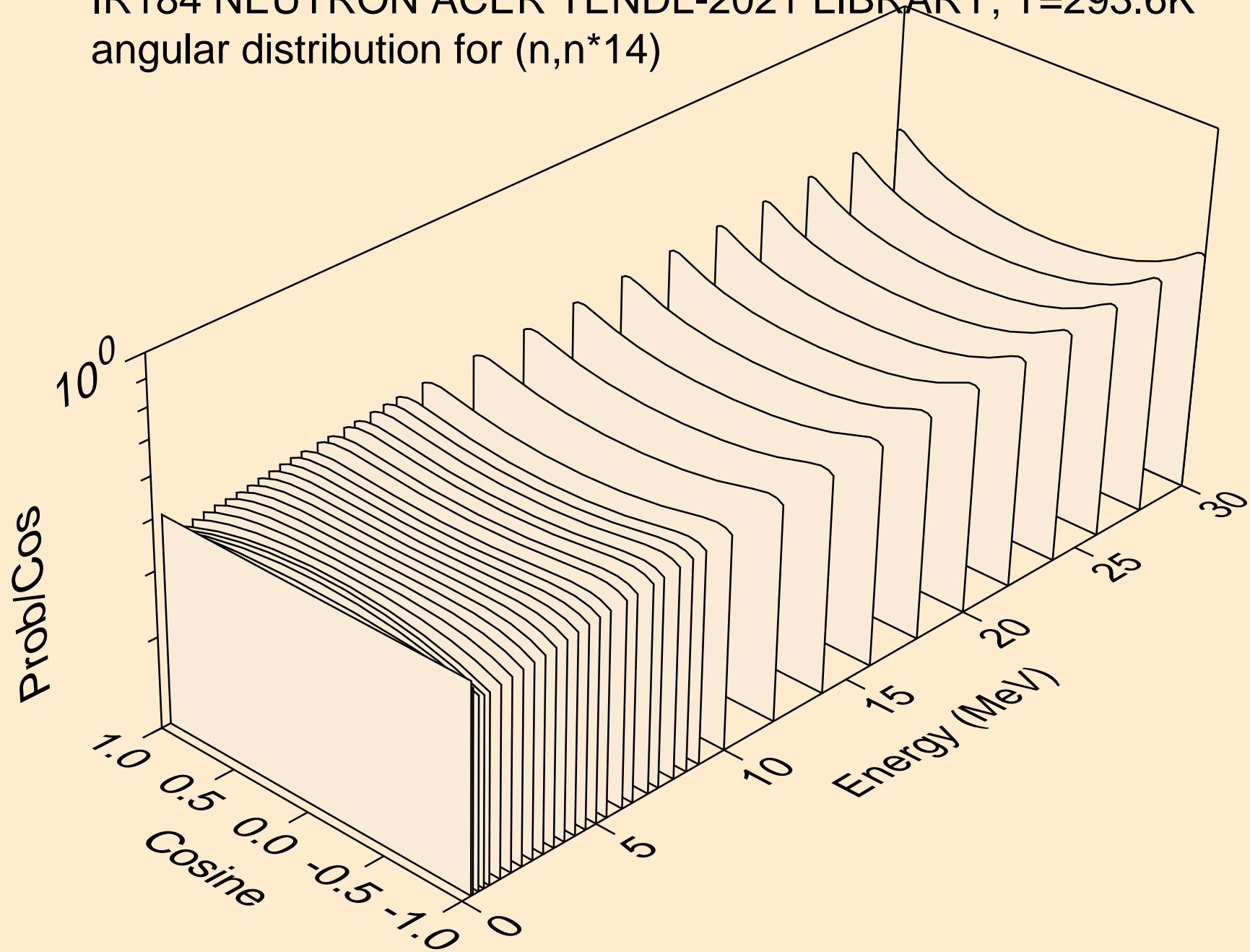

IR184 NEUTRON ACER TENDL-2021 LIBRARY; T=293.6K  
Neutron emission for (n,x)

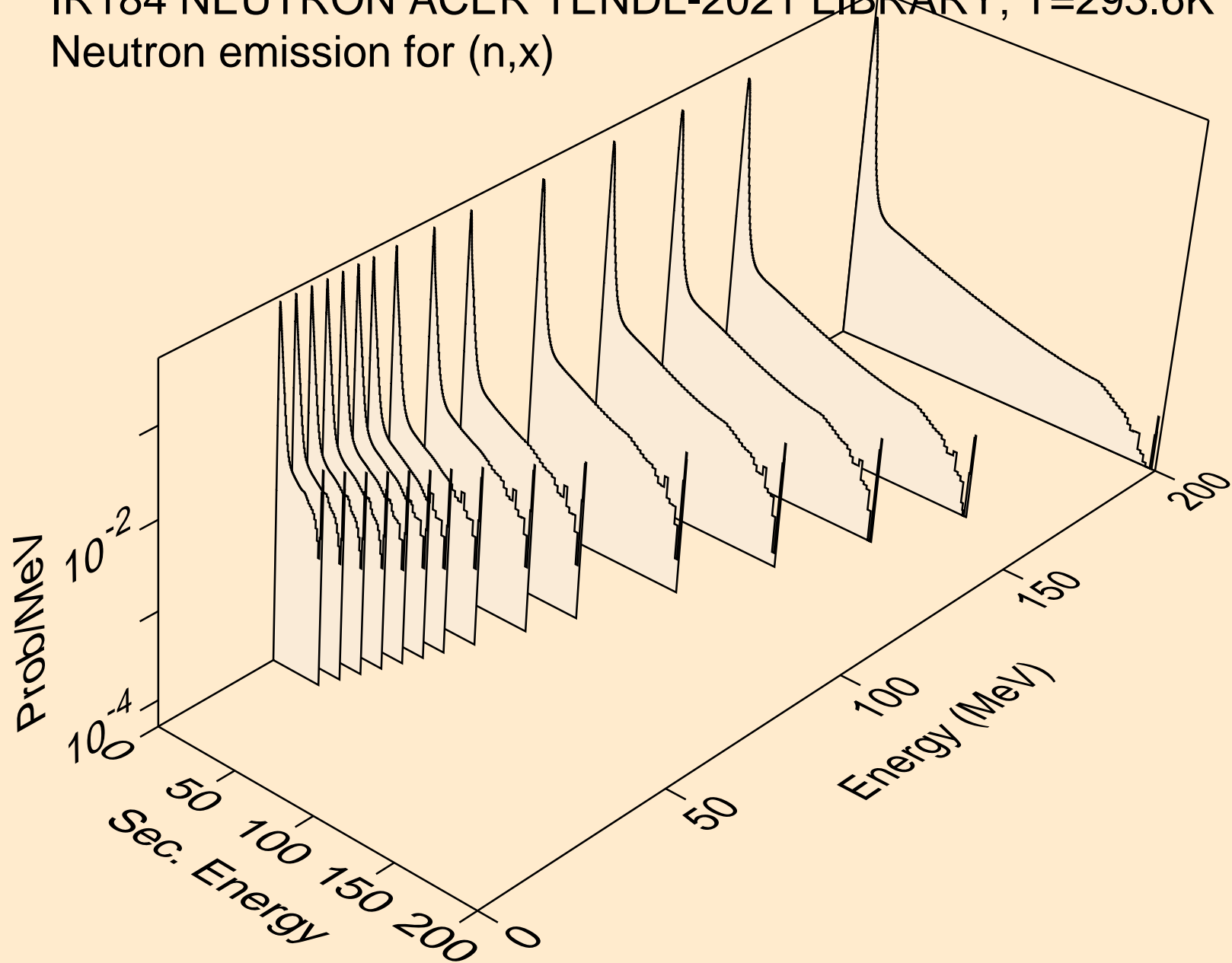

IR184 NEUTRON ACER TENDL-2021 LIBRARY; T=293.6K  
Neutron emission for (n,2nd)

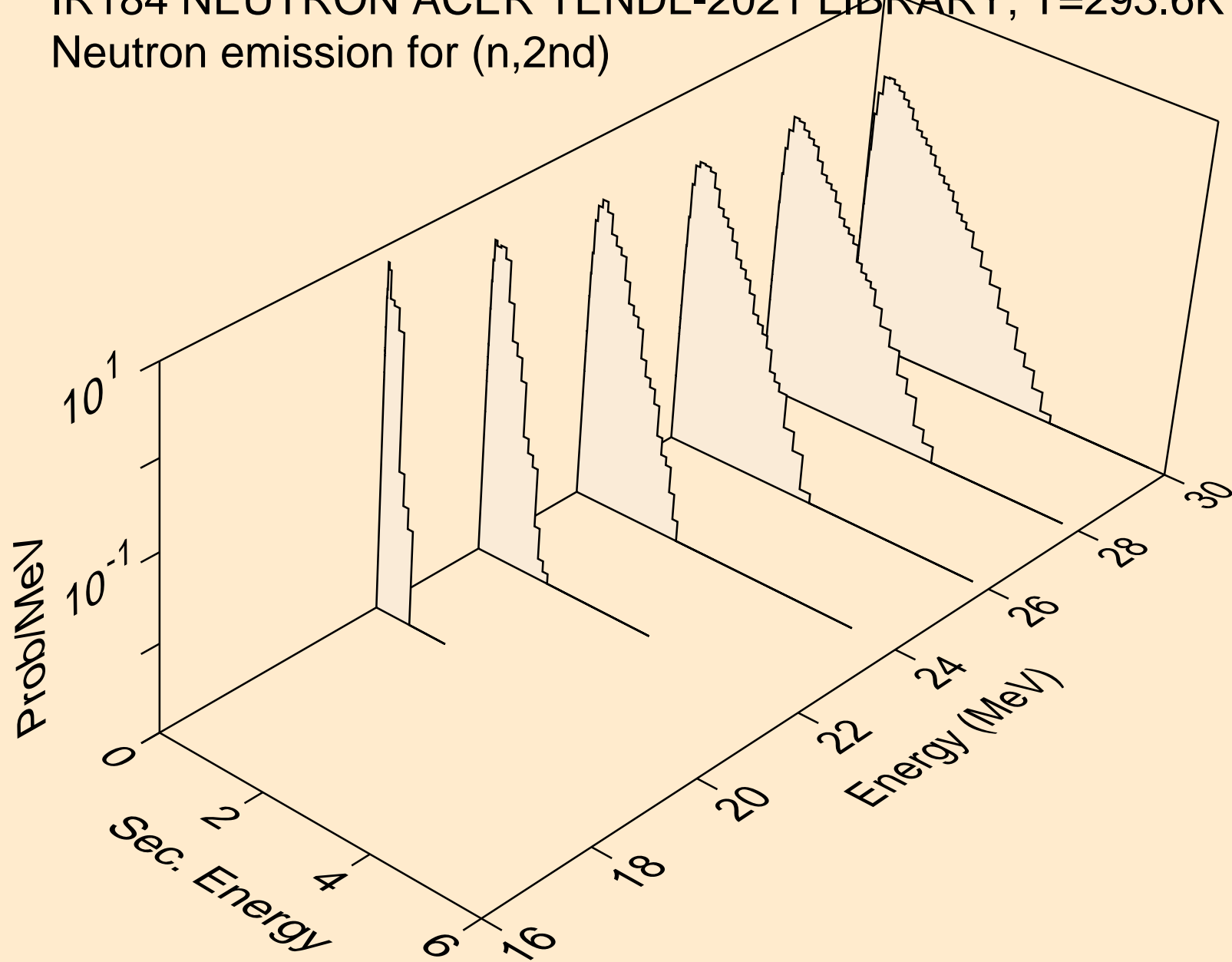



IR184 NEUTRON ACER TENDL-2021 LIBRARY; T=293.6K  
Neutron emission for (n,2n)

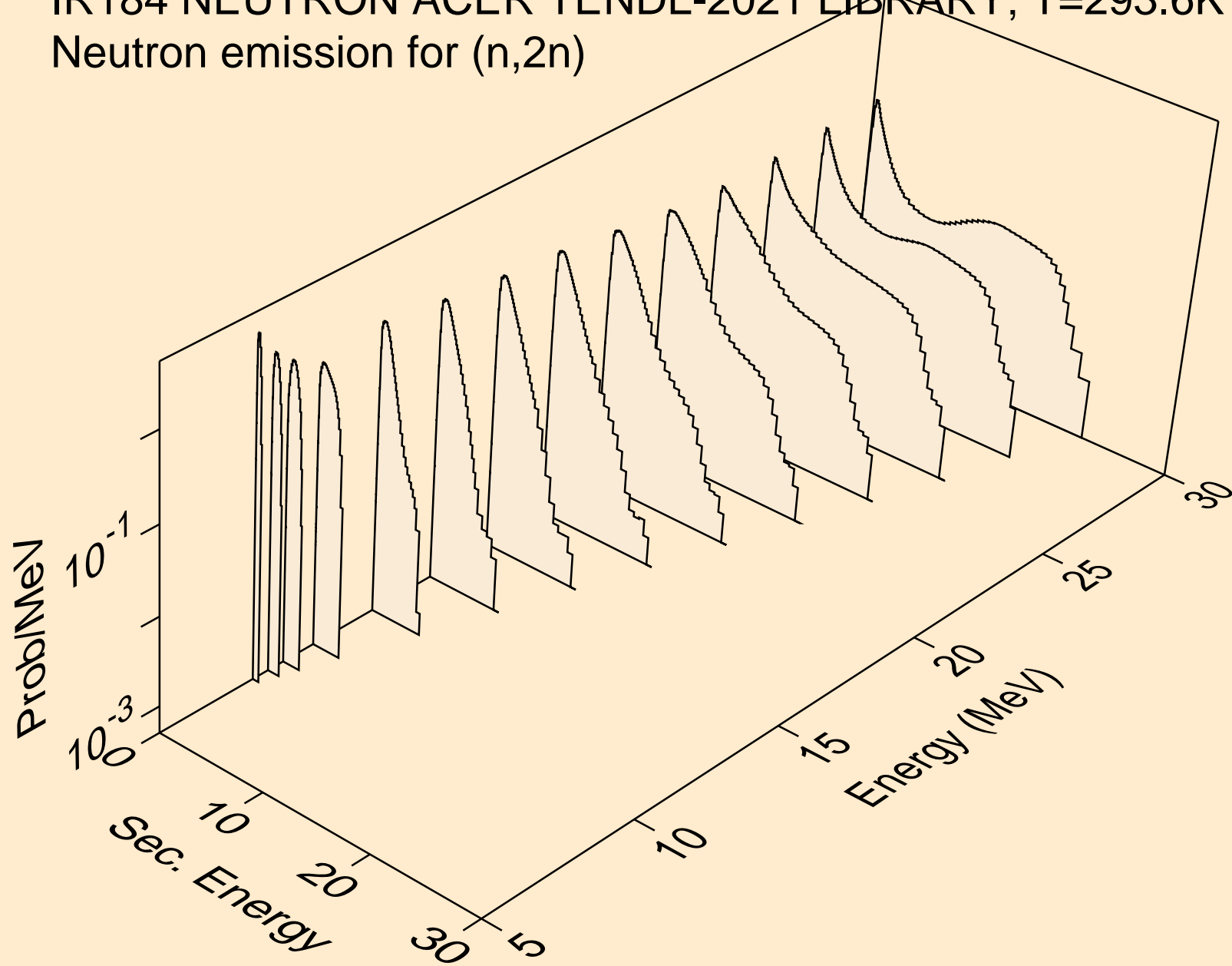

IR184 NEUTRON ACER TENDL-2021 LIBRARY; T=293.6K  
Neutron emission for (n,3n)

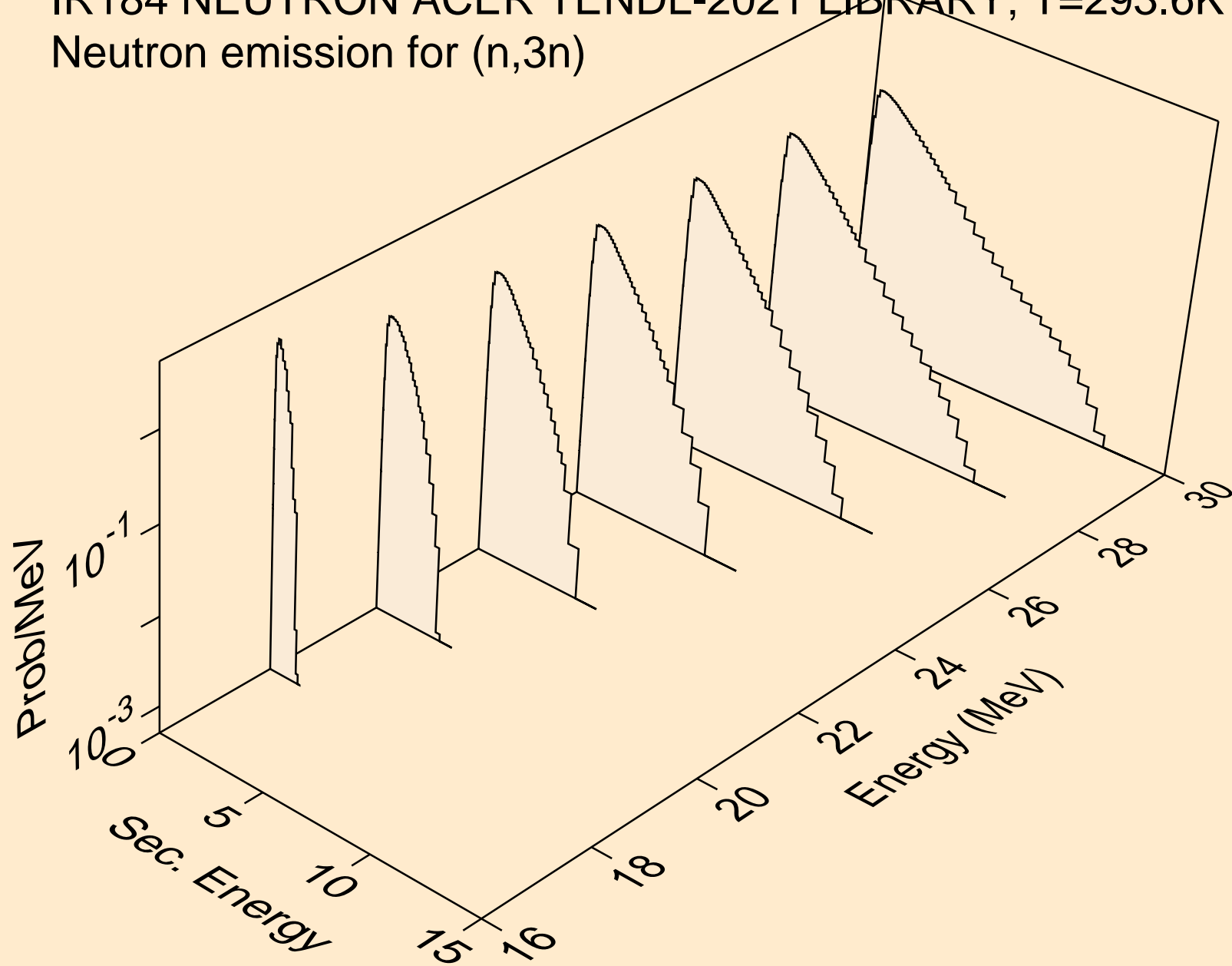

IR184 NEUTRON ACER TENDL-2021 LIBRARY; T=293.6K  
Neutron emission for (n,n\*)a

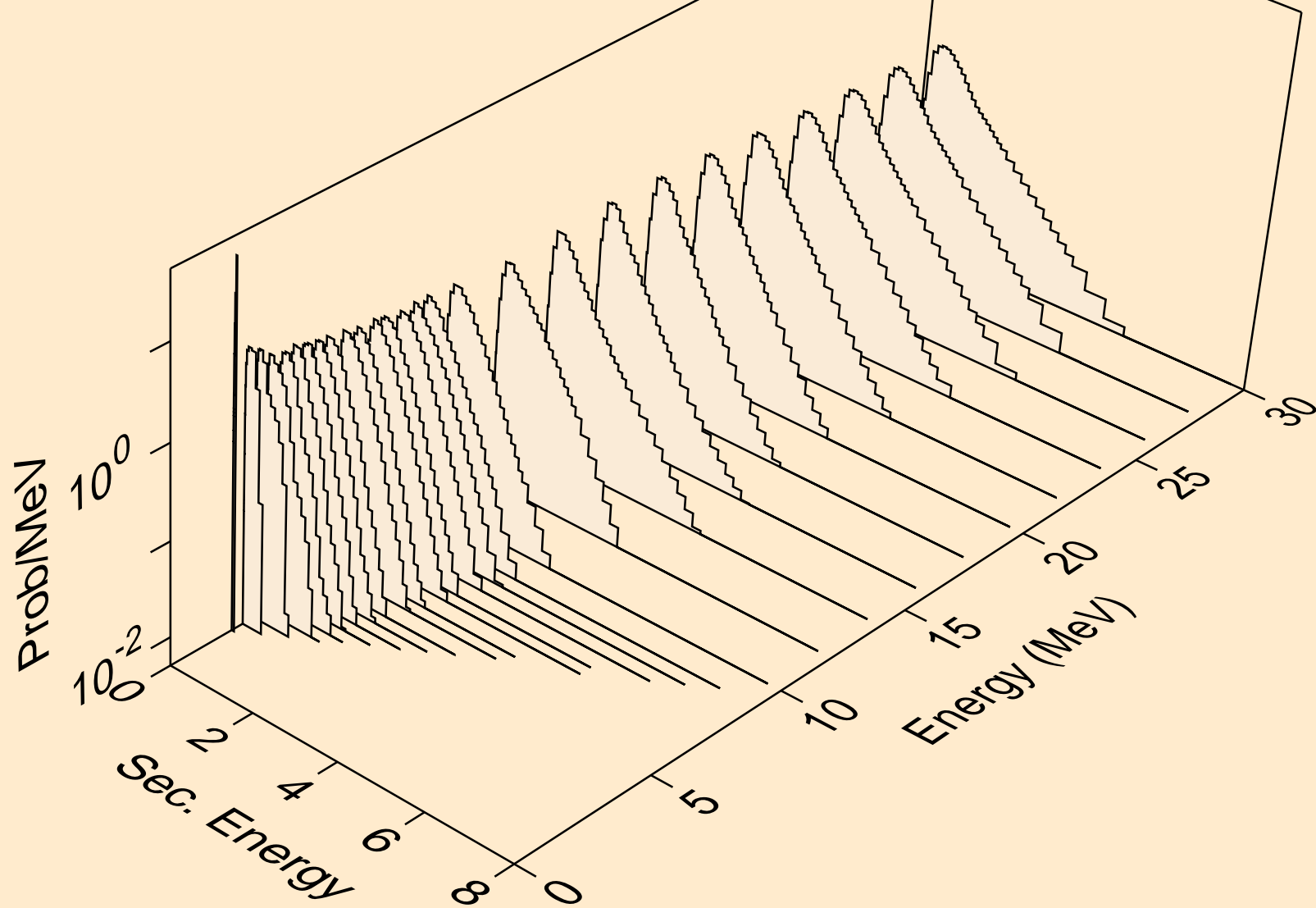

IR184 NEUTRON ACER TENDL-2021 LIBRARY; T=293.6K  
Neutron emission for (n,2n)a

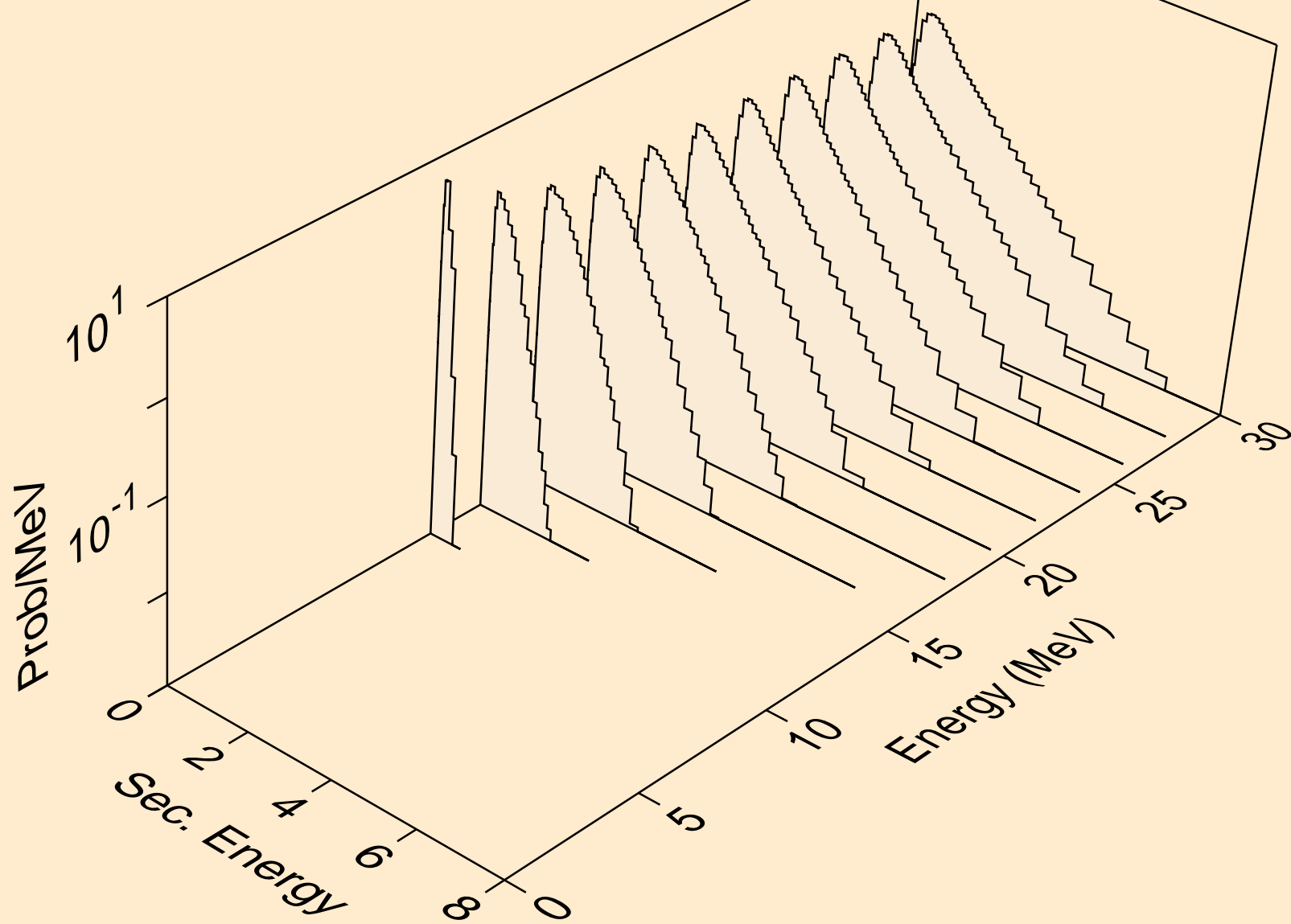

IR184 NEUTRON ACER TENDL-2021 LIBRARY; T=293.6K  
Neutron emission for (n,3n)a

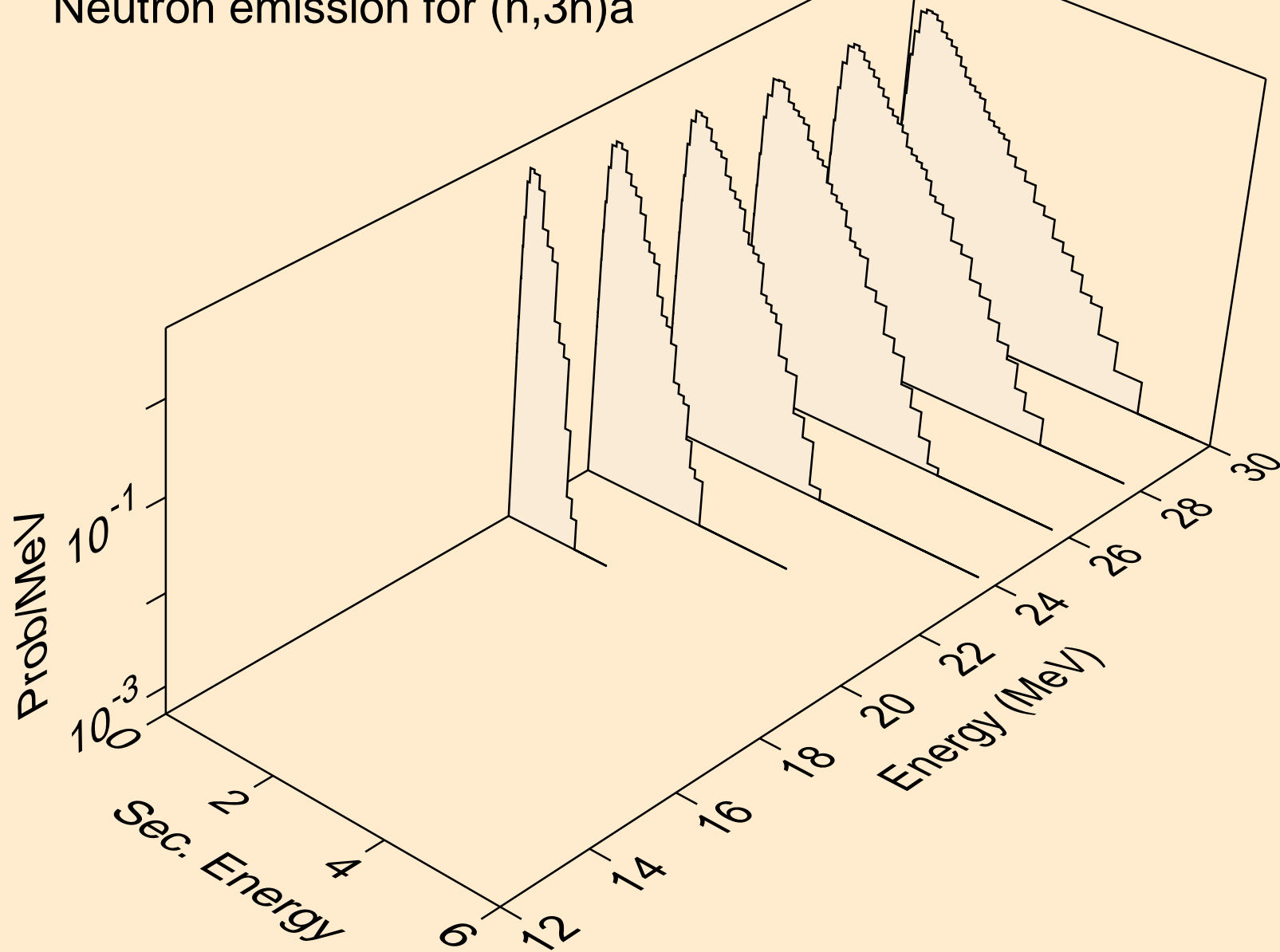

IR184 NEUTRON ACER TENDL-2021 LIBRARY; T=293.6K  
Neutron emission for (n,n\*)p

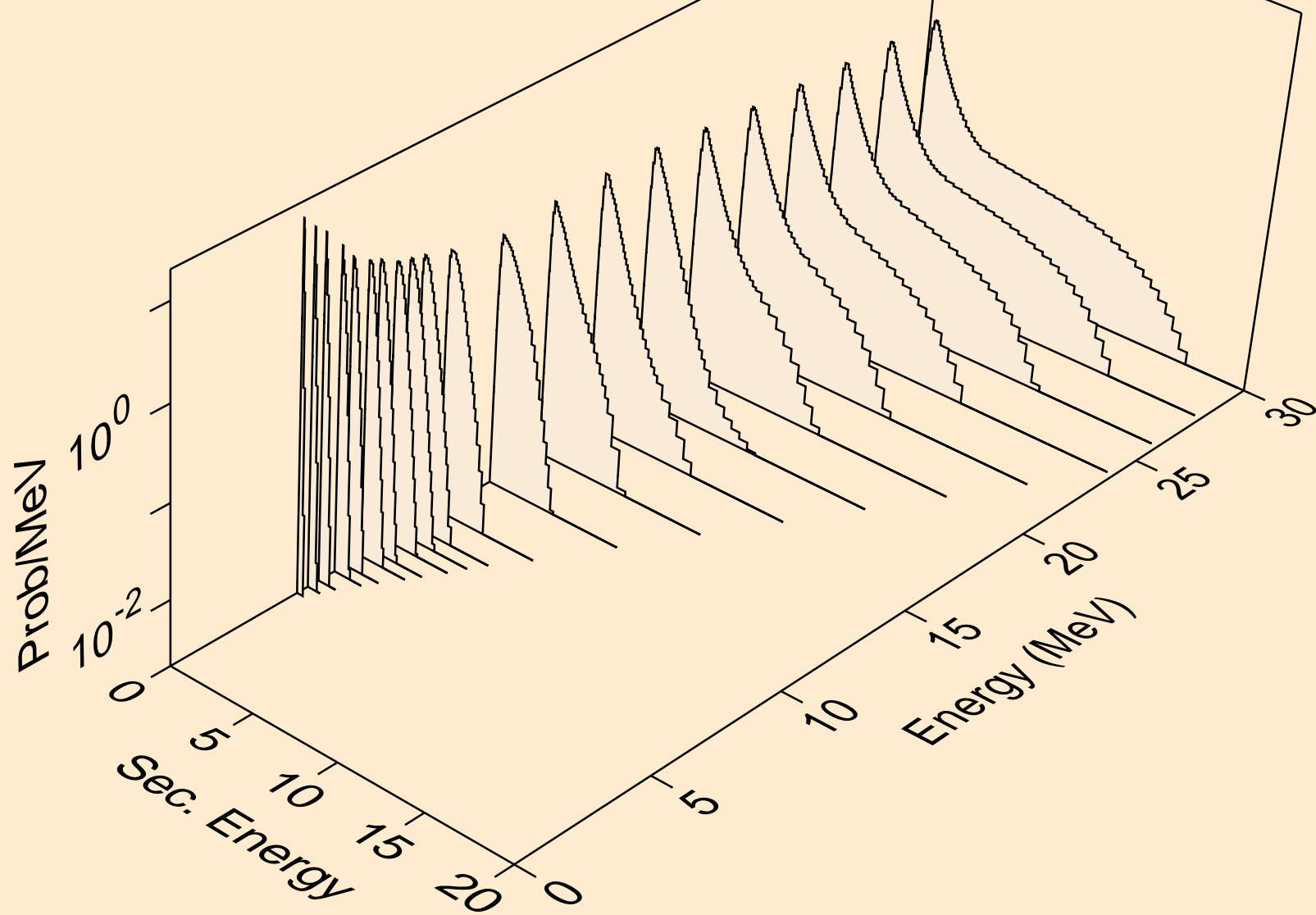

IR184 NEUTRON ACER TENDL-2021 LIBRARY; T=293.6K  
Neutron emission for (n,n\*)2a

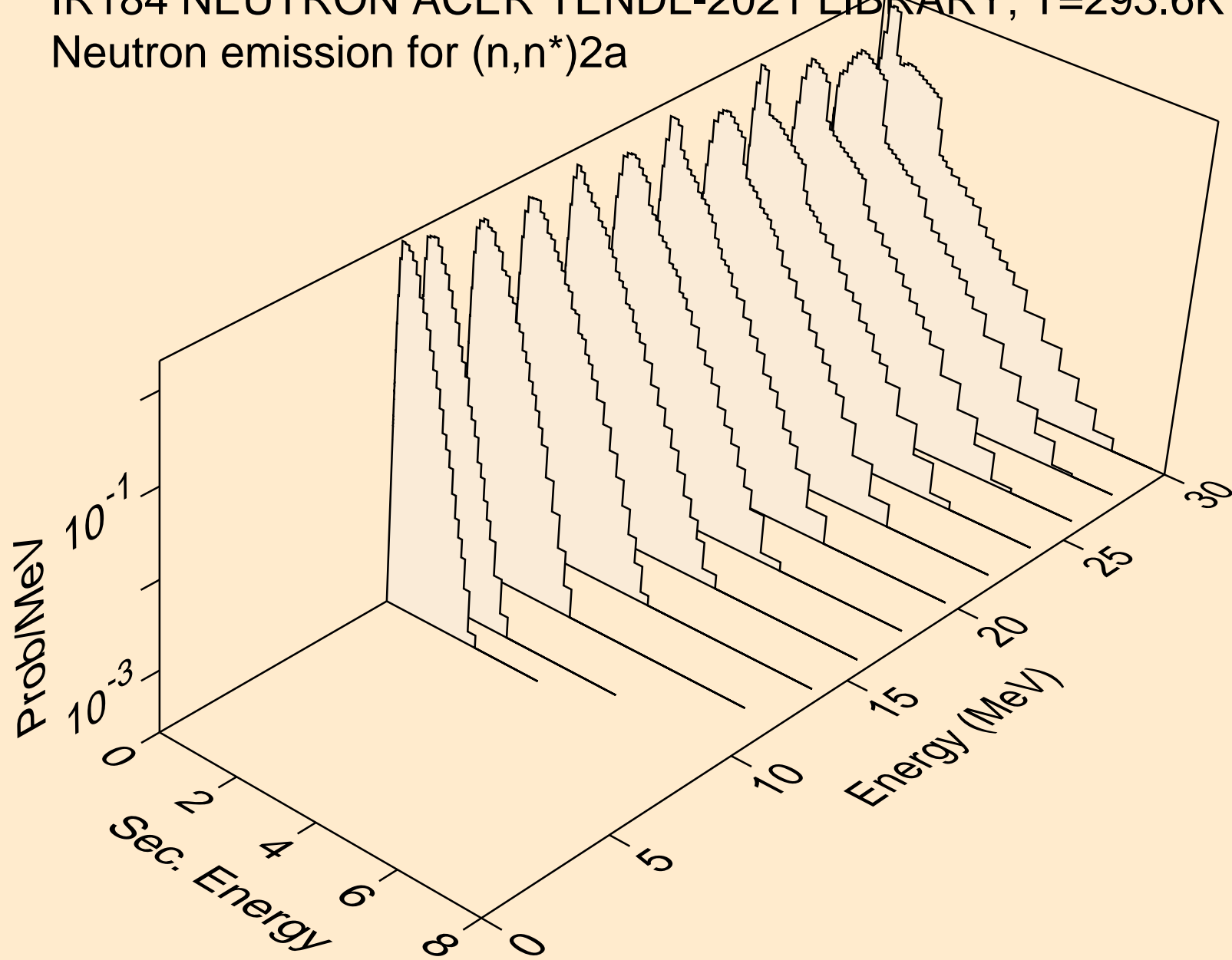

IR184 NEUTRON ACER TENDL-2021 LIBRARY; T=293.6K  
Neutron emission for (n,2n)2a

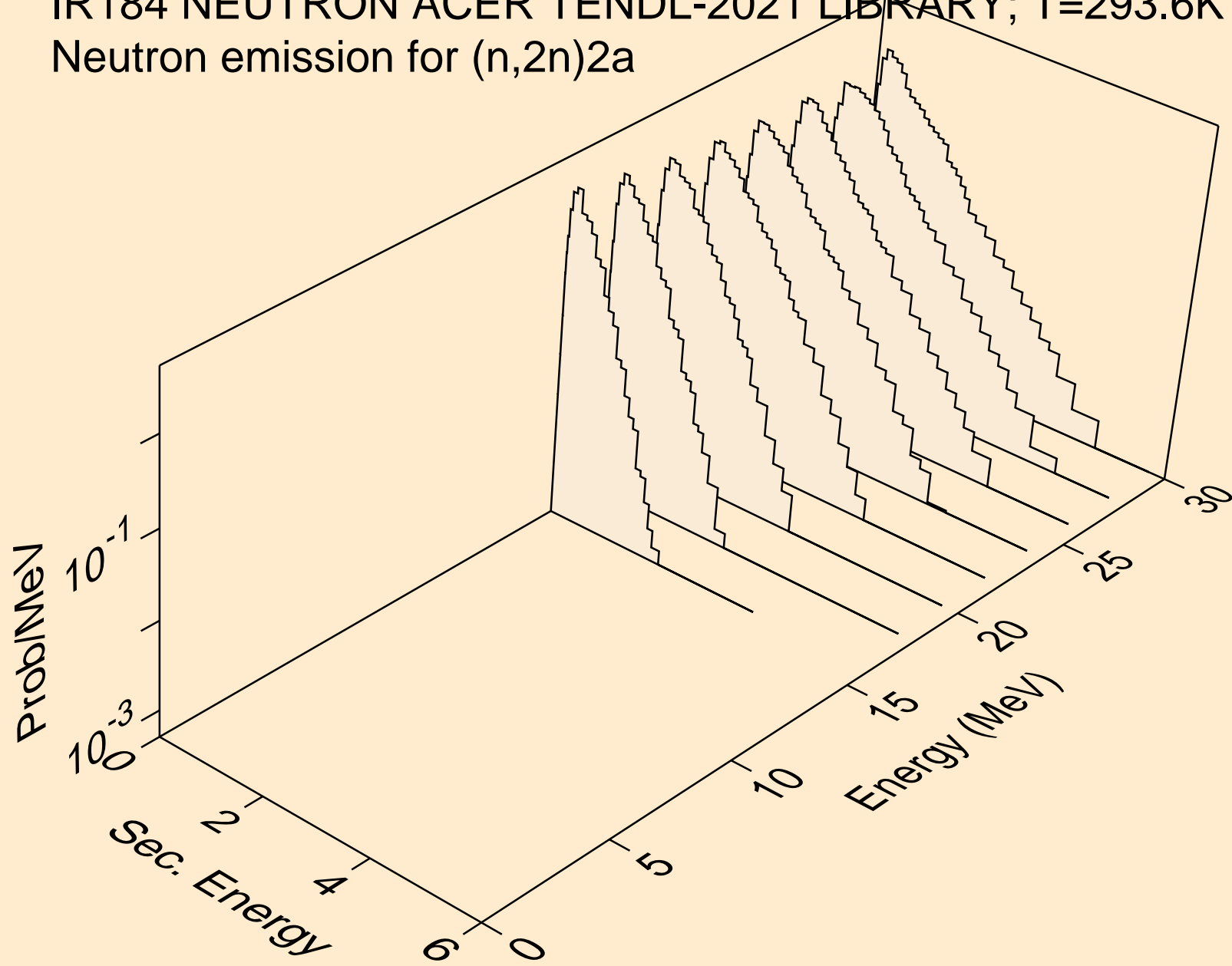



IR184 NEUTRON ACER TENDL-2021 LIBRARY; T=293.6K  
Neutron emission for (n,n\*)d

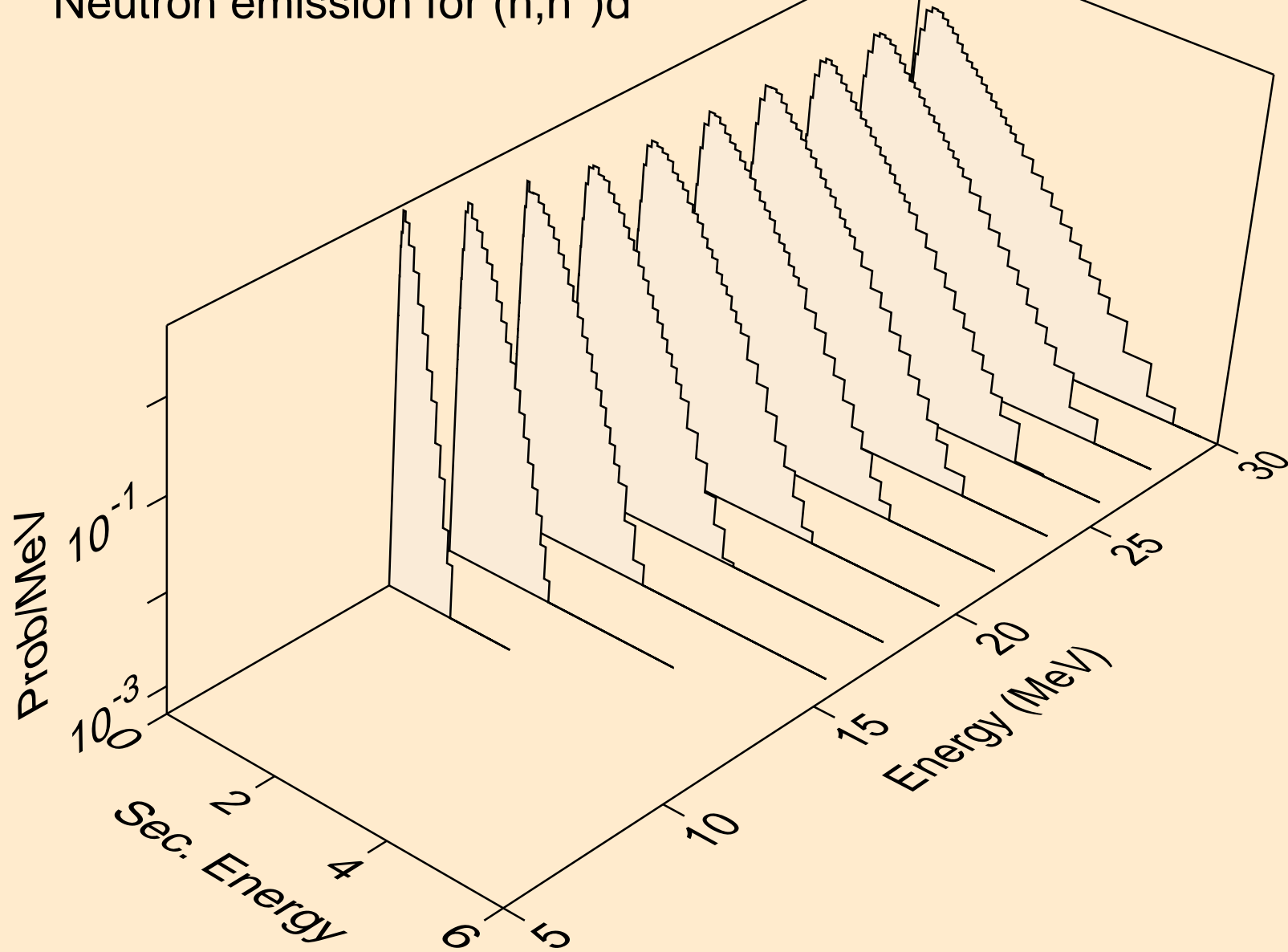

IR184 NEUTRON ACER TENDL-2021 LIBRARY; T=293.6K  
Neutron emission for (n,n\*)t

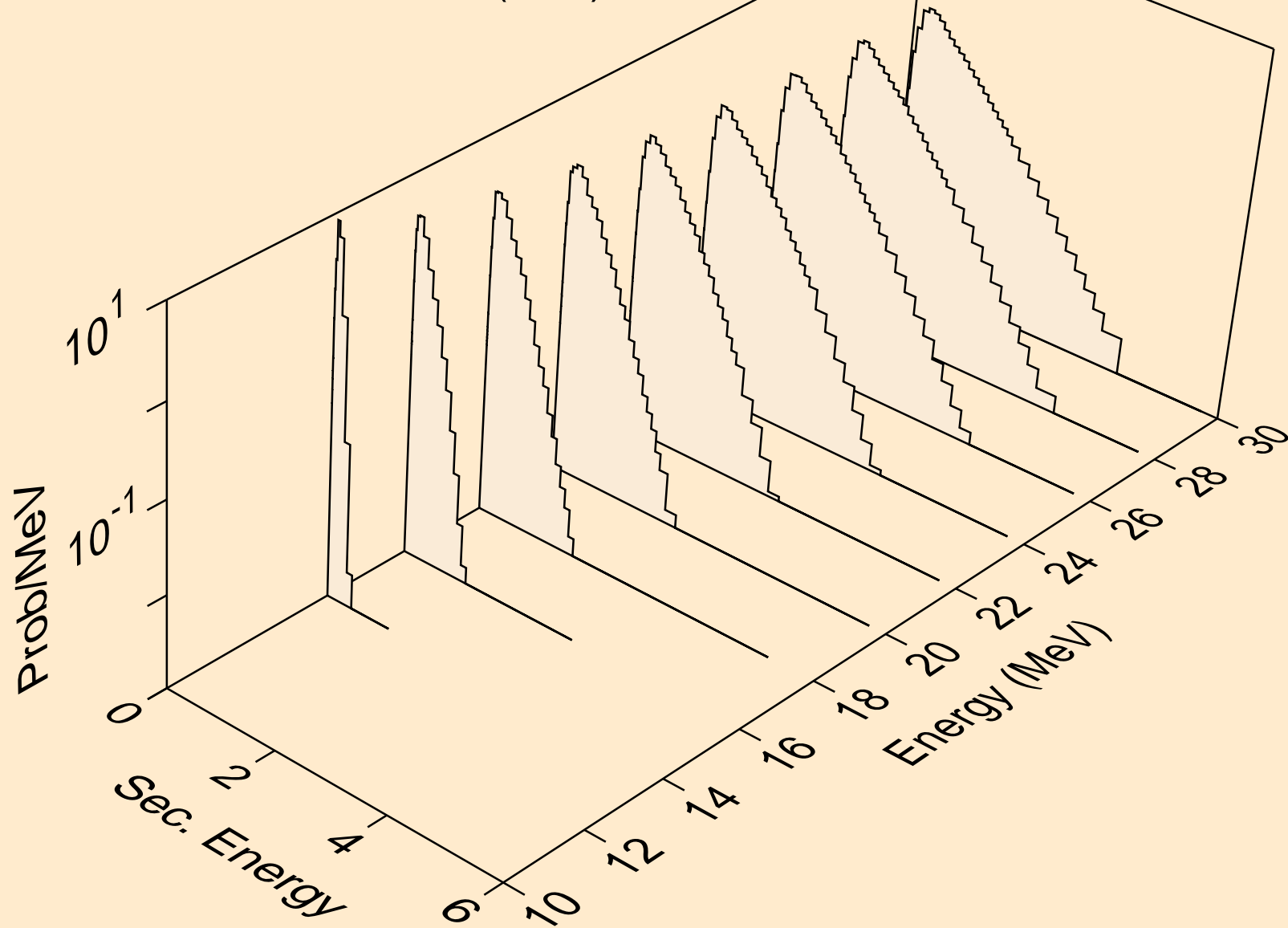

IR184 NEUTRON ACER TENDL-2021 LIBRARY; T=293.6K  
Neutron emission for (n,n\*)he3

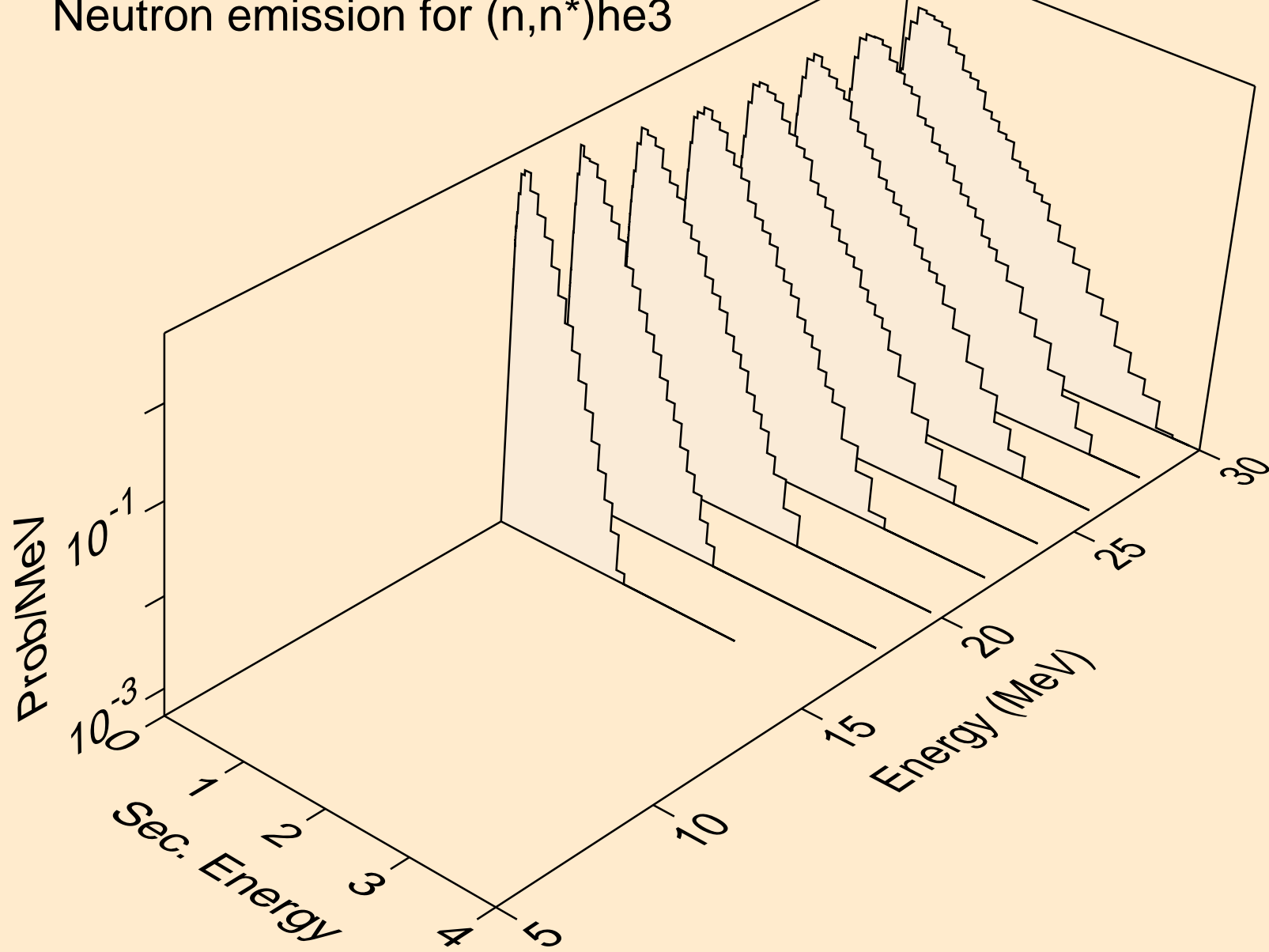

IR184 NEUTRON ACER TENDL-2021 LIBRARY; T=293.6K  
Neutron emission for (n,4n)

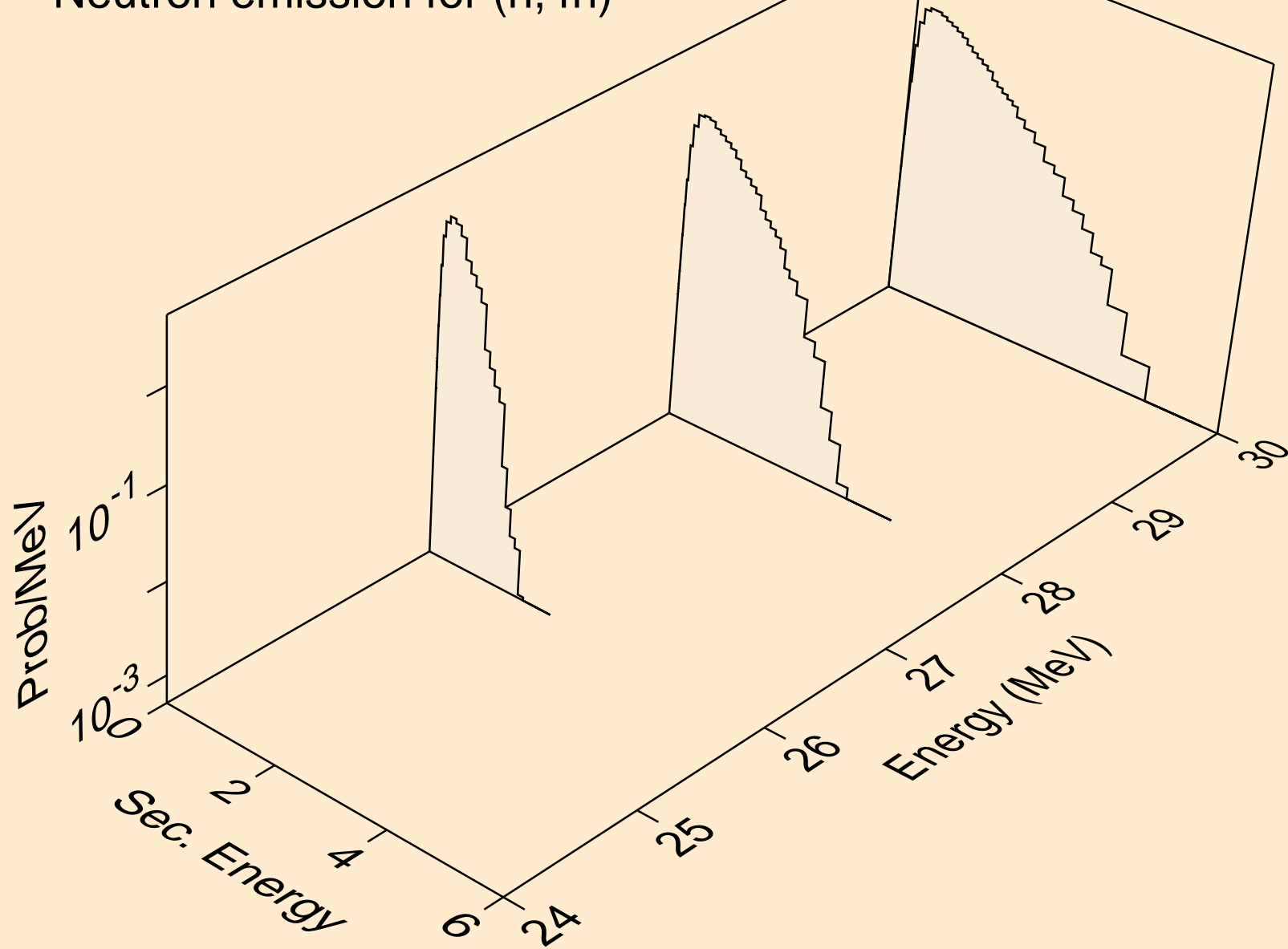

IR184 NEUTRON ACER TENDL-2021 LIBRARY; T=293.6K  
Neutron emission for (n,2np)

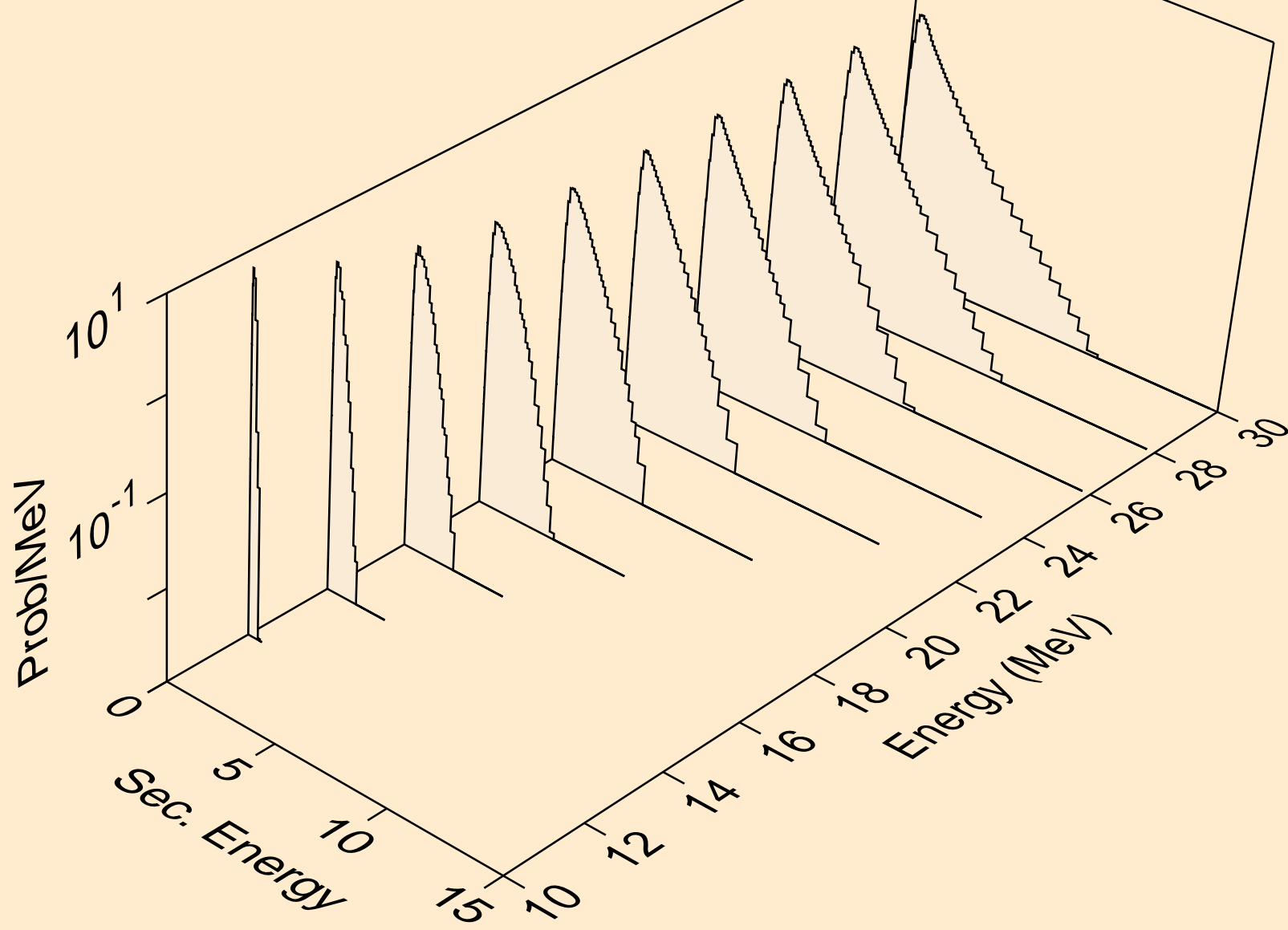

IR184 NEUTRON ACER TENDL-2021 LIBRARY; T=293.6K  
Neutron emission for (n,3np)

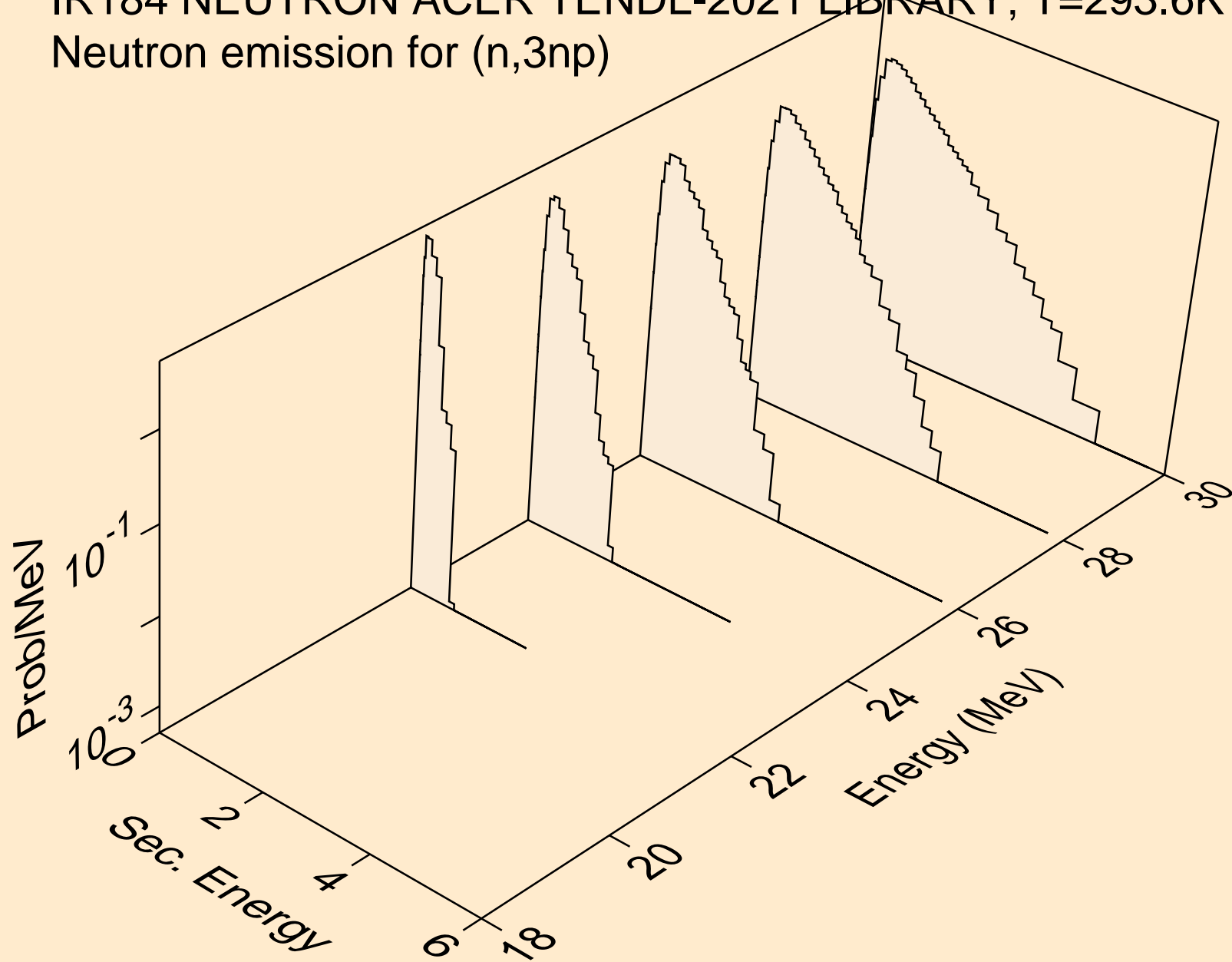

IR184 NEUTRON ACER TENDL-2021 LIBRARY; T=293.6K  
Neutron emission for (n,2np)

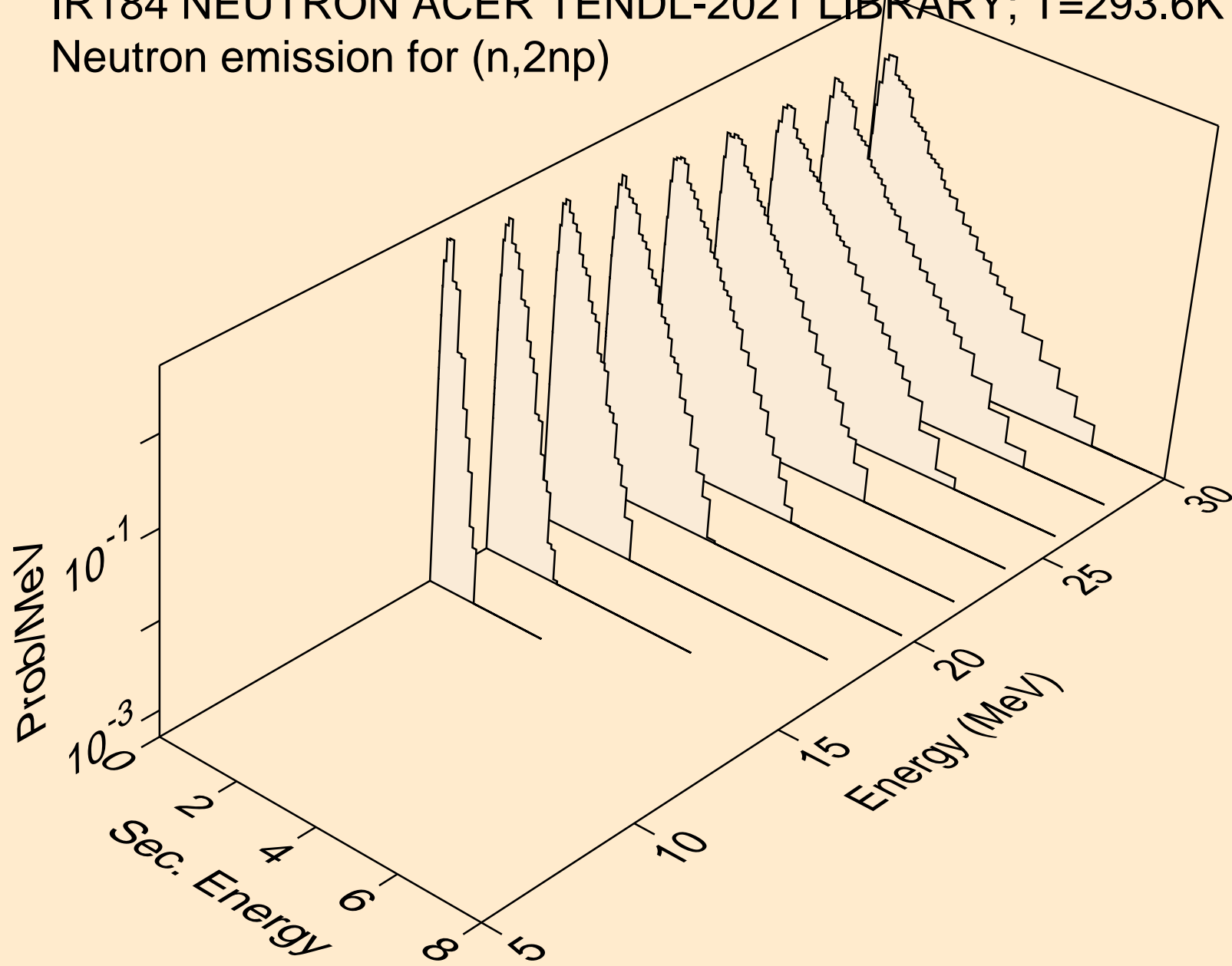

IR184 NEUTRON ACER TENDL-2021 LIBRARY; T=293.6K  
Neutron emission for (n,npa)

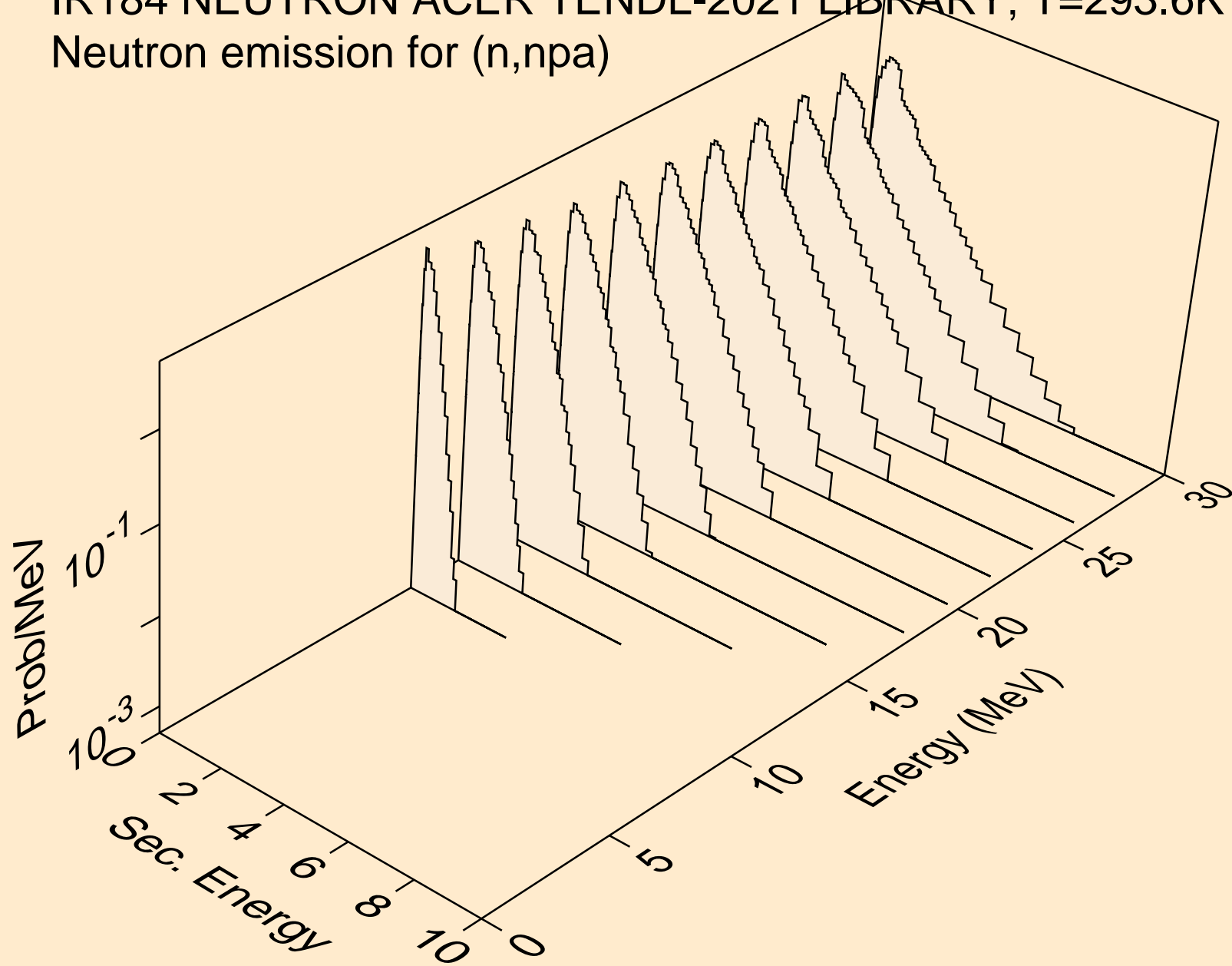



IR184 NEUTRON ACER TENDL-2021 LIBRARY; T=293.6K  
Neutron emission for (n,n\*c)

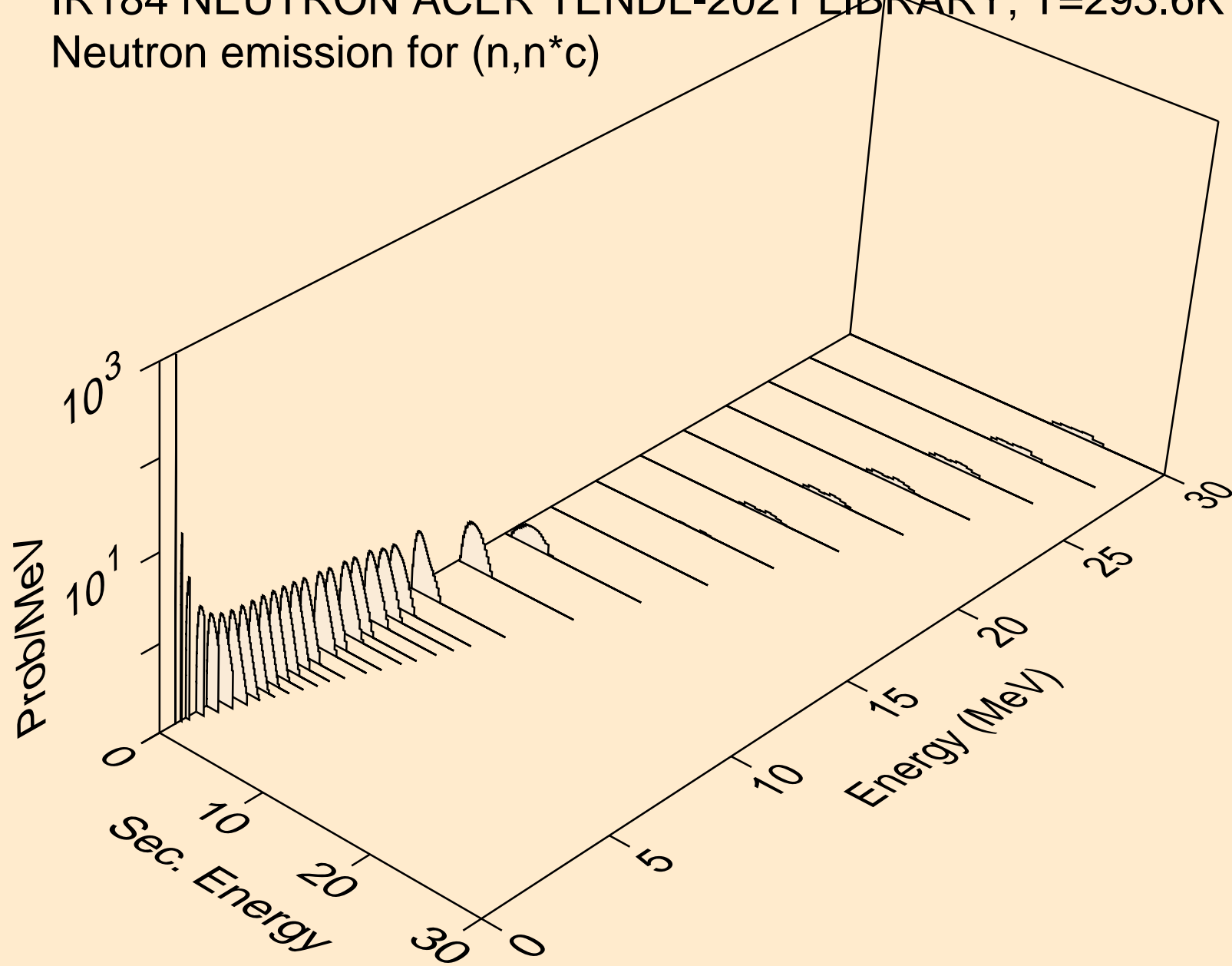

IR184 NEUTRON ACER TENDL-2021 LIBRARY; T=293.6K  
Photon emission for (n,x)

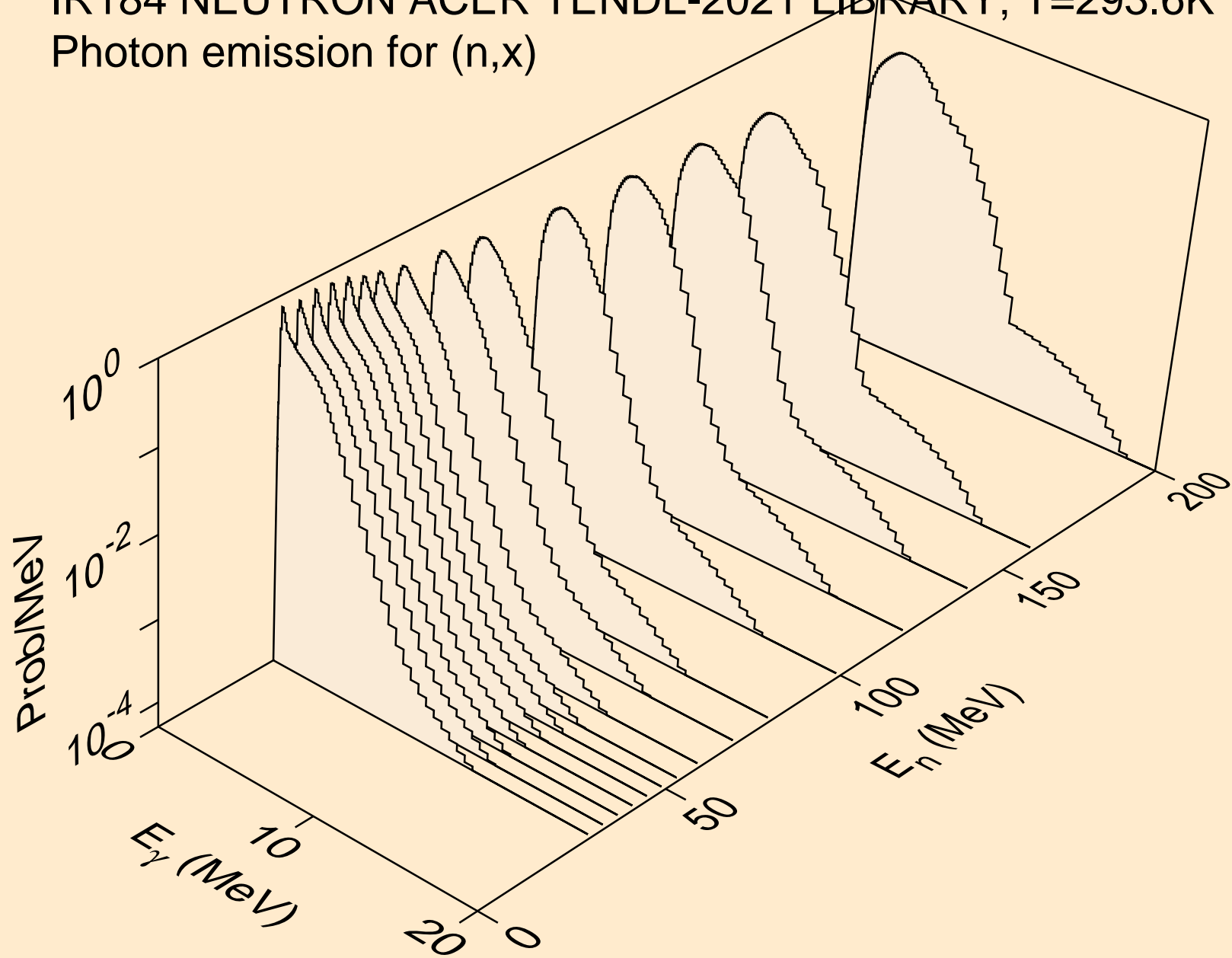

IR184 NEUTRON ACER TENDL-2021 LIBRARY; T=293.6K  
Photon emission for (n,2nd)

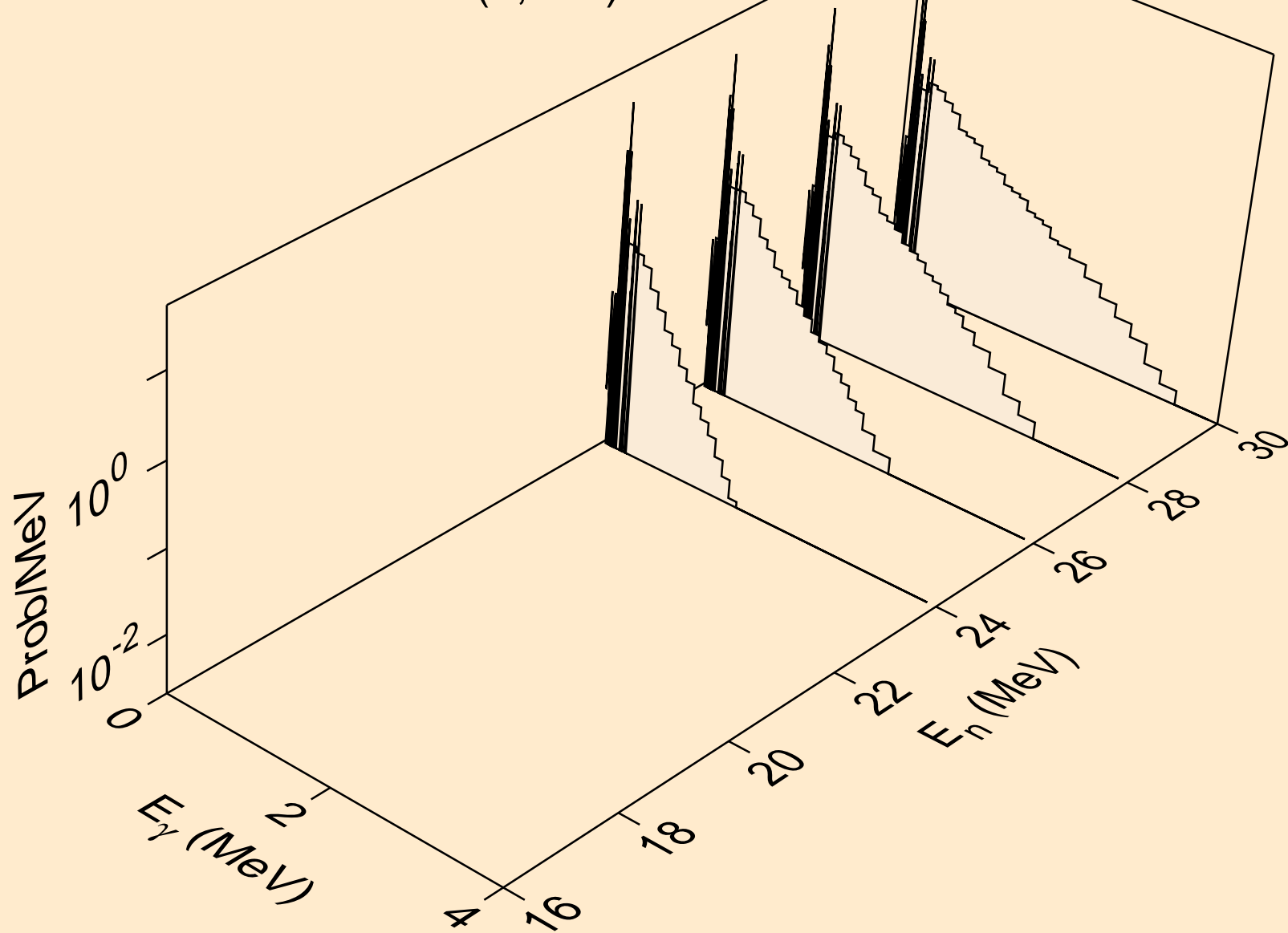

IR184 NEUTRON ACER TENDL-2021 LIBRARY; T=293.6K  
Photon emission for (n,2n)

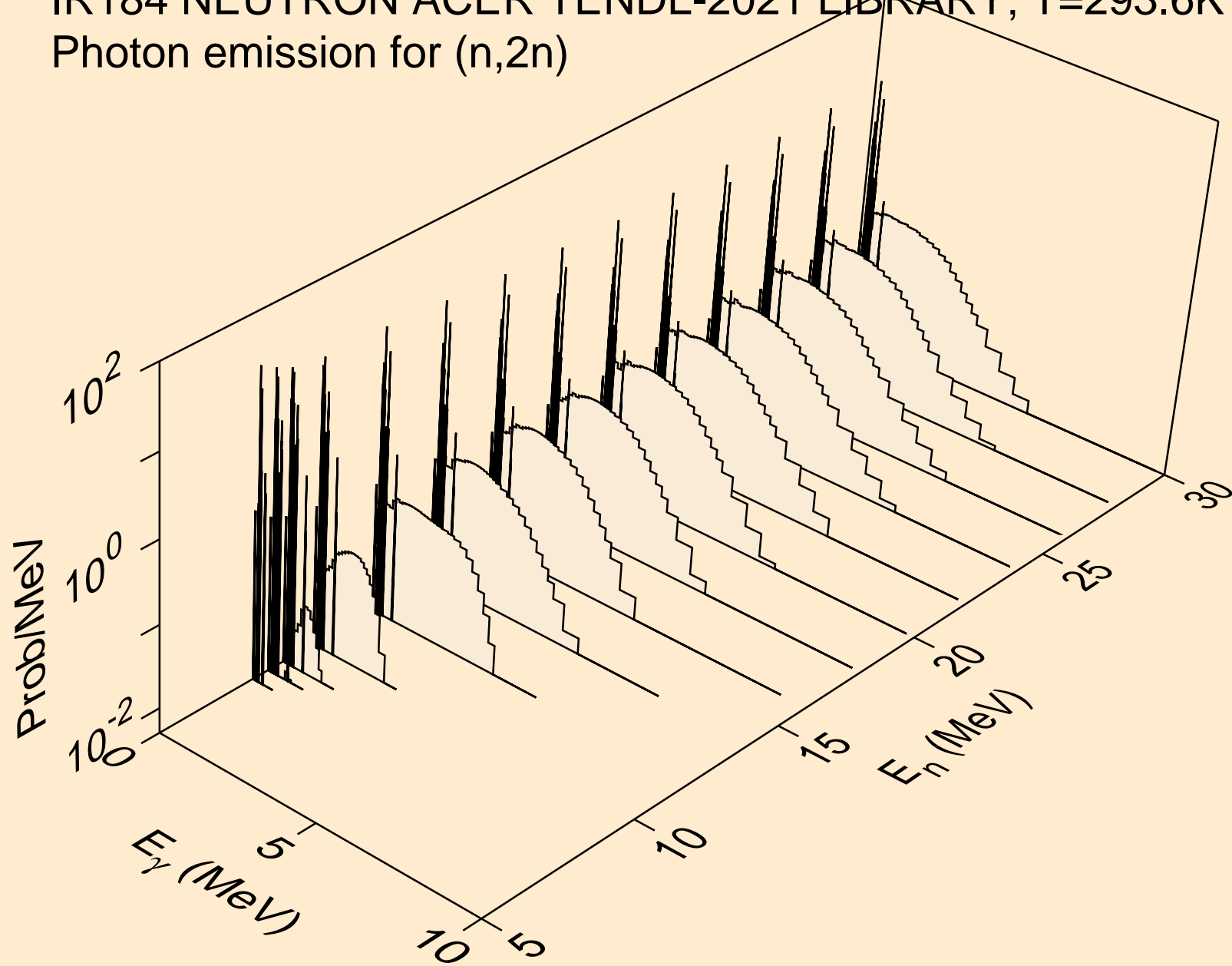

IR184 NEUTRON ACER TENDL-2021 LIBRARY; T=293.6K  
Photon emission for (n,3n)

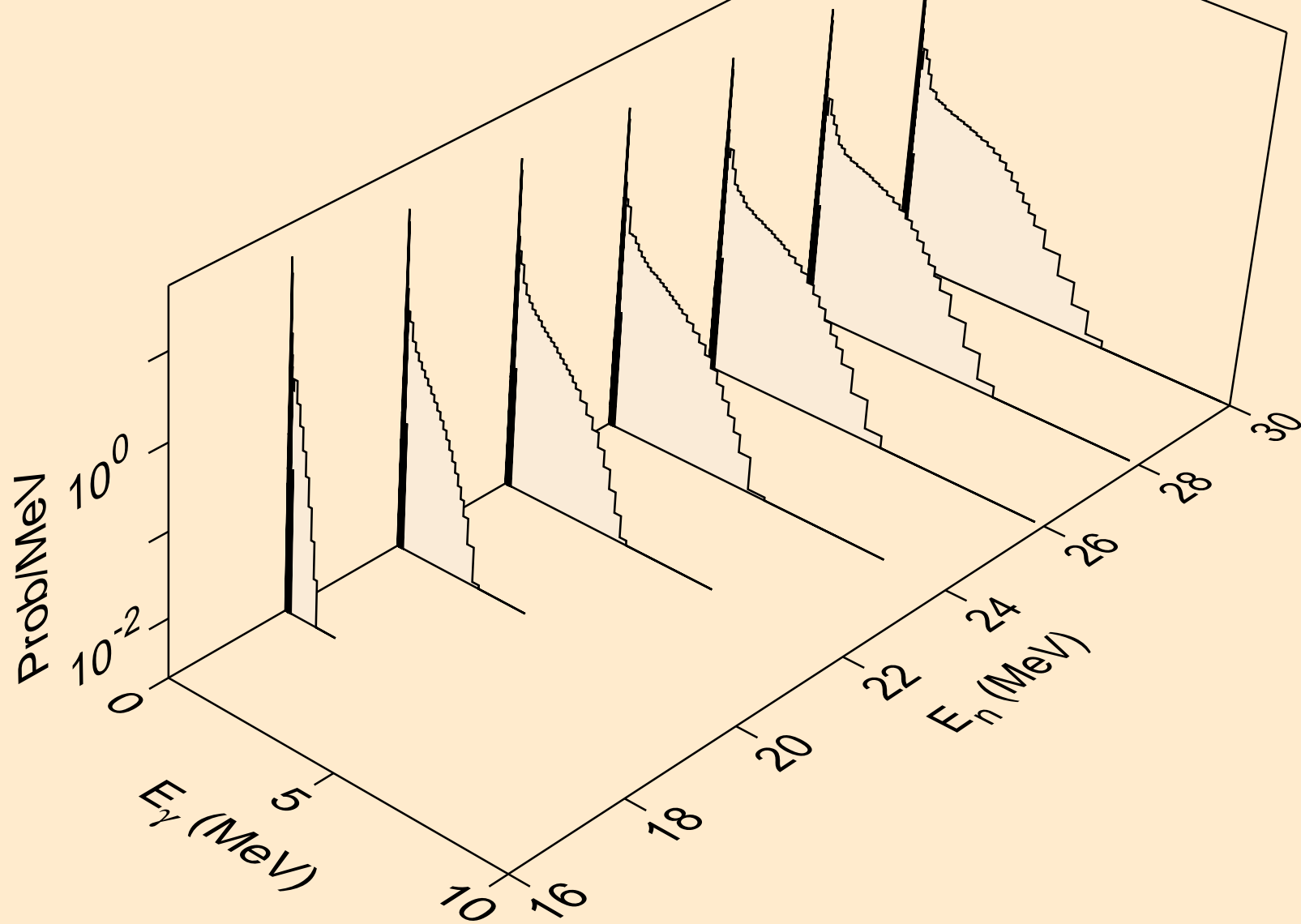

IR184 NEUTRON ACER TENDL-2021 LIBRARY; T=293.6K  
Photon emission for (n,n\*)a

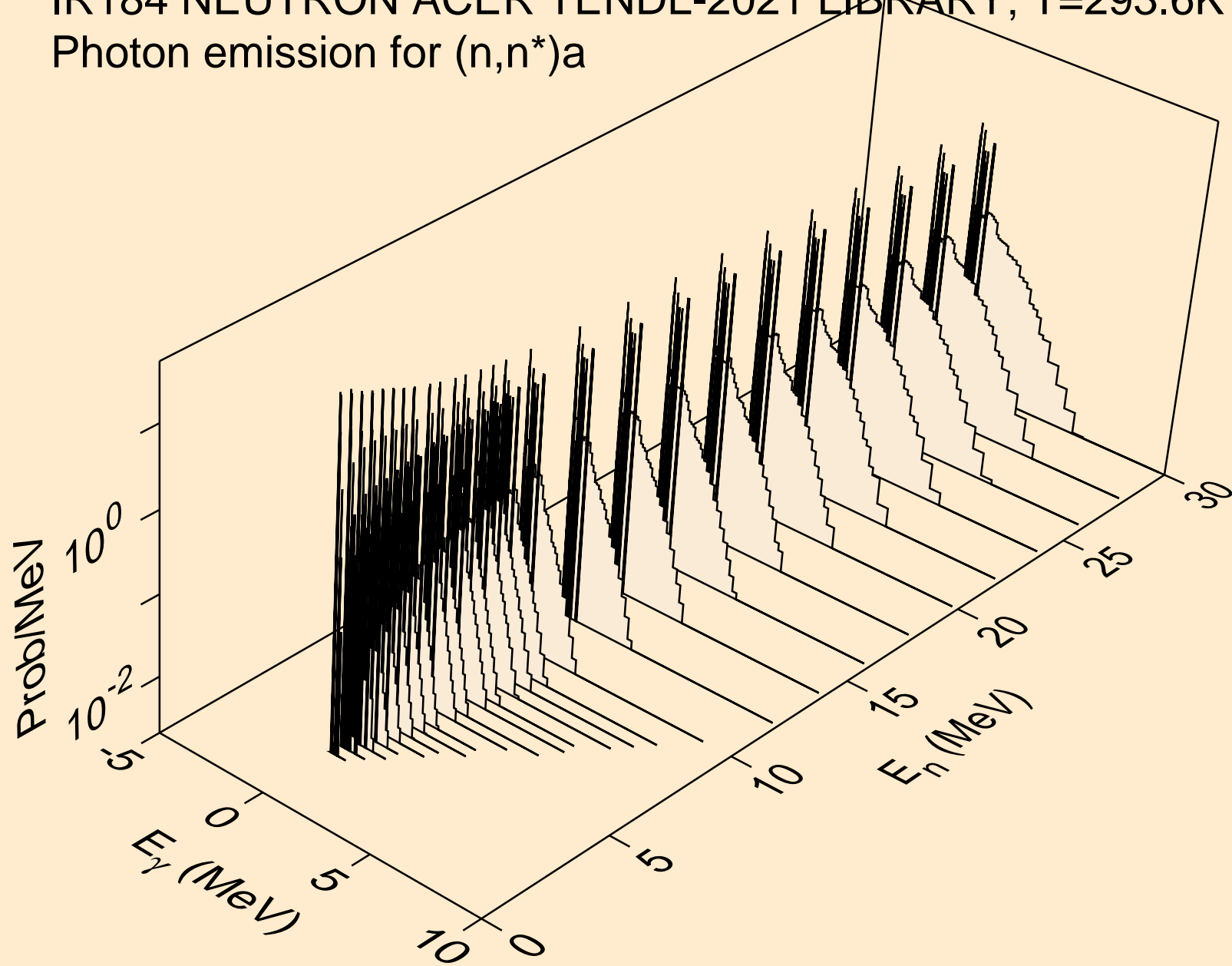

IR184 NEUTRON ACER TENDL-2021 LIBRARY; T=293.6K  
Photon emission for (n,2n)a

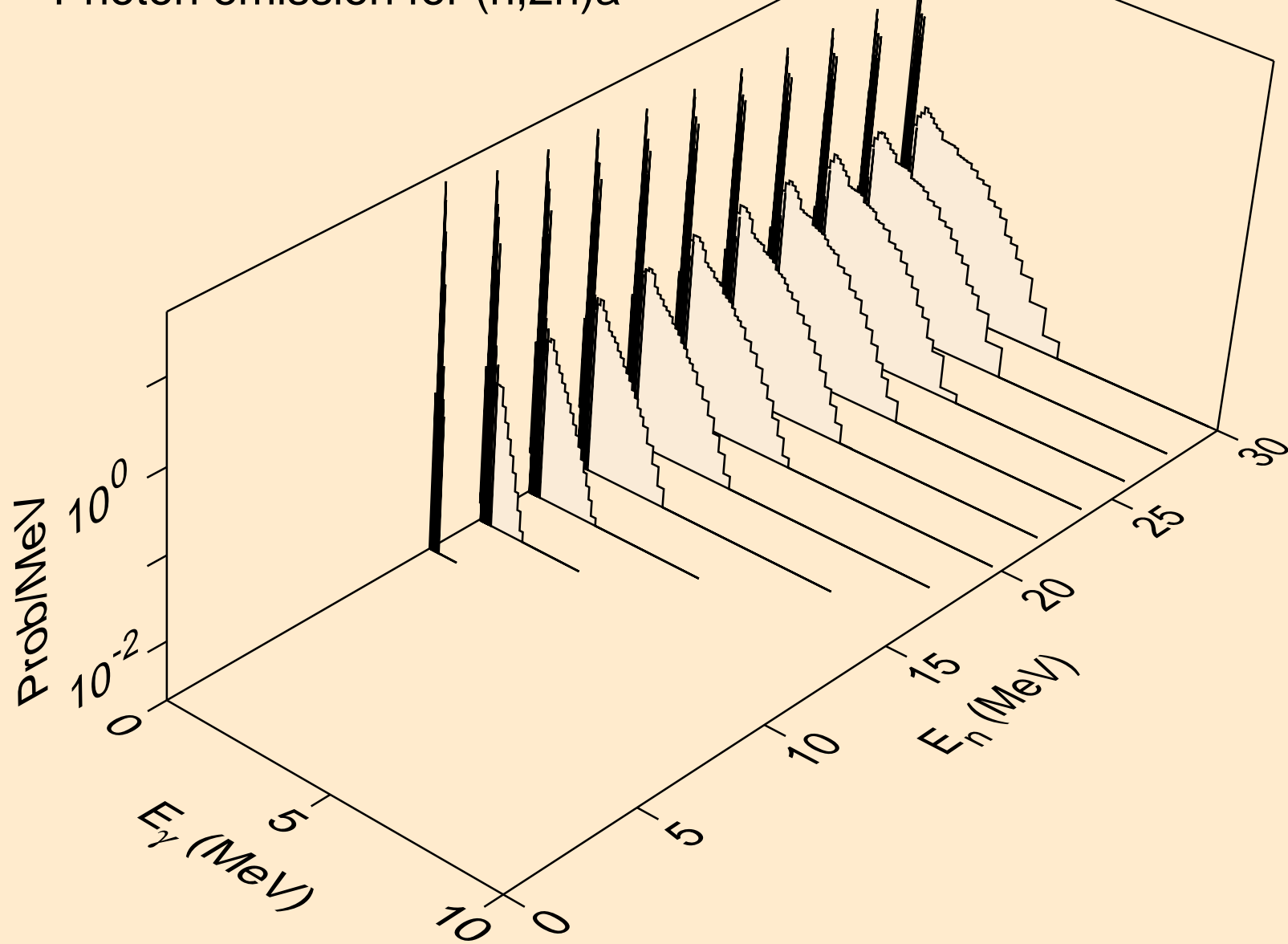

IR184 NEUTRON ACER TENDL-2021 LIBRARY; T=293.6K  
Photon emission for (n,3n)a

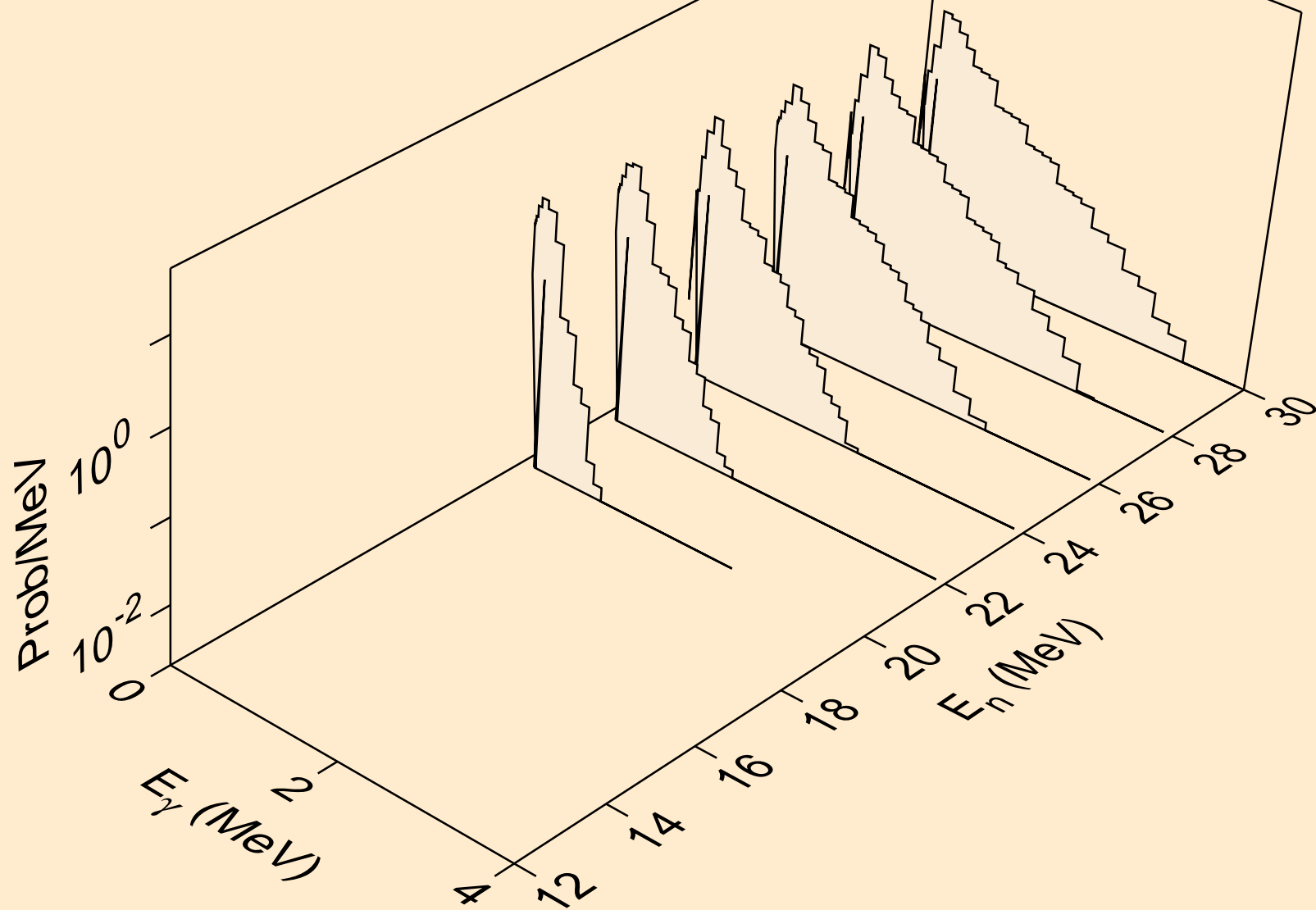



IR184 NEUTRON ACER TENDL-2021 LIBRARY; T=293.6K  
Photon emission for (n,n\*)p

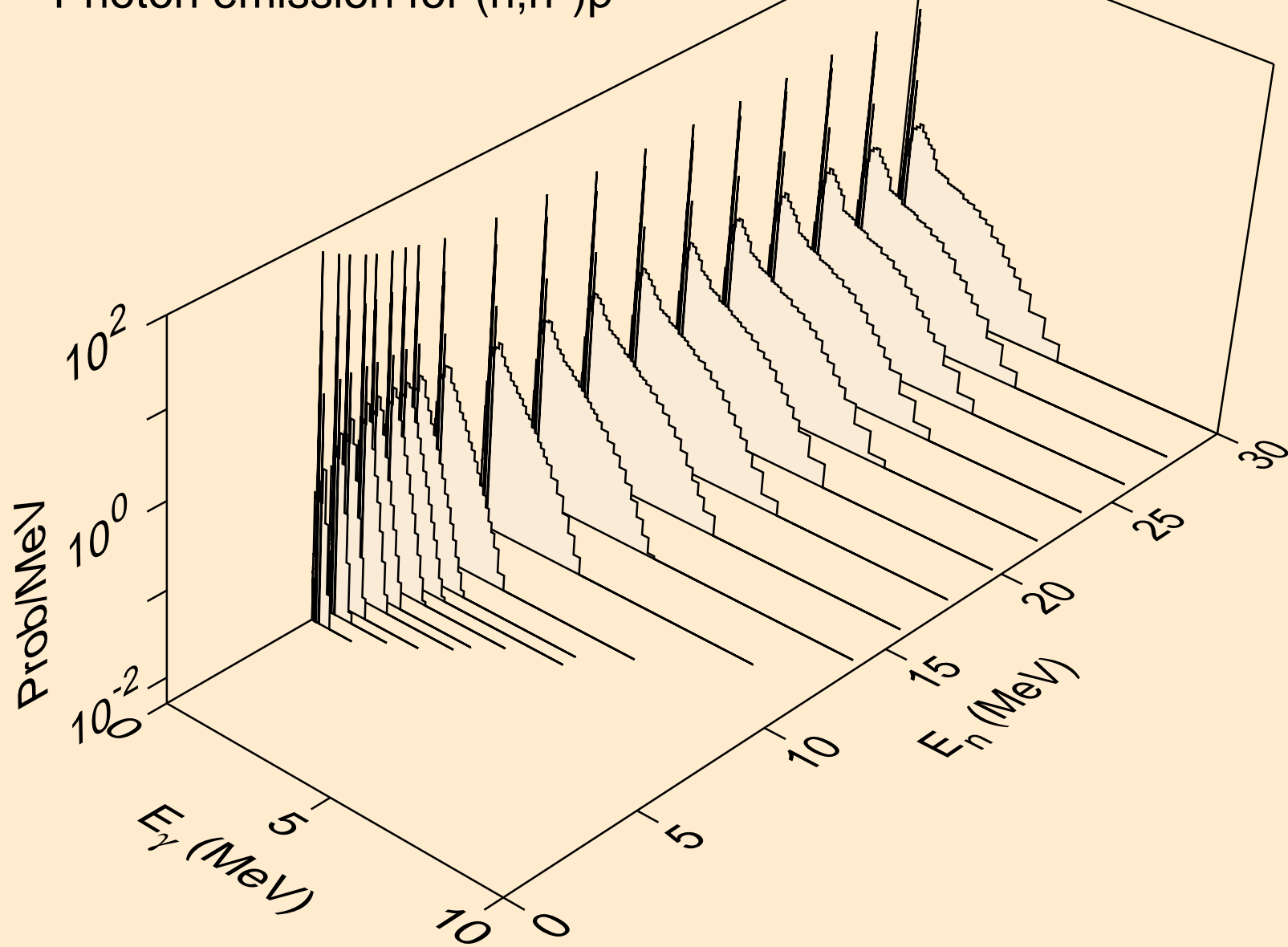

IR184 NEUTRON ACER TENDL-2021 LIBRARY; T=293.6K  
Photon emission for (n,n\*)2a

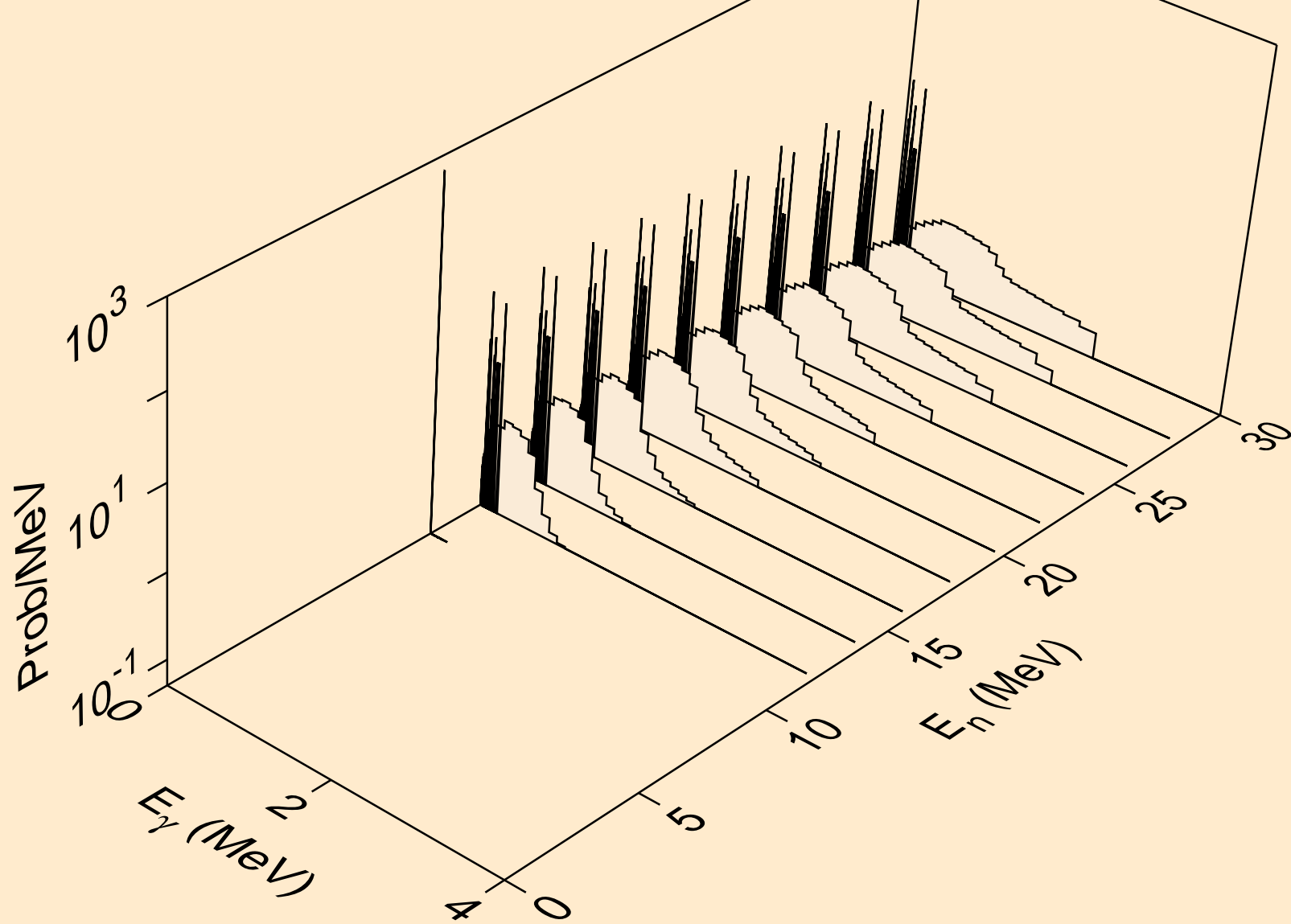

IR184 NEUTRON ACER TENDL-2021 LIBRARY; T=293.6K  
Photon emission for (n,2n)2a

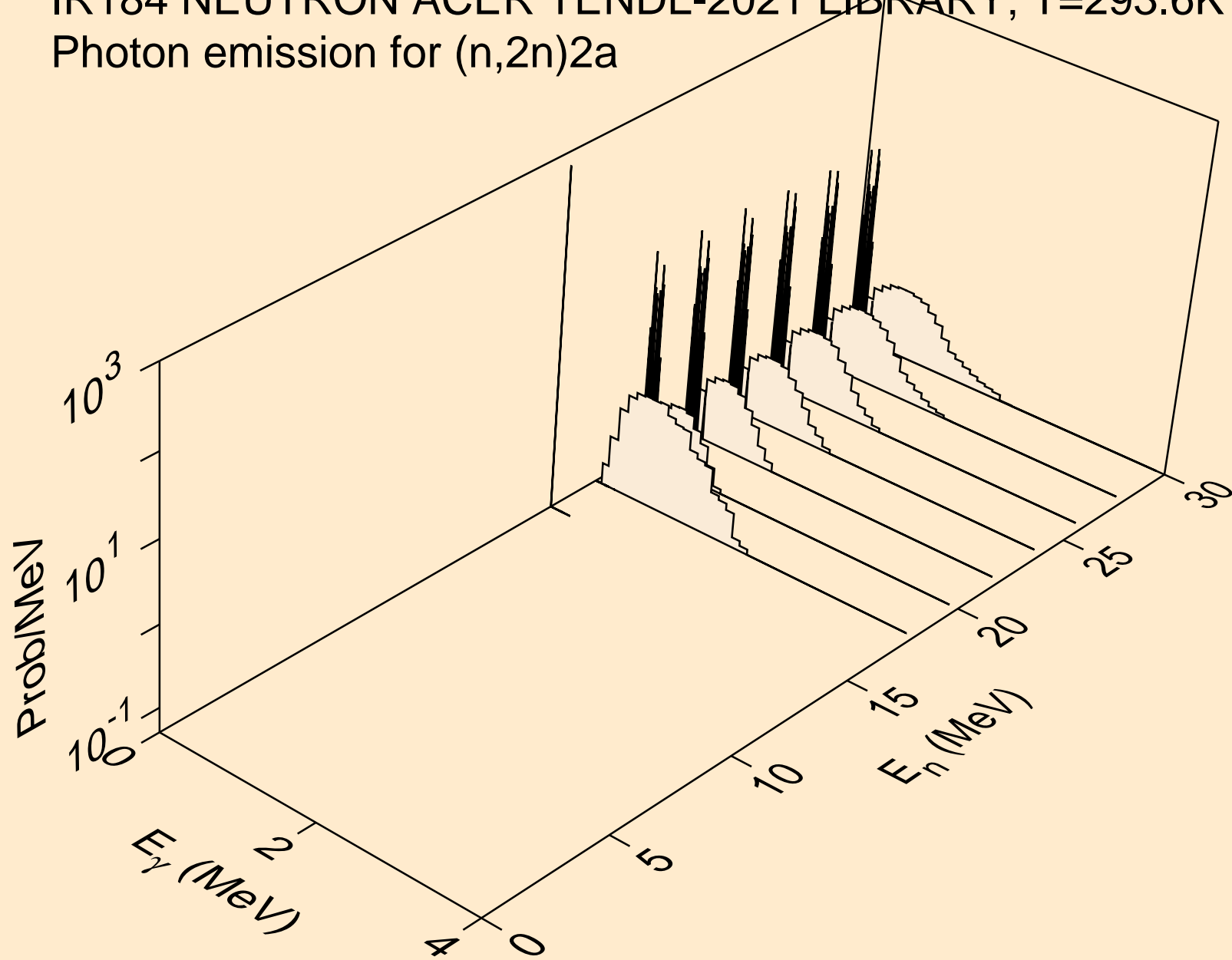

IR184 NEUTRON ACER TENDL-2021 LIBRARY; T=293.6K  
Photon emission for (n,n\*)d

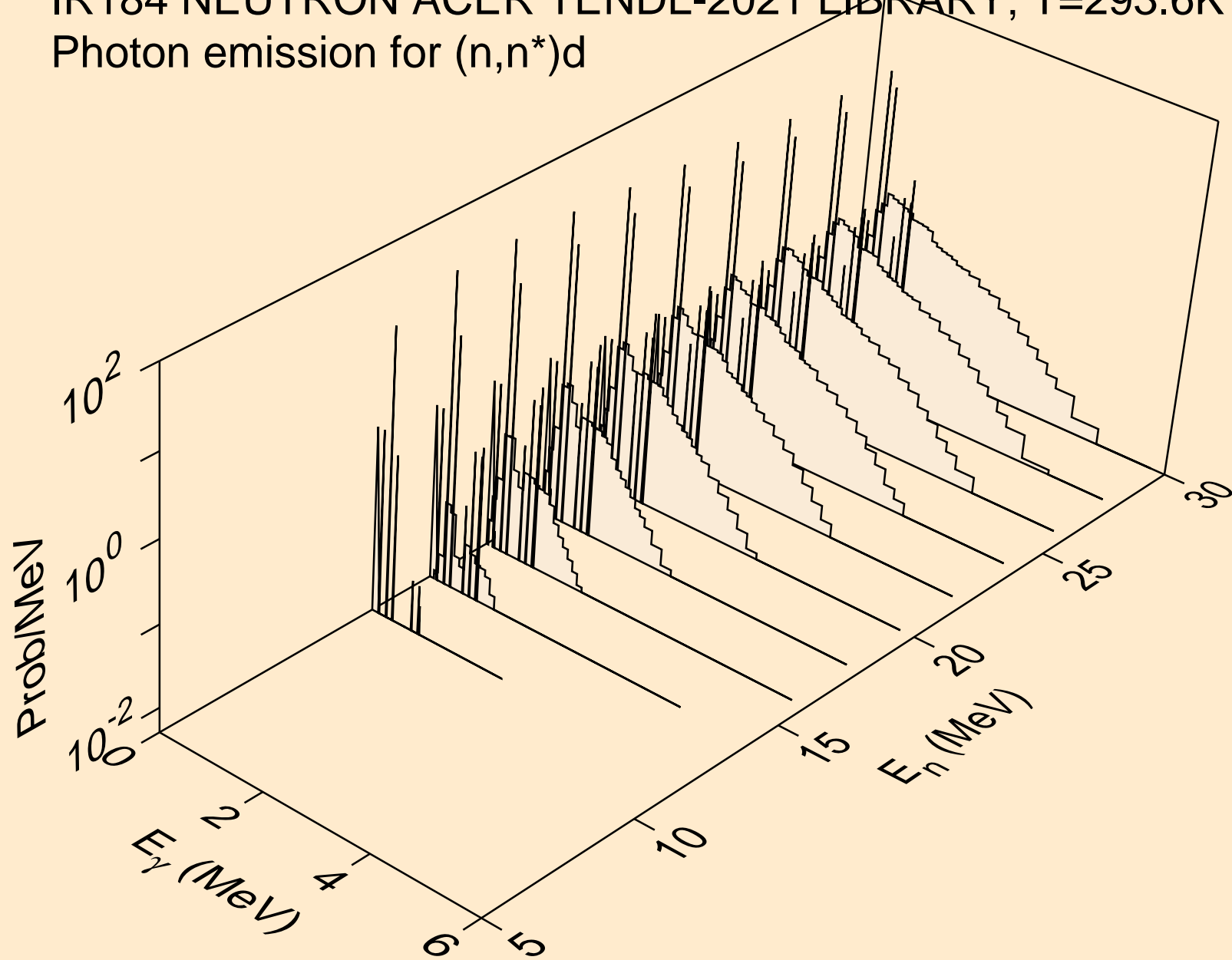

IR184 NEUTRON ACER TENDL-2021 LIBRARY; T=293.6K  
Photon emission for (n,n\*)t

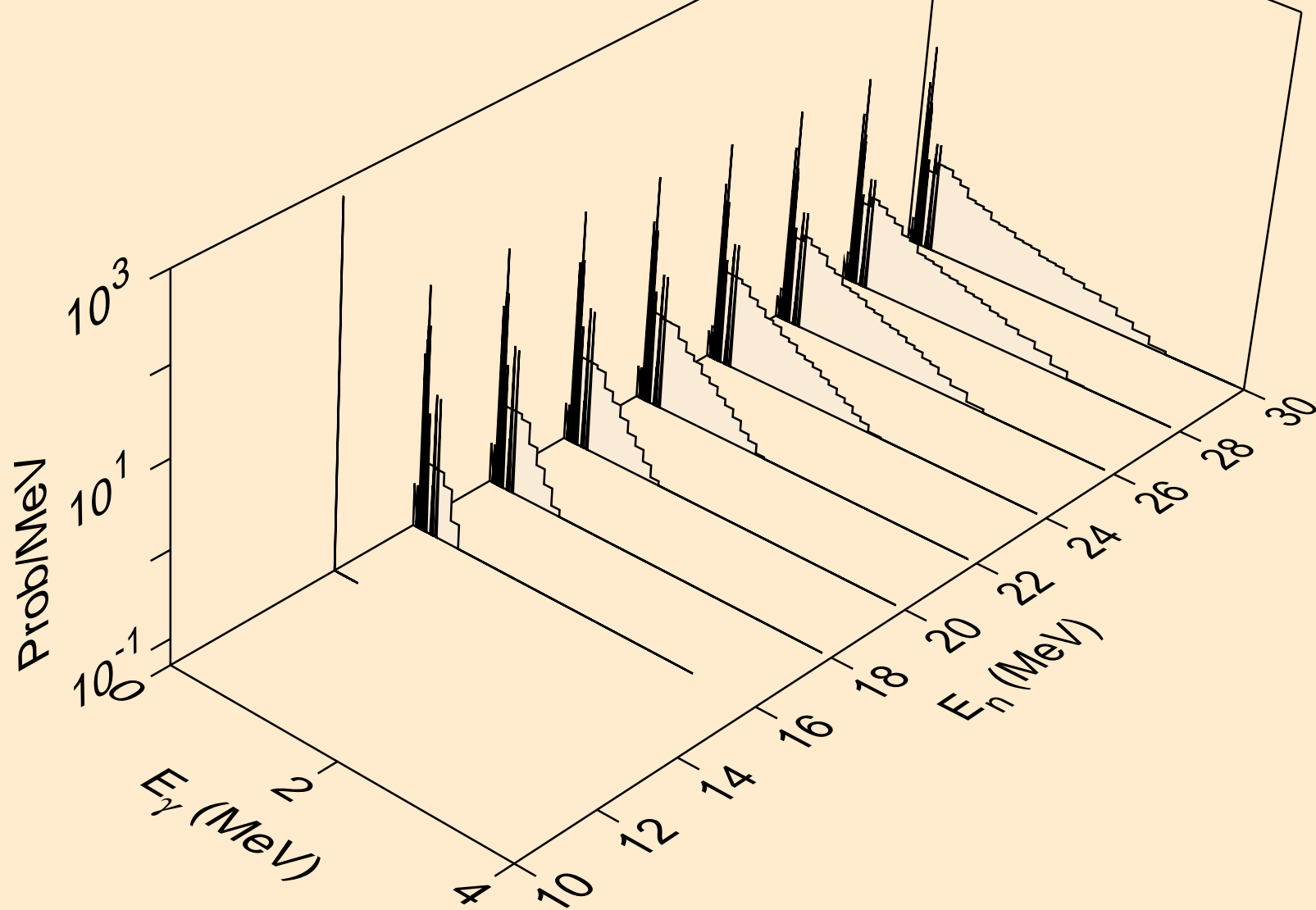

IR184 NEUTRON ACER TENDL-2021 LIBRARY; T=293.6K  
Photon emission for (n,n\*)he3

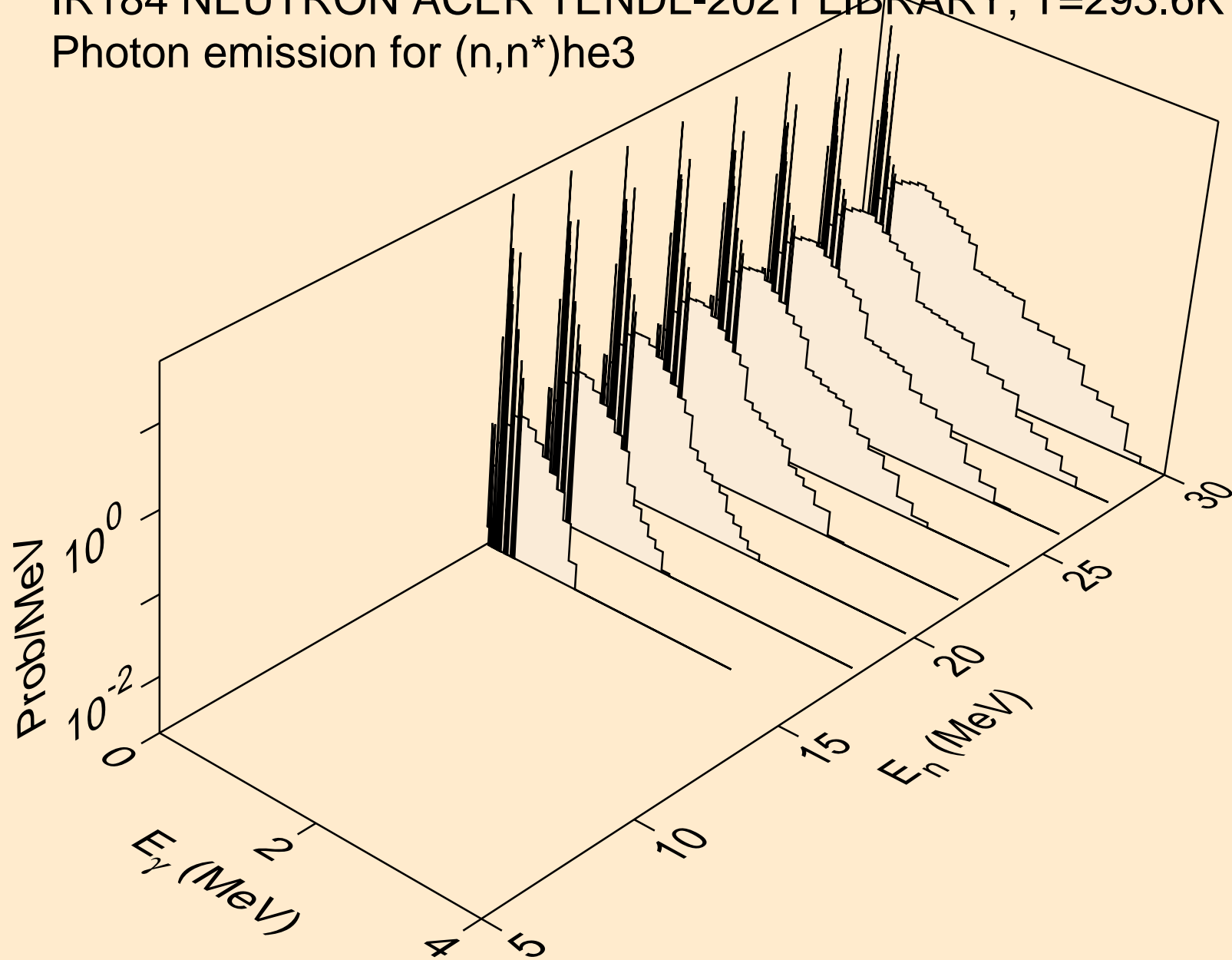

IR184 NEUTRON ACER TENDL-2021 LIBRARY; T=293.6K  
Photon emission for (n,4n)

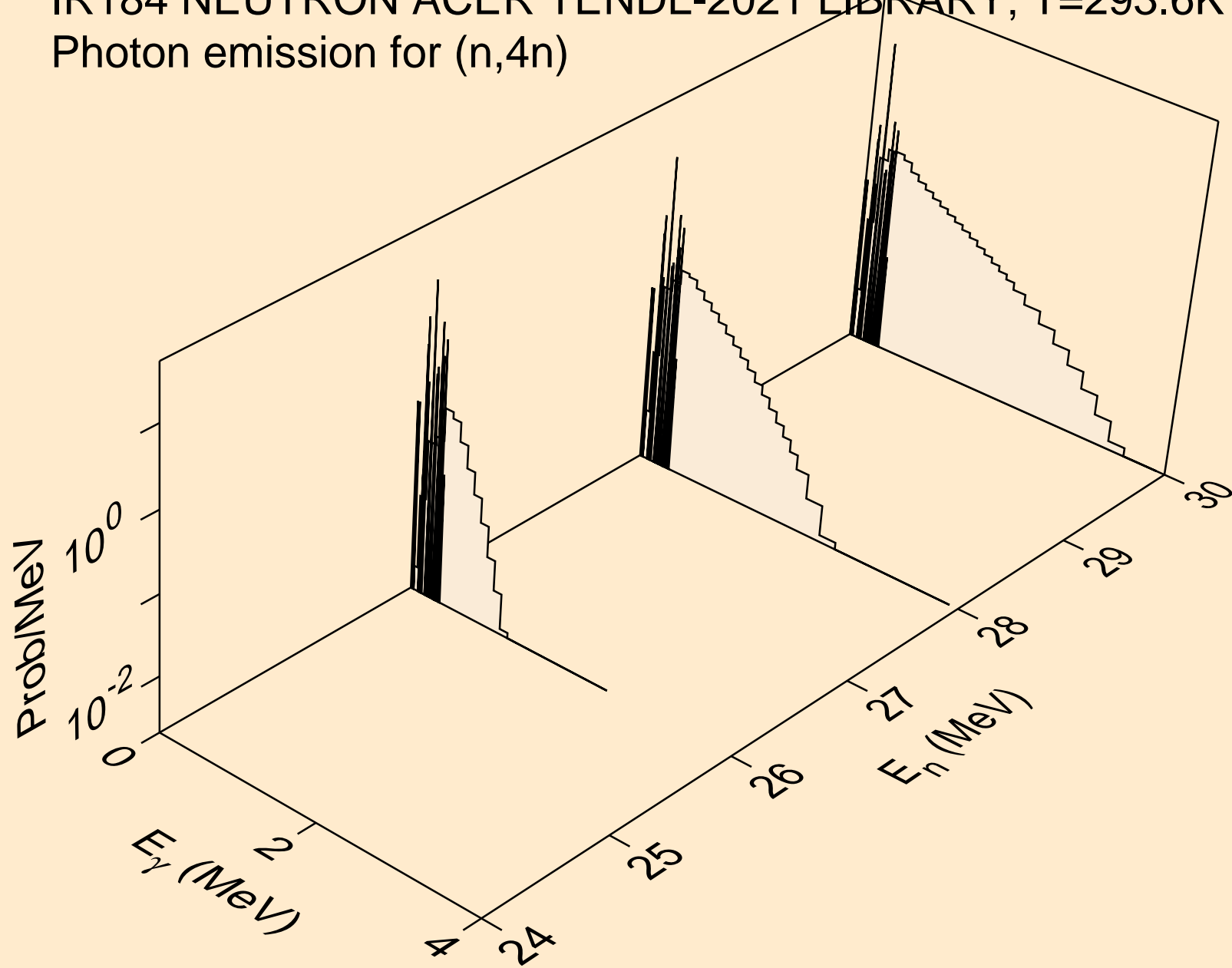

IR184 NEUTRON ACER TENDL-2021 LIBRARY; T=293.6K  
Photon emission for (n,2np)

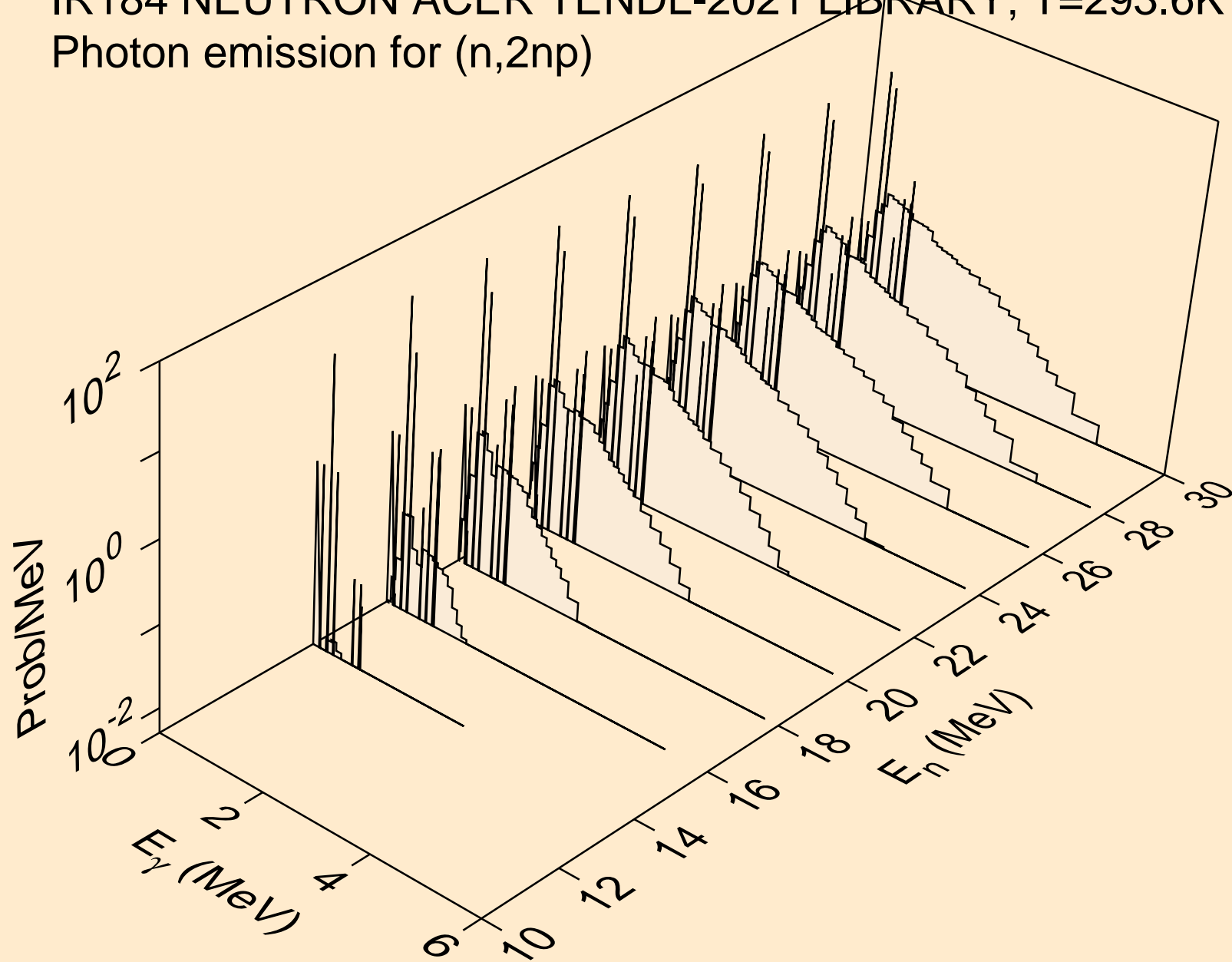



IR184 NEUTRON ACER TENDL-2021 LIBRARY; T=293.6K  
Photon emission for (n,3np)

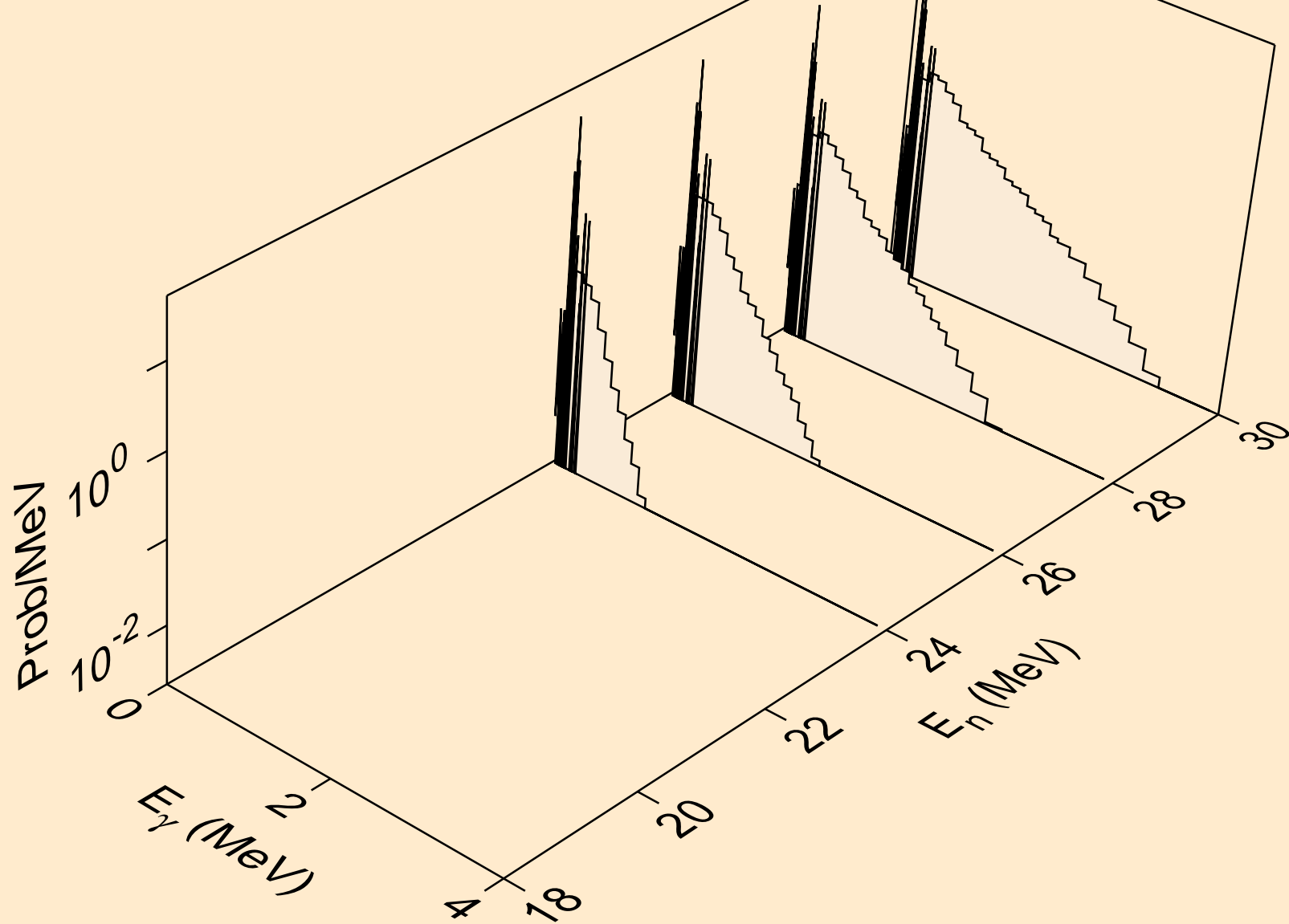

IR184 NEUTRON ACER TENDL-2021 LIBRARY; T=293.6K  
Photon emission for (n,2np)

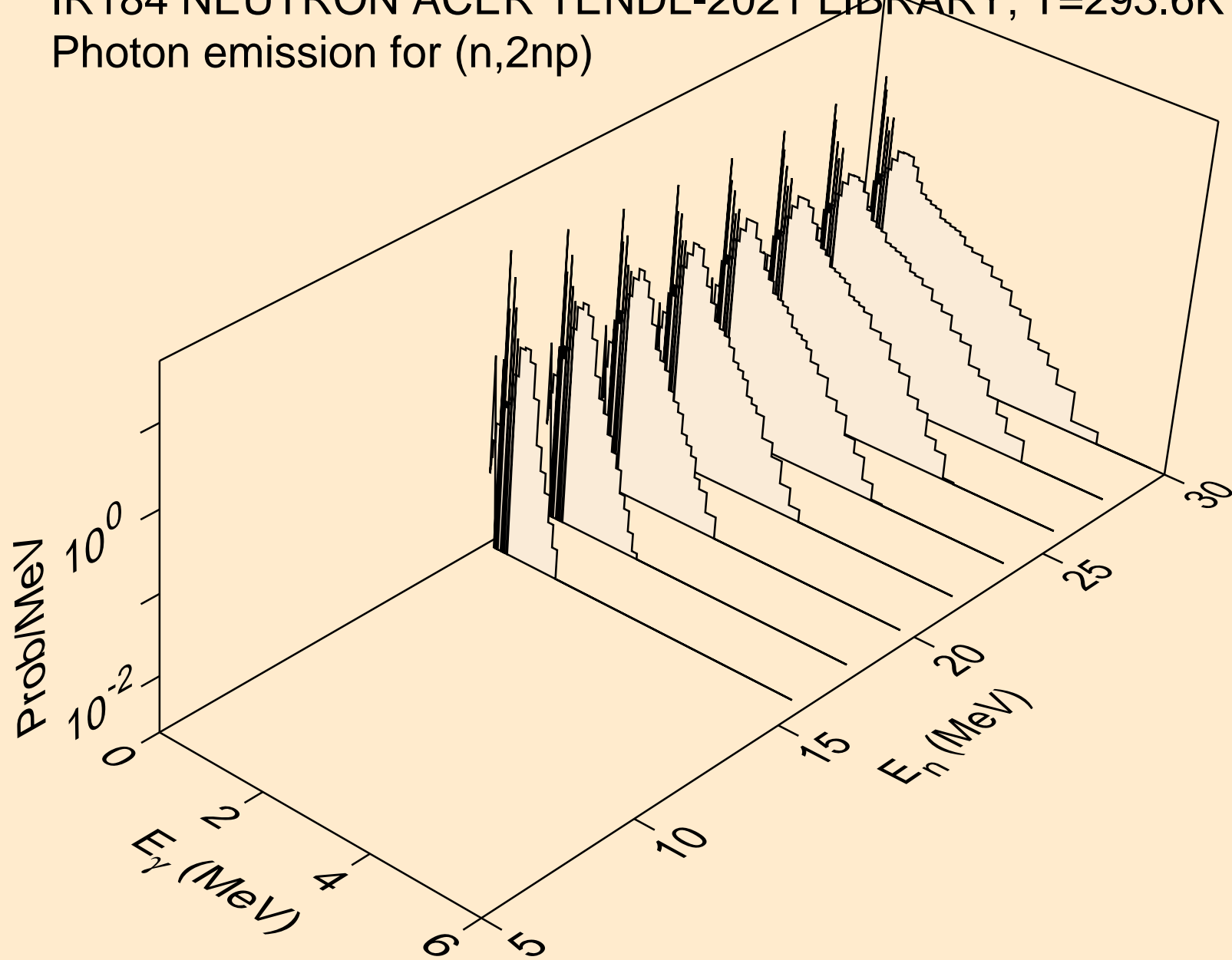

IR184 NEUTRON ACER TENDL-2021 LIBRARY; T=293.6K  
Photon emission for (n,npa)

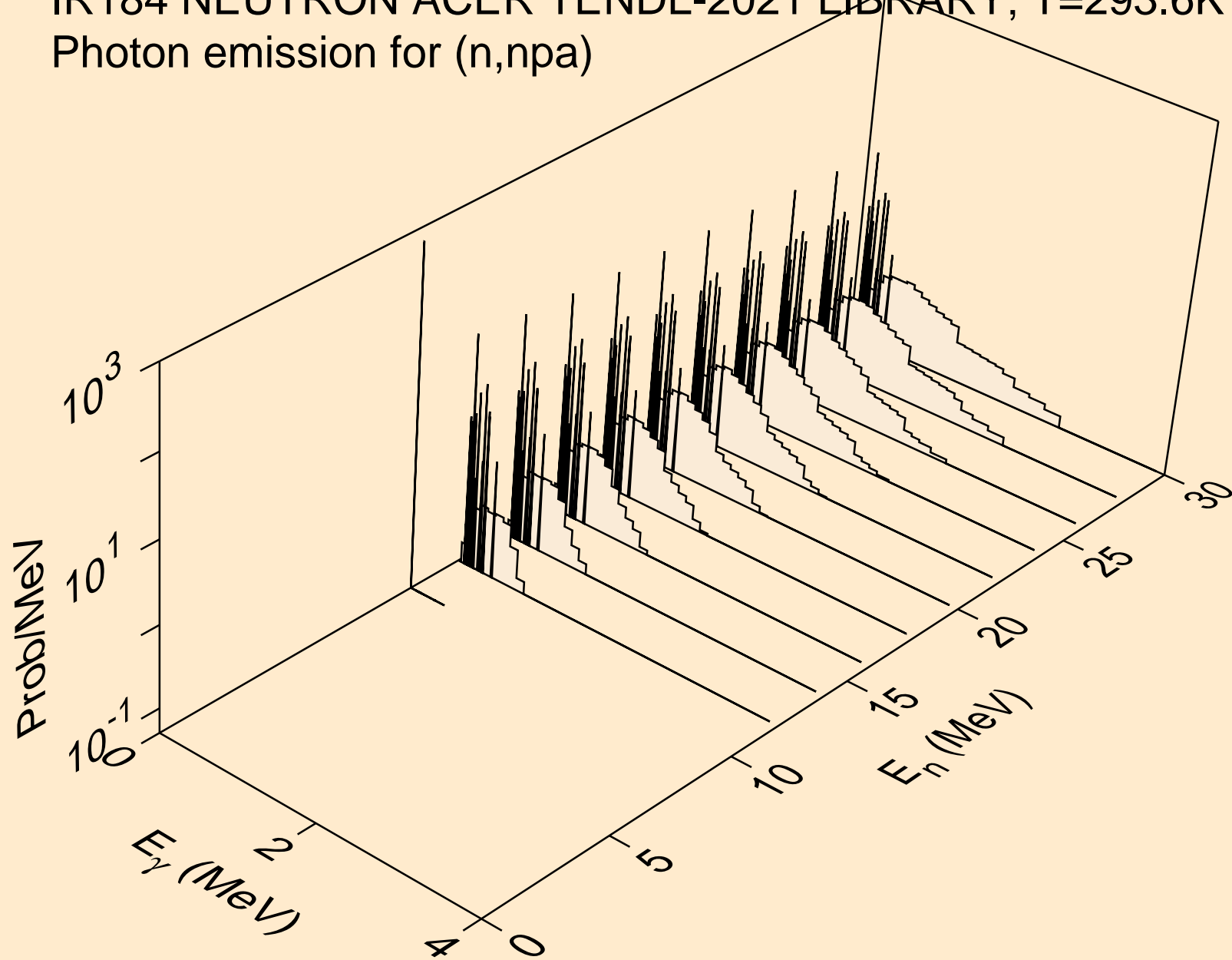

IR184 NEUTRON ACER TENDL-2021 LIBRARY; T=293.6K  
Photon emission for (n,n\*c)

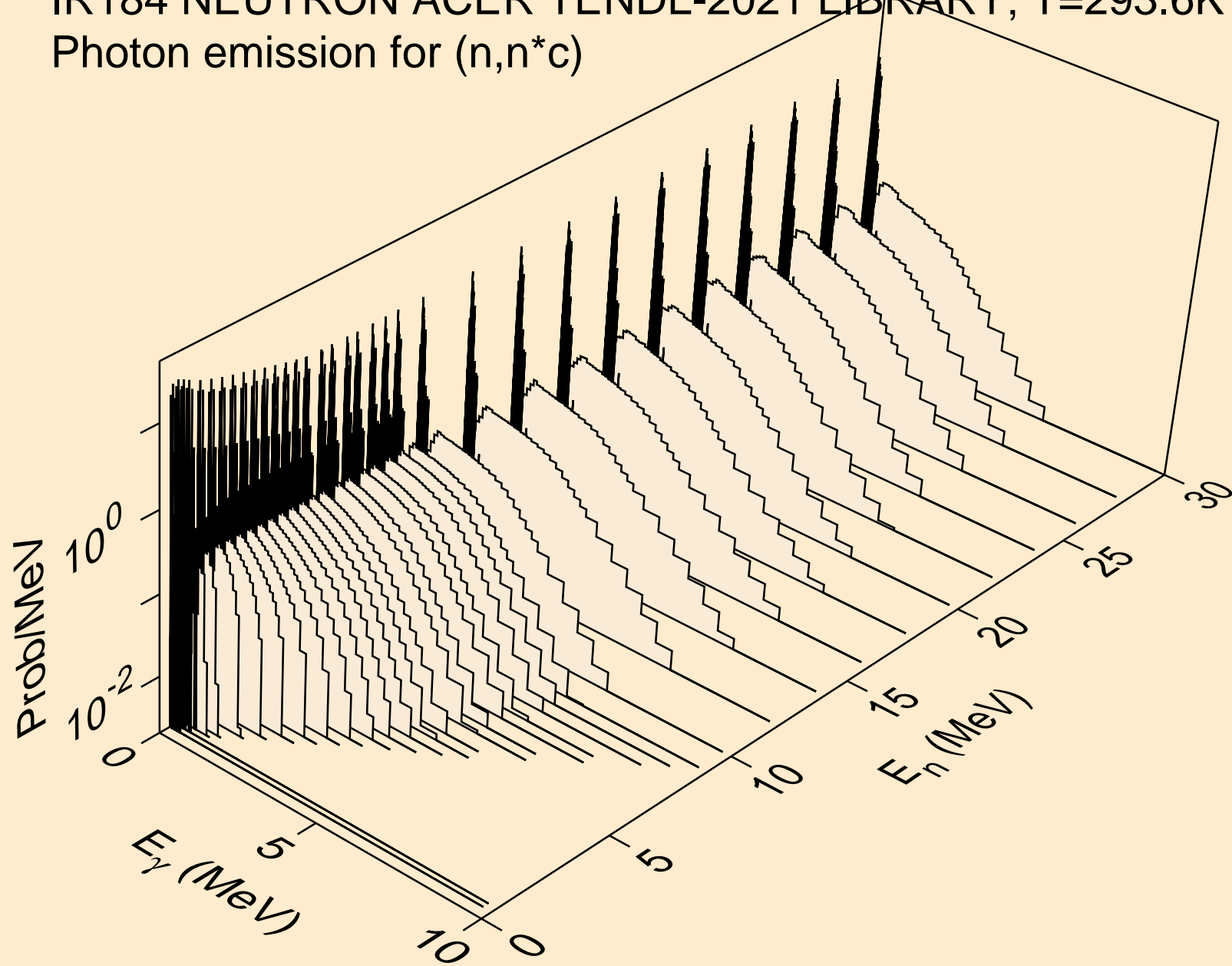

IR184 NEUTRON ACER TENDL-2021 LIBRARY; T=293.6K  
Photon emission for (n,gma)

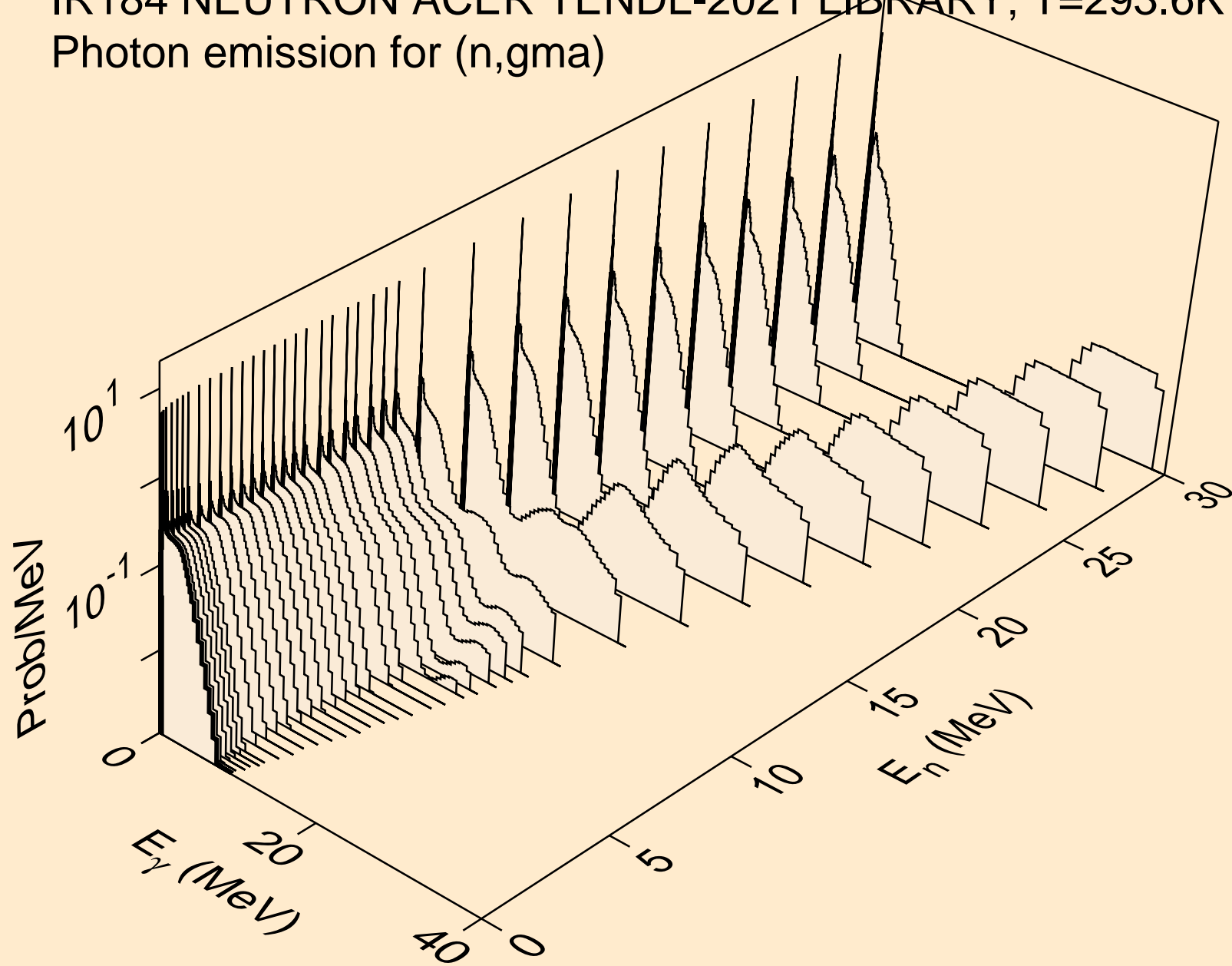

IR184 NEUTRON ACER TENDL-2021 LIBRARY; T=293.6K  
Photon emission for (n,p)

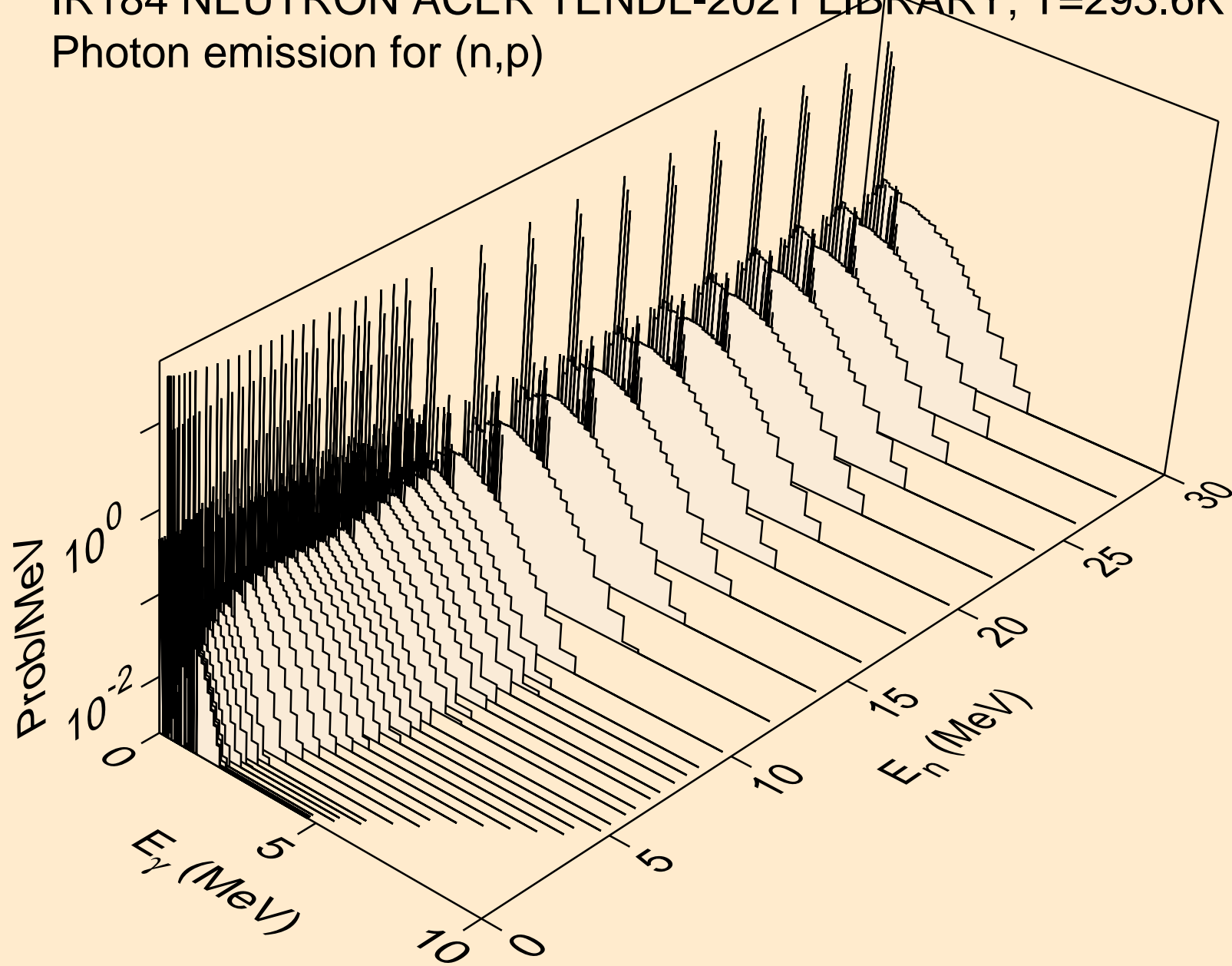

IR184 NEUTRON ACER TENDL-2021 LIBRARY; T=293.6K  
Photon emission for (n,d)

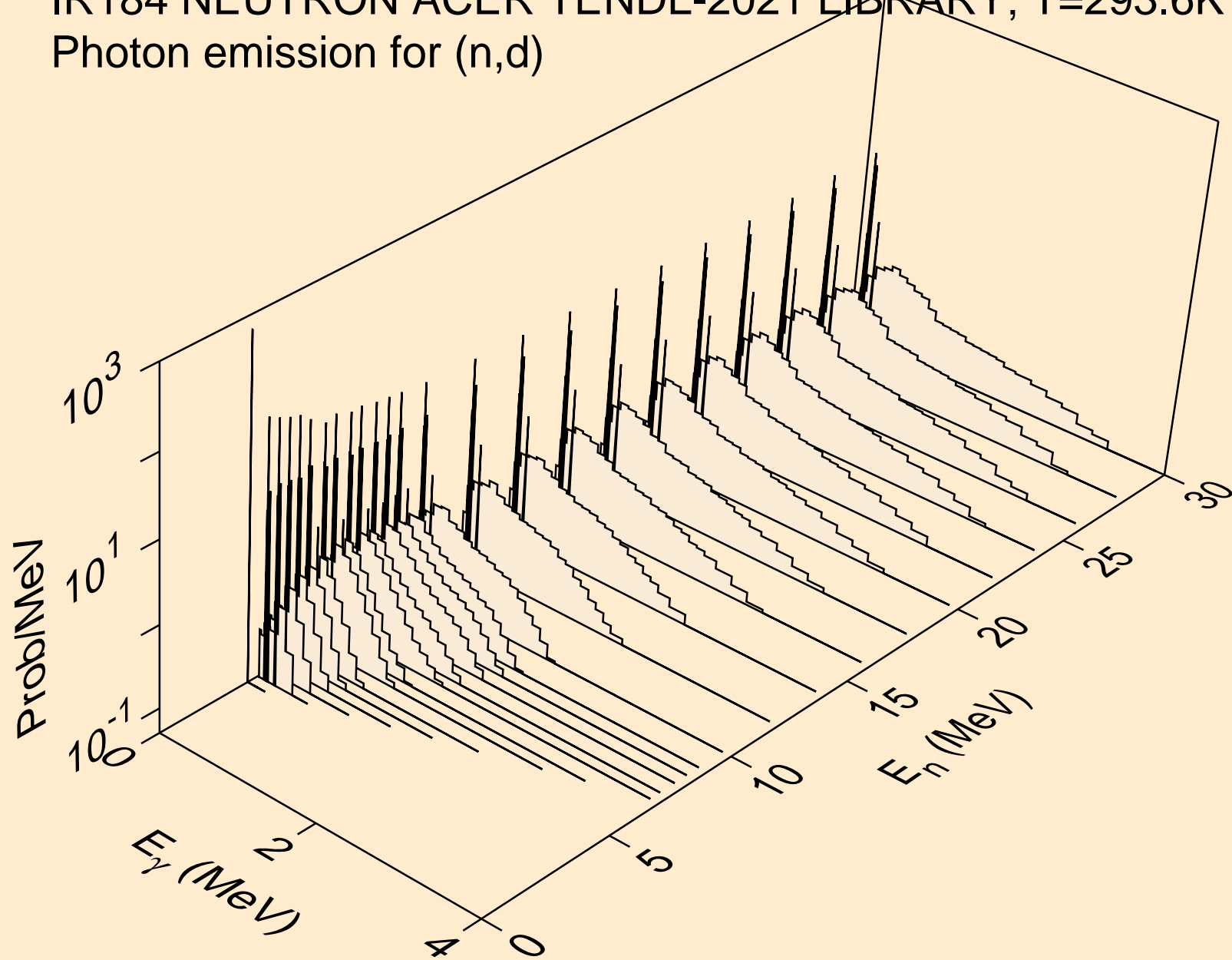

IR184 NEUTRON ACER TENDL-2021 LIBRARY; T=293.6K  
Photon emission for (n,t)

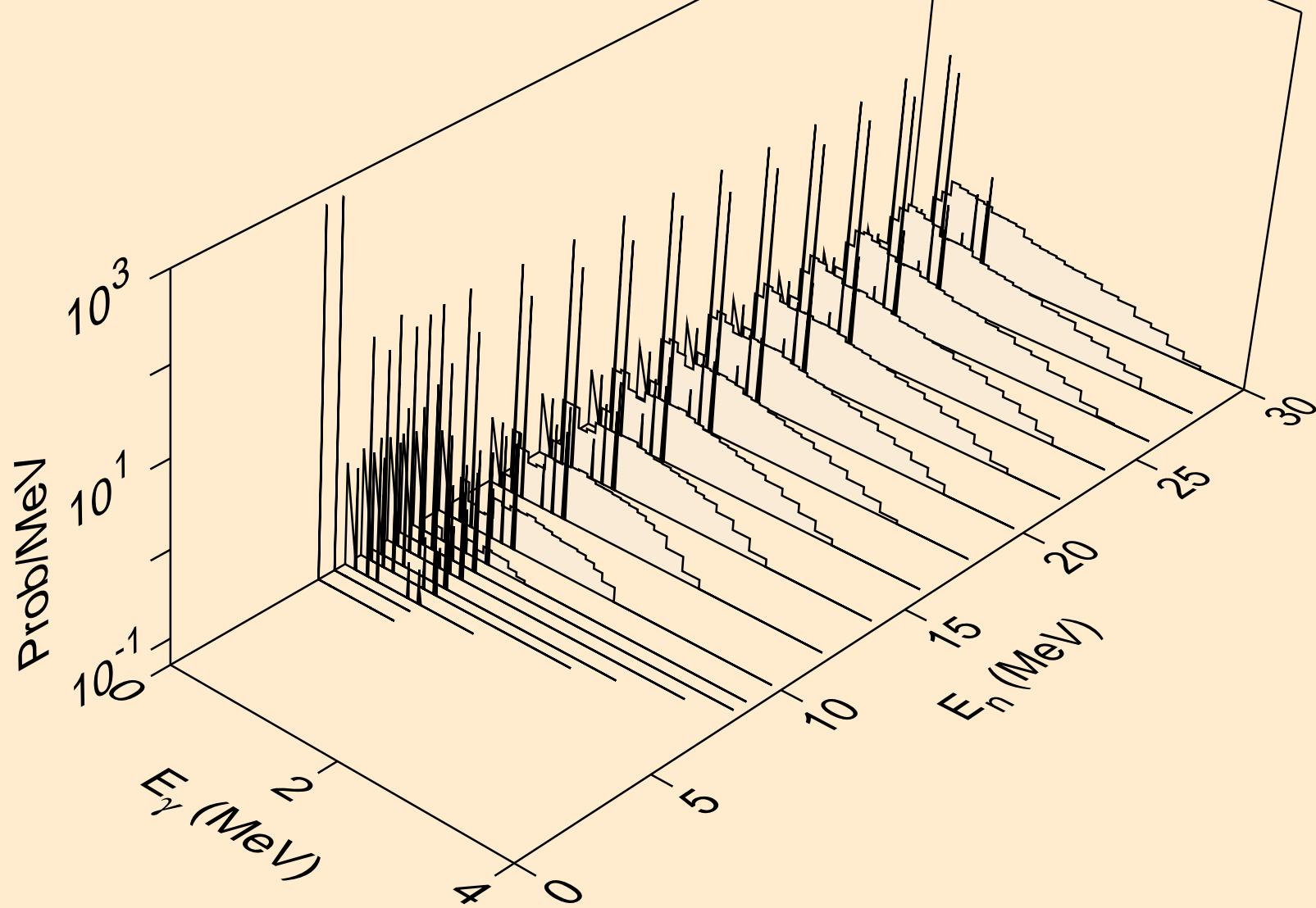



IR184 NEUTRON ACER TENDL-2021 LIBRARY; T=293.6K  
Photon emission for (n,he3)

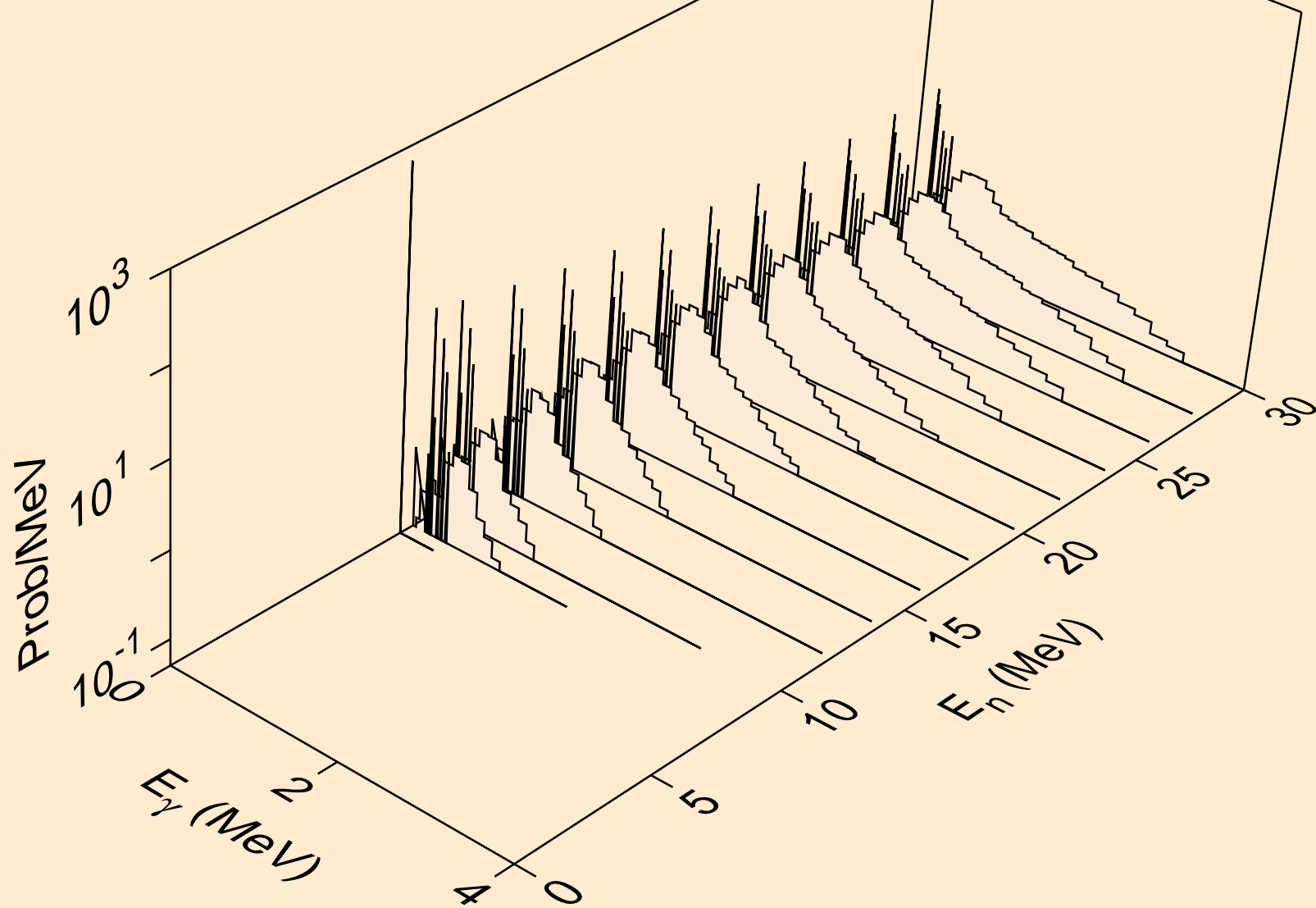

IR184 NEUTRON ACER TENDL-2021 LIBRARY; T=293.6K  
Photon emission for (n,a)

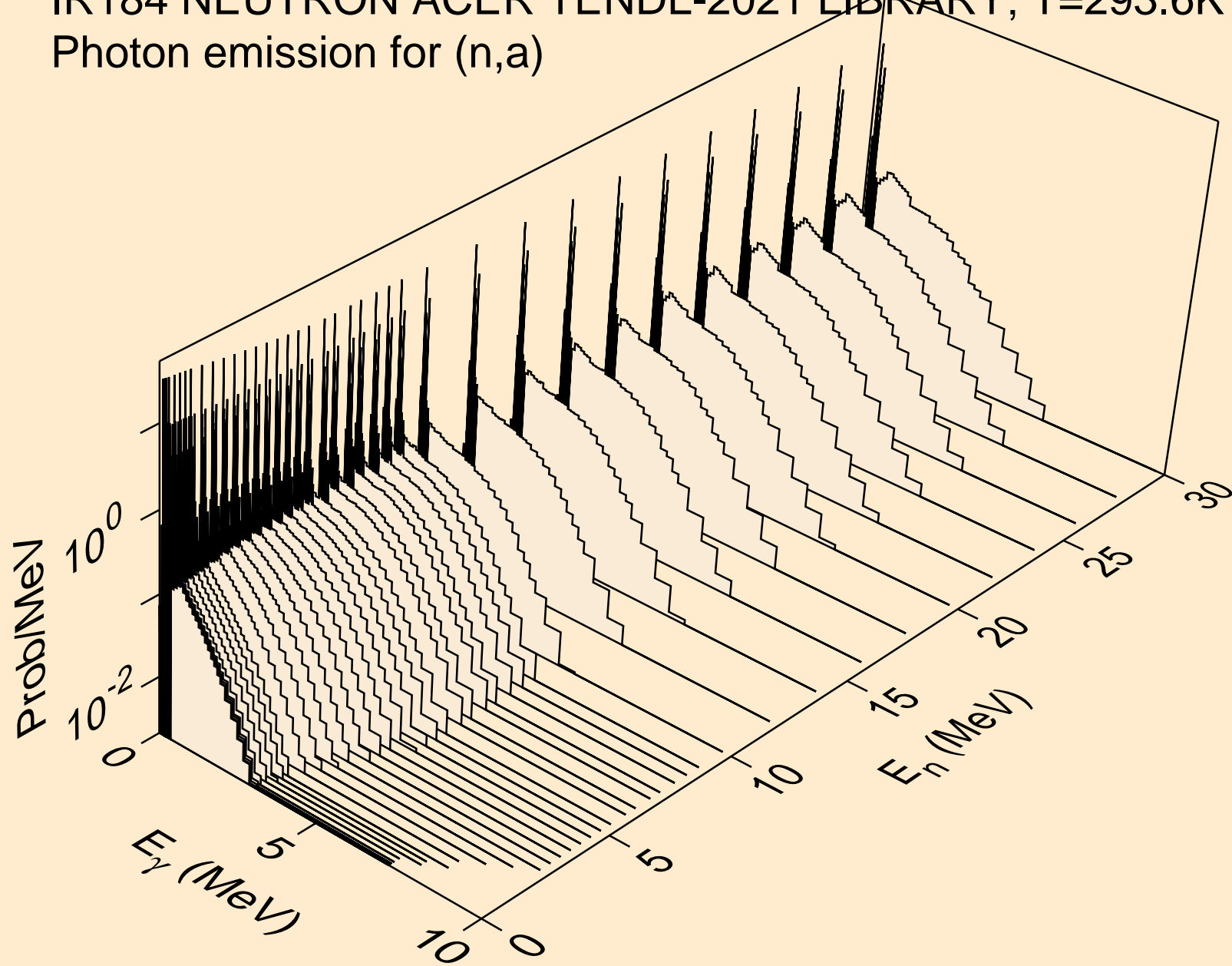

IR184 NEUTRON ACER TENDL-2021 LIBRARY; T=293.6K  
Photon emission for (n,2a)

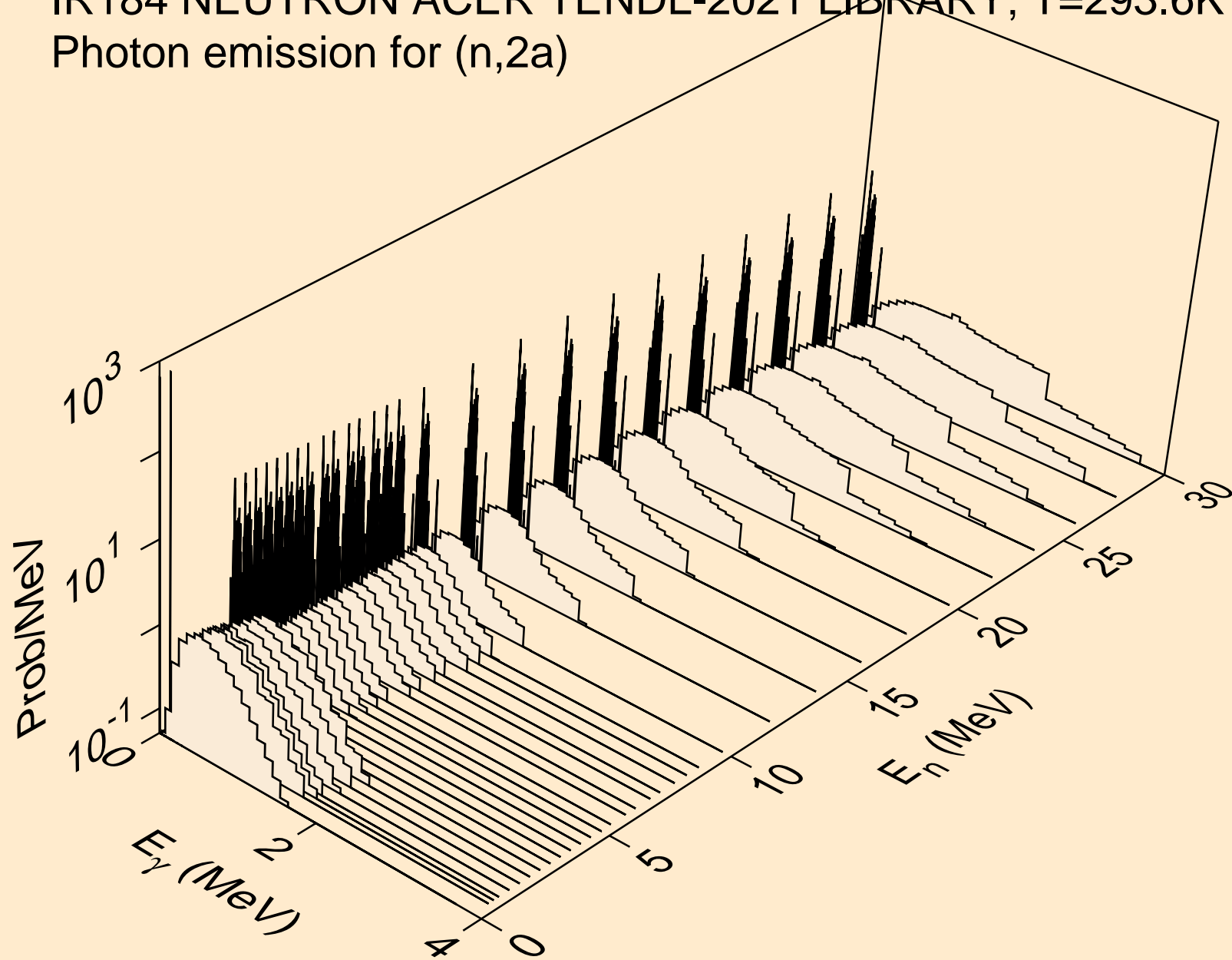

IR184 NEUTRON ACER TENDL-2021 LIBRARY; T=293.6K  
Photon emission for (n,2p)

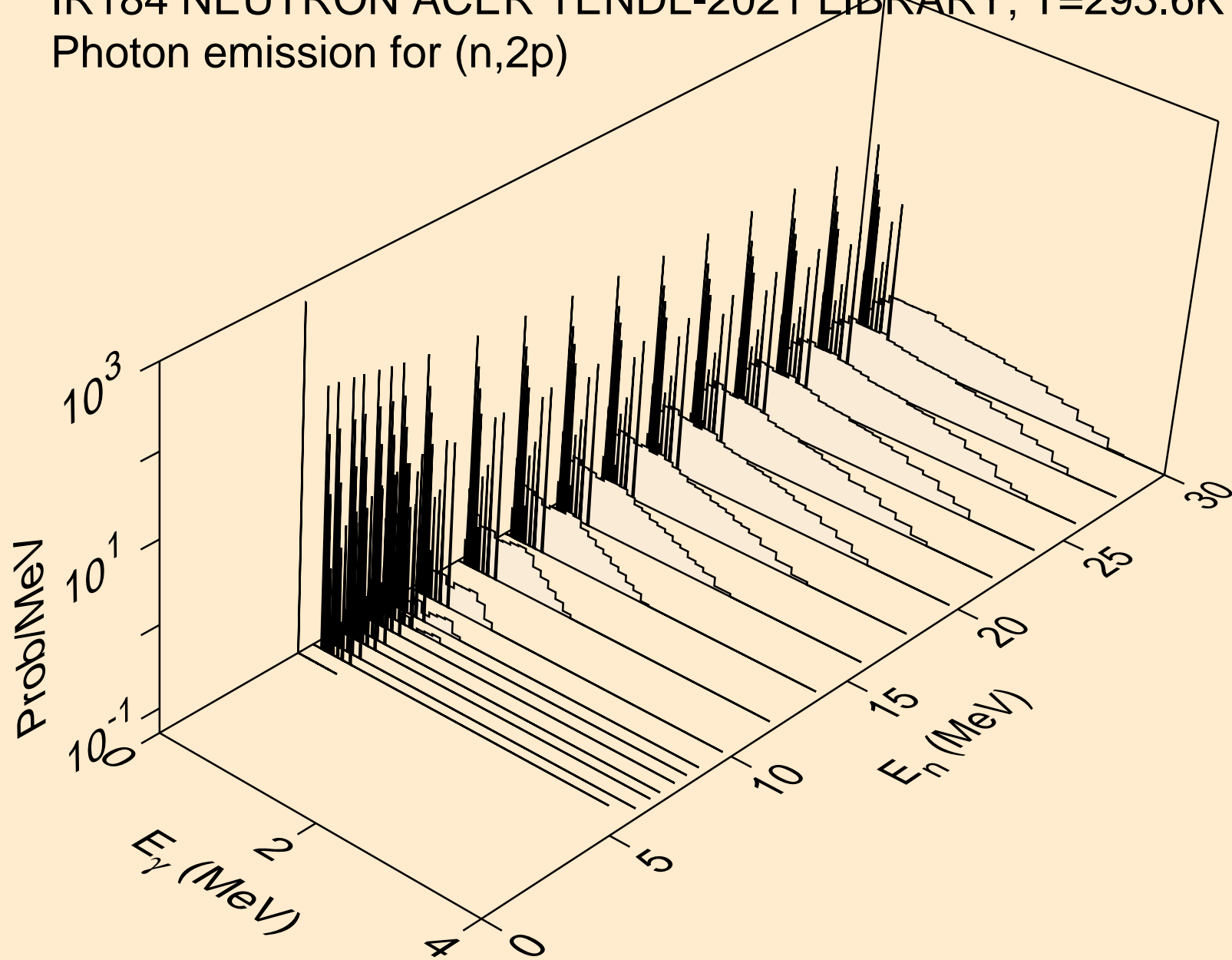

IR184 NEUTRON ACER TENDL-2021 LIBRARY; T=293.6K  
Photon emission for (n,p)

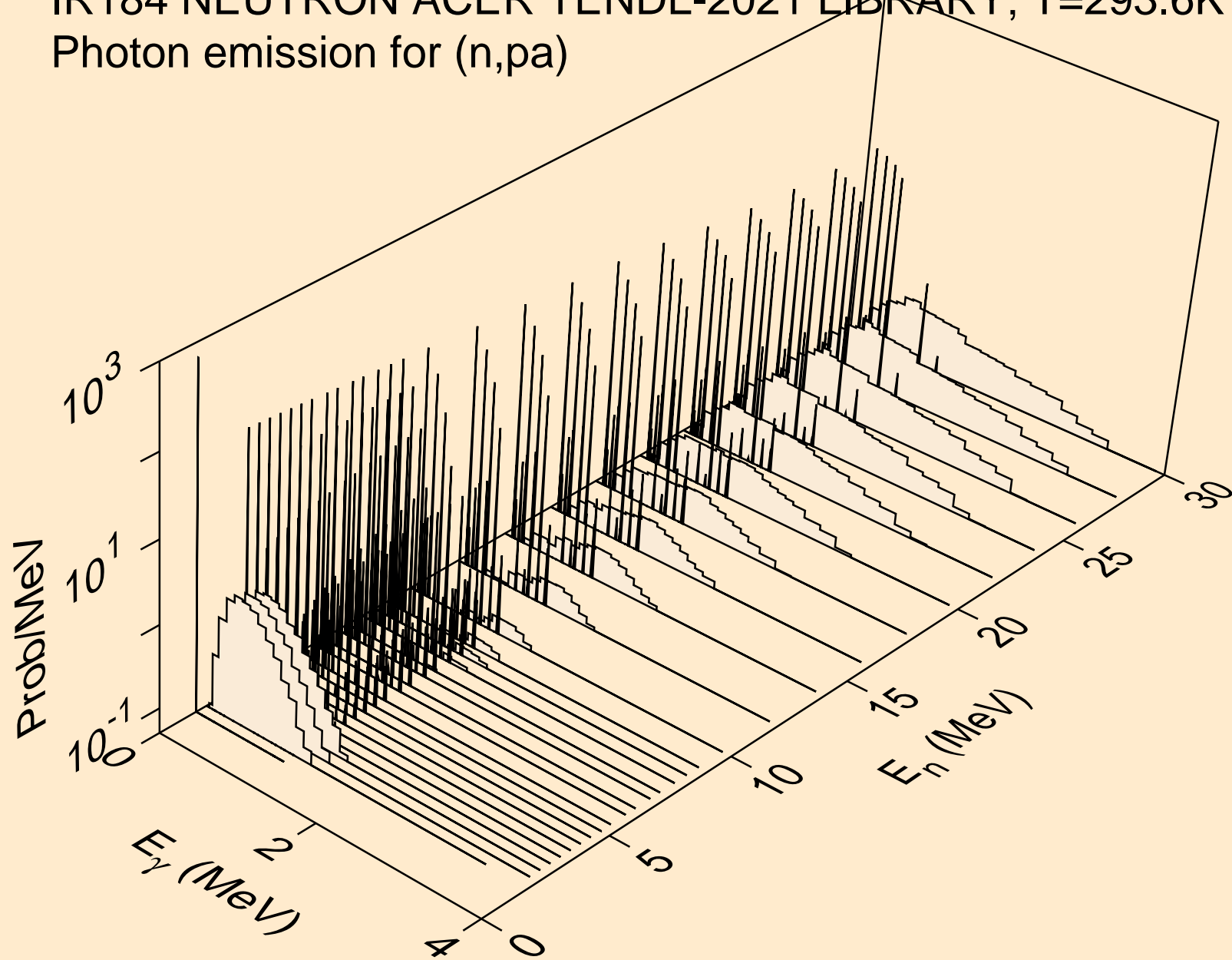

IR184 NEUTRON ACER TENDL-2021 LIBRARY; T=293.6K  
Photon emission for (n,pd)

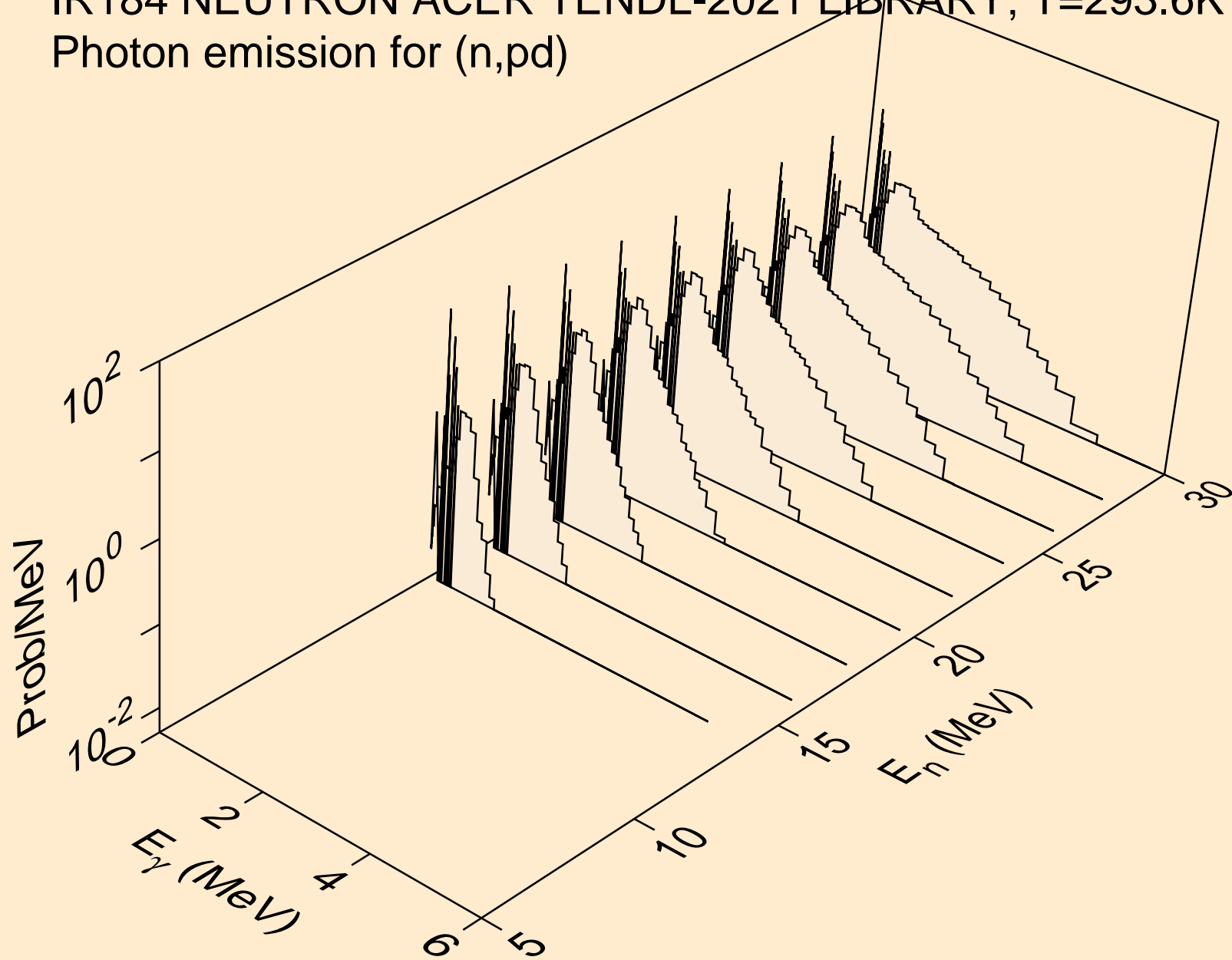

IR184 NEUTRON ACER TENDL-2021 LIBRARY; T=293.6K  
Photon emission for (n,pt)

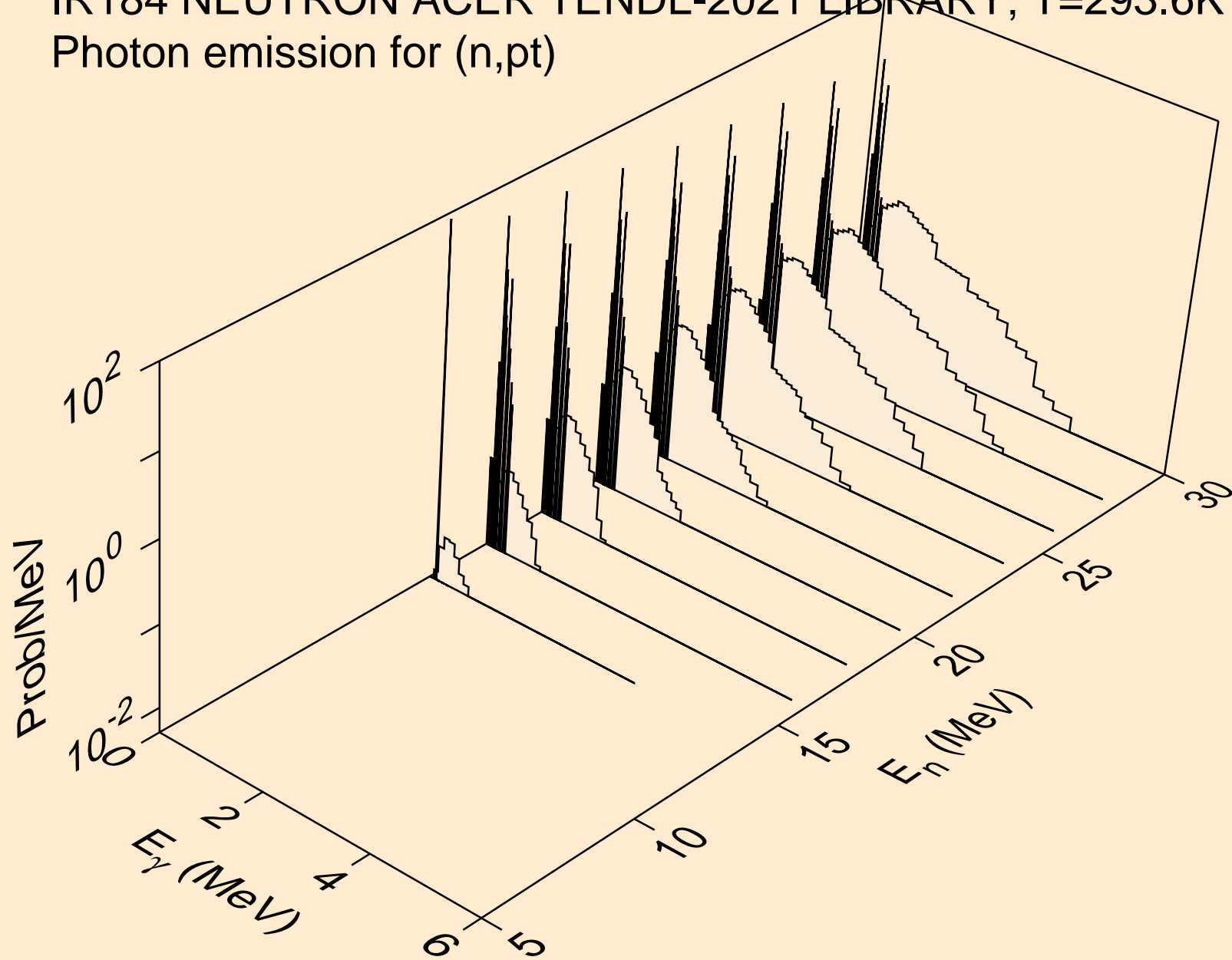

IR184 NEUTRON ACER TENDL-2021 LIBRARY; T=293.6K  
Photon emission for (n,da)

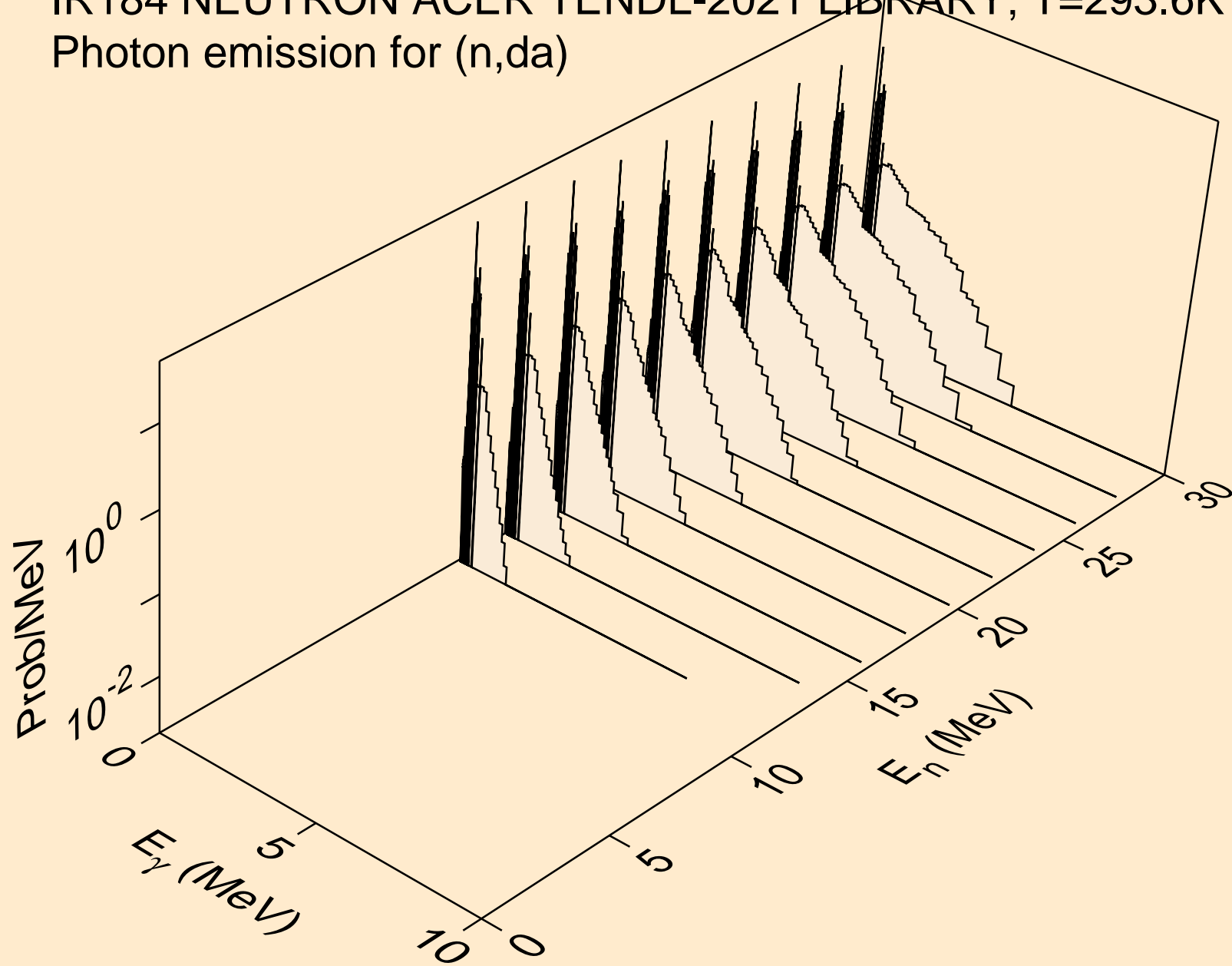



IR184 NEUTRON ACER TENDL-2021 LIBRARY; T=293.6K  
thermal capture photon spectrum

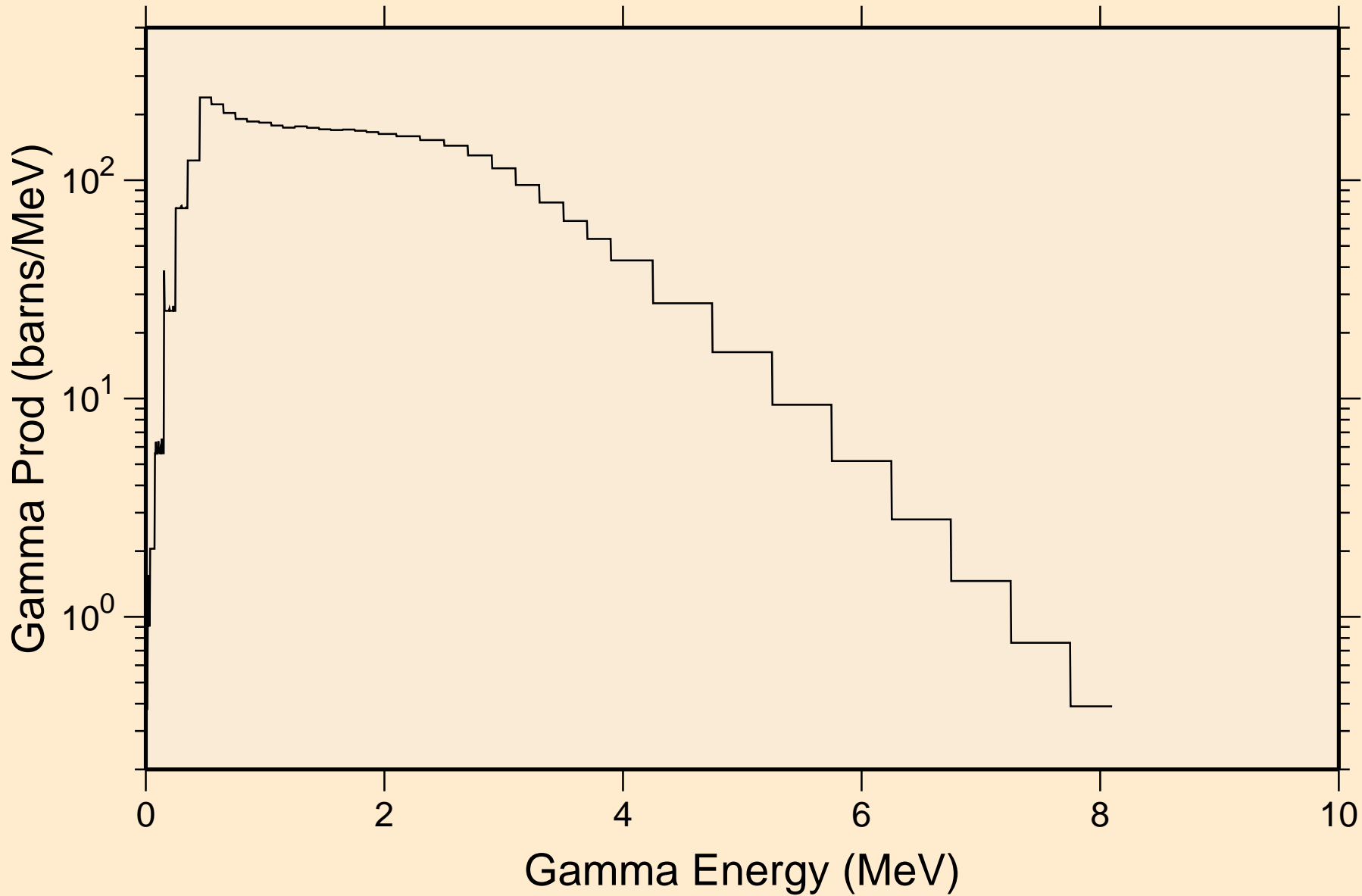

IR184 NEUTRON ACER TENDL-2021 LIBRARY; T=293.6K  
14 MeV photon spectrum

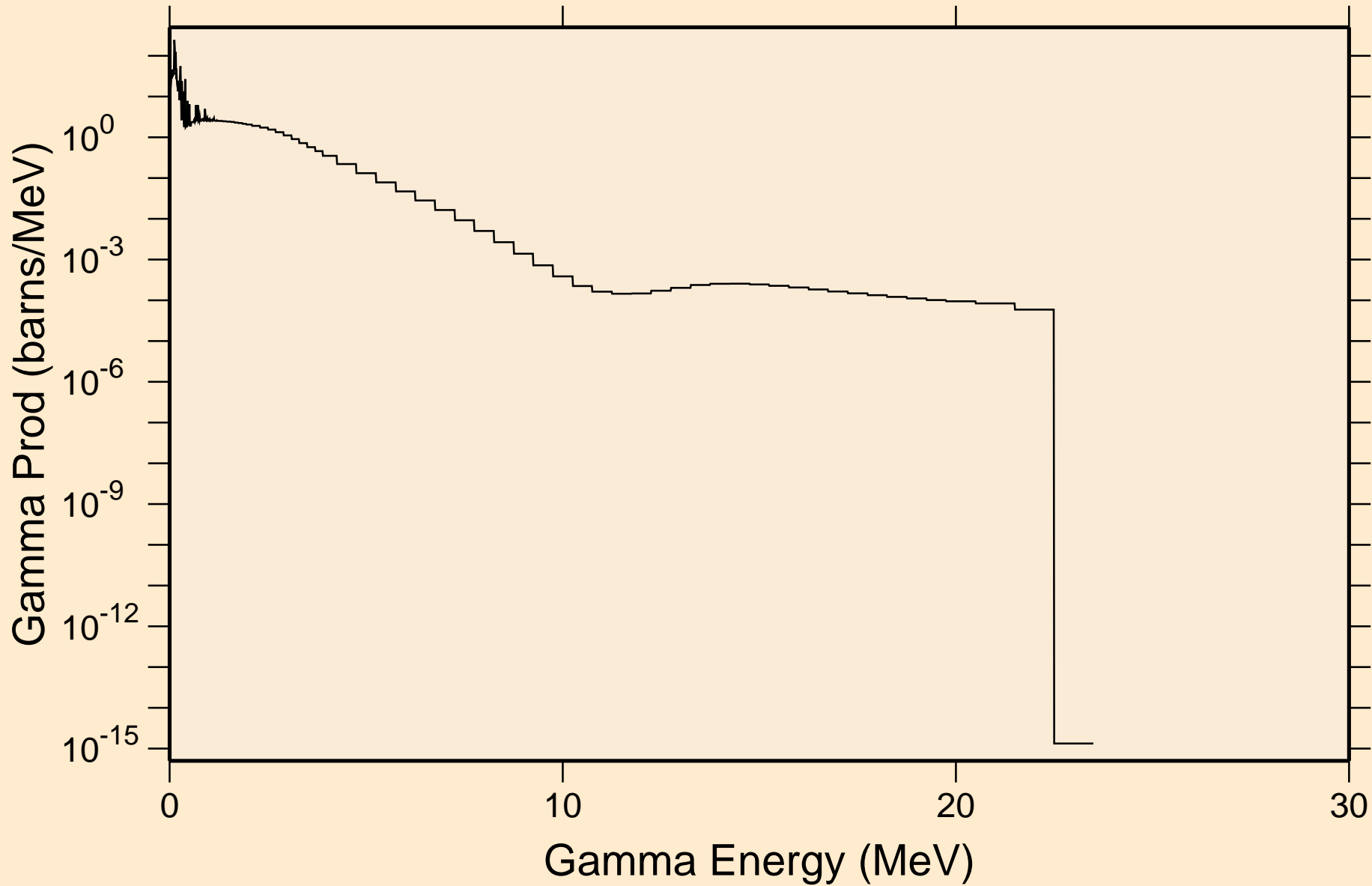

# IR184 NEUTRON ACER TENDL-2021 LIBRARY; T=293.6K

## Particle heating contributions

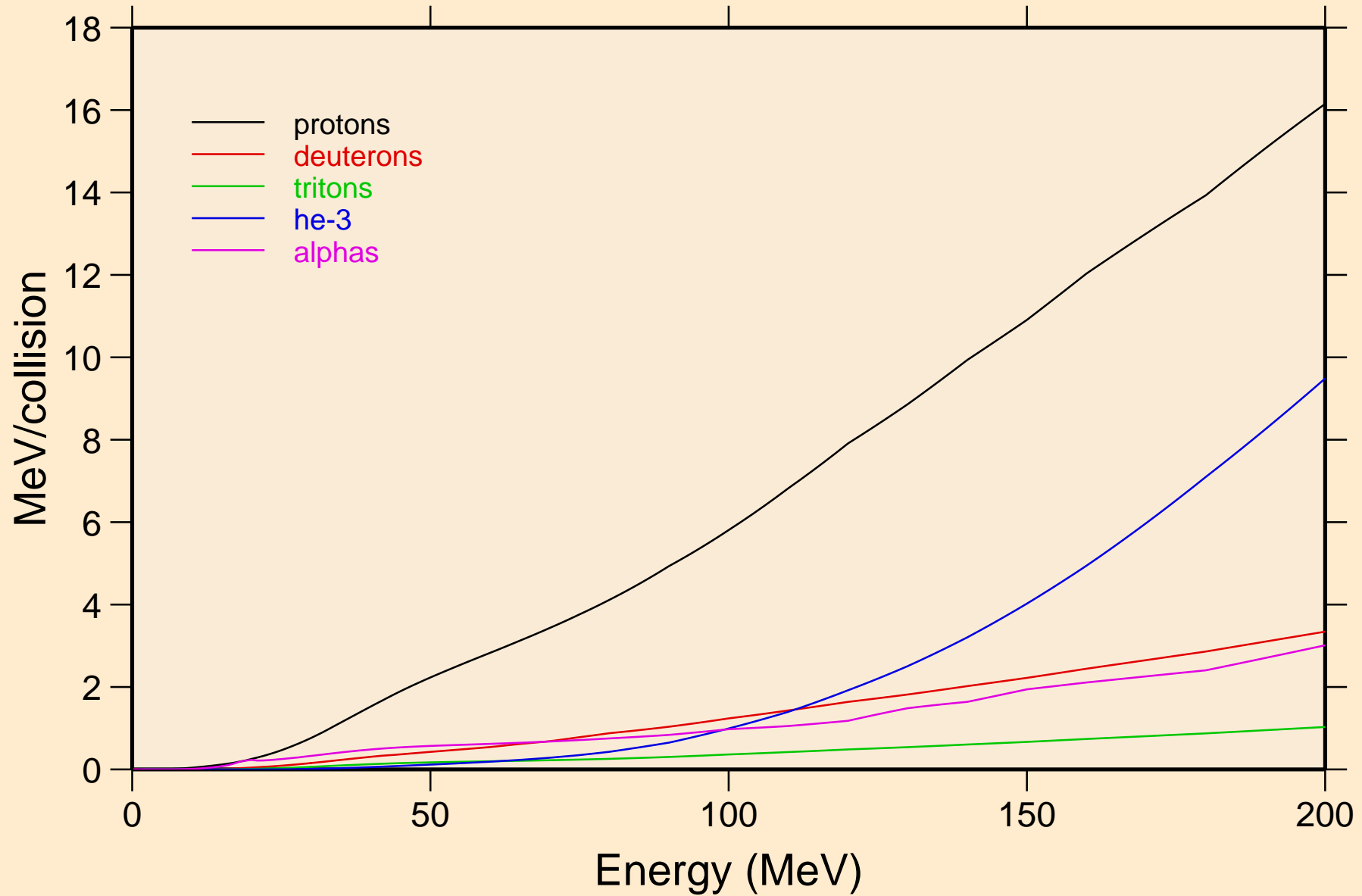

IR184 NEUTRON ACER TENDL-2021 LIBRARY; T=293.6K  
Recoil Heating

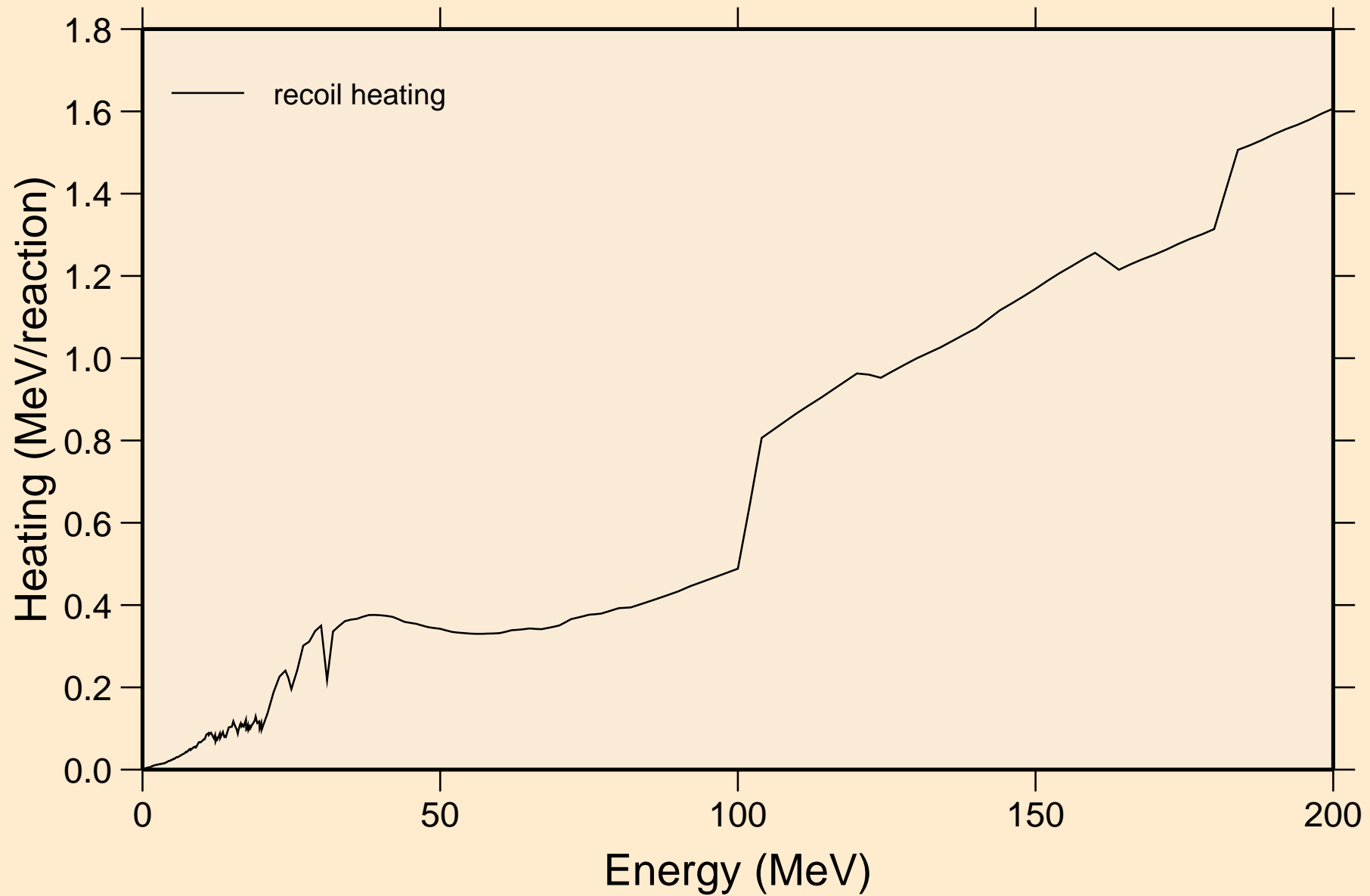

IR184 NEUTRON ACER TENDL-2021 LIBRARY; T=293.6K  
Particle production cross sections

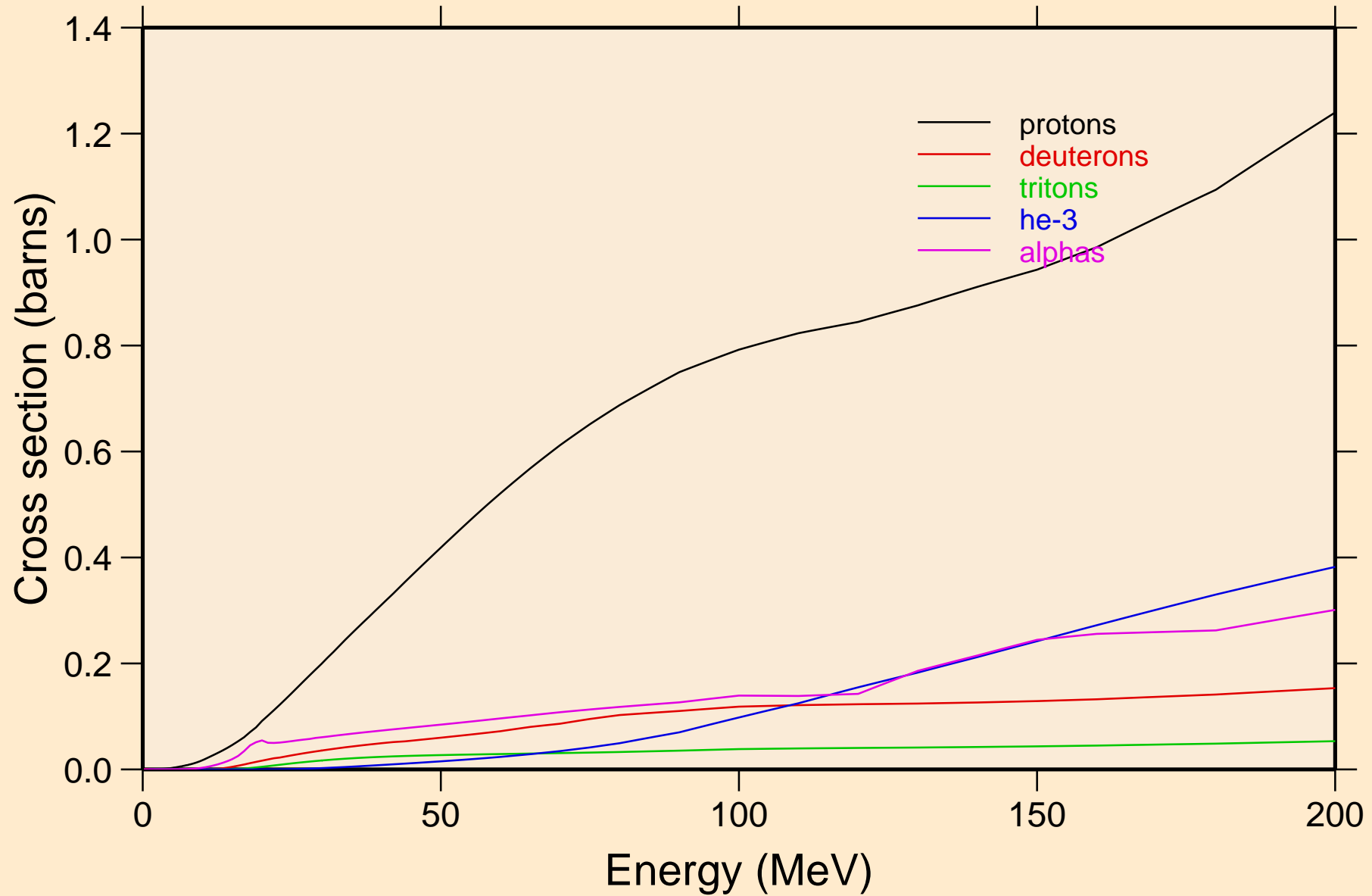

IR184 NEUTRON ACER TENDL-2021 LIBRARY; T=293.6K  
protons from (n,x)

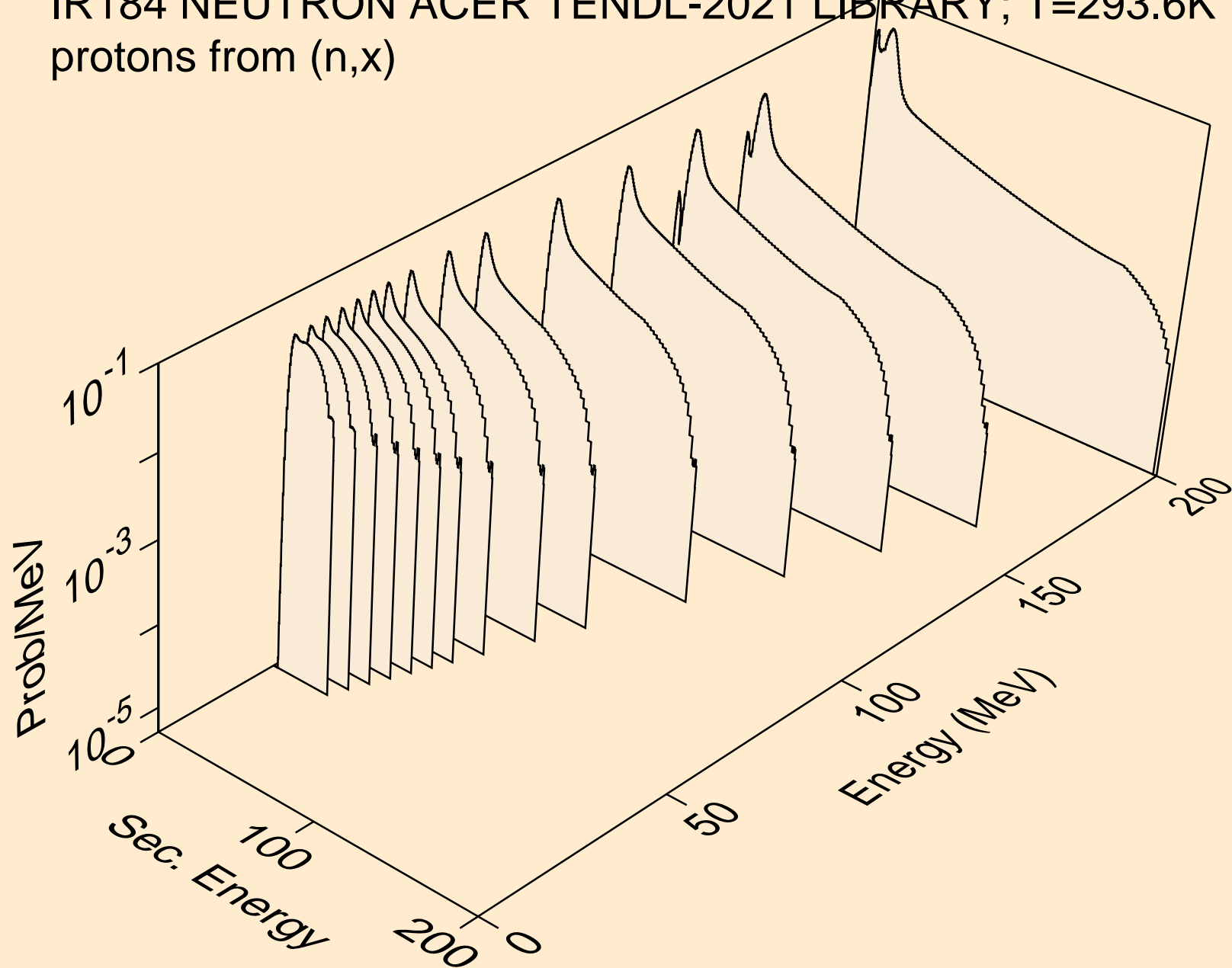

IR184 NEUTRON ACER TENDL-2021 LIBRARY; T=293.6K  
protons from (n,n\*)p

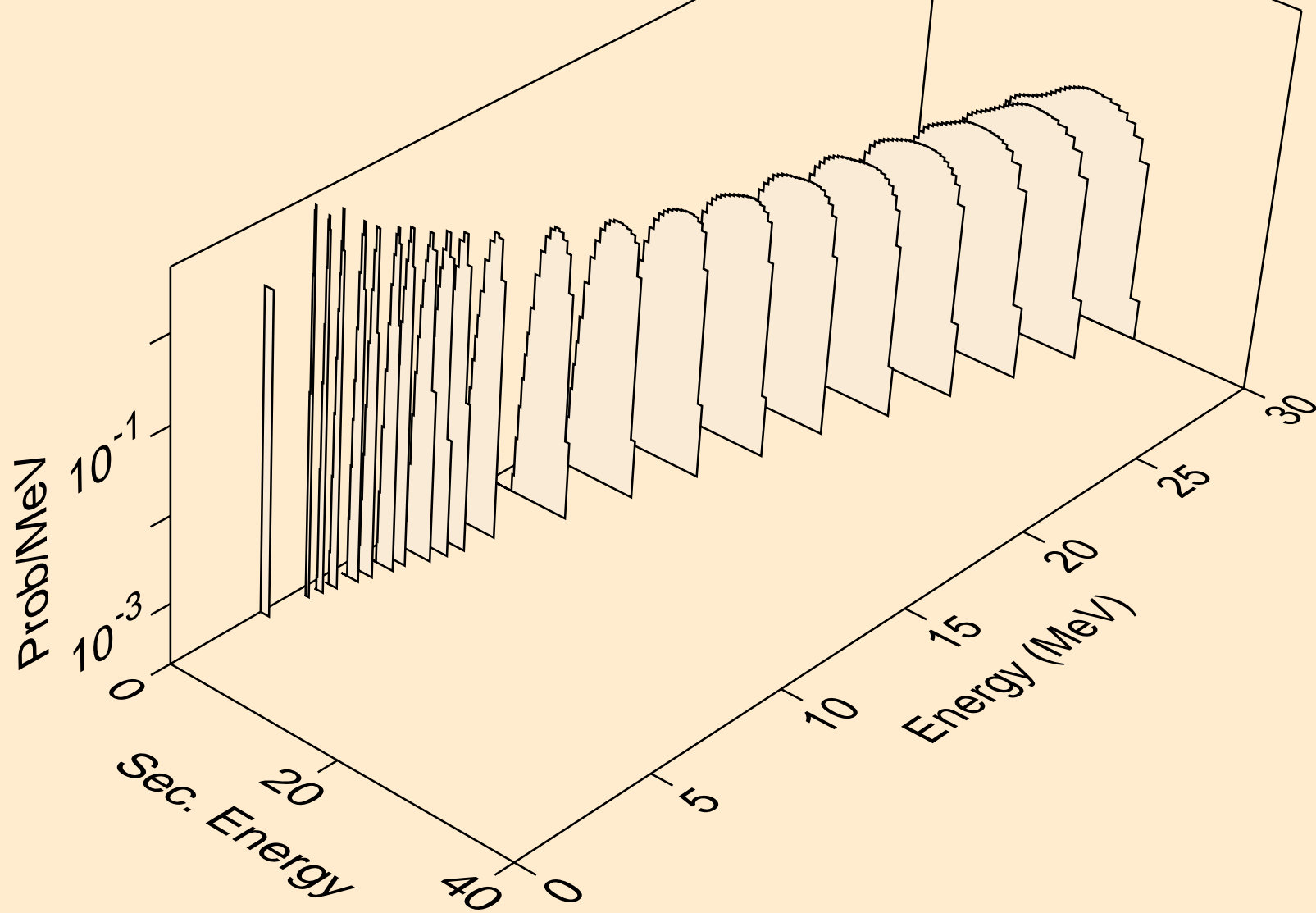

IR184 NEUTRON ACER TENDL-2021 LIBRARY; T=293.6K  
protons from (n,2np)

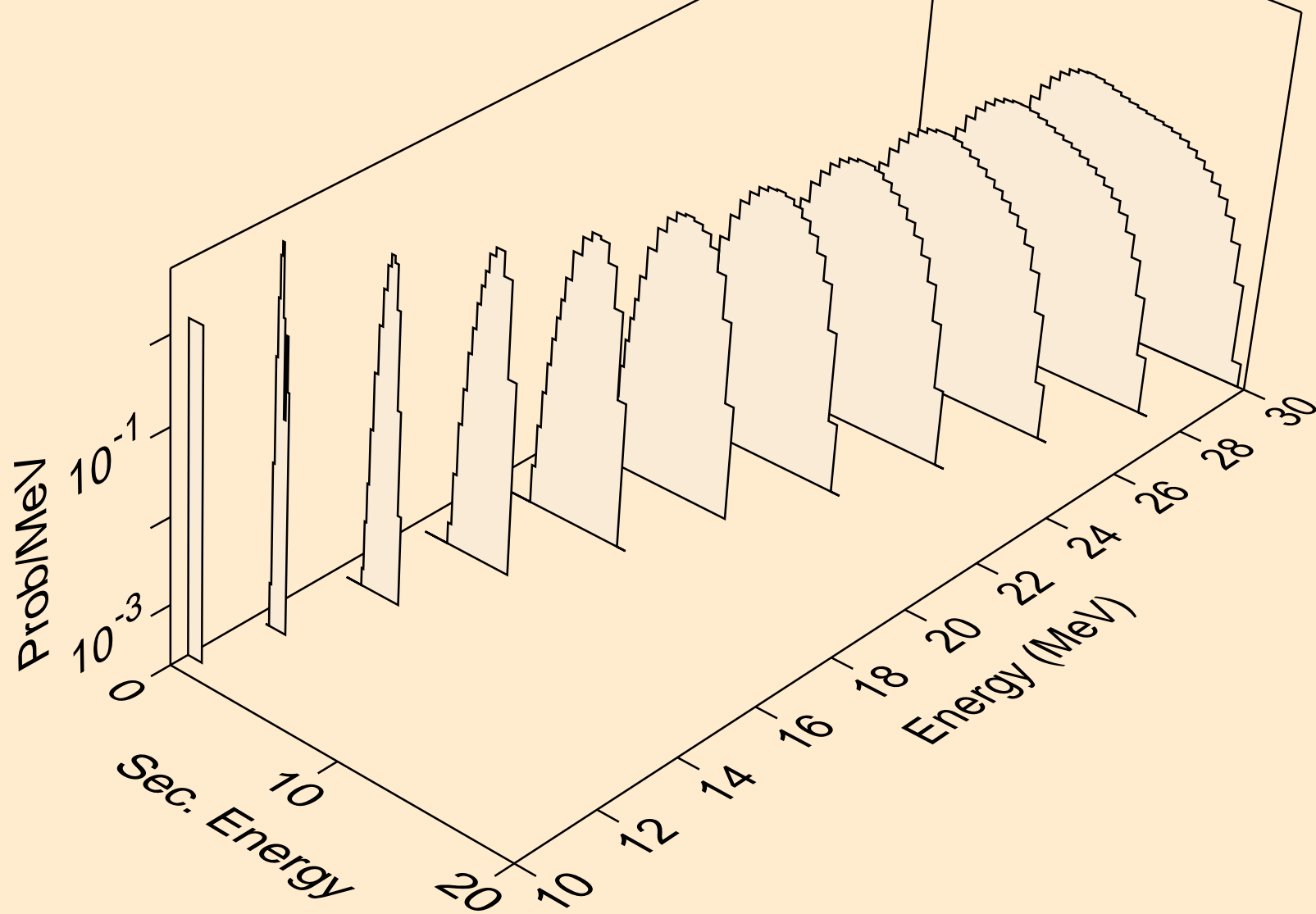



IR184 NEUTRON ACER TENDL-2021 LIBRARY; T=293.6K  
protons from (n,3np)

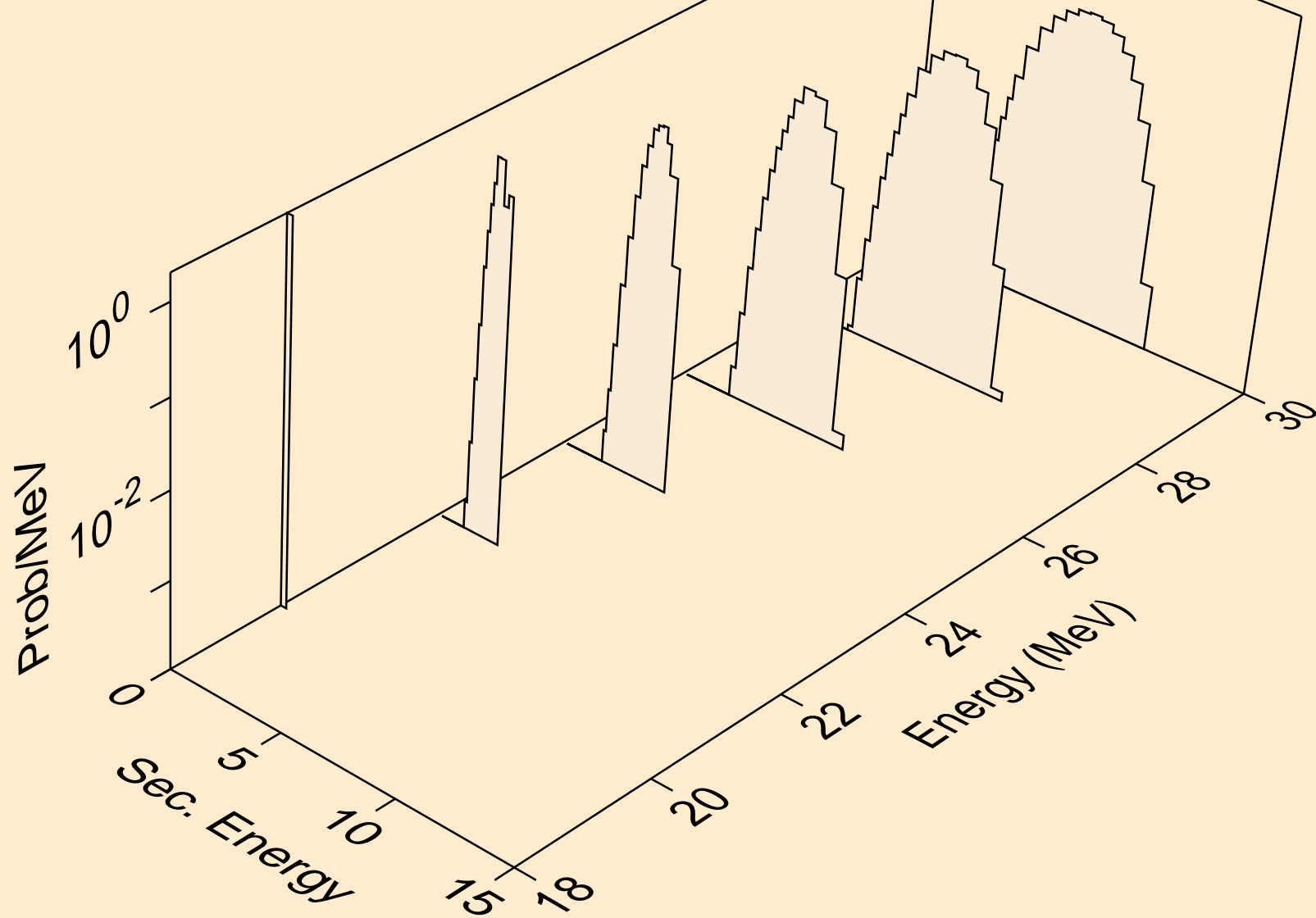

IR184 NEUTRON ACER TENDL-2021 LIBRARY; T=293.6K  
protons from (n,2np)

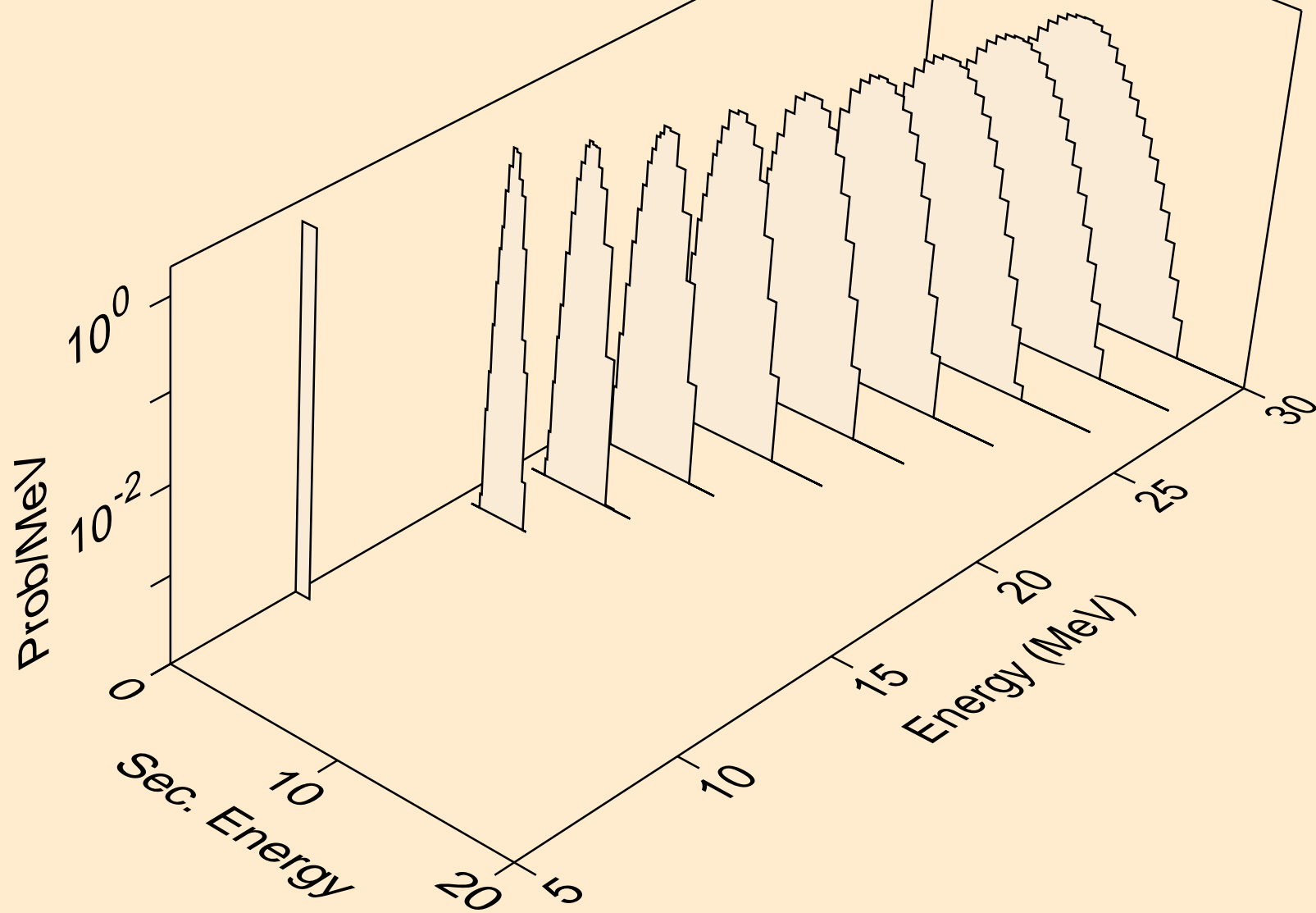

IR184 NEUTRON ACER TENDL-2021 LIBRARY; T=293.6K  
protons from (n,npa)

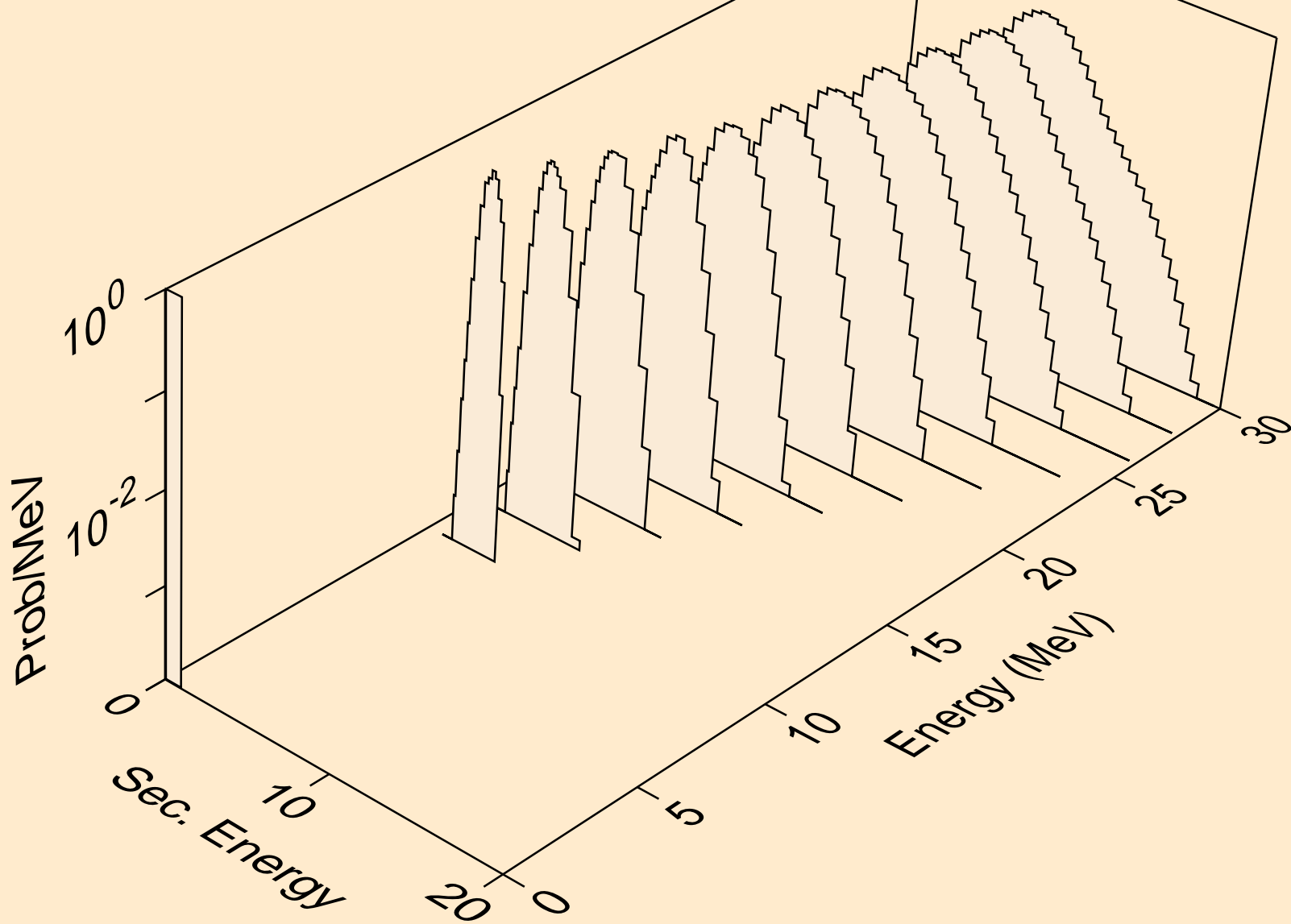

IR184 NEUTRON ACER TENDL-2021 LIBRARY; T=293.6K  
protons from (n,p)

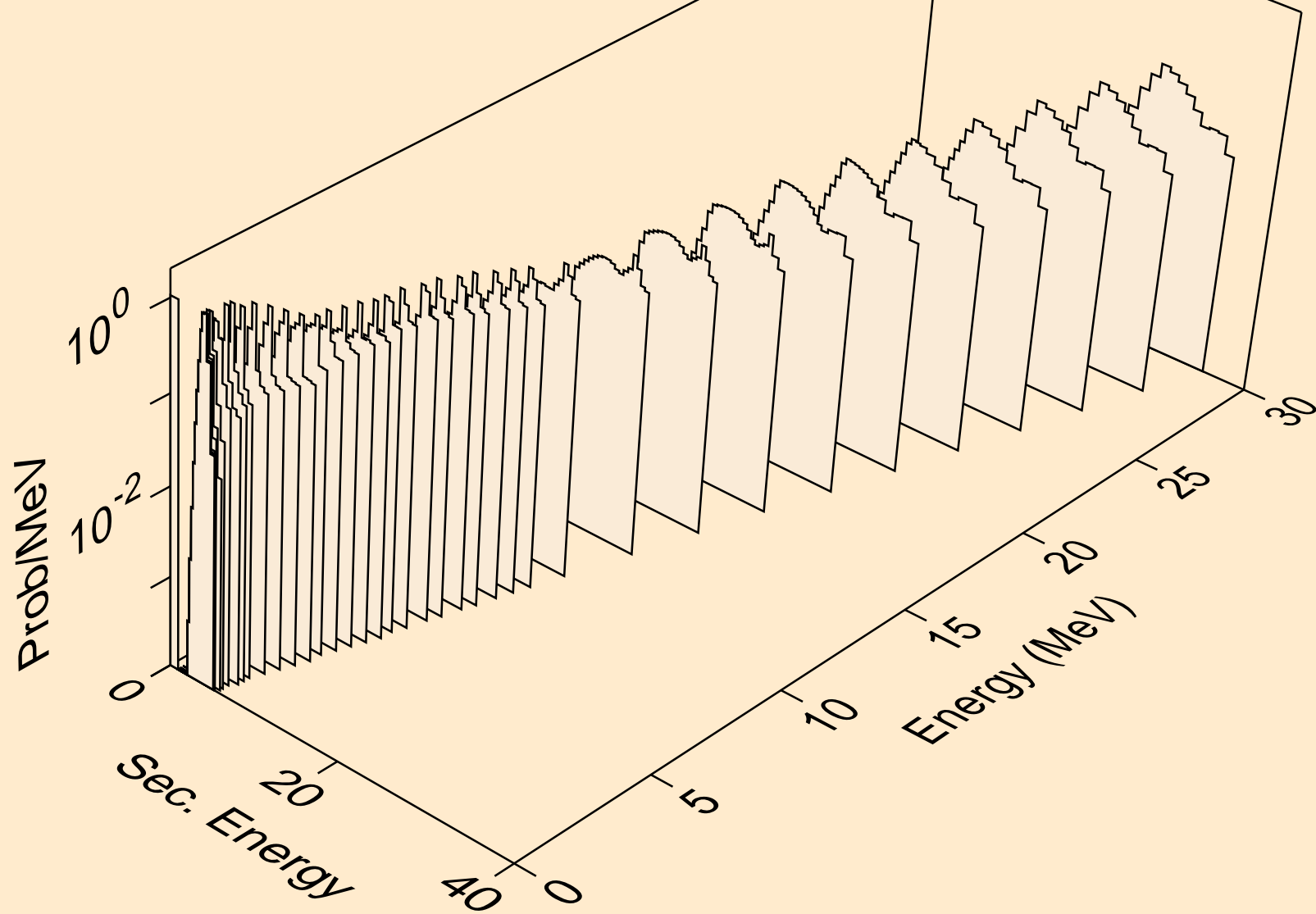

IR184 NEUTRON ACER TENDL-2021 LIBRARY; T=293.6K  
protons from (n,2p)

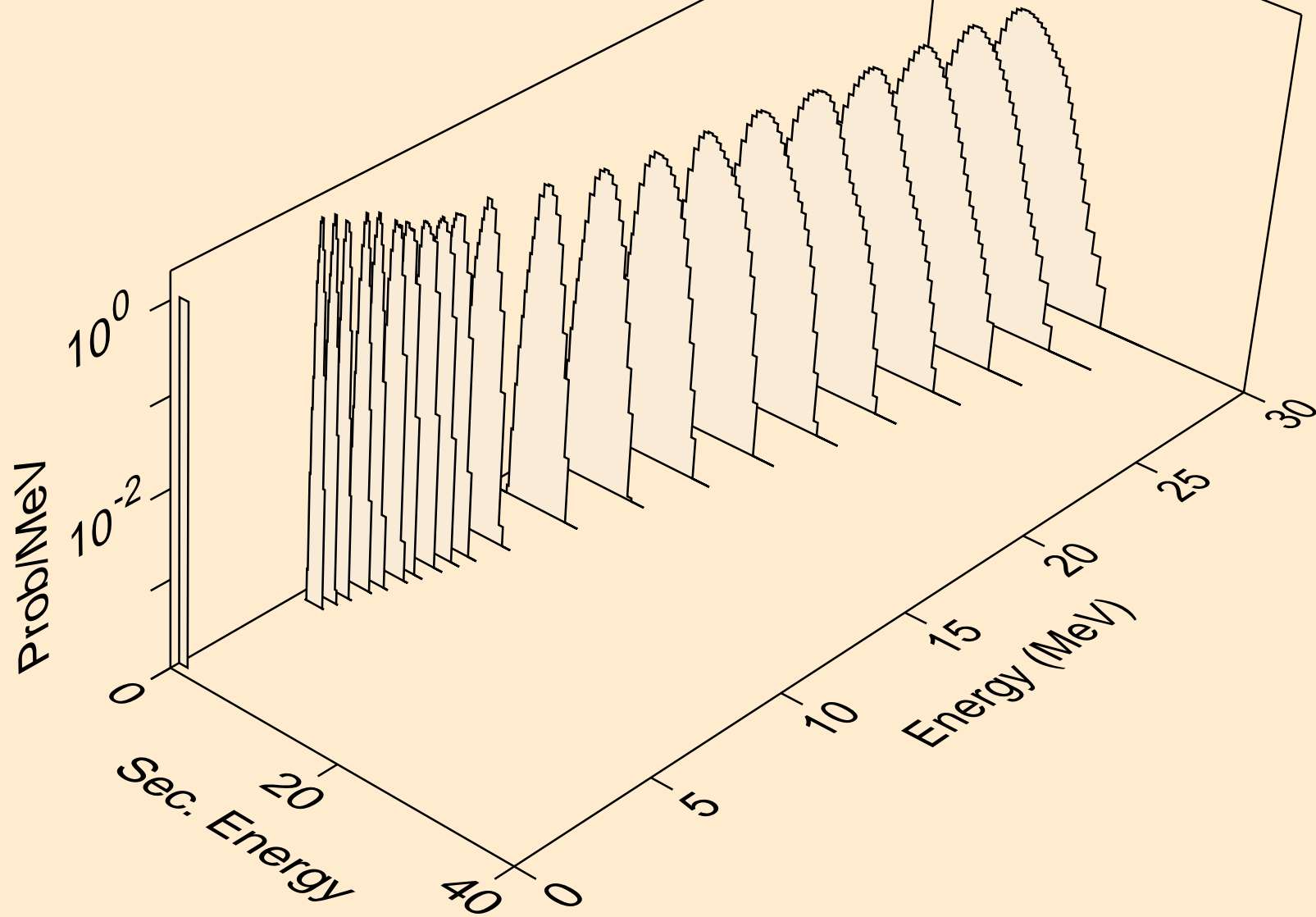

IR184 NEUTRON ACER TENDL-2021 LIBRARY; T=293.6K  
protons from (n,p)

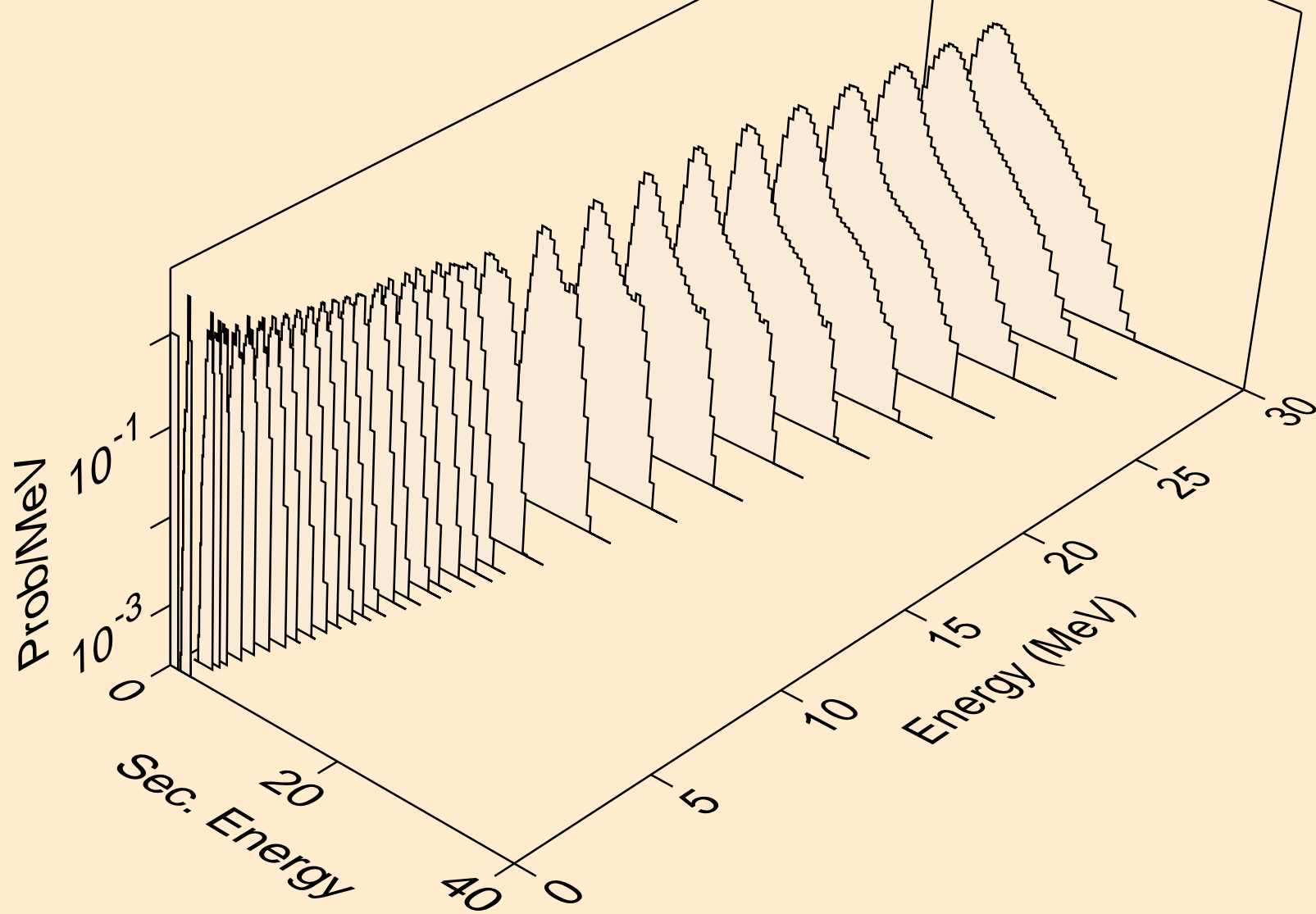

IR184 NEUTRON ACER TENDL-2021 LIBRARY; T=293.6K  
protons from (n,pd)

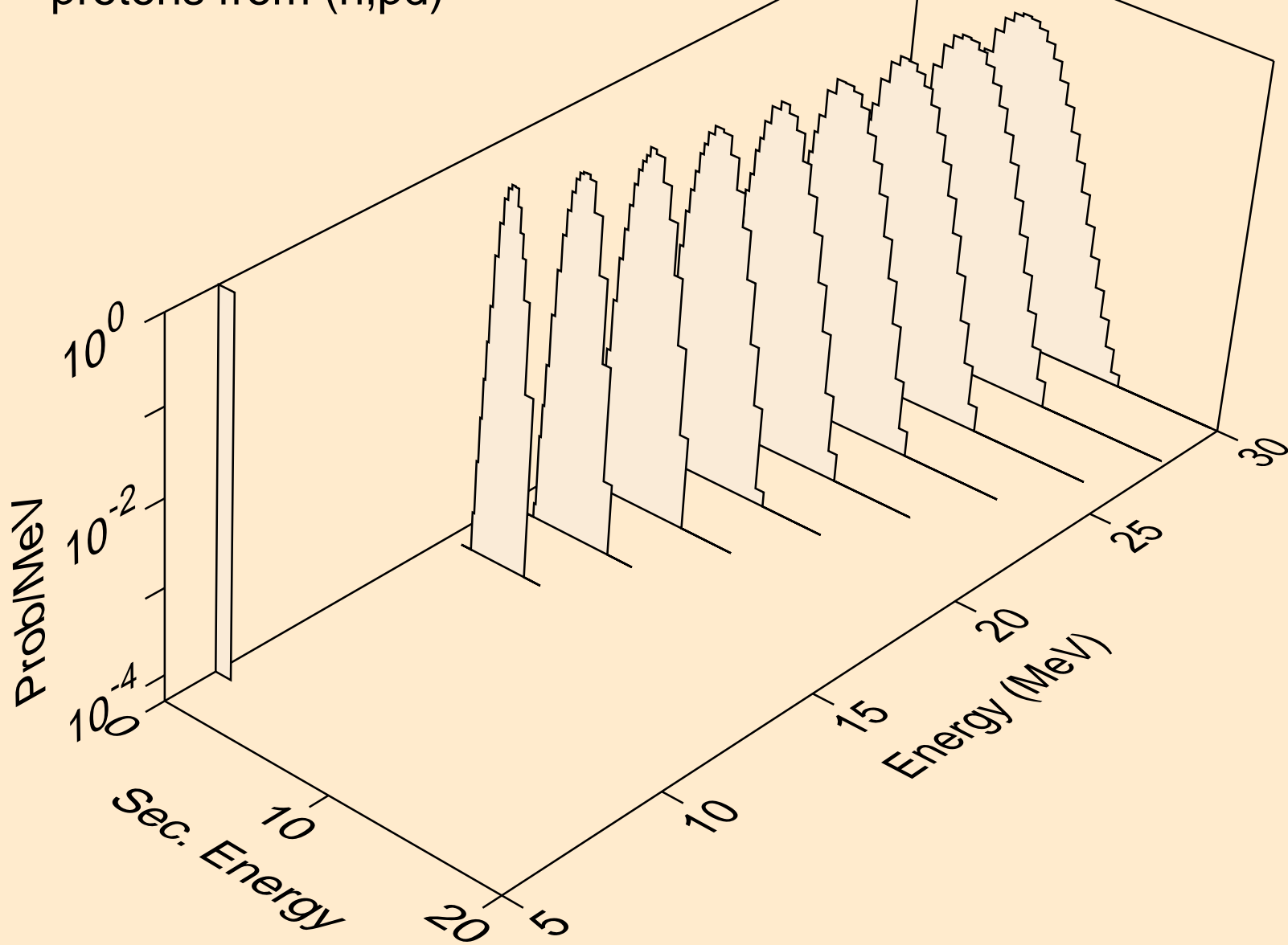

IR184 NEUTRON ACER TENDL-2021 LIBRARY; T=293.6K  
protons from (n,pt)

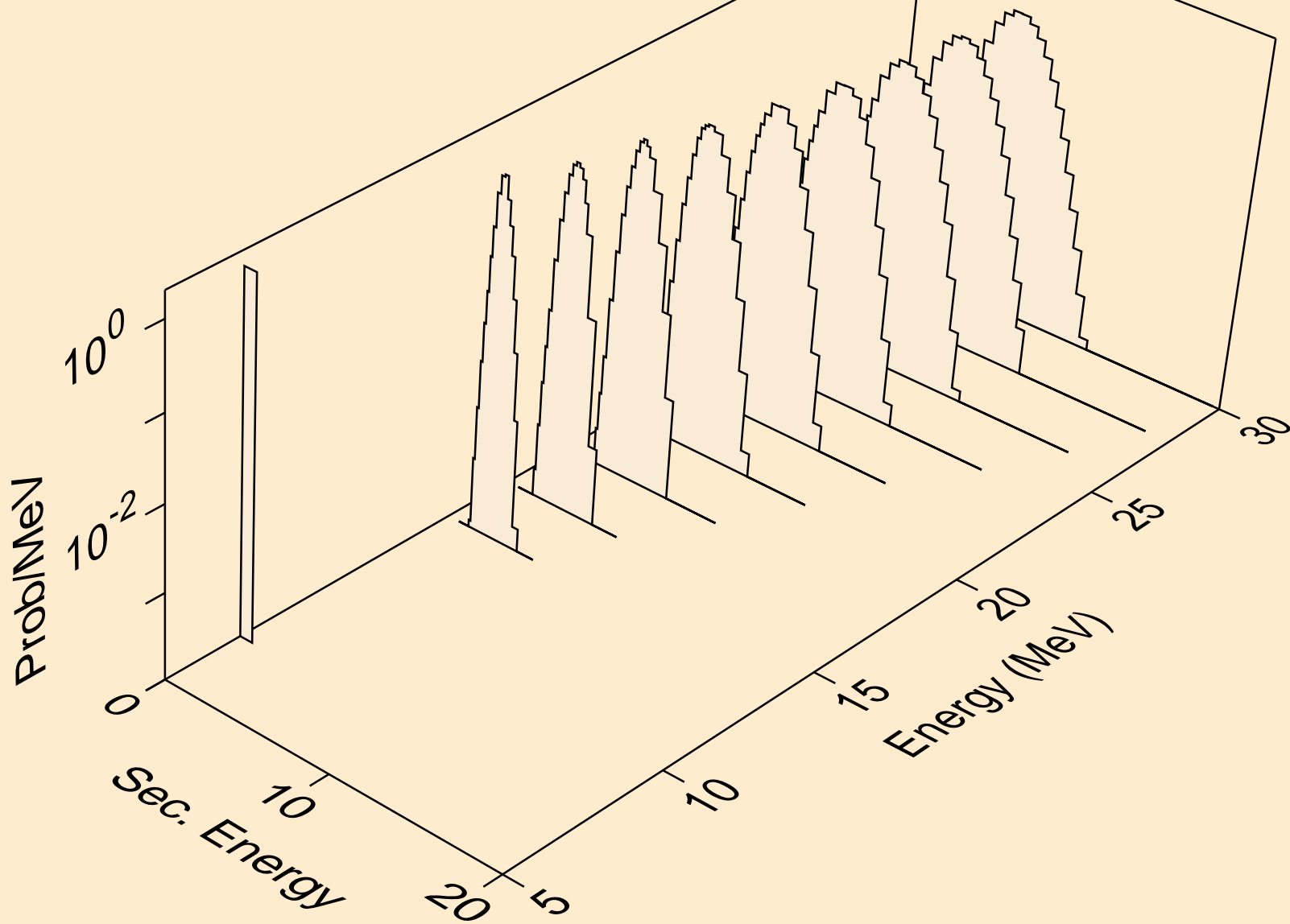



IR184 NEUTRON ACER TENDL-2021 LIBRARY; T=293.6K  
deuterons from (n,x)

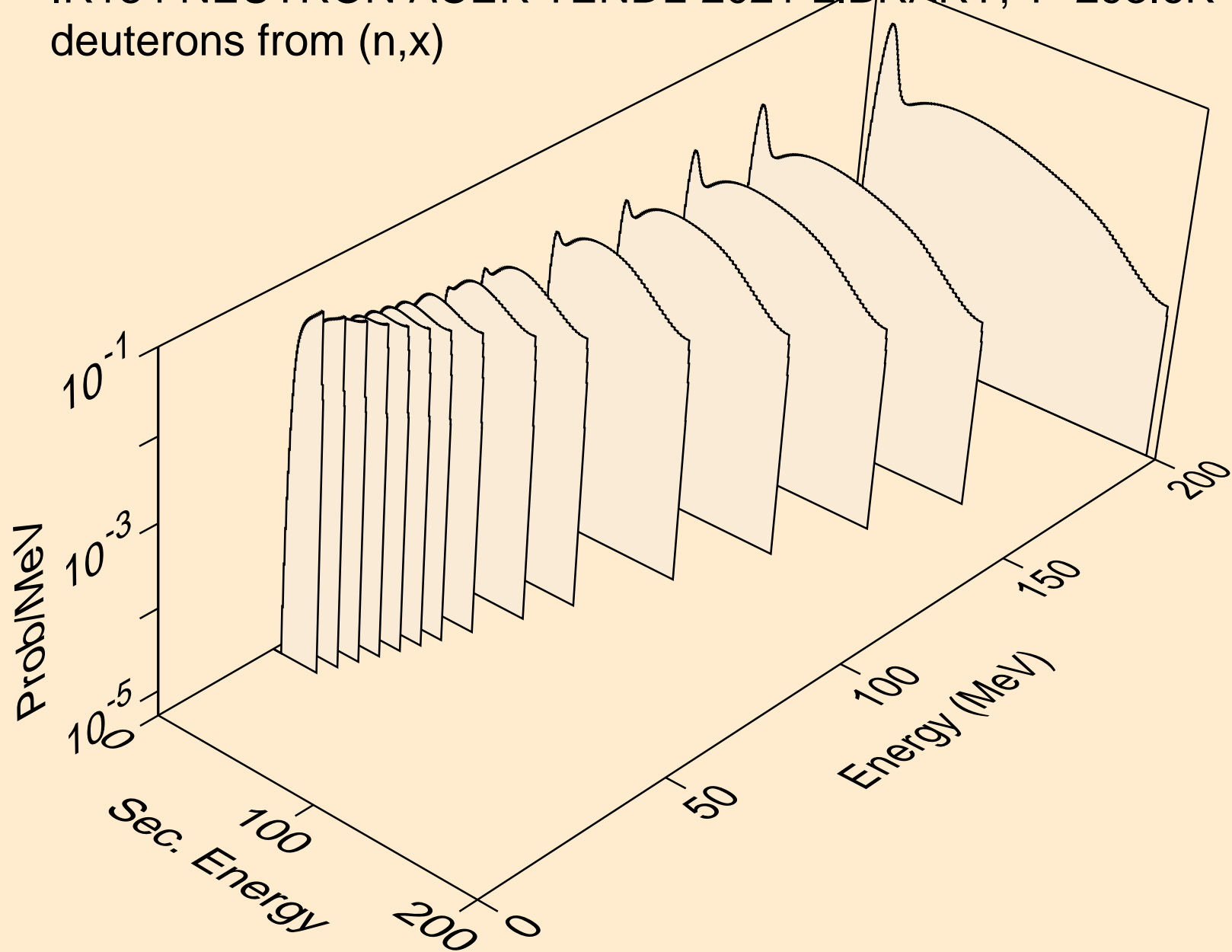

IR184 NEUTRON ACER TENDL-2021 LIBRARY; T=293.6K  
deuterons from (n,2nd)

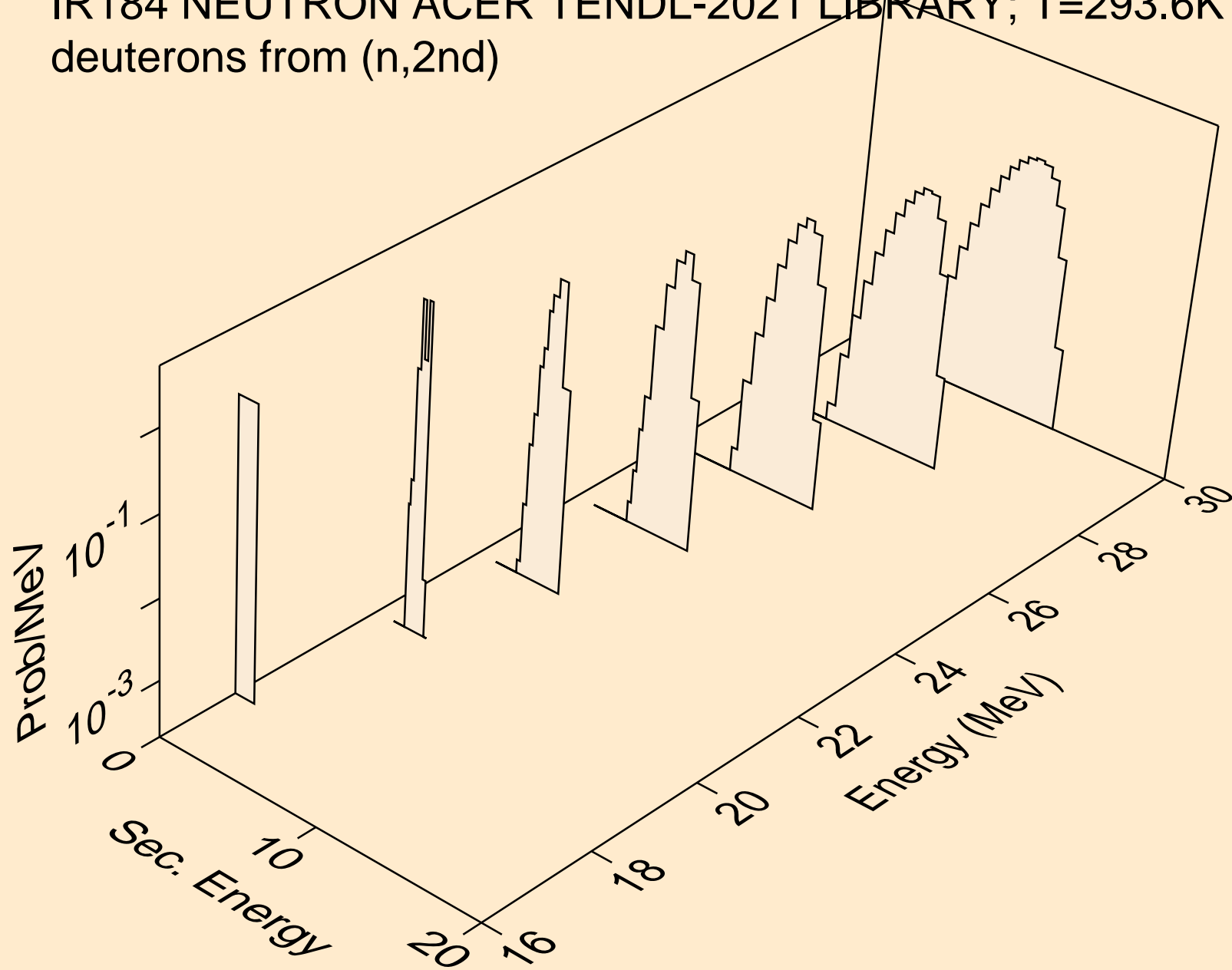

IR184 NEUTRON ACER TENDL-2021 LIBRARY; T=293.6K  
deuterons from (n,n\*)d

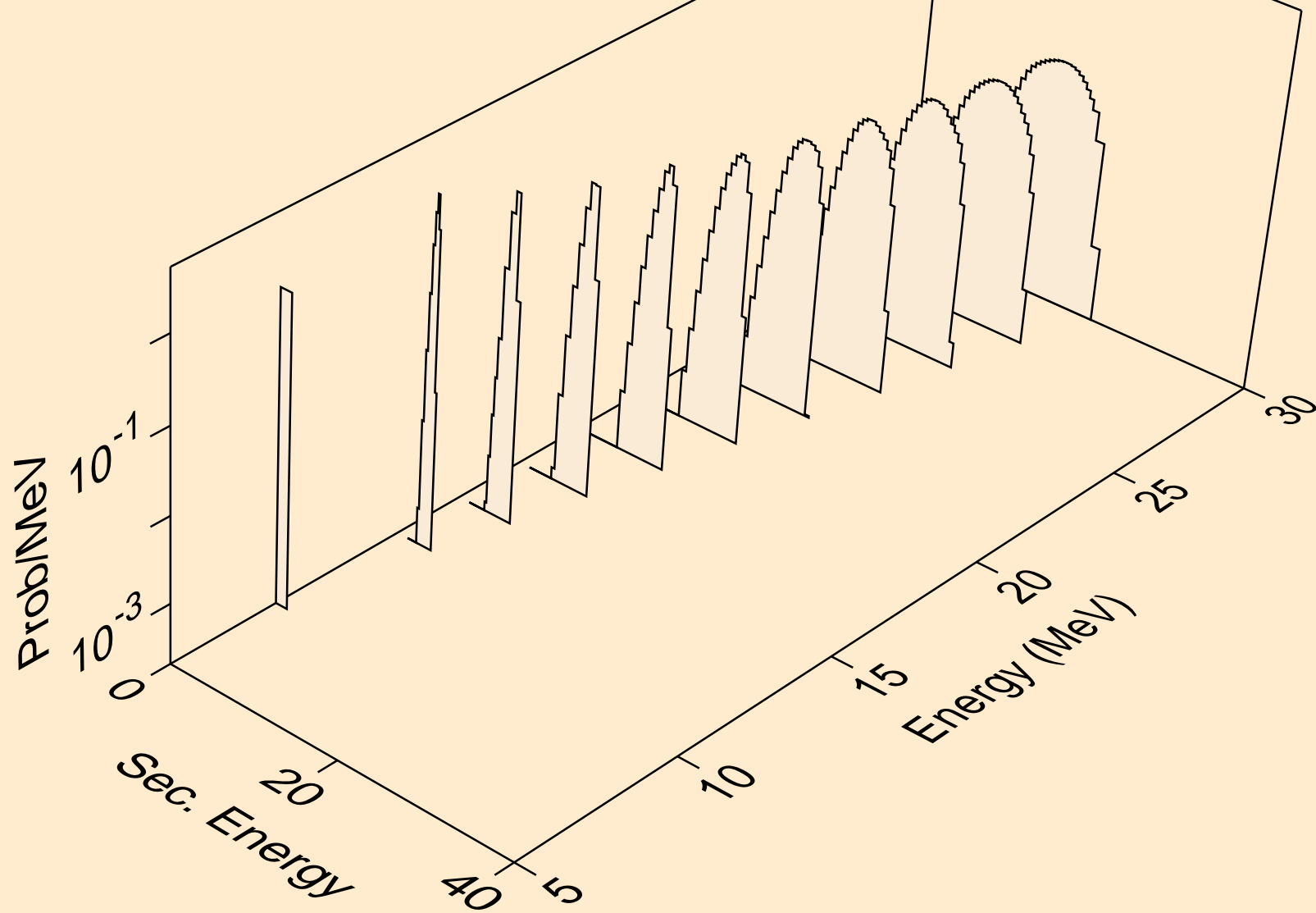

IR184 NEUTRON ACER TENDL-2021 LIBRARY; T=293.6K  
deuterons from (n,d)

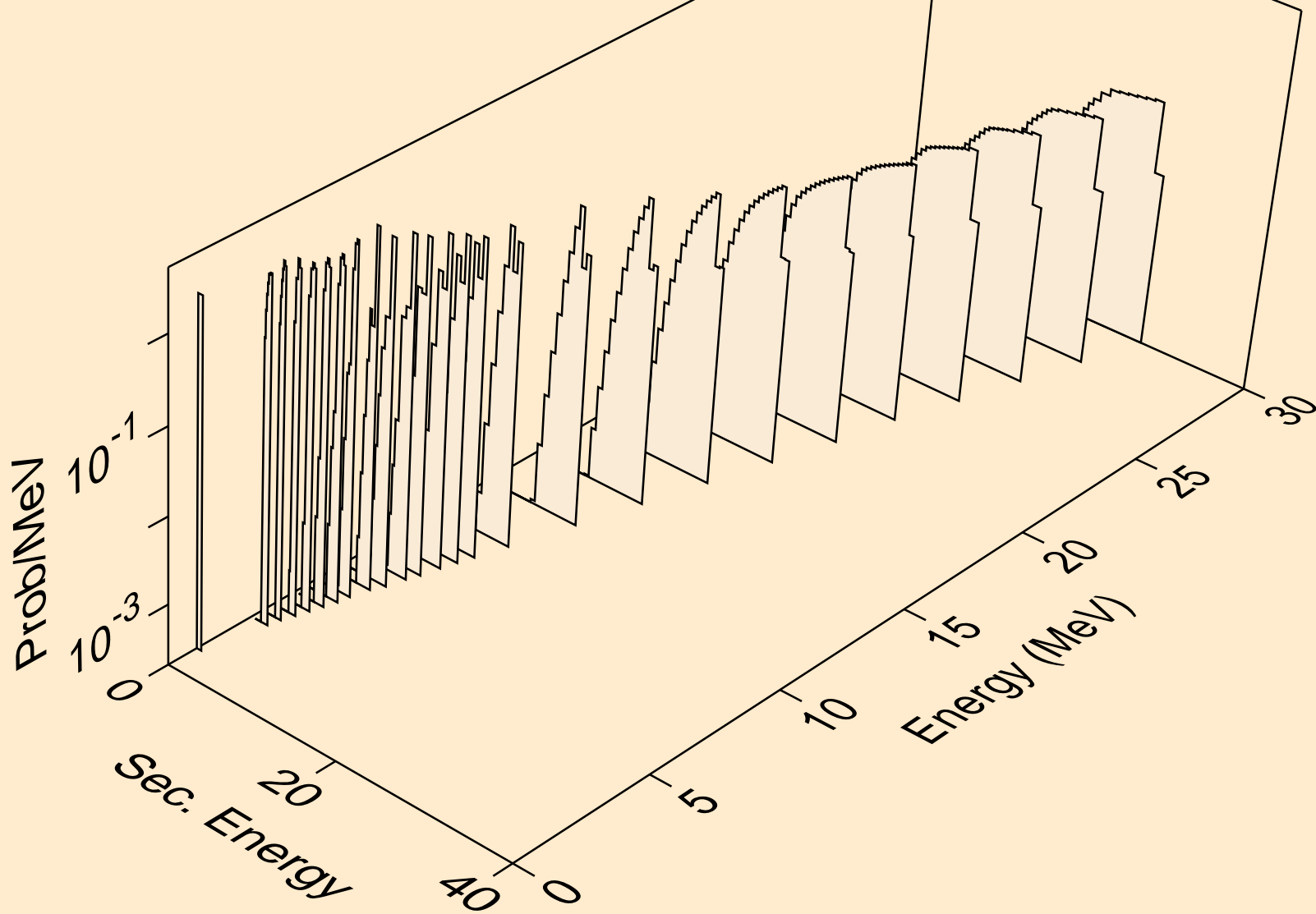

IR184 NEUTRON ACER TENDL-2021 LIBRARY; T=293.6K  
deuterons from (n,pd)

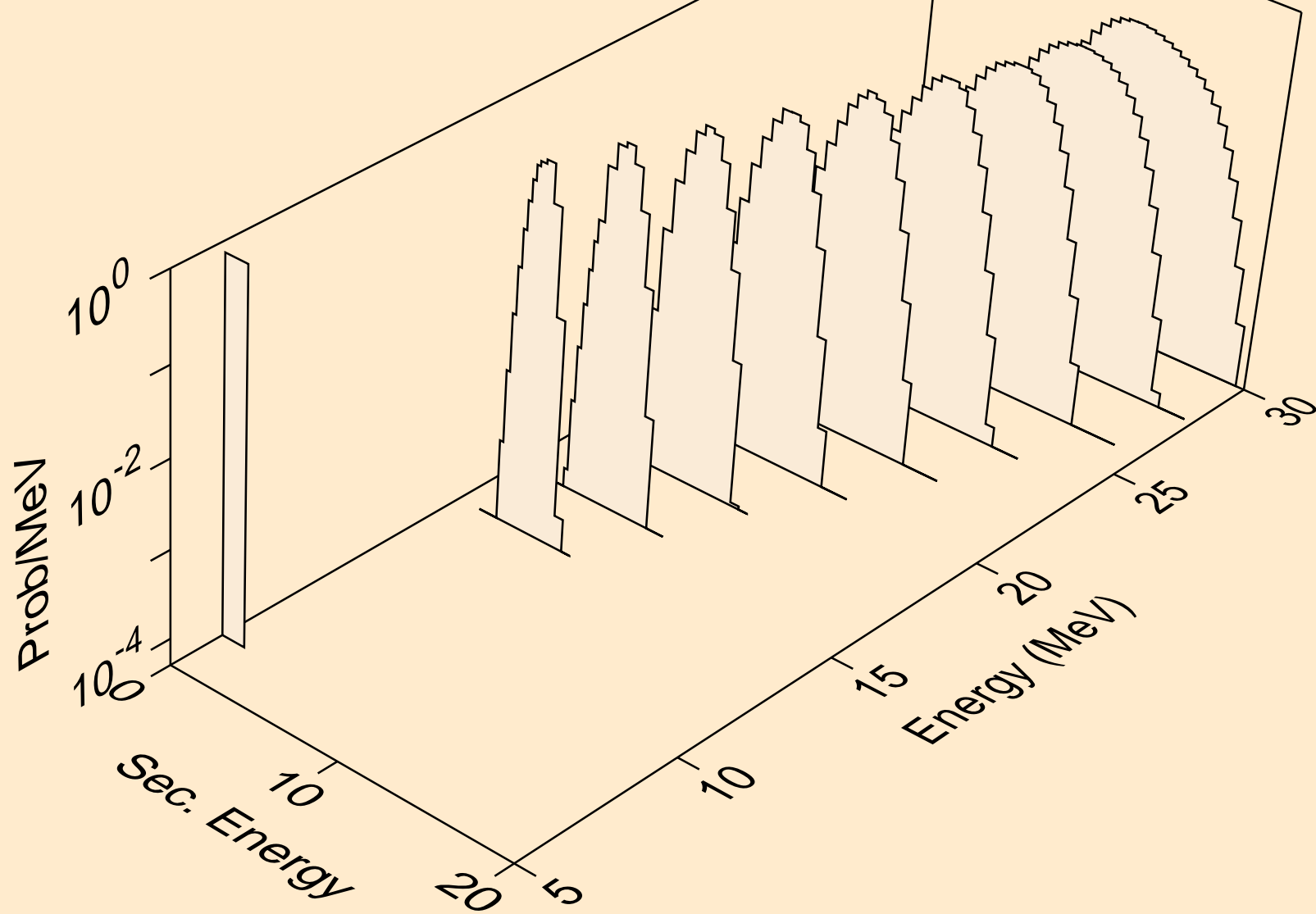

IR184 NEUTRON ACER TENDL-2021 LIBRARY; T=293.6K  
deuterons from (n,da)

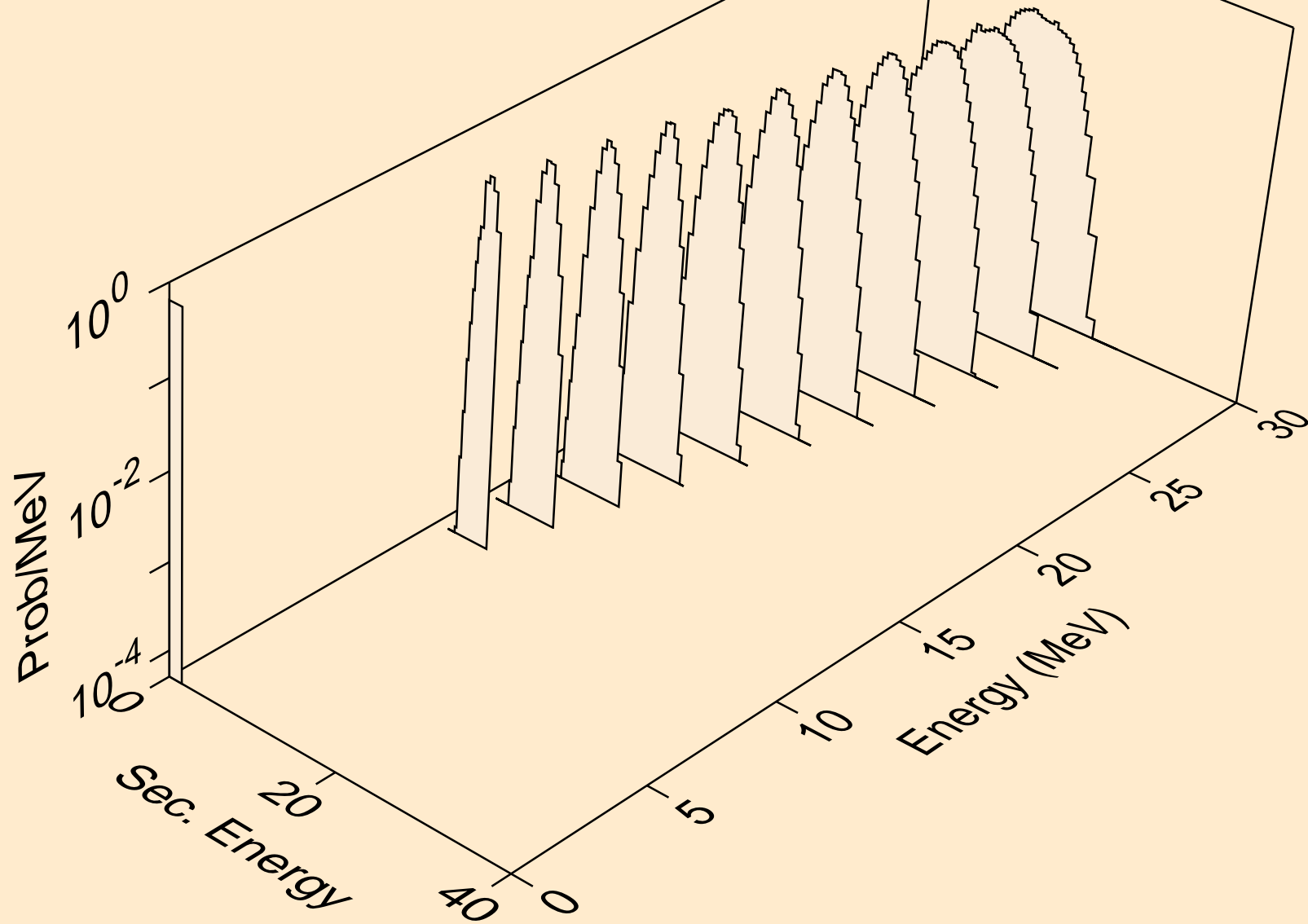

IR184 NEUTRON ACER TENDL-2021 LIBRARY; T=293.6K  
tritons from (n,x)

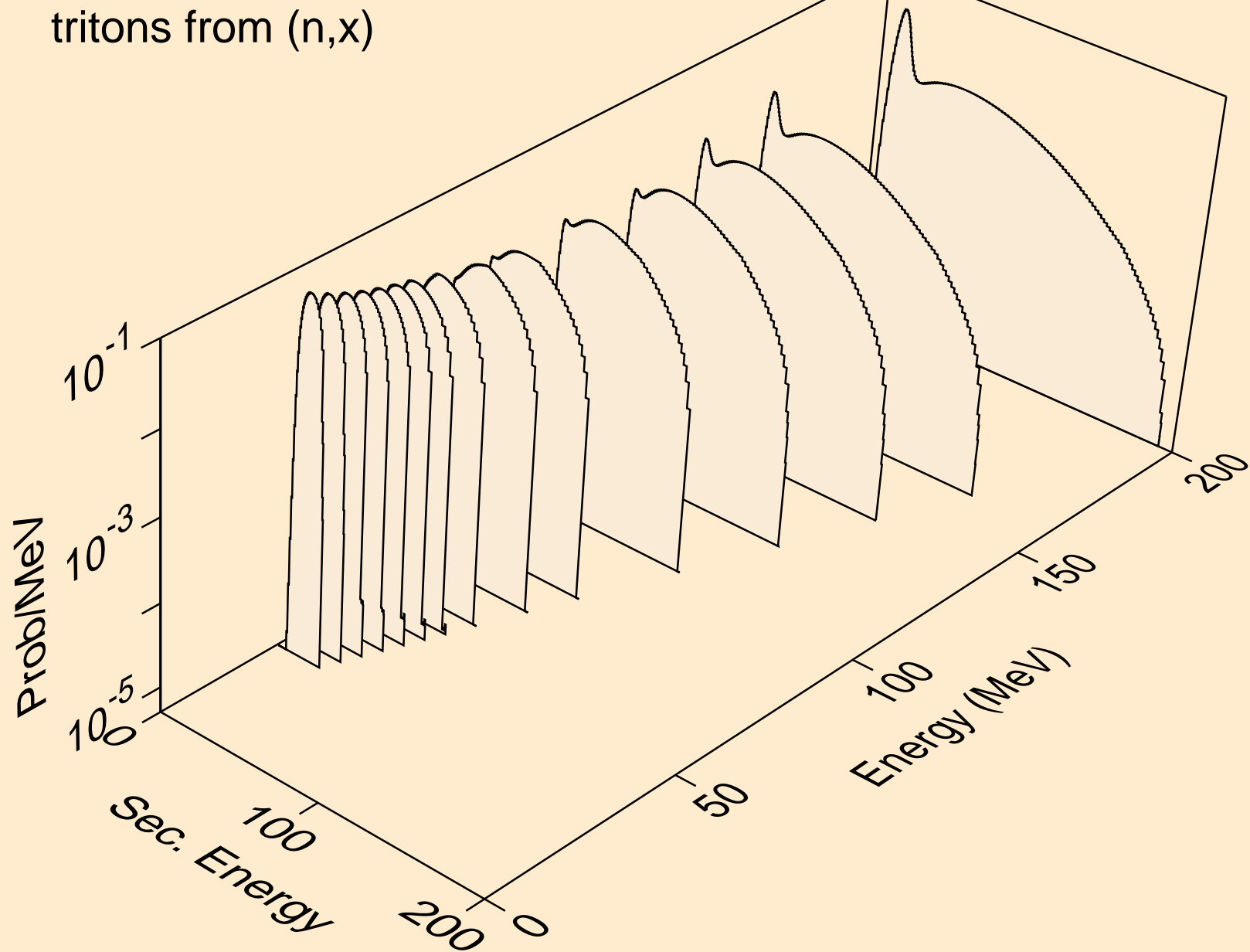

IR184 NEUTRON ACER TENDL-2021 LIBRARY; T=293.6K  
tritons from (n,n\*)t

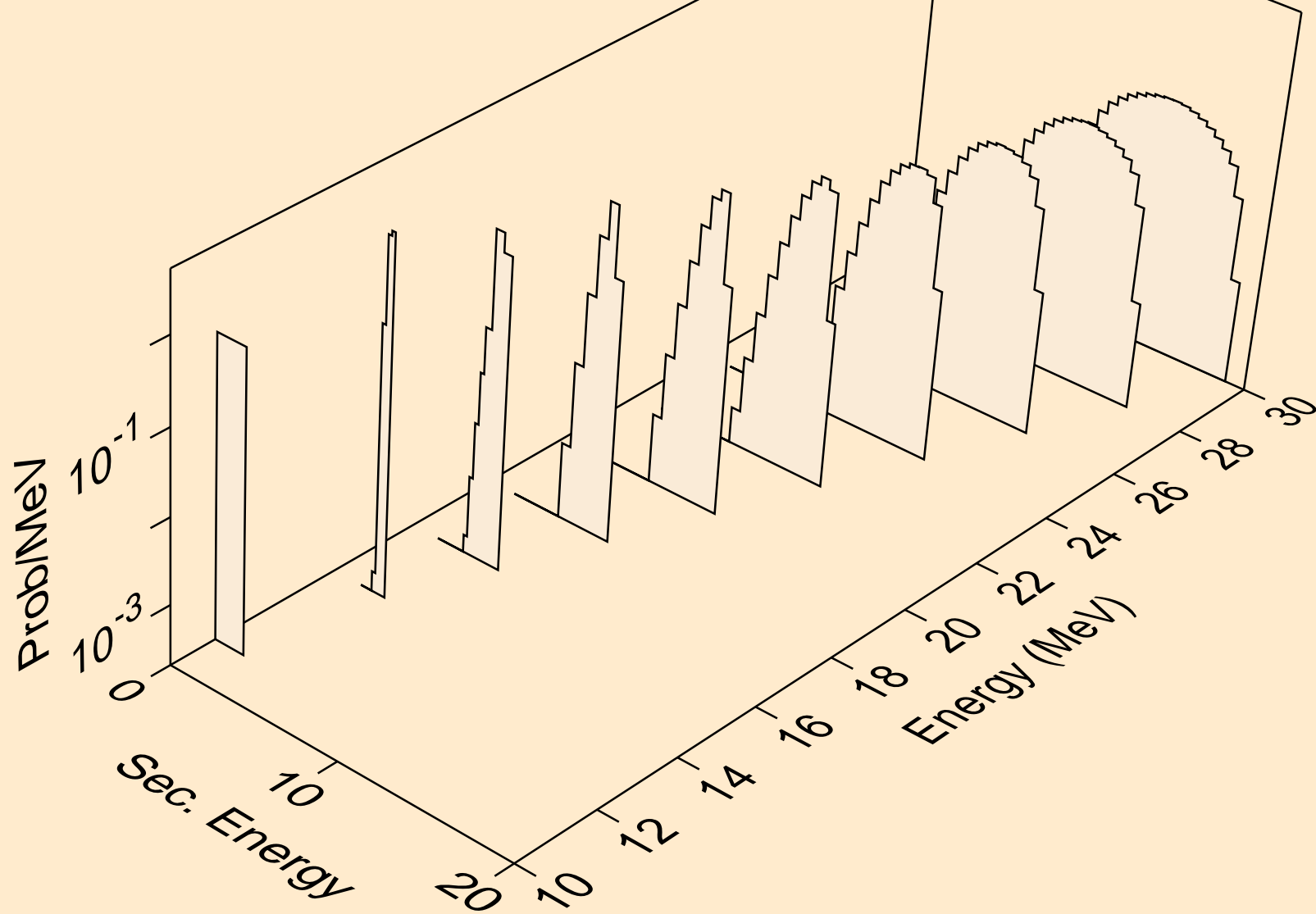



IR184 NEUTRON ACER TENDL-2021 LIBRARY; T=293.6K  
tritons from (n,t)

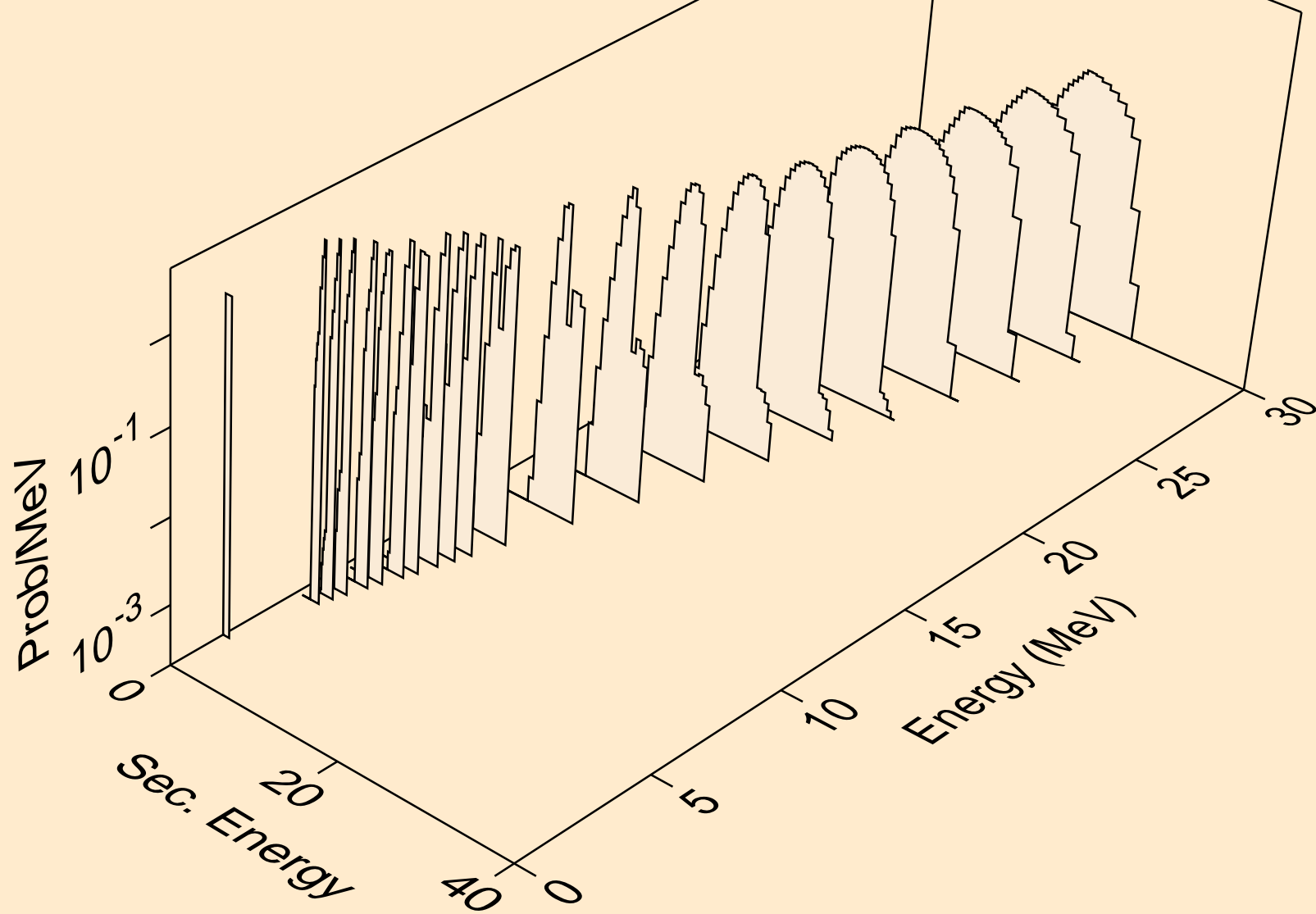

IR184 NEUTRON ACER TENDL-2021 LIBRARY; T=293.6K  
tritons from (n,pt)

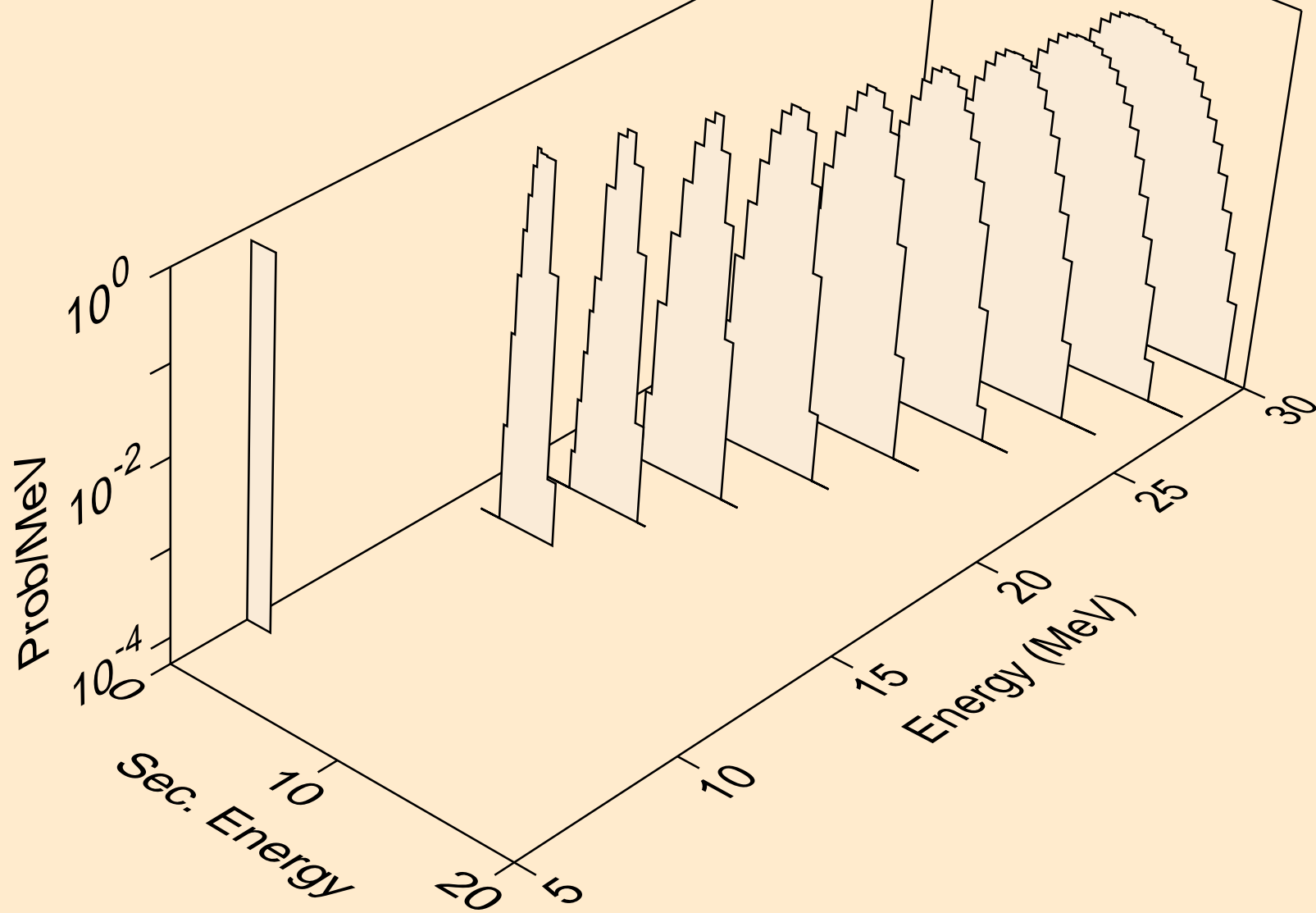

IR184 NEUTRON ACER TENDL-2021 LIBRARY; T=293.6K  
he3s from (n,x)

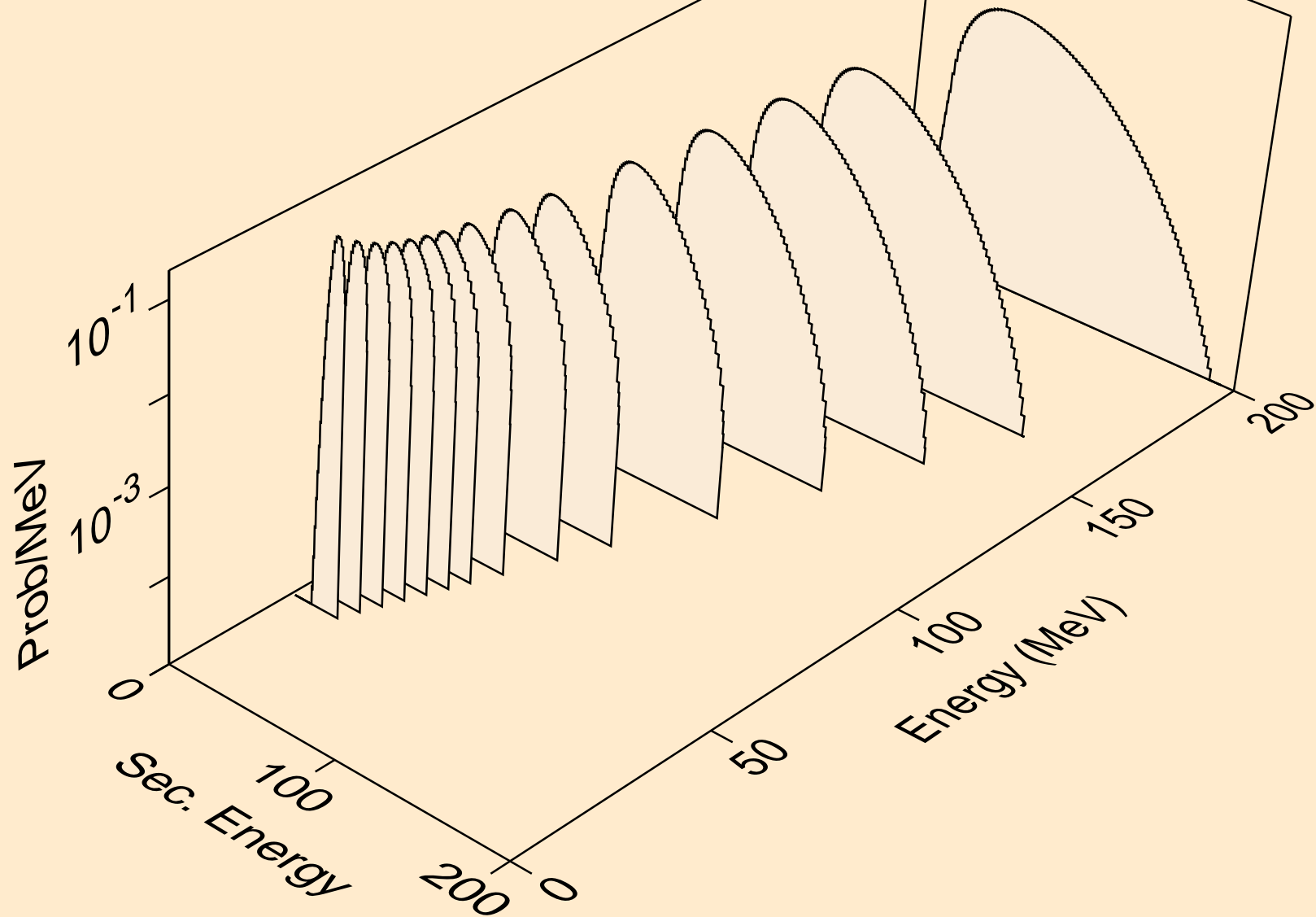

IR184 NEUTRON ACER TENDL-2021 LIBRARY; T=293.6K  
he3s from (n,n\*)he3

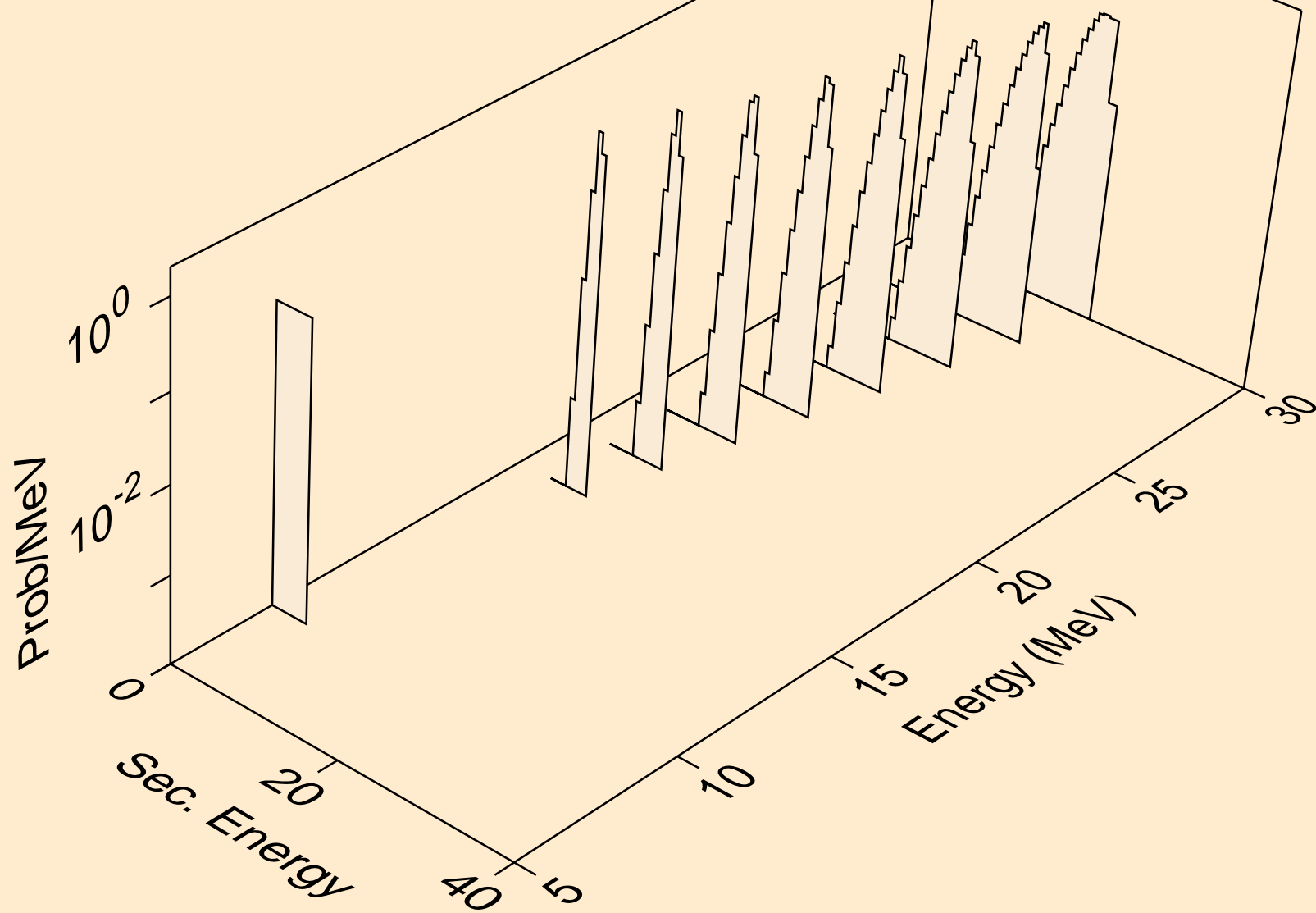

IR184 NEUTRON ACER TENDL-2021 LIBRARY; T=293.6K  
he3s from (n,he3)

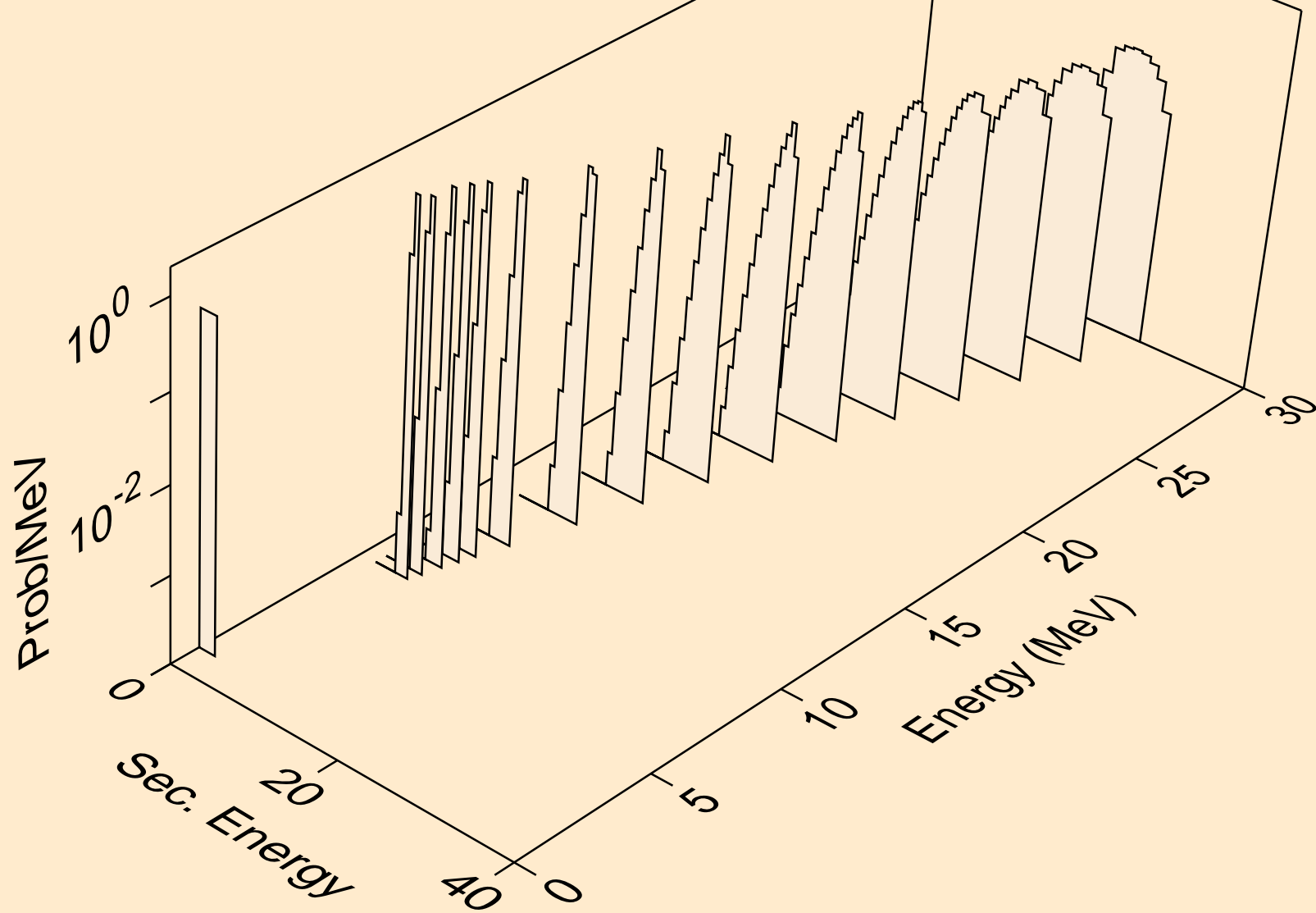

IR184 NEUTRON ACER TENDL-2021 LIBRARY; T=293.6K  
alphas from (n,x)

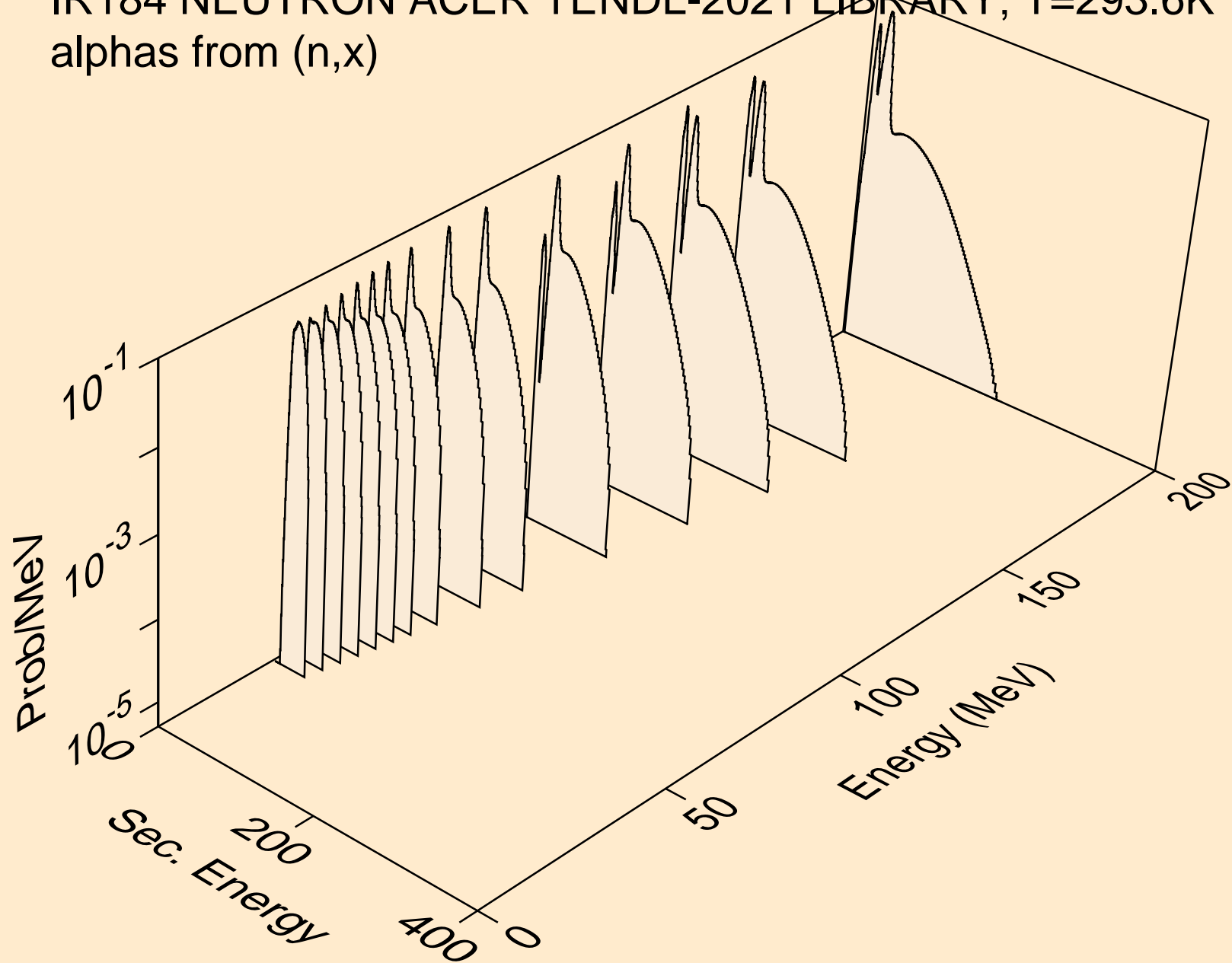

IR184 NEUTRON ACER TENDL-2021 LIBRARY; T=293.6K  
alphas from (n,n\*)a

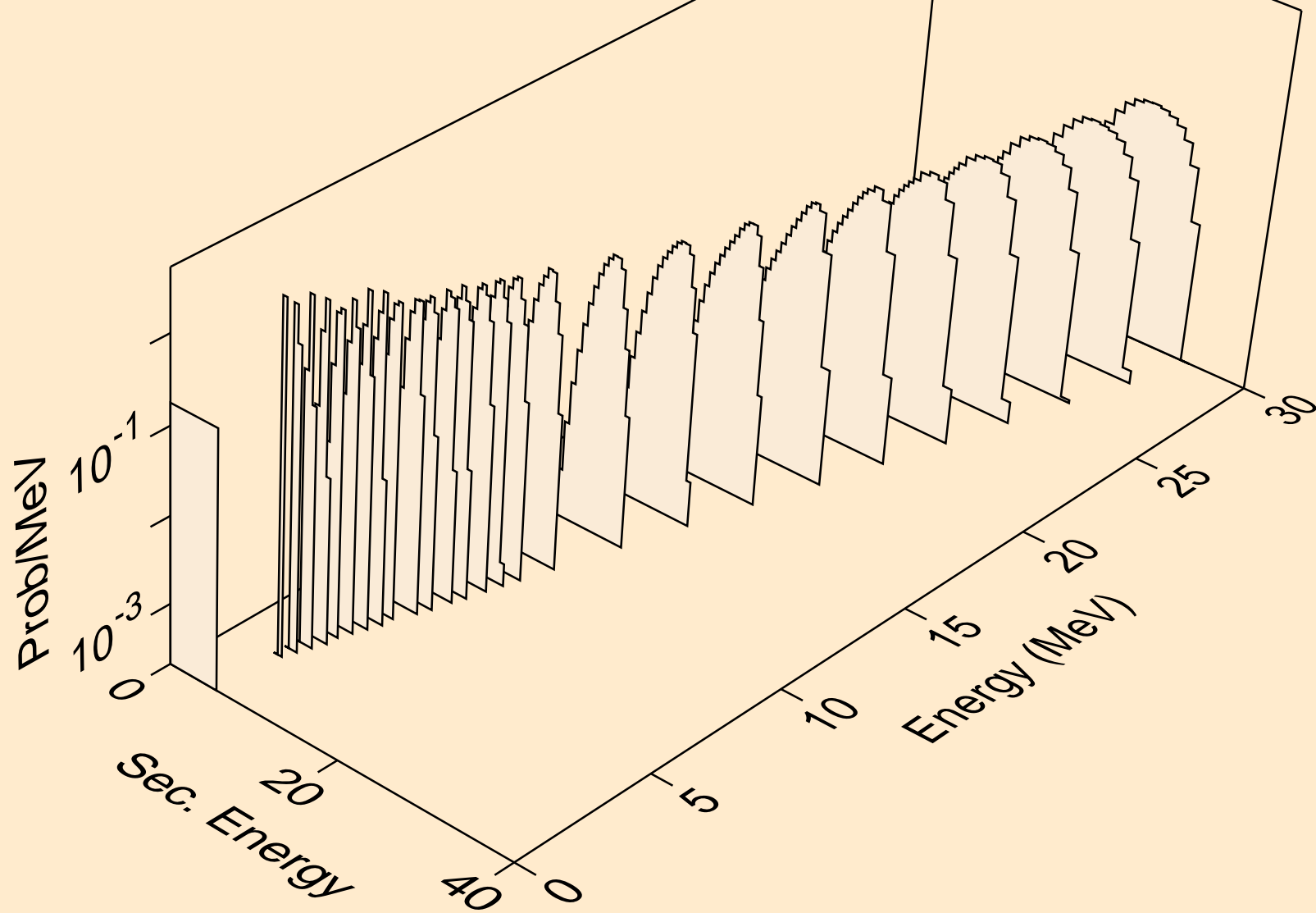

IR184 NEUTRON ACER TENDL-2021 LIBRARY; T=293.6K  
alphas from (n,2n)a

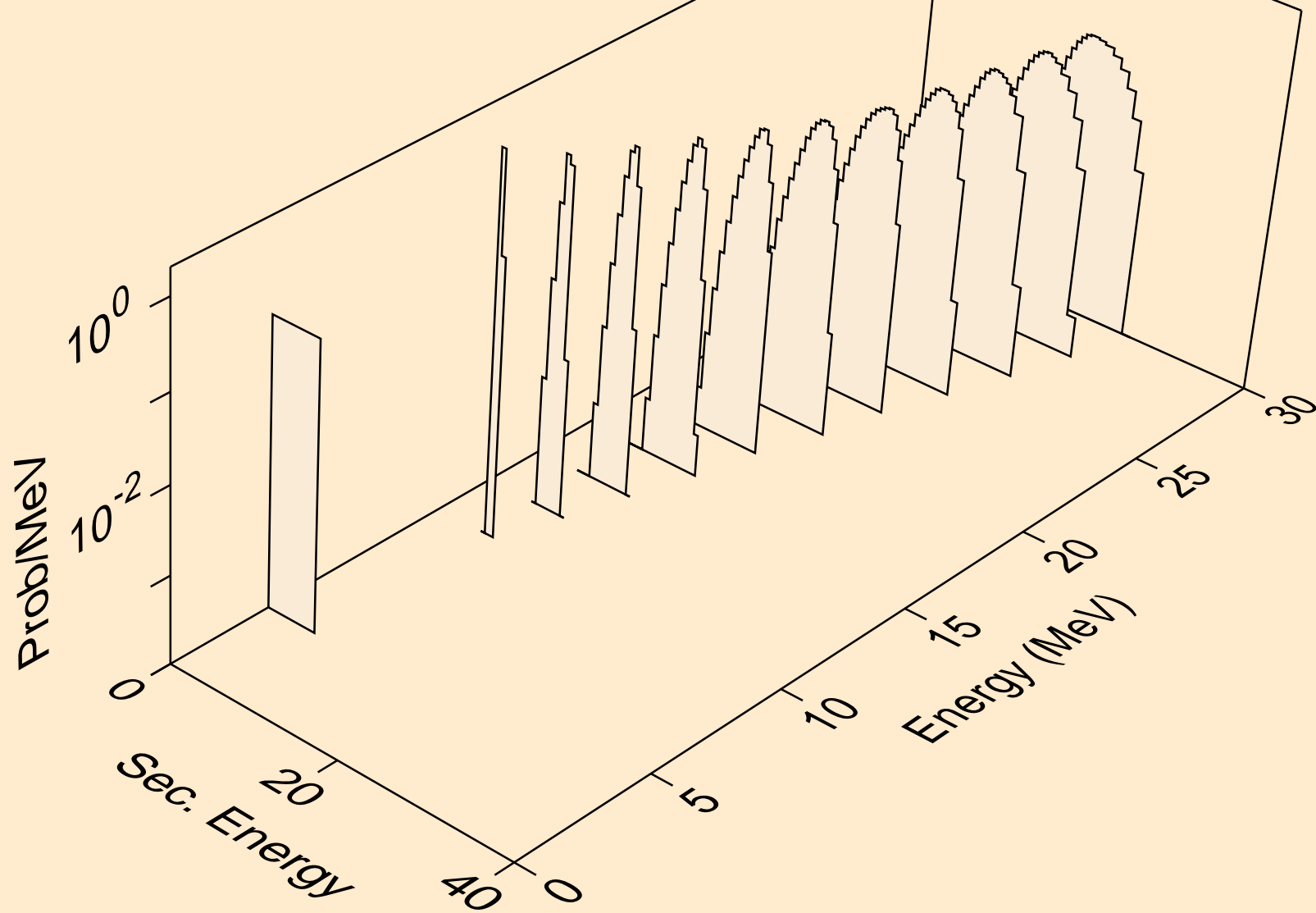



IR184 NEUTRON ACER TENDL-2021 LIBRARY; T=293.6K  
alphas from (n,3n)a

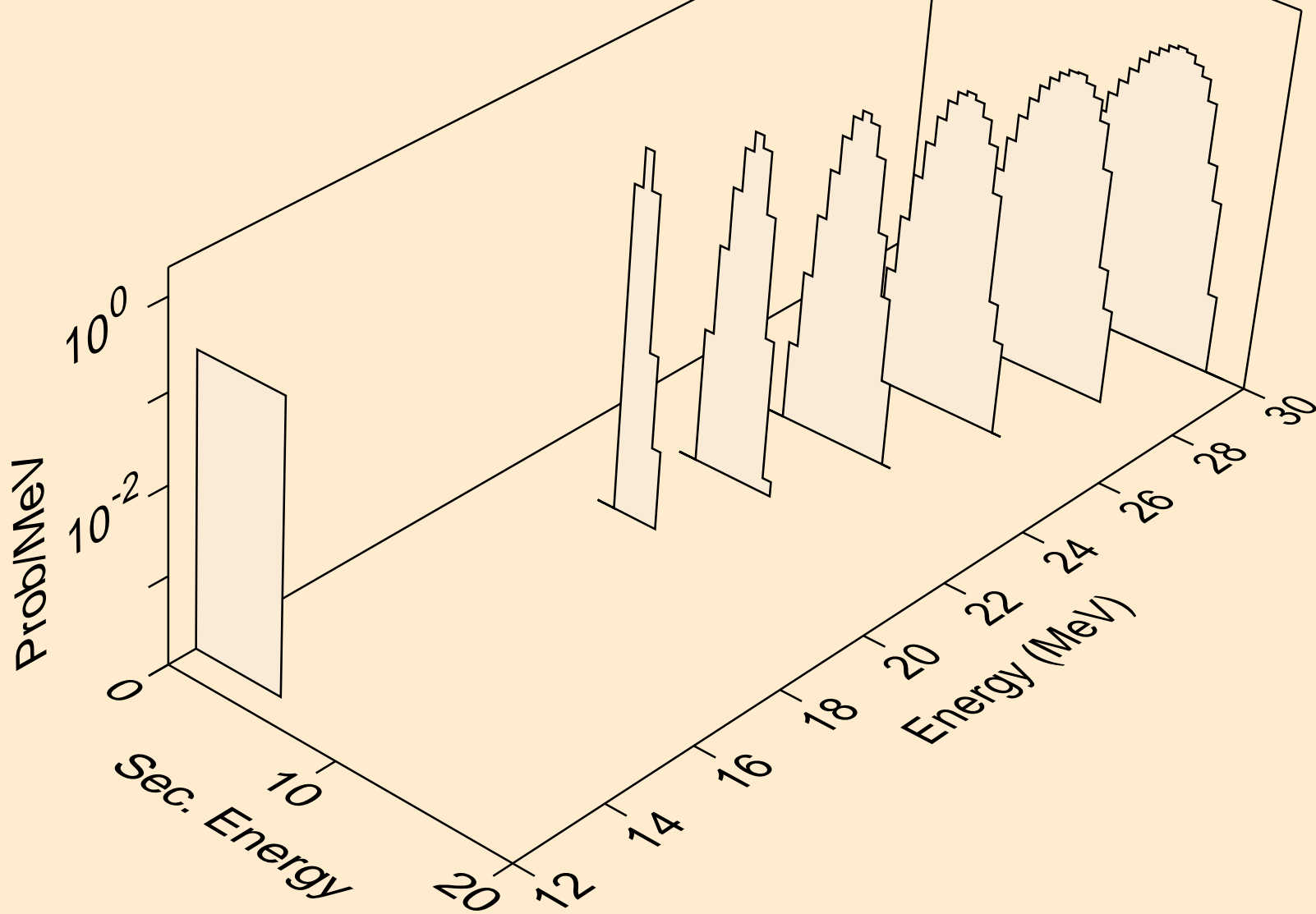

IR184 NEUTRON ACER TENDL-2021 LIBRARY; T=293.6K  
alphas from (n,n\*)2a

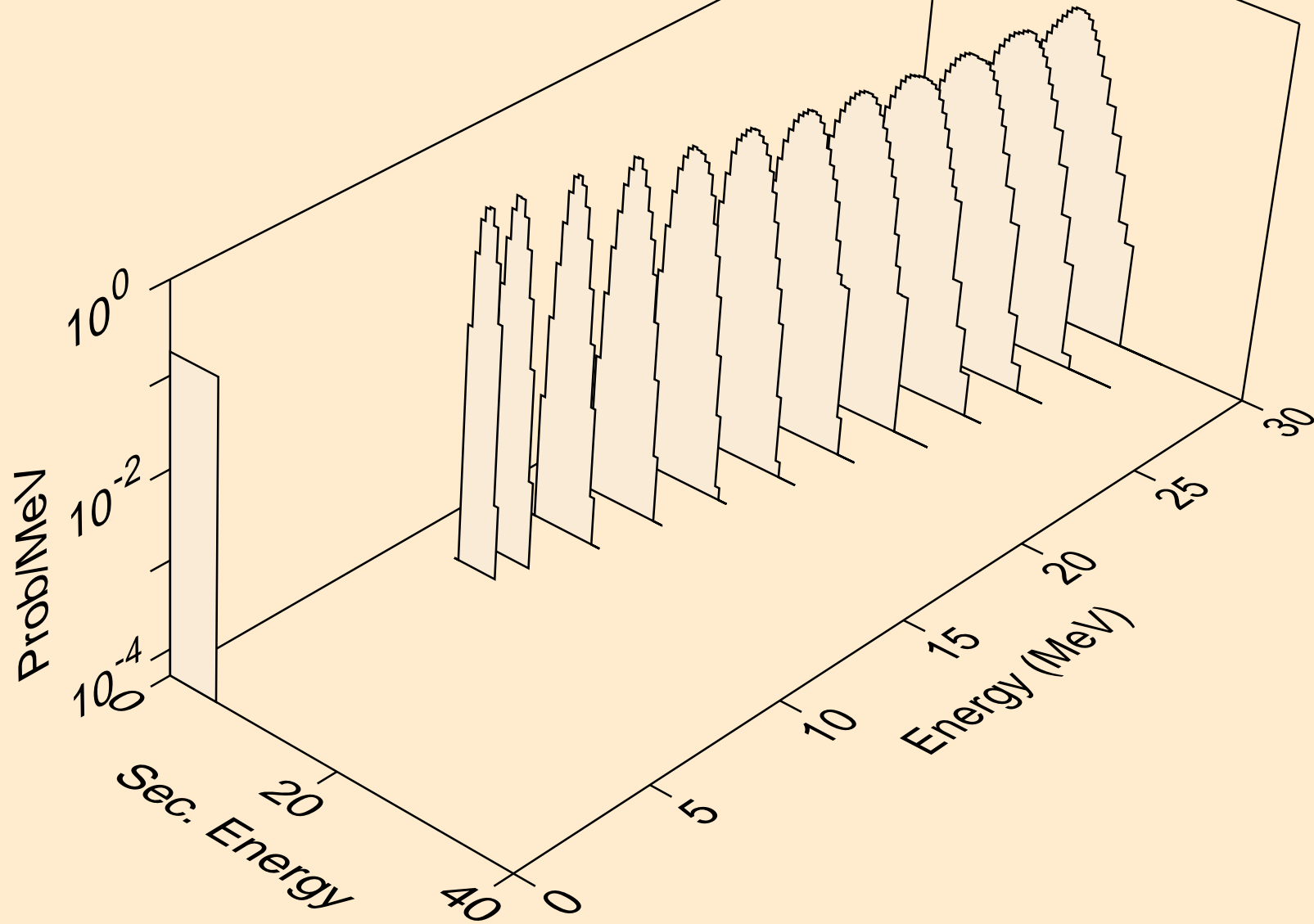

IR184 NEUTRON ACER TENDL-2021 LIBRARY; T=293.6K  
alphas from (n,2n)2a

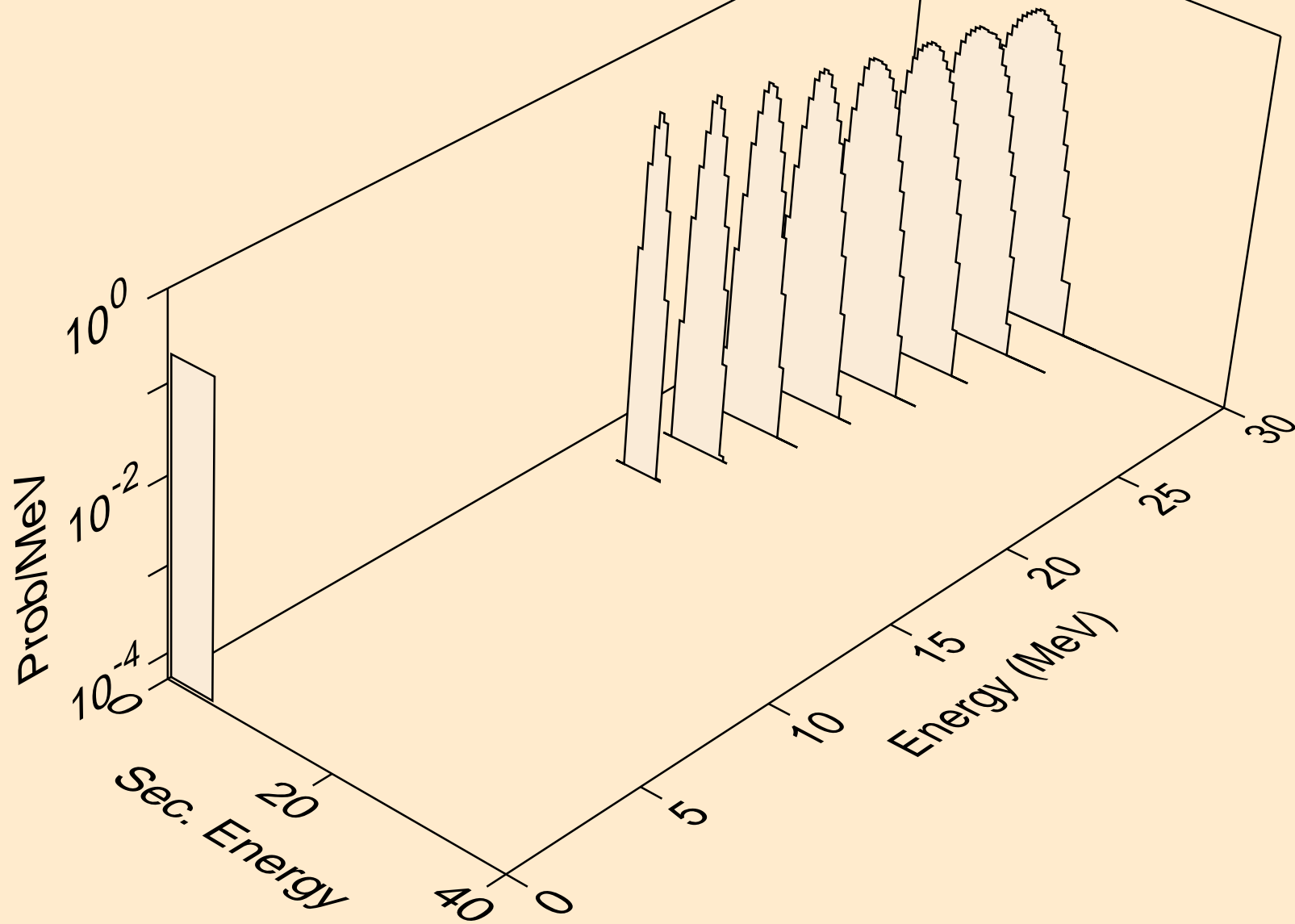

IR184 NEUTRON ACER TENDL-2021 LIBRARY; T=293.6K  
alphas from (n,npa)

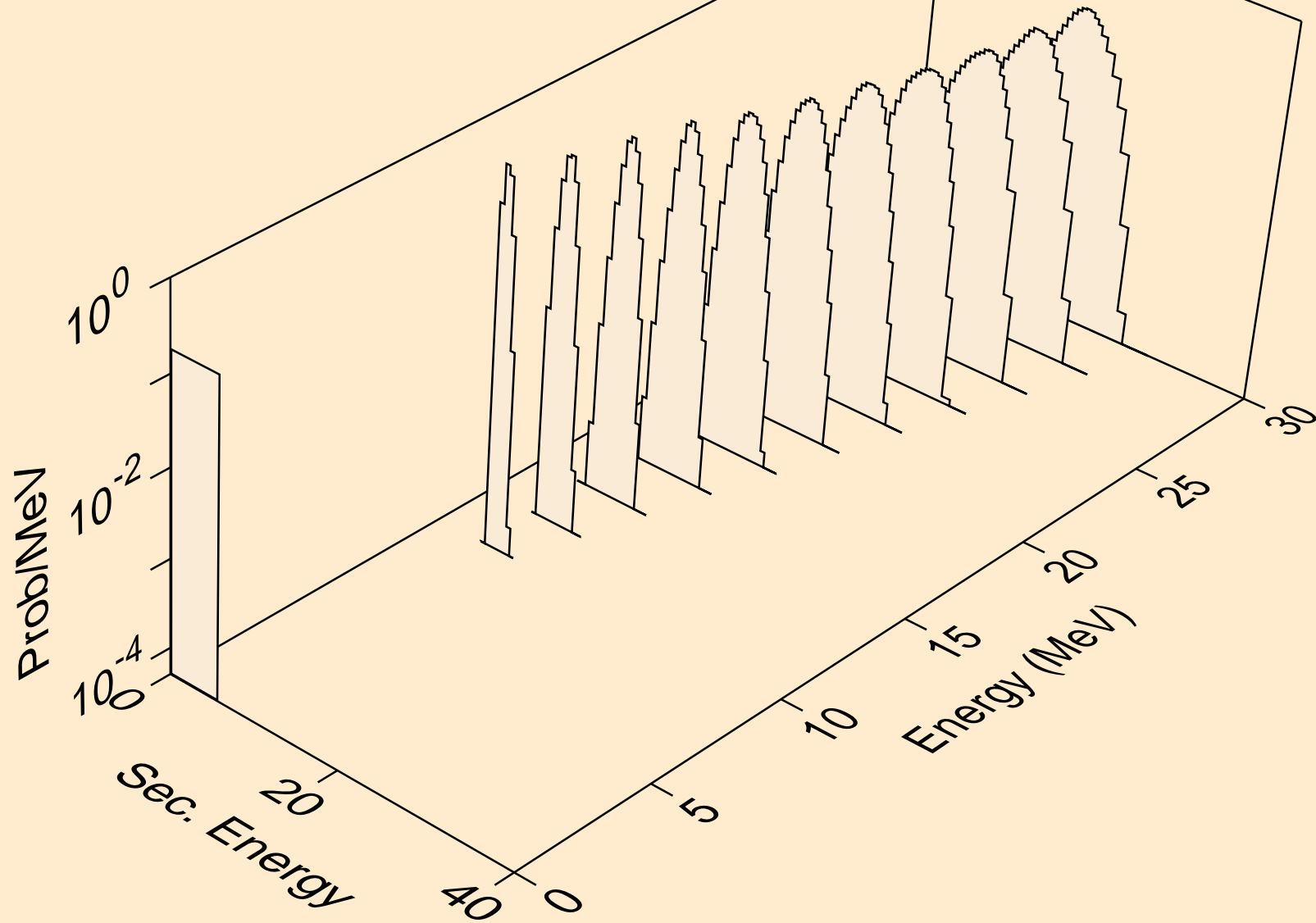

IR184 NEUTRON ACER TENDL-2021 LIBRARY; T=293.6K  
alphas from (n,a)

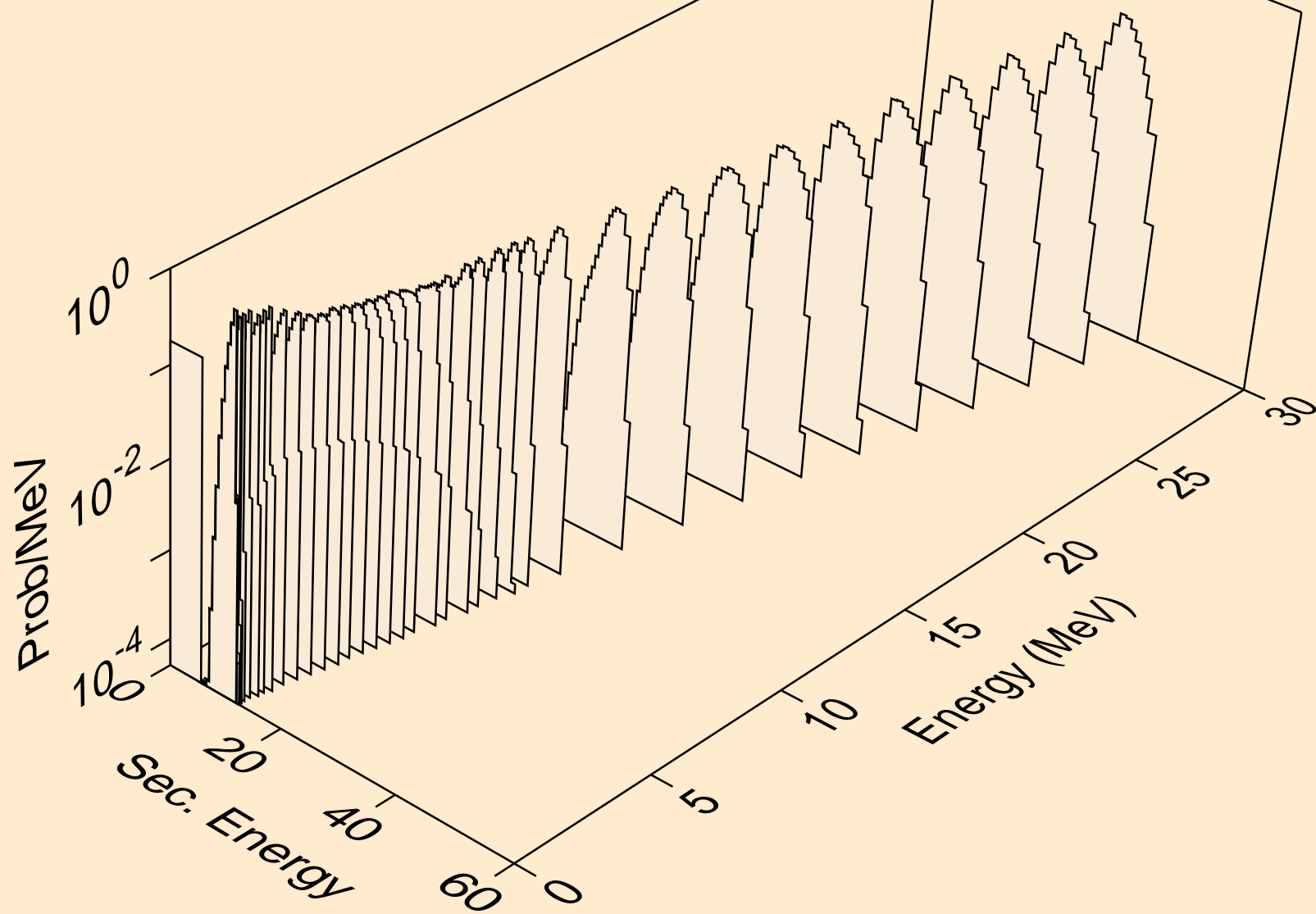

IR184 NEUTRON ACER TENDL-2021 LIBRARY; T=293.6K  
alphas from (n,2a)

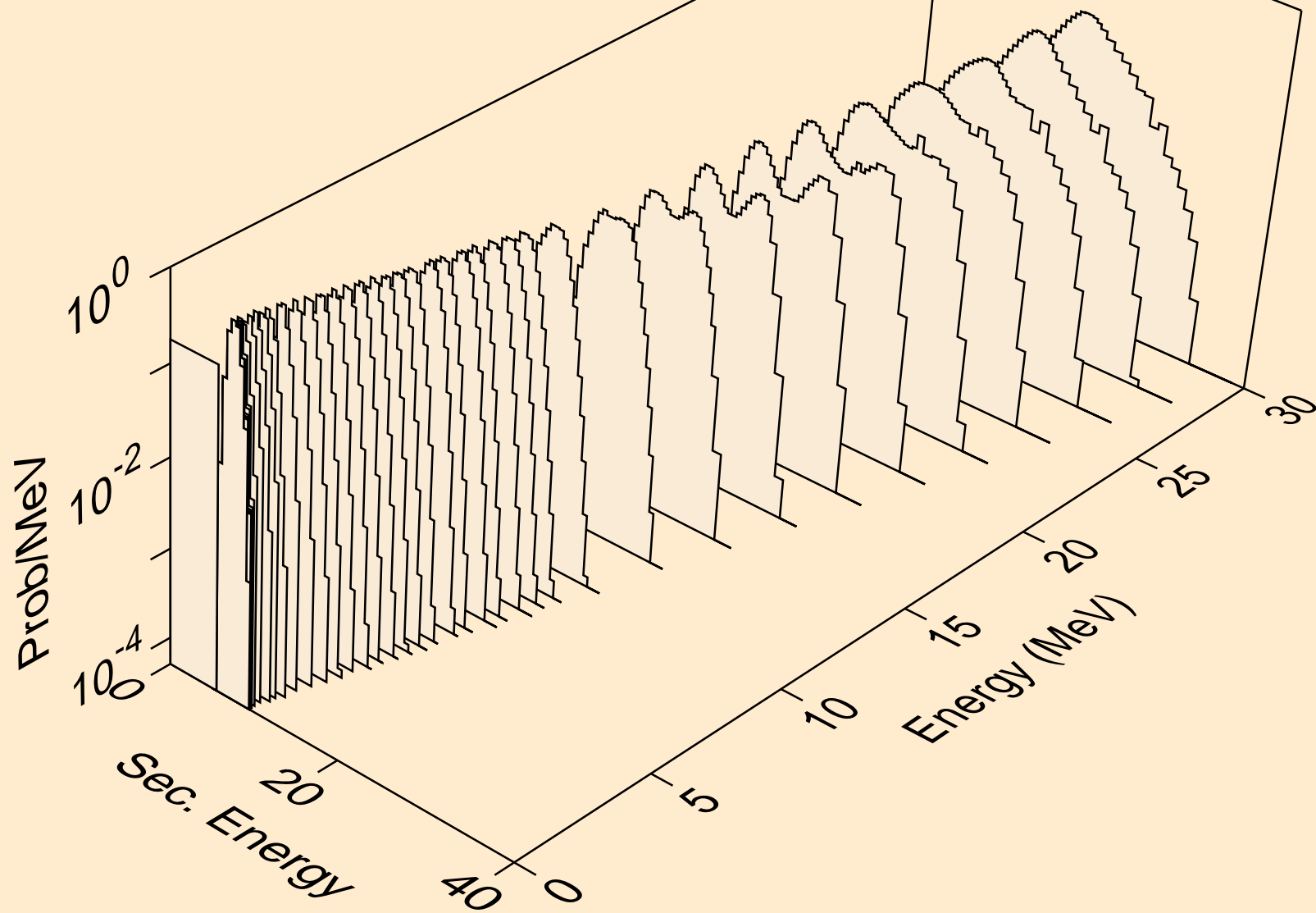

IR184 NEUTRON ACER TENDL-2021 LIBRARY; T=293.6K  
alphas from (n,pa)

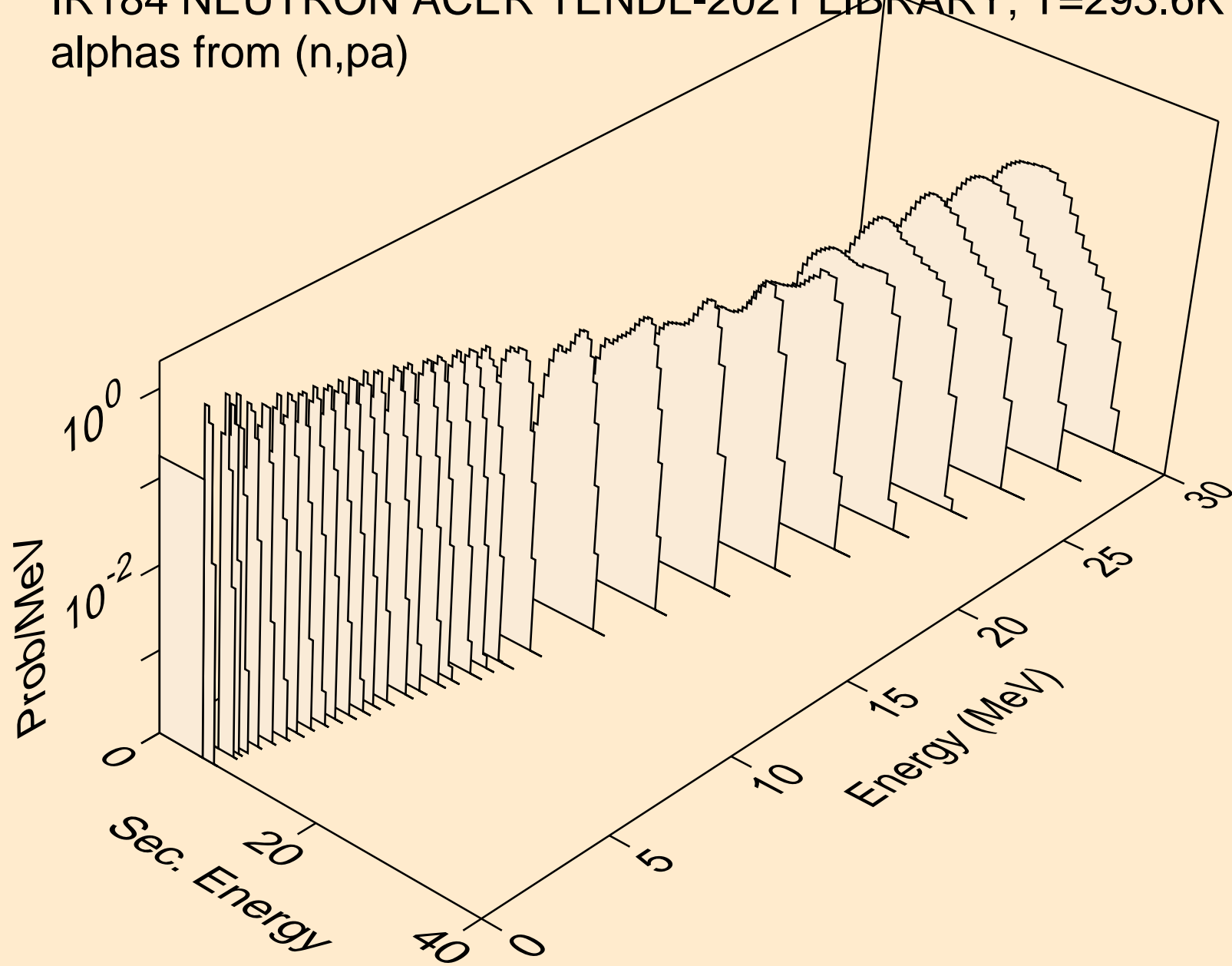

IR184 NEUTRON ACER TENDL-2021 LIBRARY; T=293.6K  
alphas from (n,da)

