

IR193 NEUTRON ACER TENDL-2021 LIBRARY; T=293.6K

Principal cross sections

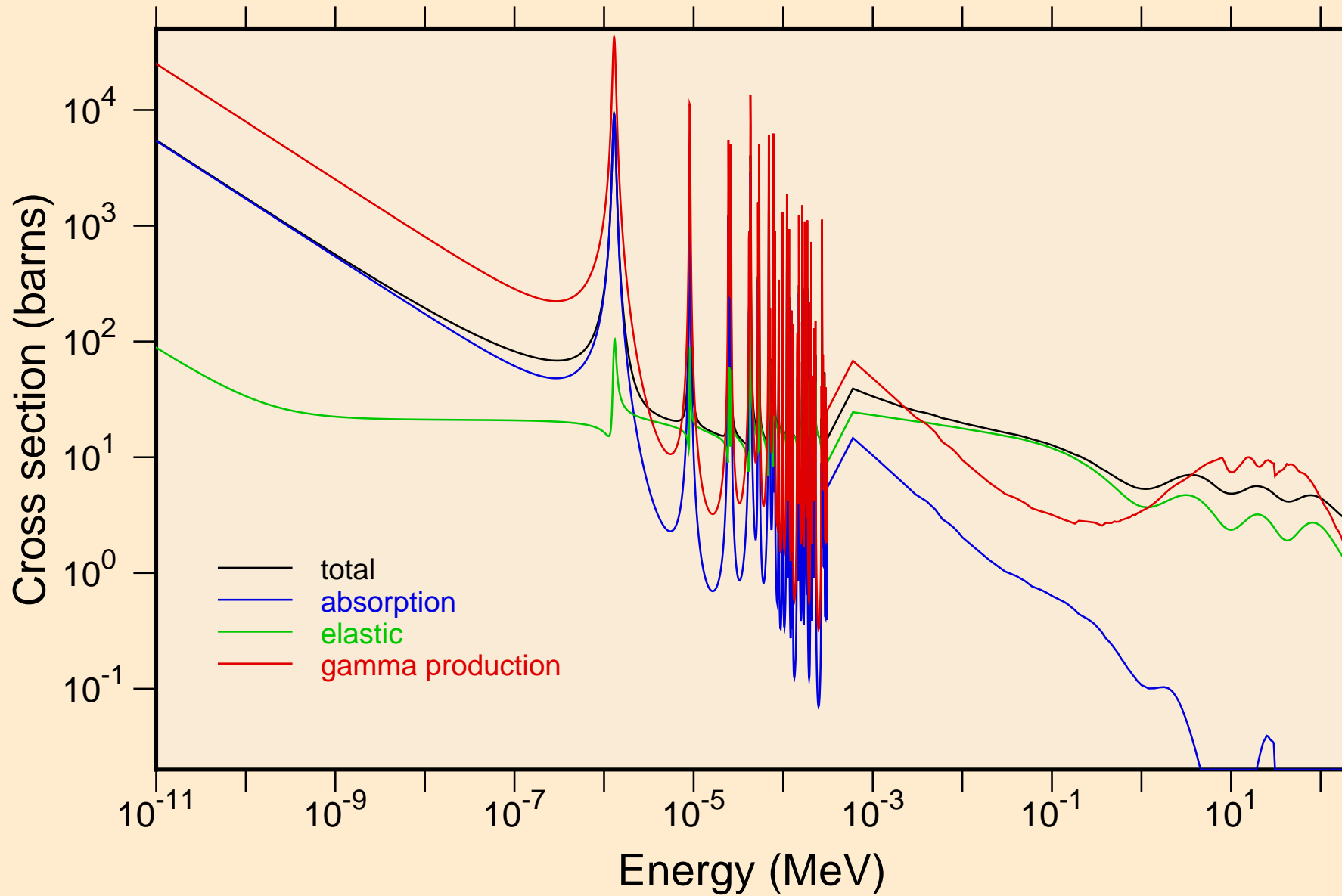

IR193 NEUTRON ACER TENDL-2021 LIBRARY; T=293.6K
resonance total cross section

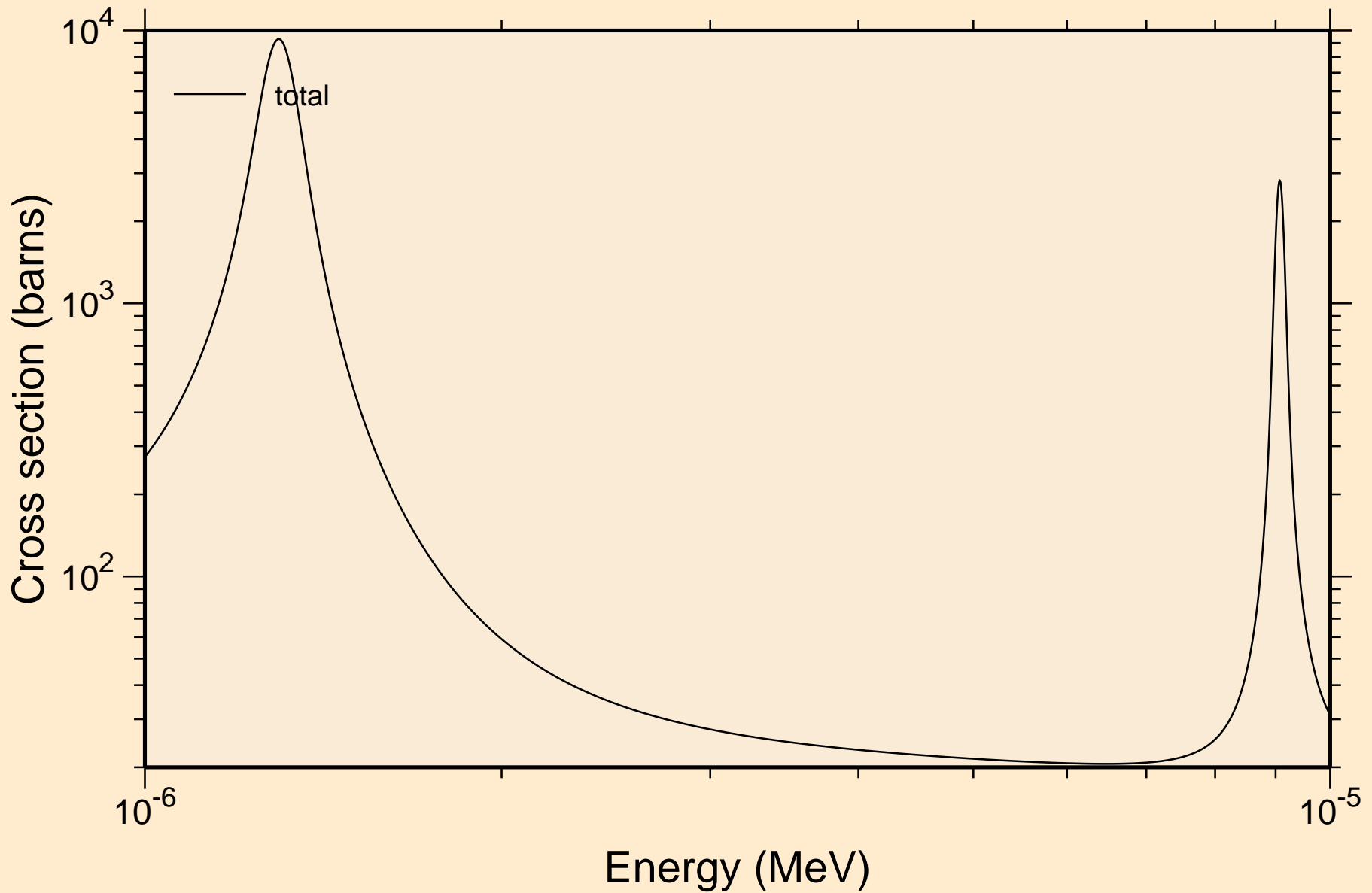

IR193 NEUTRON ACER TENDL-2021 LIBRARY; T=293.6K
resonance total cross section

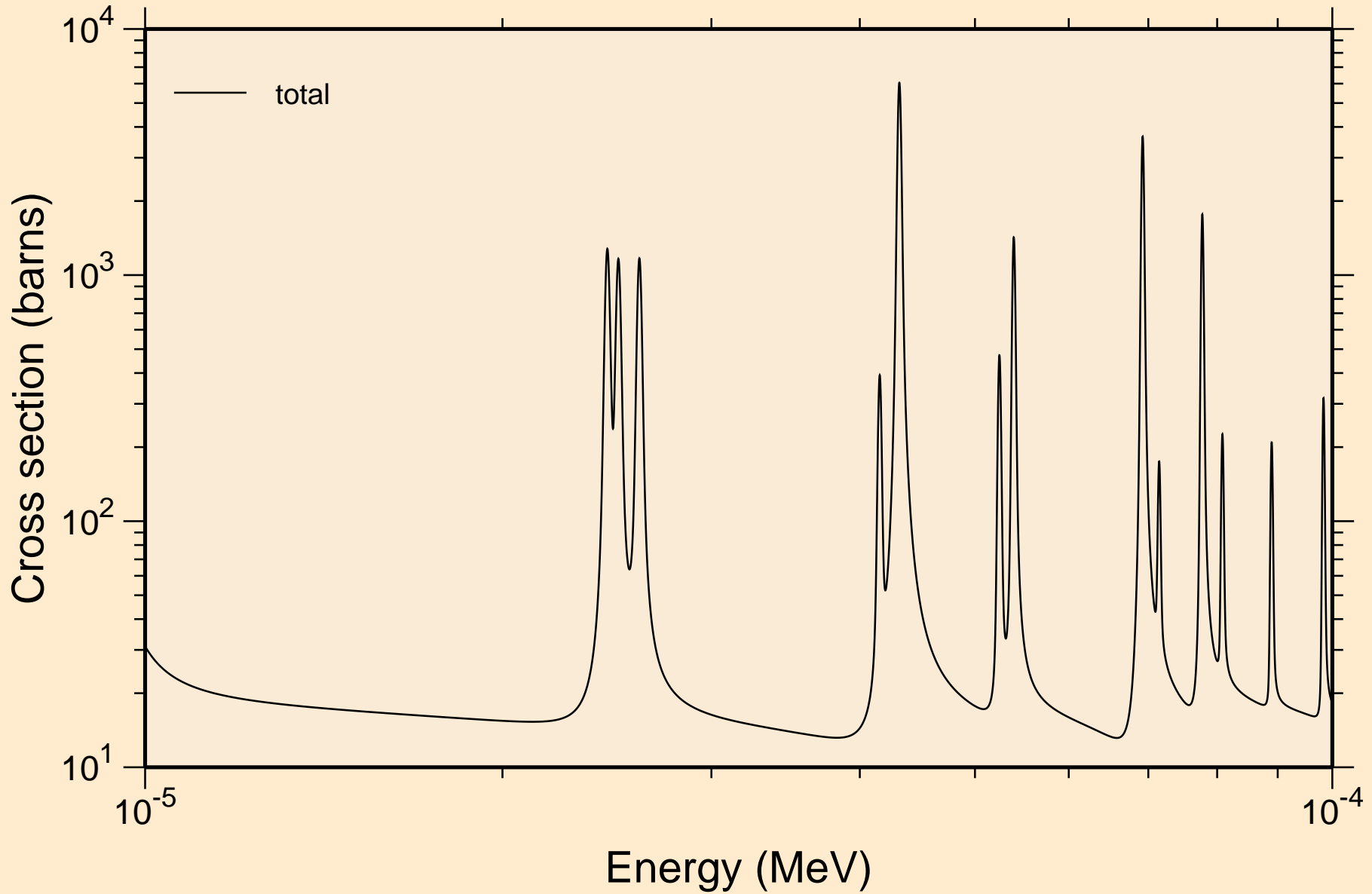

IR193 NEUTRON ACER TENDL-2021 LIBRARY; T=293.6K
resonance total cross section

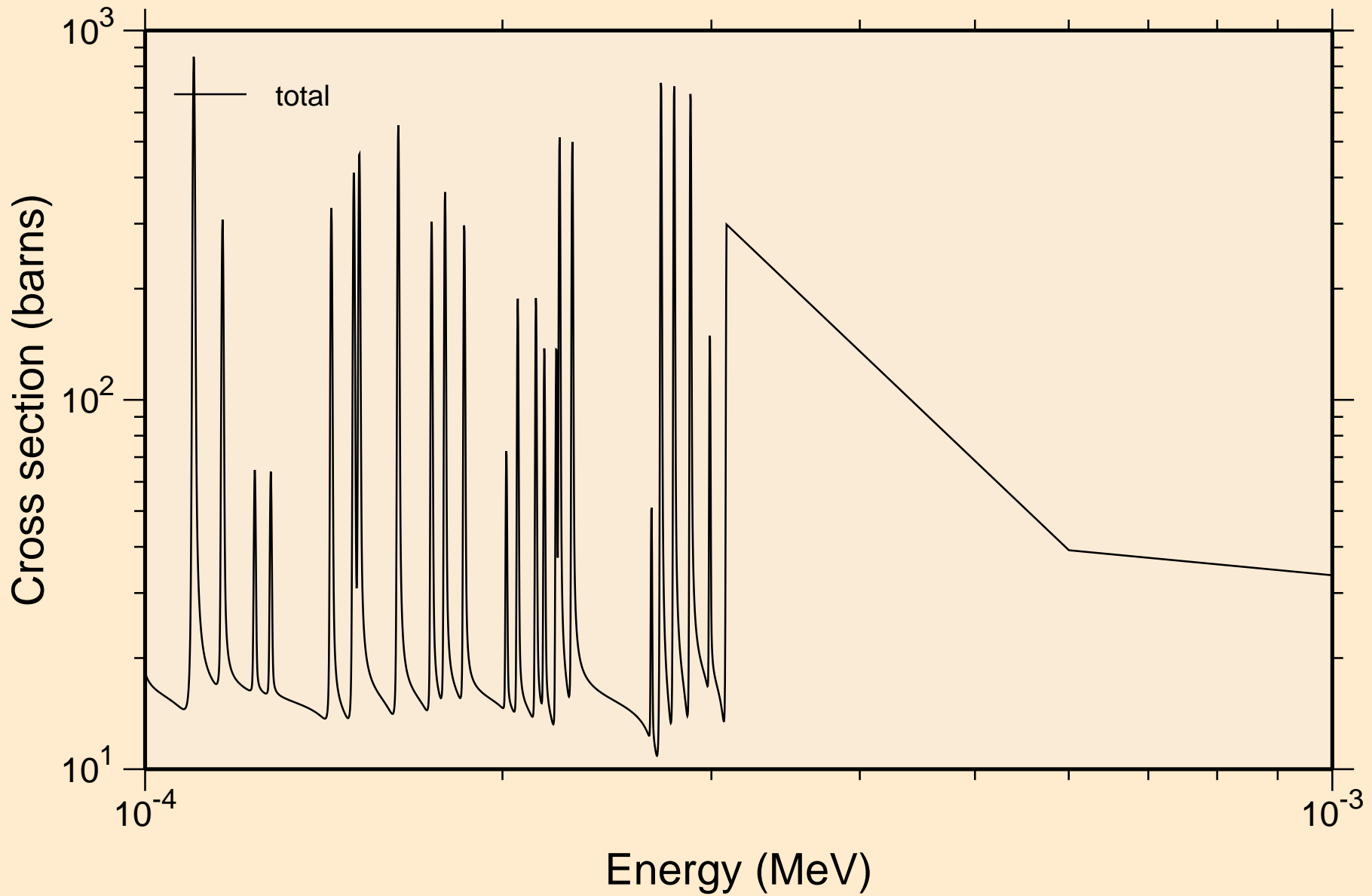

IR193 NEUTRON ACER TENDL-2021 LIBRARY; T=293.6K
resonance total cross section

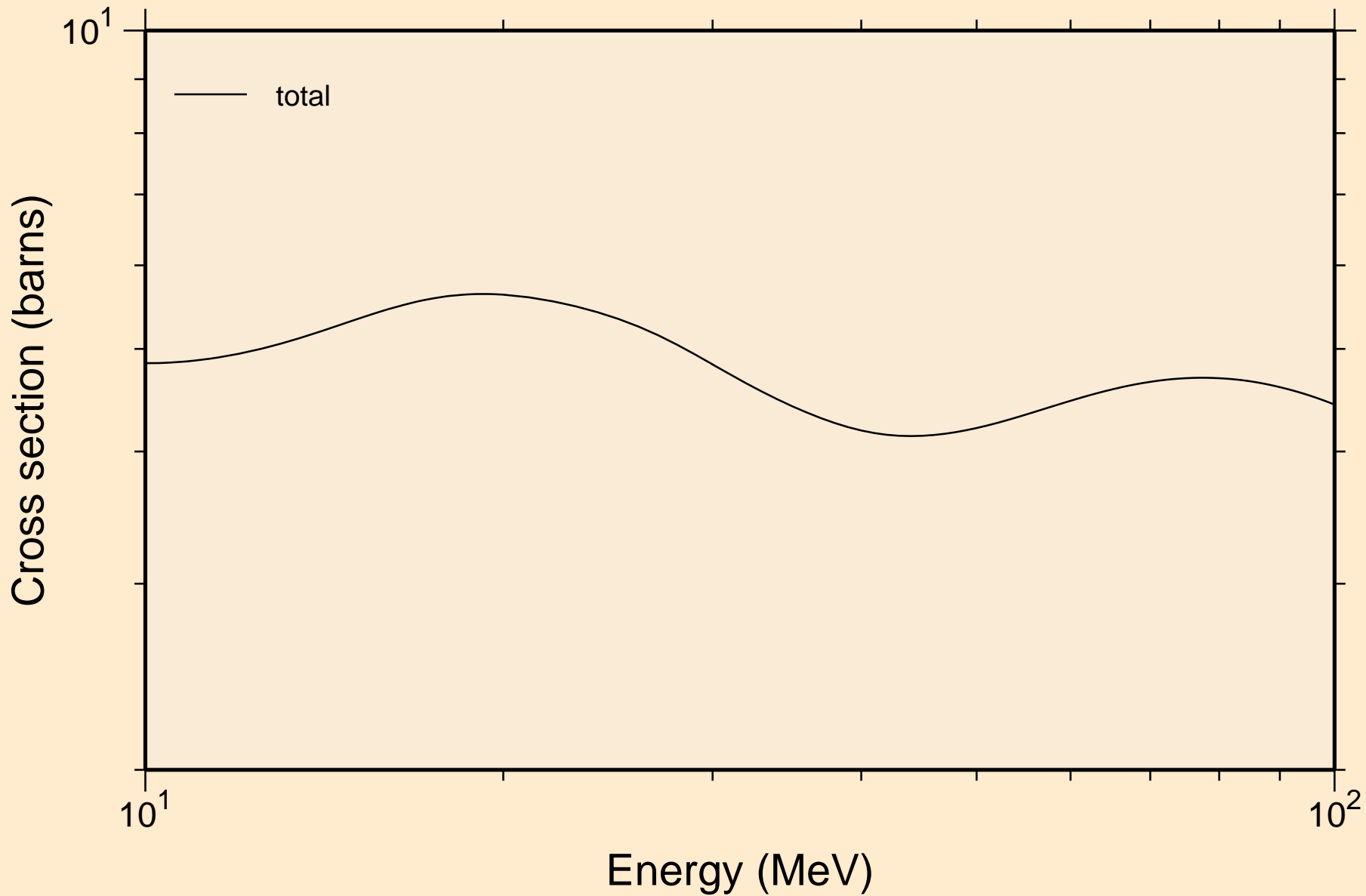

IR193 NEUTRON ACER TENDL-2021 LIBRARY; T=293.6K
resonance absorption cross sections

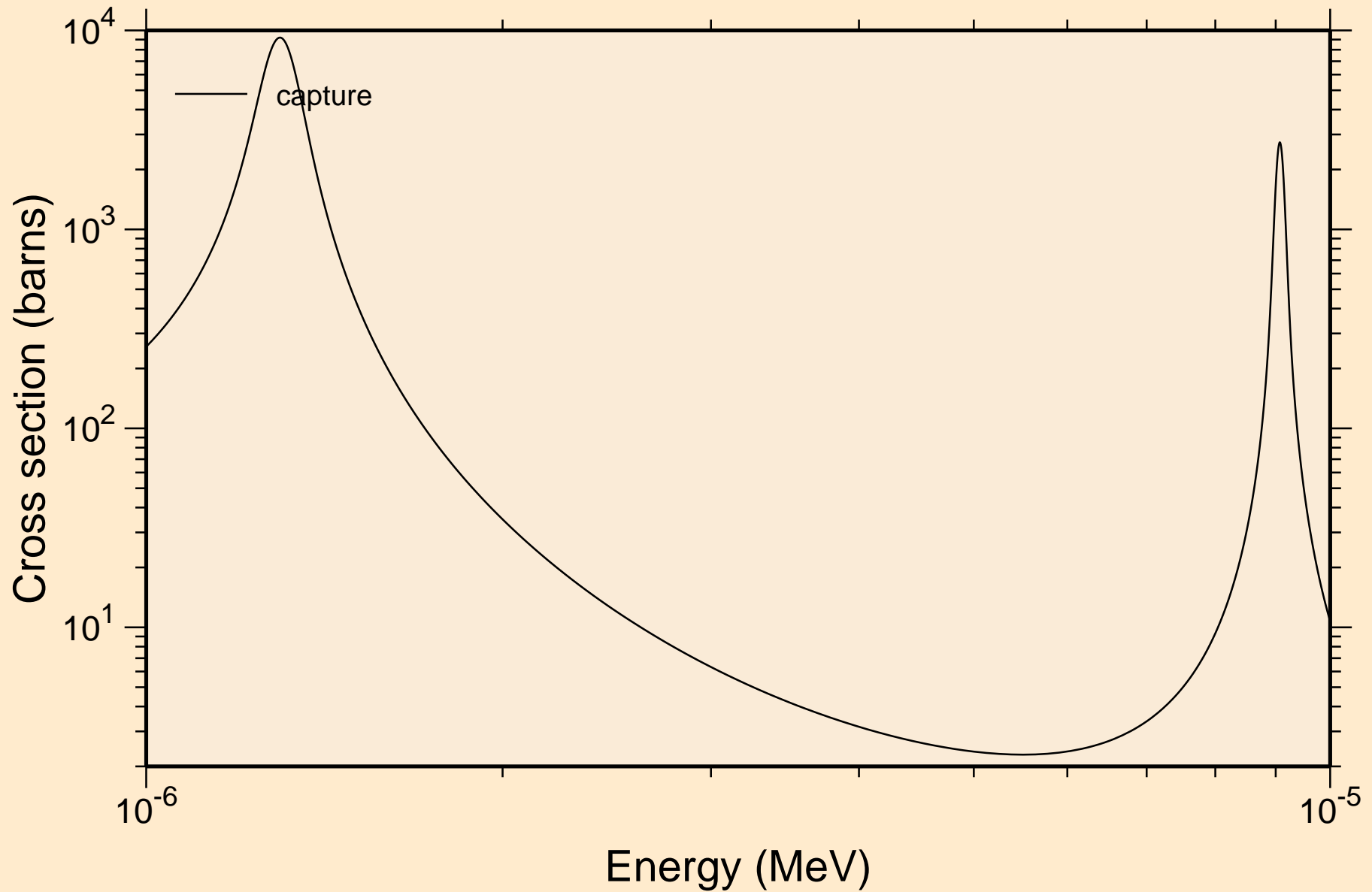

IR193 NEUTRON ACER TENDL-2021 LIBRARY; T=293.6K
resonance absorption cross sections

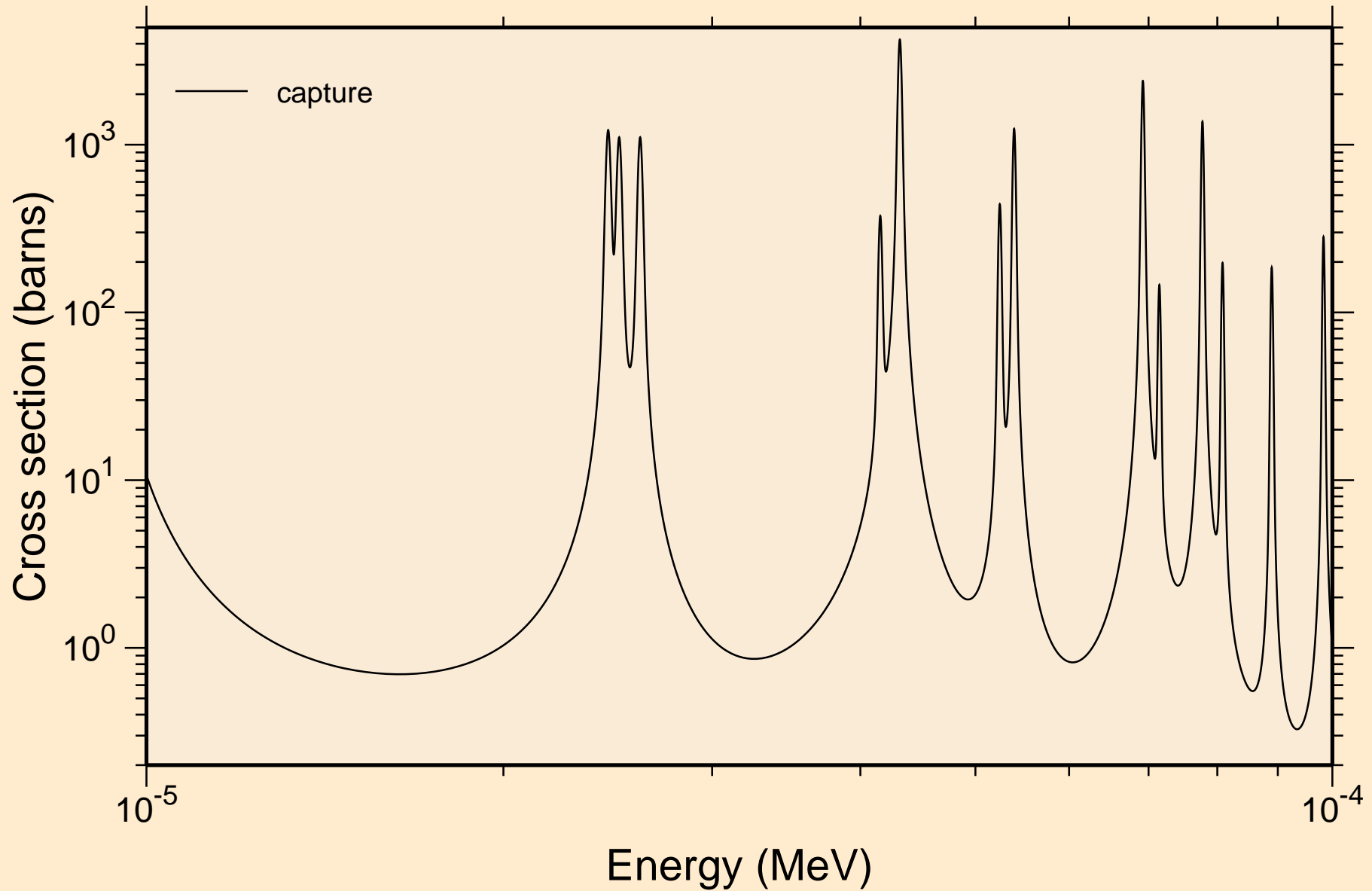

IR193 NEUTRON ACER TENDL-2021 LIBRARY; T=293.6K
resonance absorption cross sections

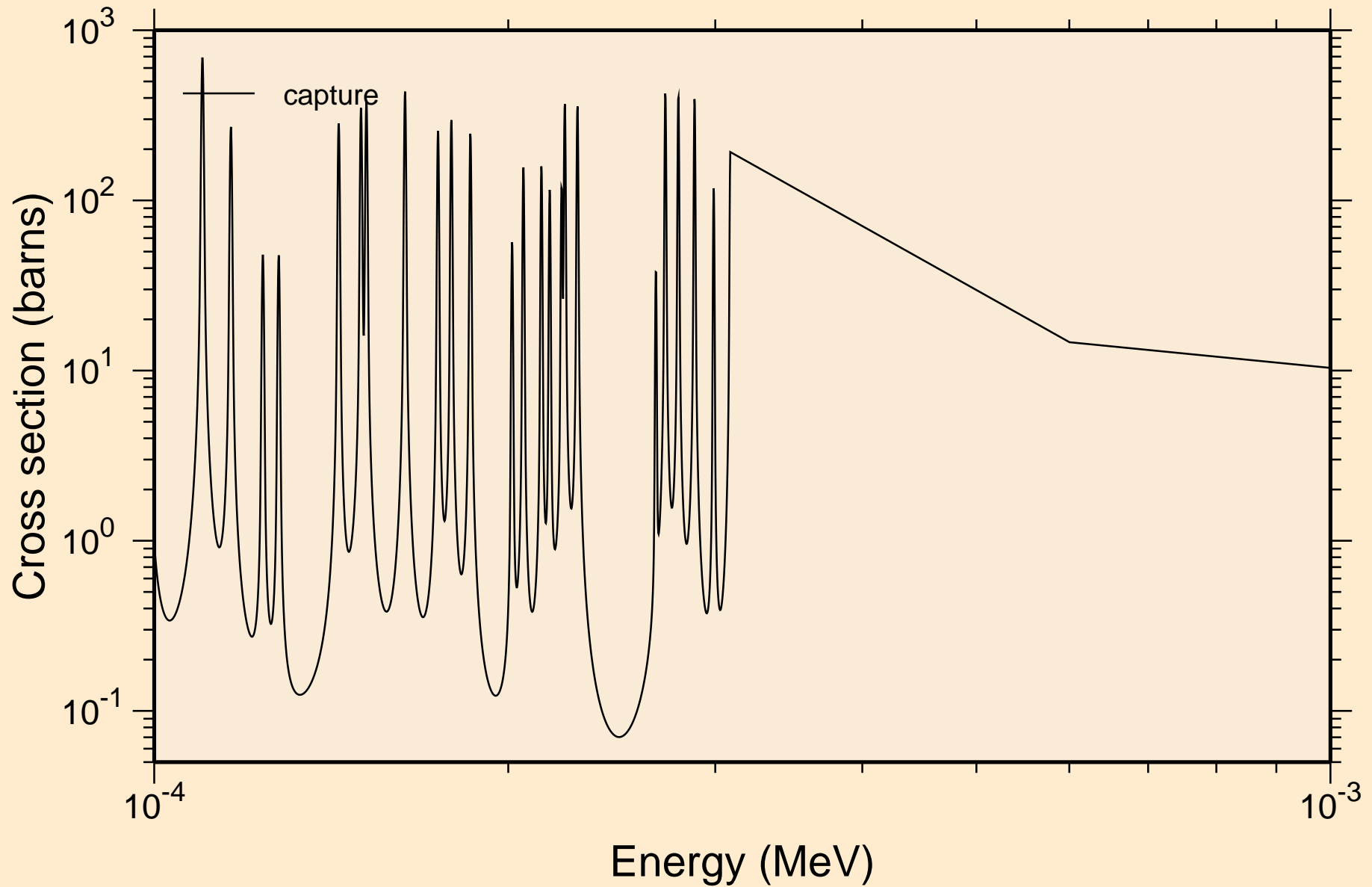

IR193 NEUTRON ACER TENDL-2021 LIBRARY; T=293.6K
resonance absorption cross sections

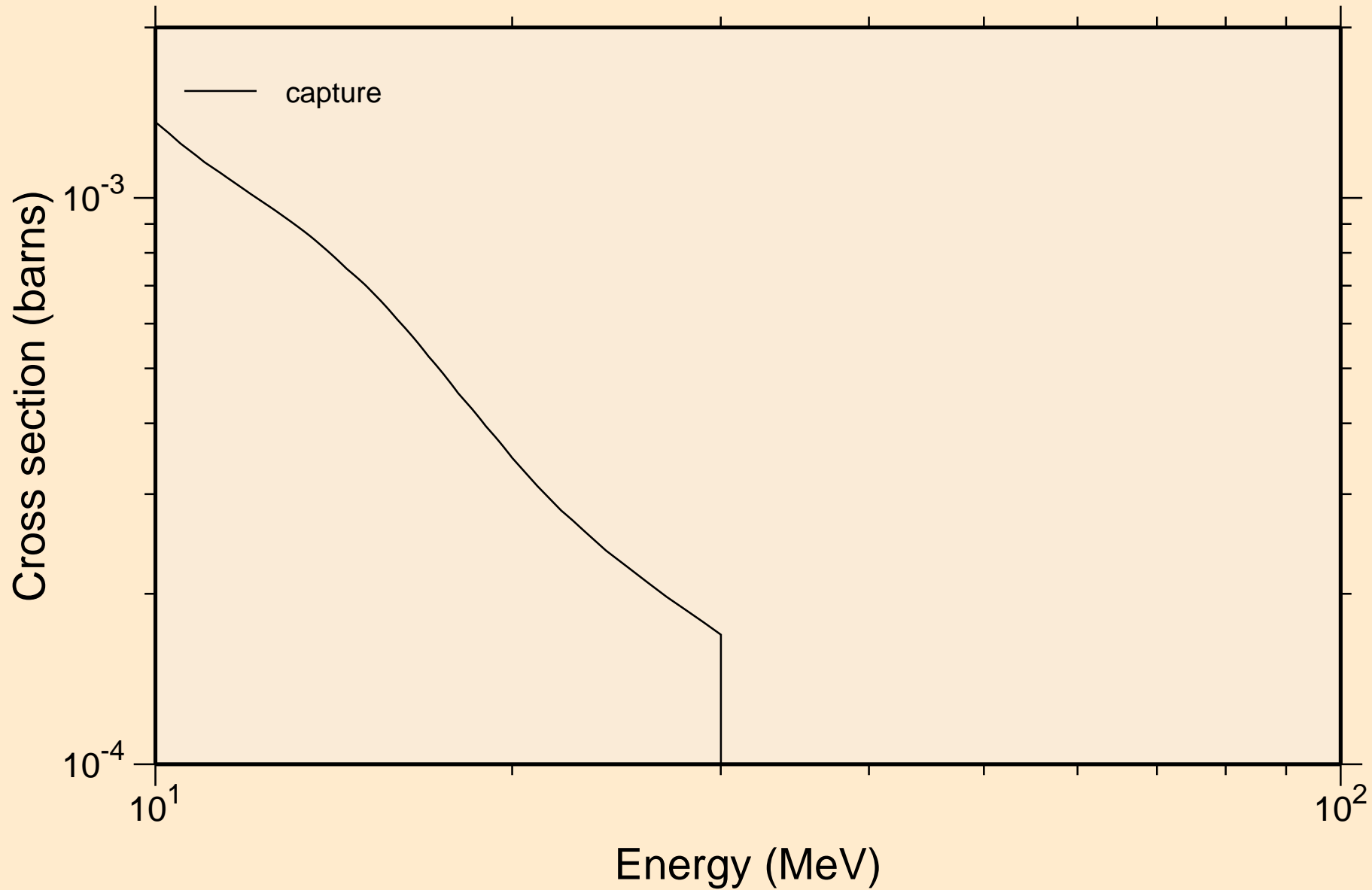

IR193 NEUTRON ACER TENDL-2021 LIBRARY; T=293.6K
Heating

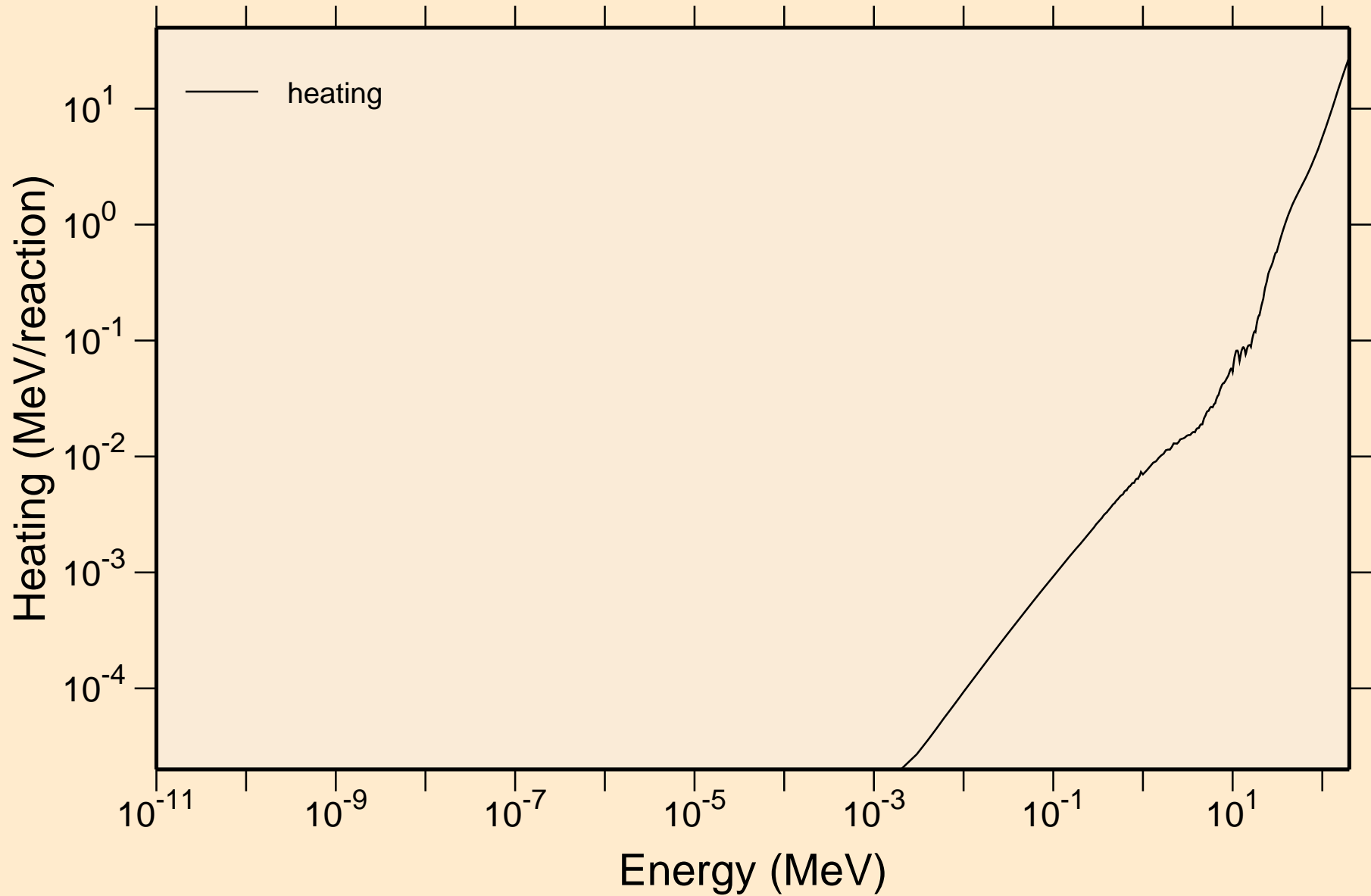

IR193 NEUTRON ACER TENDL-2021 LIBRARY; T=293.6K
Damage

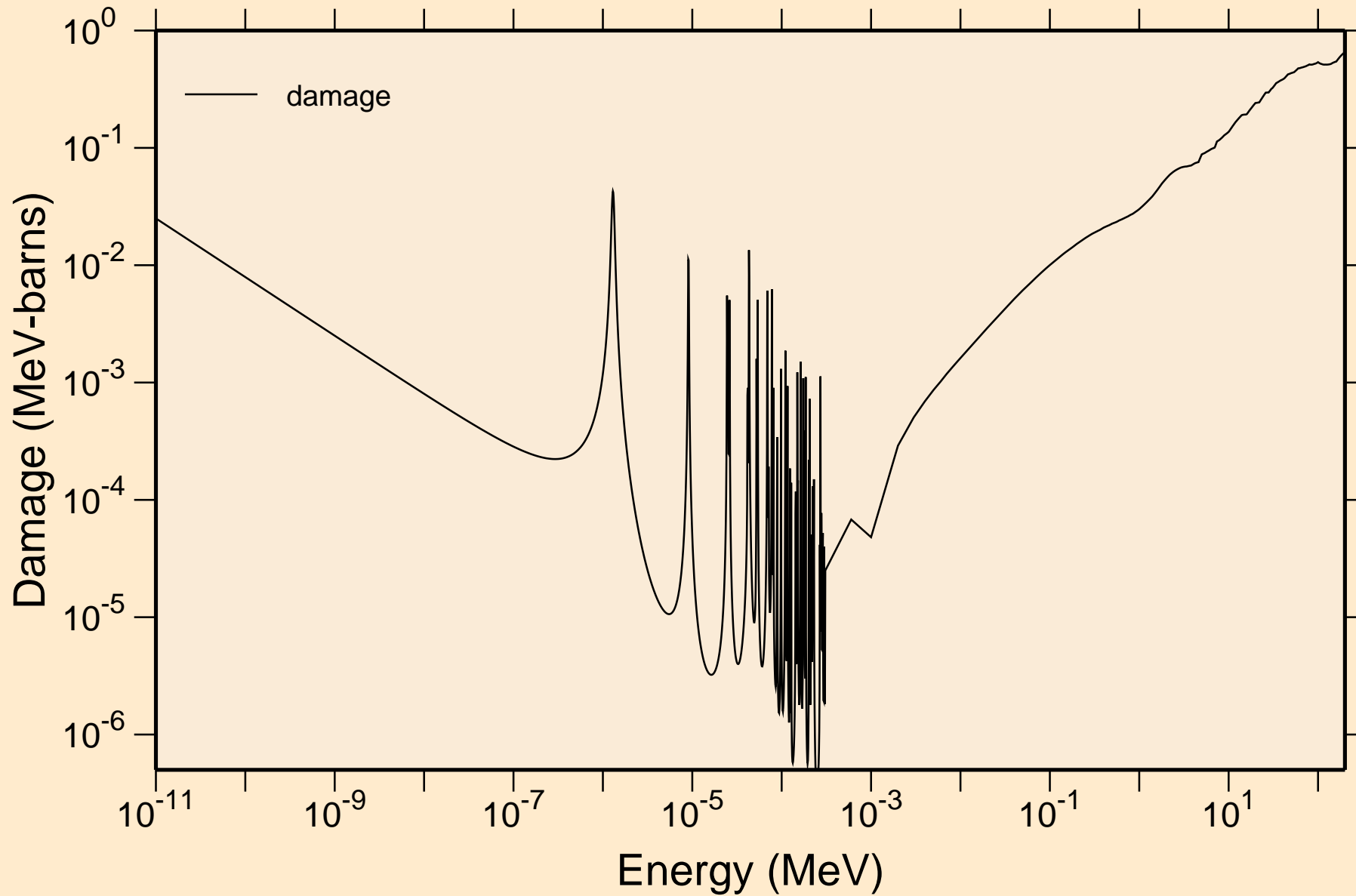

IR193 NEUTRON ACER TENDL-2021 LIBRARY; T=293.6K
Non-threshold reactions

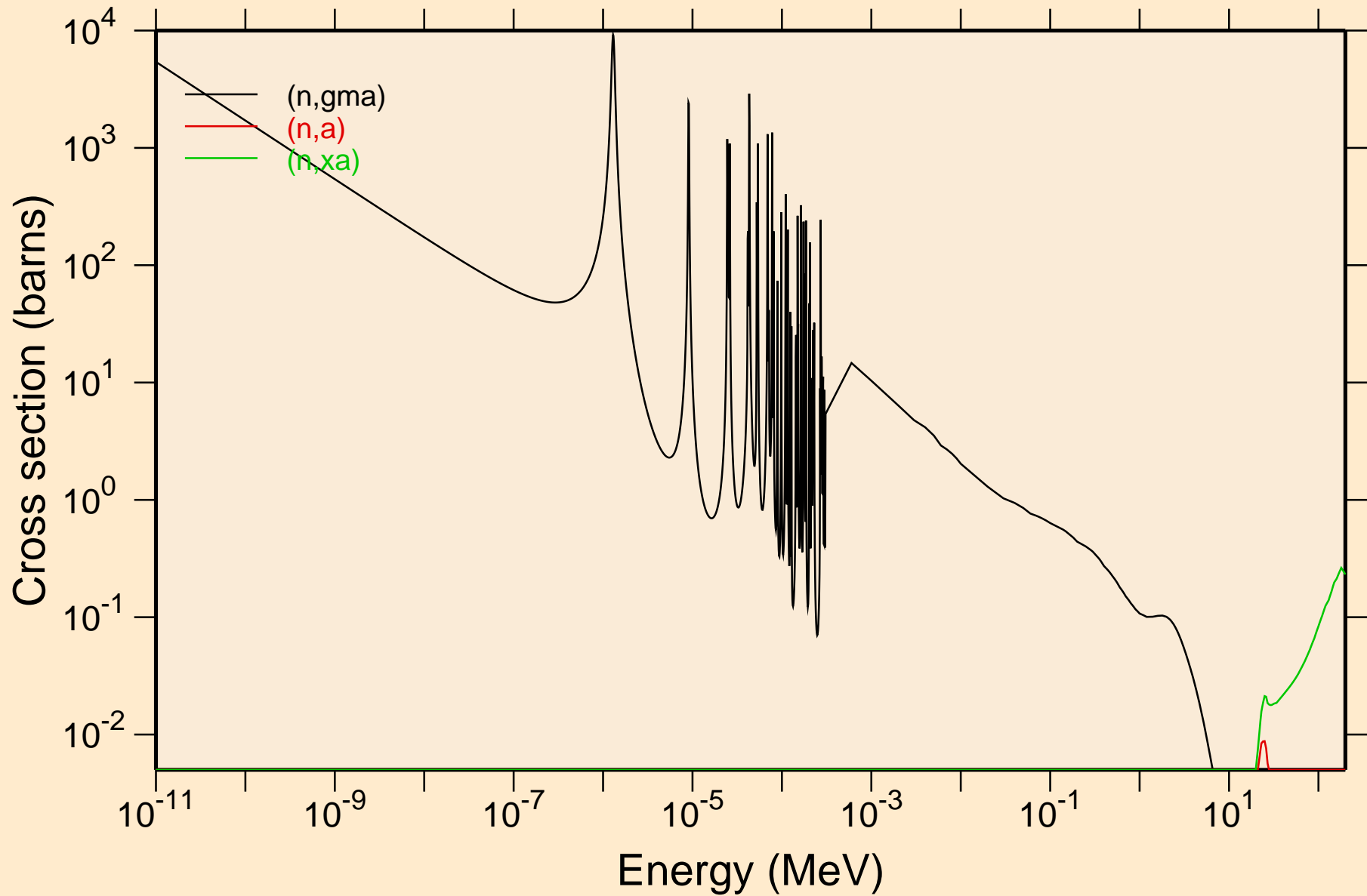

IR193 NEUTRON ACER TENDL-2021 LIBRARY; T=293.6K
Principal cross sections

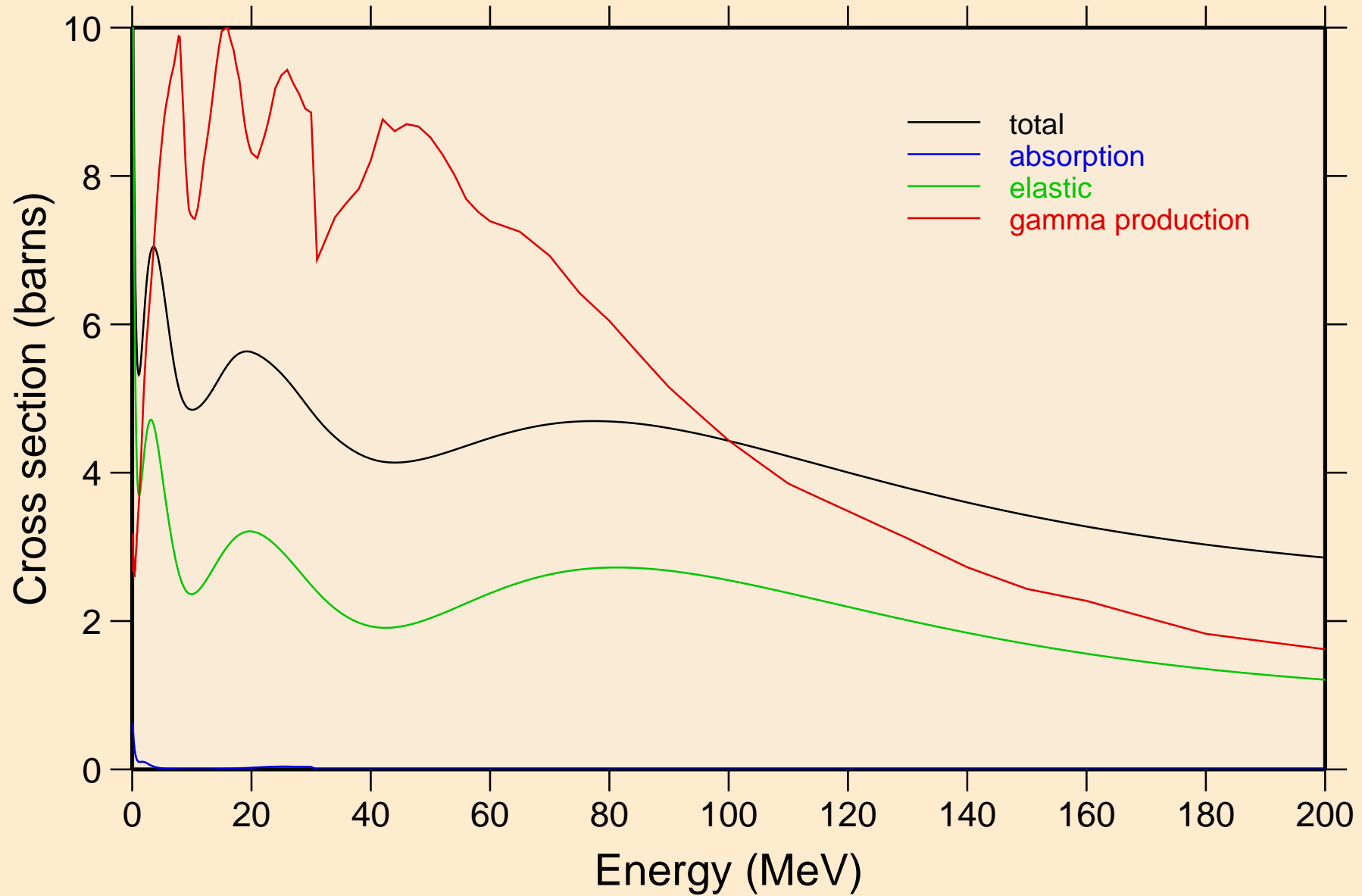

IR193 NEUTRON ACER TENDL-2021 LIBRARY; T=293.6K

Heating

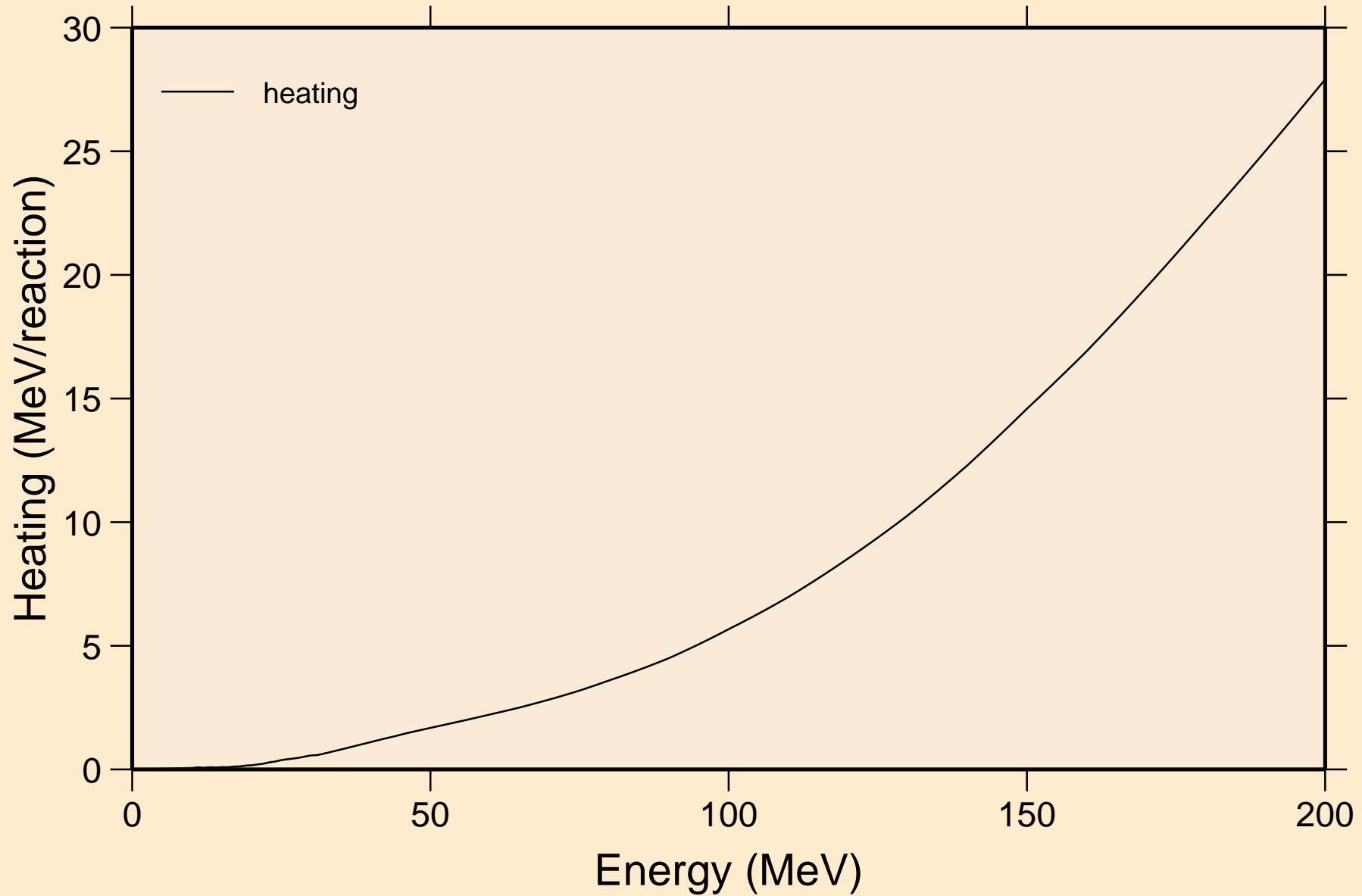

IR193 NEUTRON ACER TENDL-2021 LIBRARY; T=293.6K
Damage

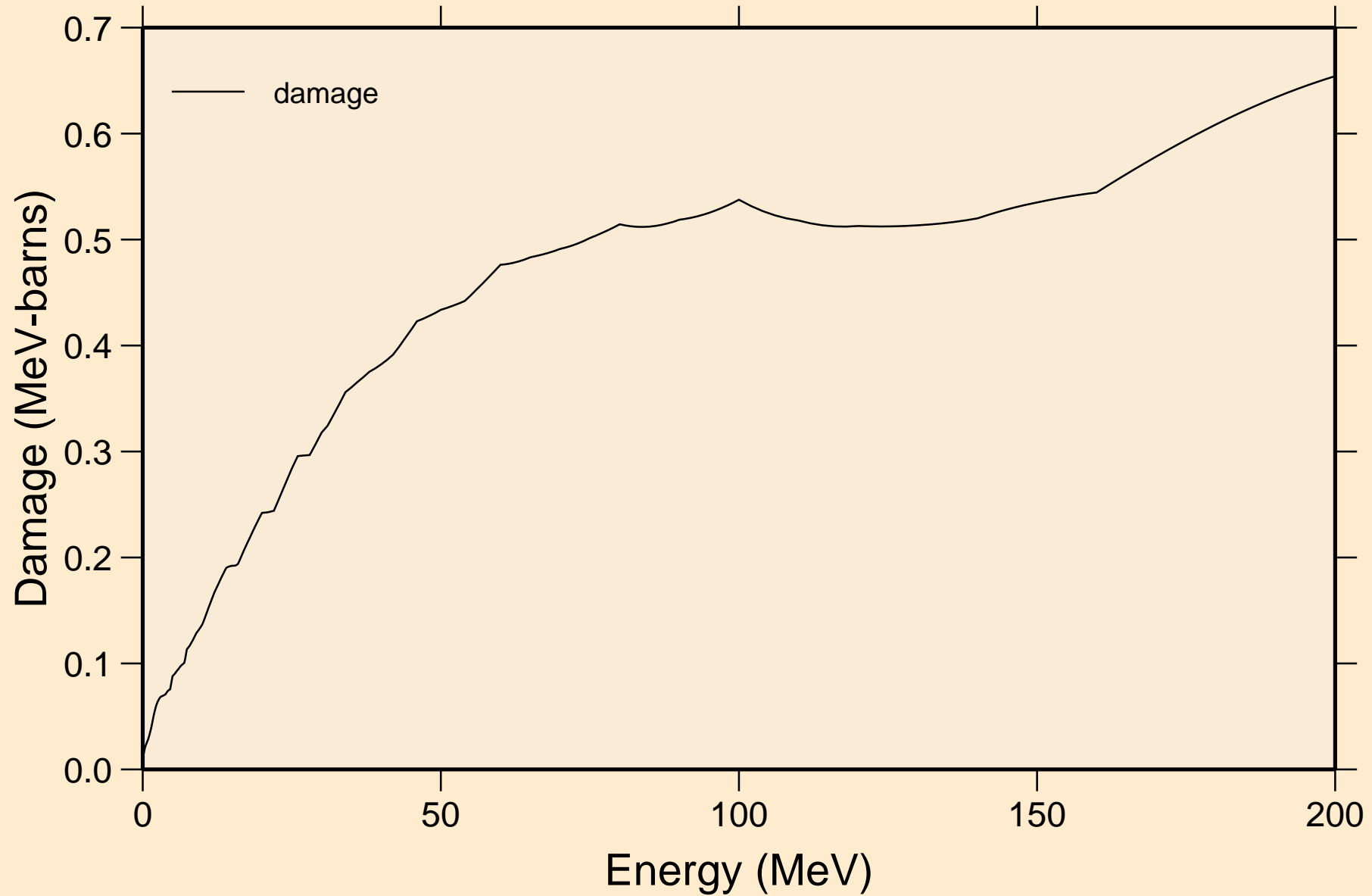

IR193 NEUTRON ACER TENDL-2021 LIBRARY; T=293.6K
Non-threshold reactions

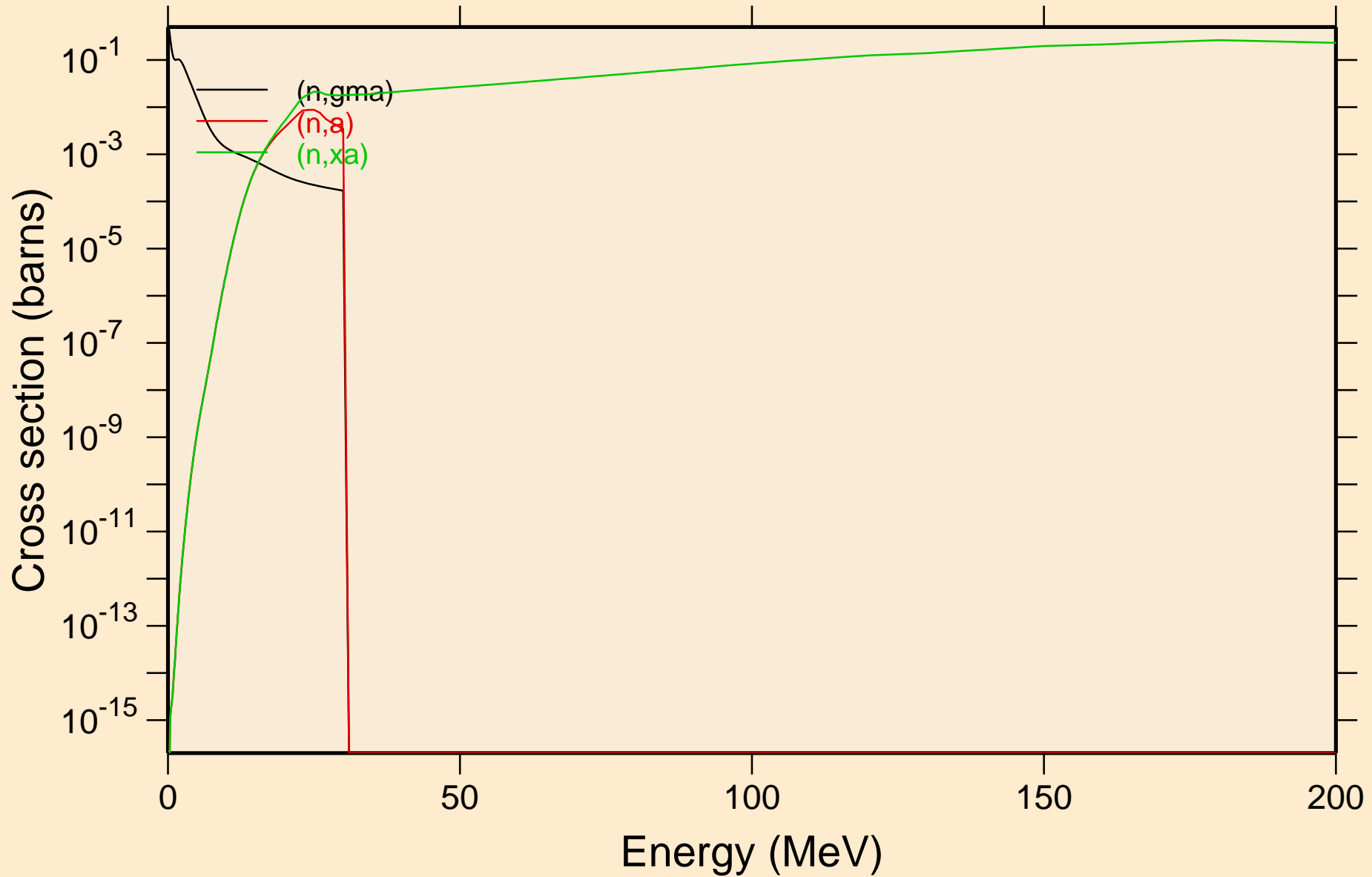

IR193 NEUTRON ACER TENDL-2021 LIBRARY; T=293.6K
Inelastic levels

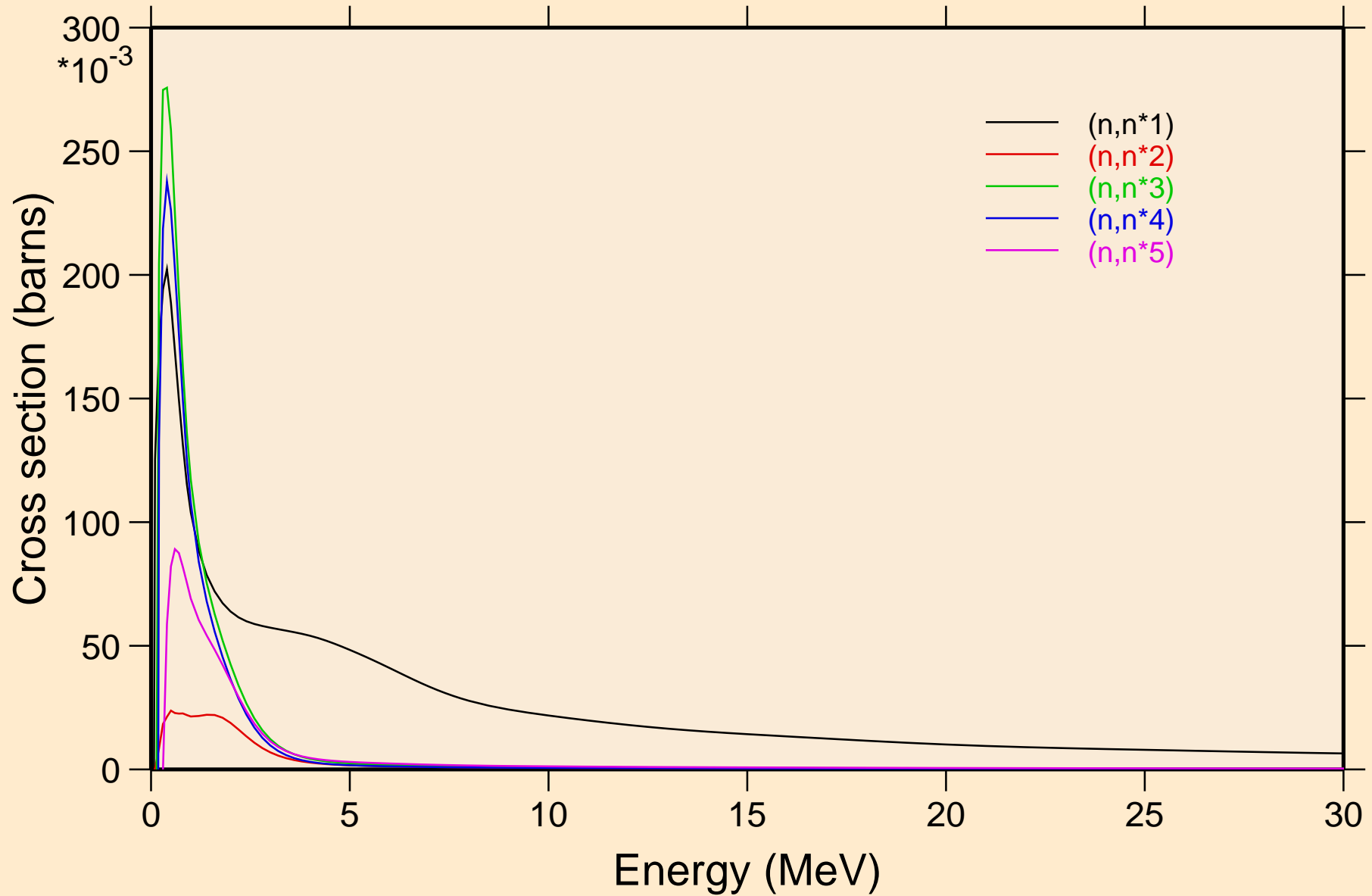

IR193 NEUTRON ACER TENDL-2021 LIBRARY; T=293.6K
Inelastic levels

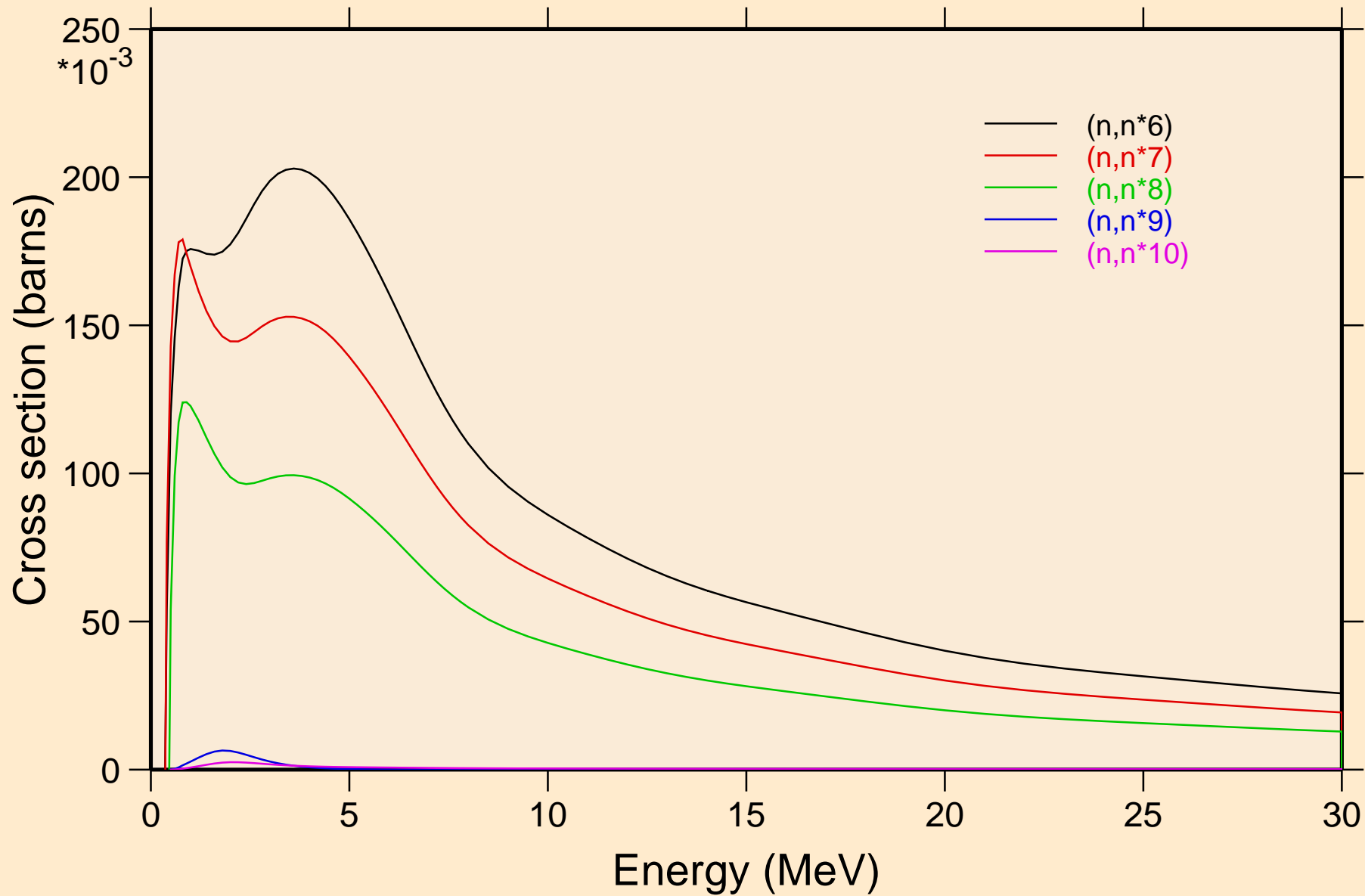

IR193 NEUTRON ACER TENDL-2021 LIBRARY; T=293.6K
Inelastic levels

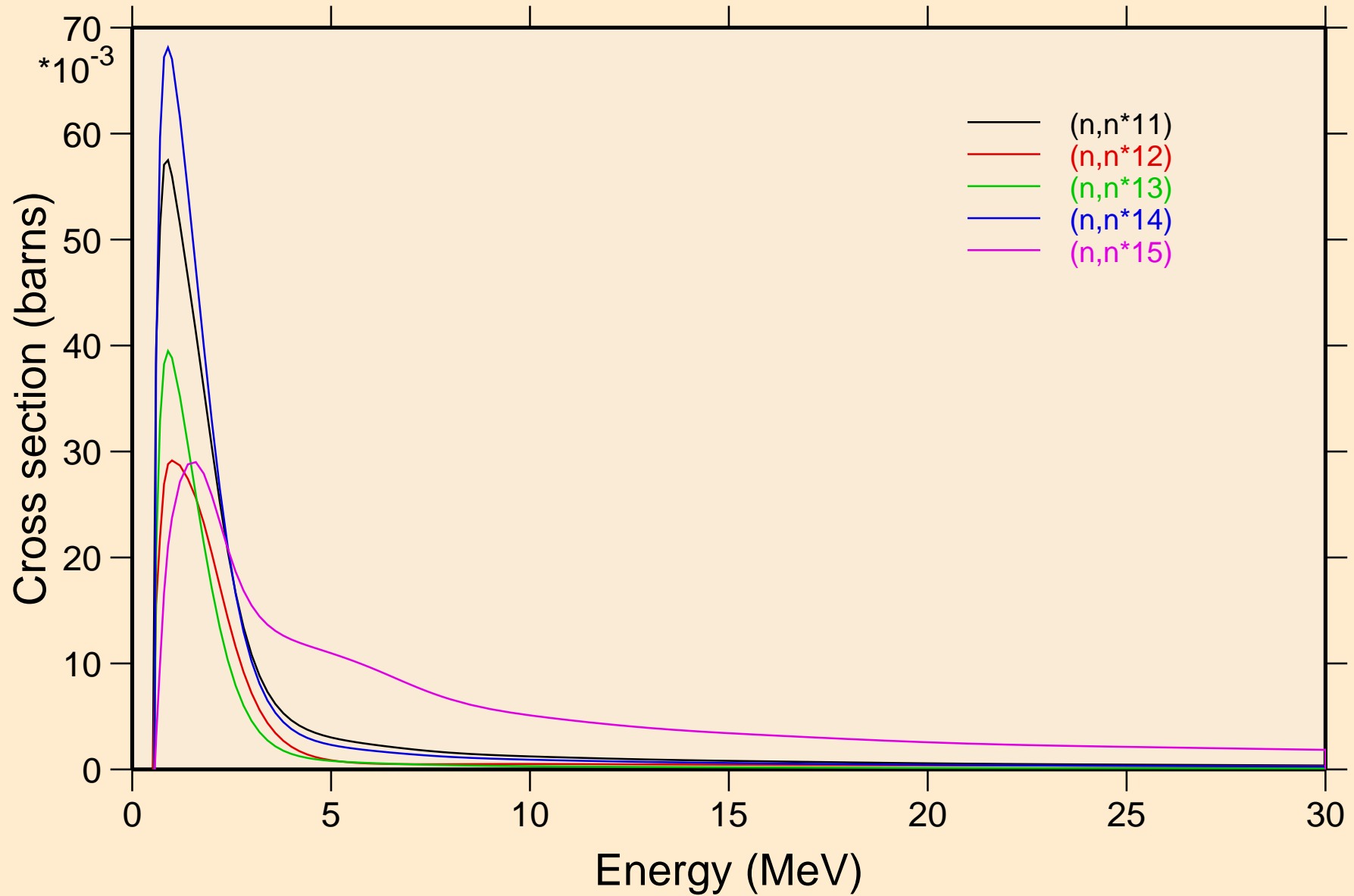

IR193 NEUTRON ACER TENDL-2021 LIBRARY; T=293.6K
Inelastic levels

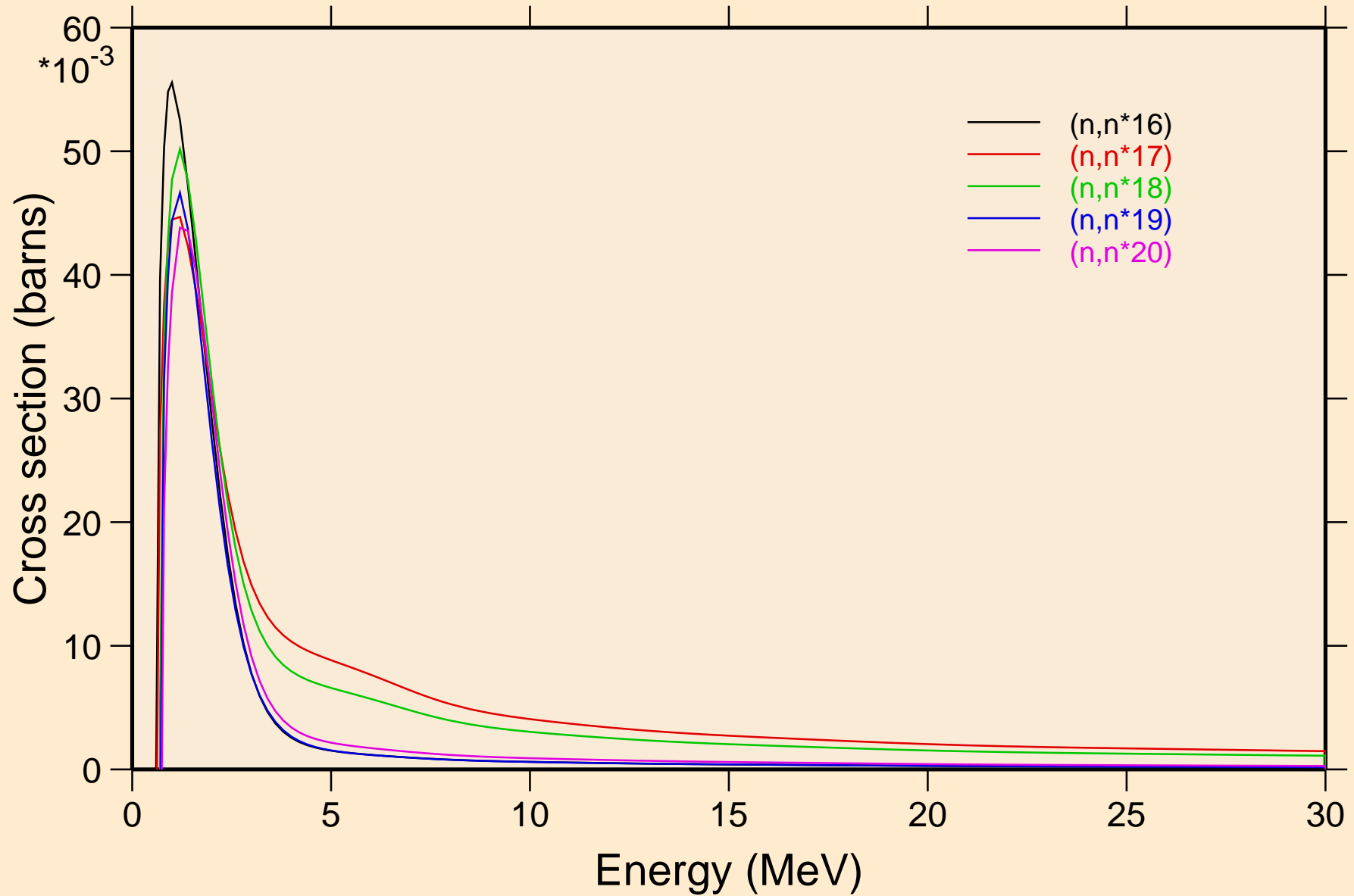

IR193 NEUTRON ACER TENDL-2021 LIBRARY; T=293.6K
Inelastic levels

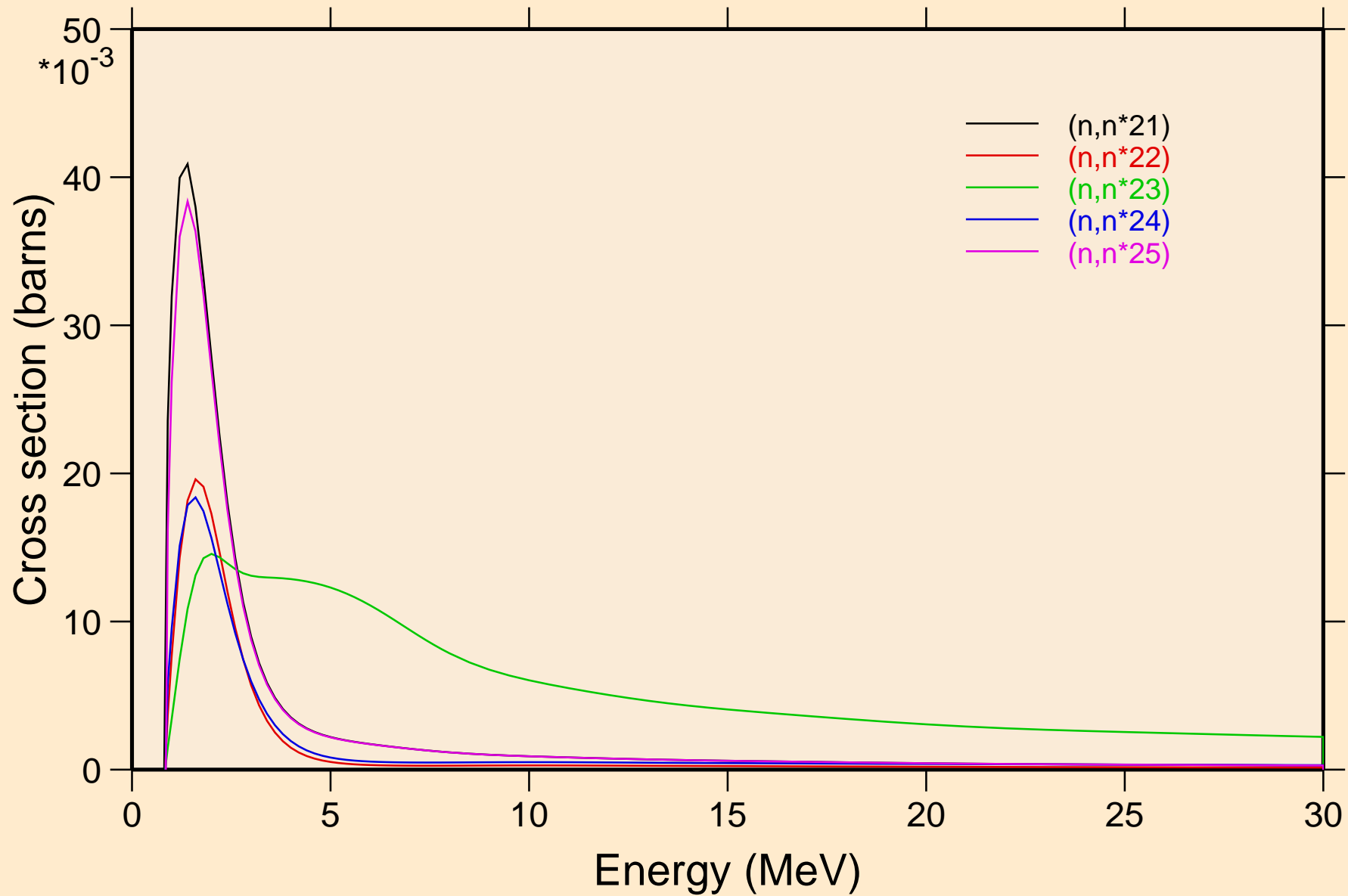

IR193 NEUTRON ACER TENDL-2021 LIBRARY; T=293.6K
Inelastic levels

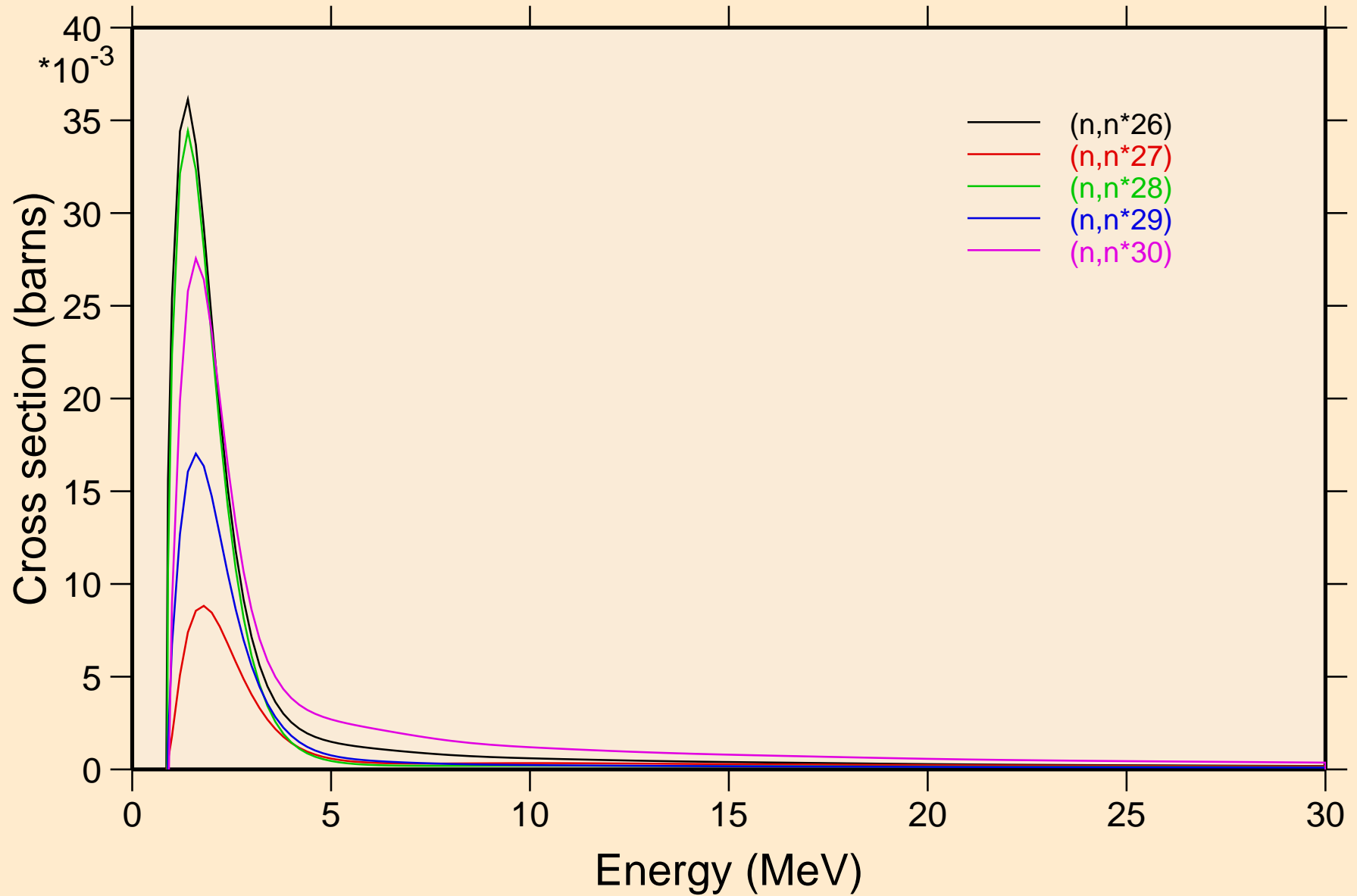

IR193 NEUTRON ACER TENDL-2021 LIBRARY; T=293.6K
Threshold reactions

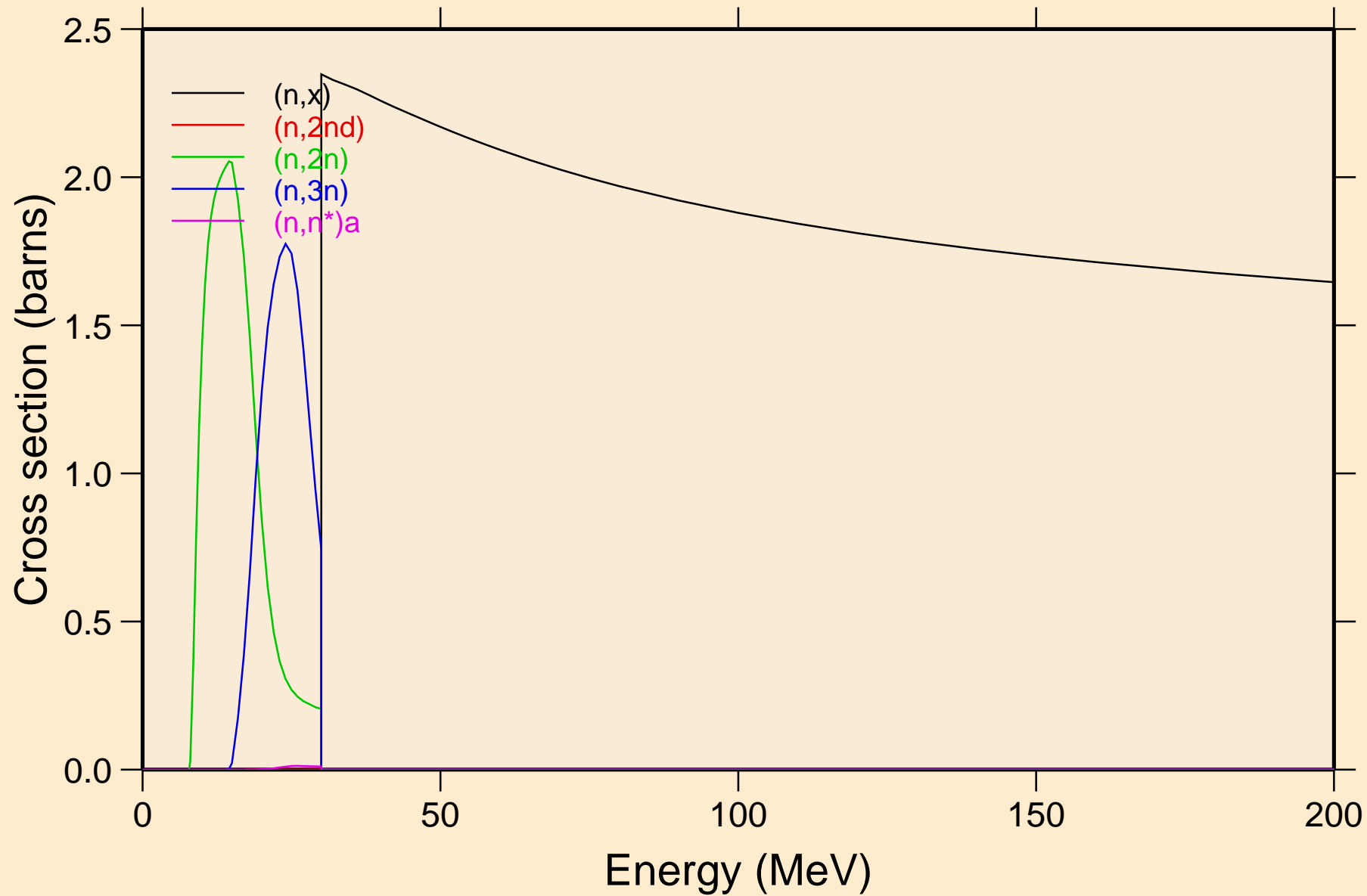

IR193 NEUTRON ACER TENDL-2021 LIBRARY; T=293.6K
Threshold reactions

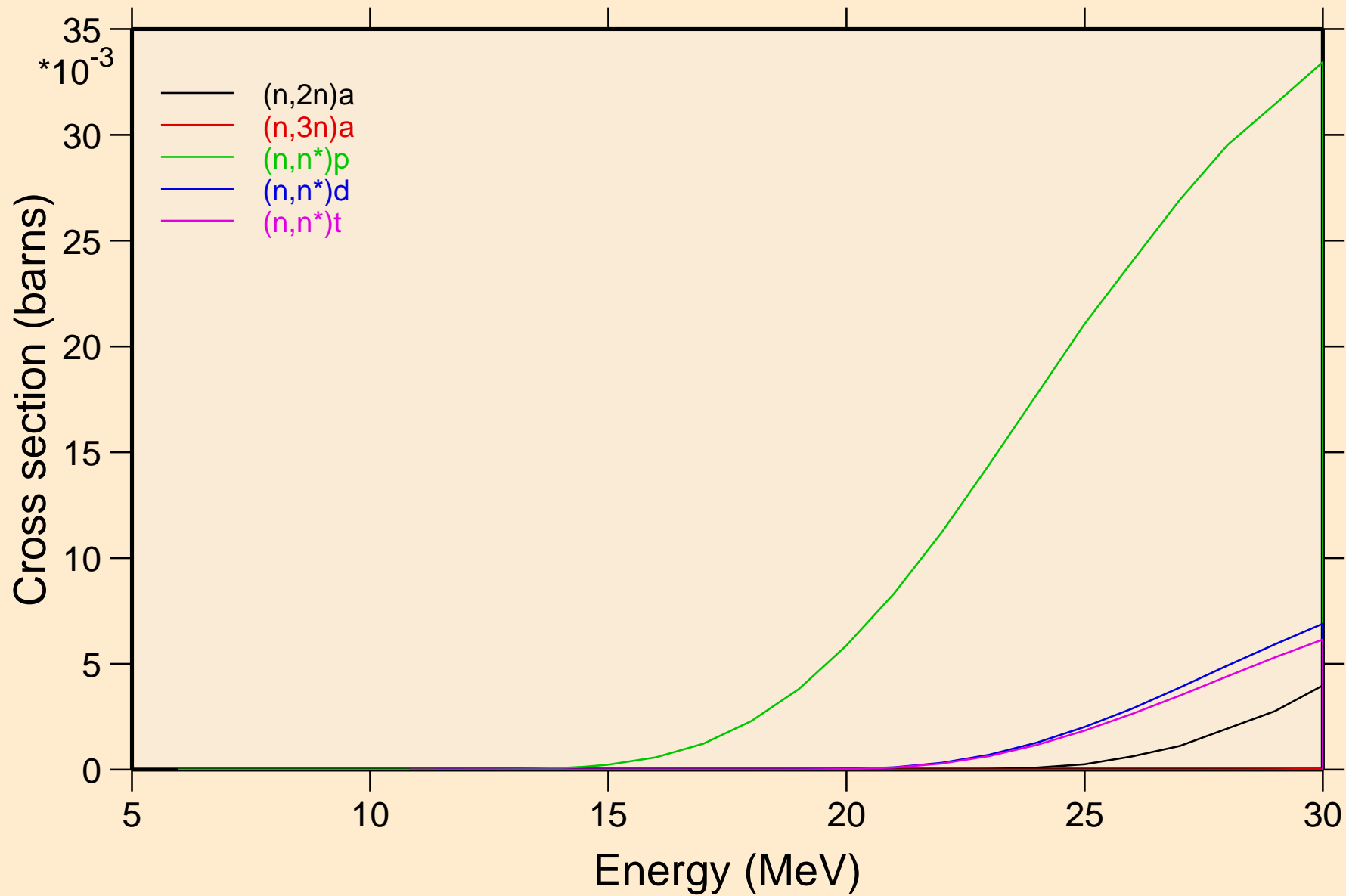

IR193 NEUTRON ACER TENDL-2021 LIBRARY; T=293.6K
Threshold reactions

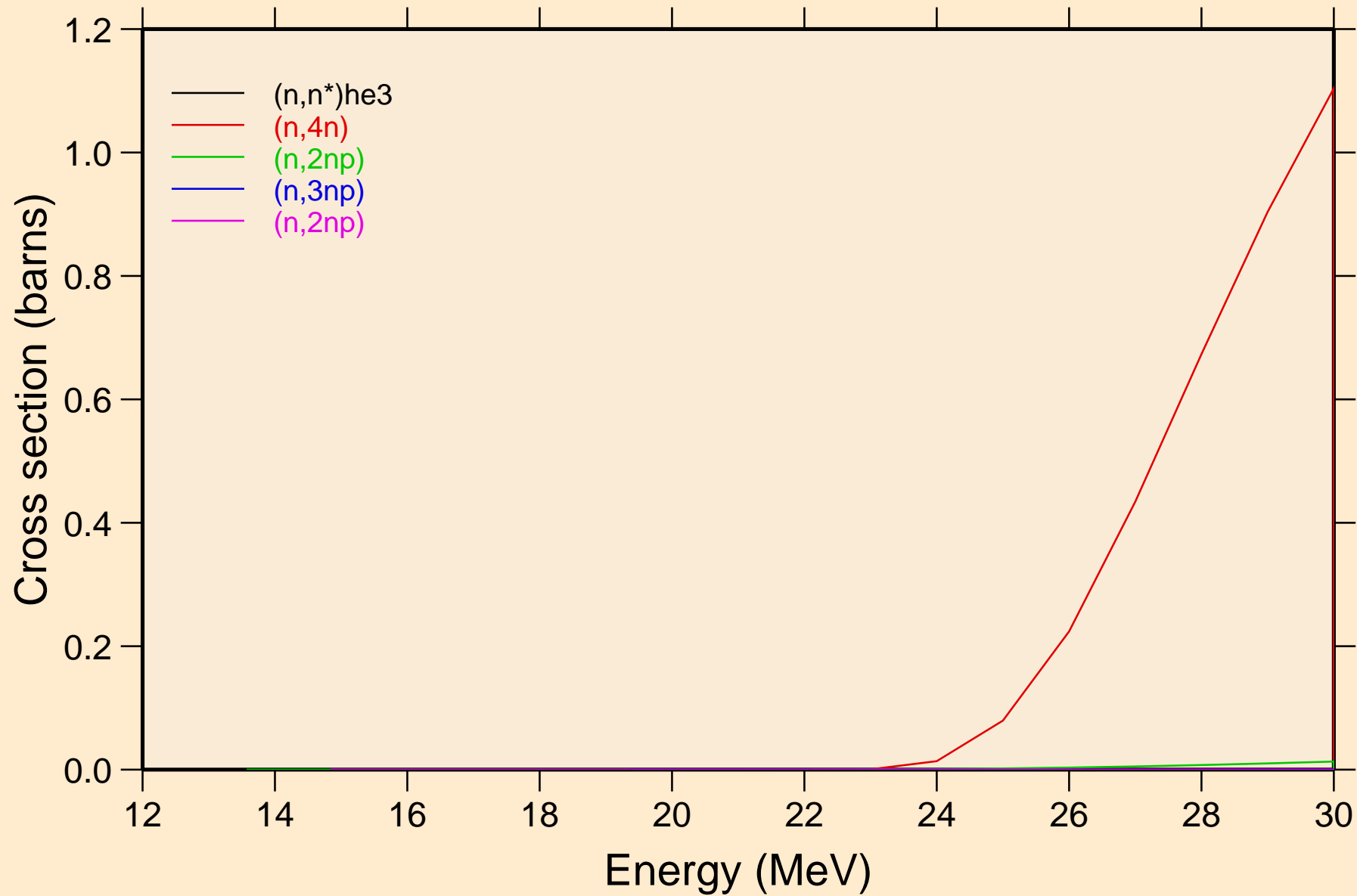

IR193 NEUTRON ACER TENDL-2021 LIBRARY; T=293.6K
Threshold reactions

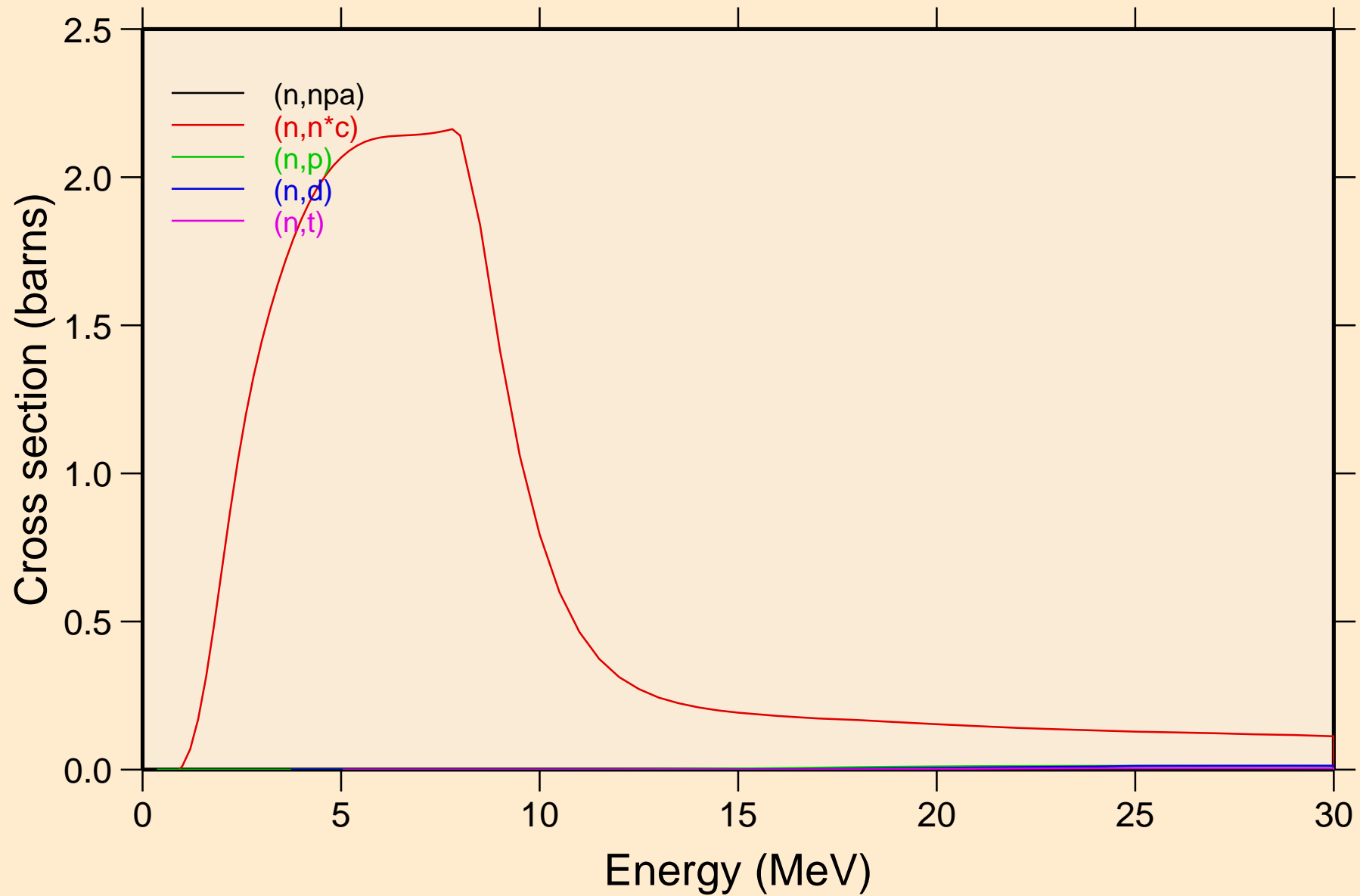

IR193 NEUTRON ACER TENDL-2021 LIBRARY; T=293.6K
Threshold reactions

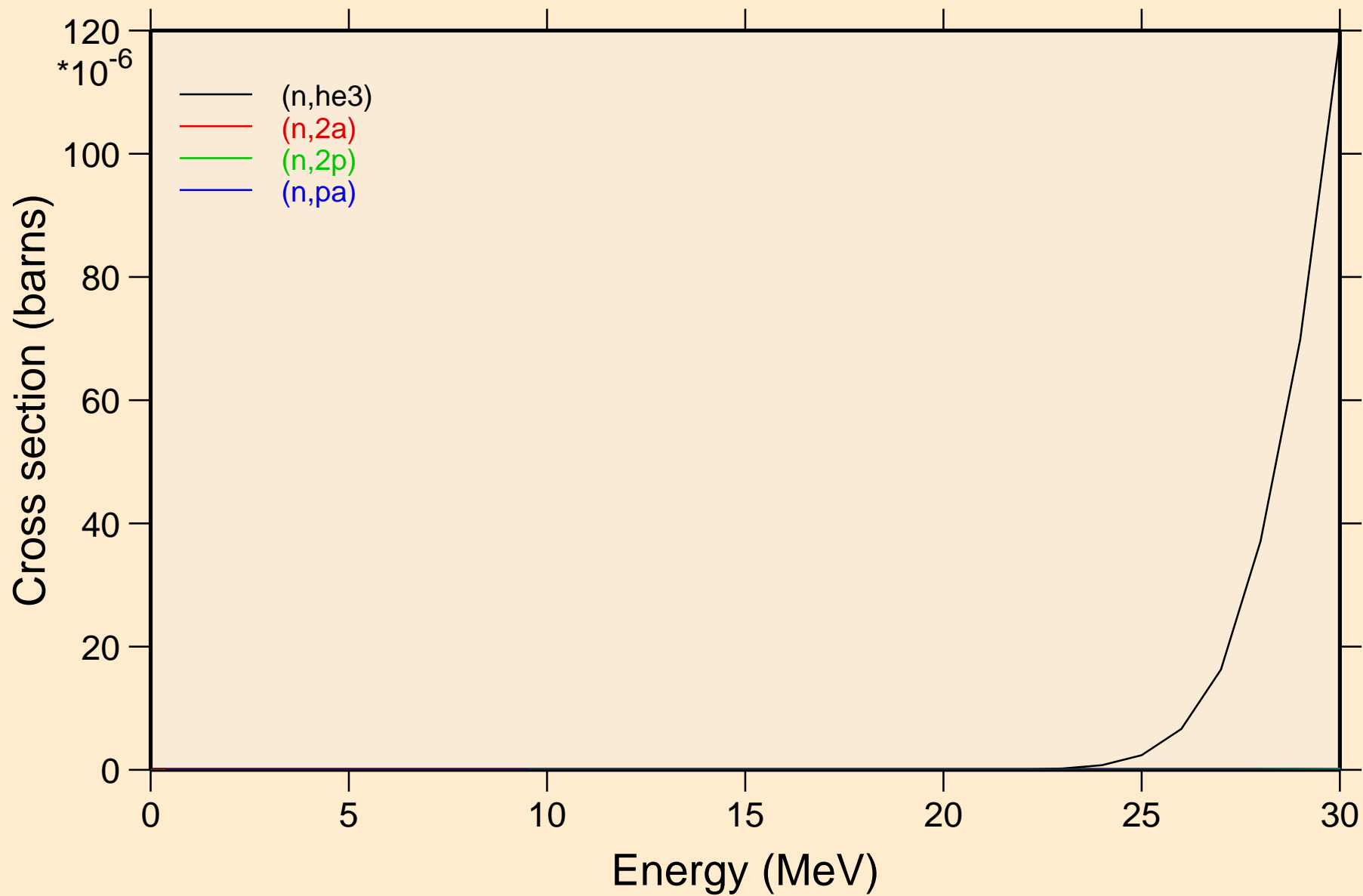

IR193 NEUTRON ACER TENDL-2021 LIBRARY; T=293.6K
Threshold reactions

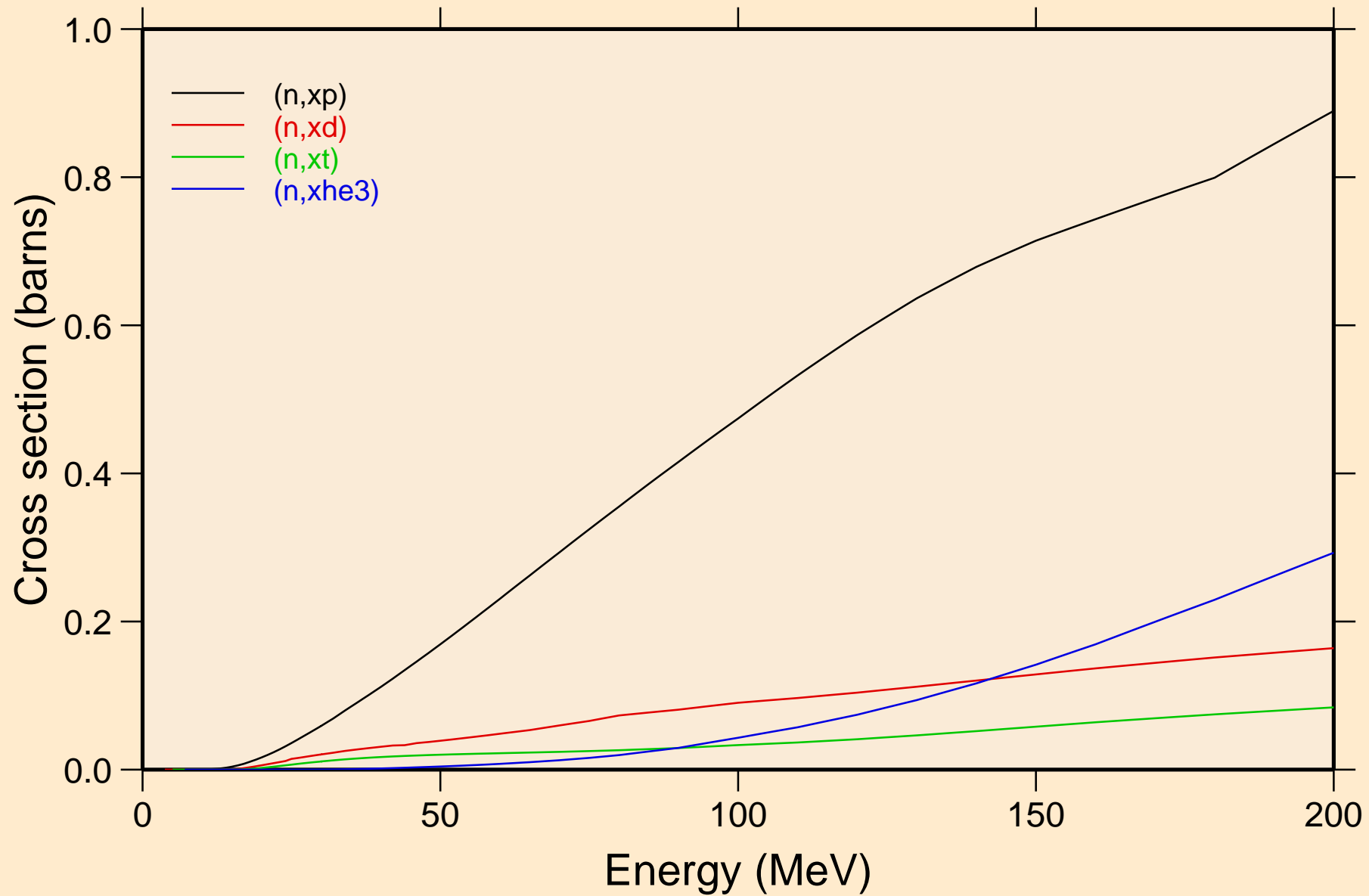

IR193 NEUTRON ACER TENDL-2021 LIBRARY; T=293.6K
angular distribution for elastic

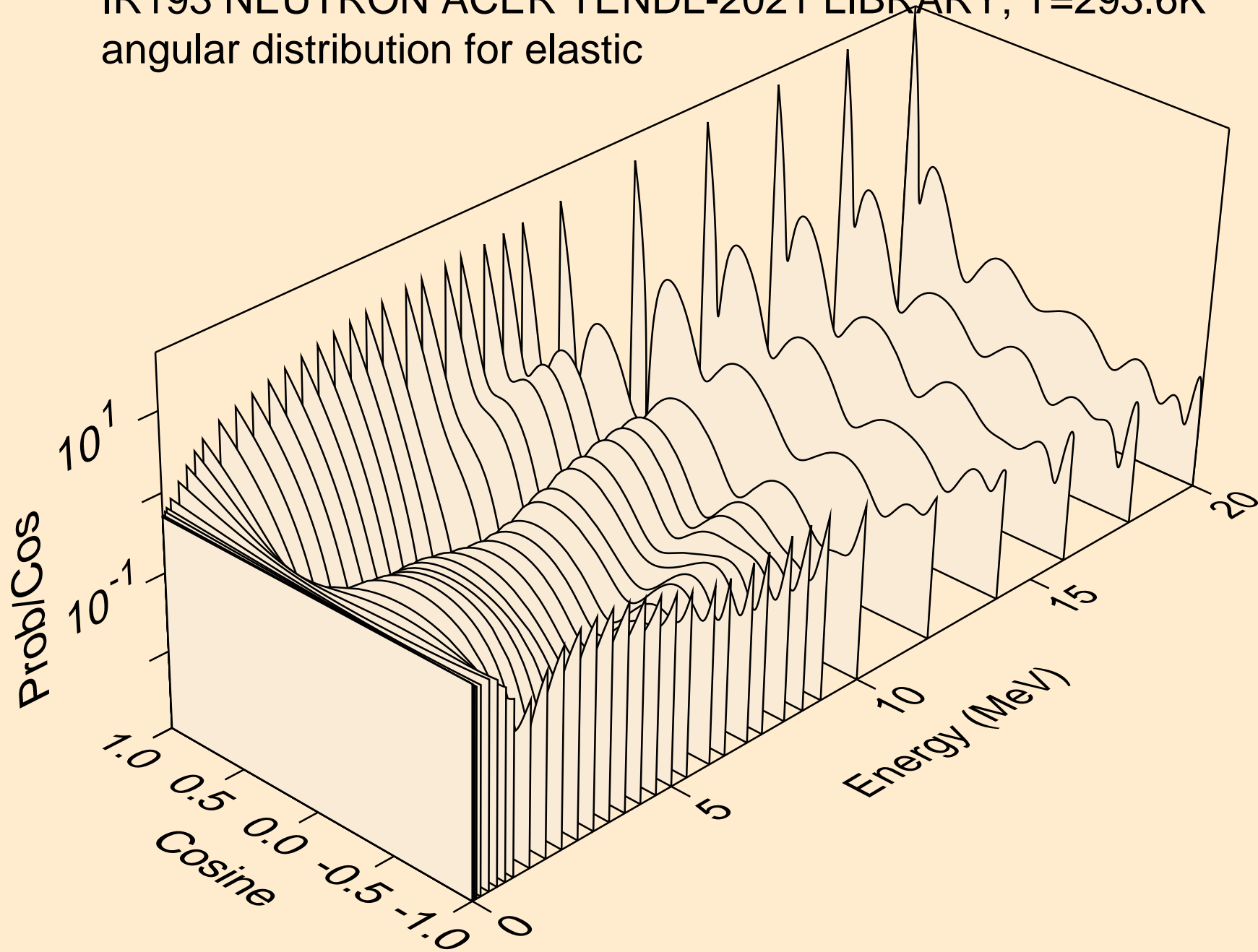

IR193 NEUTRON ACER TENDL-2021 LIBRARY; T=293.6K
angular distribution for elastic

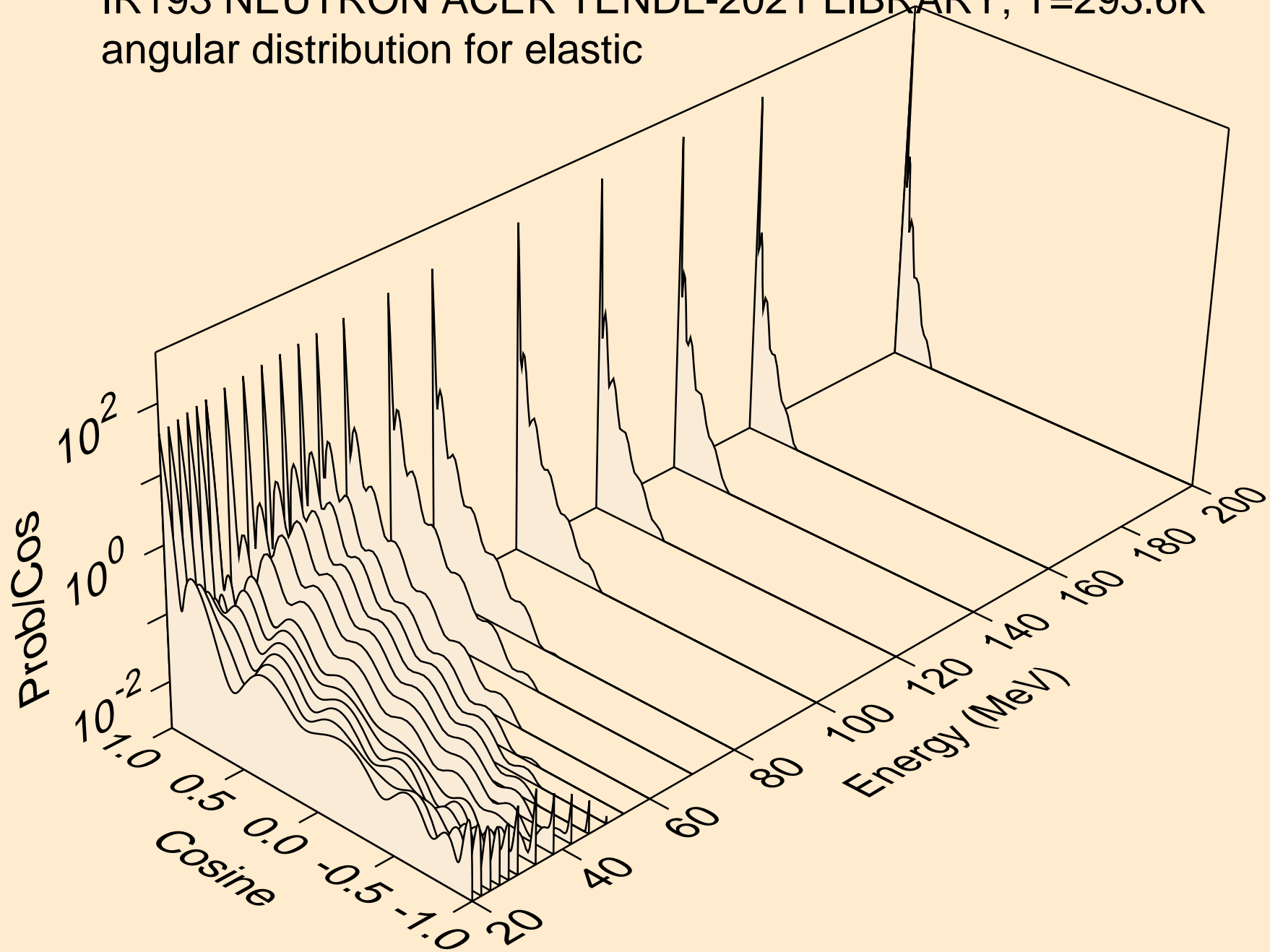

IR193 NEUTRON ACER TENDL-2021 LIBRARY; T=293.6K
angular distribution for (n,n*1)

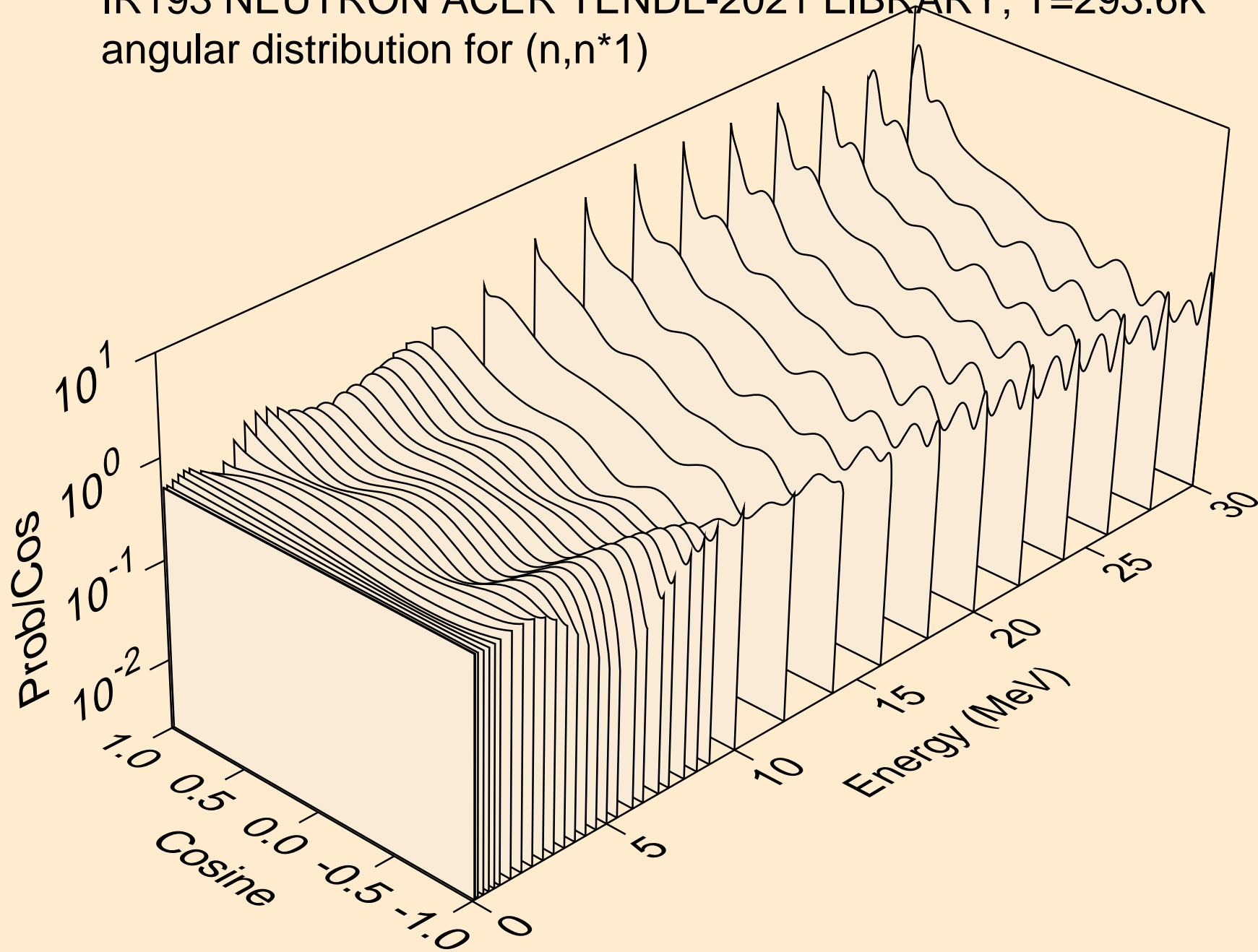

IR193 NEUTRON ACER TENDL-2021 LIBRARY; T=293.6K
angular distribution for (n,n*2)

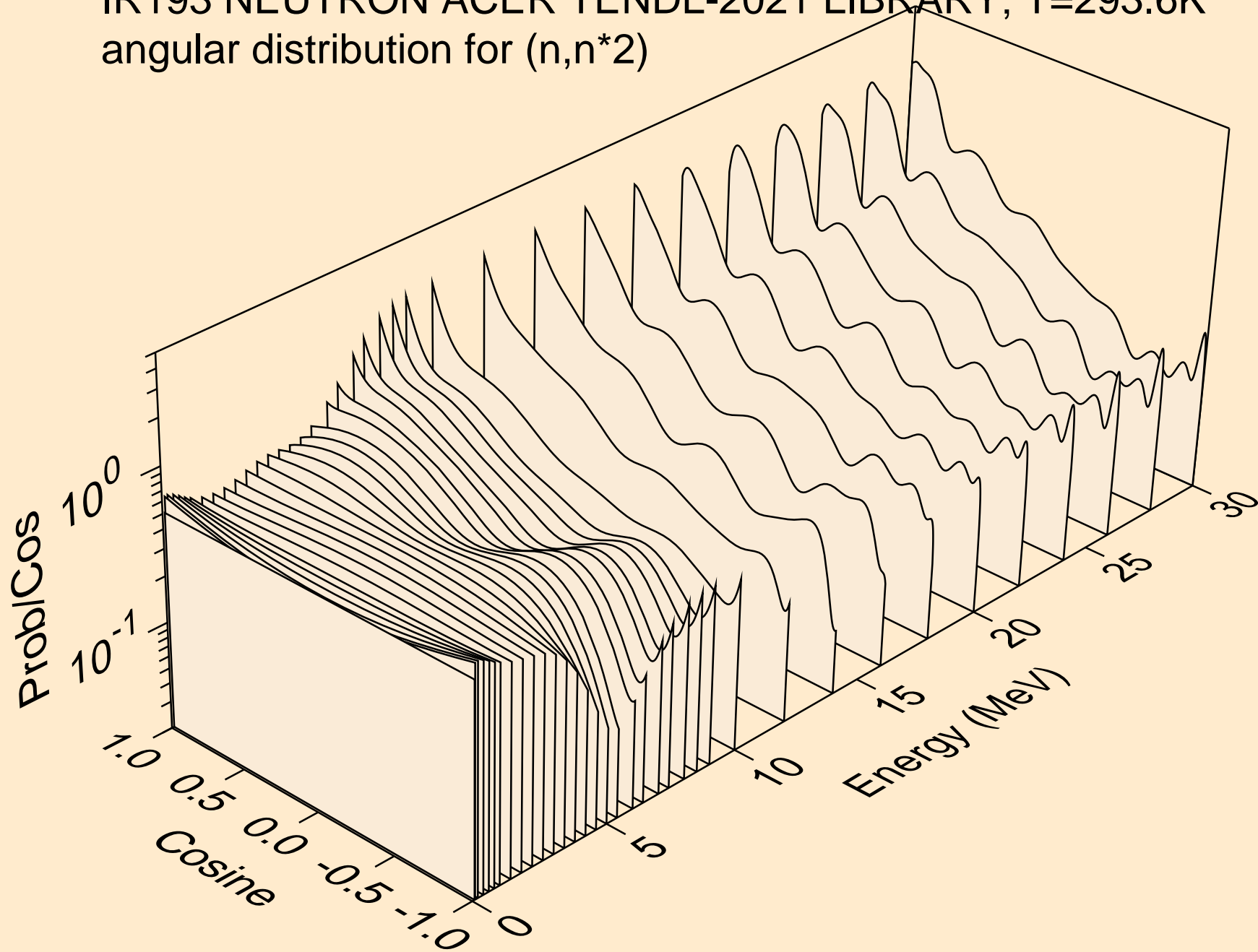

IR193 NEUTRON ACER TENDL-2021 LIBRARY; T=293.6K
angular distribution for (n,n*3)

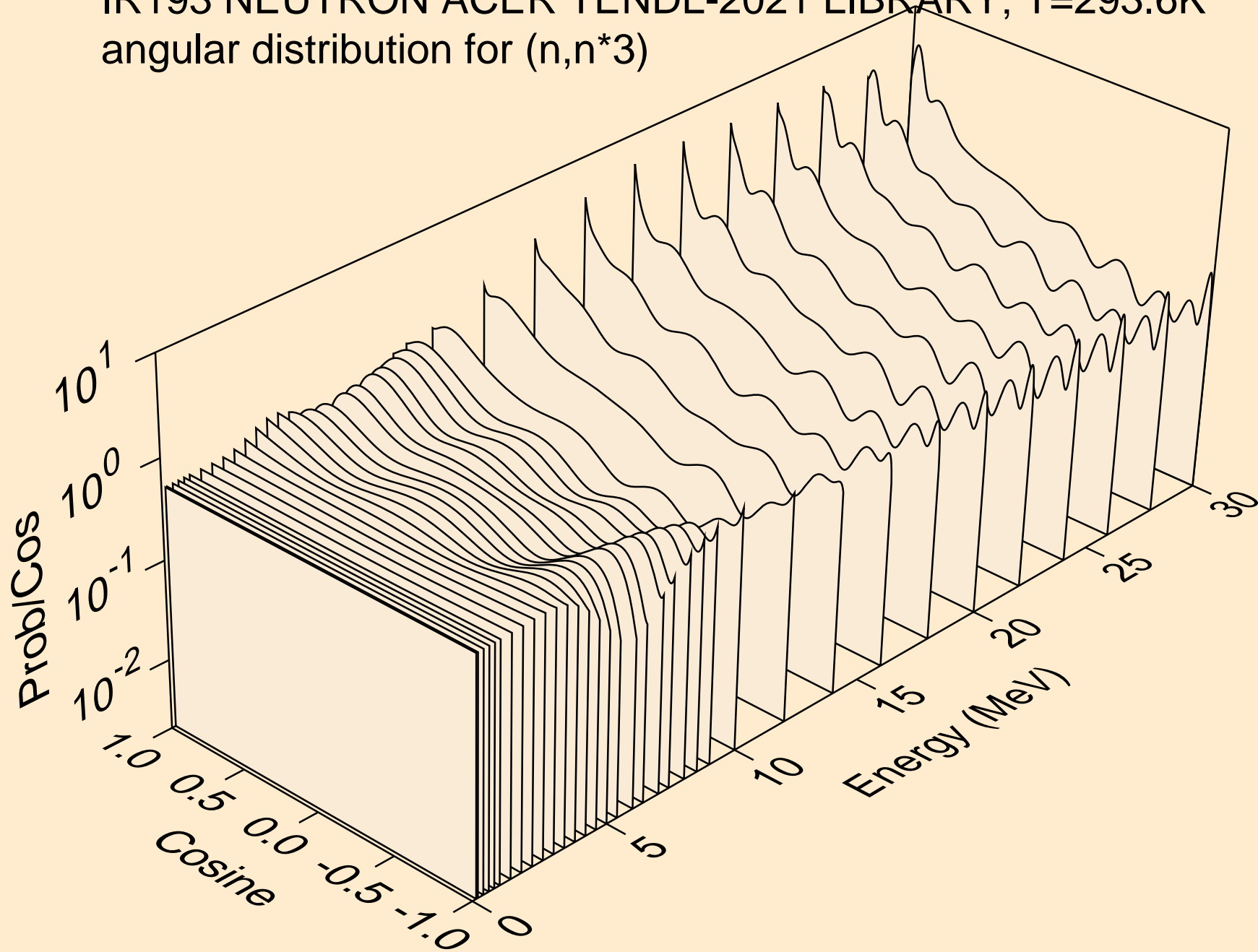

IR193 NEUTRON ACER TENDL-2021 LIBRARY; T=293.6K
angular distribution for (n,n*4)

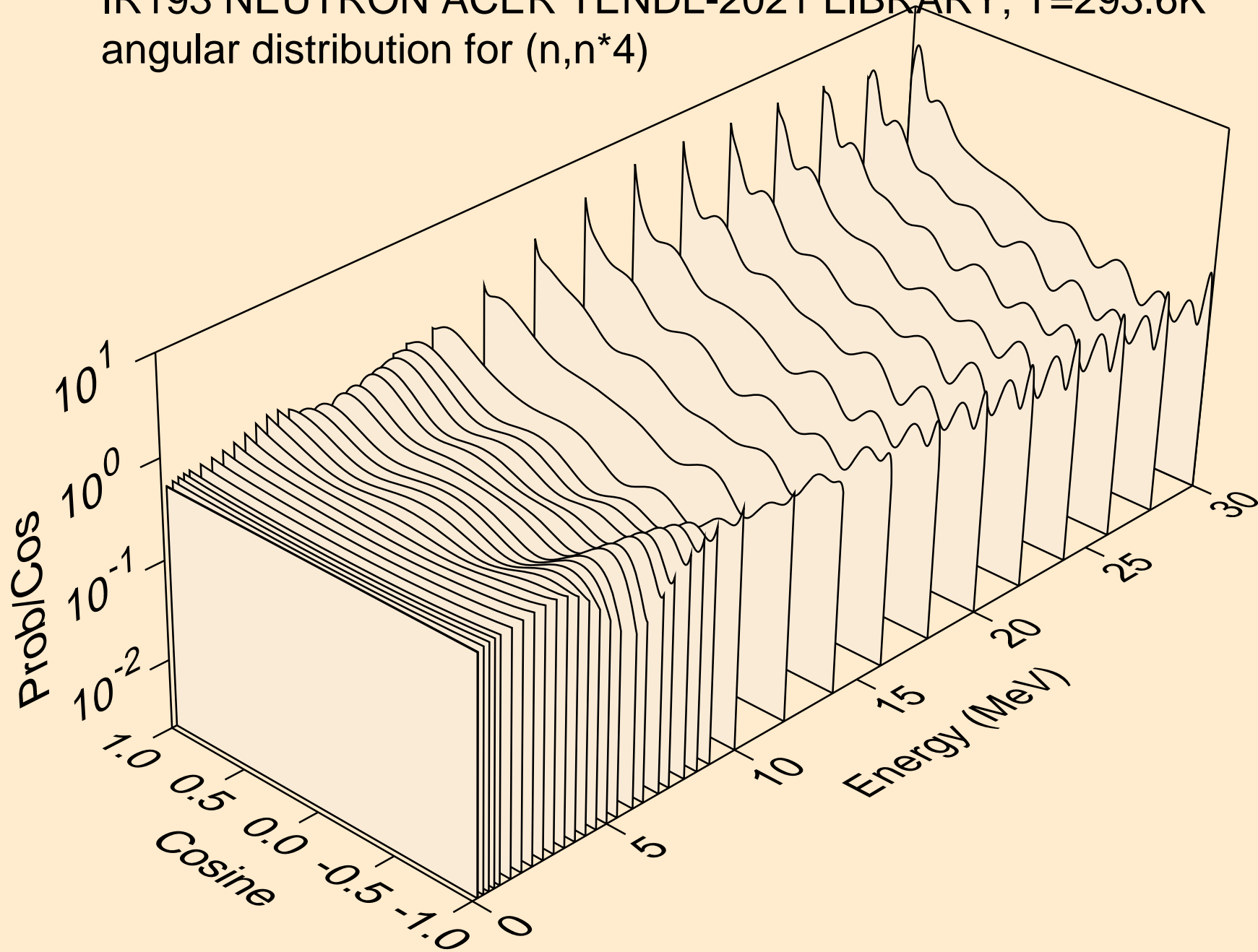

IR193 NEUTRON ACER TENDL-2021 LIBRARY; T=293.6K
angular distribution for (n,n*5)

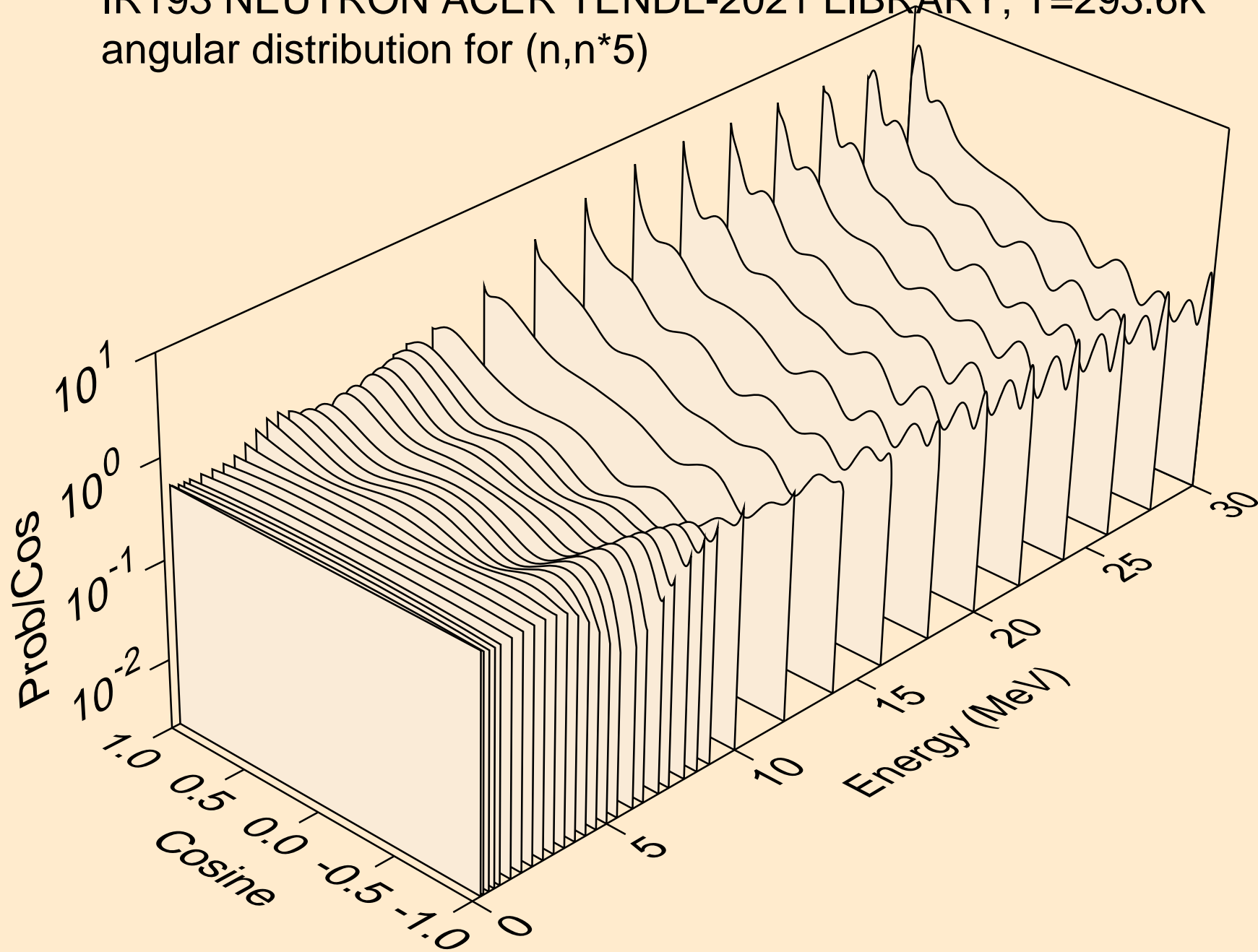

IR193 NEUTRON ACER TENDL-2021 LIBRARY; T=293.6K
angular distribution for (n,n*6)

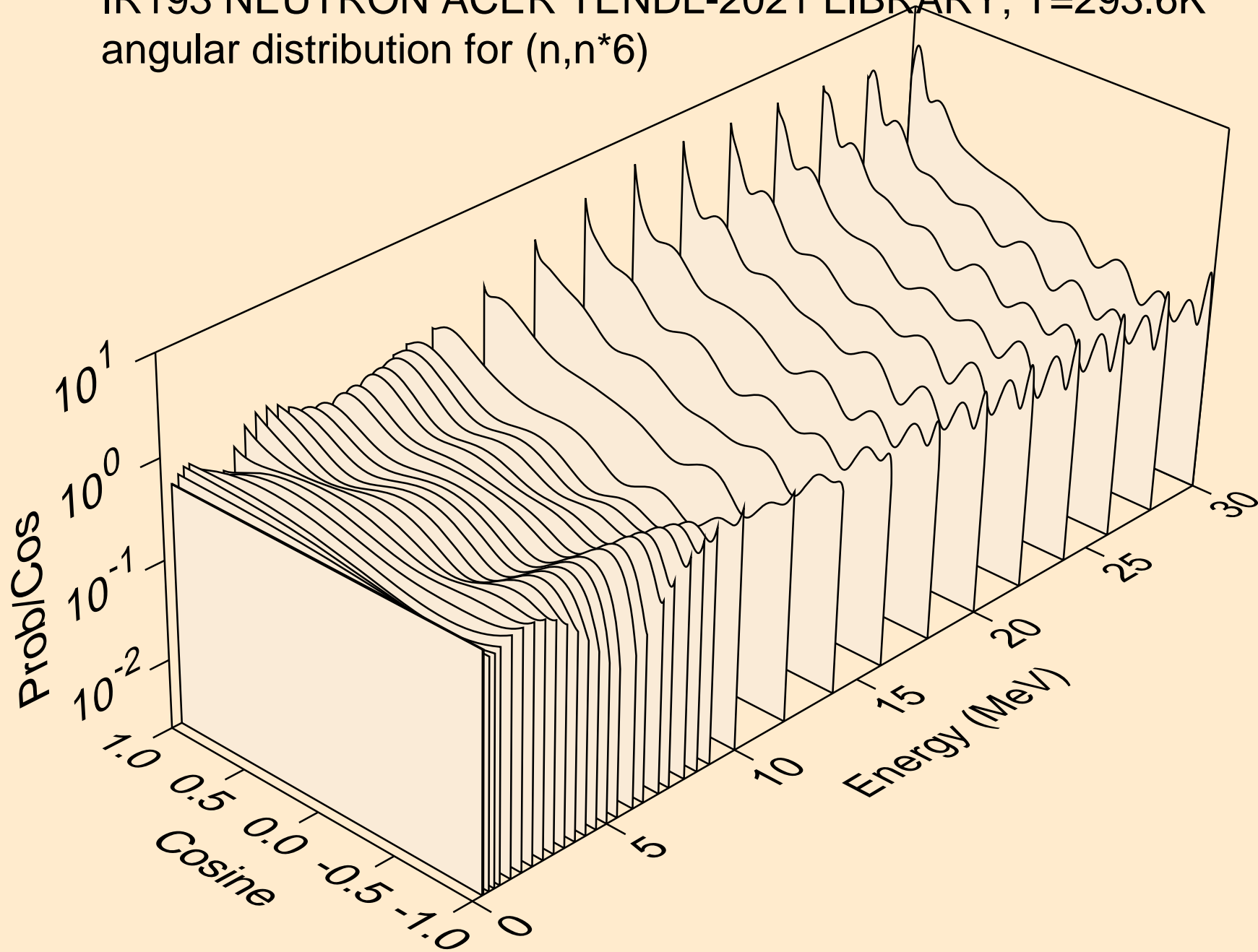

IR193 NEUTRON ACER TENDL-2021 LIBRARY; T=293.6K
angular distribution for (n,n*7)

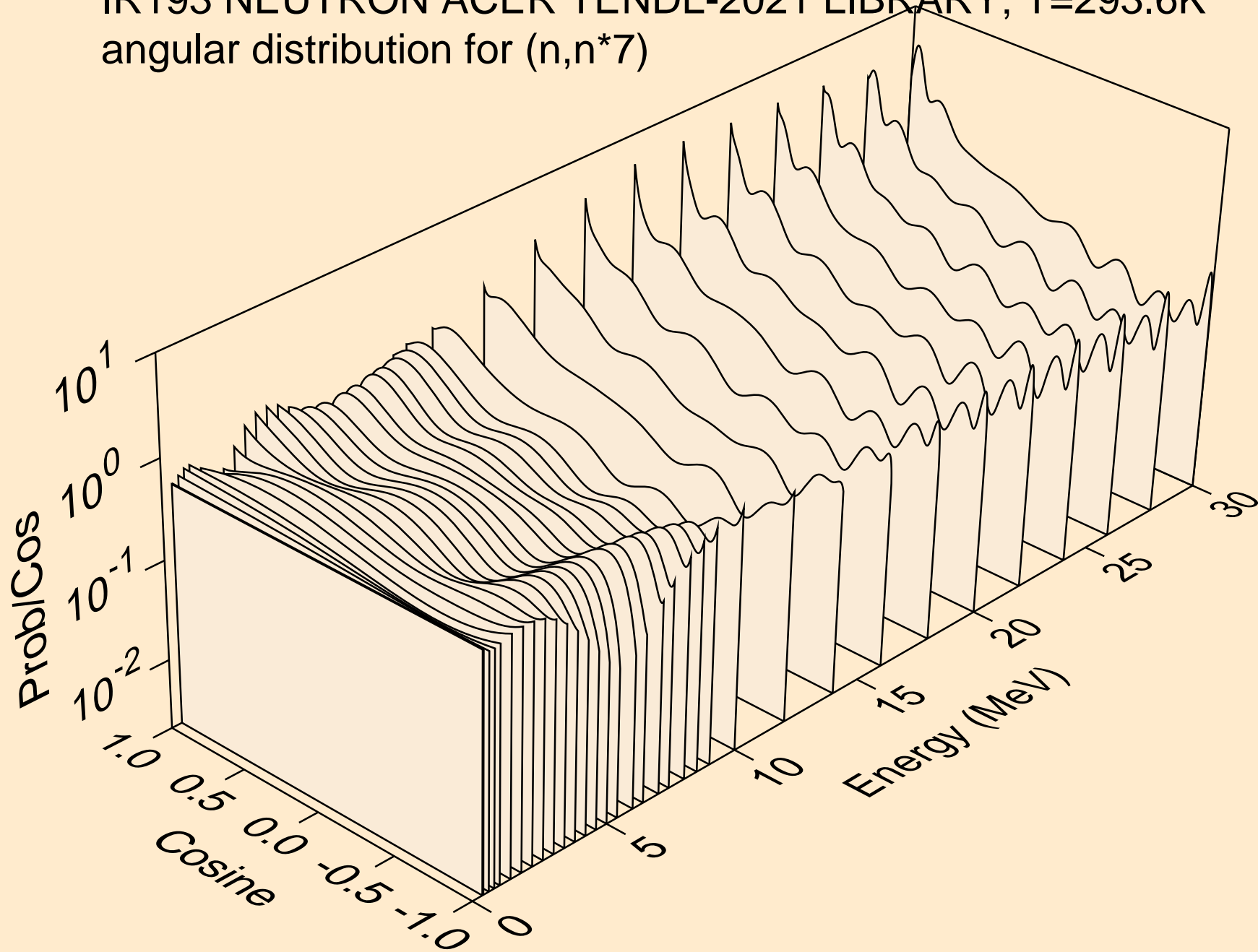

IR193 NEUTRON ACER TENDL-2021 LIBRARY; T=293.6K
angular distribution for (n,n*8)

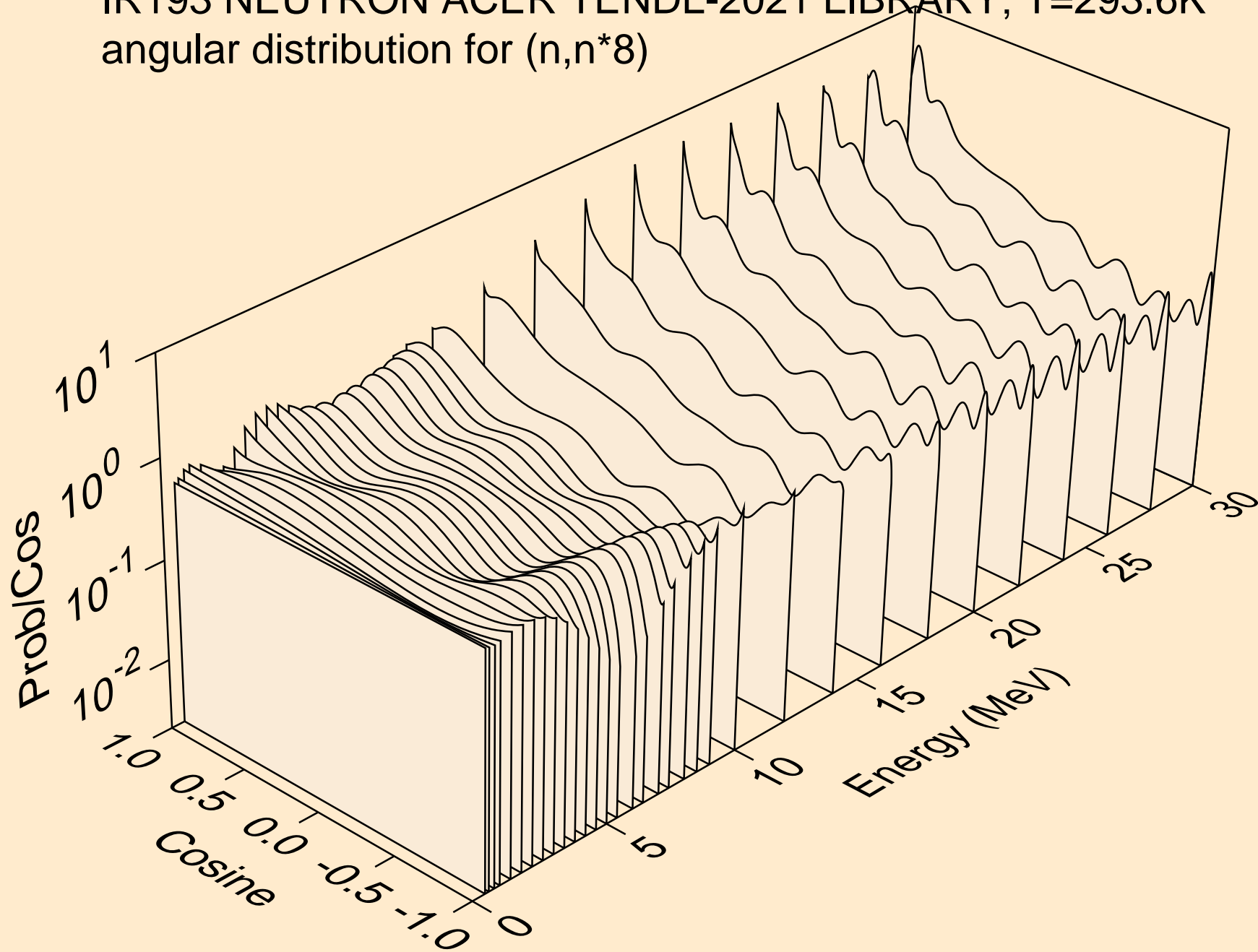

IR193 NEUTRON ACER TENDL-2021 LIBRARY; T=293.6K
angular distribution for (n,n*9)

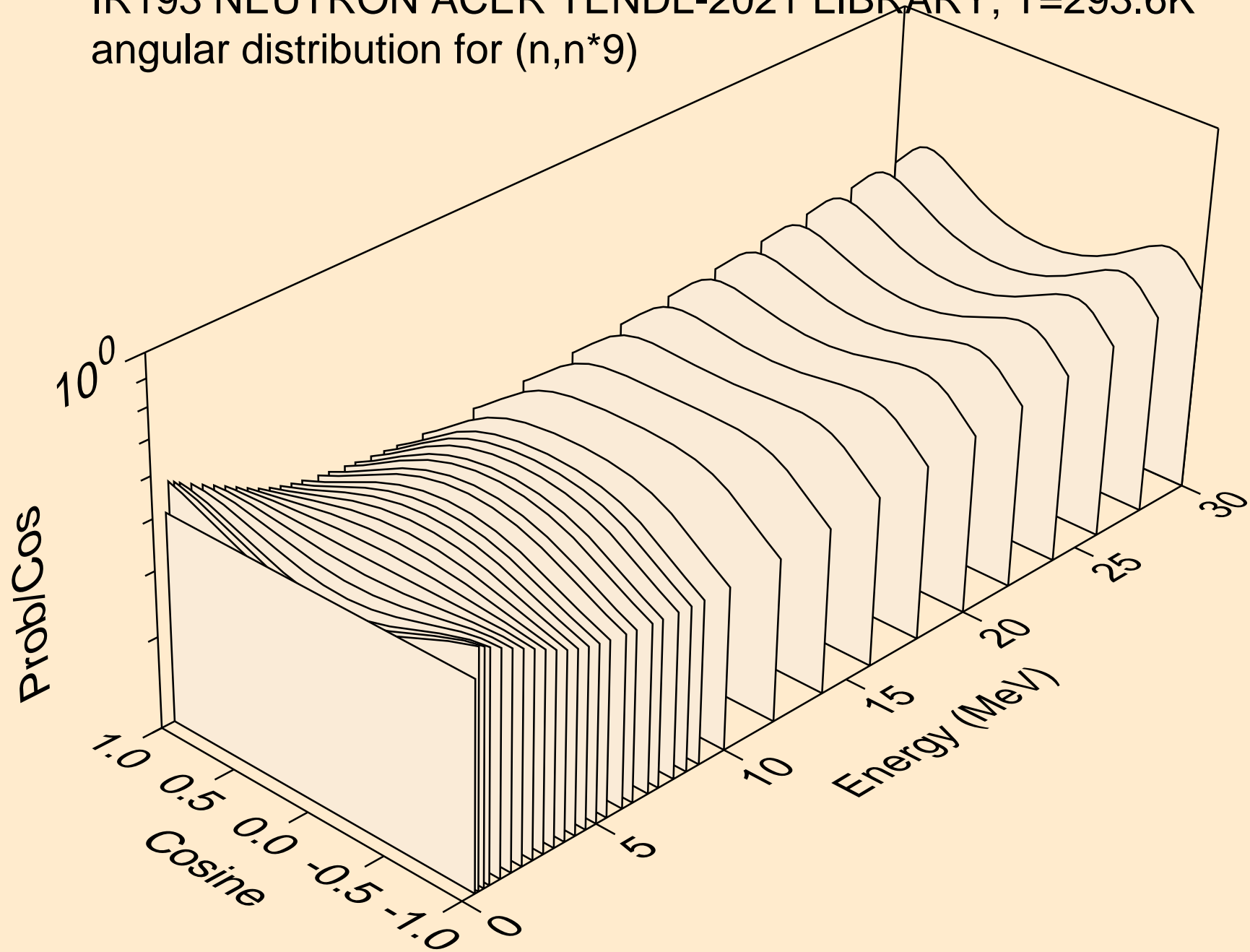

IR193 NEUTRON ACER TENDL-2021 LIBRARY; T=293.6K
angular distribution for (n,n*10)

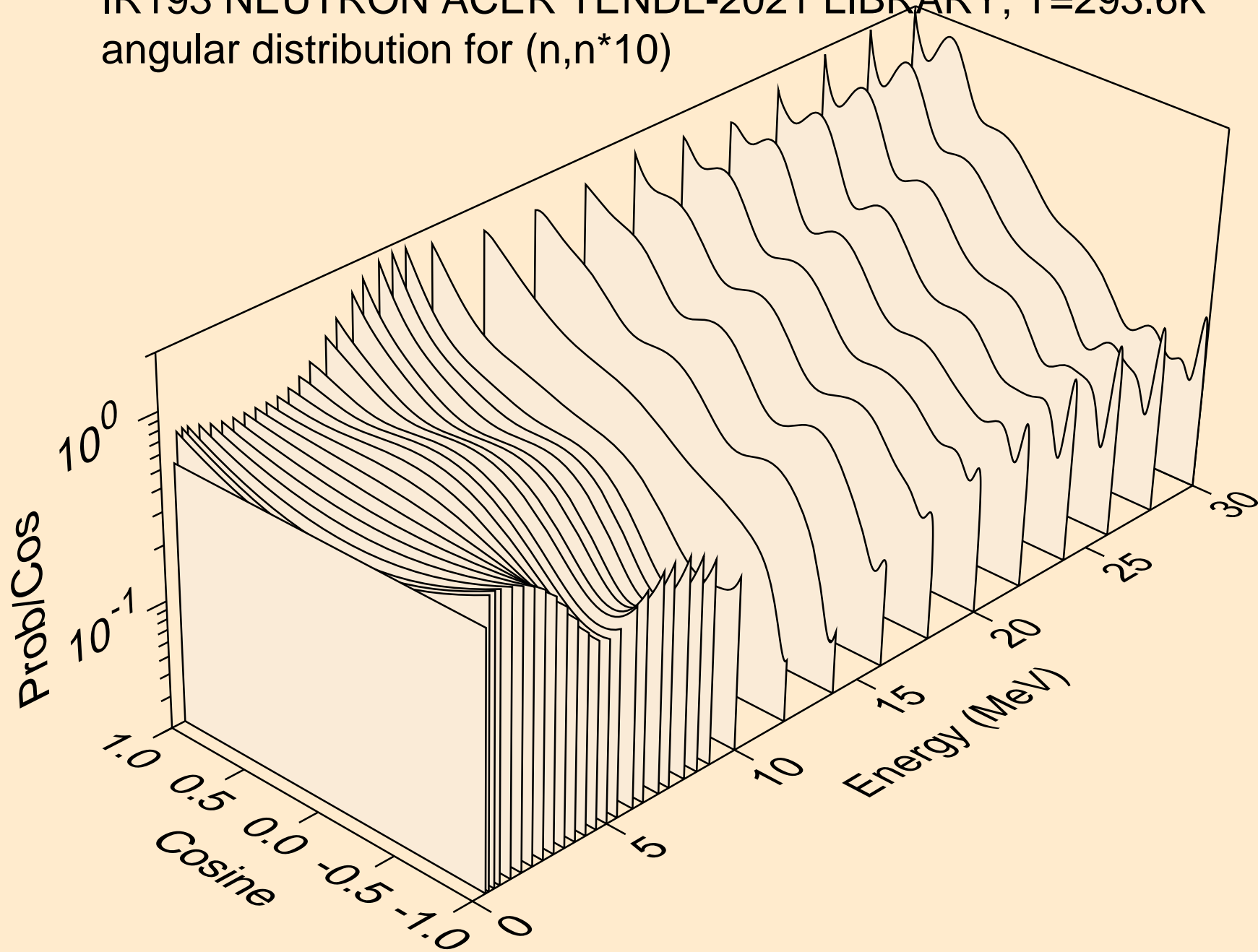

IR193 NEUTRON ACER TENDL-2021 LIBRARY; T=293.6K
angular distribution for (n,n*11)

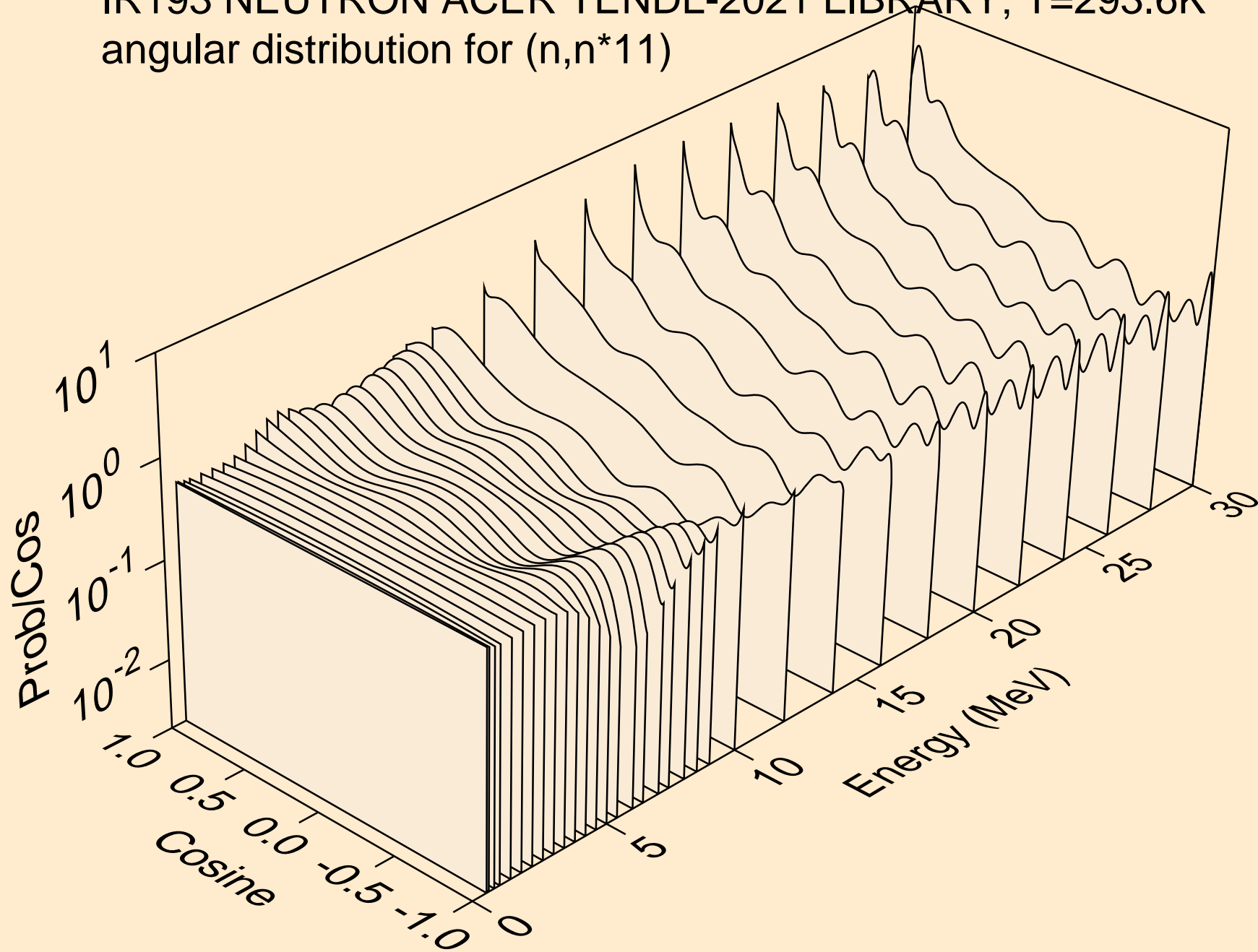

IR193 NEUTRON ACER TENDL-2021 LIBRARY; T=293.6K
angular distribution for (n,n*12)

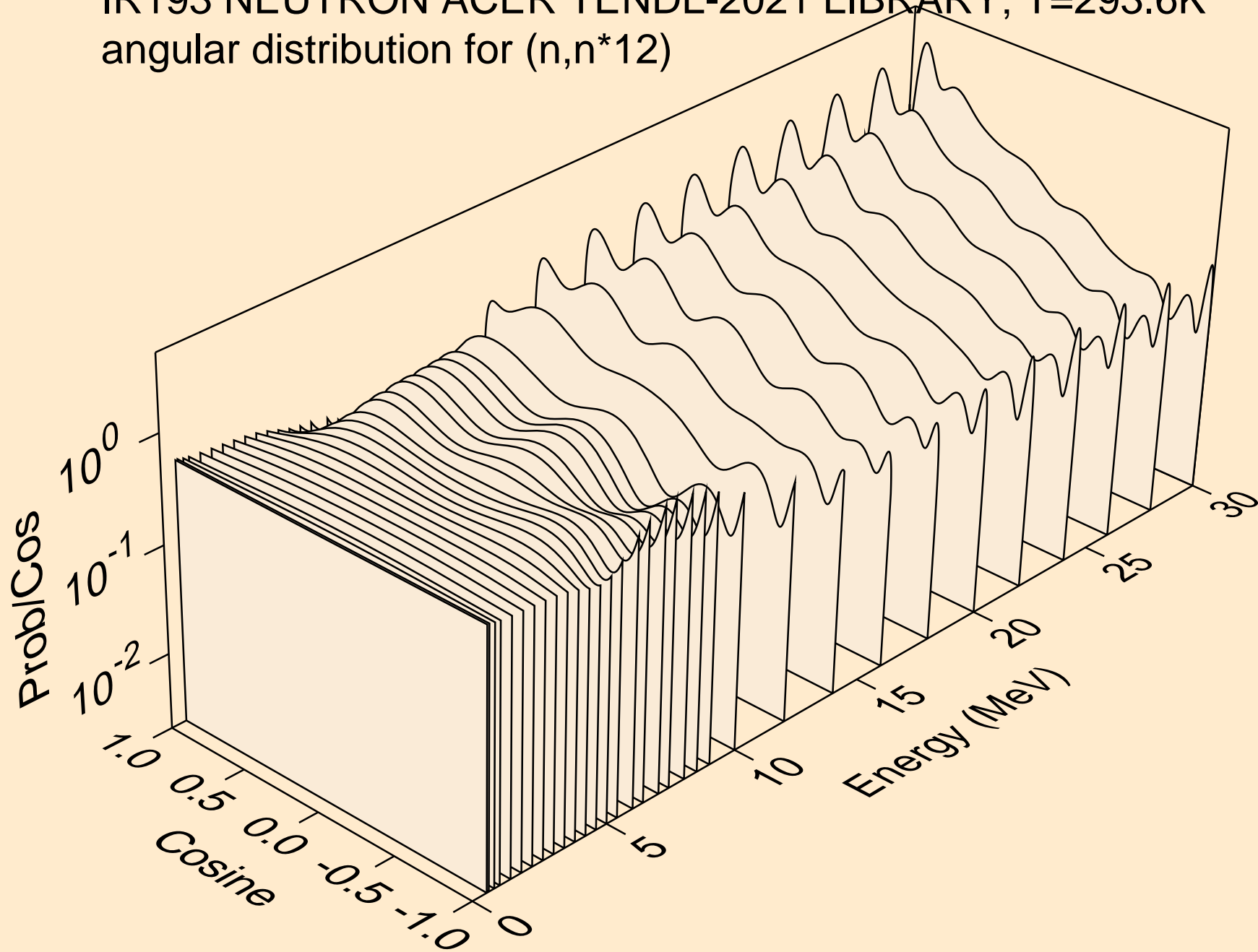

IR193 NEUTRON ACER TENDL-2021 LIBRARY; T=293.6K
angular distribution for (n,n*13)

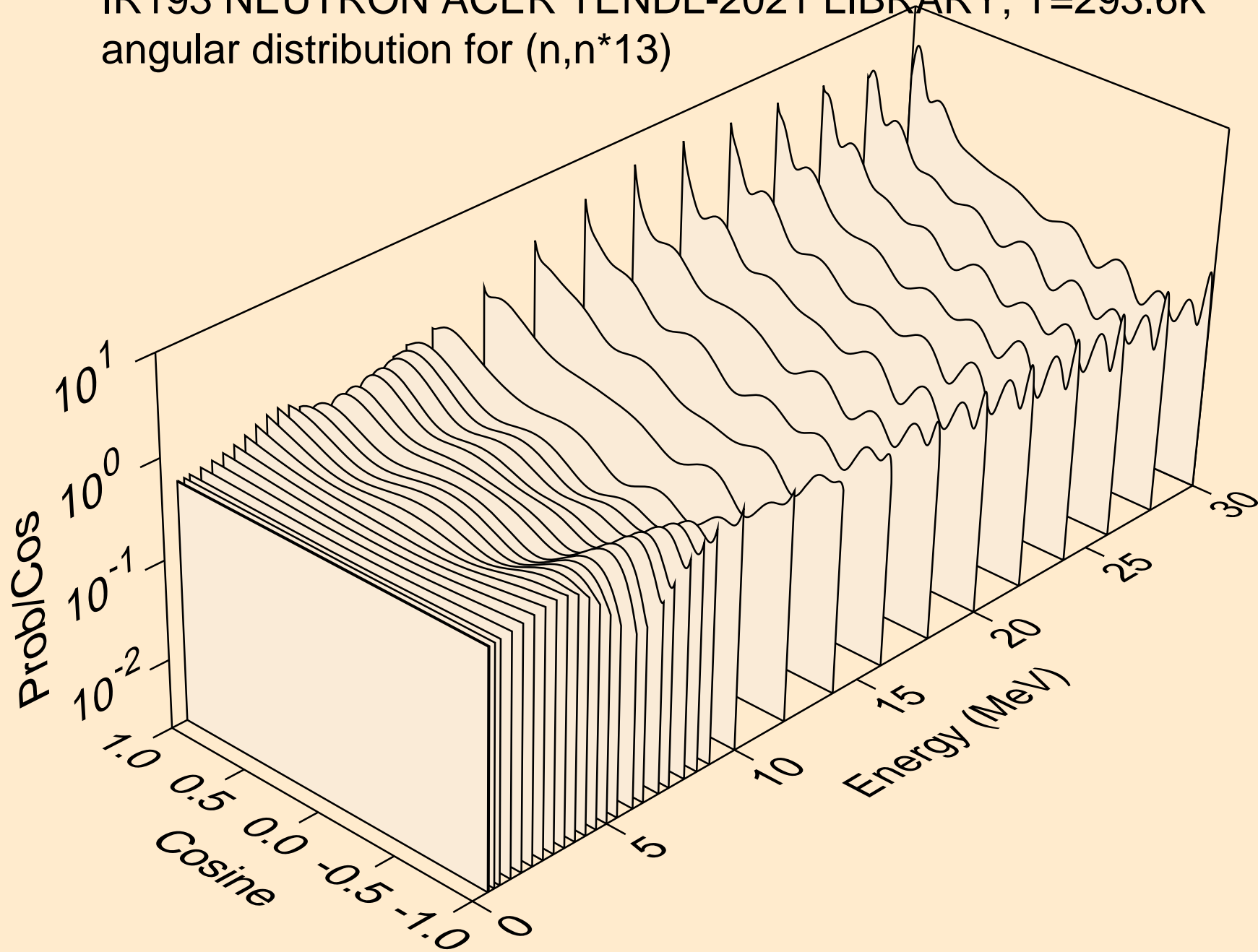

IR193 NEUTRON ACER TENDL-2021 LIBRARY; T=293.6K
angular distribution for (n,n*14)

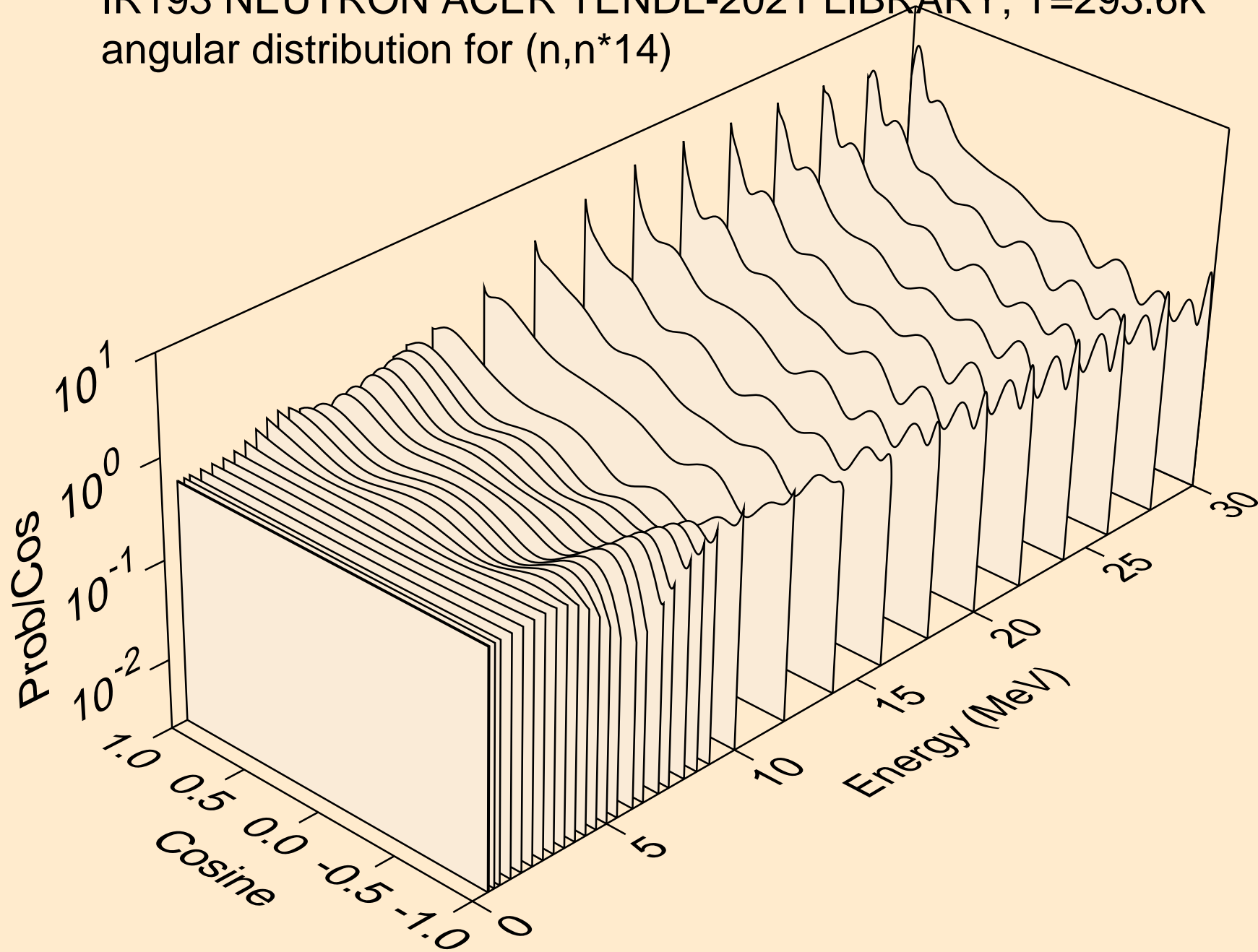

IR193 NEUTRON ACER TENDL-2021 LIBRARY; T=293.6K
angular distribution for (n,n*15)

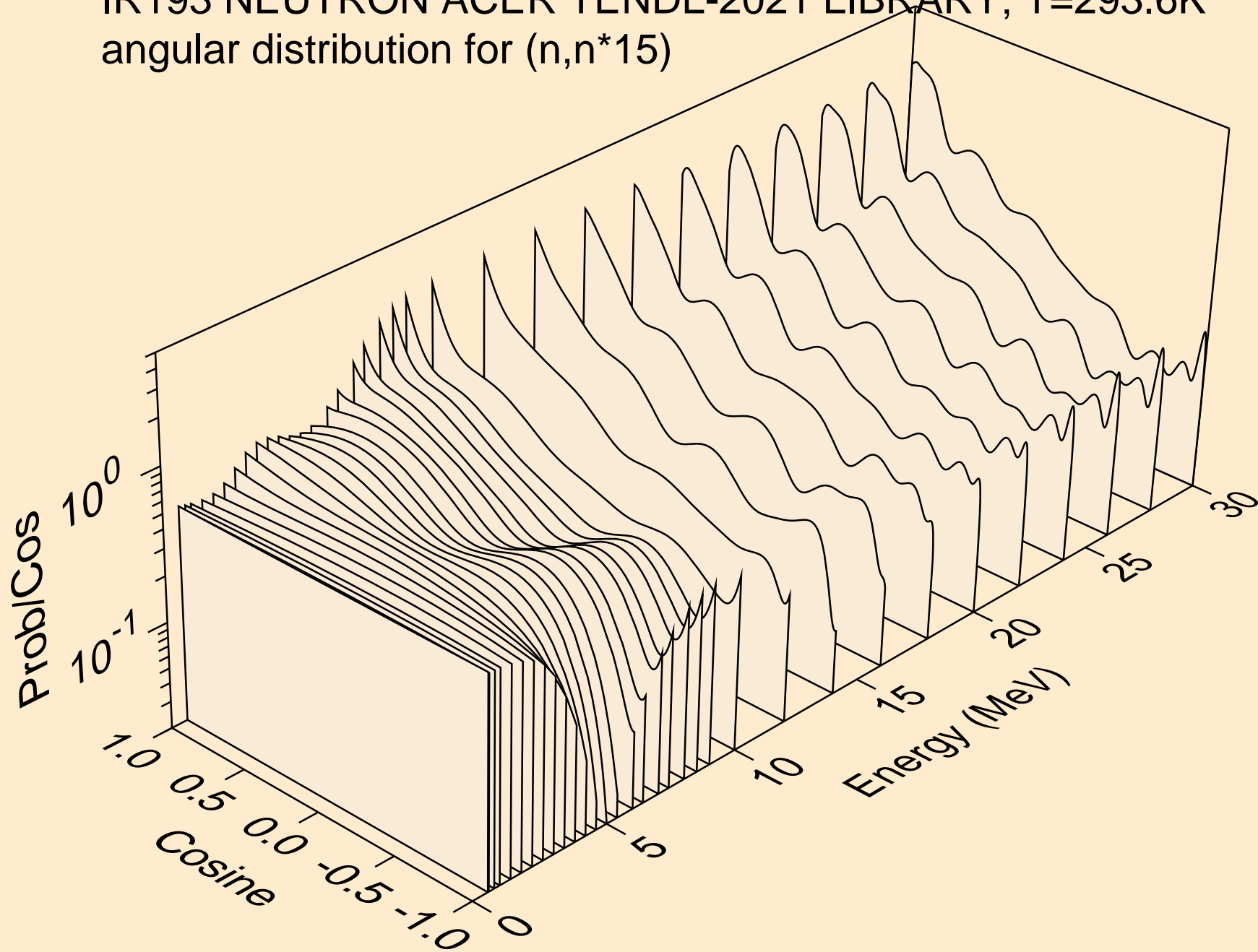

IR193 NEUTRON ACER TENDL-2021 LIBRARY; T=293.6K
angular distribution for (n,n*16)

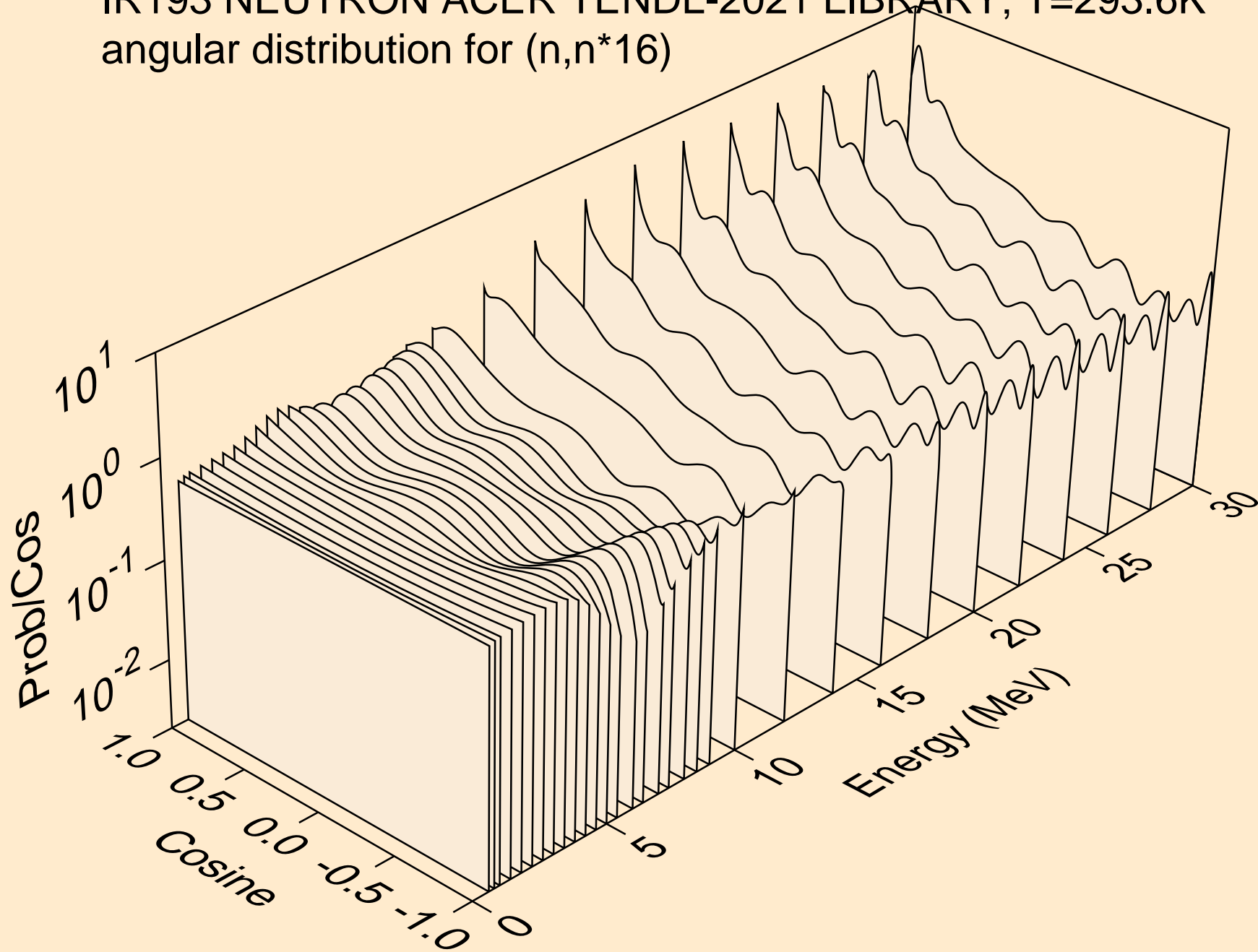

IR193 NEUTRON ACER TENDL-2021 LIBRARY; T=293.6K
angular distribution for (n,n*17)

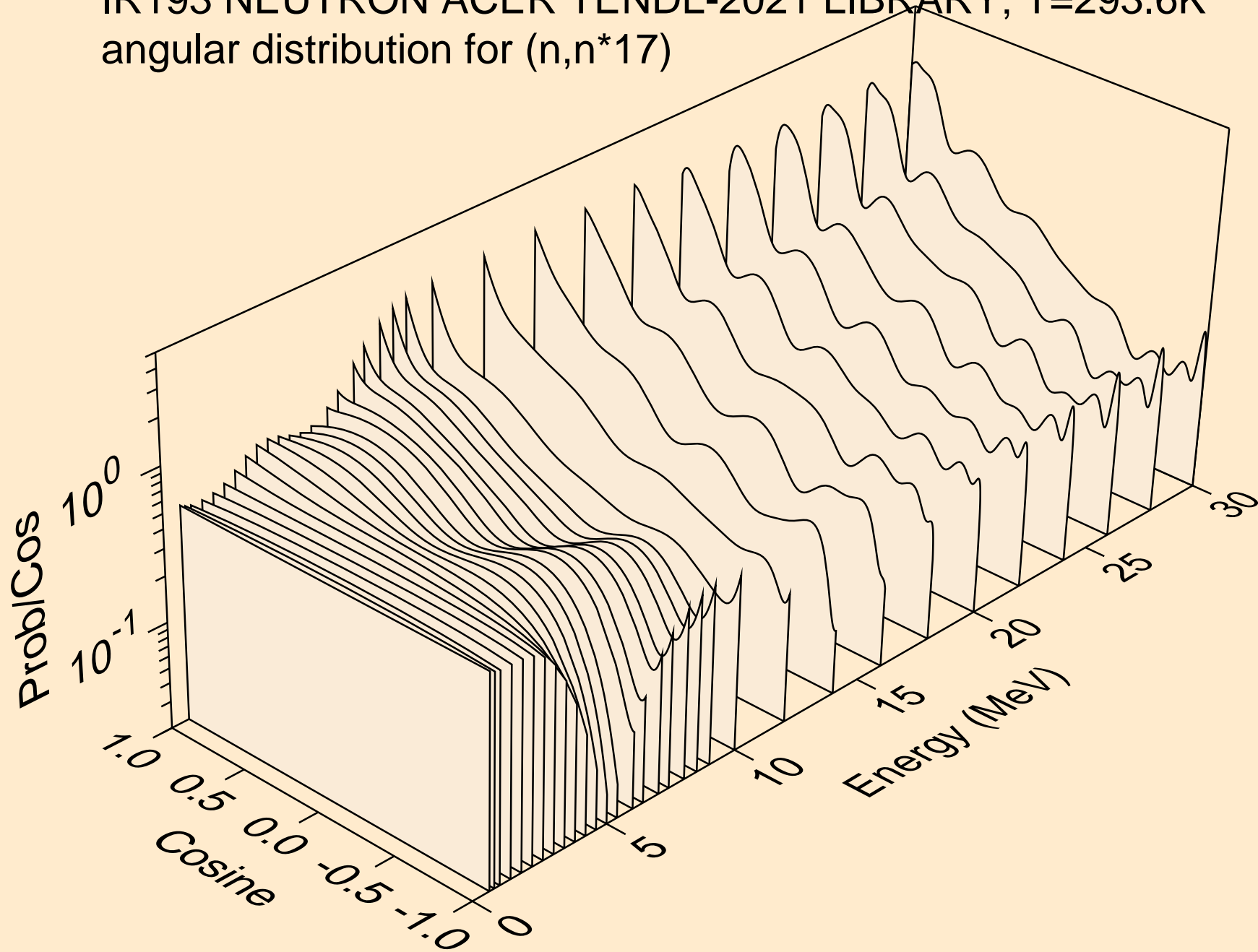

IR193 NEUTRON ACER TENDL-2021 LIBRARY; T=293.6K
angular distribution for (n,n*18)

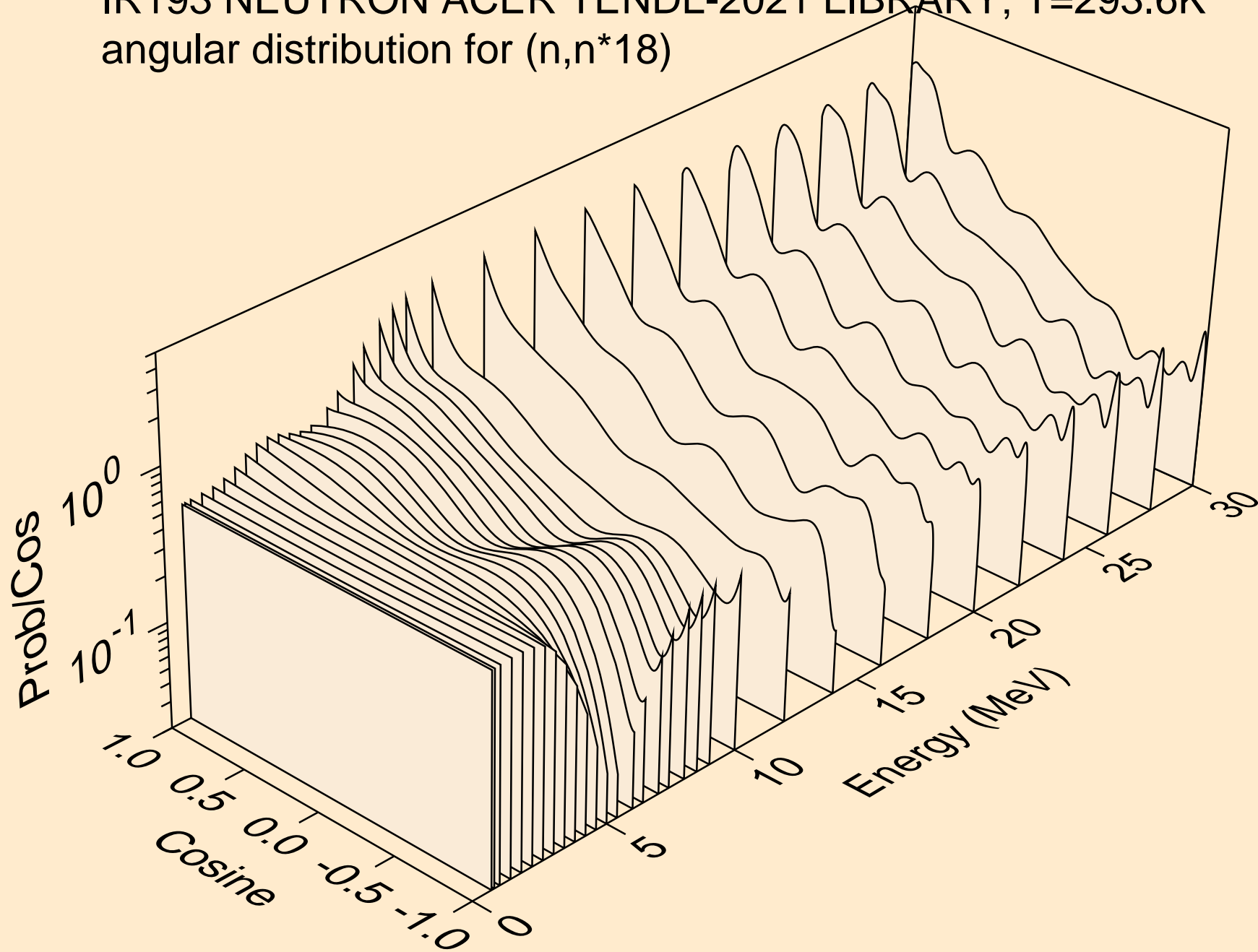

IR193 NEUTRON ACER TENDL-2021 LIBRARY; T=293.6K
angular distribution for (n,n*19)

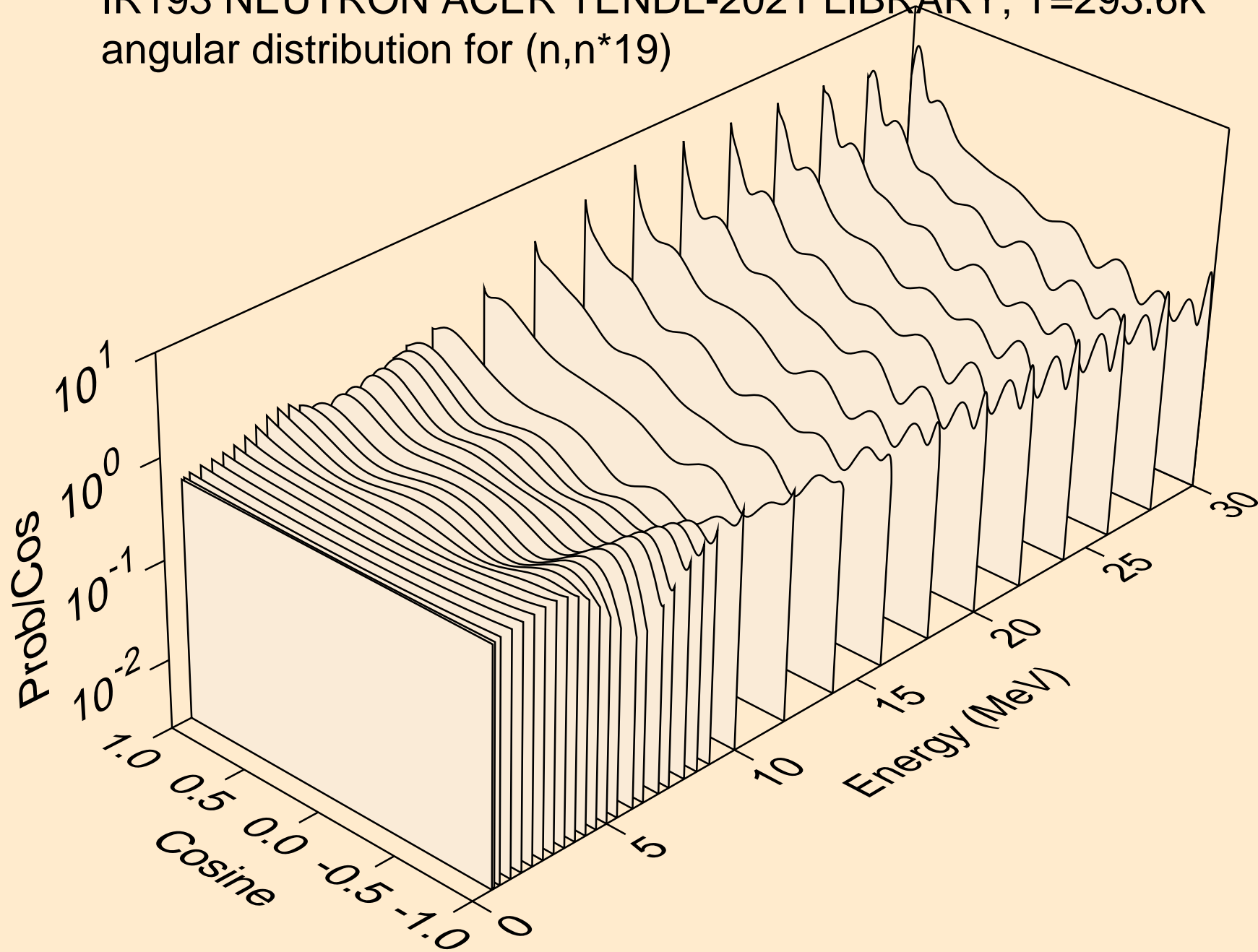

IR193 NEUTRON ACER TENDL-2021 LIBRARY; T=293.6K
angular distribution for (n,n*20)

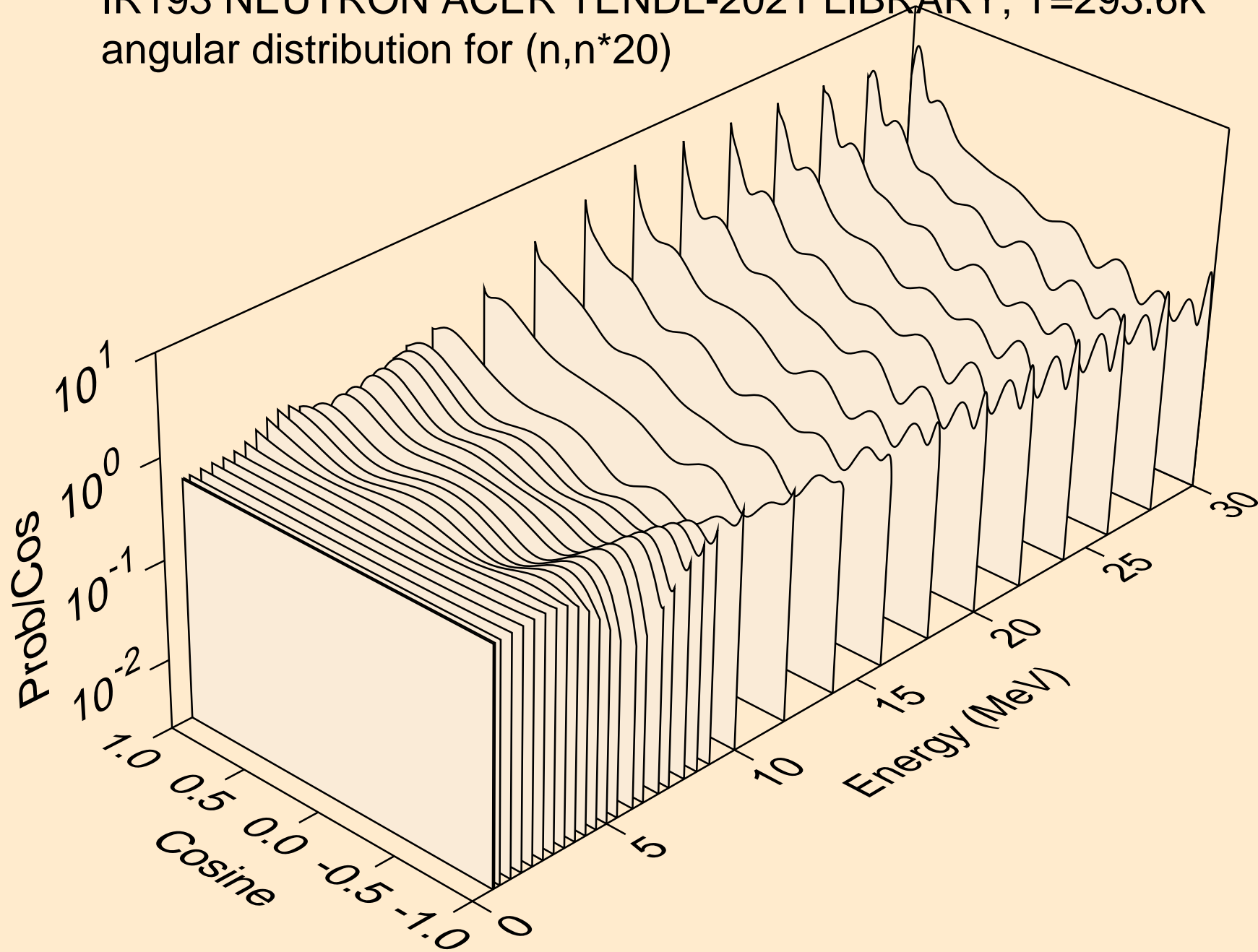

IR193 NEUTRON ACER TENDL-2021 LIBRARY; T=293.6K
angular distribution for (n,n*21)

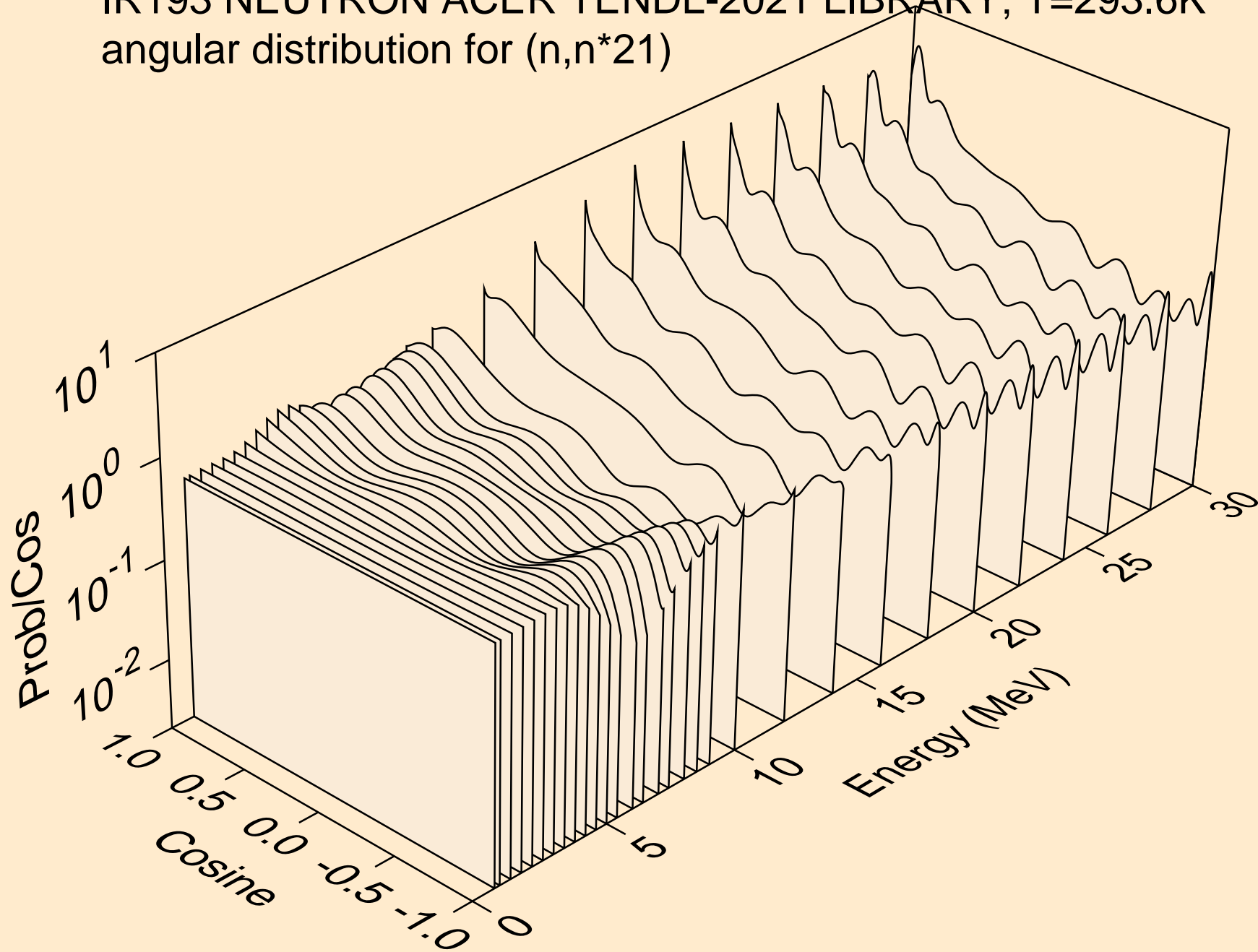

IR193 NEUTRON ACER TENDL-2021 LIBRARY; T=293.6K
angular distribution for (n,n*22)

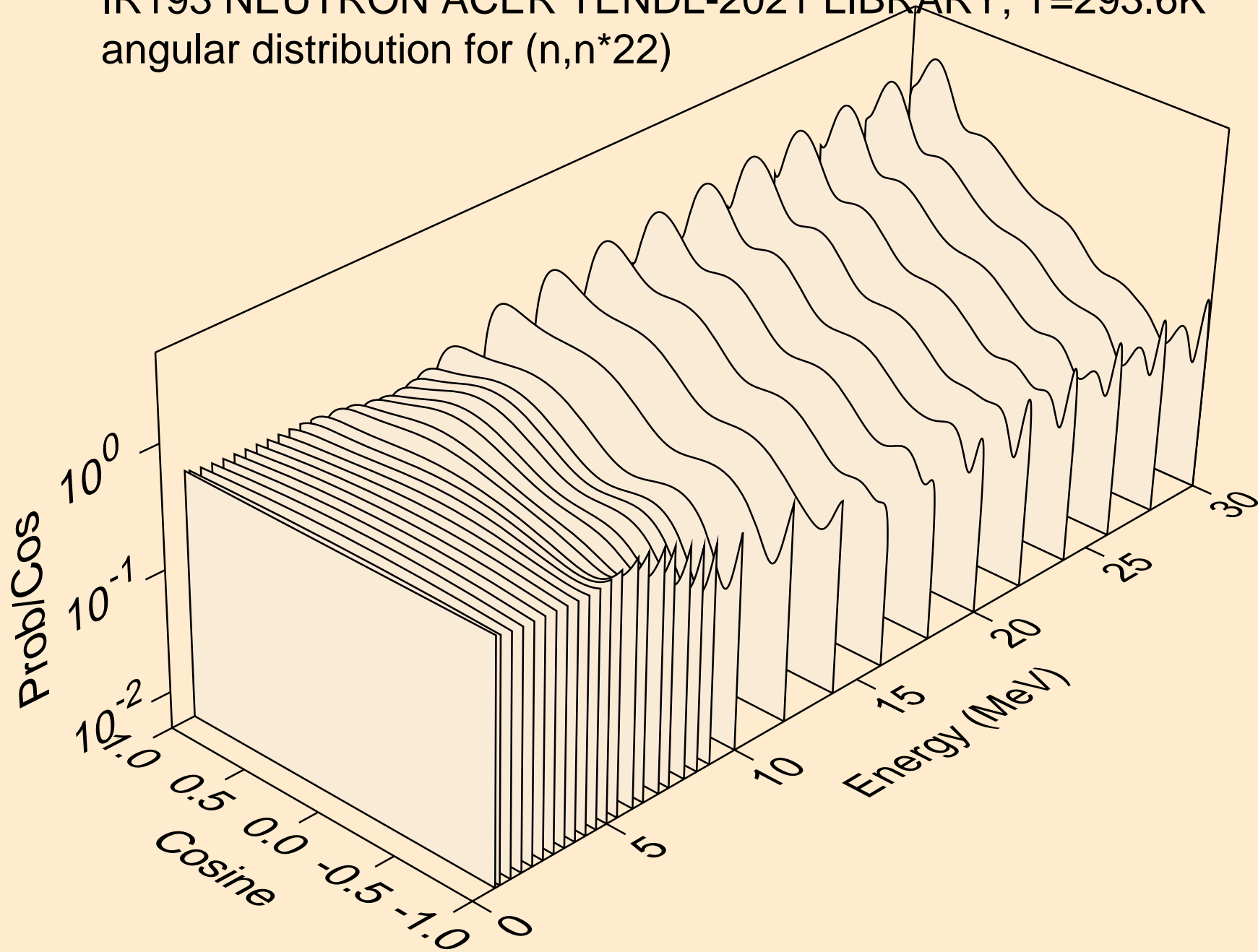

IR193 NEUTRON ACER TENDL-2021 LIBRARY; T=293.6K
angular distribution for (n,n*23)

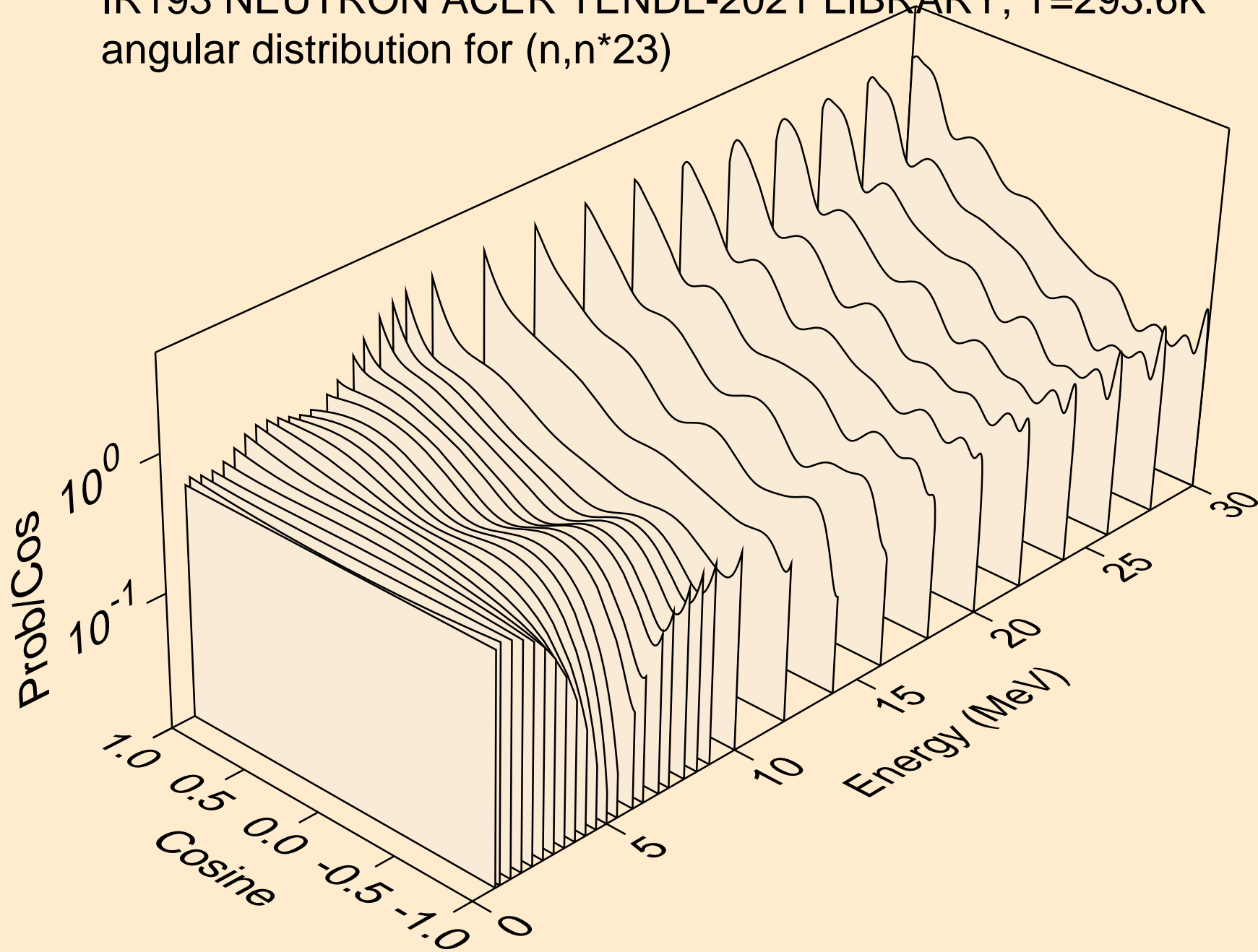

IR193 NEUTRON ACER TENDL-2021 LIBRARY; T=293.6K
angular distribution for (n,n*24)

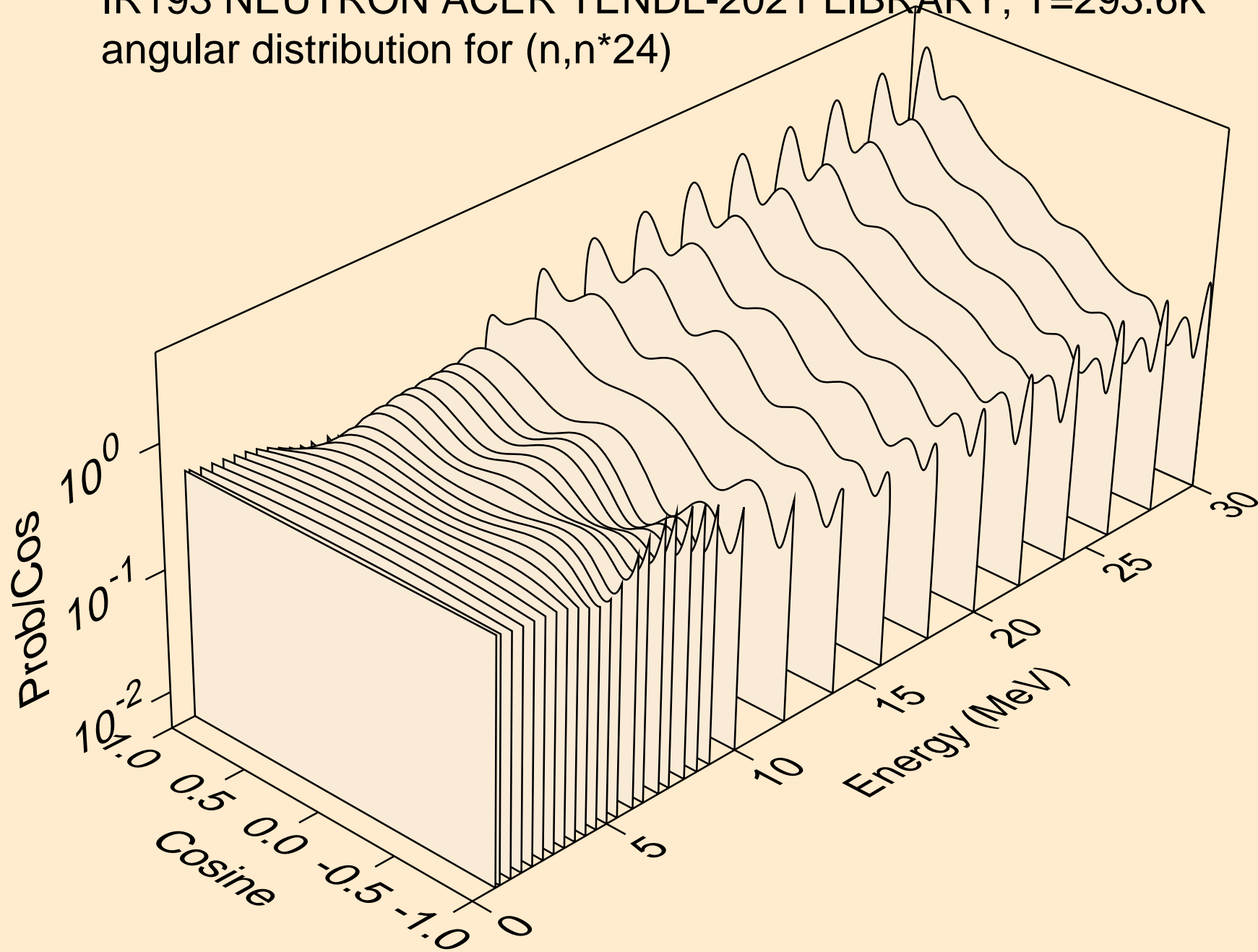

IR193 NEUTRON ACER TENDL-2021 LIBRARY; T=293.6K
angular distribution for (n,n*25)

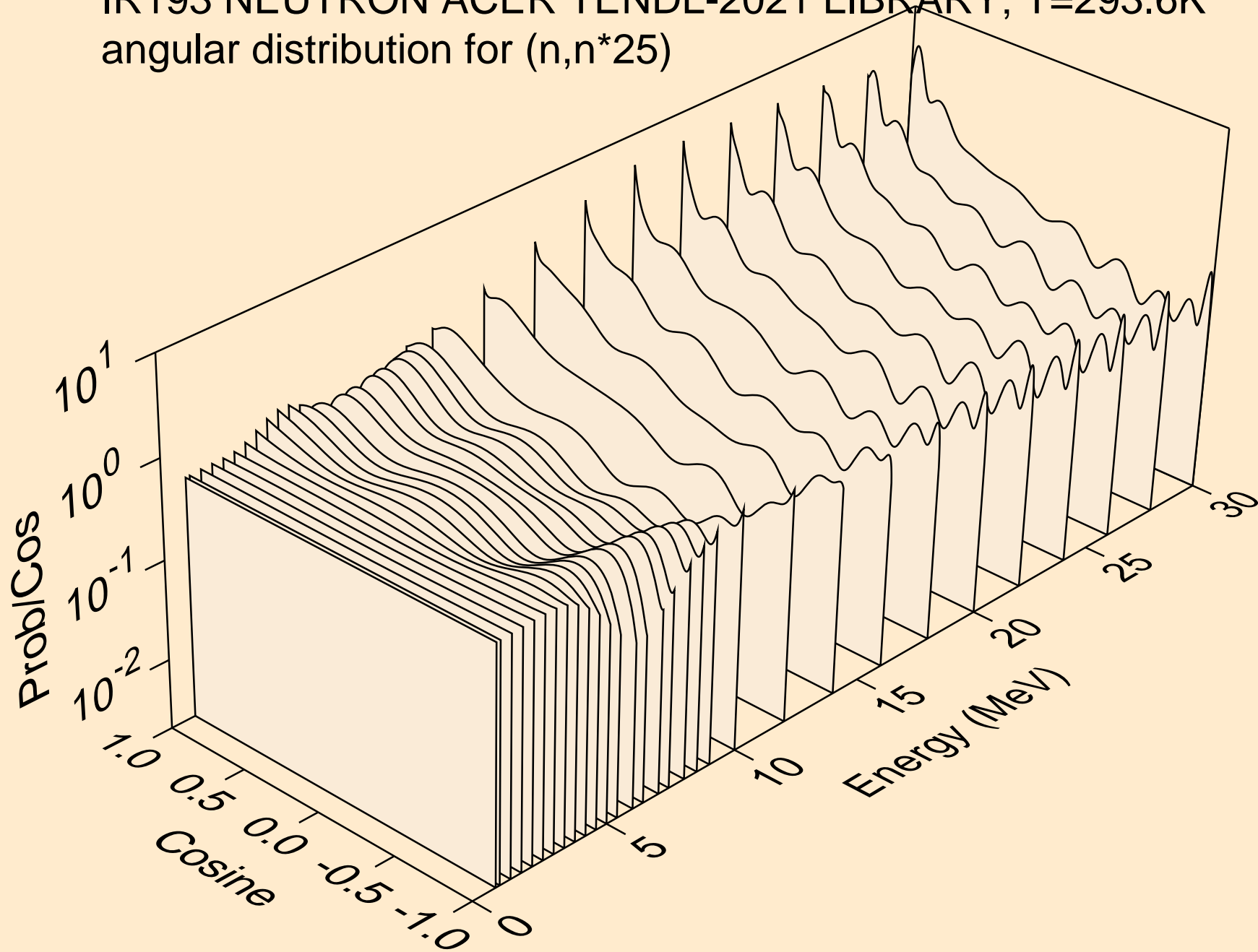

IR193 NEUTRON ACER TENDL-2021 LIBRARY; T=293.6K
angular distribution for (n,n*26)

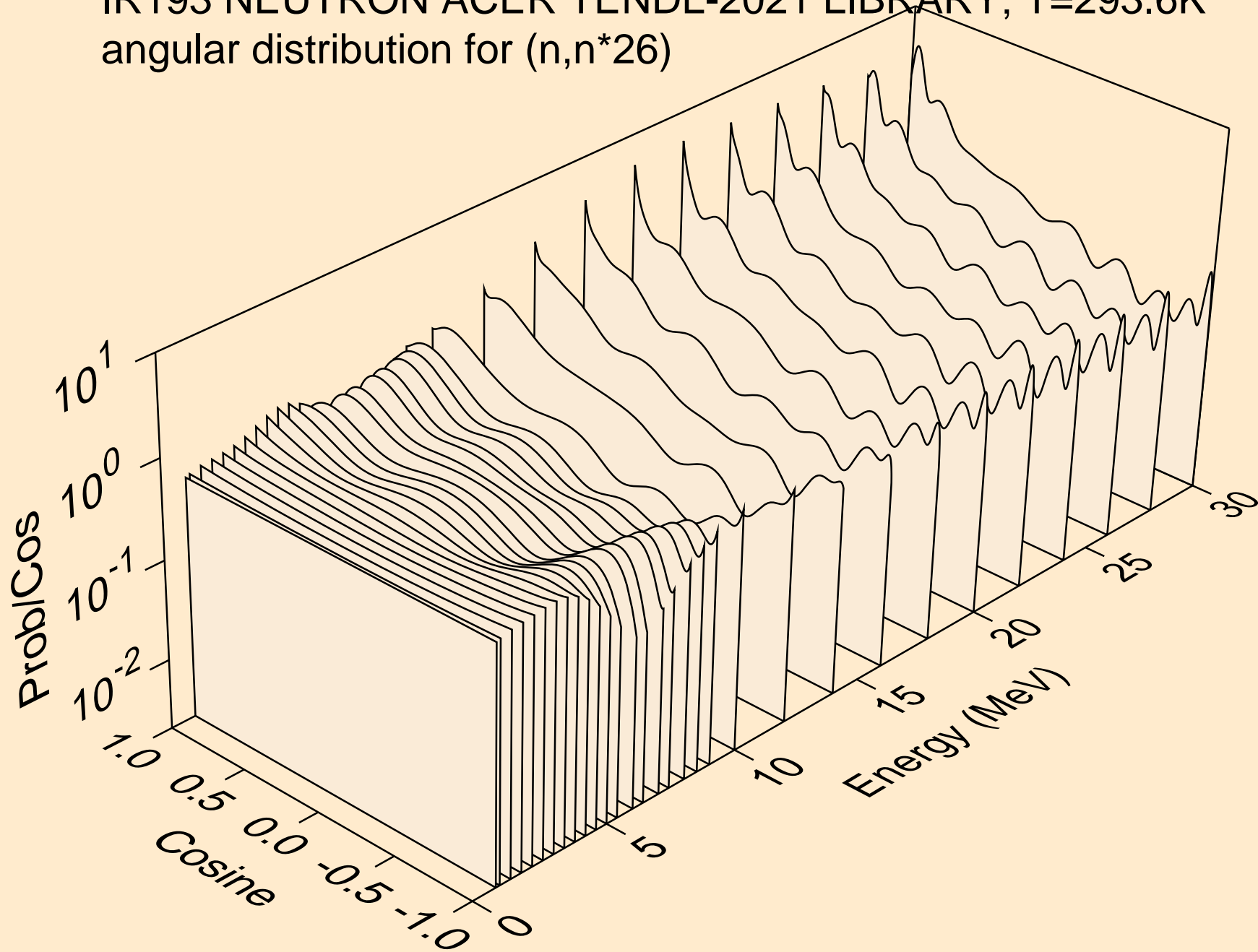

IR193 NEUTRON ACER TENDL-2021 LIBRARY; T=293.6K
angular distribution for (n,n*27)

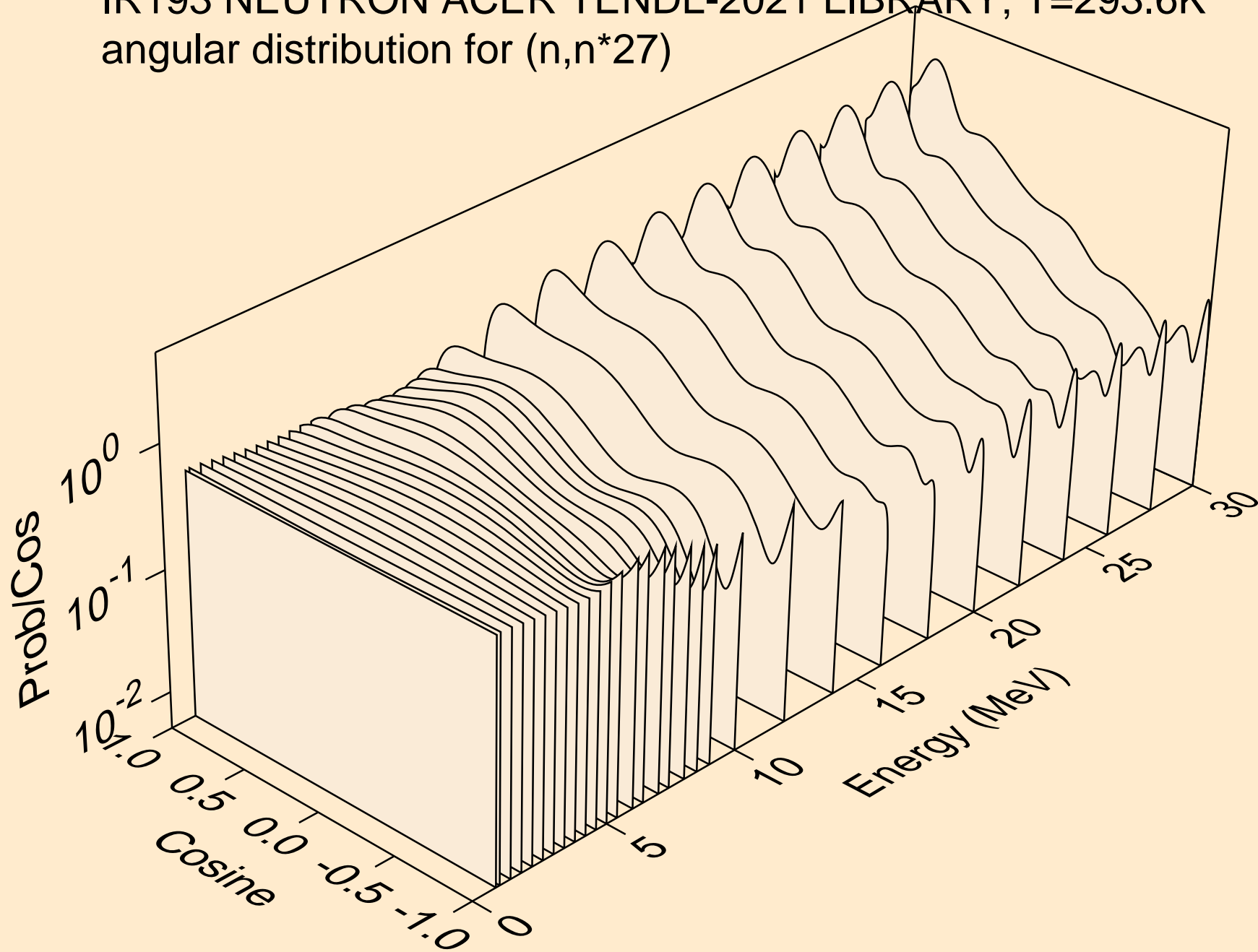

IR193 NEUTRON ACER TENDL-2021 LIBRARY; T=293.6K
angular distribution for (n,n*28)

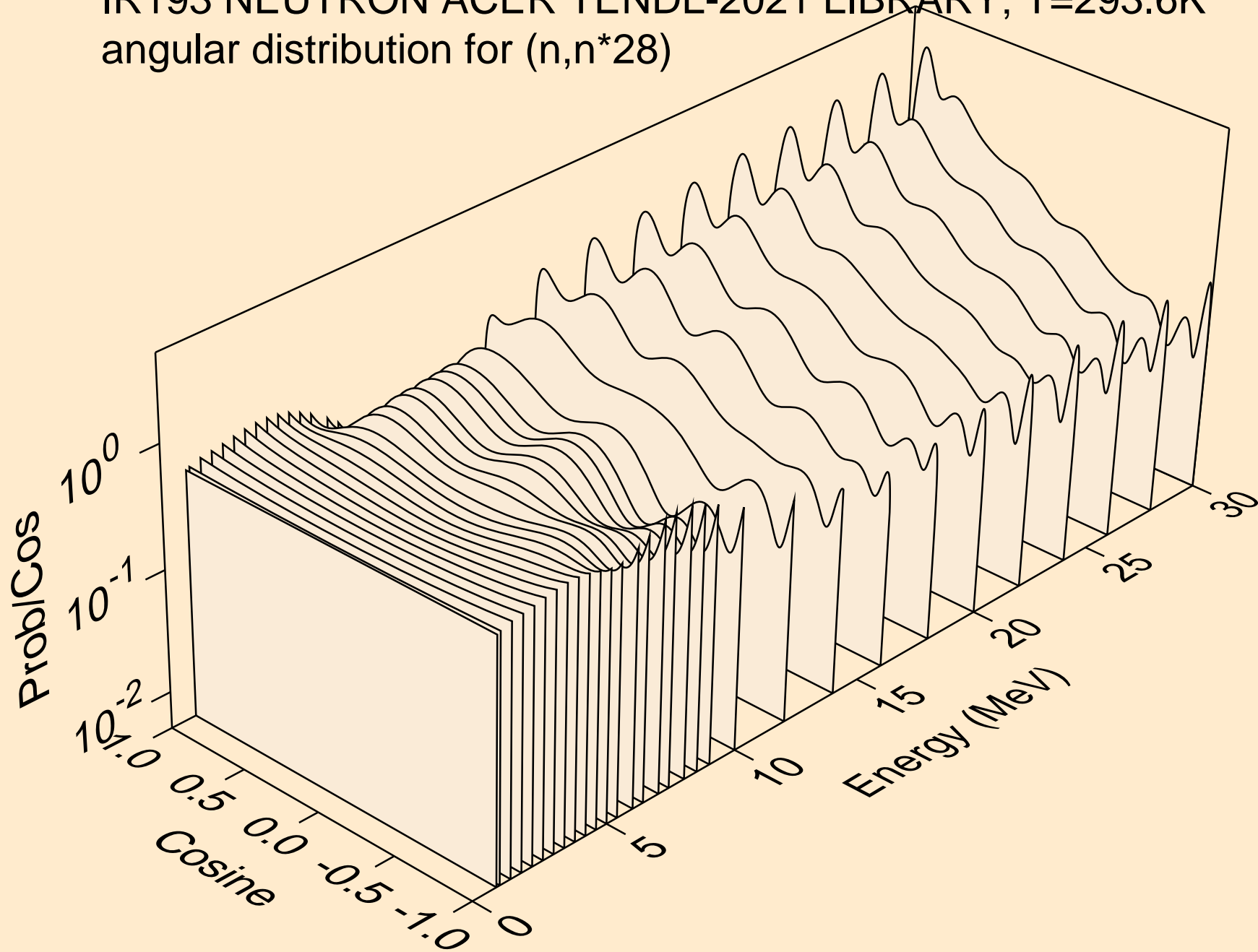

IR193 NEUTRON ACER TENDL-2021 LIBRARY; T=293.6K
angular distribution for (n,n*29)

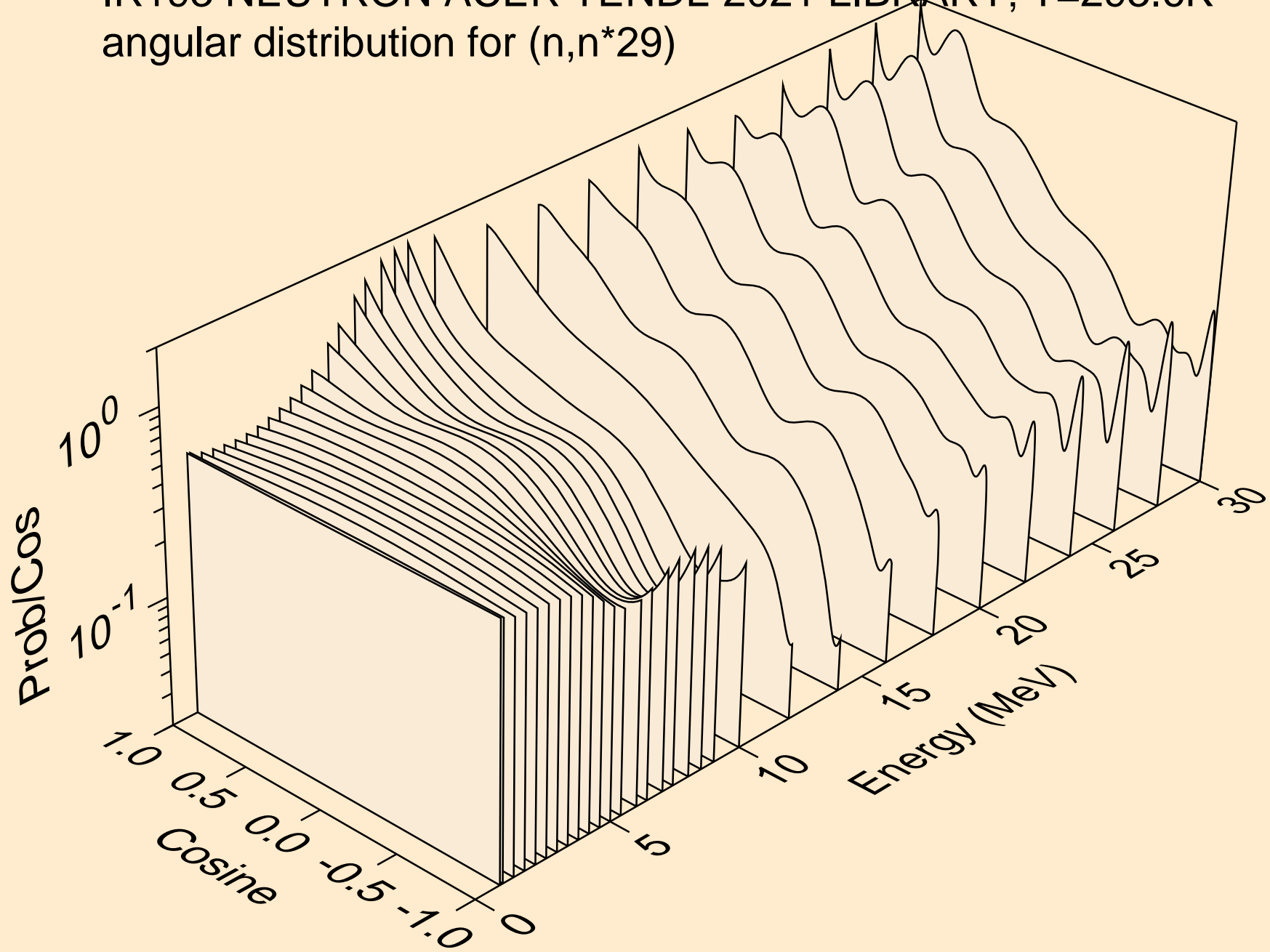

IR193 NEUTRON ACER TENDL-2021 LIBRARY; T=293.6K
angular distribution for (n,n*30)

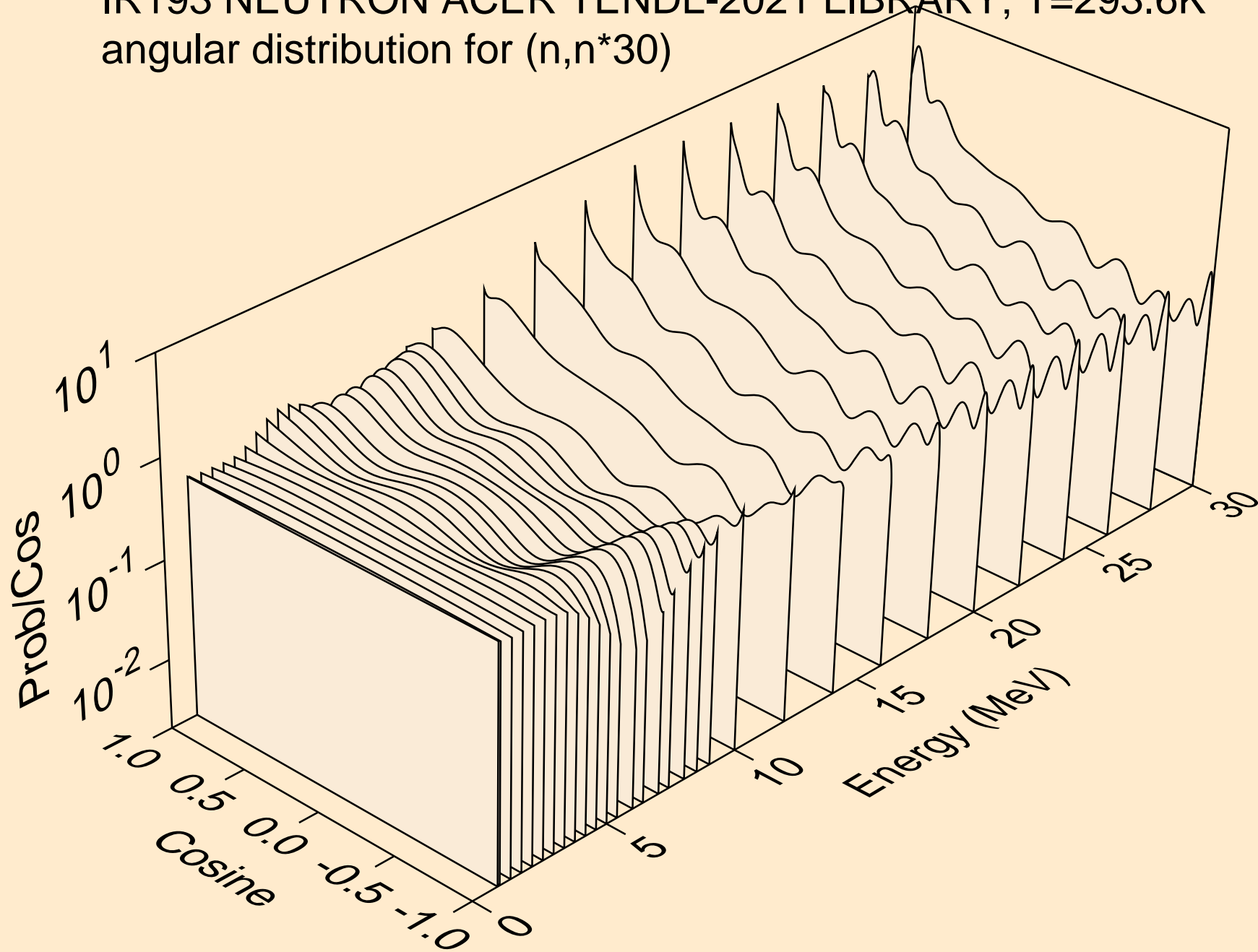

IR193 NEUTRON ACER TENDL-2021 LIBRARY; T=293.6K
Neutron emission for (n,x)

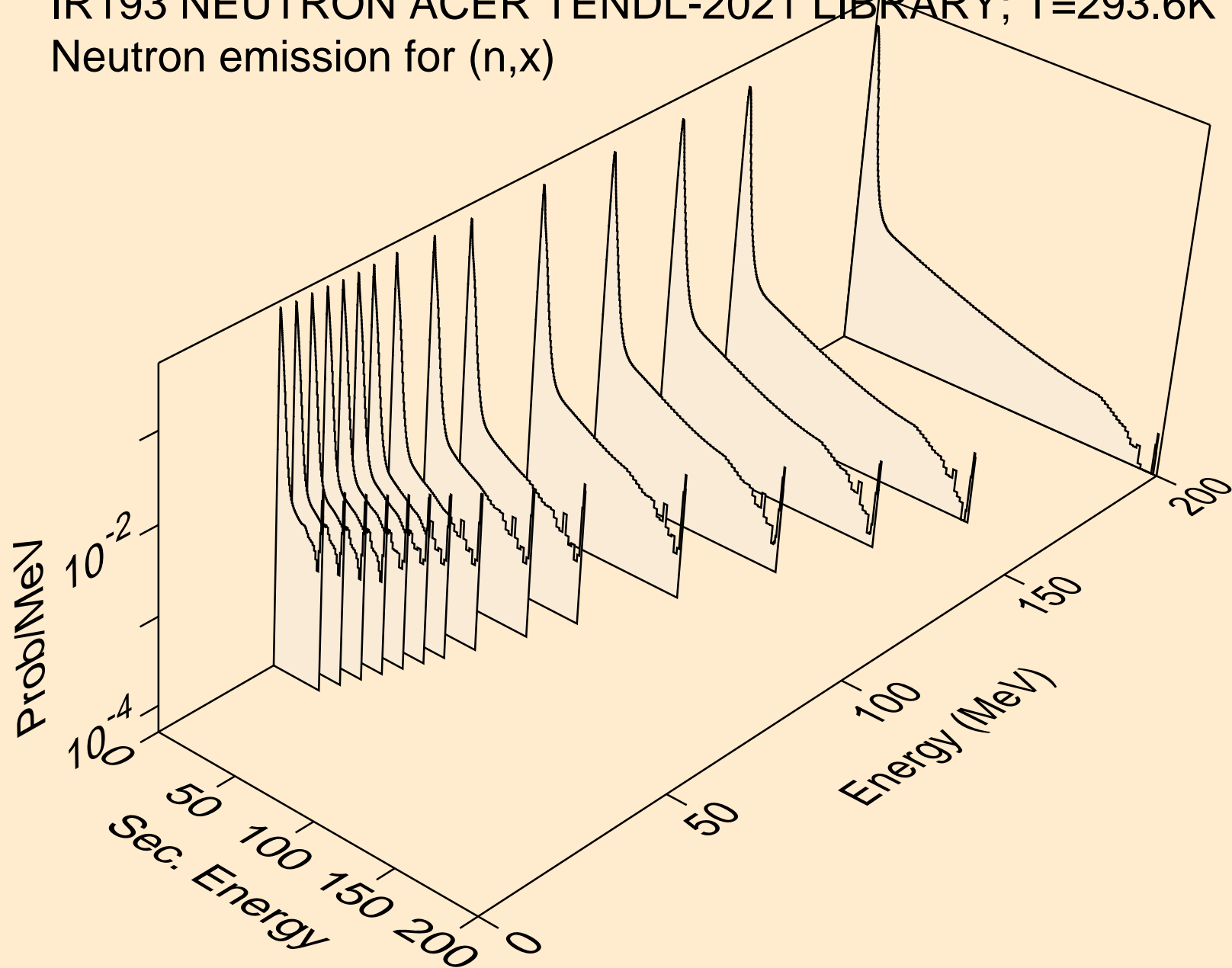

IR193 NEUTRON ACER TENDL-2021 LIBRARY; T=293.6K
Neutron emission for (n,2nd)

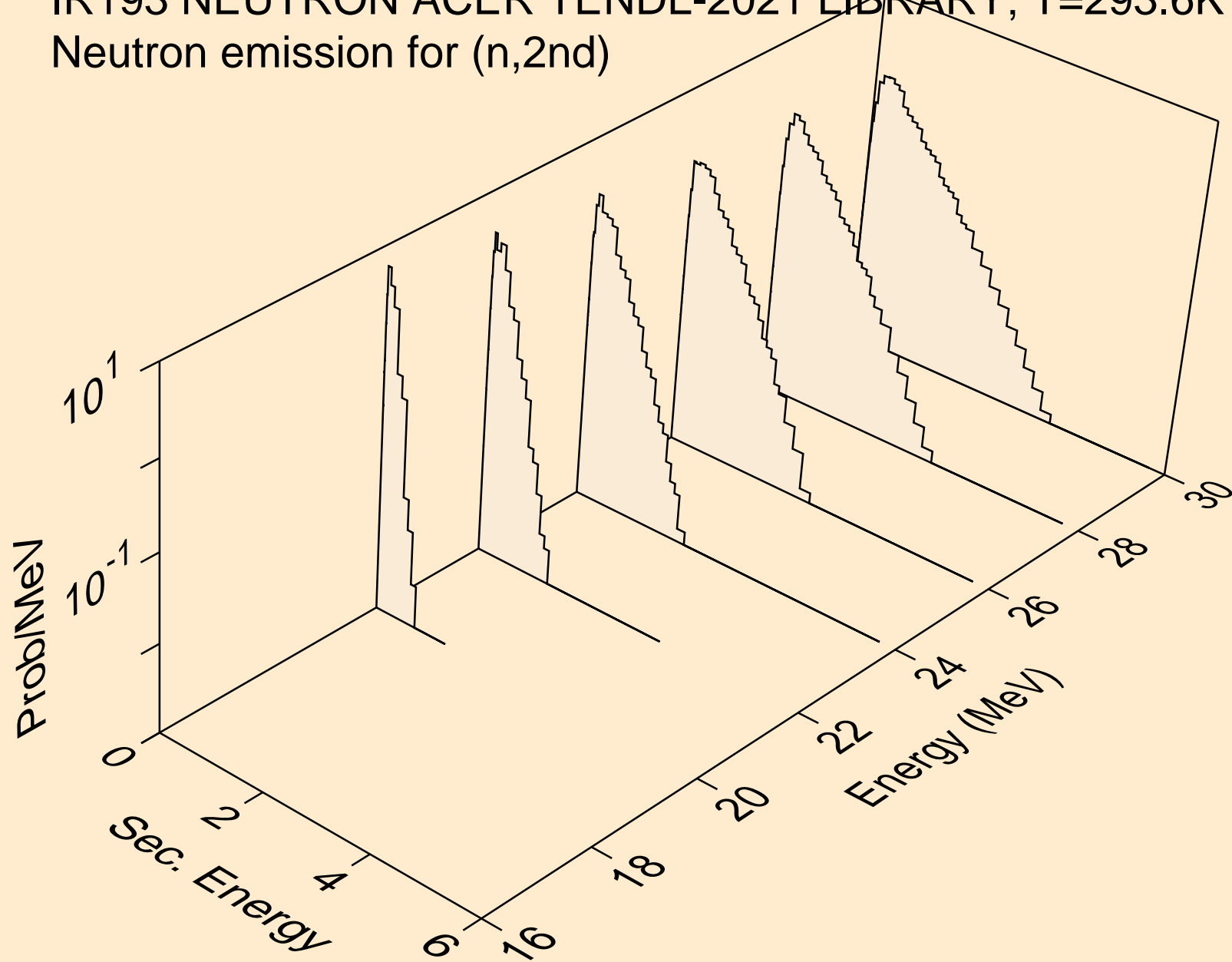

IR193 NEUTRON ACER TENDL-2021 LIBRARY; T=293.6K
Neutron emission for (n,2n)

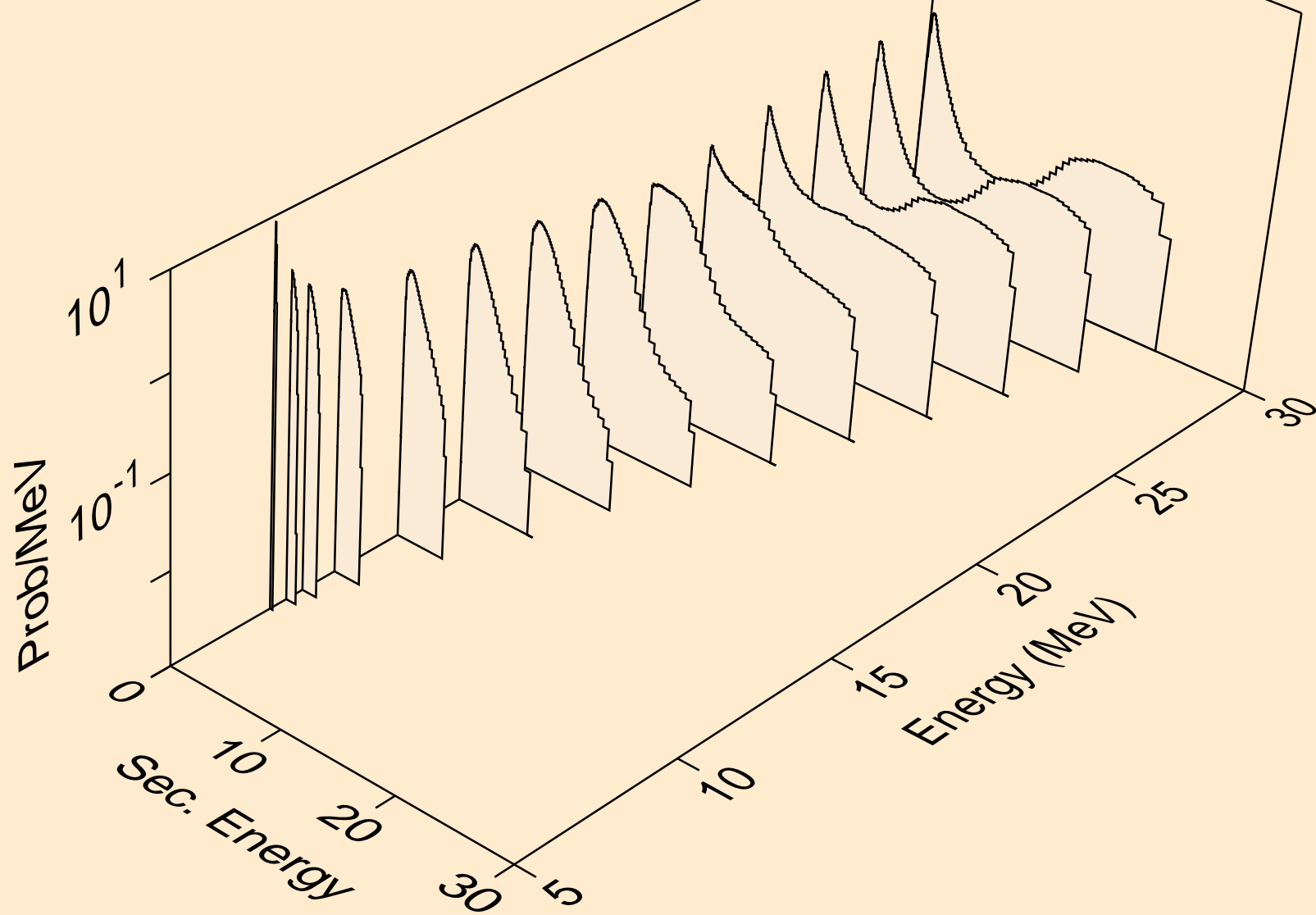

IR193 NEUTRON ACER TENDL-2021 LIBRARY; T=293.6K
Neutron emission for (n,3n)

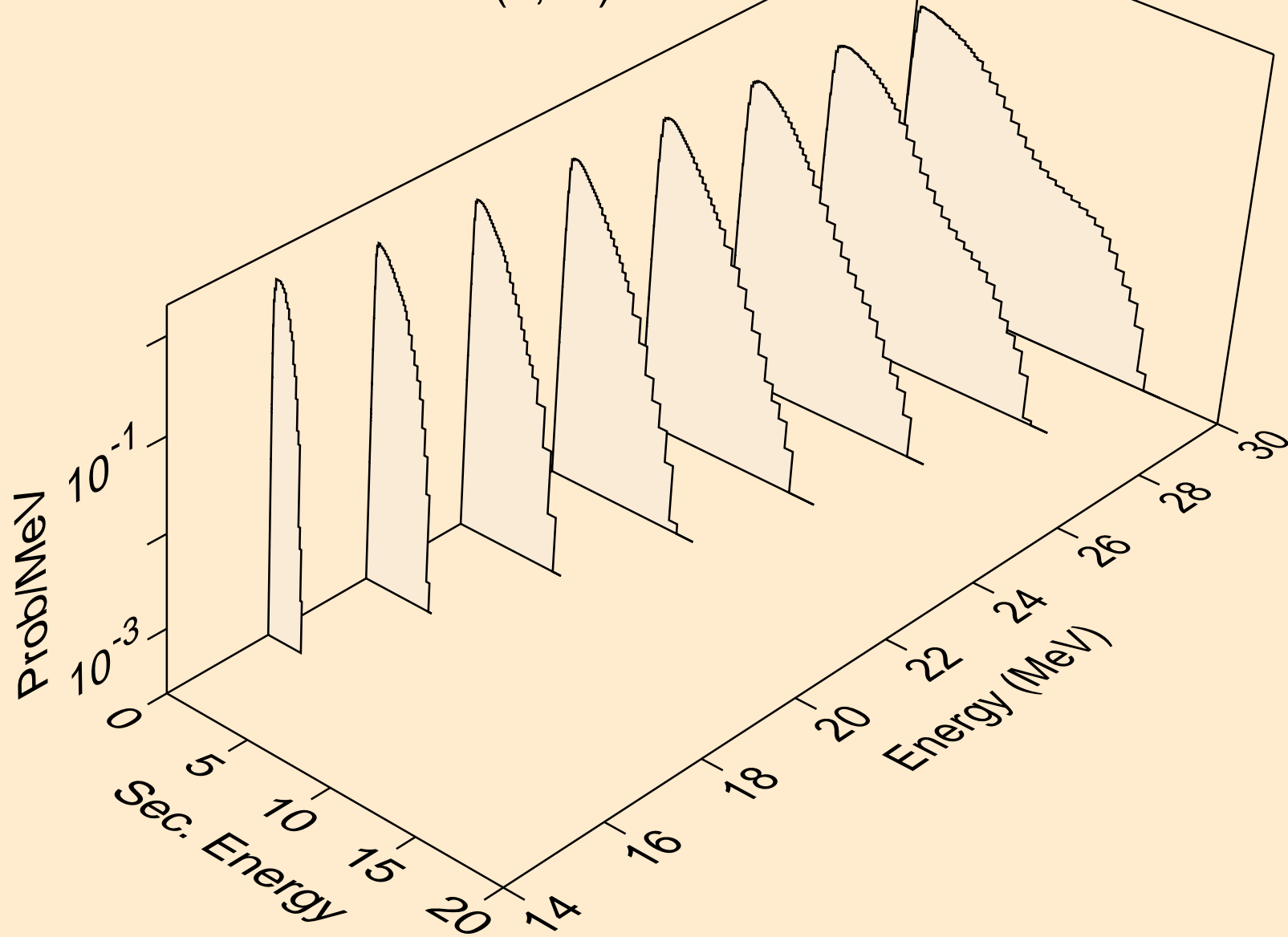

IR193 NEUTRON ACER TENDL-2021 LIBRARY; T=293.6K
Neutron emission for (n,n*)a

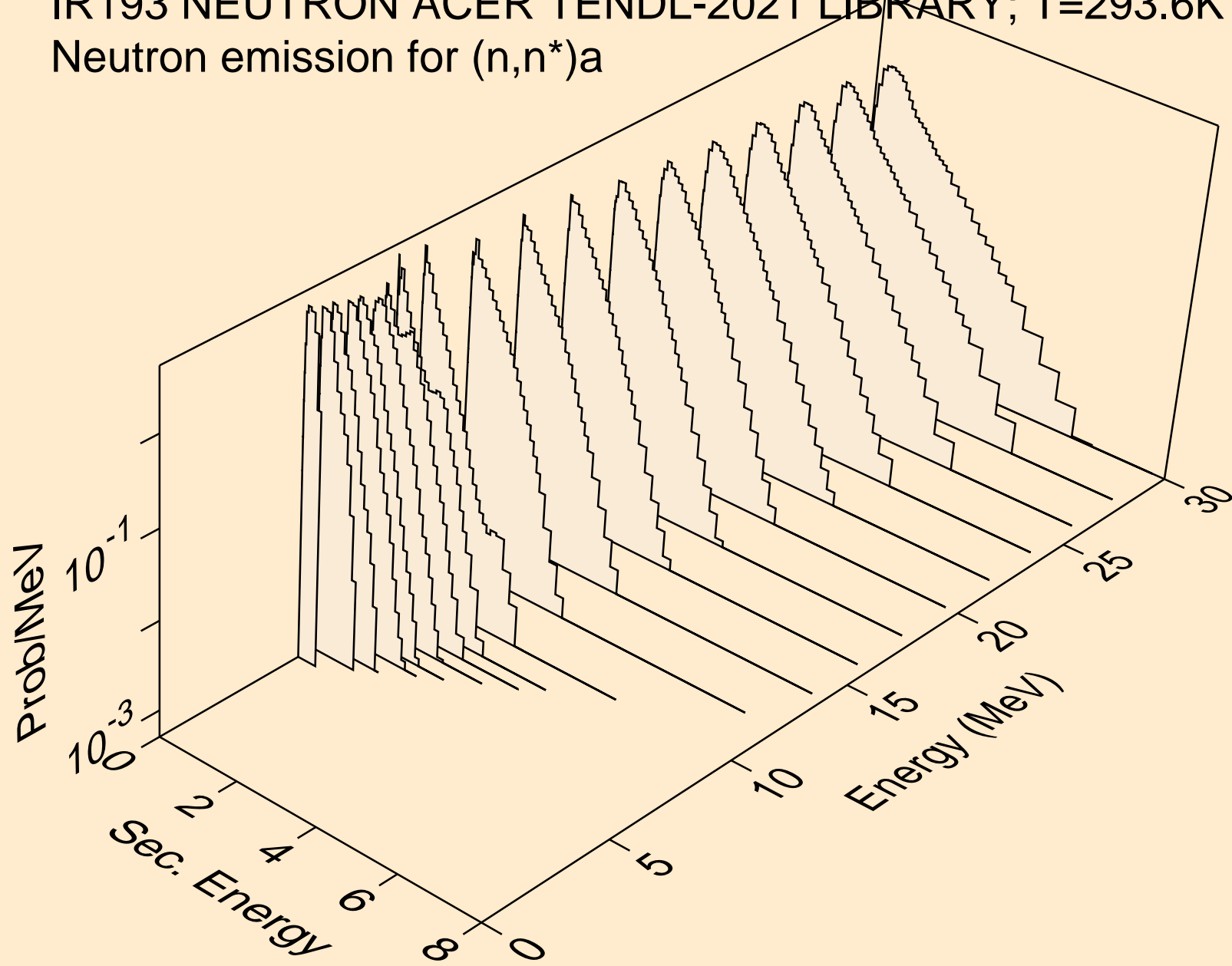

IR193 NEUTRON ACER TENDL-2021 LIBRARY; T=293.6K
Neutron emission for (n,2n)_a

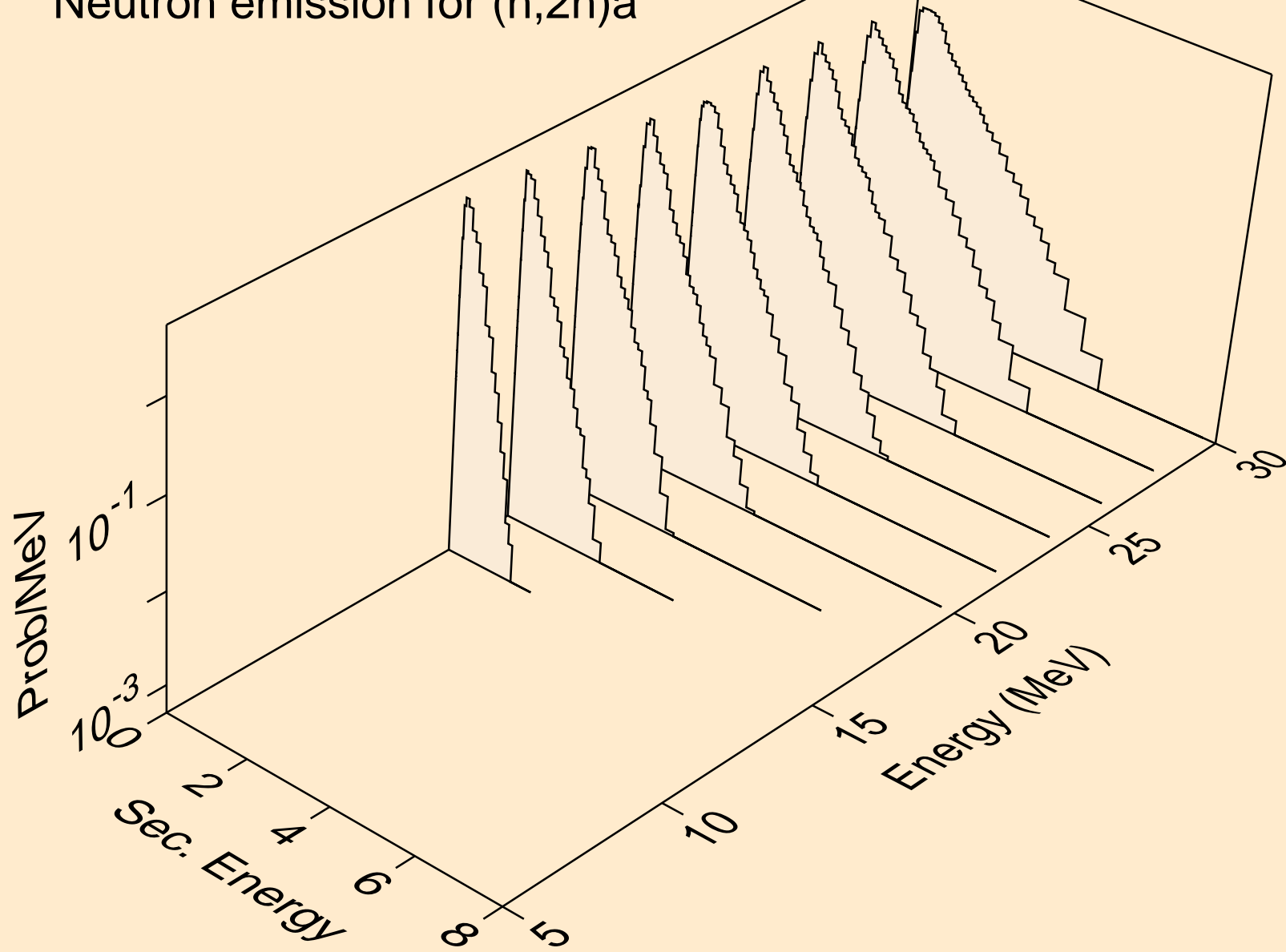

IR193 NEUTRON ACER TENDL-2021 LIBRARY; T=293.6K
Neutron emission for (n,3n)_a

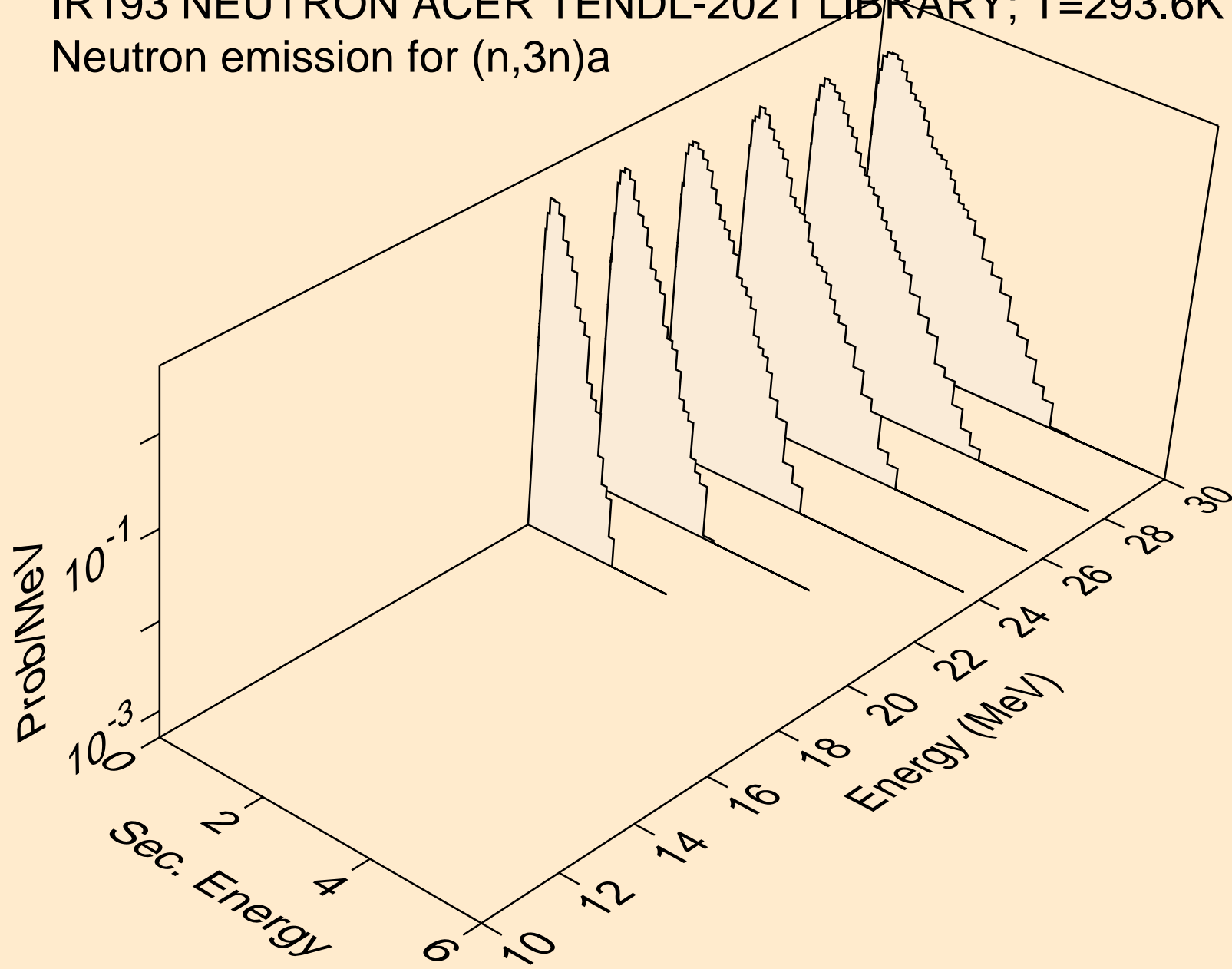

IR193 NEUTRON ACER TENDL-2021 LIBRARY; T=293.6K
Neutron emission for (n,n*)p

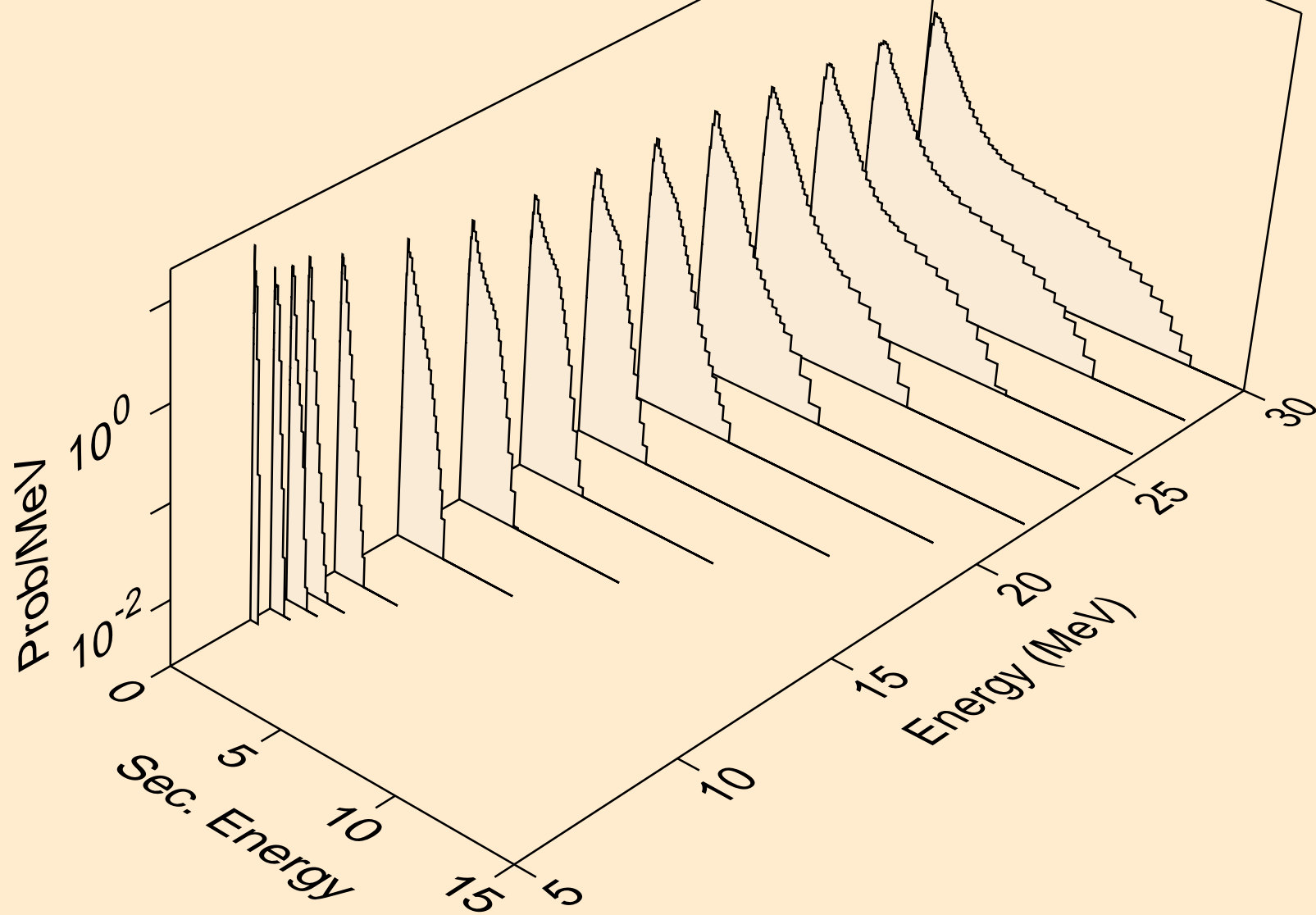

IR193 NEUTRON ACER TENDL-2021 LIBRARY; T=293.6K
Neutron emission for (n,n*)d

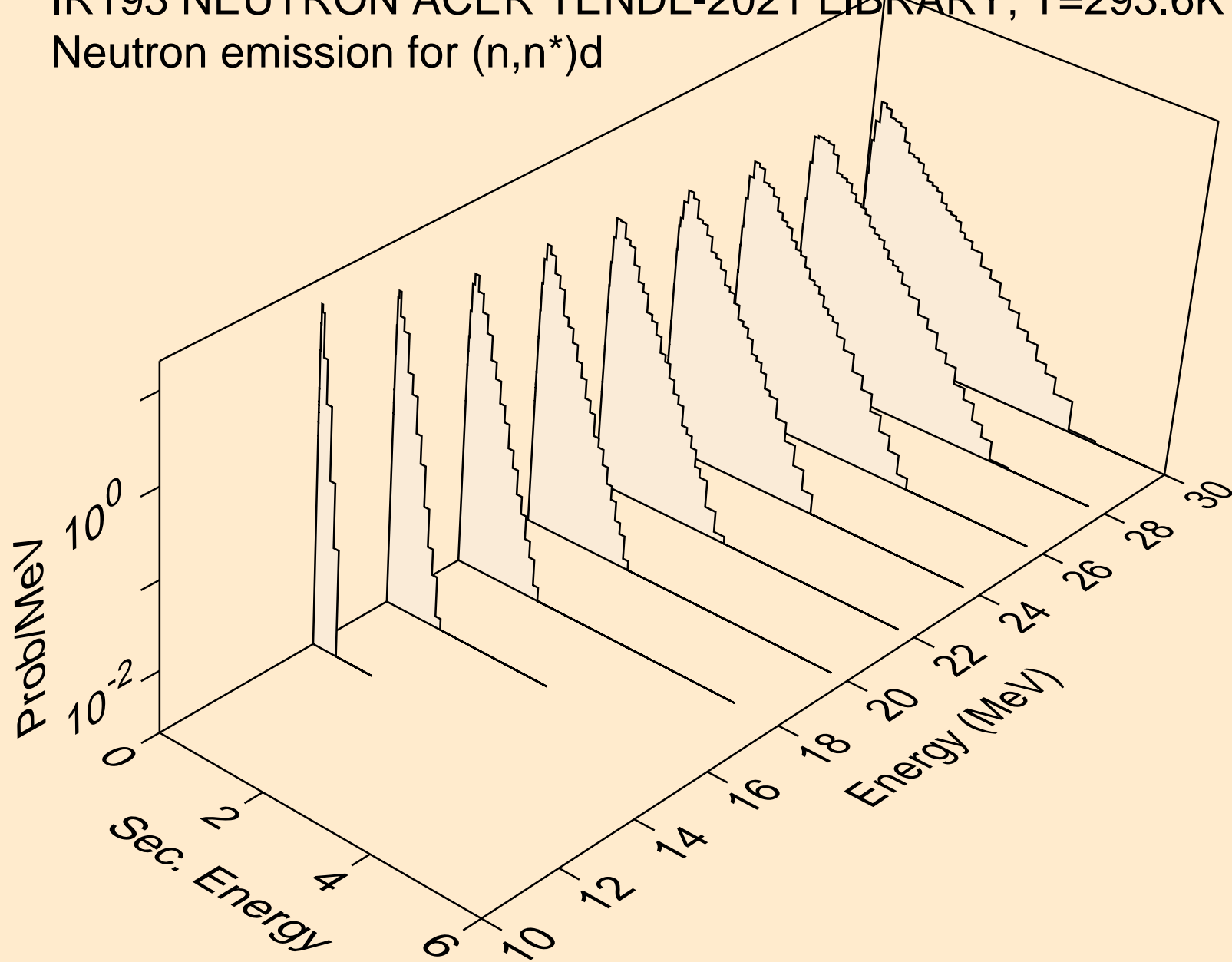

IR193 NEUTRON ACER TENDL-2021 LIBRARY; T=293.6K
Neutron emission for (n,n*)t

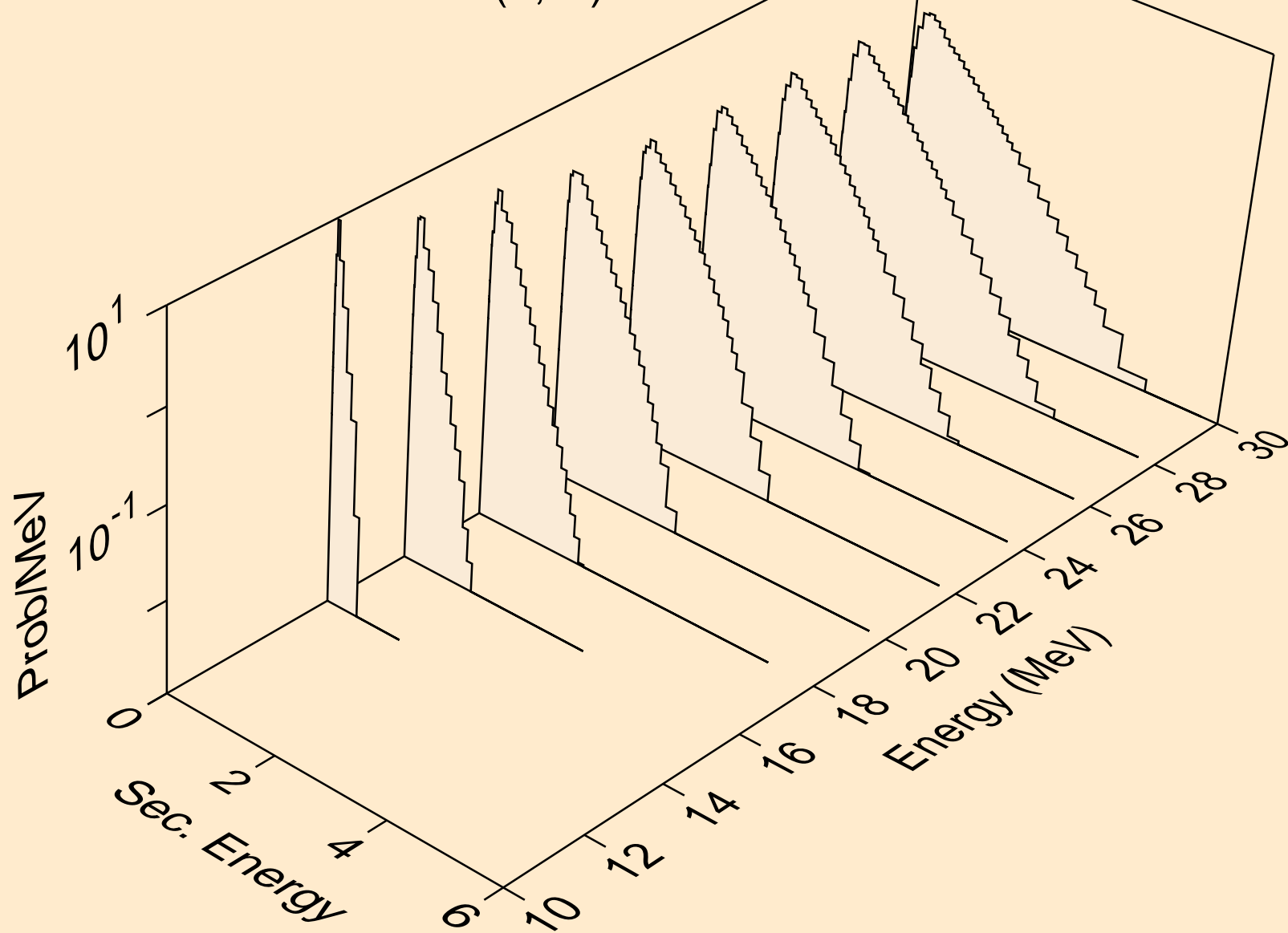

IR193 NEUTRON ACER TENDL-2021 LIBRARY; T=293.6K
Neutron emission for (n,n*)he3

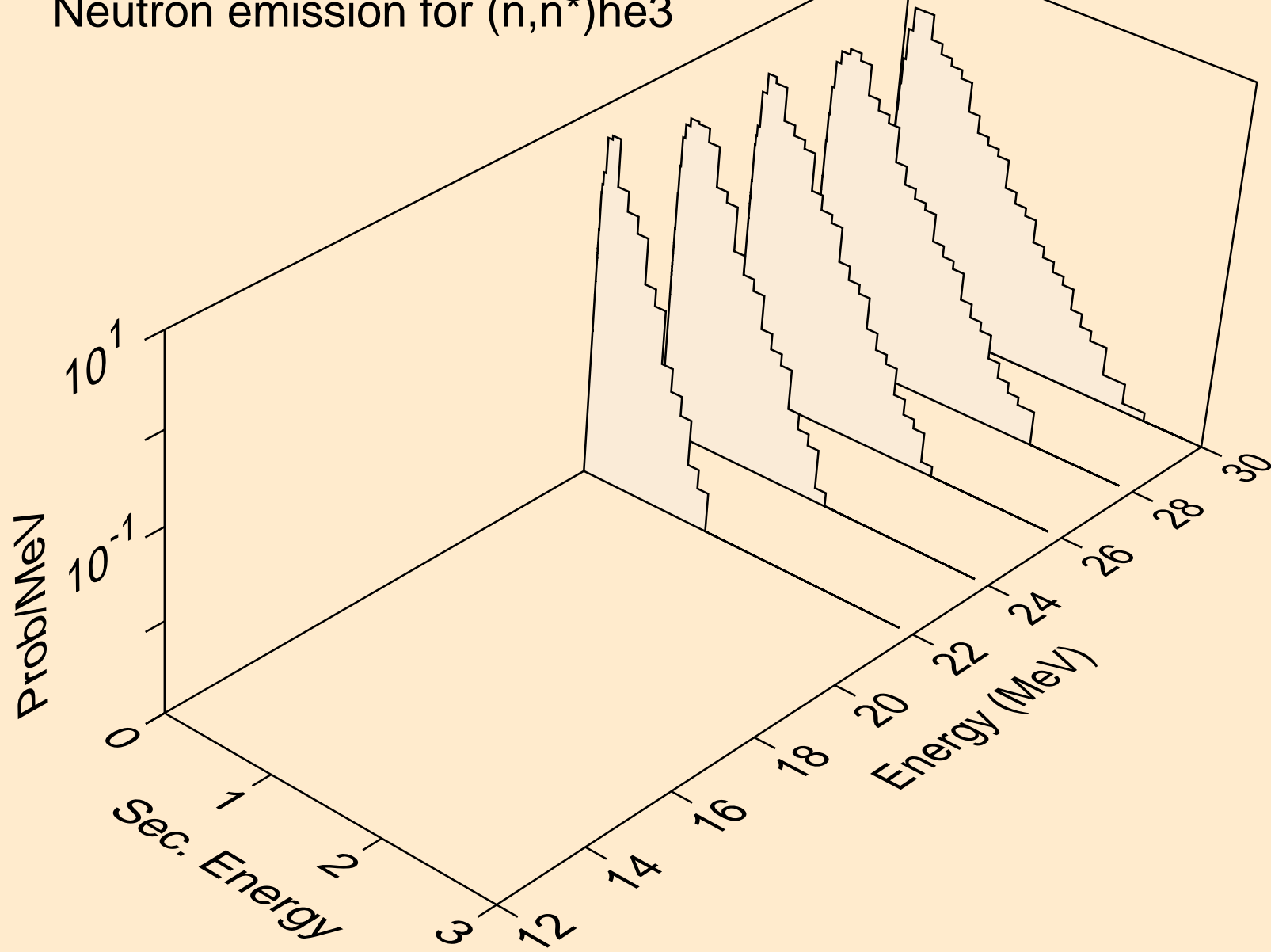

IR193 NEUTRON ACER TENDL-2021 LIBRARY; T=293.6K
Neutron emission for (n,4n)

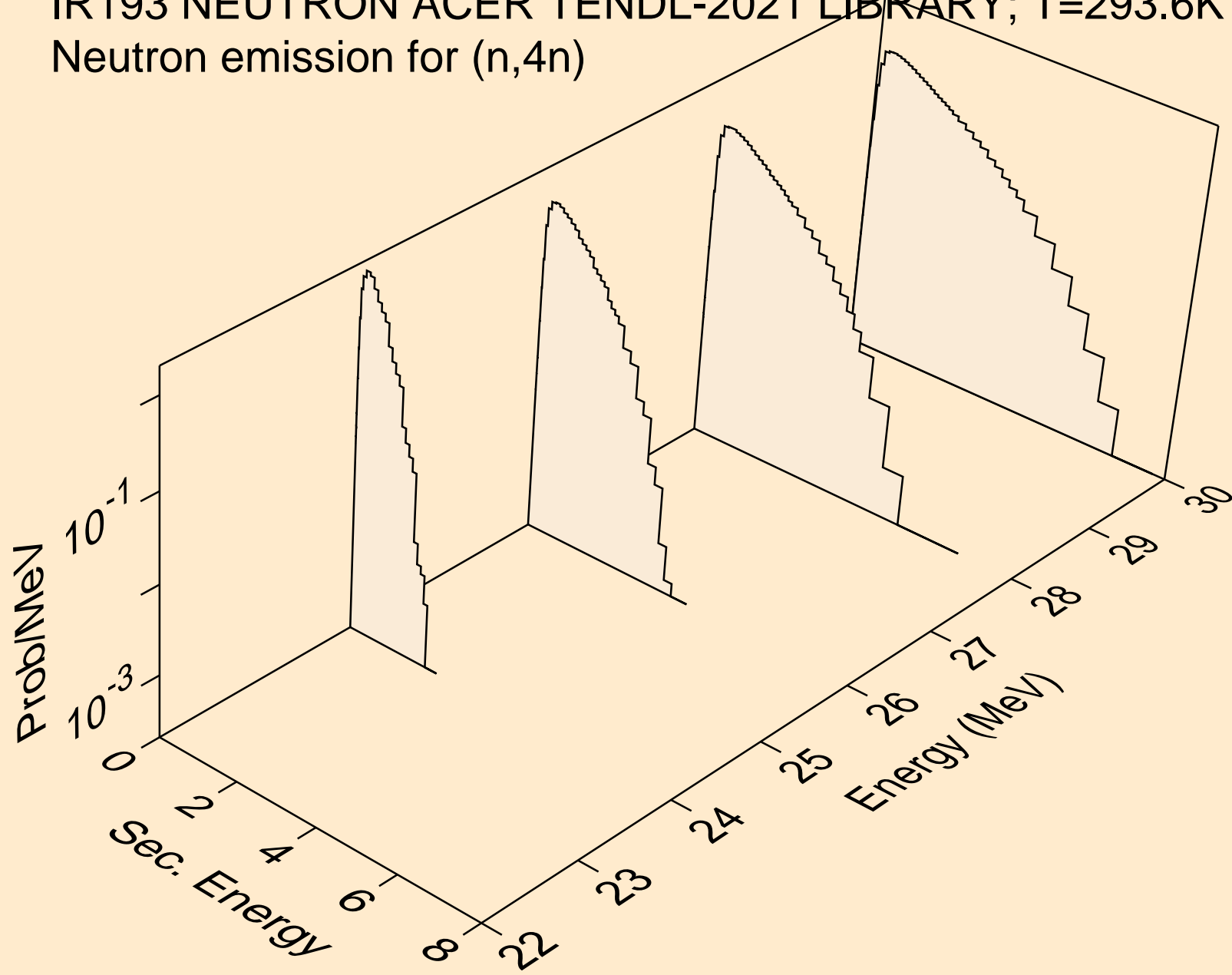

IR193 NEUTRON ACER TENDL-2021 LIBRARY; T=293.6K
Neutron emission for (n,2np)

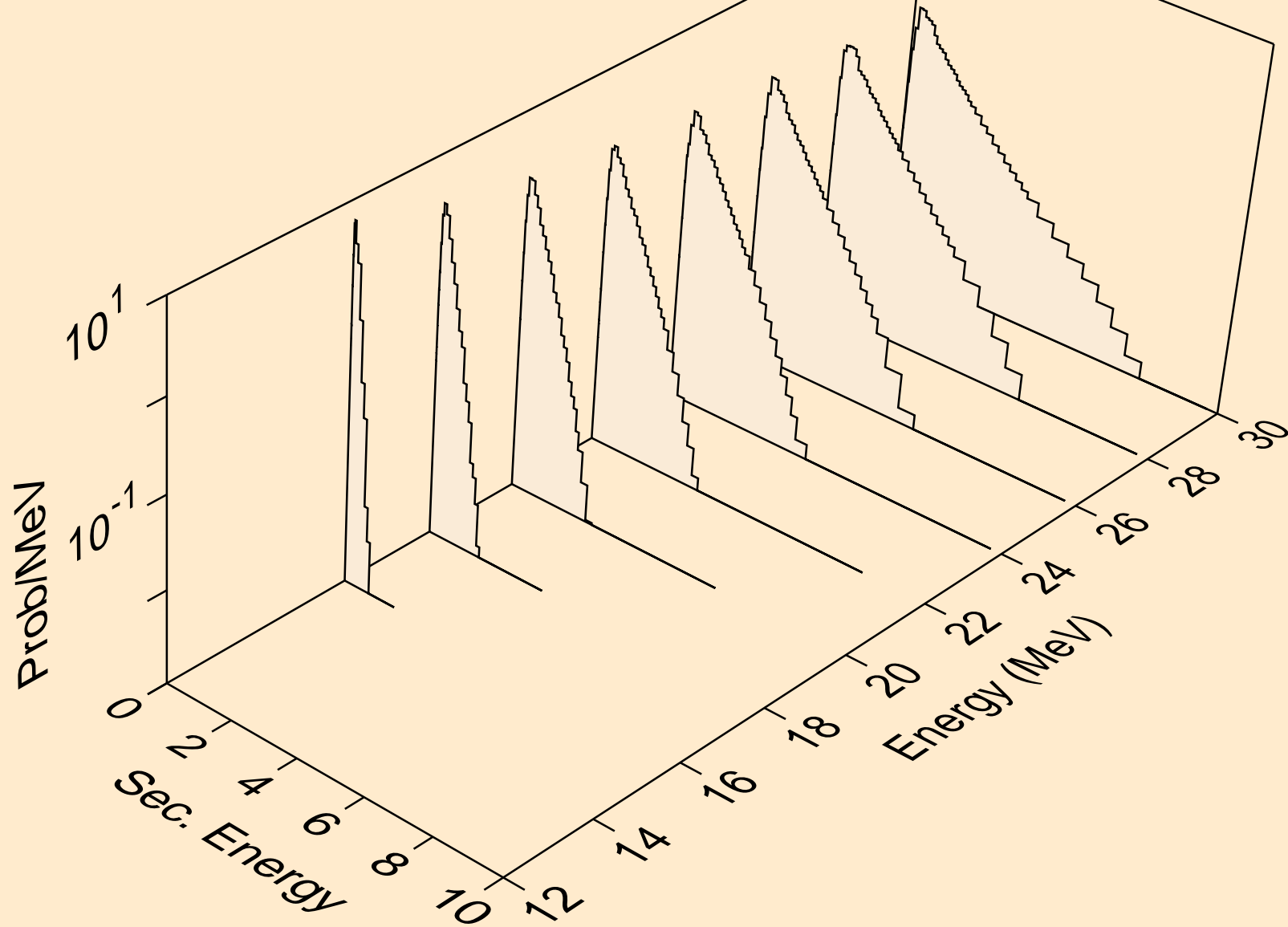

IR193 NEUTRON ACER TENDL-2021 LIBRARY; T=293.6K
Neutron emission for (n,3np)

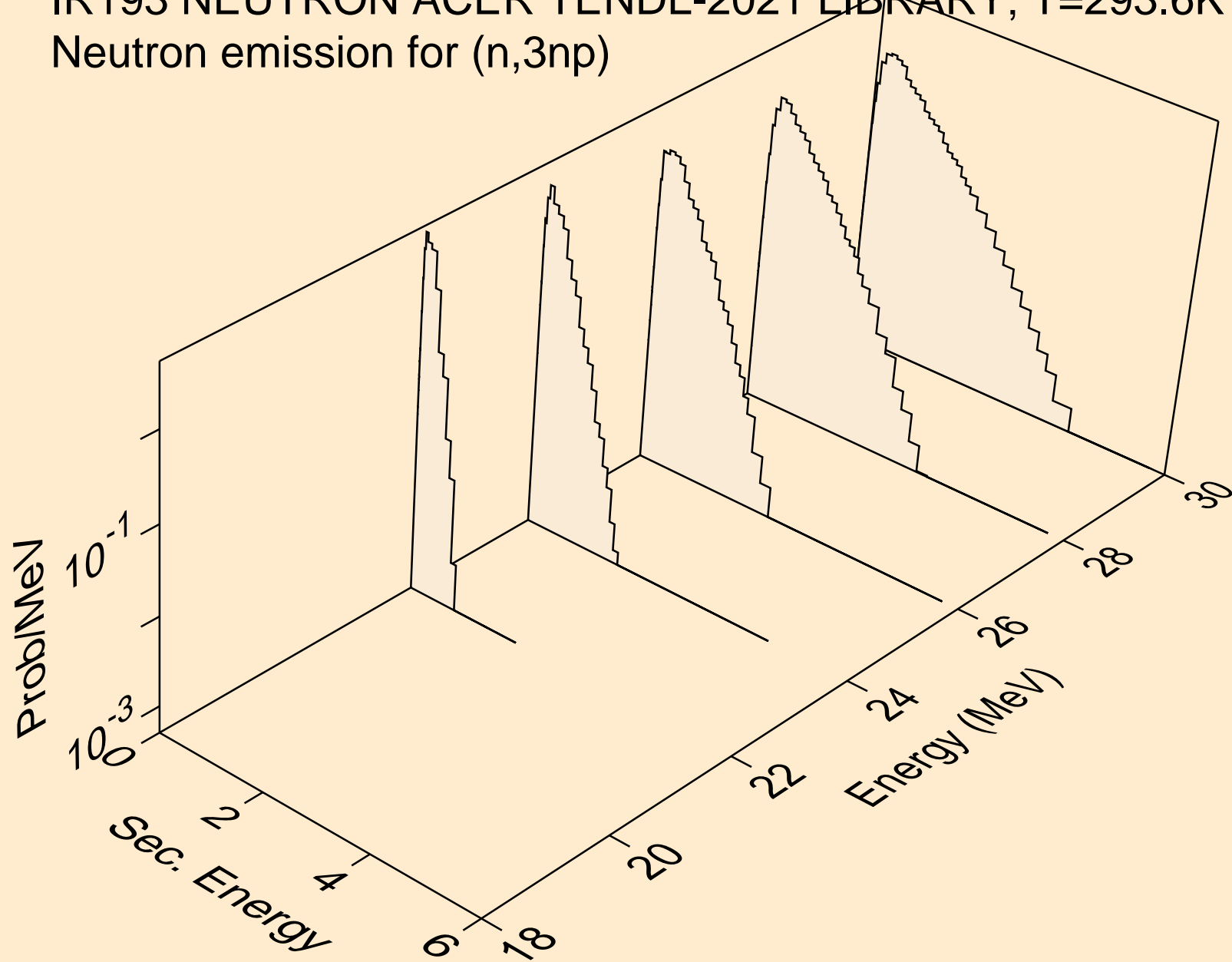

IR193 NEUTRON ACER TENDL-2021 LIBRARY; T=293.6K
Neutron emission for (n,2np)

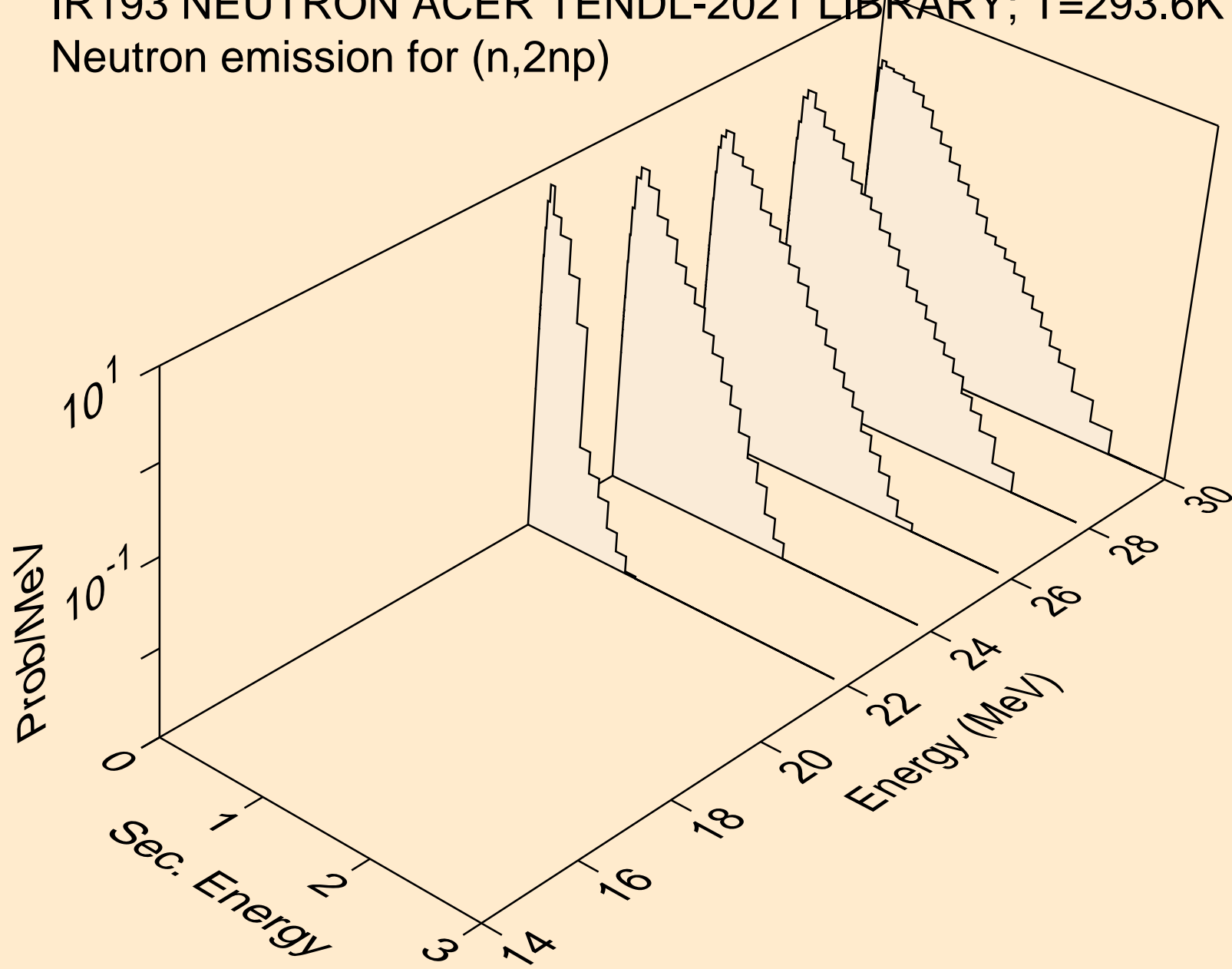

IR193 NEUTRON ACER TENDL-2021 LIBRARY; T=293.6K
Neutron emission for (n,npa)

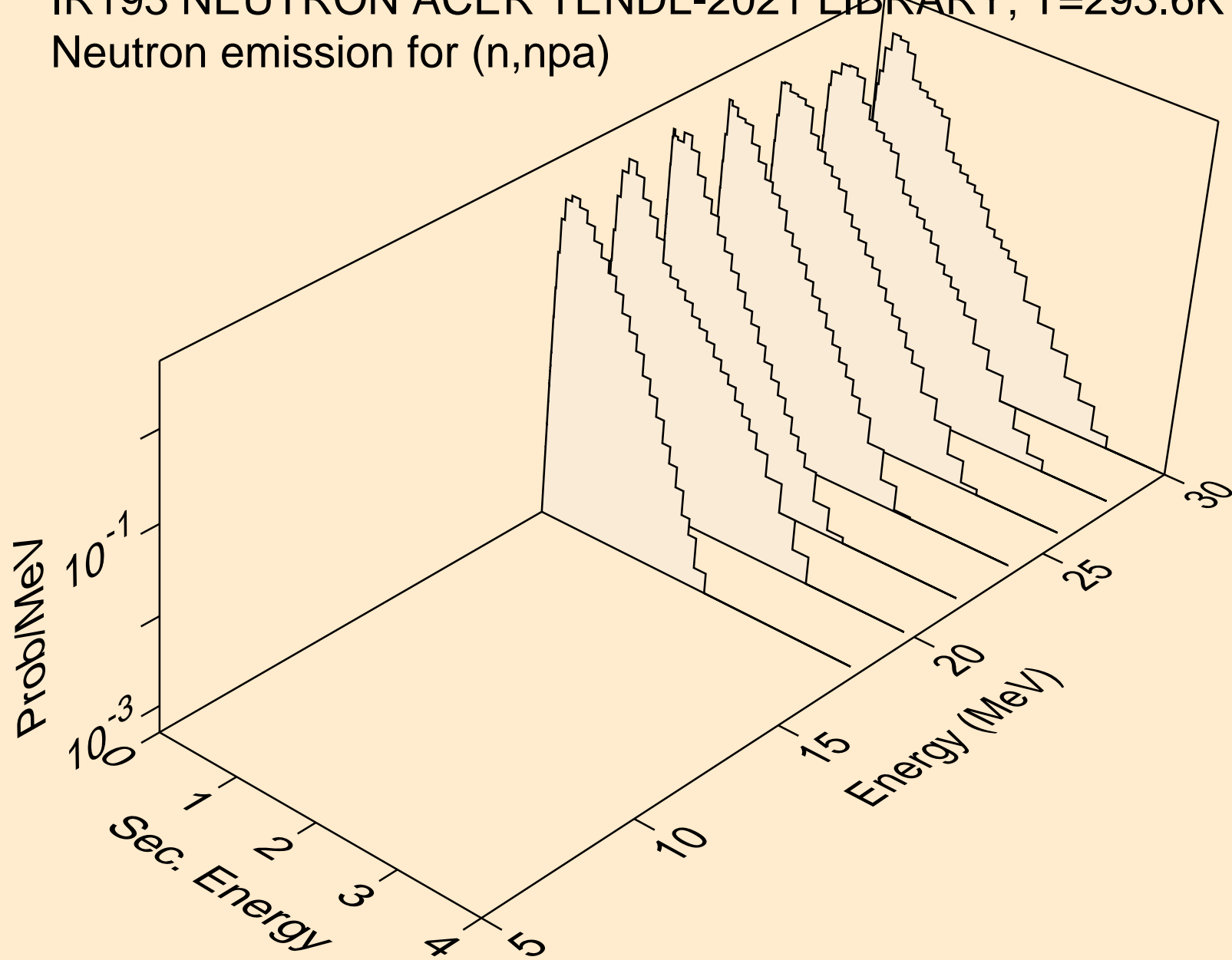

IR193 NEUTRON ACER TENDL-2021 LIBRARY; T=293.6K
Neutron emission for (n,n*c)

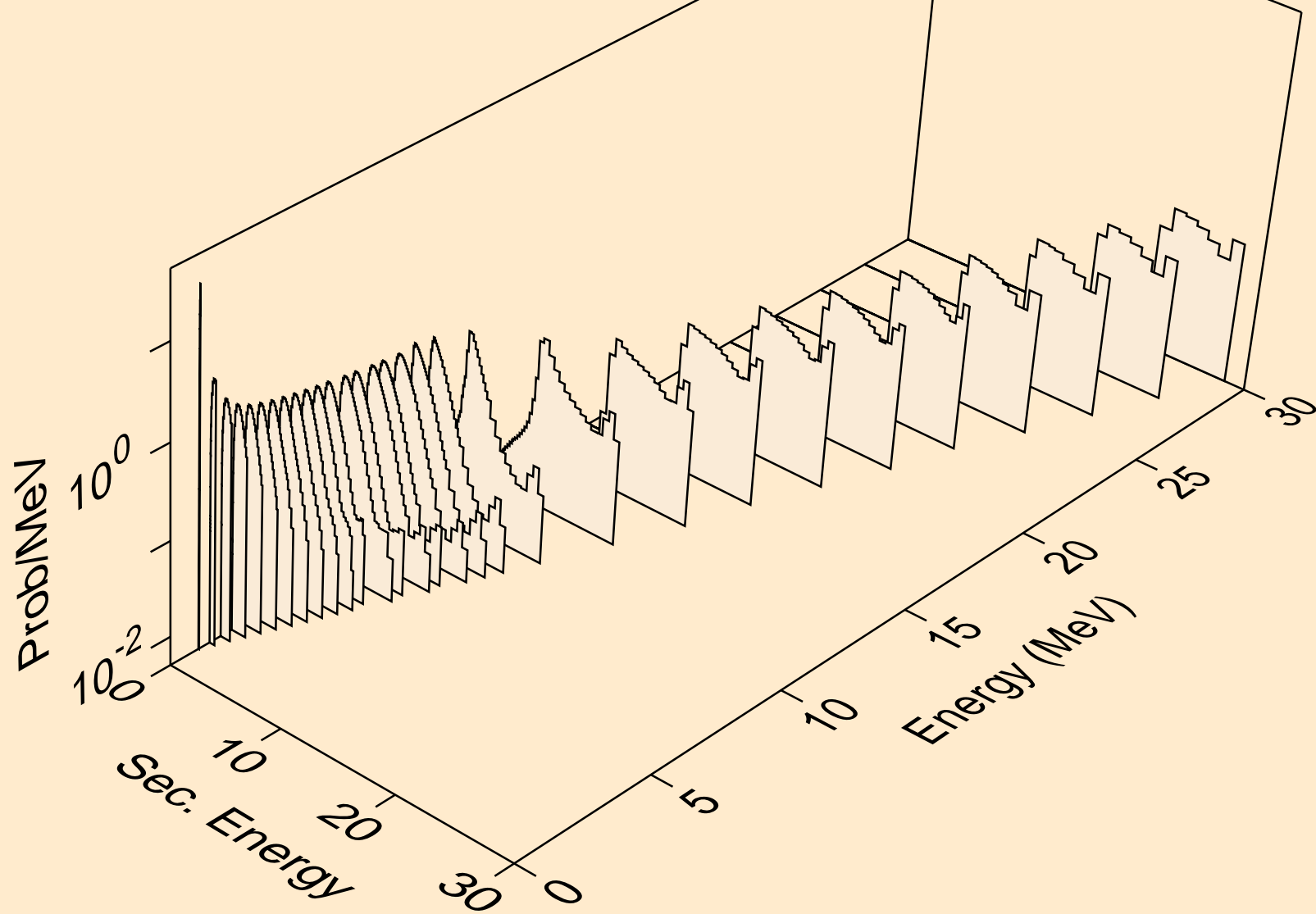

IR193 NEUTRON ACER TENDL-2021 LIBRARY; T=293.6K
Photon emission for (n,x)

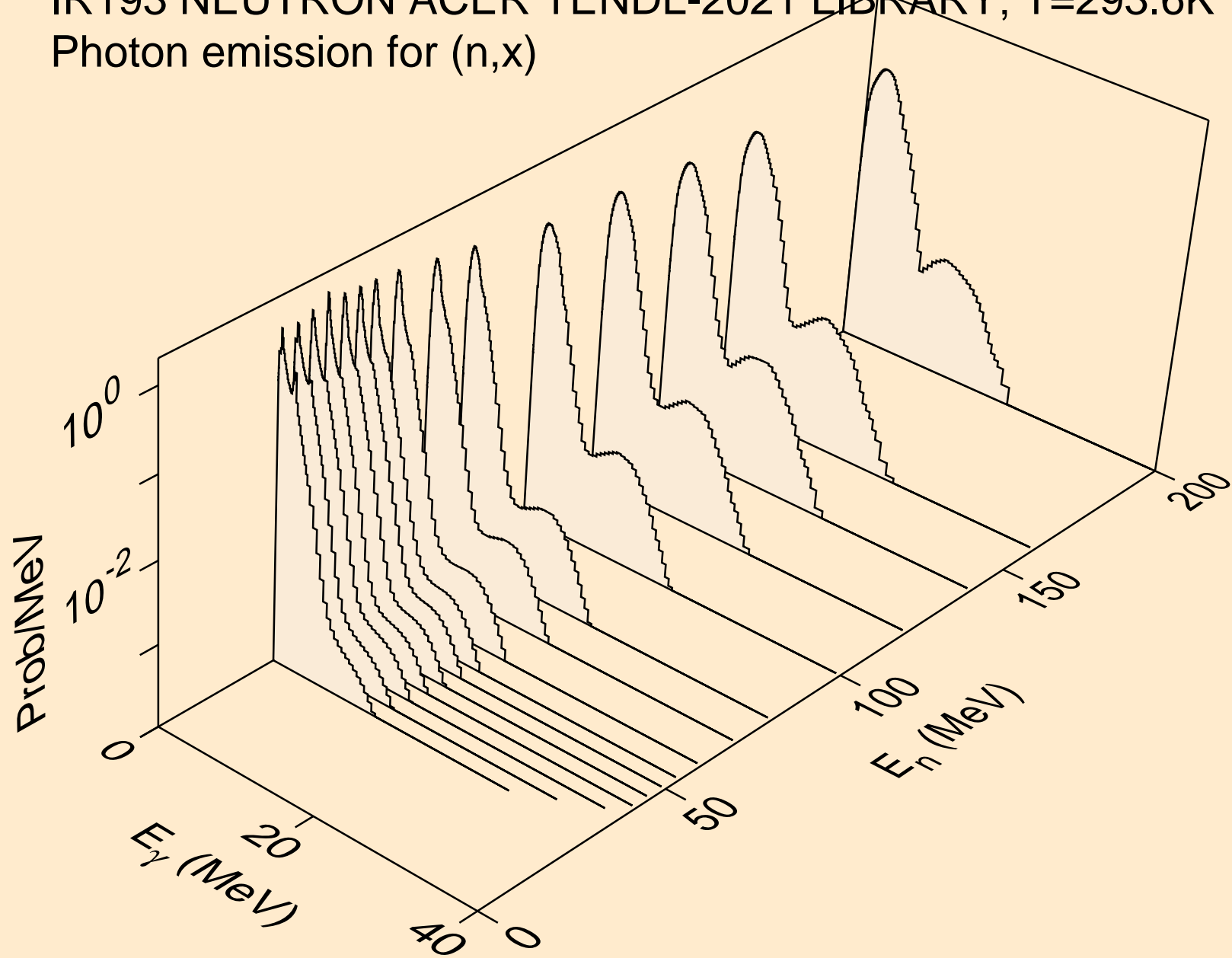

IR193 NEUTRON ACER TENDL-2021 LIBRARY; T=293.6K
Photon emission for (n,2nd)

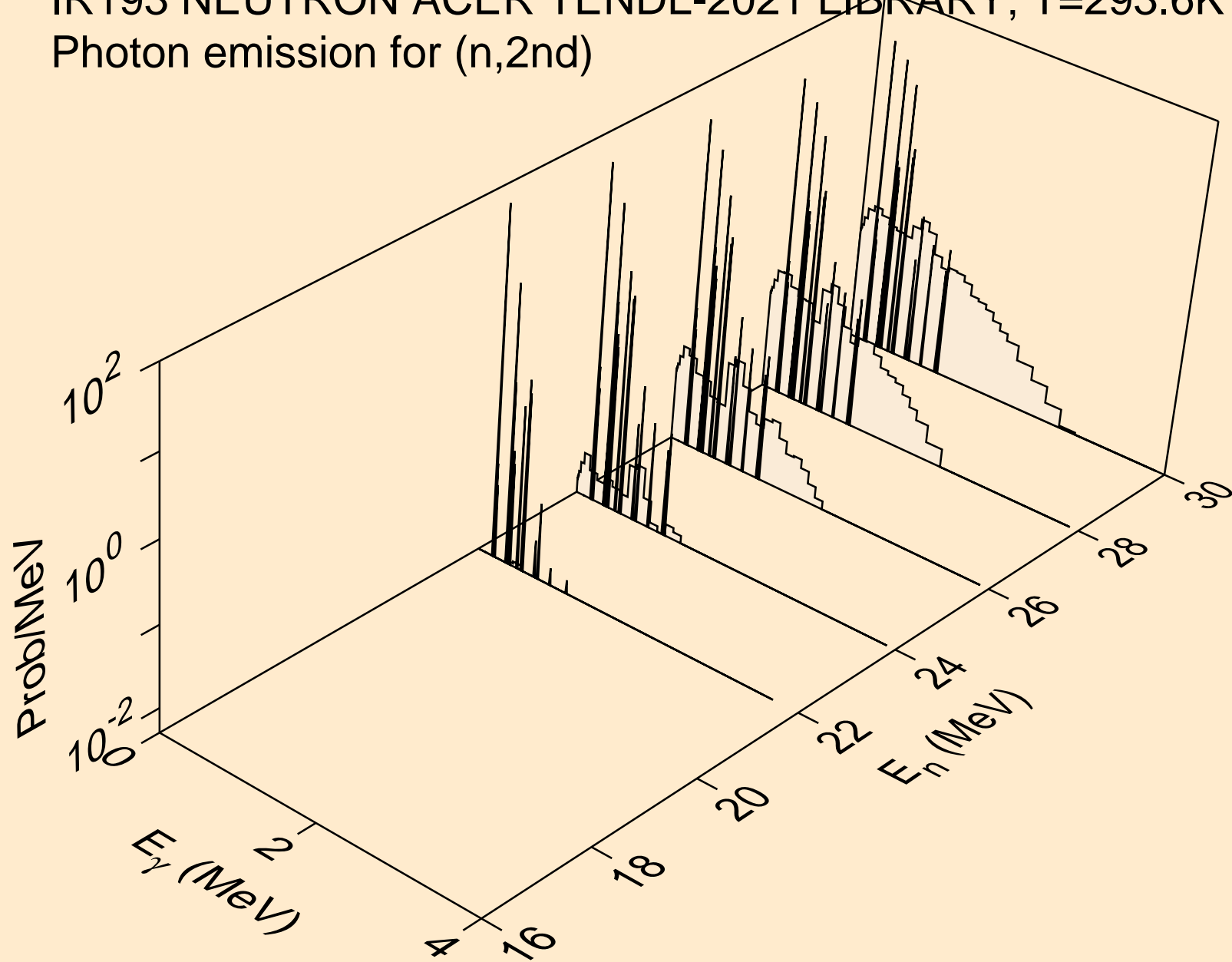

IR193 NEUTRON ACER TENDL-2021 LIBRARY; T=293.6K
Photon emission for (n,2n)

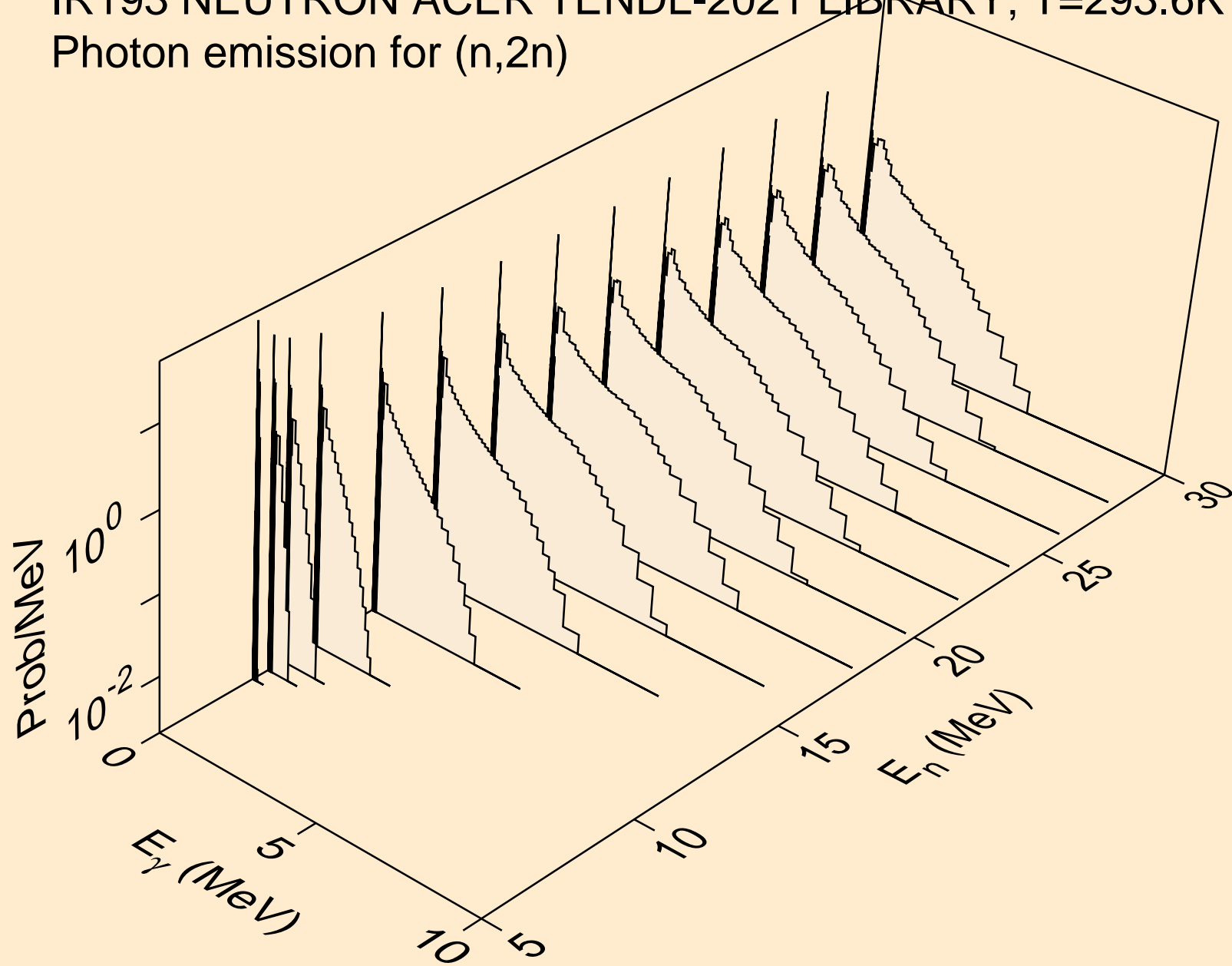

IR193 NEUTRON ACER TENDL-2021 LIBRARY; T=293.6K
Photon emission for (n,3n)

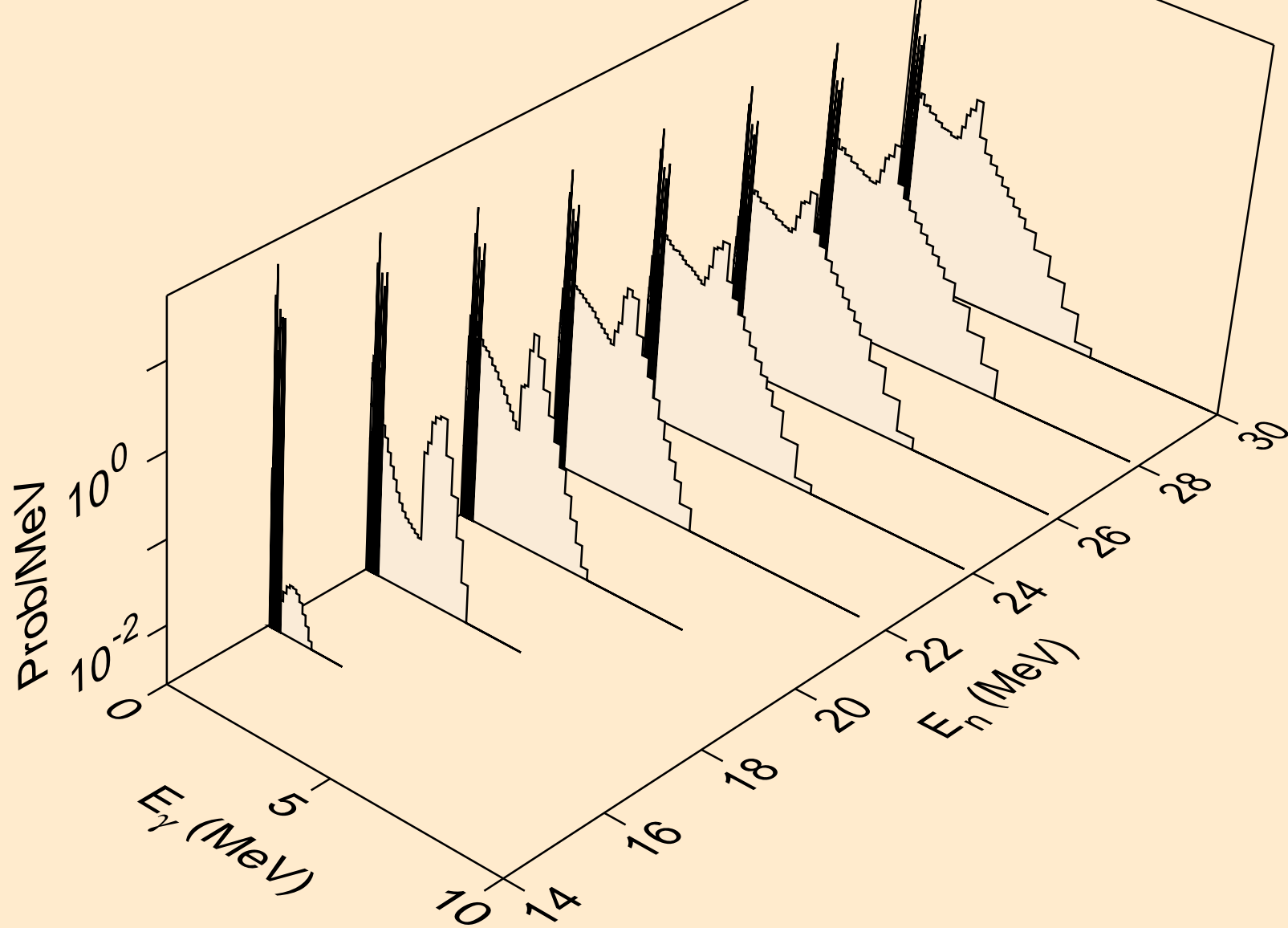

IR193 NEUTRON ACER TENDL-2021 LIBRARY; T=293.6K
Photon emission for (n,n*)a

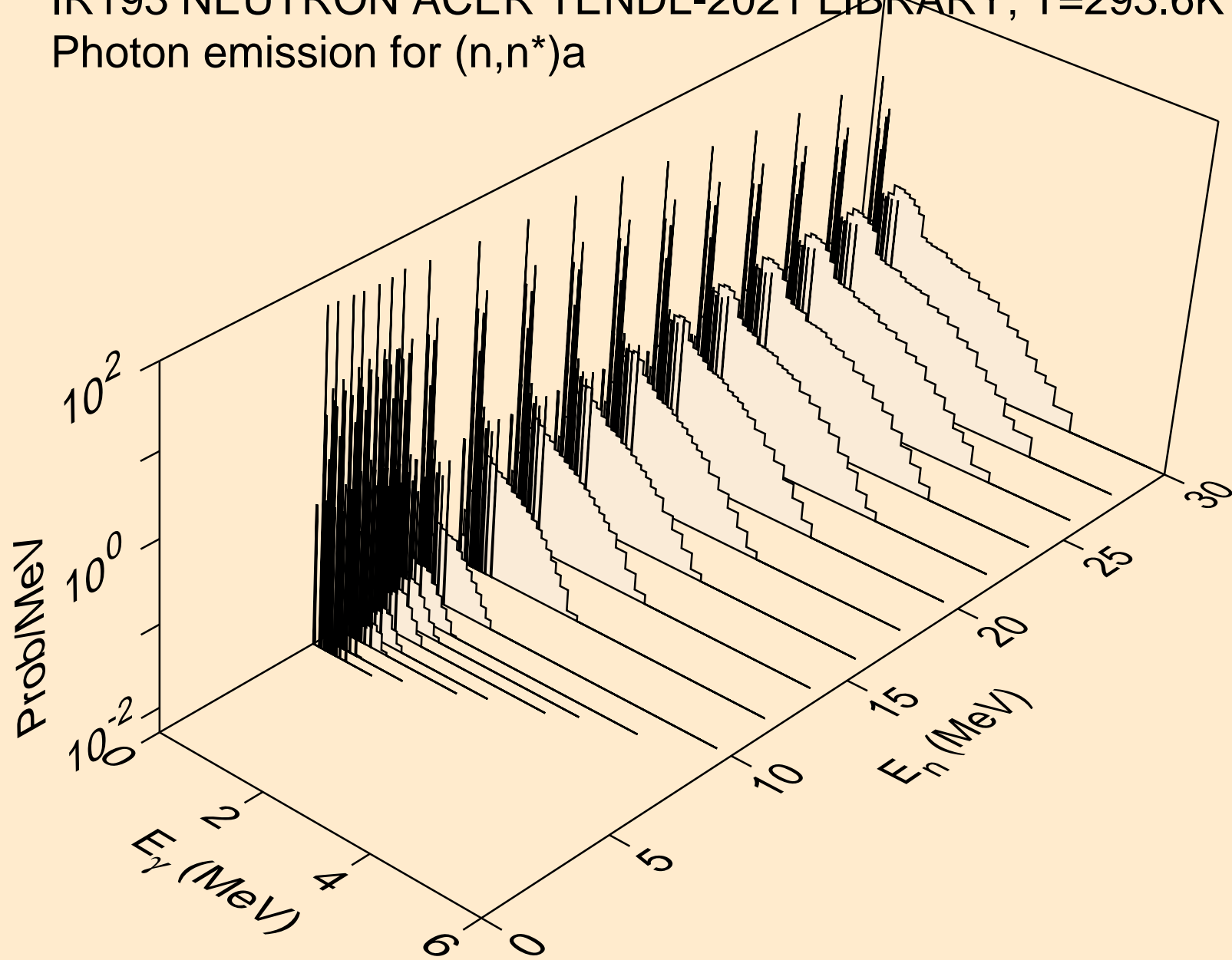

IR193 NEUTRON ACER TENDL-2021 LIBRARY; T=293.6K
Photon emission for (n,2n)a

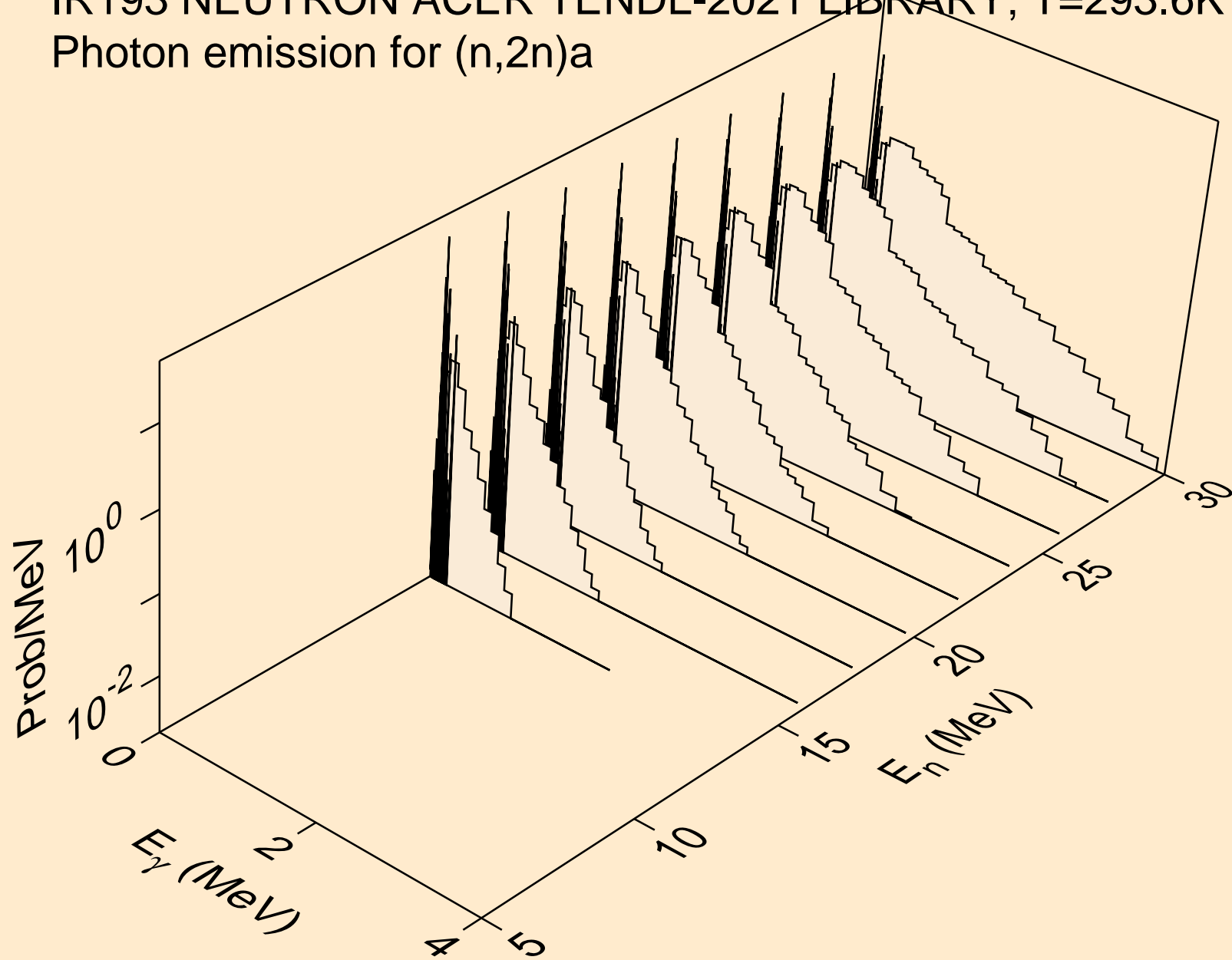

IR193 NEUTRON ACER TENDL-2021 LIBRARY; T=293.6K
Photon emission for (n,3n)a

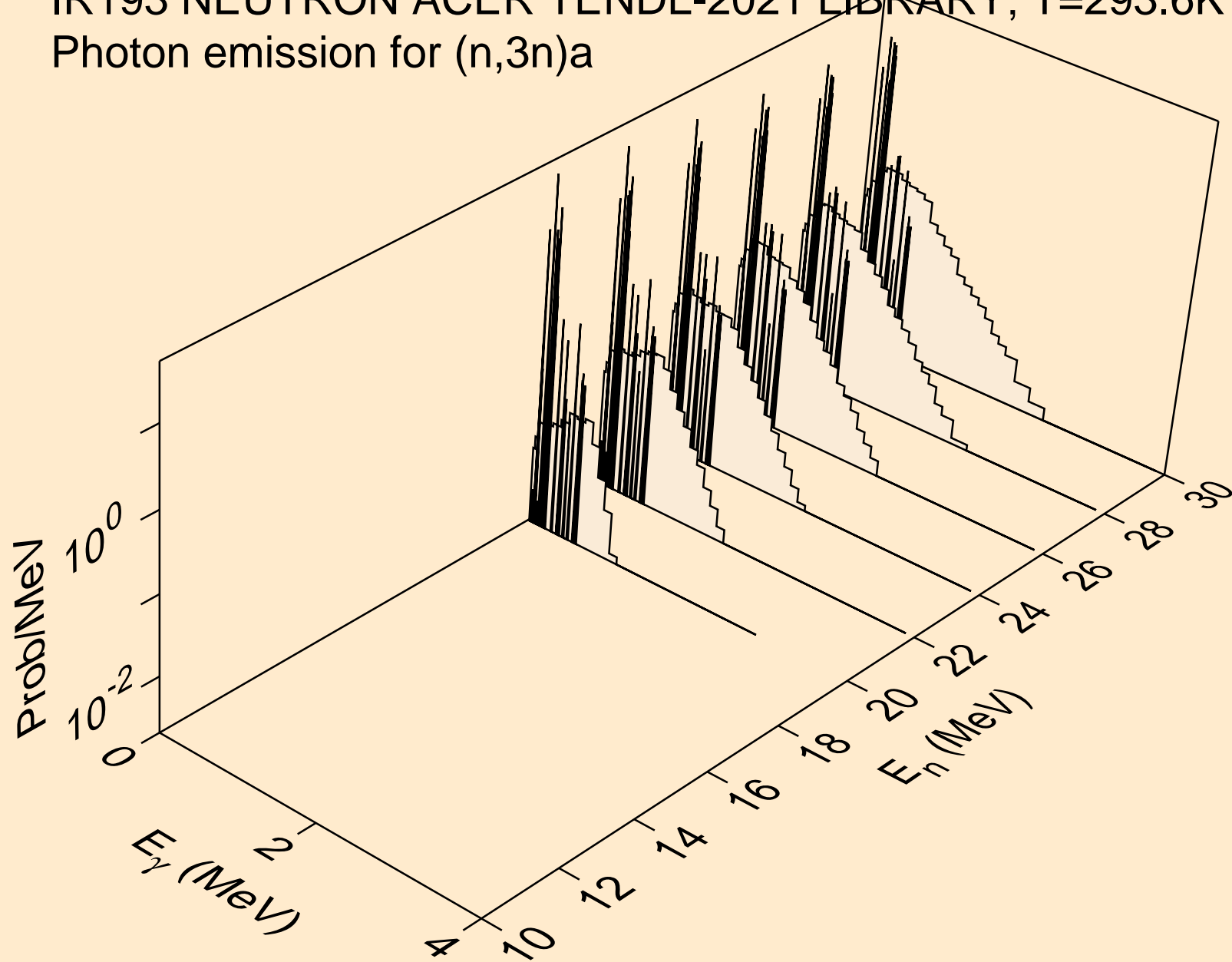

IR193 NEUTRON ACER TENDL-2021 LIBRARY; T=293.6K
Photon emission for (n,n*)p

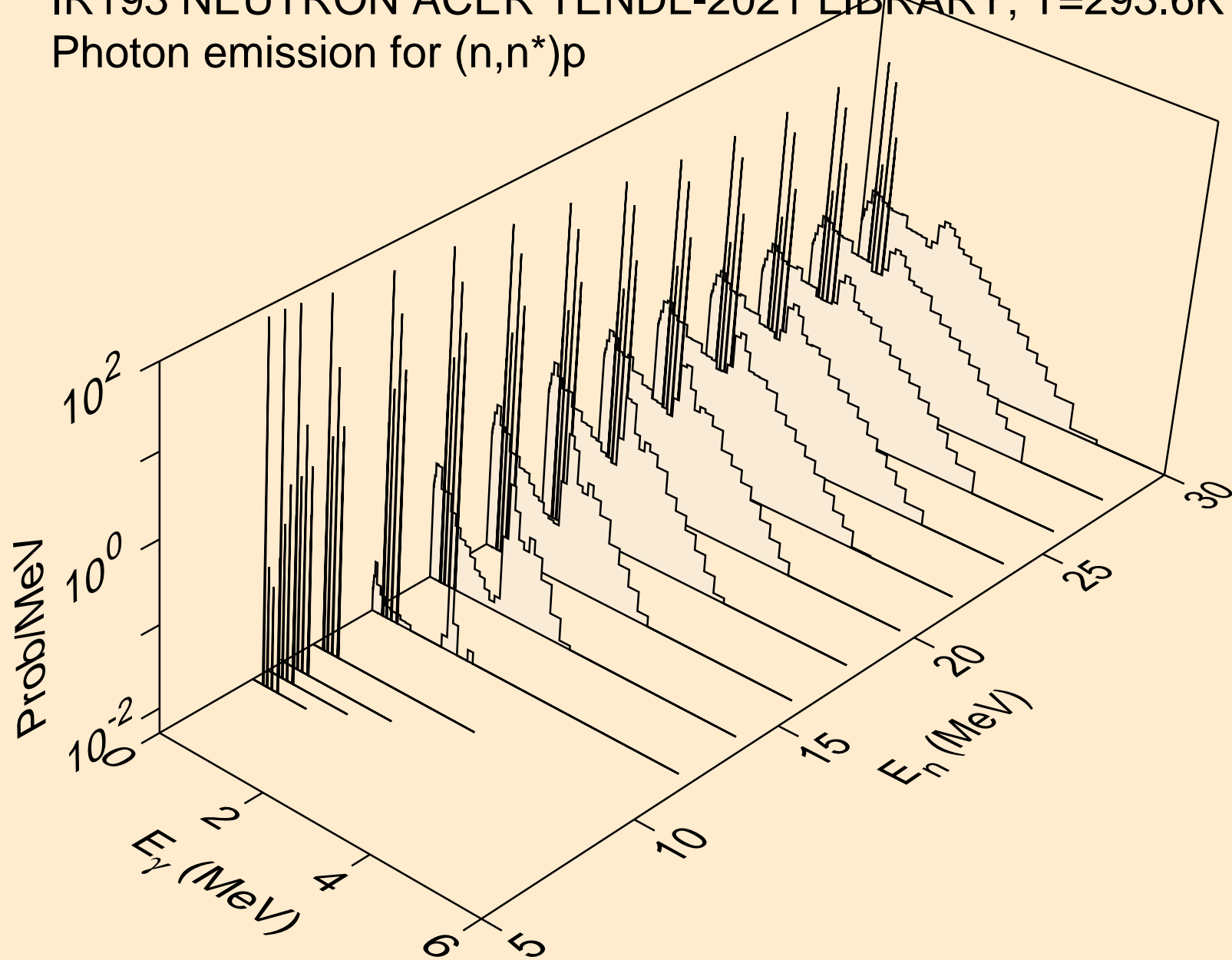

IR193 NEUTRON ACER TENDL-2021 LIBRARY; T=293.6K
Photon emission for (n,n*)d

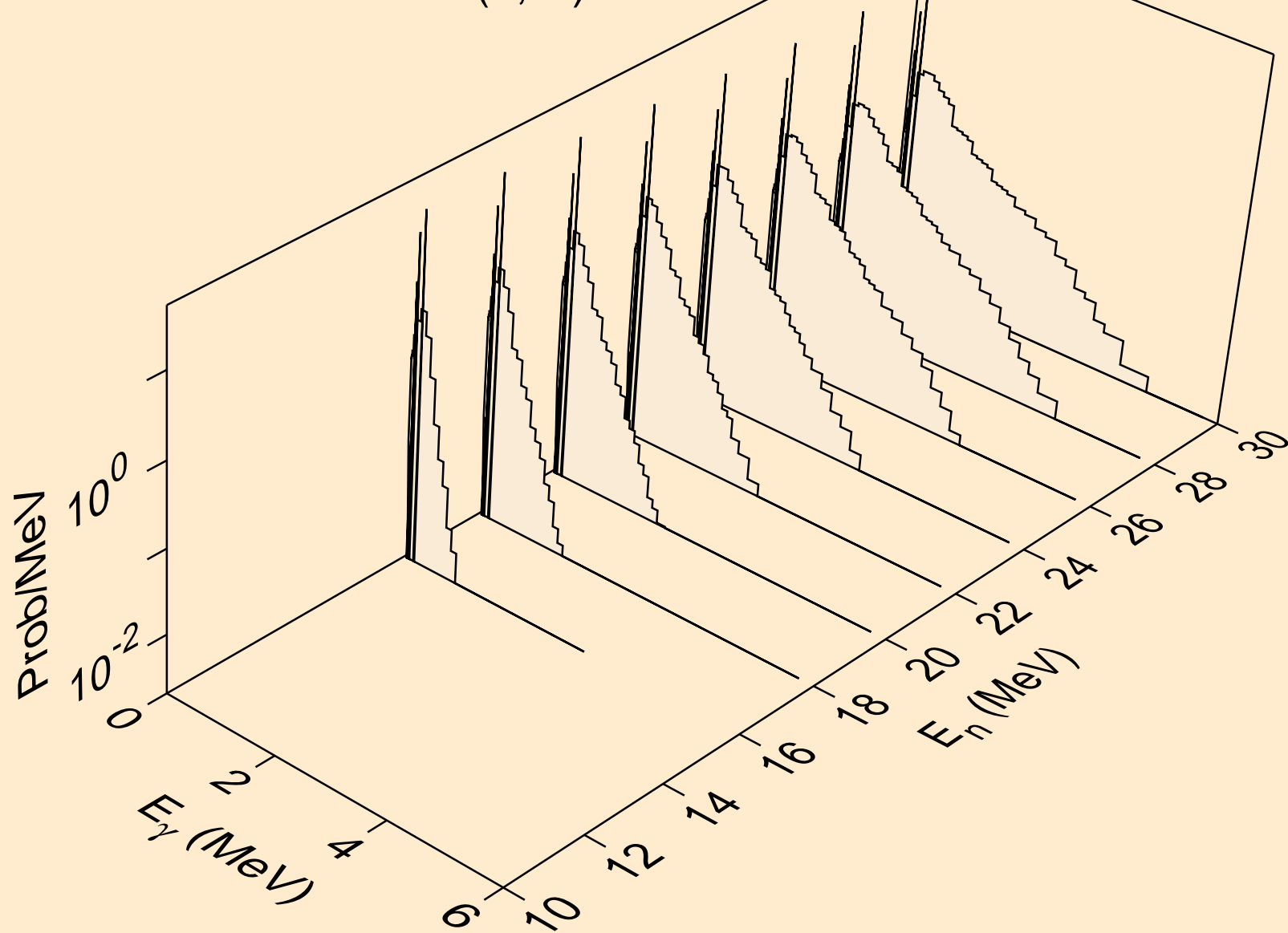

IR193 NEUTRON ACER TENDL-2021 LIBRARY; T=293.6K
Photon emission for (n,n*)t

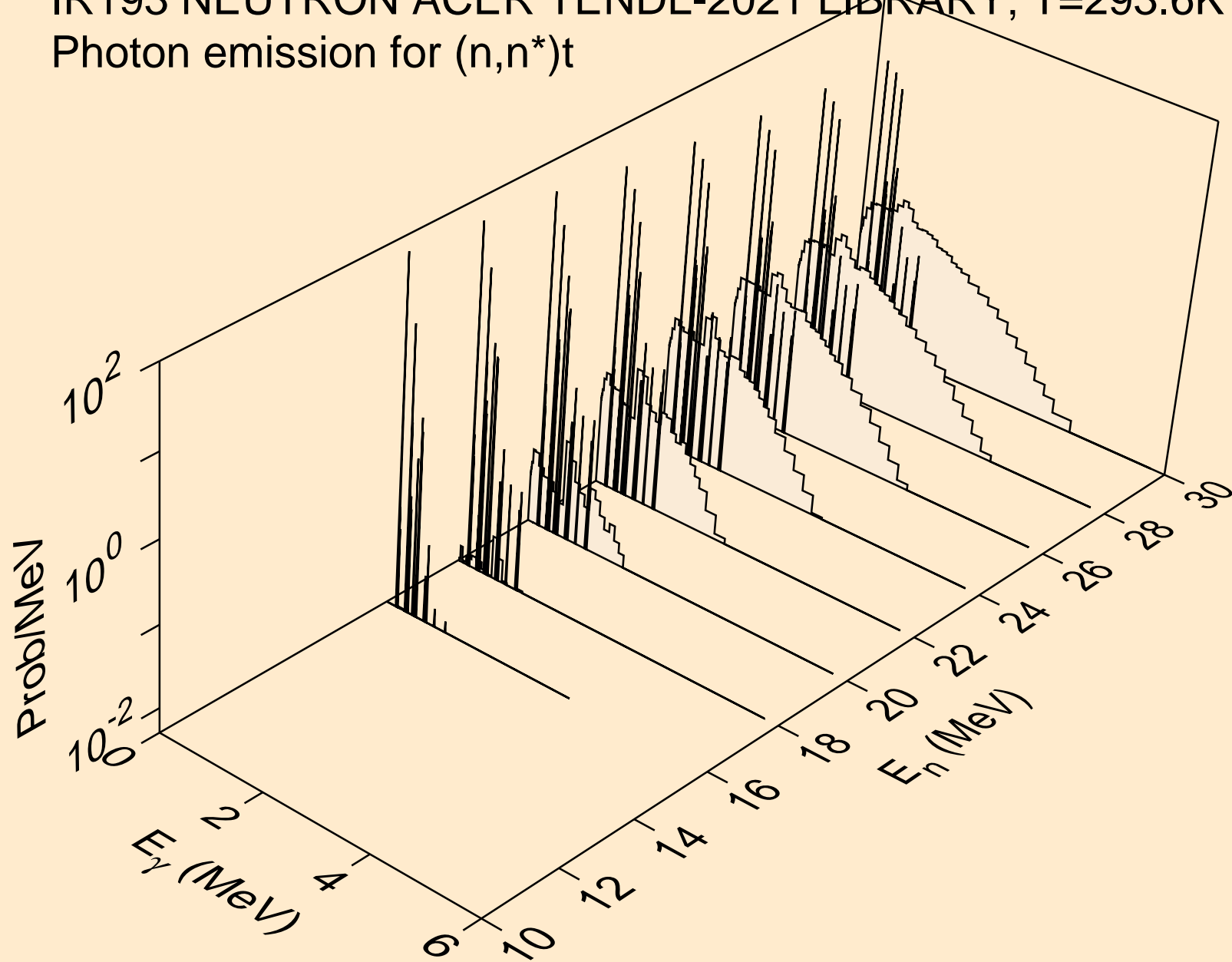

IR193 NEUTRON ACER TENDL-2021 LIBRARY; T=293.6K
Photon emission for (n,n*)he3

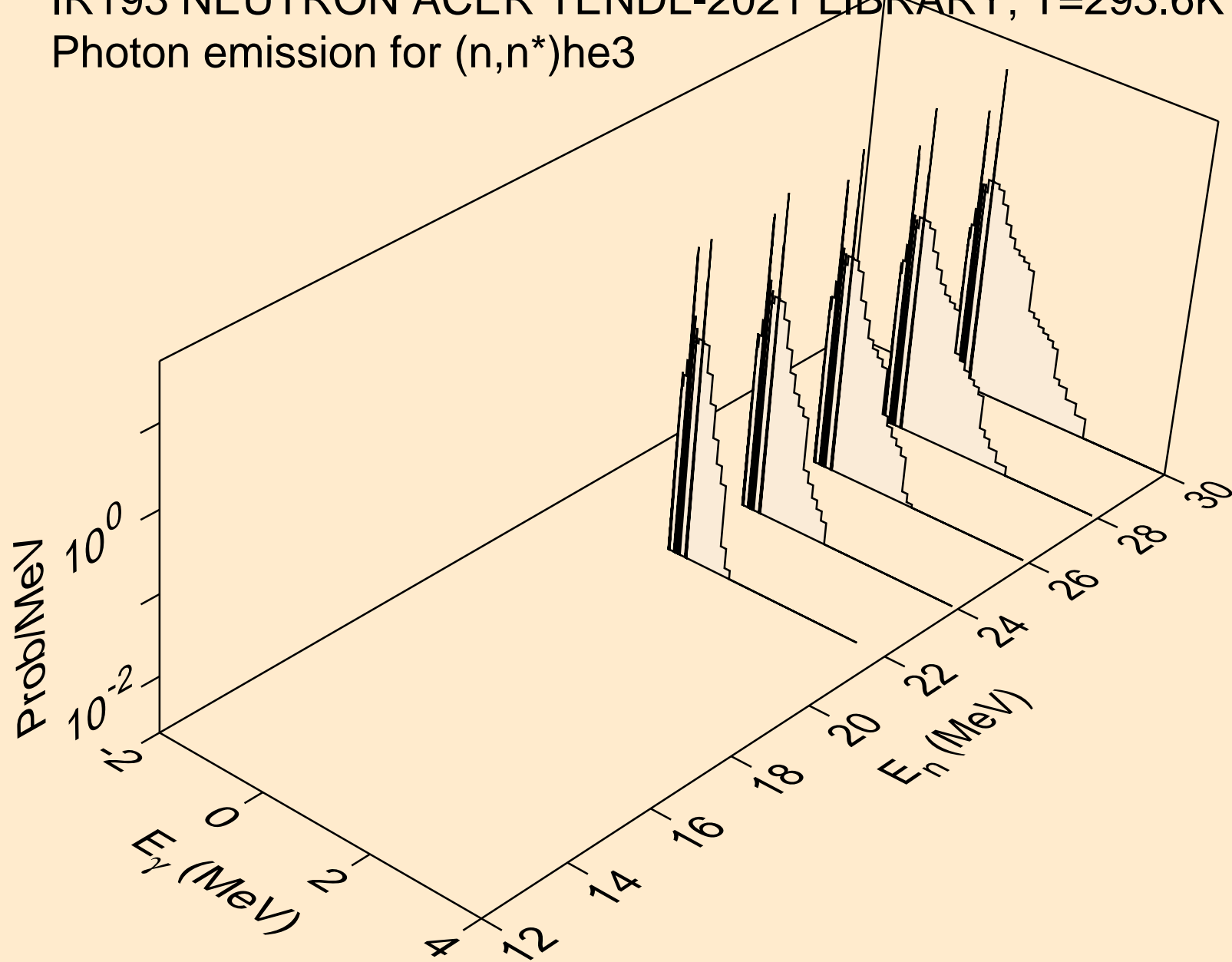

IR193 NEUTRON ACER TENDL-2021 LIBRARY; T=293.6K
Photon emission for (n,4n)

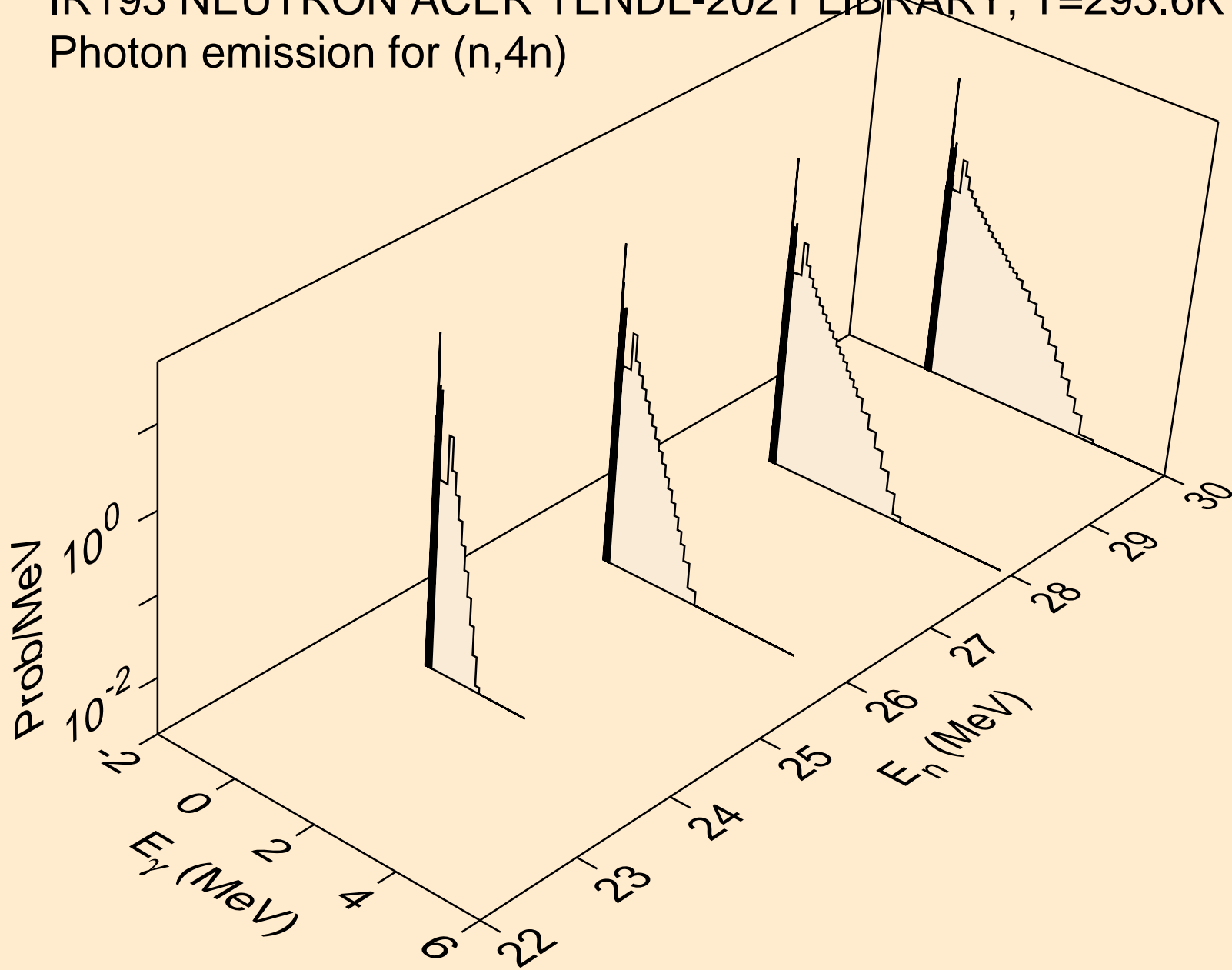

IR193 NEUTRON ACER TENDL-2021 LIBRARY; T=293.6K
Photon emission for (n,2np)

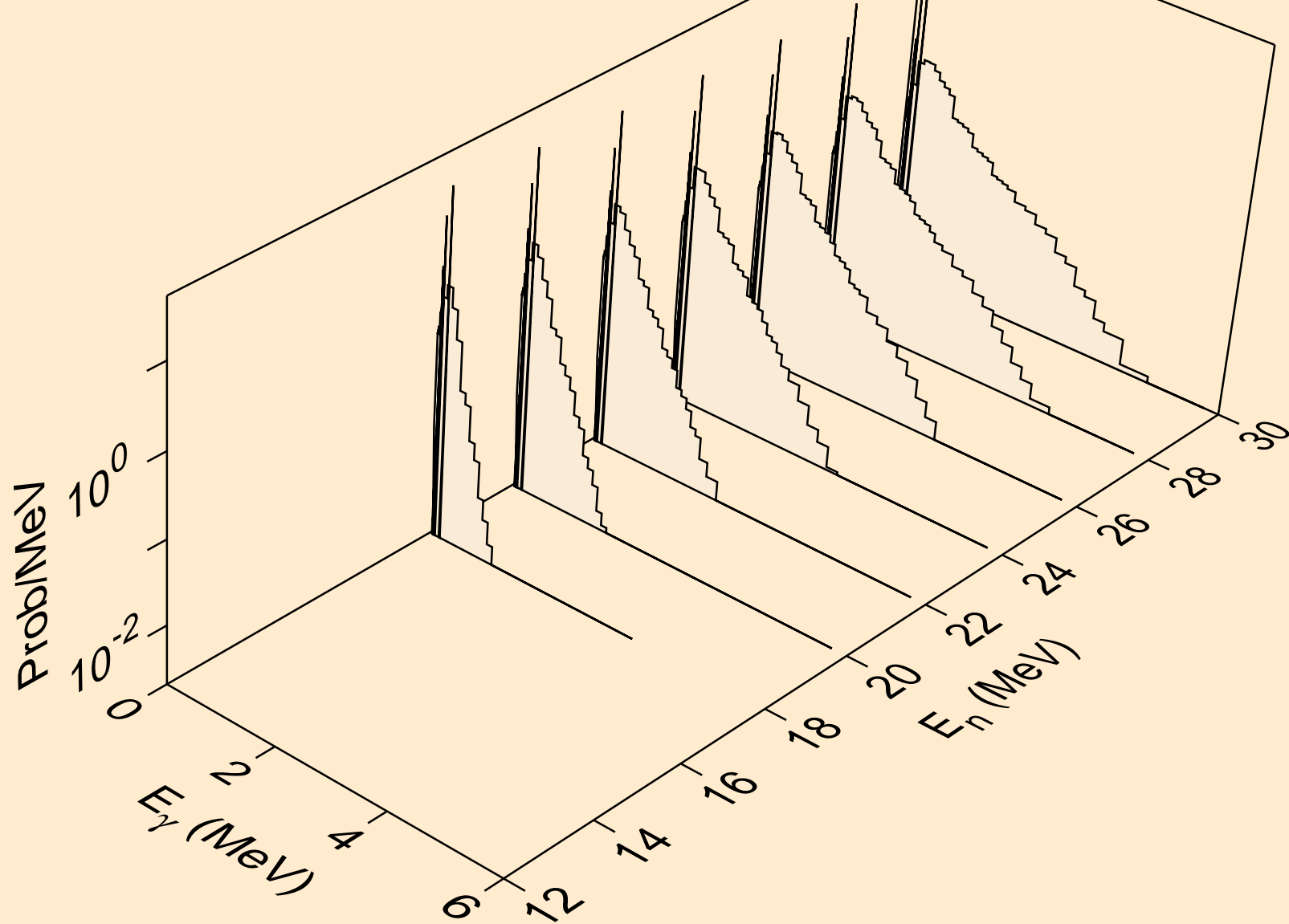

IR193 NEUTRON ACER TENDL-2021 LIBRARY; T=293.6K
Photon emission for (n,3np)

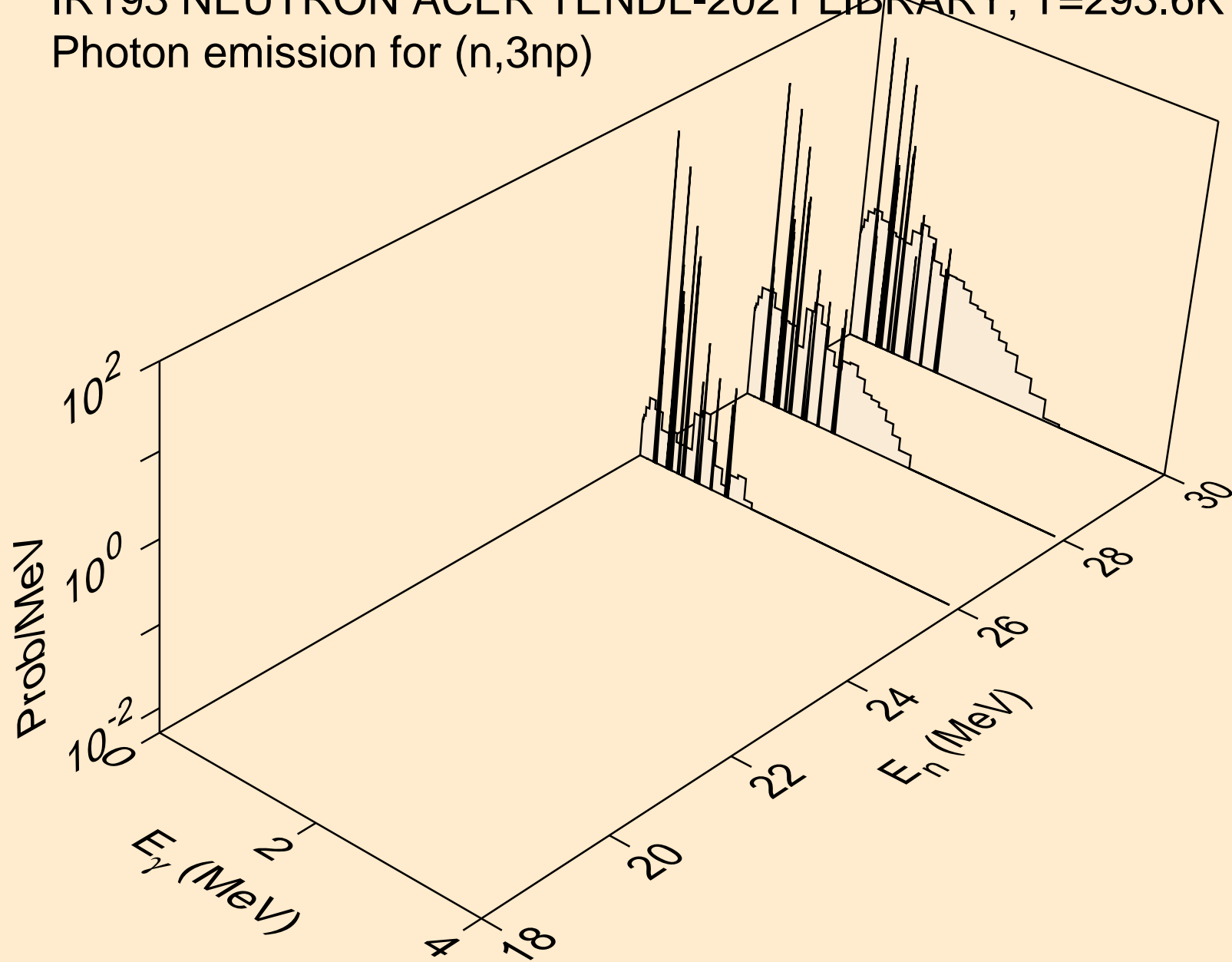

IR193 NEUTRON ACER TENDL-2021 LIBRARY; T=293.6K
Photon emission for (n,2np)

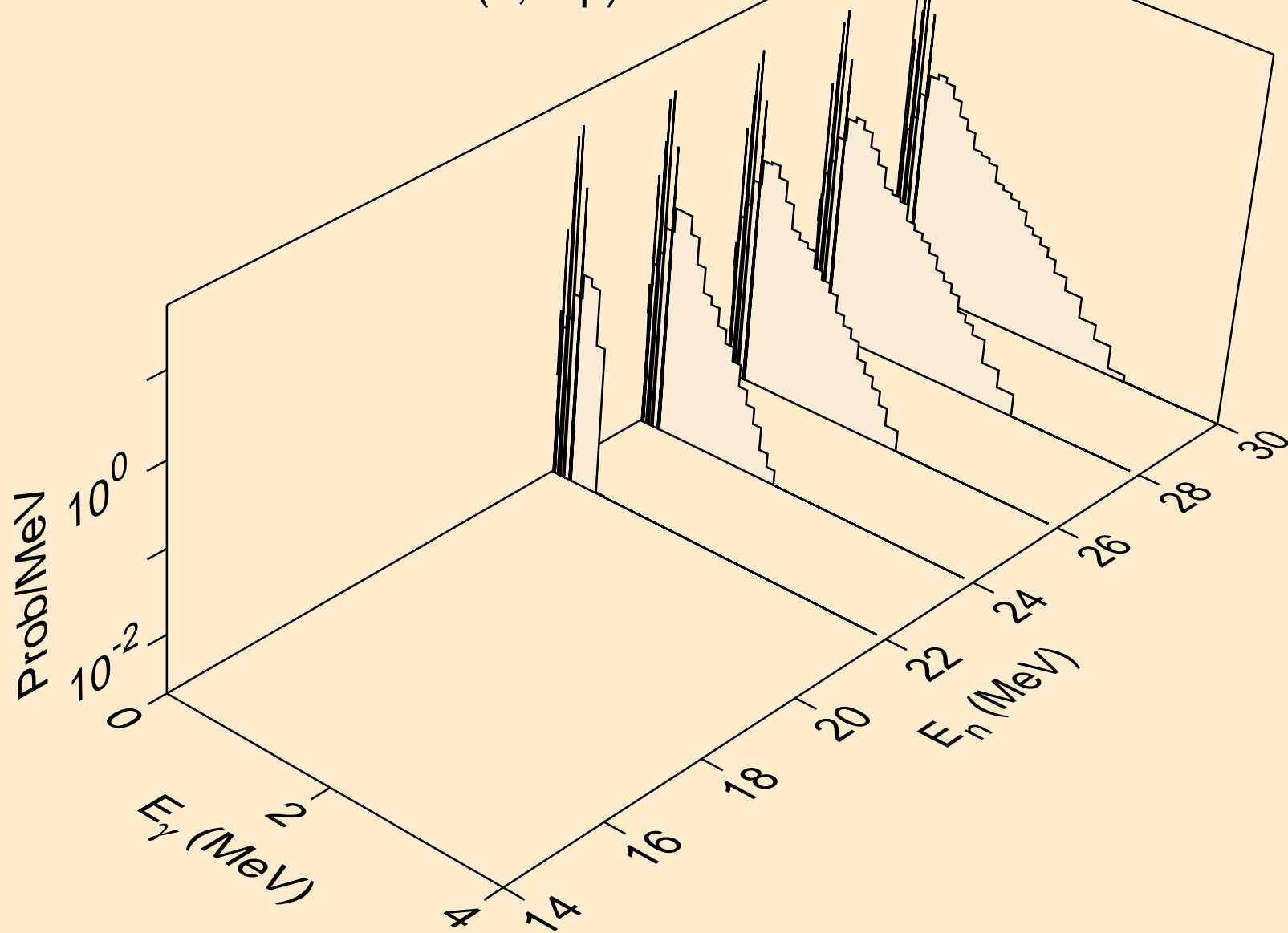

IR193 NEUTRON ACER TENDL-2021 LIBRARY; T=293.6K
Photon emission for (n,npa)

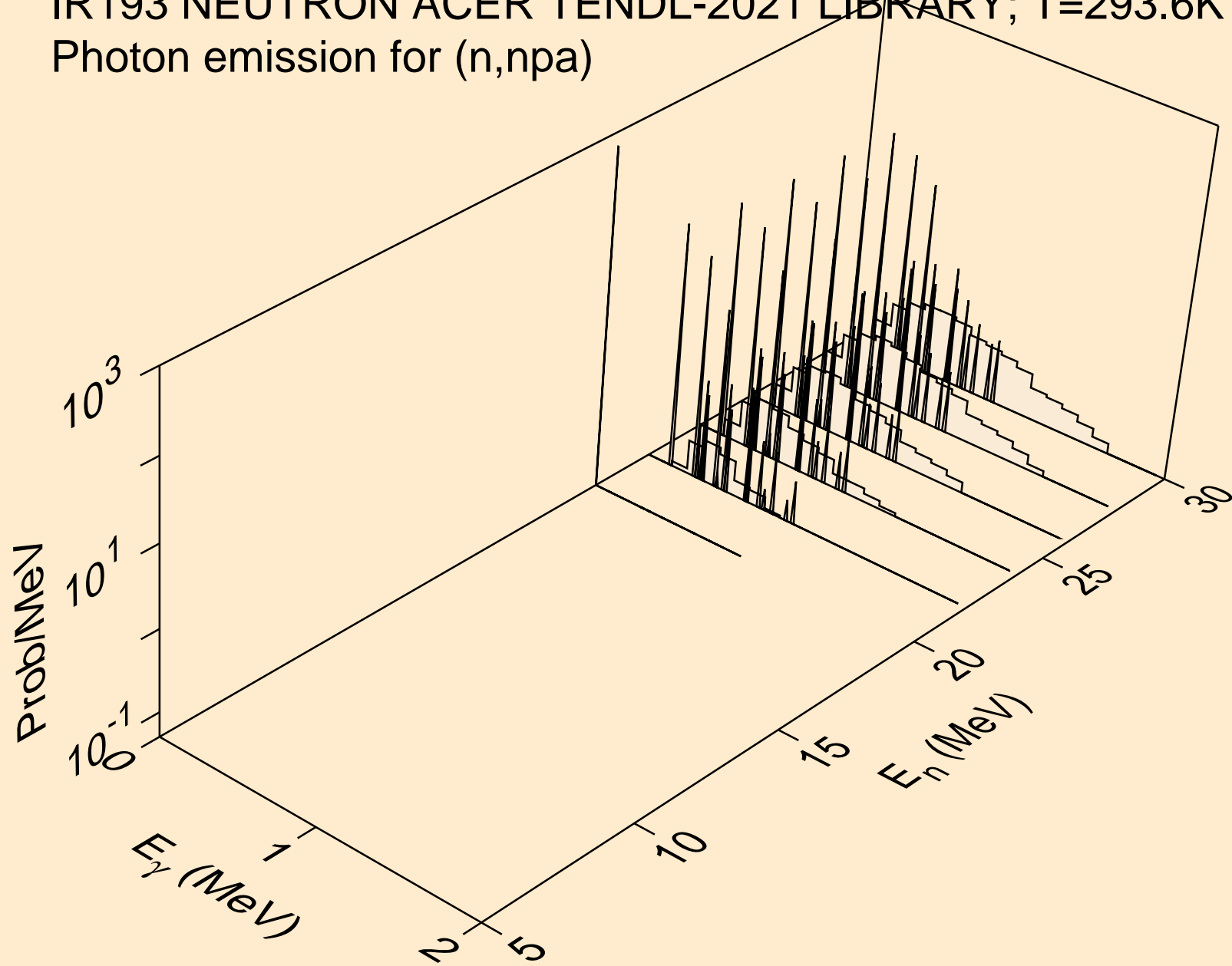

IR193 NEUTRON ACER TENDL-2021 LIBRARY; T=293.6K
Photon emission for (n,n*c)

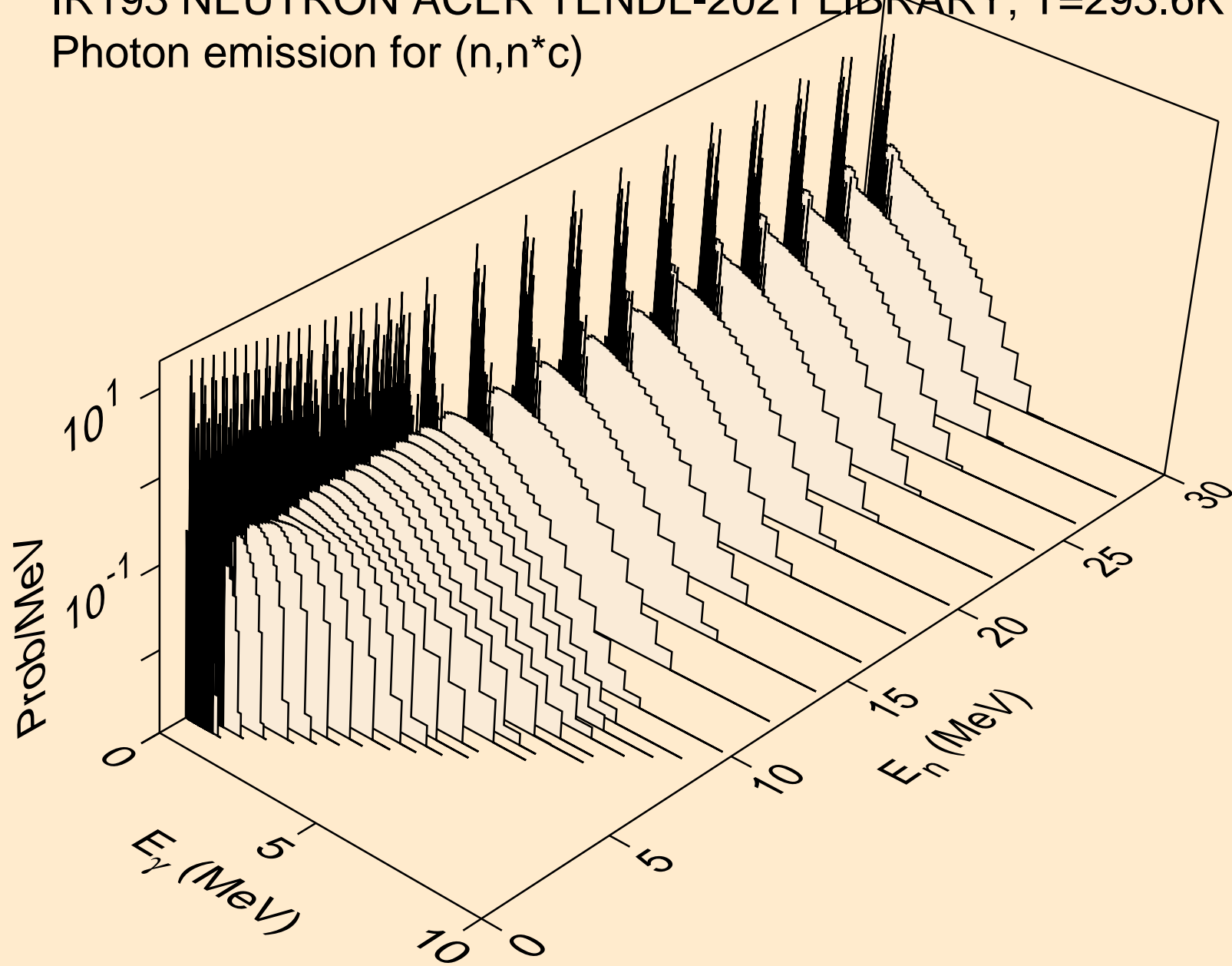

IR193 NEUTRON ACER TENDL-2021 LIBRARY; T=293.6K
Photon emission for (n,gma)

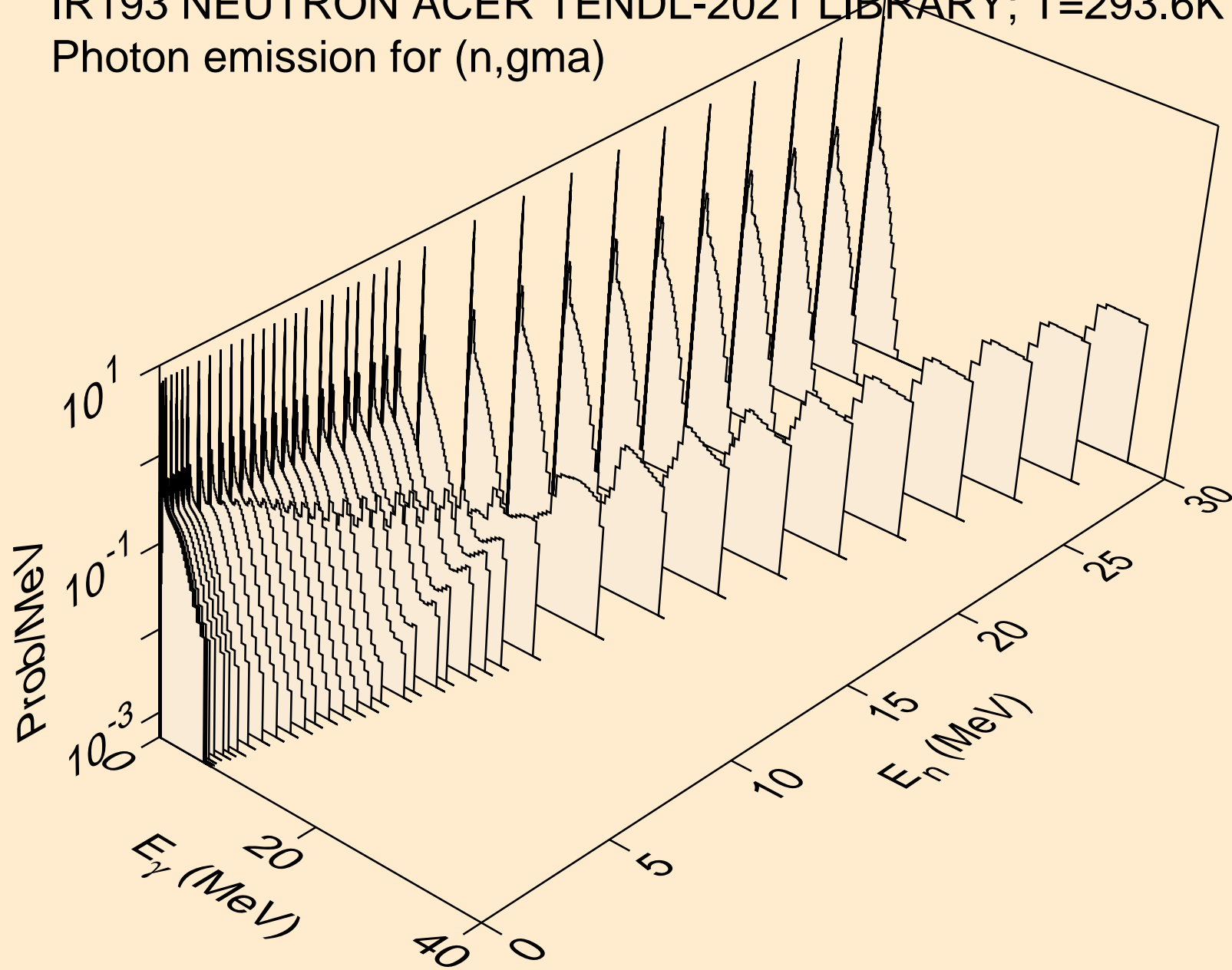

IR193 NEUTRON ACER TENDL-2021 LIBRARY; T=293.6K
Photon emission for (n,p)

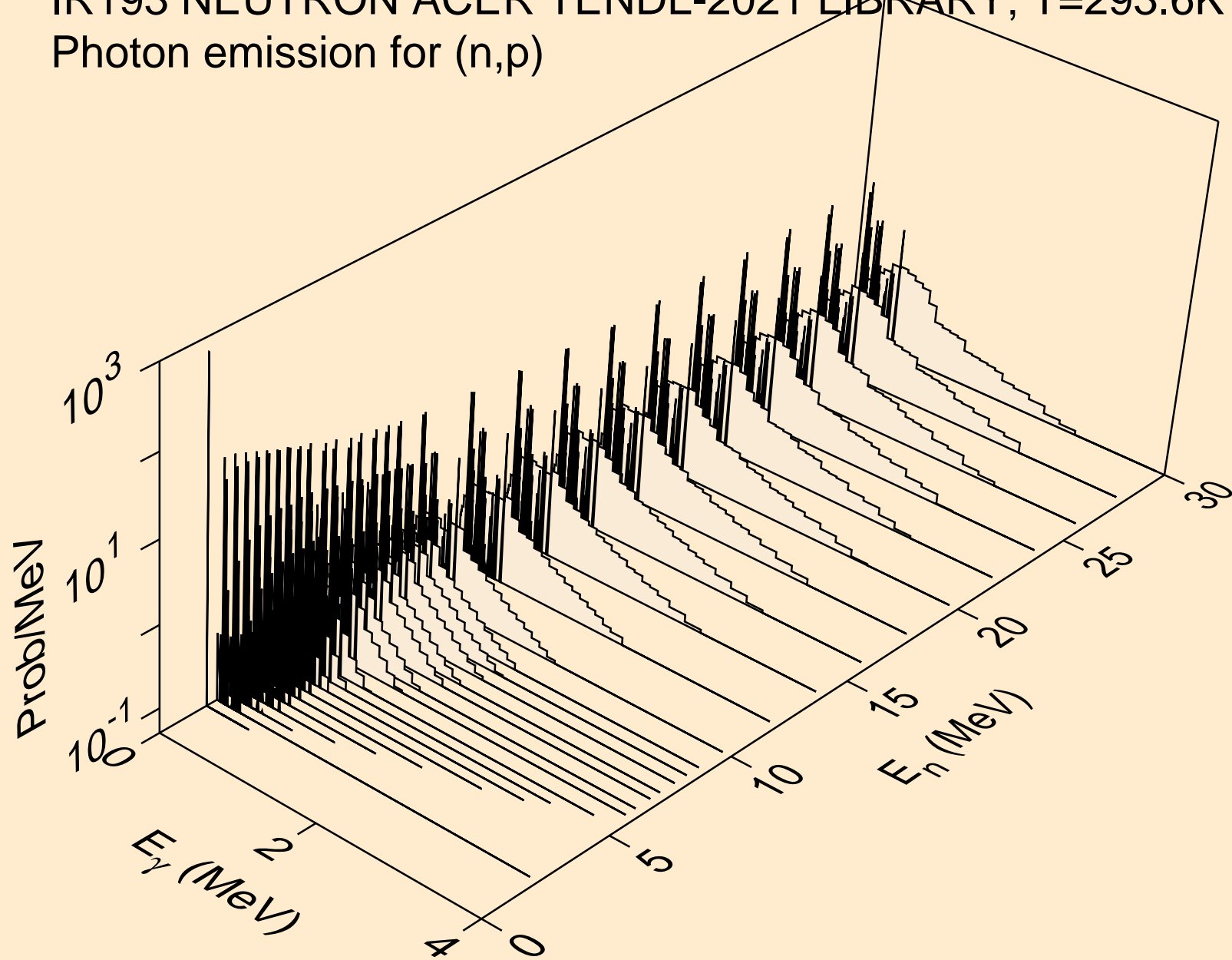

IR193 NEUTRON ACER TENDL-2021 LIBRARY; T=293.6K
Photon emission for (n,d)

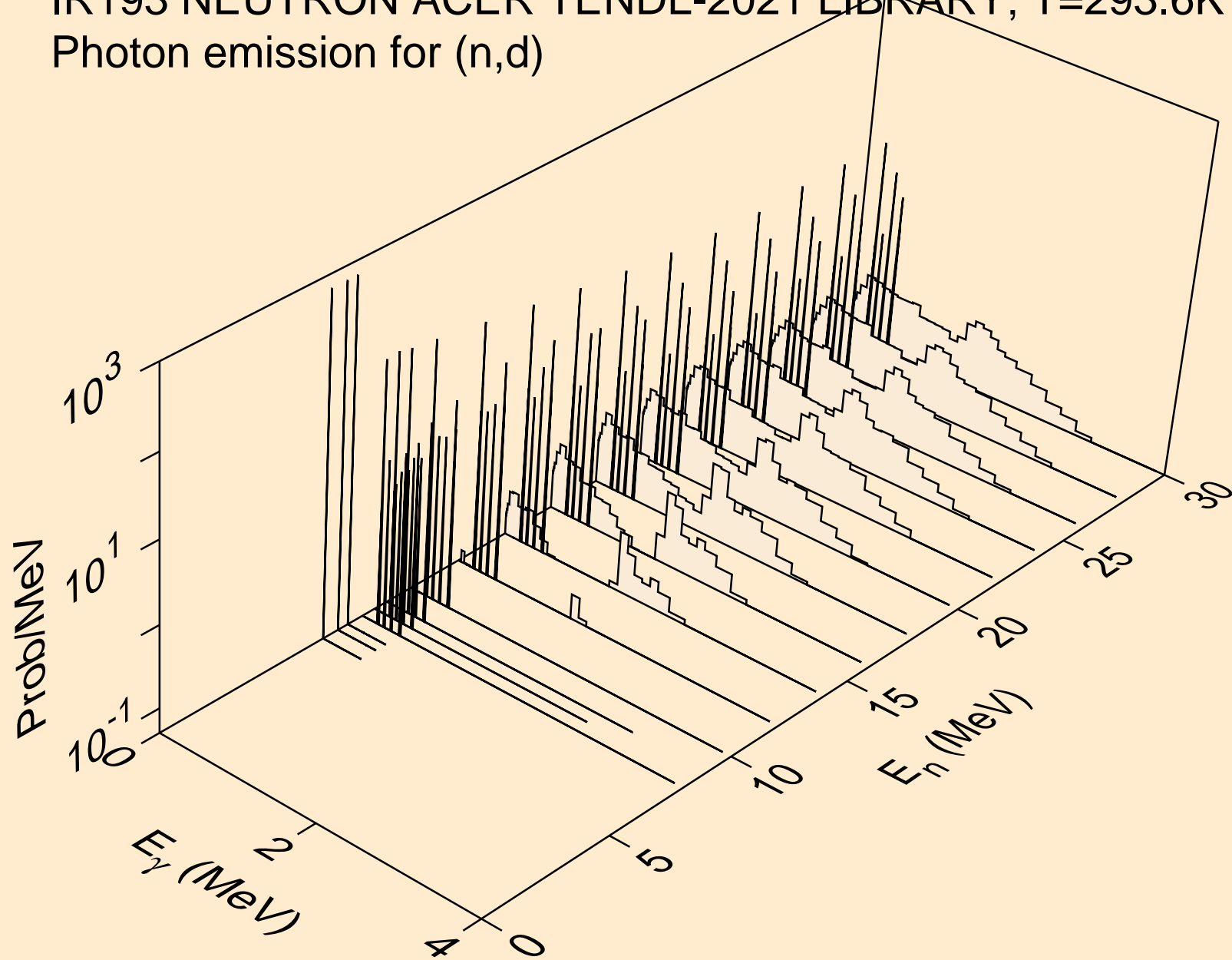

IR193 NEUTRON ACER TENDL-2021 LIBRARY; T=293.6K
Photon emission for (n,t)

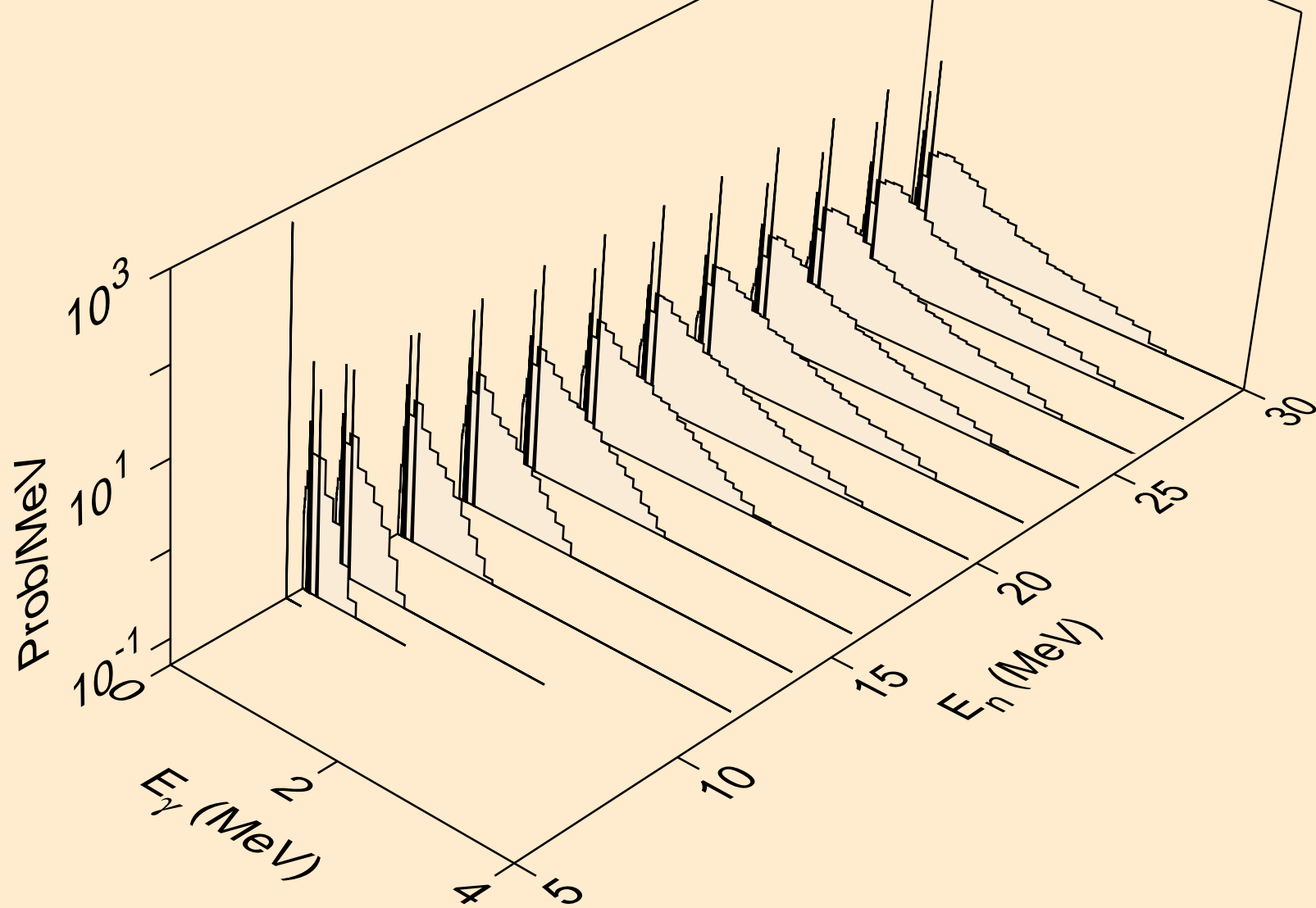

IR193 NEUTRON ACER TENDL-2021 LIBRARY; T=293.6K
Photon emission for (n,he3)

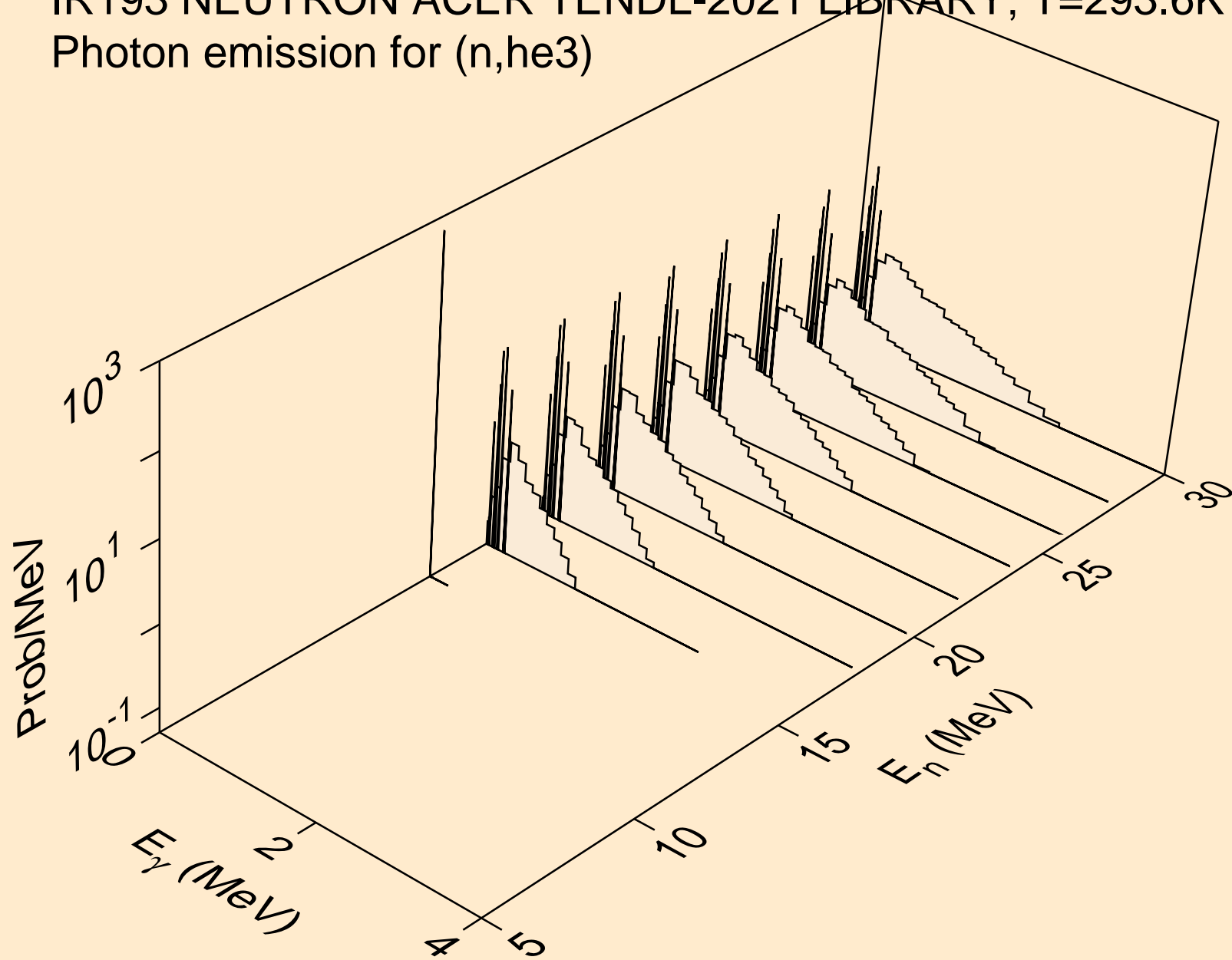

IR193 NEUTRON ACER TENDL-2021 LIBRARY; T=293.6K
Photon emission for (n,a)

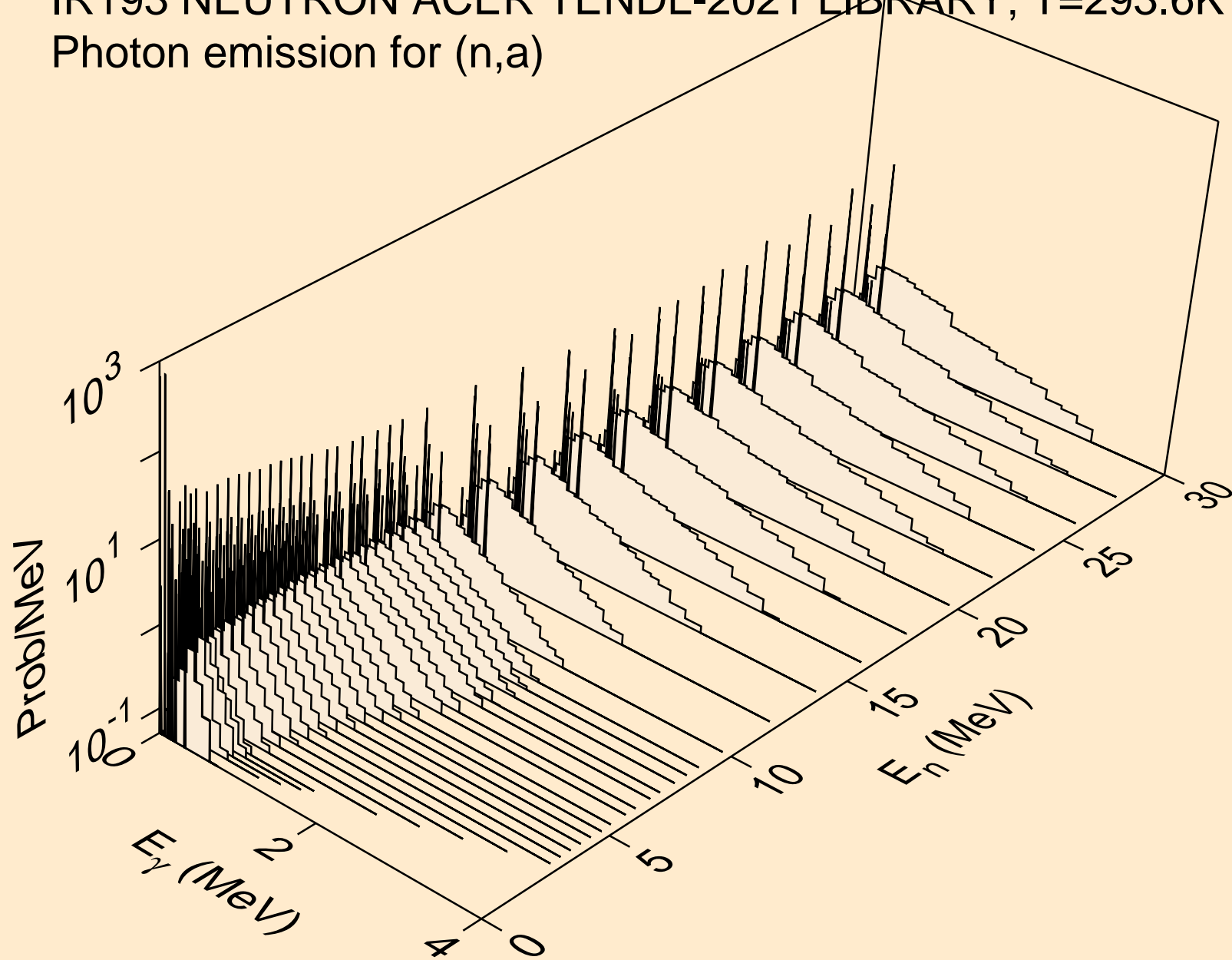

IR193 NEUTRON ACER TENDL-2021 LIBRARY; T=293.6K
Photon emission for (n,2a)

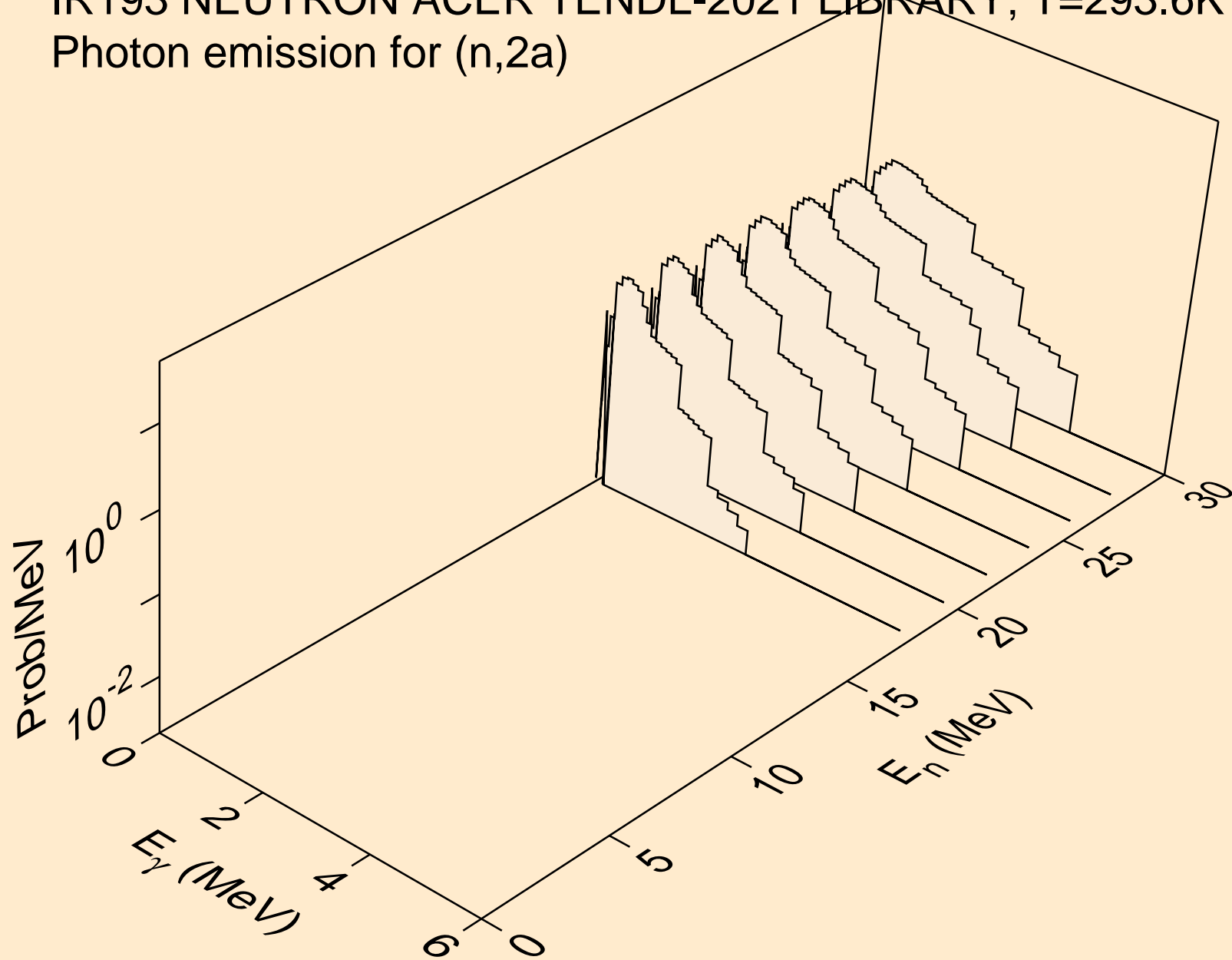

IR193 NEUTRON ACER TENDL-2021 LIBRARY; T=293.6K
Photon emission for (n,2p)

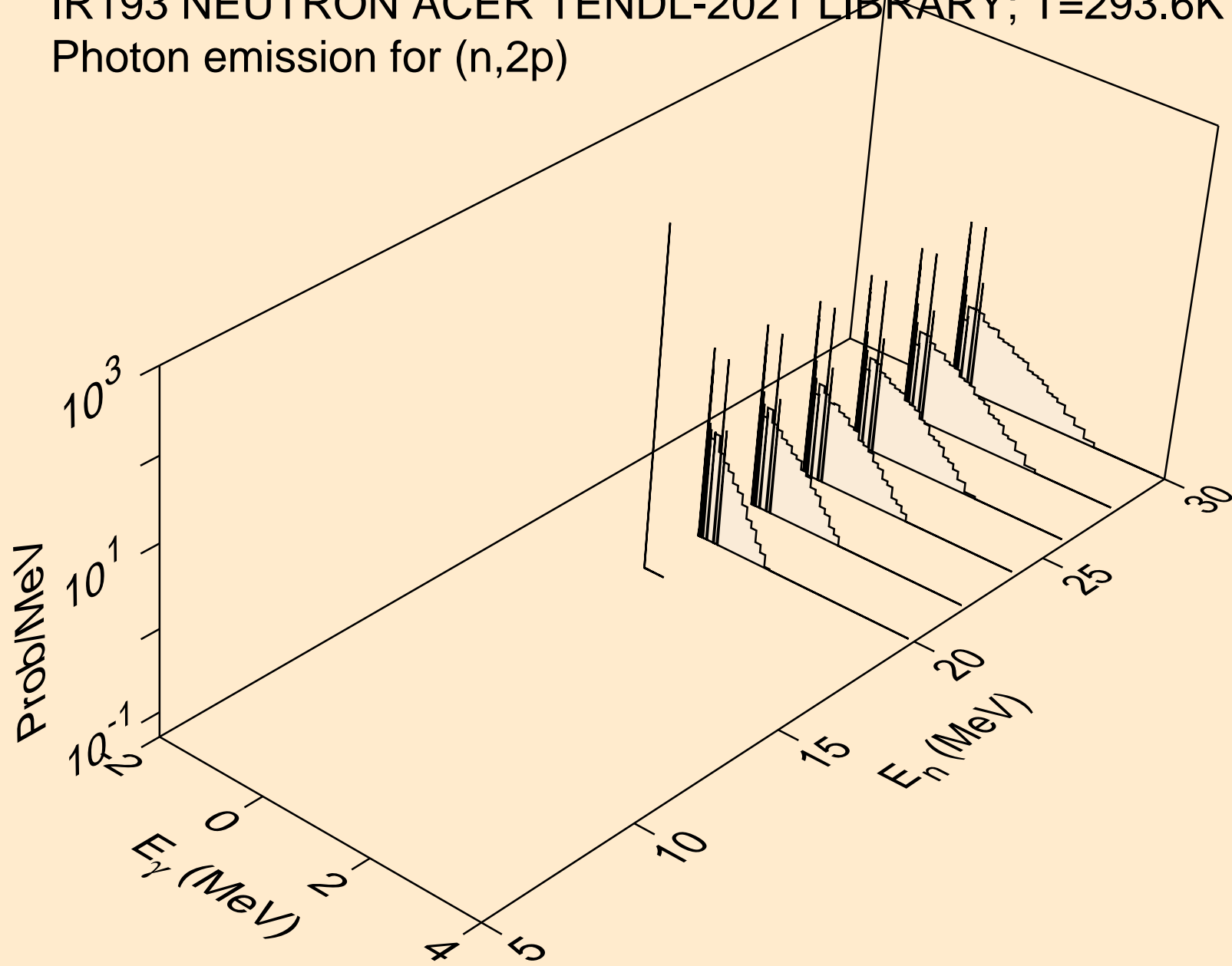

IR193 NEUTRON ACER TENDL-2021 LIBRARY; T=293.6K
Photon emission for (n,p)

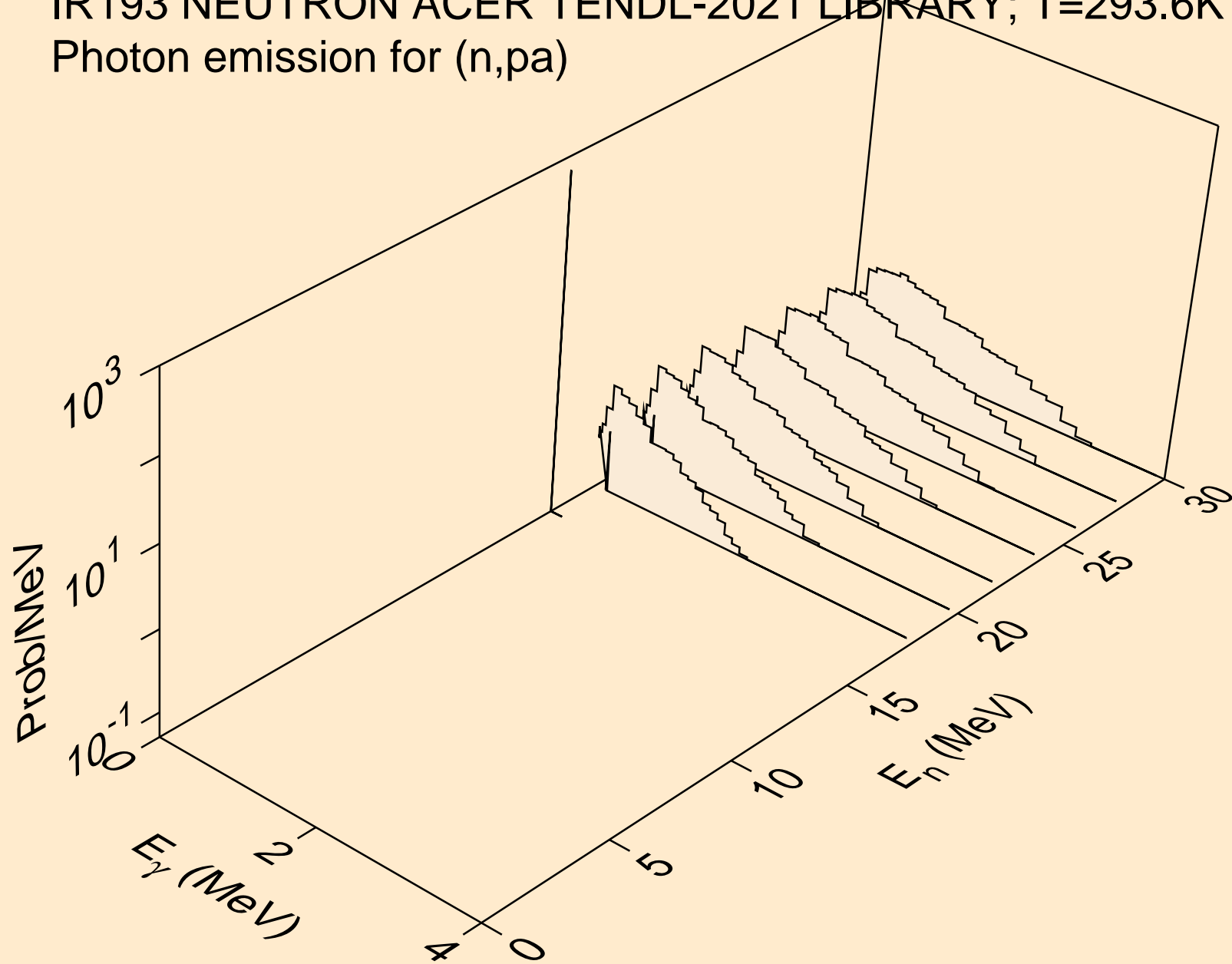

IR193 NEUTRON ACER TENDL-2021 LIBRARY; T=293.6K
thermal capture photon spectrum

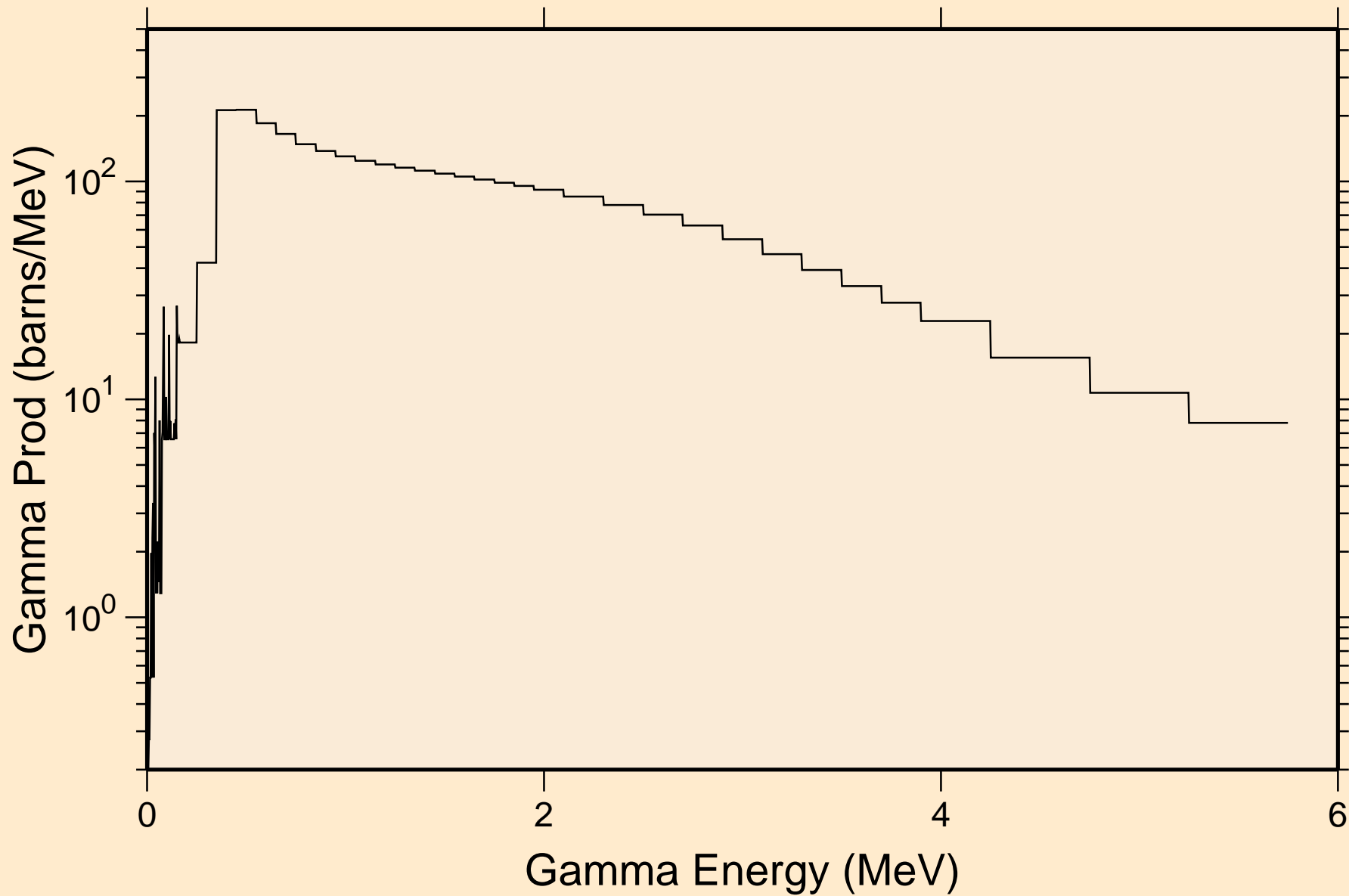

IR193 NEUTRON ACER TENDL-2021 LIBRARY; T=293.6K
14 MeV photon spectrum

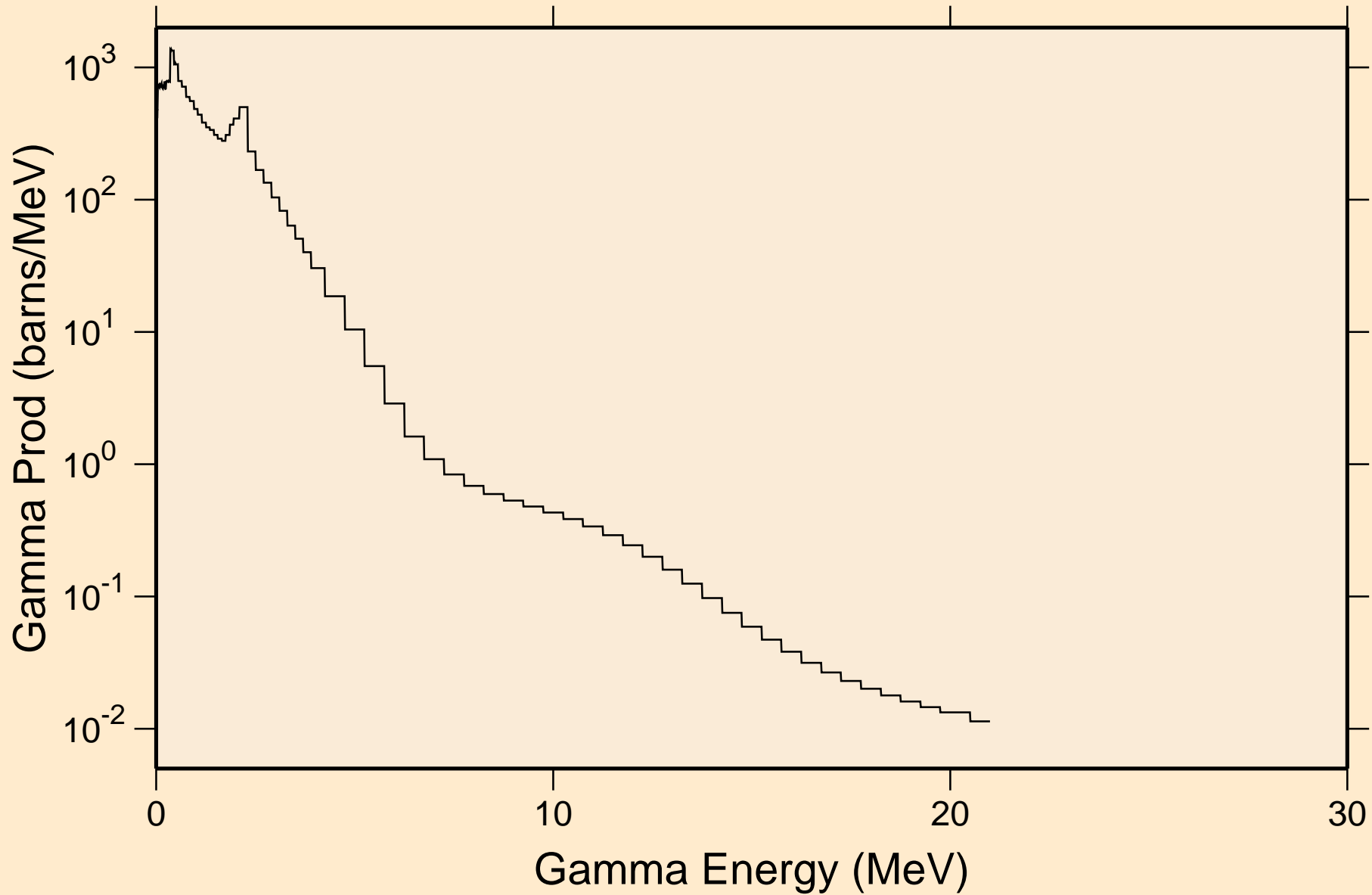

IR193 NEUTRON ACER TENDL-2021 LIBRARY; T=293.6K
Particle heating contributions

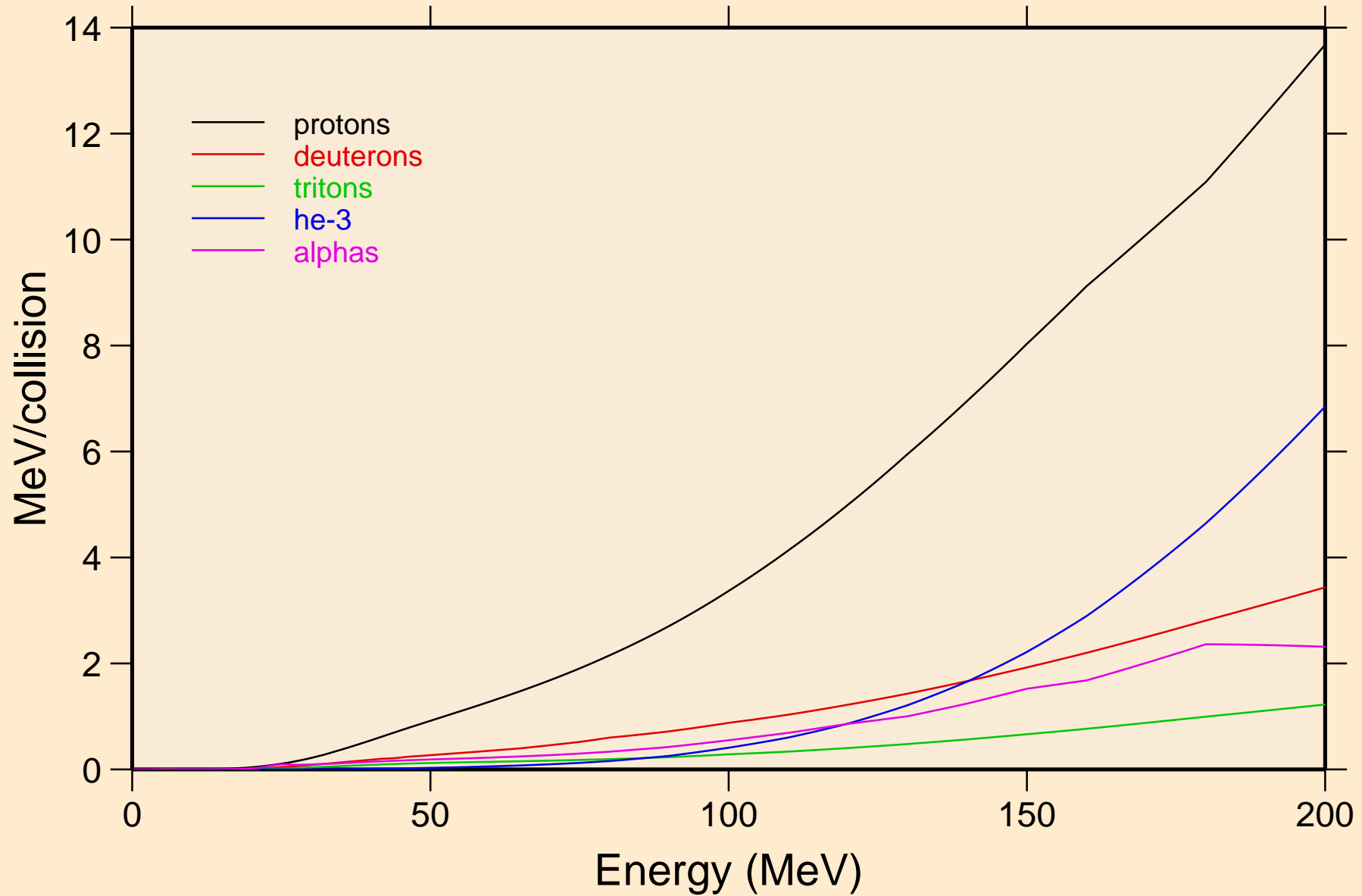

IR193 NEUTRON ACER TENDL-2021 LIBRARY; T=293.6K
Recoil Heating

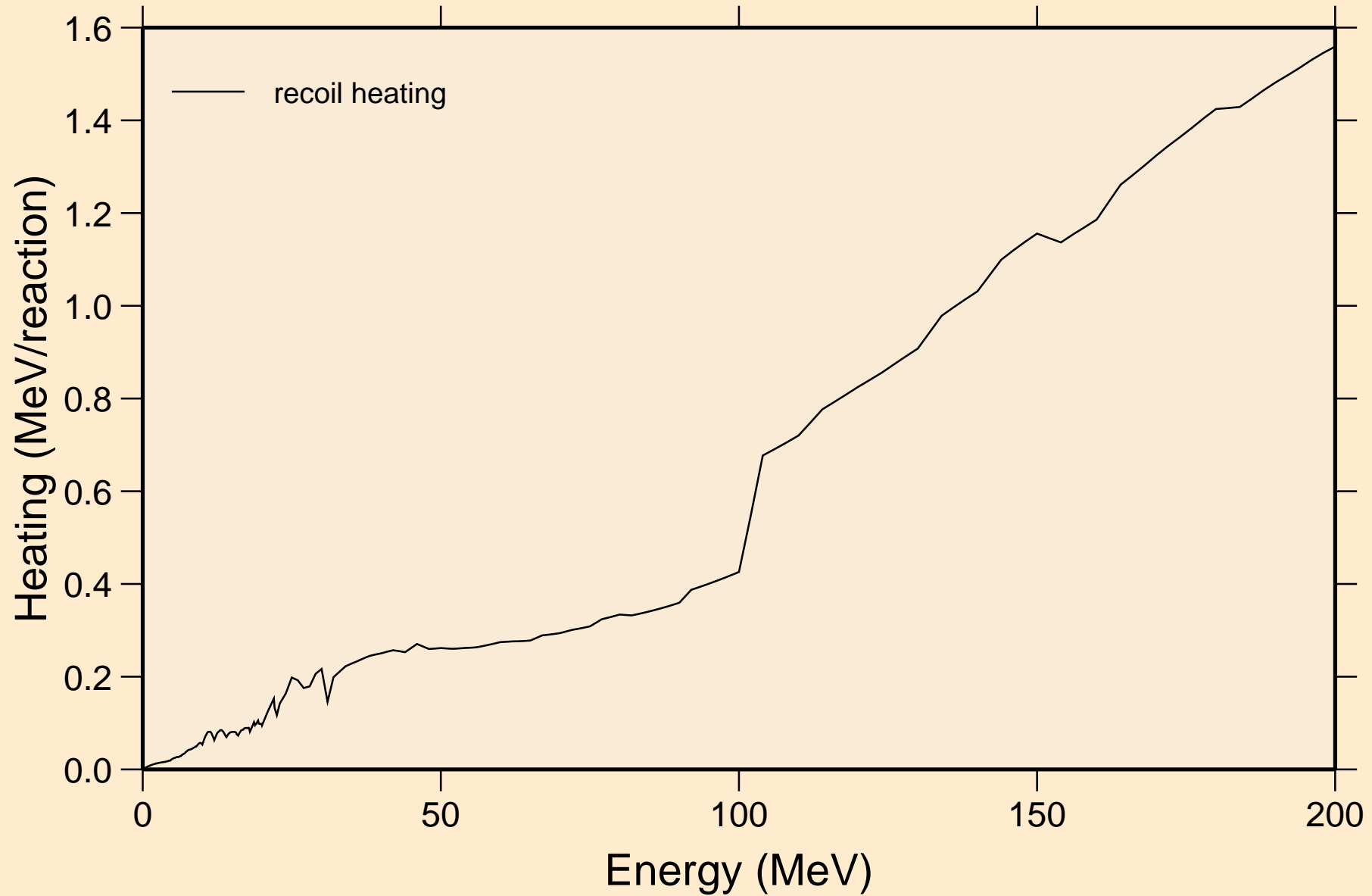

IR193 NEUTRON ACER TENDL-2021 LIBRARY; T=293.6K
Particle production cross sections

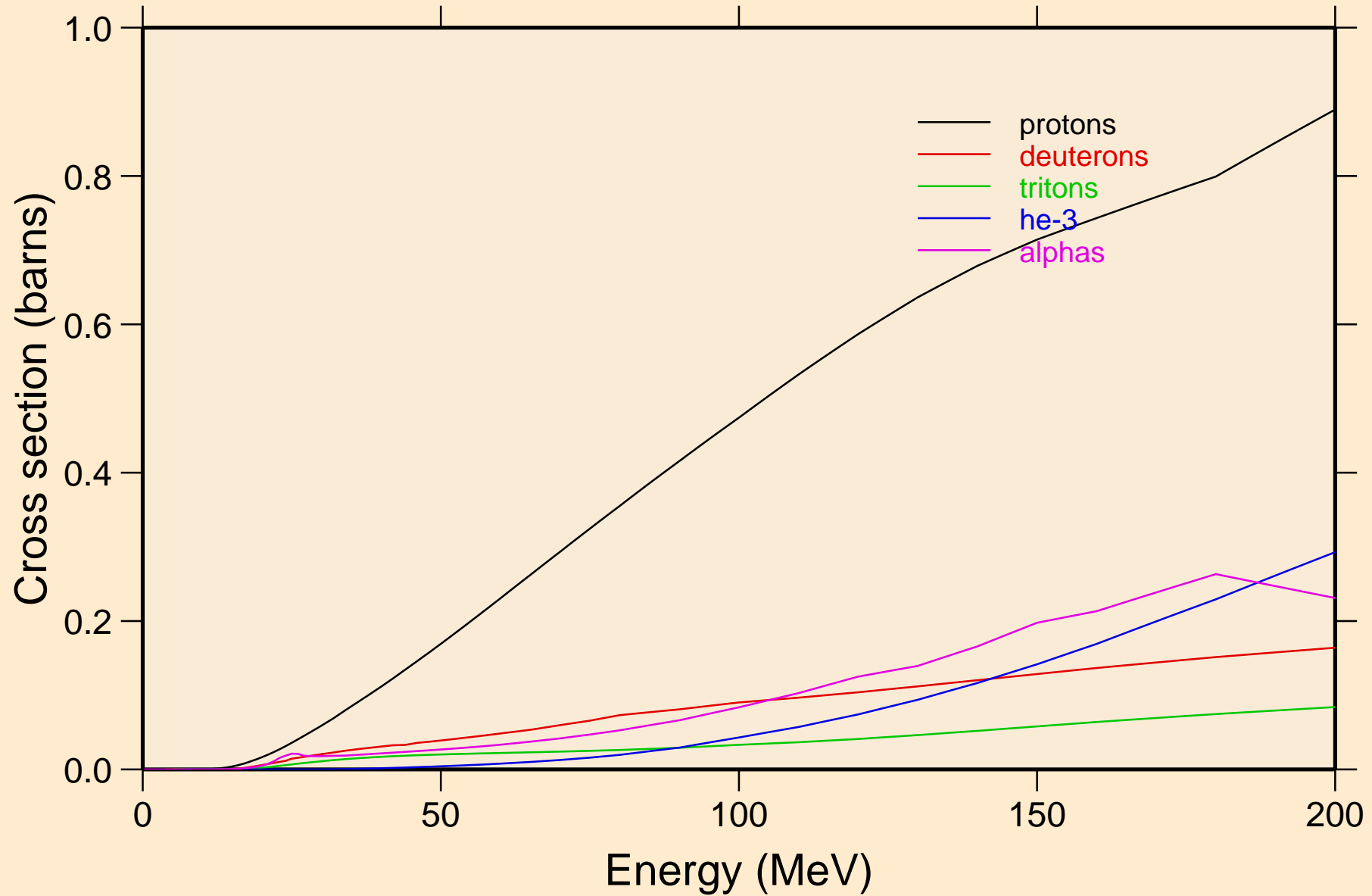

IR193 NEUTRON ACER TENDL-2021 LIBRARY; T=293.6K
protons from (n,x)

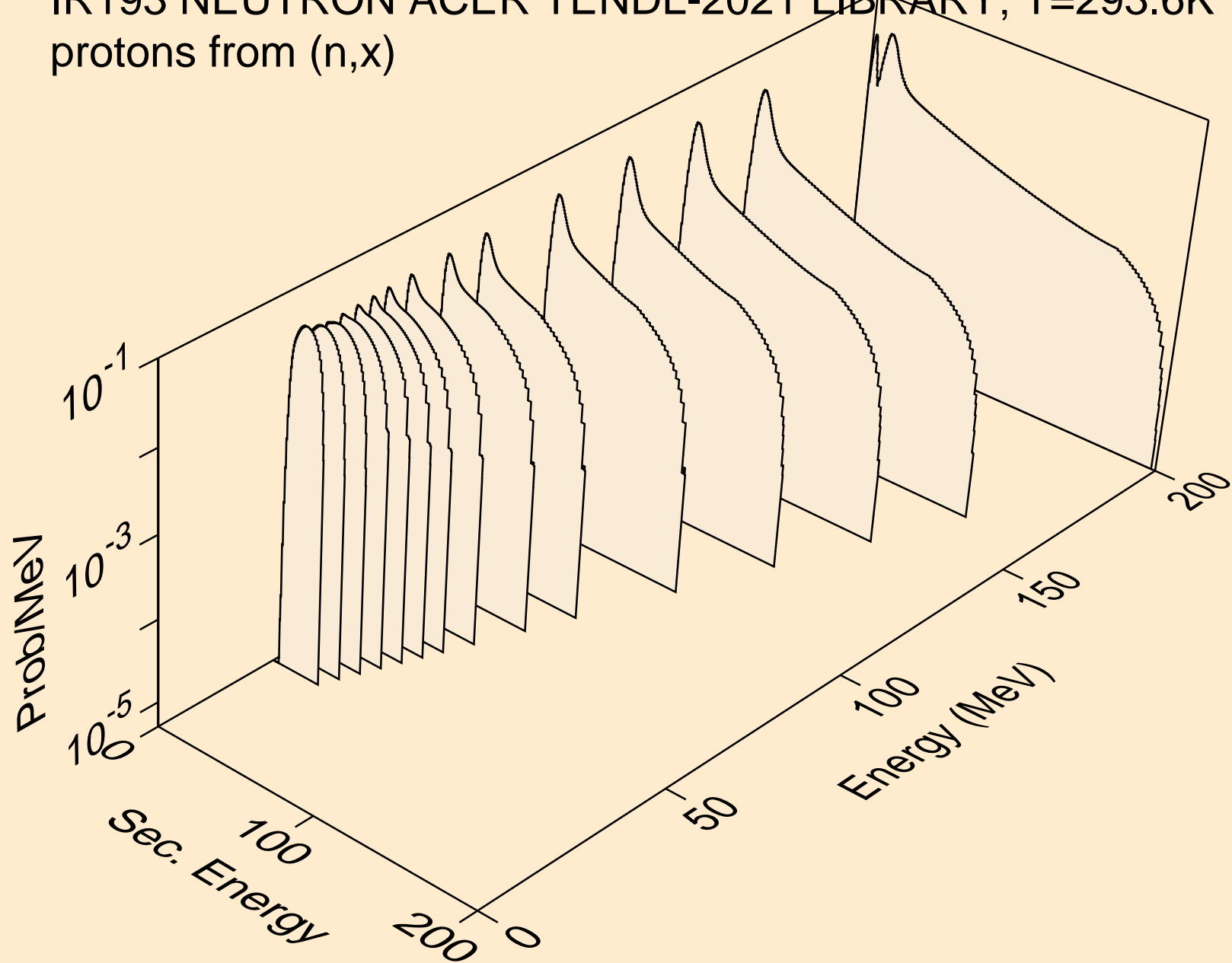

IR193 NEUTRON ACER TENDL-2021 LIBRARY; T=293.6K
protons from (n,n*)p

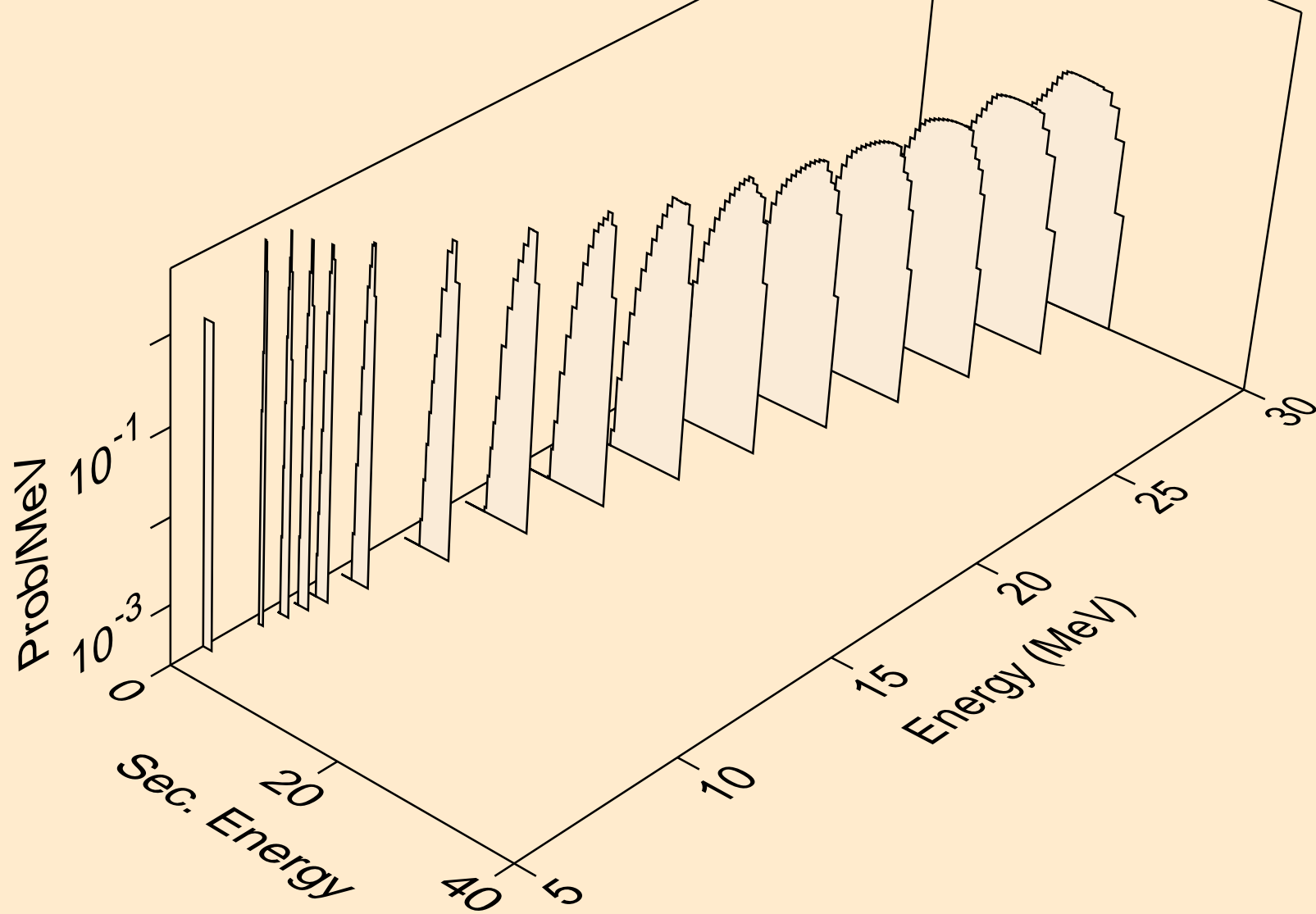

IR193 NEUTRON ACER TENDL-2021 LIBRARY; T=293.6K
protons from (n,2np)

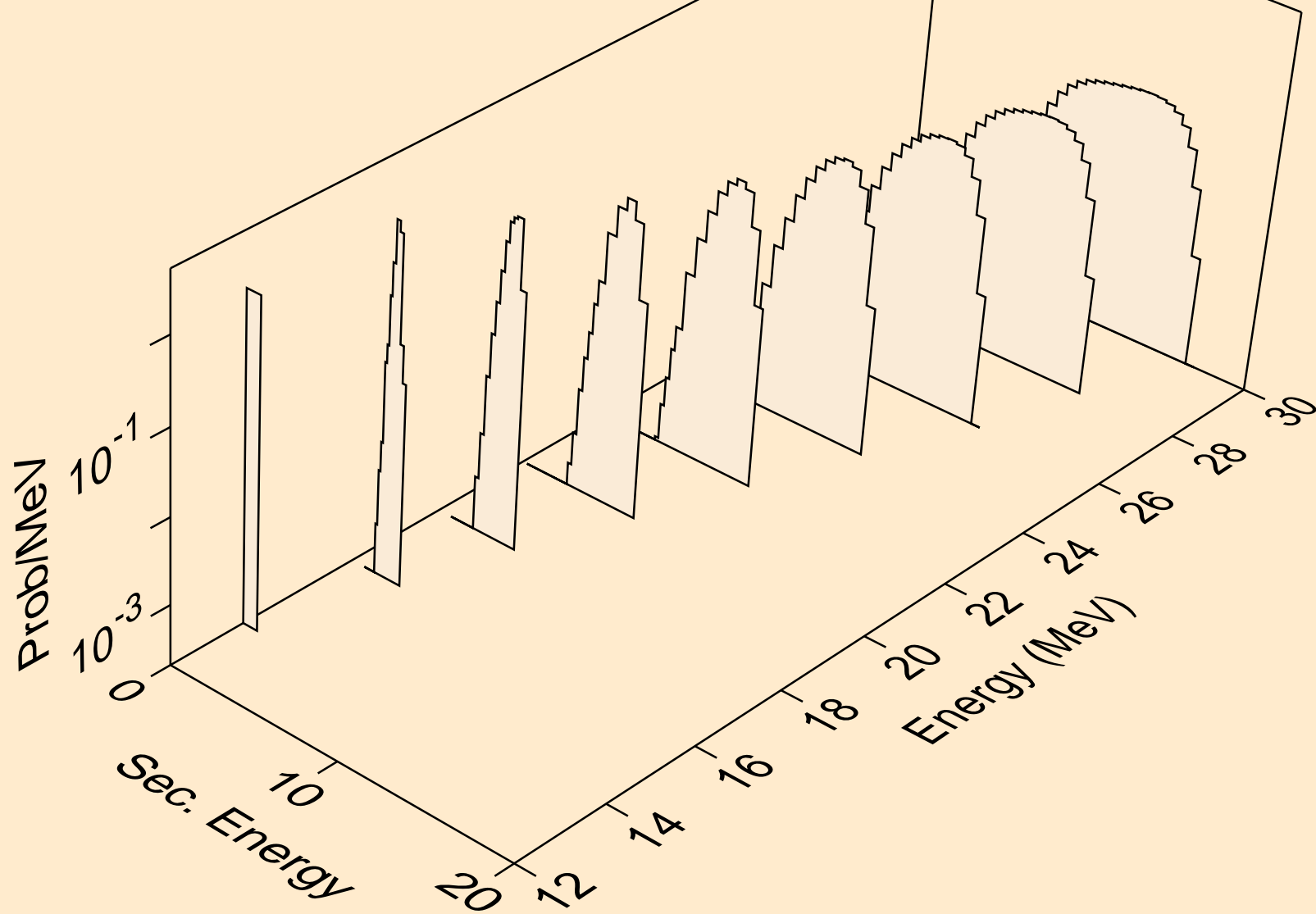

IR193 NEUTRON ACER TENDL-2021 LIBRARY; T=293.6K
protons from (n,3np)

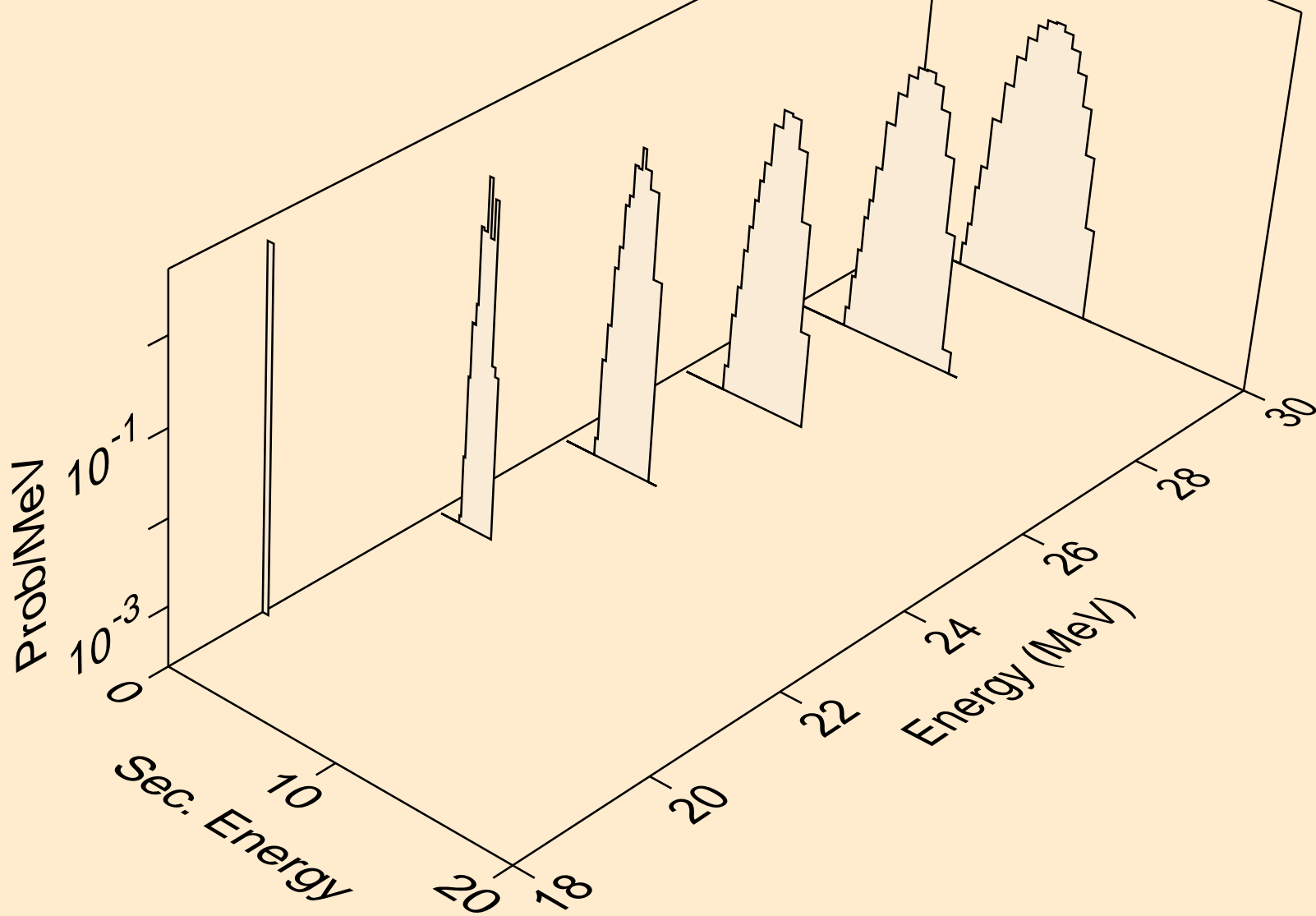

IR193 NEUTRON ACER TENDL-2021 LIBRARY; T=293.6K
protons from (n,2np)

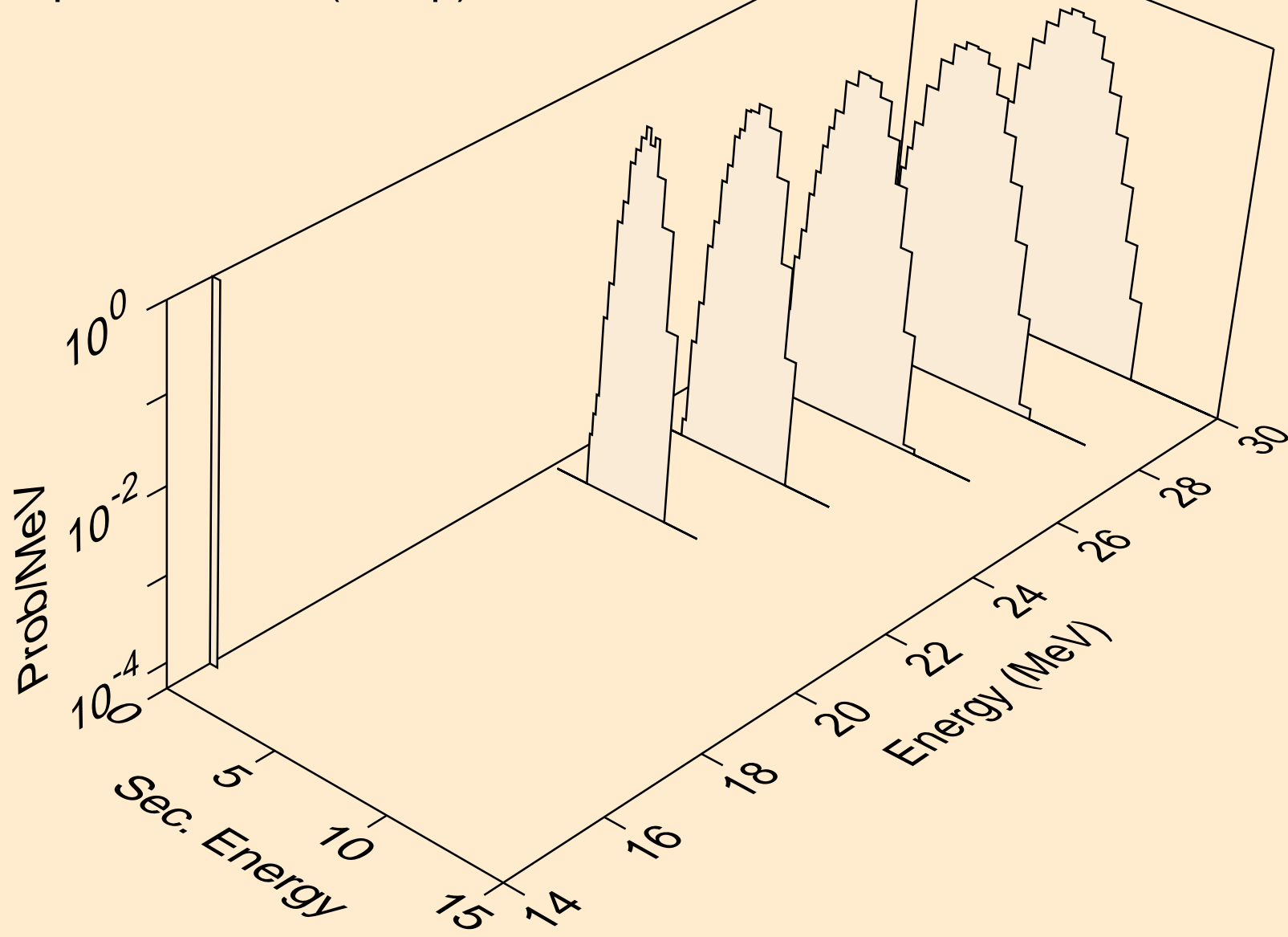

IR193 NEUTRON ACER TENDL-2021 LIBRARY; T=293.6K
protons from (n,npa)

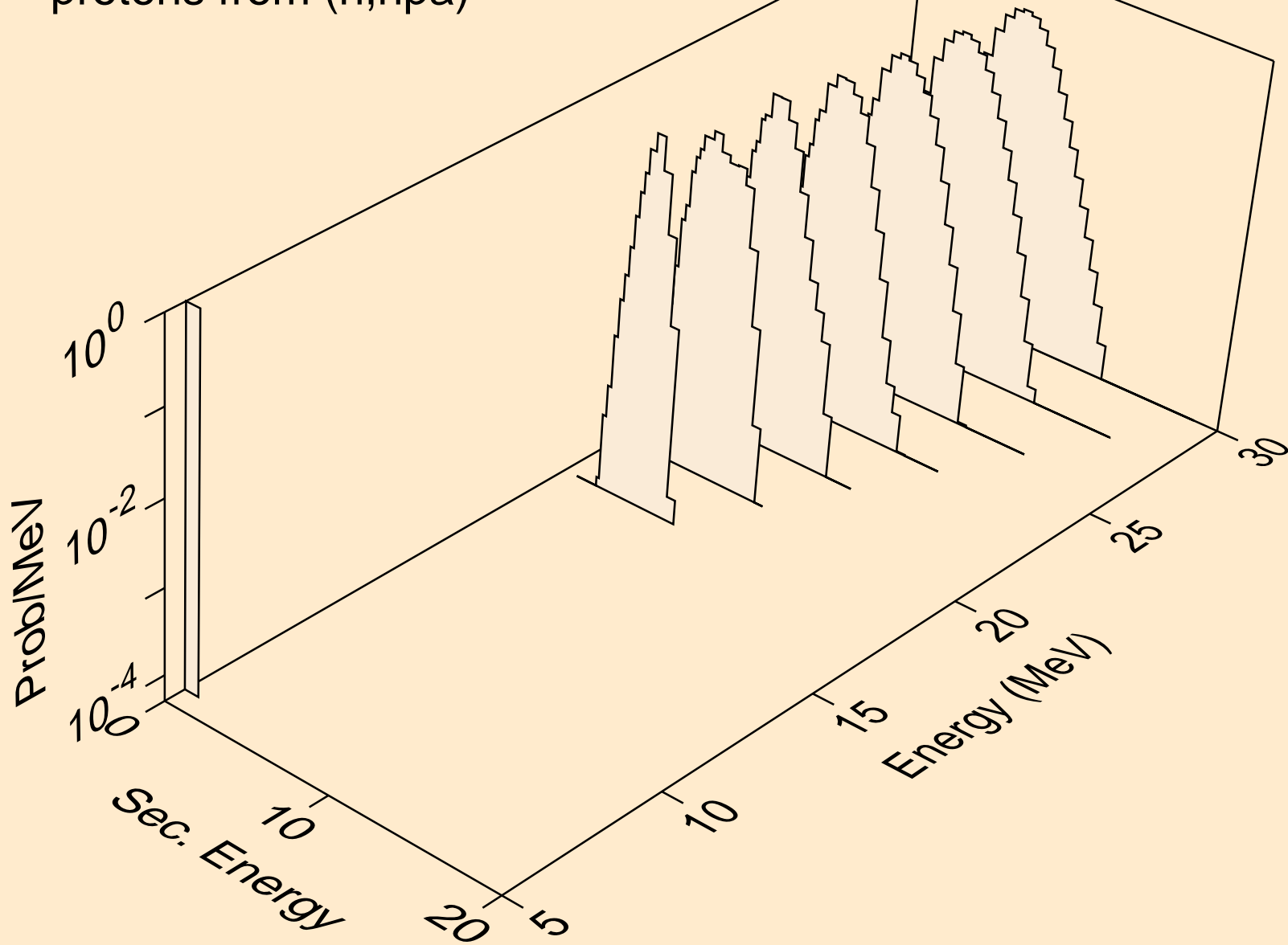

IR193 NEUTRON ACER TENDL-2021 LIBRARY; T=293.6K
protons from (n,p)

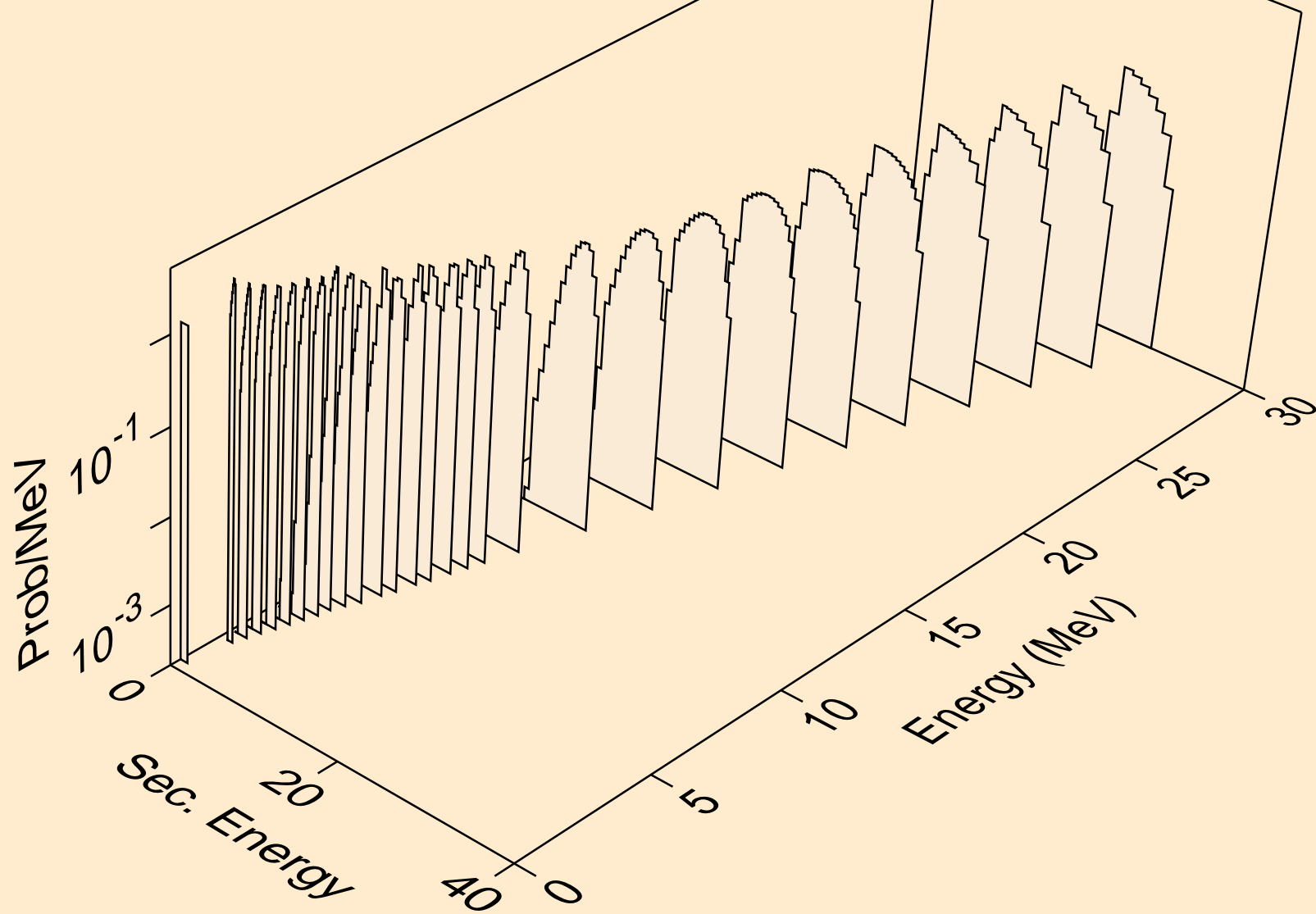

IR193 NEUTRON ACER TENDL-2021 LIBRARY; T=293.6K
protons from (n,2p)

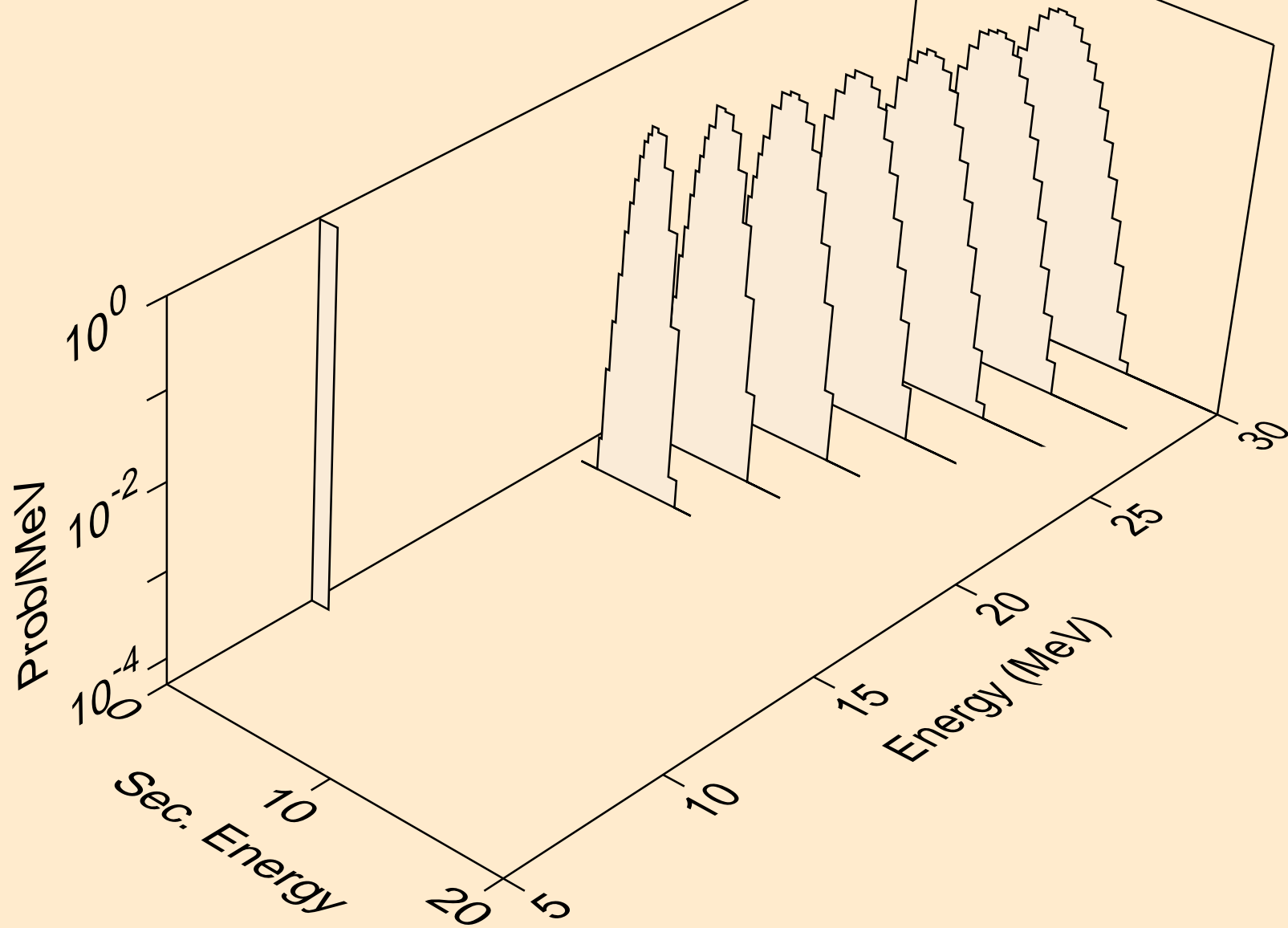

IR193 NEUTRON ACER TENDL-2021 LIBRARY; T=293.6K
protons from (n,p)

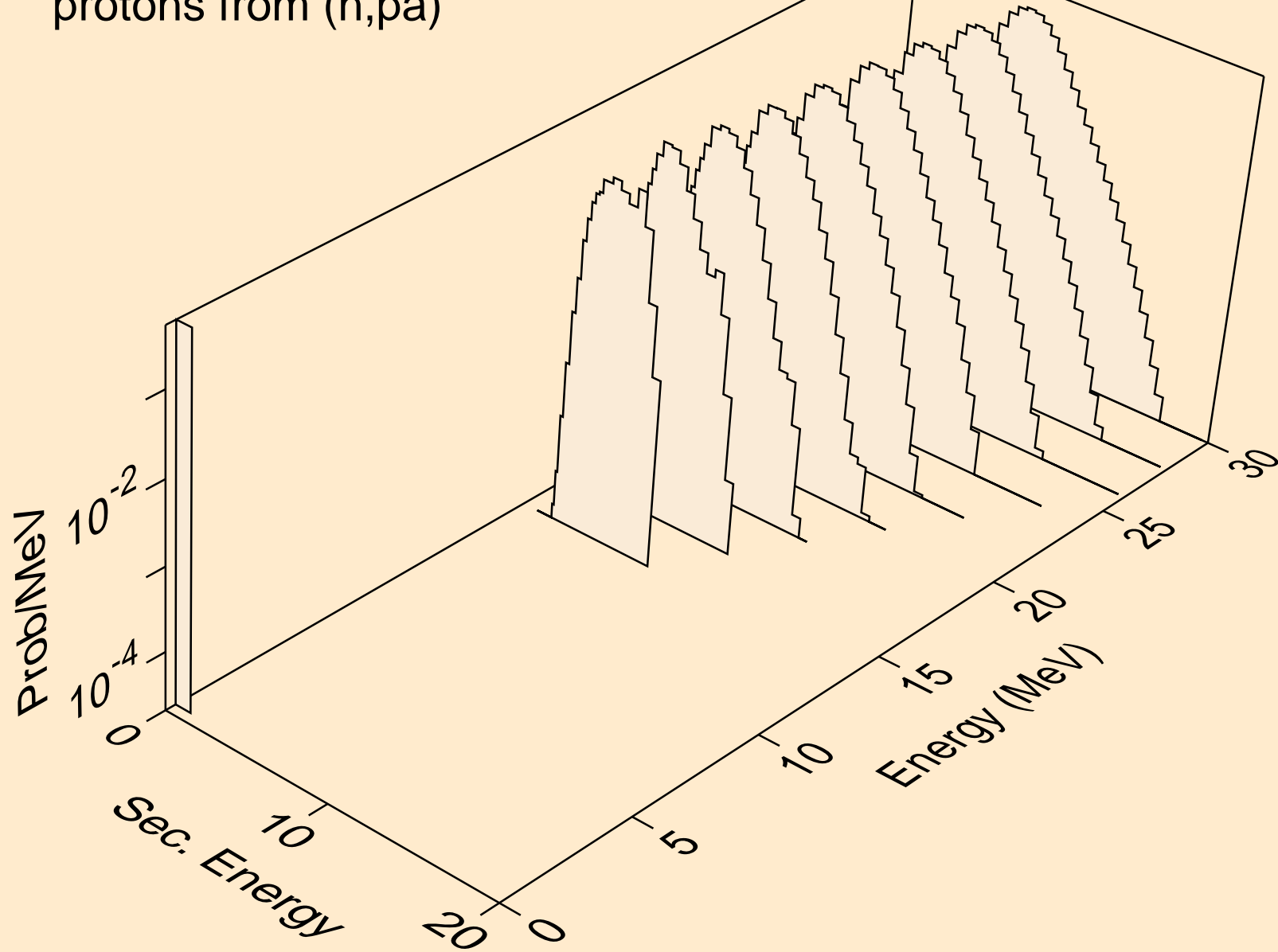

IR193 NEUTRON ACER TENDL-2021 LIBRARY; T=293.6K
deuterons from (n,x)

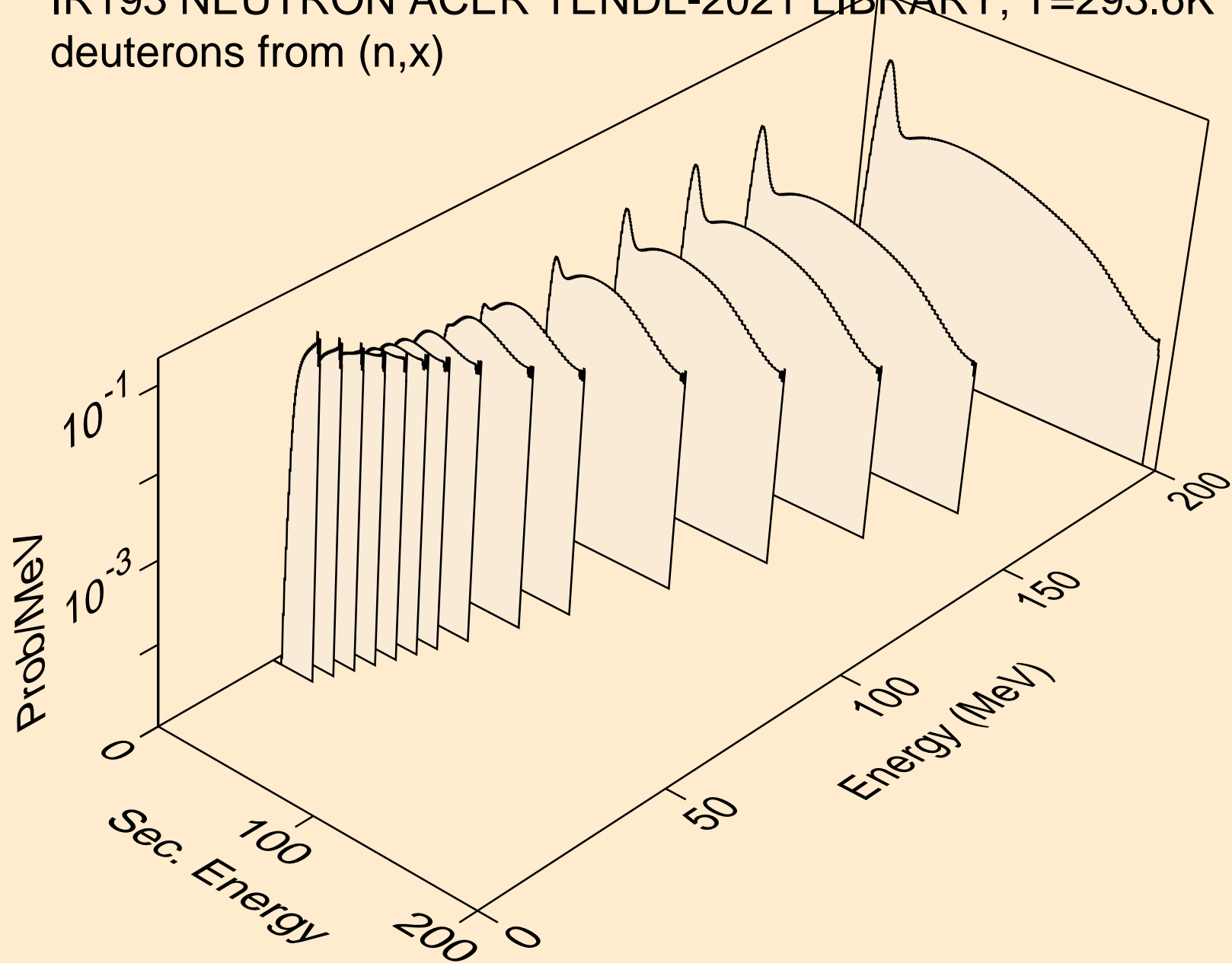

IR193 NEUTRON ACER TENDL-2021 LIBRARY; T=293.6K
deuterons from (n,2nd)

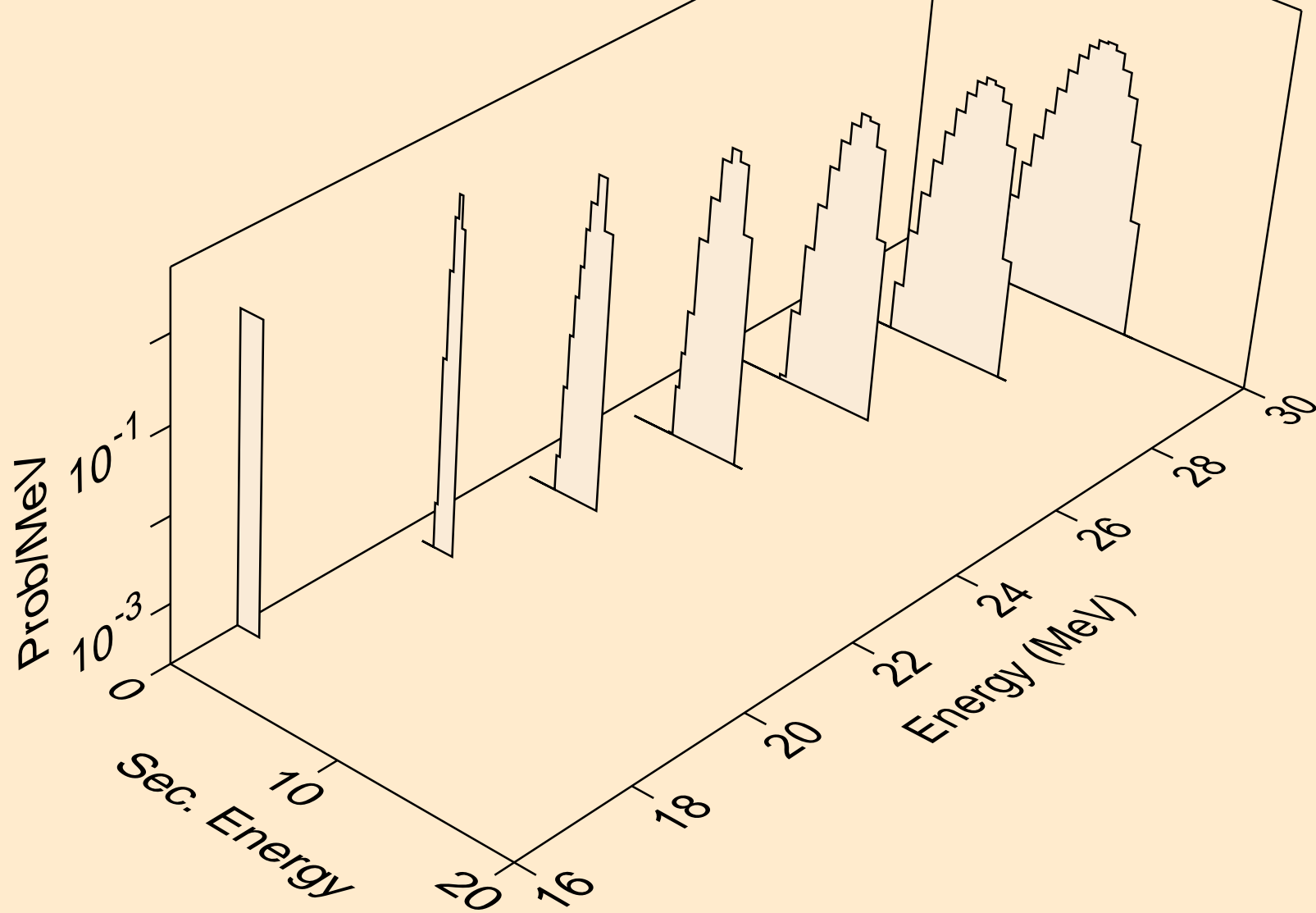

IR193 NEUTRON ACER TENDL-2021 LIBRARY; T=293.6K
deuterons from (n,n*)d

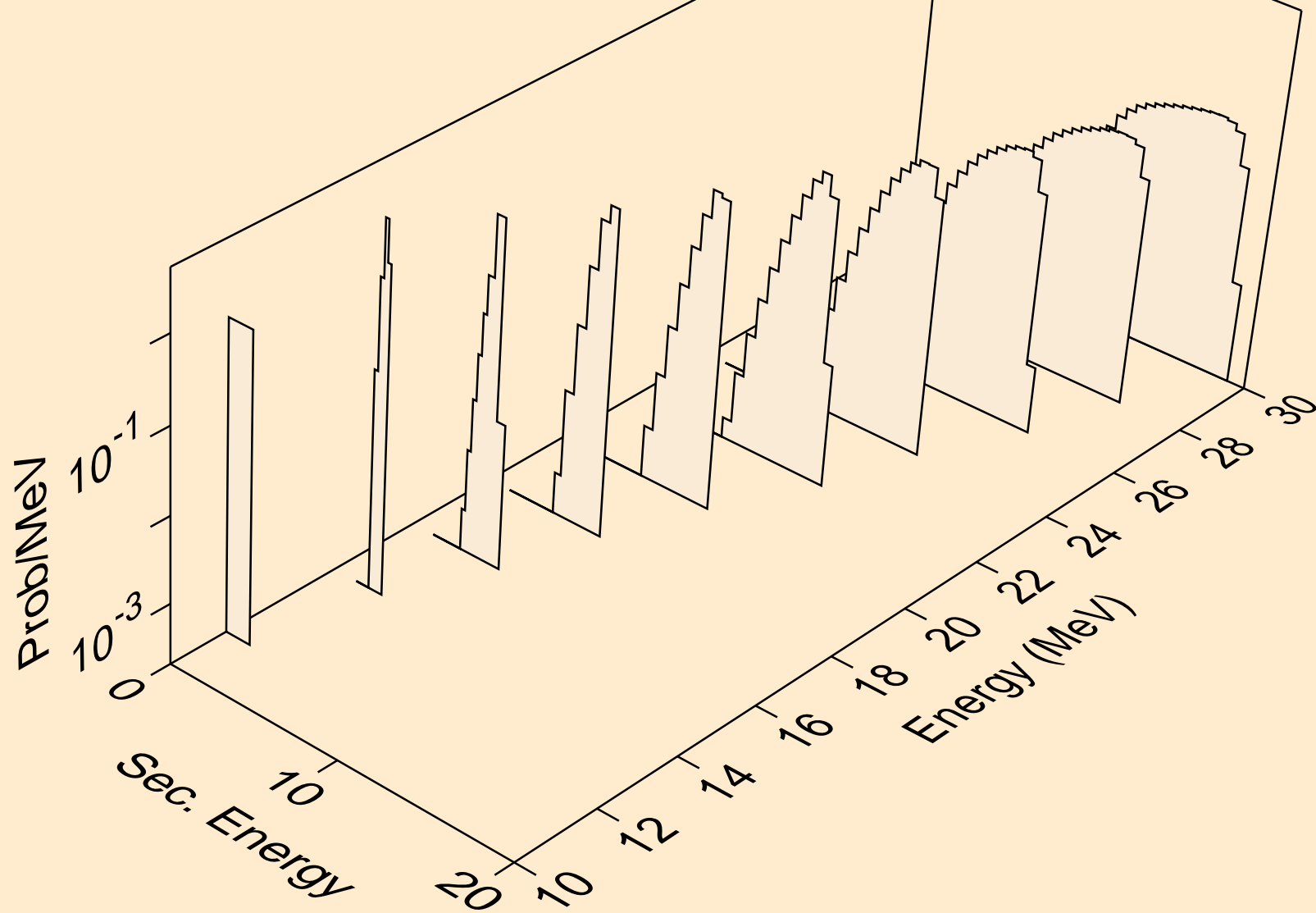

IR193 NEUTRON ACER TENDL-2021 LIBRARY; T=293.6K
deuterons from (n,d)

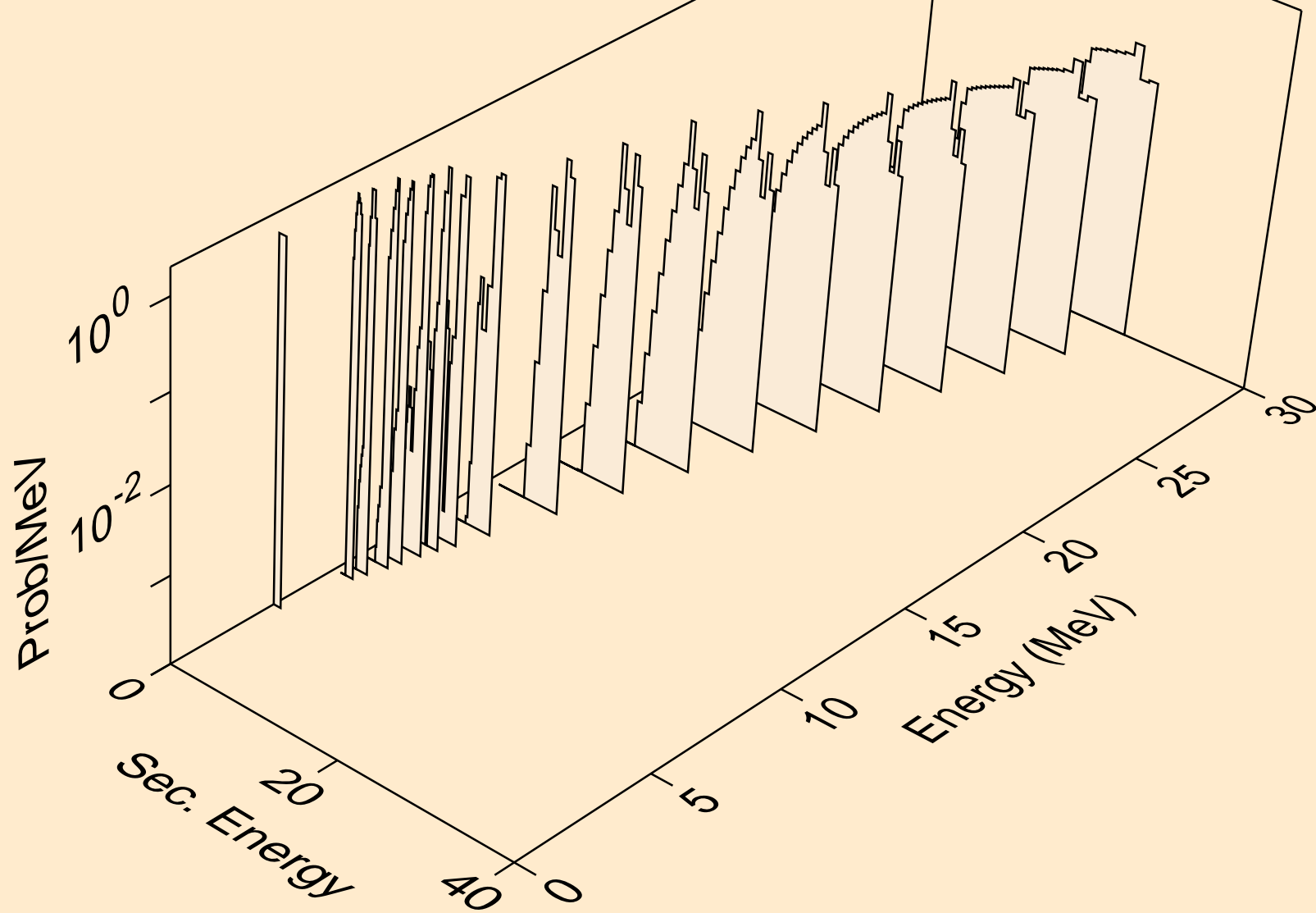

IR193 NEUTRON ACER TENDL-2021 LIBRARY; T=293.6K
tritons from (n,x)

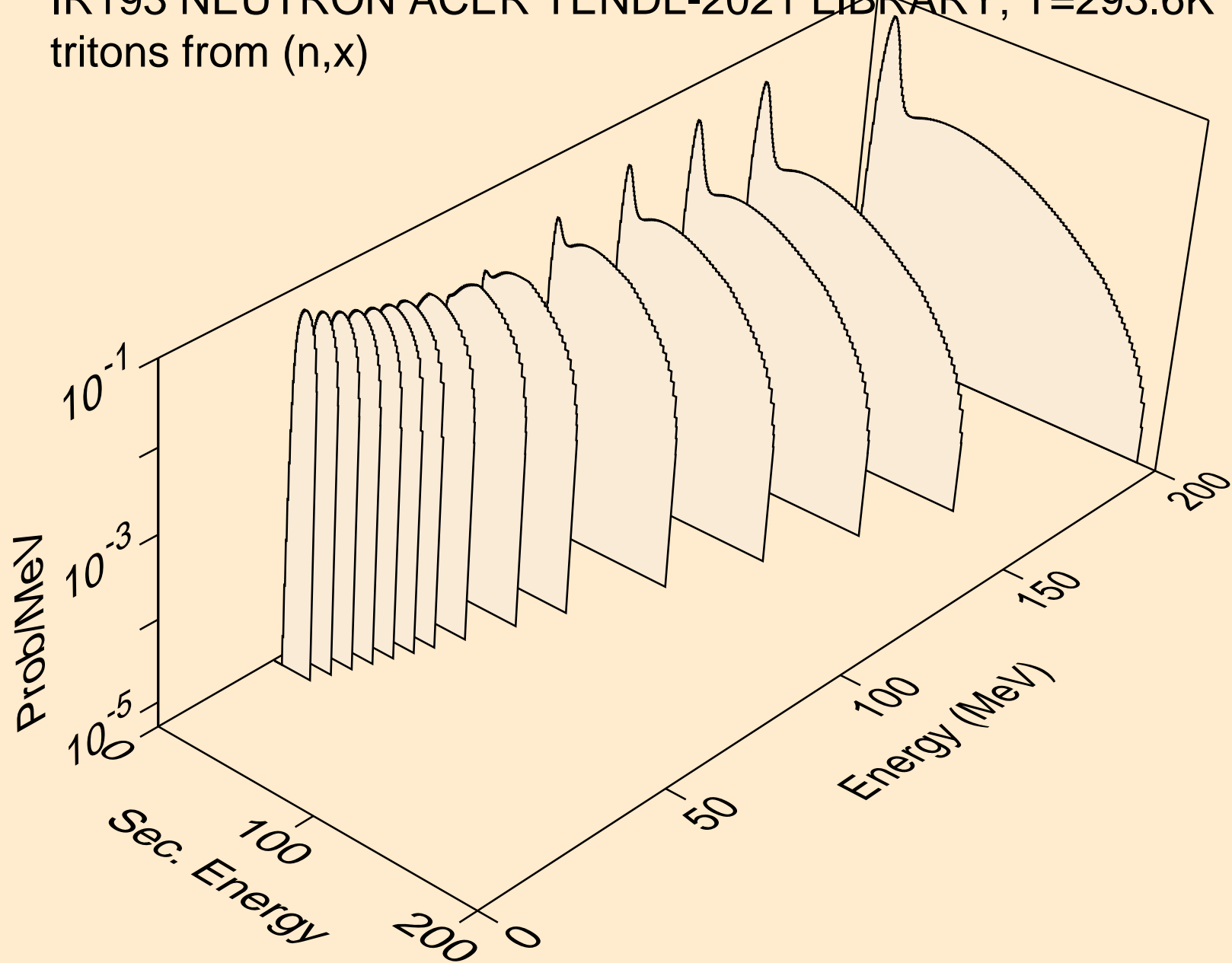

IR193 NEUTRON ACER TENDL-2021 LIBRARY; T=293.6K
tritons from (n,n*)t

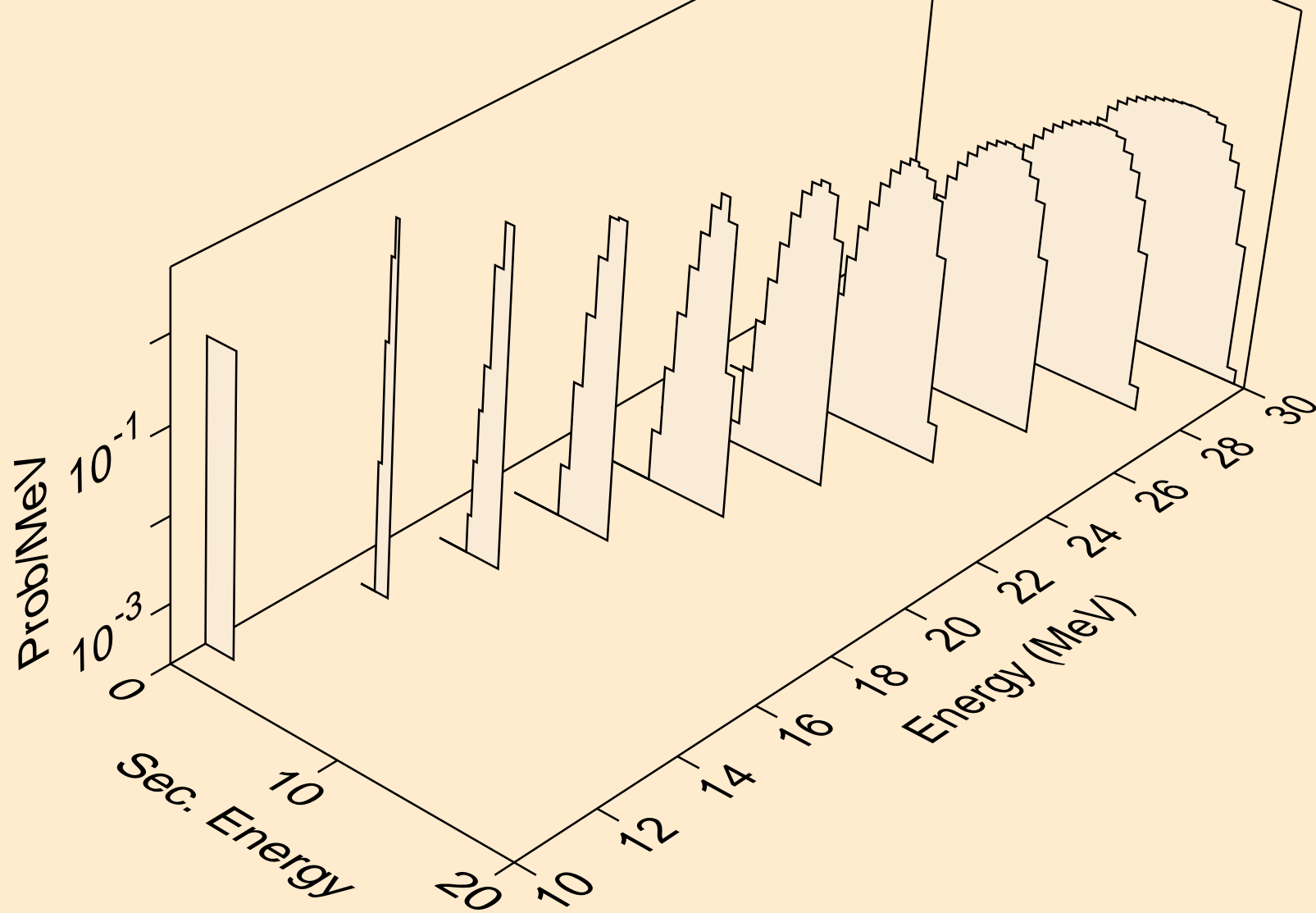

IR193 NEUTRON ACER TENDL-2021 LIBRARY; T=293.6K
tritons from (n,t)

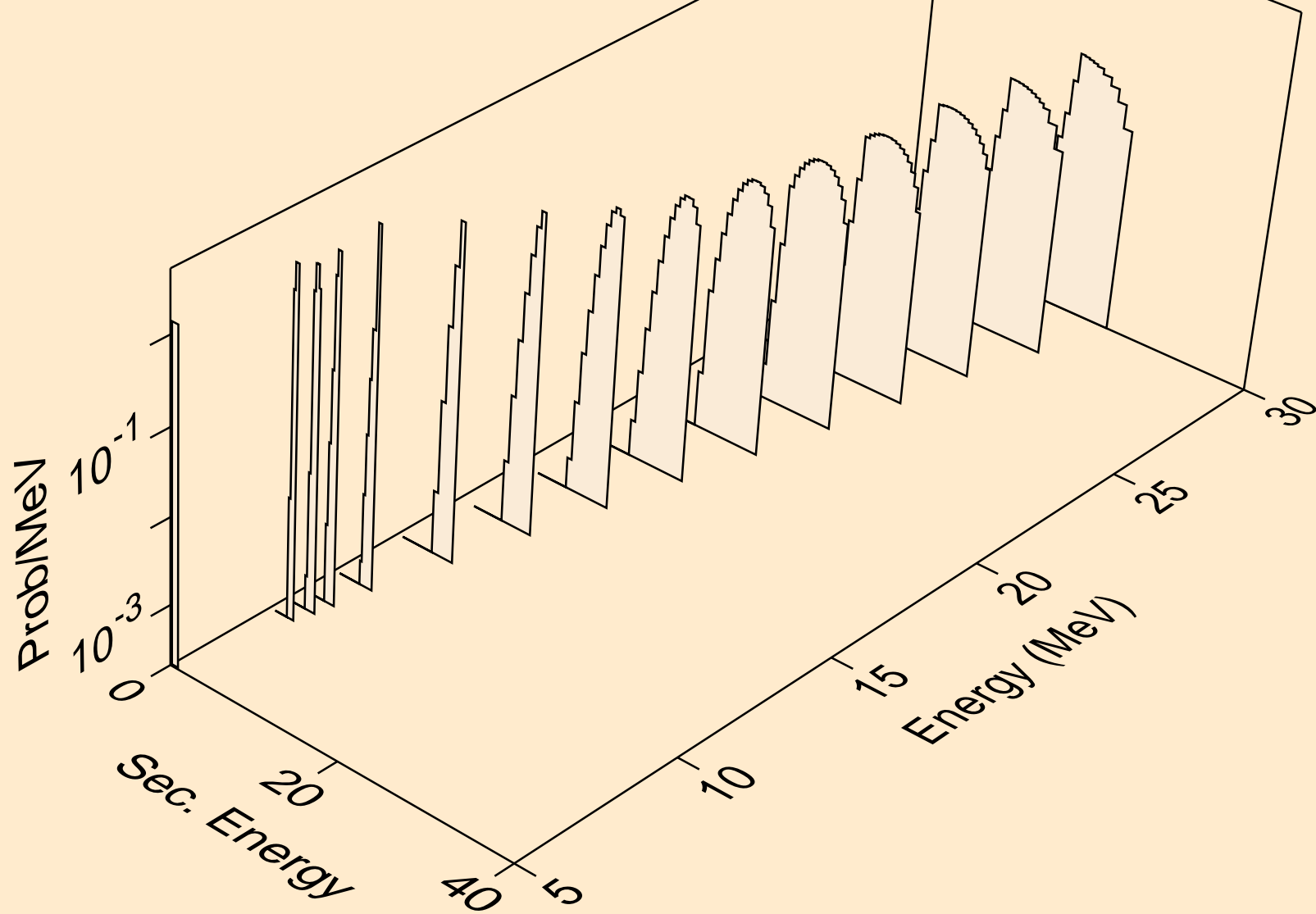

IR193 NEUTRON ACER TENDL-2021 LIBRARY; T=293.6K
he3s from (n,x)

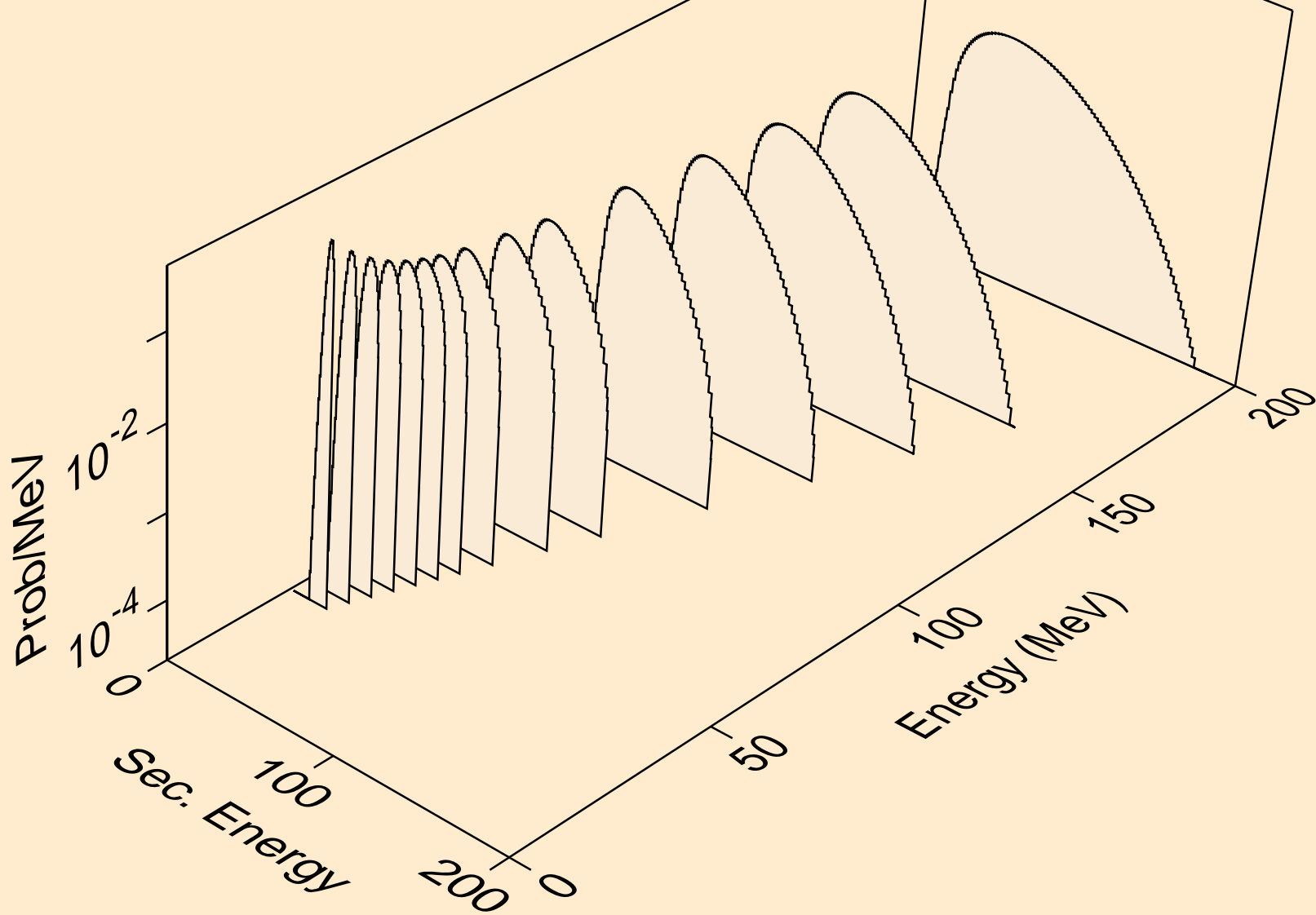

IR193 NEUTRON ACER TENDL-2021 LIBRARY; T=293.6K
he3s from (n,n*)he3

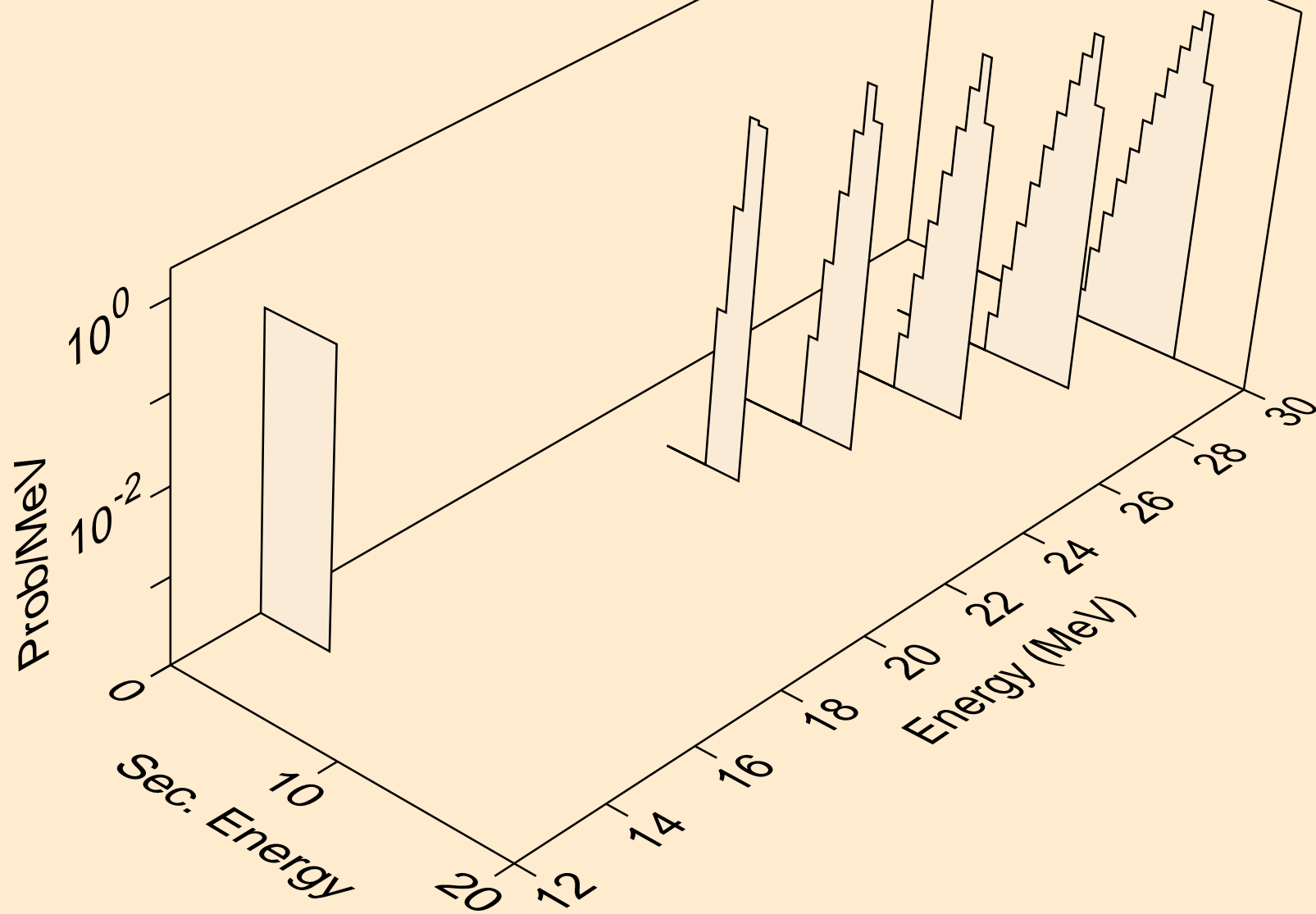

IR193 NEUTRON ACER TENDL-2021 LIBRARY; T=293.6K
he3s from (n,he3)

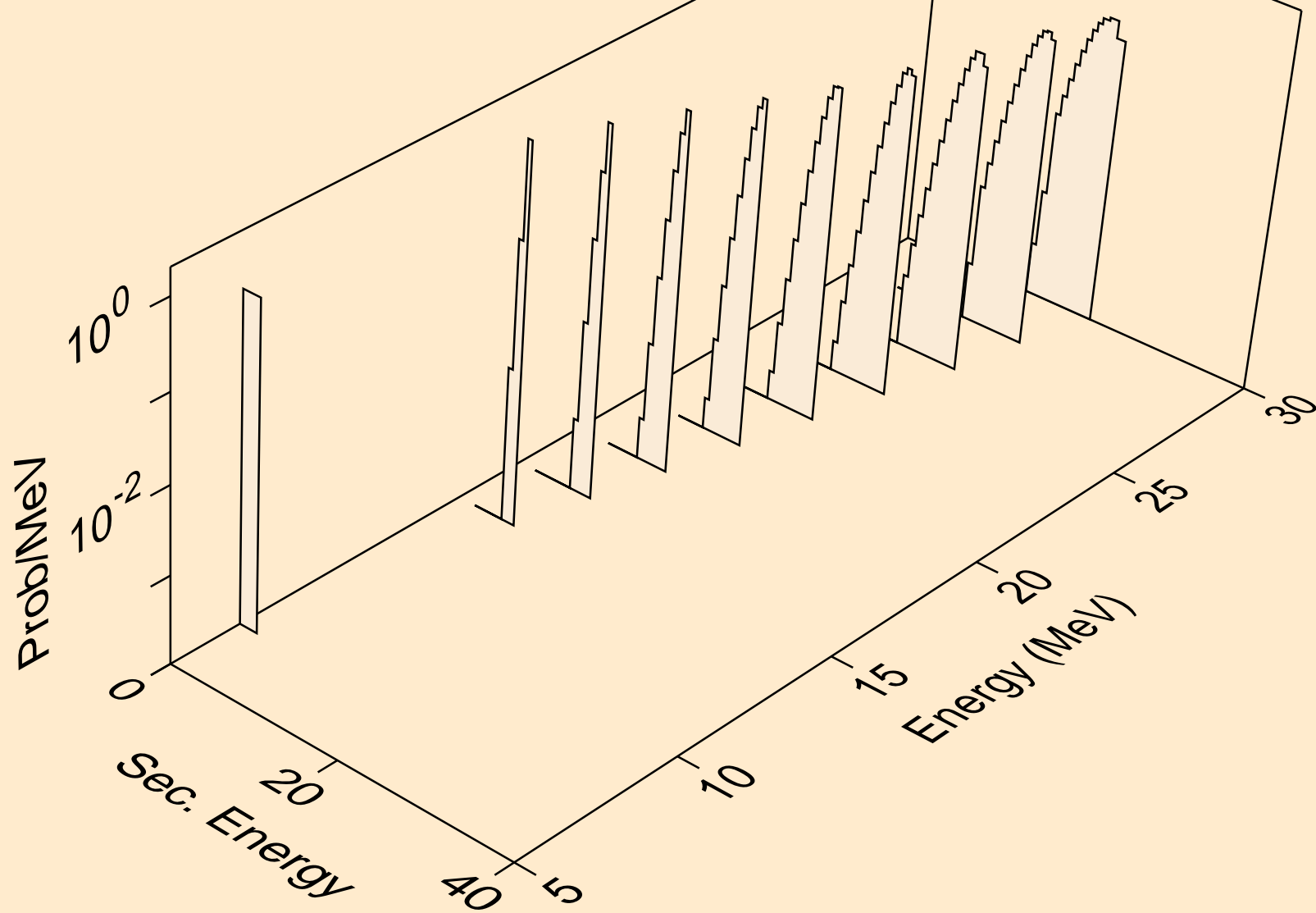

IR193 NEUTRON ACER TENDL-2021 LIBRARY; T=293.6K
alphas from (n,x)

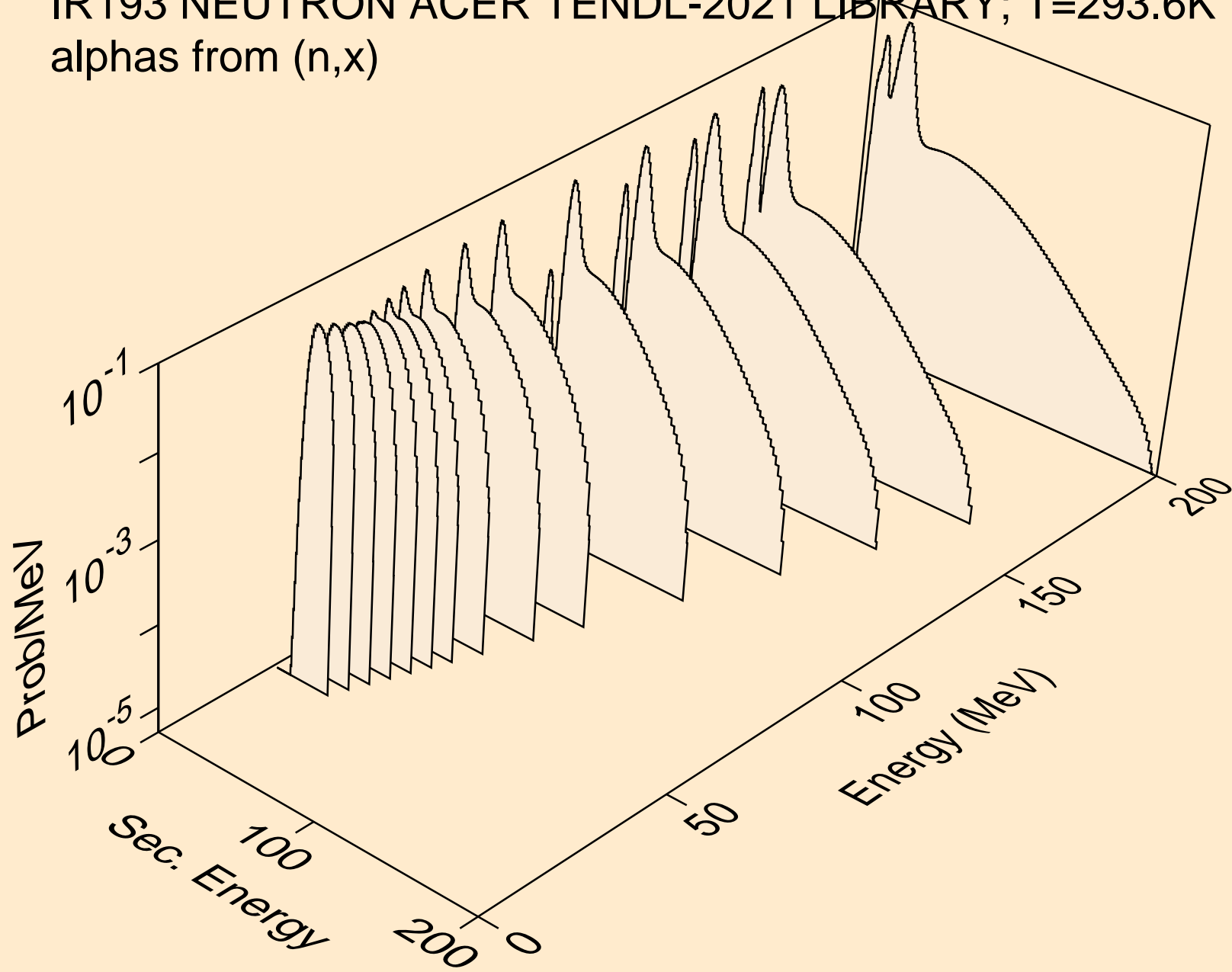

IR193 NEUTRON ACER TENDL-2021 LIBRARY; T=293.6K
alphas from (n,n*)a

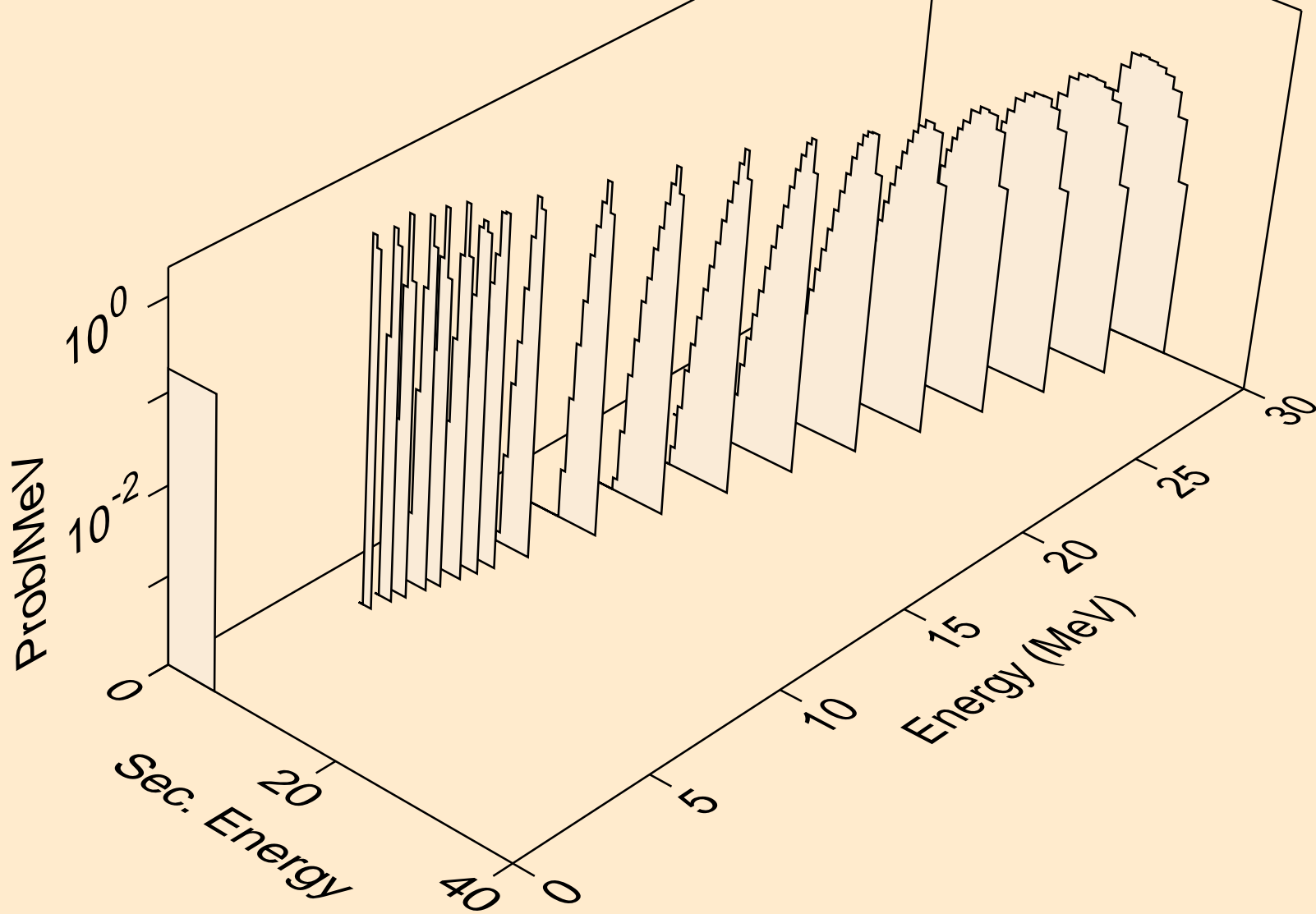

IR193 NEUTRON ACER TENDL-2021 LIBRARY; T=293.6K
alphas from (n,2n)a

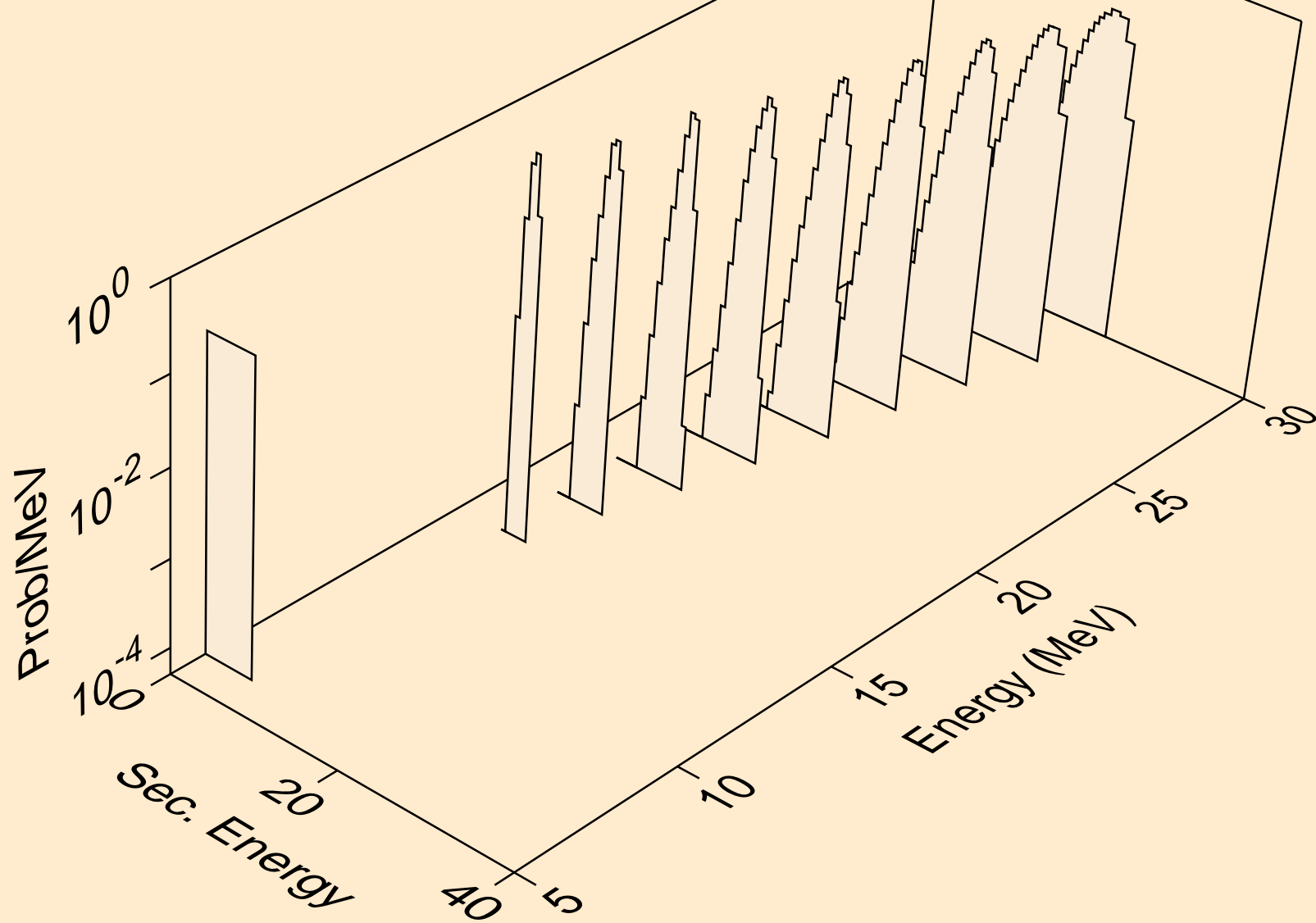

IR193 NEUTRON ACER TENDL-2021 LIBRARY; T=293.6K
alphas from (n,3n)a

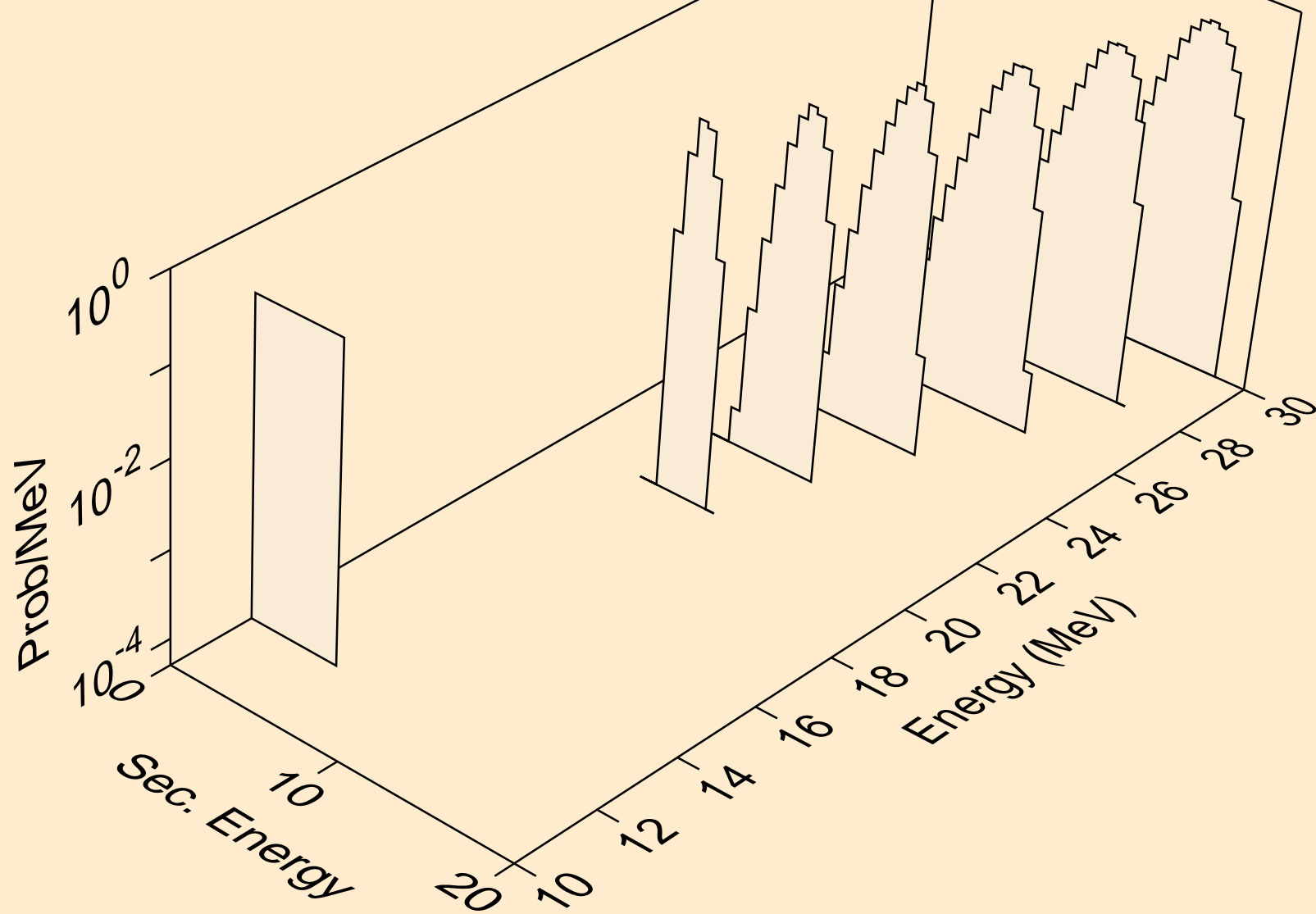

IR193 NEUTRON ACER TENDL-2021 LIBRARY; T=293.6K
alphas from (n,npa)

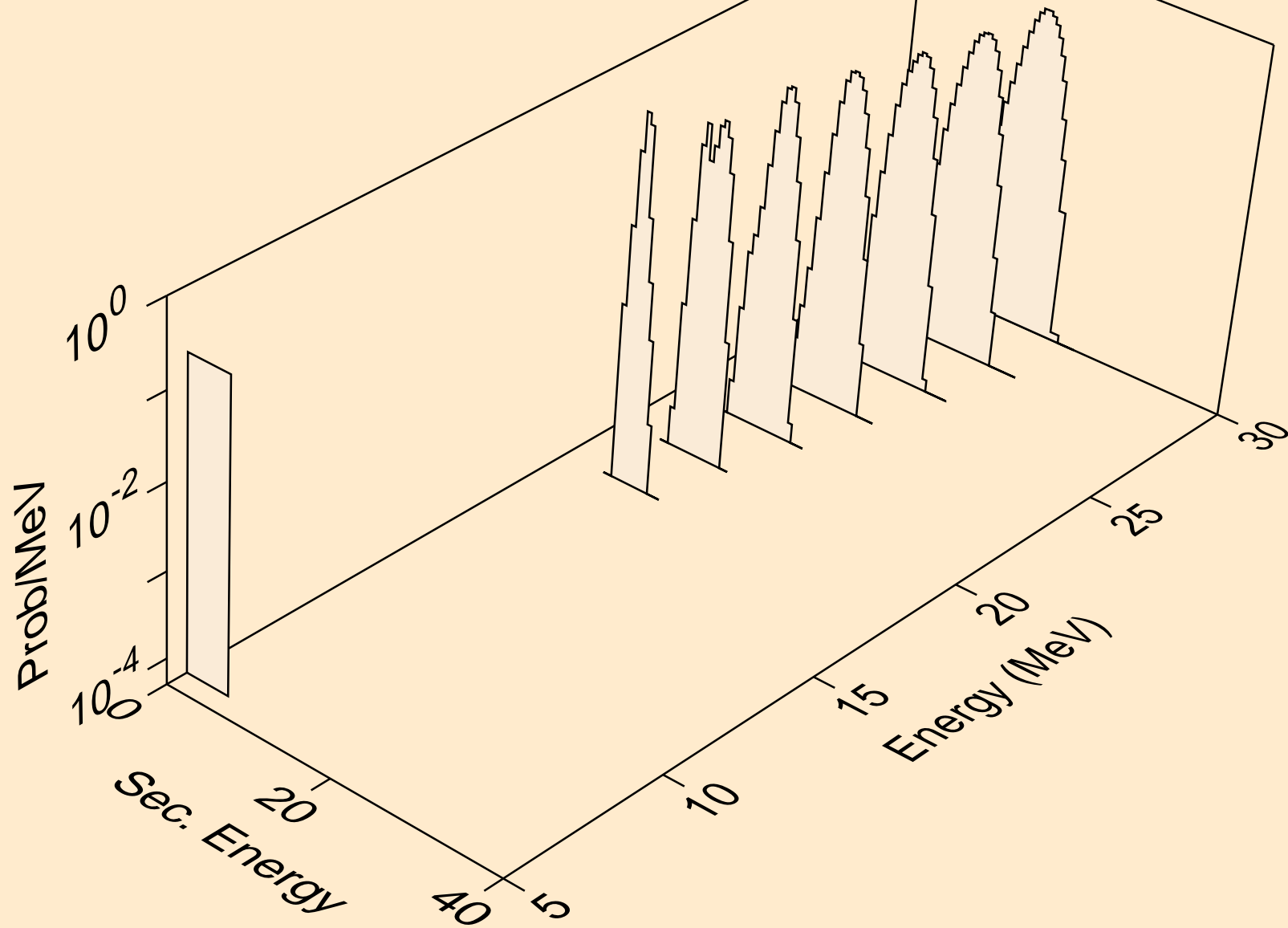

IR193 NEUTRON ACER TENDL-2021 LIBRARY; T=293.6K
alphas from (n,a)

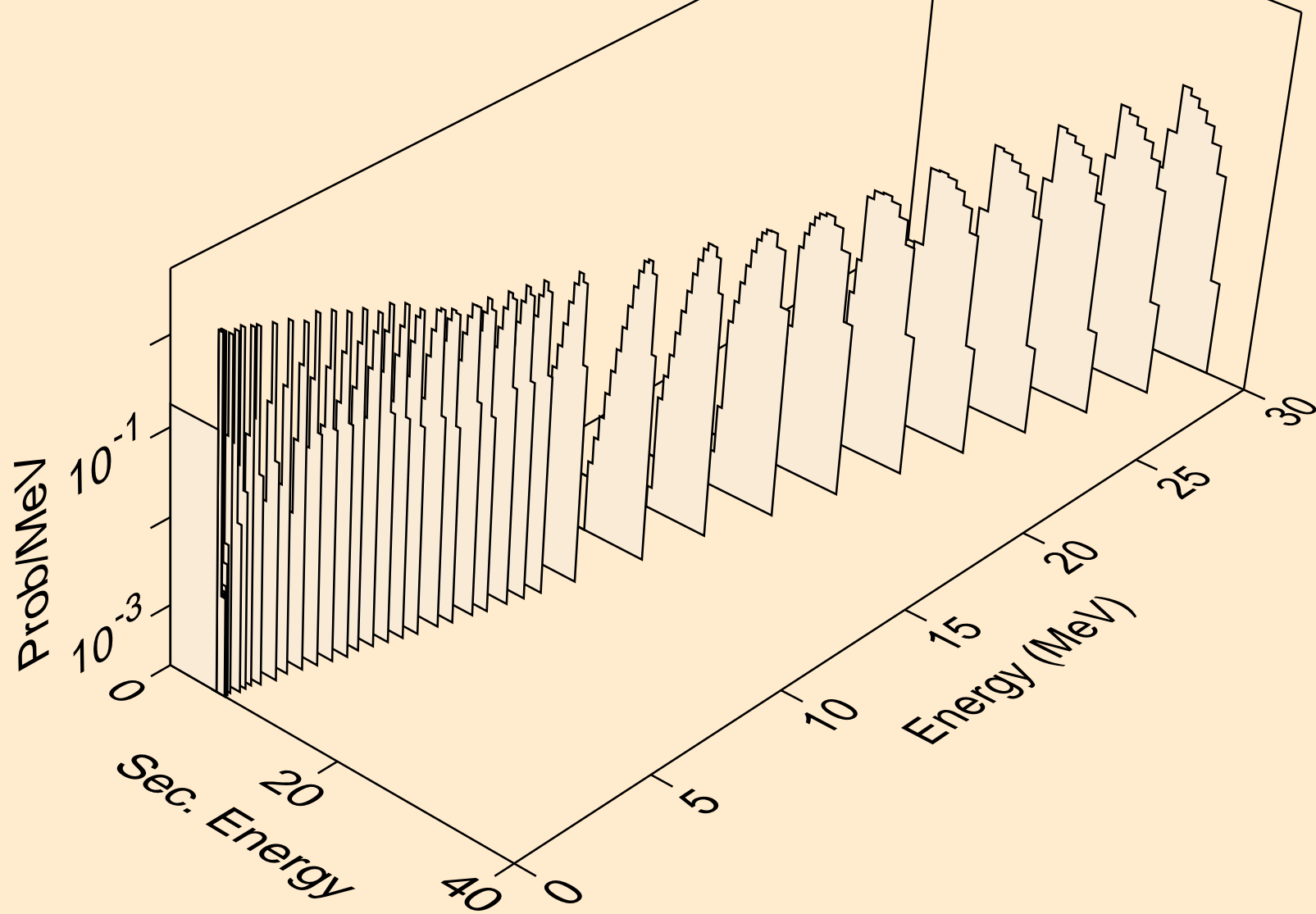

IR193 NEUTRON ACER TENDL-2021 LIBRARY; T=293.6K
alphas from (n,2a)

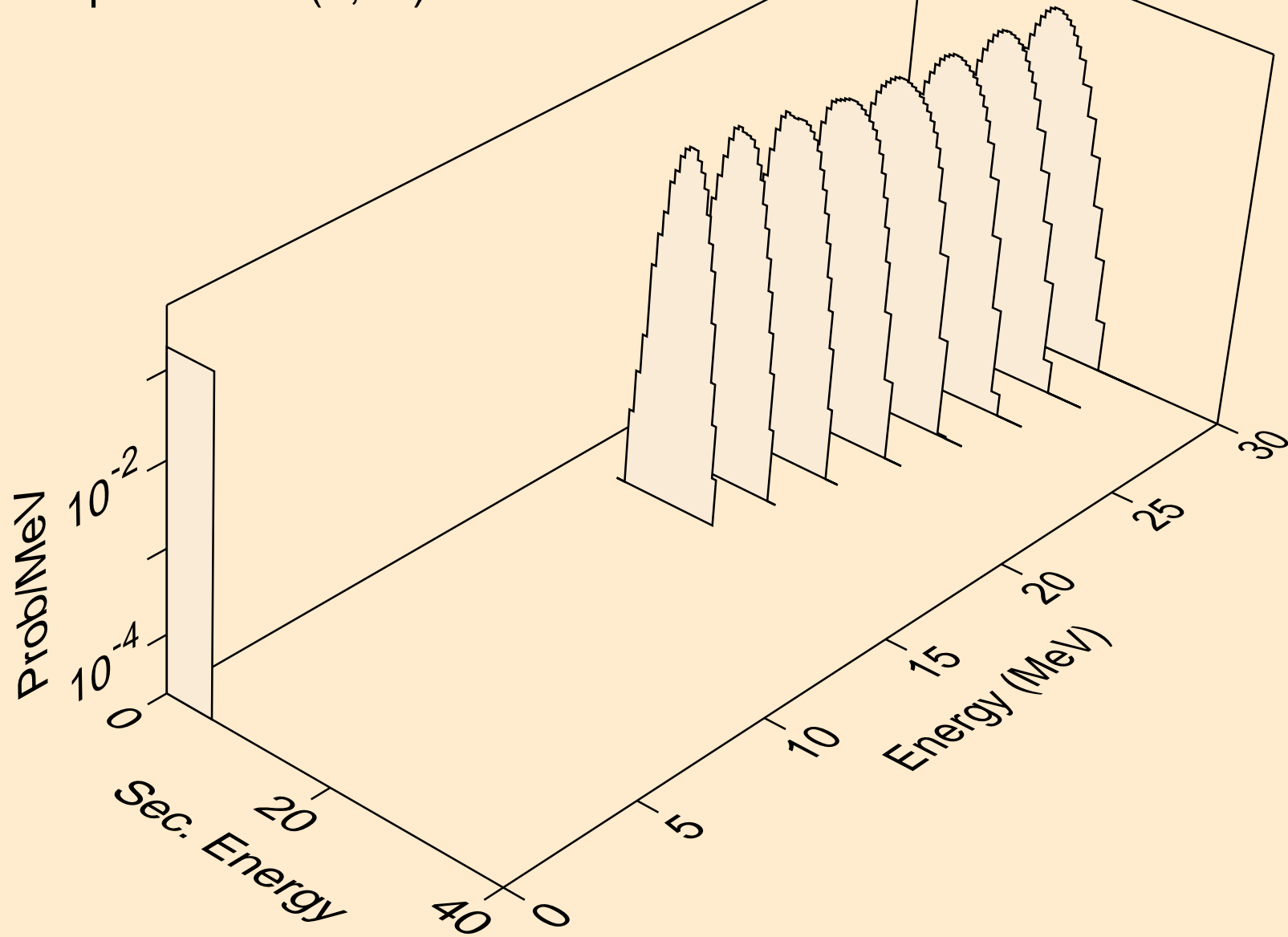

IR193 NEUTRON ACER TENDL-2021 LIBRARY; T=293.6K
alphas from (n,pa)

