

IR203 NEUTRON ACER TENDL-2021 LIBRARY; T=293.6K
Principal cross sections

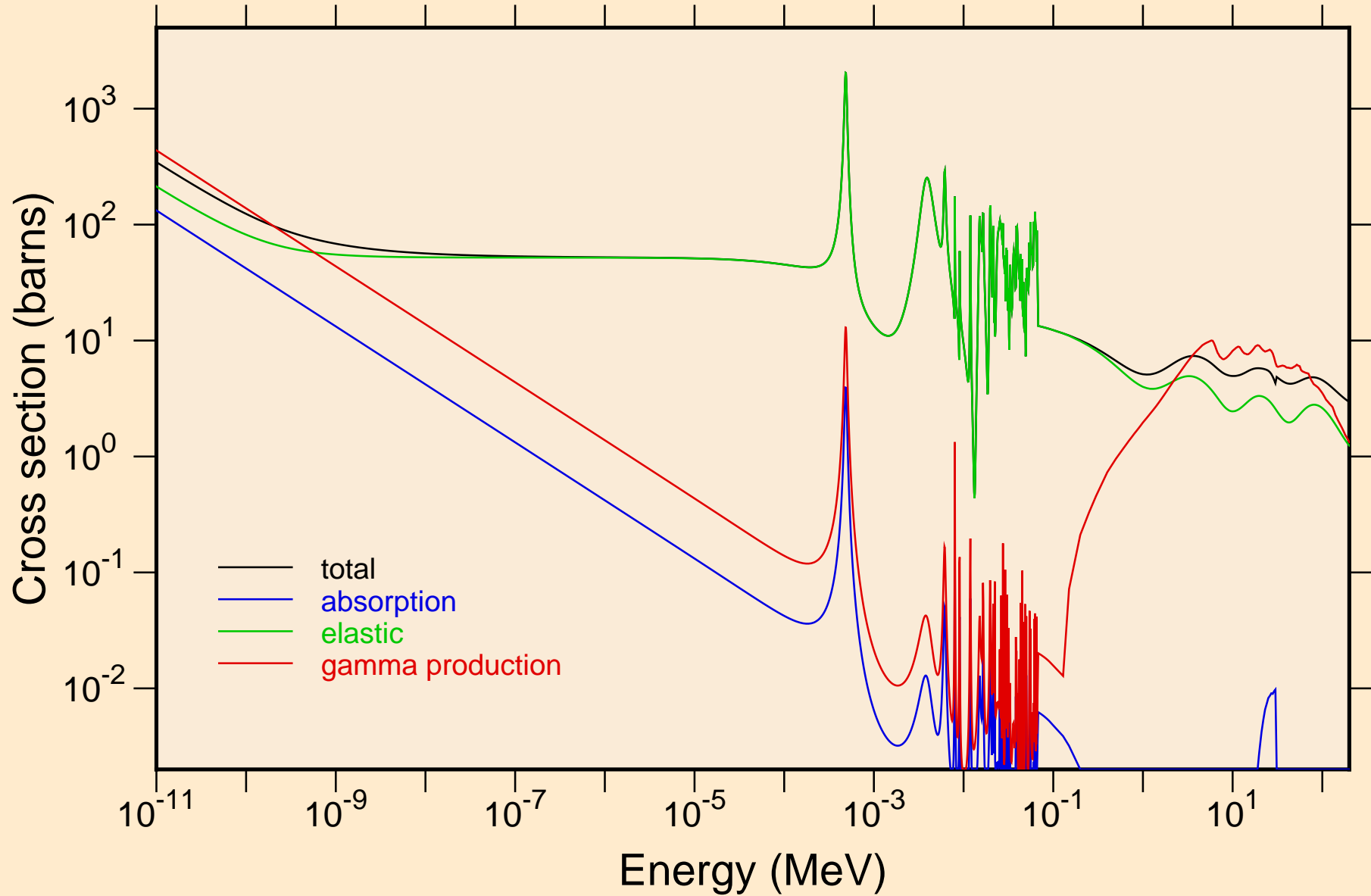

IR203 NEUTRON ACER TENDL-2021 LIBRARY; T=293.6K
resonance total cross section

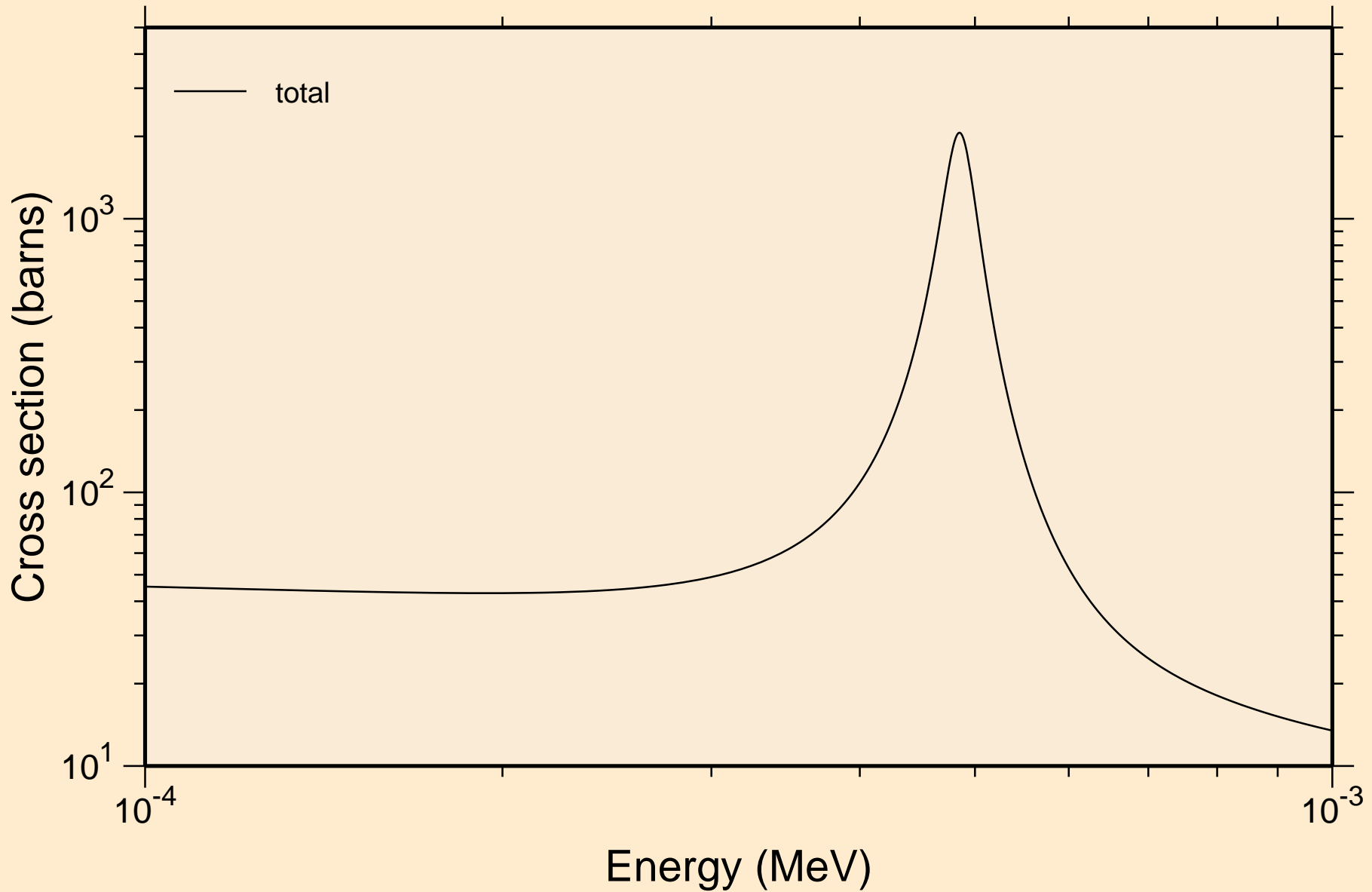

IR203 NEUTRON ACER TENDL-2021 LIBRARY; T=293.6K
resonance total cross section

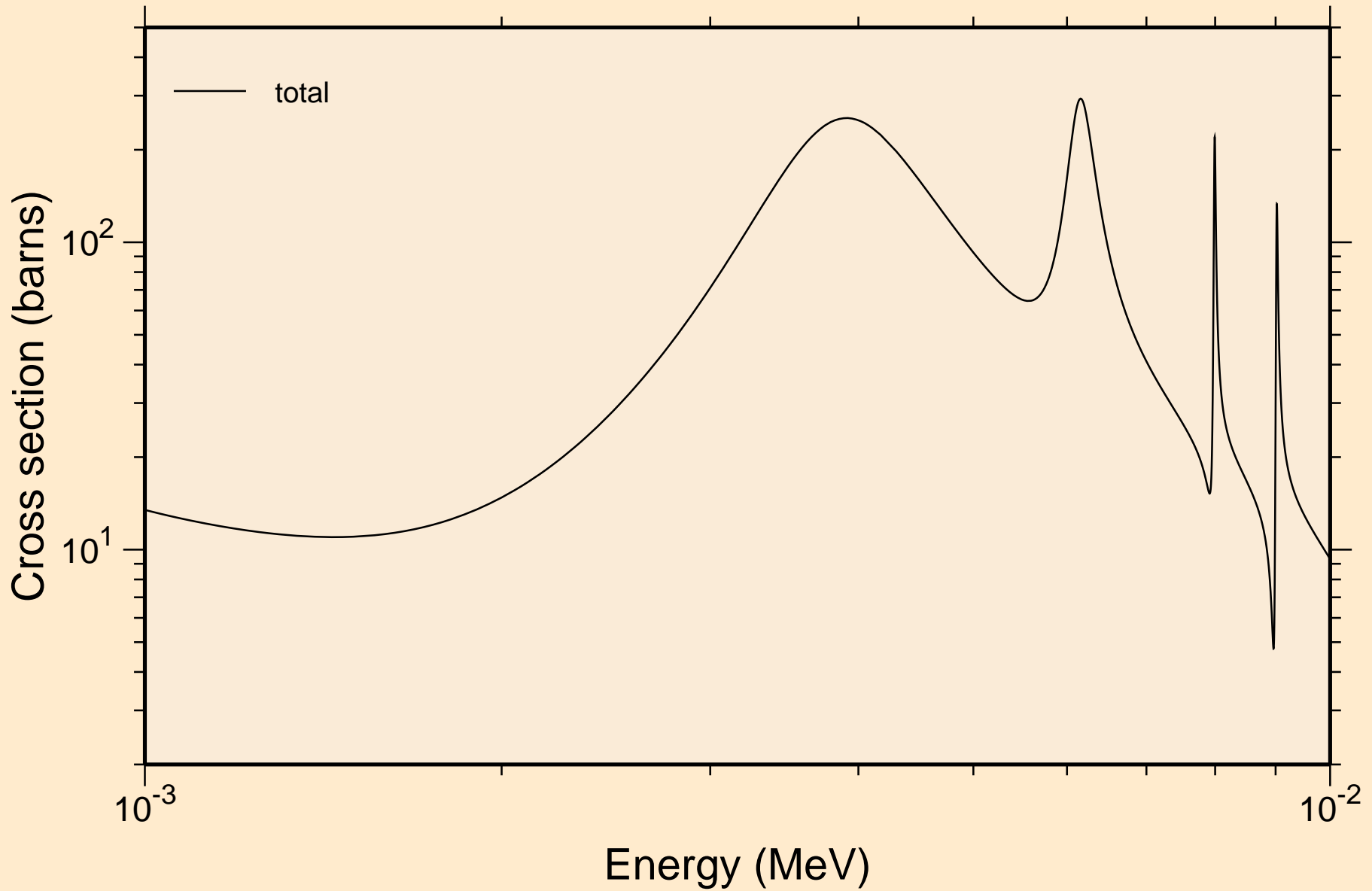

IR203 NEUTRON ACER TENDL-2021 LIBRARY; T=293.6K
resonance total cross section

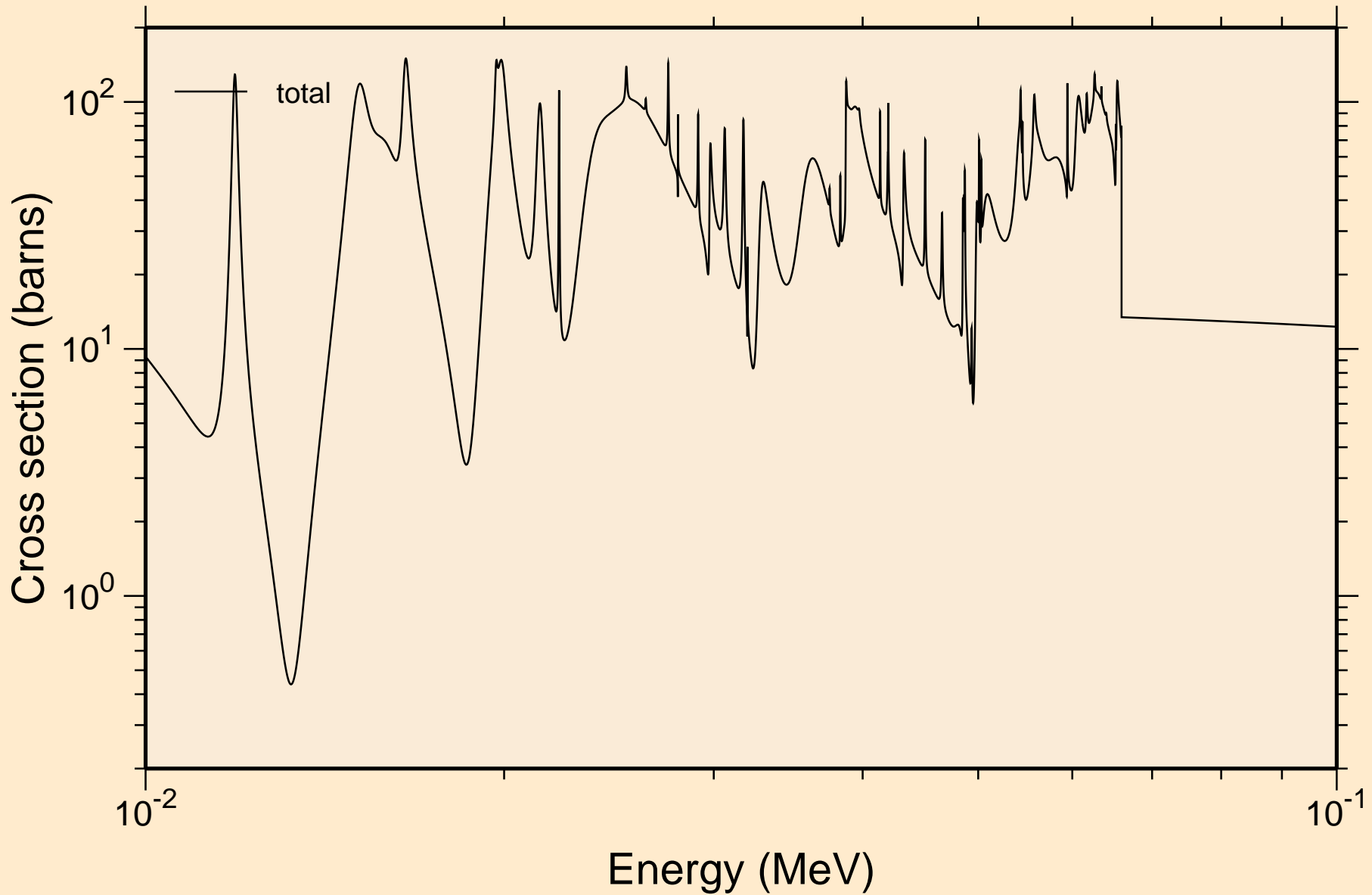

IR203 NEUTRON ACER TENDL-2021 LIBRARY; T=293.6K
resonance total cross section

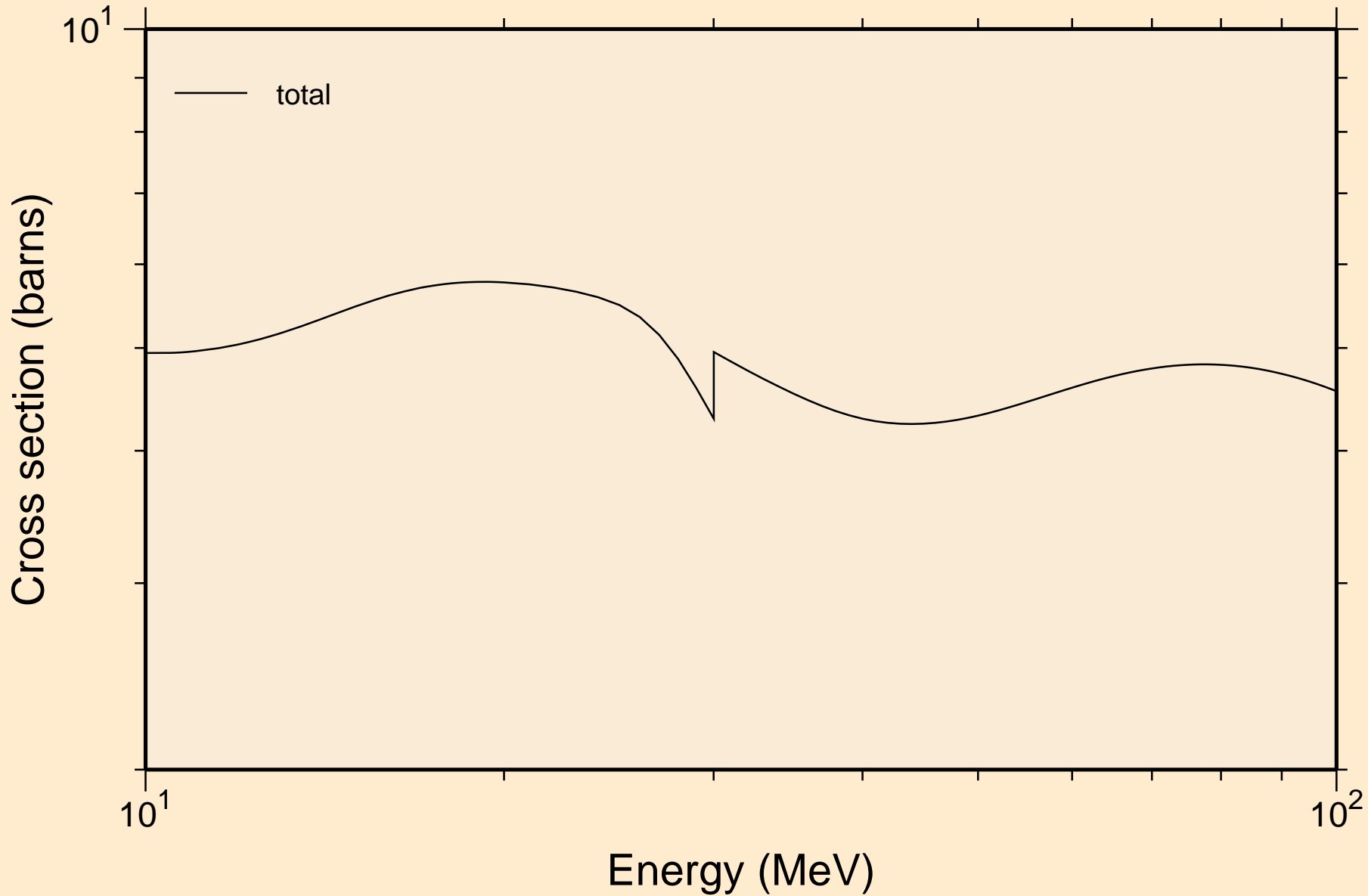

IR203 NEUTRON ACER TENDL-2021 LIBRARY; T=293.6K
resonance absorption cross sections

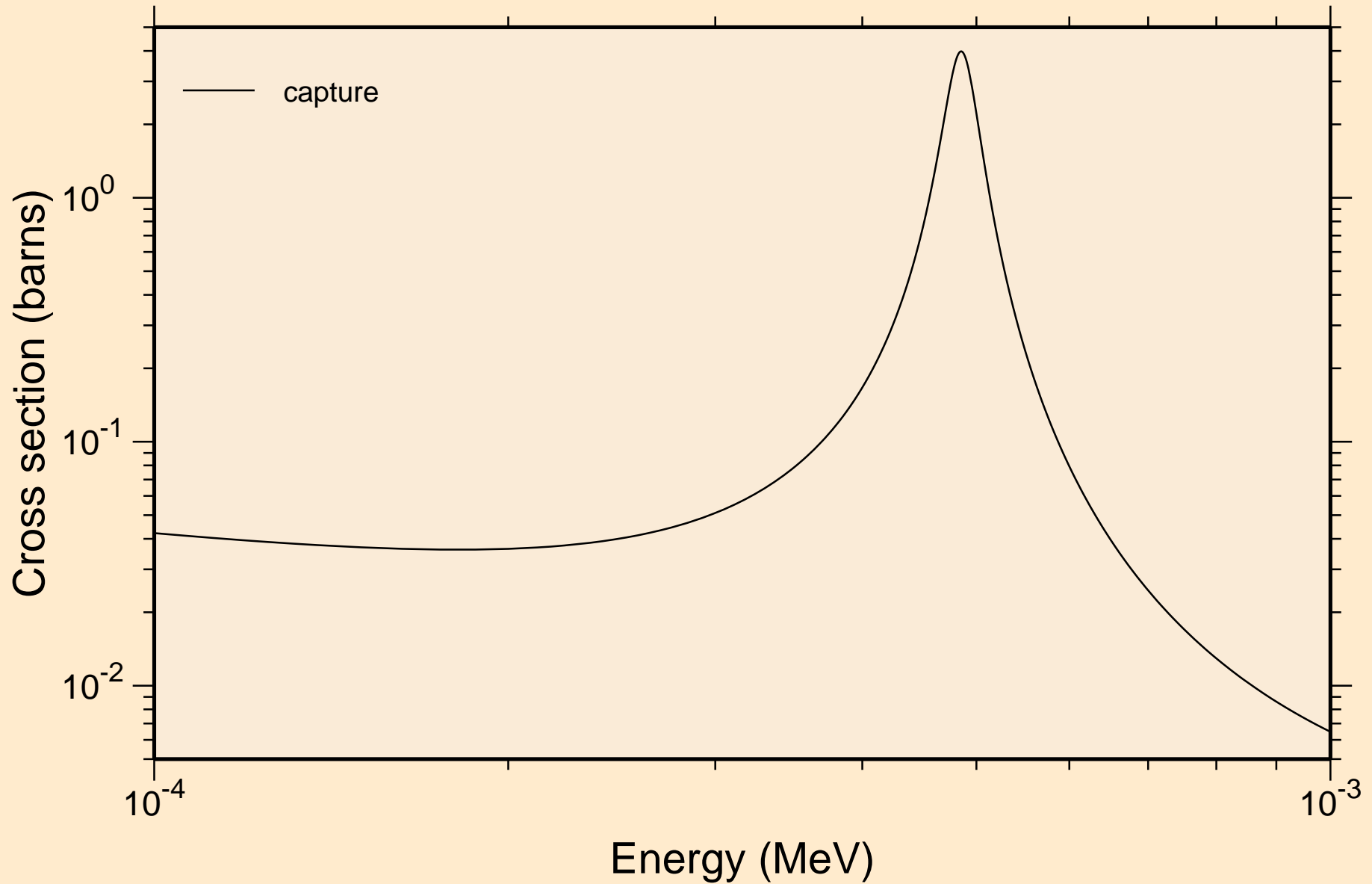

IR203 NEUTRON ACER TENDL-2021 LIBRARY; T=293.6K
resonance absorption cross sections

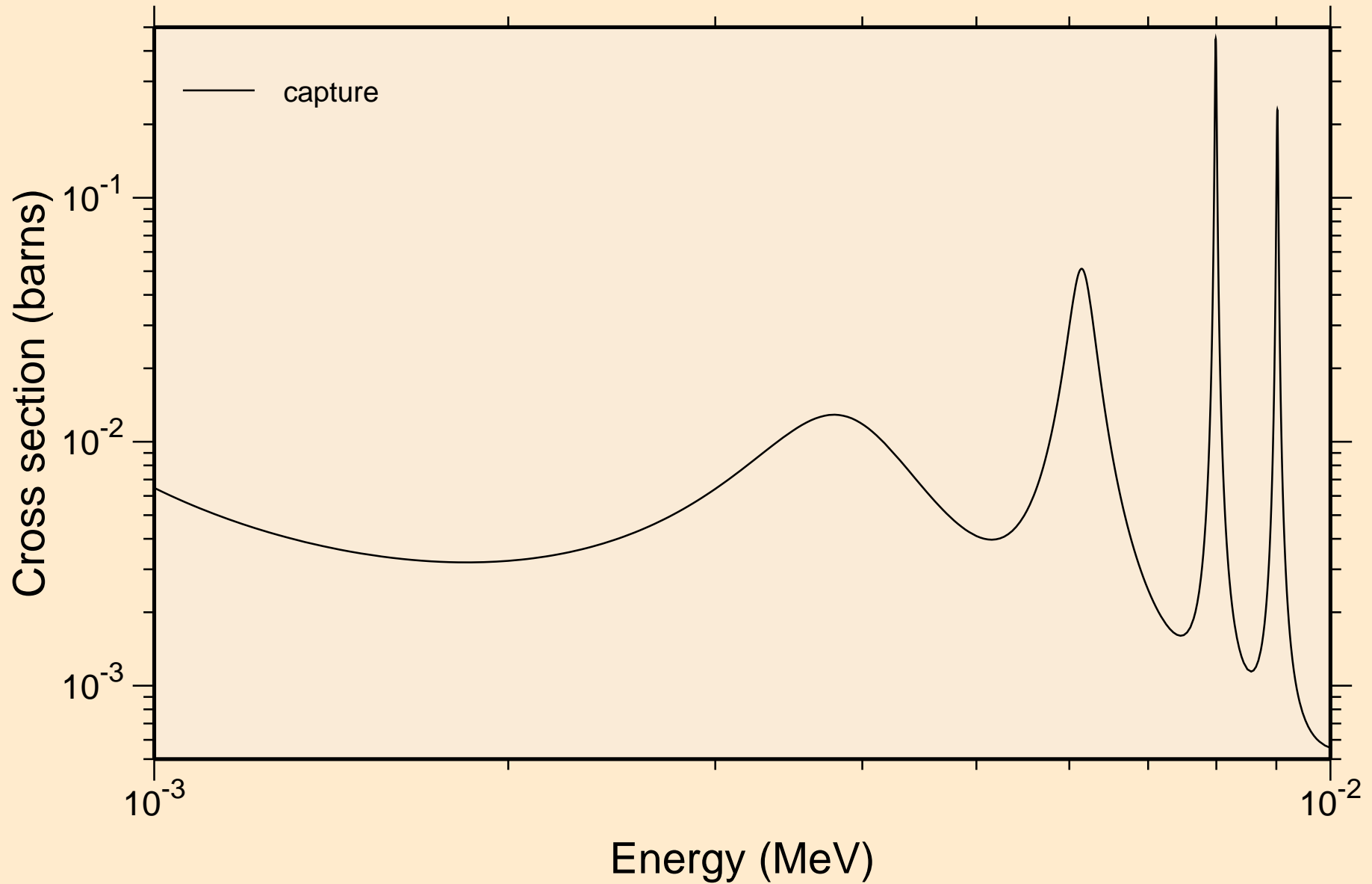

IR203 NEUTRON ACER TENDL-2021 LIBRARY; T=293.6K
resonance absorption cross sections

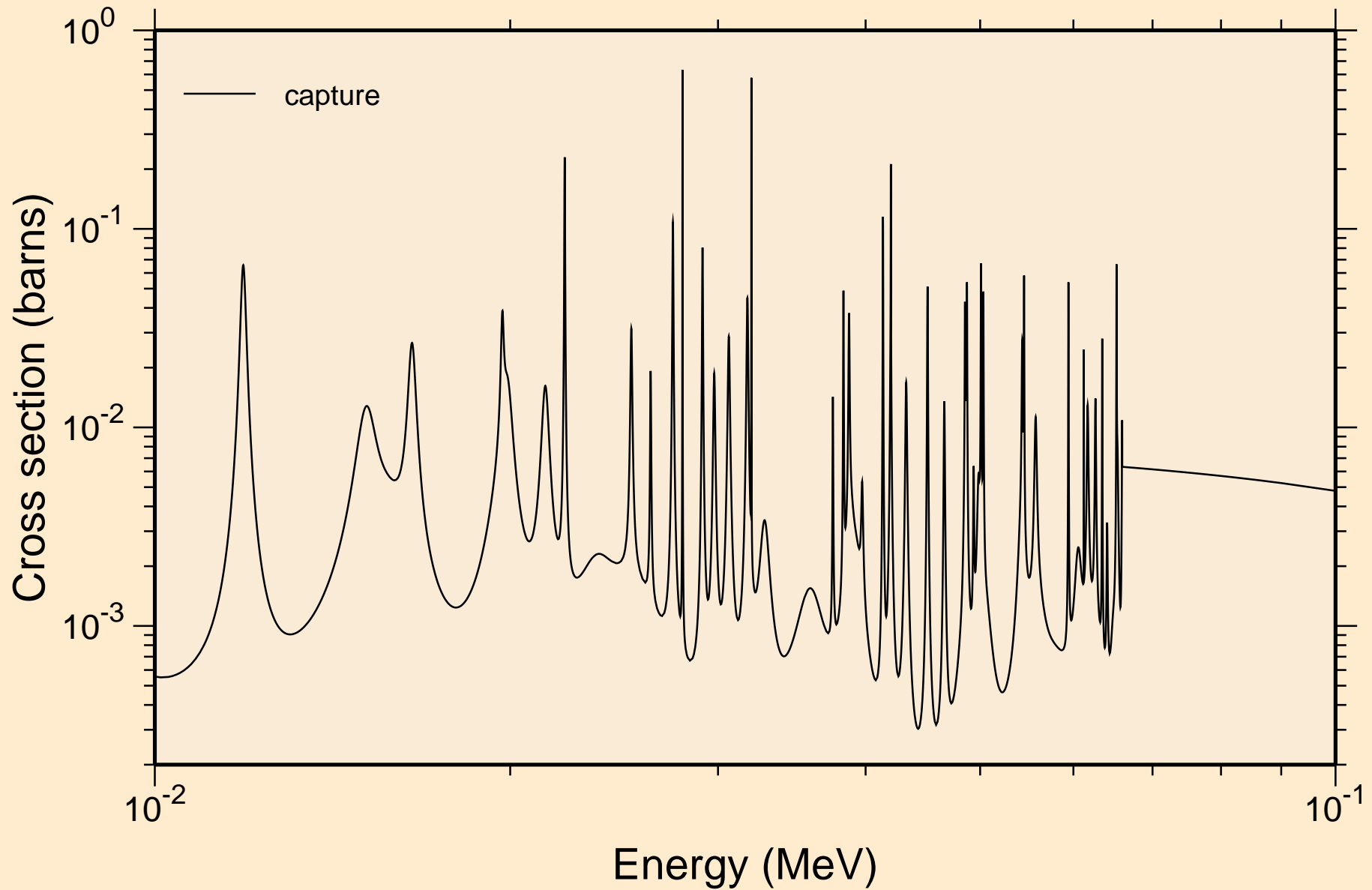

IR203 NEUTRON ACER TENDL-2021 LIBRARY; T=293.6K
resonance absorption cross sections

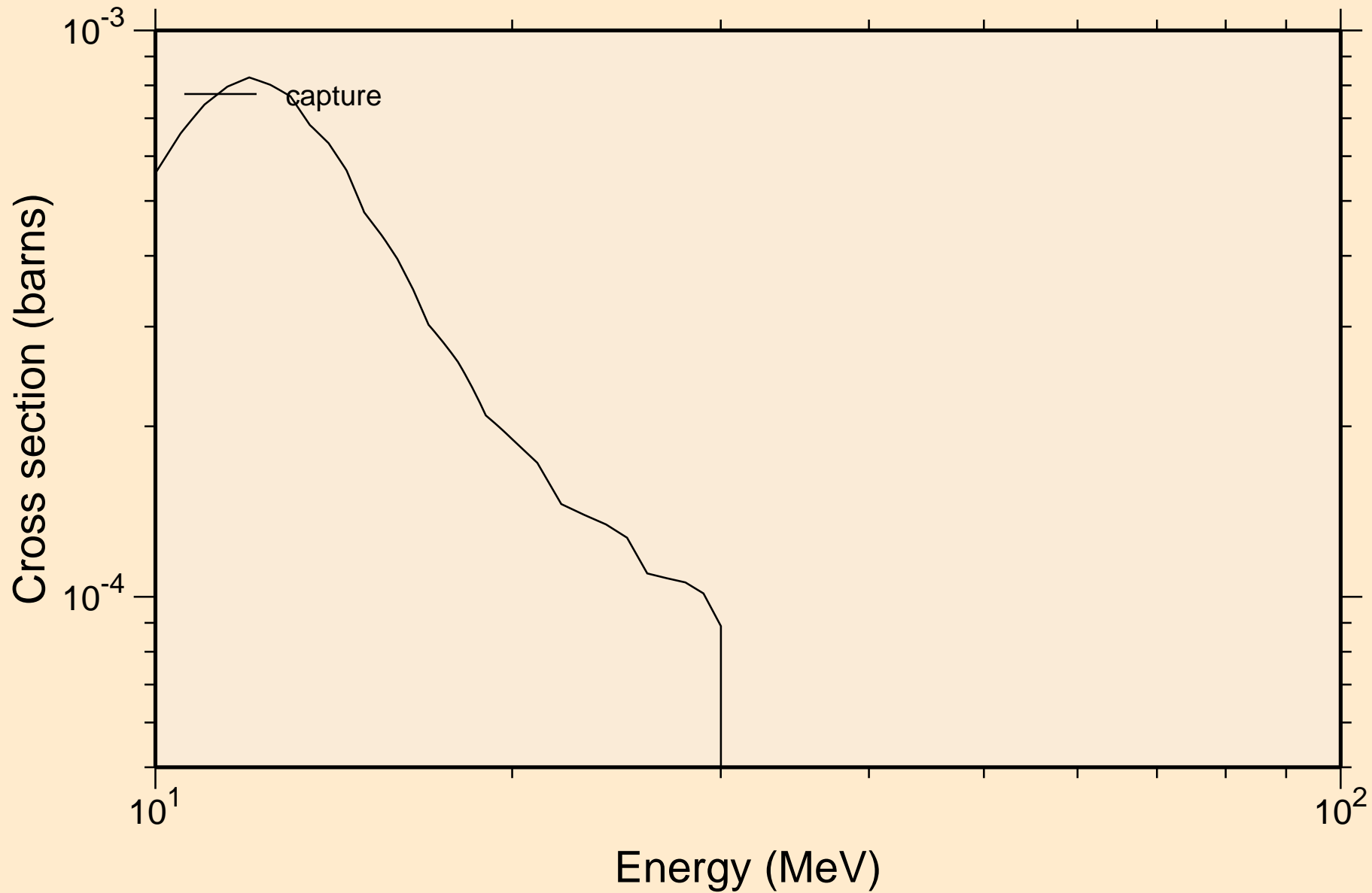

IR203 NEUTRON ACER TENDL-2021 LIBRARY; T=293.6K
Heating

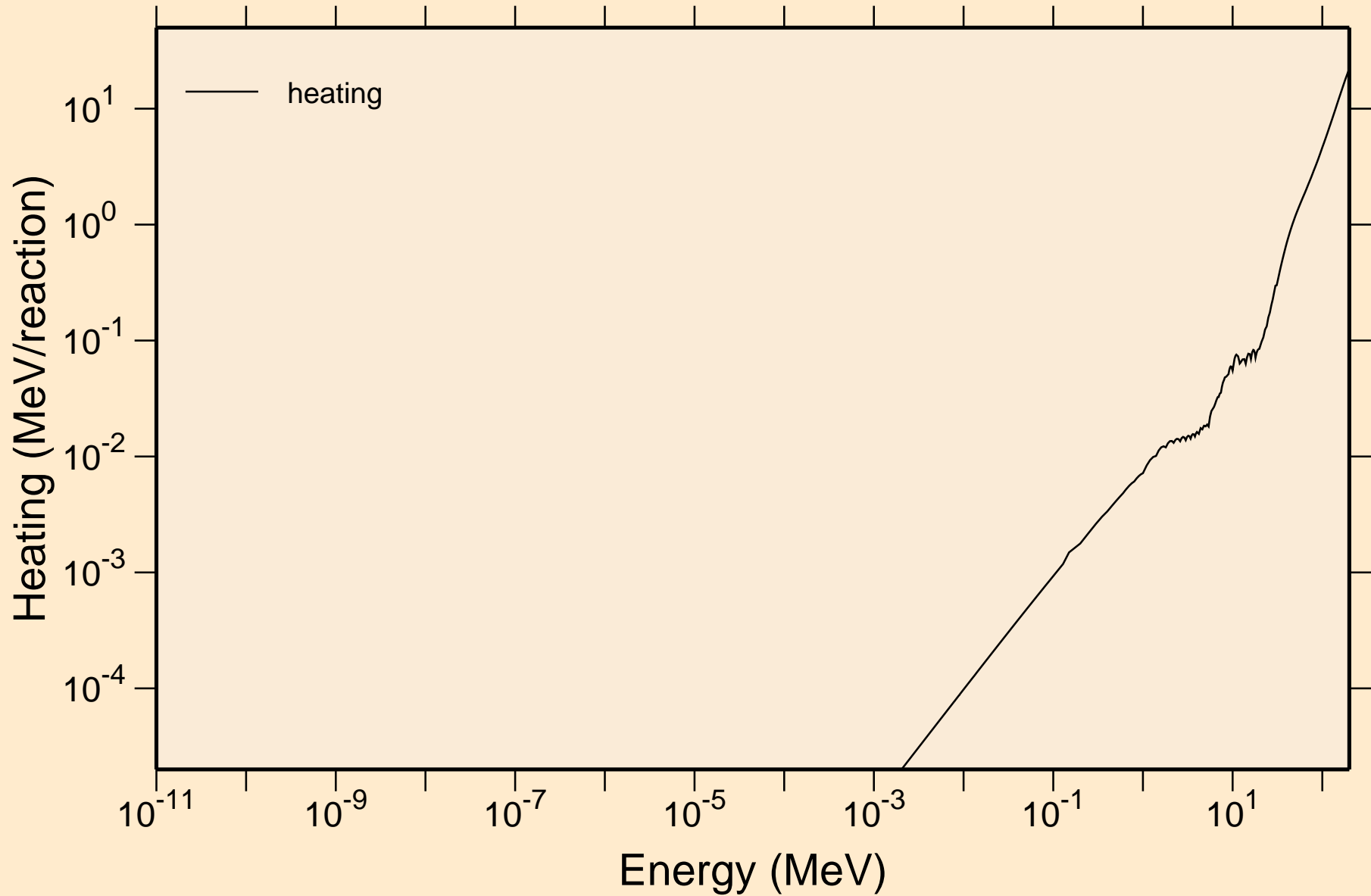

IR203 NEUTRON ACER TENDL-2021 LIBRARY; T=293.6K
Damage

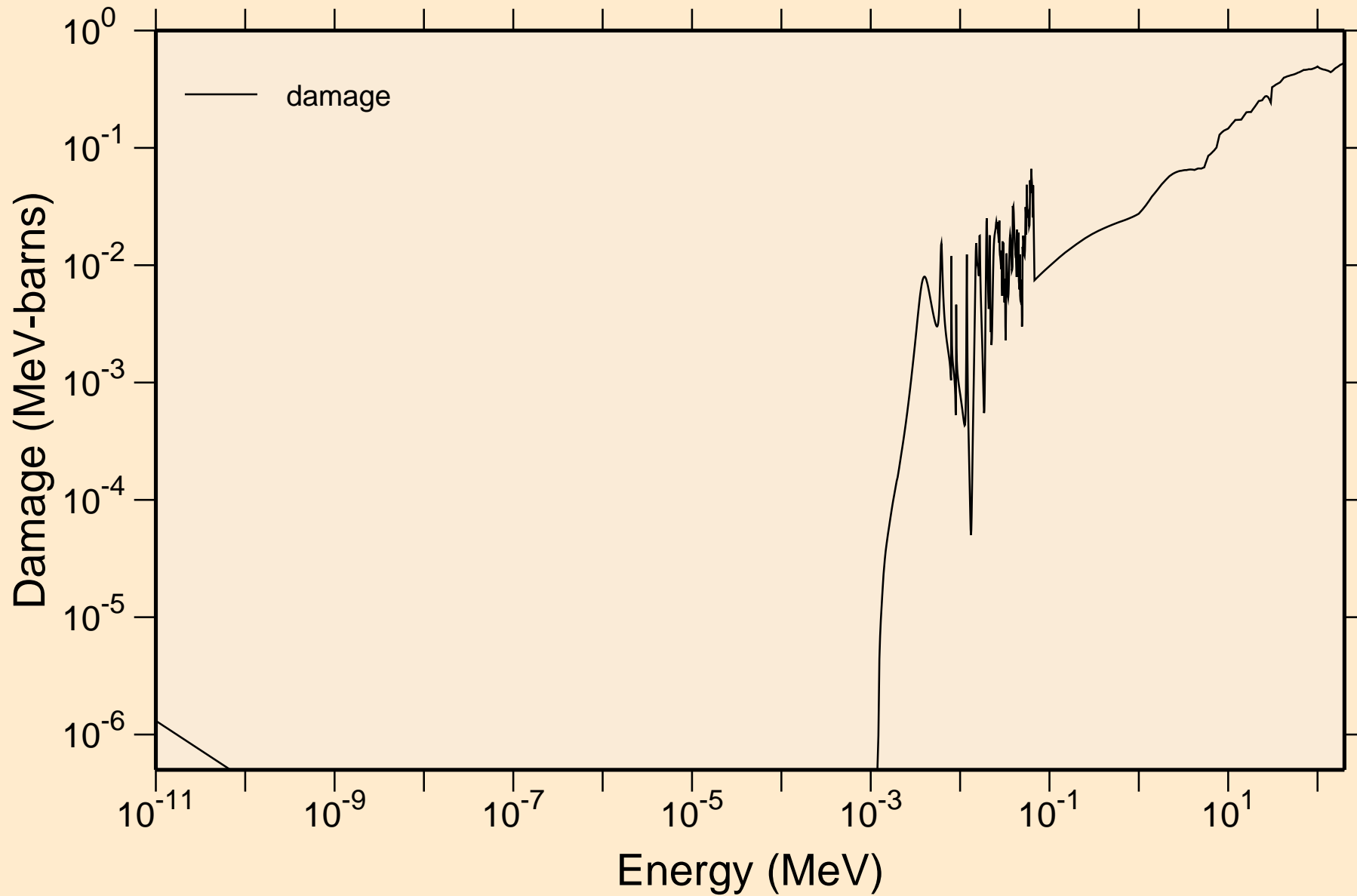

IR203 NEUTRON ACER TENDL-2021 LIBRARY; T=293.6K
Non-threshold reactions

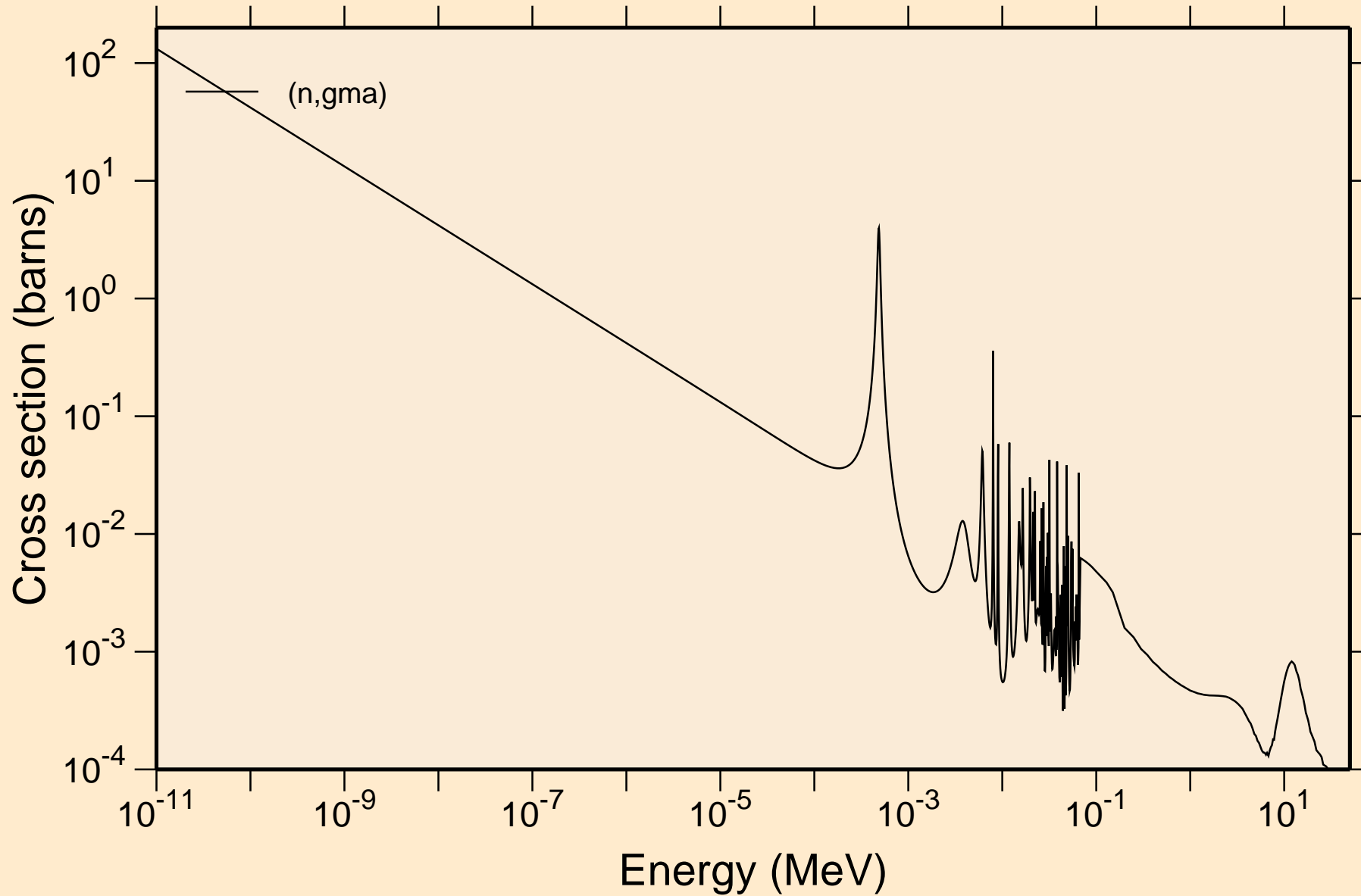

IR203 NEUTRON ACER TENDL-2021 LIBRARY; T=293.6K
Principal cross sections

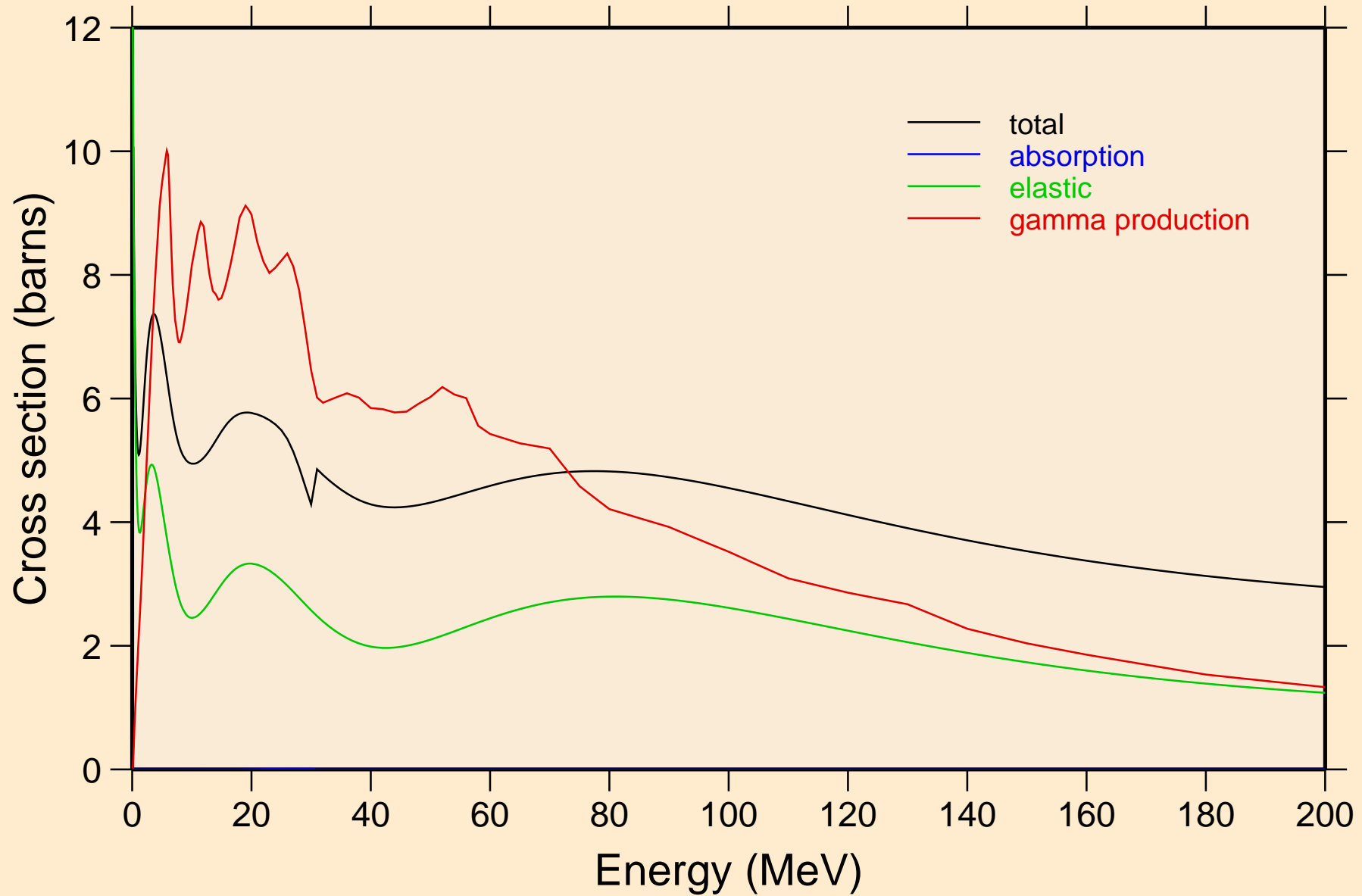

IR203 NEUTRON ACER TENDL-2021 LIBRARY; T=293.6K

Heating

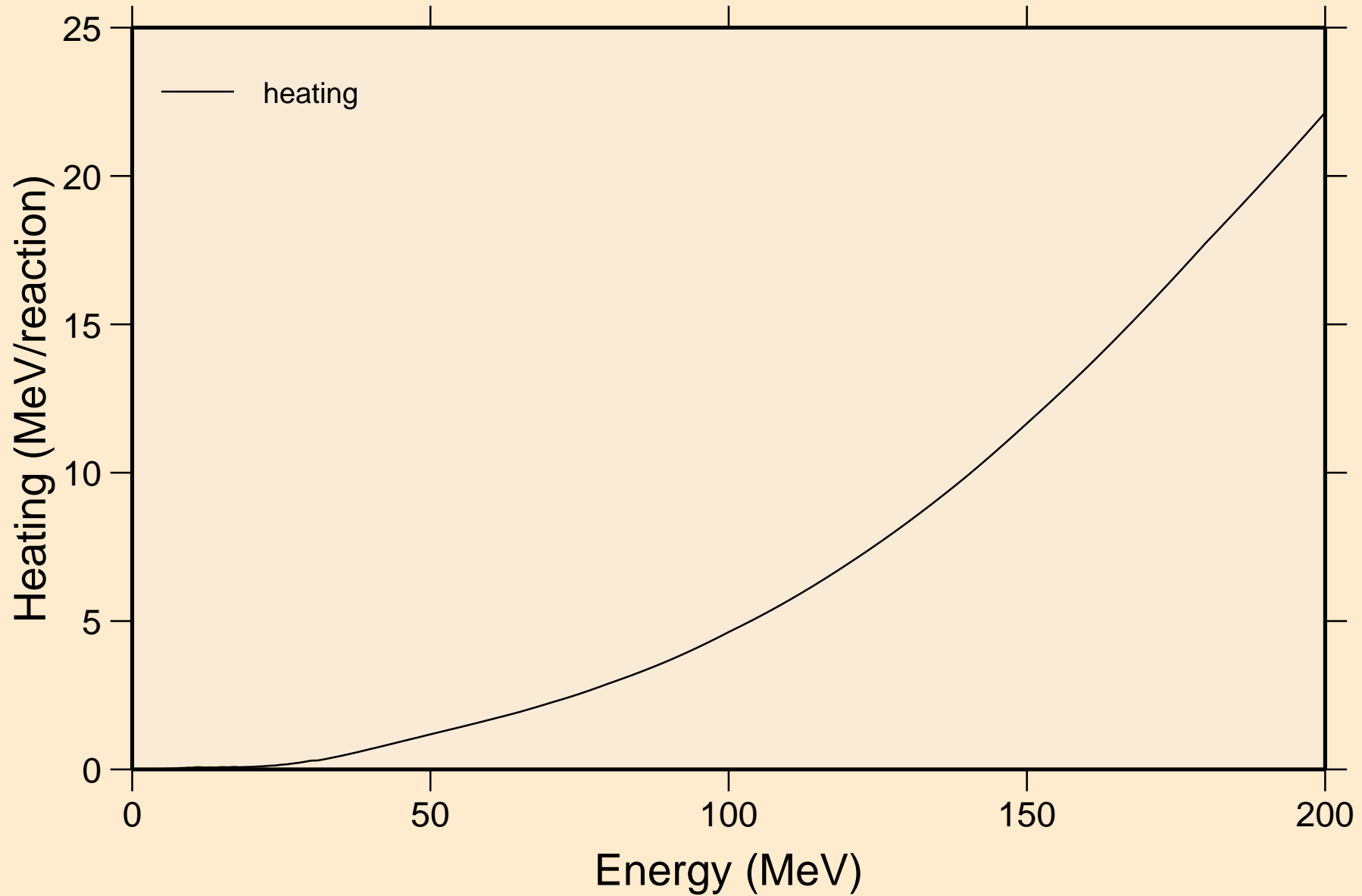

IR203 NEUTRON ACER TENDL-2021 LIBRARY; T=293.6K
Damage

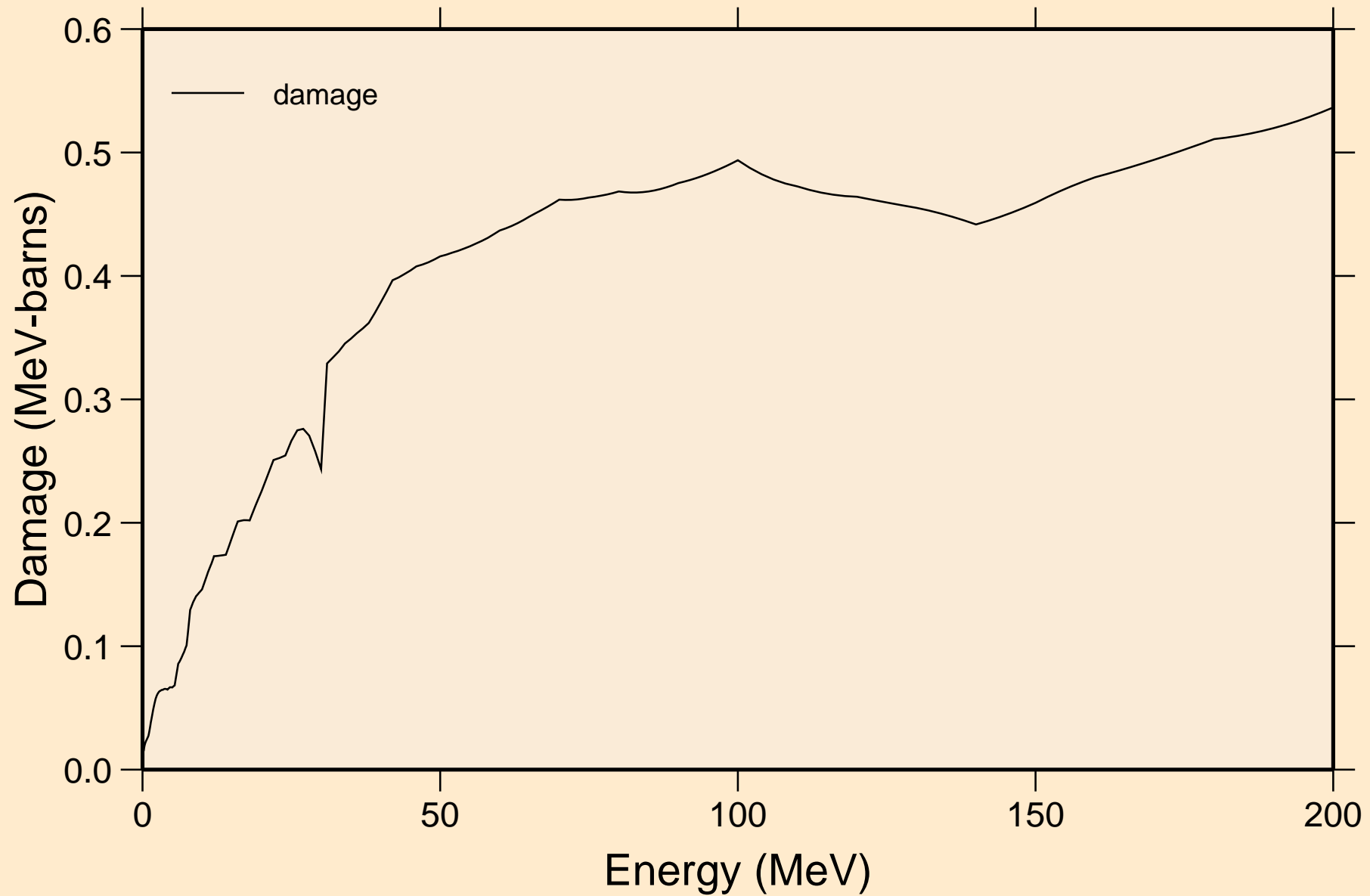

IR203 NEUTRON ACER TENDL-2021 LIBRARY; T=293.6K
Non-threshold reactions

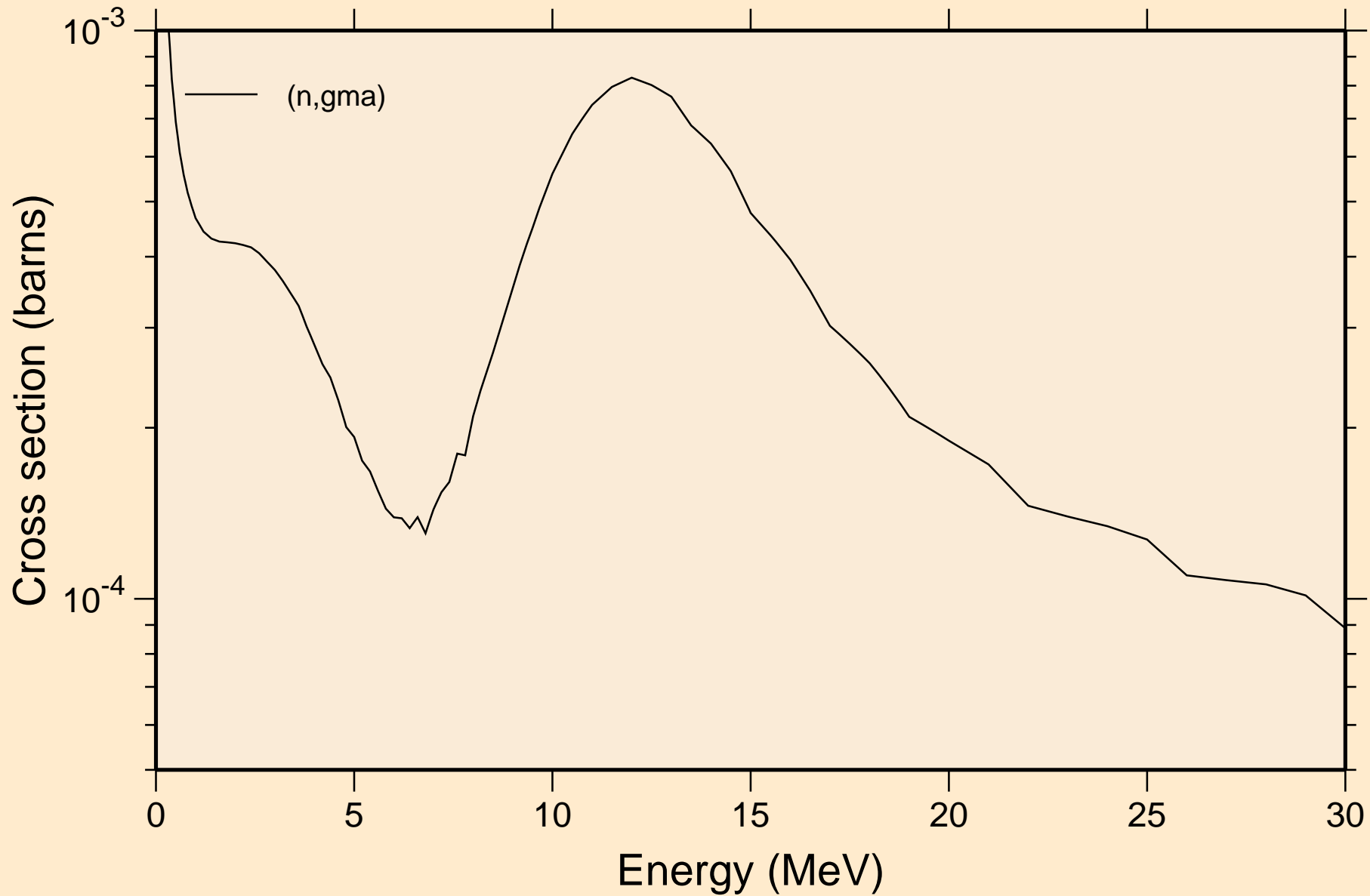

IR203 NEUTRON ACER TENDL-2021 LIBRARY; T=293.6K
Inelastic levels

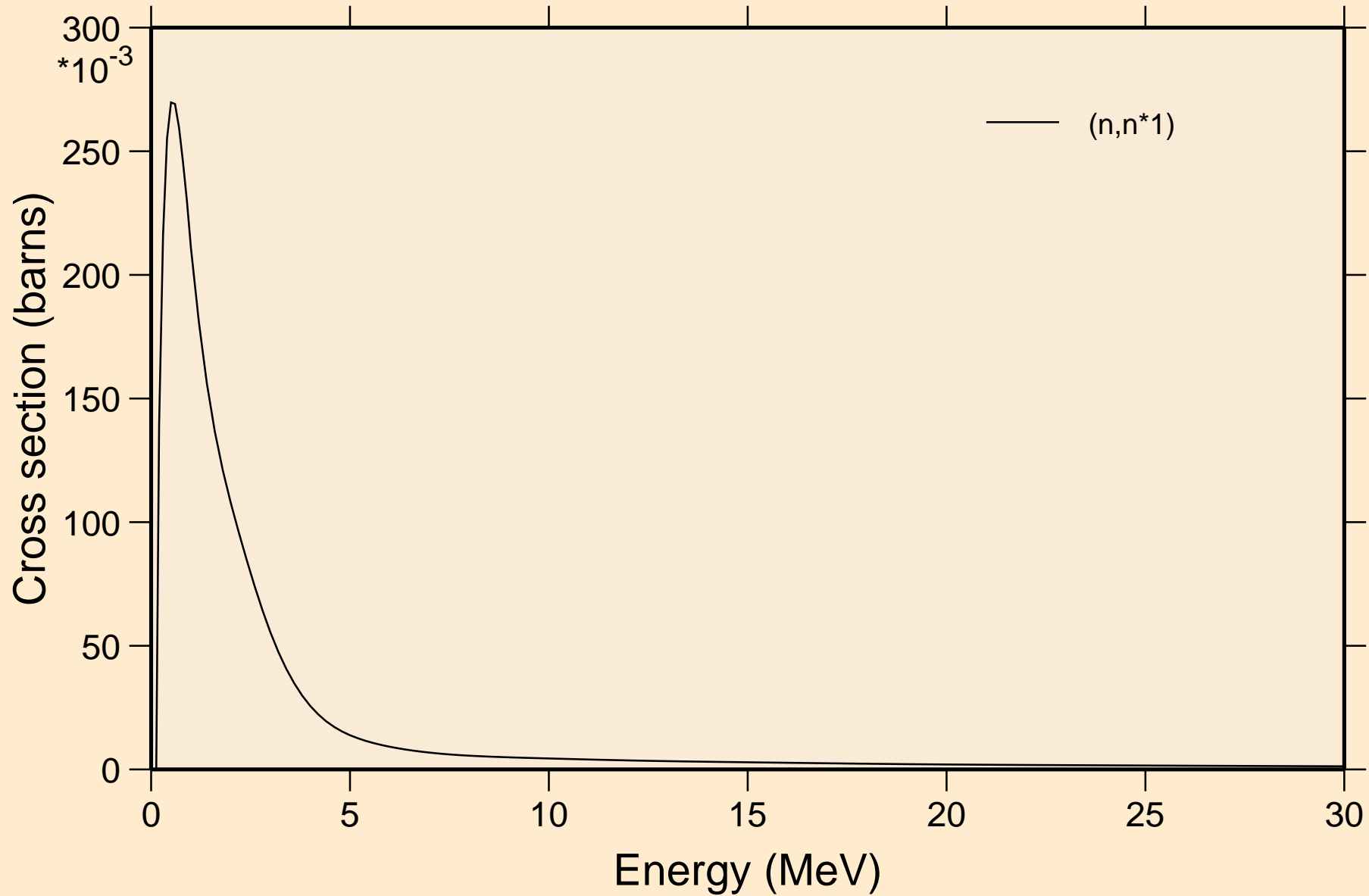

IR203 NEUTRON ACER TENDL-2021 LIBRARY; T=293.6K
Threshold reactions

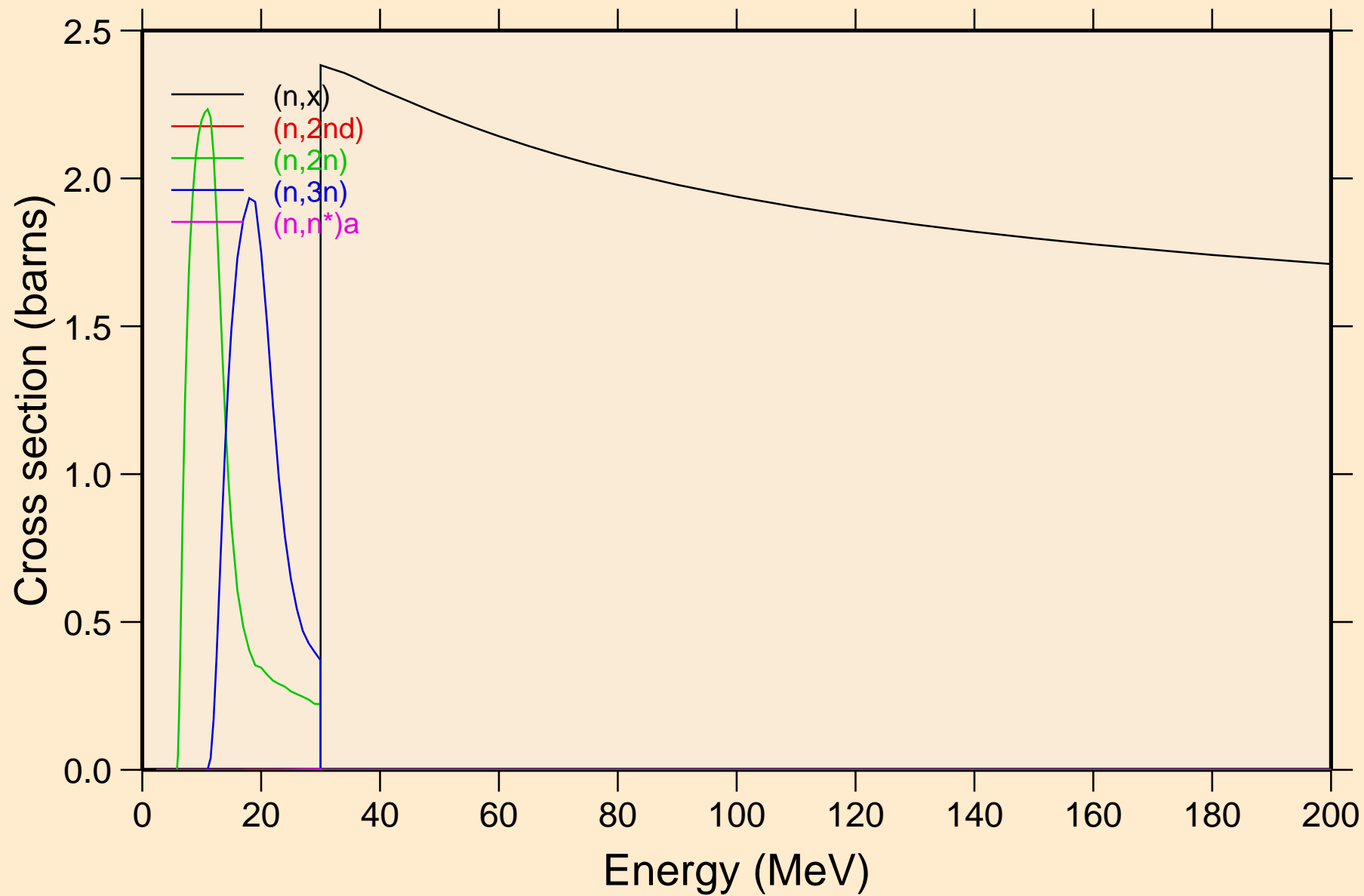

IR203 NEUTRON ACER TENDL-2021 LIBRARY; T=293.6K
Threshold reactions

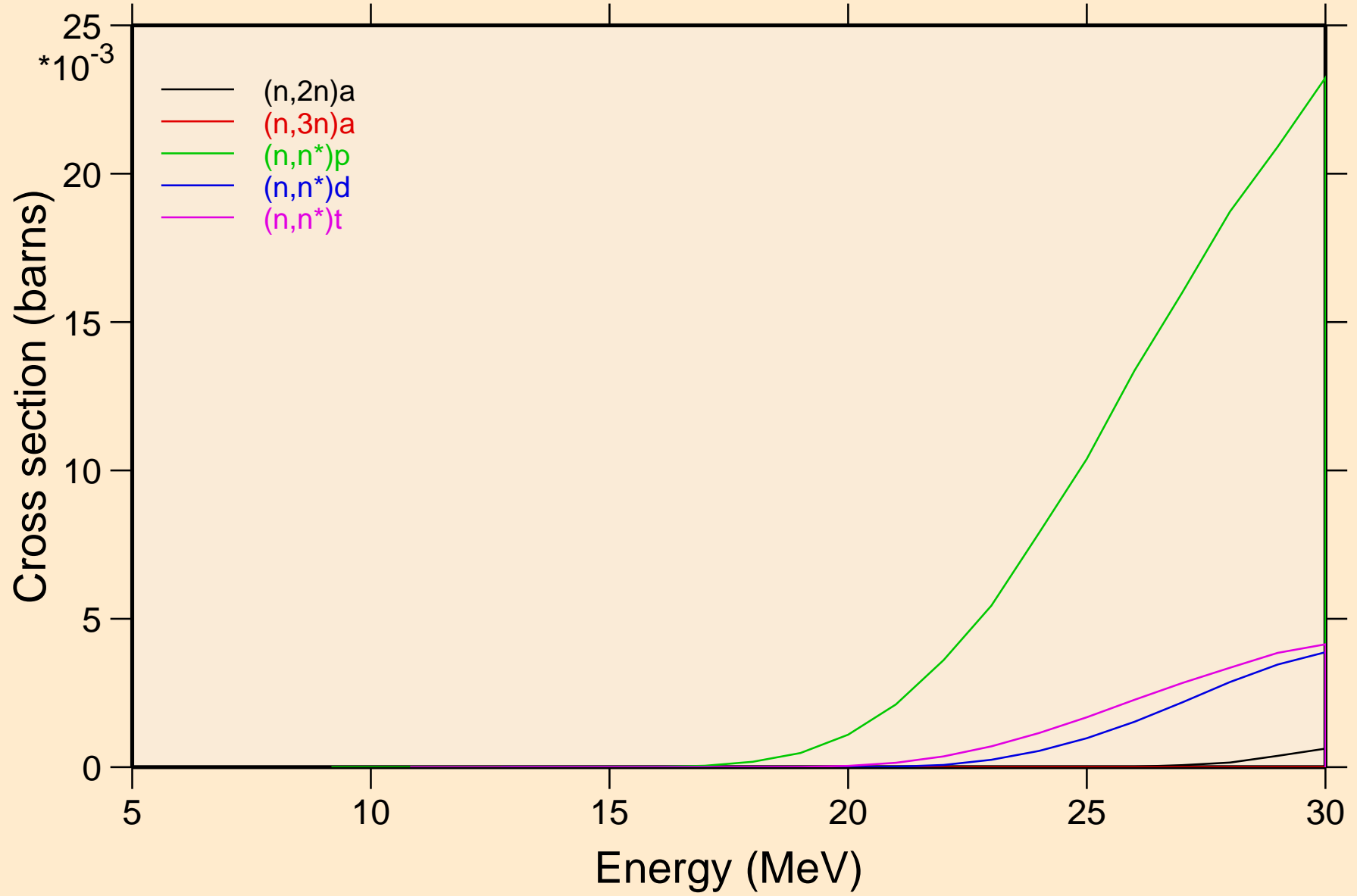

IR203 NEUTRON ACER TENDL-2021 LIBRARY; T=293.6K
Threshold reactions

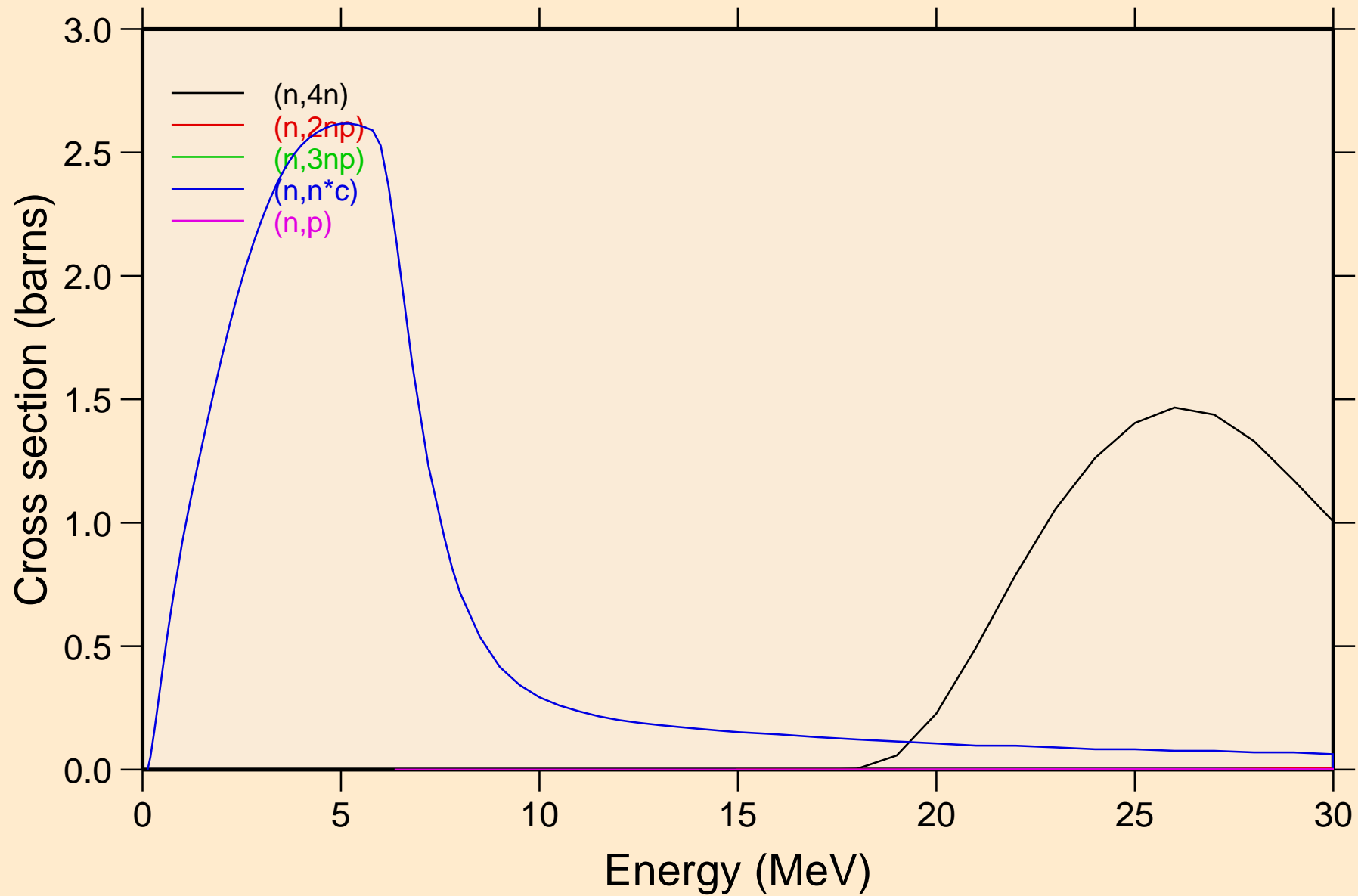

IR203 NEUTRON ACER TENDL-2021 LIBRARY; T=293.6K
Threshold reactions

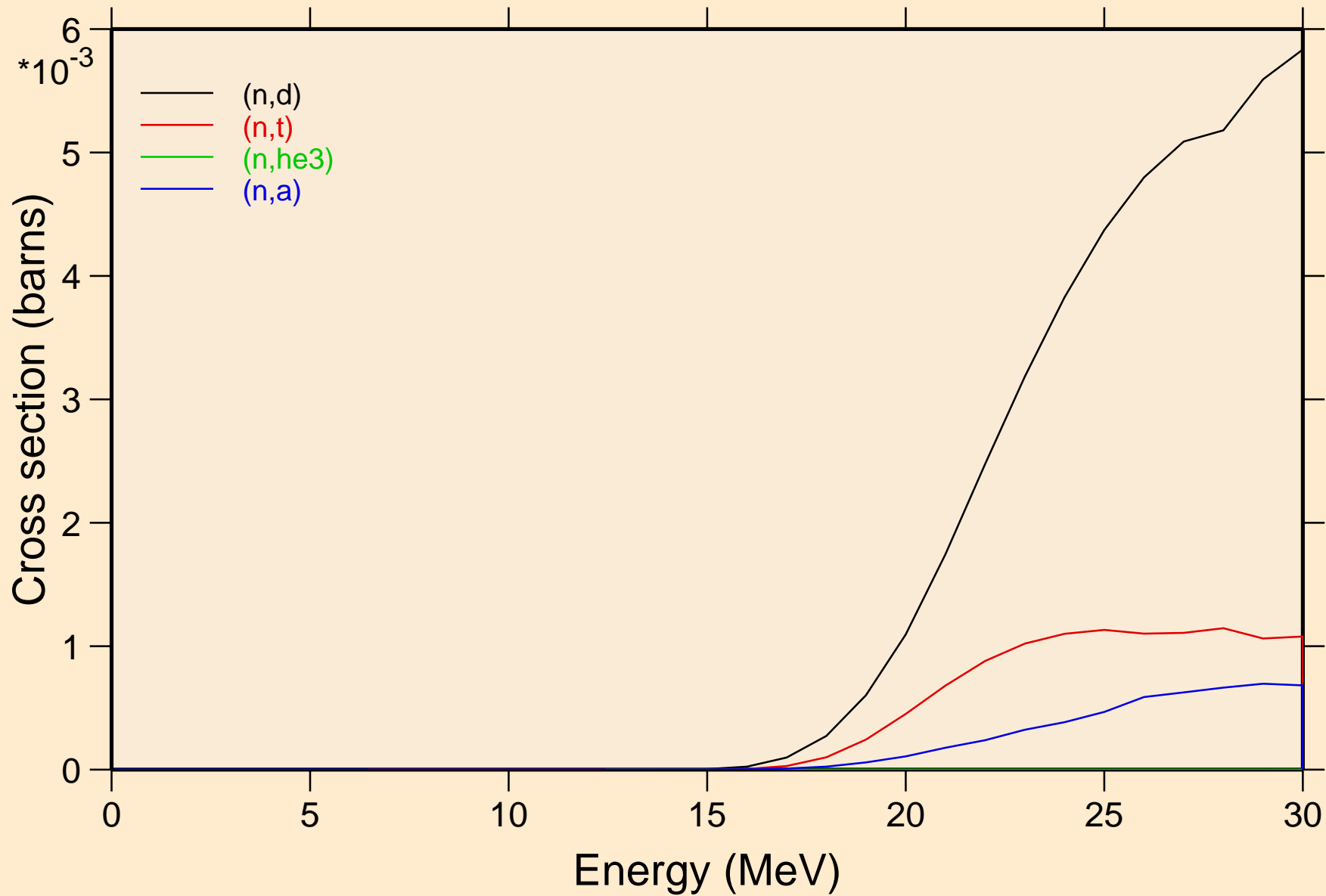

IR203 NEUTRON ACER TENDL-2021 LIBRARY; T=293.6K
Threshold reactions

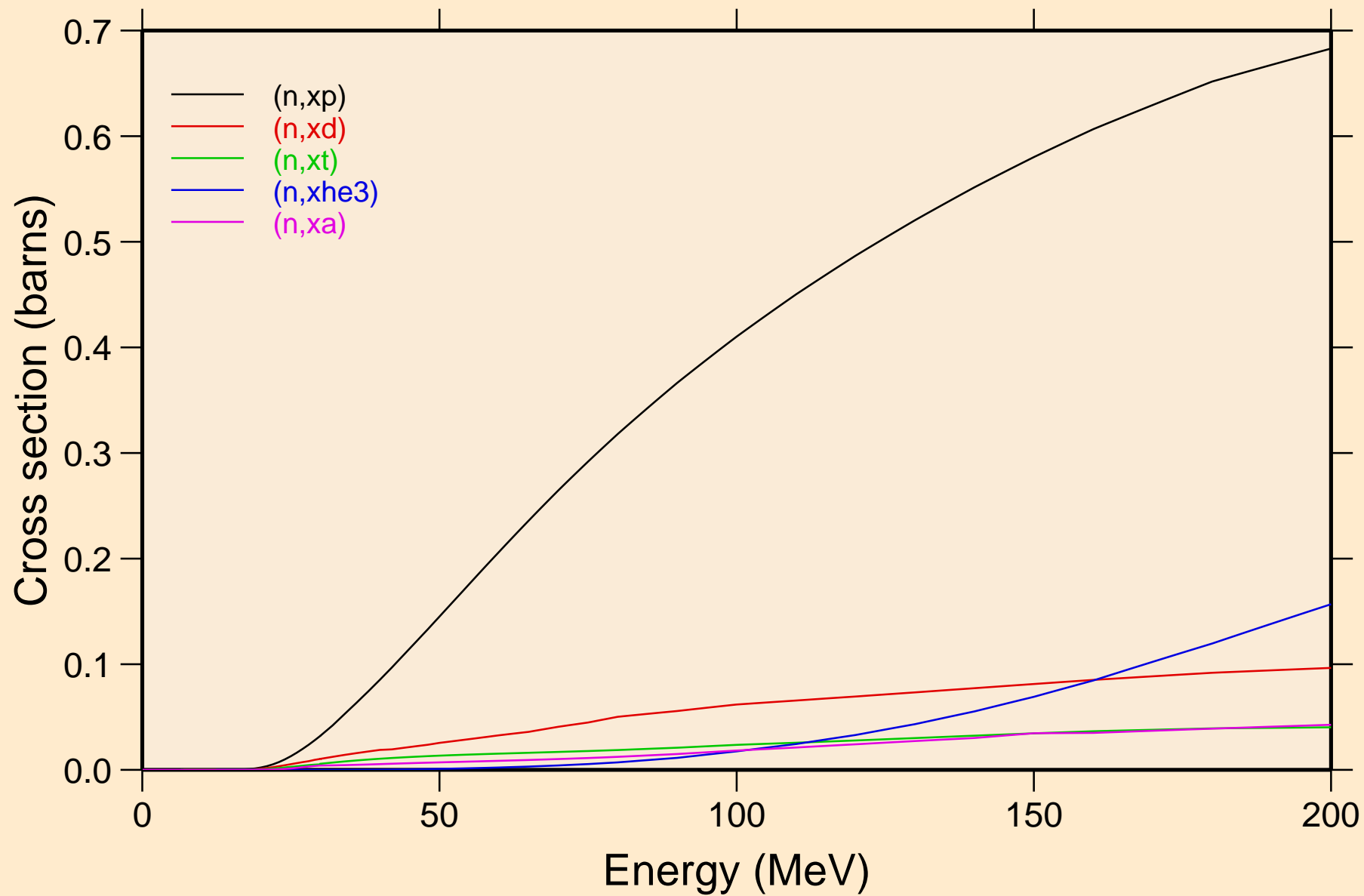

IR203 NEUTRON ACER TENDL-2021 LIBRARY; T=293.6K
angular distribution for elastic

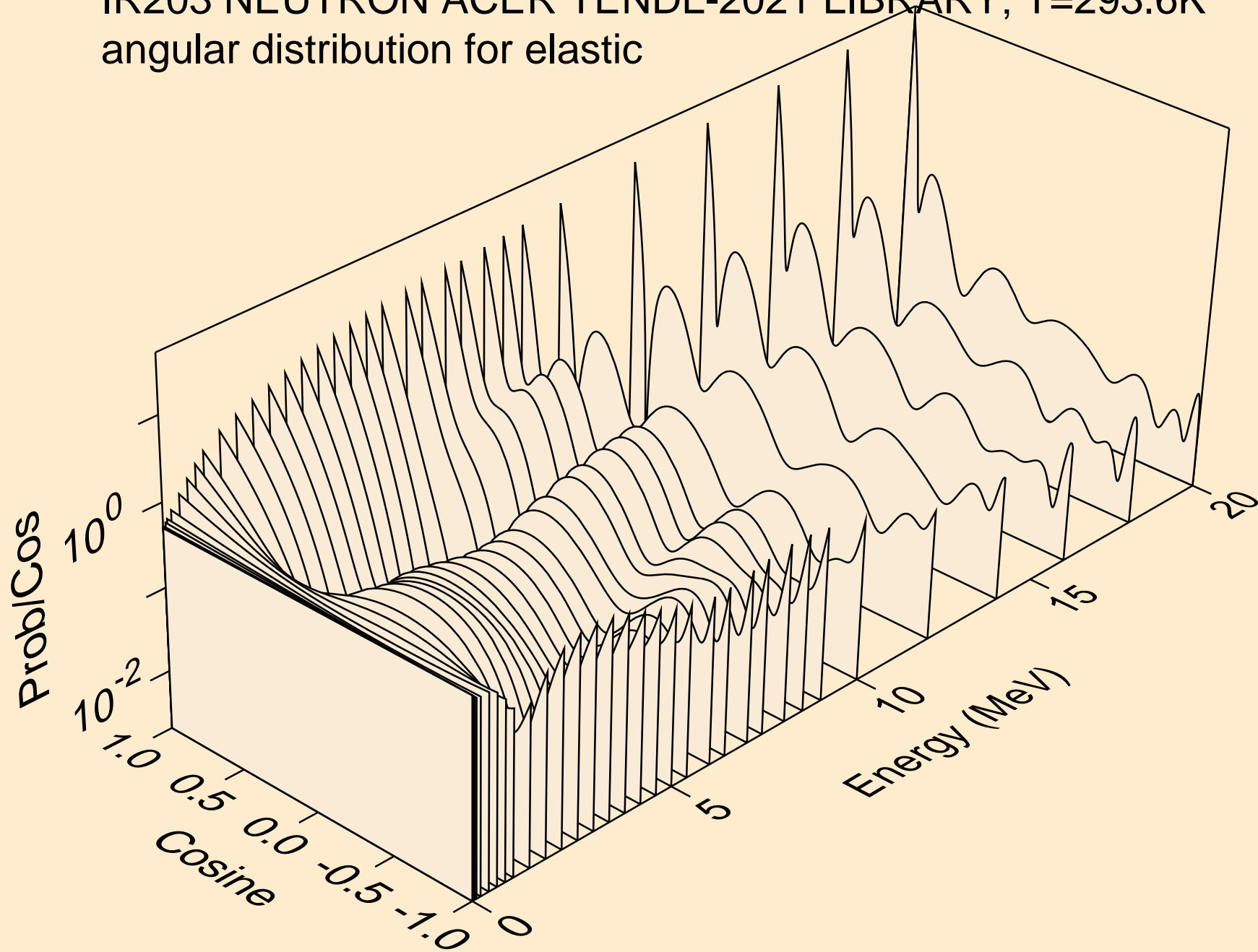

IR203 NEUTRON ACER TENDL-2021 LIBRARY; T=293.6K
angular distribution for elastic

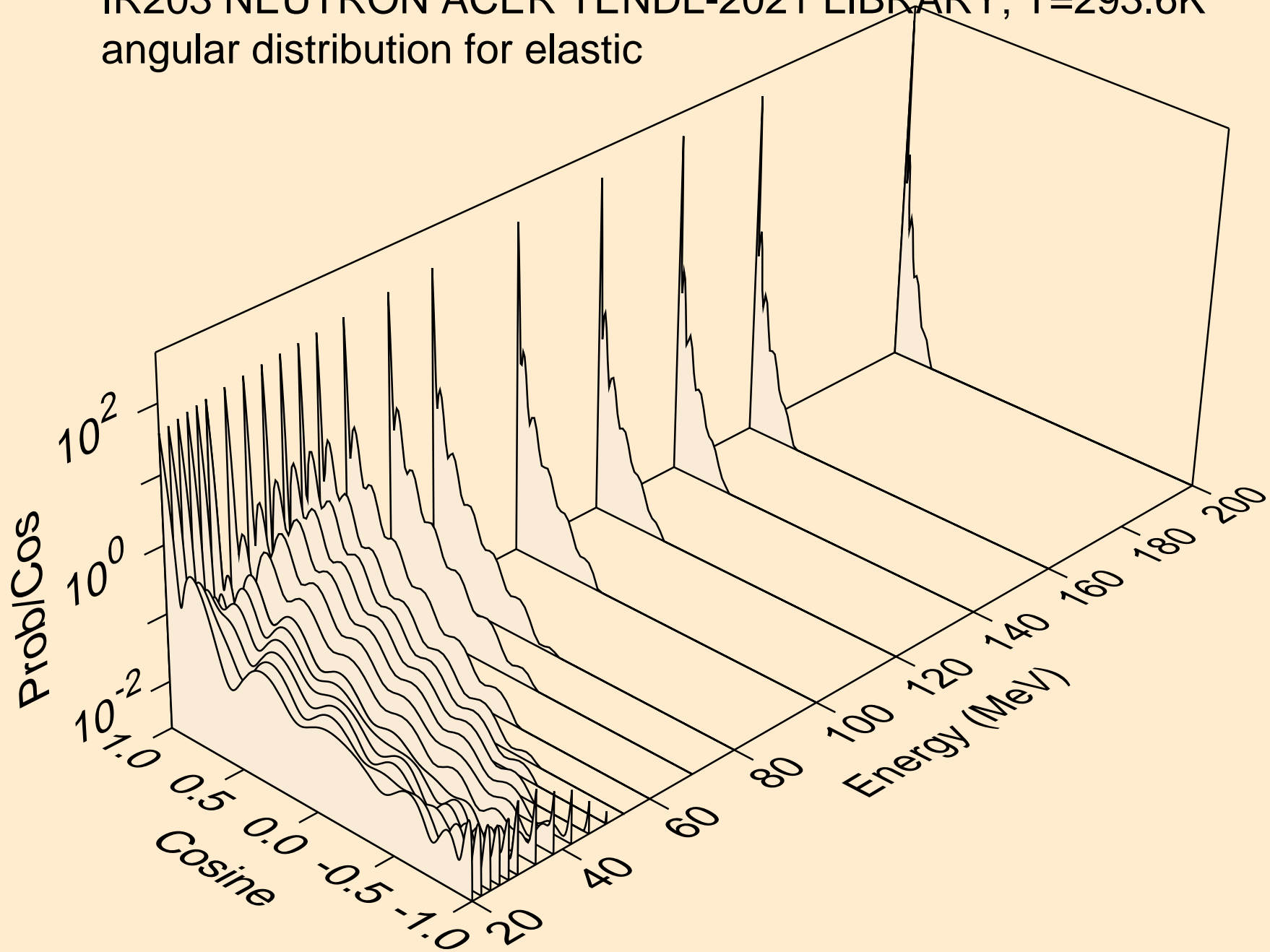

IR203 NEUTRON ACER TENDL-2021 LIBRARY; T=293.6K
angular distribution for (n,n*1)

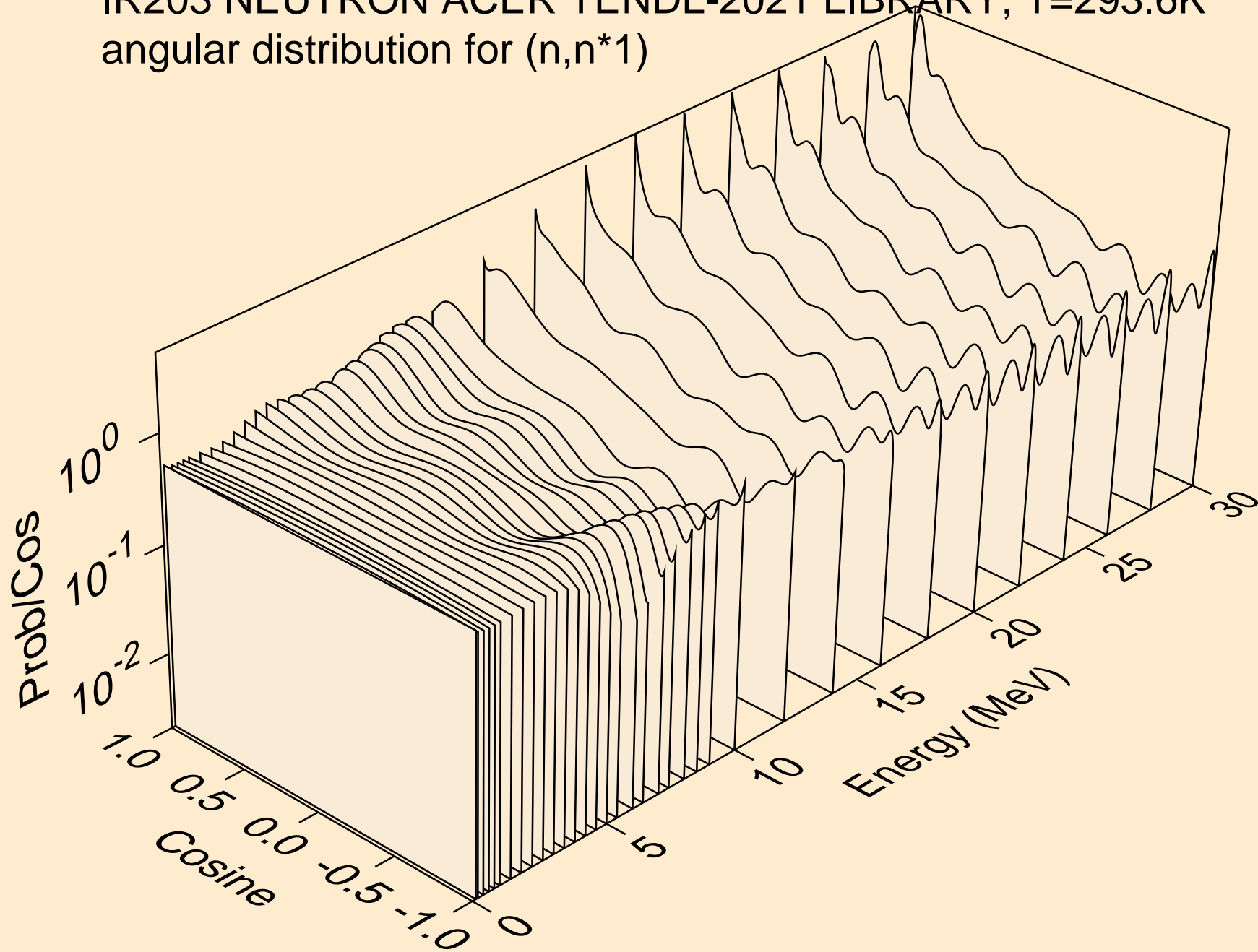

IR203 NEUTRON ACER TENDL-2021 LIBRARY; T=293.6K
Neutron emission for (n,x)

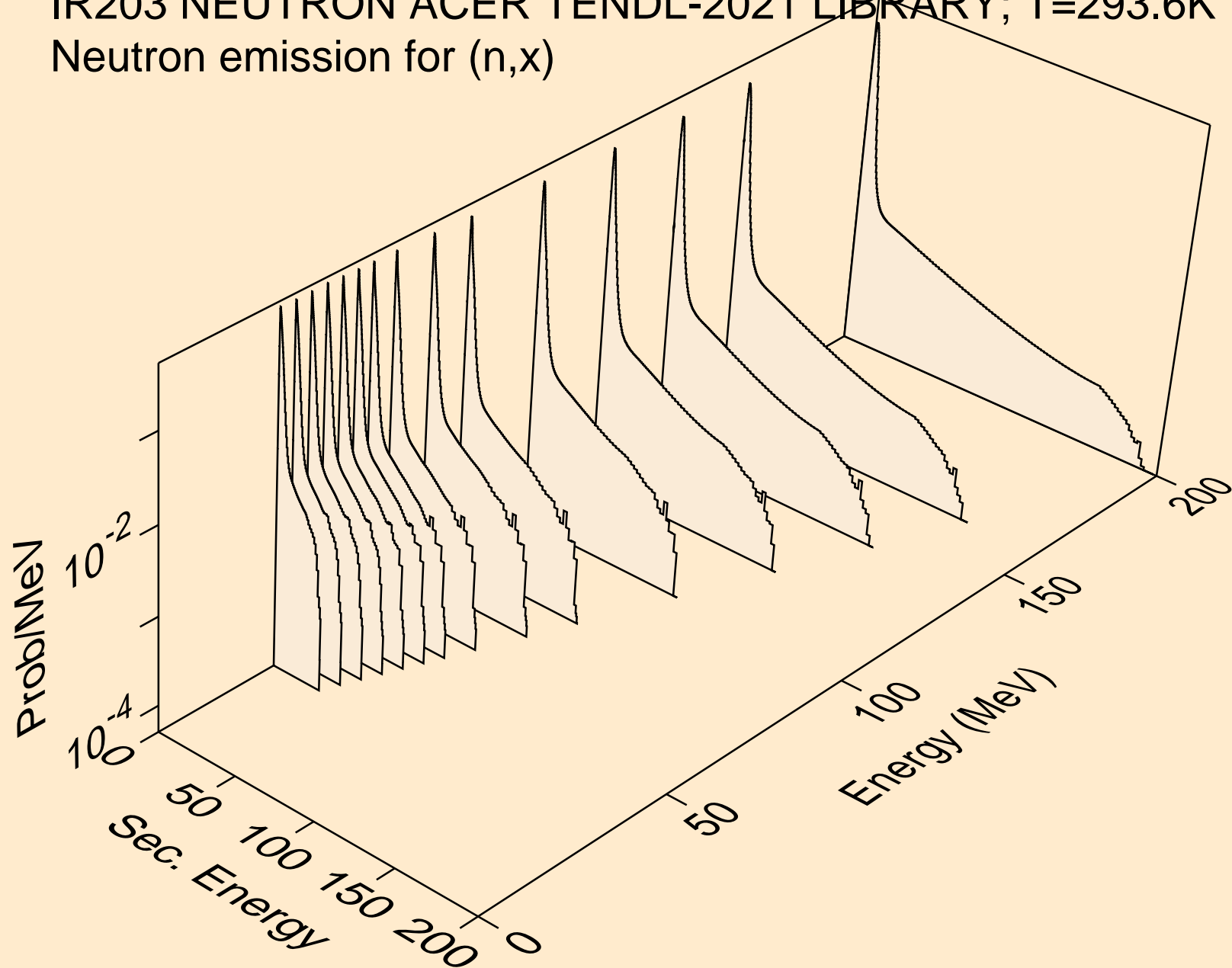

IR203 NEUTRON ACER TENDL-2021 LIBRARY; T=293.6K
Neutron emission for (n,2nd)

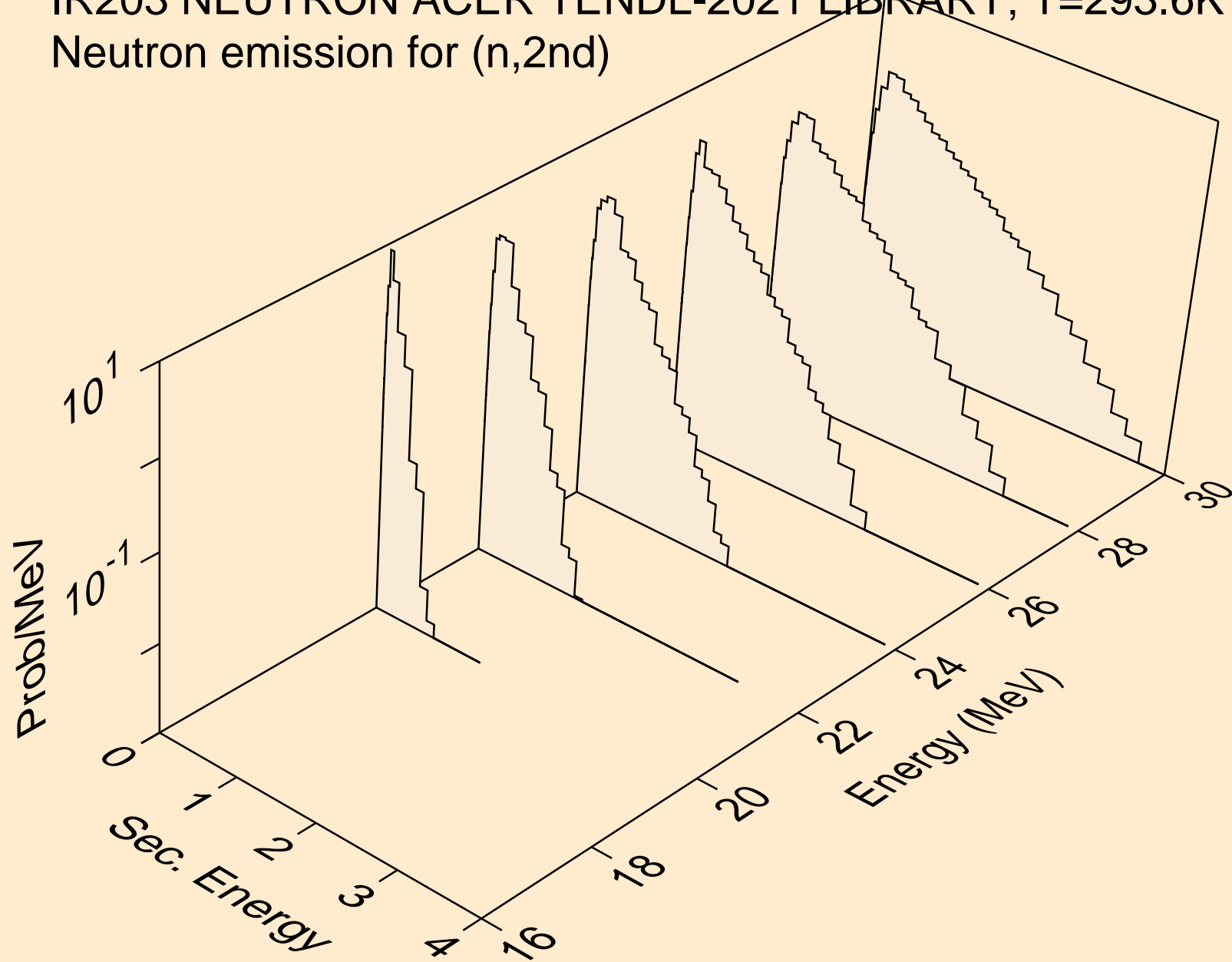

IR203 NEUTRON ACER TENDL-2021 LIBRARY; T=293.6K
Neutron emission for (n,2n)

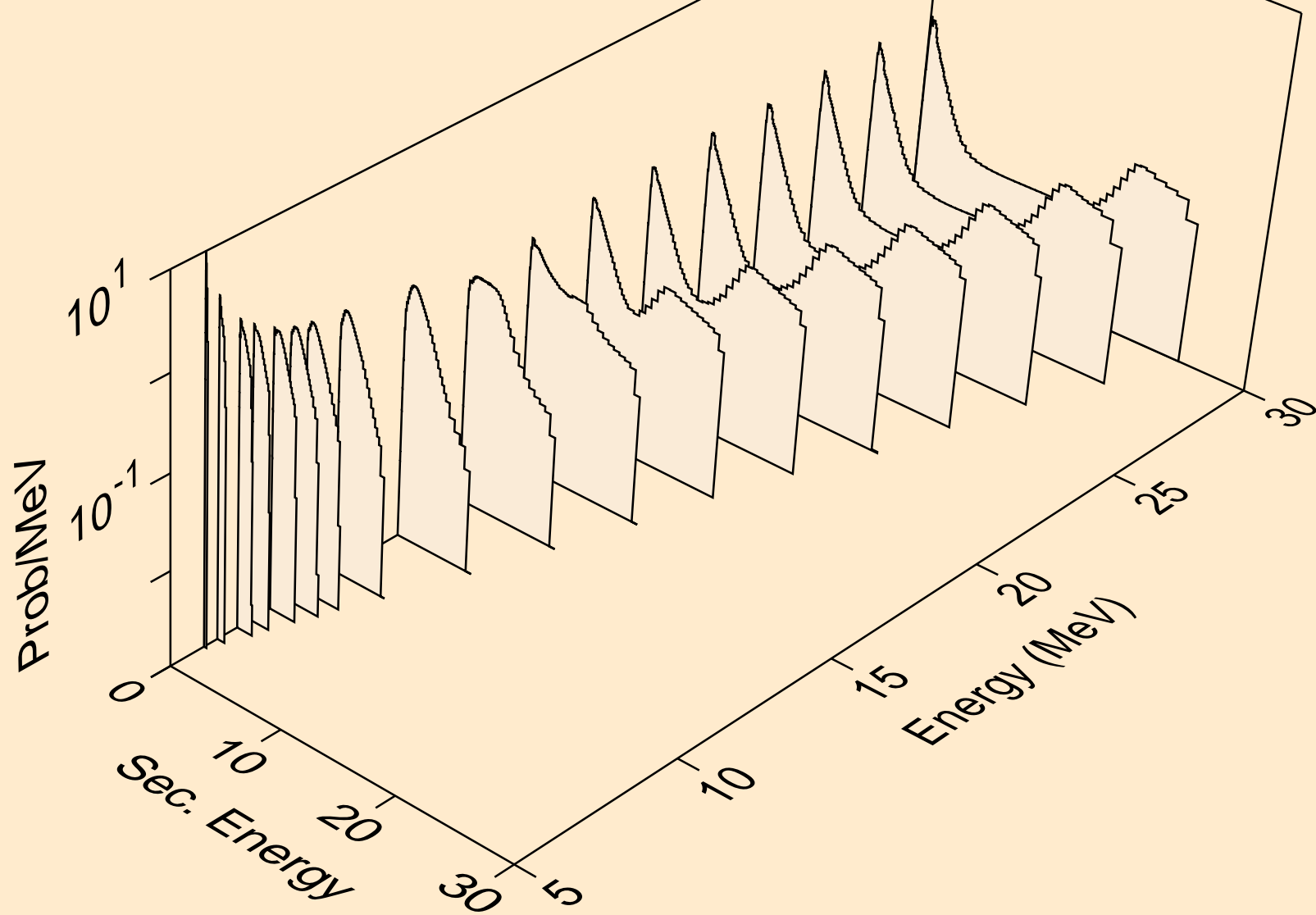

IR203 NEUTRON ACER TENDL-2021 LIBRARY; T=293.6K
Neutron emission for (n,3n)

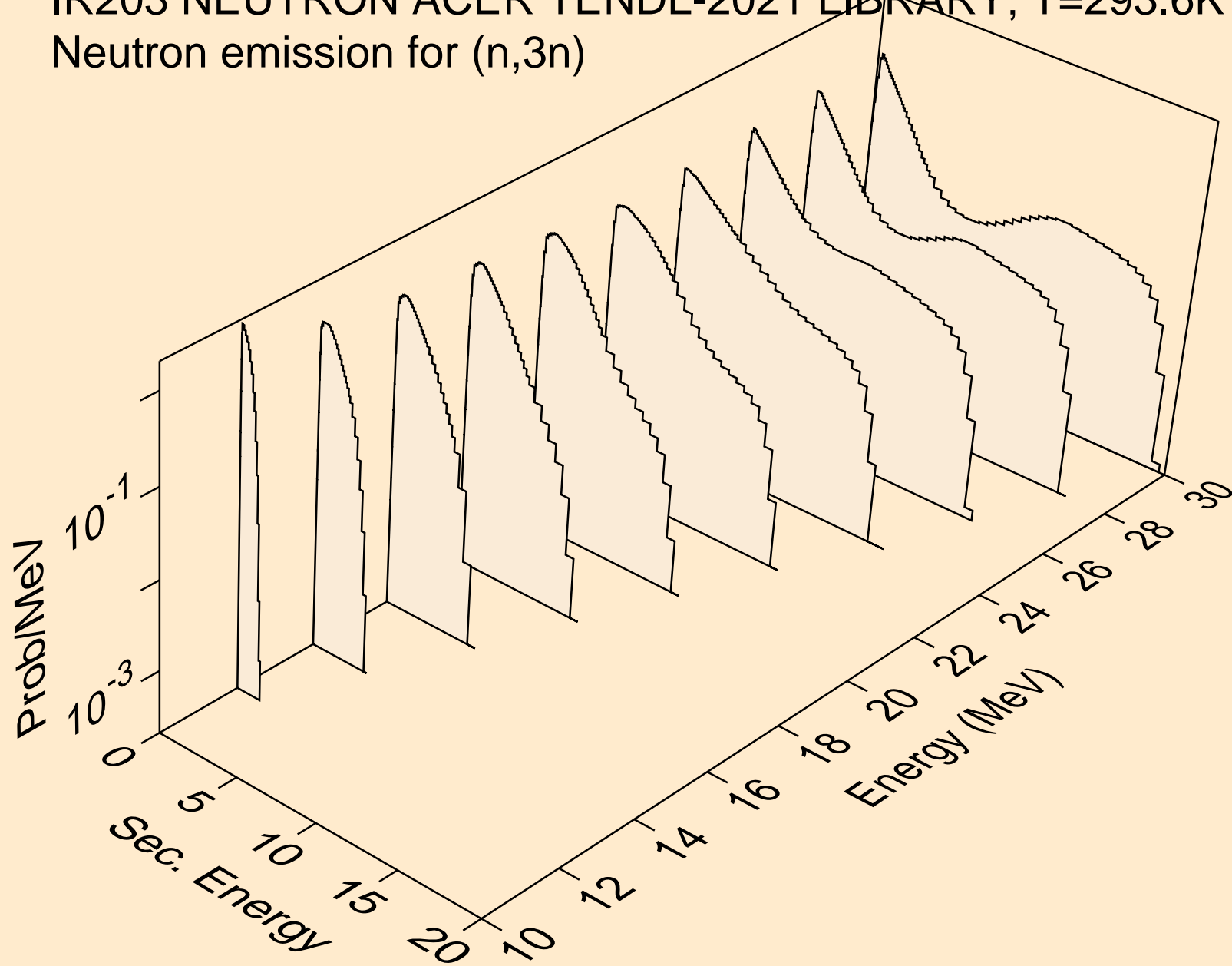

IR203 NEUTRON ACER TENDL-2021 LIBRARY; T=293.6K
Neutron emission for (n,n*)a

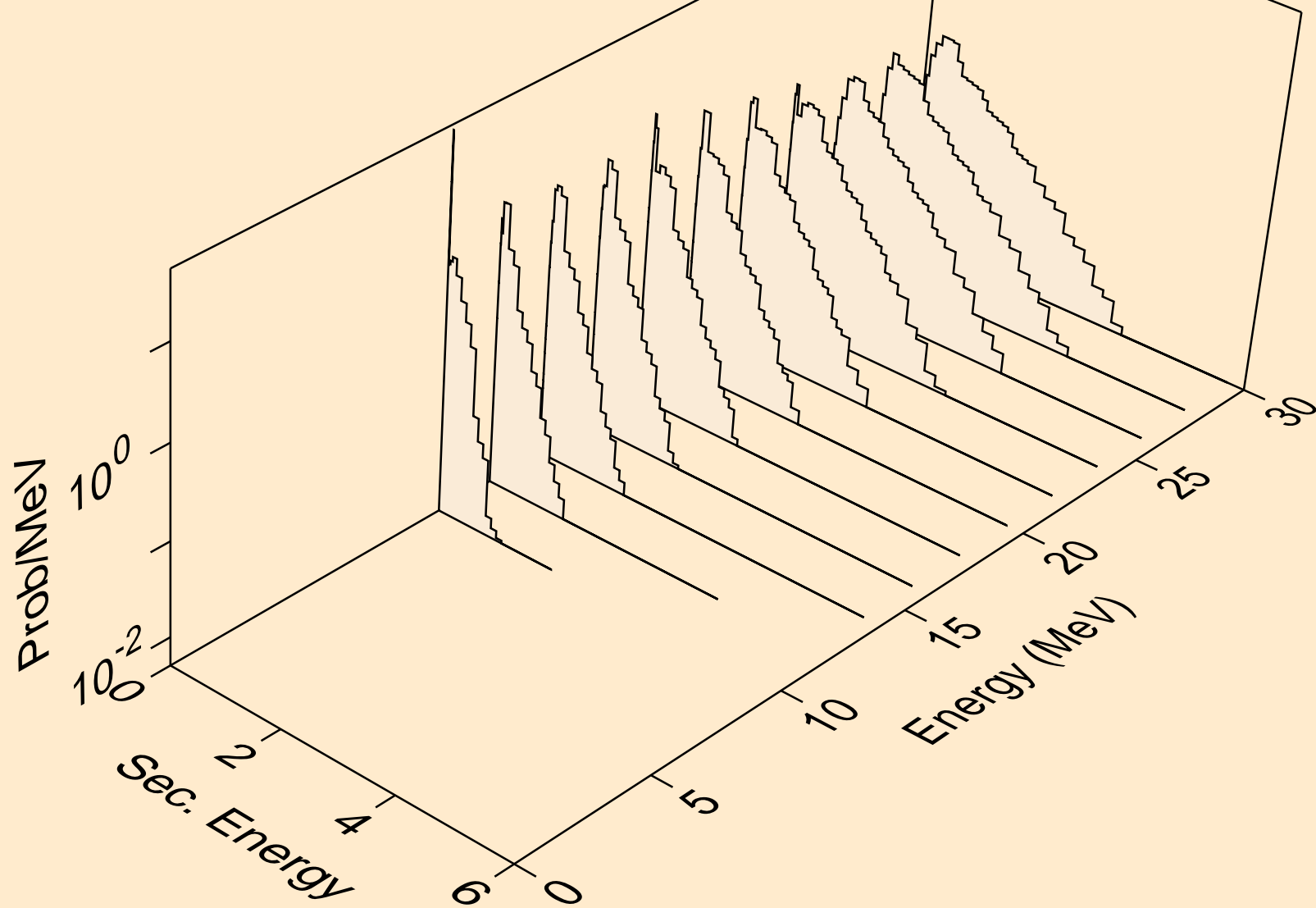

IR203 NEUTRON ACER TENDL-2021 LIBRARY; T=293.6K
Neutron emission for (n,2n)_a

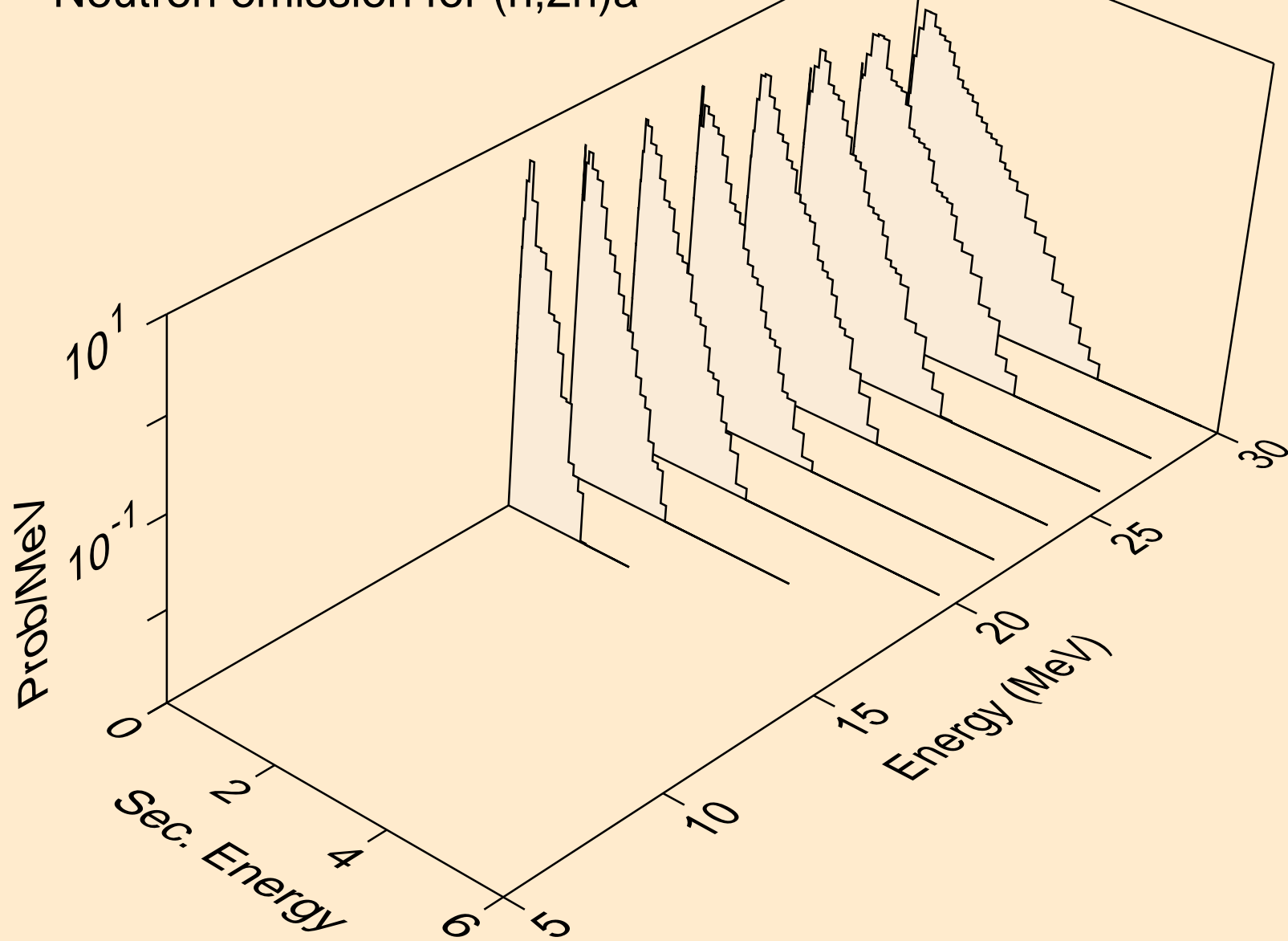

IR203 NEUTRON ACER TENDL-2021 LIBRARY; T=293.6K
Neutron emission for (n,3n)a

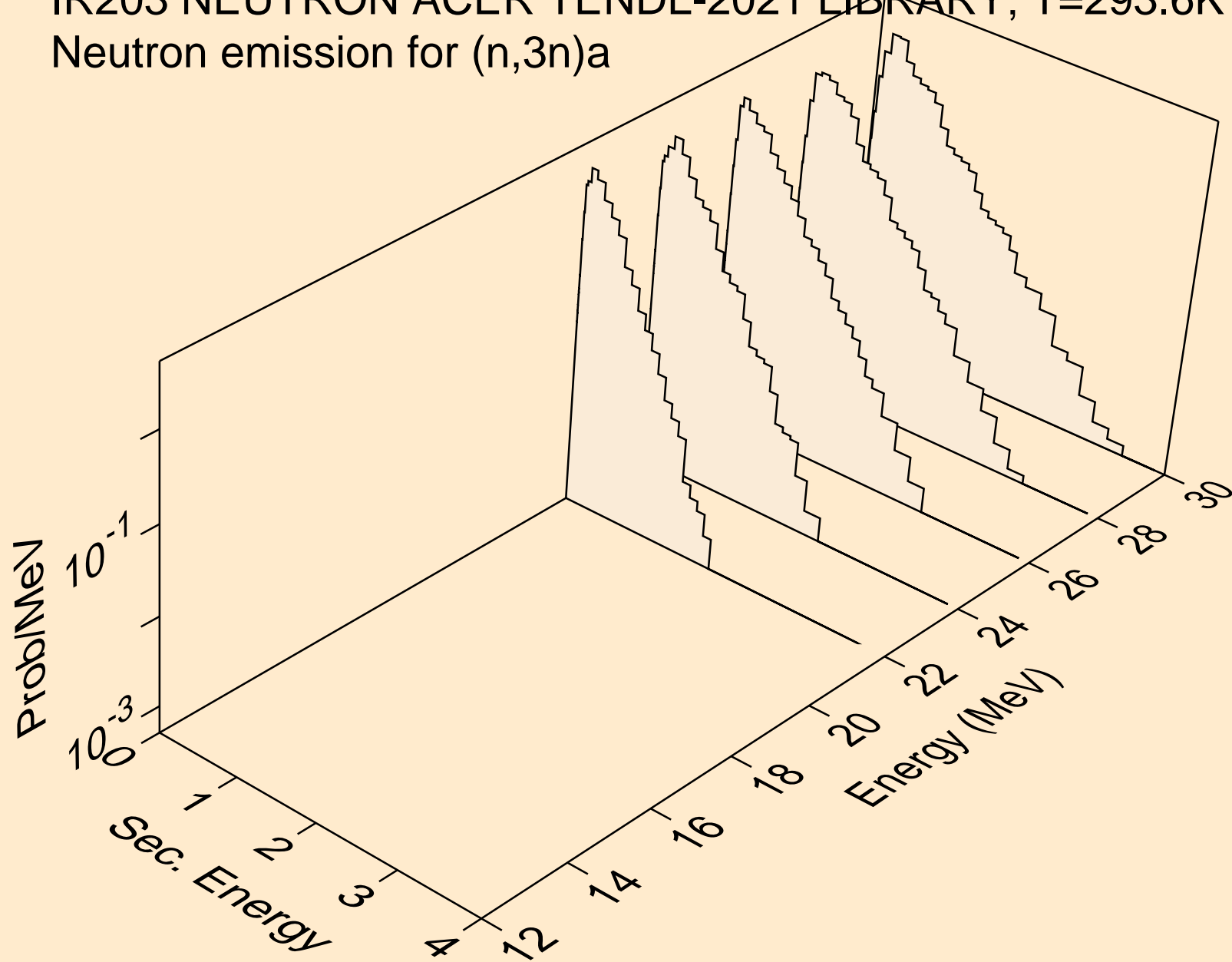

IR203 NEUTRON ACER TENDL-2021 LIBRARY; T=293.6K
Neutron emission for (n,n*)p

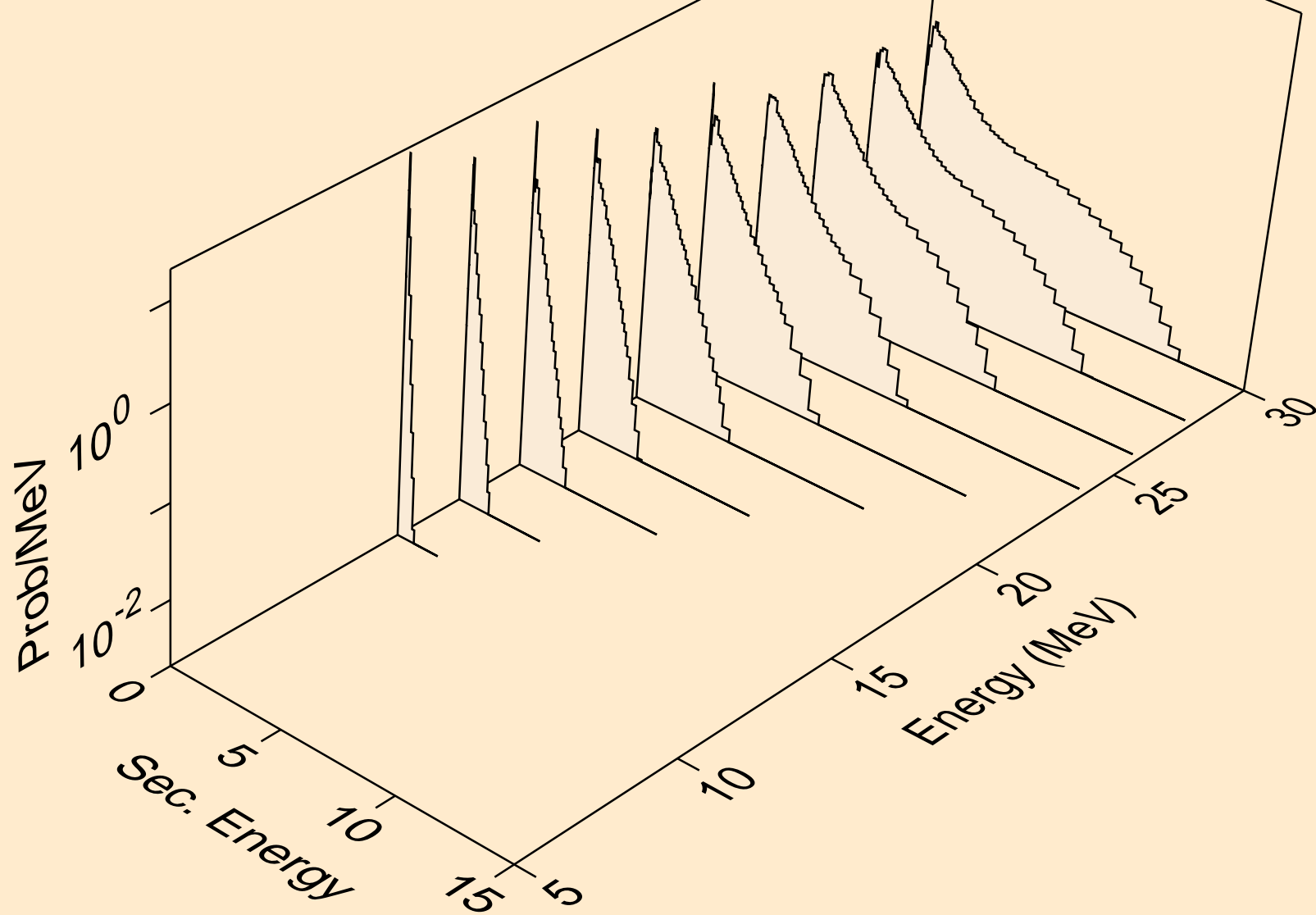

IR203 NEUTRON ACER TENDL-2021 LIBRARY; T=293.6K
Neutron emission for (n,n*)d

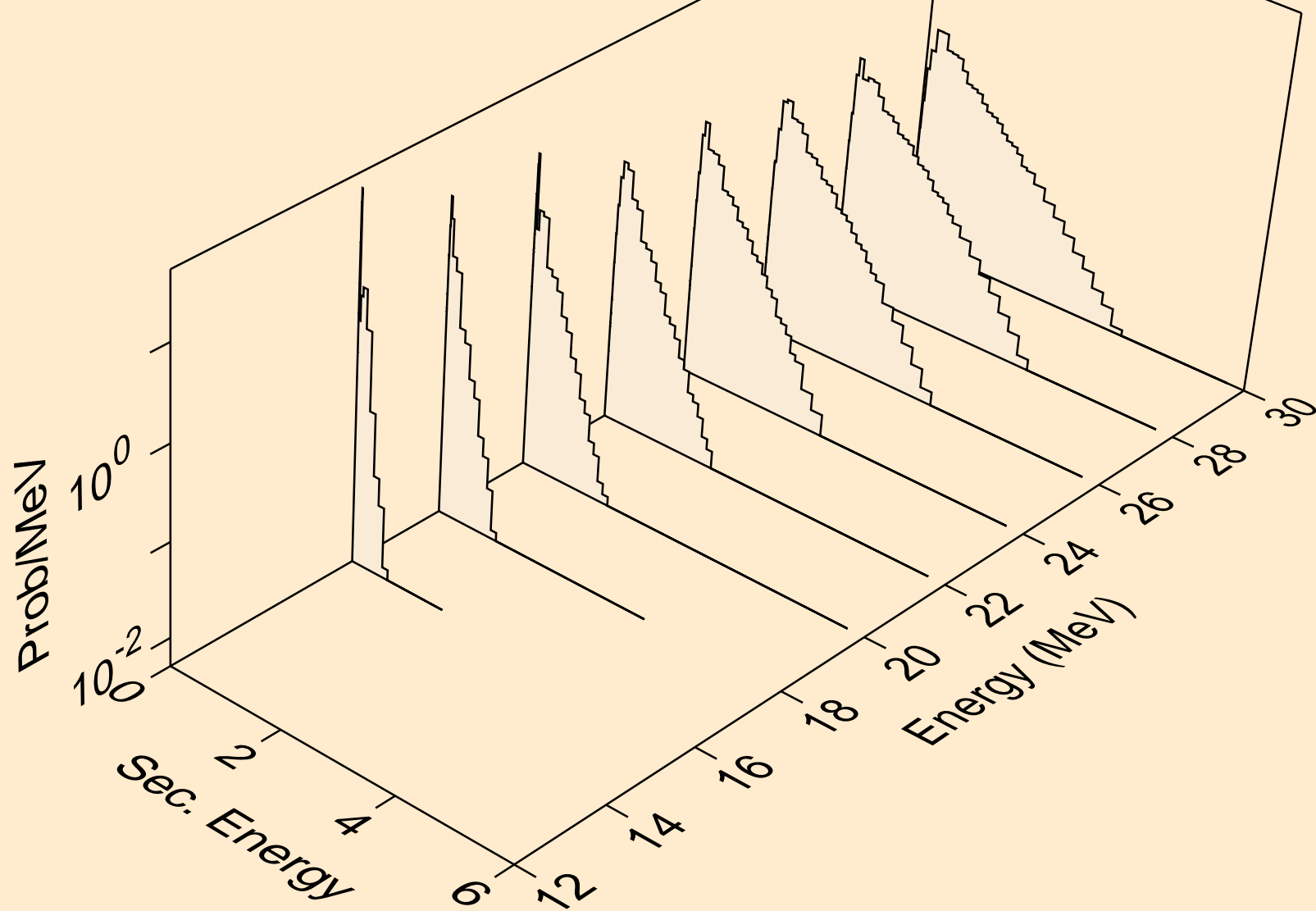

IR203 NEUTRON ACER TENDL-2021 LIBRARY; T=293.6K
Neutron emission for (n,n*)t

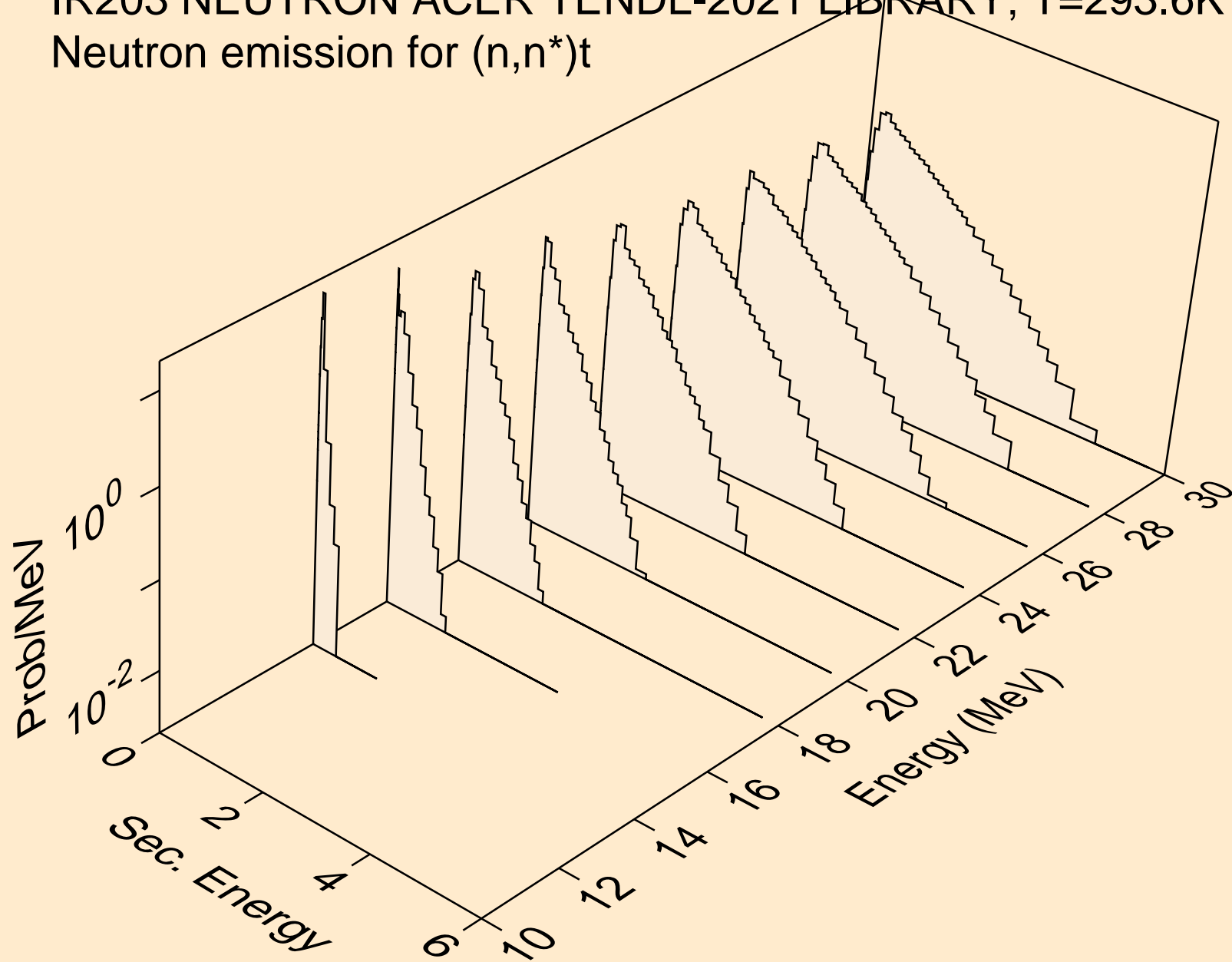

IR203 NEUTRON ACER TENDL-2021 LIBRARY; T=293.6K
Neutron emission for (n,4n)

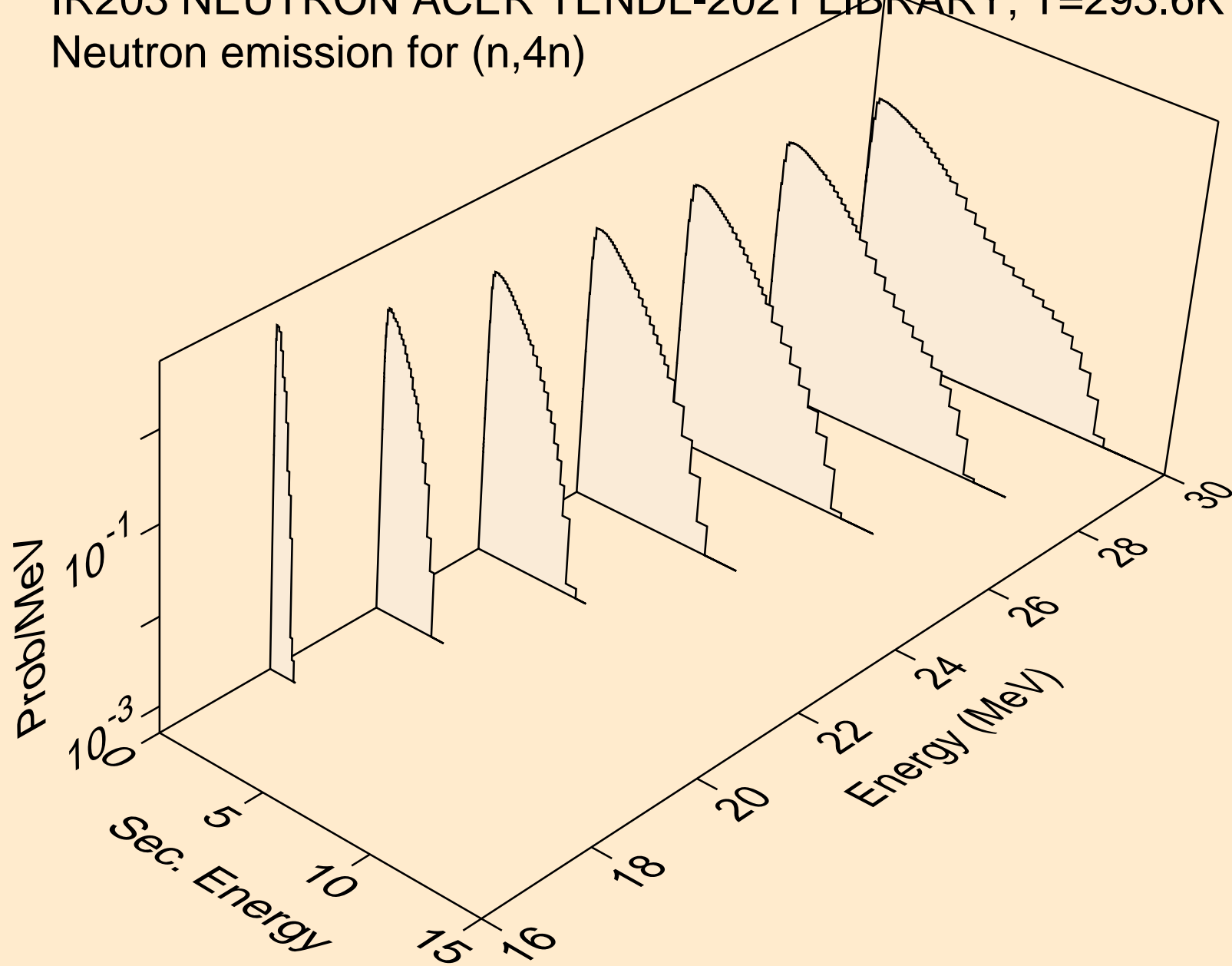

IR203 NEUTRON ACER TENDL-2021 LIBRARY; T=293.6K
Neutron emission for (n,2np)

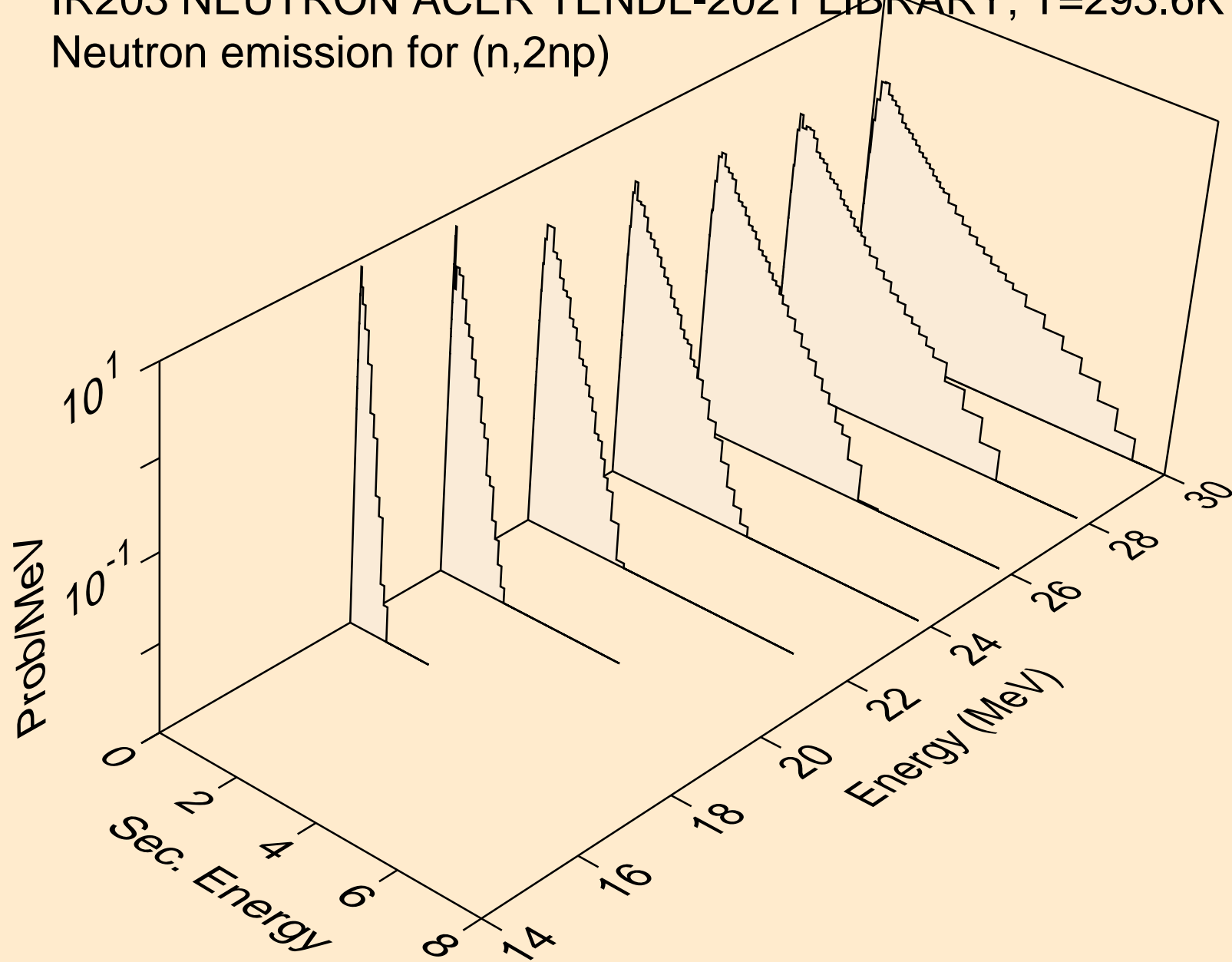

IR203 NEUTRON ACER TENDL-2021 LIBRARY; T=293.6K
Neutron emission for (n,3np)

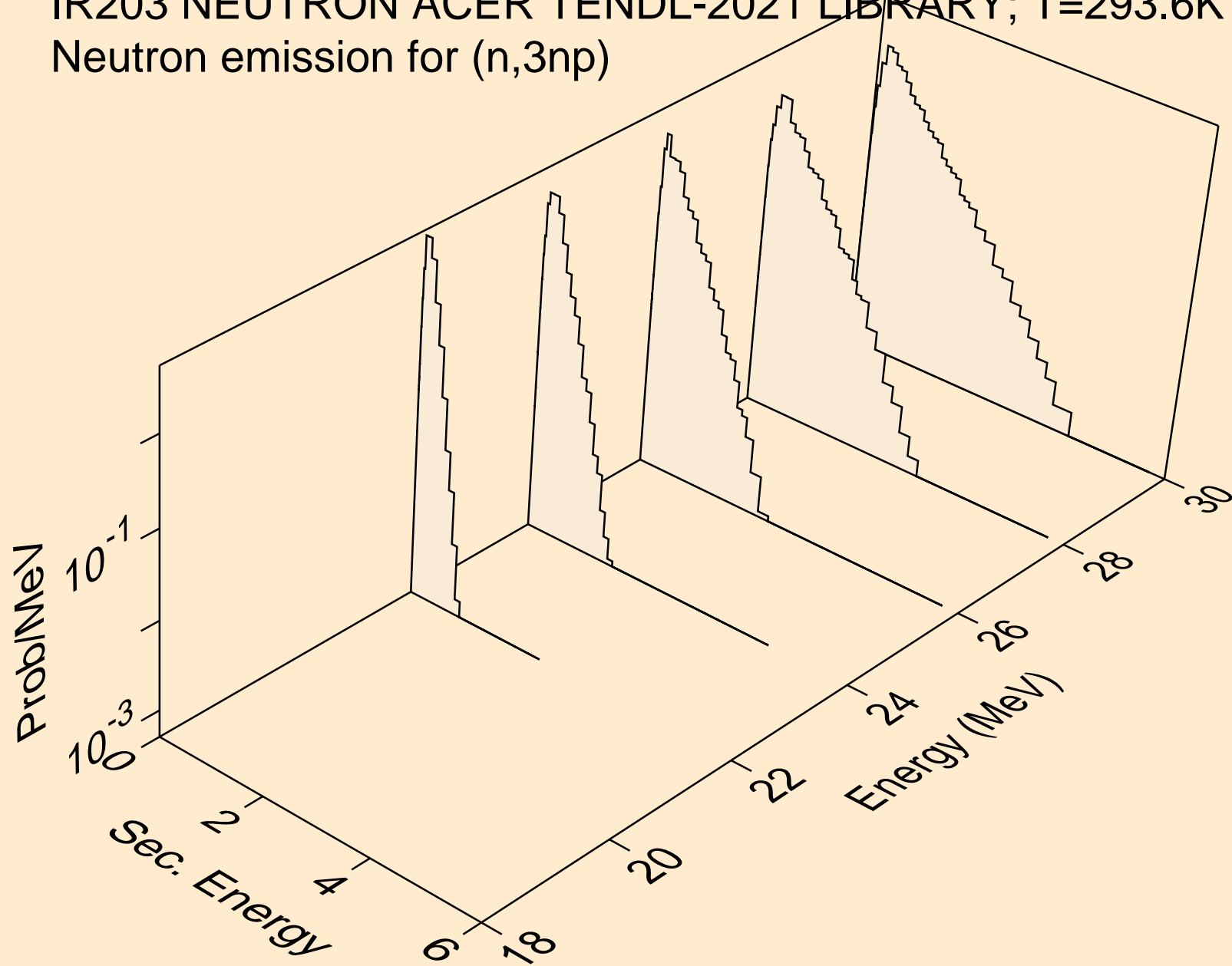

IR203 NEUTRON ACER TENDL-2021 LIBRARY; T=293.6K
Neutron emission for (n,n*c)

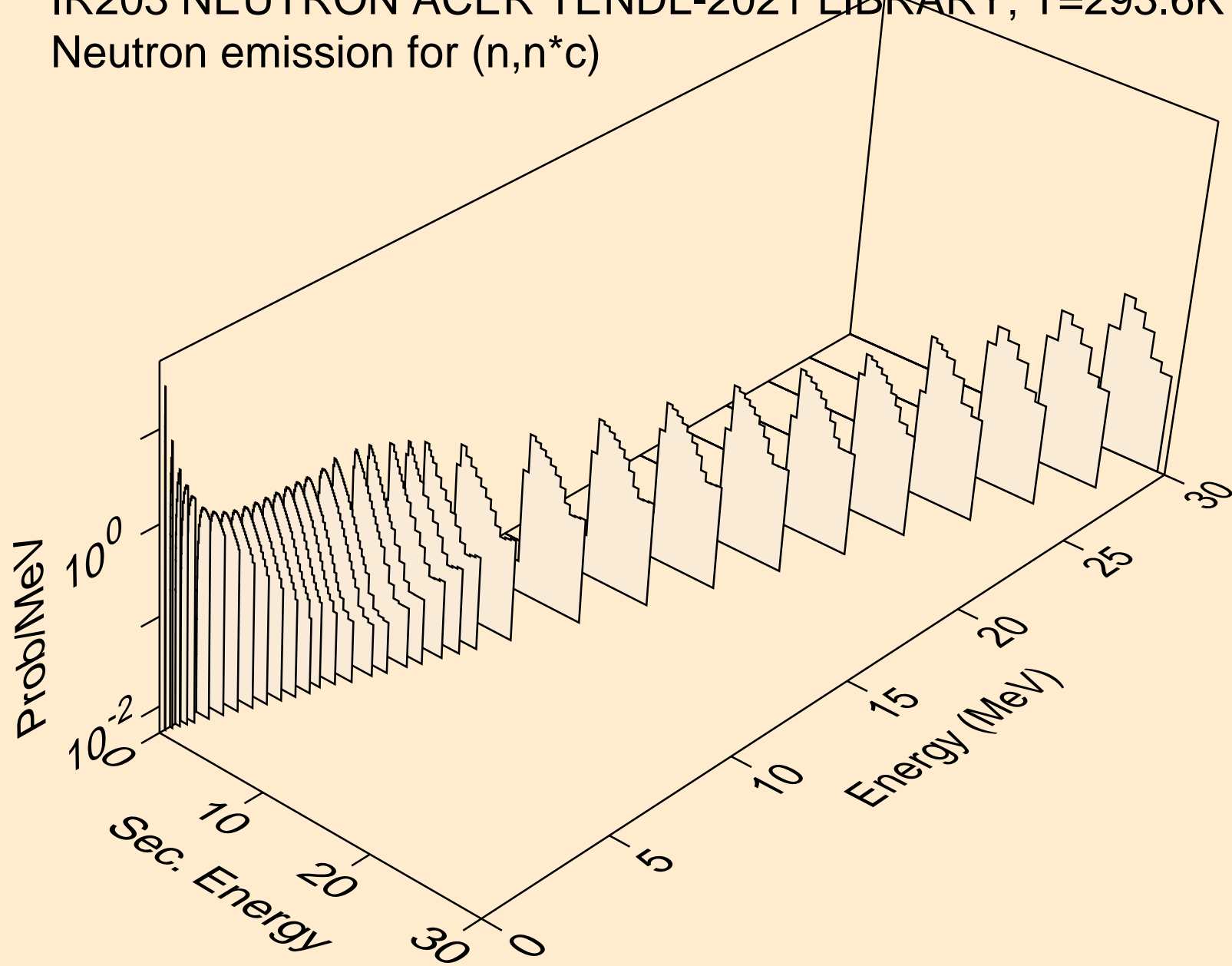

IR203 NEUTRON ACER TENDL-2021 LIBRARY; T=293.6K
Photon emission for (n,x)

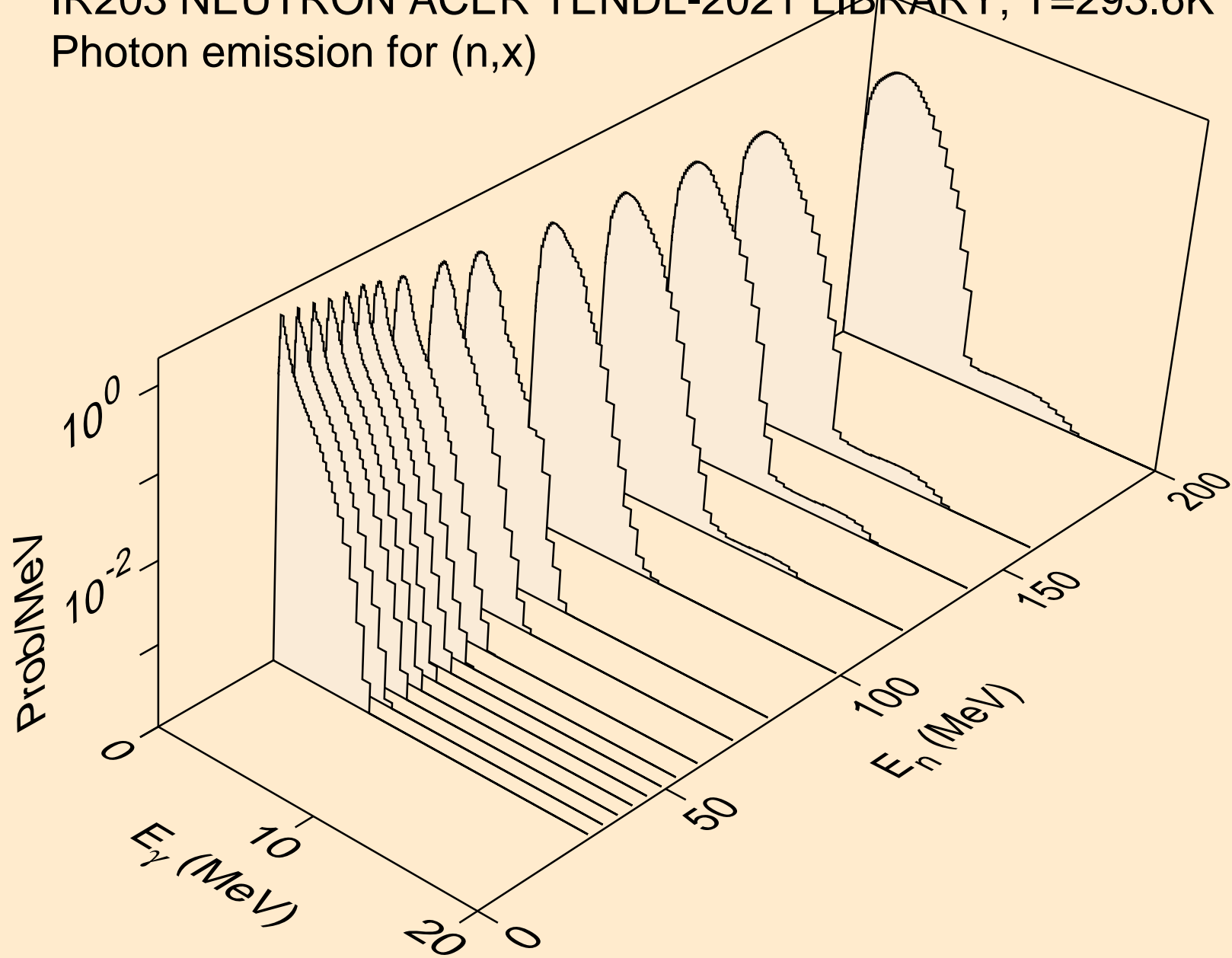

IR203 NEUTRON ACER TENDL-2021 LIBRARY; T=293.6K
Photon emission for (n,2nd)

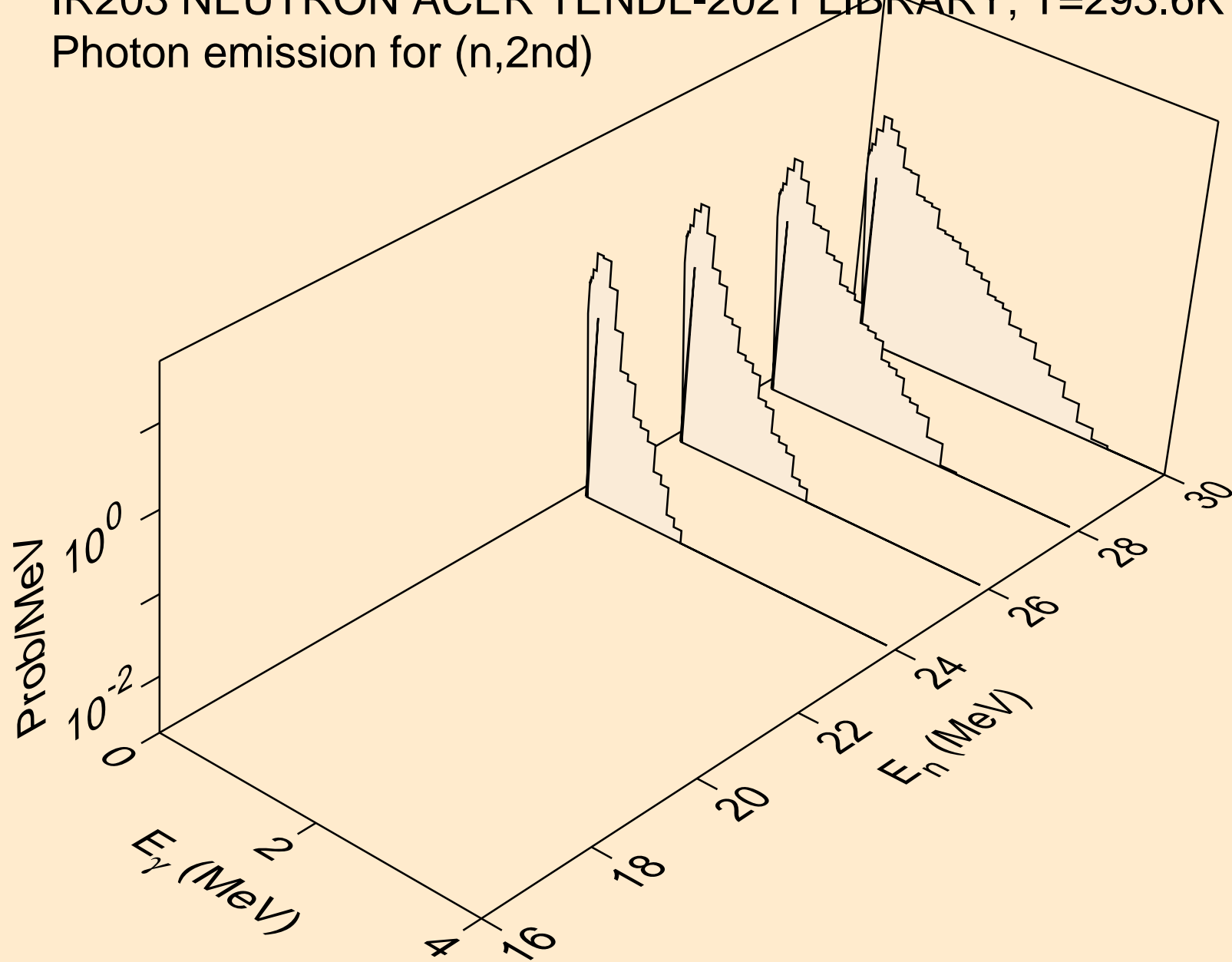

IR203 NEUTRON ACER TENDL-2021 LIBRARY; T=293.6K
Photon emission for (n,2n)

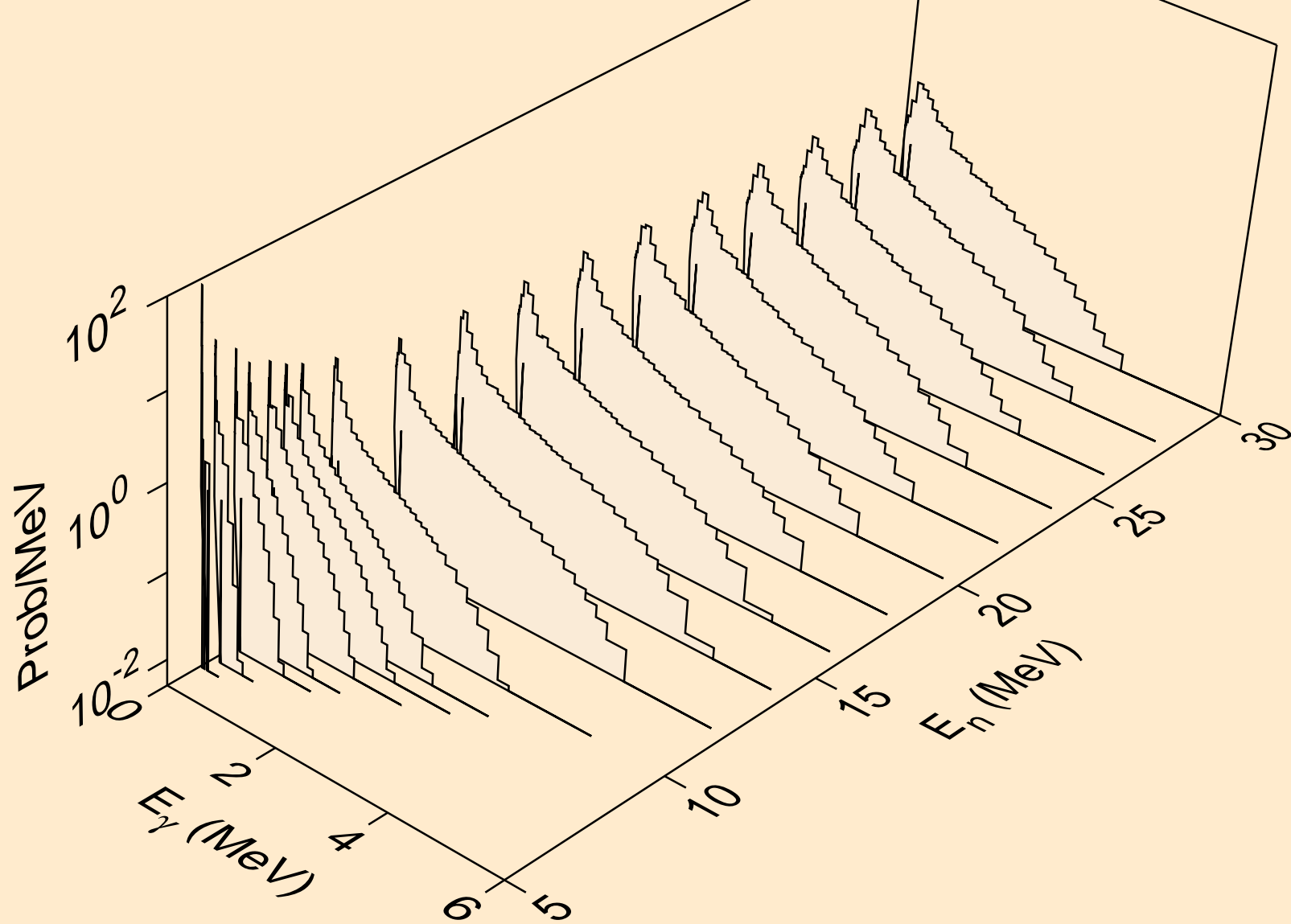

IR203 NEUTRON ACER TENDL-2021 LIBRARY; T=293.6K
Photon emission for (n,3n)

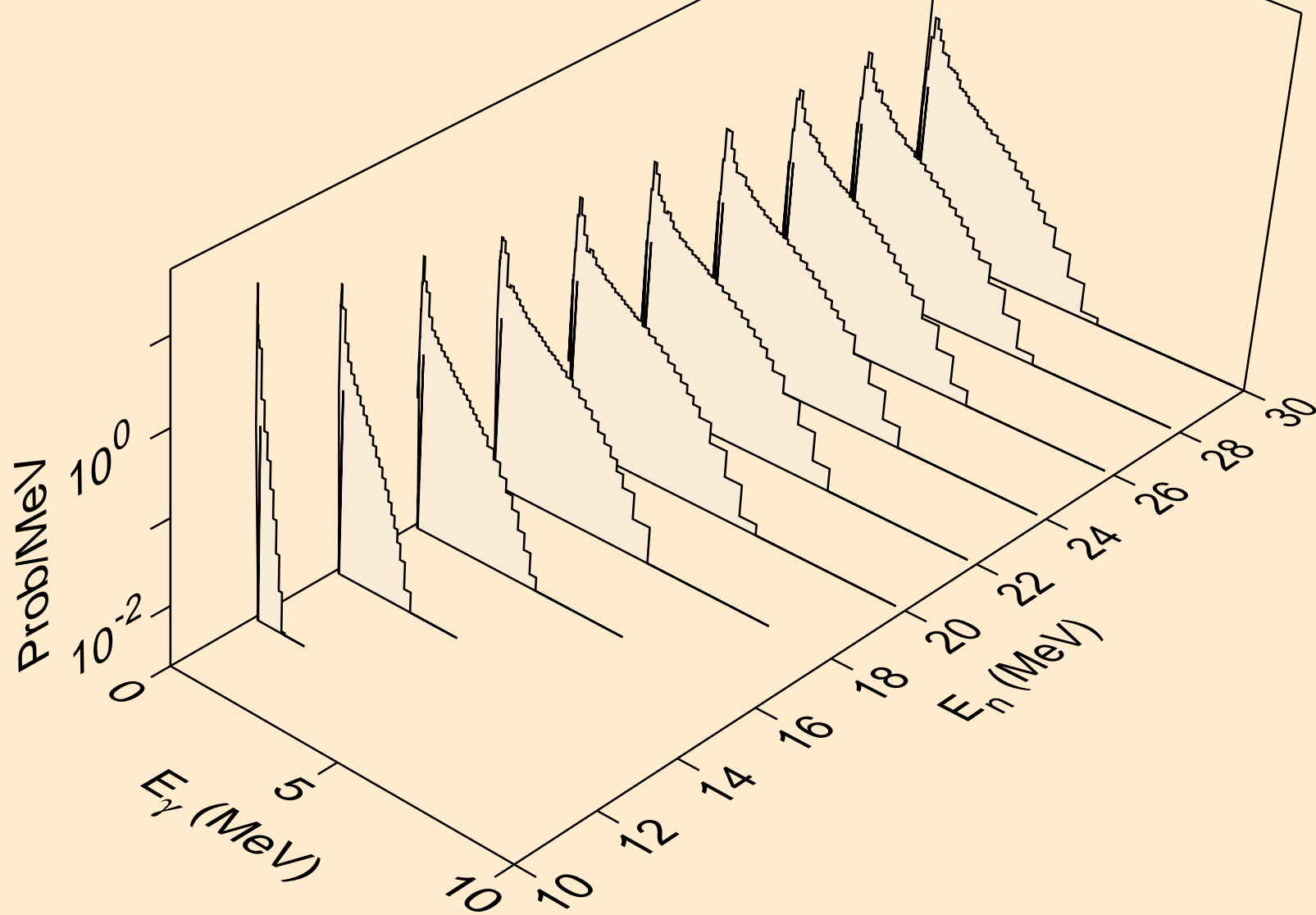

IR203 NEUTRON ACER TENDL-2021 LIBRARY; T=293.6K
Photon emission for (n,n*)a

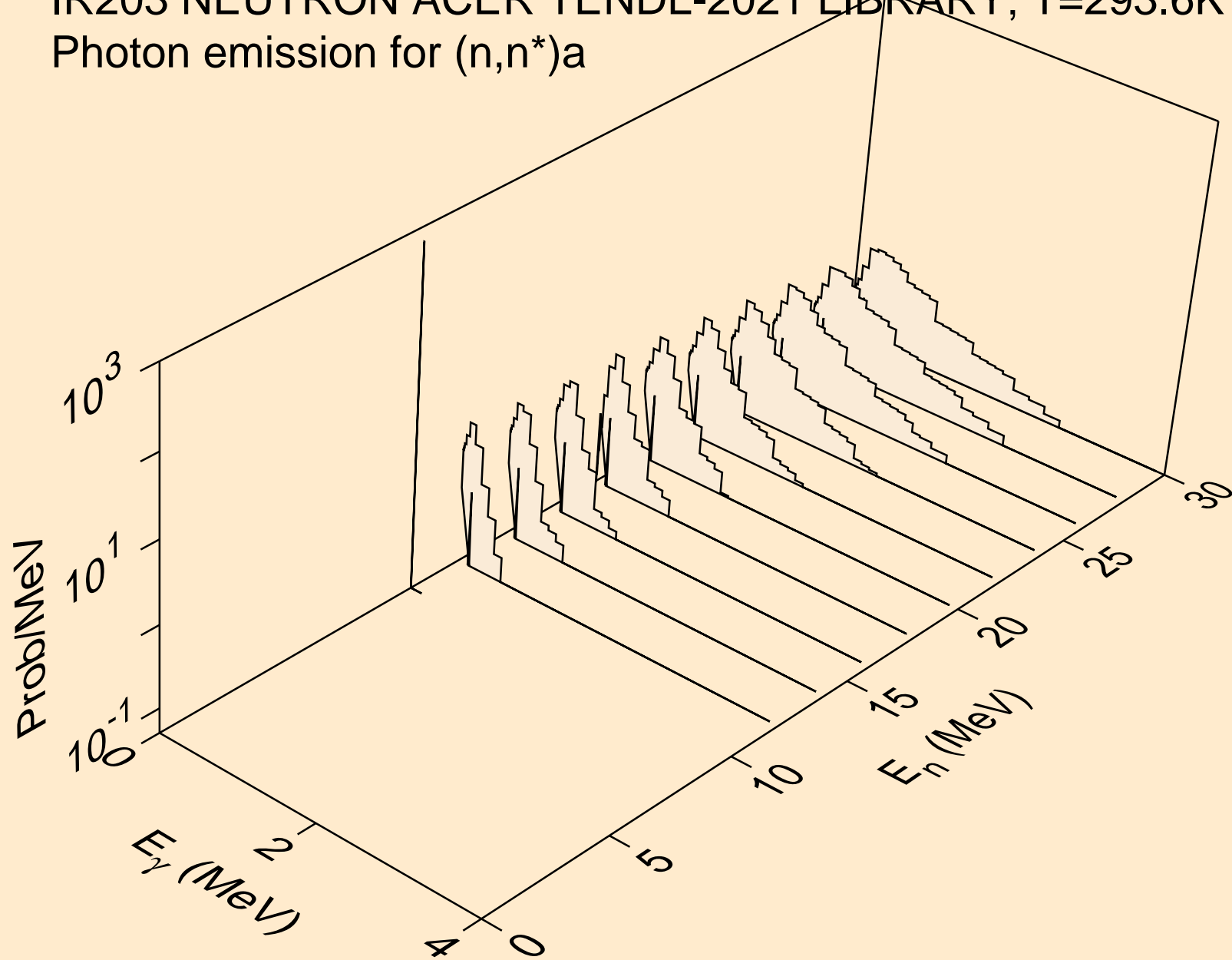

IR203 NEUTRON ACER TENDL-2021 LIBRARY; T=293.6K
Photon emission for (n,2n)a

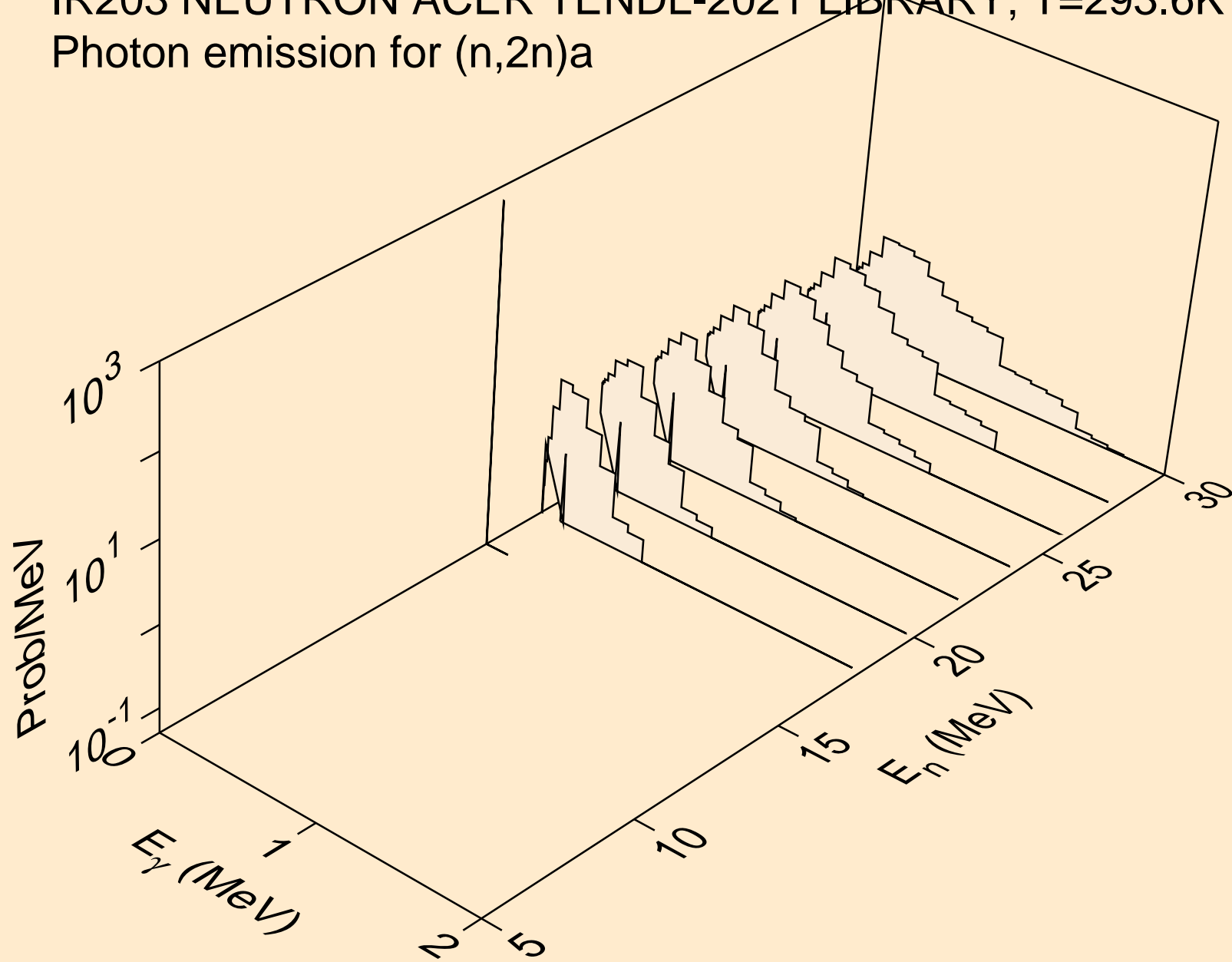

IR203 NEUTRON ACER TENDL-2021 LIBRARY; T=293.6K
Photon emission for (n,3n)a

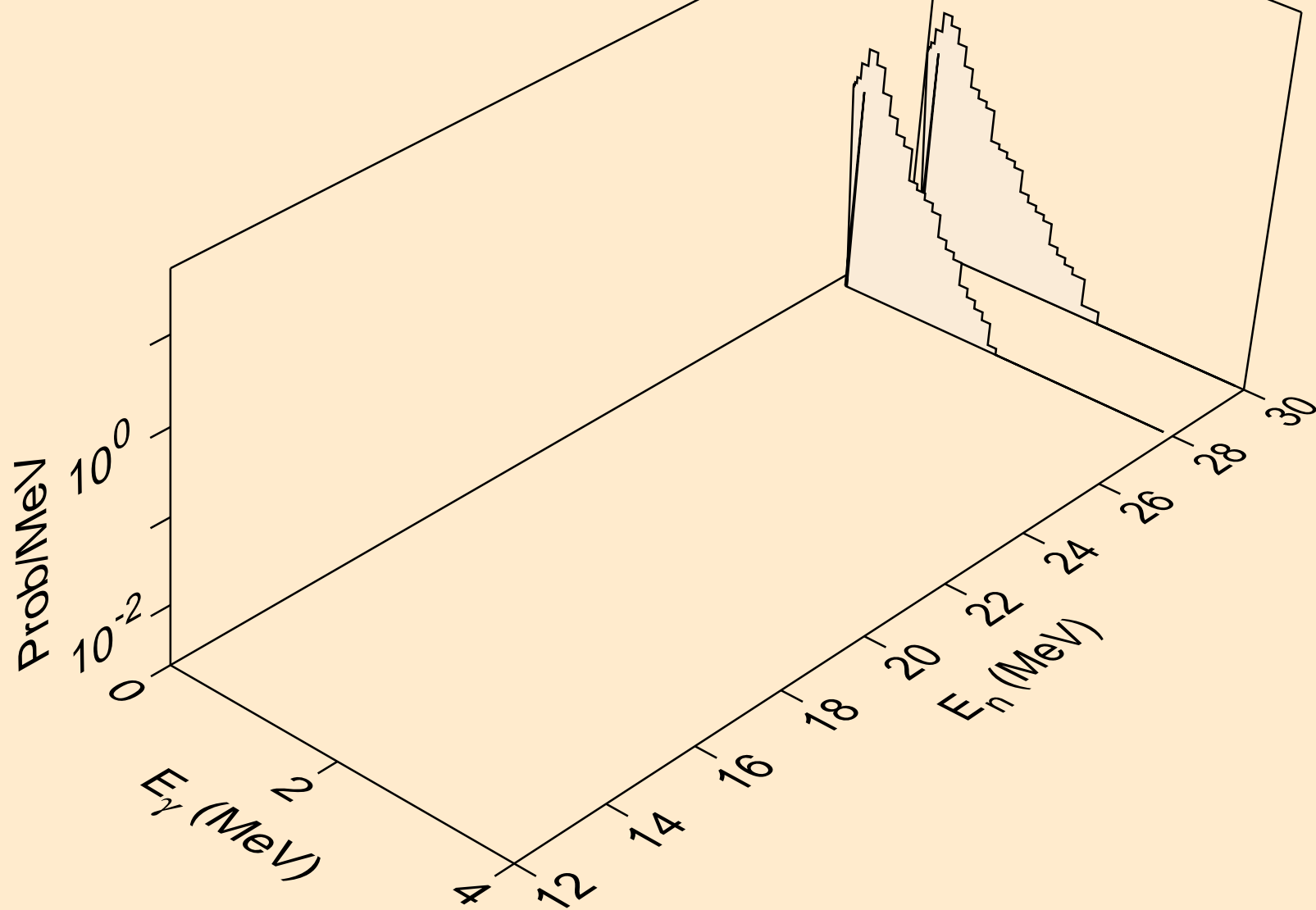

IR203 NEUTRON ACER TENDL-2021 LIBRARY; T=293.6K
Photon emission for (n,n*)p

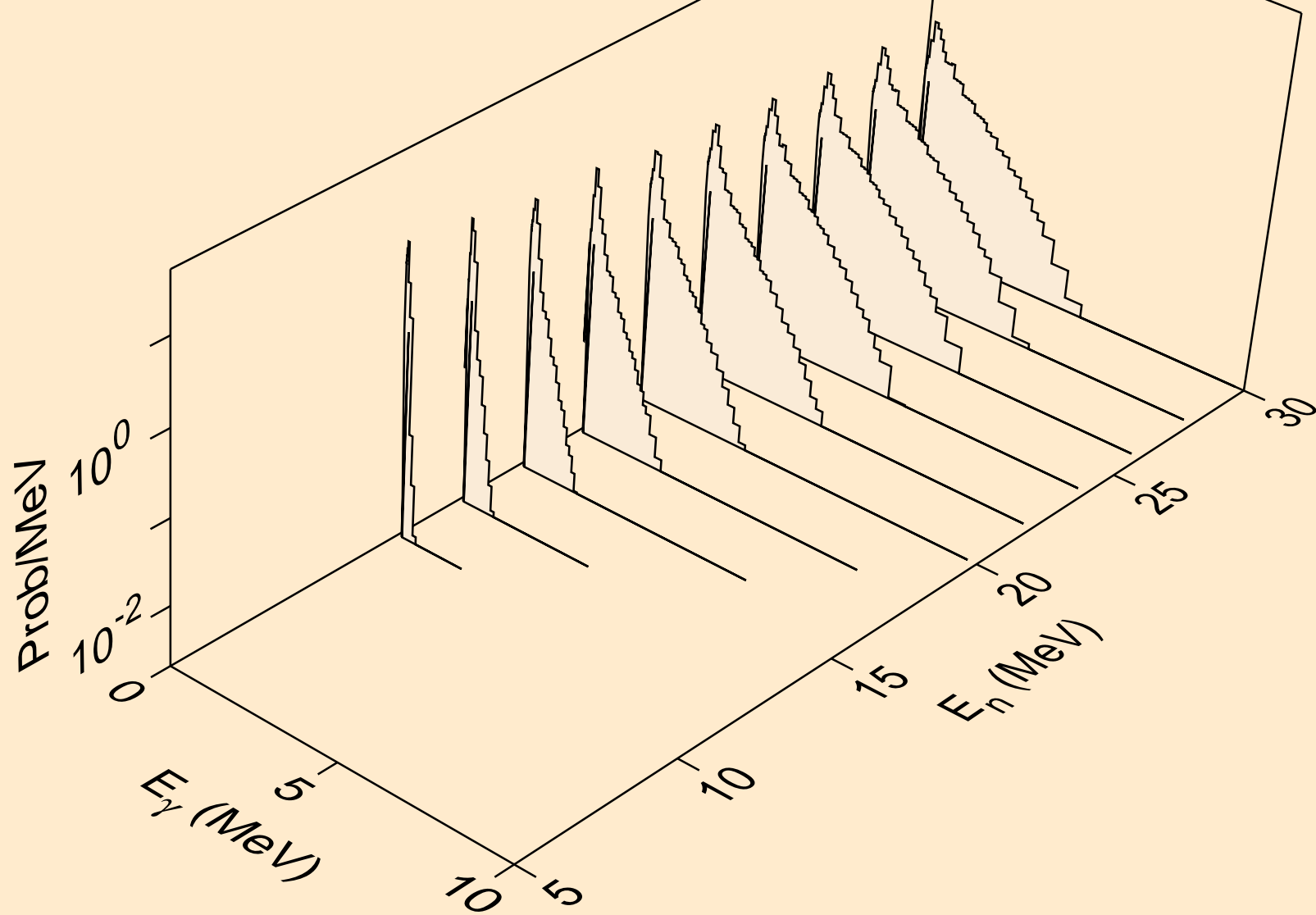

IR203 NEUTRON ACER TENDL-2021 LIBRARY; T=293.6K
Photon emission for (n,n*)d

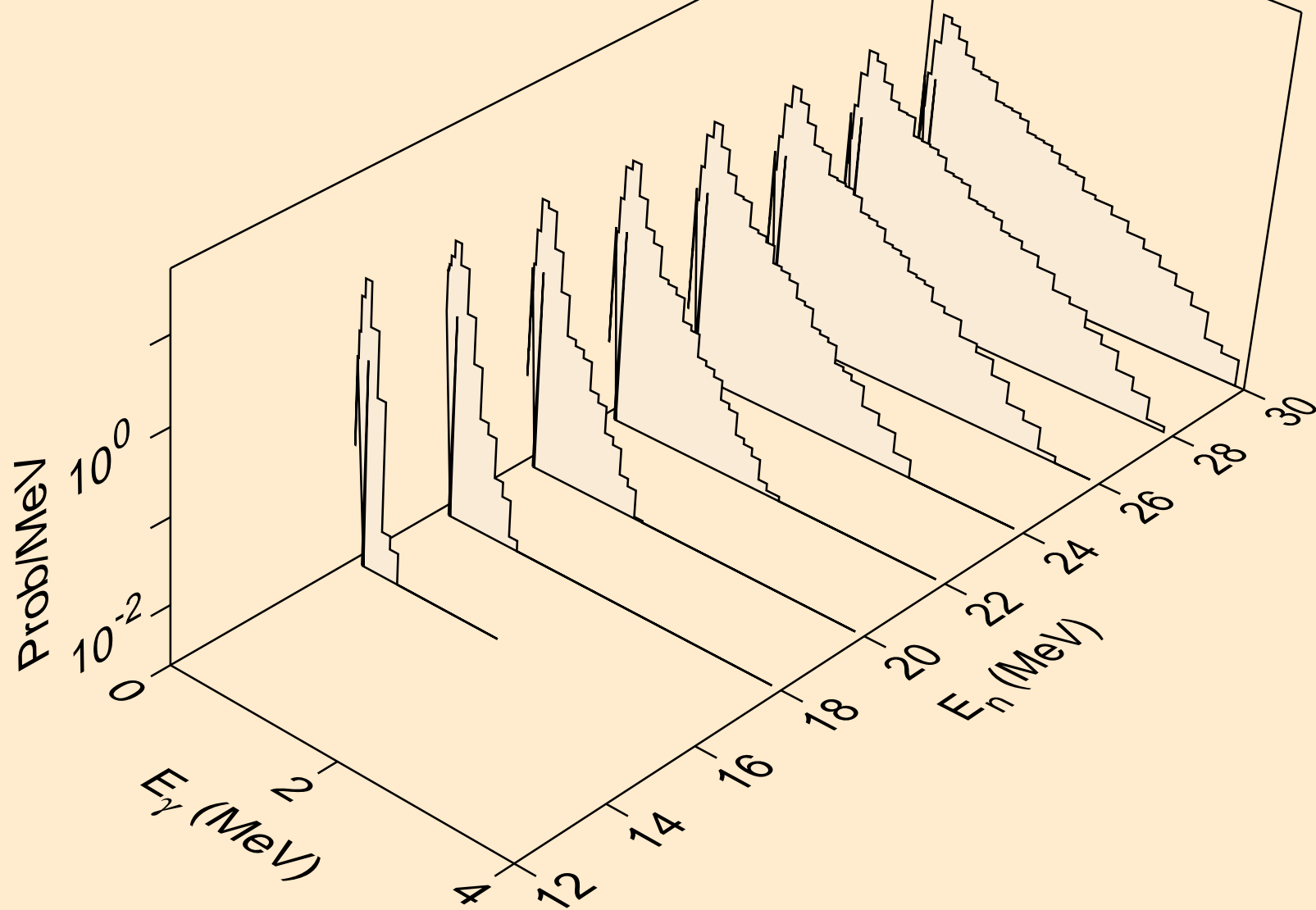

IR203 NEUTRON ACER TENDL-2021 LIBRARY; T=293.6K
Photon emission for (n,n*)t

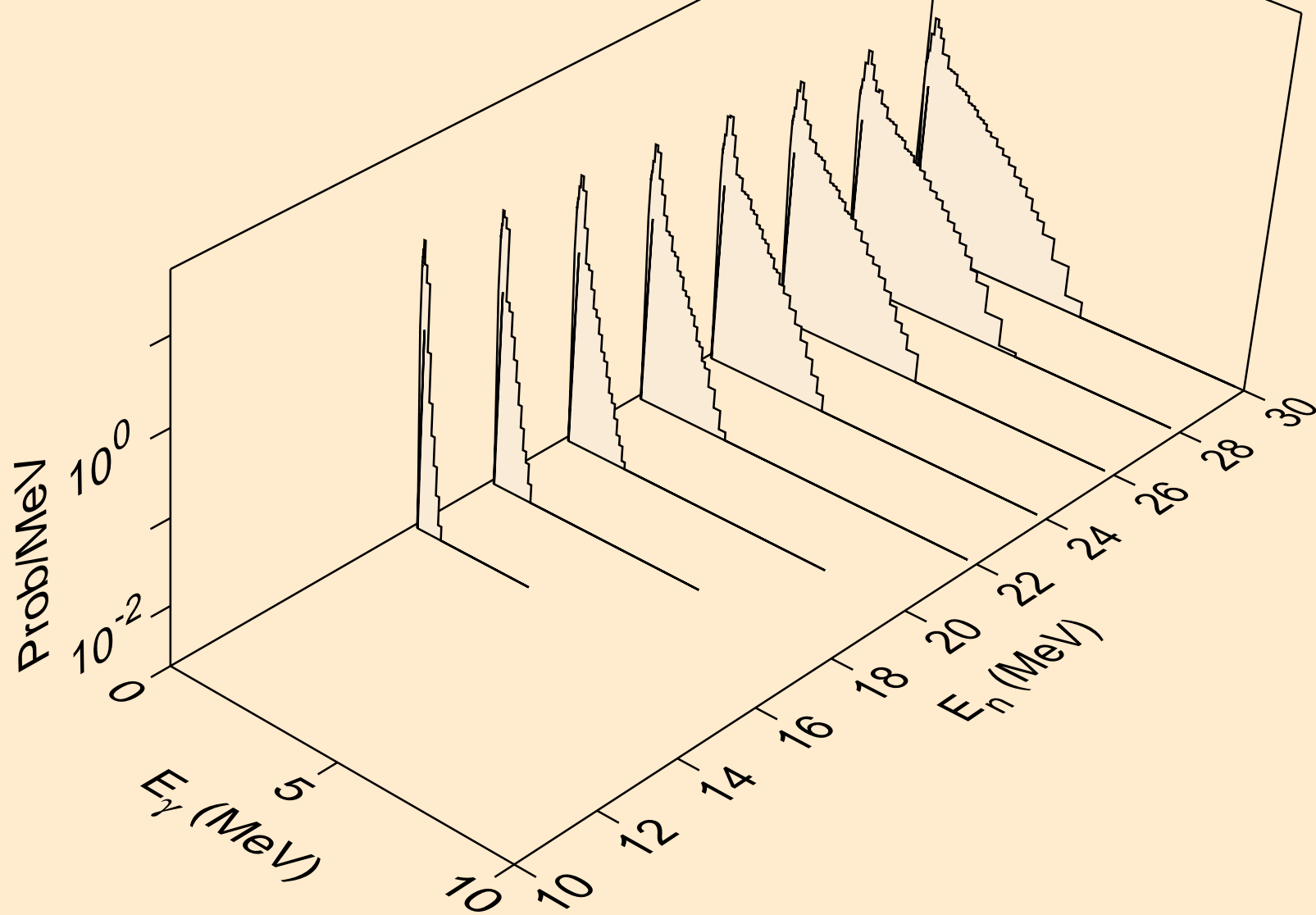

IR203 NEUTRON ACER TENDL-2021 LIBRARY; T=293.6K
Photon emission for (n,4n)

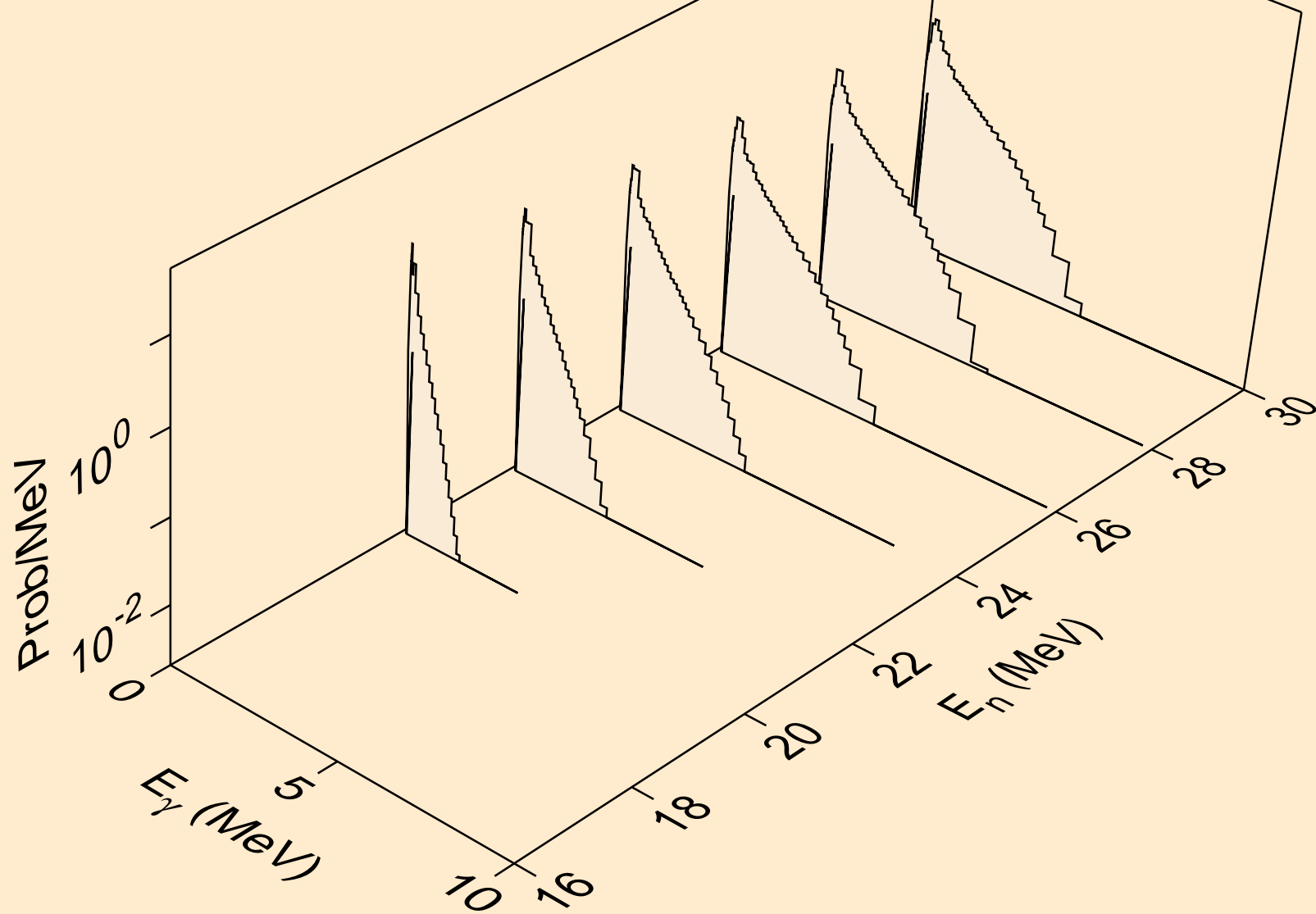

IR203 NEUTRON ACER TENDL-2021 LIBRARY; T=293.6K
Photon emission for (n,2np)

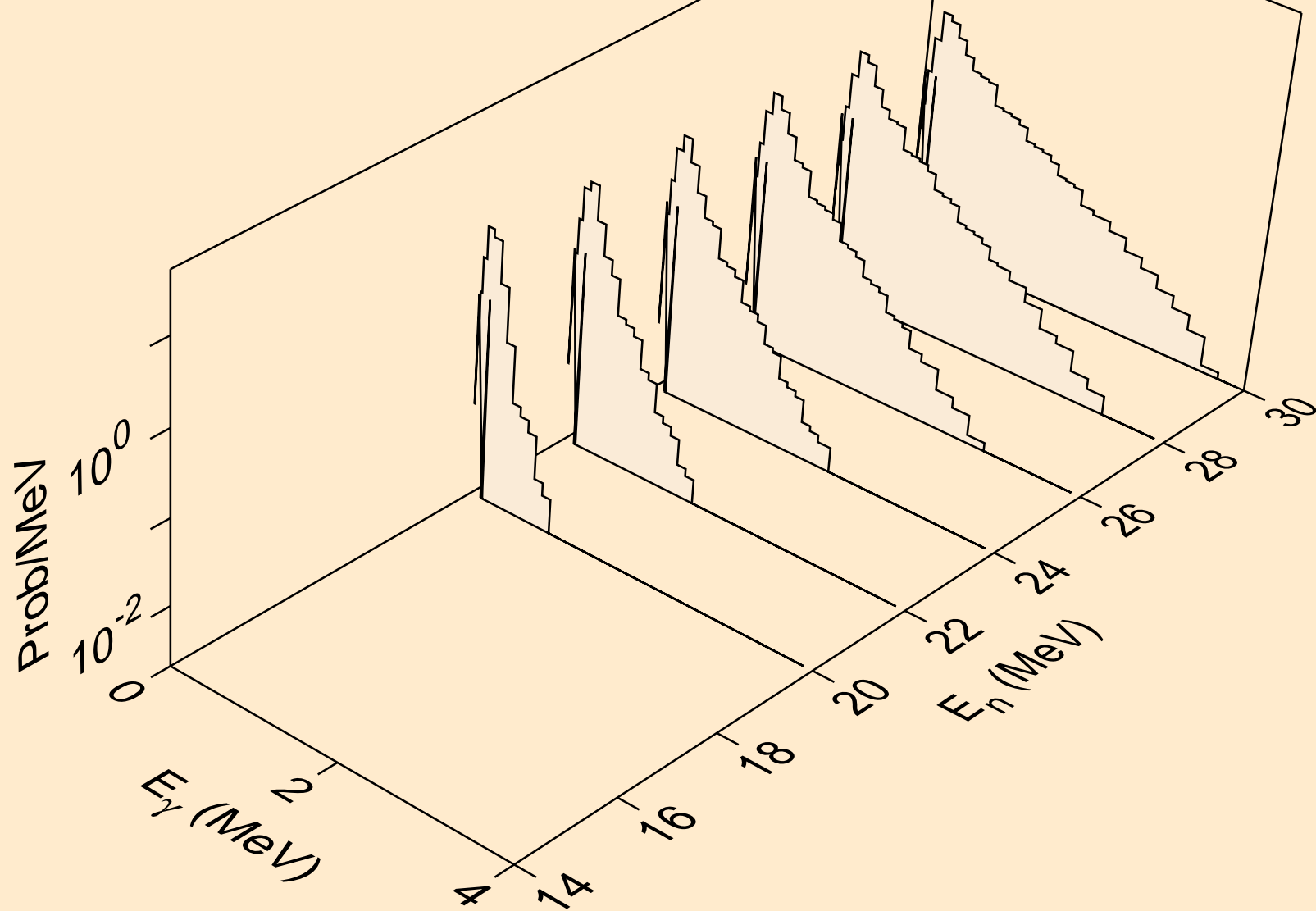

IR203 NEUTRON ACER TENDL-2021 LIBRARY; T=293.6K
Photon emission for (n,3np)

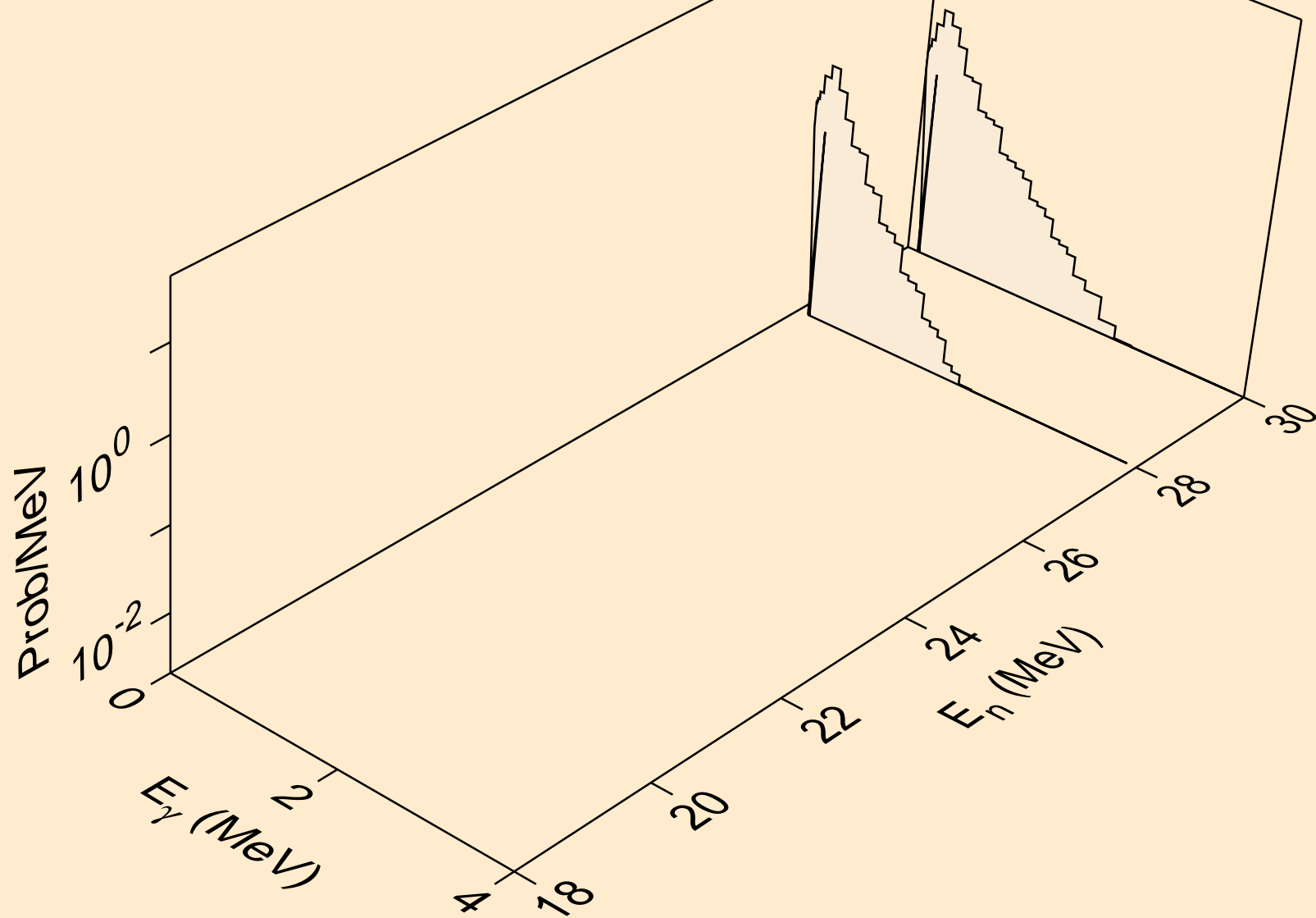

IR203 NEUTRON ACER TENDL-2021 LIBRARY; T=293.6K
Photon emission for (n,n*c)

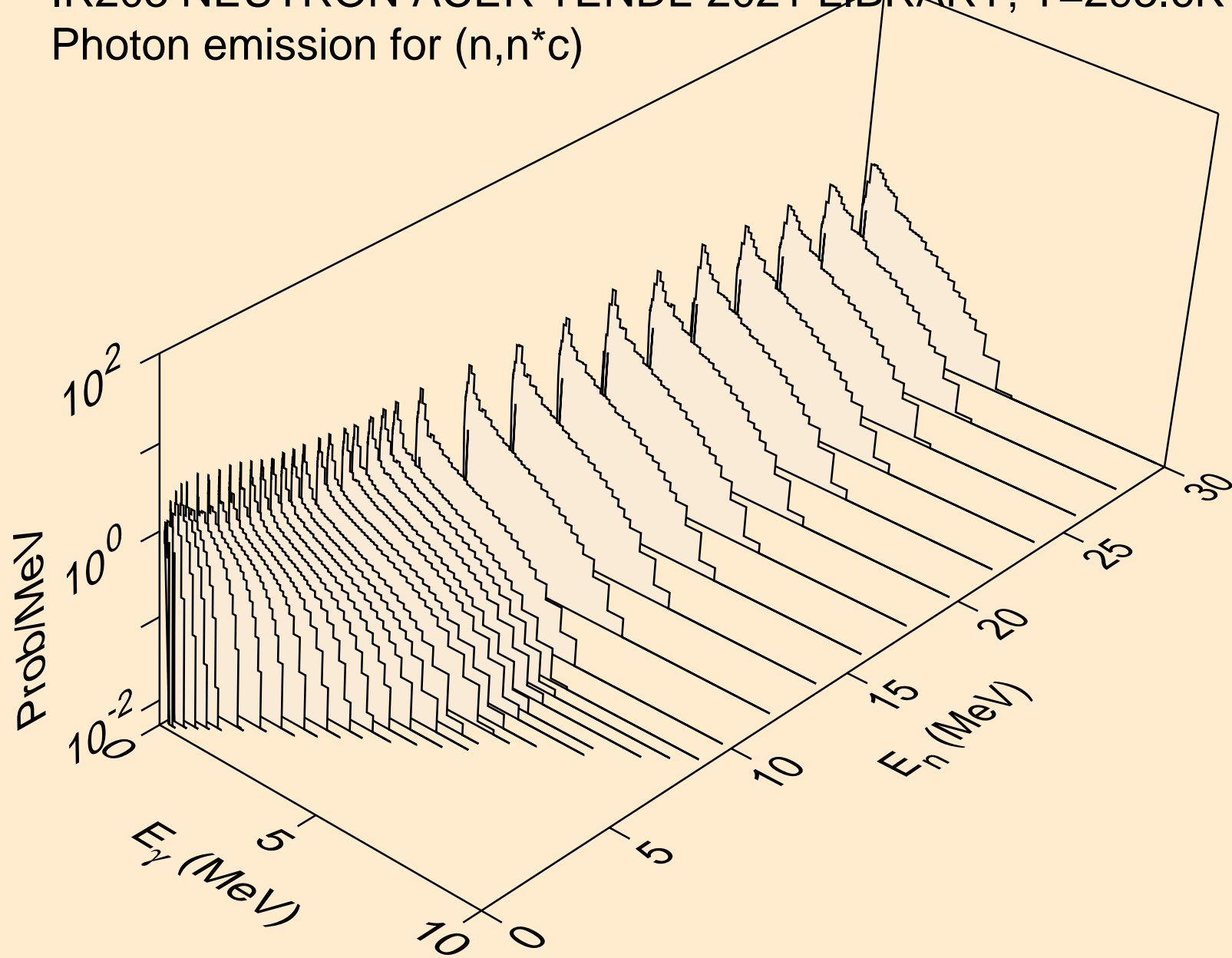

IR203 NEUTRON ACER TENDL-2021 LIBRARY; T=293.6K
Photon emission for (n,gma)

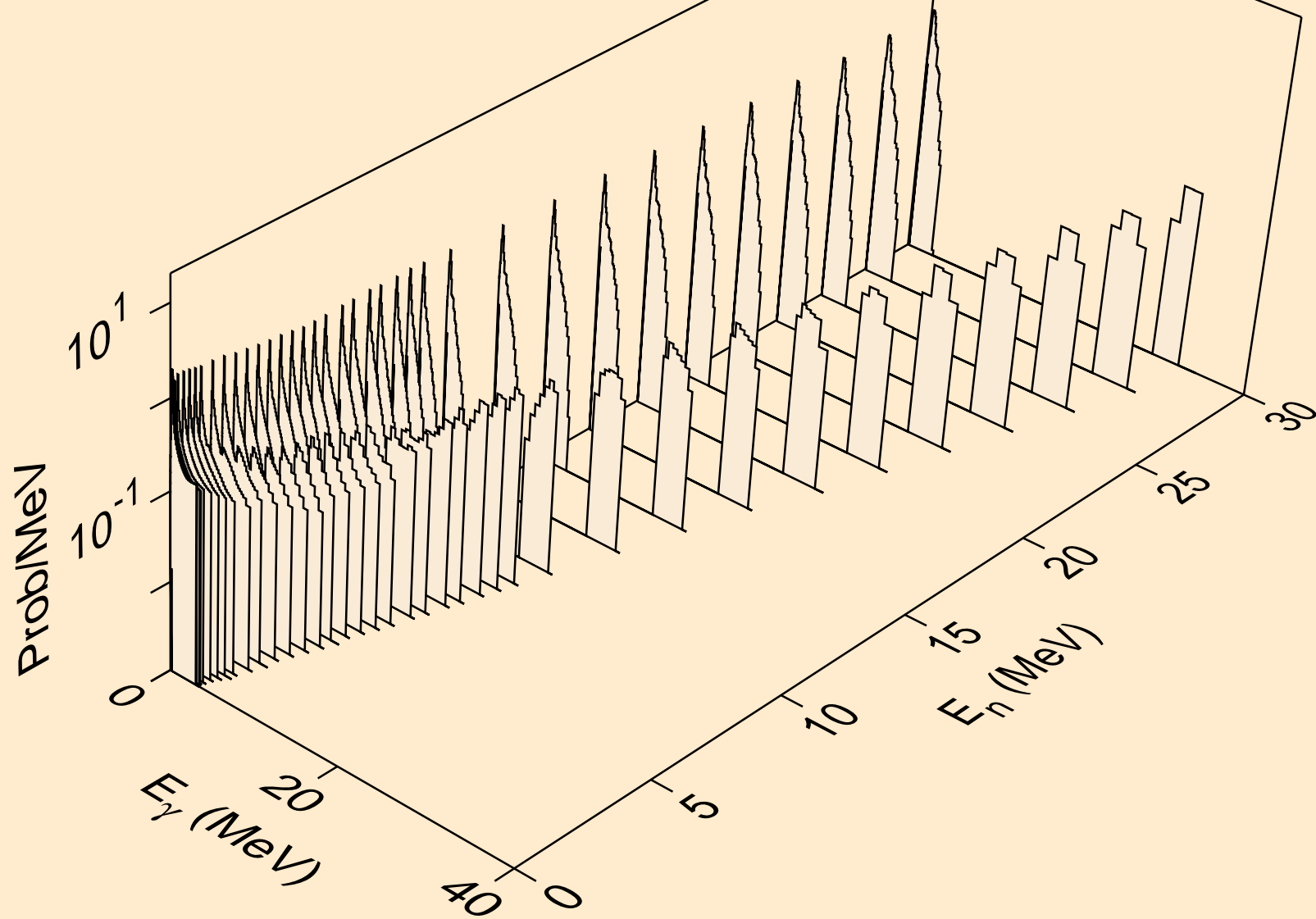

IR203 NEUTRON ACER TENDL-2021 LIBRARY; T=293.6K
Photon emission for (n,p)

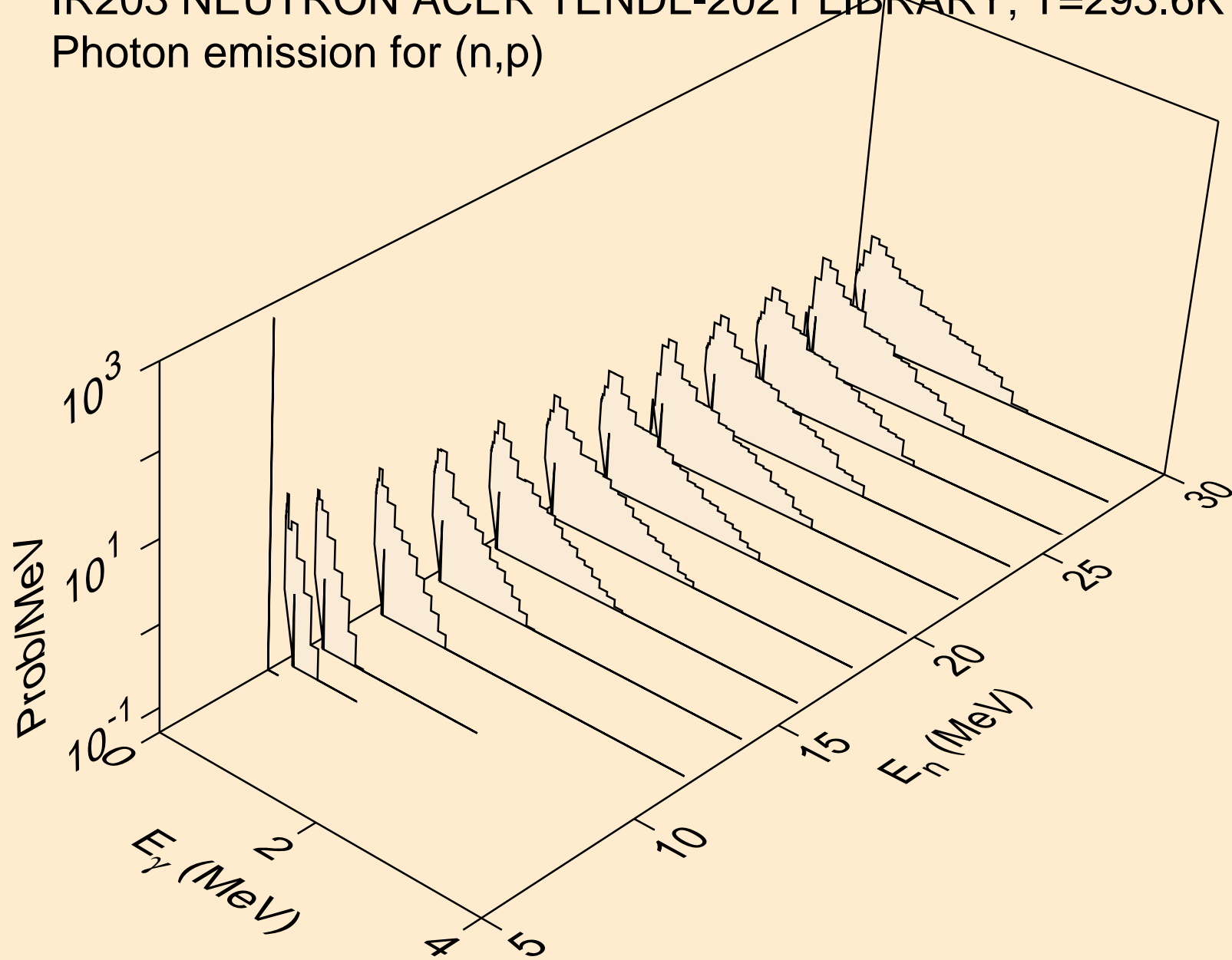

IR203 NEUTRON ACER TENDL-2021 LIBRARY; T=293.6K
Photon emission for (n,d)

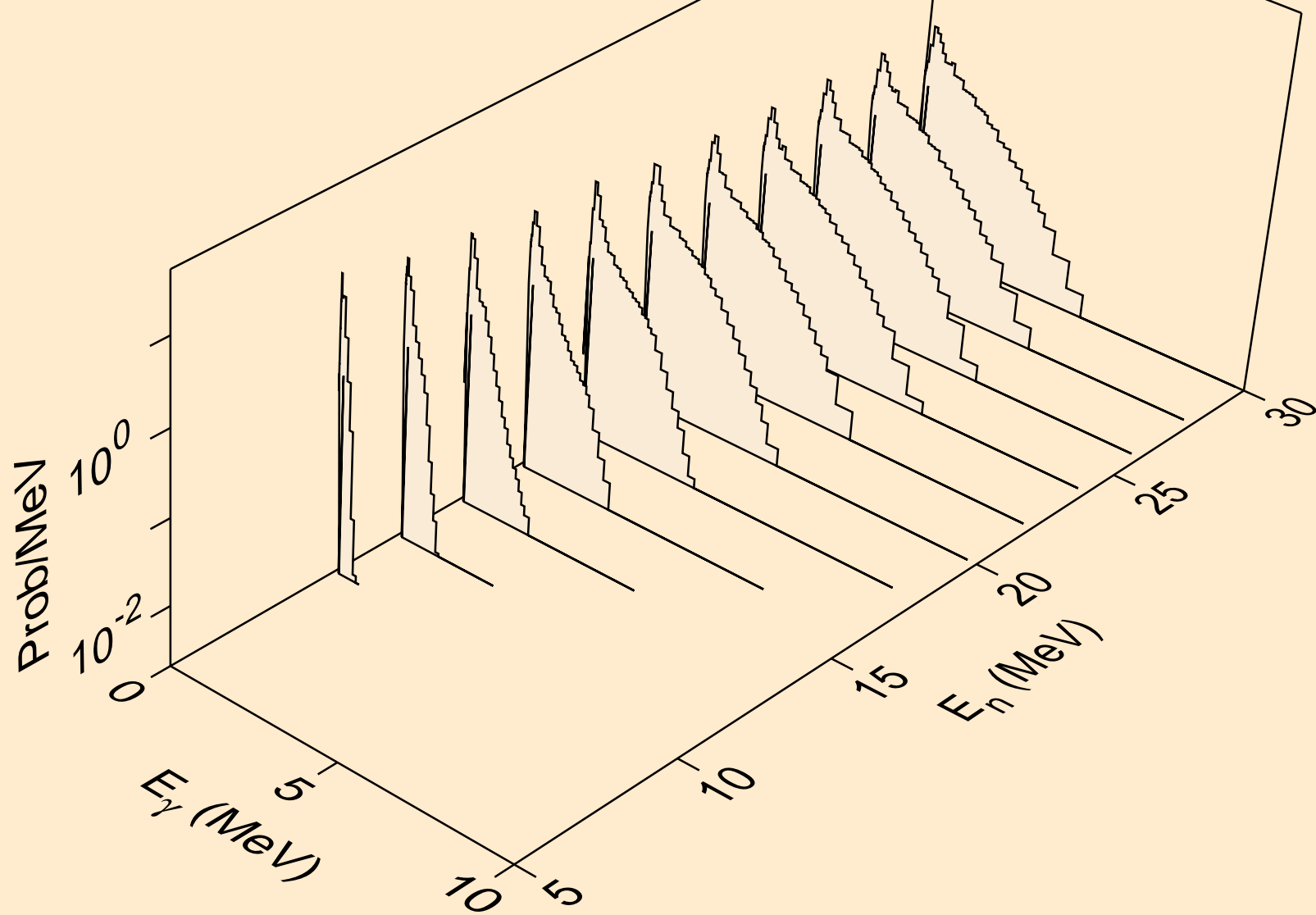

IR203 NEUTRON ACER TENDL-2021 LIBRARY; T=293.6K
Photon emission for (n,t)

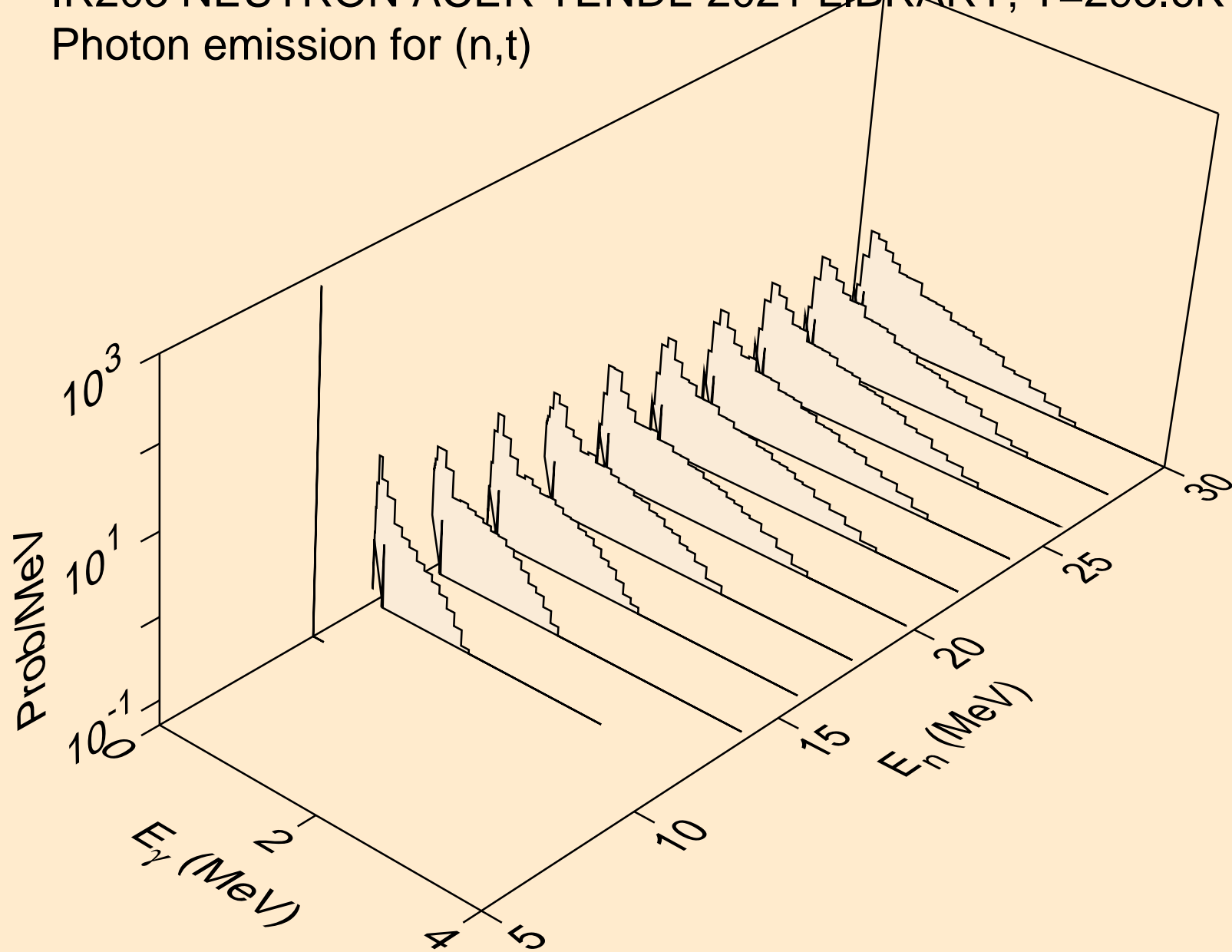

IR203 NEUTRON ACER TENDL-2021 LIBRARY; T=293.6K
Photon emission for (n,he3)

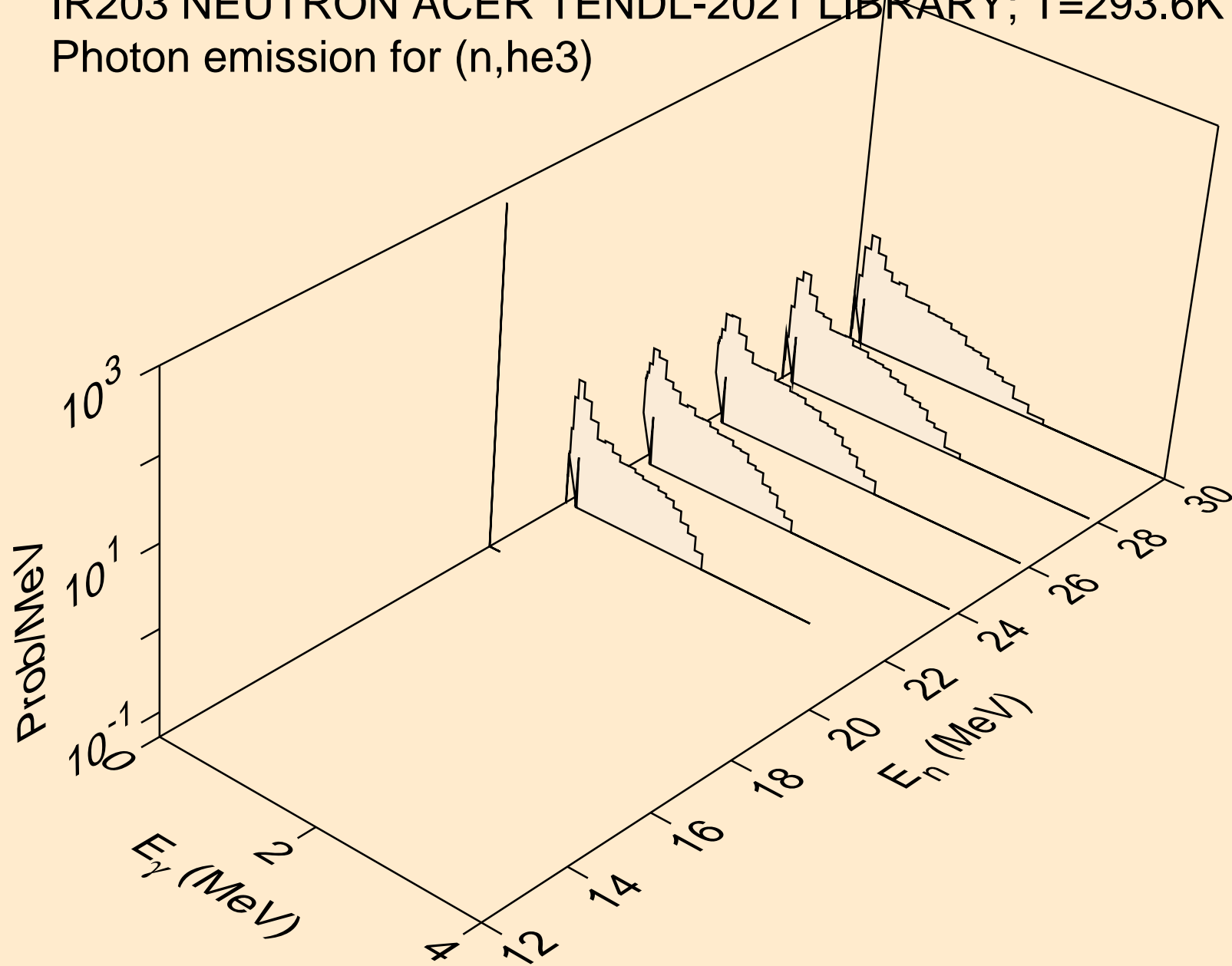

IR203 NEUTRON ACER TENDL-2021 LIBRARY; T=293.6K
Photon emission for (n,a)

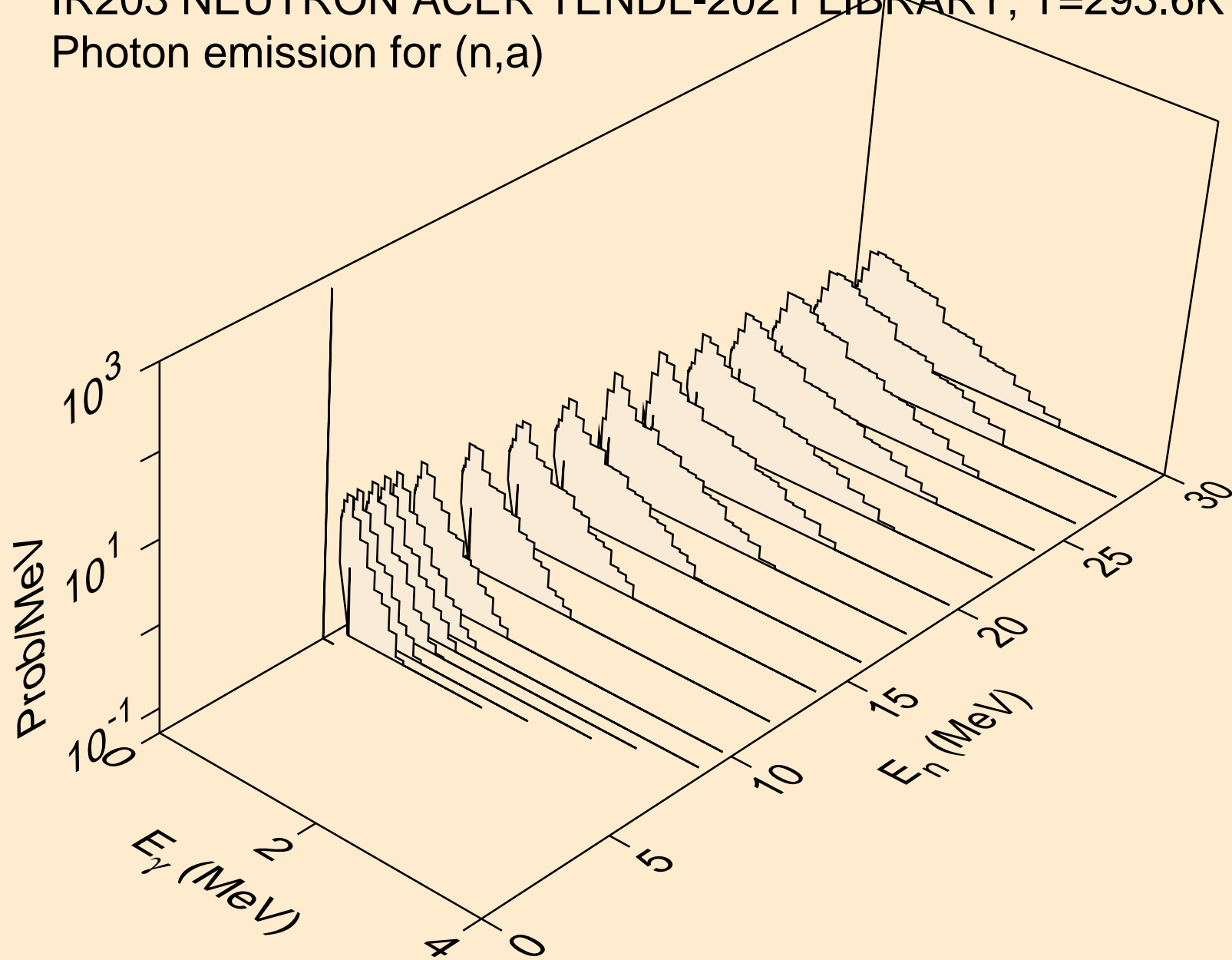

IR203 NEUTRON ACER TENDL-2021 LIBRARY; T=293.6K
thermal capture photon spectrum

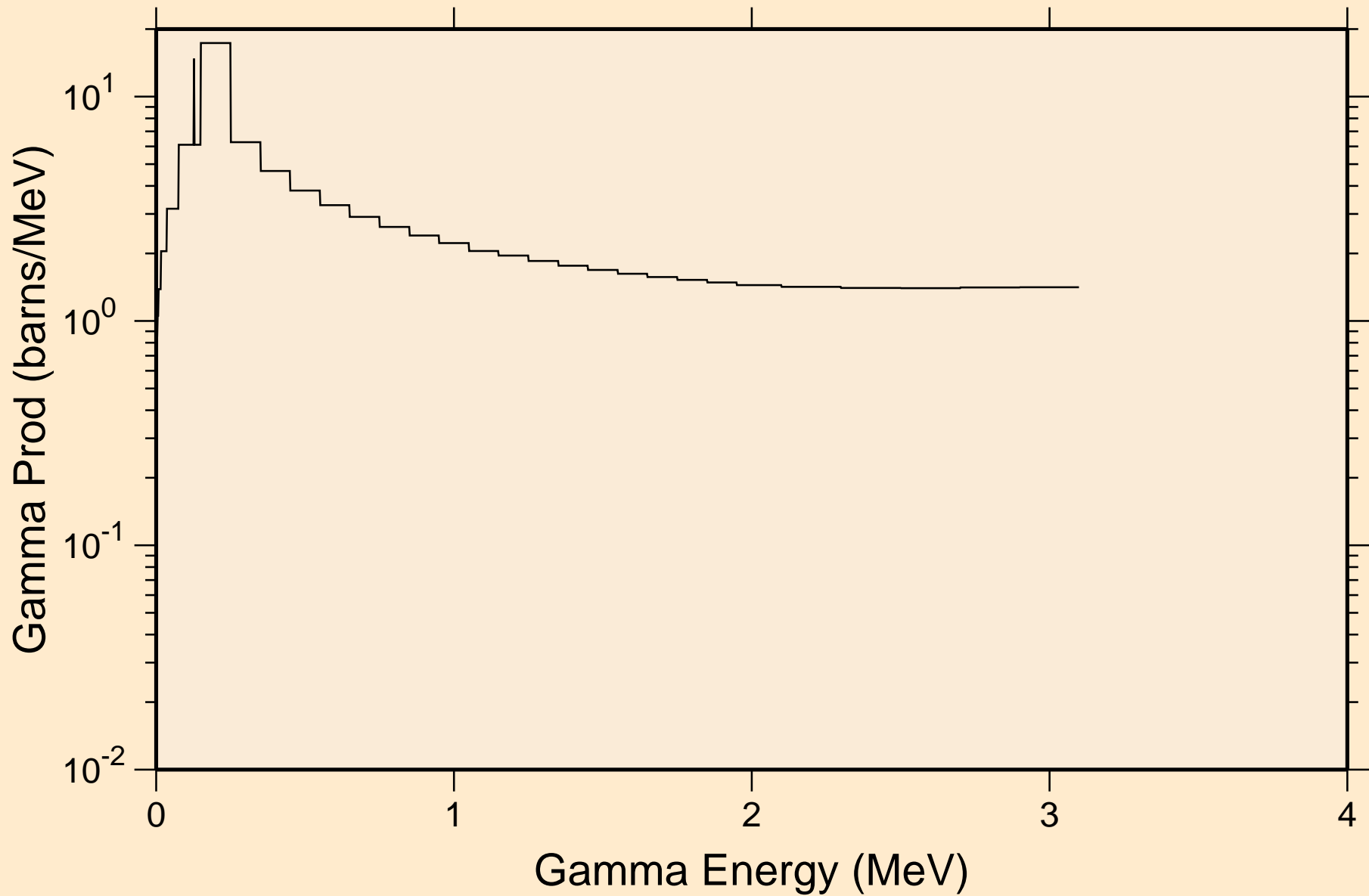

IR203 NEUTRON ACER TENDL-2021 LIBRARY; T=293.6K
14 MeV photon spectrum

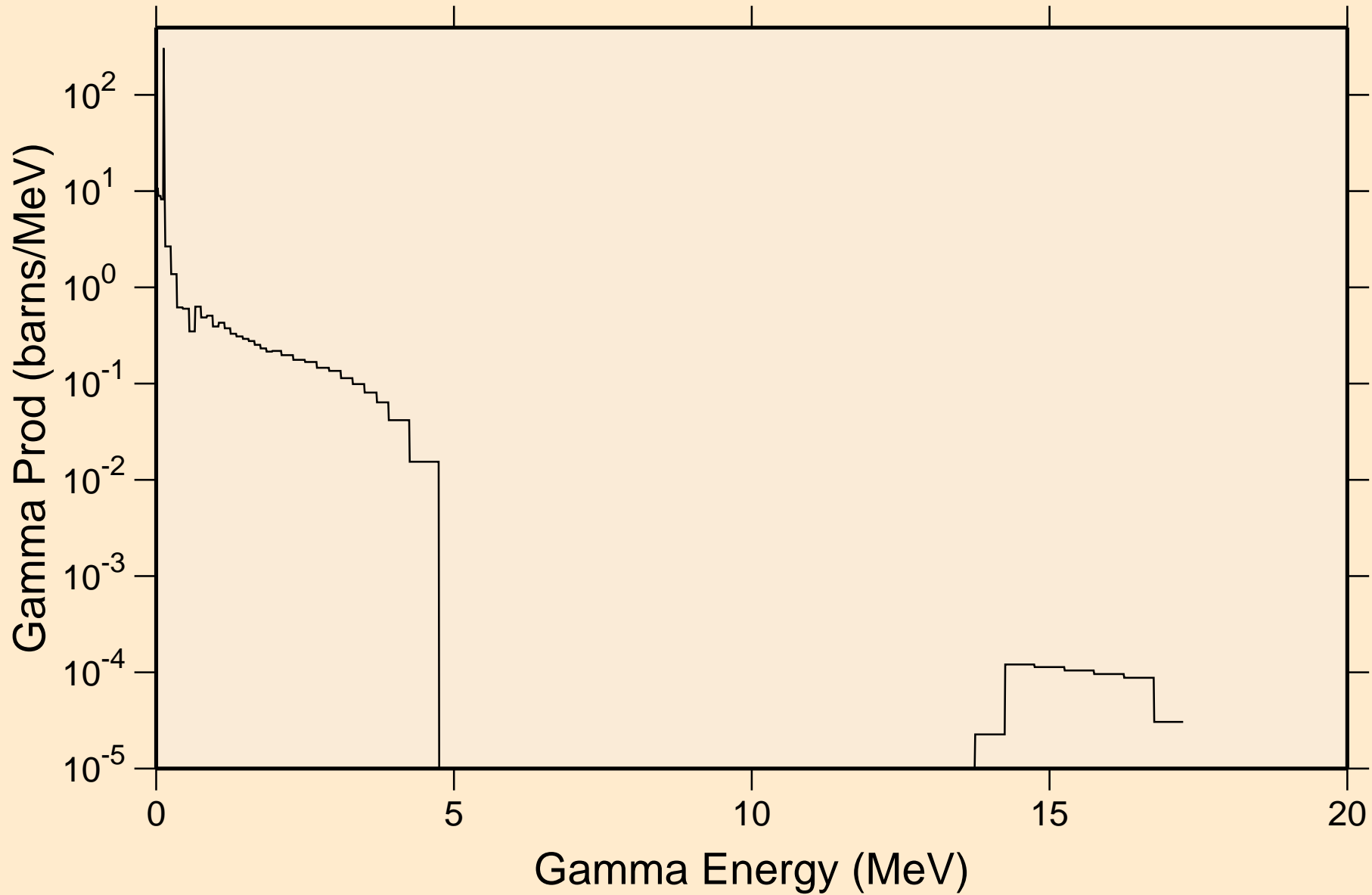

IR203 NEUTRON ACER TENDL-2021 LIBRARY; T=293.6K
Particle heating contributions

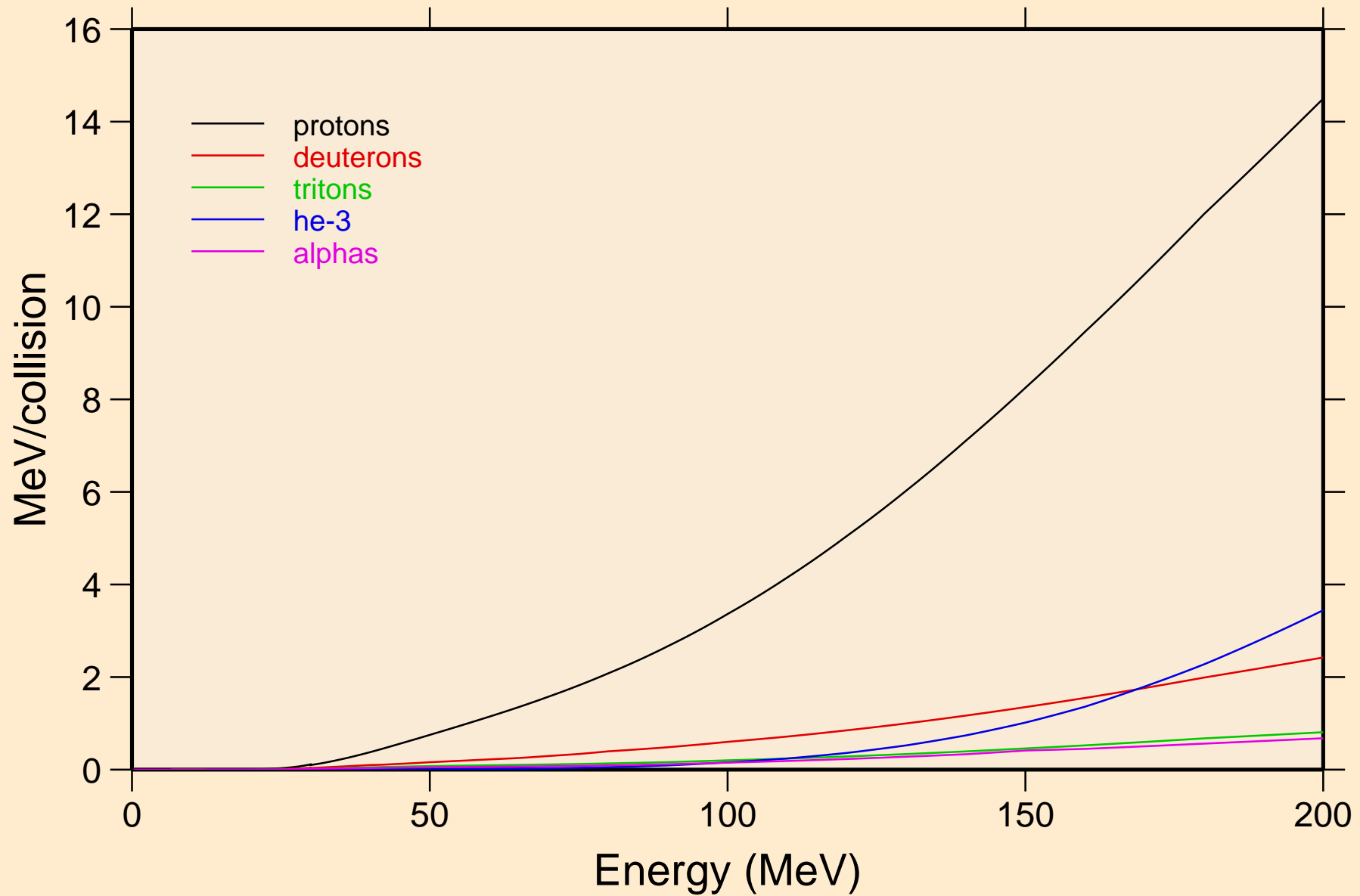

IR203 NEUTRON ACER TENDL-2021 LIBRARY; T=293.6K
Recoil Heating

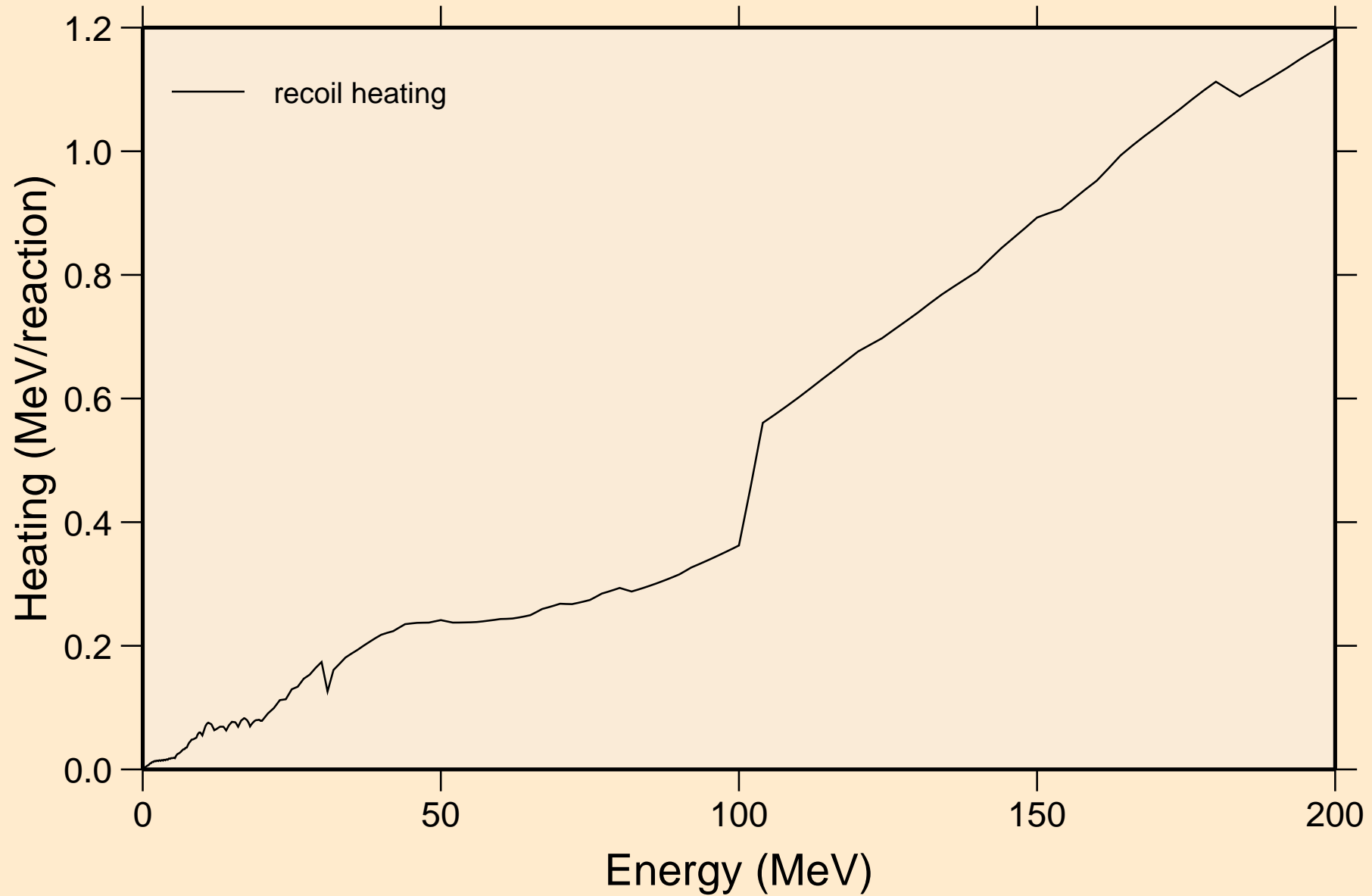

IR203 NEUTRON ACER TENDL-2021 LIBRARY; T=293.6K
Particle production cross sections

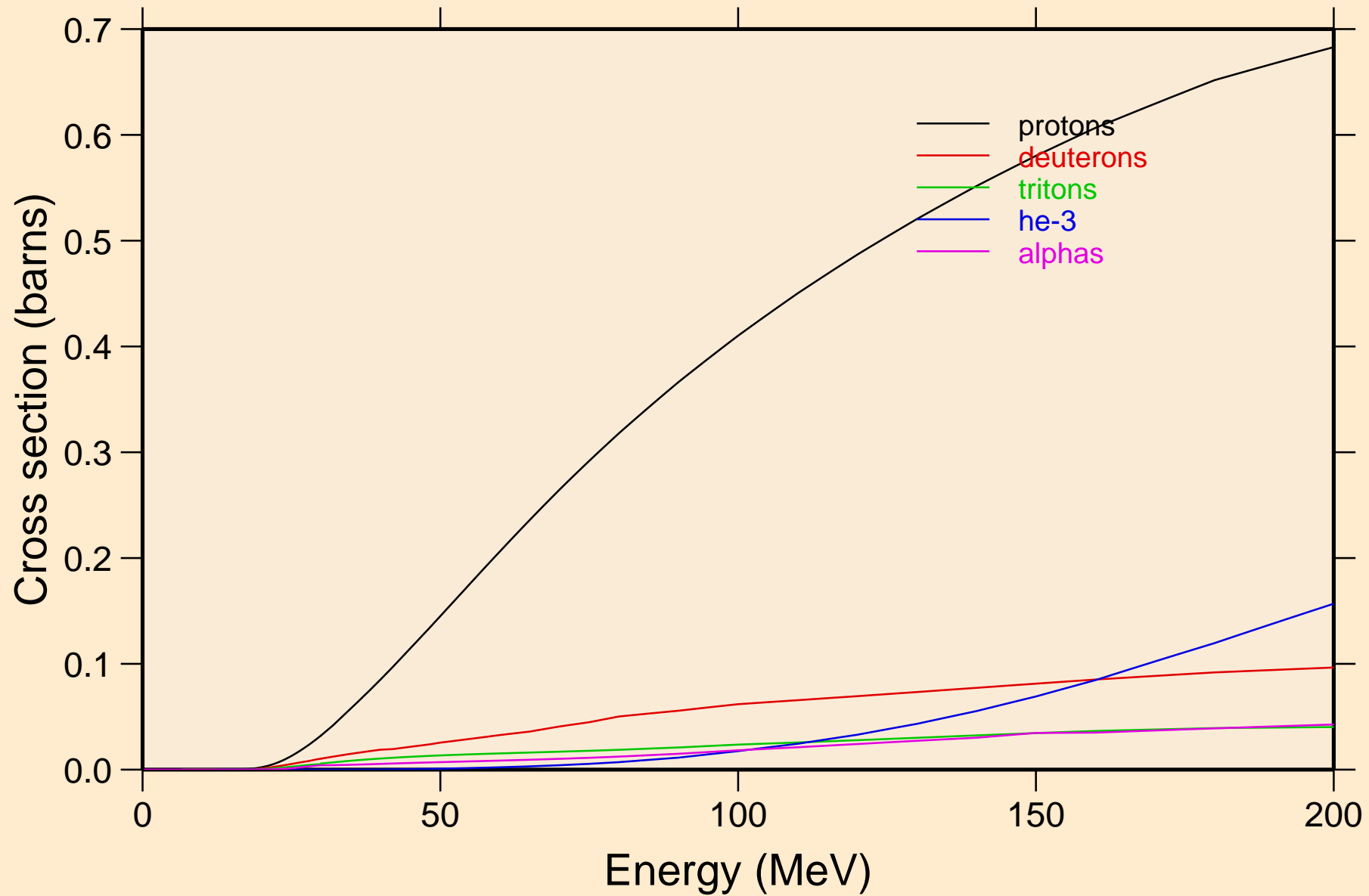

IR203 NEUTRON ACER TENDL-2021 LIBRARY; T=293.6K
protons from (n,x)

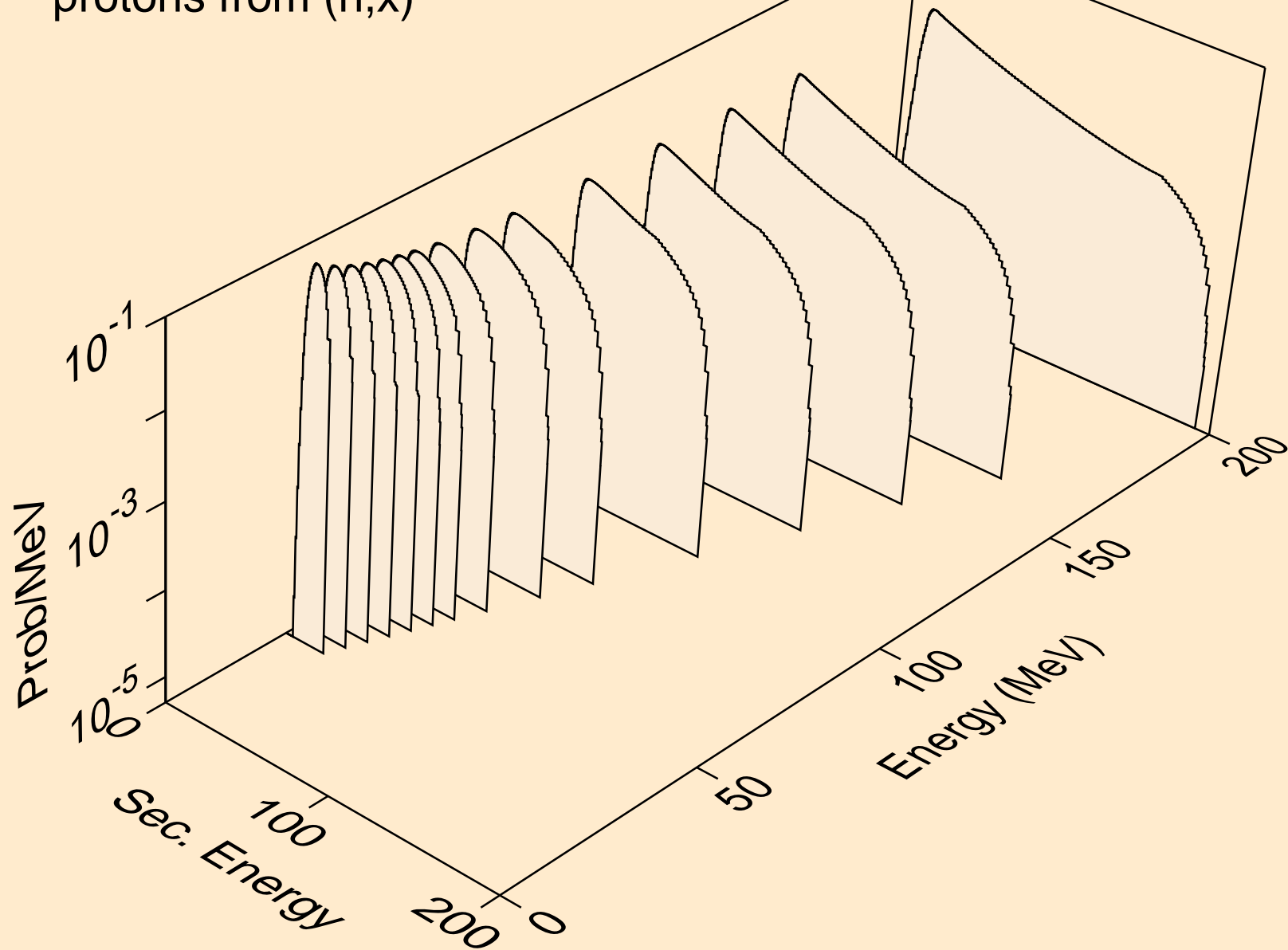

IR203 NEUTRON ACER TENDL-2021 LIBRARY; T=293.6K
protons from (n,n*)p

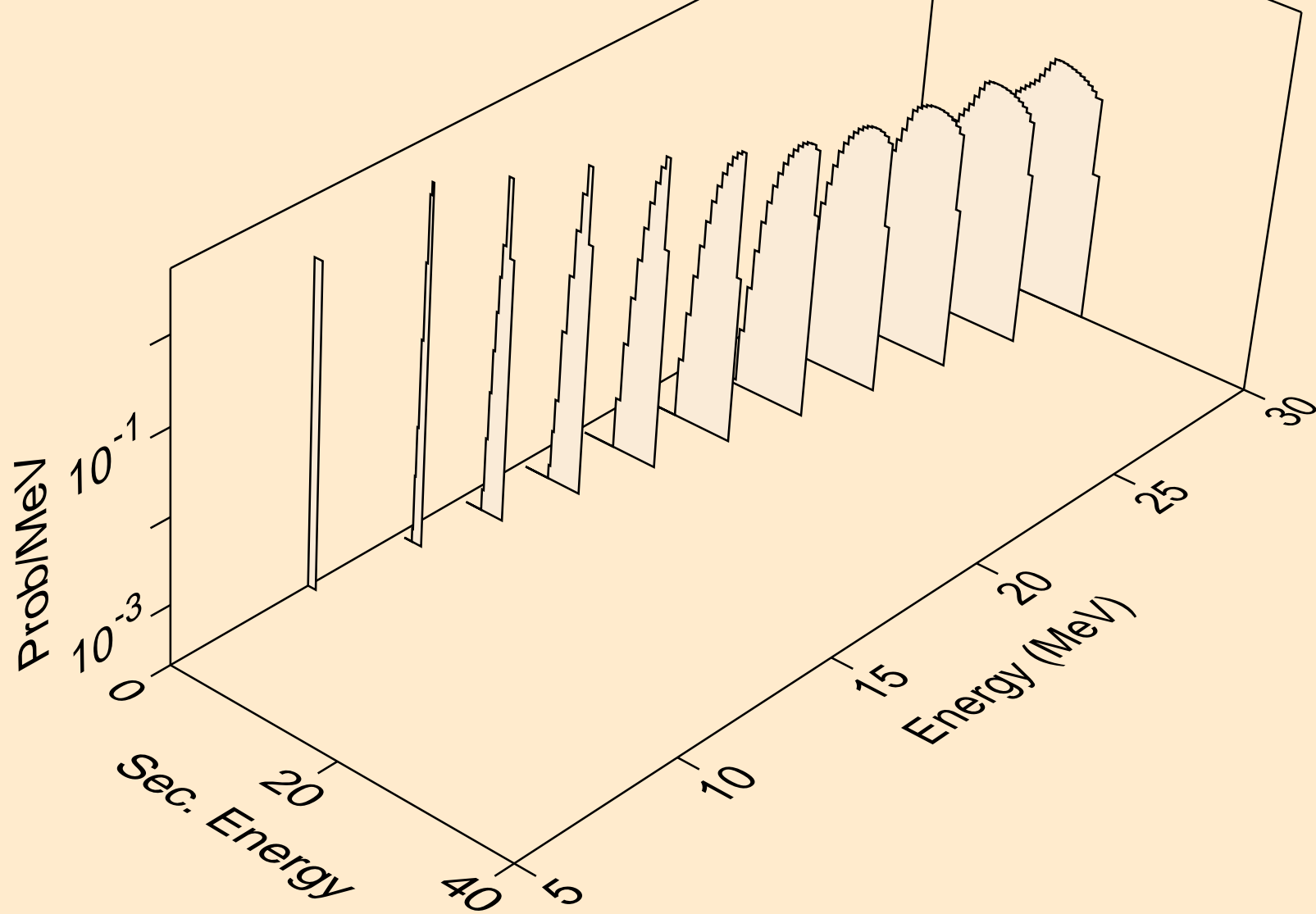

IR203 NEUTRON ACER TENDL-2021 LIBRARY; T=293.6K
protons from (n,2np)

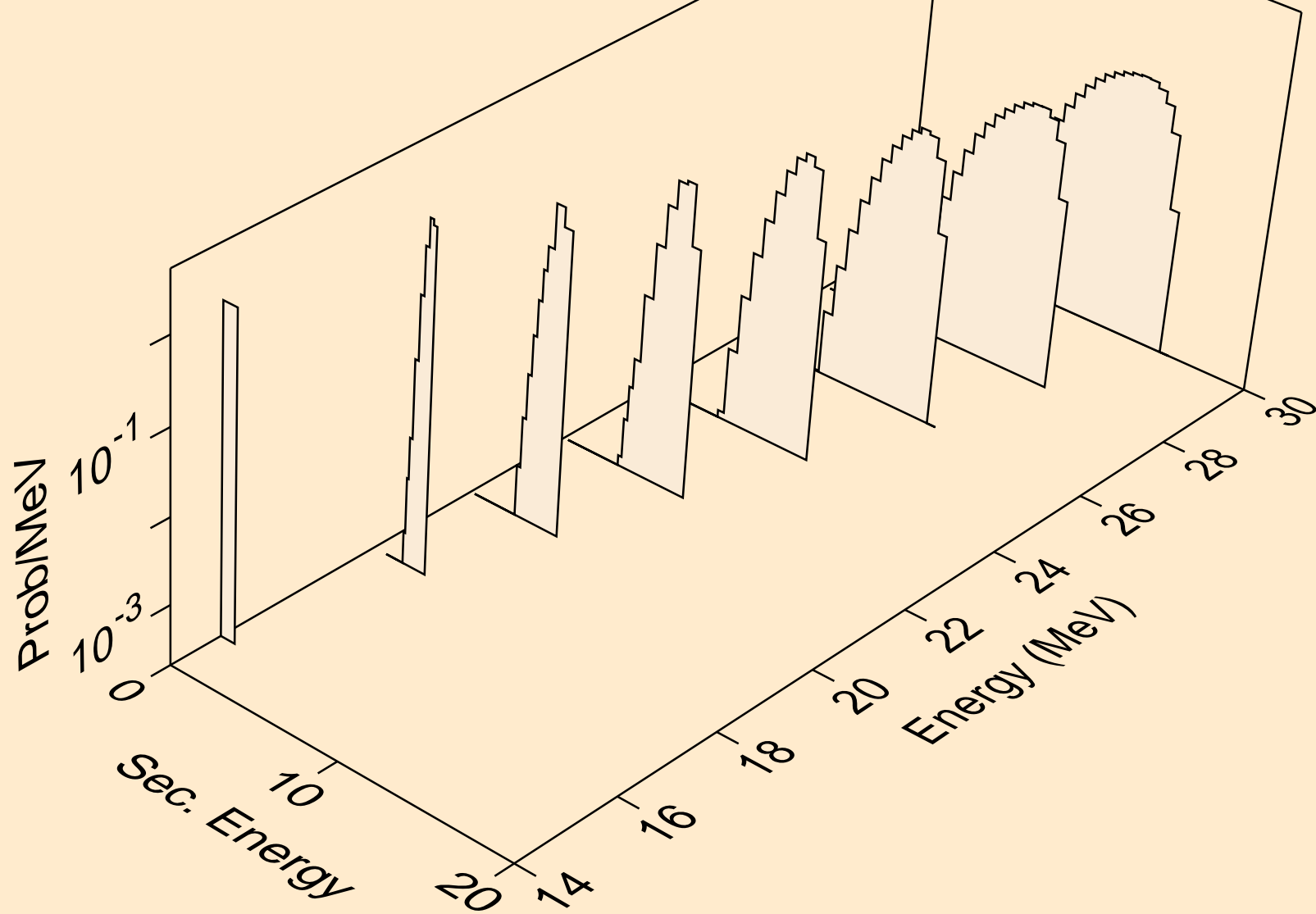

IR203 NEUTRON ACER TENDL-2021 LIBRARY; T=293.6K
protons from (n,3np)

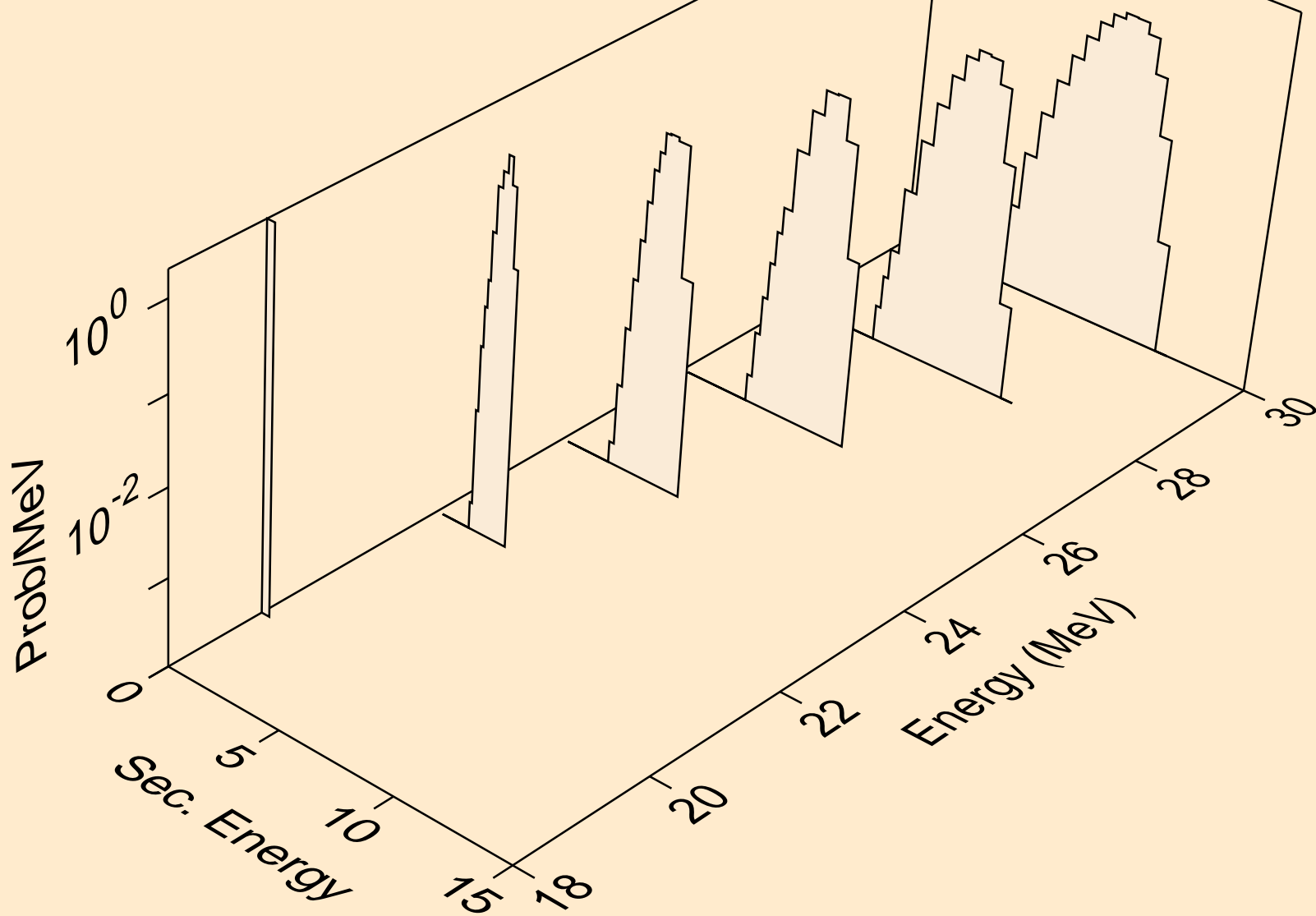

IR203 NEUTRON ACER TENDL-2021 LIBRARY; T=293.6K
protons from (n,p)

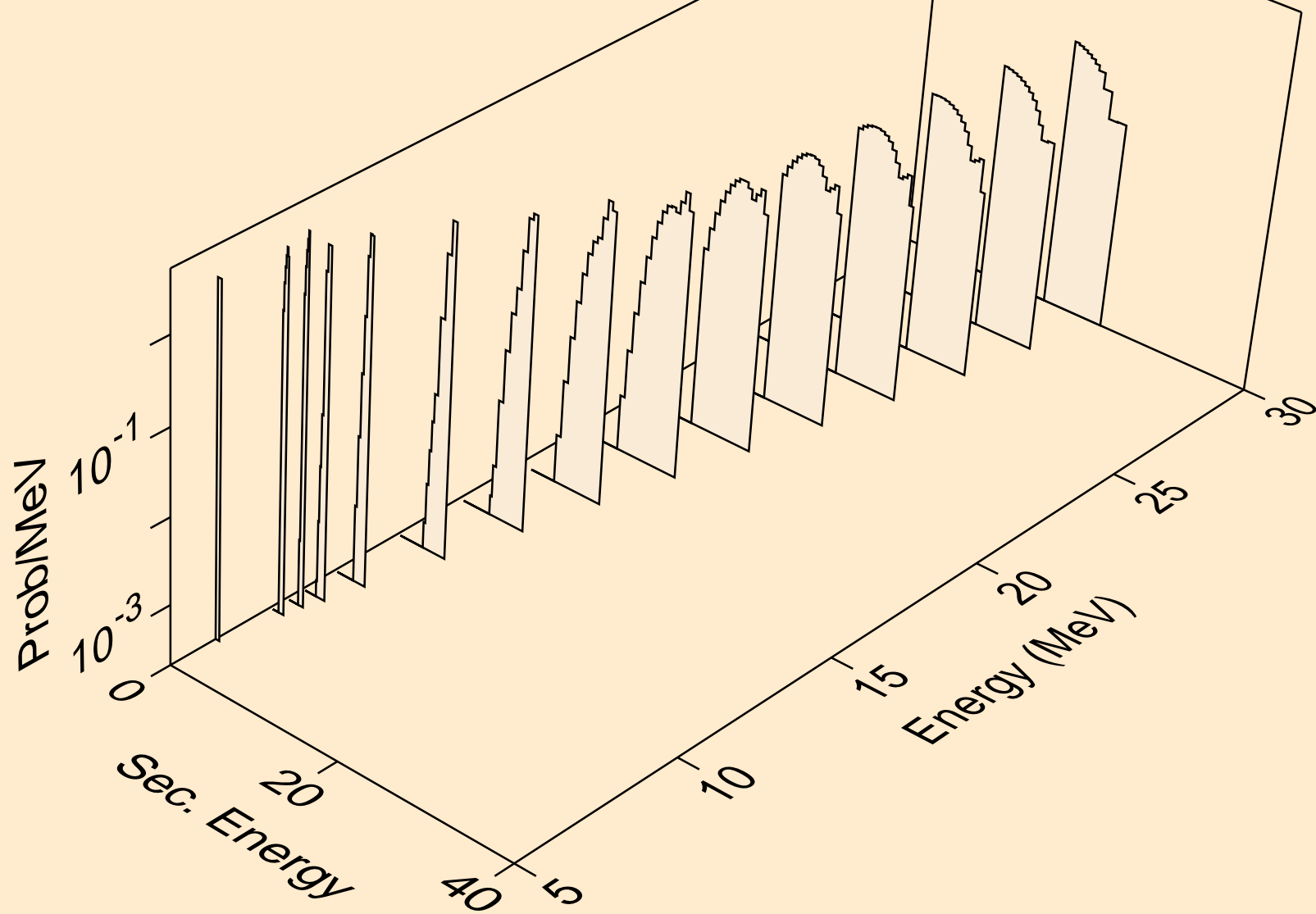

IR203 NEUTRON ACER TENDL-2021 LIBRARY; T=293.6K
deuterons from (n,x)

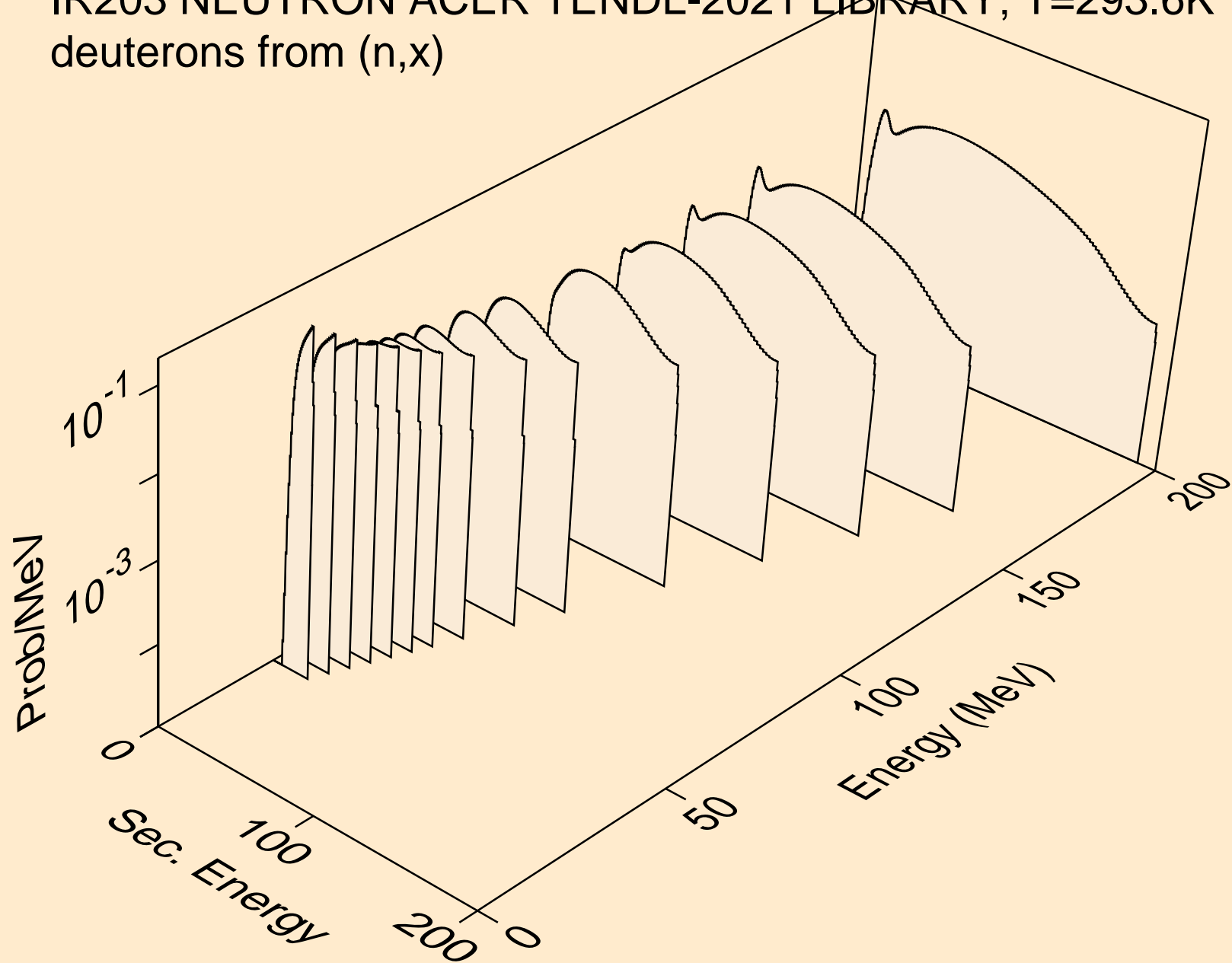

IR203 NEUTRON ACER TENDL-2021 LIBRARY; T=293.6K
deuterons from (n,2nd)

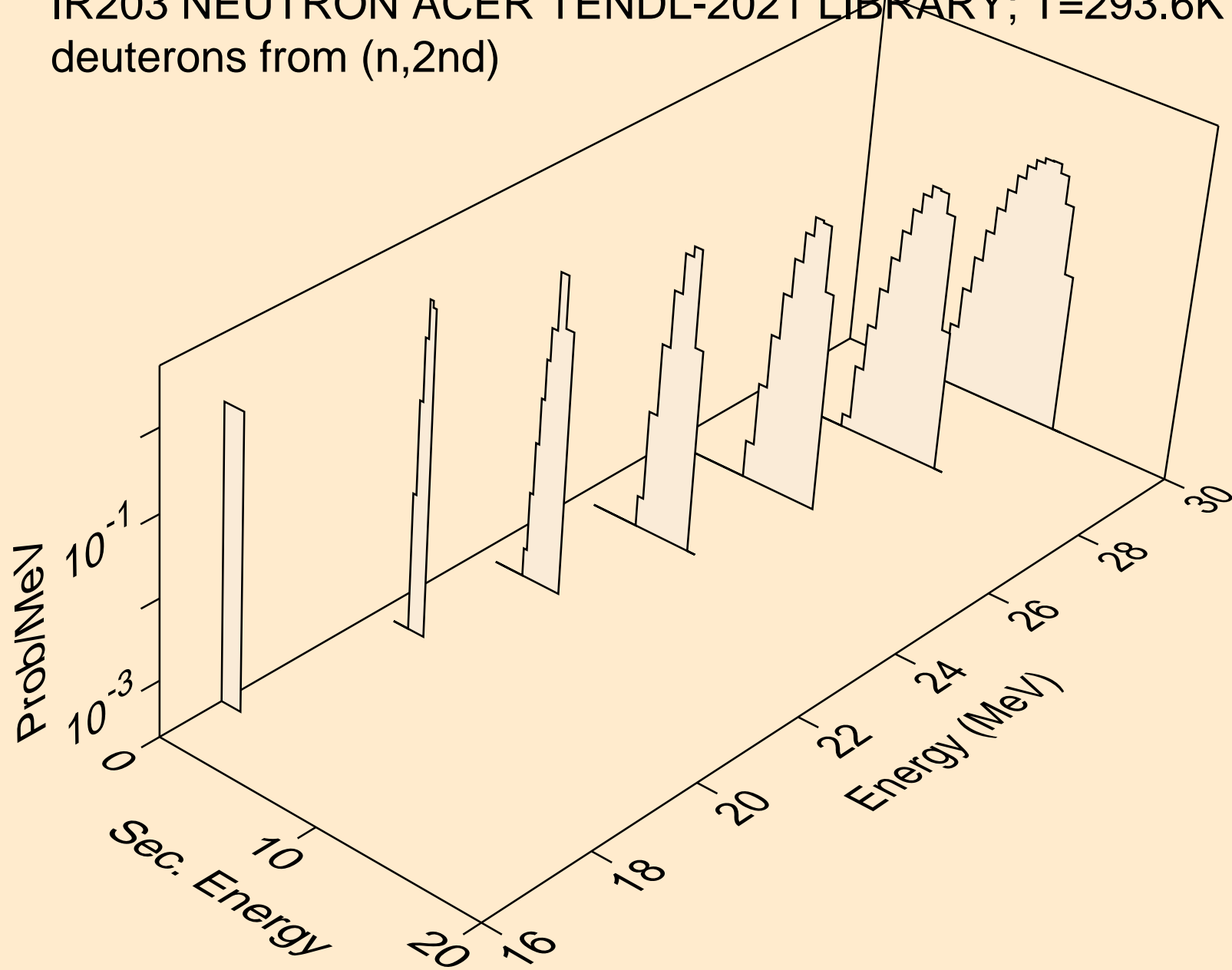

IR203 NEUTRON ACER TENDL-2021 LIBRARY; T=293.6K
deuterons from (n,n*)d

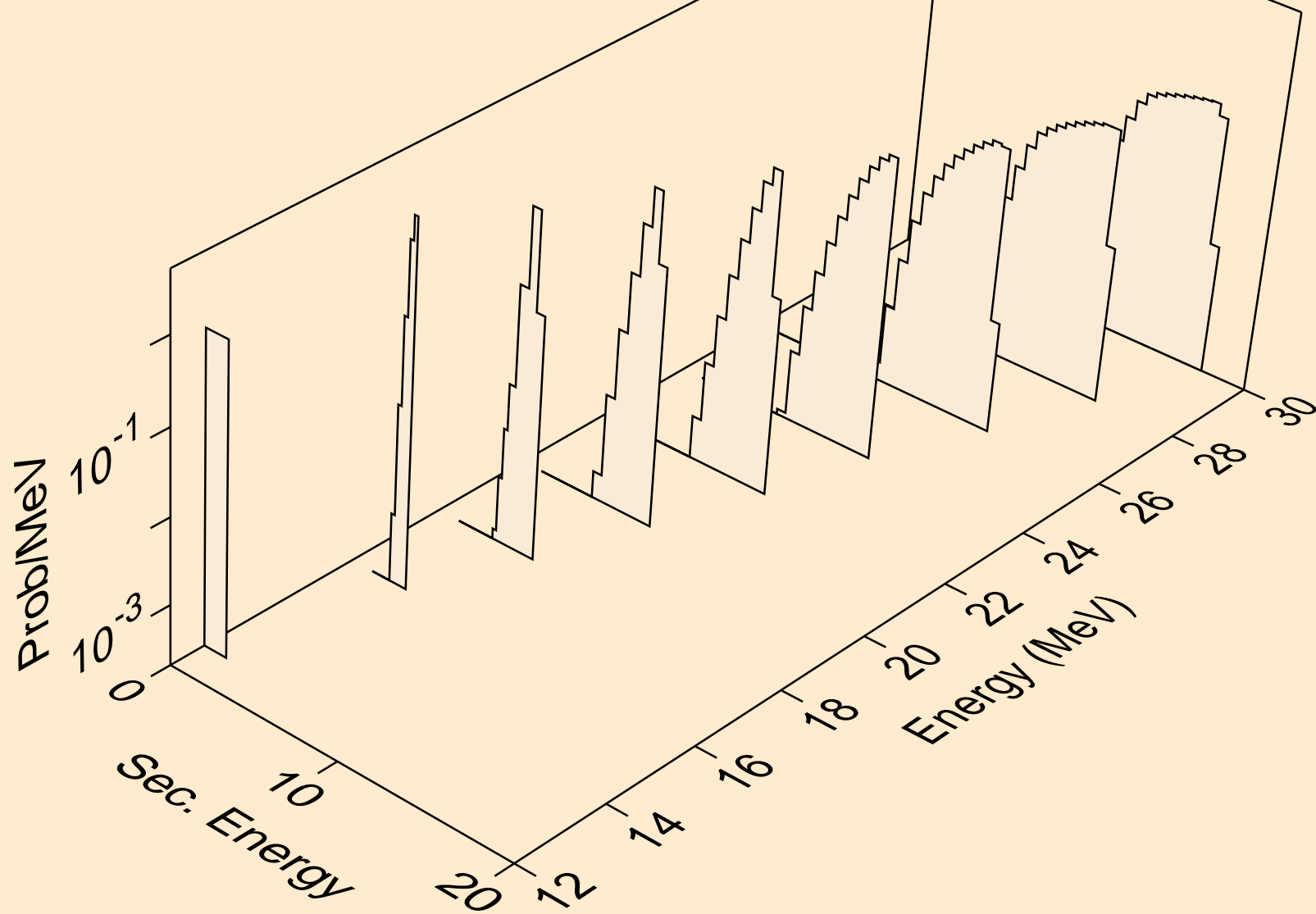

IR203 NEUTRON ACER TENDL-2021 LIBRARY; T=293.6K
deuterons from (n,d)

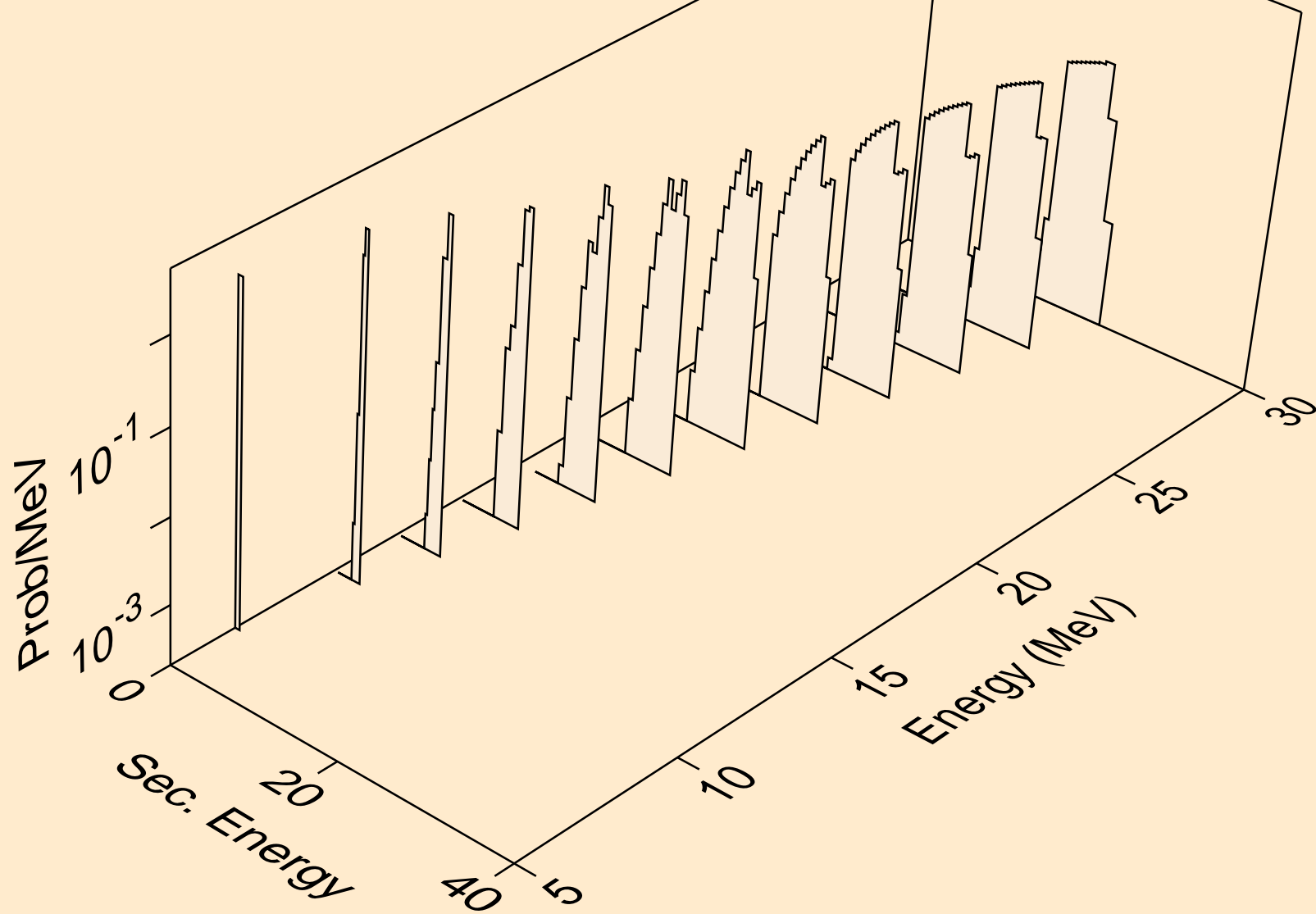

IR203 NEUTRON ACER TENDL-2021 LIBRARY; T=293.6K
tritons from (n,x)

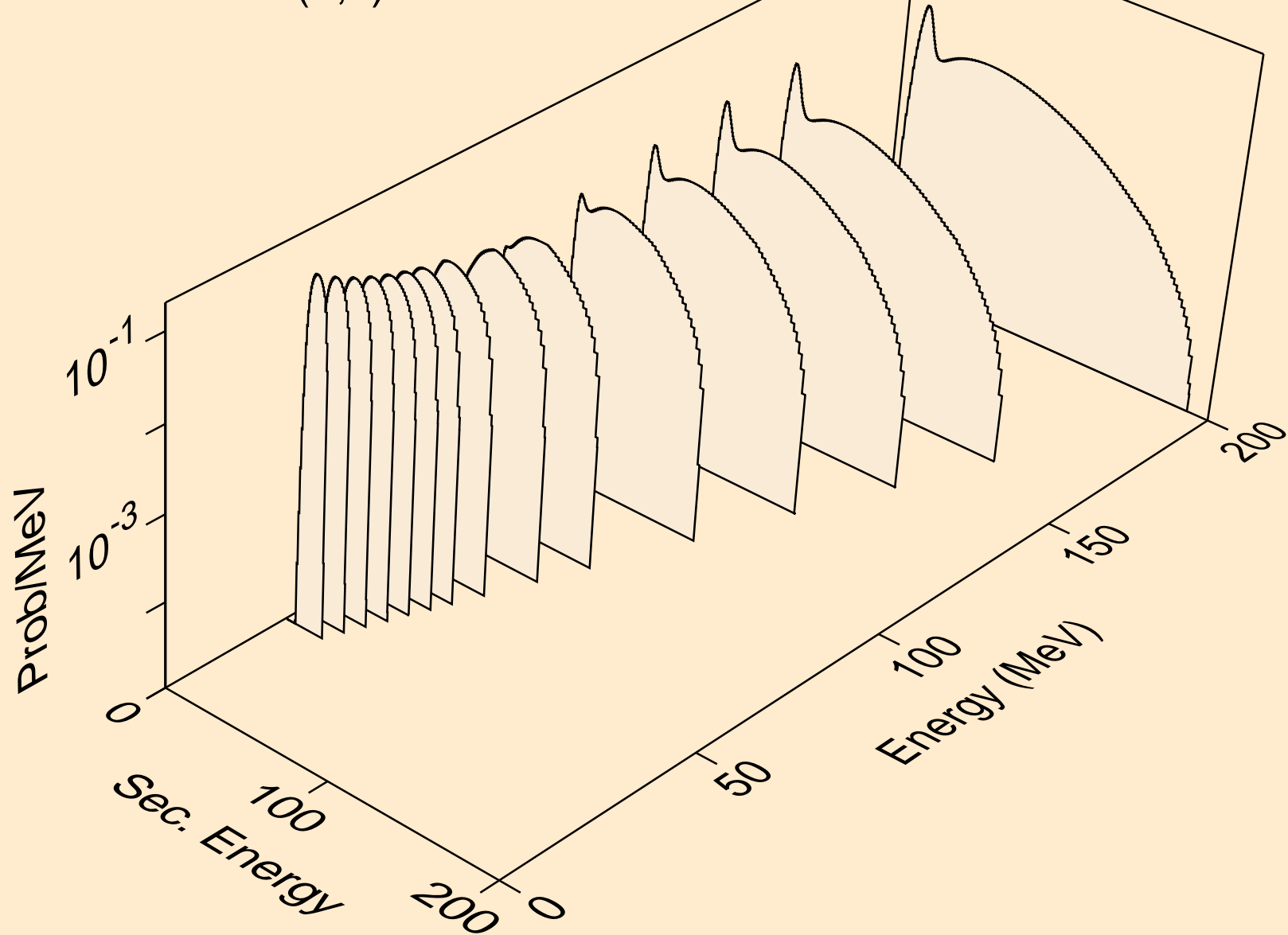

IR203 NEUTRON ACER TENDL-2021 LIBRARY; T=293.6K
tritons from (n,n*)t

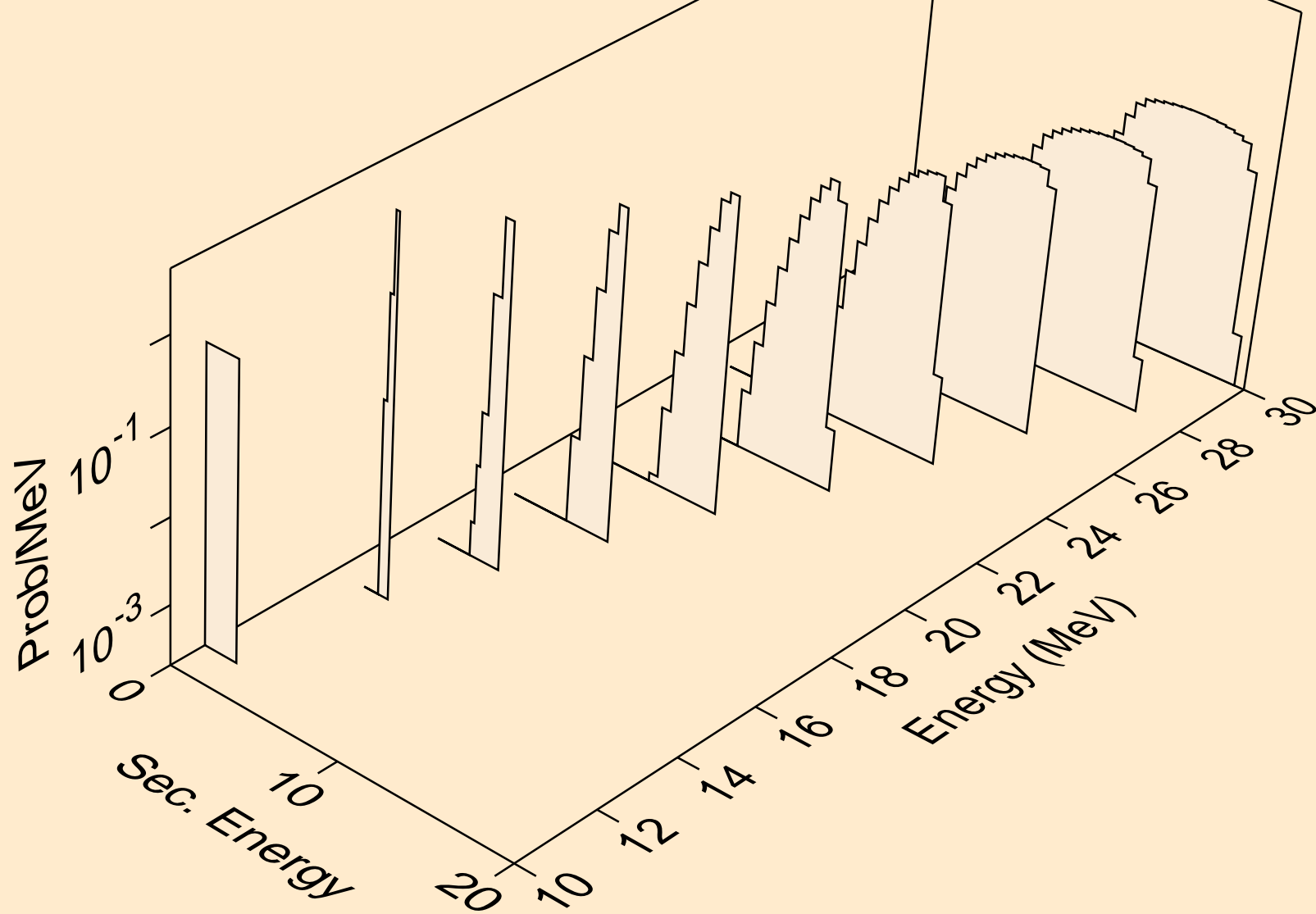

IR203 NEUTRON ACER TENDL-2021 LIBRARY; T=293.6K
tritons from (n,t)

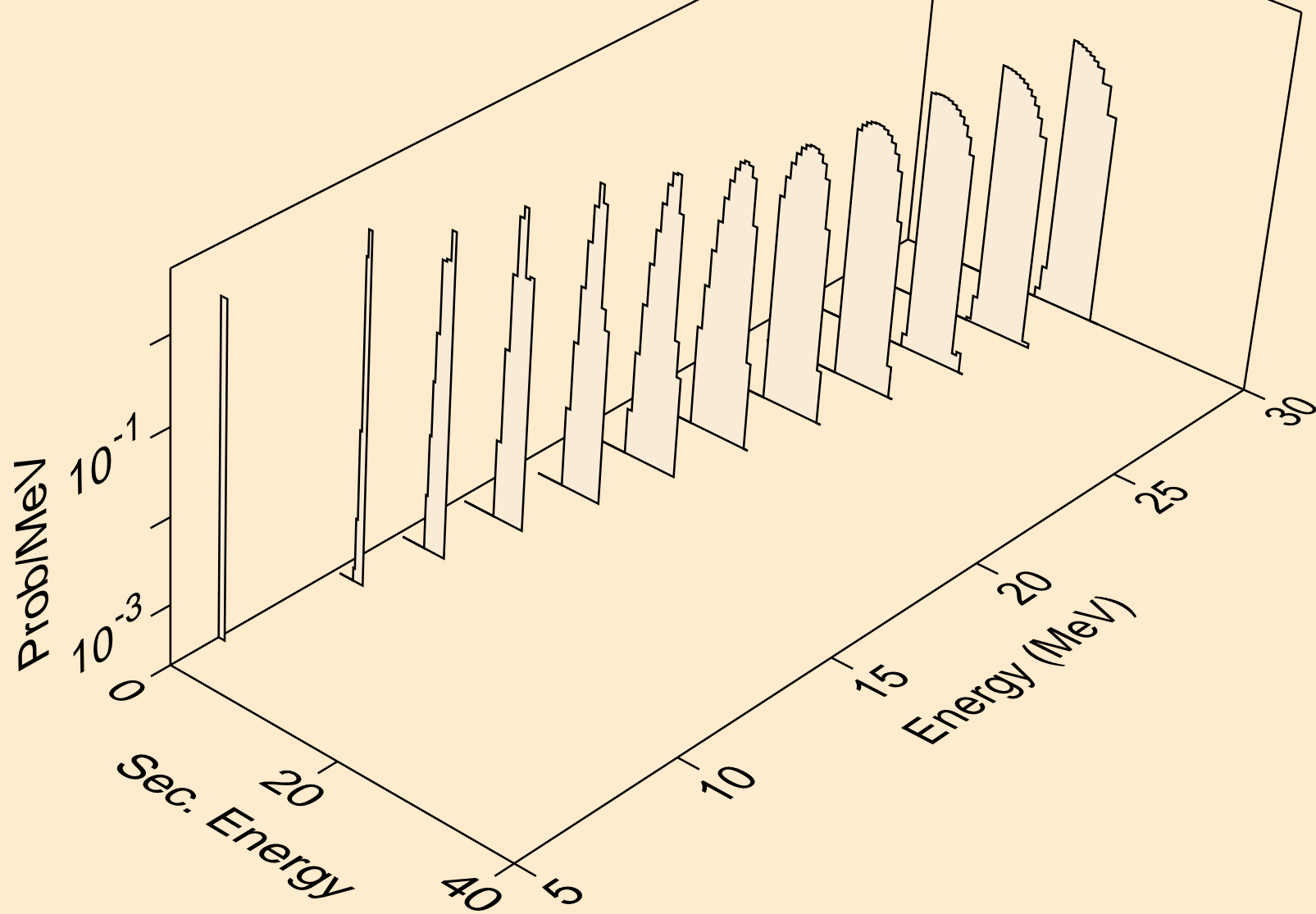

IR203 NEUTRON ACER TENDL-2021 LIBRARY; T=293.6K
he3s from (n,x)

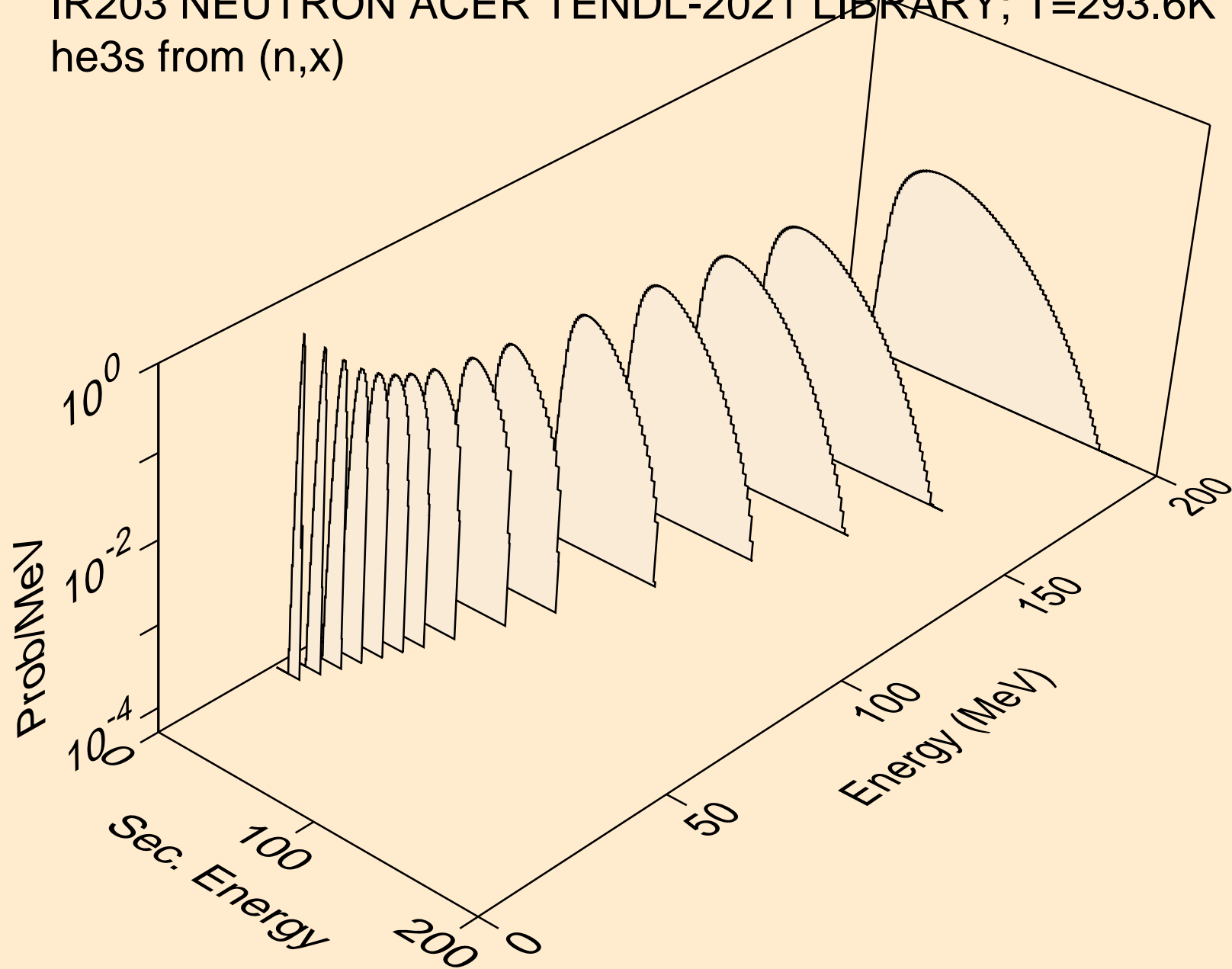

IR203 NEUTRON ACER TENDL-2021 LIBRARY; T=293.6K
he3s from (n,he3)

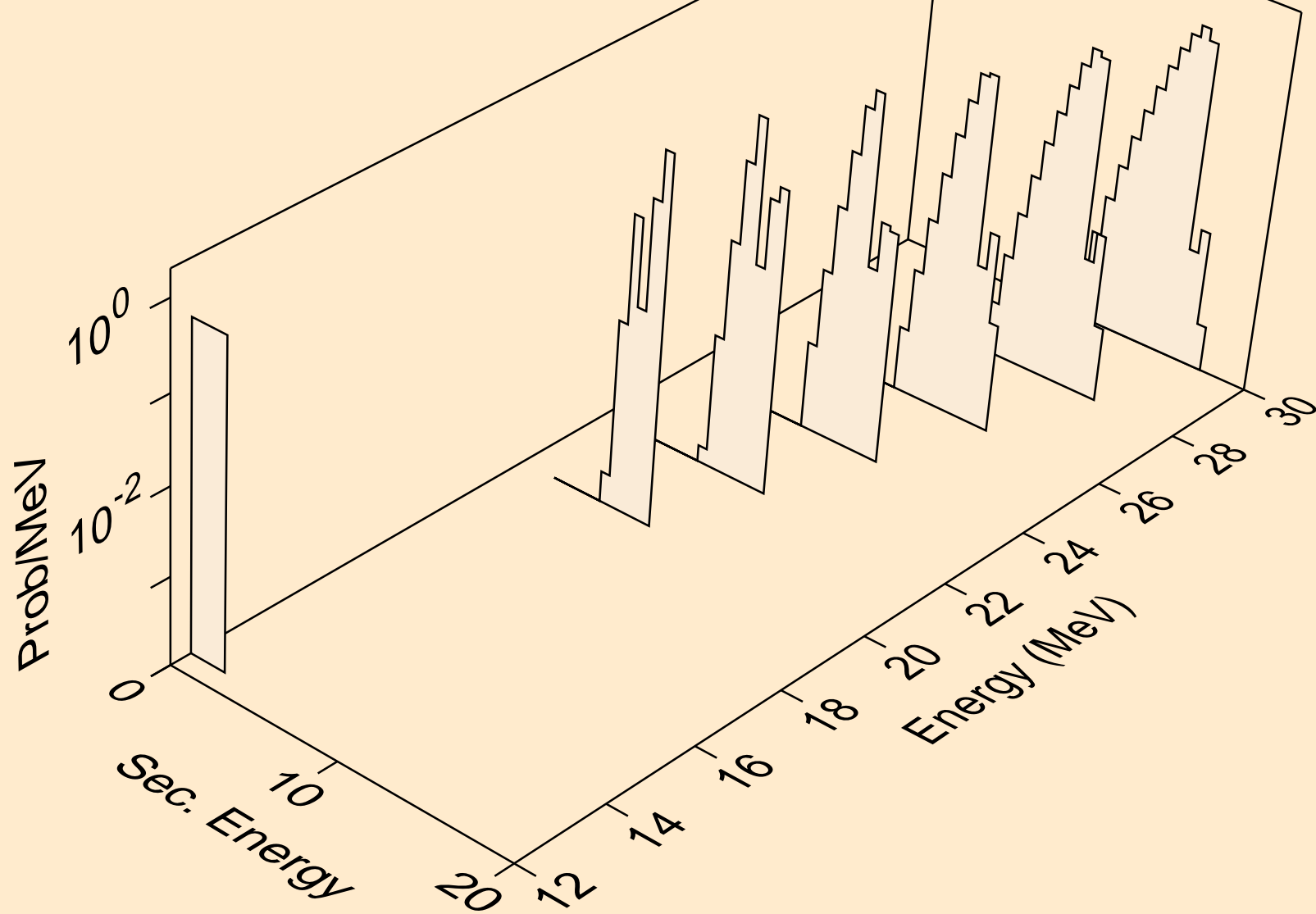

IR203 NEUTRON ACER TENDL-2021 LIBRARY; T=293.6K
alphas from (n,x)

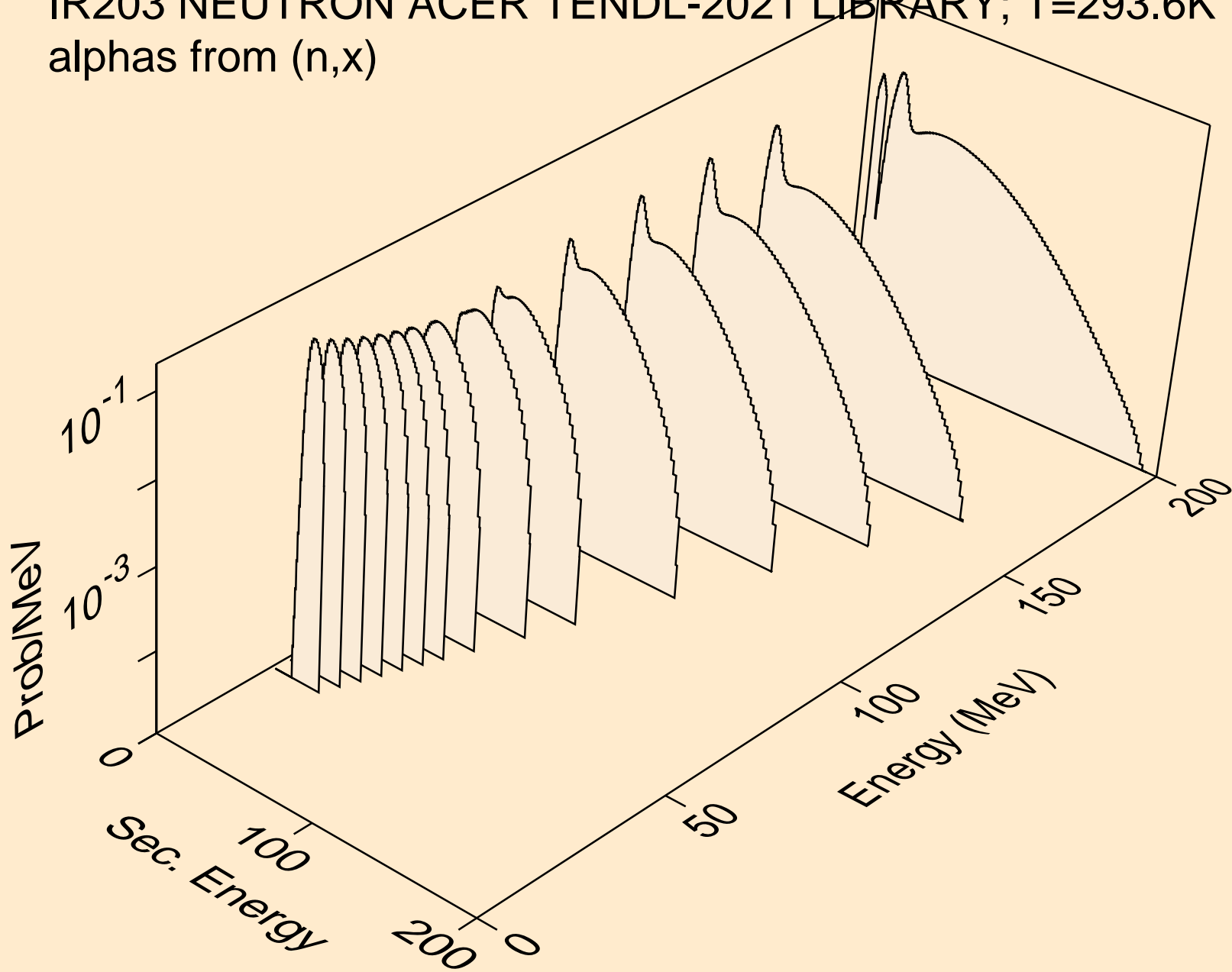

IR203 NEUTRON ACER TENDL-2021 LIBRARY; T=293.6K
alphas from (n,n*)a

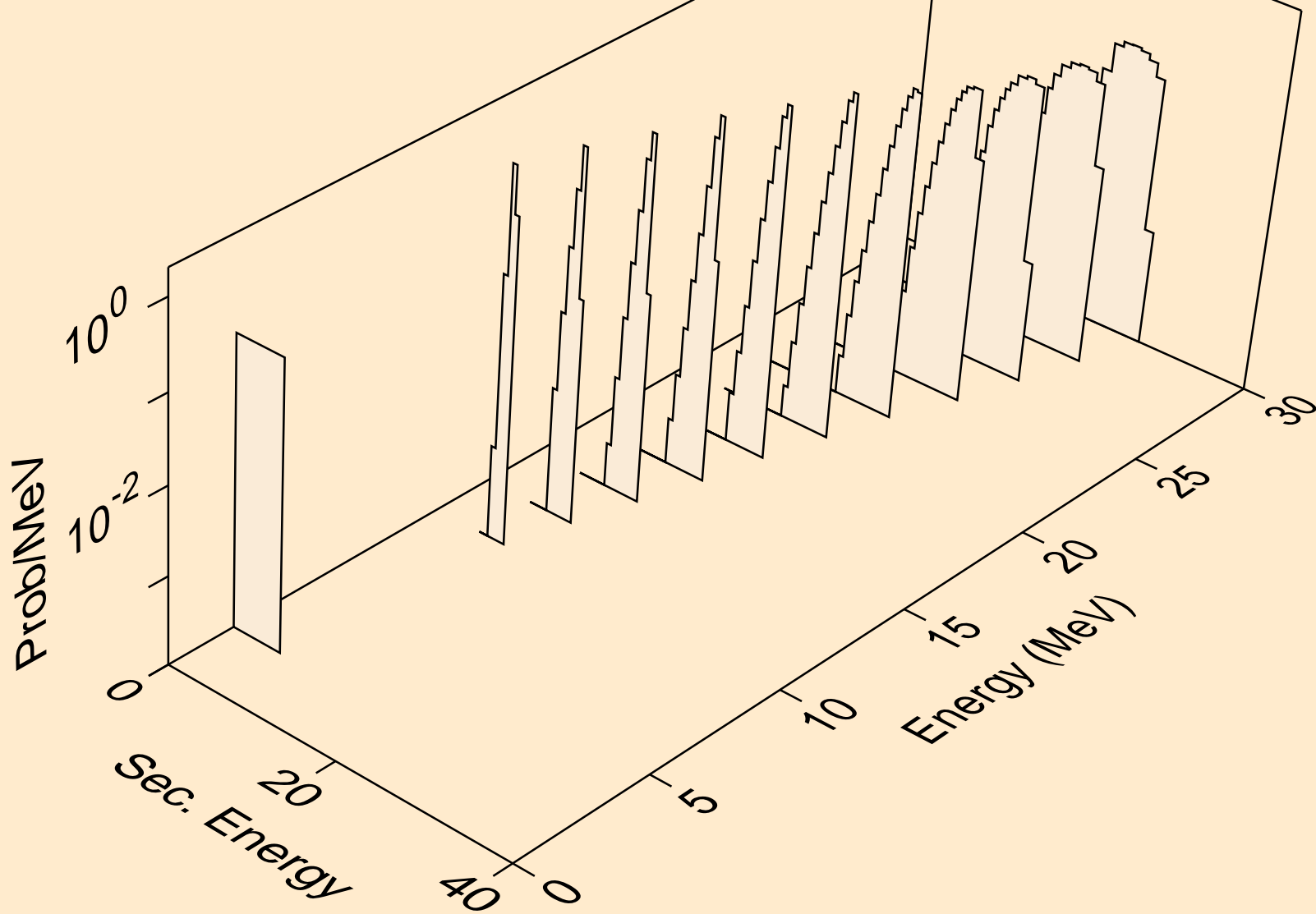

IR203 NEUTRON ACER TENDL-2021 LIBRARY; T=293.6K
alphas from (n,2n)a

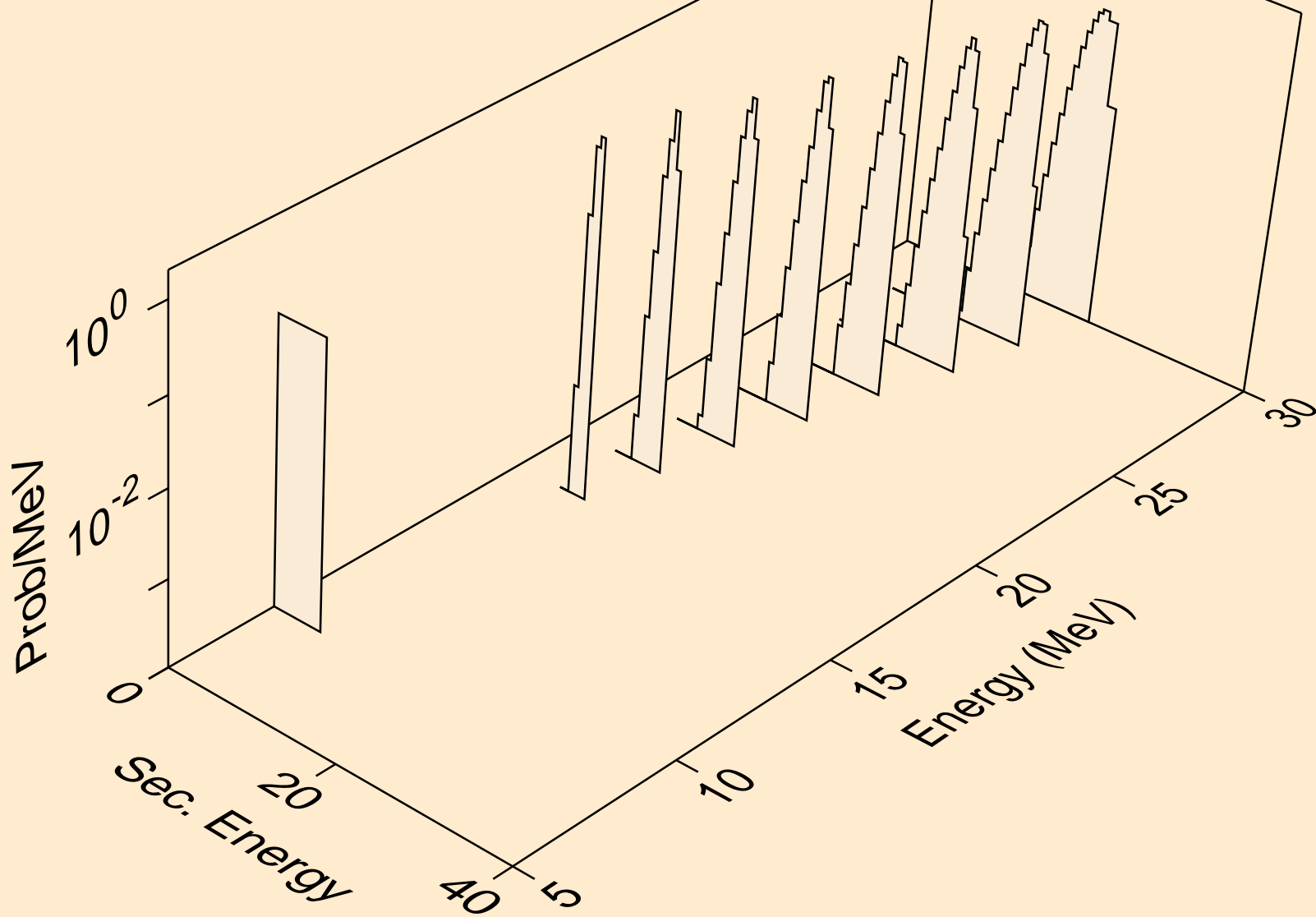

IR203 NEUTRON ACER TENDL-2021 LIBRARY; T=293.6K
alphas from (n,3n)a

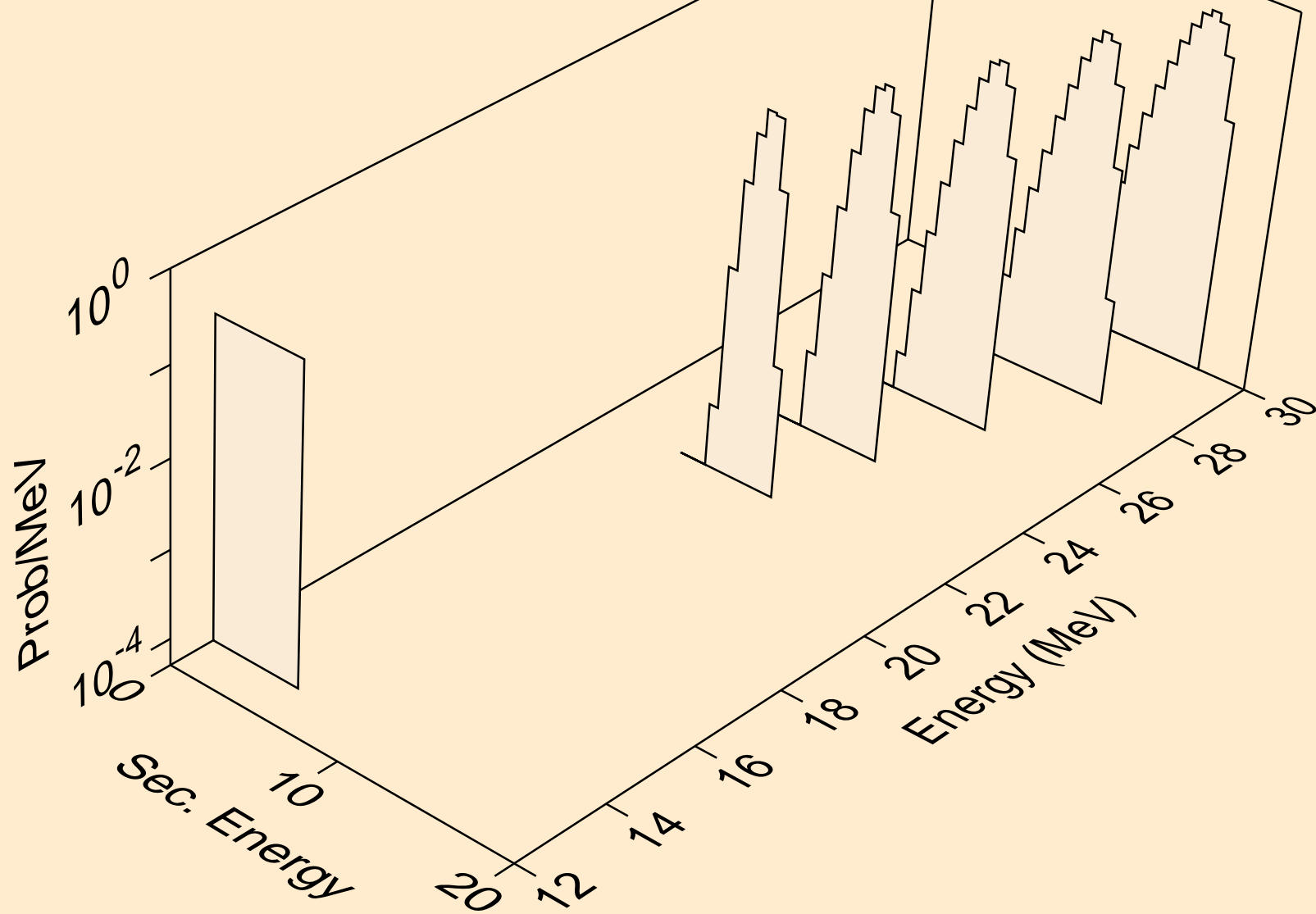

IR203 NEUTRON ACER TENDL-2021 LIBRARY; T=293.6K
alphas from (n,a)

