

K047 NEUTRON ACER TENDL-2021 LIBRARY; T=293.6K

Principal cross sections

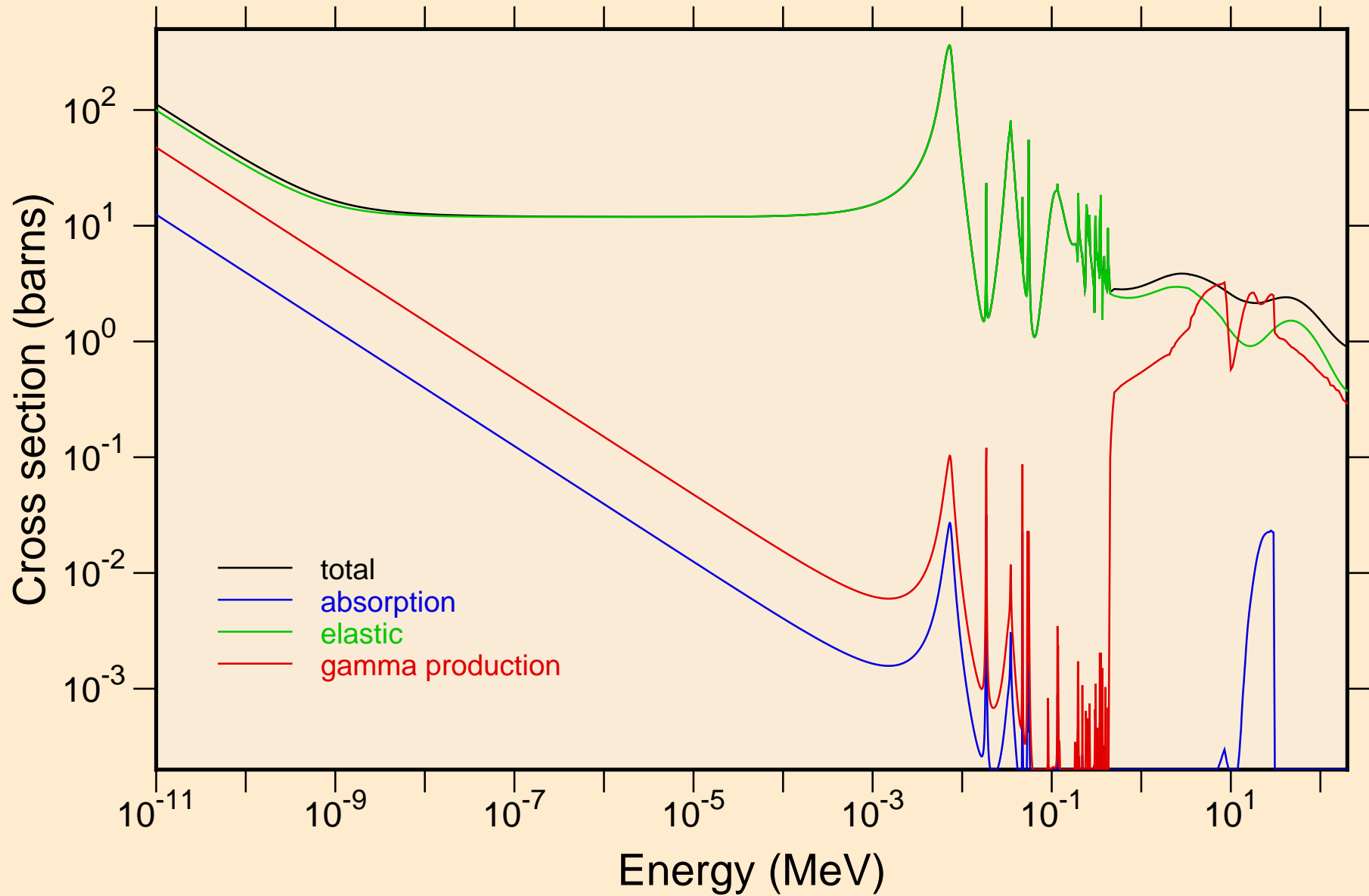

K047 NEUTRON ACER TENDL-2021 LIBRARY; T=293.6K
resonance total cross section

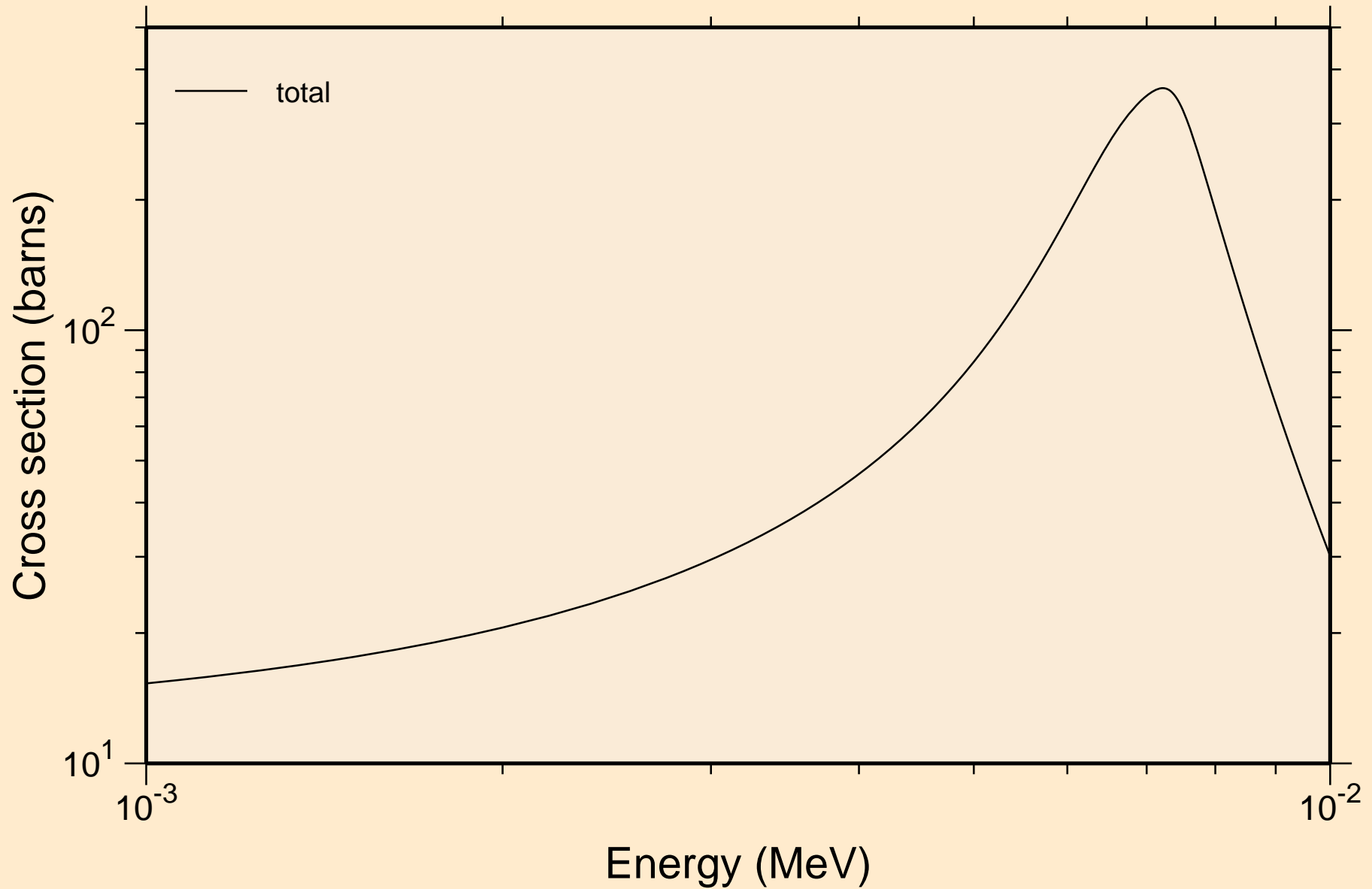

K047 NEUTRON ACER TENDL-2021 LIBRARY; T=293.6K
resonance total cross section

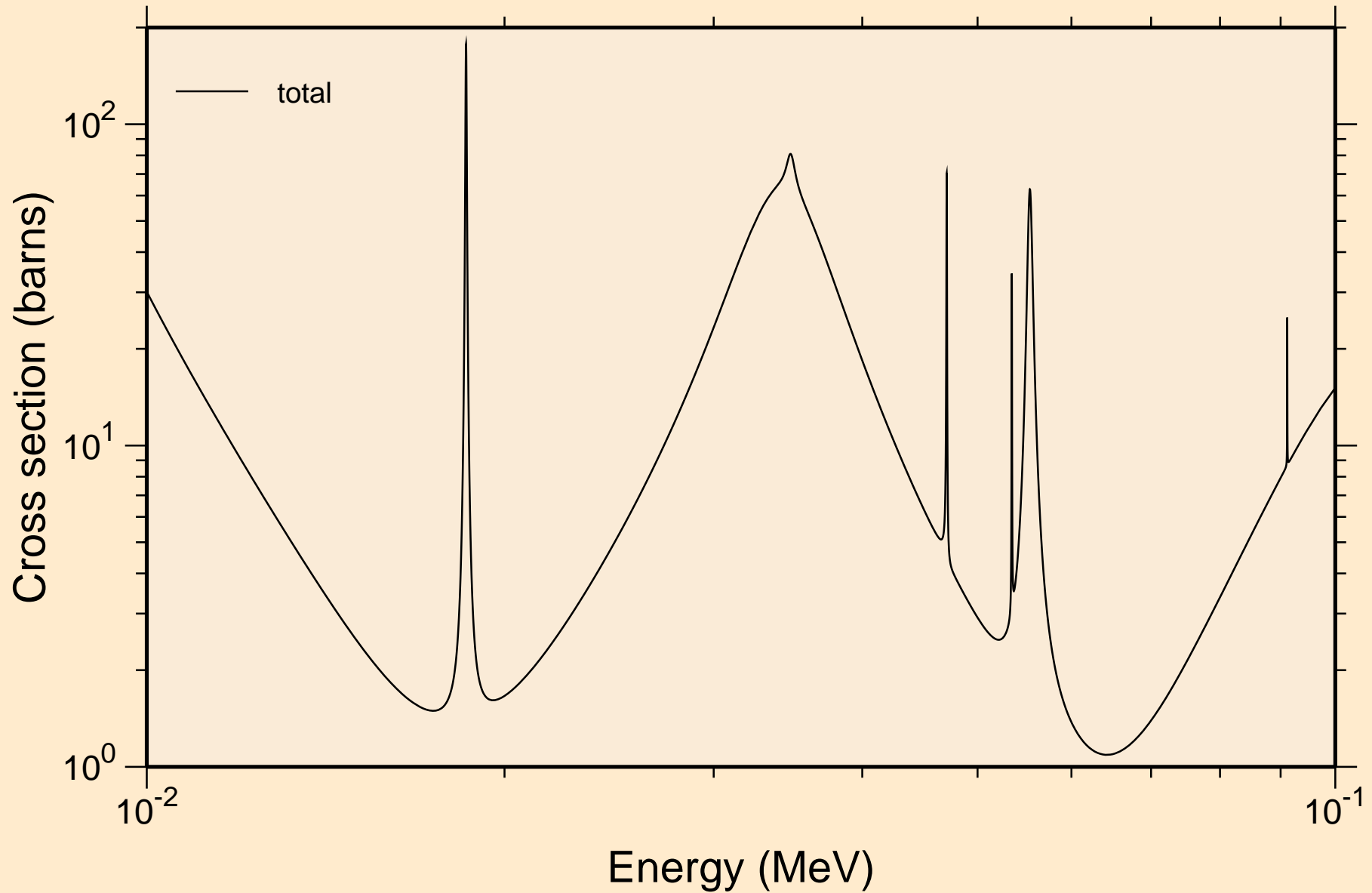

K047 NEUTRON ACER TENDL-2021 LIBRARY; T=293.6K
resonance total cross section

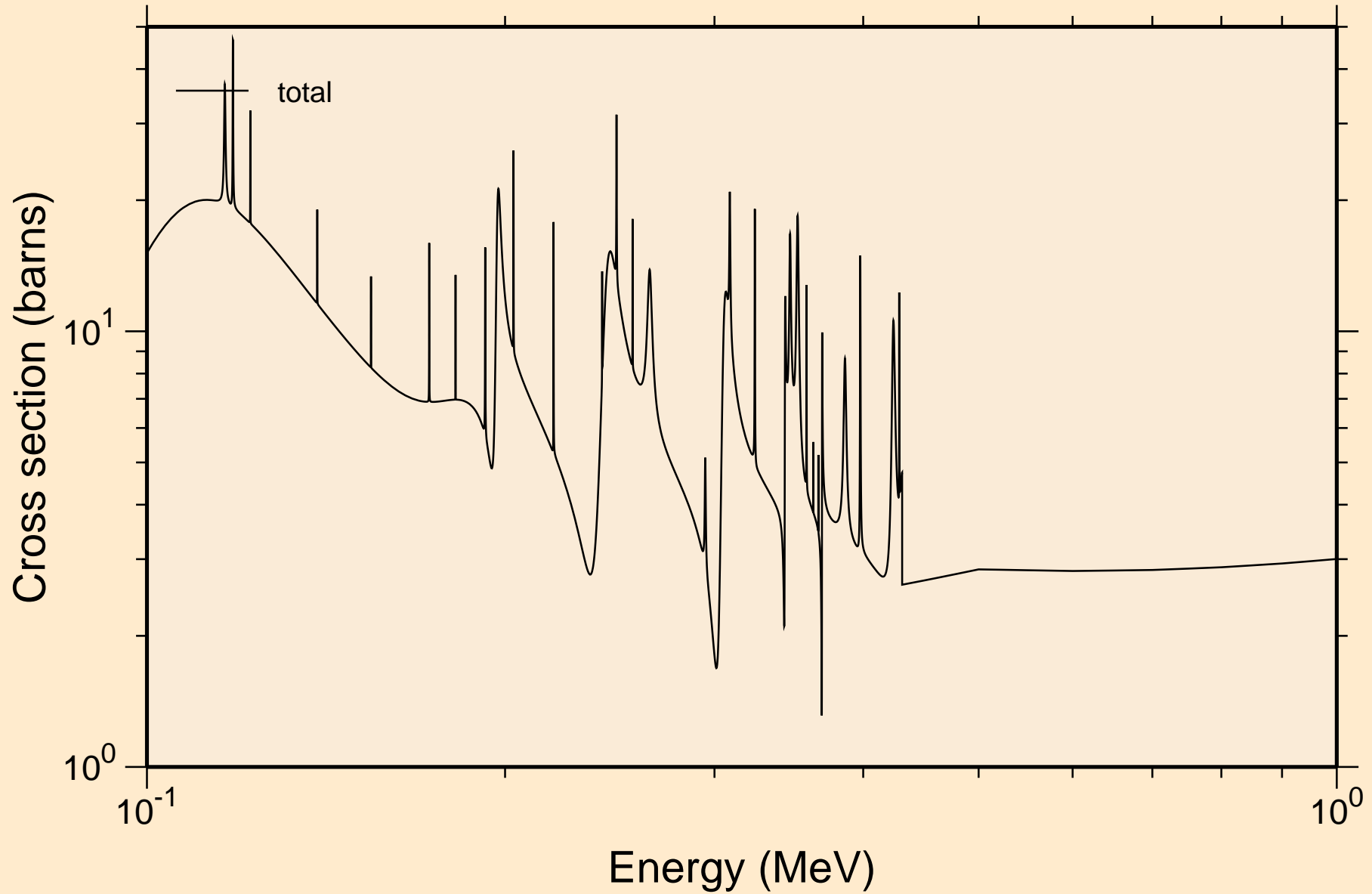

K047 NEUTRON ACER TENDL-2021 LIBRARY; T=293.6K
resonance total cross section

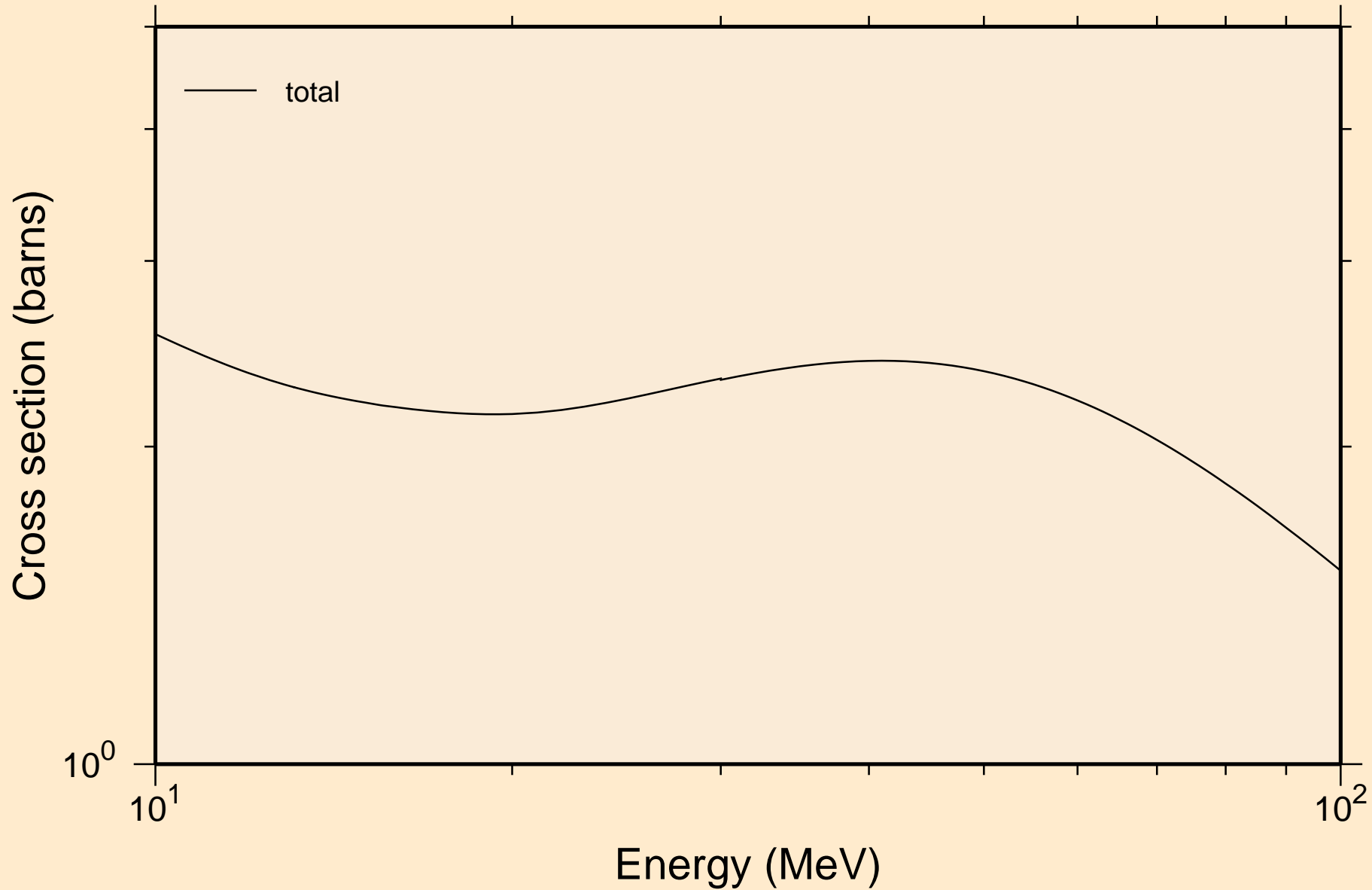

K047 NEUTRON ACER TENDL-2021 LIBRARY; T=293.6K
resonance absorption cross sections

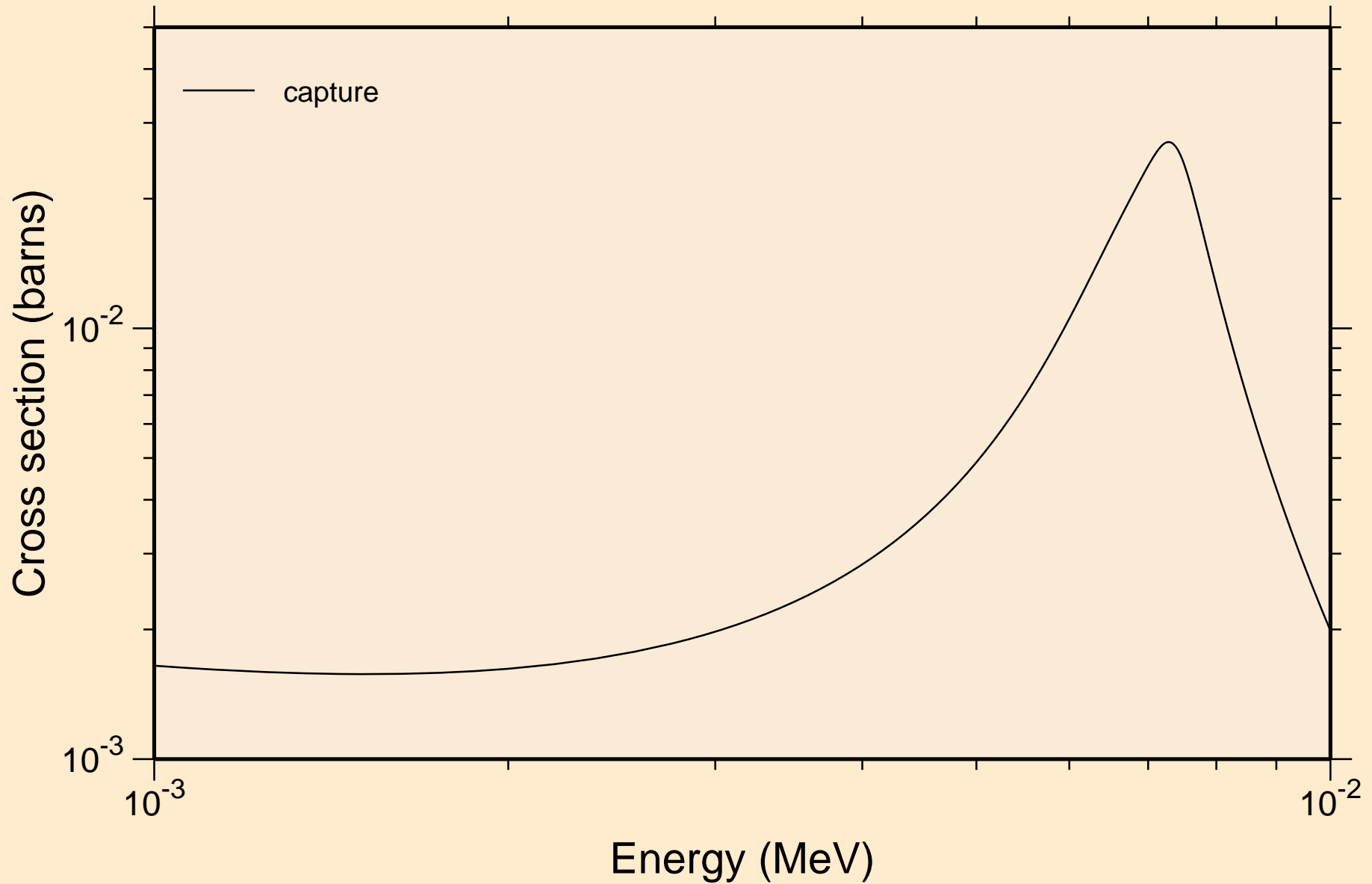

K047 NEUTRON ACER TENDL-2021 LIBRARY; T=293.6K
resonance absorption cross sections

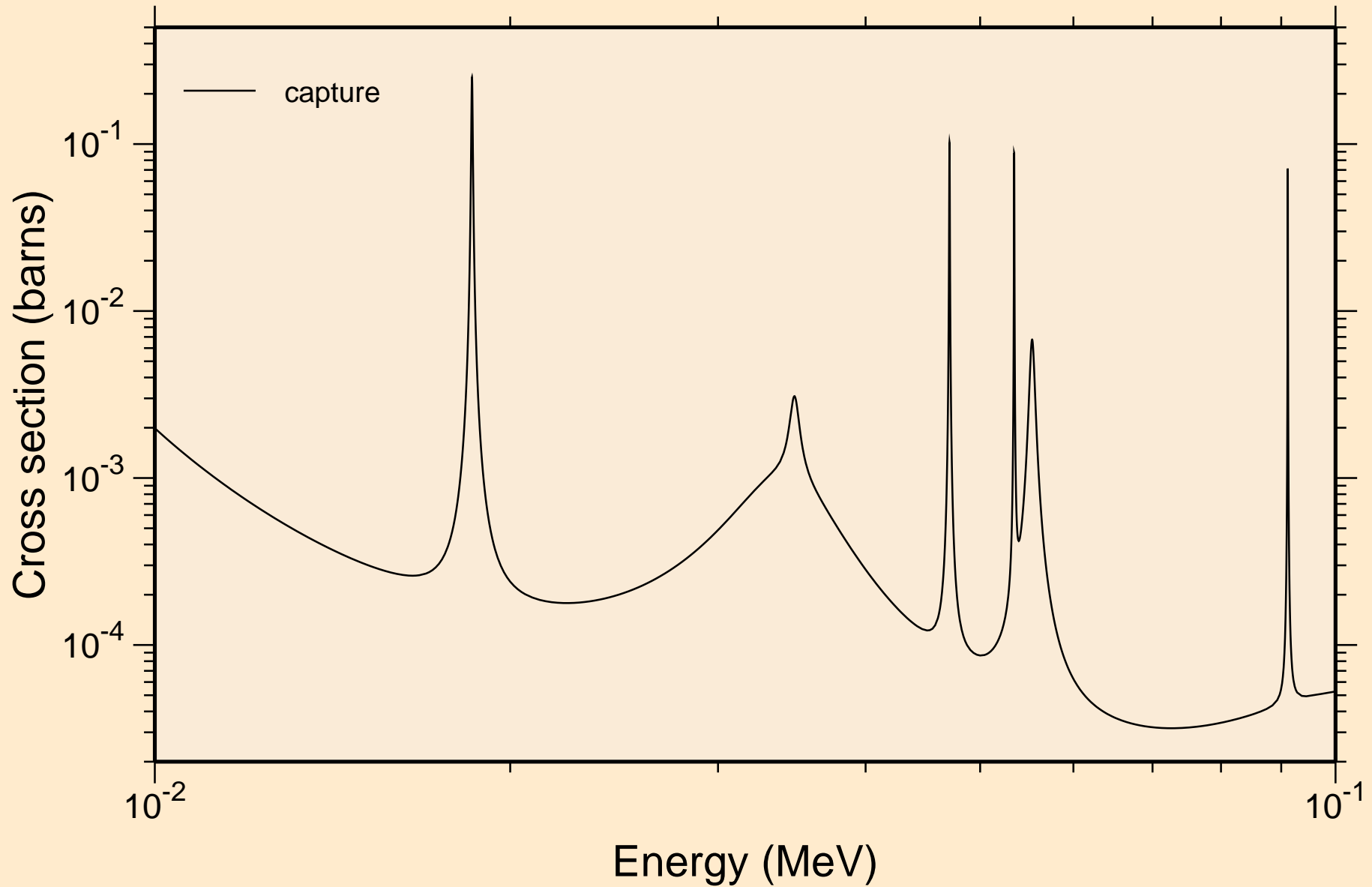

K047 NEUTRON ACER TENDL-2021 LIBRARY; T=293.6K
resonance absorption cross sections

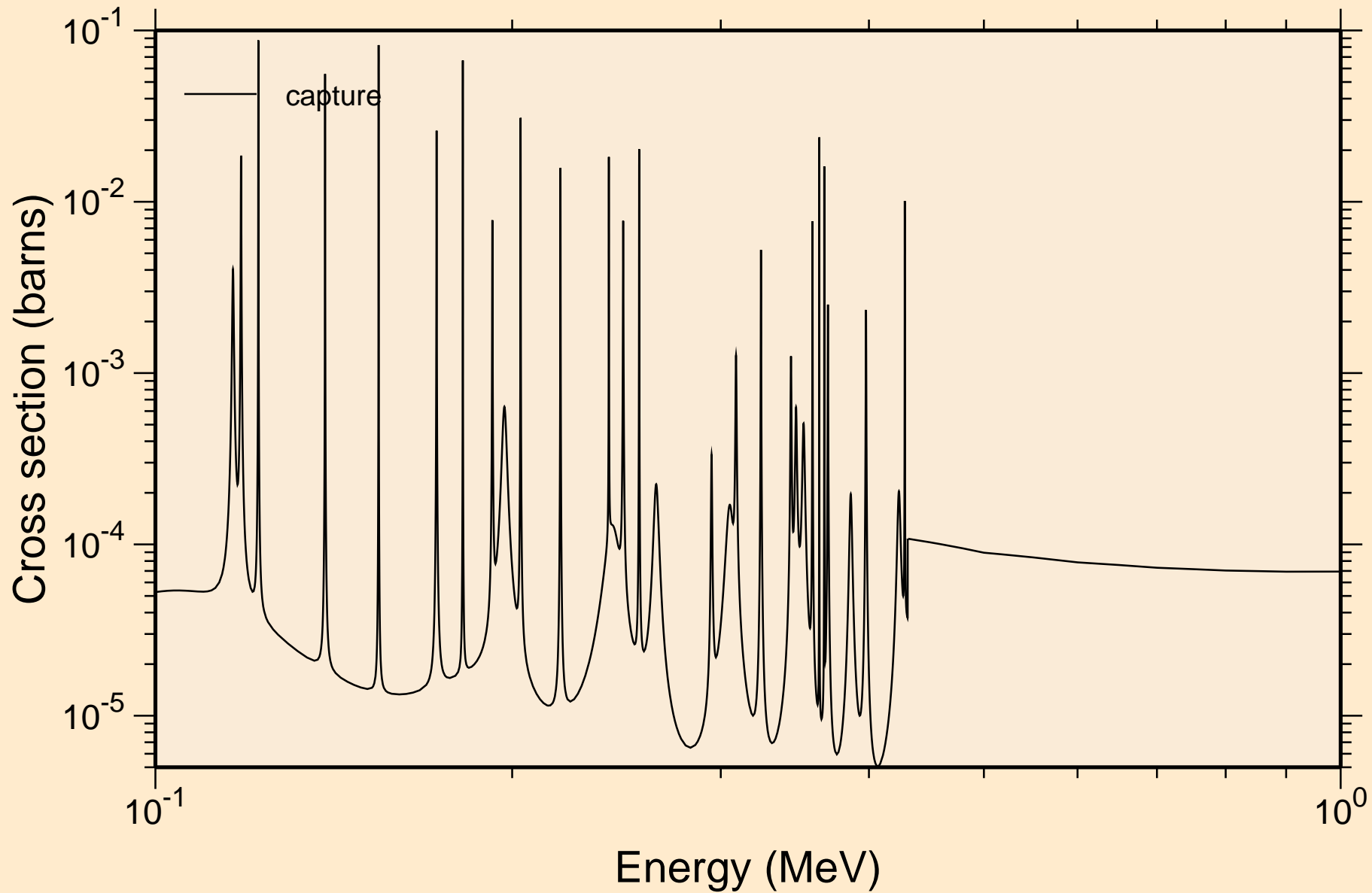

K047 NEUTRON ACER TENDL-2021 LIBRARY; T=293.6K
resonance absorption cross sections

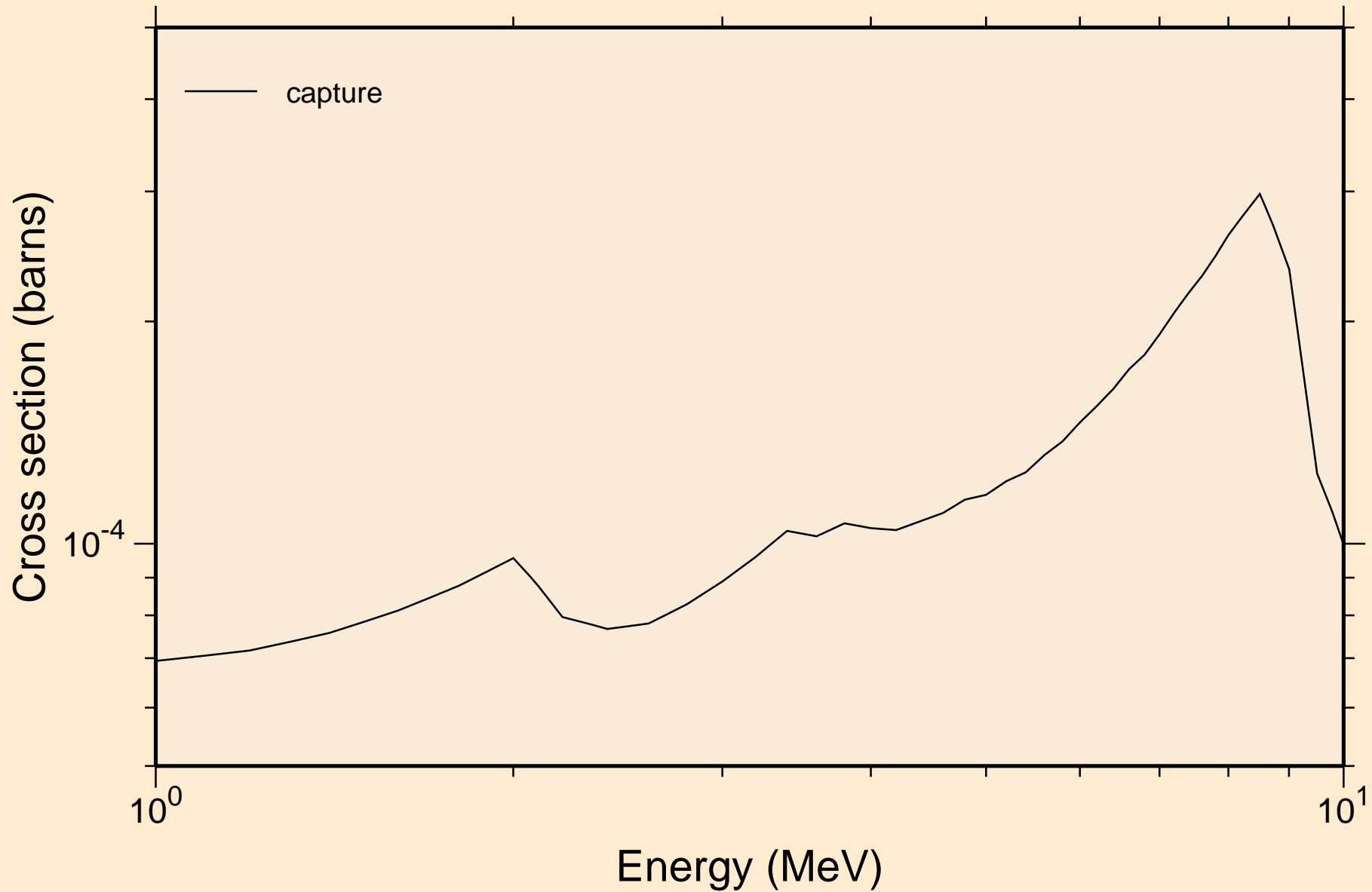

K047 NEUTRON ACER TENDL-2021 LIBRARY; T=293.6K
Heating

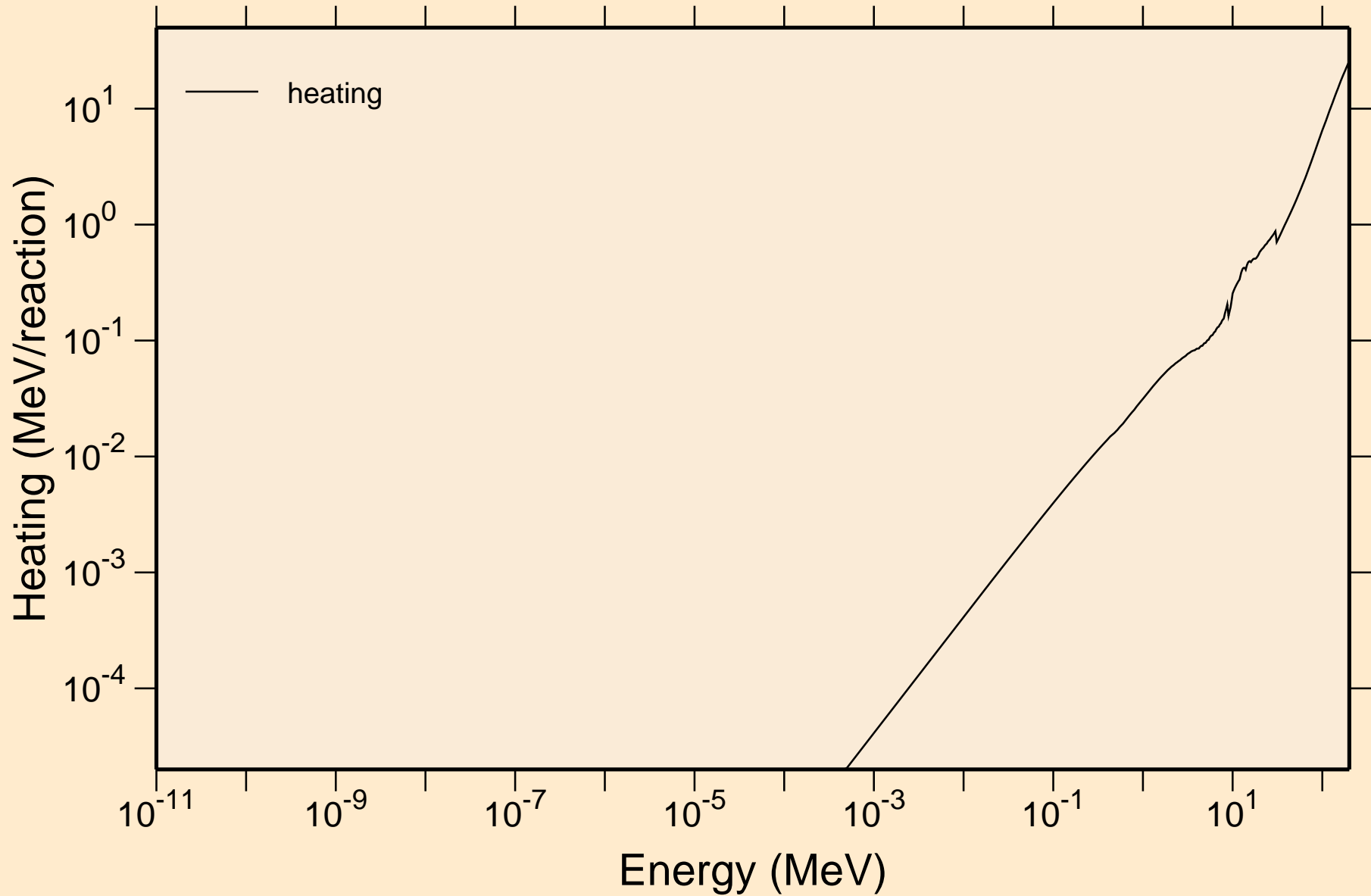

K047 NEUTRON ACER TENDL-2021 LIBRARY; T=293.6K
Damage

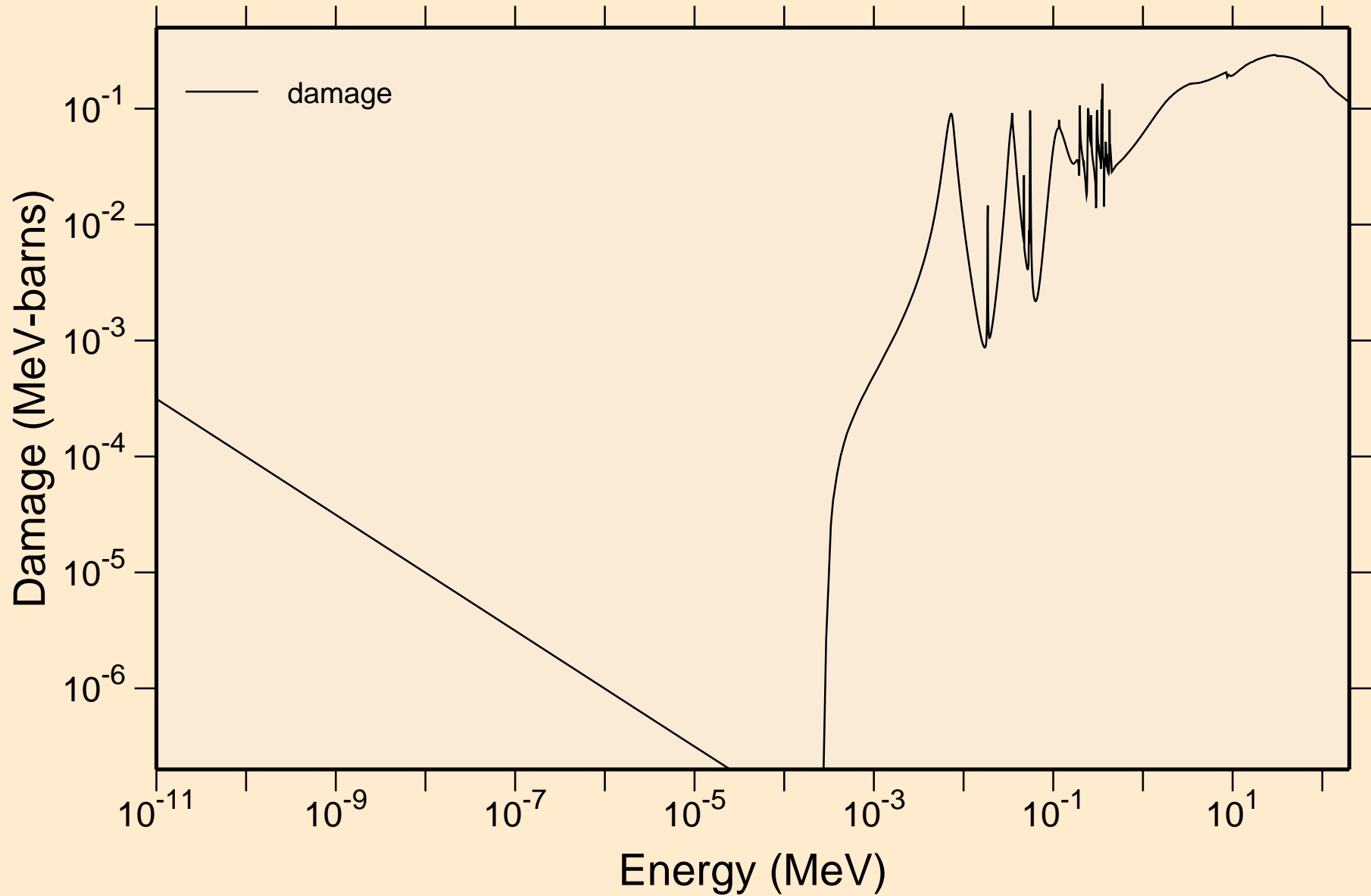

K047 NEUTRON ACER TENDL-2021 LIBRARY; T=293.6K
Non-threshold reactions

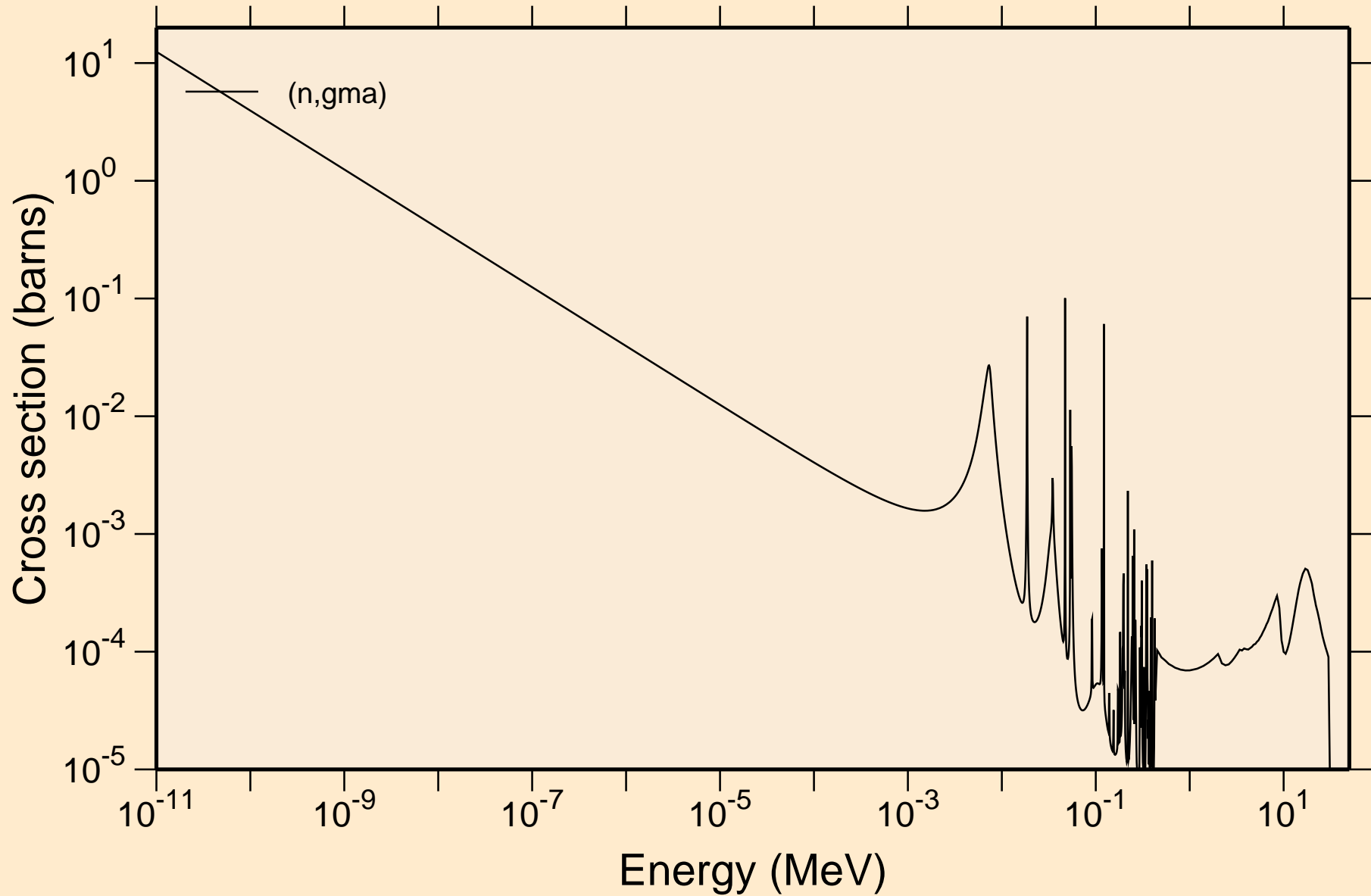

K047 NEUTRON ACER TENDL-2021 LIBRARY; T=293.6K

Principal cross sections

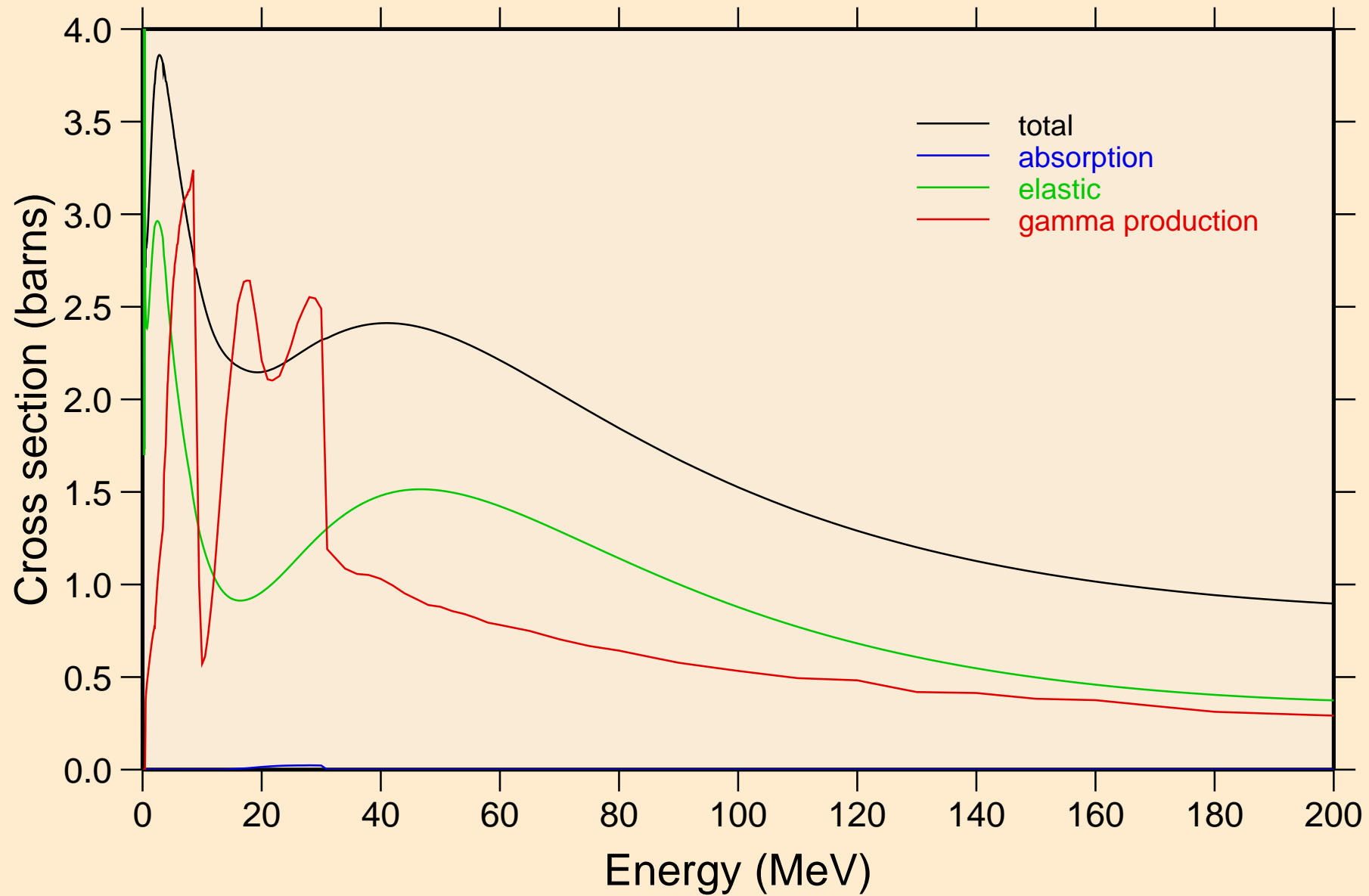

K047 NEUTRON ACER TENDL-2021 LIBRARY; T=293.6K

Heating

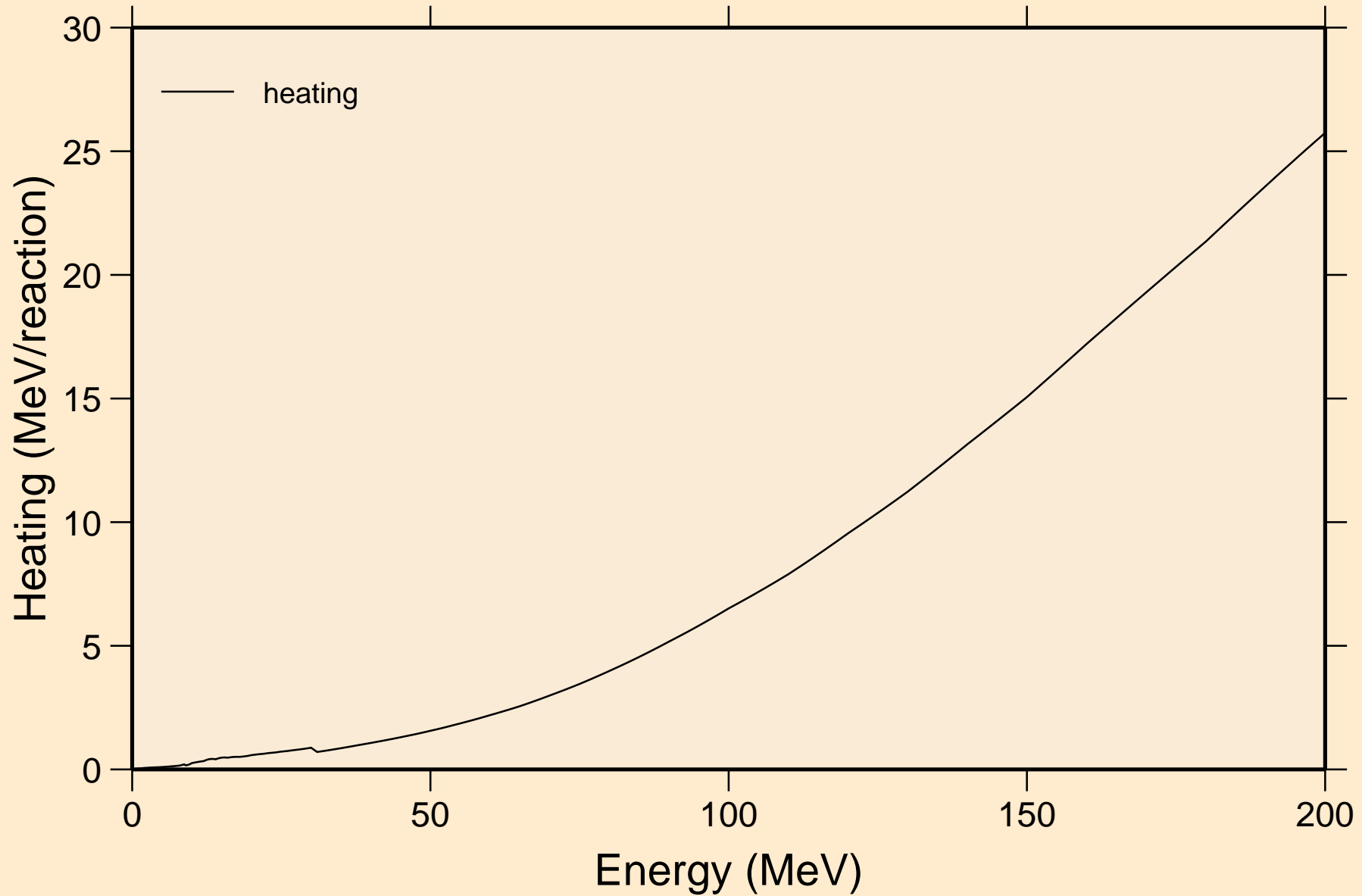

K047 NEUTRON ACER TENDL-2021 LIBRARY; T=293.6K

Damage

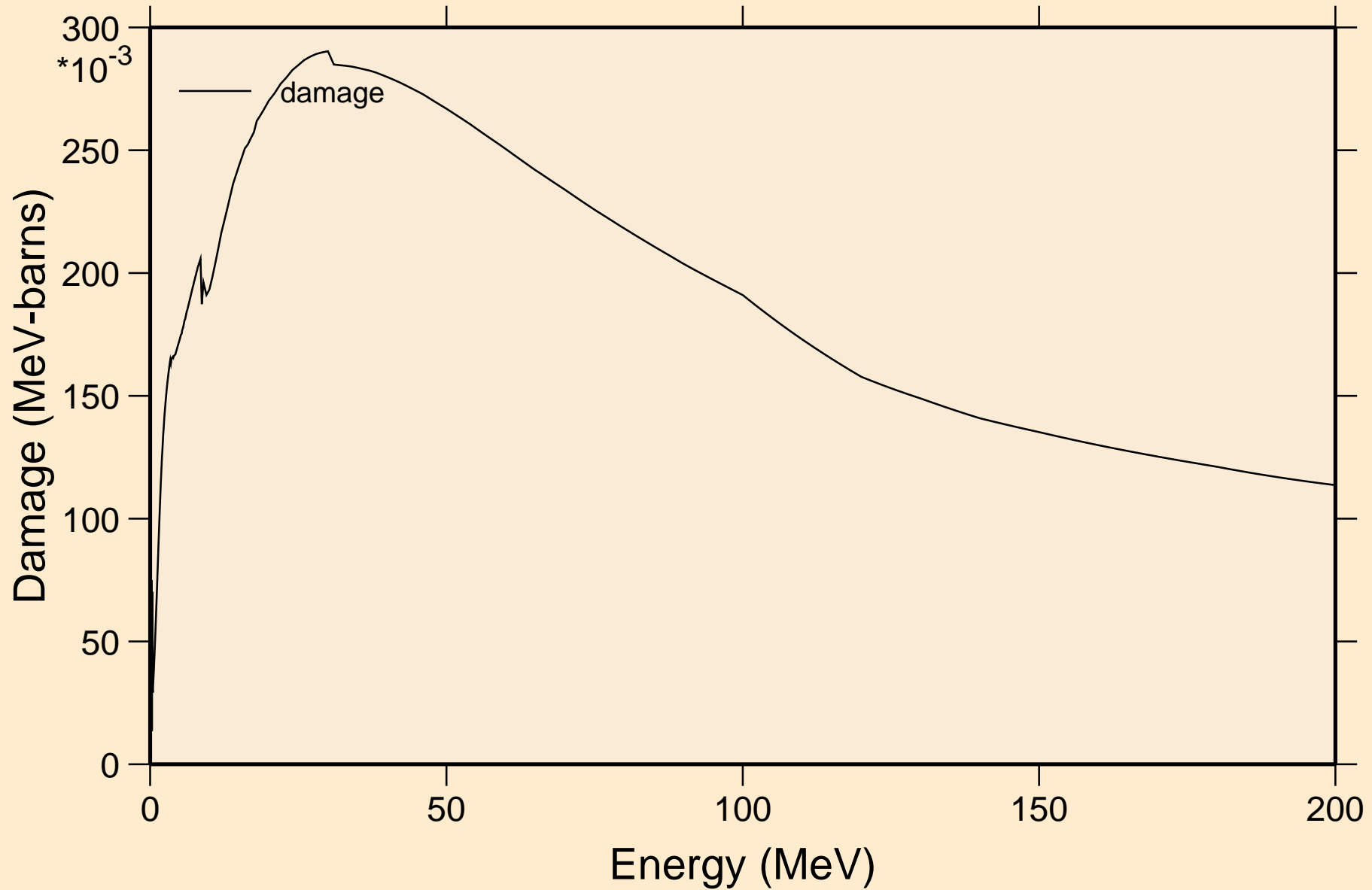

K047 NEUTRON ACER TENDL-2021 LIBRARY; T=293.6K
Non-threshold reactions

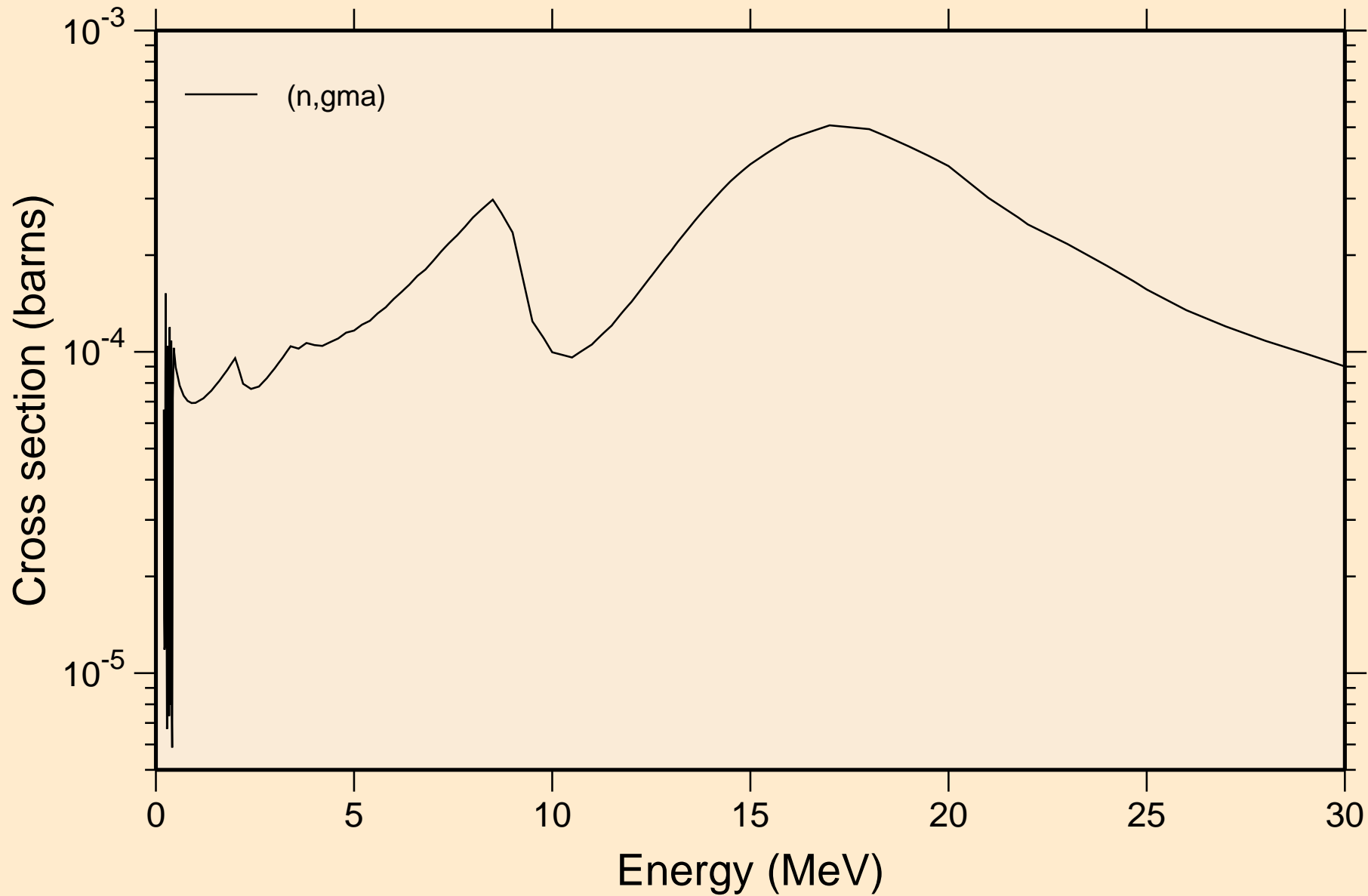

K047 NEUTRON ACER TENDL-2021 LIBRARY; T=293.6K
Inelastic levels

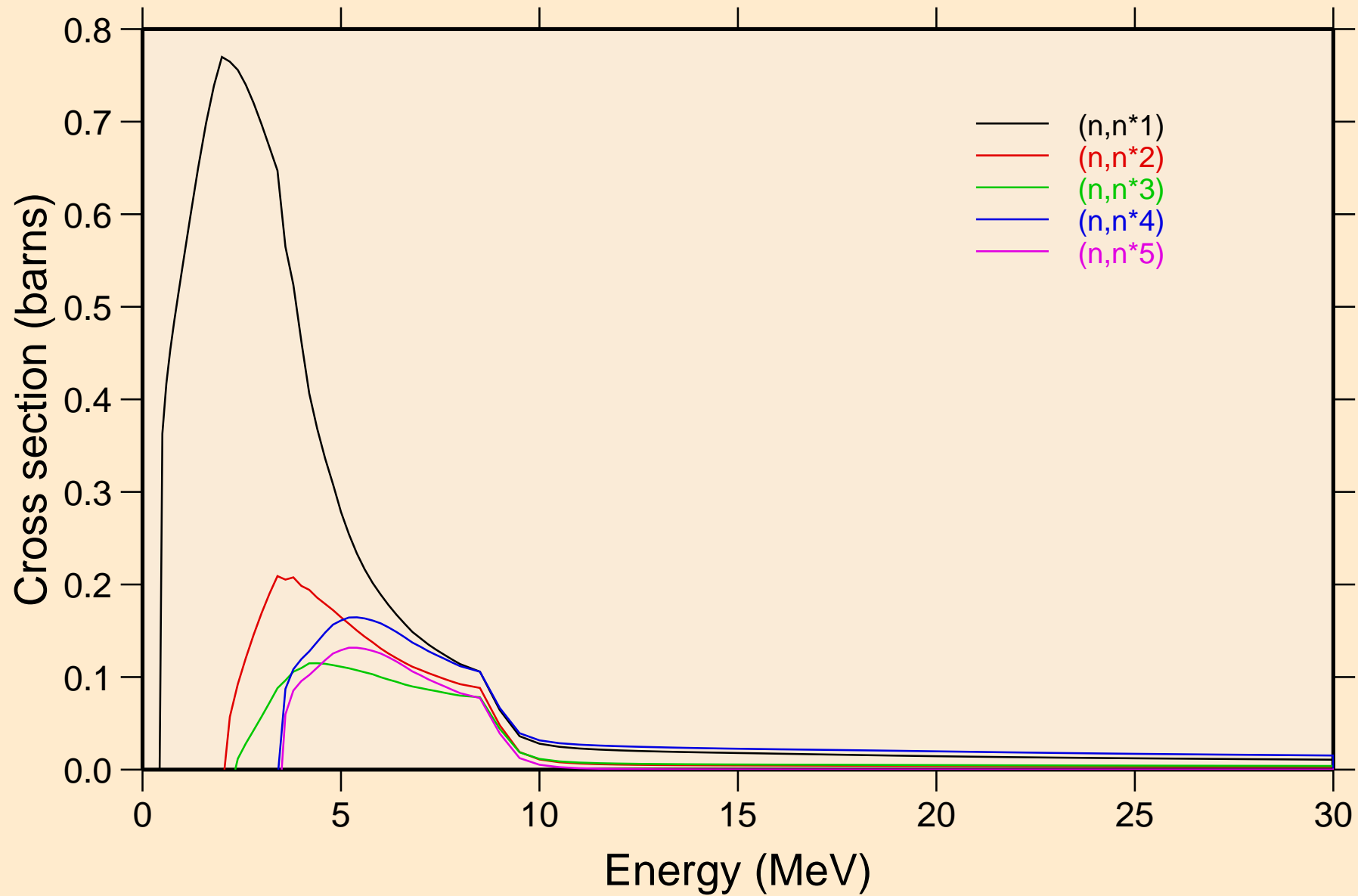

K047 NEUTRON ACER TENDL-2021 LIBRARY; T=293.6K
Inelastic levels

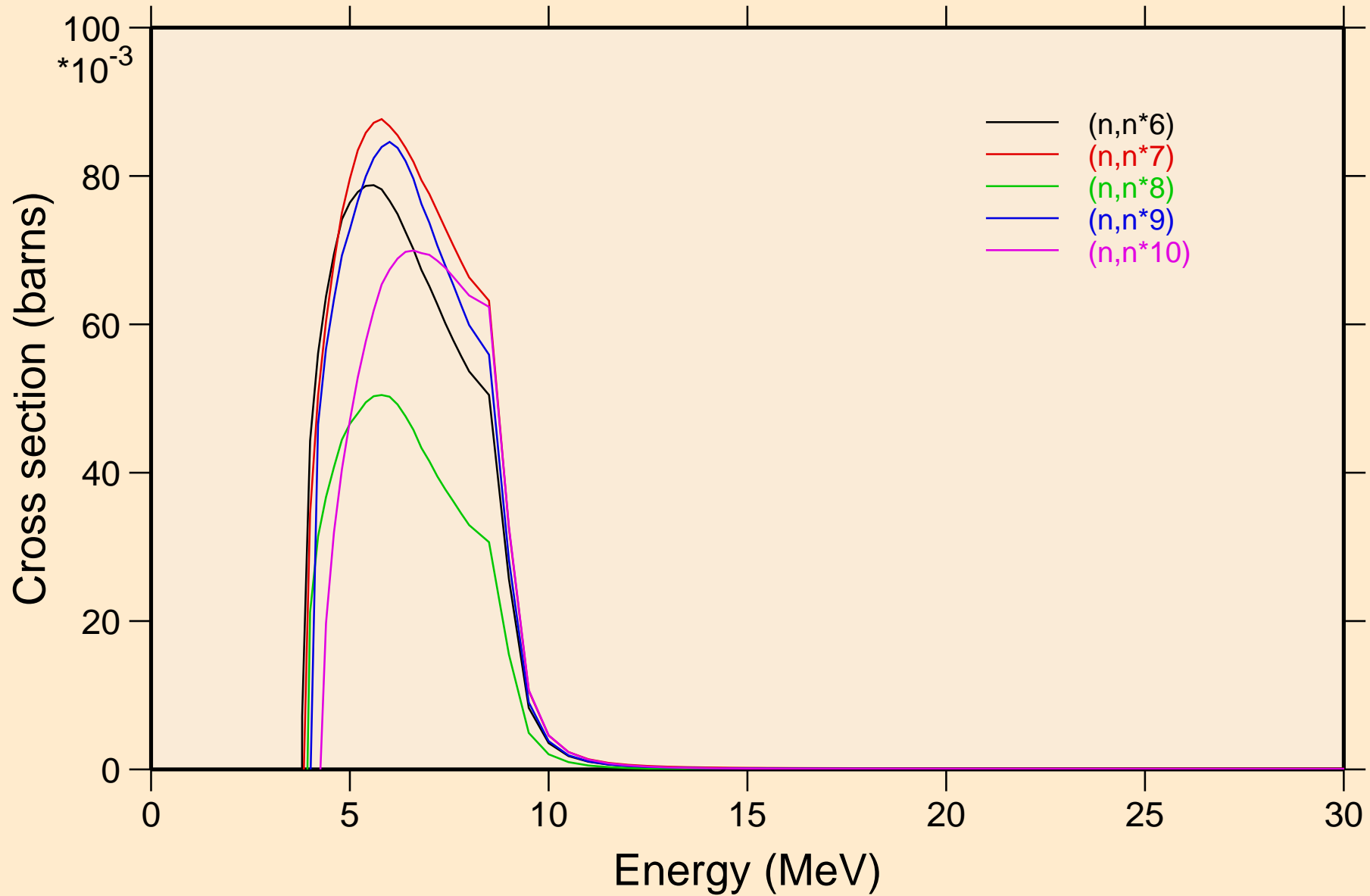

K047 NEUTRON ACER TENDL-2021 LIBRARY; T=293.6K
Inelastic levels

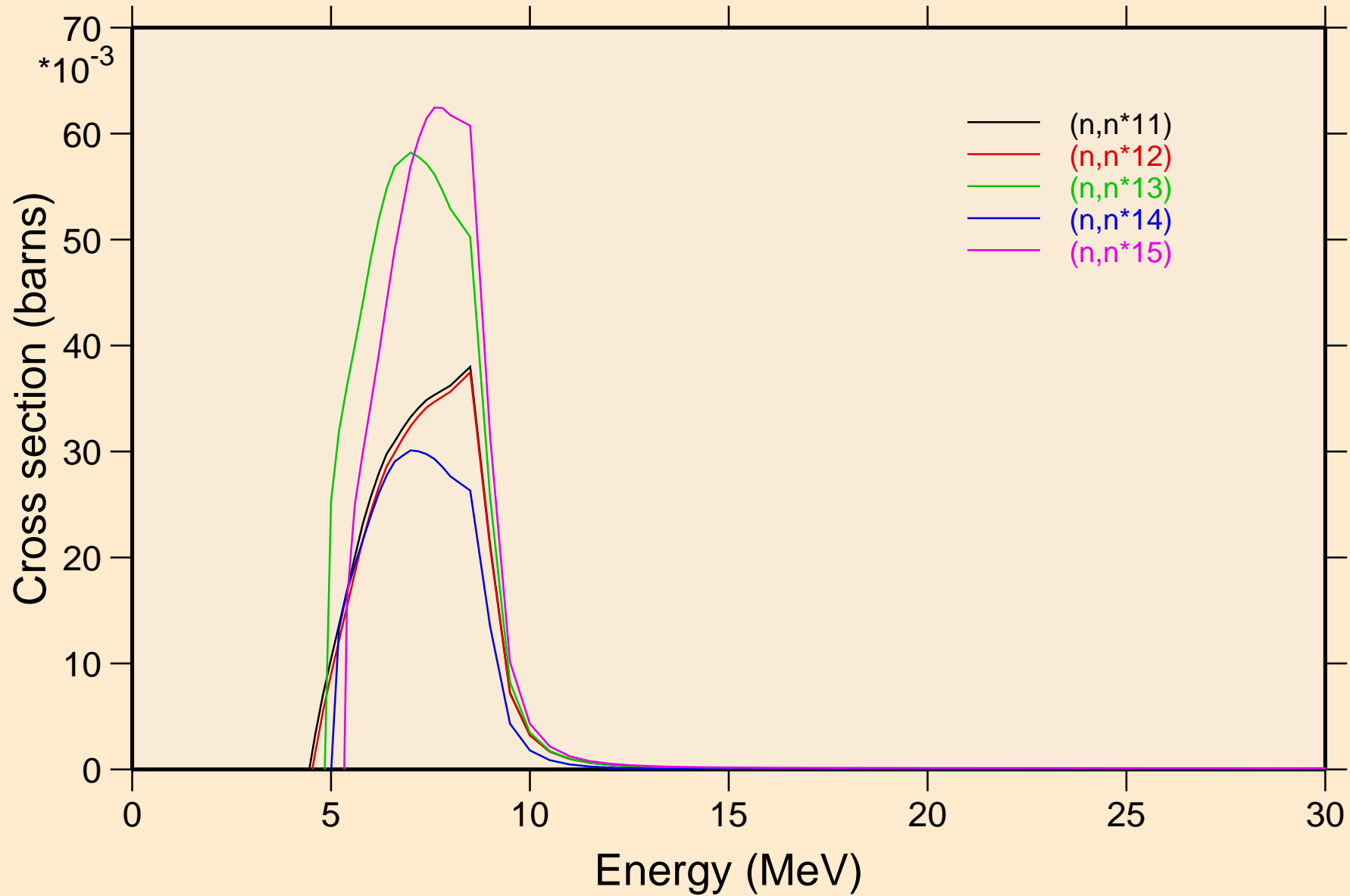

K047 NEUTRON ACER TENDL-2021 LIBRARY; T=293.6K
Inelastic levels

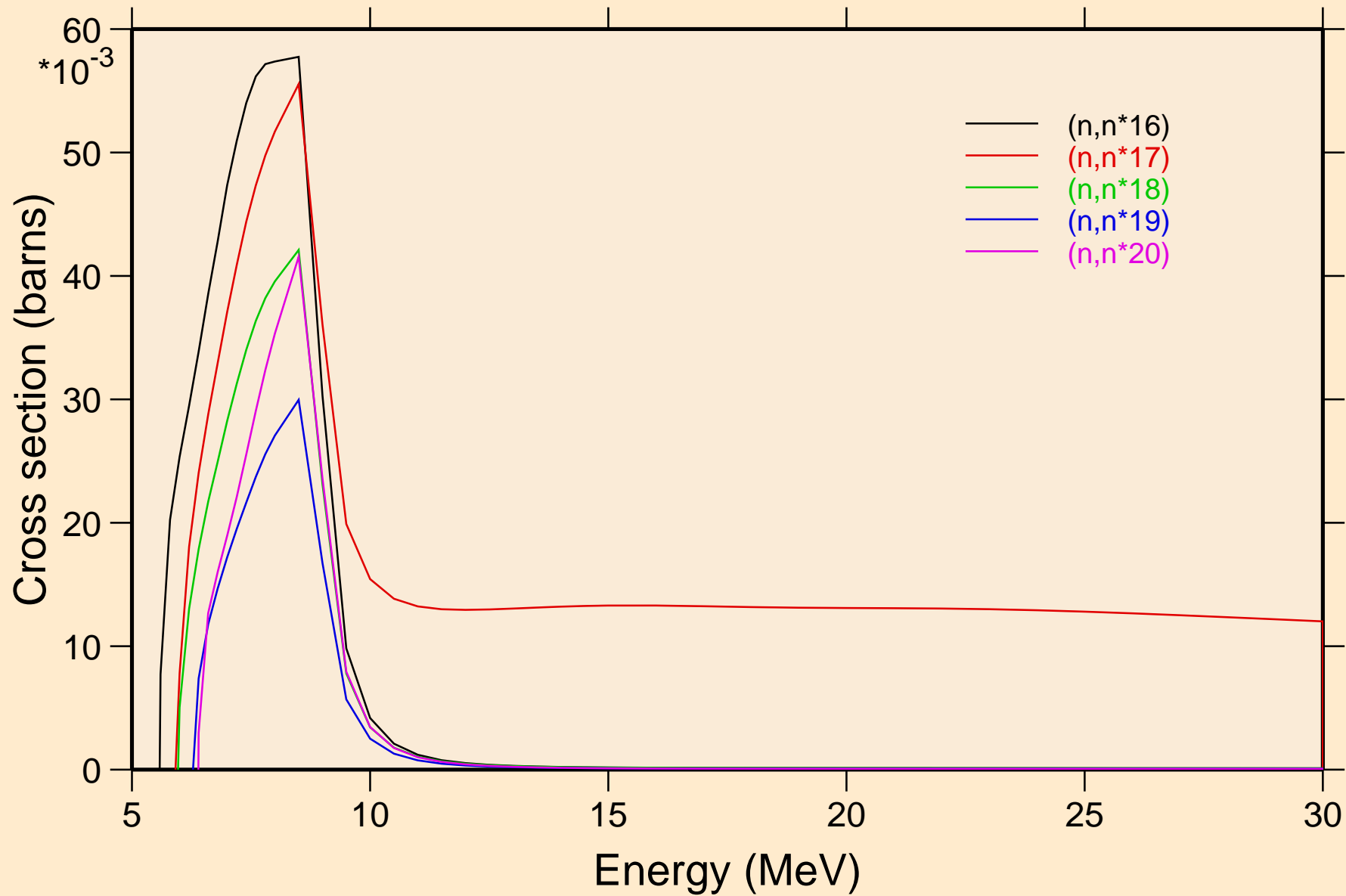

K047 NEUTRON ACER TENDL-2021 LIBRARY; T=293.6K
Inelastic levels

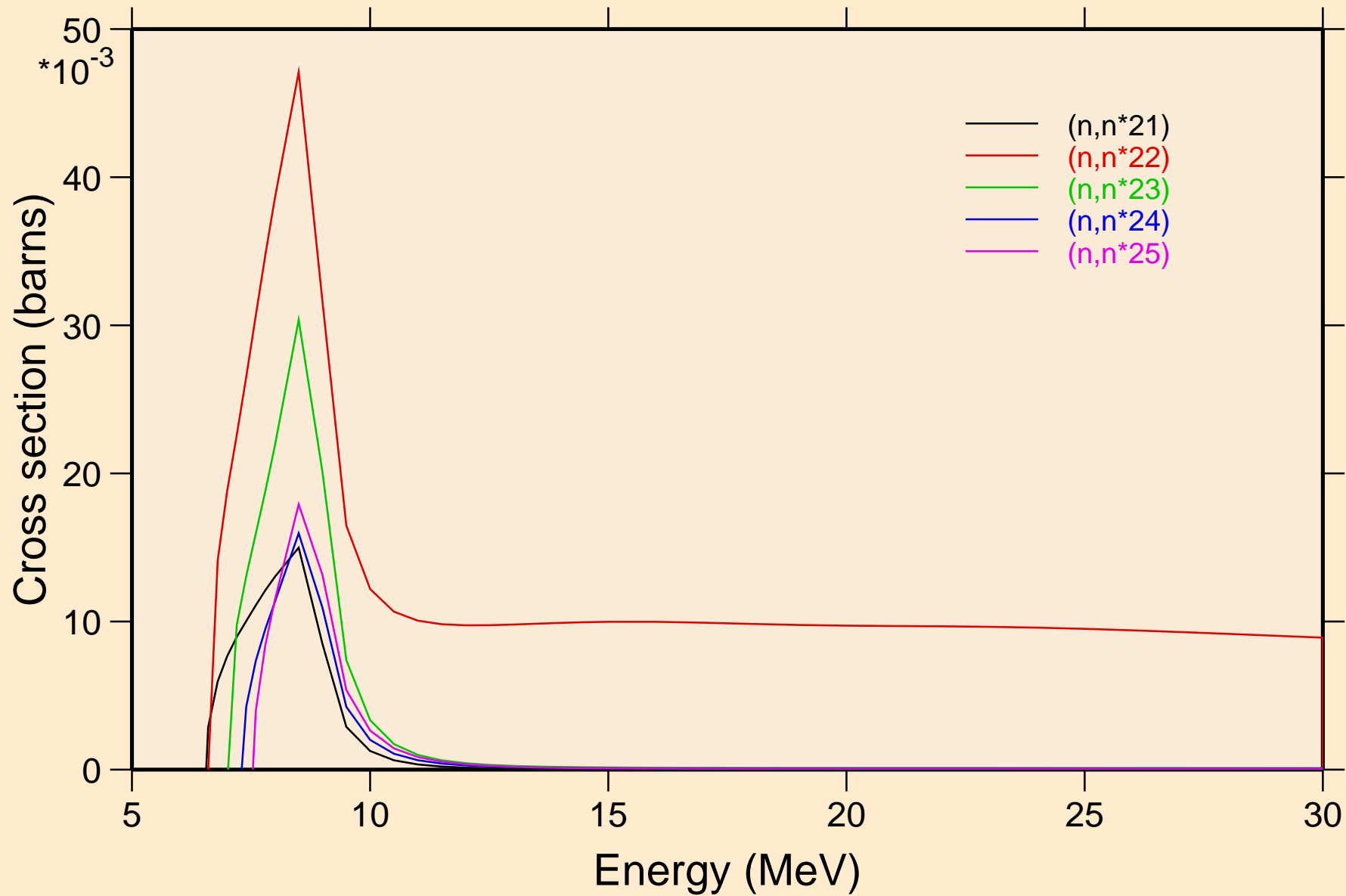

K047 NEUTRON ACER TENDL-2021 LIBRARY; T=293.6K
Inelastic levels

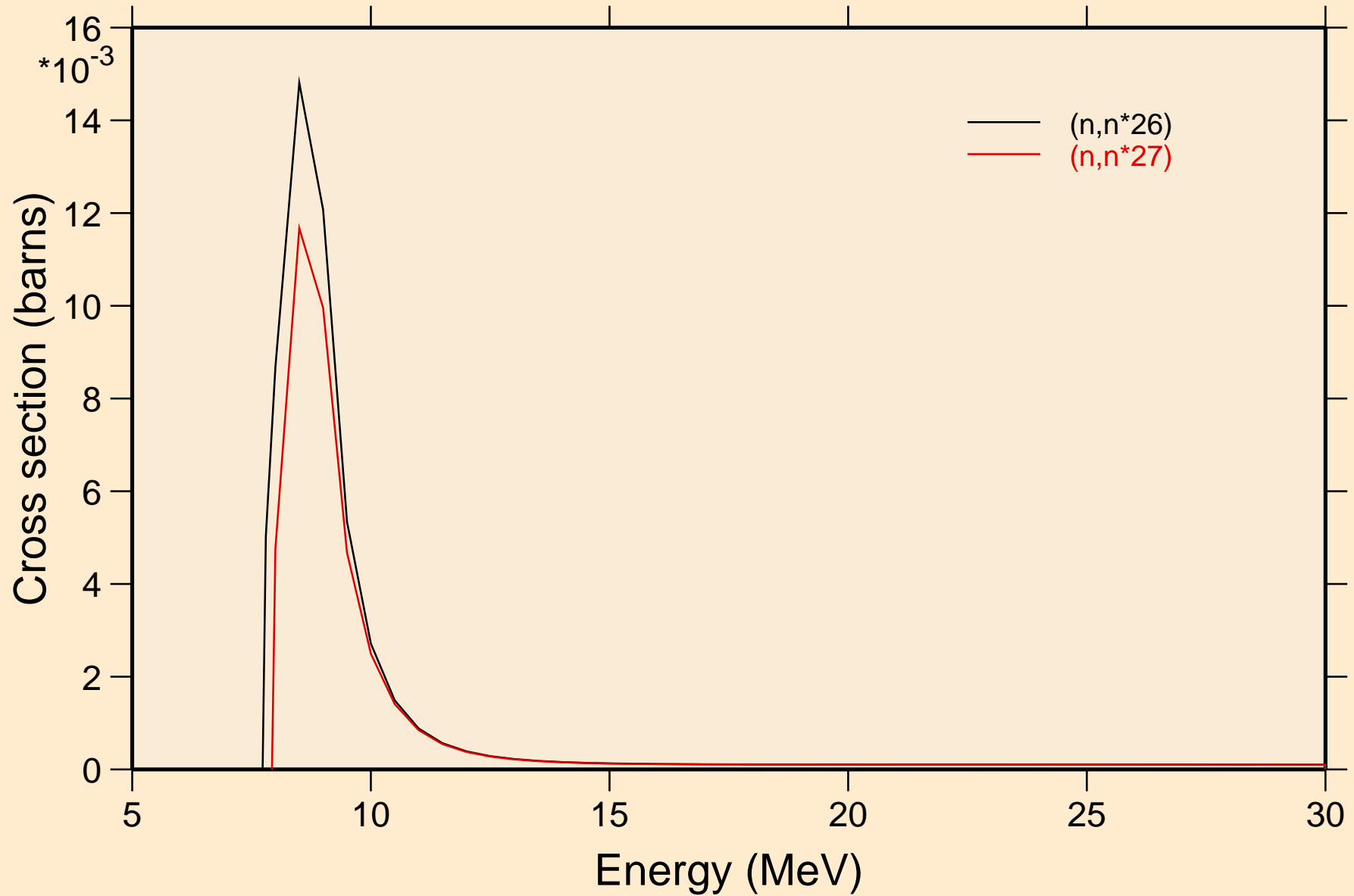

K047 NEUTRON ACER TENDL-2021 LIBRARY; T=293.6K
Threshold reactions

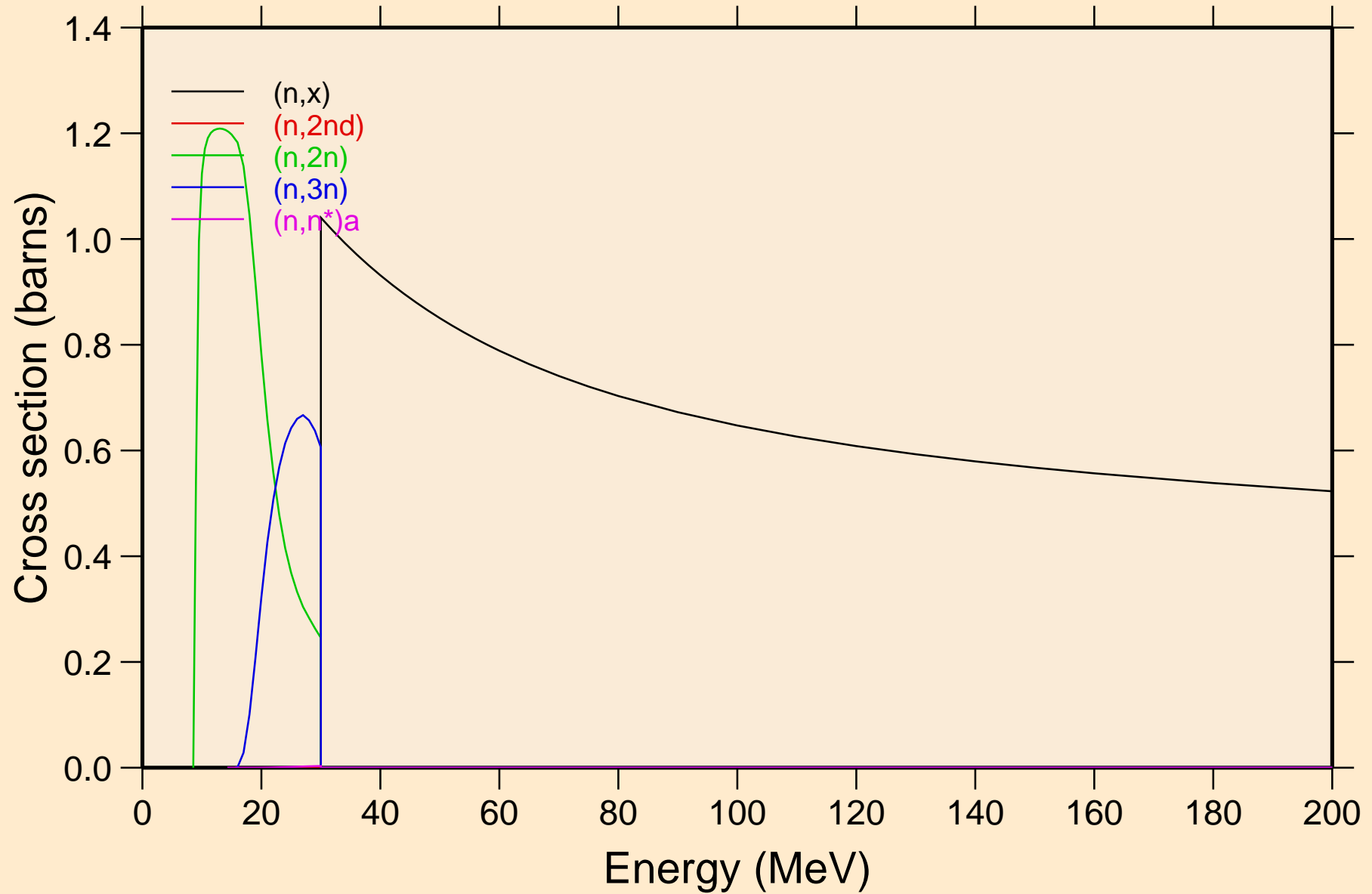

K047 NEUTRON ACER TENDL-2021 LIBRARY; T=293.6K
Threshold reactions

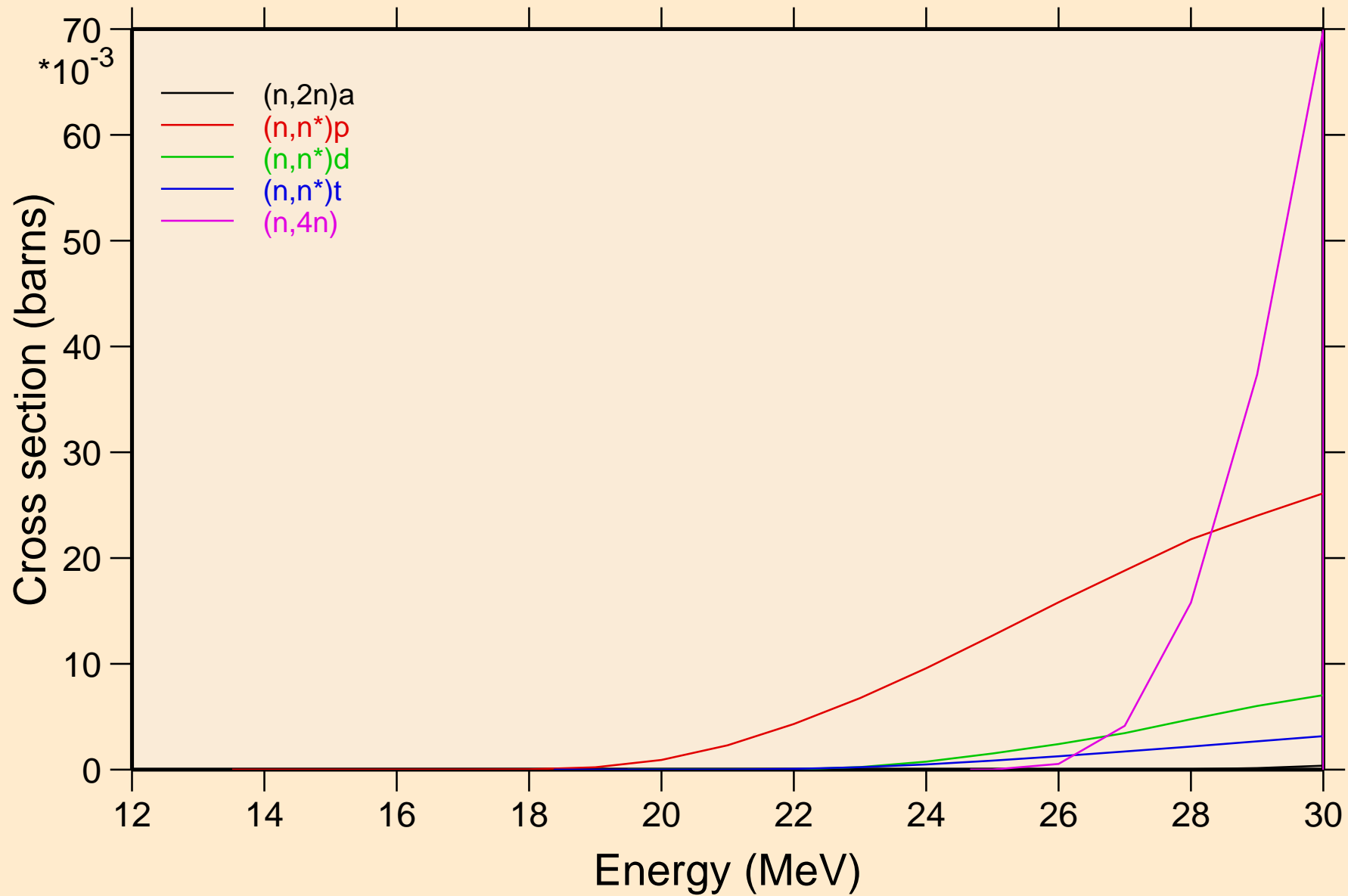

K047 NEUTRON ACER TENDL-2021 LIBRARY; T=293.6K
Threshold reactions

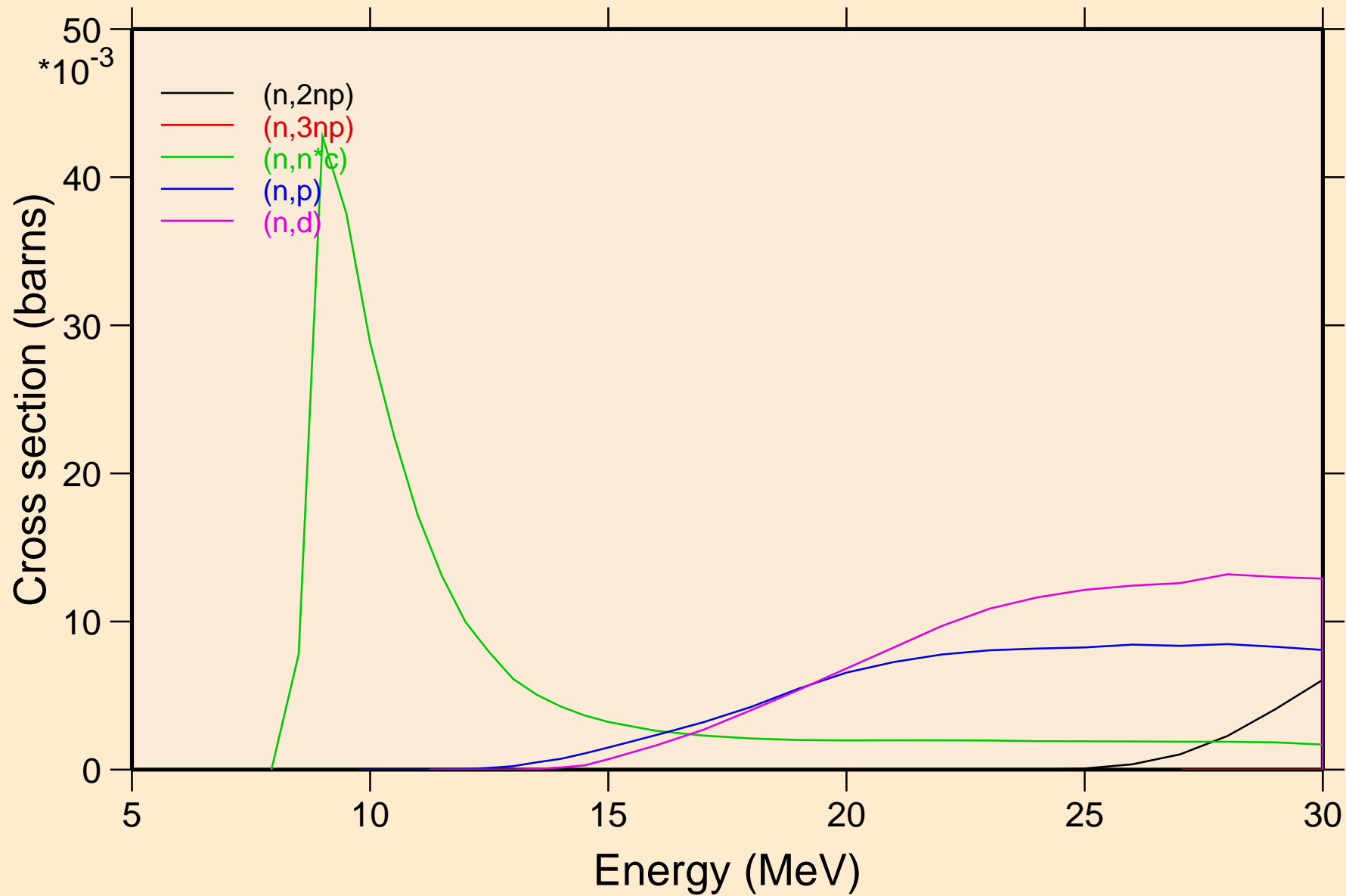

K047 NEUTRON ACER TENDL-2021 LIBRARY; T=293.6K
Threshold reactions

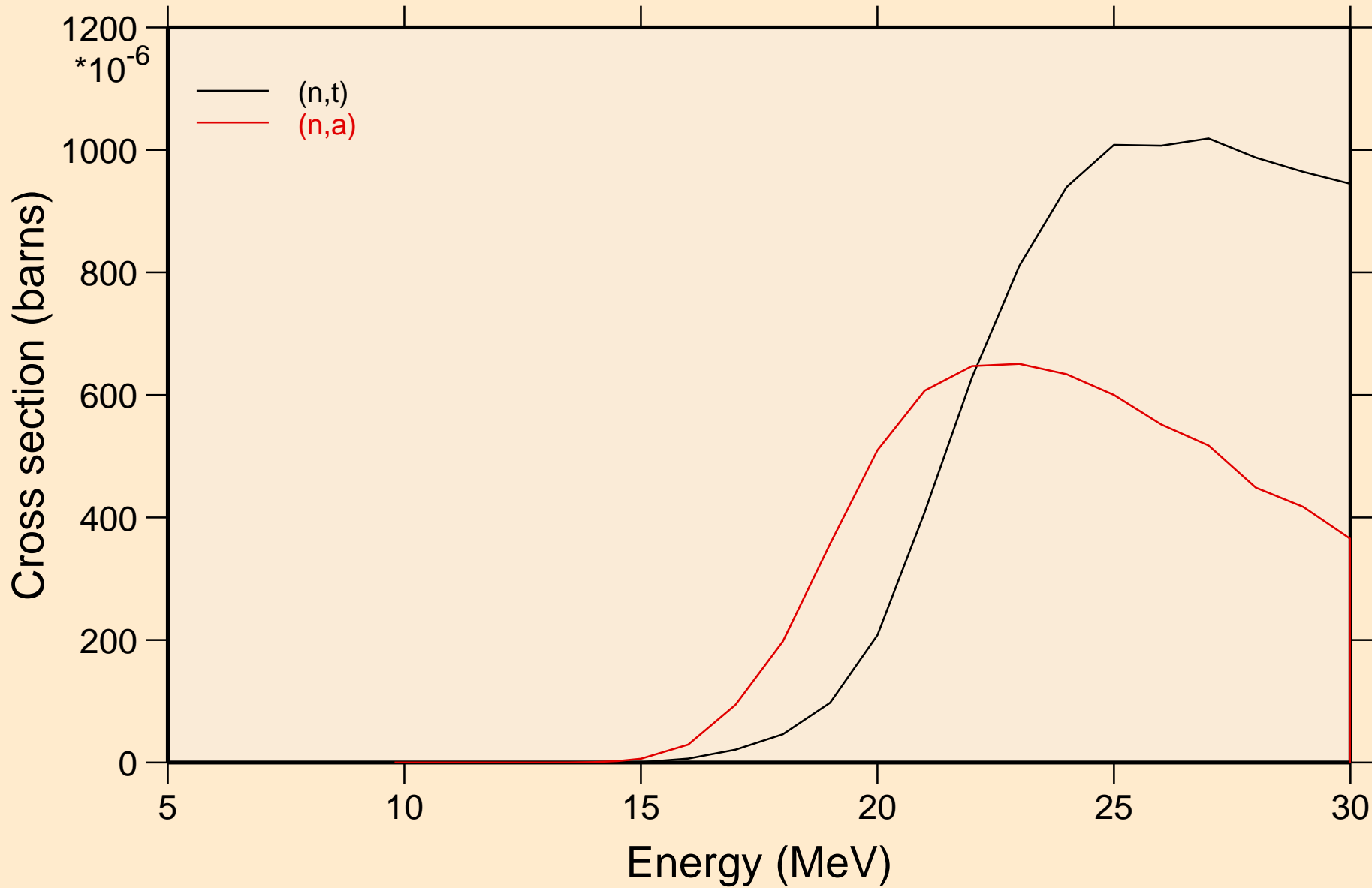

K047 NEUTRON ACER TENDL-2021 LIBRARY; T=293.6K

Threshold reactions

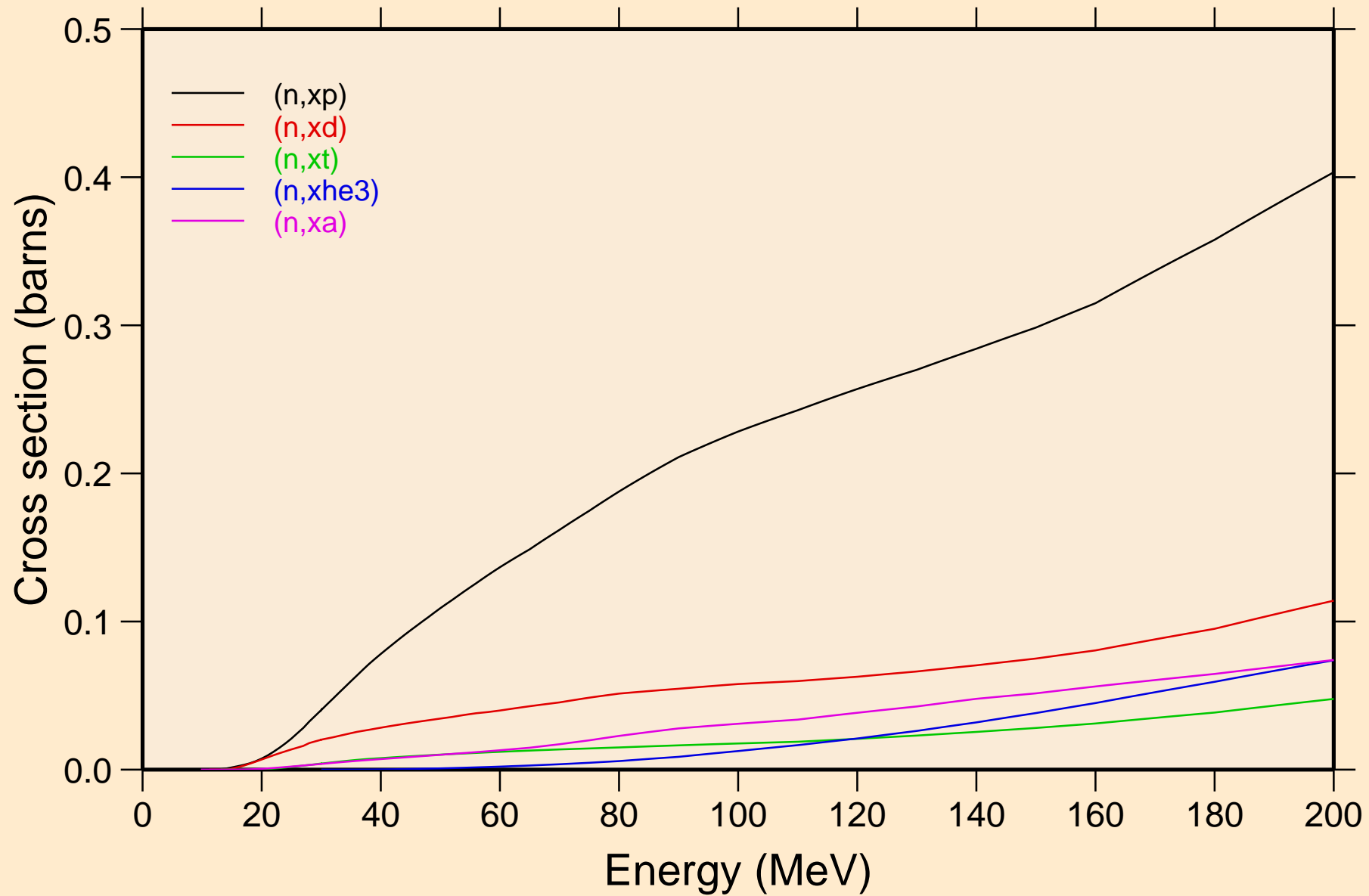

K047 NEUTRON ACER TENDL-2021 LIBRARY; T=293.6K
angular distribution for elastic

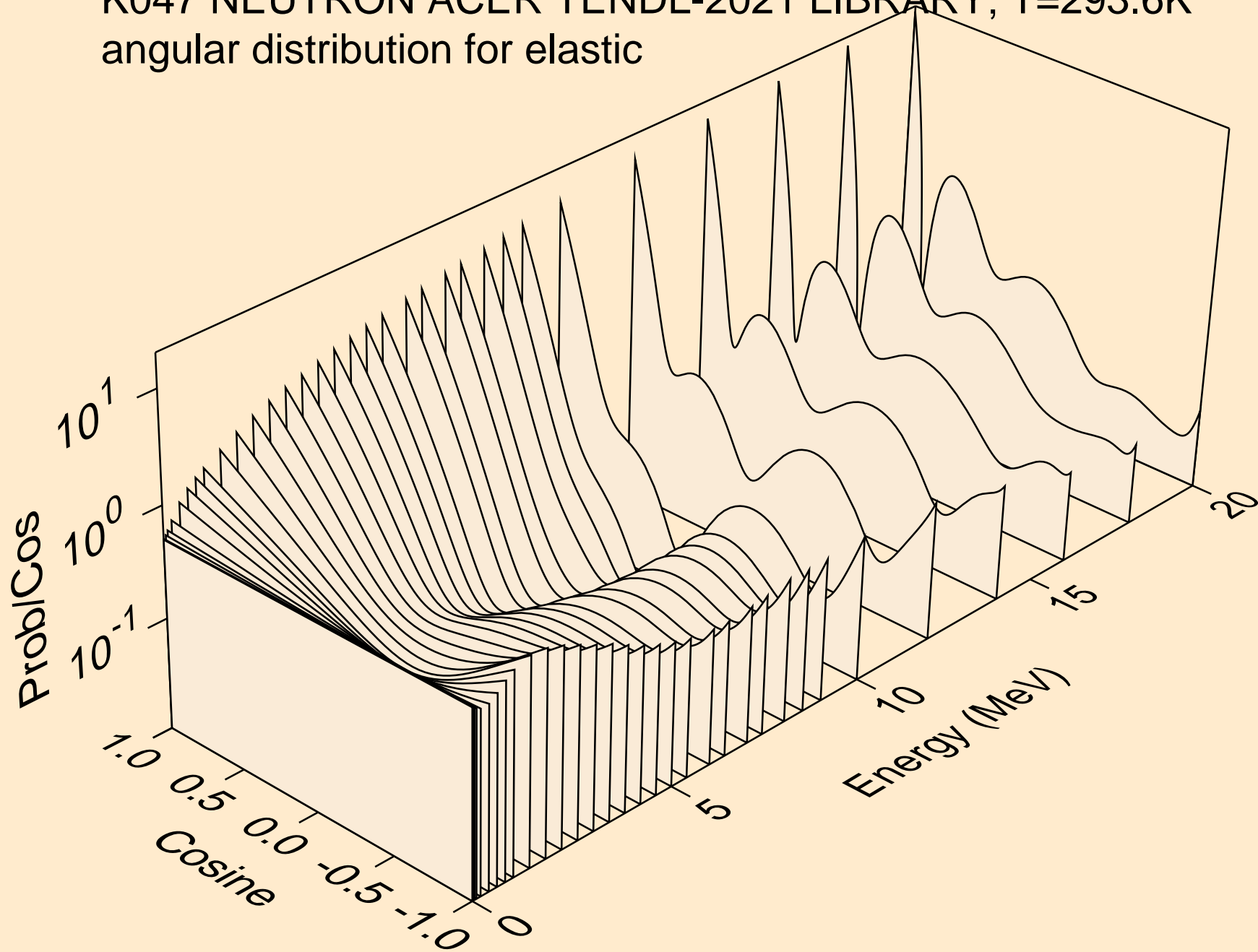

K047 NEUTRON ACER TENDL-2021 LIBRARY; T=293.6K
angular distribution for elastic

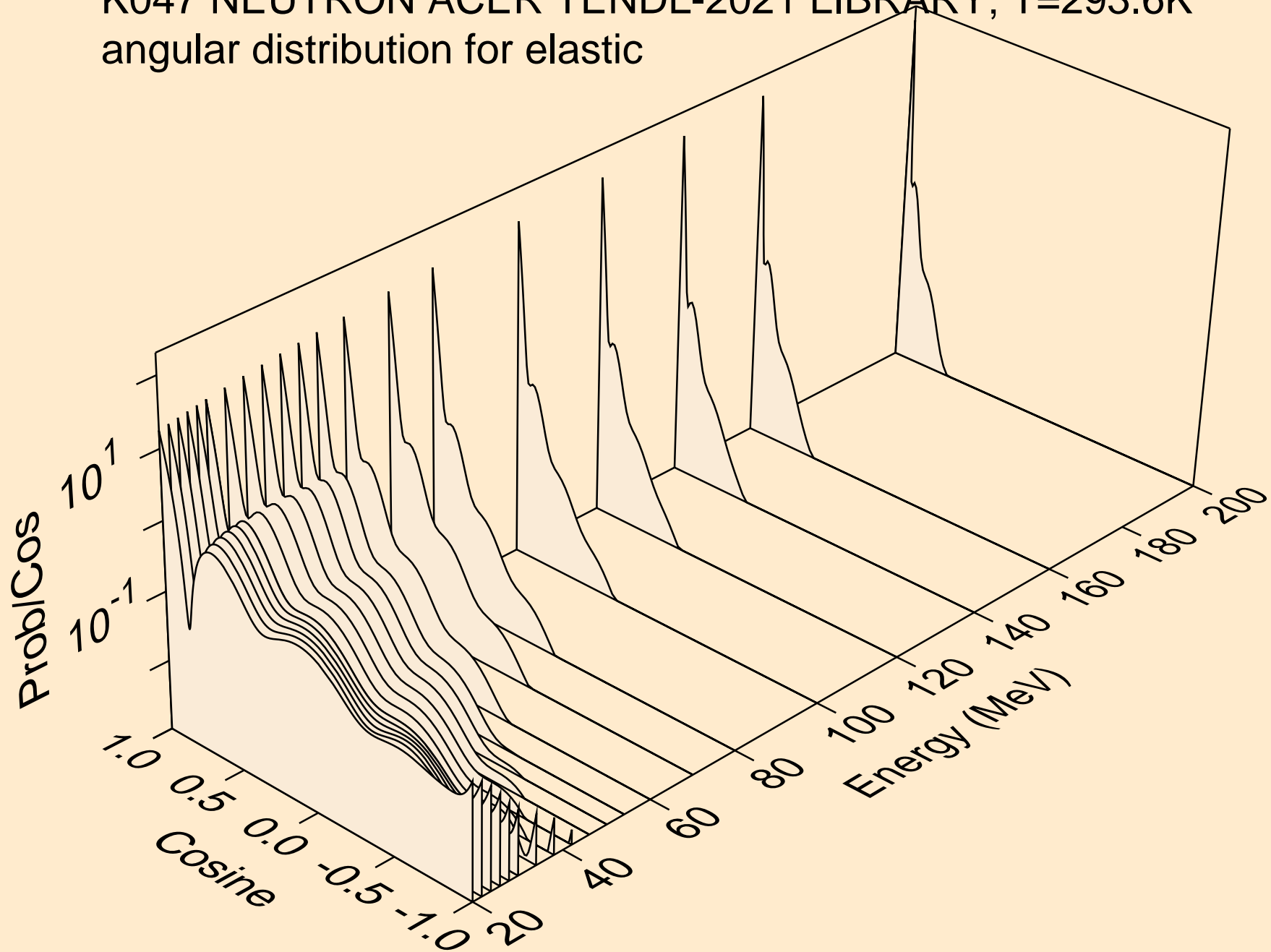

K047 NEUTRON ACER TENDL-2021 LIBRARY; T=293.6K
angular distribution for (n,n*1)

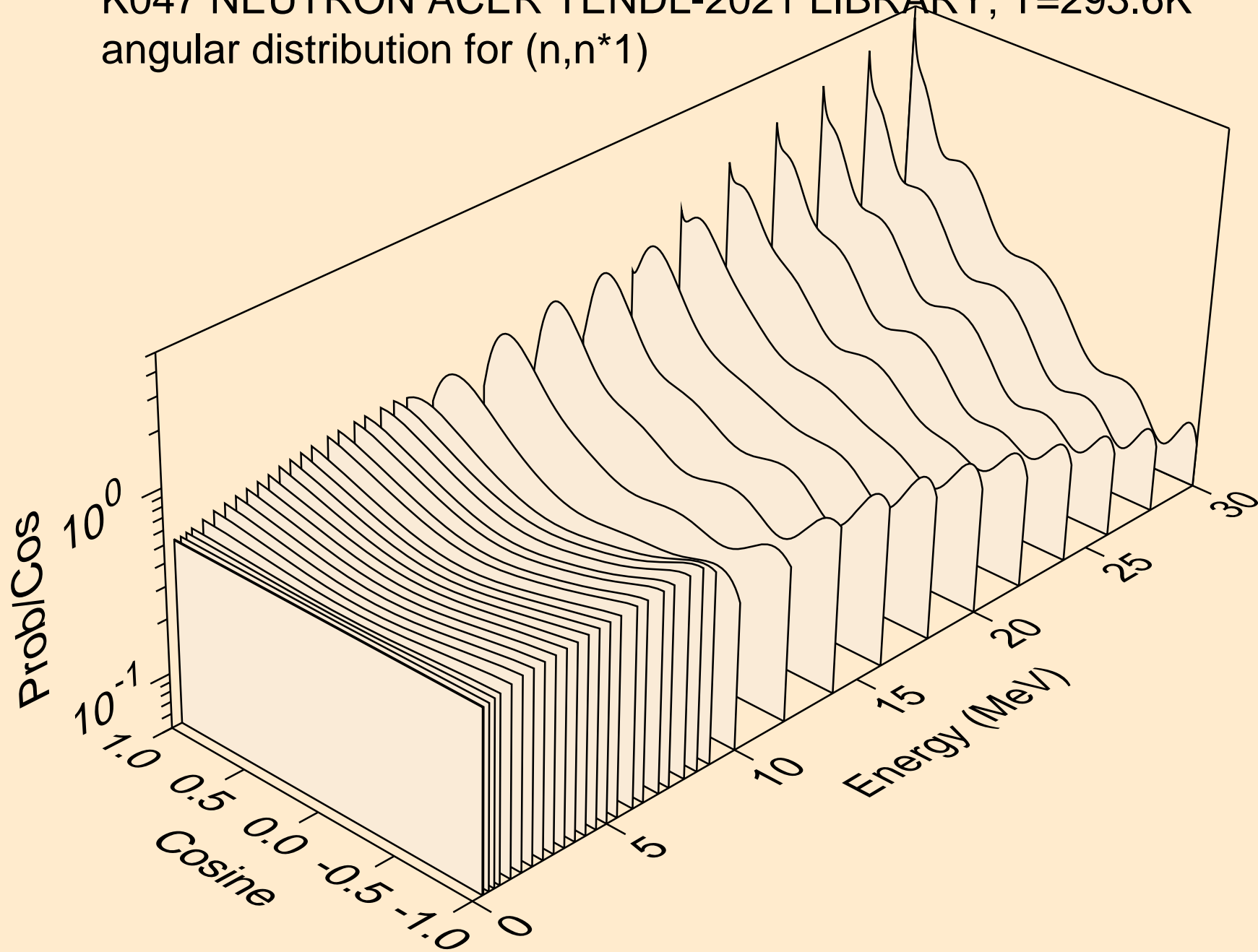

K047 NEUTRON ACER TENDL-2021 LIBRARY; T=293.6K
angular distribution for (n,n*2)

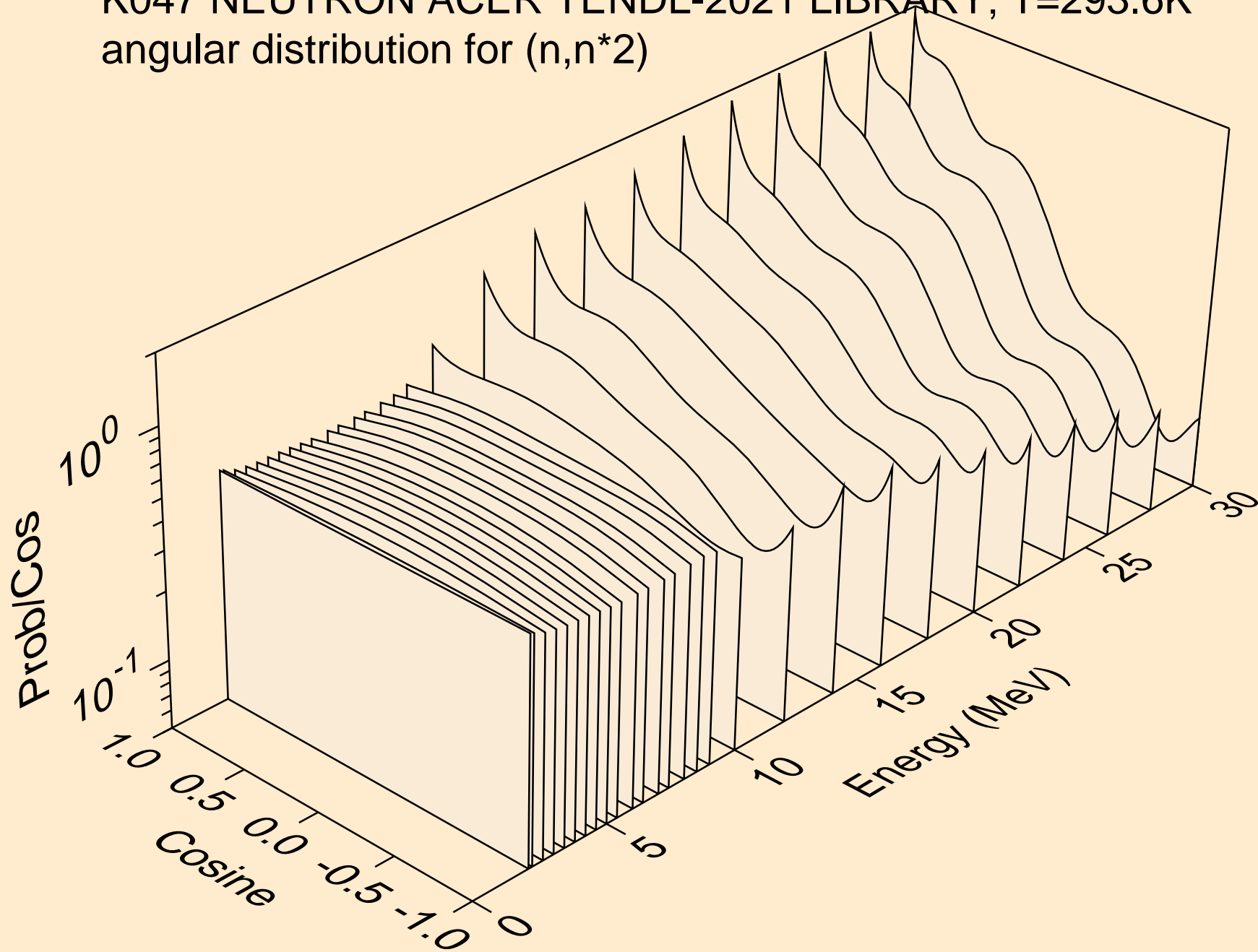

K047 NEUTRON ACER TENDL-2021 LIBRARY; T=293.6K
angular distribution for (n,n*3)

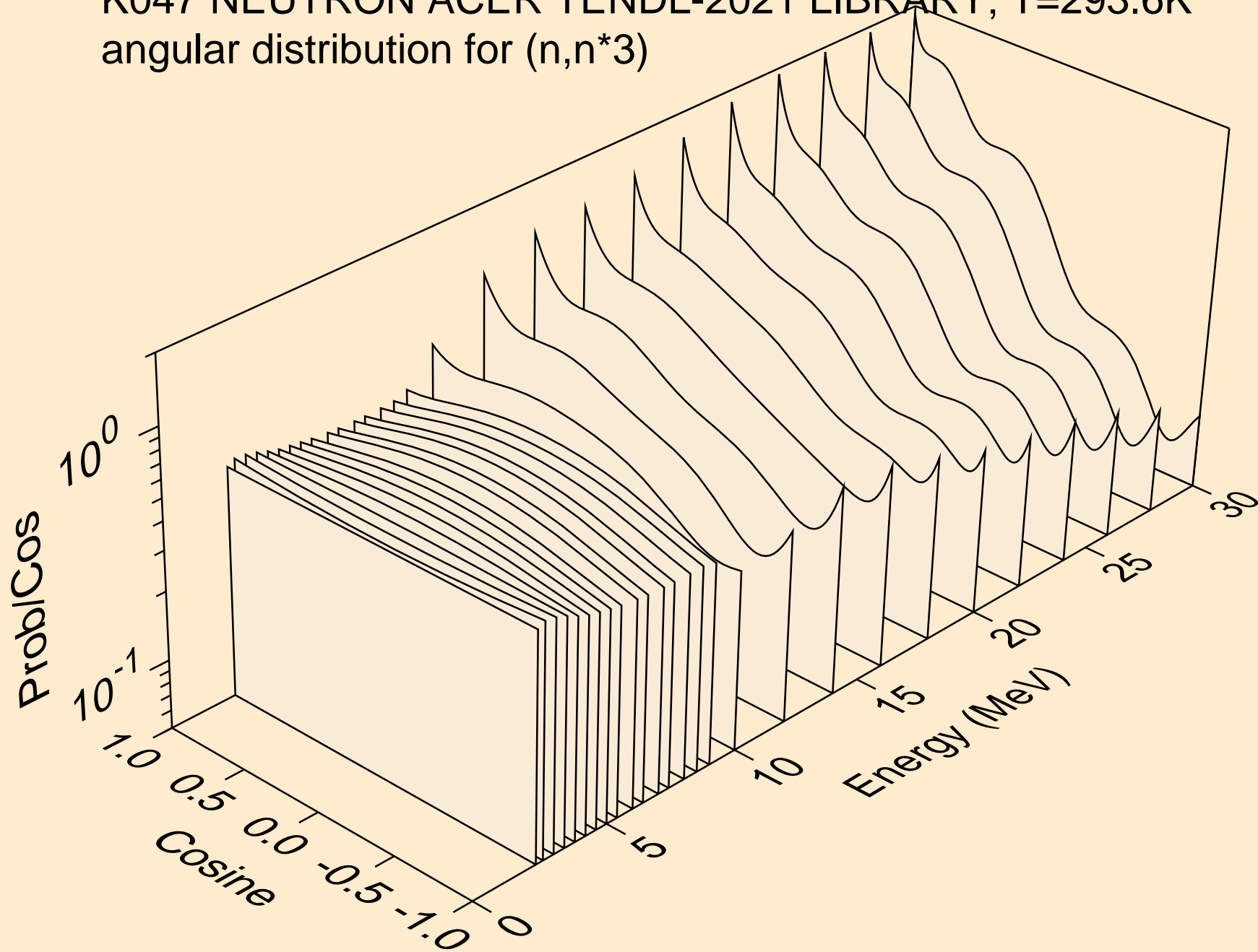

K047 NEUTRON ACER TENDL-2021 LIBRARY; T=293.6K
angular distribution for (n,n*4)

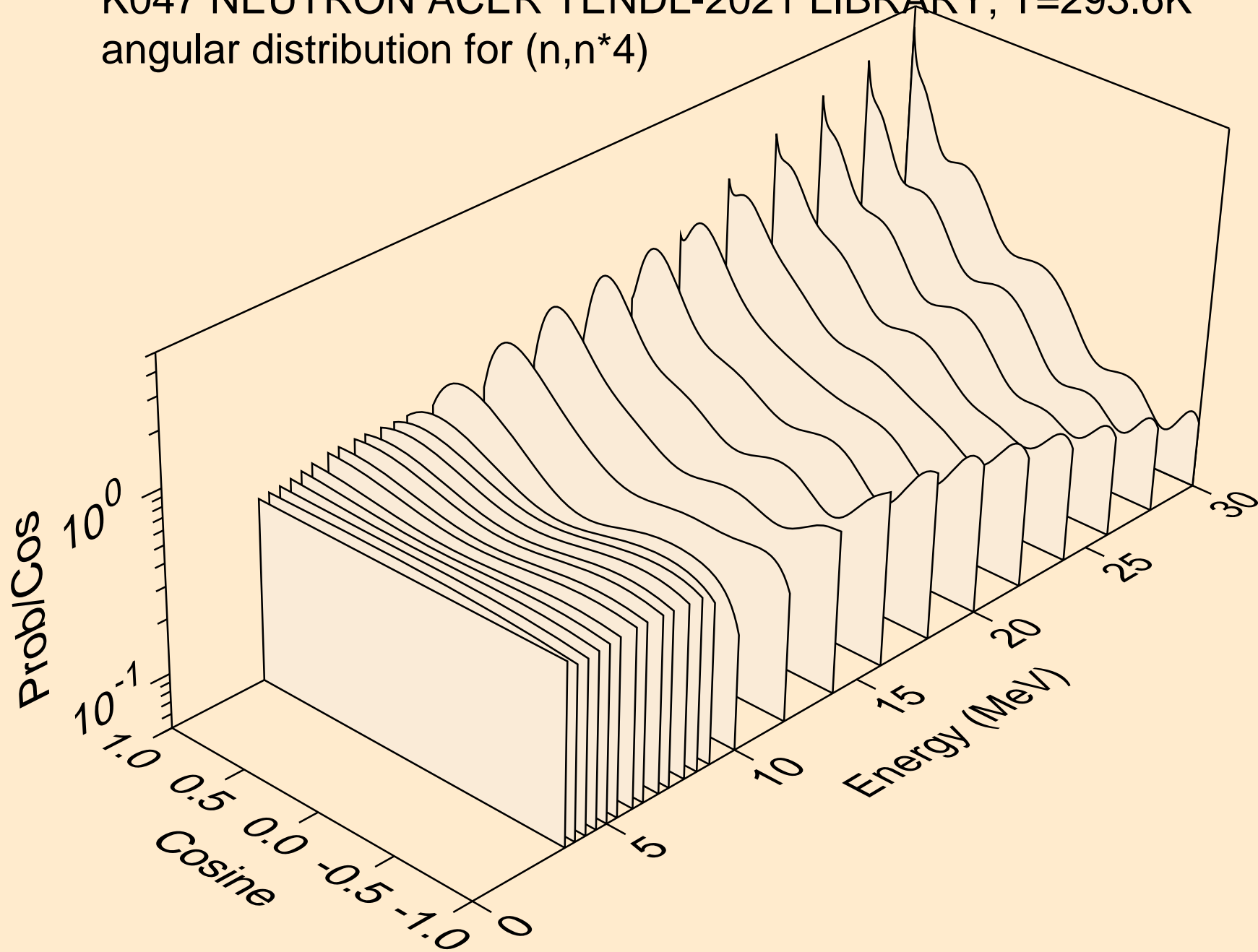

K047 NEUTRON ACER TENDL-2021 LIBRARY; T=293.6K
angular distribution for (n,n*5)

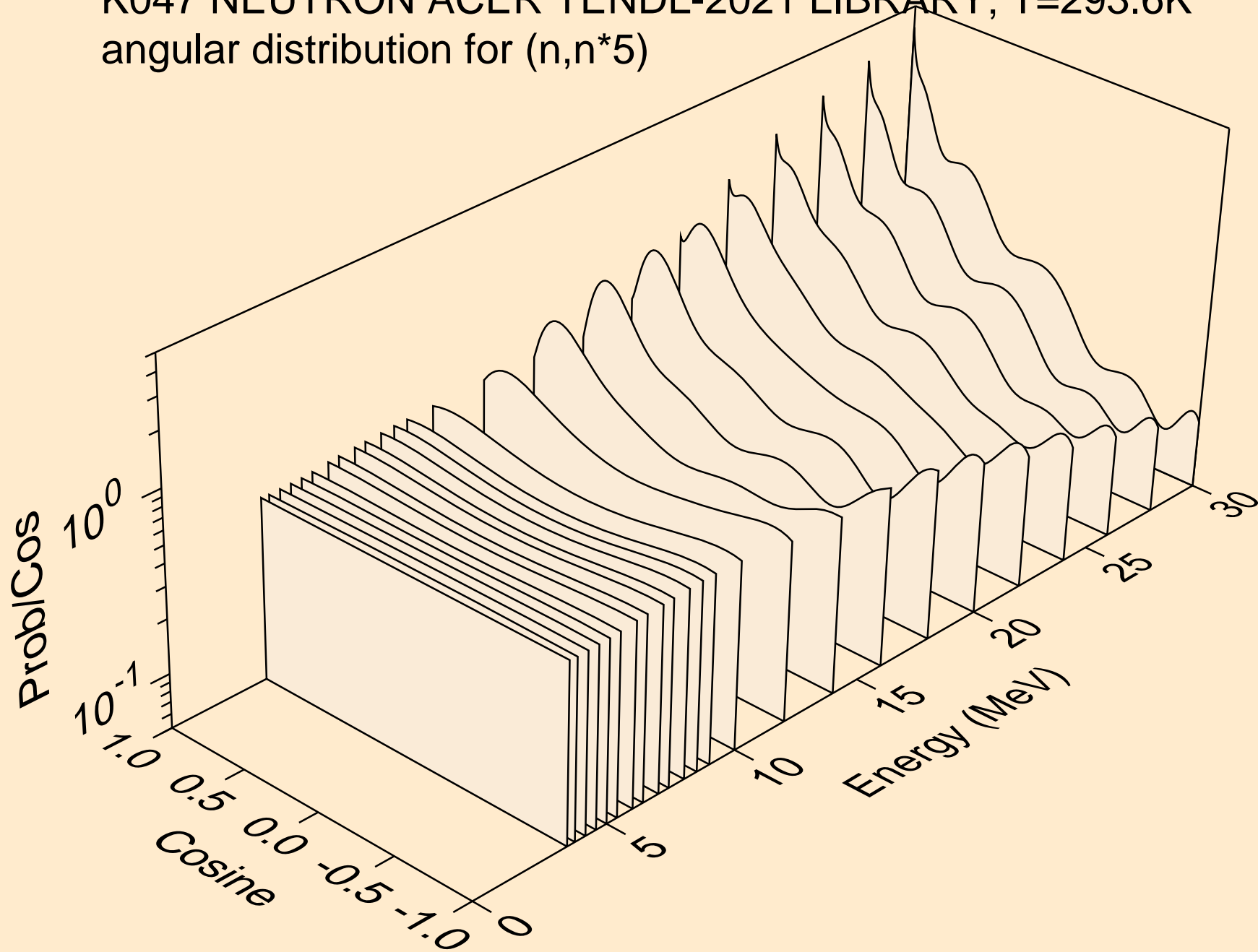

K047 NEUTRON ACER TENDL-2021 LIBRARY; T=293.6K
angular distribution for (n,n*6)

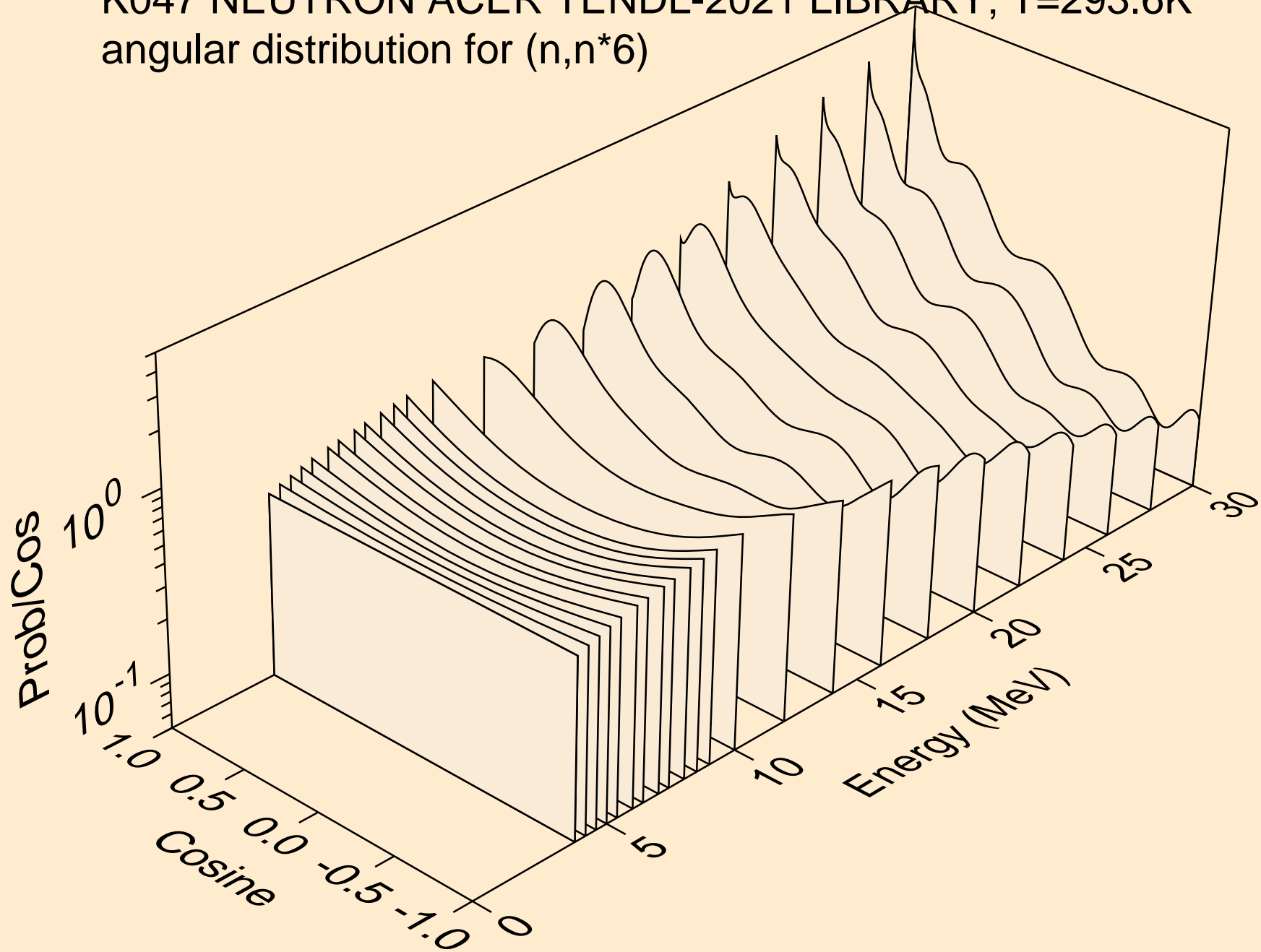

K047 NEUTRON ACER TENDL-2021 LIBRARY; T=293.6K
angular distribution for (n,n*7)

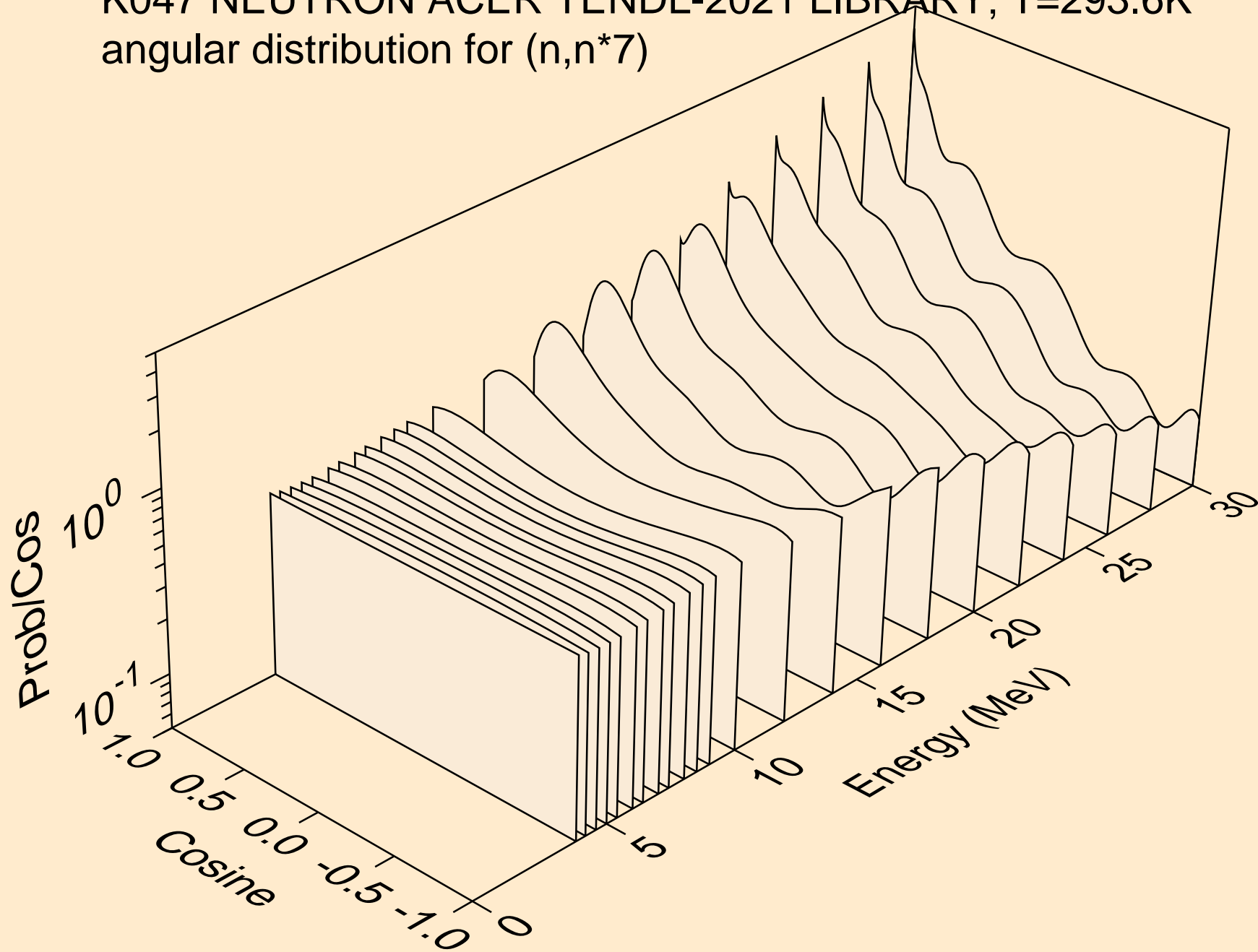

K047 NEUTRON ACER TENDL-2021 LIBRARY; T=293.6K
angular distribution for (n,n*8)

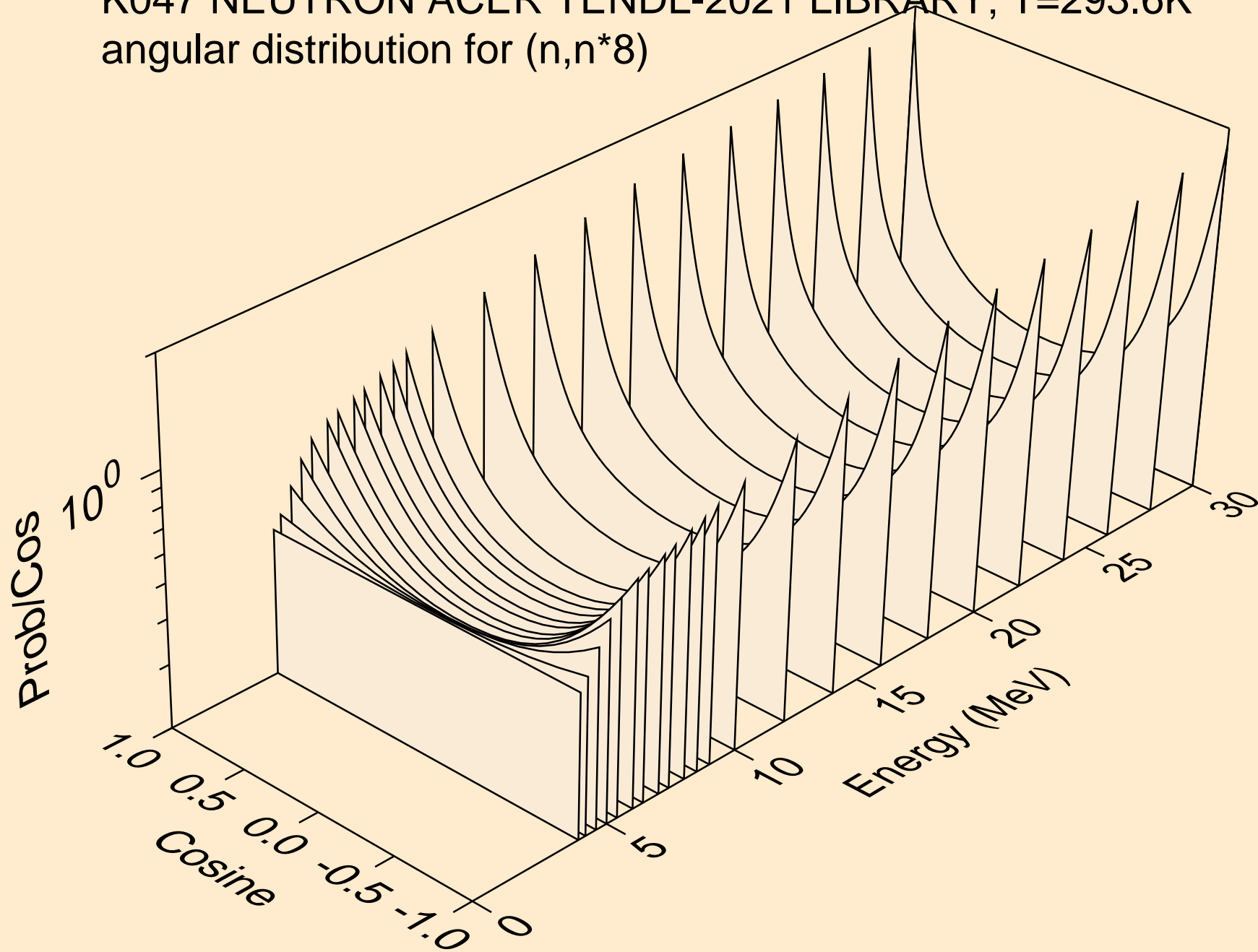

K047 NEUTRON ACER TENDL-2021 LIBRARY; T=293.6K
angular distribution for (n,n*9)

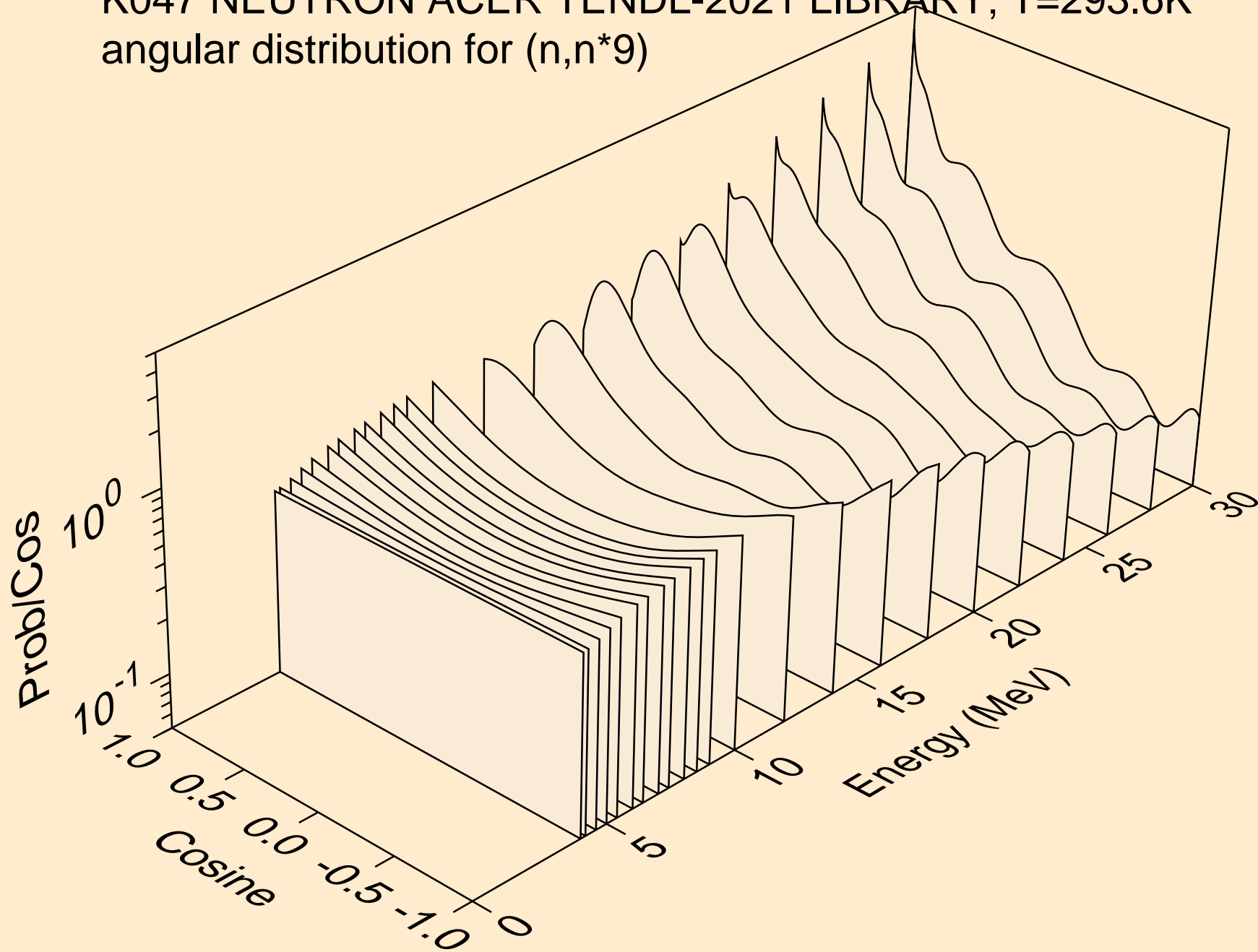

K047 NEUTRON ACER TENDL-2021 LIBRARY; T=293.6K
angular distribution for (n,n*10)

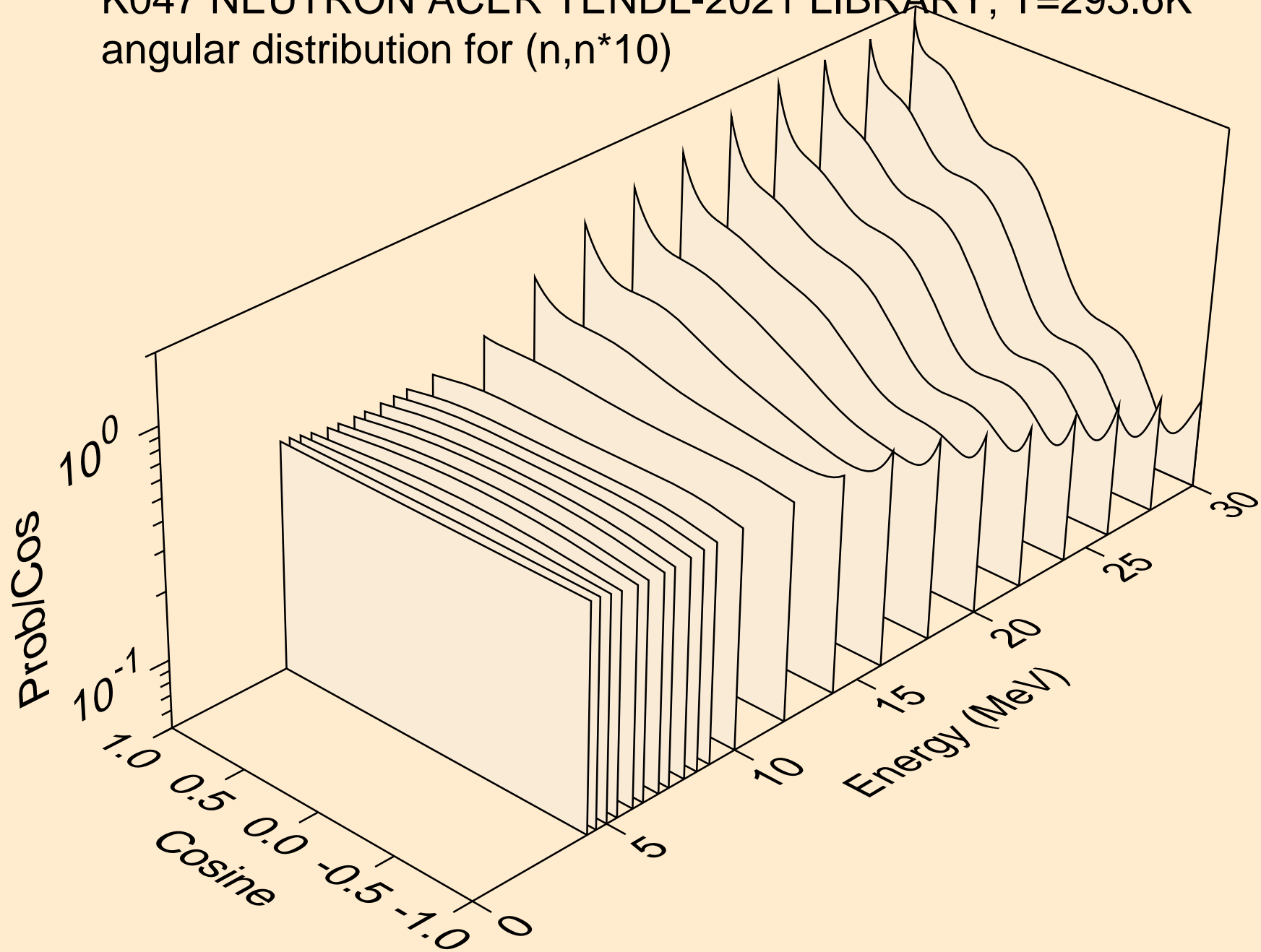

K047 NEUTRON ACER TENDL-2021 LIBRARY; T=293.6K
angular distribution for (n,n*11)

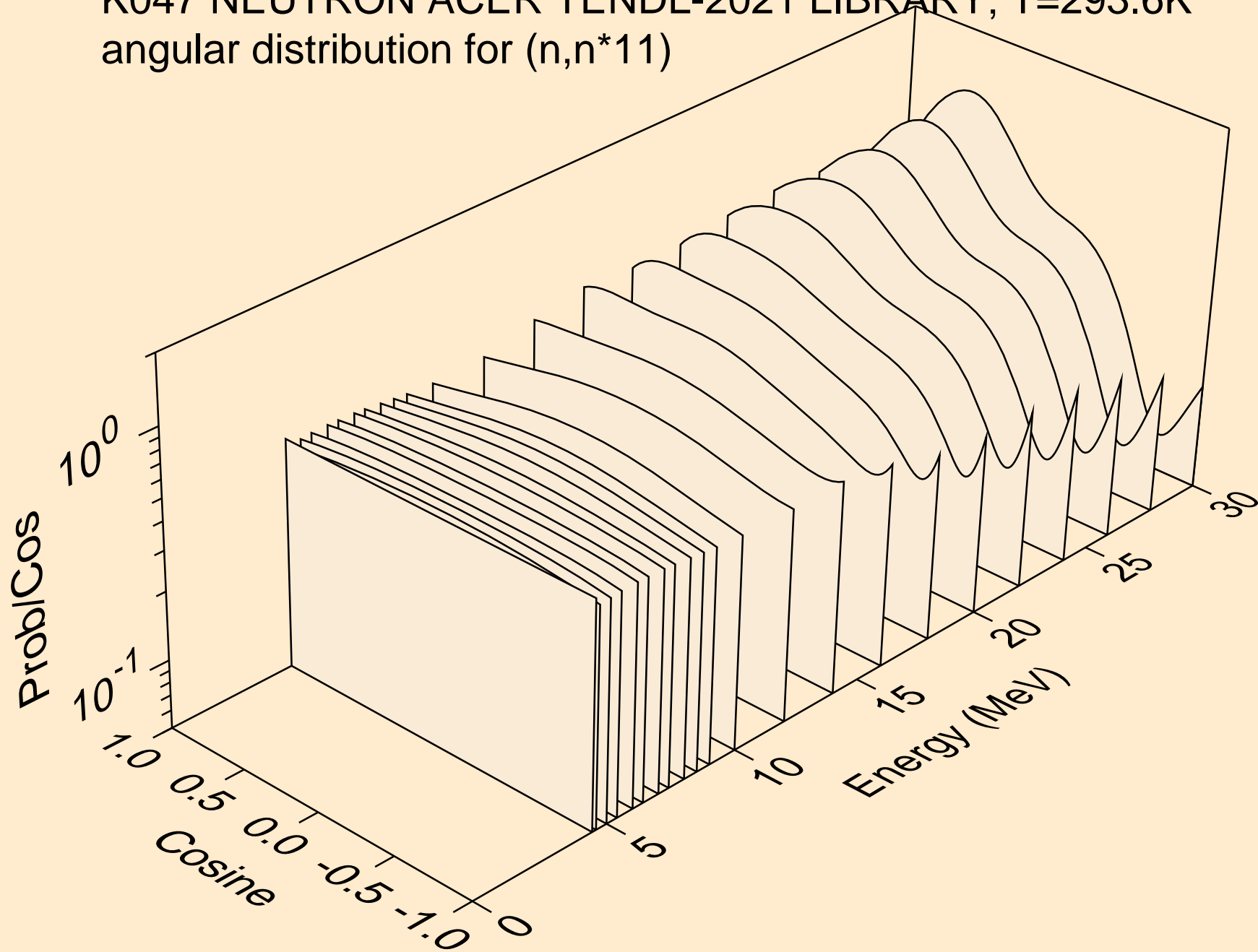

K047 NEUTRON ACER TENDL-2021 LIBRARY; T=293.6K
angular distribution for (n,n*12)

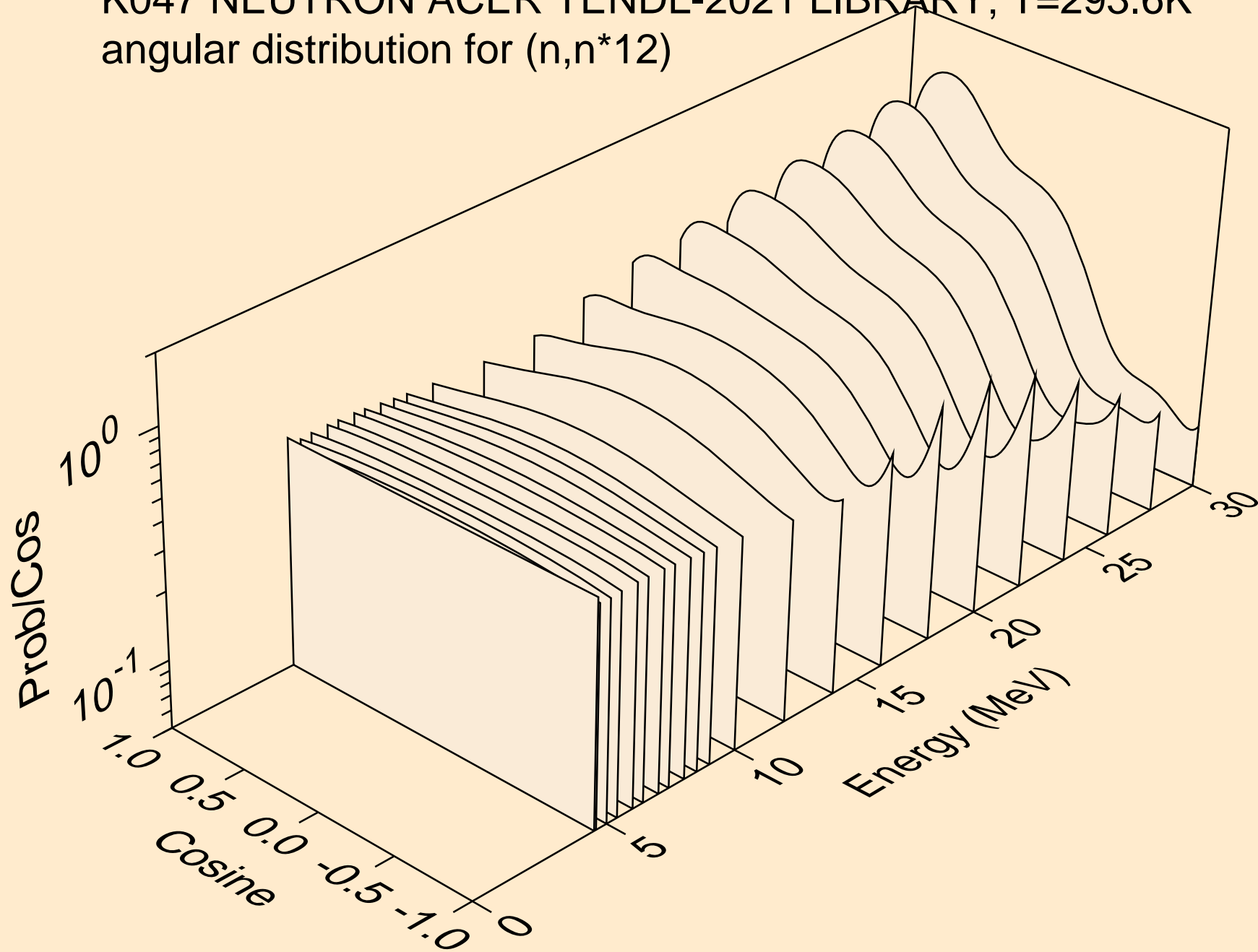

K047 NEUTRON ACER TENDL-2021 LIBRARY; T=293.6K
angular distribution for (n,n*13)

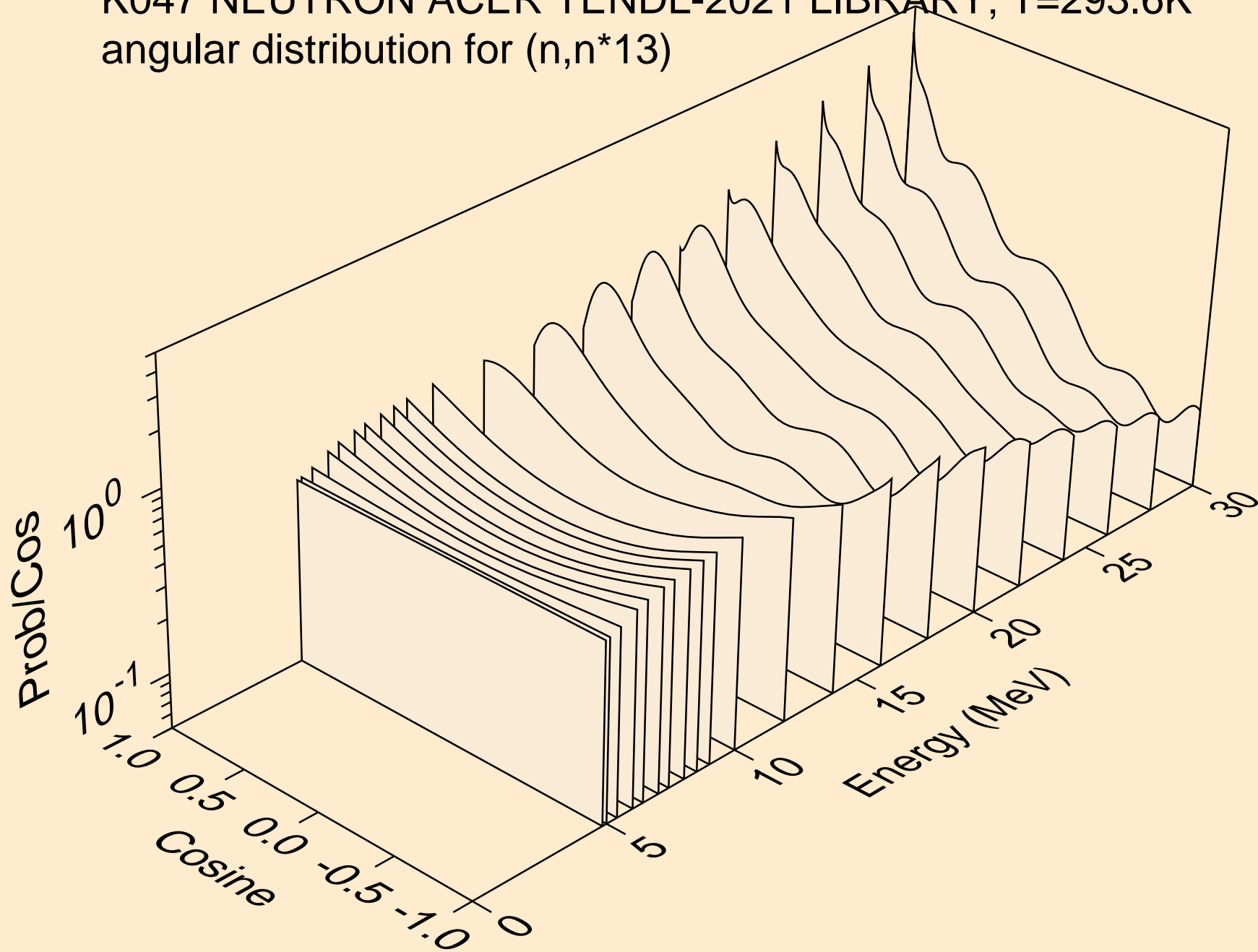

K047 NEUTRON ACER TENDL-2021 LIBRARY; T=293.6K
angular distribution for (n,n*14)

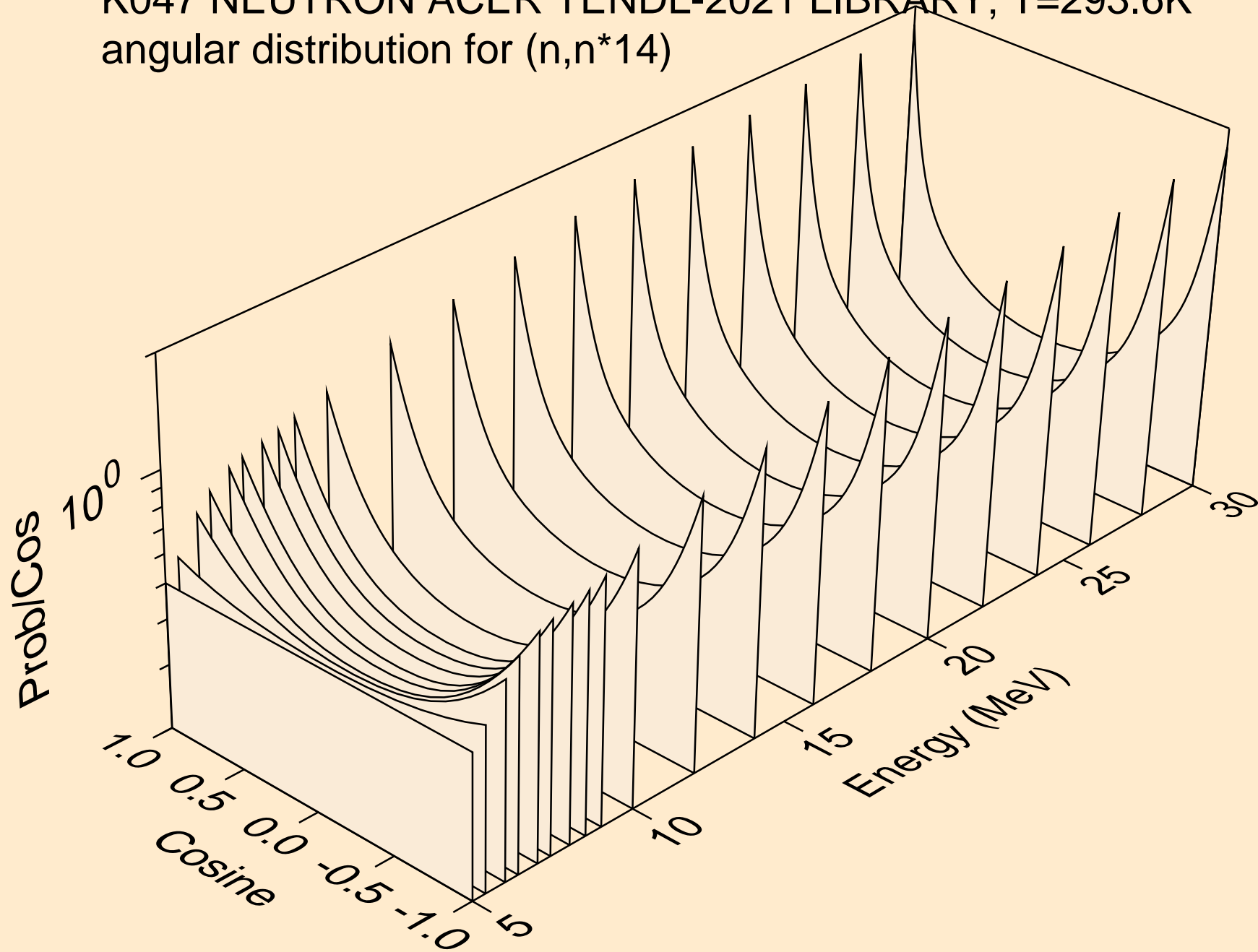

K047 NEUTRON ACER TENDL-2021 LIBRARY; T=293.6K
angular distribution for (n,n*15)

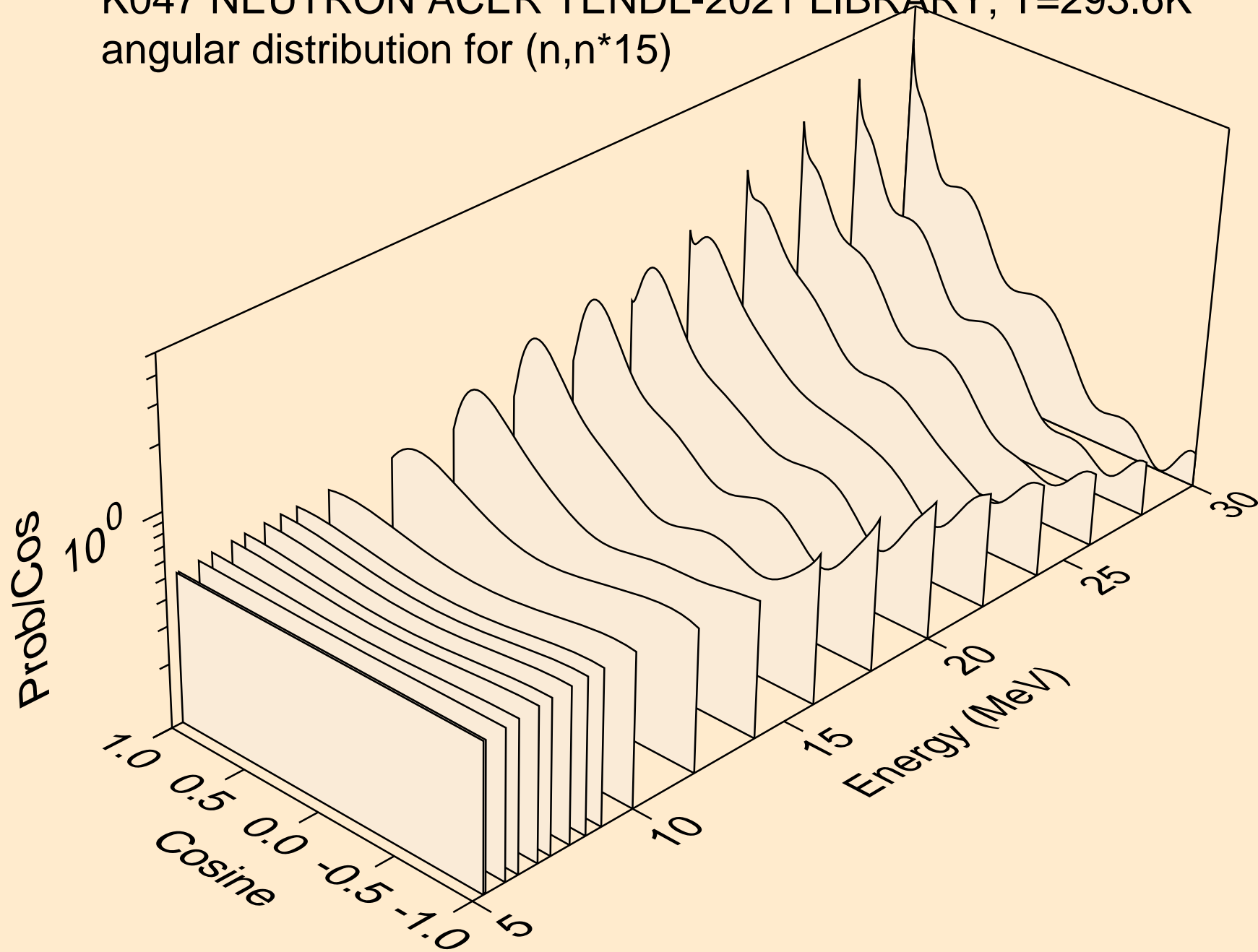

K047 NEUTRON ACER TENDL-2021 LIBRARY; T=293.6K
angular distribution for (n,n*16)

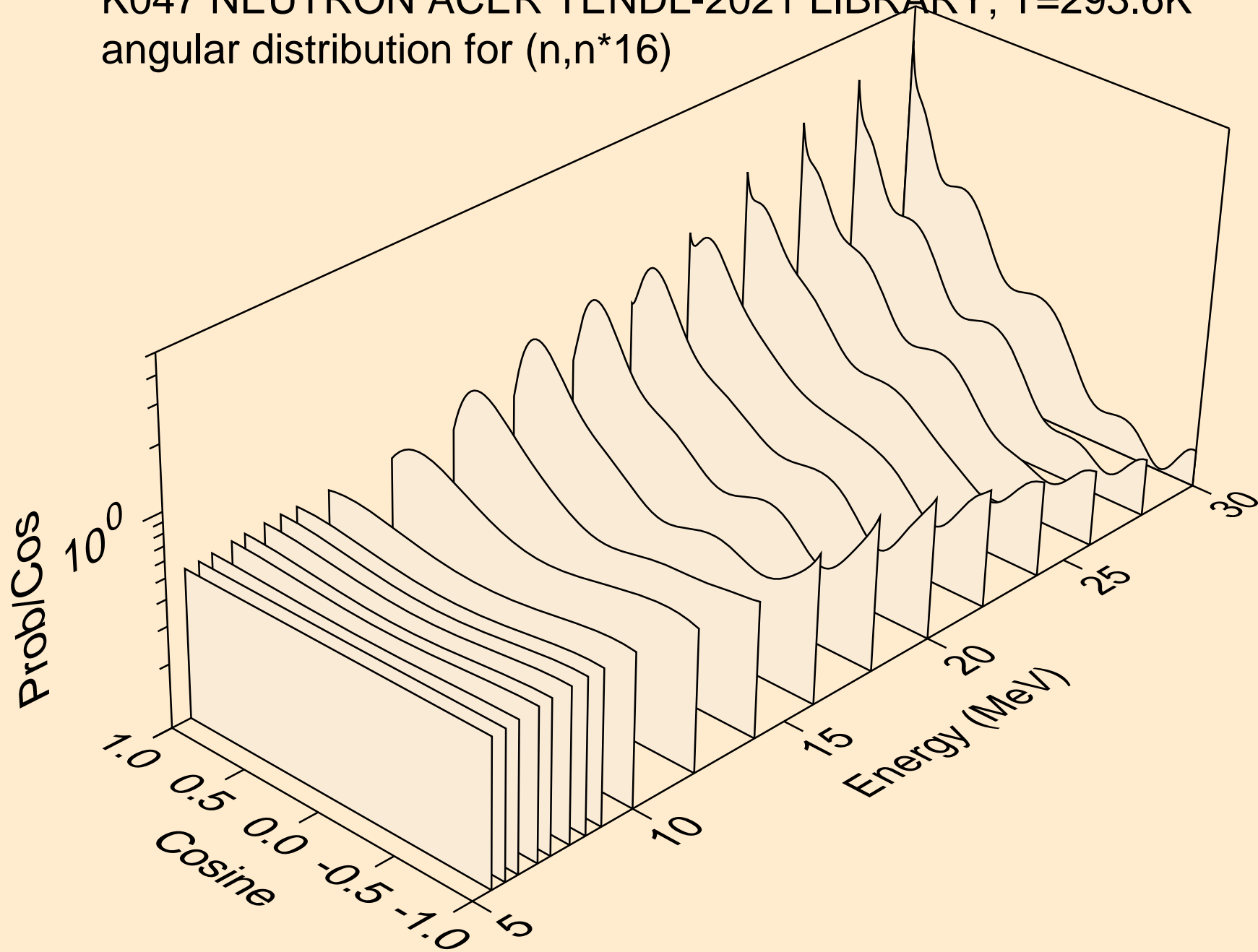

K047 NEUTRON ACER TENDL-2021 LIBRARY; T=293.6K
angular distribution for (n,n*17)

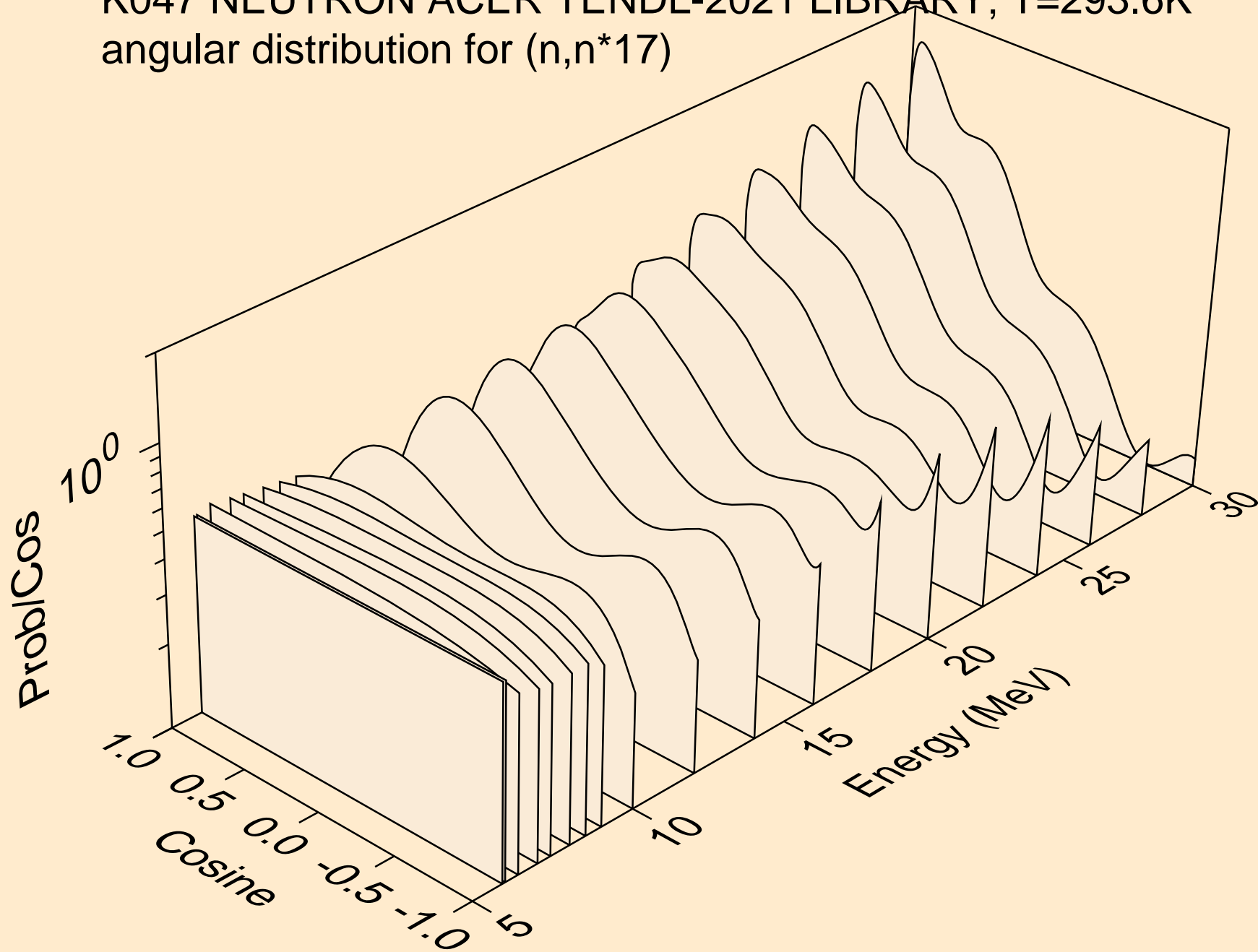

K047 NEUTRON ACER TENDL-2021 LIBRARY; T=293.6K
angular distribution for (n,n*18)

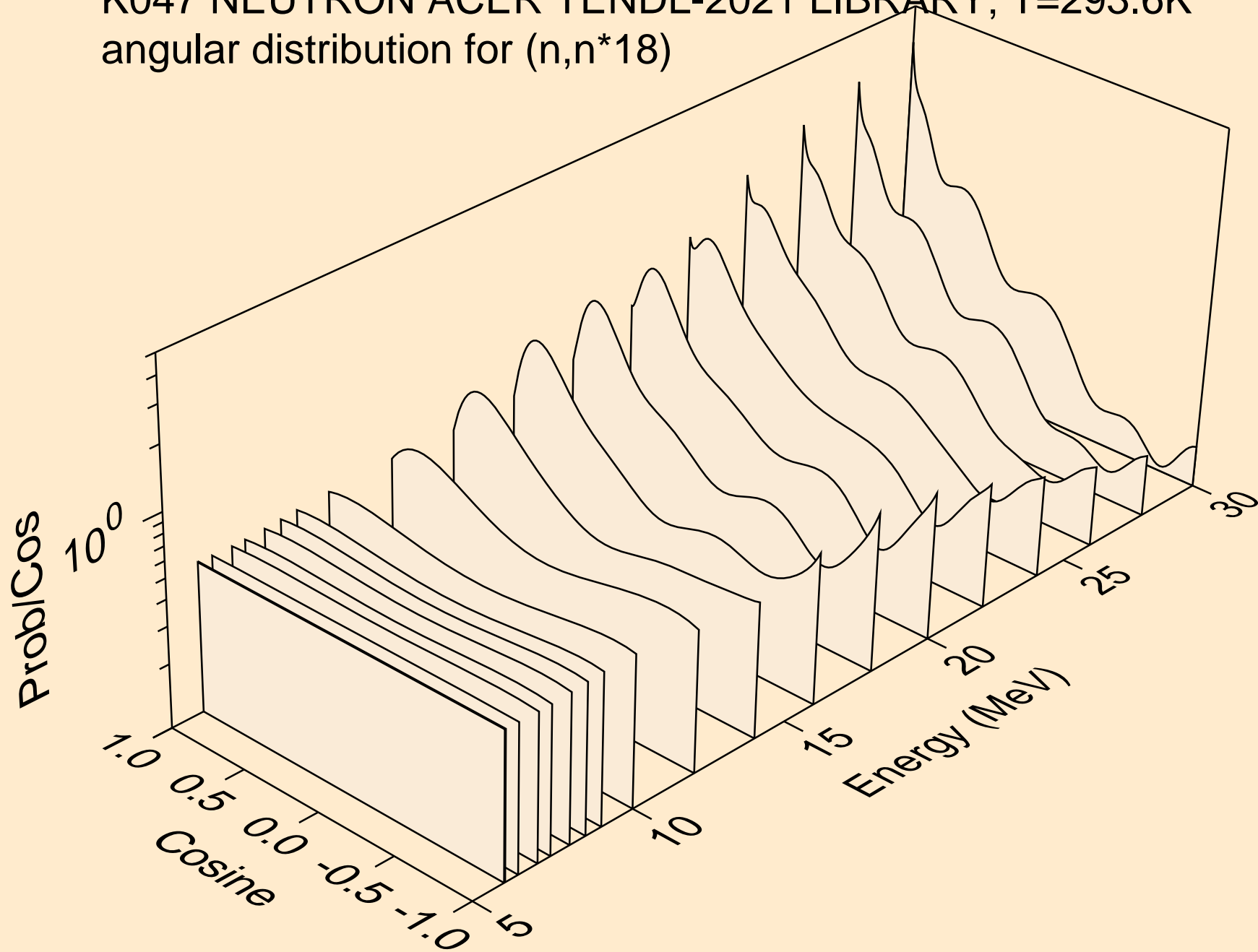

K047 NEUTRON ACER TENDL-2021 LIBRARY; T=293.6K
angular distribution for (n,n*19)

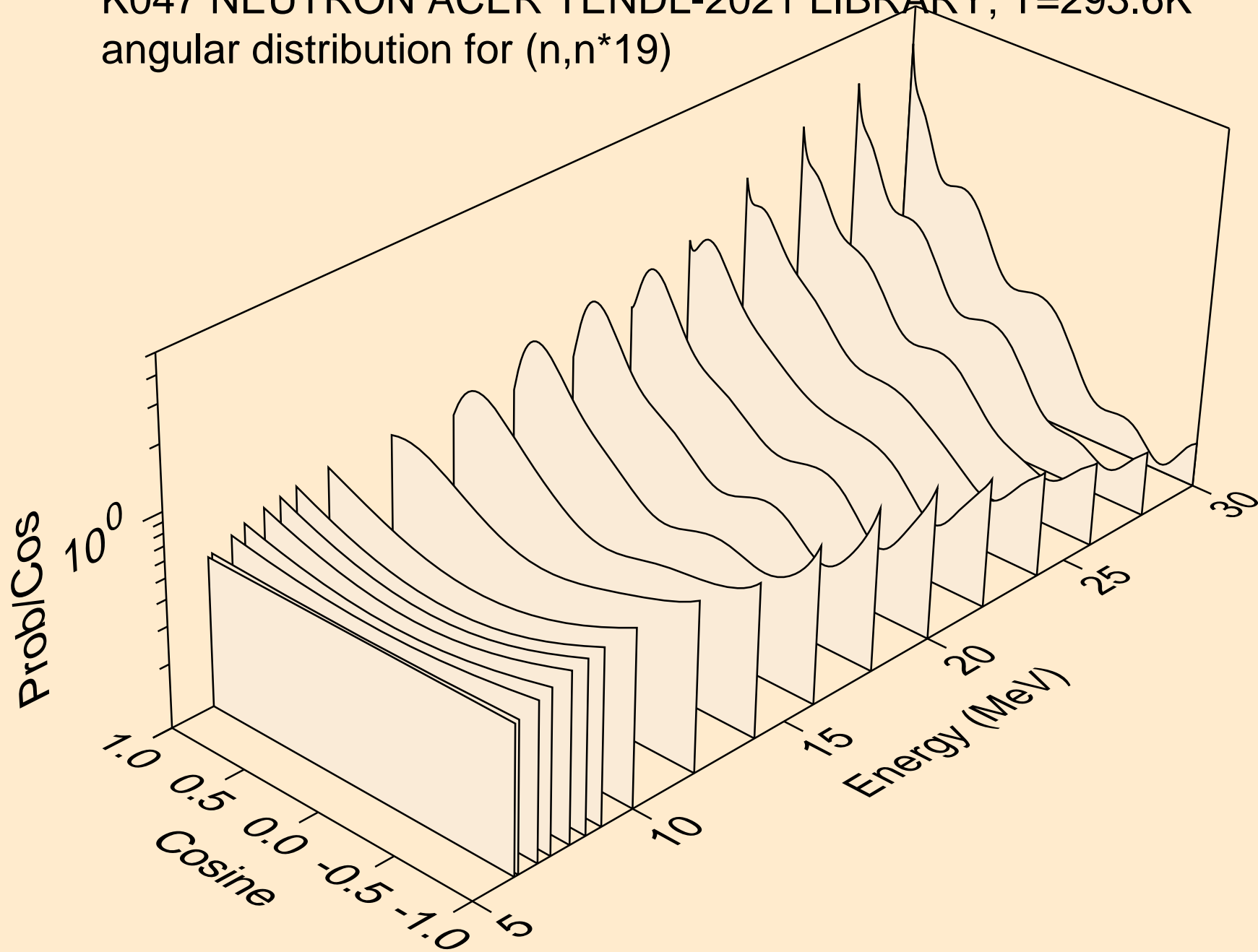

K047 NEUTRON ACER TENDL-2021 LIBRARY; T=293.6K
angular distribution for (n,n*20)

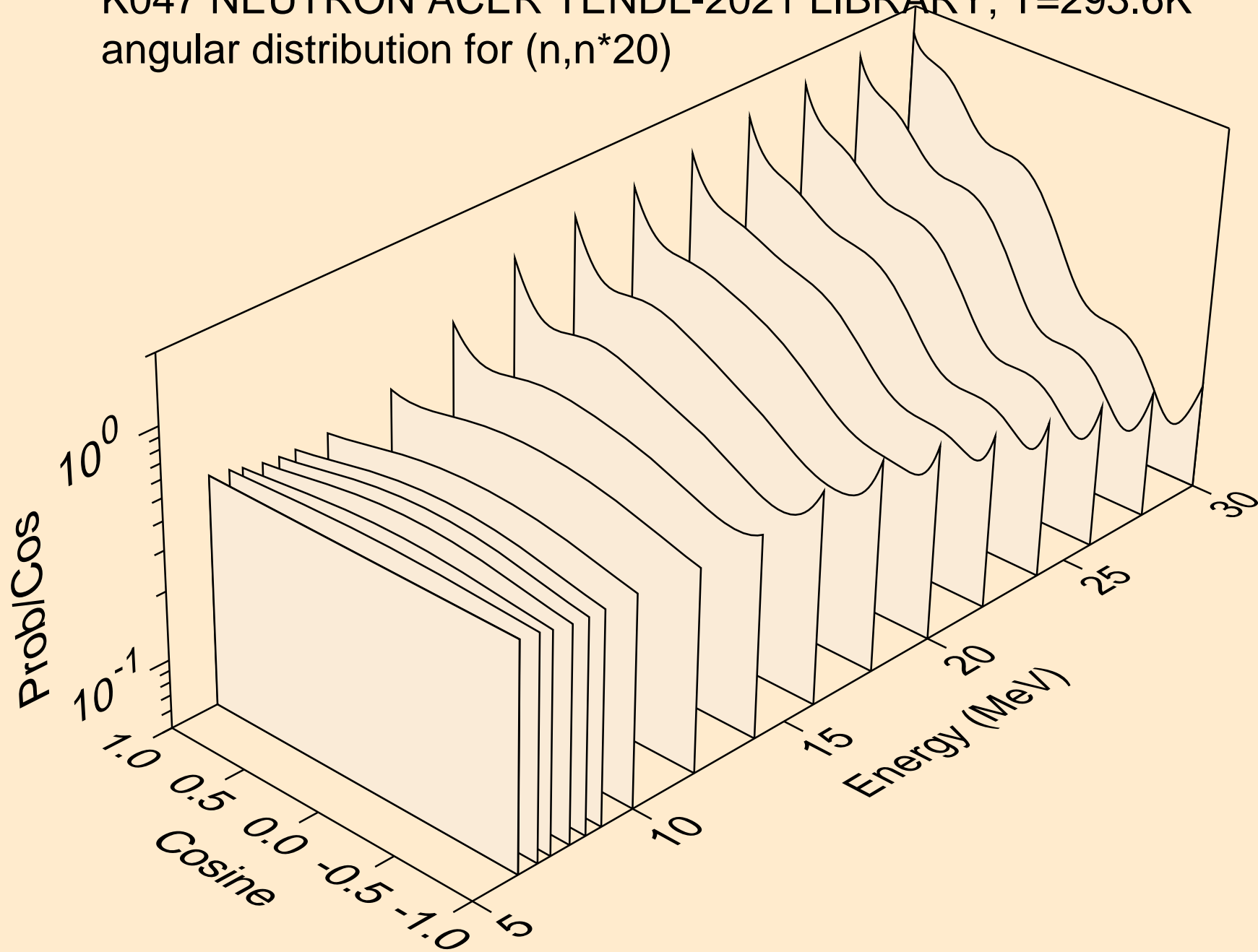

K047 NEUTRON ACER TENDL-2021 LIBRARY; T=293.6K
angular distribution for (n,n*21)

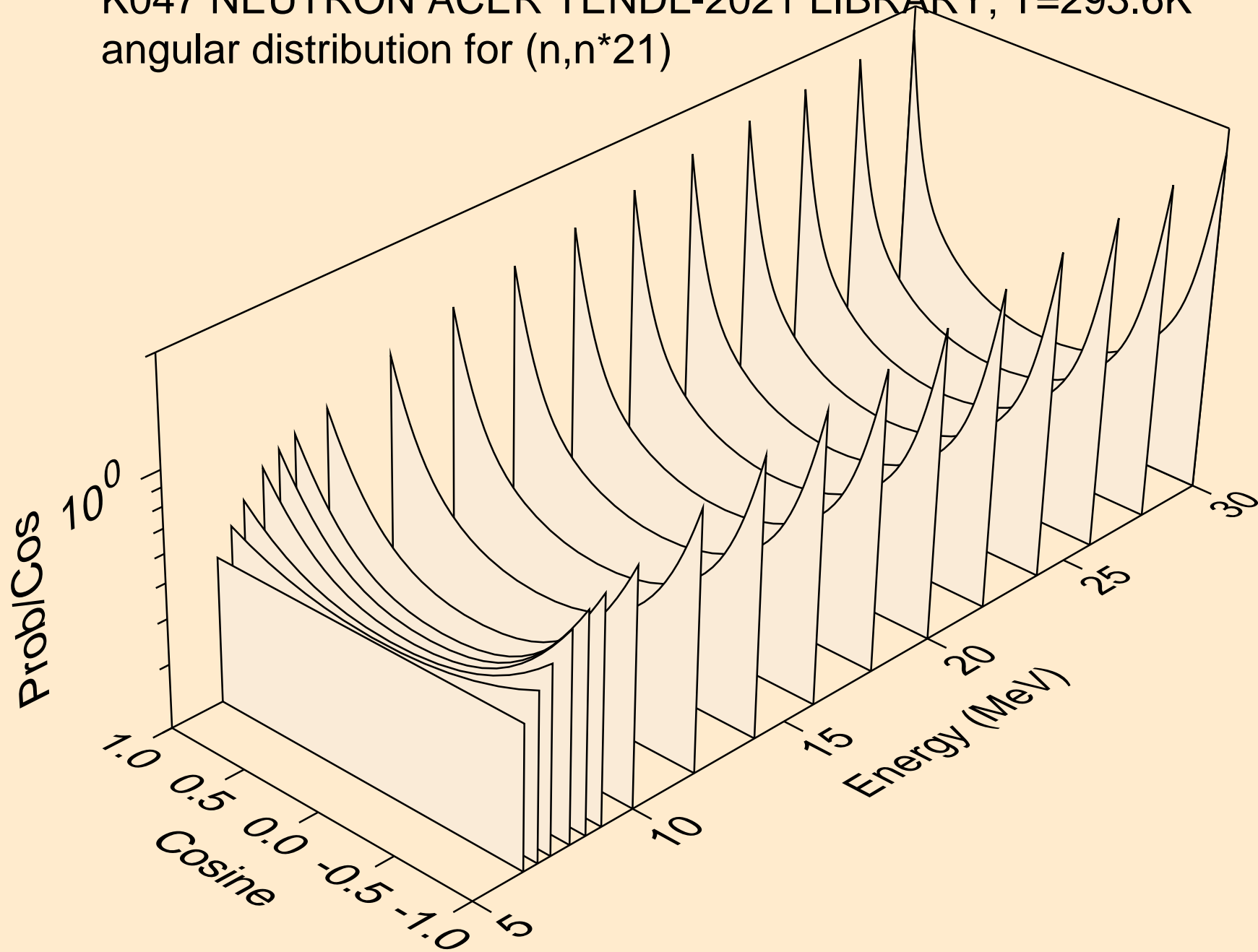

K047 NEUTRON ACER TENDL-2021 LIBRARY; T=293.6K
angular distribution for (n,n*22)

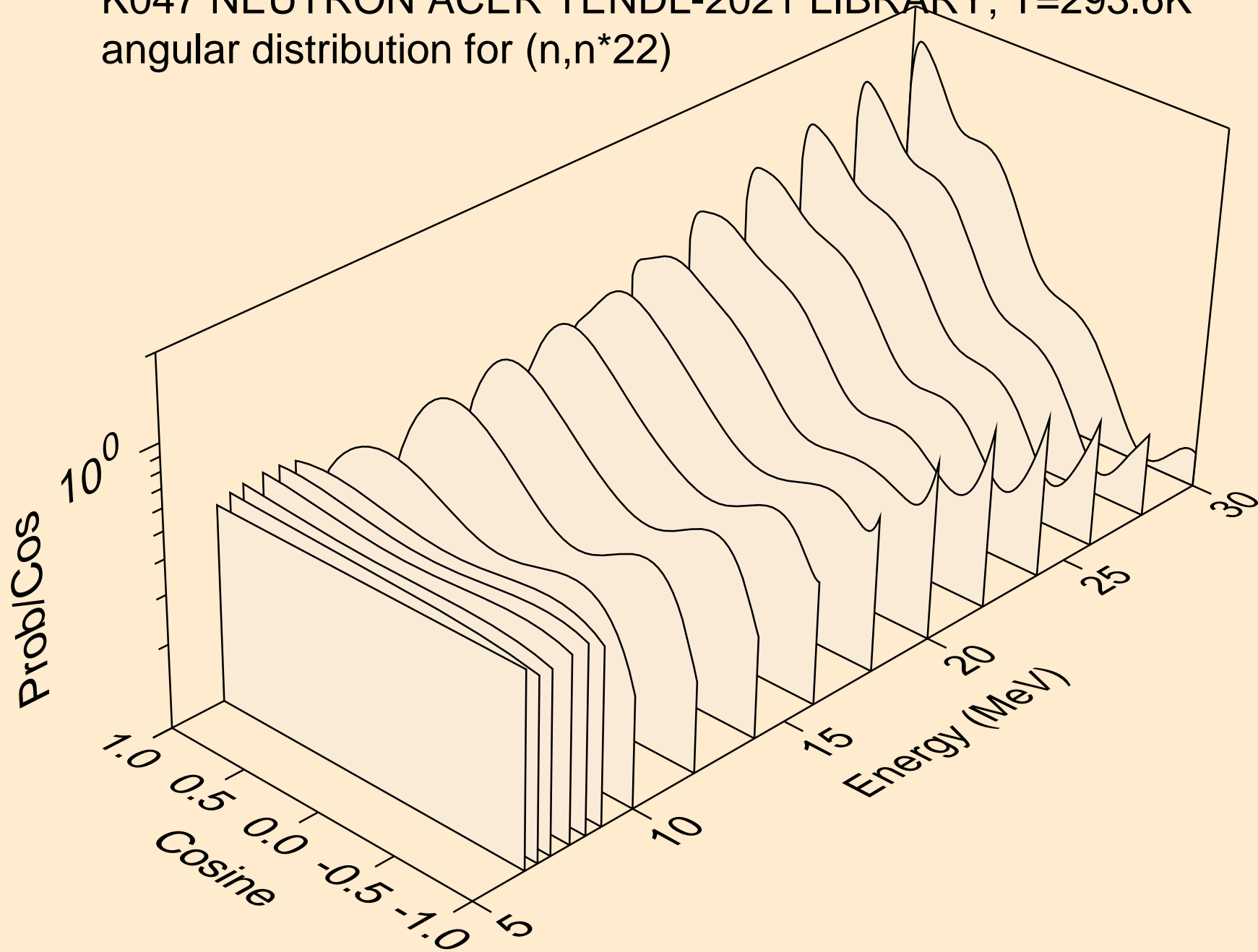

K047 NEUTRON ACER TENDL-2021 LIBRARY; T=293.6K
angular distribution for (n,n*23)

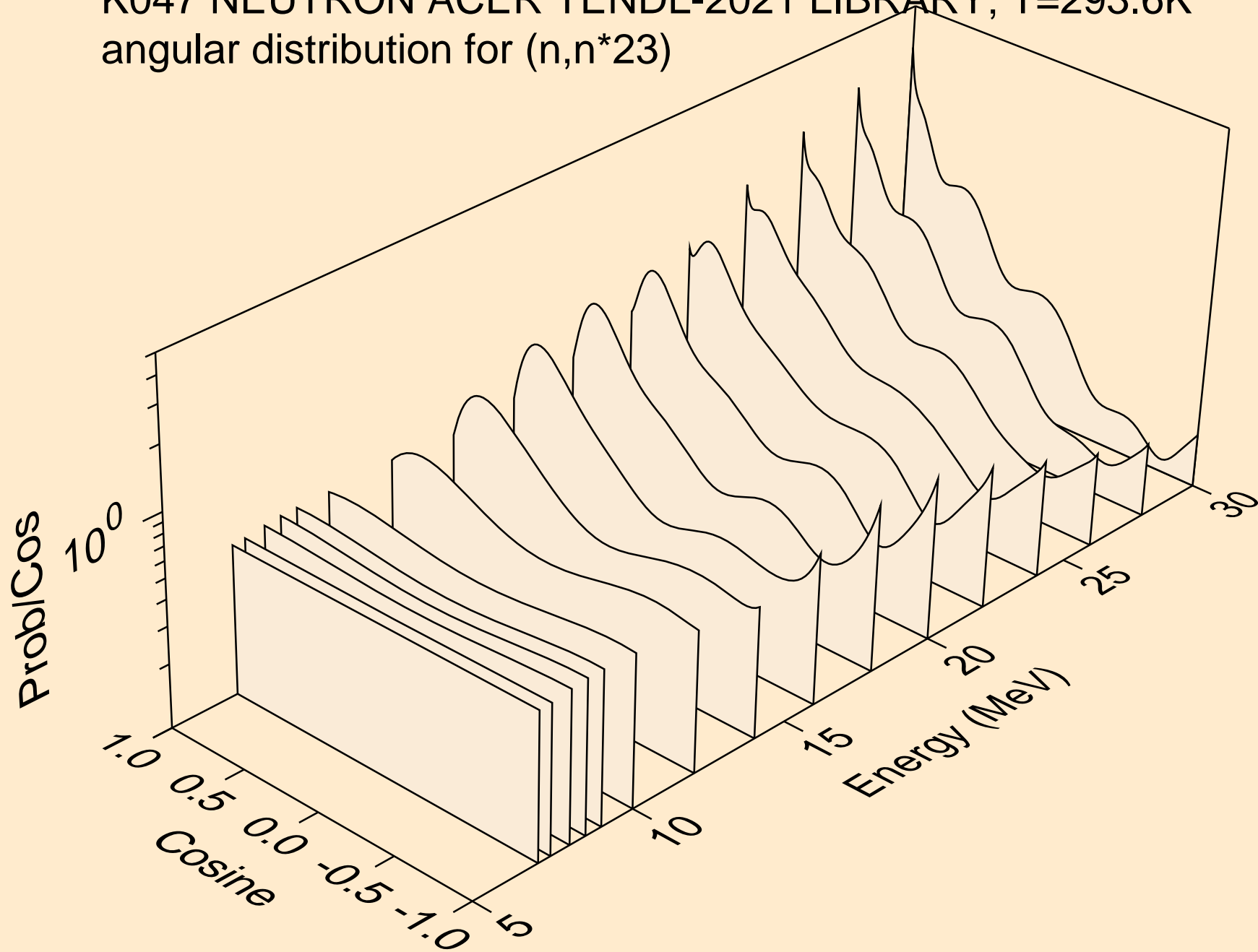

K047 NEUTRON ACER TENDL-2021 LIBRARY; T=293.6K
angular distribution for (n,n*24)

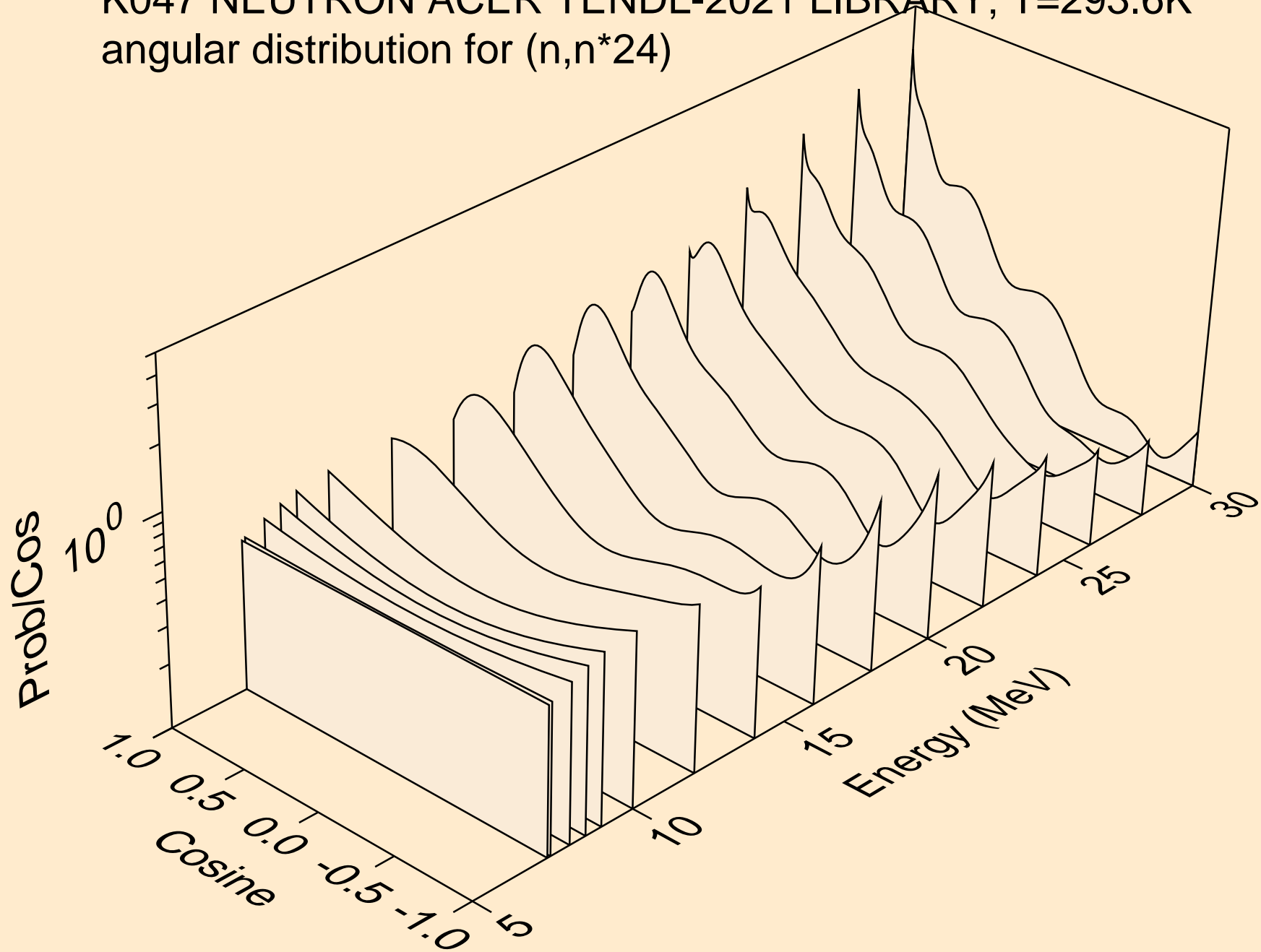

K047 NEUTRON ACER TENDL-2021 LIBRARY; T=293.6K
angular distribution for (n,n*25)

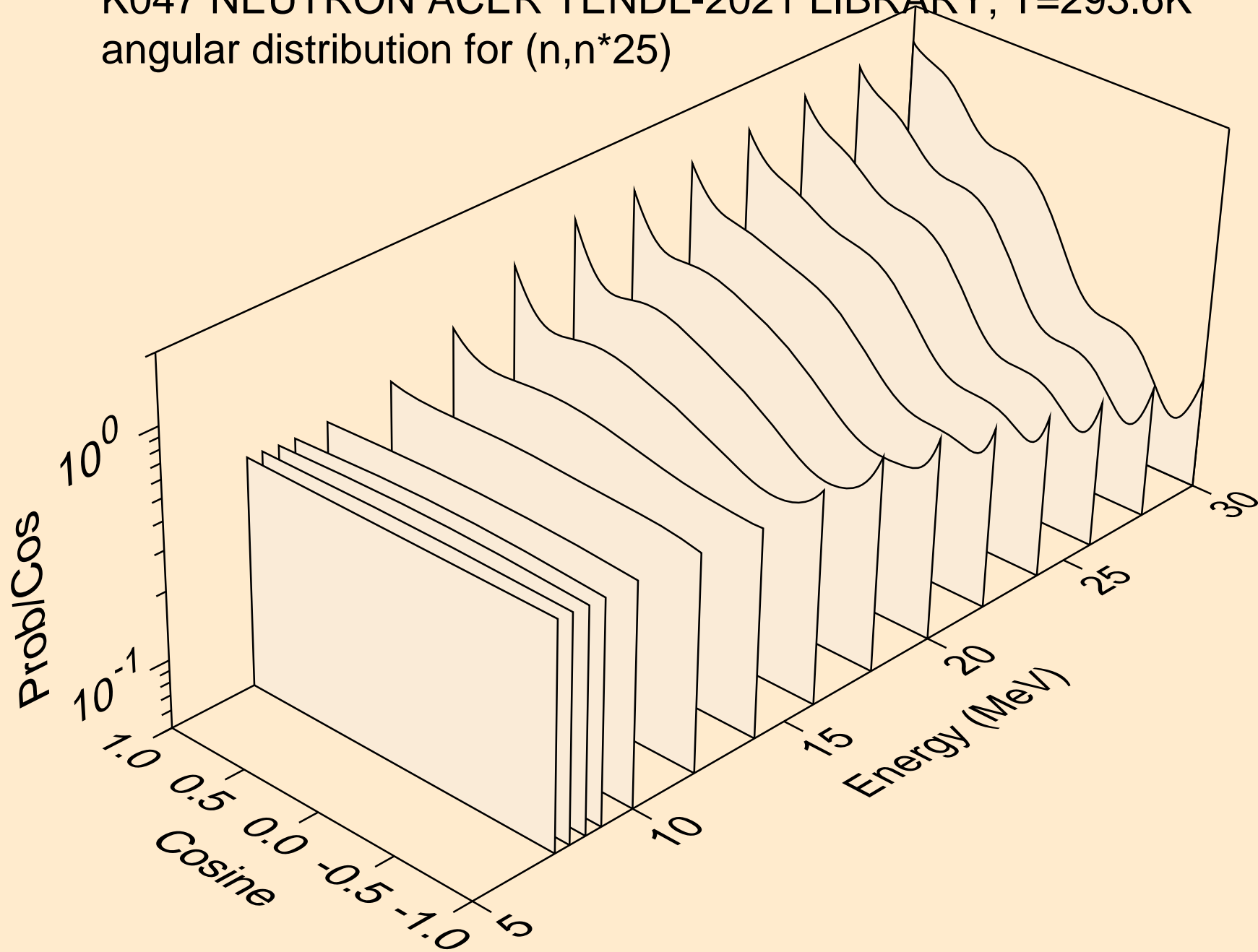

K047 NEUTRON ACER TENDL-2021 LIBRARY; T=293.6K
angular distribution for (n,n*26)

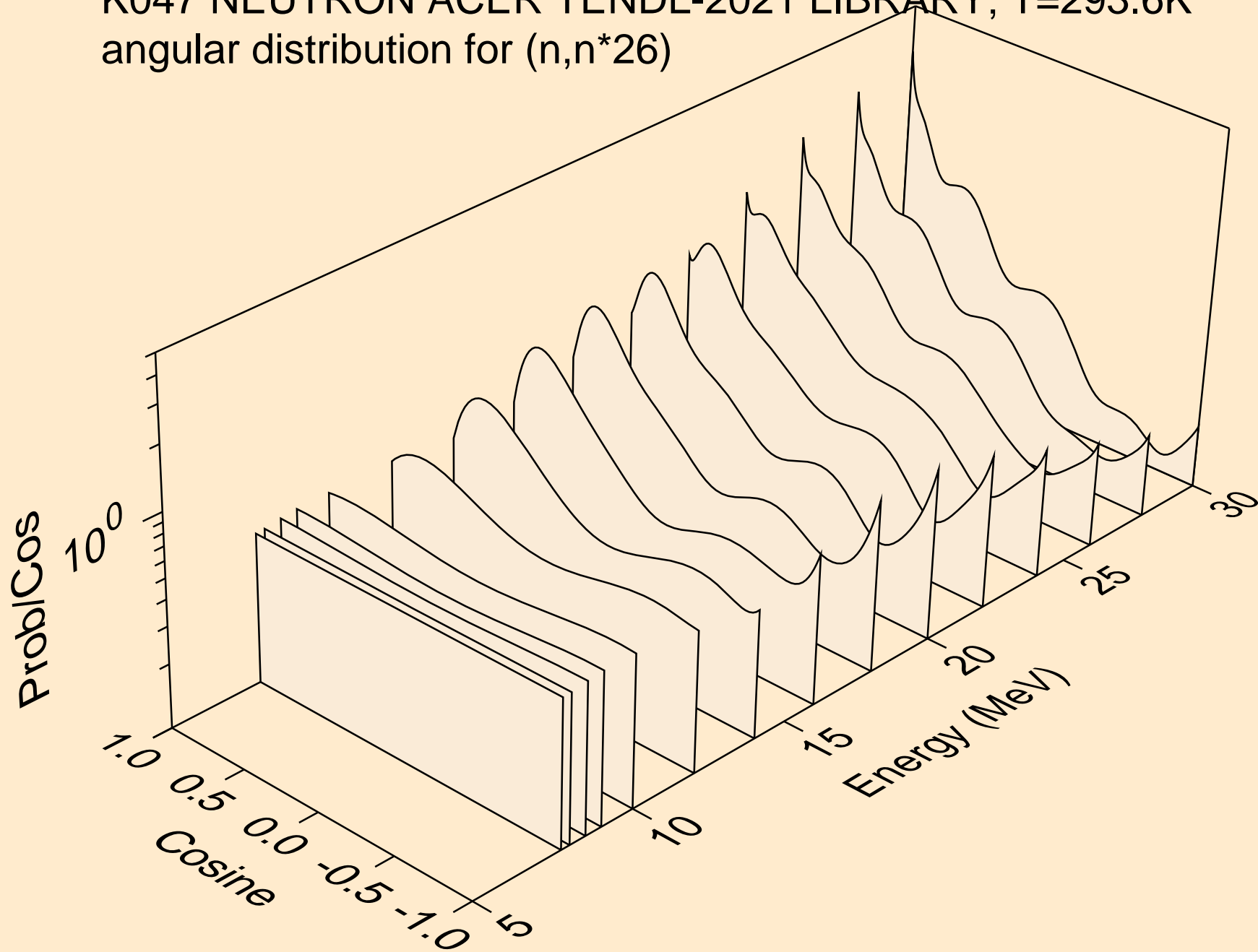

K047 NEUTRON ACER TENDL-2021 LIBRARY; T=293.6K
angular distribution for (n,n*27)

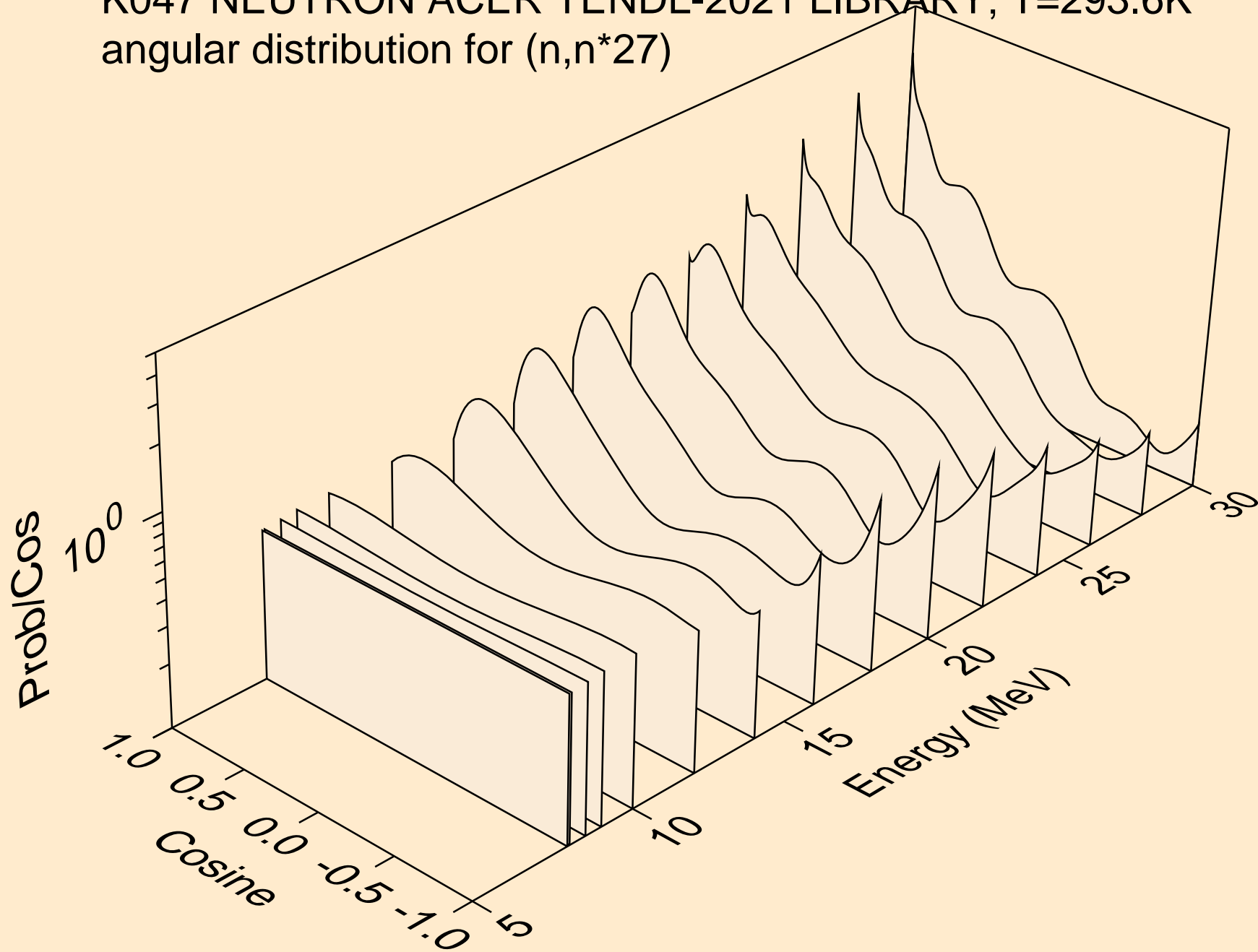

K047 NEUTRON ACER TENDL-2021 LIBRARY; T=293.6K
Neutron emission for (n,x)

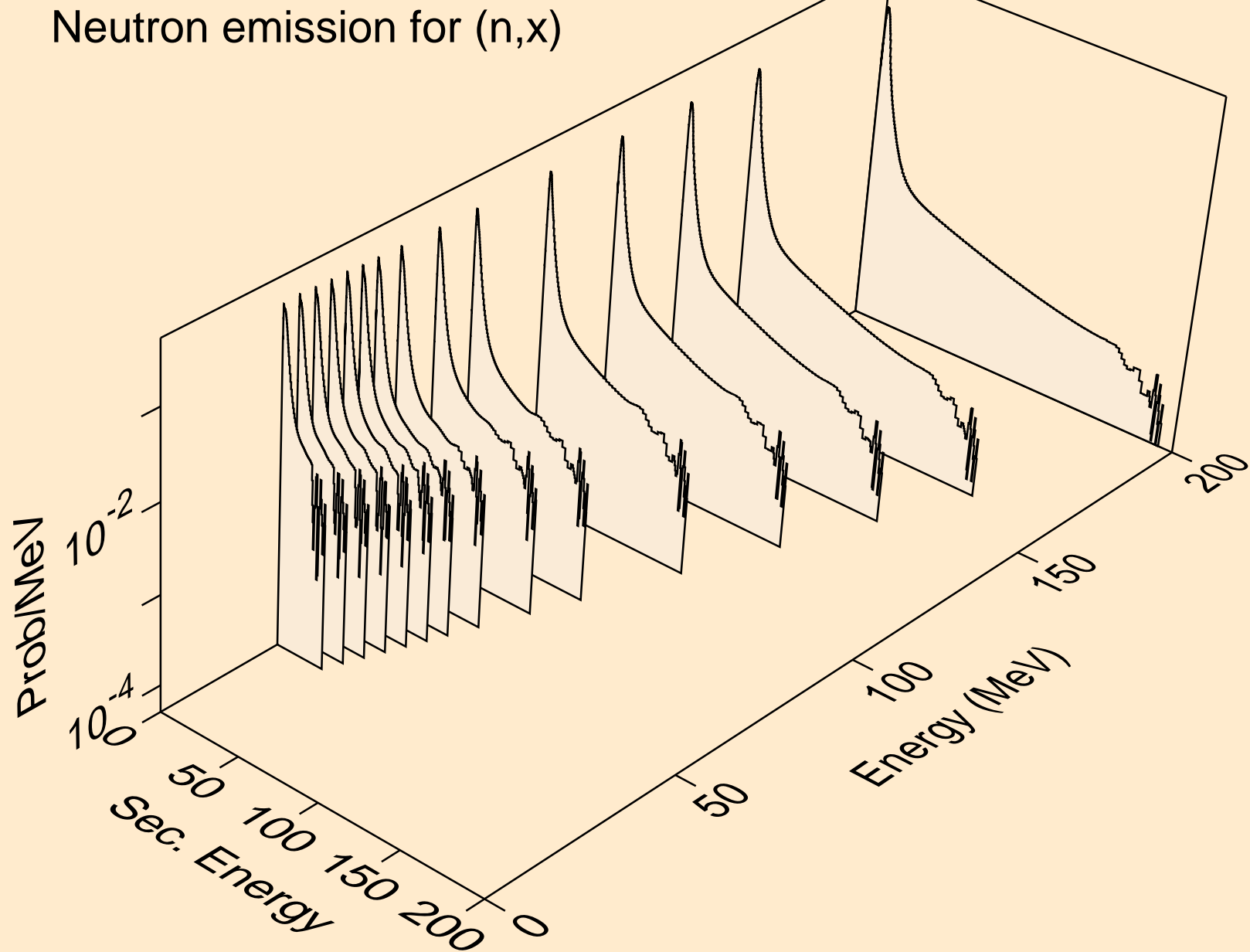

K047 NEUTRON ACER TENDL-2021 LIBRARY; T=293.6K
Neutron emission for (n,2nd)

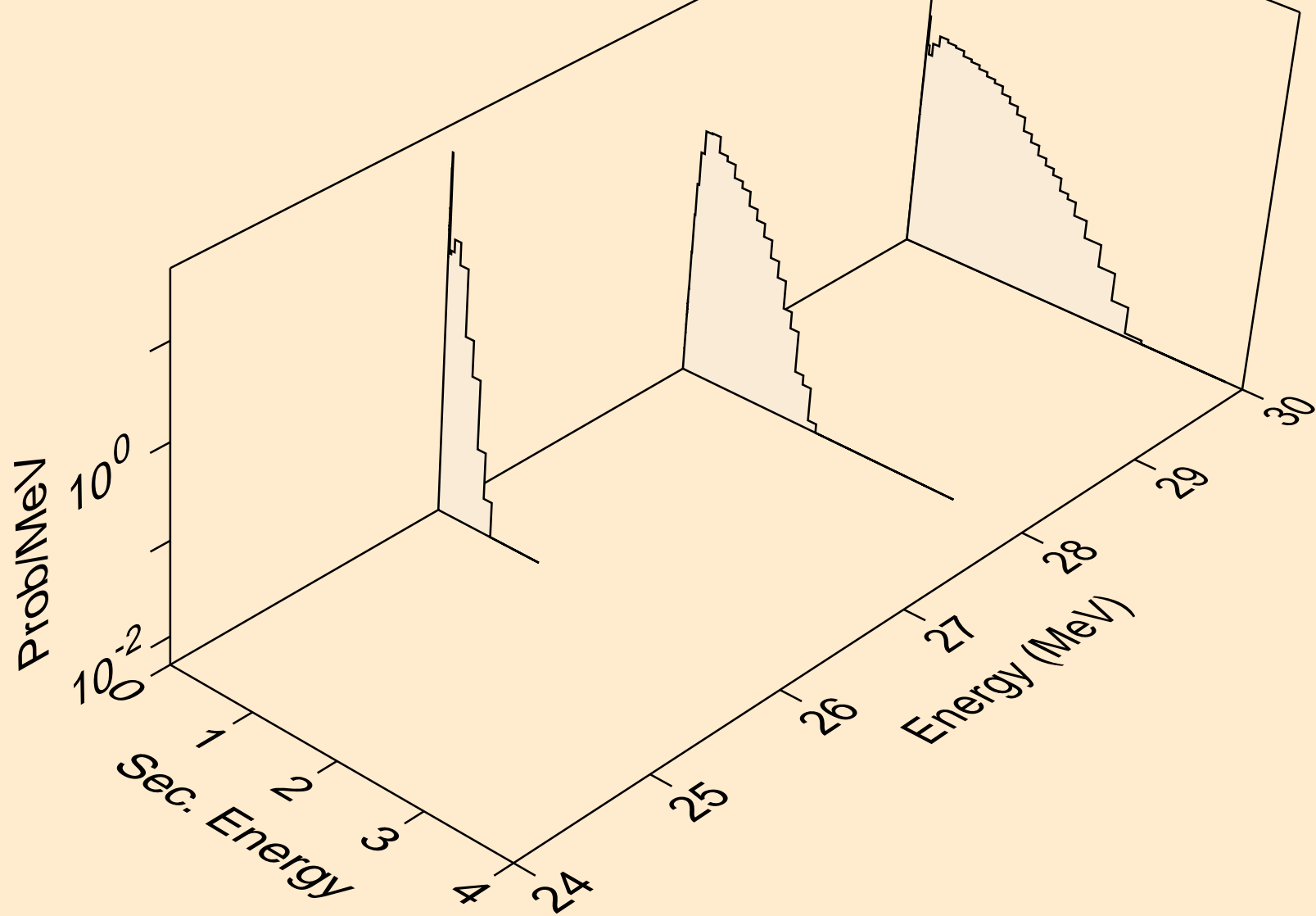

K047 NEUTRON ACER TENDL-2021 LIBRARY; T=293.6K
Neutron emission for (n,2n)

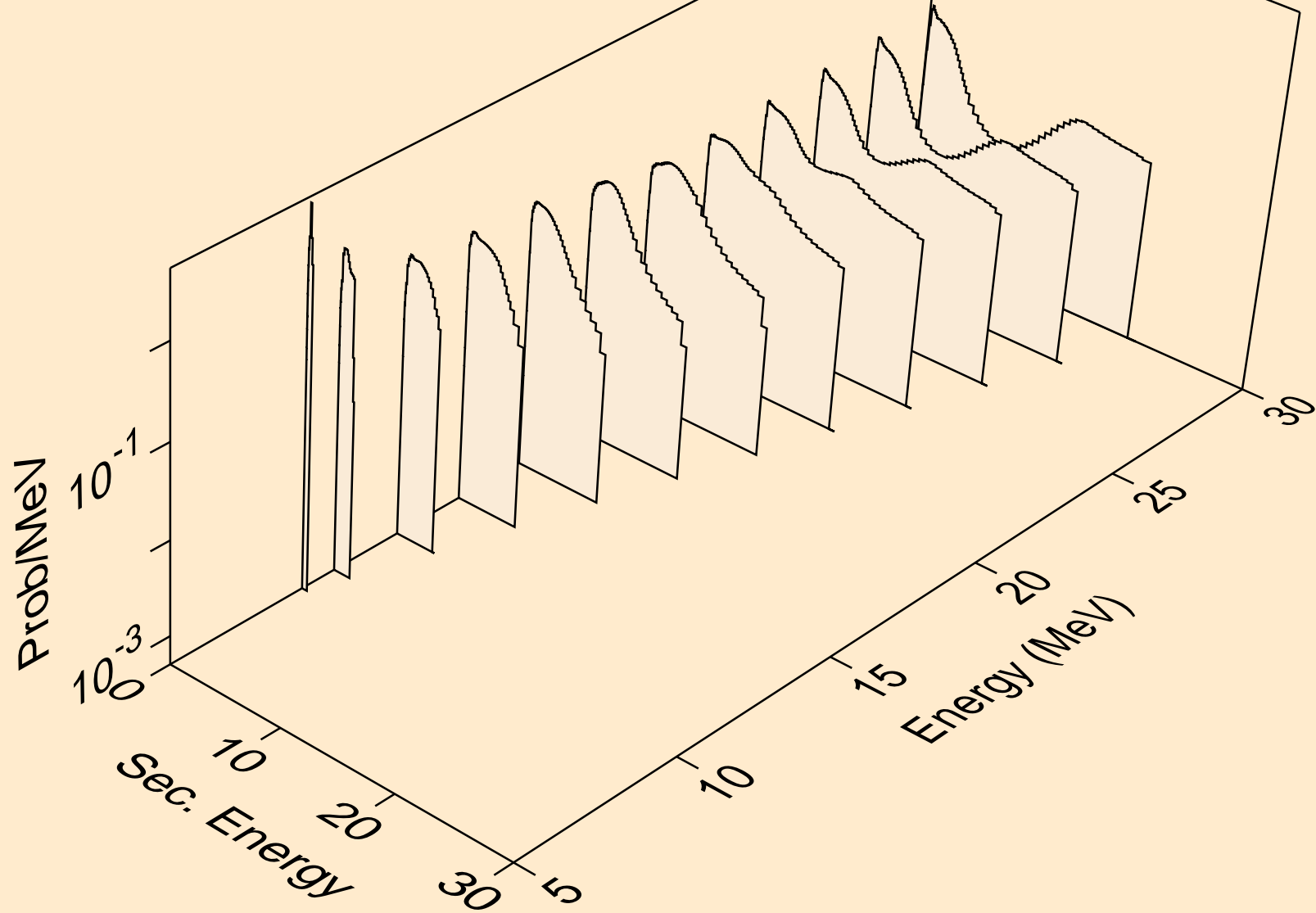

K047 NEUTRON ACER TENDL-2021 LIBRARY; T=293.6K
Neutron emission for (n,3n)

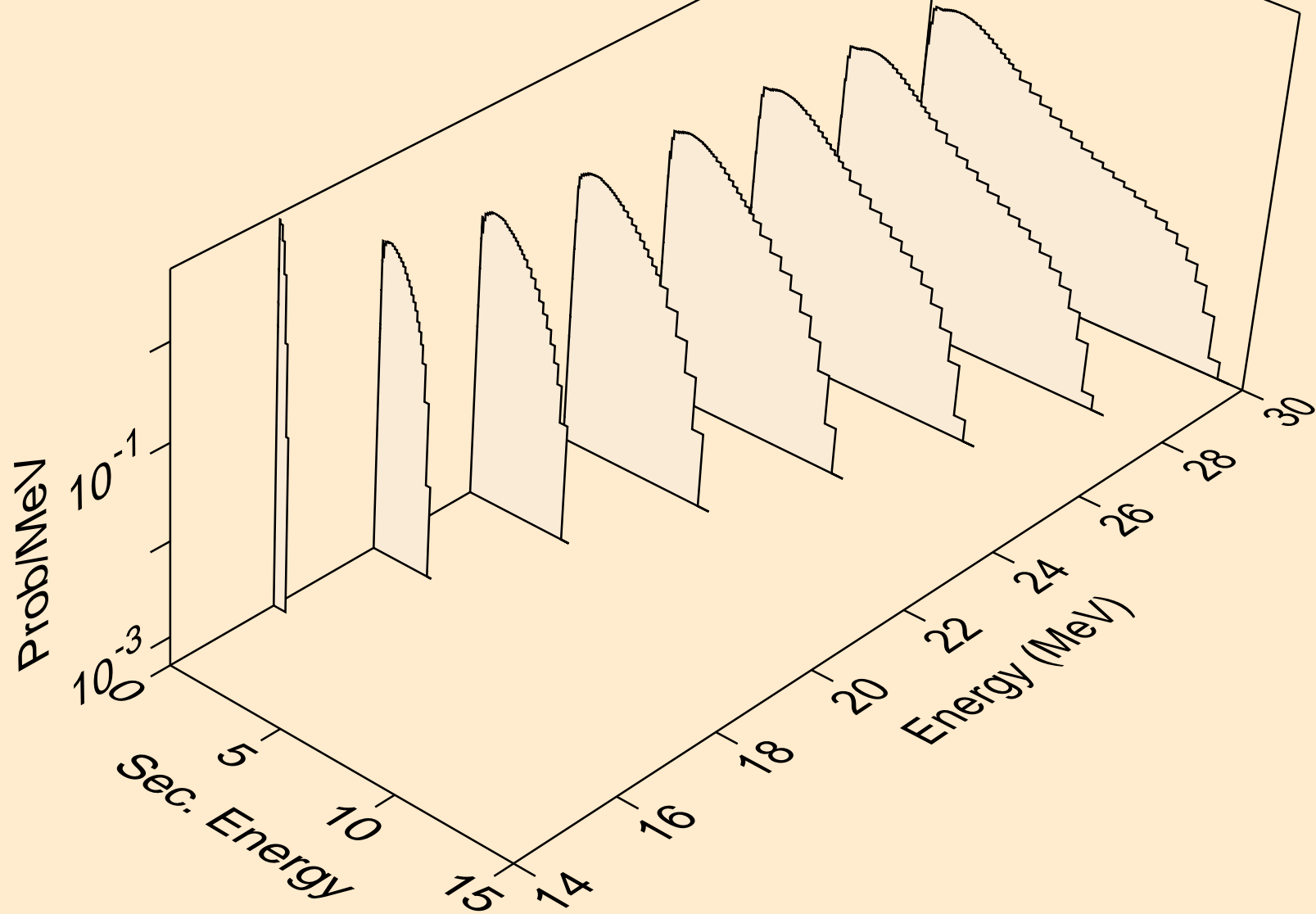

K047 NEUTRON ACER TENDL-2021 LIBRARY; T=293.6K
Neutron emission for (n,n*)a

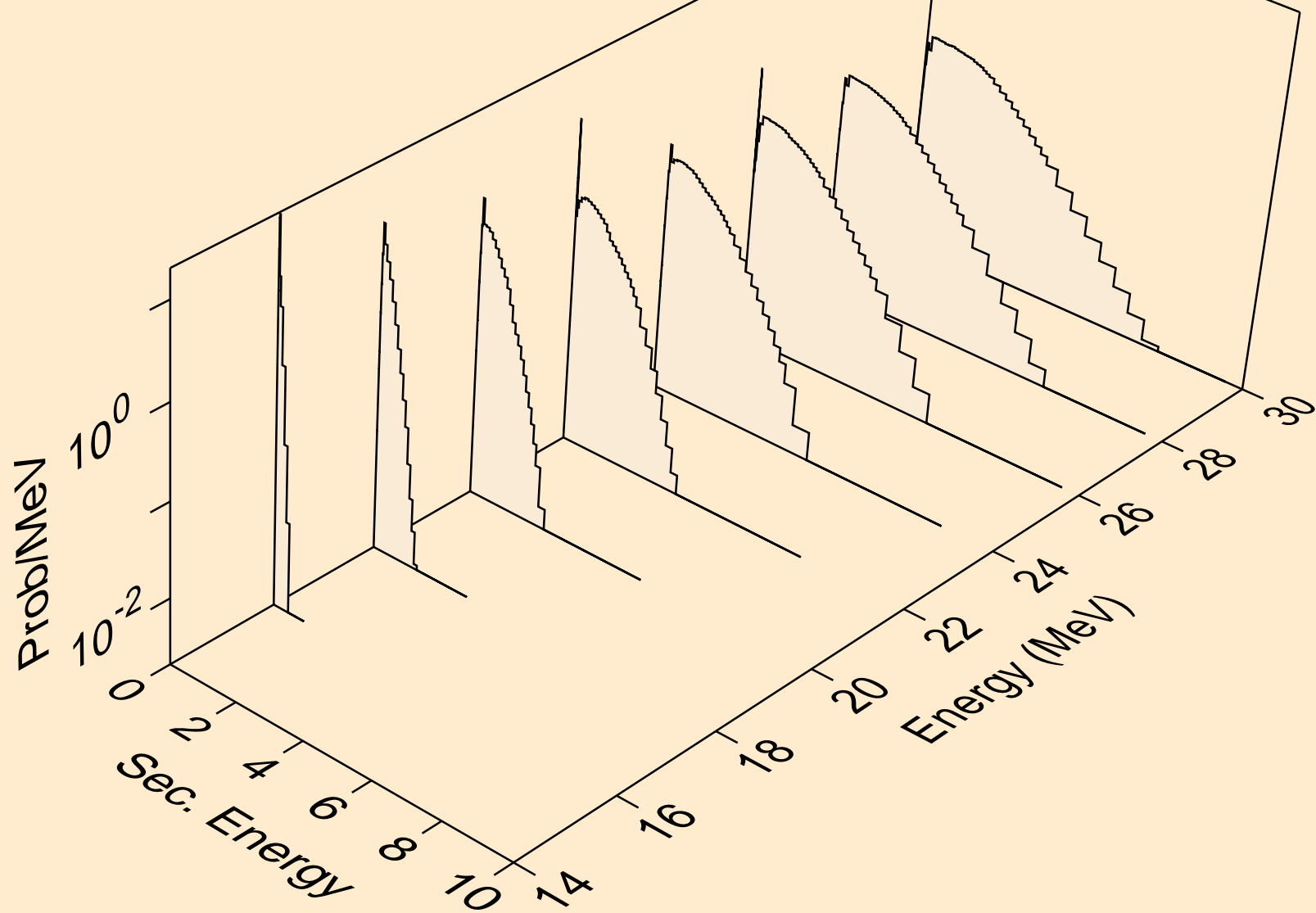

K047 NEUTRON ACER TENDL-2021 LIBRARY; T=293.6K
Neutron emission for (n,2n)a

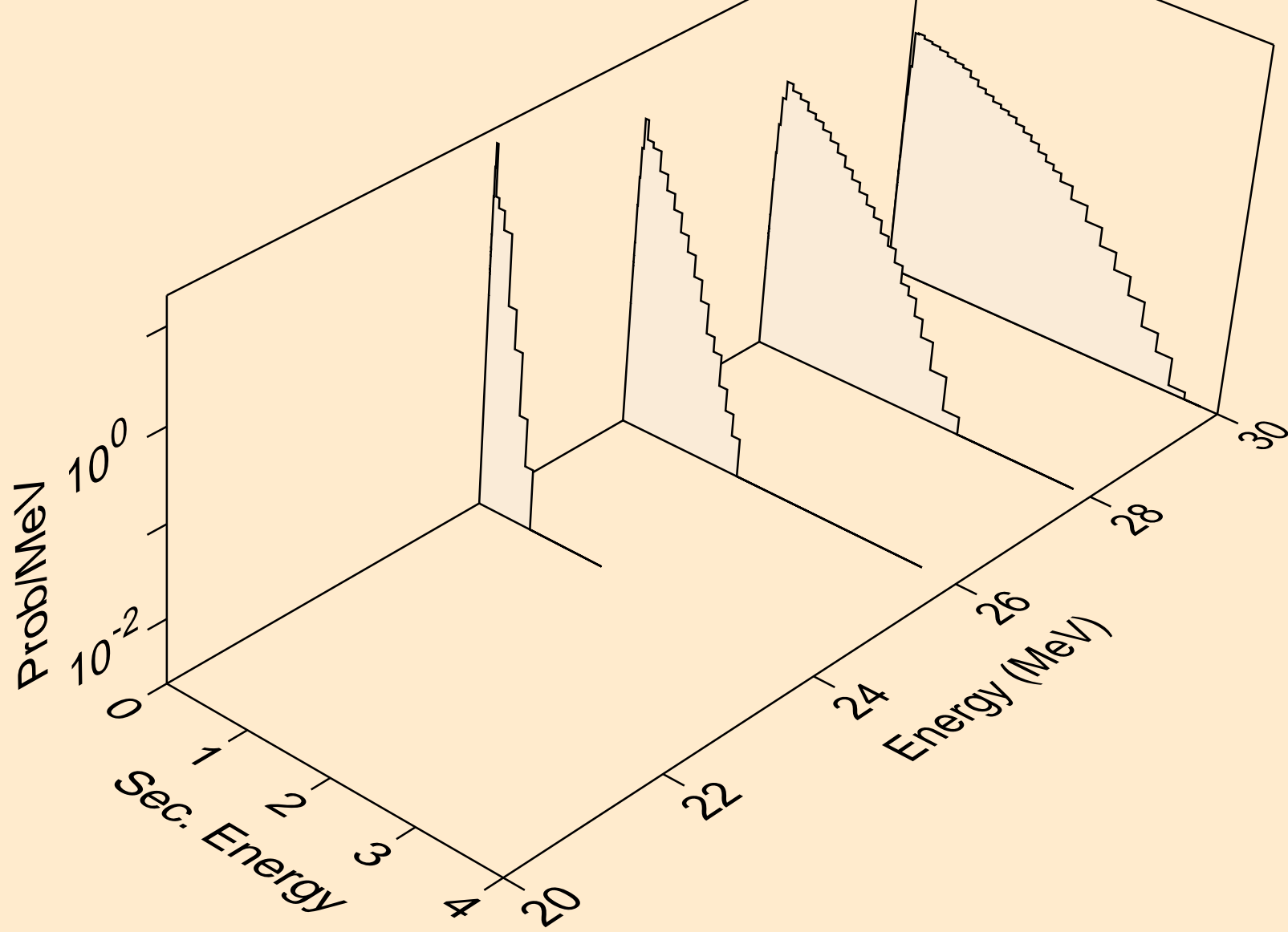

K047 NEUTRON ACER TENDL-2021 LIBRARY; T=293.6K
Neutron emission for (n,n*)p

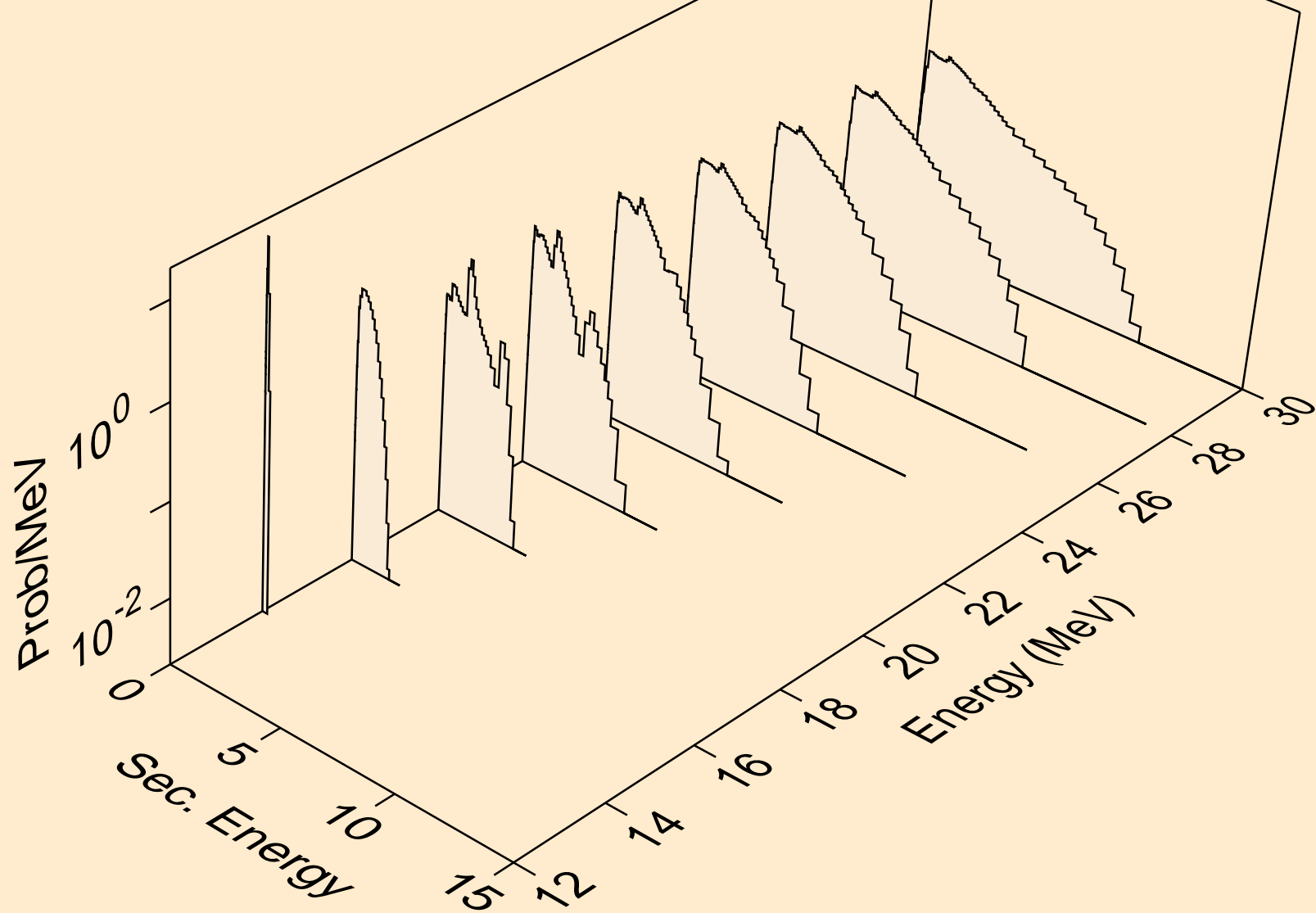

K047 NEUTRON ACER TENDL-2021 LIBRARY; T=293.6K
Neutron emission for (n,n*)d

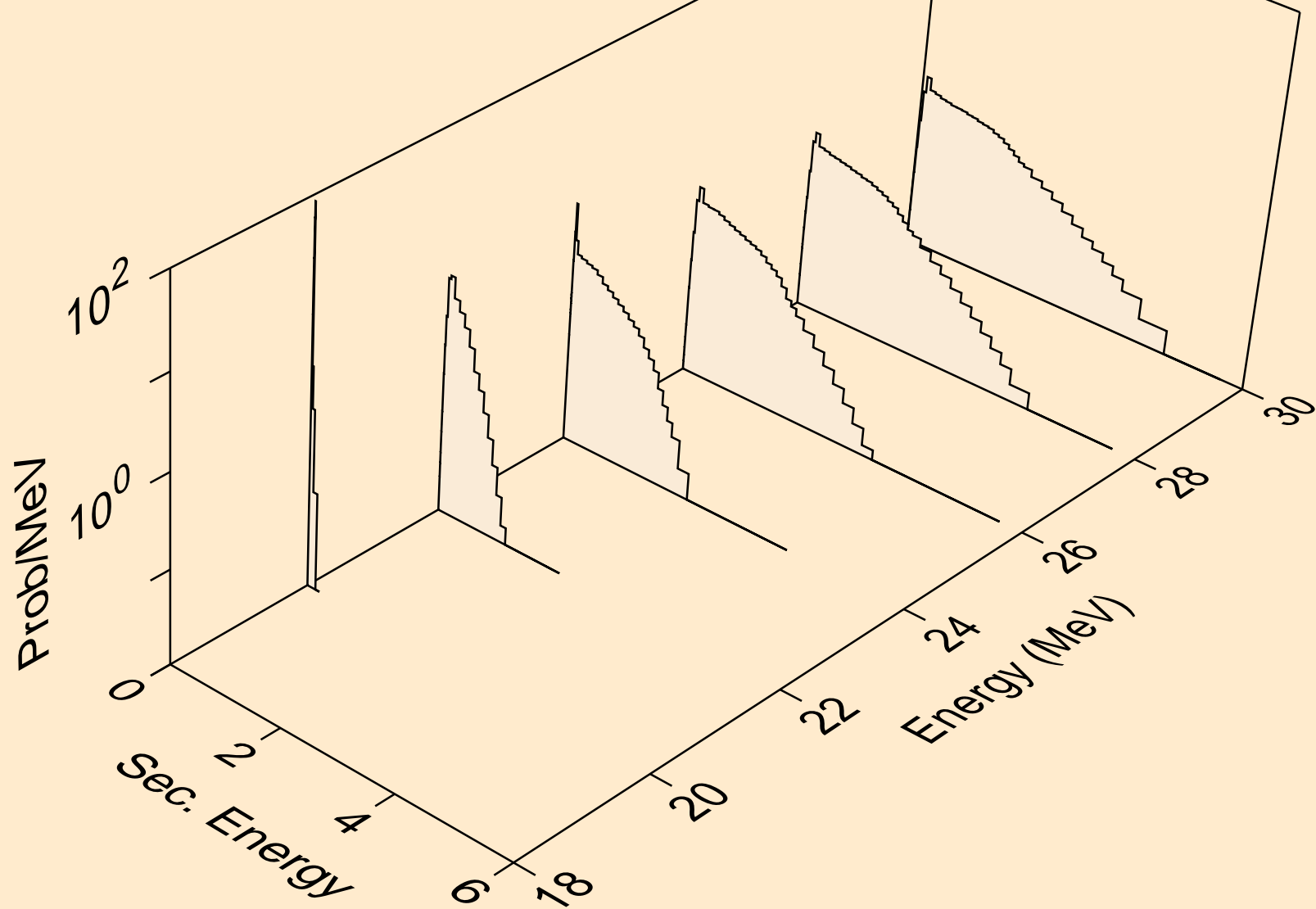

K047 NEUTRON ACER TENDL-2021 LIBRARY; T=293.6K
Neutron emission for (n,n*)t

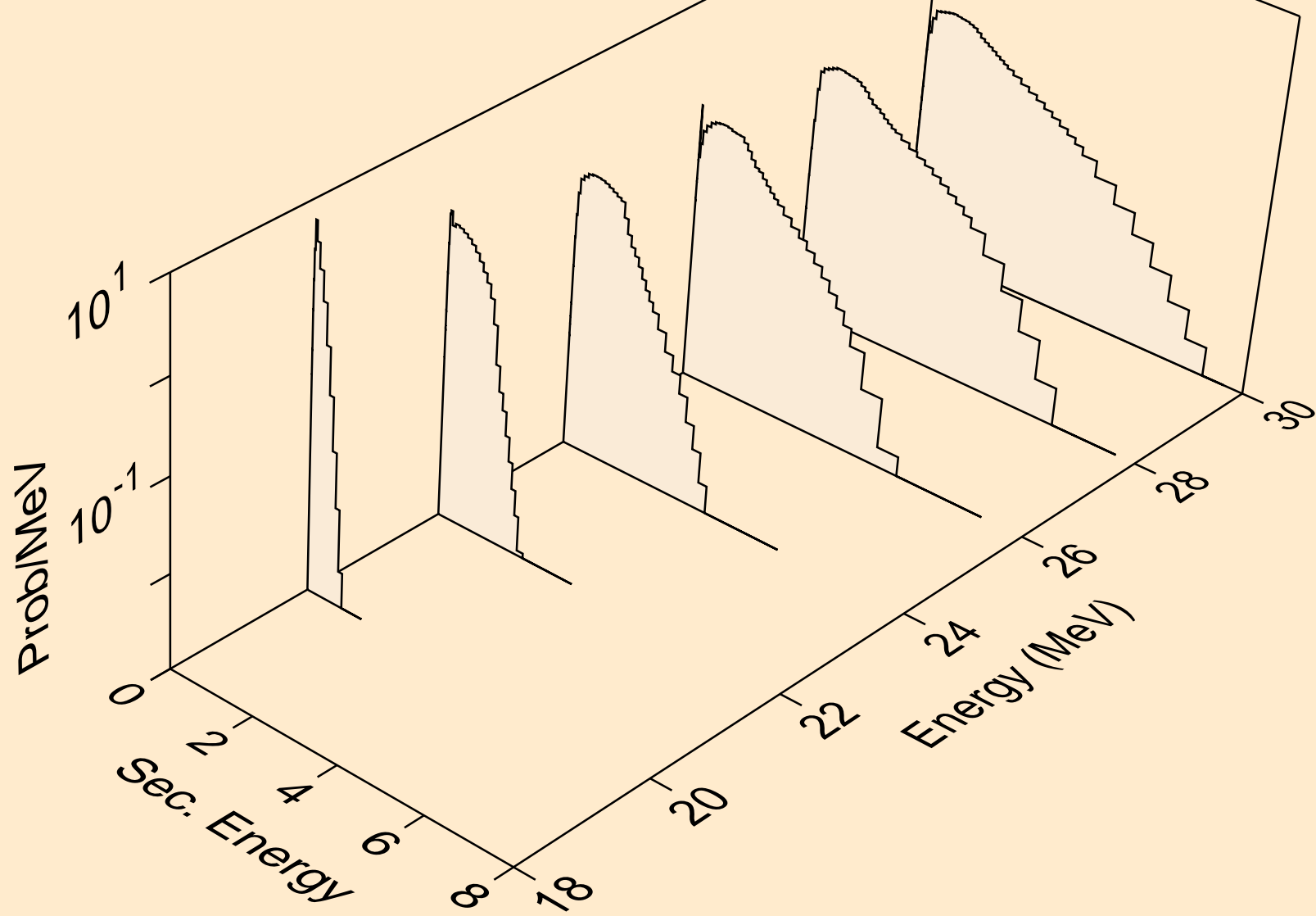

K047 NEUTRON ACER TENDL-2021 LIBRARY; T=293.6K
Neutron emission for (n,4n)

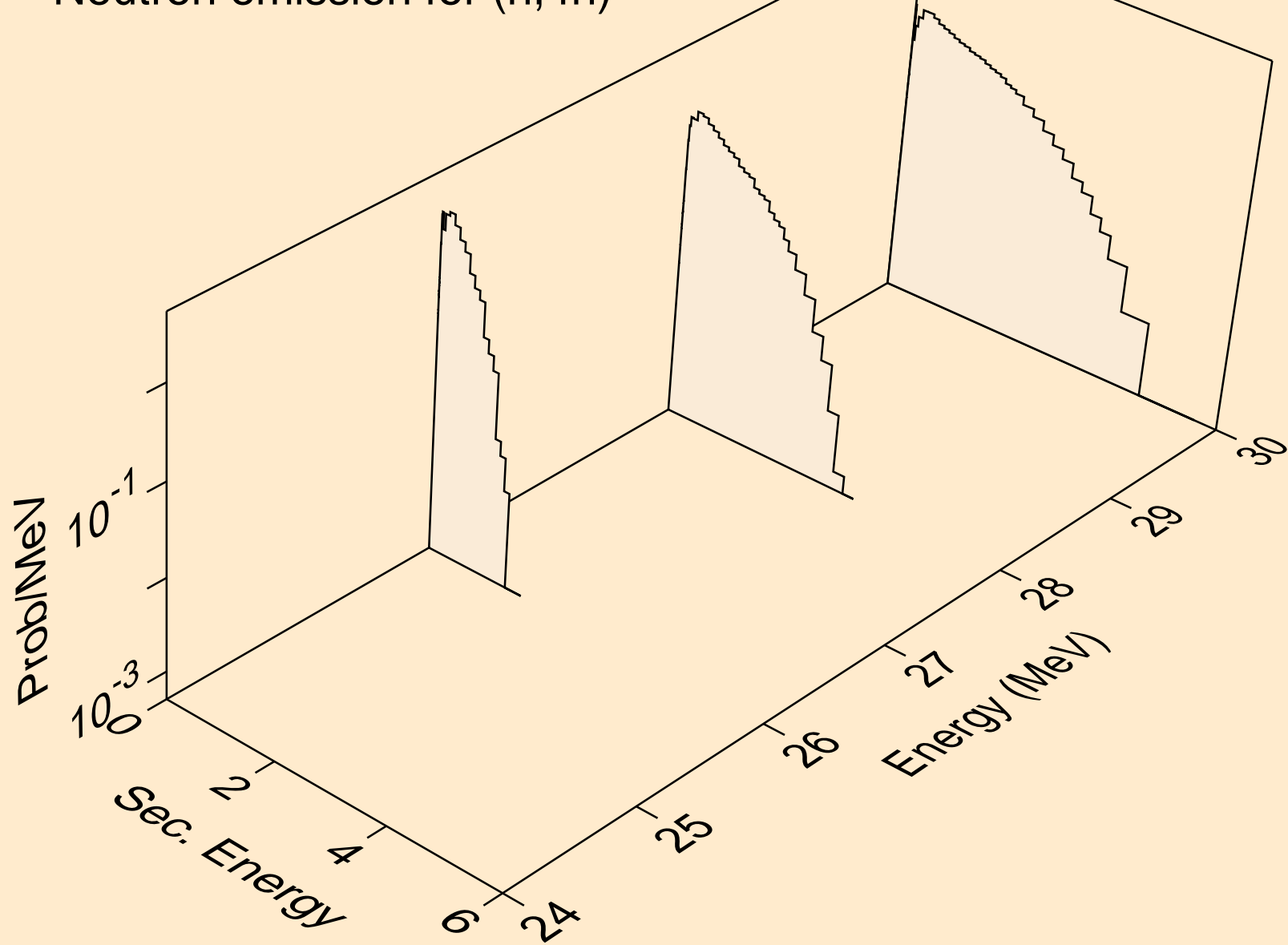

K047 NEUTRON ACER TENDL-2021 LIBRARY; T=293.6K
Neutron emission for (n,2np)

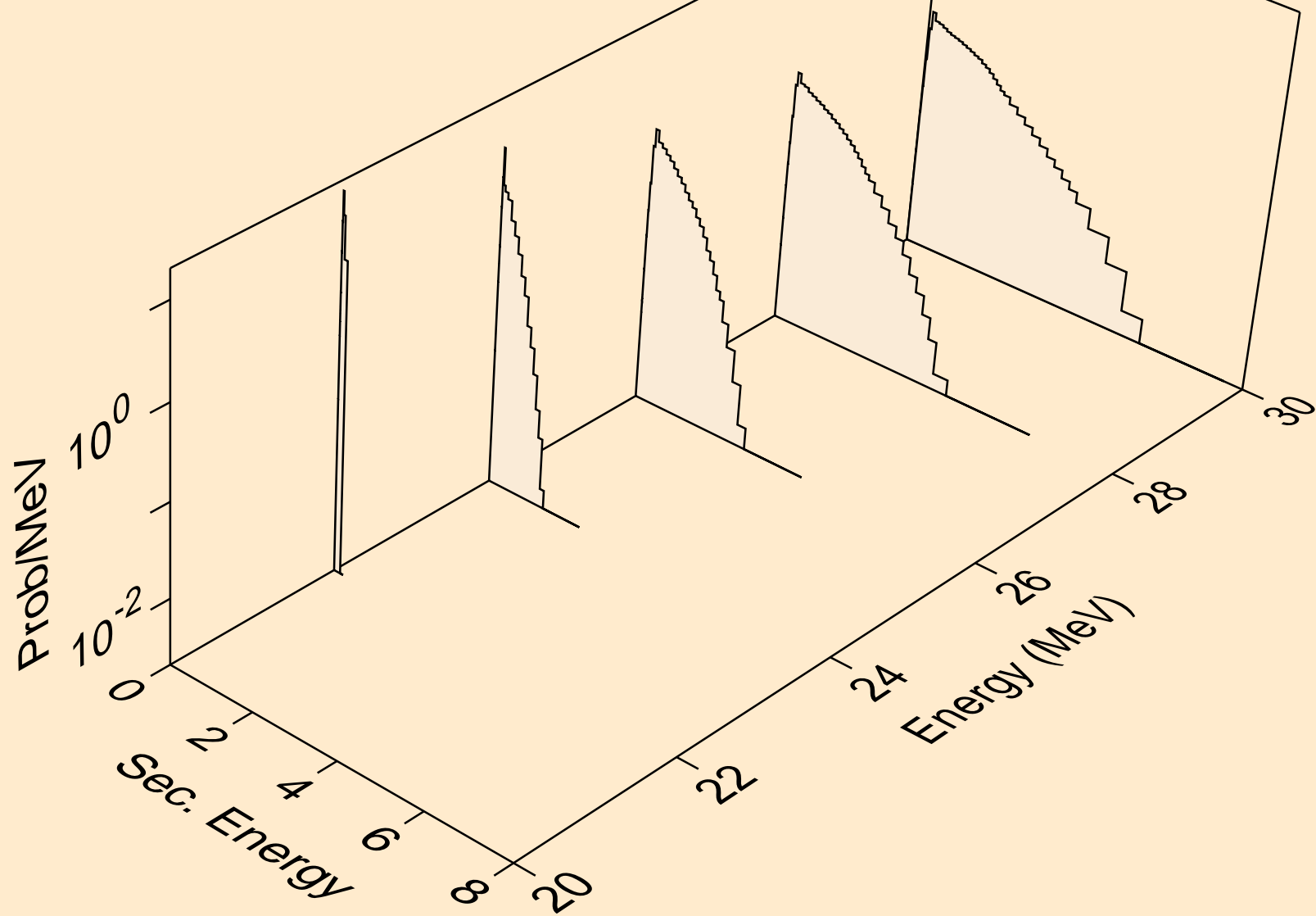

K047 NEUTRON ACER TENDL-2021 LIBRARY; T=293.6K
Neutron emission for (n,3np)

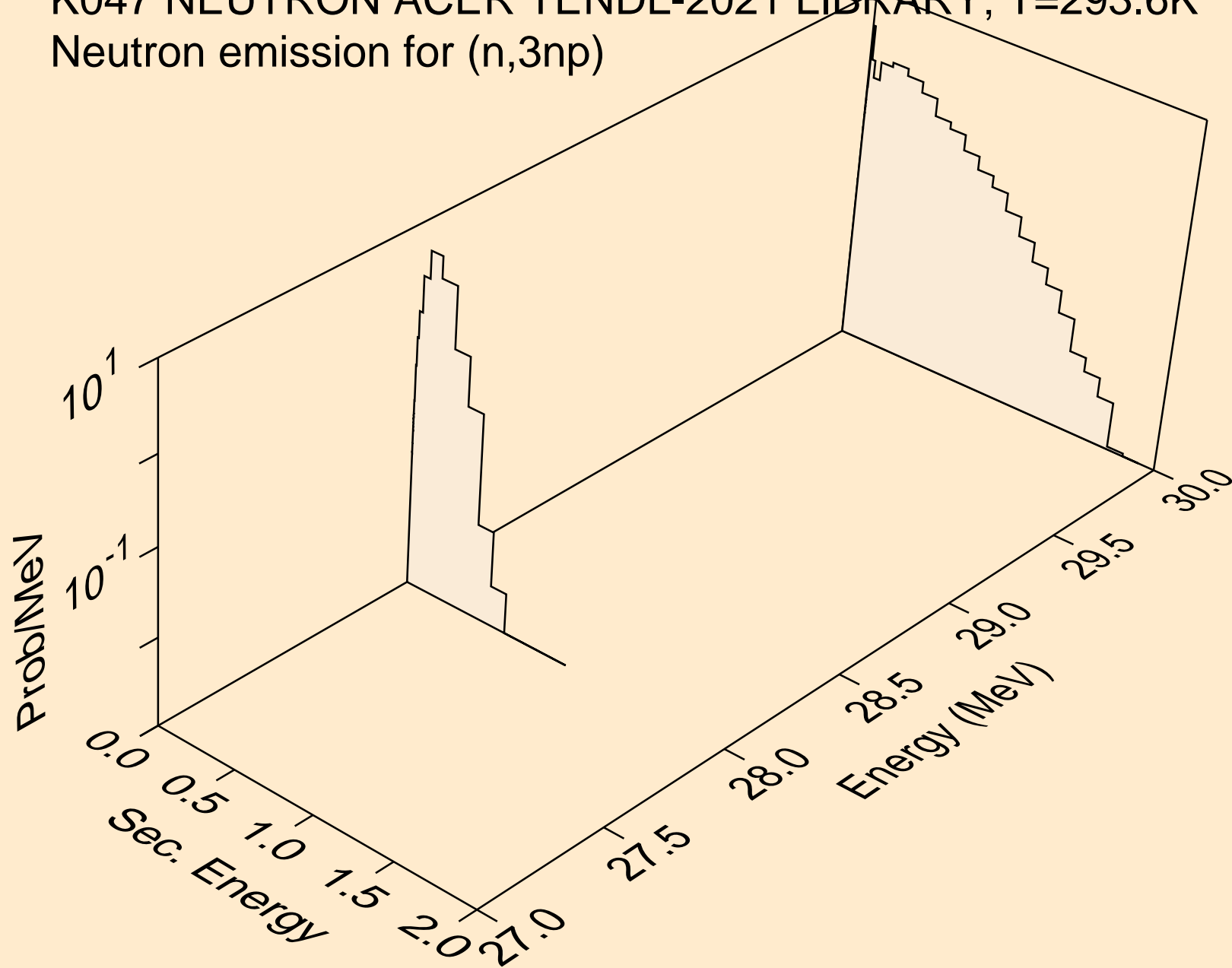

K047 NEUTRON ACER TENDL-2021 LIBRARY; T=293.6K
Neutron emission for (n,n*c)

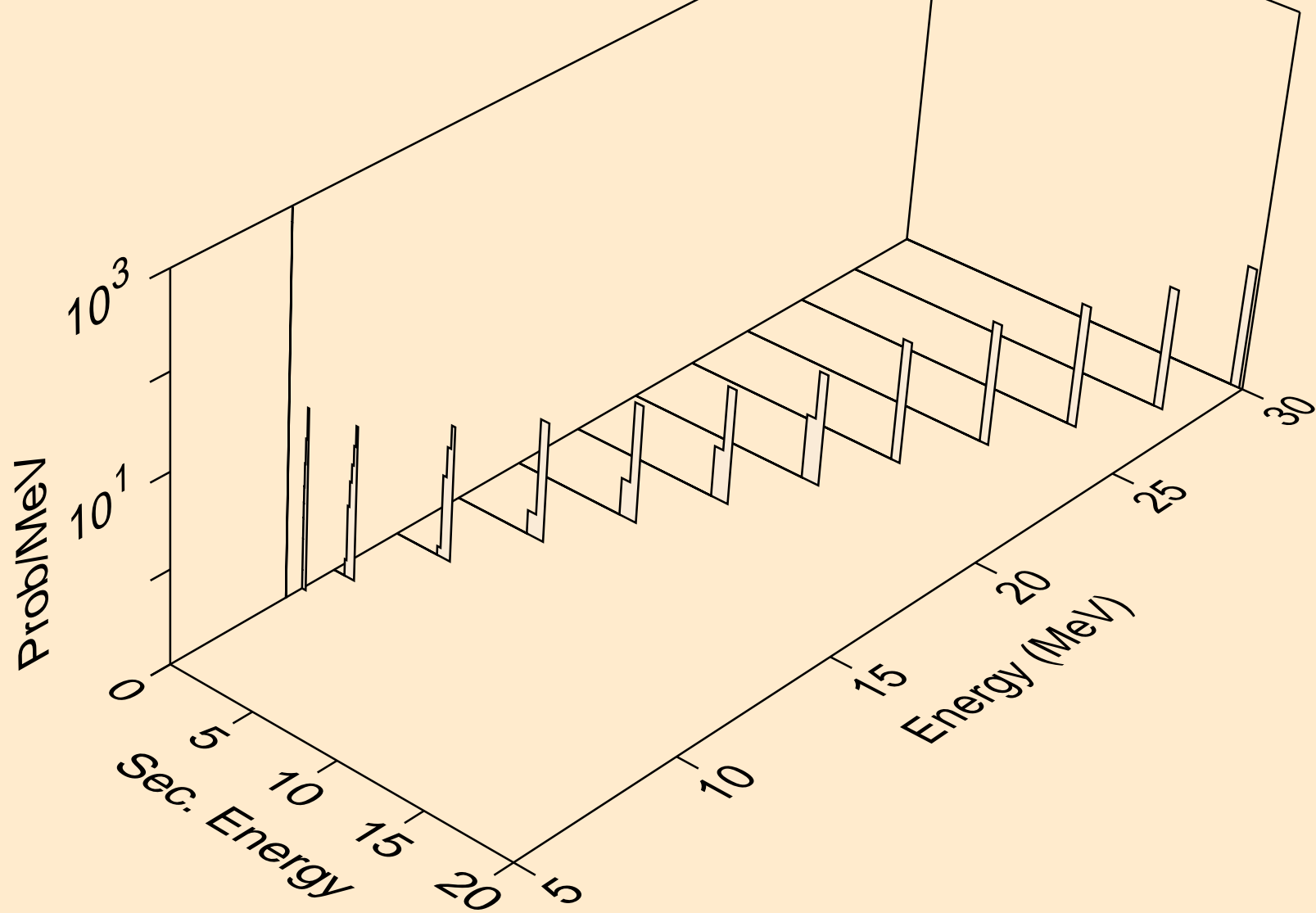

K047 NEUTRON ACER TENDL-2021 LIBRARY; T=293.6K
Photon emission for (n,x)

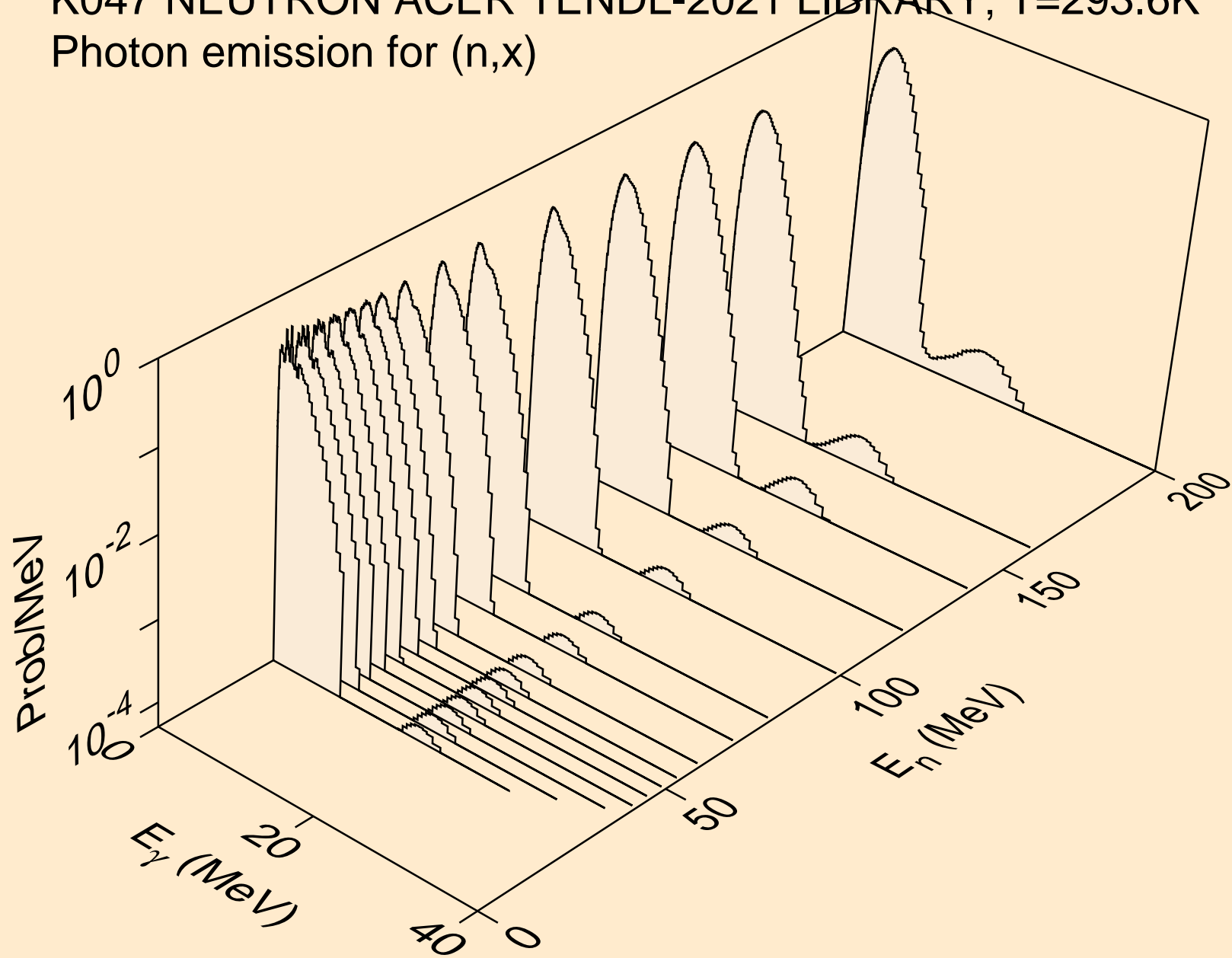

K047 NEUTRON ACER TENDL-2021 LIBRARY; T=293.6K
Photon emission for (n,2nd)

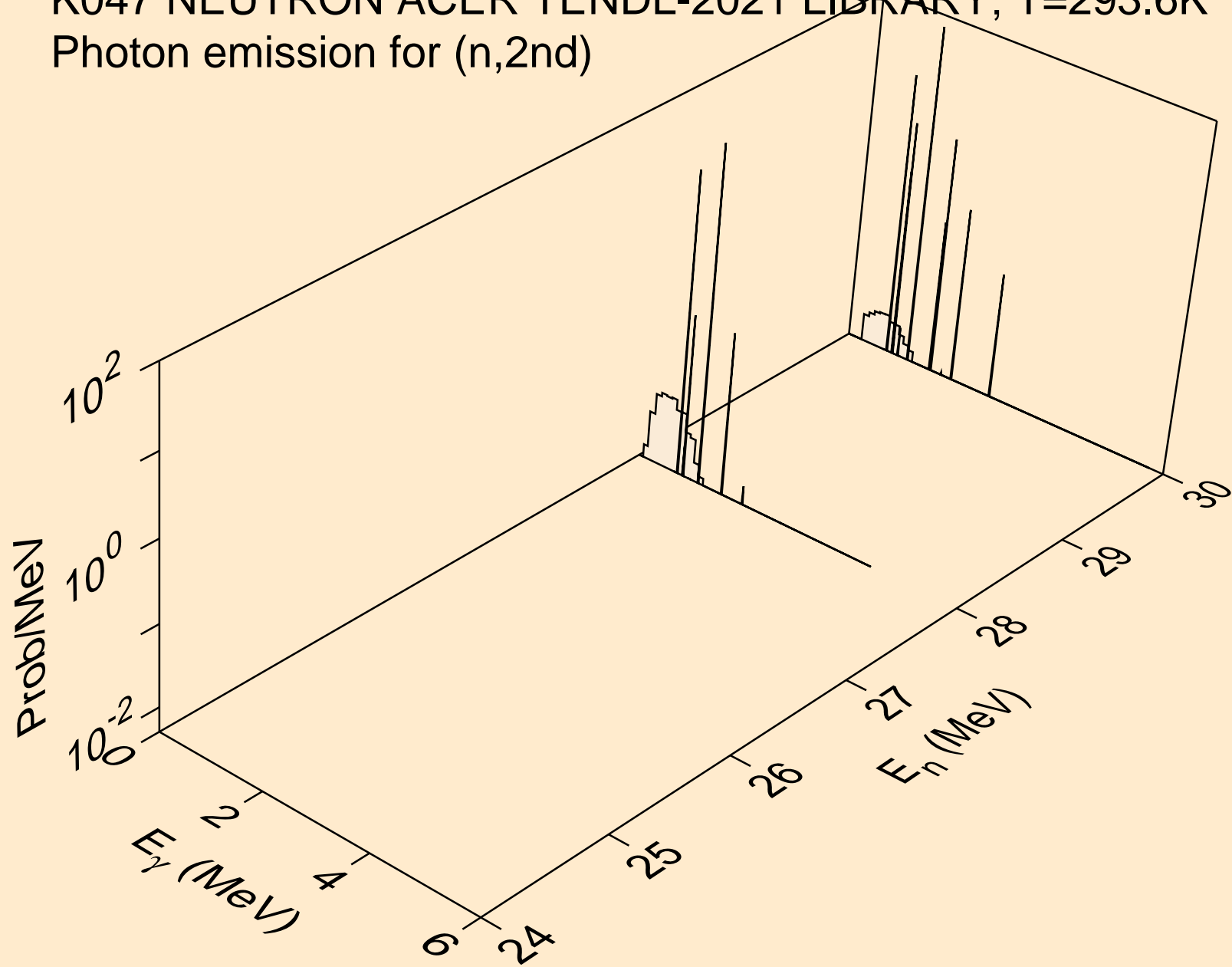

K047 NEUTRON ACER TENDL-2021 LIBRARY; T=293.6K
Photon emission for (n,2n)

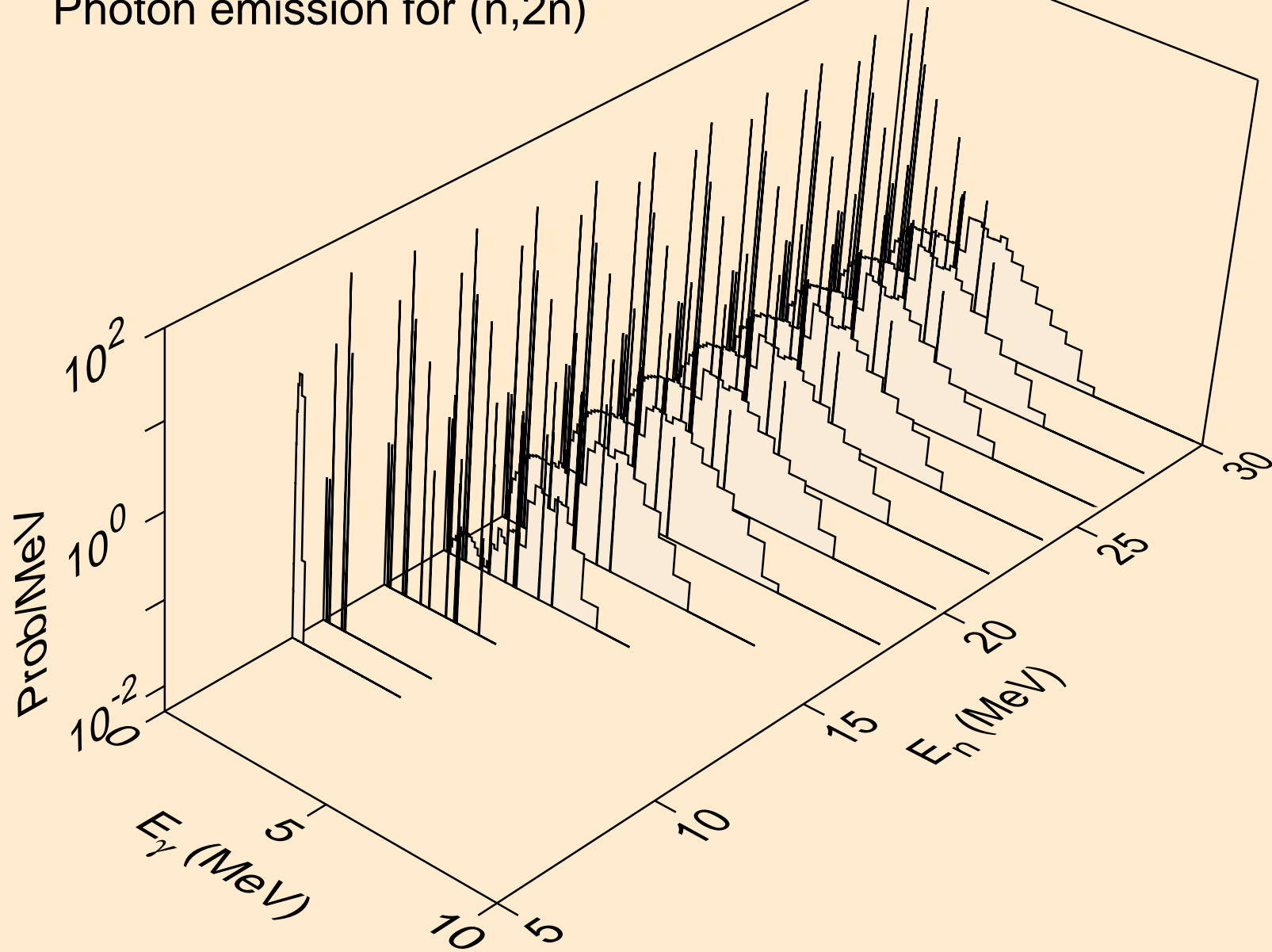

K047 NEUTRON ACER TENDL-2021 LIBRARY; T=293.6K
Photon emission for (n,3n)

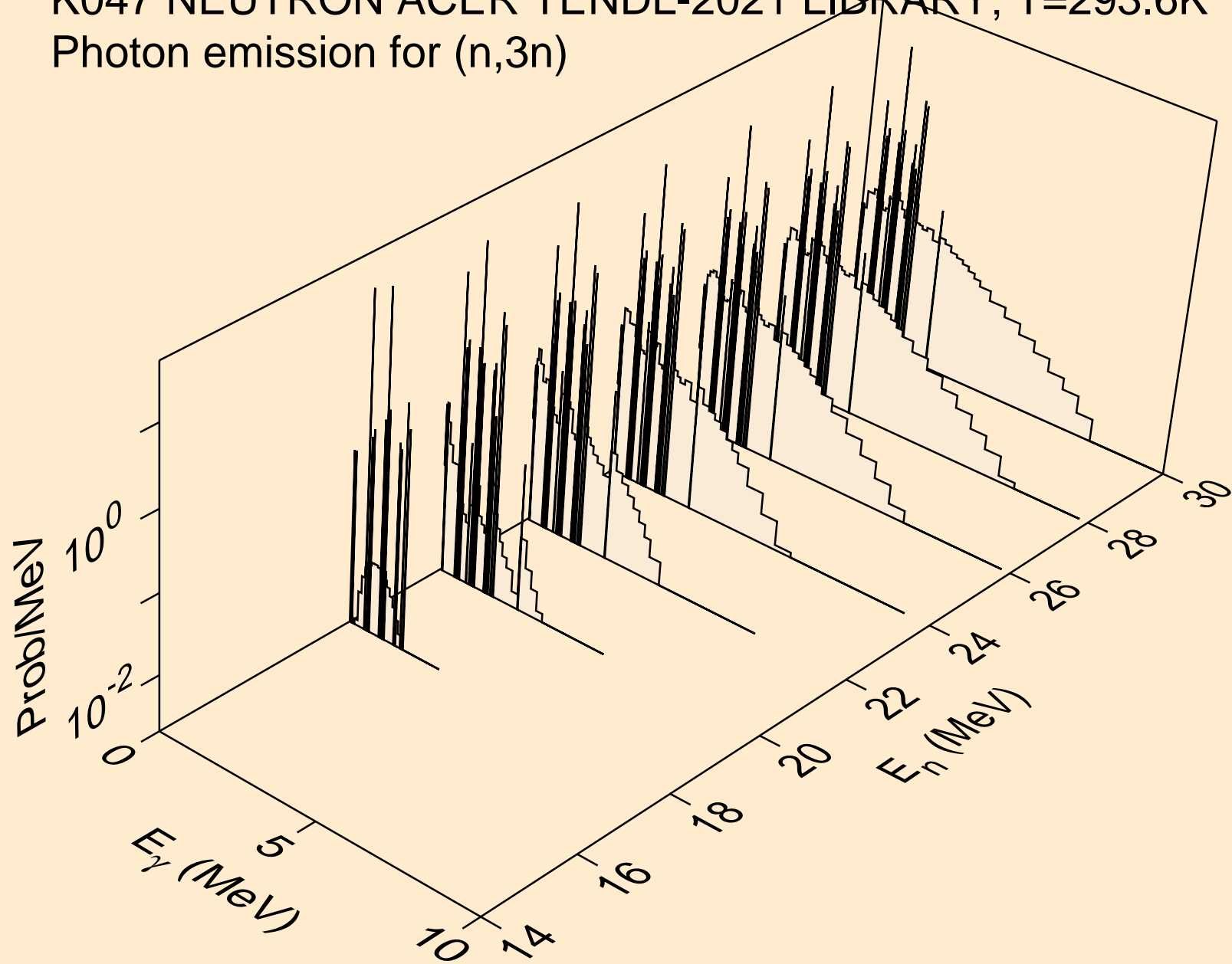

K047 NEUTRON ACER TENDL-2021 LIBRARY; T=293.6K
Photon emission for (n,n*)a

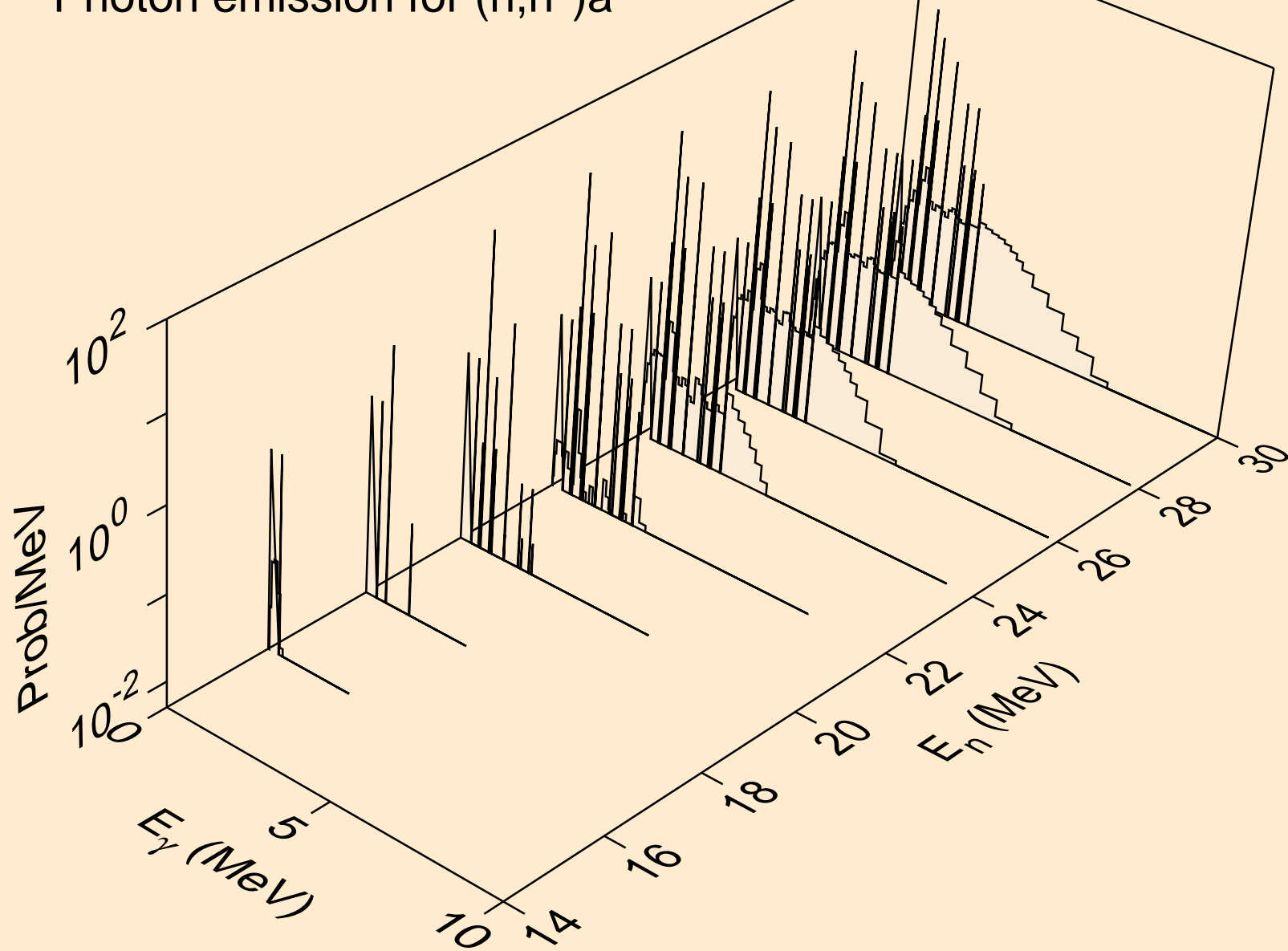

K047 NEUTRON ACER TENDL-2021 LIBRARY; T=293.6K
Photon emission for (n,2n)a

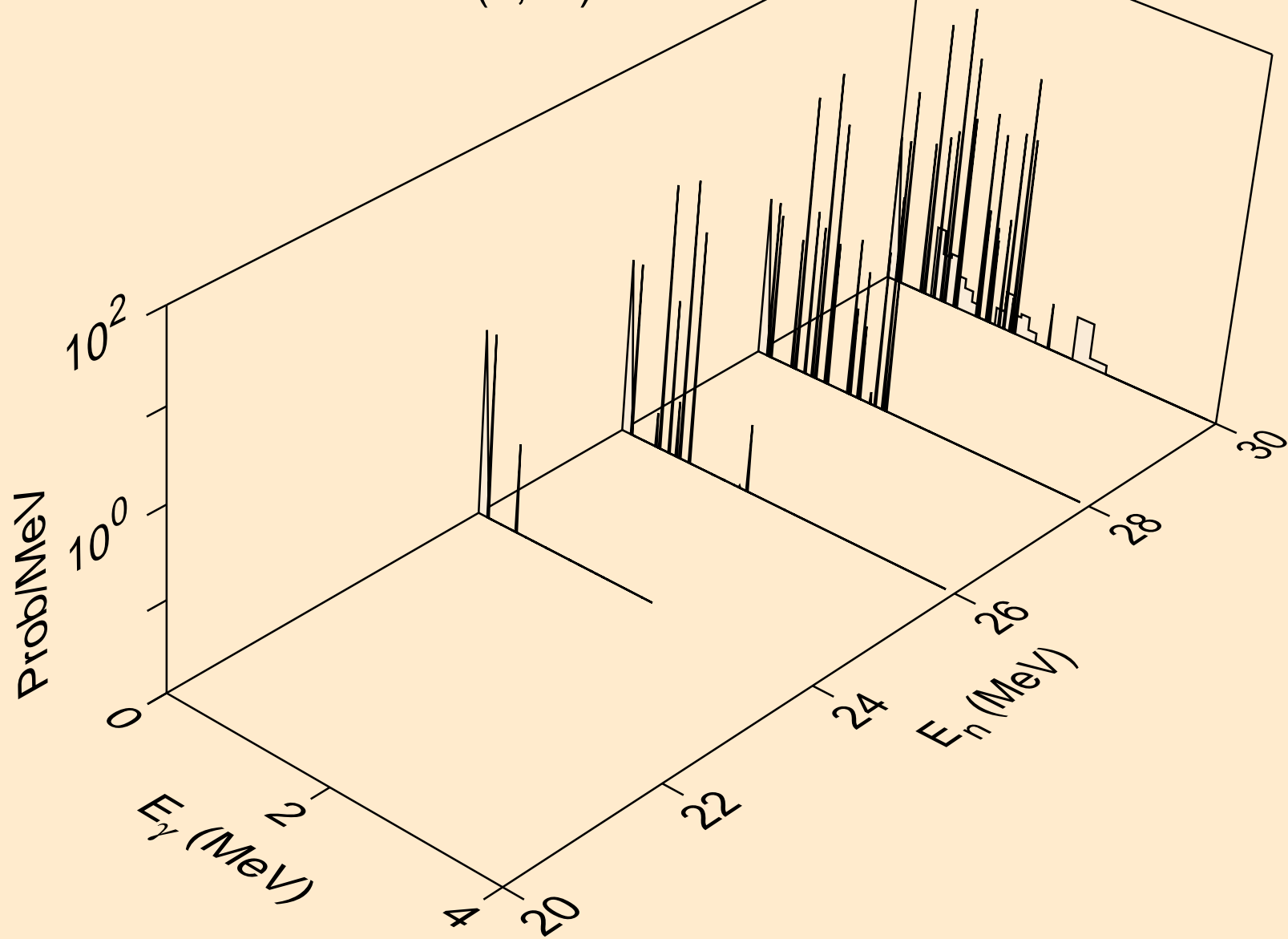

K047 NEUTRON ACER TENDL-2021 LIBRARY; T=293.6K
Photon emission for (n,n*)p

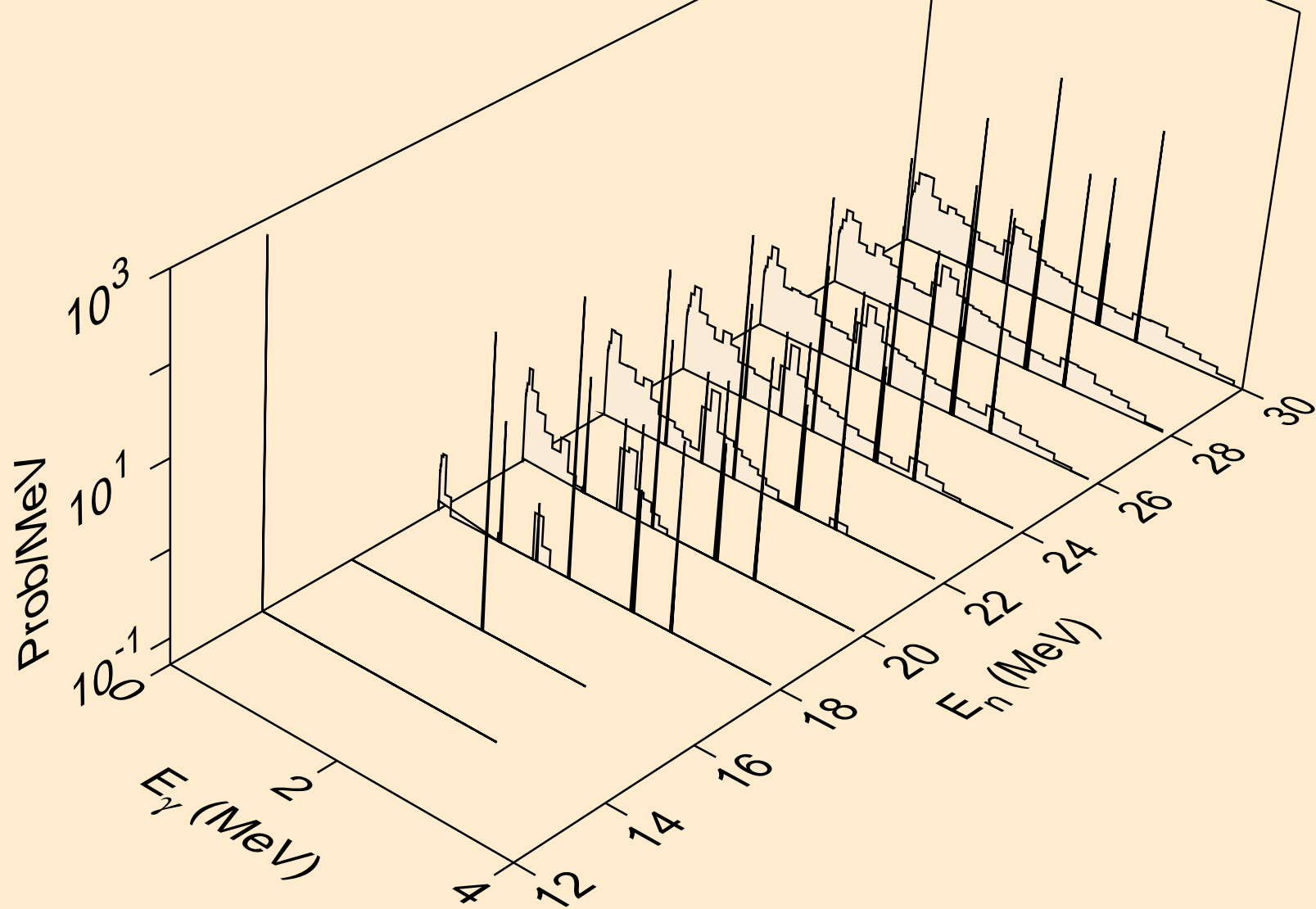

K047 NEUTRON ACER TENDL-2021 LIBRARY; T=293.6K
Photon emission for (n,n*)d

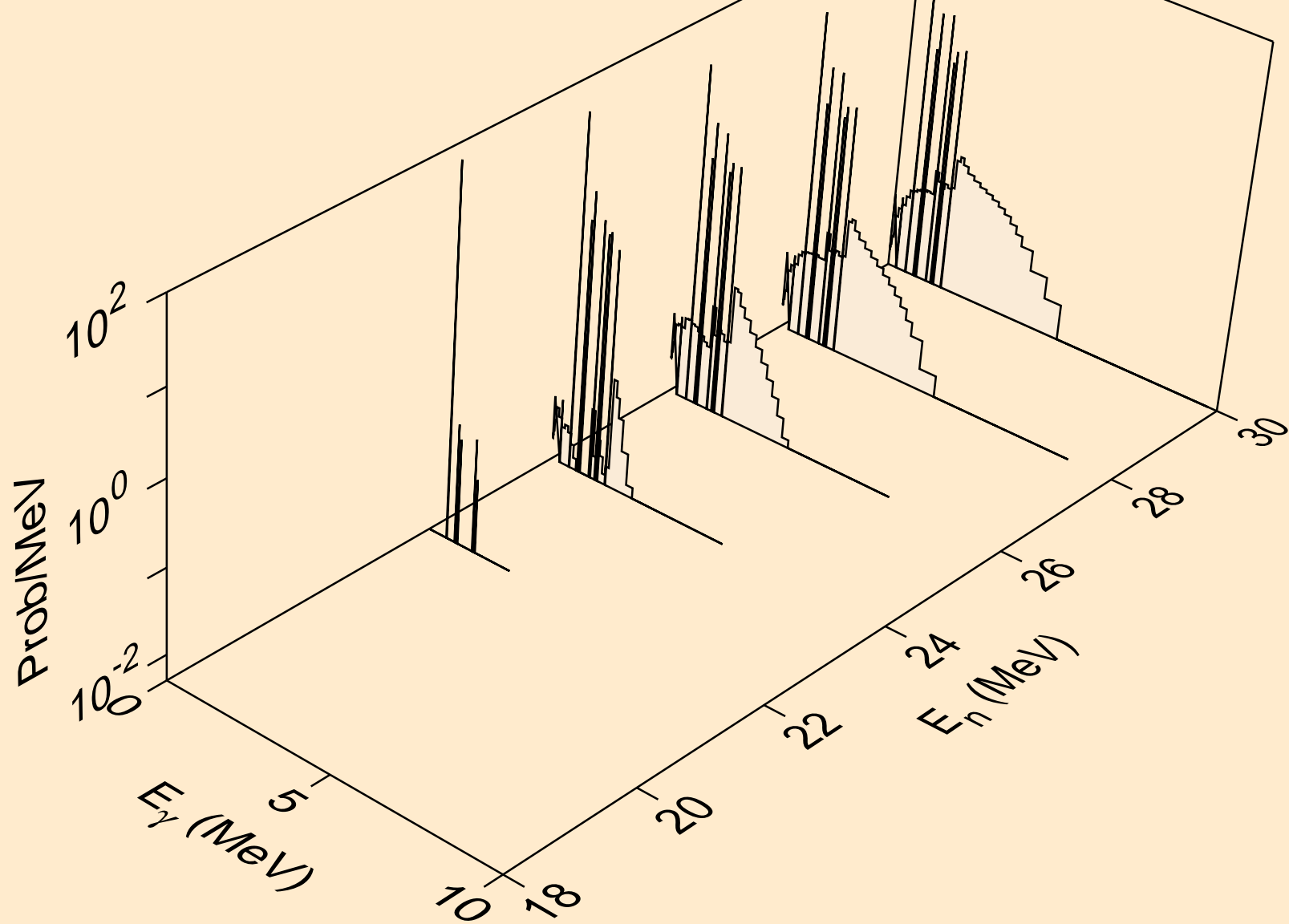

K047 NEUTRON ACER TENDL-2021 LIBRARY; T=293.6K
Photon emission for (n,n*)t

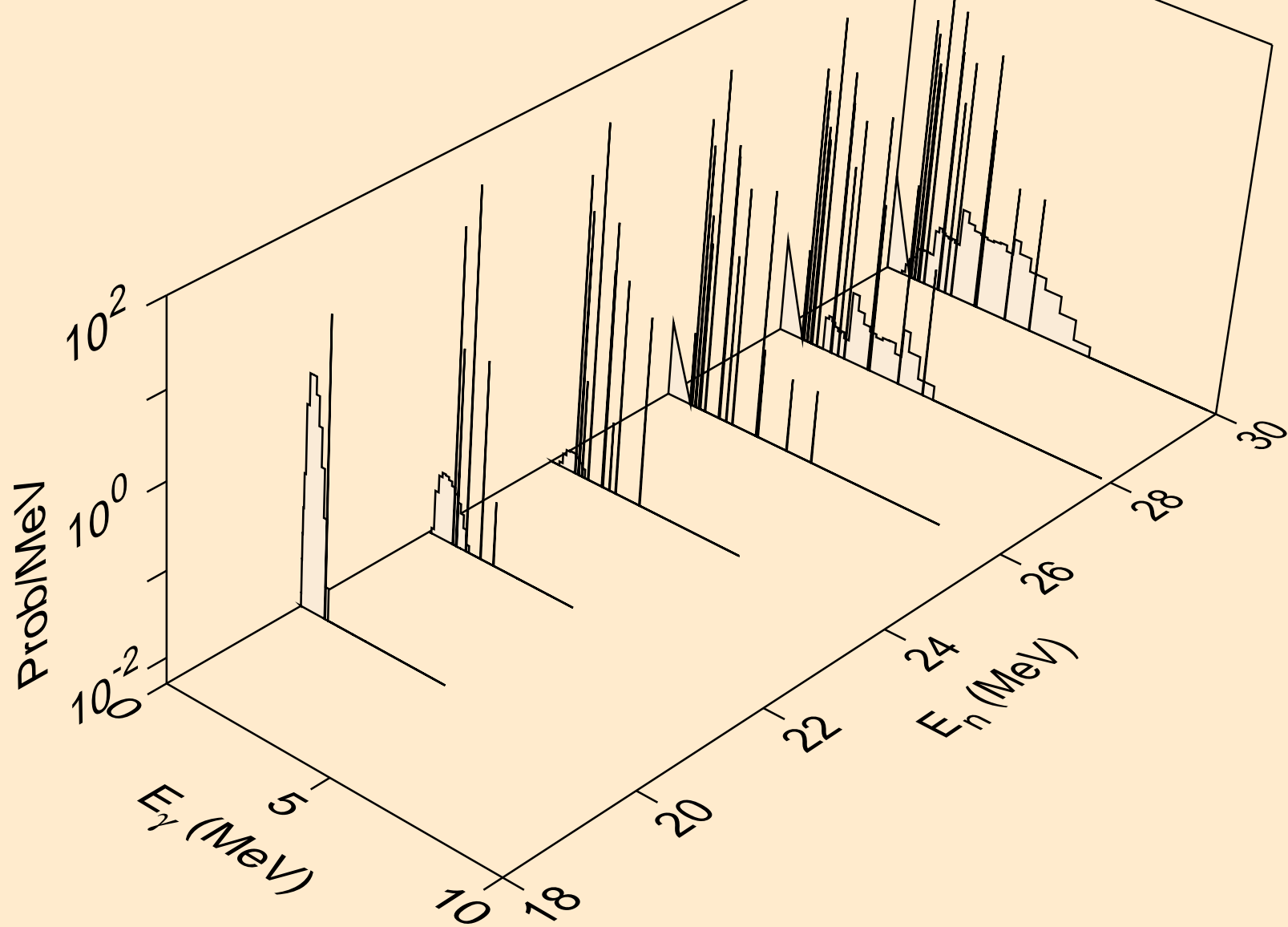

K047 NEUTRON ACER TENDL-2021 LIBRARY; T=293.6K
Photon emission for (n,4n)

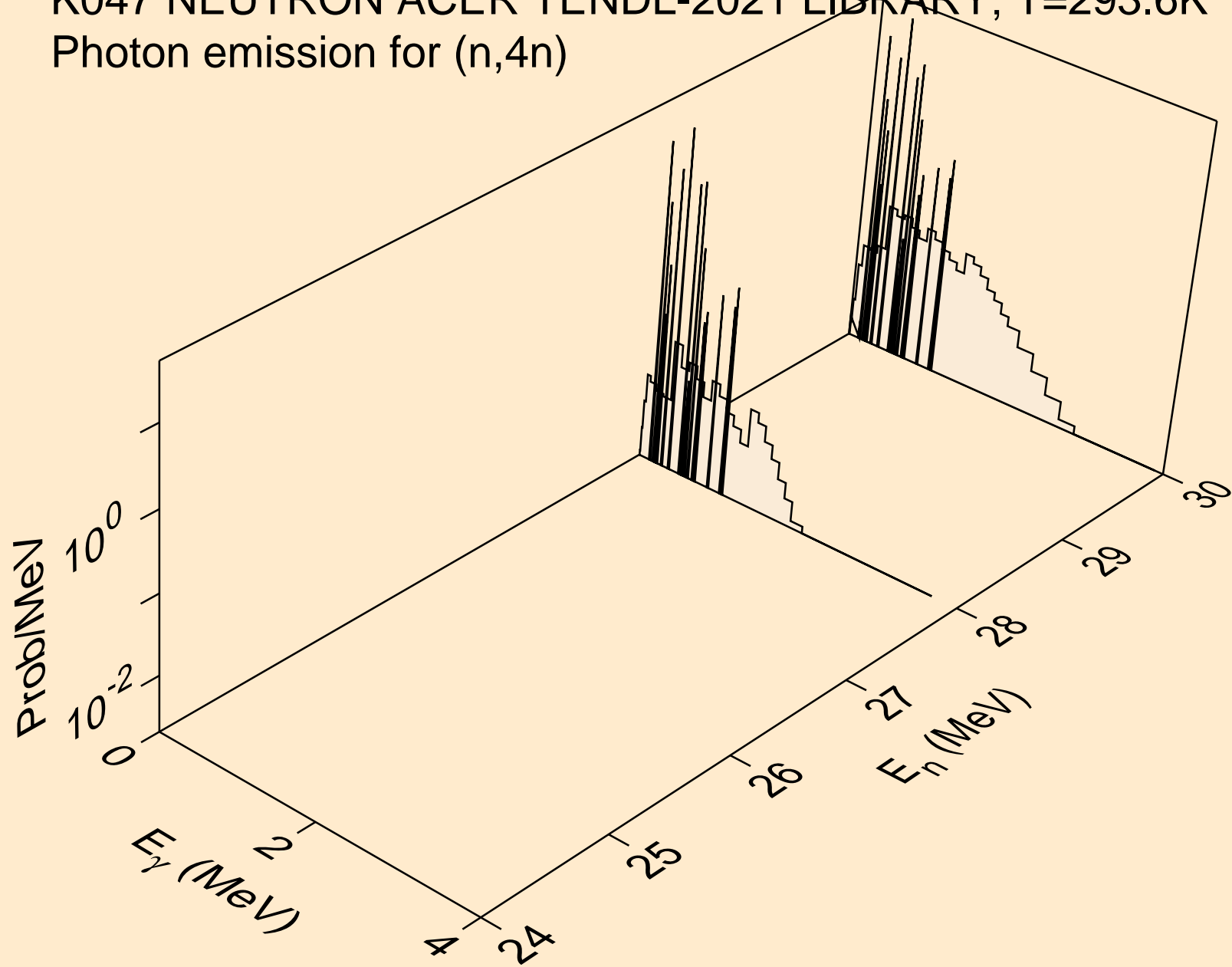

K047 NEUTRON ACER TENDL-2021 LIBRARY; T=293.6K
Photon emission for (n,2np)

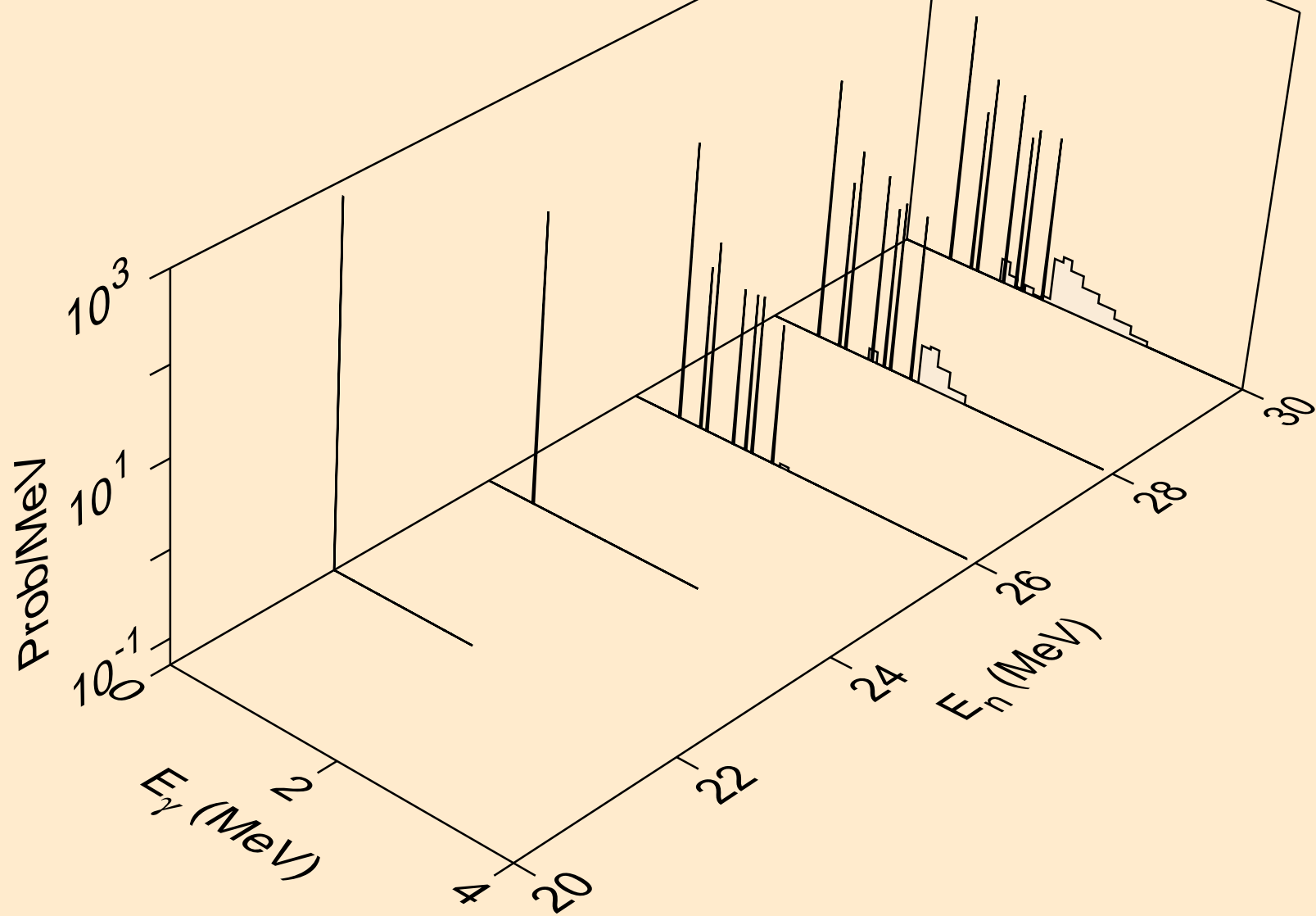

K047 NEUTRON ACER TENDL-2021 LIBRARY; T=293.6K
Photon emission for (n,3np)

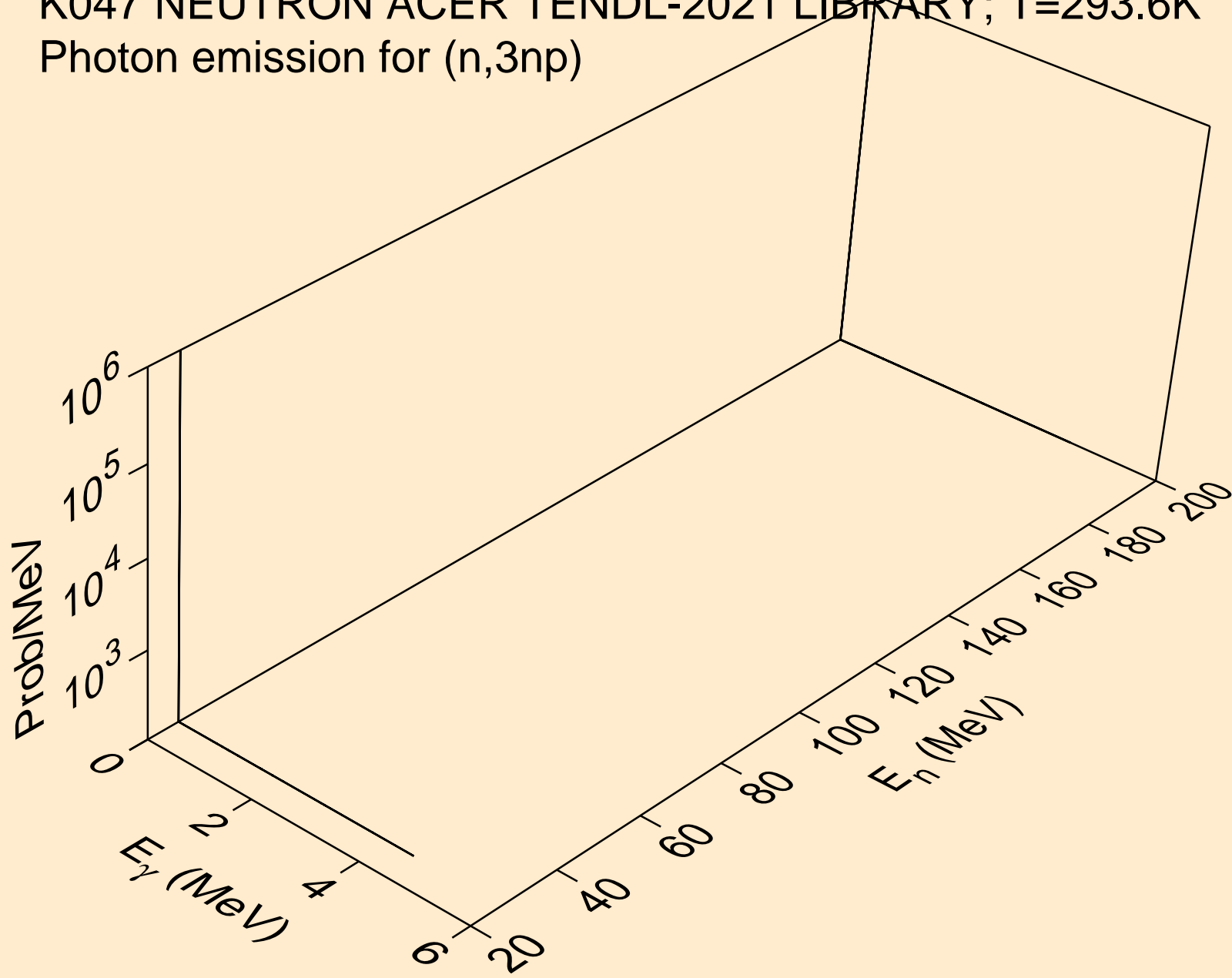

K047 NEUTRON ACER TENDL-2021 LIBRARY; T=293.6K
Photon emission for (n,n*c)

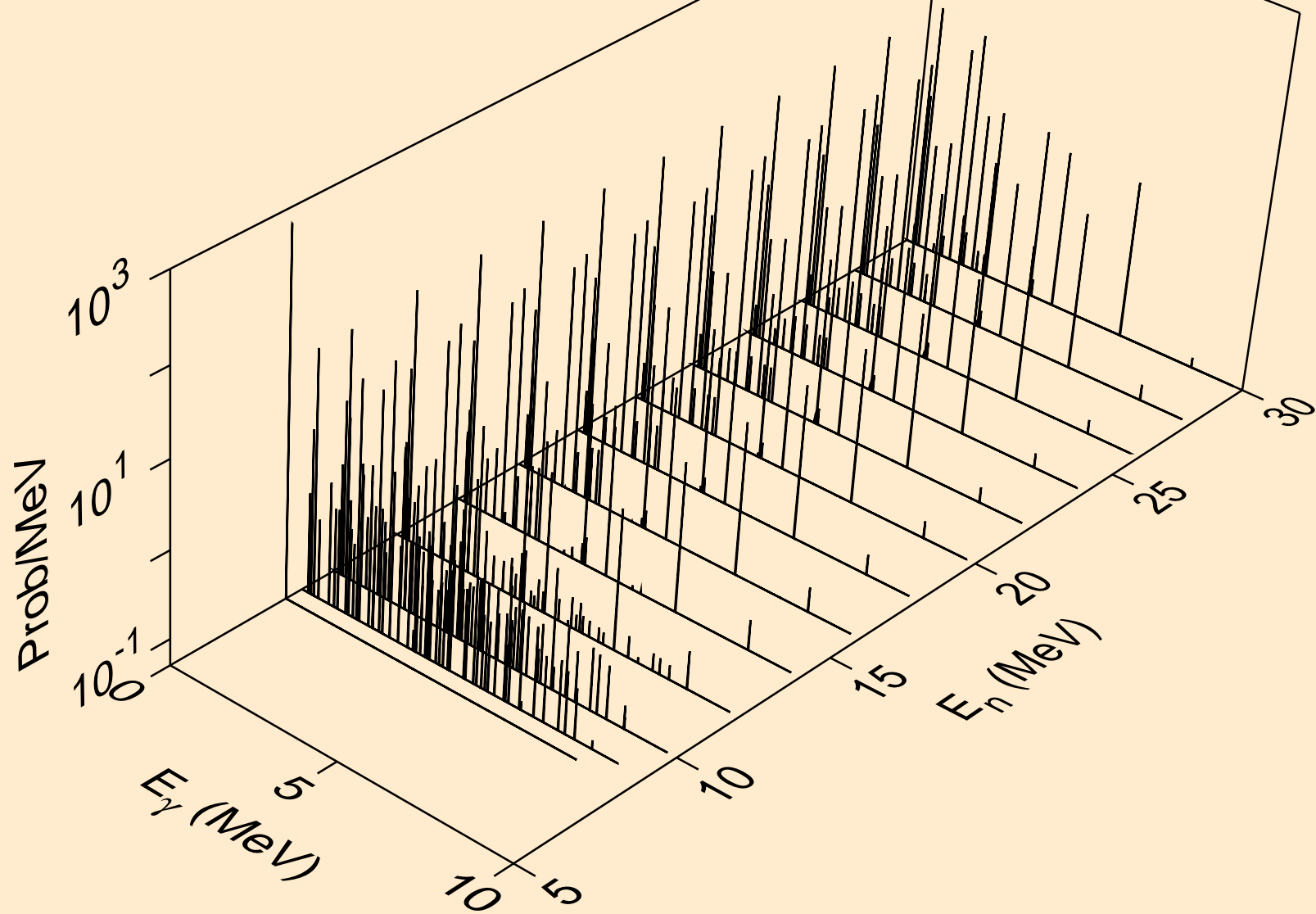

K047 NEUTRON ACER TENDL-2021 LIBRARY; T=293.6K
Photon emission for (n,gma)

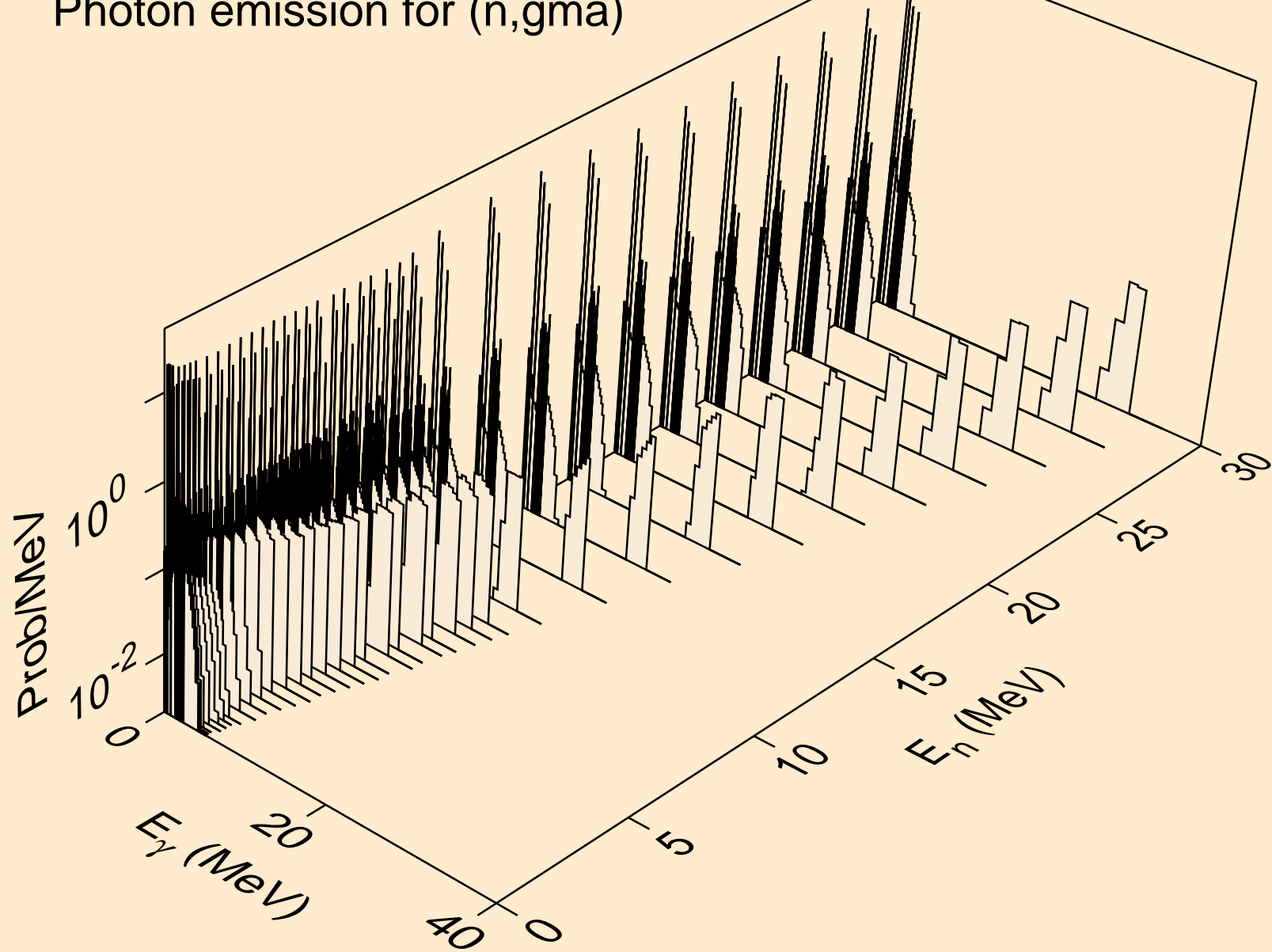

K047 NEUTRON ACER TENDL-2021 LIBRARY; T=293.6K
Photon emission for (n,p)

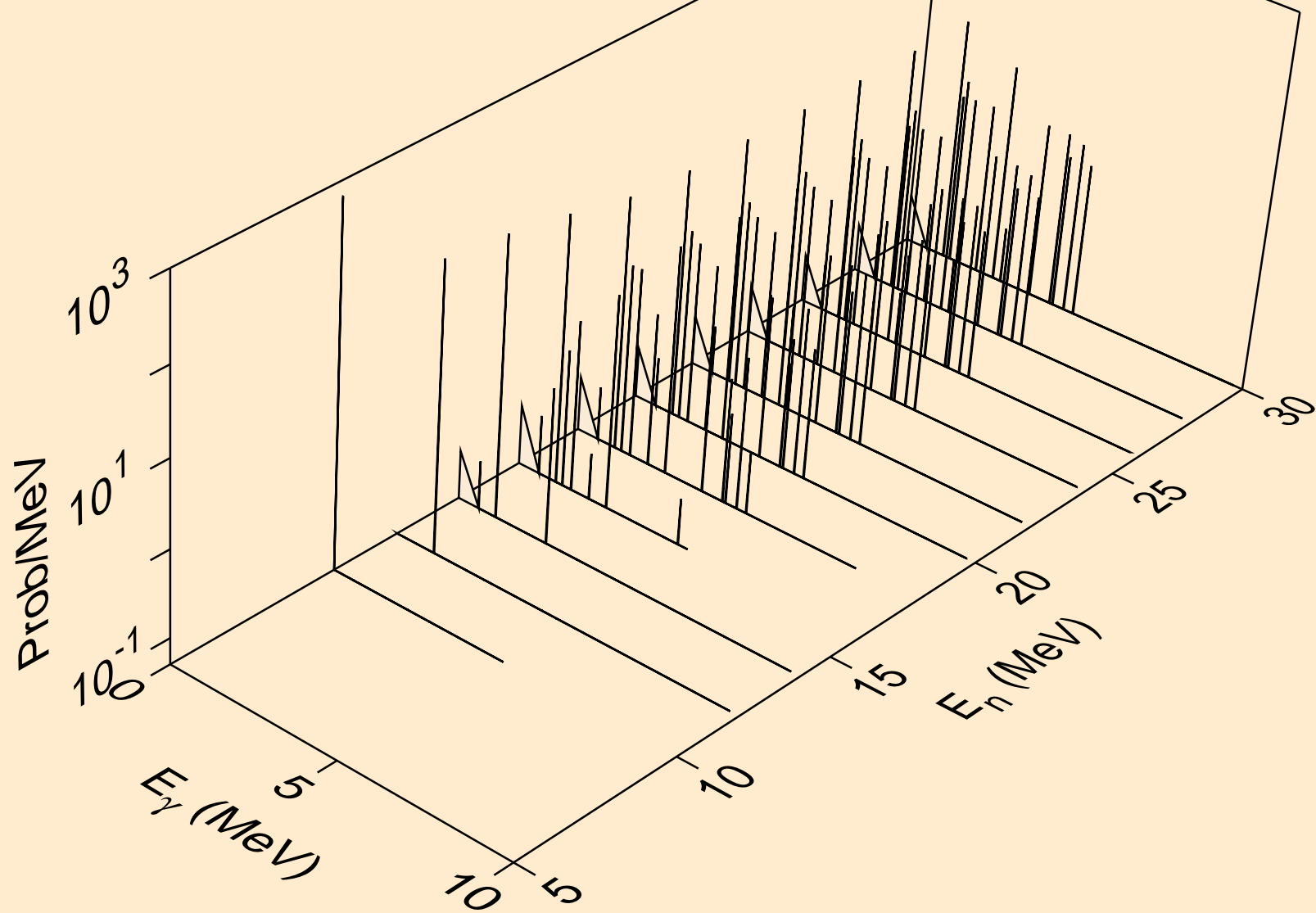

K047 NEUTRON ACER TENDL-2021 LIBRARY; T=293.6K
Photon emission for (n,d)

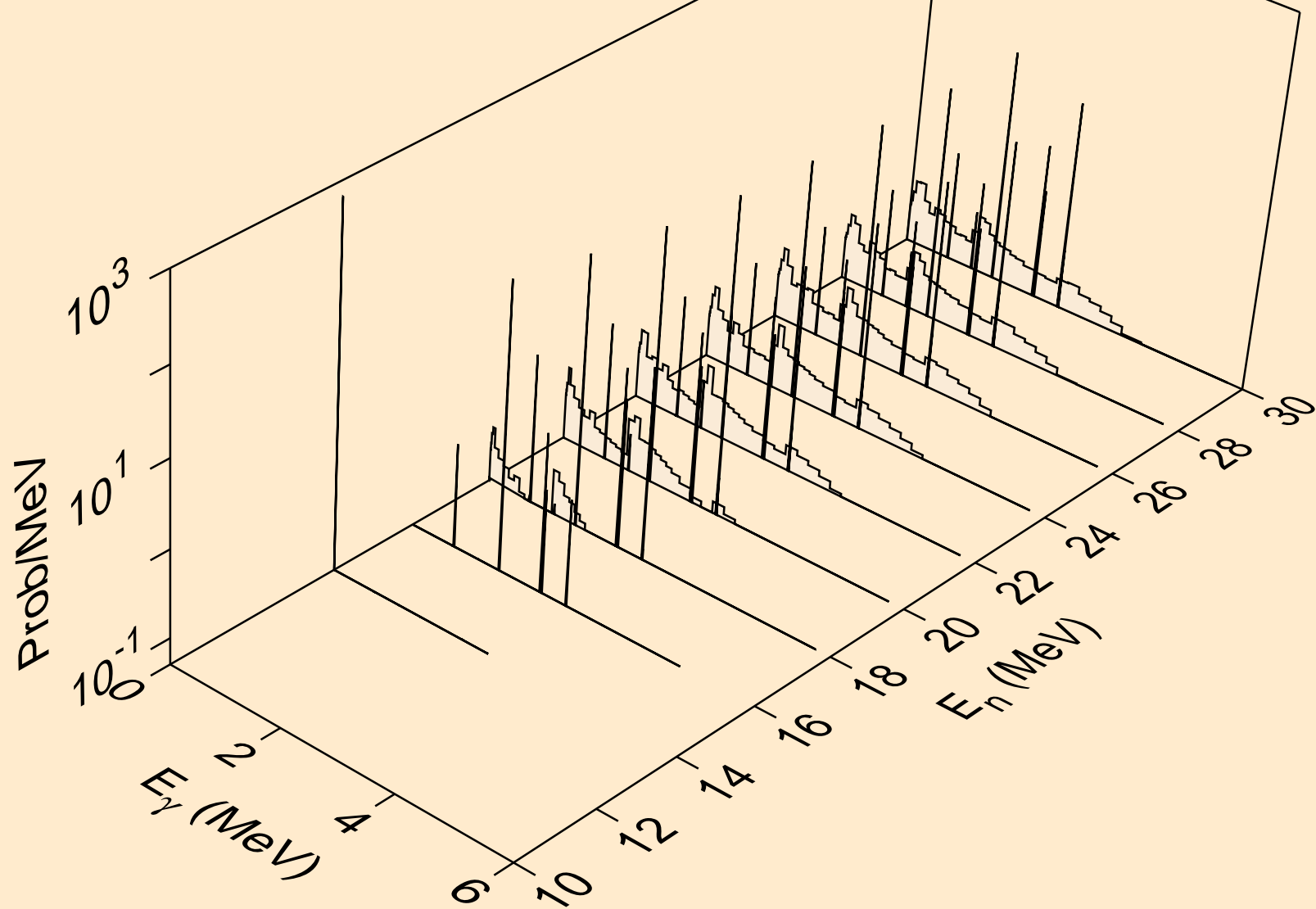

K047 NEUTRON ACER TENDL-2021 LIBRARY; T=293.6K
Photon emission for (n,t)

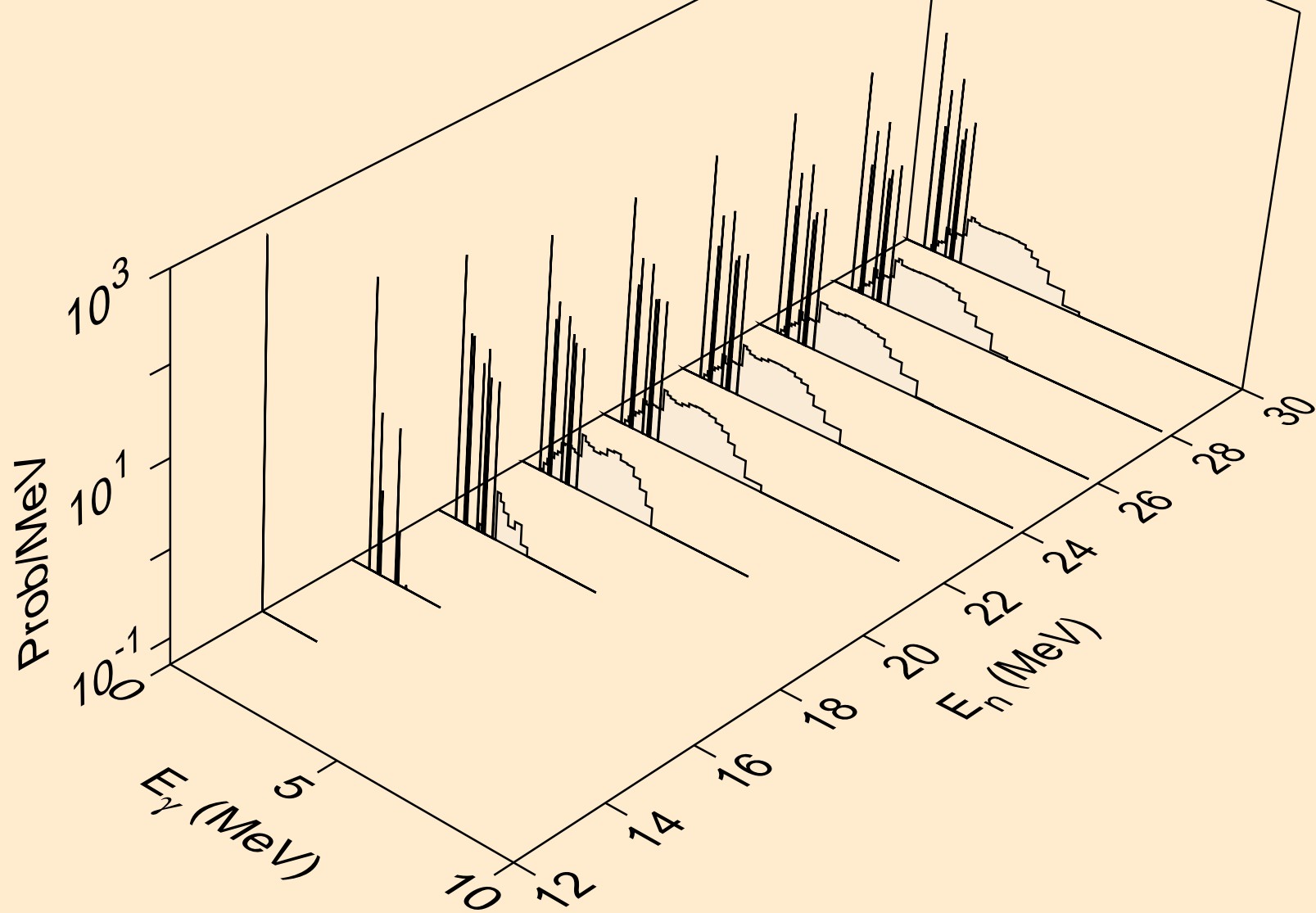

K047 NEUTRON ACER TENDL-2021 LIBRARY; T=293.6K
Photon emission for (n,a)

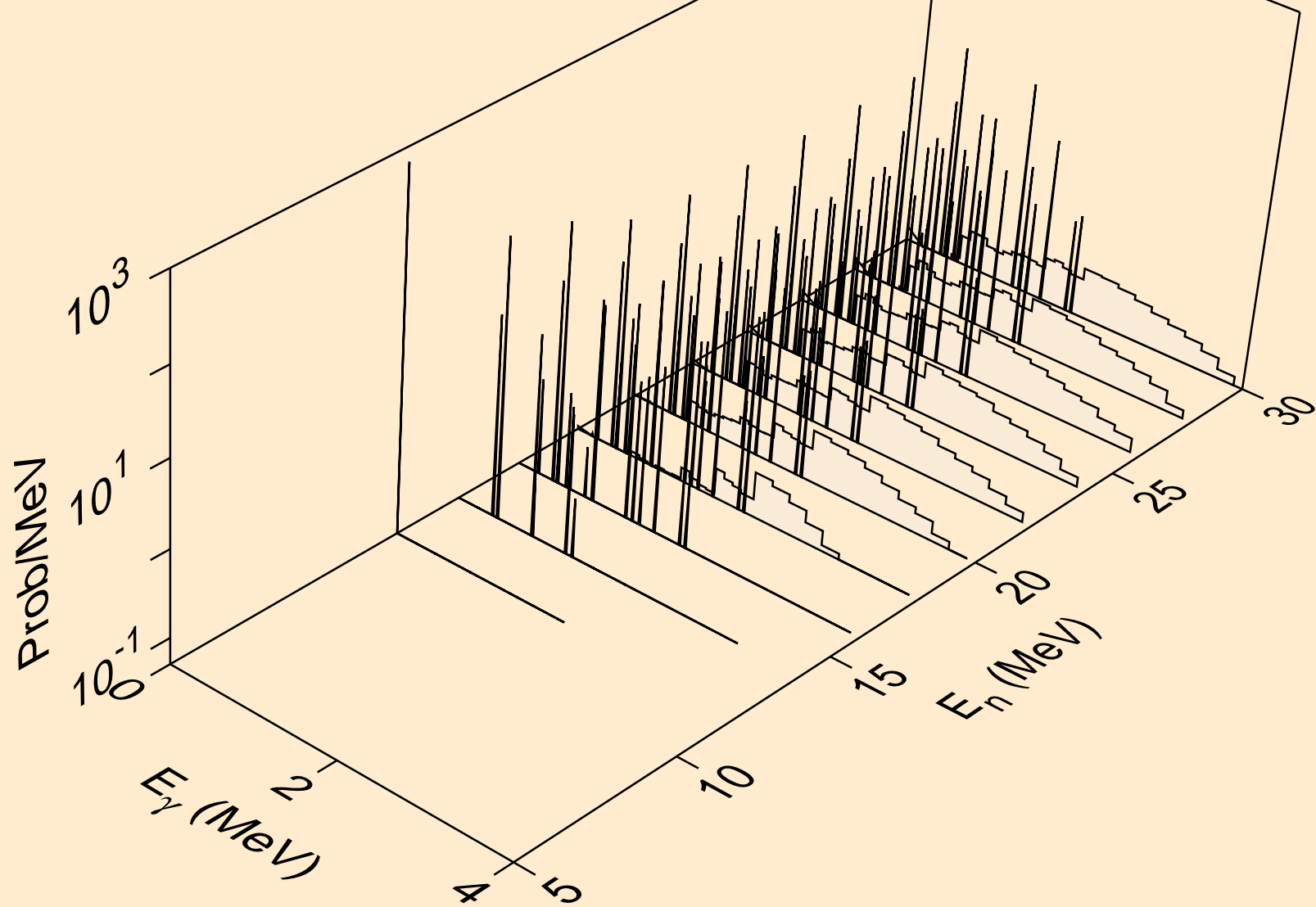

K047 NEUTRON ACER TENDL-2021 LIBRARY; T=293.6K
thermal capture photon spectrum

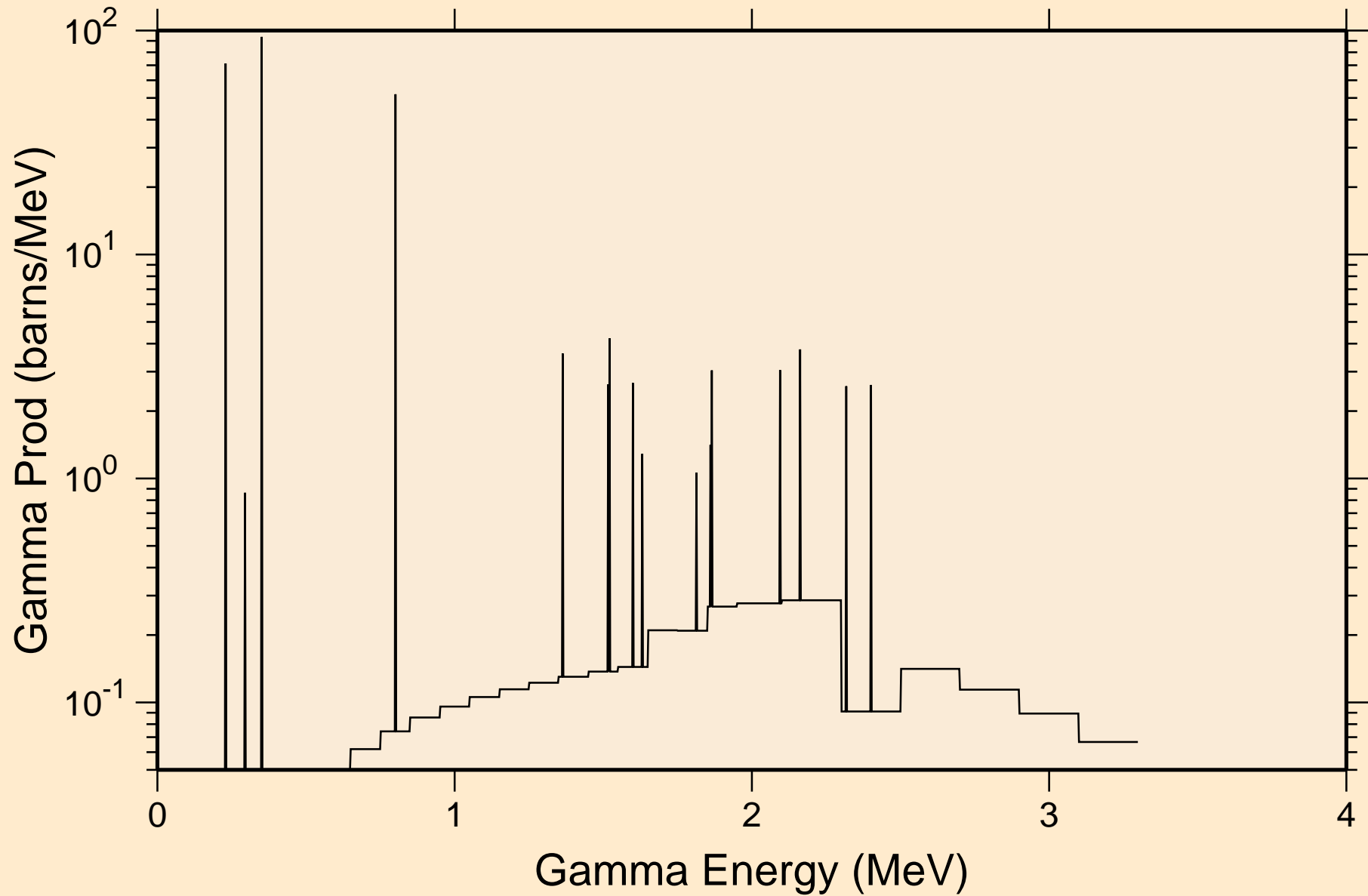

K047 NEUTRON ACER TENDL-2021 LIBRARY; T=293.6K
14 MeV photon spectrum

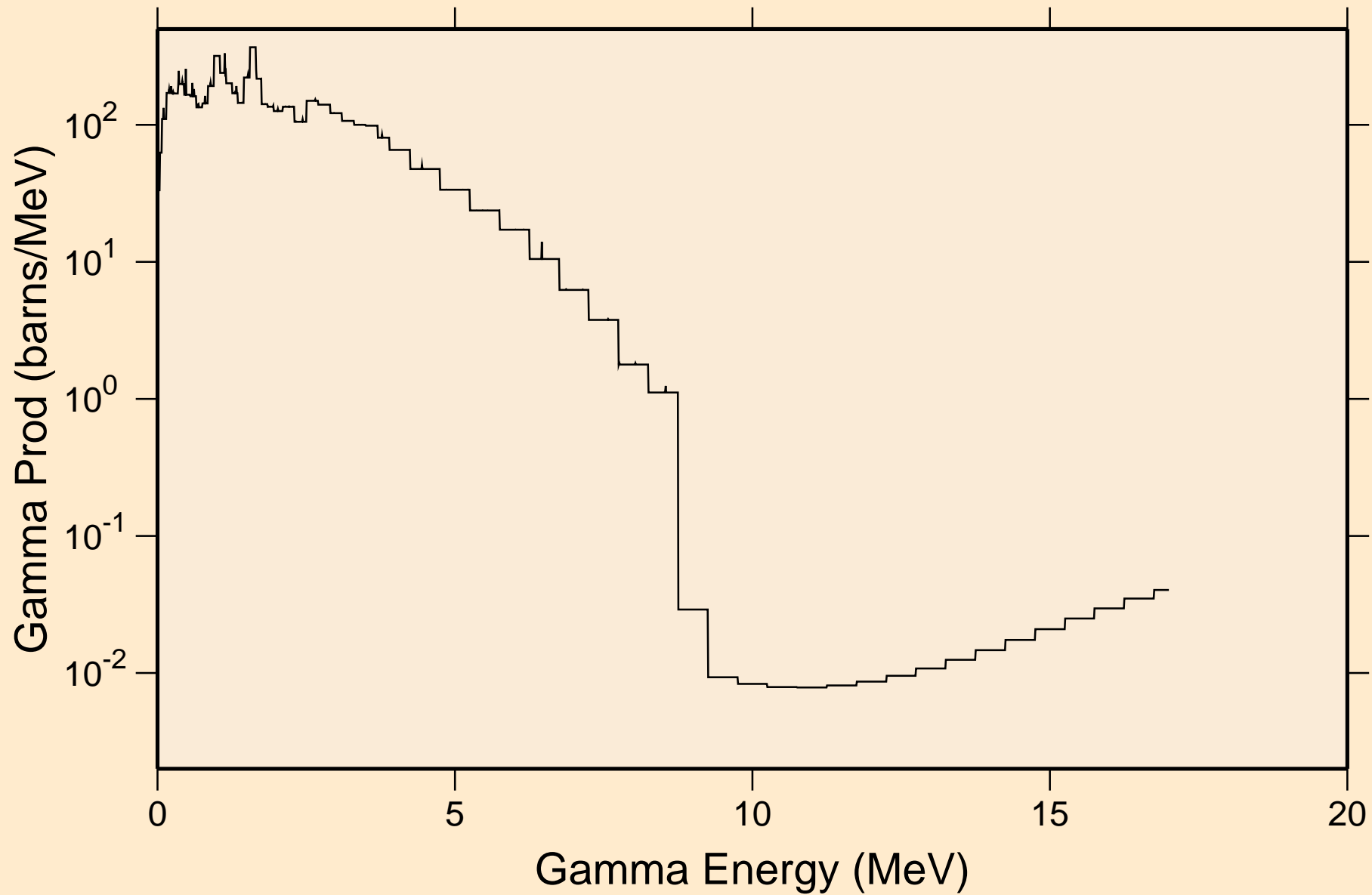

K047 NEUTRON ACER TENDL-2021 LIBRARY; T=293.6K
Particle heating contributions

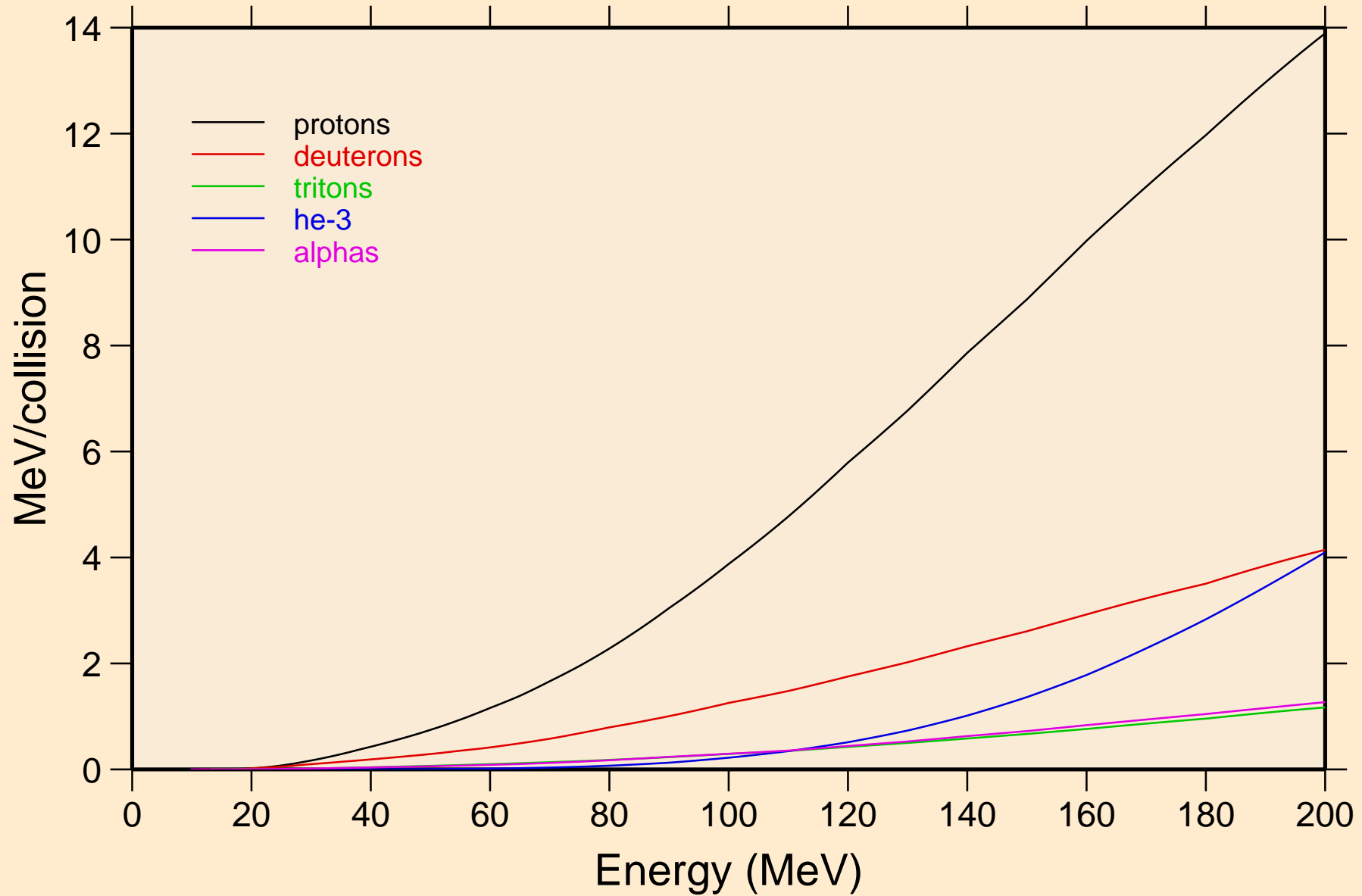

K047 NEUTRON ACER TENDL-2021 LIBRARY; T=293.6K
Recoil Heating

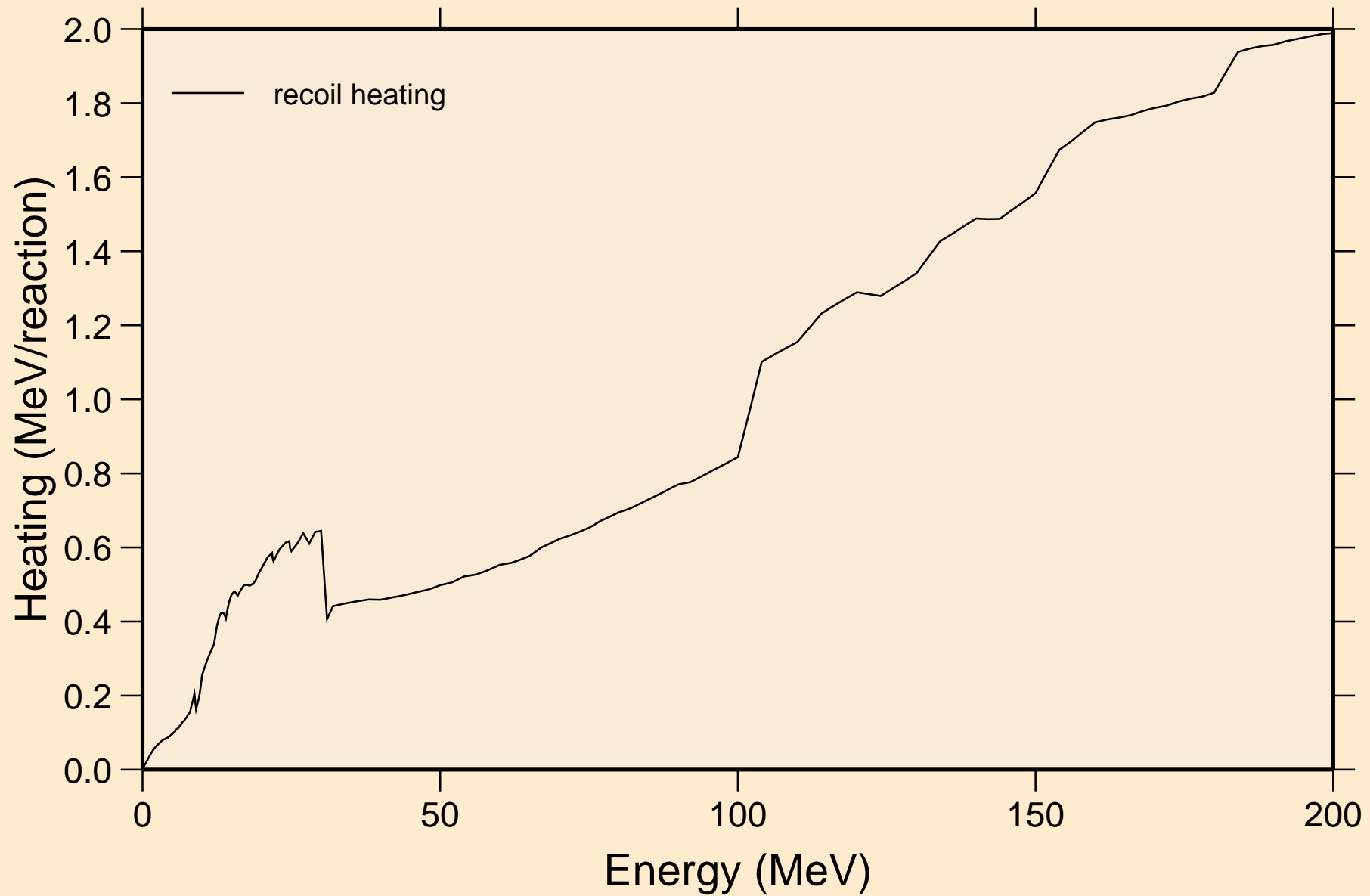

K047 NEUTRON ACER TENDL-2021 LIBRARY; T=293.6K
Particle production cross sections

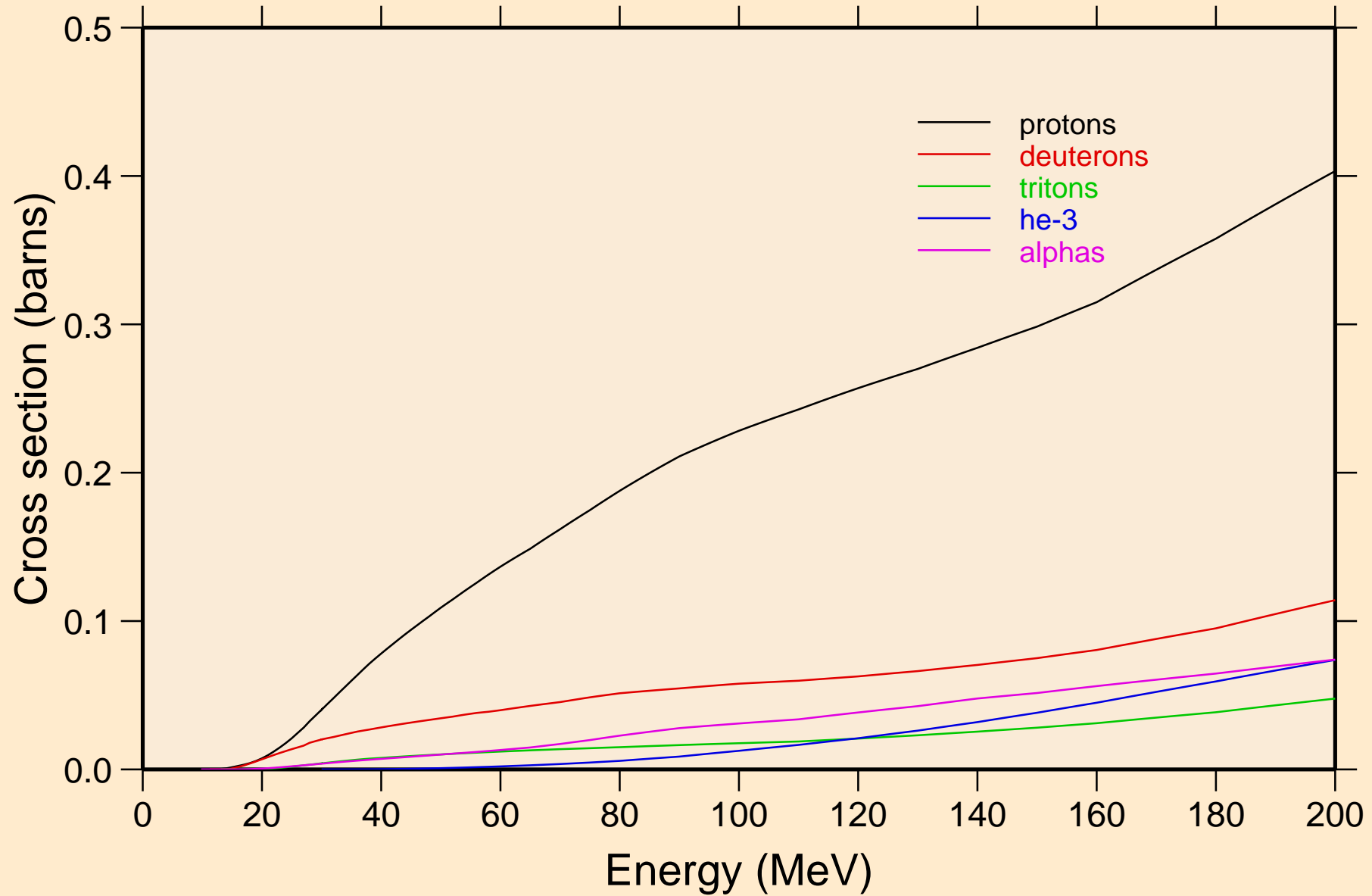

K047 NEUTRON ACER TENDL-2021 LIBRARY; T=293.6K
protons from (n,x)

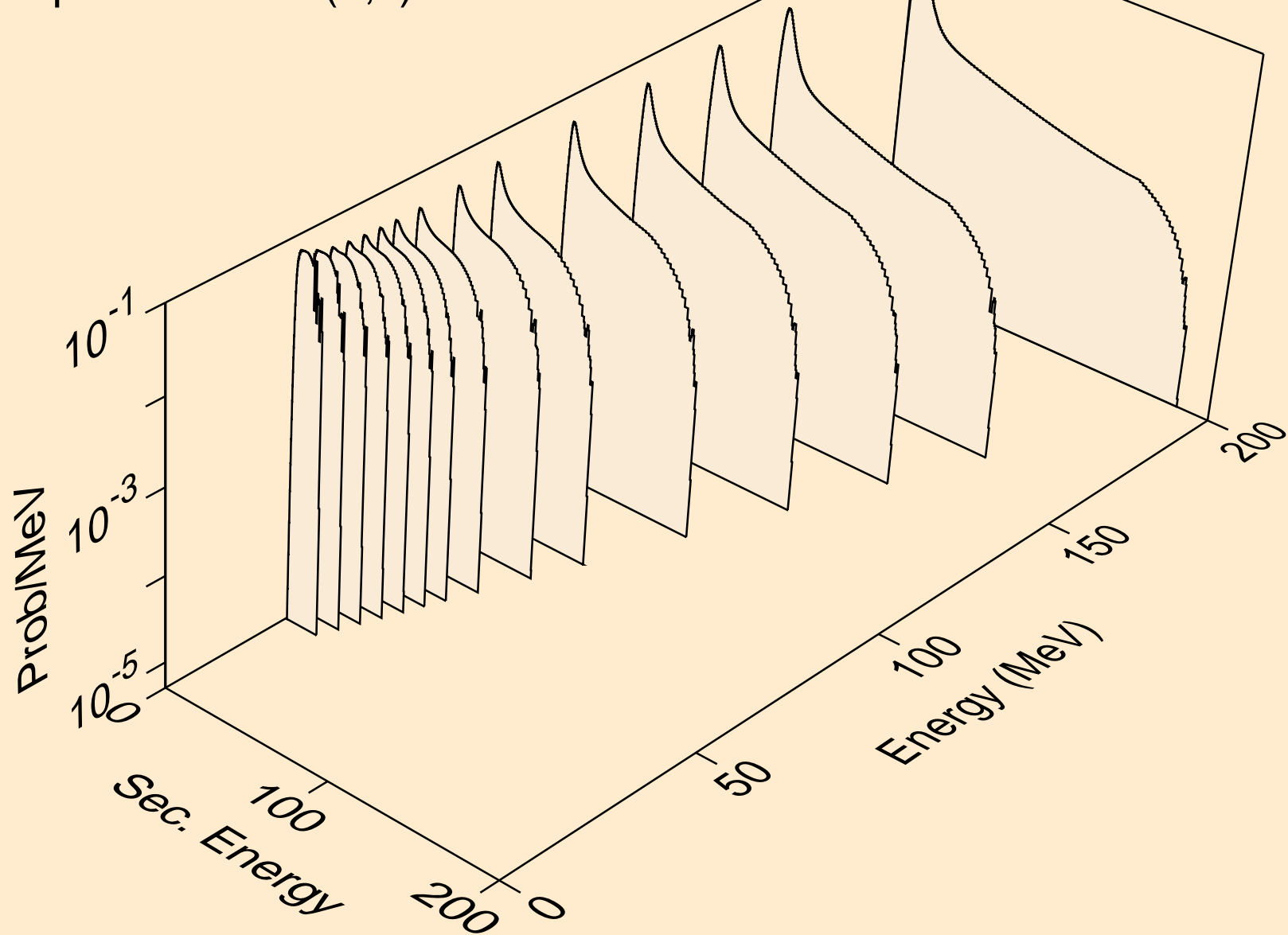

K047 NEUTRON ACER TENDL-2021 LIBRARY; T=293.6K
protons from (n,n*)p

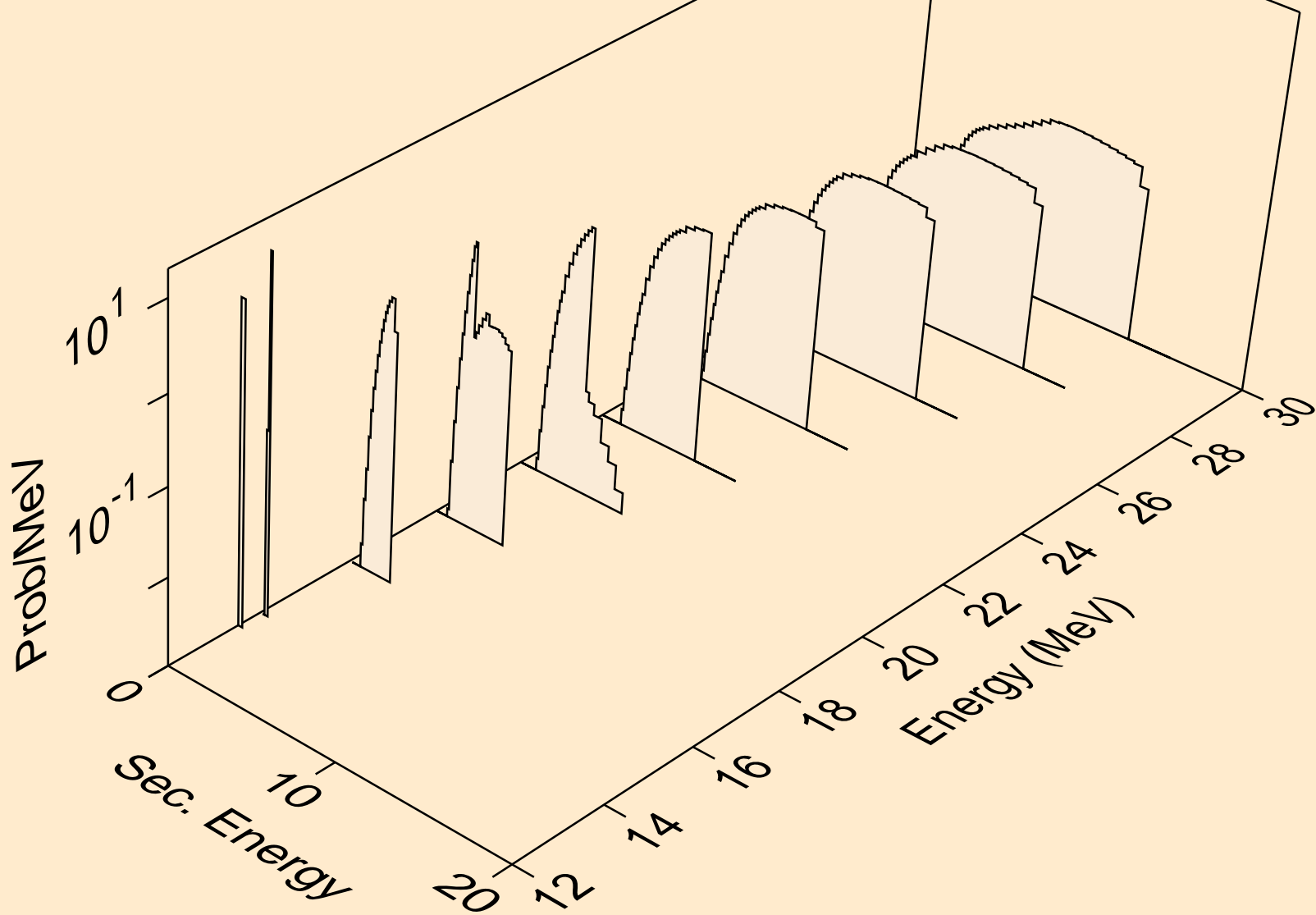

K047 NEUTRON ACER TENDL-2021 LIBRARY; T=293.6K
protons from (n,2np)

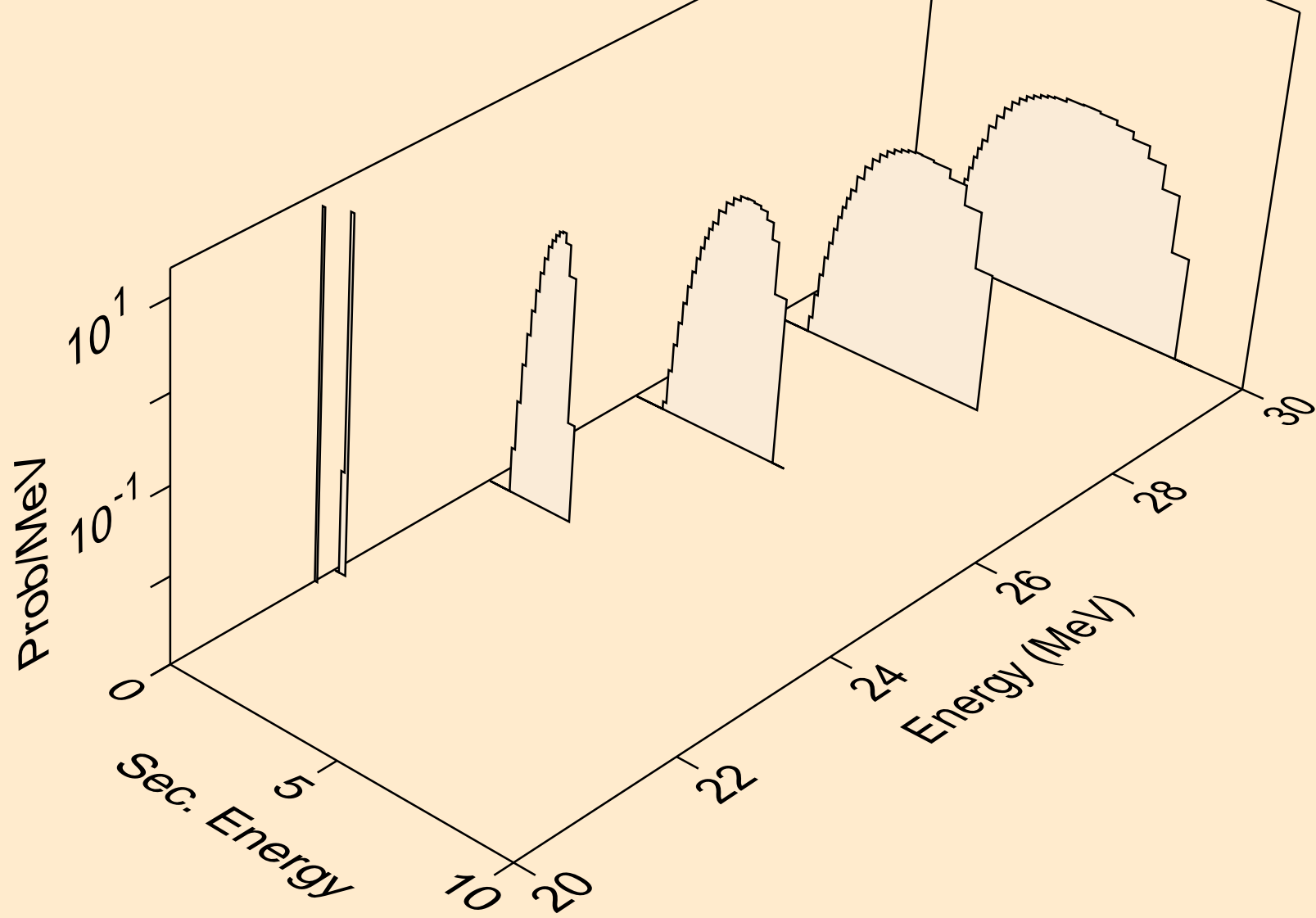

K047 NEUTRON ACER TENDL-2021 LIBRARY; T=293.6K
protons from (n,3np)

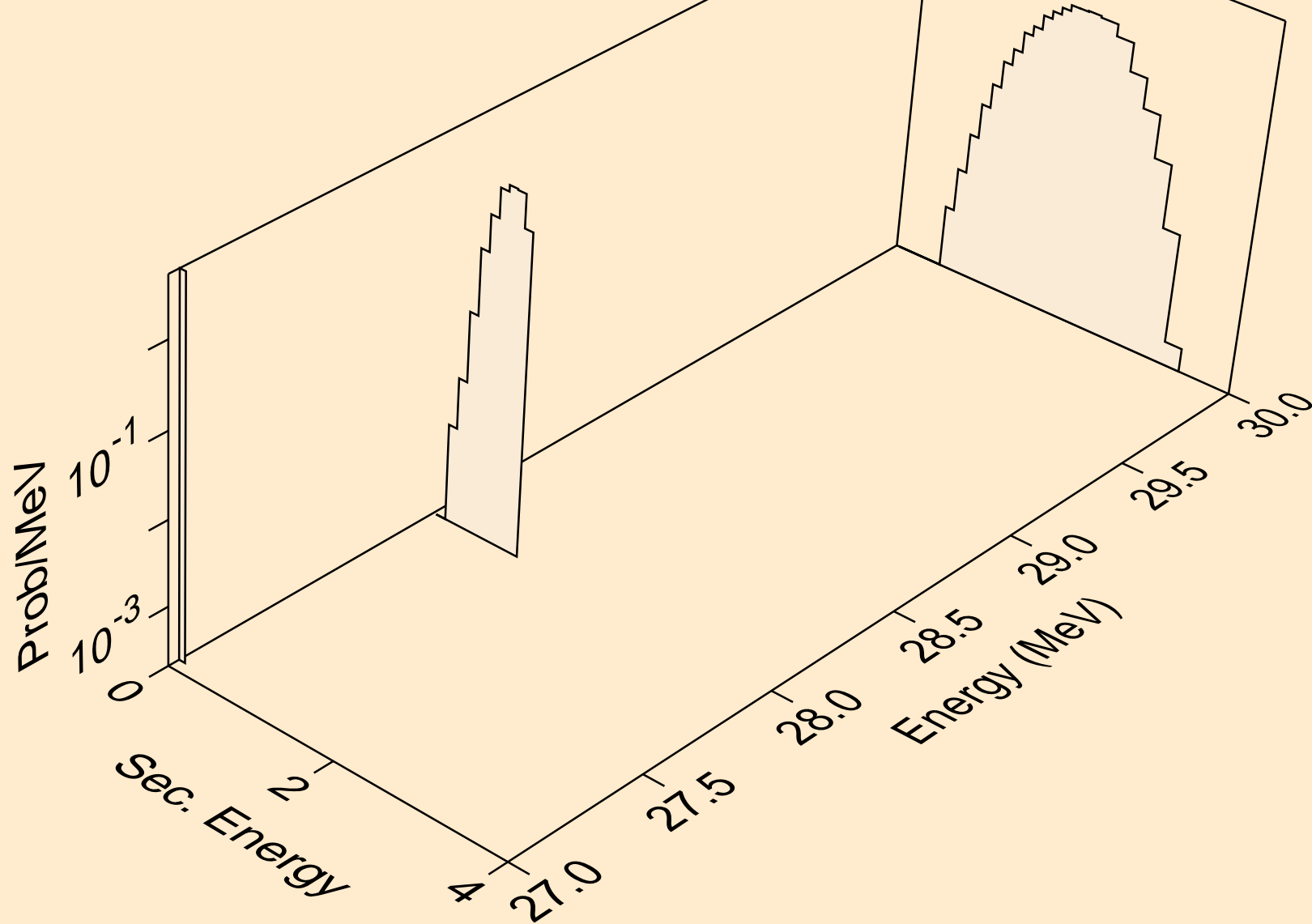

K047 NEUTRON ACER TENDL-2021 LIBRARY; T=293.6K
protons from (n,p)

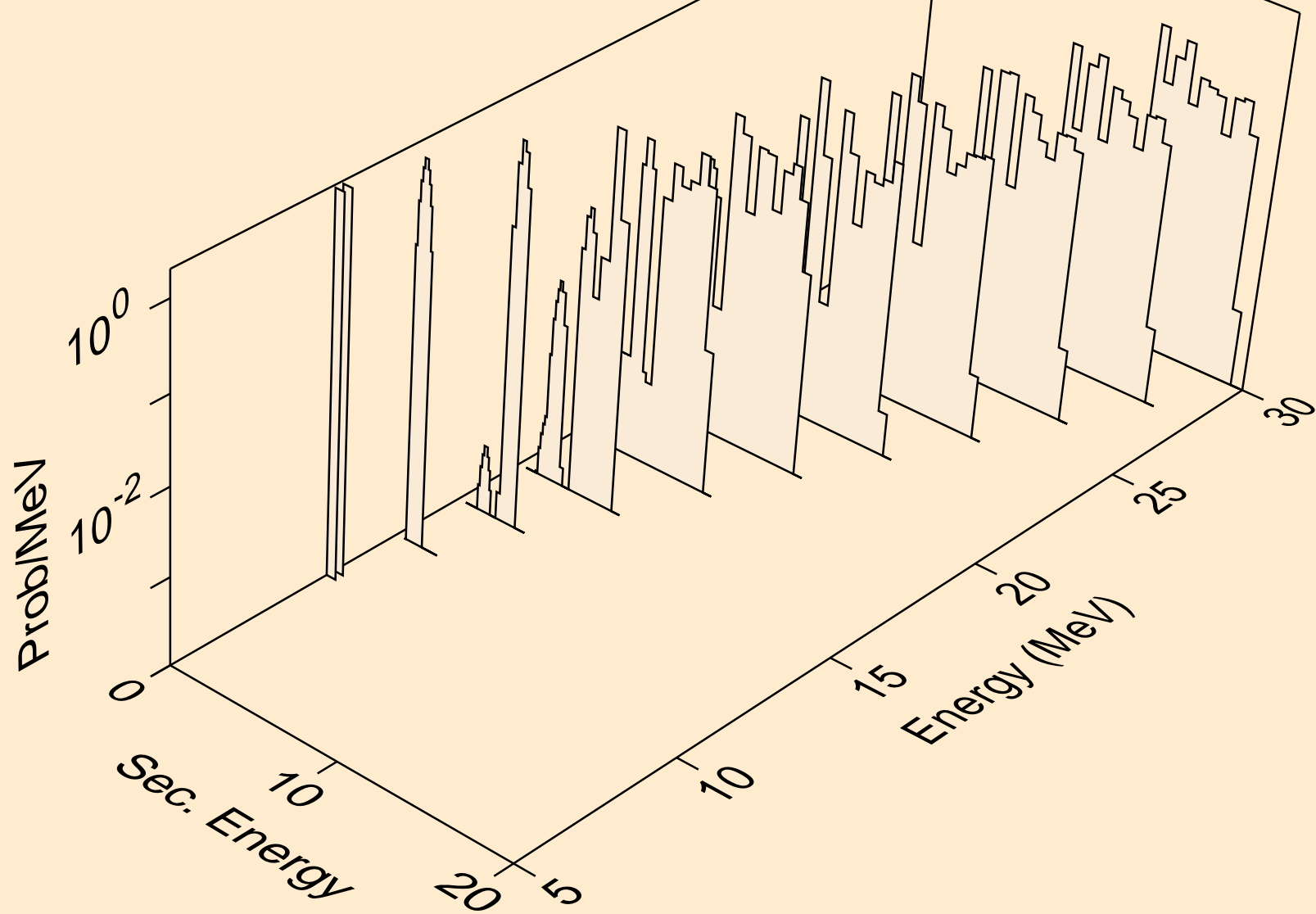

K047 NEUTRON ACER TENDL-2021 LIBRARY; T=293.6K
deuterons from (n,x)

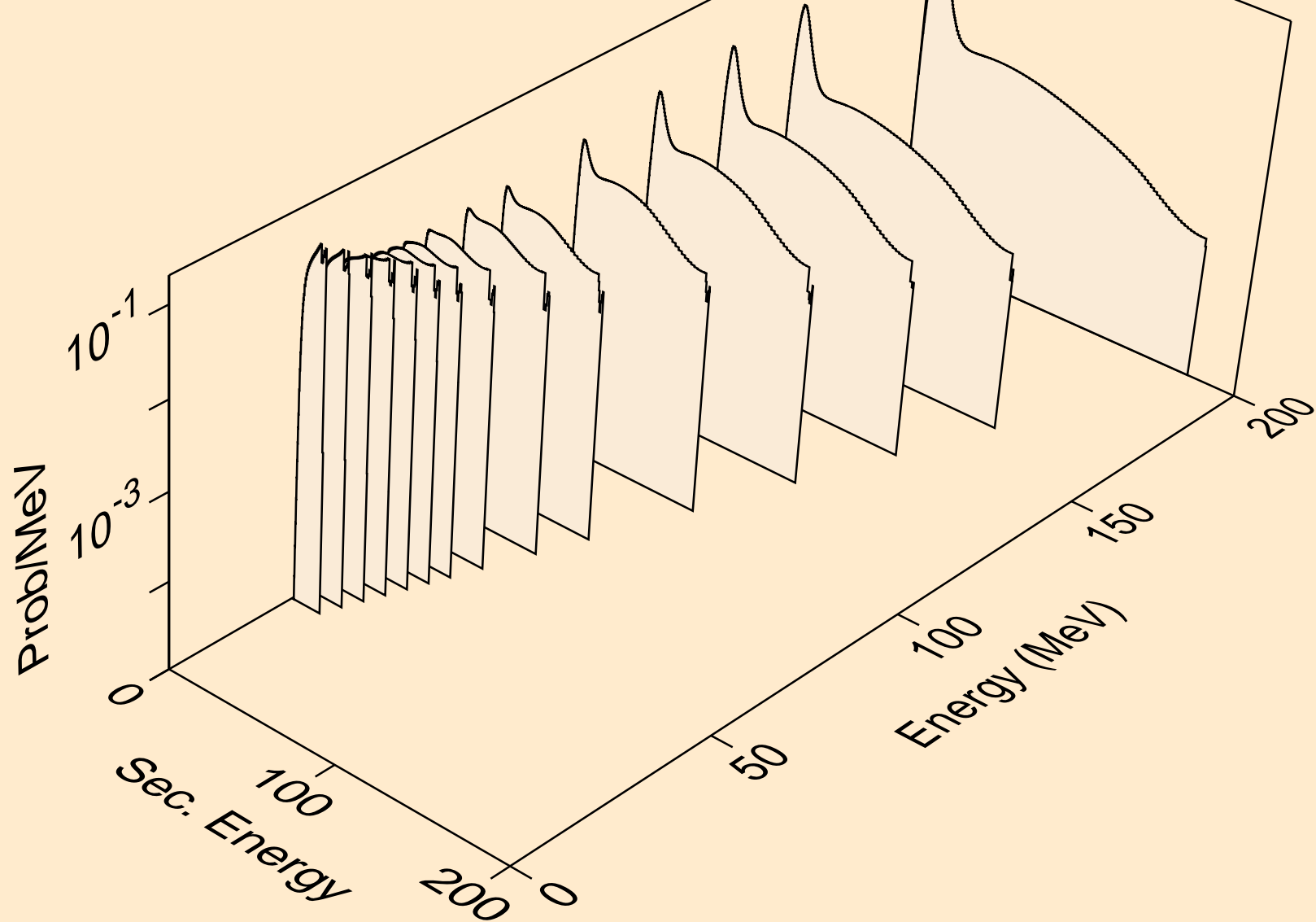

K047 NEUTRON ACER TENDL-2021 LIBRARY; T=293.6K
deuterons from (n,2nd)

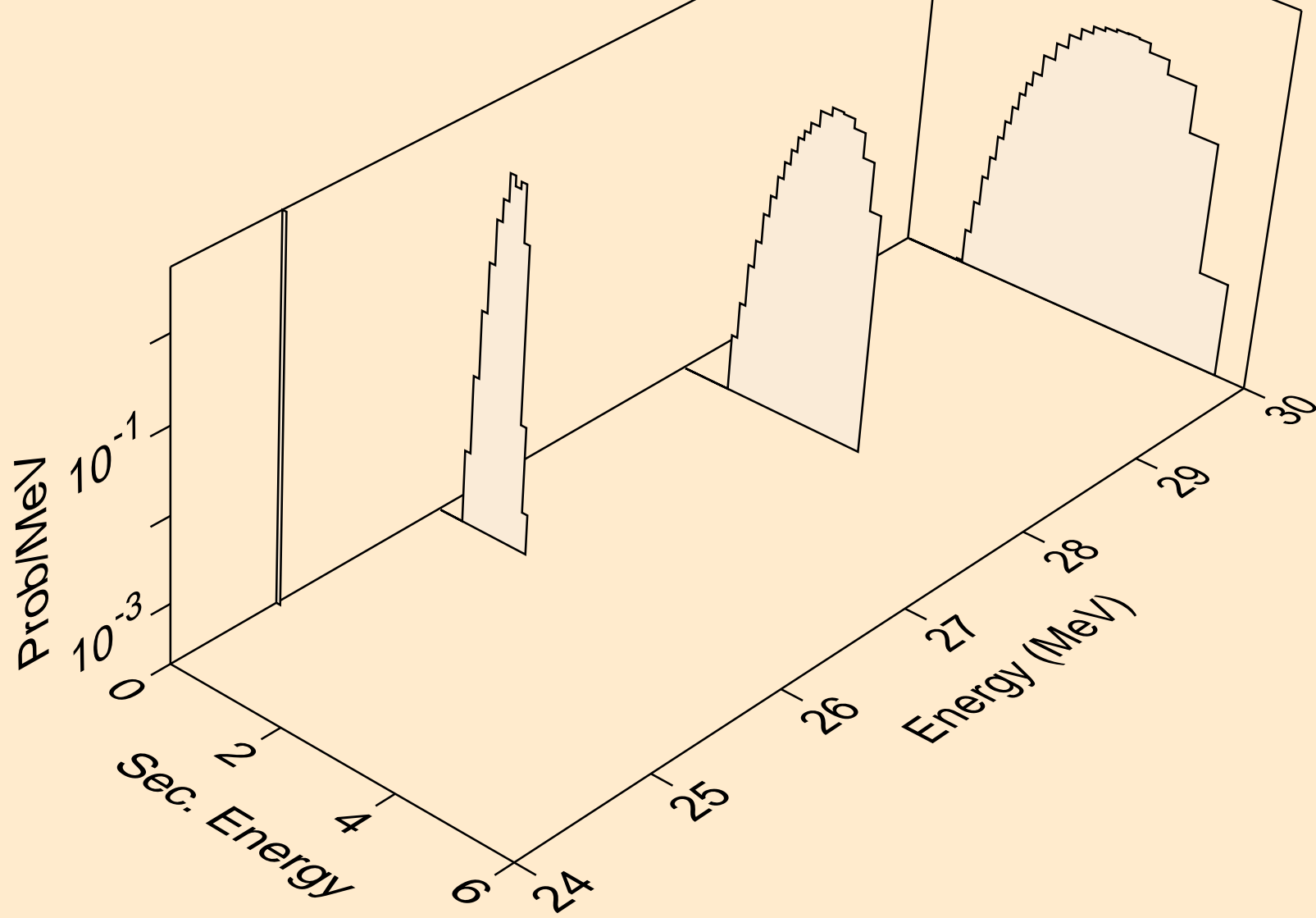

K047 NEUTRON ACER TENDL-2021 LIBRARY; T=293.6K
deuterons from (n,n*)d

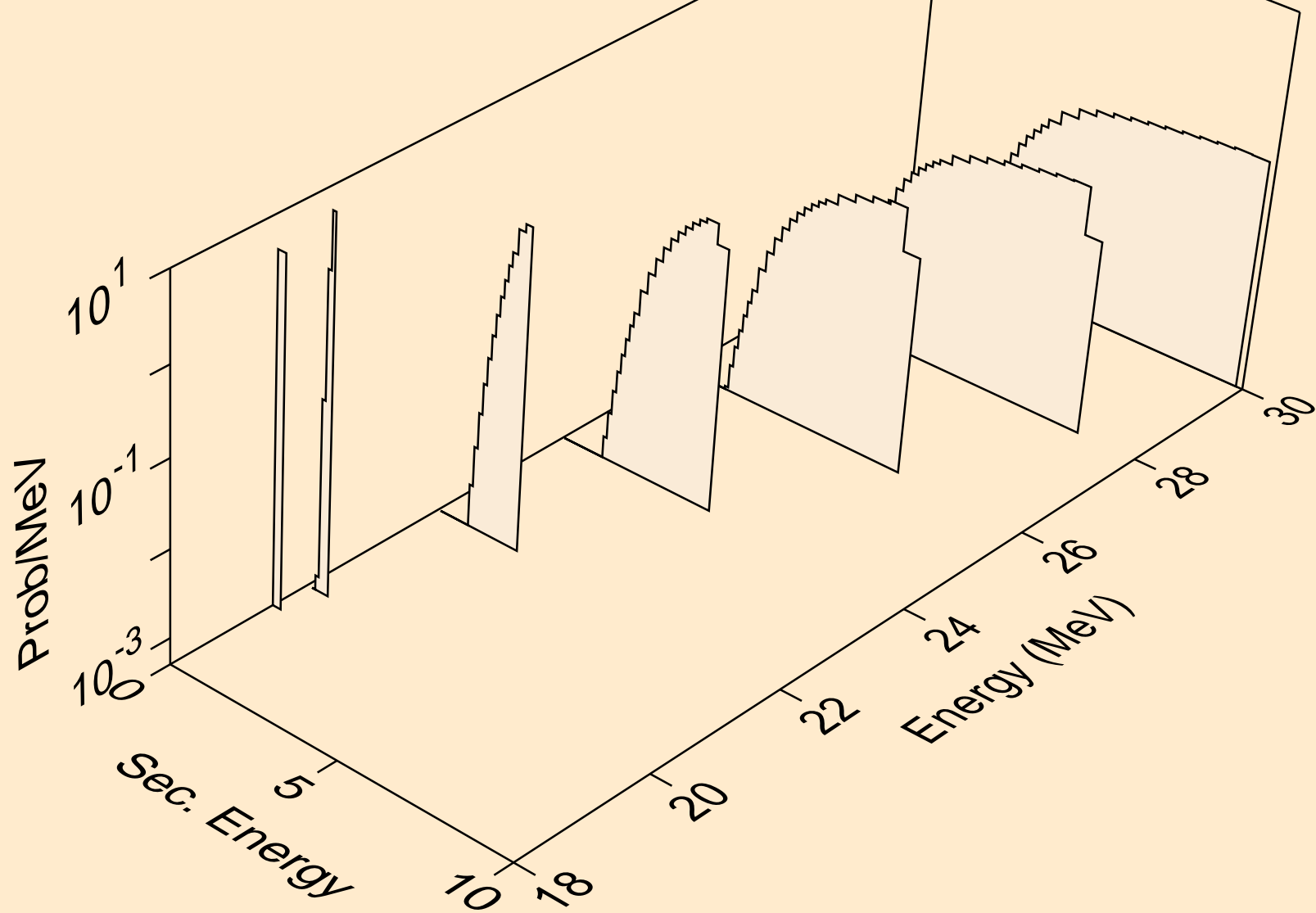

K047 NEUTRON ACER TENDL-2021 LIBRARY; T=293.6K
deuterons from (n,d)

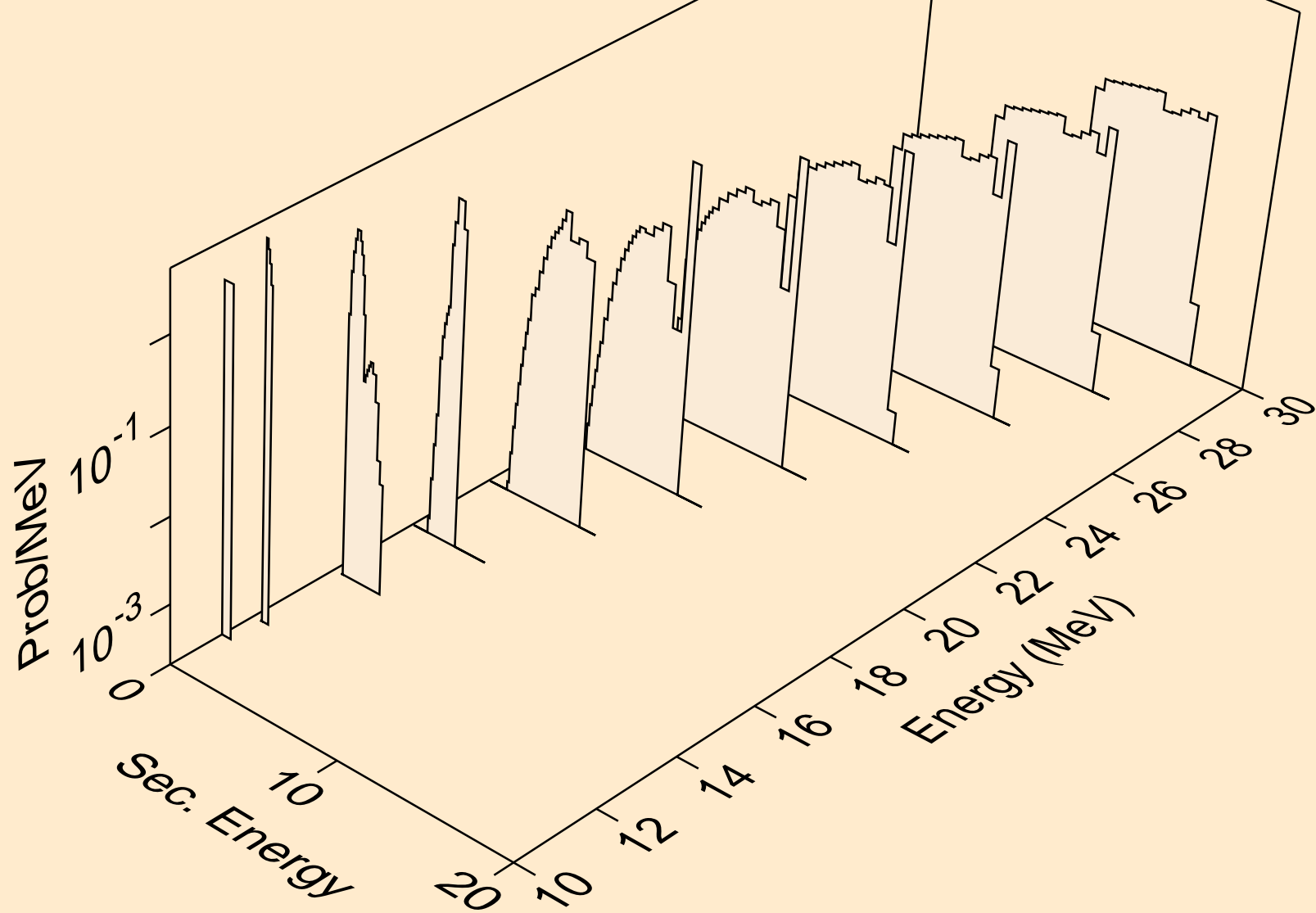

K047 NEUTRON ACER TENDL-2021 LIBRARY; T=293.6K
tritons from (n,x)

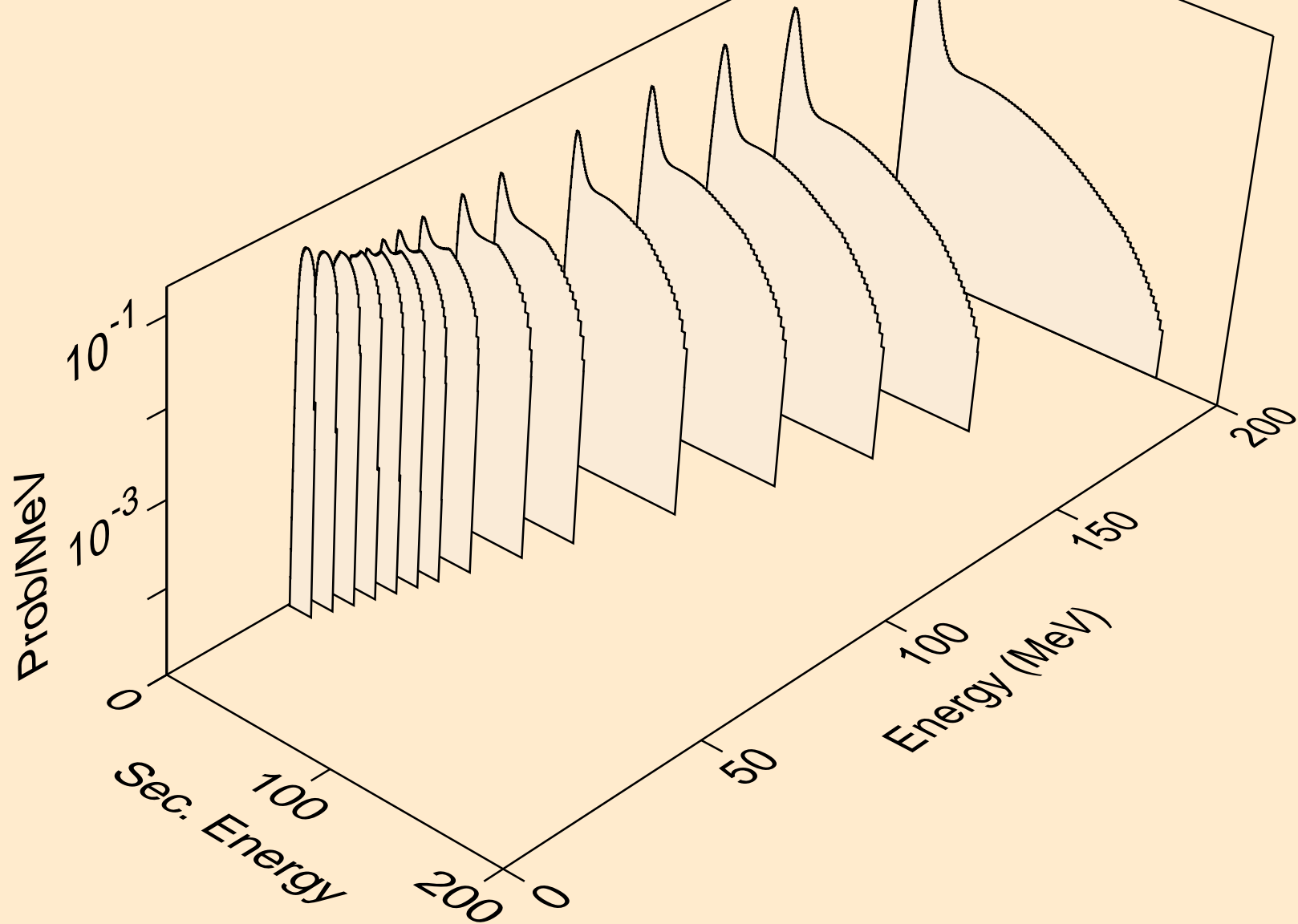

K047 NEUTRON ACER TENDL-2021 LIBRARY; T=293.6K
tritons from (n,n*)t

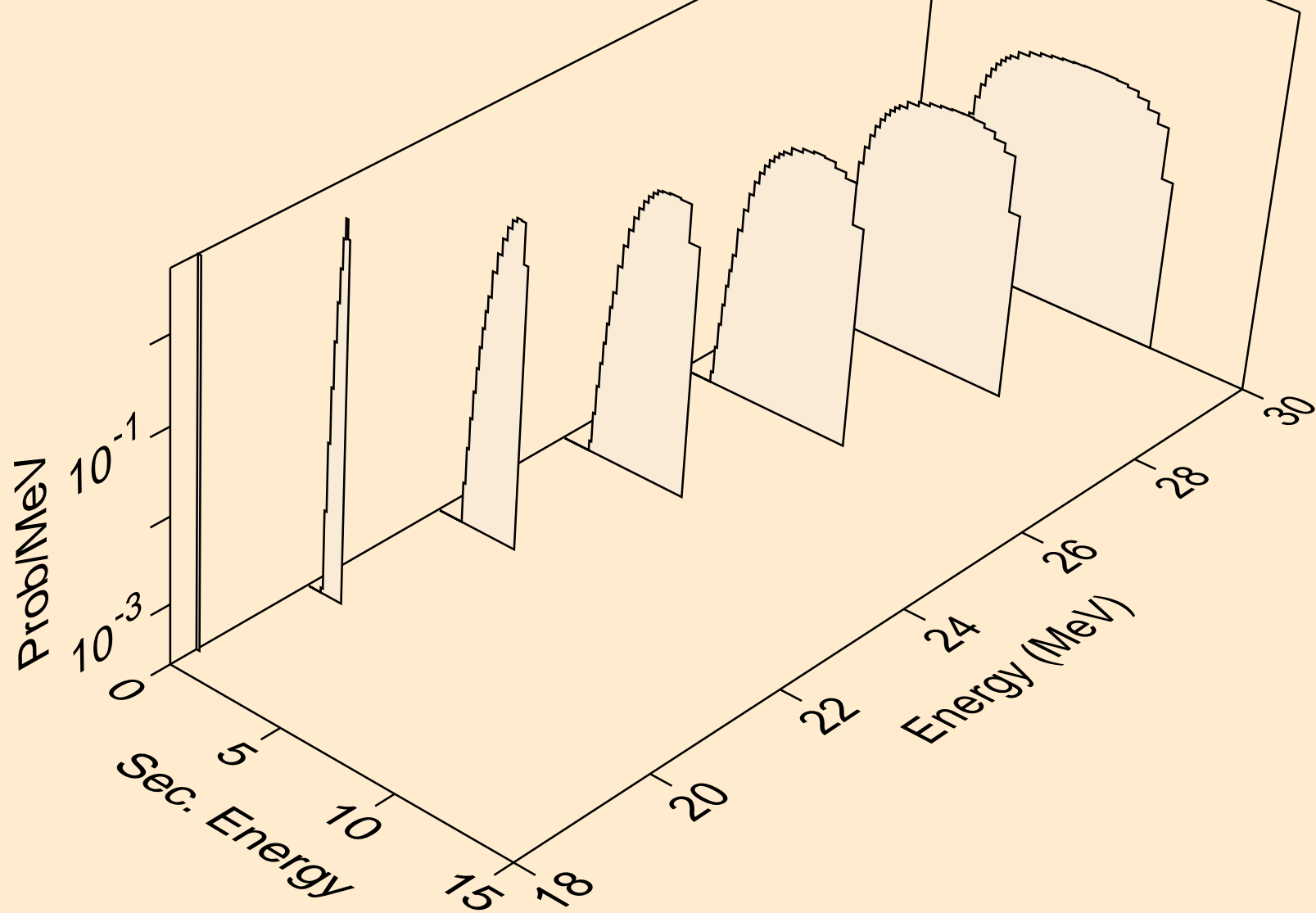

K047 NEUTRON ACER TENDL-2021 LIBRARY; T=293.6K
tritons from (n,t)

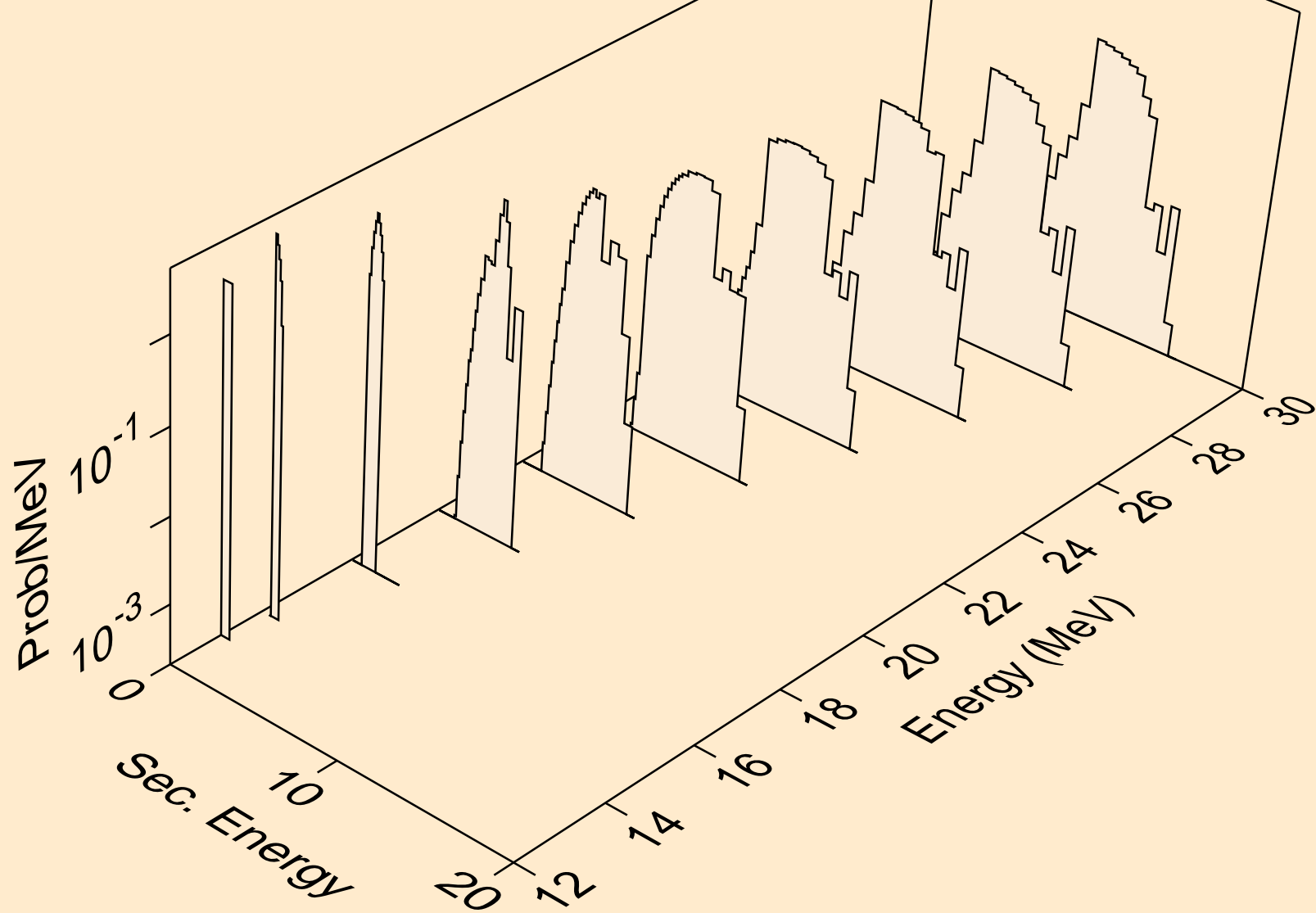

K047 NEUTRON ACER TENDL-2021 LIBRARY; T=293.6K
he3s from (n,x)

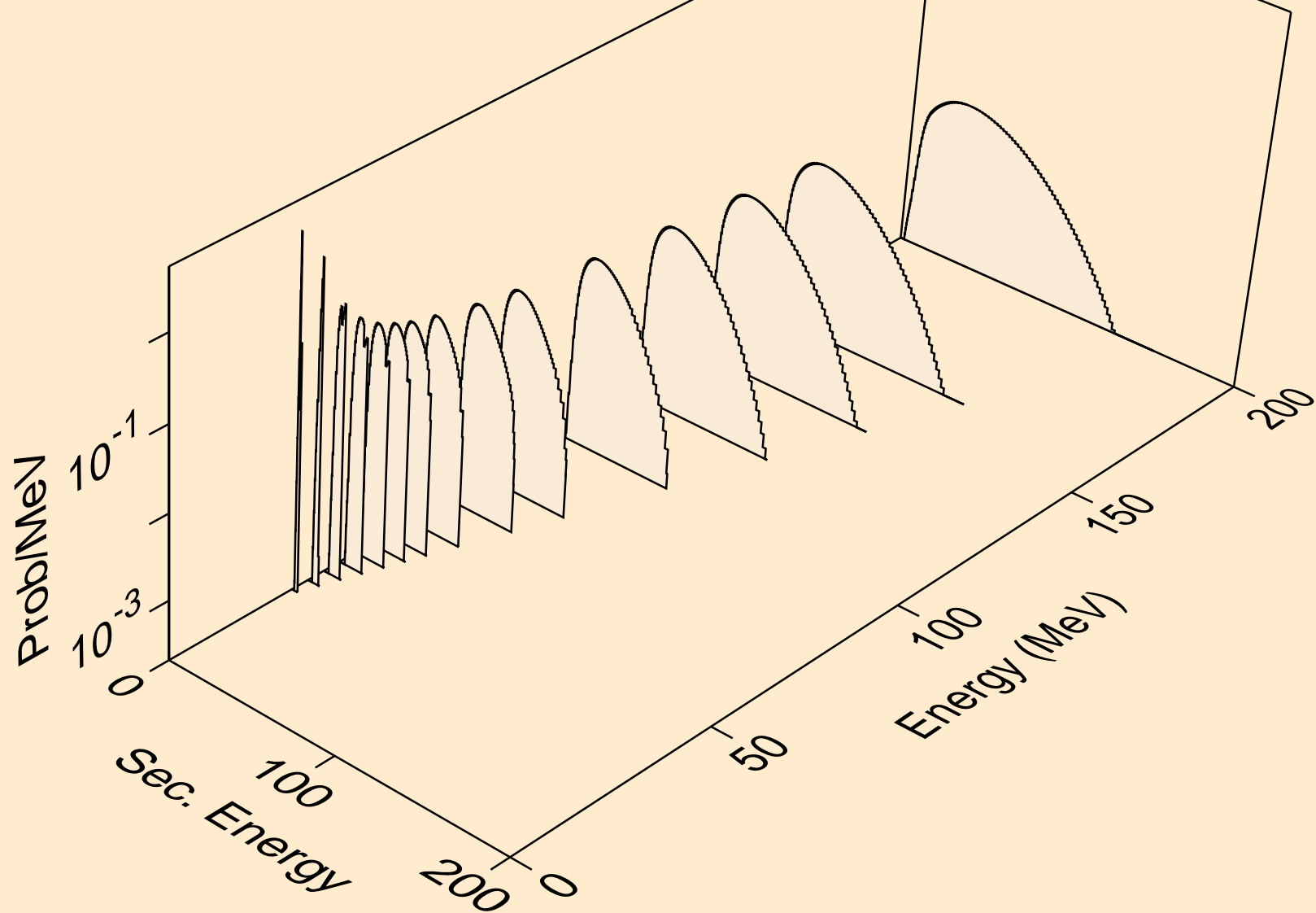

K047 NEUTRON ACER TENDL-2021 LIBRARY; T=293.6K
alphas from (n,x)

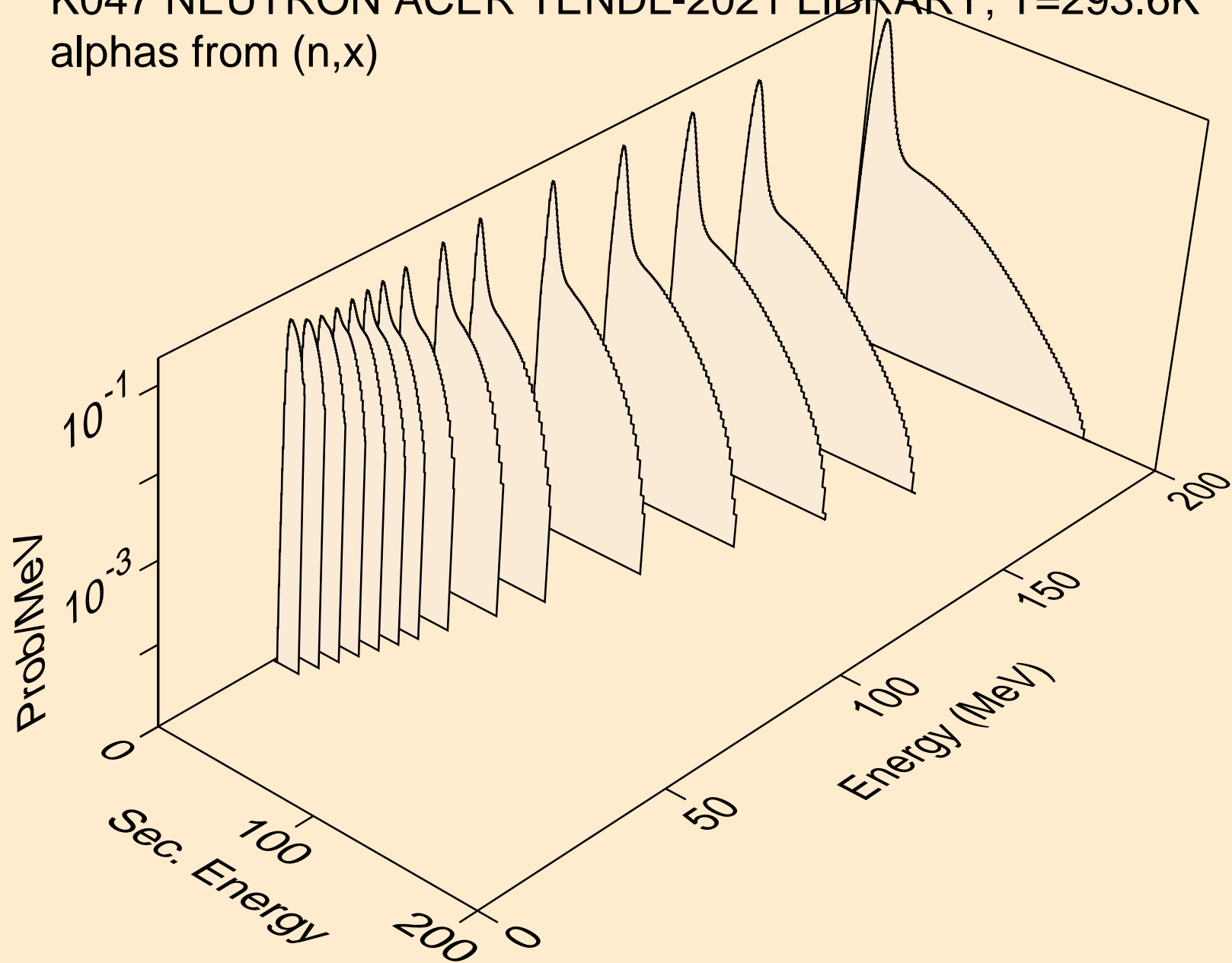

K047 NEUTRON ACER TENDL-2021 LIBRARY; T=293.6K
alphas from (n,n*)a

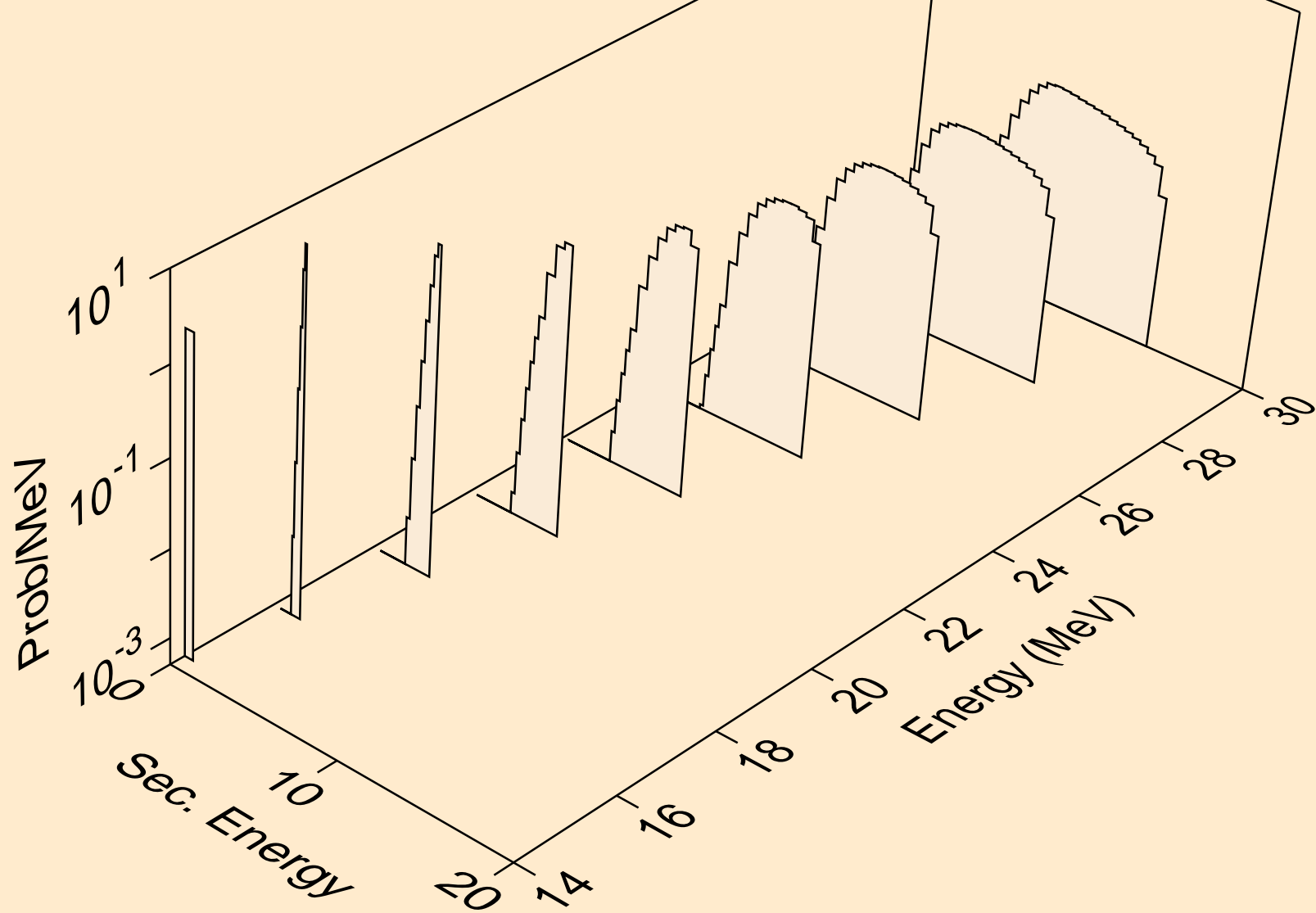

K047 NEUTRON ACER TENDL-2021 LIBRARY; T=293.6K
alphas from (n,2n)a

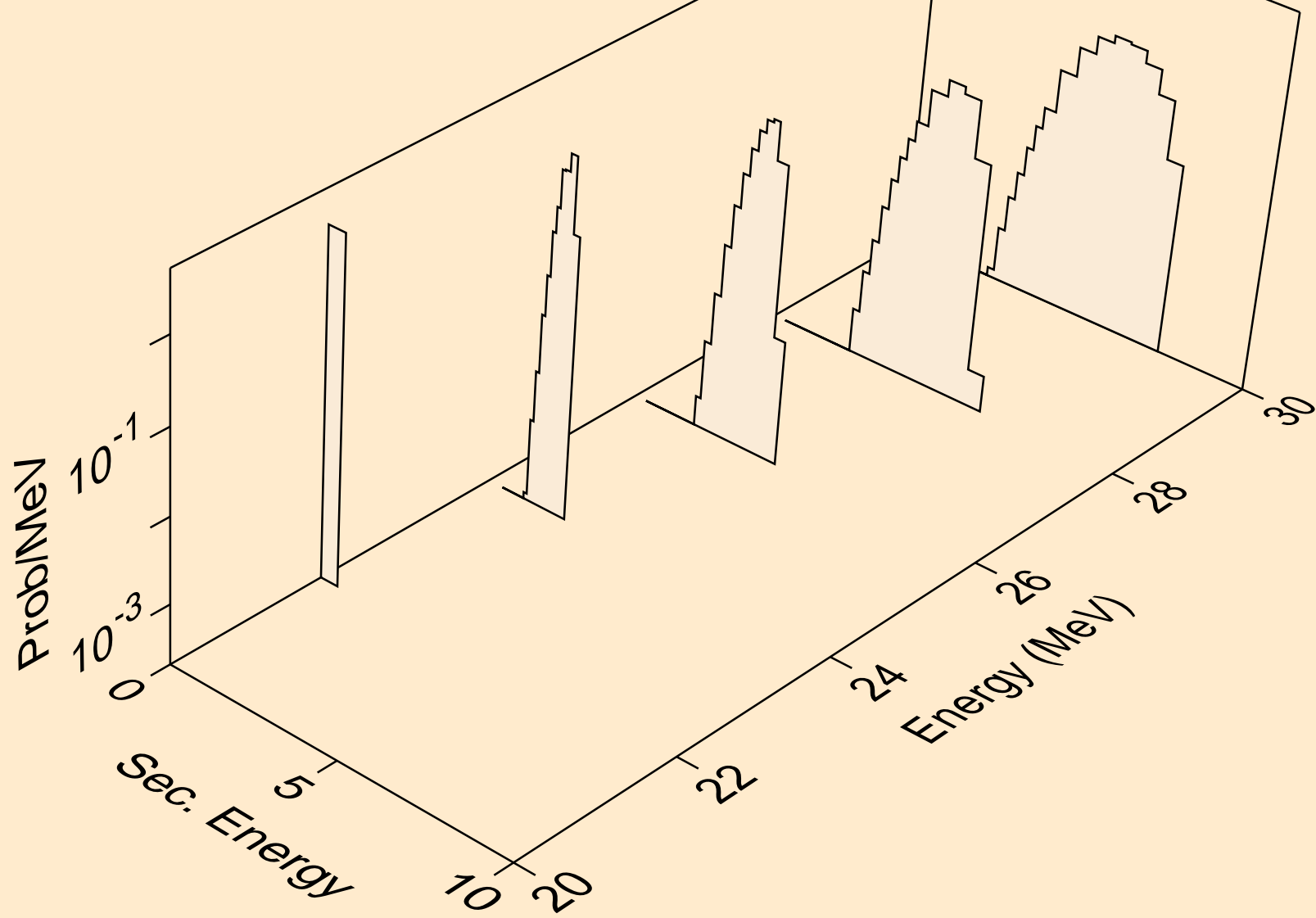

K047 NEUTRON ACER TENDL-2021 LIBRARY; T=293.6K
alphas from (n,a)

