

KR083 NEUTRON ACER TENDL-2021 LIBRARY; T=293.6K

Principal cross sections

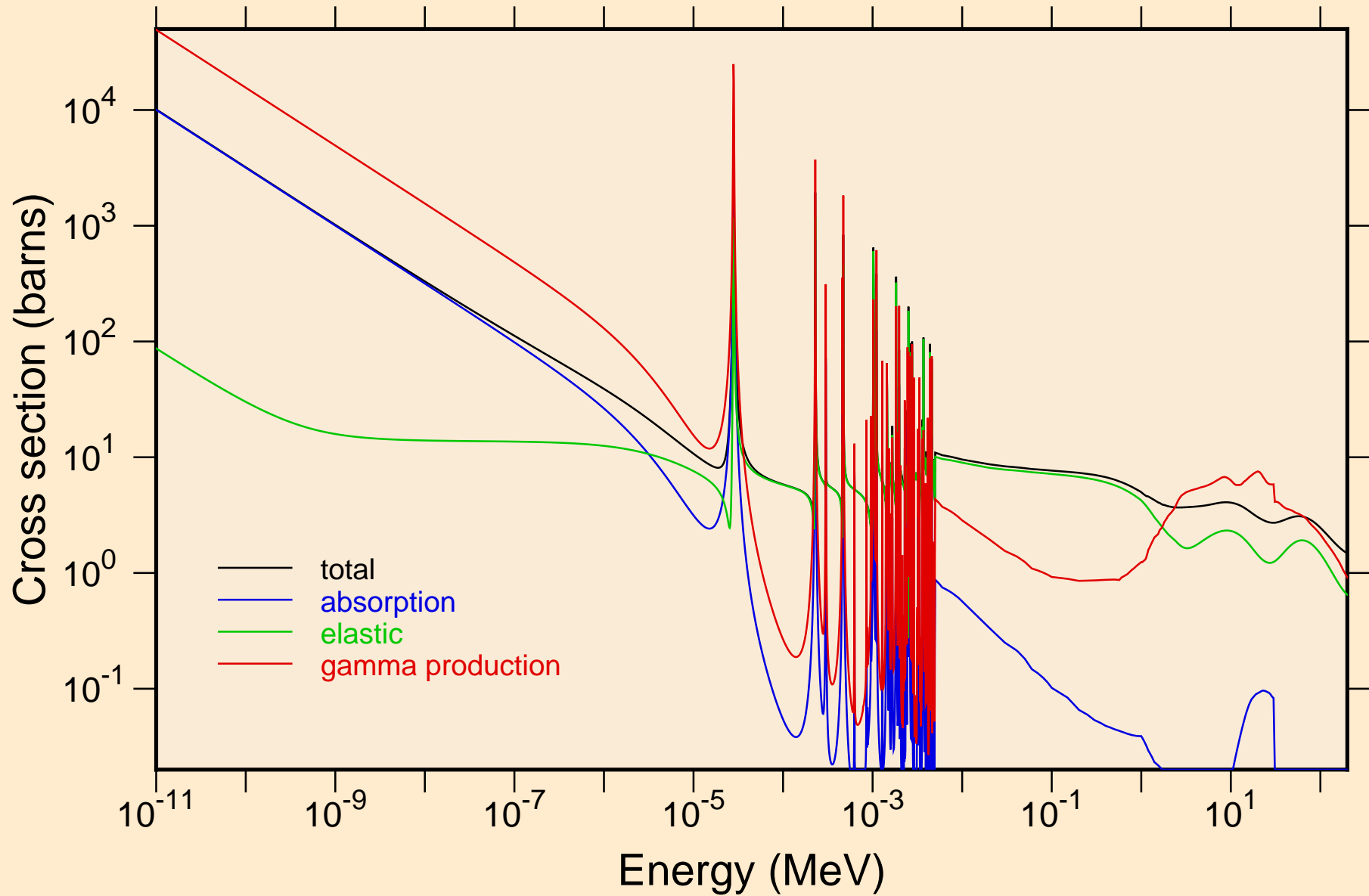

KR083 NEUTRON ACER TENDL-2021 LIBRARY; T=293.6K
resonance total cross section

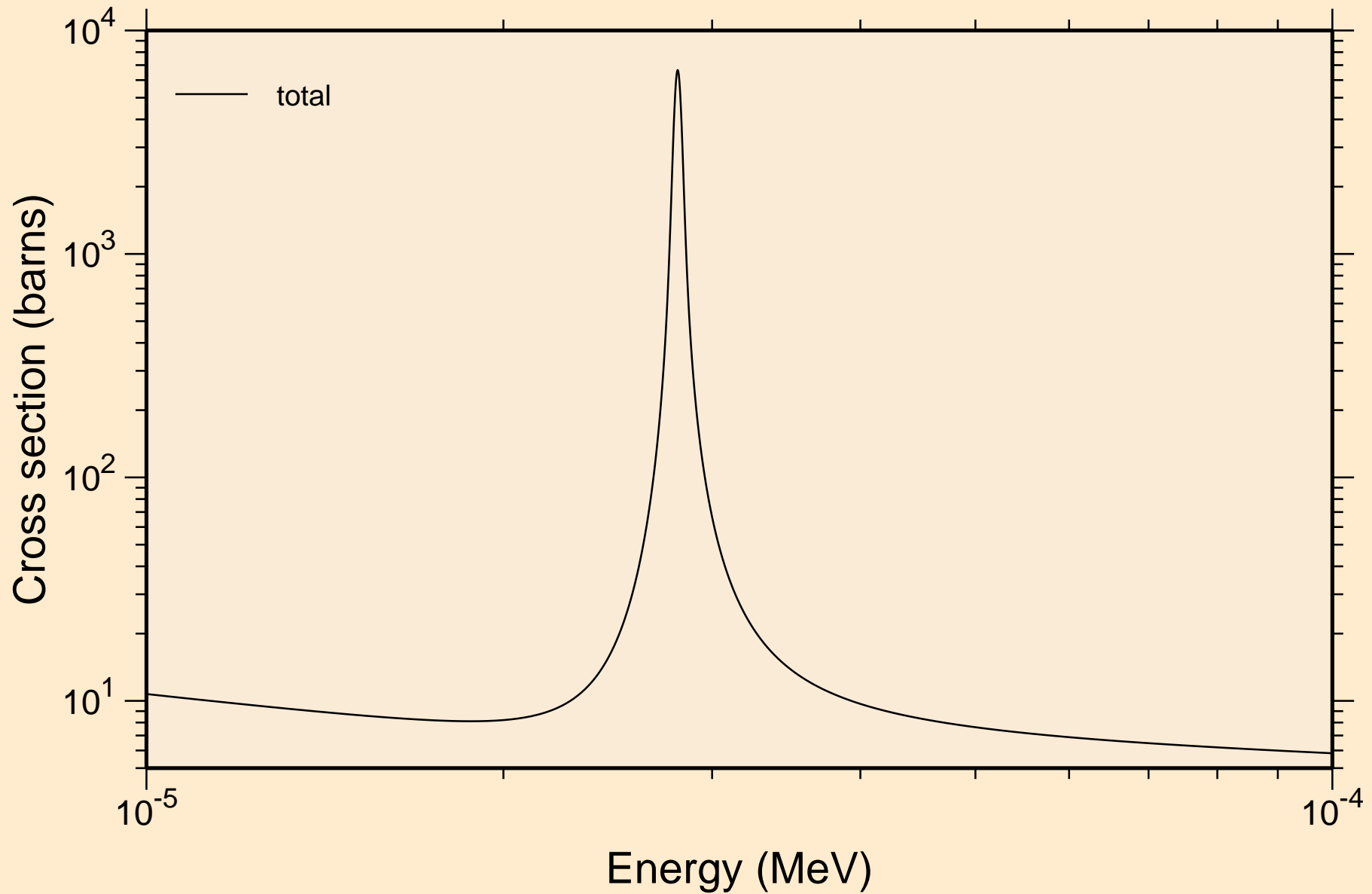

KR083 NEUTRON ACER TENDL-2021 LIBRARY; T=293.6K
resonance total cross section

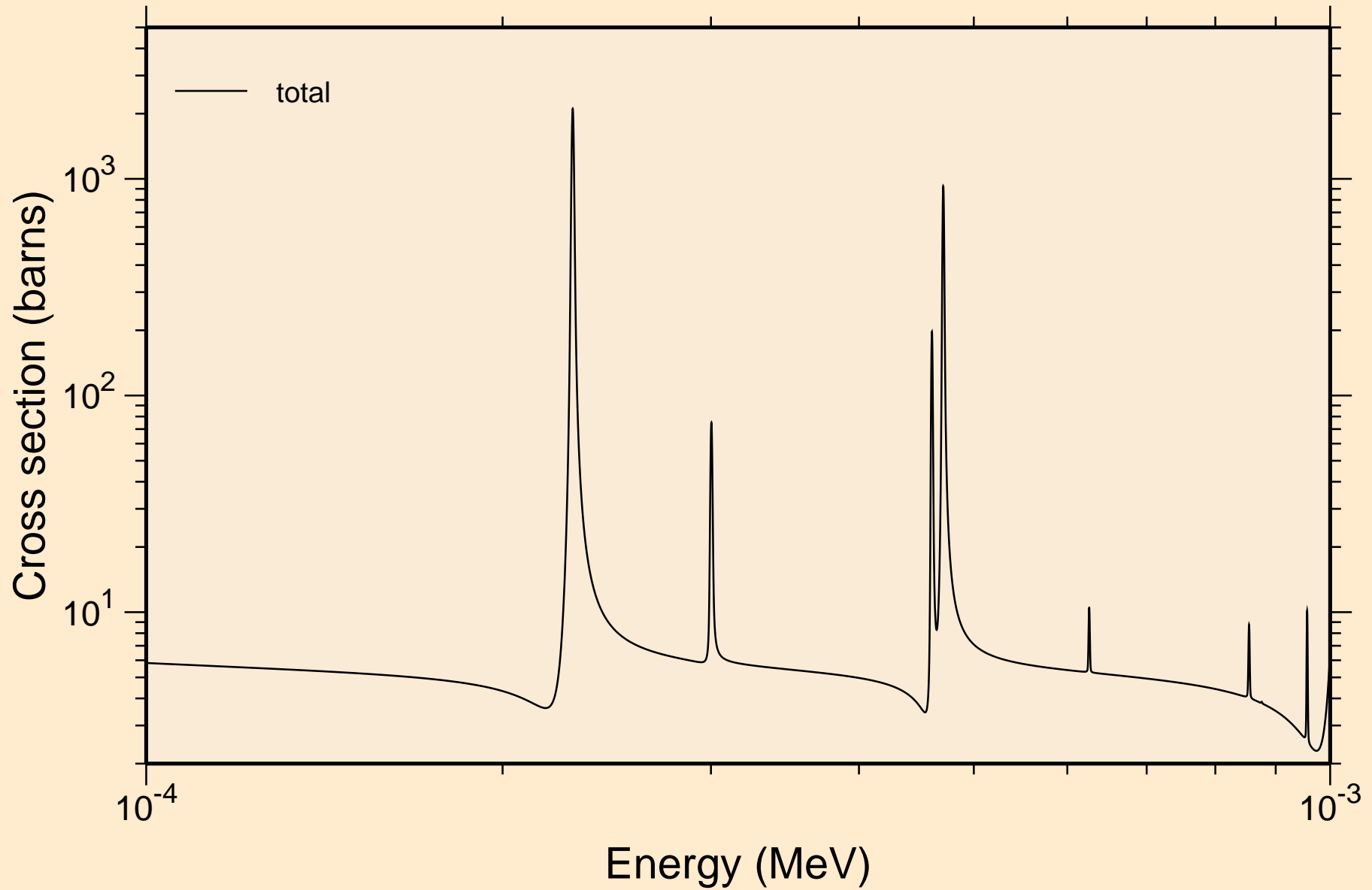

KR083 NEUTRON ACER TENDL-2021 LIBRARY; T=293.6K
resonance total cross section

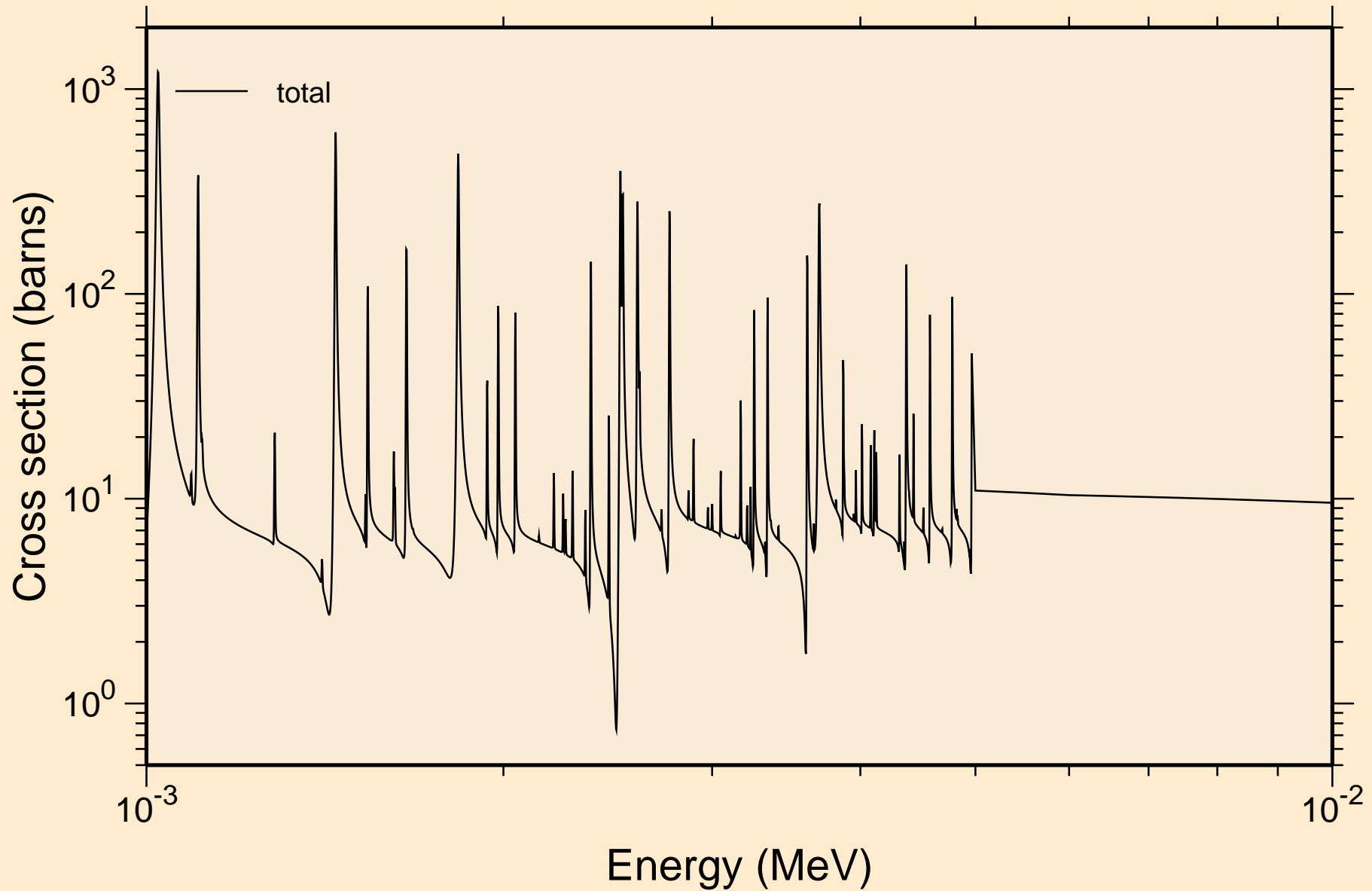

KR083 NEUTRON ACER TENDL-2021 LIBRARY; T=293.6K
resonance total cross section

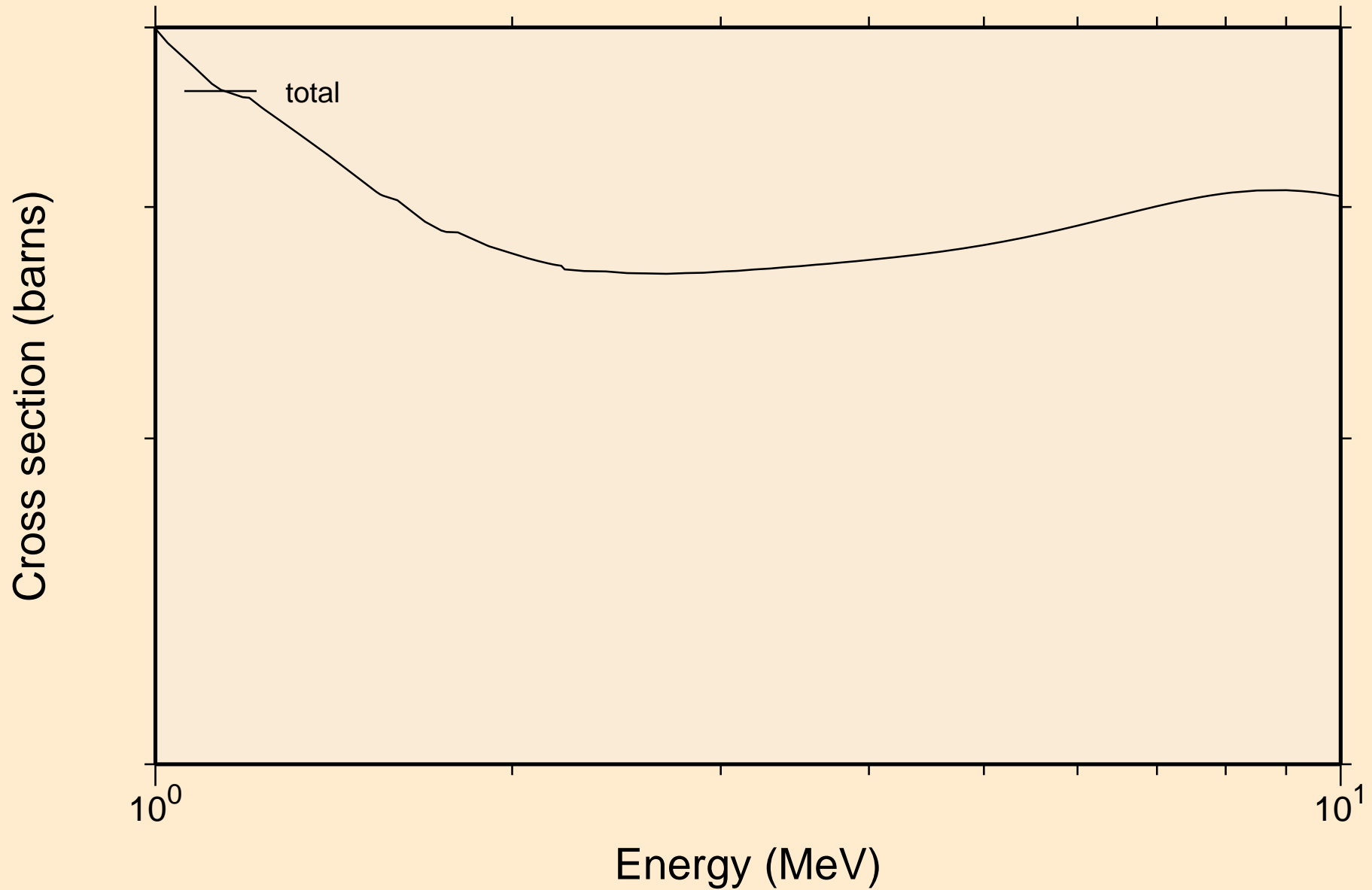

KR083 NEUTRON ACER TENDL-2021 LIBRARY; T=293.6K
resonance absorption cross sections

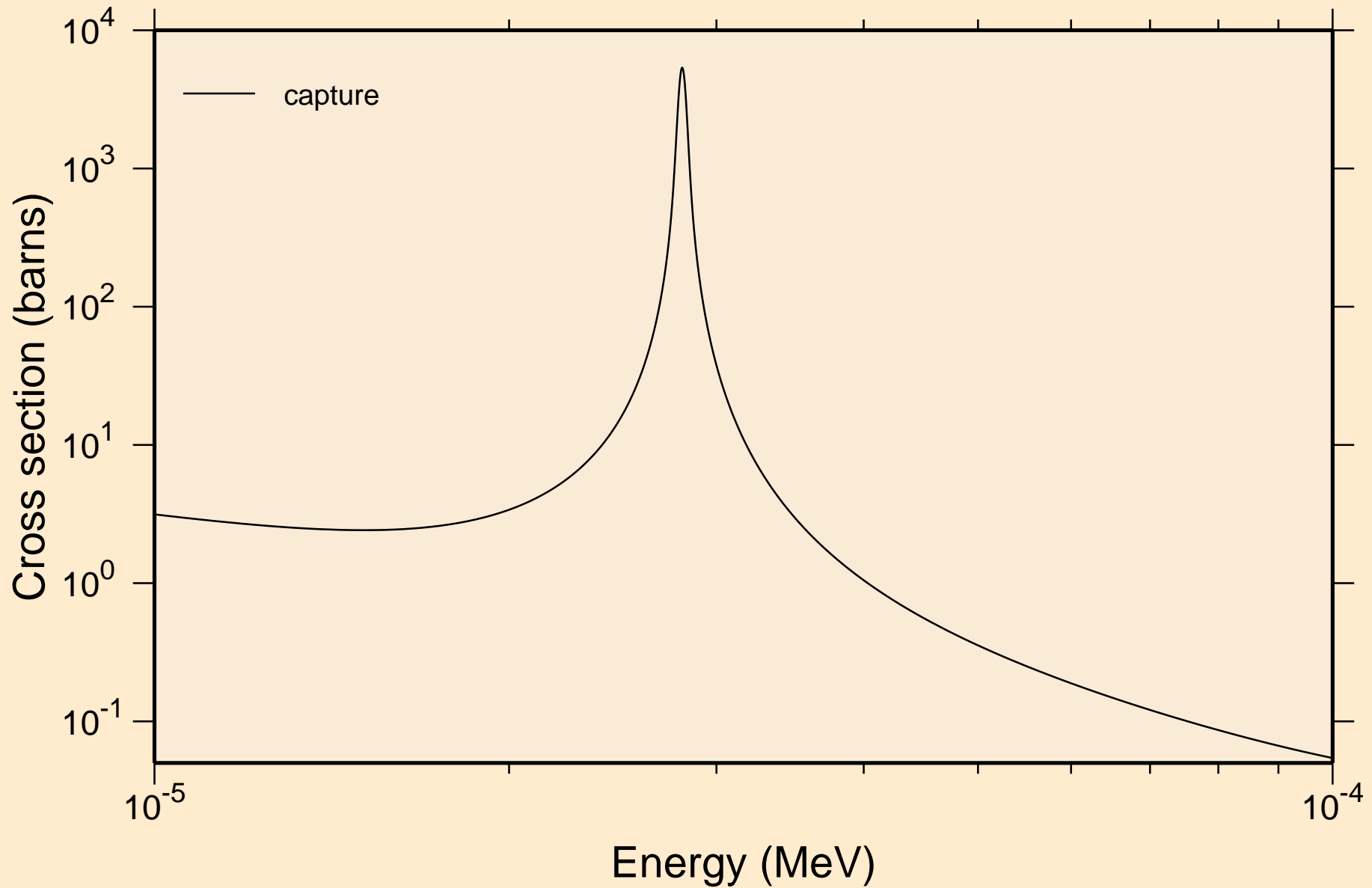

KR083 NEUTRON ACER TENDL-2021 LIBRARY; T=293.6K
resonance absorption cross sections

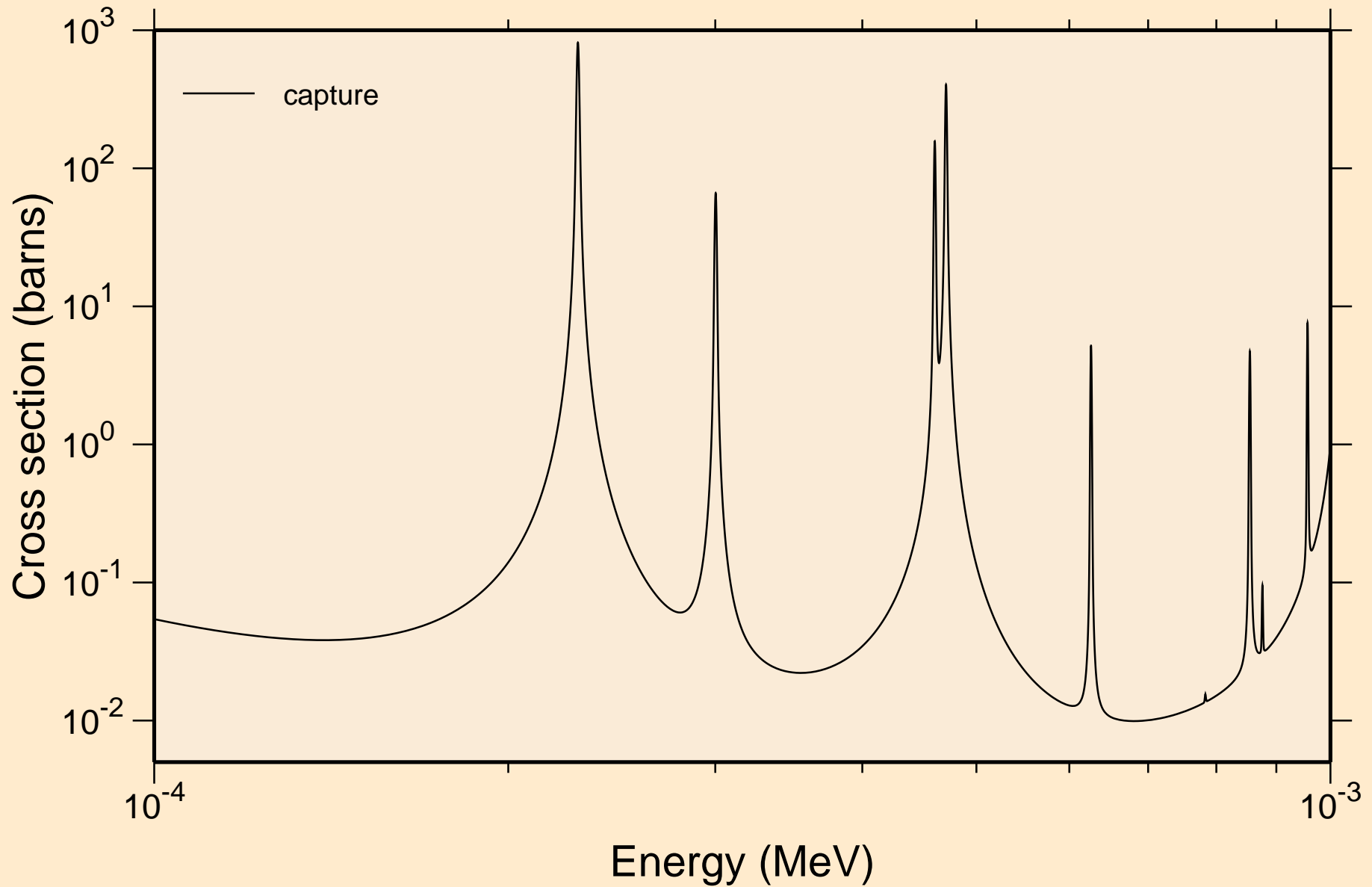

KR083 NEUTRON ACER TENDL-2021 LIBRARY; T=293.6K
resonance absorption cross sections

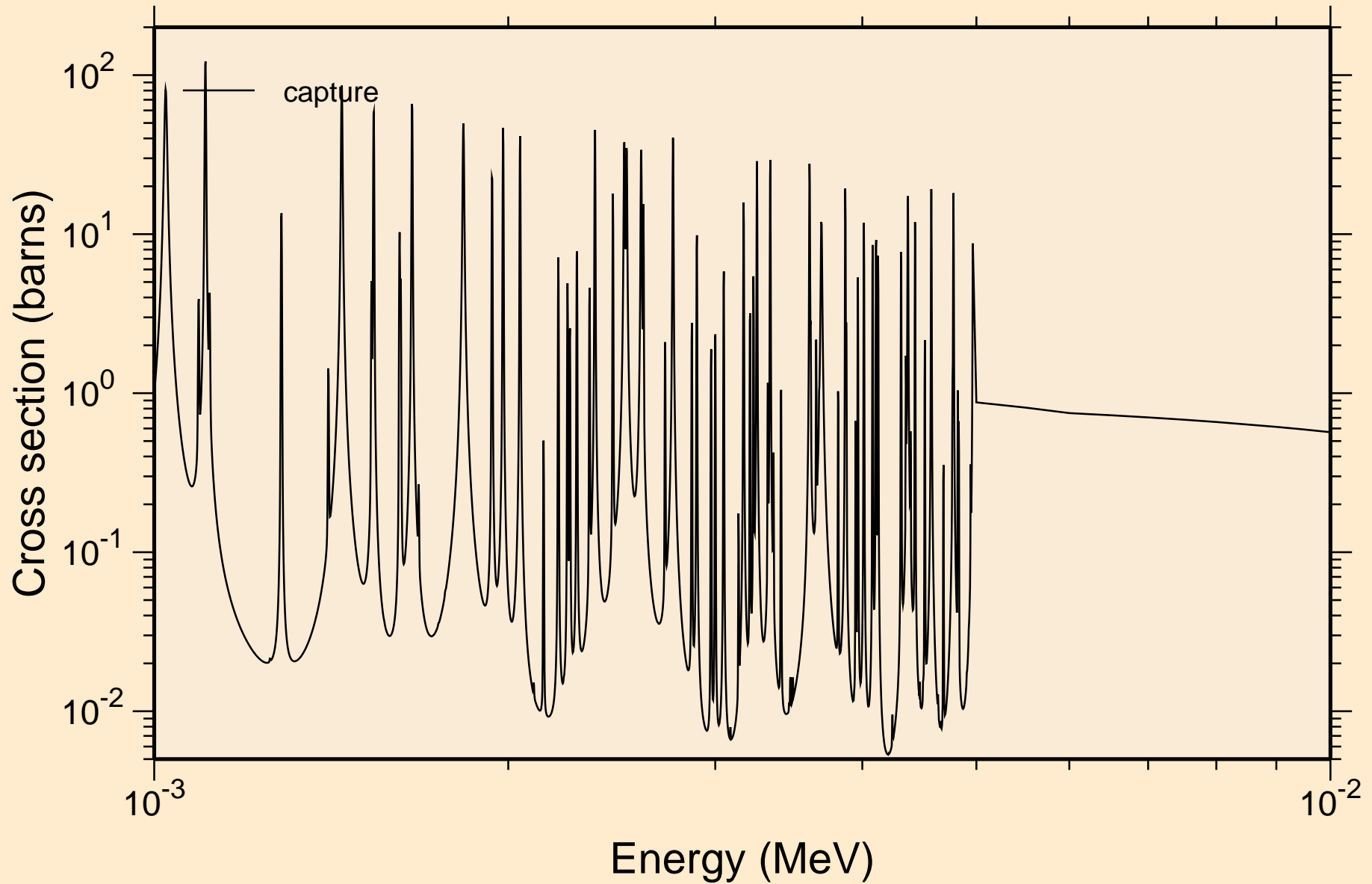

KR083 NEUTRON ACER TENDL-2021 LIBRARY; T=293.6K
resonance absorption cross sections

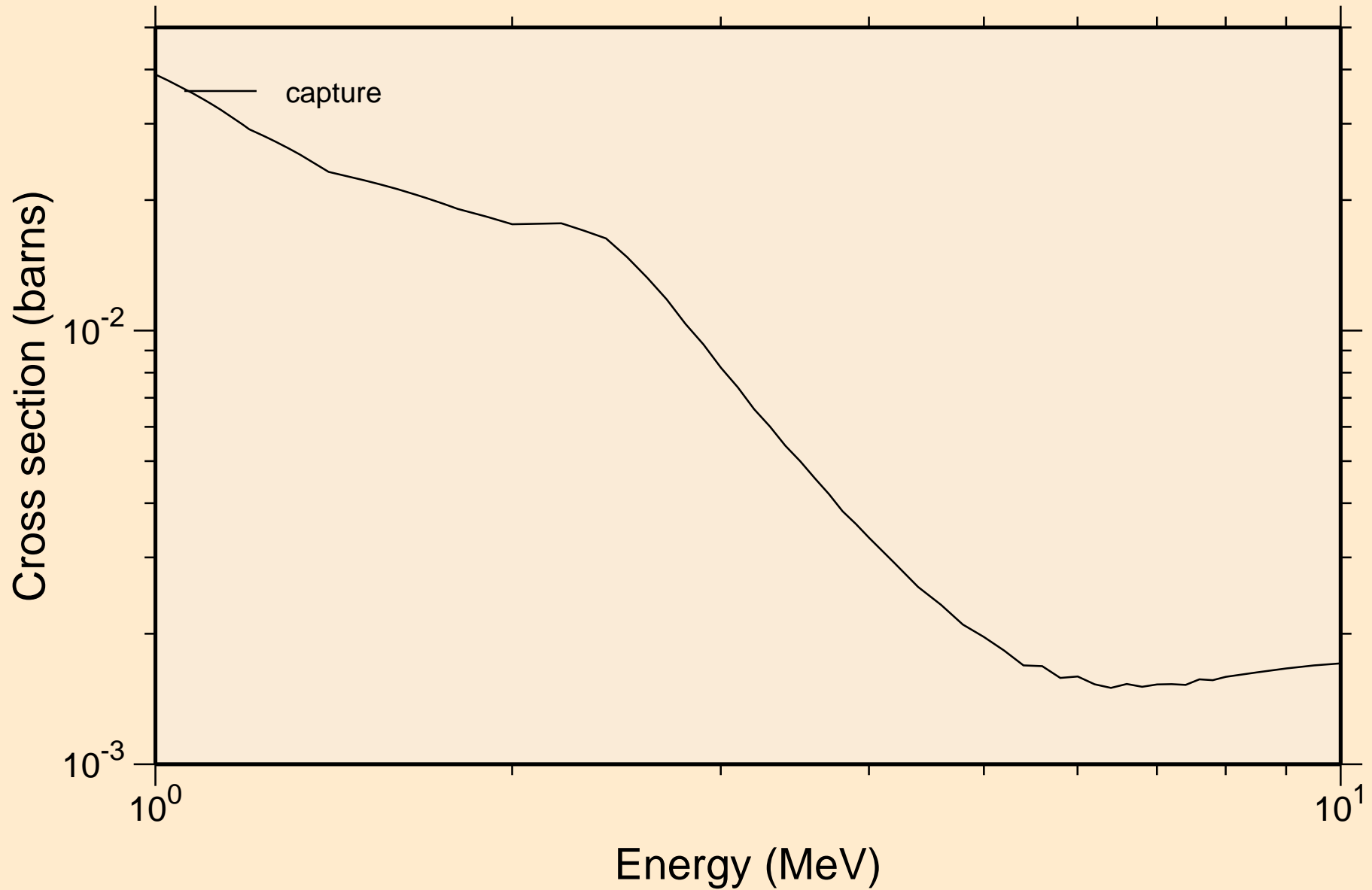

KR083 NEUTRON ACER TENDL-2021 LIBRARY; T=293.6K
Heating

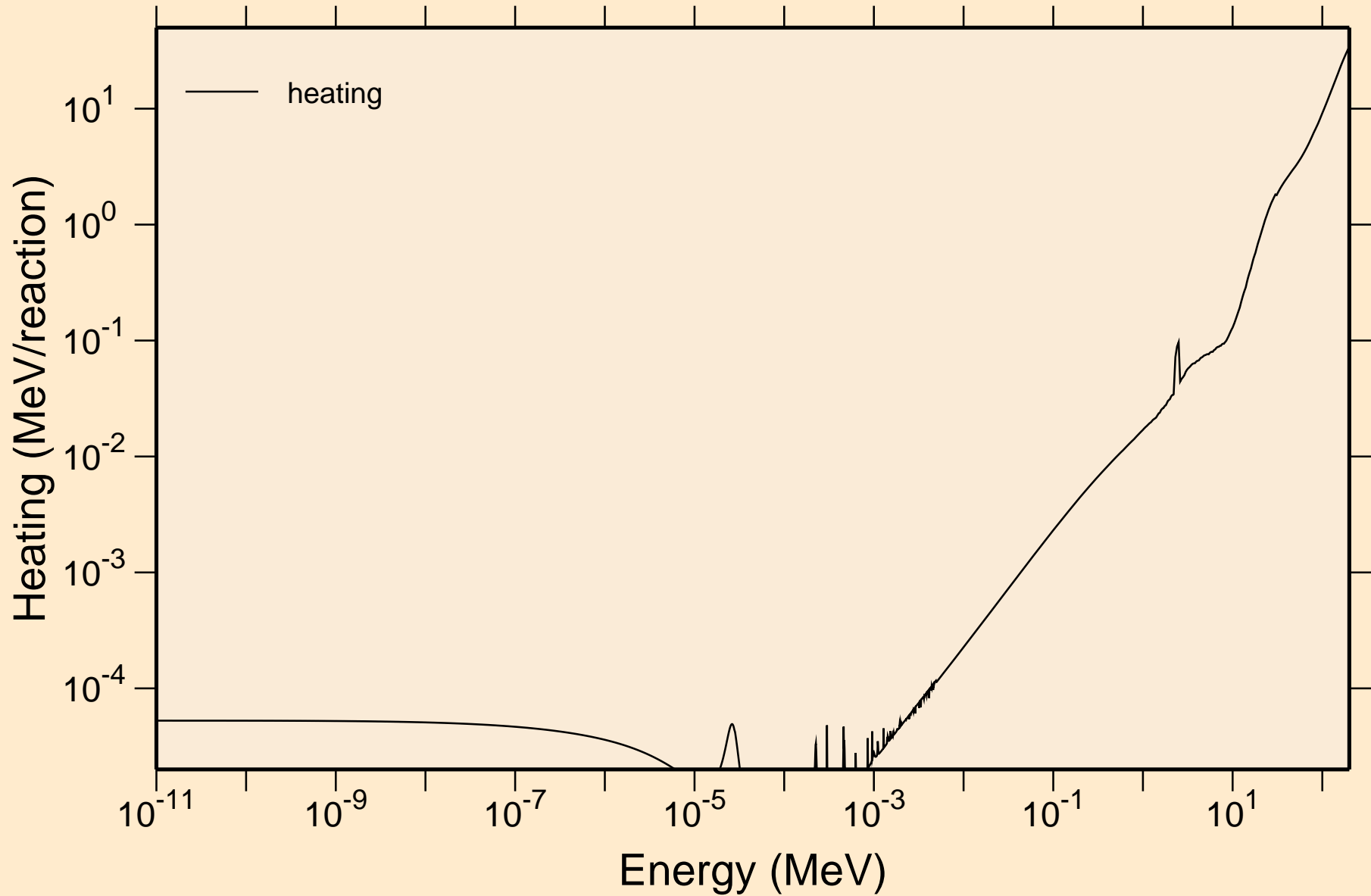

KR083 NEUTRON ACER TENDL-2021 LIBRARY; T=293.6K
Damage

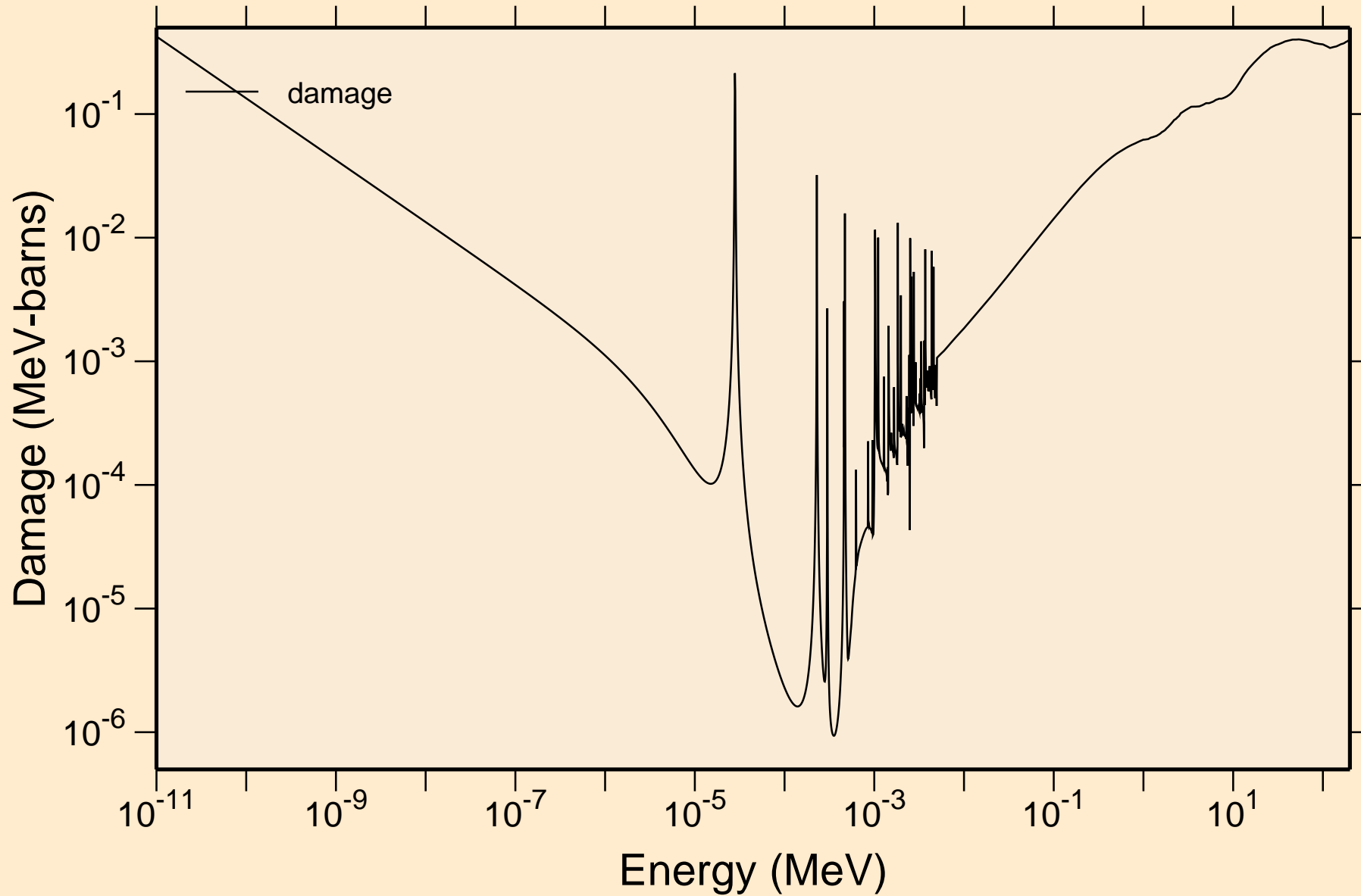

KR083 NEUTRON ACER TENDL-2021 LIBRARY; T=293.6K
Non-threshold reactions

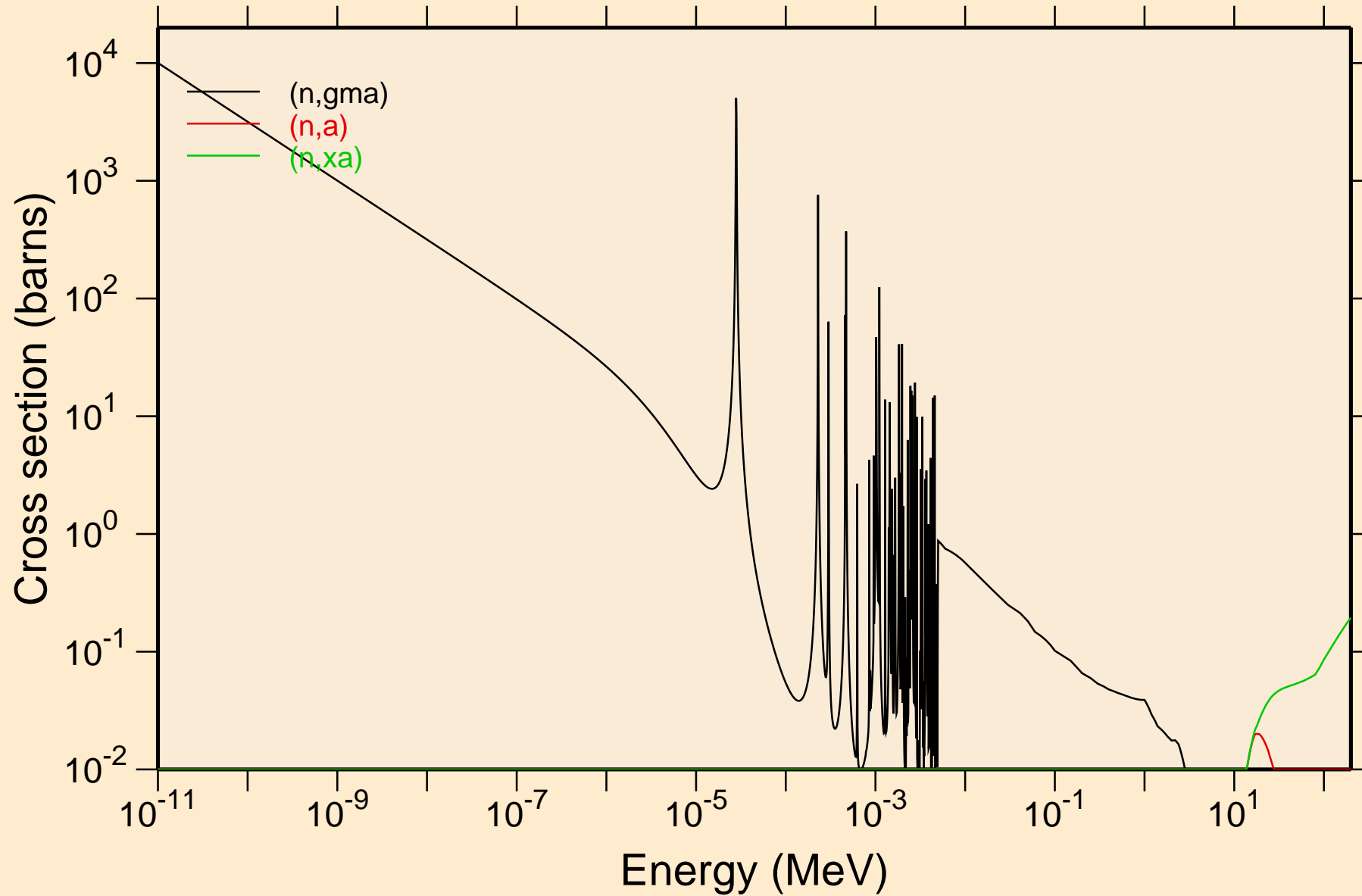

KR083 NEUTRON ACER TENDL-2021 LIBRARY; T=293.6K
Principal cross sections

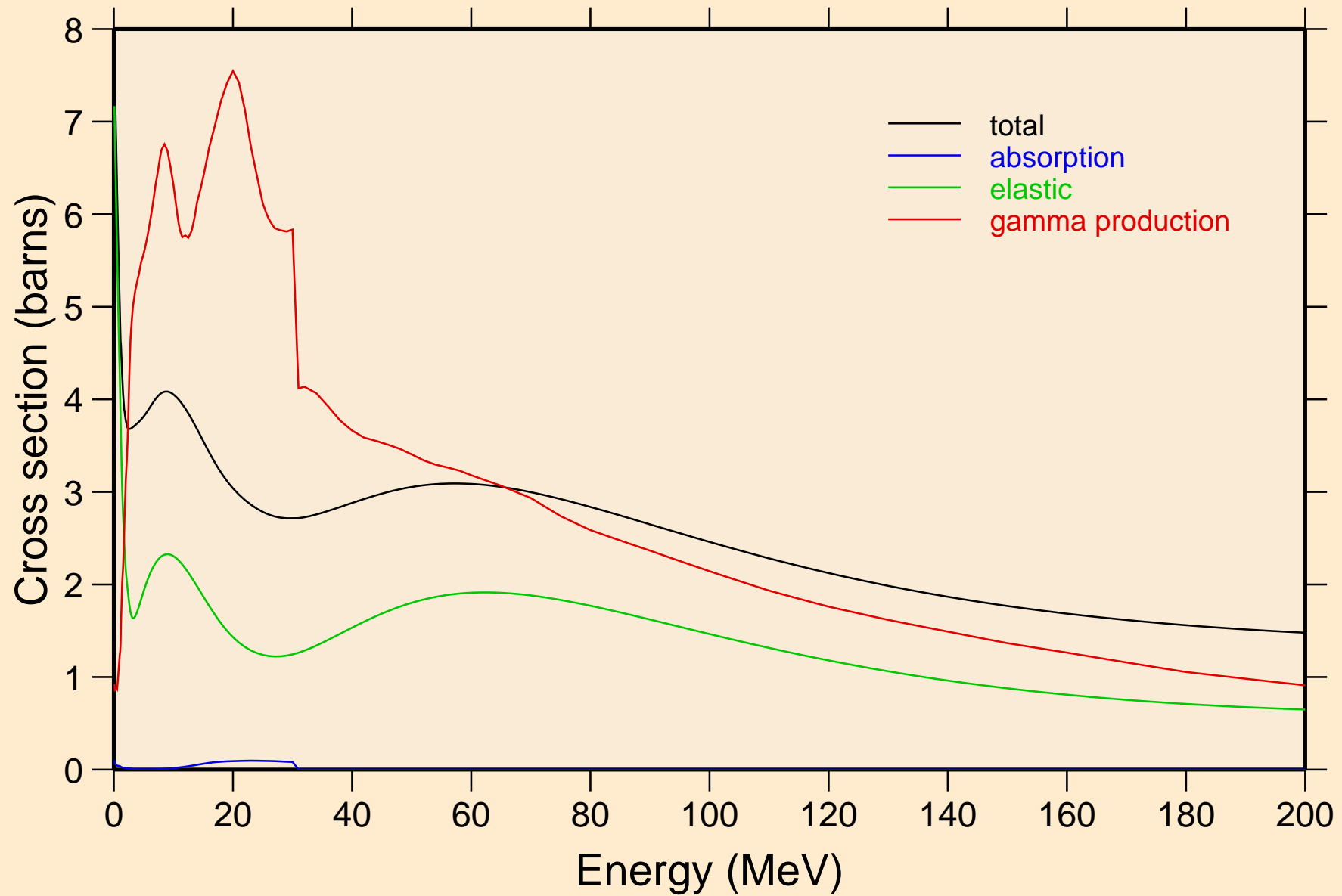

KR083 NEUTRON ACER TENDL-2021 LIBRARY; T=293.6K
Heating

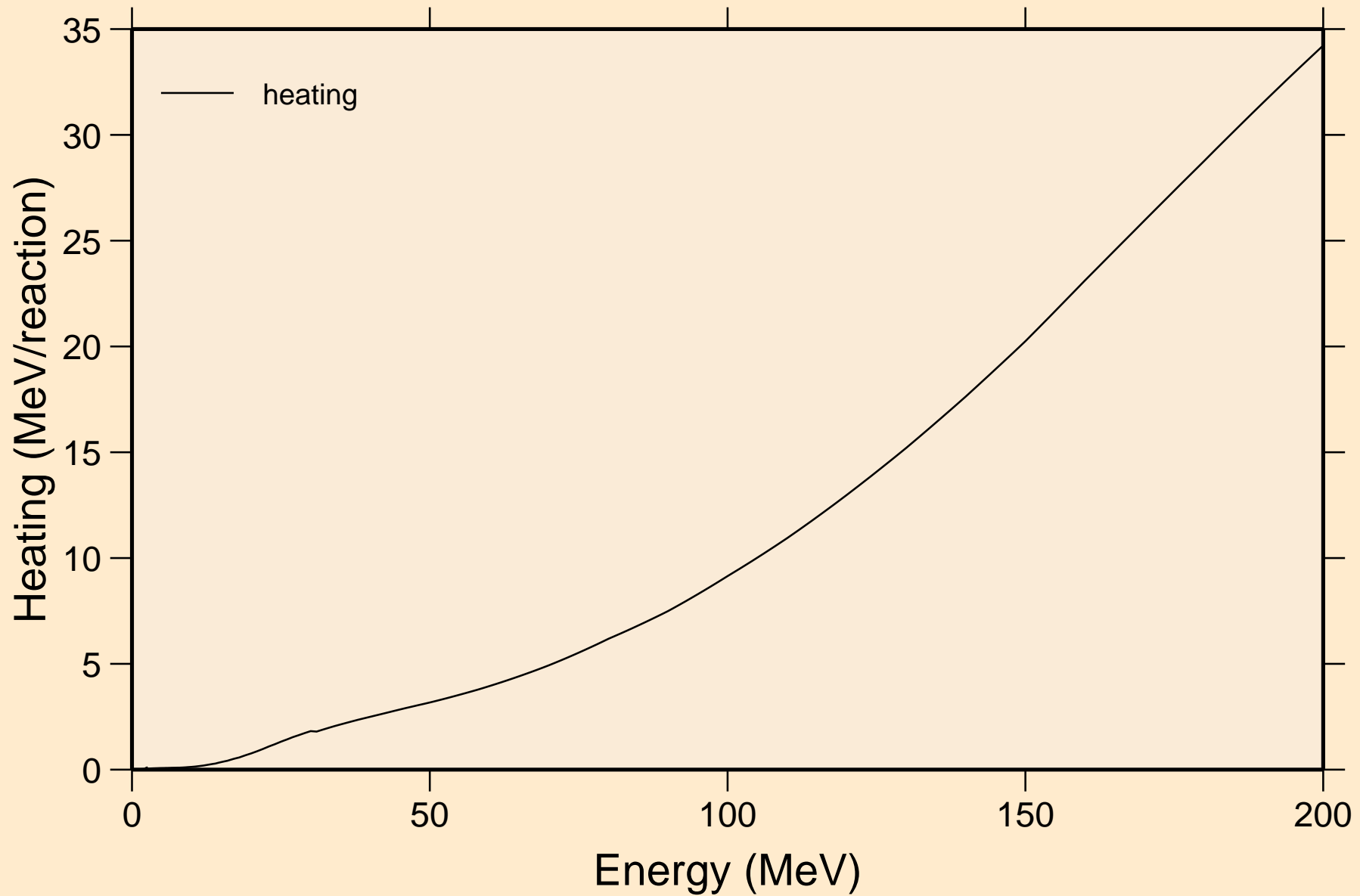

KR083 NEUTRON ACER TENDL-2021 LIBRARY; T=293.6K
Damage

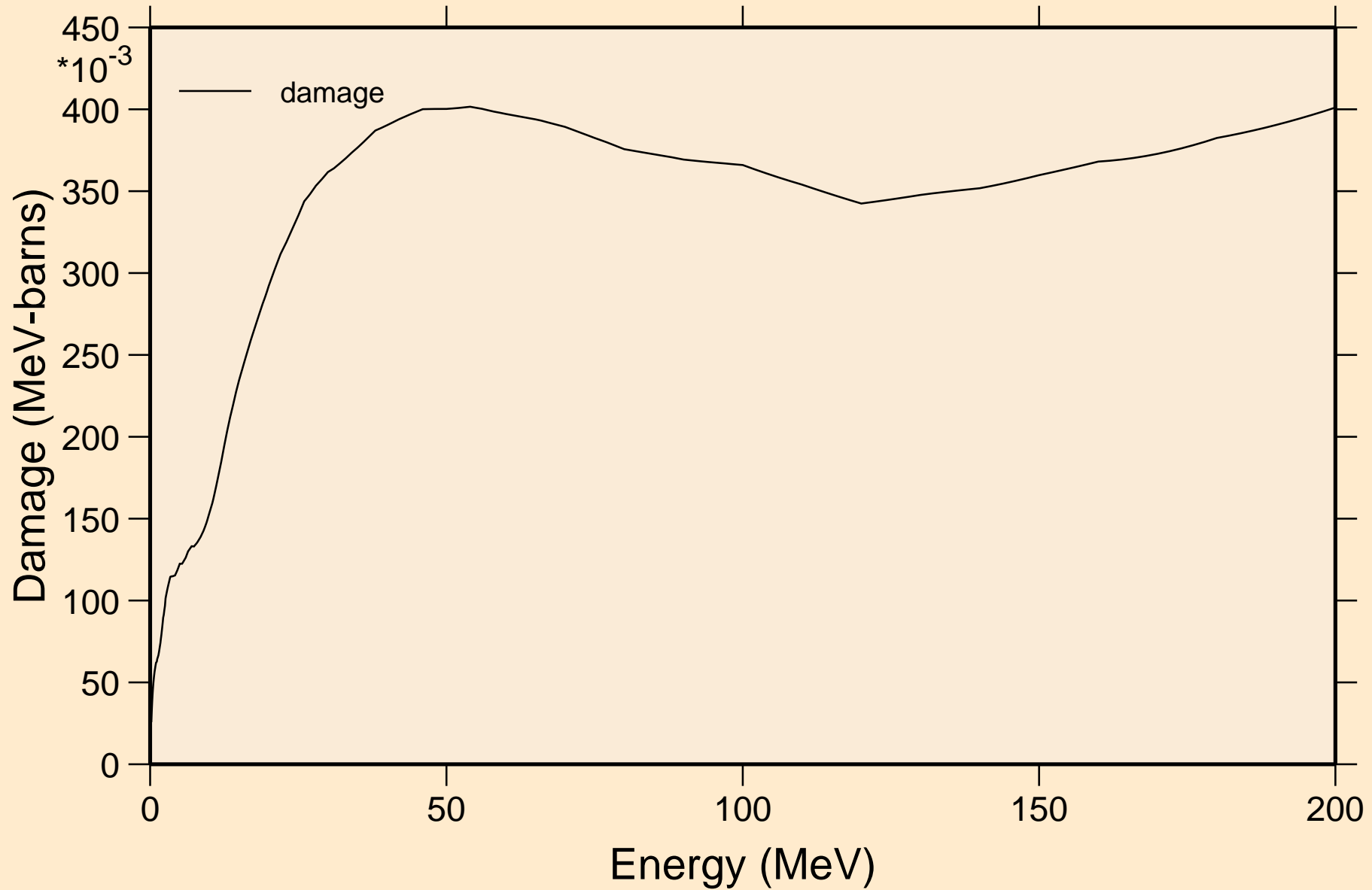

KR083 NEUTRON ACER TENDL-2021 LIBRARY; T=293.6K
Non-threshold reactions

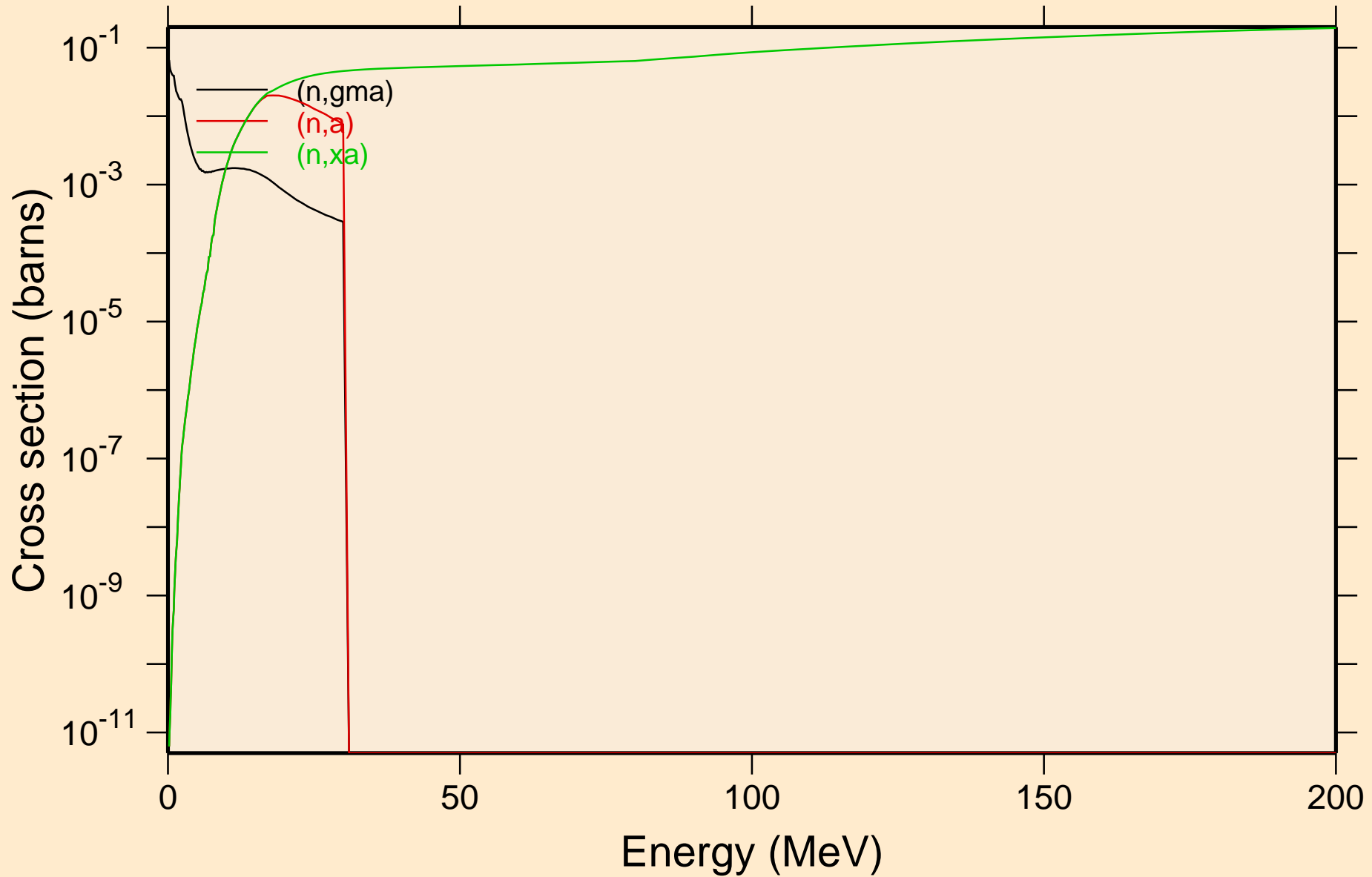

KR083 NEUTRON ACER TENDL-2021 LIBRARY; T=293.6K
Inelastic levels

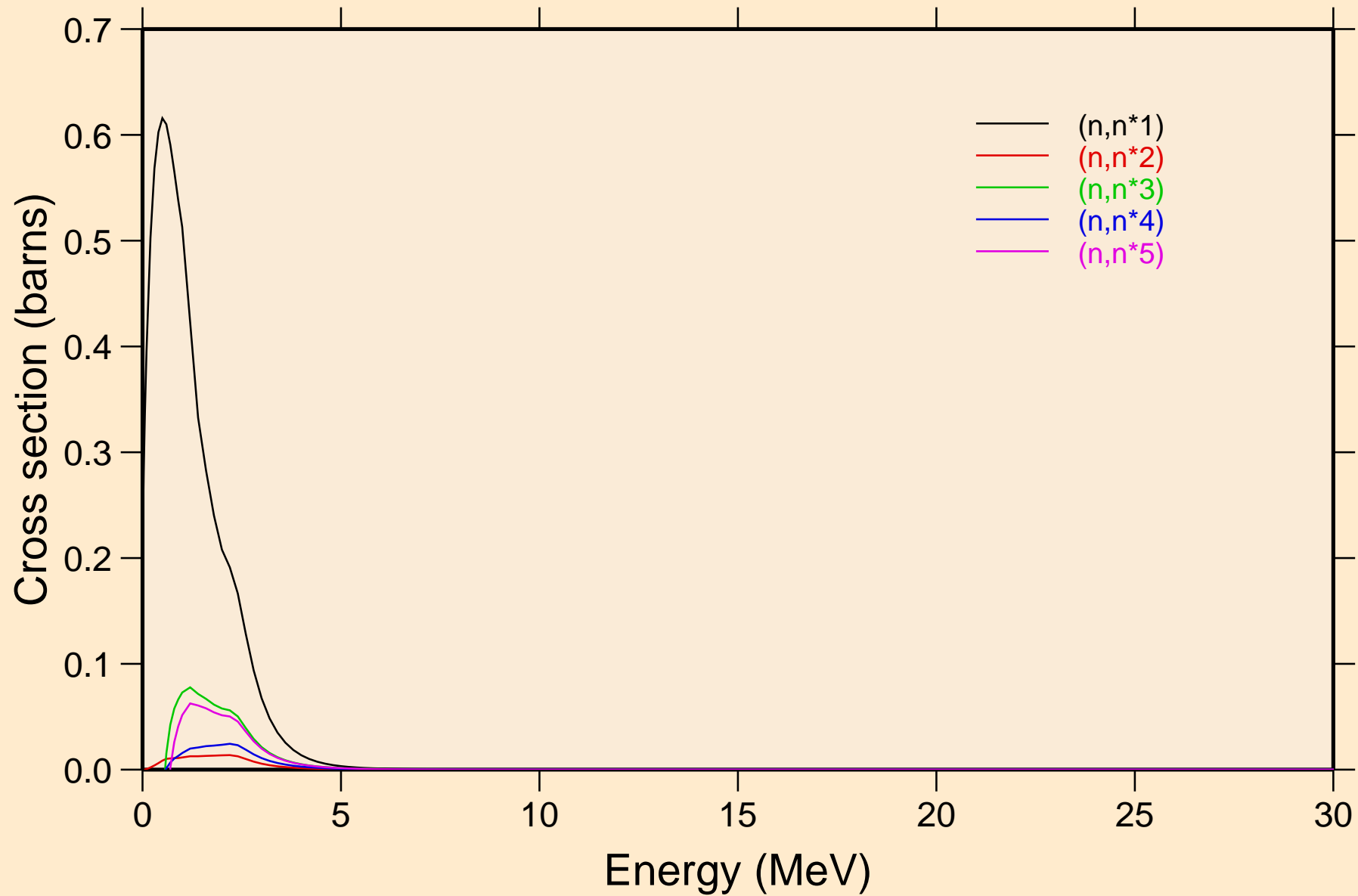

KR083 NEUTRON ACER TENDL-2021 LIBRARY; T=293.6K
Inelastic levels

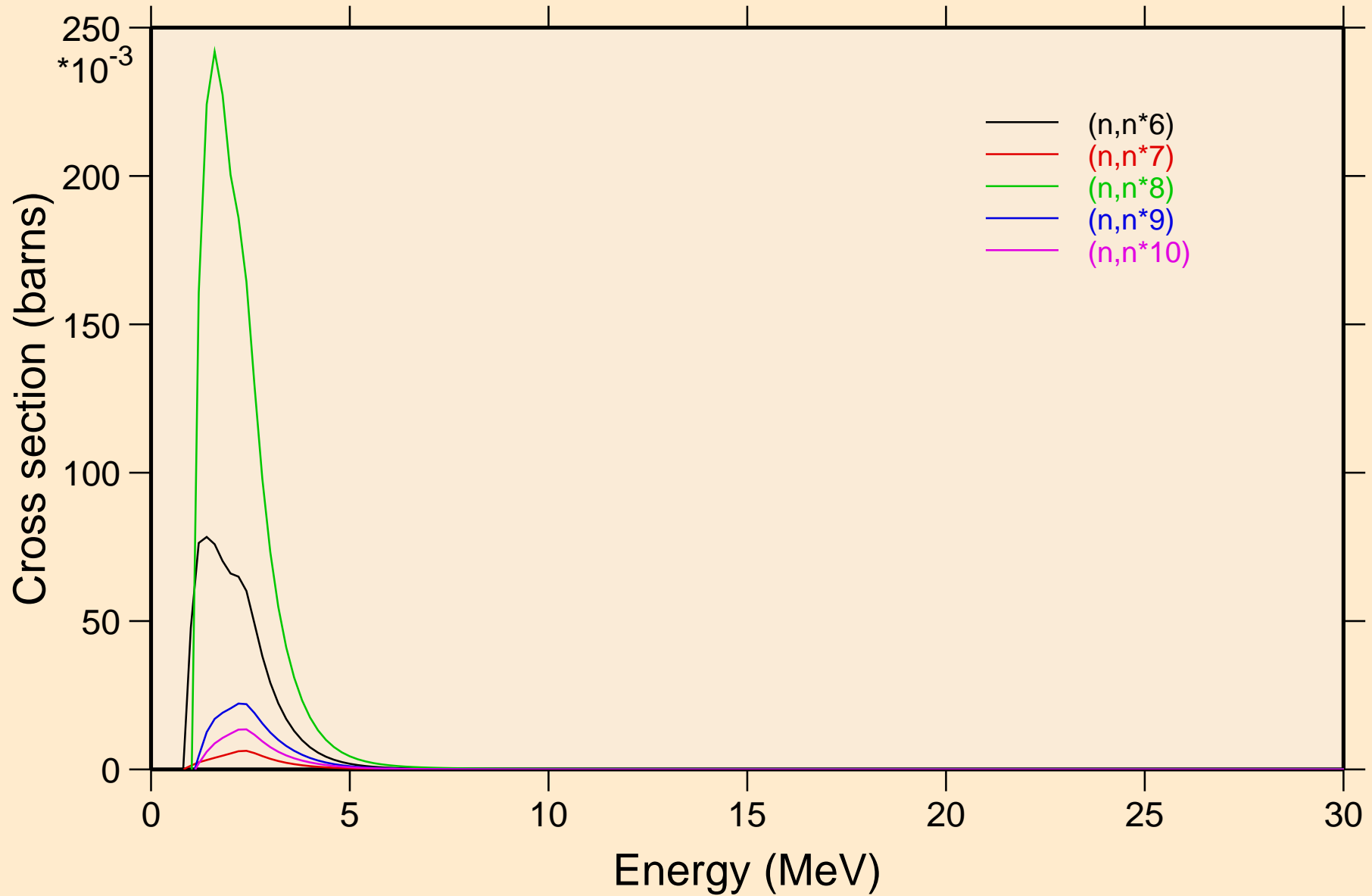

KR083 NEUTRON ACER TENDL-2021 LIBRARY; T=293.6K
Inelastic levels

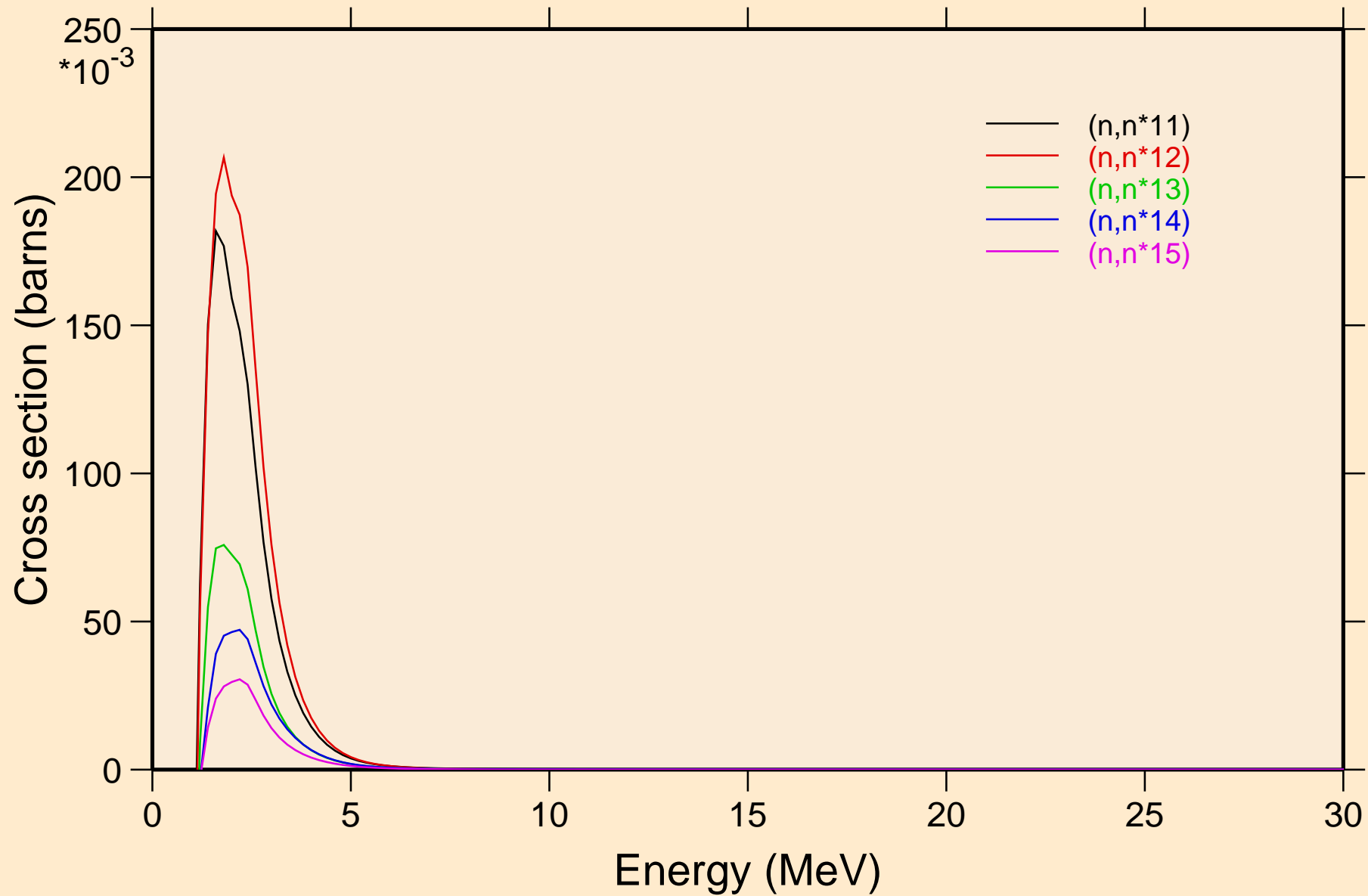

KR083 NEUTRON ACER TENDL-2021 LIBRARY; T=293.6K
Inelastic levels

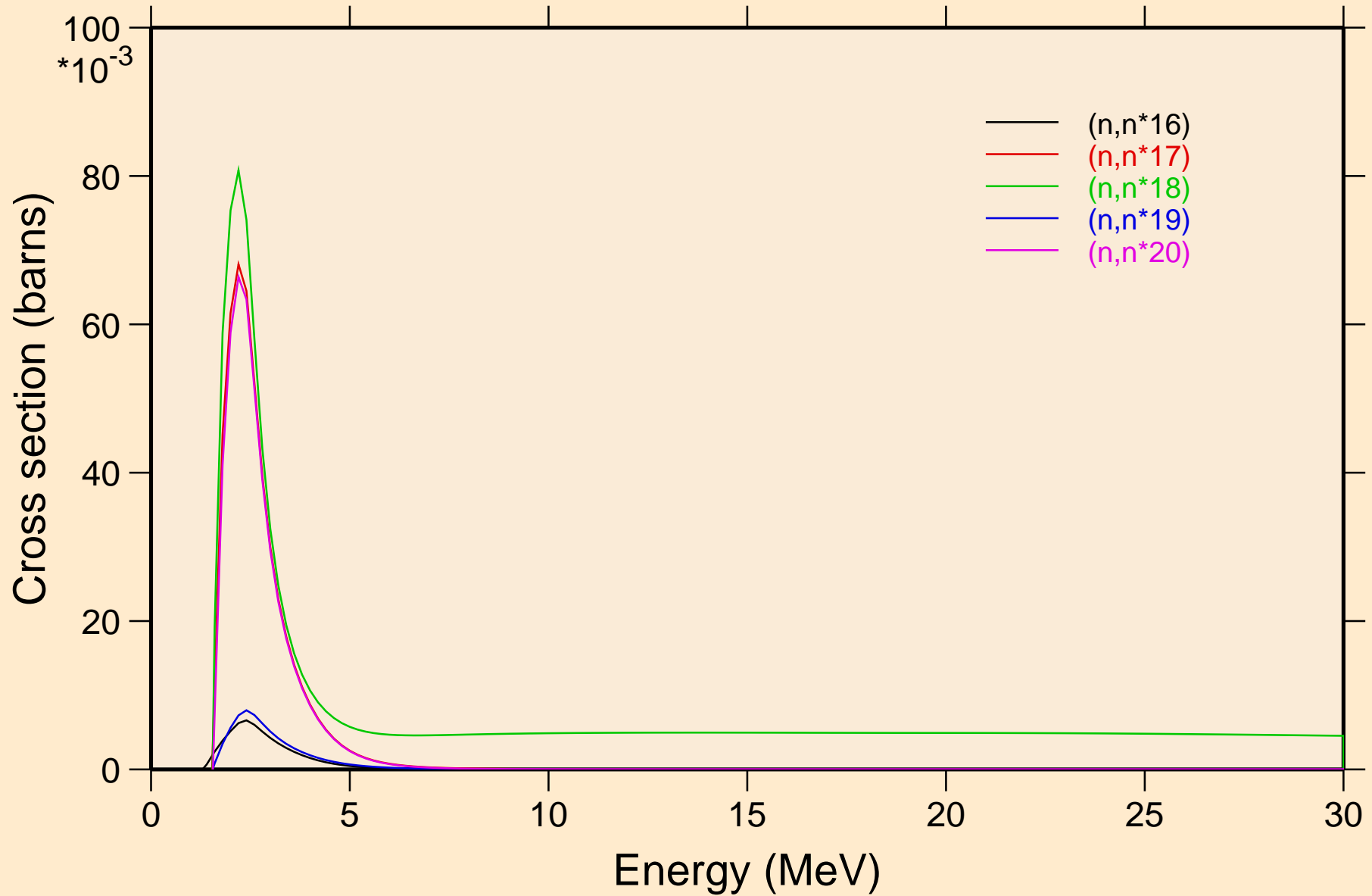

KR083 NEUTRON ACER TENDL-2021 LIBRARY; T=293.6K
Inelastic levels

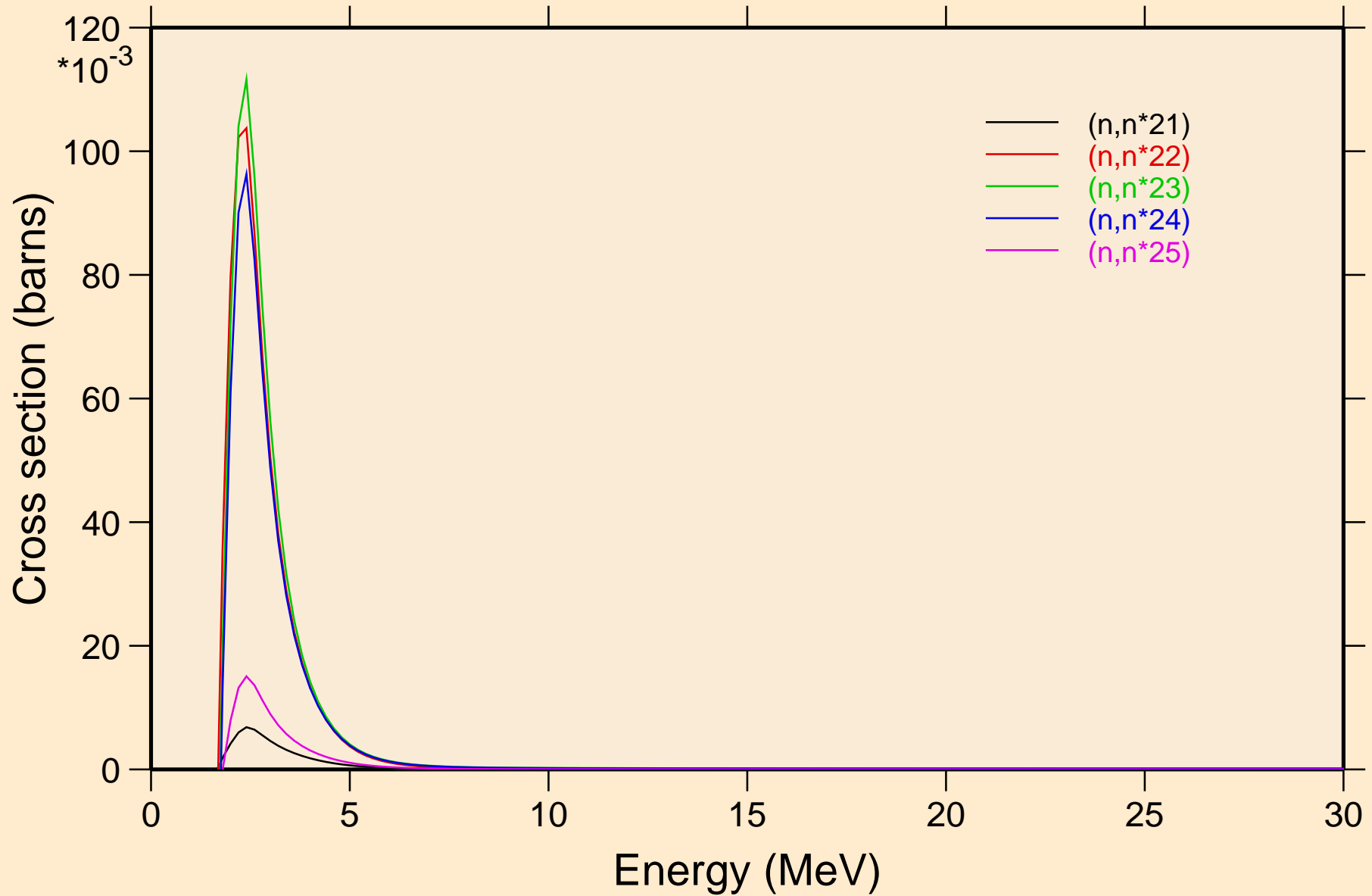

KR083 NEUTRON ACER TENDL-2021 LIBRARY; T=293.6K
Inelastic levels

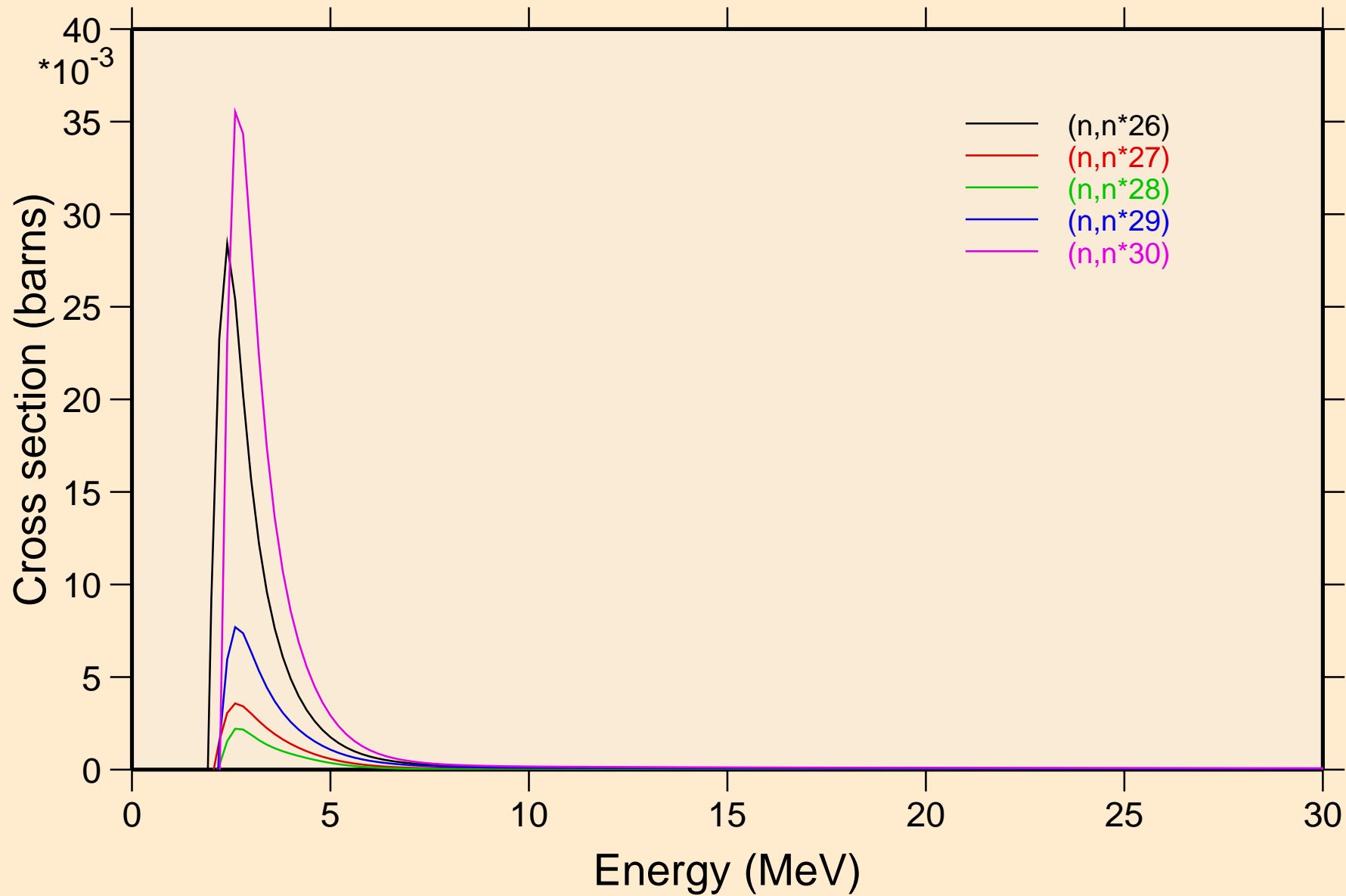

KR083 NEUTRON ACER TENDL-2021 LIBRARY; T=293.6K
Threshold reactions

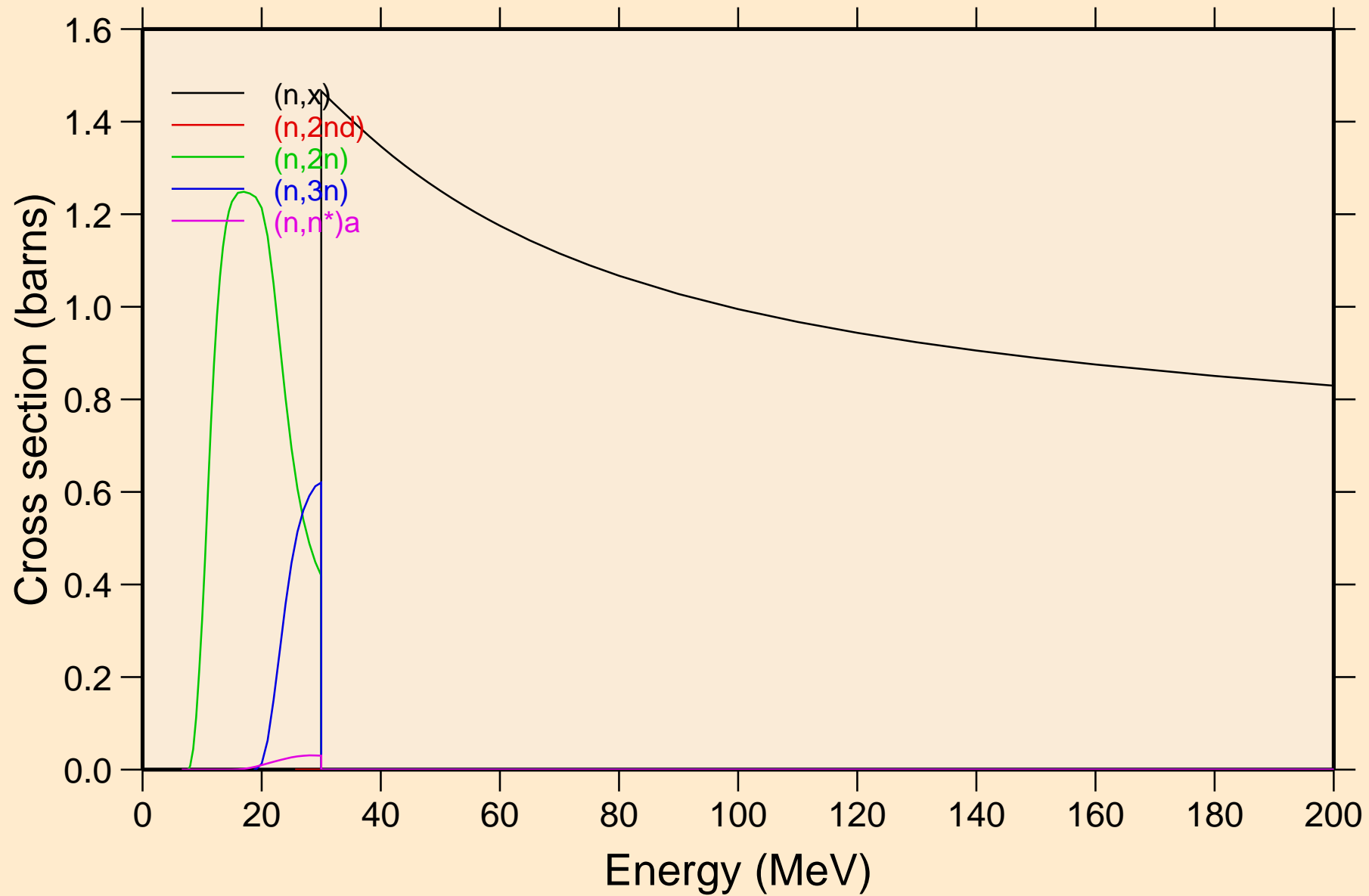

KR083 NEUTRON ACER TENDL-2021 LIBRARY; T=293.6K
Threshold reactions

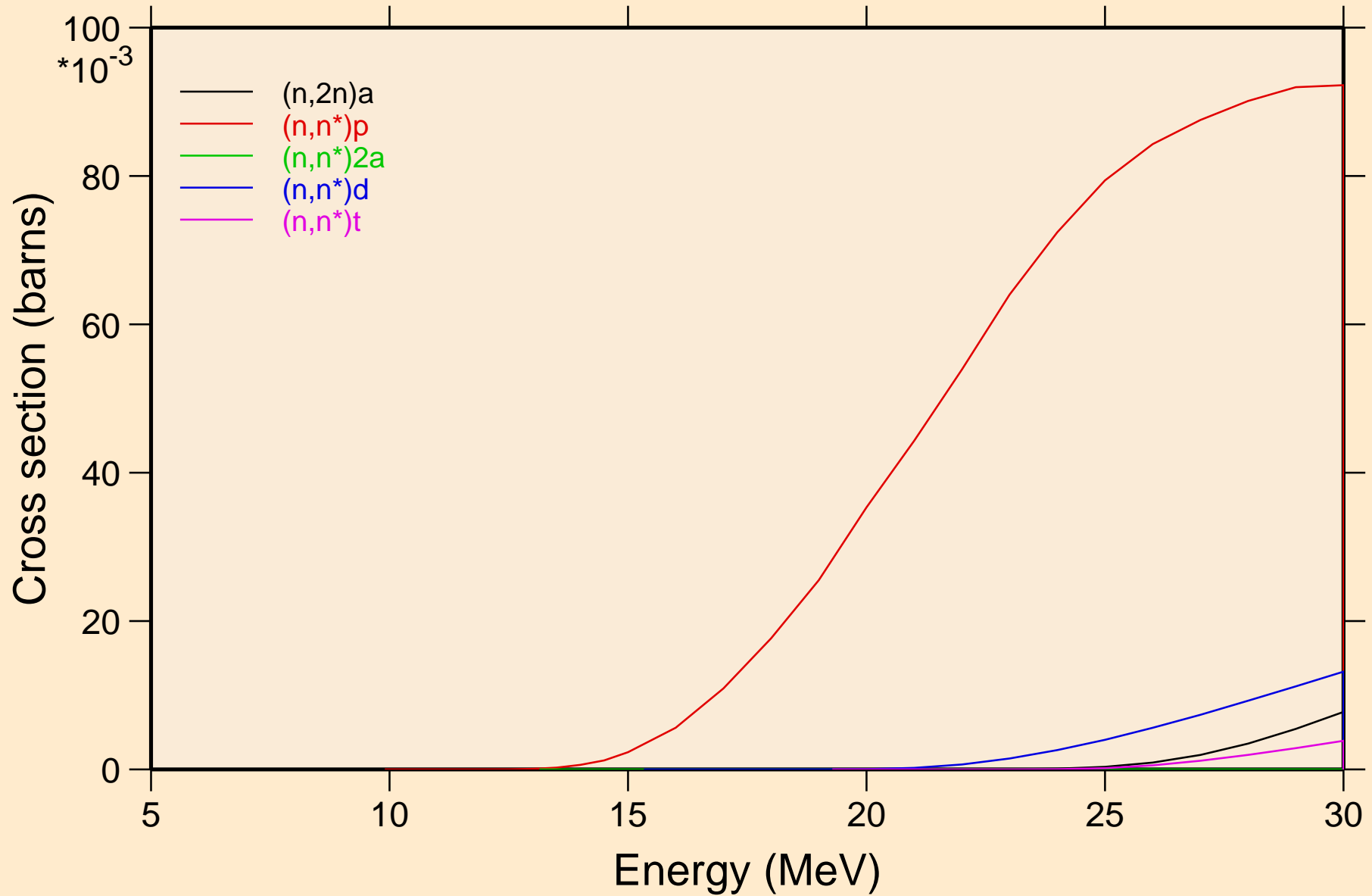

KR083 NEUTRON ACER TENDL-2021 LIBRARY; T=293.6K
Threshold reactions

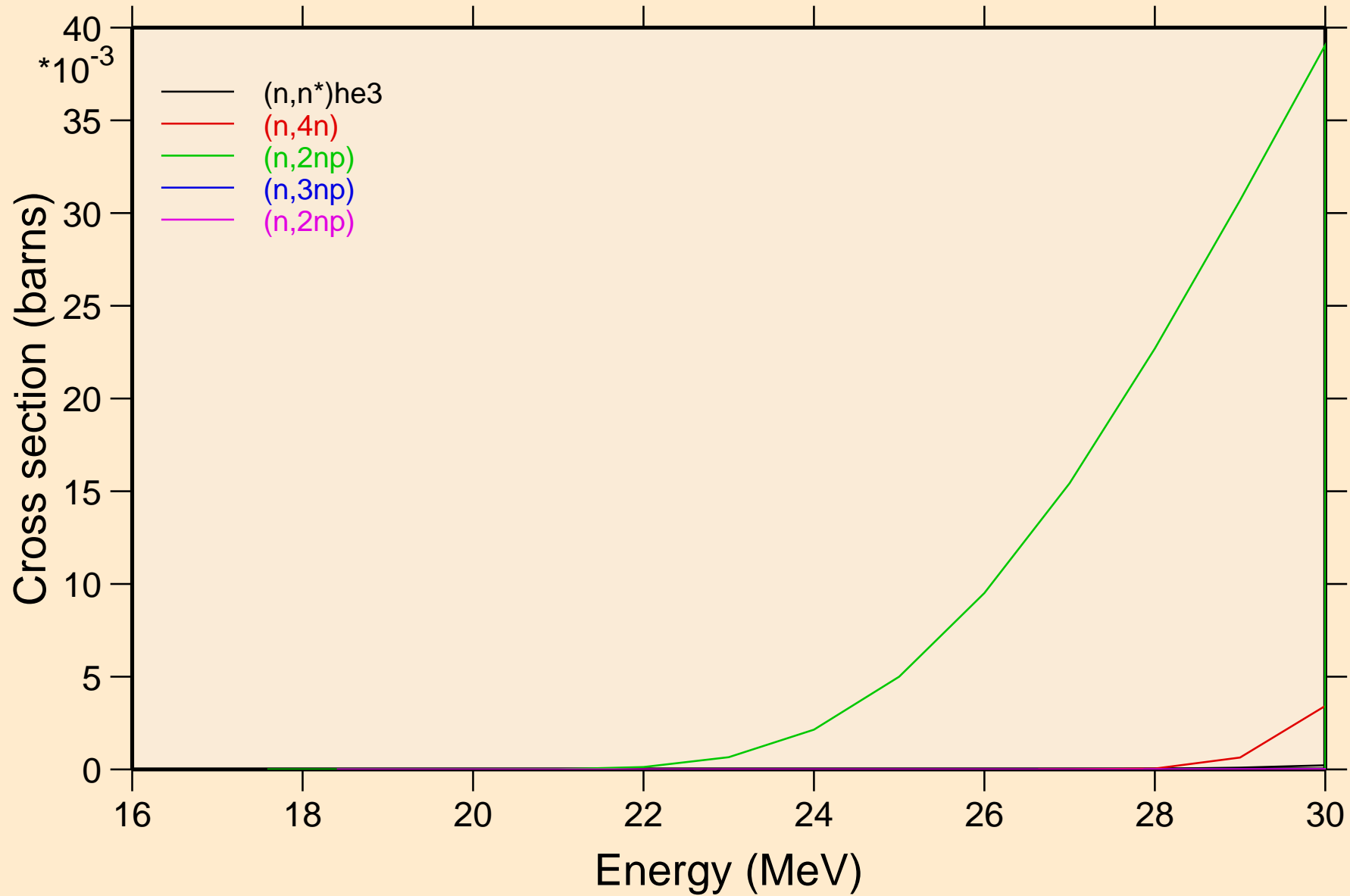

KR083 NEUTRON ACER TENDL-2021 LIBRARY; T=293.6K
Threshold reactions

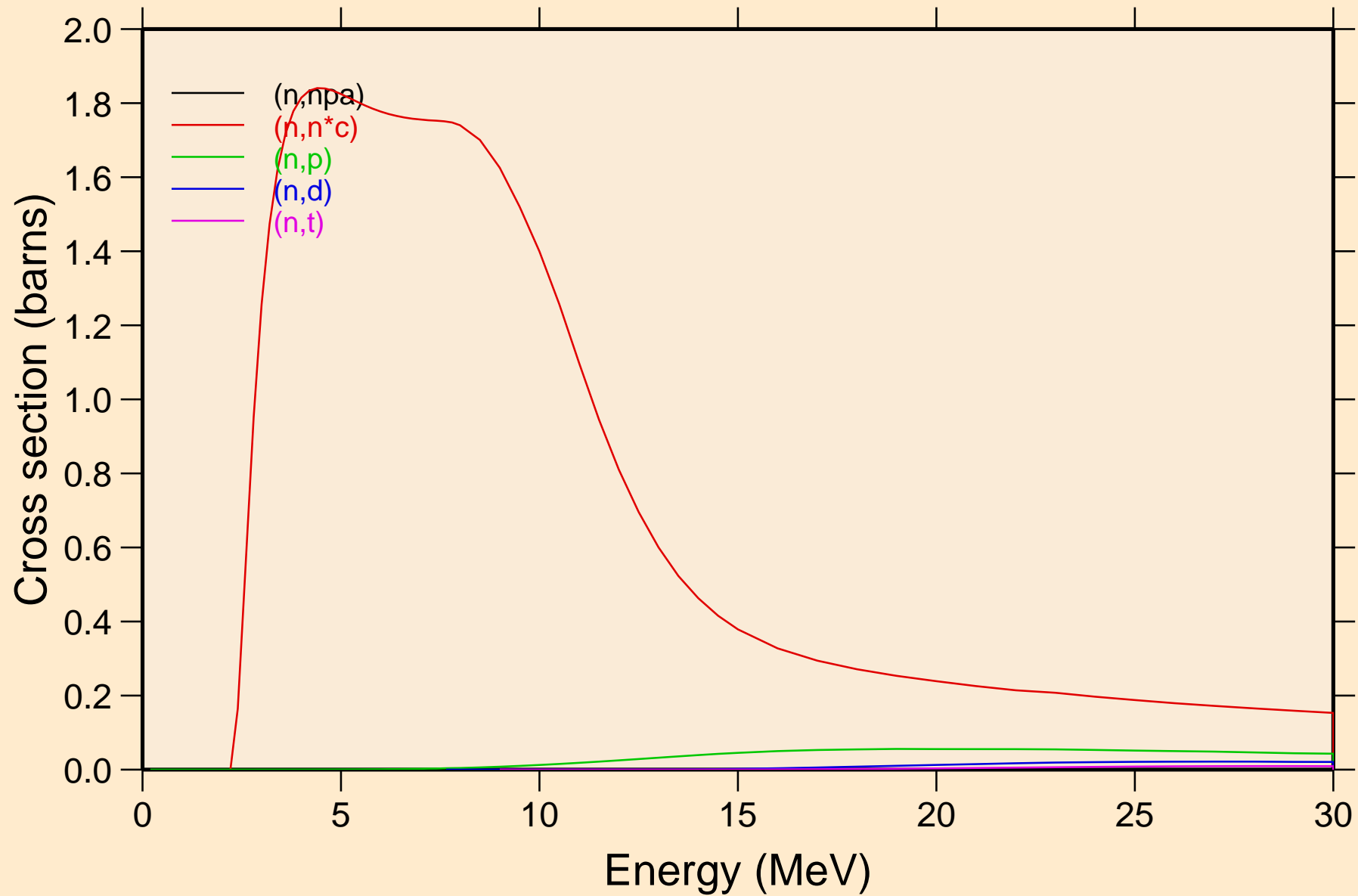

KR083 NEUTRON ACER TENDL-2021 LIBRARY; T=293.6K

Threshold reactions

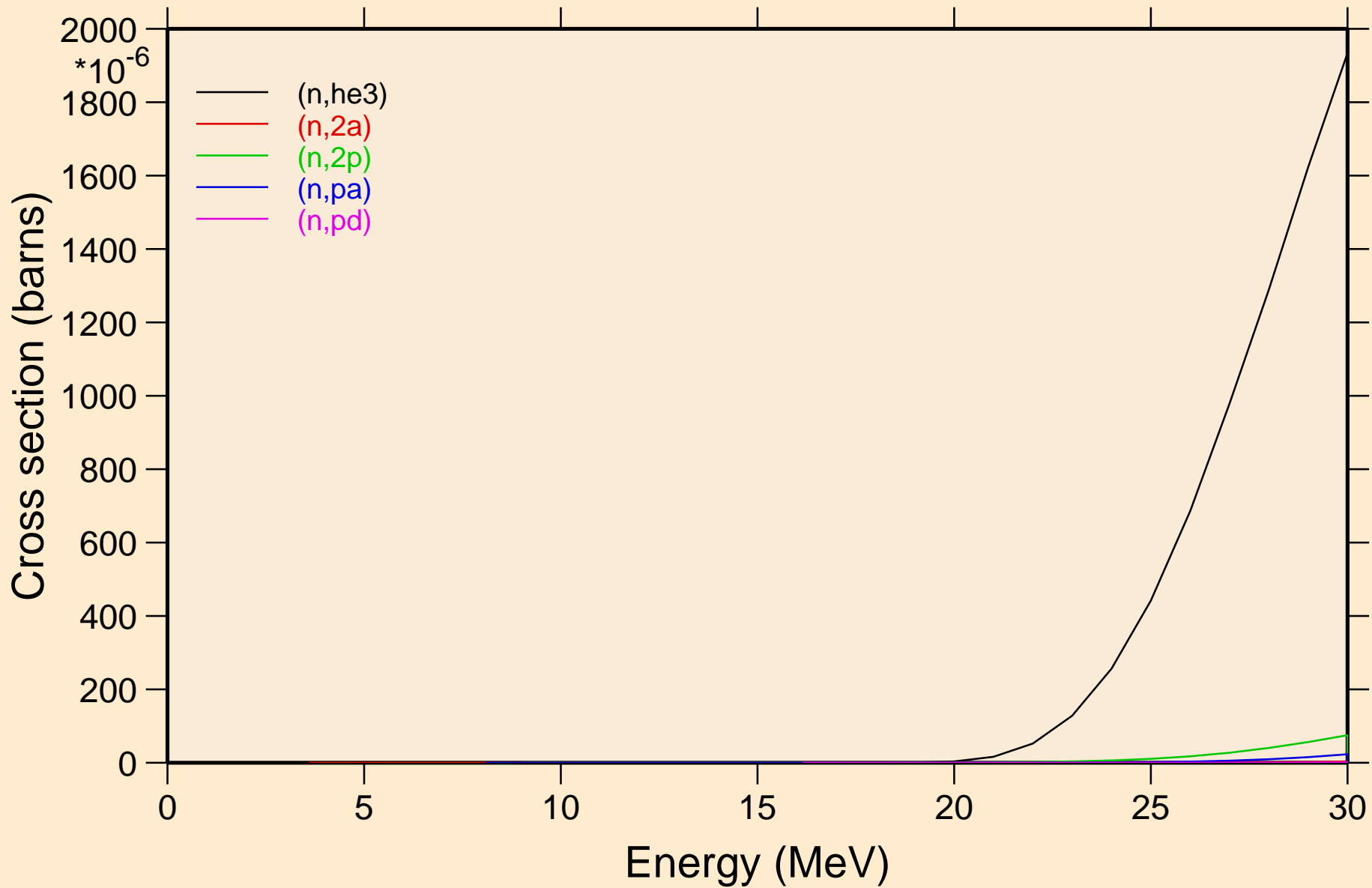

KR083 NEUTRON ACER TENDL-2021 LIBRARY; T=293.6K
Threshold reactions

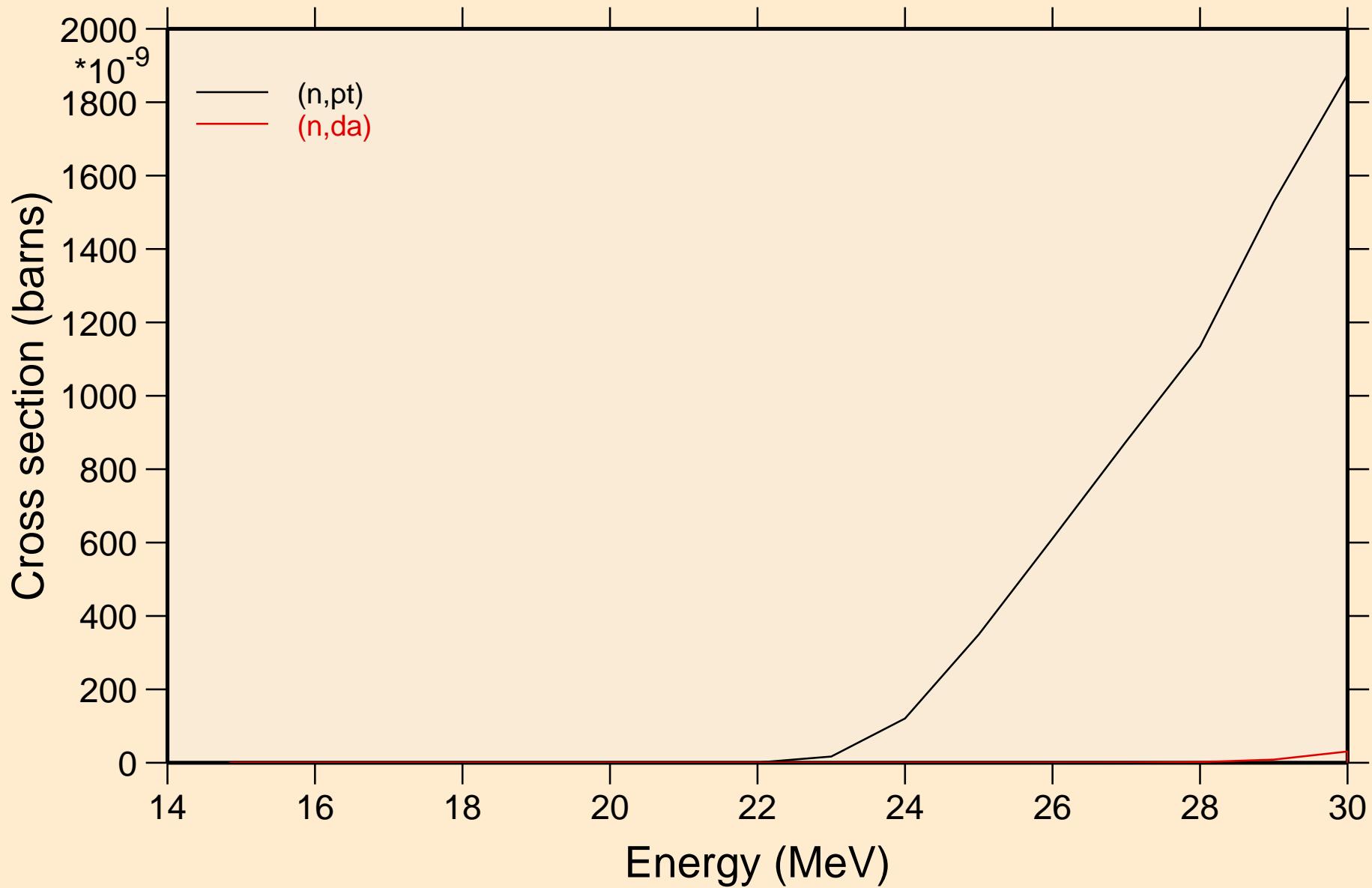

KR083 NEUTRON ACER TENDL-2021 LIBRARY; T=293.6K
Threshold reactions

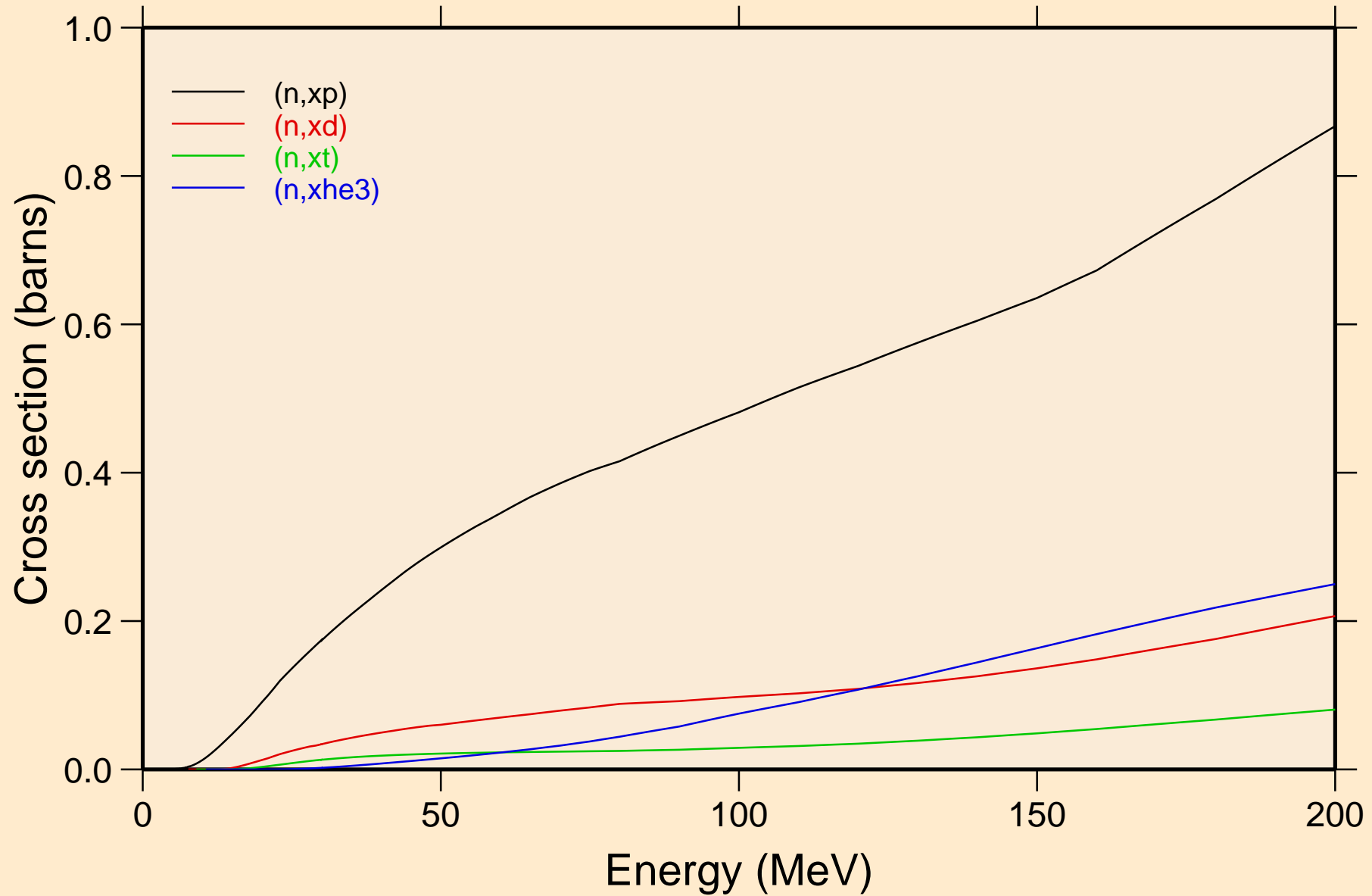

KR083 NEUTRON ACER TENDL-2021 LIBRARY; T=293.6K
angular distribution for elastic

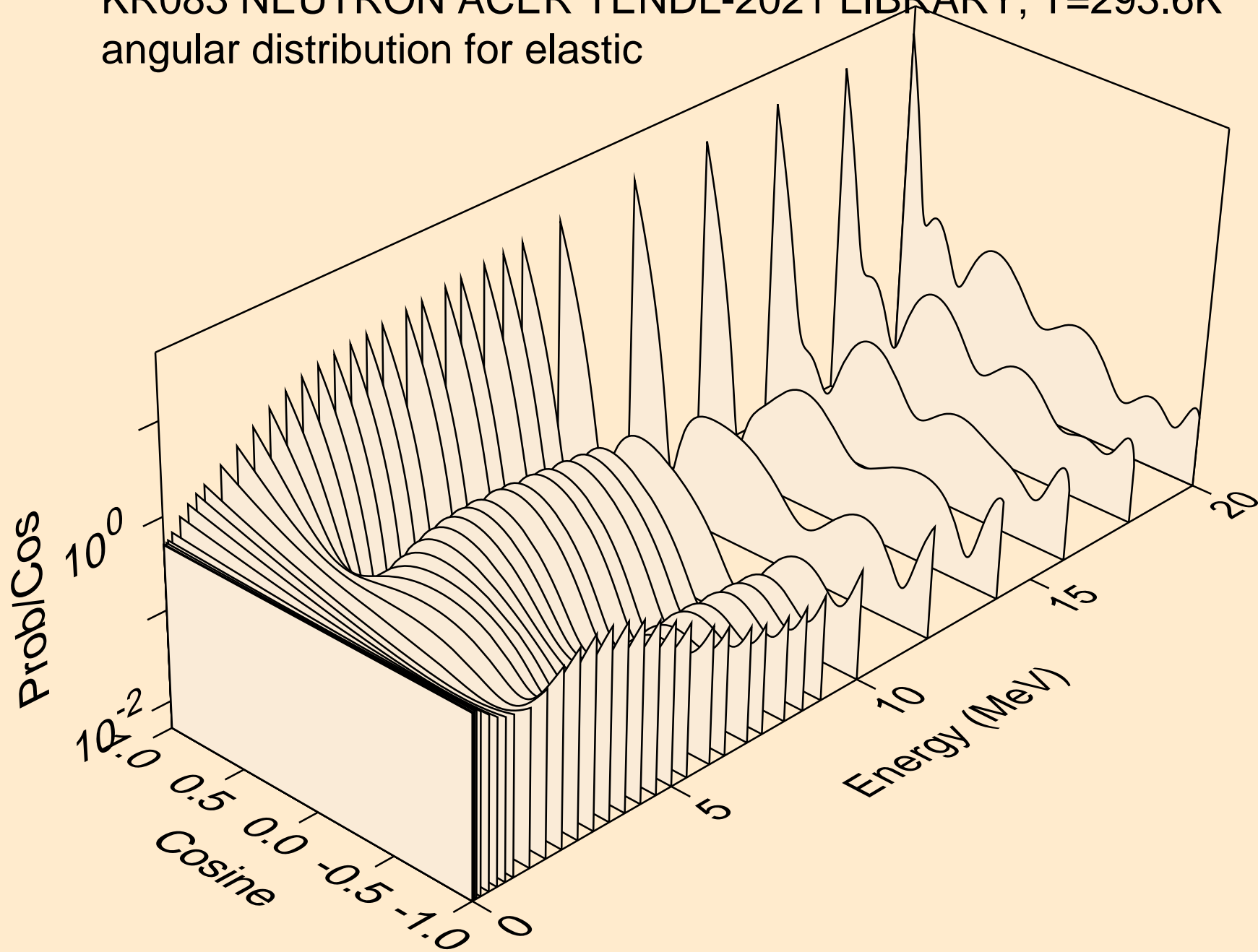

KR083 NEUTRON ACER TENDL-2021 LIBRARY; T=293.6K
angular distribution for elastic

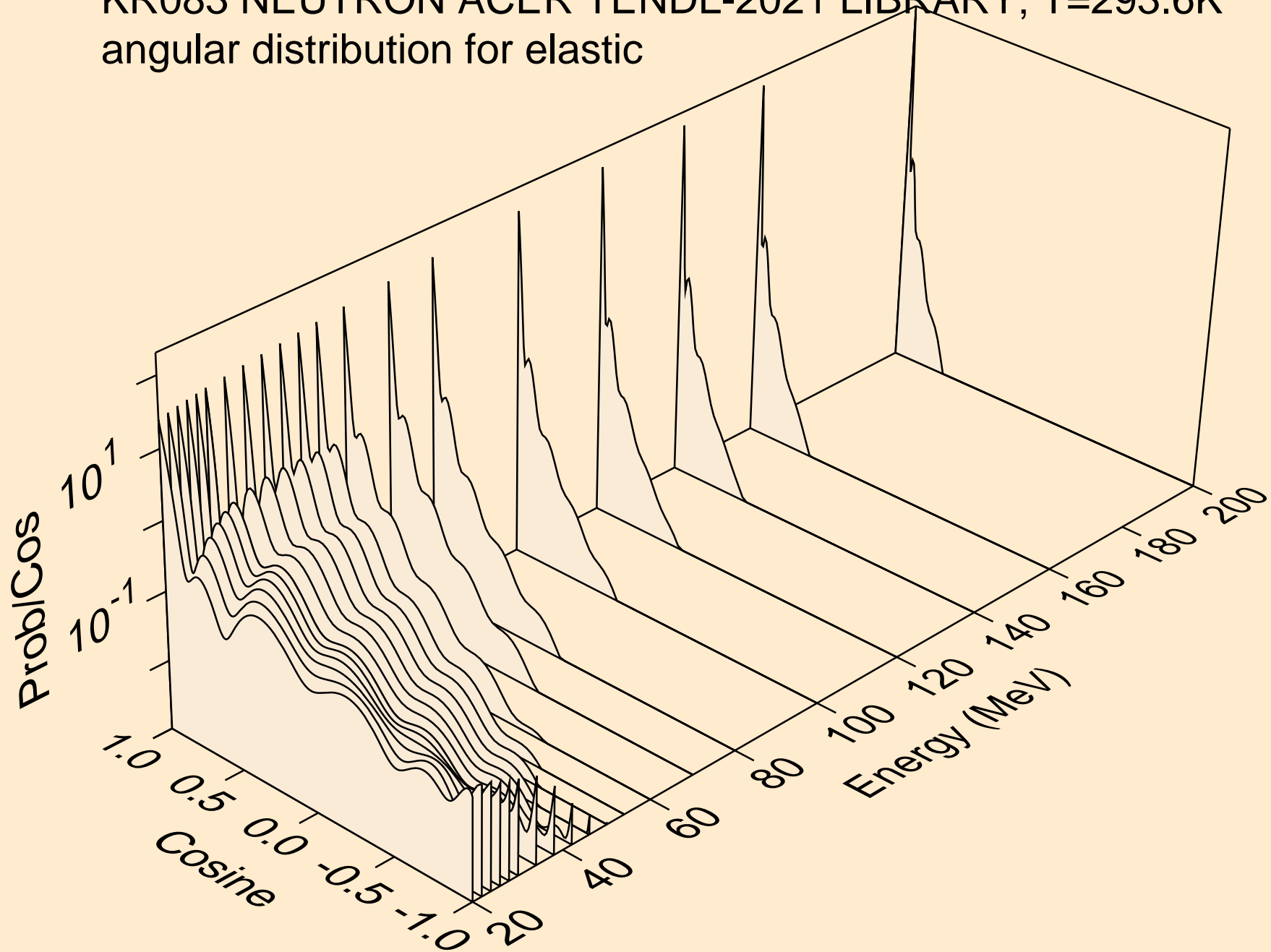

KR083 NEUTRON ACER TENDL-2021 LIBRARY; T=293.6K
angular distribution for (n,n*1)

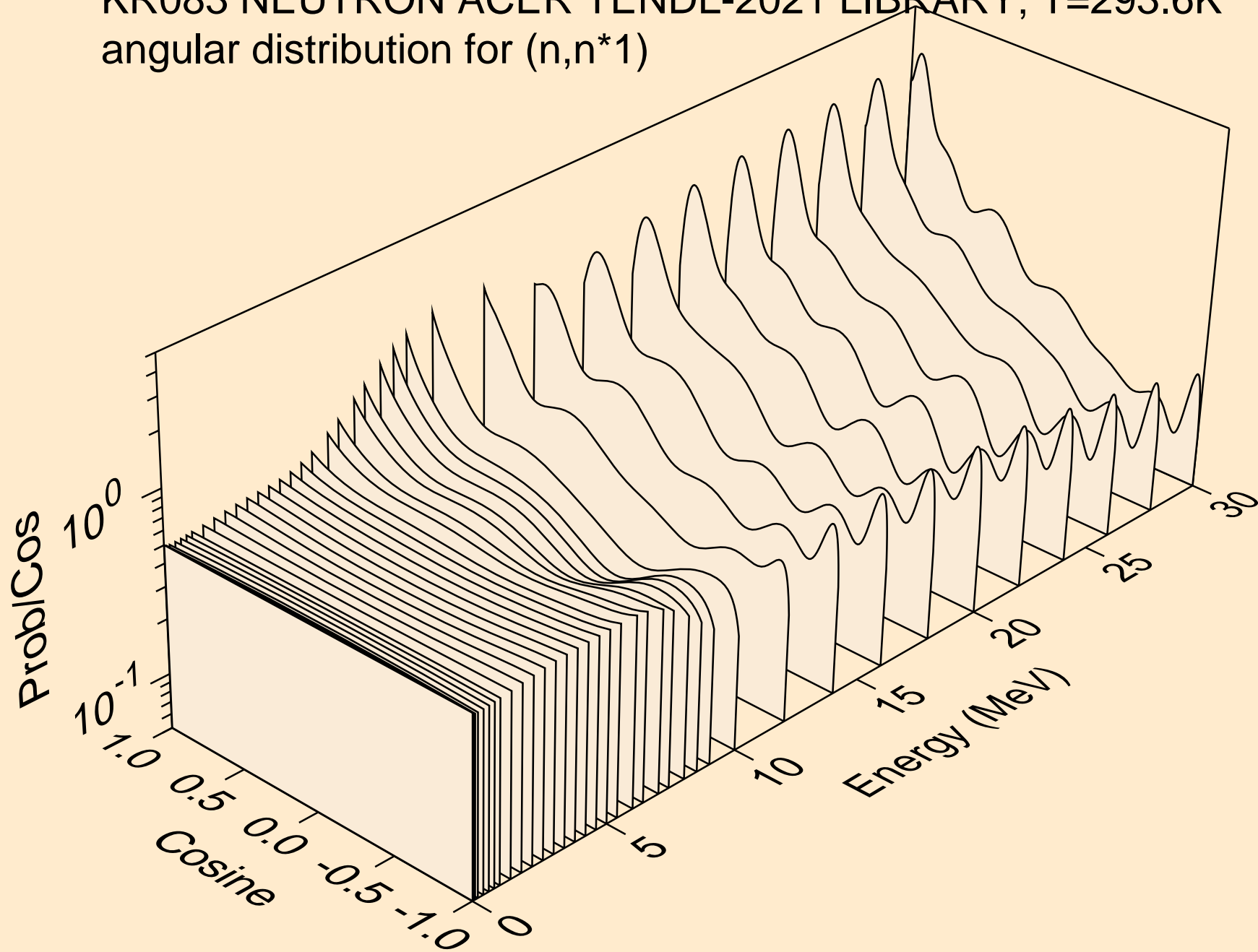

KR083 NEUTRON ACER TENDL-2021 LIBRARY; T=293.6K
angular distribution for (n,n*2)

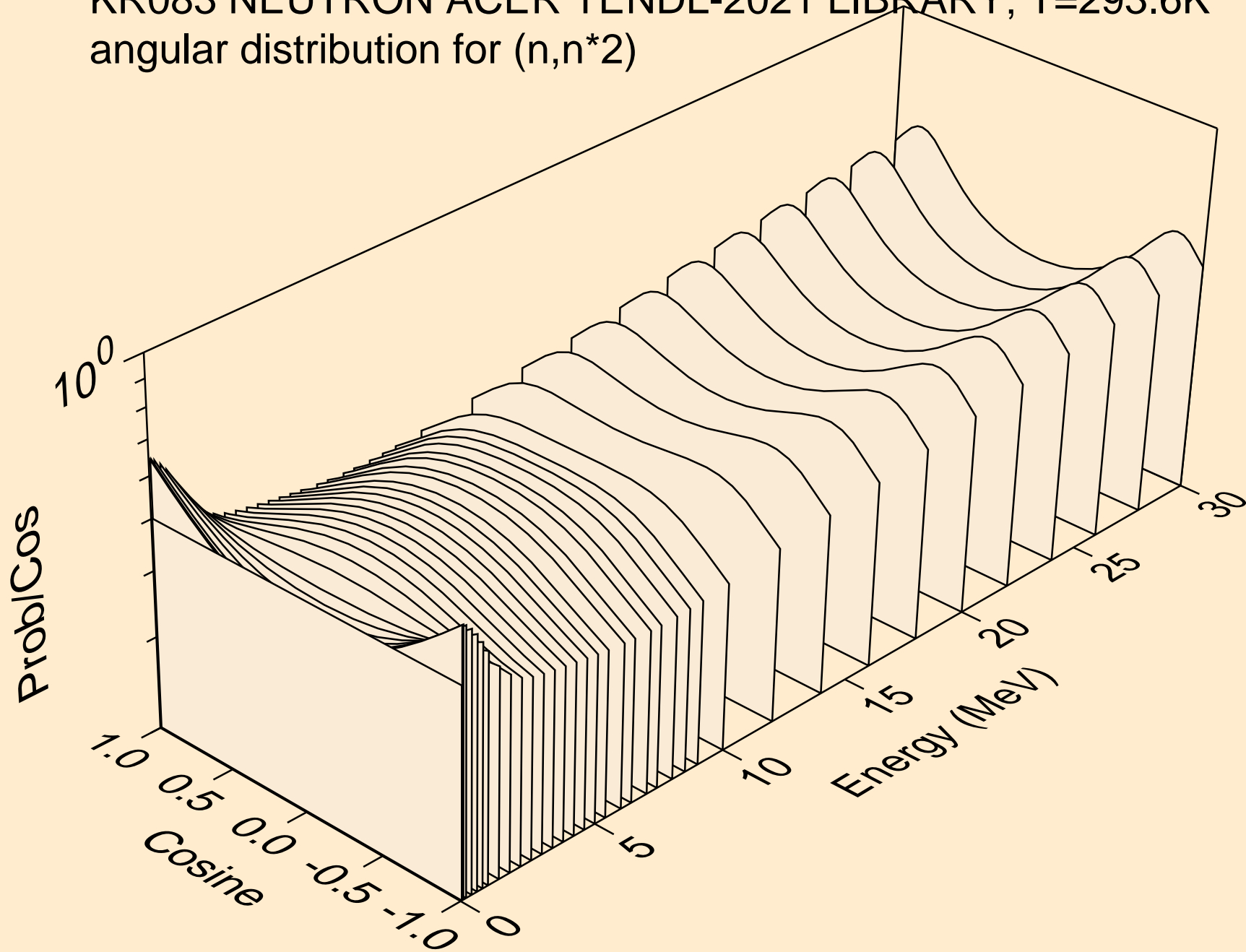

KR083 NEUTRON ACER TENDL-2021 LIBRARY; T=293.6K
angular distribution for (n,n*3)

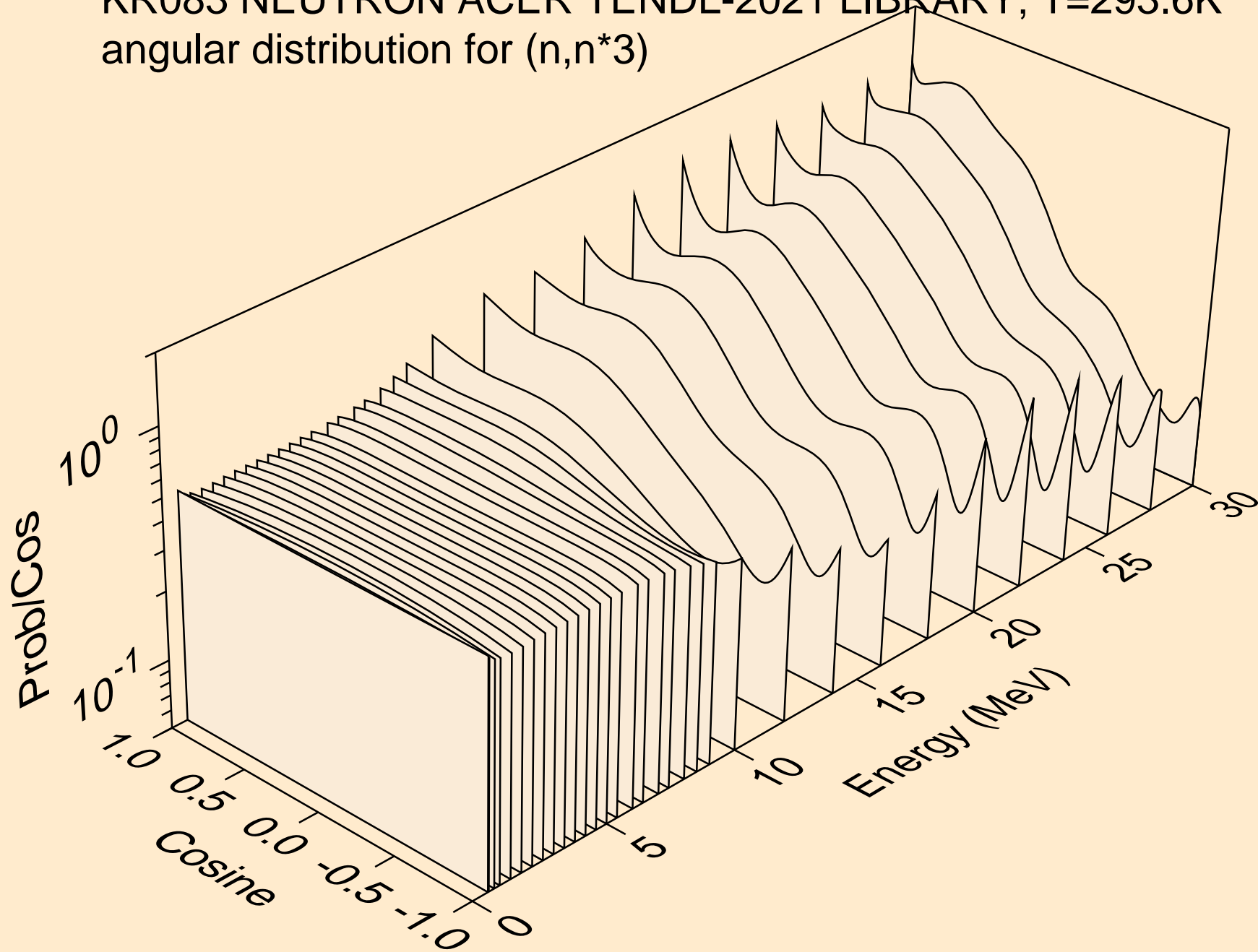

KR083 NEUTRON ACER TENDL-2021 LIBRARY; T=293.6K
angular distribution for (n,n*4)

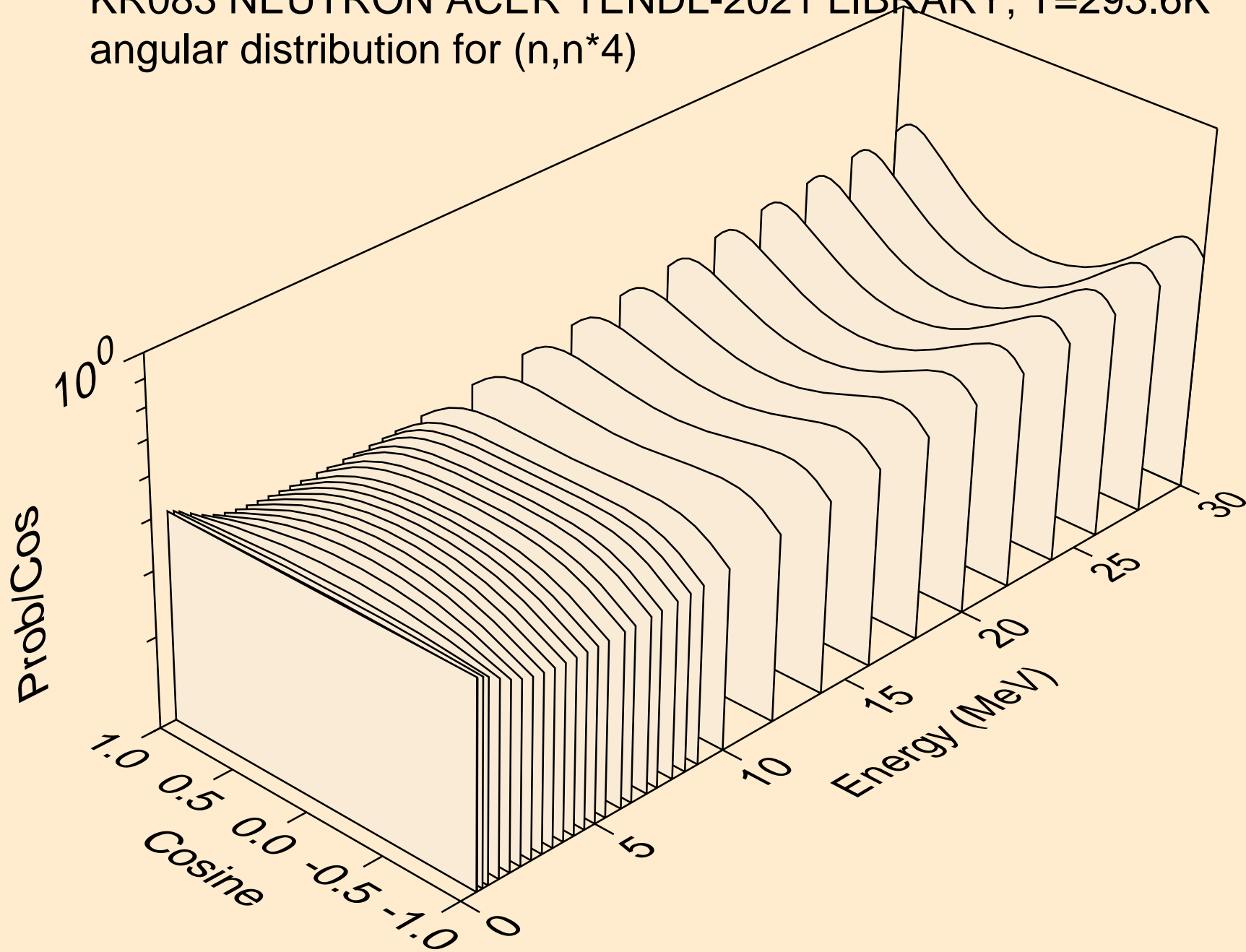

KR083 NEUTRON ACER TENDL-2021 LIBRARY; T=293.6K
angular distribution for (n,n*5)

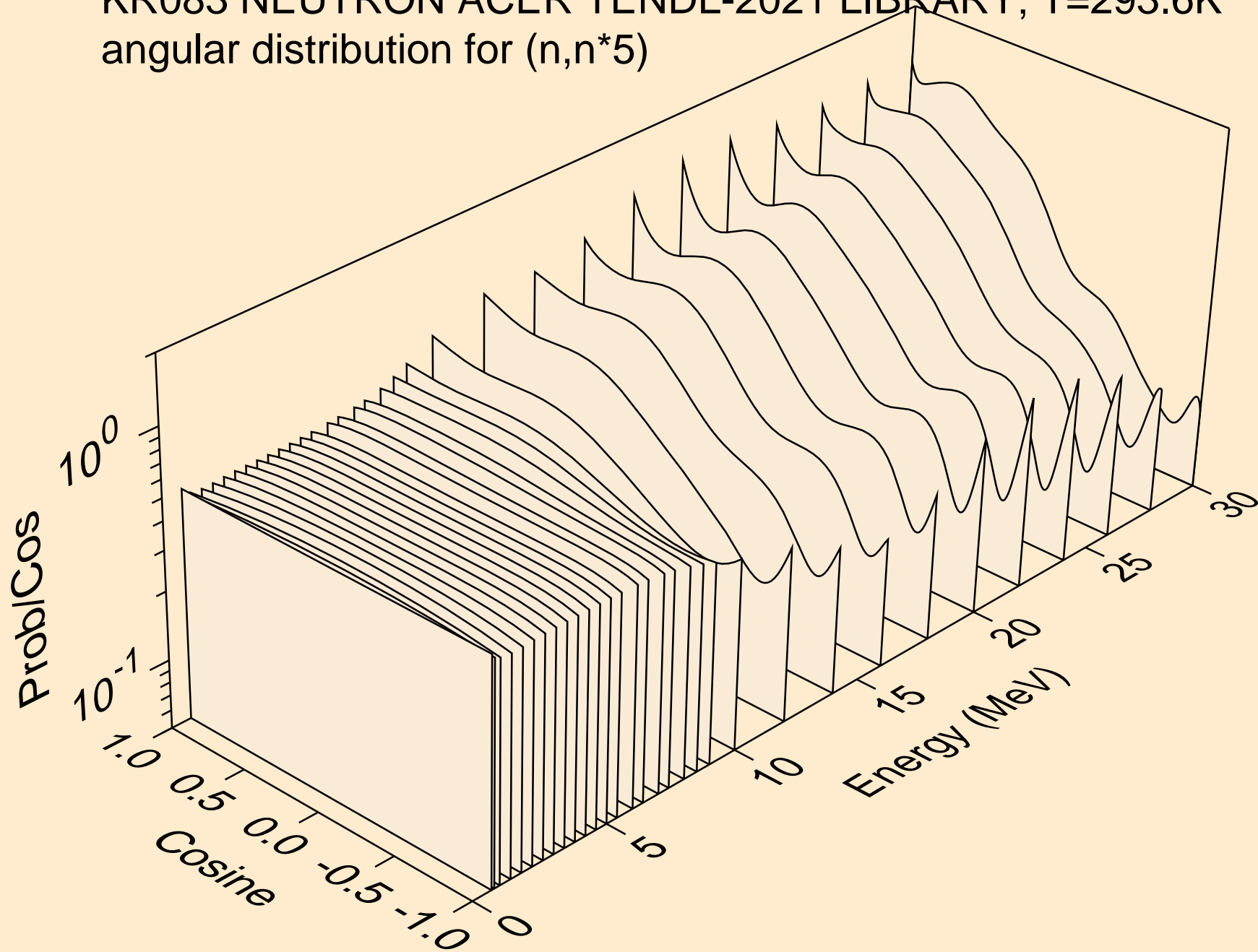

KR083 NEUTRON ACER TENDL-2021 LIBRARY; T=293.6K
angular distribution for (n,n*6)

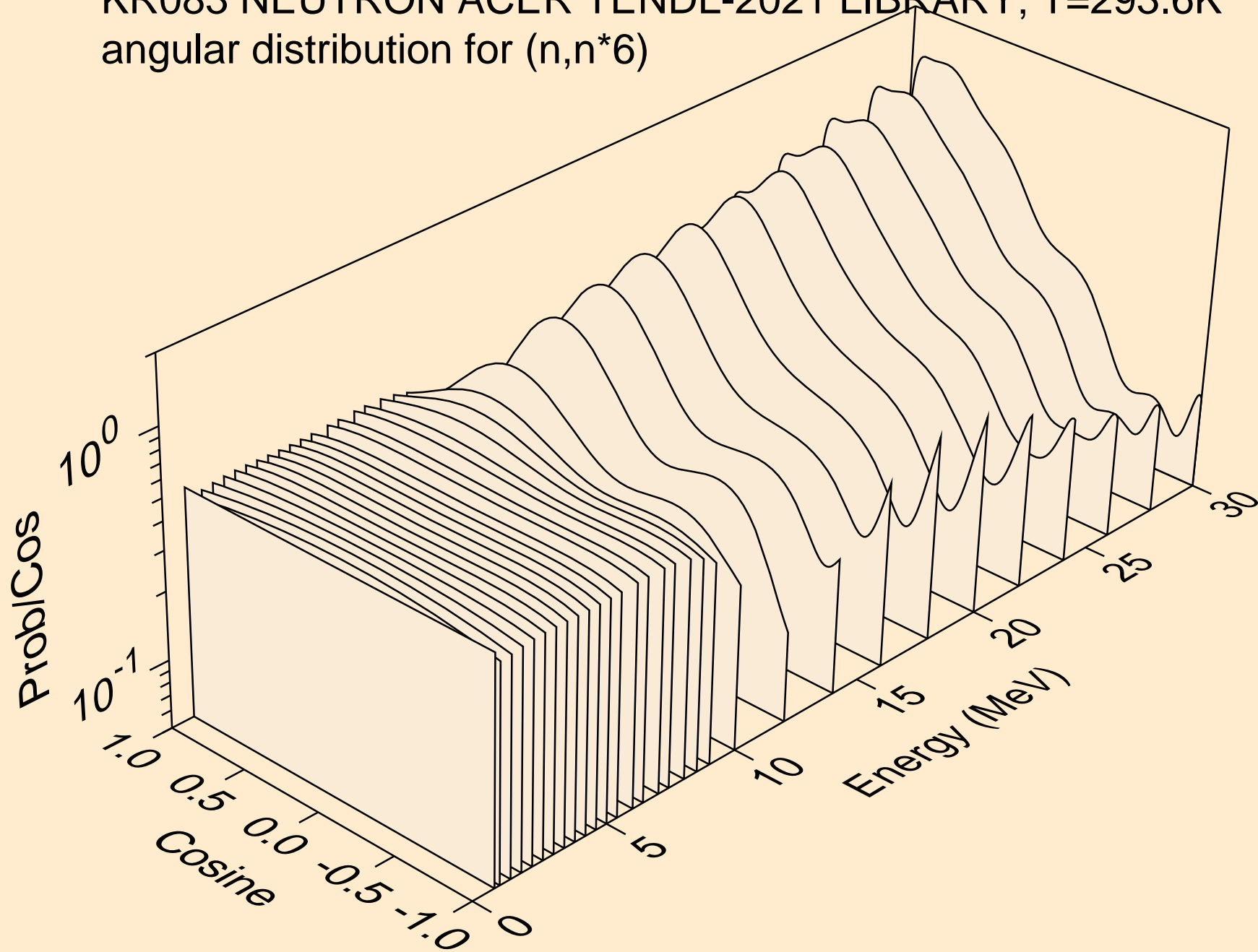

KR083 NEUTRON ACER TENDL-2021 LIBRARY; T=293.6K
angular distribution for (n,n*7)

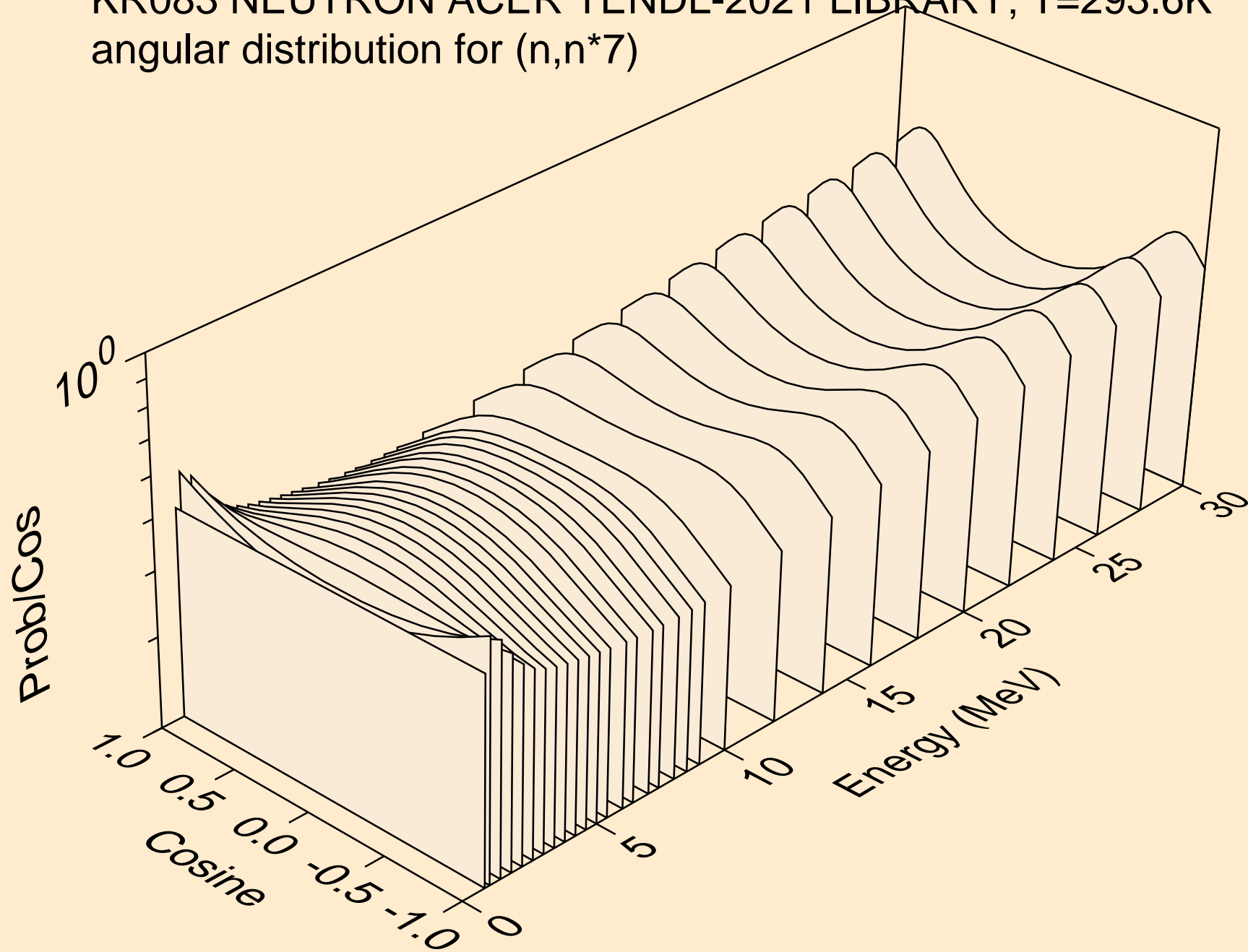

KR083 NEUTRON ACER TENDL-2021 LIBRARY; T=293.6K
angular distribution for (n,n*8)

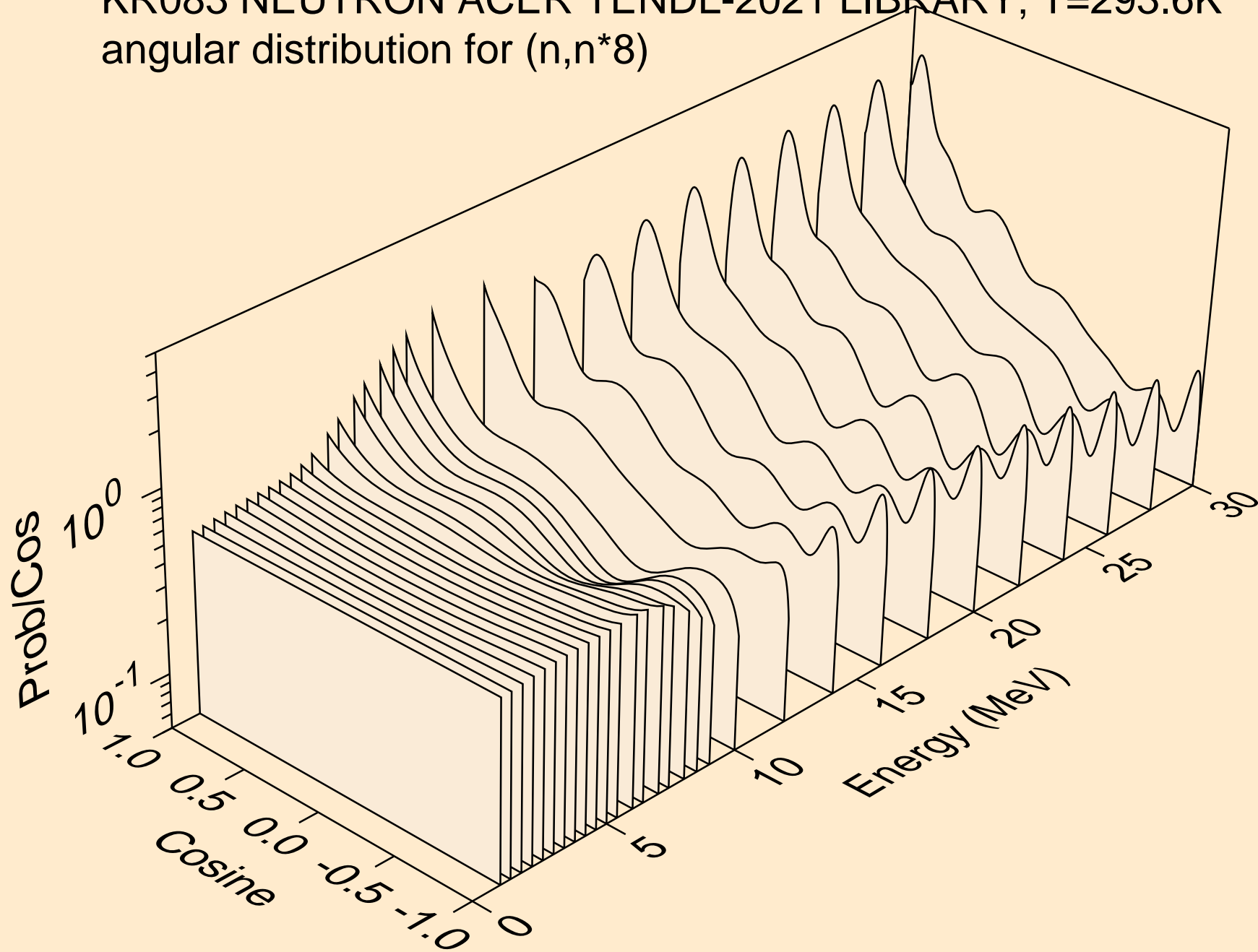

KR083 NEUTRON ACER TENDL-2021 LIBRARY; T=293.6K
angular distribution for (n,n*9)

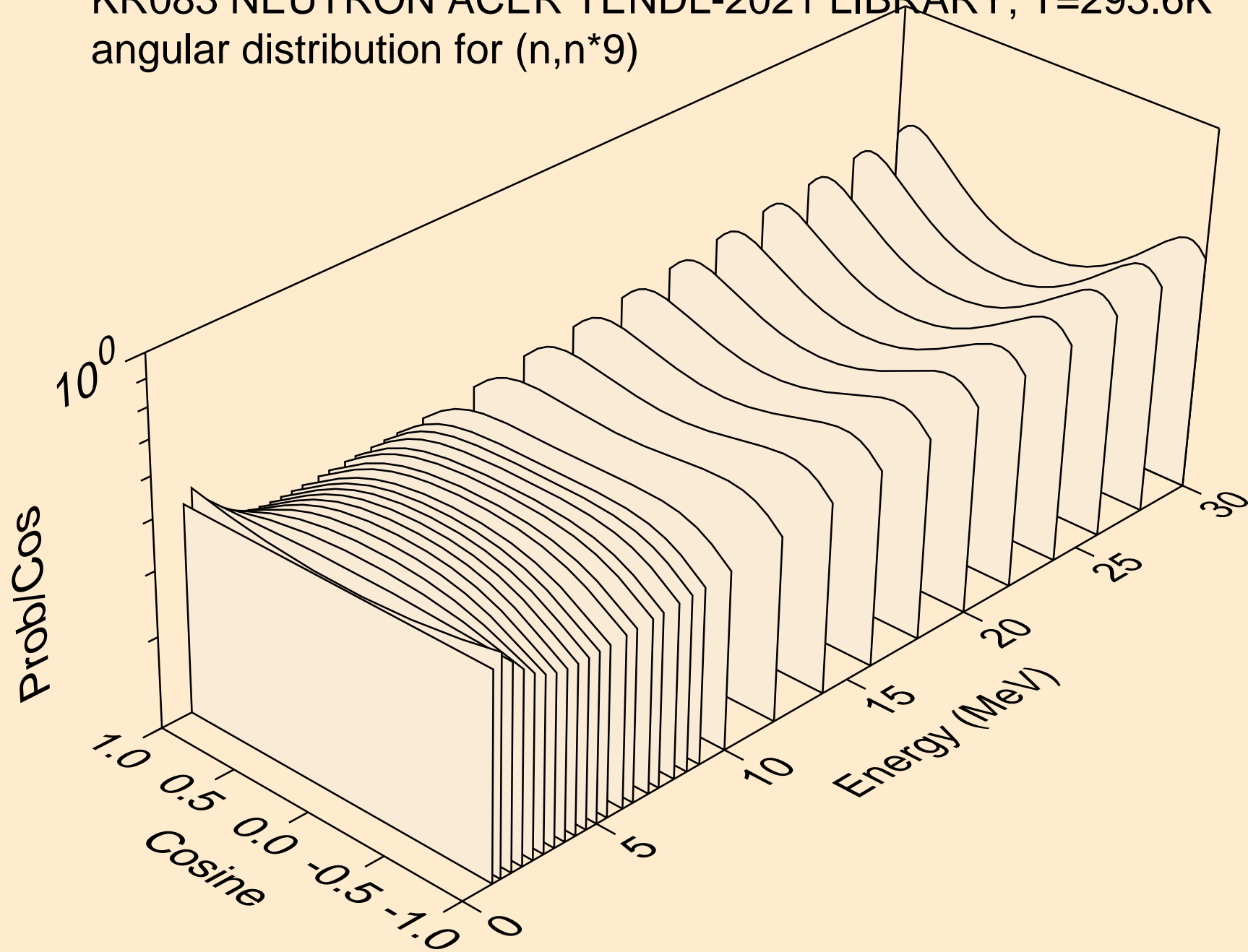

KR083 NEUTRON ACER TENDL-2021 LIBRARY; T=293.6K
angular distribution for (n,n*10)

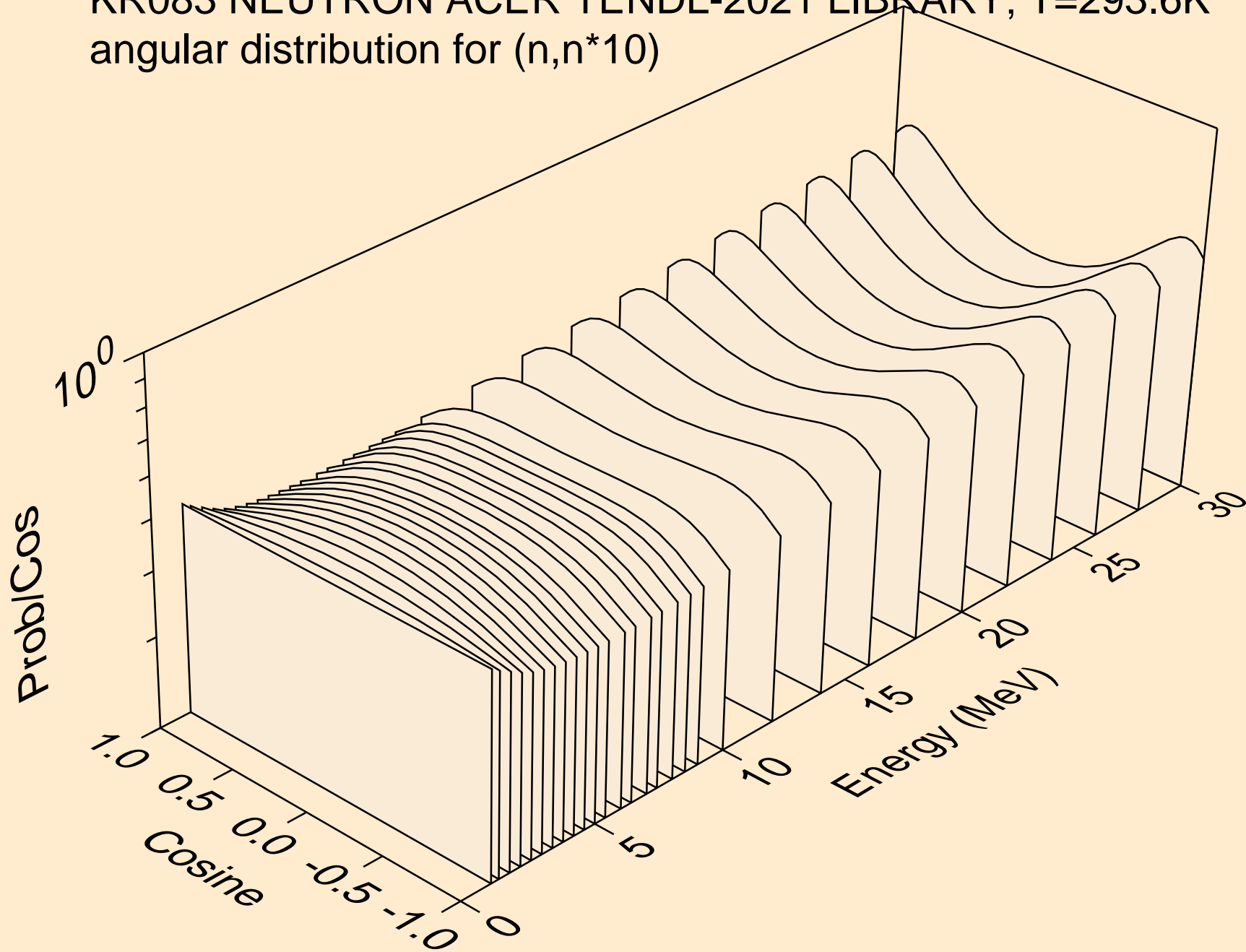

KR083 NEUTRON ACER TENDL-2021 LIBRARY; T=293.6K
angular distribution for (n,n*11)

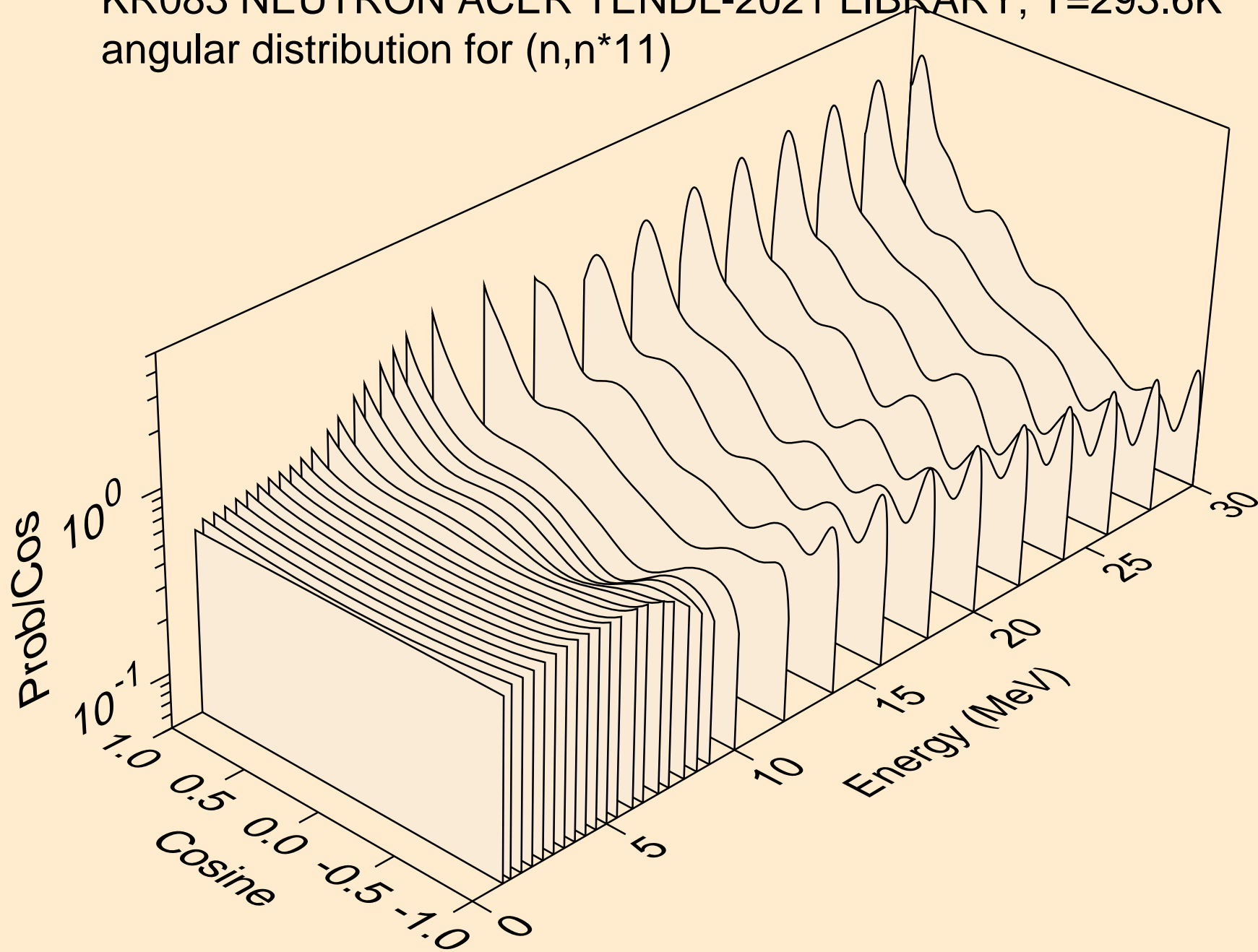

KR083 NEUTRON ACER TENDL-2021 LIBRARY; T=293.6K
angular distribution for (n,n*12)

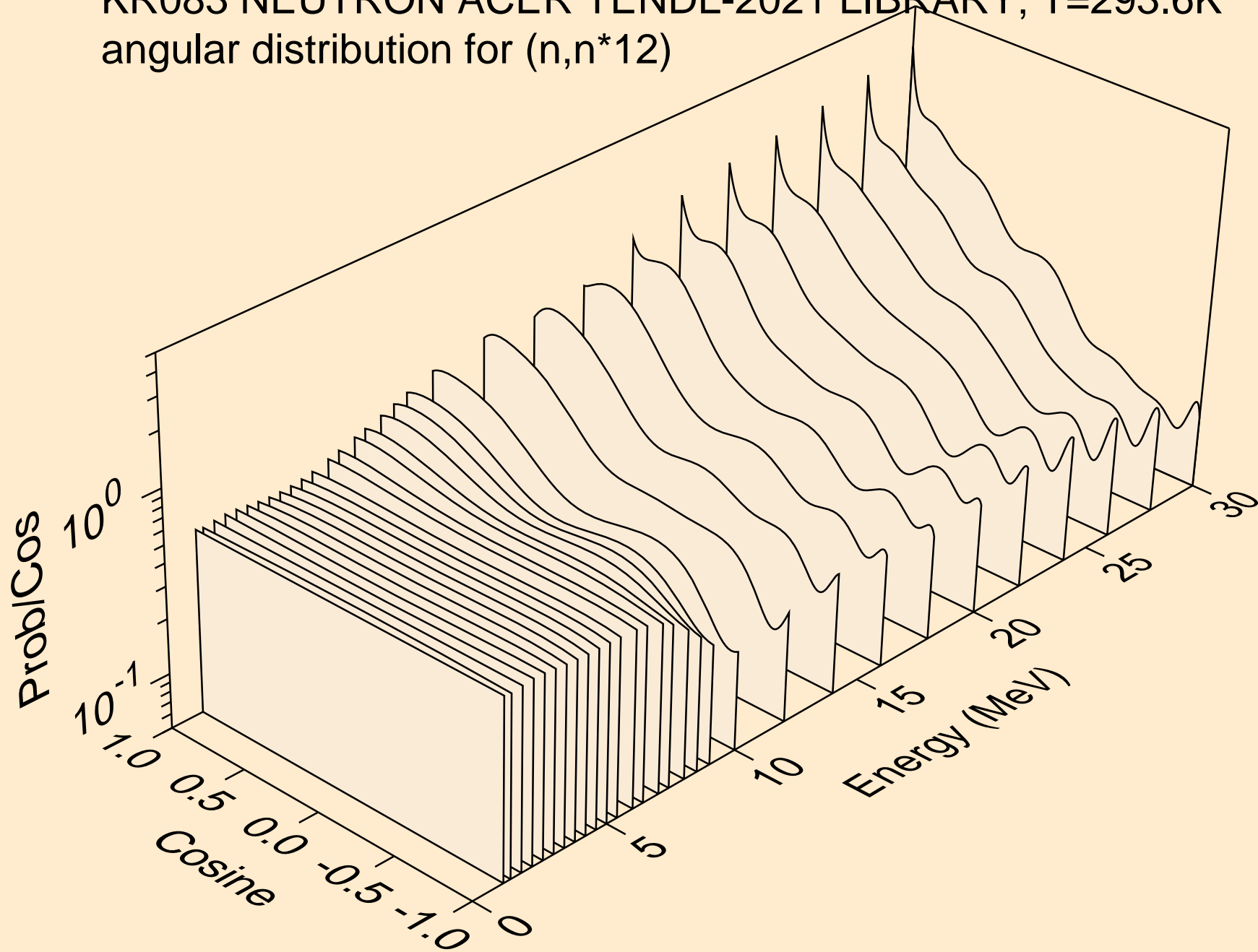

KR083 NEUTRON ACER TENDL-2021 LIBRARY; T=293.6K
angular distribution for (n,n*13)

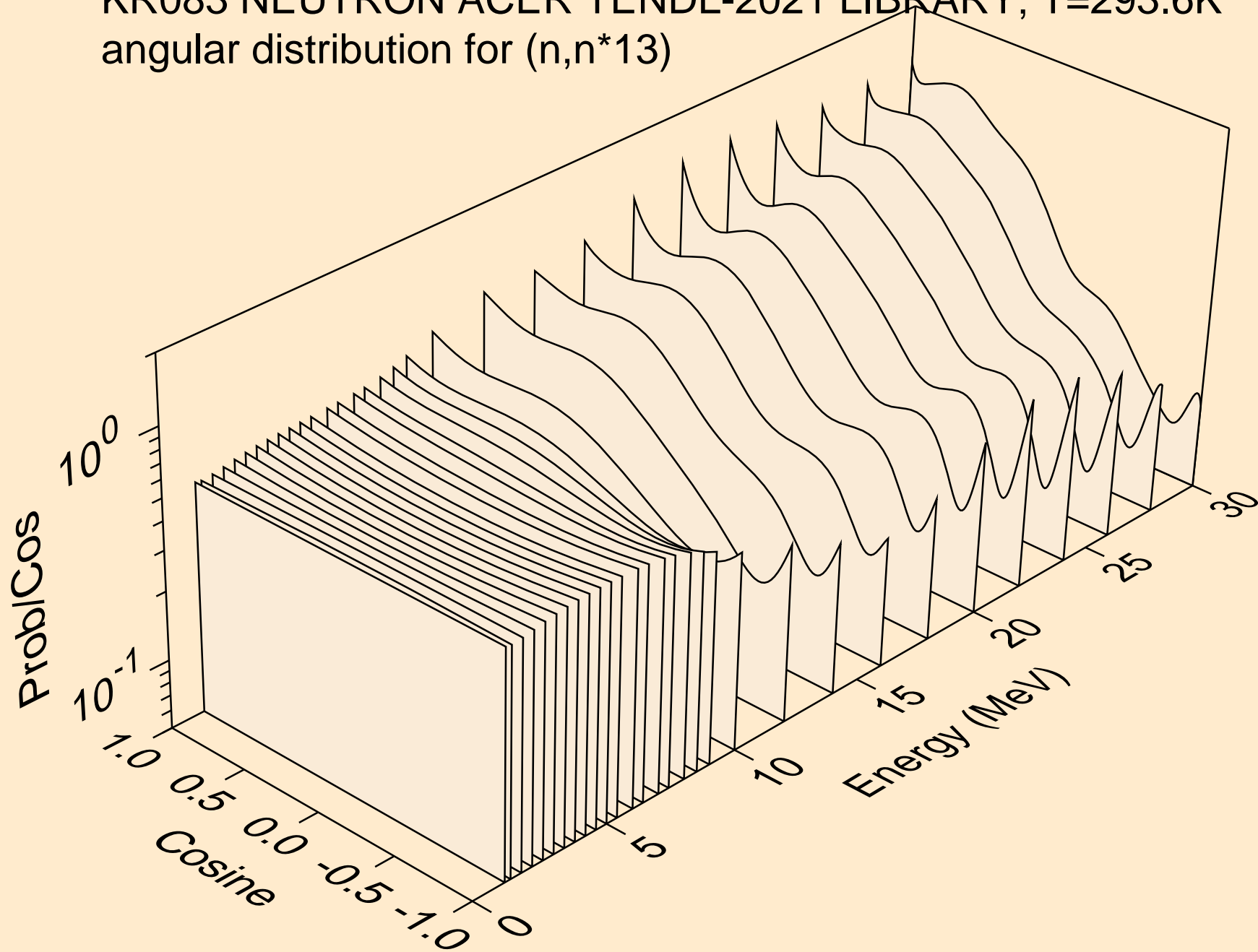

KR083 NEUTRON ACER TENDL-2021 LIBRARY; T=293.6K
angular distribution for (n,n*14)

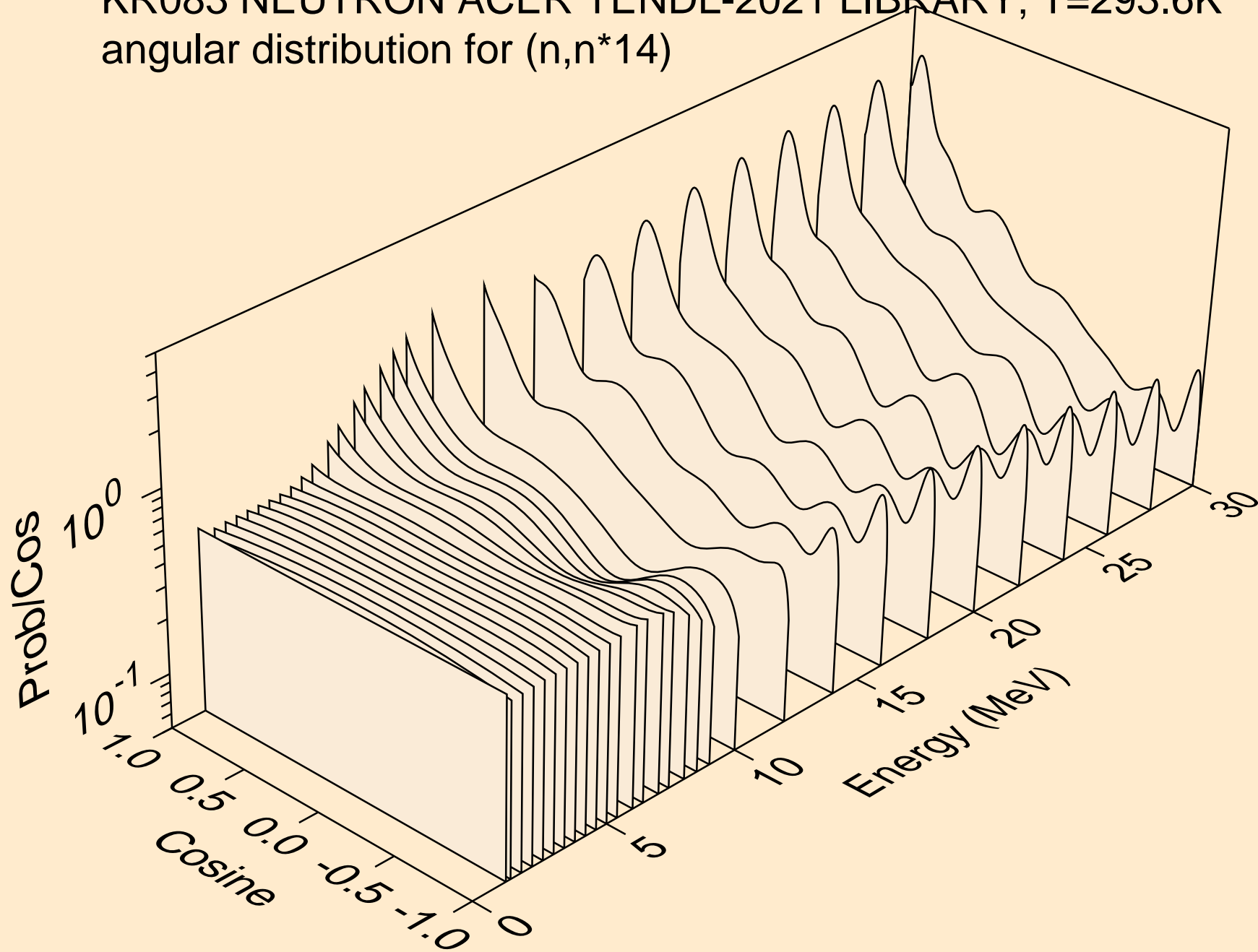

KR083 NEUTRON ACER TENDL-2021 LIBRARY; T=293.6K
angular distribution for (n,n*15)

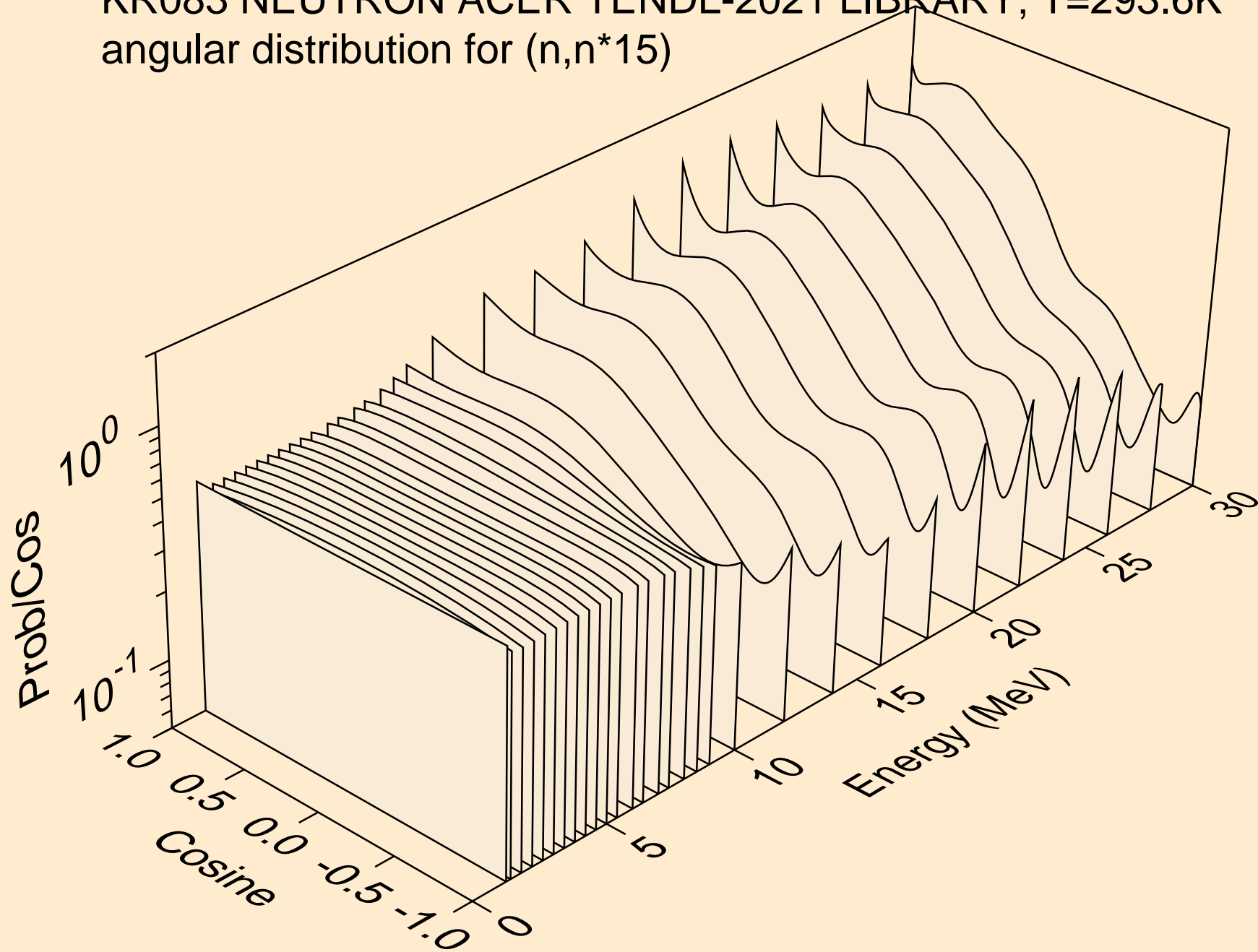

KR083 NEUTRON ACER TENDL-2021 LIBRARY; T=293.6K
angular distribution for (n,n*16)

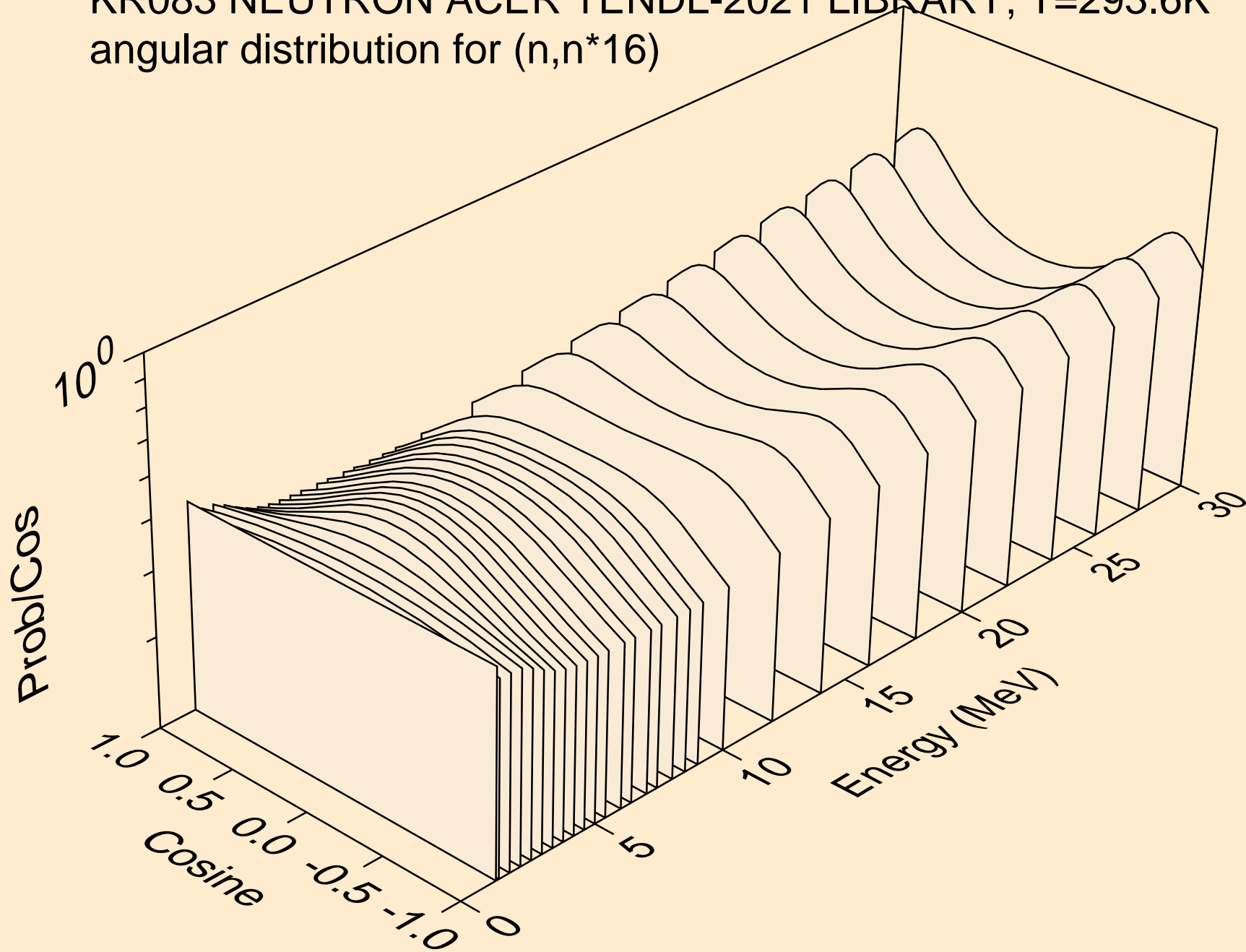

KR083 NEUTRON ACER TENDL-2021 LIBRARY; T=293.6K
angular distribution for (n,n*17)

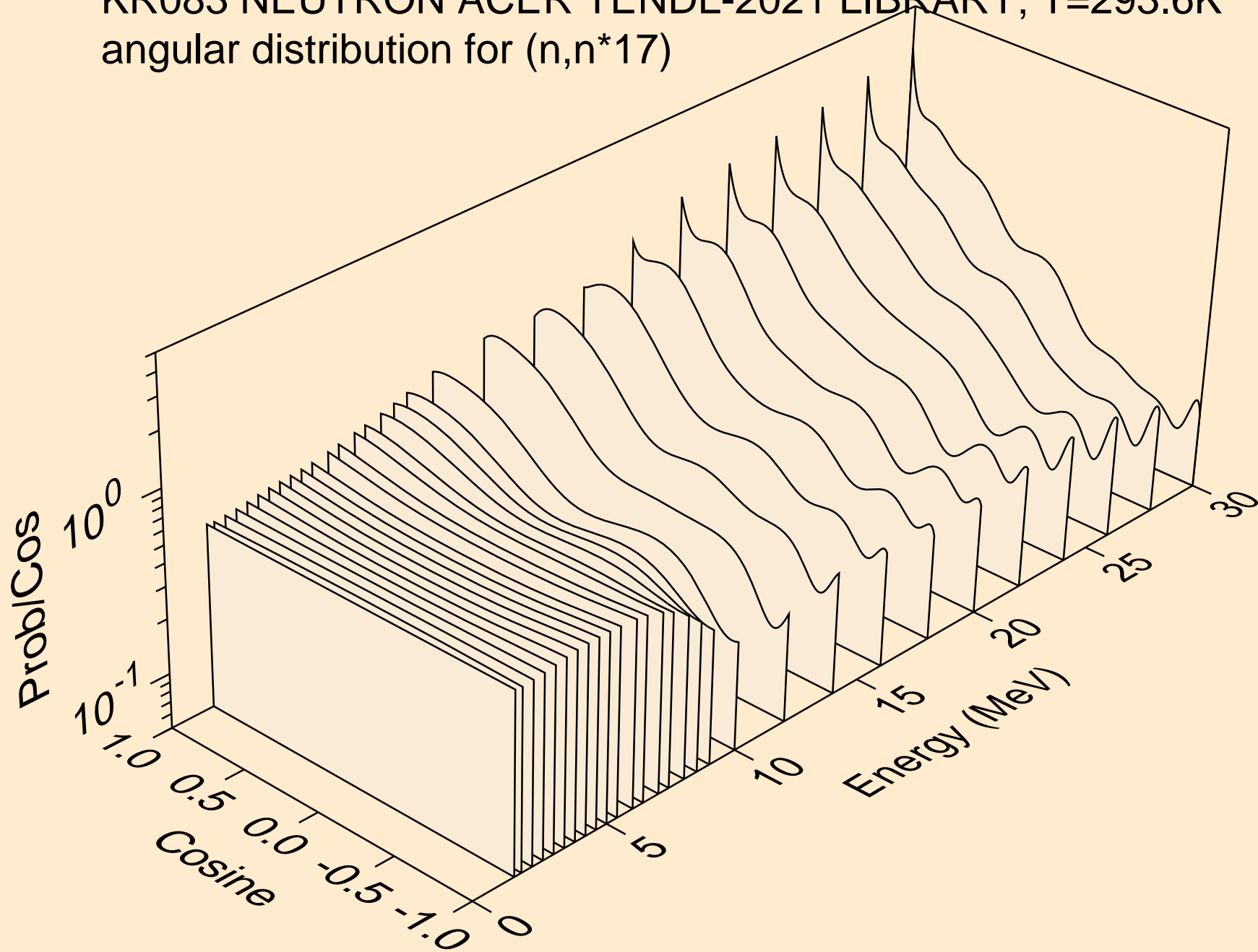

KR083 NEUTRON ACER TENDL-2021 LIBRARY; T=293.6K
angular distribution for (n,n*18)

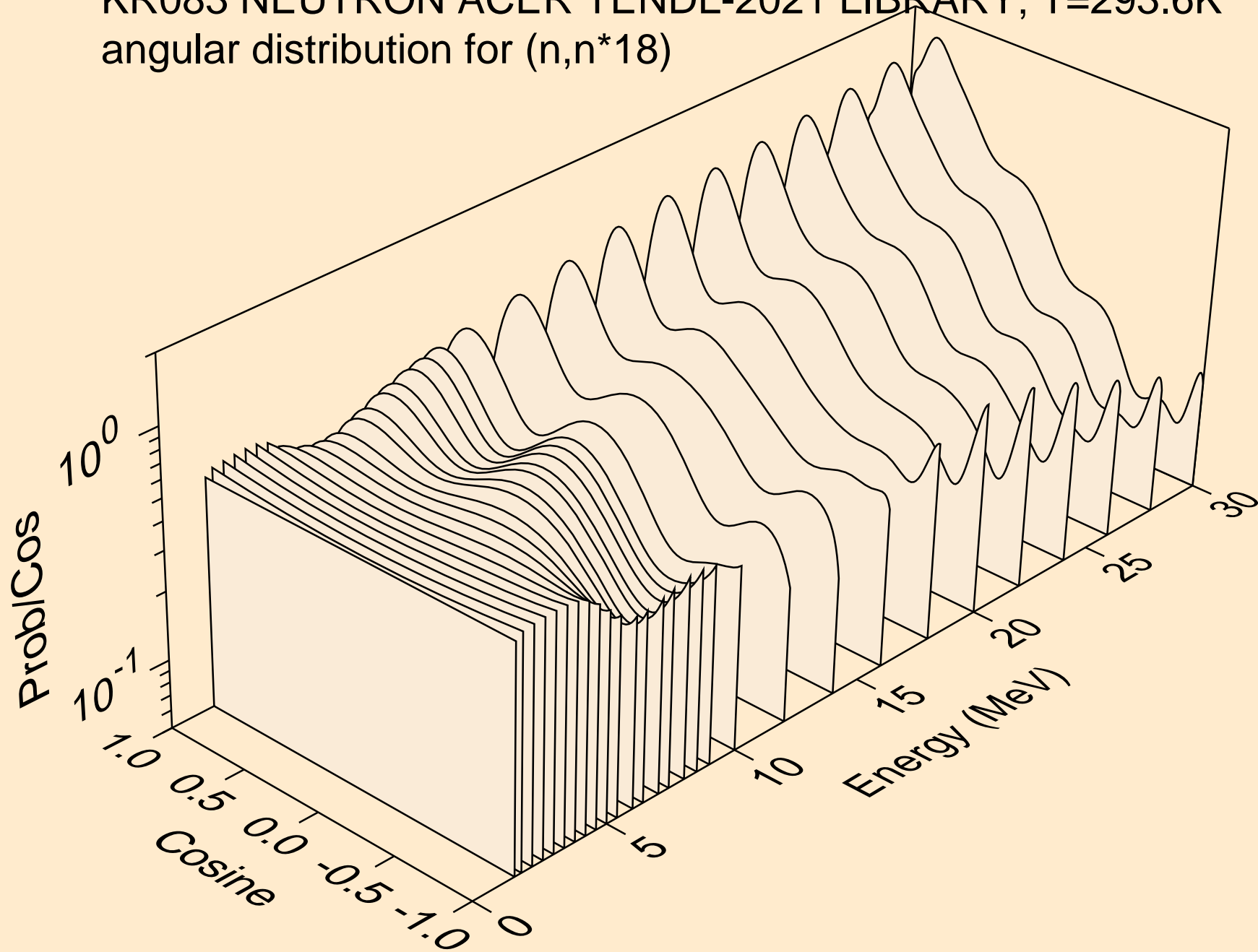

KR083 NEUTRON ACER TENDL-2021 LIBRARY; T=293.6K
angular distribution for (n,n*19)

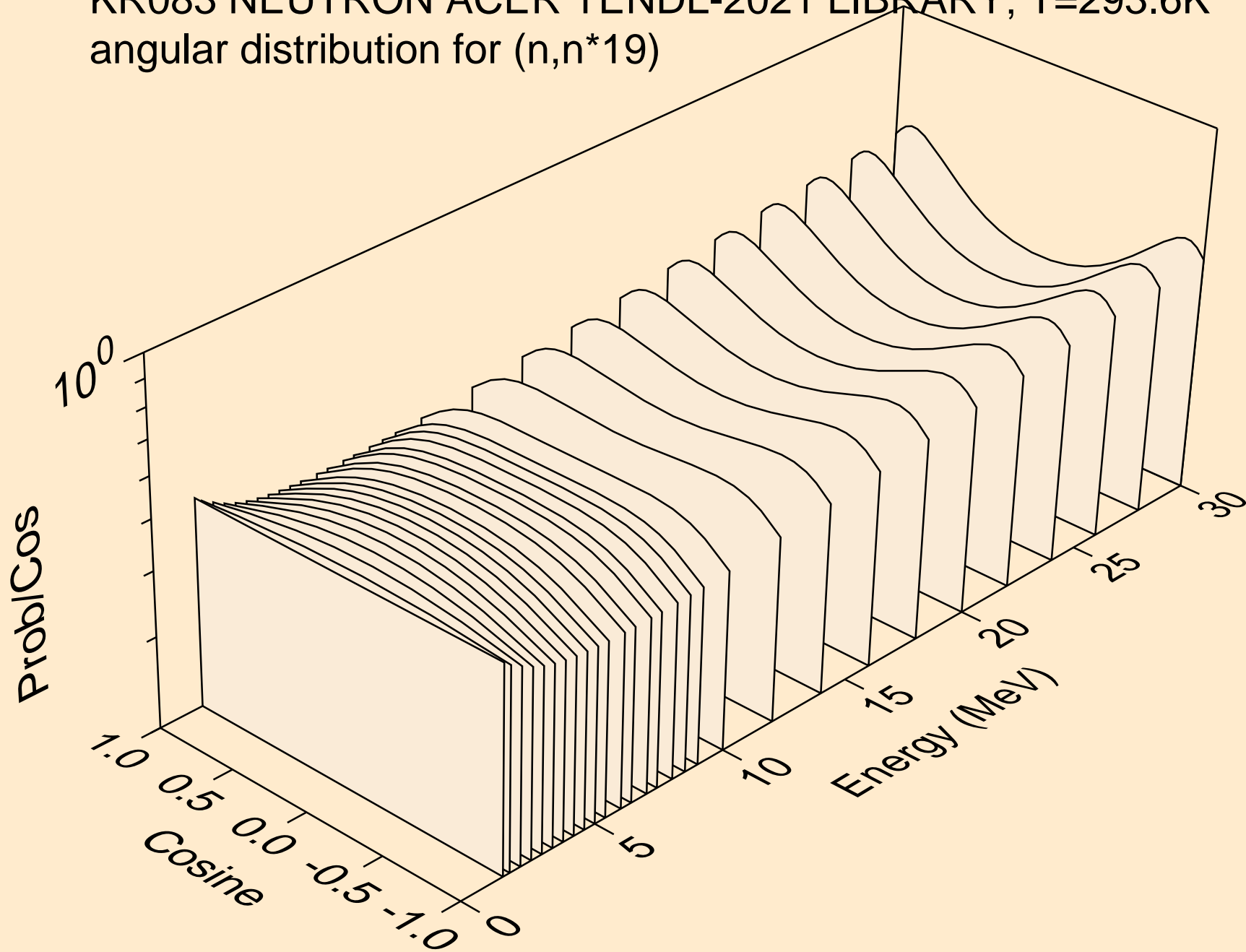

KR083 NEUTRON ACER TENDL-2021 LIBRARY; T=293.6K
angular distribution for (n,n*20)

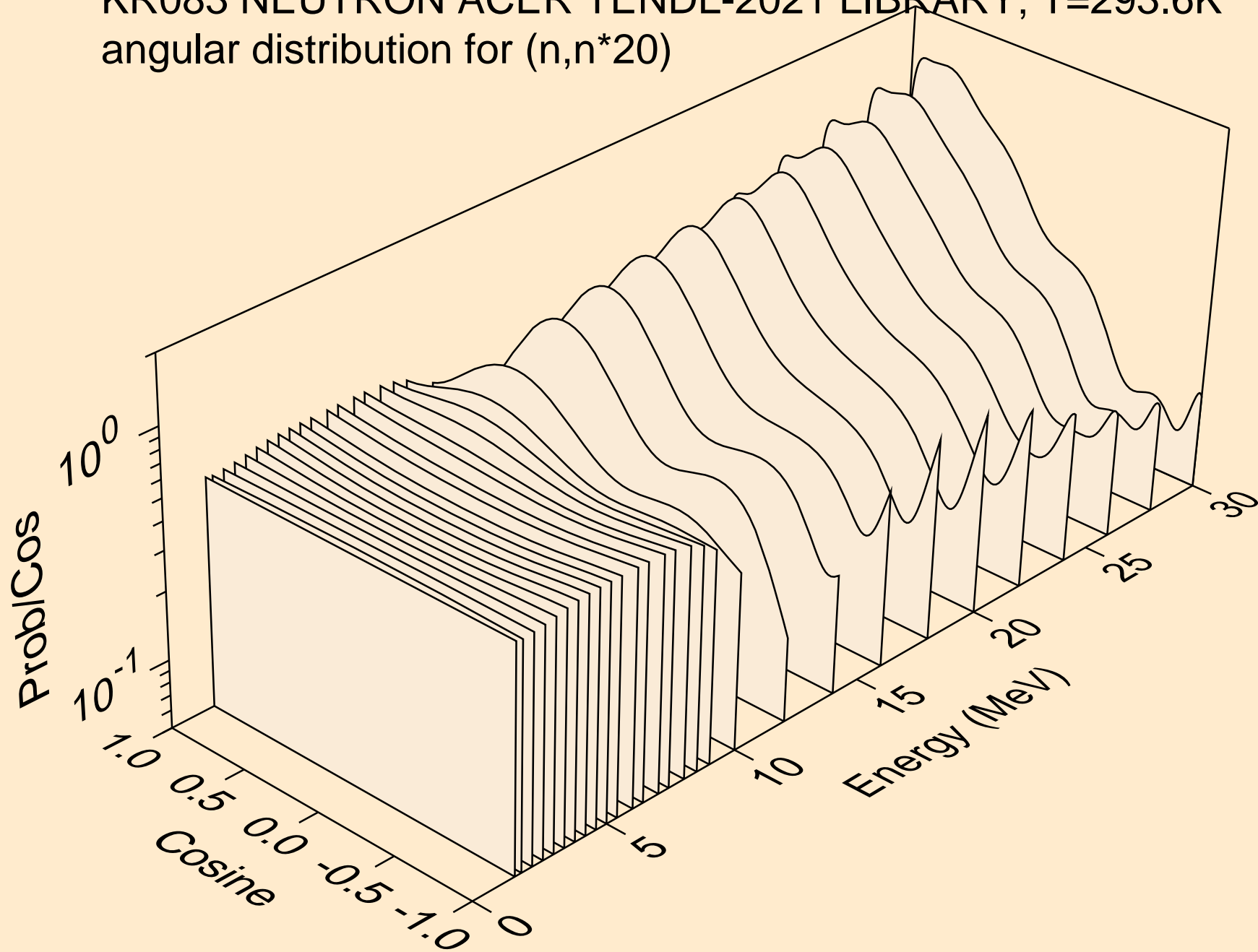

KR083 NEUTRON ACER TENDL-2021 LIBRARY; T=293.6K
angular distribution for (n,n*21)

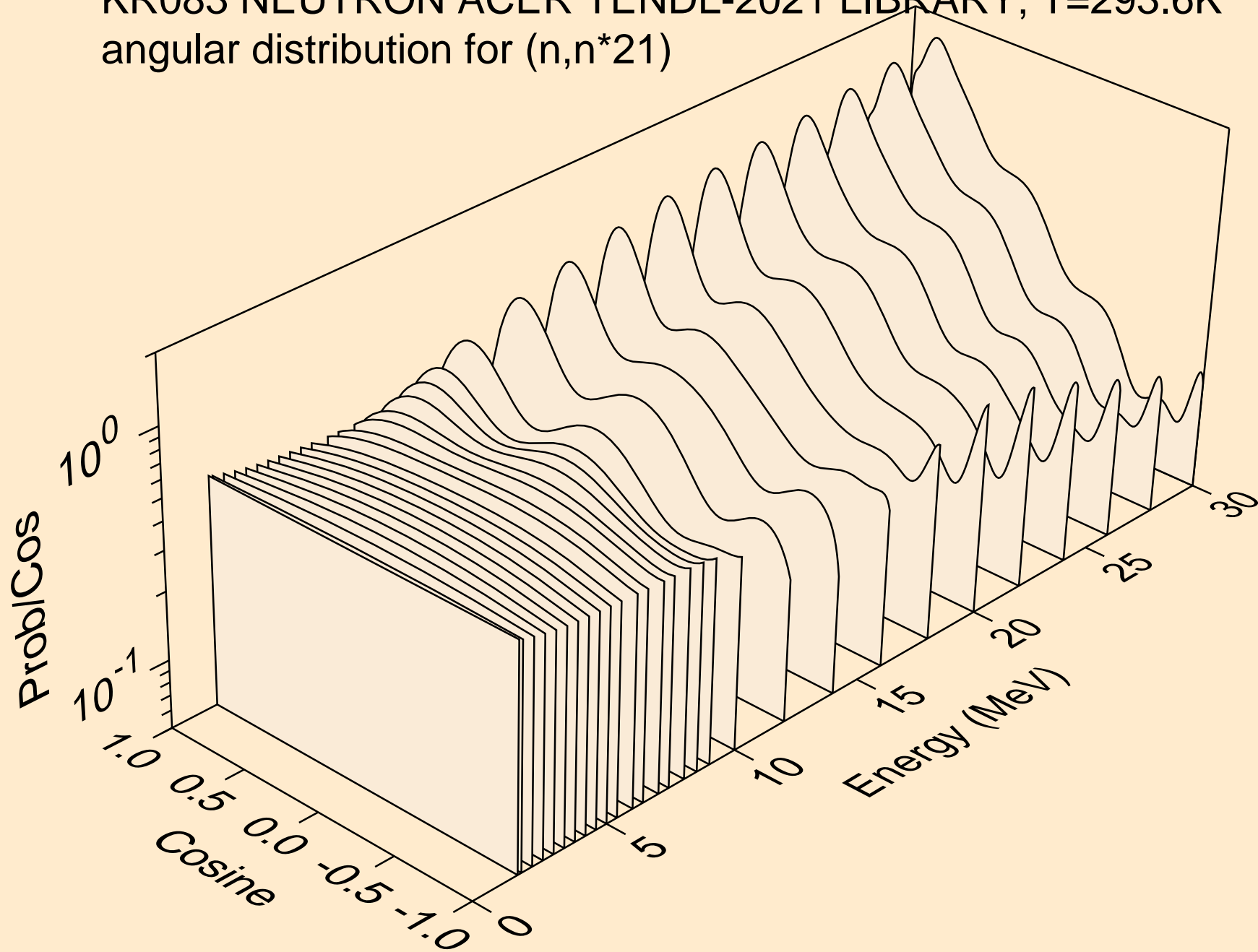

KR083 NEUTRON ACER TENDL-2021 LIBRARY; T=293.6K
angular distribution for (n,n*22)

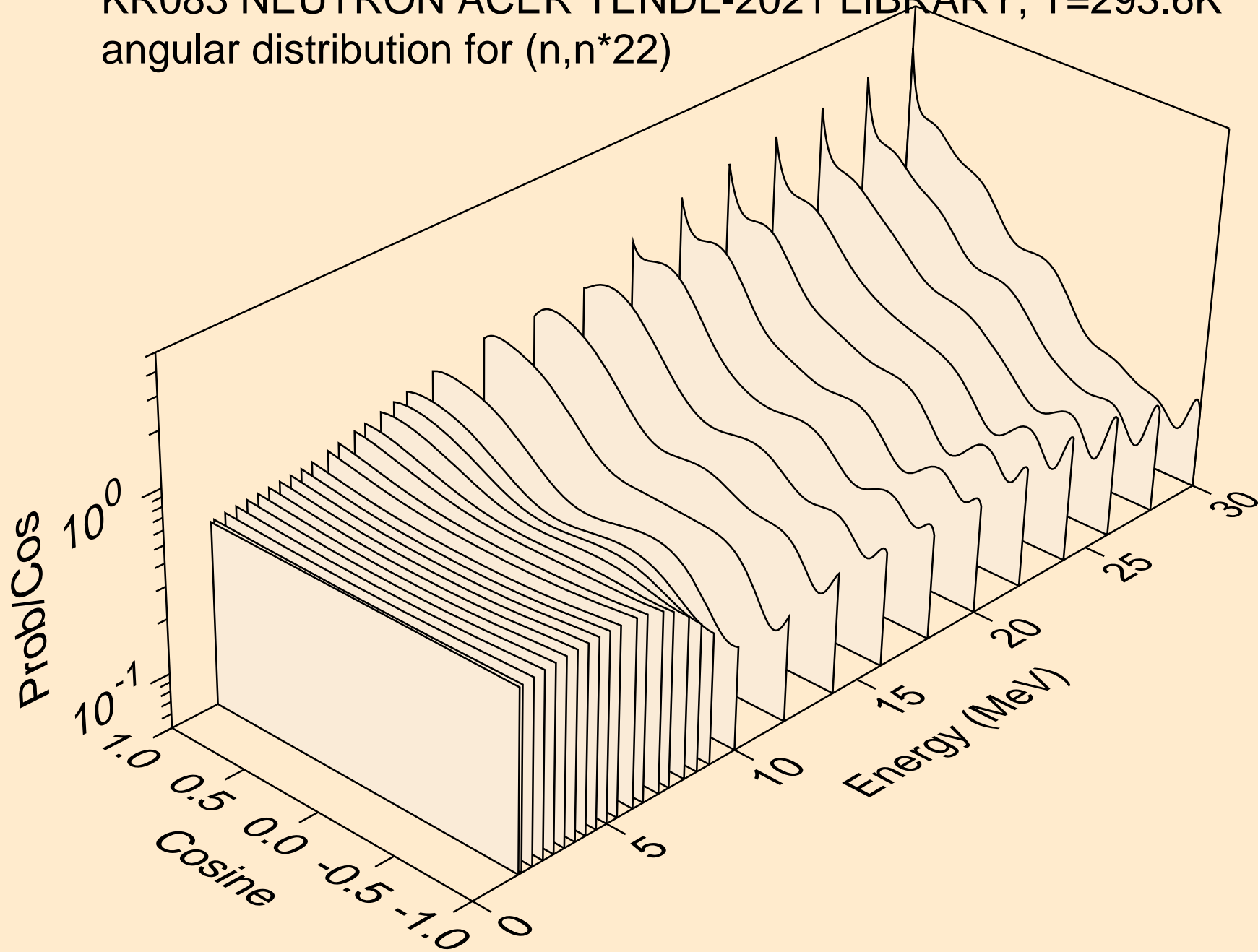

KR083 NEUTRON ACER TENDL-2021 LIBRARY; T=293.6K
angular distribution for (n,n*23)

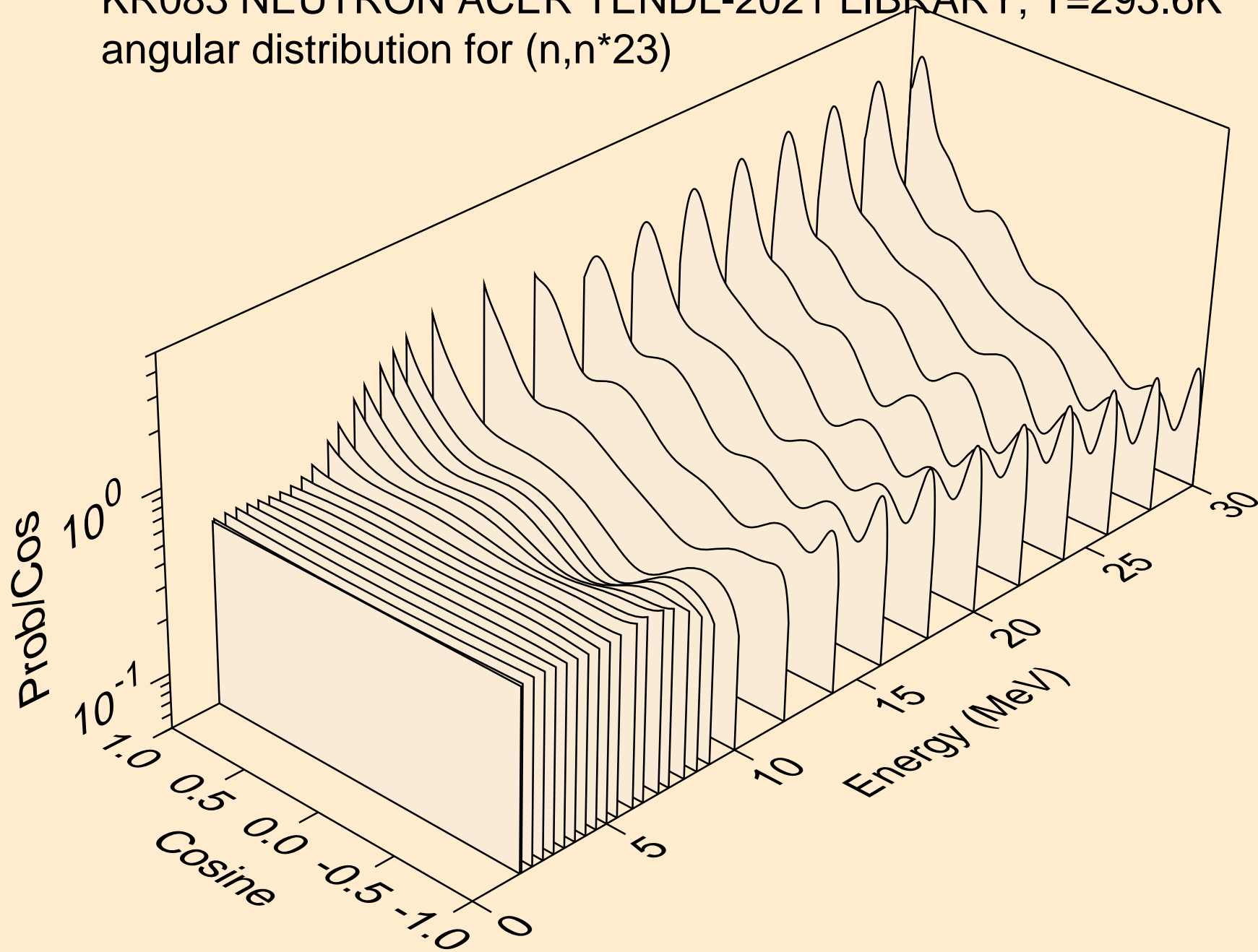

KR083 NEUTRON ACER TENDL-2021 LIBRARY; T=293.6K
angular distribution for (n,n*24)

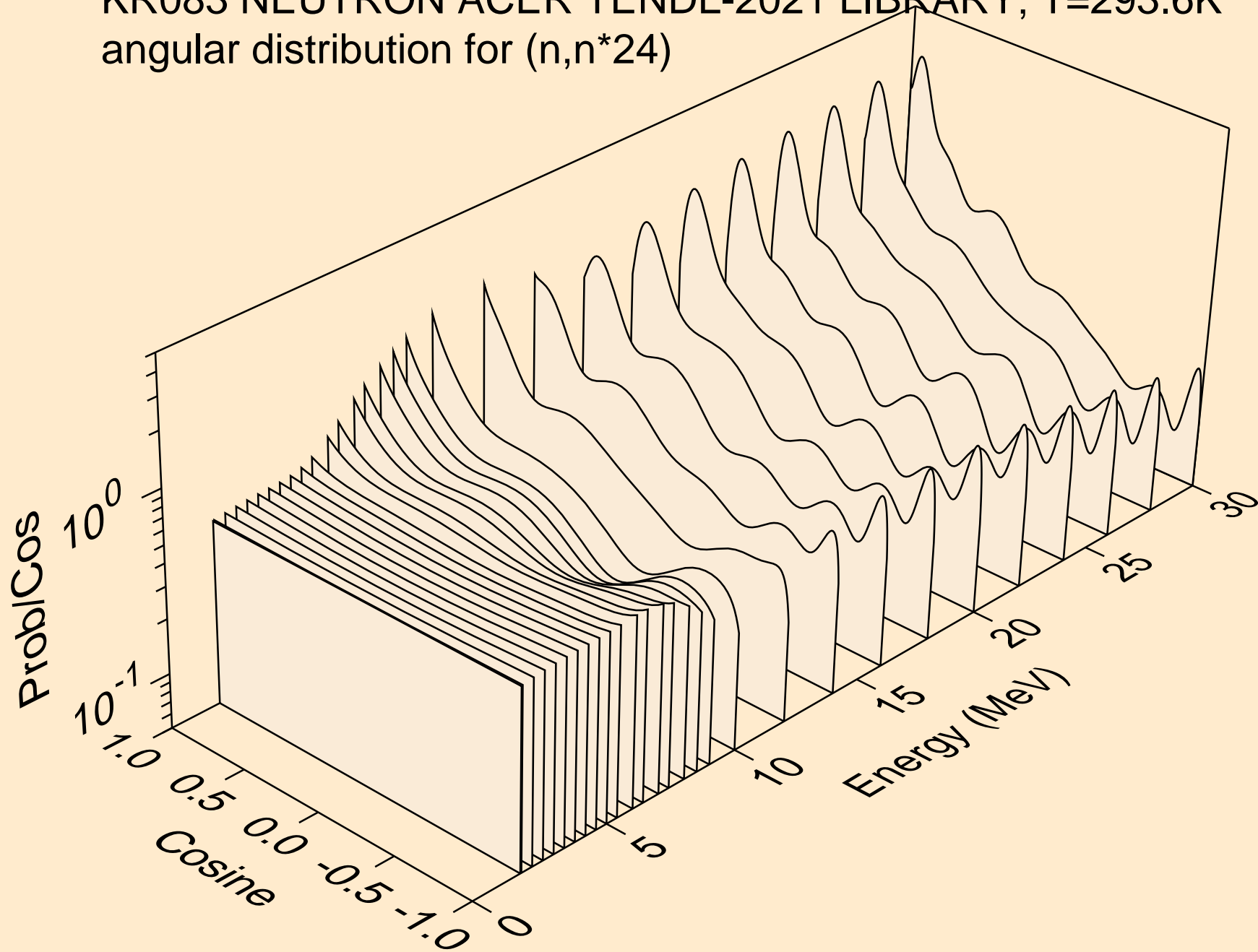

KR083 NEUTRON ACER TENDL-2021 LIBRARY; T=293.6K
angular distribution for (n,n*25)

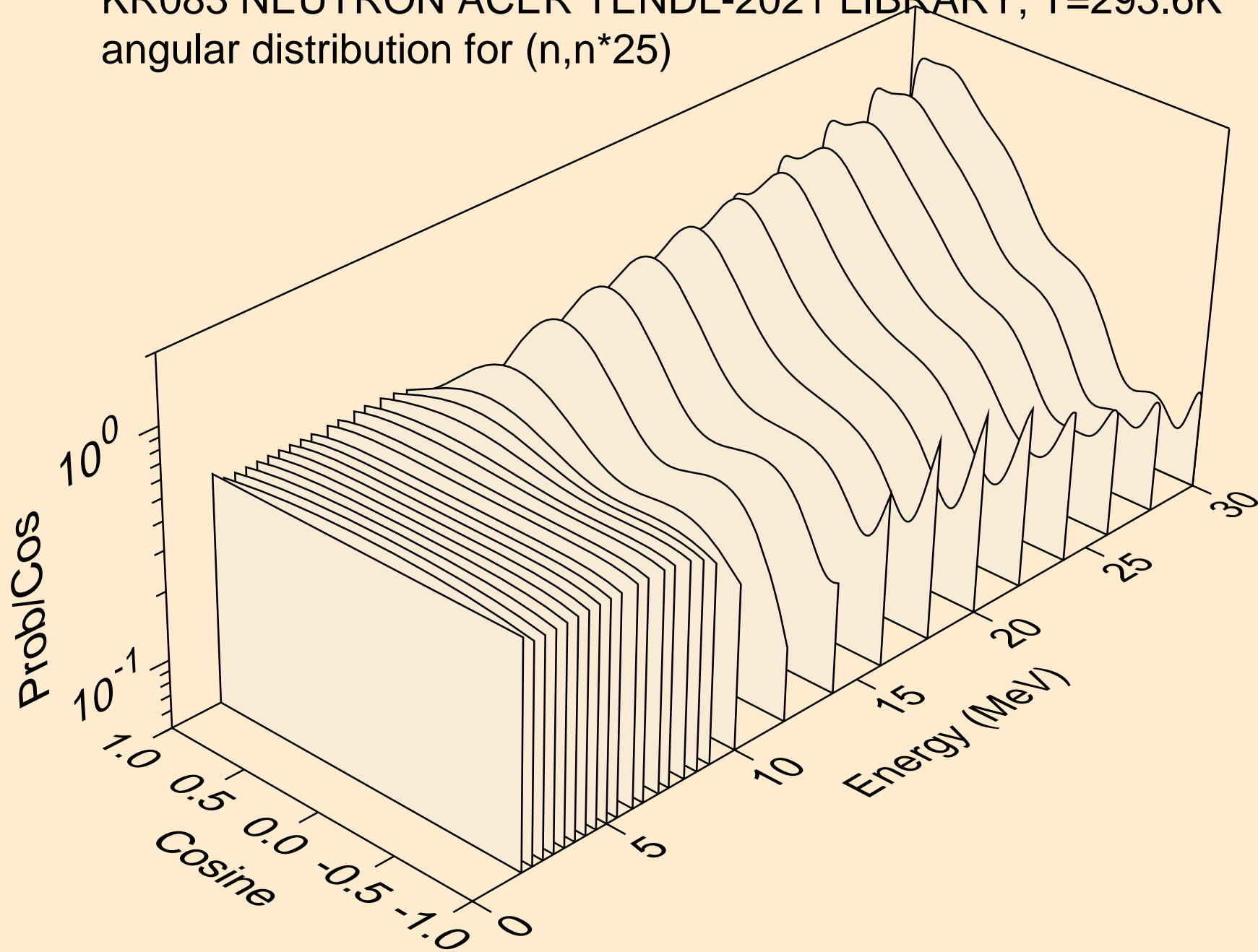

KR083 NEUTRON ACER TENDL-2021 LIBRARY; T=293.6K
angular distribution for (n,n*26)

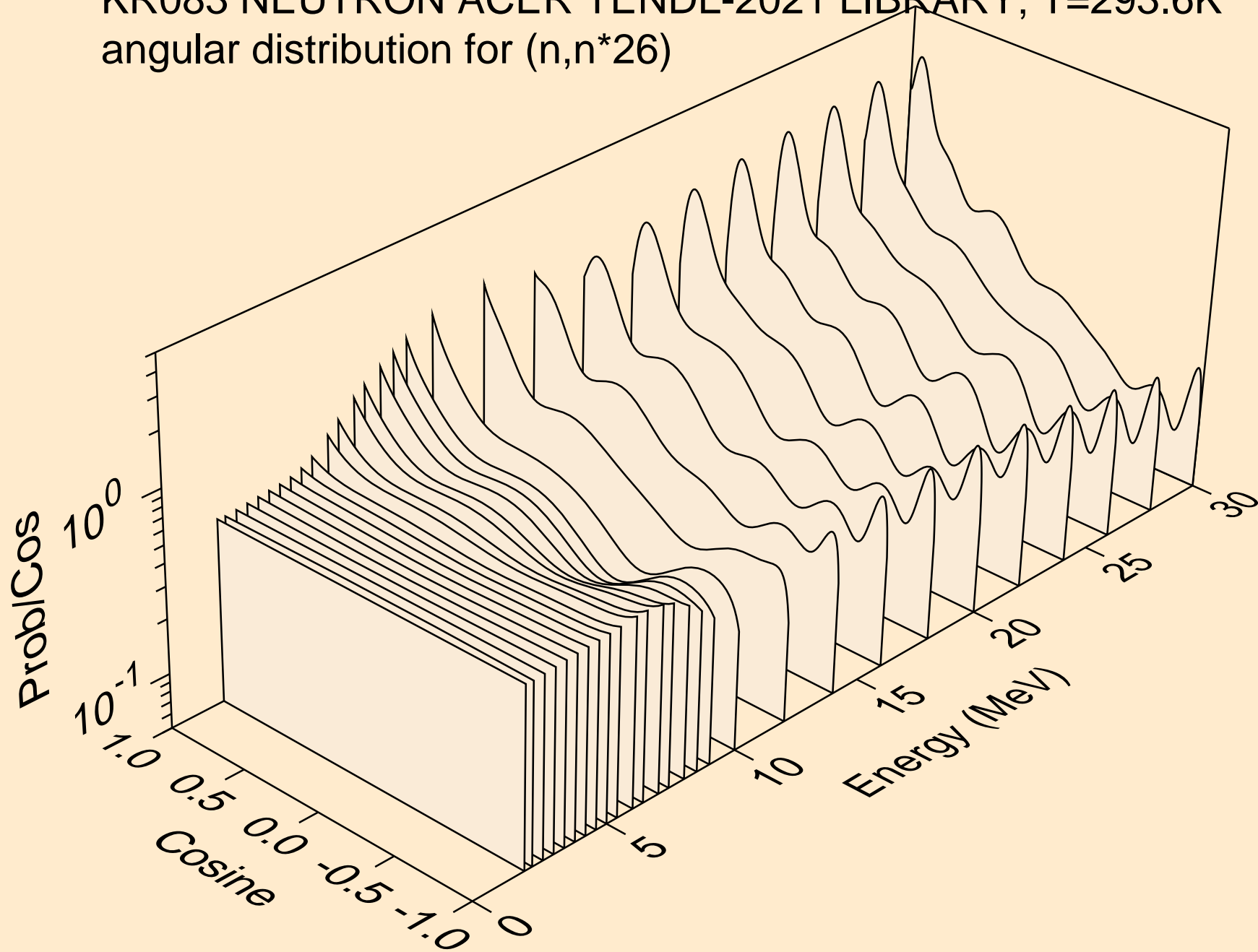

KR083 NEUTRON ACER TENDL-2021 LIBRARY; T=293.6K
angular distribution for (n,n*27)

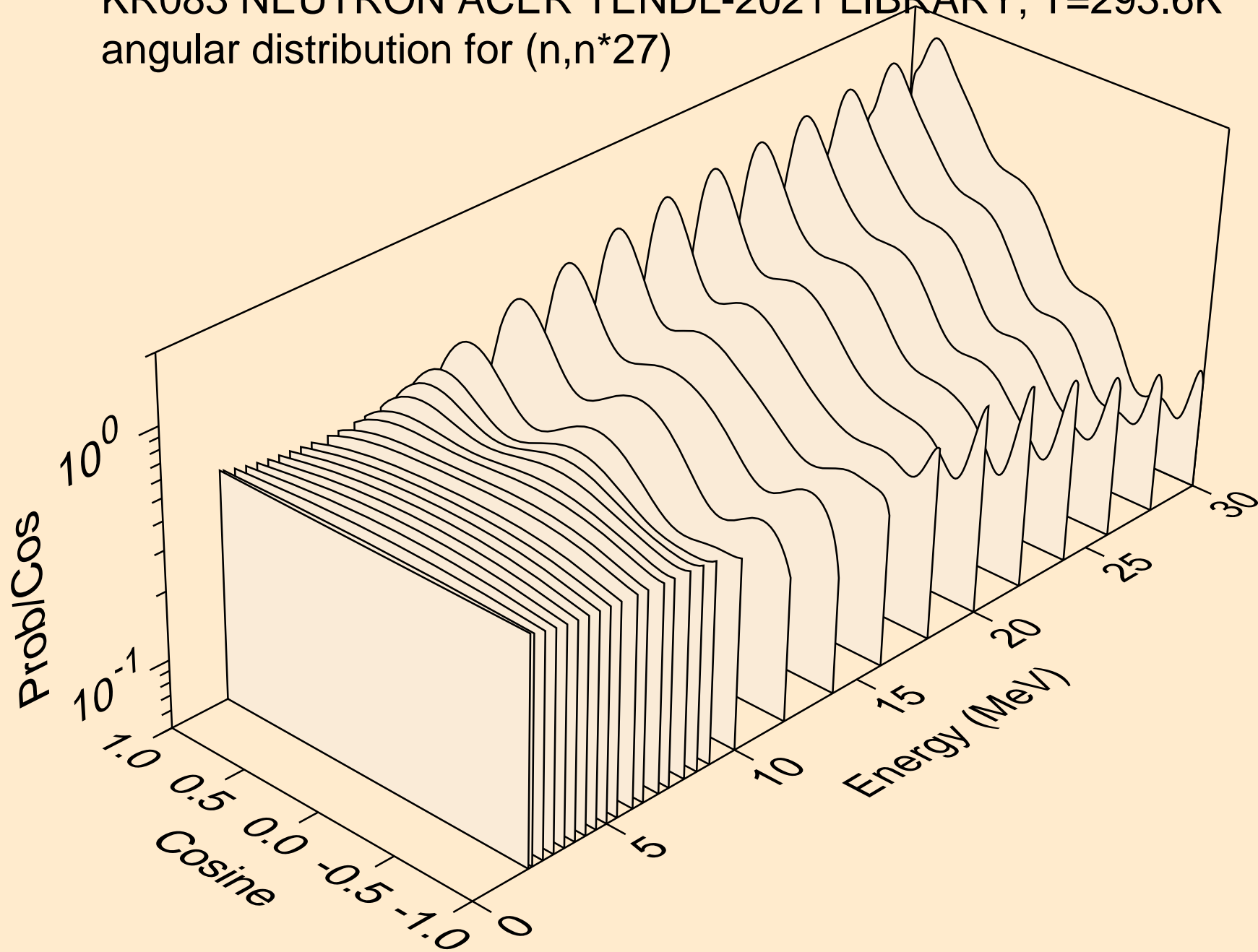

KR083 NEUTRON ACER TENDL-2021 LIBRARY; T=293.6K
angular distribution for (n,n*28)

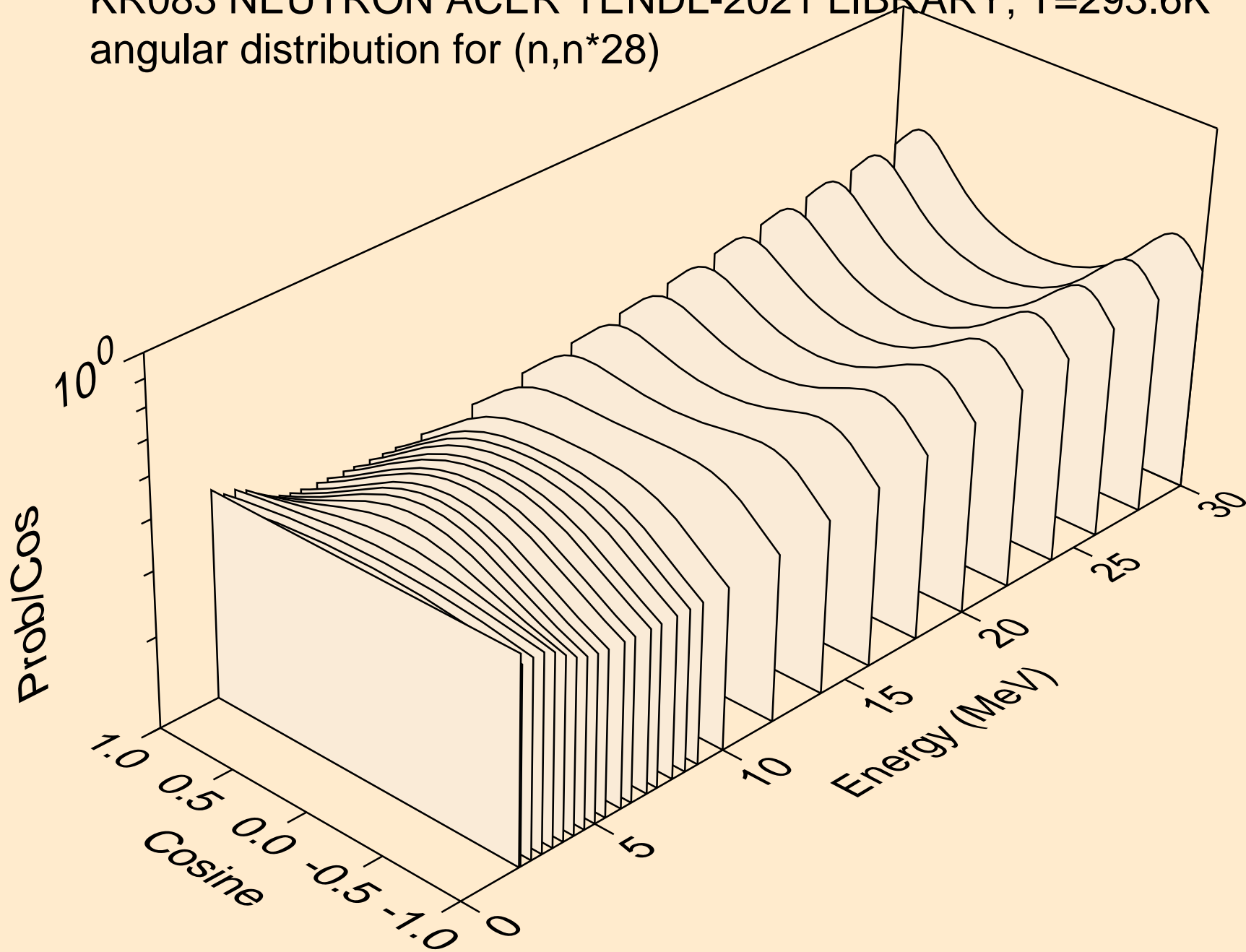

KR083 NEUTRON ACER TENDL-2021 LIBRARY; T=293.6K
angular distribution for (n,n*29)

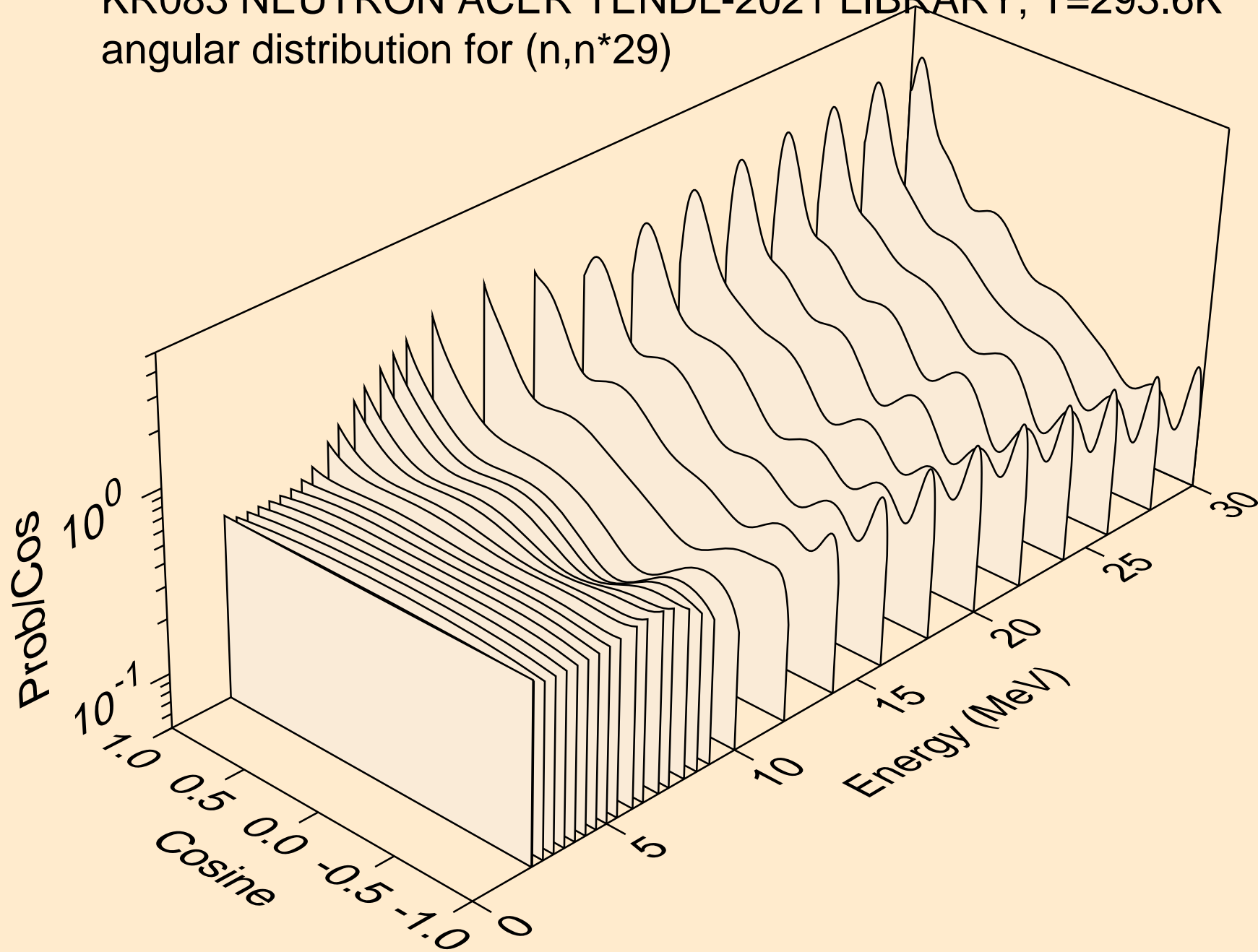

KR083 NEUTRON ACER TENDL-2021 LIBRARY; T=293.6K
angular distribution for (n,n*30)

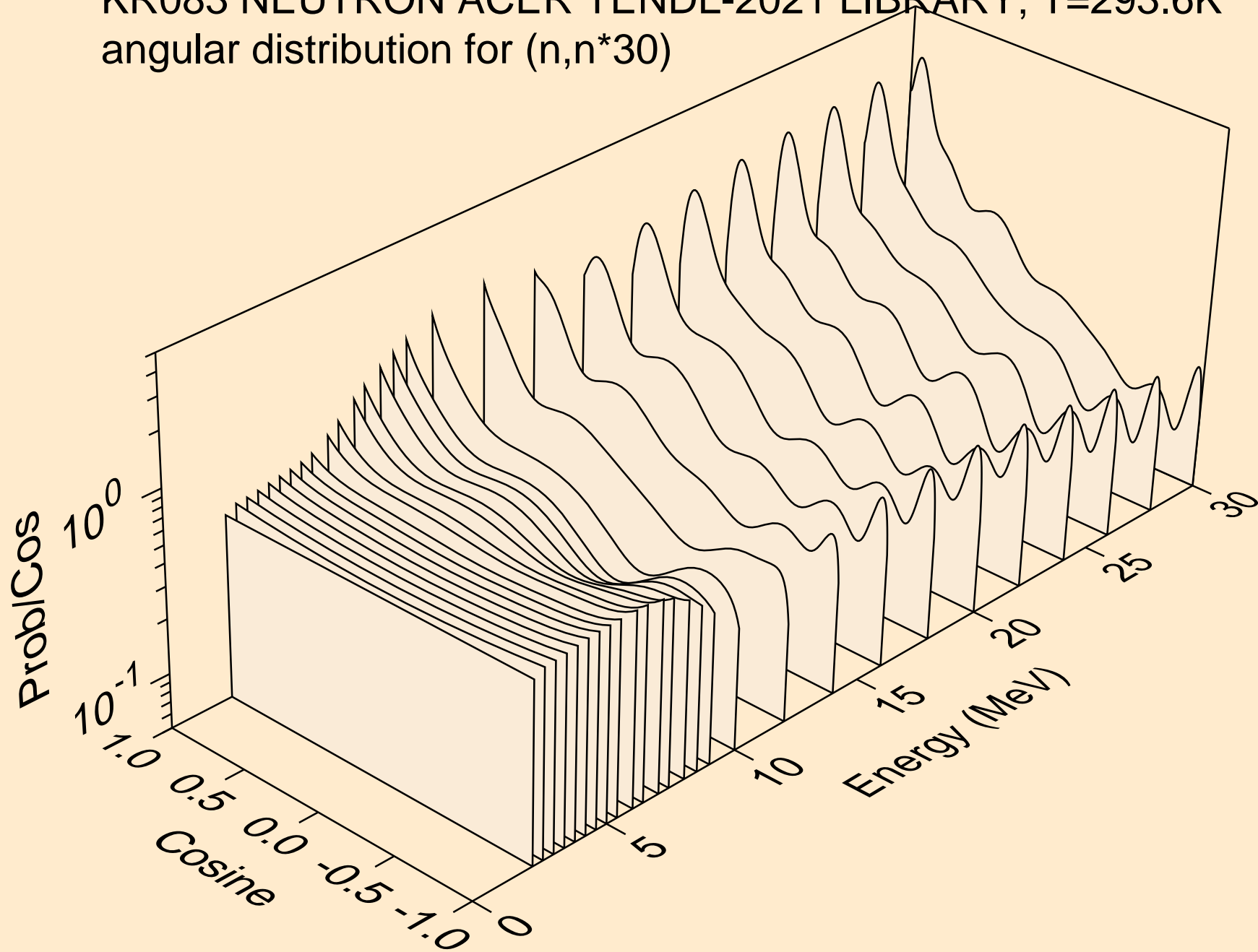

KR083 NEUTRON ACER TENDL-2021 LIBRARY; T=293.6K
Neutron emission for (n,x)

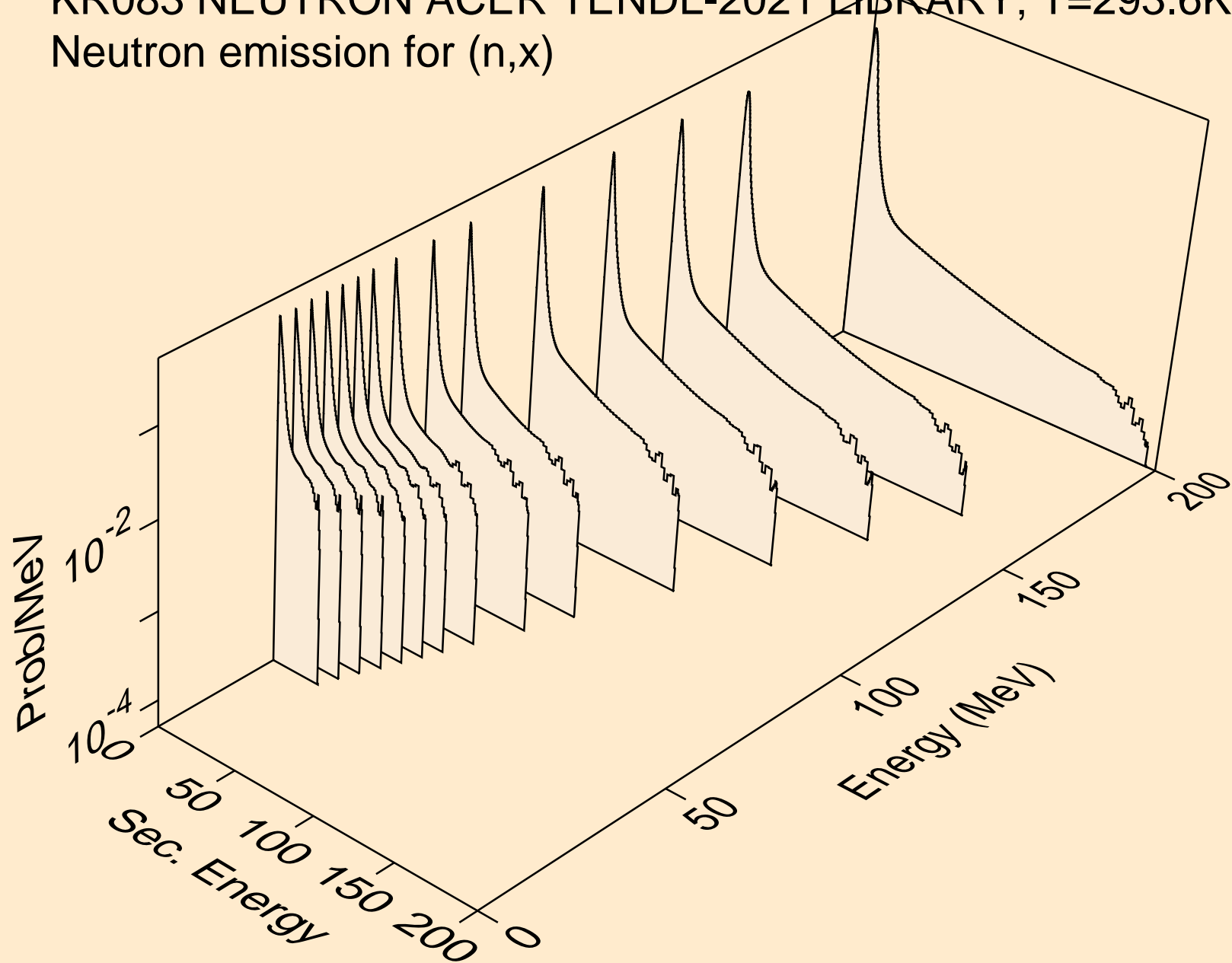

KR083 NEUTRON ACER TENDL-2021 LIBRARY; T=293.6K
Neutron emission for (n,2nd)

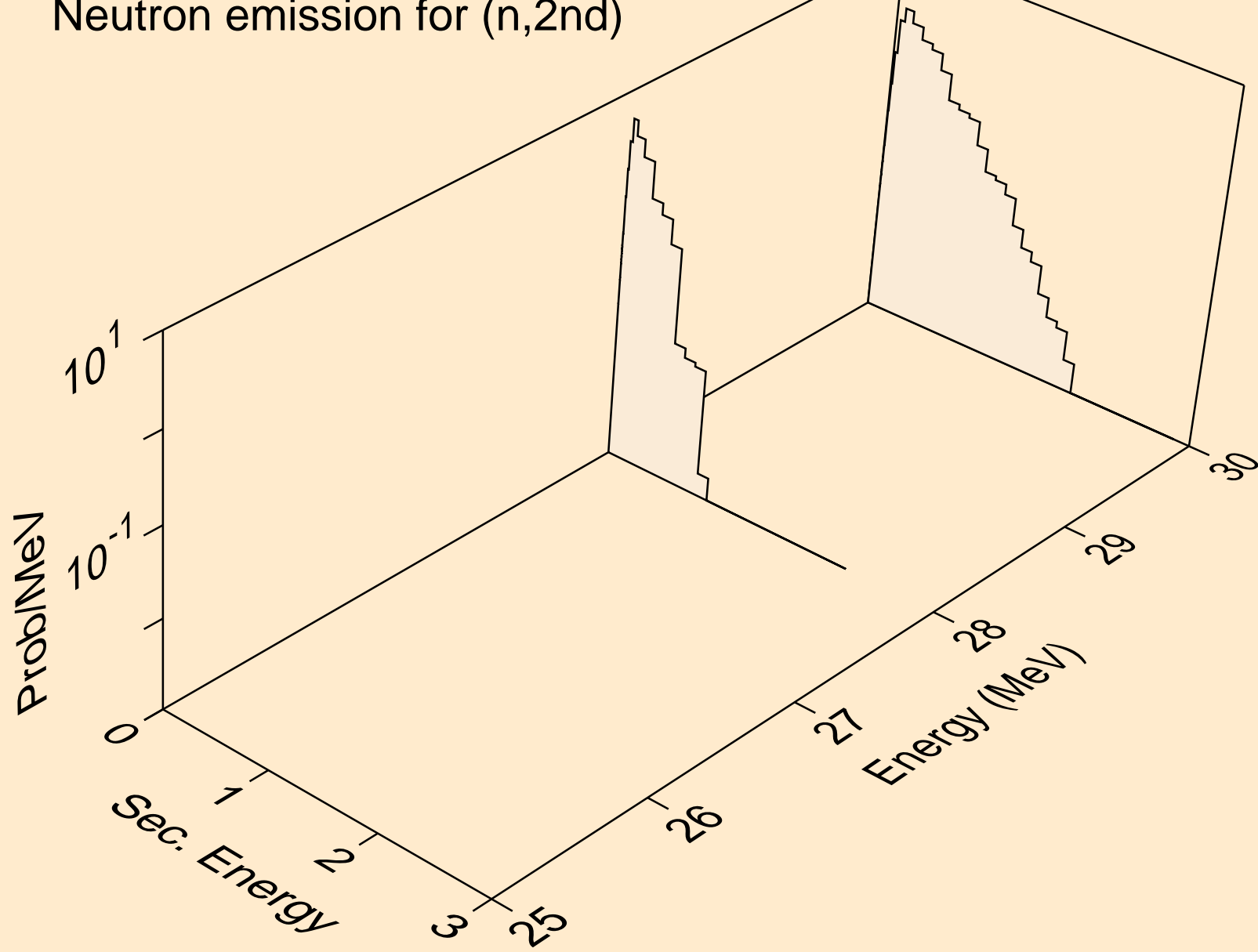

KR083 NEUTRON ACER TENDL-2021 LIBRARY; T=293.6K
Neutron emission for (n,2n)

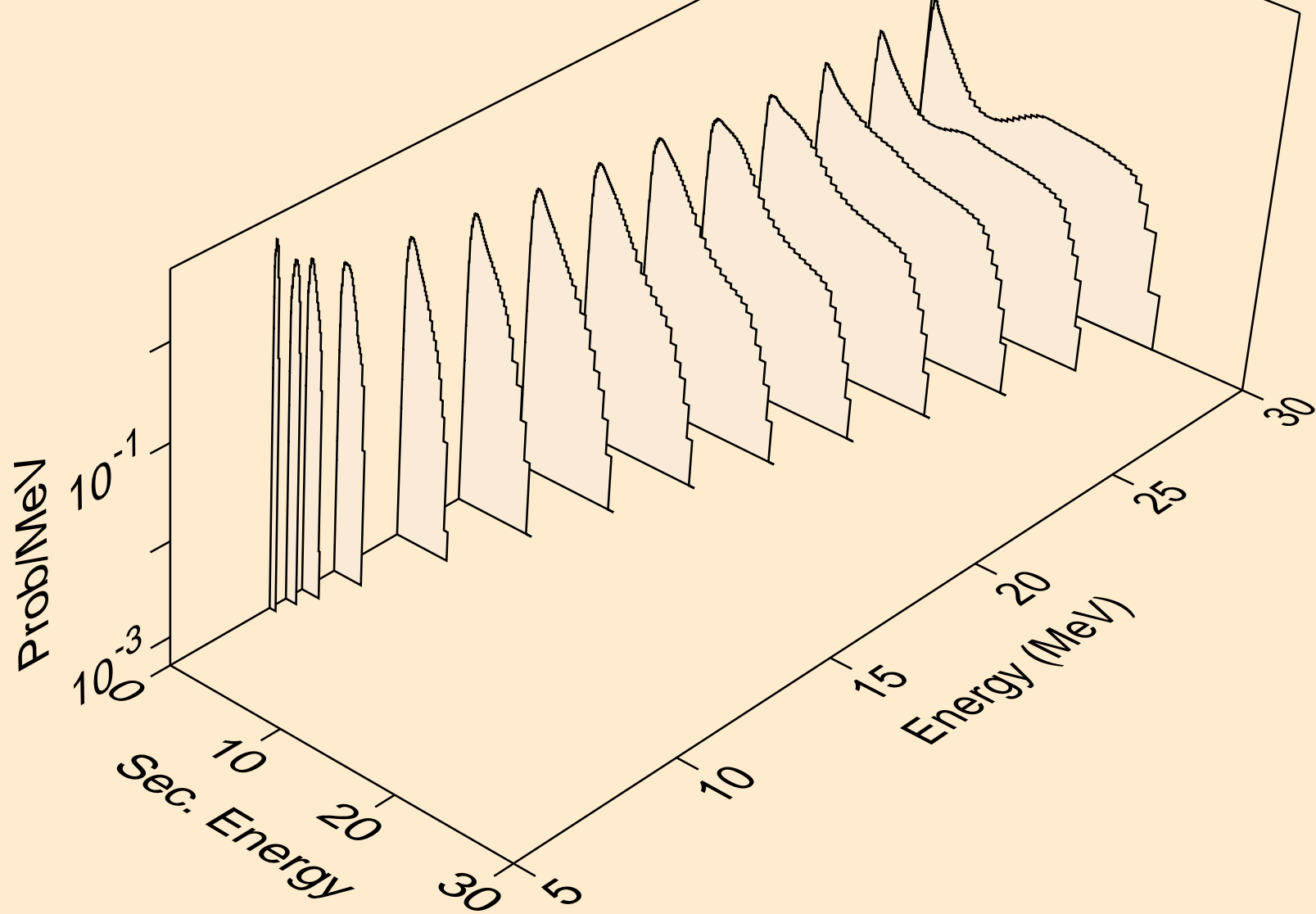

KR083 NEUTRON ACER TENDL-2021 LIBRARY; T=293.6K
Neutron emission for (n,3n)

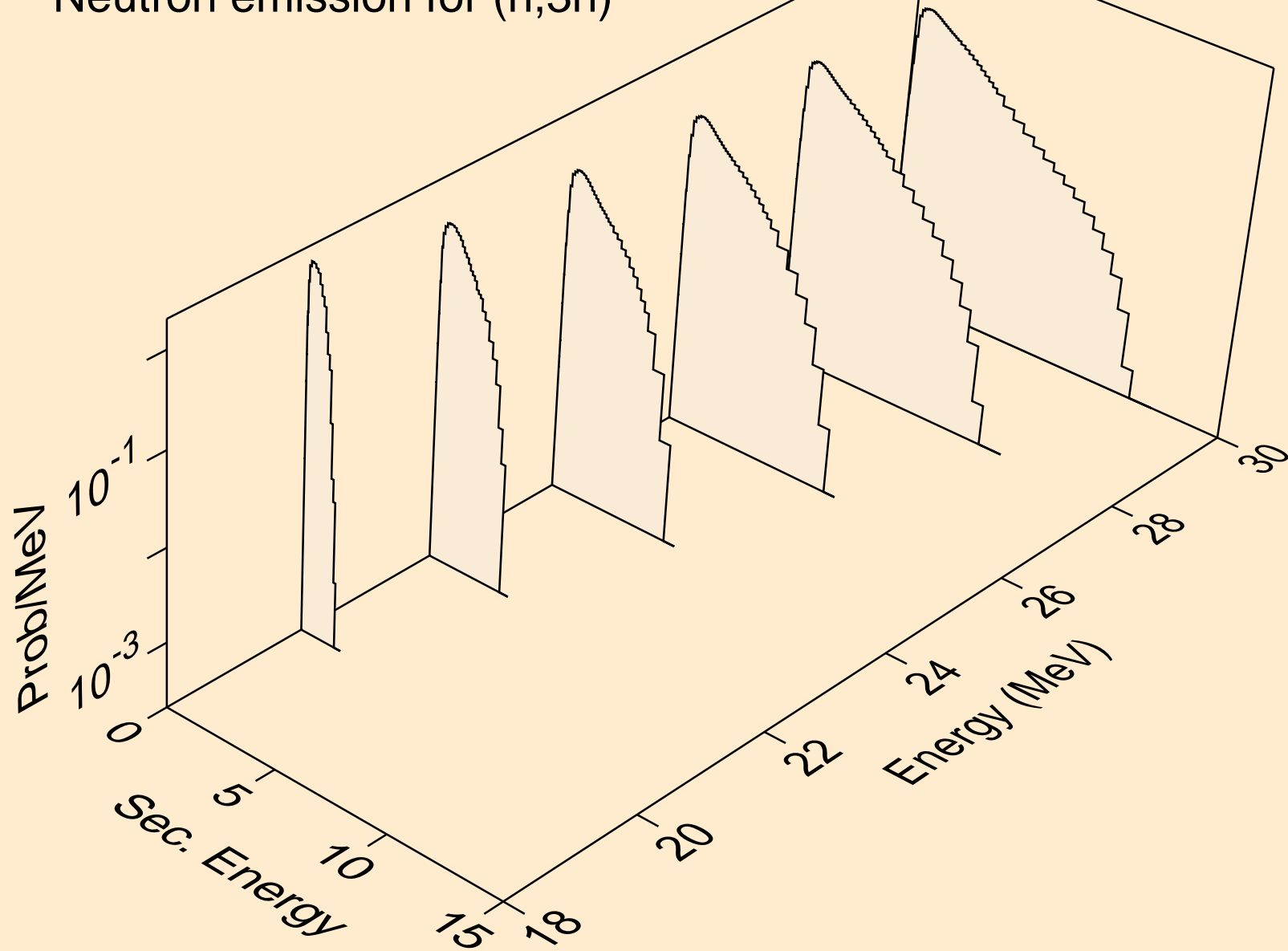

KR083 NEUTRON ACER TENDL-2021 LIBRARY; T=293.6K
Neutron emission for (n,n*)a

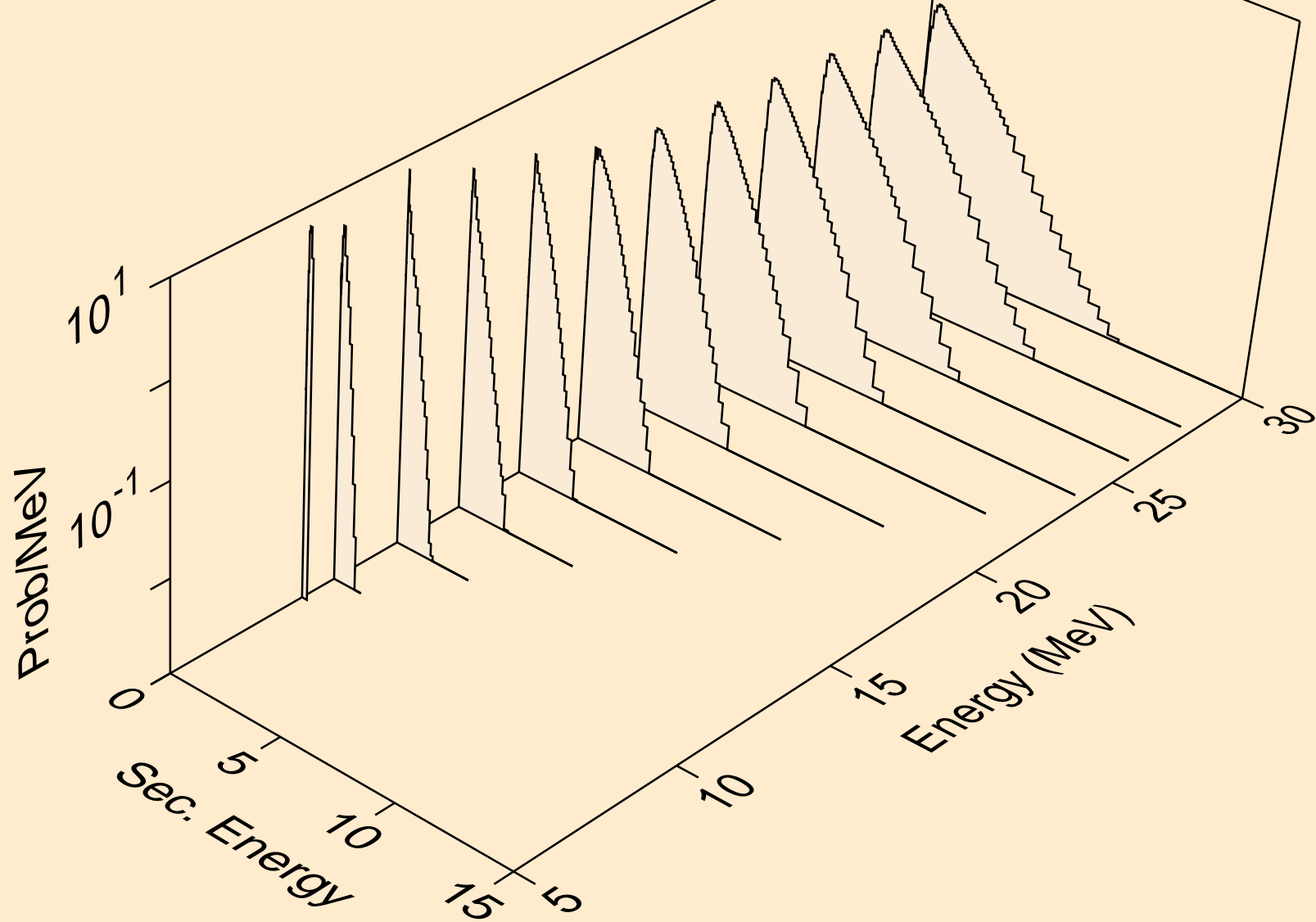

KR083 NEUTRON ACER TENDL-2021 LIBRARY; T=293.6K
Neutron emission for (n,2n)_a

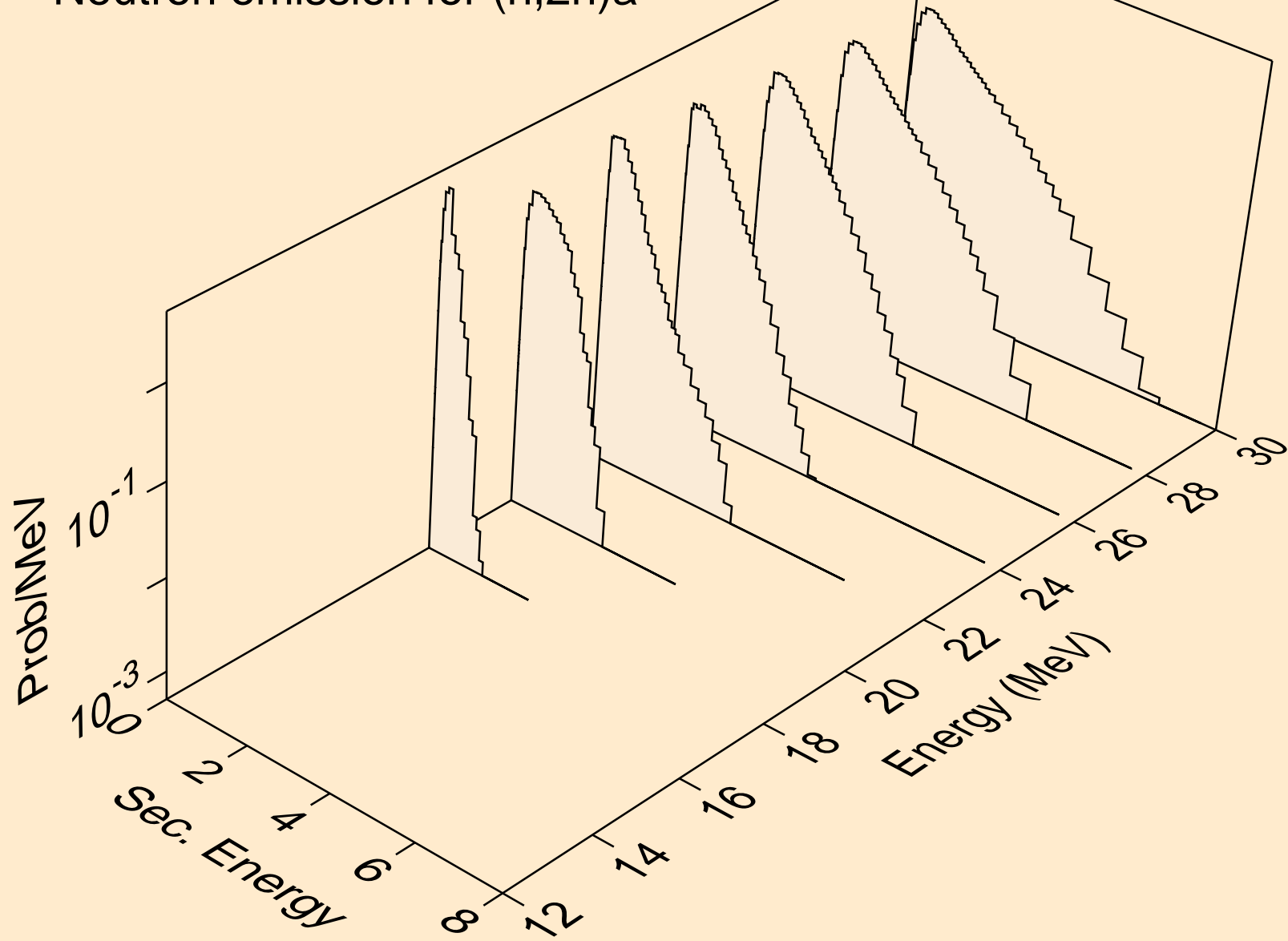

KR083 NEUTRON ACER TENDL-2021 LIBRARY; T=293.6K
Neutron emission for (n,n*)p

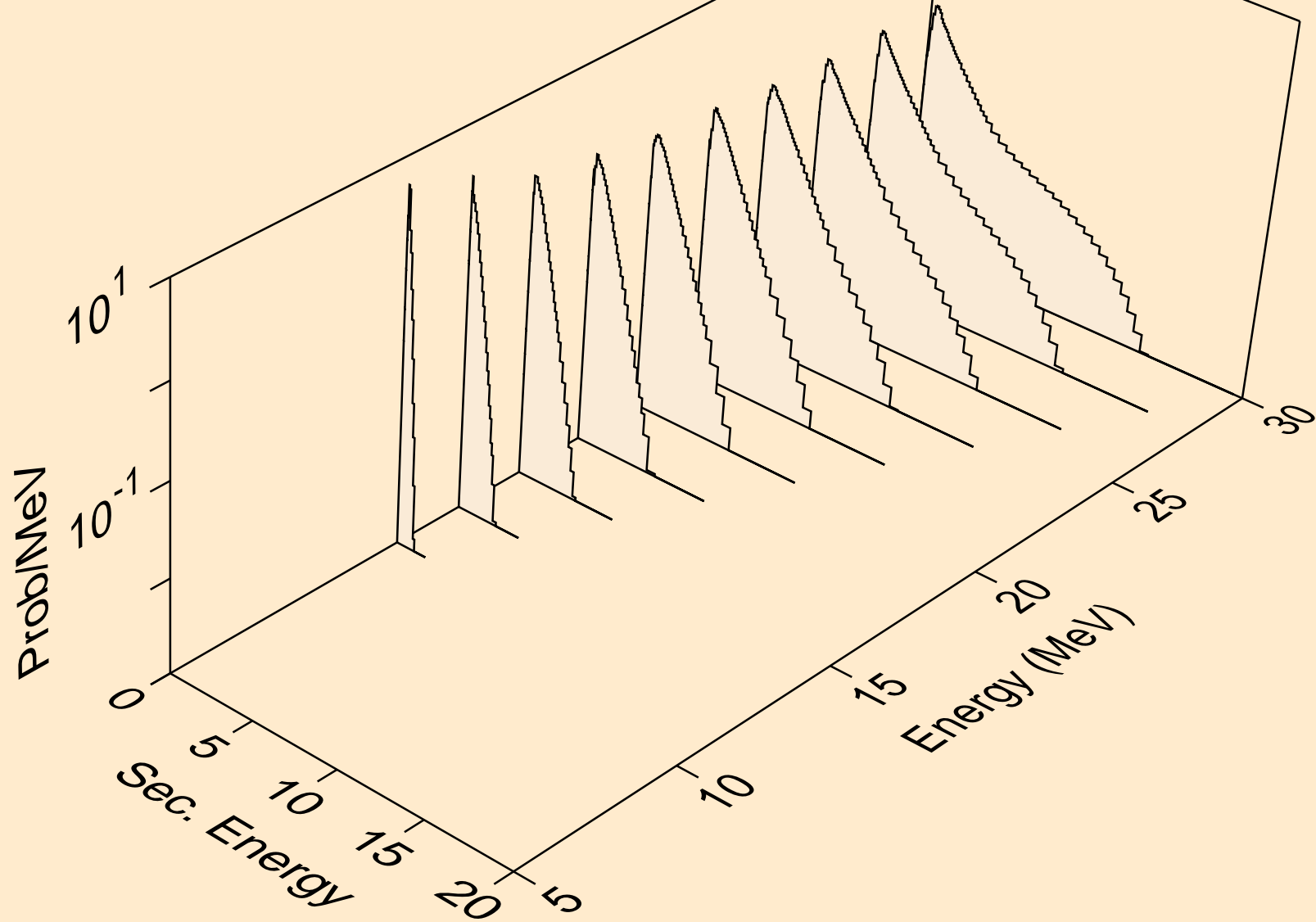

KR083 NEUTRON ACER TENDL-2021 LIBRARY; T=293.6K
Neutron emission for (n,n*)2a

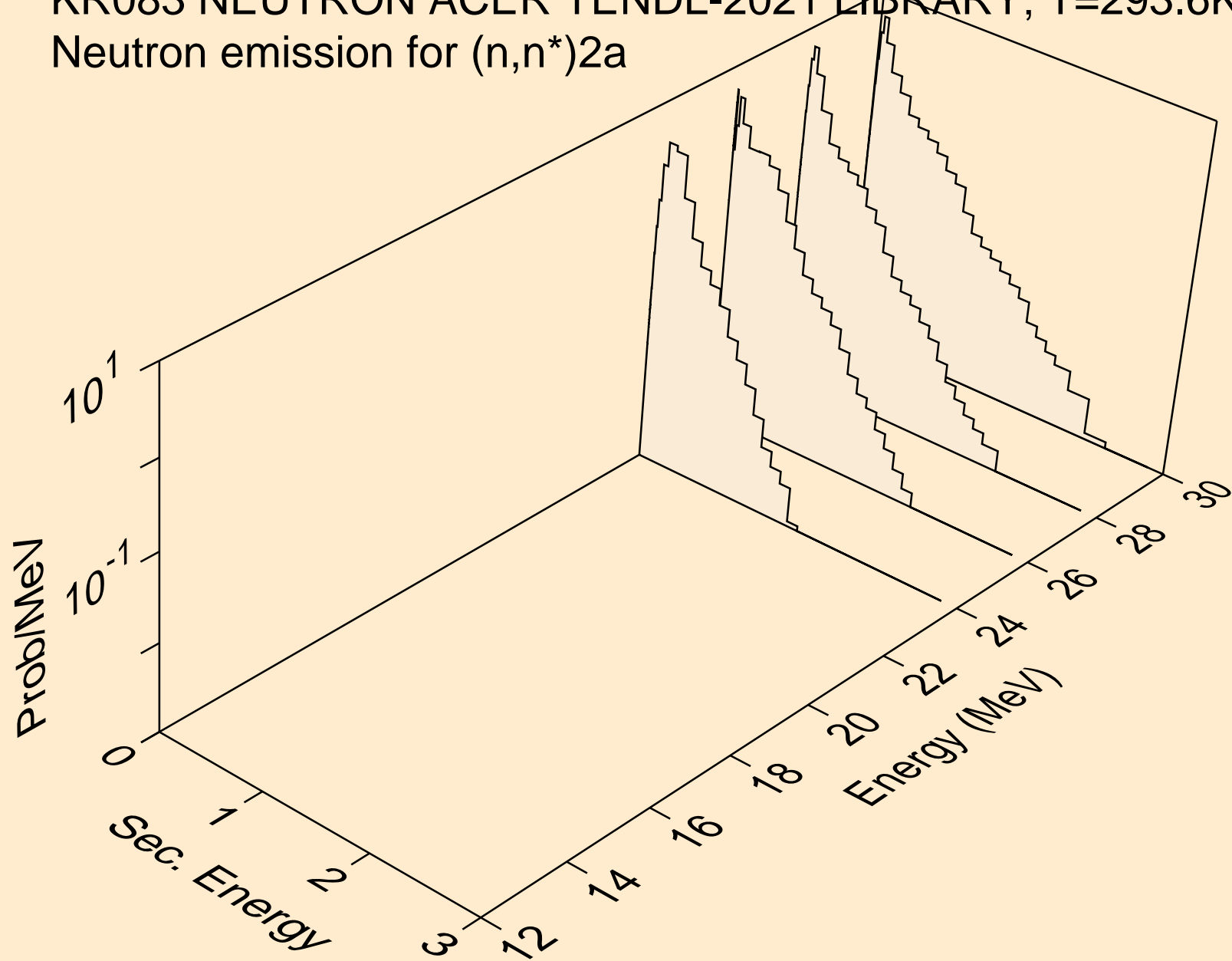

KR083 NEUTRON ACER TENDL-2021 LIBRARY; T=293.6K
Neutron emission for (n,n*)d

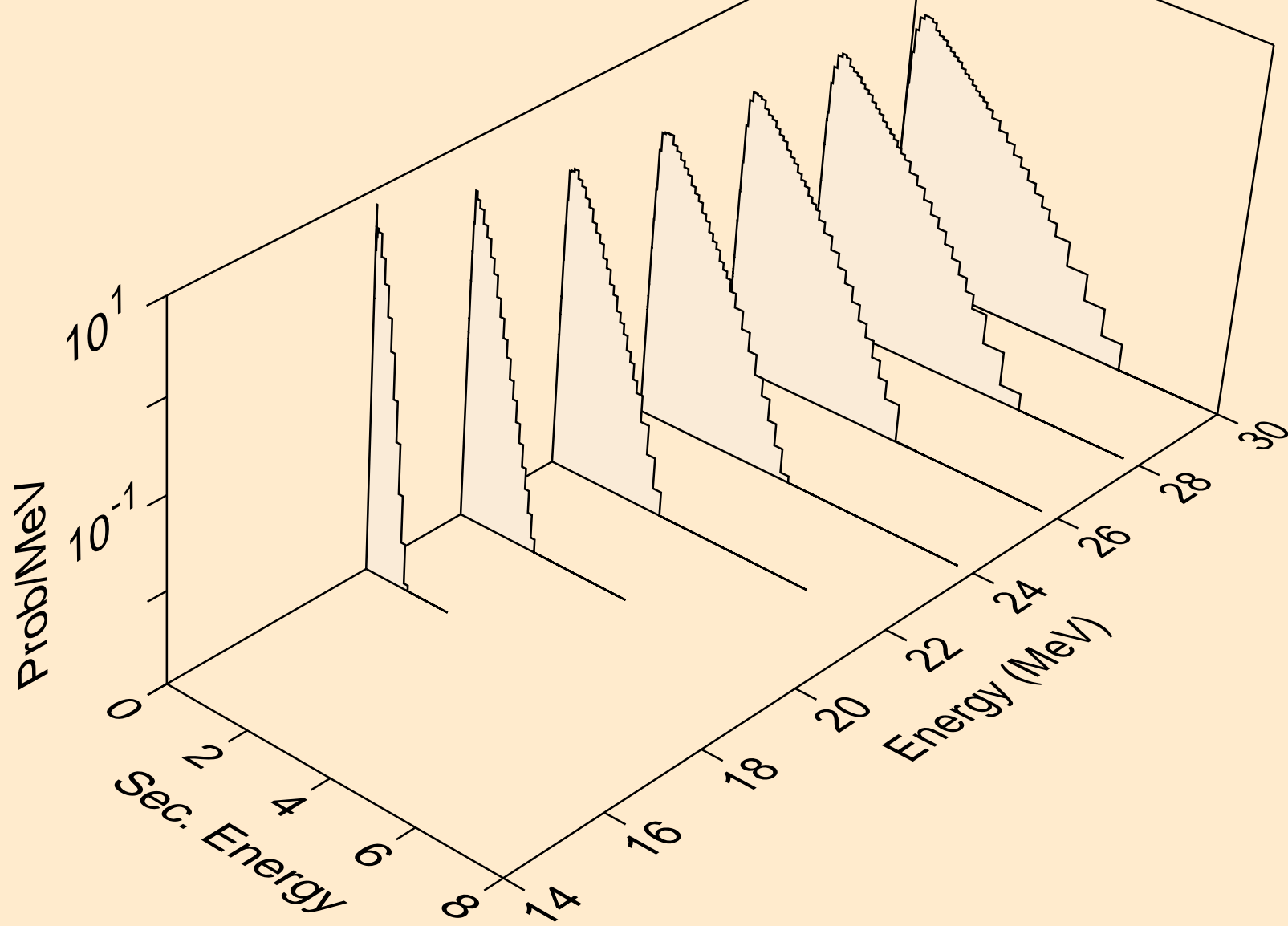

KR083 NEUTRON ACER TENDL-2021 LIBRARY; T=293.6K
Neutron emission for (n,n*)t

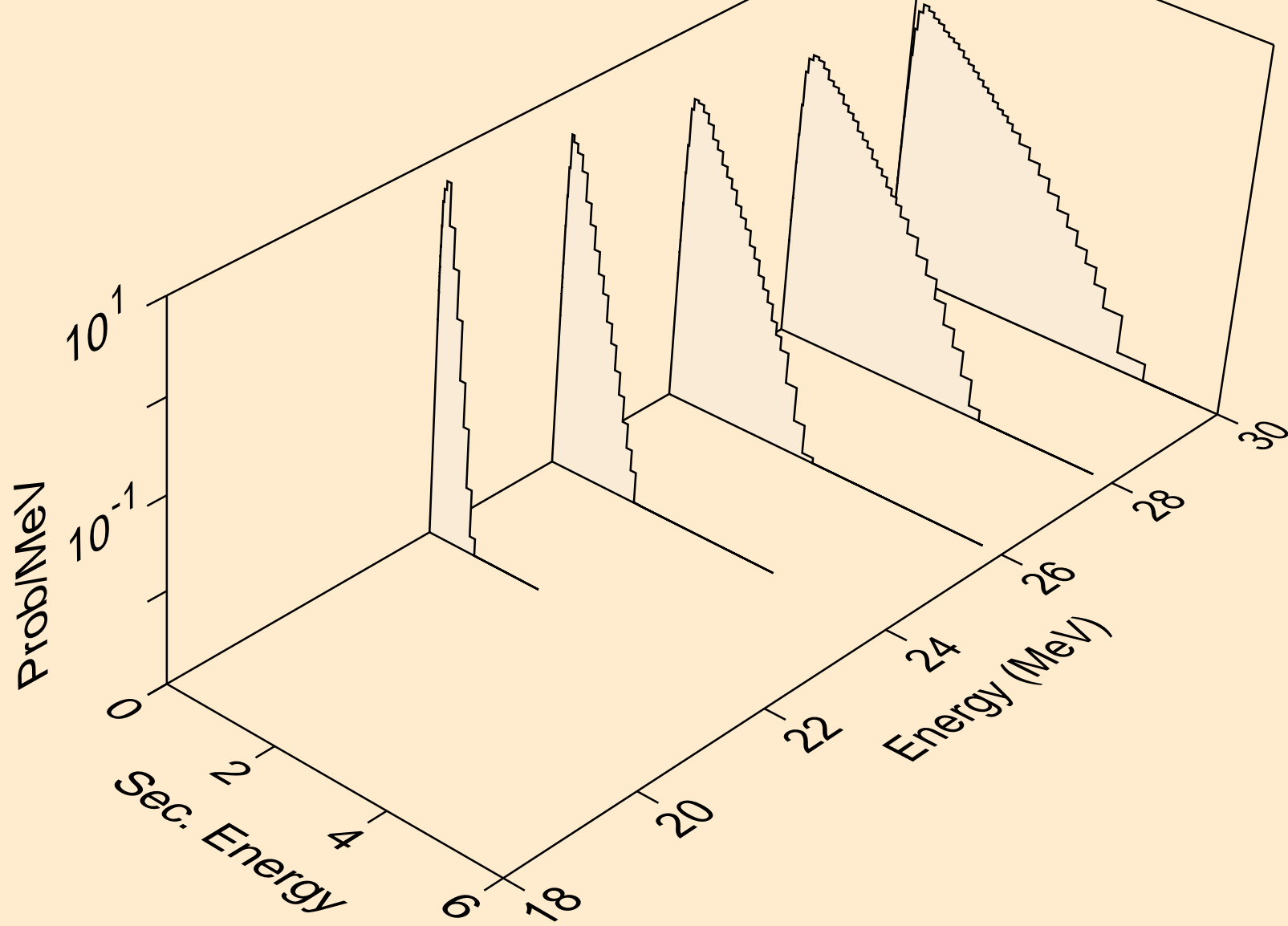

KR083 NEUTRON ACER TENDL-2021 LIBRARY; T=293.6K
Neutron emission for (n,n*)he3

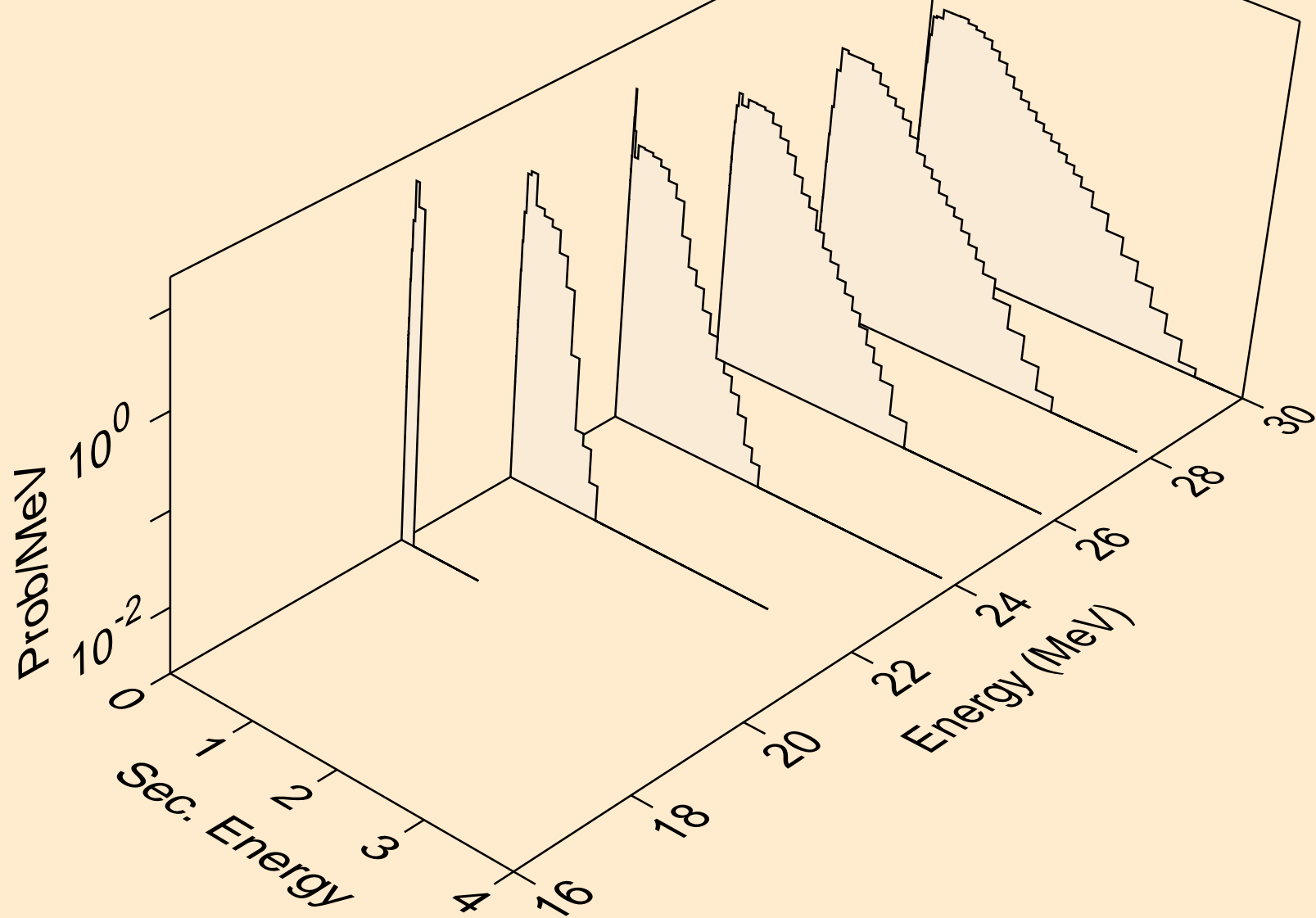

KR083 NEUTRON ACER TENDL-2021 LIBRARY; T=293.6K
Neutron emission for (n,4n)

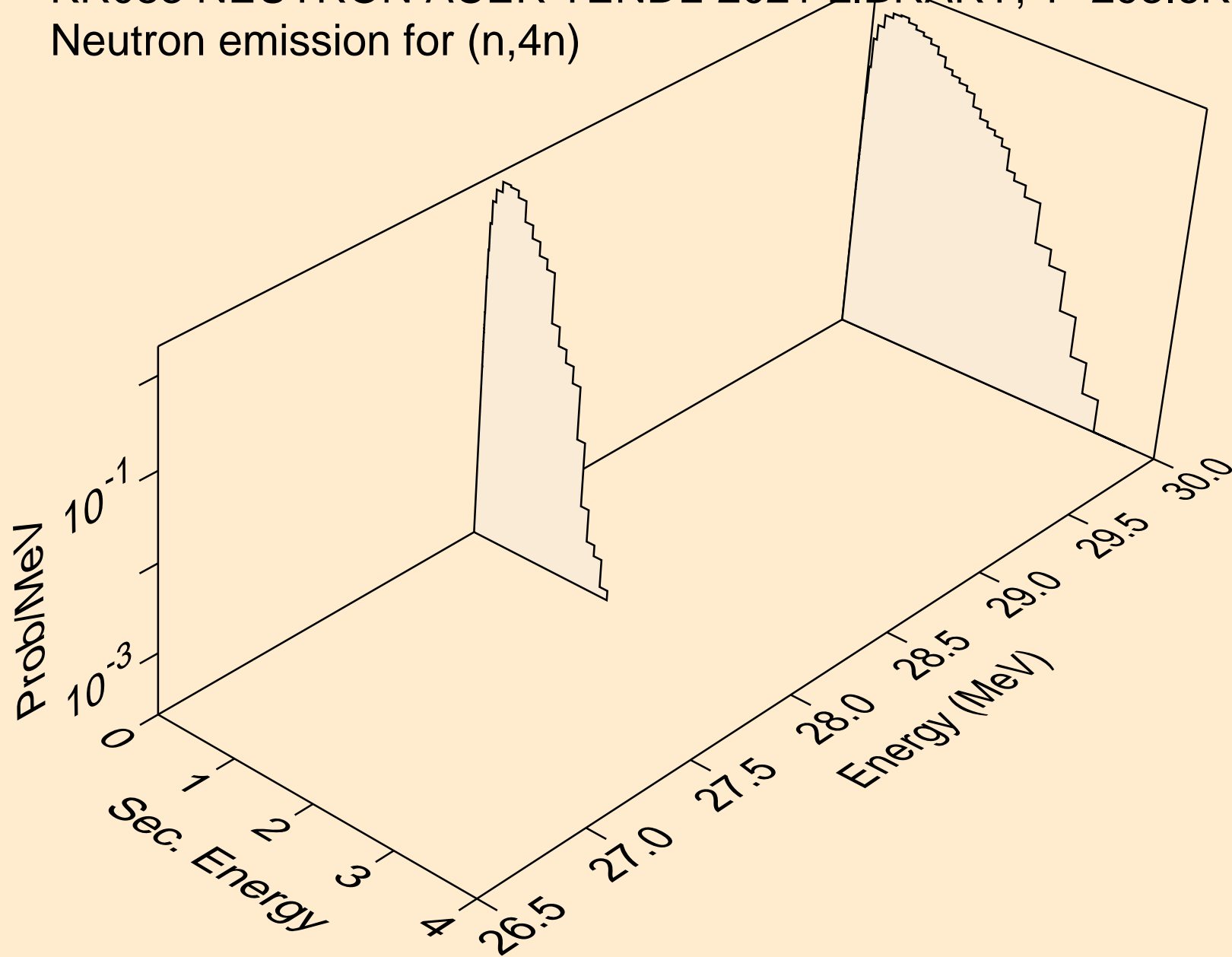

KR083 NEUTRON ACER TENDL-2021 LIBRARY; T=293.6K
Neutron emission for (n,2np)

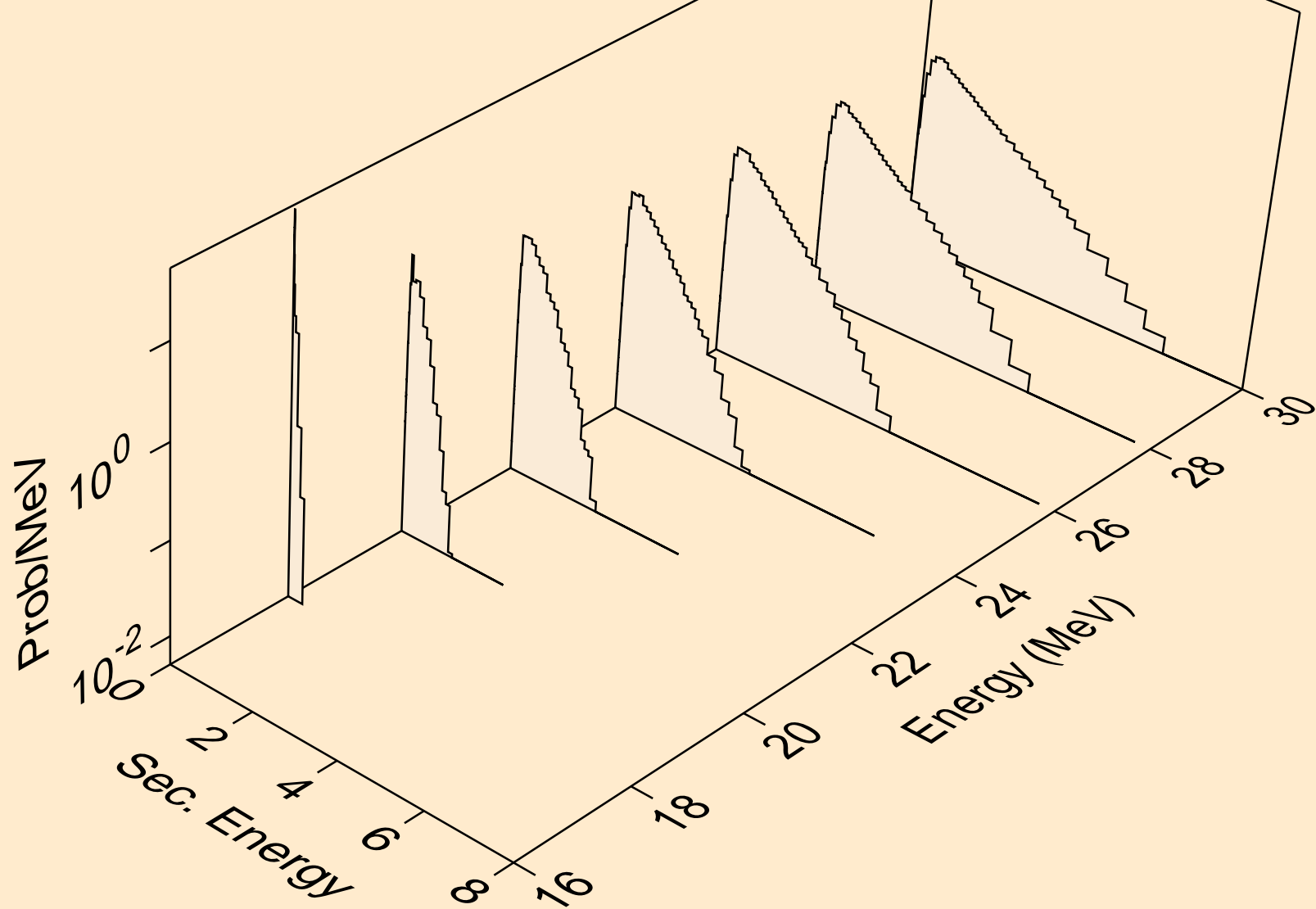

KR083 NEUTRON ACER TENDL-2021 LIBRARY; T=293.6K
Neutron emission for (n,3np)

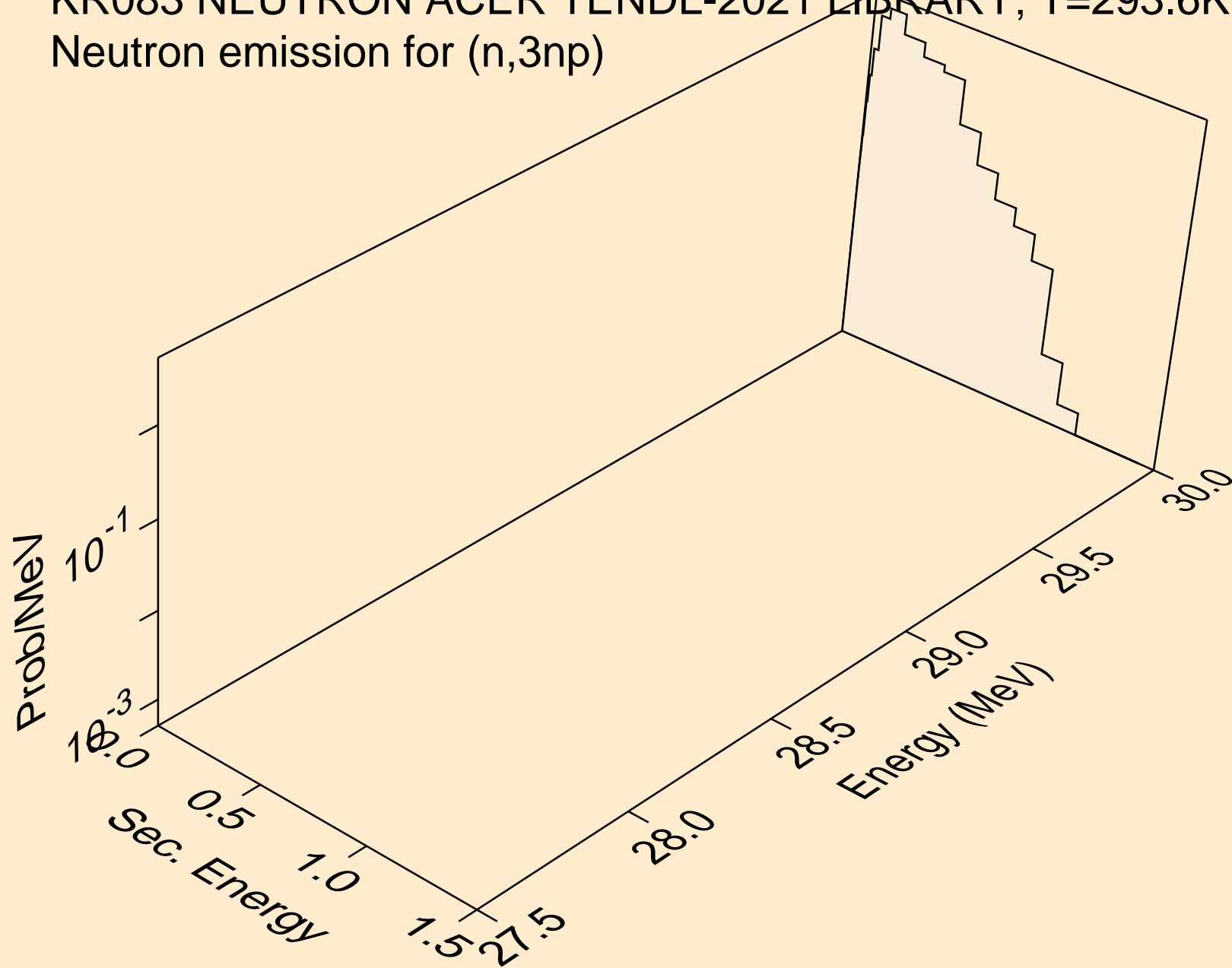

KR083 NEUTRON ACER TENDL-2021 LIBRARY; T=293.6K
Neutron emission for (n,2np)

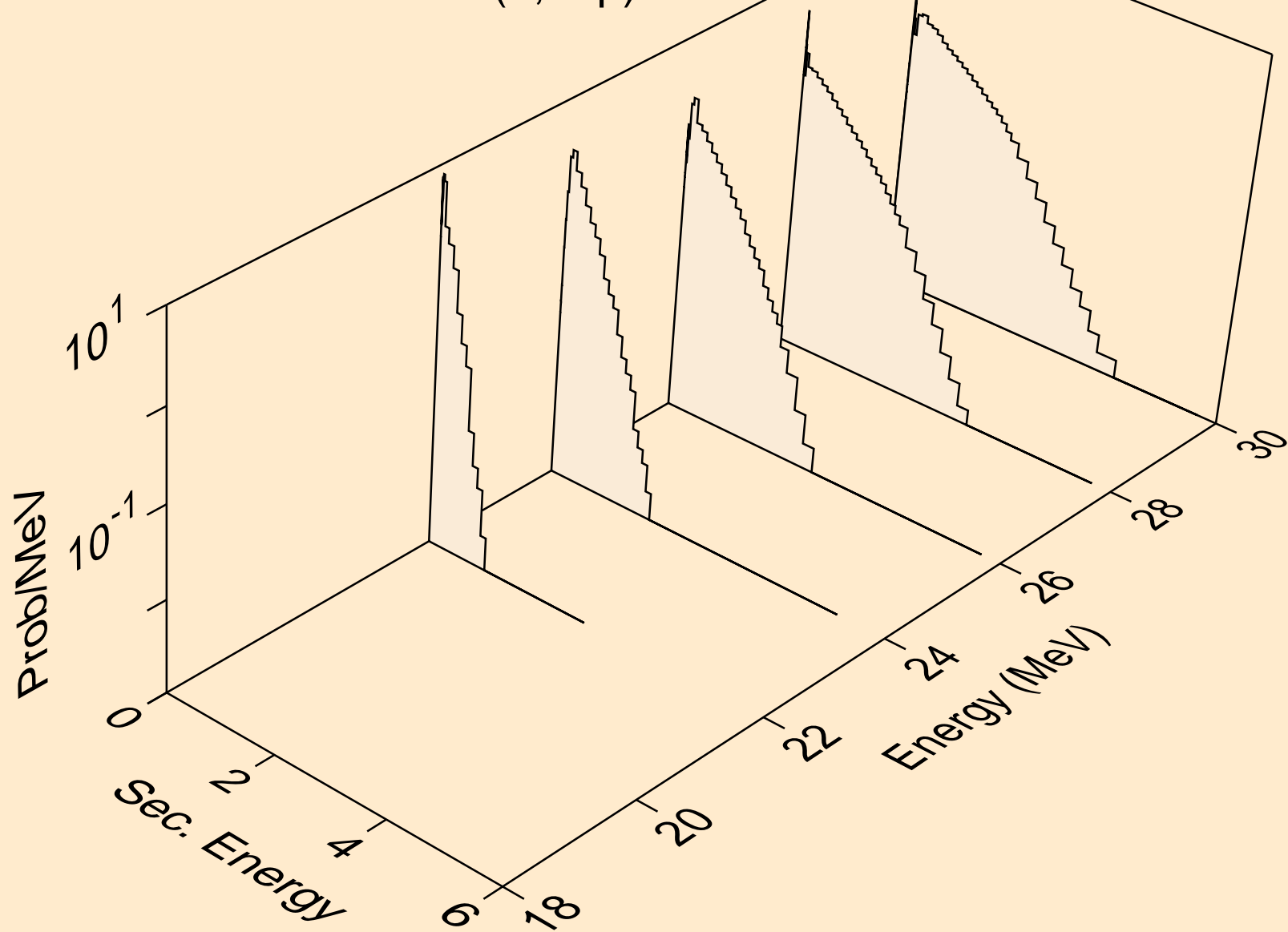

KR083 NEUTRON ACER TENDL-2021 LIBRARY; T=293.6K
Neutron emission for (n,npa)

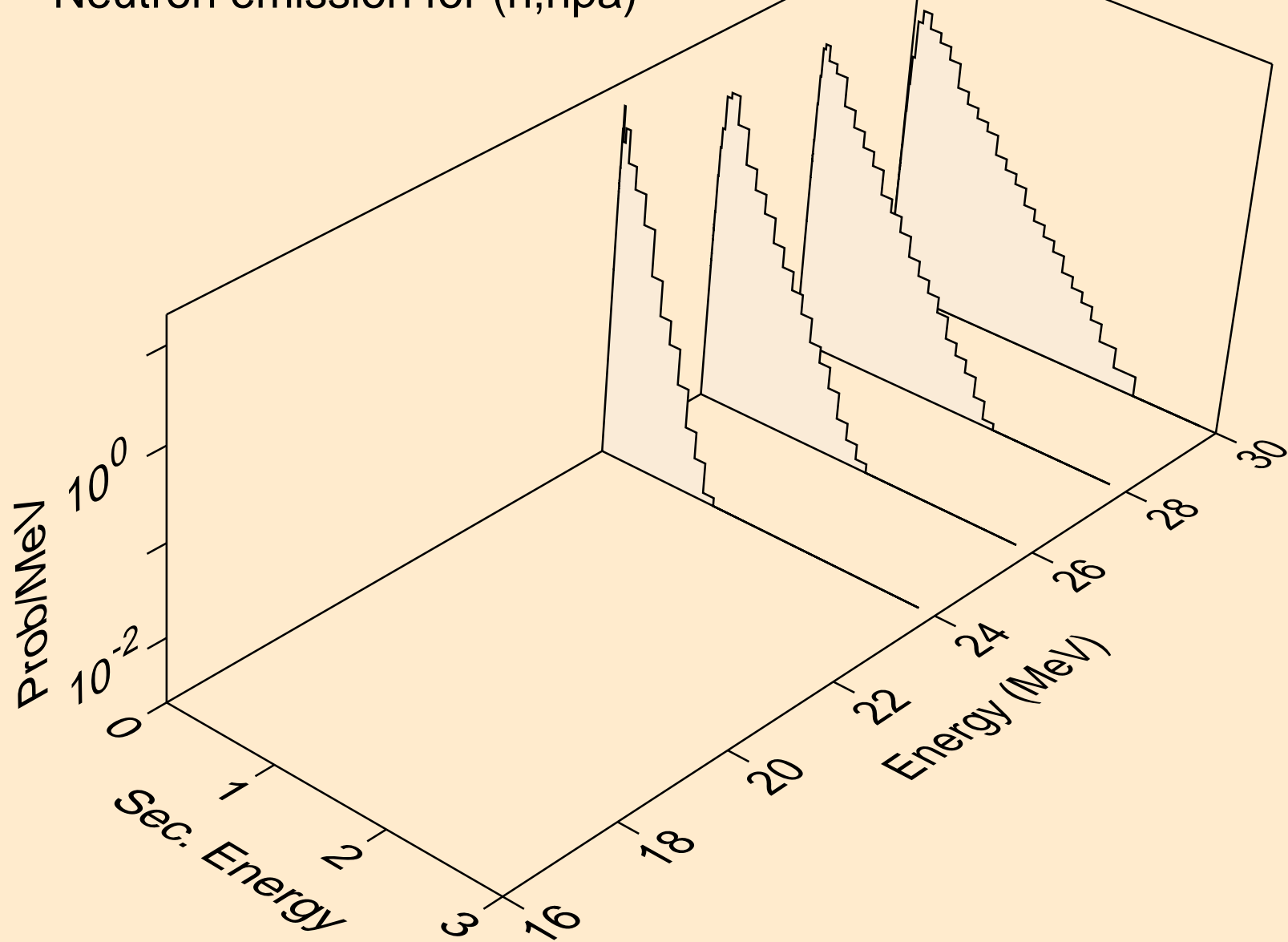

KR083 NEUTRON ACER TENDL-2021 LIBRARY; T=293.6K
Neutron emission for (n,n*c)

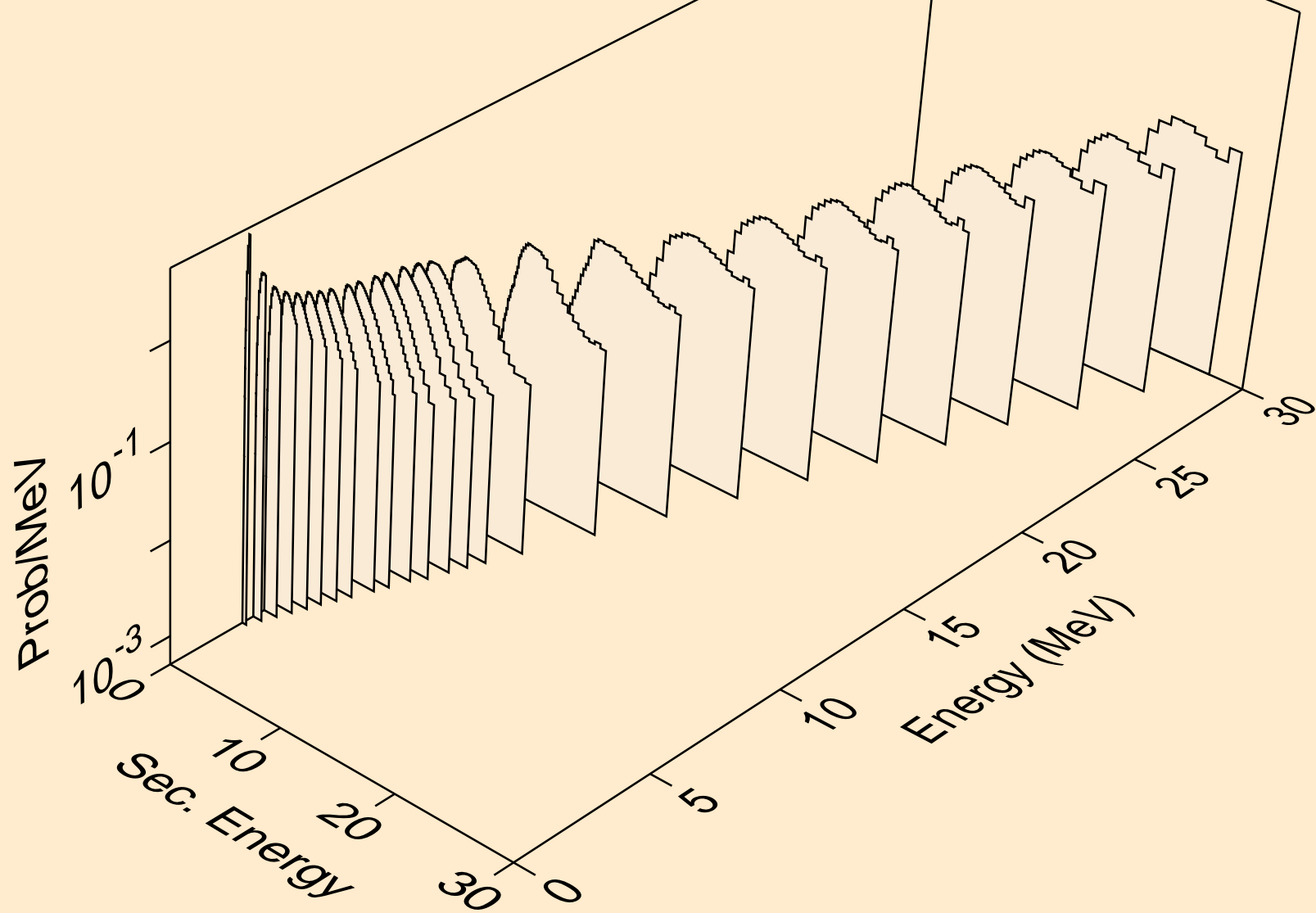

KR083 NEUTRON ACER TENDL-2021 LIBRARY; T=293.6K
Photon emission for (n,x)

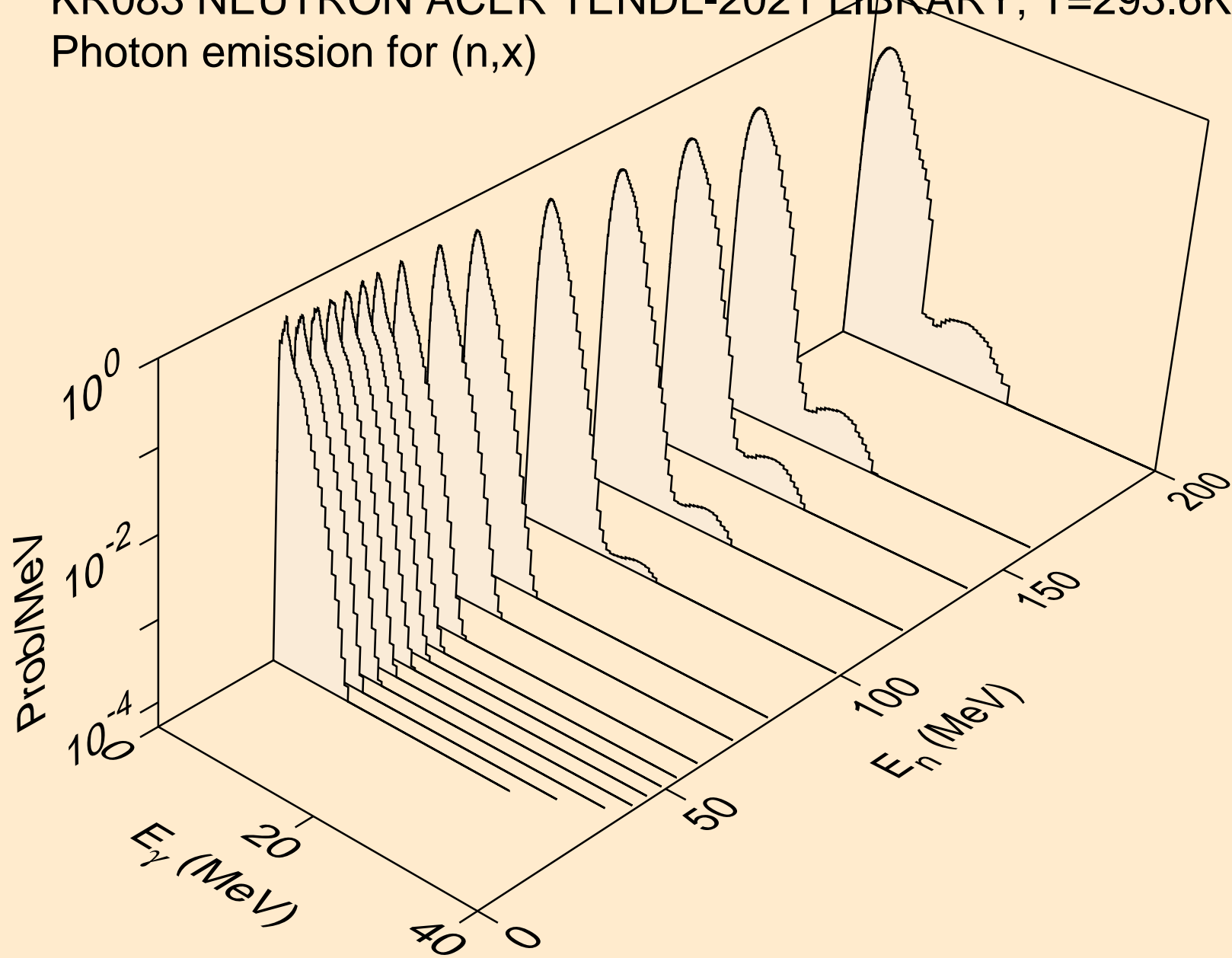

KR083 NEUTRON ACER TENDL-2021 LIBRARY; T=293.6K
Photon emission for (n,2nd)

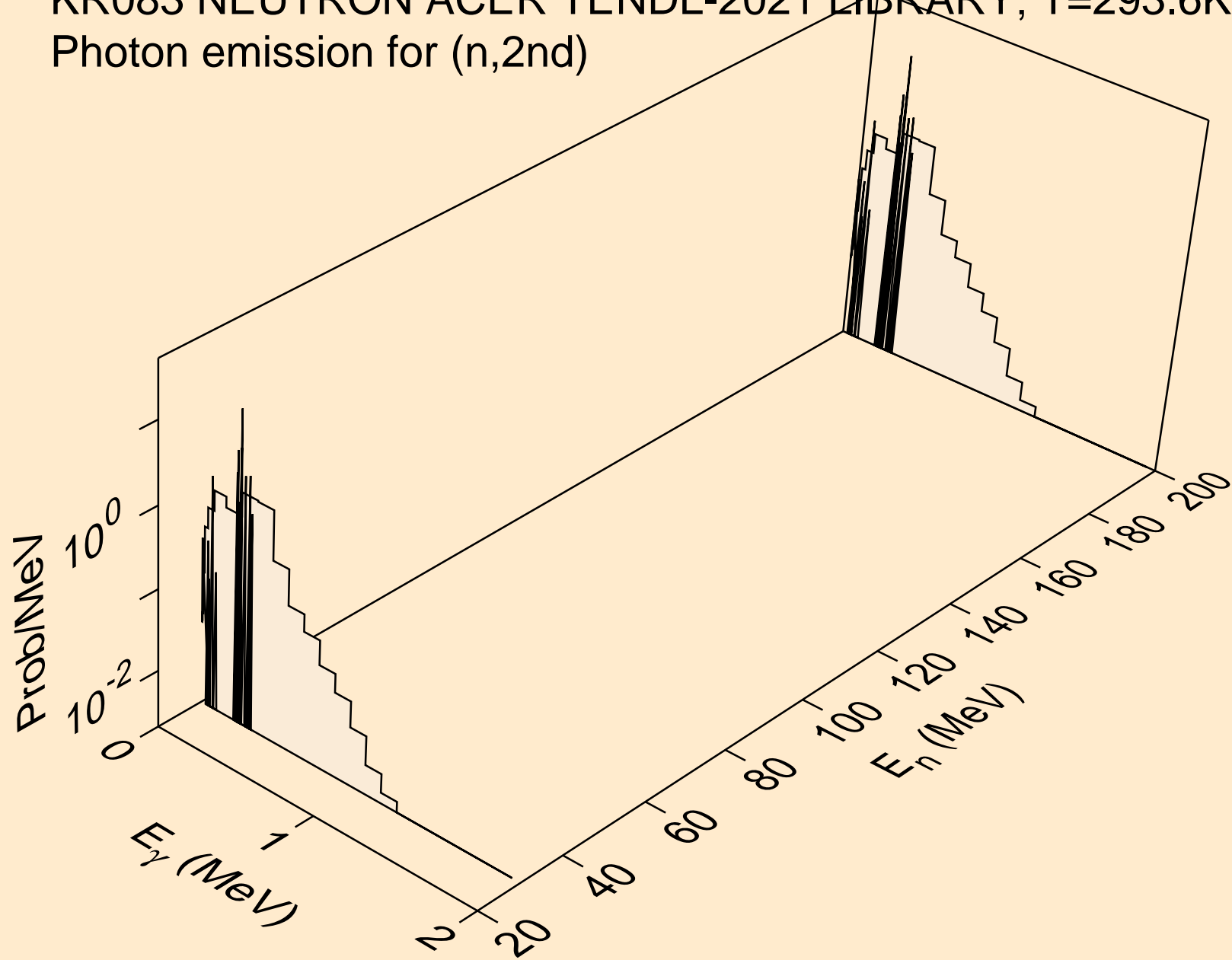

KR083 NEUTRON ACER TENDL-2021 LIBRARY; T=293.6K
Photon emission for (n,2n)

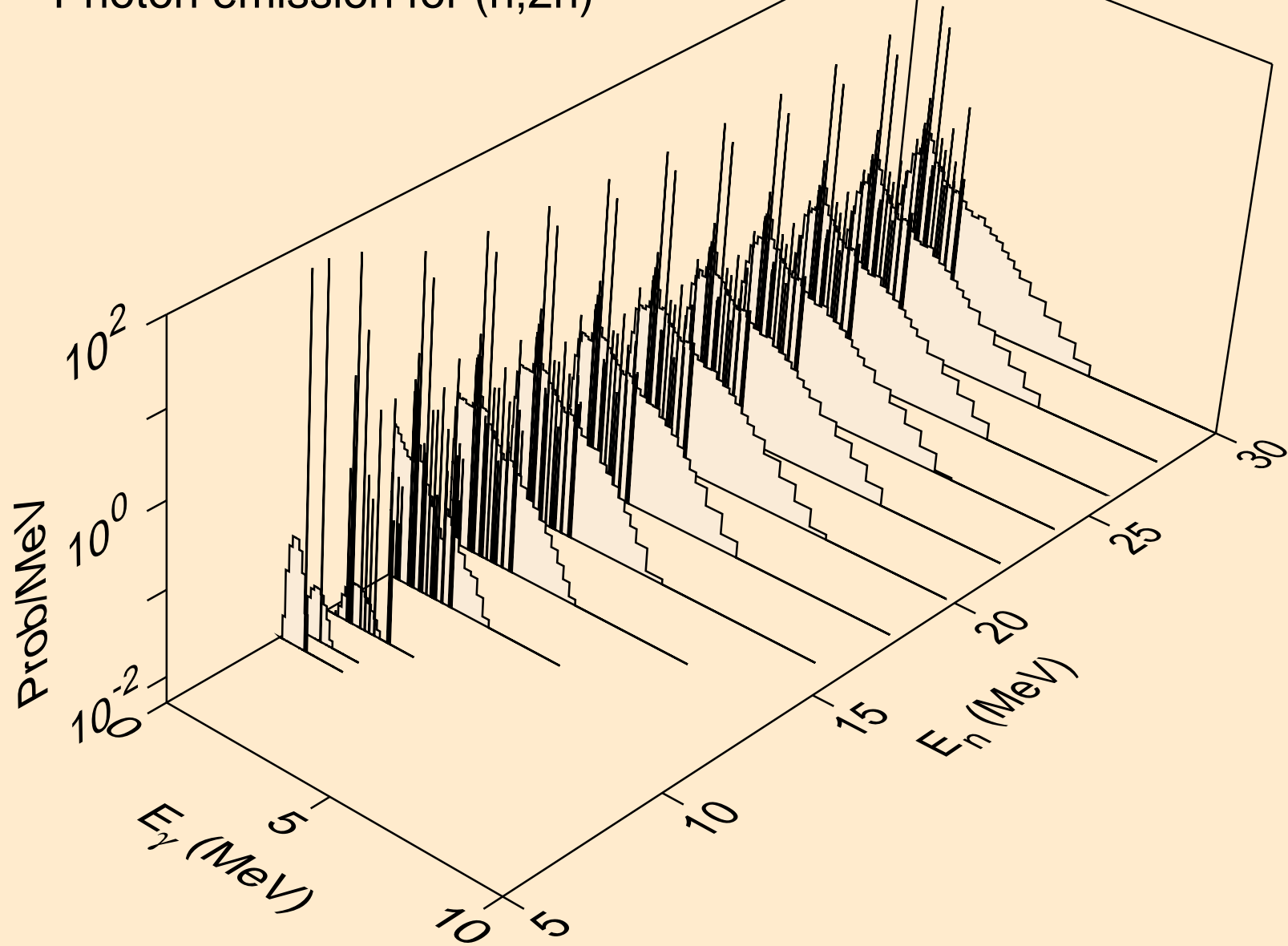

KR083 NEUTRON ACER TENDL-2021 LIBRARY; T=293.6K
Photon emission for (n,3n)

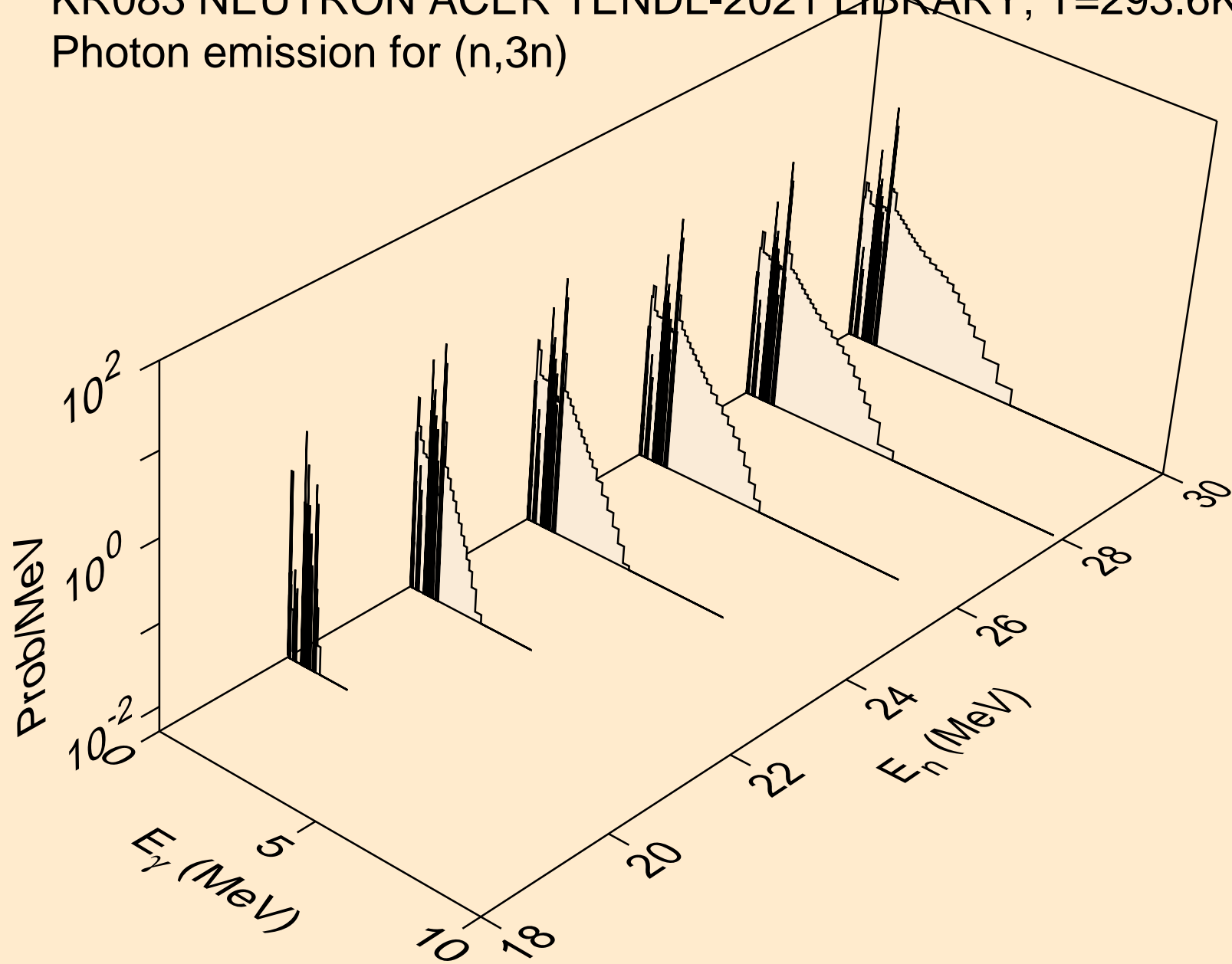

KR083 NEUTRON ACER TENDL-2021 LIBRARY; T=293.6K
Photon emission for (n,n*)a

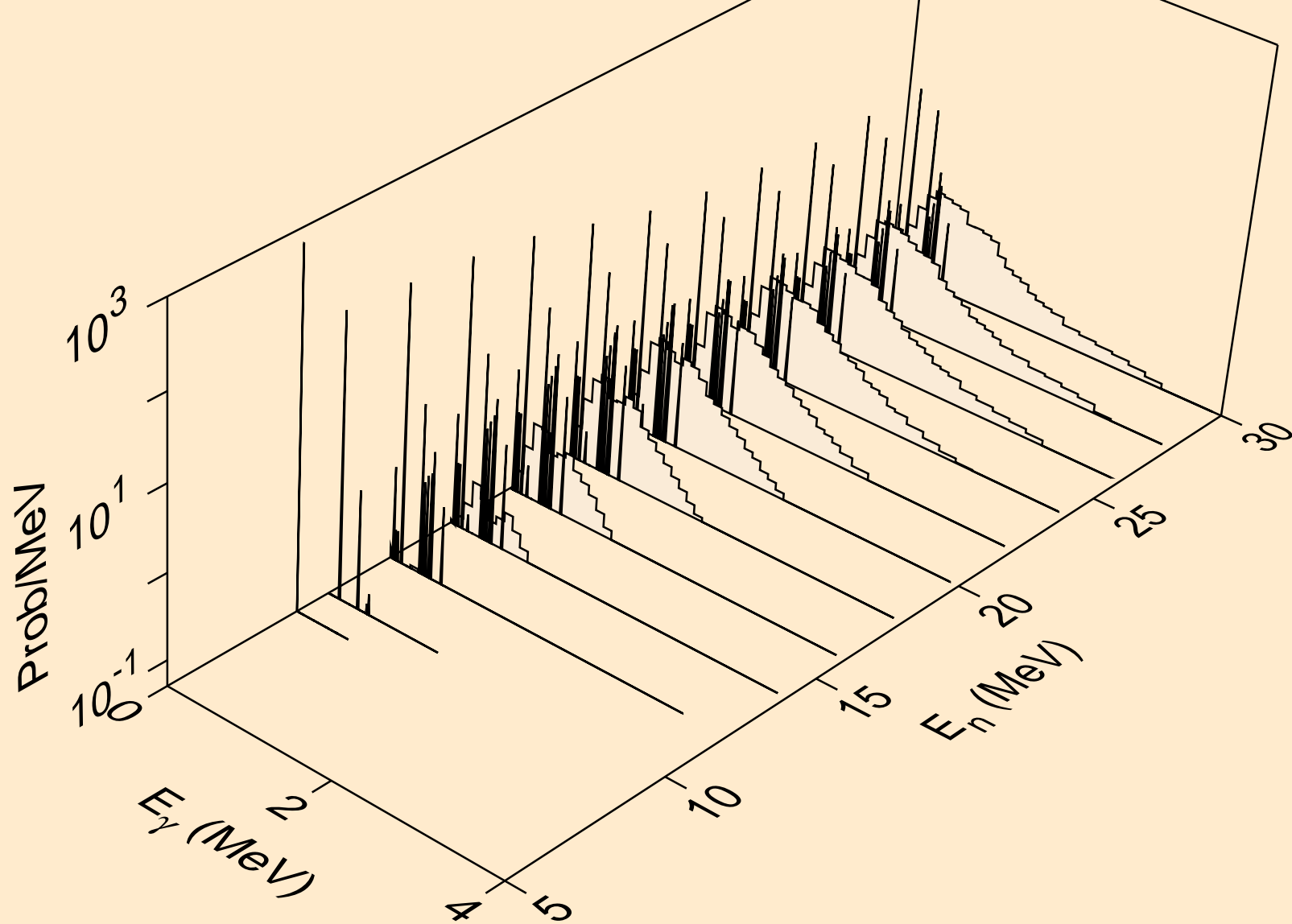

KR083 NEUTRON ACER TENDL-2021 LIBRARY; T=293.6K
Photon emission for (n,2n)a

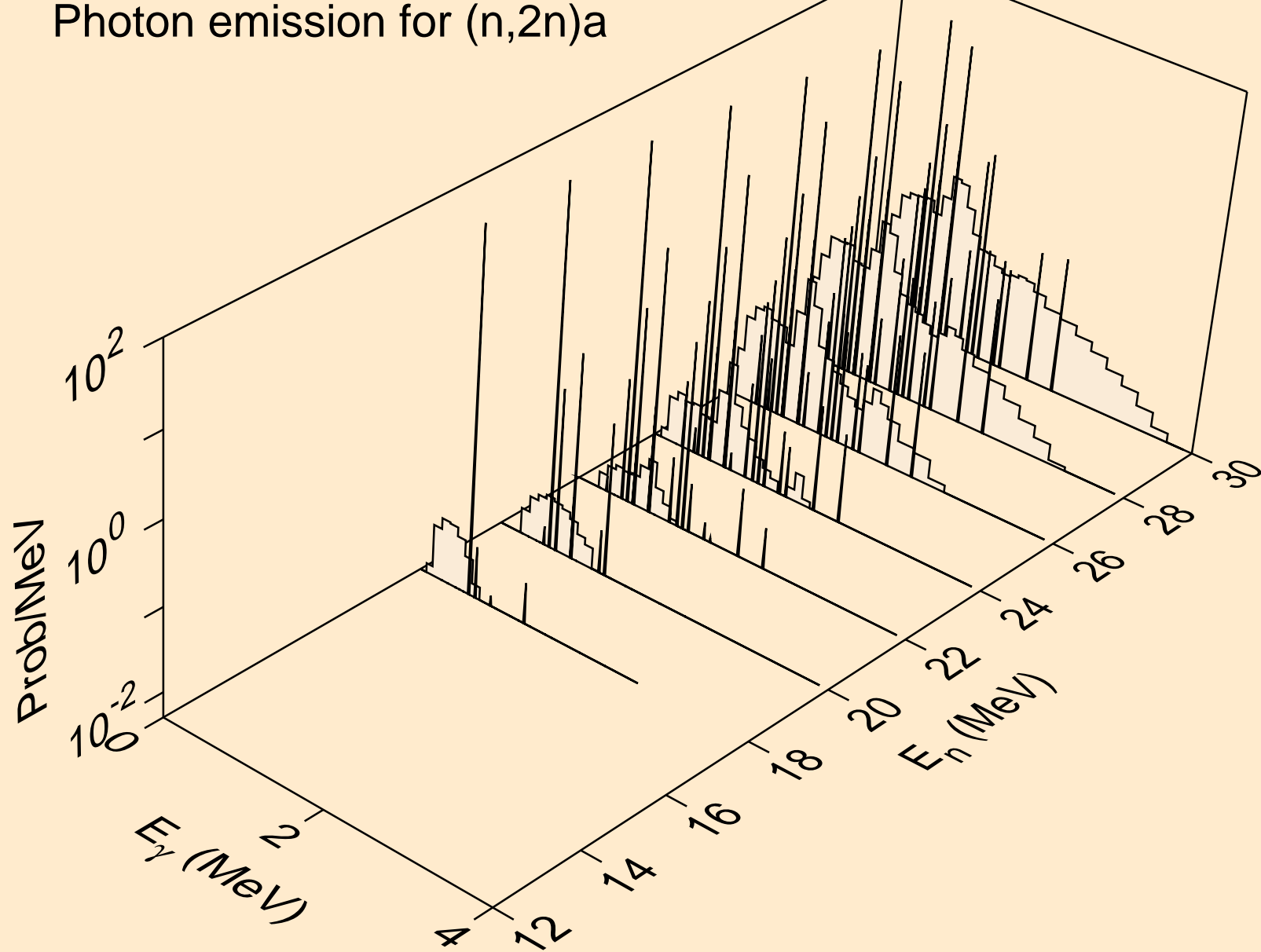

KR083 NEUTRON ACER TENDL-2021 LIBRARY; T=293.6K
Photon emission for (n,n*)p

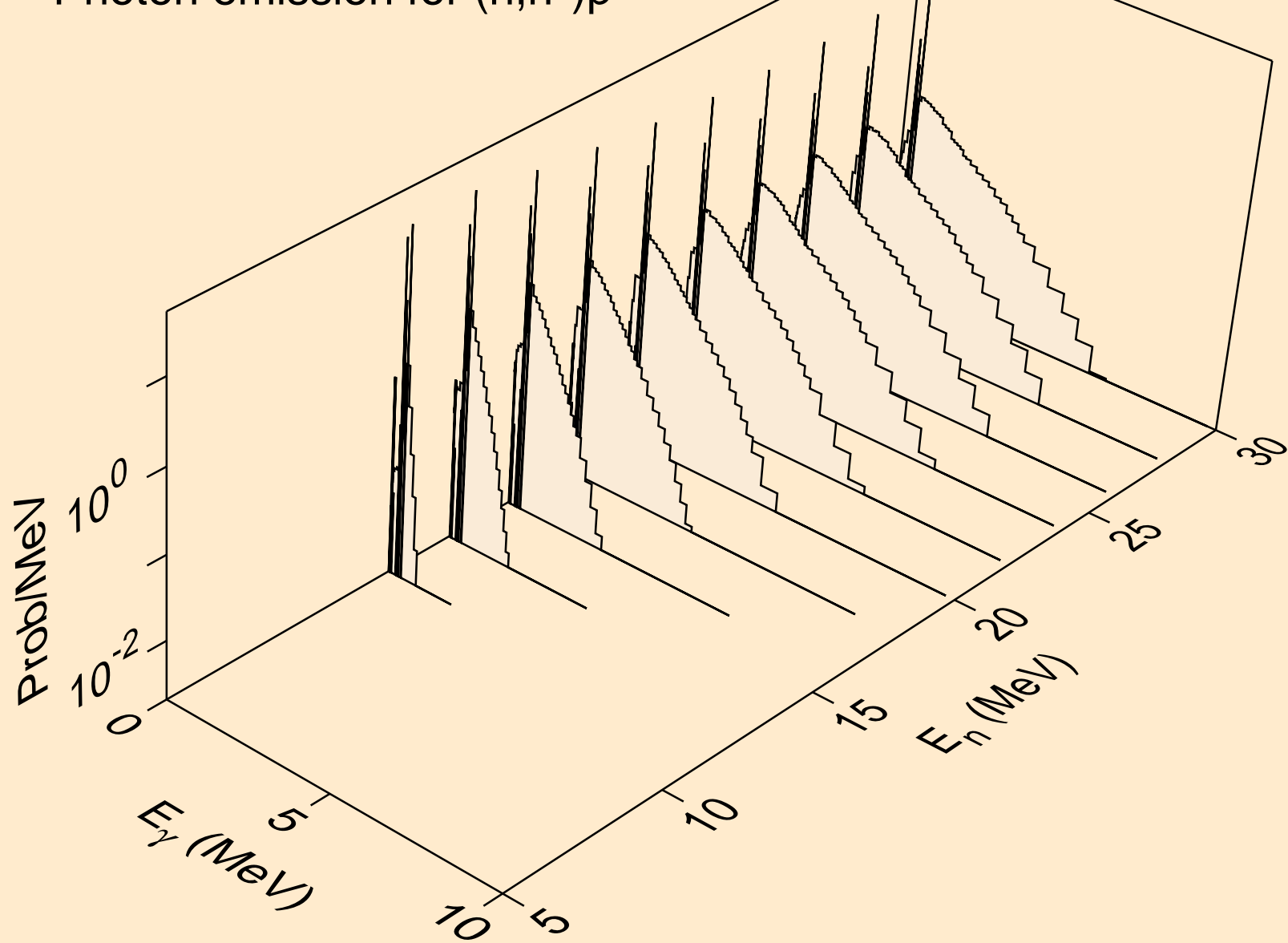

KR083 NEUTRON ACER TENDL-2021 LIBRARY; T=293.6K
Photon emission for (n,n*)2a

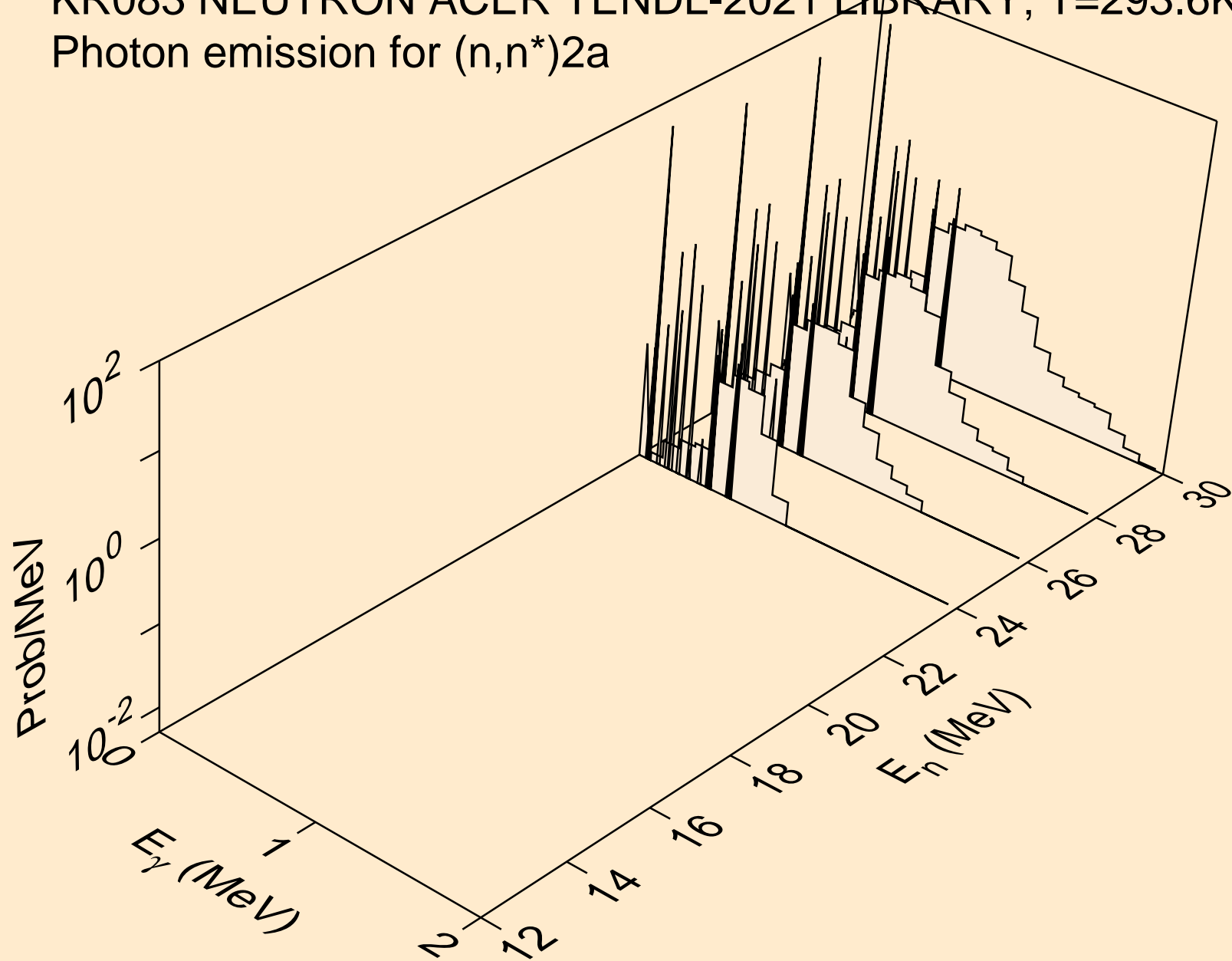

KR083 NEUTRON ACER TENDL-2021 LIBRARY; T=293.6K
Photon emission for (n,n*)d

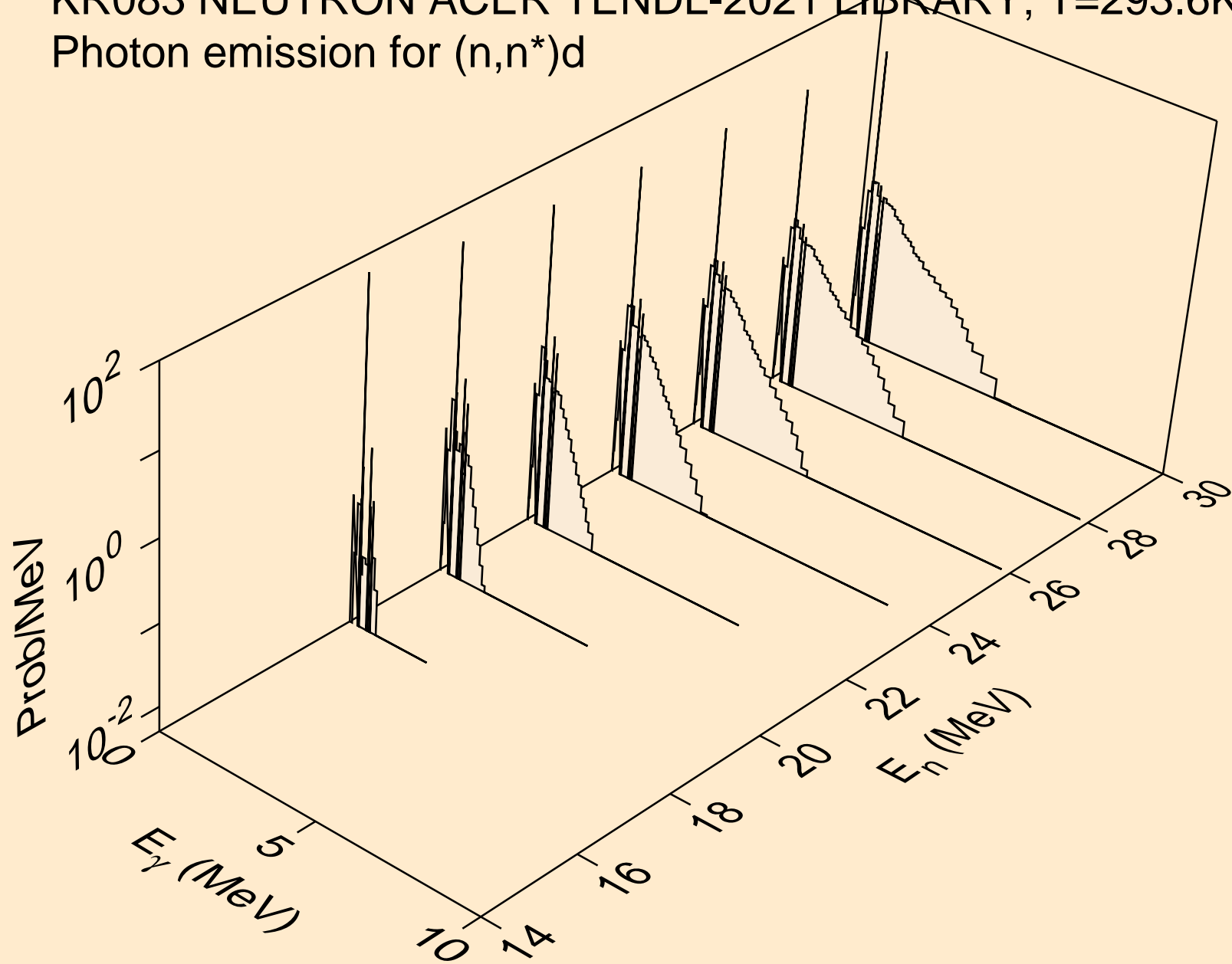

KR083 NEUTRON ACER TENDL-2021 LIBRARY; T=293.6K
Photon emission for (n,n*)t

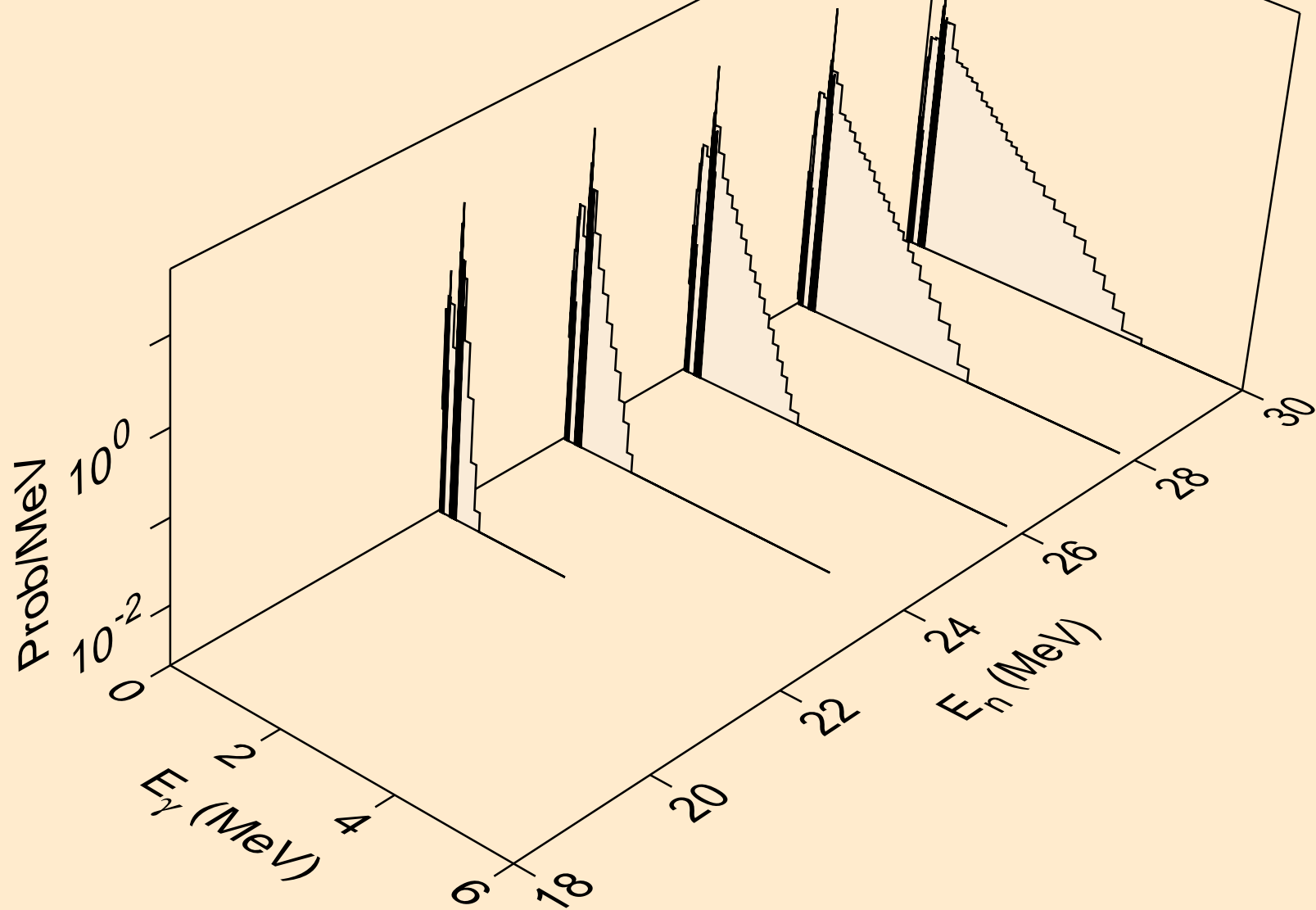

KR083 NEUTRON ACER TENDL-2021 LIBRARY; T=293.6K
Photon emission for (n,n*)he3

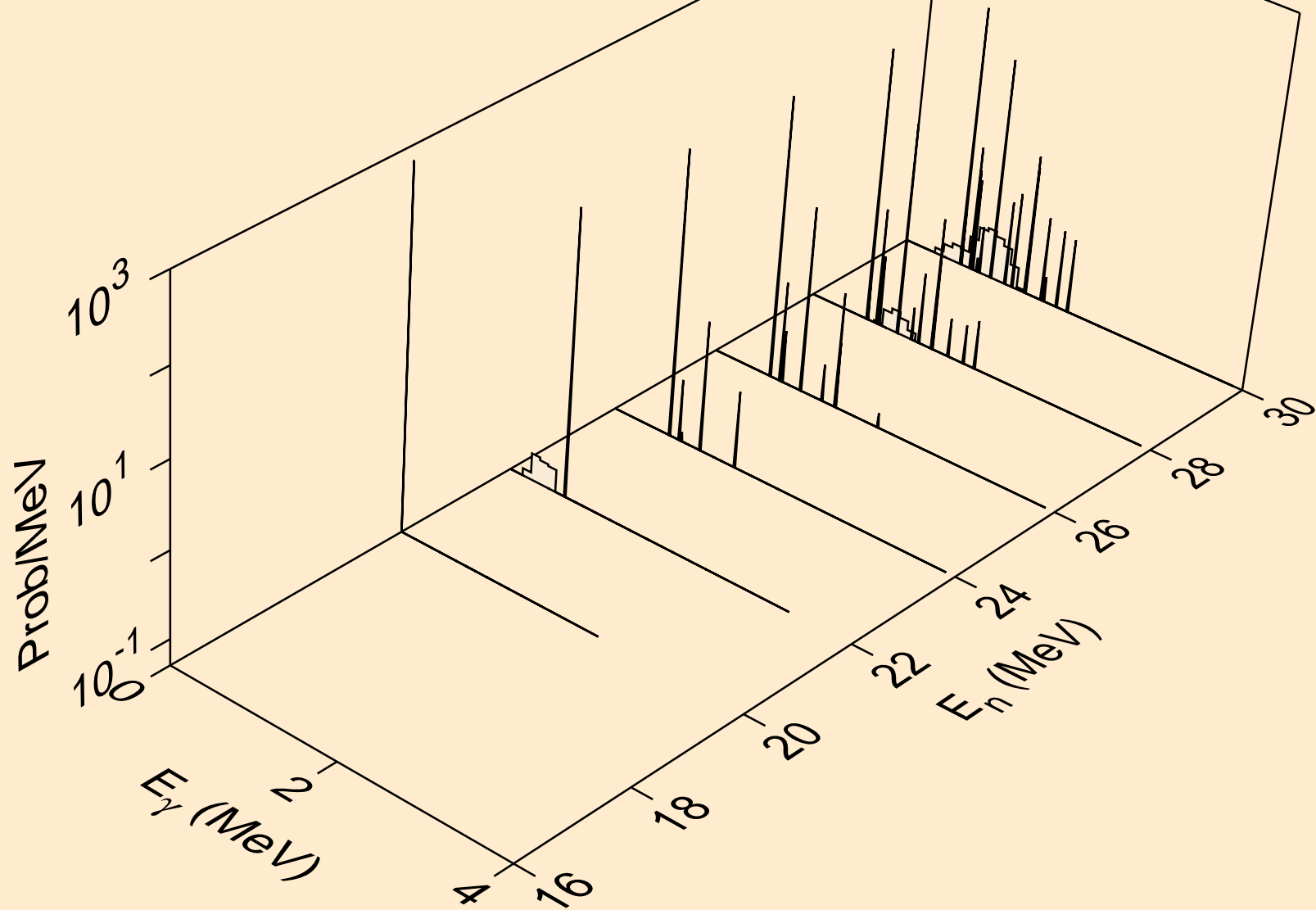

KR083 NEUTRON ACER TENDL-2021 LIBRARY; T=293.6K
Photon emission for (n,4n)

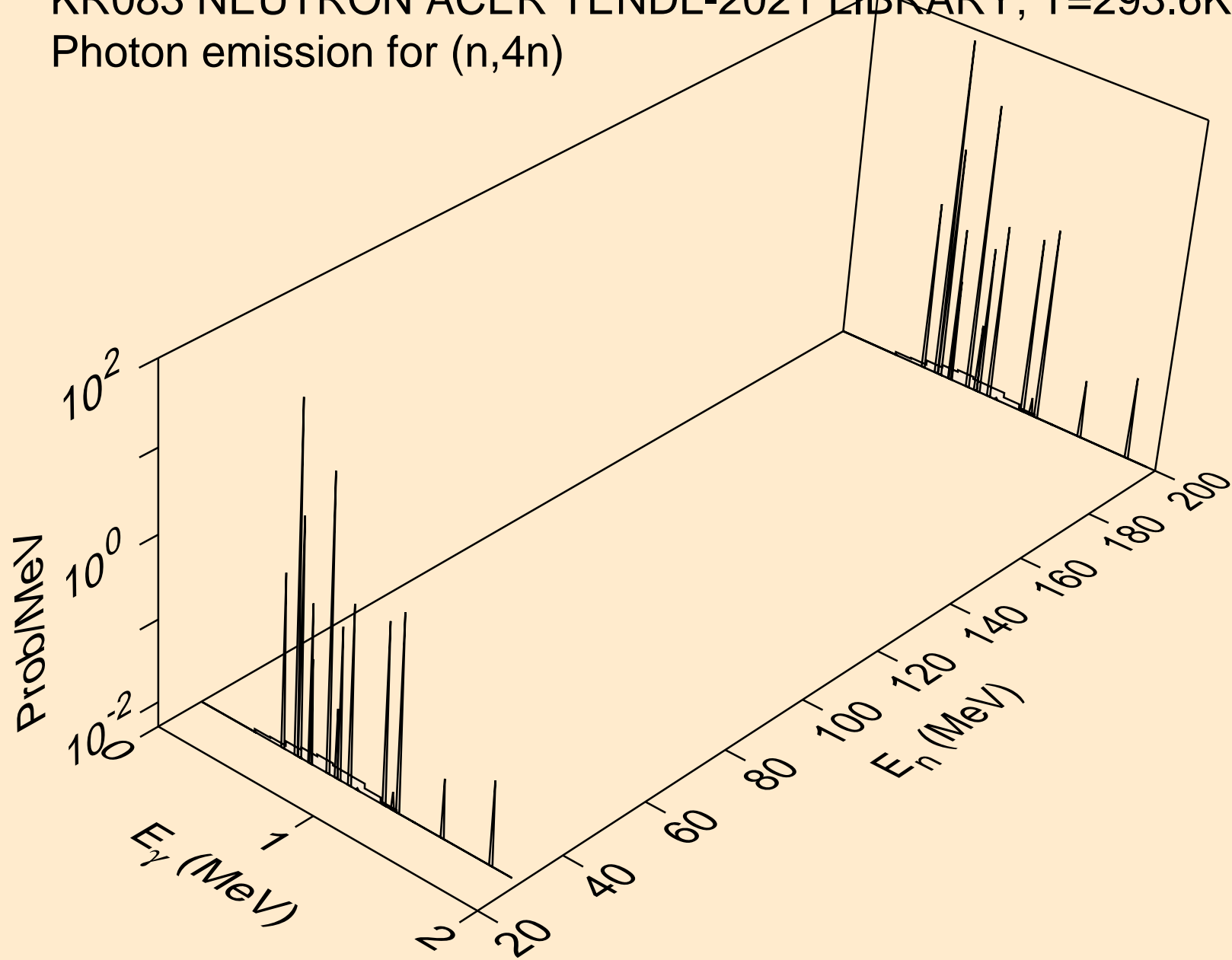

KR083 NEUTRON ACER TENDL-2021 LIBRARY; T=293.6K
Photon emission for (n,2np)

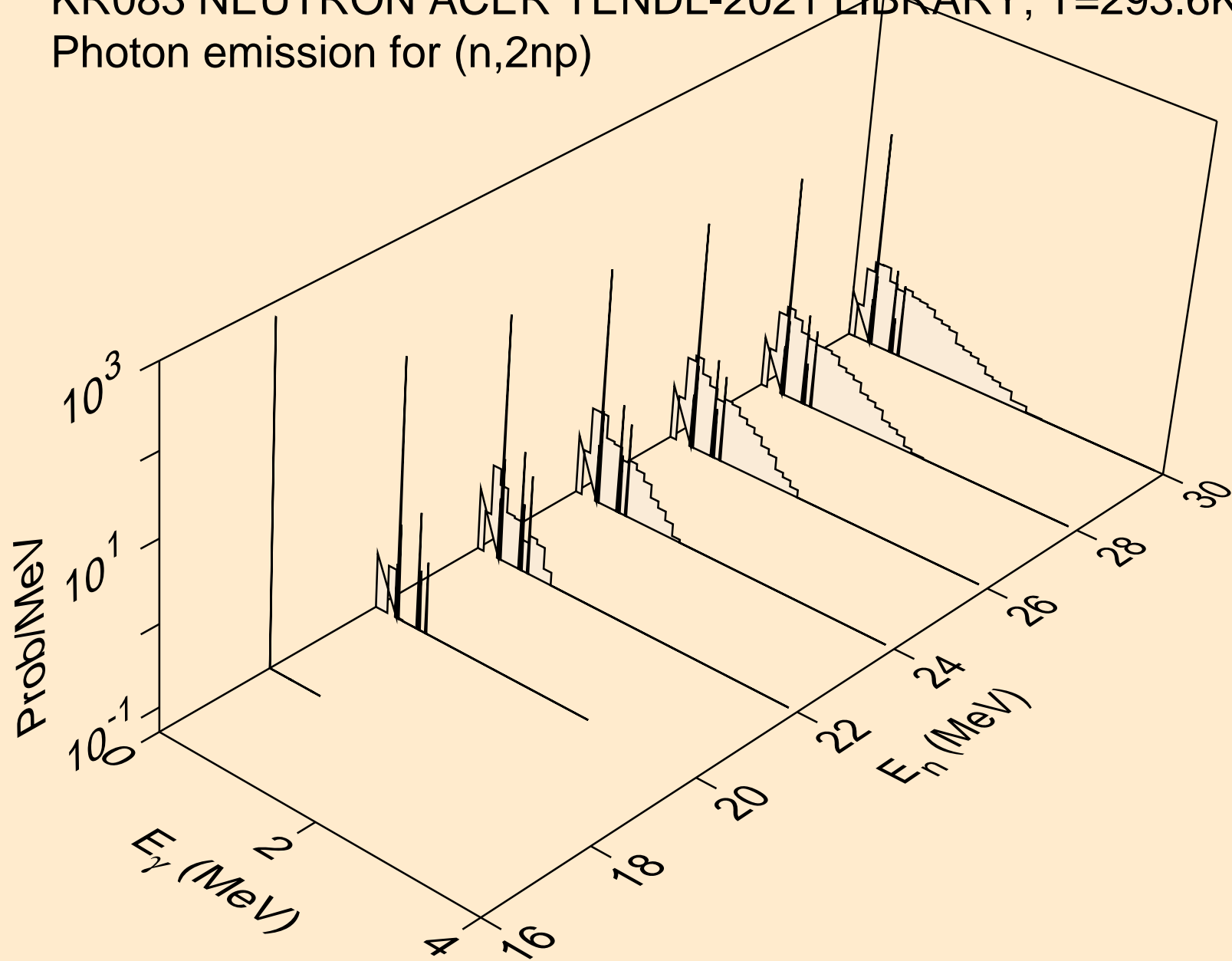

KR083 NEUTRON ACER TENDL-2021 LIBRARY; T=293.6K
Photon emission for (n,3np)

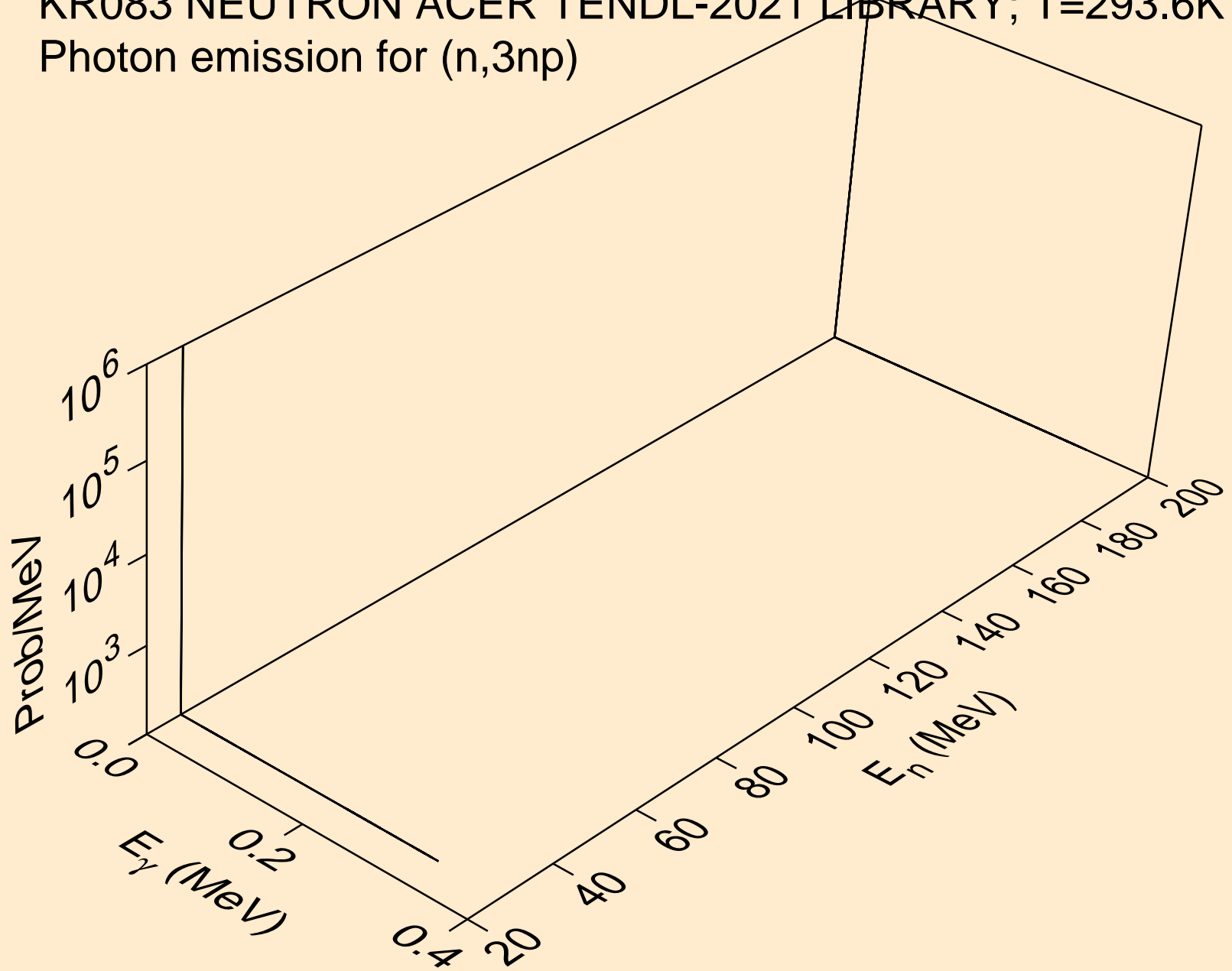

KR083 NEUTRON ACER TENDL-2021 LIBRARY; T=293.6K
Photon emission for (n,2np)

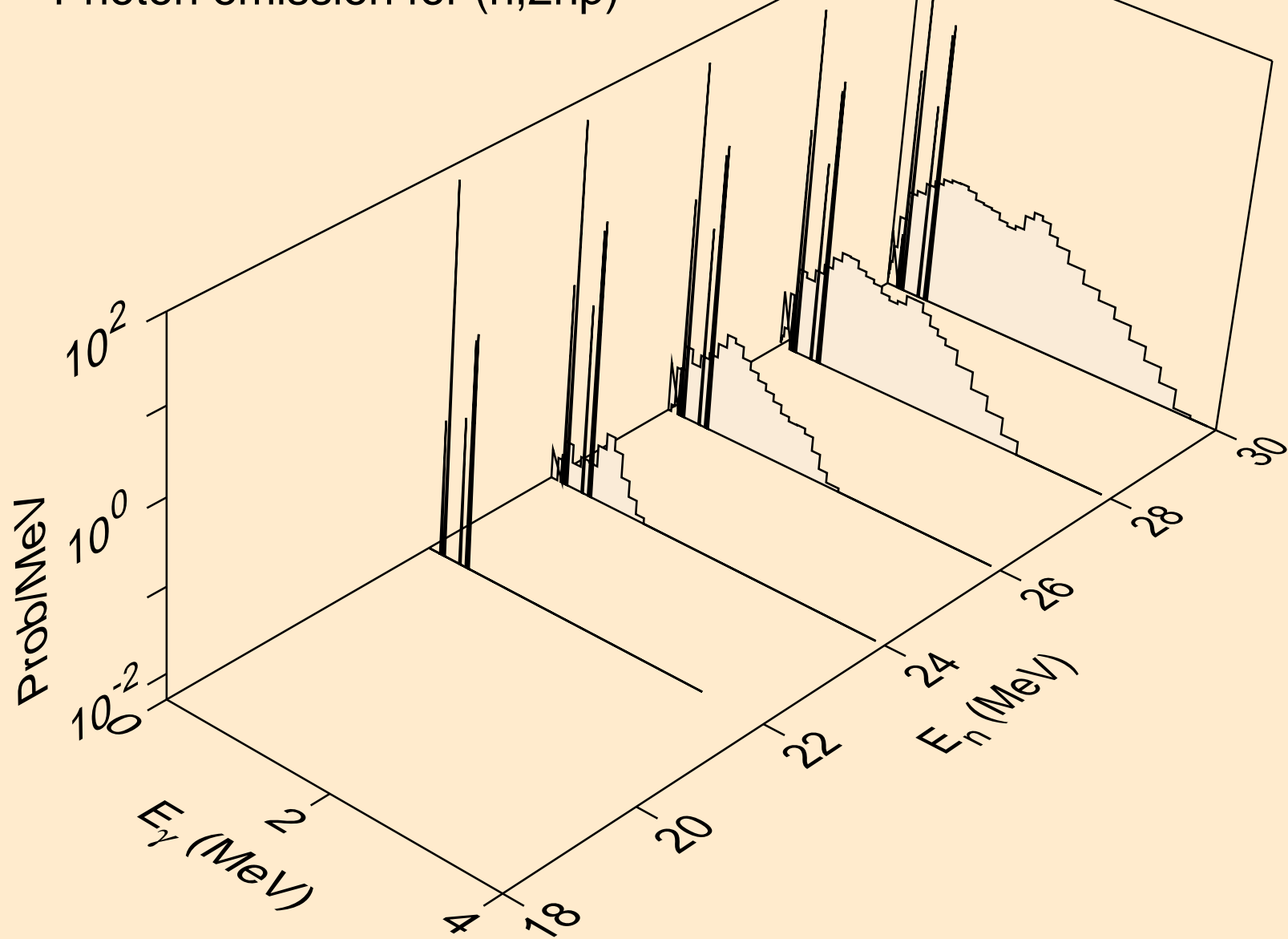

KR083 NEUTRON ACER TENDL-2021 LIBRARY; T=293.6K
Photon emission for (n,npa)

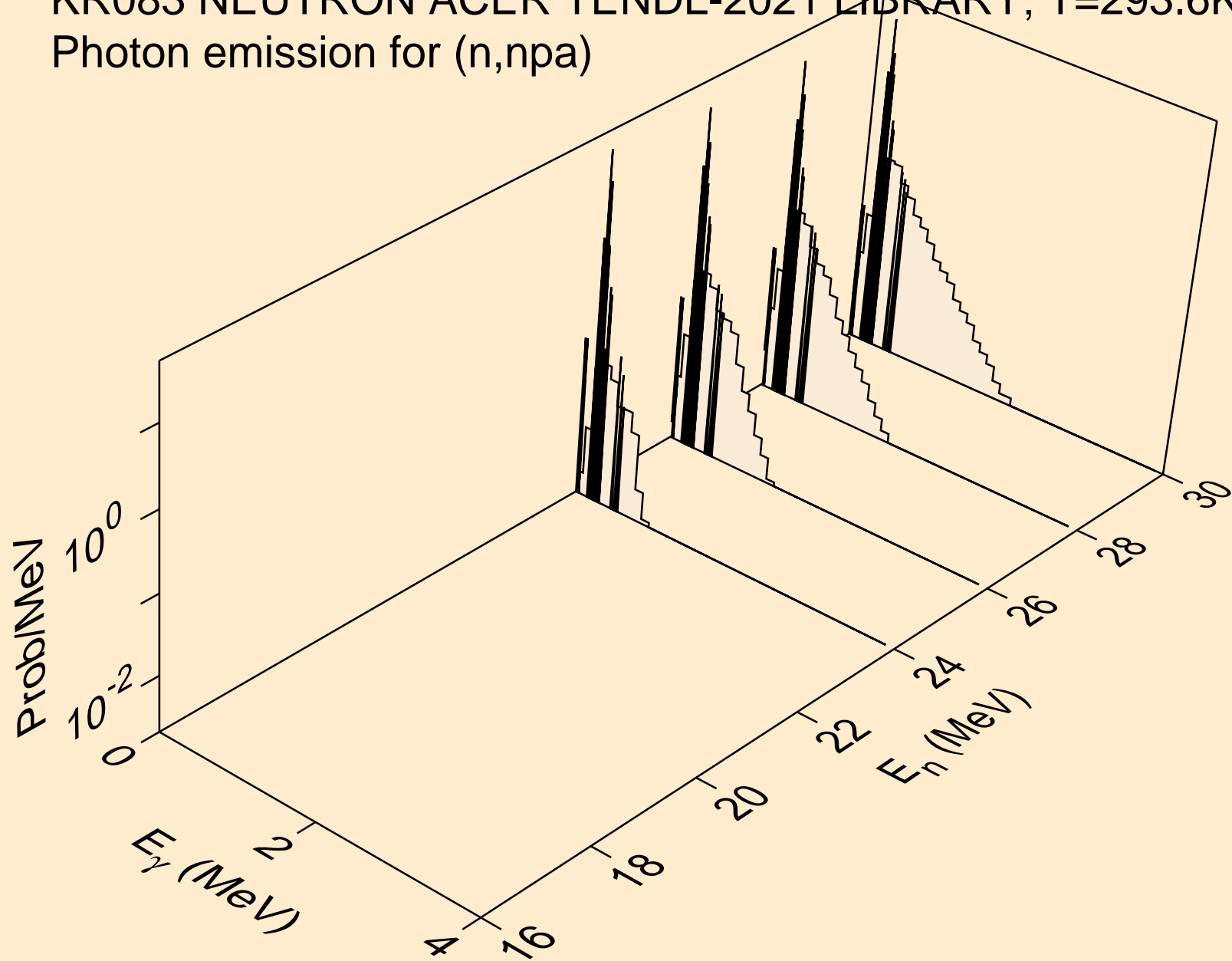

KR083 NEUTRON ACER TENDL-2021 LIBRARY; T=293.6K
Photon emission for (n,n*c)

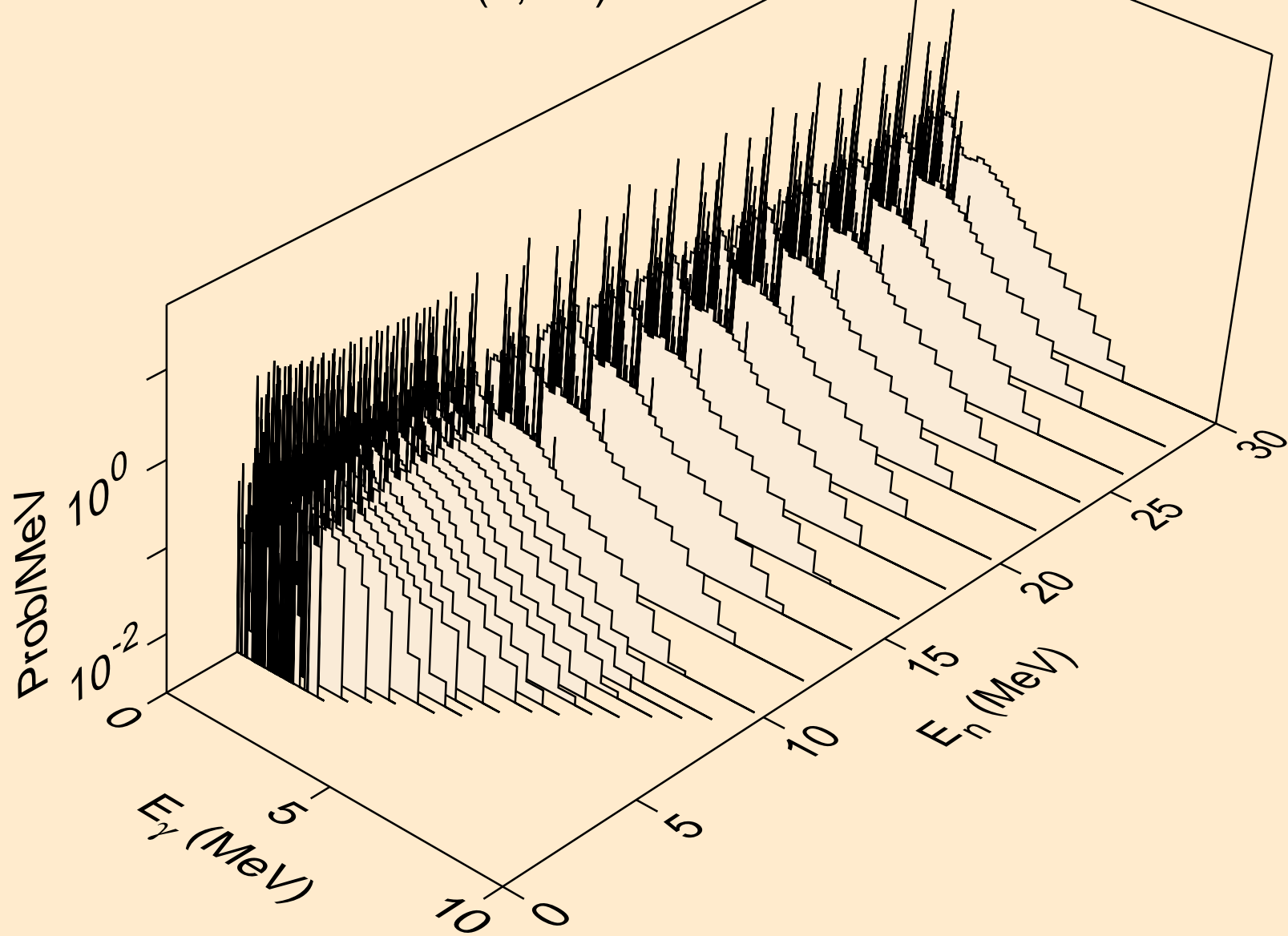

KR083 NEUTRON ACER TENDL-2021 LIBRARY; T=293.6K
Photon emission for (n,gma)

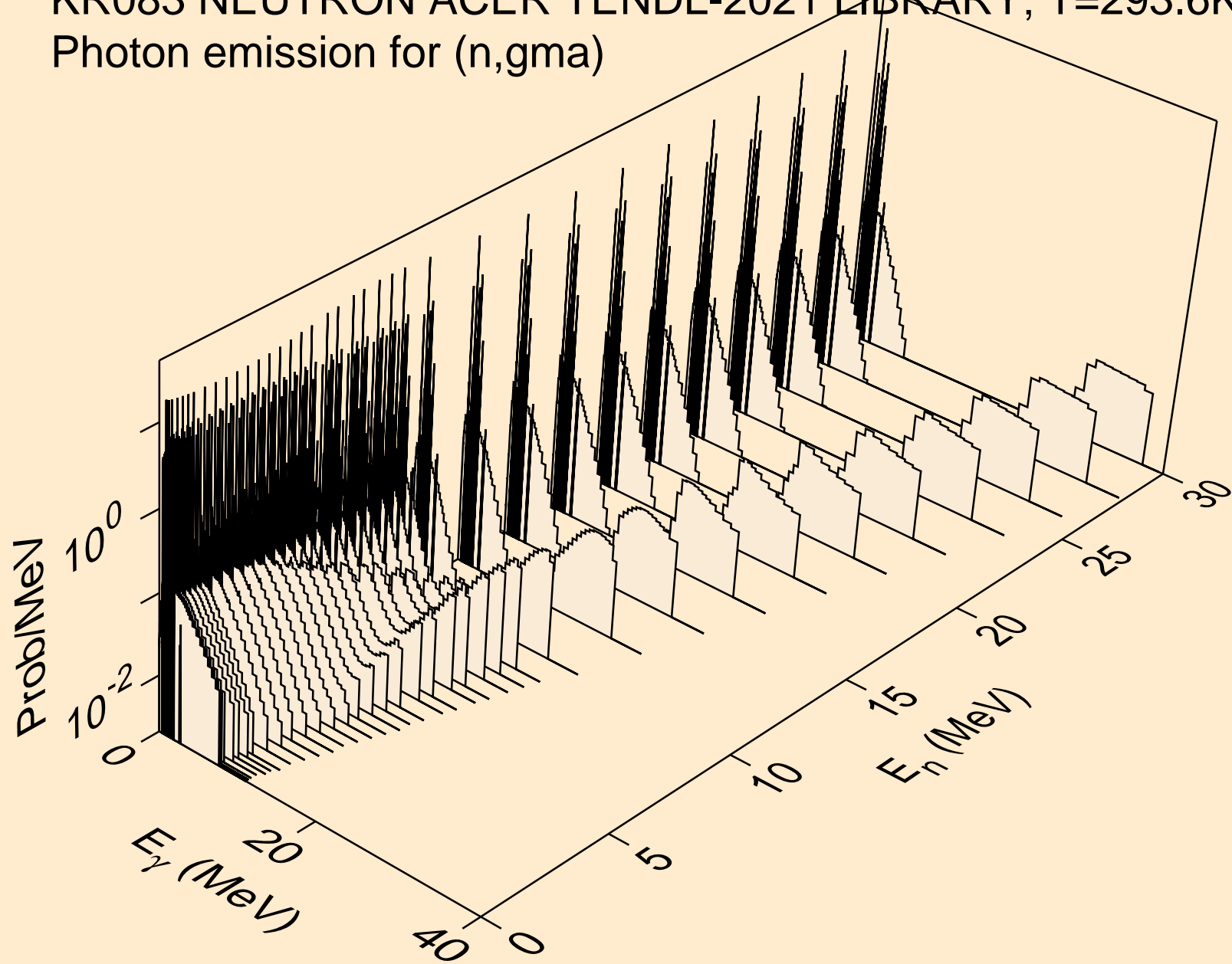

KR083 NEUTRON ACER TENDL-2021 LIBRARY; T=293.6K
Photon emission for (n,p)

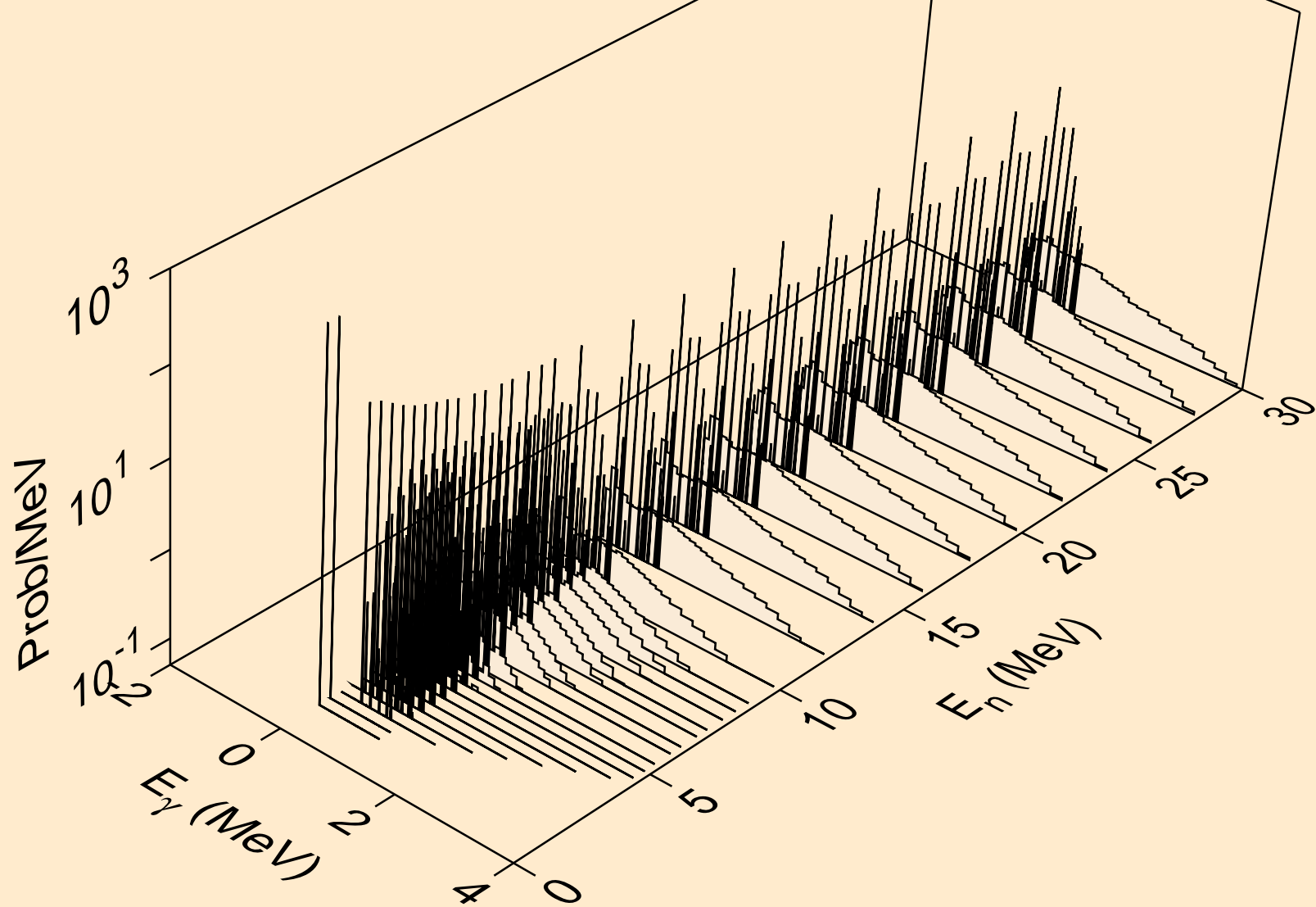

KR083 NEUTRON ACER TENDL-2021 LIBRARY; T=293.6K
Photon emission for (n,d)

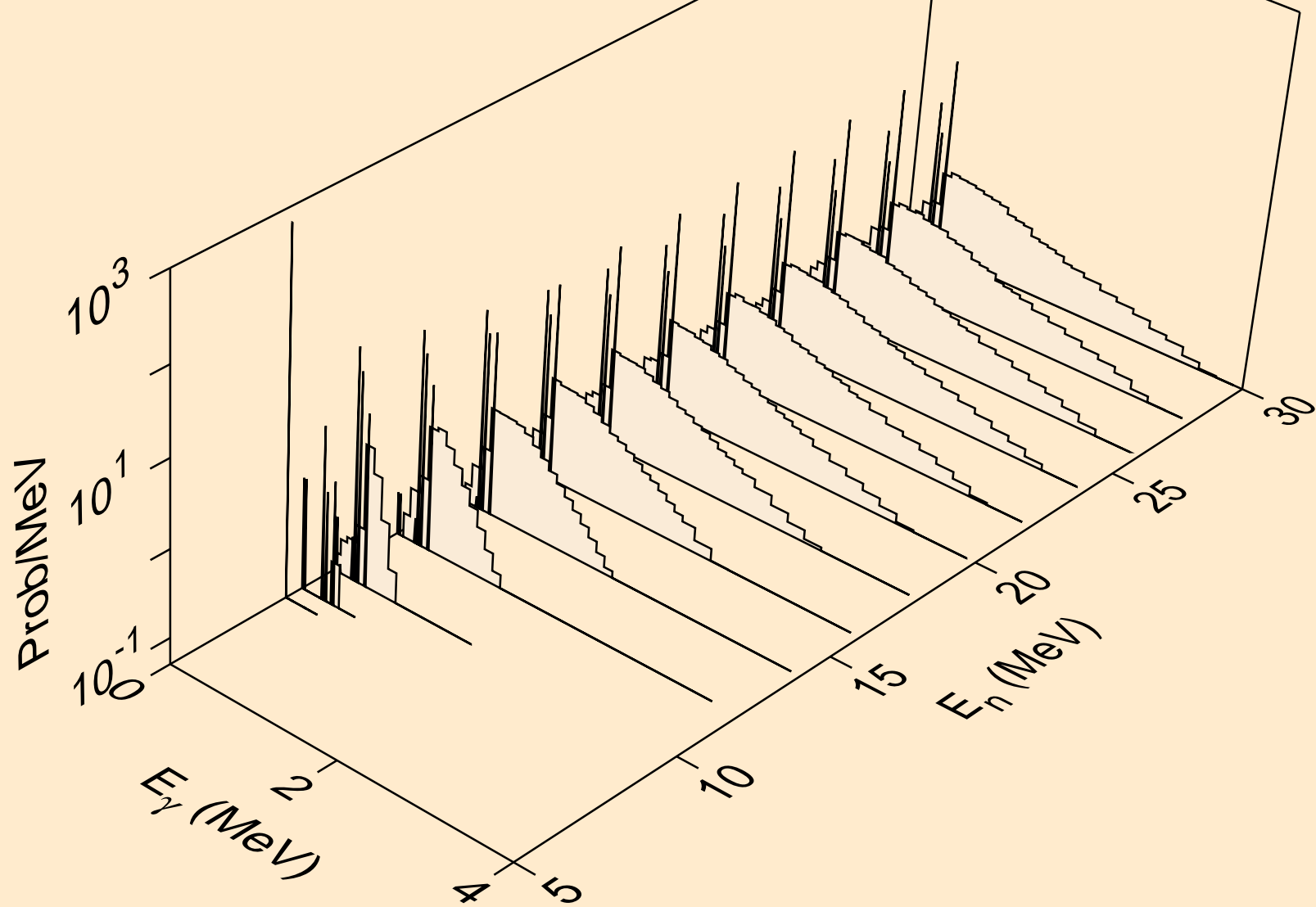

KR083 NEUTRON ACER TENDL-2021 LIBRARY; T=293.6K
Photon emission for (n,t)

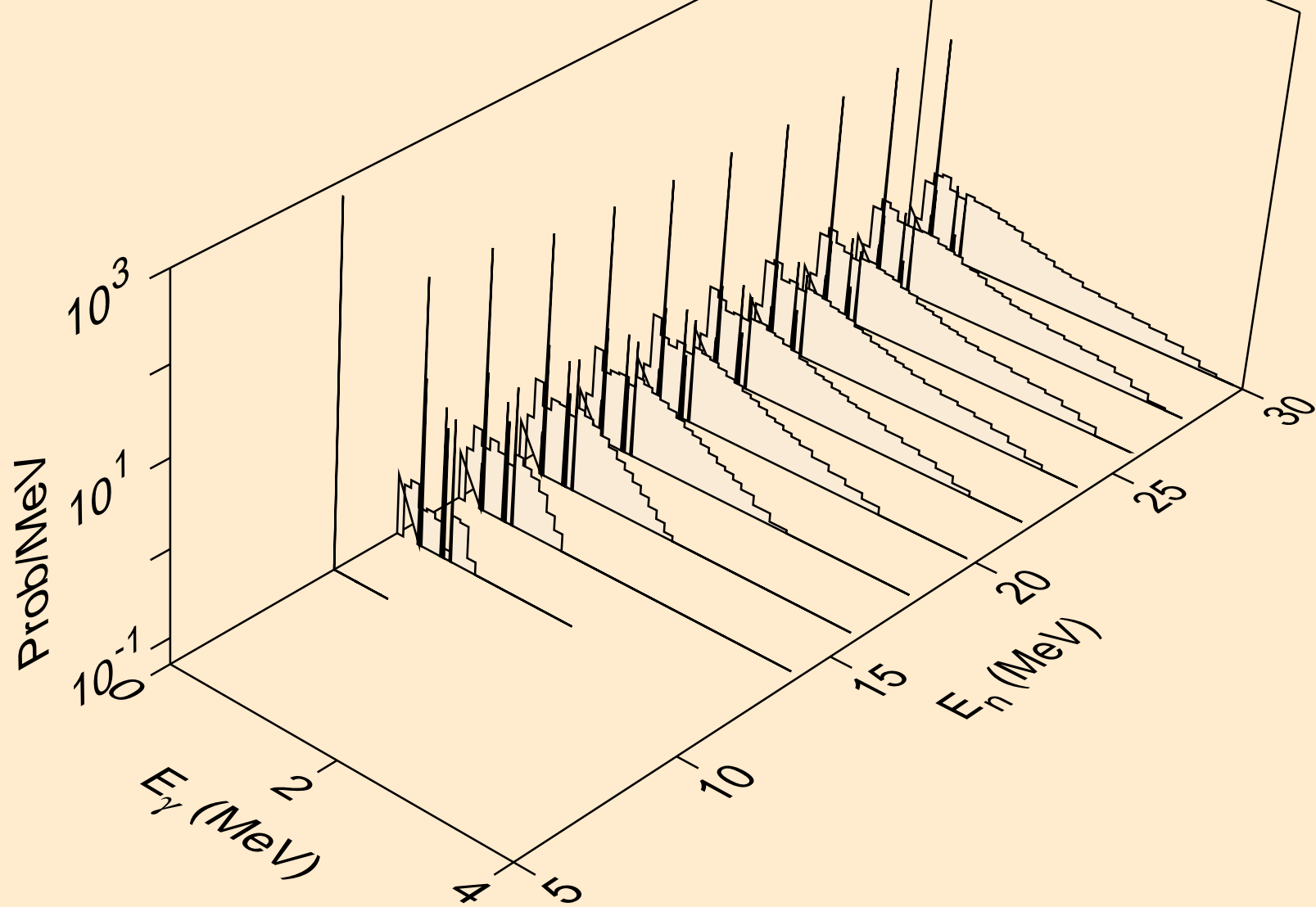

KR083 NEUTRON ACER TENDL-2021 LIBRARY; T=293.6K
Photon emission for (n,he3)

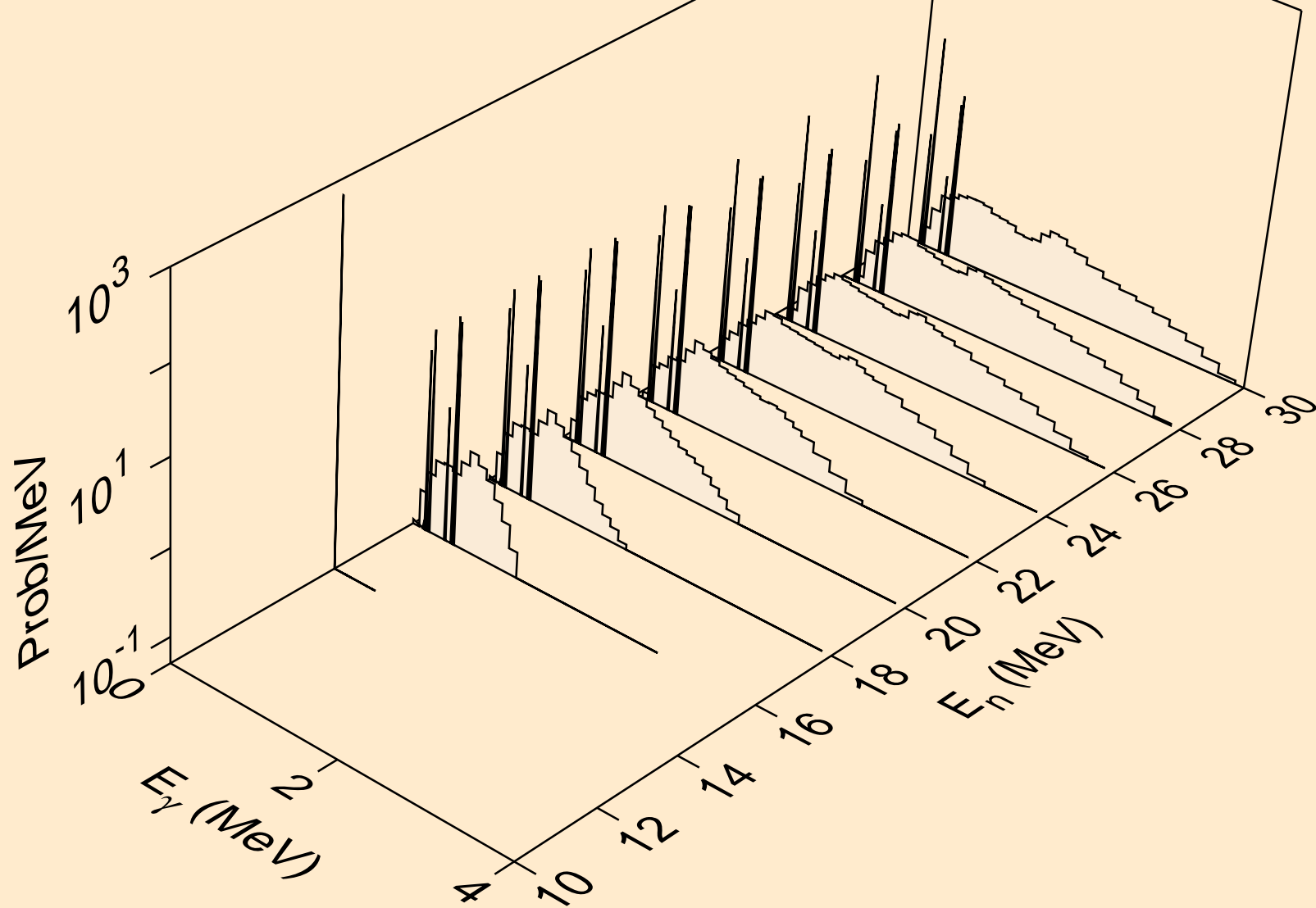

KR083 NEUTRON ACER TENDL-2021 LIBRARY; T=293.6K
Photon emission for (n,a)

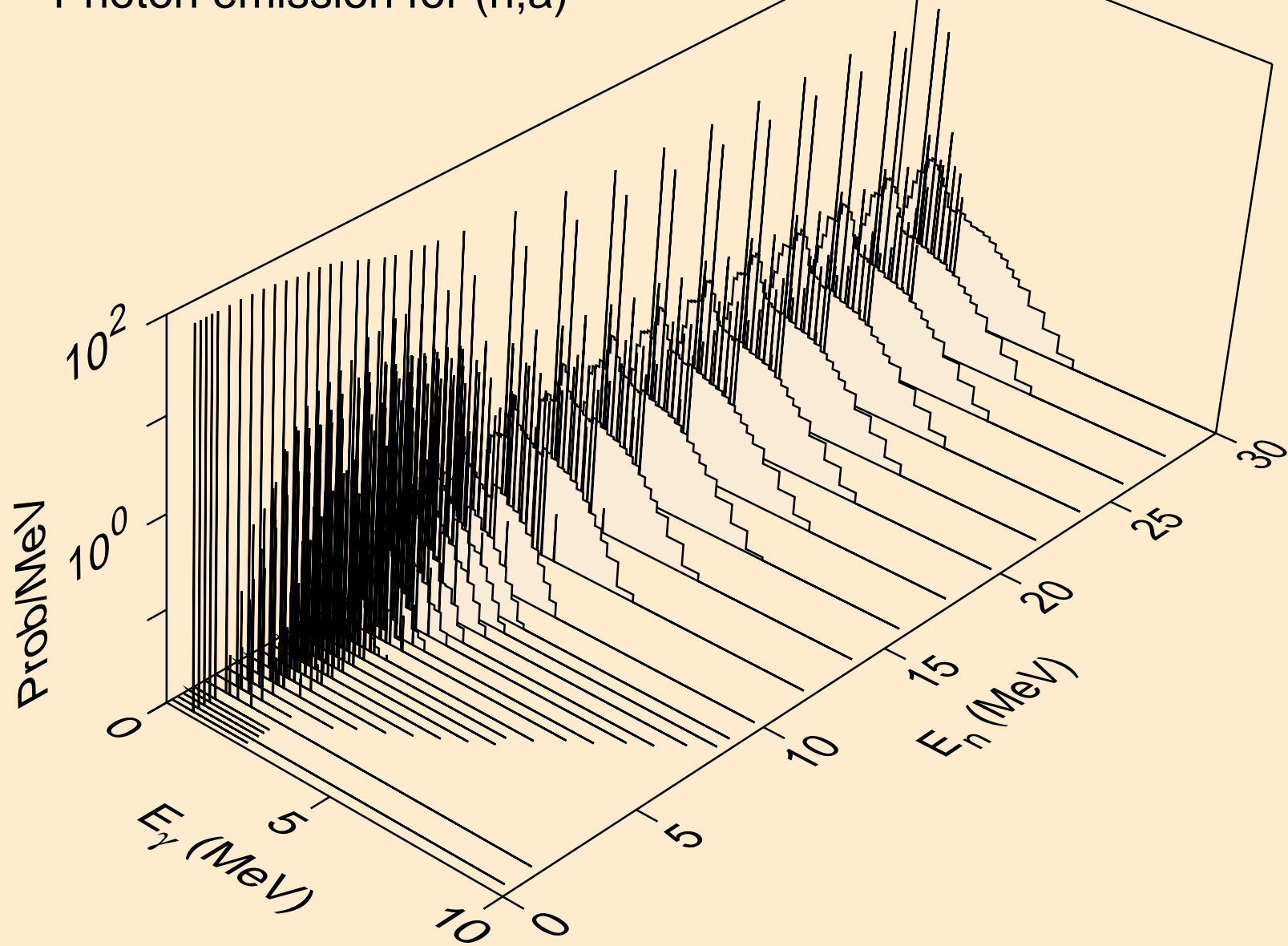

KR083 NEUTRON ACER TENDL-2021 LIBRARY; T=293.6K
Photon emission for (n,2a)

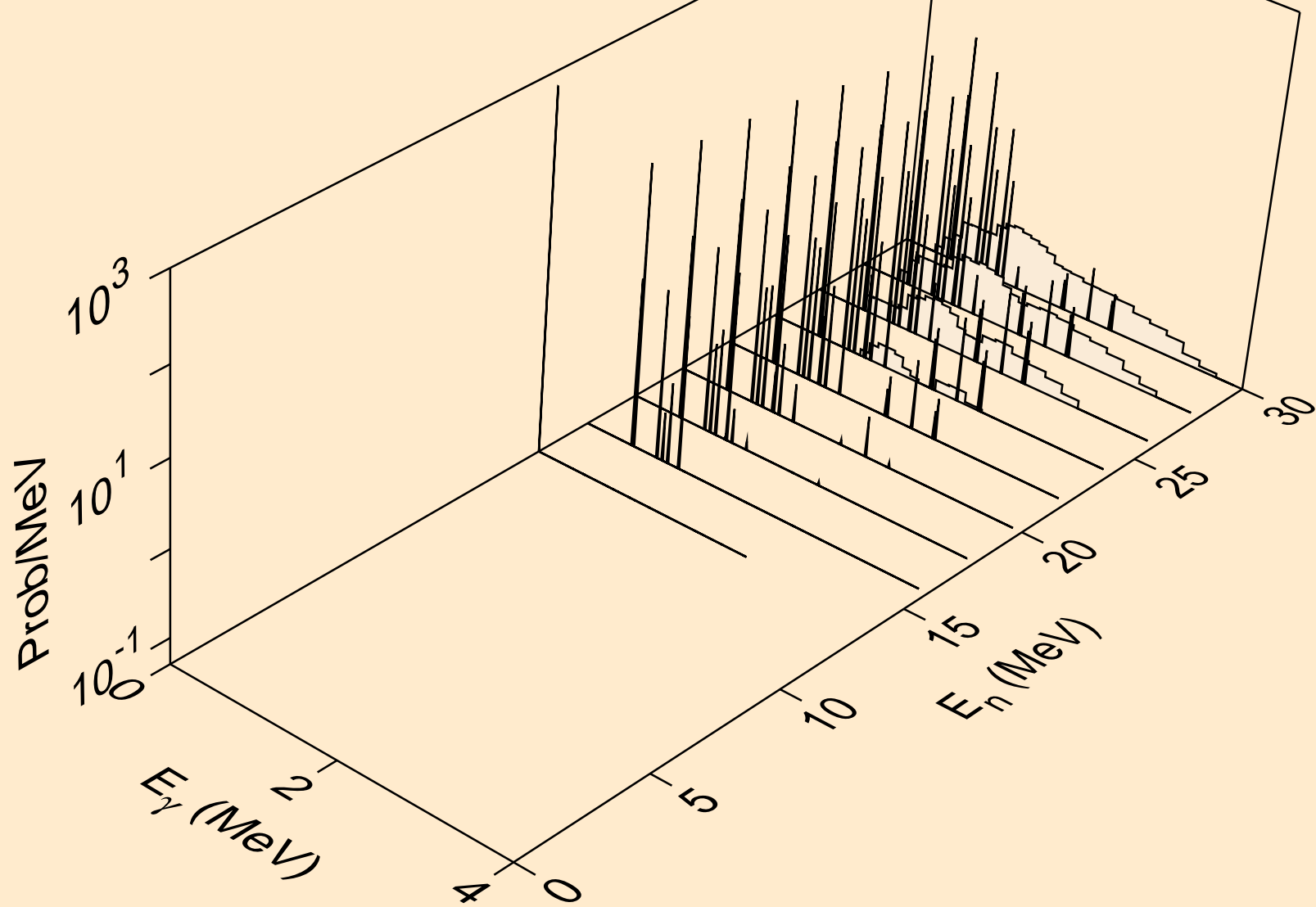

KR083 NEUTRON ACER TENDL-2021 LIBRARY; T=293.6K
Photon emission for (n,2p)

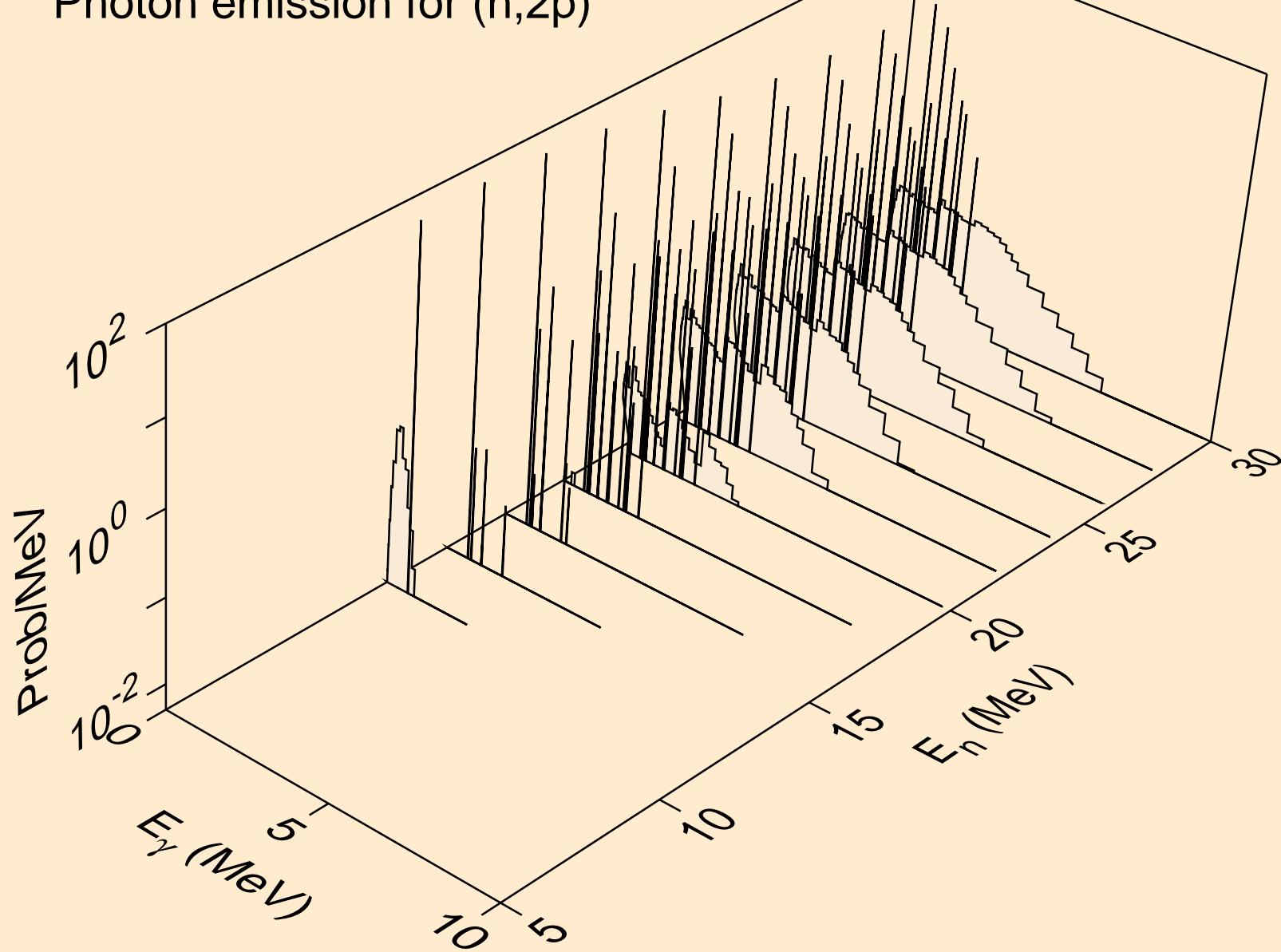

KR083 NEUTRON ACER TENDL-2021 LIBRARY; T=293.6K
Photon emission for (n,p)

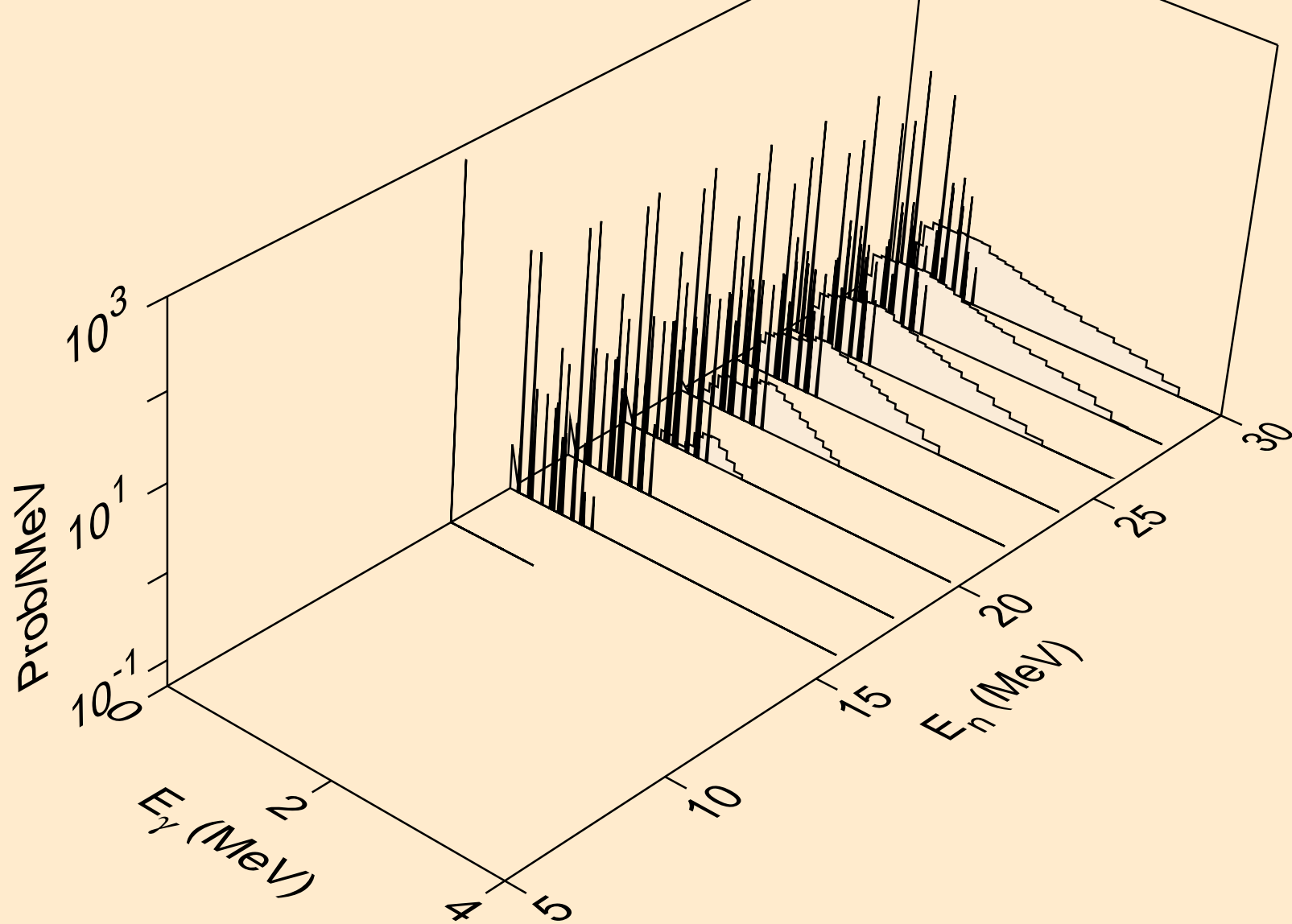

KR083 NEUTRON ACER TENDL-2021 LIBRARY; T=293.6K
Photon emission for (n,pd)

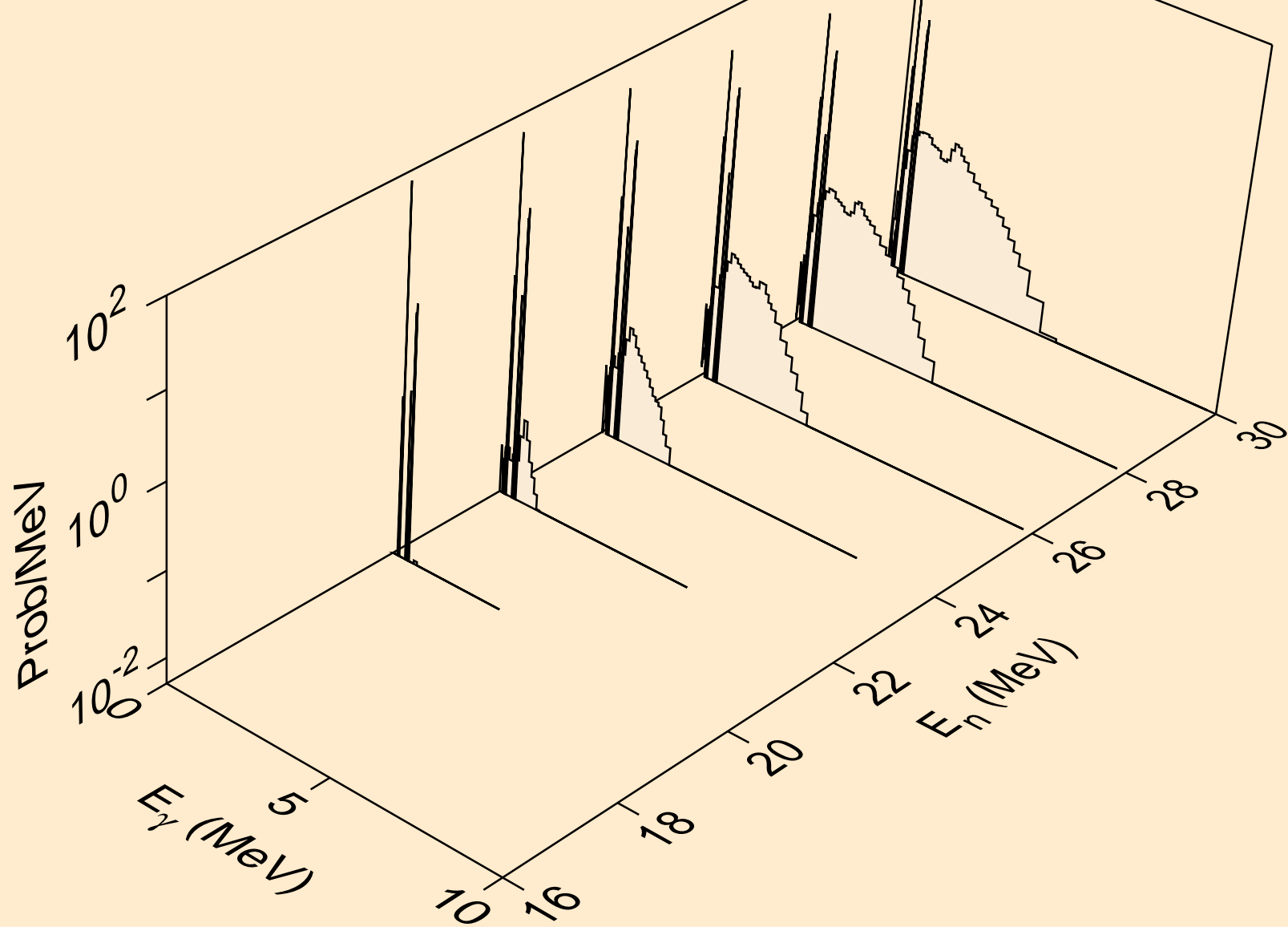

KR083 NEUTRON ACER TENDL-2021 LIBRARY; T=293.6K
Photon emission for (n,pt)

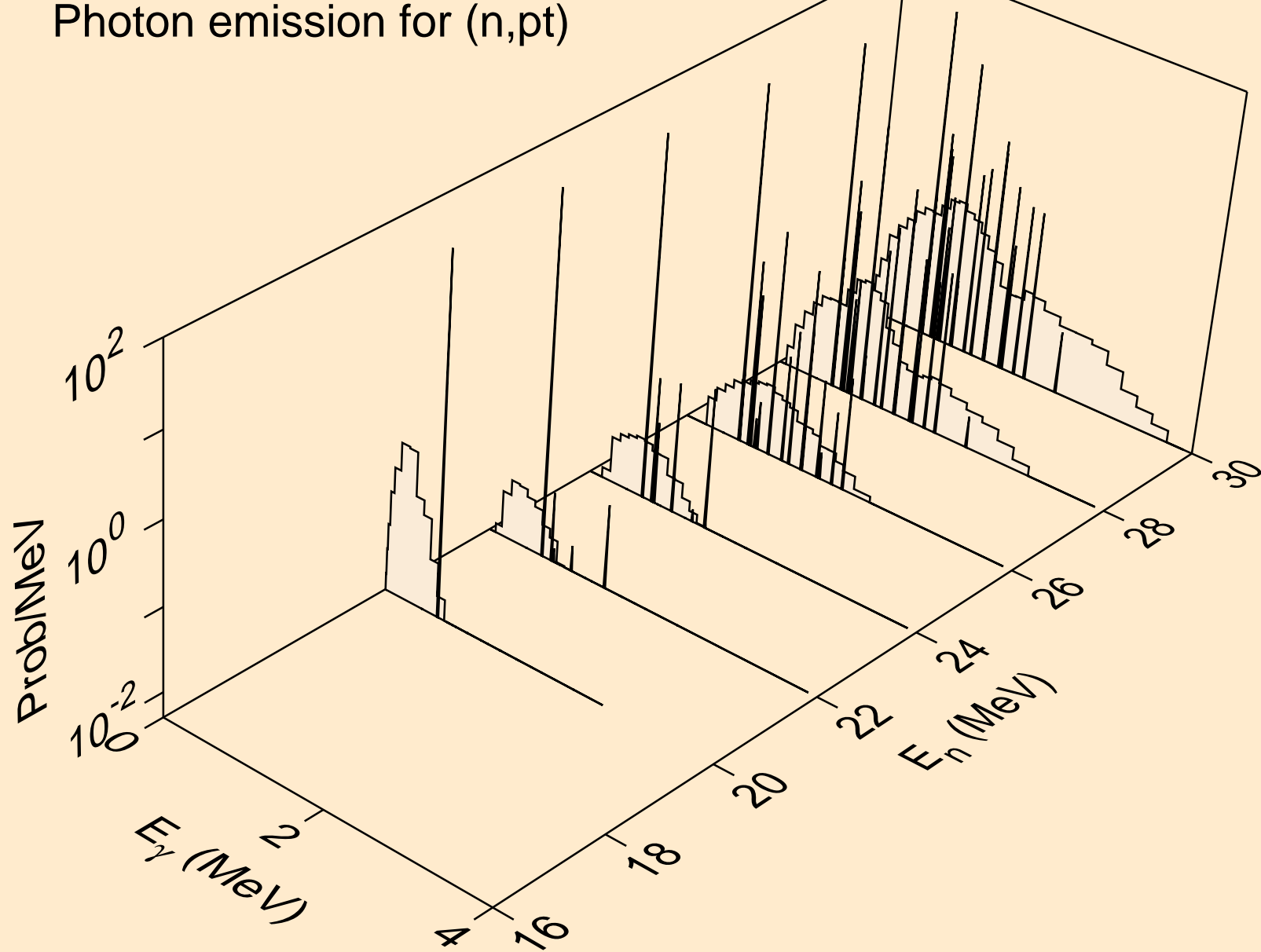

KR083 NEUTRON ACER TENDL-2021 LIBRARY; T=293.6K
Photon emission for (n,da)

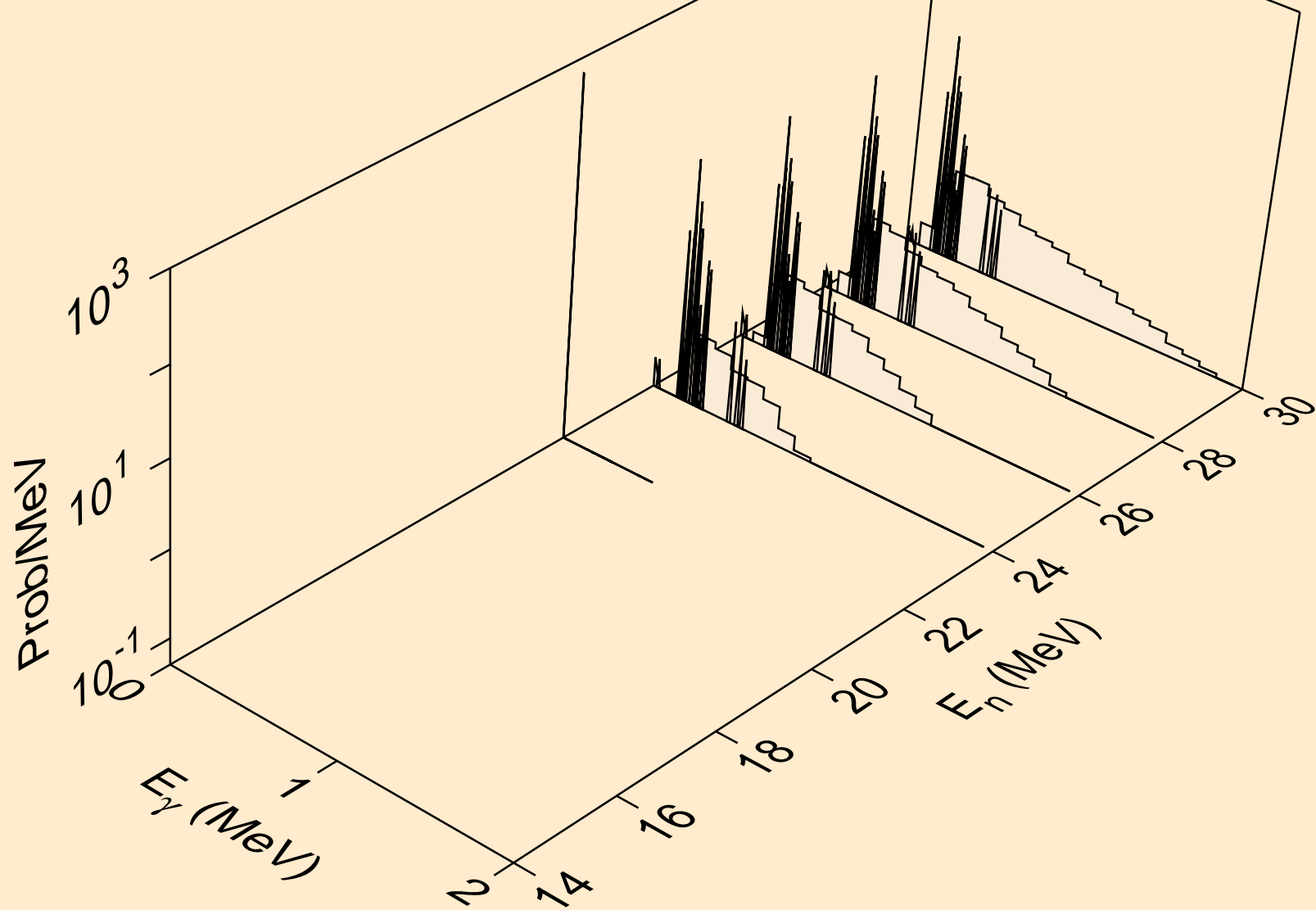

KR083 NEUTRON ACER TENDL-2021 LIBRARY; T=293.6K
thermal capture photon spectrum

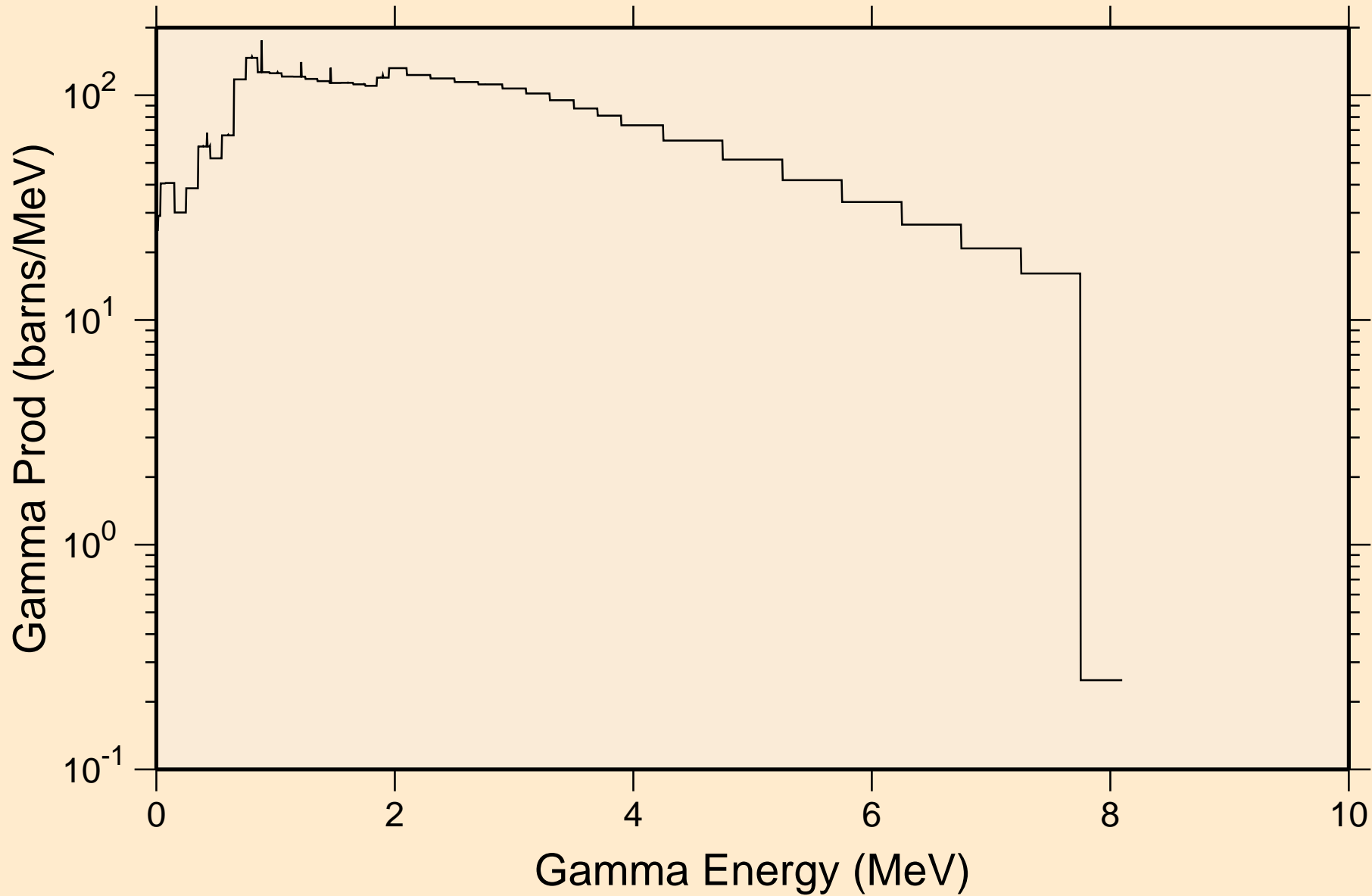

KR083 NEUTRON ACER TENDL-2021 LIBRARY; T=293.6K
14 MeV photon spectrum

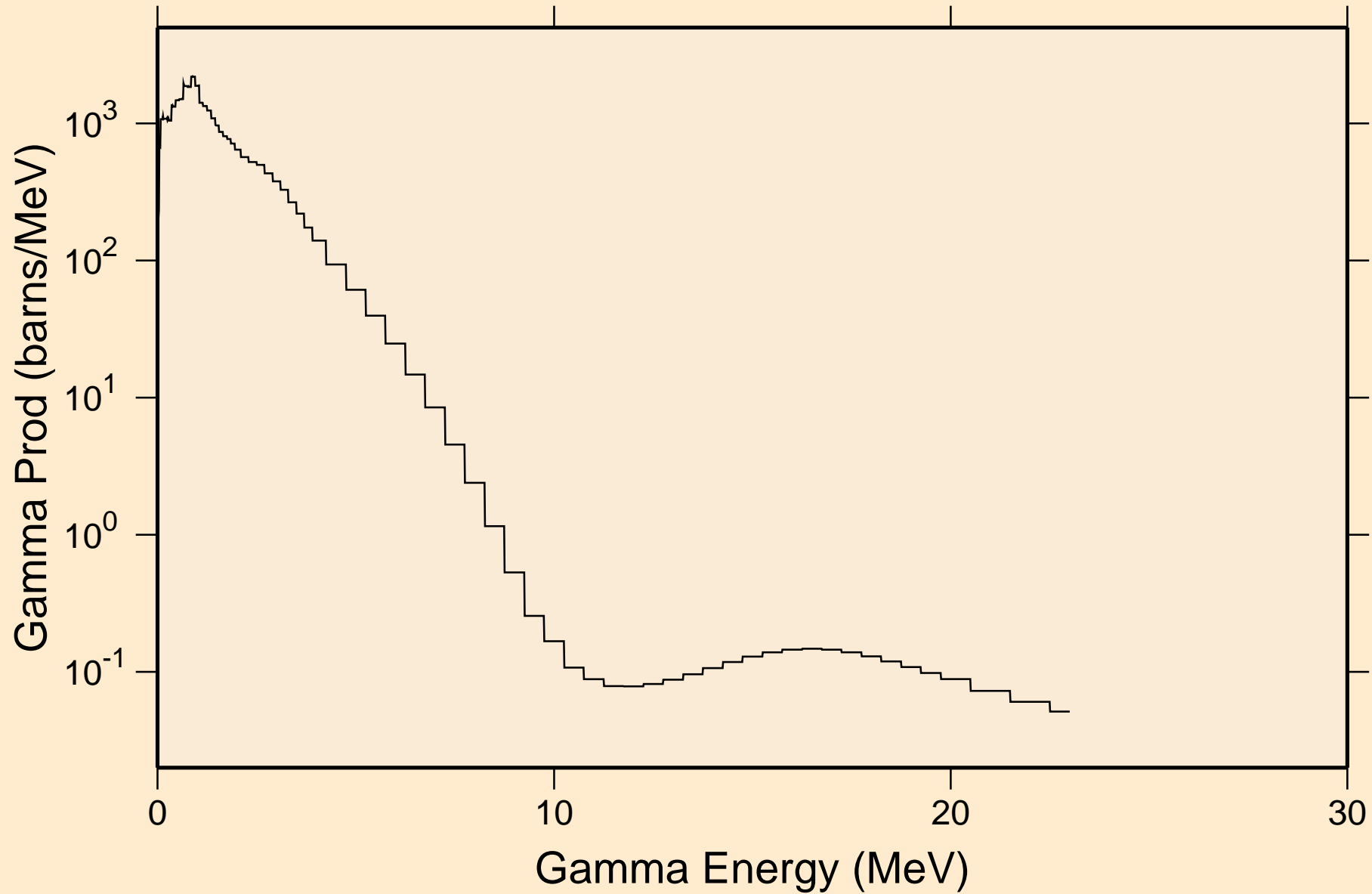

KR083 NEUTRON ACER TENDL-2021 LIBRARY; T=293.6K

Particle heating contributions

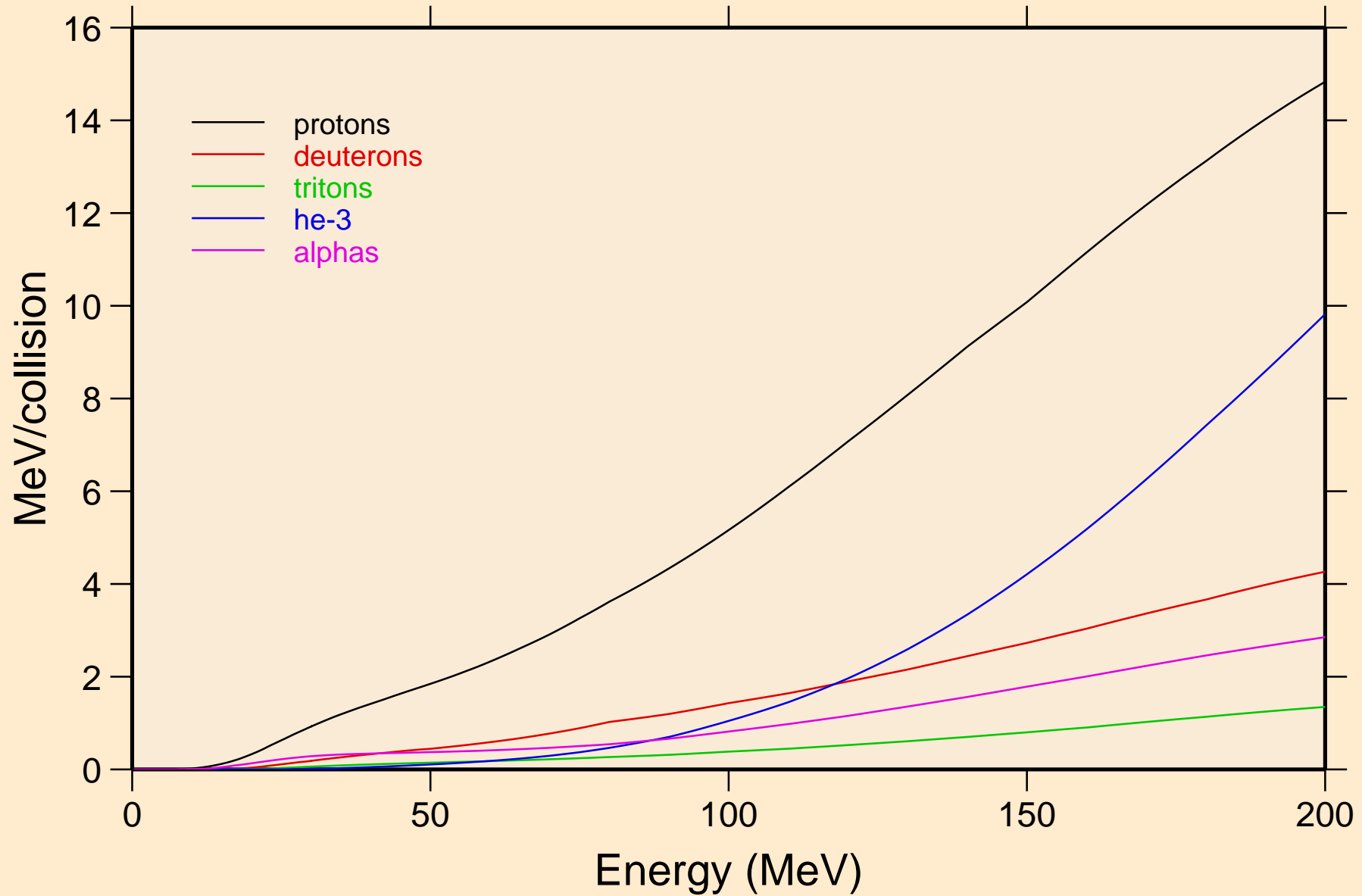

KR083 NEUTRON ACER TENDL-2021 LIBRARY; T=293.6K
Recoil Heating

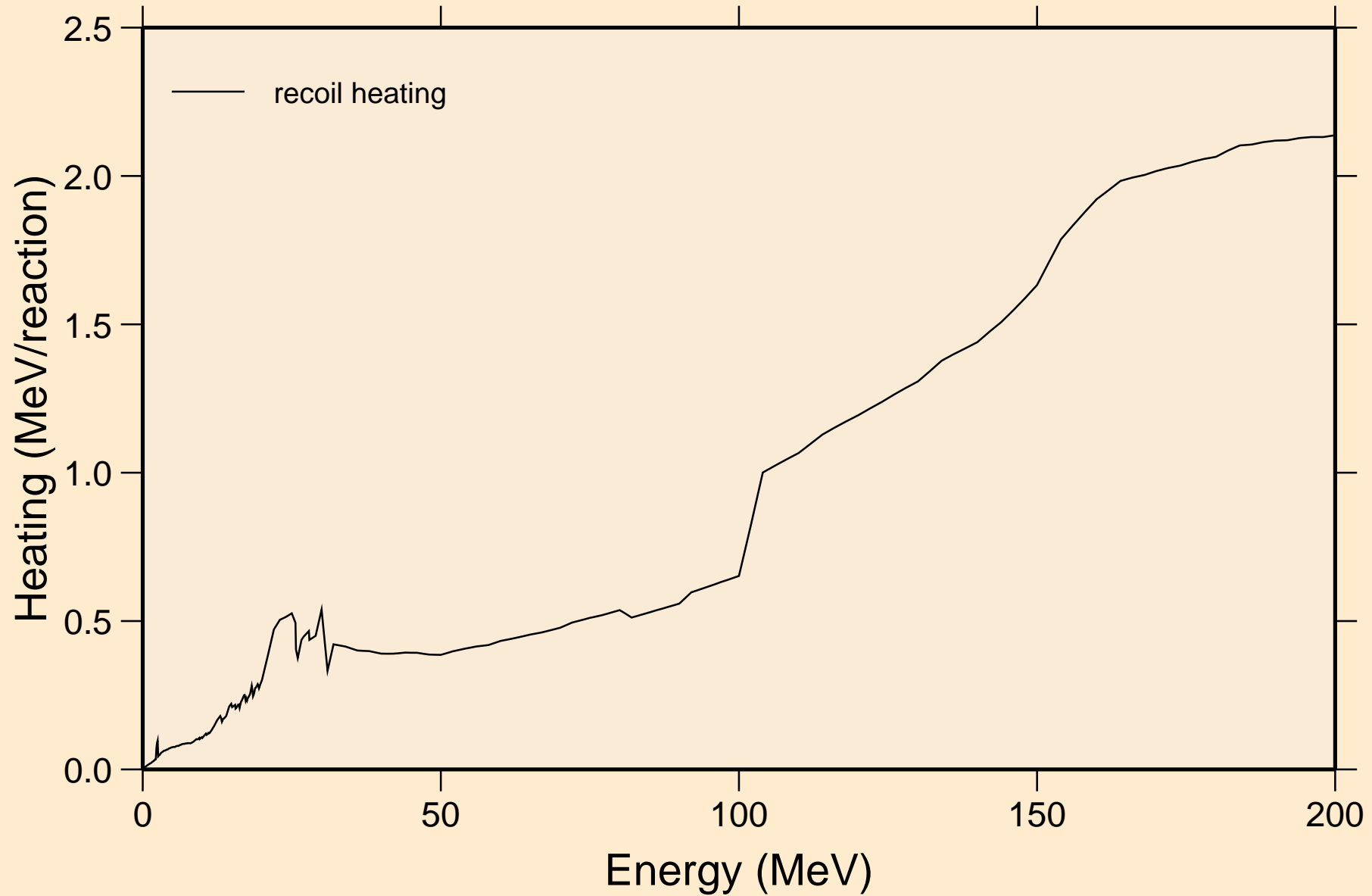

KR083 NEUTRON ACER TENDL-2021 LIBRARY; T=293.6K
Particle production cross sections

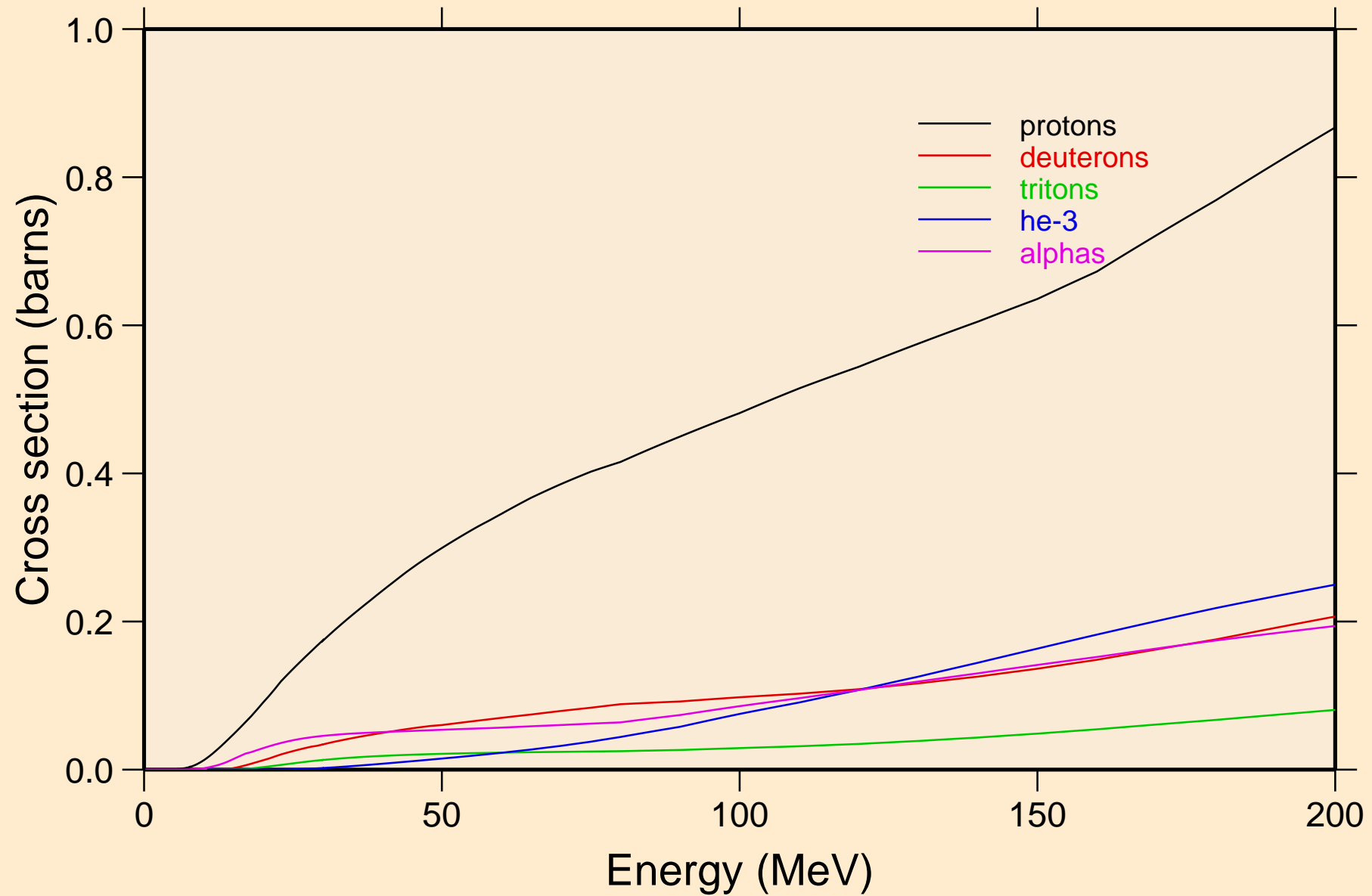

KR083 NEUTRON ACER TENDL-2021 LIBRARY; T=293.6K
protons from (n,x)

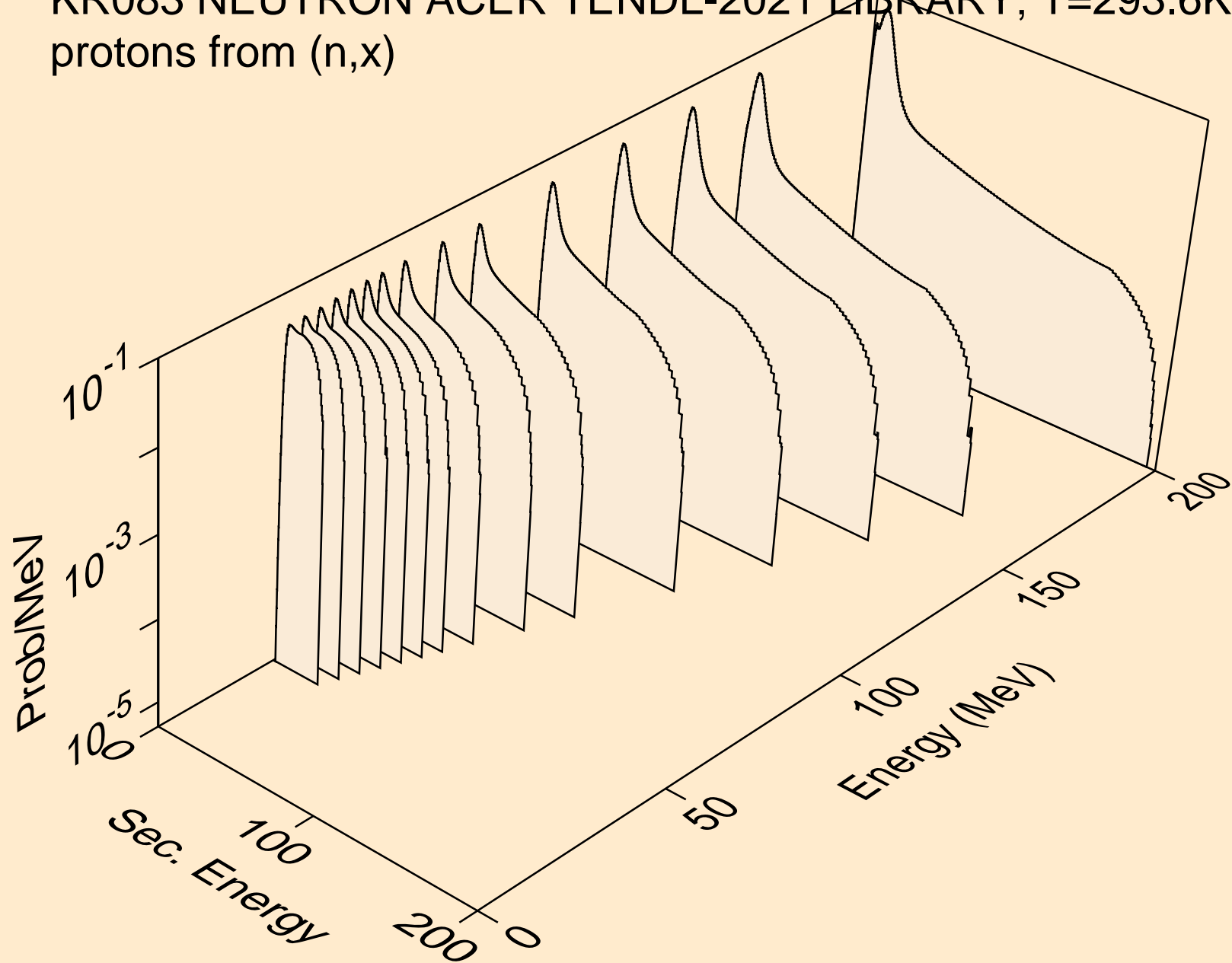

KR083 NEUTRON ACER TENDL-2021 LIBRARY; T=293.6K
protons from (n,n*)p

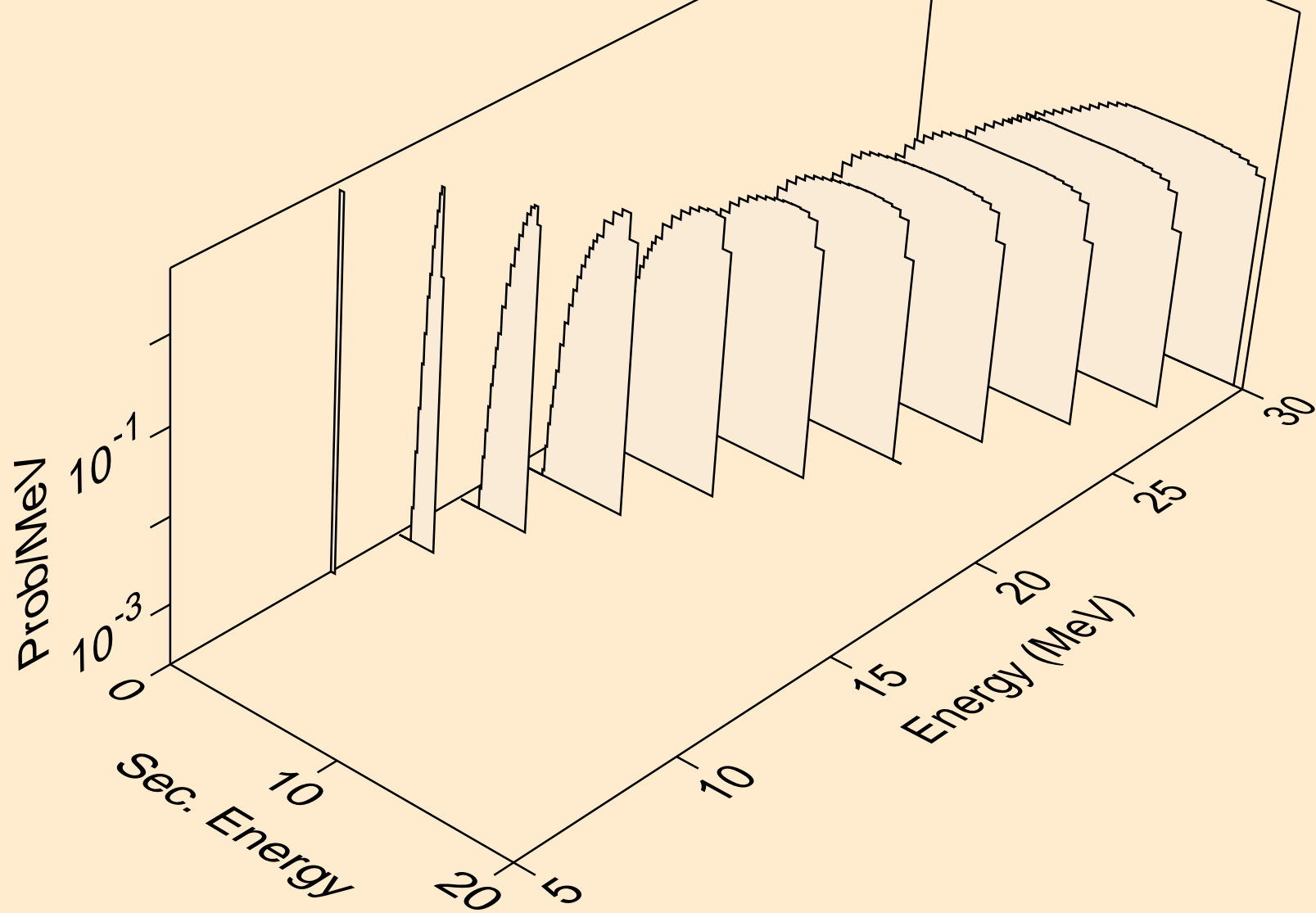

KR083 NEUTRON ACER TENDL-2021 LIBRARY; T=293.6K
protons from (n,2np)

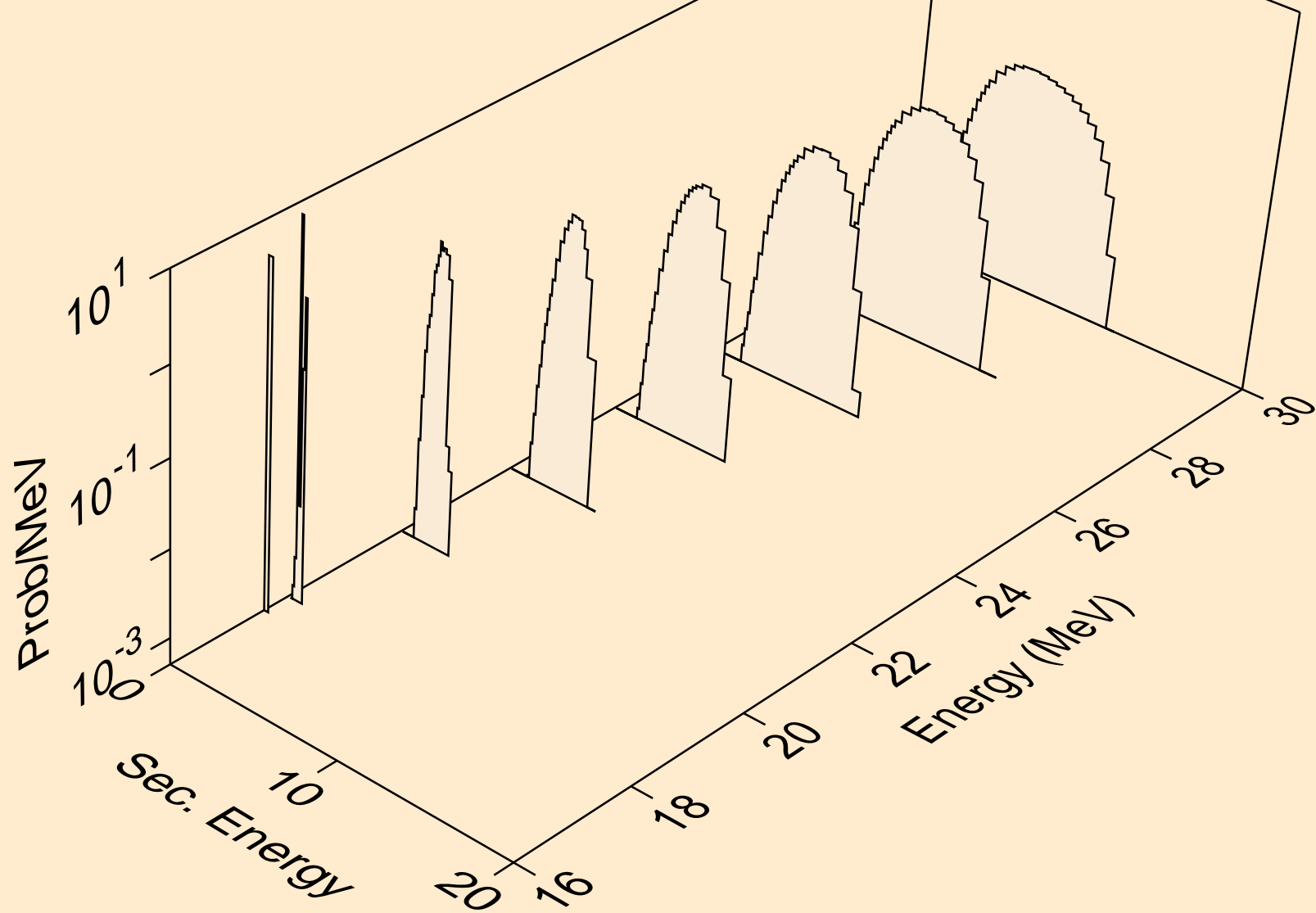

KR083 NEUTRON ACER TENDL-2021 LIBRARY; T=293.6K
protons from (n,3np)

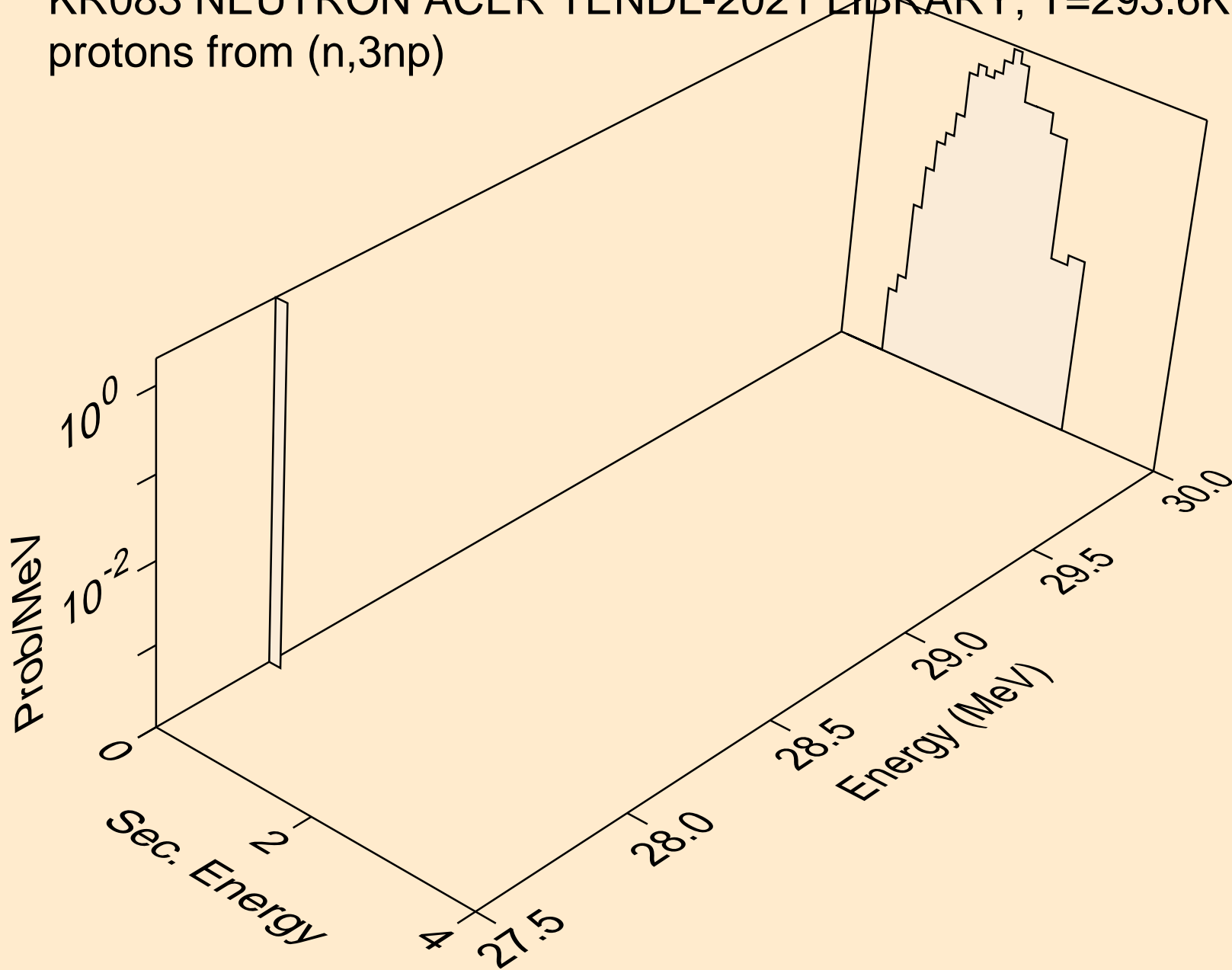

KR083 NEUTRON ACER TENDL-2021 LIBRARY; T=293.6K
protons from (n,2np)

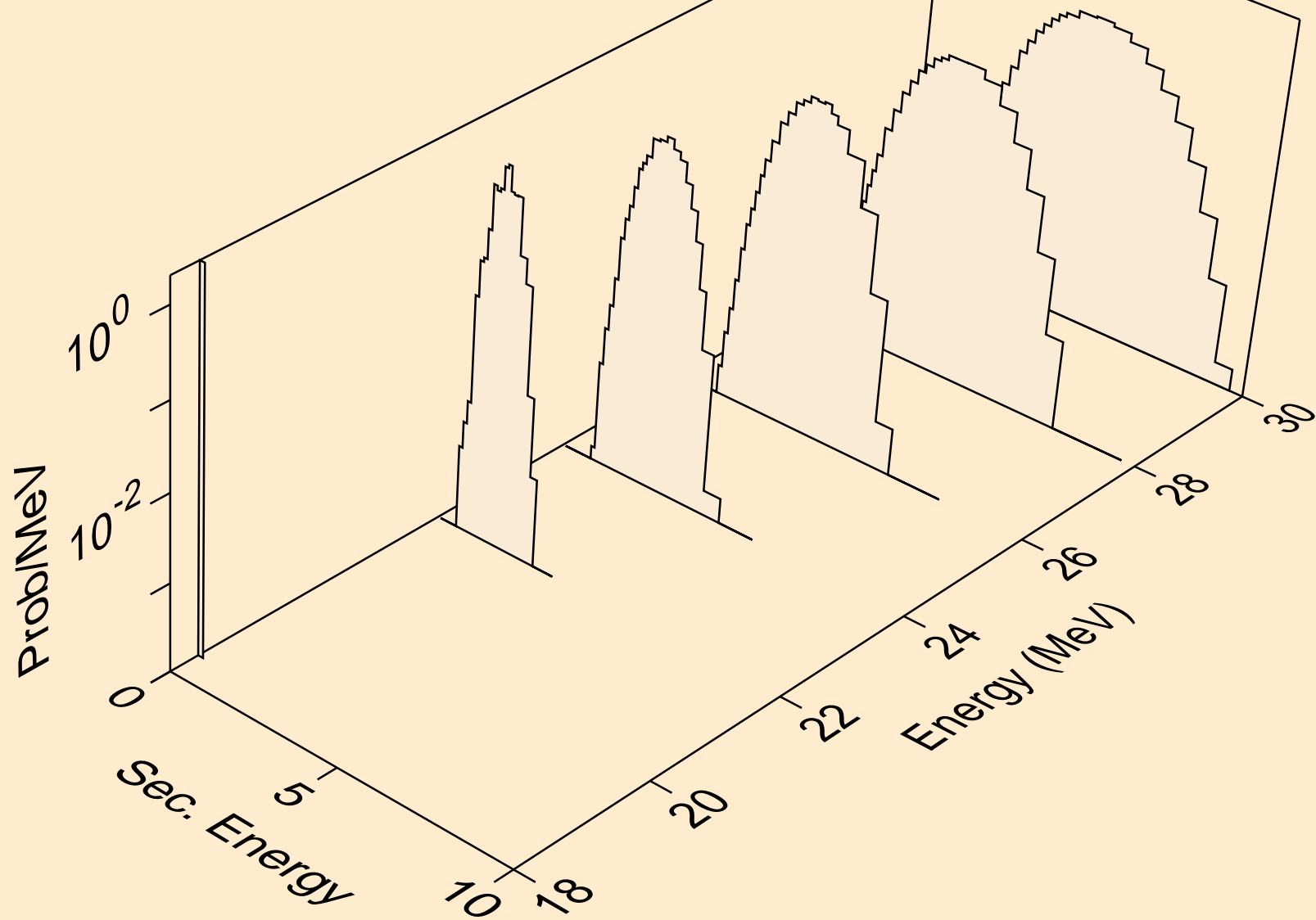

KR083 NEUTRON ACER TENDL-2021 LIBRARY; T=293.6K
protons from (n,npa)

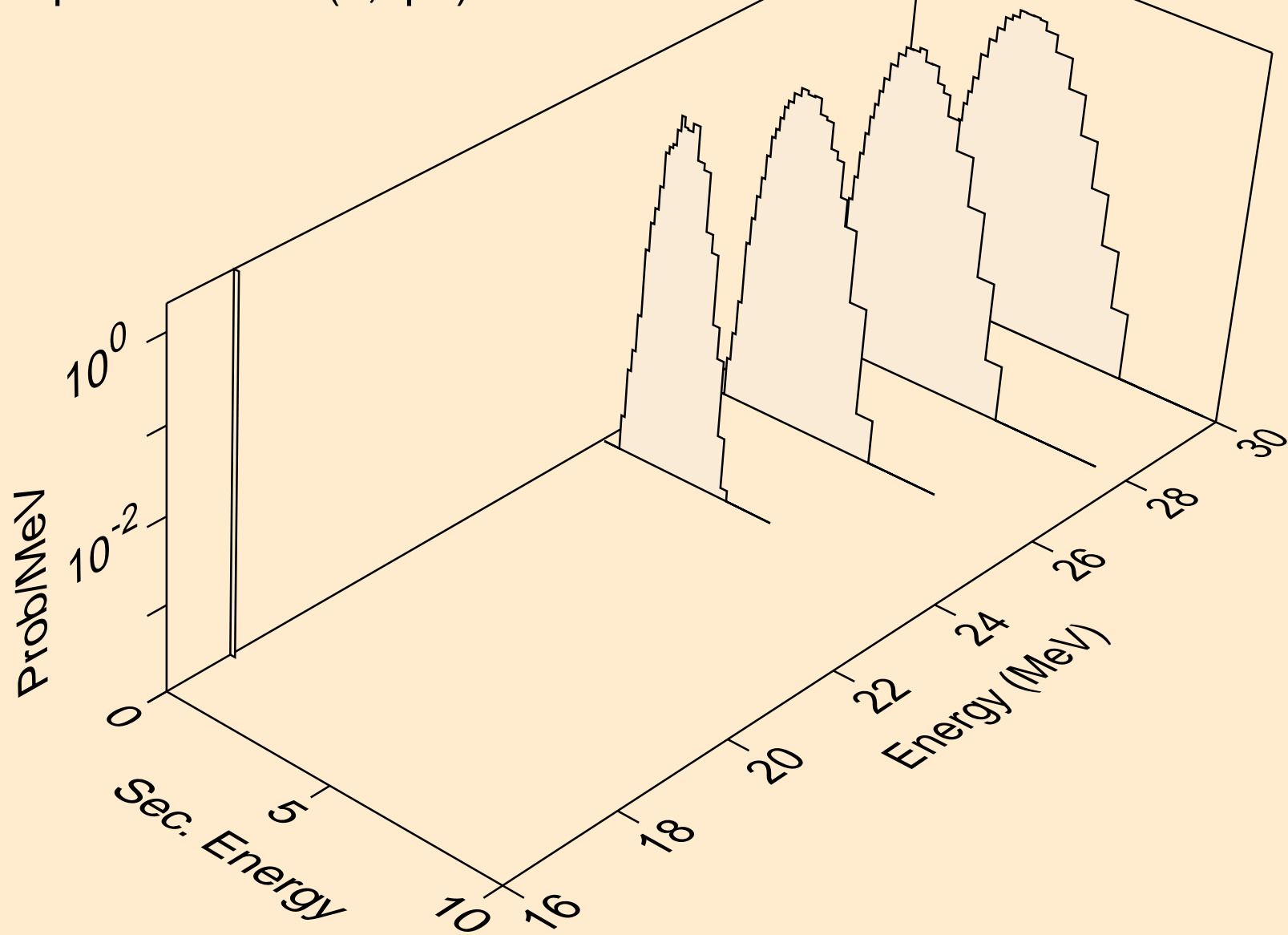

KR083 NEUTRON ACER TENDL-2021 LIBRARY; T=293.6K
protons from (n,p)

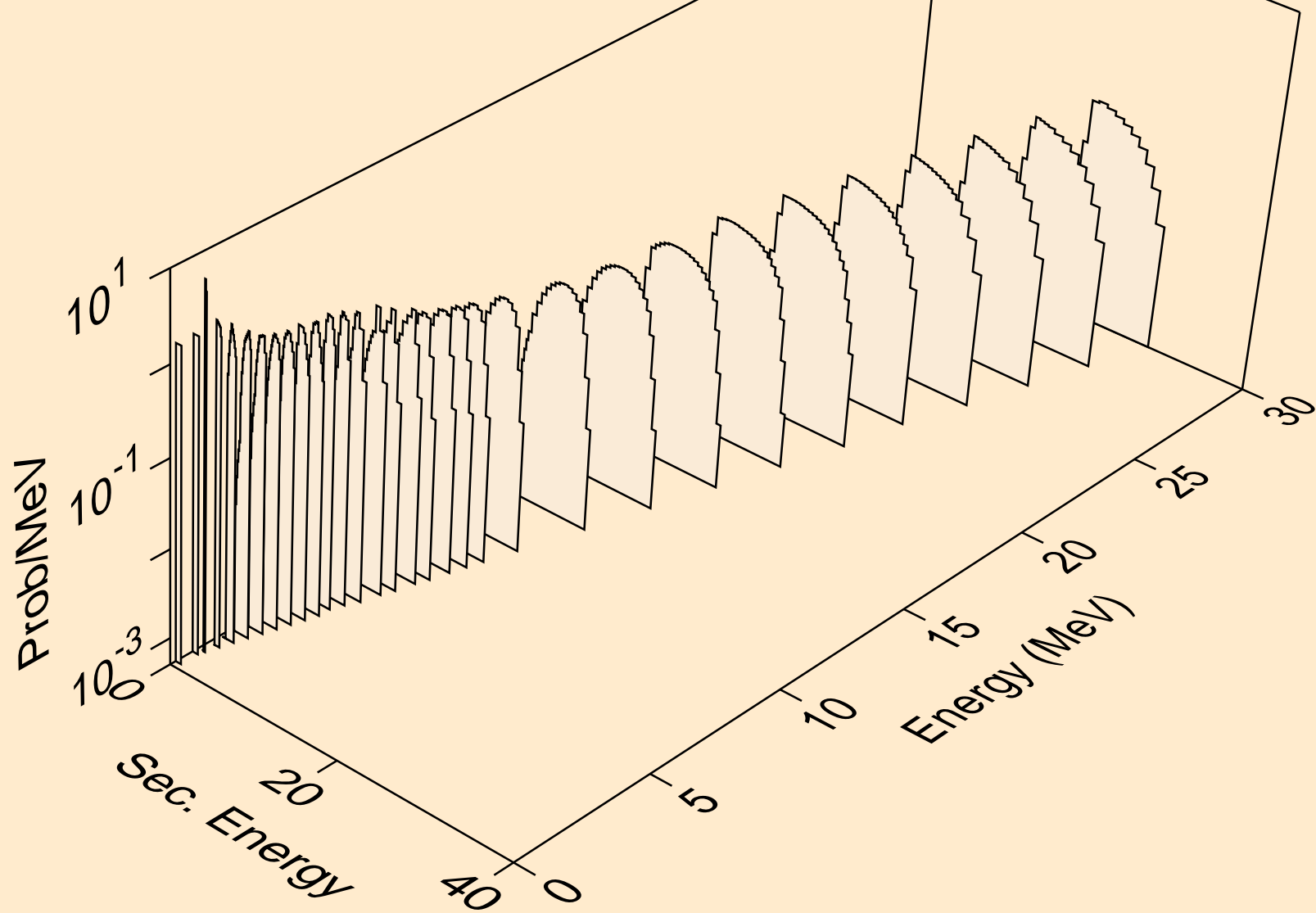

KR083 NEUTRON ACER TENDL-2021 LIBRARY; T=293.6K
protons from (n,2p)

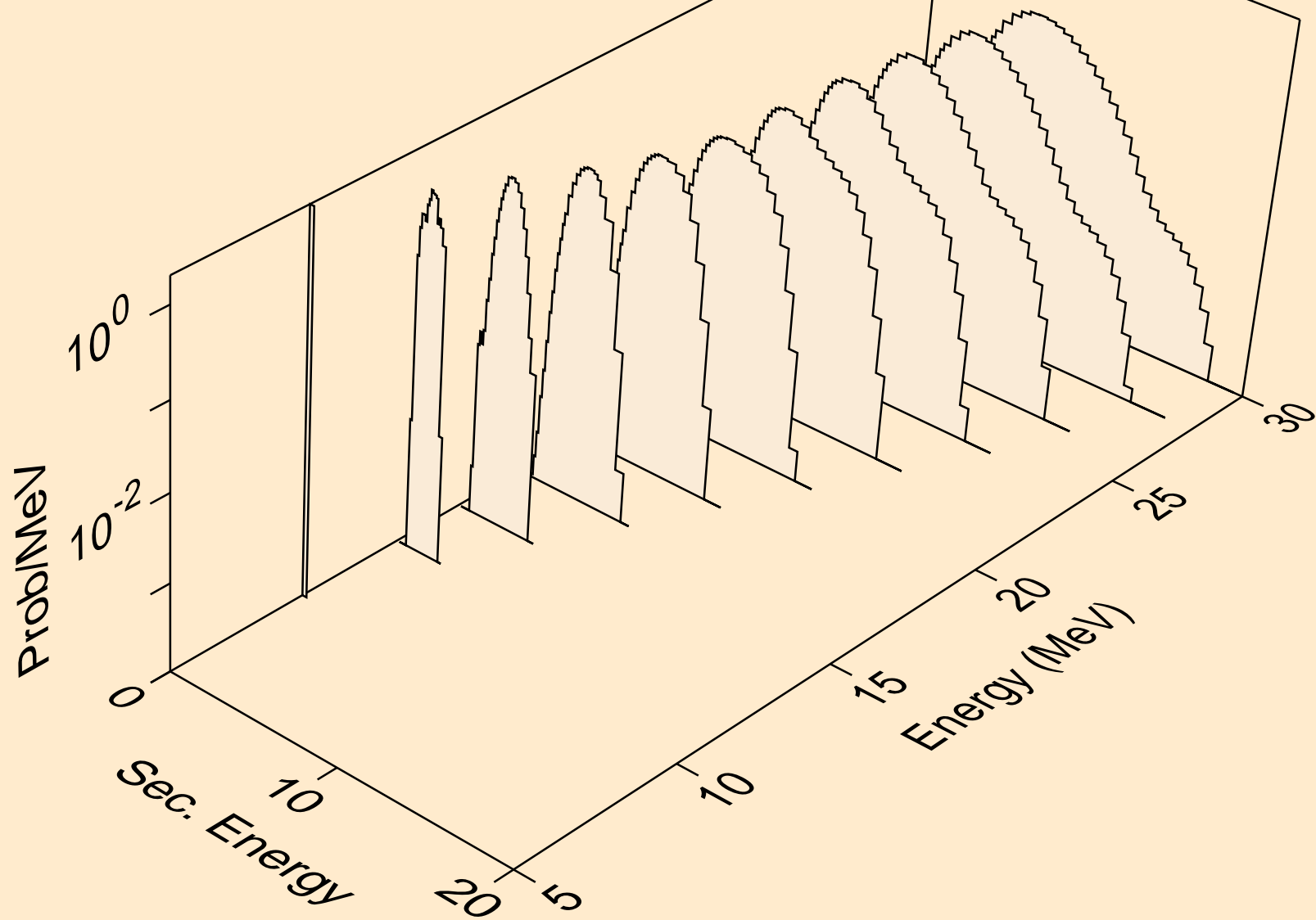

KR083 NEUTRON ACER TENDL-2021 LIBRARY; T=293.6K
protons from (n,p)

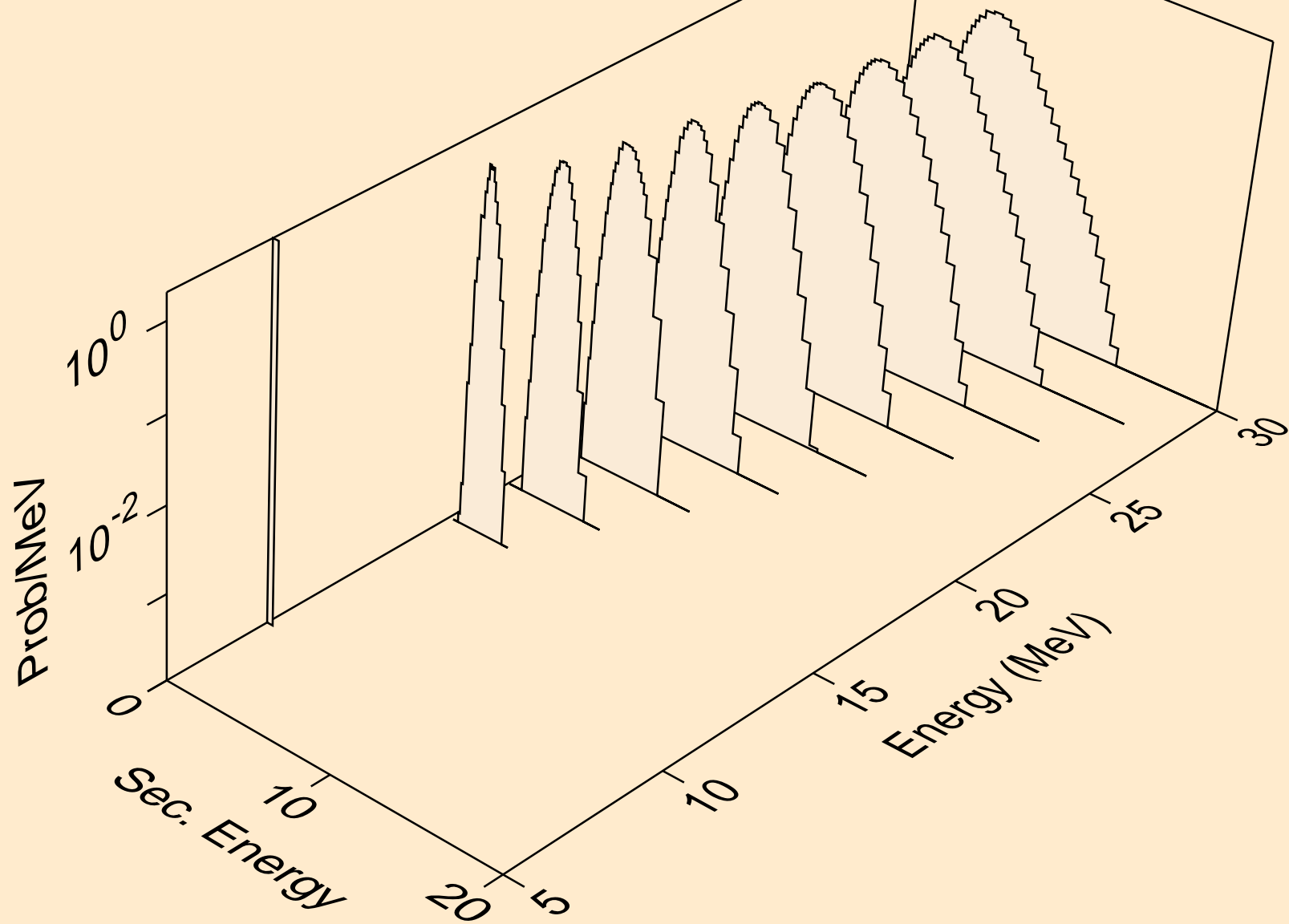

KR083 NEUTRON ACER TENDL-2021 LIBRARY; T=293.6K
protons from (n,pd)

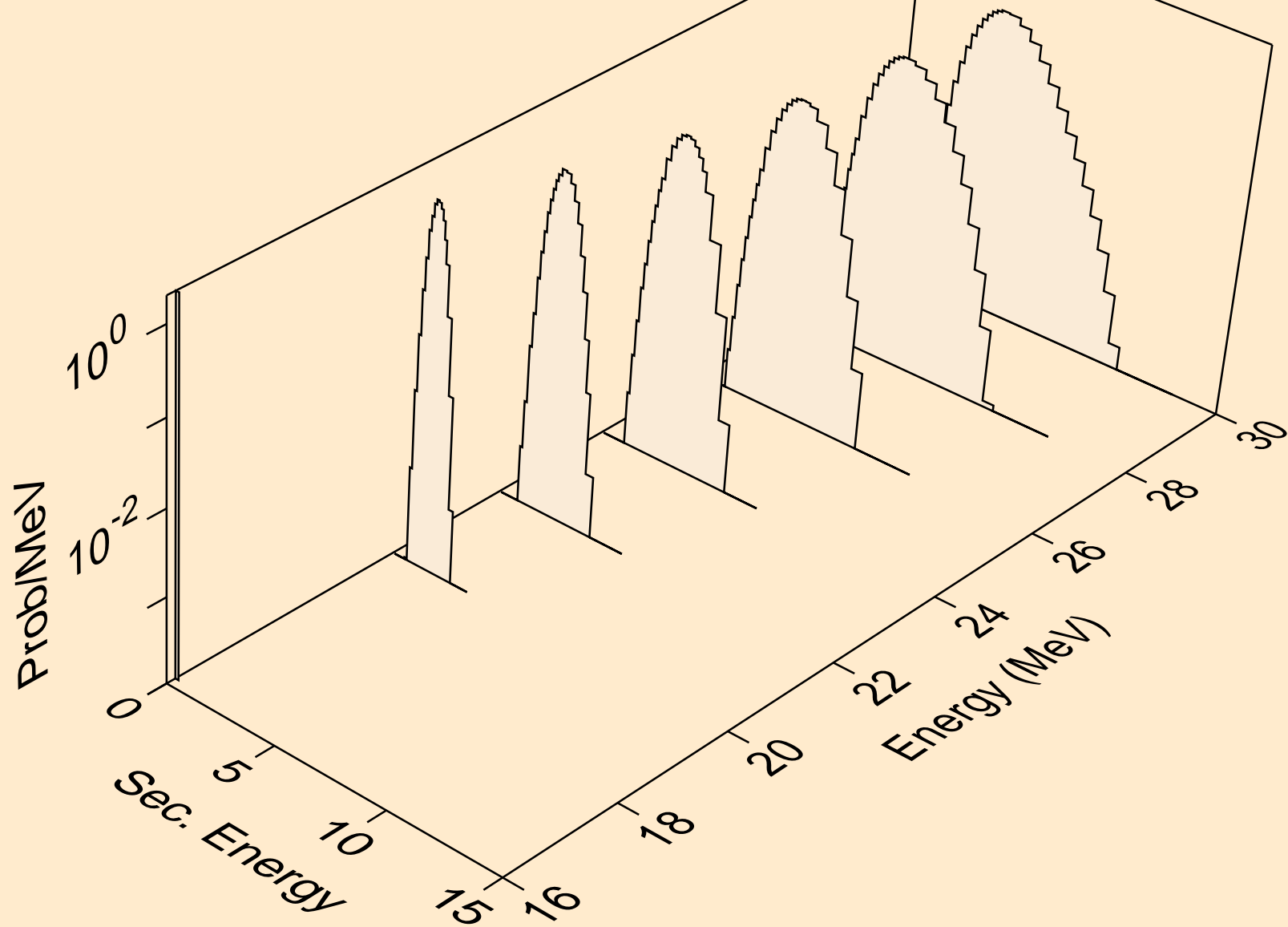

KR083 NEUTRON ACER TENDL-2021 LIBRARY; T=293.6K
protons from (n,pt)

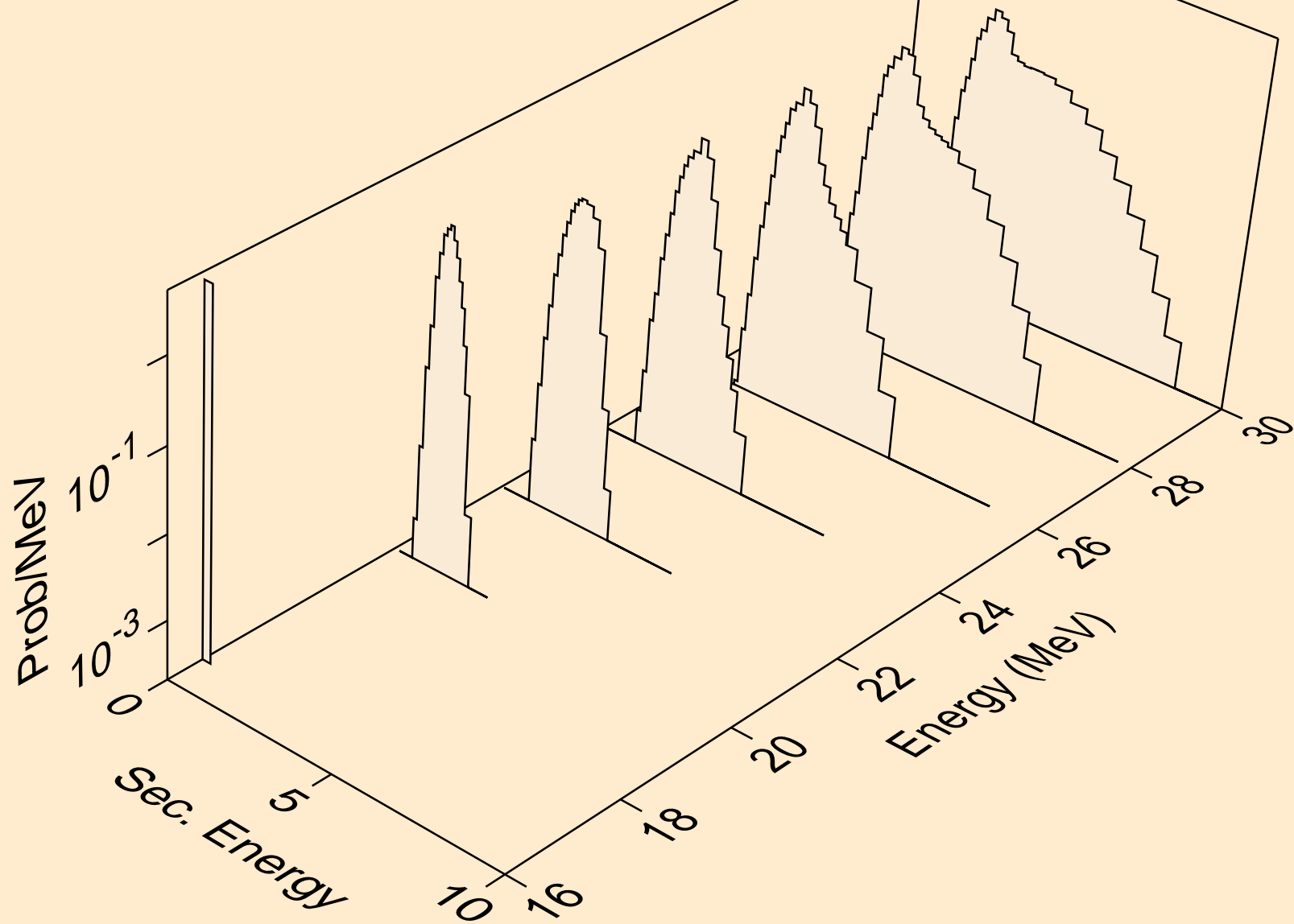

KR083 NEUTRON ACER TENDL-2021 LIBRARY; T=293.6K
deuterons from (n,x)

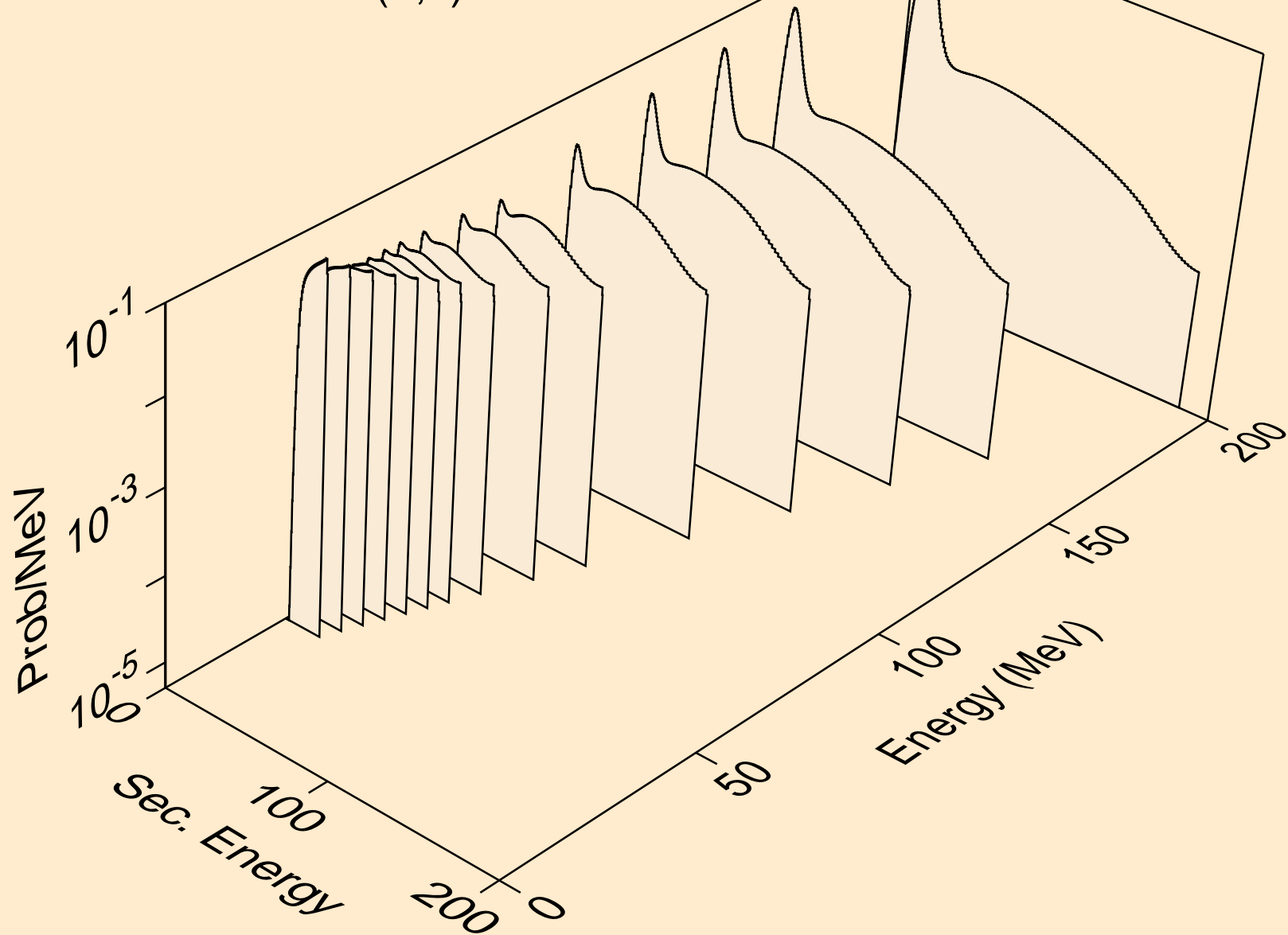

KR083 NEUTRON ACER TENDL-2021 LIBRARY; T=293.6K
deuterons from (n,2nd)

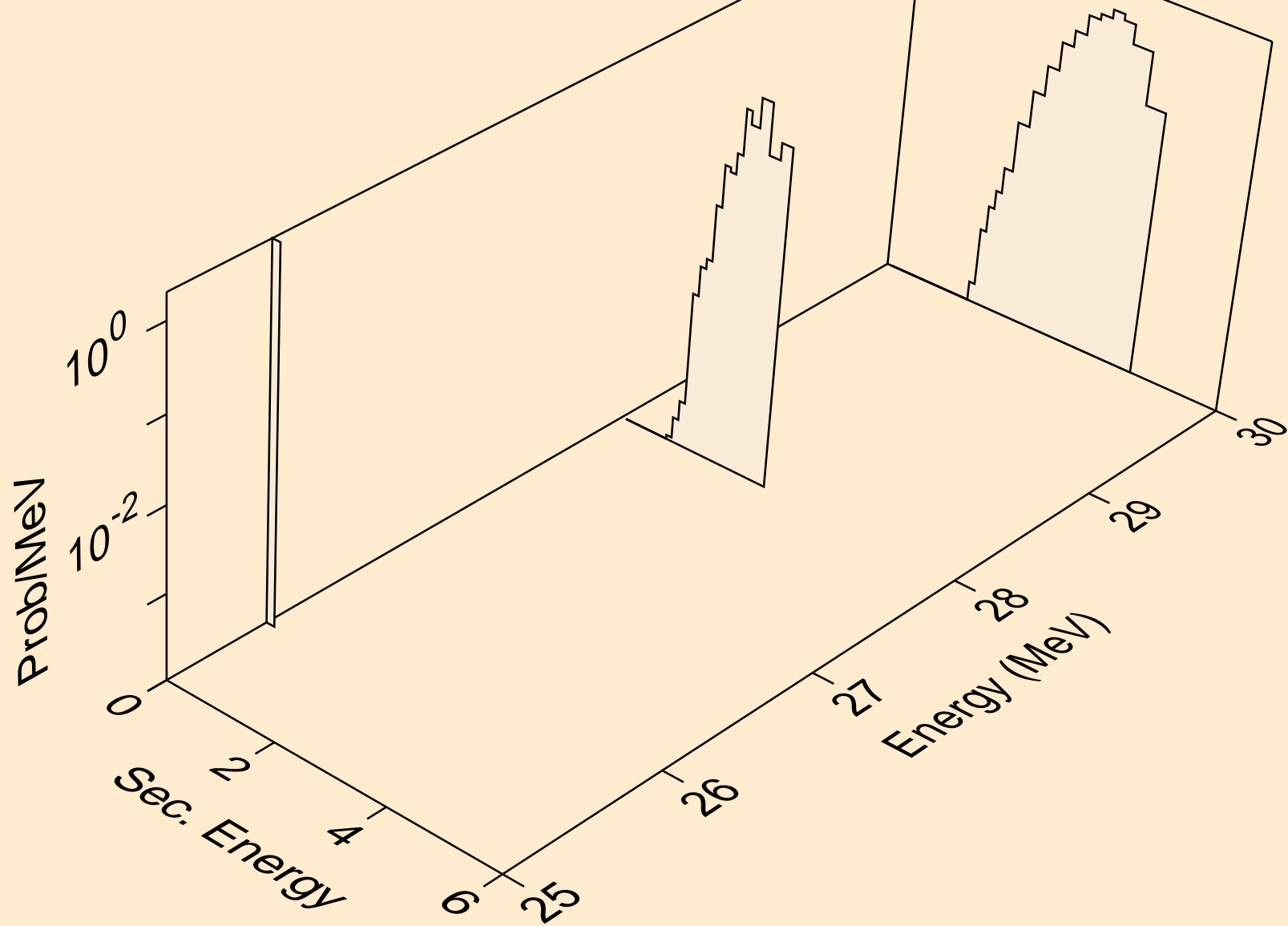

KR083 NEUTRON ACER TENDL-2021 LIBRARY; T=293.6K
deuterons from (n,n*)d

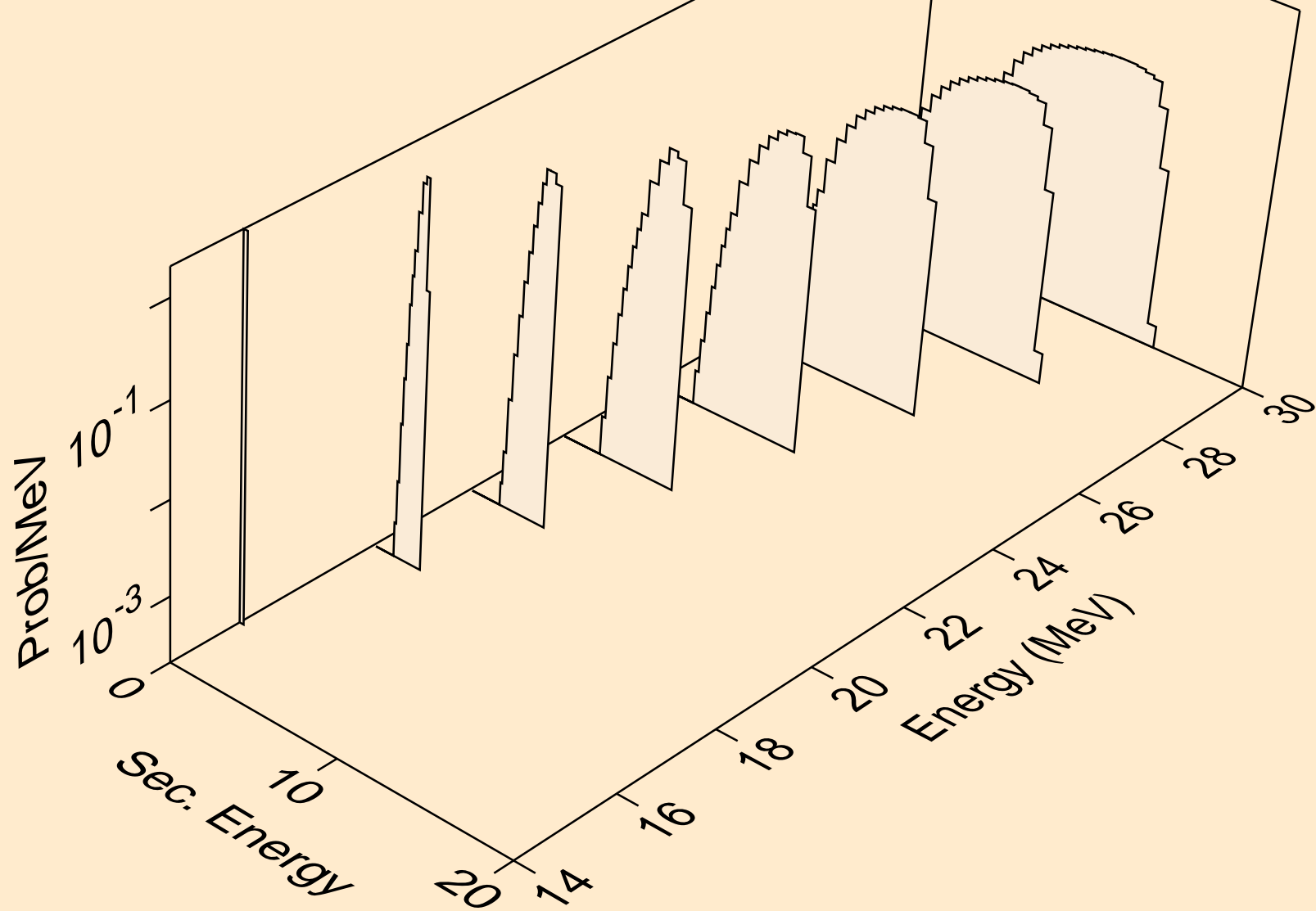

KR083 NEUTRON ACER TENDL-2021 LIBRARY; T=293.6K
deuterons from (n,d)

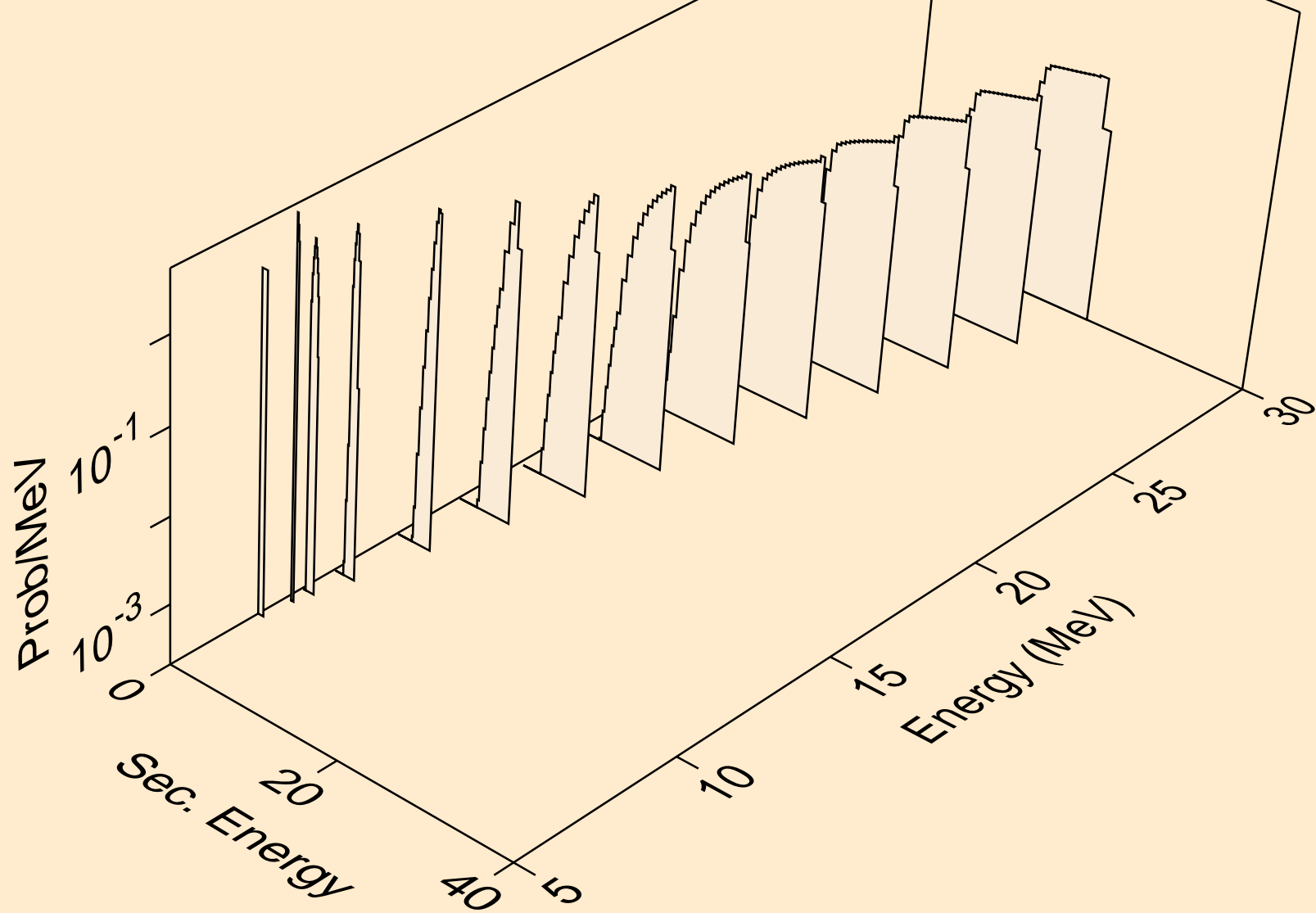

KR083 NEUTRON ACER TENDL-2021 LIBRARY; T=293.6K
deuterons from (n,pd)

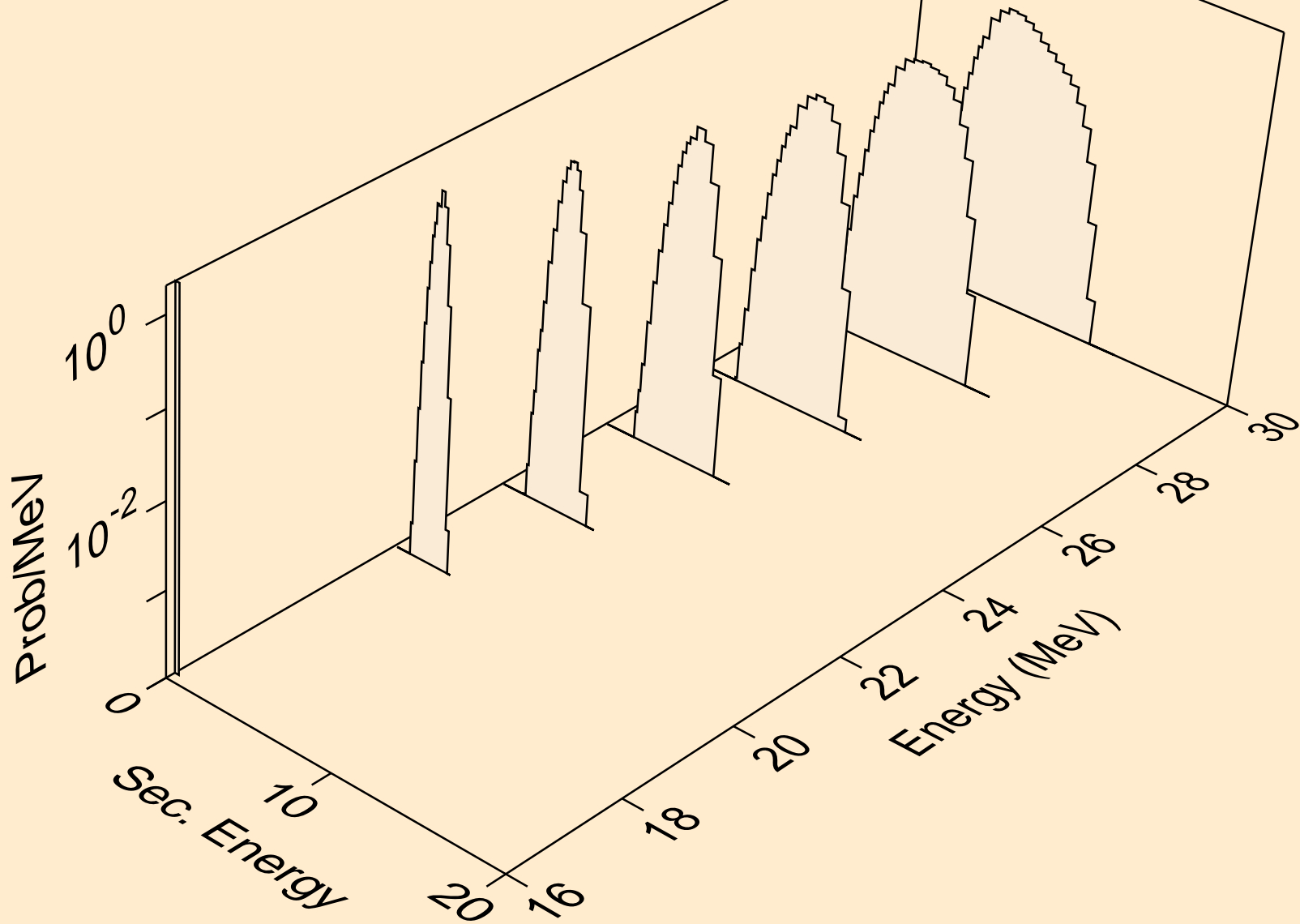

KR083 NEUTRON ACER TENDL-2021 LIBRARY; T=293.6K
deuterons from (n,da)

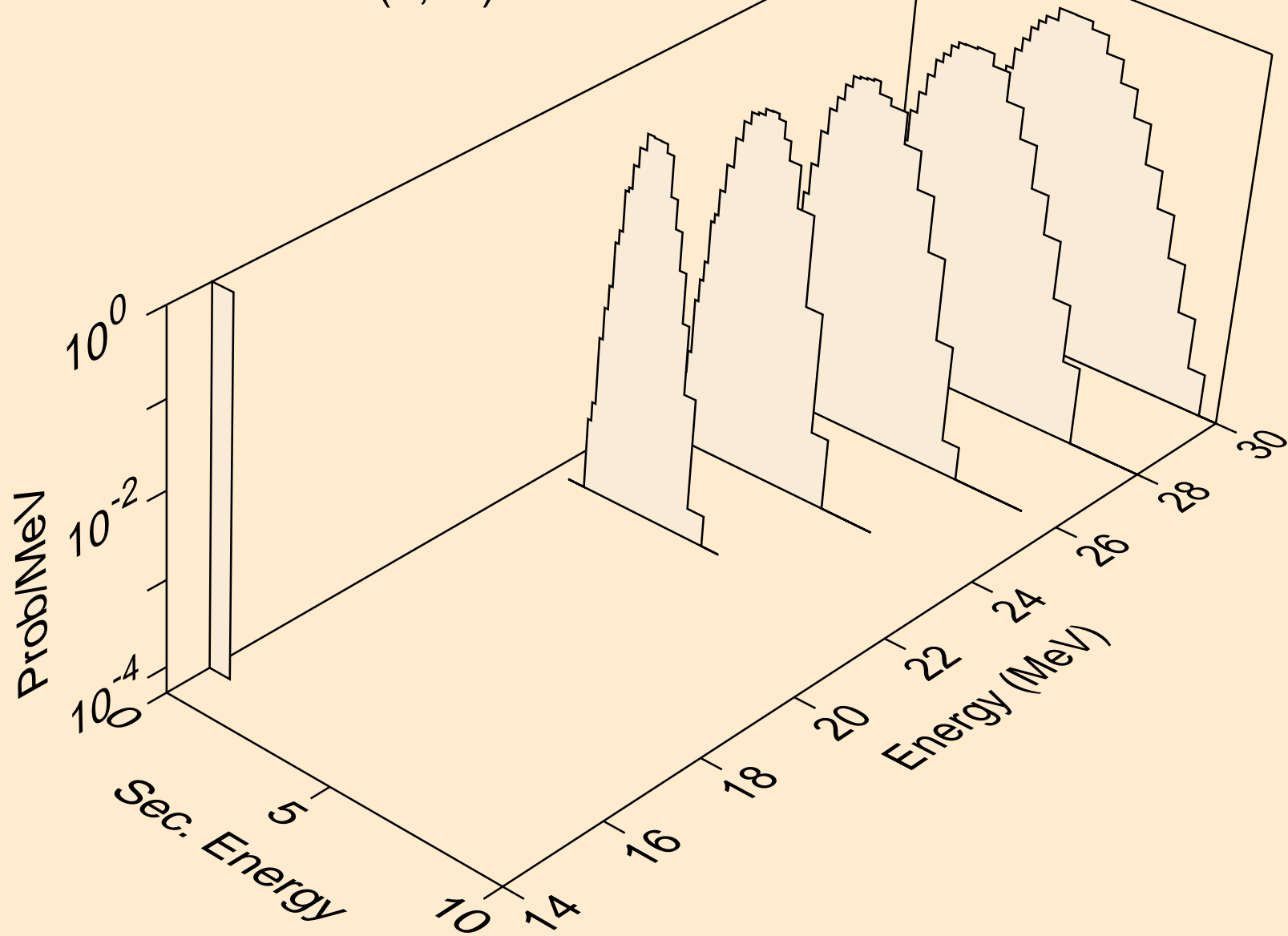

KR083 NEUTRON ACER TENDL-2021 LIBRARY; T=293.6K
tritons from (n,x)

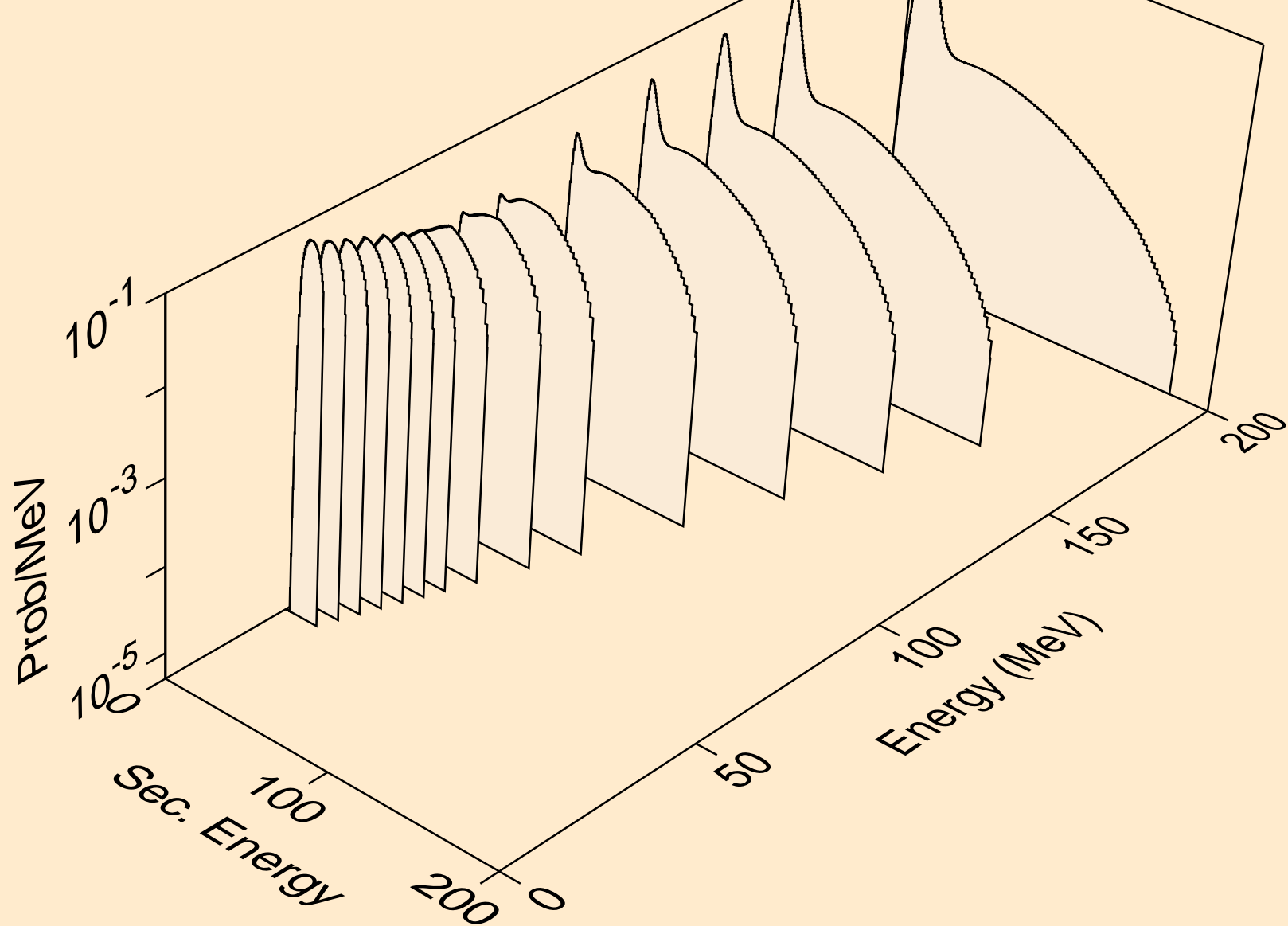

KR083 NEUTRON ACER TENDL-2021 LIBRARY; T=293.6K
tritons from (n,n*)t

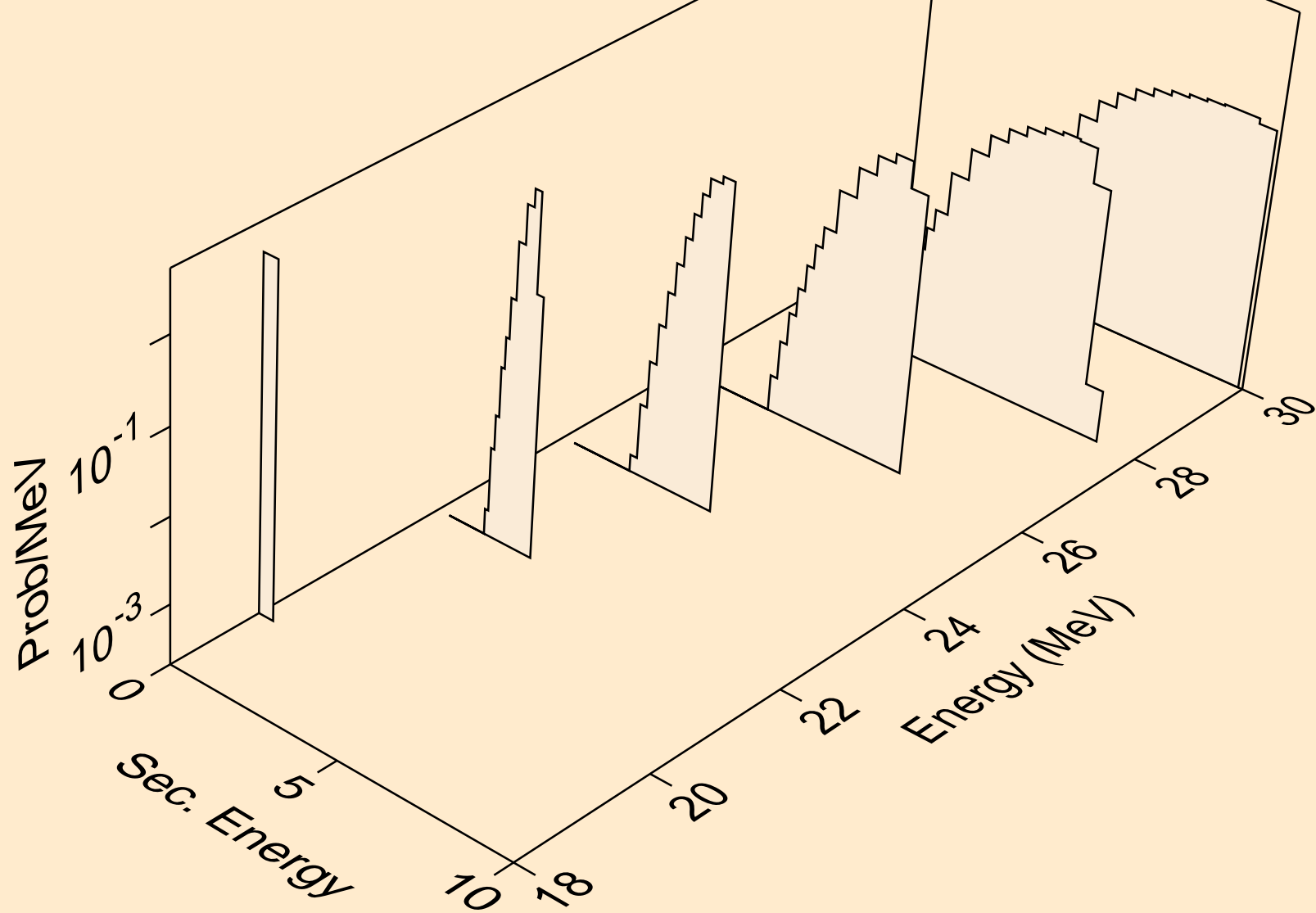

KR083 NEUTRON ACER TENDL-2021 LIBRARY; T=293.6K
tritons from (n,t)

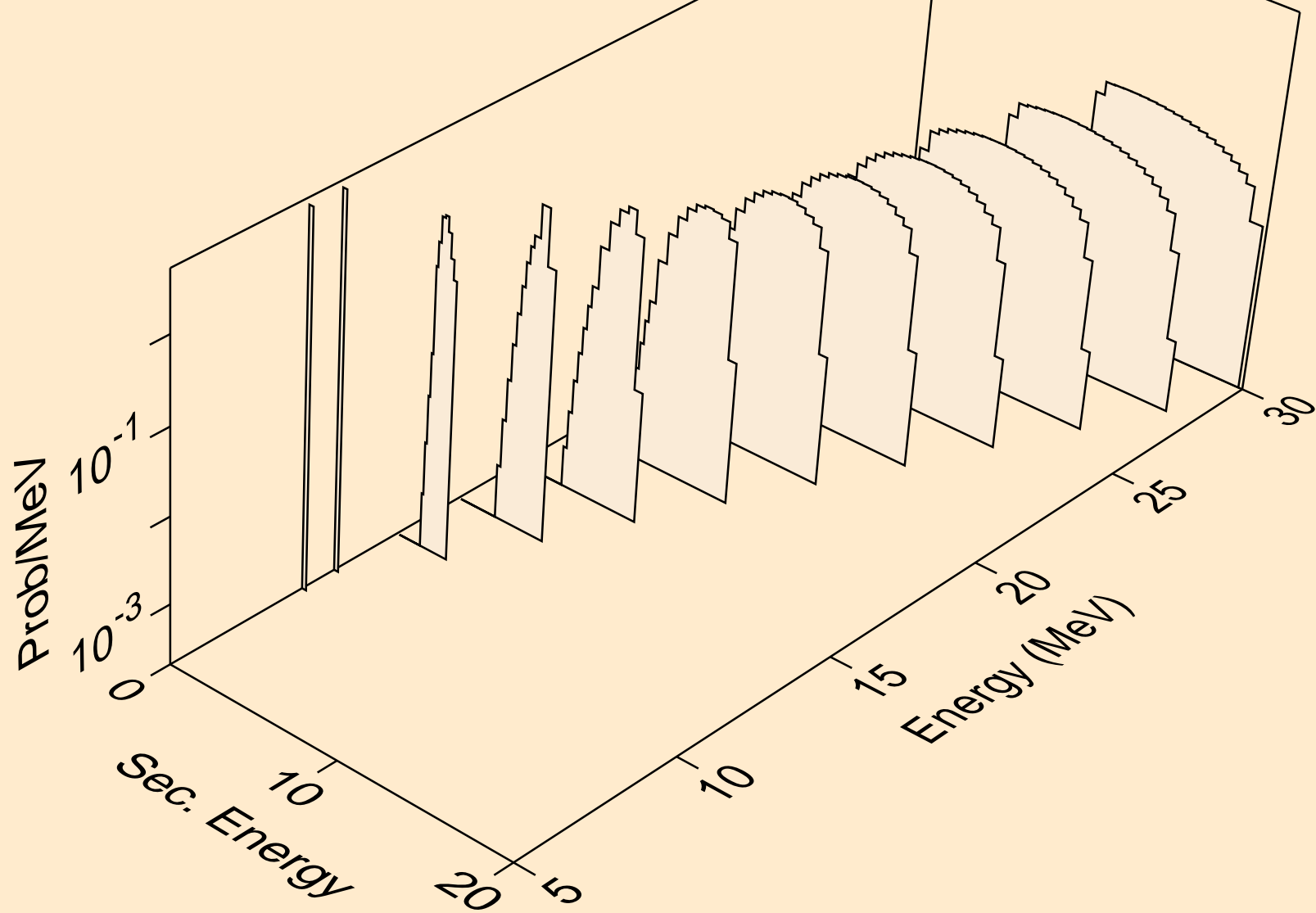

KR083 NEUTRON ACER TENDL-2021 LIBRARY; T=293.6K
tritons from (n,pt)

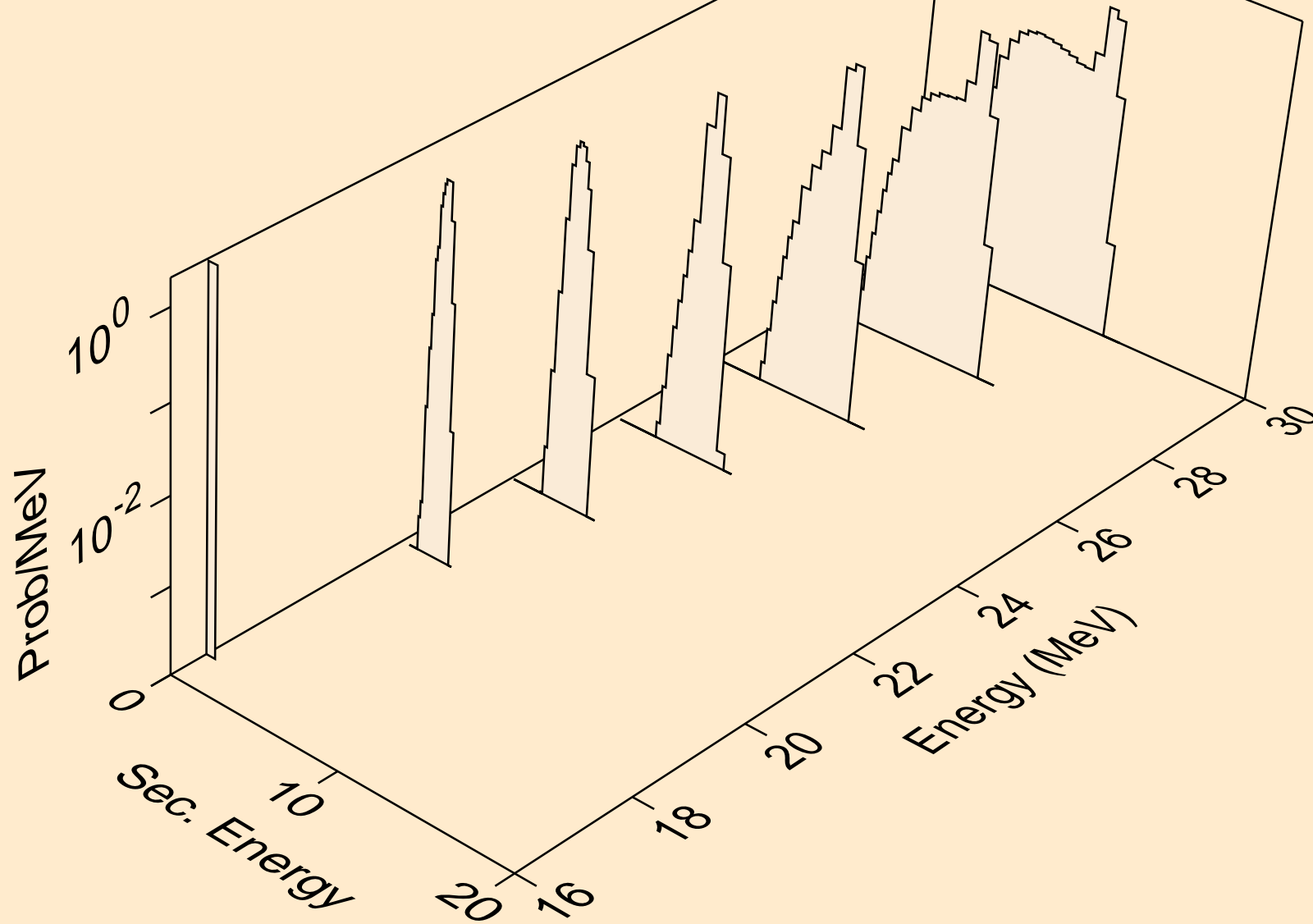

KR083 NEUTRON ACER TENDL-2021 LIBRARY; T=293.6K
he3s from (n,x)

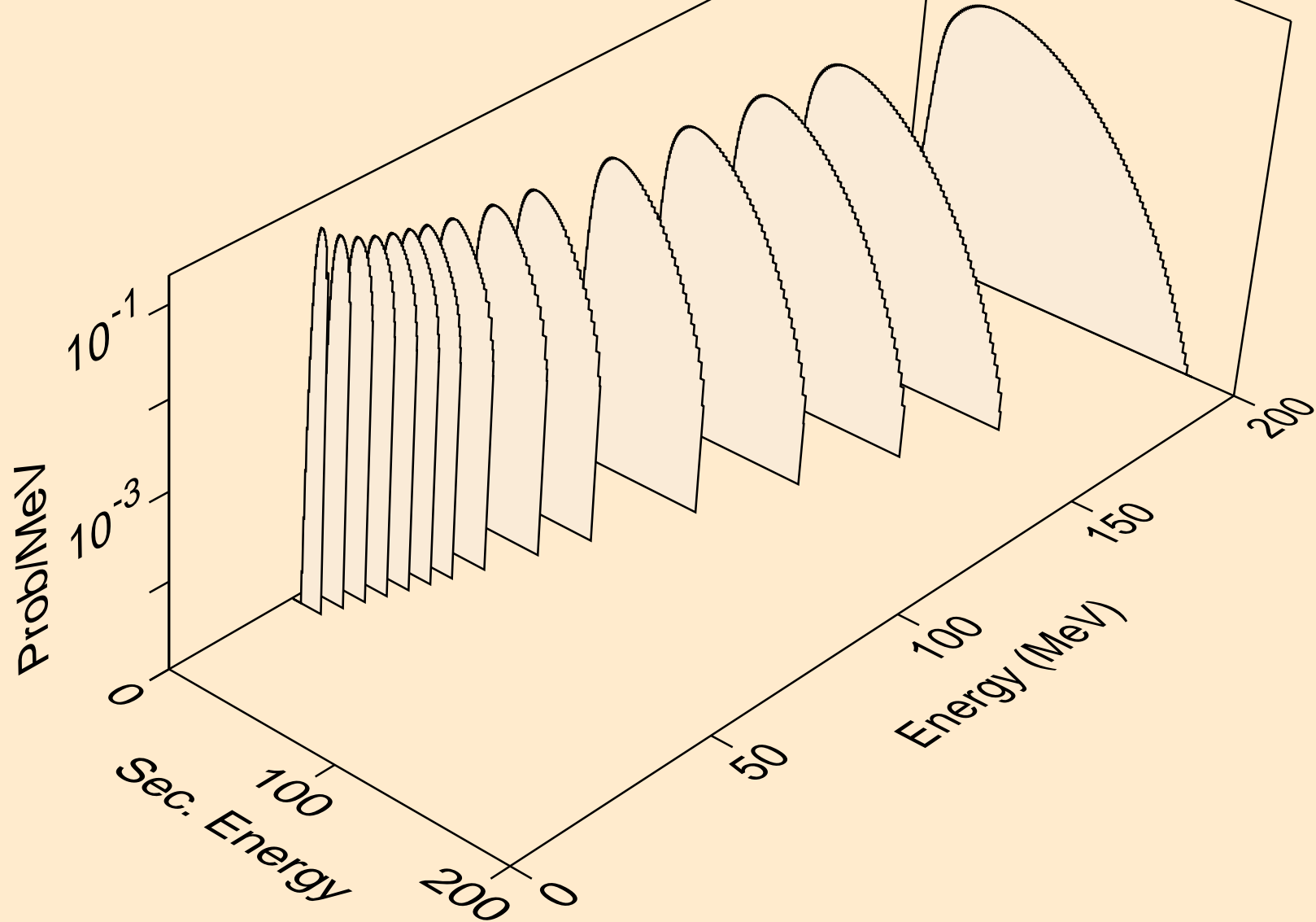

KR083 NEUTRON ACER TENDL-2021 LIBRARY; T=293.6K
he3s from (n,n*)he3

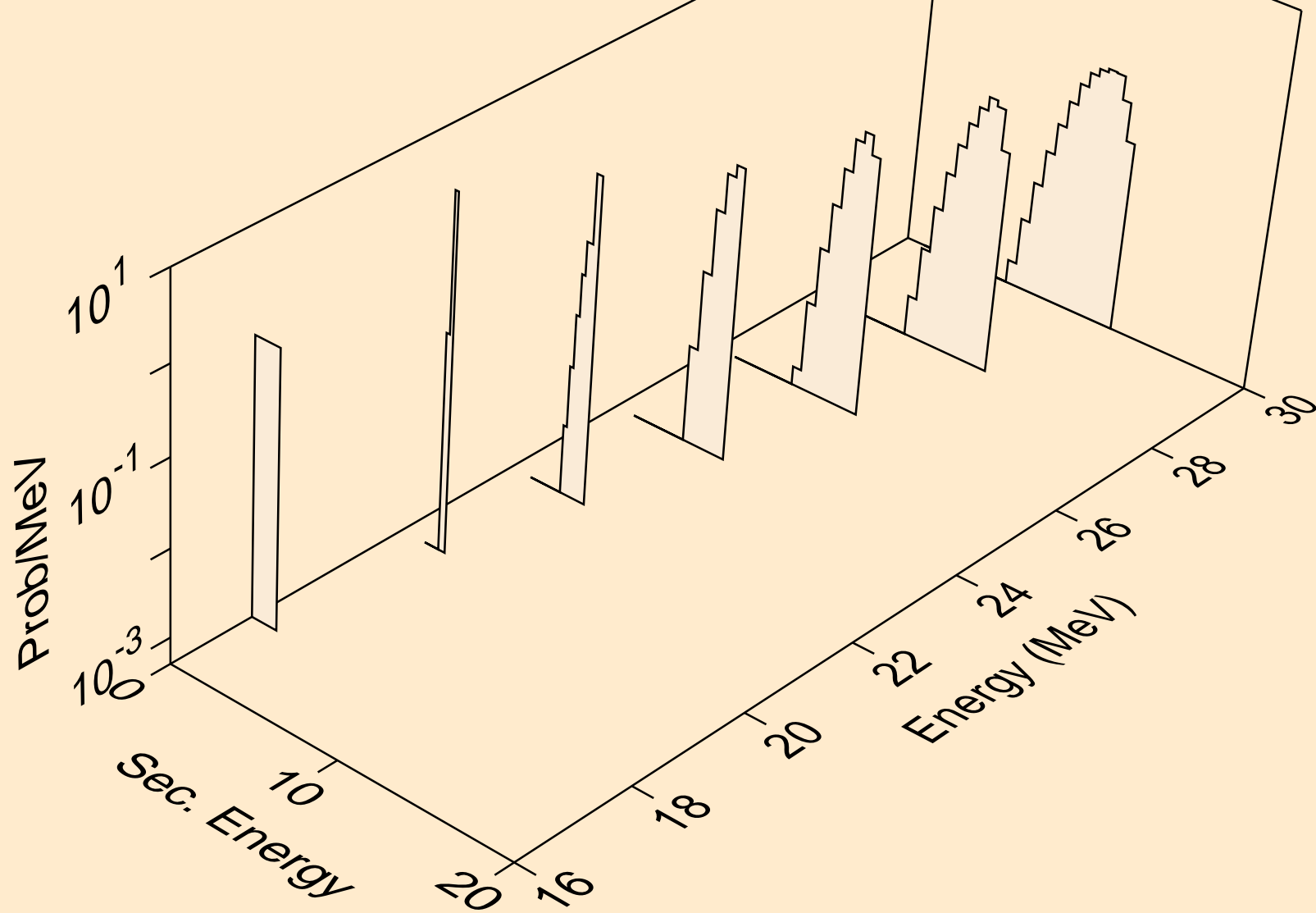

KR083 NEUTRON ACER TENDL-2021 LIBRARY; T=293.6K
he3s from (n,he3)

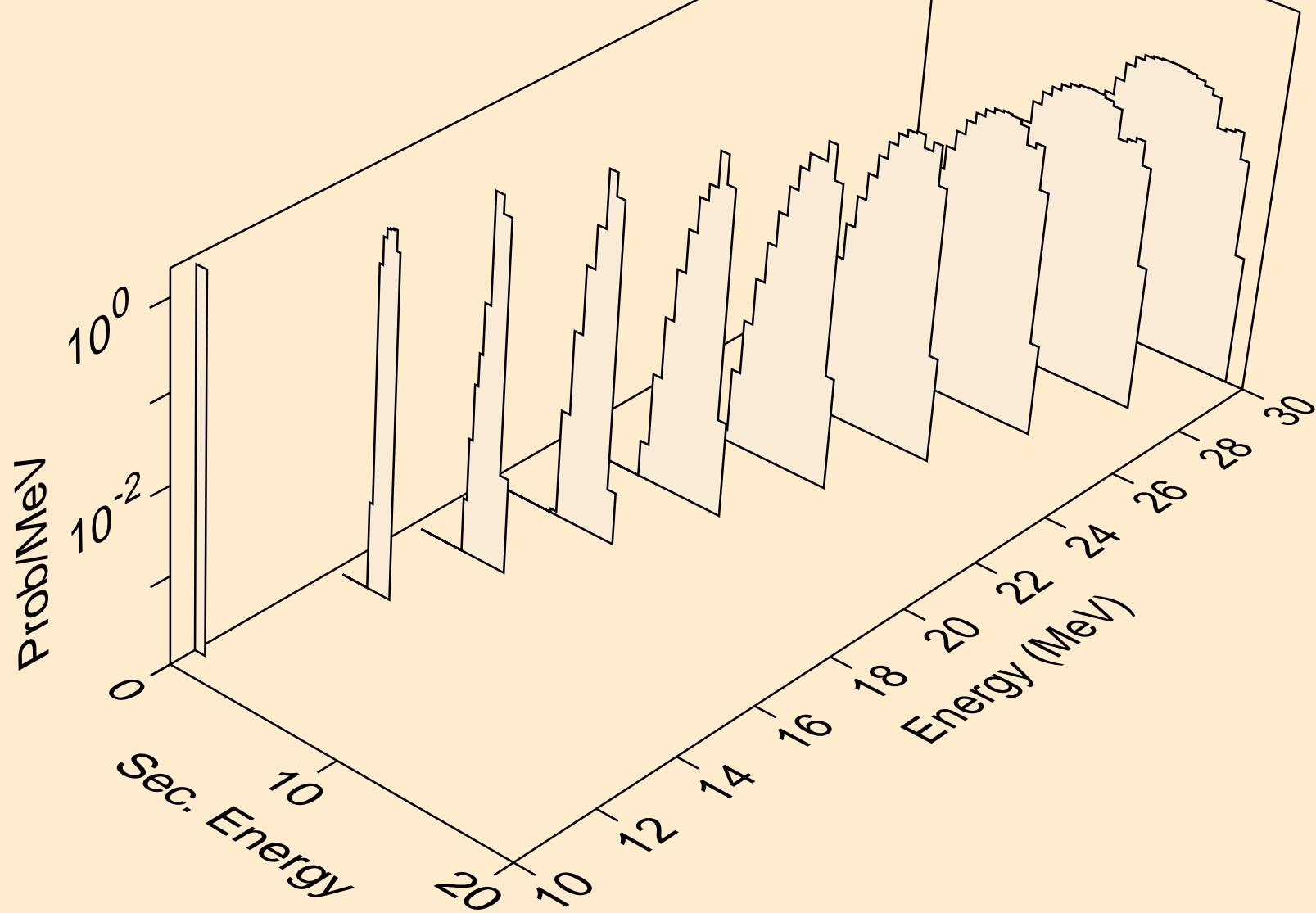

KR083 NEUTRON ACER TENDL-2021 LIBRARY; T=293.6K
alphas from (n,x)

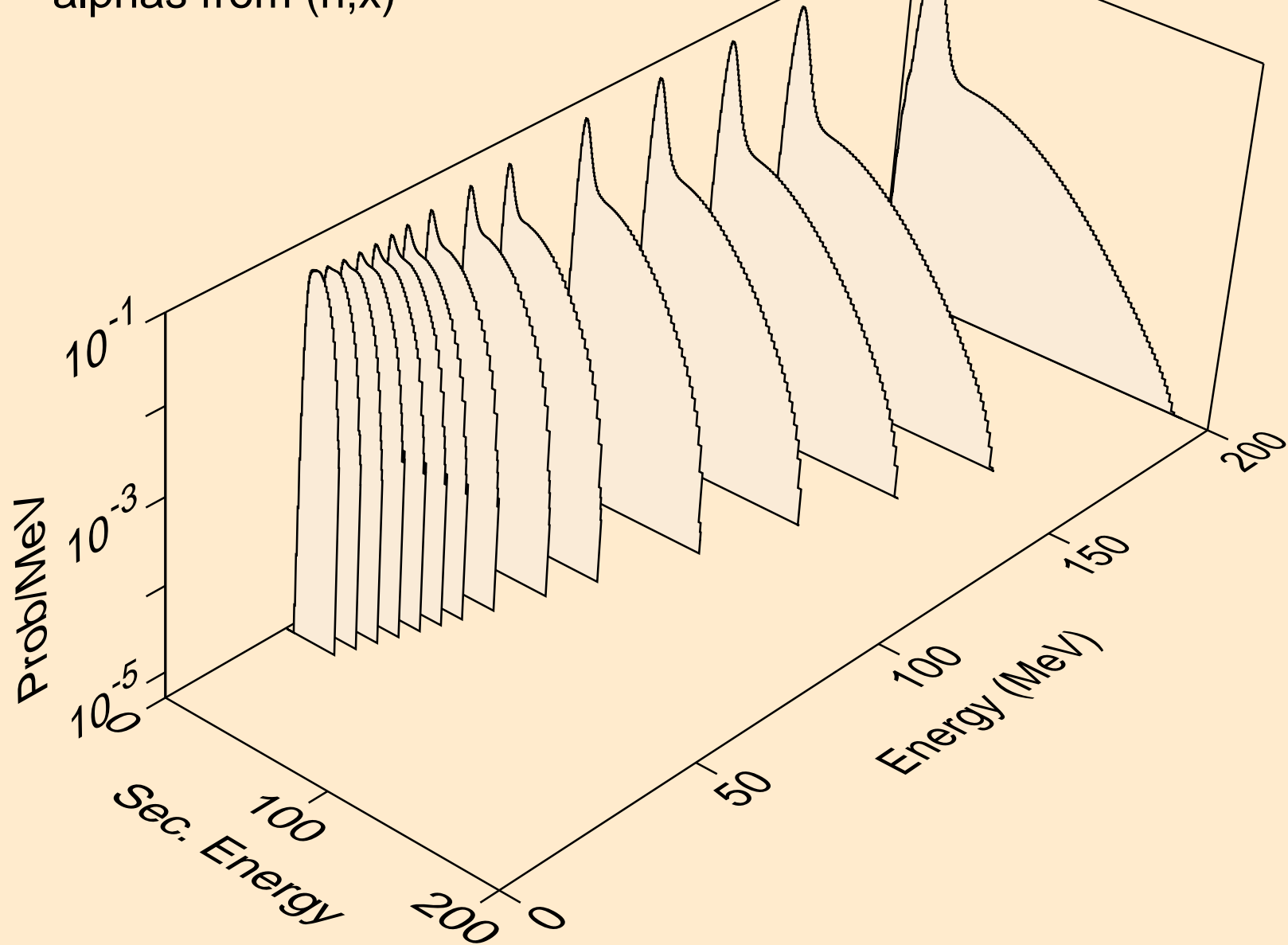

KR083 NEUTRON ACER TENDL-2021 LIBRARY; T=293.6K
alphas from (n,n*)a

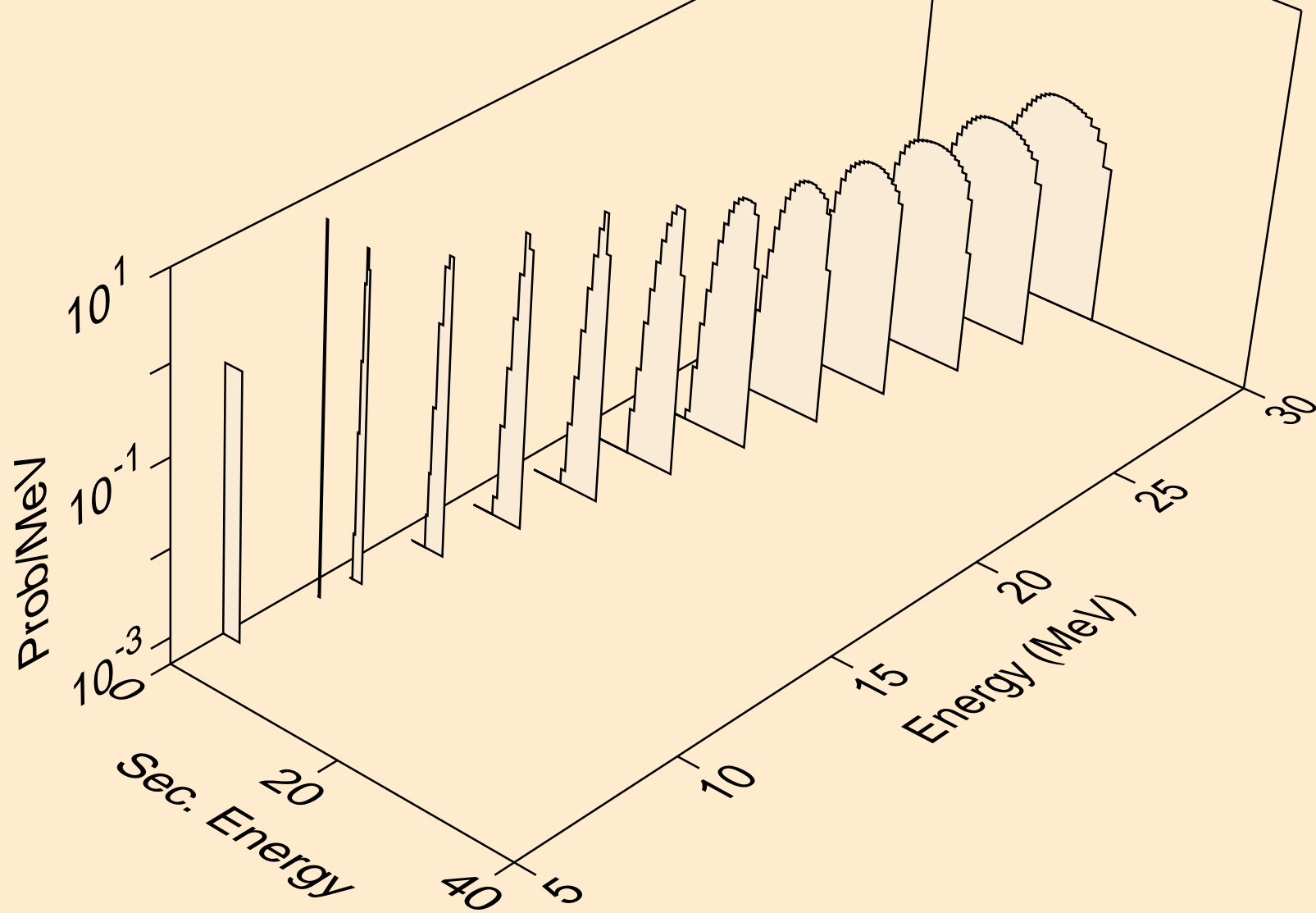

KR083 NEUTRON ACER TENDL-2021 LIBRARY; T=293.6K
alphas from (n,2n)a

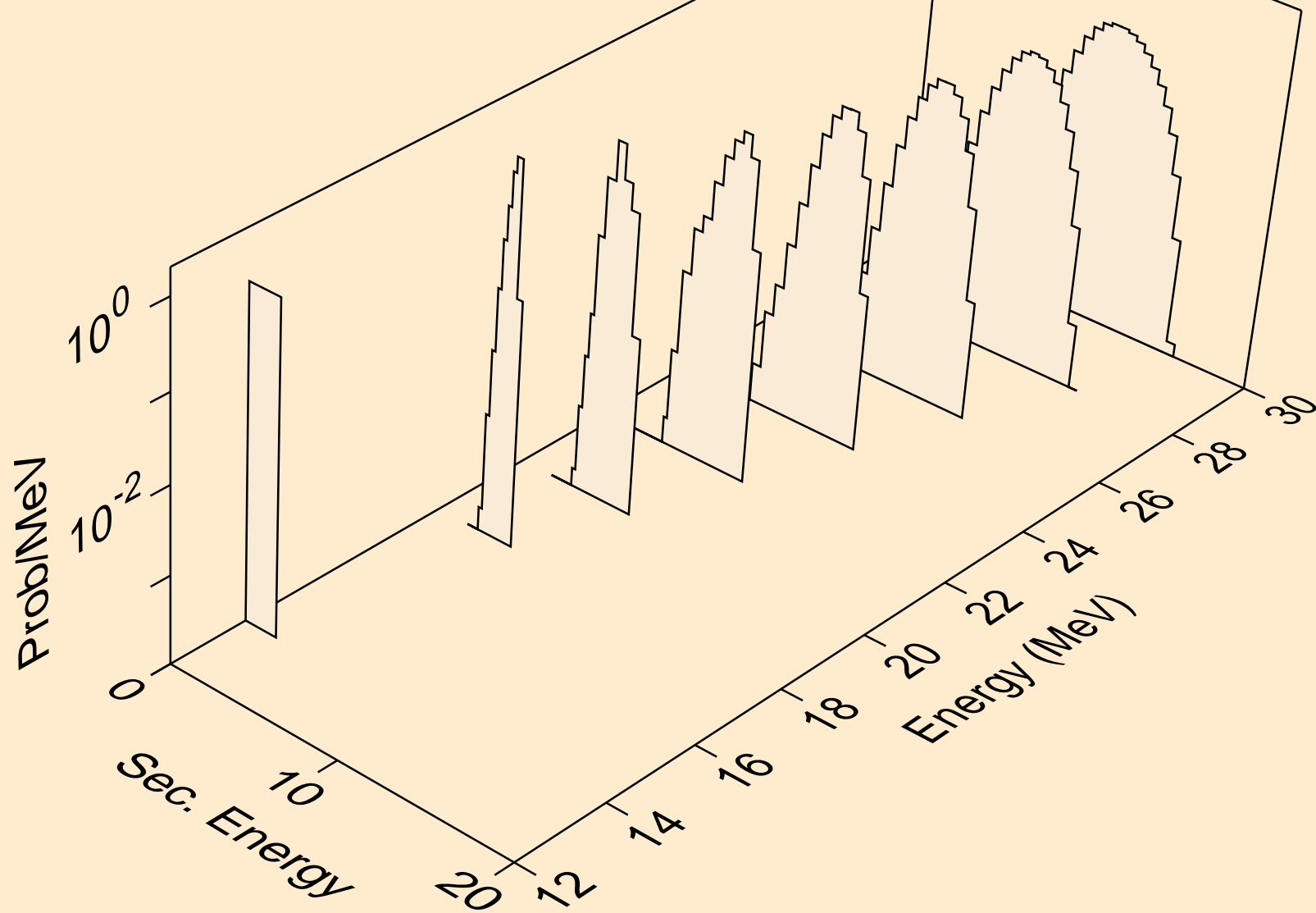

KR083 NEUTRON ACER TENDL-2021 LIBRARY; T=293.6K
alphas from (n,n*)2a

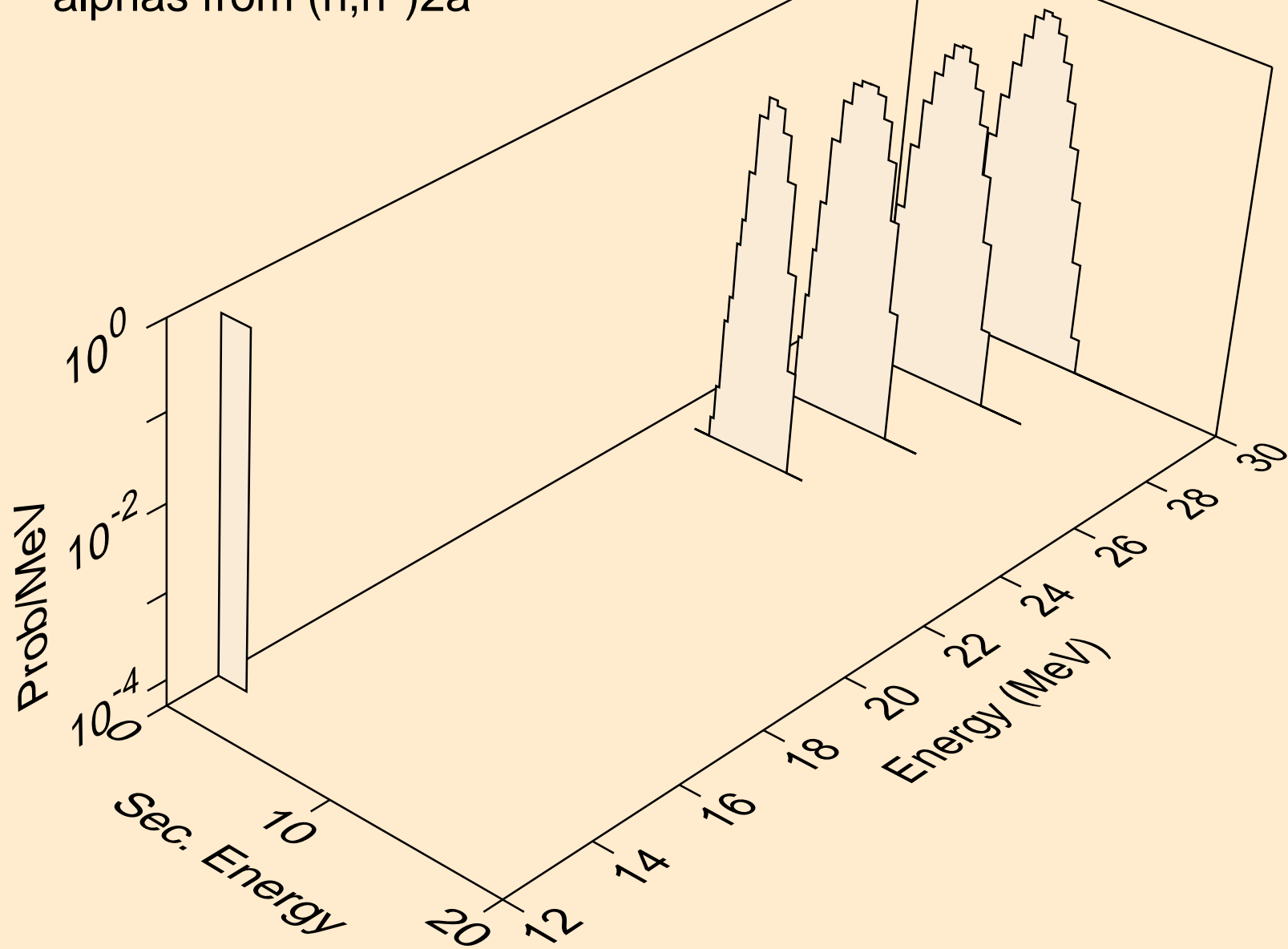

KR083 NEUTRON ACER TENDL-2021 LIBRARY; T=293.6K
alphas from (n,npa)

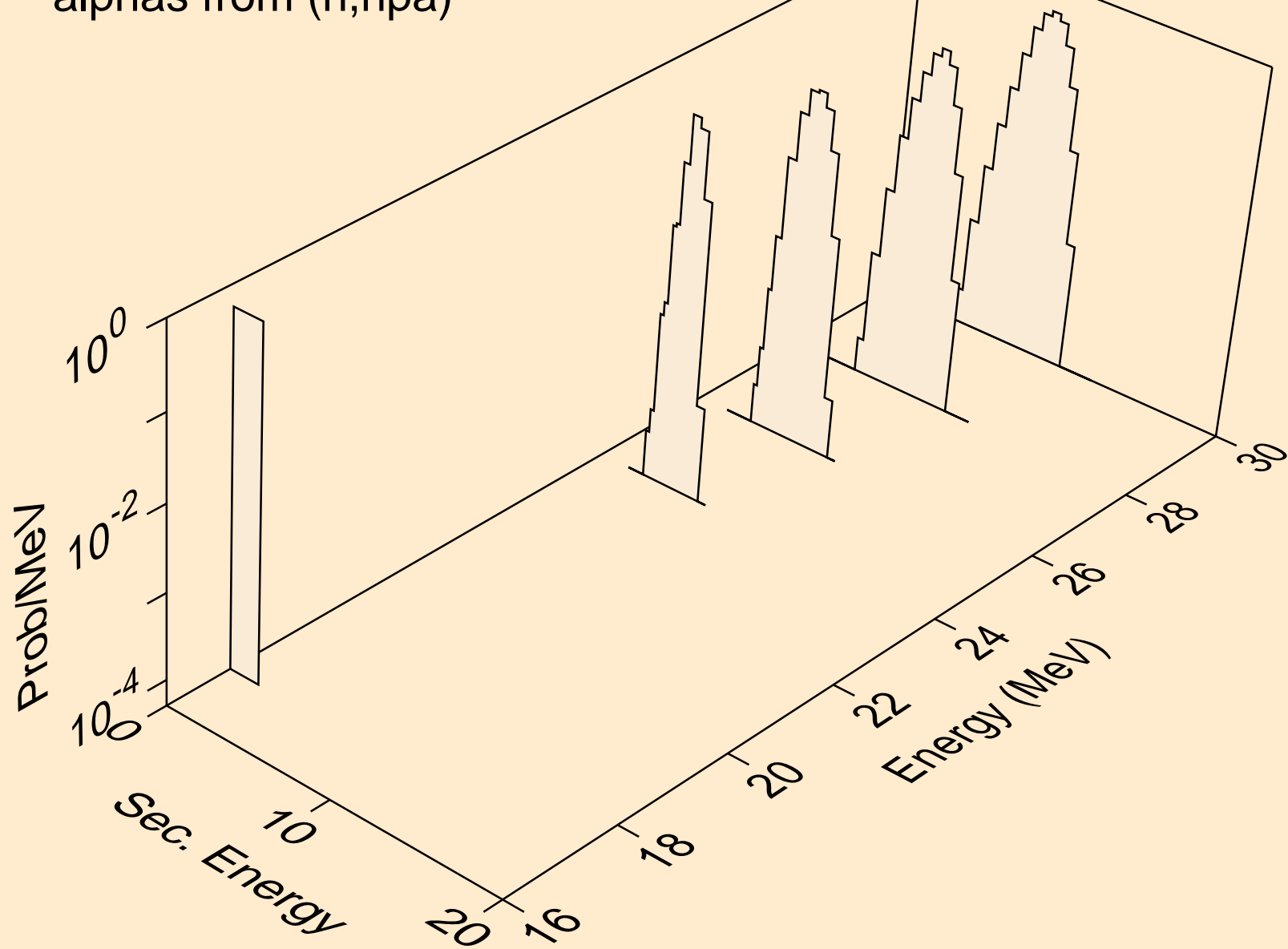

KR083 NEUTRON ACER TENDL-2021 LIBRARY; T=293.6K
alphas from (n,a)

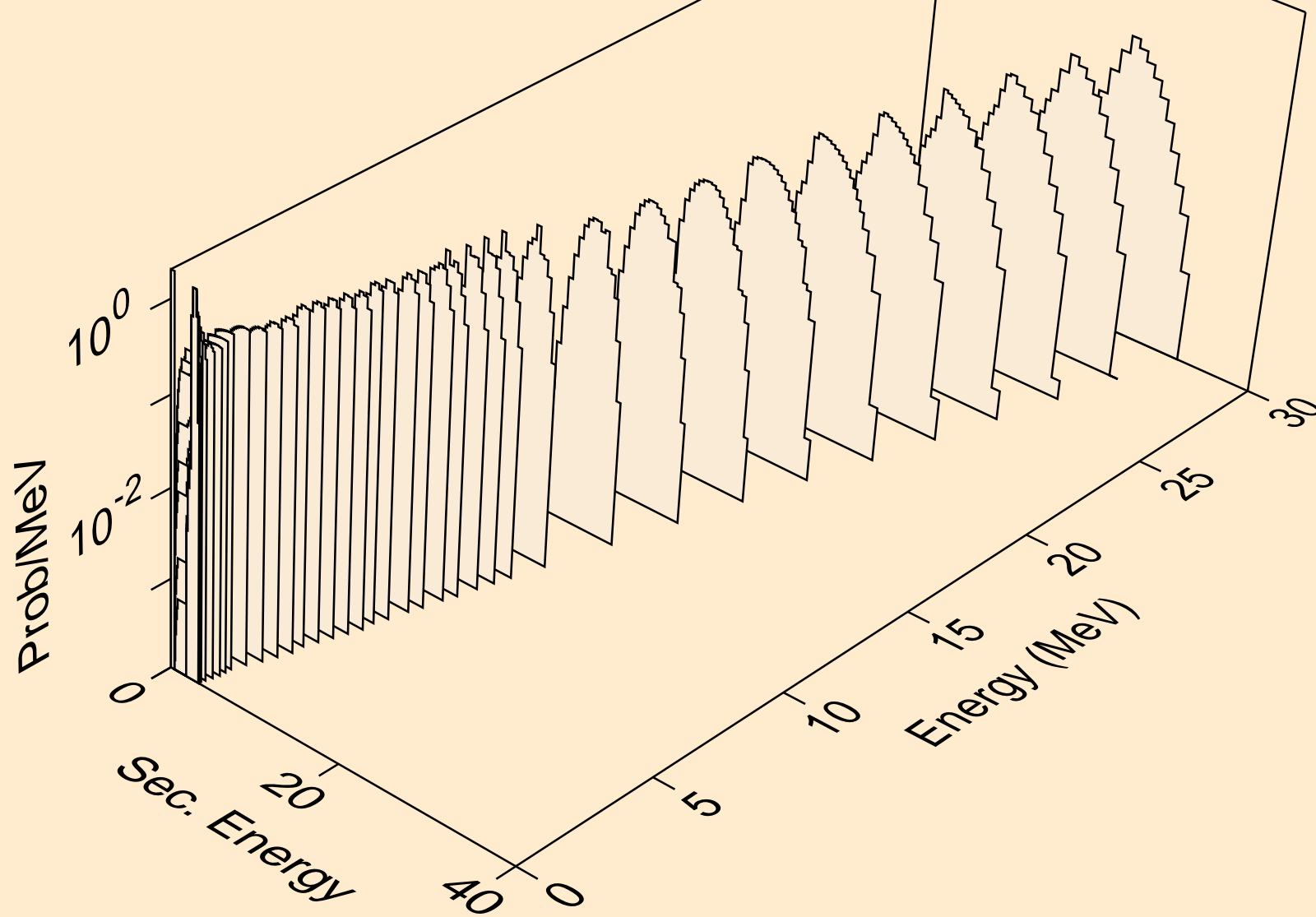

KR083 NEUTRON ACER TENDL-2021 LIBRARY; T=293.6K
alphas from (n,2a)

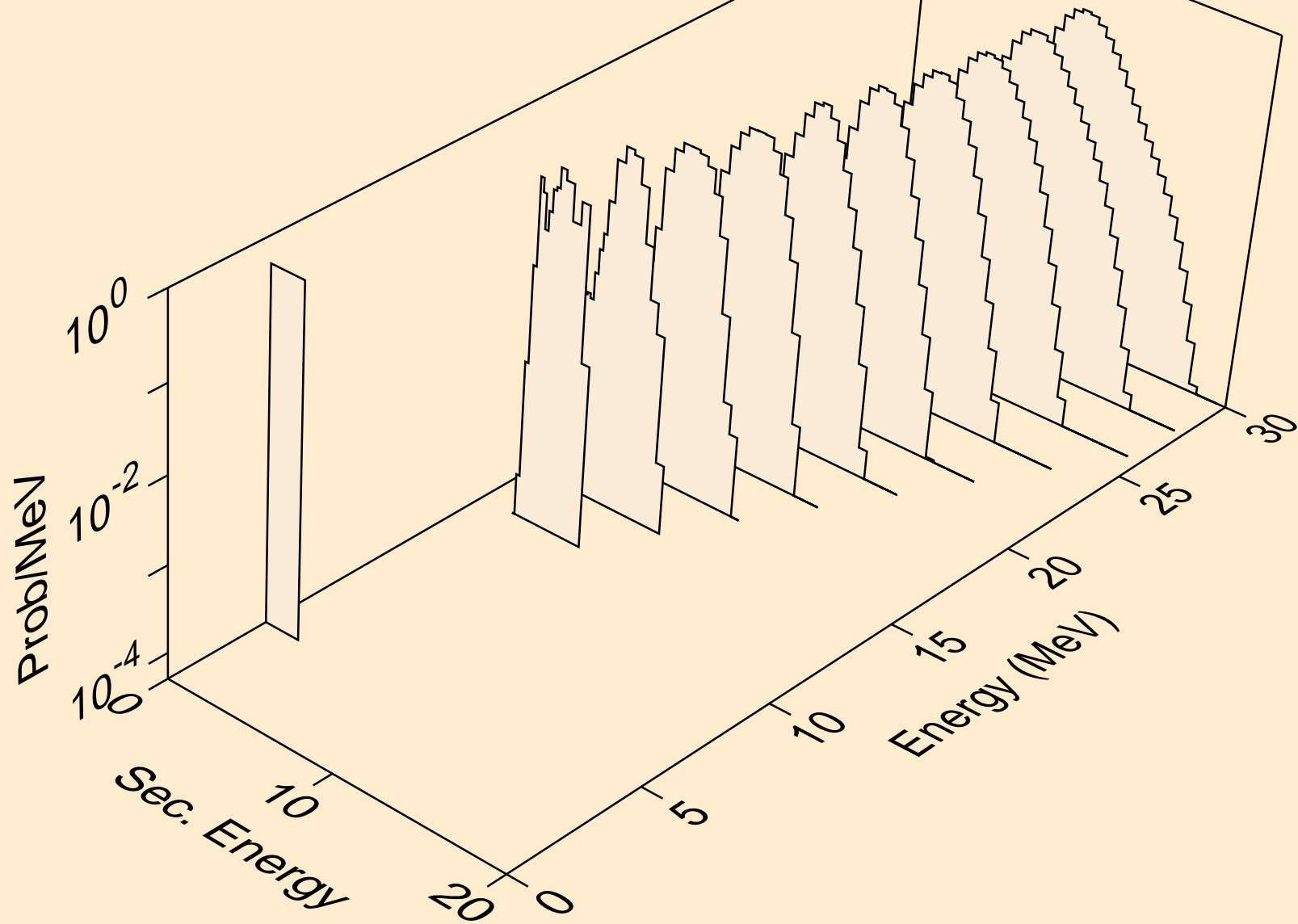

KR083 NEUTRON ACER TENDL-2021 LIBRARY; T=293.6K
alphas from (n,pa)

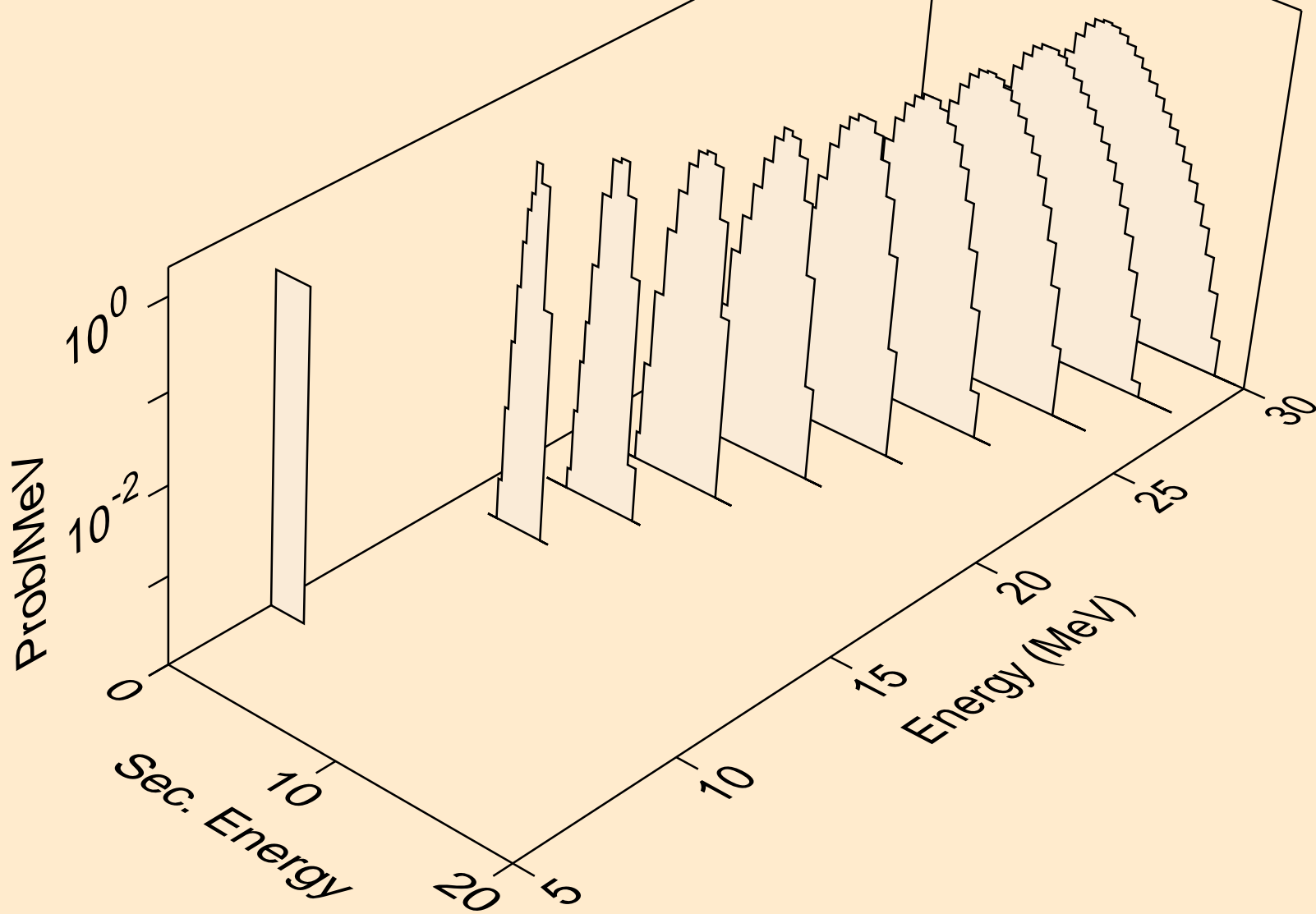

KR083 NEUTRON ACER TENDL-2021 LIBRARY; T=293.6K
alphas from (n,da)

