

LA124 NEUTRON ACER TENDL-2021 LIBRARY; T=293.6K
Principal cross sections

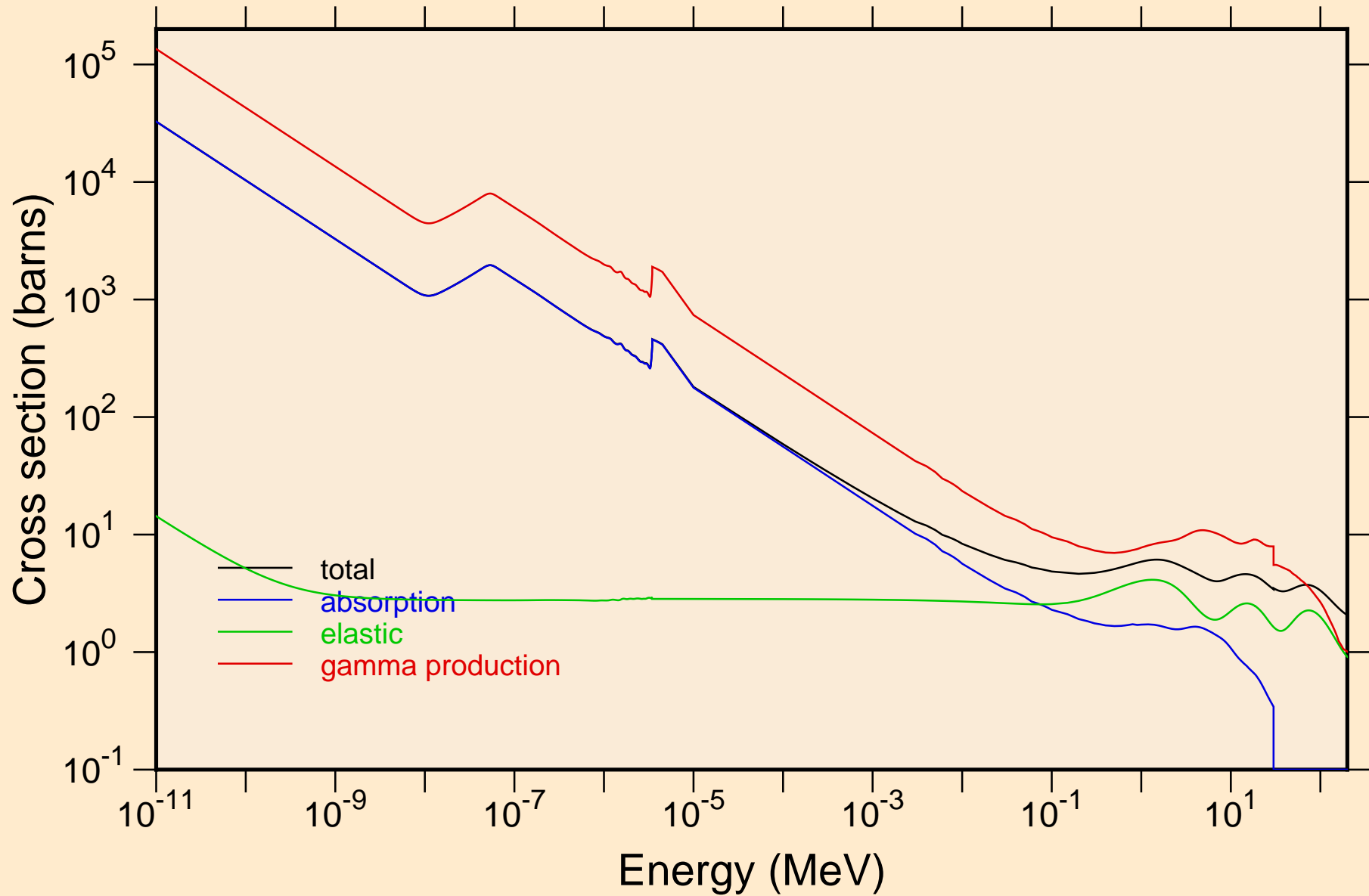

LA124 NEUTRON ACER TENDL-2021 LIBRARY; T=293.6K

Heating

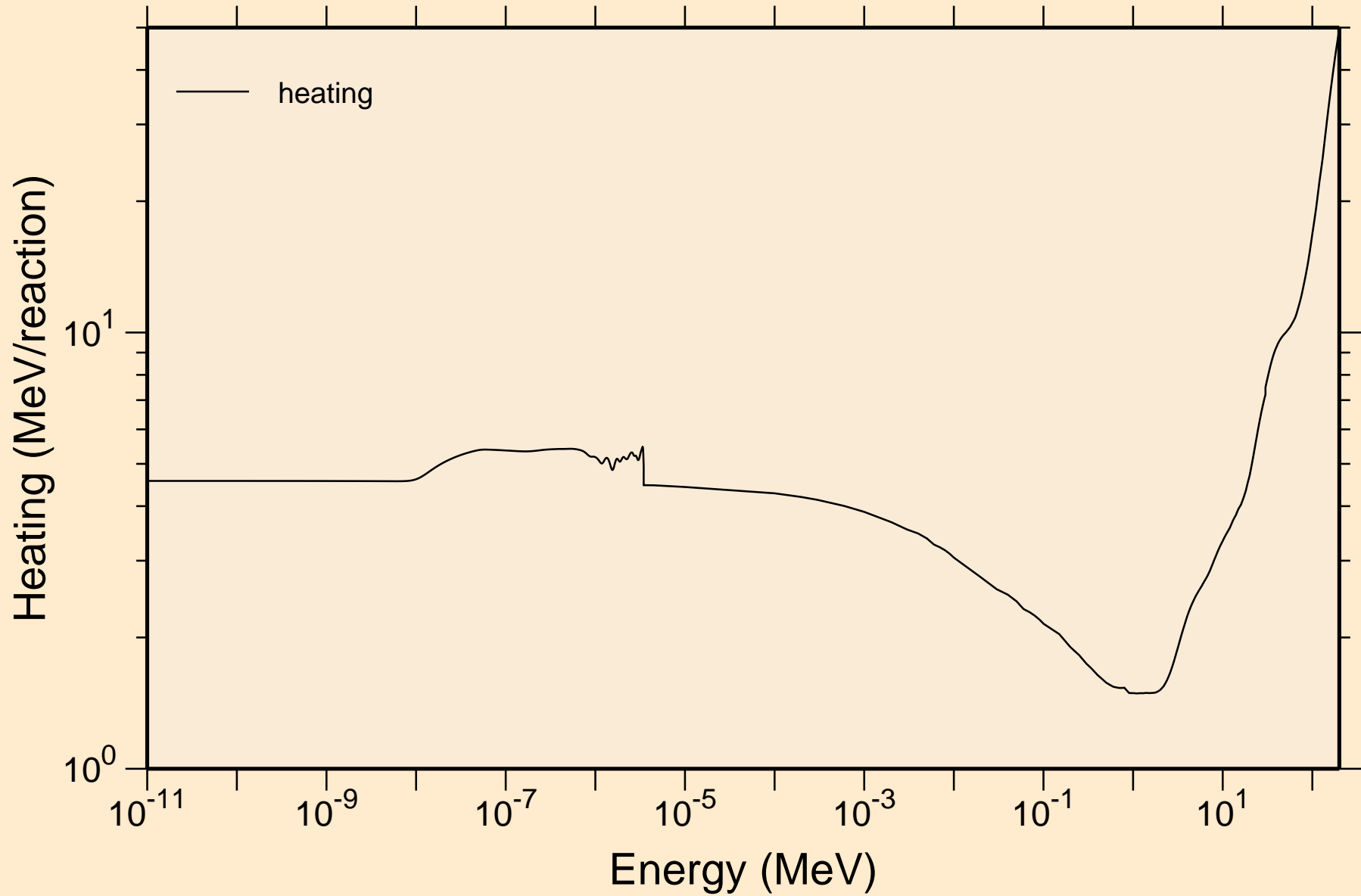

LA124 NEUTRON ACER TENDL-2021 LIBRARY; T=293.6K
Damage

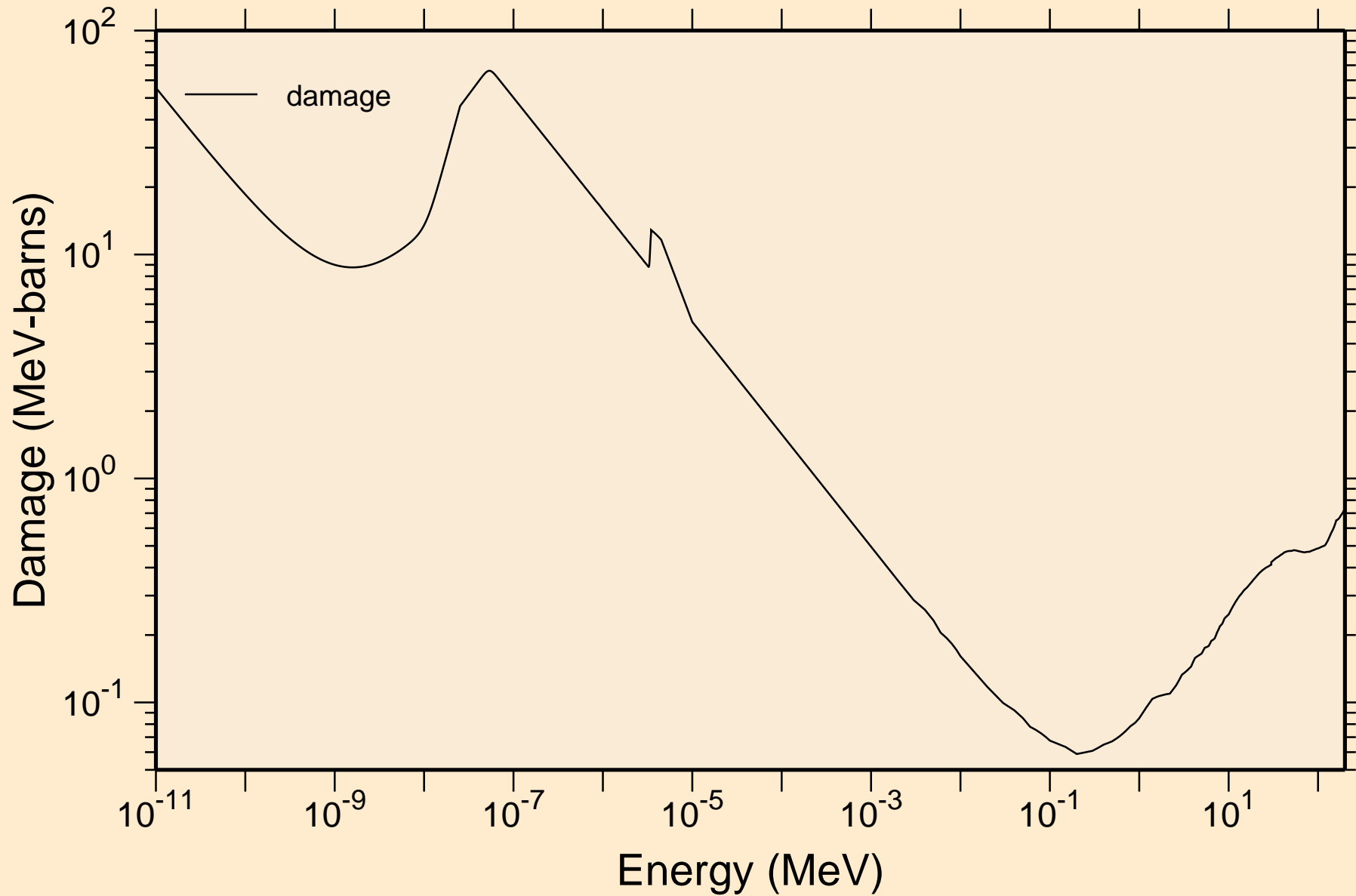

LA124 NEUTRON ACER TENDL-2021 LIBRARY; T=293.6K
Non-threshold reactions

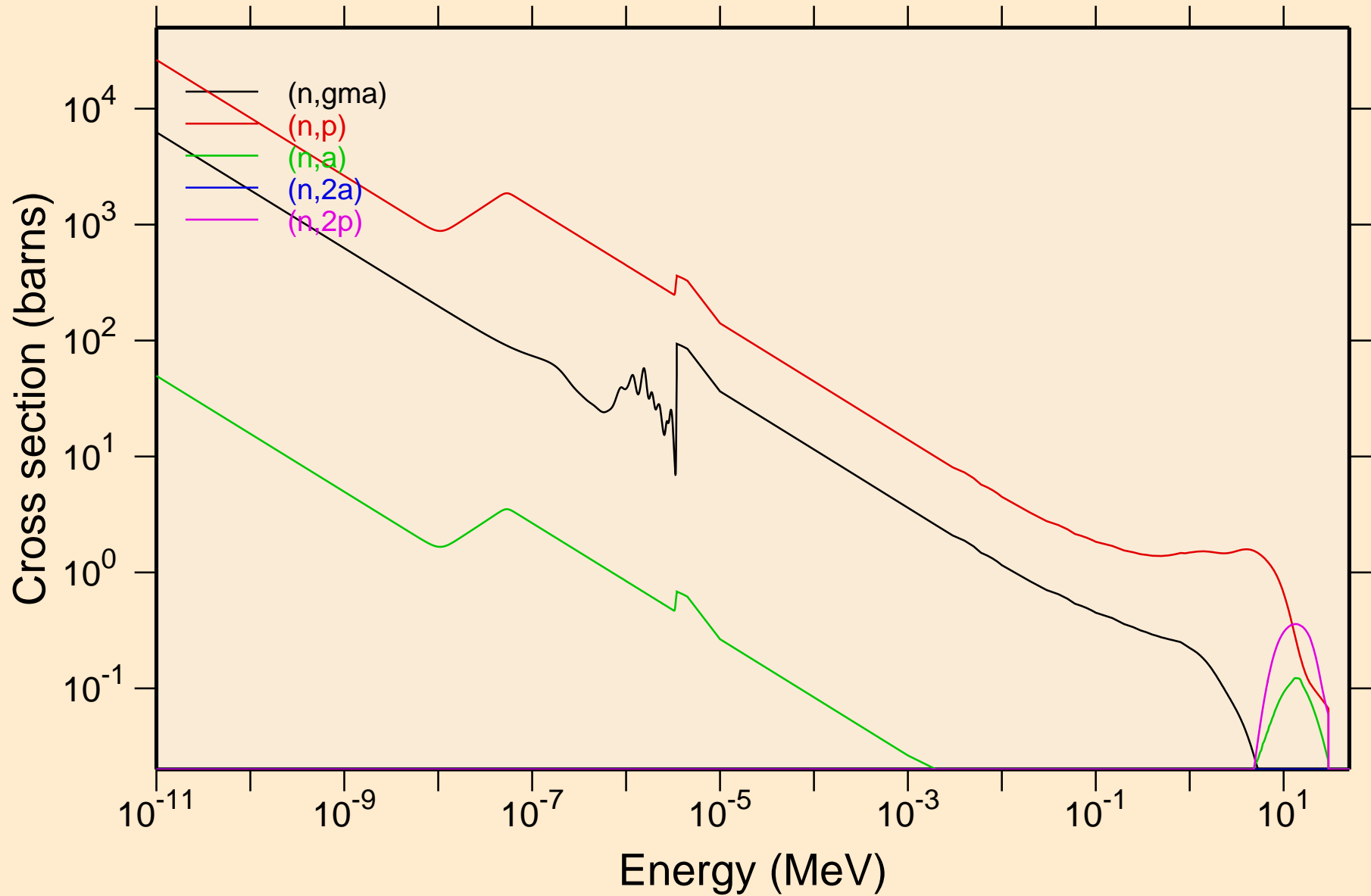

LA124 NEUTRON ACER TENDL-2021 LIBRARY; T=293.6K
Non-threshold reactions

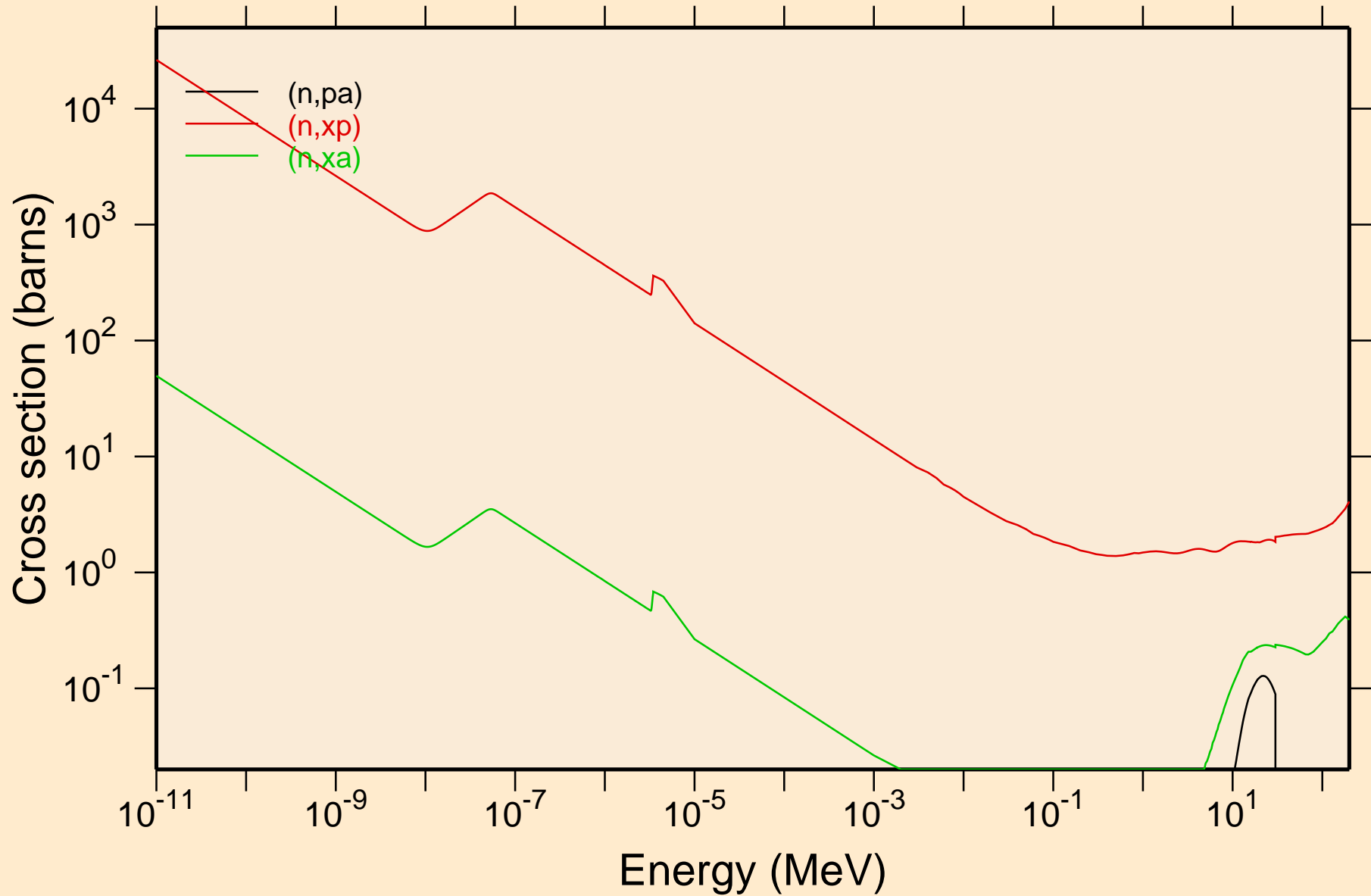

LA124 NEUTRON ACER TENDL-2021 LIBRARY; T=293.6K
Principal cross sections

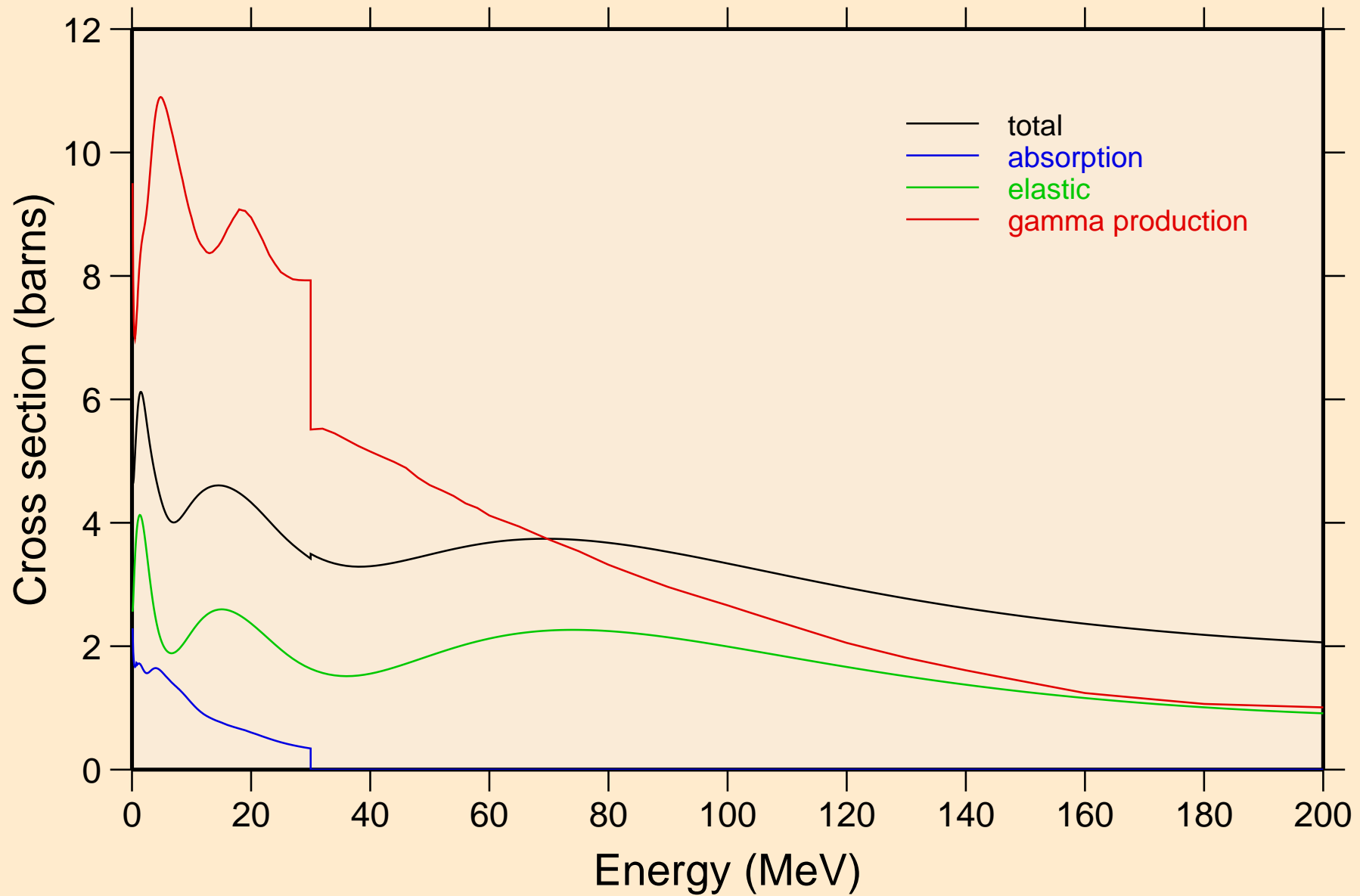

LA124 NEUTRON ACER TENDL-2021 LIBRARY; T=293.6K

Heating

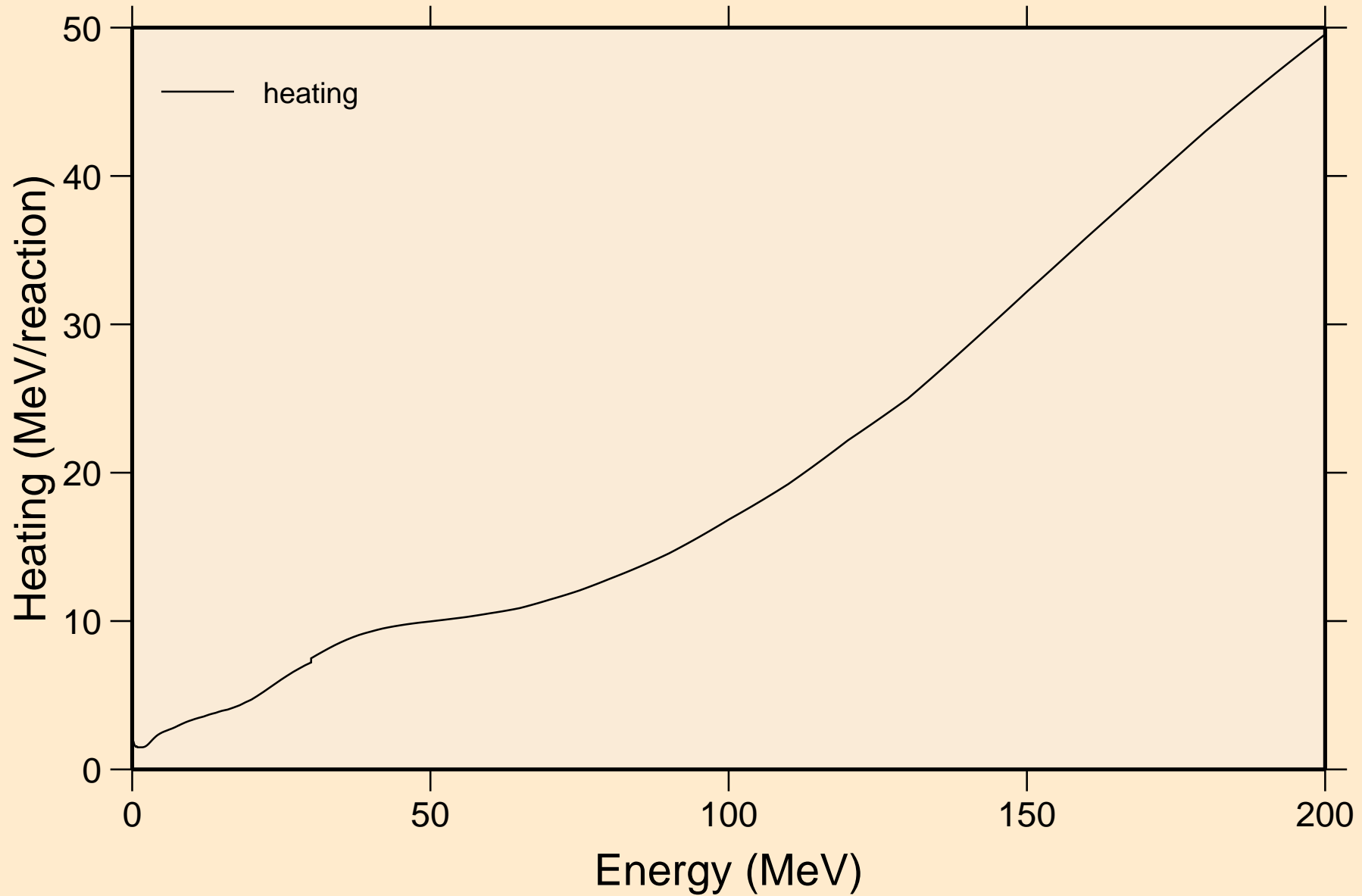

LA124 NEUTRON ACER TENDL-2021 LIBRARY; T=293.6K
Damage

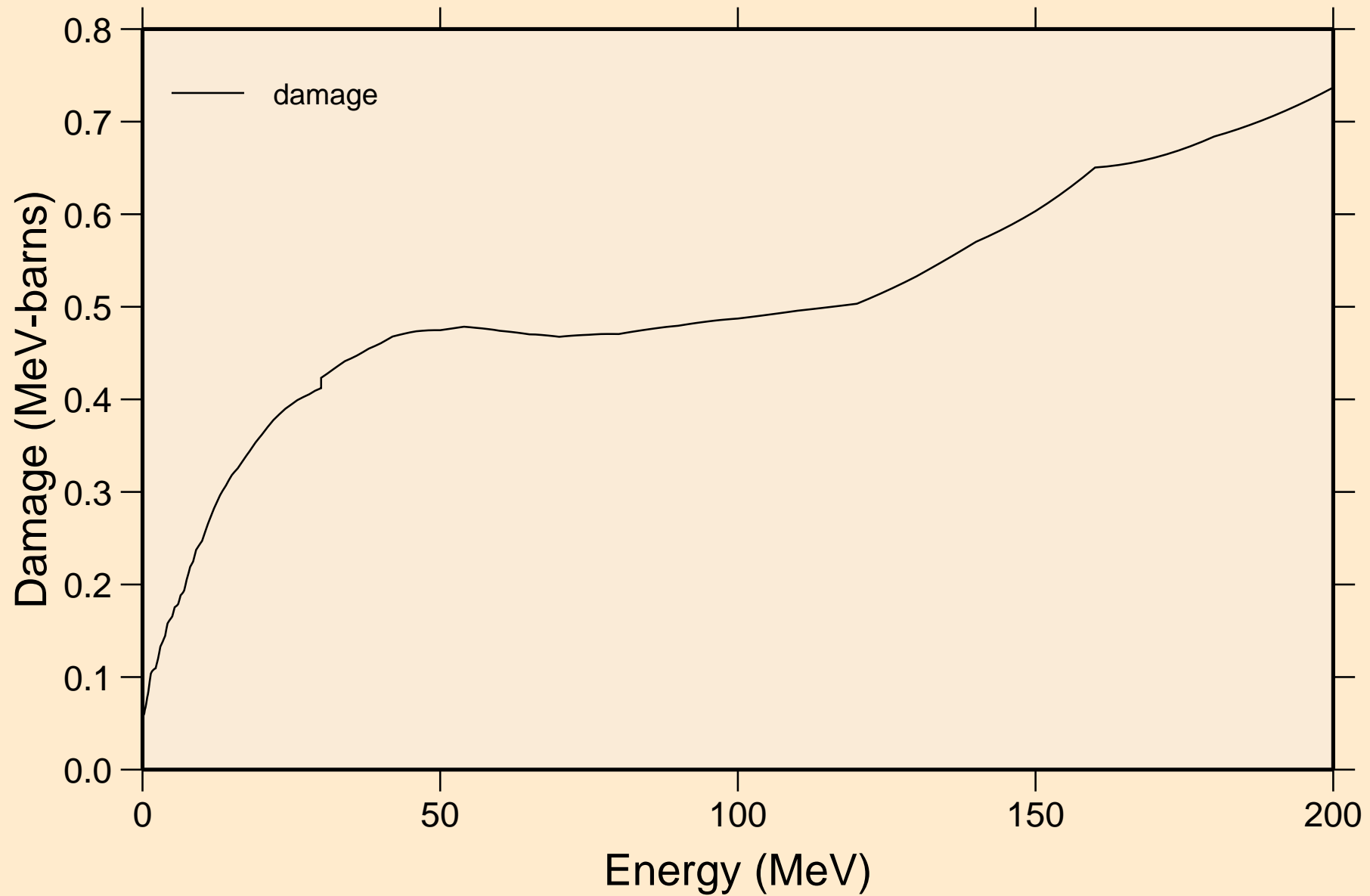

LA124 NEUTRON ACER TENDL-2021 LIBRARY; T=293.6K
Non-threshold reactions

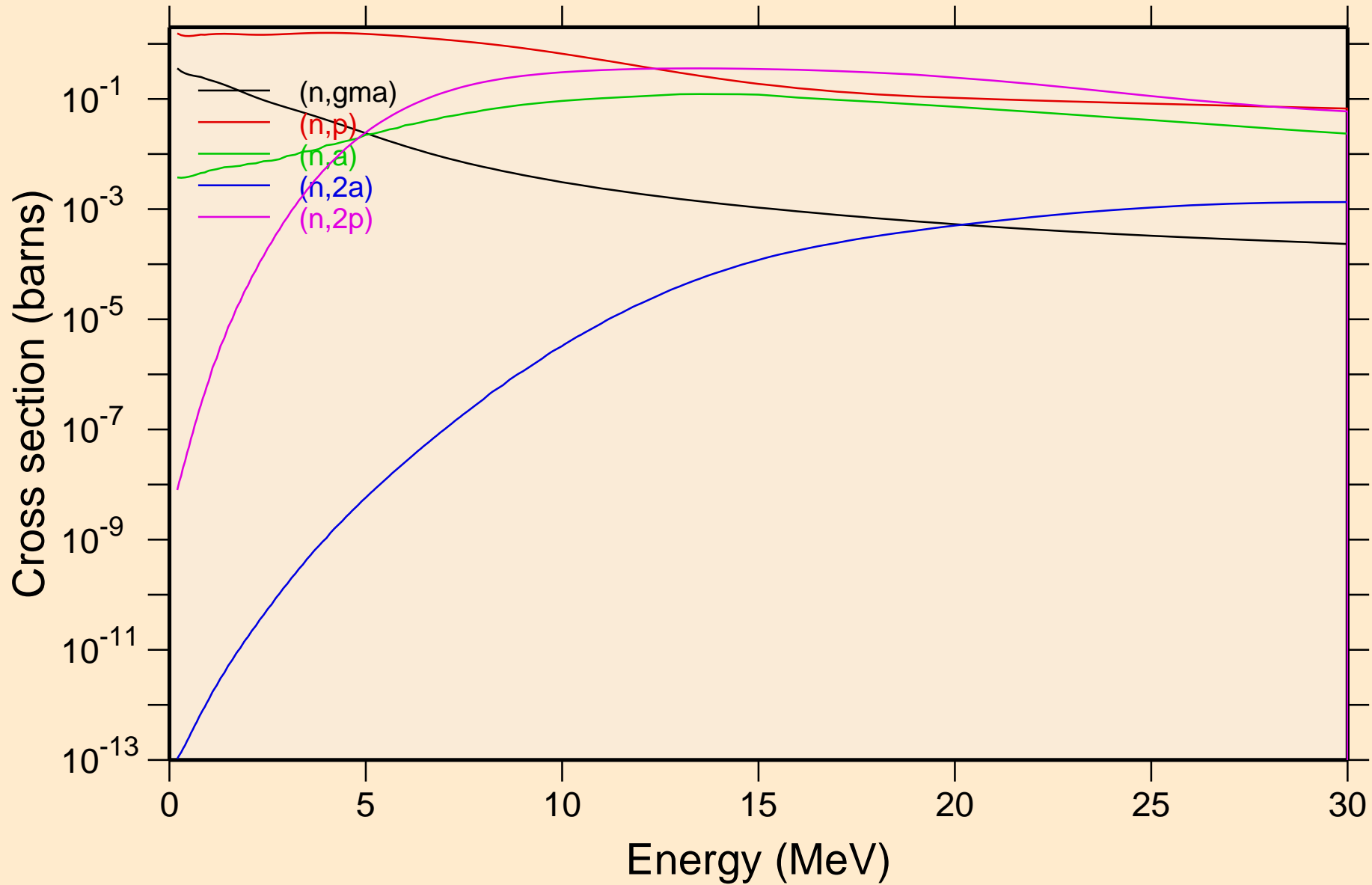

LA124 NEUTRON ACER TENDL-2021 LIBRARY; T=293.6K
Non-threshold reactions

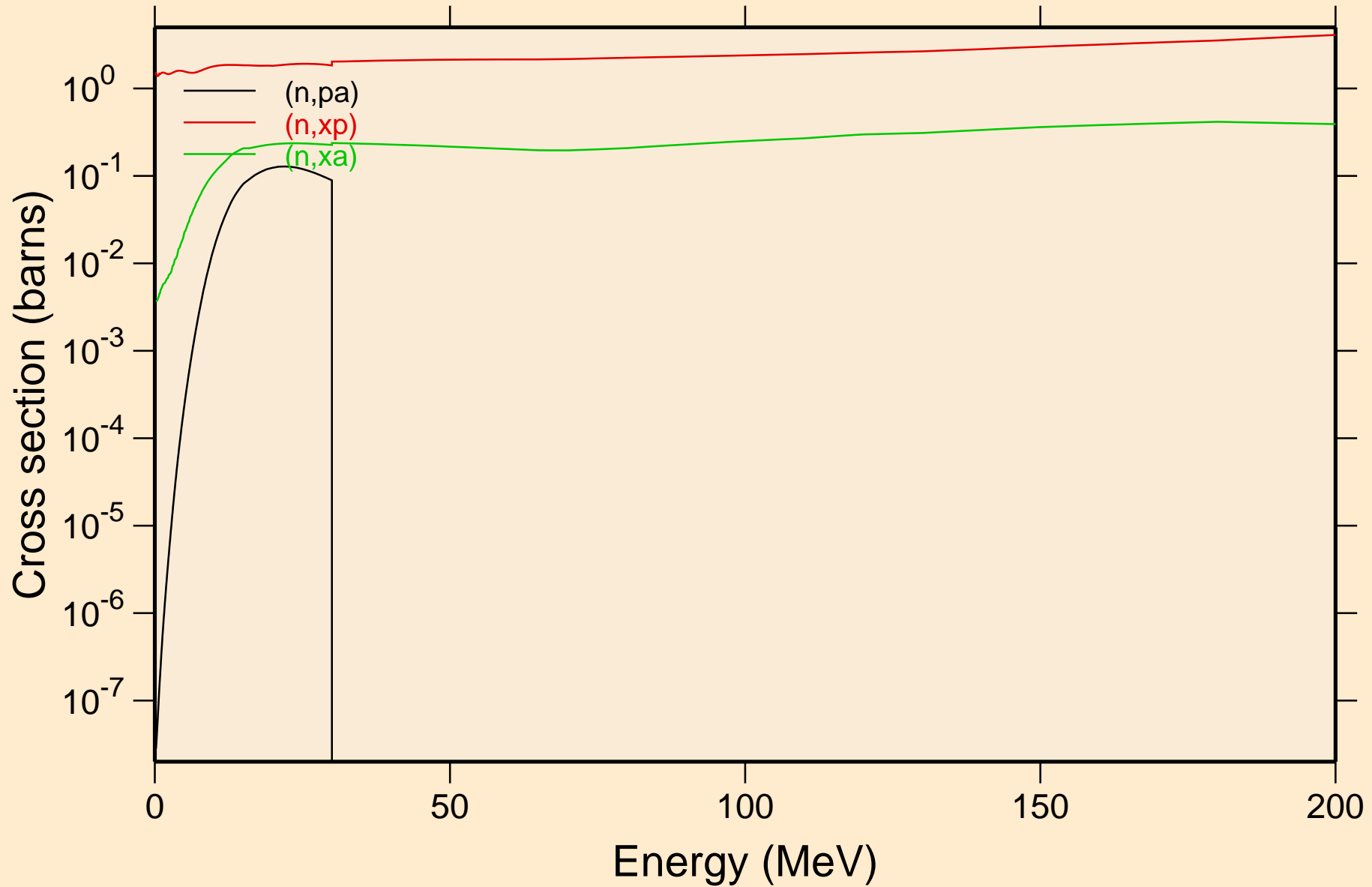

LA124 NEUTRON ACER TENDL-2021 LIBRARY; T=293.6K
Inelastic levels

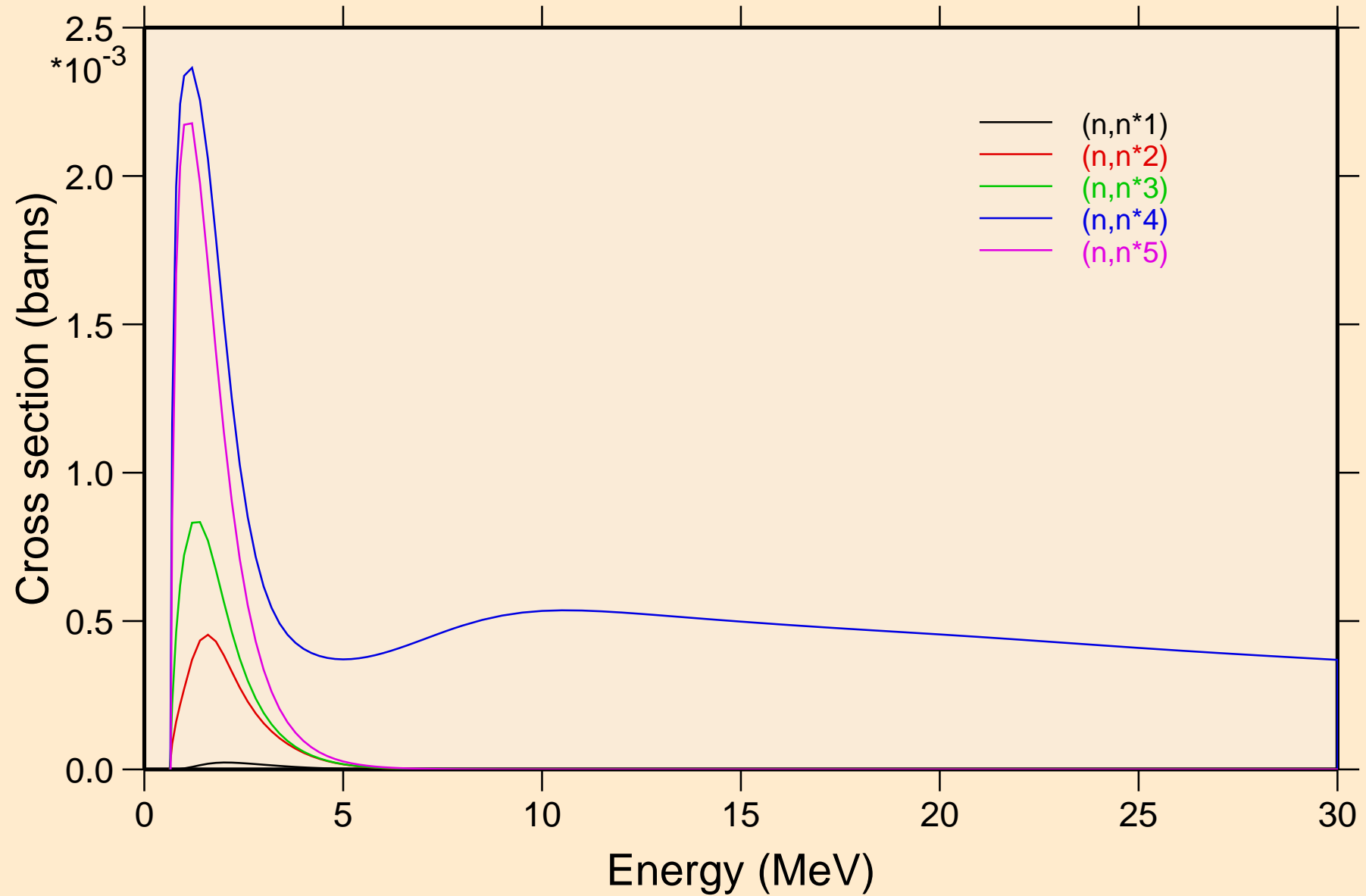

LA124 NEUTRON ACER TENDL-2021 LIBRARY; T=293.6K
Inelastic levels

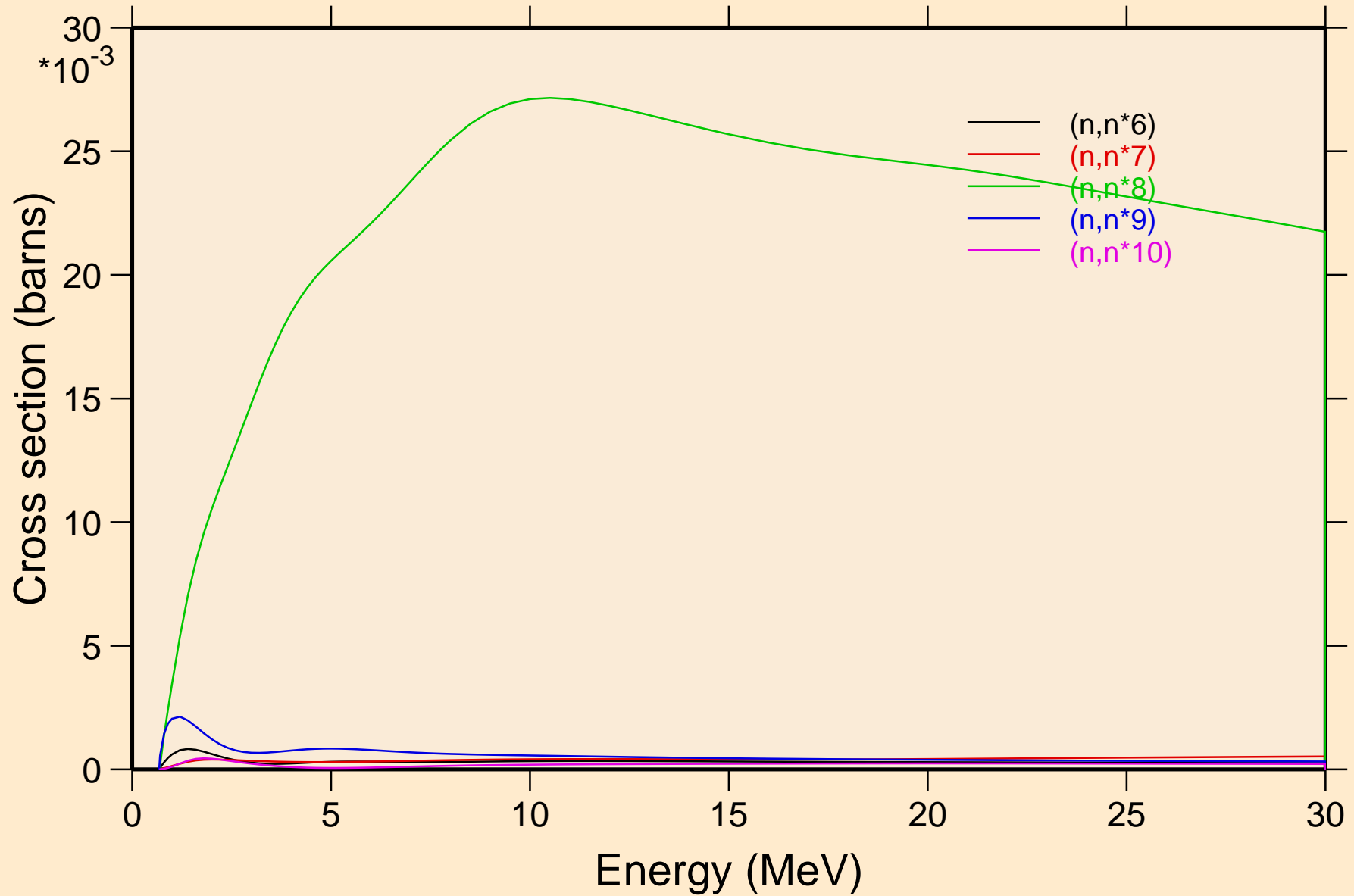

LA124 NEUTRON ACER TENDL-2021 LIBRARY; T=293.6K
Inelastic levels

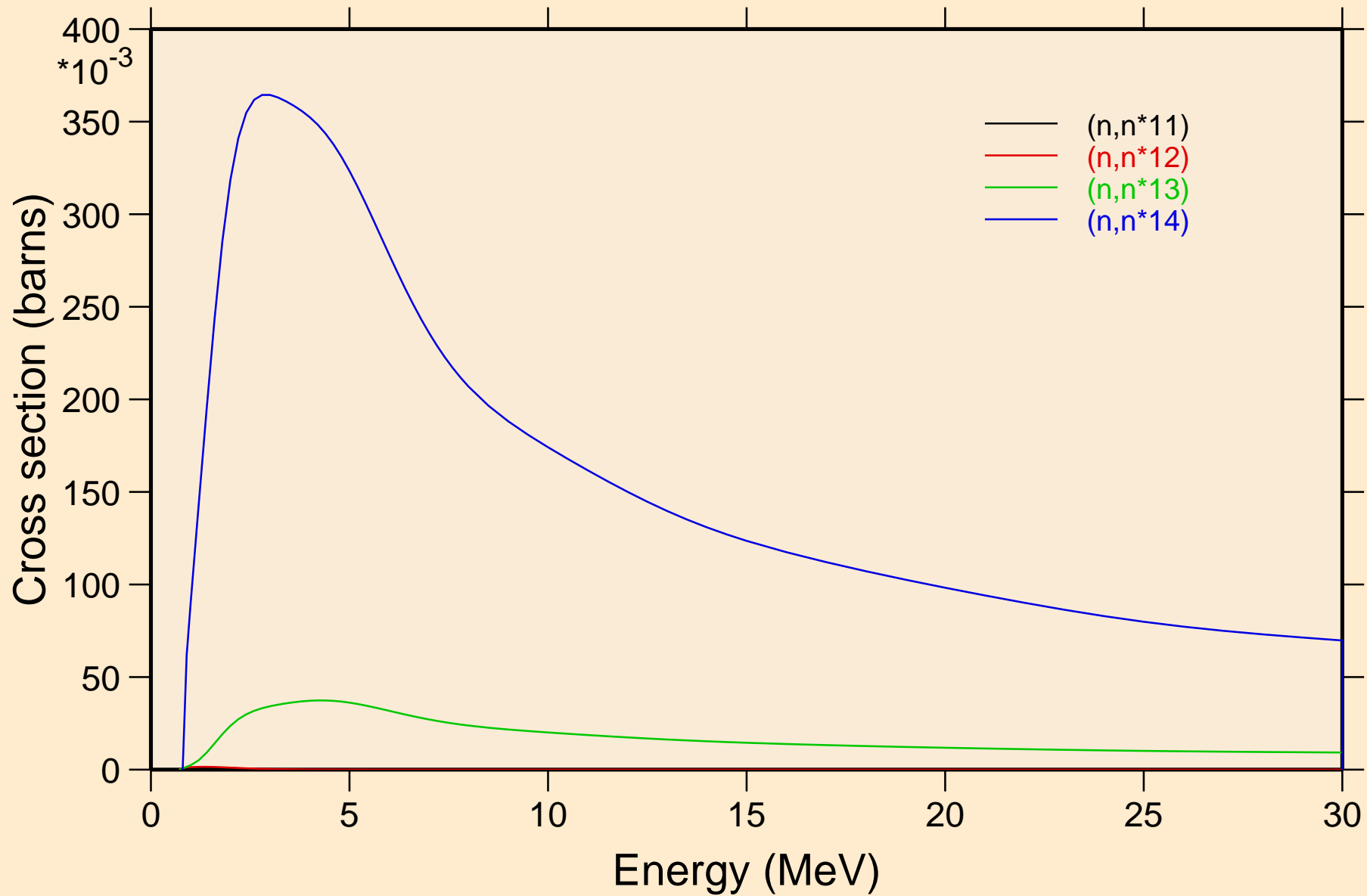

LA124 NEUTRON ACER TENDL-2021 LIBRARY; T=293.6K
Threshold reactions

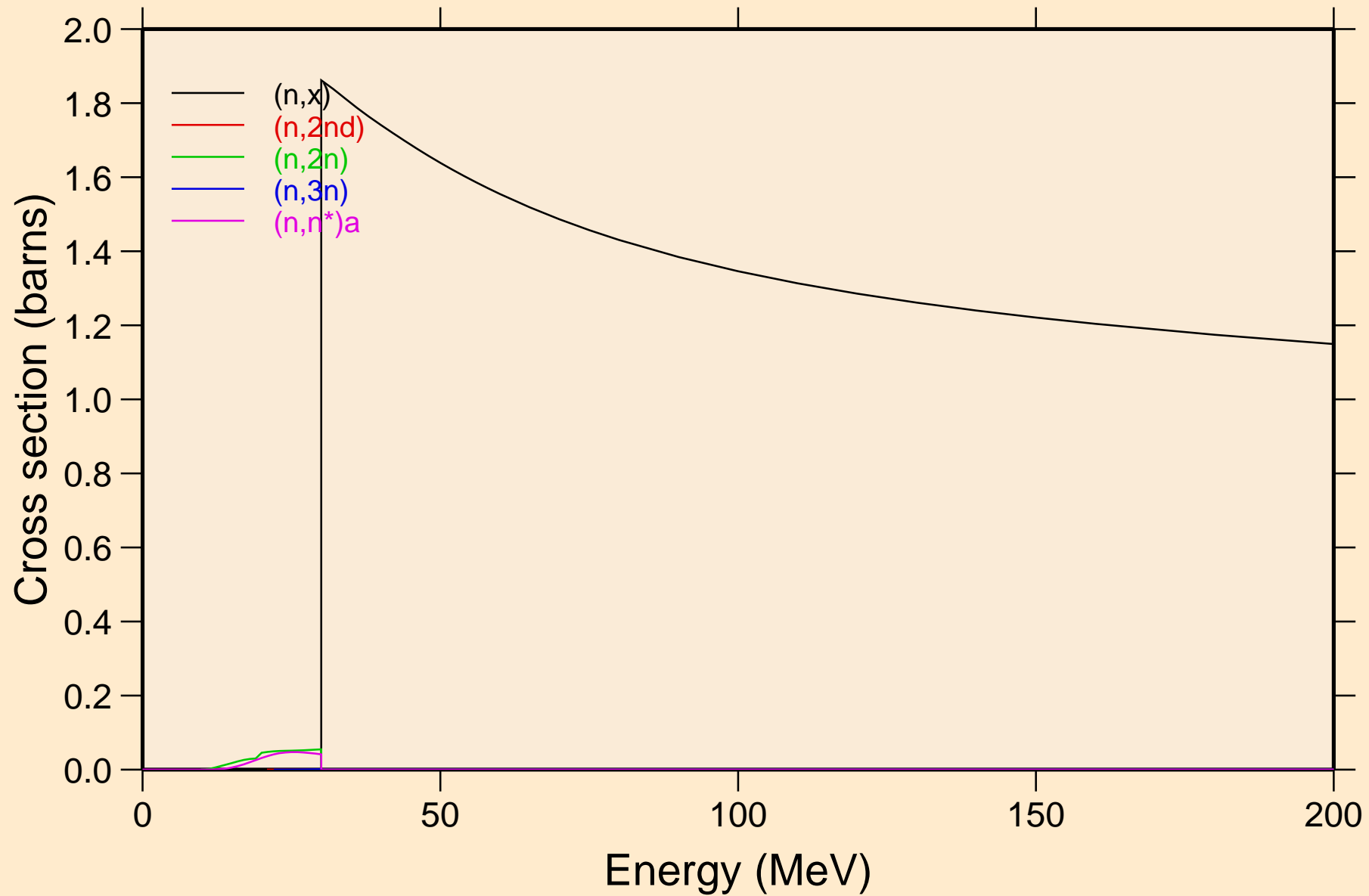

LA124 NEUTRON ACER TENDL-2021 LIBRARY; T=293.6K
Threshold reactions

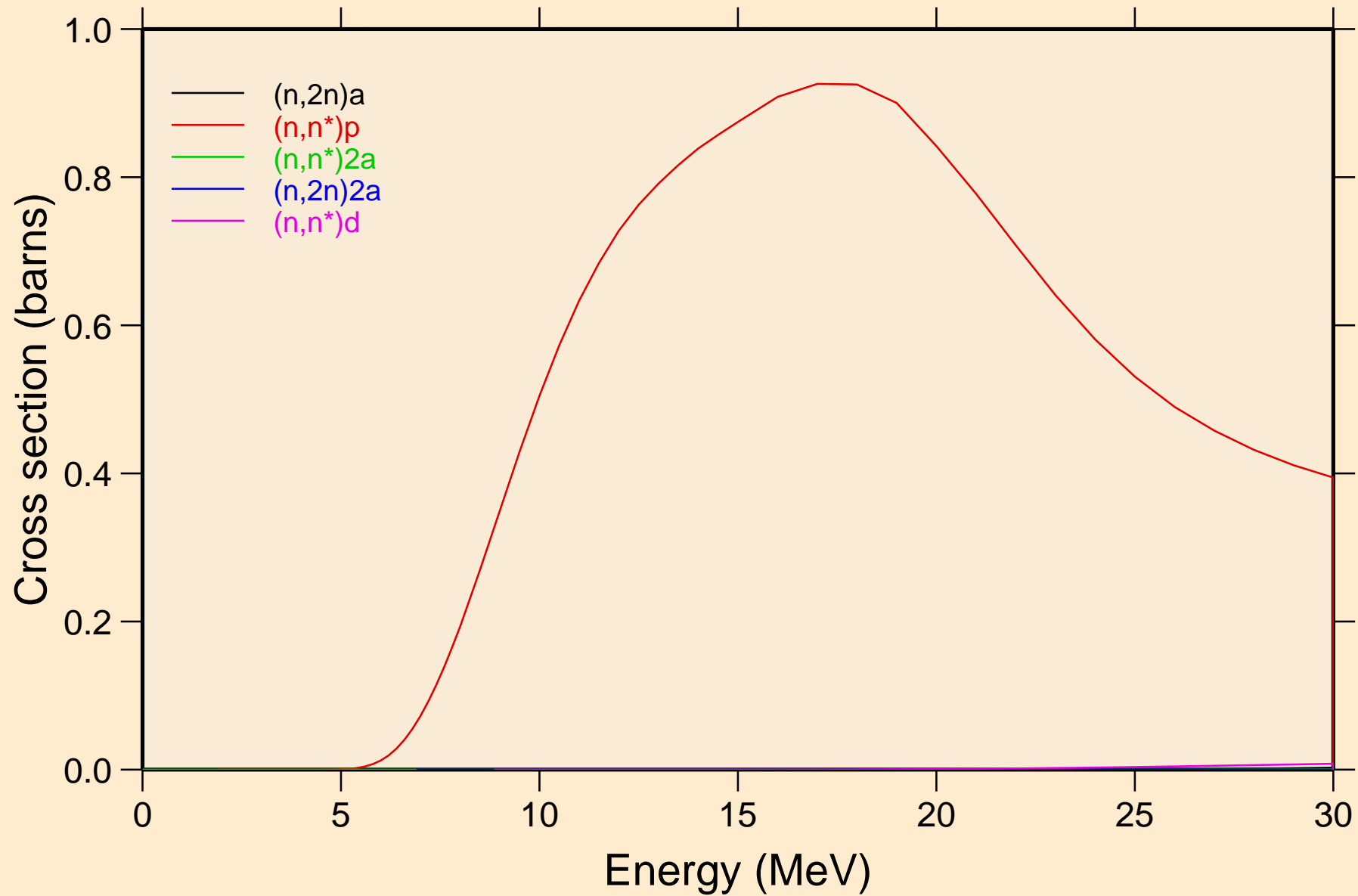

LA124 NEUTRON ACER TENDL-2021 LIBRARY; T=293.6K
Threshold reactions

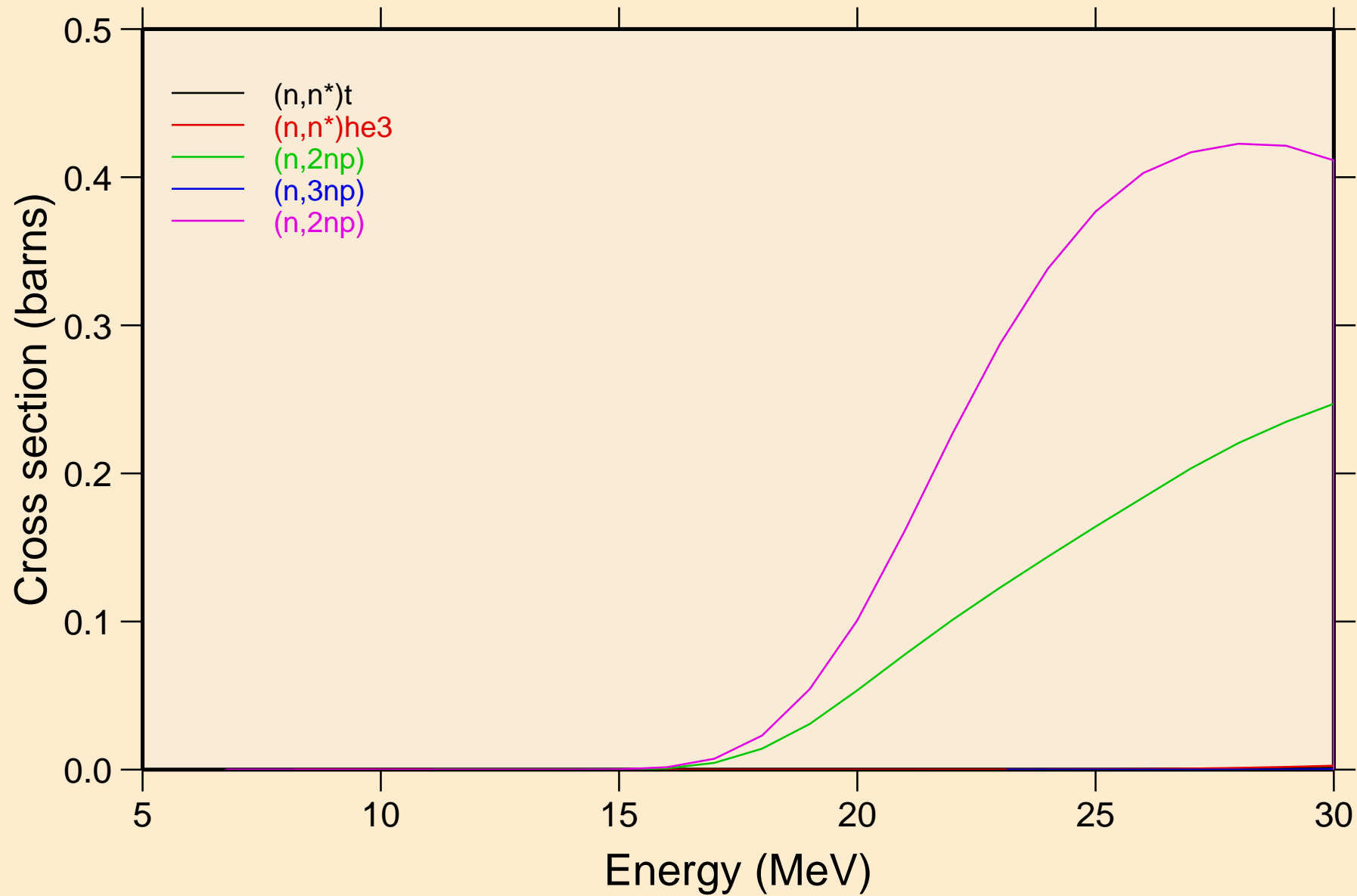

LA124 NEUTRON ACER TENDL-2021 LIBRARY; T=293.6K
Threshold reactions

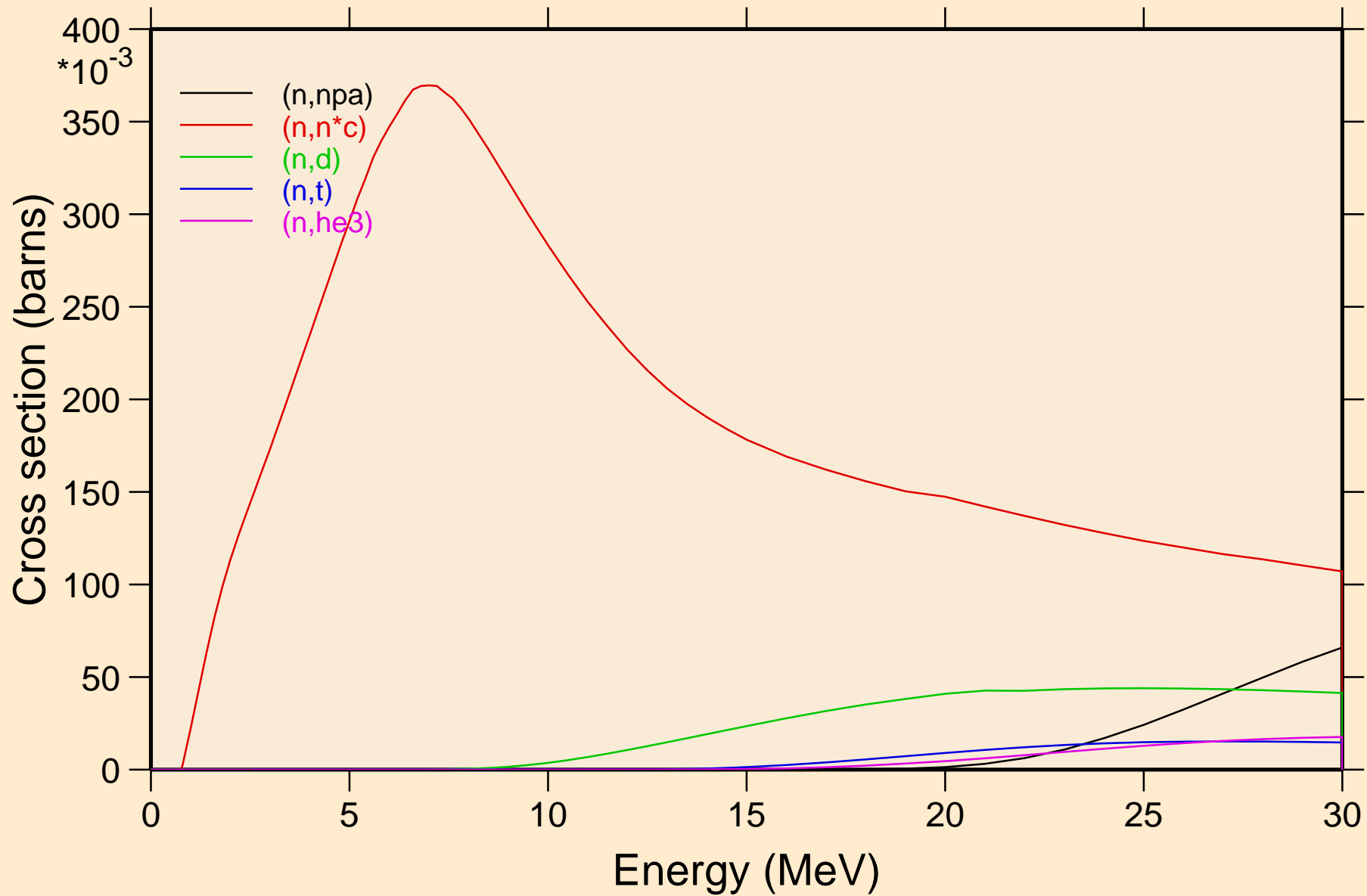

LA124 NEUTRON ACER TENDL-2021 LIBRARY; T=293.6K
Threshold reactions

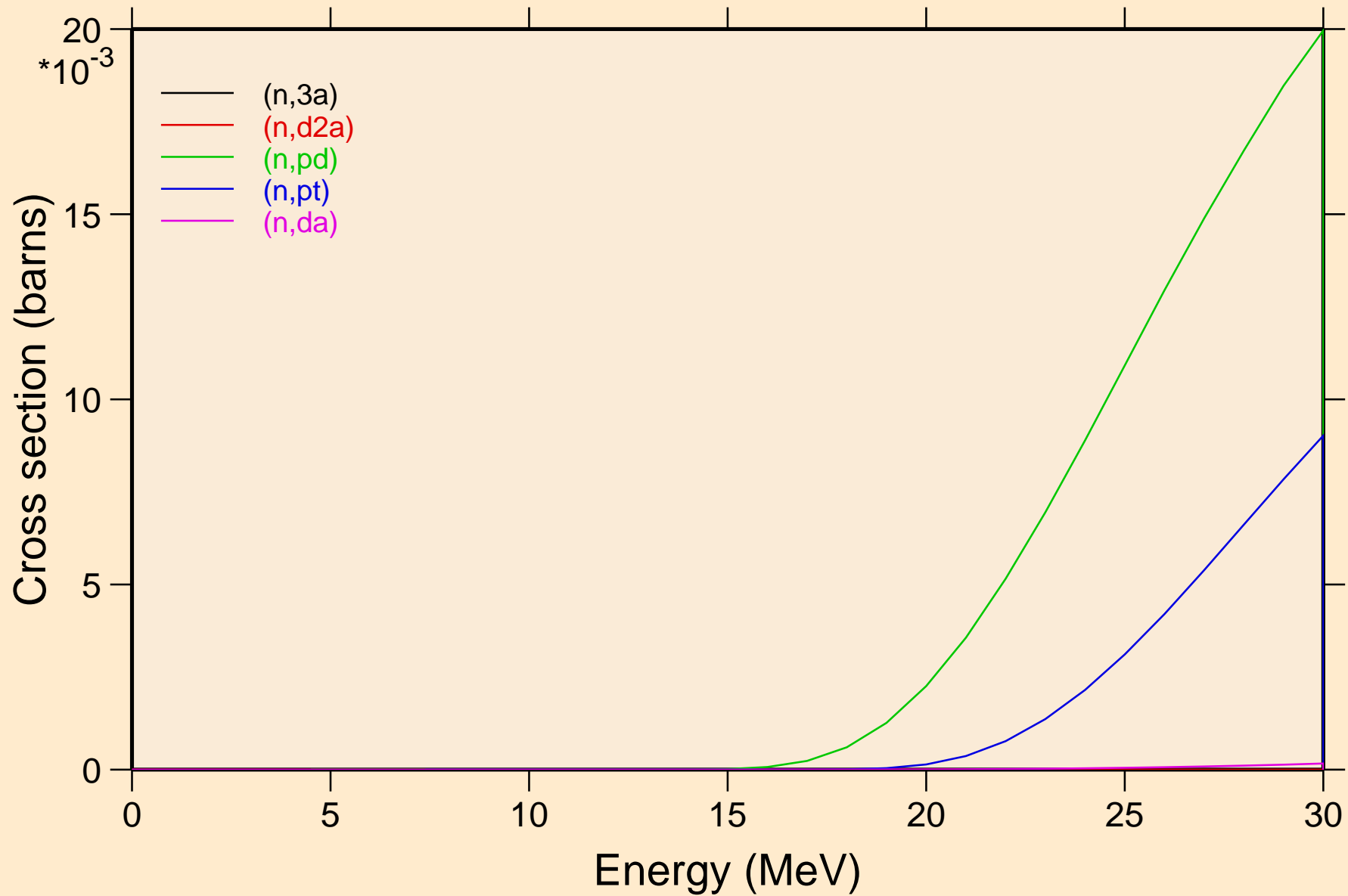

LA124 NEUTRON ACER TENDL-2021 LIBRARY; T=293.6K
Threshold reactions

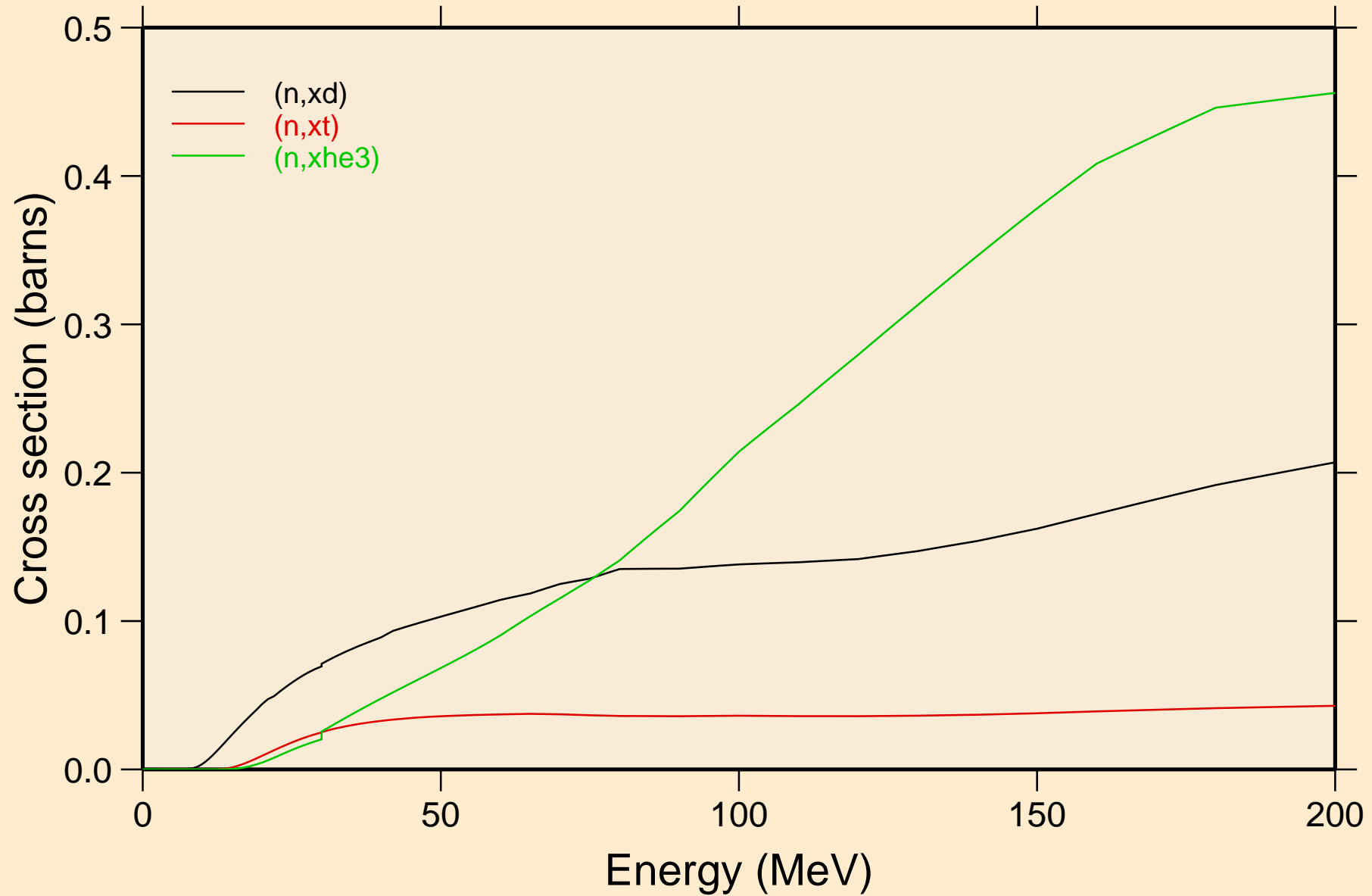

LA124 NEUTRON ACER TENDL-2021 LIBRARY; T=293.6K
angular distribution for elastic

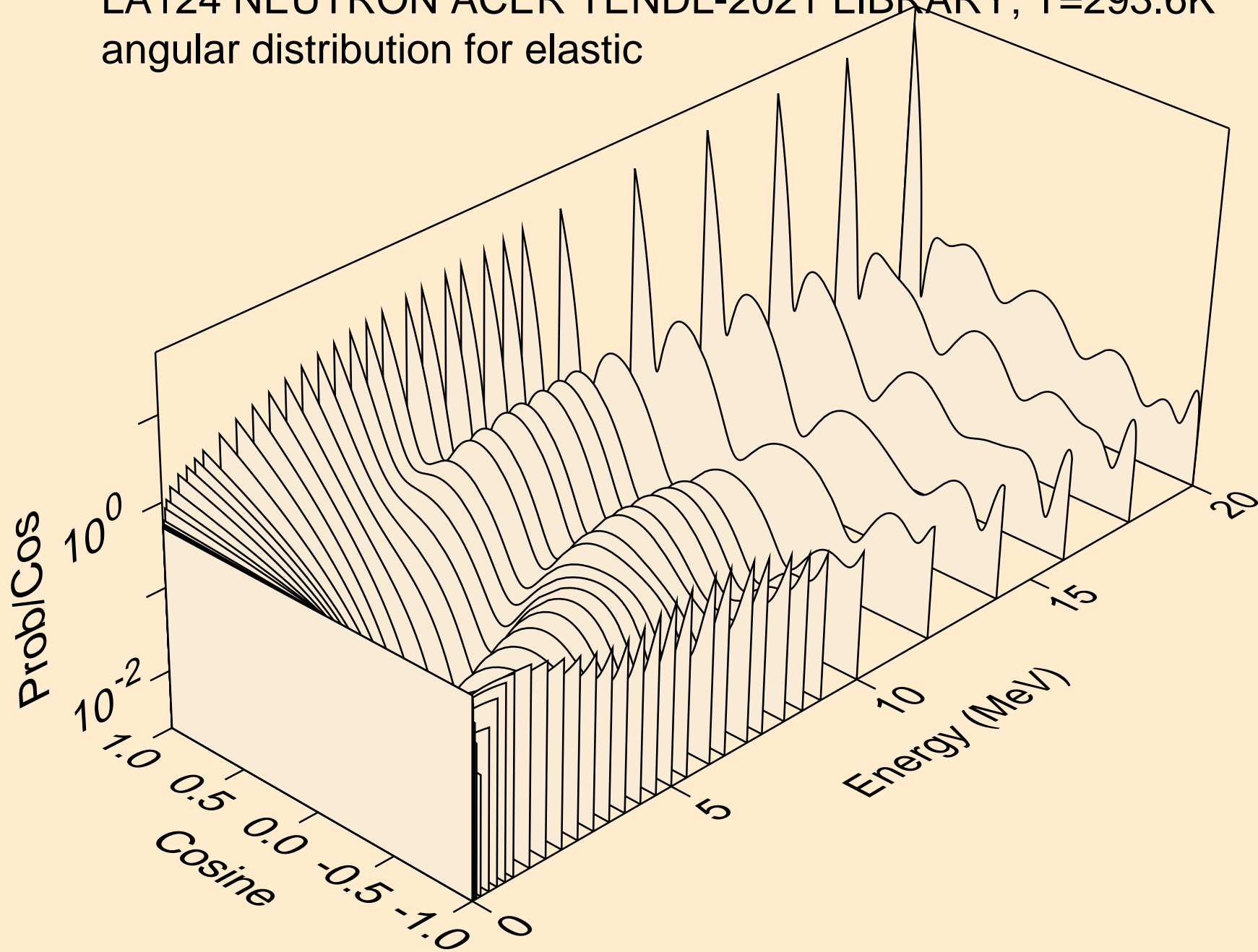

LA124 NEUTRON ACER TENDL-2021 LIBRARY; T=293.6K
angular distribution for elastic

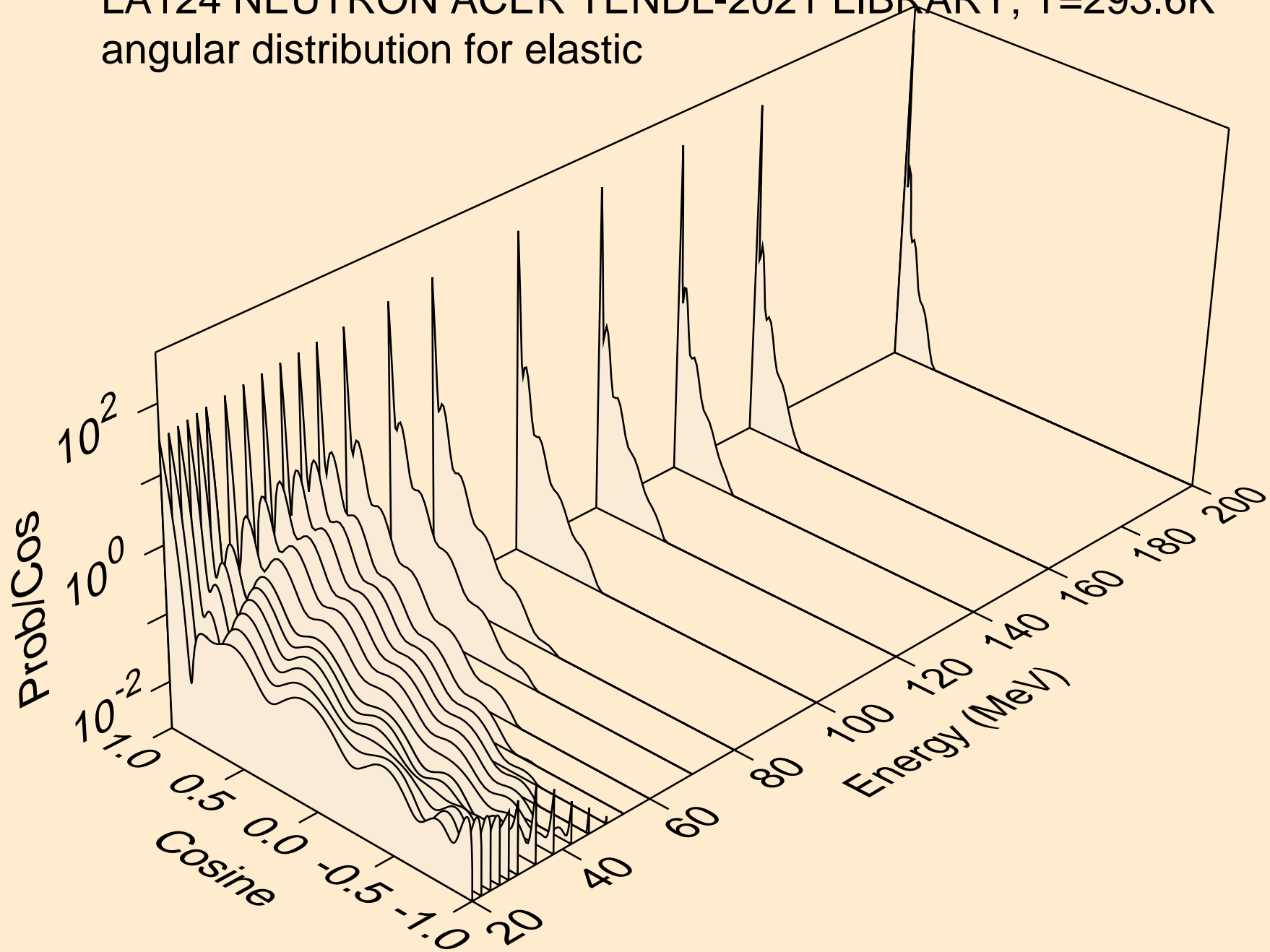

LA124 NEUTRON ACER TENDL-2021 LIBRARY; T=293.6K
angular distribution for (n,n*1)

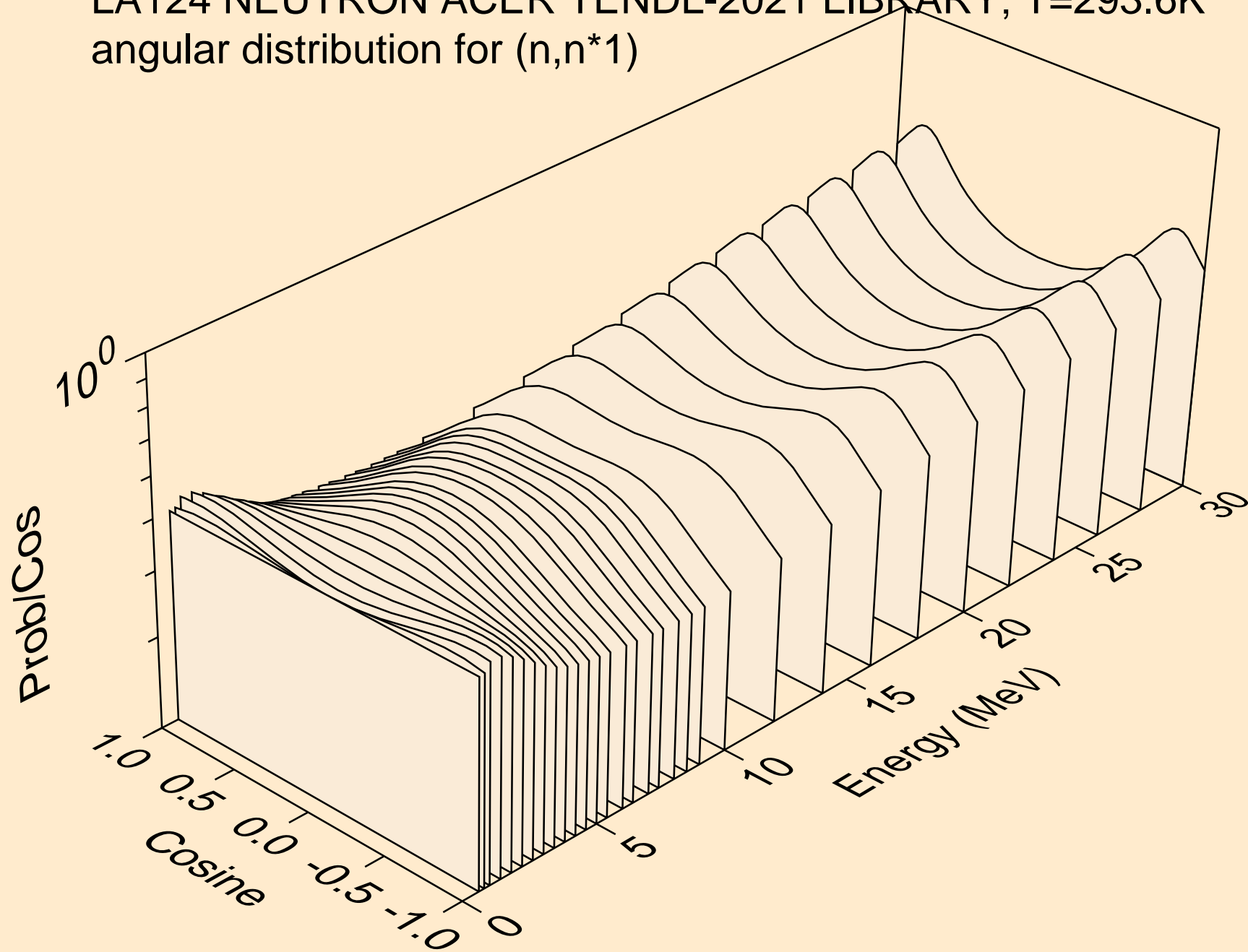

LA124 NEUTRON ACER TENDL-2021 LIBRARY; T=293.6K
angular distribution for (n,n*2)

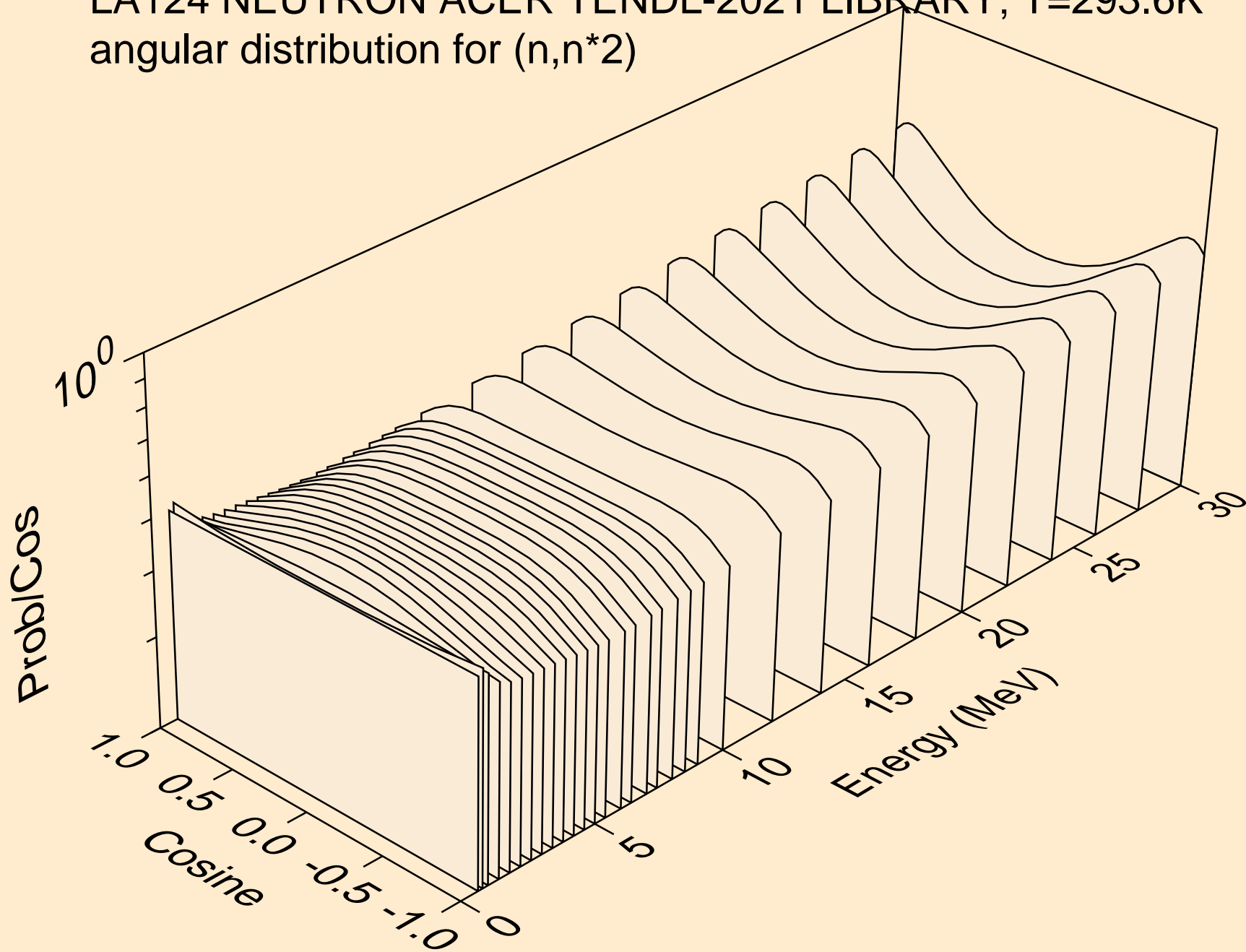

LA124 NEUTRON ACER TENDL-2021 LIBRARY; T=293.6K
angular distribution for (n,n*3)

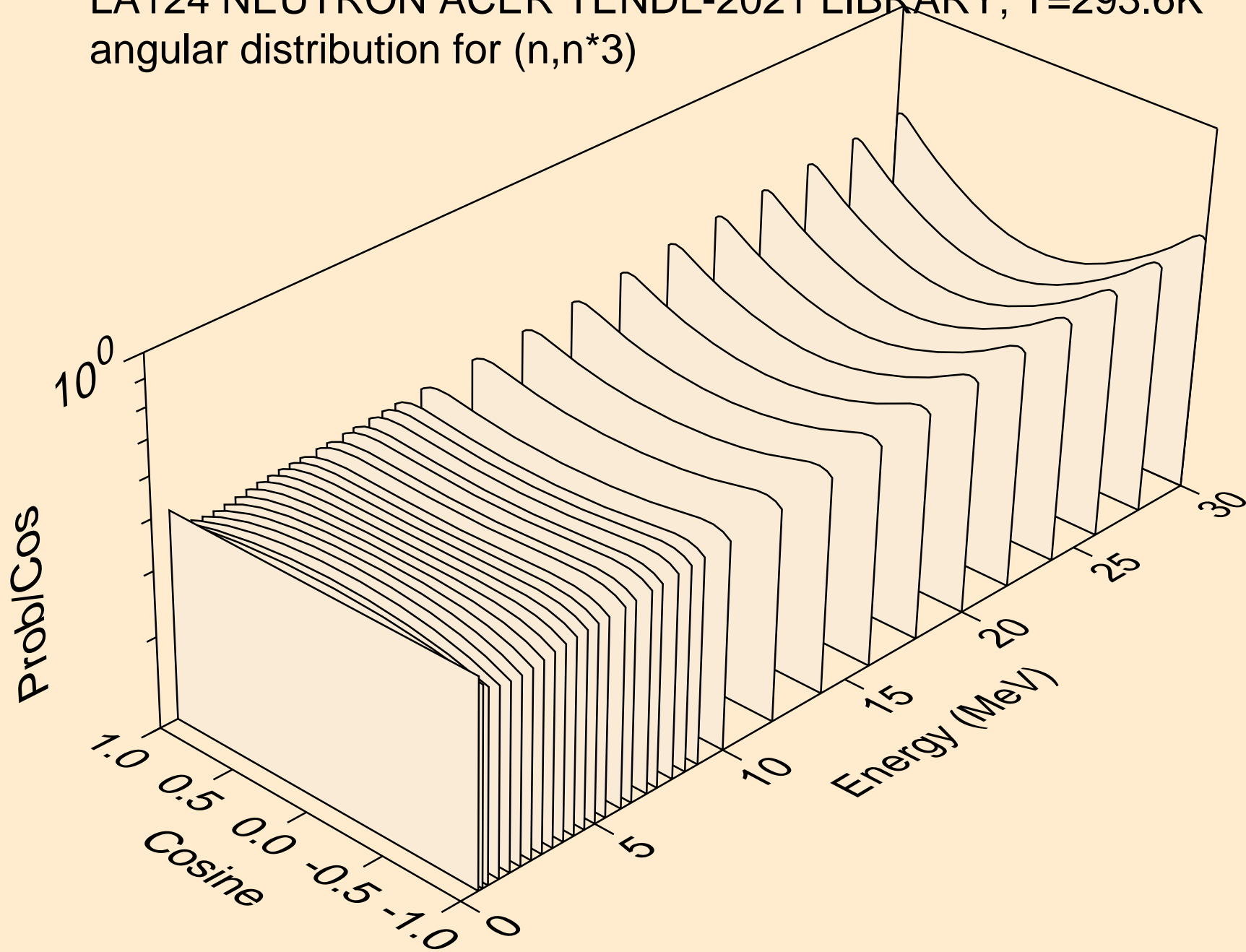

LA124 NEUTRON ACER TENDL-2021 LIBRARY; T=293.6K
angular distribution for (n,n*4)

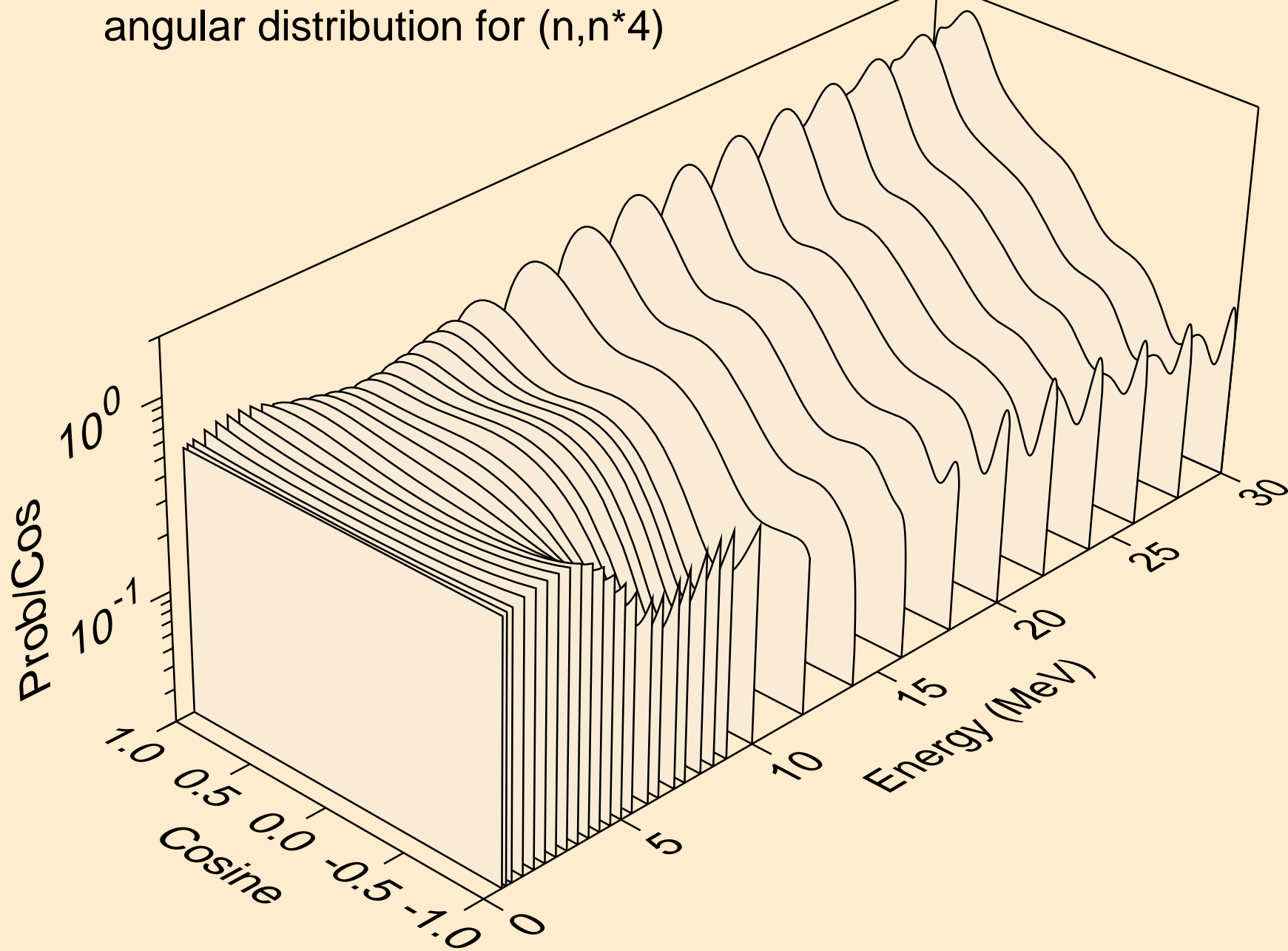

LA124 NEUTRON ACER TENDL-2021 LIBRARY; T=293.6K
angular distribution for (n,n*5)

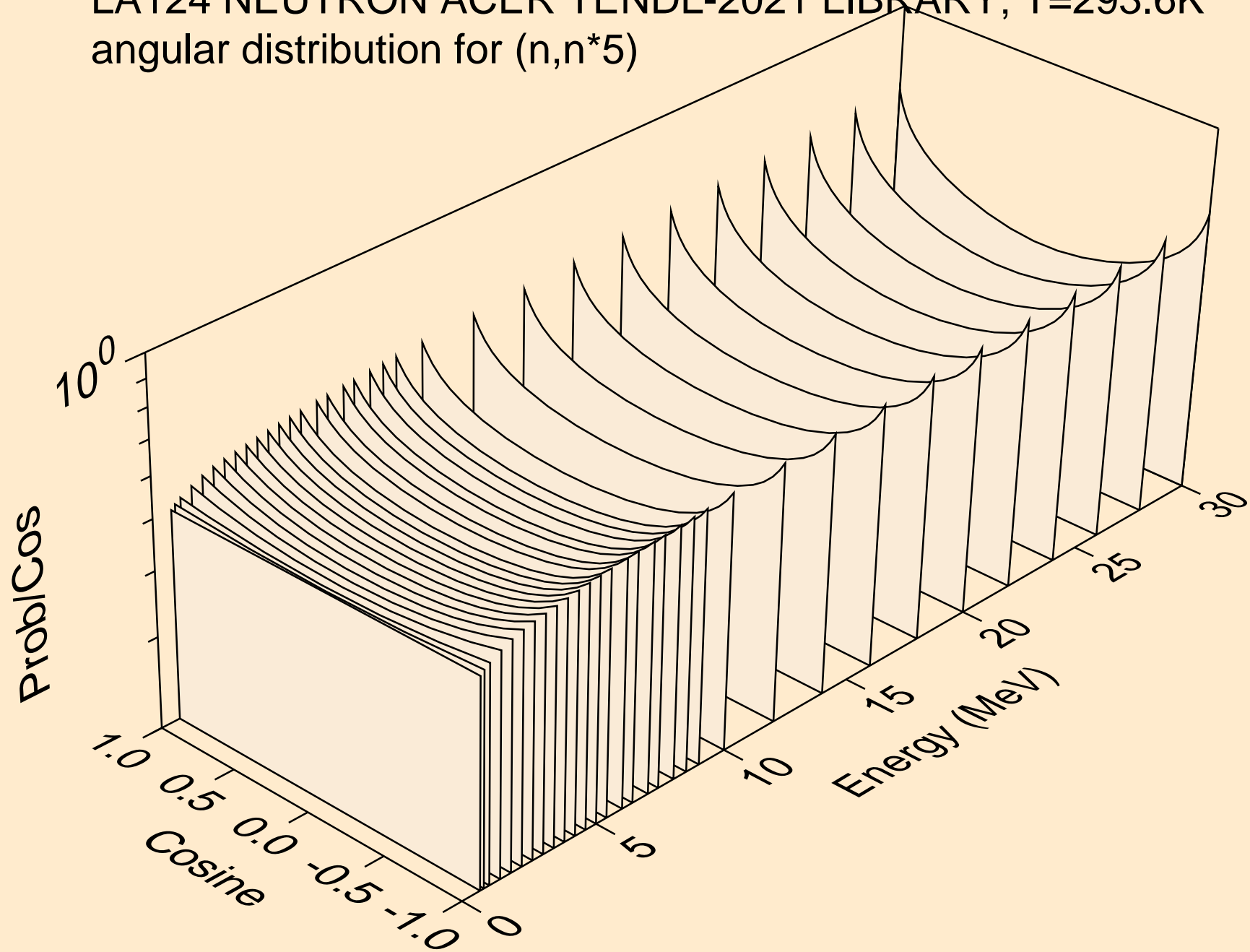

LA124 NEUTRON ACER TENDL-2021 LIBRARY; T=293.6K
angular distribution for (n,n*6)

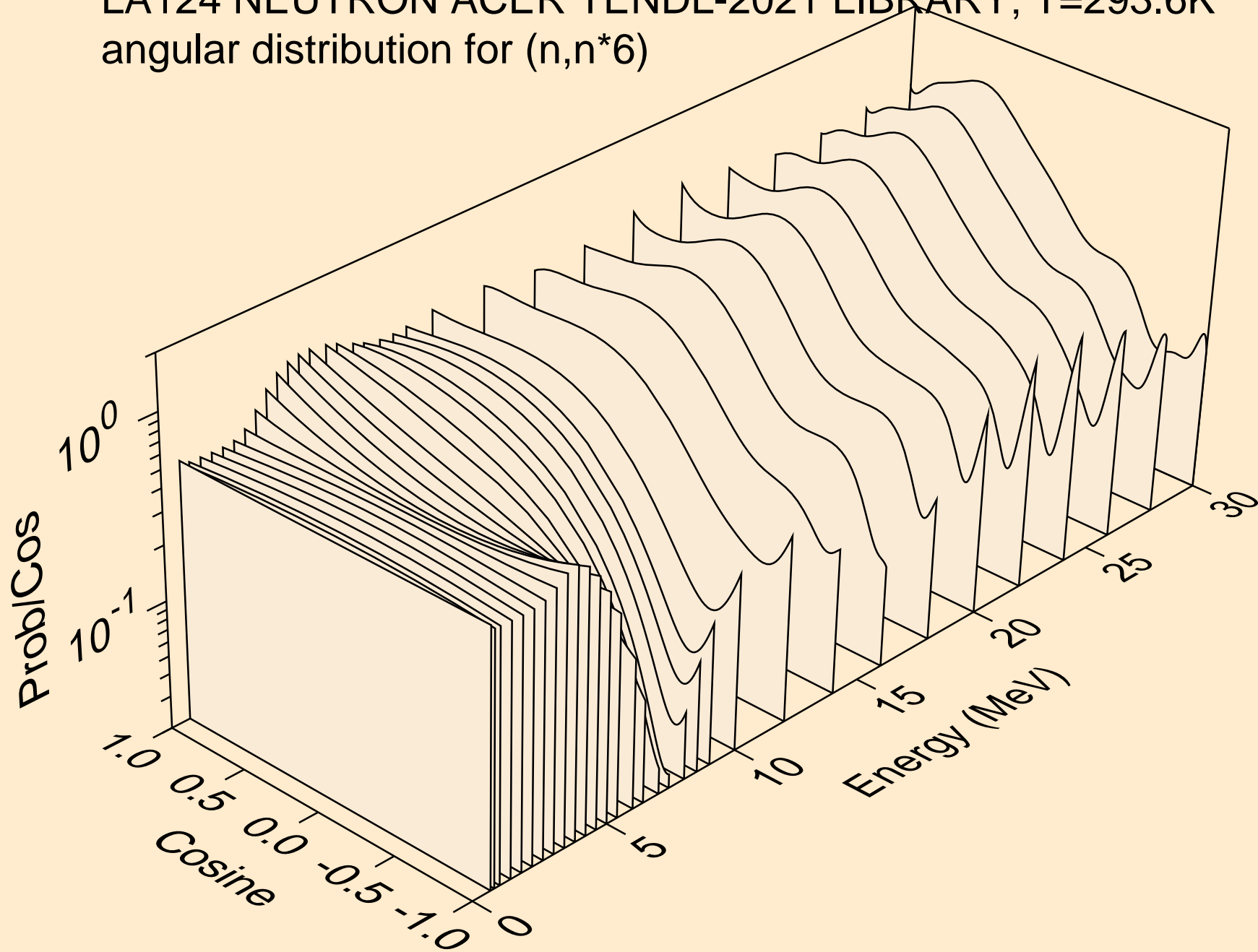

LA124 NEUTRON ACER TENDL-2021 LIBRARY; T=293.6K
angular distribution for (n,n*7)

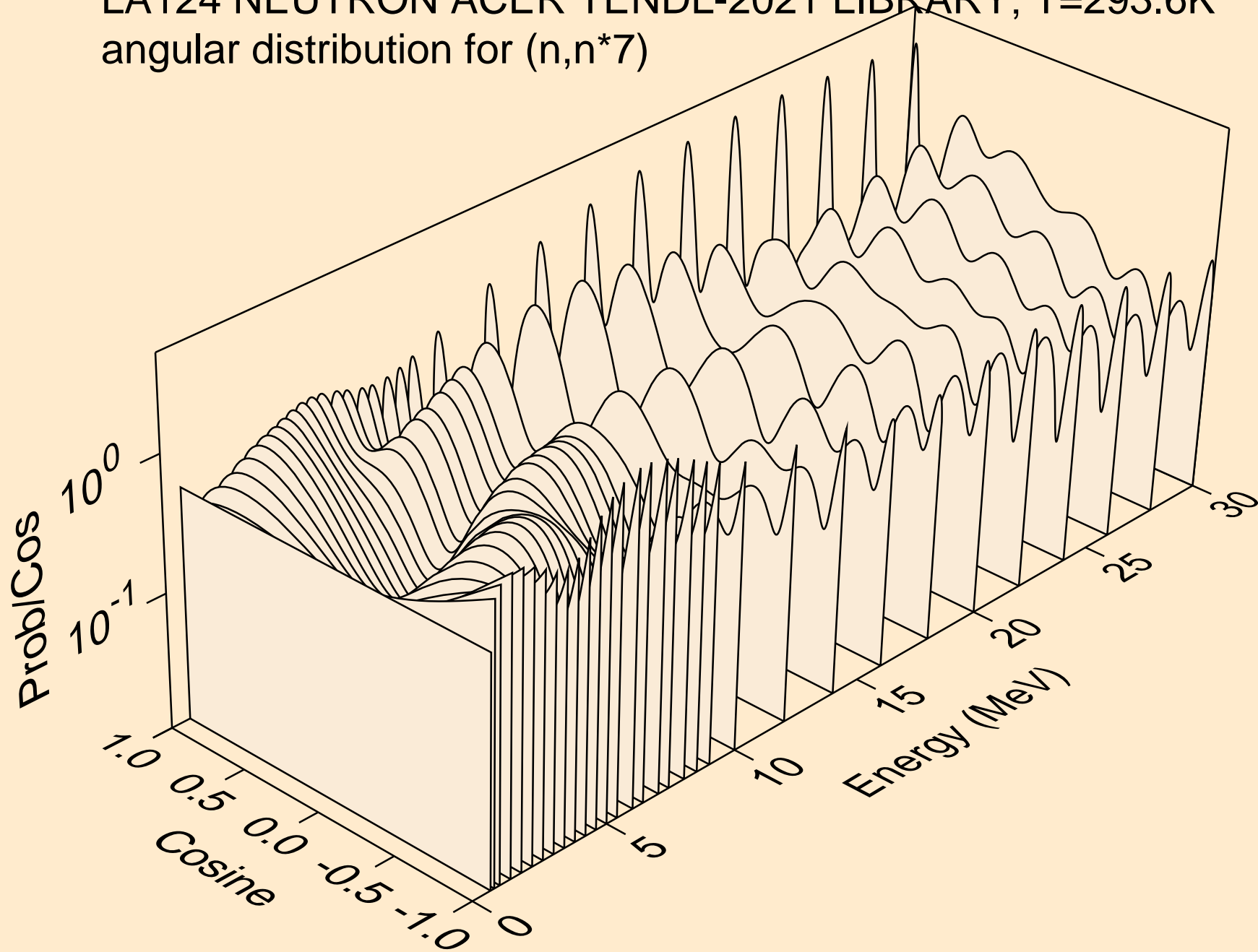

LA124 NEUTRON ACER TENDL-2021 LIBRARY; T=293.6K
angular distribution for (n,n*8)

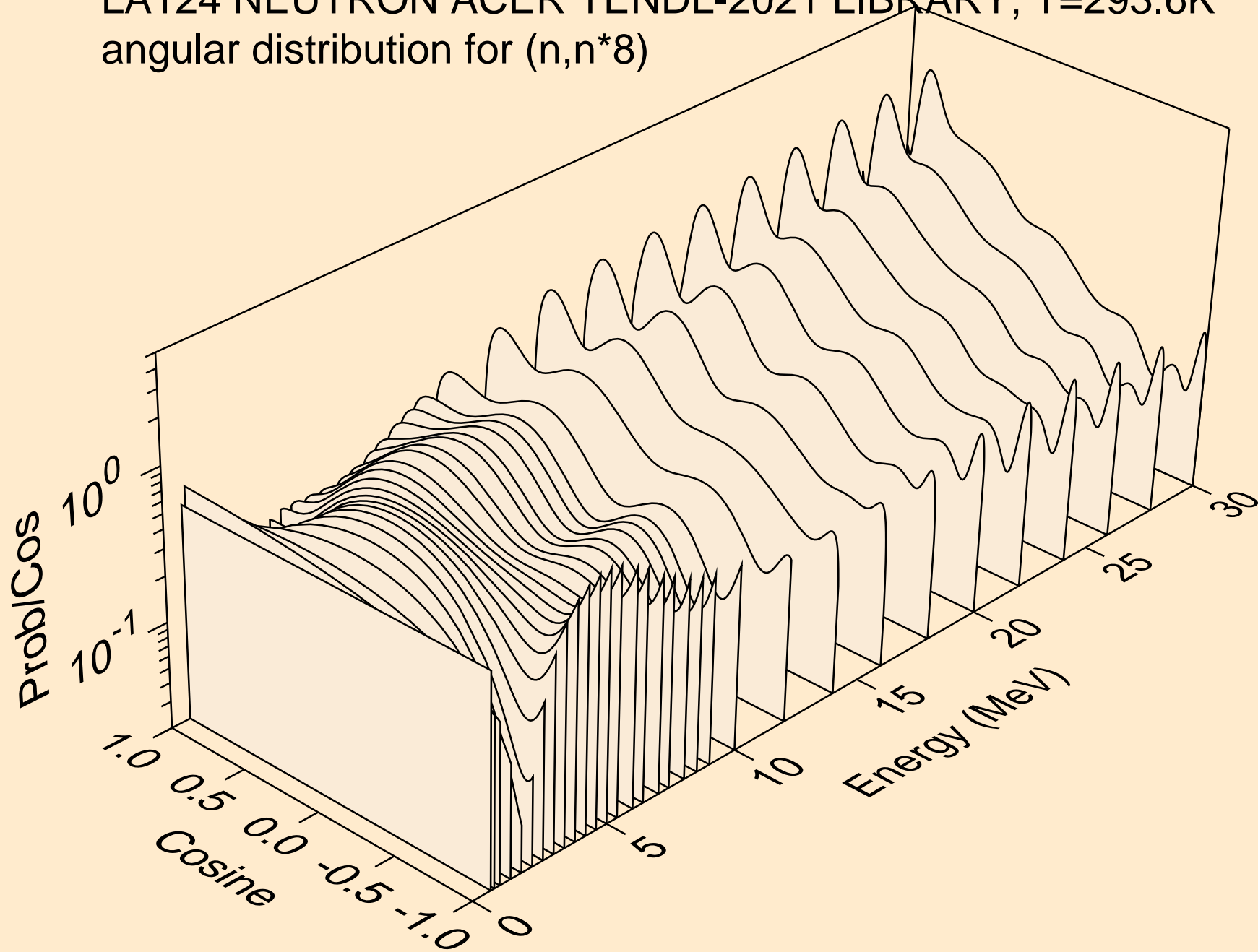

LA124 NEUTRON ACER TENDL-2021 LIBRARY; T=293.6K
angular distribution for (n,n*9)

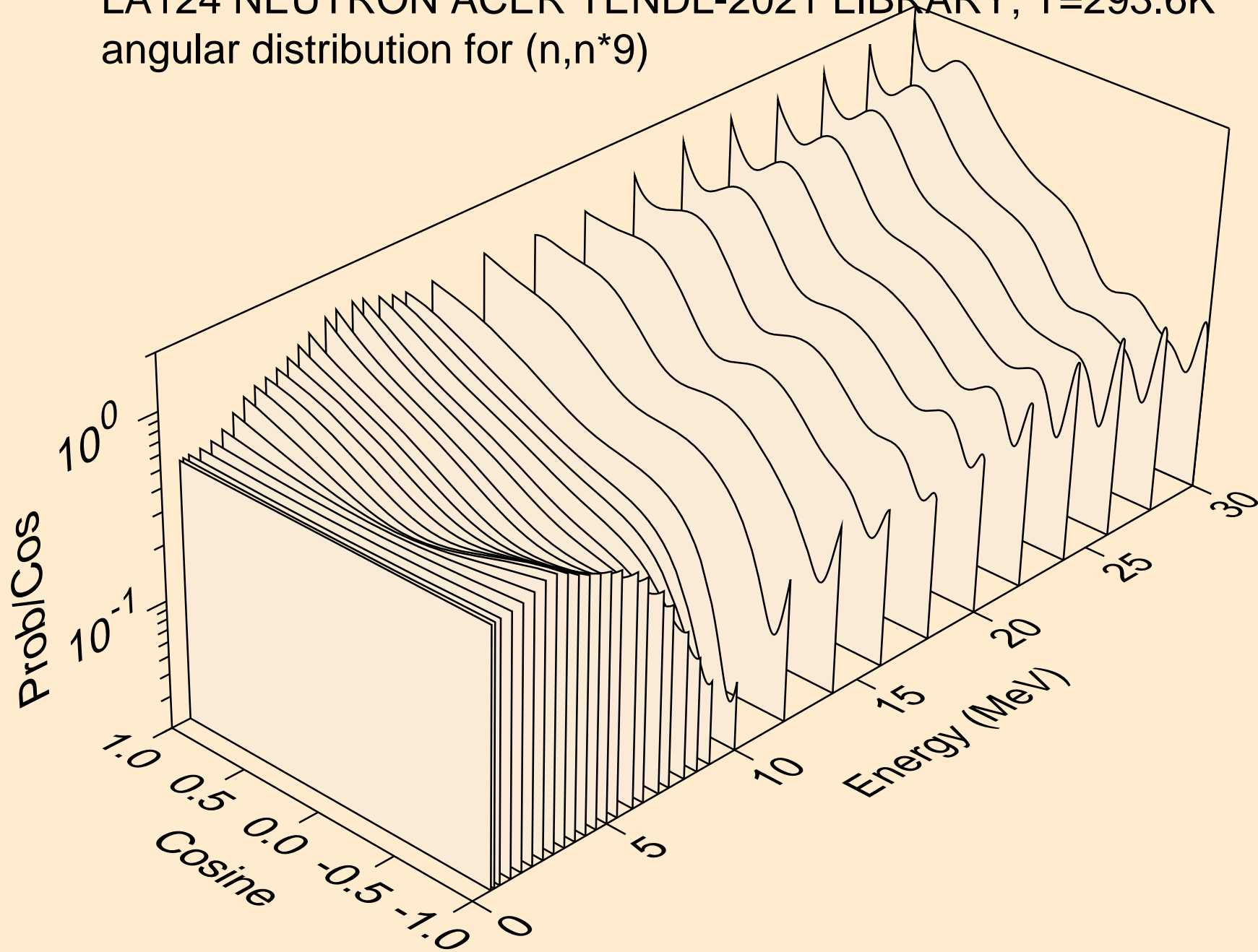

LA124 NEUTRON ACER TENDL-2021 LIBRARY; T=293.6K
angular distribution for (n,n*10)

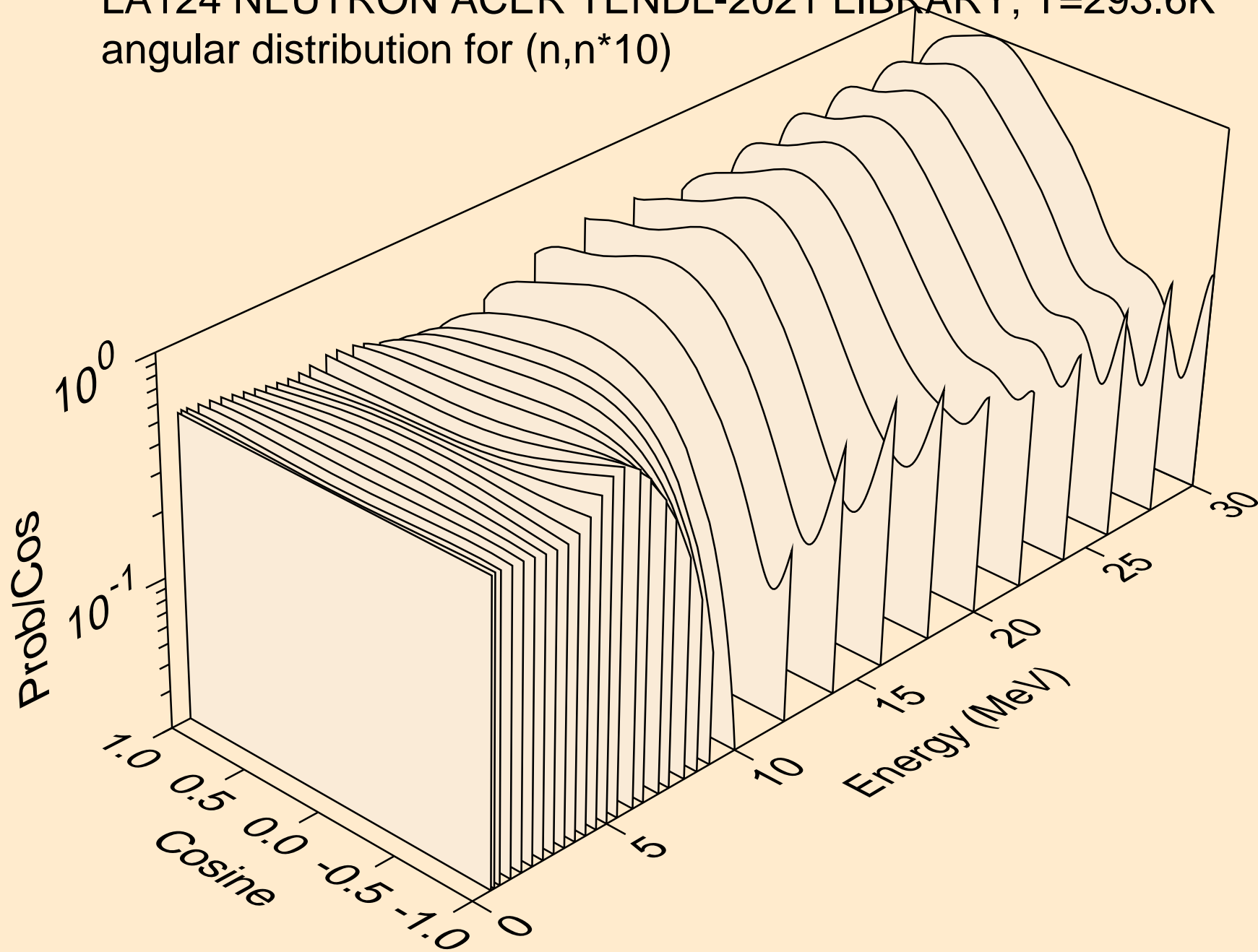

LA124 NEUTRON ACER TENDL-2021 LIBRARY; T=293.6K
angular distribution for (n,n*11)

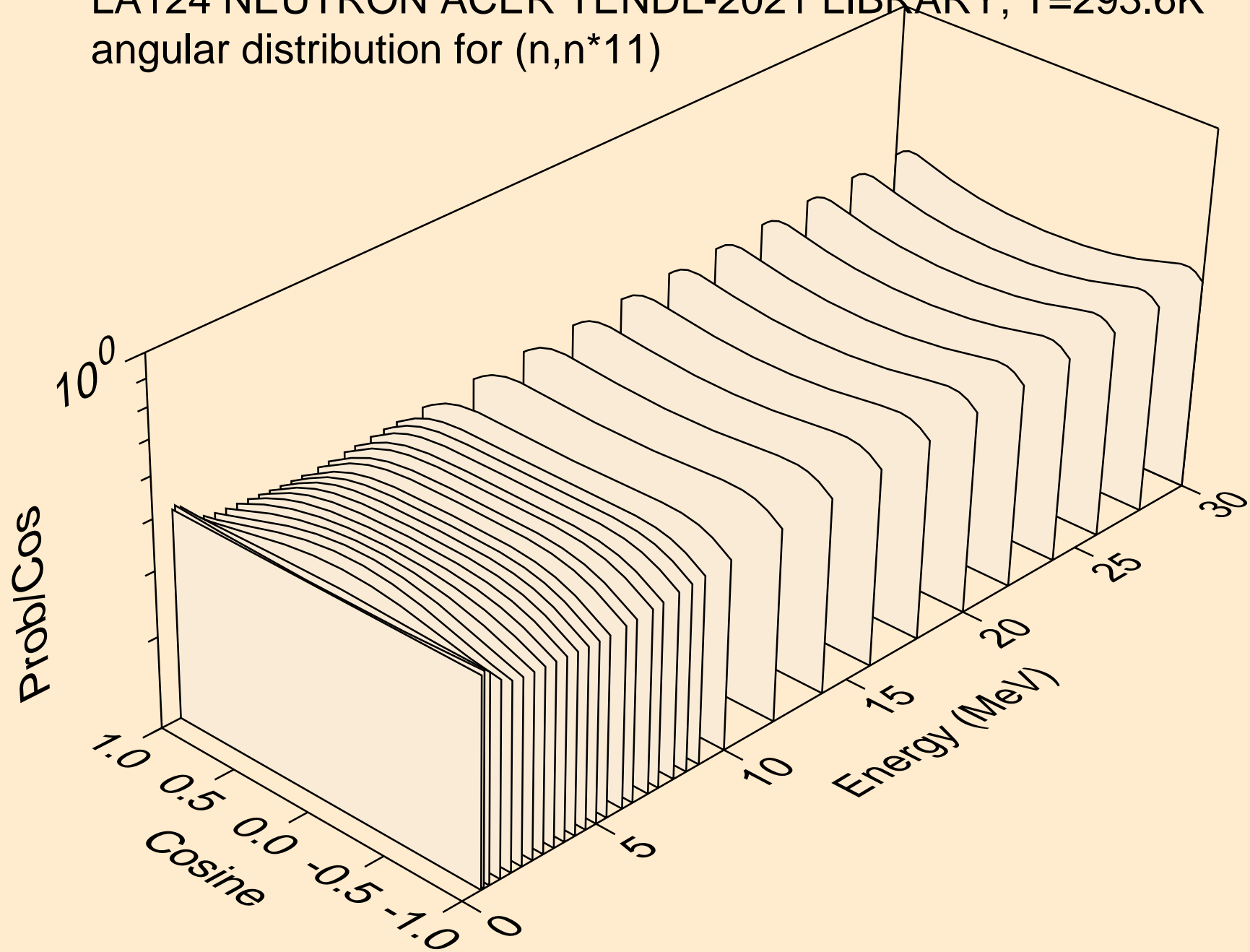

LA124 NEUTRON ACER TENDL-2021 LIBRARY; T=293.6K
angular distribution for (n,n*12)

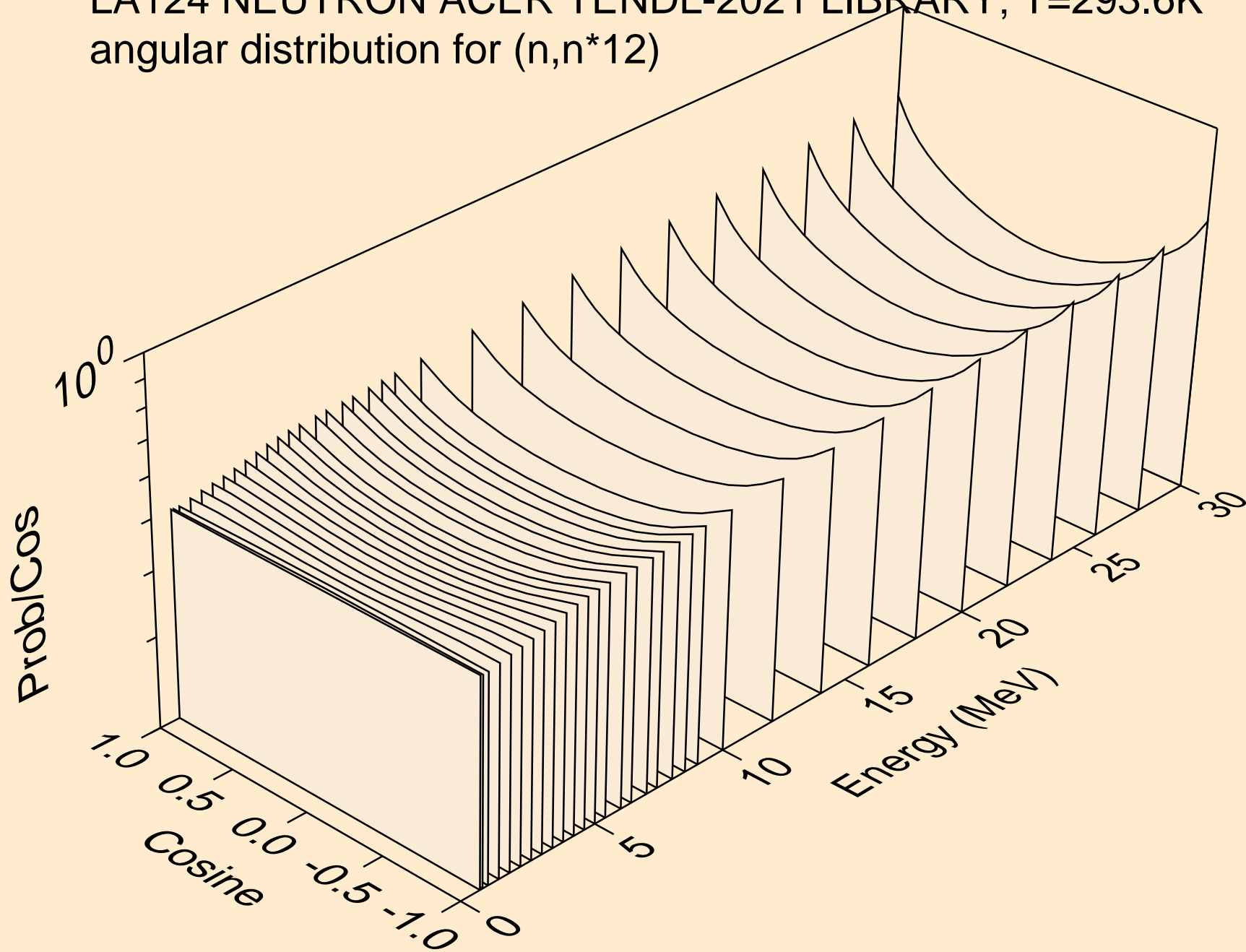

LA124 NEUTRON ACER TENDL-2021 LIBRARY; T=293.6K
angular distribution for (n,n*13)

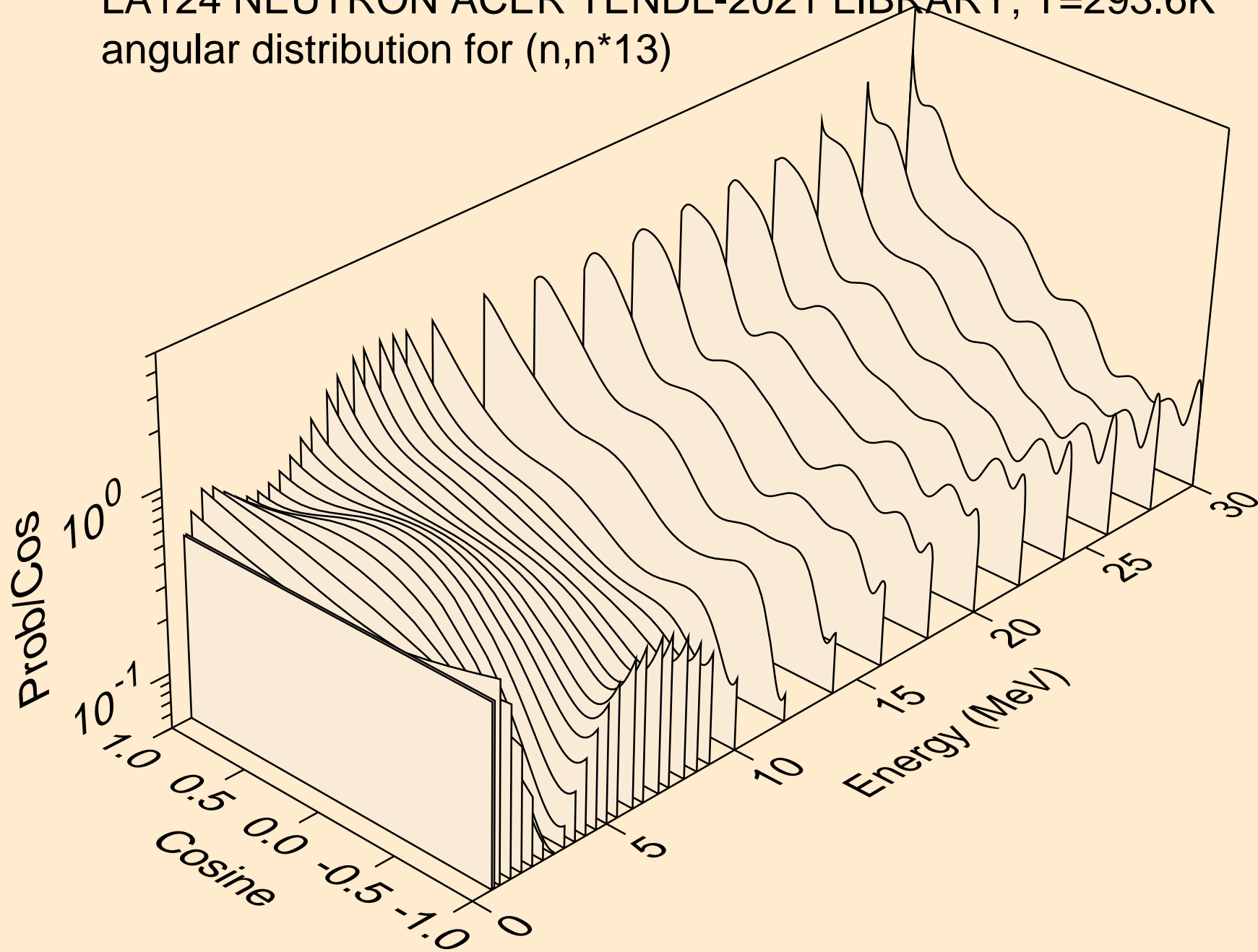

LA124 NEUTRON ACER TENDL-2021 LIBRARY; T=293.6K
angular distribution for (n,n*14)

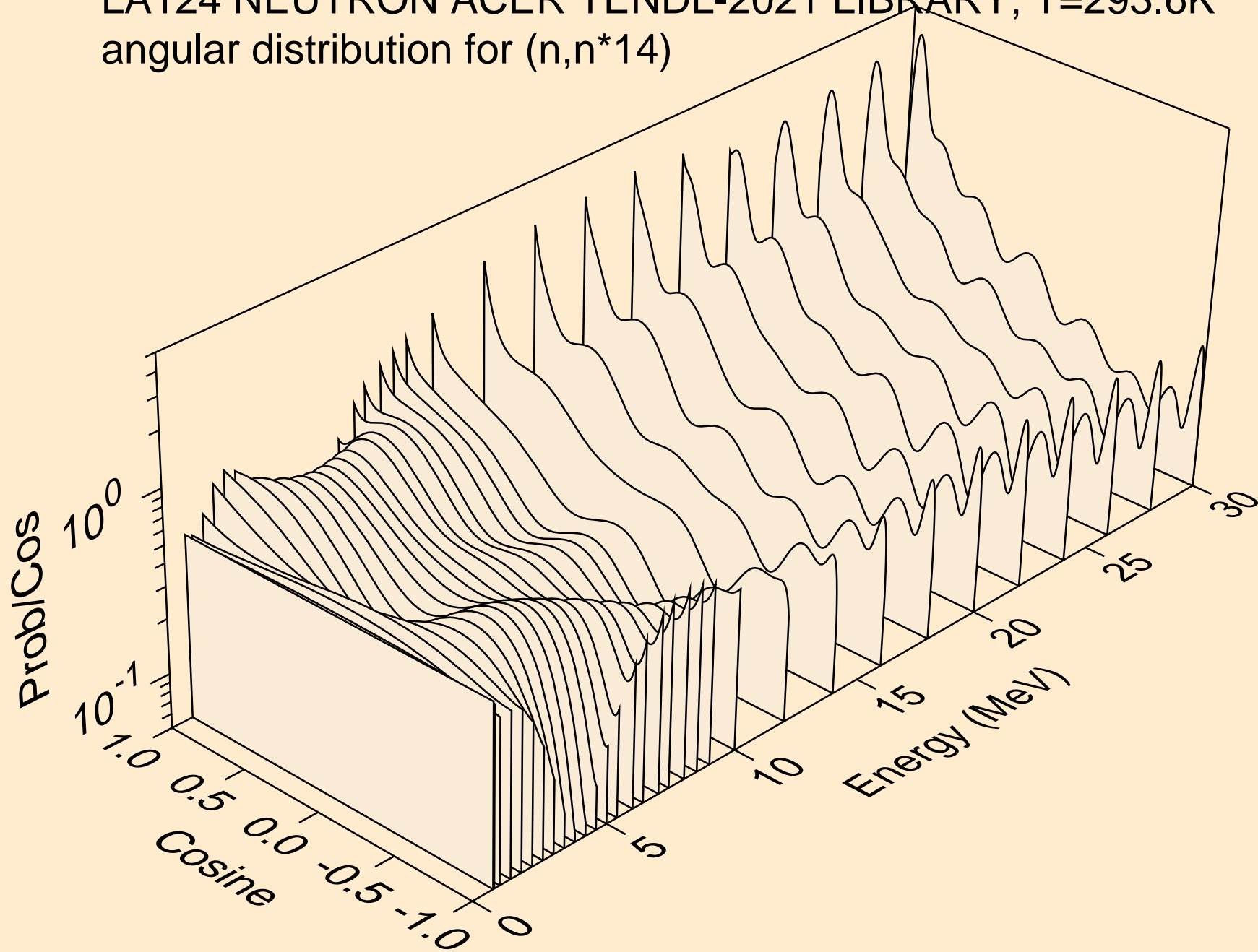

LA124 NEUTRON ACER TENDL-2021 LIBRARY; T=293.6K
Neutron emission for (n,x)

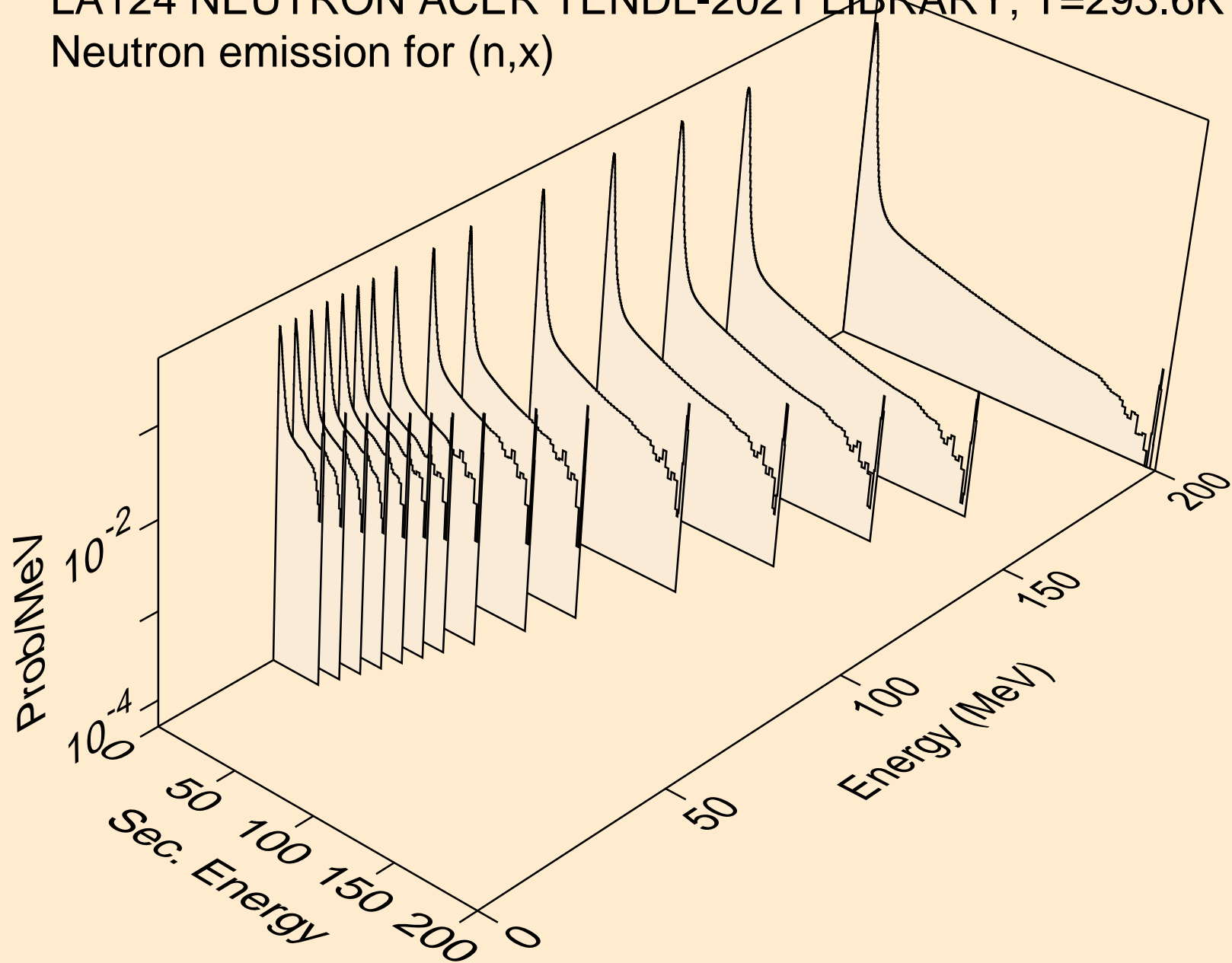

LA124 NEUTRON ACER TENDL-2021 LIBRARY; T=293.6K
Neutron emission for (n,2nd)

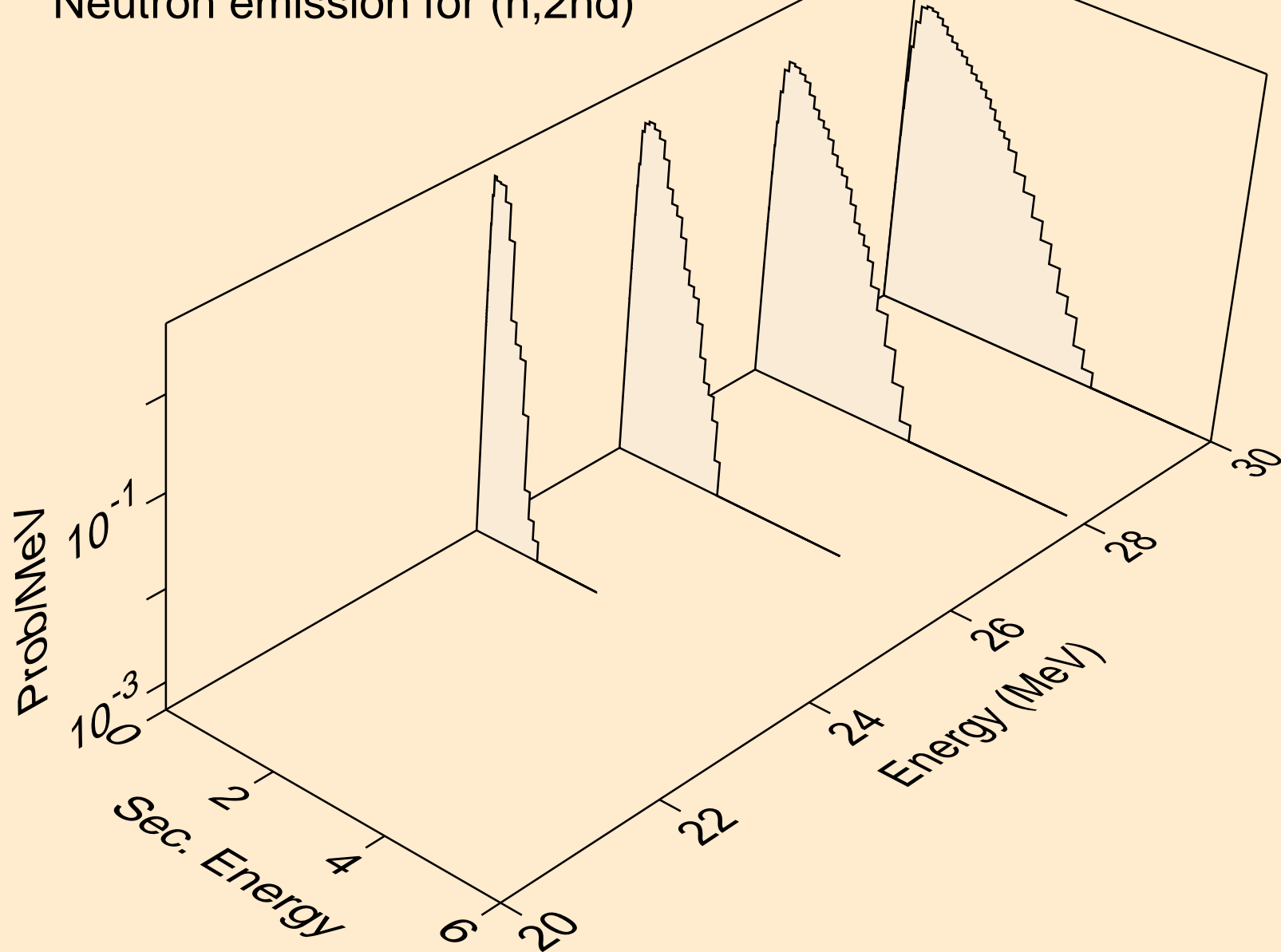

LA124 NEUTRON ACER TENDL-2021 LIBRARY; T=293.6K
Neutron emission for (n,2n)

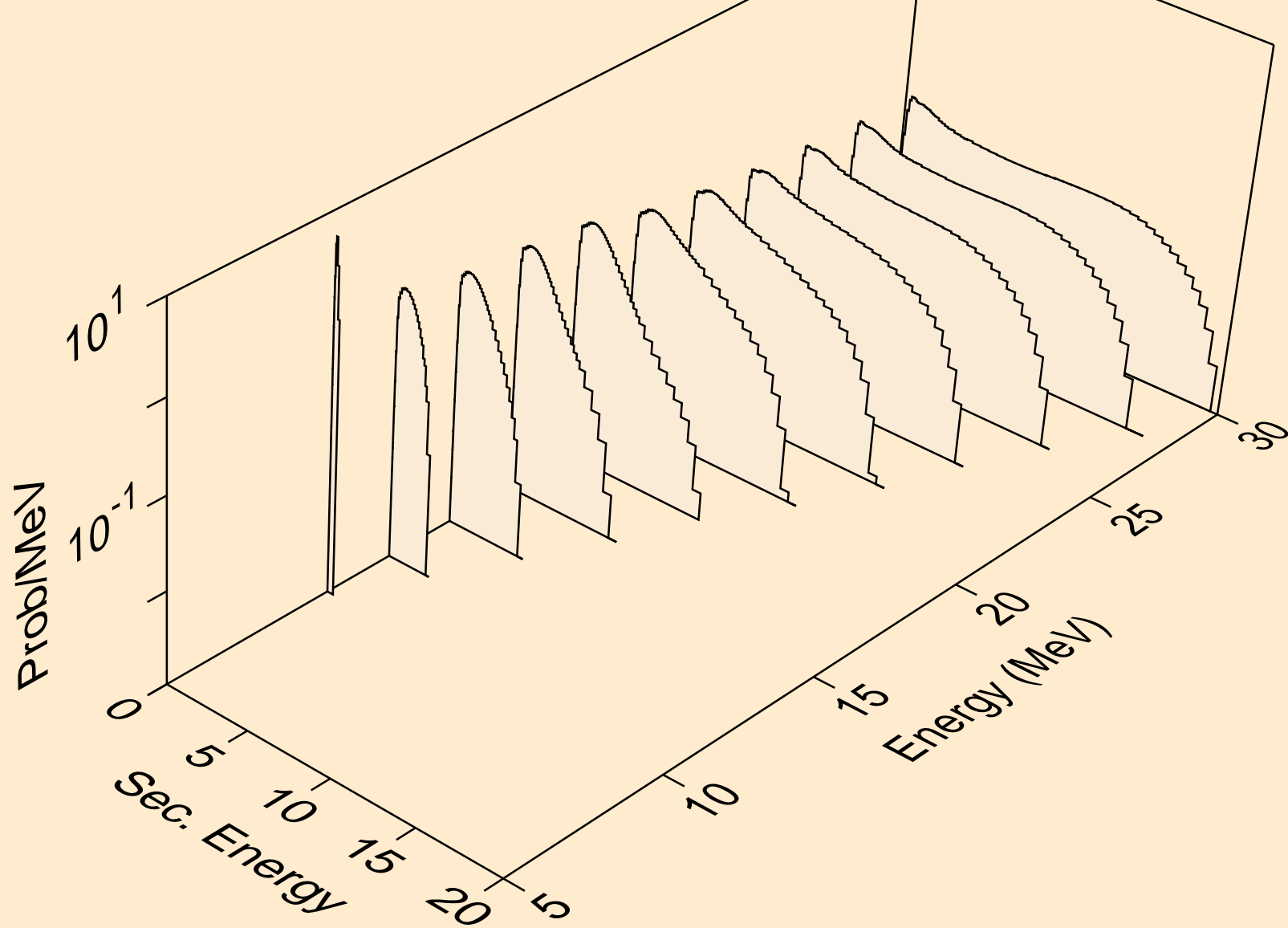

LA124 NEUTRON ACER TENDL-2021 LIBRARY; T=293.6K
Neutron emission for (n,3n)

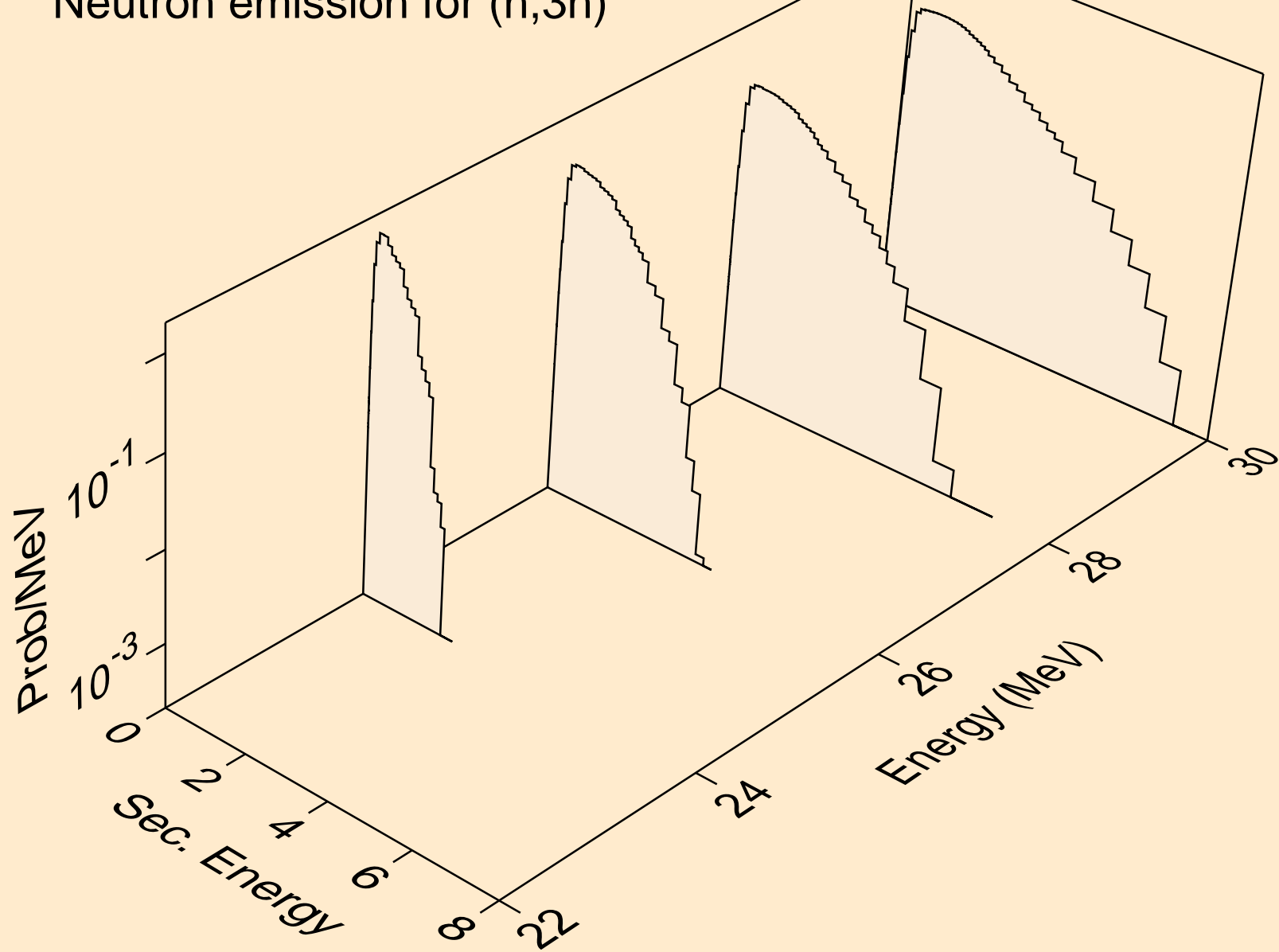

LA124 NEUTRON ACER TENDL-2021 LIBRARY; T=293.6K
Neutron emission for (n,n*)a

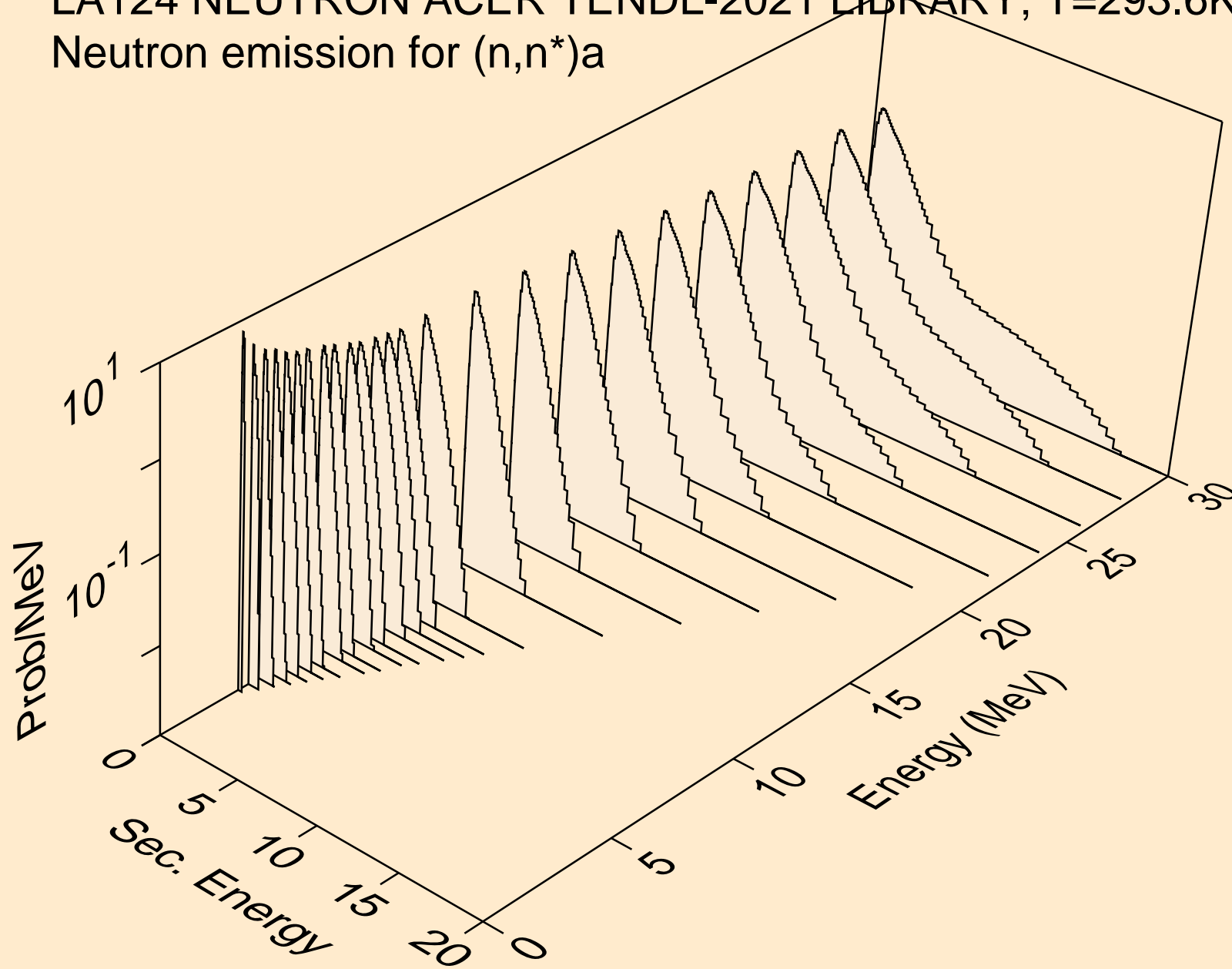

LA124 NEUTRON ACER TENDL-2021 LIBRARY; T=293.6K
Neutron emission for (n,2n)_a

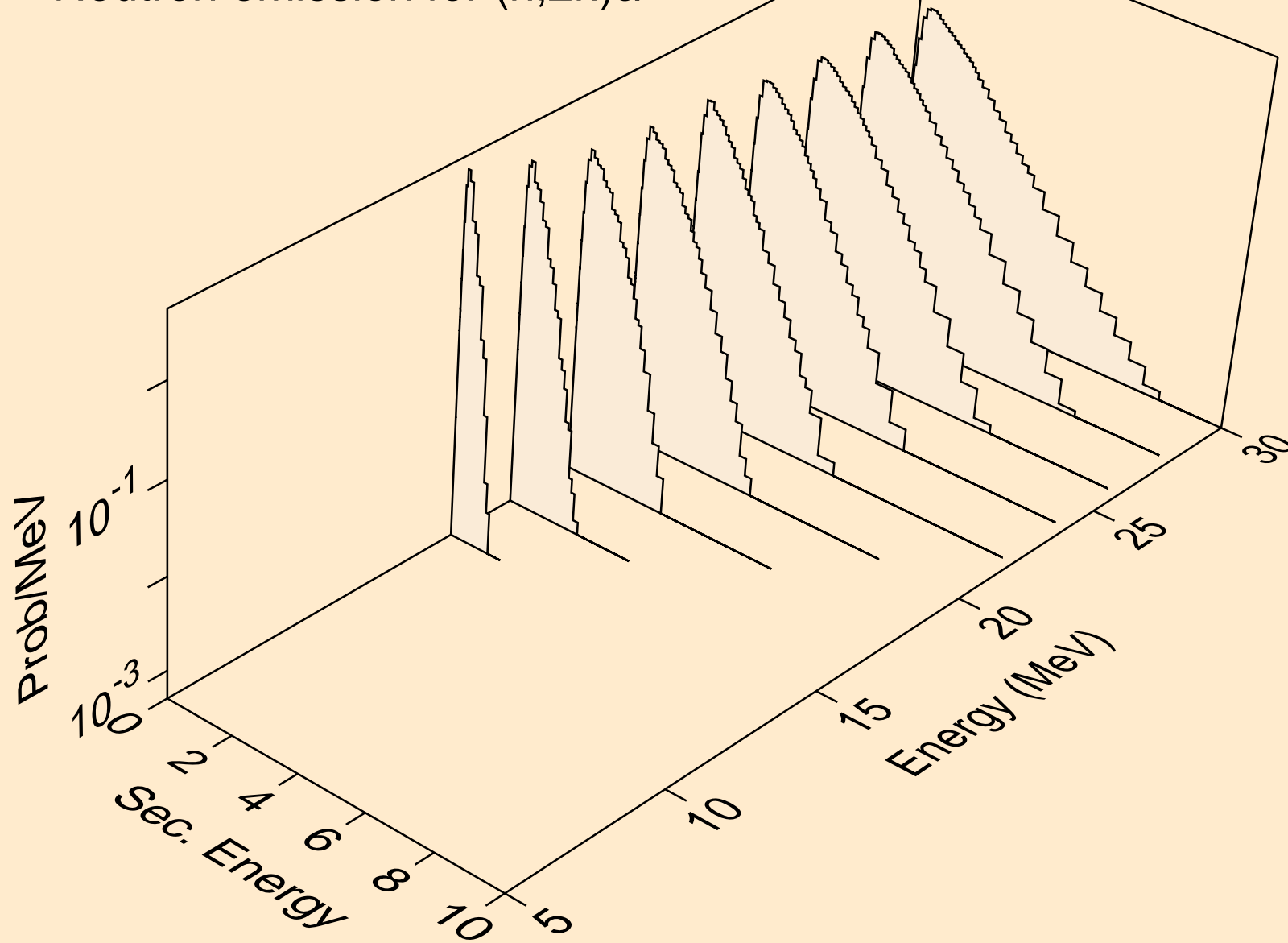

LA124 NEUTRON ACER TENDL-2021 LIBRARY; T=293.6K
Neutron emission for (n,n*)p

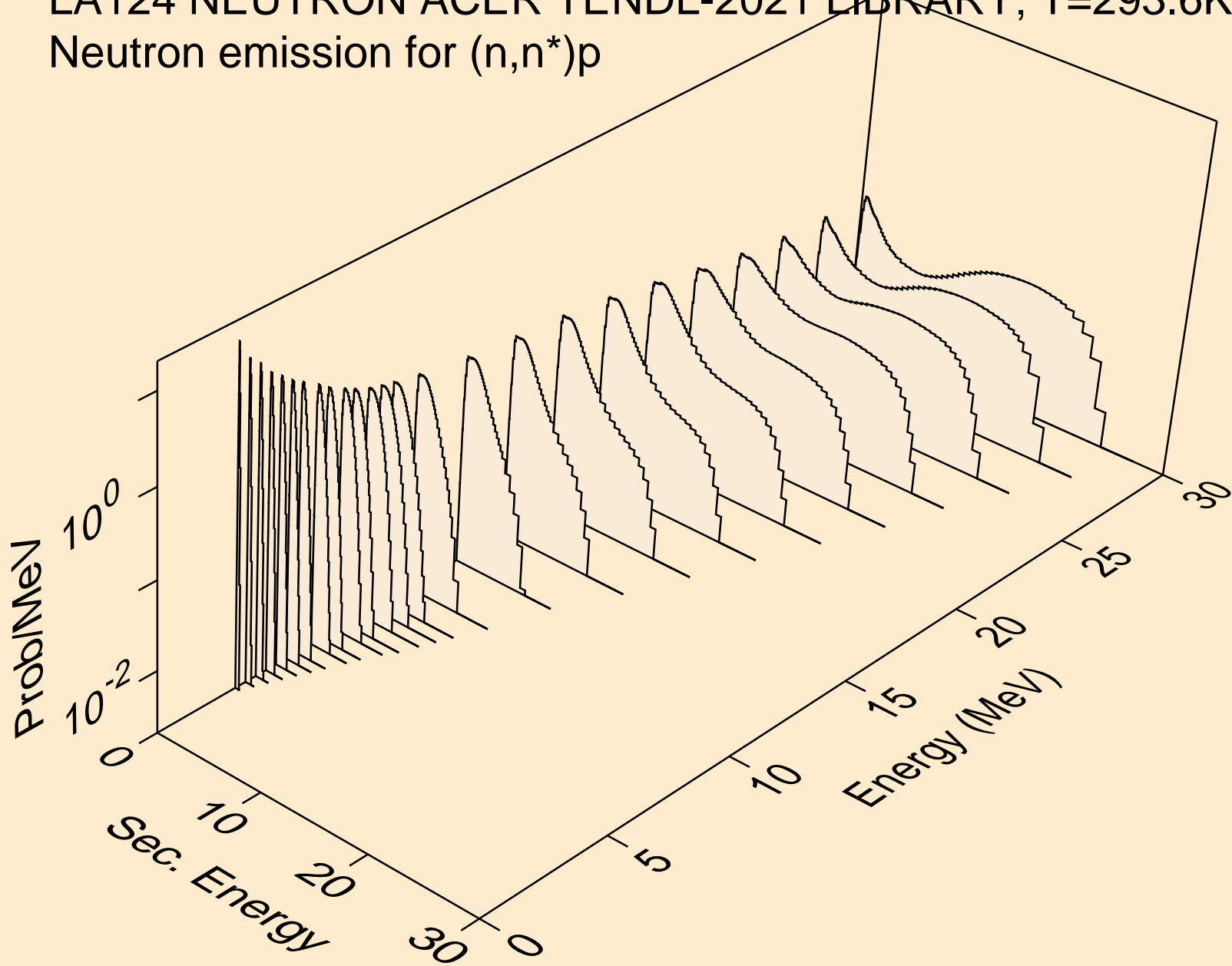

LA124 NEUTRON ACER TENDL-2021 LIBRARY; T=293.6K
Neutron emission for (n,n*)2a

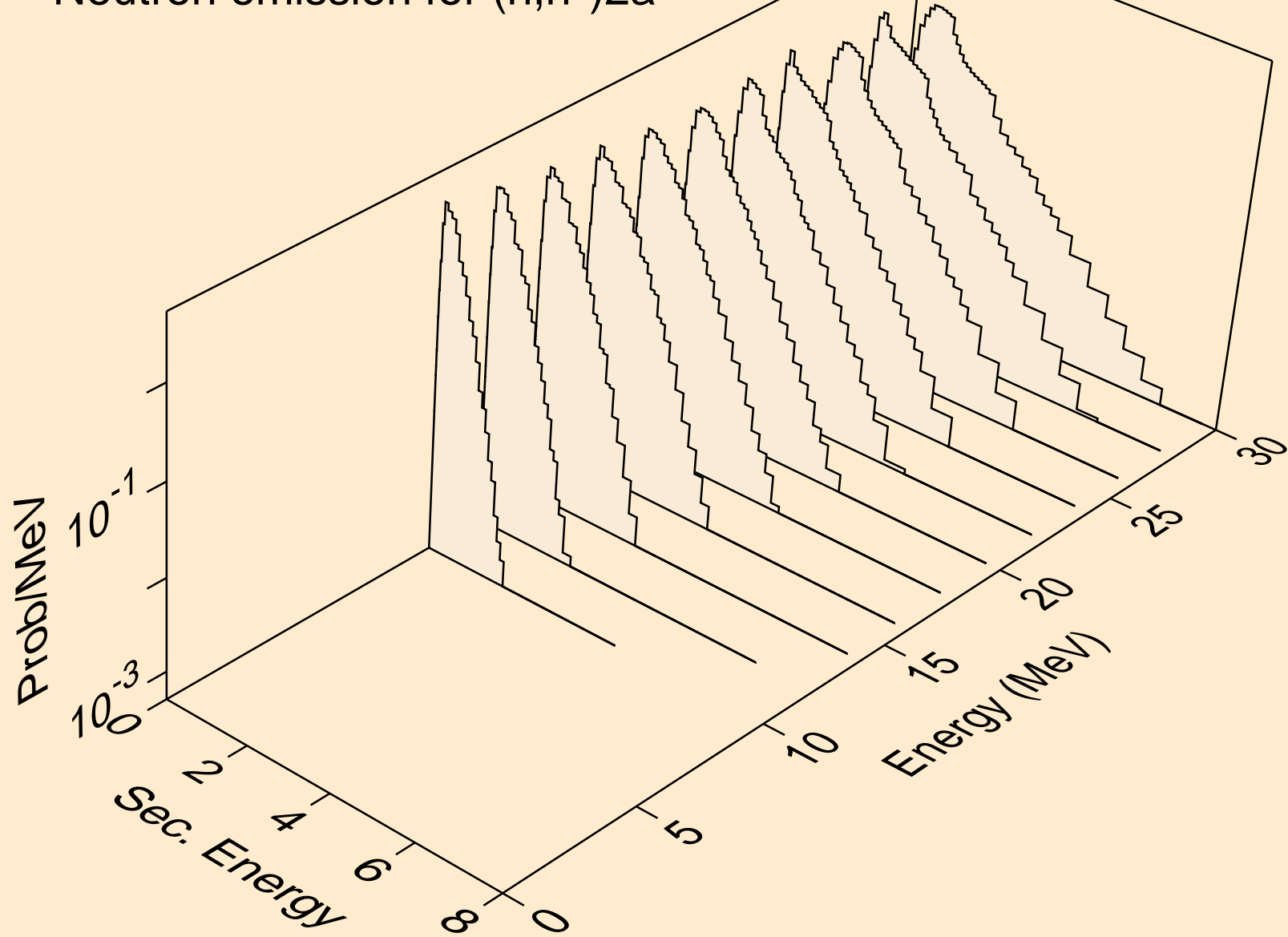

LA124 NEUTRON ACER TENDL-2021 LIBRARY; T=293.6K
Neutron emission for (n,2n)2a

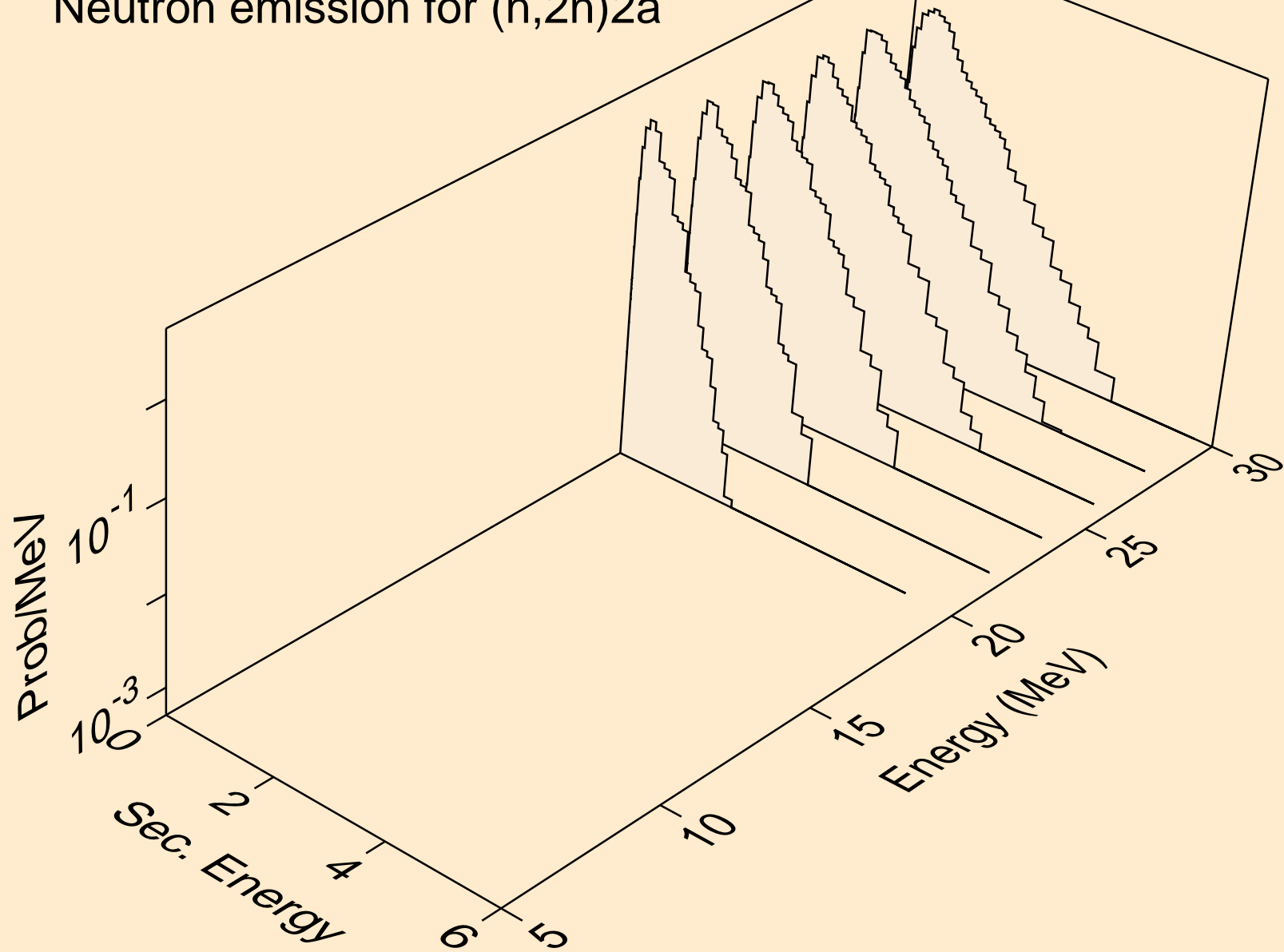

LA124 NEUTRON ACER TENDL-2021 LIBRARY; T=293.6K
Neutron emission for (n,n*)d

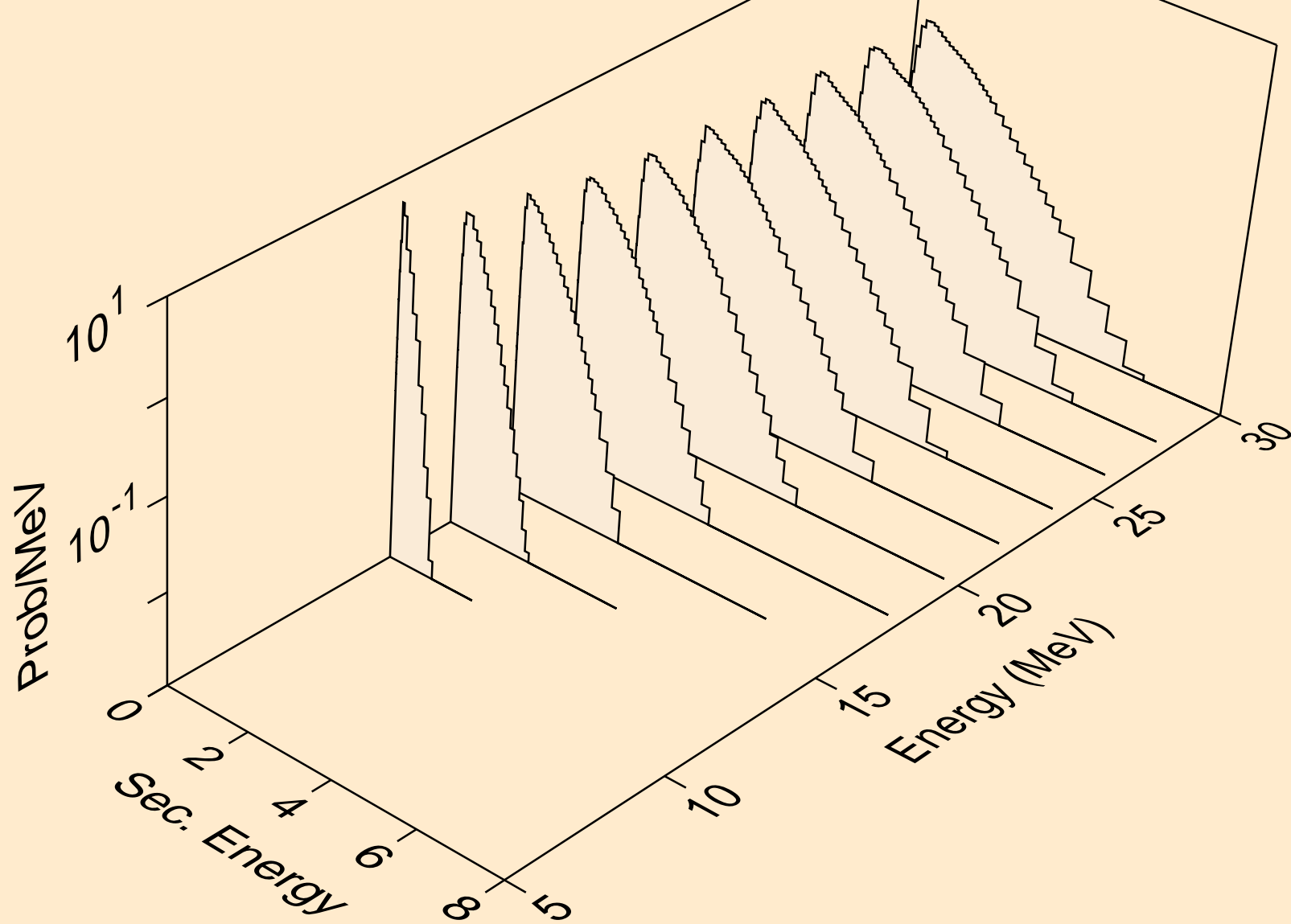

LA124 NEUTRON ACER TENDL-2021 LIBRARY; T=293.6K
Neutron emission for (n,n*)t

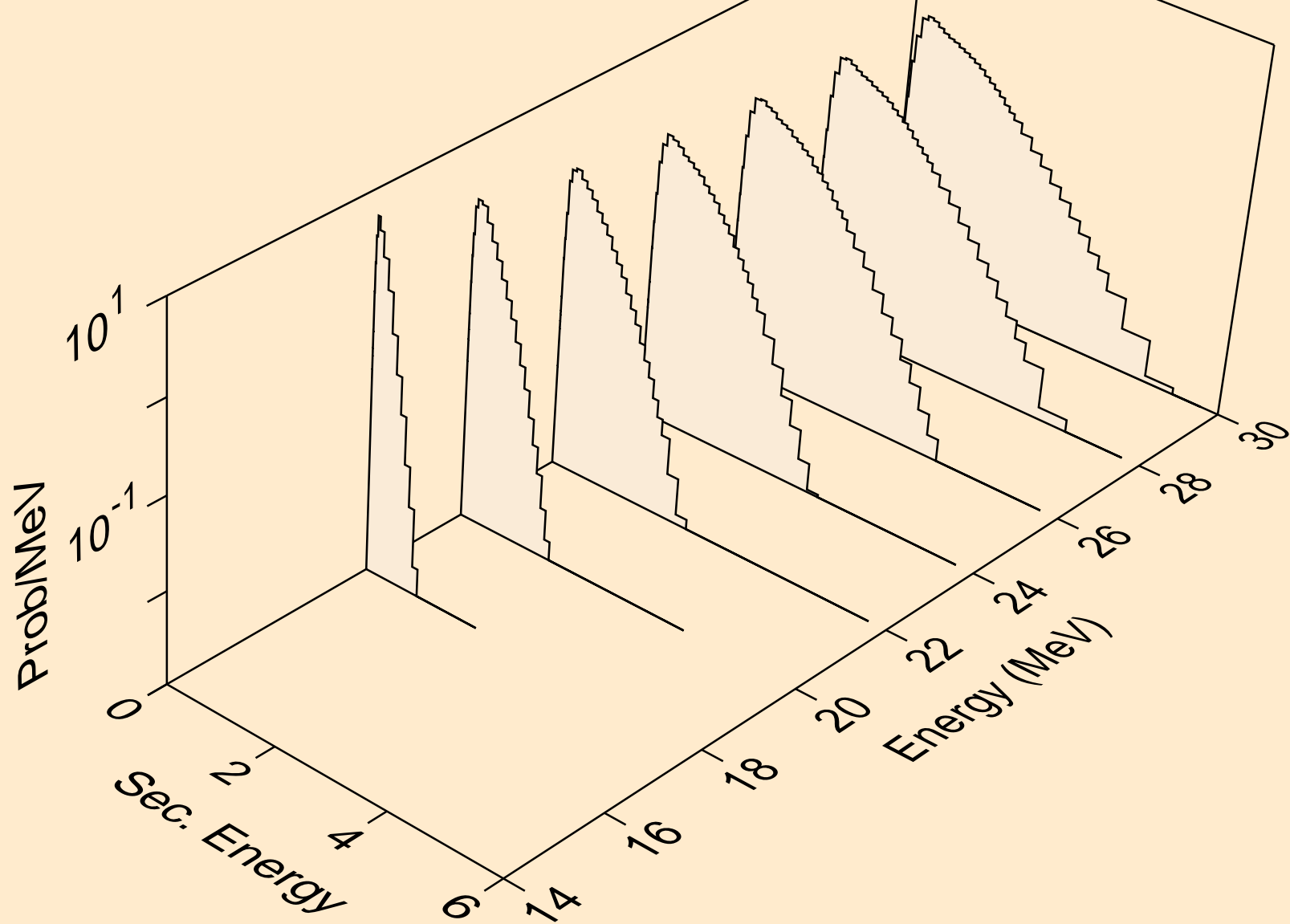

LA124 NEUTRON ACER TENDL-2021 LIBRARY; T=293.6K
Neutron emission for (n,n*)he3

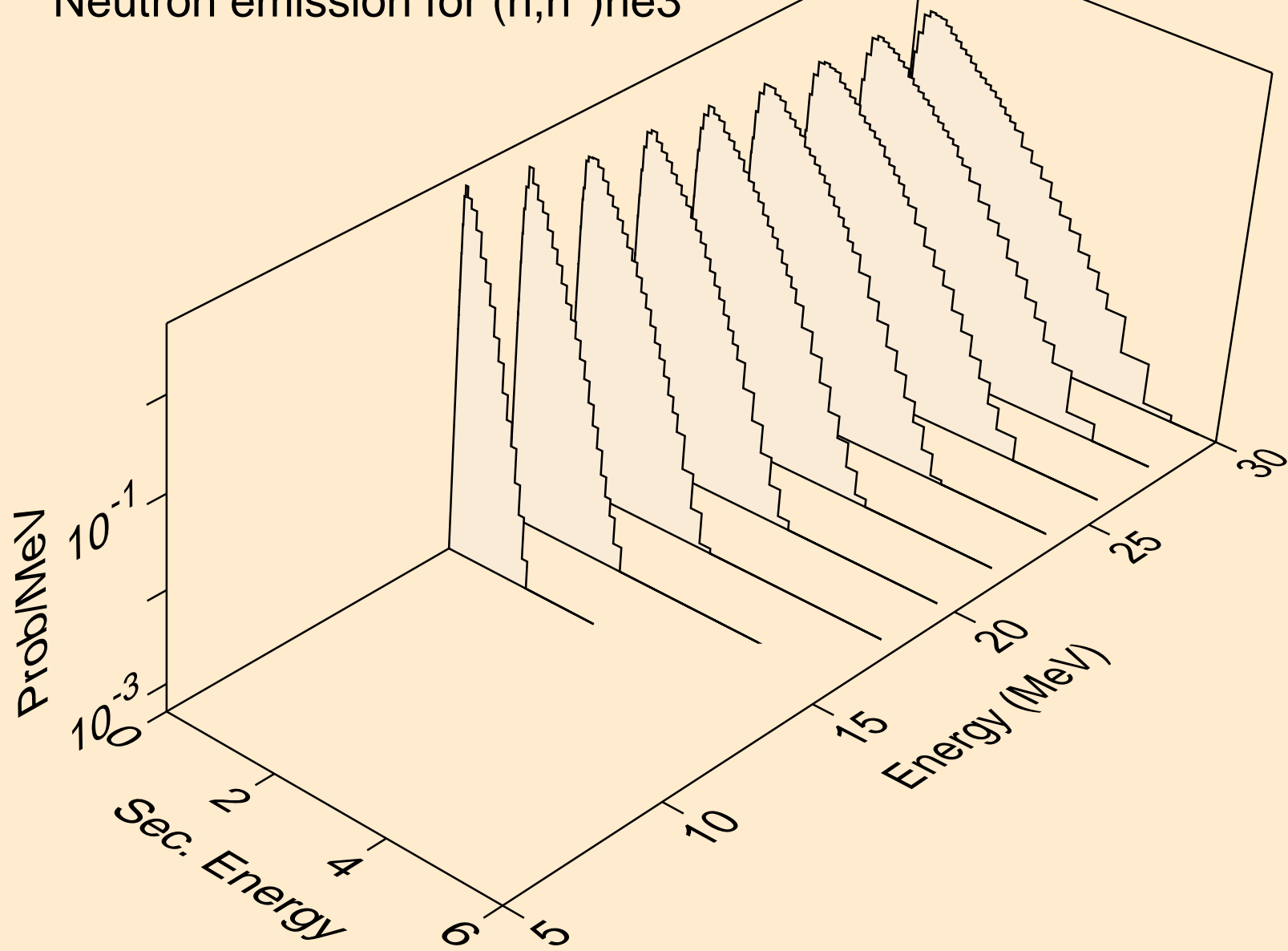

LA124 NEUTRON ACER TENDL-2021 LIBRARY; T=293.6K
Neutron emission for (n,2np)

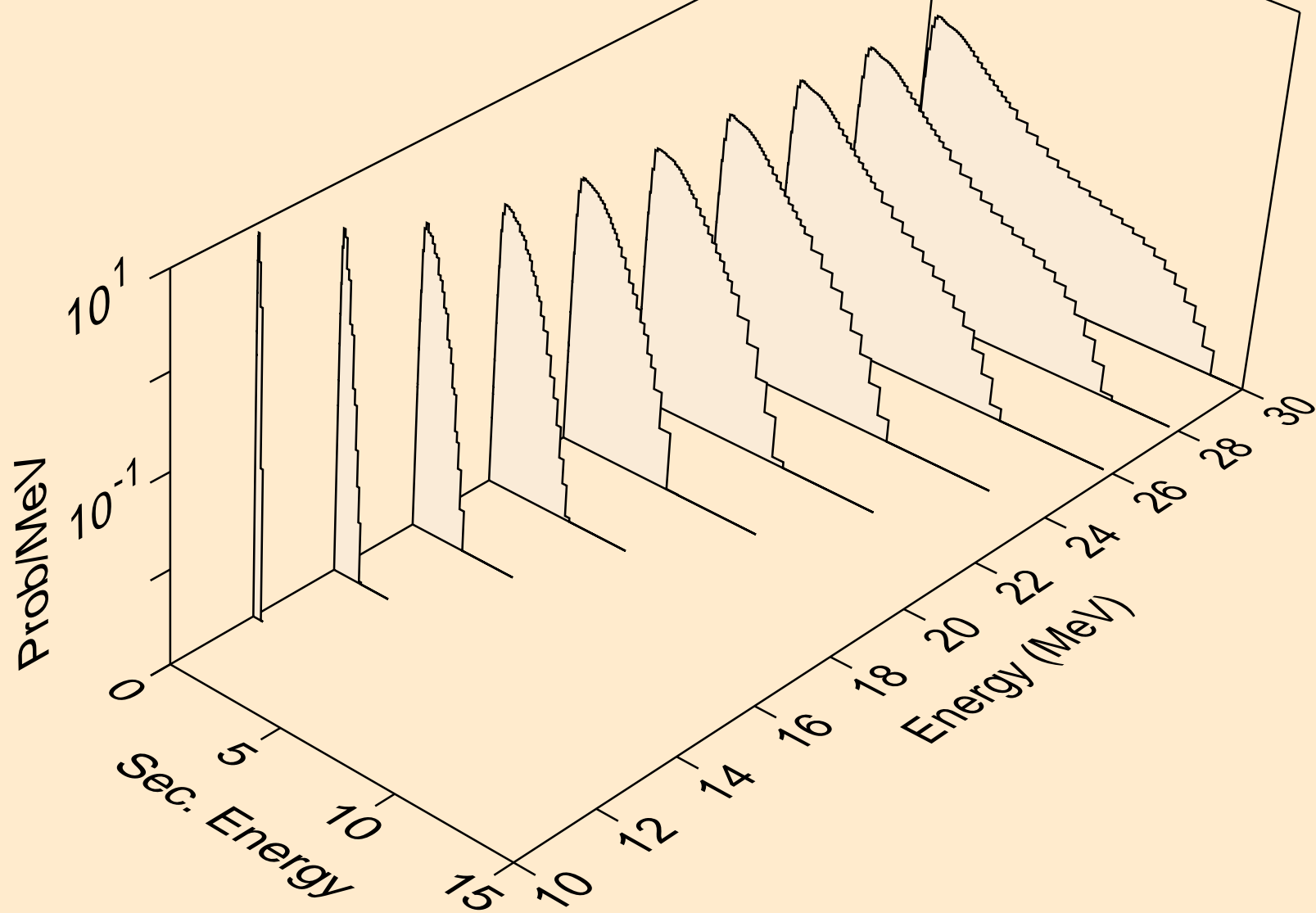

LA124 NEUTRON ACER TENDL-2021 LIBRARY; T=293.6K
Neutron emission for (n,3np)

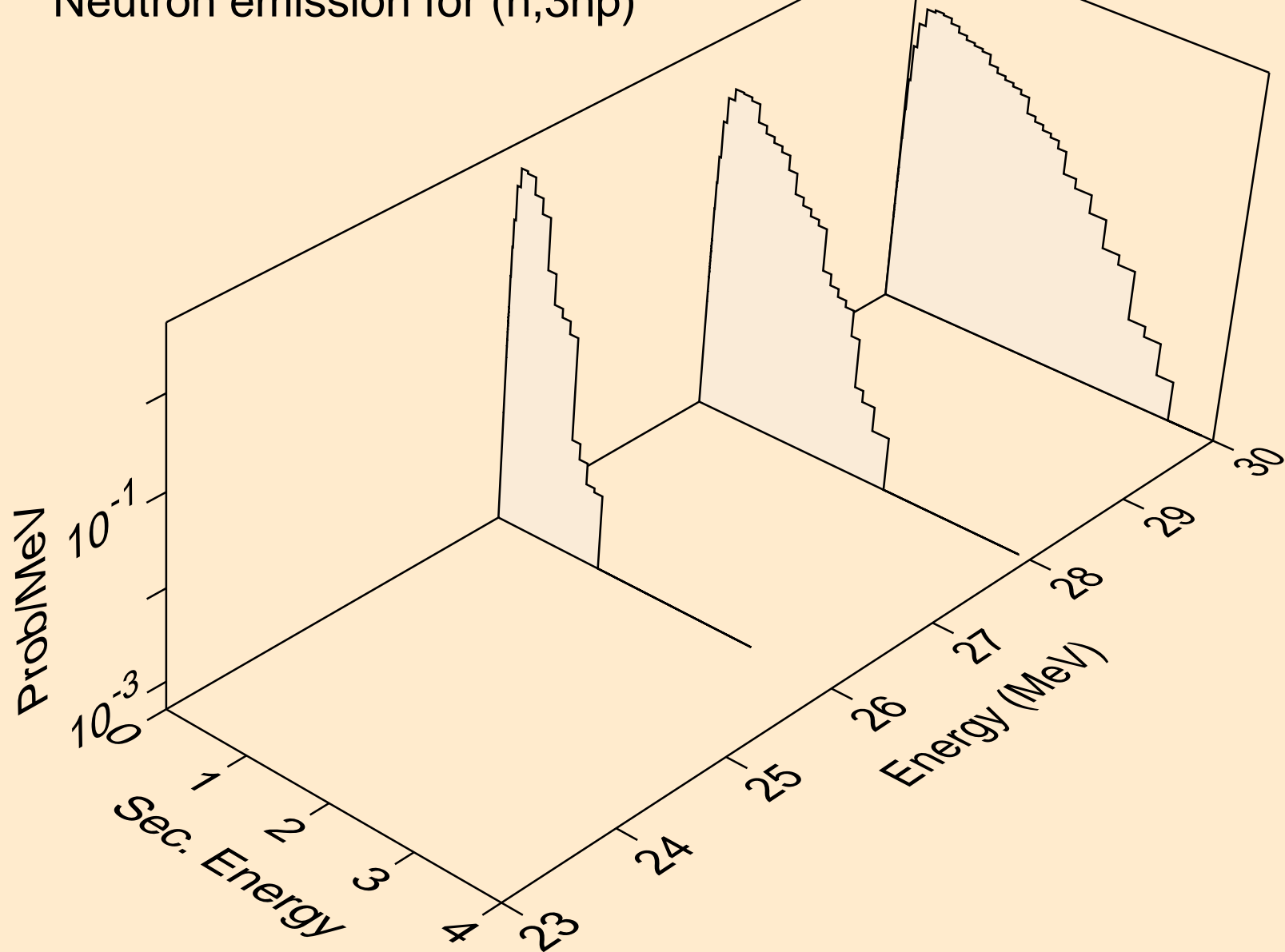

LA124 NEUTRON ACER TENDL-2021 LIBRARY; T=293.6K
Neutron emission for (n,2np)

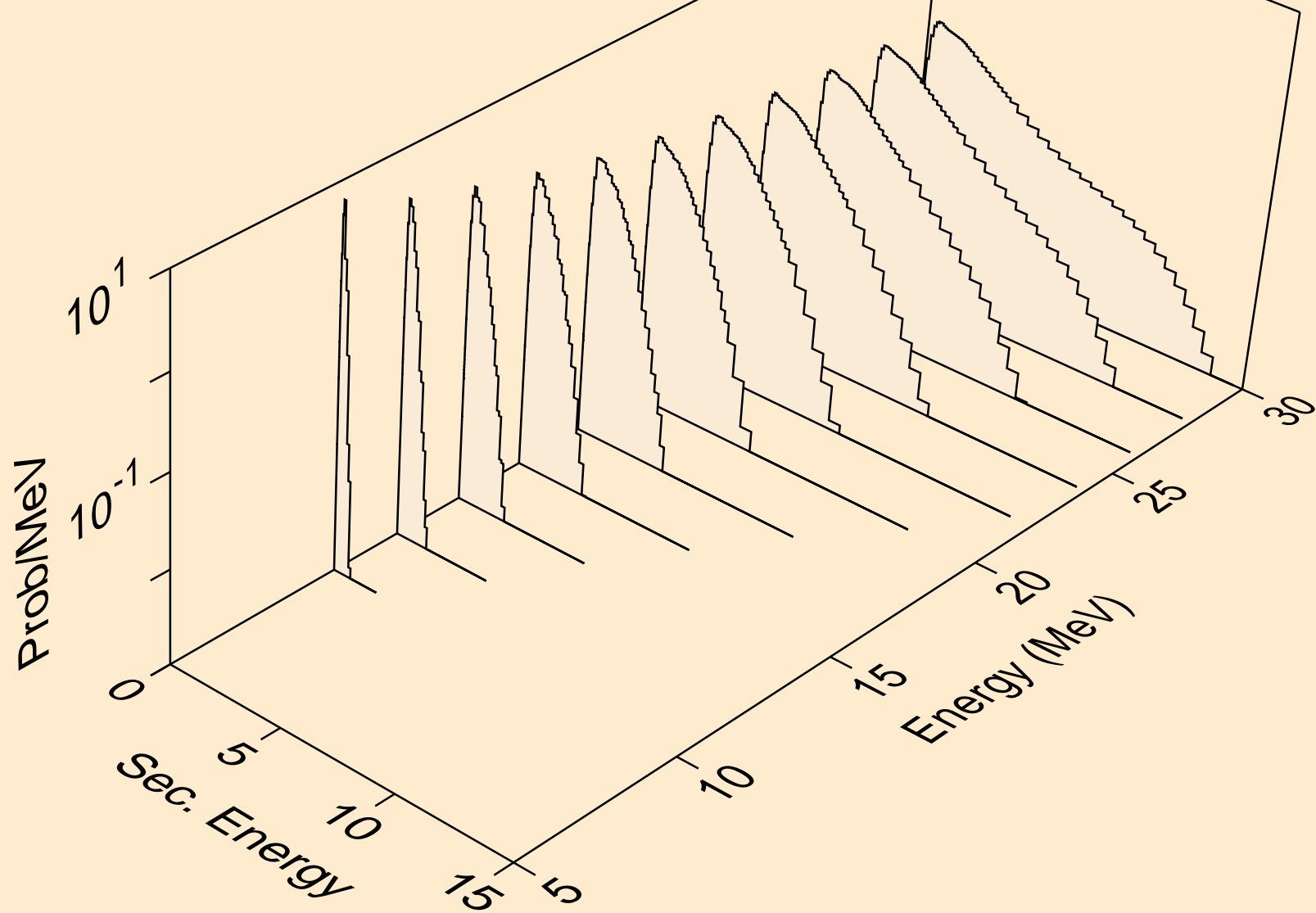

LA124 NEUTRON ACER TENDL-2021 LIBRARY; T=293.6K
Neutron emission for (n,npa)

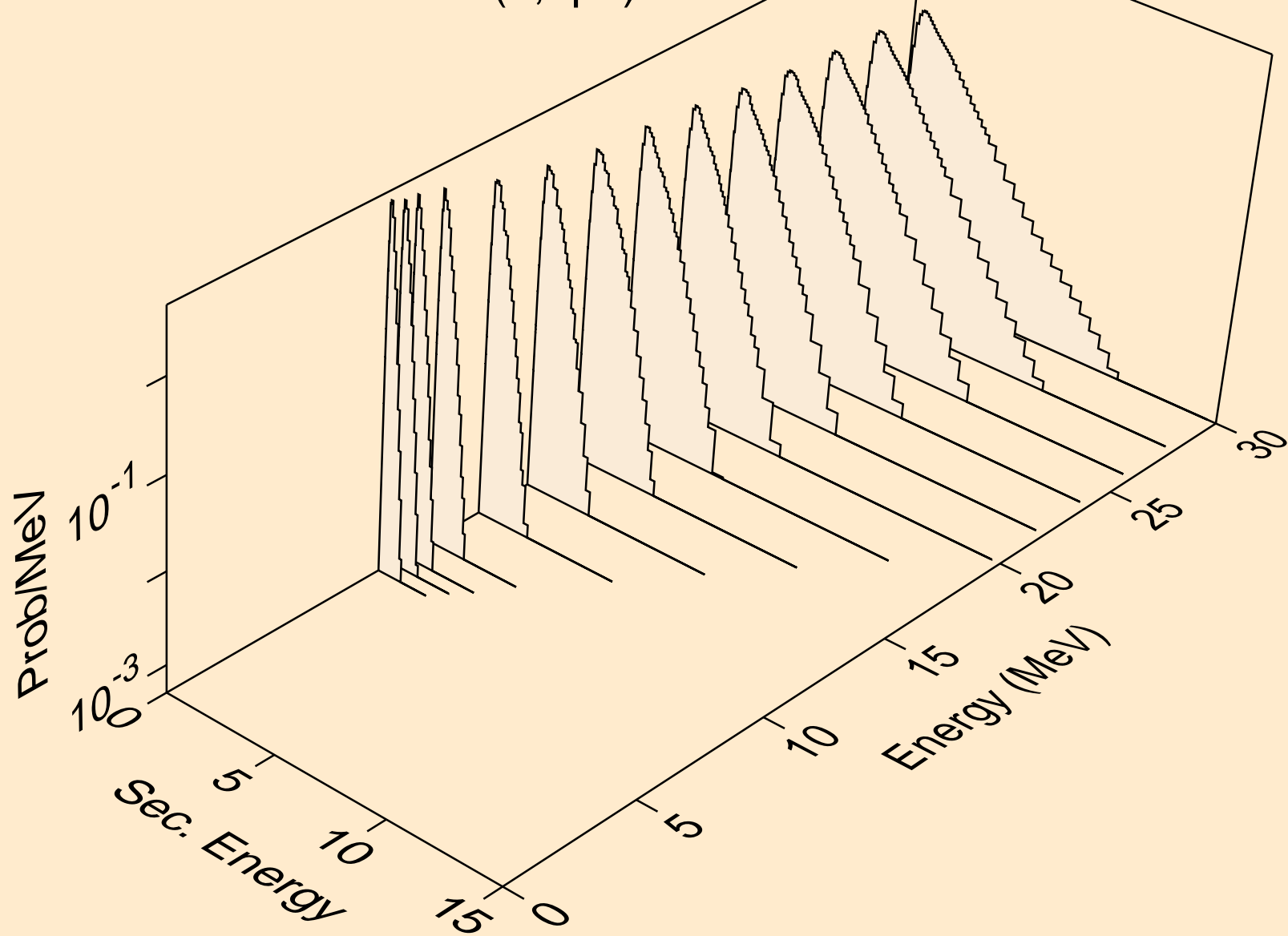

LA124 NEUTRON ACER TENDL-2021 LIBRARY; T=293.6K
Neutron emission for (n,n*c)

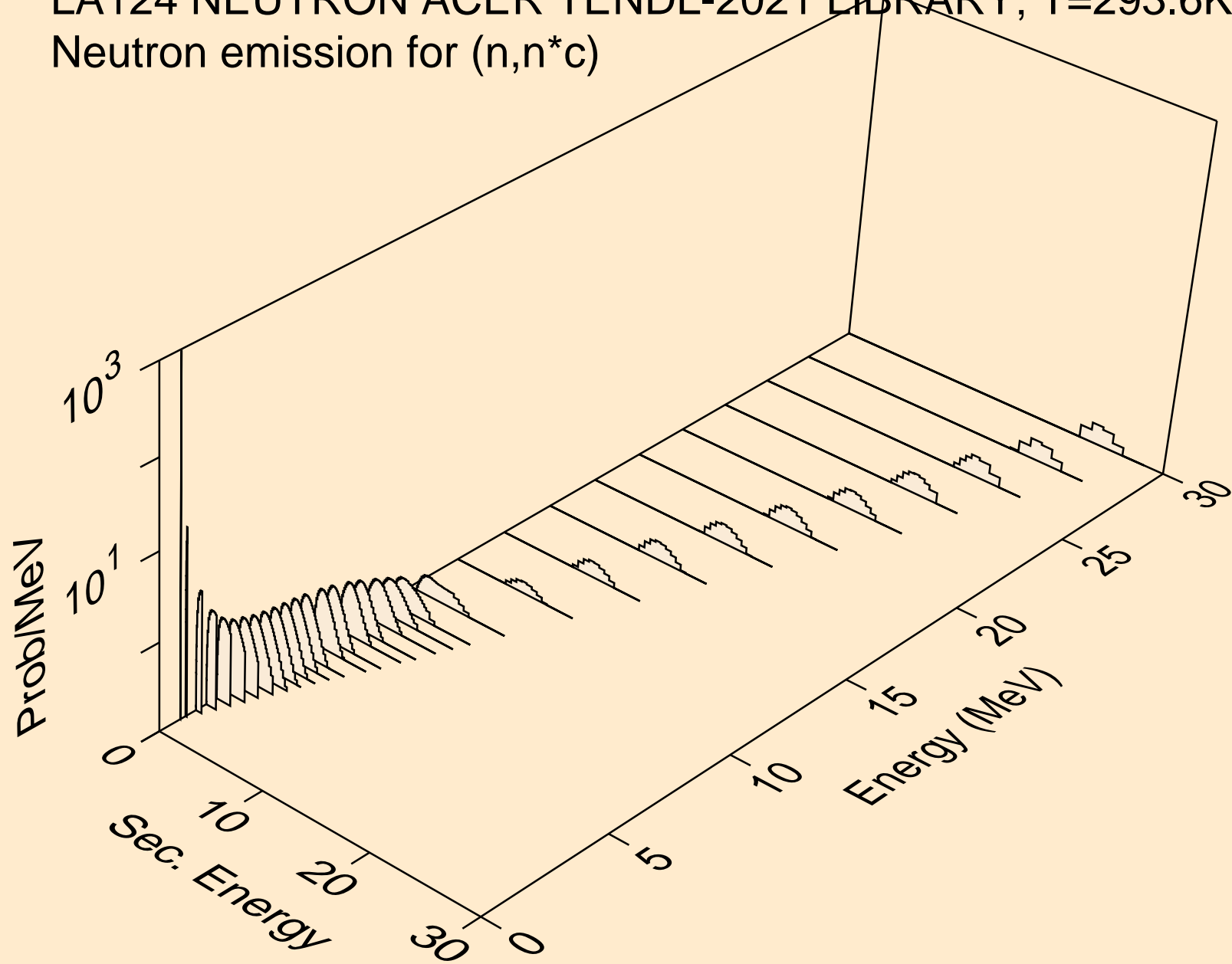

LA124 NEUTRON ACER TENDL-2021 LIBRARY; T=293.6K
Photon emission for (n,x)

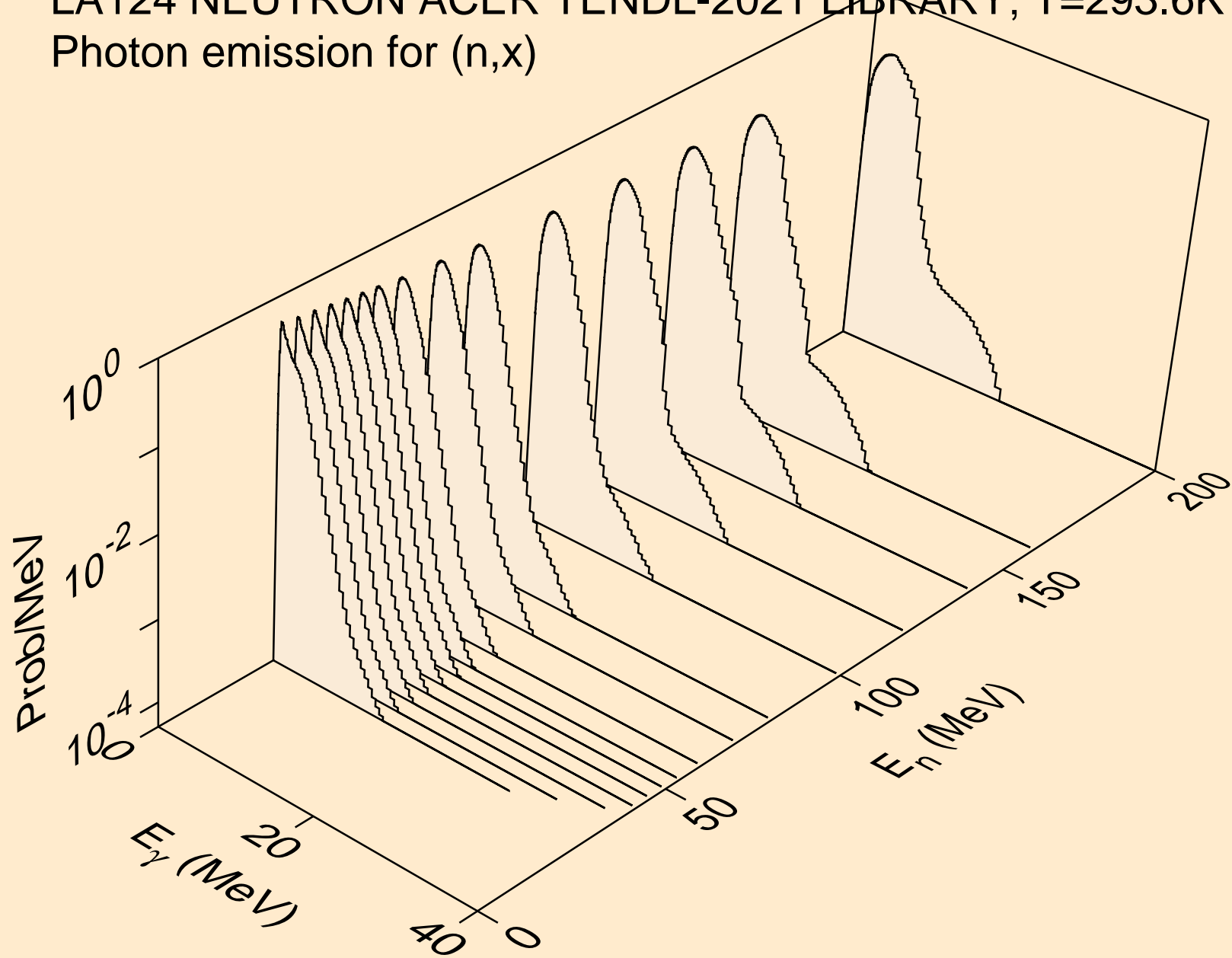

LA124 NEUTRON ACER TENDL-2021 LIBRARY; T=293.6K
Photon emission for (n,2nd)

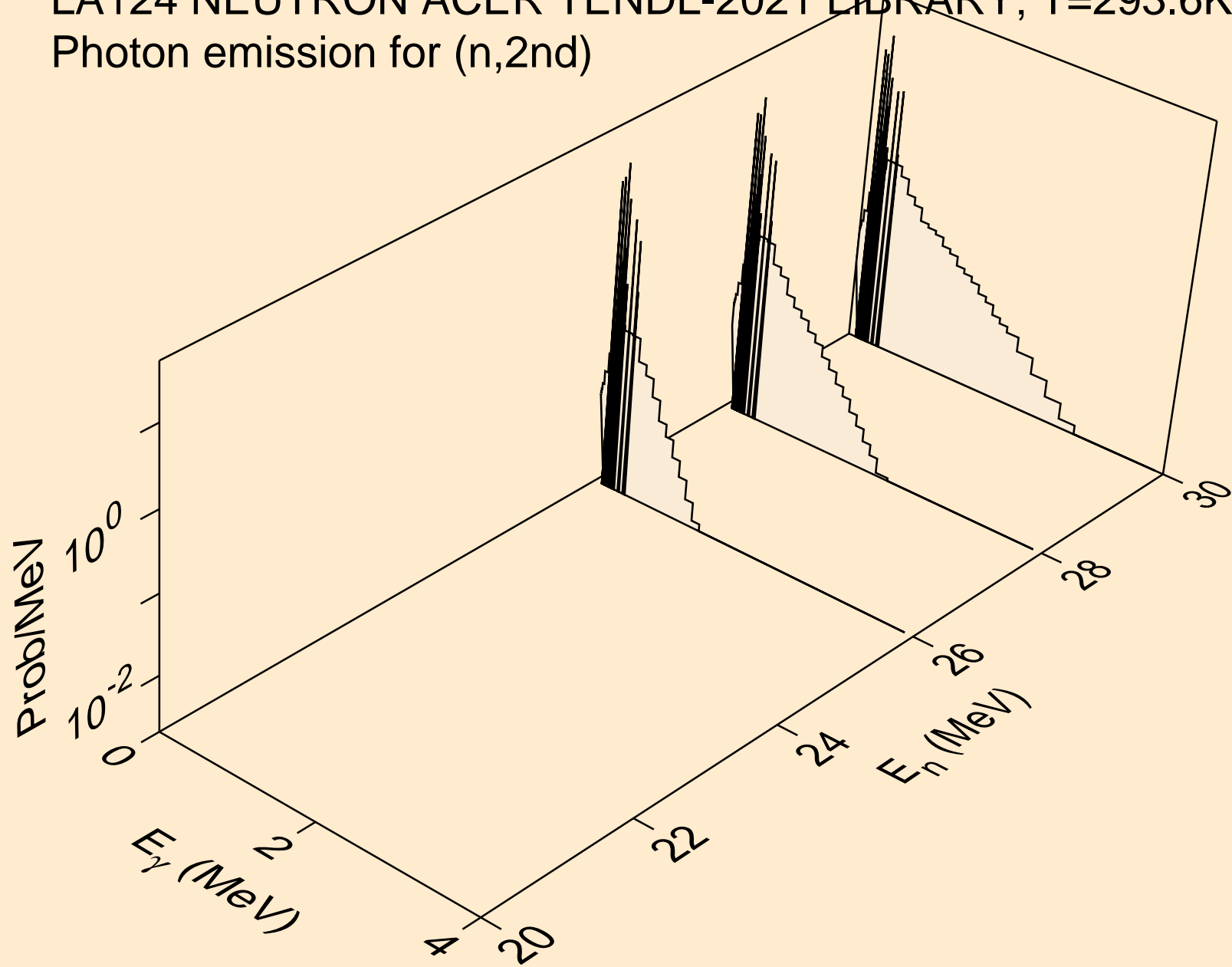

LA124 NEUTRON ACER TENDL-2021 LIBRARY; T=293.6K
Photon emission for (n,2n)

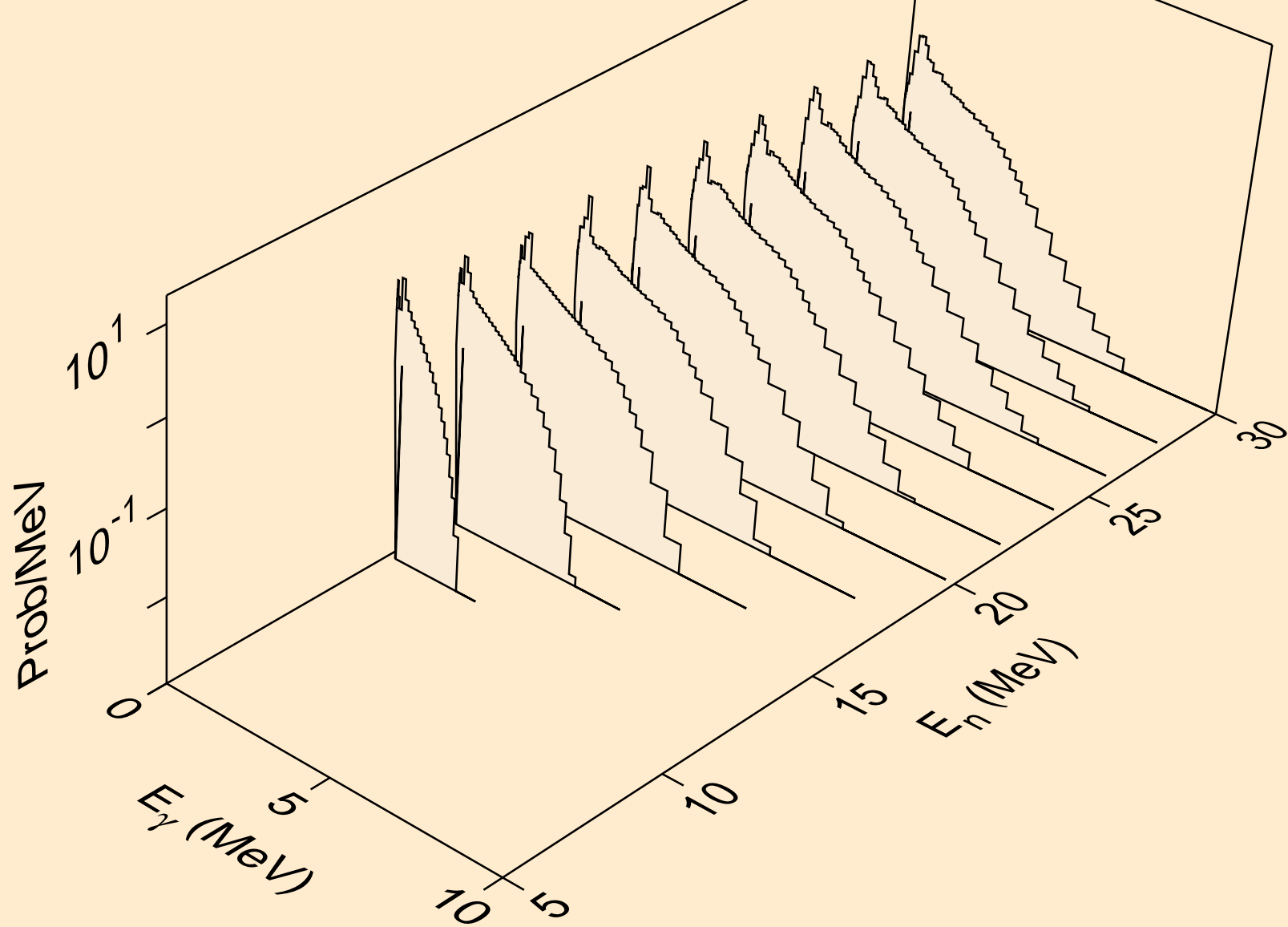

LA124 NEUTRON ACER TENDL-2021 LIBRARY; T=293.6K
Photon emission for (n,3n)

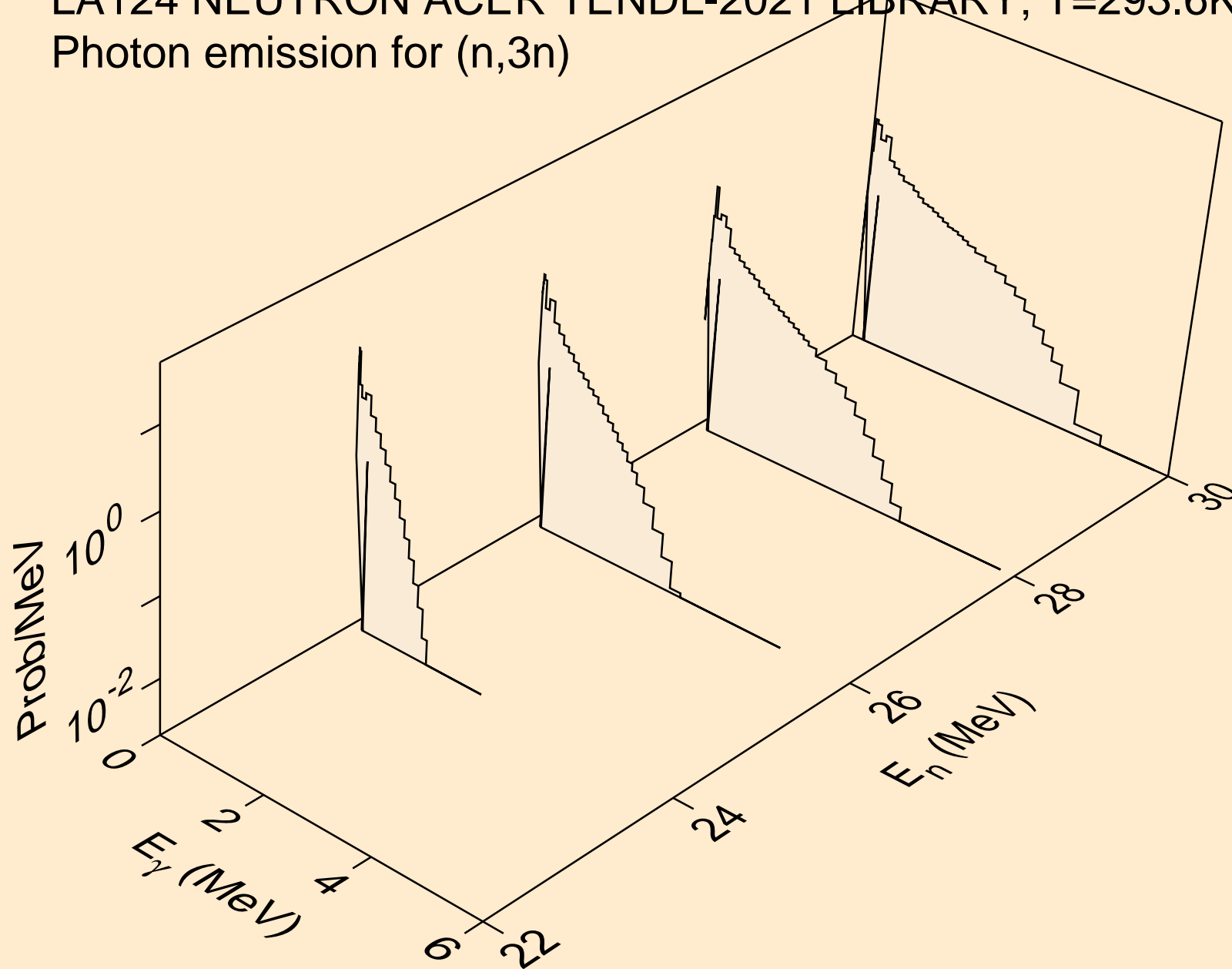

LA124 NEUTRON ACER TENDL-2021 LIBRARY; T=293.6K
Photon emission for (n,n*)a

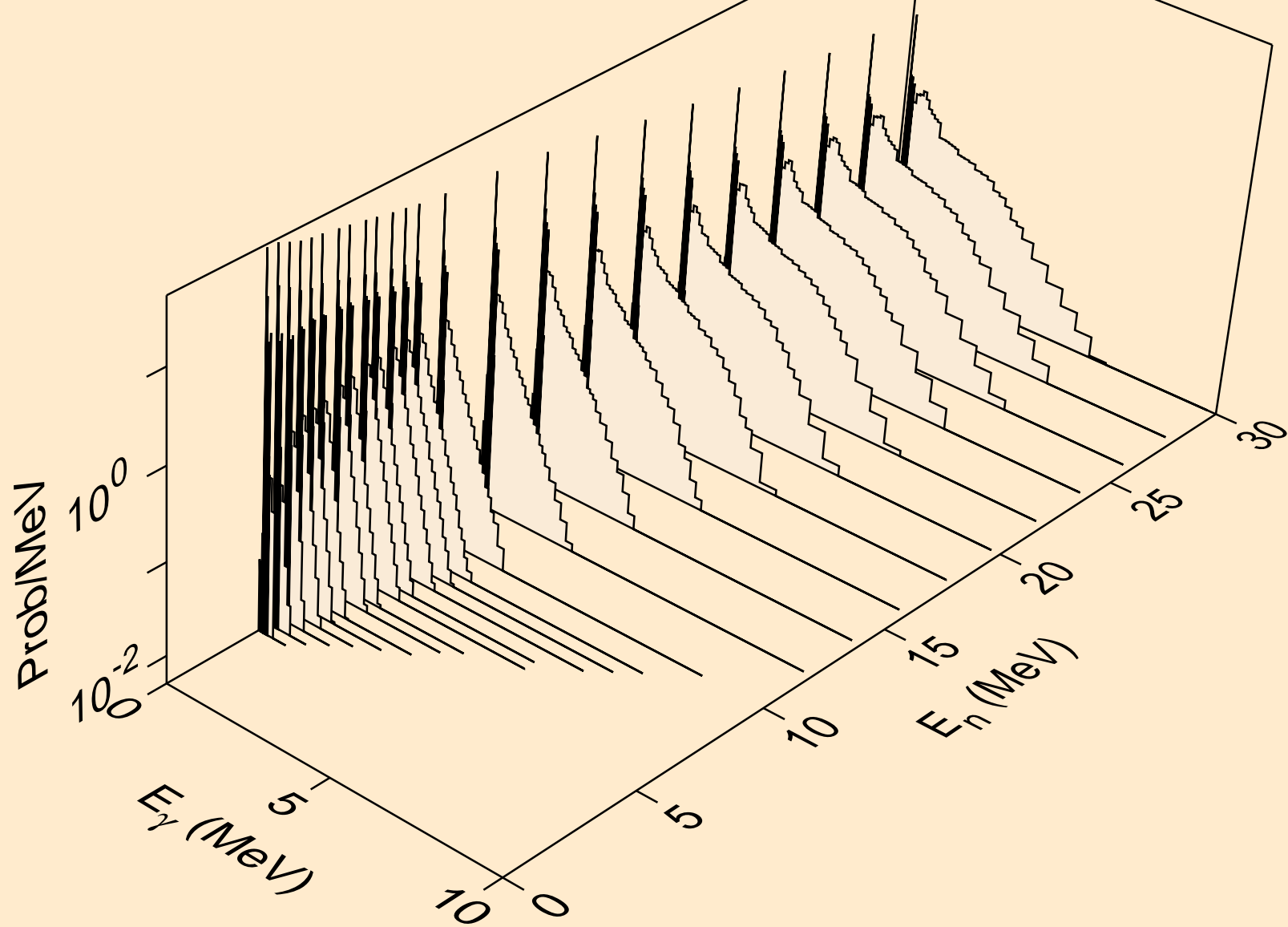

LA124 NEUTRON ACER TENDL-2021 LIBRARY; T=293.6K
Photon emission for (n,2n)a

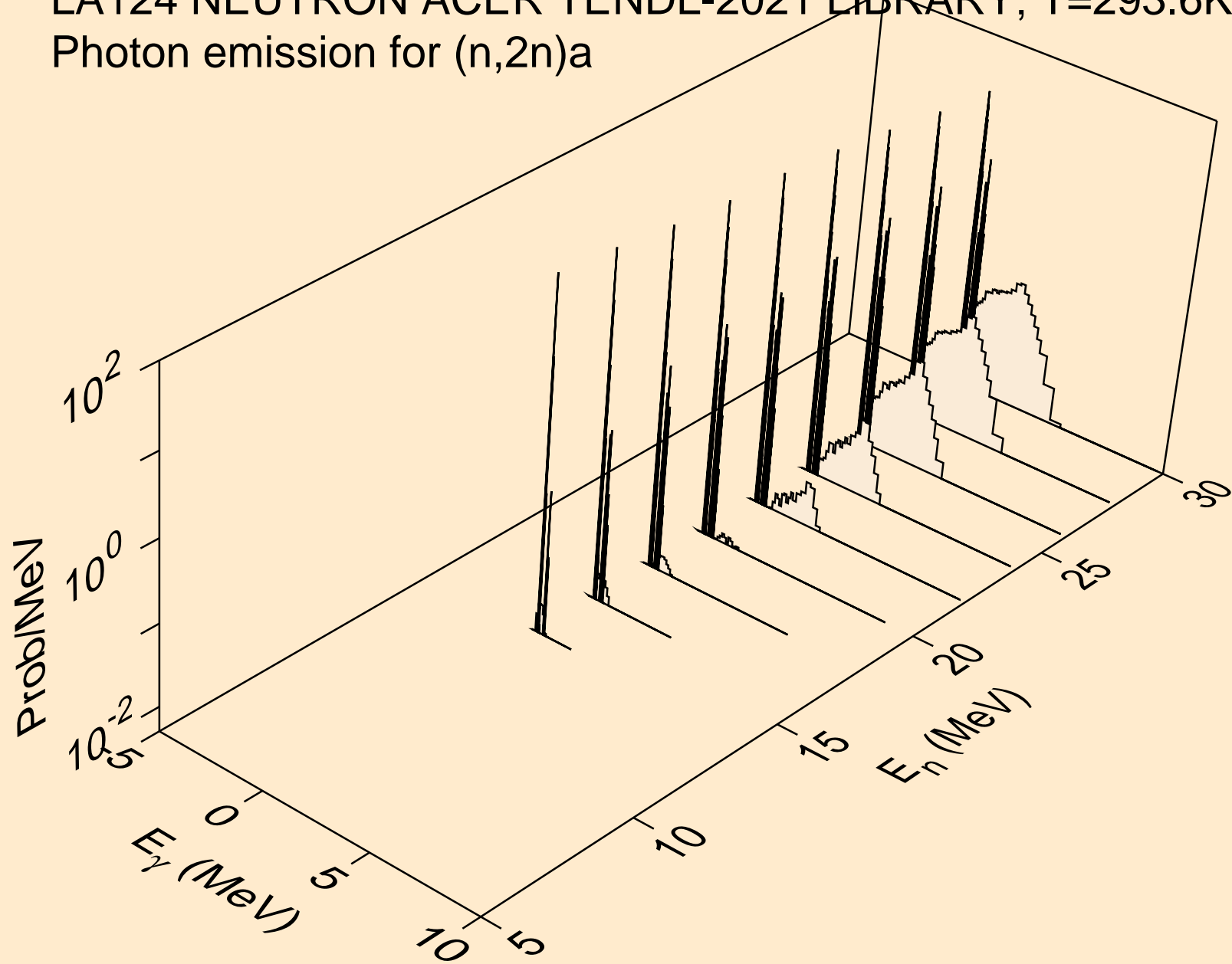

LA124 NEUTRON ACER TENDL-2021 LIBRARY; T=293.6K
Photon emission for (n,n*)p

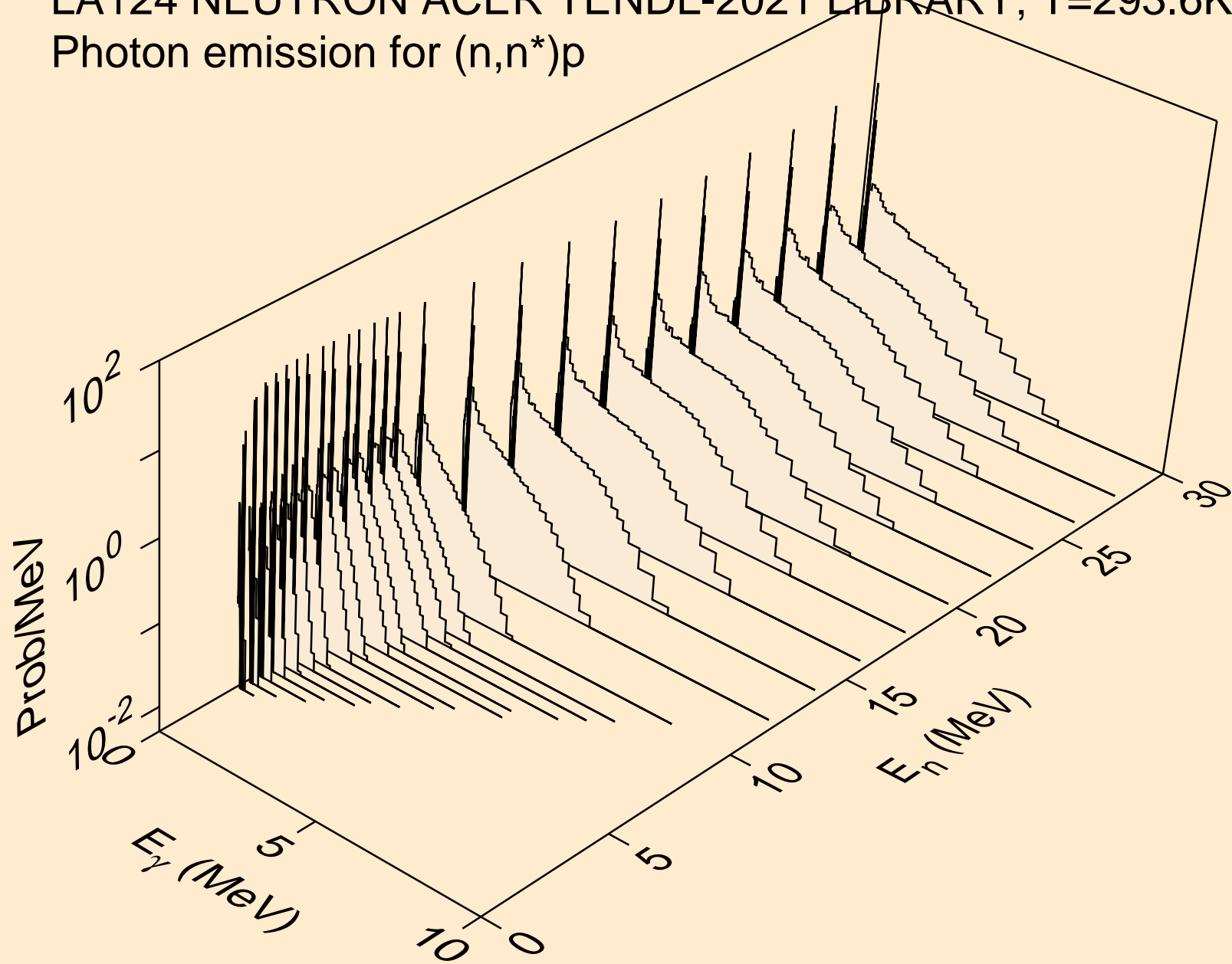

LA124 NEUTRON ACER TENDL-2021 LIBRARY; T=293.6K
Photon emission for (n,n*)2a

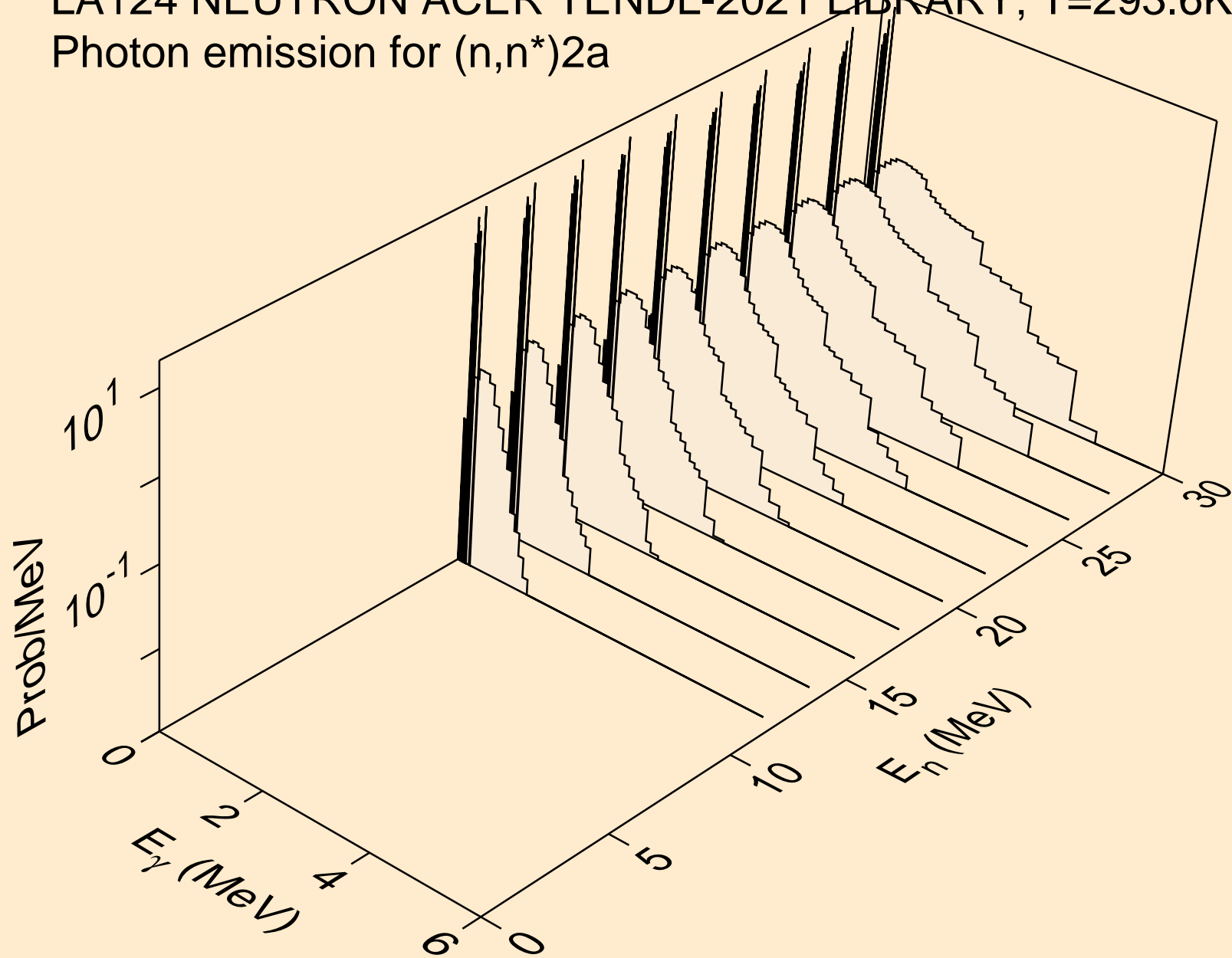

LA124 NEUTRON ACER TENDL-2021 LIBRARY; T=293.6K
Photon emission for (n,2n)2a

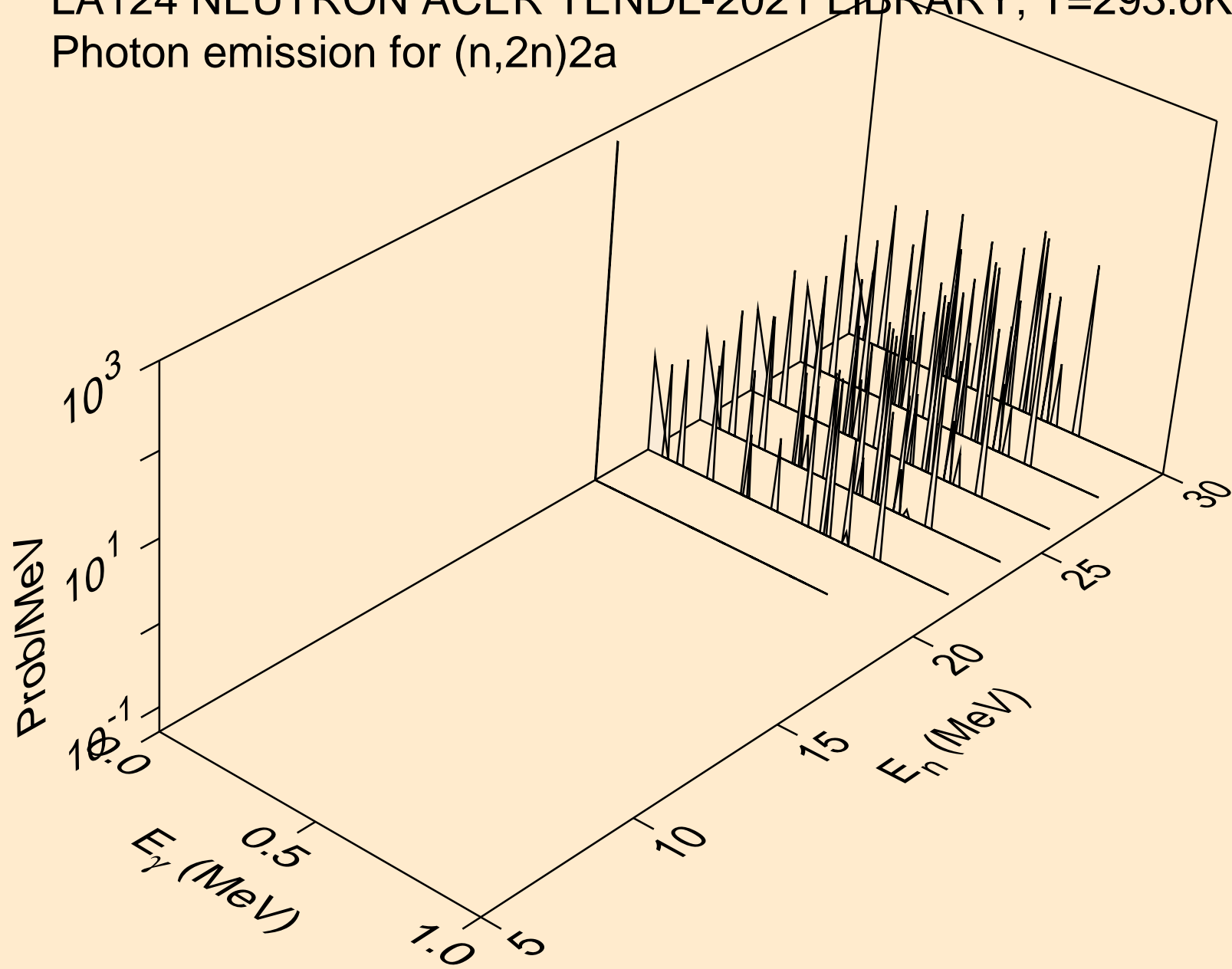

LA124 NEUTRON ACER TENDL-2021 LIBRARY; T=293.6K
Photon emission for (n,n*)d

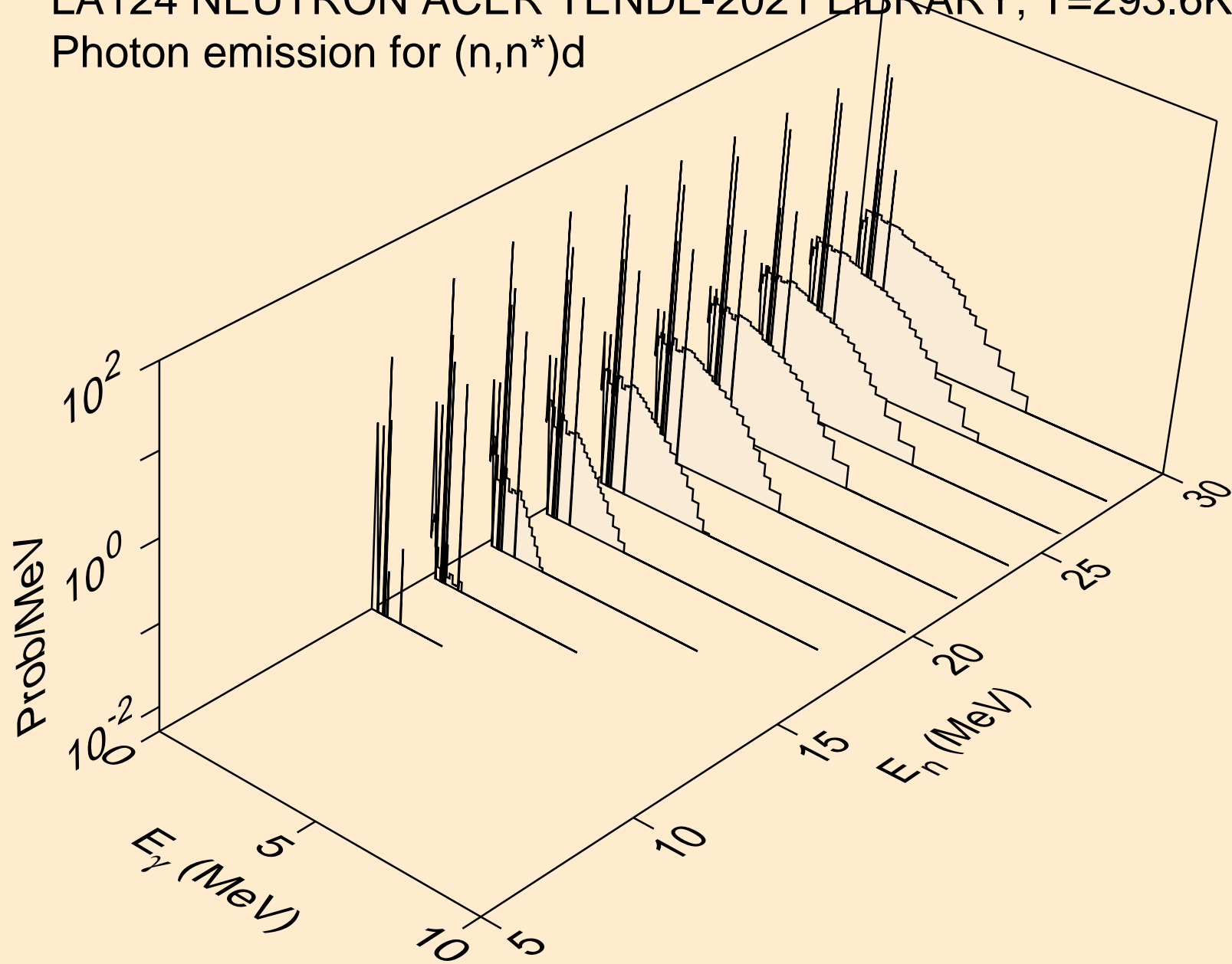

LA124 NEUTRON ACER TENDL-2021 LIBRARY; T=293.6K
Photon emission for (n,n*)t

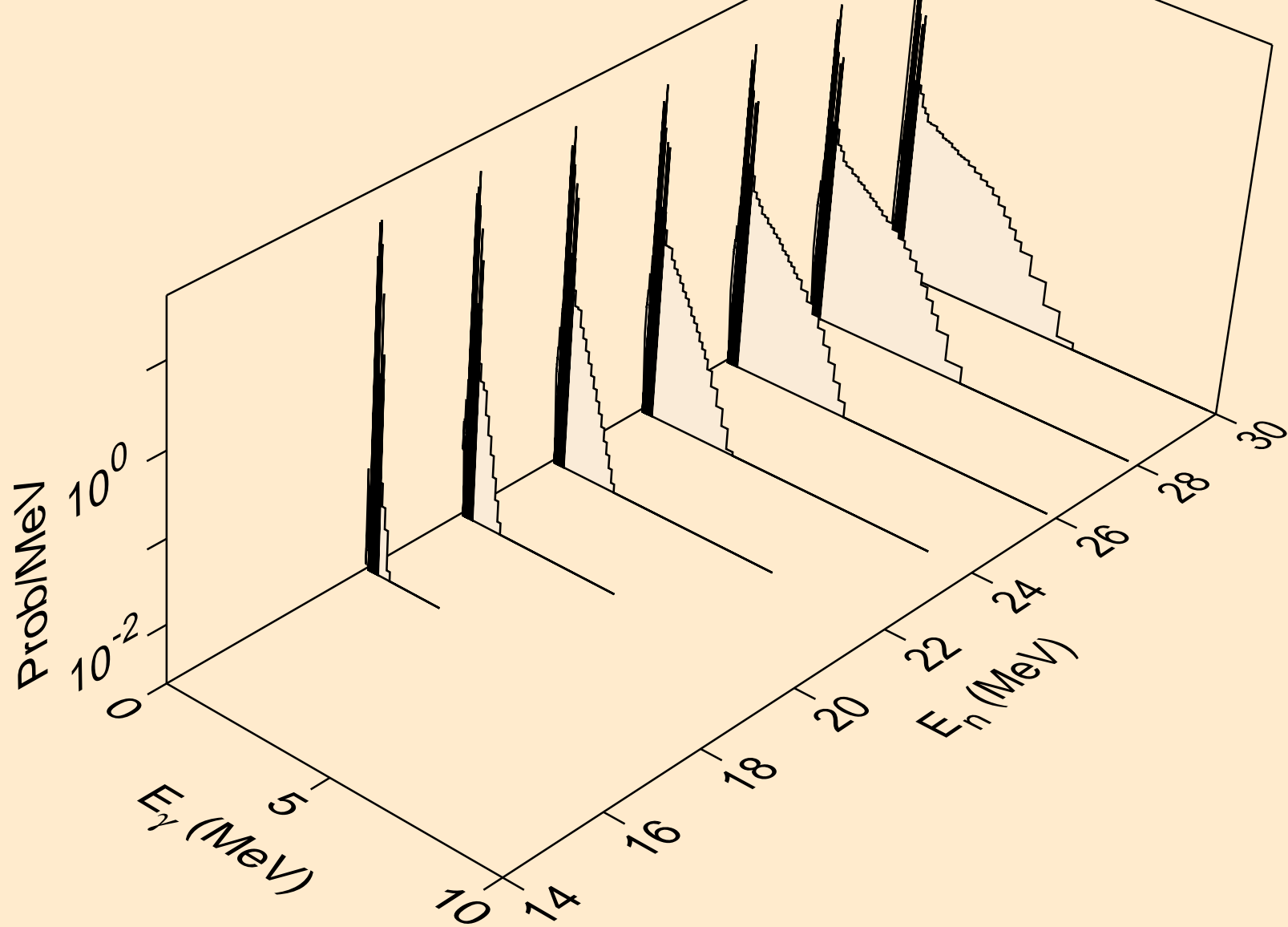

LA124 NEUTRON ACER TENDL-2021 LIBRARY; T=293.6K
Photon emission for (n,n*)he3

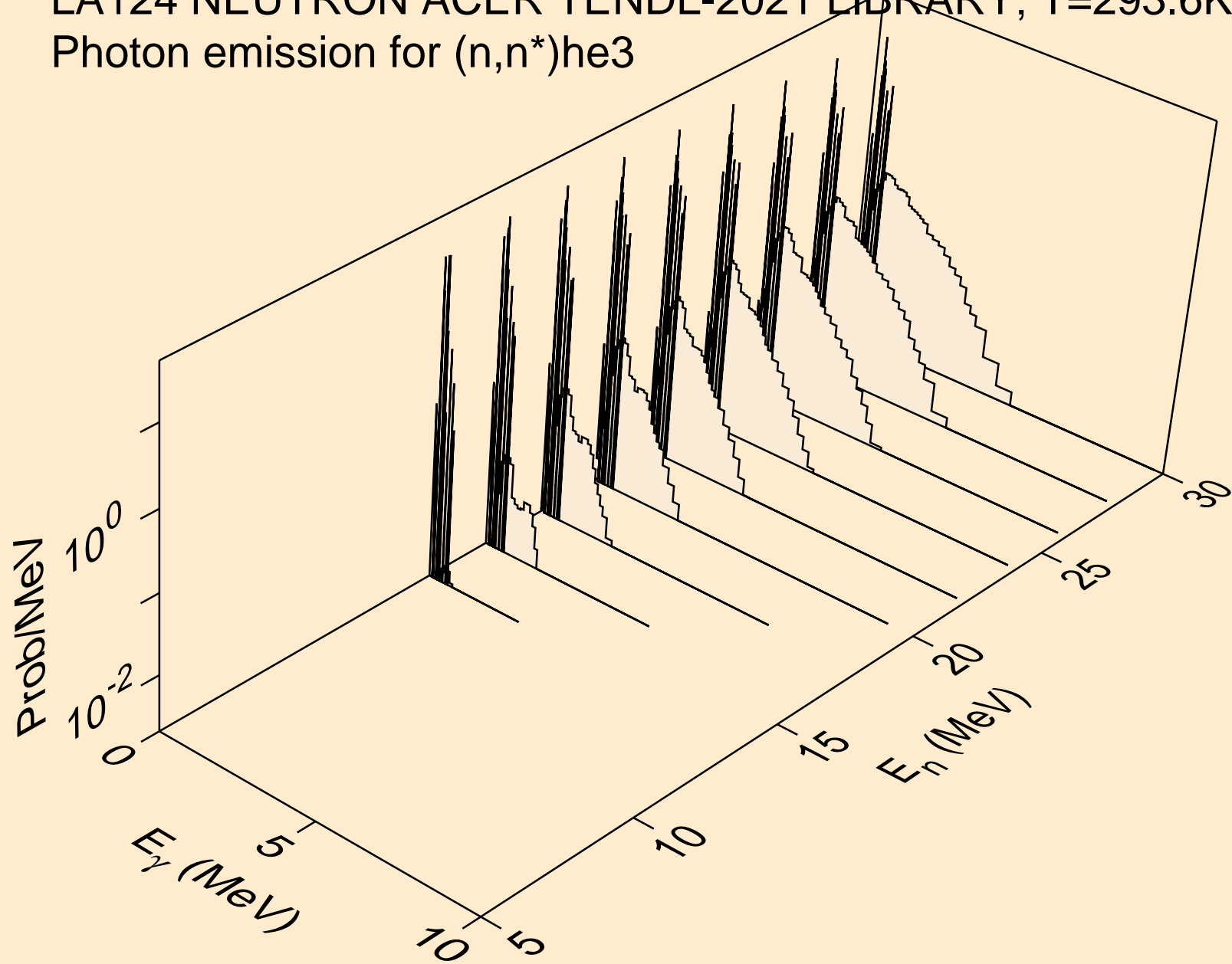

LA124 NEUTRON ACER TENDL-2021 LIBRARY; T=293.6K
Photon emission for (n,2np)

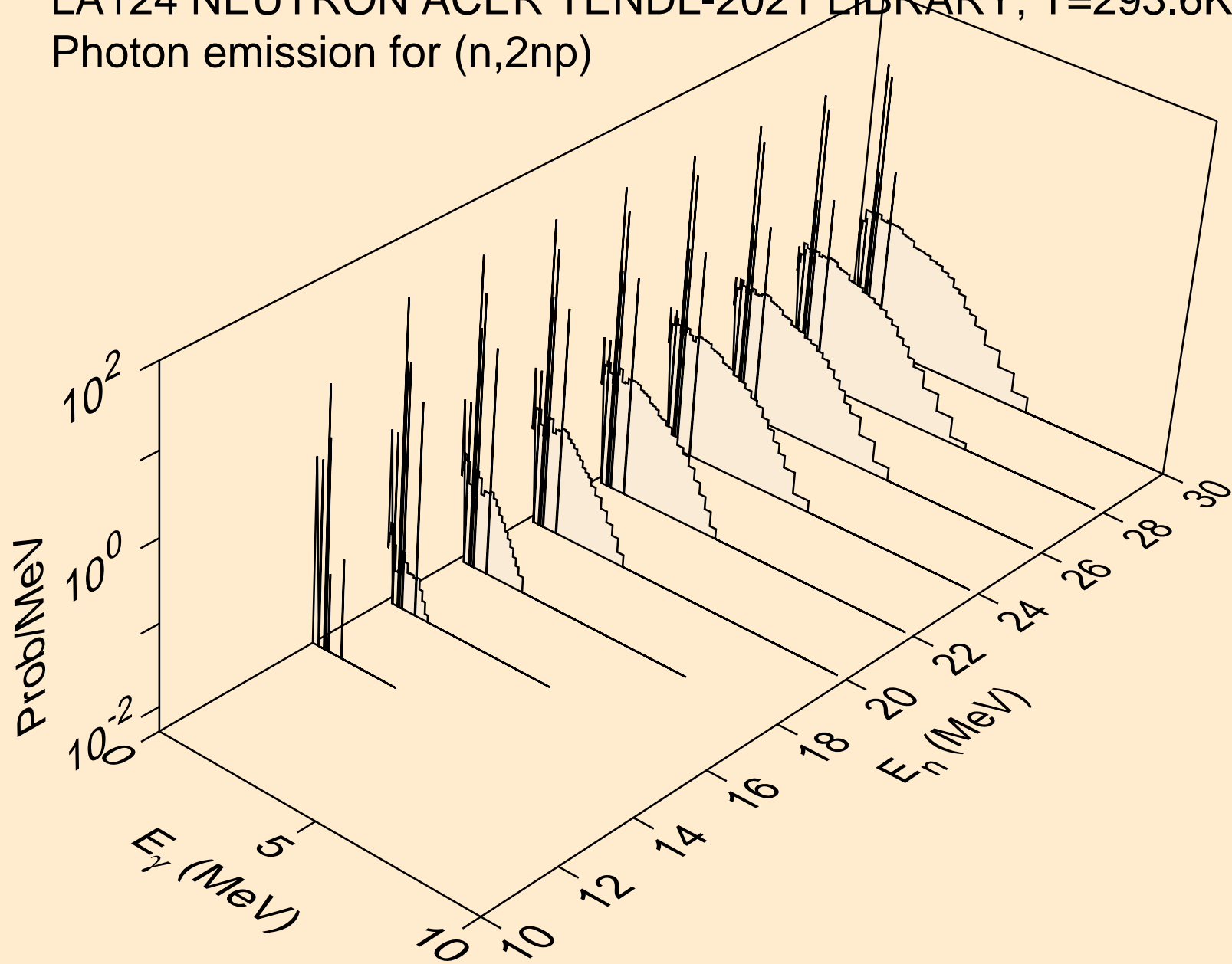

LA124 NEUTRON ACER TENDL-2021 LIBRARY; T=293.6K
Photon emission for (n,3np)

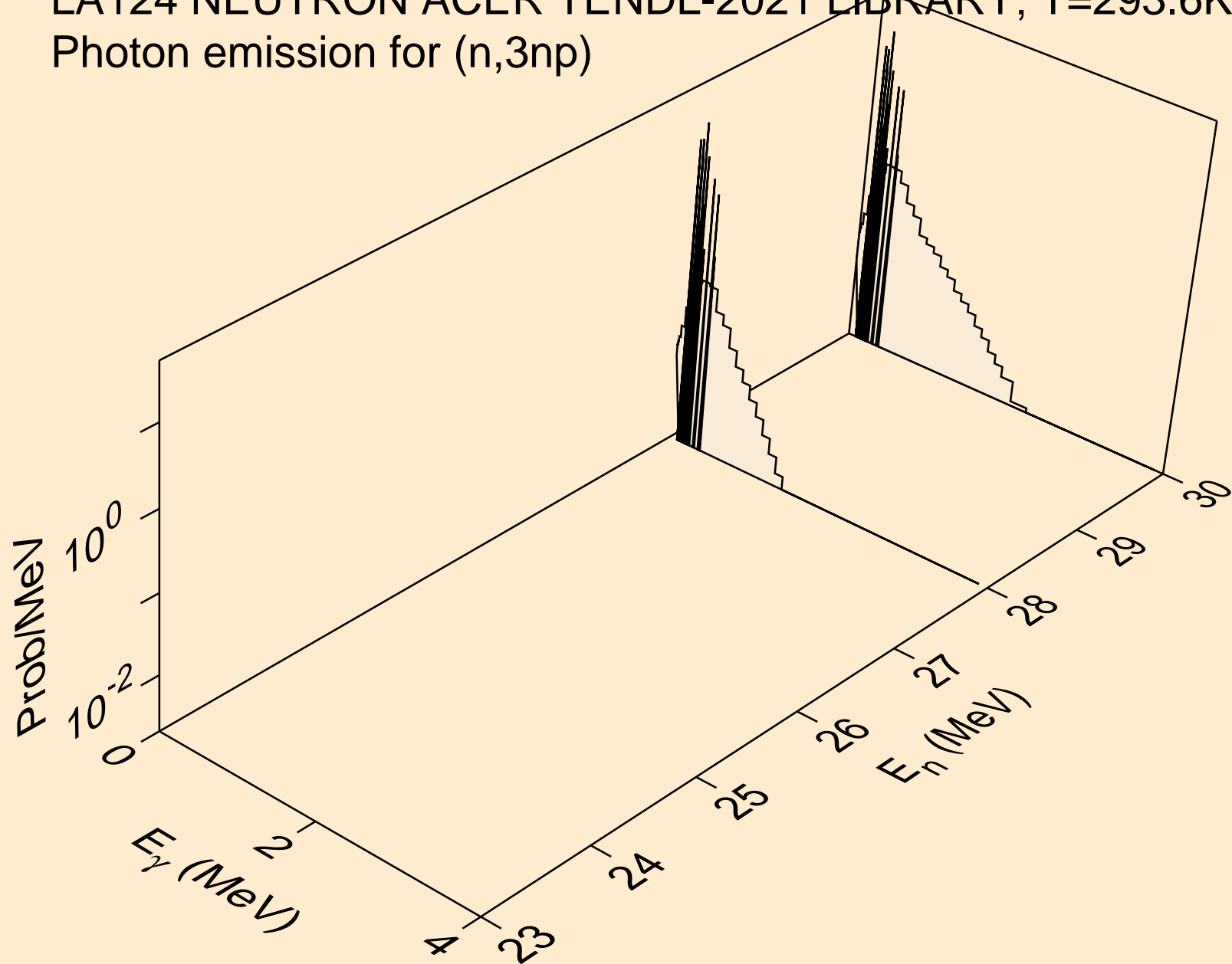

LA124 NEUTRON ACER TENDL-2021 LIBRARY; T=293.6K
Photon emission for (n,2np)

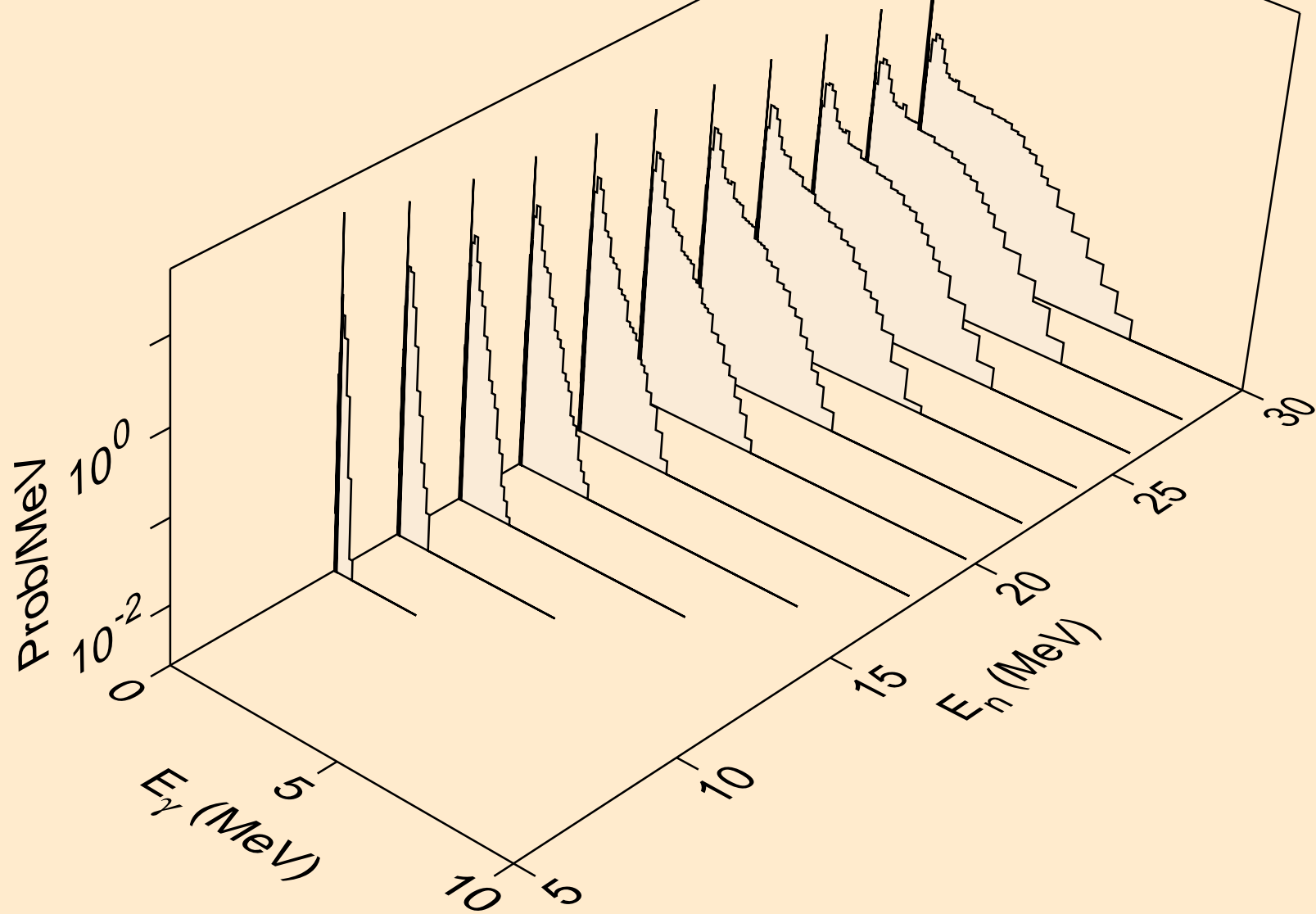

LA124 NEUTRON ACER TENDL-2021 LIBRARY; T=293.6K
Photon emission for (n,npa)

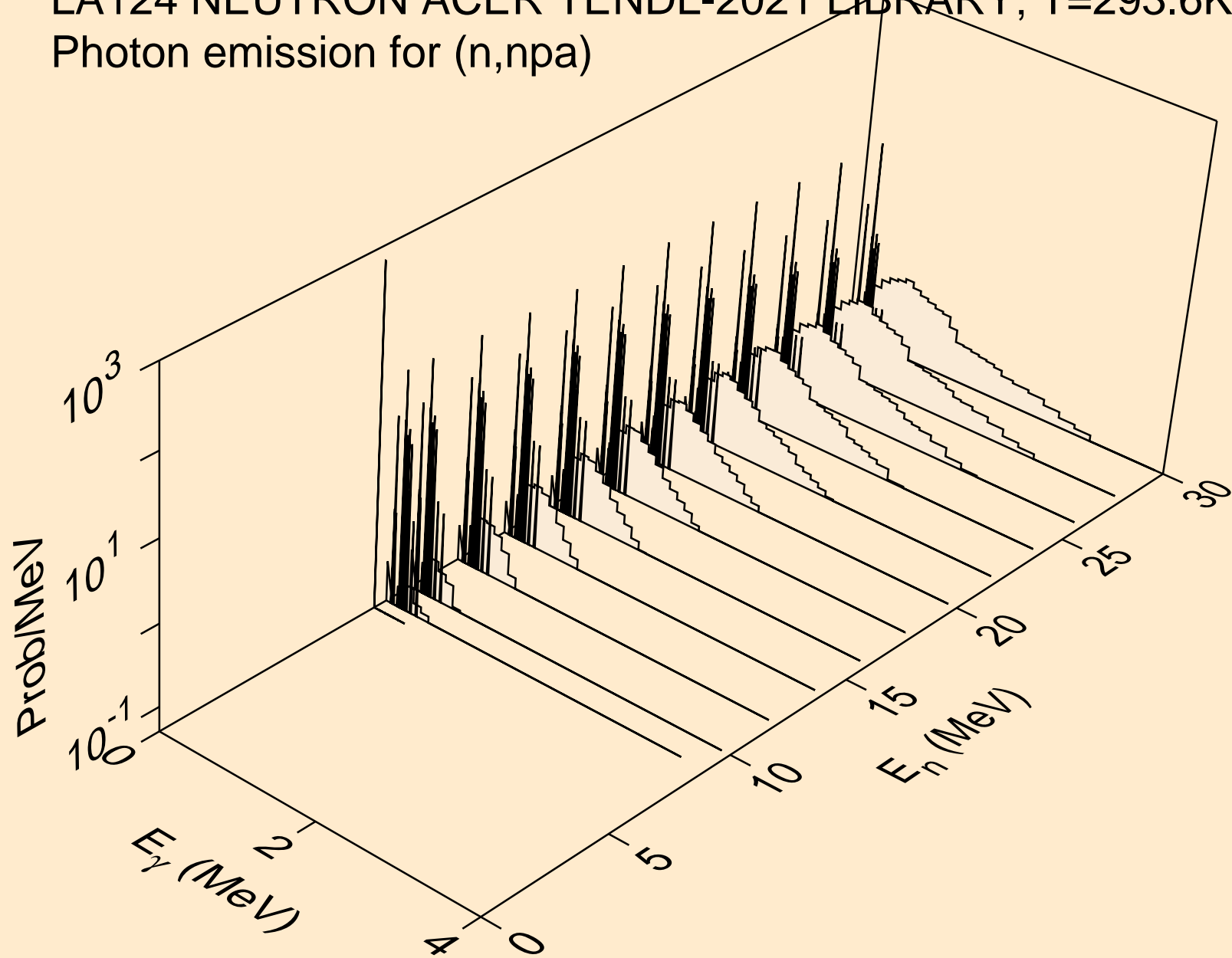

LA124 NEUTRON ACER TENDL-2021 LIBRARY; T=293.6K
Photon emission for (n,n*c)

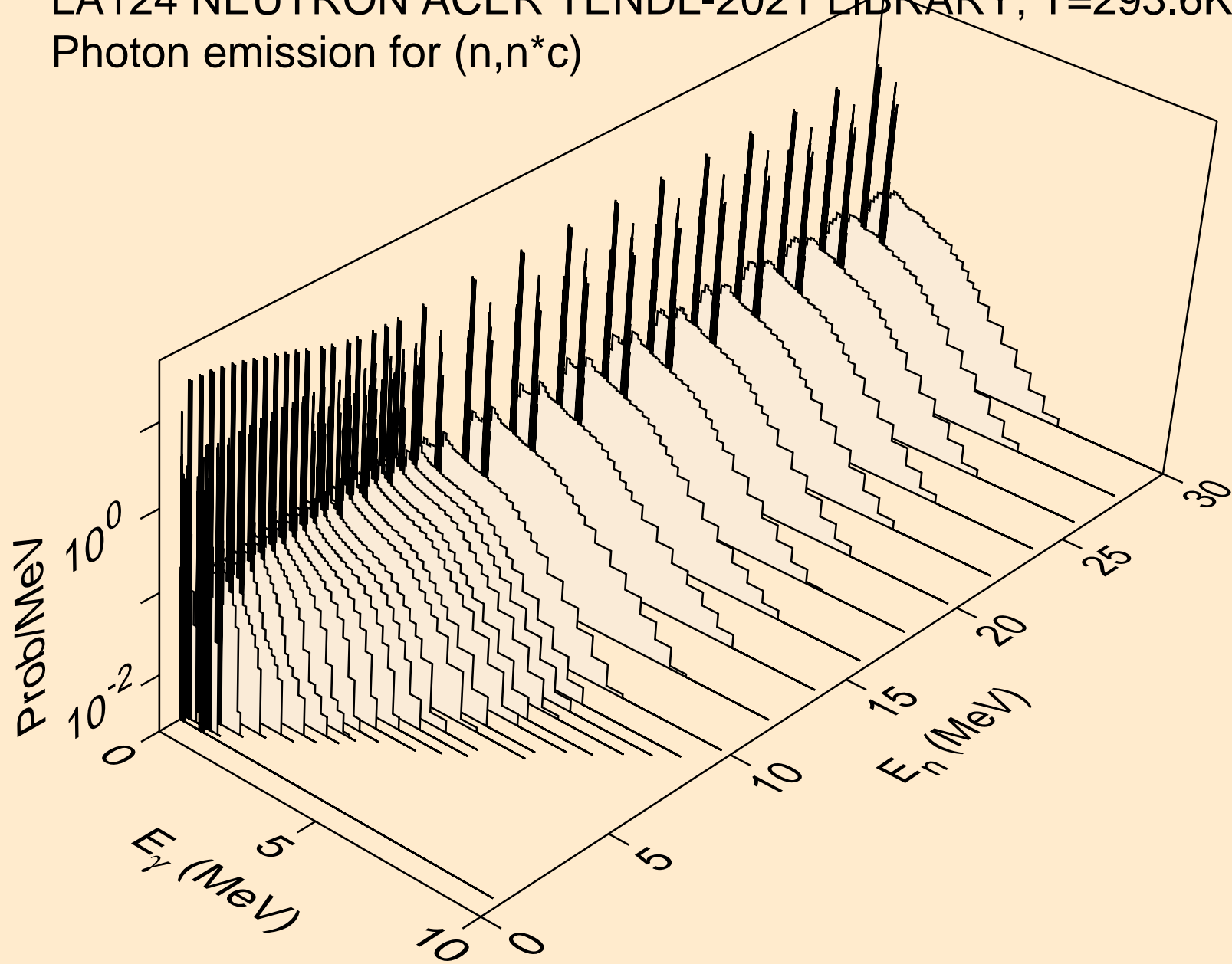

LA124 NEUTRON ACER TENDL-2021 LIBRARY; T=293.6K
Photon emission for (n,gma)

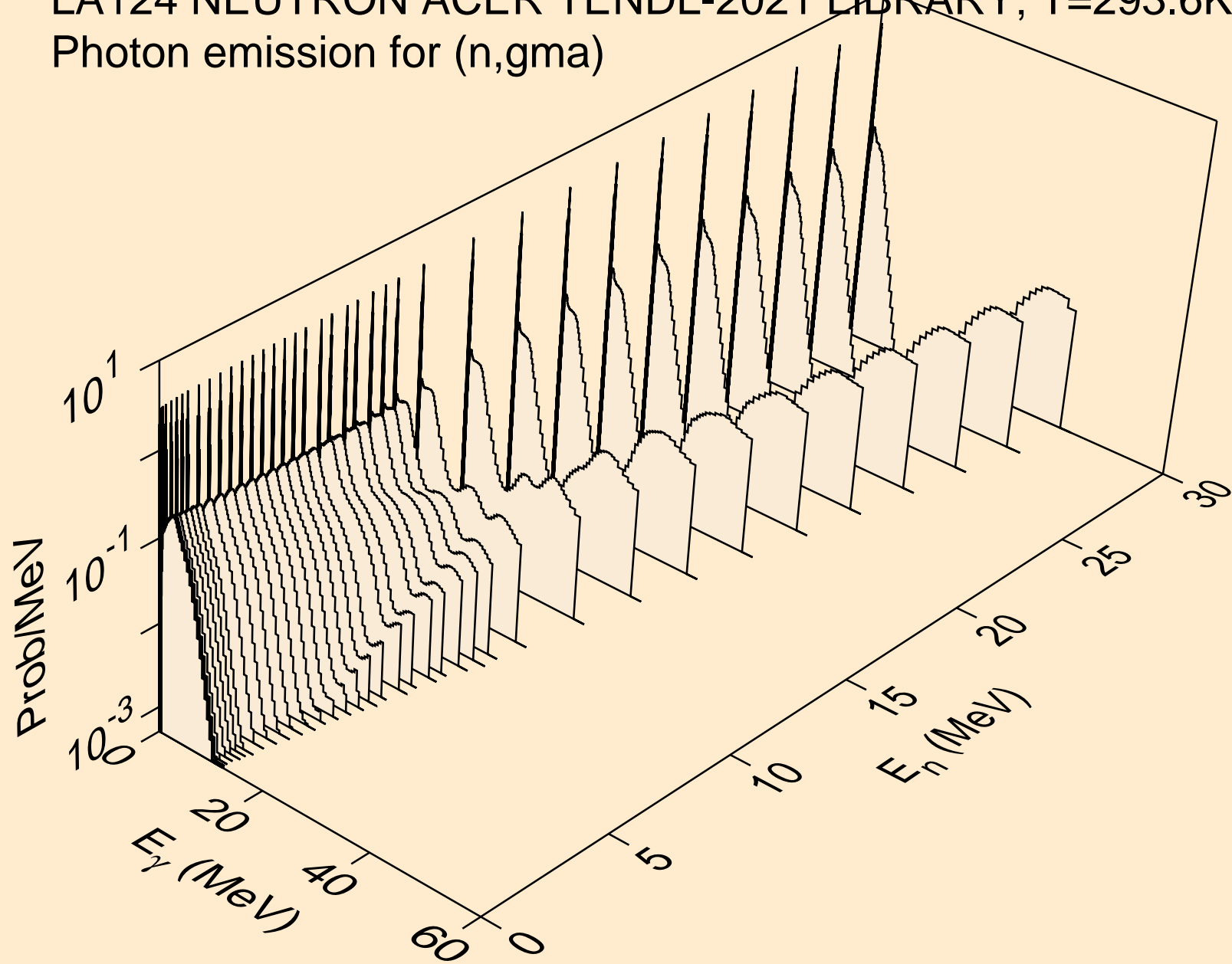

LA124 NEUTRON ACER TENDL-2021 LIBRARY; T=293.6K
Photon emission for (n,p)

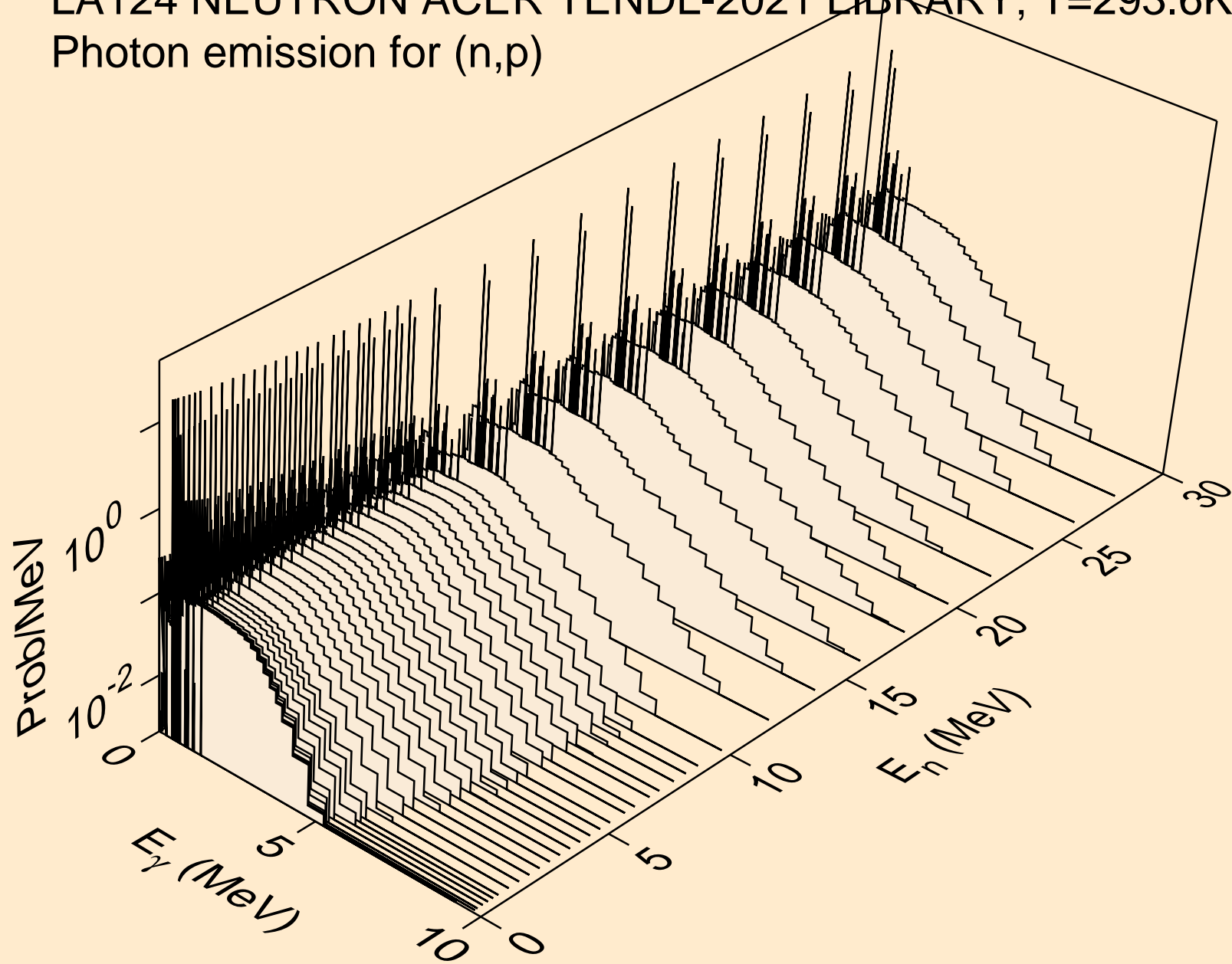

LA124 NEUTRON ACER TENDL-2021 LIBRARY; T=293.6K
Photon emission for (n,d)

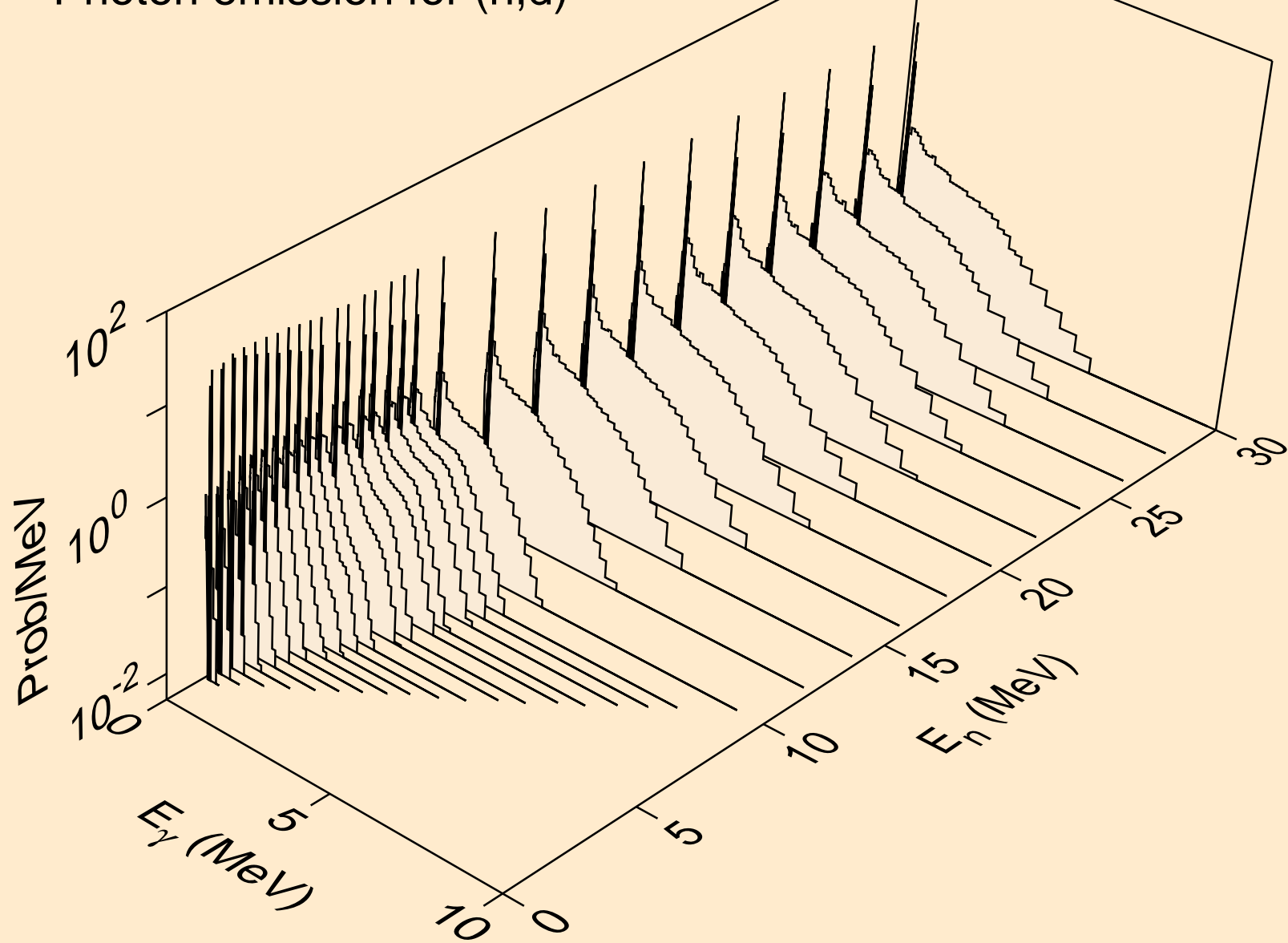

LA124 NEUTRON ACER TENDL-2021 LIBRARY; T=293.6K
Photon emission for (n,t)

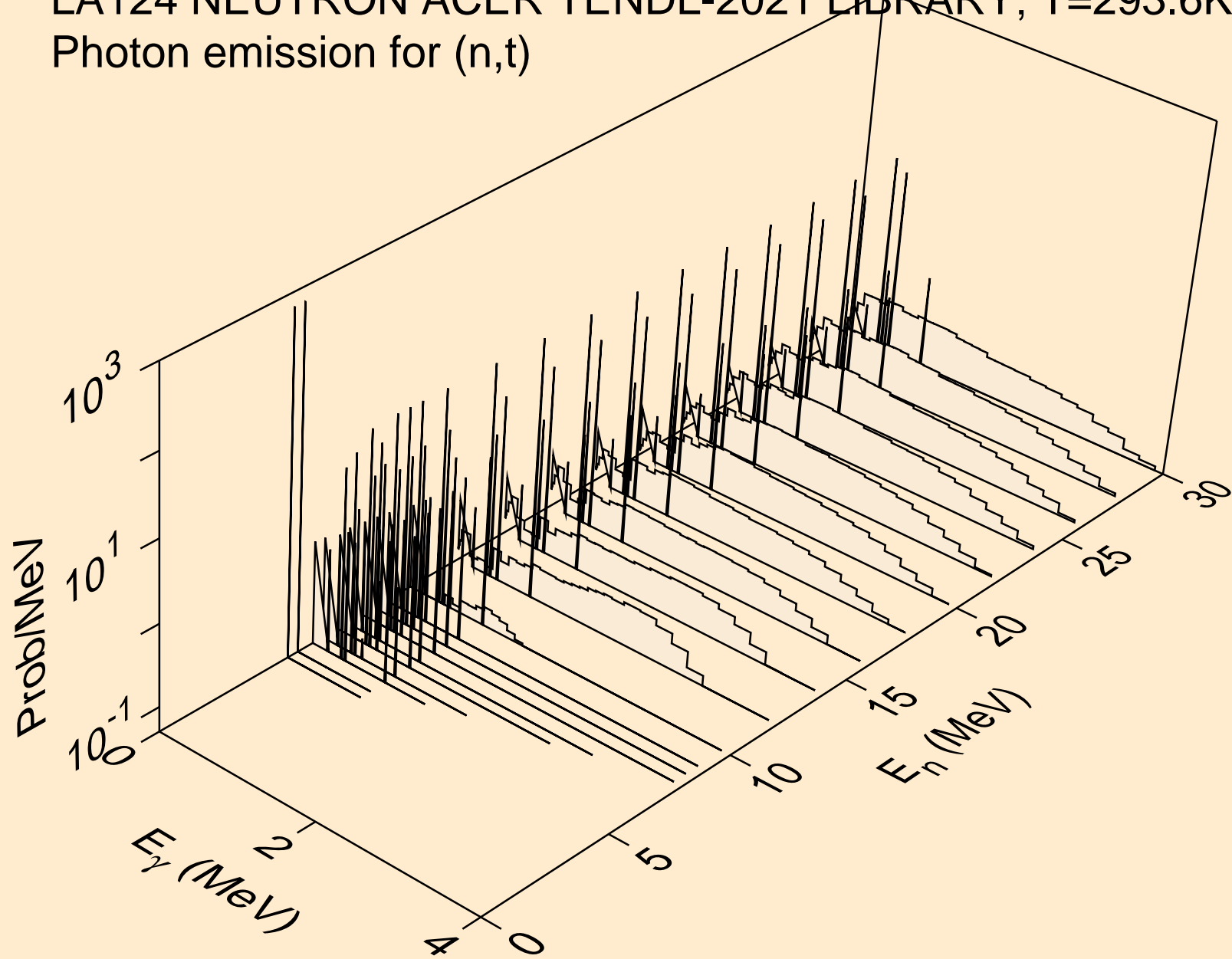

LA124 NEUTRON ACER TENDL-2021 LIBRARY; T=293.6K
Photon emission for (n,he3)

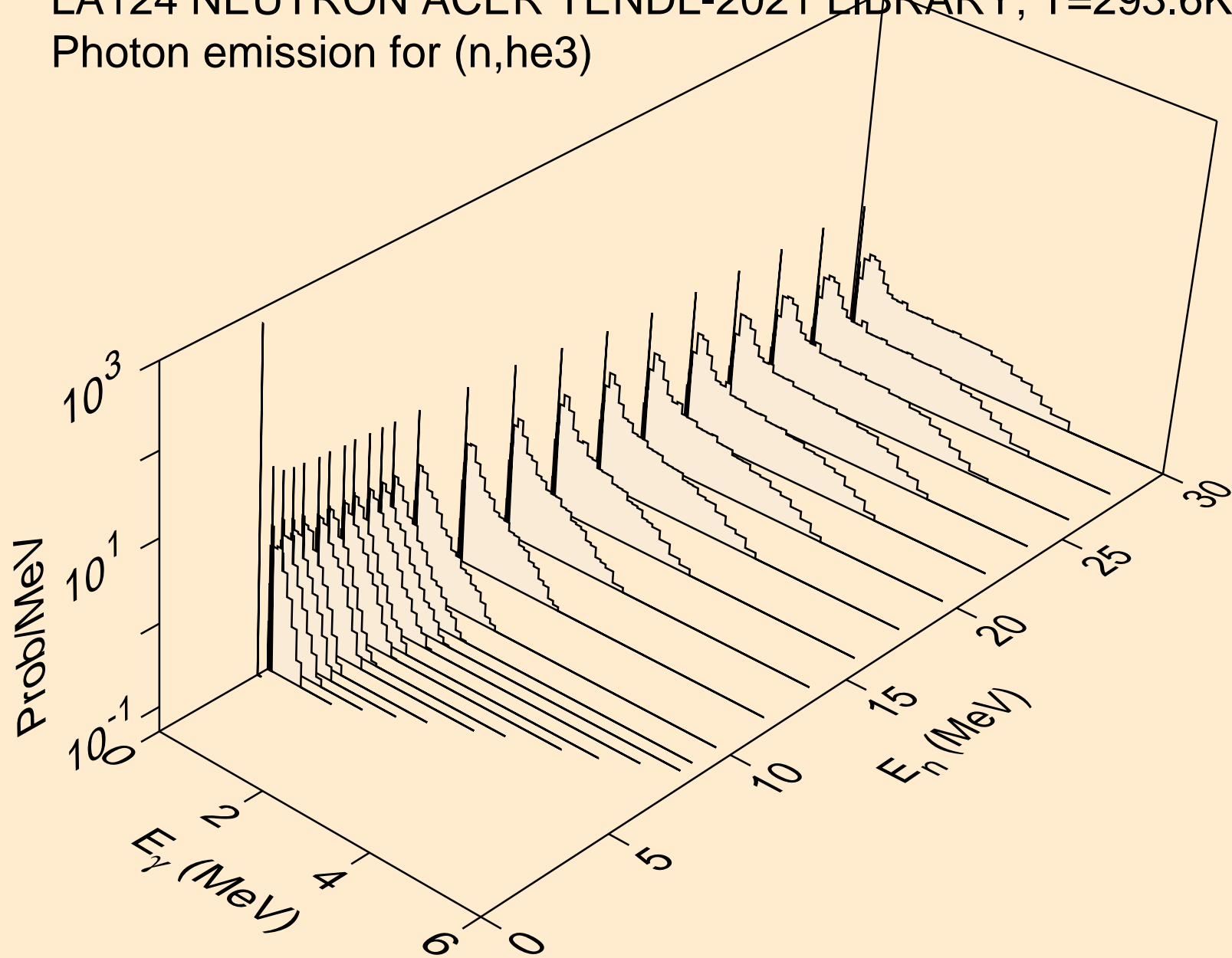

LA124 NEUTRON ACER TENDL-2021 LIBRARY; T=293.6K
Photon emission for (n,a)

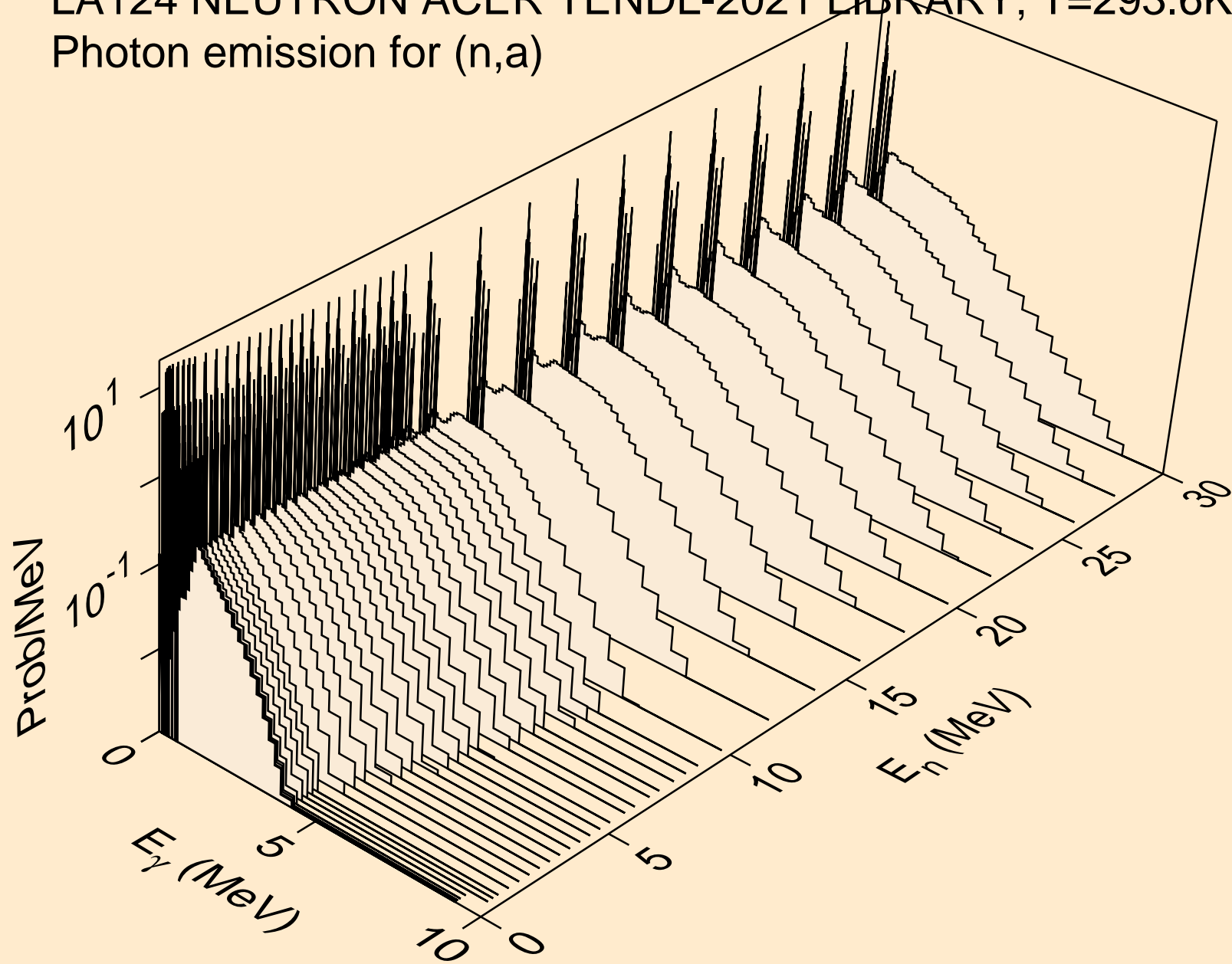

LA124 NEUTRON ACER TENDL-2021 LIBRARY; T=293.6K
Photon emission for (n,2a)

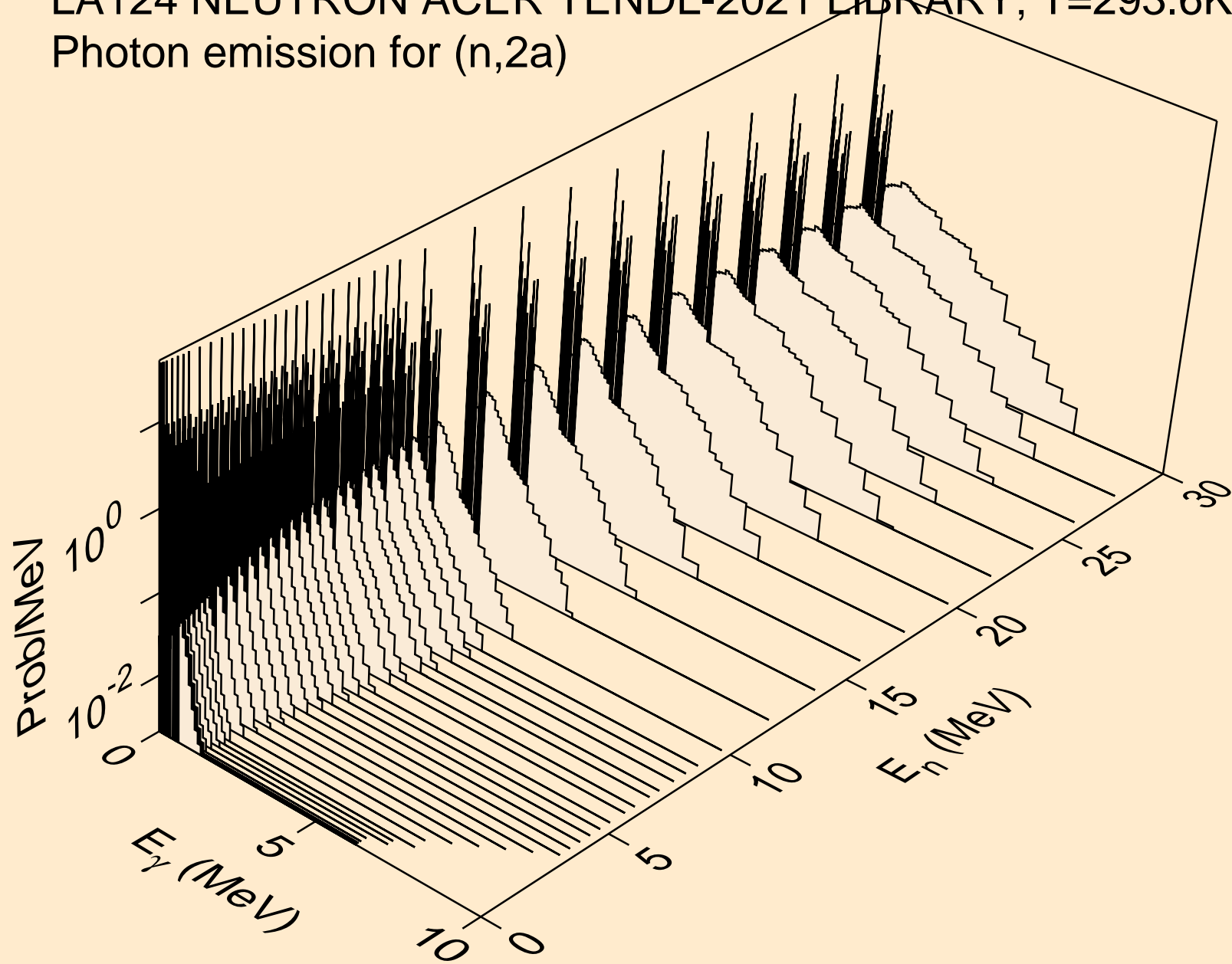

LA124 NEUTRON ACER TENDL-2021 LIBRARY; T=293.6K
Photon emission for (n,3a)

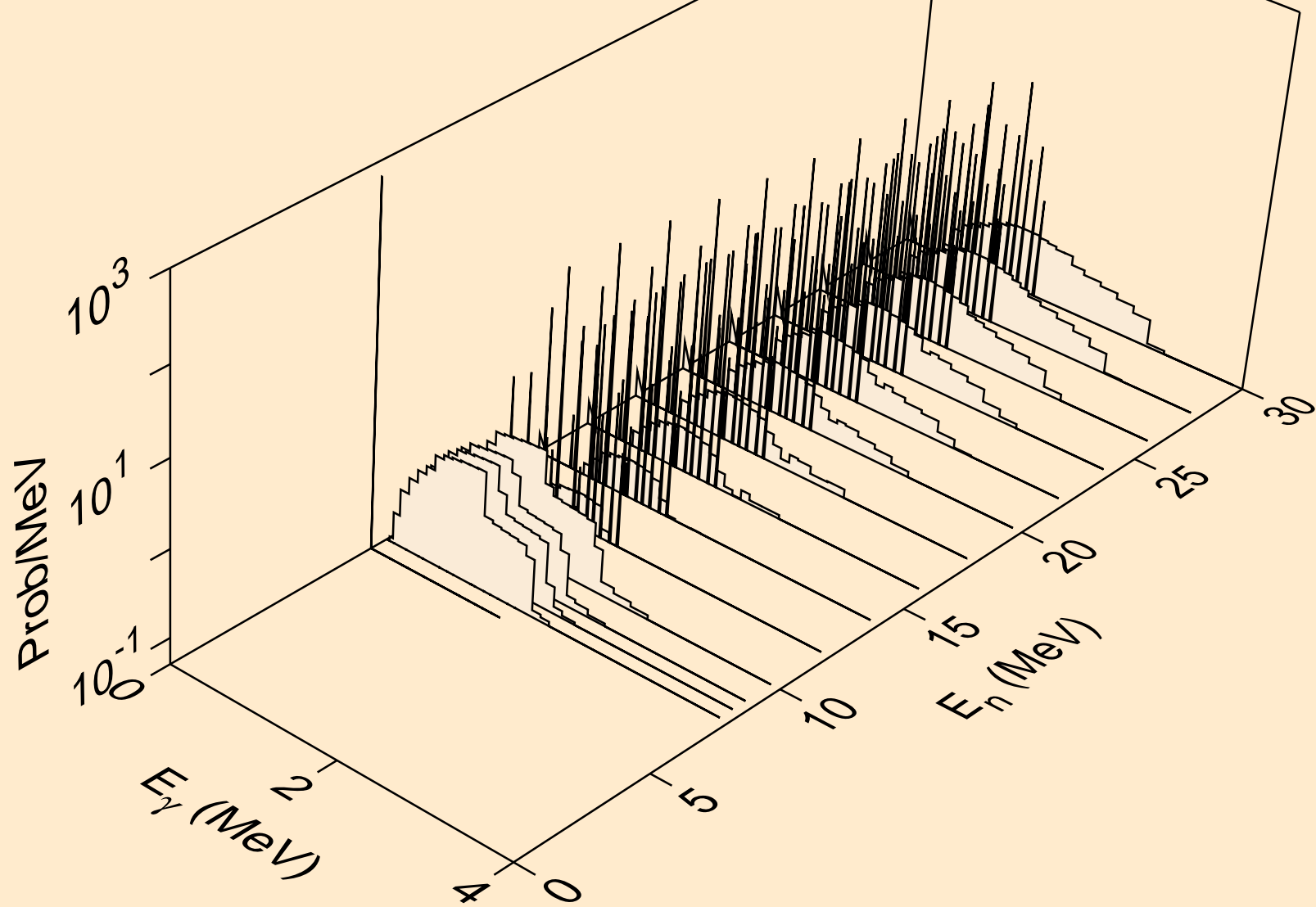

LA124 NEUTRON ACER TENDL-2021 LIBRARY; T=293.6K
Photon emission for (n,2p)

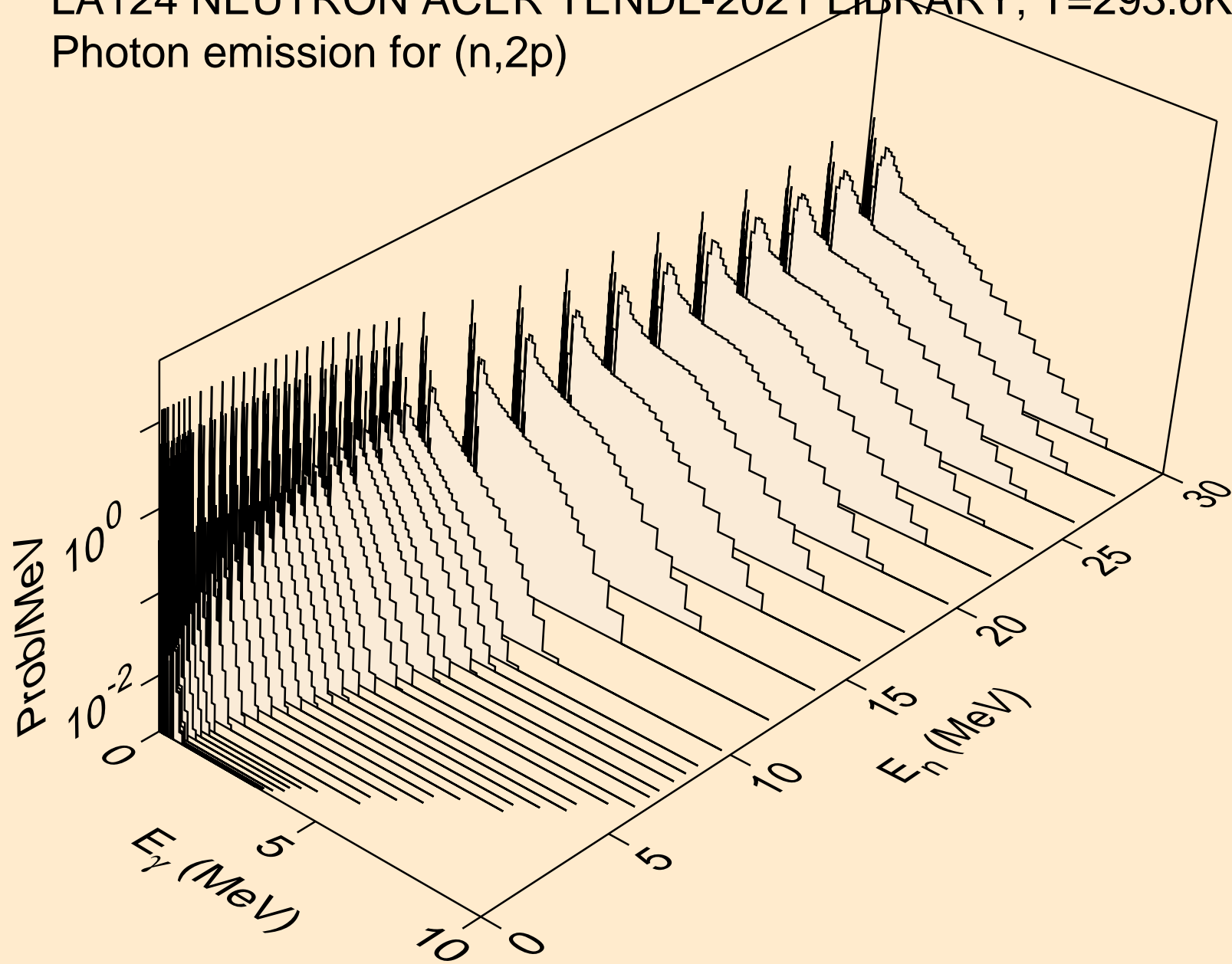

LA124 NEUTRON ACER TENDL-2021 LIBRARY; T=293.6K
Photon emission for (n,p α)

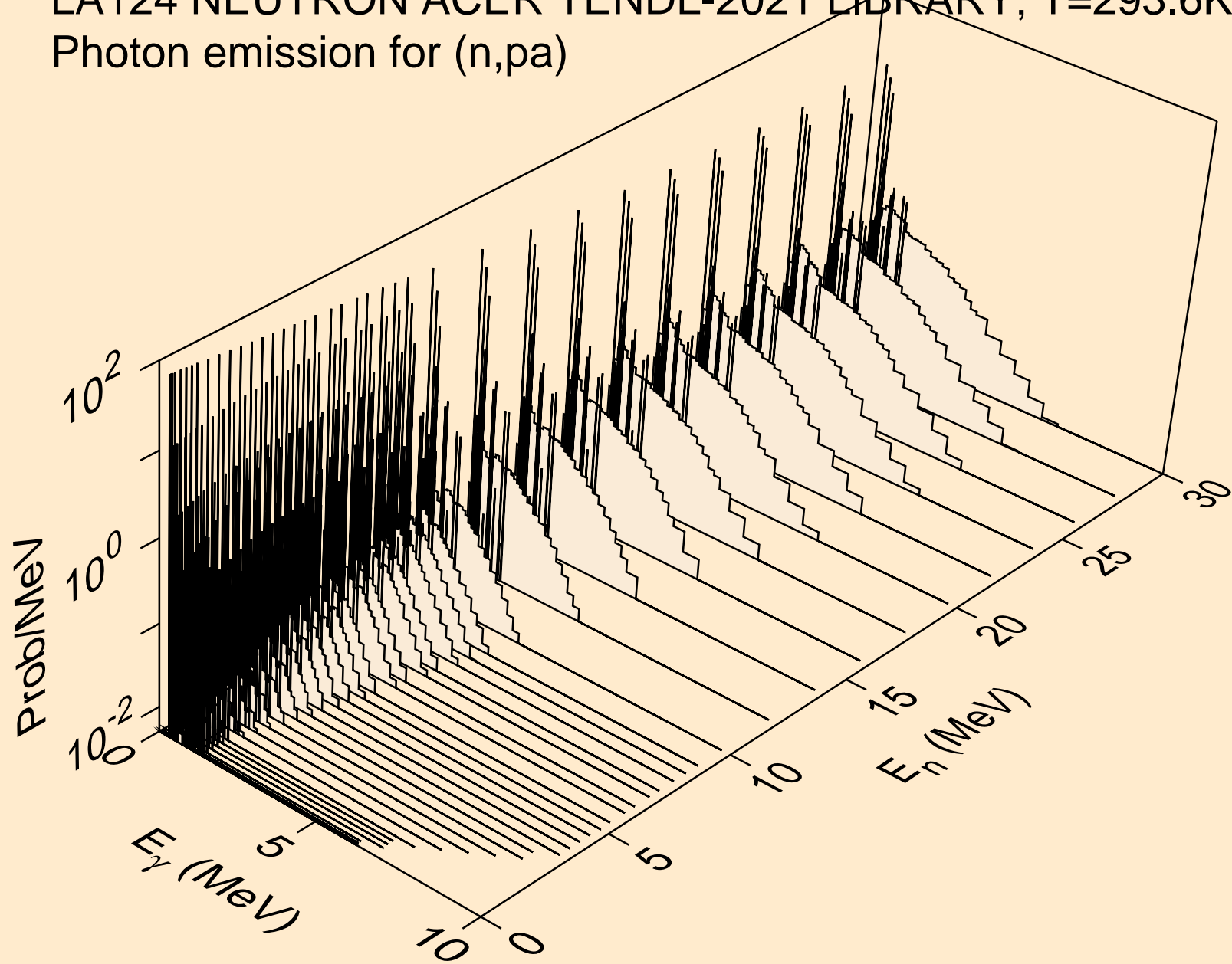

LA124 NEUTRON ACER TENDL-2021 LIBRARY; T=293.6K
Photon emission for (n,d2a)

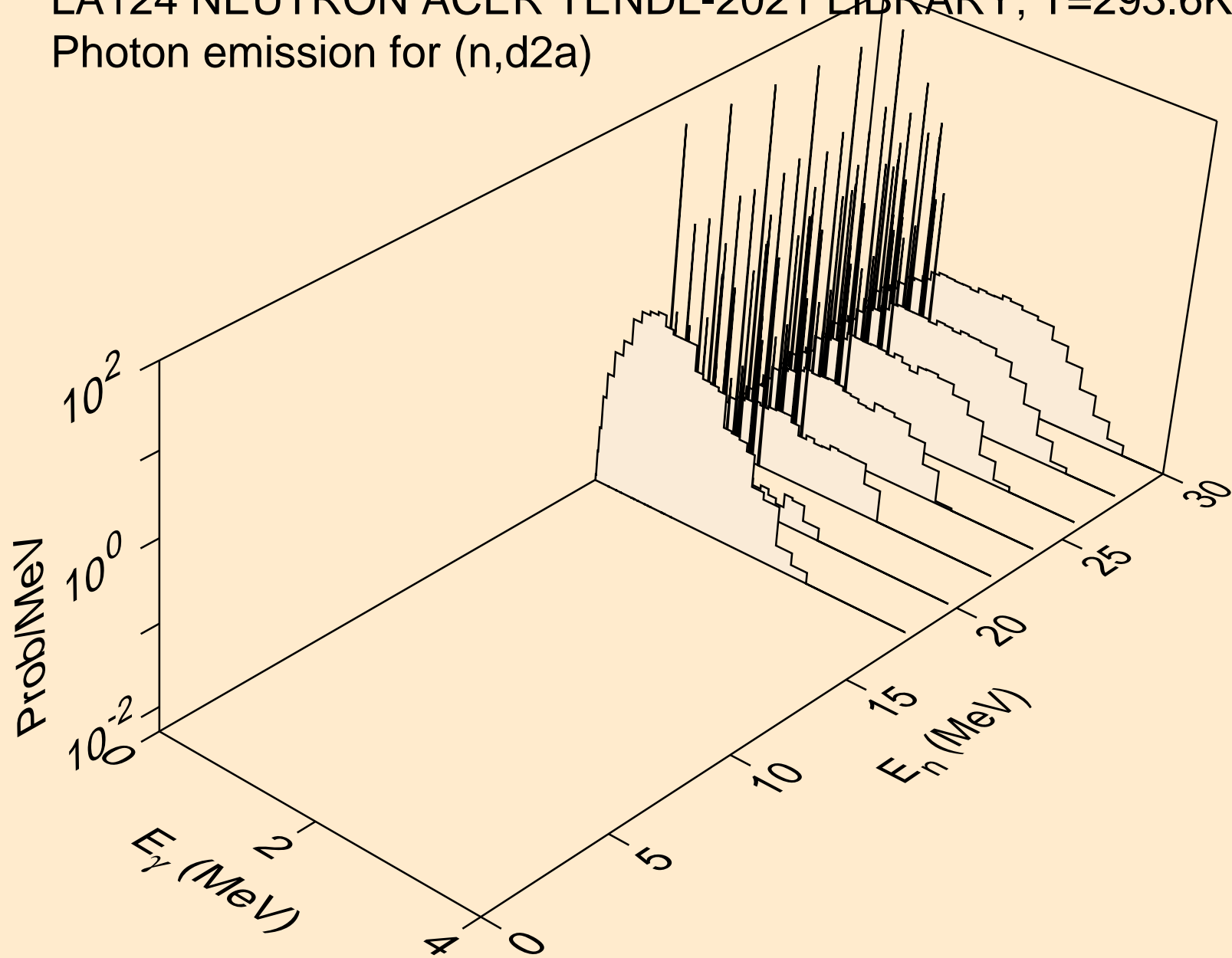

LA124 NEUTRON ACER TENDL-2021 LIBRARY; T=293.6K
Photon emission for (n,pd)

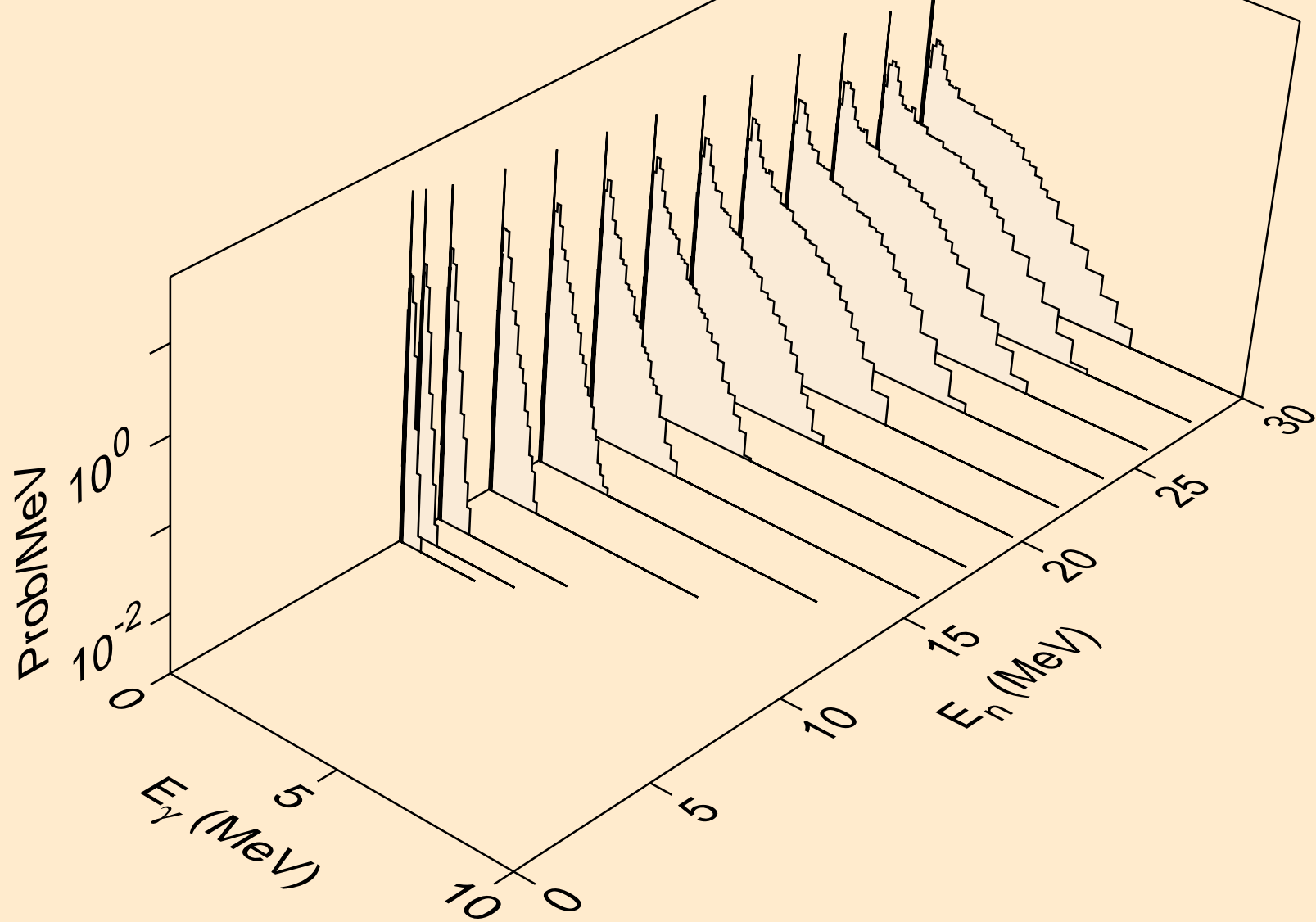

LA124 NEUTRON ACER TENDL-2021 LIBRARY; T=293.6K
Photon emission for (n,pt)

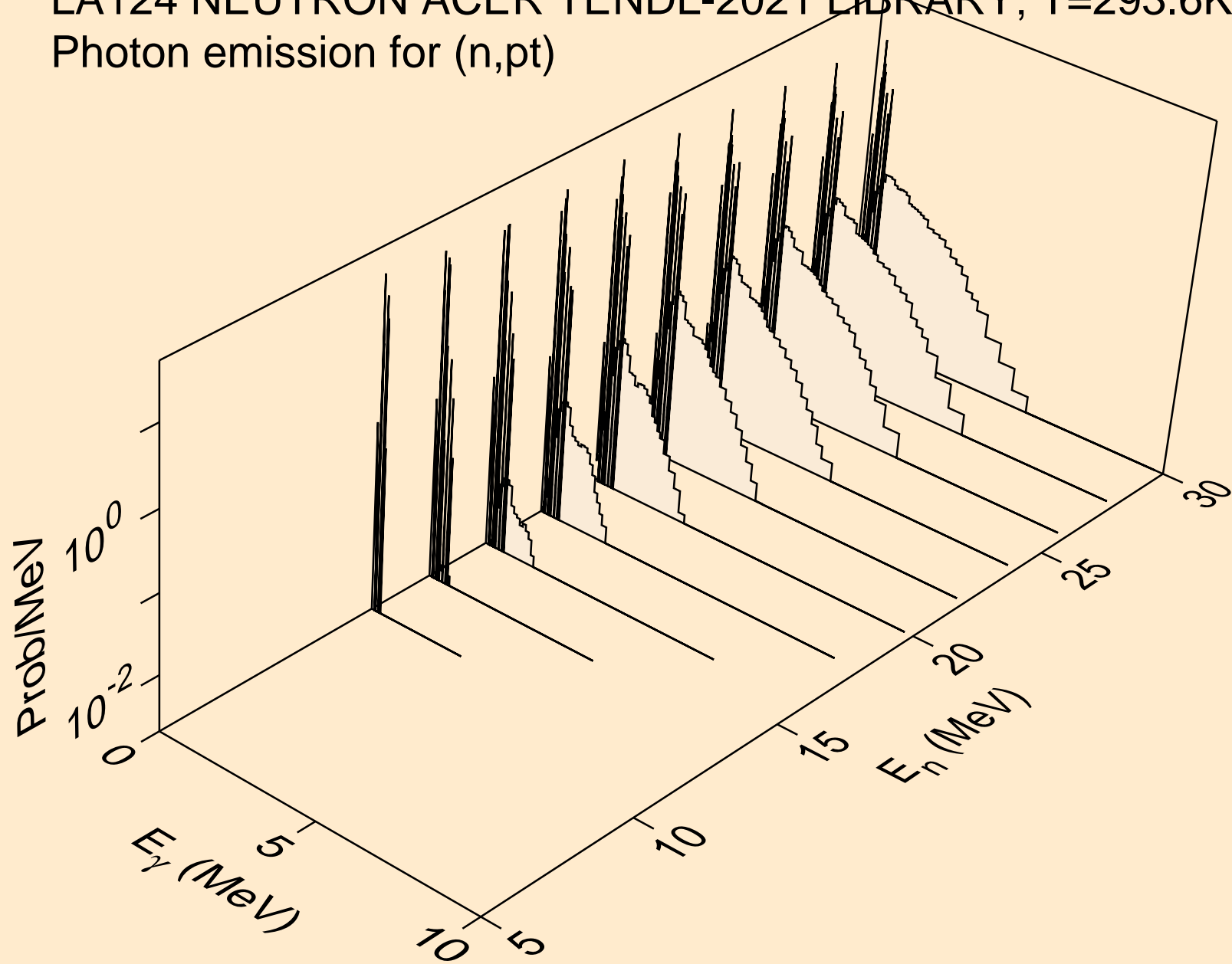

LA124 NEUTRON ACER TENDL-2021 LIBRARY; T=293.6K
Photon emission for (n,da)

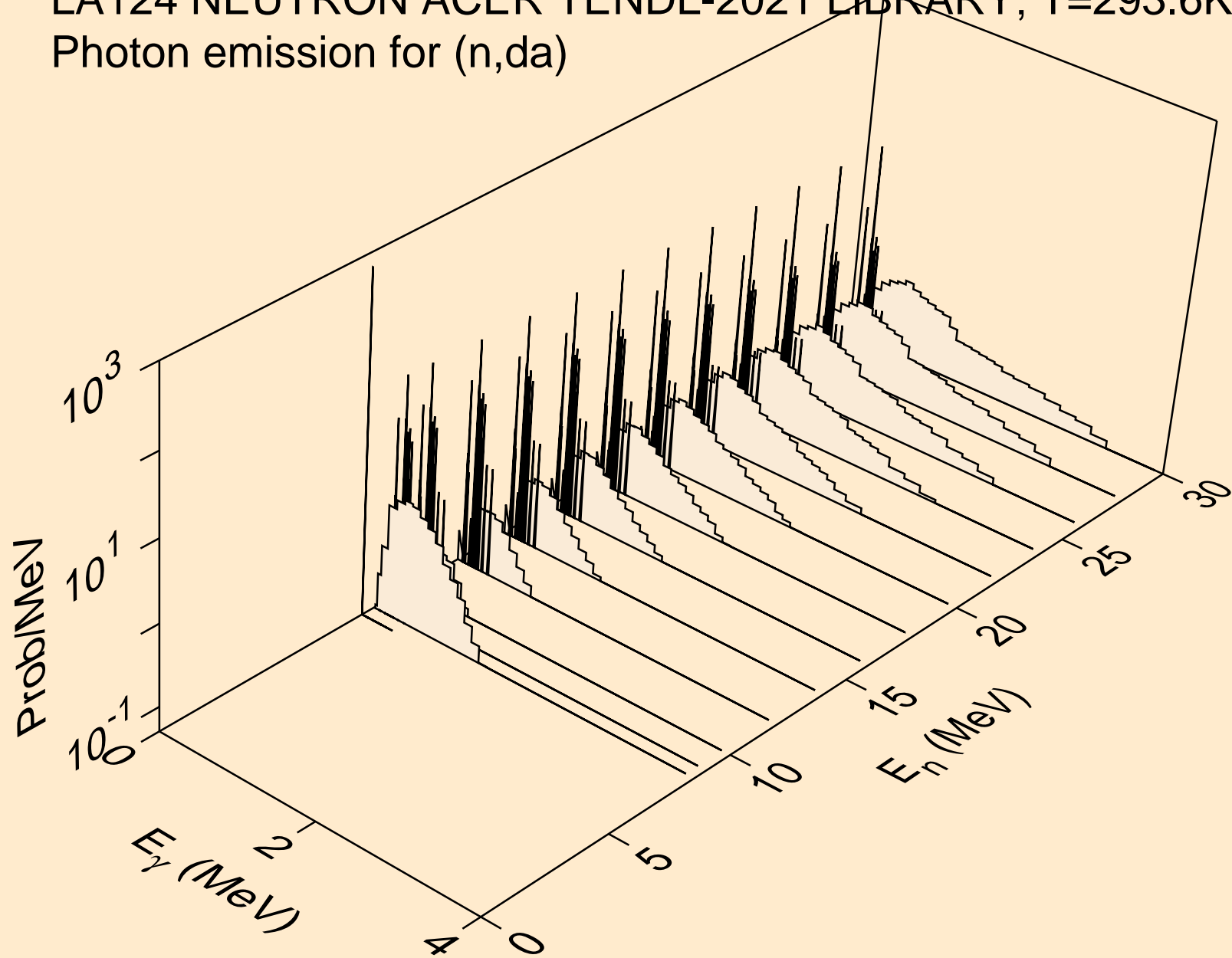

LA124 NEUTRON ACER TENDL-2021 LIBRARY; T=293.6K
thermal capture photon spectrum

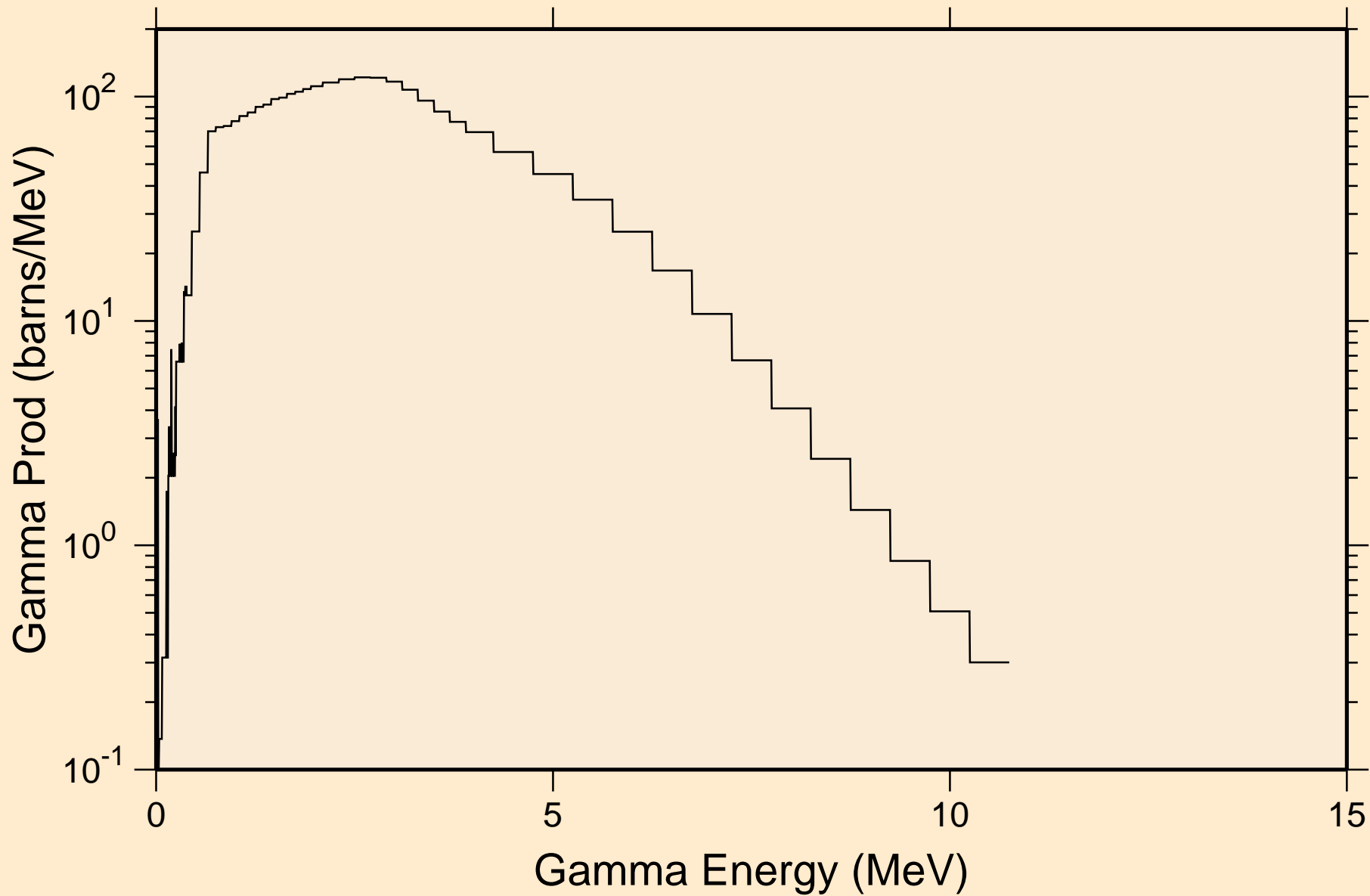

LA124 NEUTRON ACER TENDL-2021 LIBRARY; T=293.6K
14 MeV photon spectrum

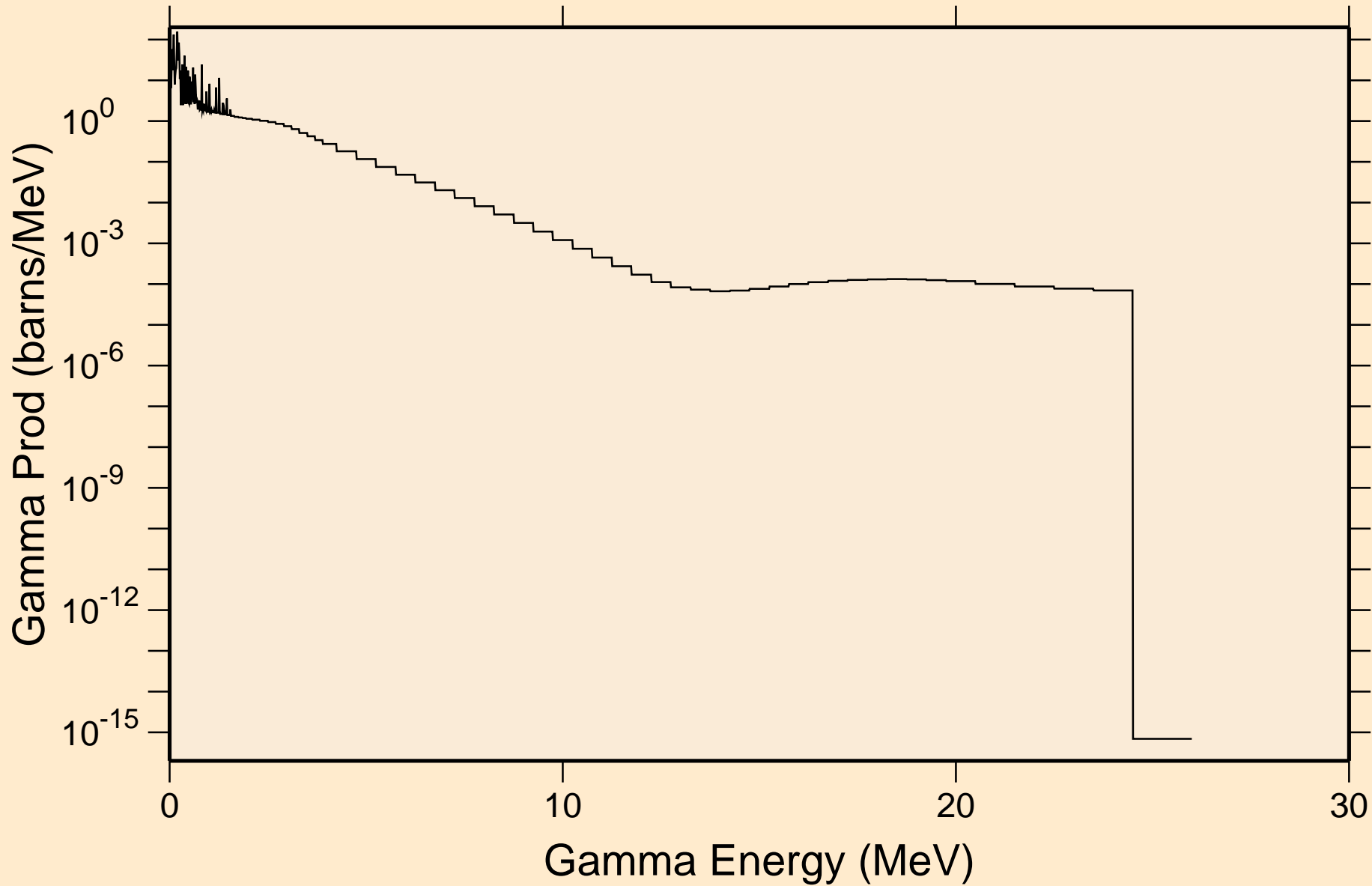

LA124 NEUTRON ACER TENDL-2021 LIBRARY; T=293.6K
Particle heating contributions

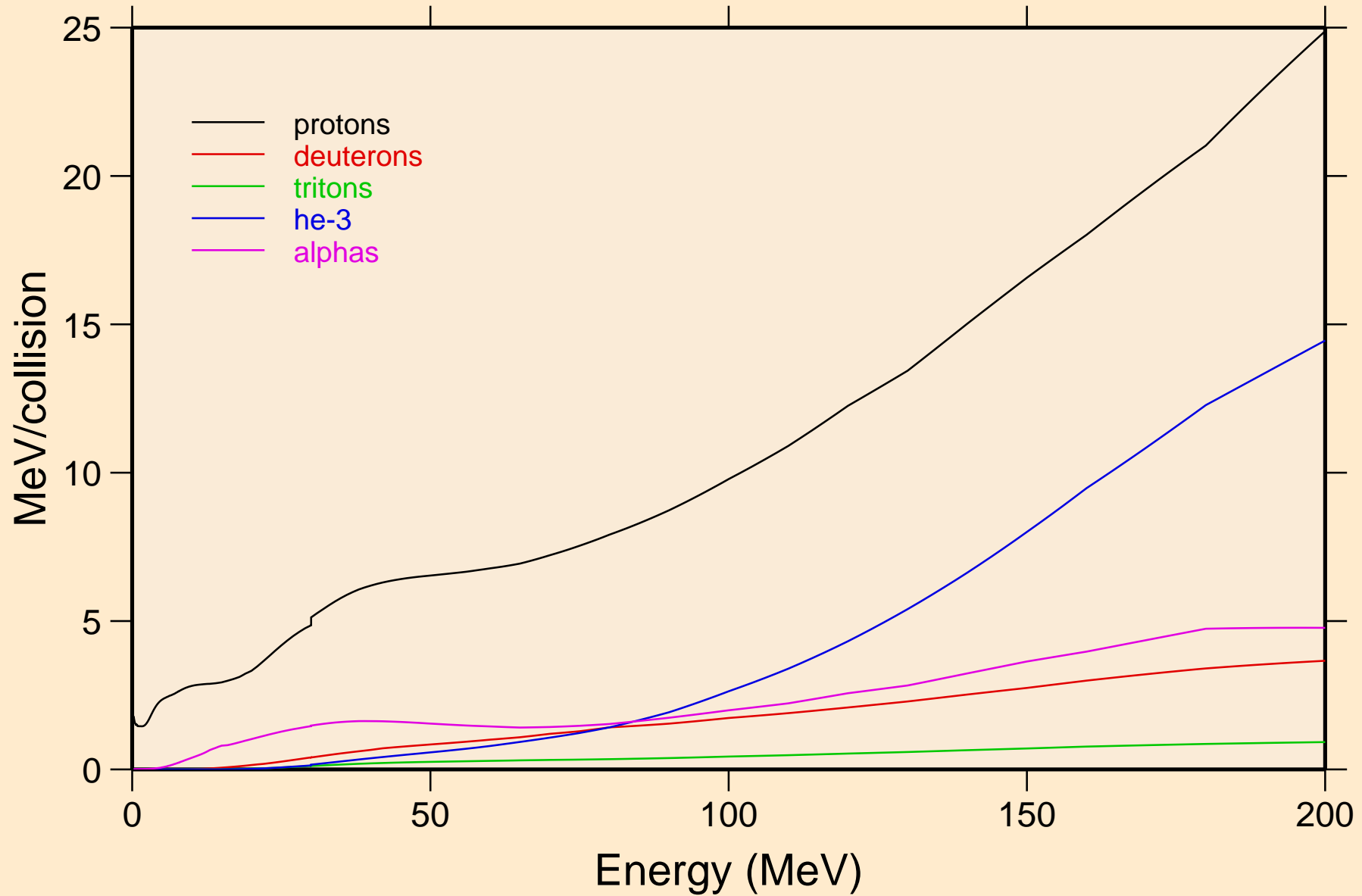

LA124 NEUTRON ACER TENDL-2021 LIBRARY; T=293.6K
Recoil Heating

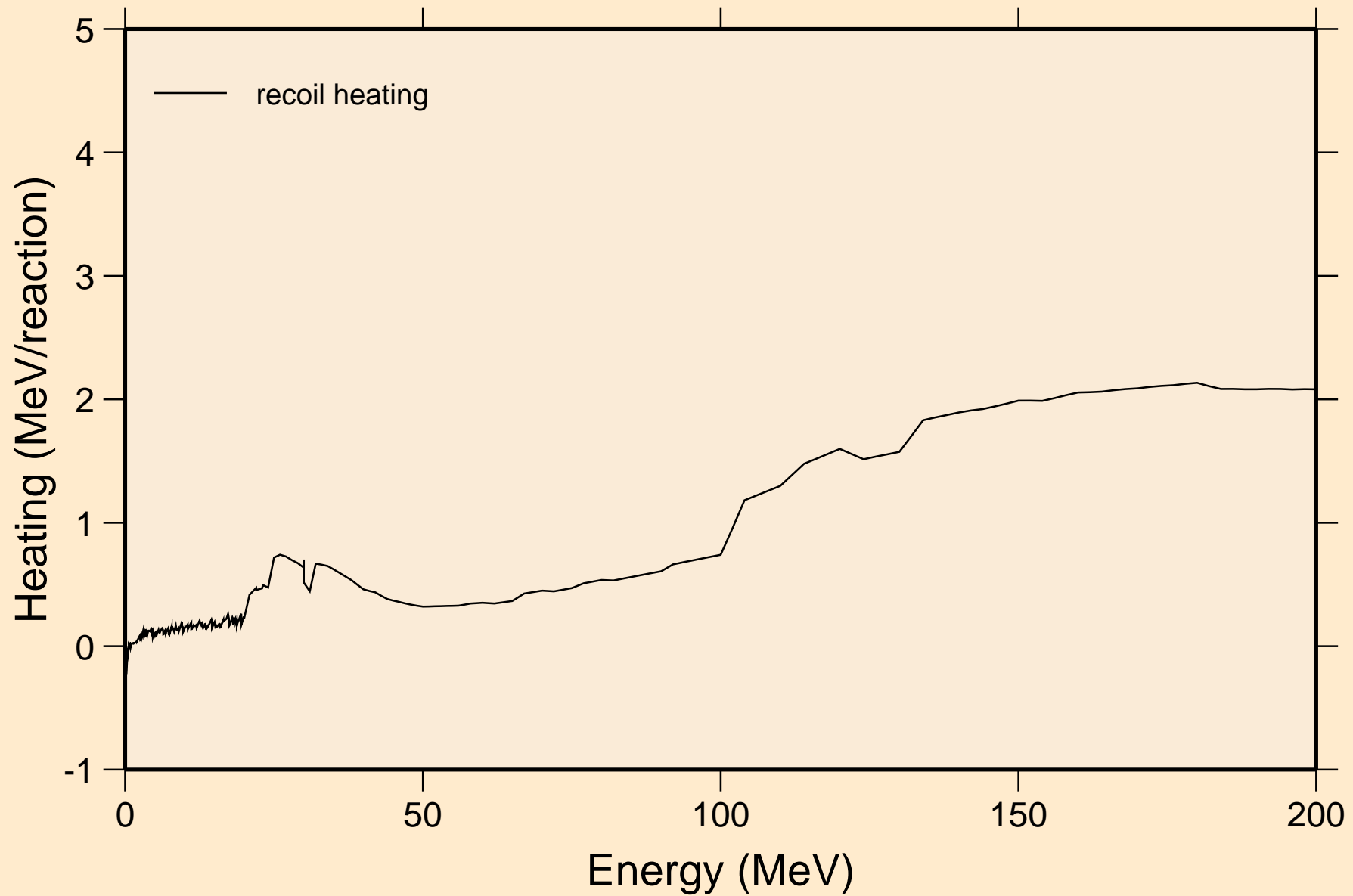

LA124 NEUTRON ACER TENDL-2021 LIBRARY; T=293.6K
Particle production cross sections

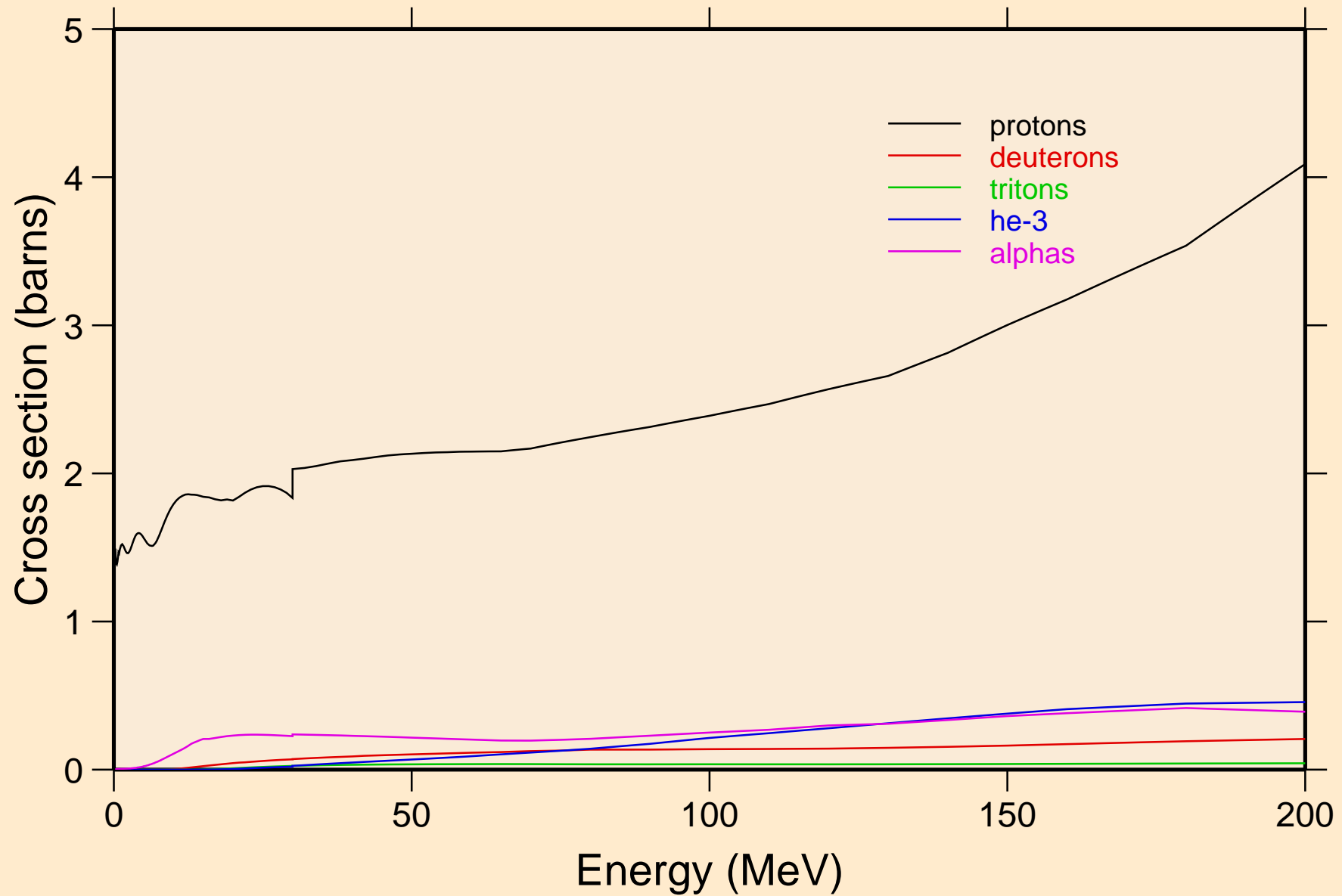

LA124 NEUTRON ACER TENDL-2021 LIBRARY; T=293.6K
protons from (n,x)

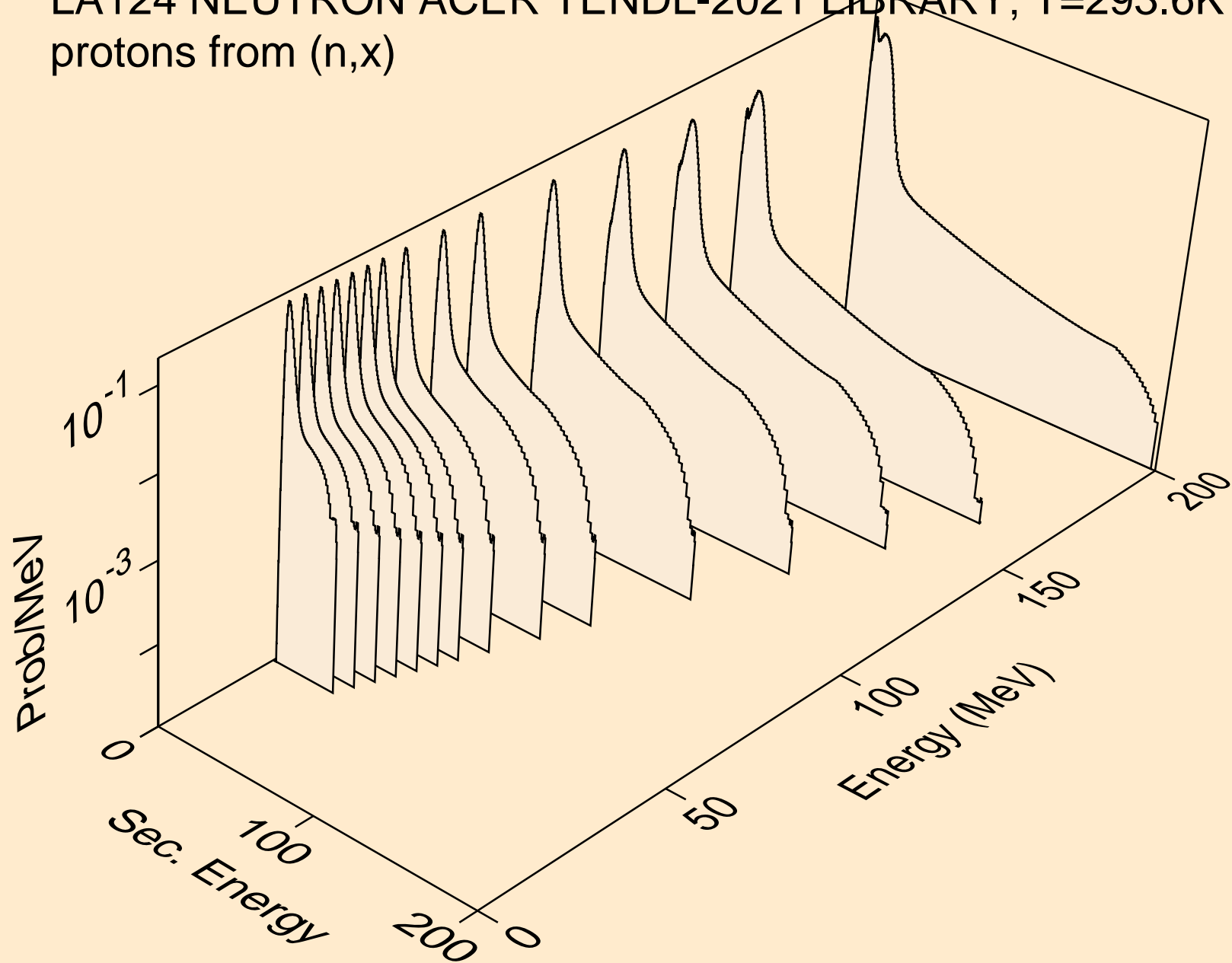

LA124 NEUTRON ACER TENDL-2021 LIBRARY; T=293.6K
protons from (n,n*)p

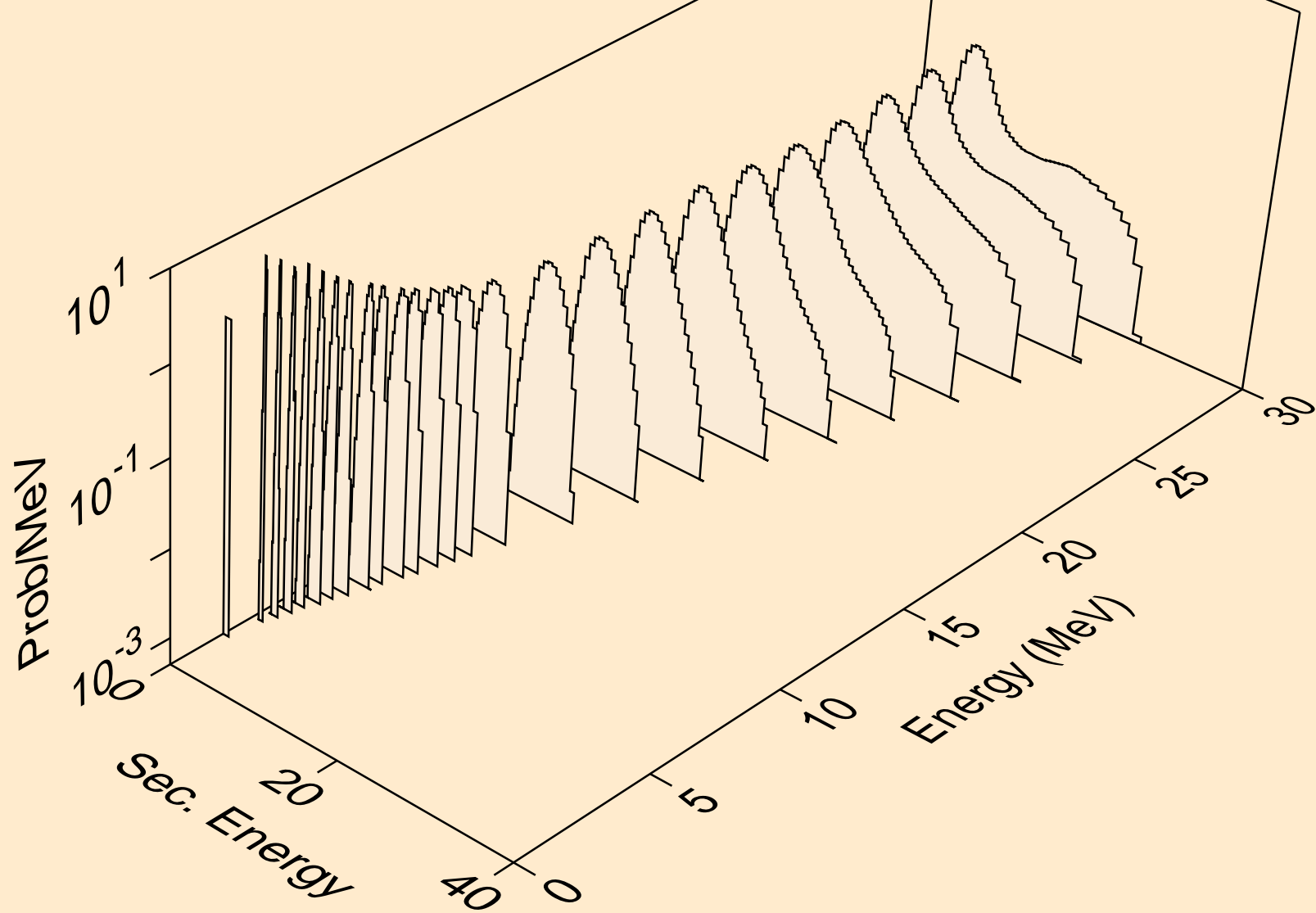

LA124 NEUTRON ACER TENDL-2021 LIBRARY; T=293.6K
protons from (n,2np)

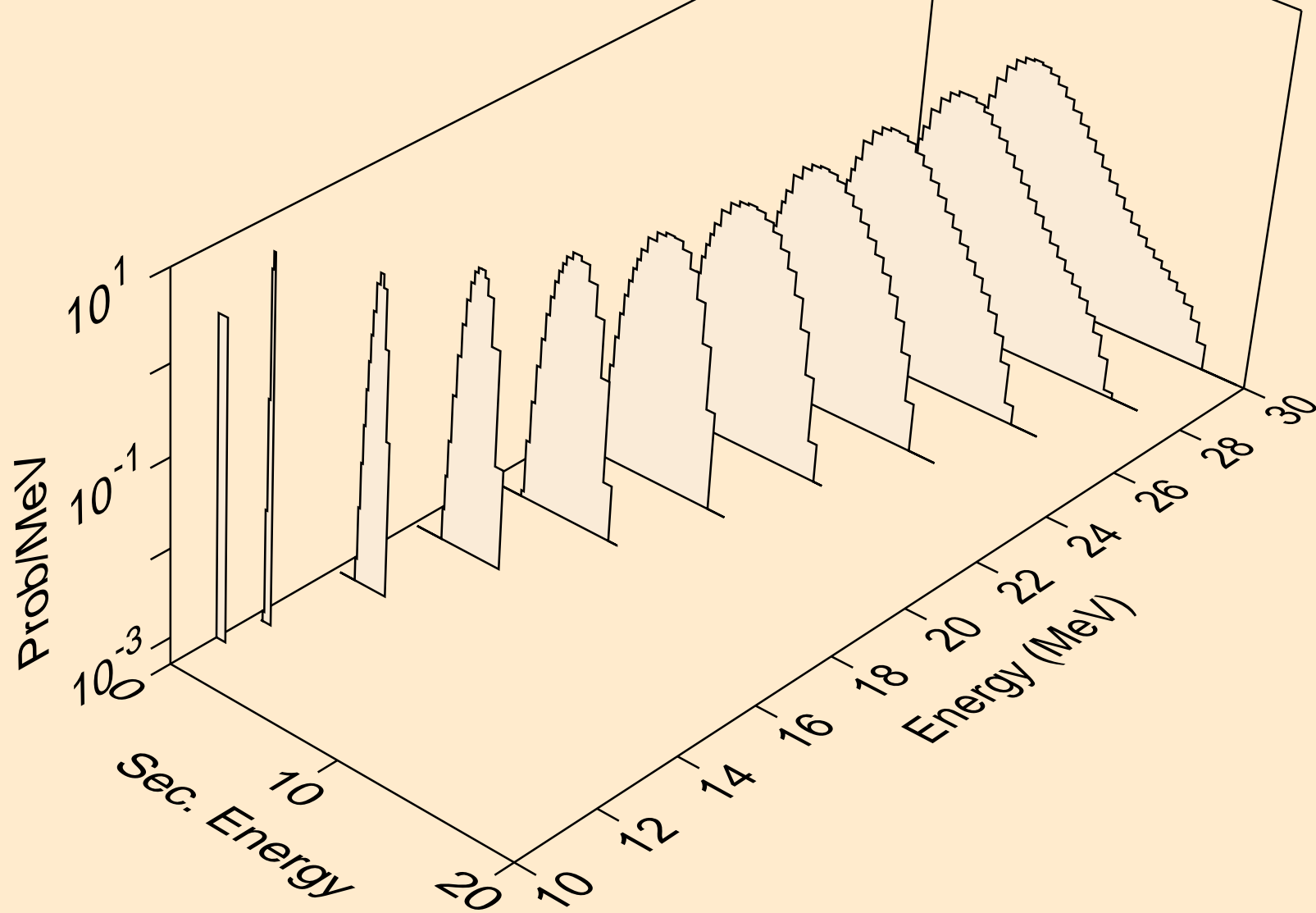

LA124 NEUTRON ACER TENDL-2021 LIBRARY; T=293.6K
protons from (n,3np)

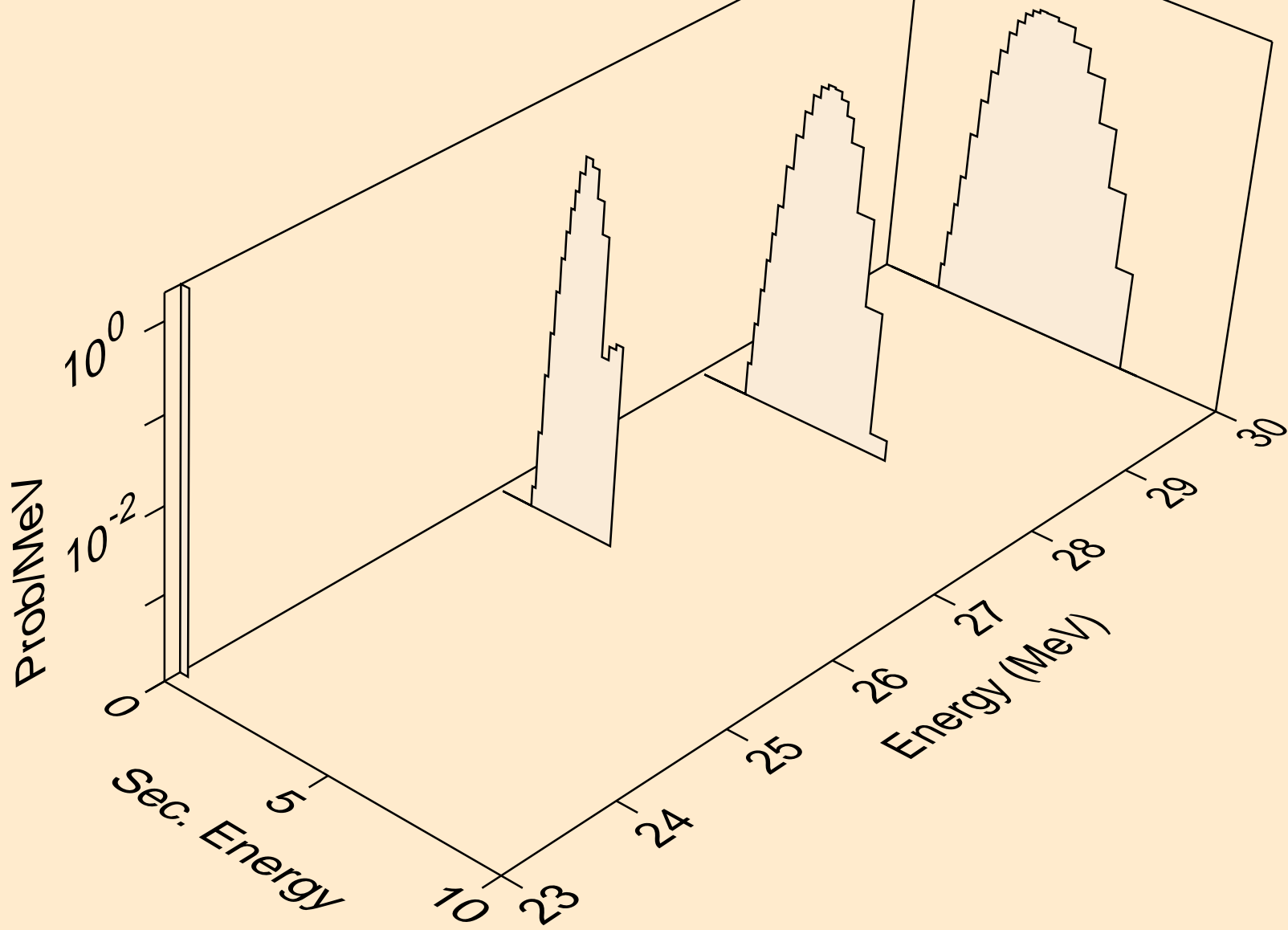

LA124 NEUTRON ACER TENDL-2021 LIBRARY; T=293.6K
protons from (n,2np)

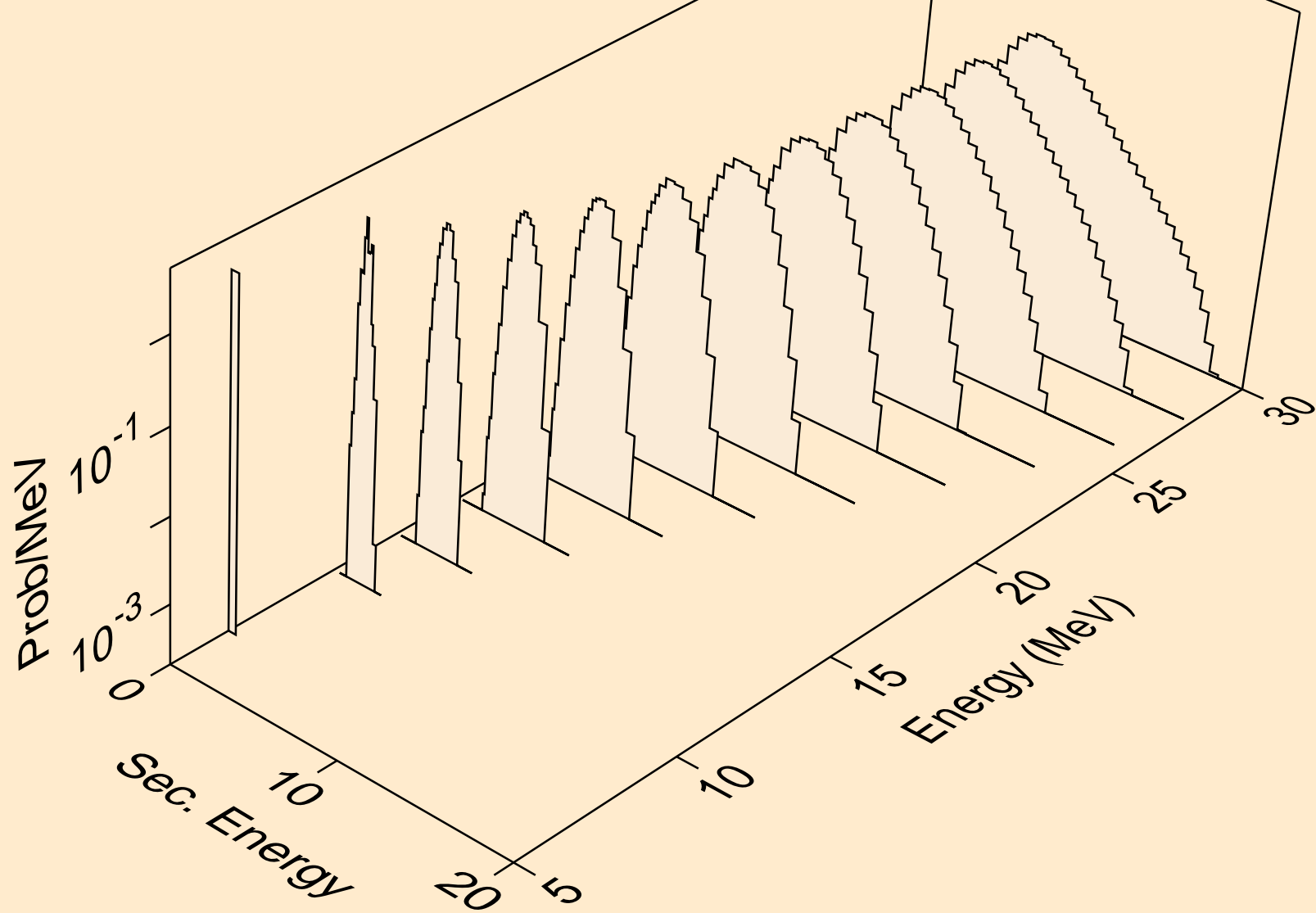

LA124 NEUTRON ACER TENDL-2021 LIBRARY; T=293.6K
protons from (n,npa)

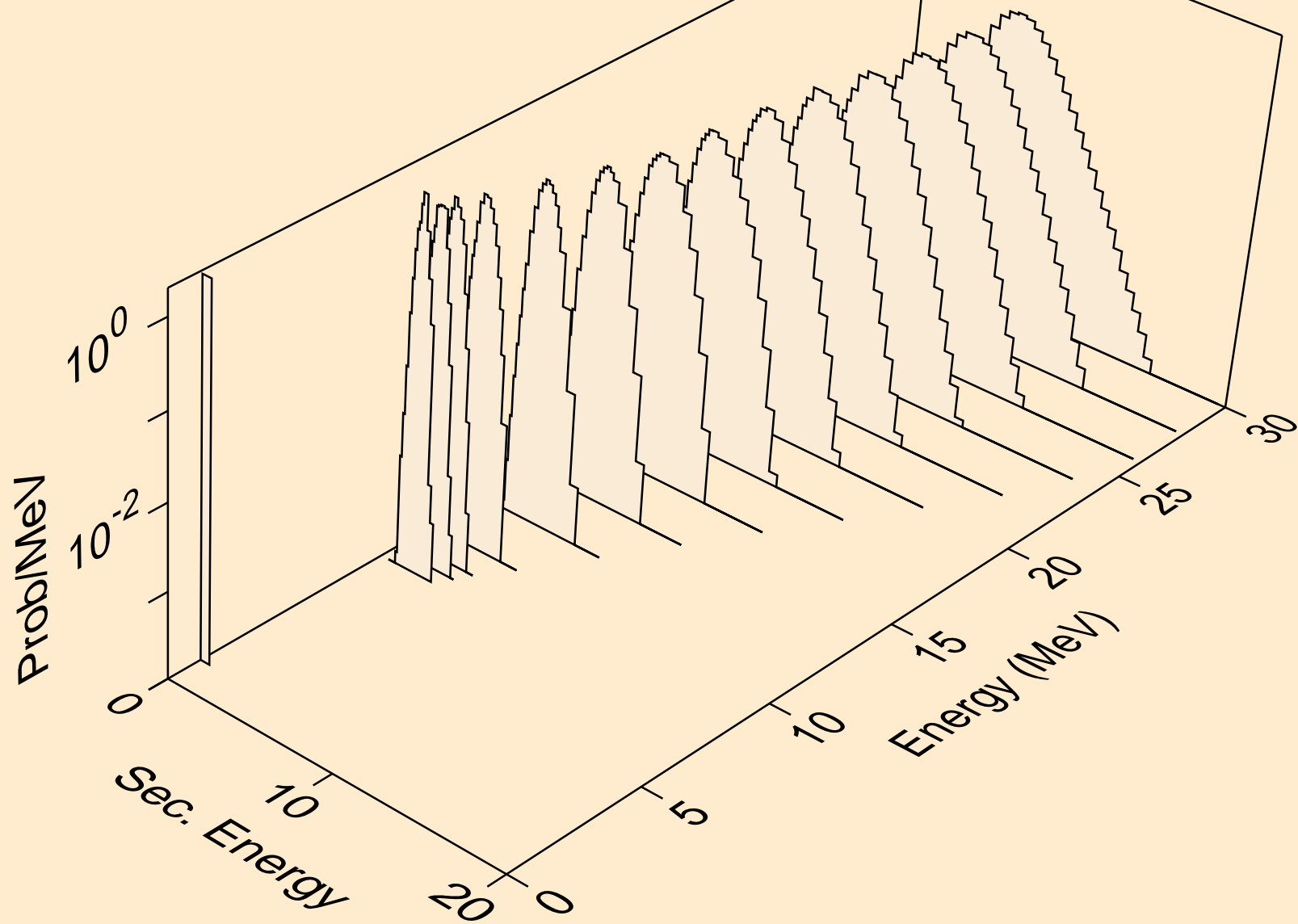

LA124 NEUTRON ACER TENDL-2021 LIBRARY; T=293.6K
protons from (n,p)

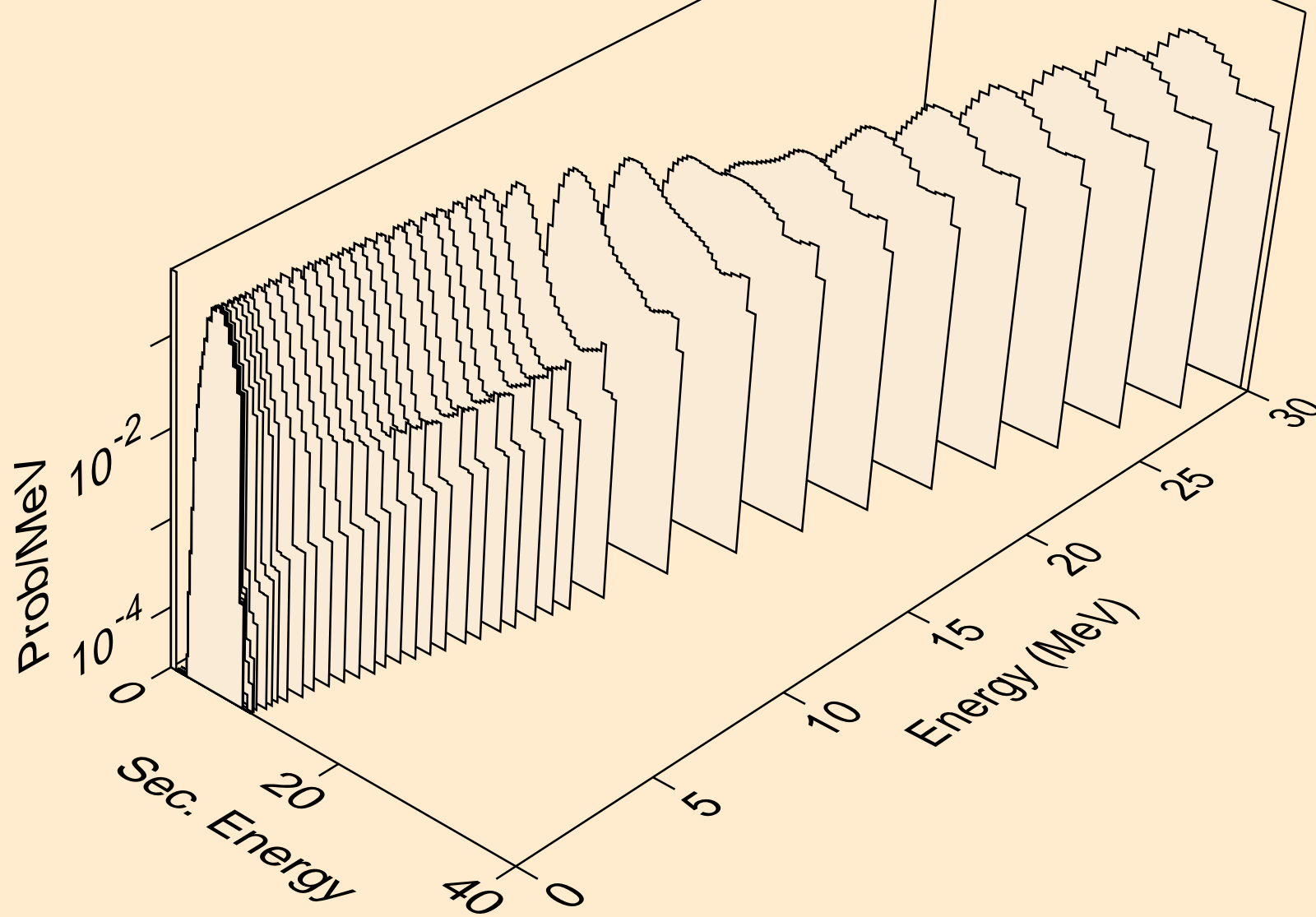

LA124 NEUTRON ACER TENDL-2021 LIBRARY; T=293.6K
protons from (n,2p)

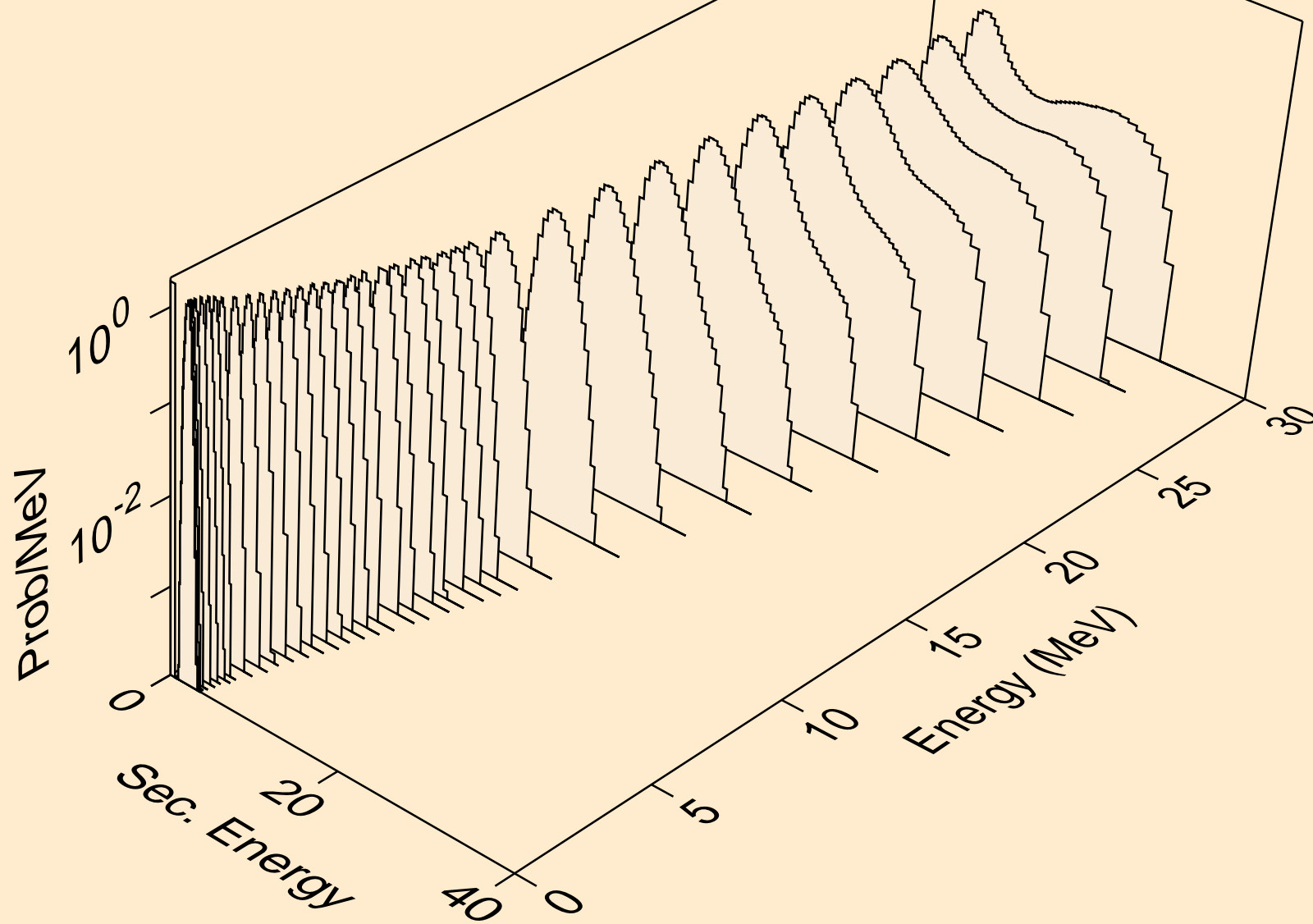

LA124 NEUTRON ACER TENDL-2021 LIBRARY; T=293.6K
protons from (n,p)

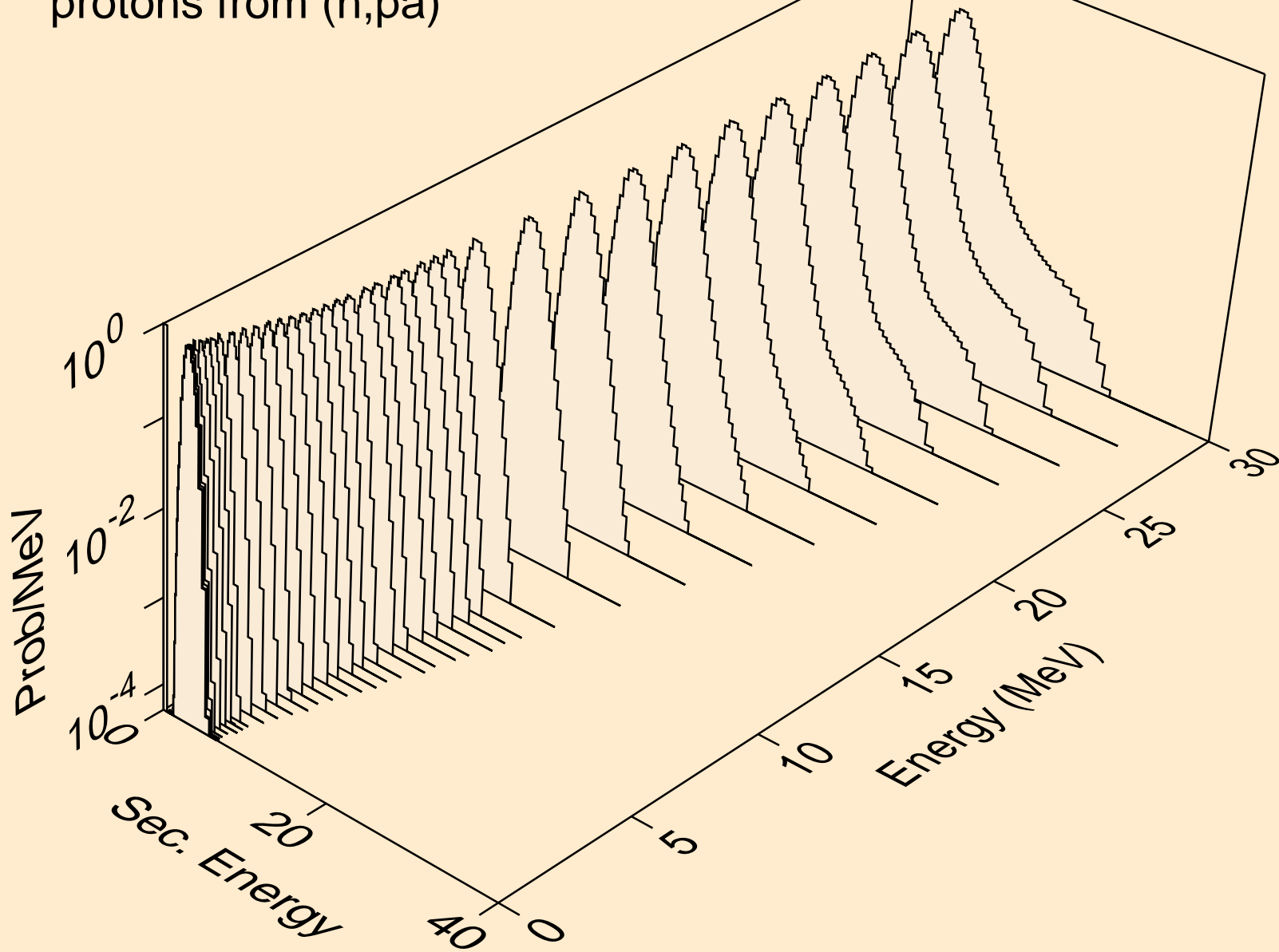

LA124 NEUTRON ACER TENDL-2021 LIBRARY; T=293.6K
protons from (n,pd)

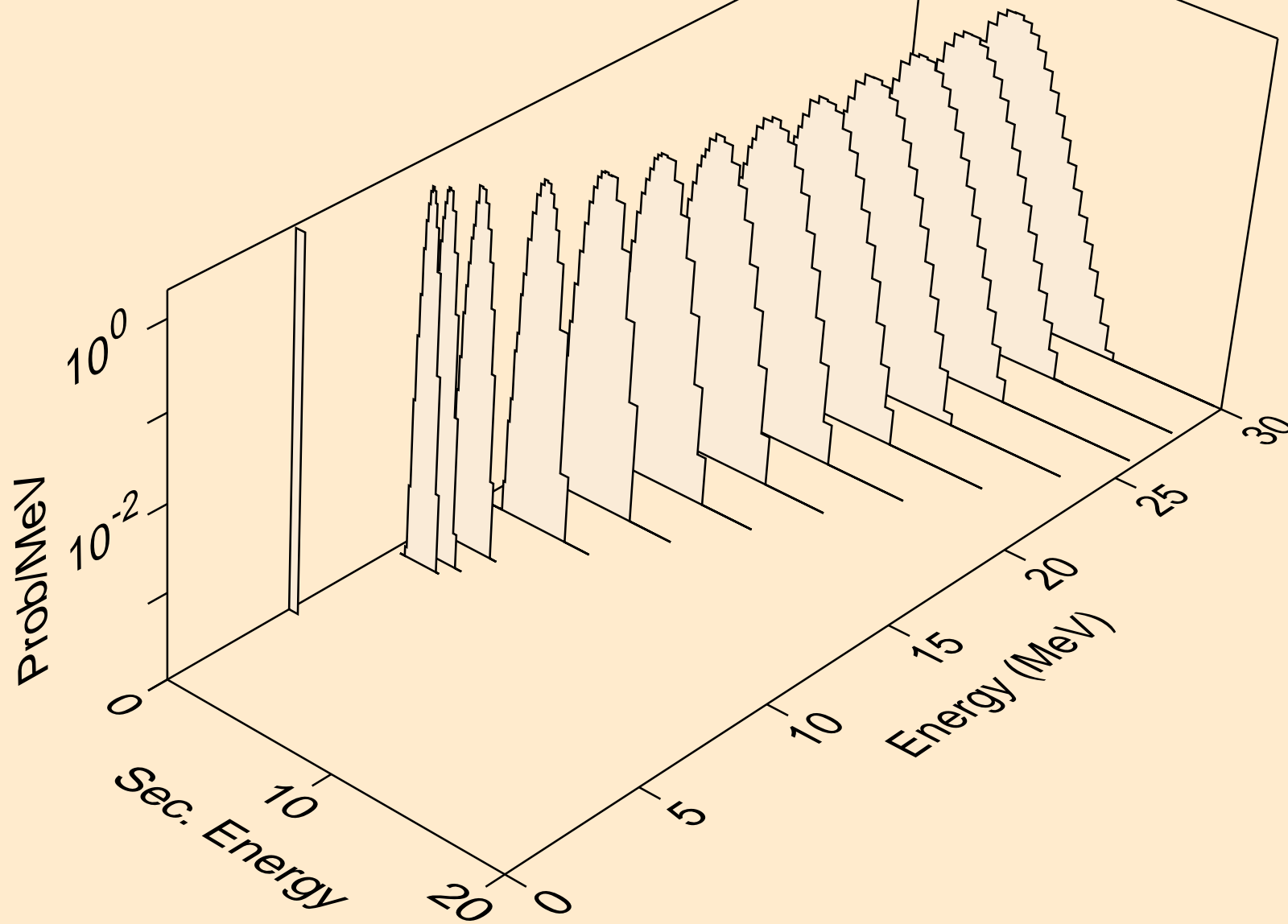

LA124 NEUTRON ACER TENDL-2021 LIBRARY; T=293.6K
protons from (n,pt)

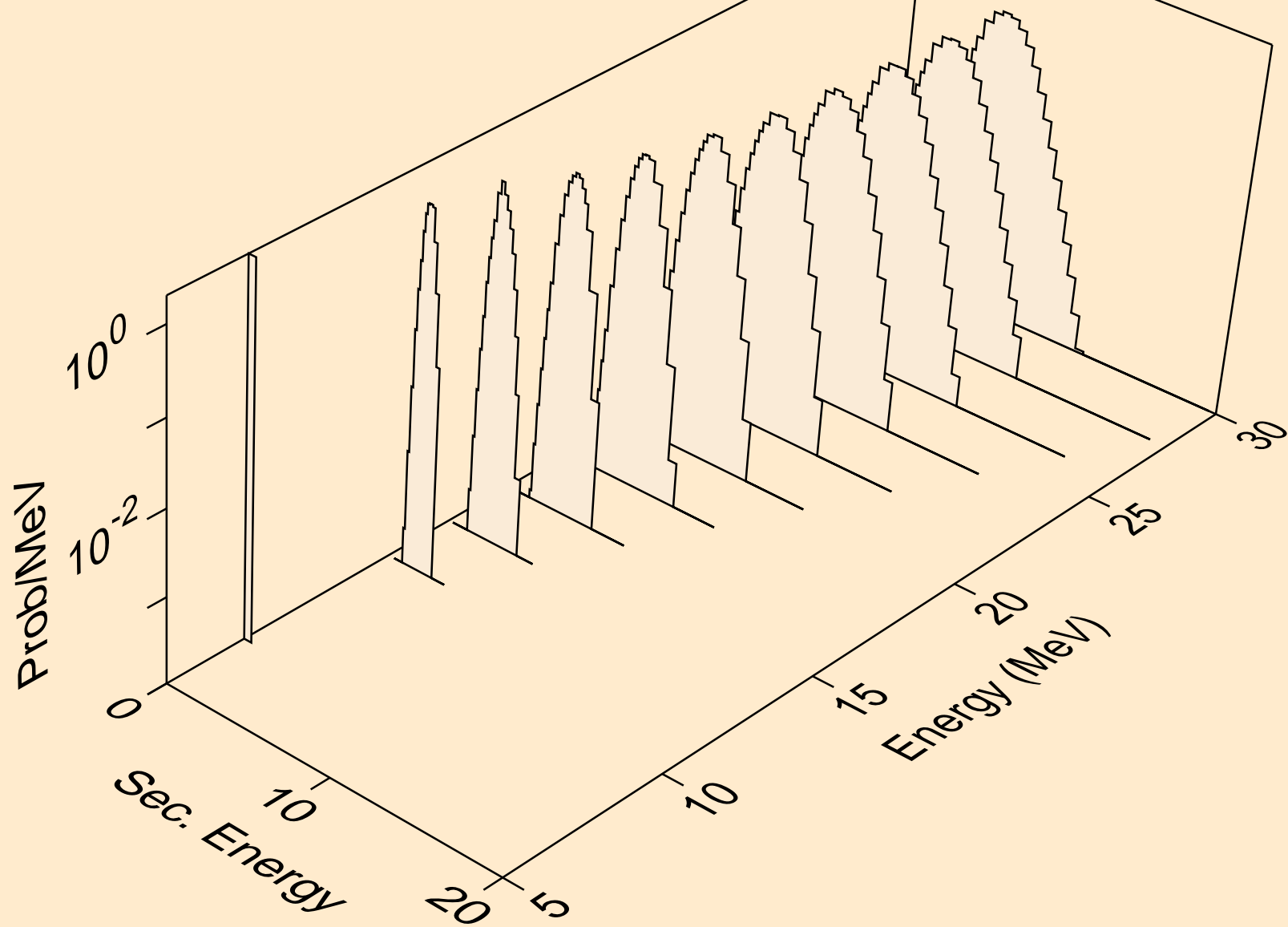

LA124 NEUTRON ACER TENDL-2021 LIBRARY; T=293.6K
deuterons from (n,x)

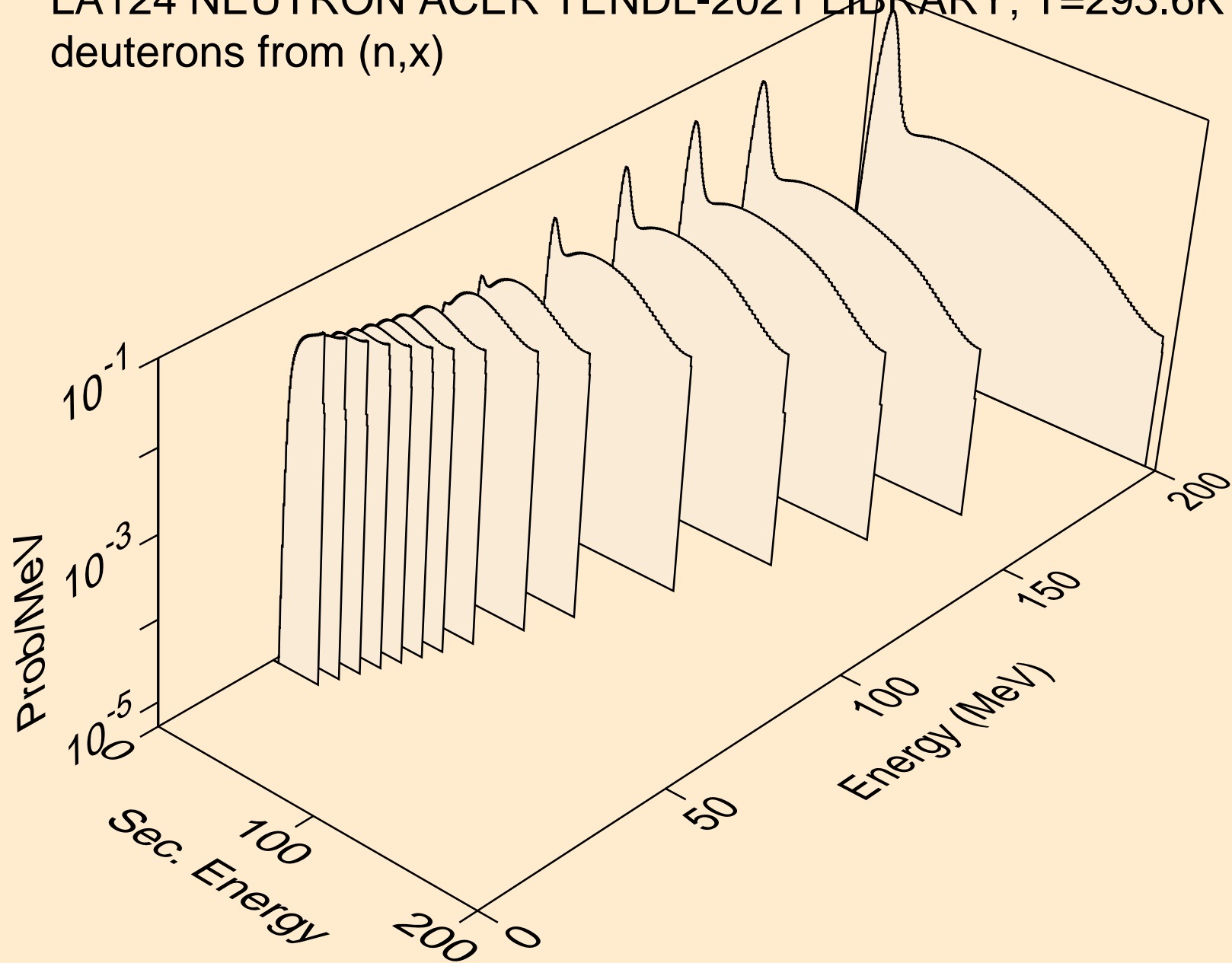

LA124 NEUTRON ACER TENDL-2021 LIBRARY; T=293.6K
deuterons from (n,2nd)

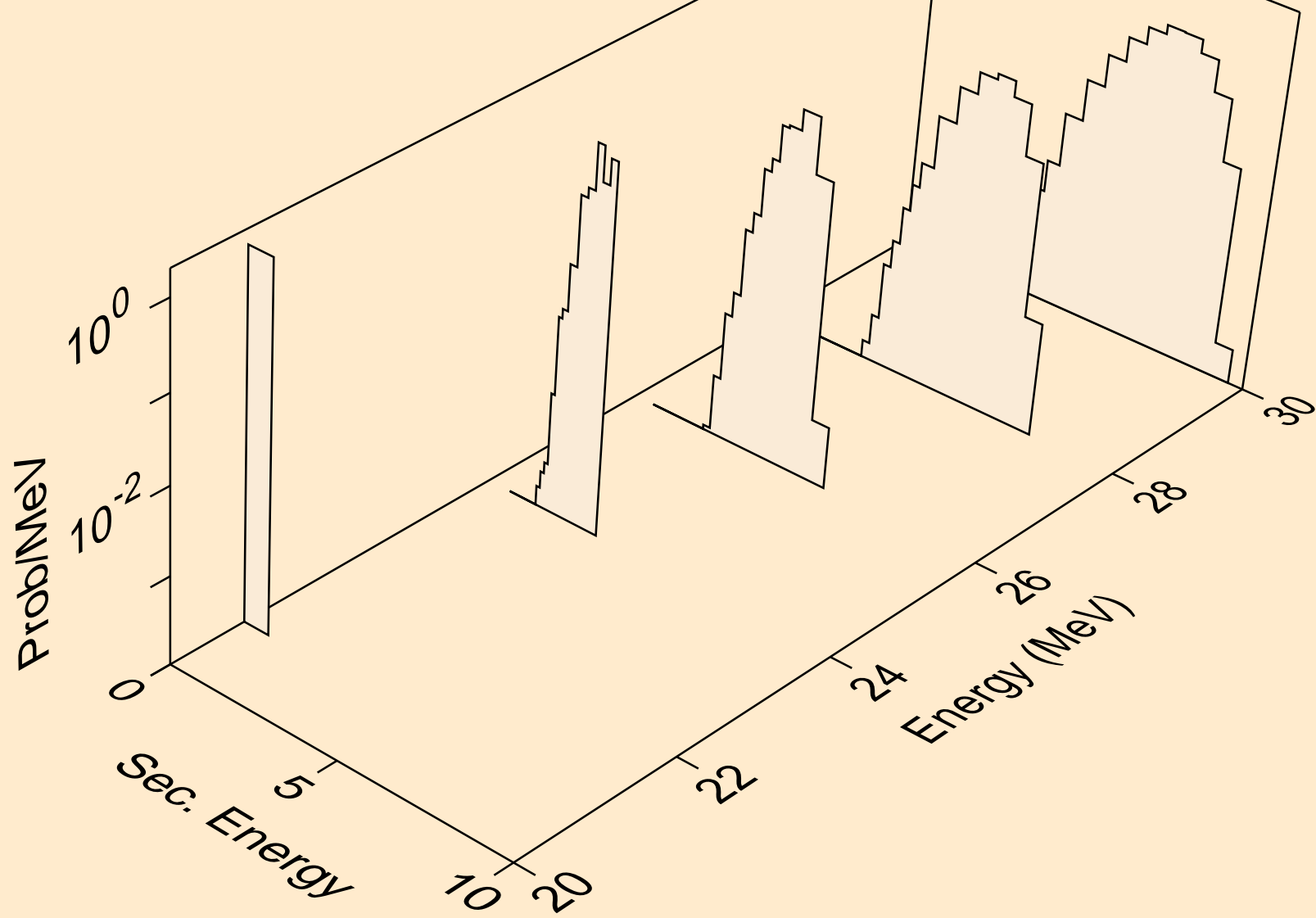

LA124 NEUTRON ACER TENDL-2021 LIBRARY; T=293.6K
deuterons from (n,n*)d

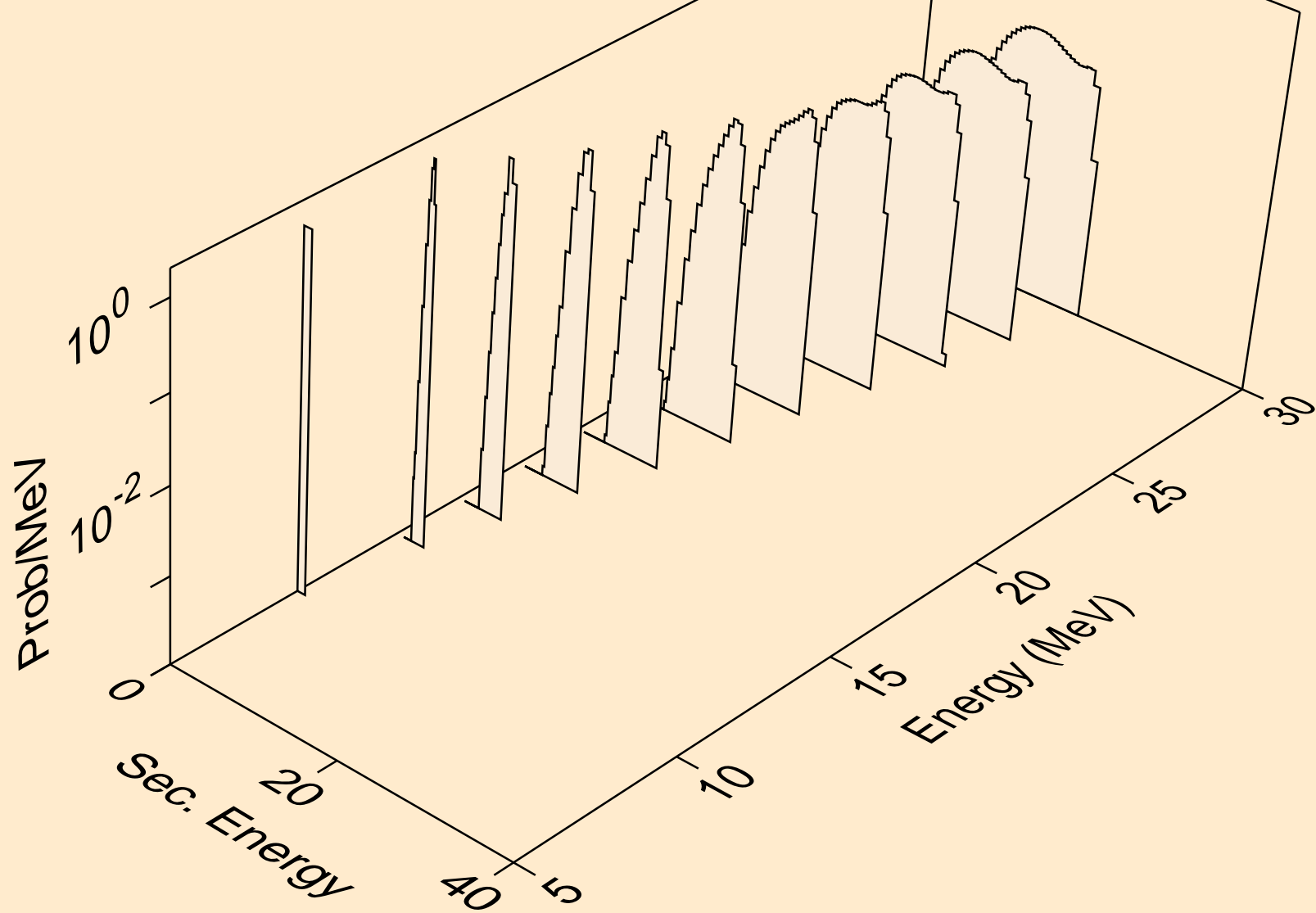

LA124 NEUTRON ACER TENDL-2021 LIBRARY; T=293.6K
deuterons from (n,d)

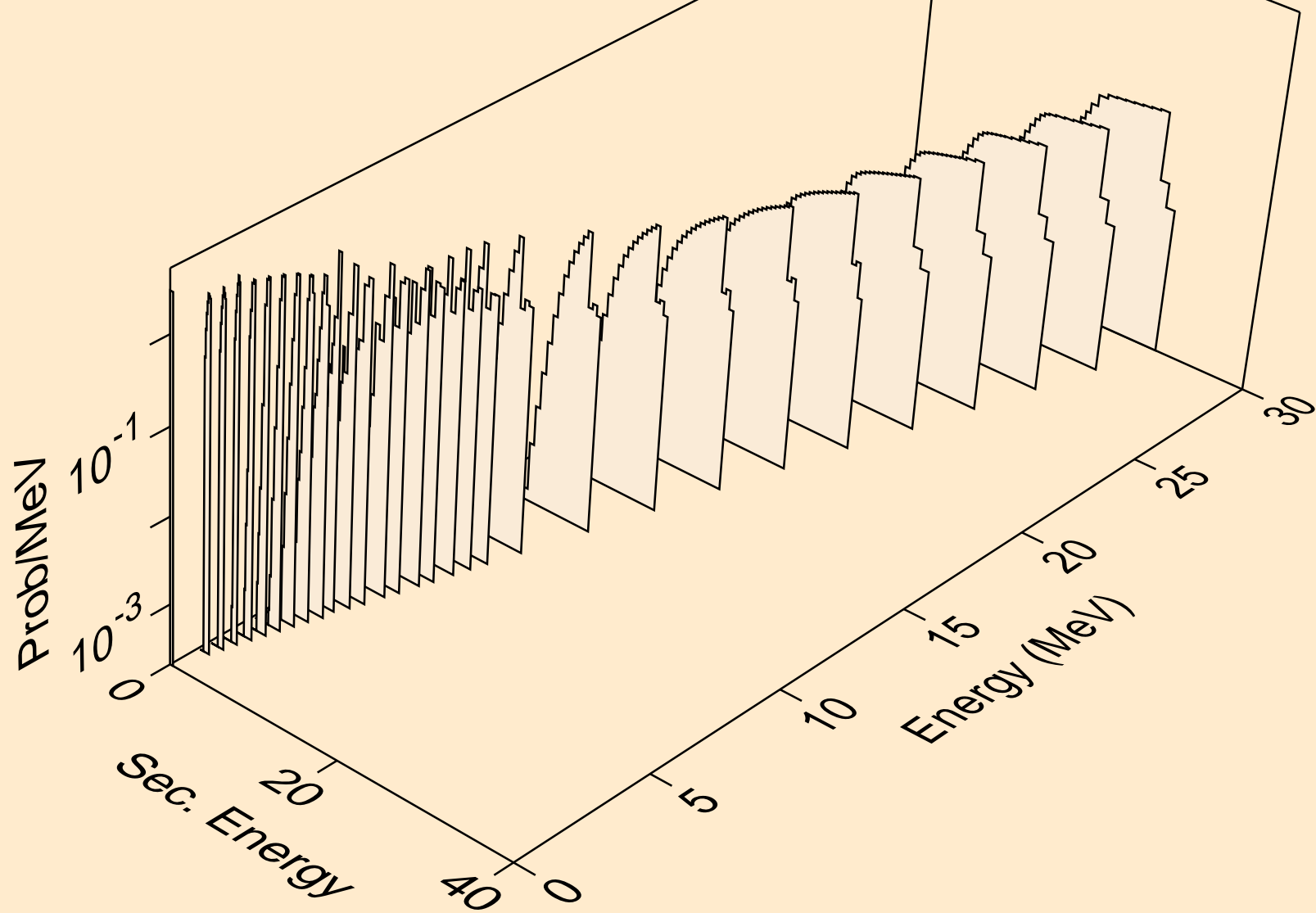

LA124 NEUTRON ACER TENDL-2021 LIBRARY; T=293.6K
deuterons from (n,d2a)

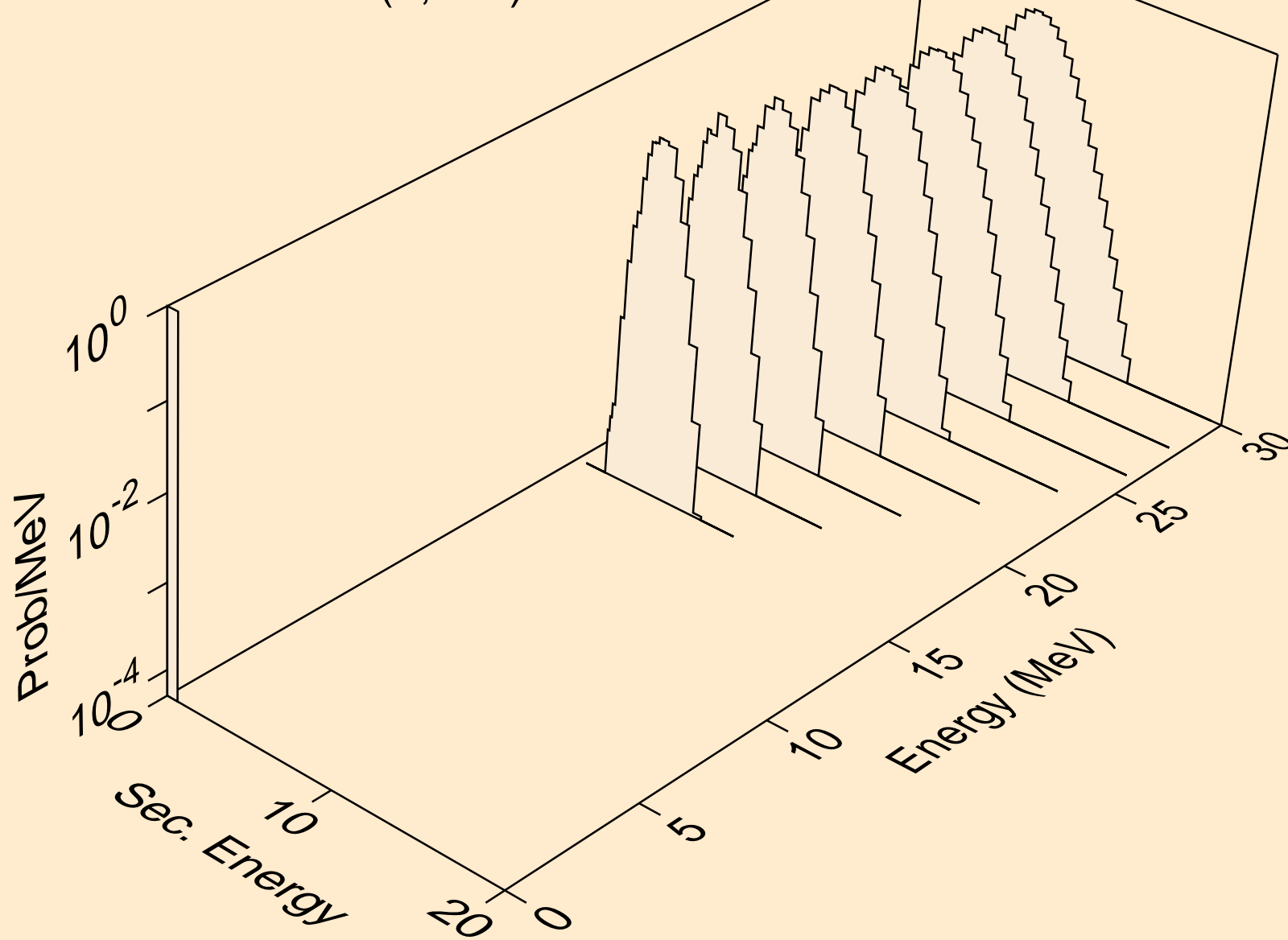

LA124 NEUTRON ACER TENDL-2021 LIBRARY; T=293.6K
deuterons from (n,pd)

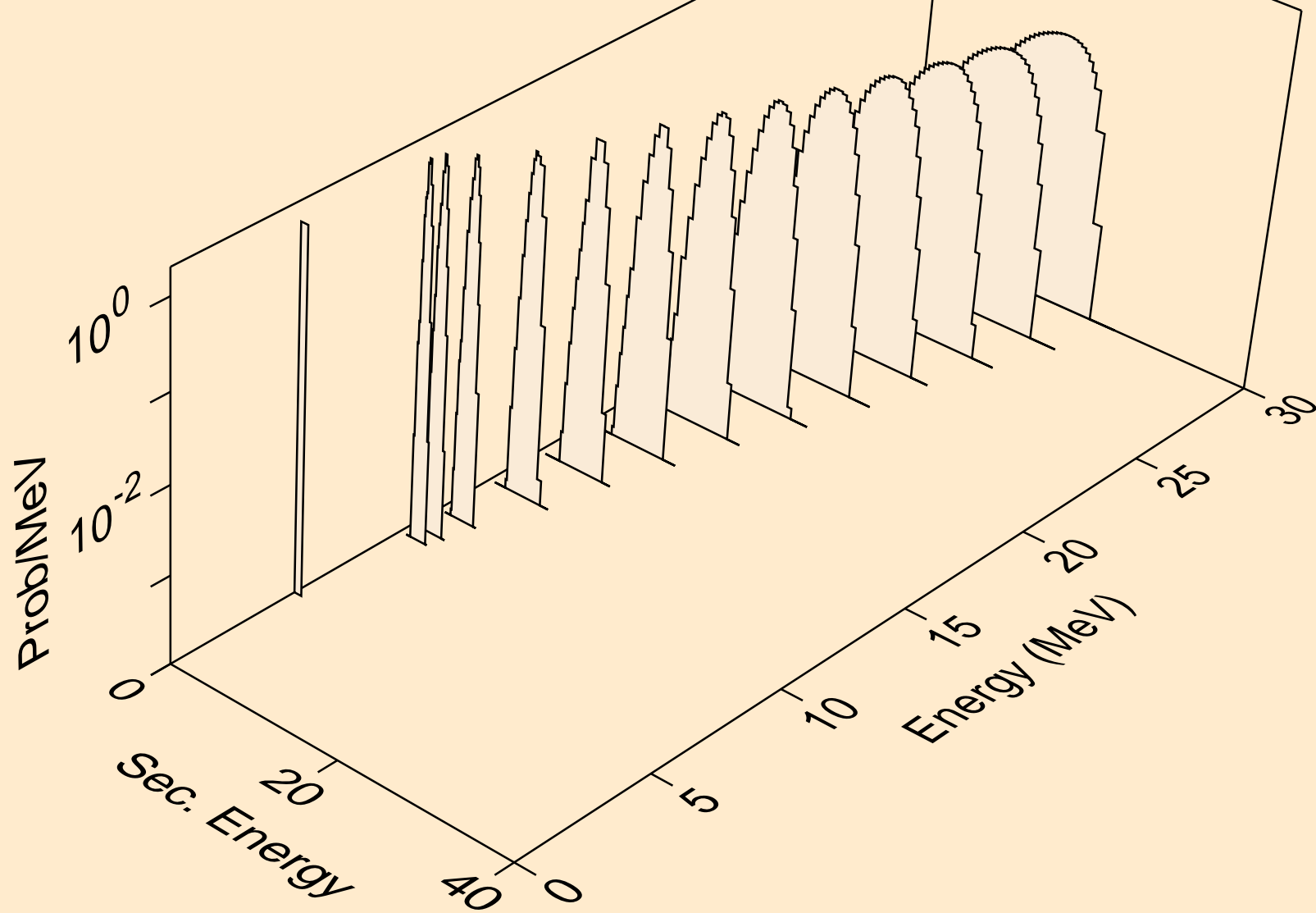

LA124 NEUTRON ACER TENDL-2021 LIBRARY; T=293.6K
deuterons from (n,da)

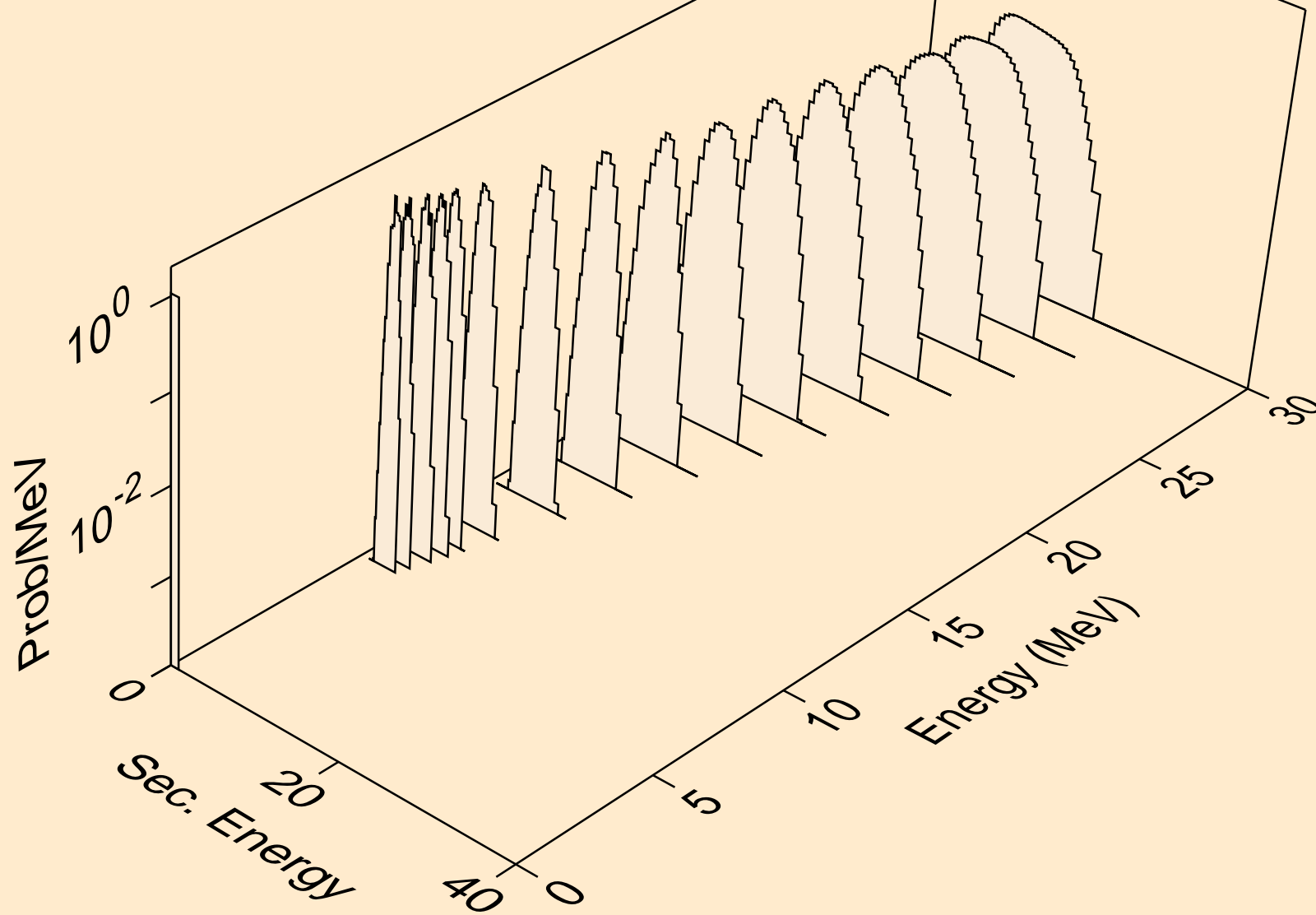

LA124 NEUTRON ACER TENDL-2021 LIBRARY; T=293.6K
tritons from (n,x)

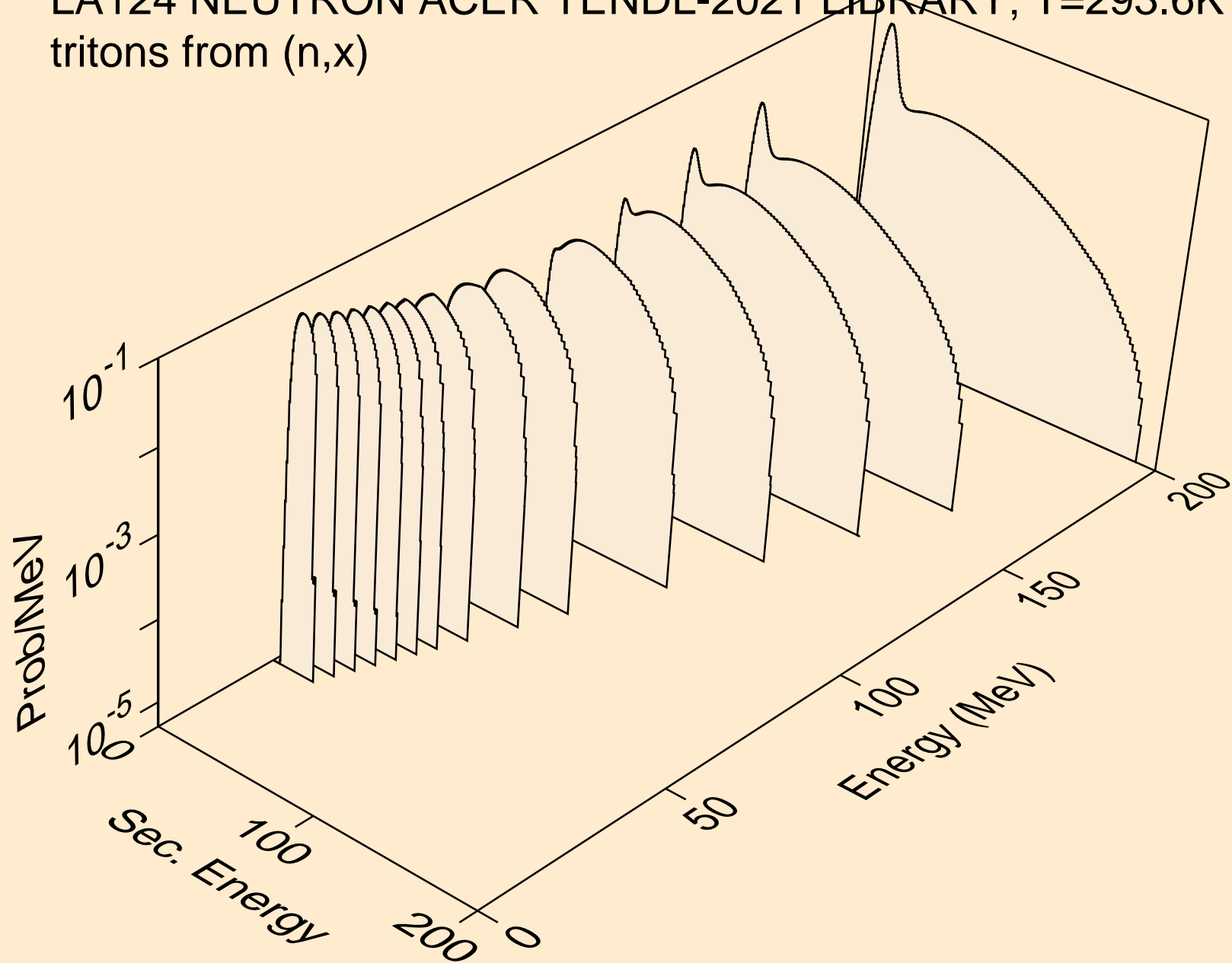

LA124 NEUTRON ACER TENDL-2021 LIBRARY; T=293.6K
tritons from (n,n*)t

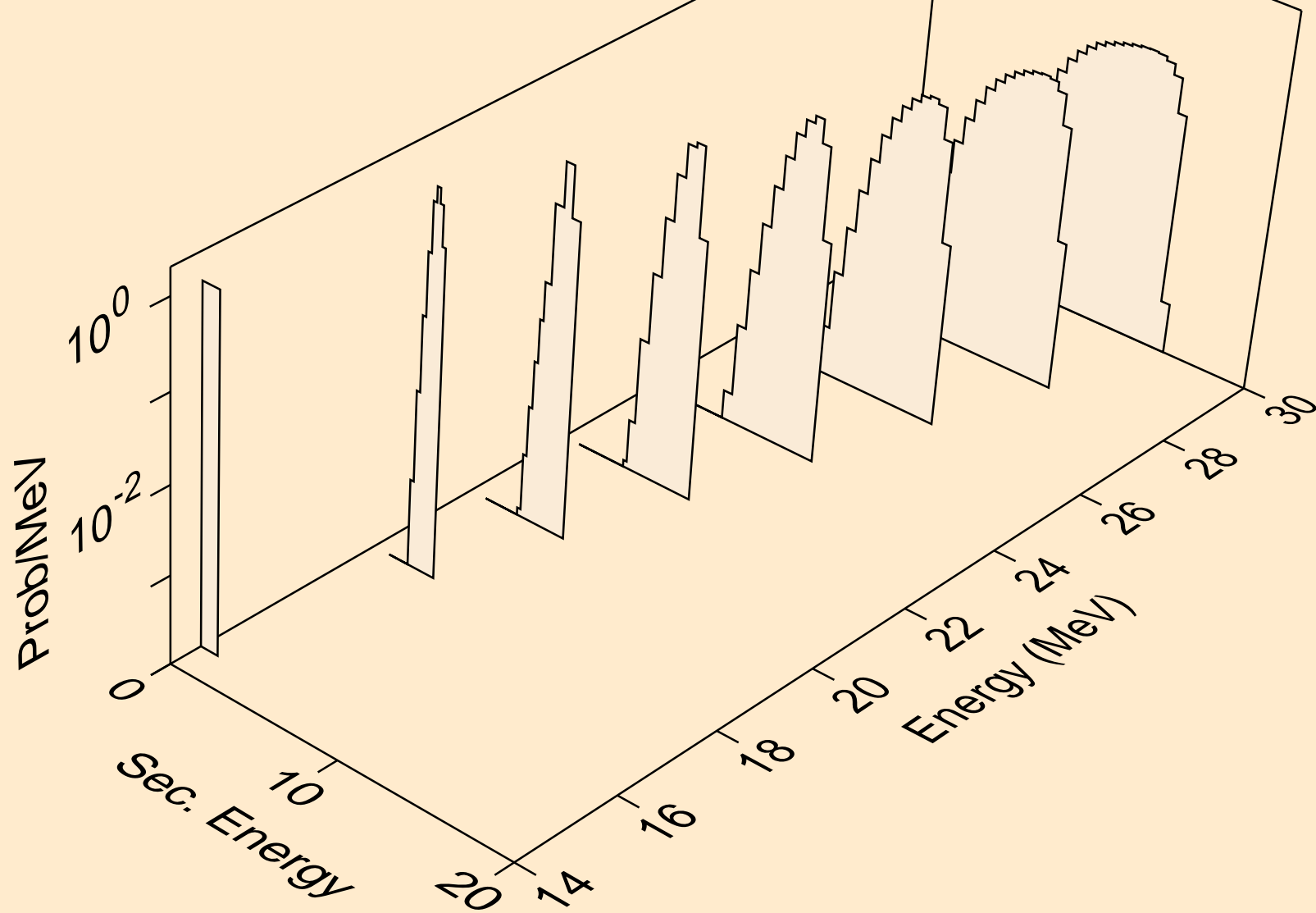

LA124 NEUTRON ACER TENDL-2021 LIBRARY; T=293.6K
tritons from (n,t)

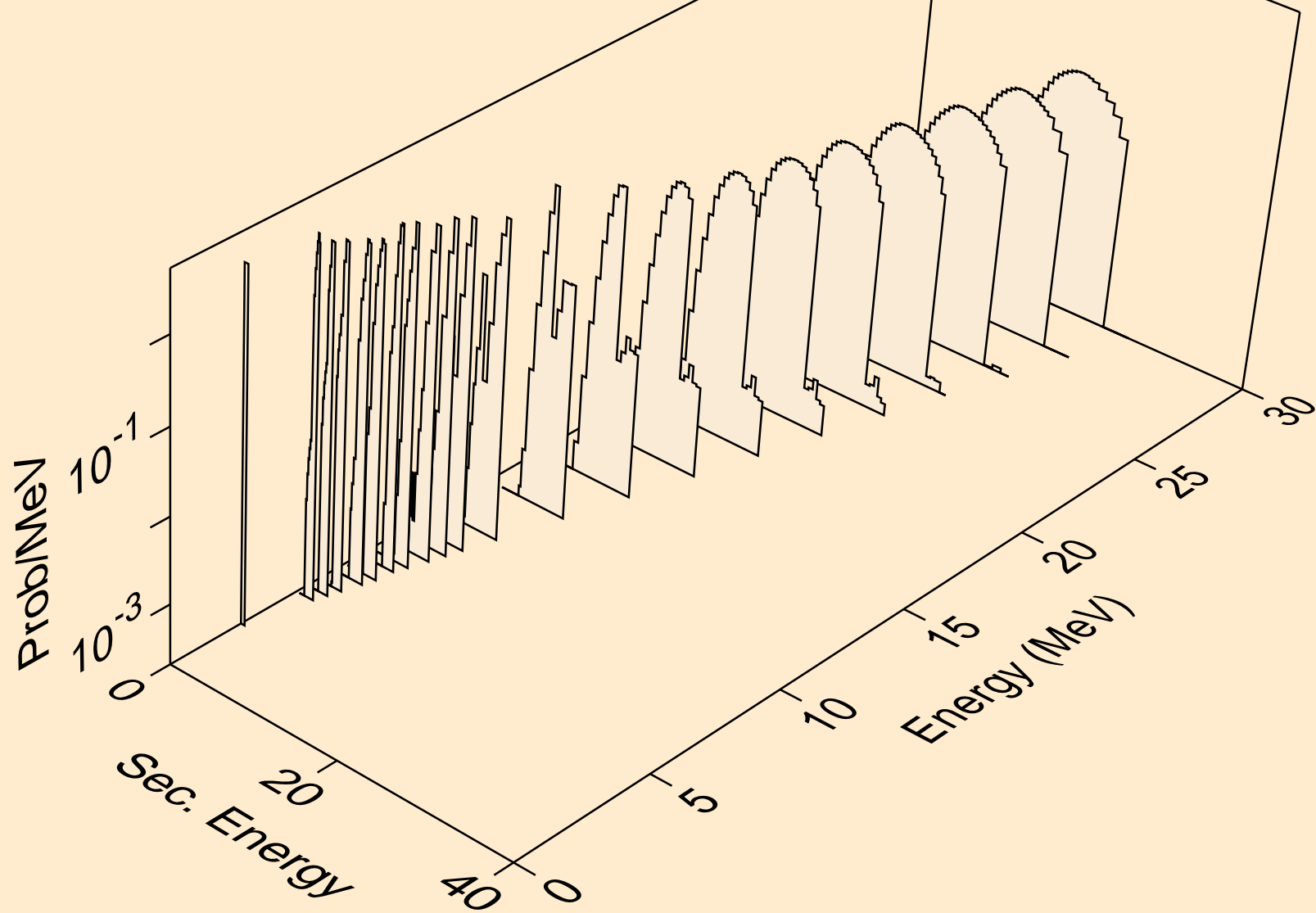

LA124 NEUTRON ACER TENDL-2021 LIBRARY; T=293.6K
tritons from (n,pt)

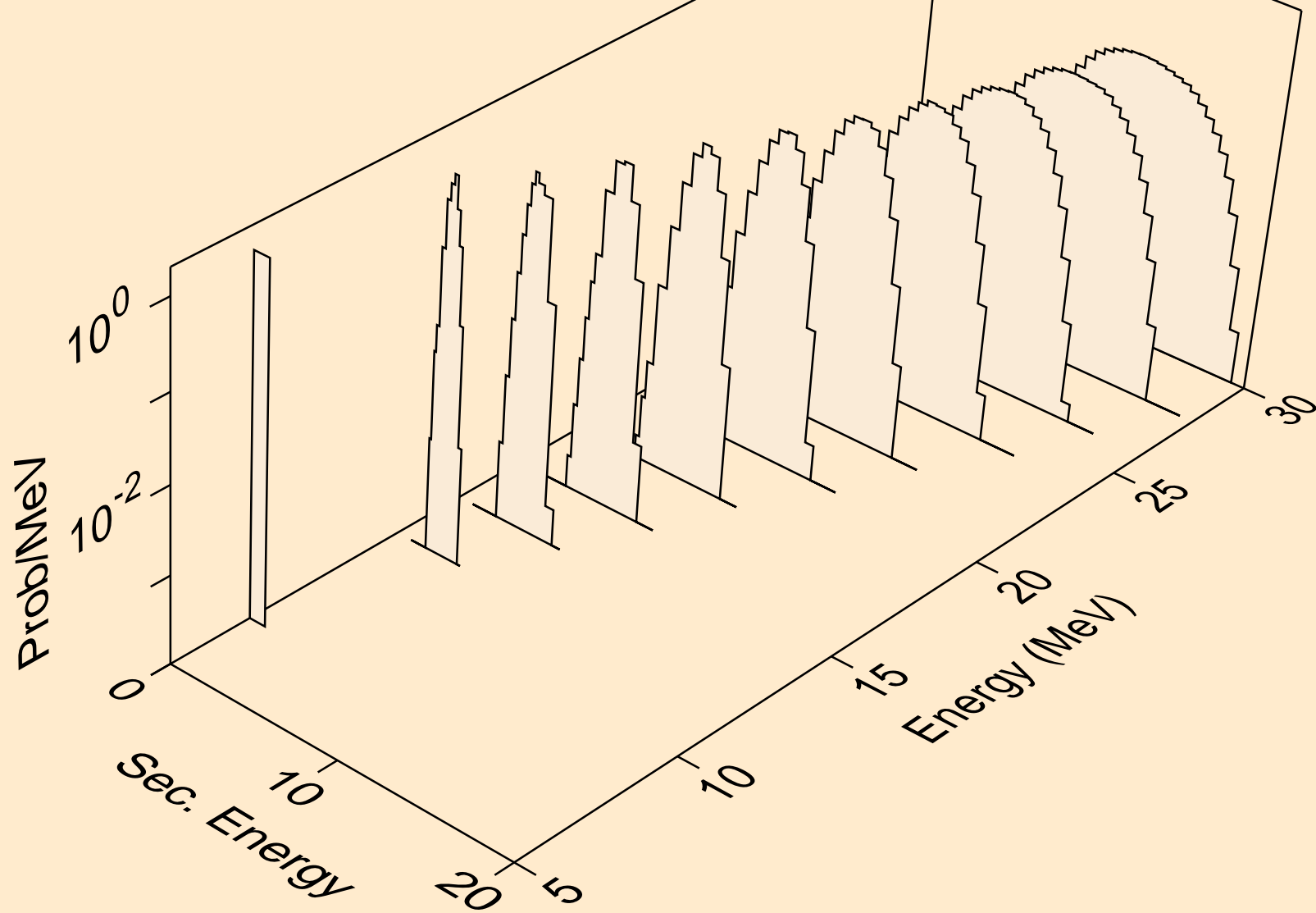

LA124 NEUTRON ACER TENDL-2021 LIBRARY; T=293.6K
he3s from (n,x)

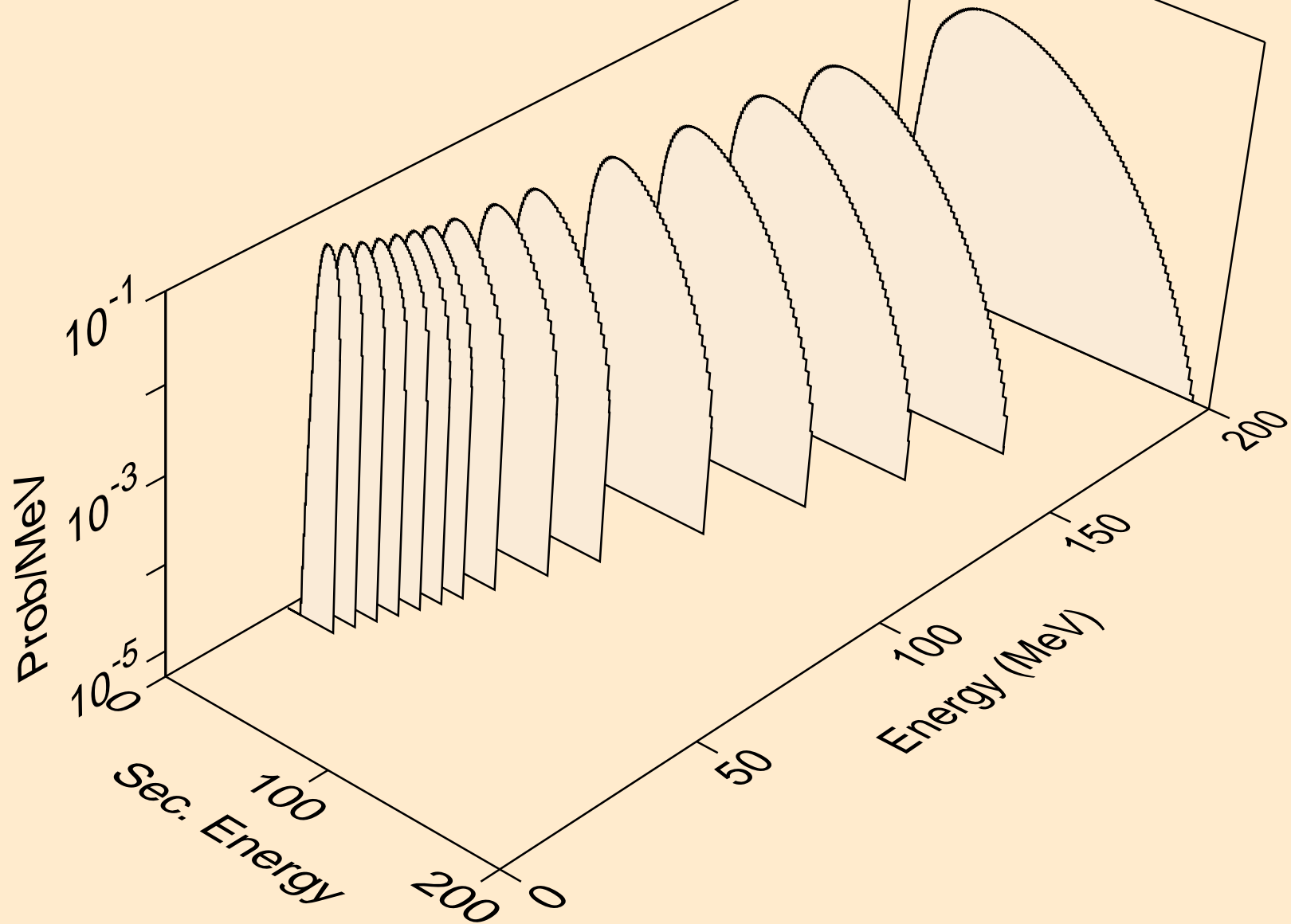

LA124 NEUTRON ACER TENDL-2021 LIBRARY; T=293.6K
he3s from (n,n*)he3

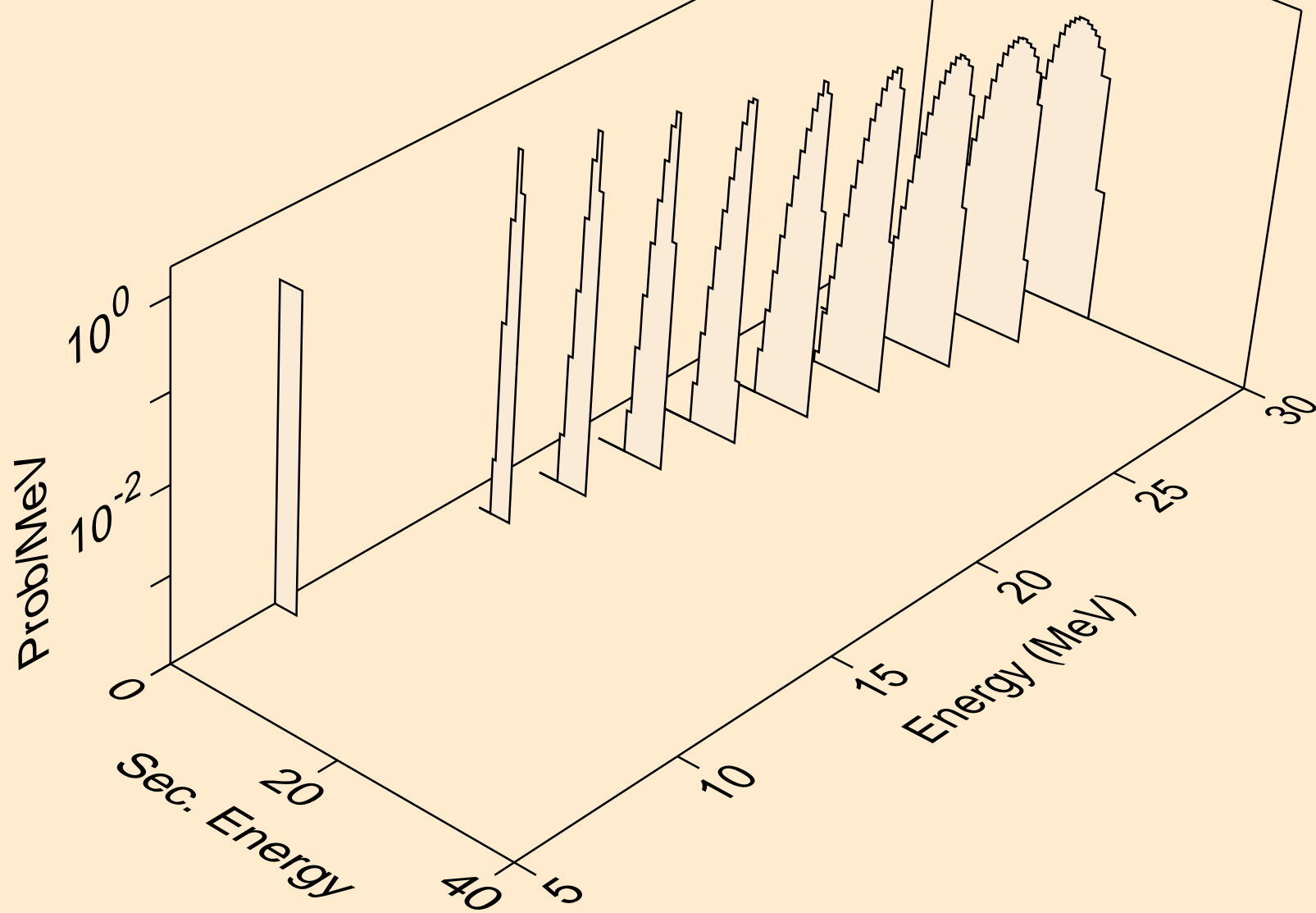

LA124 NEUTRON ACER TENDL-2021 LIBRARY; T=293.6K
he3s from (n,he3)

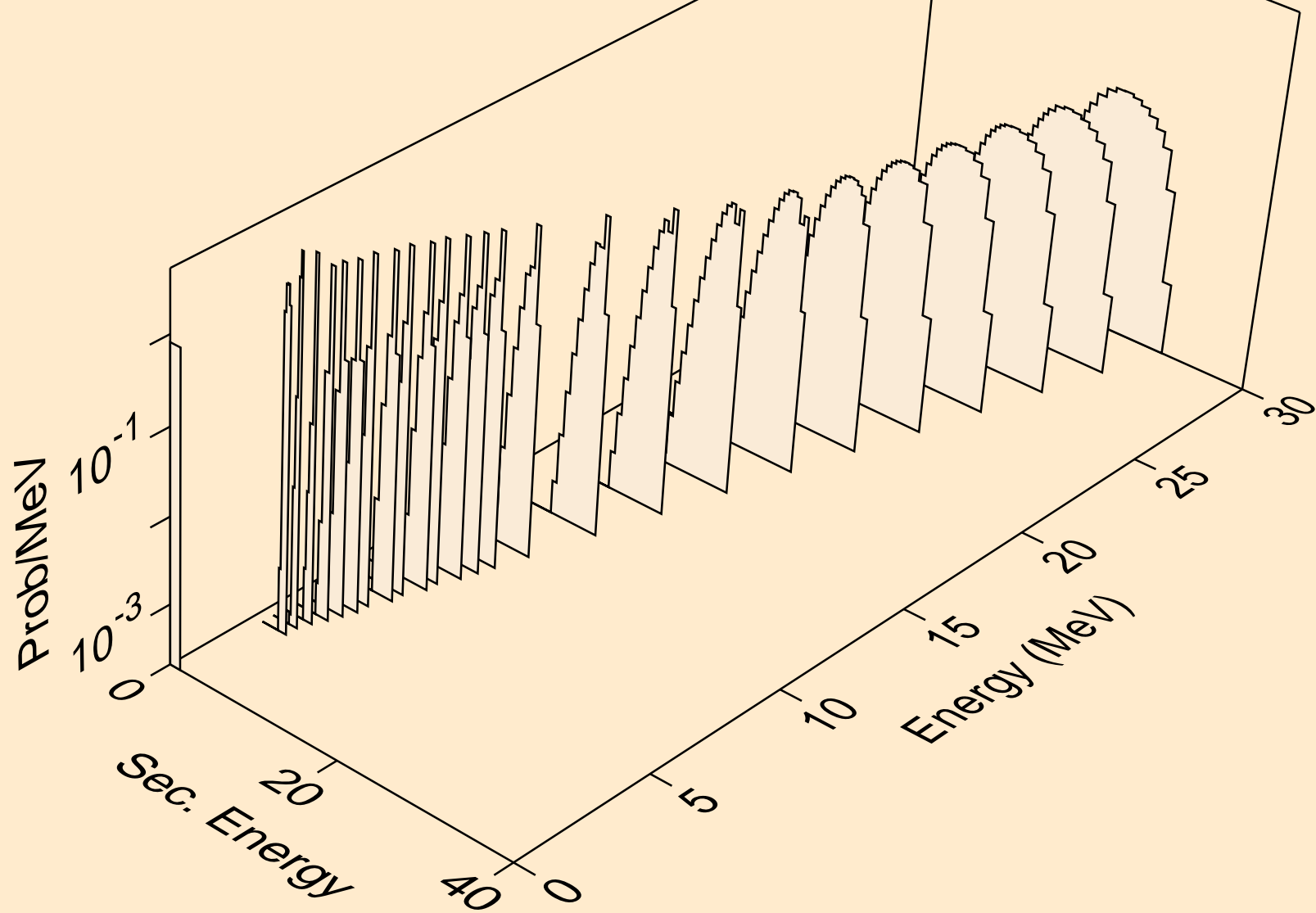

LA124 NEUTRON ACER TENDL-2021 LIBRARY; T=293.6K
alphas from (n,x)

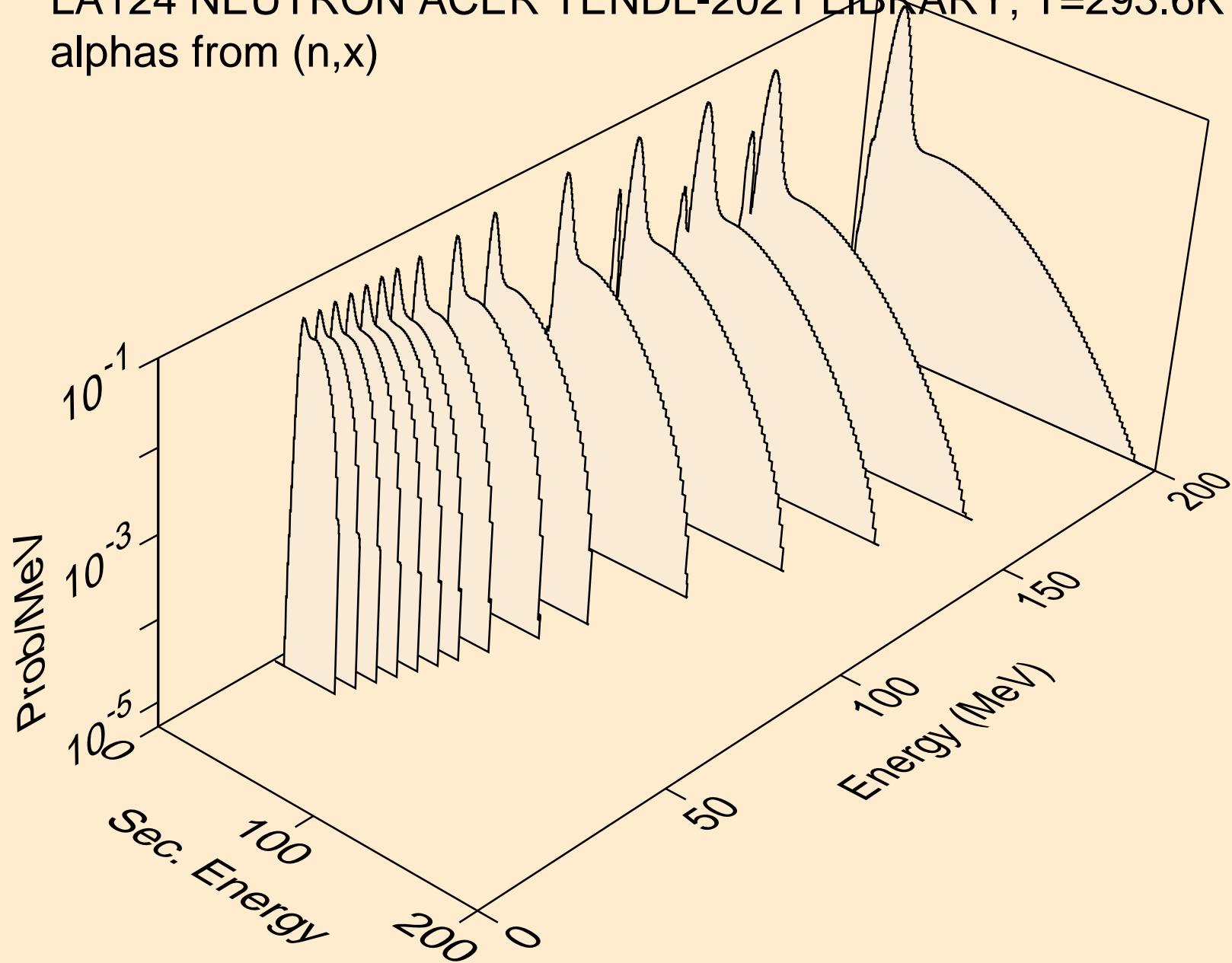

LA124 NEUTRON ACER TENDL-2021 LIBRARY; T=293.6K
alphas from (n,n*)a

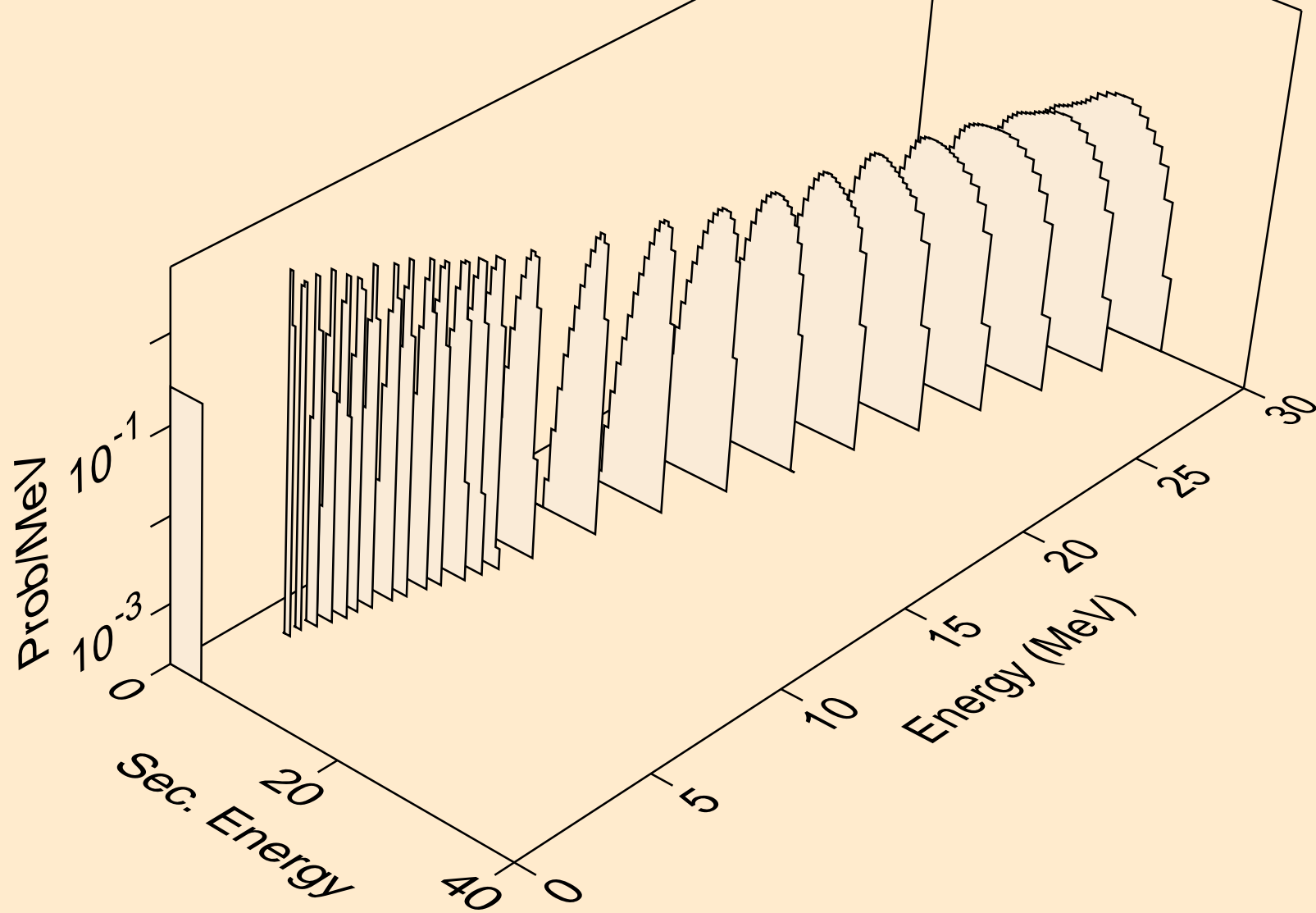

LA124 NEUTRON ACER TENDL-2021 LIBRARY; T=293.6K
alphas from (n,2n)a

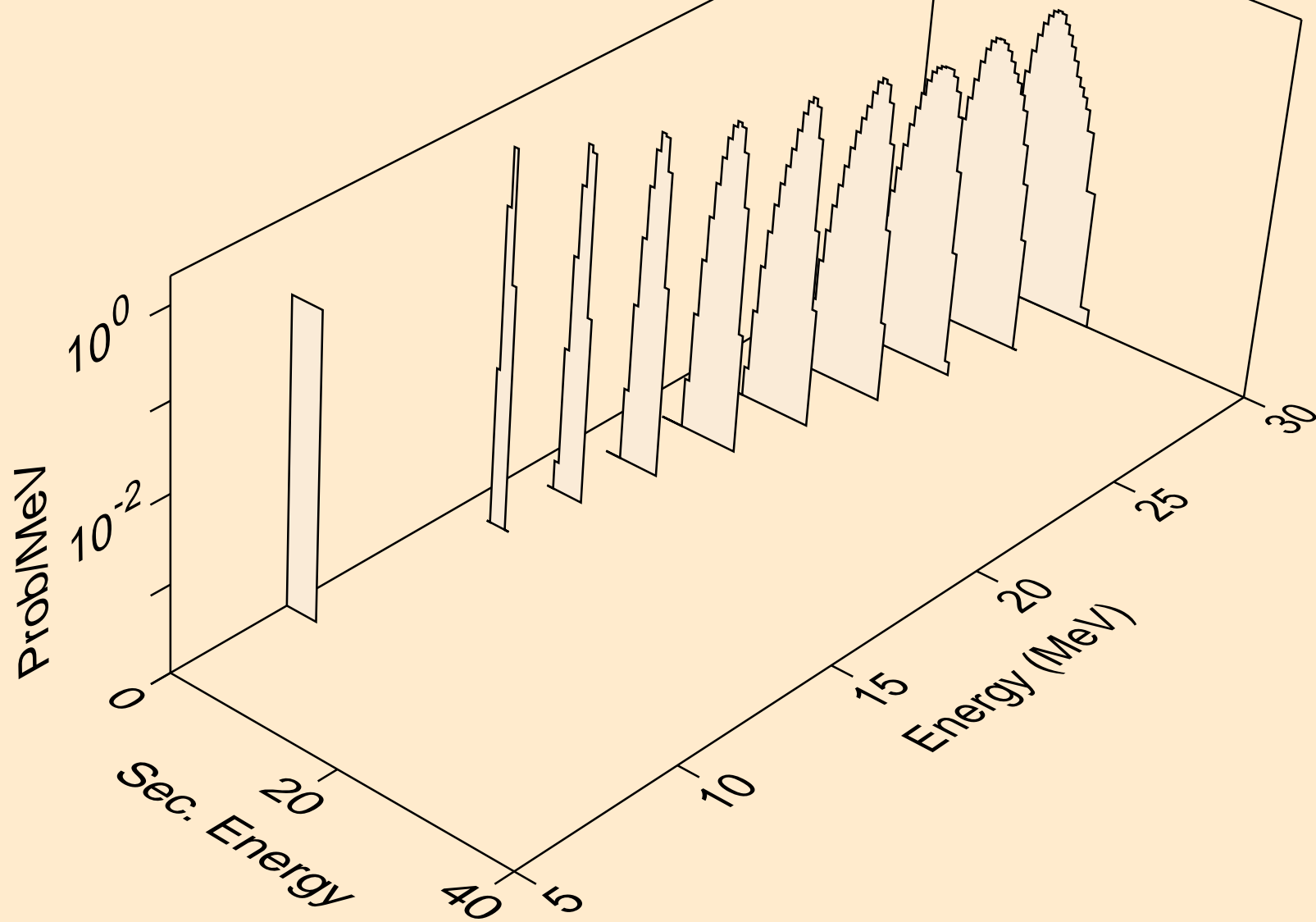

LA124 NEUTRON ACER TENDL-2021 LIBRARY; T=293.6K
alphas from (n,n*)2a

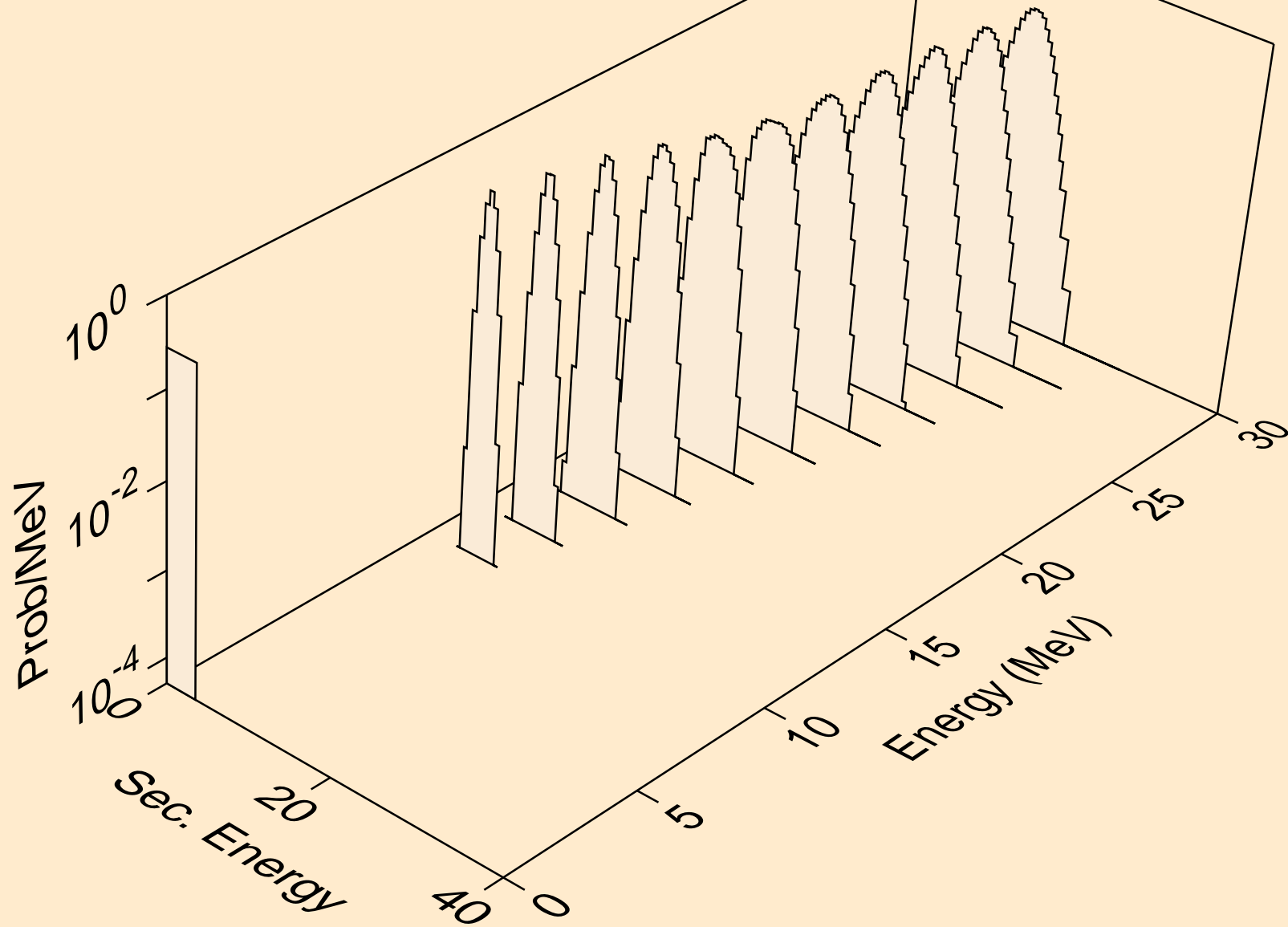

LA124 NEUTRON ACER TENDL-2021 LIBRARY; T=293.6K
alphas from (n,2n)2a

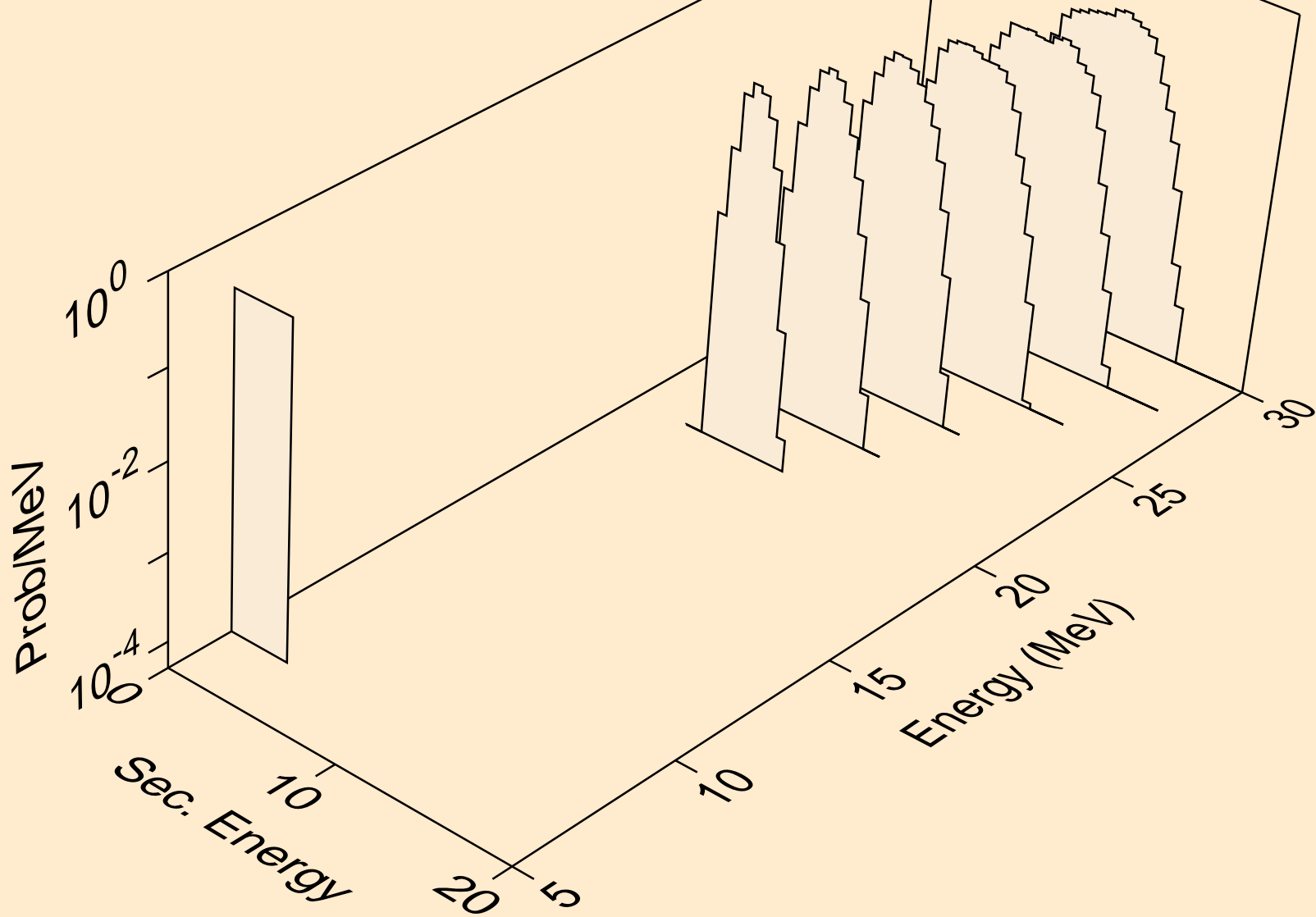

LA124 NEUTRON ACER TENDL-2021 LIBRARY; T=293.6K
alphas from (n,npa)

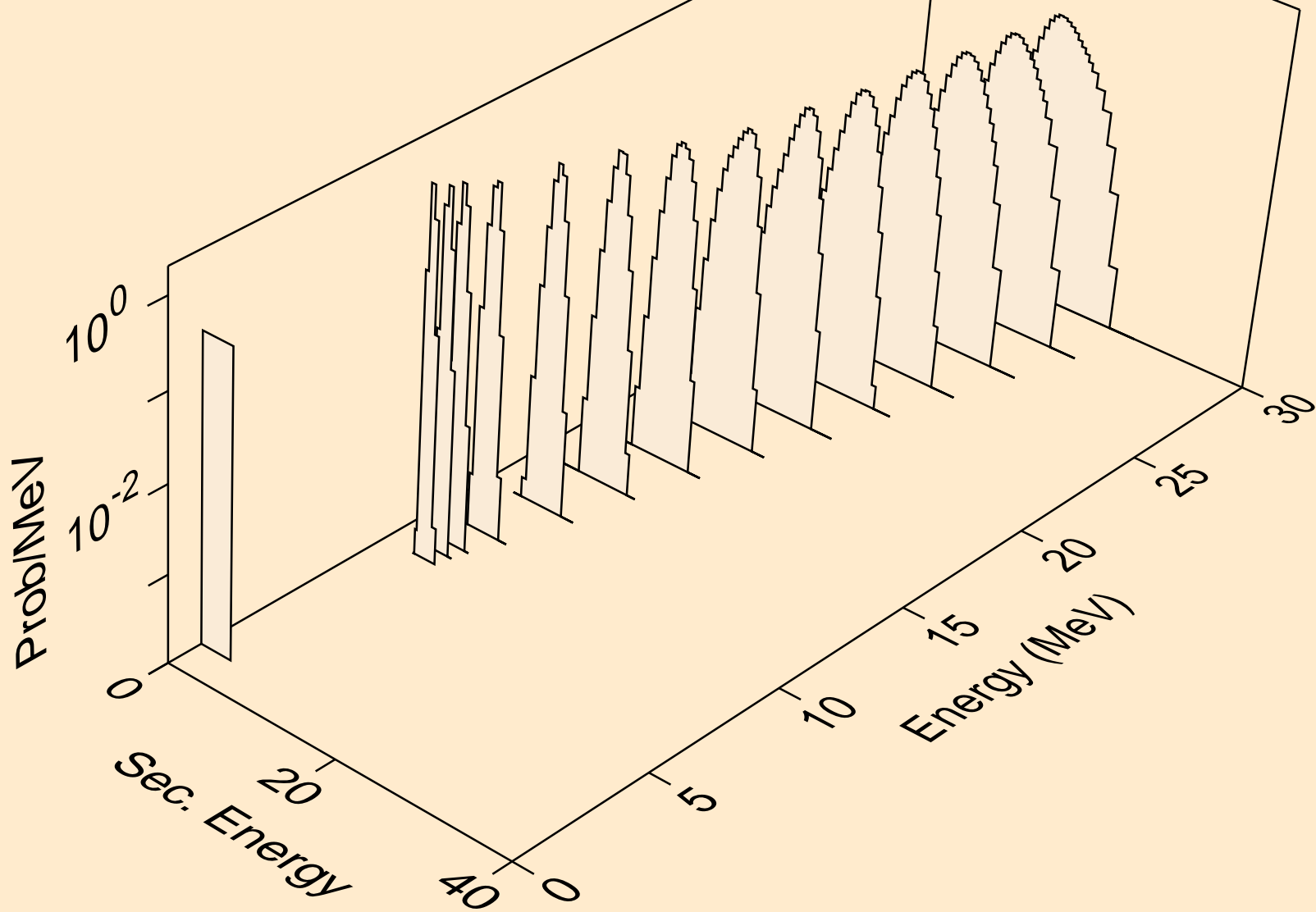

LA124 NEUTRON ACER TENDL-2021 LIBRARY; T=293.6K
alphas from (n,a)

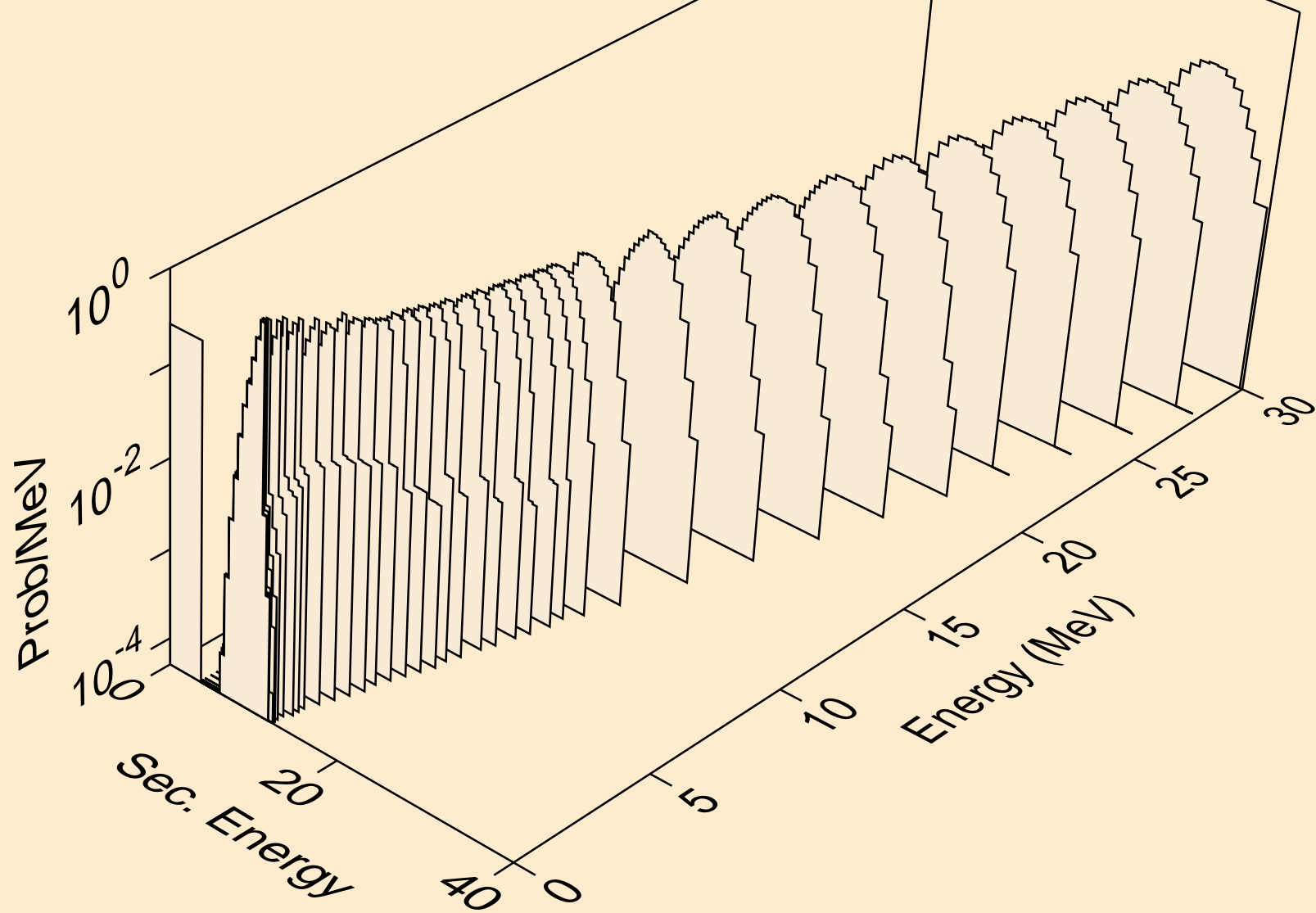

LA124 NEUTRON ACER TENDL-2021 LIBRARY; T=293.6K
alphas from (n,2a)

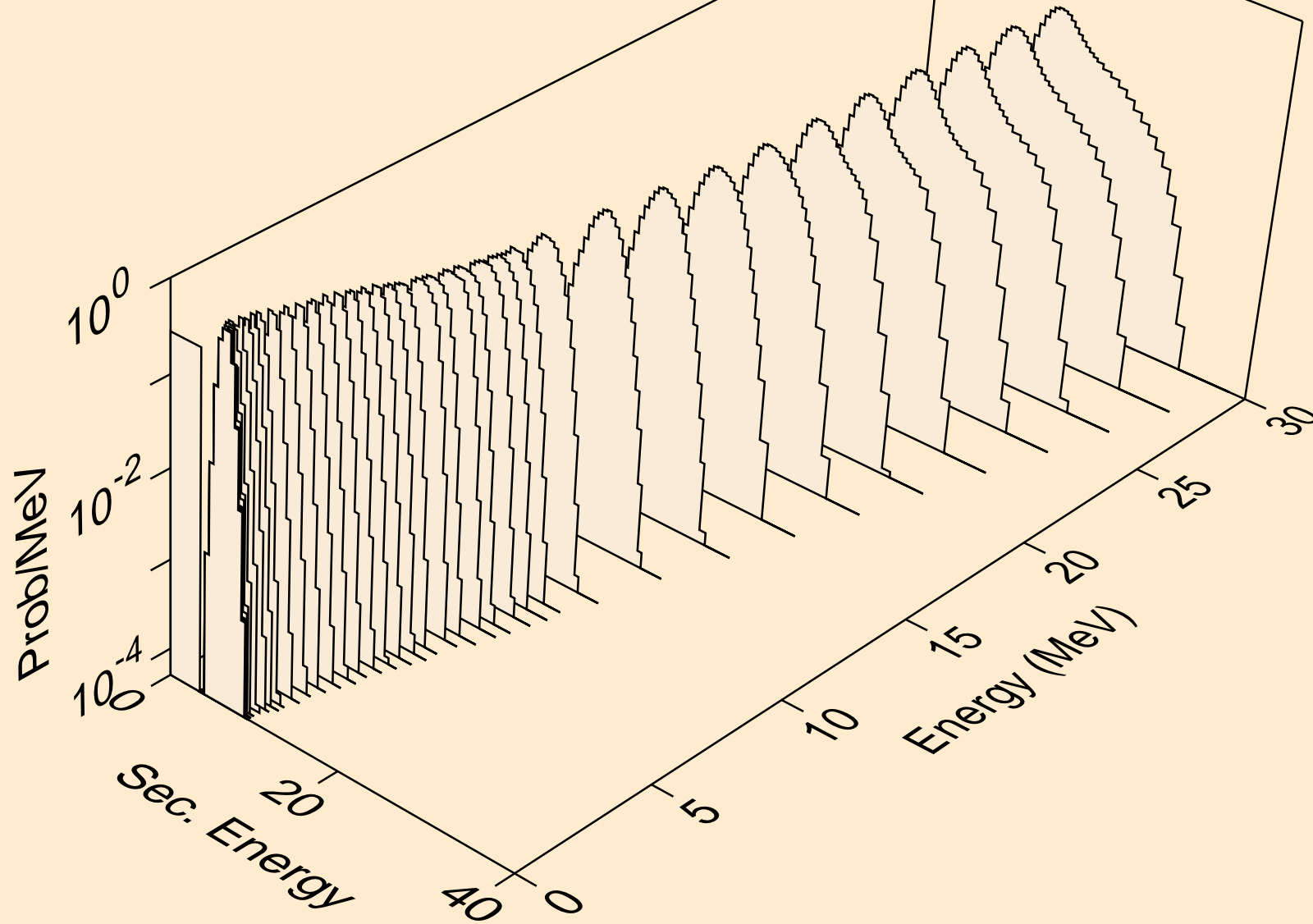

LA124 NEUTRON ACER TENDL-2021 LIBRARY; T=293.6K
alphas from (n,3a)

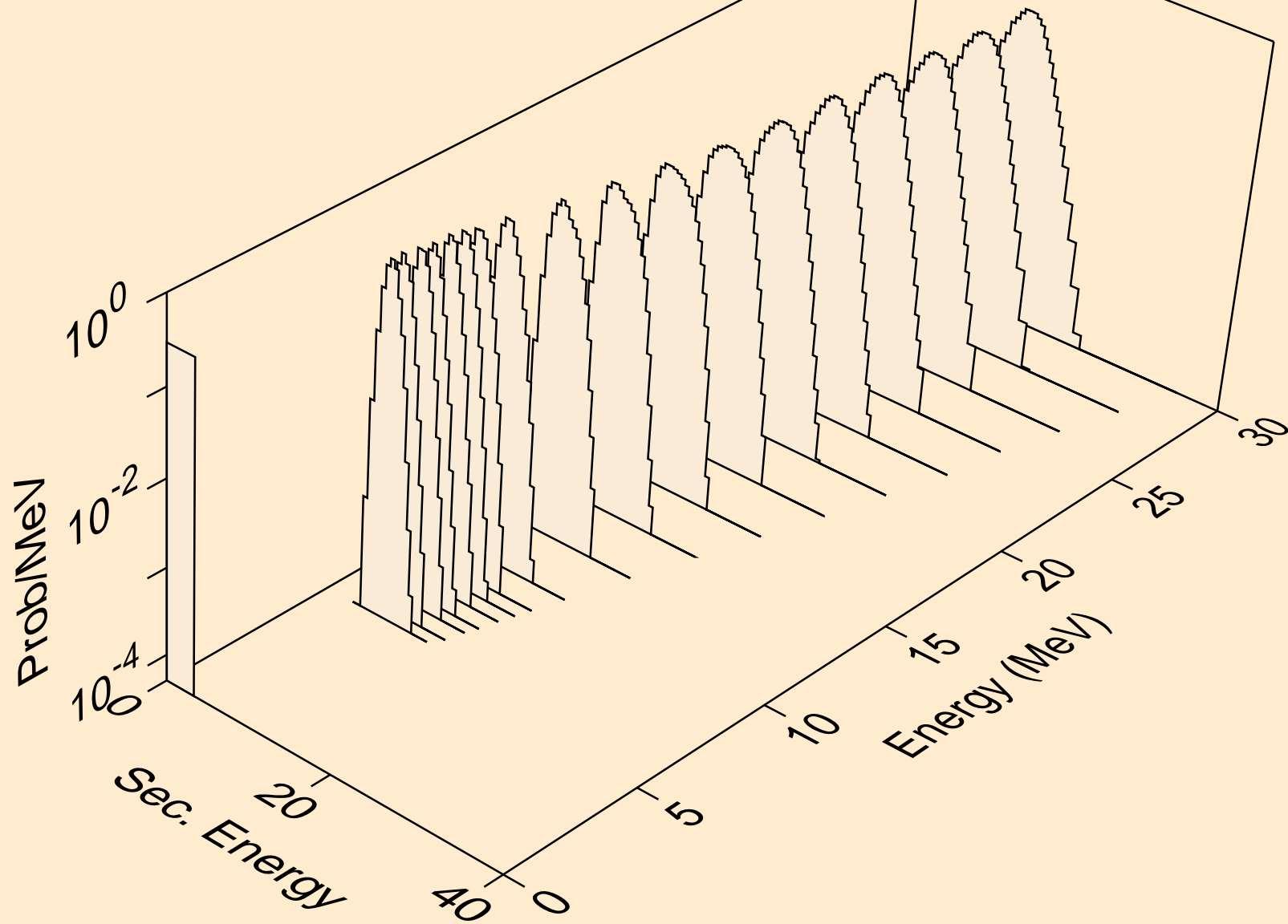

LA124 NEUTRON ACER TENDL-2021 LIBRARY; T=293.6K
alphas from (n,pa)

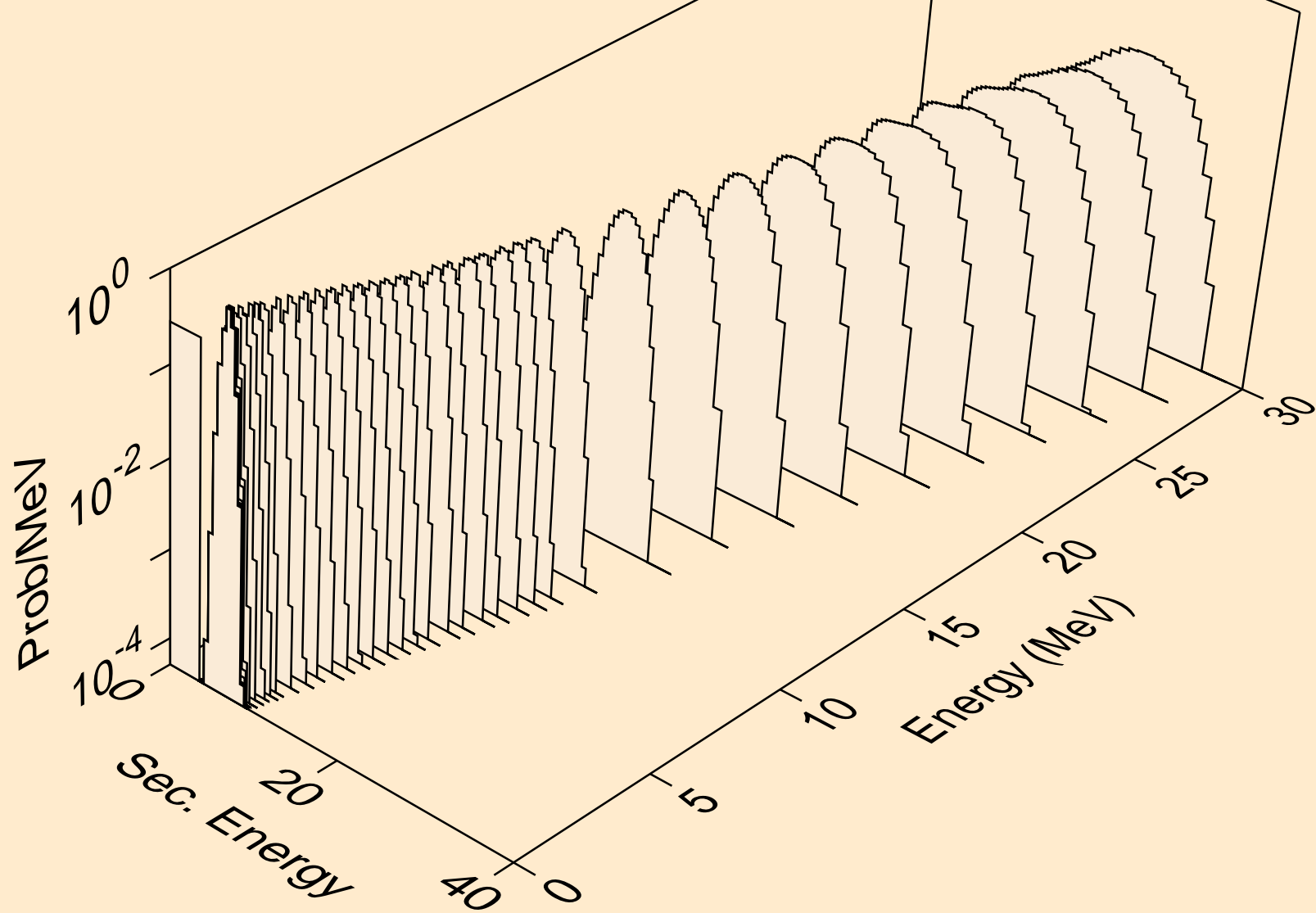

LA124 NEUTRON ACER TENDL-2021 LIBRARY; T=293.6K
alphas from (n,d2a)

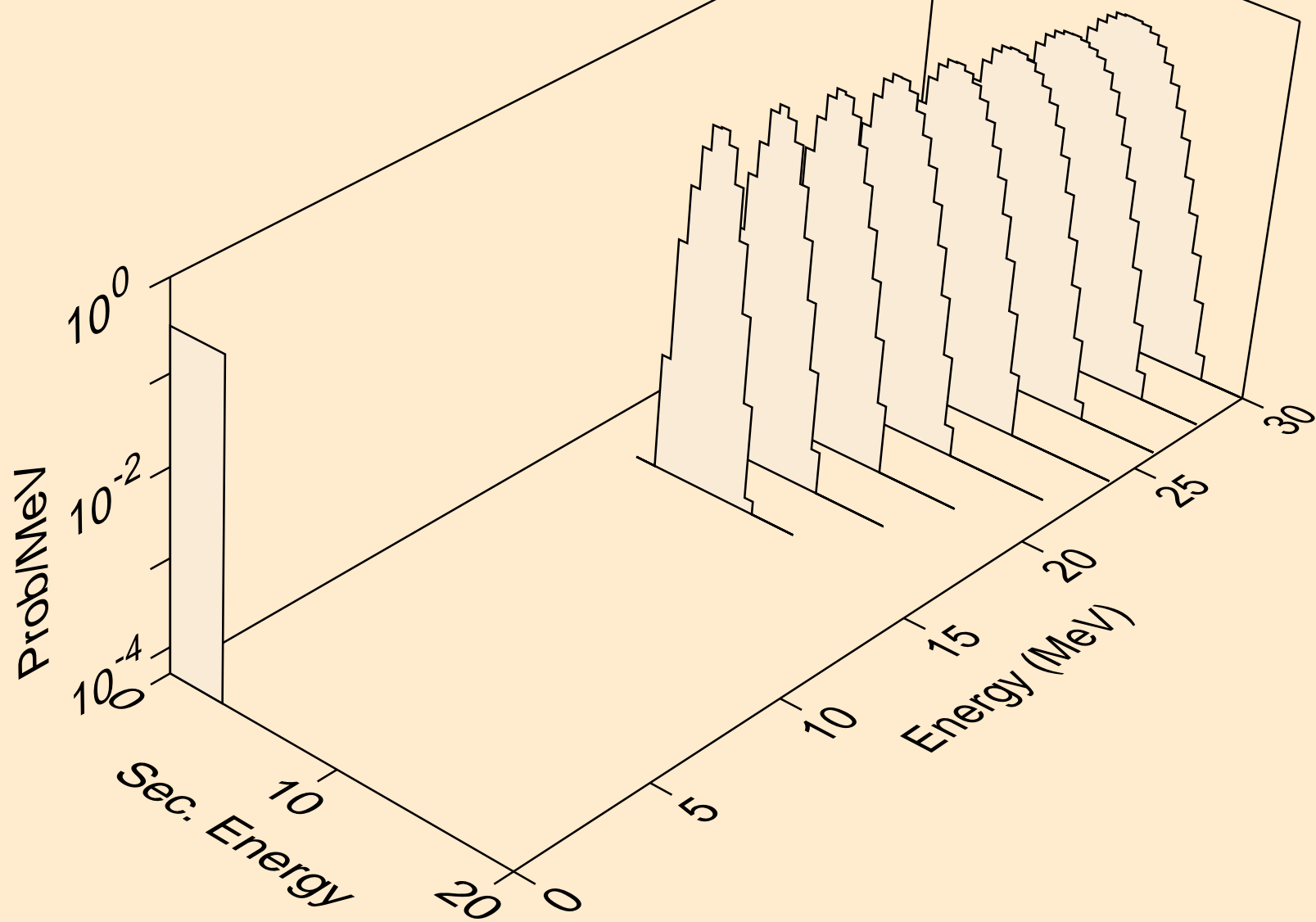

LA124 NEUTRON ACER TENDL-2021 LIBRARY; T=293.6K
alphas from (n,da)

