

Program EVALPLOT
(Version 2018-1)

by

Dermott E. Cullen
(Present Contact Information)

Dermott E. Cullen
1466 Hudson Way
Livermore, CA 94550
U.S.A.

Tele: 925-443-1911

E.Mail:redcullen1@comcast.net

Web:redcullen1.net/HOMEPAGE.NEW

Press Mouse Button to Start

MAT 5740

Major
293 Kelvin Cross Sections

57-La-143

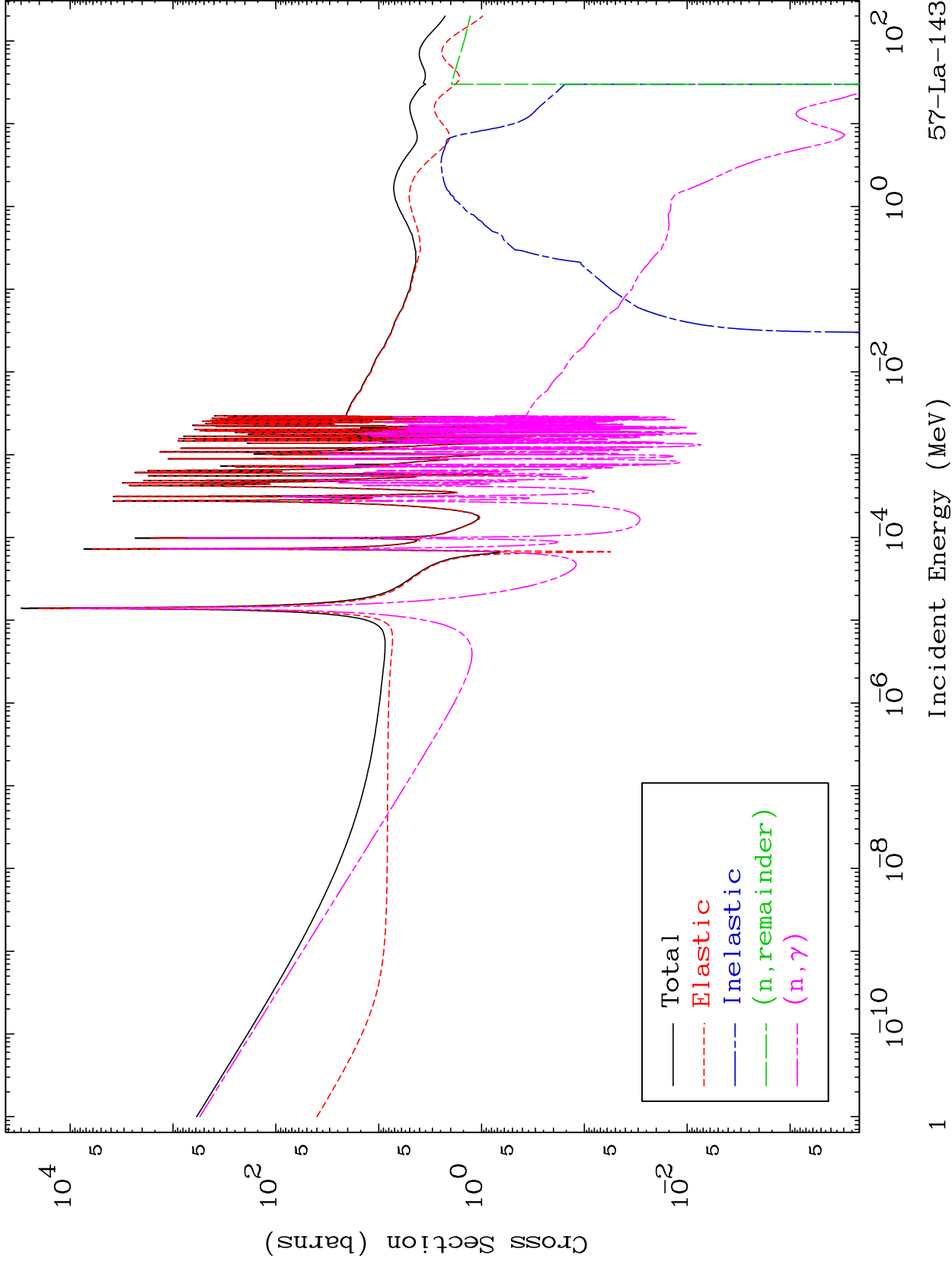

MAT 5740

Neutron Production
293 Kelvin Cross Sections

57-La-143

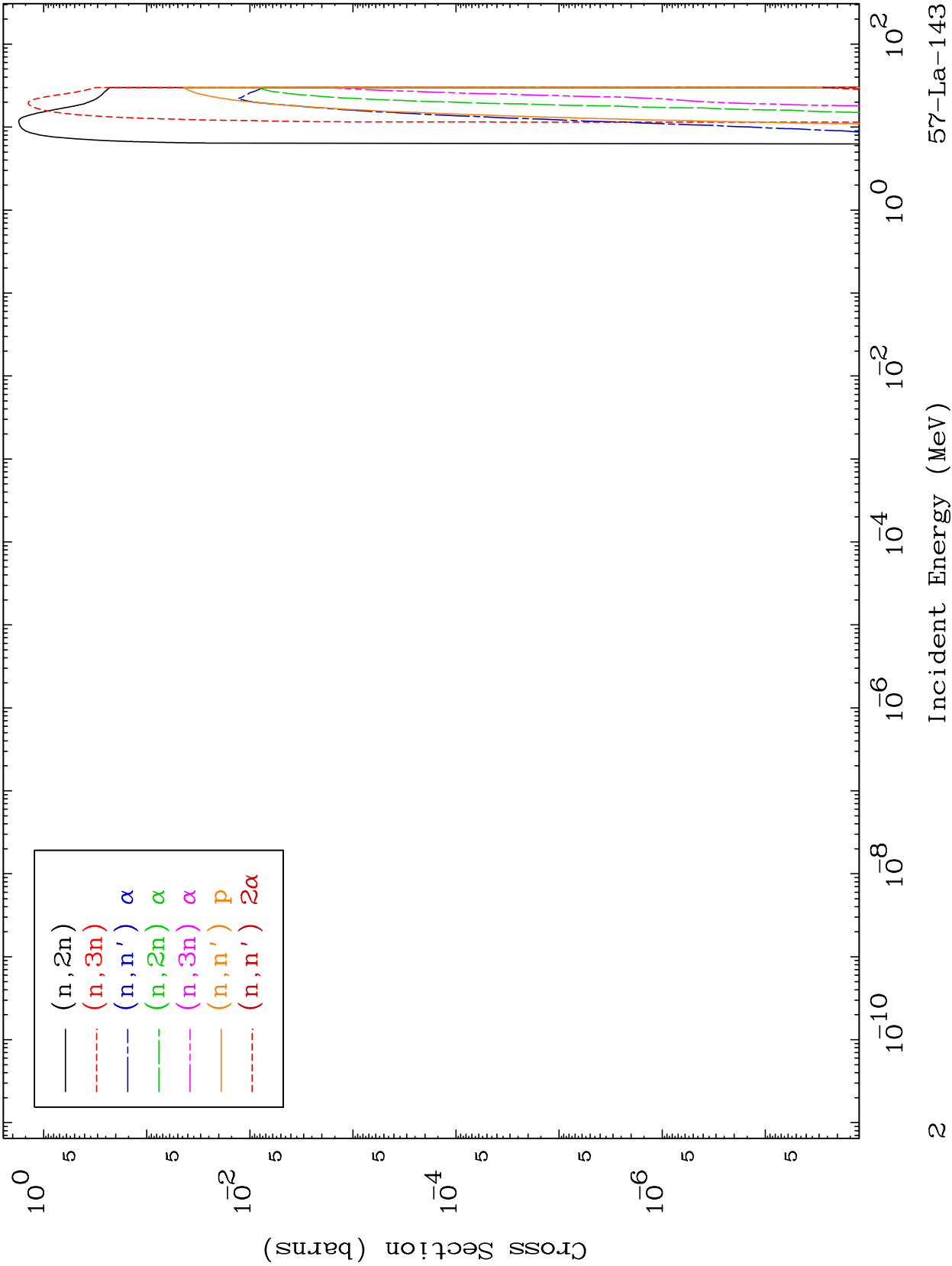

MAT 5740

Neutron Production
293 Kelvin Cross Sections

57-La-143

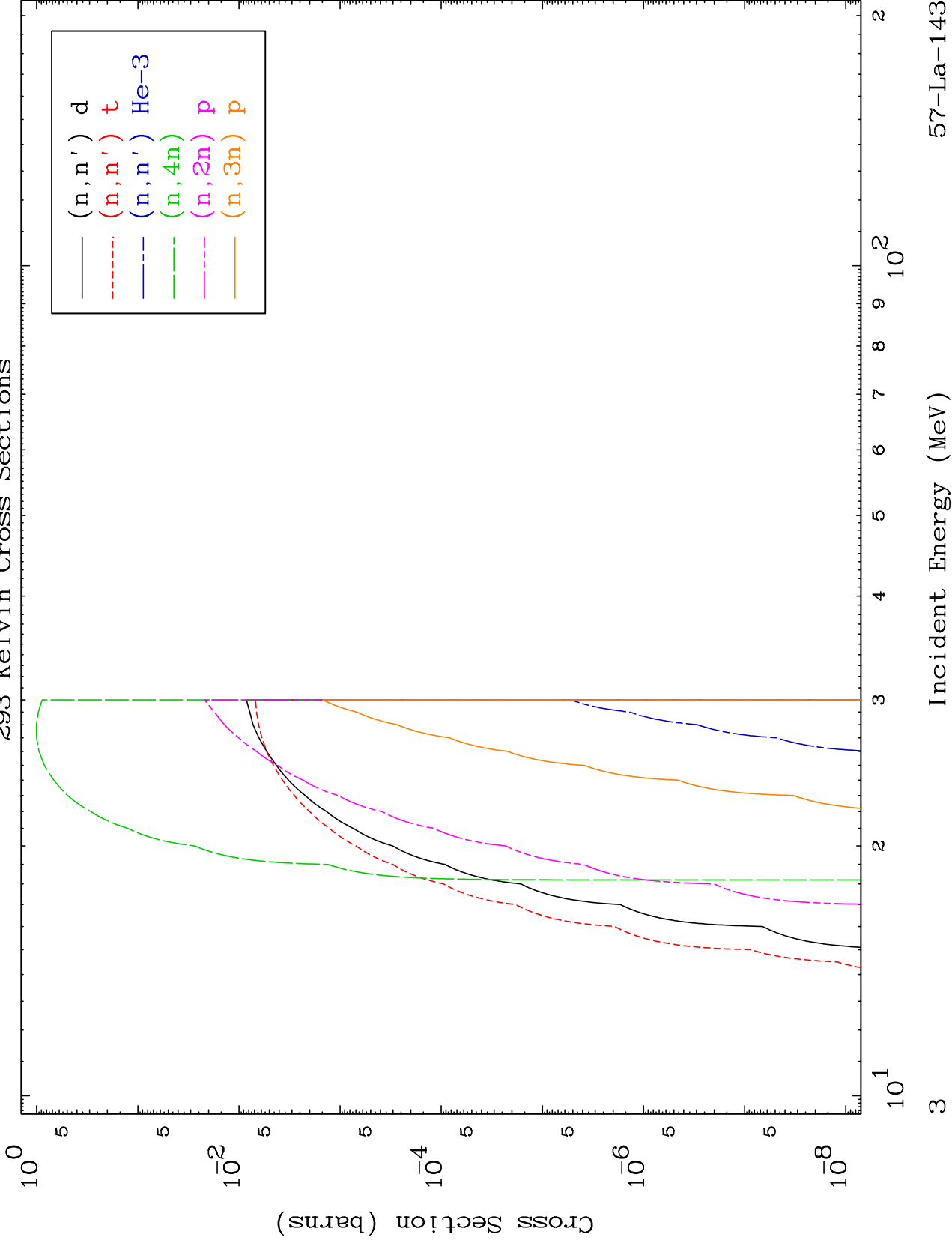

57-La-143

Incident Energy (MeV)

MAT 5740

Charged Particle
293 Kelvin Cross Sections

57-La-143

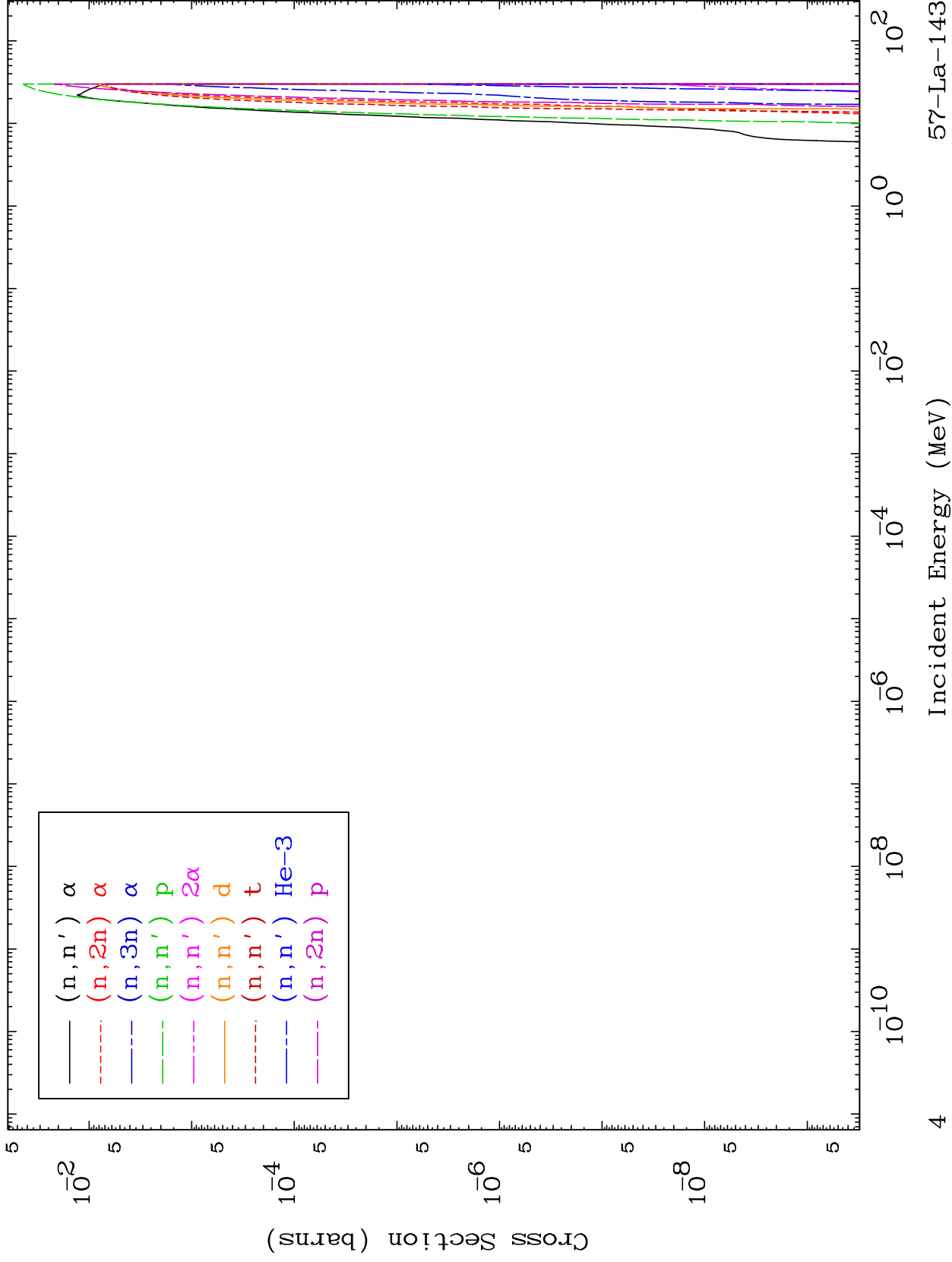

MAT 5740

Charged Particle
293 Kelvin Cross Sections

57-La-143

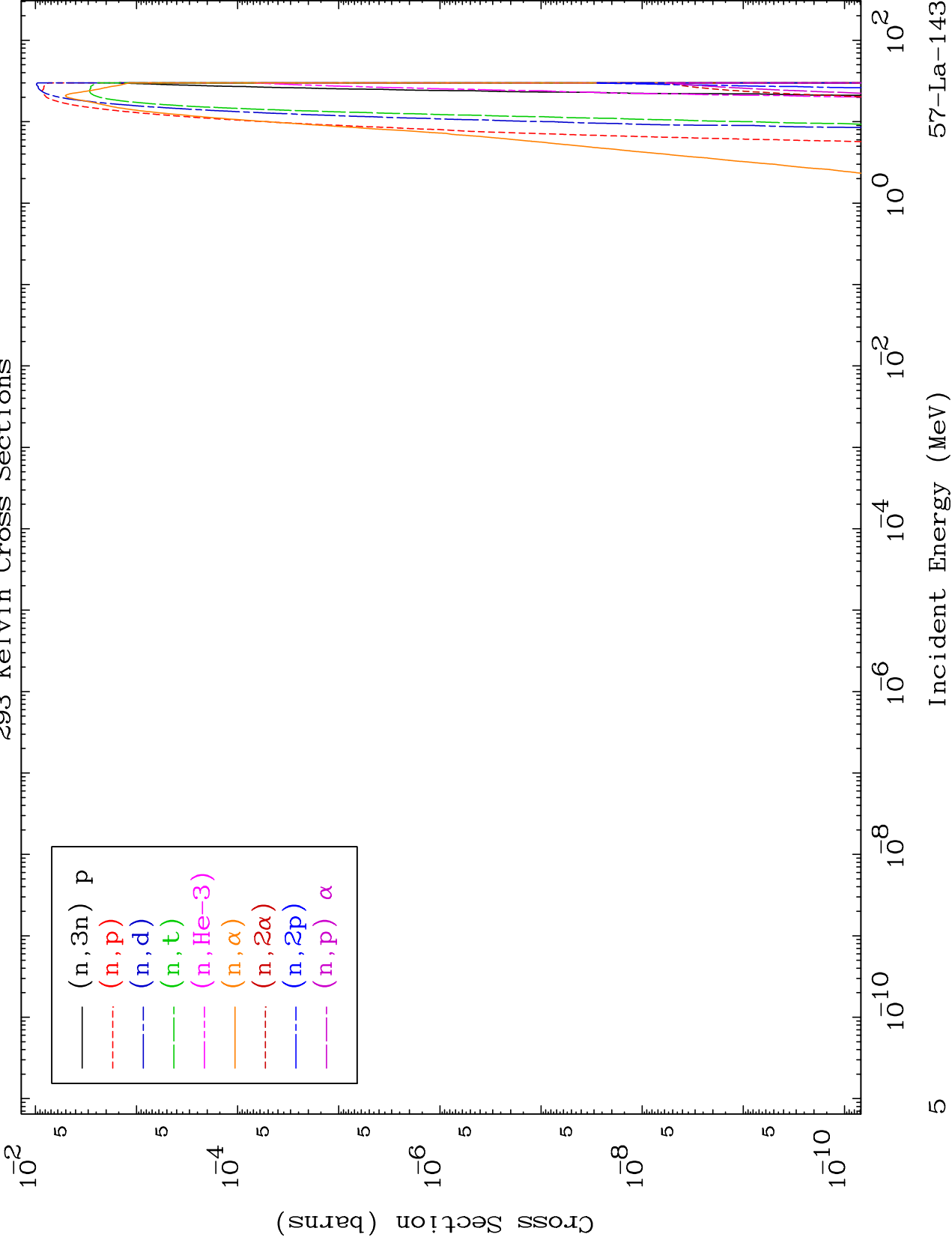

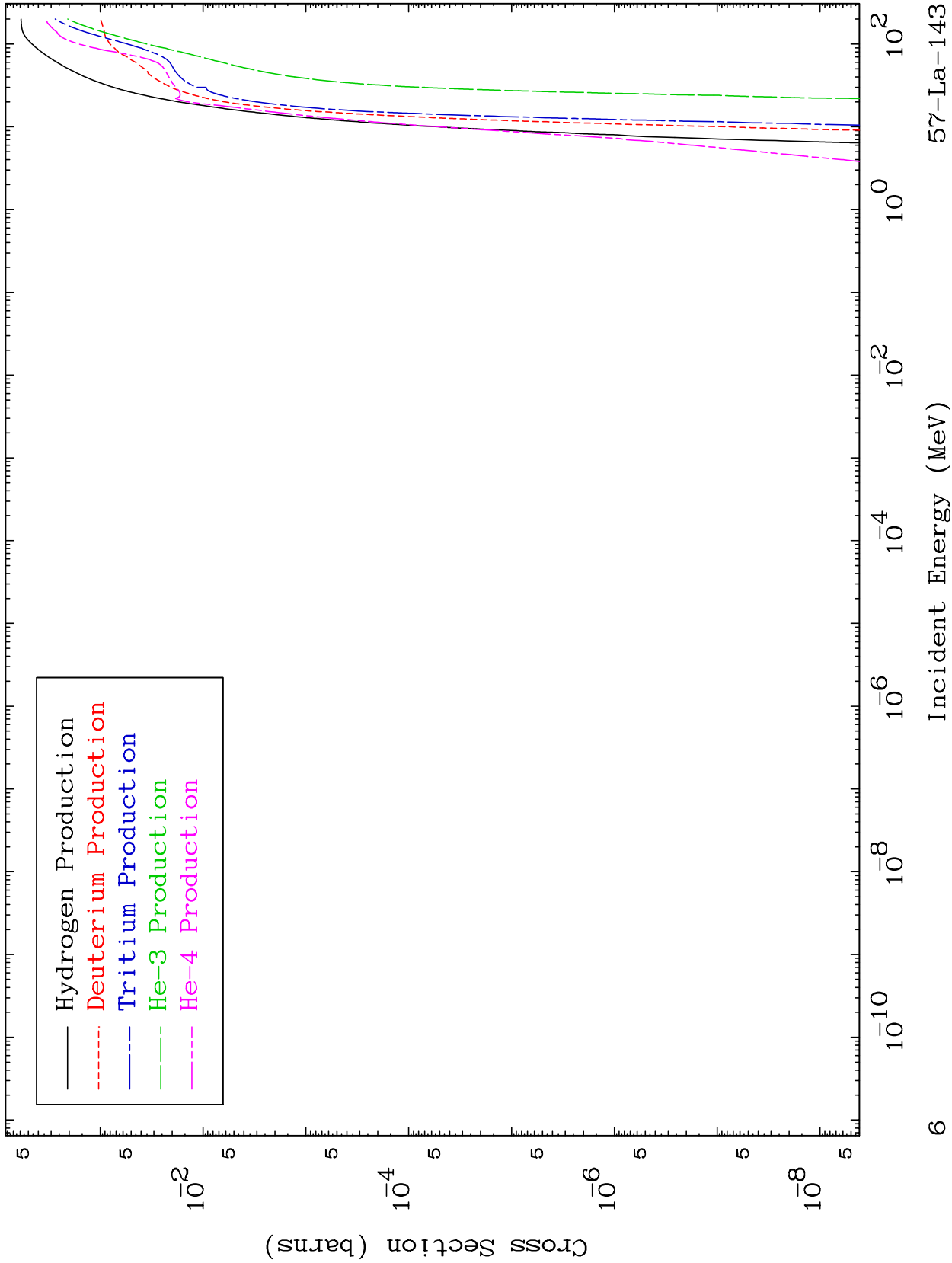

MAT 5740

(n,n') Level
293 Kelvin Cross Sections

57-La-143

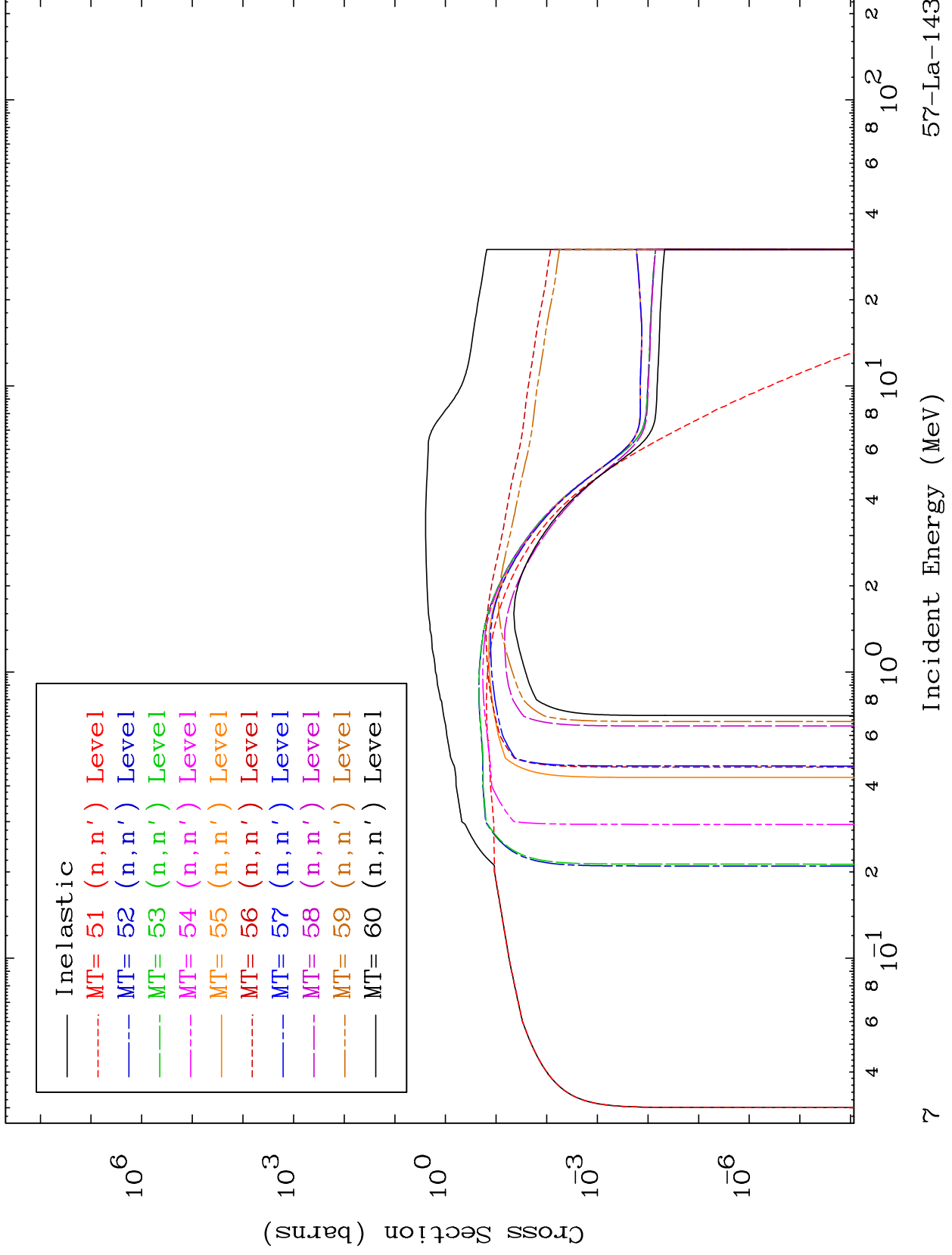

MAT 5740

(n,n') Level

57-La-143

293 Kelvin Cross Sections

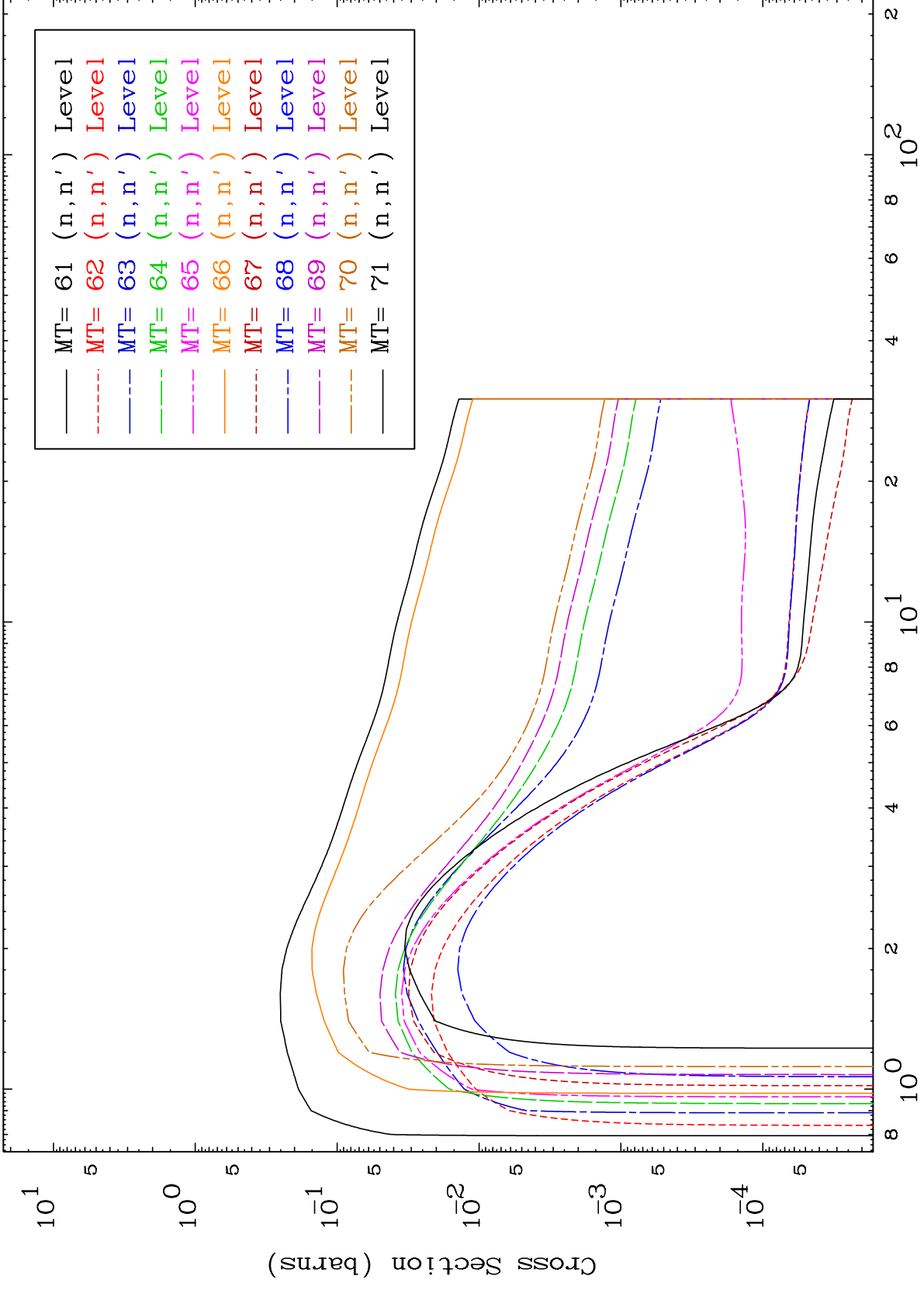

Line Style	MT	Level	Level
Solid	61	(n,n')	Level
Dashed	62	(n,n')	Level
Dashed	63	(n,n')	Level
Dashed	64	(n,n')	Level
Dashed	65	(n,n')	Level
Solid	66	(n,n')	Level
Dashed	67	(n,n')	Level
Dashed	68	(n,n')	Level
Dashed	69	(n,n')	Level
Dashed	70	(n,n')	Level
Solid	71	(n,n')	Level

8

Incident Energy (MeV)

57-La-143

293 Kelvin Cross Sections

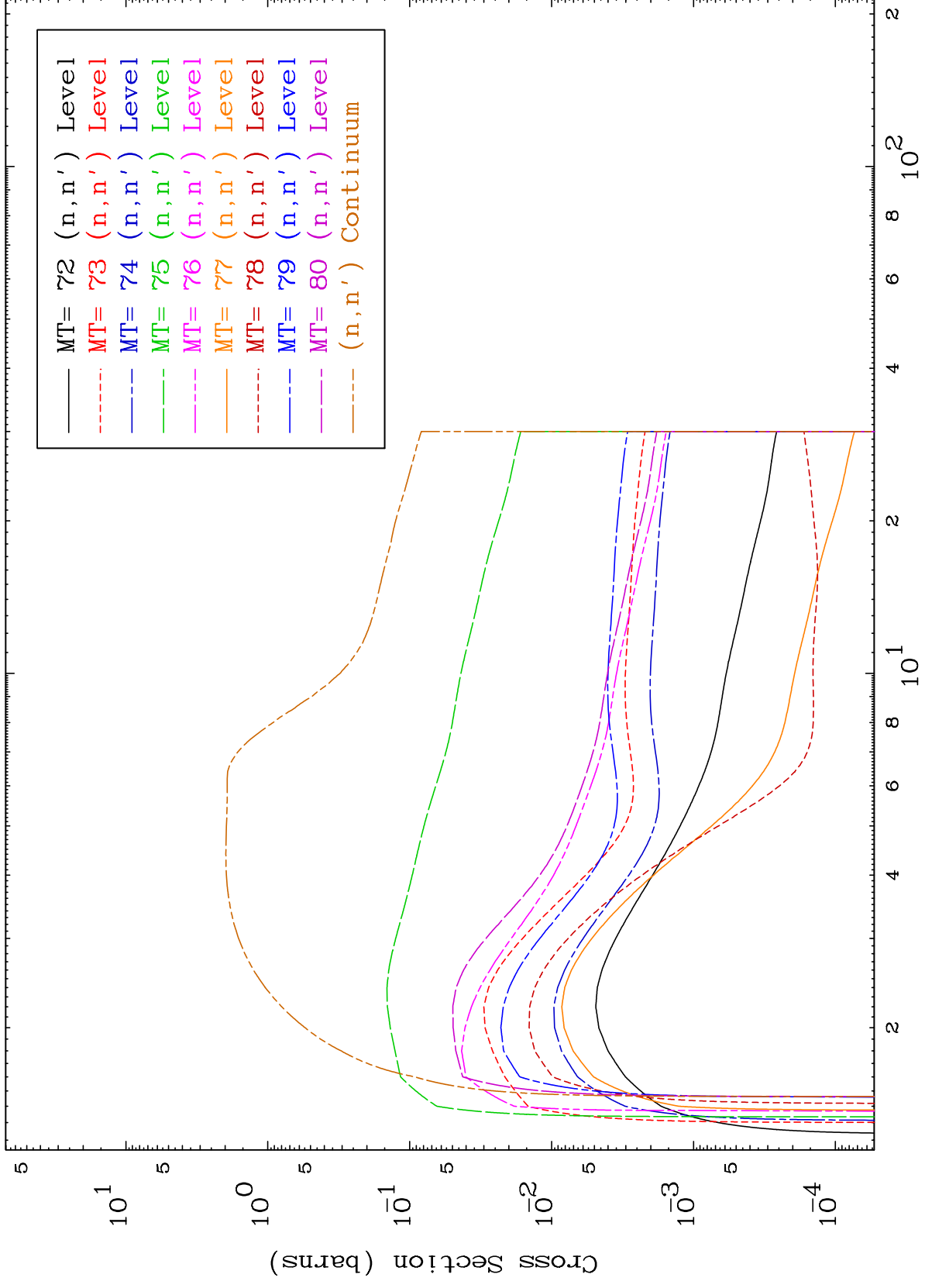

MAT 5740

(n,p) Levels
293 Kelvin Cross Sections

57-La-143

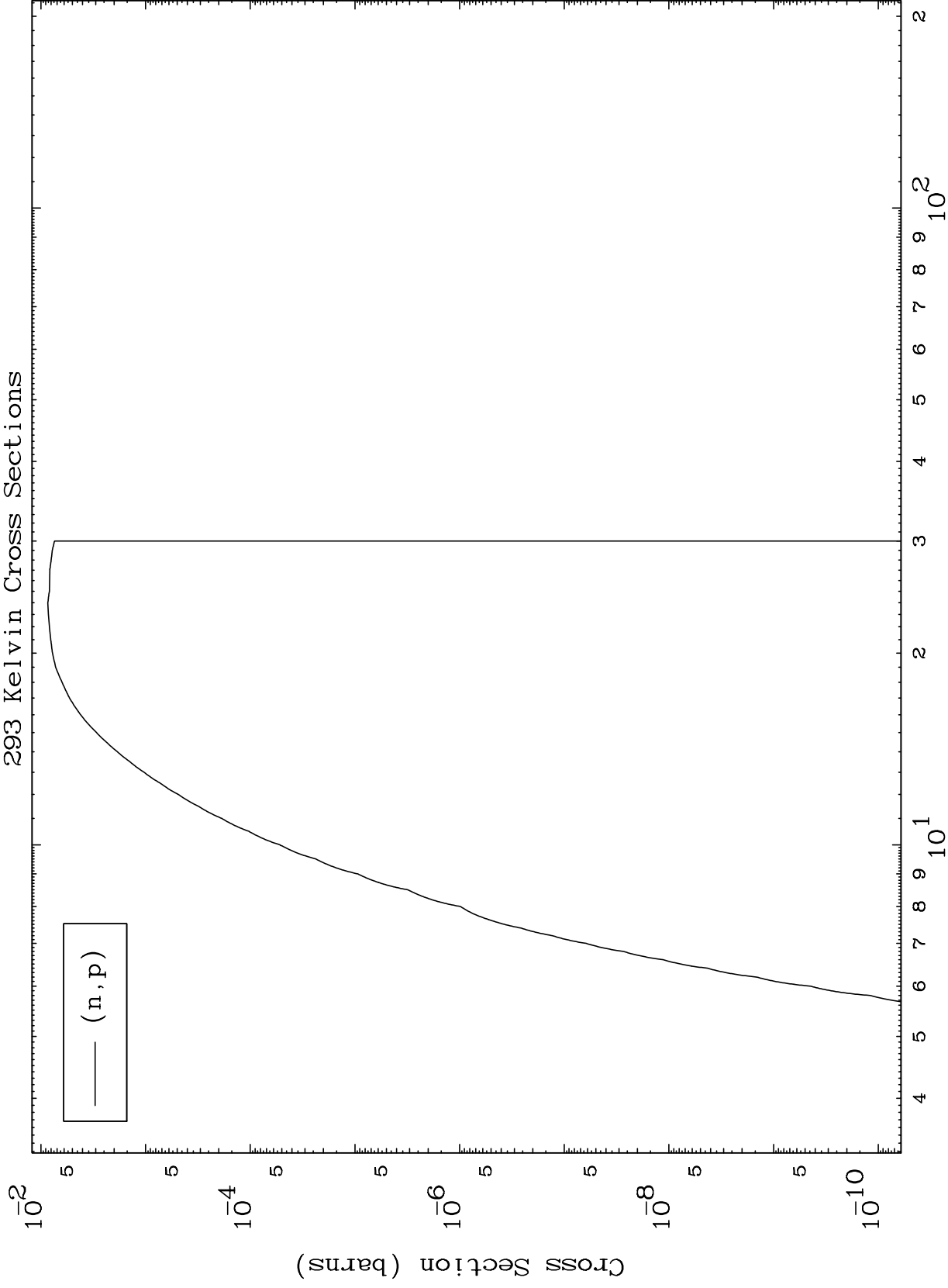

10

Incident Energy (MeV)

57-La-143

MAT 5740

(n,d) Levels
293 Kelvin Cross Sections

57-La-143

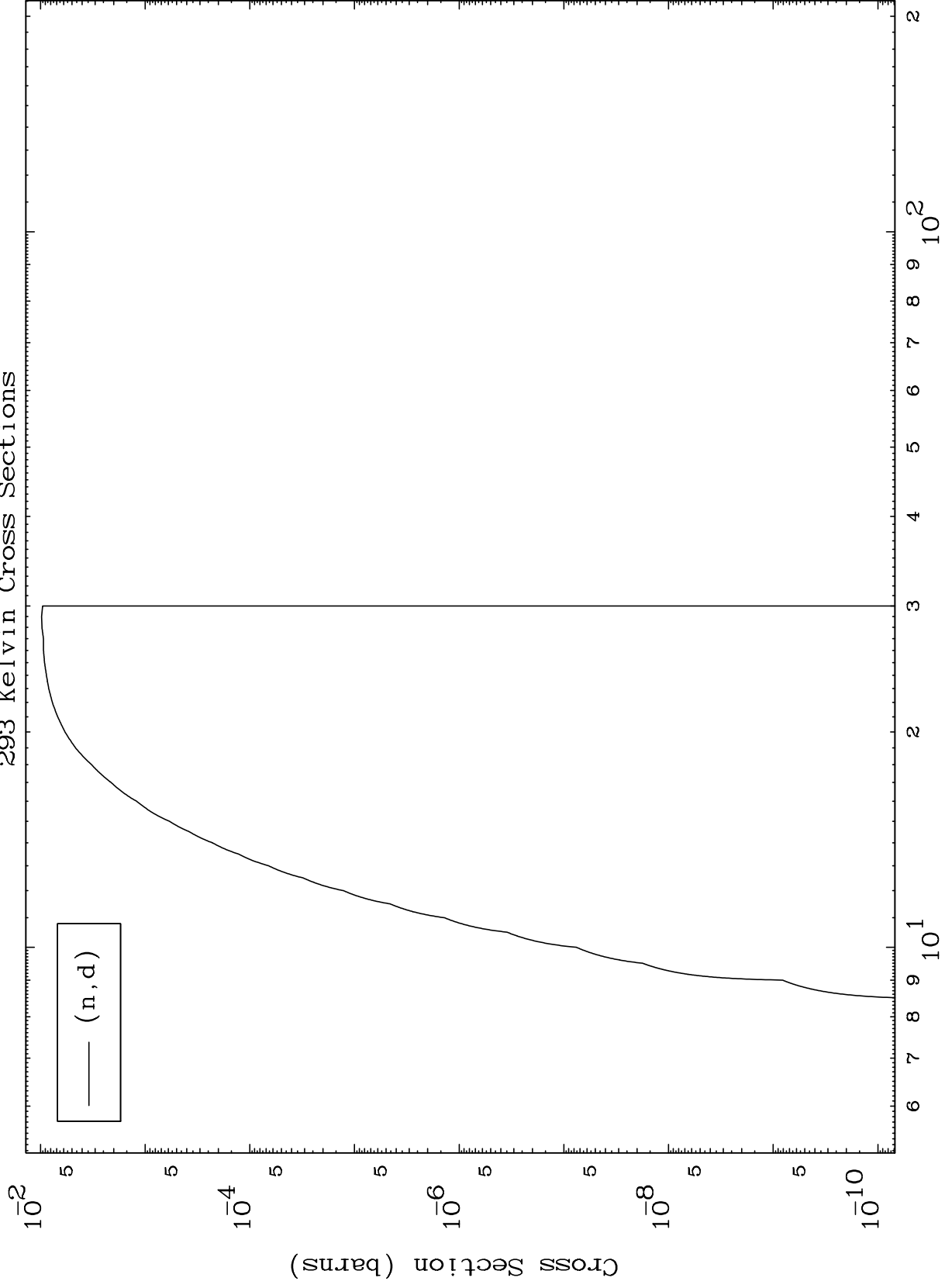

MAT 5740

(n,t) Levels
293 Kelvin Cross Sections

57-La-143

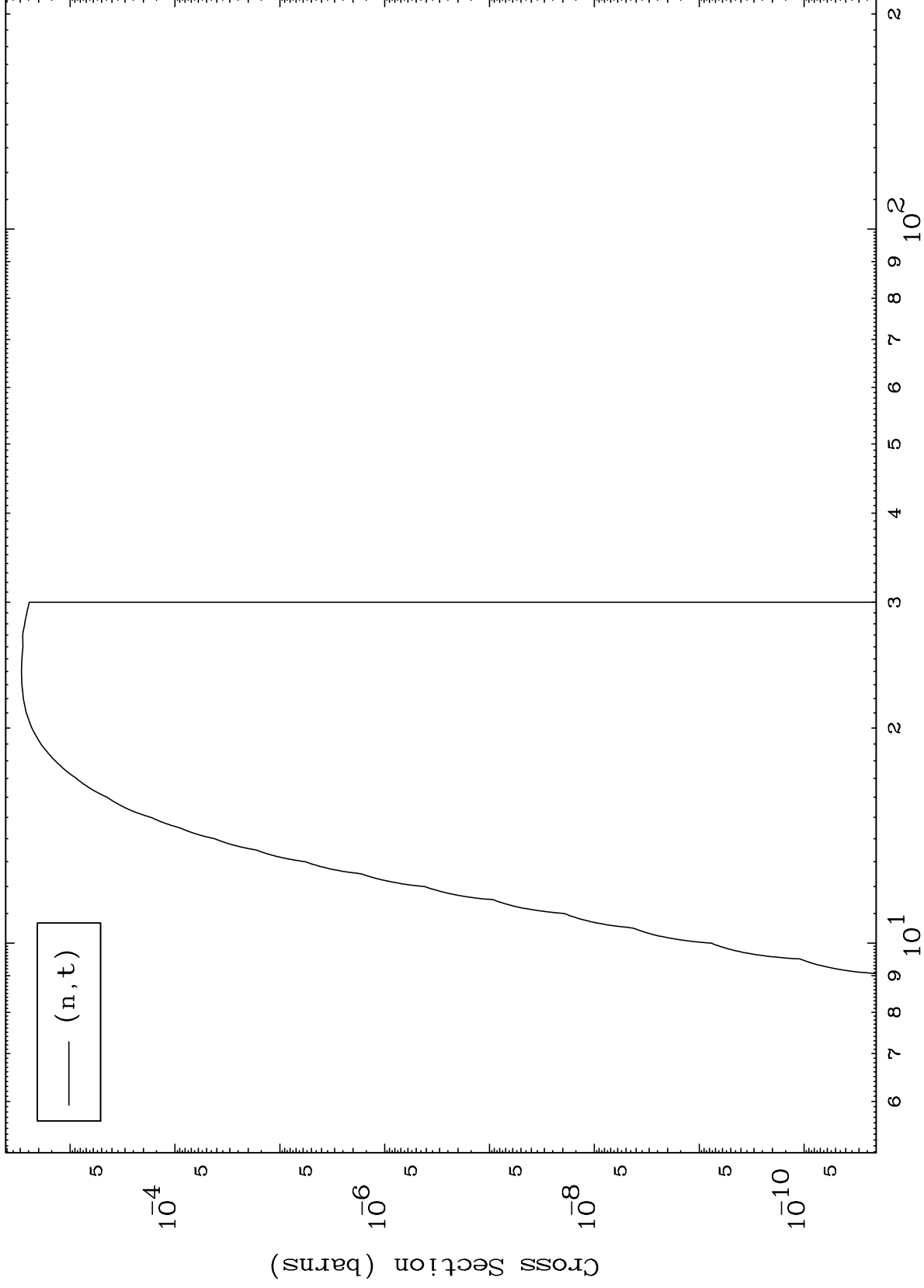

12

Incident Energy (MeV)

57-La-143

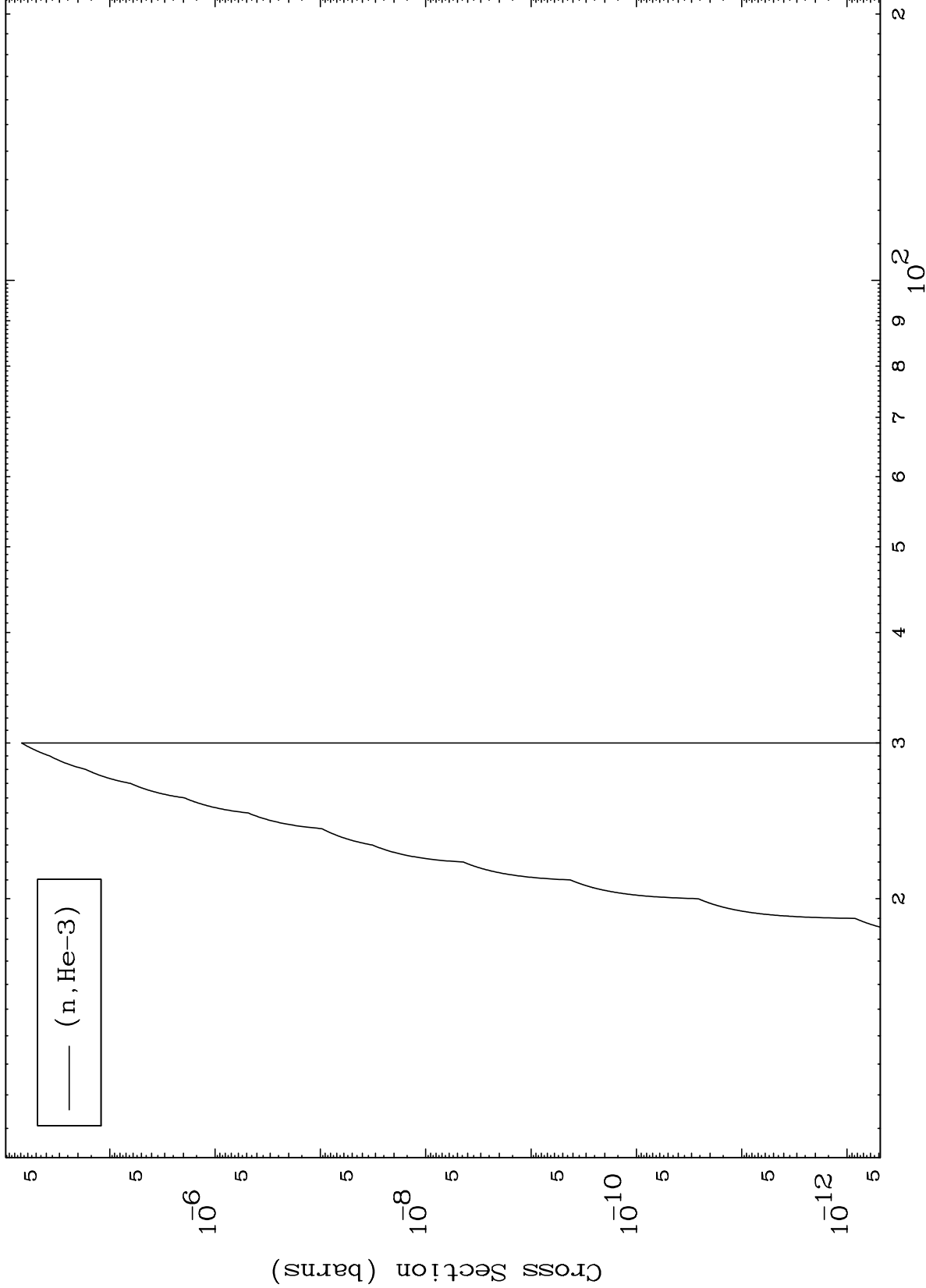

MAT 5740

(n, α) Levels
293 Kelvin Cross Sections

57-La-143

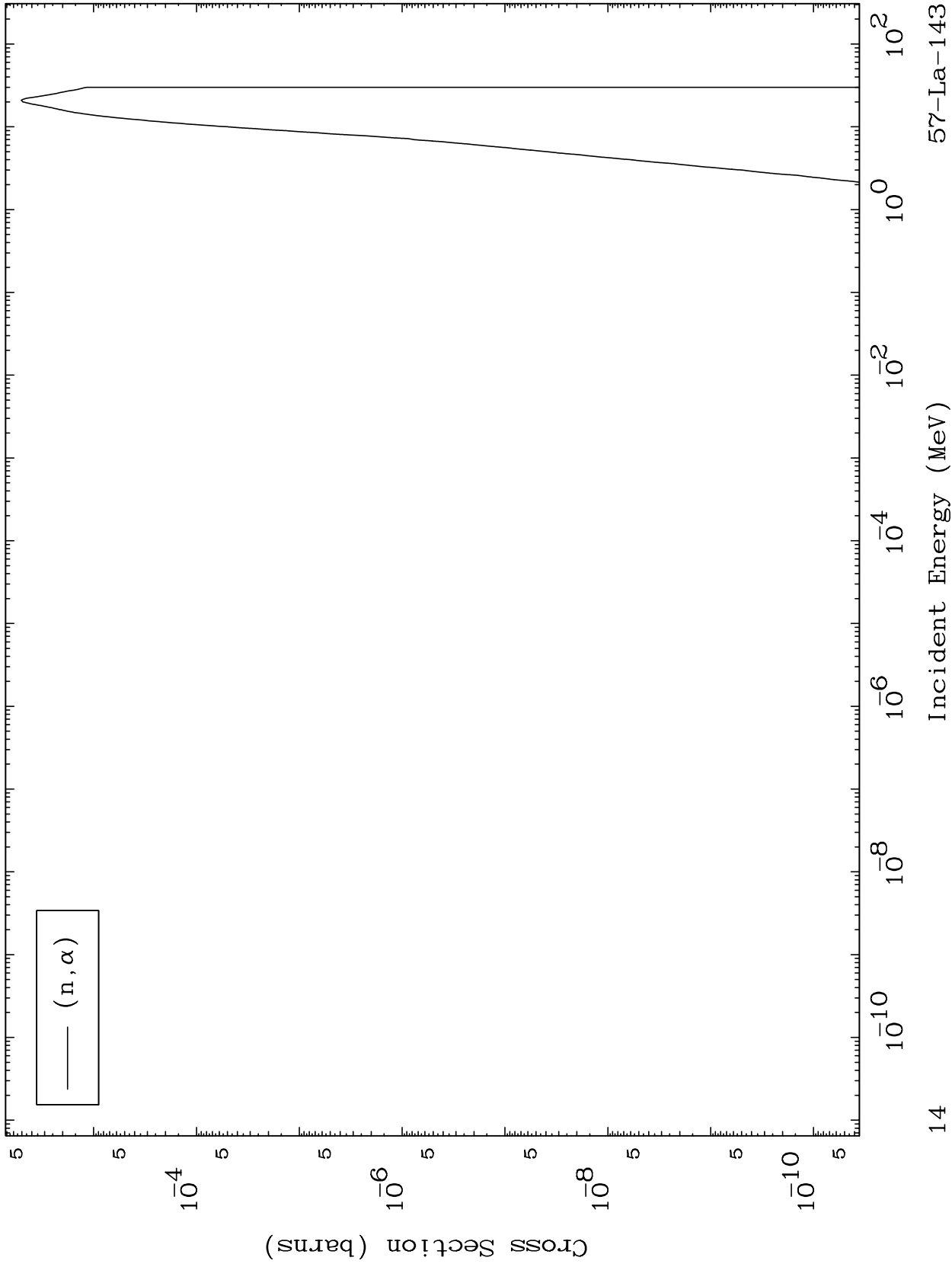

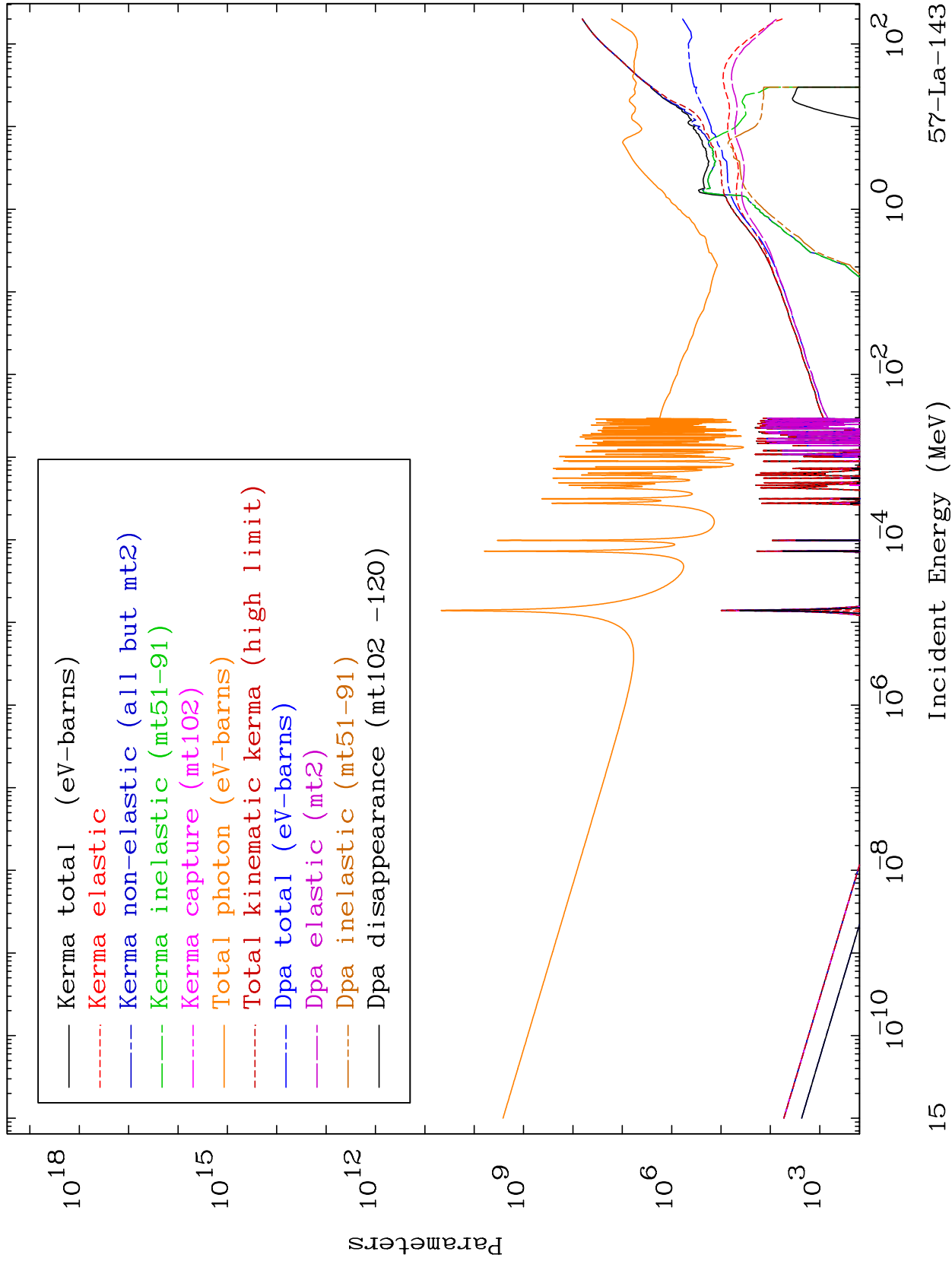

MAT 5740

Elastic Legendre Coefficients

57-La-143

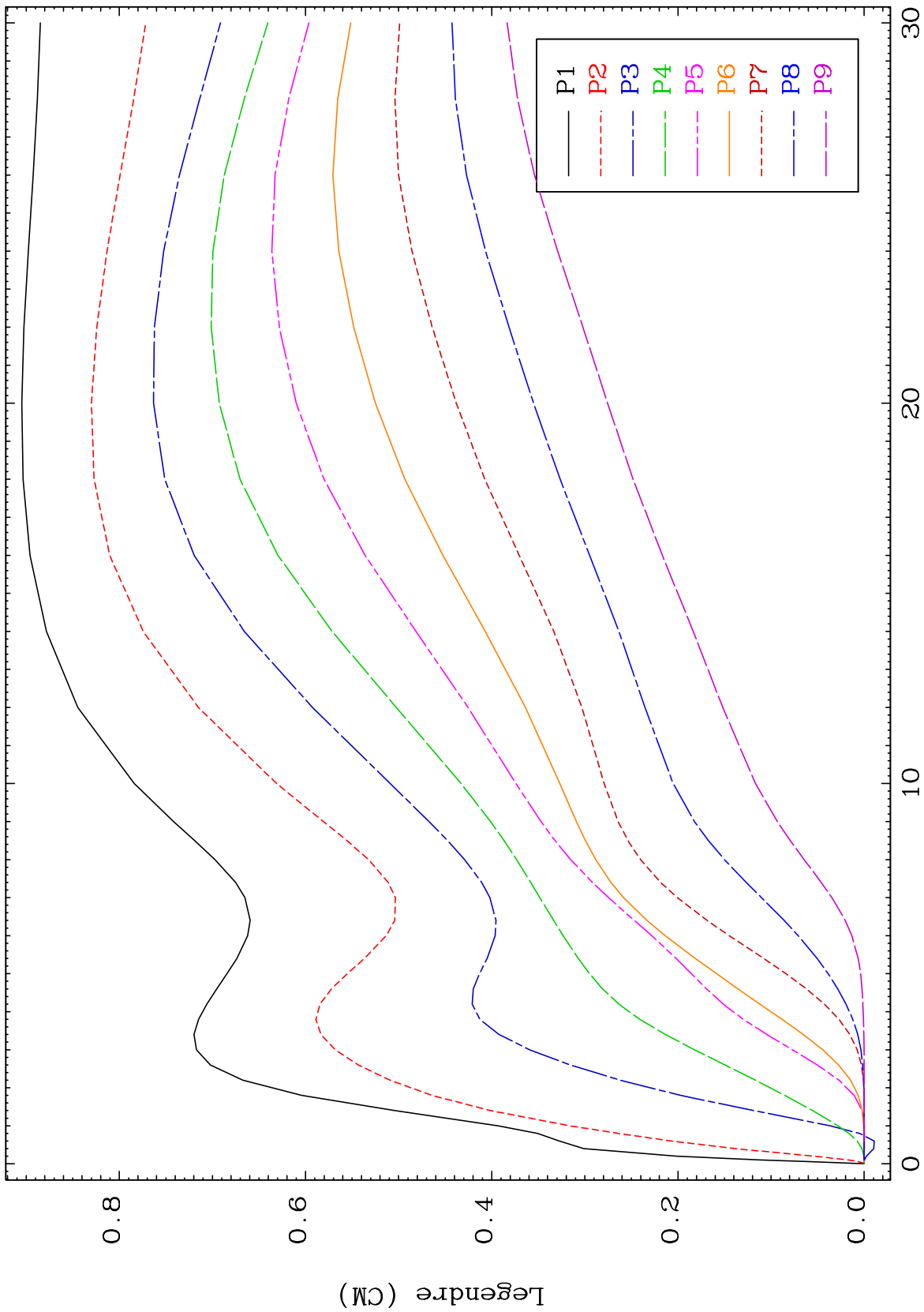

16

Incident Energy (MeV)

57-La-143

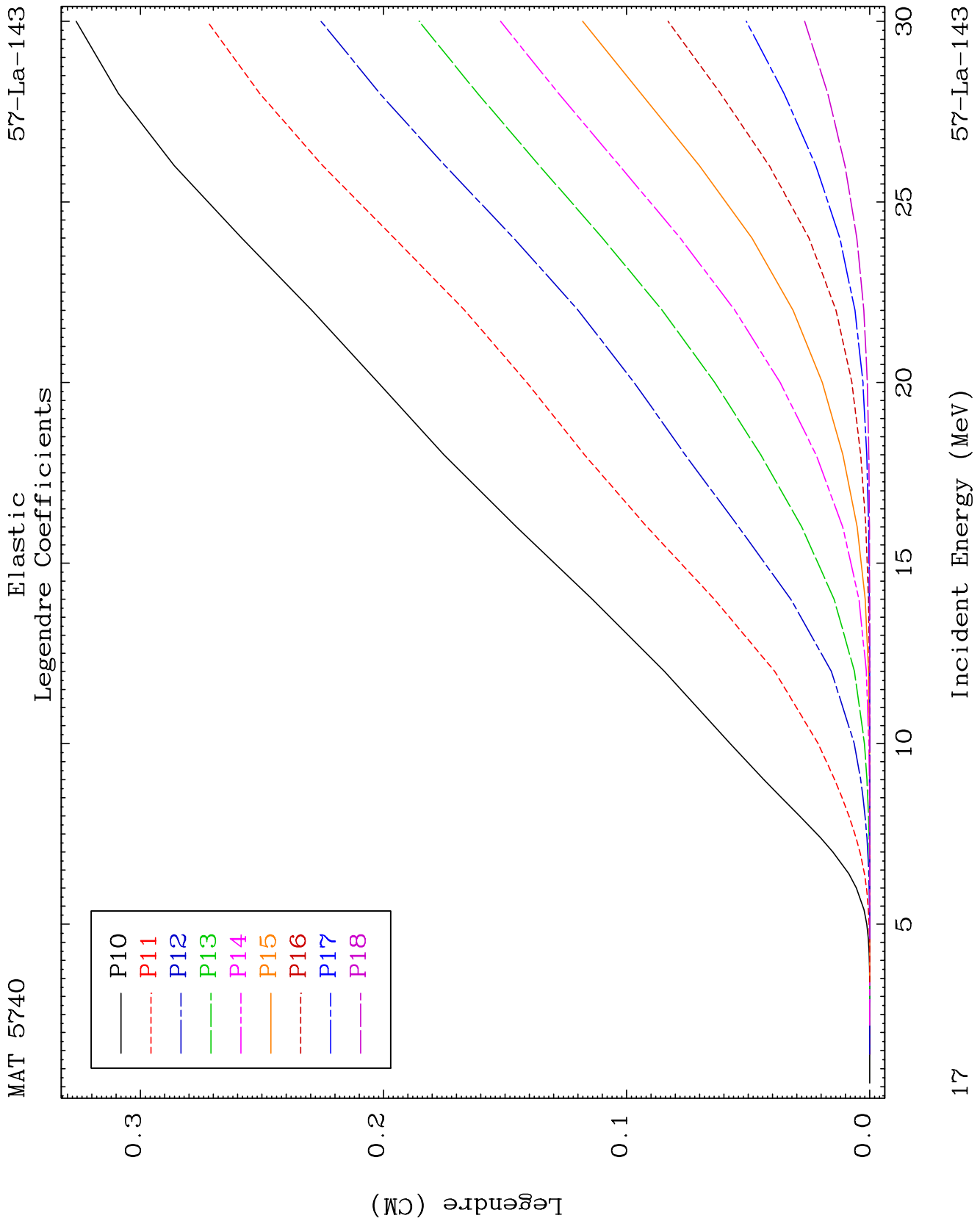

MAT 5740

Elastic Legendre Coefficients

57-La-143

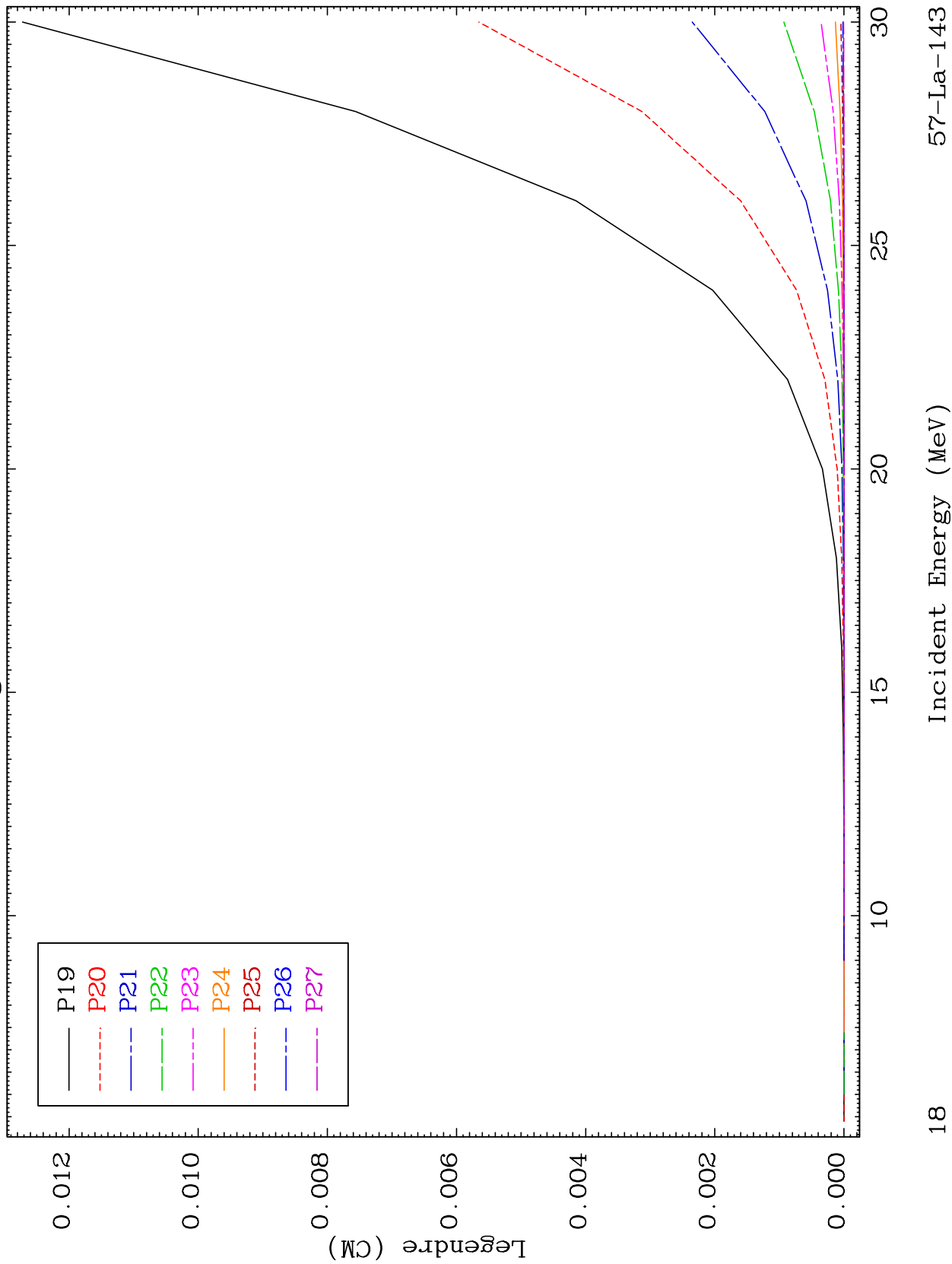

18

Incident Energy (MeV)

57-La-143

MAT 5740

Elastic
Legendre Coefficients

57-La-143

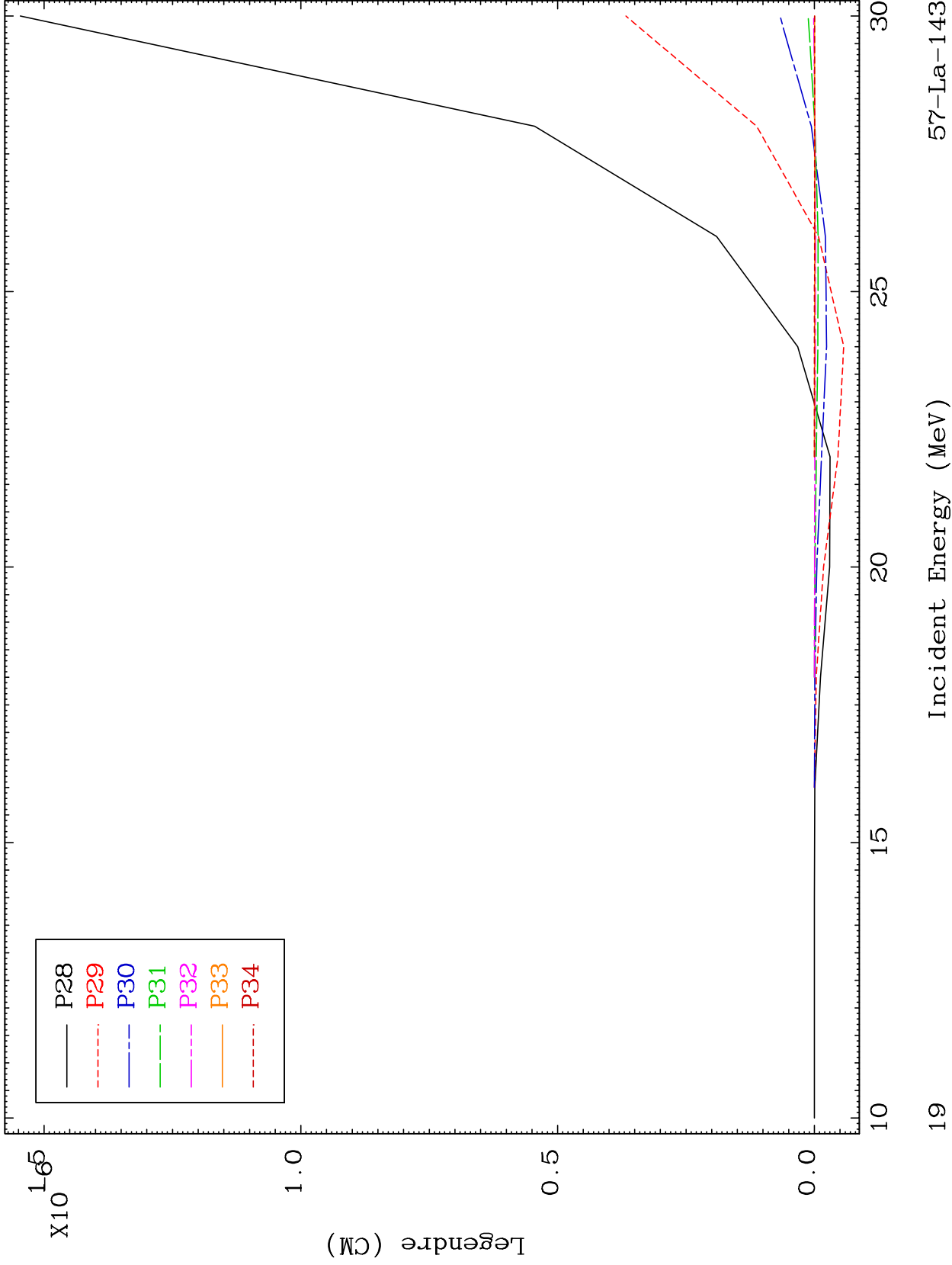

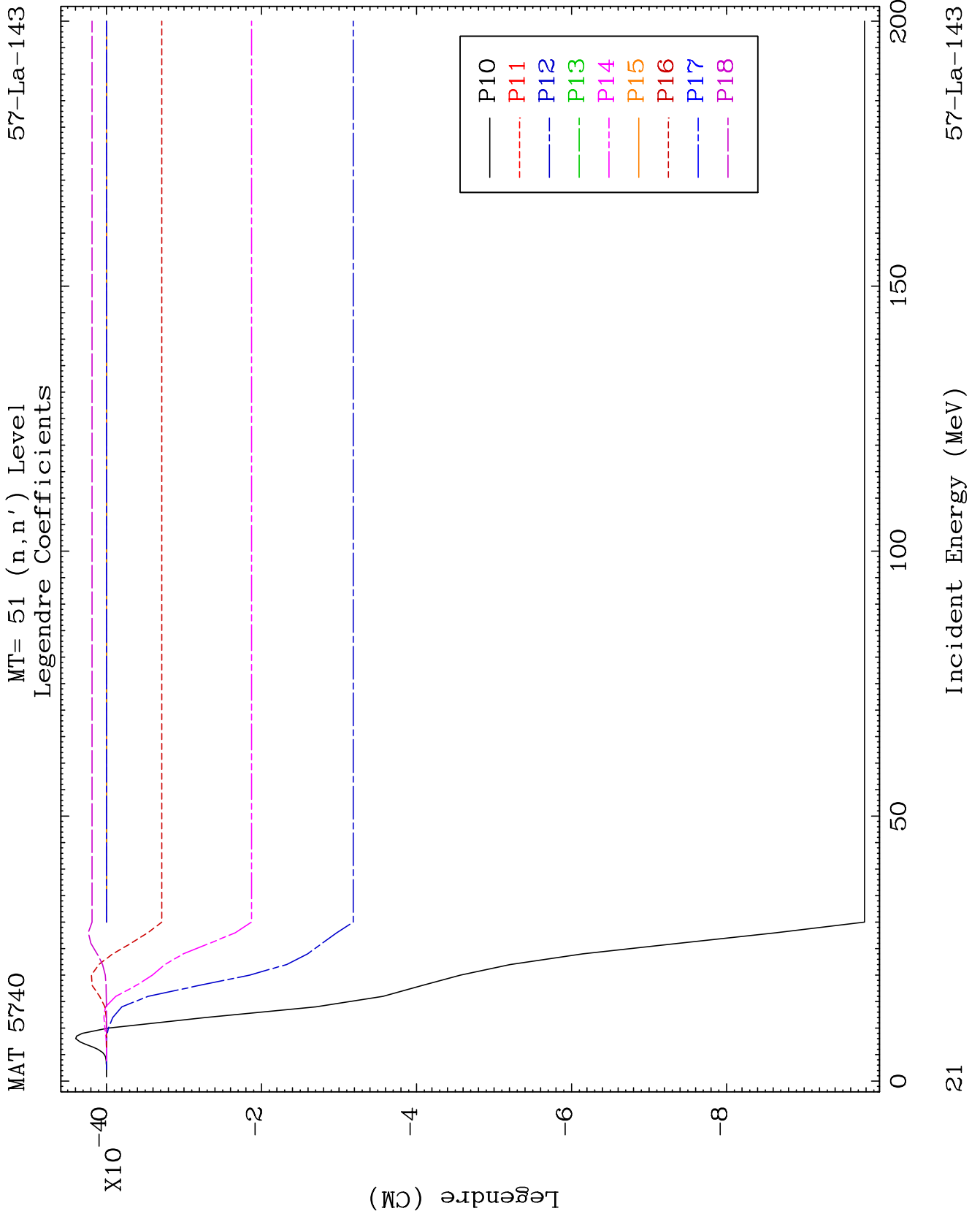

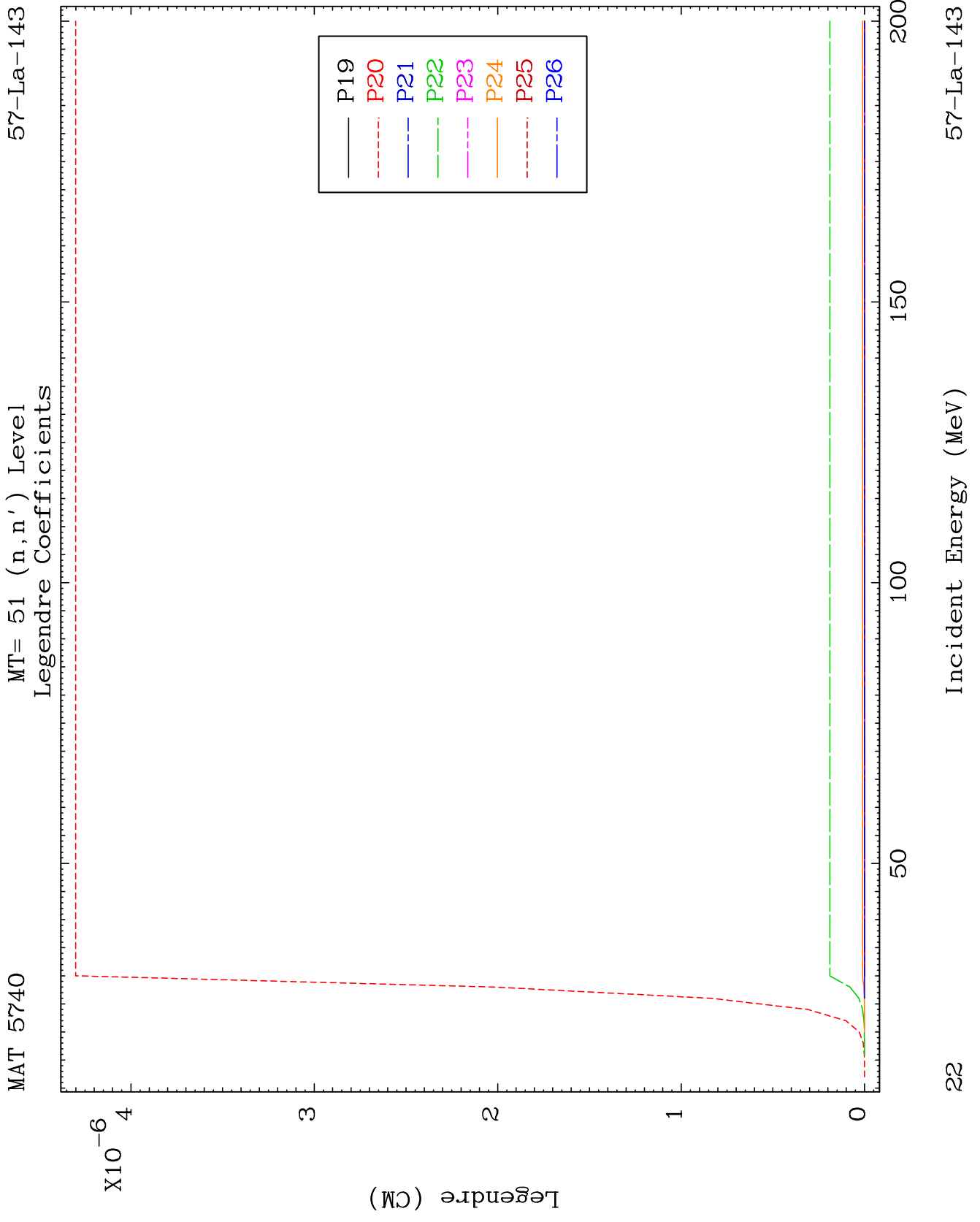

MAT 5740

MT= 52 (n,n') Level
Legendre Coefficients

57-La-143

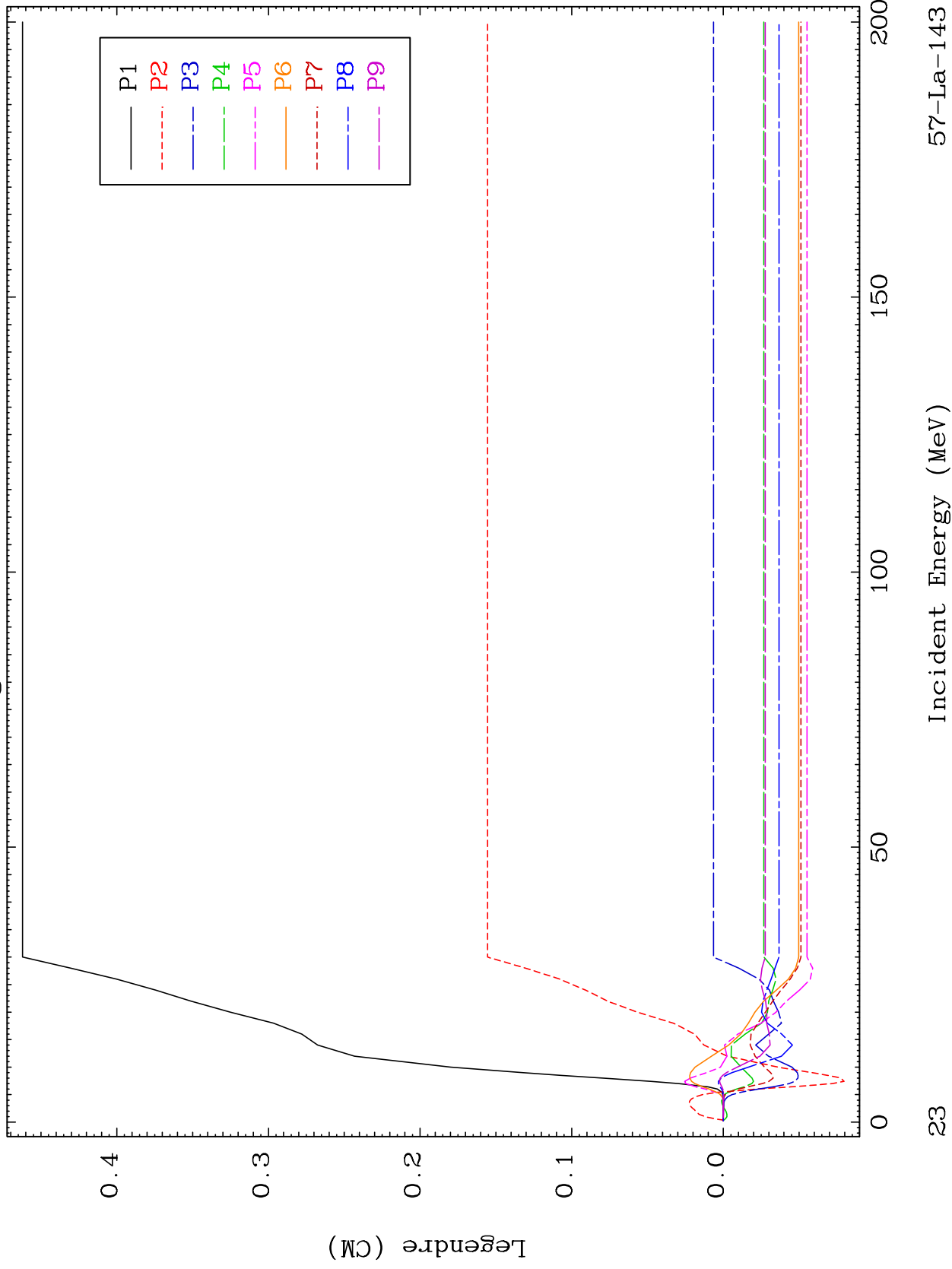

57-La-143

Incident Energy (MeV)

23

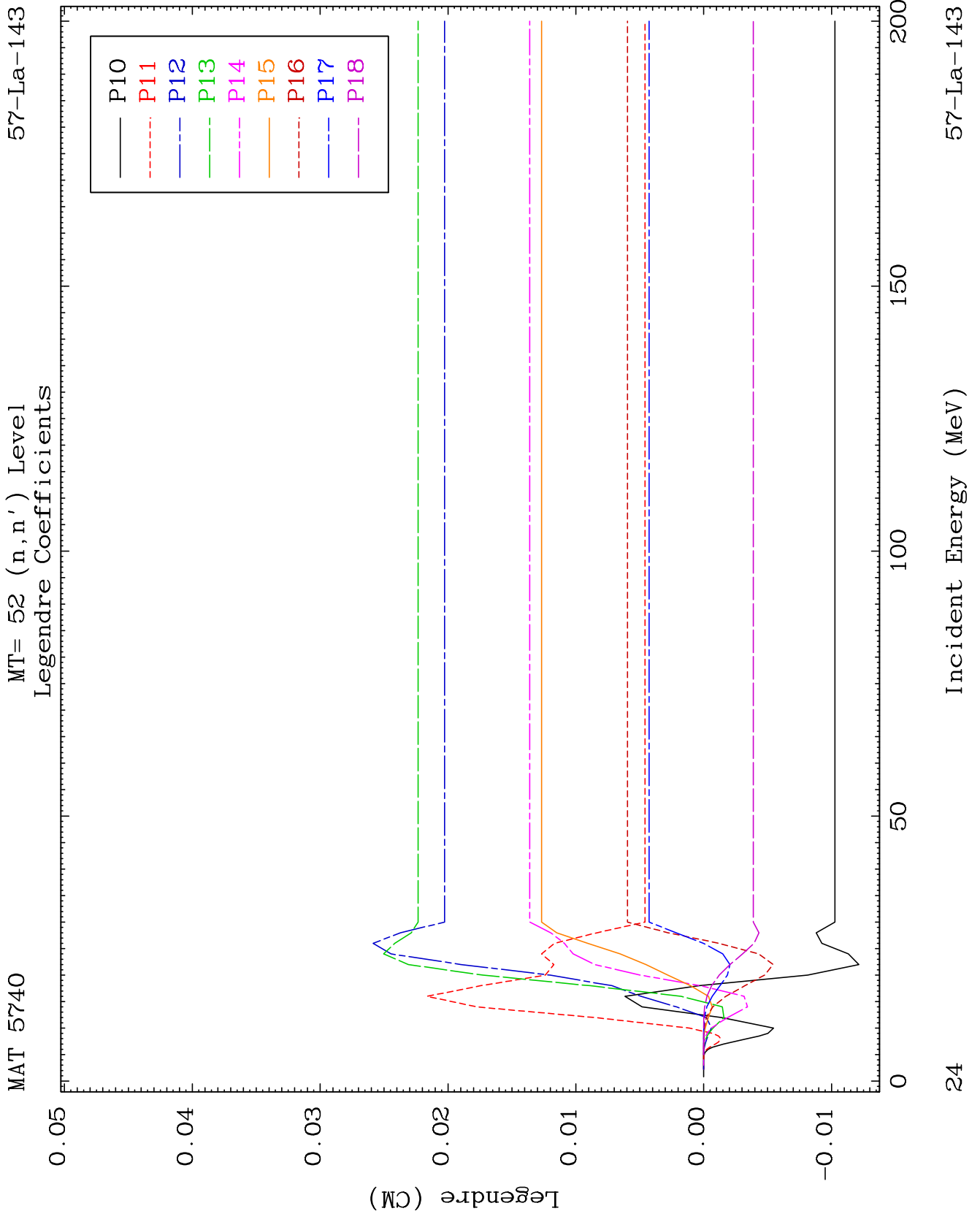

57-La-143

Incident Energy (MeV)

24

MAT 5740

MT= 52 (n,n') Level
Legendre Coefficients

57-La-143

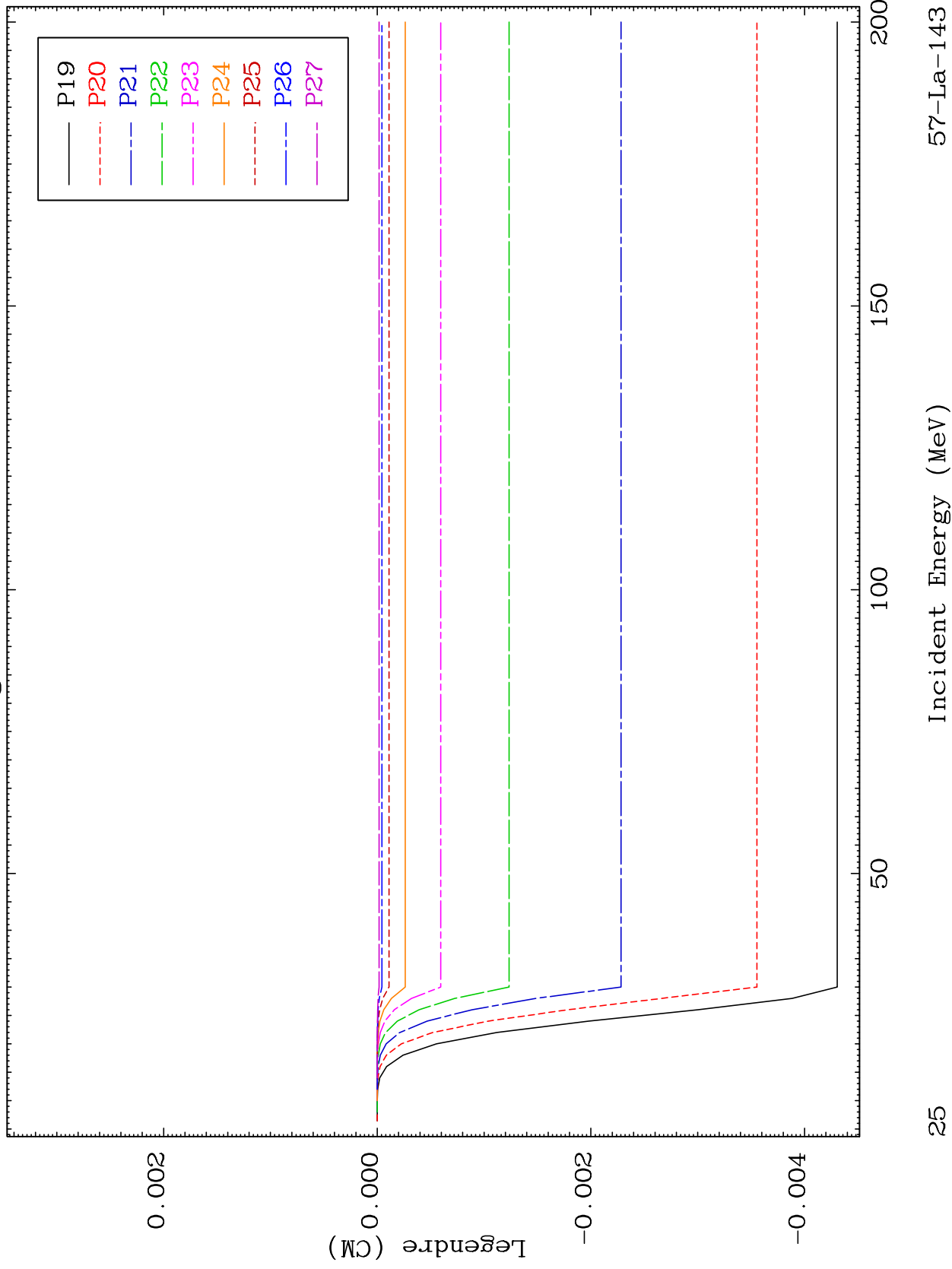

57-La-143

Incident Energy (MeV)

25

MAT 5740

MT= 52 (n,n') Level
Legendre Coefficients

57-La-143

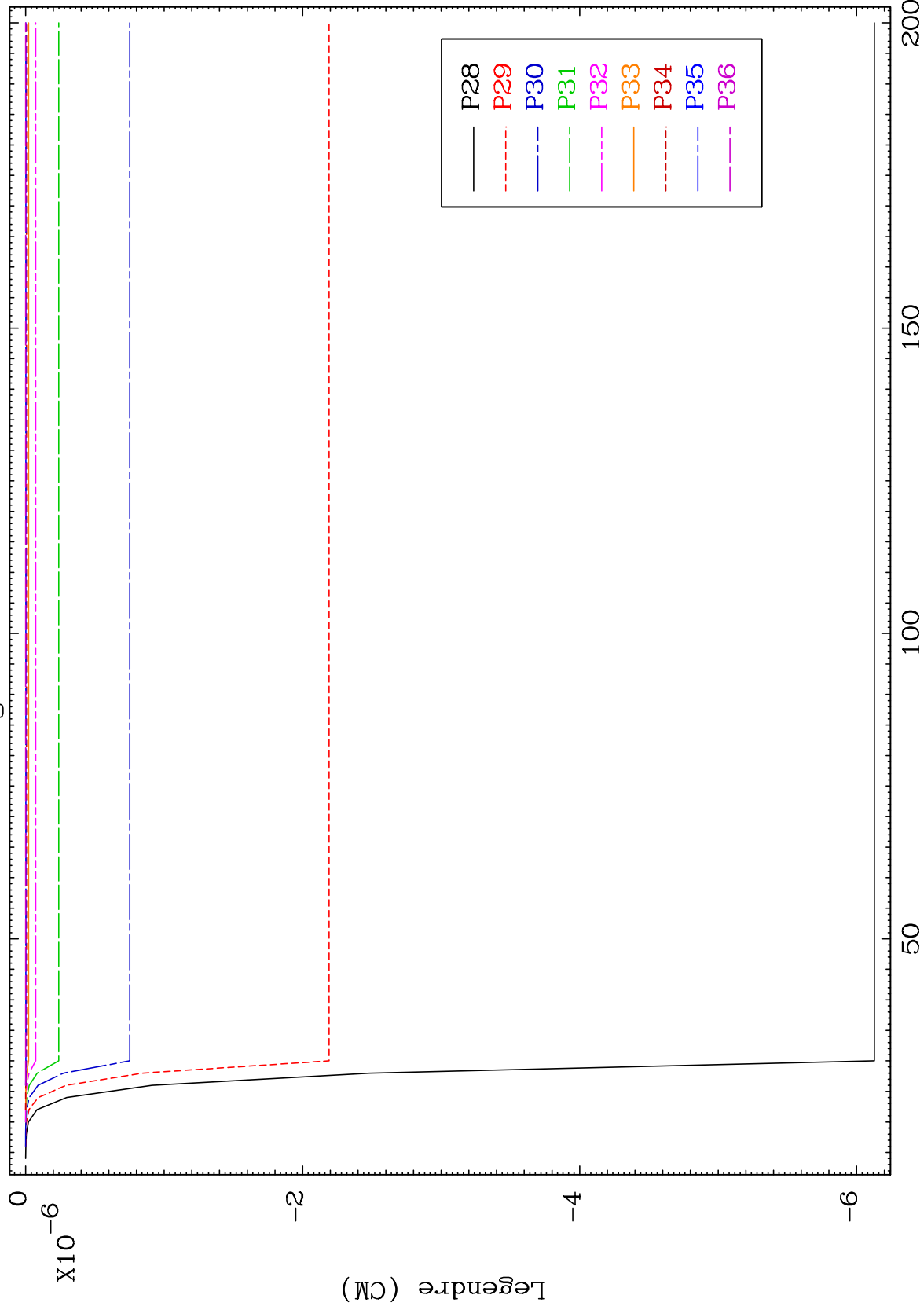

26

Incident Energy (MeV)

57-La-143

MAT 5740

MT= 53 (n,n') Level
Legendre Coefficients

57-La-143

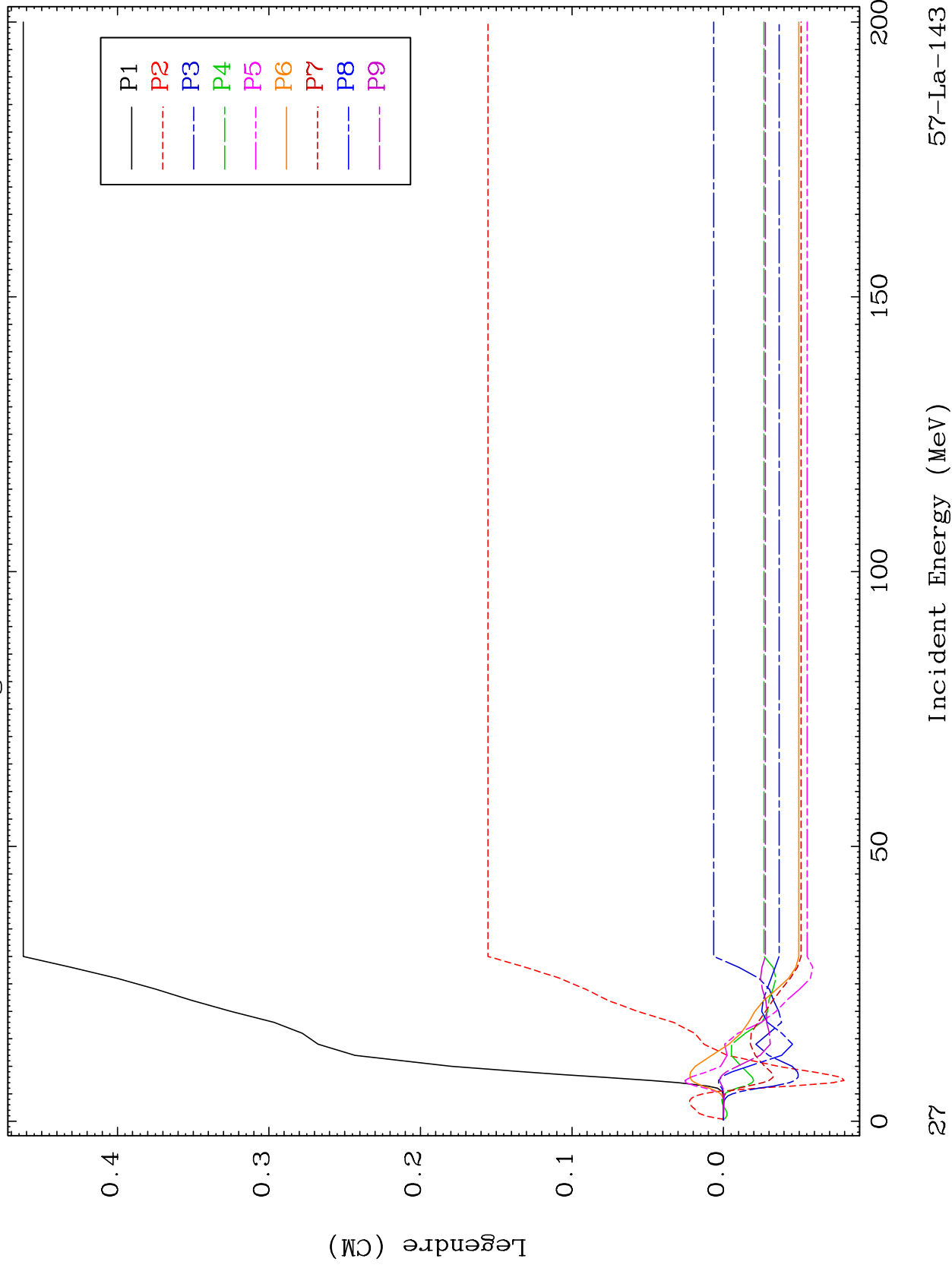

57-La-143

Incident Energy (MeV)

27

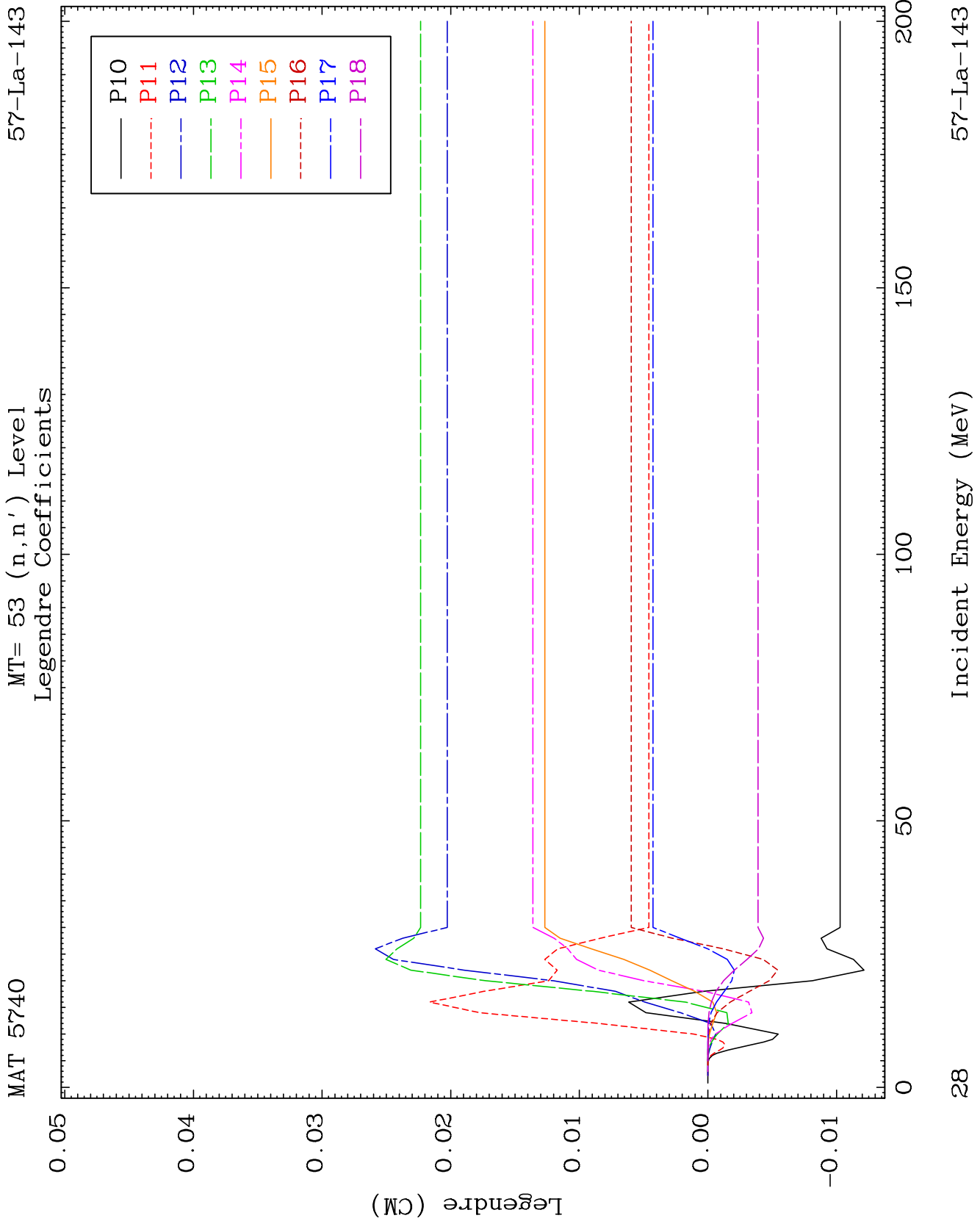

MAT 5740

MT= 53 (n,n') Level
Legendre Coefficients

57-La-143

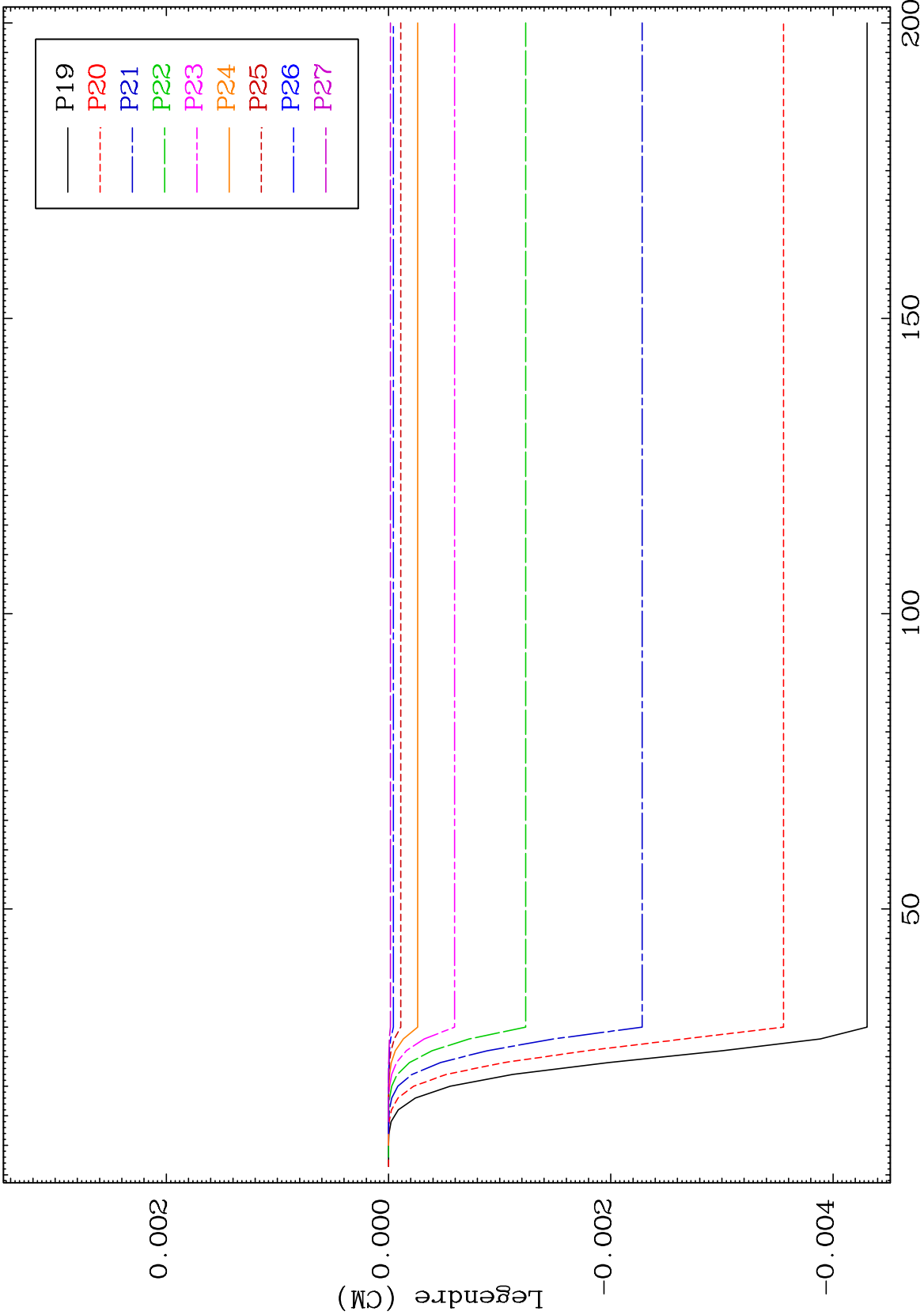

MAT 5740

MT= 53 (n,n') Level

57-La-143

Legendre Coefficients

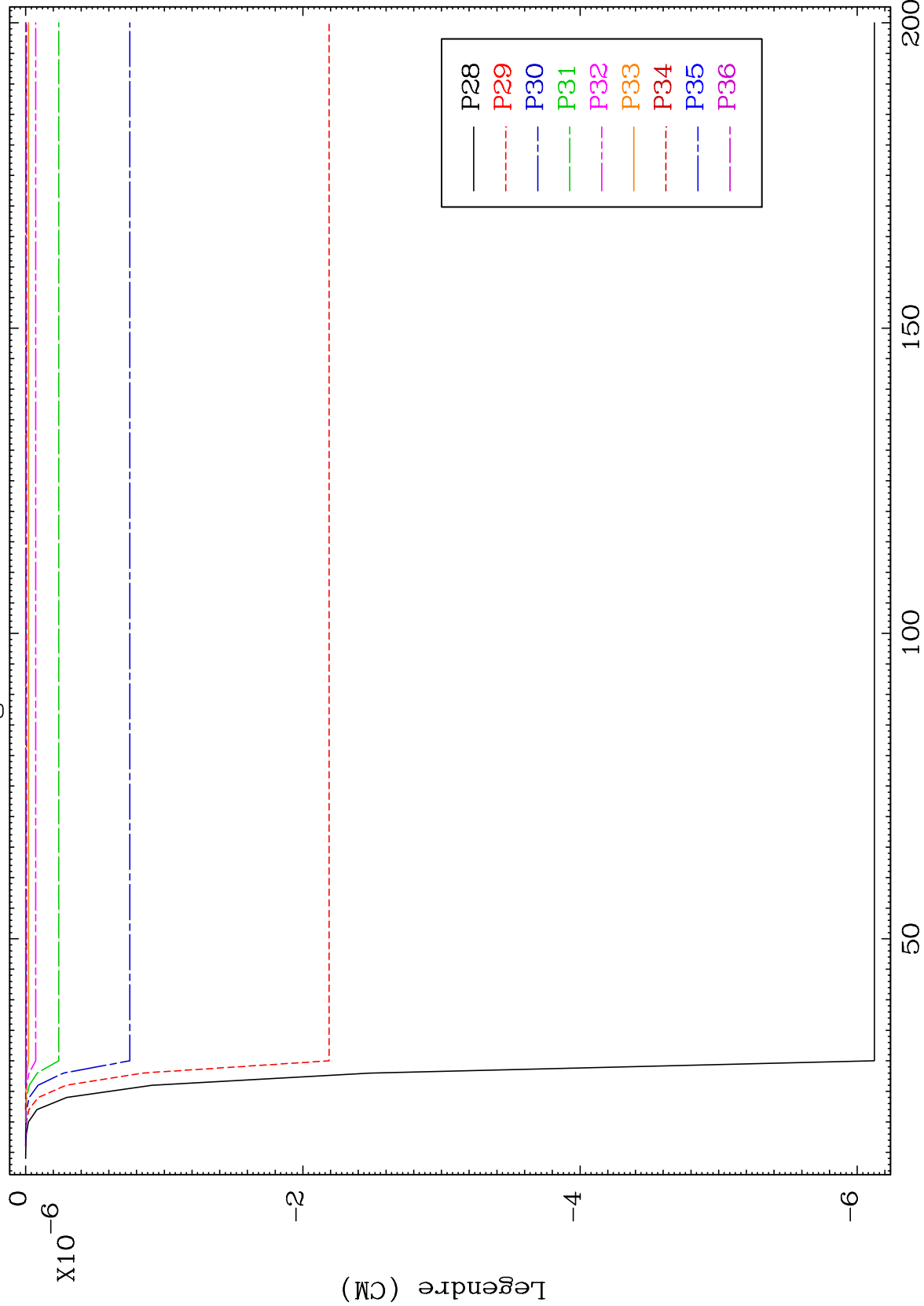

57-La-143

Incident Energy (MeV)

30

MAT 5740

MT= 54 (n,n') Level
Legendre Coefficients

57-La-143

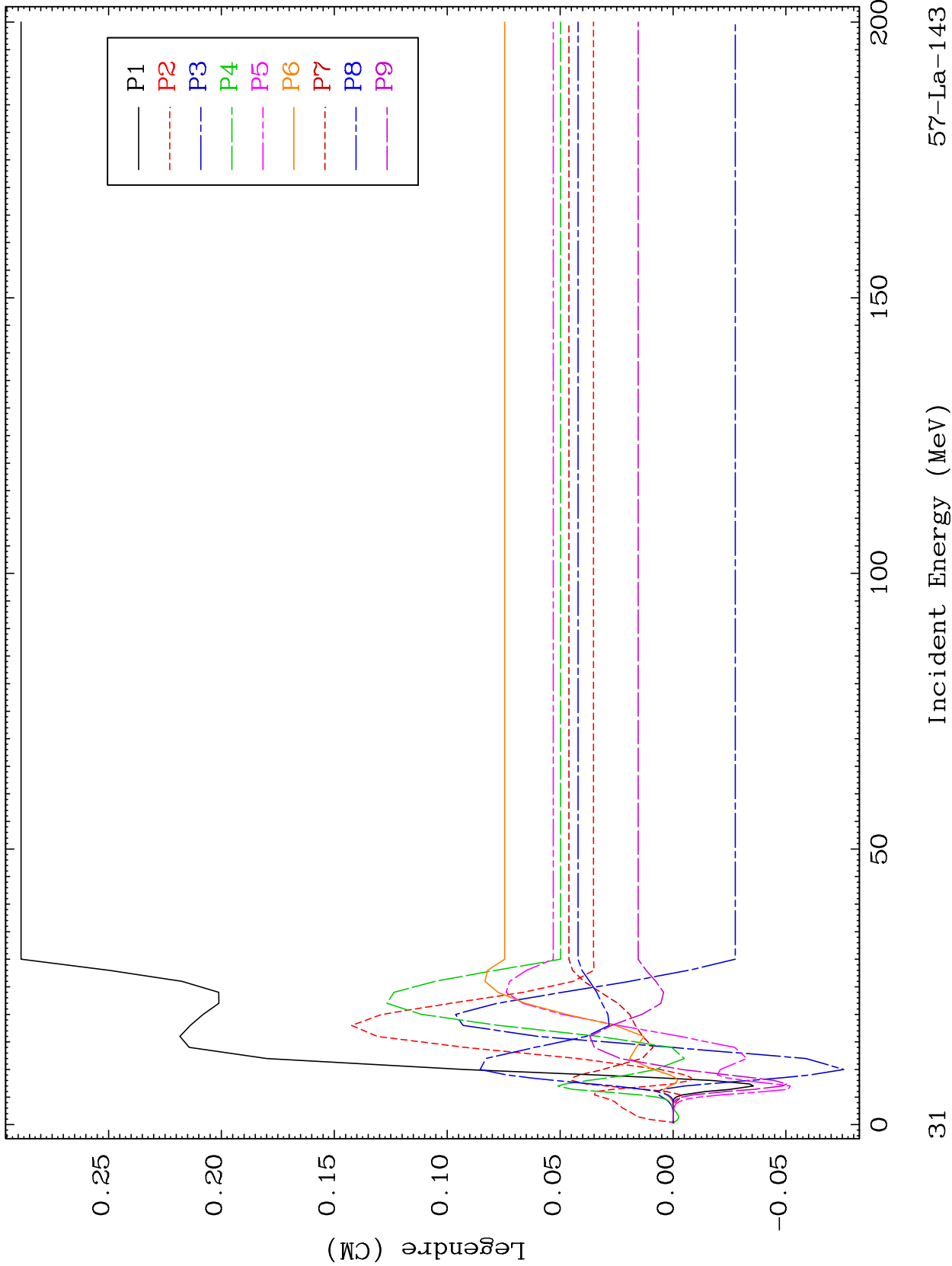

57-La-143

Incident Energy (MeV)

31

MAT 5740

MT= 54 (n,n') Level
Legendre Coefficients

57-La-143

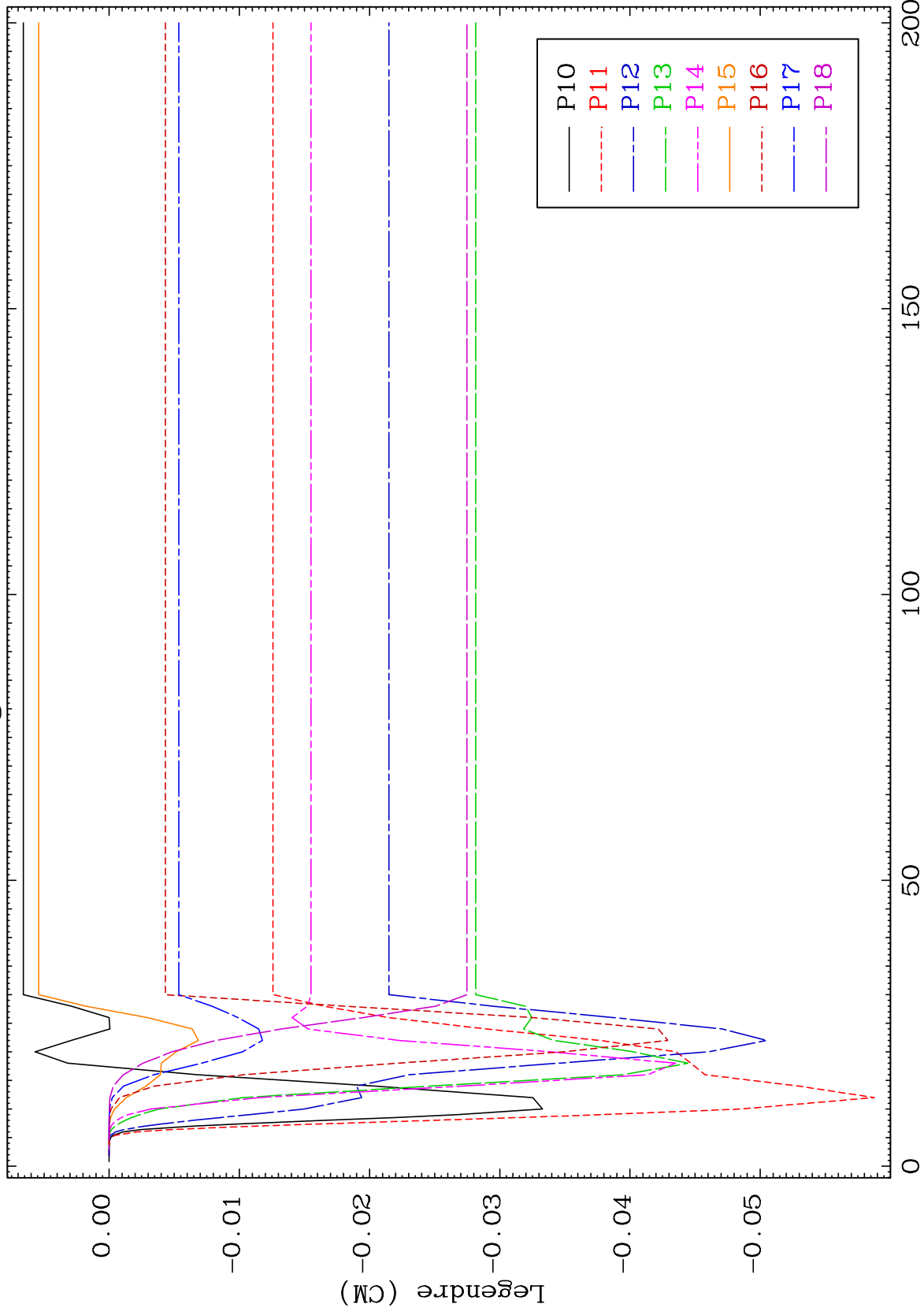

32

Incident Energy (MeV)

57-La-143

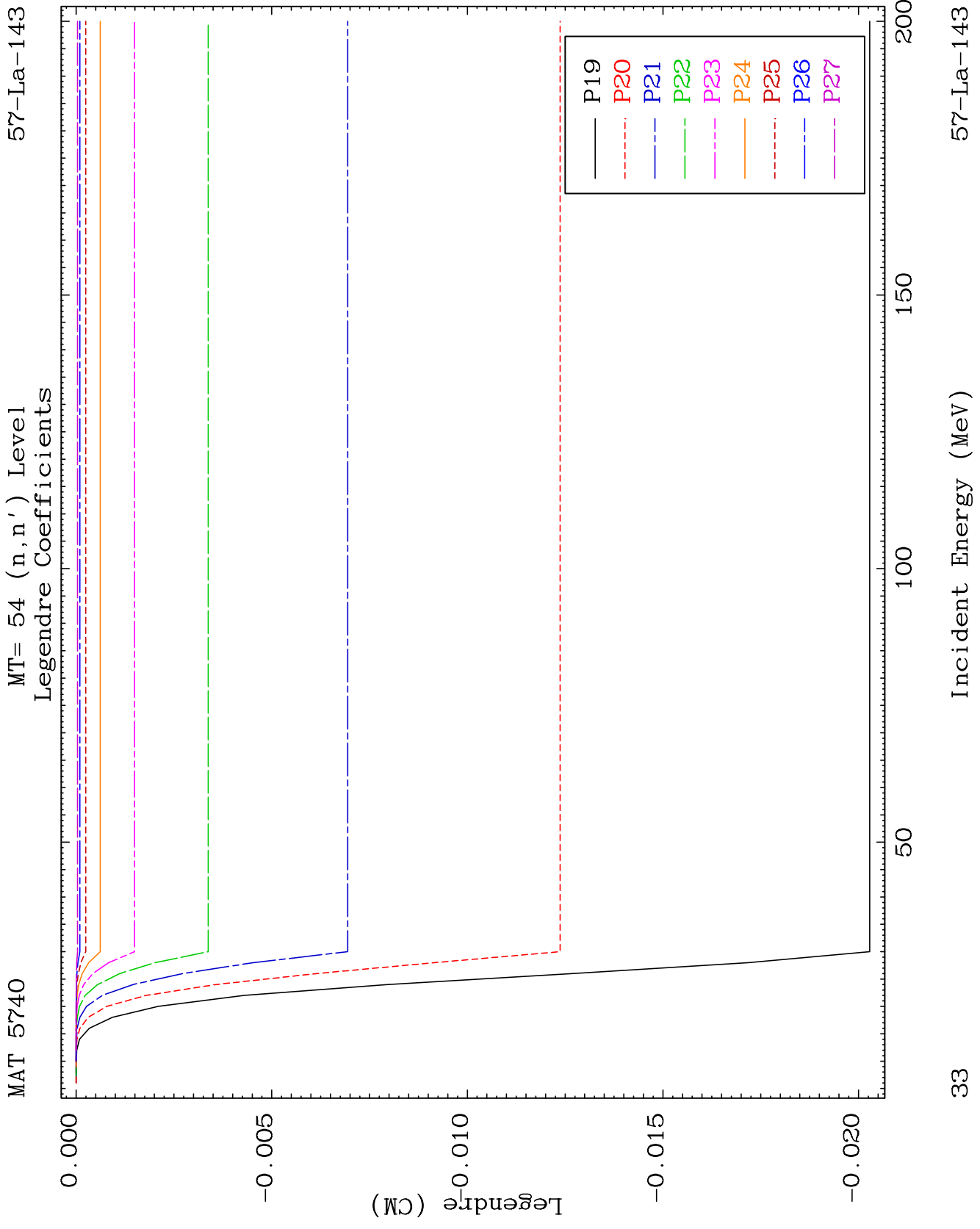

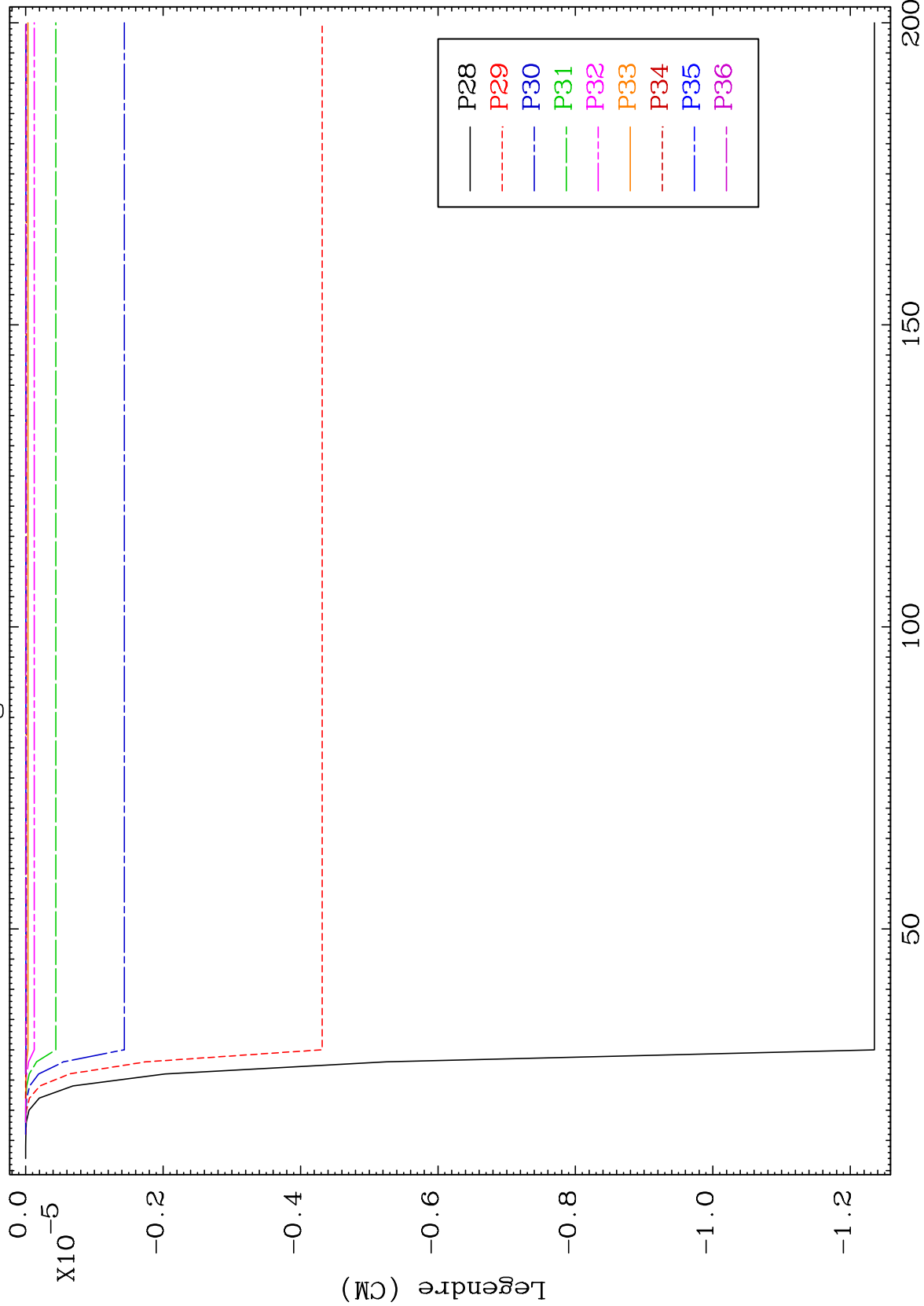

MAT 5740

MT= 55 (n,n') Level
Legendre Coefficients

57-La-143

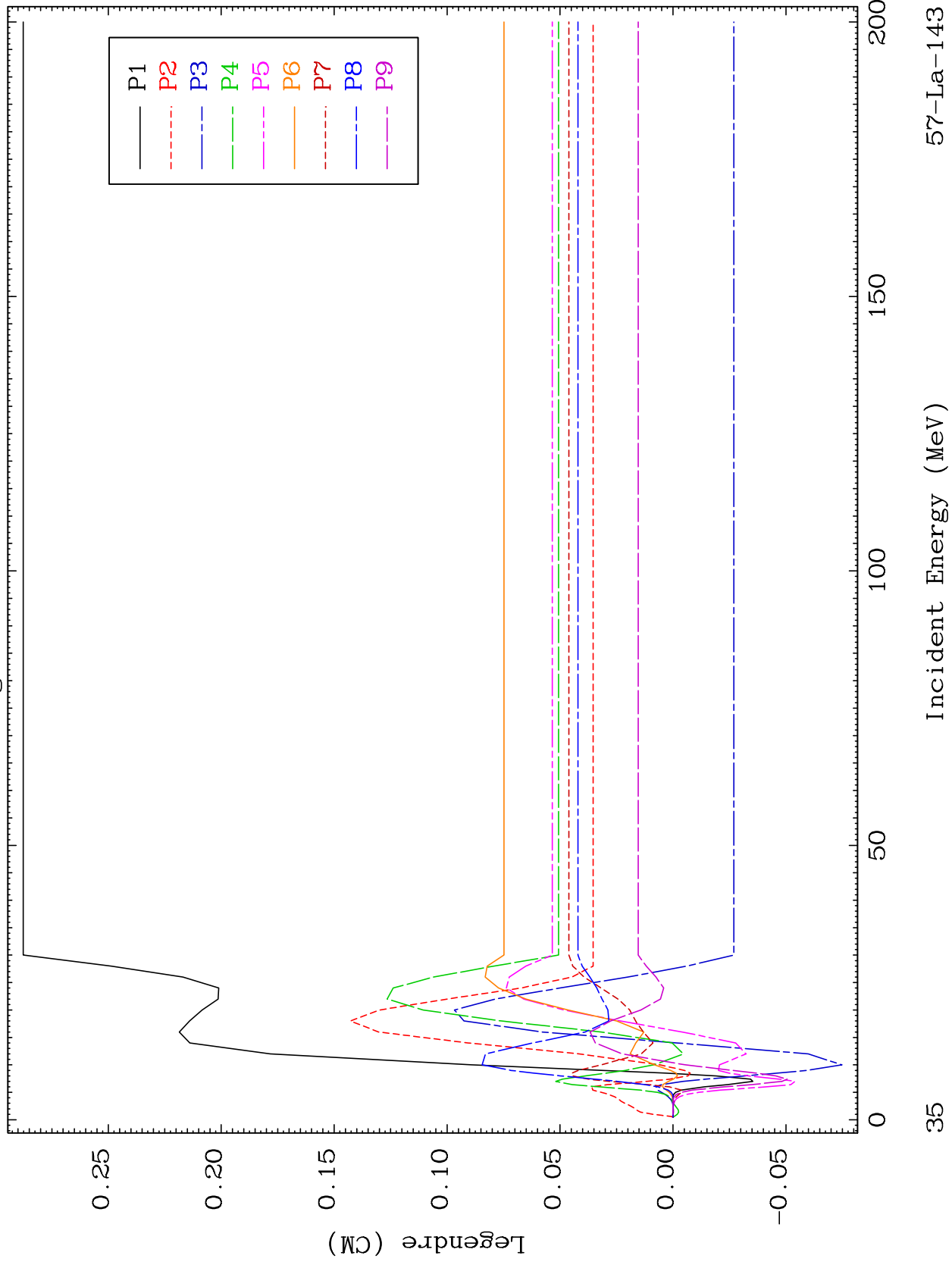

57-La-143

Incident Energy (MeV)

35

MAT 5740

MT= 55 (n,n') Level
Legendre Coefficients

57-La-143

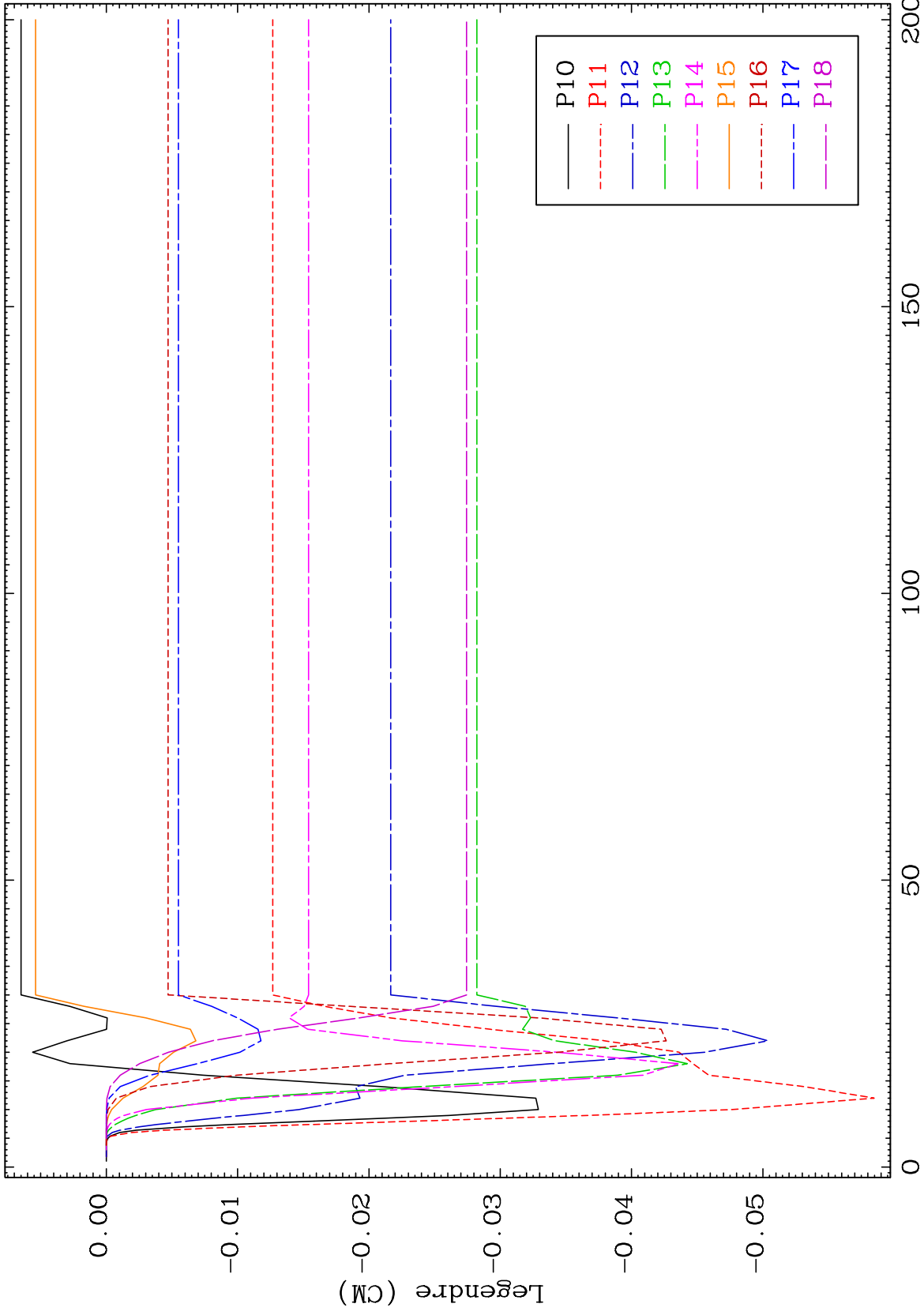

36

Incident Energy (MeV)

57-La-143

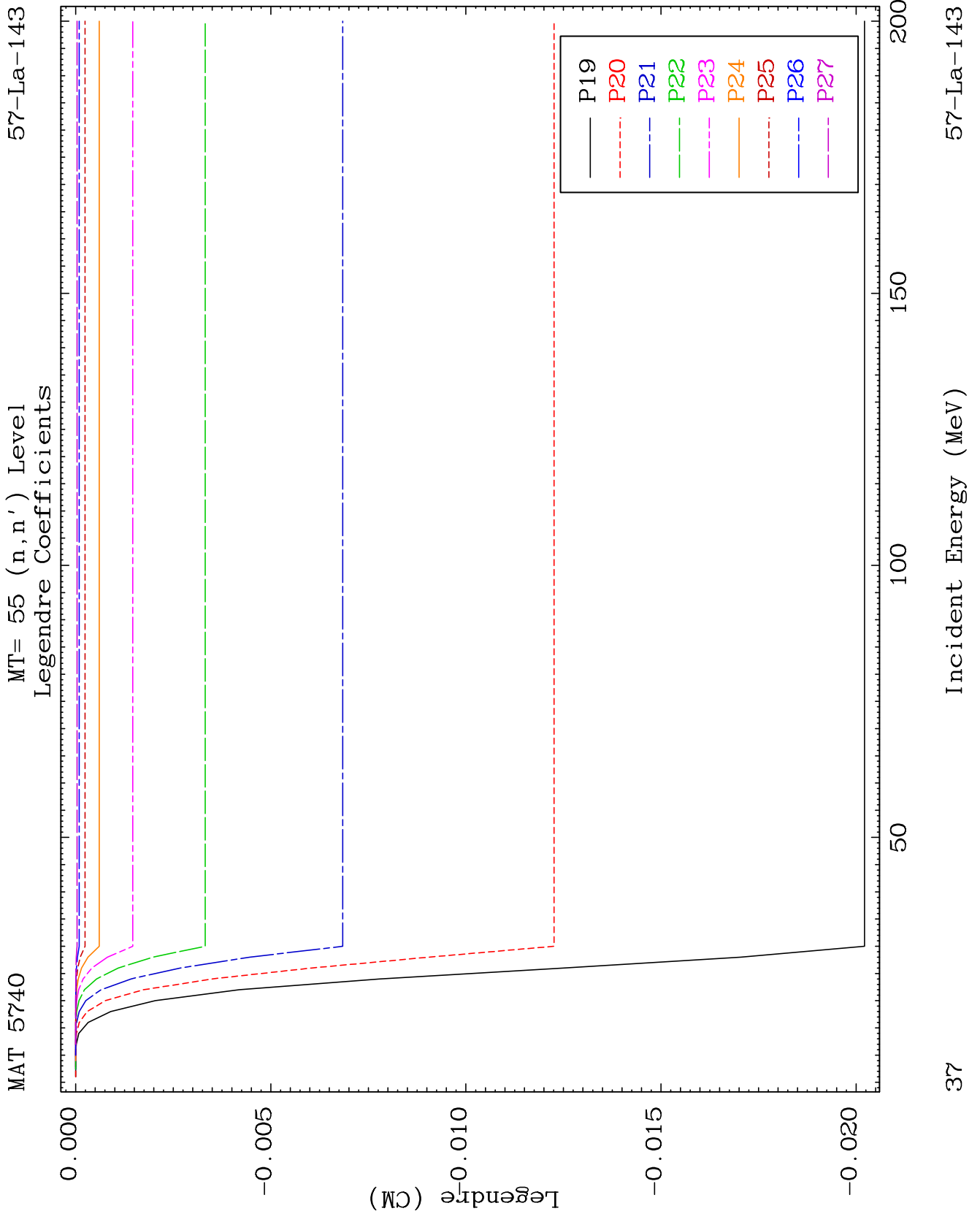

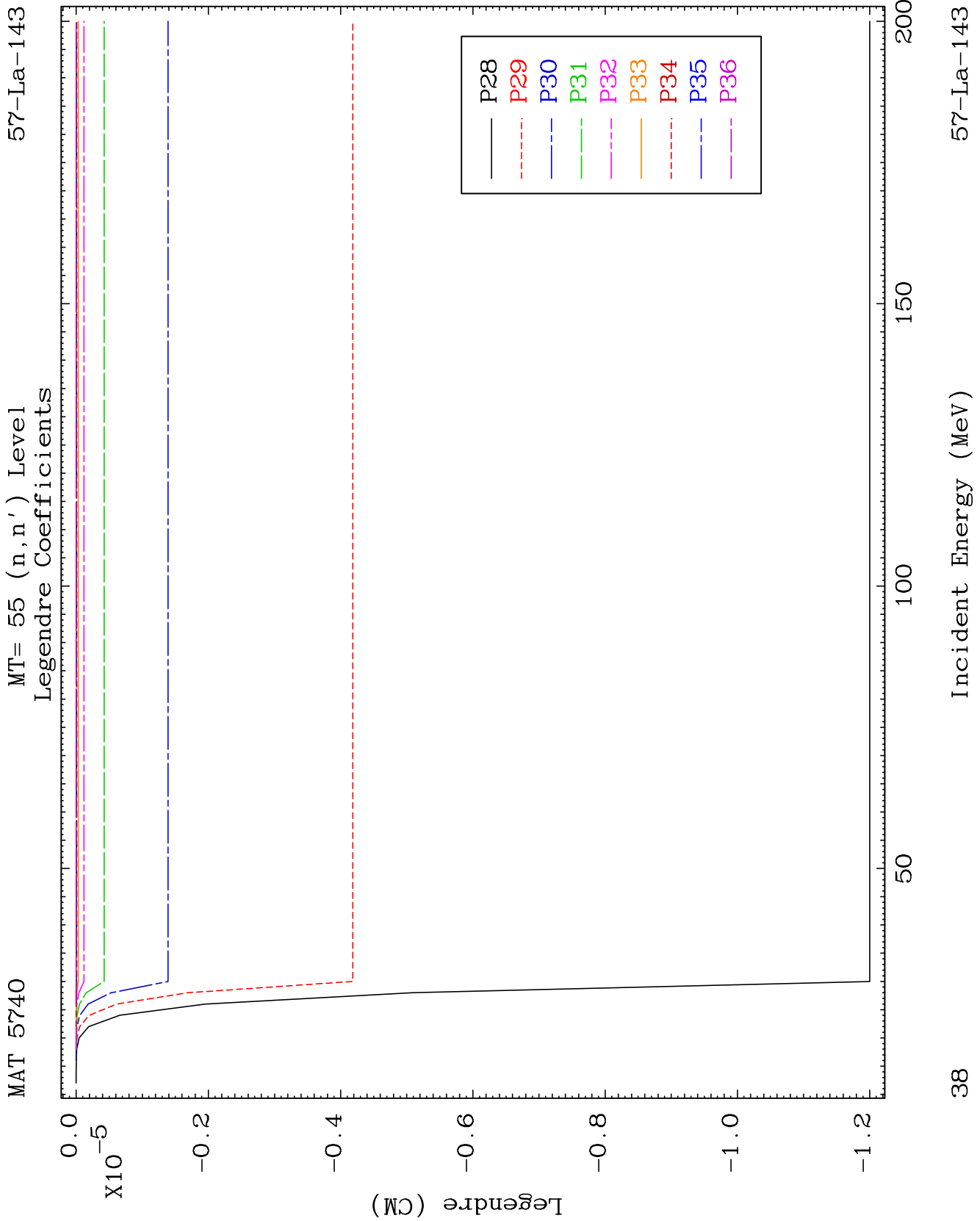

MAT 5740

MT= 56 (n,n') Level
Legendre Coefficients

57-La-143

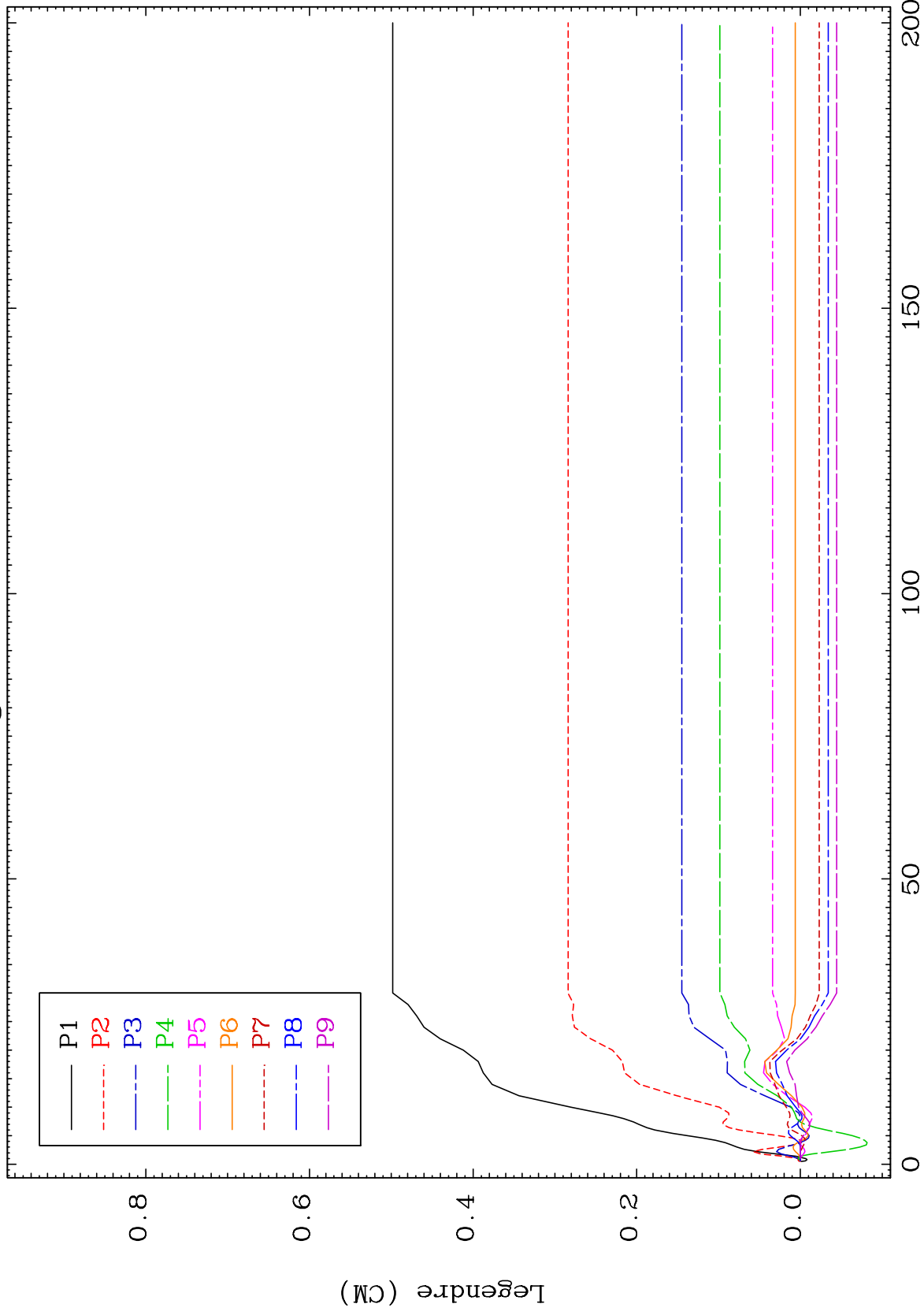

57-La-143

Incident Energy (MeV)

39

MAT 5740

MT= 56 (n,n') Level
Legendre Coefficients

57-La-143

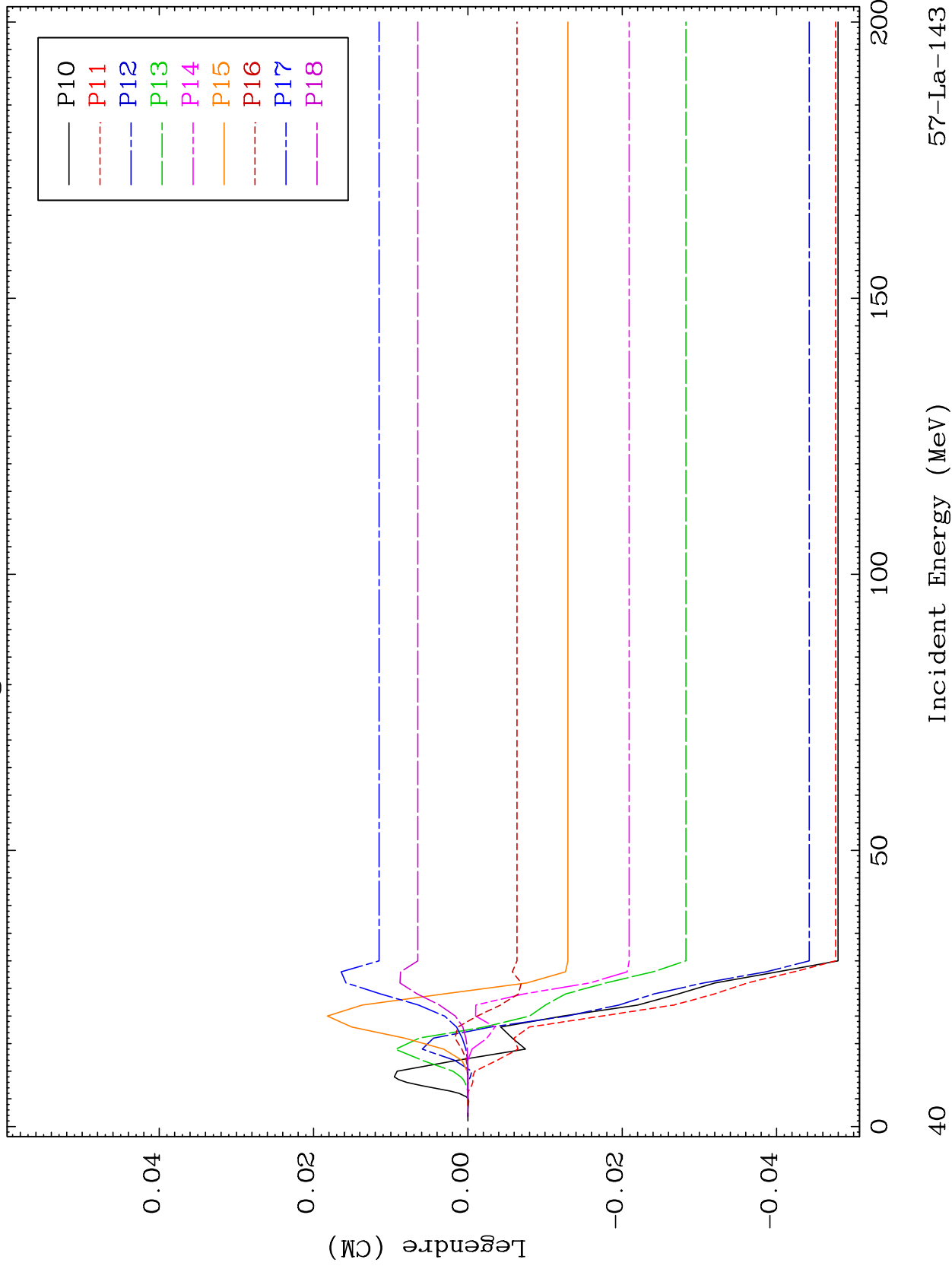

57-La-143

Incident Energy (MeV)

40

MAT 5740

MT= 56 (n,n') Level
Legendre Coefficients

57-La-143

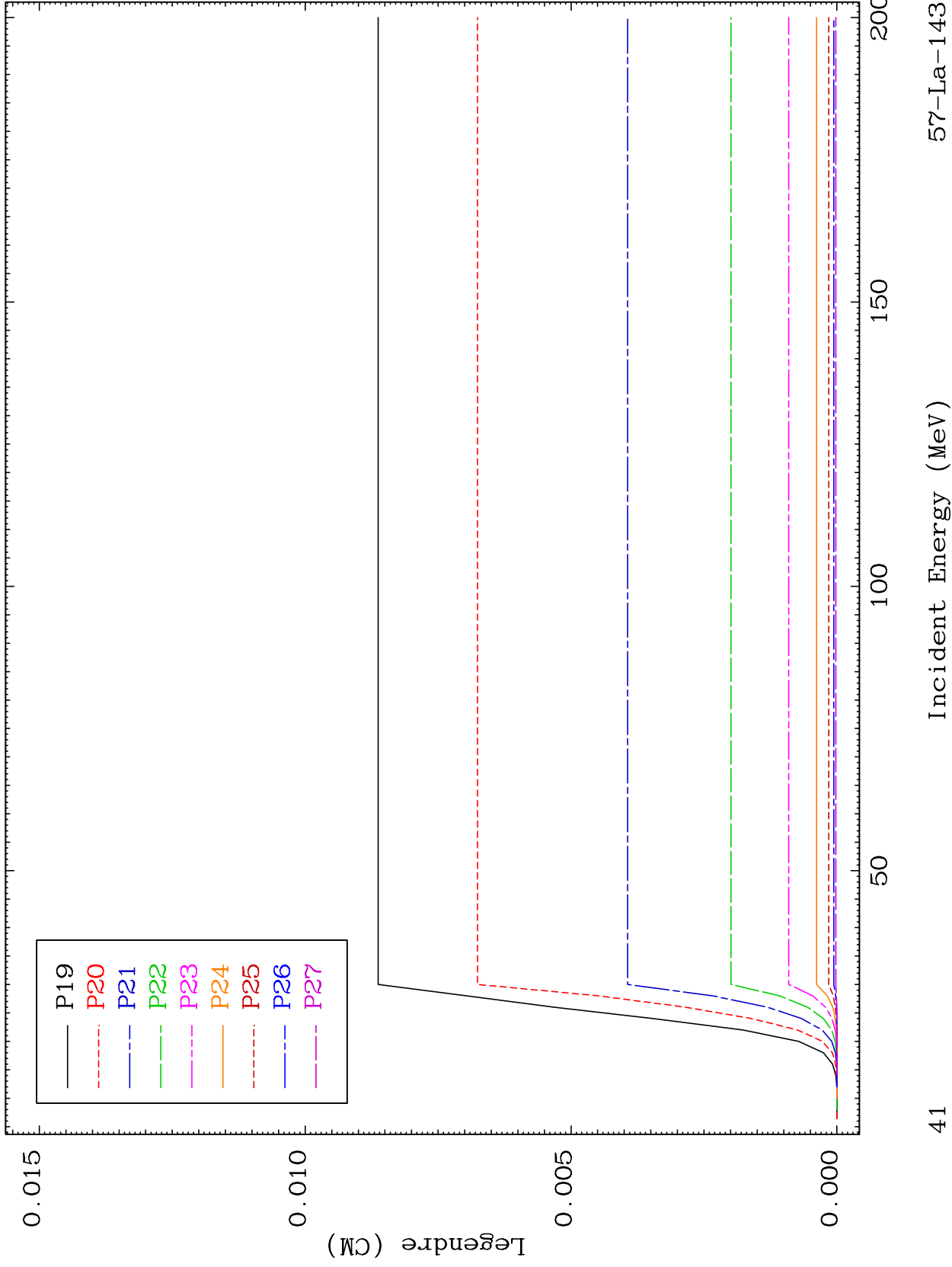

41

Incident Energy (MeV)

57-La-143

MAT 5740

MT= 56 (n,n') Level
Legendre Coefficients

57-La-143

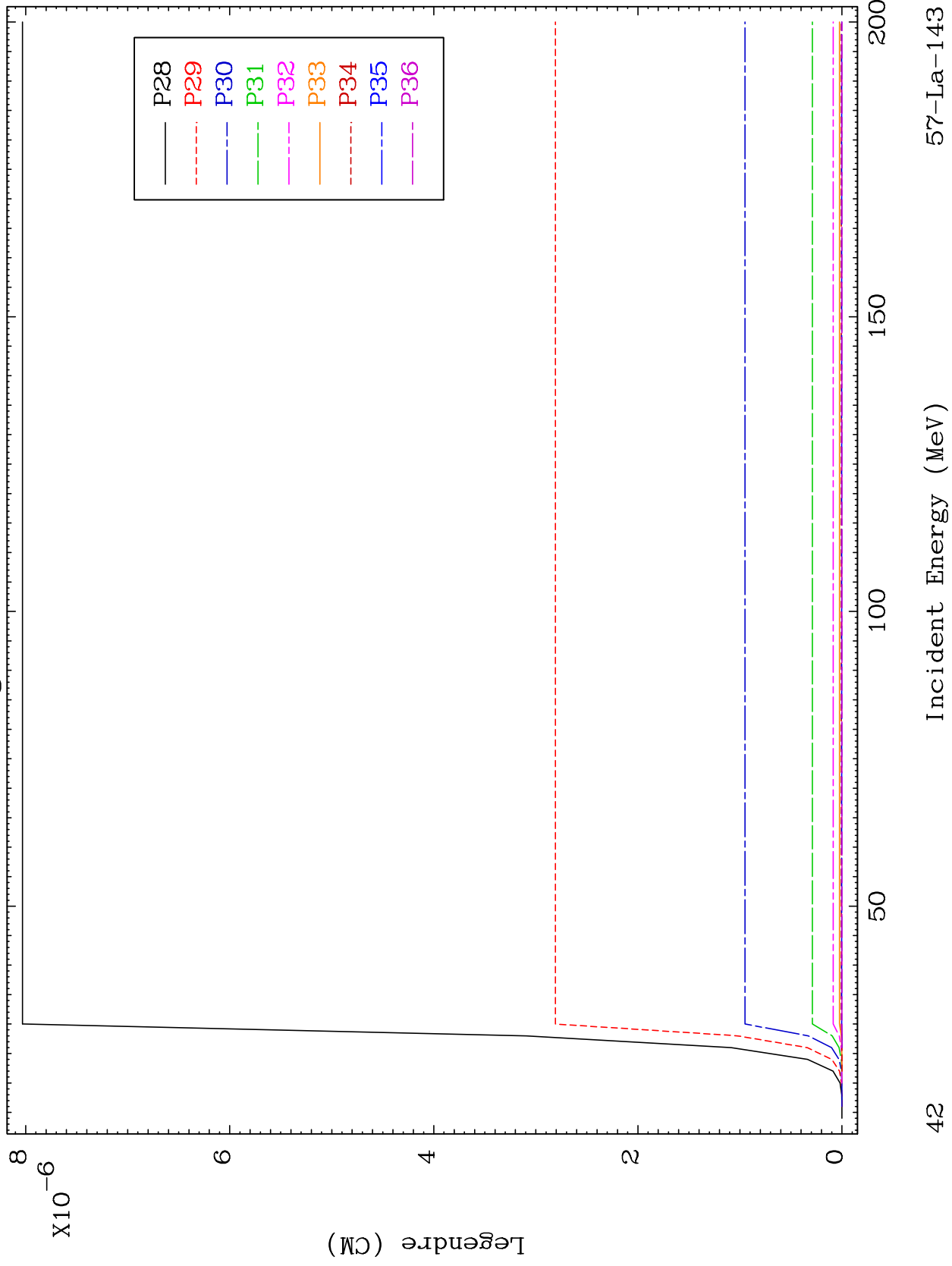

42

Incident Energy (MeV)

57-La-143

MAT 5740

MT= 57 (n,n') Level
Legendre Coefficients

57-La-143

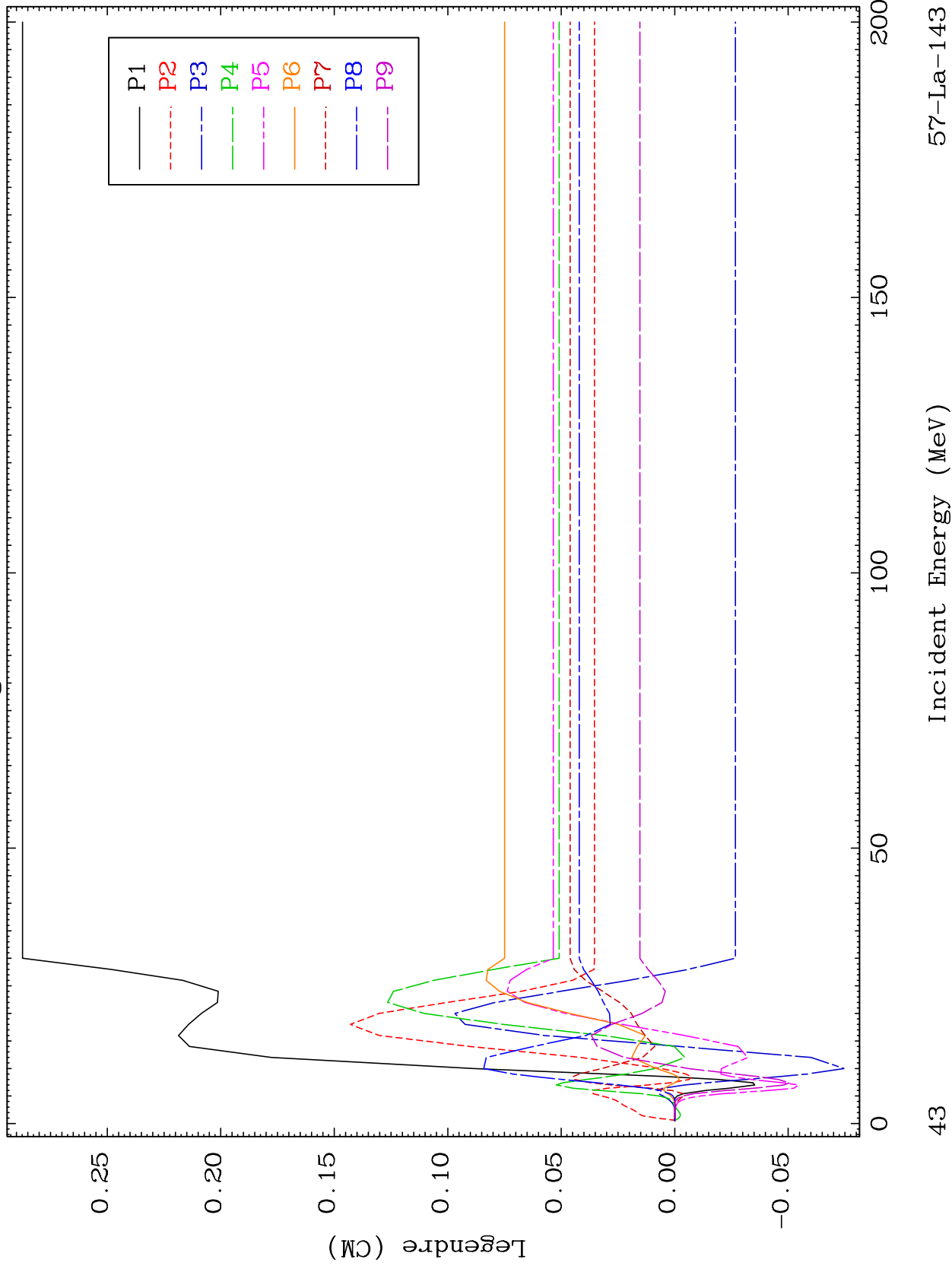

57-La-143

Incident Energy (MeV)

43

MAT 5740

MT= 57 (n,n') Level

57-La-143

Legendre Coefficients

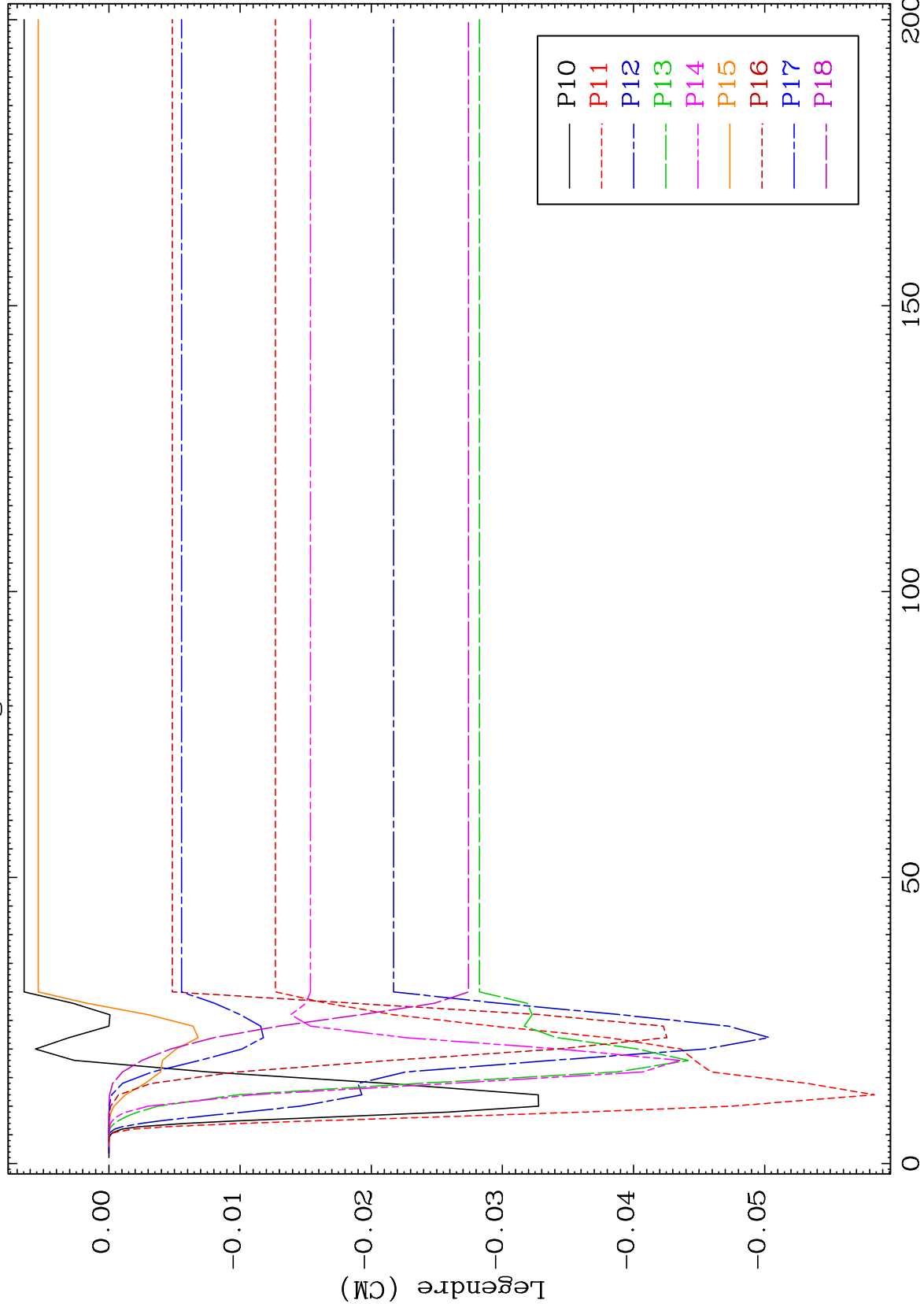

44

Incident Energy (MeV)

57-La-143

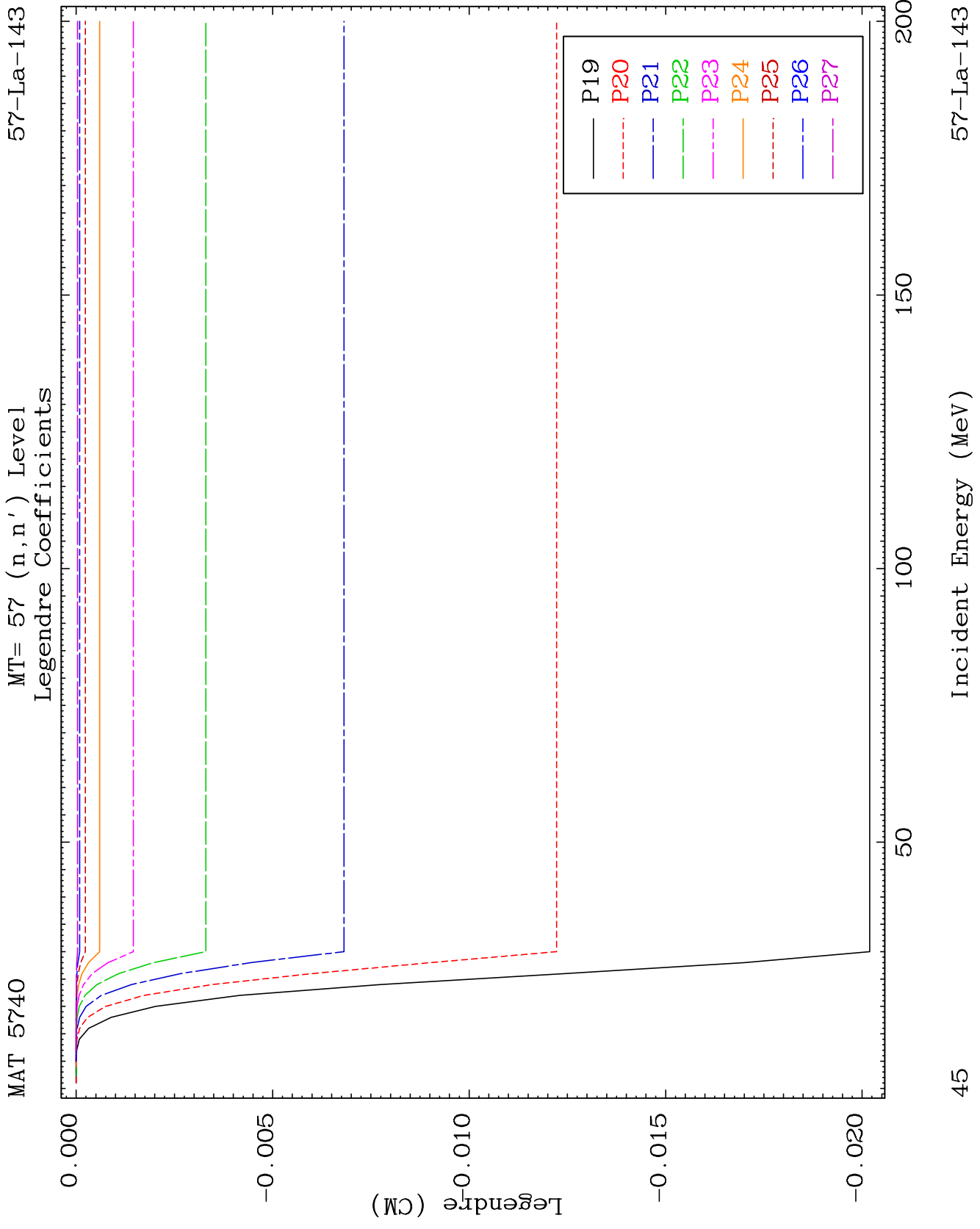

MAT 5740

MT= 57 (n,n') Level
Legendre Coefficients

57-La-143

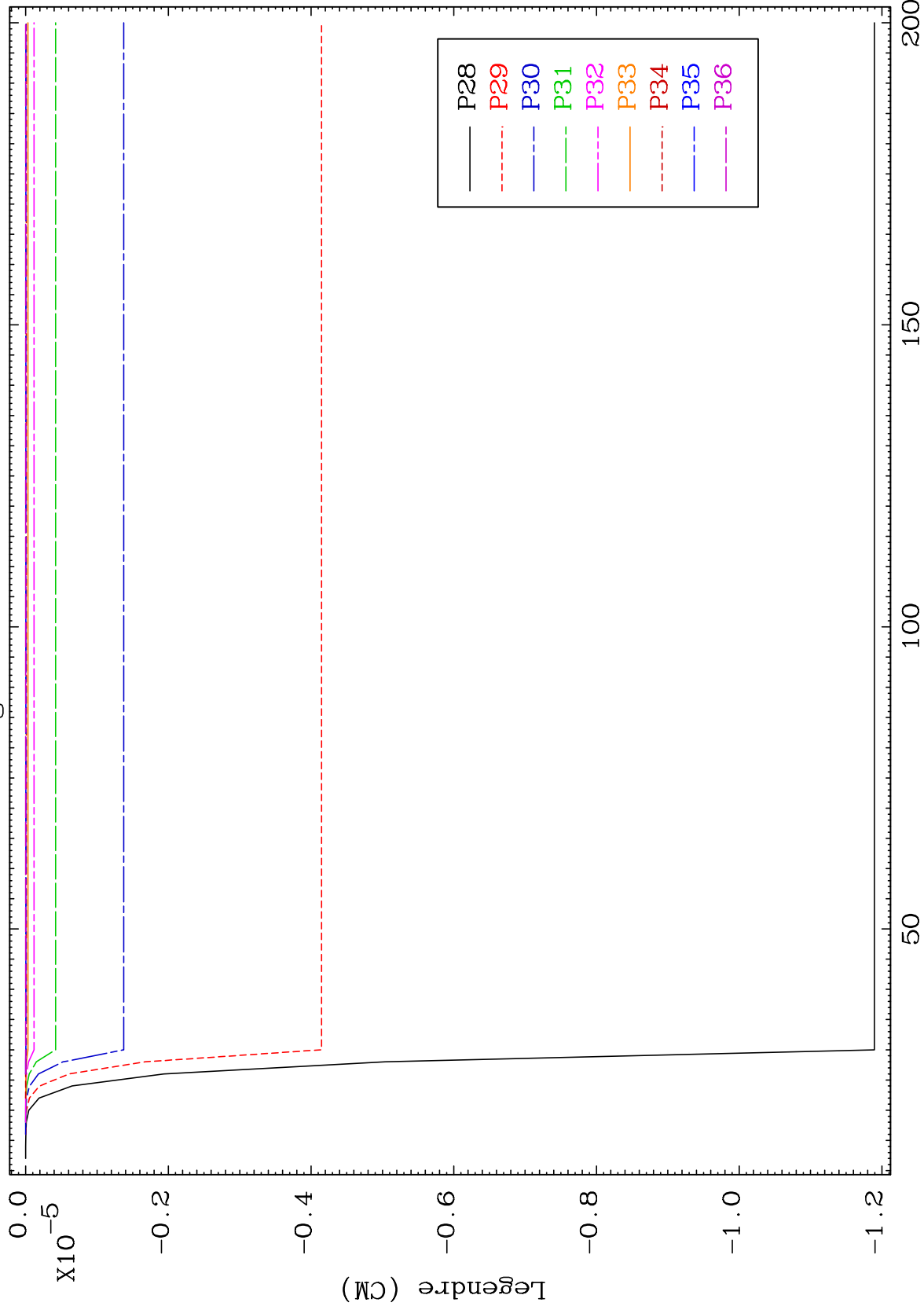

57-La-143

Incident Energy (MeV)

46

MAT 5740

MT= 58 (n,n') Level
Legendre Coefficients

57-La-143

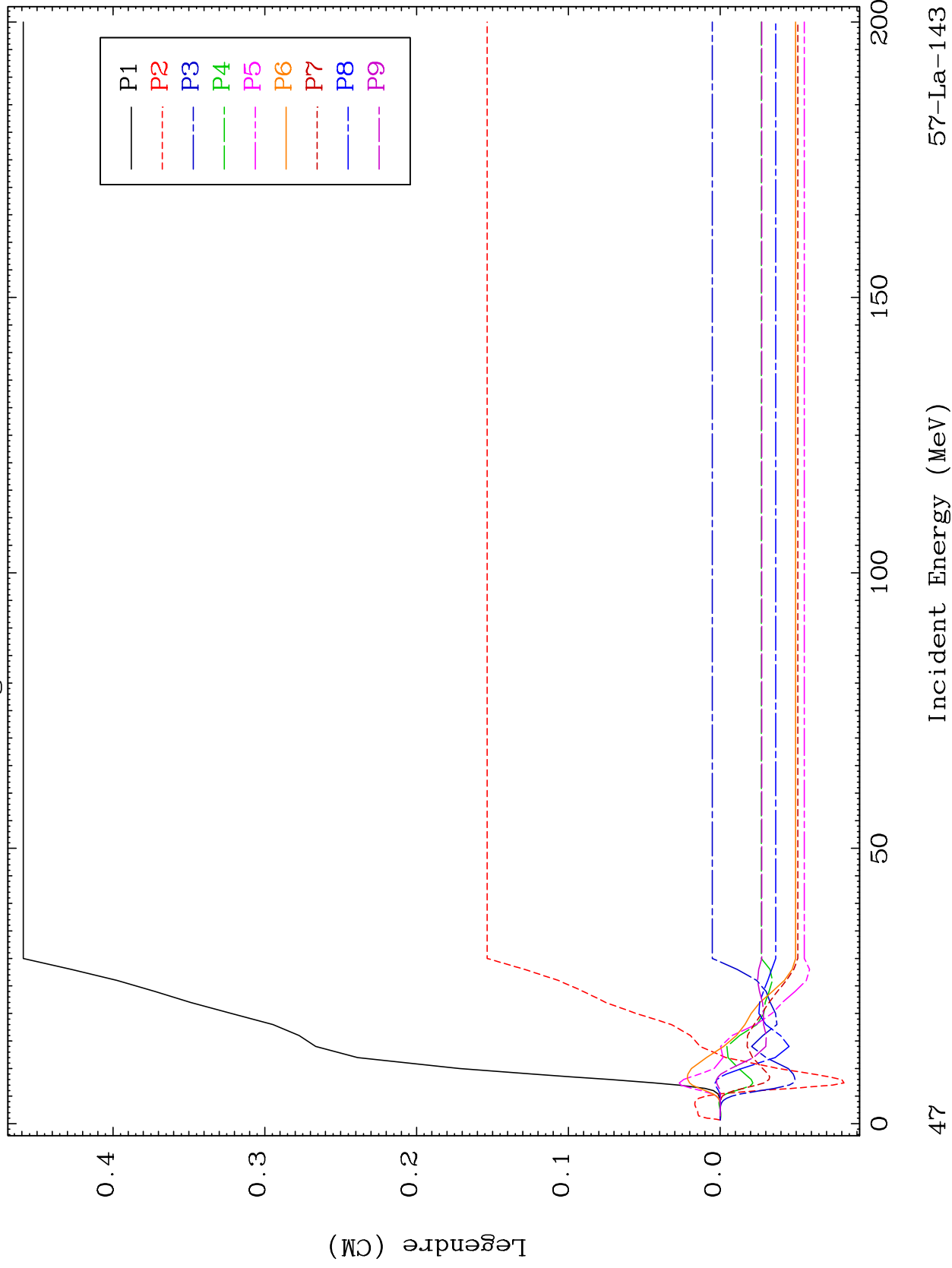

MAT 5740

MT= 58 (n,n') Level
Legendre Coefficients

57-La-143

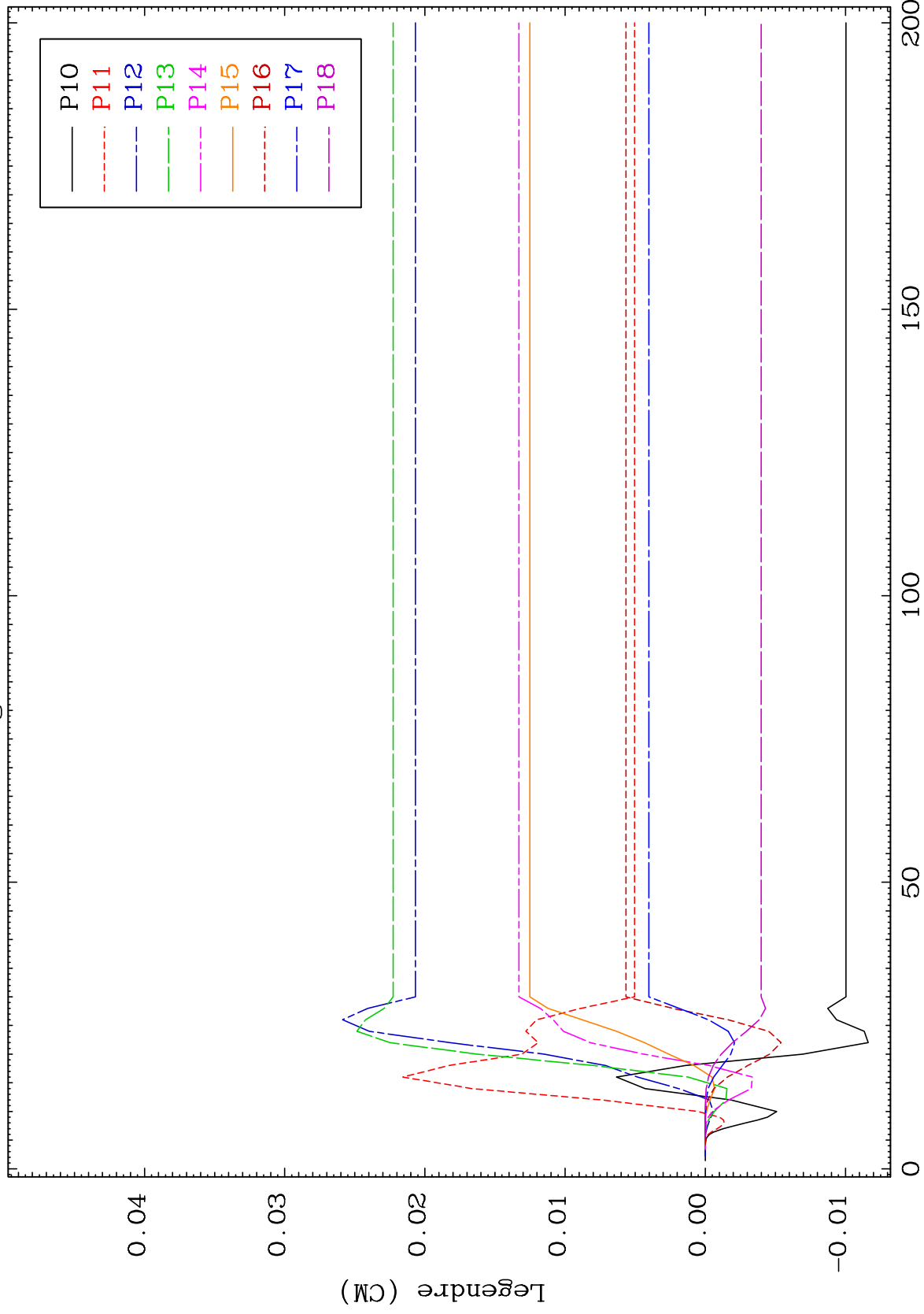

48

57-La-143

MAT 5740

MT= 58 (n,n') Level
Legendre Coefficients

57-La-143

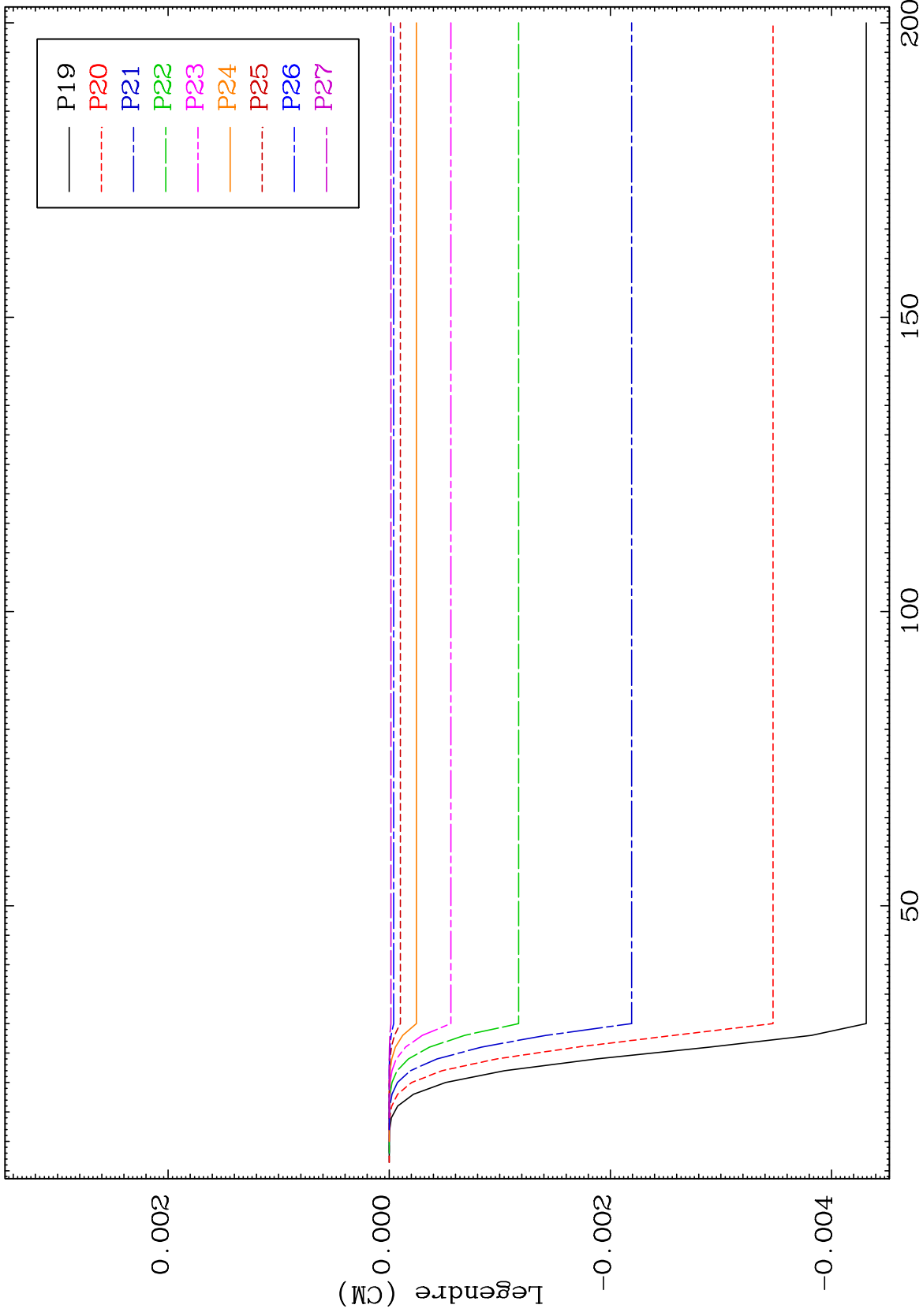

49

Incident Energy (MeV)

57-La-143

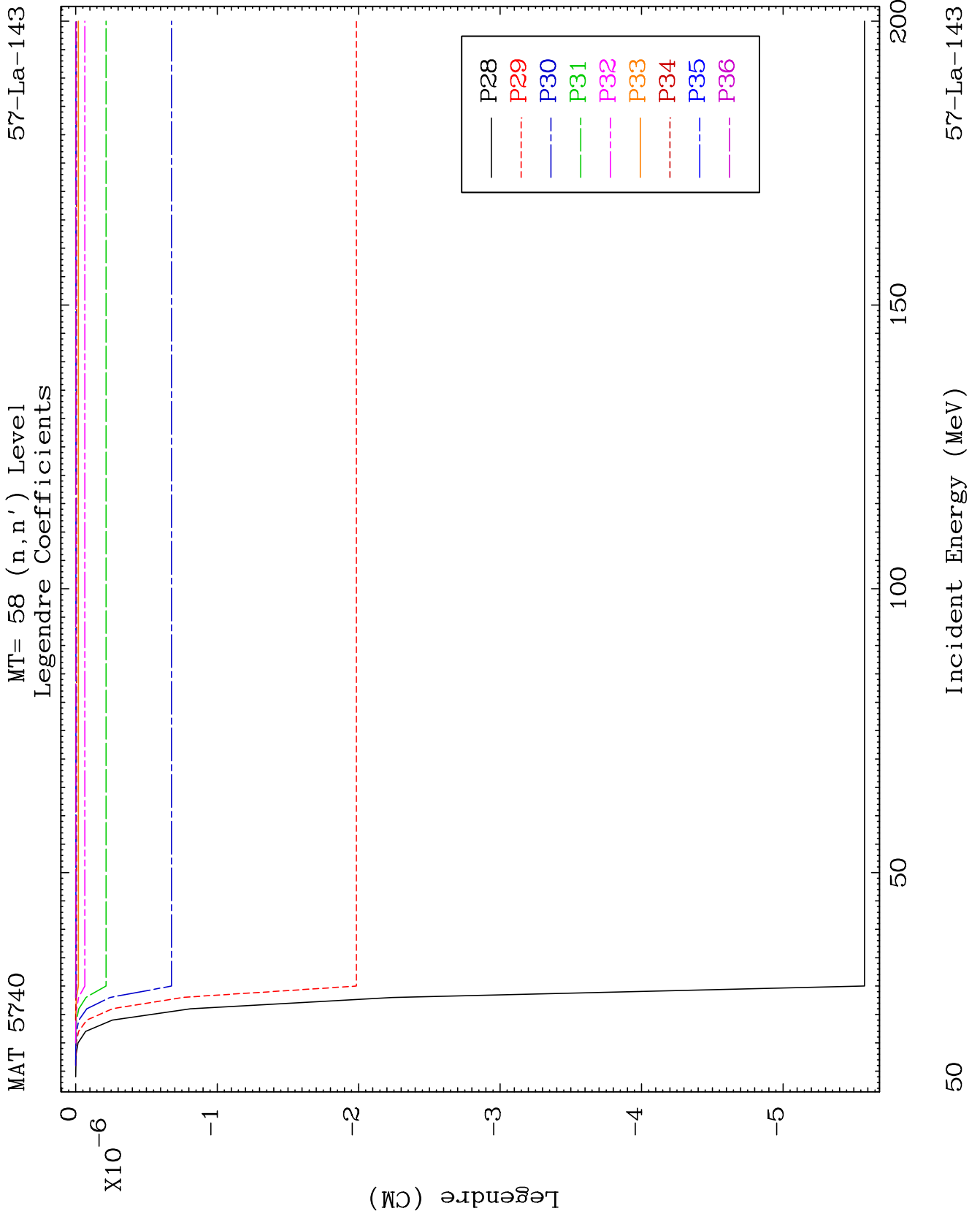

MAT 5740

MT= 59 (n,n') Level
Legendre Coefficients

57-La-143

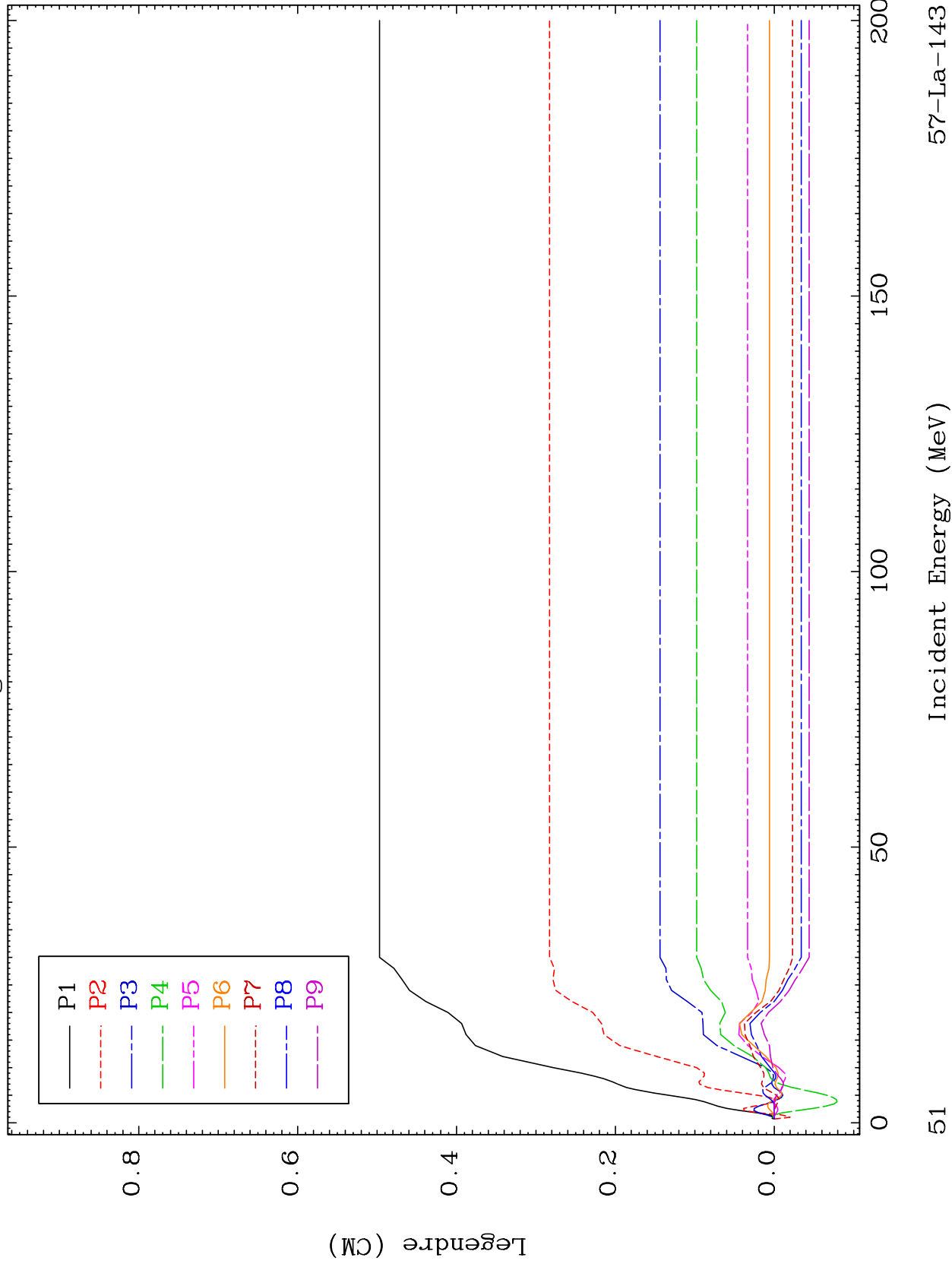

57-La-143

Incident Energy (MeV)

51

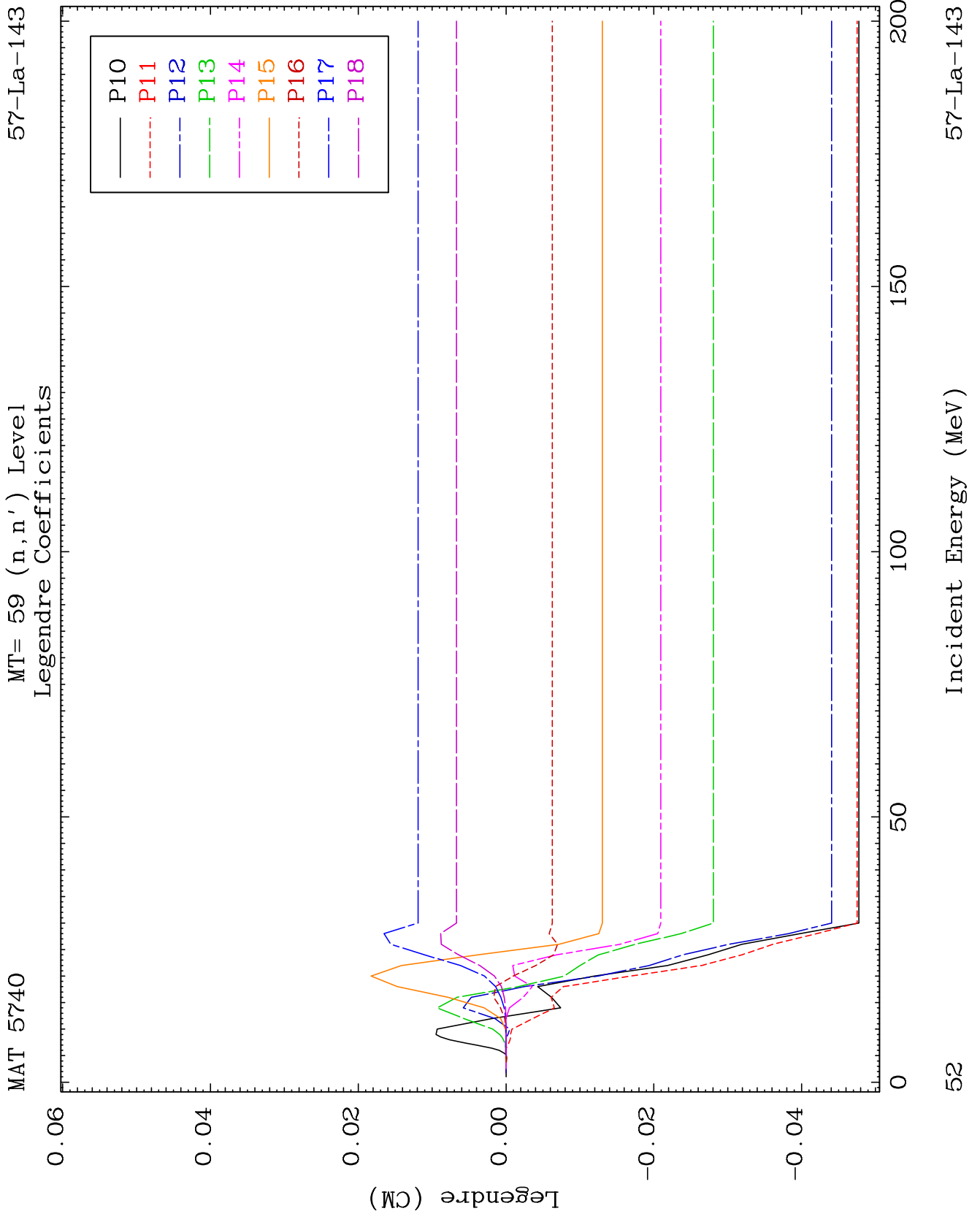

MAT 5740

MT= 59 (n,n') Level
Legendre Coefficients

57-La-143

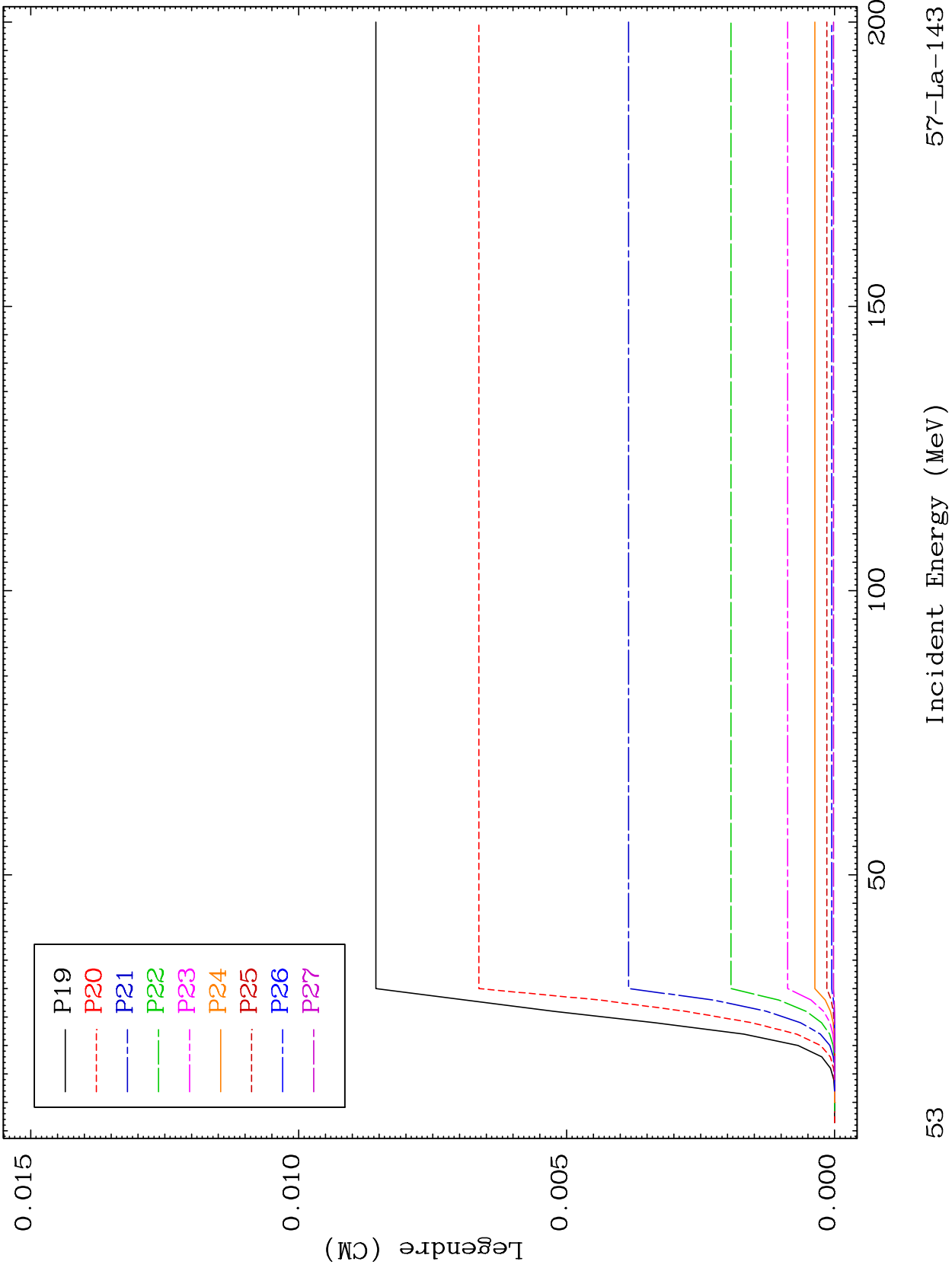

53

57-La-143

MAT 5740

MT= 59 (n,n') Level
Legendre Coefficients

57-La-143

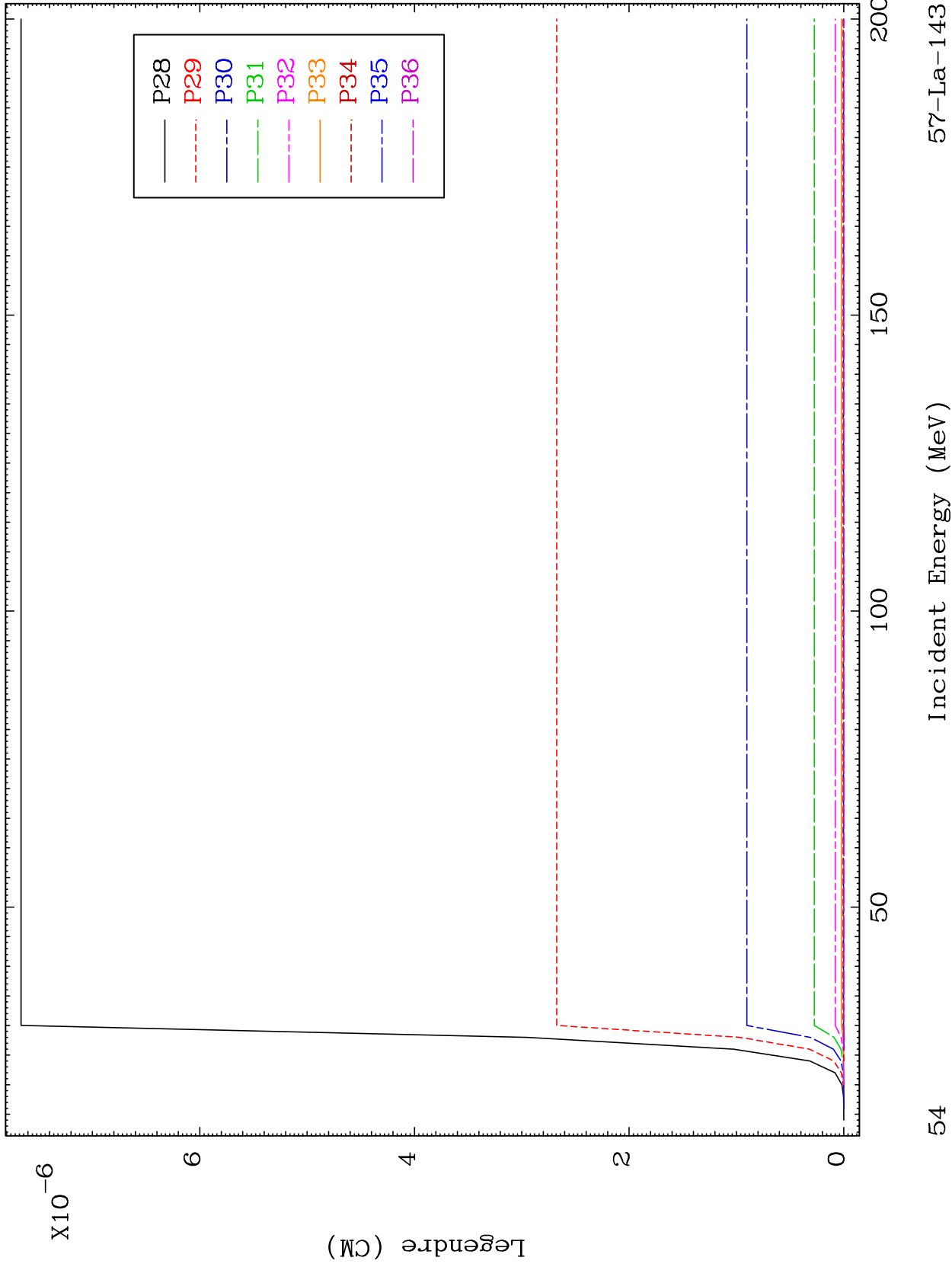

57-La-143

Incident Energy (MeV)

54

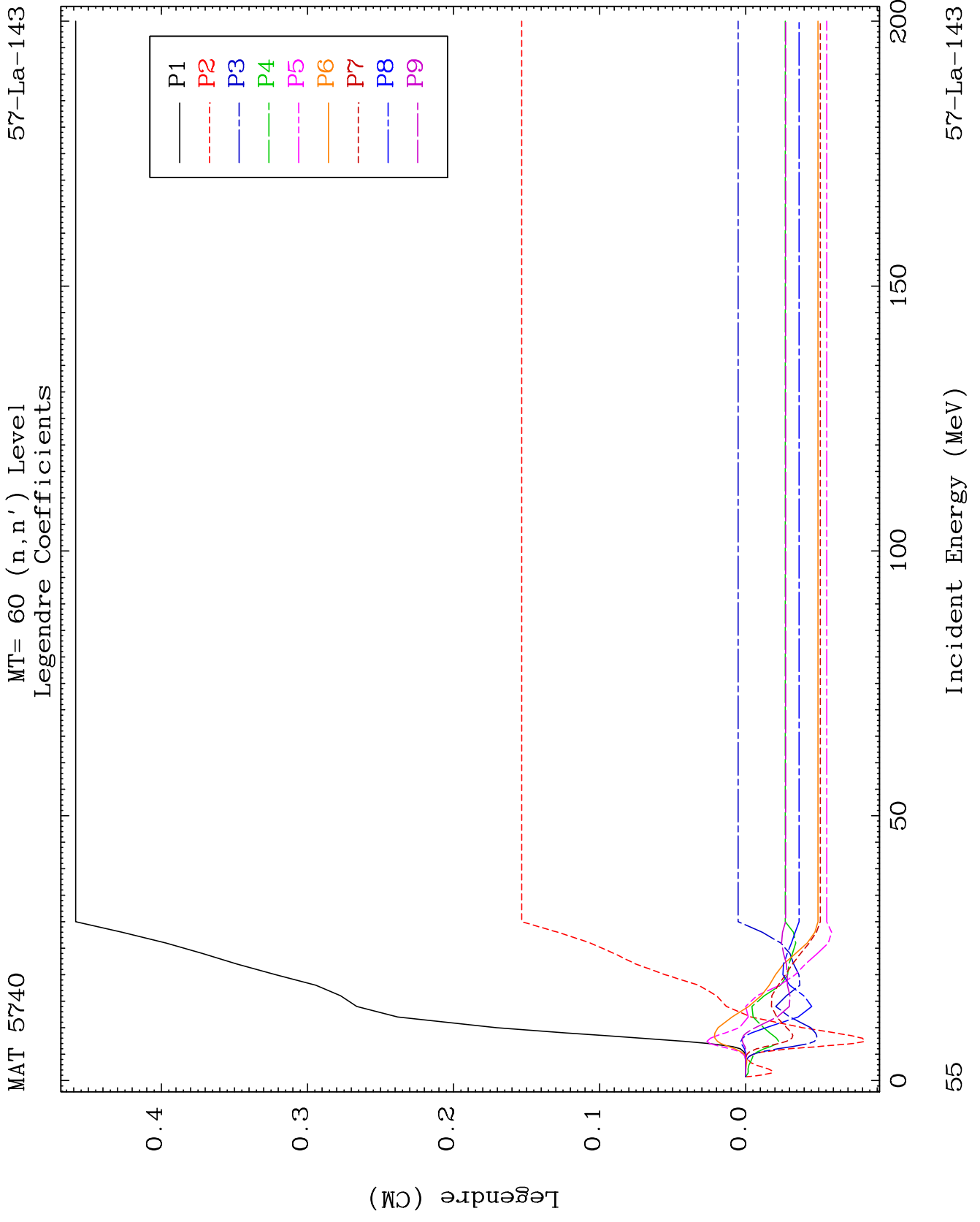

MAT 5740

MT= 60 (n,n') Level
Legendre Coefficients

57-La-143

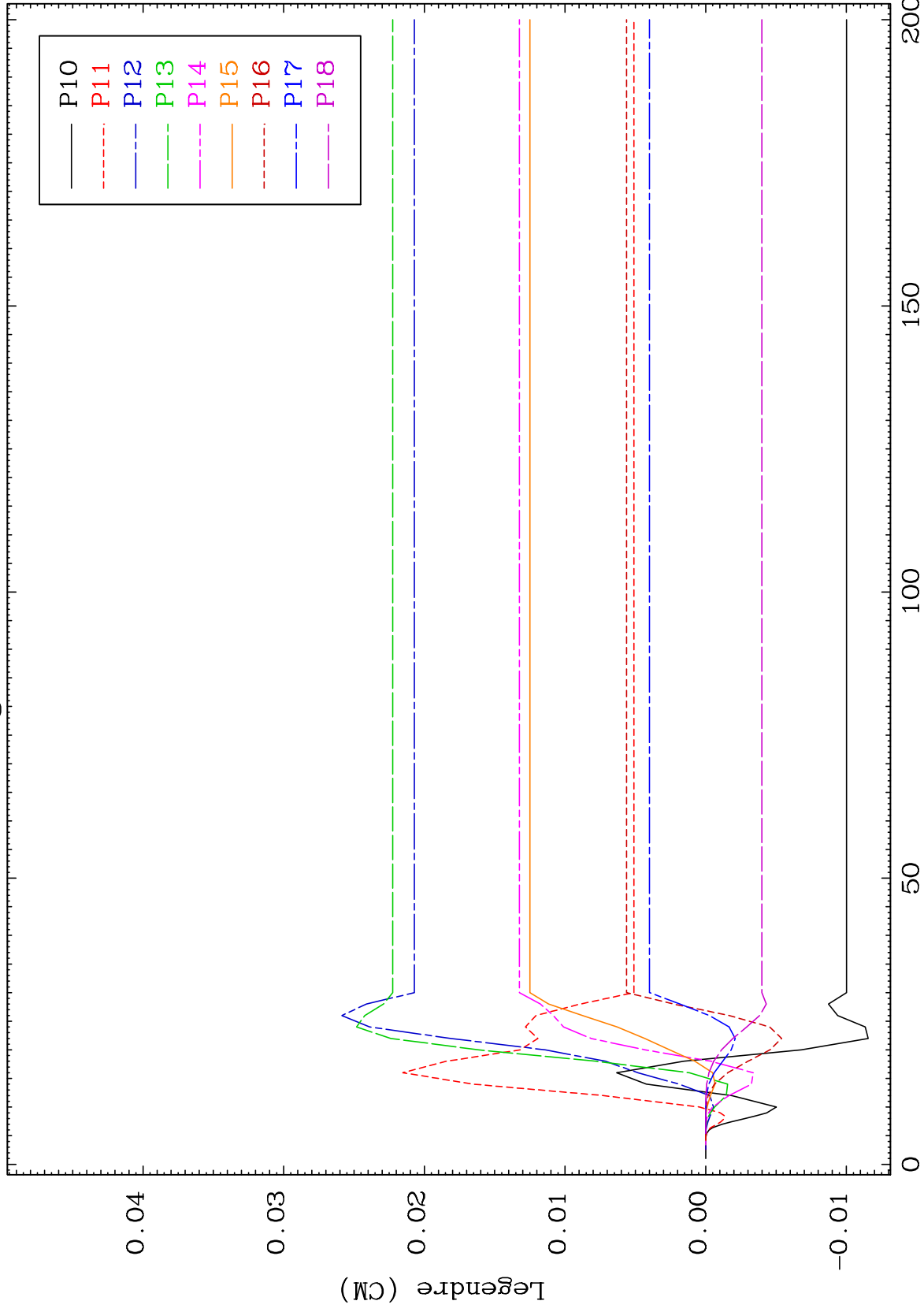

56

Incident Energy (MeV)

57-La-143

MAT 5740

MT= 60 (n,n') Level
Legendre Coefficients

57-La-143

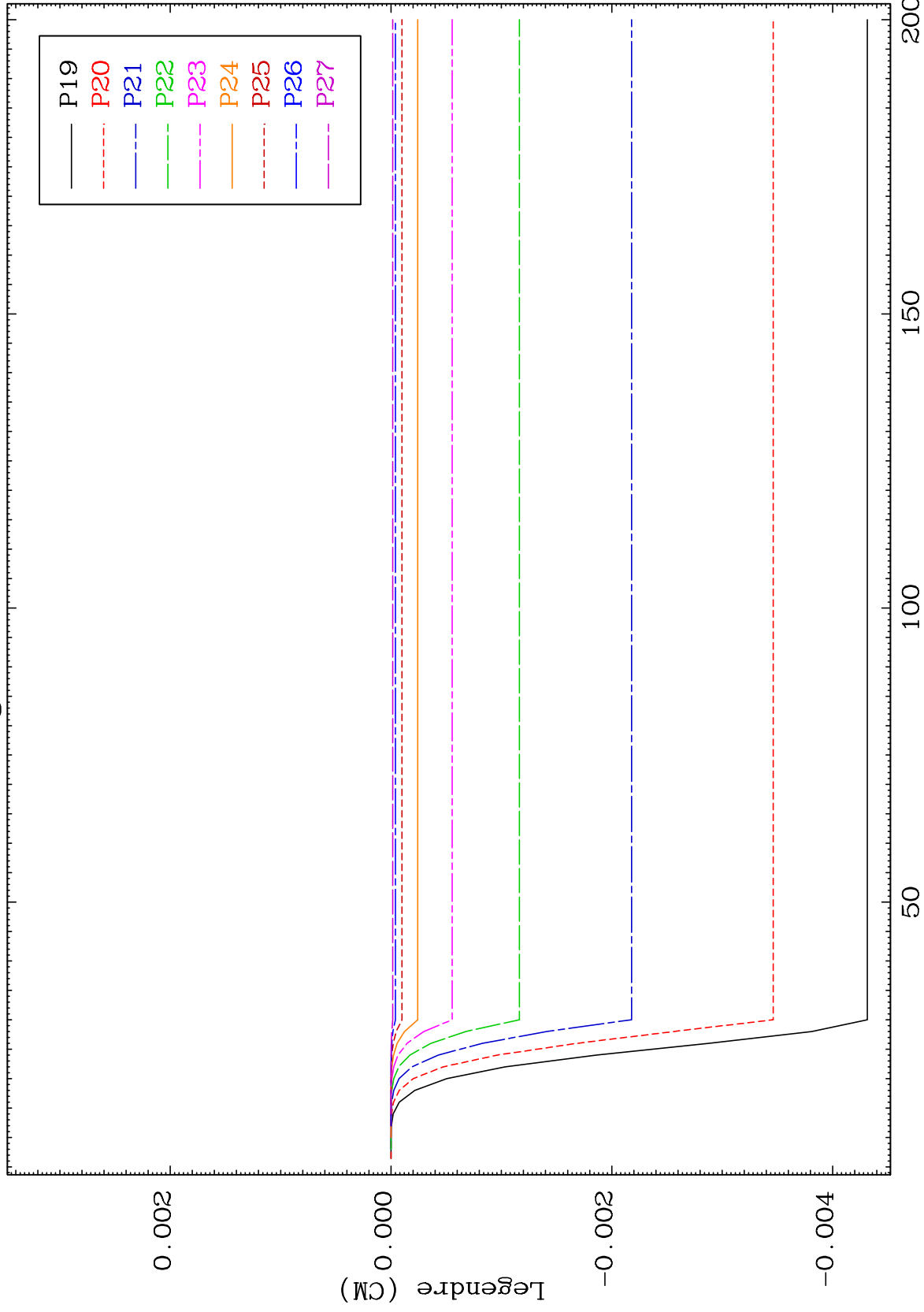

57

Incident Energy (MeV)

57-La-143

MAT 5740

MT= 60 (n,n') Level
Legendre Coefficients

57-La-143

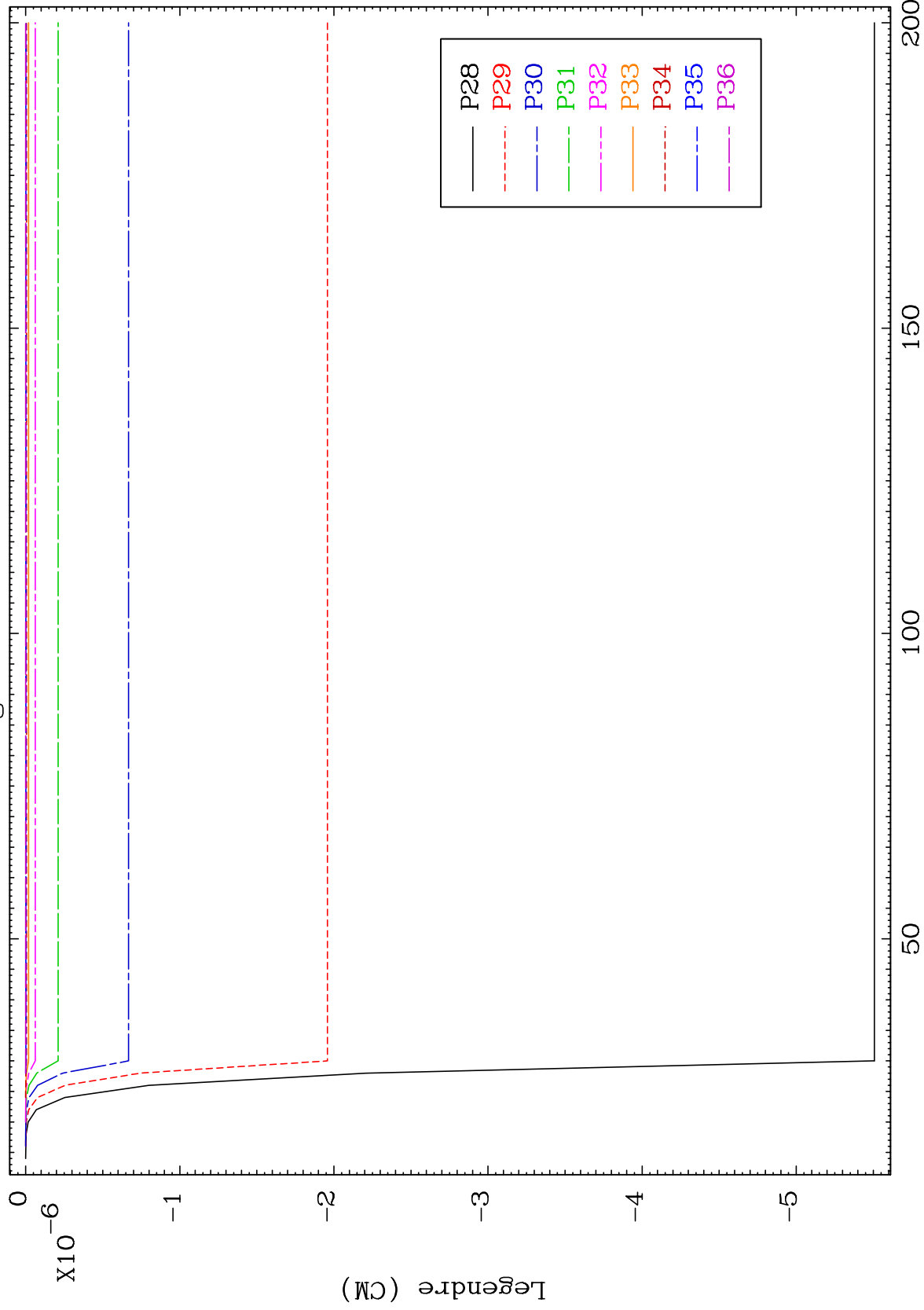

58

Incident Energy (MeV)

57-La-143

MAT 5740

MT= 61 (n,n') Level
Legendre Coefficients

57-La-143

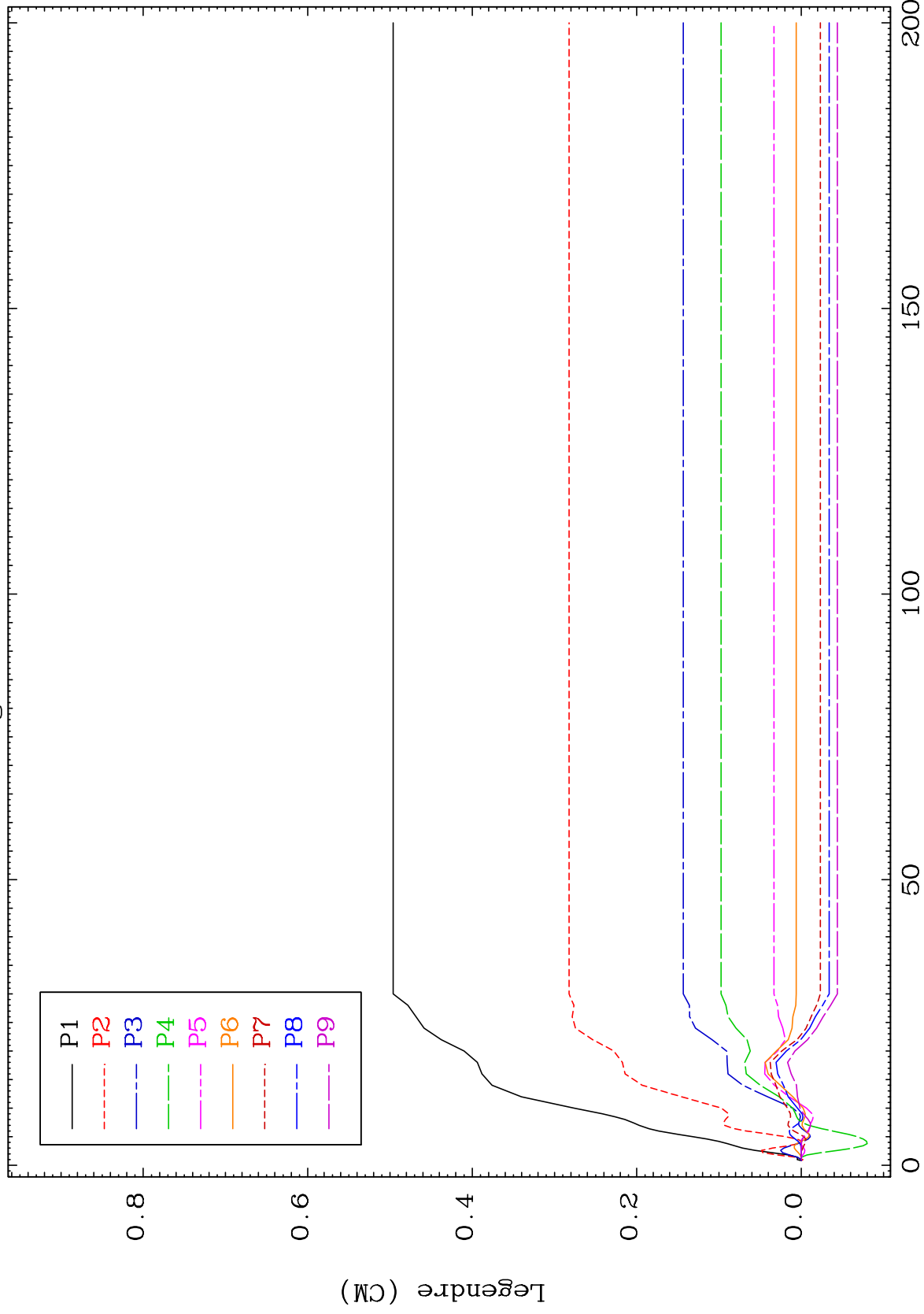

59

Incident Energy (MeV)

57-La-143

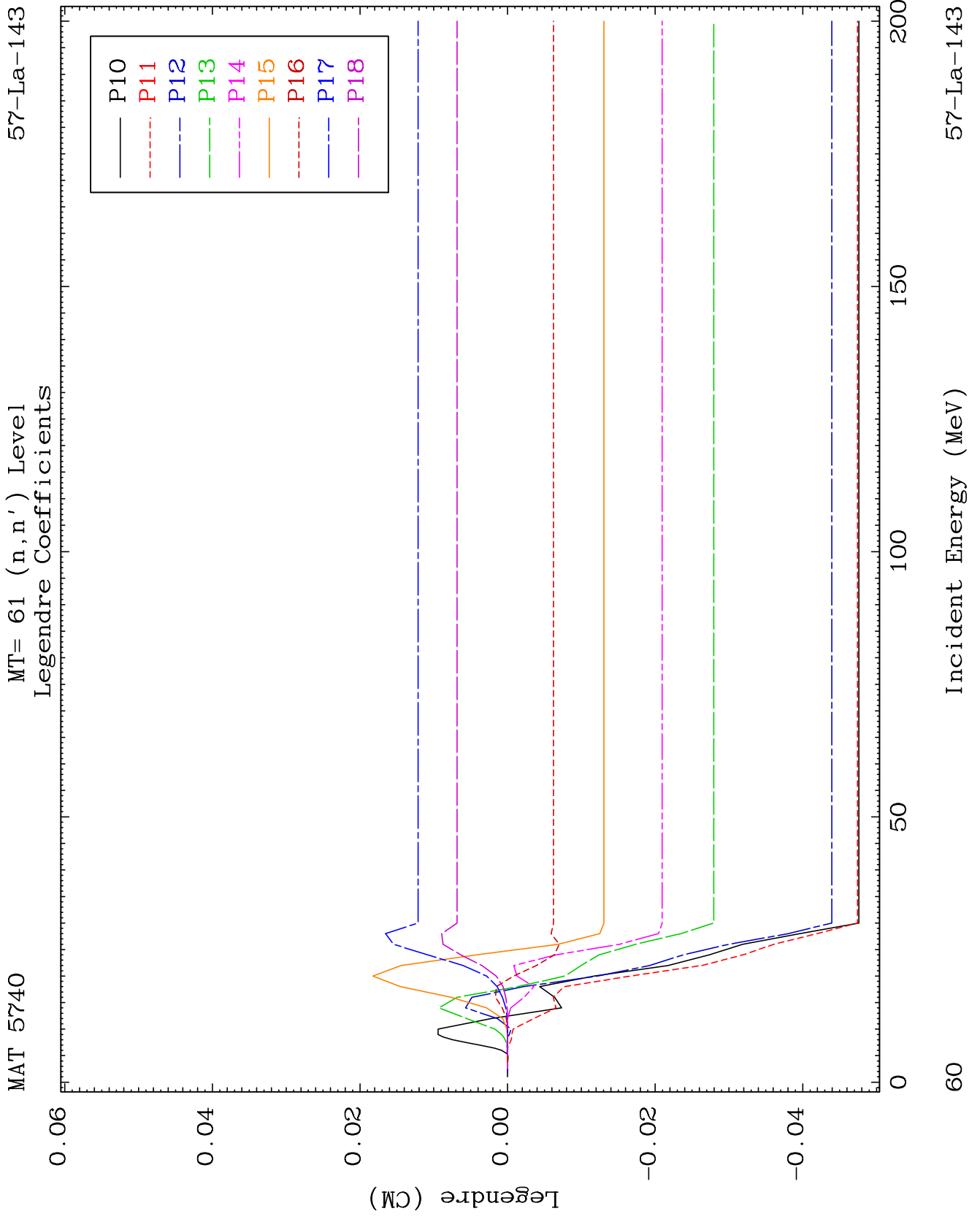

MAT 5740

MT= 61 (n,n') Level
Legendre Coefficients

57-La-143

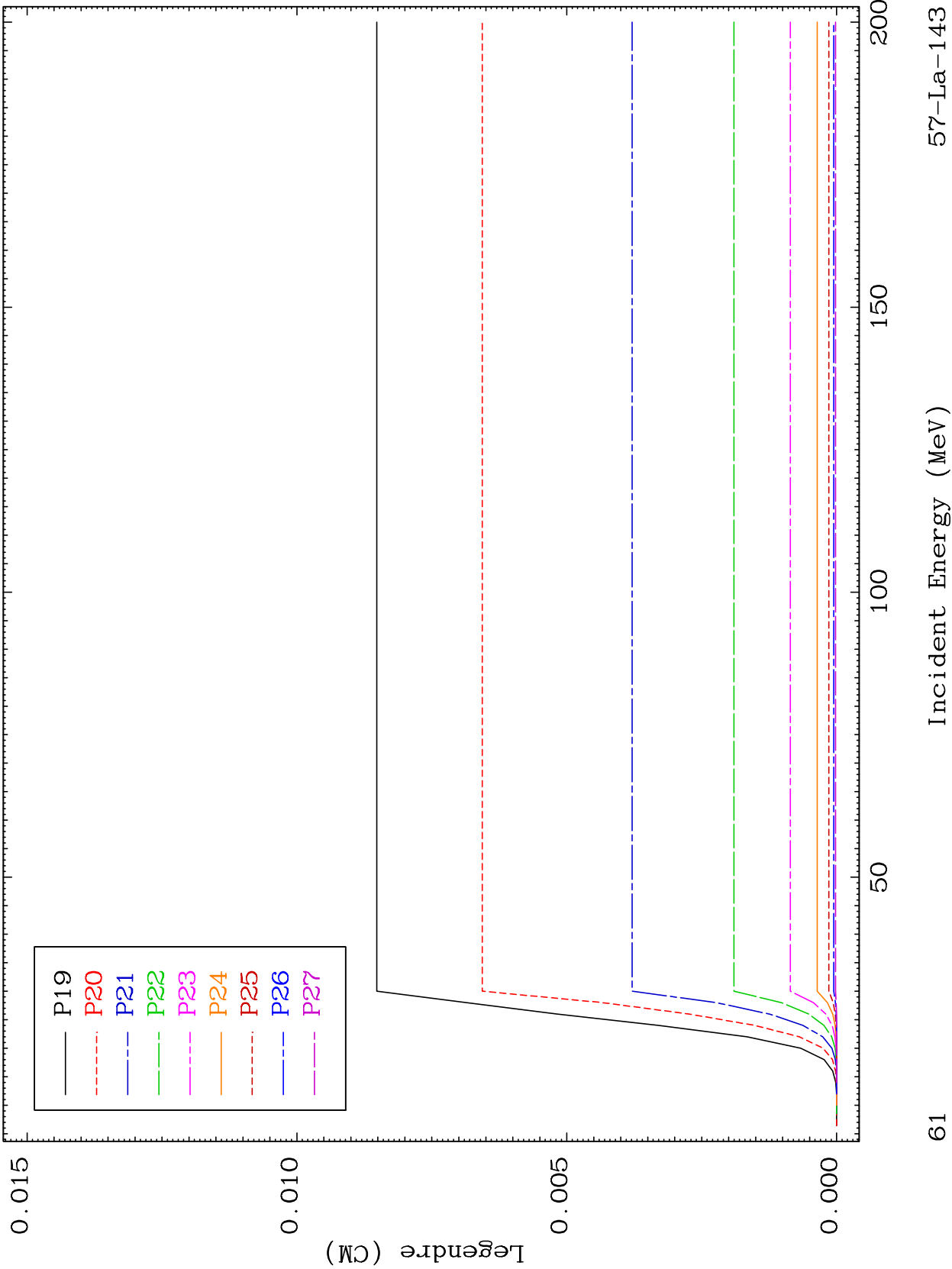

61

Incident Energy (MeV)

57-La-143

MAT 5740

MT= 61 (n,n') Level
Legendre Coefficients

57-La-143

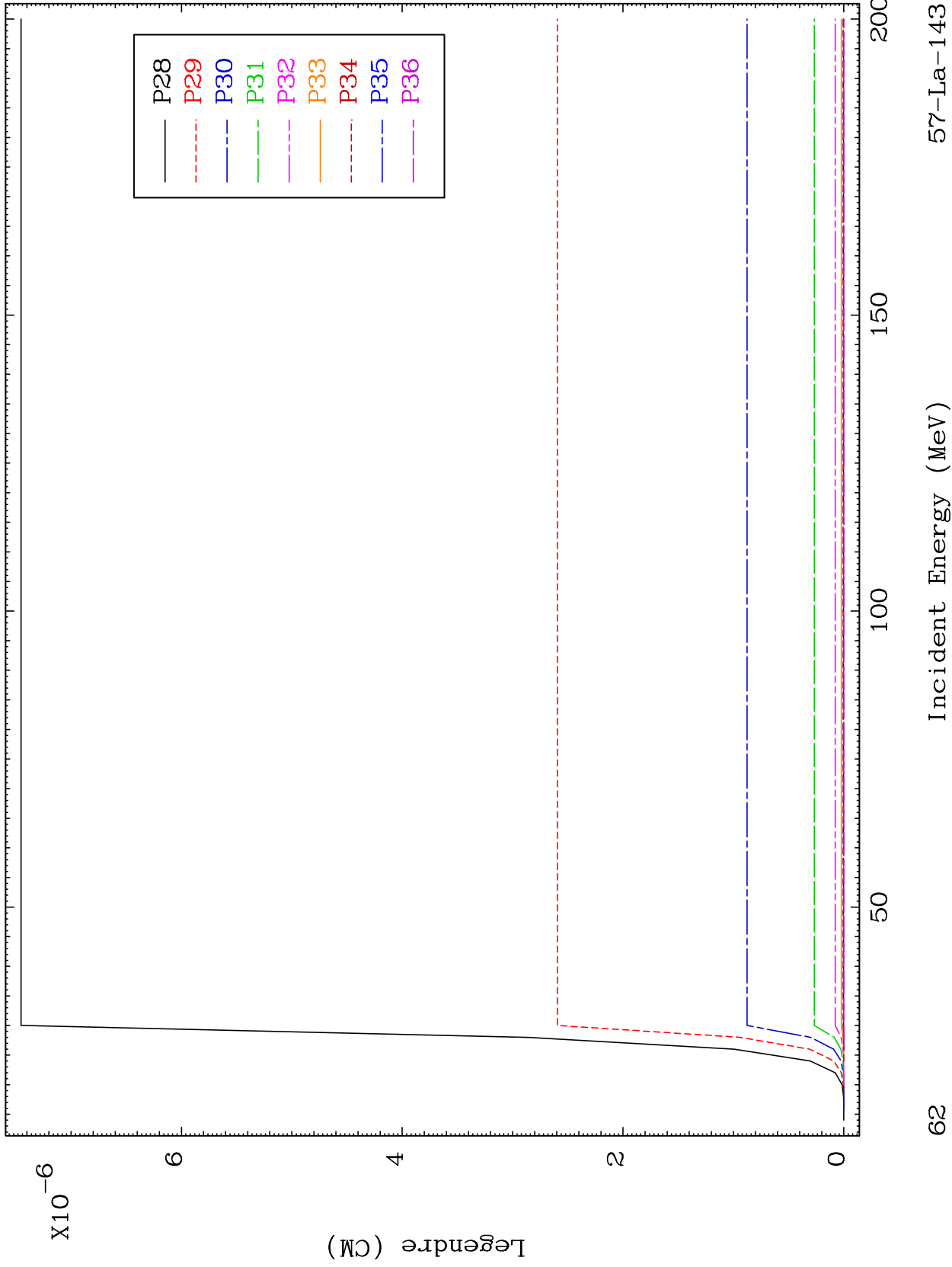

MAT 5740

MT= 62 (n,n') Level
Legendre Coefficients

57-La-143

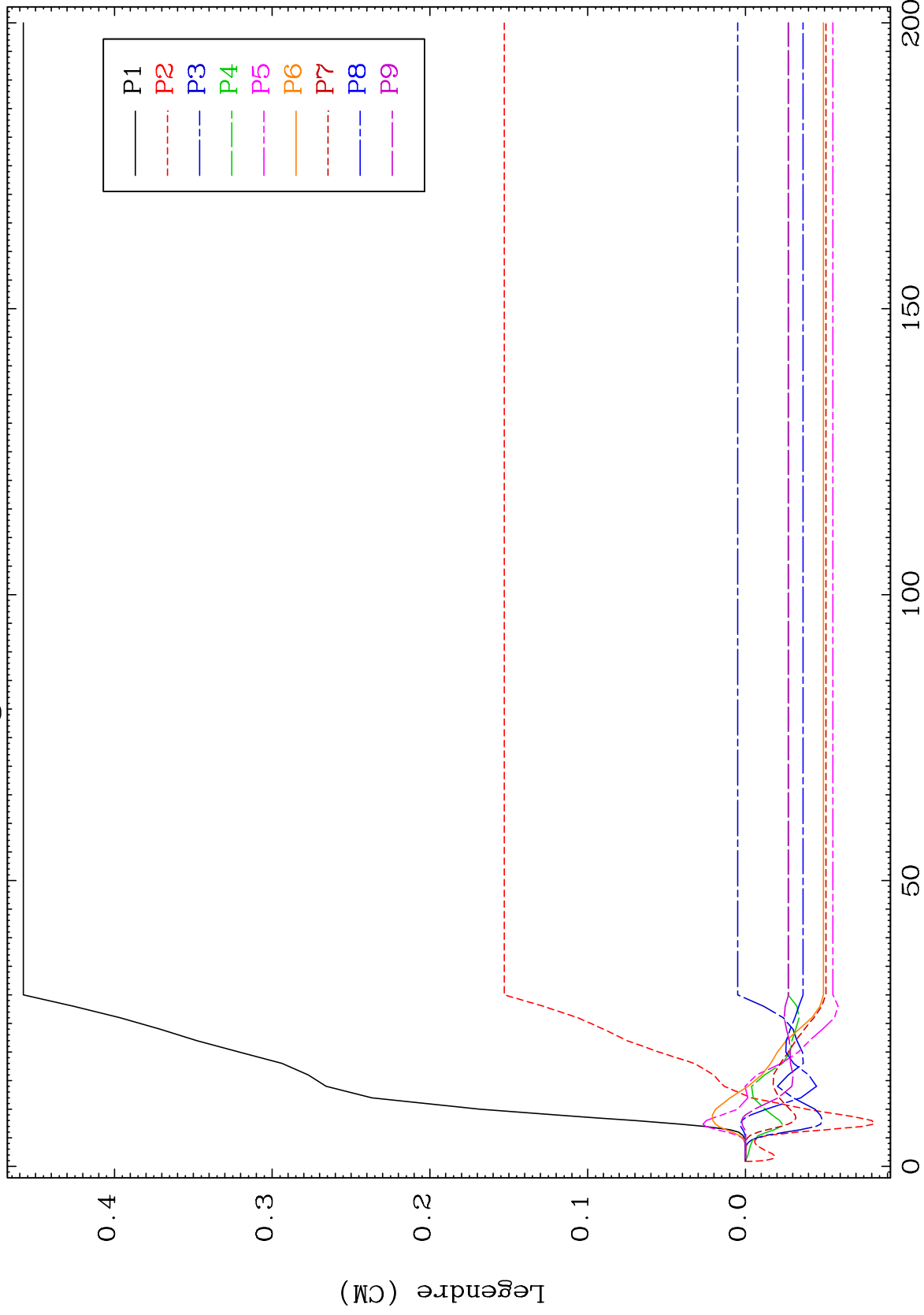

63

Incident Energy (MeV)

57-La-143

MAT 5740

MT= 62 (n,n') Level
Legendre Coefficients

57-La-143

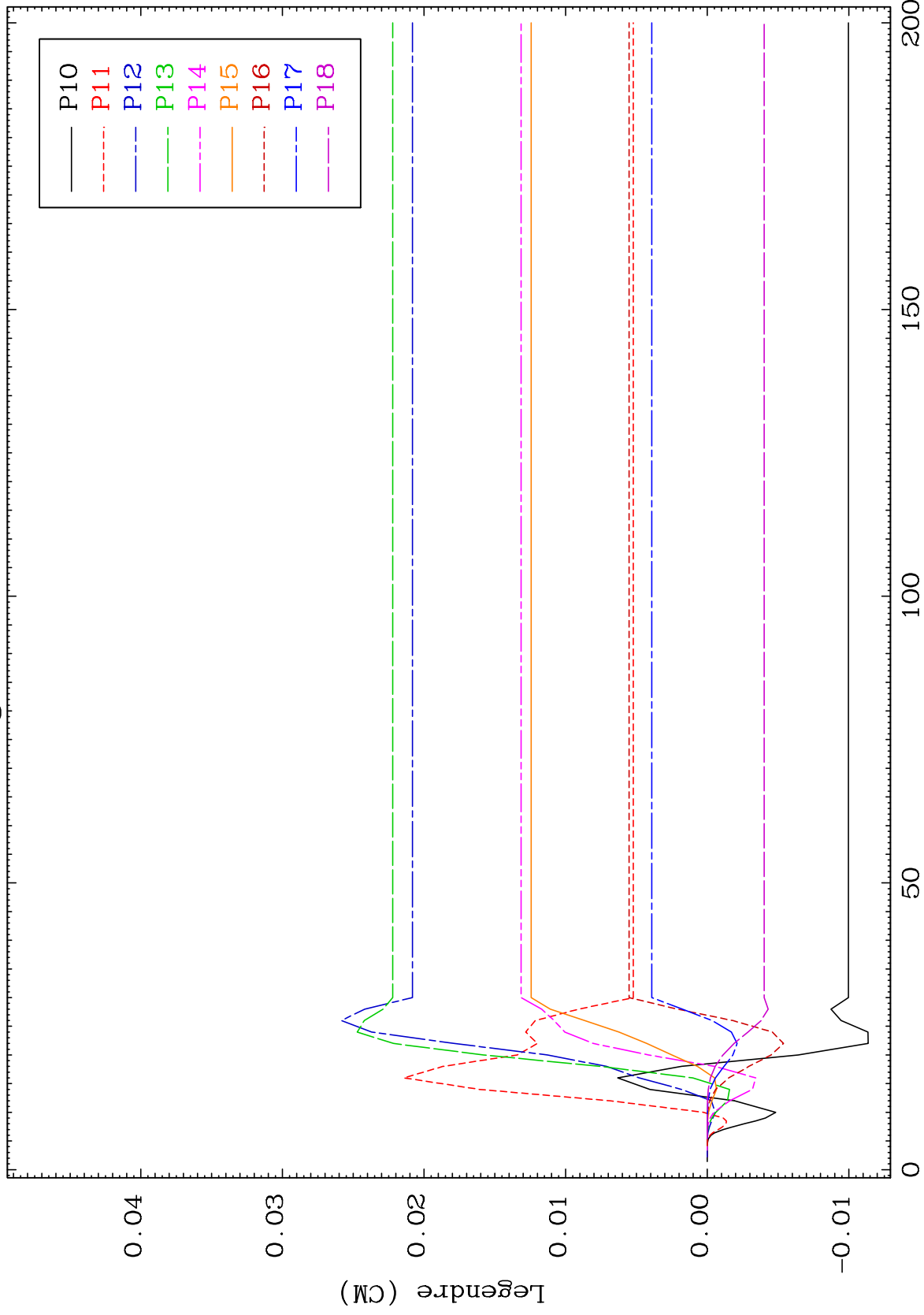

64

Incident Energy (MeV)

57-La-143

MAT 5740

MT= 62 (n,n') Level
Legendre Coefficients

57-La-143

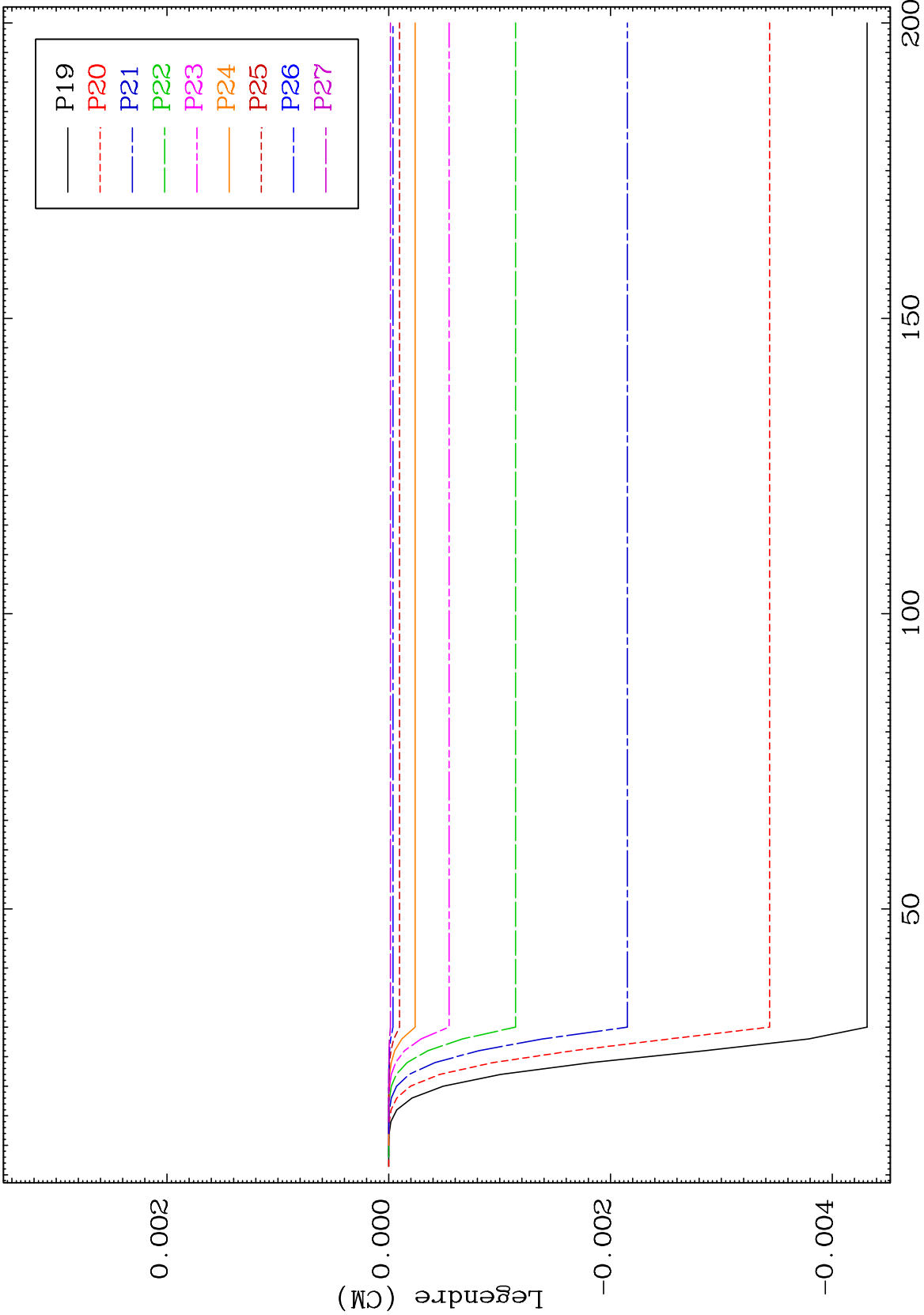

65

Incident Energy (MeV)

57-La-143

MAT 5740

MT= 62 (n,n') Level
Legendre Coefficients

57-La-143

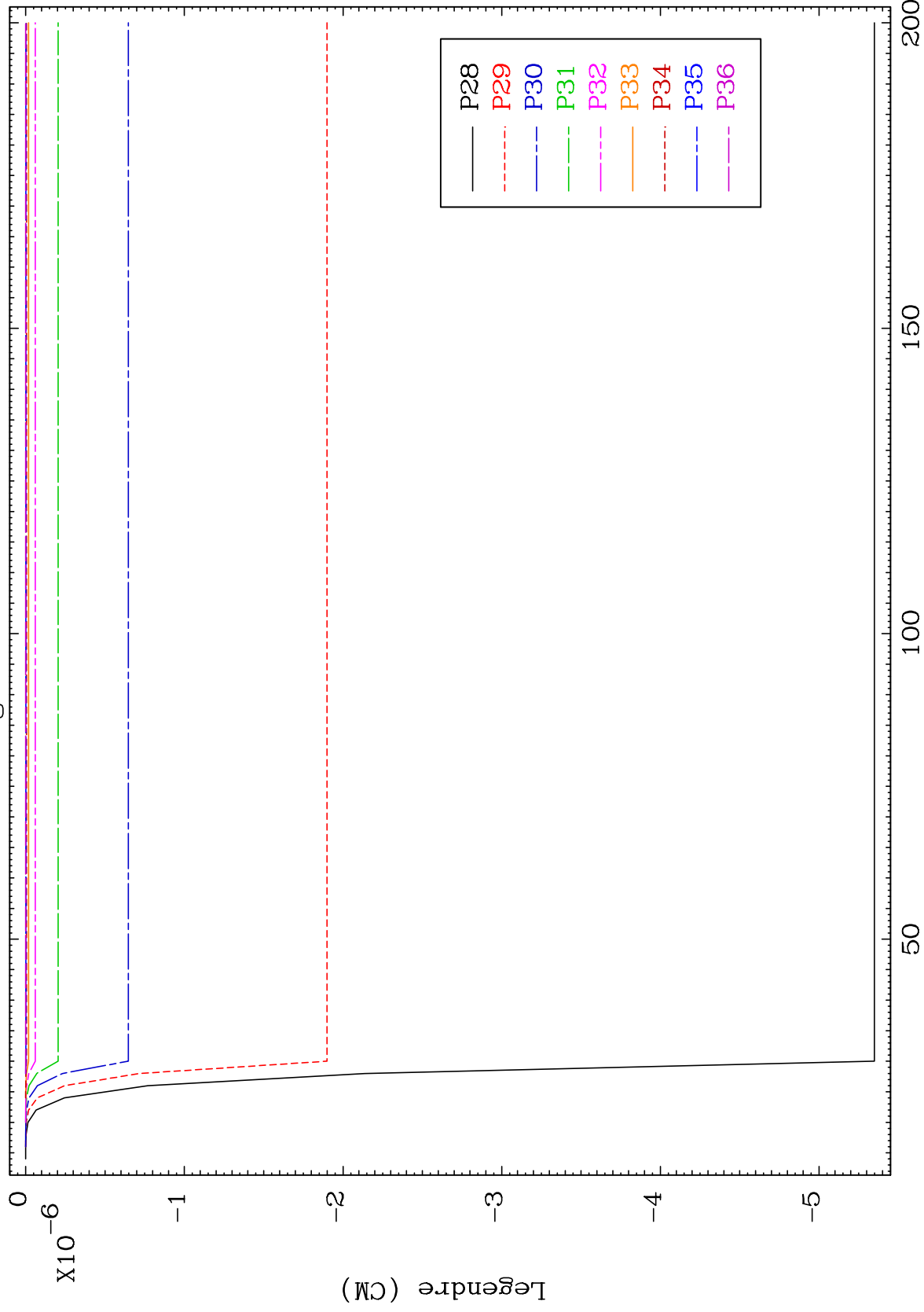

66

Incident Energy (MeV)

57-La-143

MAT 5740

MT= 63 (n,n') Level
Legendre Coefficients

57-La-143

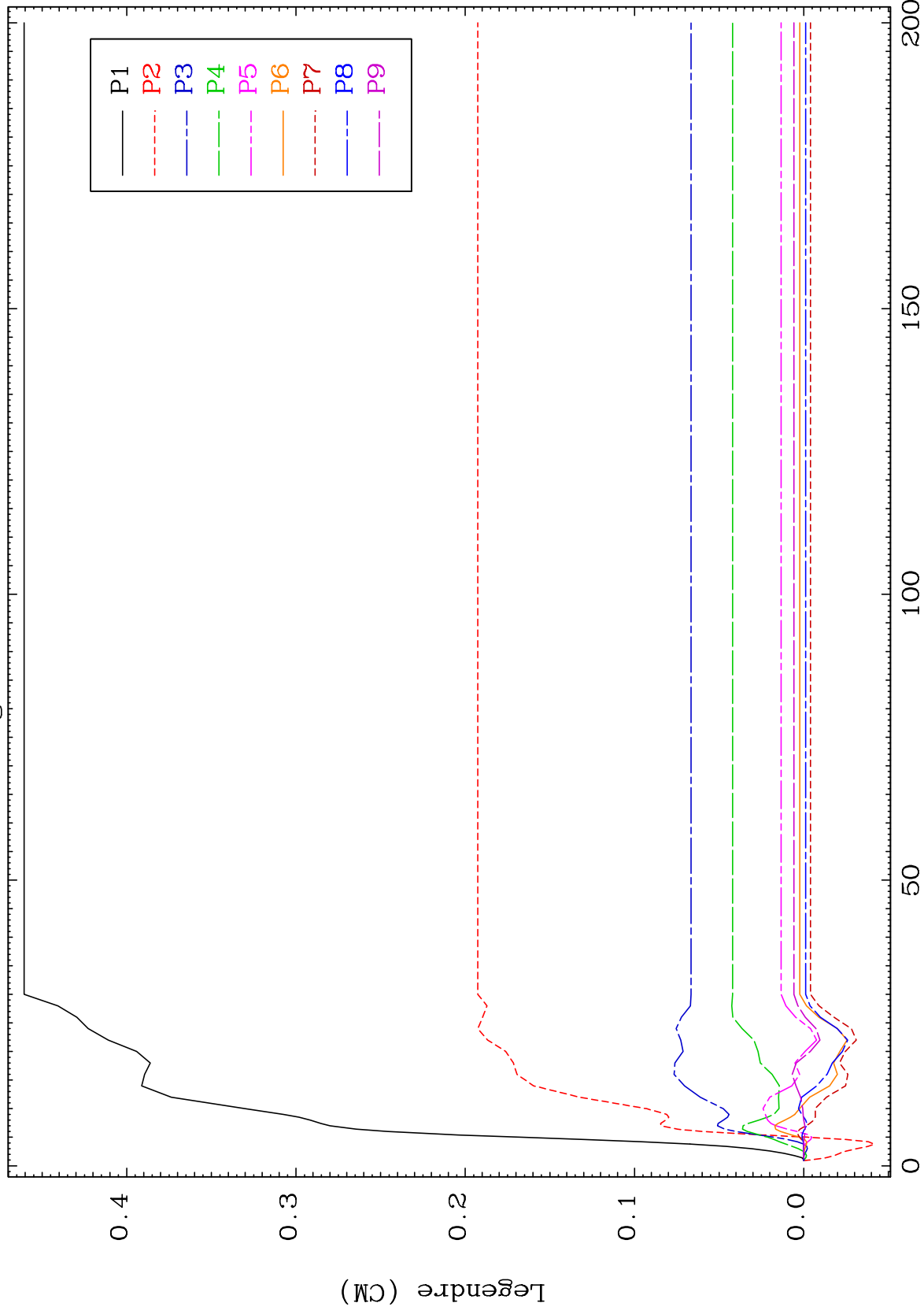

67

57-La-143

MAT 5740

MT= 63 (n,n') Level
Legendre Coefficients

57-La-143

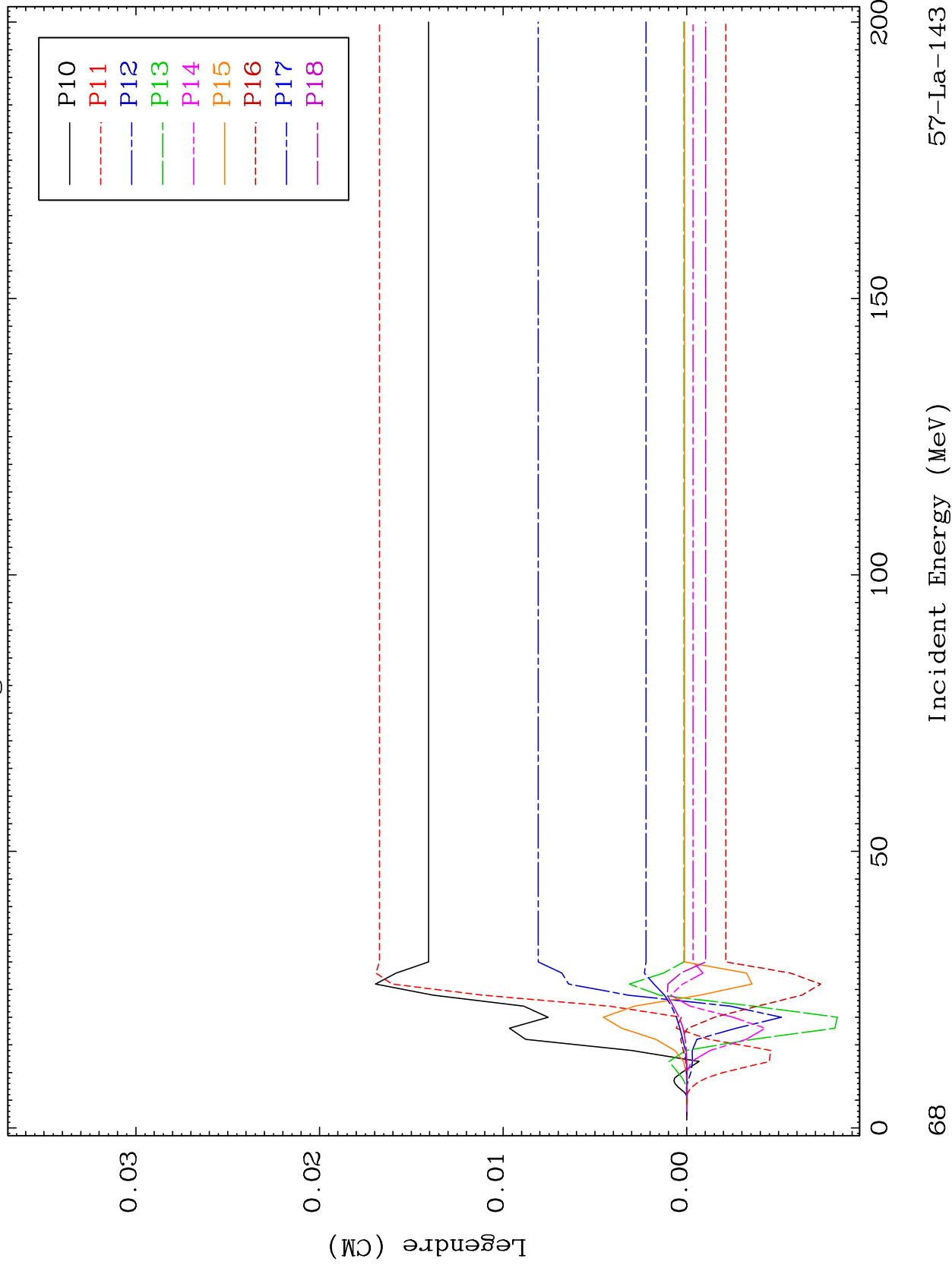

57-La-143

Incident Energy (MeV)

68

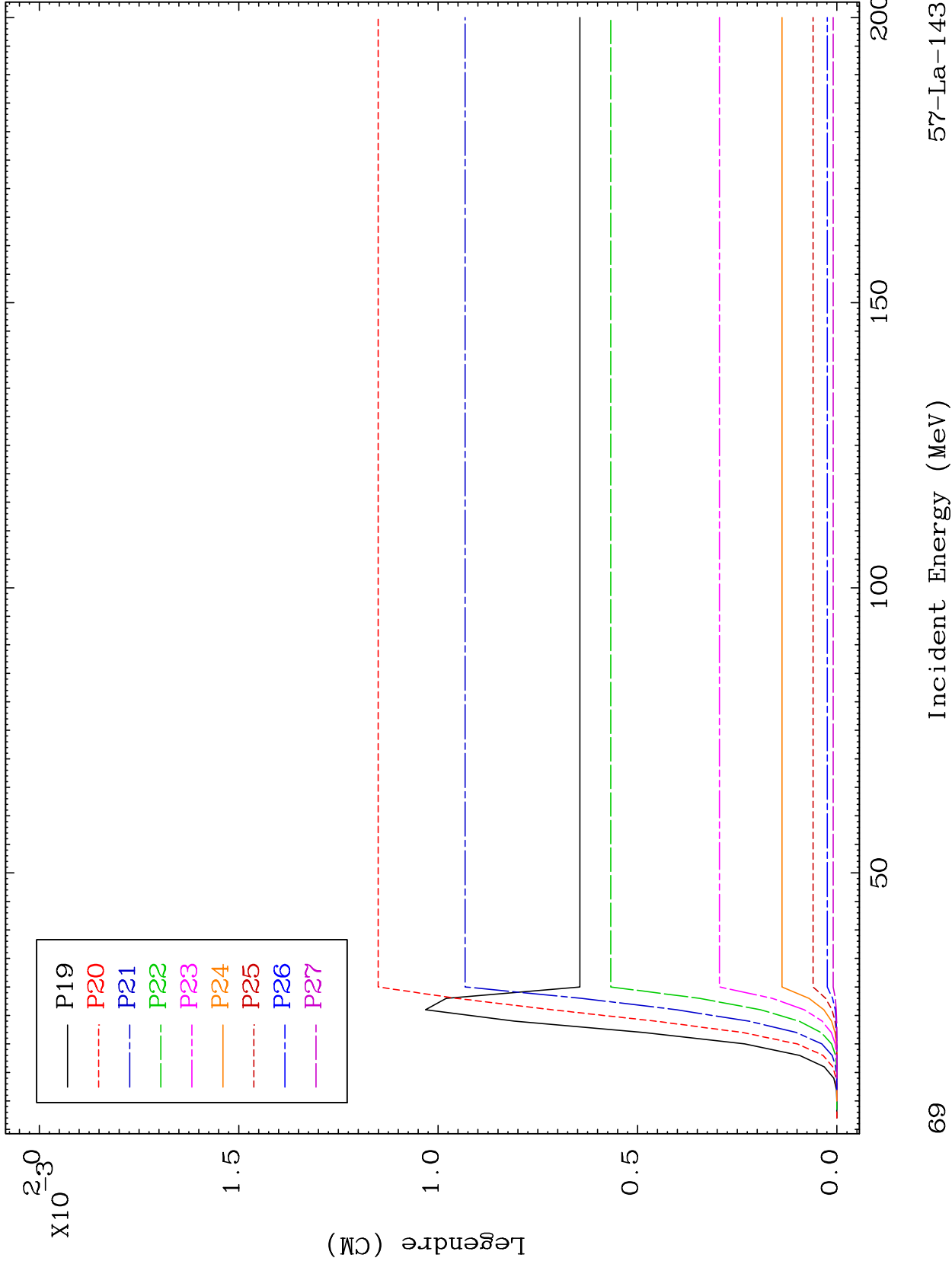

MAT 5740

MT= 63 (n,n') Level
Legendre Coefficients

57-La-143

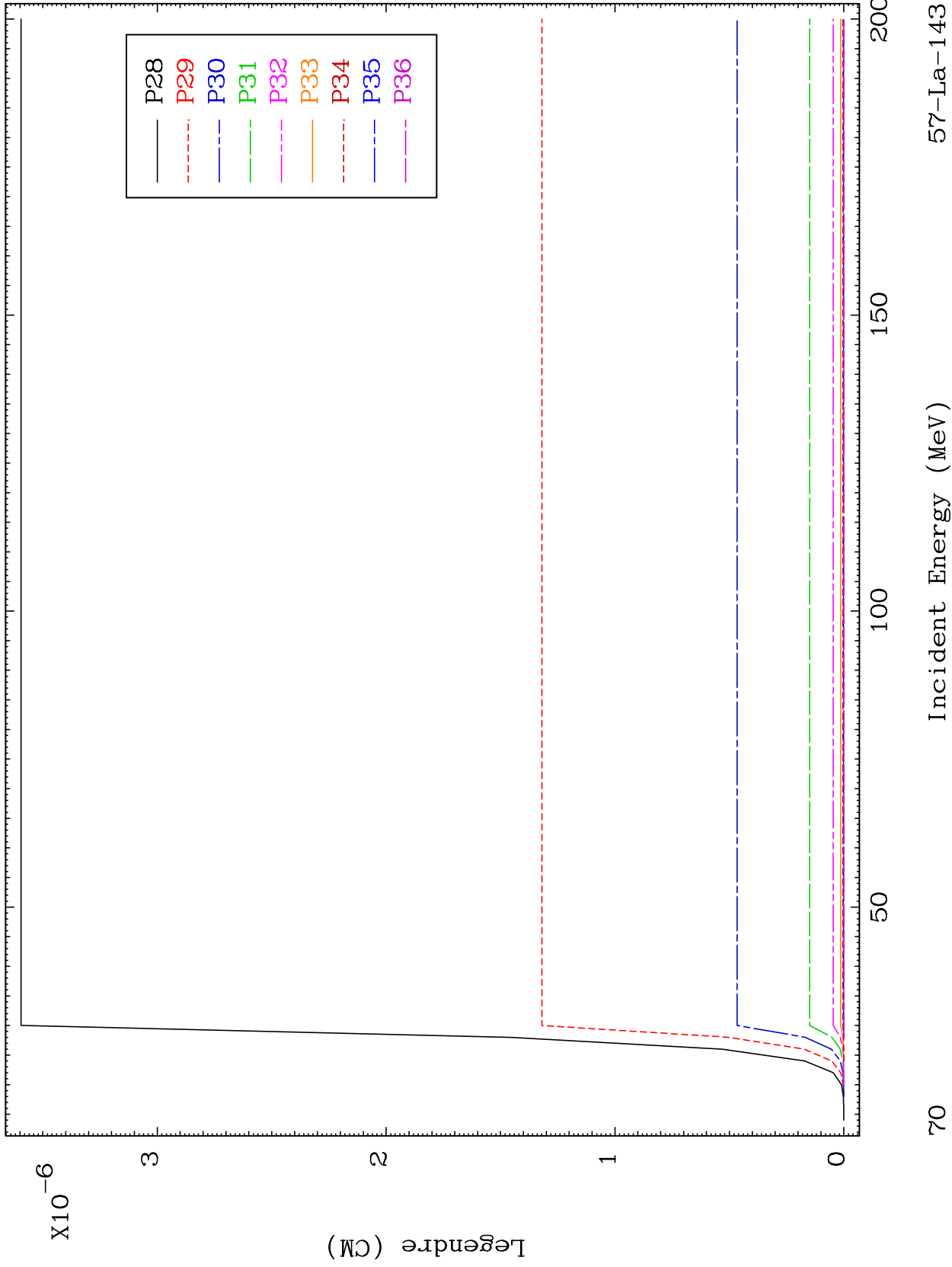

57-La-143

Incident Energy (MeV)

70

MAT 5740

MT= 64 (n,n') Level
Legendre Coefficients

57-La-143

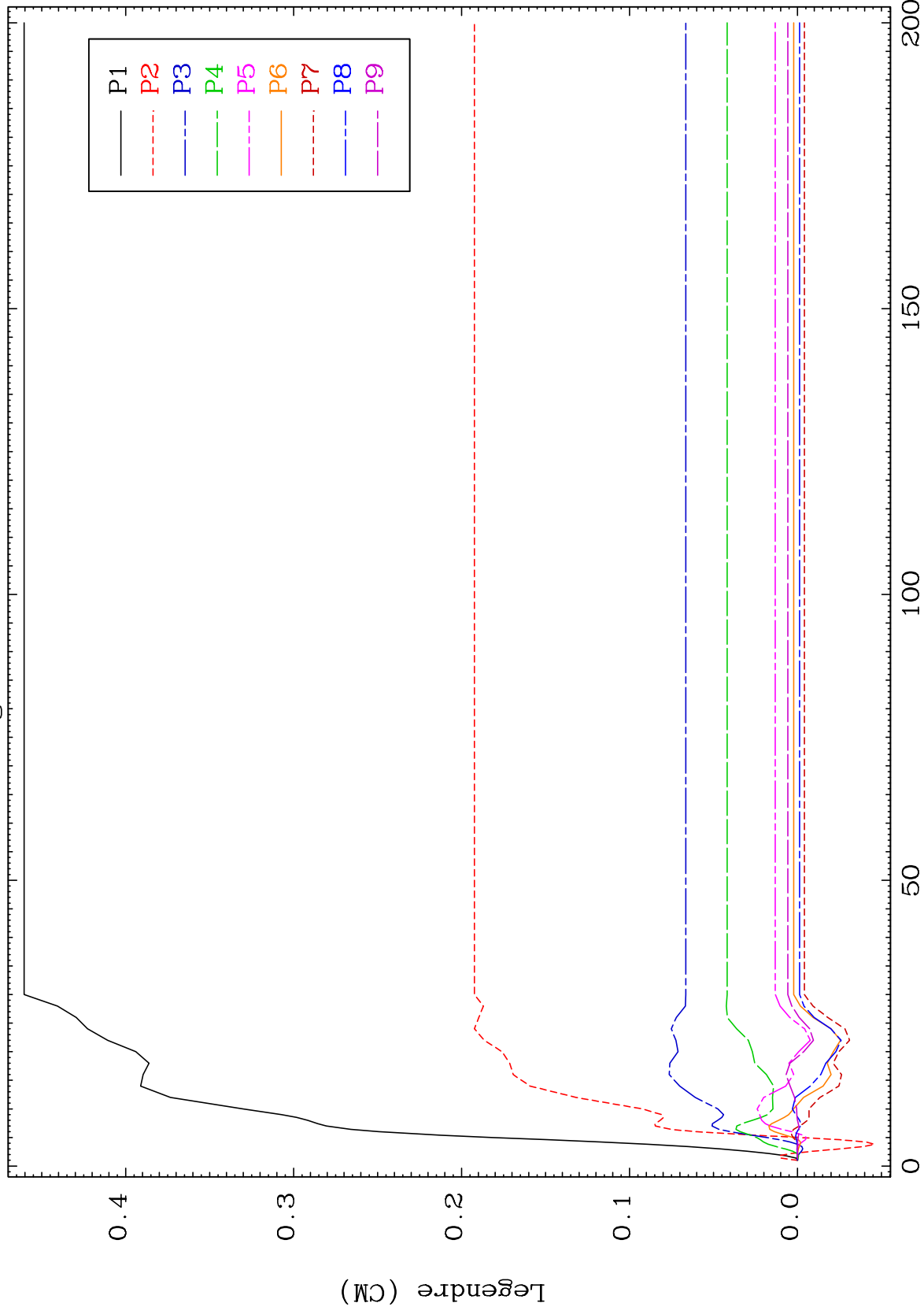

71

Incident Energy (MeV)

57-La-143

MAT 5740

MT= 64 (n,n') Level
Legendre Coefficients

57-La-143

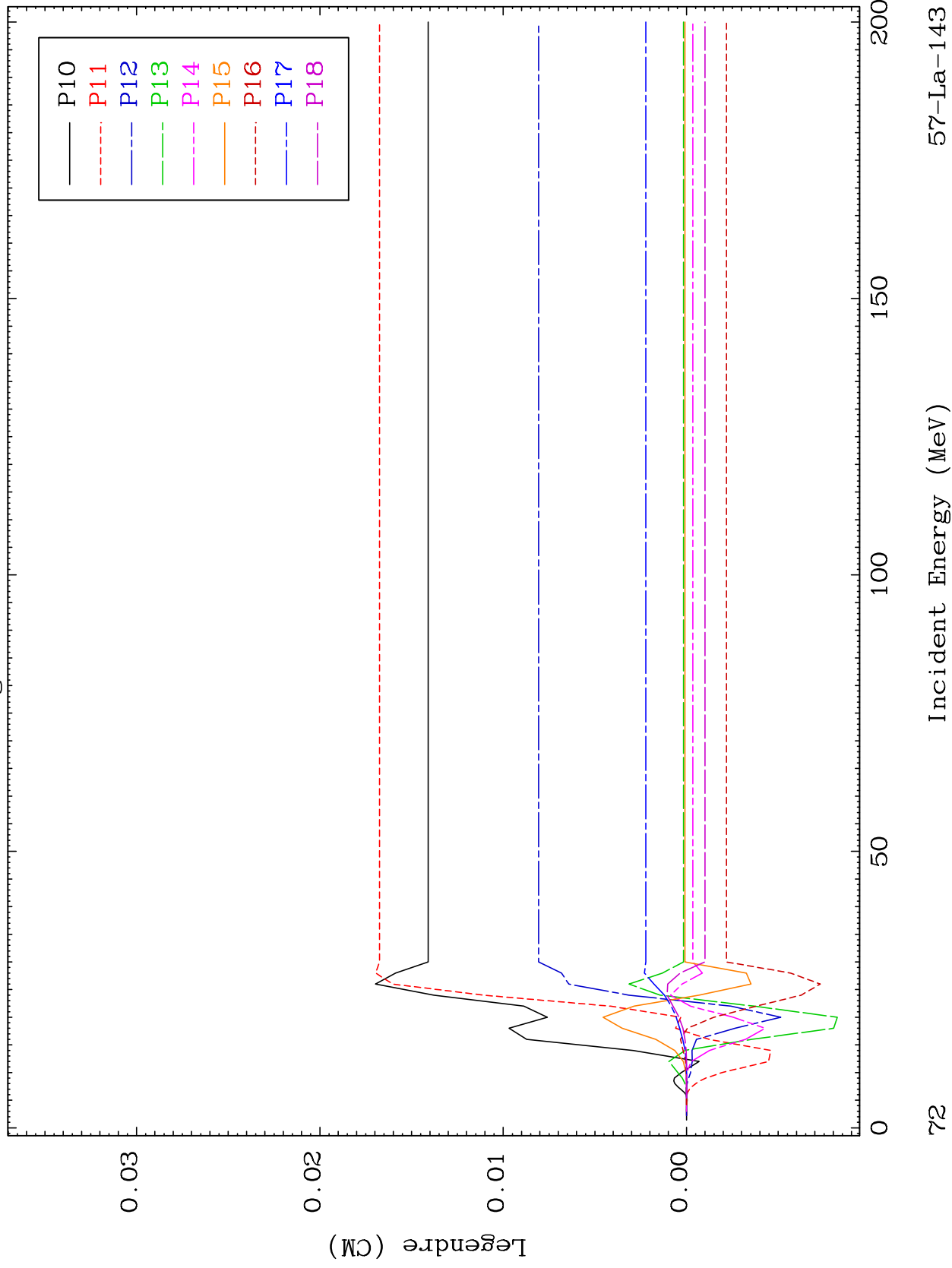

57-La-143

Incident Energy (MeV)

72

MAT 5740

MT= 64 (n,n') Level
Legendre Coefficients

57-La-143

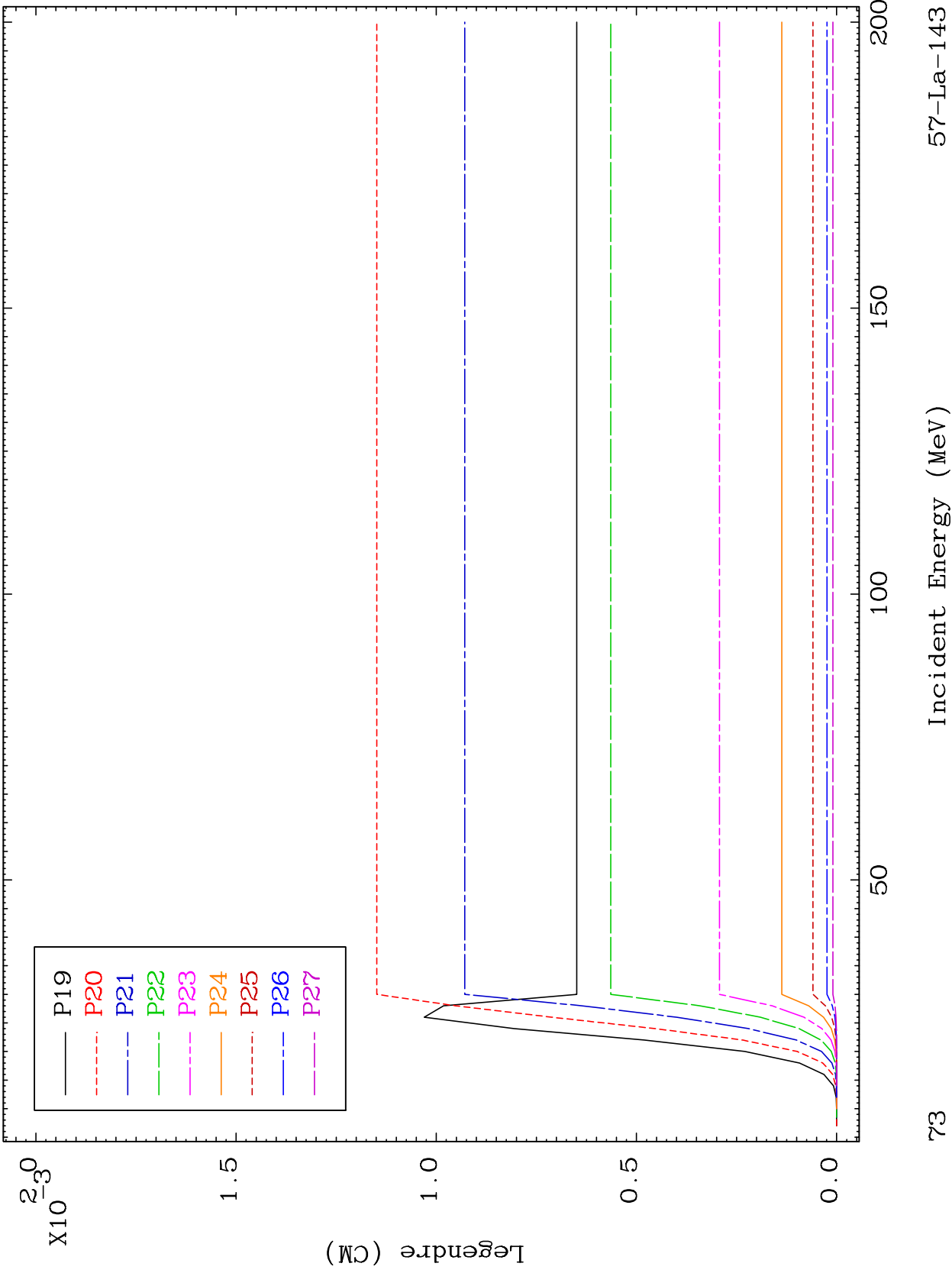

73

57-La-143

MAT 5740

MT= 64 (n,n') Level
Legendre Coefficients

57-La-143

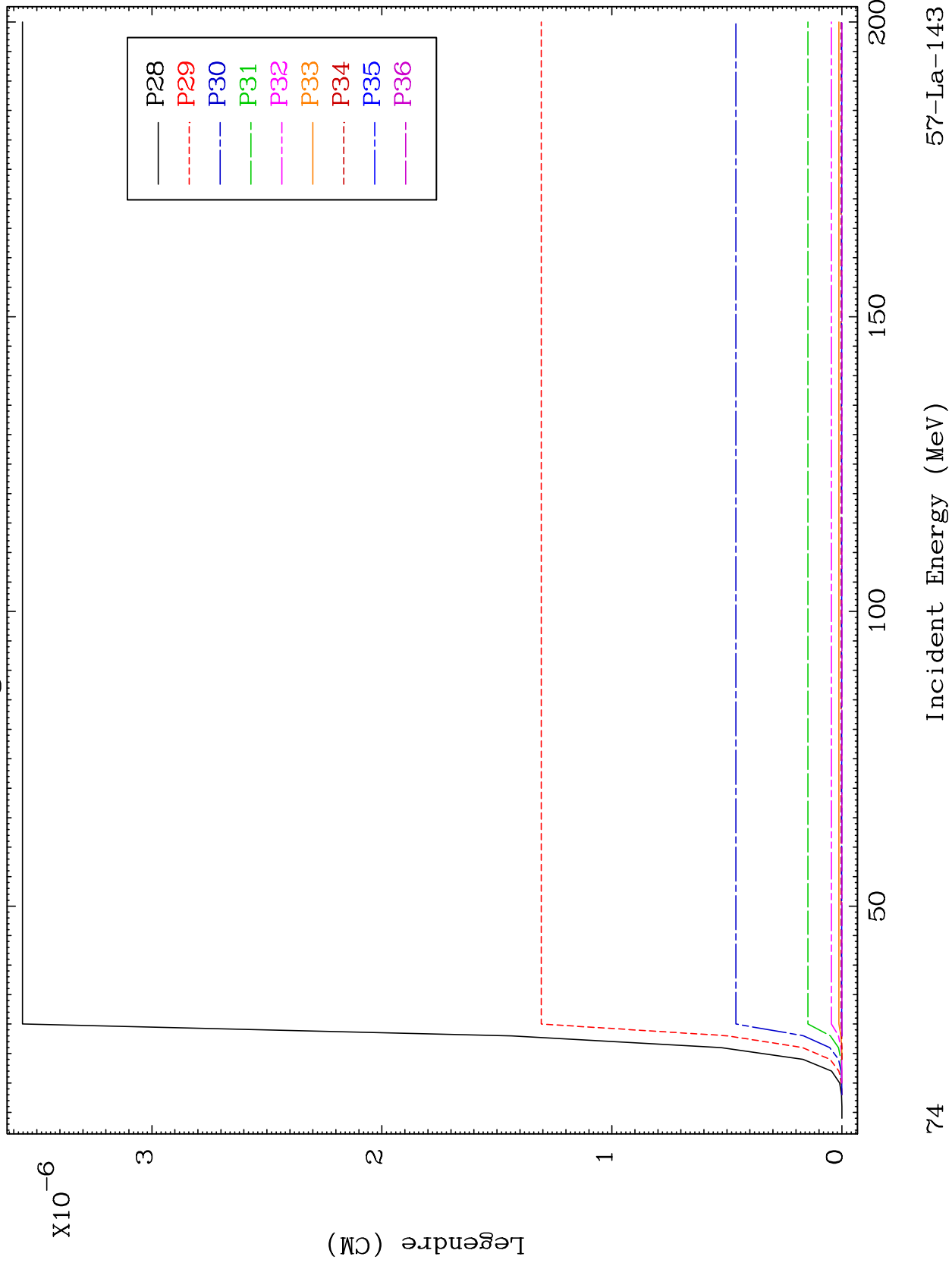

MAT 5740

MT= 65 (n,n') Level
Legendre Coefficients

57-La-143

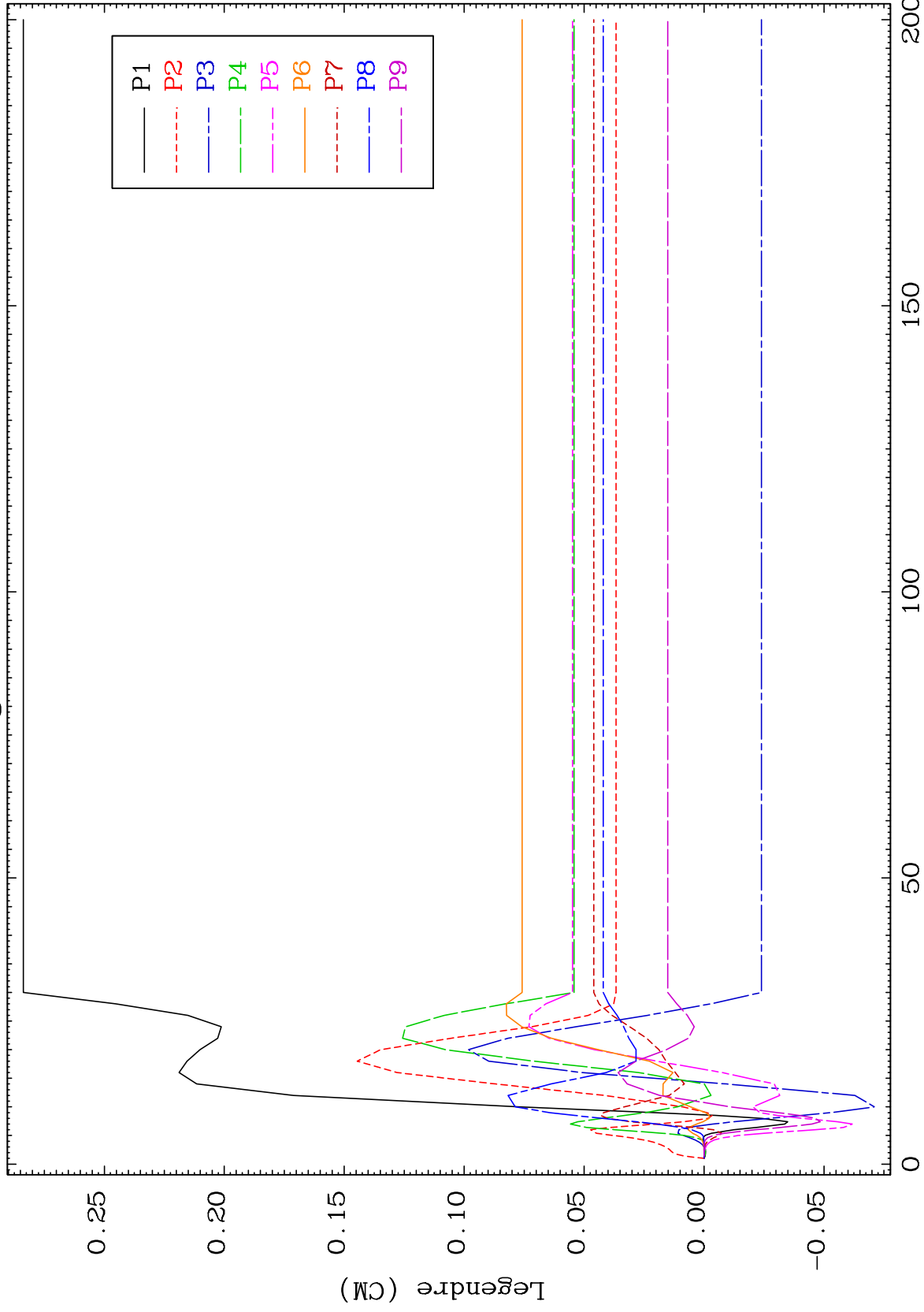

57-La-143

Incident Energy (MeV)

75

MAT 5740

MT= 65 (n,n') Level
Legendre Coefficients

57-La-143

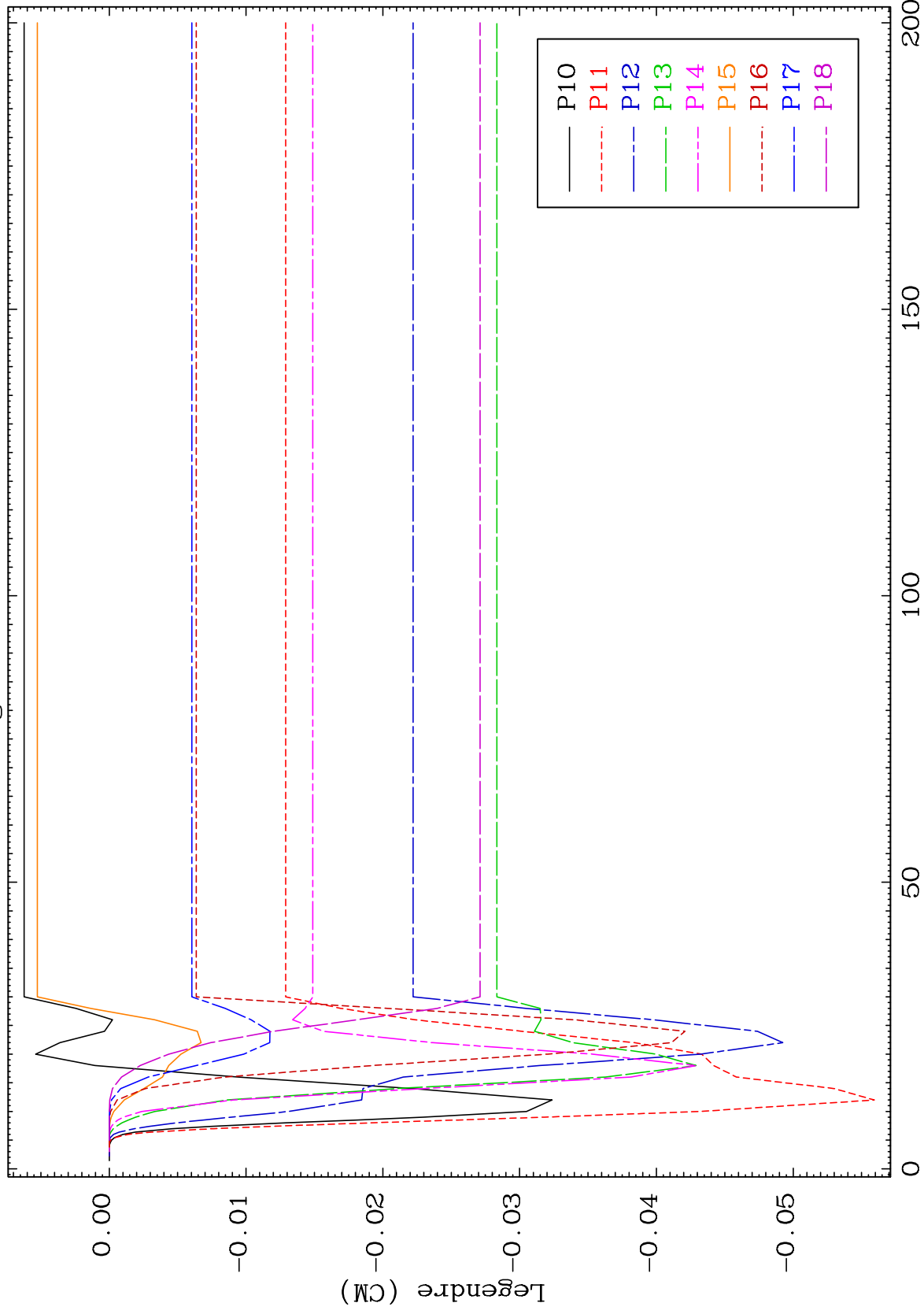

76

Incident Energy (MeV)

57-La-143

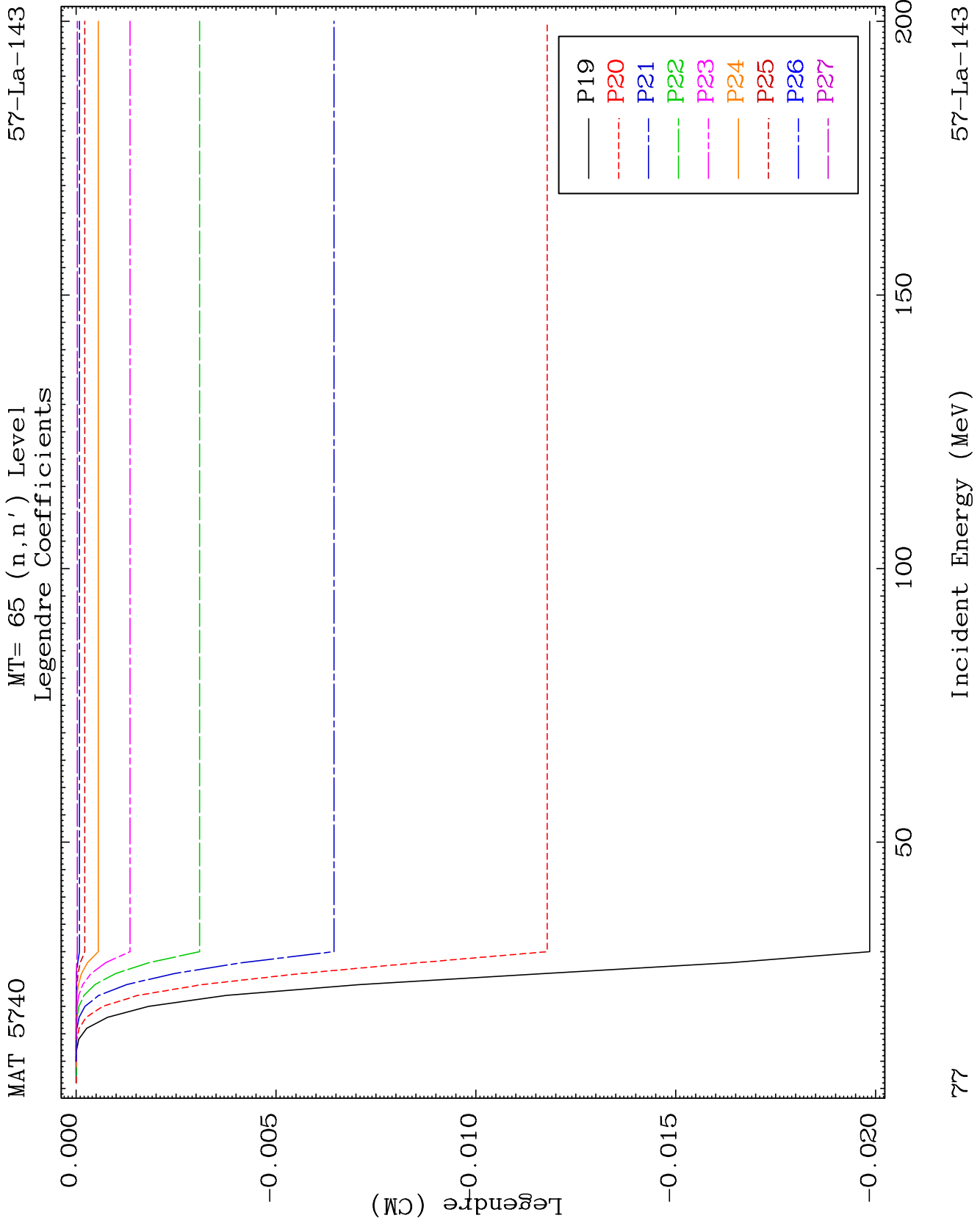

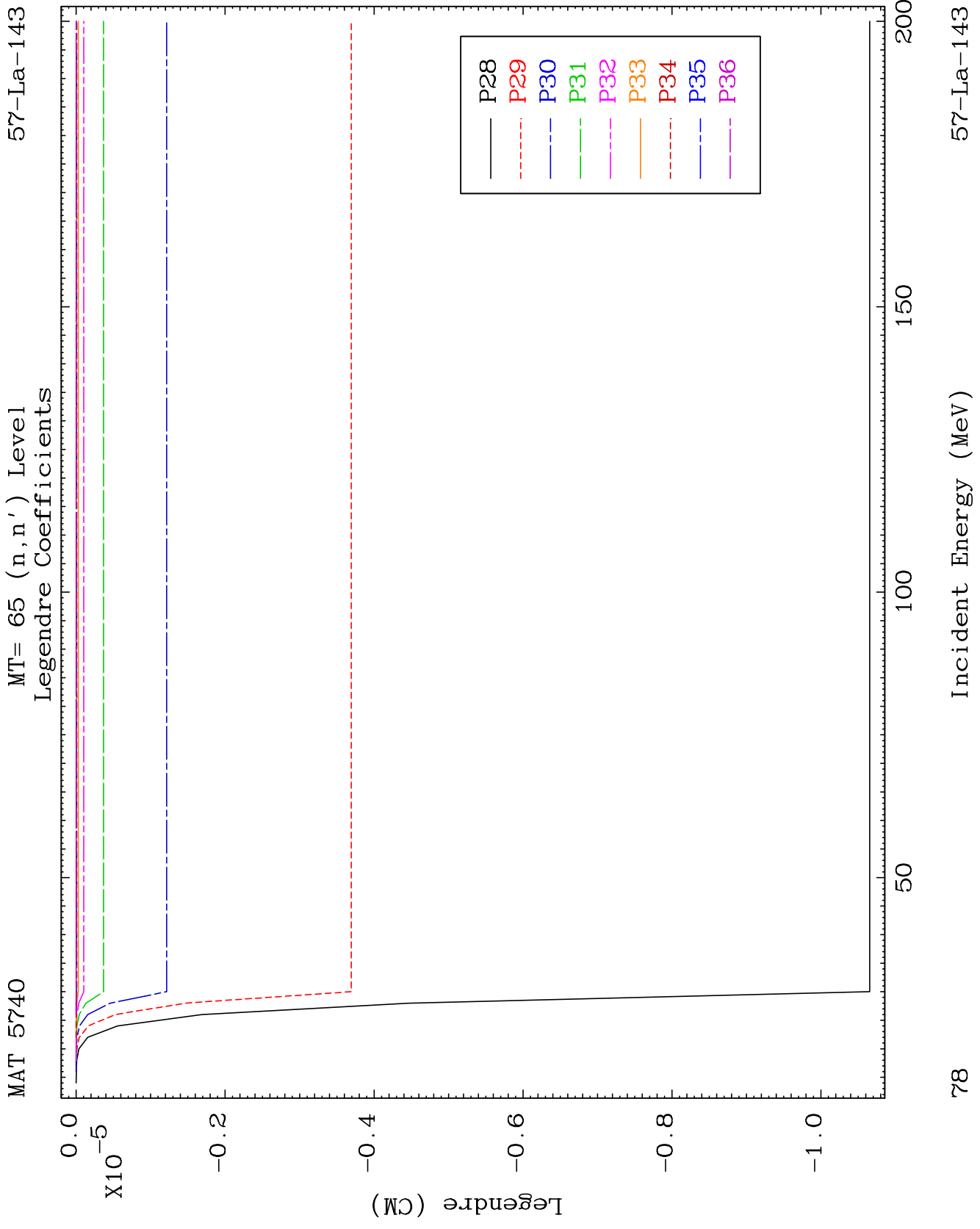

MAT 5740

MT= 66 (n,n') Level
Legendre Coefficients

57-La-143

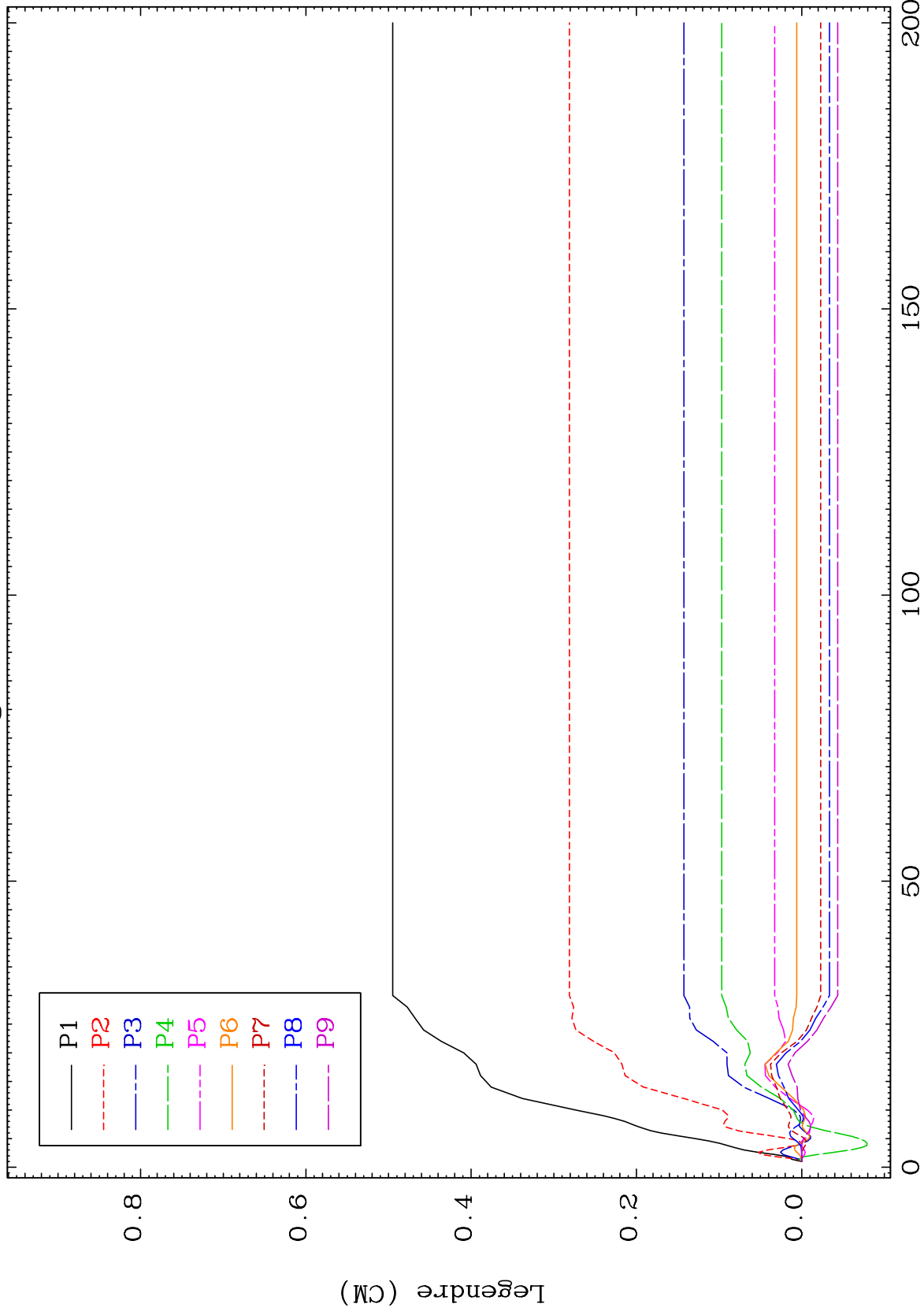

79

Incident Energy (MeV)

57-La-143

MAT 5740

MT= 66 (n,n') Level
Legendre Coefficients

57-La-143

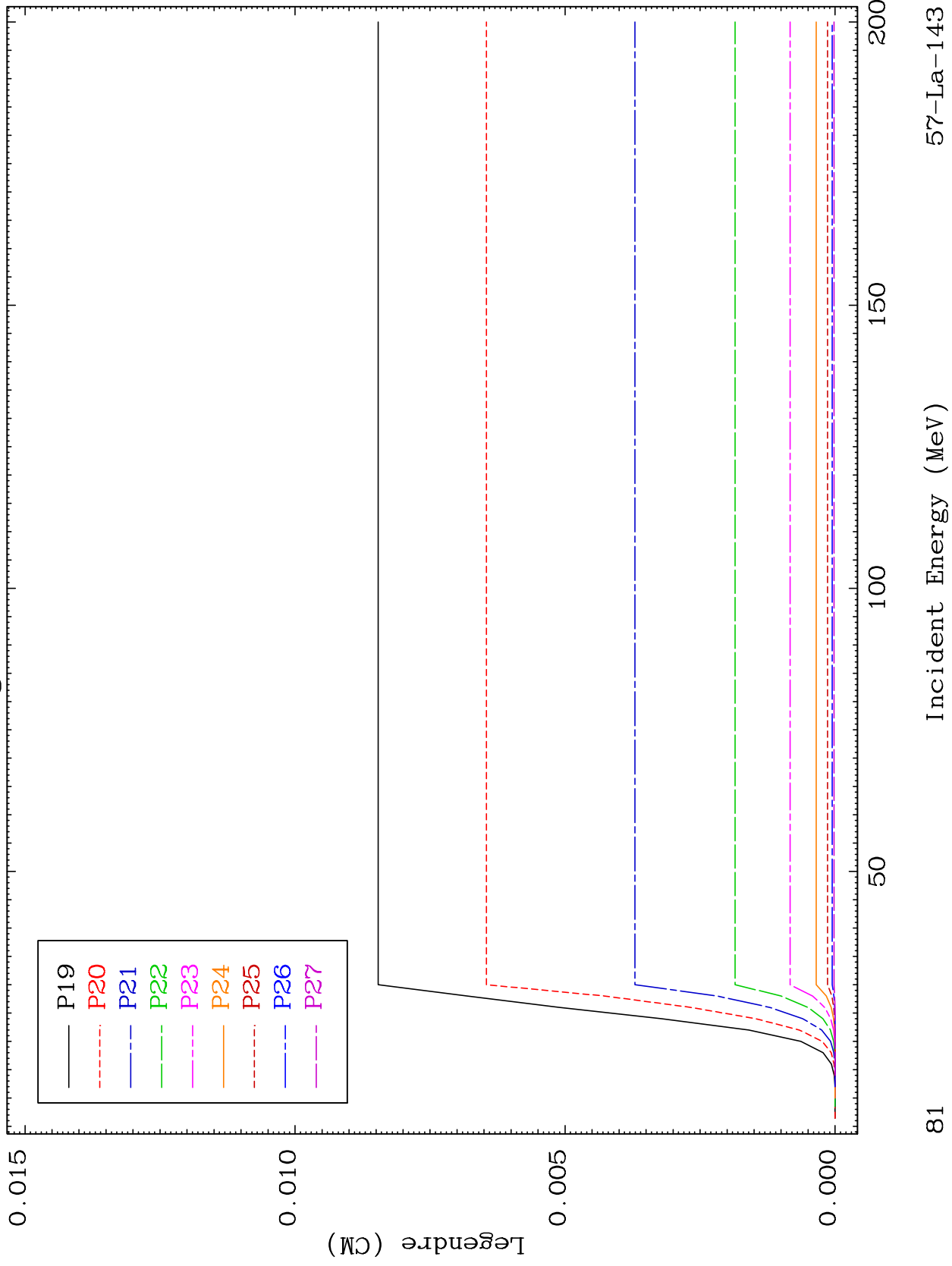

81

57-La-143

MAT 5740

MT= 66 (n,n') Level
Legendre Coefficients

57-La-143

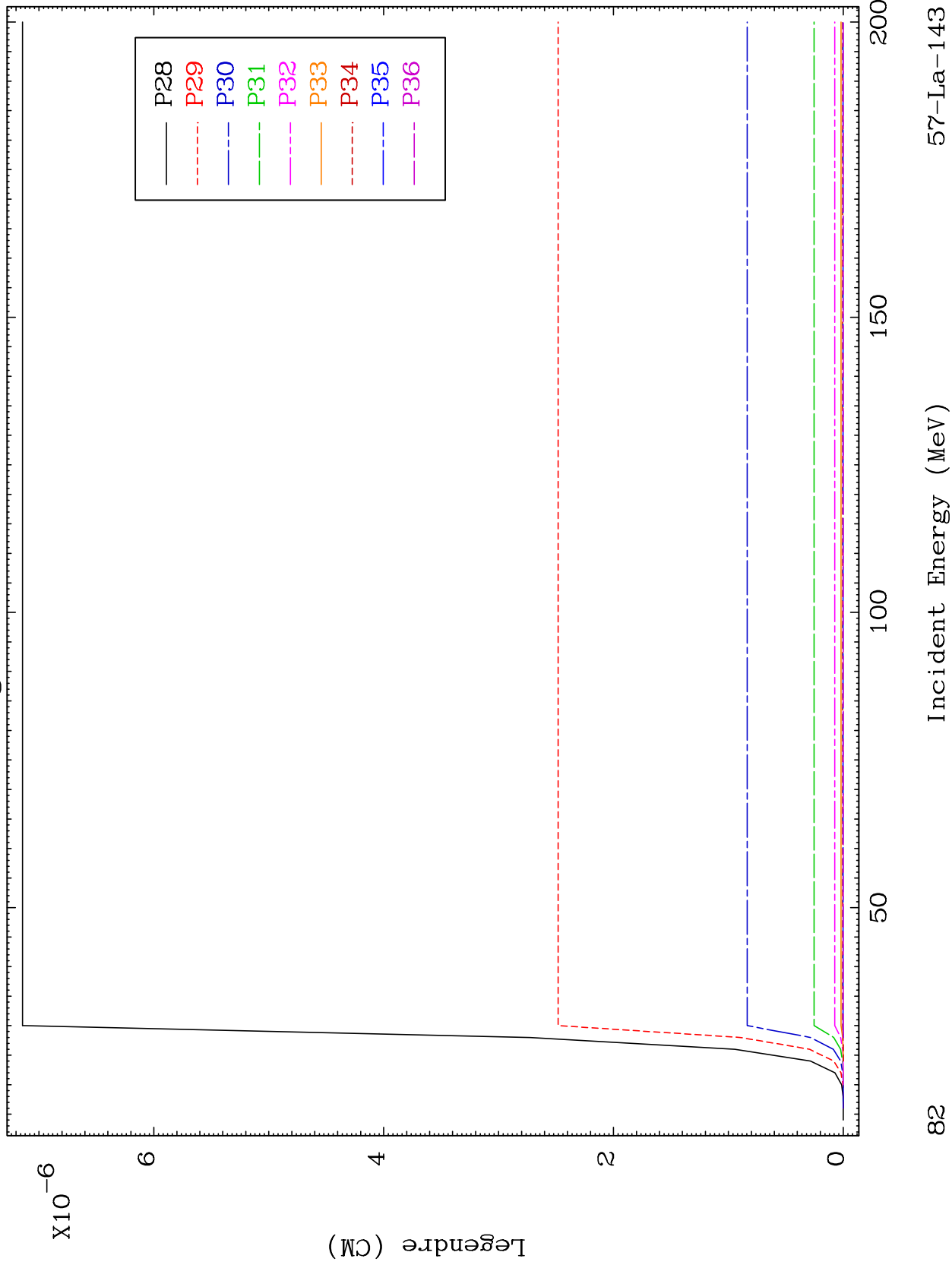

MAT 5740

MT= 67 (n,n') Level
Legendre Coefficients

57-La-143

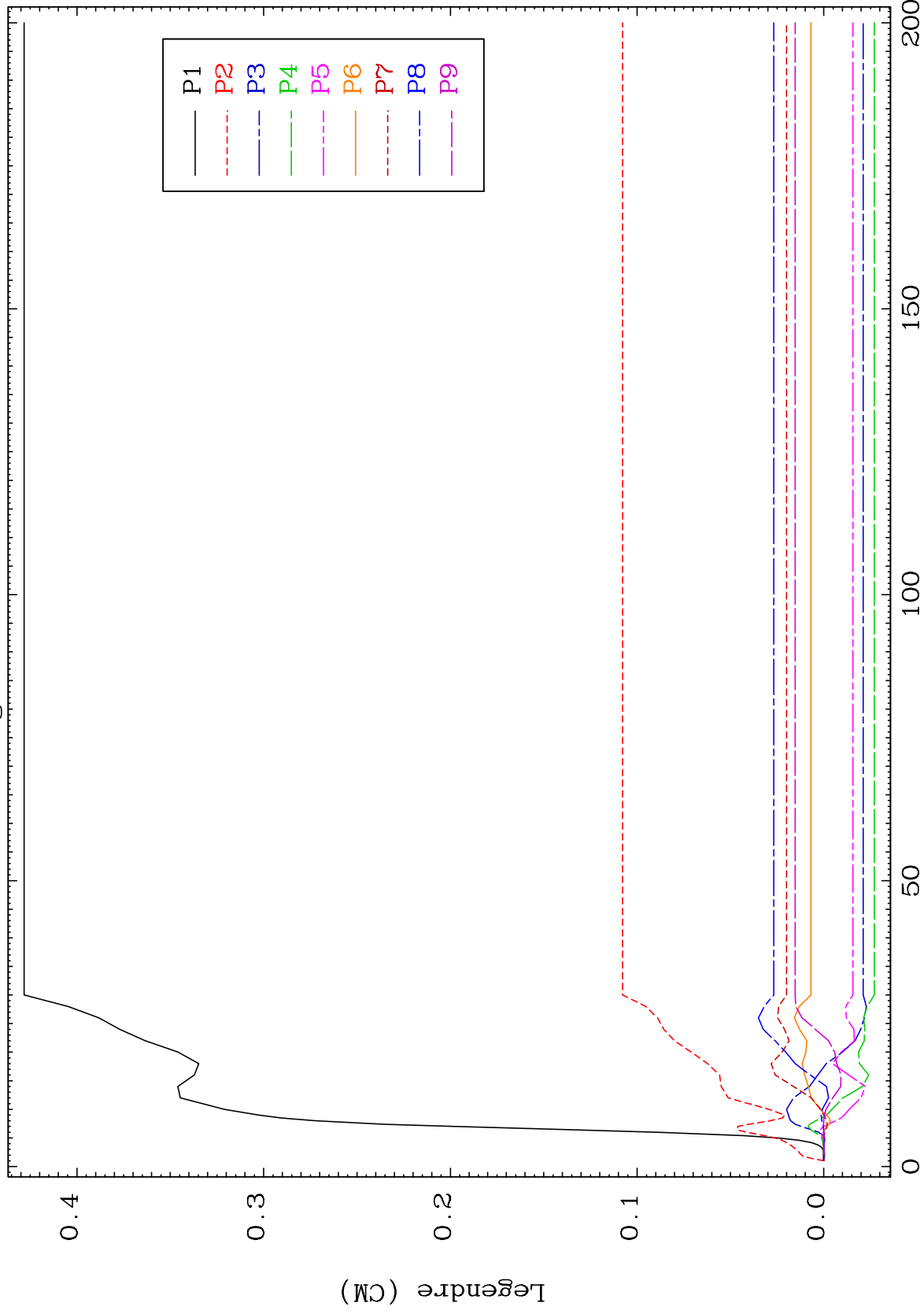

83

Incident Energy (MeV)

57-La-143

MAT 5740

MT= 67 (n,n') Level
Legendre Coefficients

57-La-143

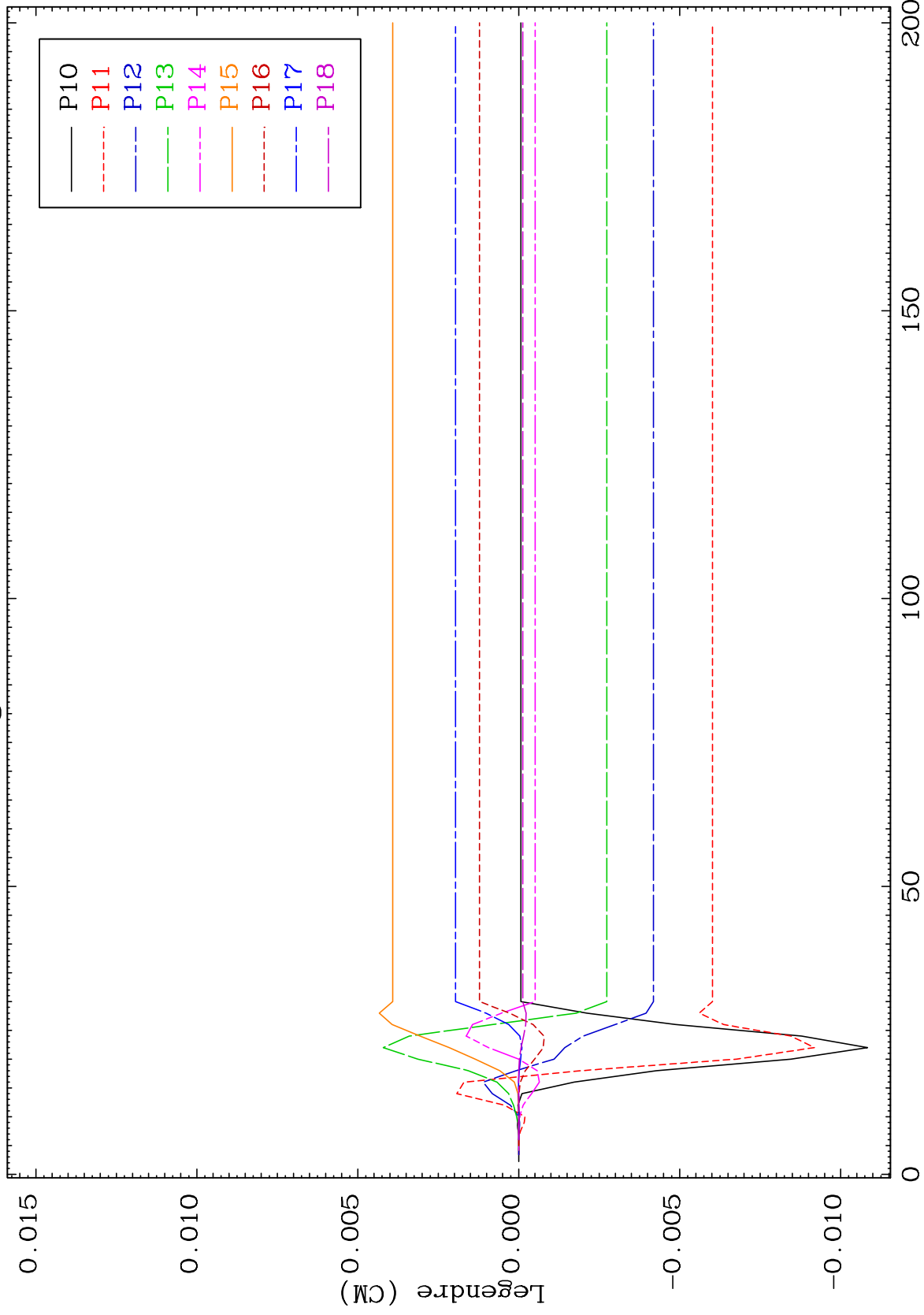

84

Incident Energy (MeV)

57-La-143

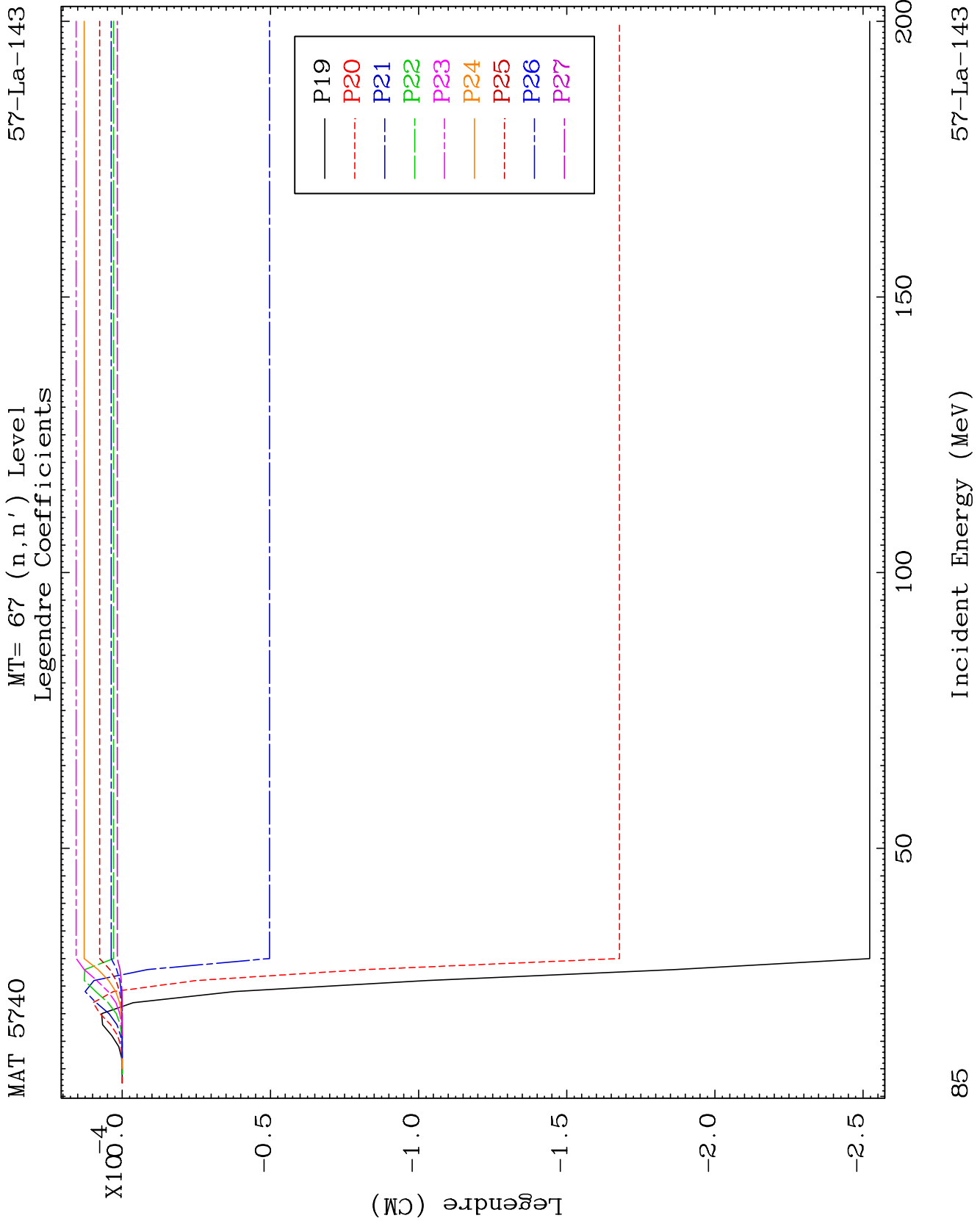

MAT 5740

MT= 67 (n,n') Level
Legendre Coefficients

57-La-143

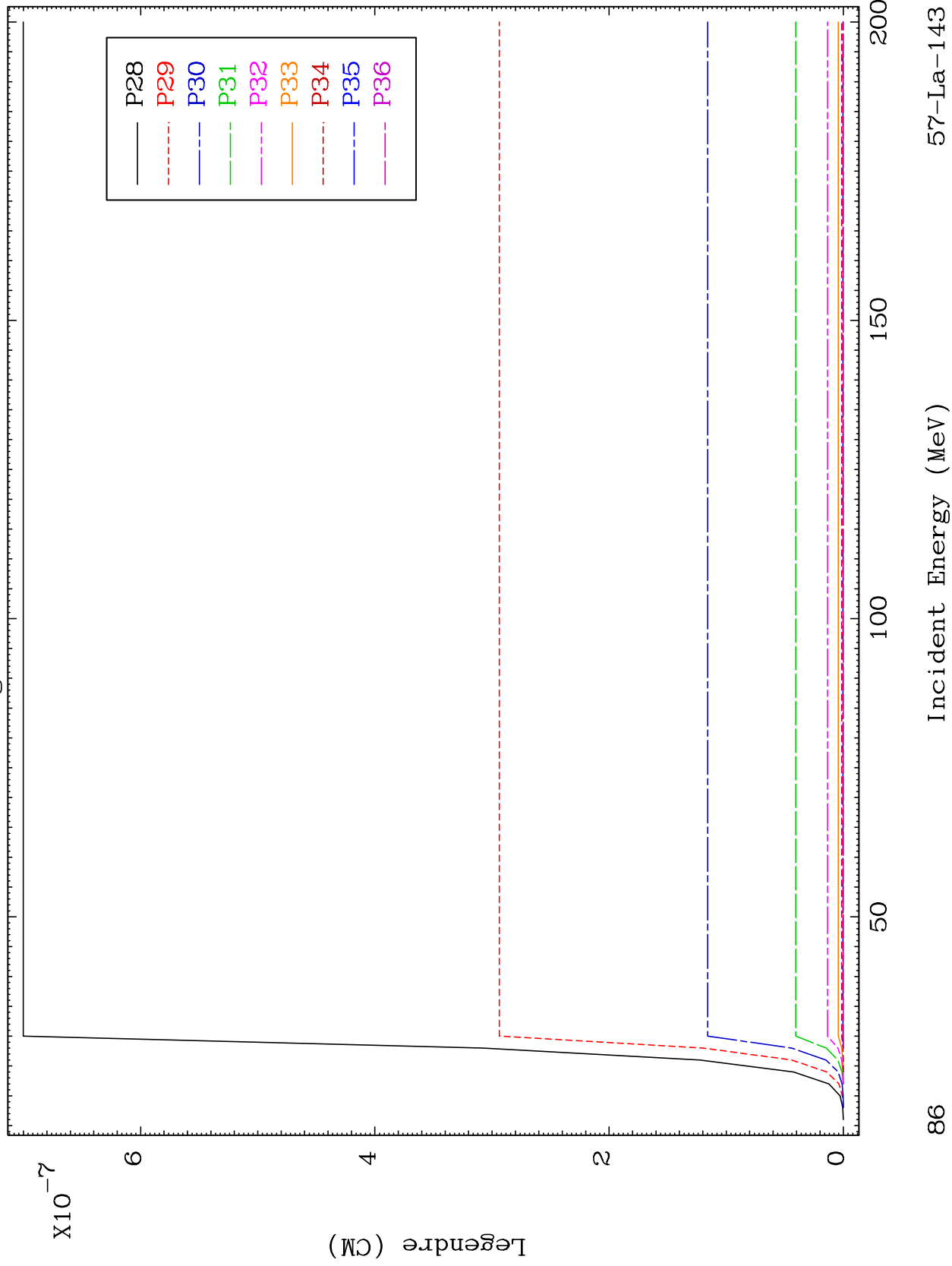

MAT 5740

MT= 68 (n,n') Level
Legendre Coefficients

57-La-143

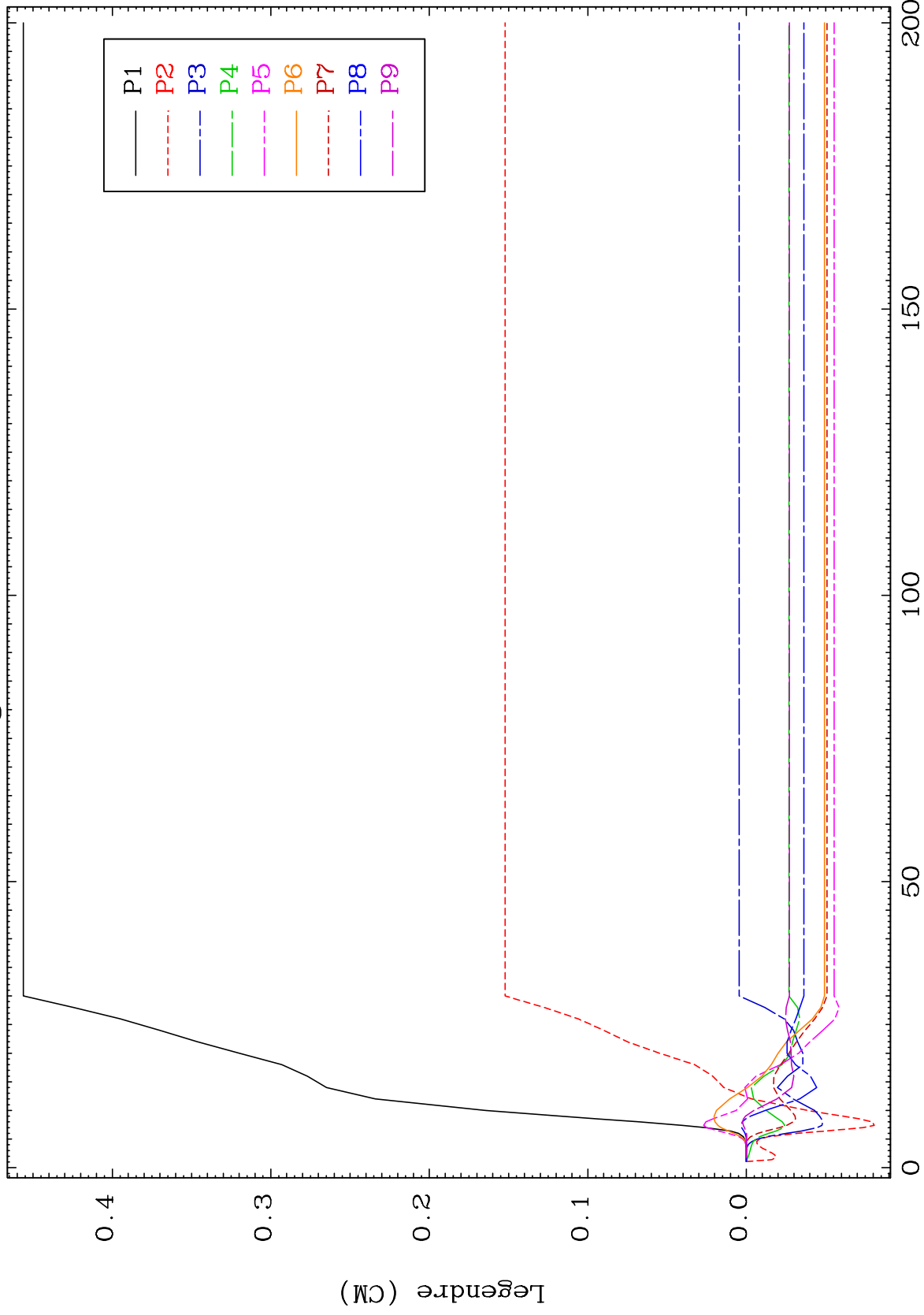

57-La-143

Incident Energy (MeV)

87

MAT 5740

MT= 68 (n,n') Level
Legendre Coefficients

57-La-143

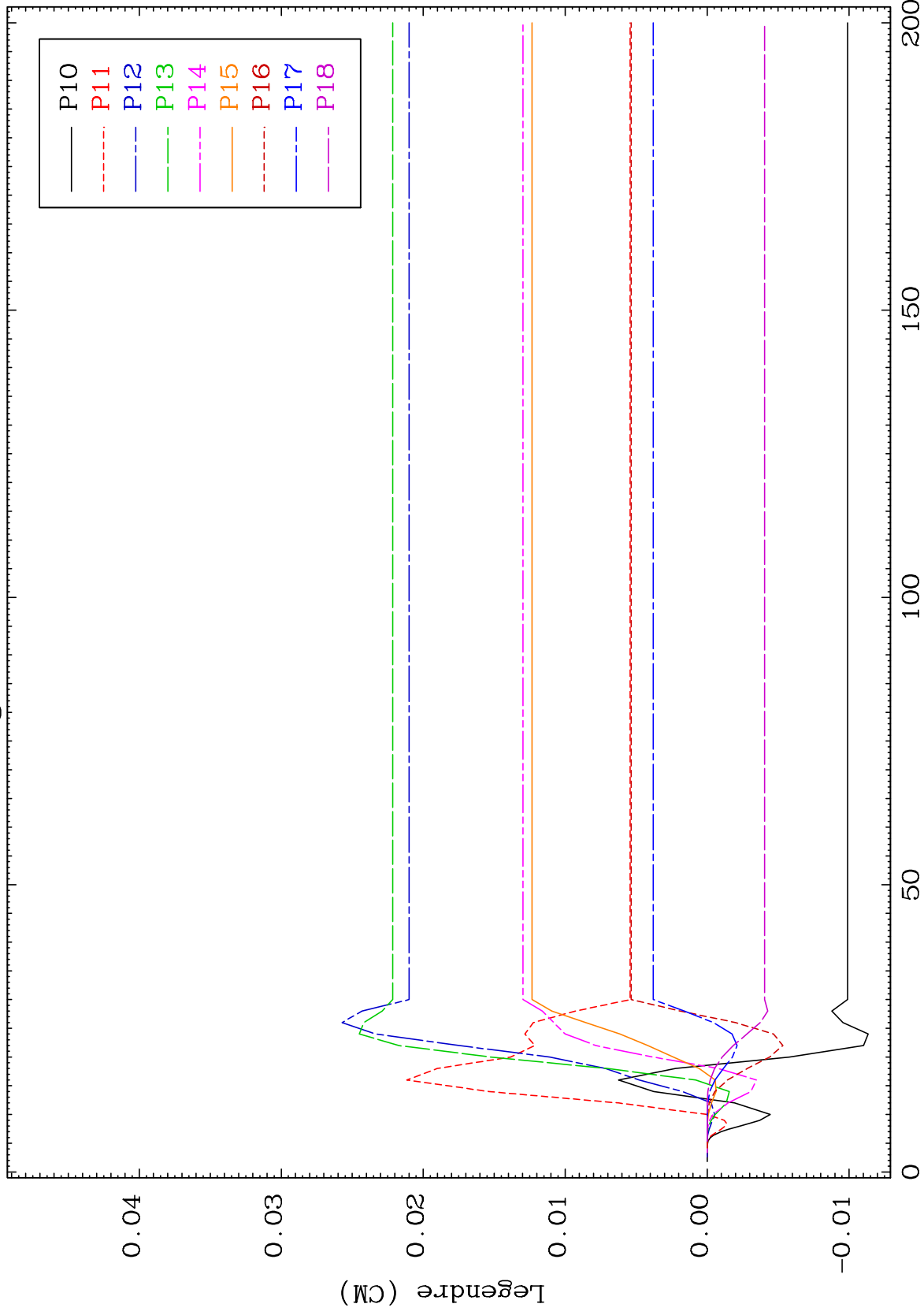

88

Incident Energy (MeV)

57-La-143

MAT 5740

MT= 68 (n,n') Level
Legendre Coefficients

57-La-143

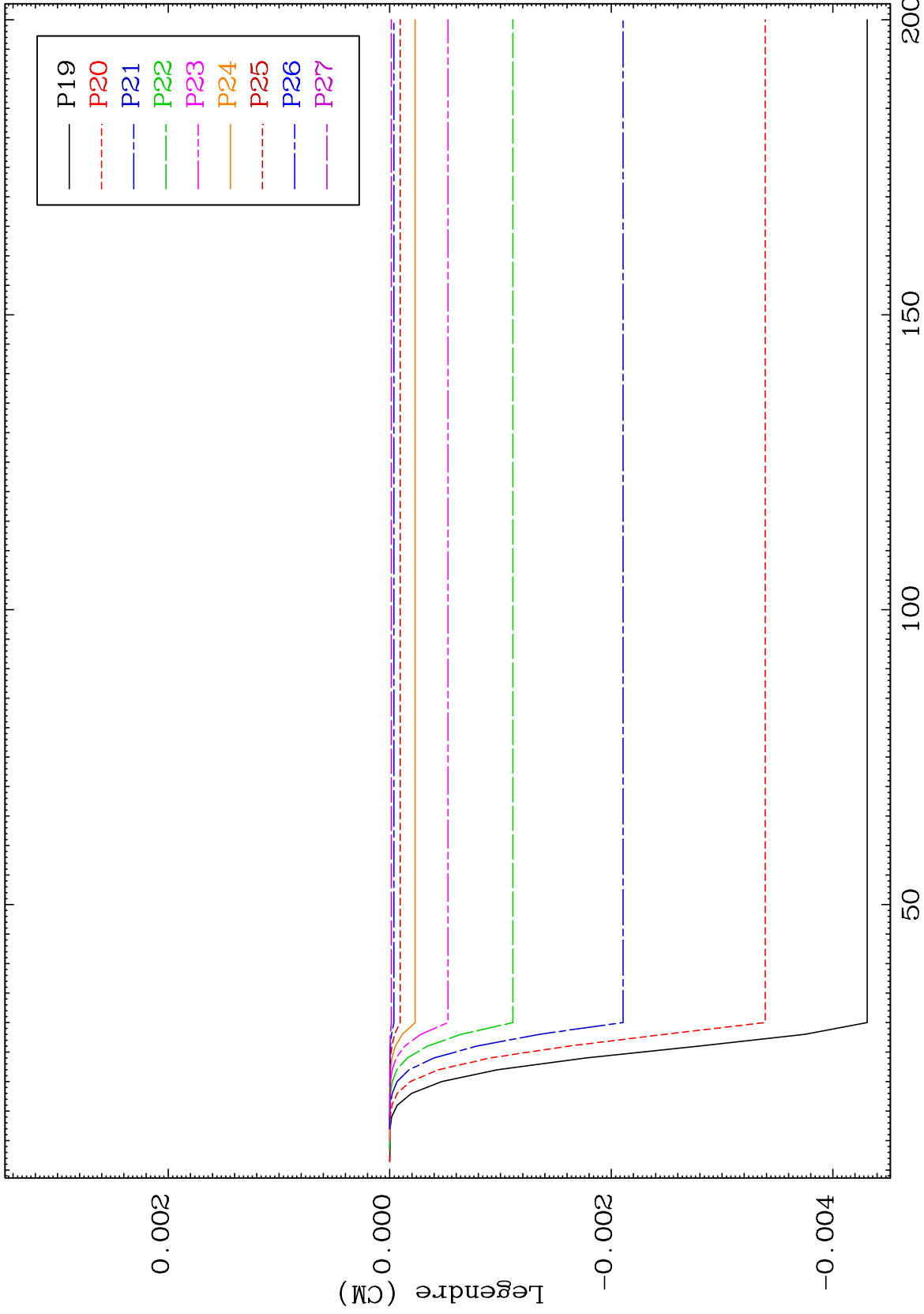

89

Incident Energy (MeV)

57-La-143

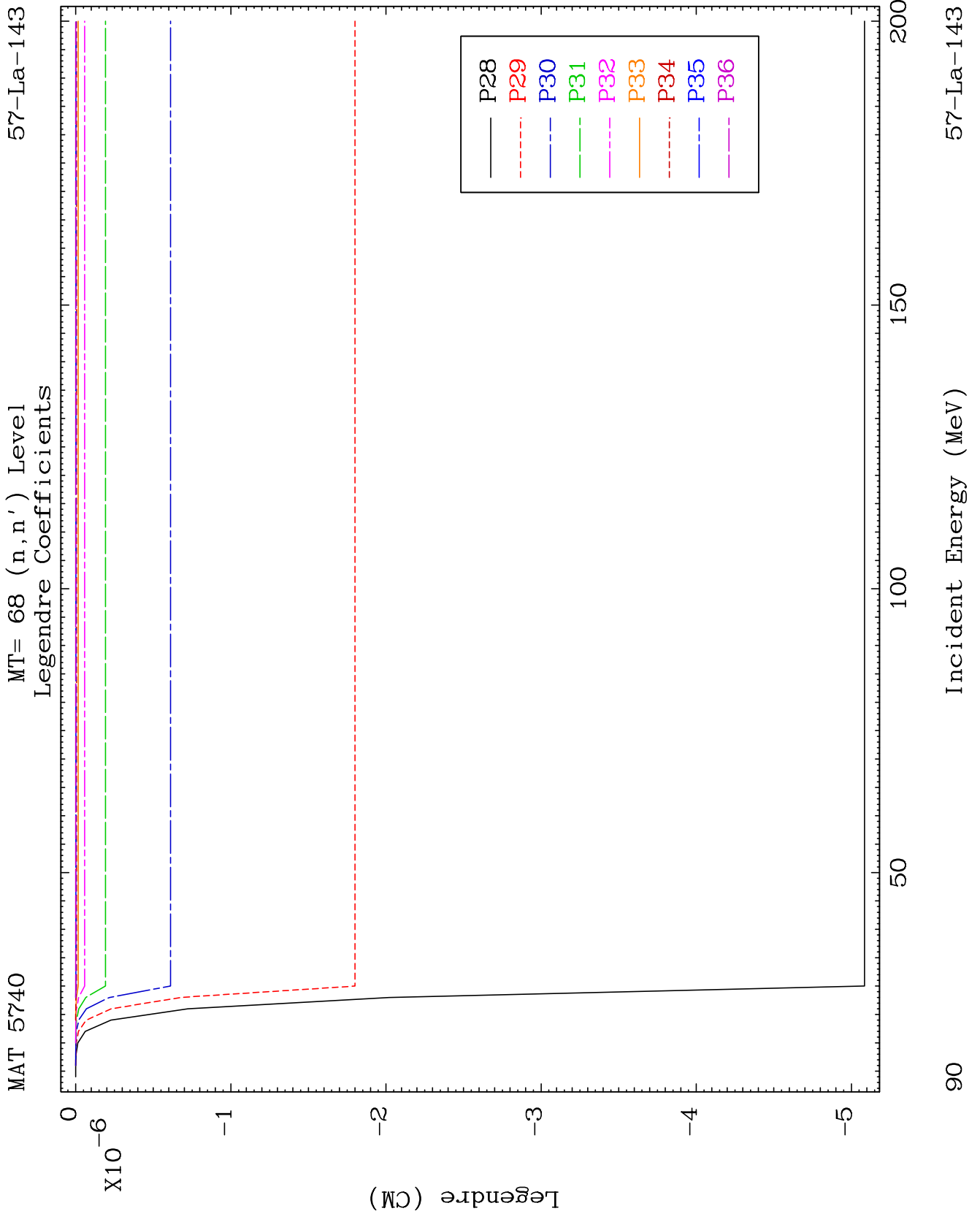

MAT 5740

MT= 69 (n,n') Level
Legendre Coefficients

57-La-143

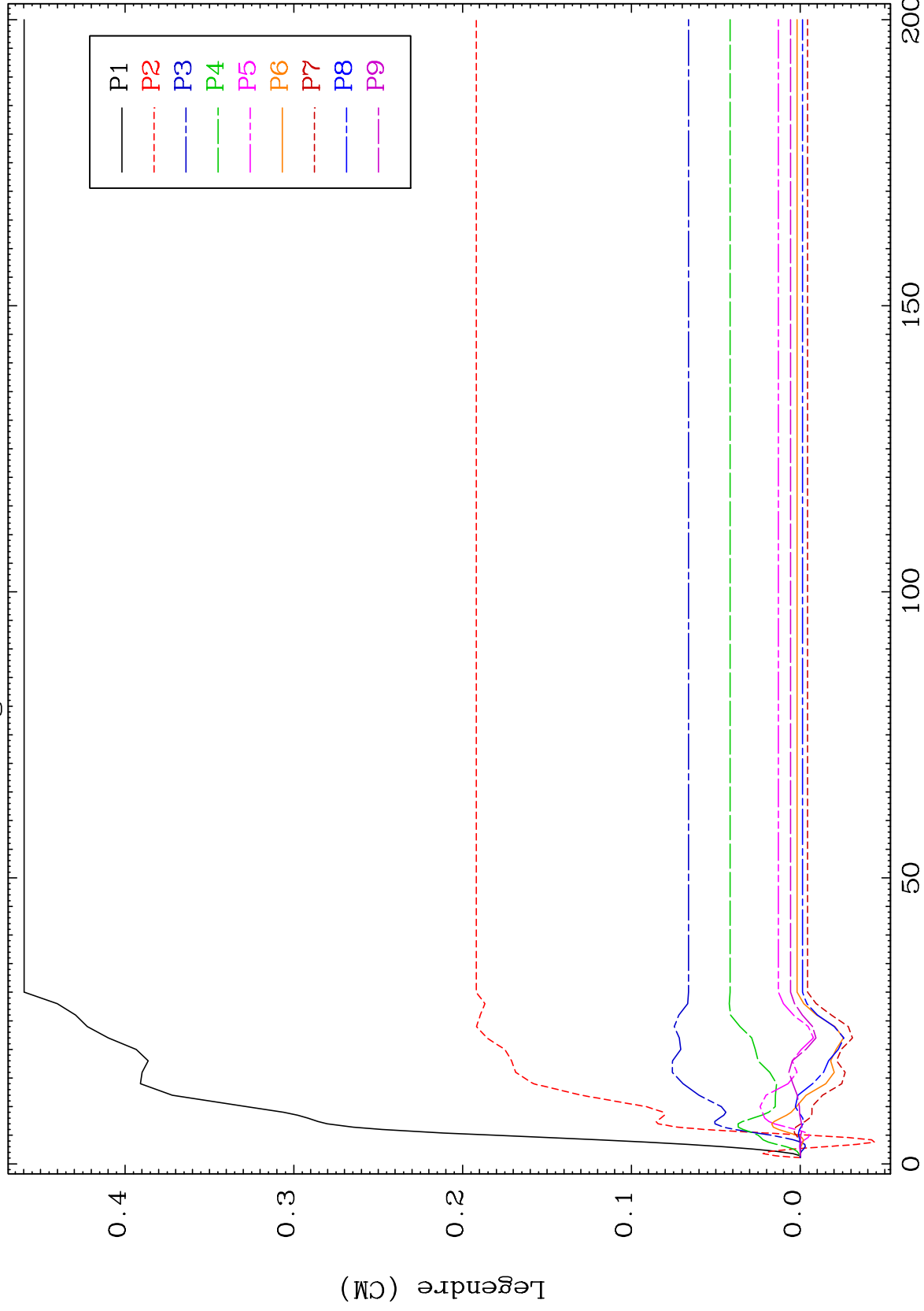

91

Incident Energy (MeV)

57-La-143

MAT 5740

MT= 69 (n,n') Level
Legendre Coefficients

57-La-143

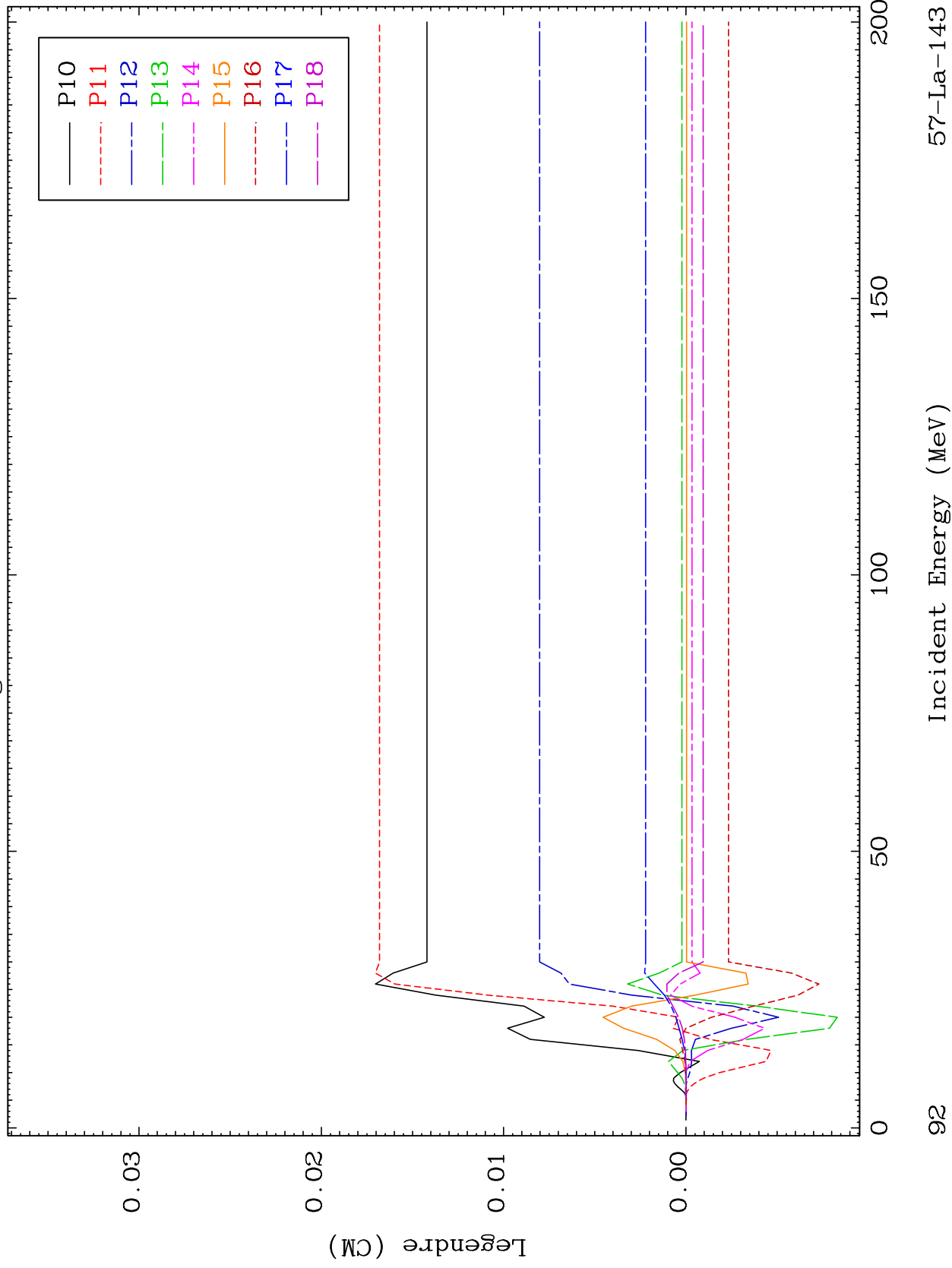

57-La-143

Incident Energy (MeV)

92

MAT 5740

MT= 69 (n,n') Level
Legendre Coefficients

57-La-143

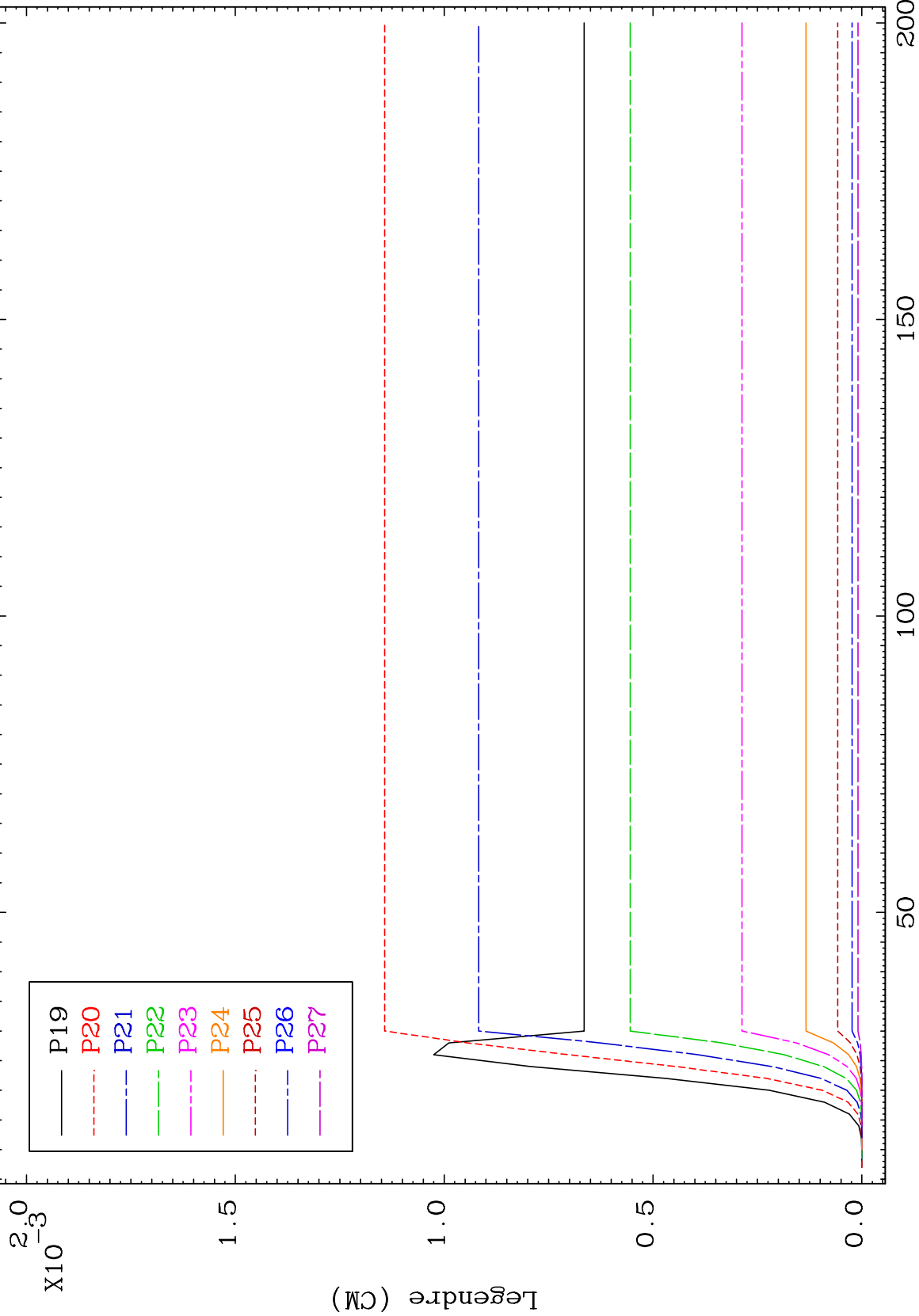

93

Incident Energy (MeV)

57-La-143

MAT 5740

MT= 69 (n,n') Level
Legendre Coefficients

57-La-143

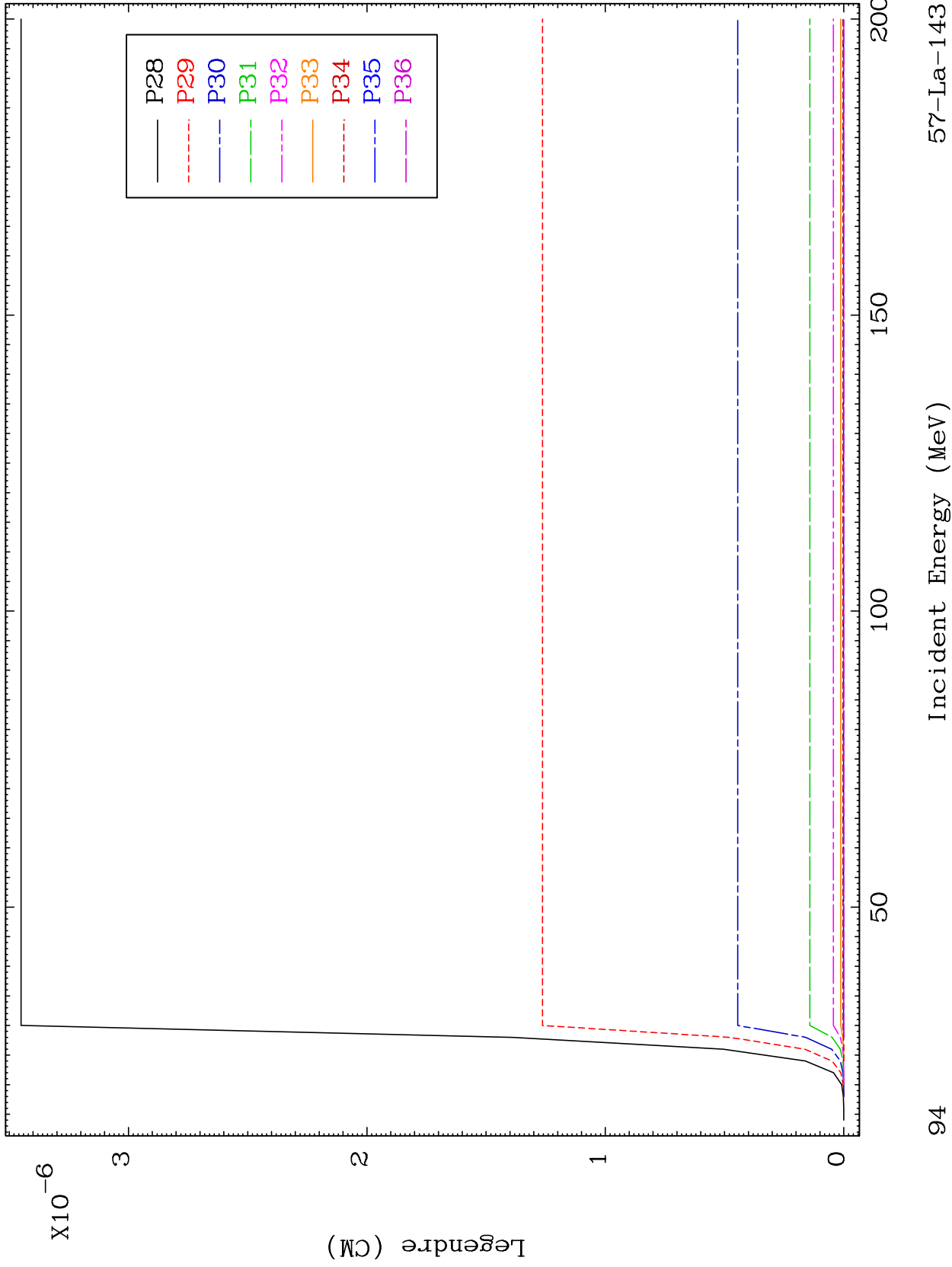

MAT 5740

MT= 70 (n,n') Level
Legendre Coefficients

57-La-143

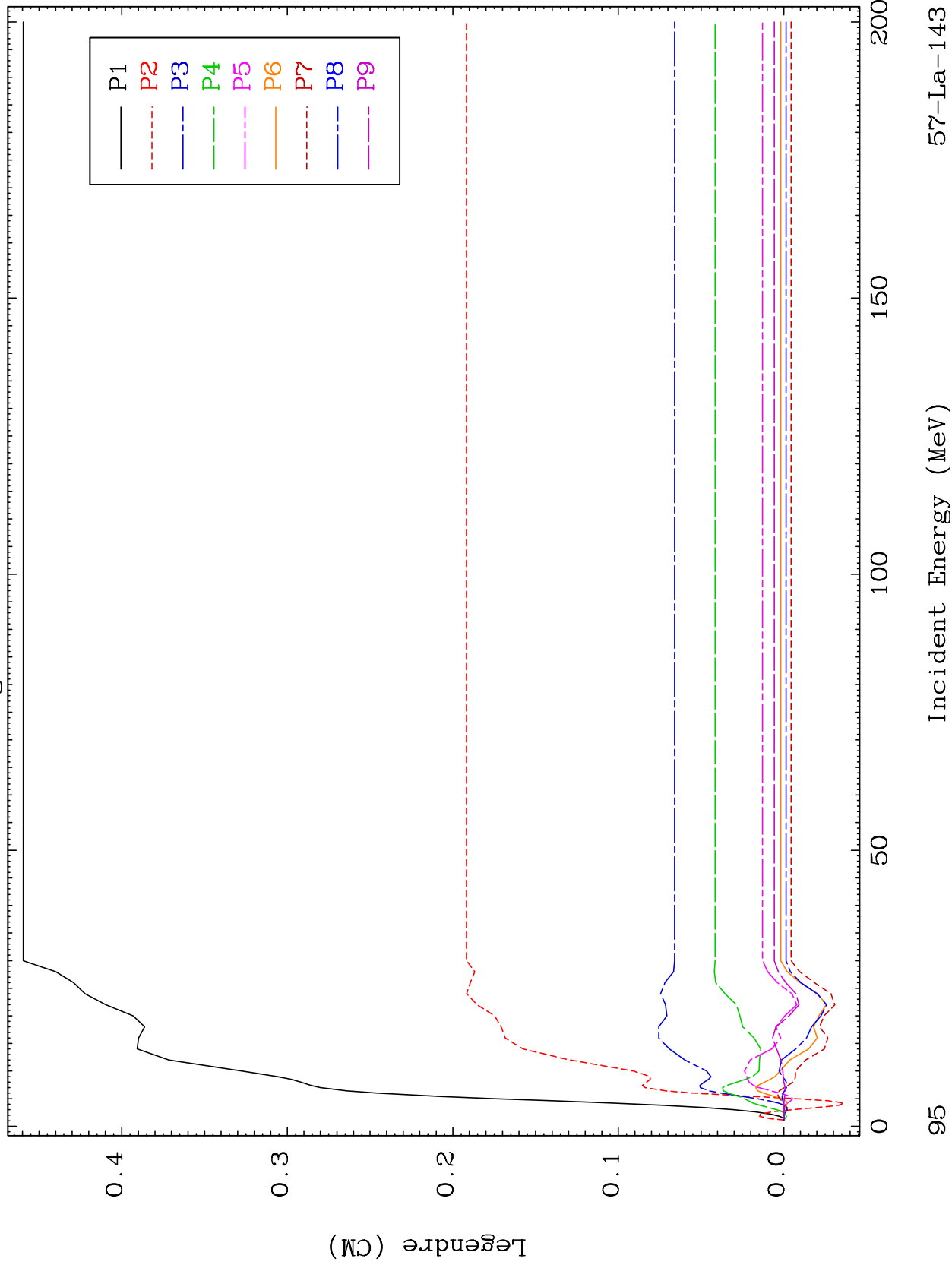

57-La-143

Incident Energy (MeV)

95

MAT 5740

MT= 70 (n,n') Level
Legendre Coefficients

57-La-143

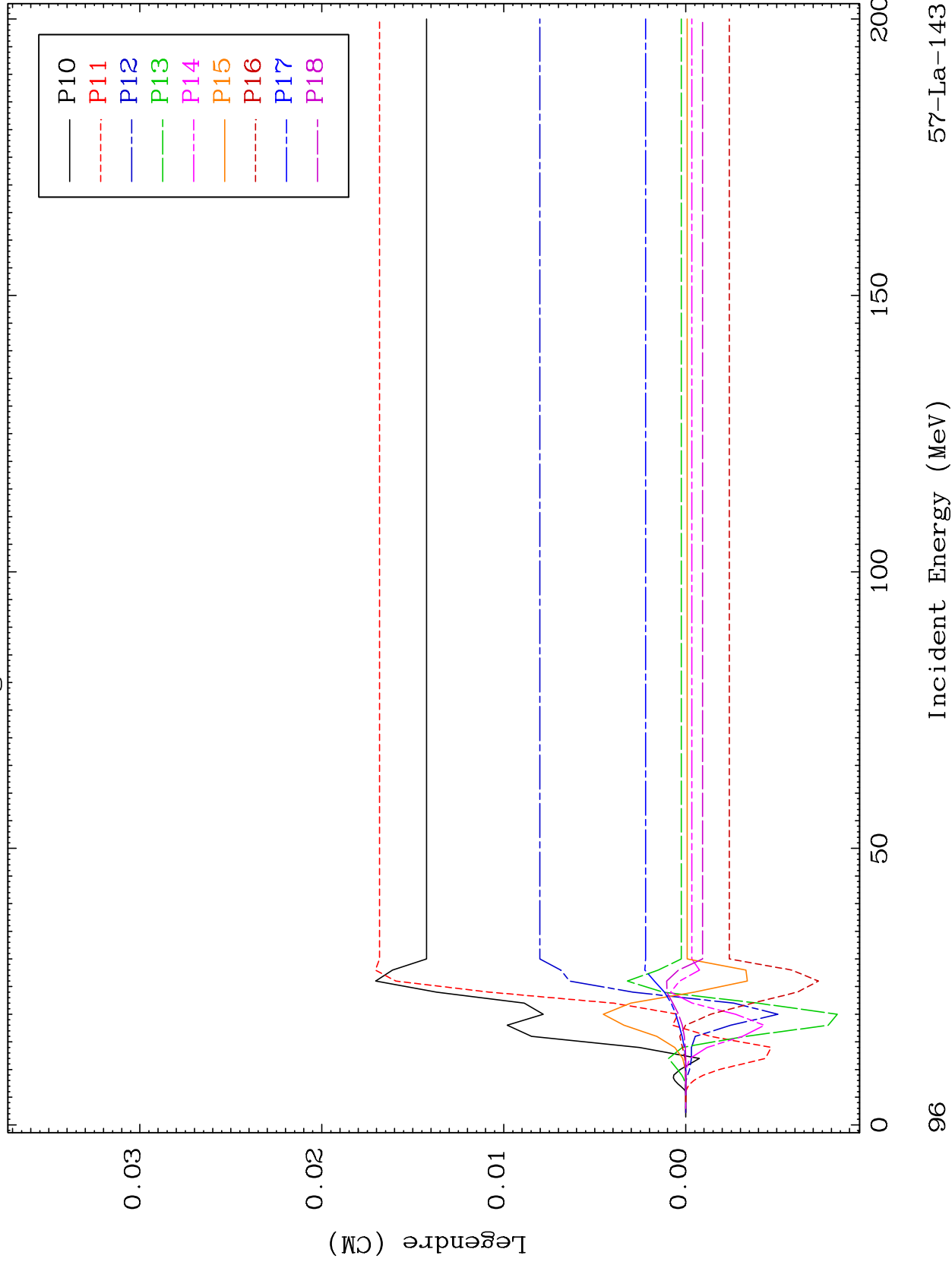

57-La-143

Incident Energy (MeV)

96

MAT 5740

MT= 70 (n,n') Level
Legendre Coefficients

57-La-143

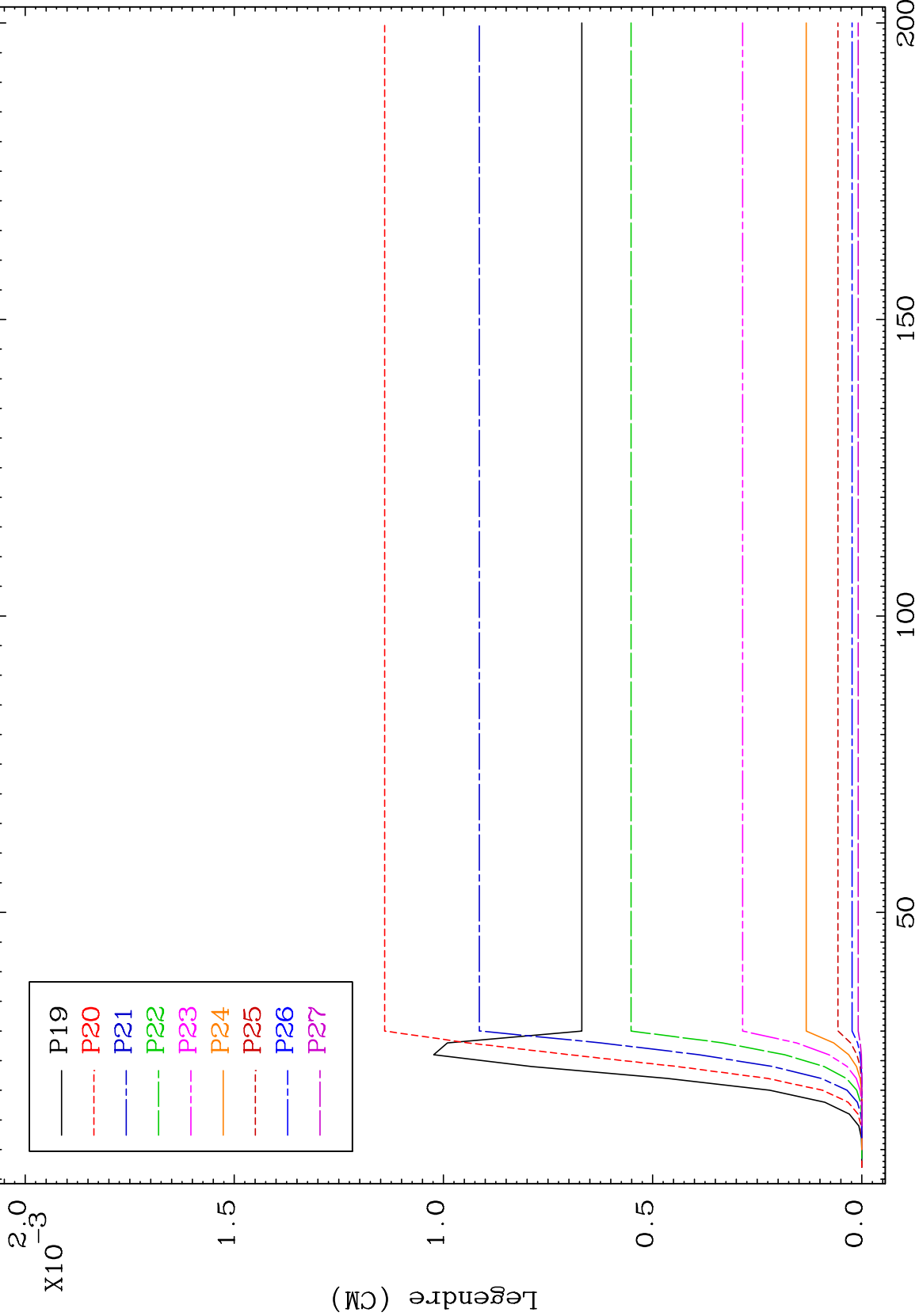

97

Incident Energy (MeV)

57-La-143

MAT 5740

MT= 70 (n,n') Level
Legendre Coefficients

57-La-143

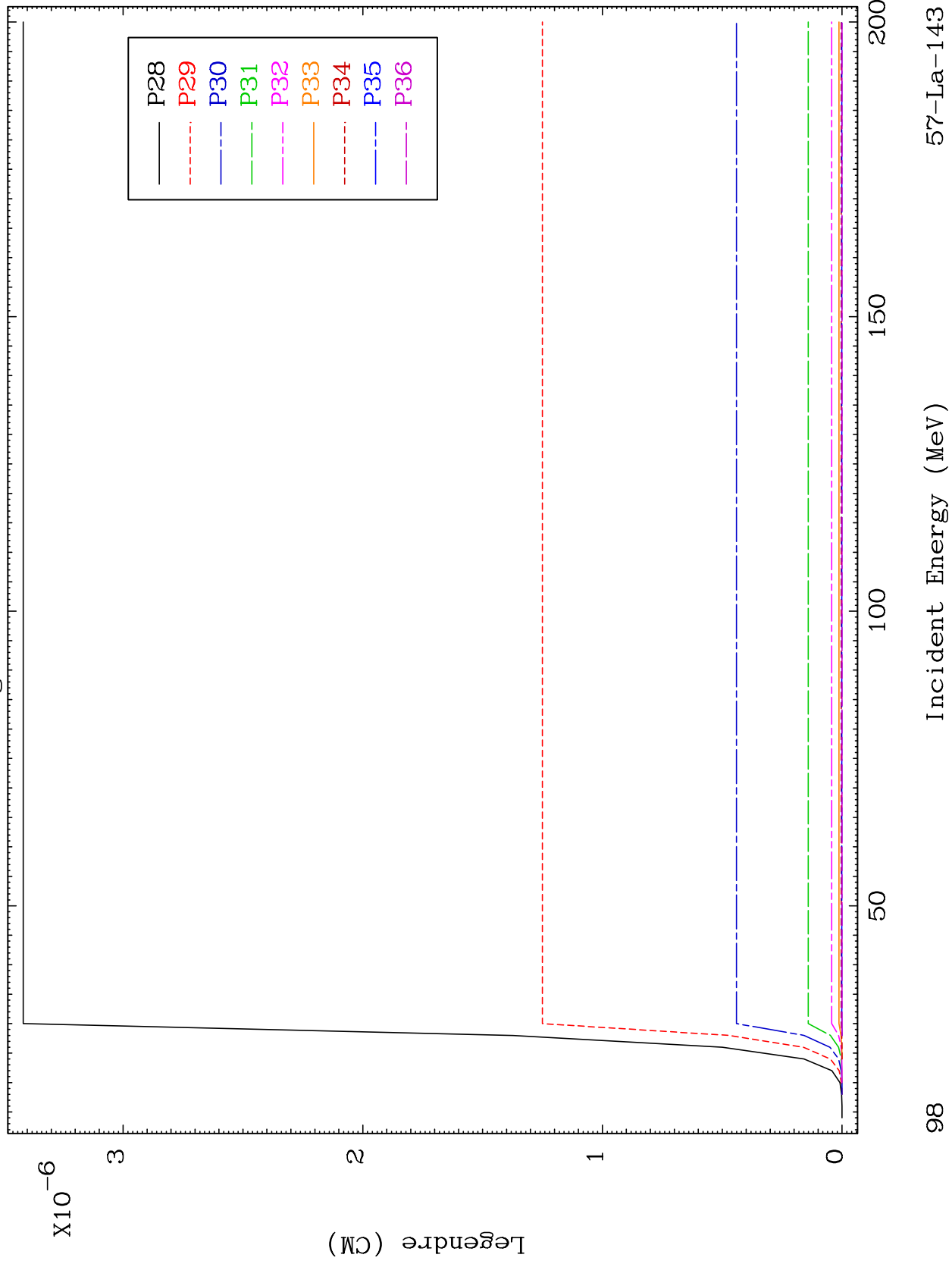

MAT 5740

MT= 71 (n,n') Level
Legendre Coefficients

57-La-143

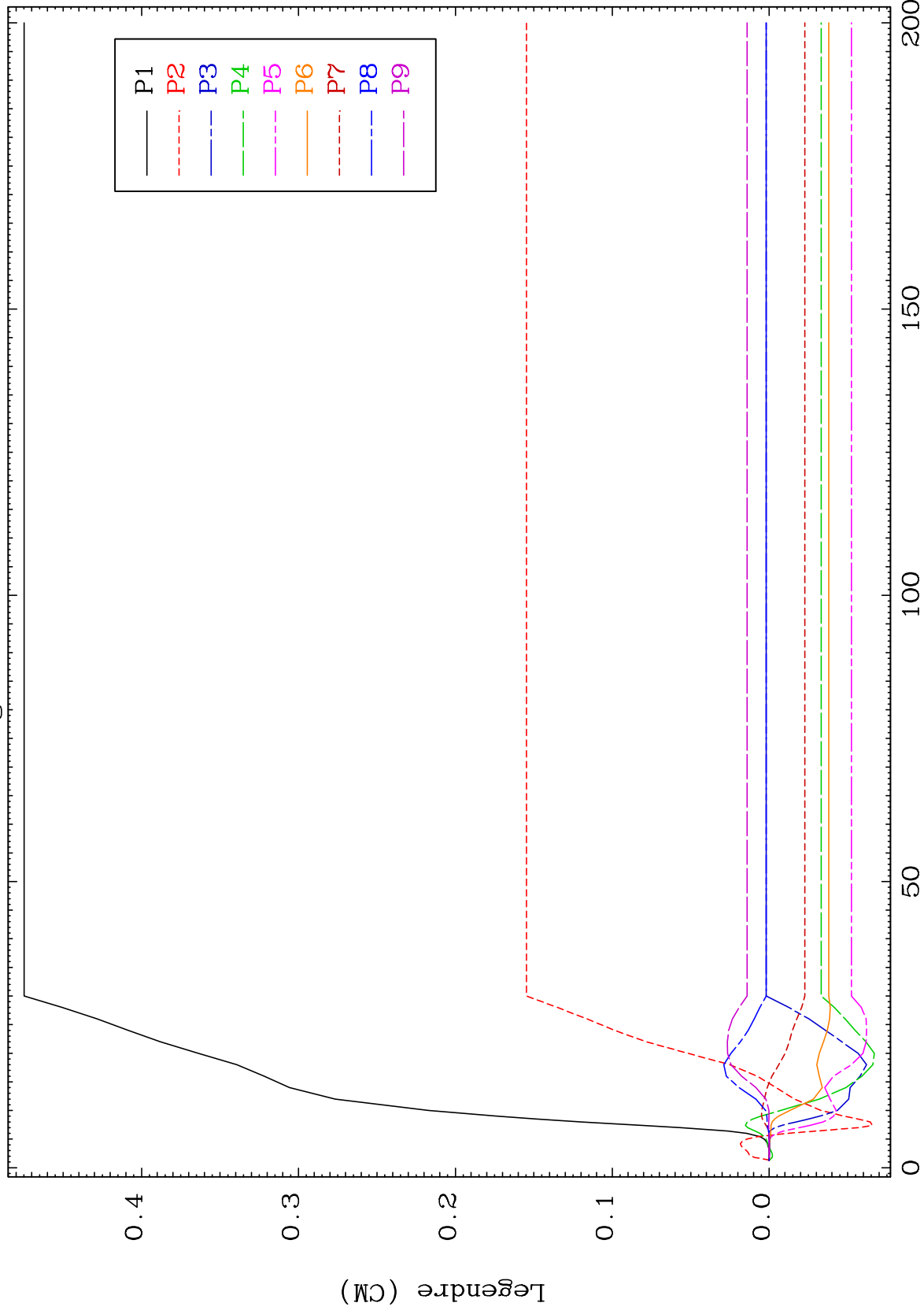

99

Incident Energy (MeV)

57-La-143

MAT 5740

MT= 71 (n,n') Level
Legendre Coefficients

57-La-143

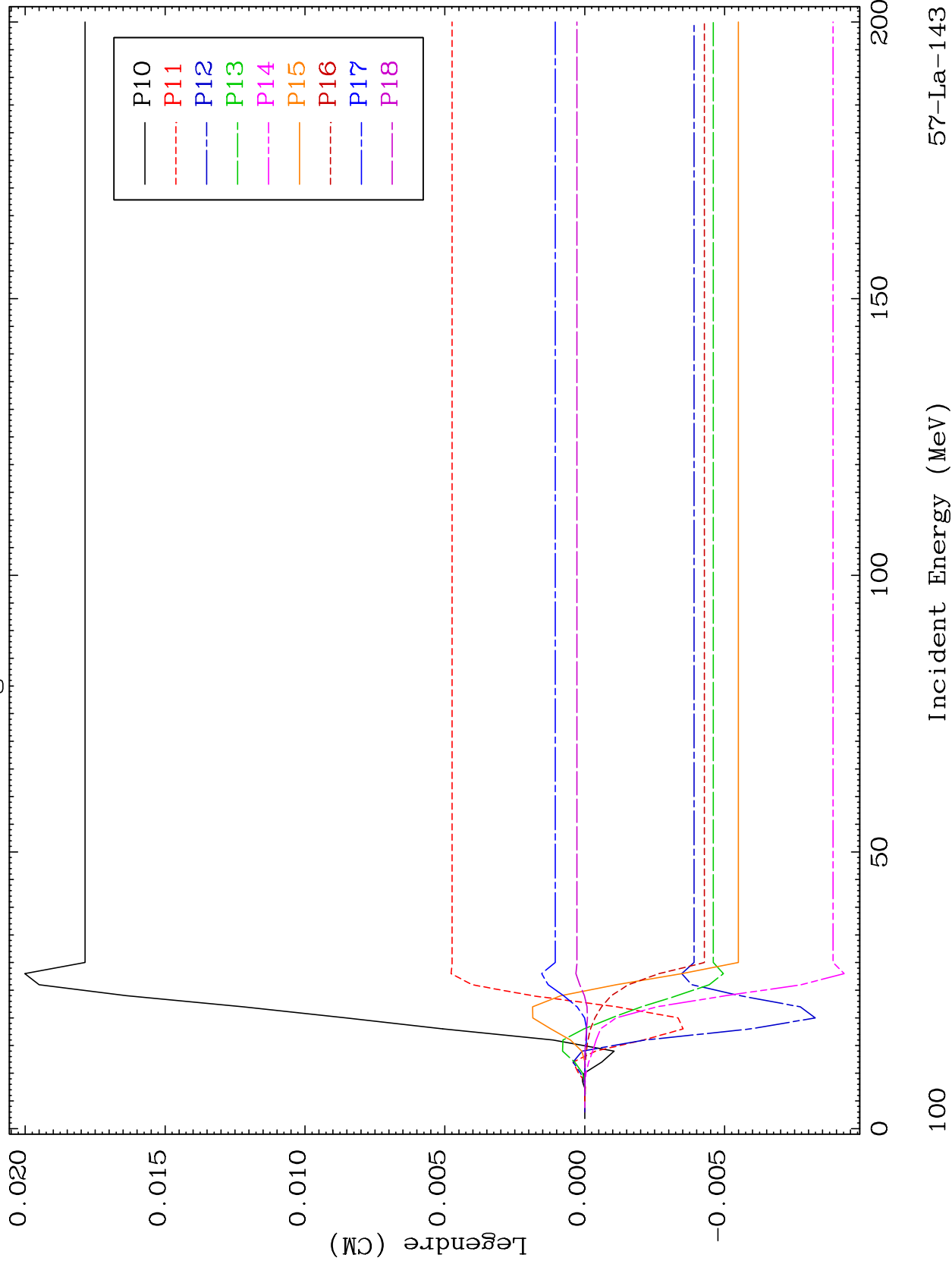

57-La-143

Incident Energy (MeV)

MAT 5740

MT= 71 (n,n') Level
Legendre Coefficients

57-La-143

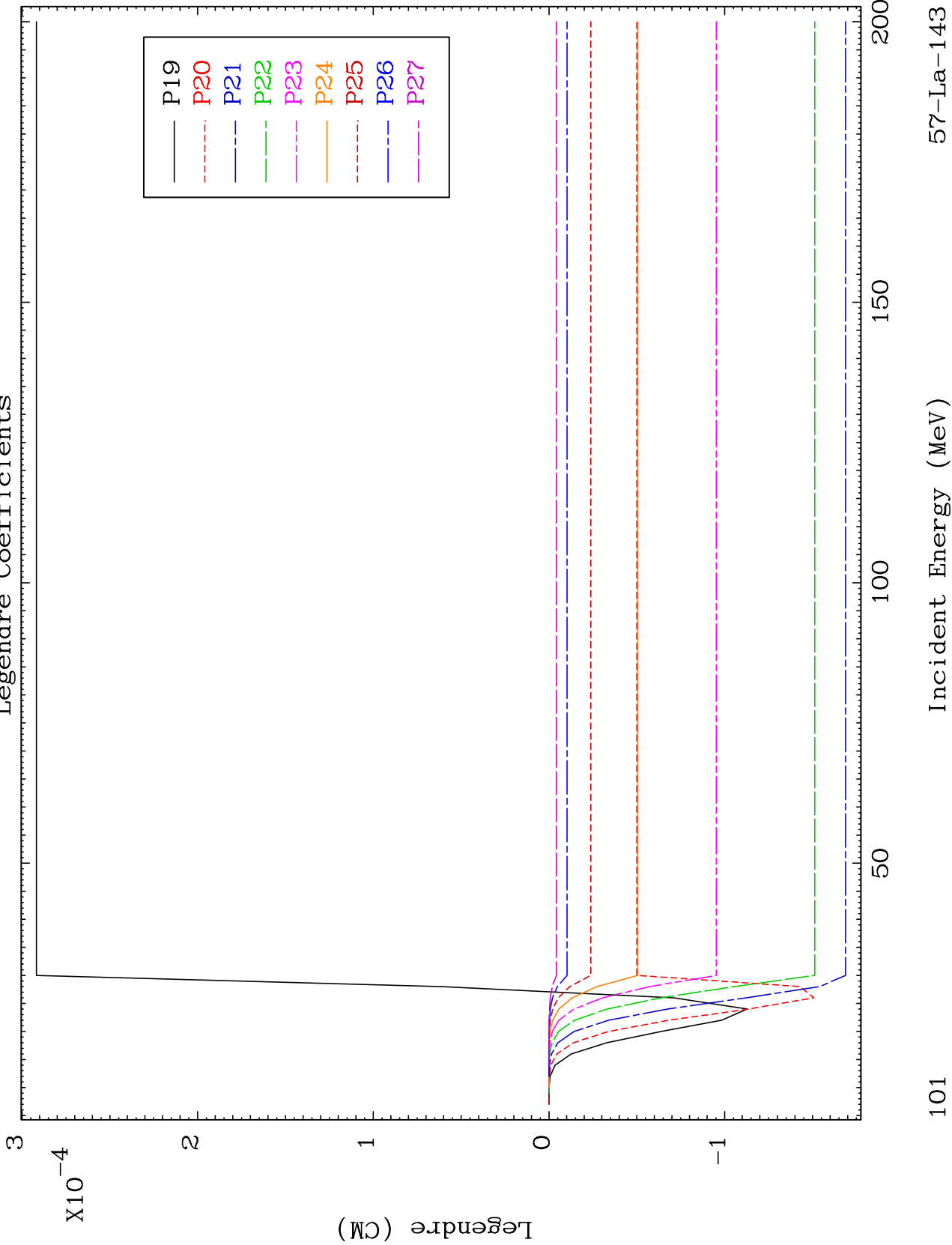

101

57-La-143

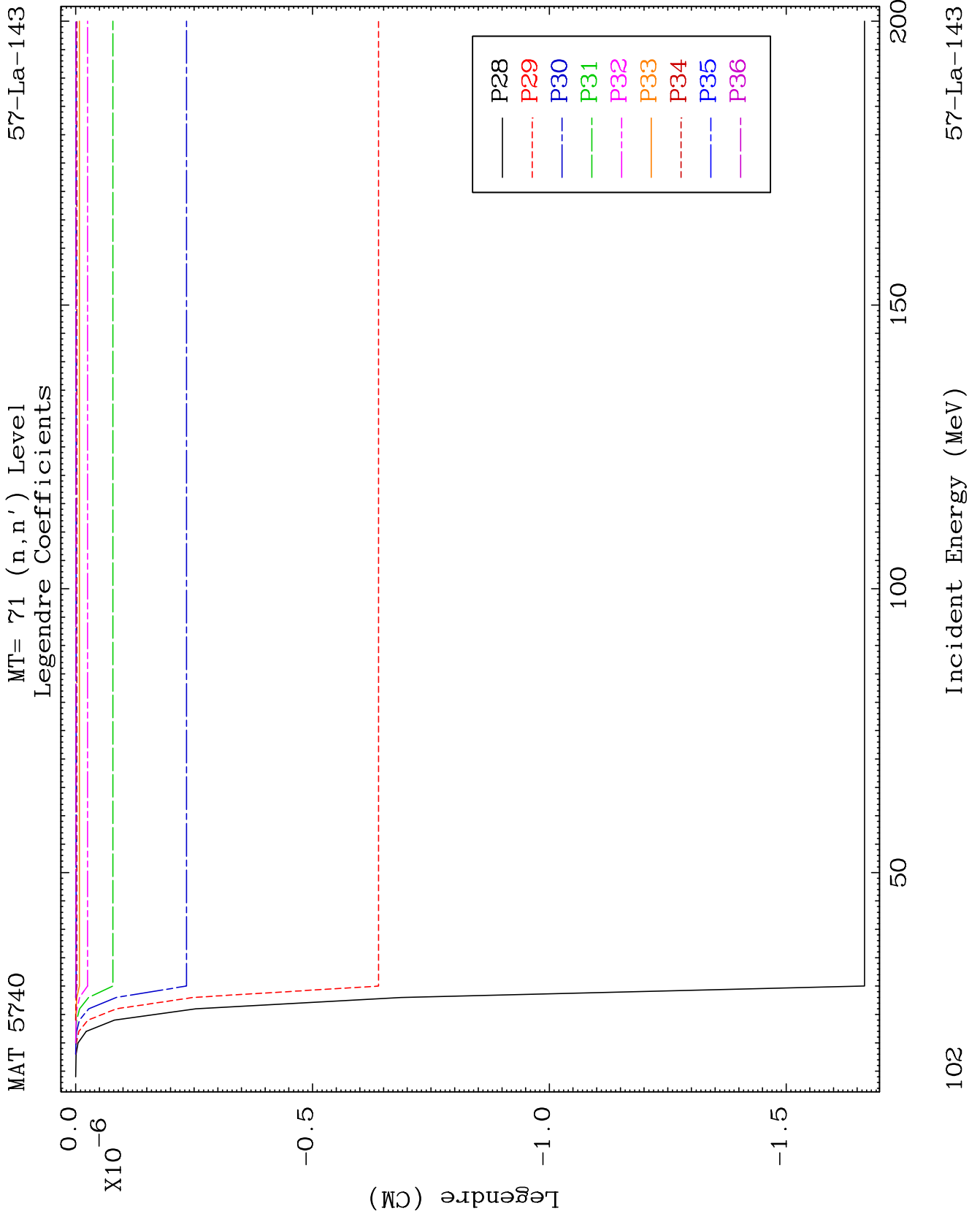

MAT 5740

MT= 72 (n,n') Level
Legendre Coefficients

57-La-143

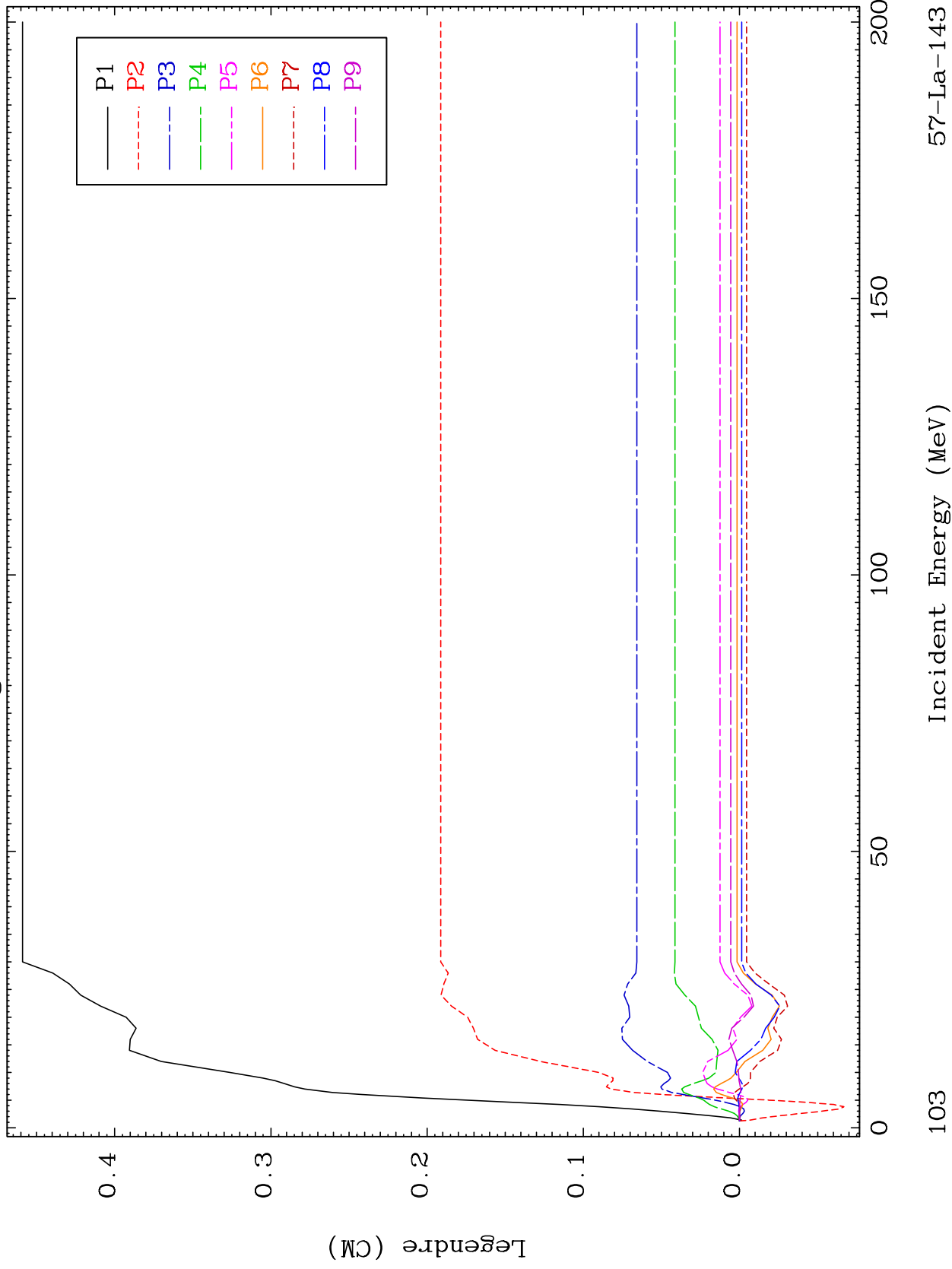

57-La-143

Incident Energy (MeV)

103

MAT 5740

MT= 72 (n,n') Level
Legendre Coefficients

57-La-143

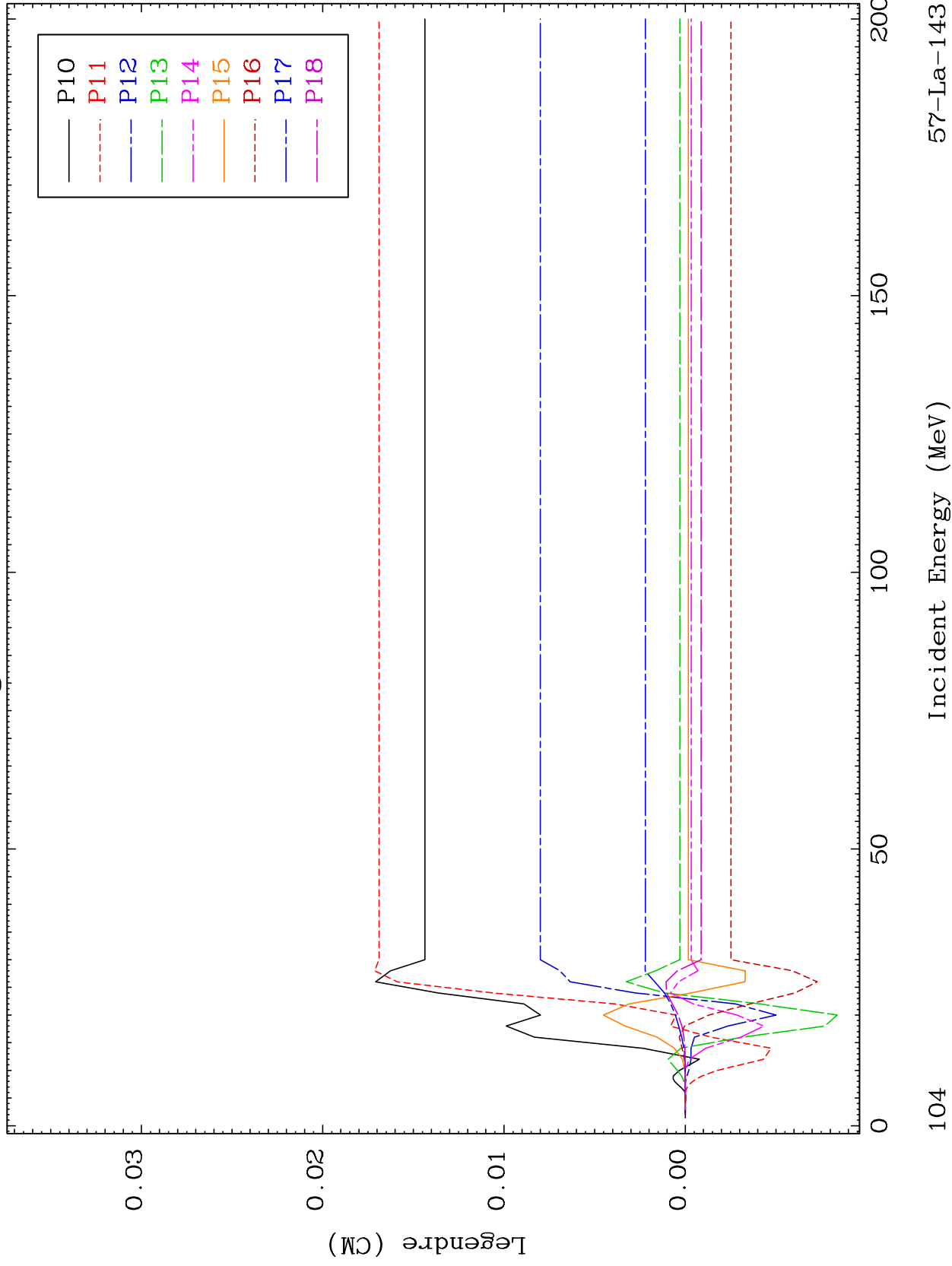

57-La-143

Incident Energy (MeV)

104

MAT 5740

MT= 72 (n,n') Level
Legendre Coefficients

57-La-143

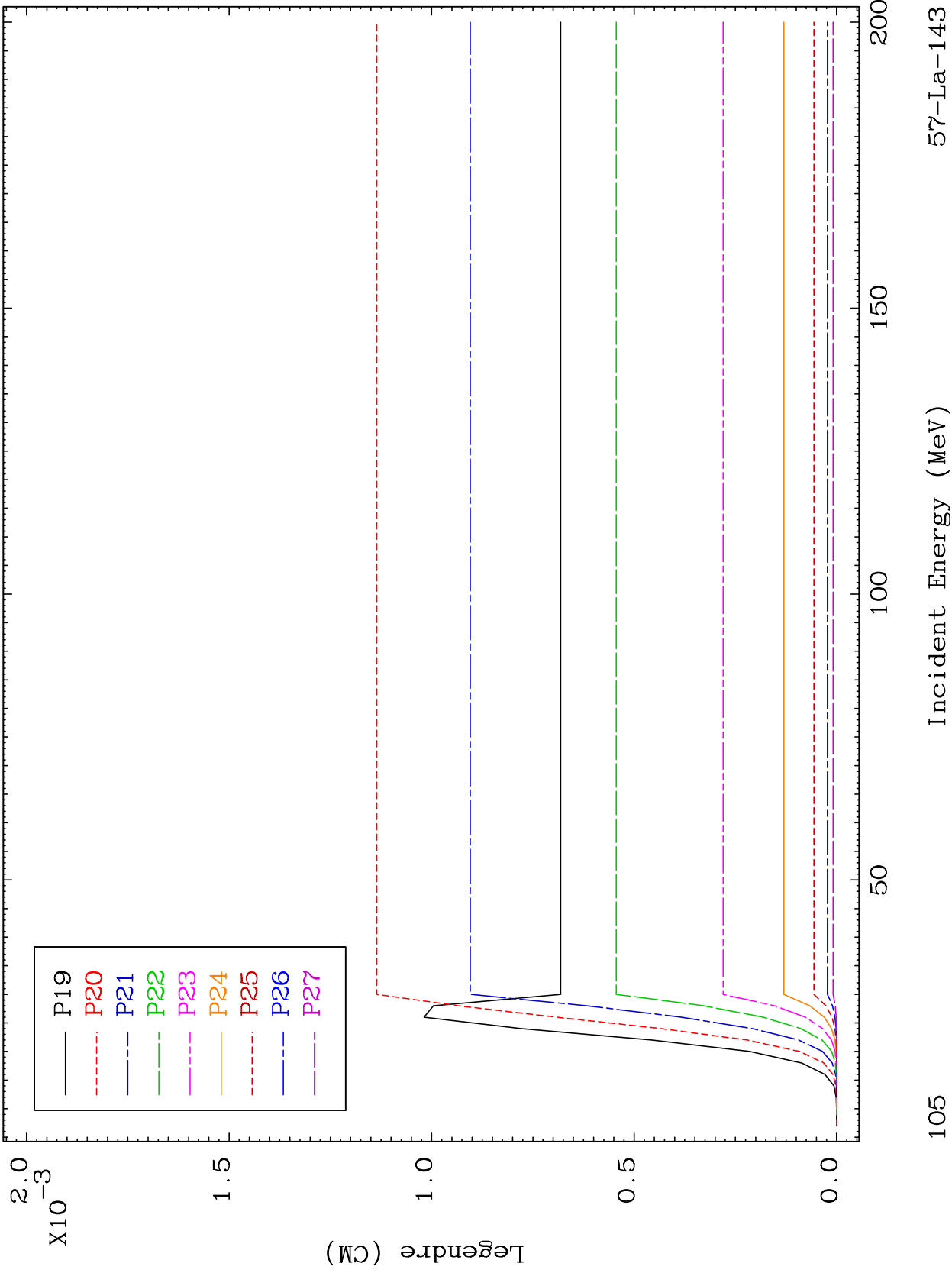

105

Incident Energy (MeV)

57-La-143

MAT 5740

MT= 72 (n,n') Level
Legendre Coefficients

57-La-143

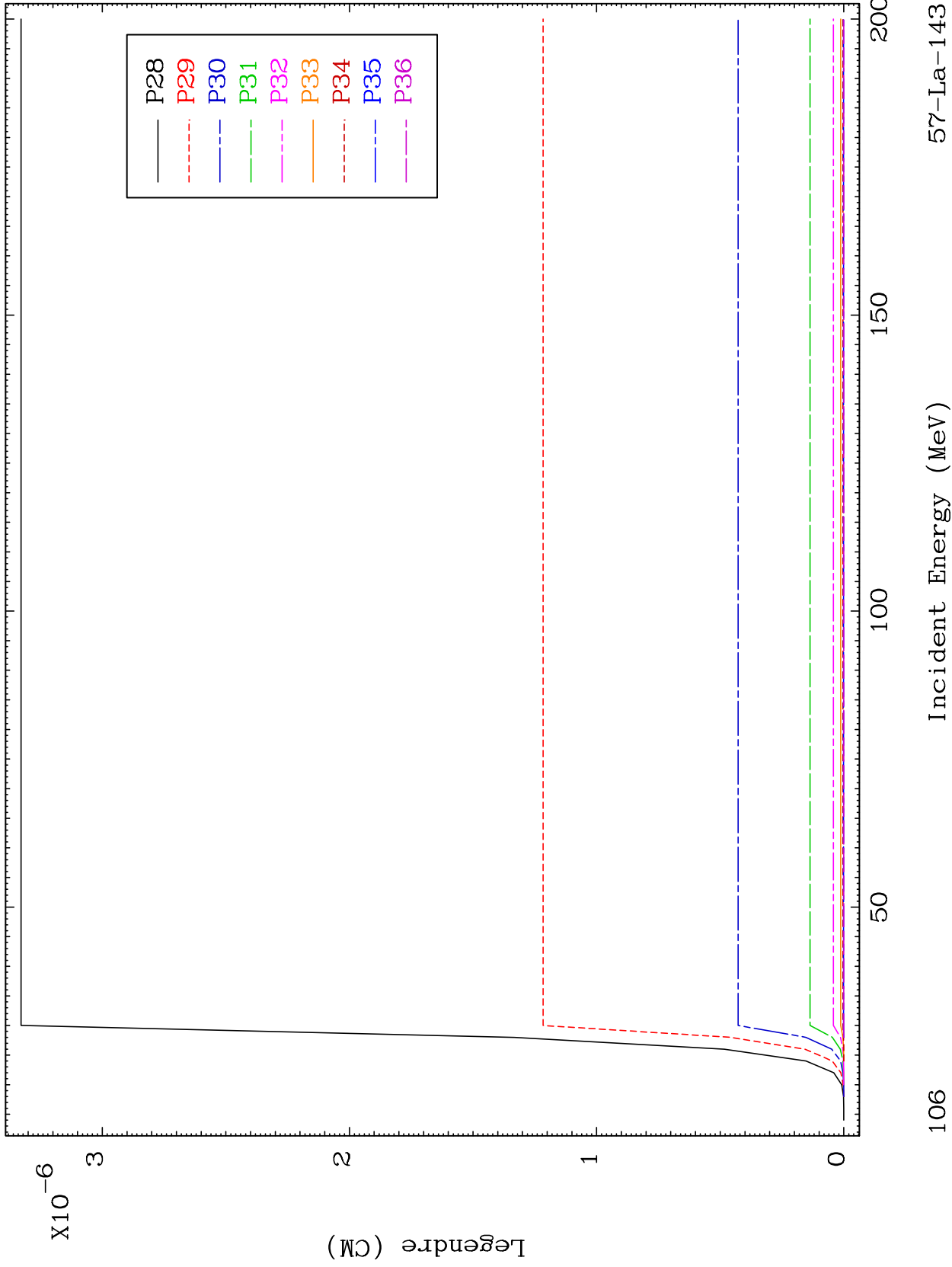

106

Incident Energy (MeV)

150

57-La-143

200

MAT 5740

MT= 73 (n,n') Level
Legendre Coefficients

57-La-143

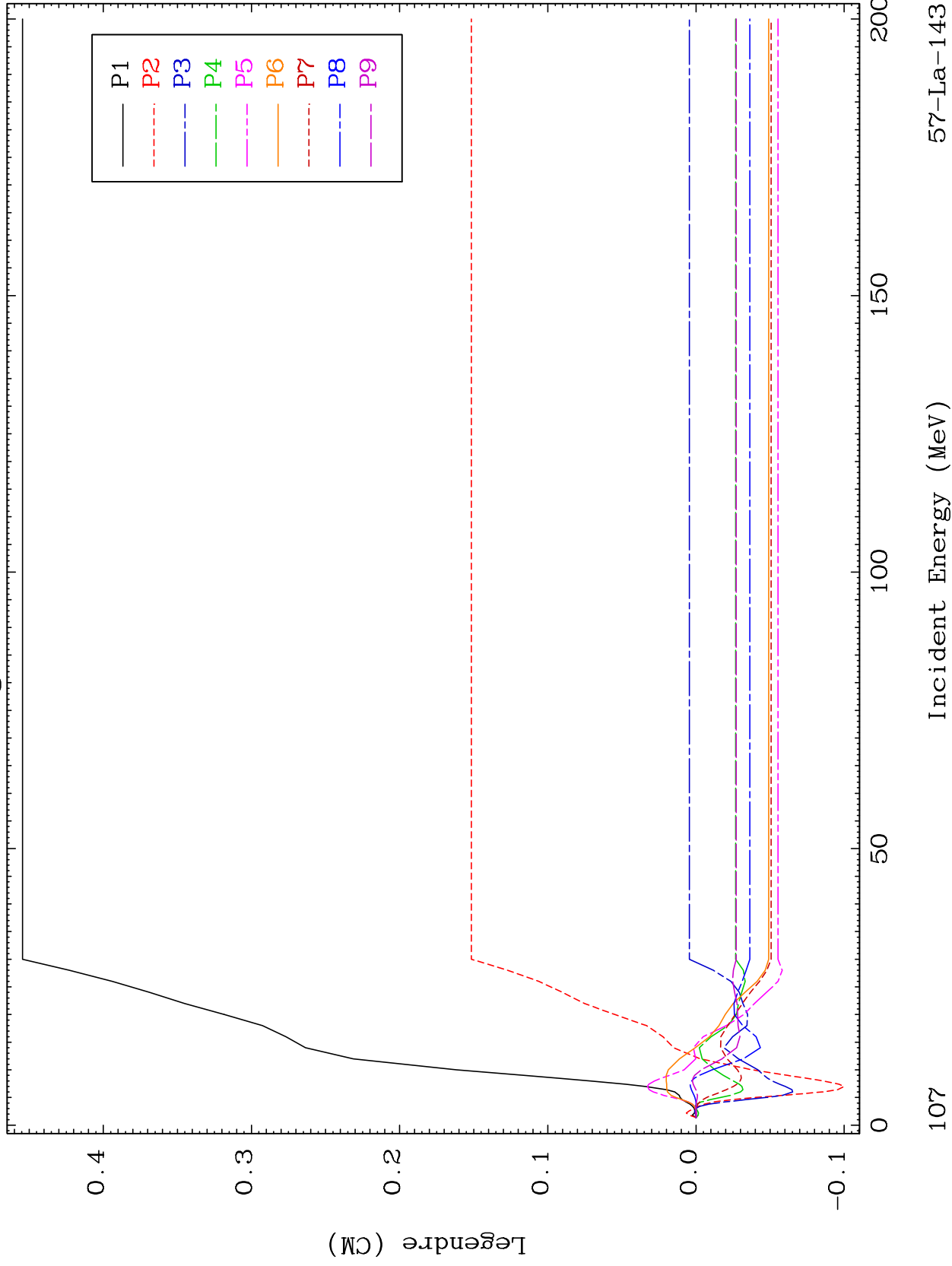

57-La-143

Incident Energy (MeV)

107

MAT 5740

MT= 73 (n,n') Level
Legendre Coefficients

57-La-143

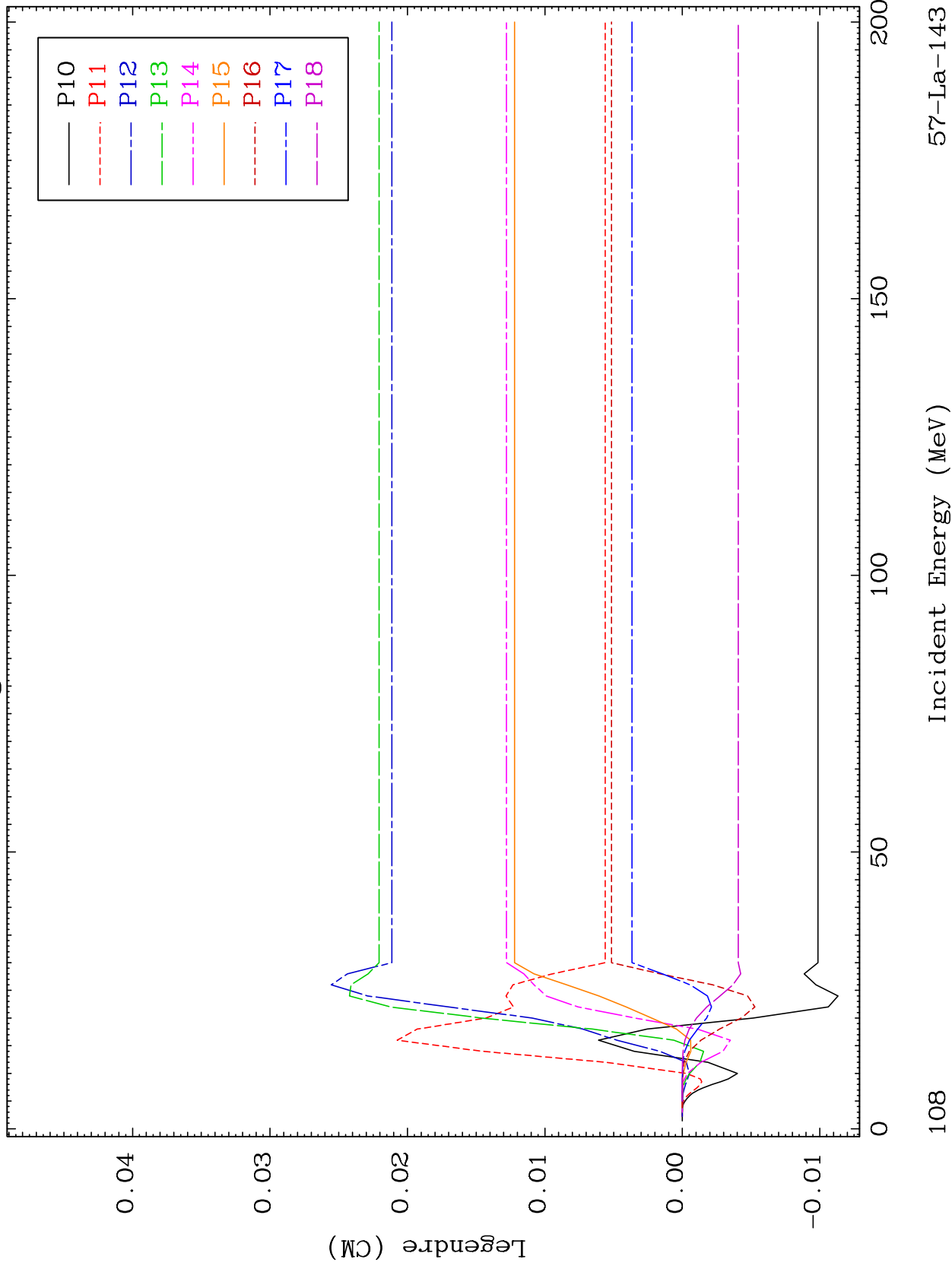

57-La-143

Incident Energy (MeV)

108

MAT 5740

MT= 73 (n,n') Level
Legendre Coefficients

57-La-143

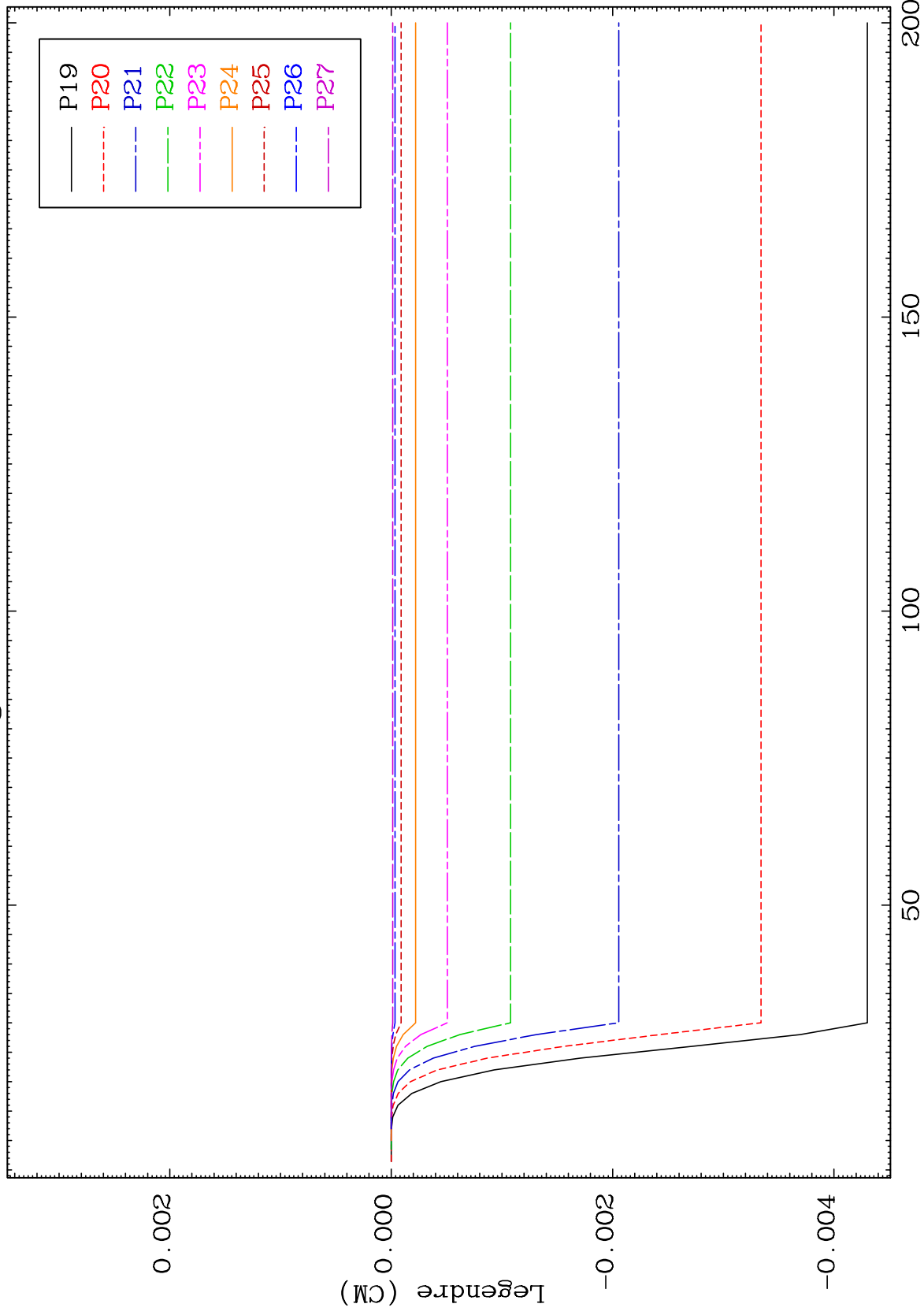

109

Incident Energy (MeV)

57-La-143

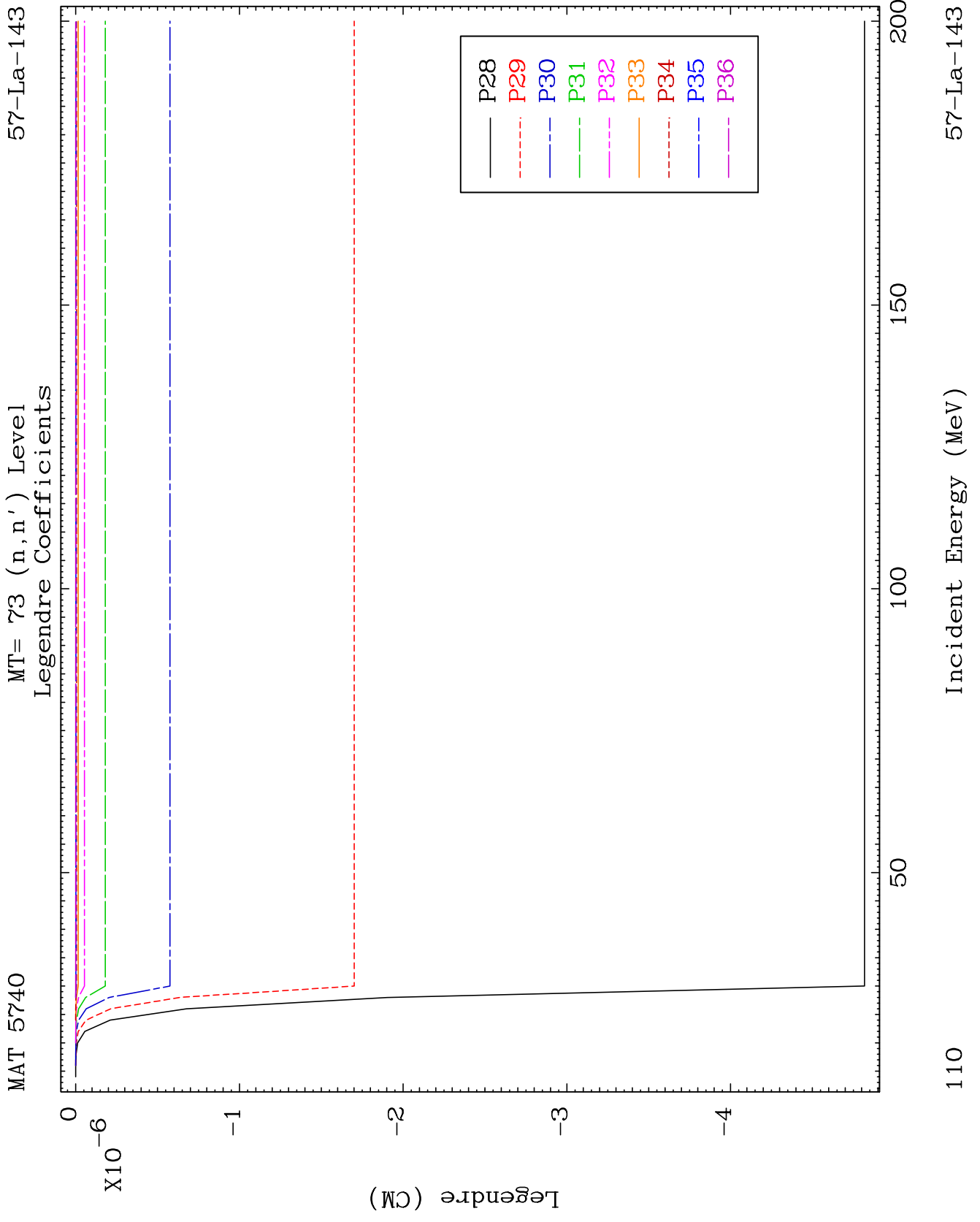

MAT 5740

MT= 74 (n,n') Level
Legendre Coefficients

57-La-143

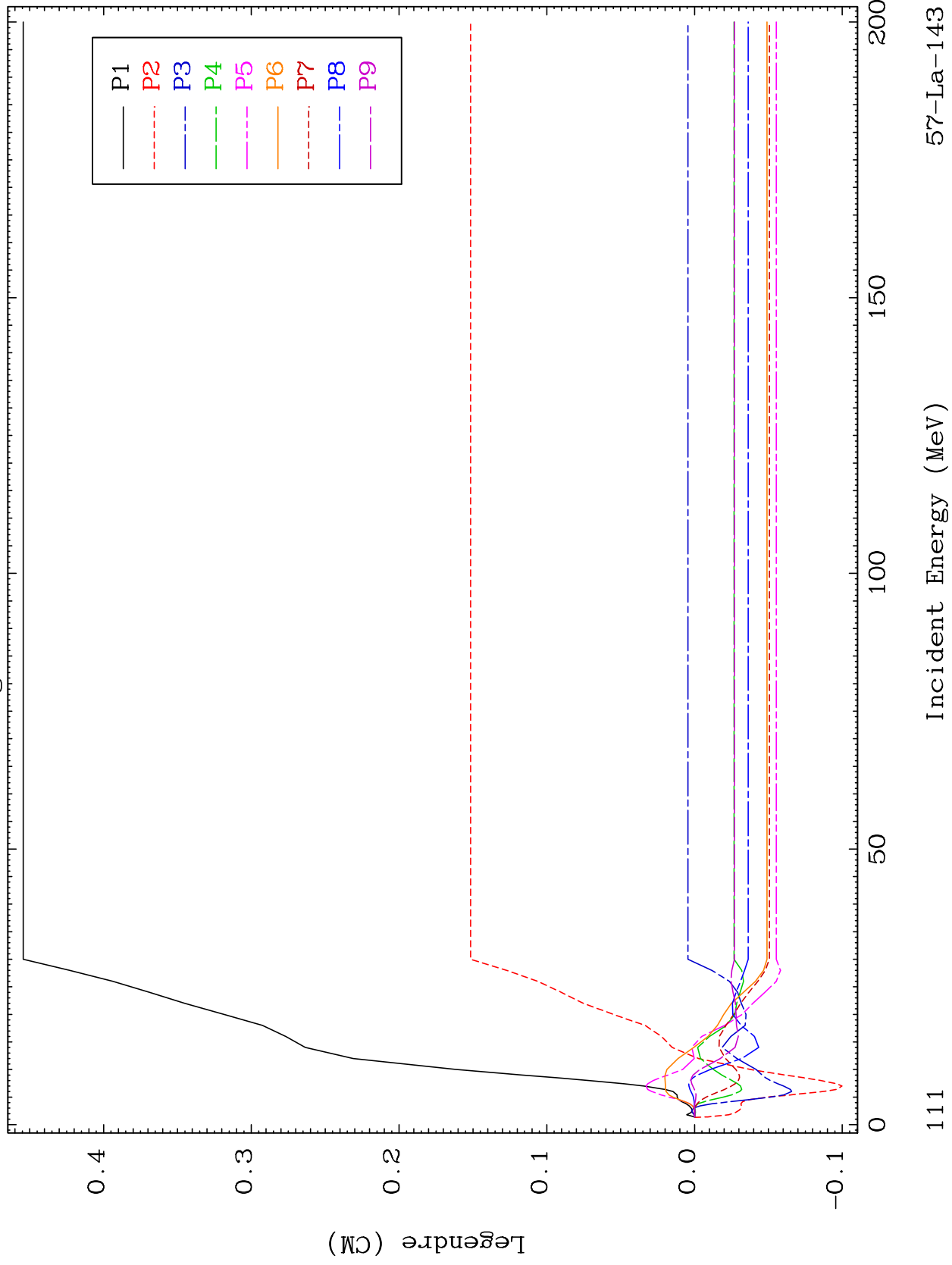

111

Incident Energy (MeV)

57-La-143

MAT 5740

MT= 74 (n,n') Level
Legendre Coefficients

57-La-143

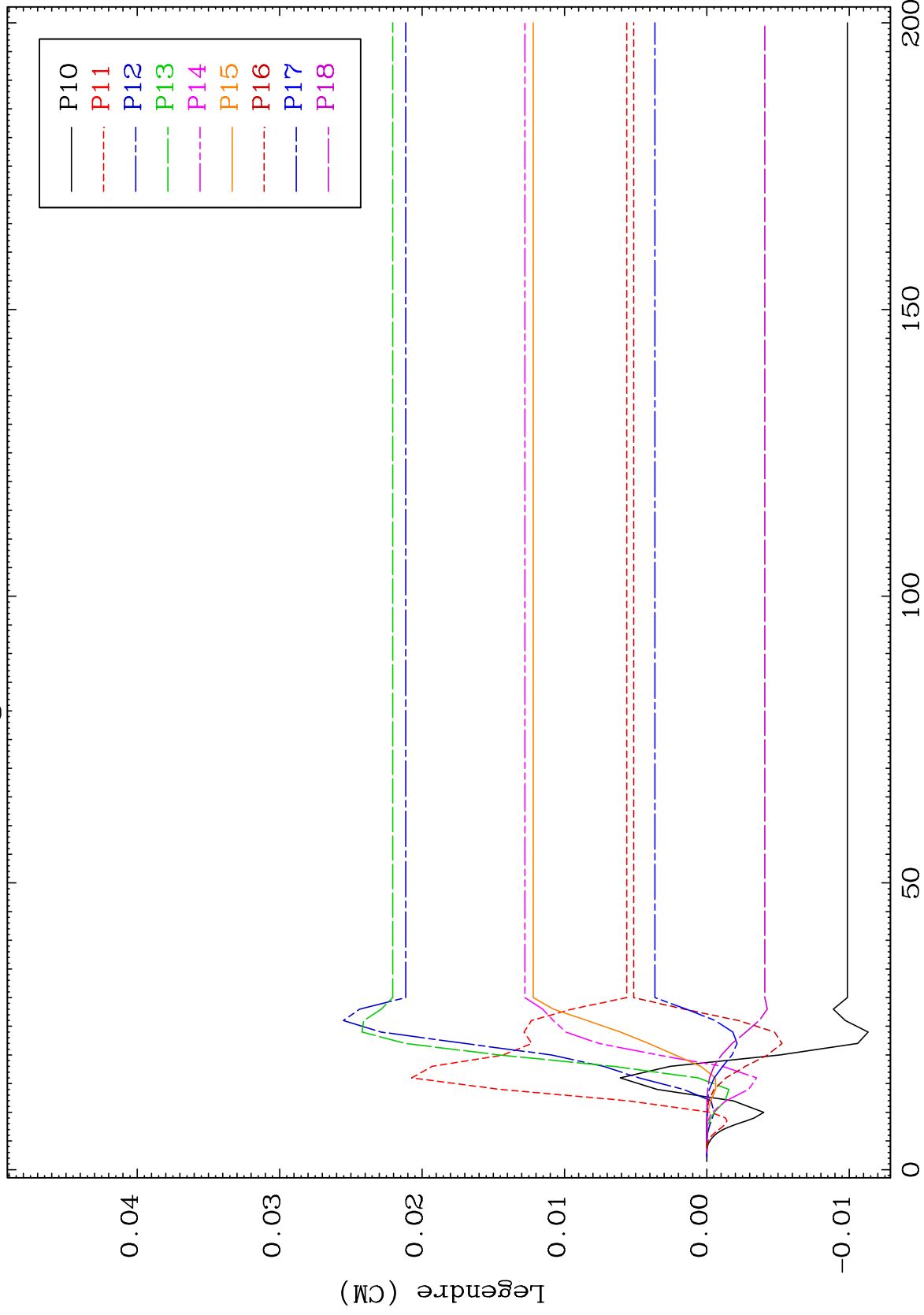

112

Incident Energy (MeV)

57-La-143

MAT 5740

MT= 74 (n,n') Level
Legendre Coefficients

57-La-143

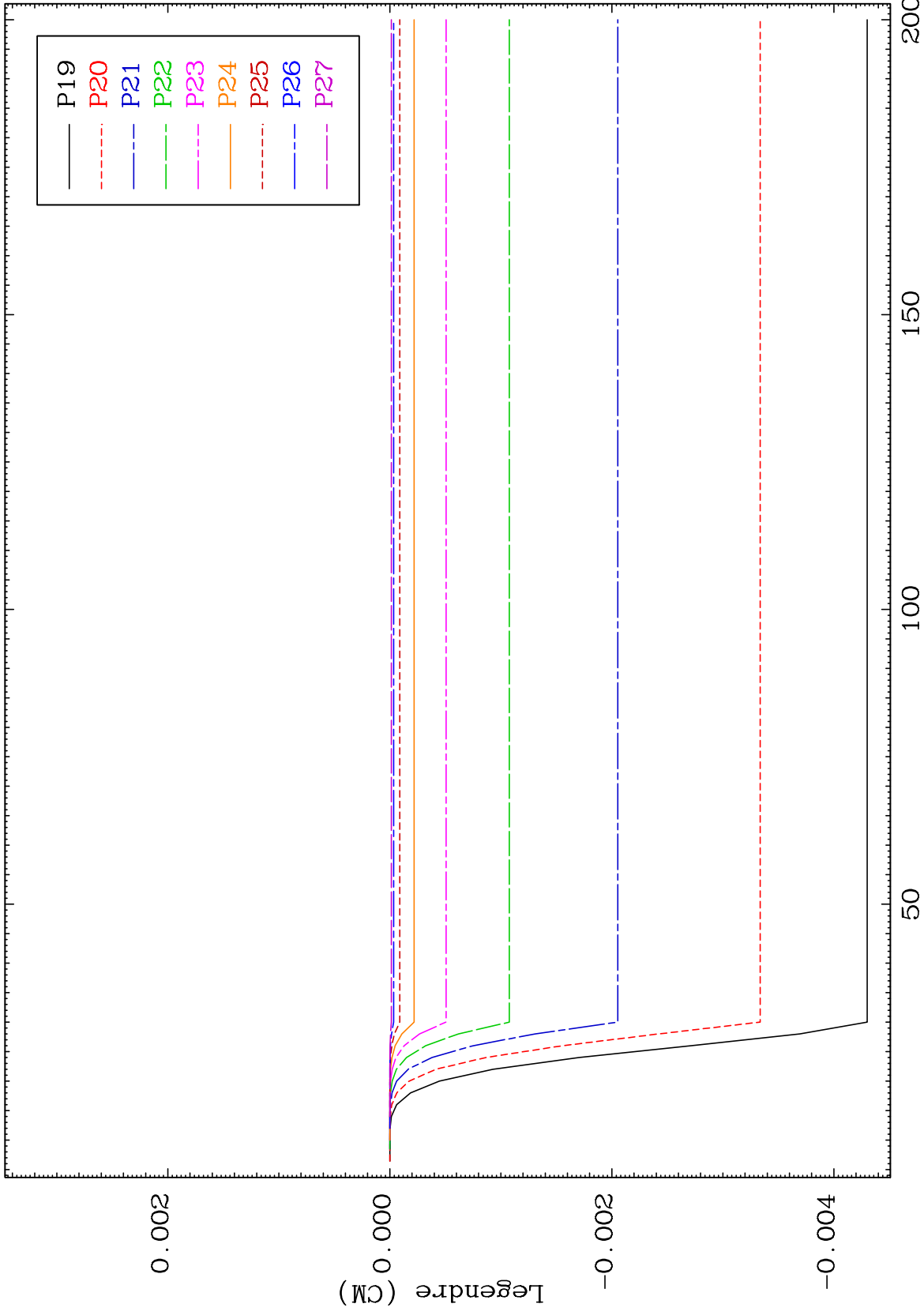

113

Incident Energy (MeV)

57-La-143

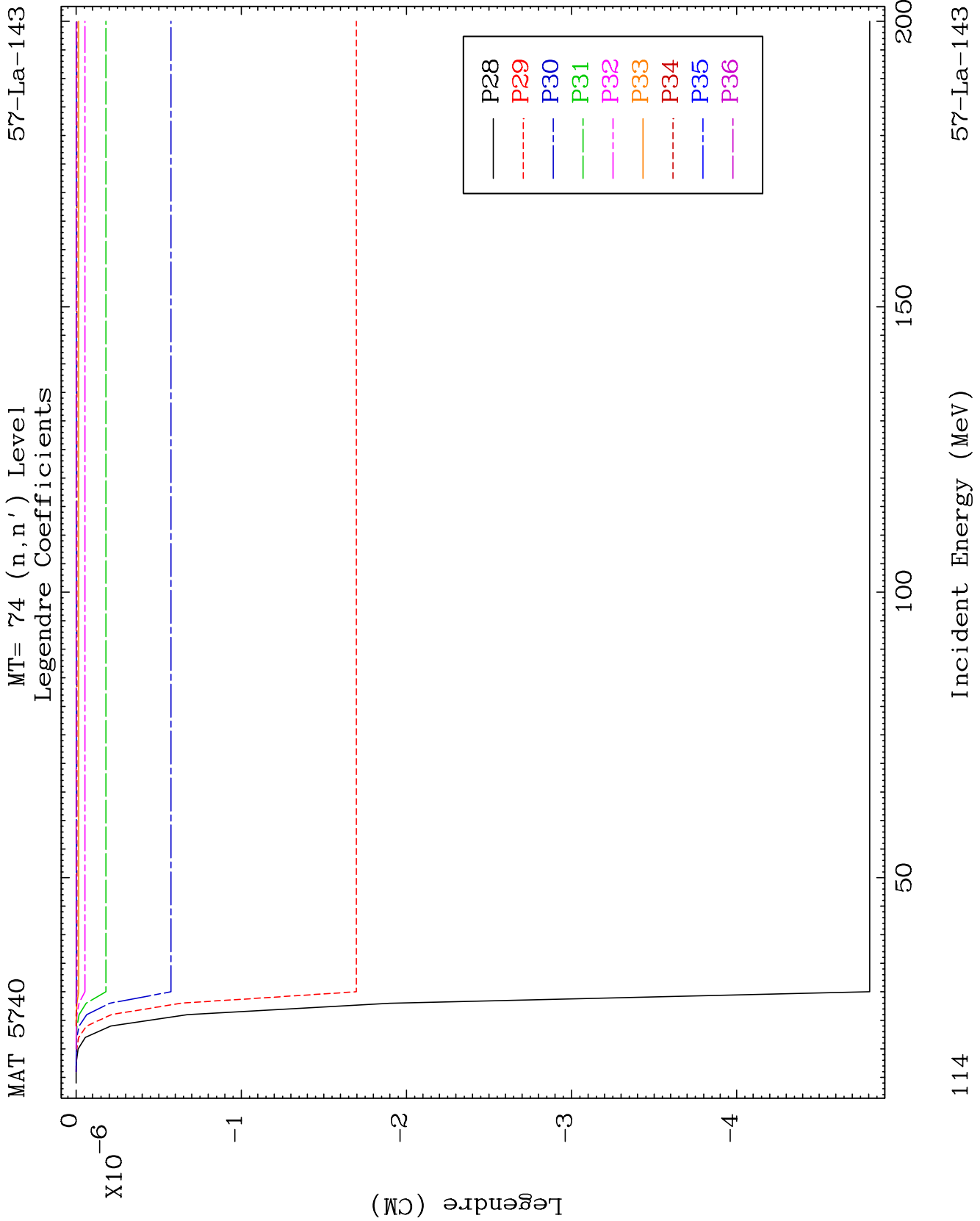

MAT 5740

MT= 75 (n,n') Level
Legendre Coefficients

57-La-143

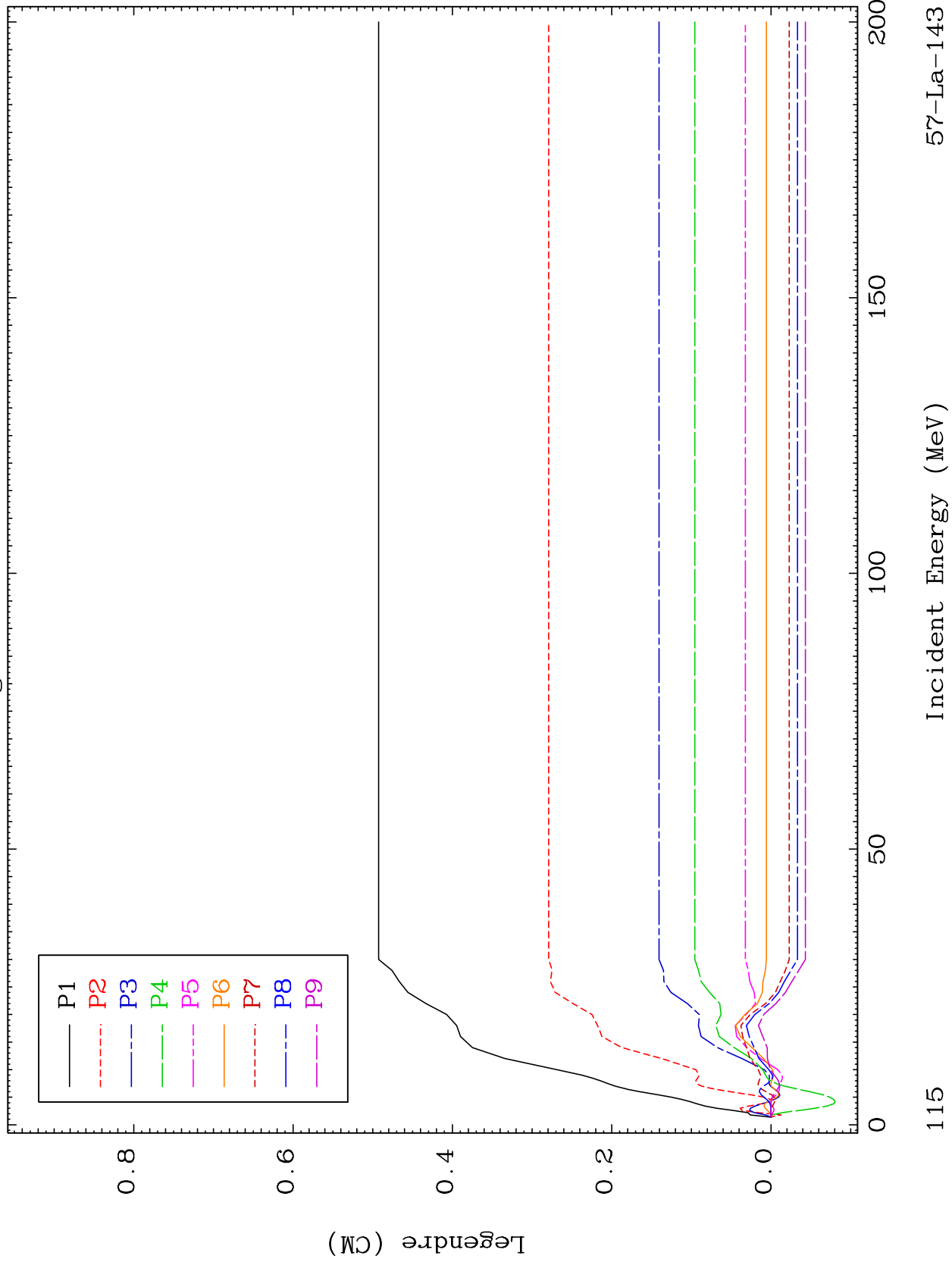

57-La-143

Incident Energy (MeV)

115

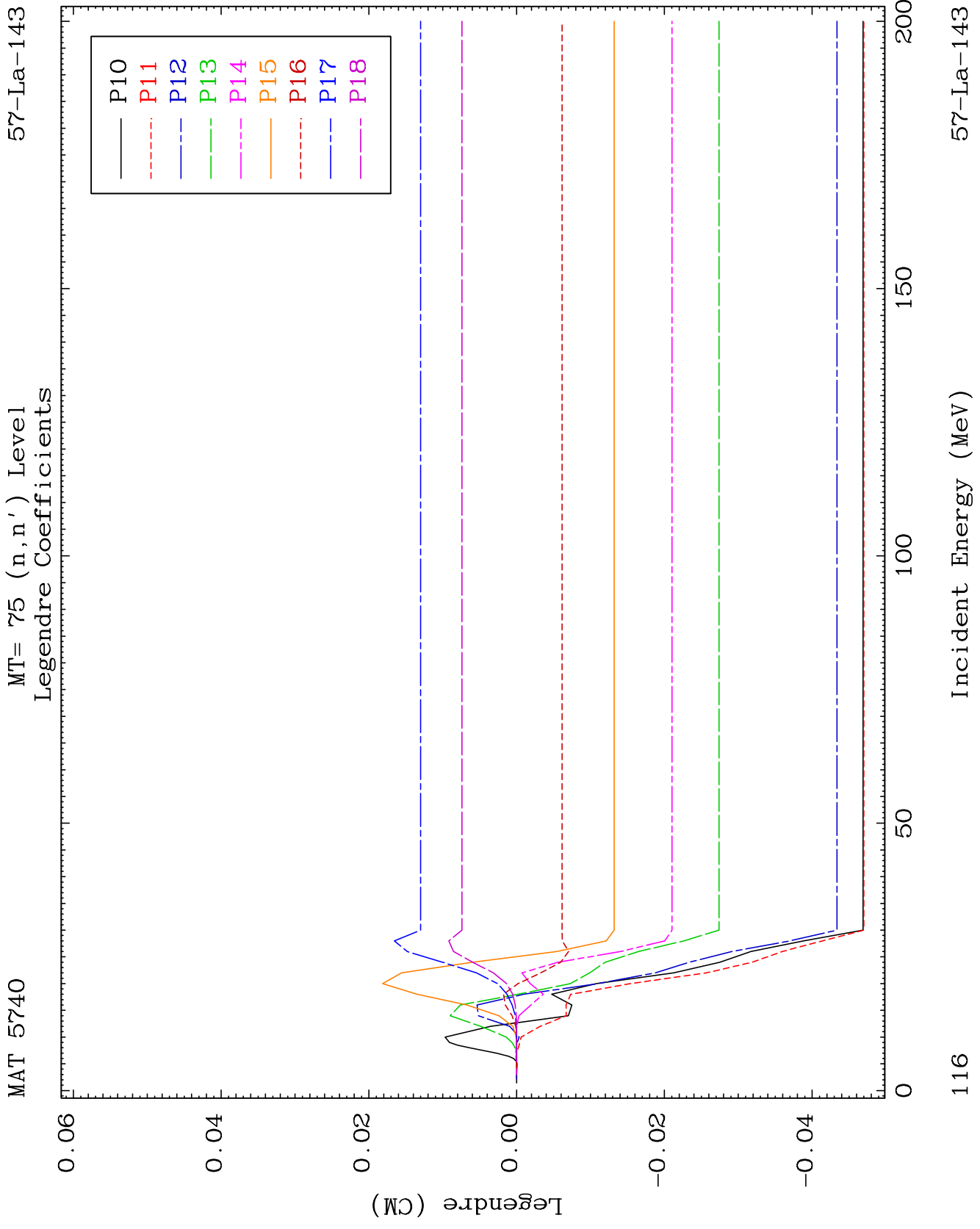

MAT 5740

MT= 75 (n,n') Level
Legendre Coefficients

57-La-143

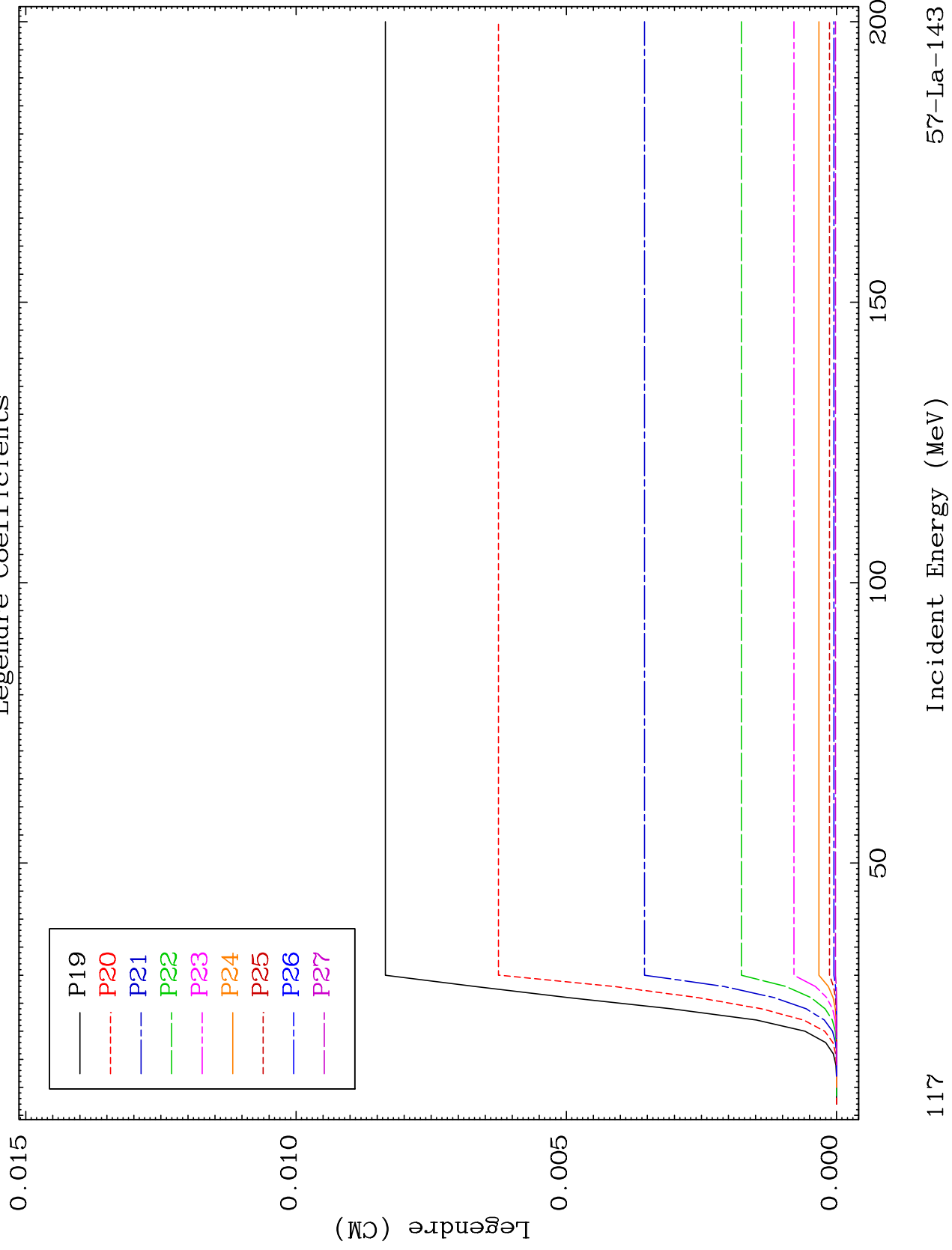

117

Incident Energy (MeV)

57-La-143

MAT 5740

MT= 75 (n,n') Level
Legendre Coefficients

57-La-143

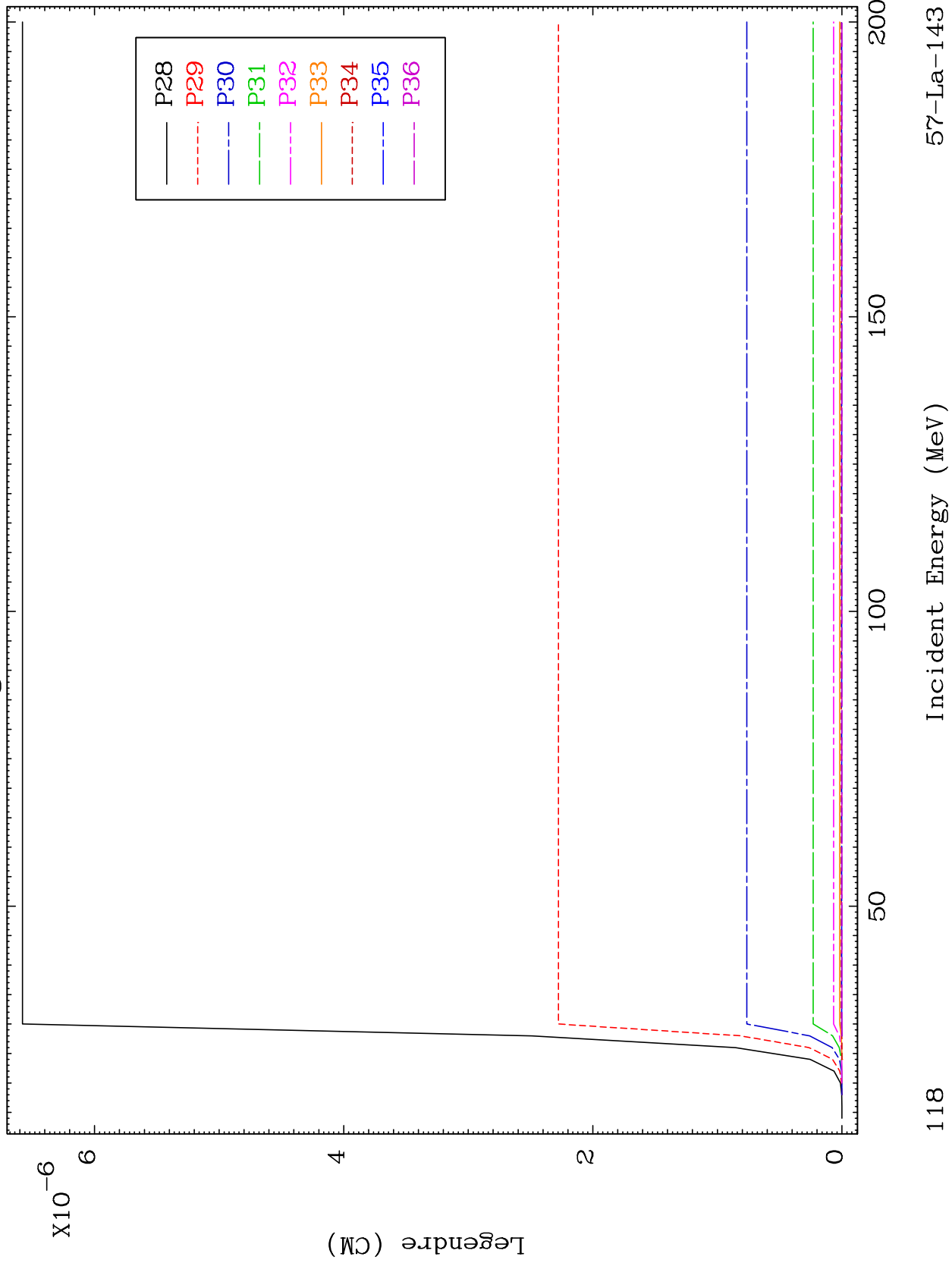

118

Incident Energy (MeV)

57-La-143

MAT 5740

MT= 76 (n,n') Level
Legendre Coefficients

57-La-143

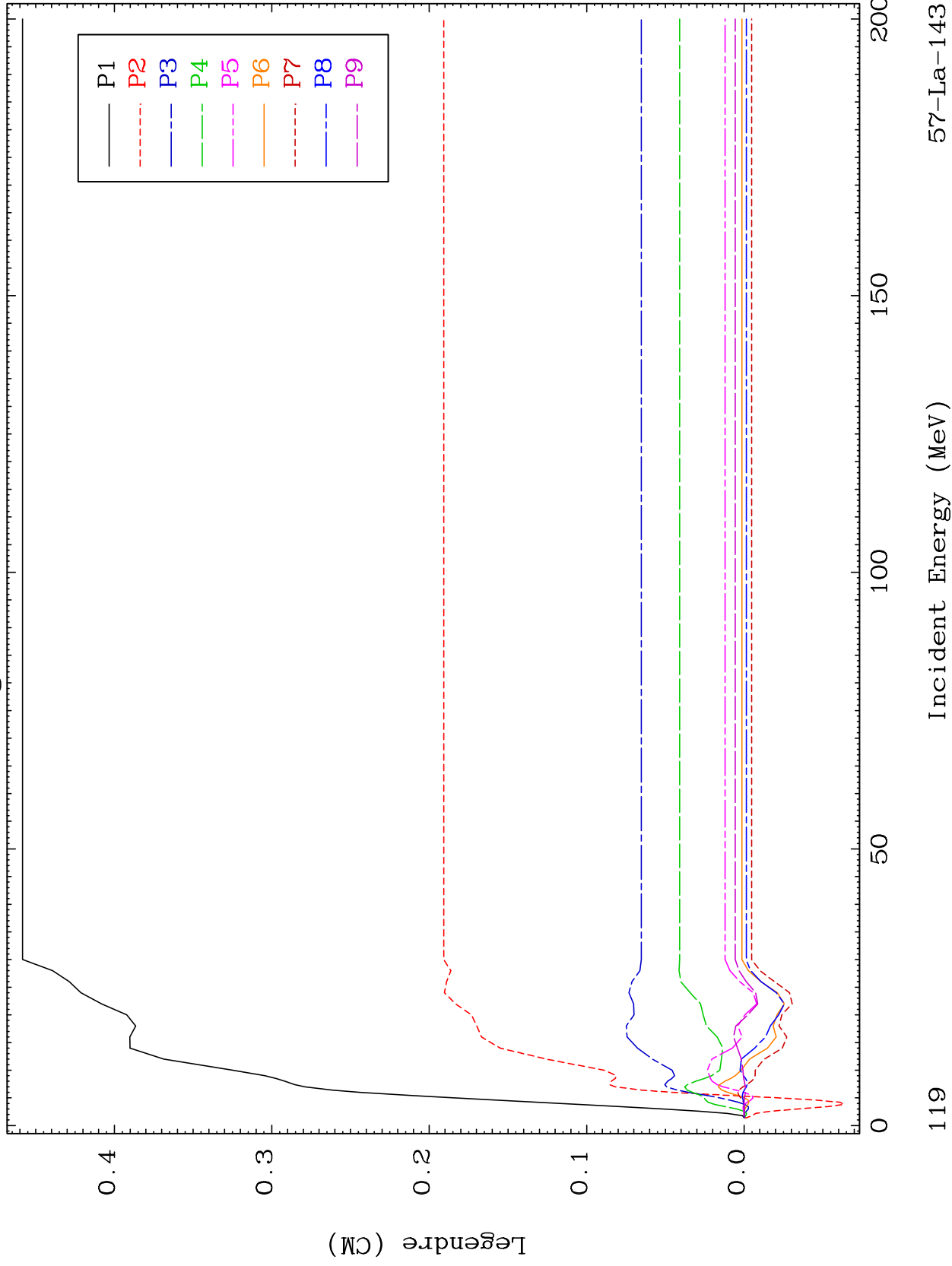

57-La-143

Incident Energy (MeV)

119

MAT 5740

MT= 76 (n,n') Level
Legendre Coefficients

57-La-143

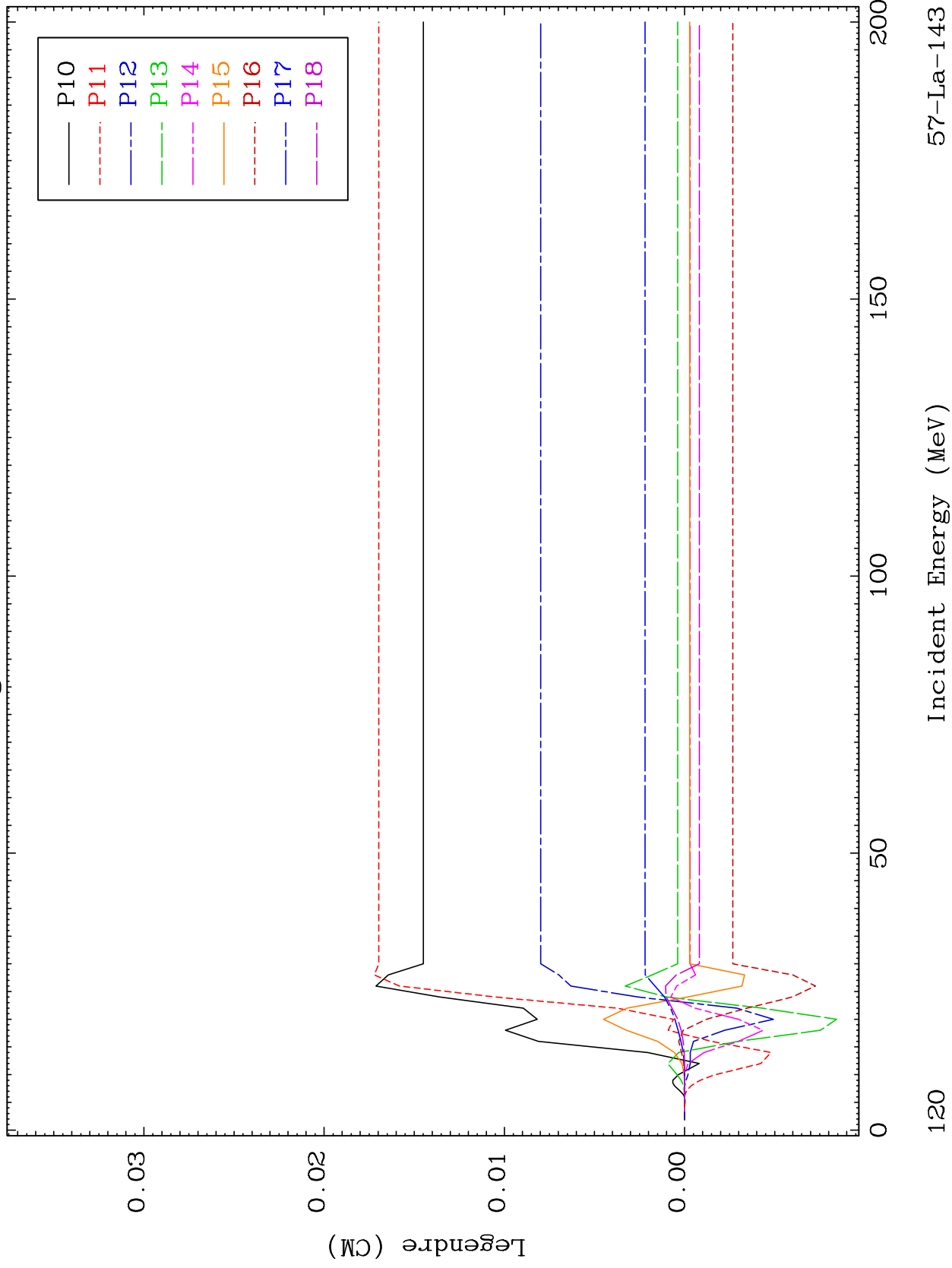

57-La-143

Incident Energy (MeV)

120

MAT 5740

MT= 76 (n,n') Level
Legendre Coefficients

57-La-143

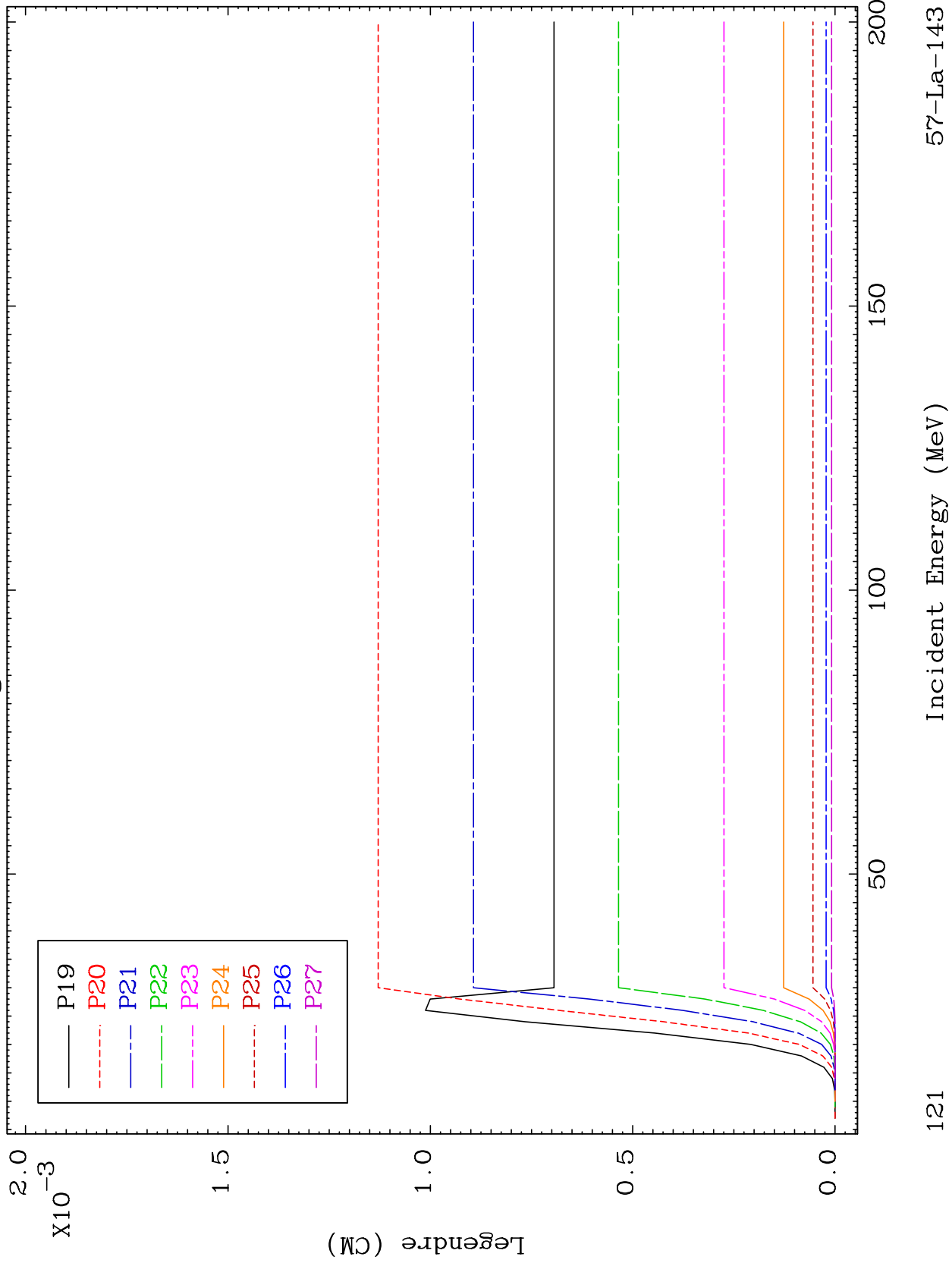

121

57-La-143

MAT 5740

MT= 76 (n,n') Level
Legendre Coefficients

57-La-143

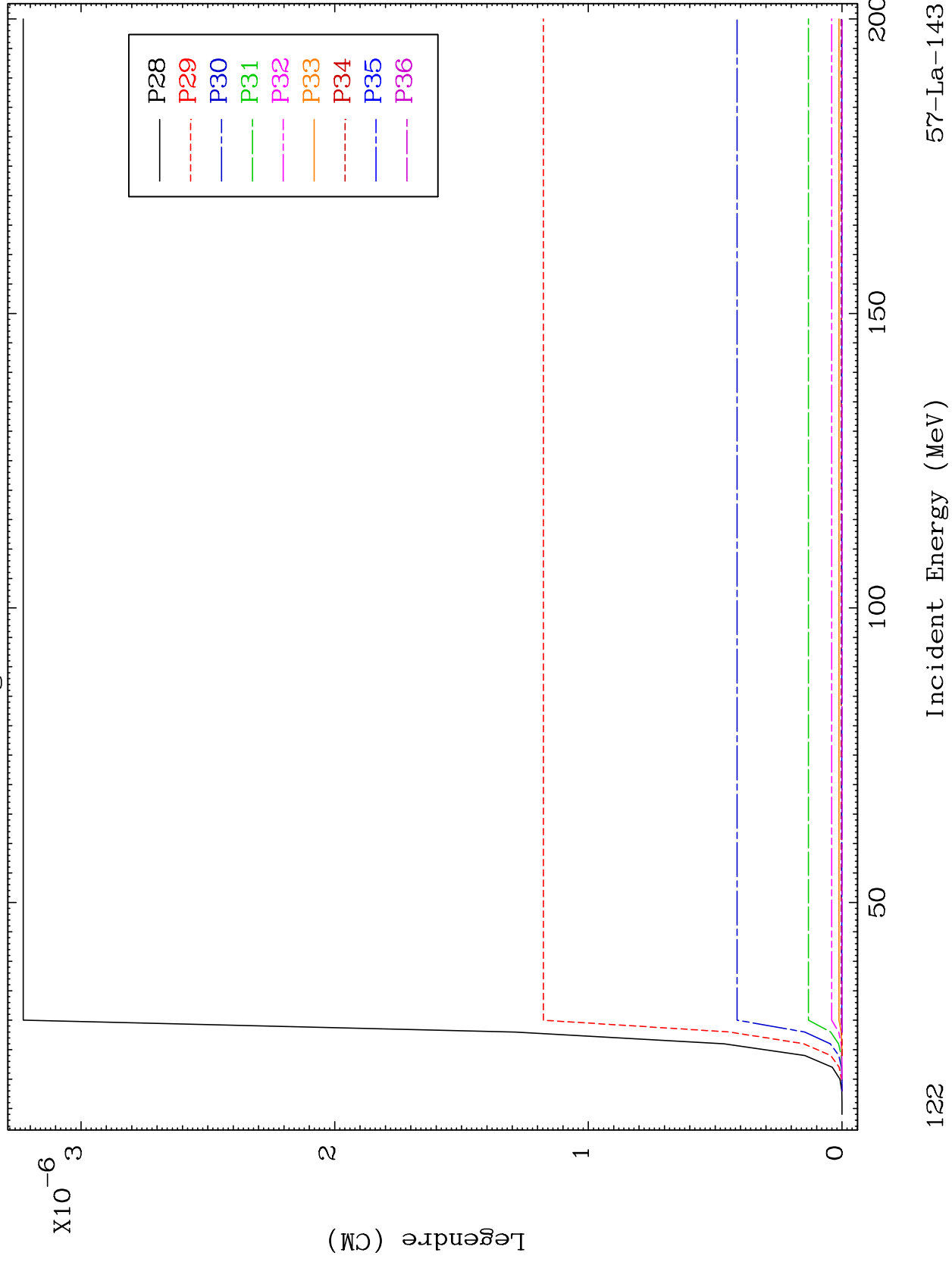

122

Incident Energy (MeV)

57-La-143

MAT 5740

MT= 77 (n,n') Level
Legendre Coefficients

57-La-143

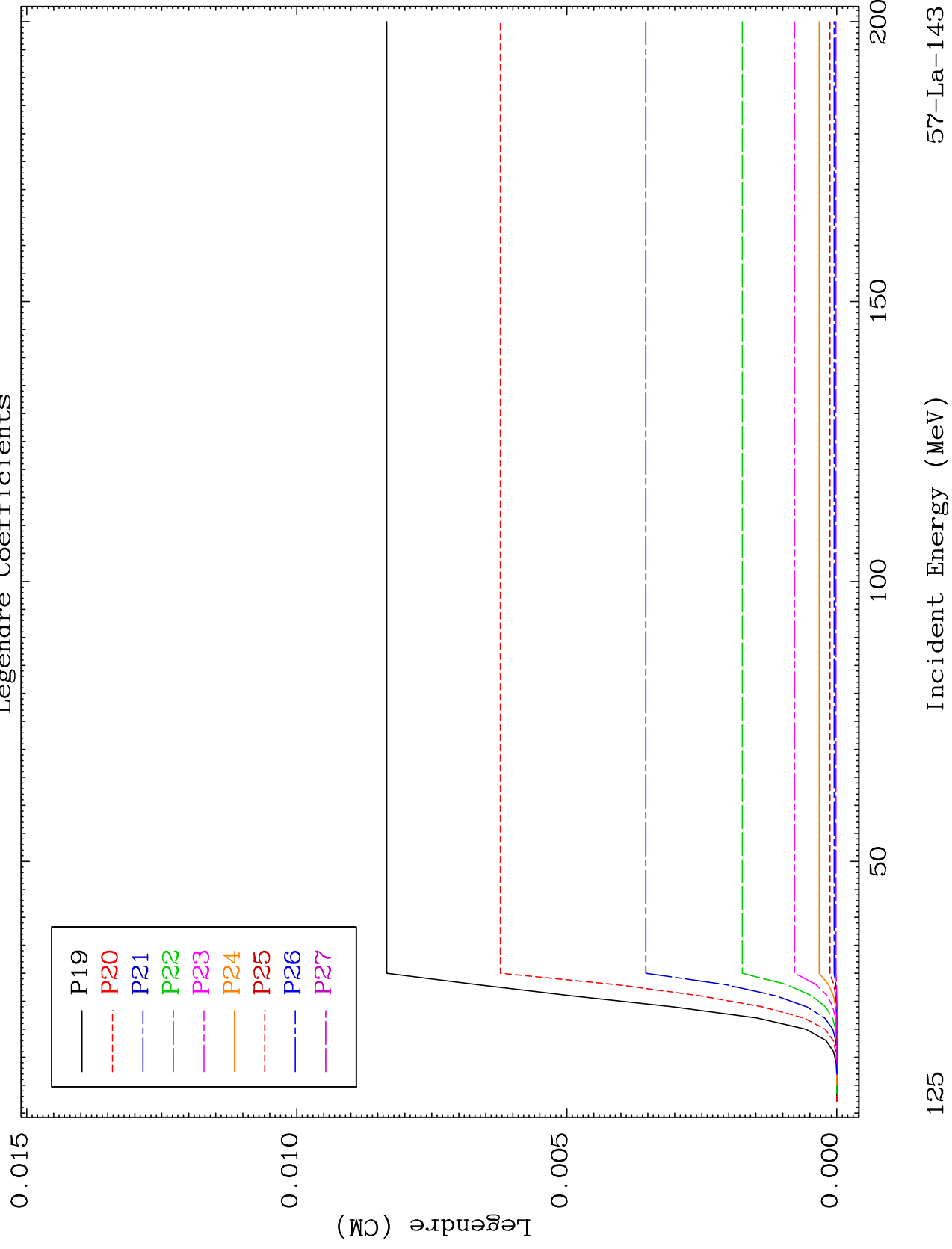

125

Incident Energy (MeV)

57-La-143

MAT 5740

MT= 77 (n,n') Level
Legendre Coefficients

57-La-143

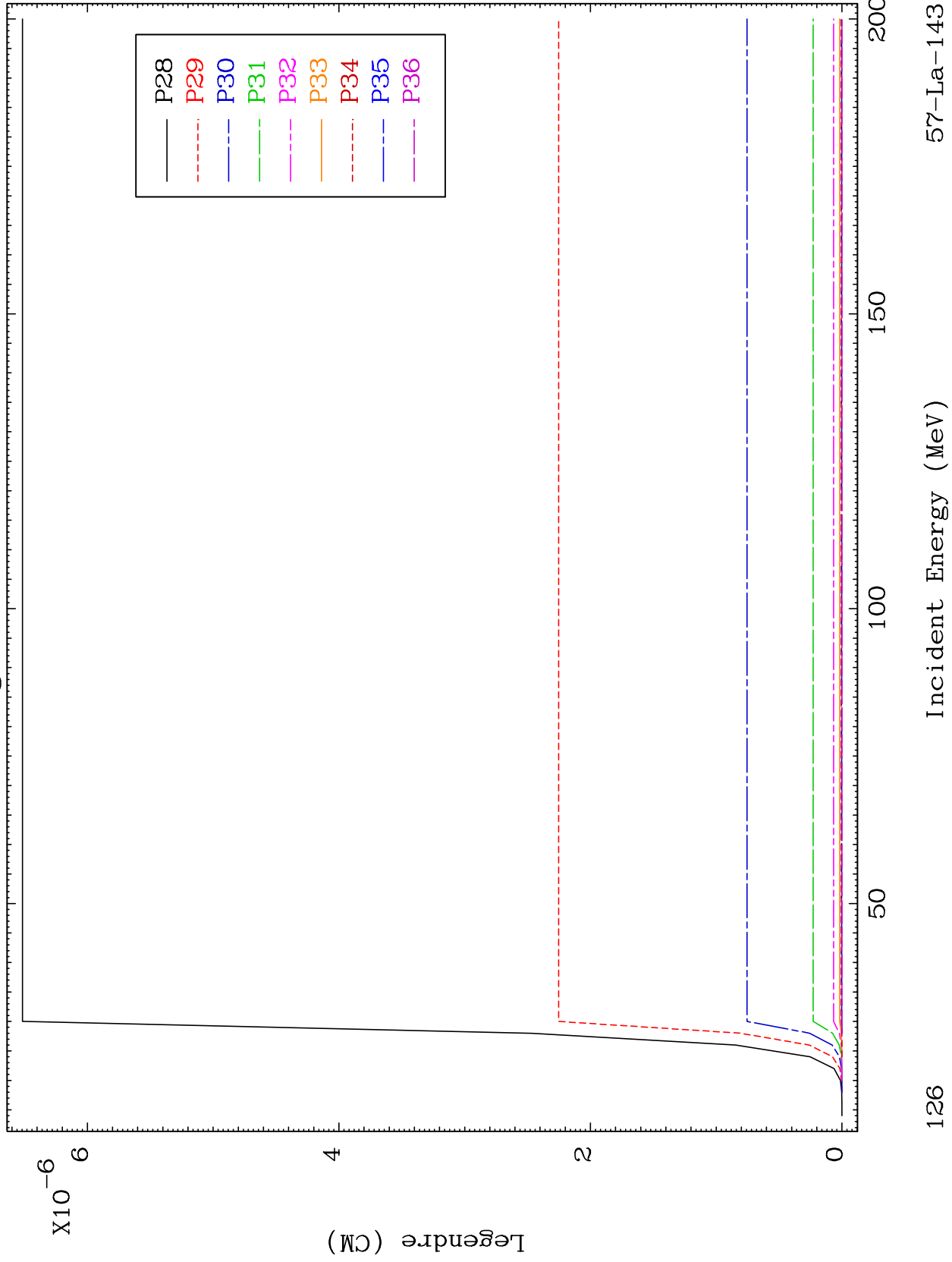

126

Incident Energy (MeV)

57-La-143

MAT 5740

MT= 78 (n,n') Level
Legendre Coefficients

57-La-143

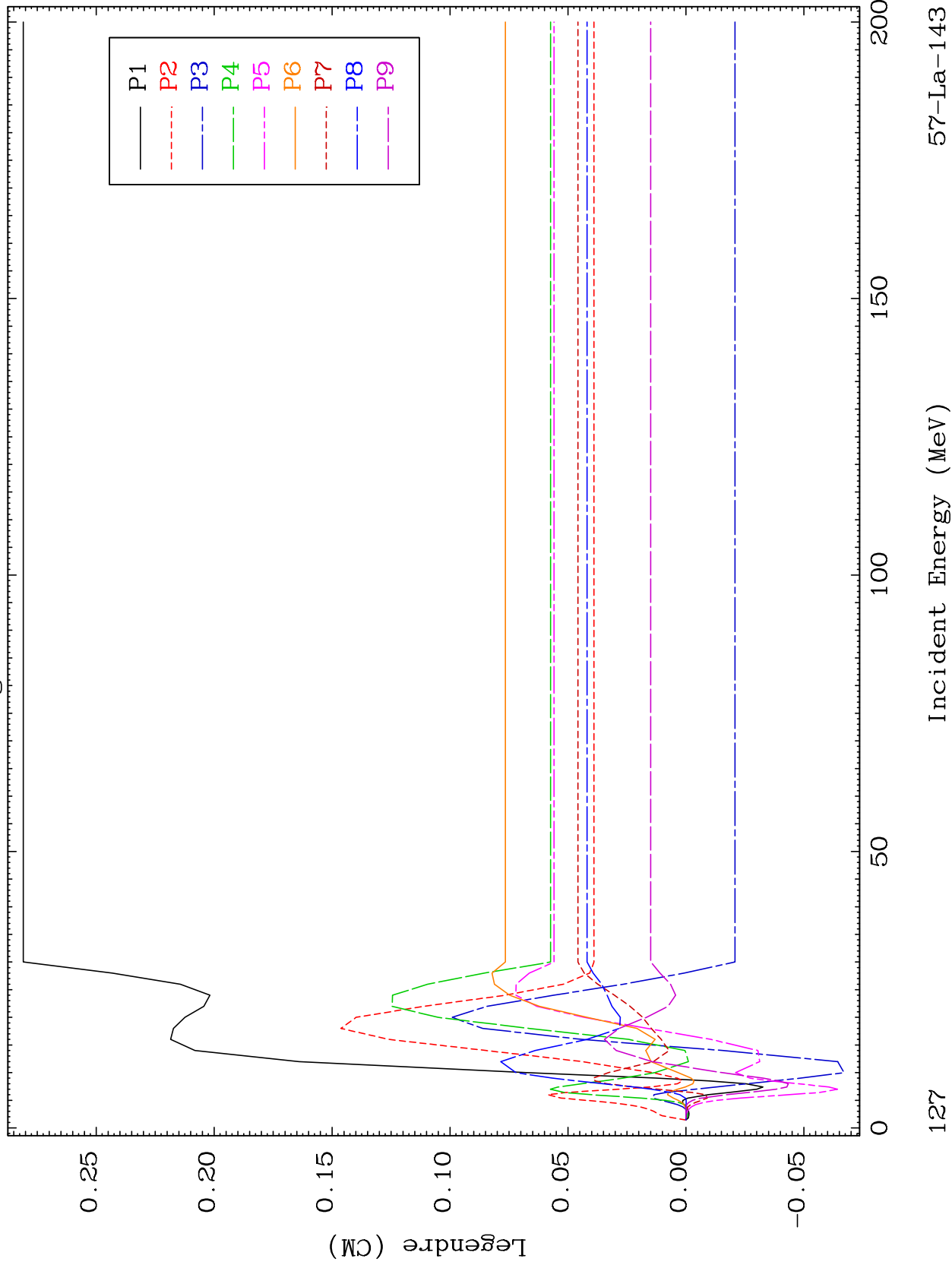

57-La-143

Incident Energy (MeV)

127

MAT 5740

MT= 78 (n,n') Level
Legendre Coefficients

57-La-143

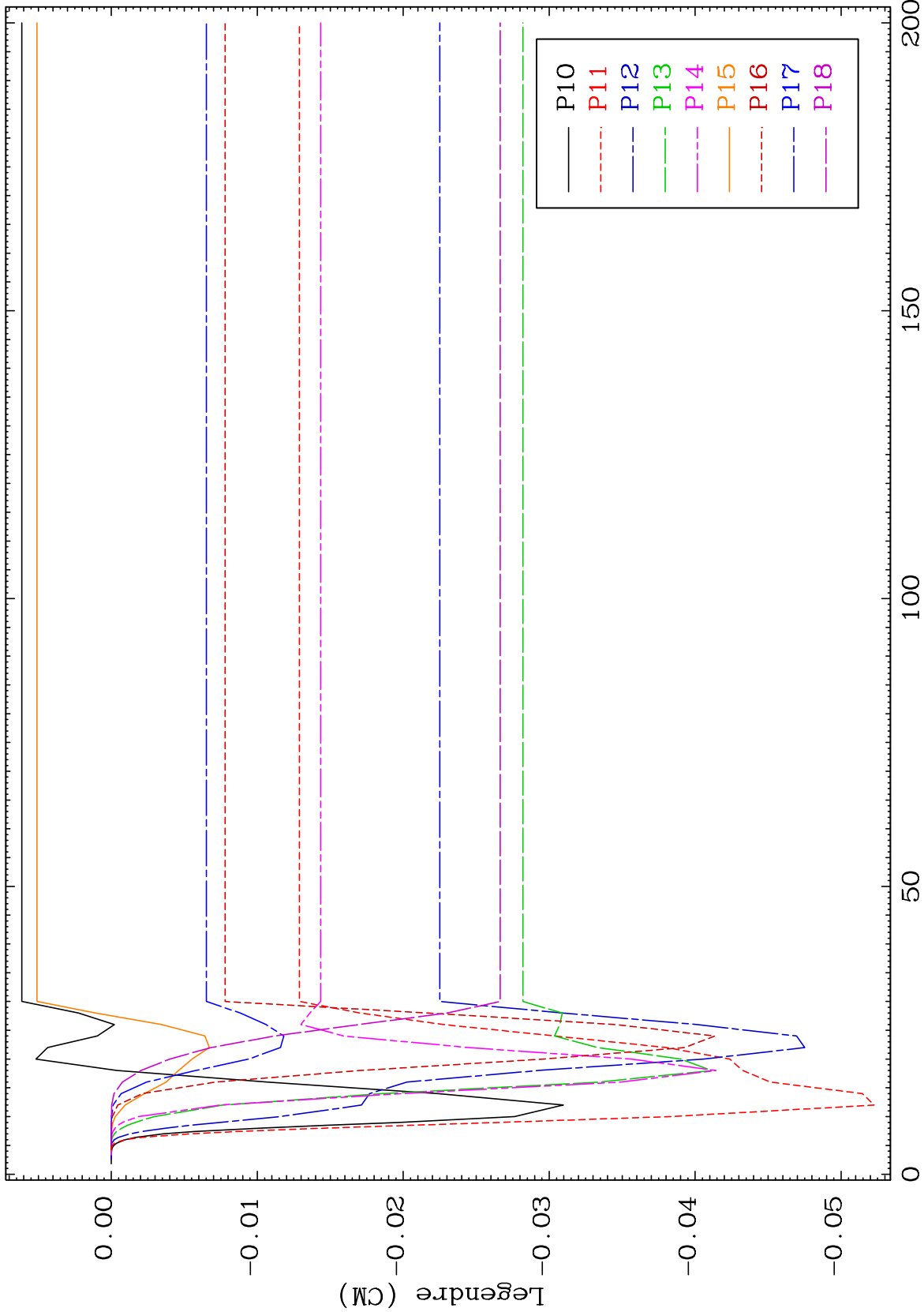

128

Incident Energy (MeV)

57-La-143

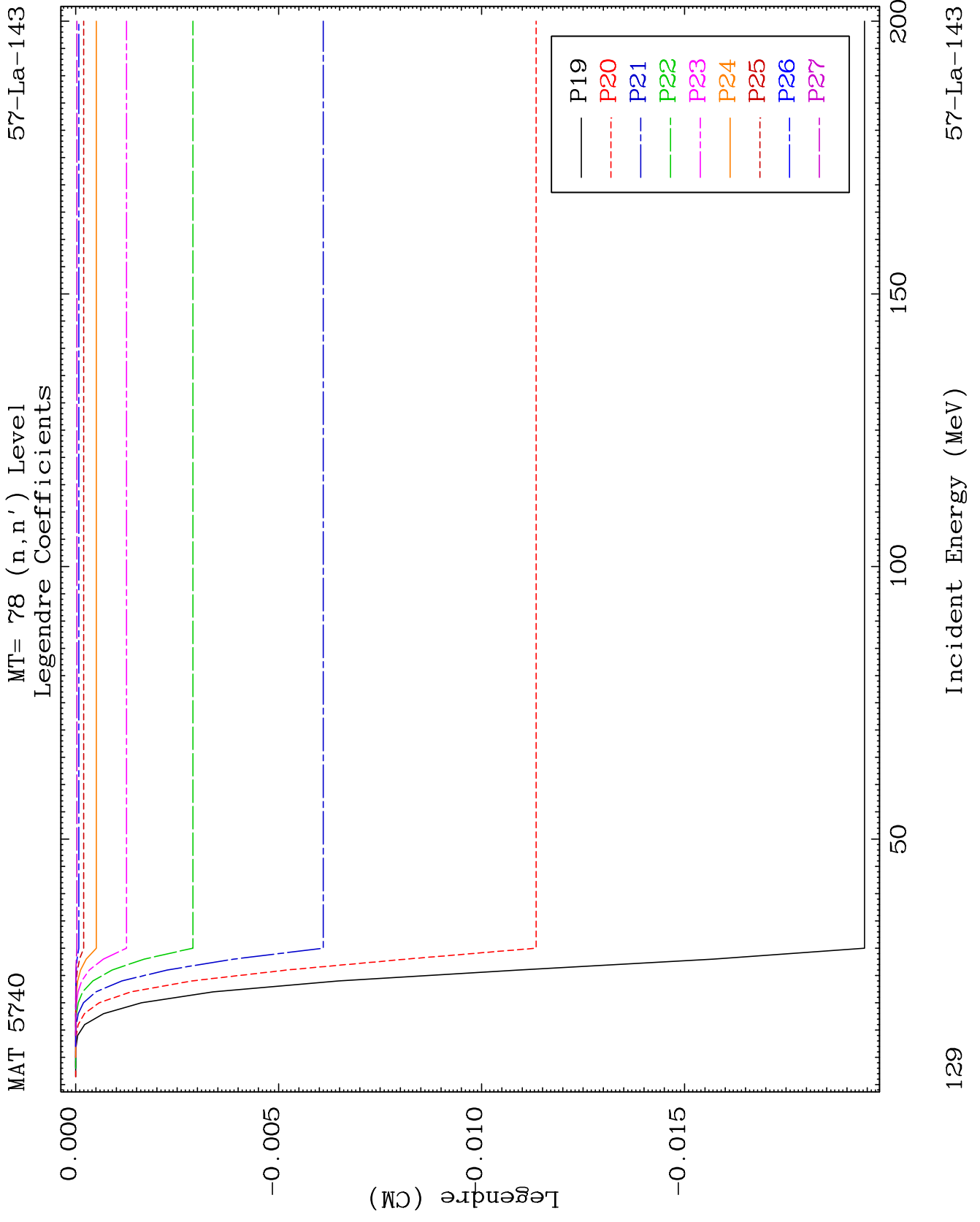

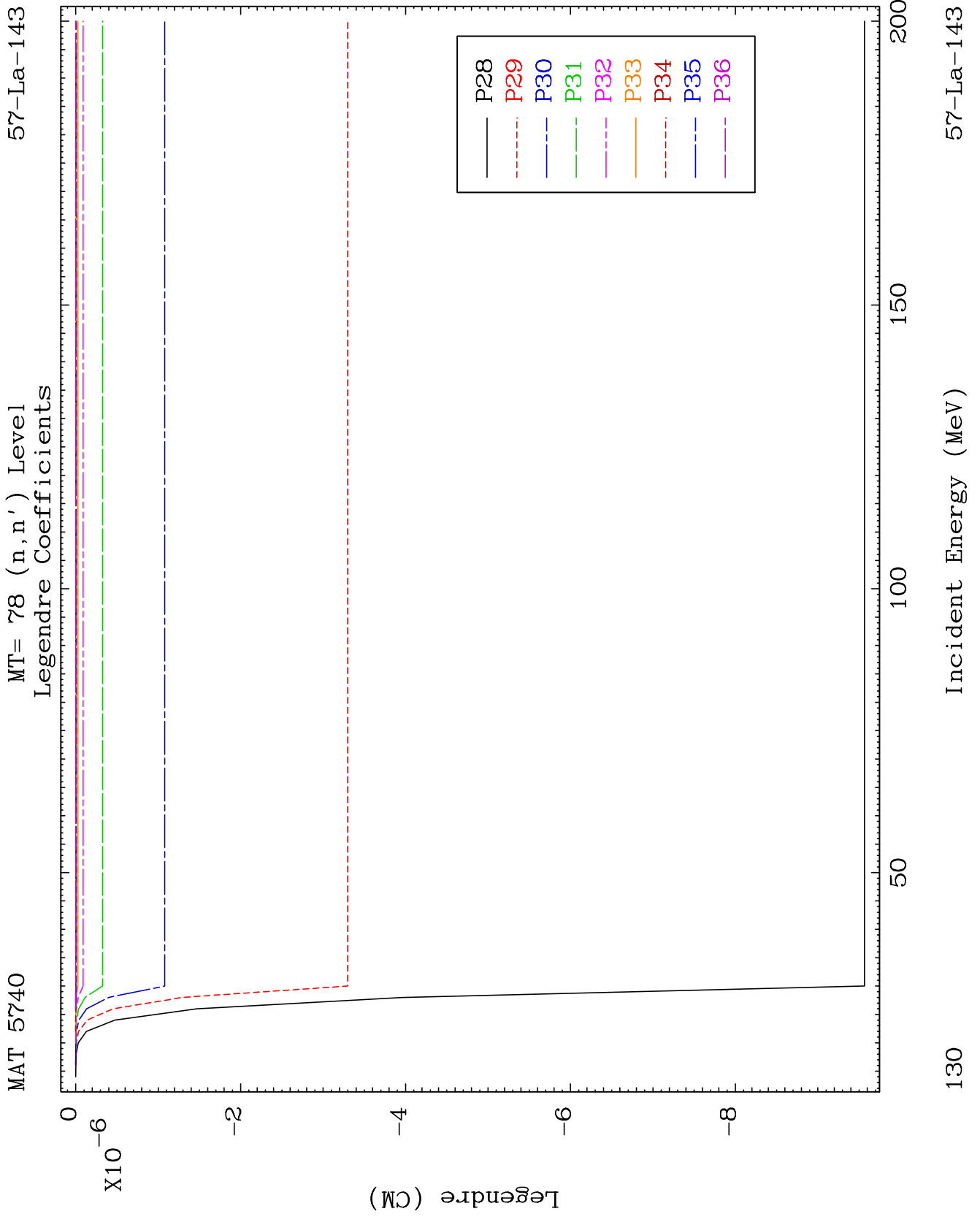

MAT 5740

MT= 79 (n,n') Level
Legendre Coefficients

57-La-143

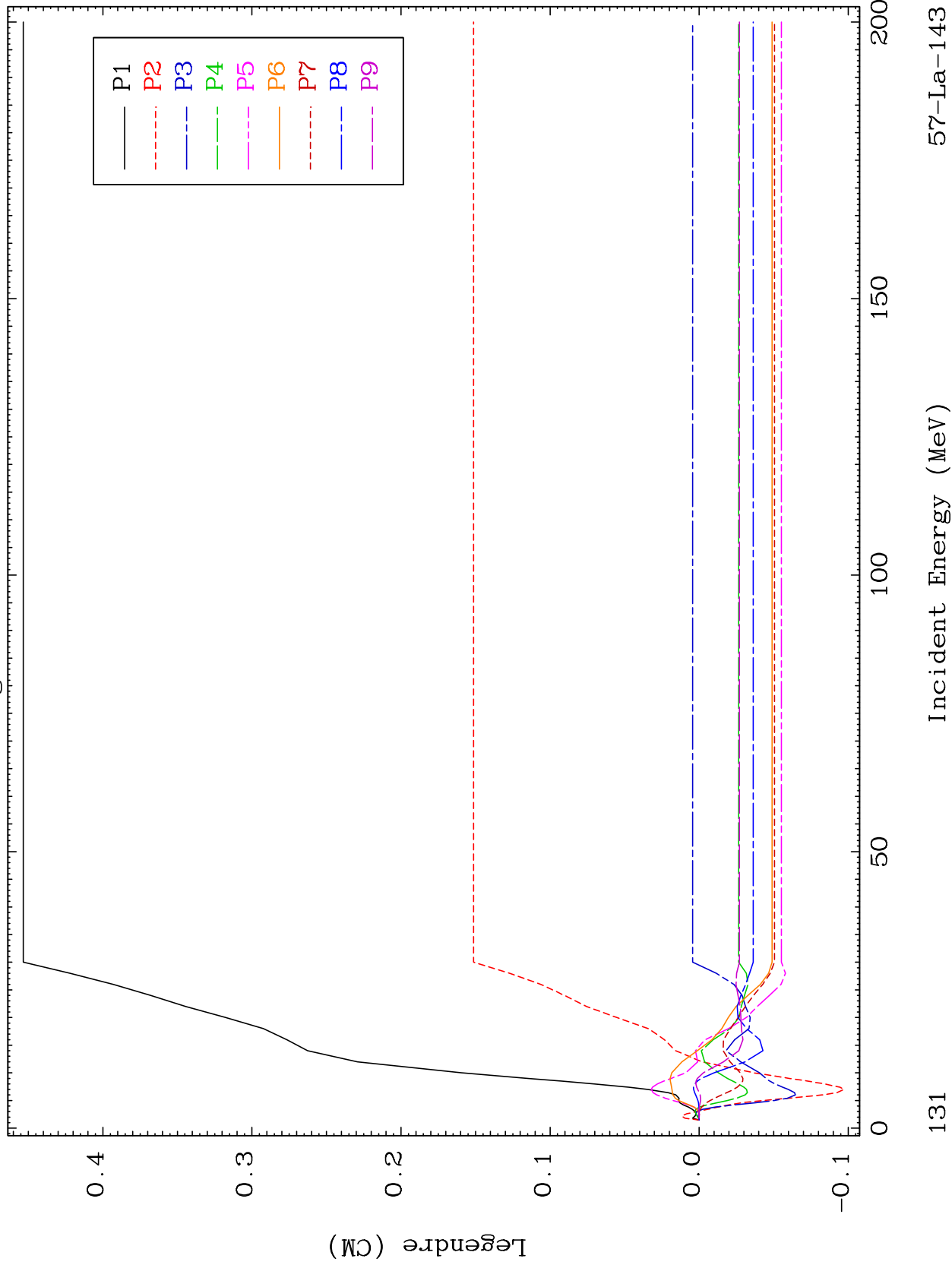

57-La-143

Incident Energy (MeV)

131

MAT 5740

MT= 79 (n,n') Level
Legendre Coefficients

57-La-143

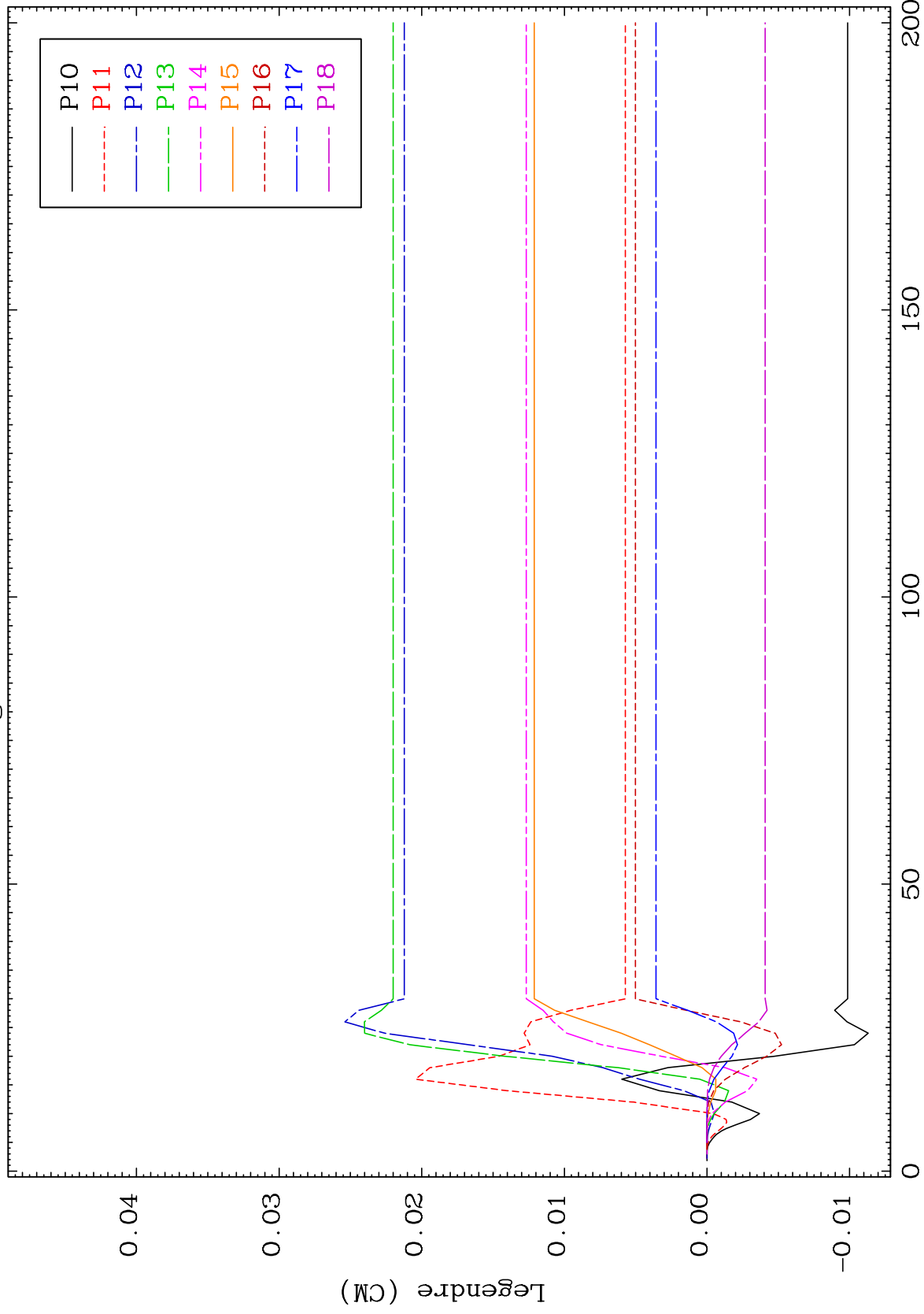

132

Incident Energy (MeV)

57-La-143

MAT 5740

MT= 79 (n,n') Level
Legendre Coefficients

57-La-143

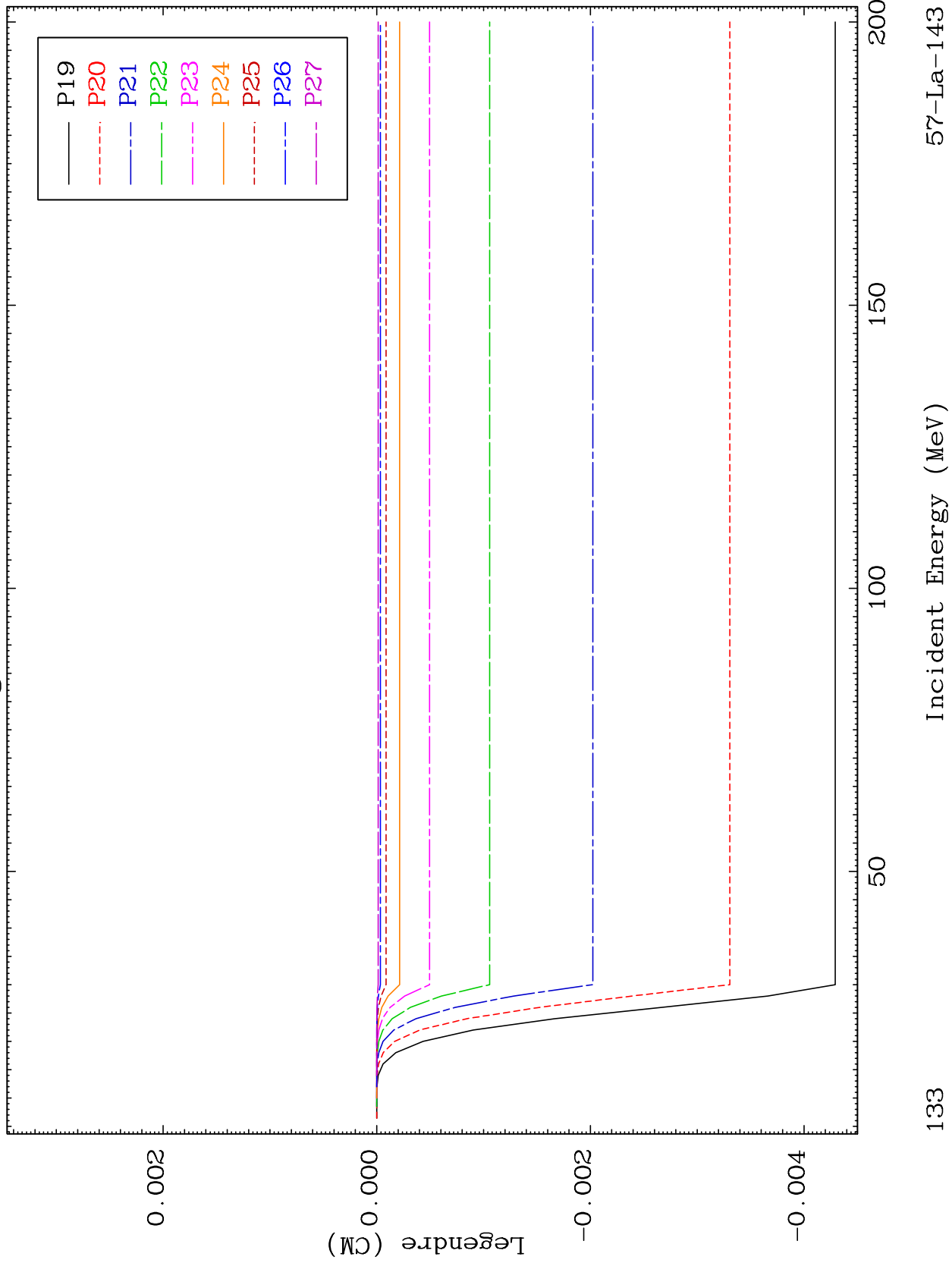

133

Incident Energy (MeV)

57-La-143

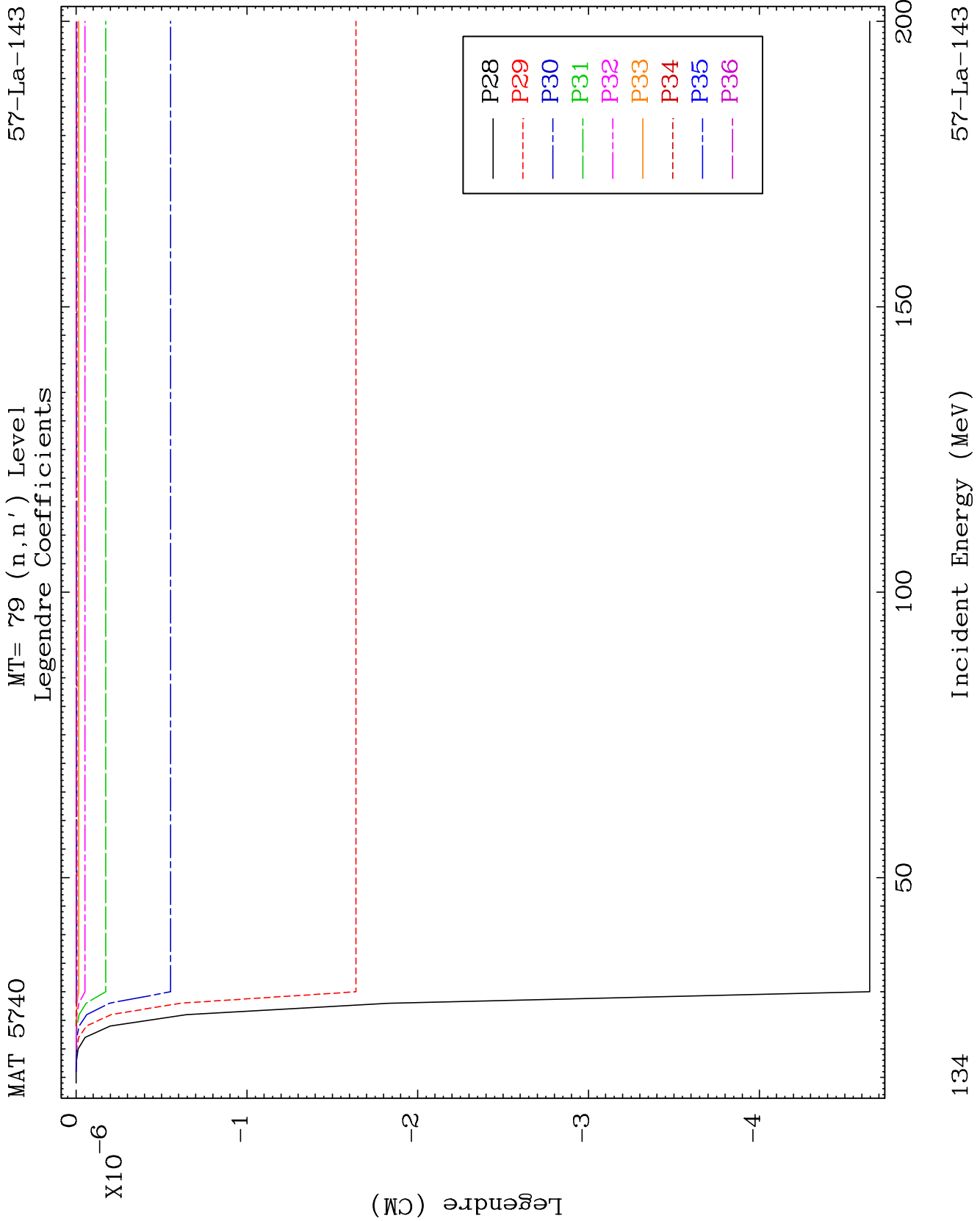

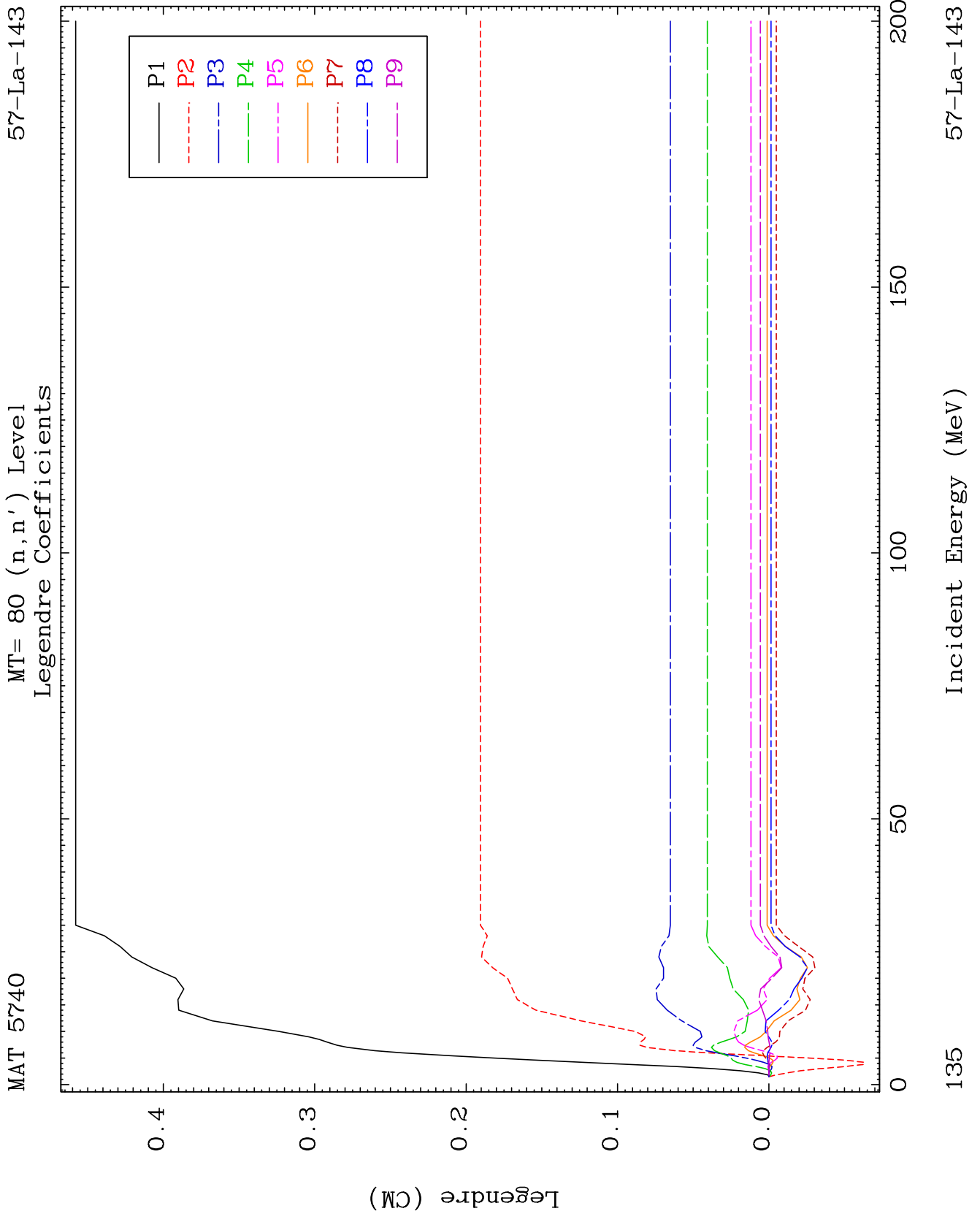

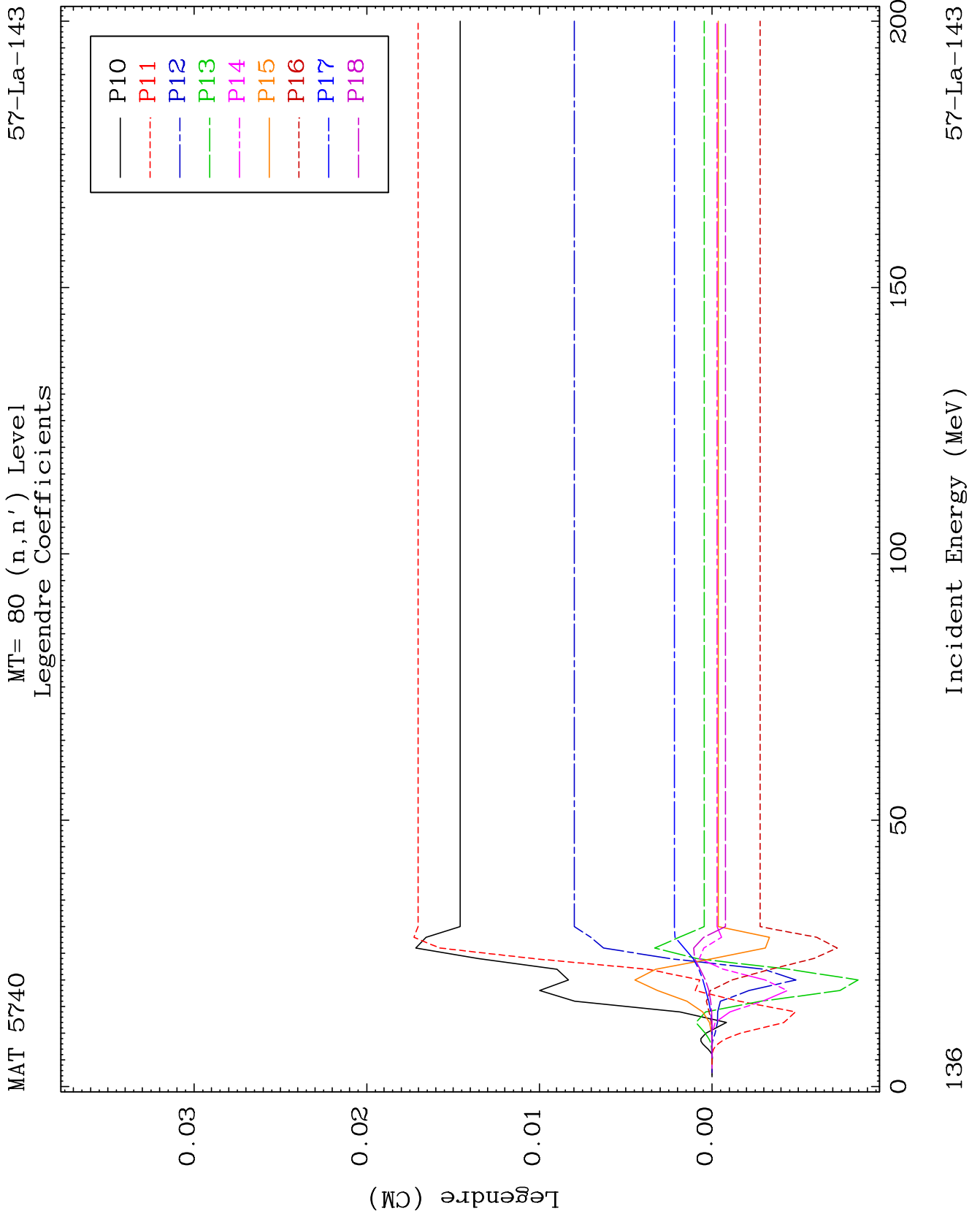

MAT 5740

MT= 80 (n,n') Level
Legendre Coefficients

57-La-143

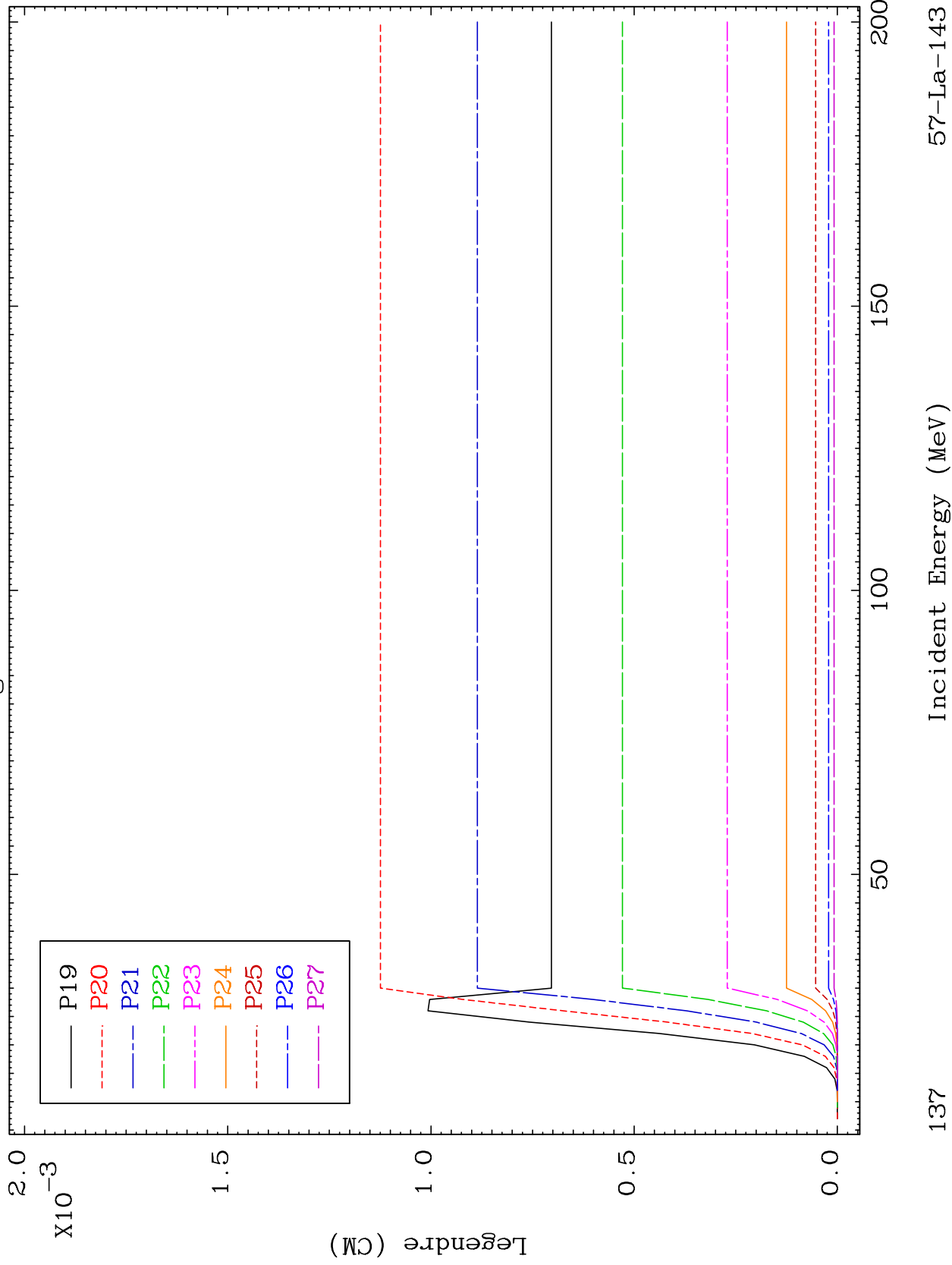

137

57-La-143

MAT 5740

MT= 80 (n,n') Level
Legendre Coefficients

57-La-143

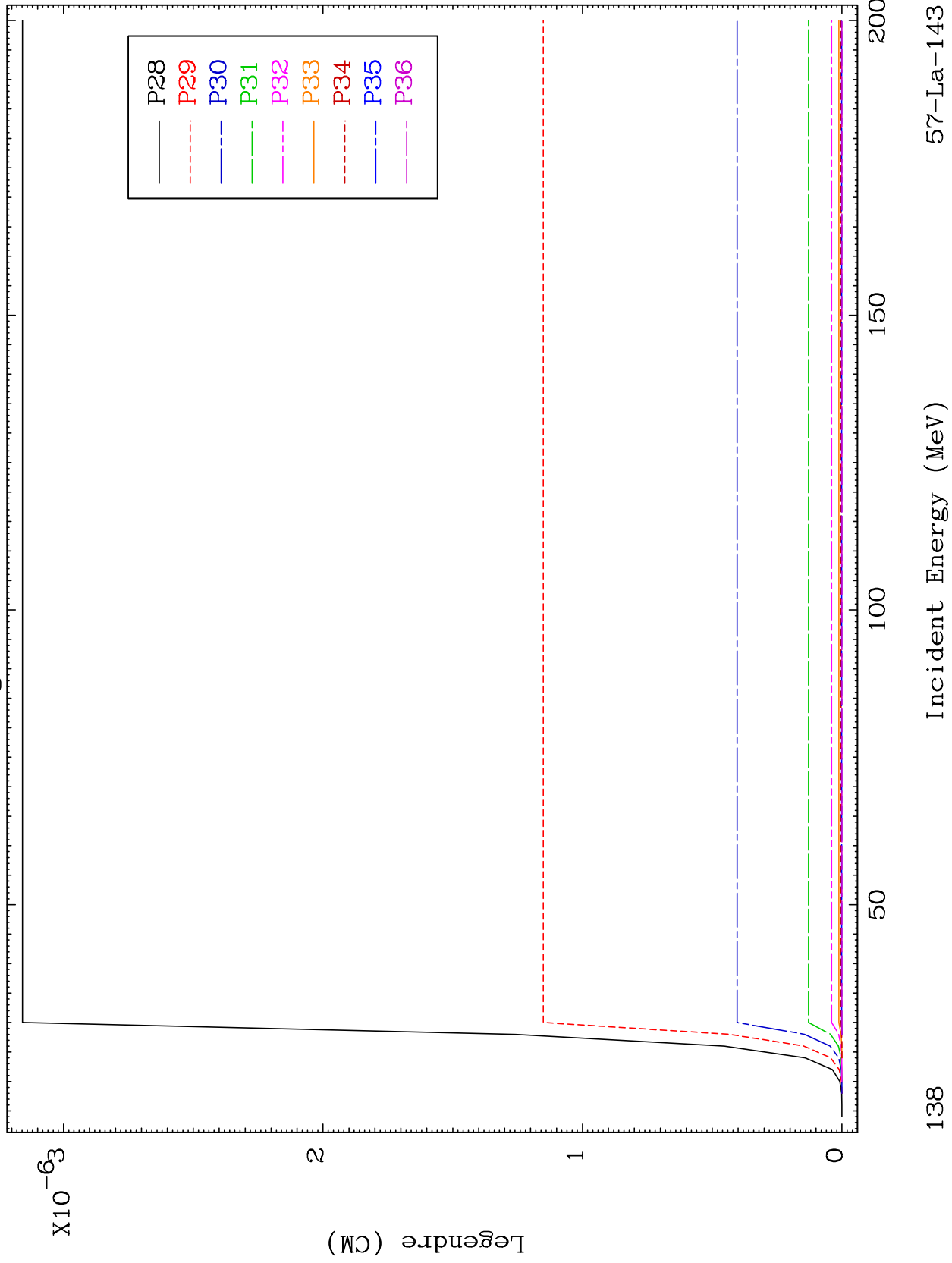

138

57-La-143

MAT 5740

$(n,2n) \alpha$

57-La-143

Radionuclide Production Cross Section

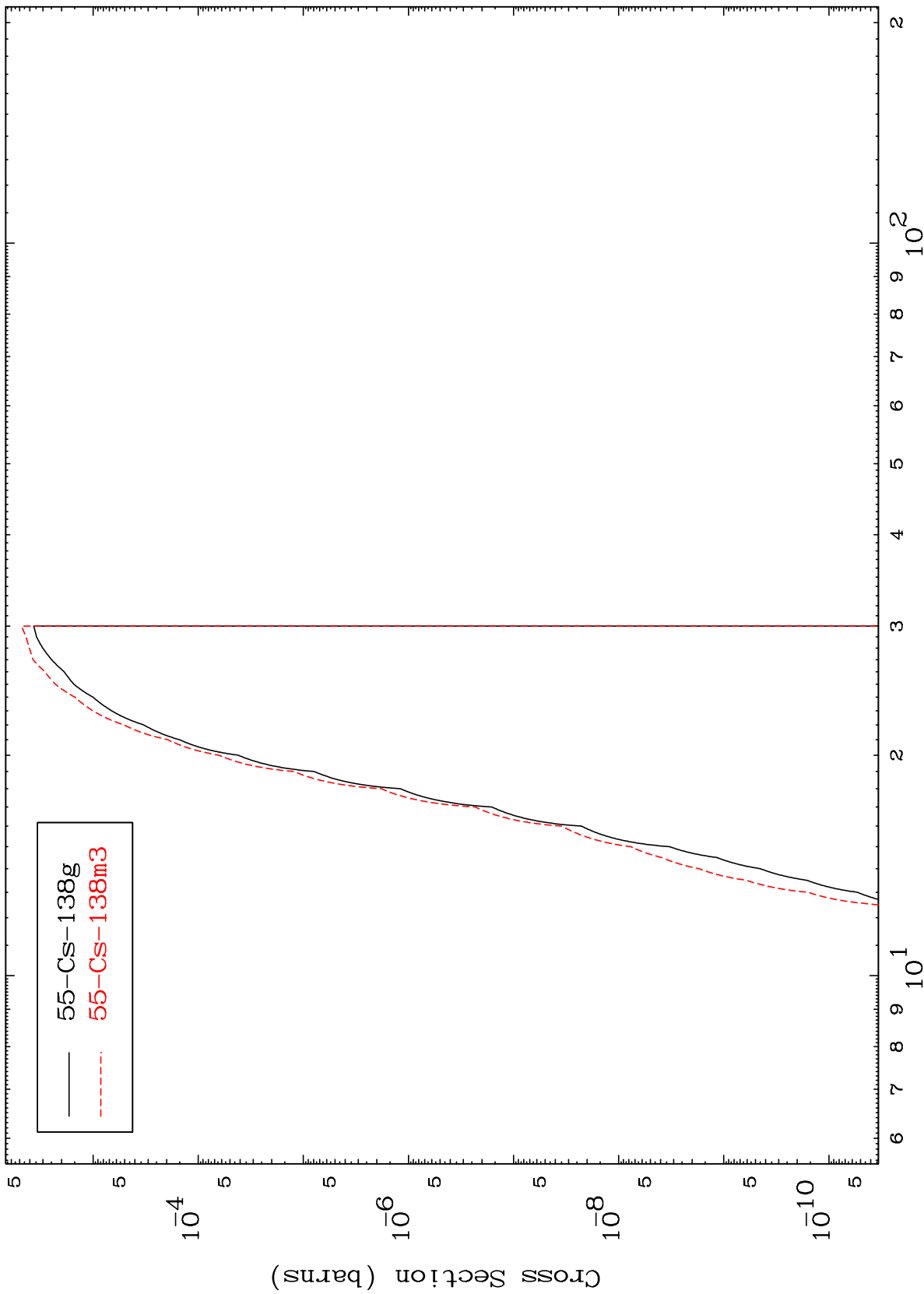

139

Incident Energy (MeV)

57-La-143

MAT 5740

(n,2α)

57-La-143

Radionuclide Production Cross Section

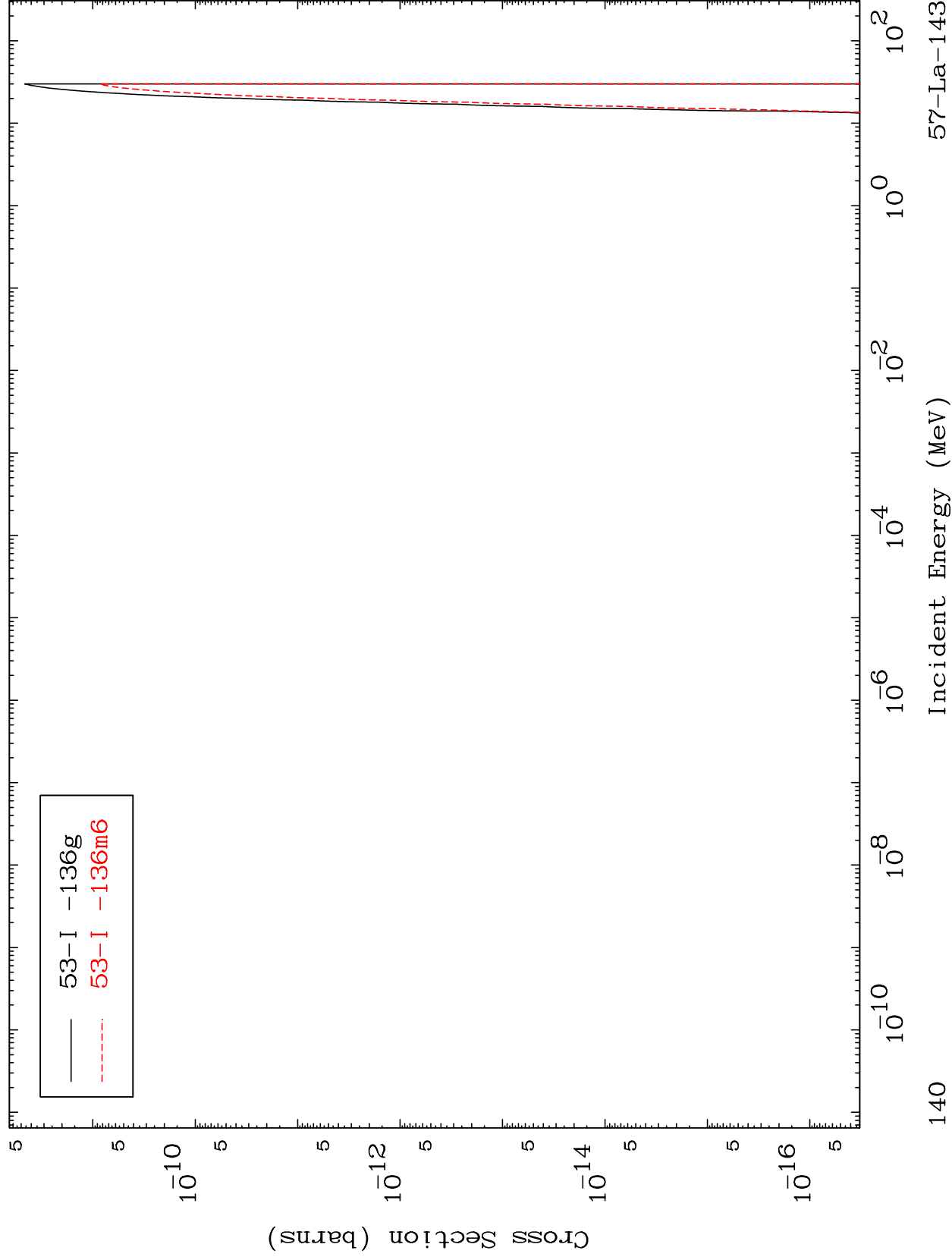

140