

LA145 NEUTRON ACER TENDL-2021 LIBRARY; T=293.6K
Principal cross sections

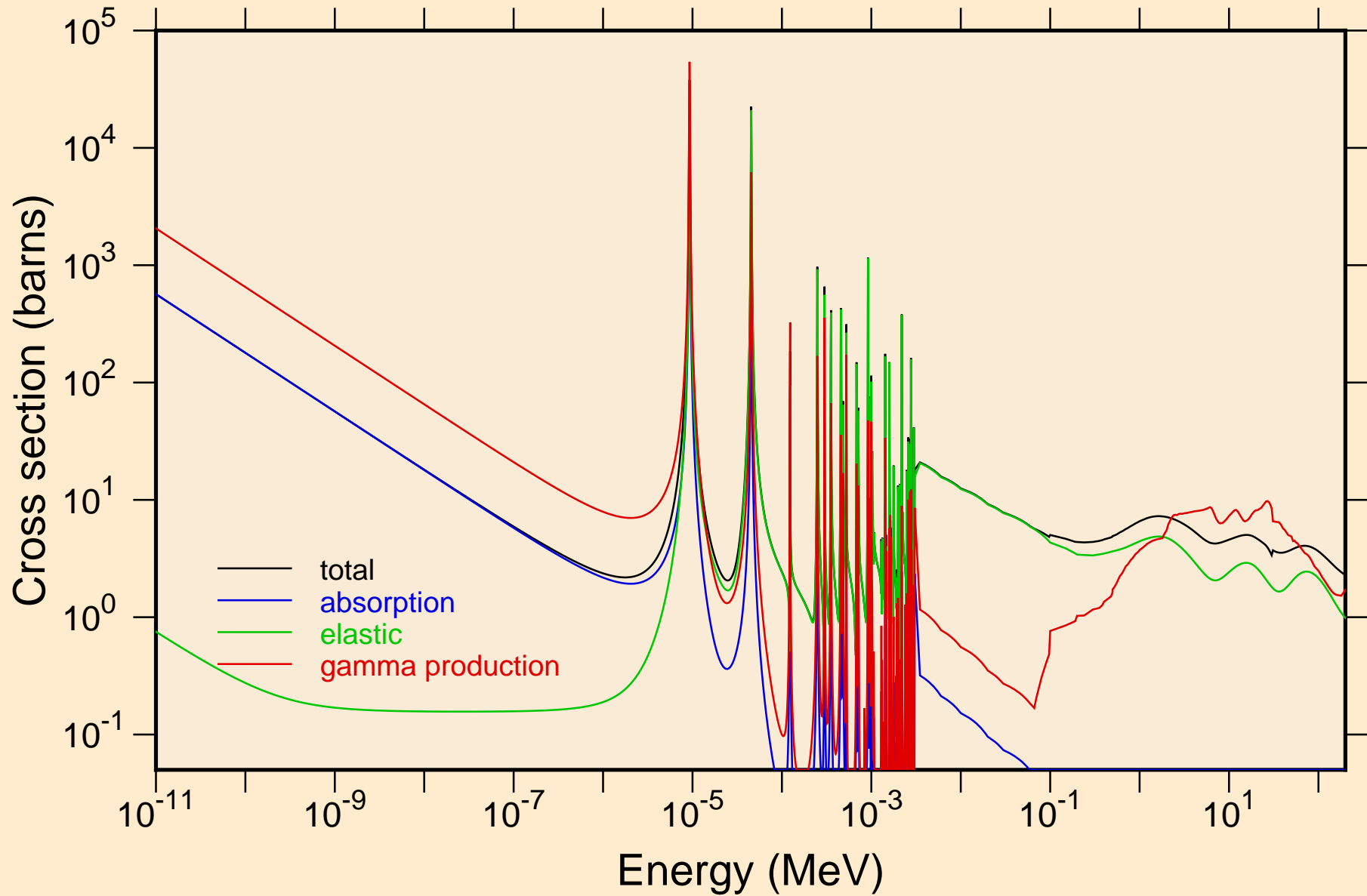

LA145 NEUTRON ACER TENDL-2021 LIBRARY; T=293.6K
resonance total cross section

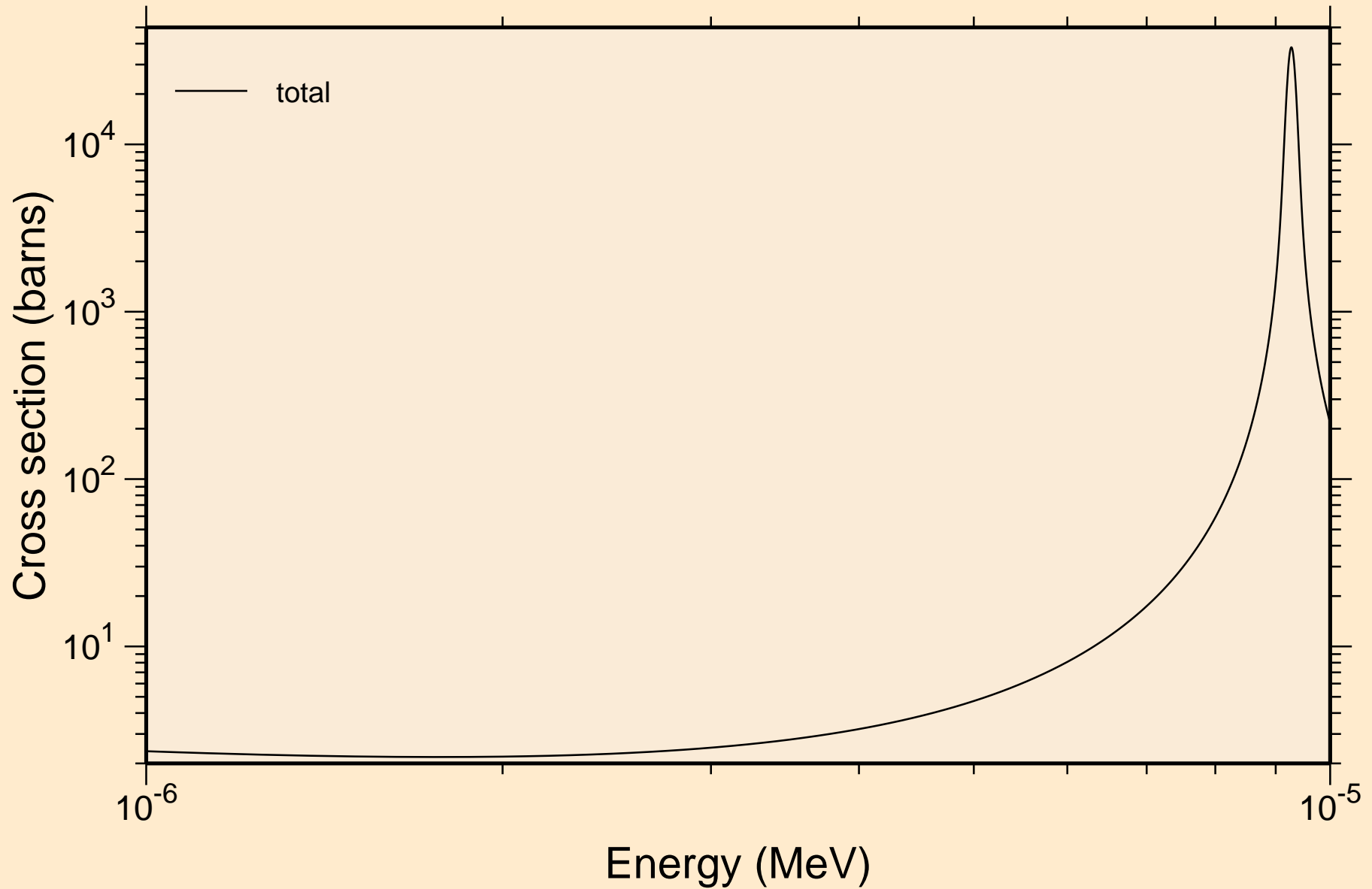

LA145 NEUTRON ACER TENDL-2021 LIBRARY; T=293.6K
resonance total cross section

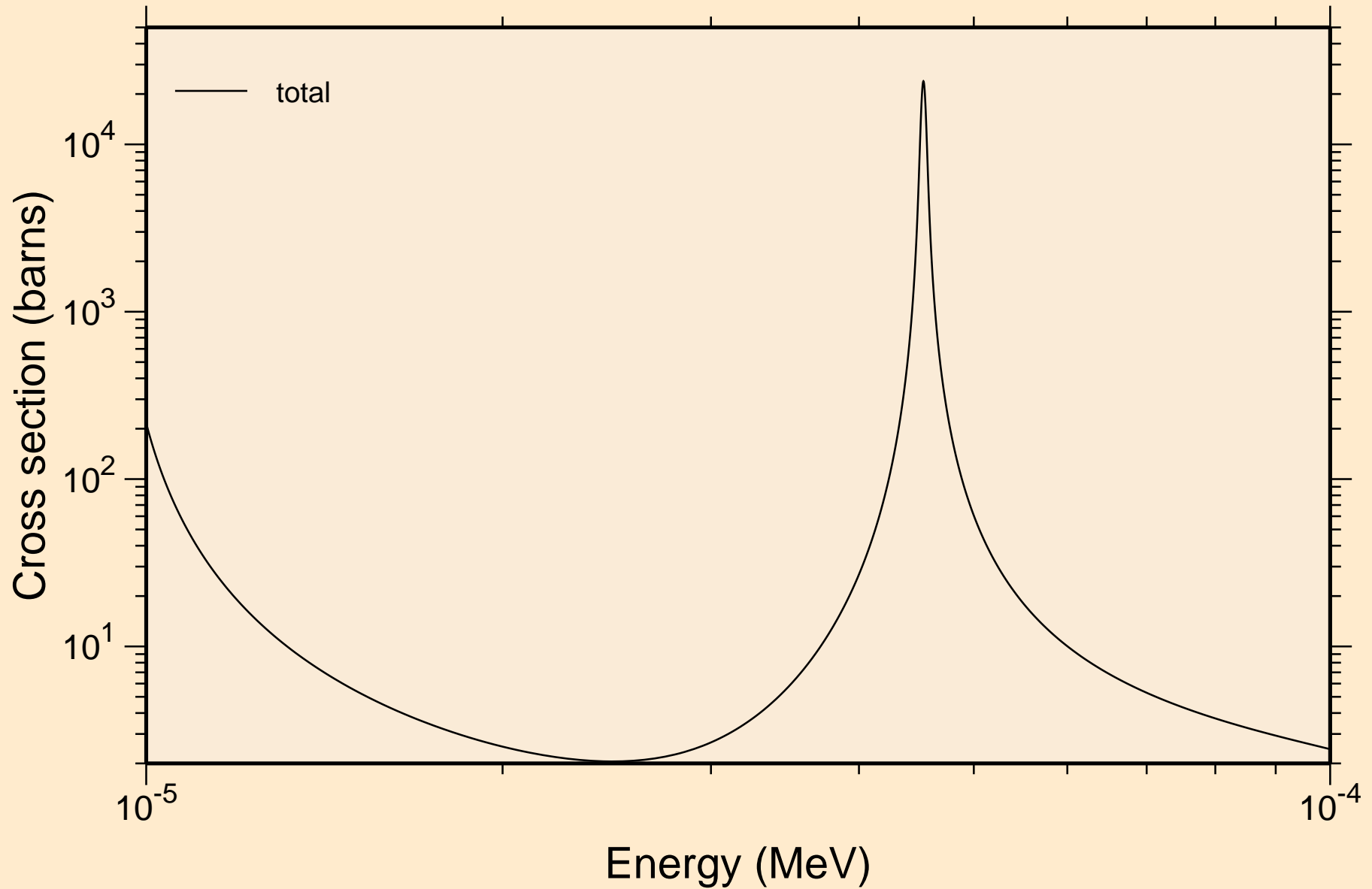

LA145 NEUTRON ACER TENDL-2021 LIBRARY; T=293.6K
resonance total cross section

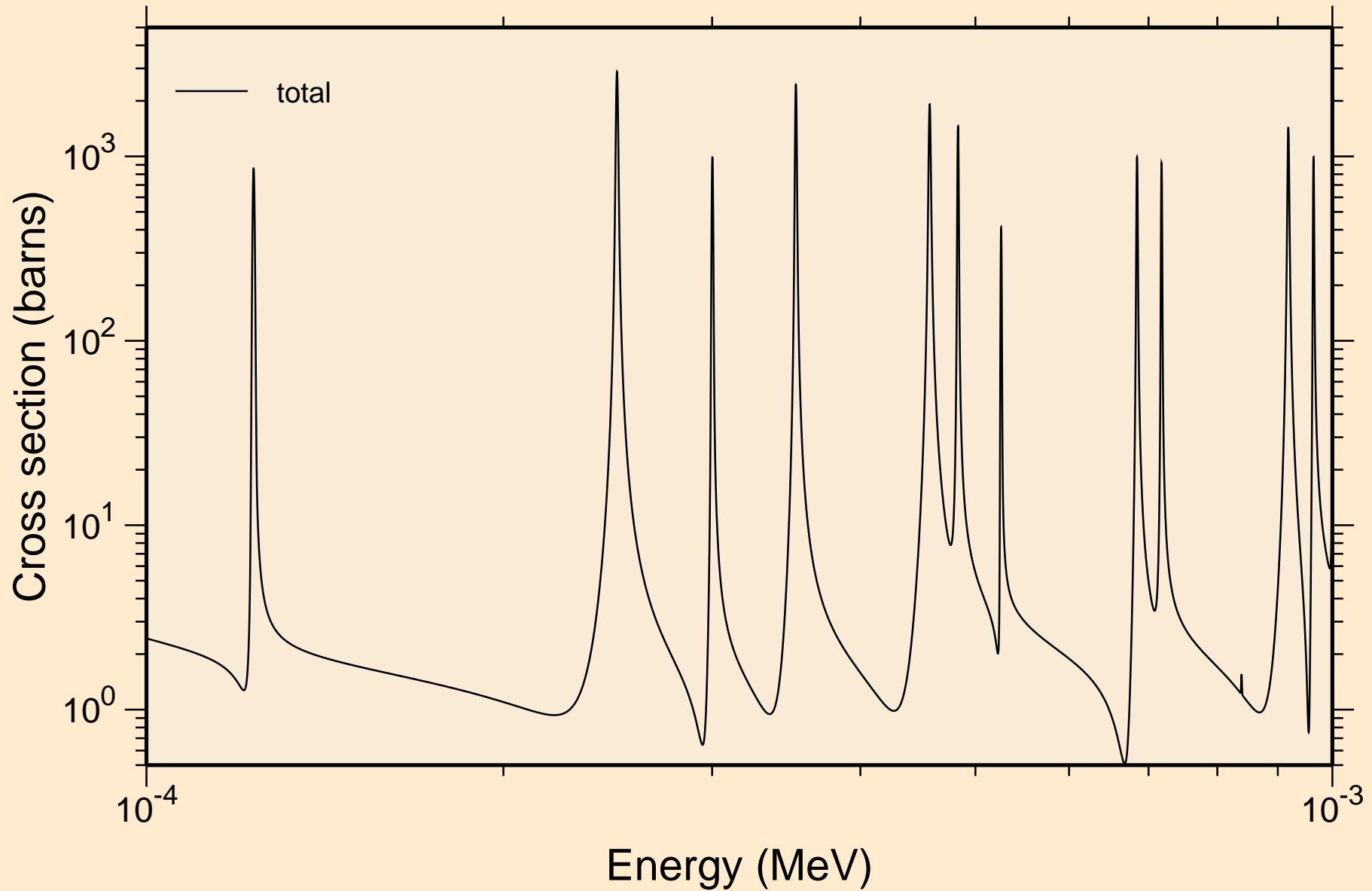

LA145 NEUTRON ACER TENDL-2021 LIBRARY; T=293.6K
resonance total cross section

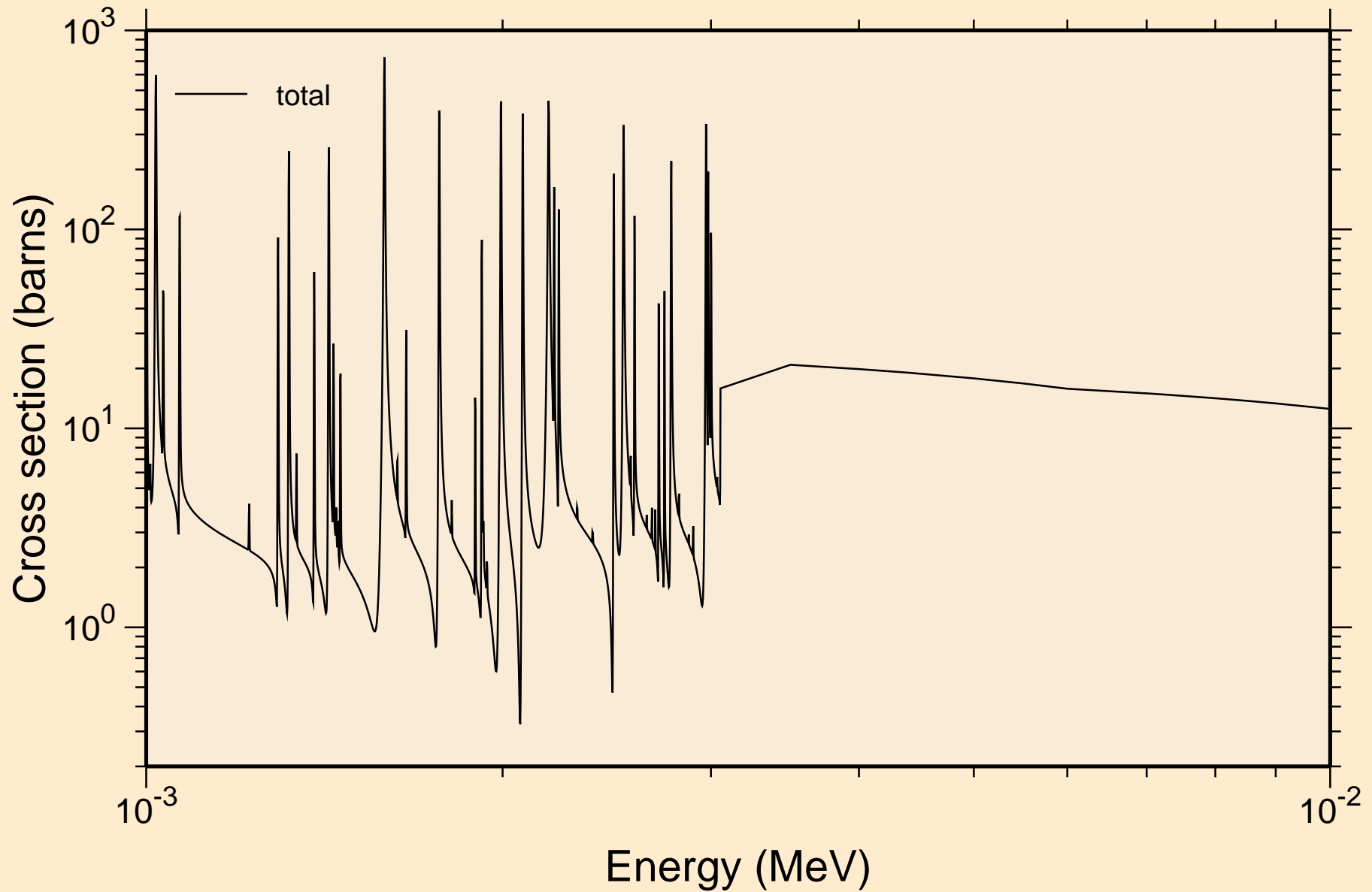

LA145 NEUTRON ACER TENDL-2021 LIBRARY; T=293.6K
resonance total cross section

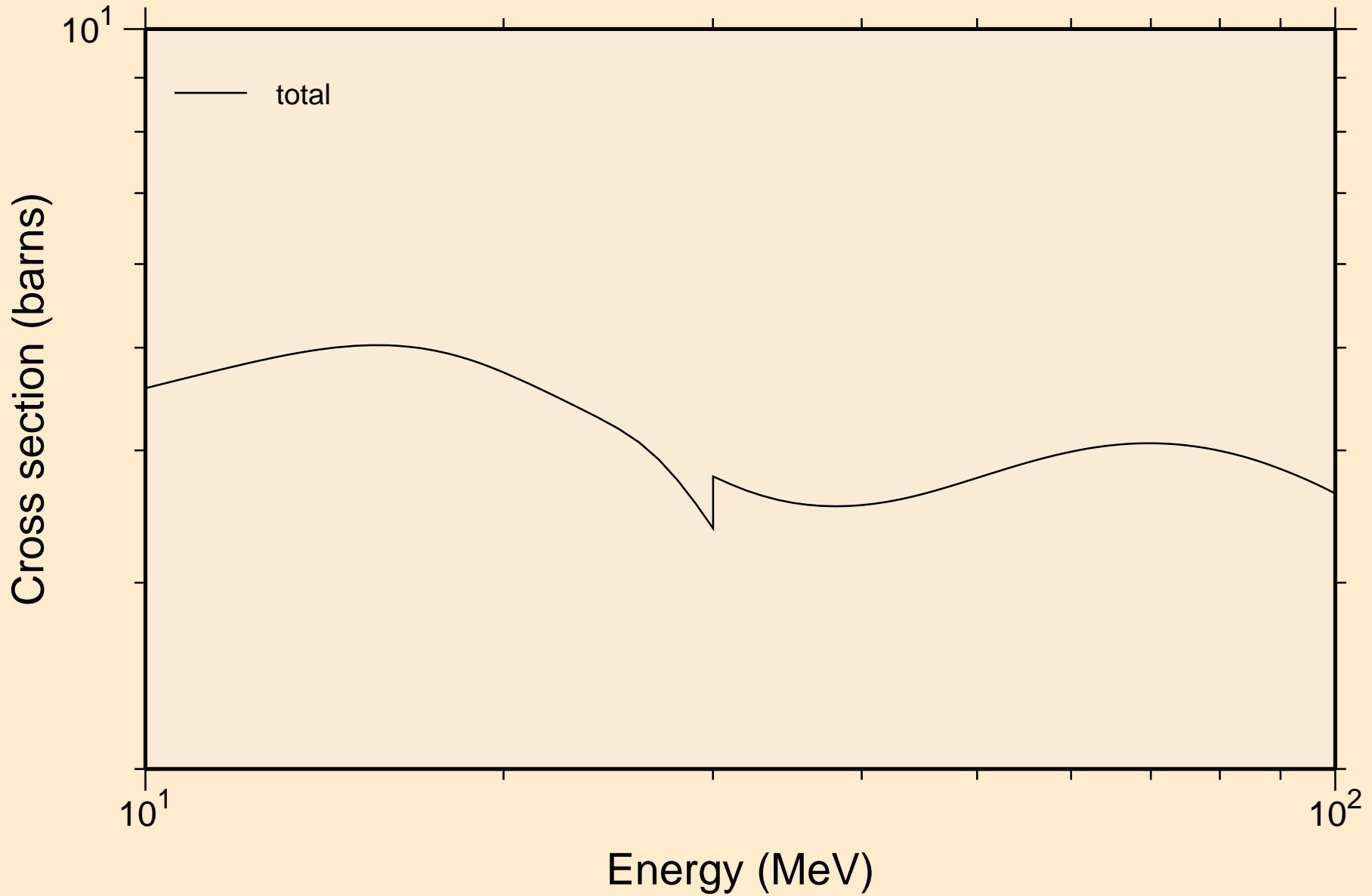

LA145 NEUTRON ACER TENDL-2021 LIBRARY; T=293.6K
resonance absorption cross sections

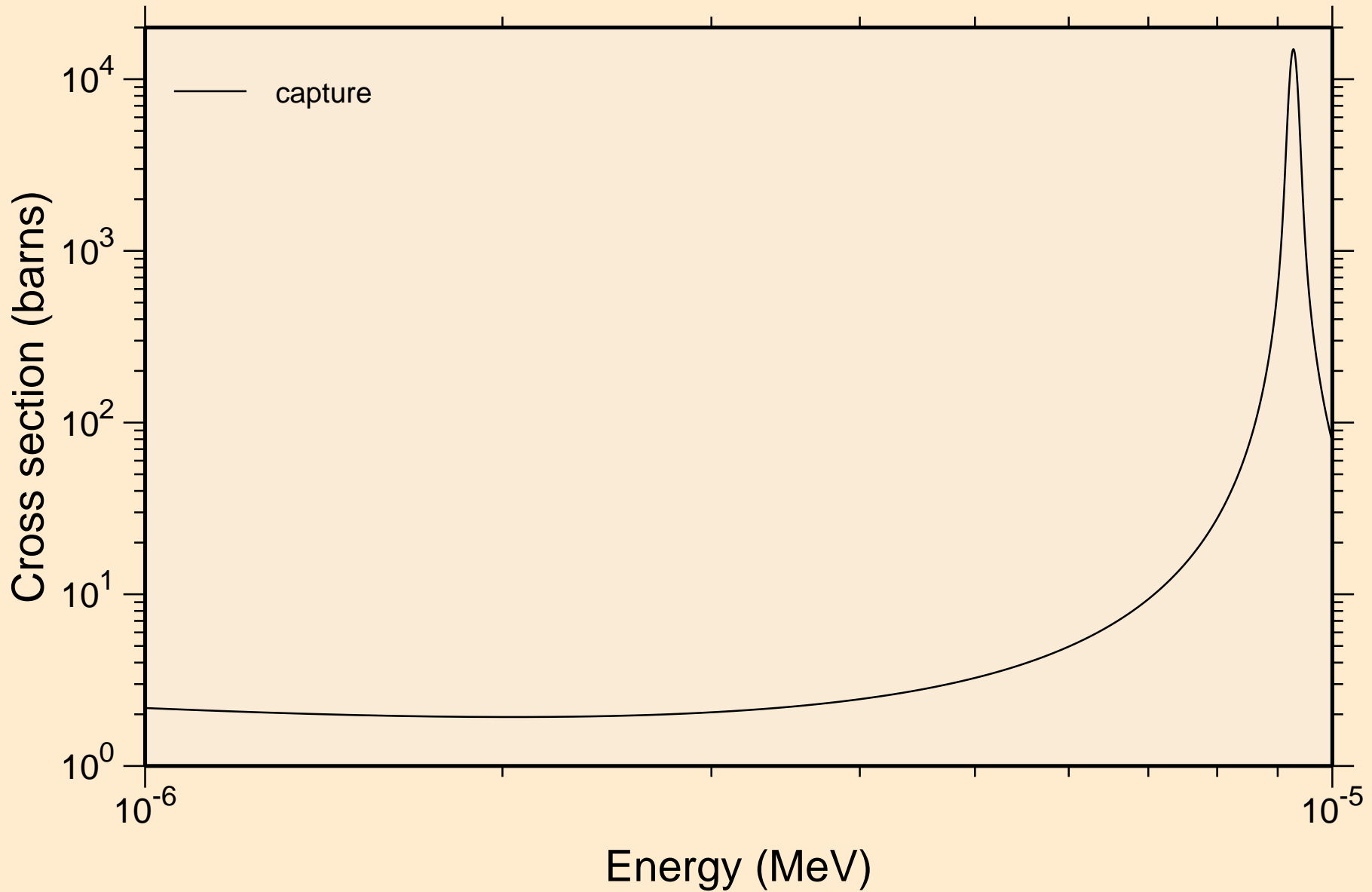

LA145 NEUTRON ACER TENDL-2021 LIBRARY; T=293.6K
resonance absorption cross sections

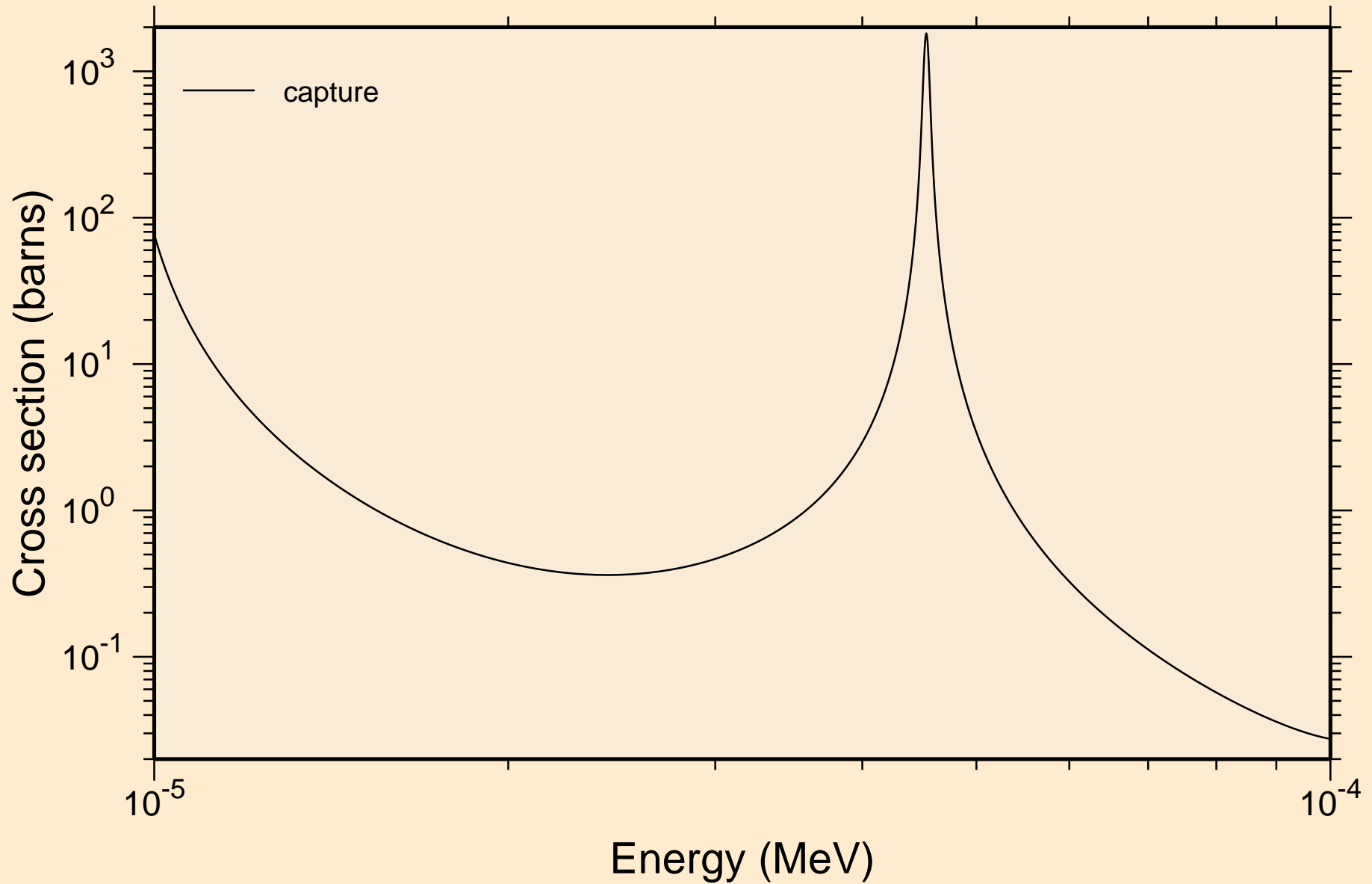

LA145 NEUTRON ACER TENDL-2021 LIBRARY; T=293.6K
resonance absorption cross sections

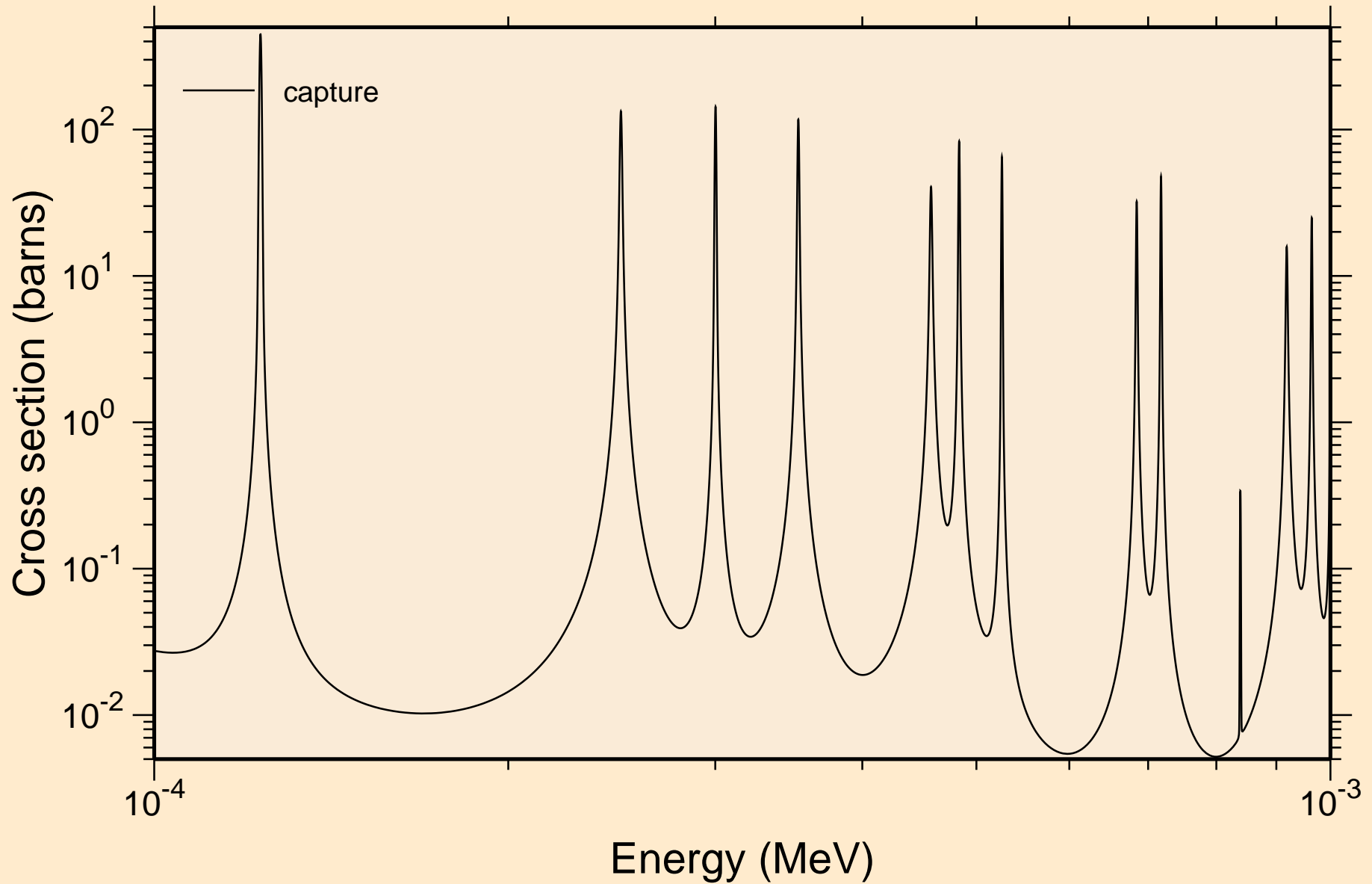

LA145 NEUTRON ACER TENDL-2021 LIBRARY; T=293.6K
resonance absorption cross sections

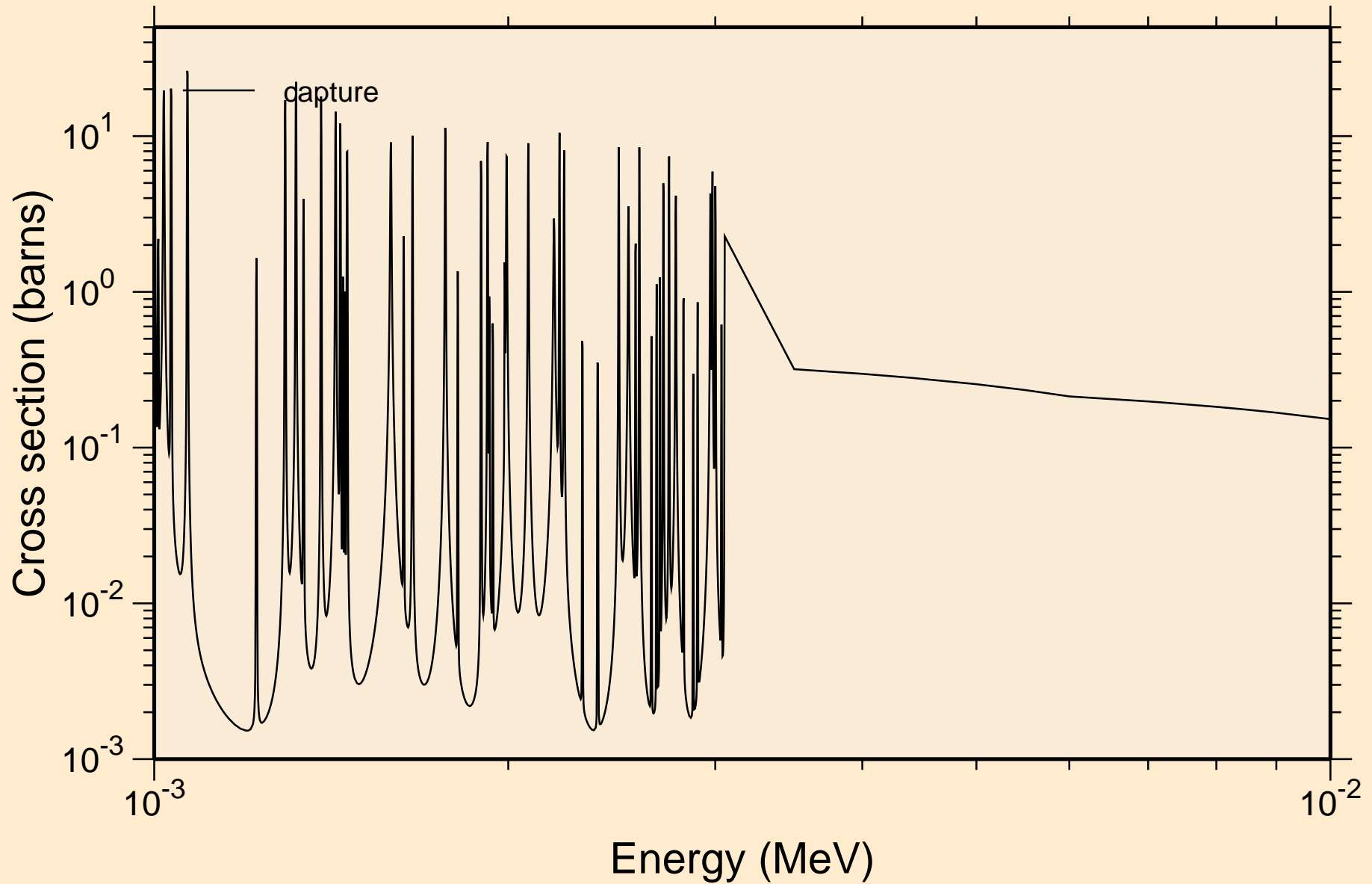

LA145 NEUTRON ACER TENDL-2021 LIBRARY; T=293.6K
resonance absorption cross sections

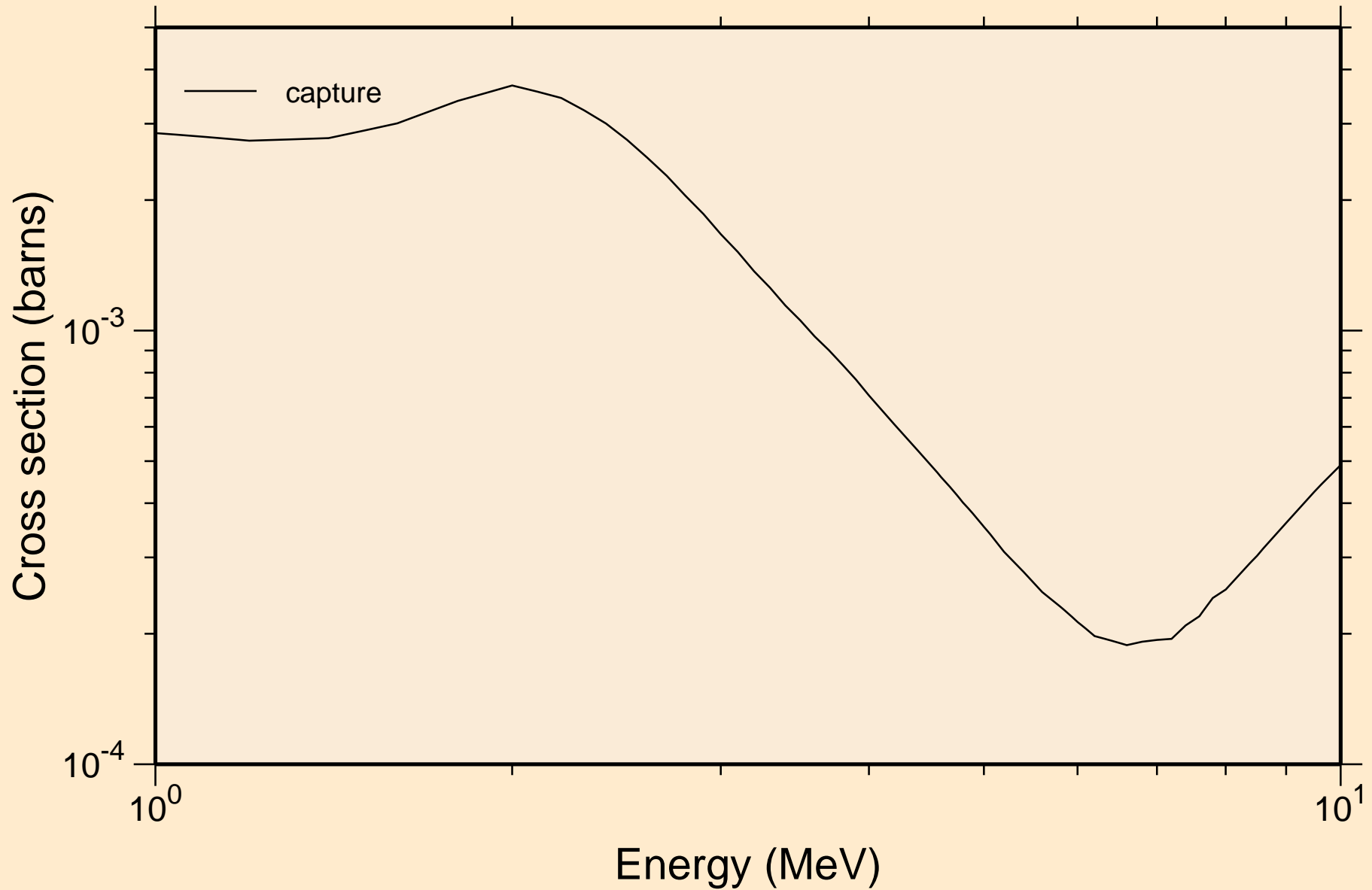

LA145 NEUTRON ACER TENDL-2021 LIBRARY; T=293.6K
Heating

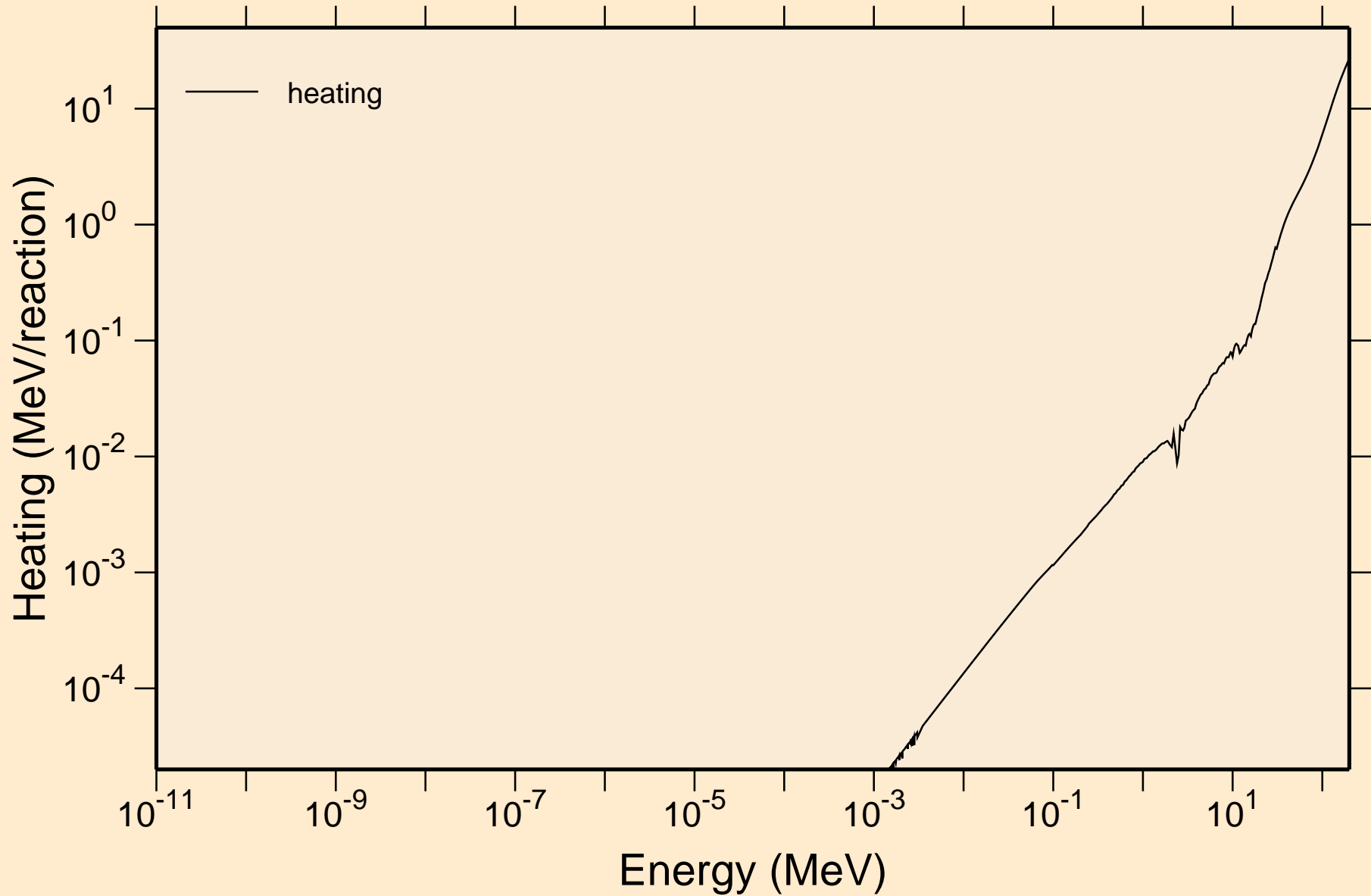

LA145 NEUTRON ACER TENDL-2021 LIBRARY; T=293.6K
Damage

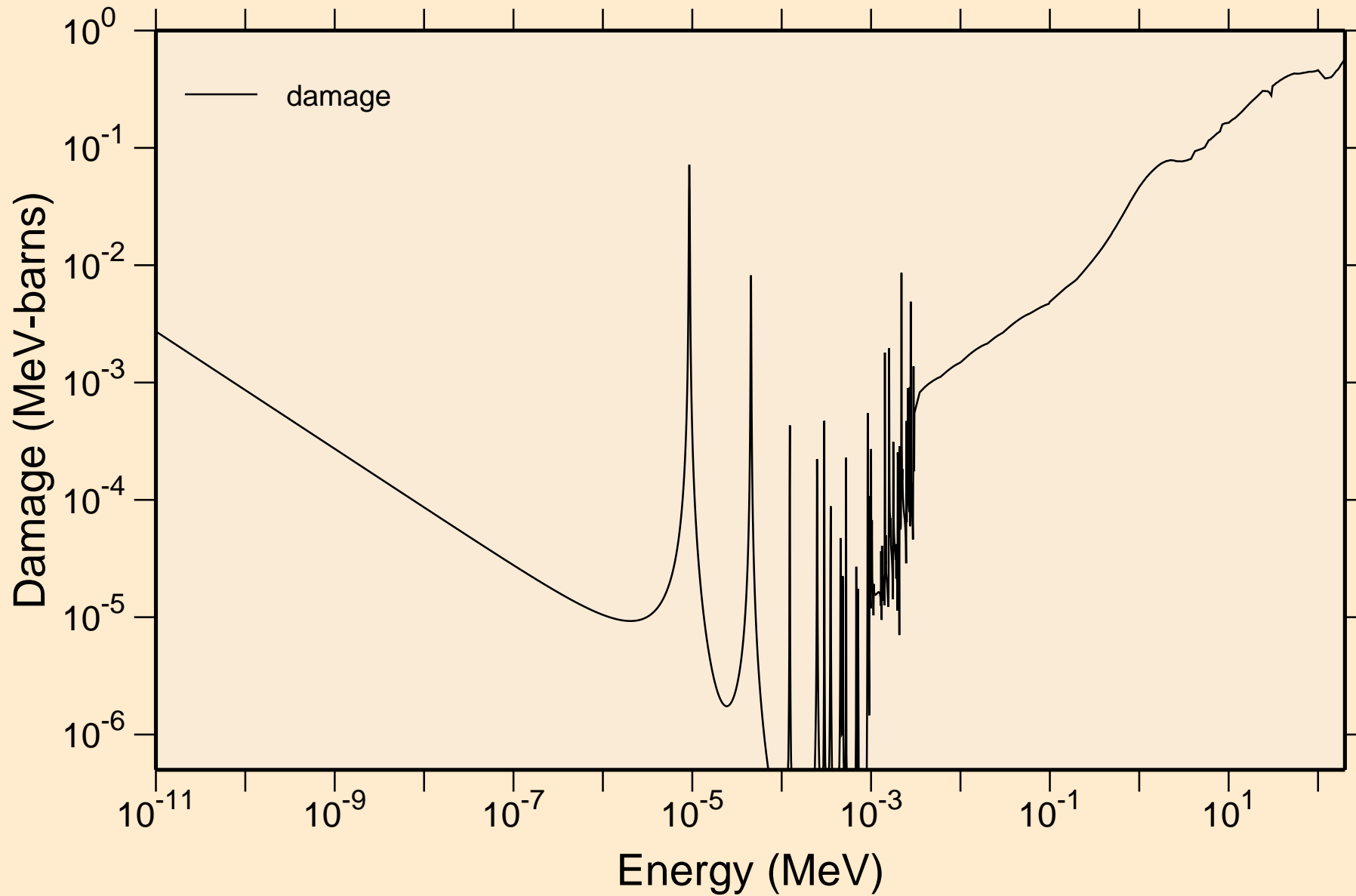

LA145 NEUTRON ACER TENDL-2021 LIBRARY; T=293.6K
Non-threshold reactions

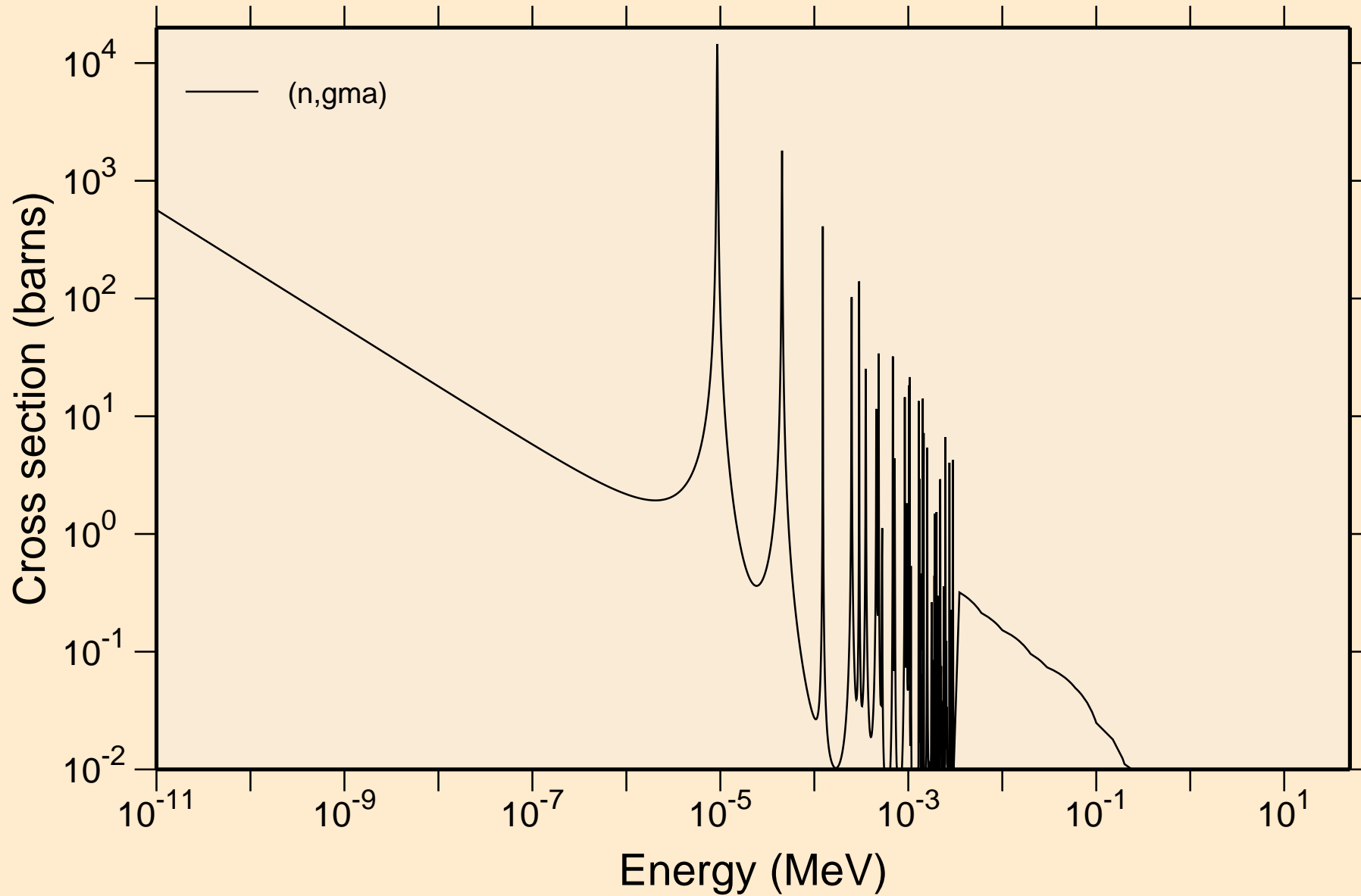

LA145 NEUTRON ACER TENDL-2021 LIBRARY; T=293.6K
Principal cross sections

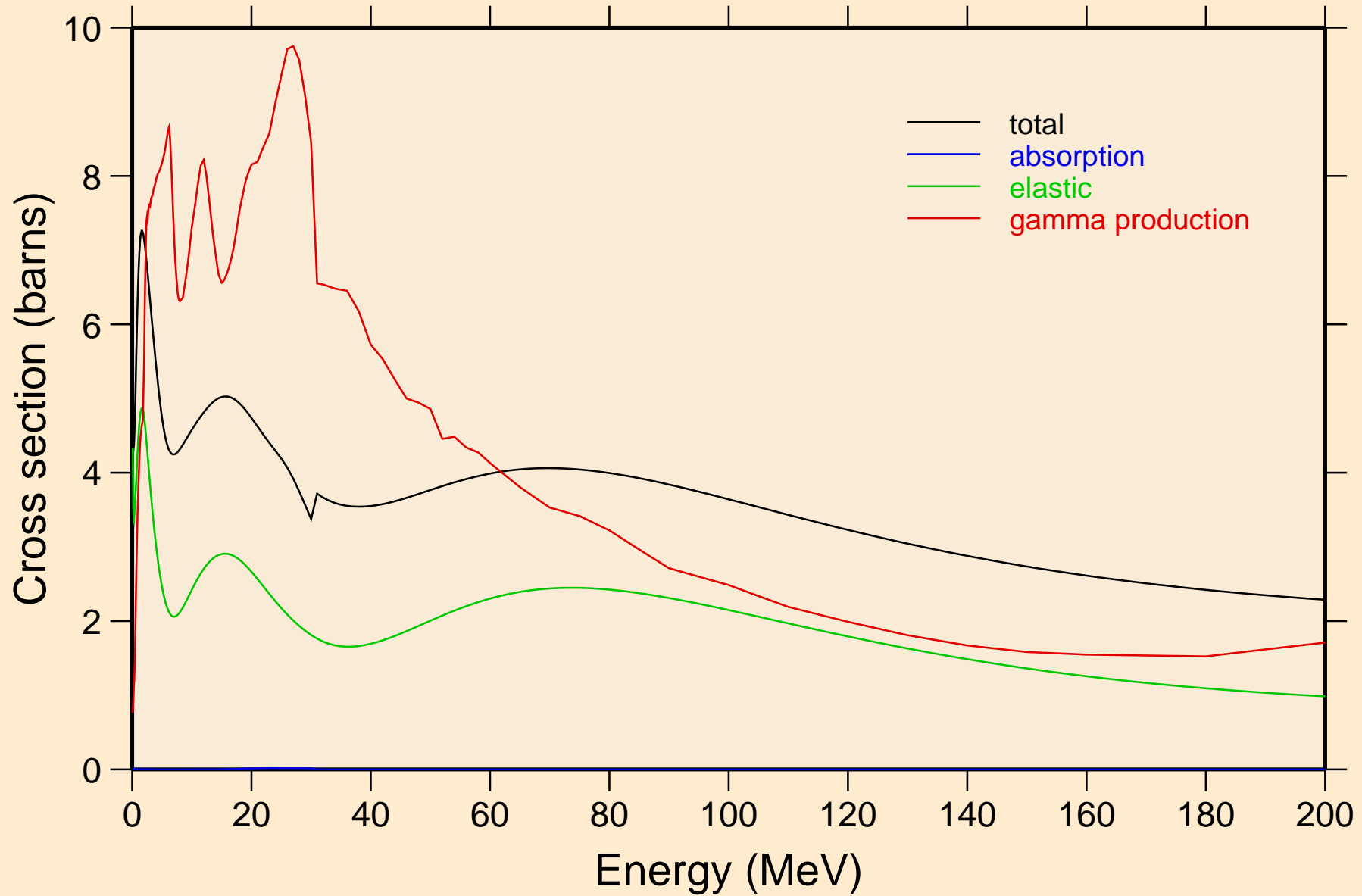

LA145 NEUTRON ACER TENDL-2021 LIBRARY; T=293.6K
Heating

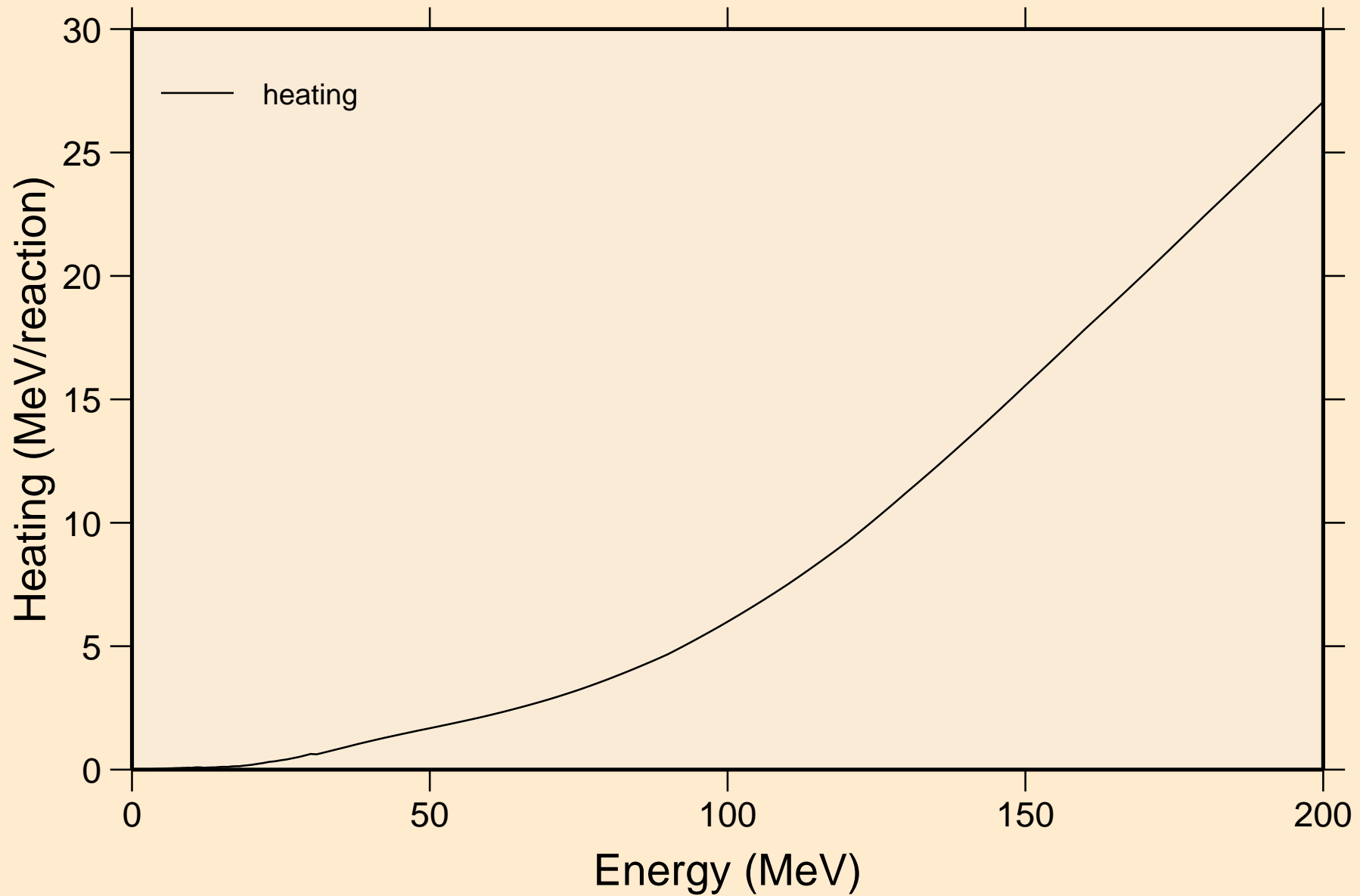

LA145 NEUTRON ACER TENDL-2021 LIBRARY; T=293.6K
Damage

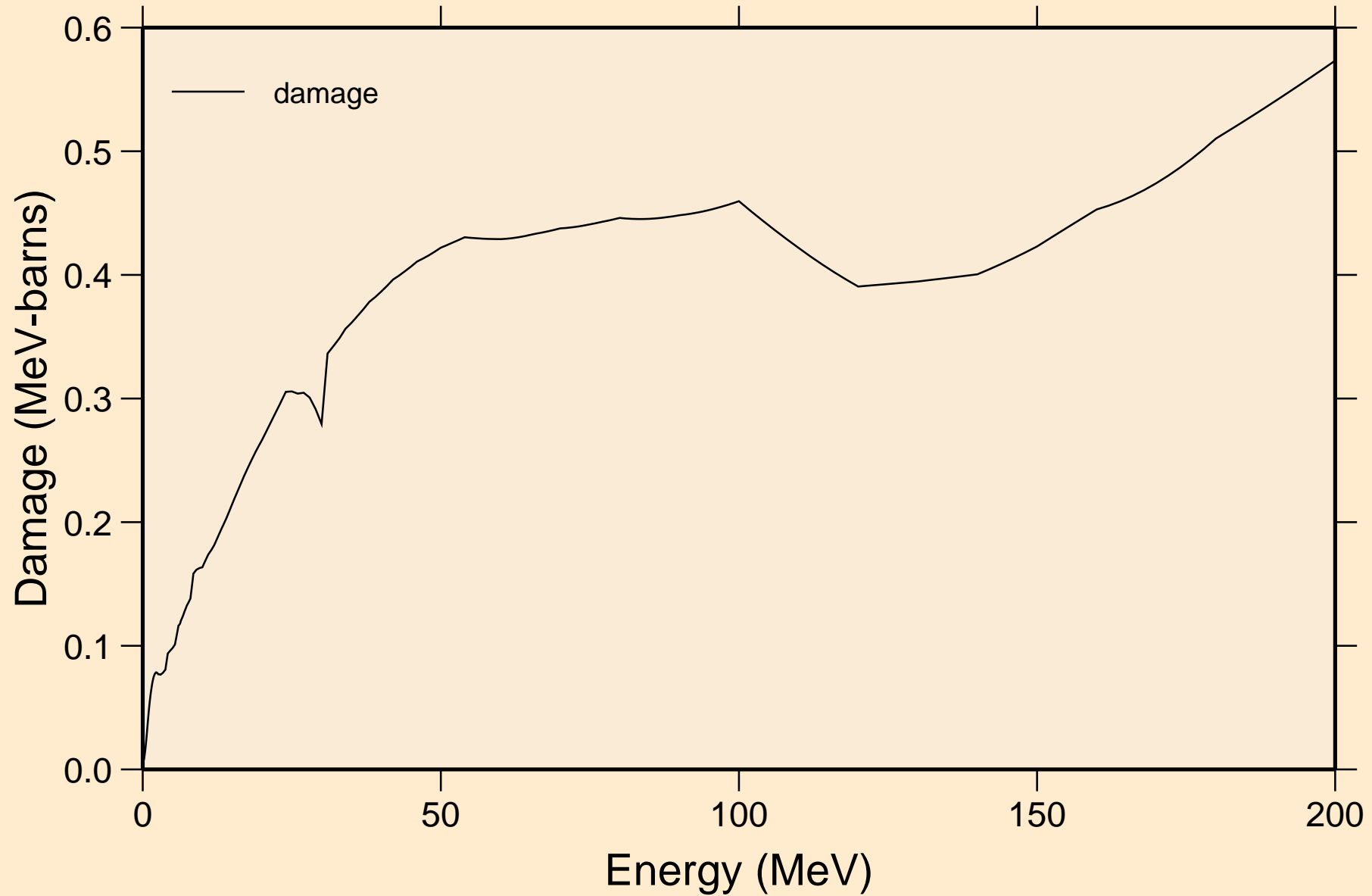

LA145 NEUTRON ACER TENDL-2021 LIBRARY; T=293.6K
Non-threshold reactions

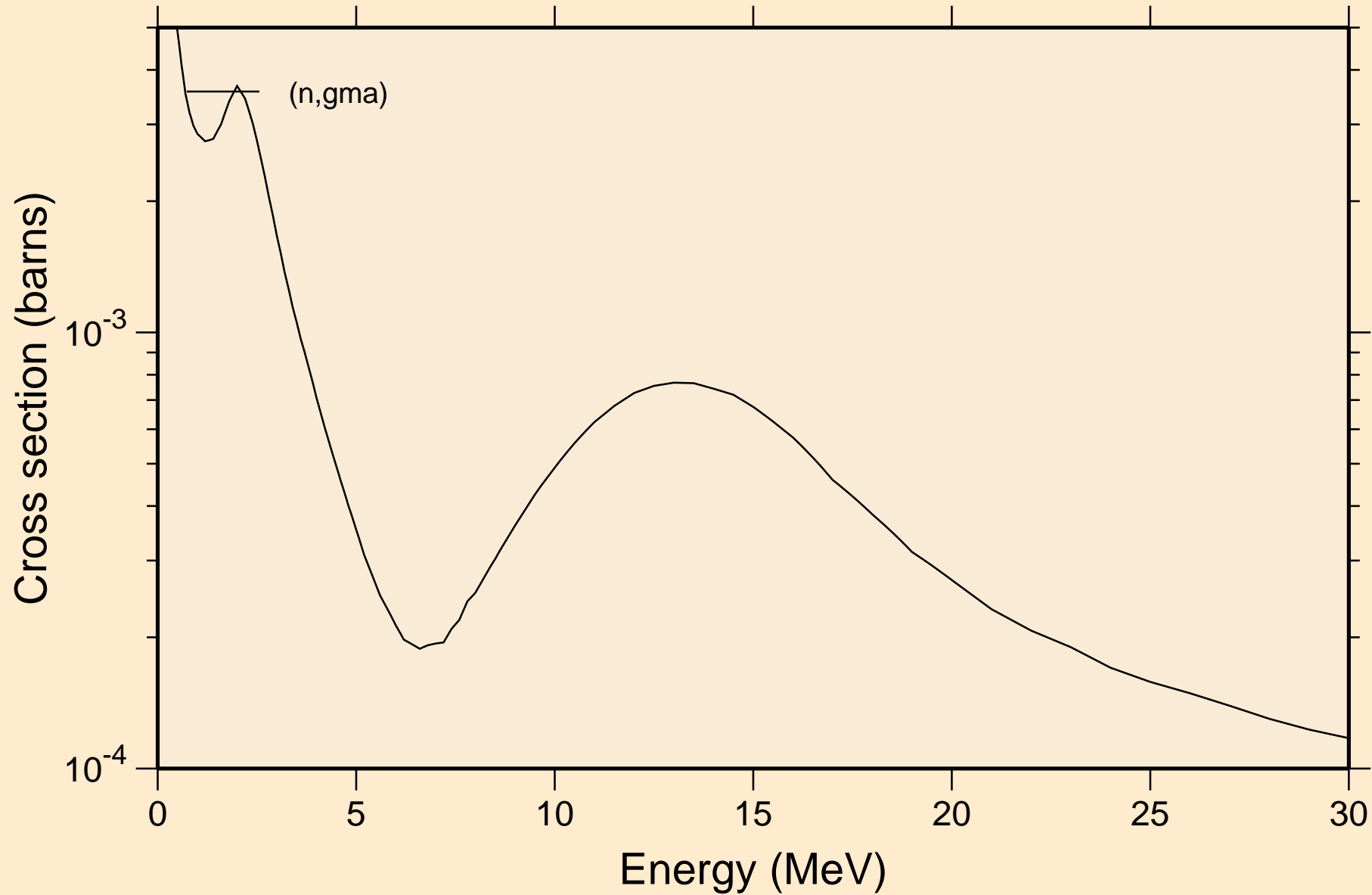

LA145 NEUTRON ACER TENDL-2021 LIBRARY; T=293.6K
Inelastic levels

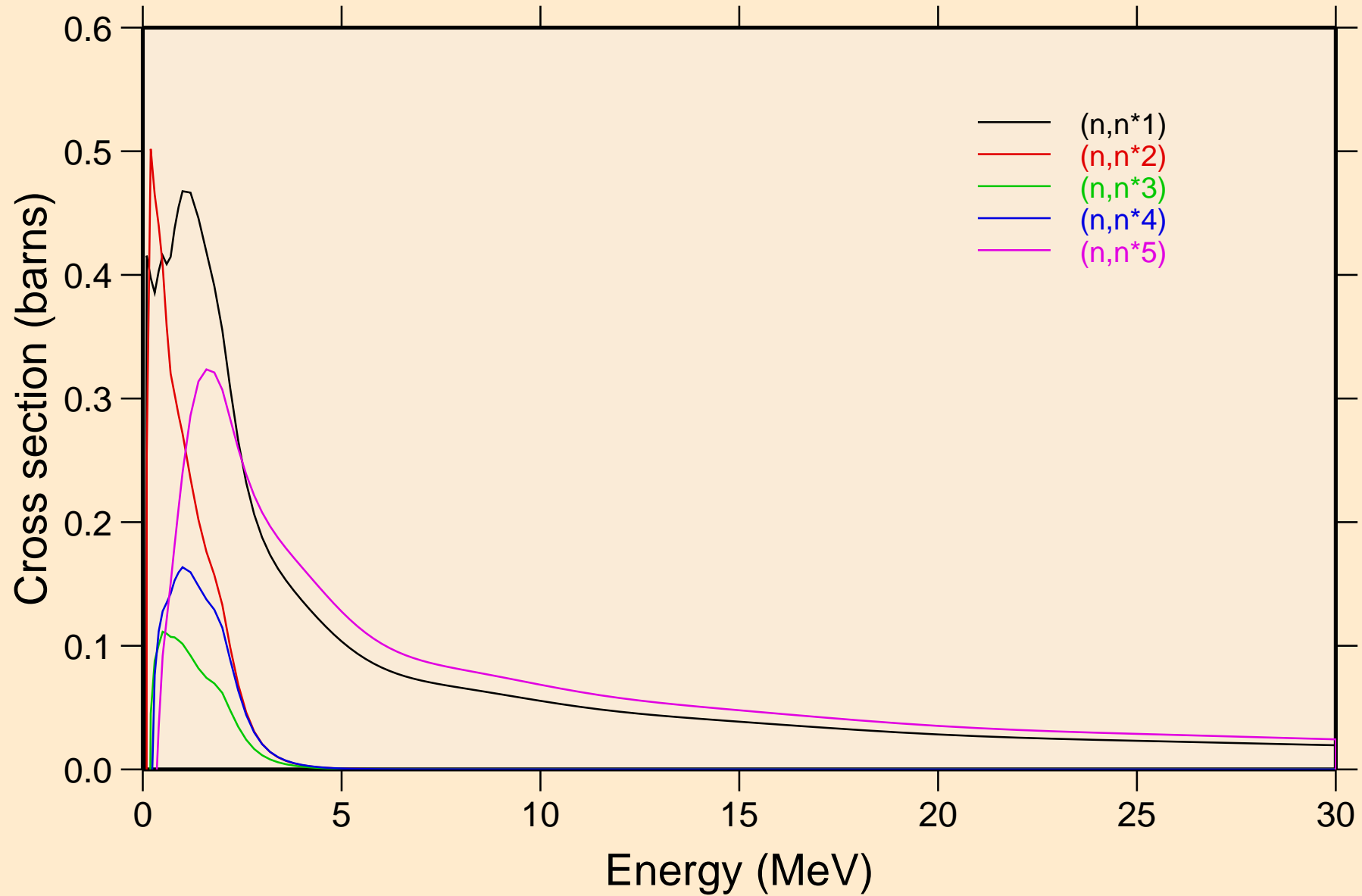

LA145 NEUTRON ACER TENDL-2021 LIBRARY; T=293.6K
Inelastic levels

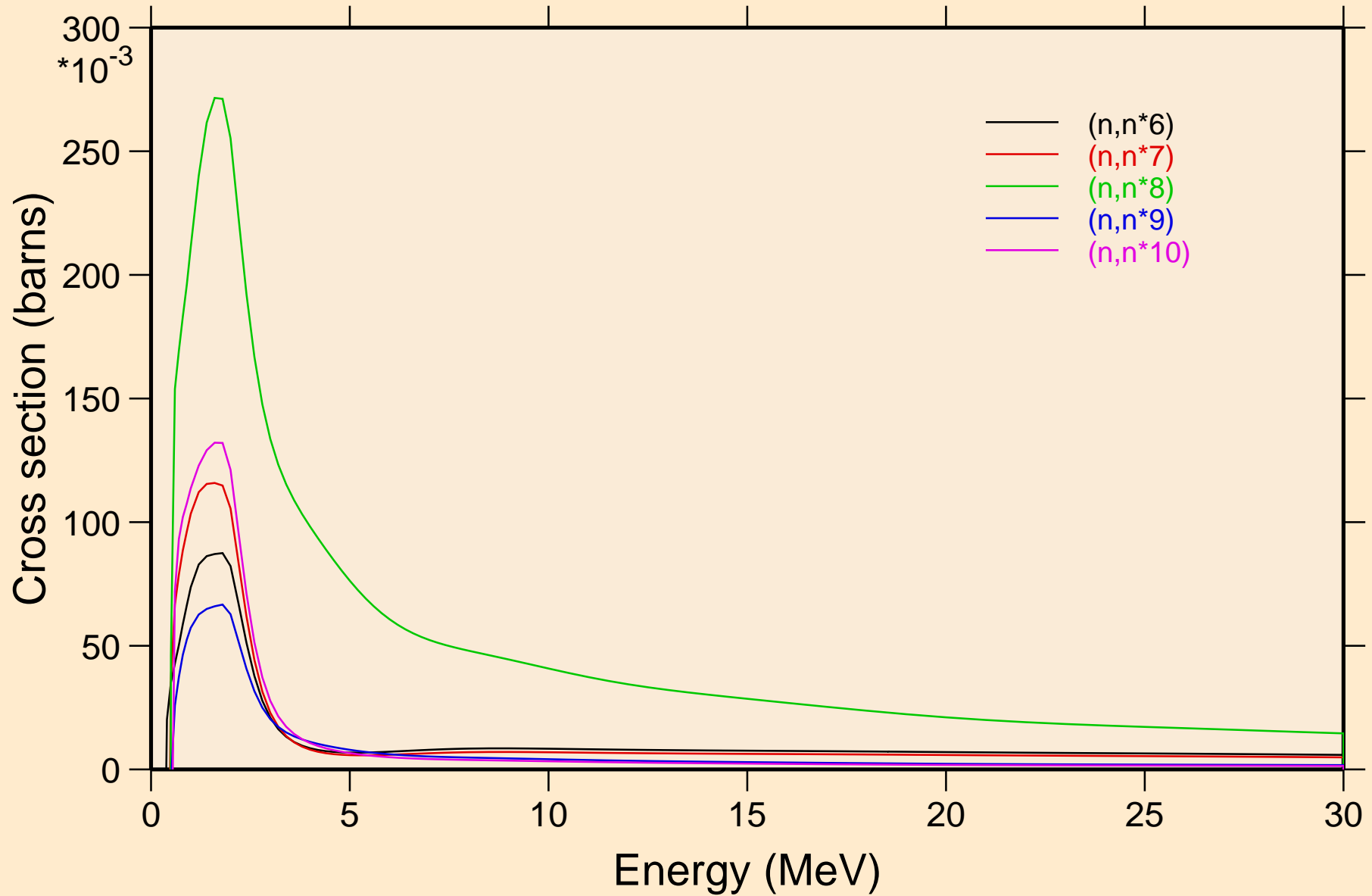

LA145 NEUTRON ACER TENDL-2021 LIBRARY; T=293.6K
Inelastic levels

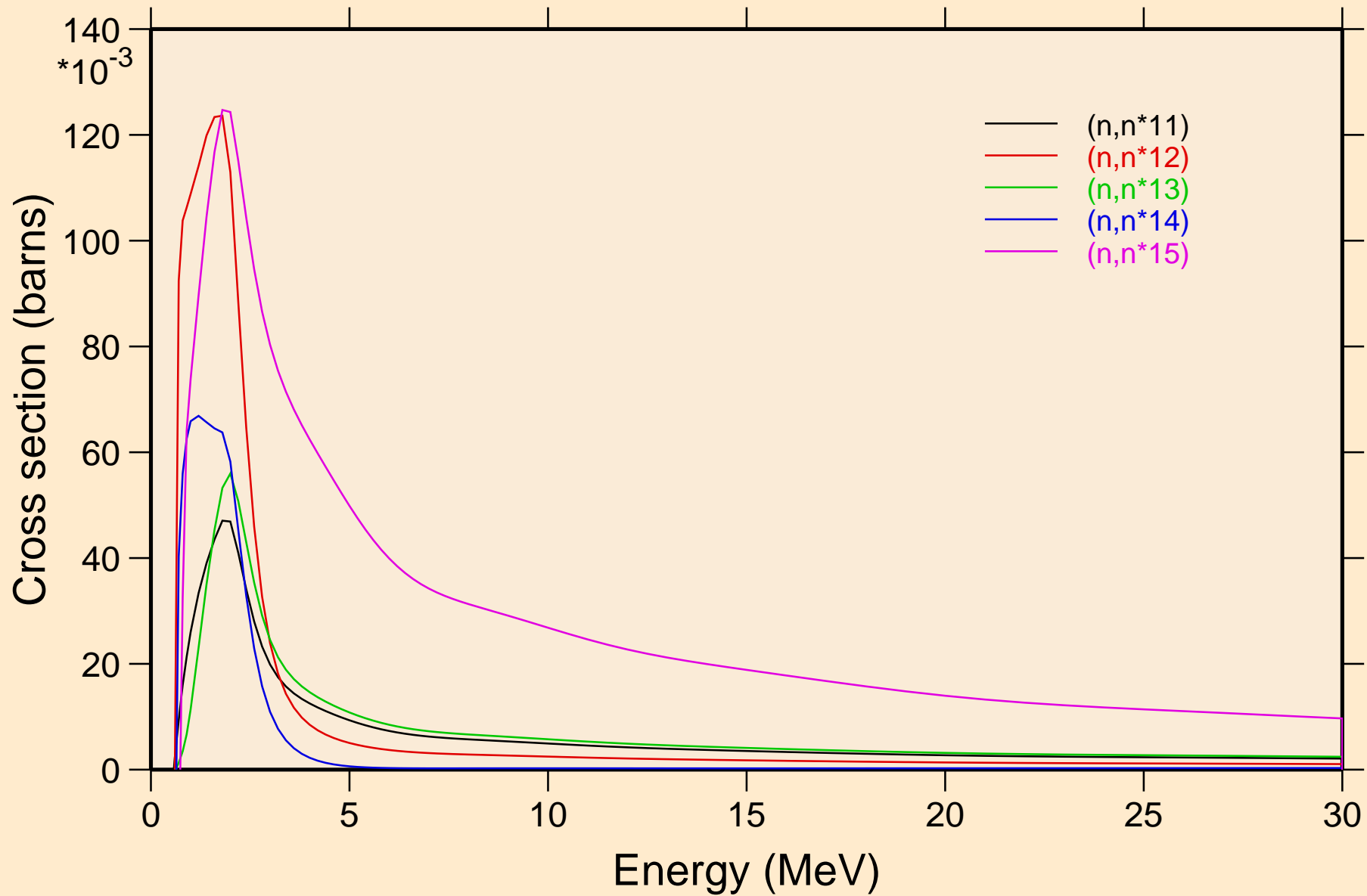

LA145 NEUTRON ACER TENDL-2021 LIBRARY; T=293.6K
Inelastic levels

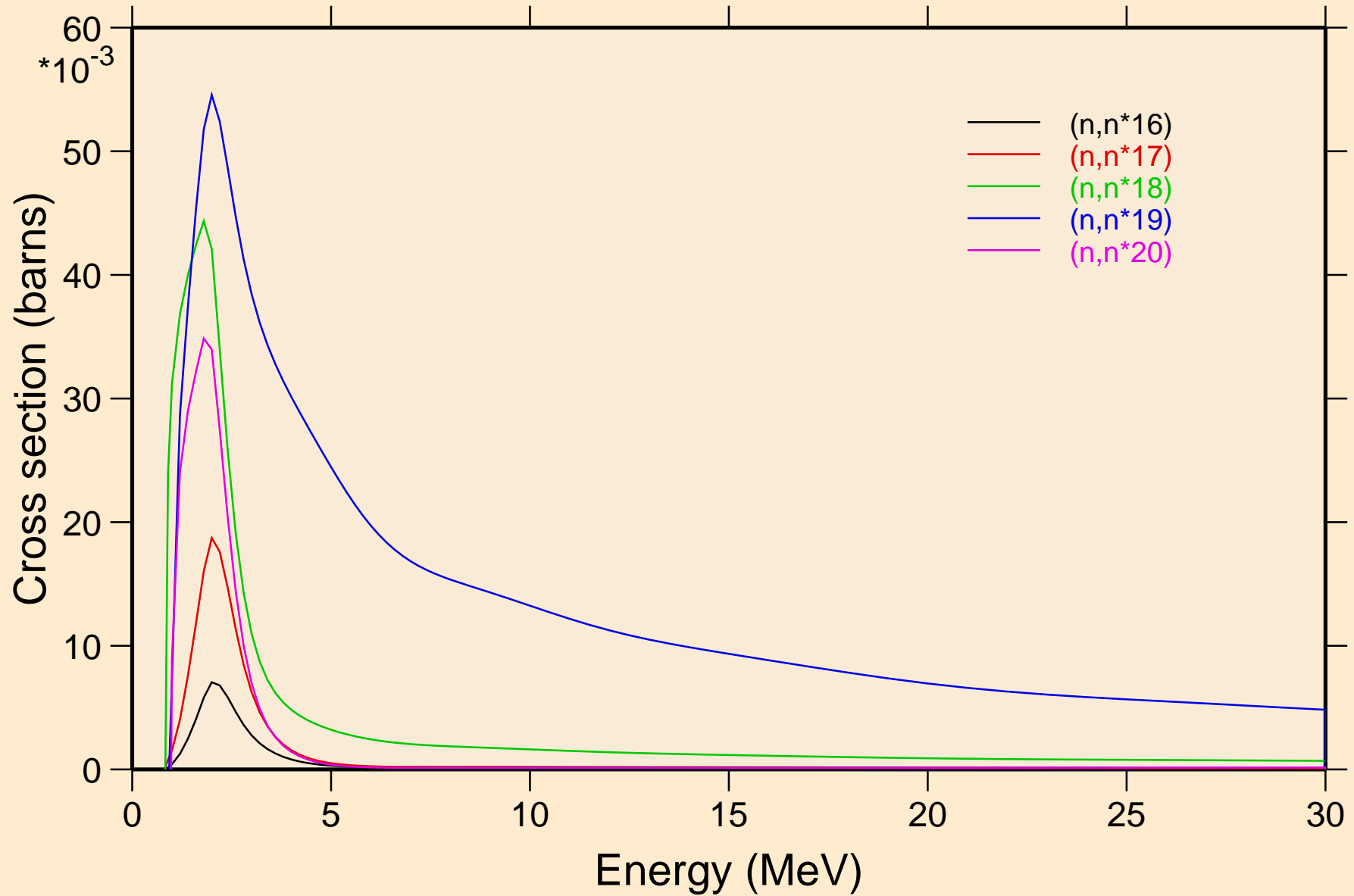

LA145 NEUTRON ACER TENDL-2021 LIBRARY; T=293.6K
Inelastic levels

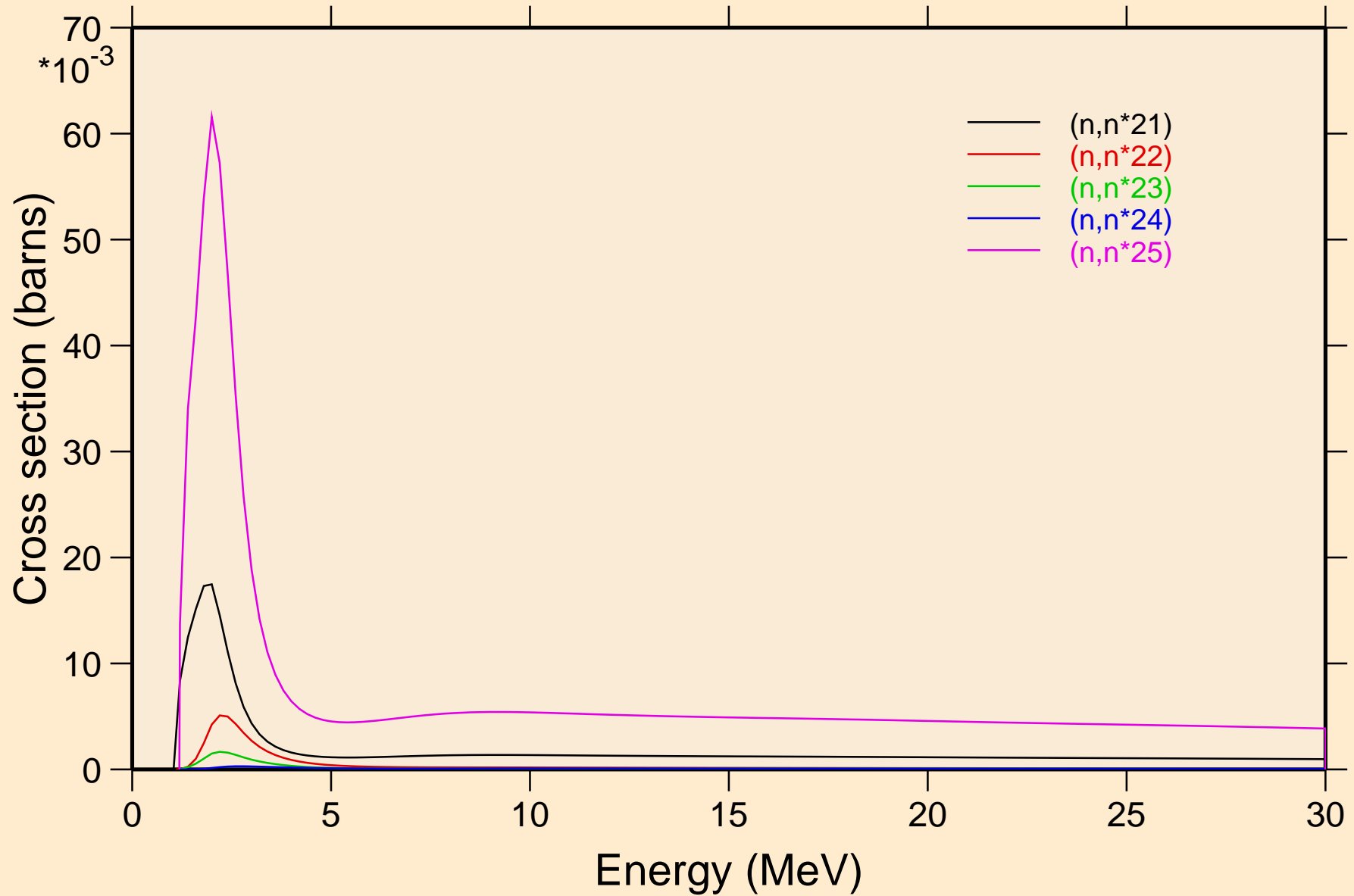

LA145 NEUTRON ACER TENDL-2021 LIBRARY; T=293.6K
Threshold reactions

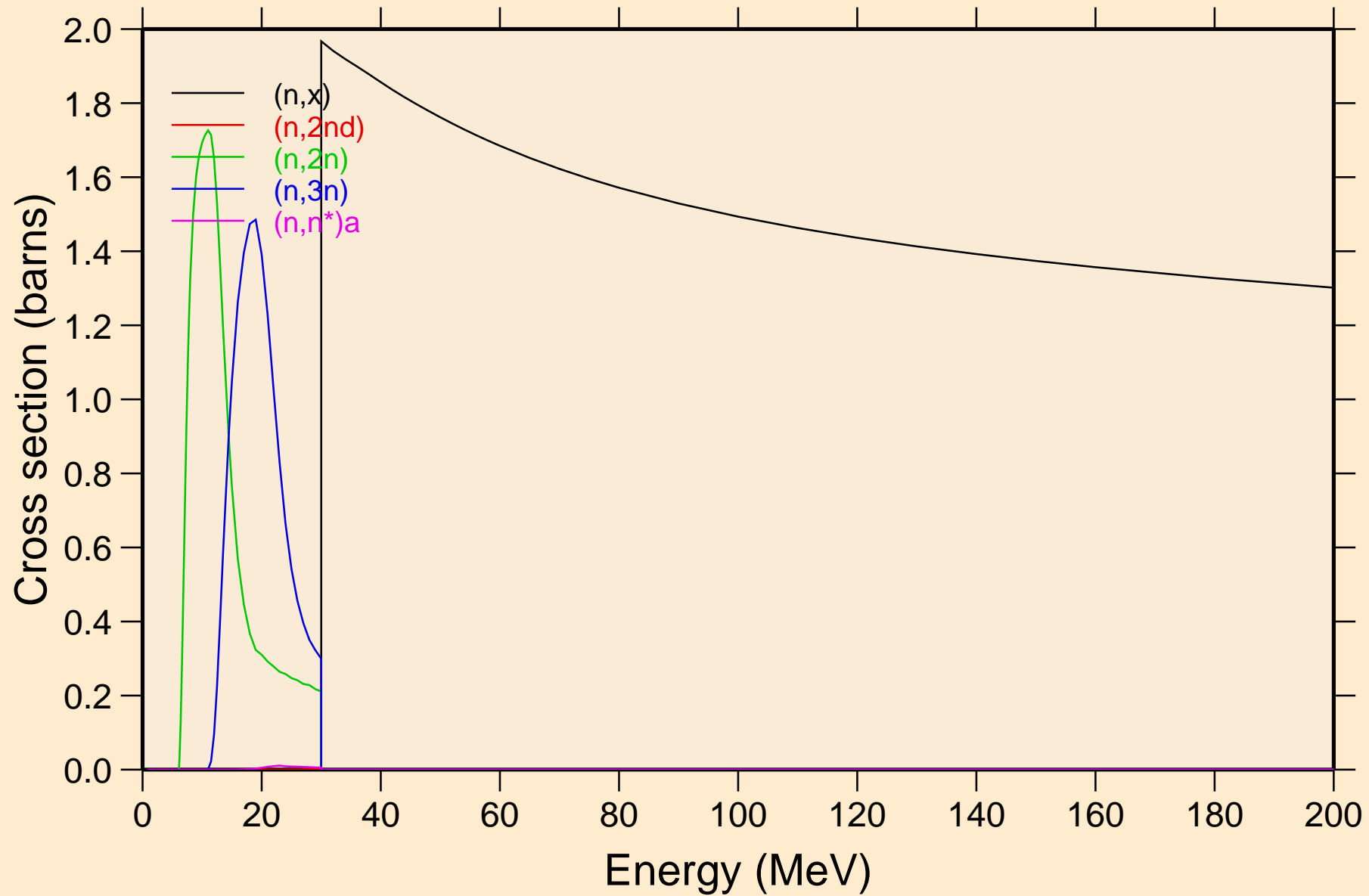

LA145 NEUTRON ACER TENDL-2021 LIBRARY; T=293.6K
Threshold reactions

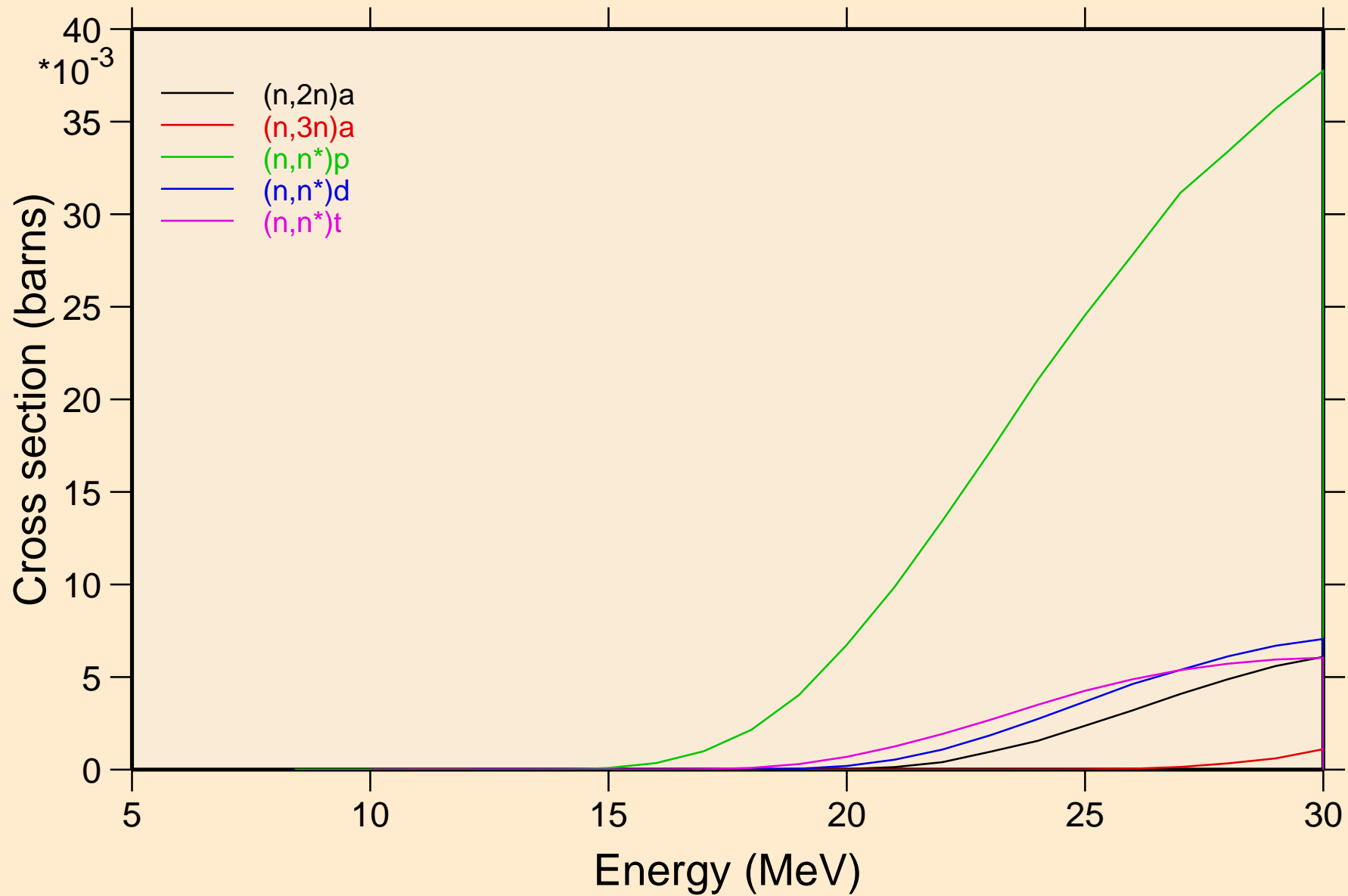

LA145 NEUTRON ACER TENDL-2021 LIBRARY; T=293.6K
Threshold reactions

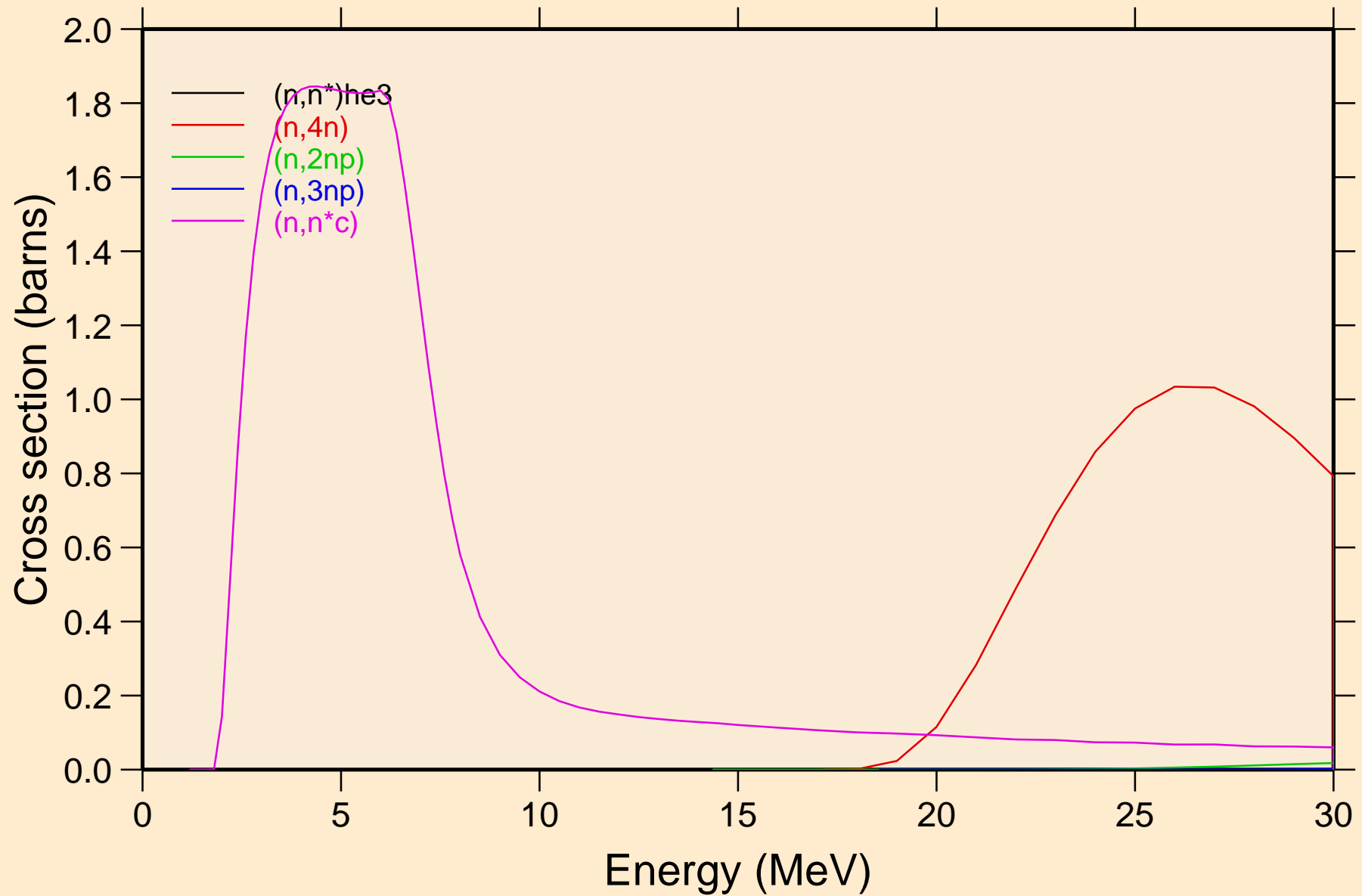

LA145 NEUTRON ACER TENDL-2021 LIBRARY; T=293.6K
Threshold reactions

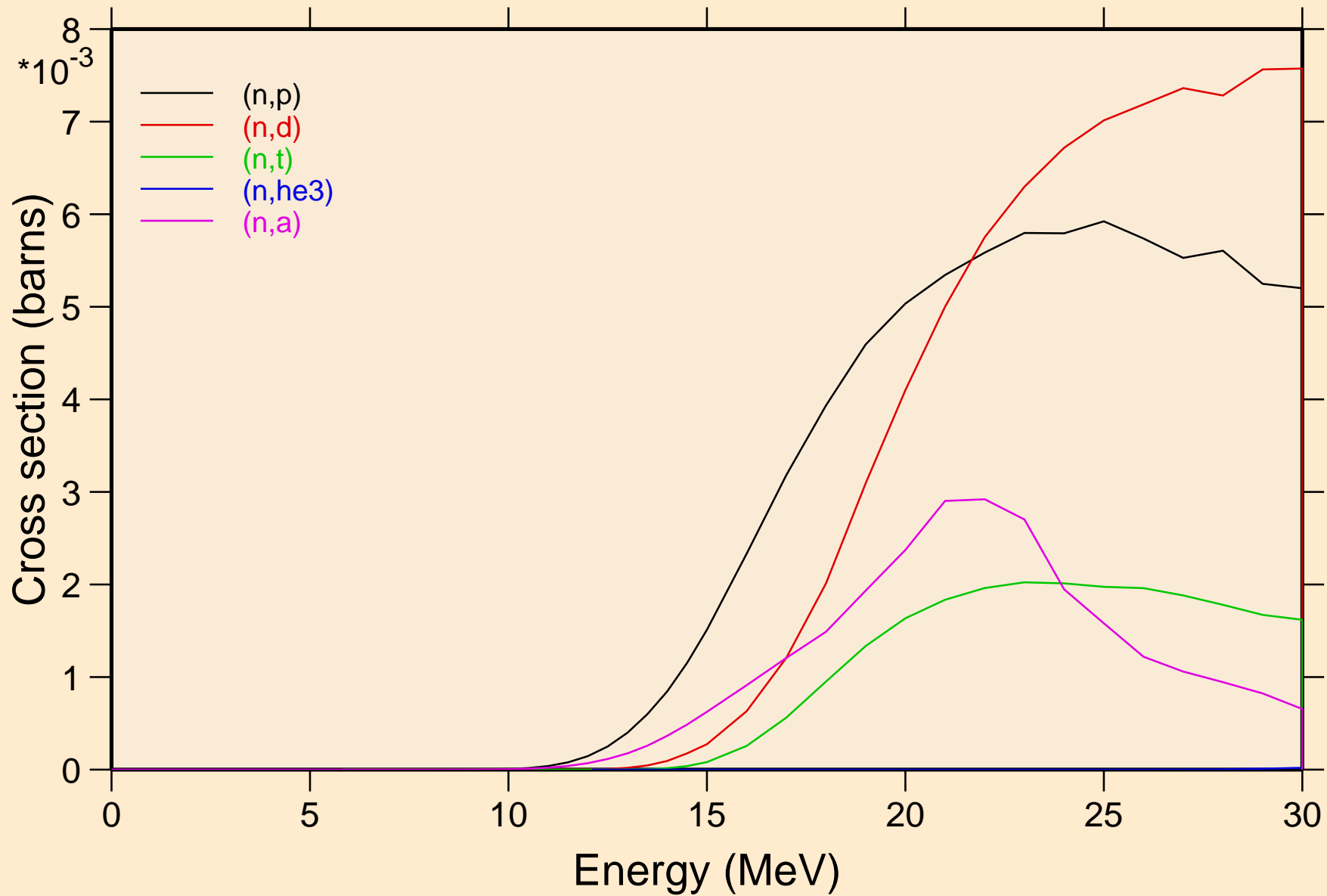

LA145 NEUTRON ACER TENDL-2021 LIBRARY; T=293.6K
Threshold reactions

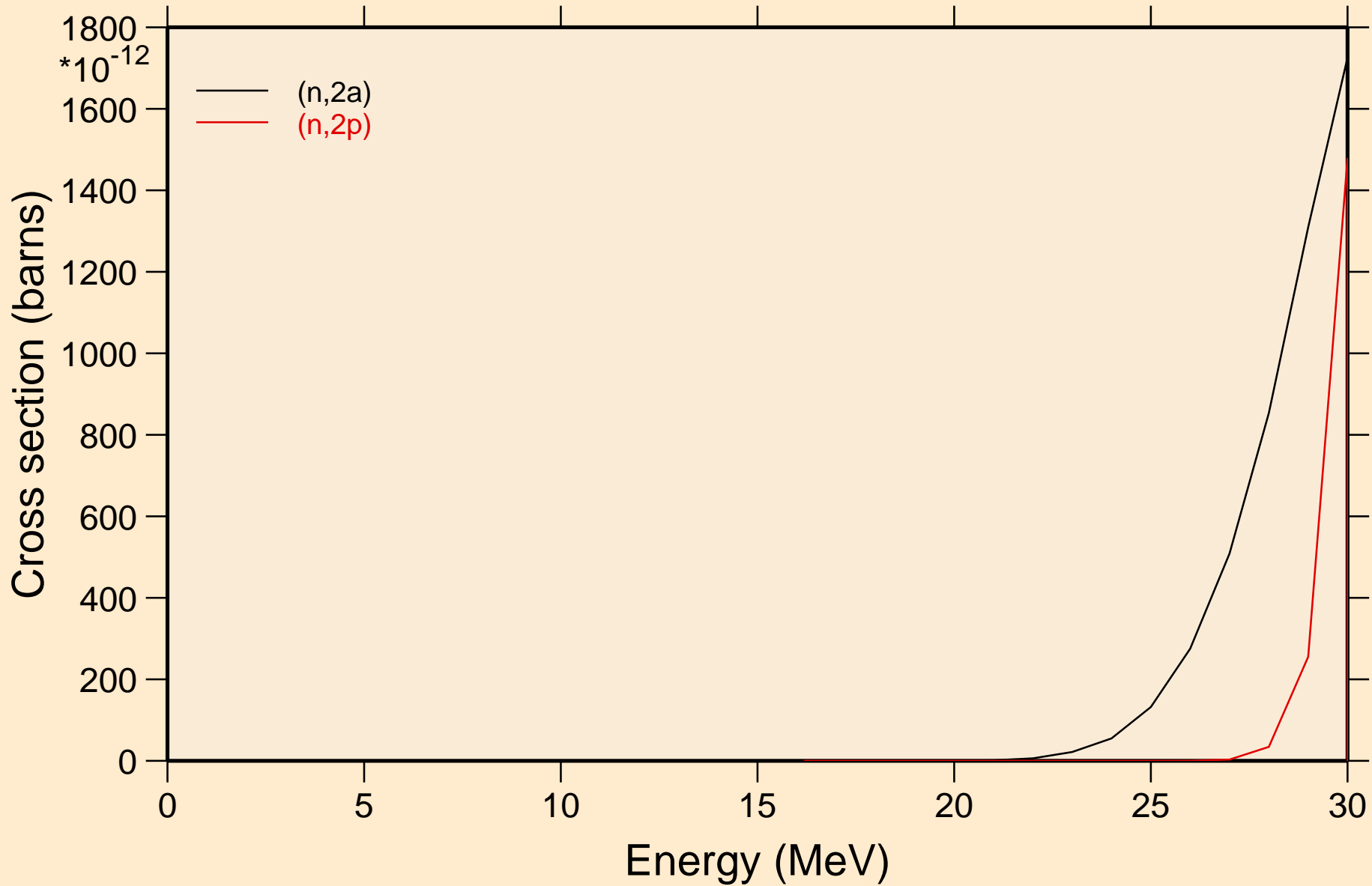

LA145 NEUTRON ACER TENDL-2021 LIBRARY; T=293.6K
Threshold reactions

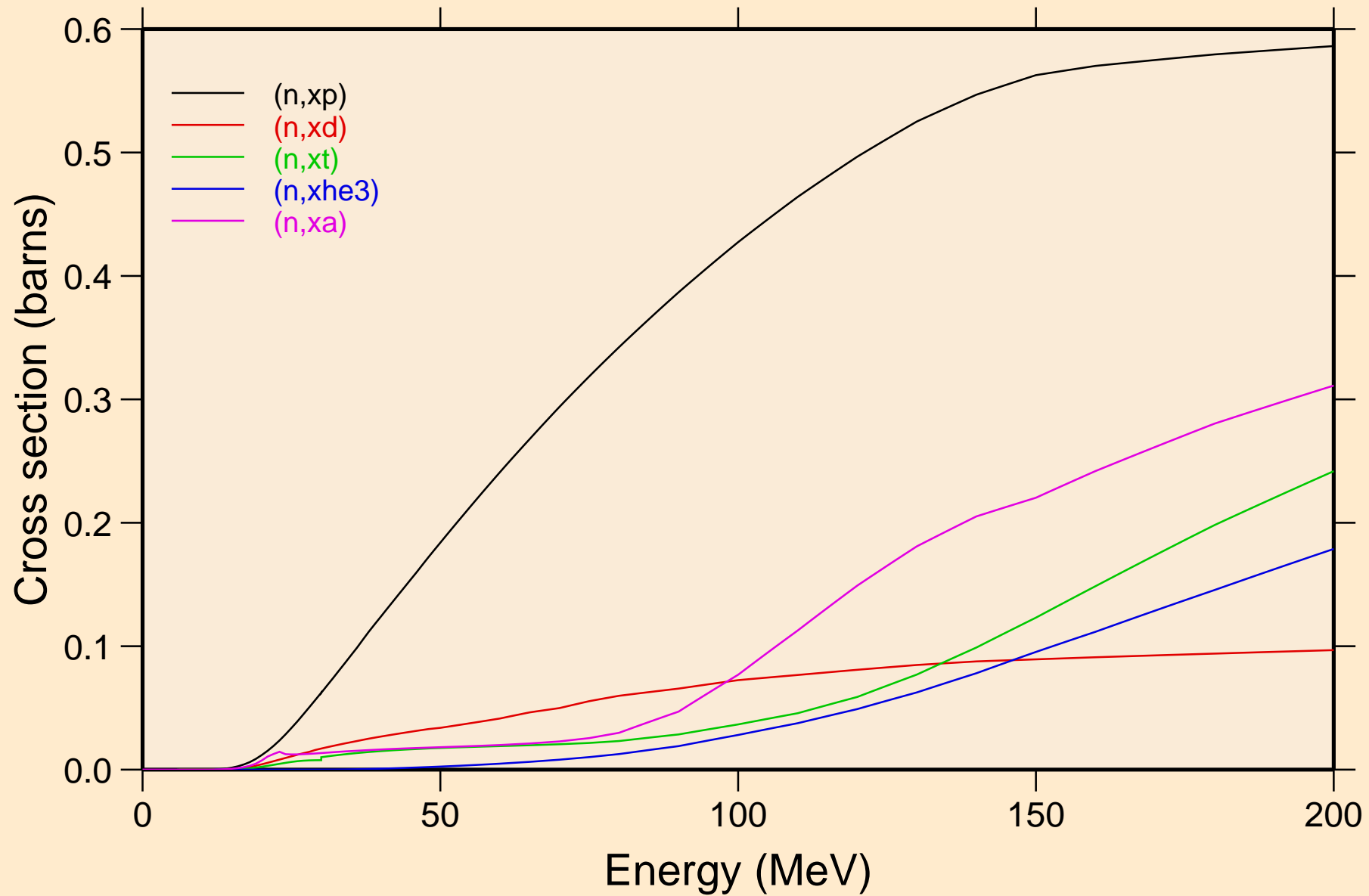

LA145 NEUTRON ACER TENDL-2021 LIBRARY; T=293.6K
angular distribution for elastic

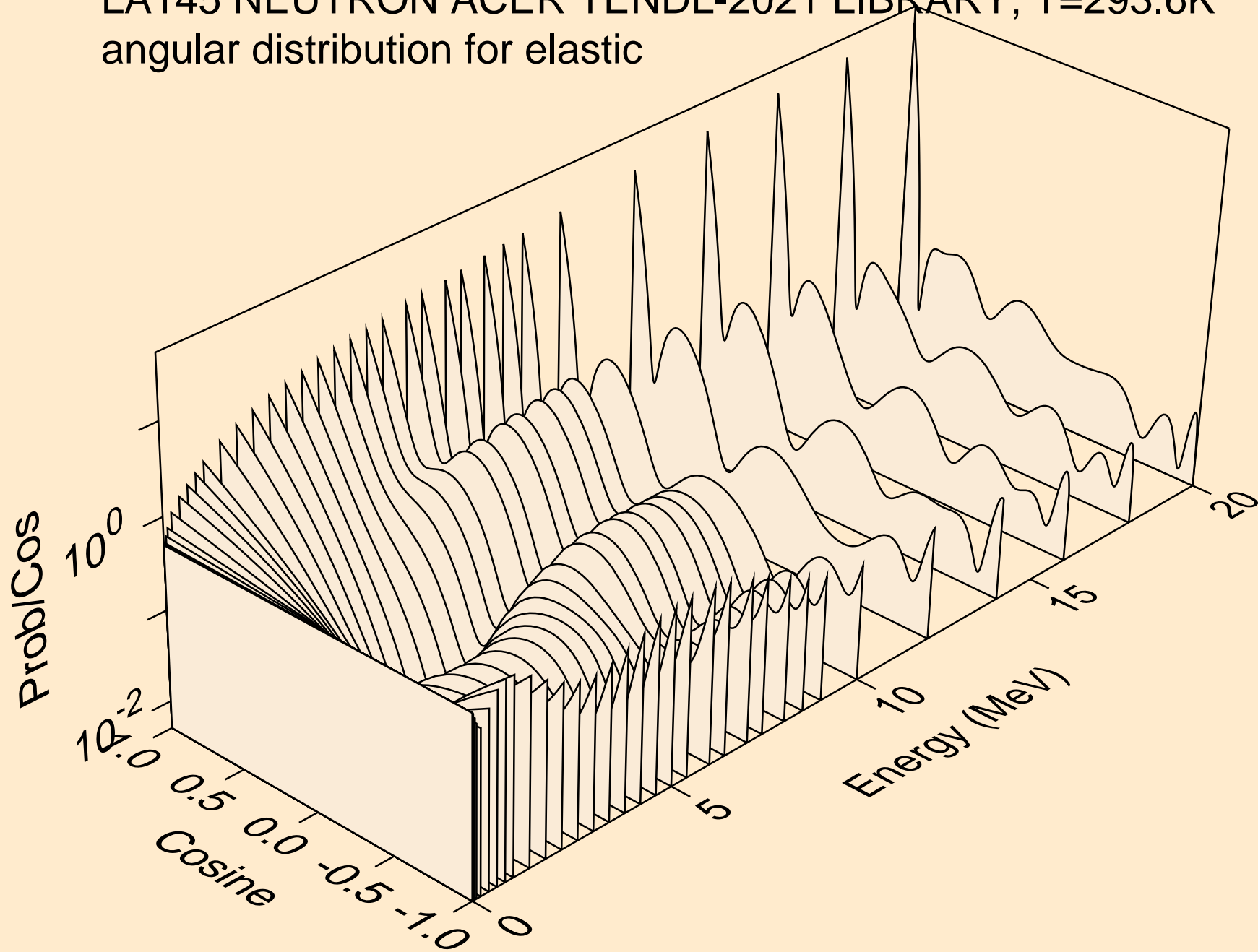

LA145 NEUTRON ACER TENDL-2021 LIBRARY; T=293.6K
angular distribution for elastic

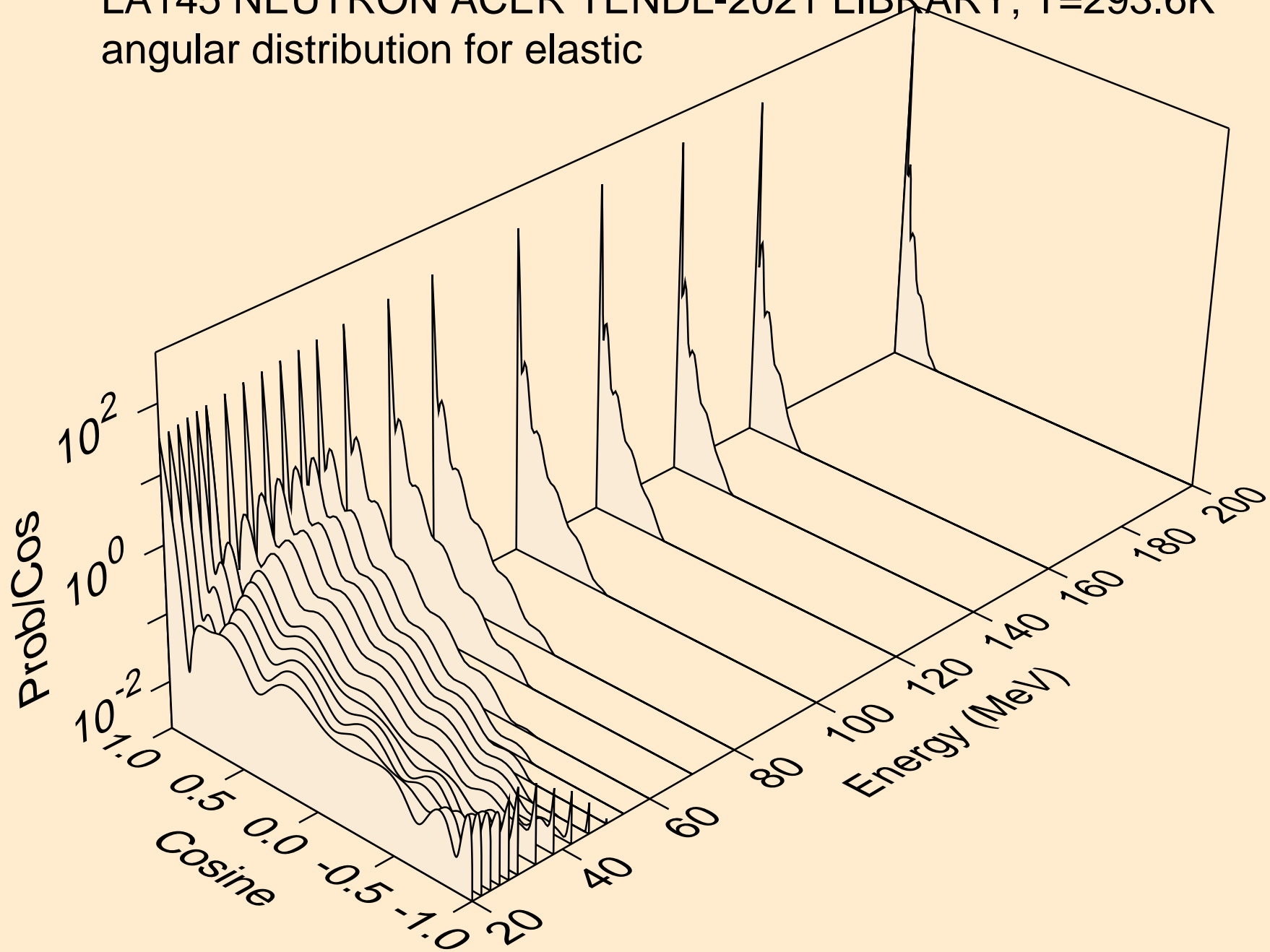

LA145 NEUTRON ACER TENDL-2021 LIBRARY; T=293.6K
angular distribution for (n,n*1)

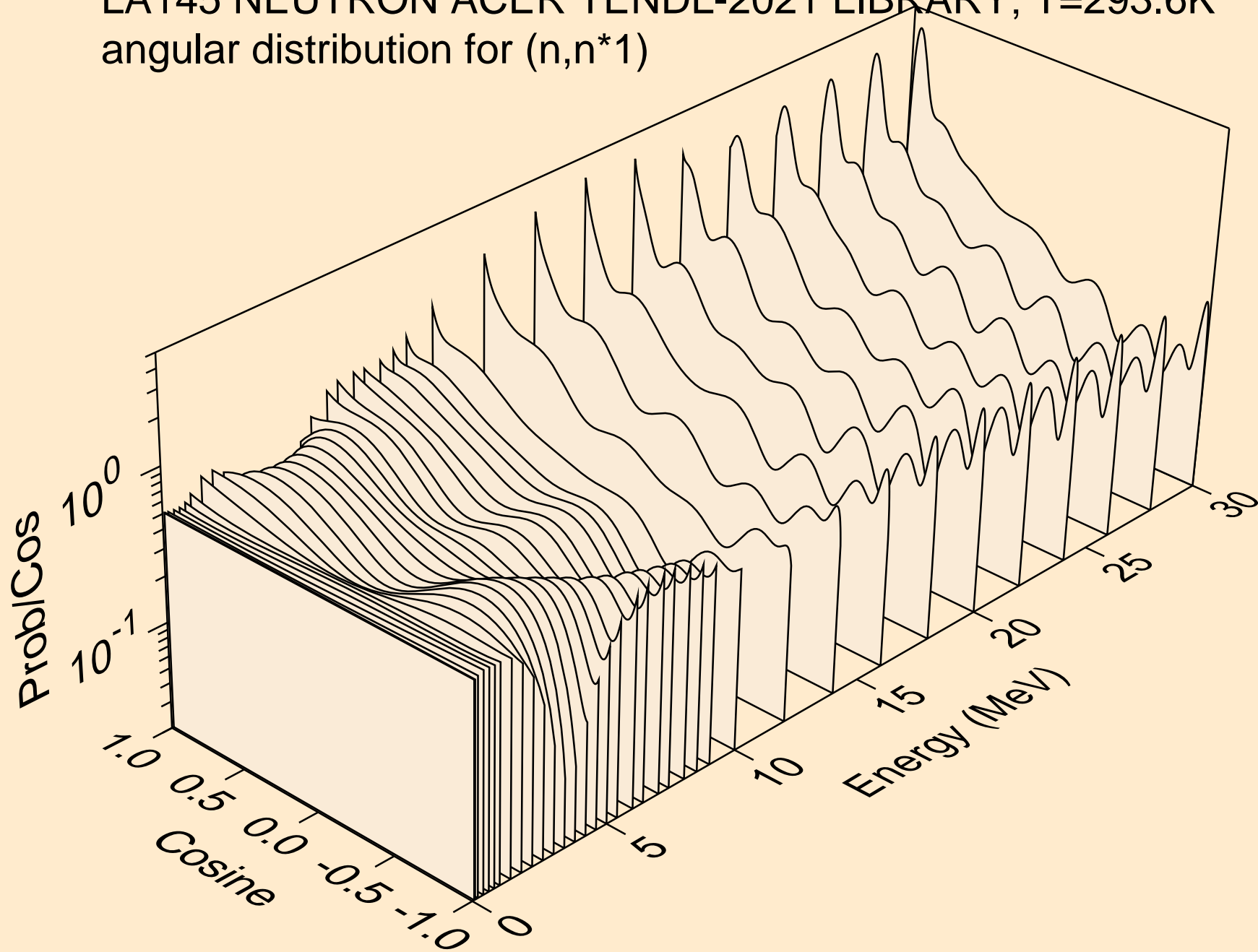

LA145 NEUTRON ACER TENDL-2021 LIBRARY; T=293.6K
angular distribution for (n,n*2)

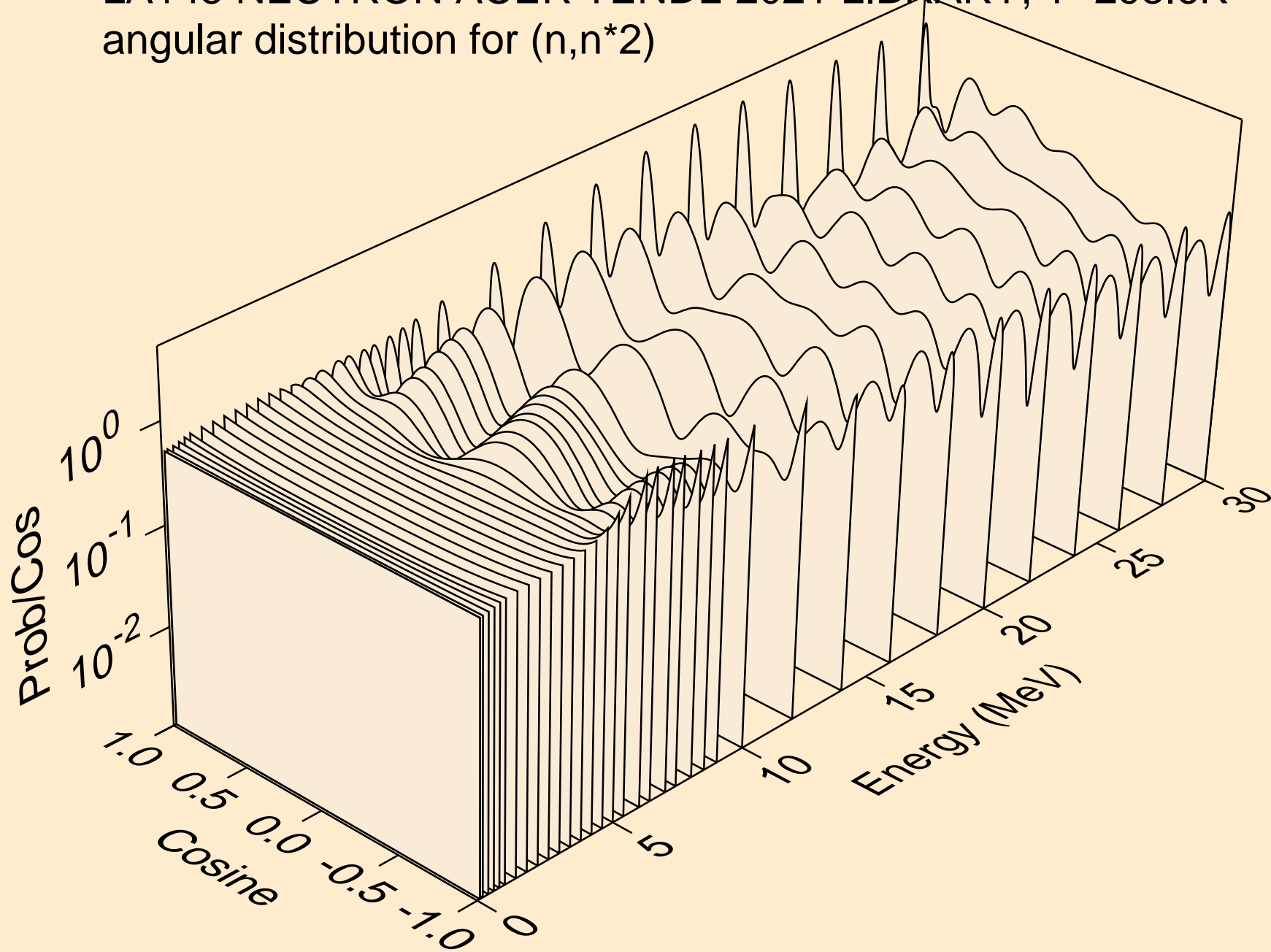

LA145 NEUTRON ACER TENDL-2021 LIBRARY; T=293.6K
angular distribution for (n,n*3)

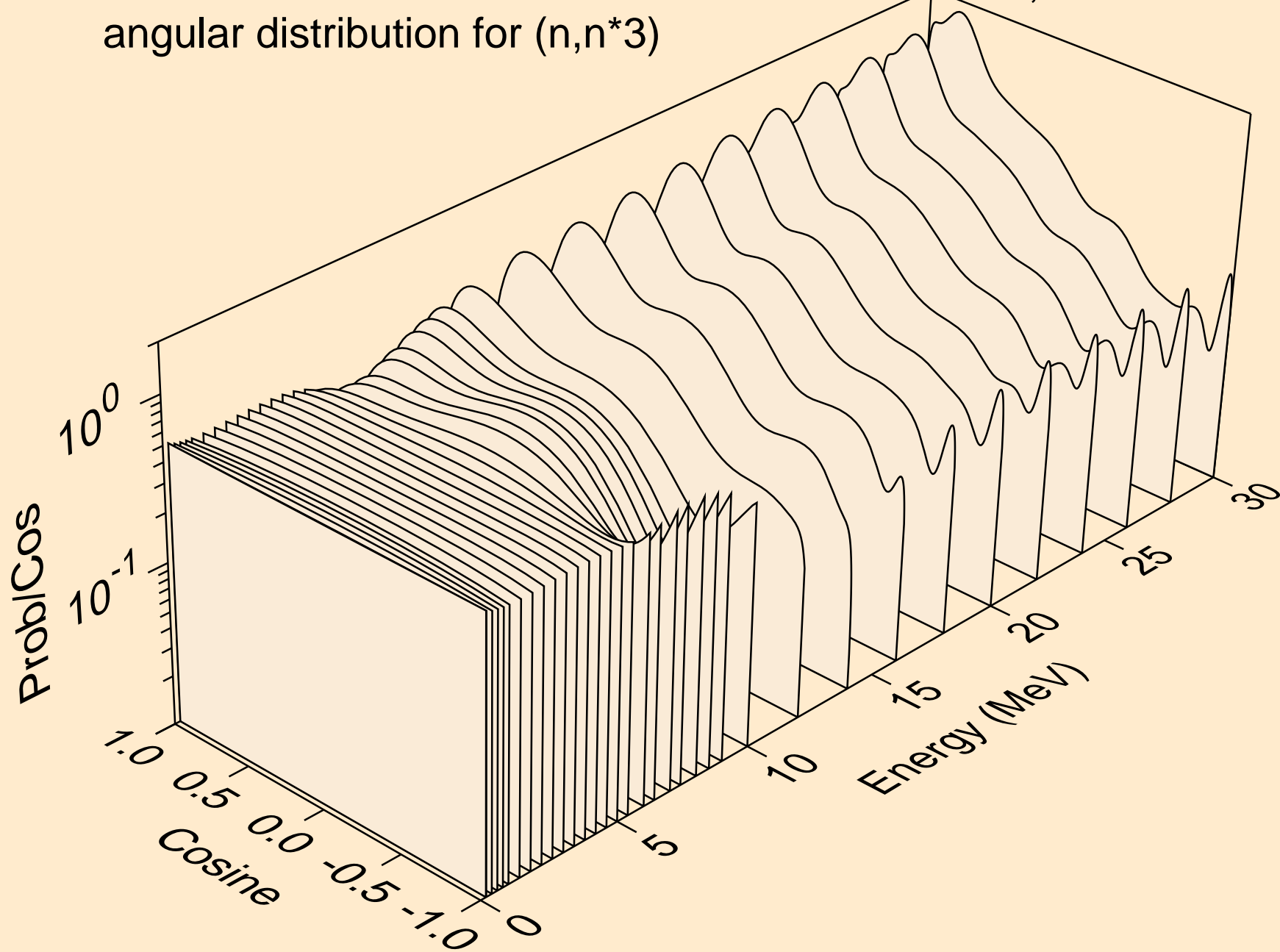

LA145 NEUTRON ACER TENDL-2021 LIBRARY; T=293.6K
angular distribution for (n,n*4)

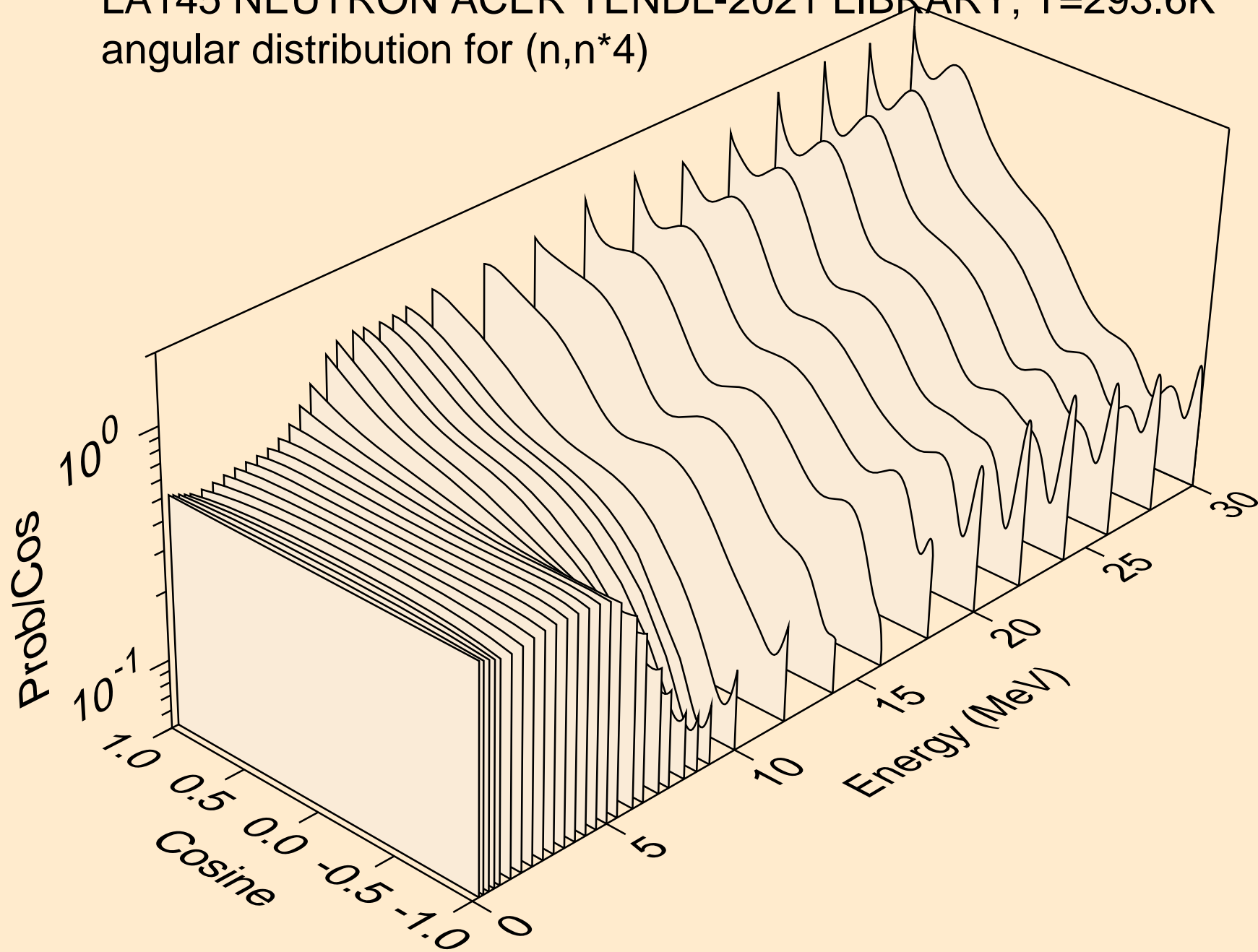

LA145 NEUTRON ACER TENDL-2021 LIBRARY; T=293.6K
angular distribution for (n,n*5)

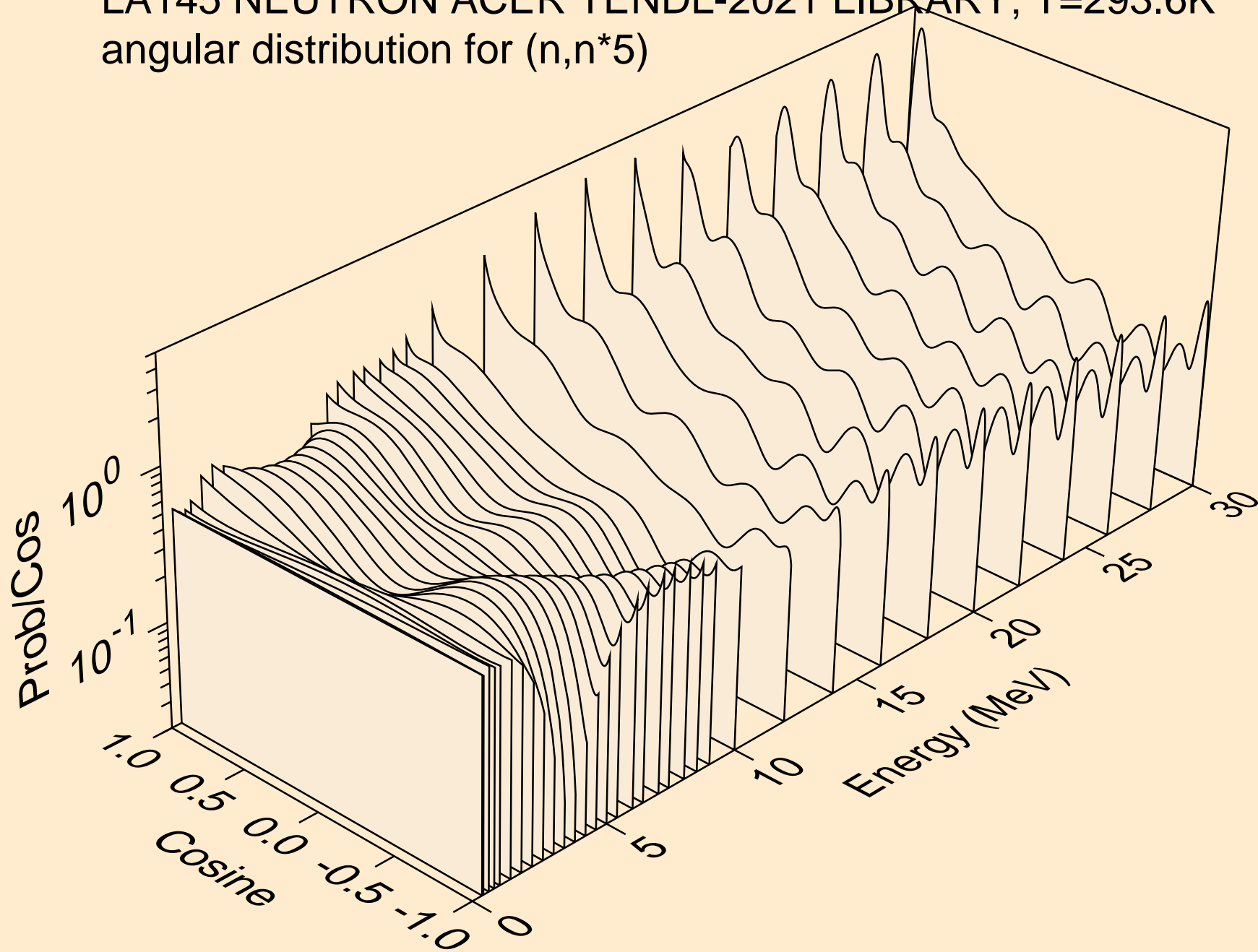

LA145 NEUTRON ACER TENDL-2021 LIBRARY; T=293.6K
angular distribution for (n,n*6)

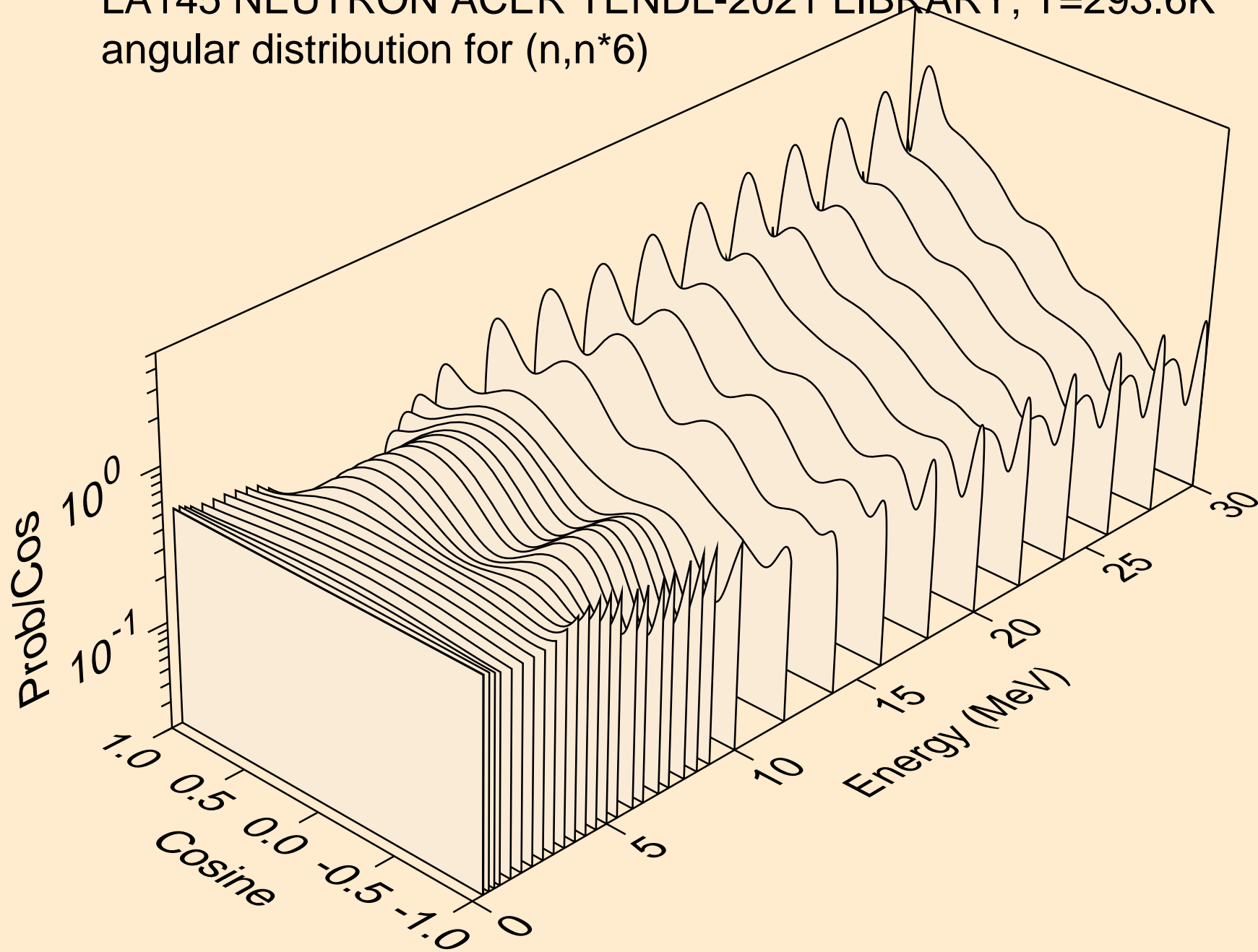

LA145 NEUTRON ACER TENDL-2021 LIBRARY; T=293.6K
angular distribution for (n,n*7)

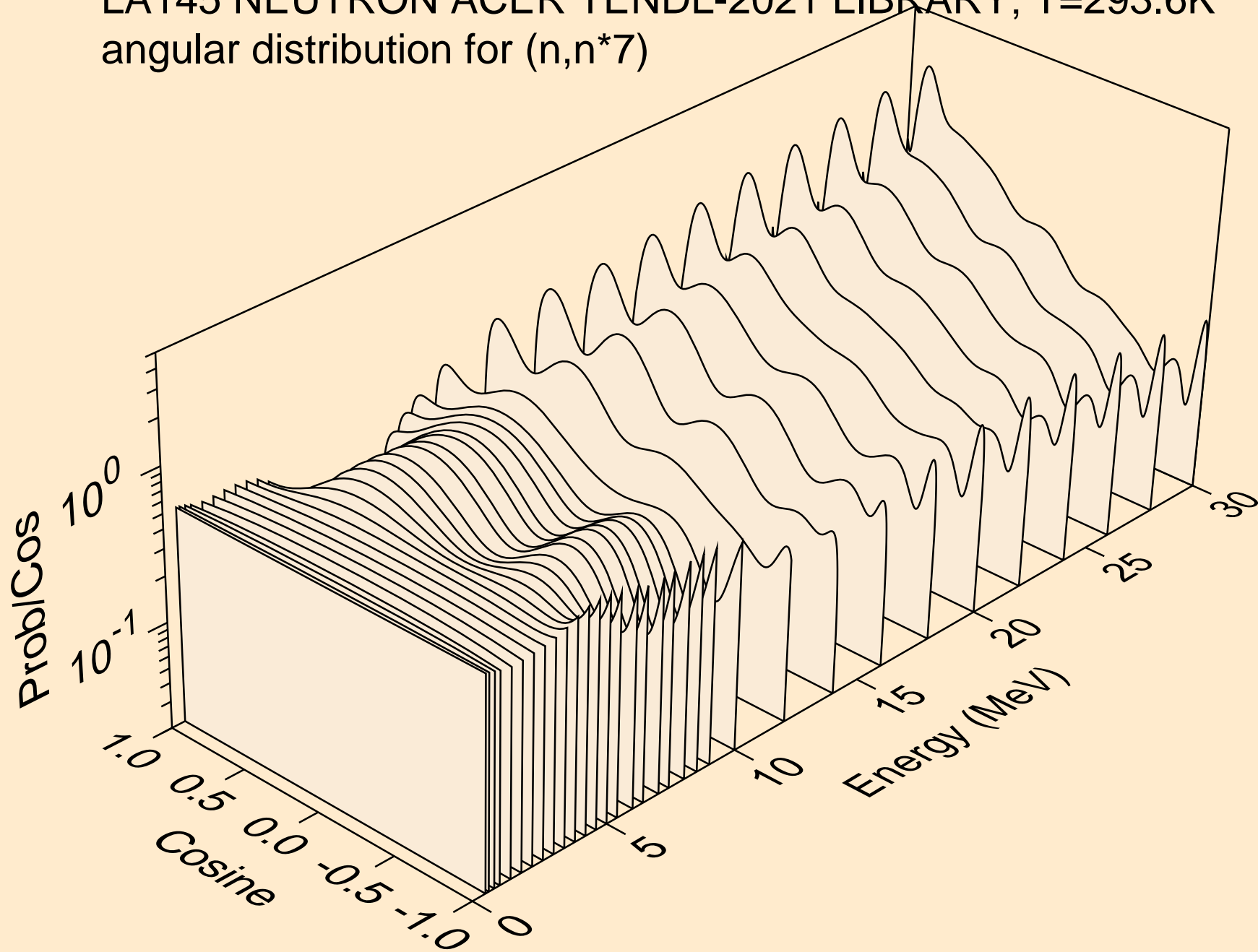

LA145 NEUTRON ACER TENDL-2021 LIBRARY; T=293.6K
angular distribution for (n,n*8)

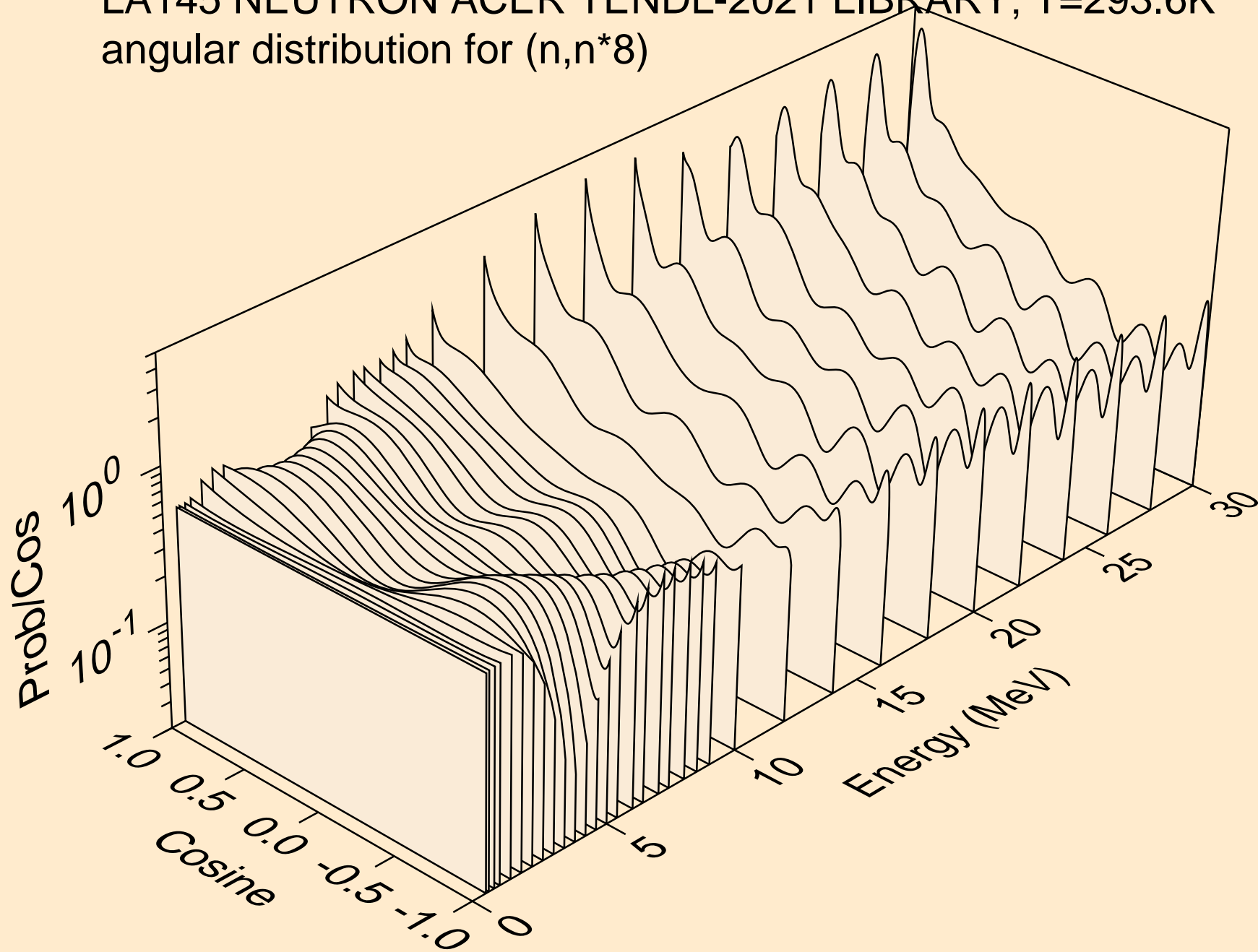

LA145 NEUTRON ACER TENDL-2021 LIBRARY; T=293.6K
angular distribution for (n,n*9)

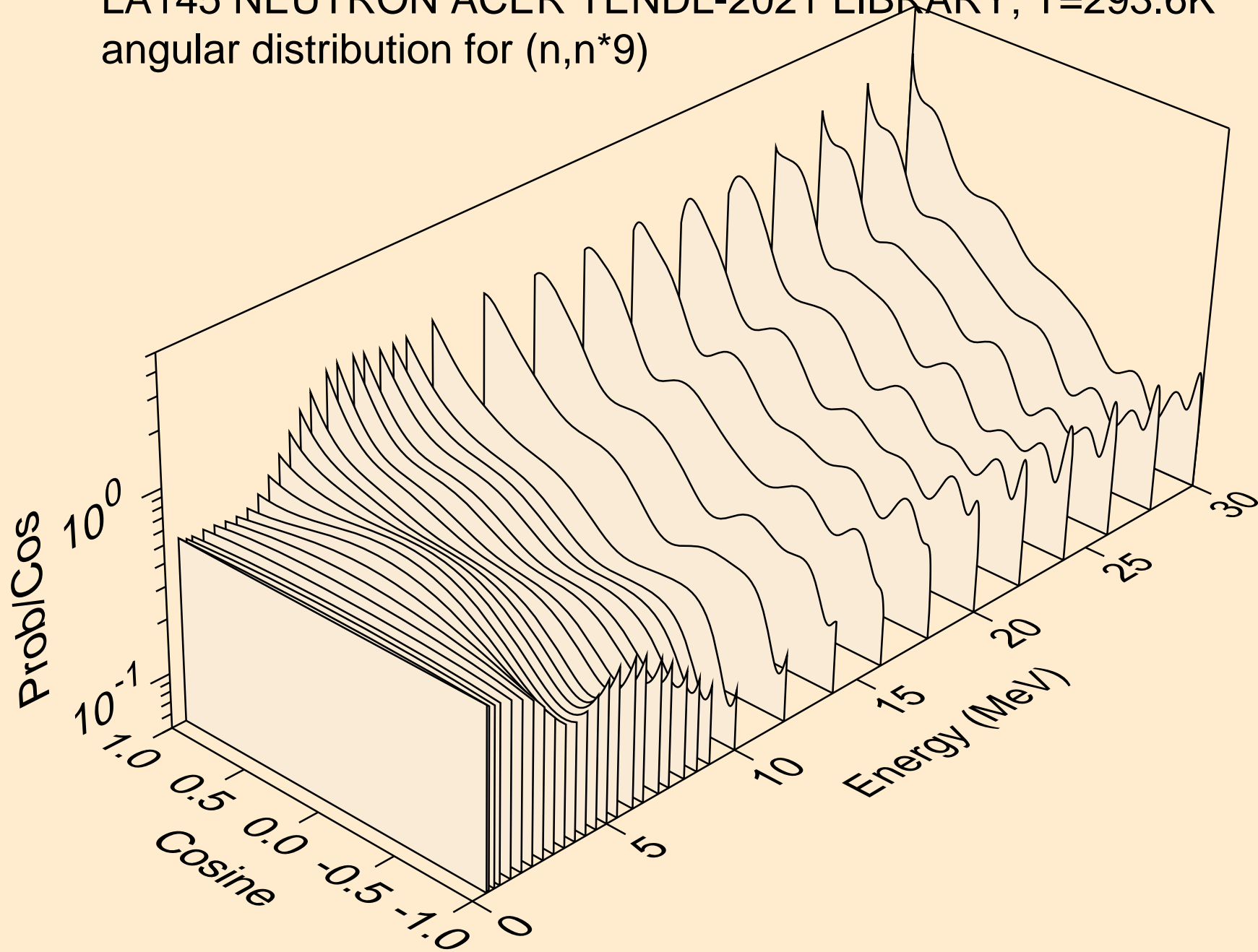

LA145 NEUTRON ACER TENDL-2021 LIBRARY; T=293.6K
angular distribution for (n,n*10)

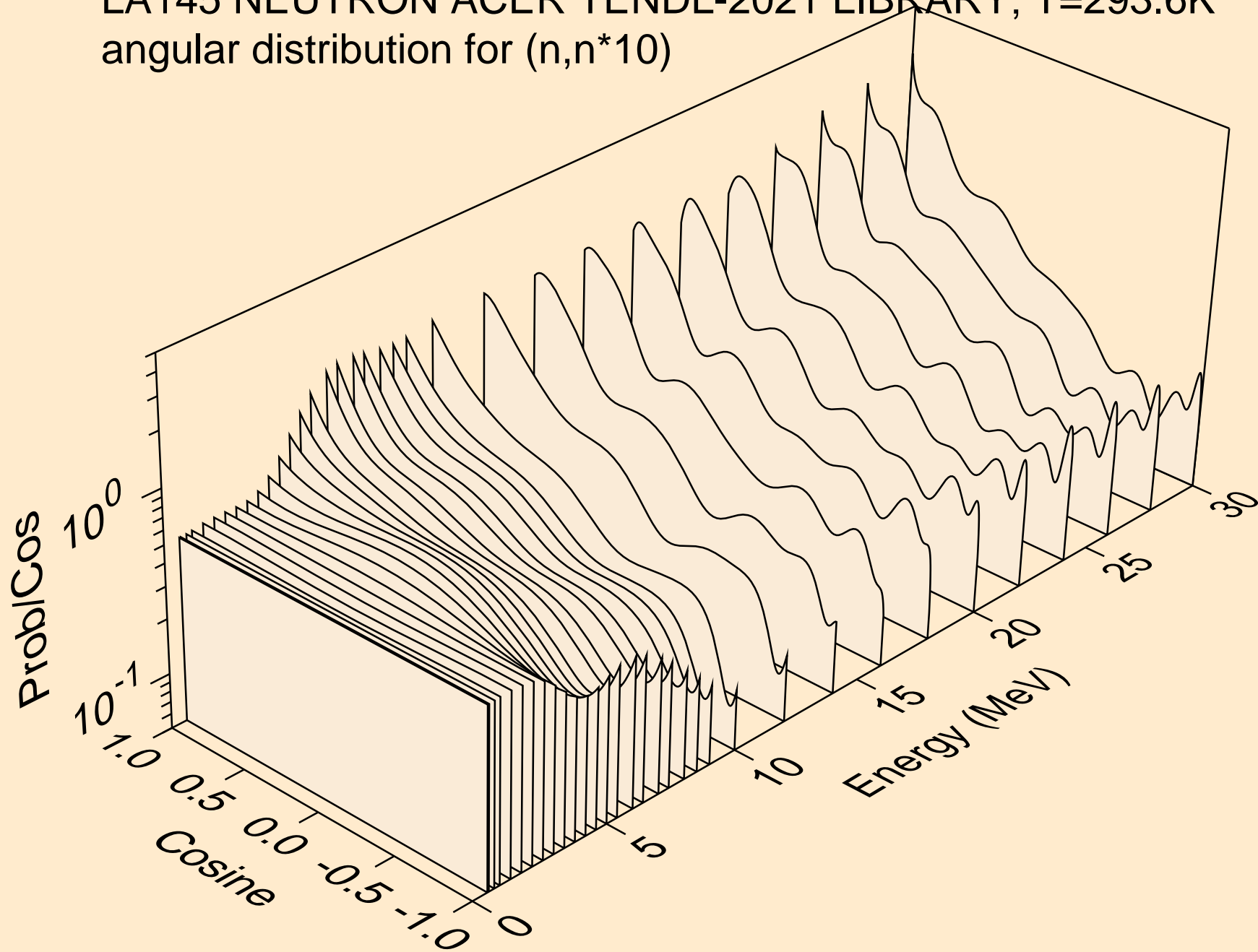

LA145 NEUTRON ACER TENDL-2021 LIBRARY; T=293.6K
angular distribution for (n,n*11)

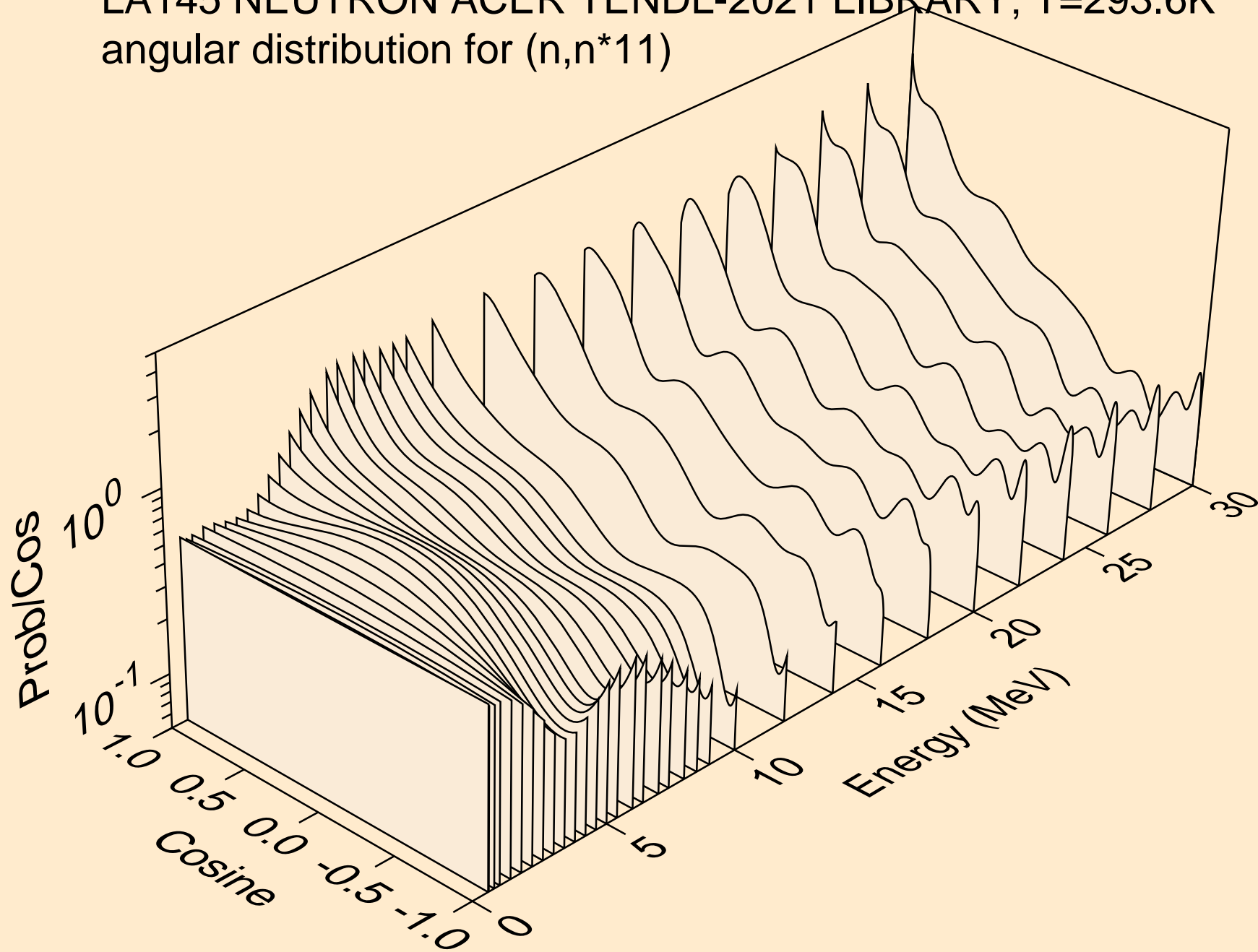

LA145 NEUTRON ACER TENDL-2021 LIBRARY; T=293.6K
angular distribution for (n,n*12)

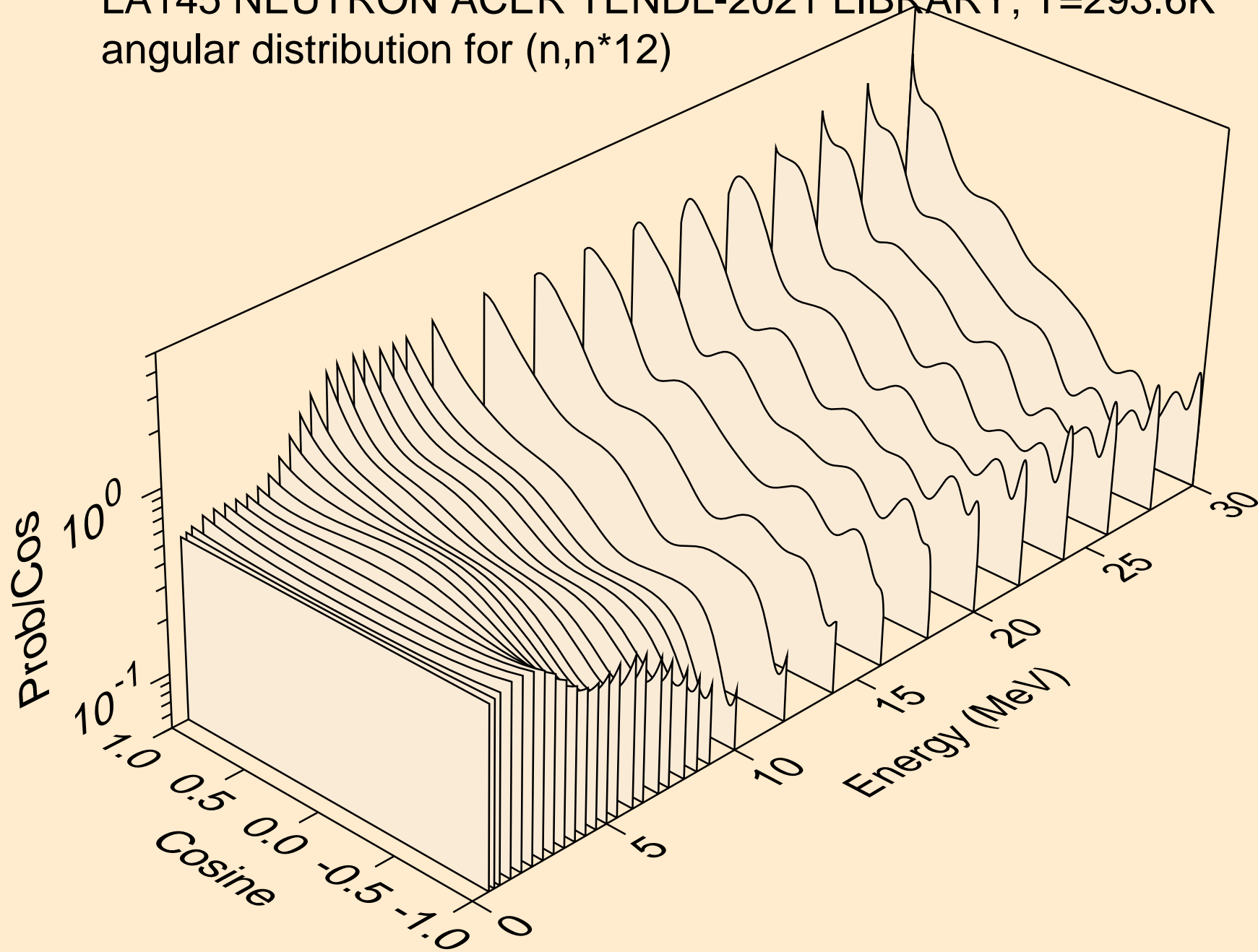

LA145 NEUTRON ACER TENDL-2021 LIBRARY; T=293.6K
angular distribution for (n,n*13)

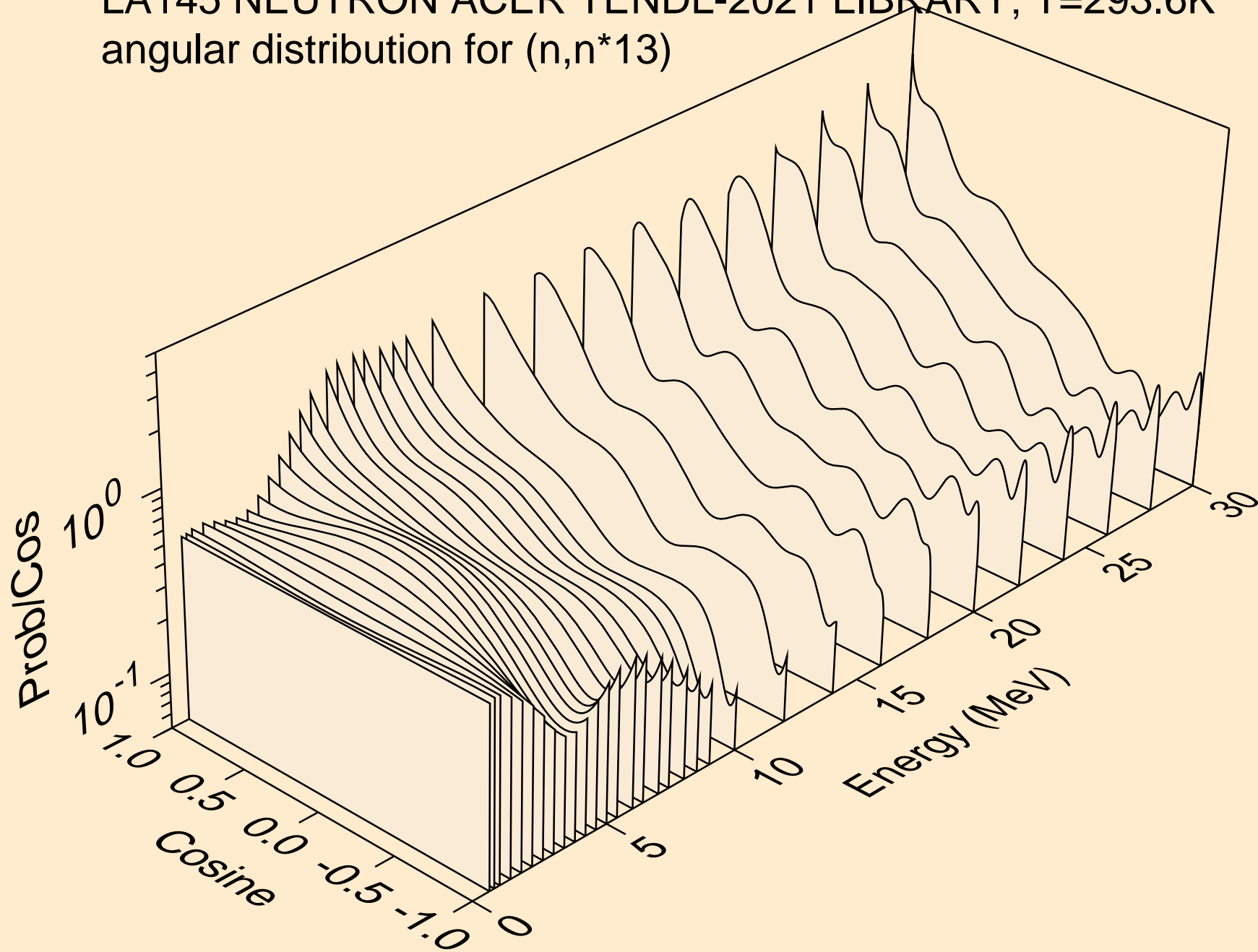

LA145 NEUTRON ACER TENDL-2021 LIBRARY; T=293.6K
angular distribution for (n,n*14)

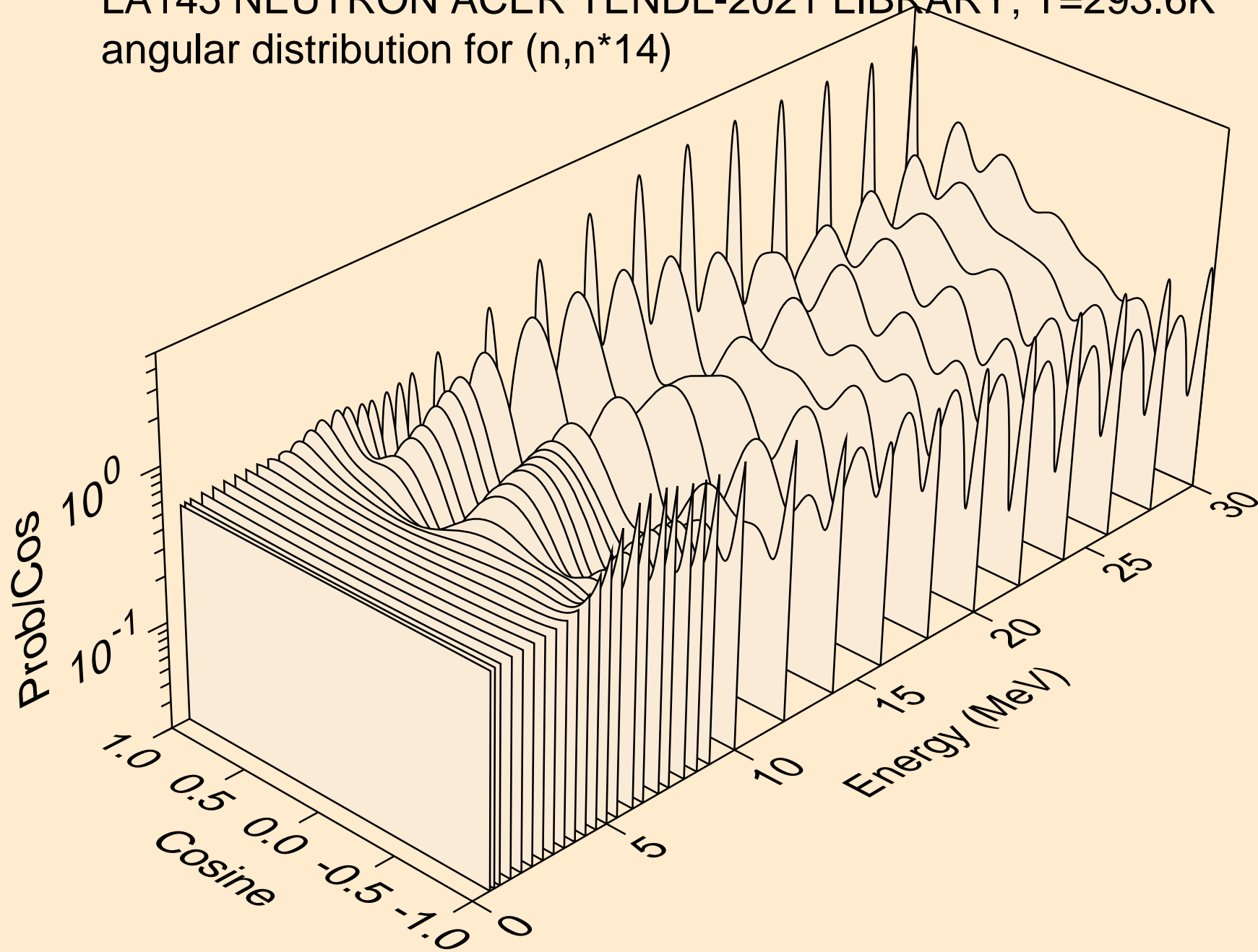

LA145 NEUTRON ACER TENDL-2021 LIBRARY; T=293.6K
angular distribution for (n,n*15)

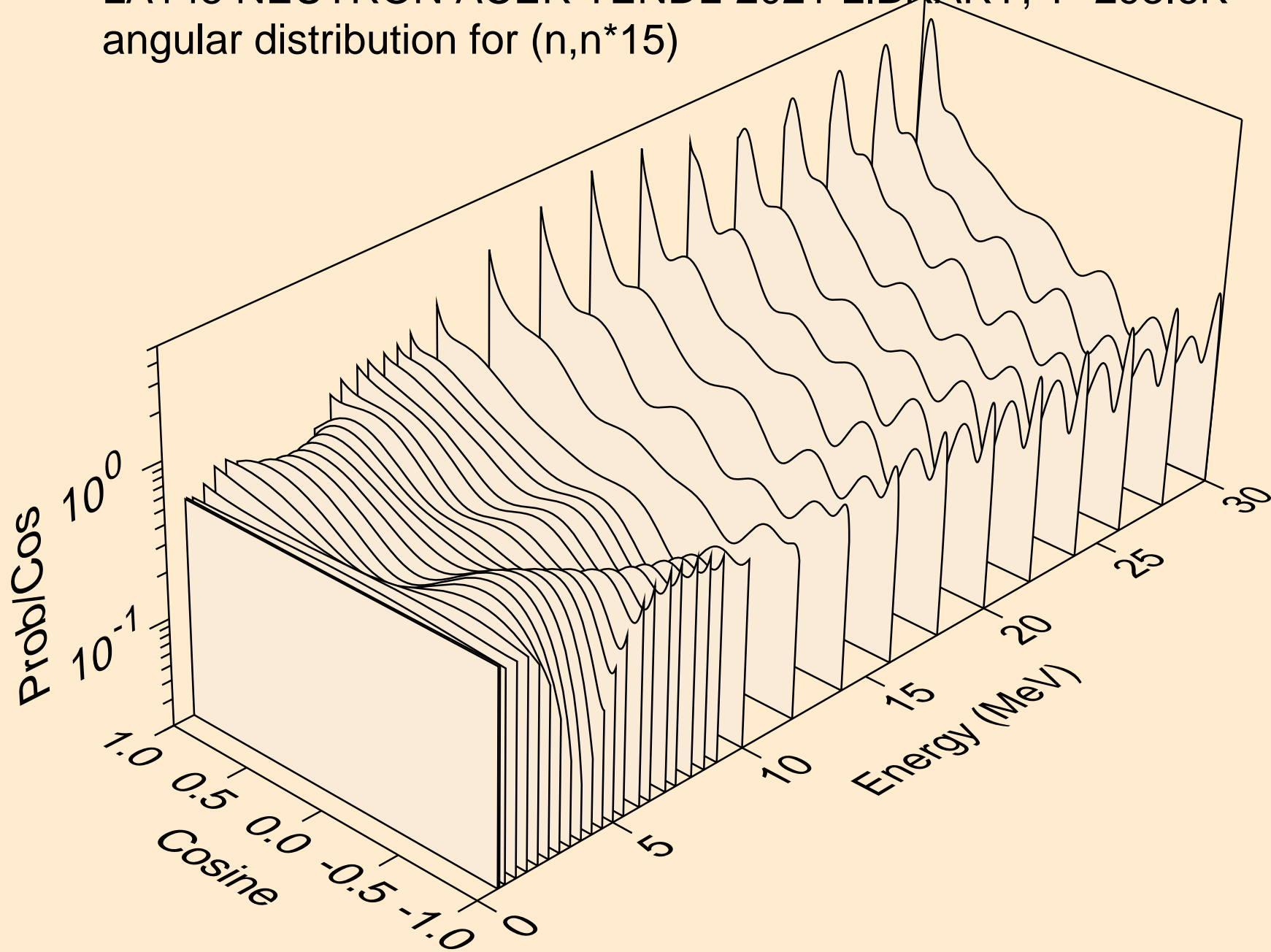

LA145 NEUTRON ACER TENDL-2021 LIBRARY; T=293.6K
angular distribution for (n,n*16)

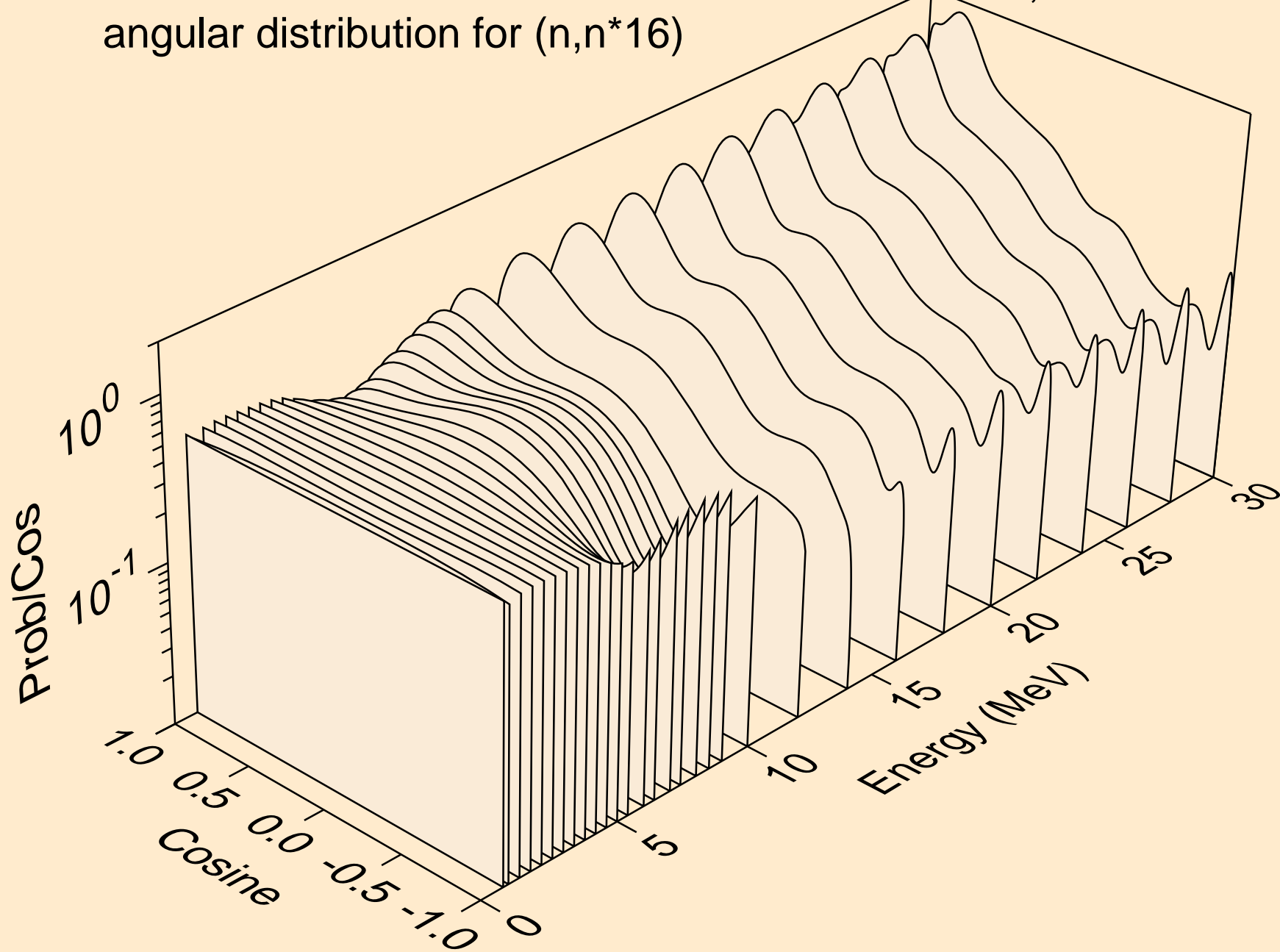

LA145 NEUTRON ACER TENDL-2021 LIBRARY; T=293.6K
angular distribution for (n,n*17)

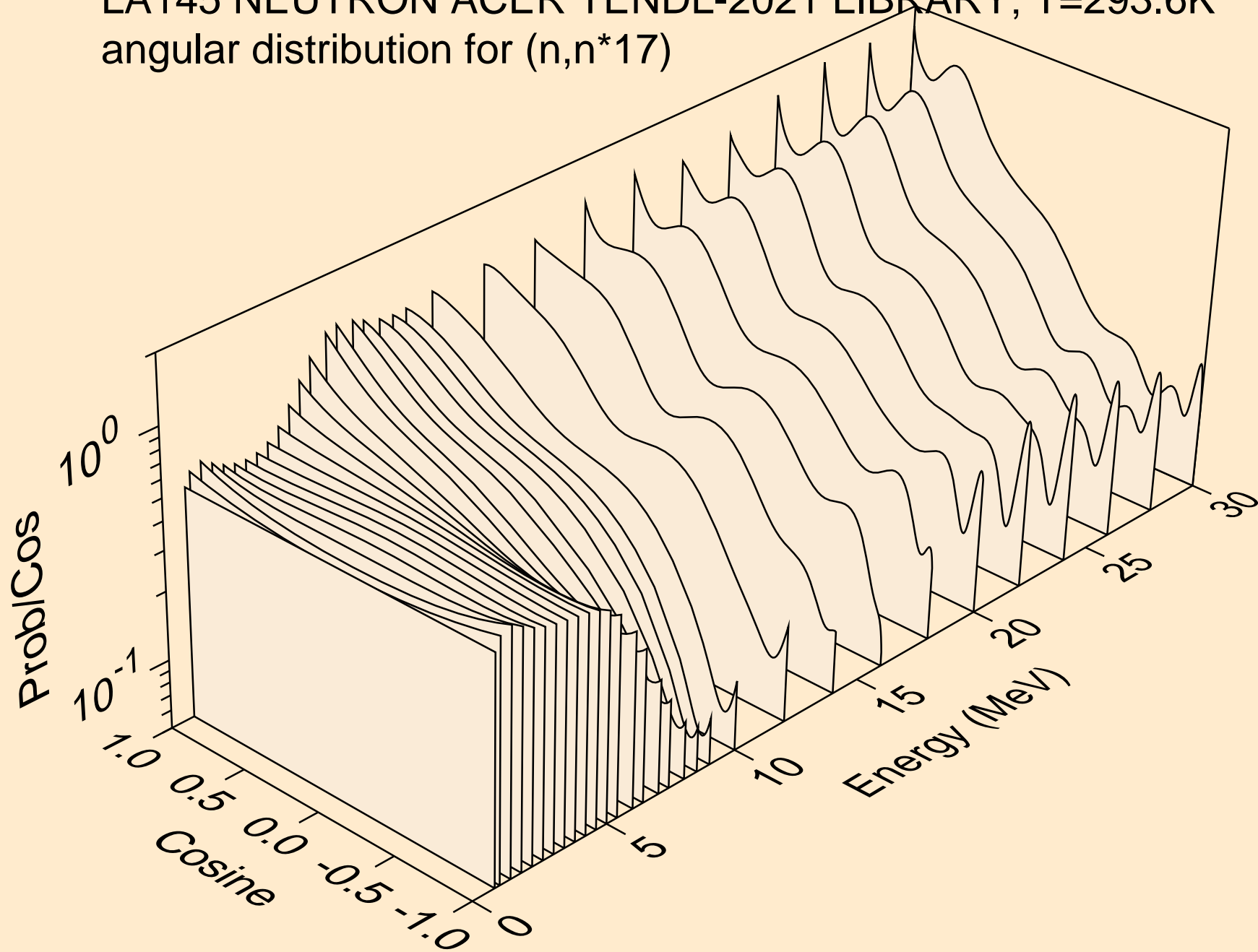

LA145 NEUTRON ACER TENDL-2021 LIBRARY; T=293.6K
angular distribution for (n,n*18)

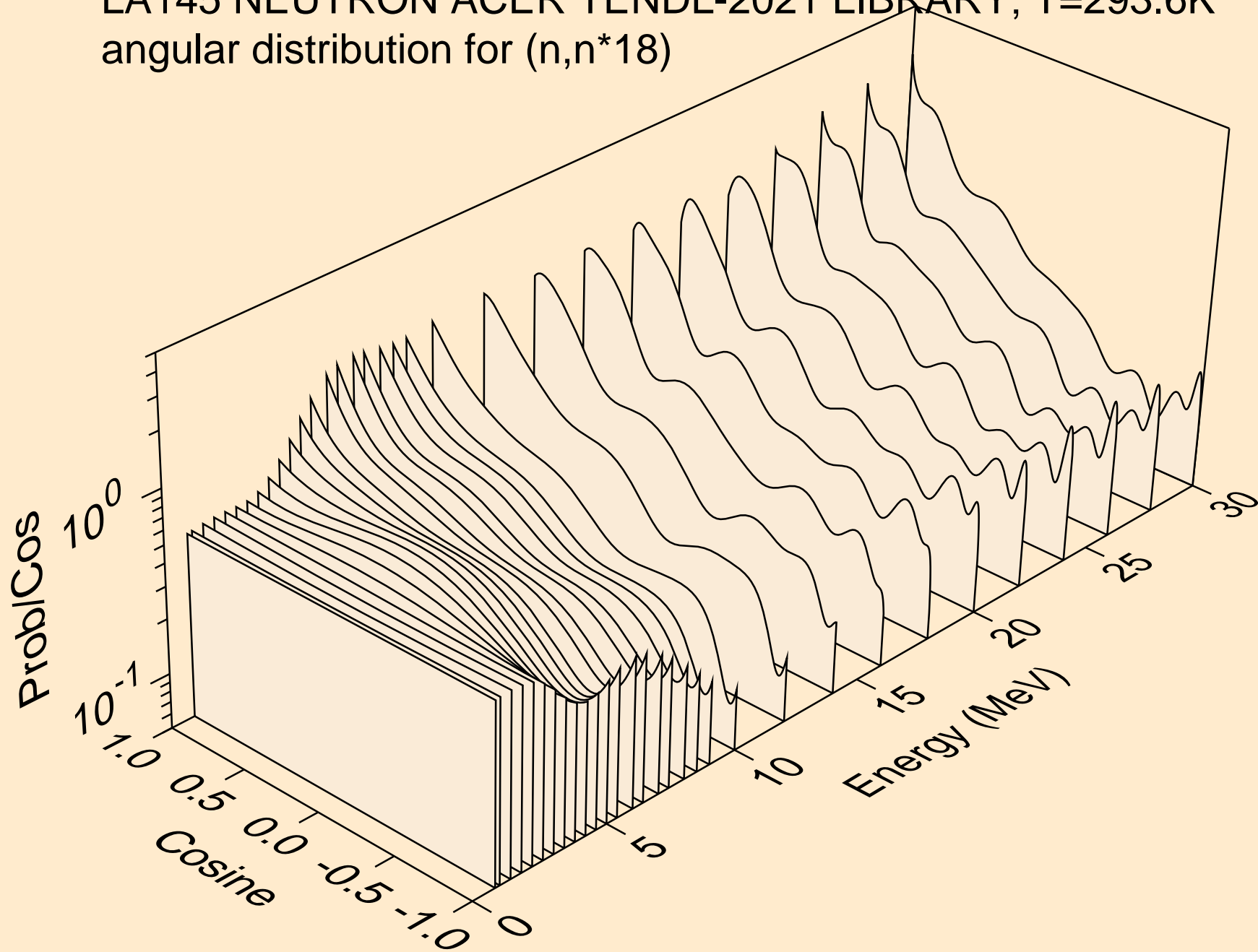

LA145 NEUTRON ACER TENDL-2021 LIBRARY; T=293.6K
angular distribution for (n,n*19)

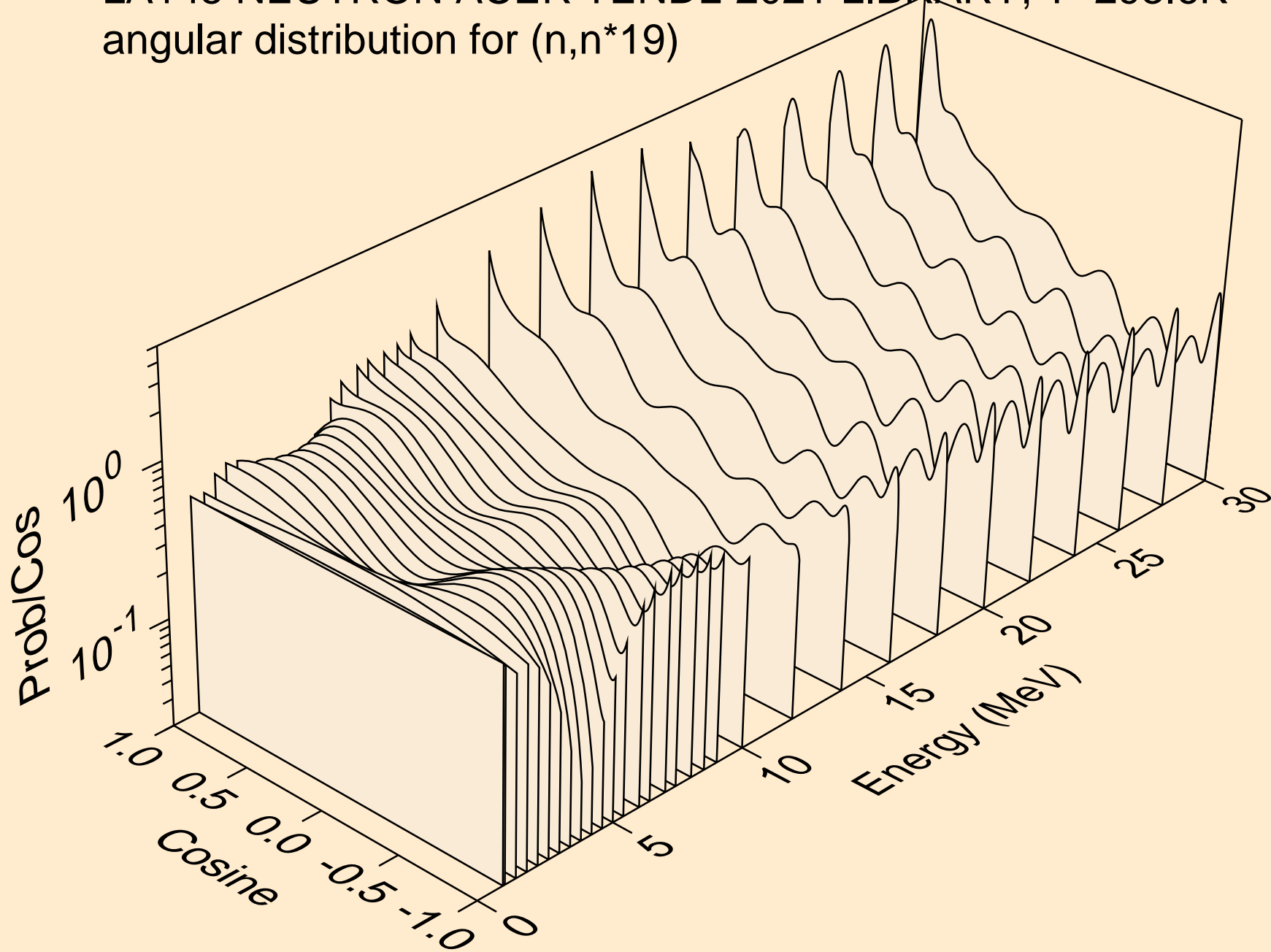

LA145 NEUTRON ACER TENDL-2021 LIBRARY; T=293.6K
angular distribution for (n,n*20)

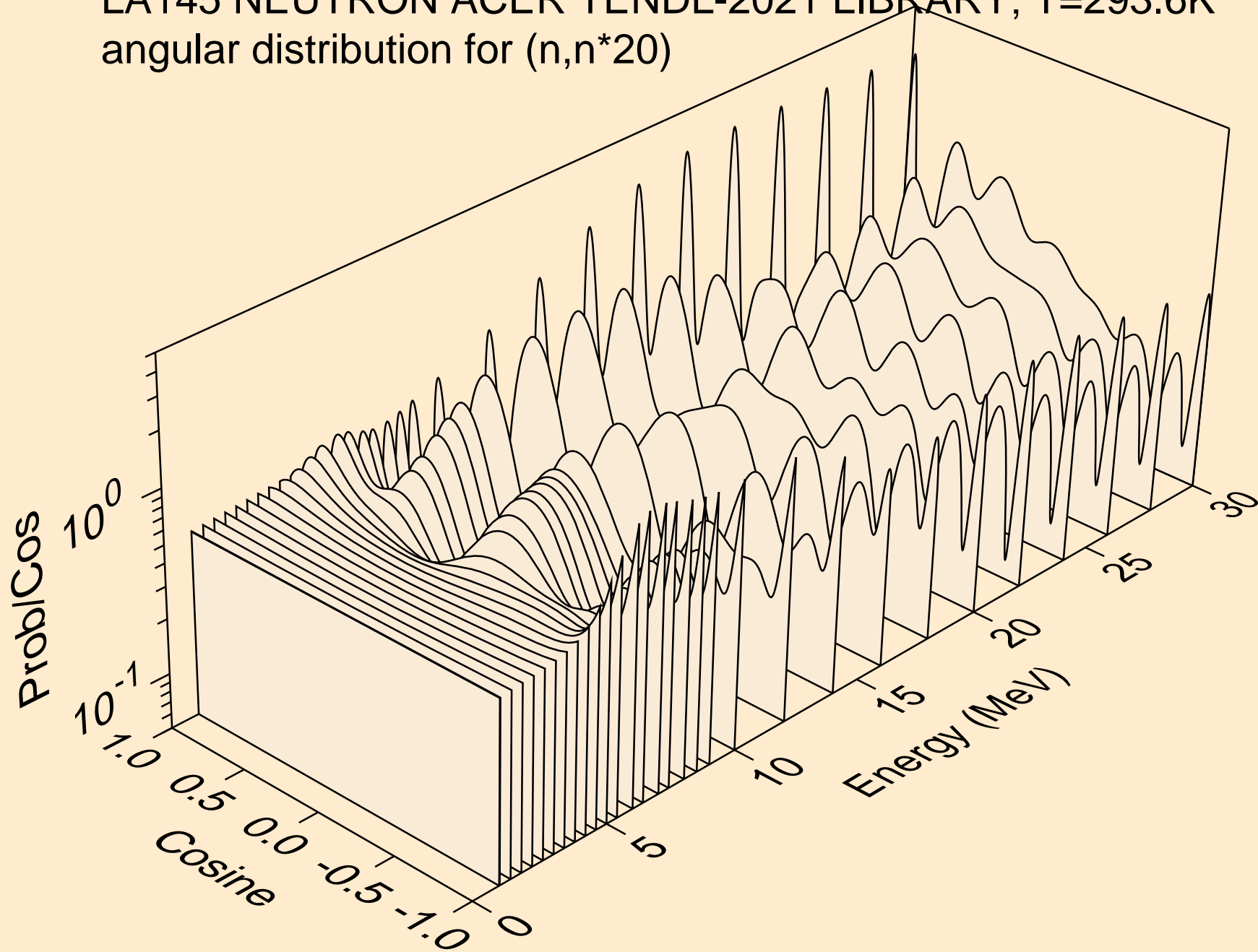

LA145 NEUTRON ACER TENDL-2021 LIBRARY; T=293.6K
angular distribution for (n,n*21)

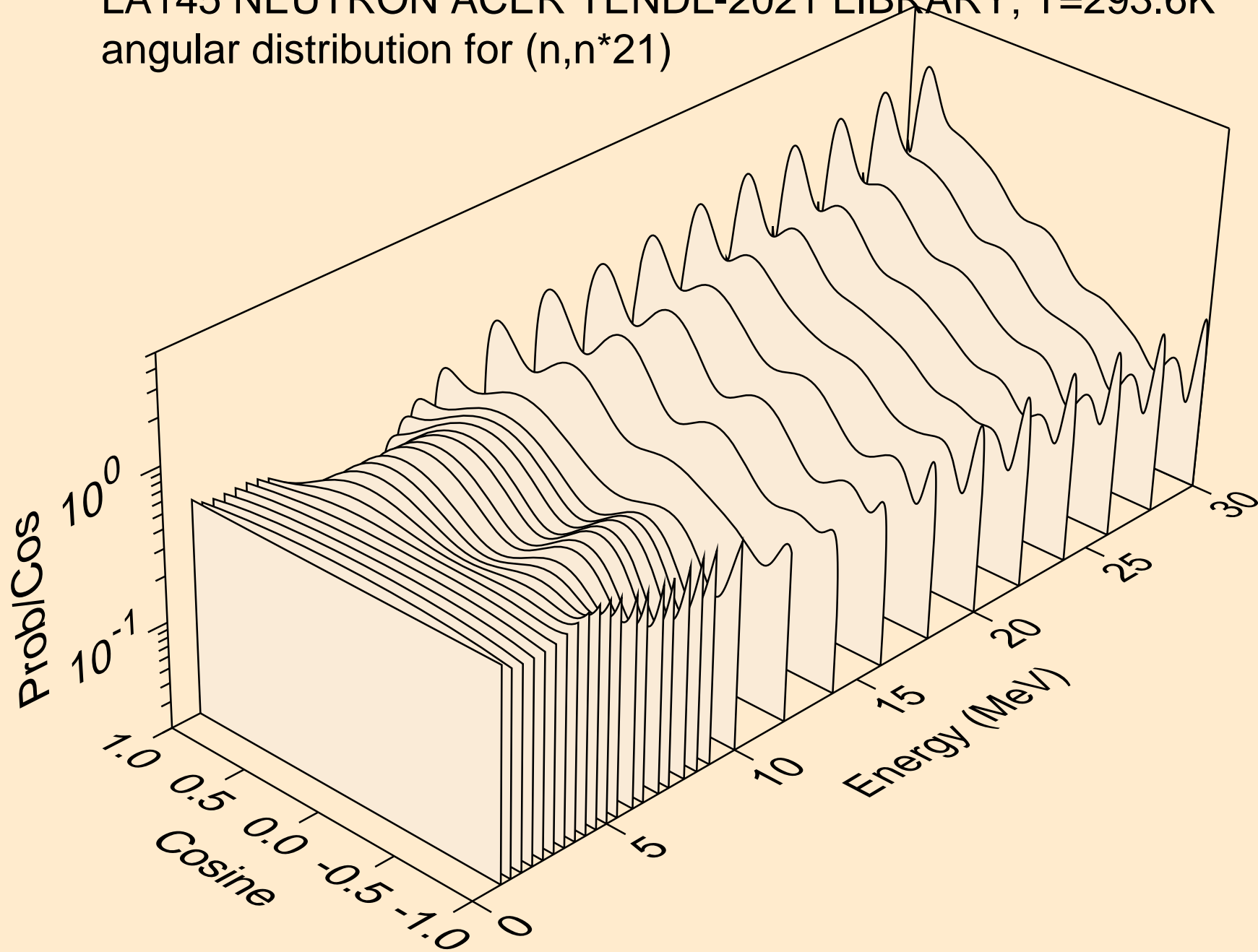

LA145 NEUTRON ACER TENDL-2021 LIBRARY; T=293.6K
angular distribution for (n,n*22)

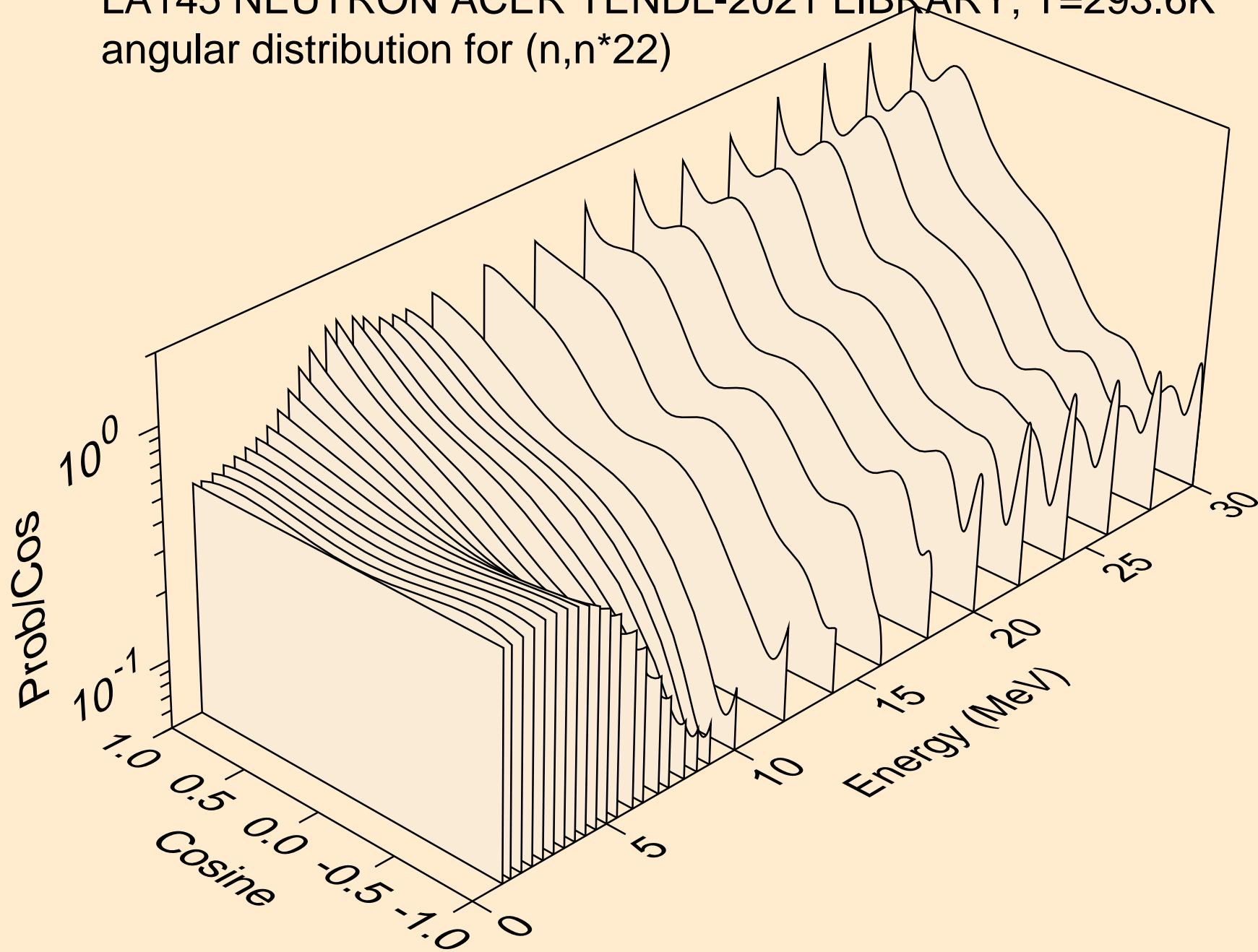

LA145 NEUTRON ACER TENDL-2021 LIBRARY; T=293.6K
angular distribution for (n,n*23)

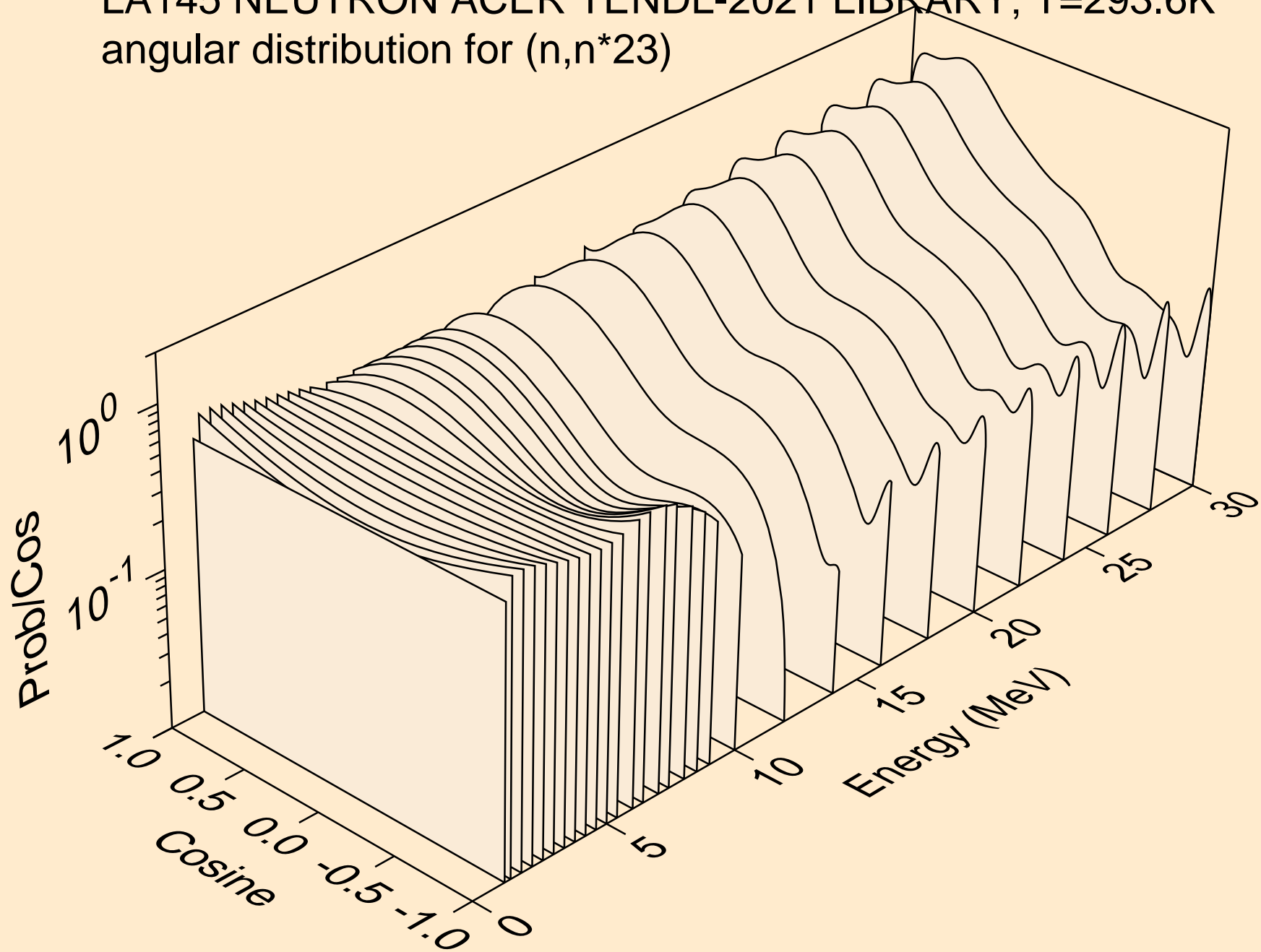

LA145 NEUTRON ACER TENDL-2021 LIBRARY; T=293.6K
angular distribution for (n,n*24)

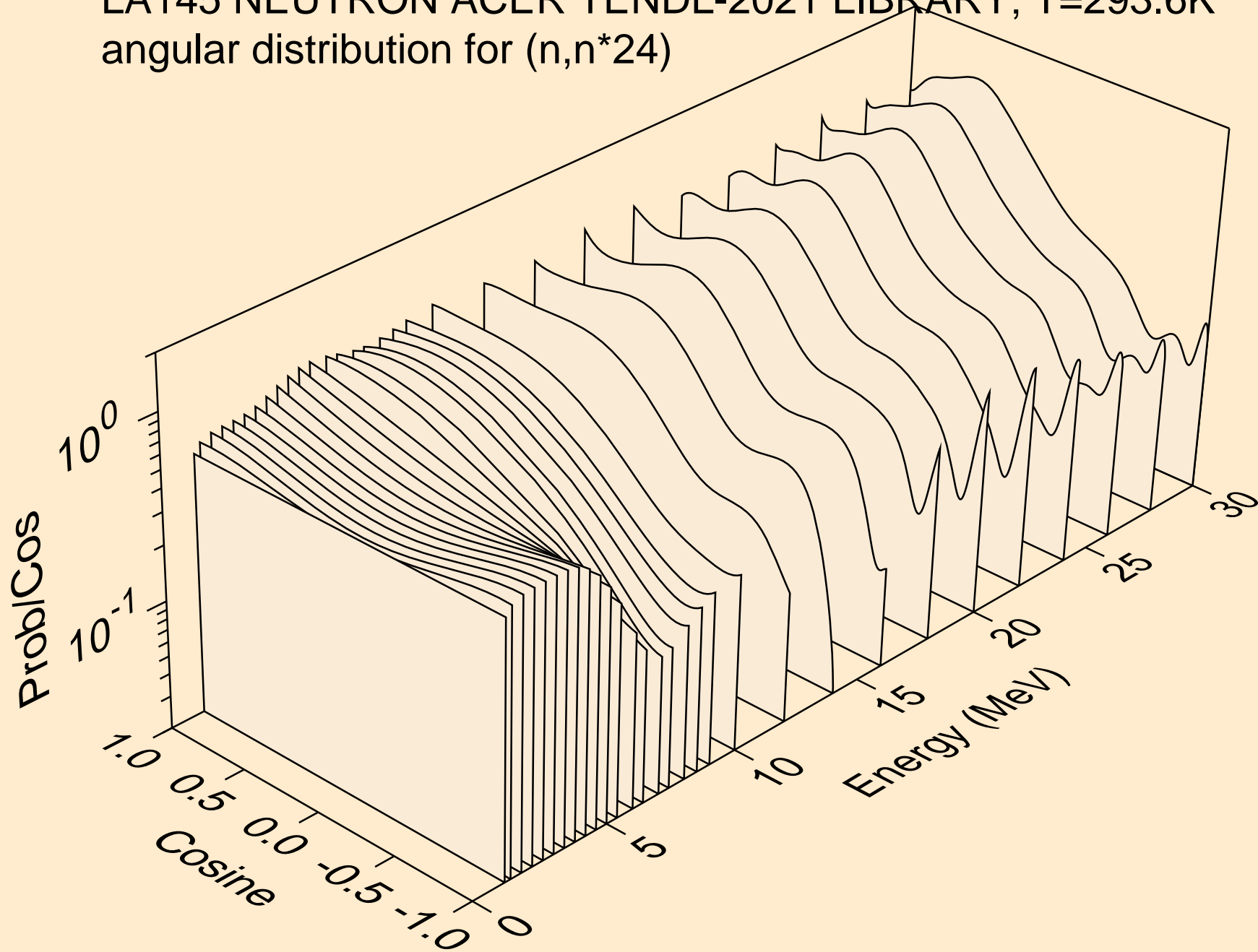

LA145 NEUTRON ACER TENDL-2021 LIBRARY; T=293.6K
angular distribution for (n,n*25)

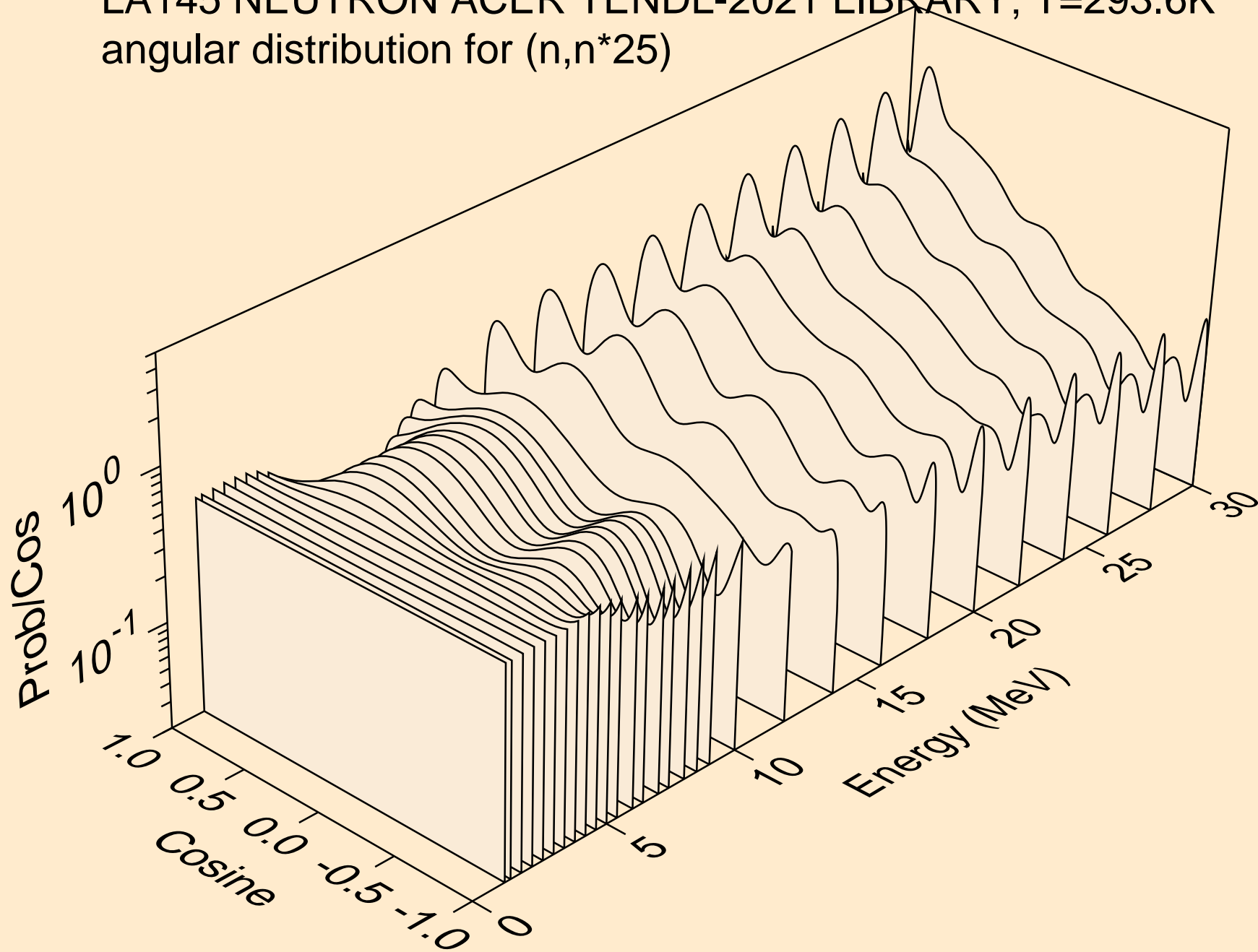

LA145 NEUTRON ACER TENDL-2021 LIBRARY; T=293.6K
Neutron emission for (n,x)

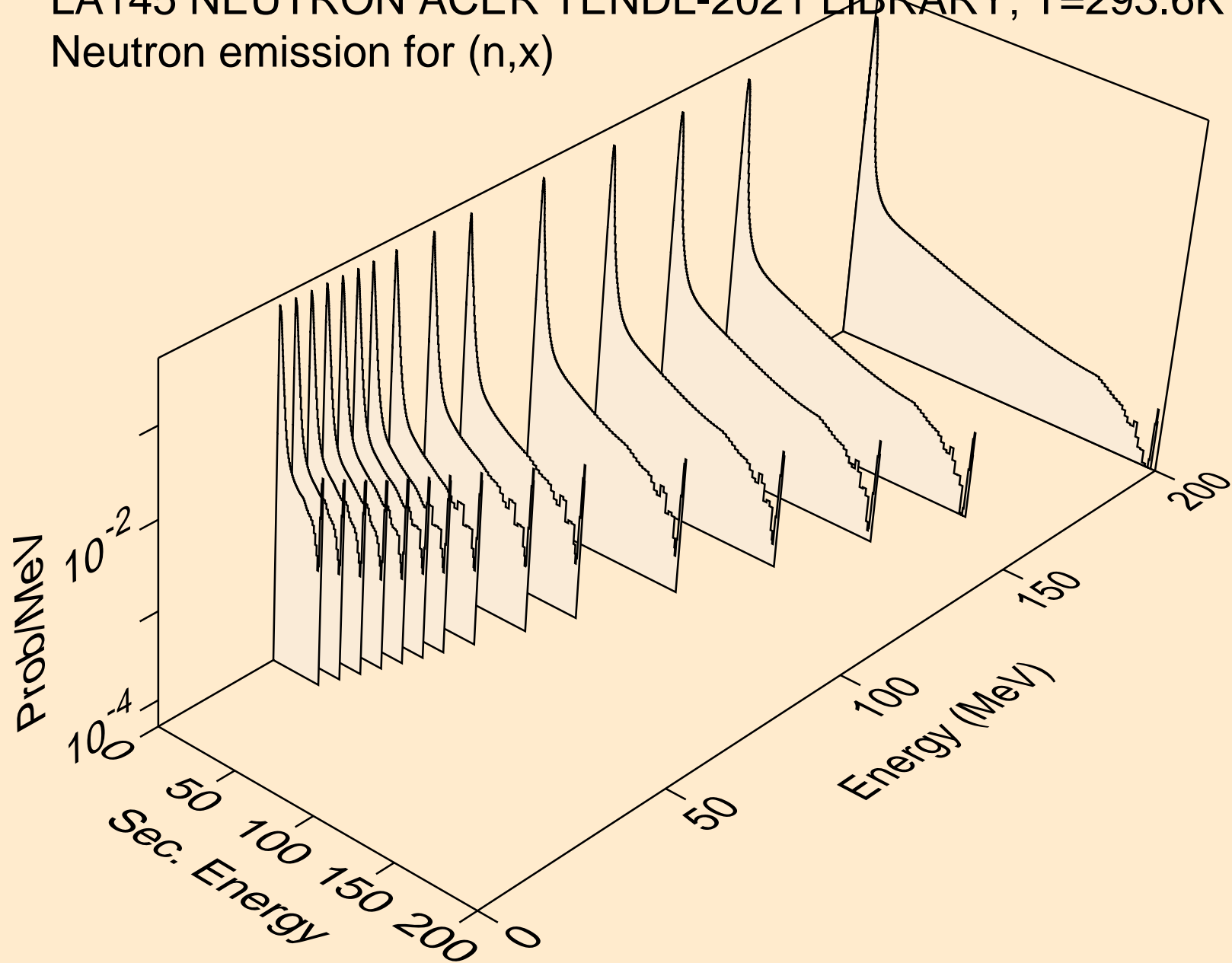

LA145 NEUTRON ACER TENDL-2021 LIBRARY; T=293.6K
Neutron emission for (n,2nd)

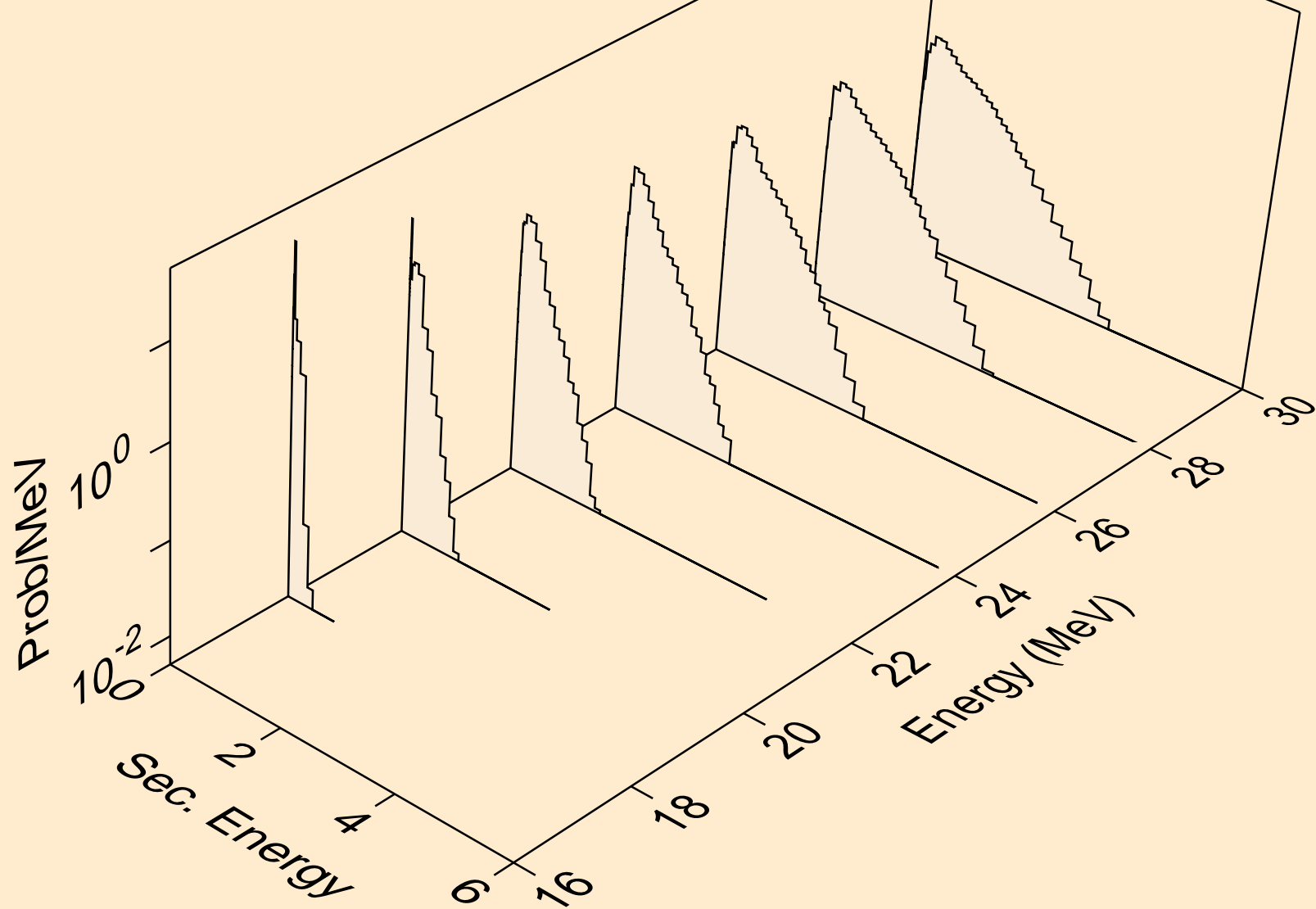

LA145 NEUTRON ACER TENDL-2021 LIBRARY; T=293.6K
Neutron emission for (n,2n)

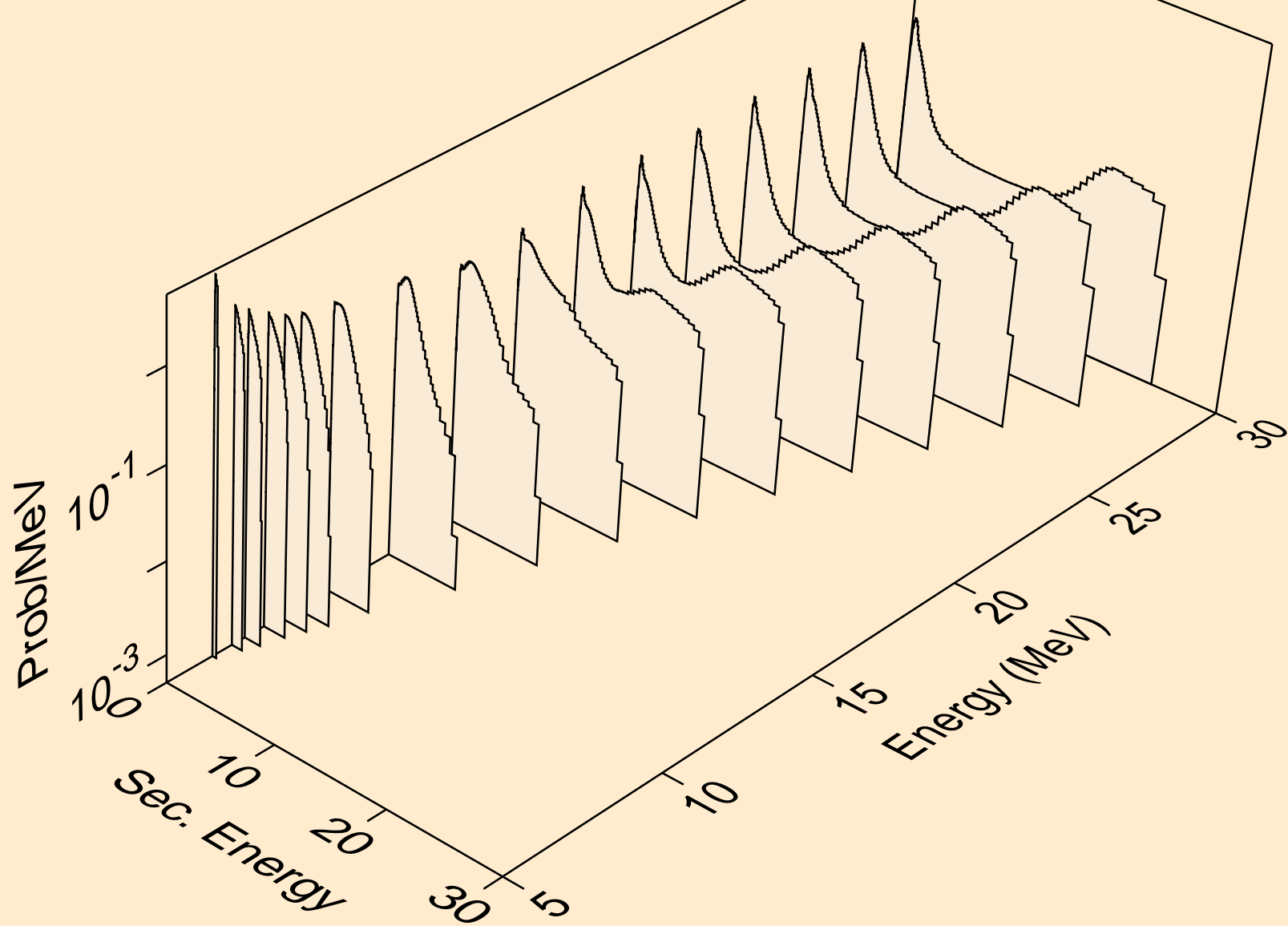

LA145 NEUTRON ACER TENDL-2021 LIBRARY; T=293.6K
Neutron emission for (n,3n)

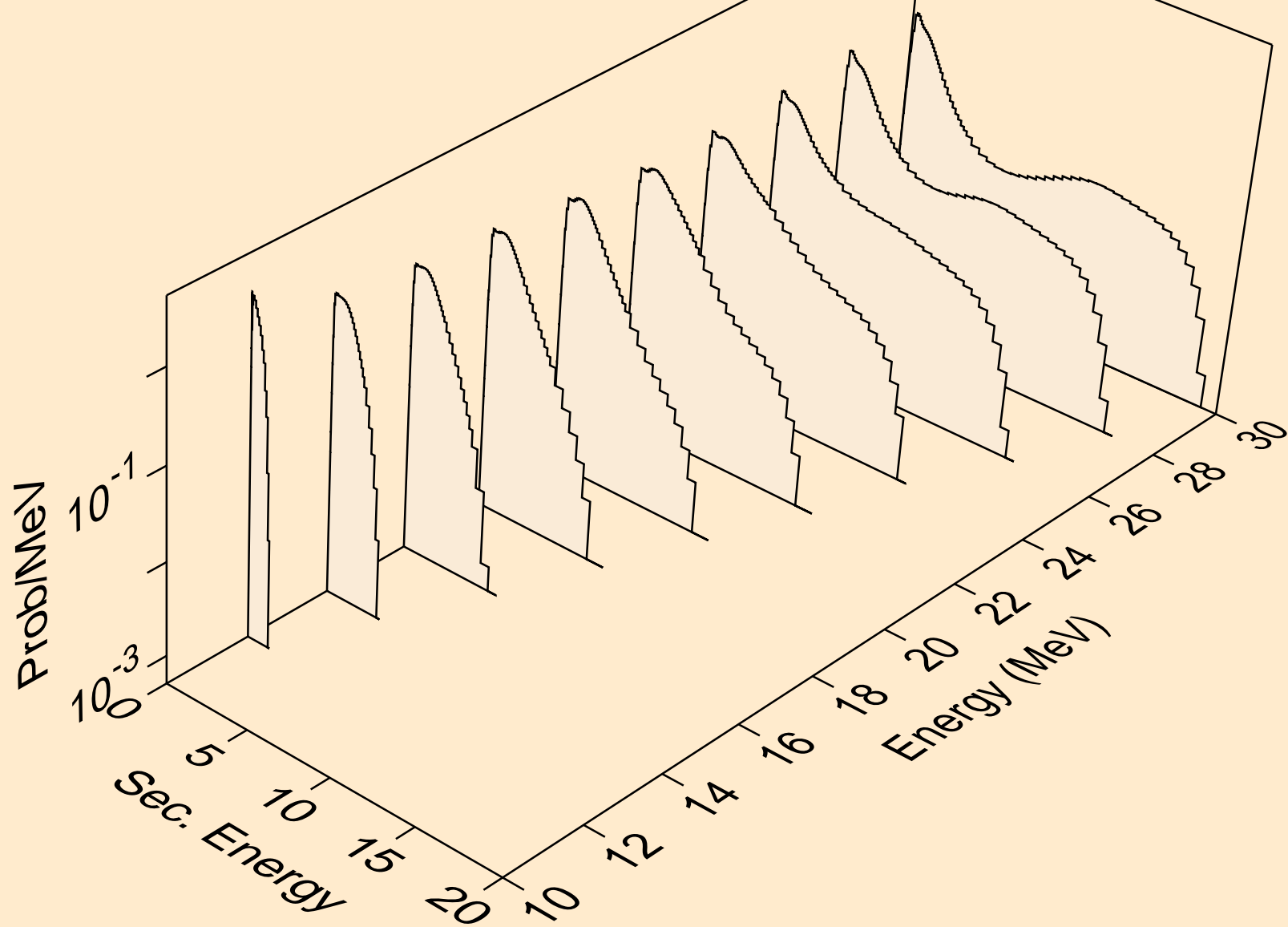

LA145 NEUTRON ACER TENDL-2021 LIBRARY; T=293.6K
Neutron emission for (n,n*)a

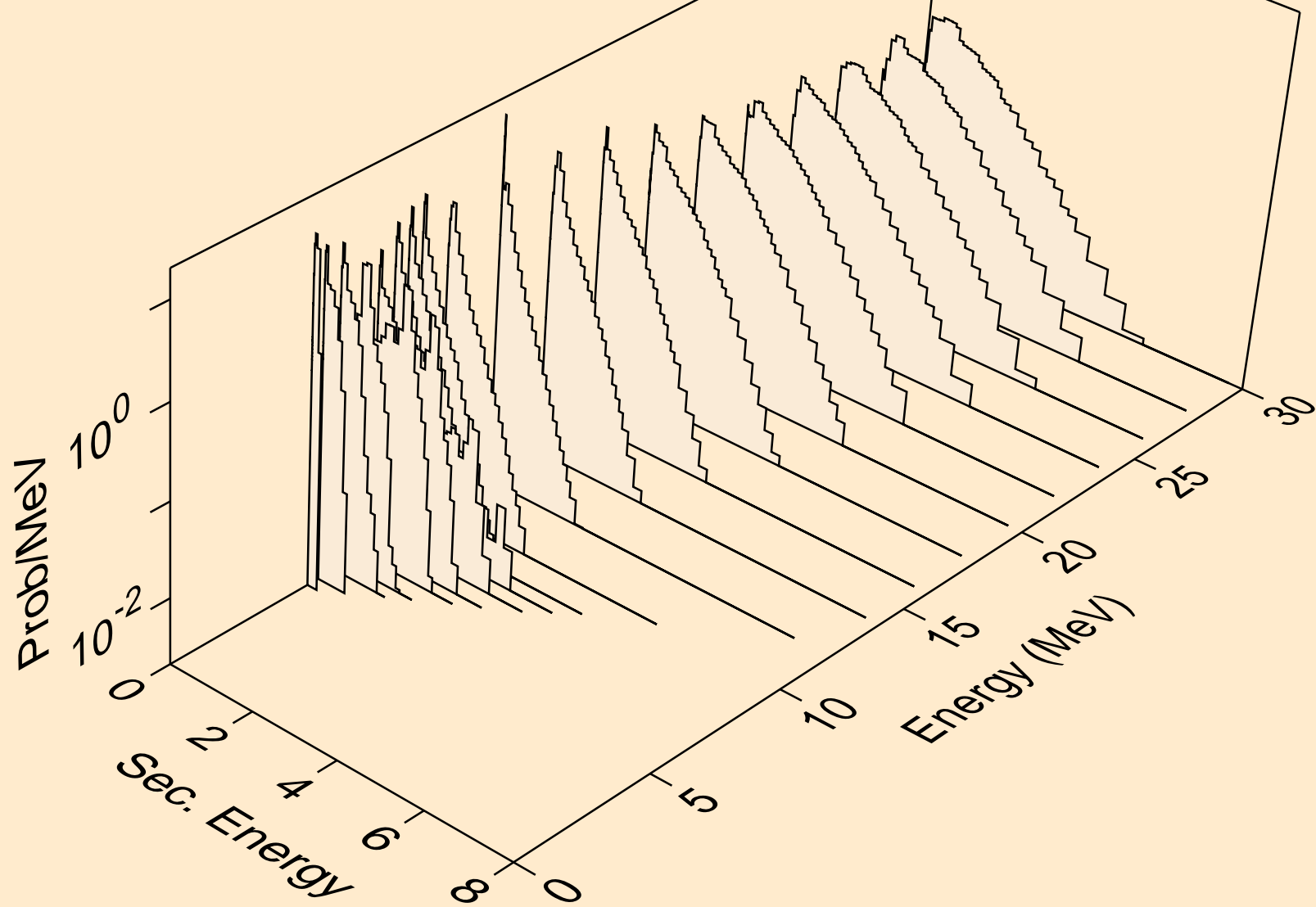

LA145 NEUTRON ACER TENDL-2021 LIBRARY; T=293.6K
Neutron emission for (n,2n)_a

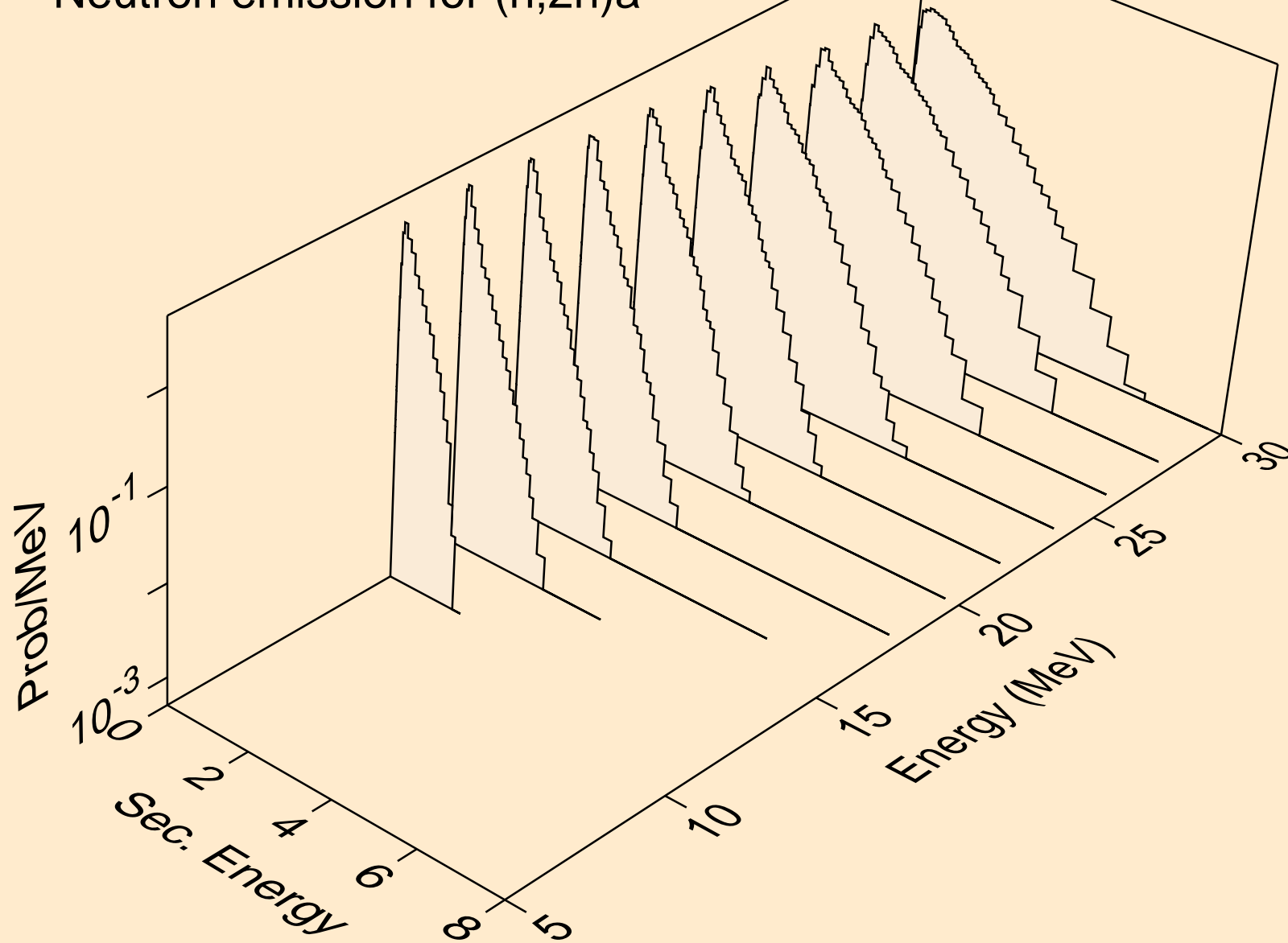

LA145 NEUTRON ACER TENDL-2021 LIBRARY; T=293.6K
Neutron emission for (n,3n)a

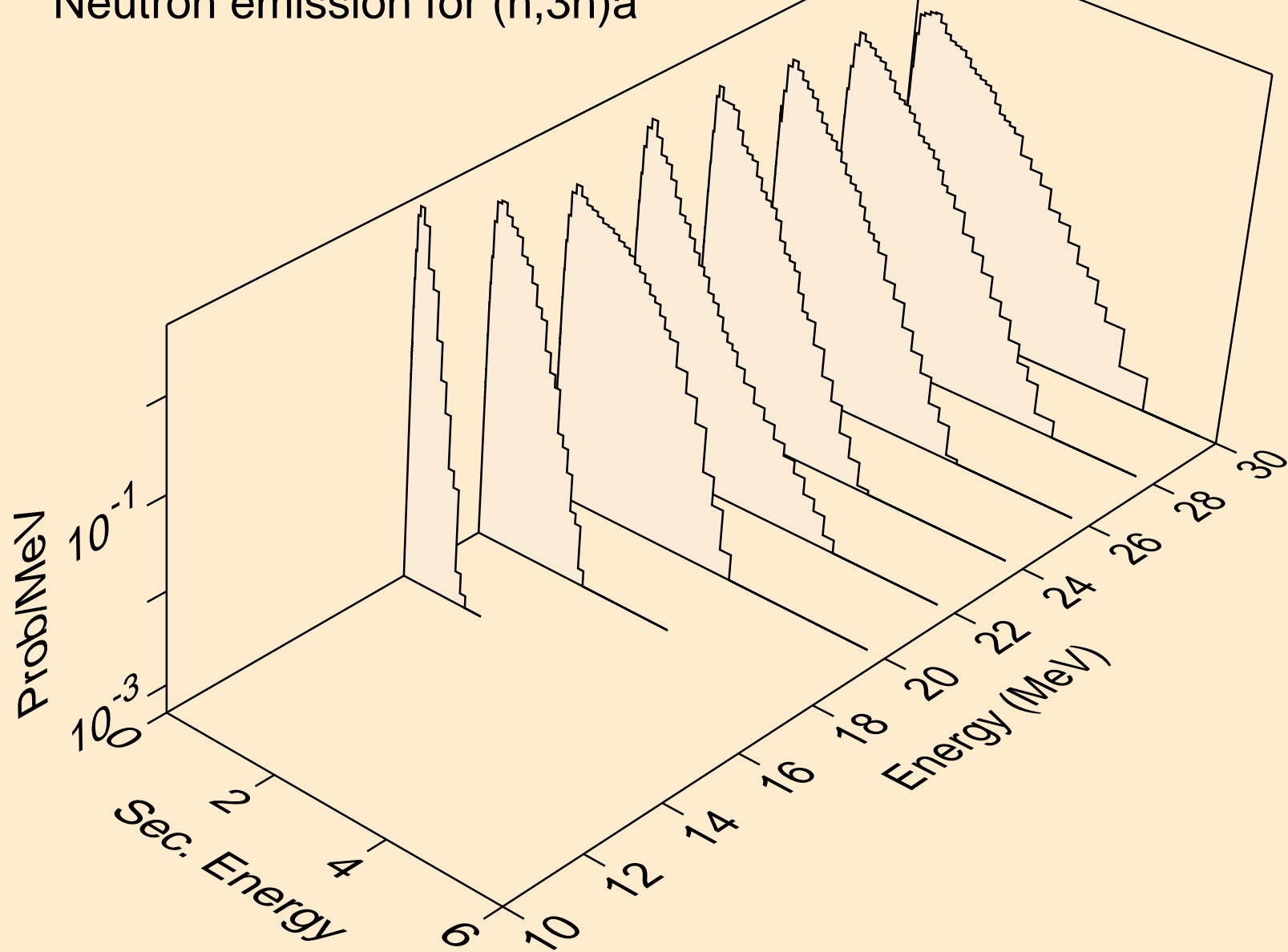

LA145 NEUTRON ACER TENDL-2021 LIBRARY; T=293.6K
Neutron emission for (n,n*)p

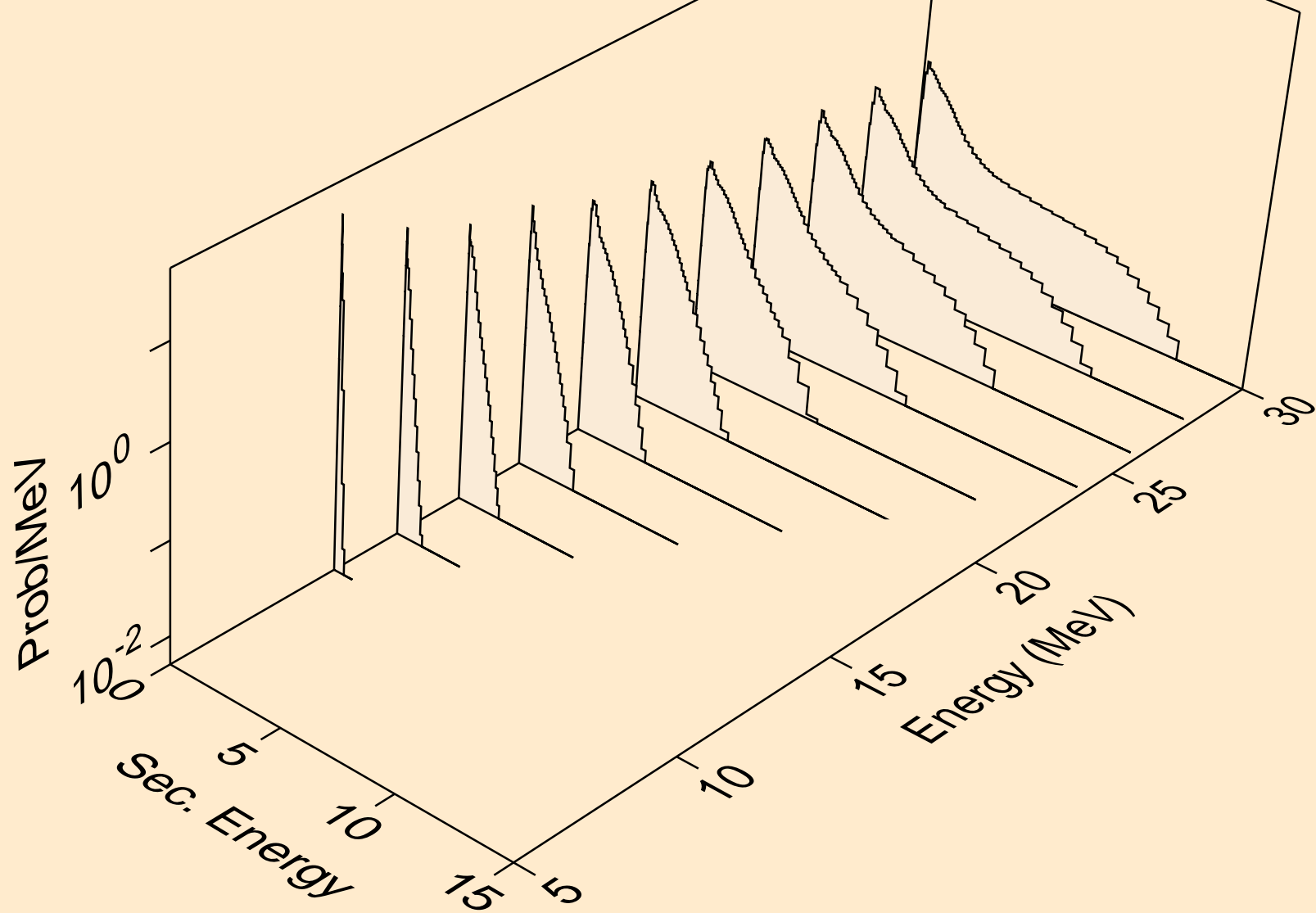

LA145 NEUTRON ACER TENDL-2021 LIBRARY; T=293.6K
Neutron emission for (n,n*)d

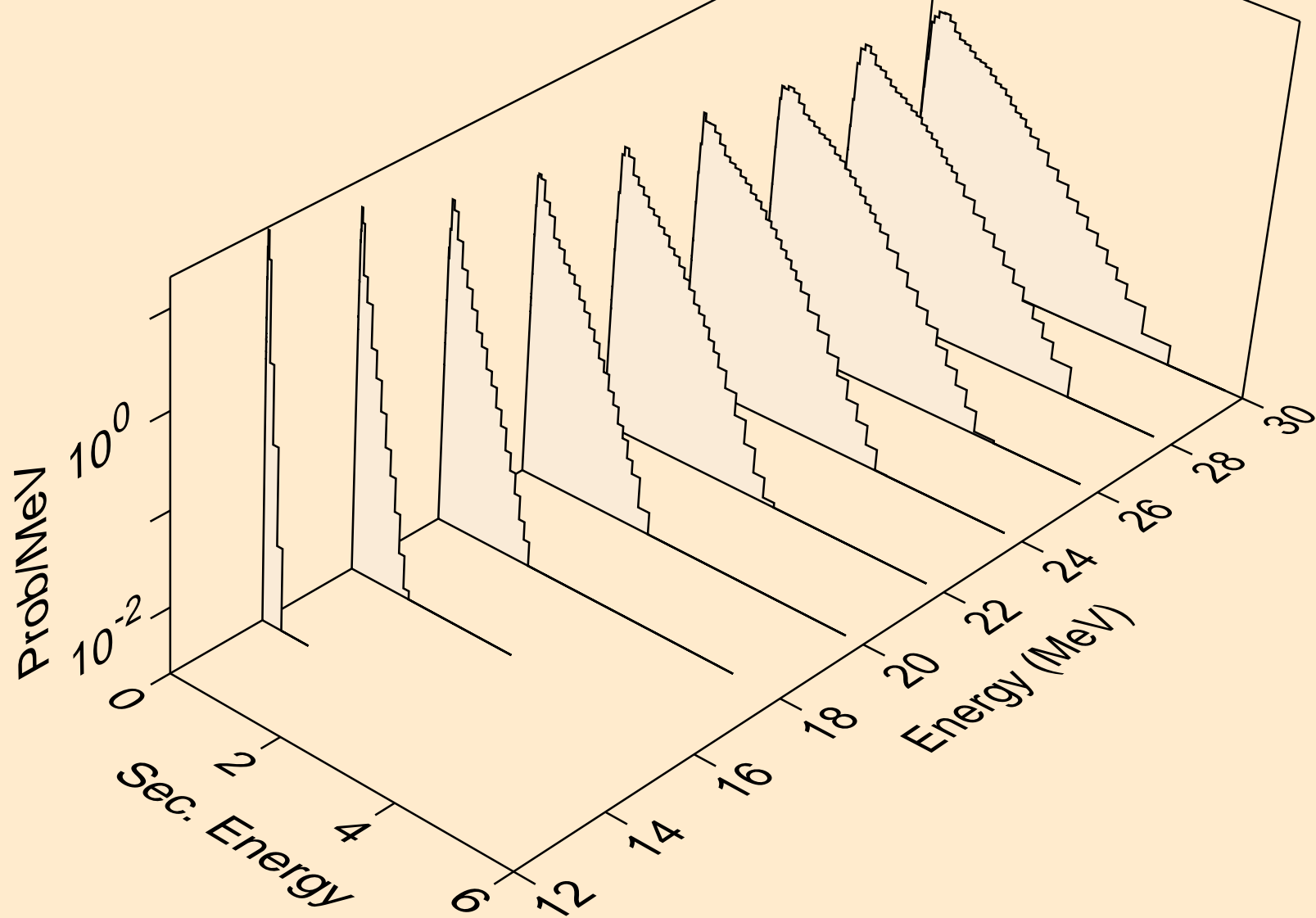

LA145 NEUTRON ACER TENDL-2021 LIBRARY; T=293.6K
Neutron emission for (n,n*)t

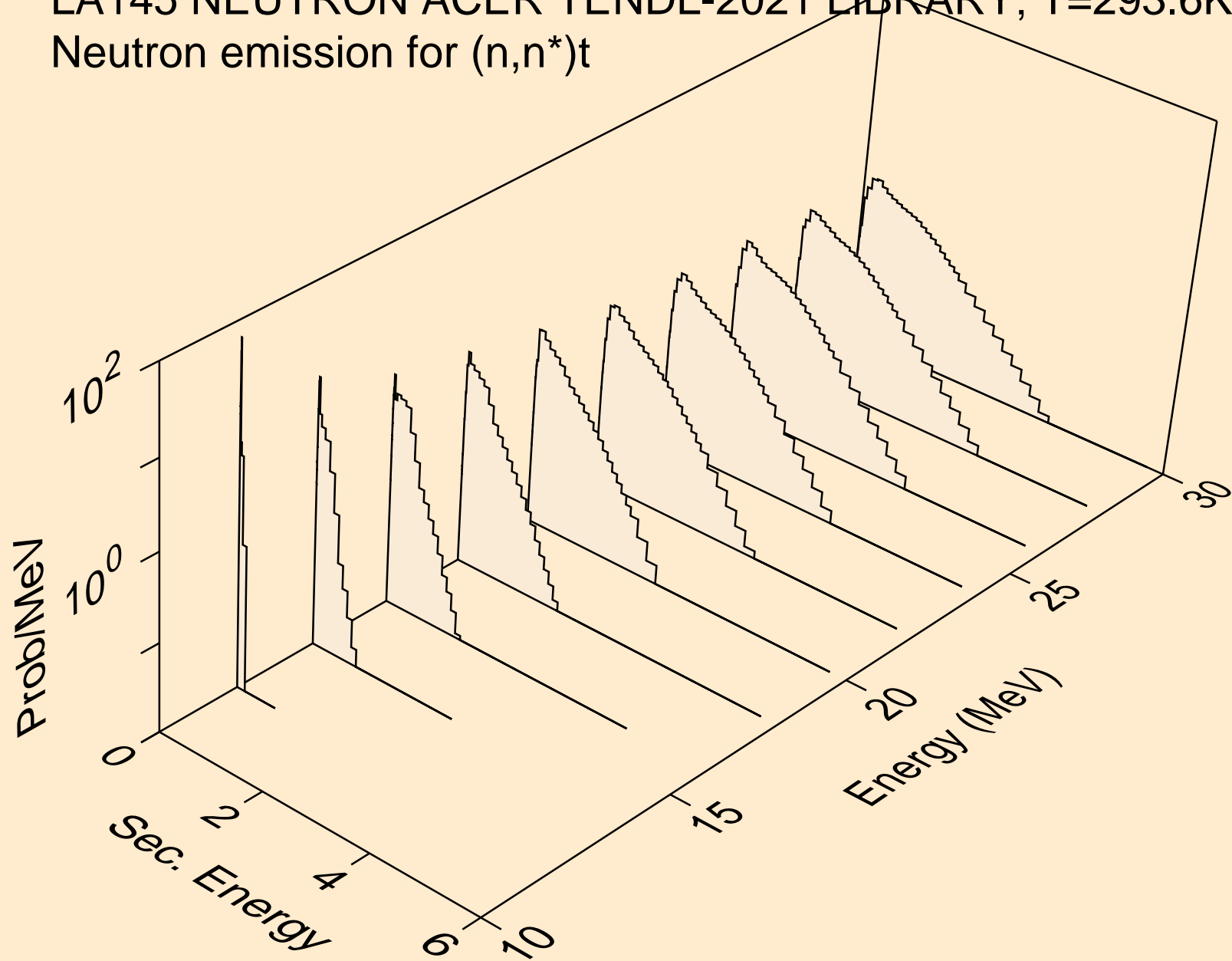

LA145 NEUTRON ACER TENDL-2021 LIBRARY; T=293.6K
Neutron emission for (n,n*)he3

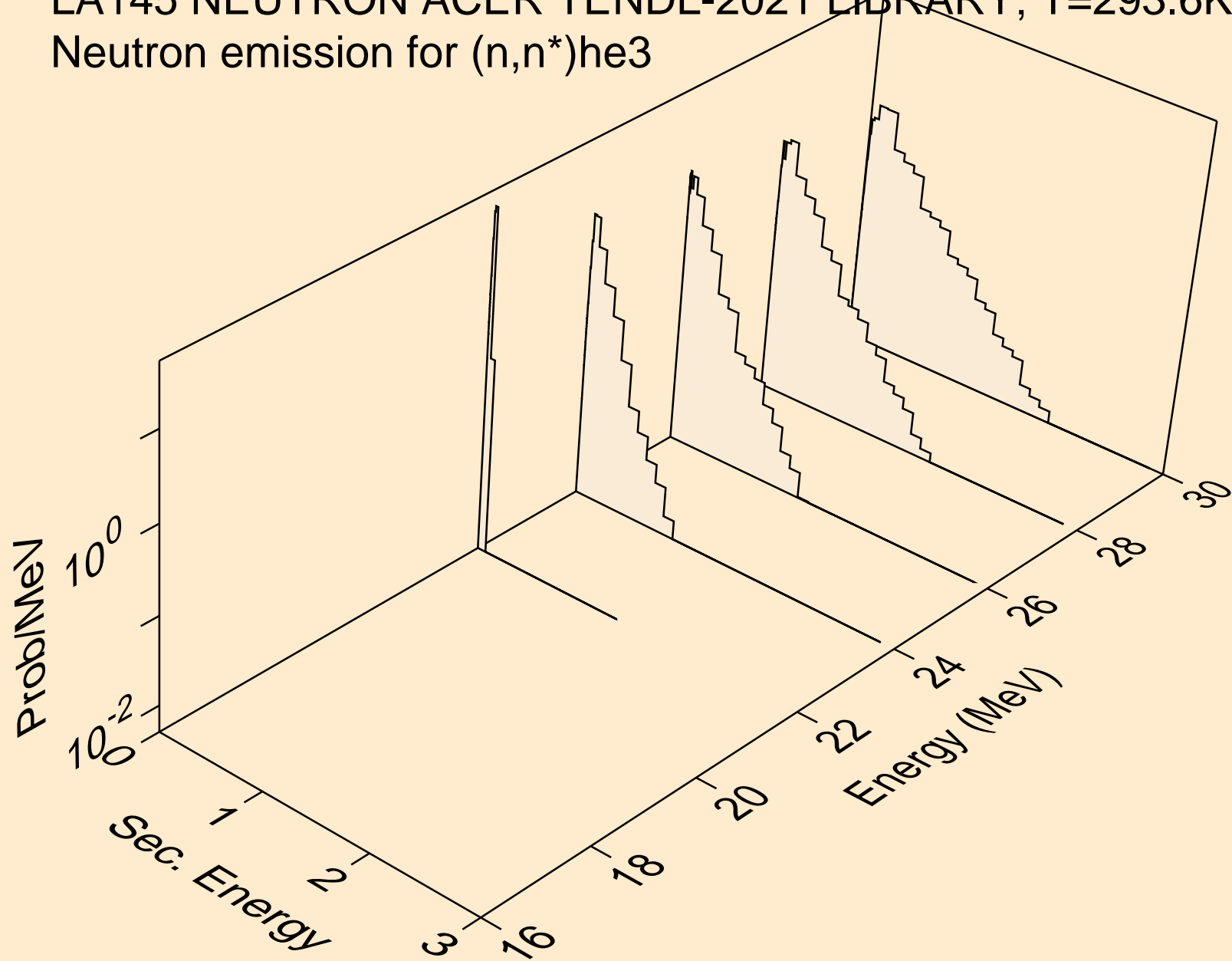

LA145 NEUTRON ACER TENDL-2021 LIBRARY; T=293.6K
Neutron emission for (n,4n)

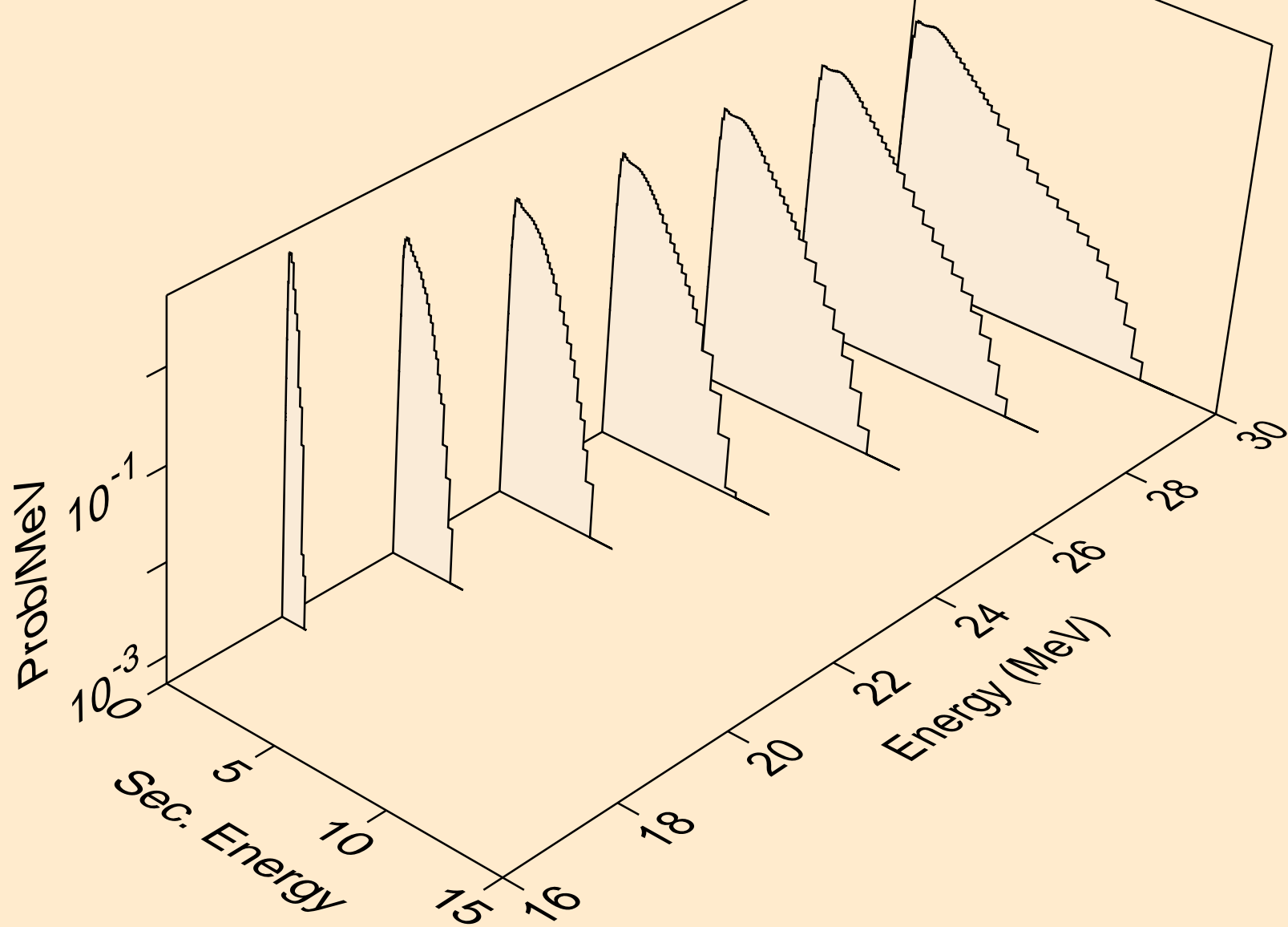

LA145 NEUTRON ACER TENDL-2021 LIBRARY; T=293.6K
Neutron emission for (n,2np)

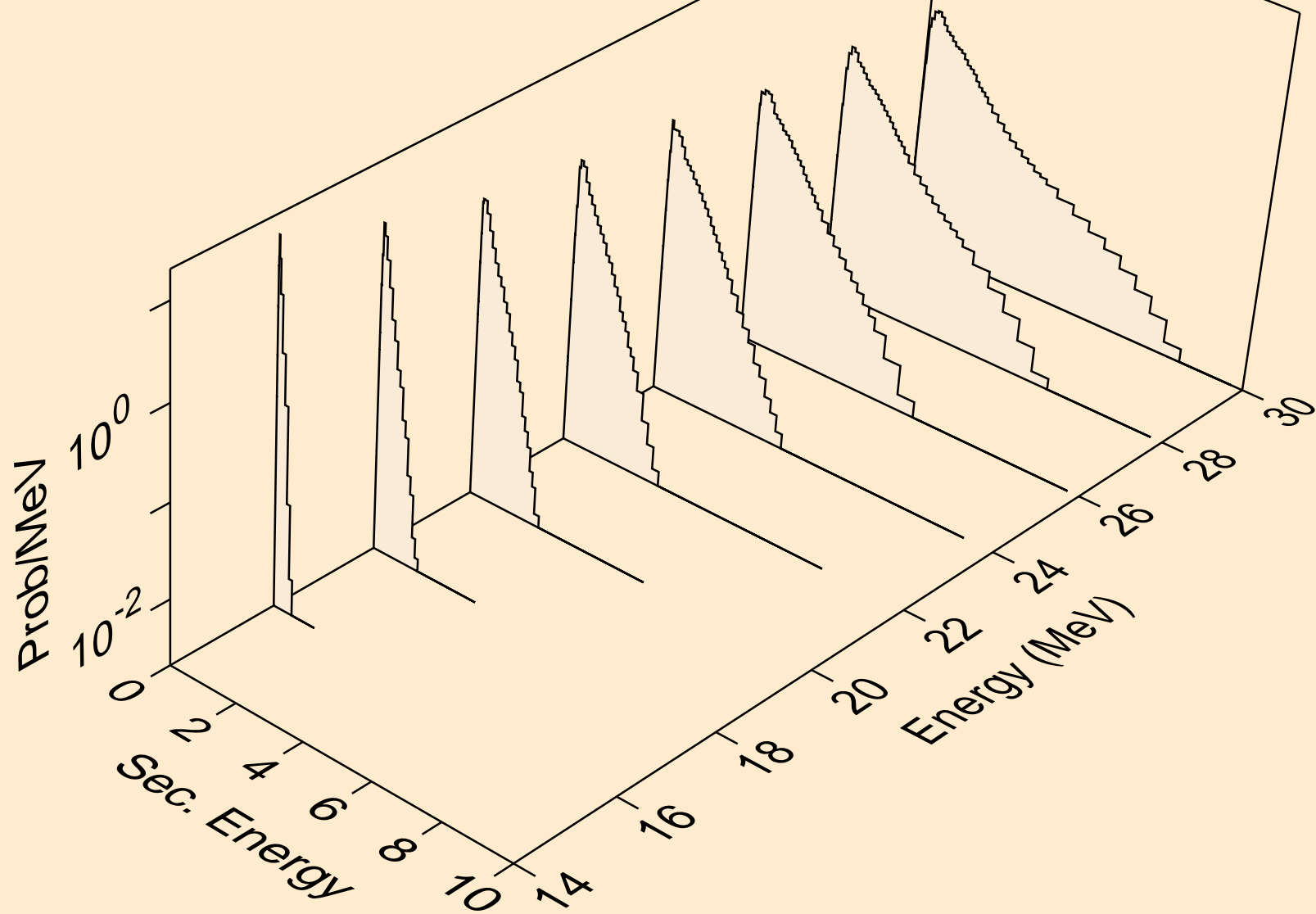

LA145 NEUTRON ACER TENDL-2021 LIBRARY; T=293.6K
Neutron emission for (n,3np)

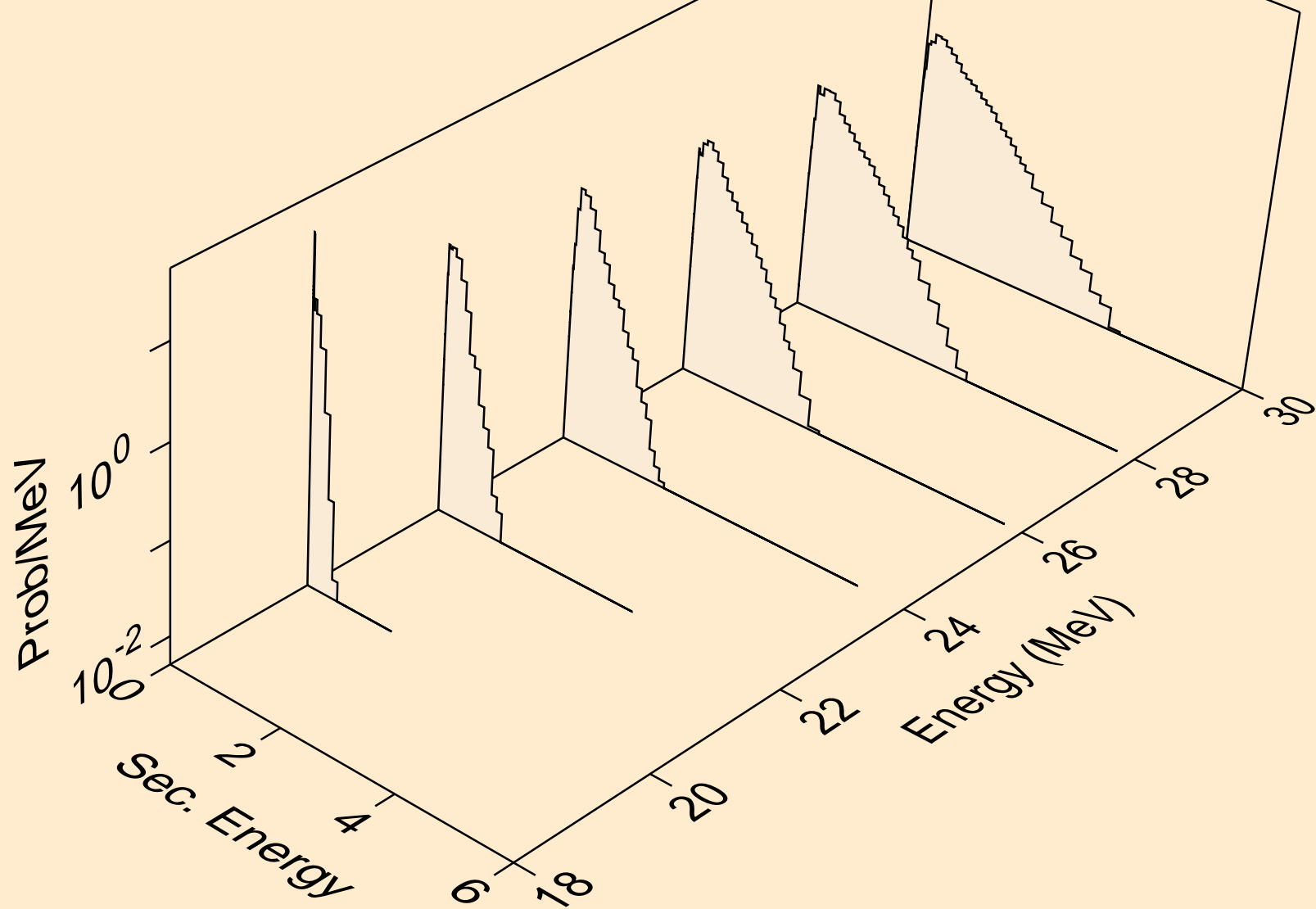

LA145 NEUTRON ACER TENDL-2021 LIBRARY; T=293.6K
Neutron emission for (n,n*c)

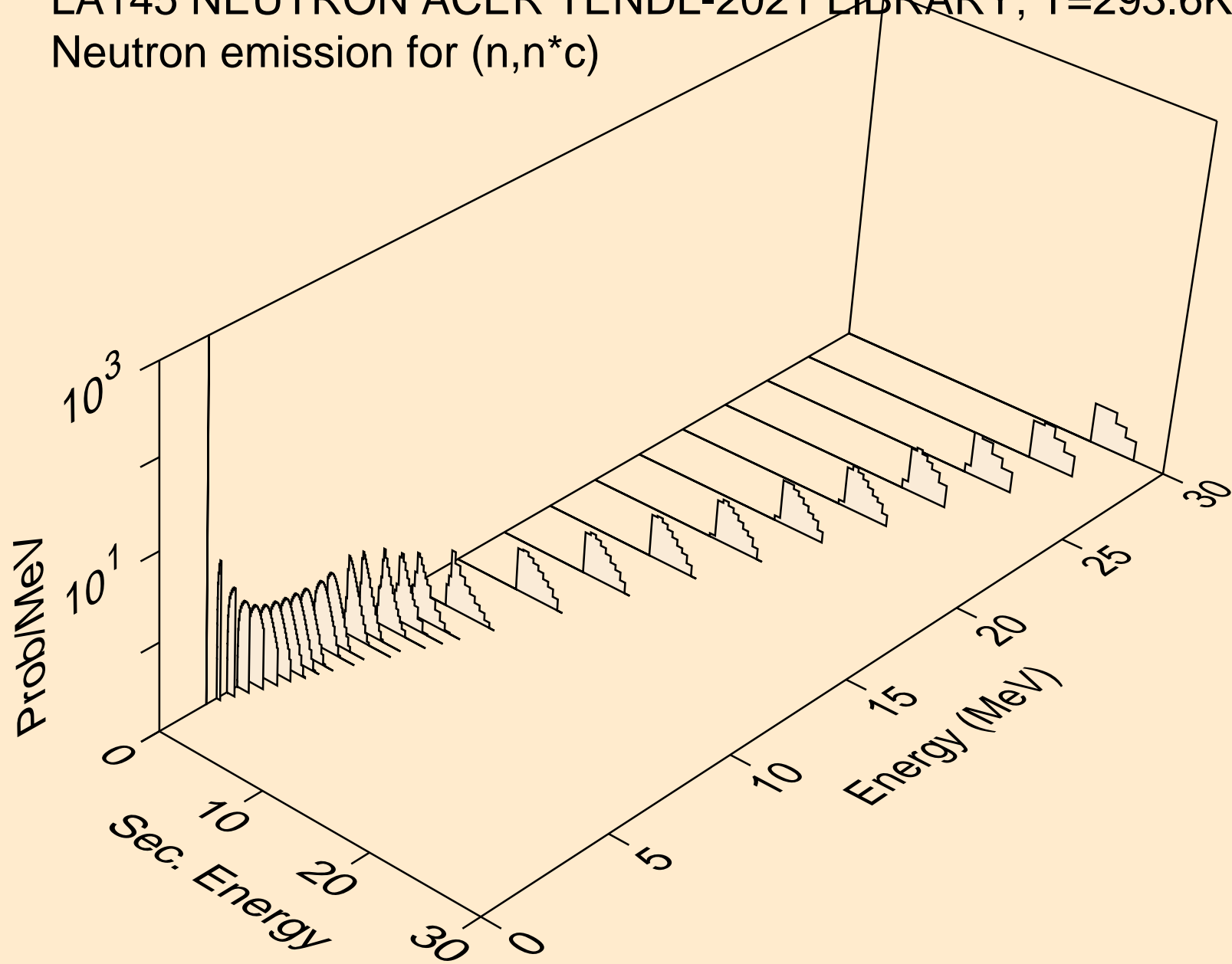

LA145 NEUTRON ACER TENDL-2021 LIBRARY; T=293.6K
Photon emission for (n,x)

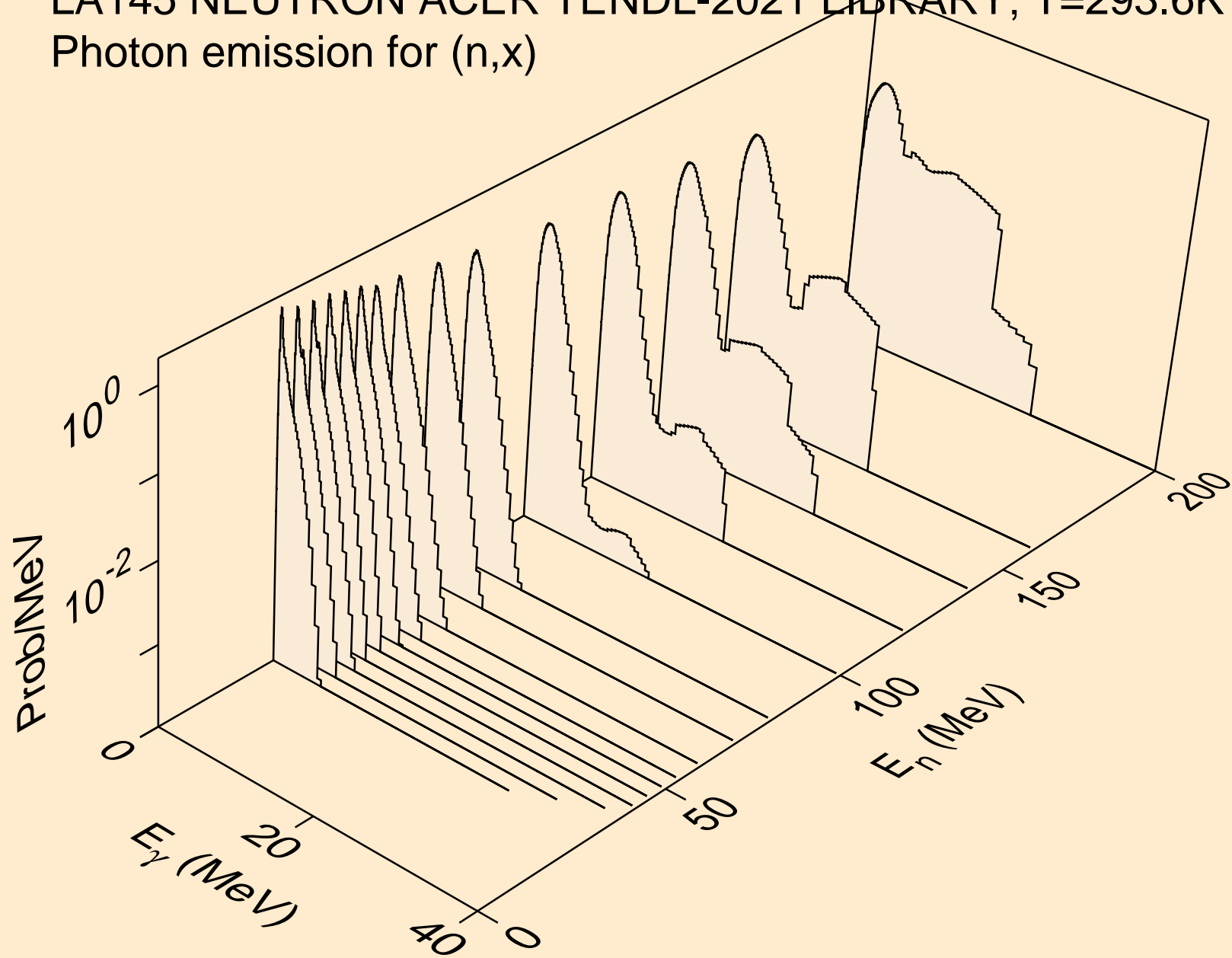

LA145 NEUTRON ACER TENDL-2021 LIBRARY; T=293.6K
Photon emission for (n,2nd)

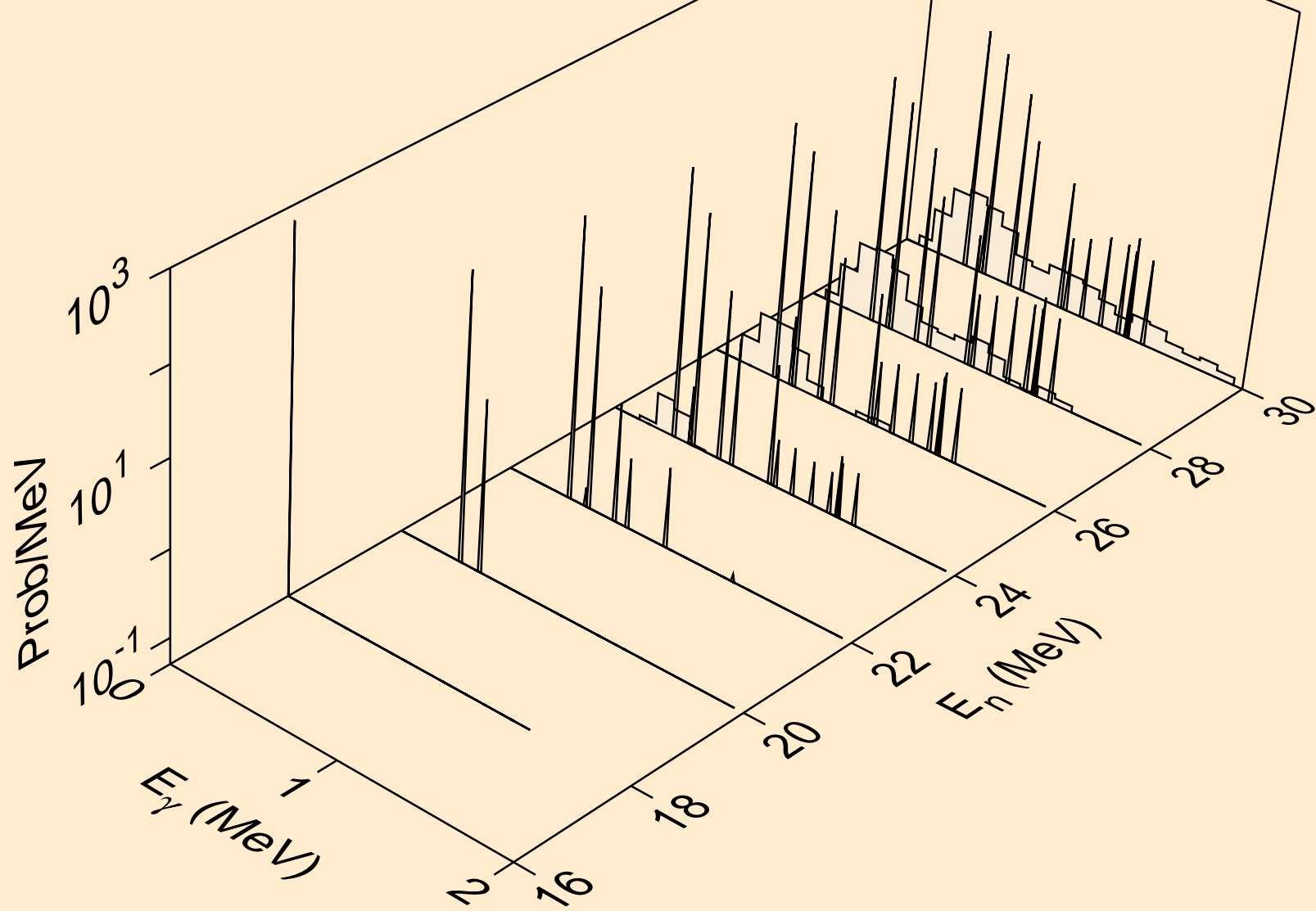

LA145 NEUTRON ACER TENDL-2021 LIBRARY; T=293.6K
Photon emission for (n,2n)

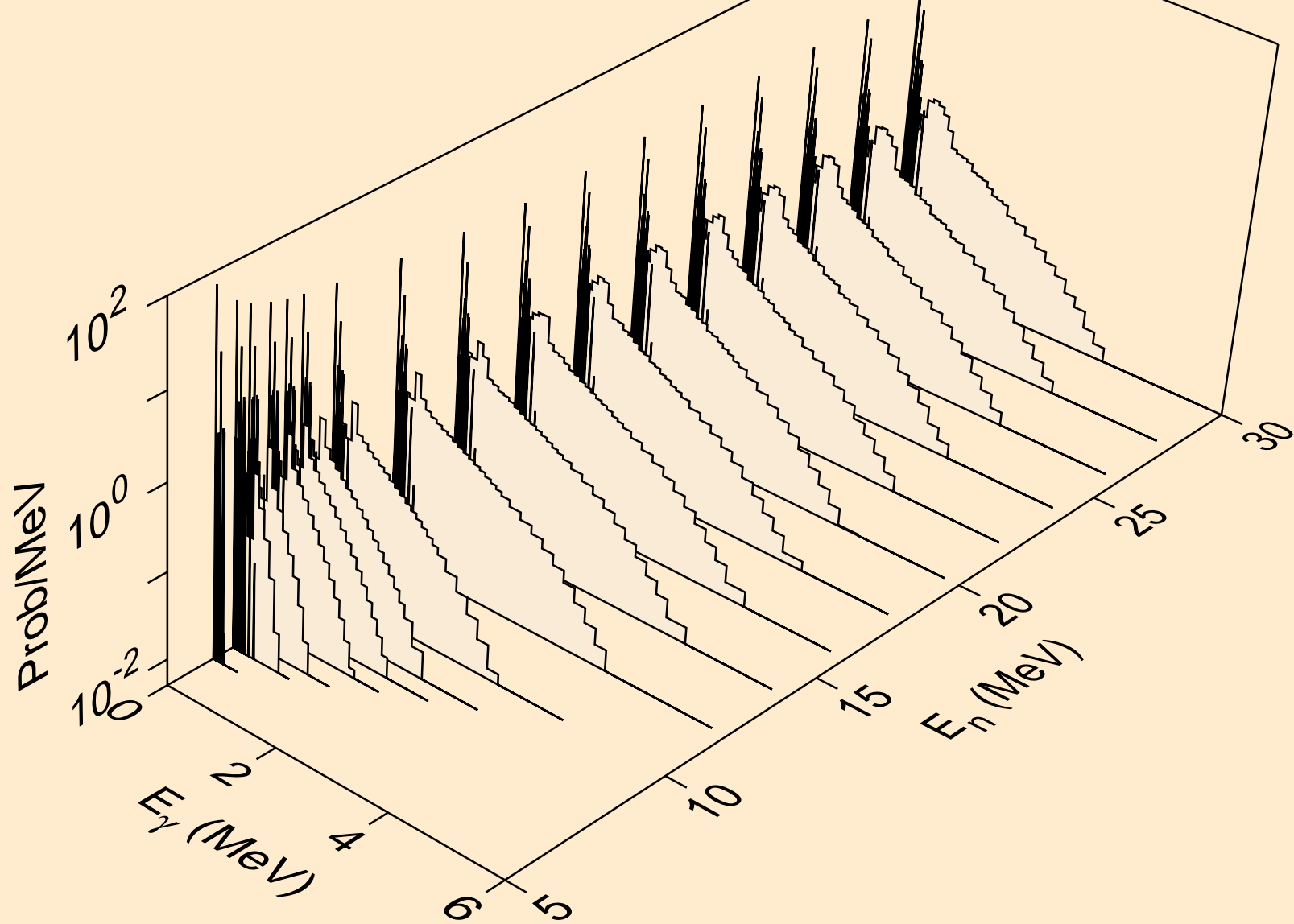

LA145 NEUTRON ACER TENDL-2021 LIBRARY; T=293.6K
Photon emission for (n,3n)

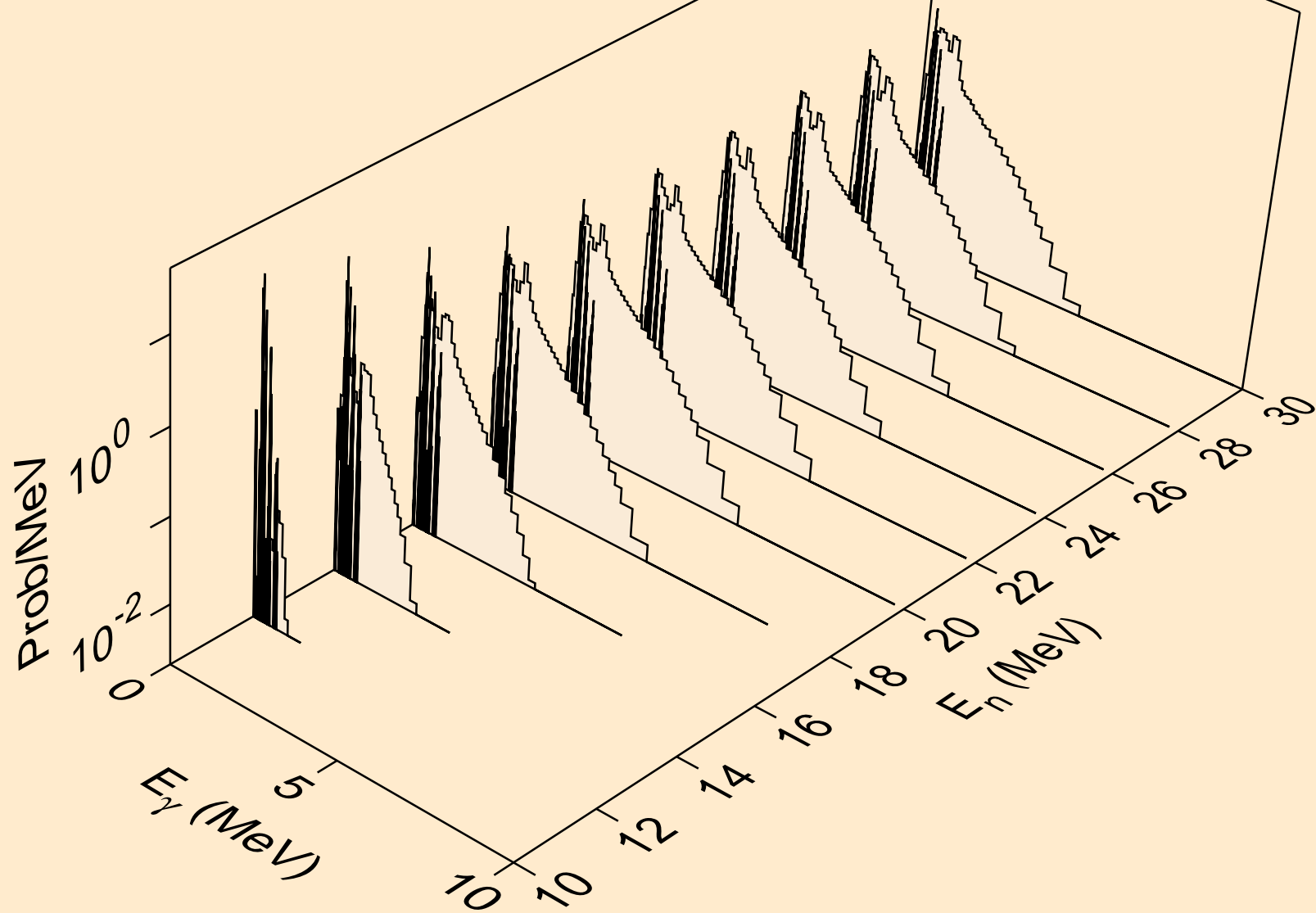

LA145 NEUTRON ACER TENDL-2021 LIBRARY; T=293.6K
Photon emission for (n,n*)a

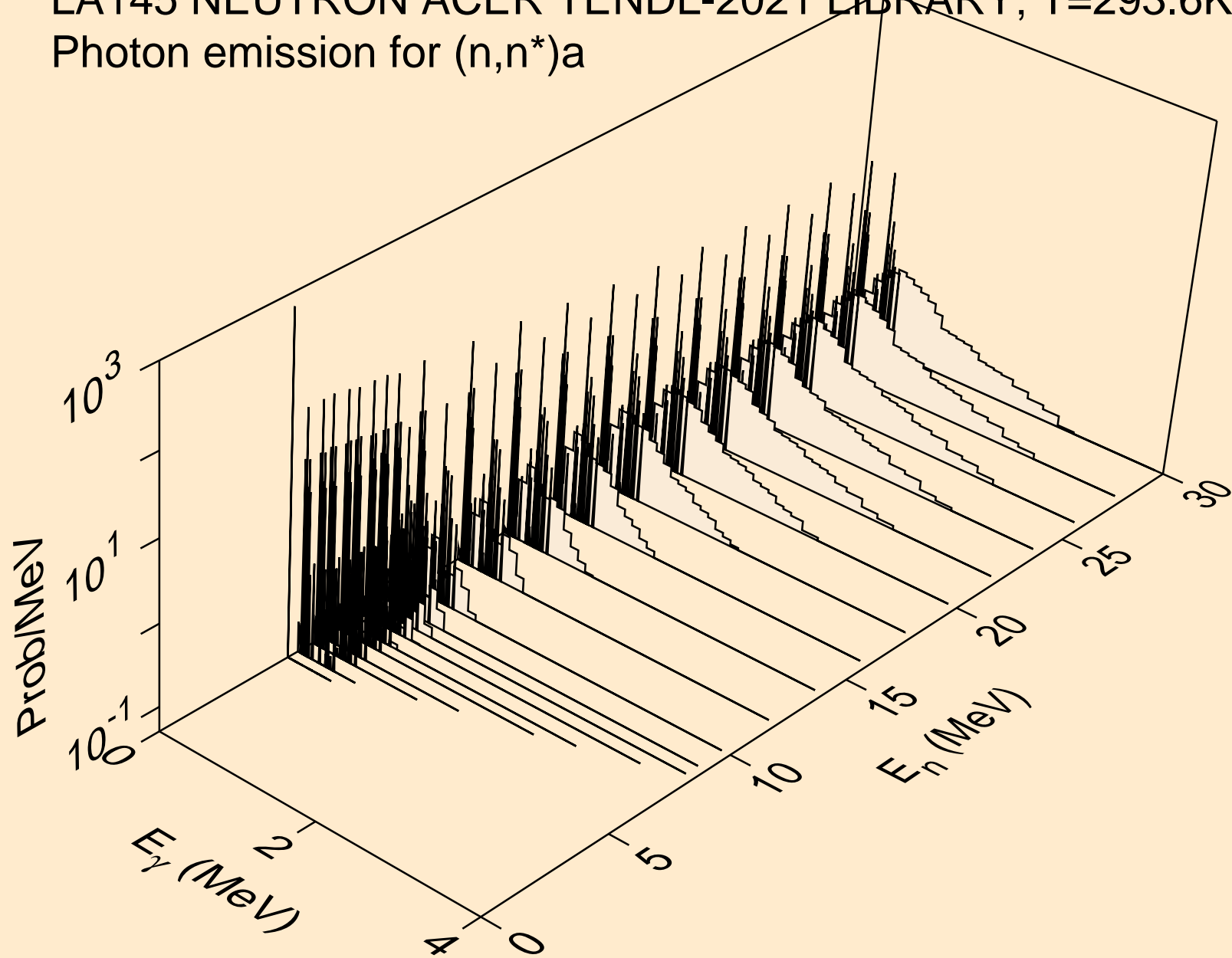

LA145 NEUTRON ACER TENDL-2021 LIBRARY; T=293.6K
Photon emission for (n,2n)a

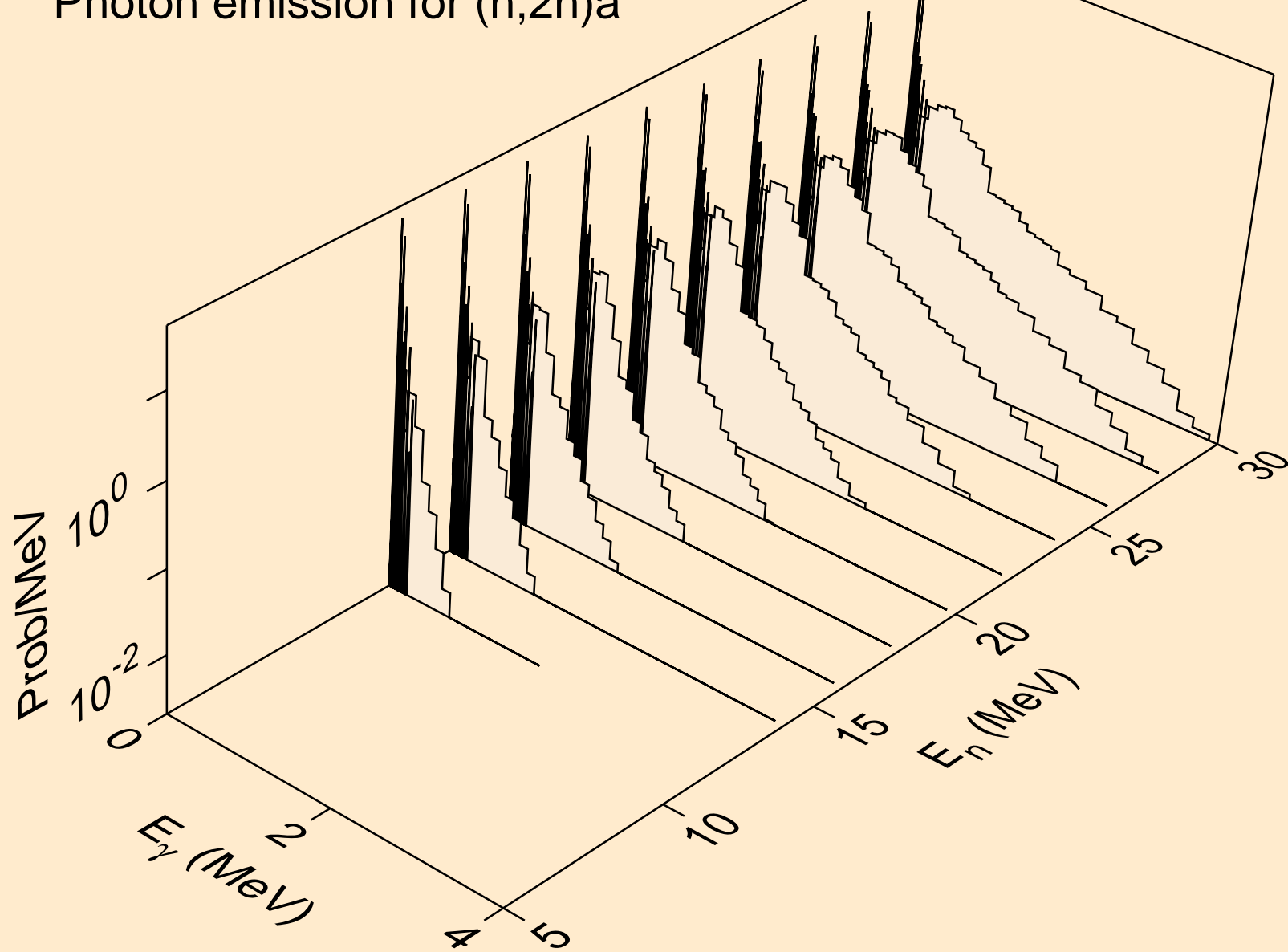

LA145 NEUTRON ACER TENDL-2021 LIBRARY; T=293.6K
Photon emission for (n,3n)a

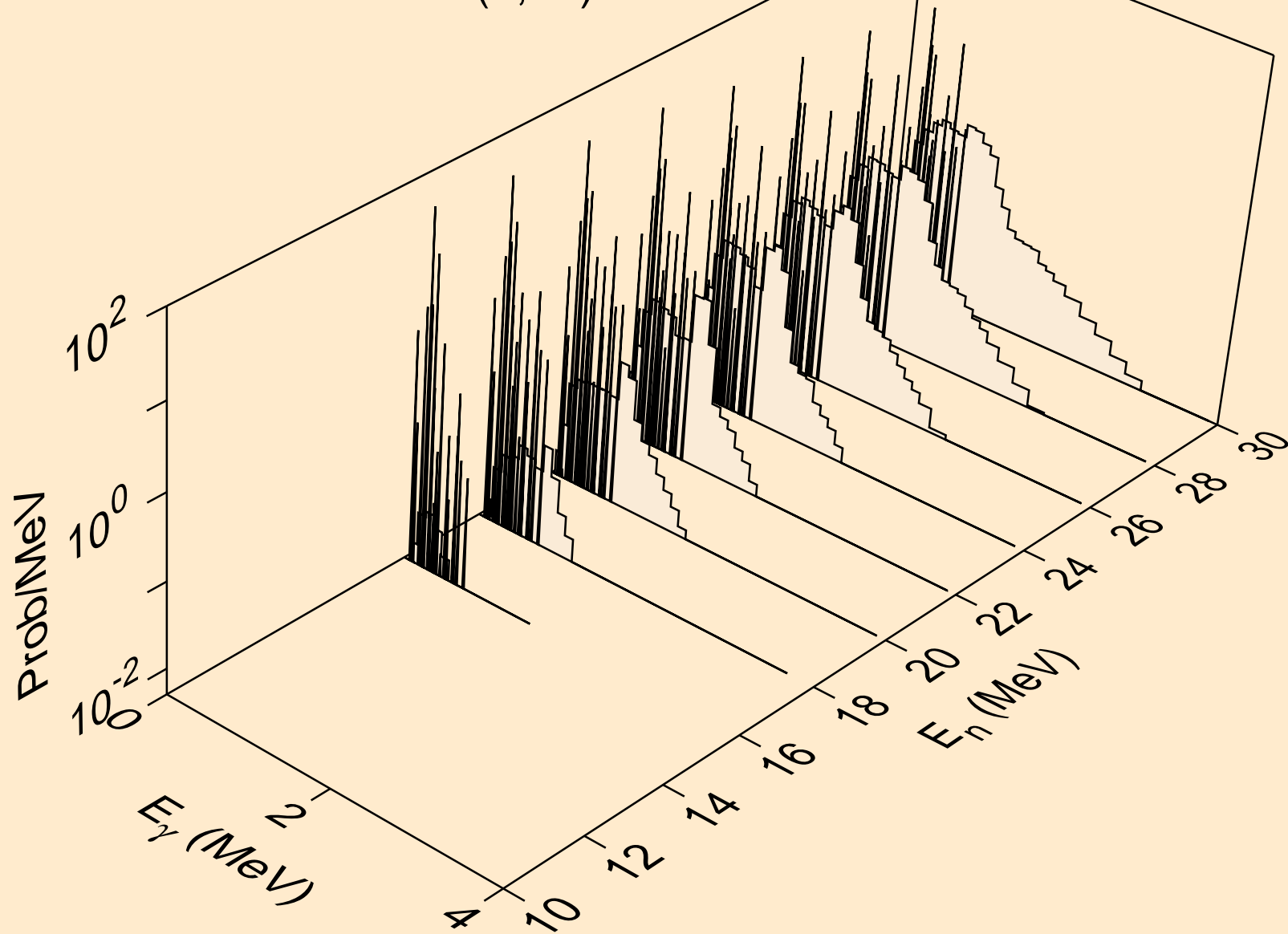

LA145 NEUTRON ACER TENDL-2021 LIBRARY; T=293.6K
Photon emission for (n,n*)p

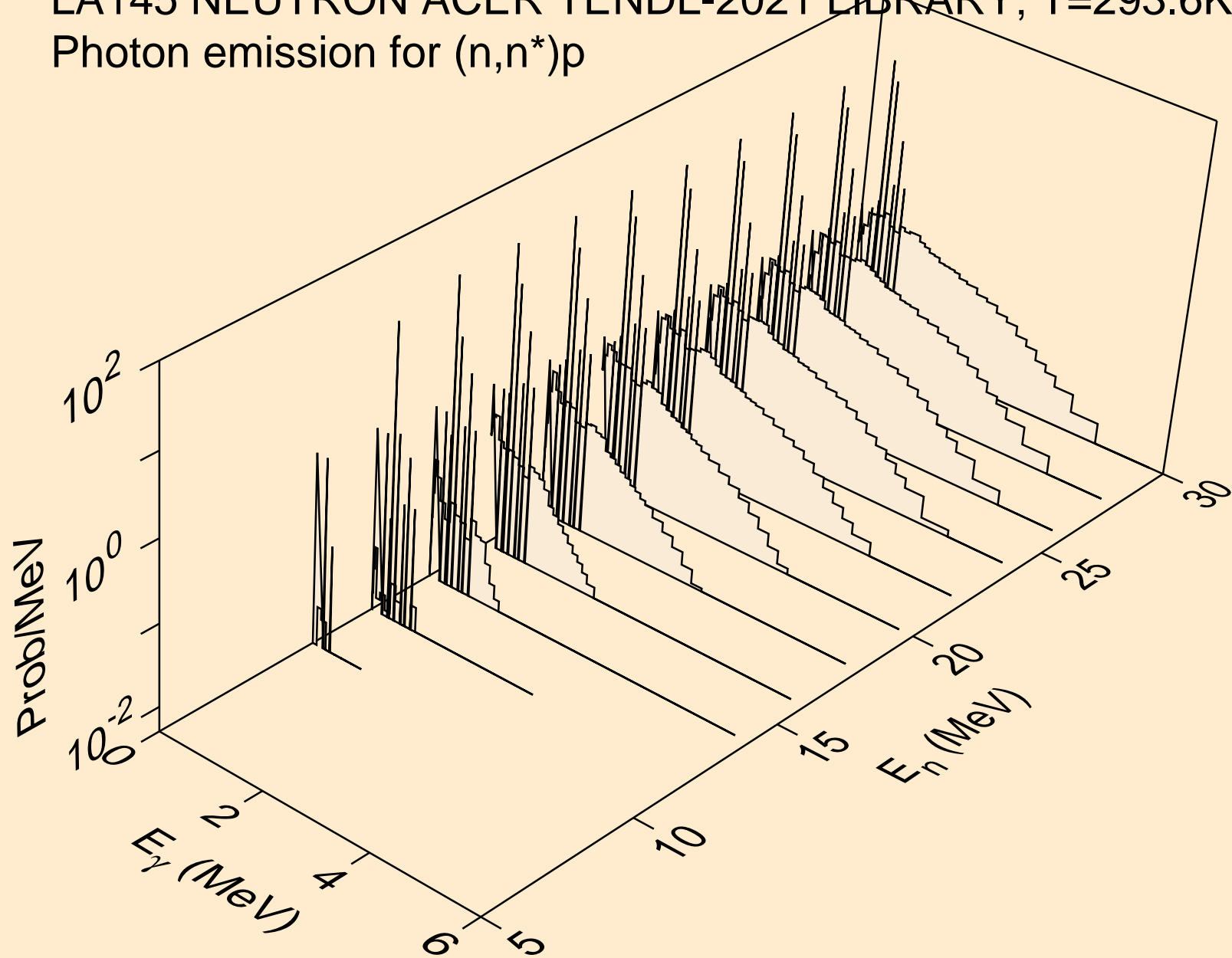

LA145 NEUTRON ACER TENDL-2021 LIBRARY; T=293.6K
Photon emission for (n,n*)d

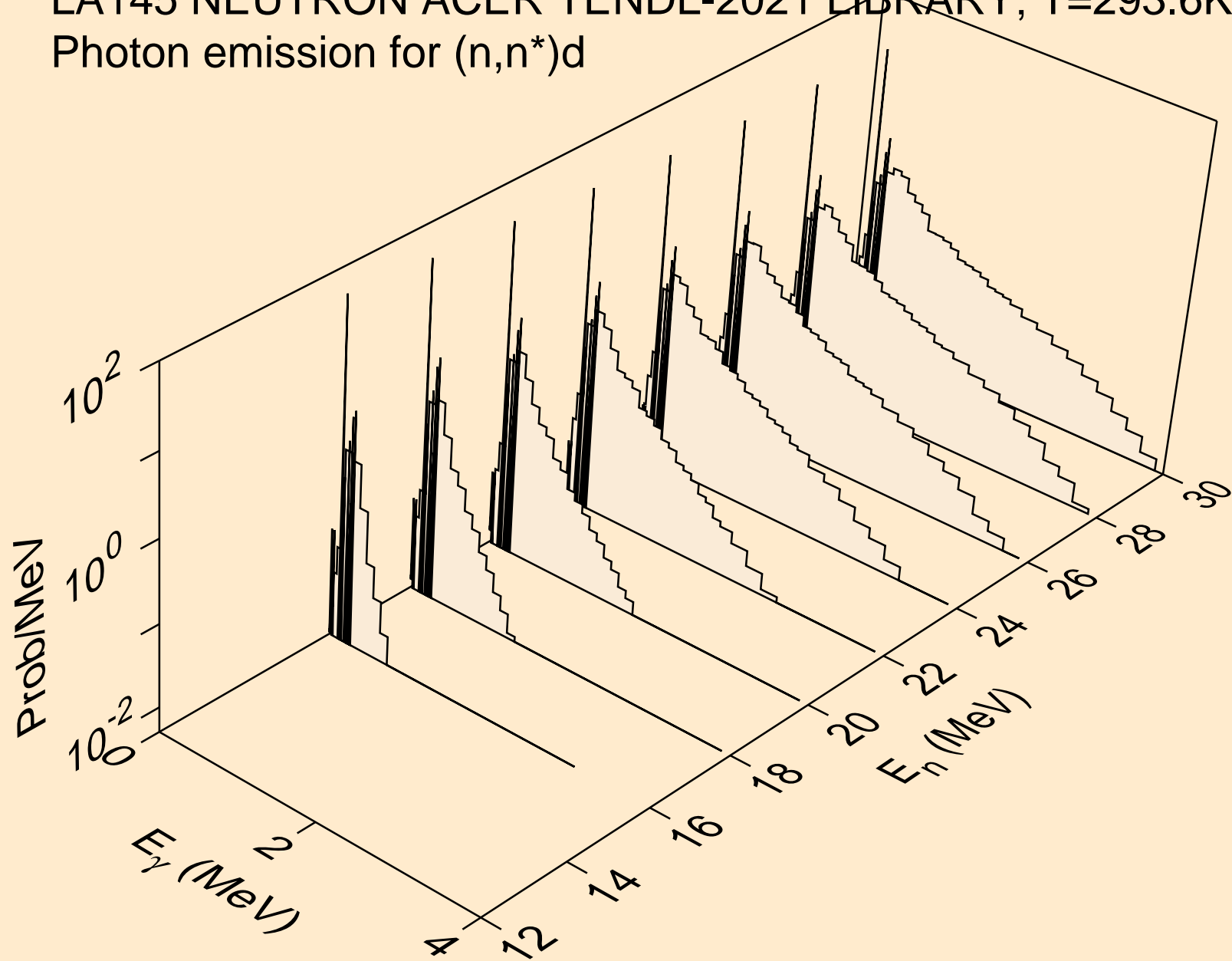

LA145 NEUTRON ACER TENDL-2021 LIBRARY; T=293.6K
Photon emission for (n,n*)t

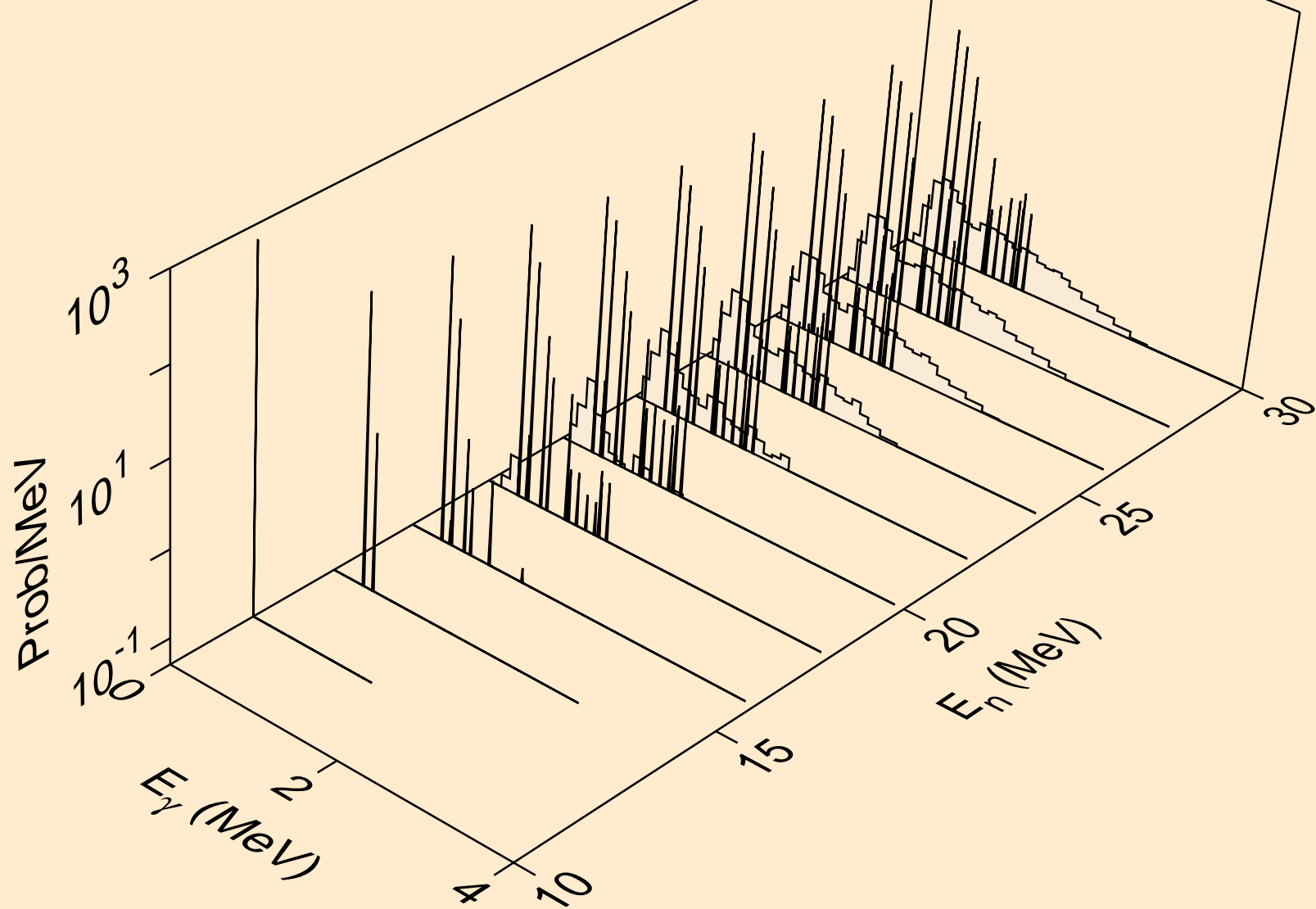

LA145 NEUTRON ACER TENDL-2021 LIBRARY; T=293.6K
Photon emission for (n,n*)he3

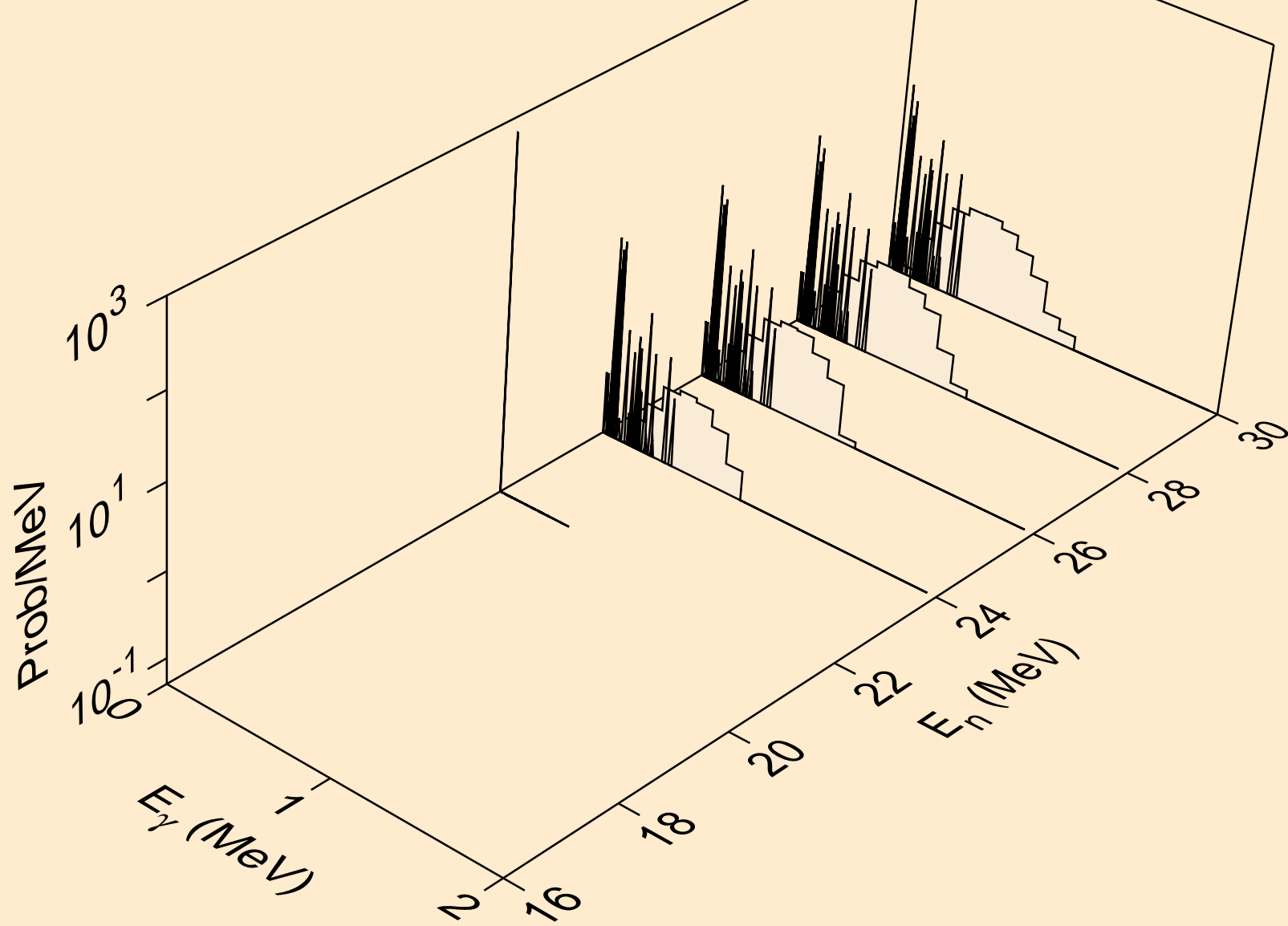

LA145 NEUTRON ACER TENDL-2021 LIBRARY; T=293.6K
Photon emission for (n,4n)

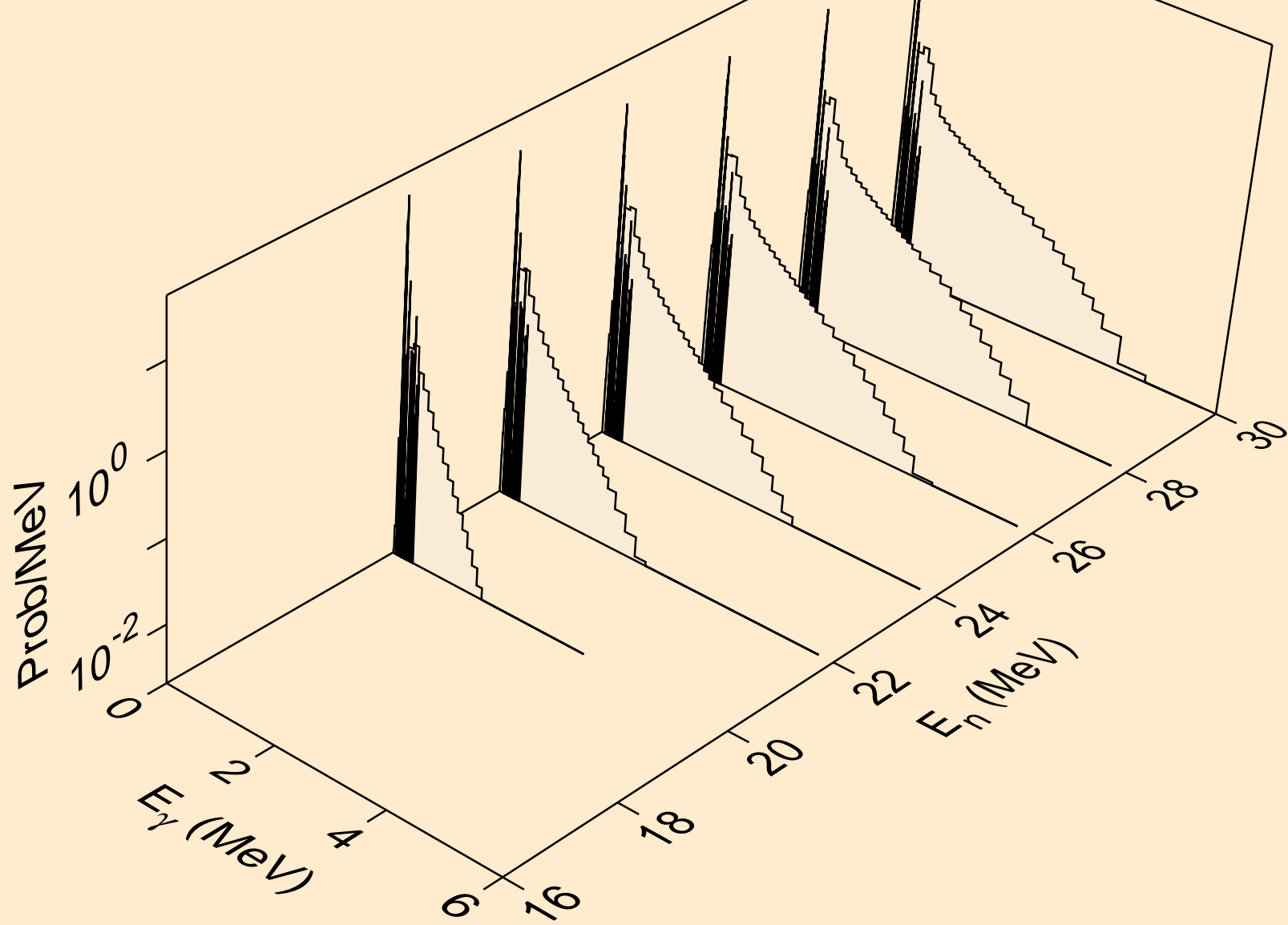

LA145 NEUTRON ACER TENDL-2021 LIBRARY; T=293.6K
Photon emission for (n,2np)

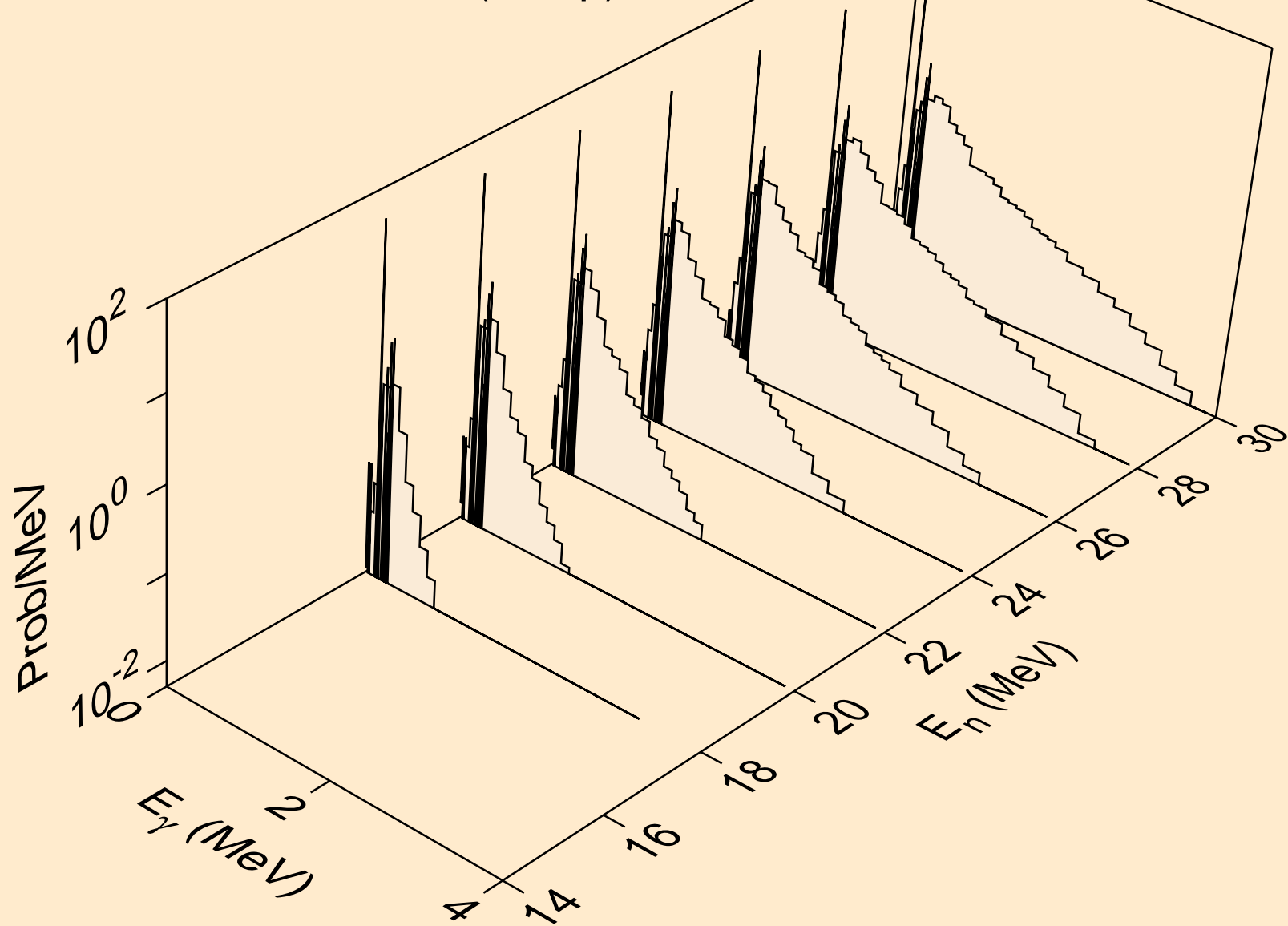

LA145 NEUTRON ACER TENDL-2021 LIBRARY; T=293.6K
Photon emission for (n,3np)

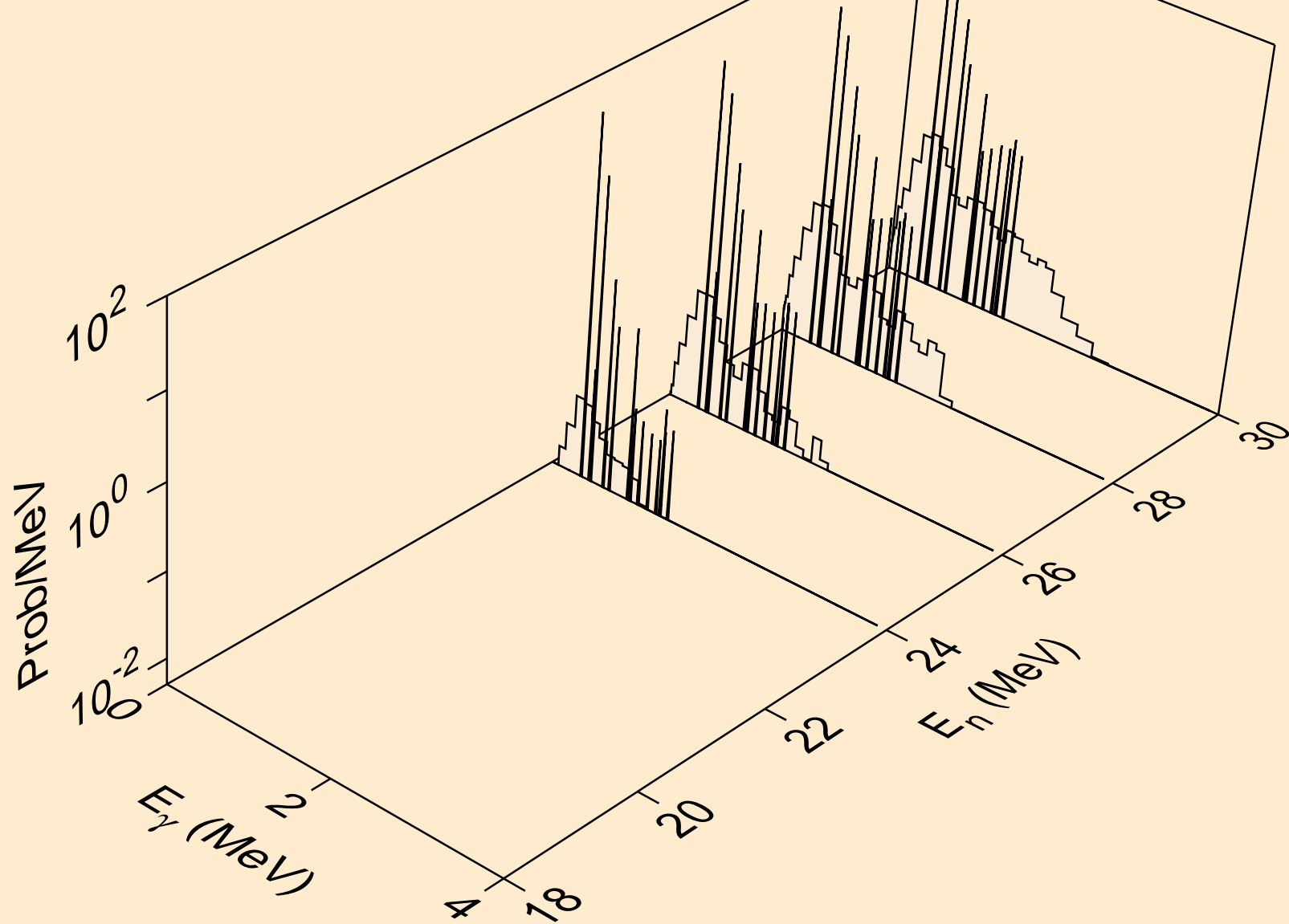

LA145 NEUTRON ACER TENDL-2021 LIBRARY; T=293.6K
Photon emission for (n,n*c)

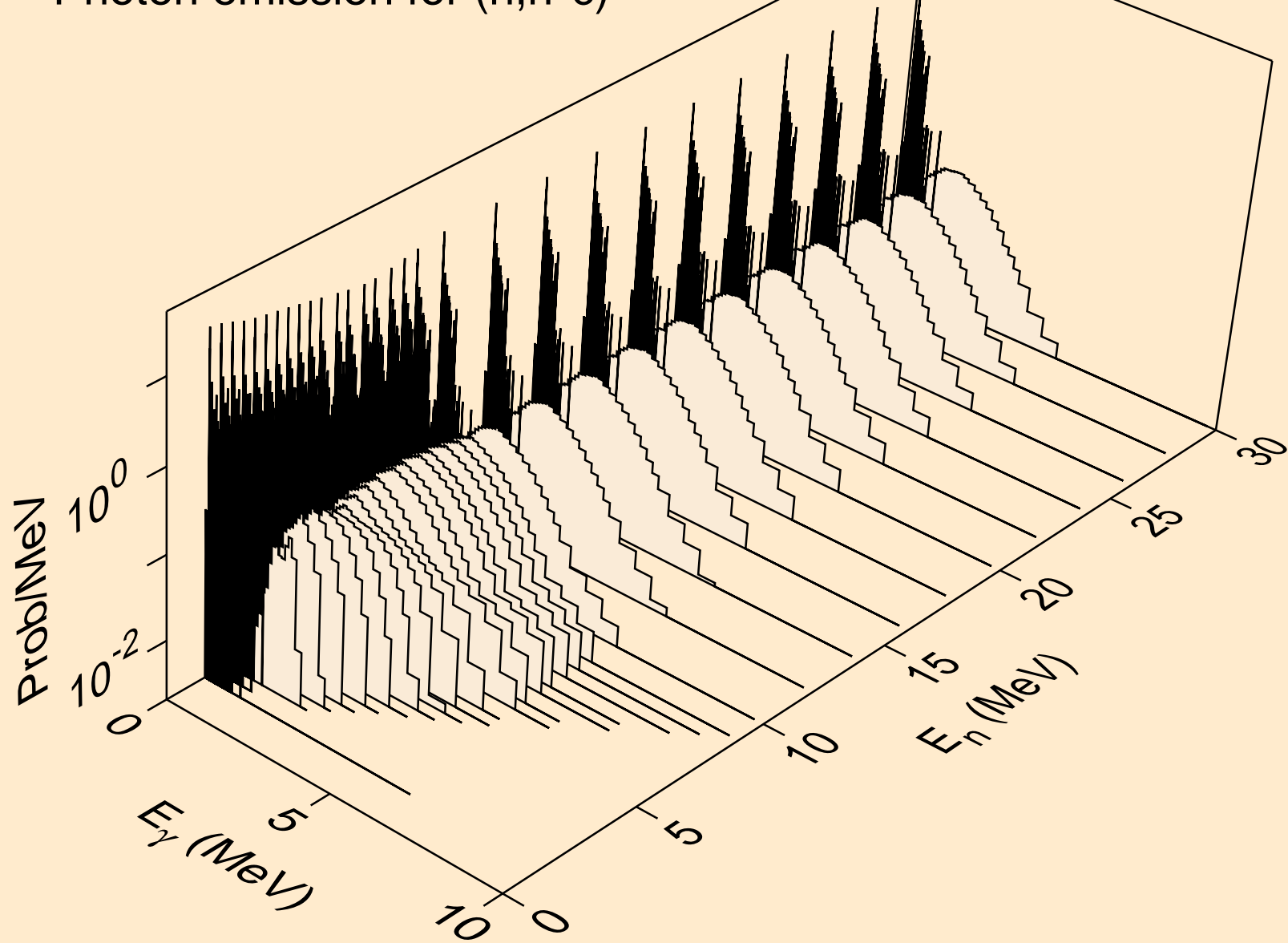

LA145 NEUTRON ACER TENDL-2021 LIBRARY; T=293.6K
Photon emission for (n,gma)

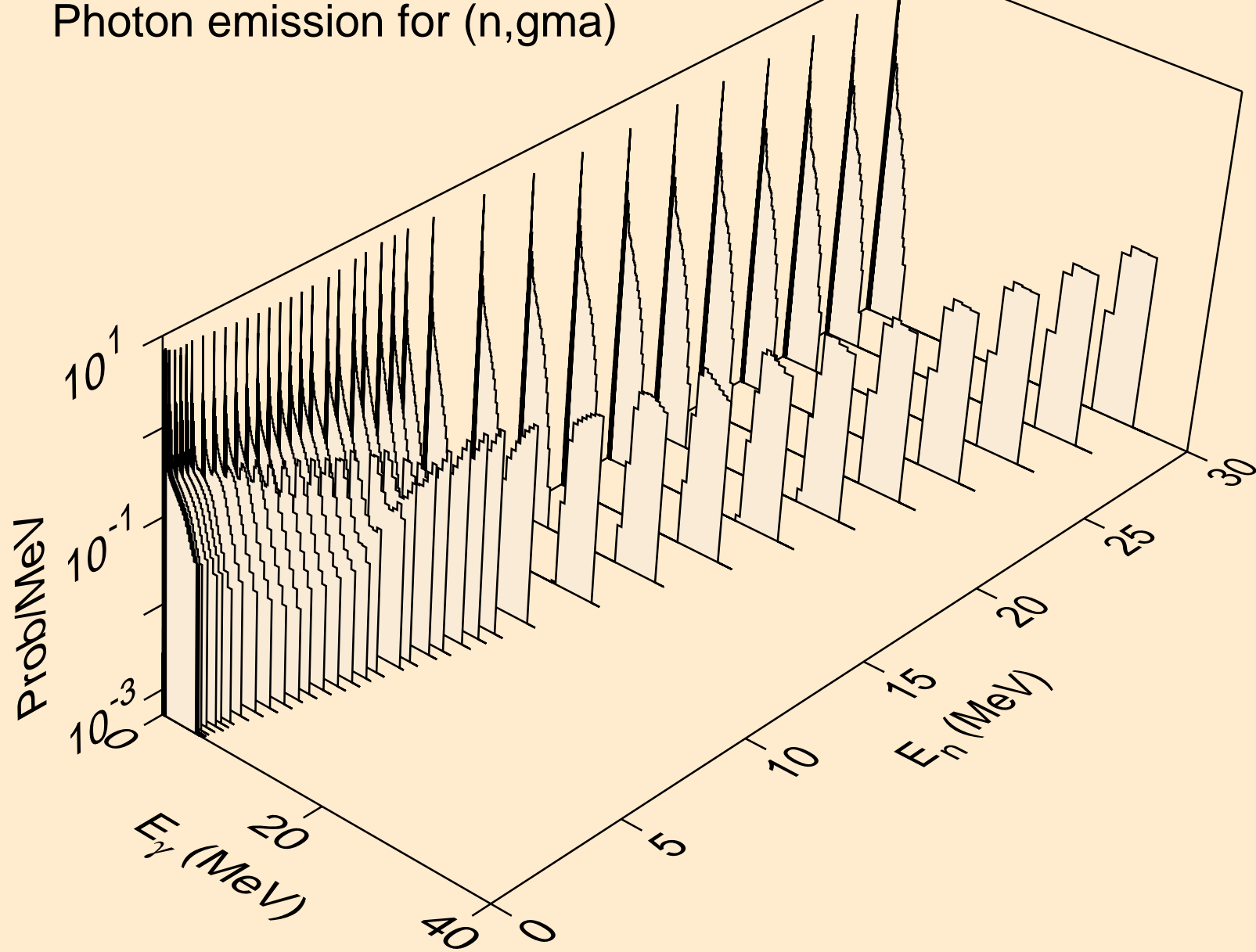

LA145 NEUTRON ACER TENDL-2021 LIBRARY; T=293.6K
Photon emission for (n,p)

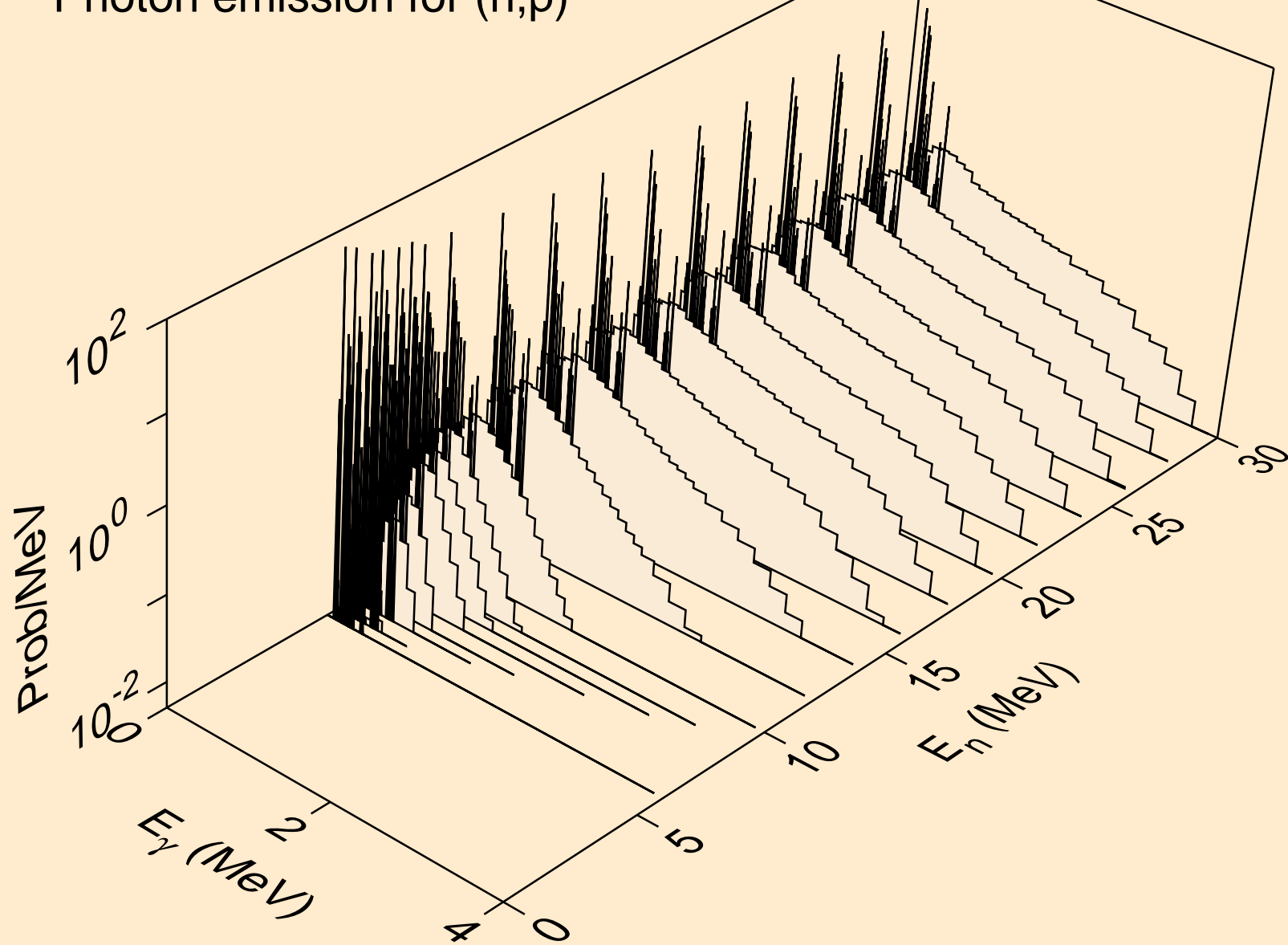

LA145 NEUTRON ACER TENDL-2021 LIBRARY; T=293.6K
Photon emission for (n,d)

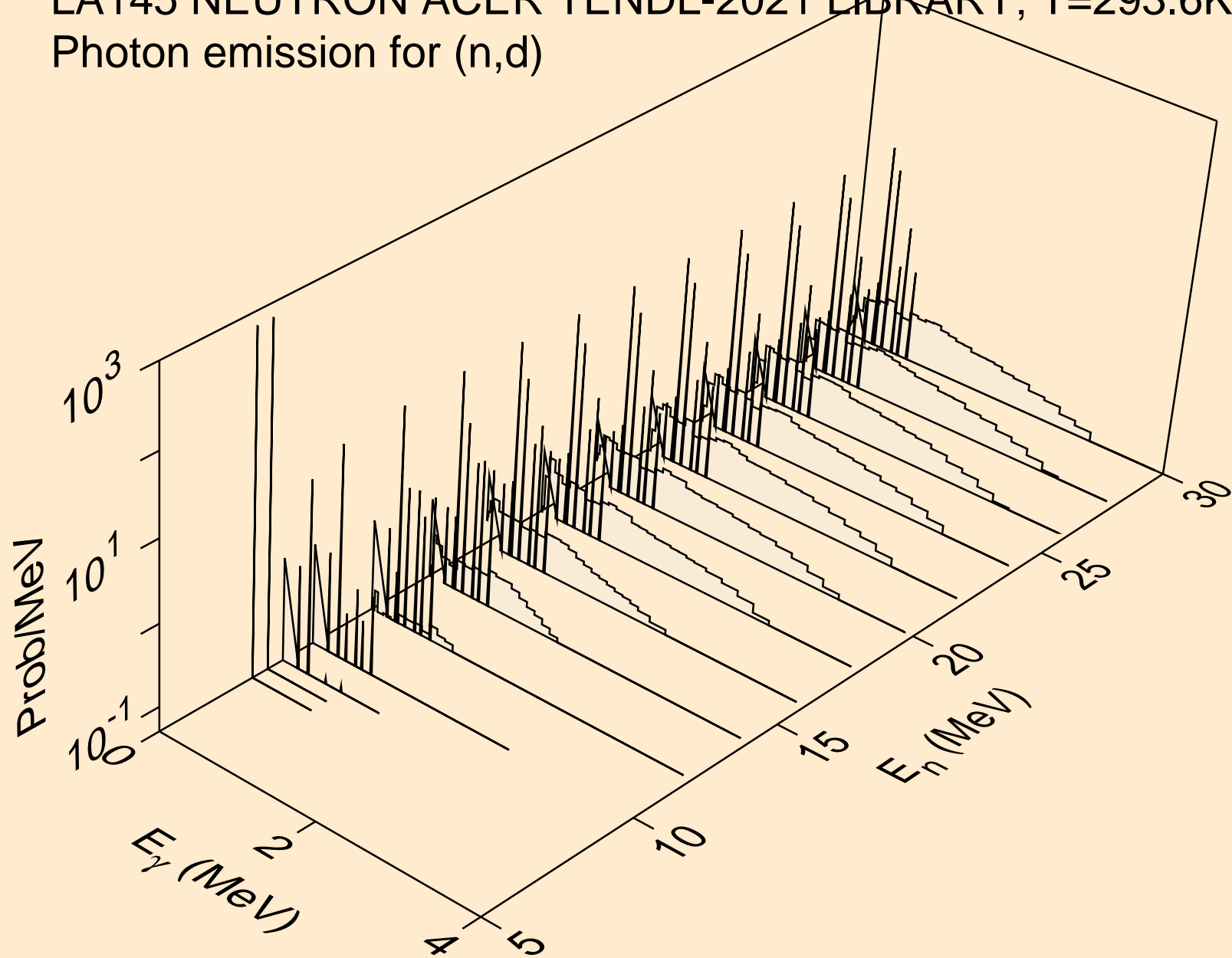

LA145 NEUTRON ACER TENDL-2021 LIBRARY; T=293.6K
Photon emission for (n,t)

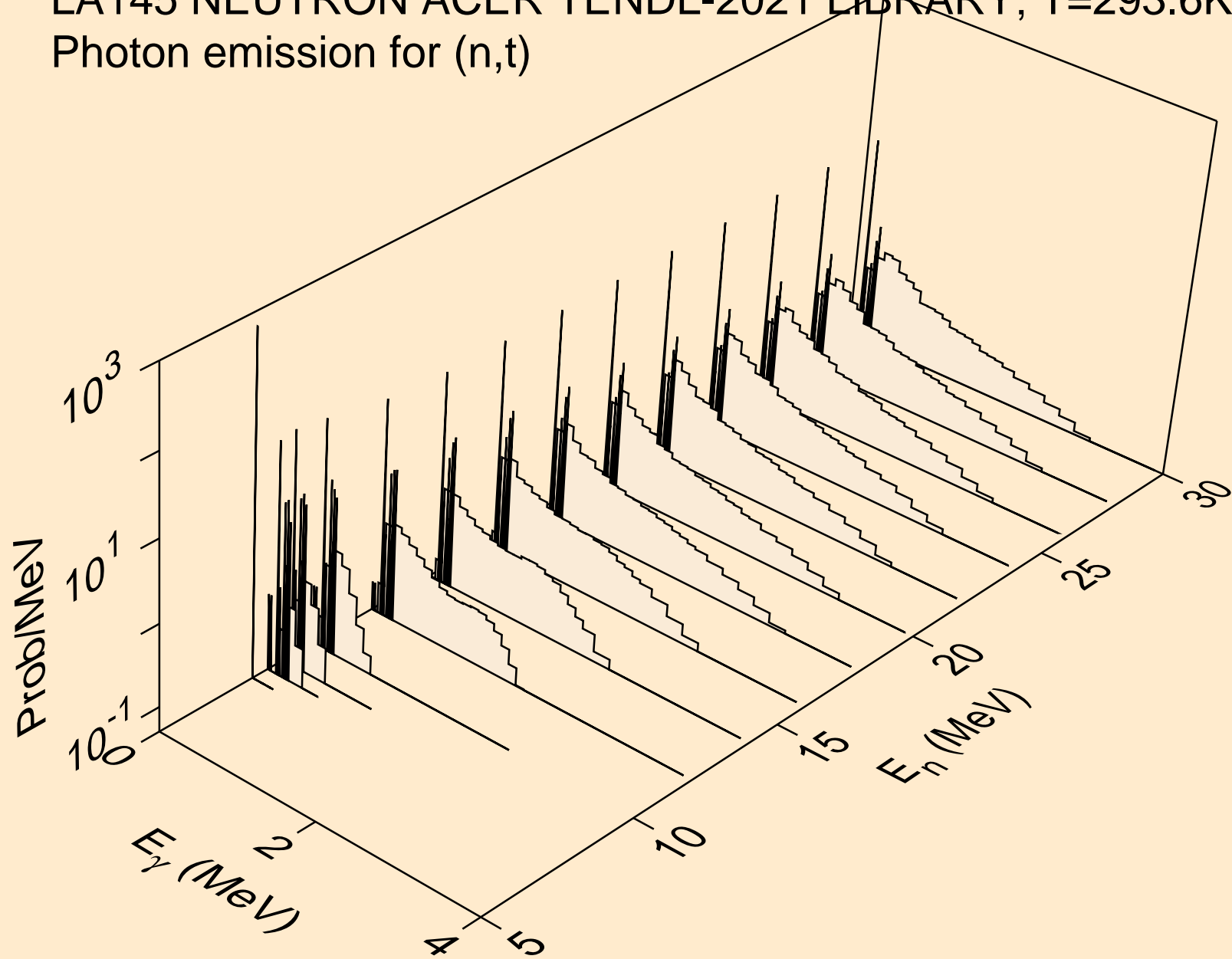

LA145 NEUTRON ACER TENDL-2021 LIBRARY; T=293.6K
Photon emission for (n,he3)

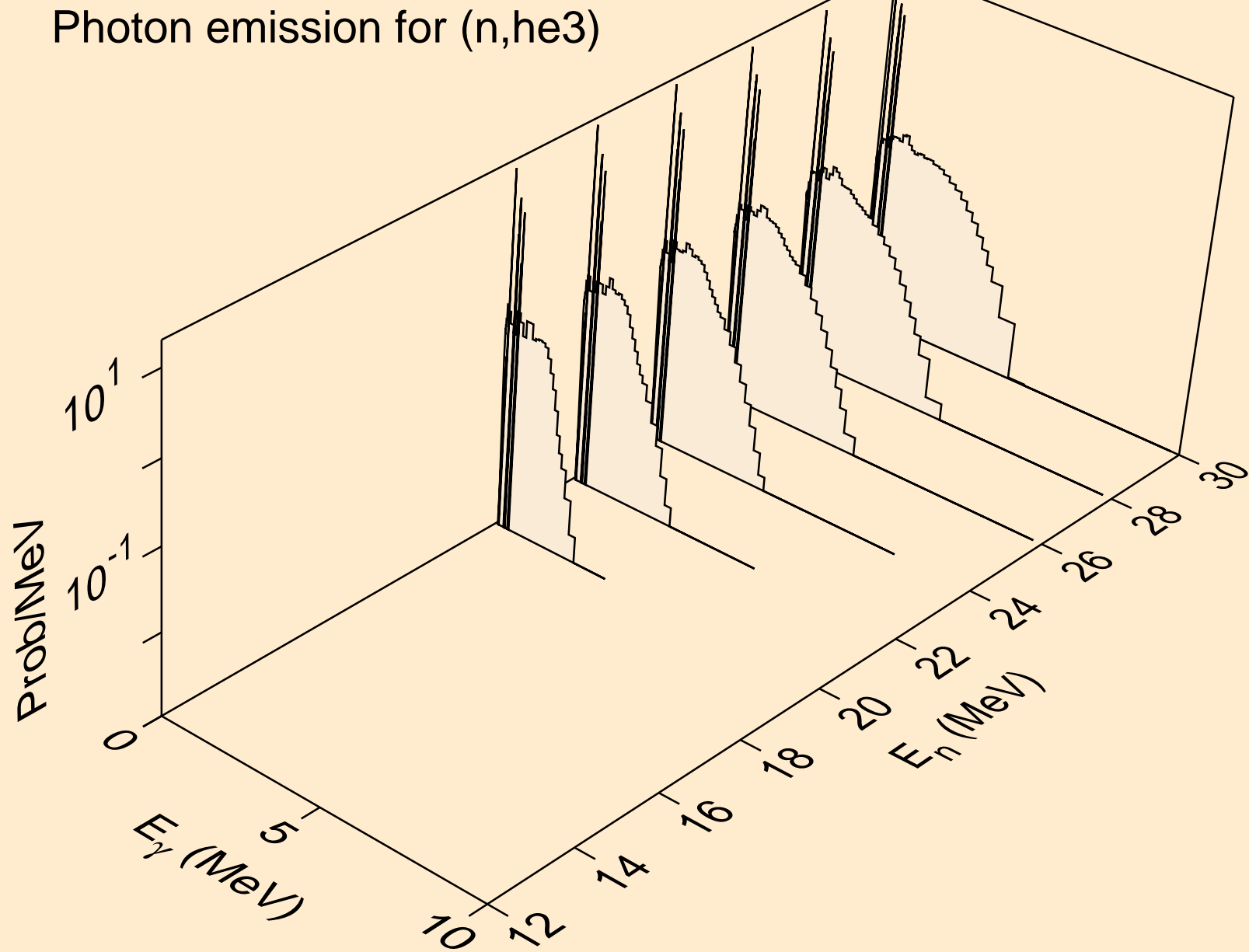

LA145 NEUTRON ACER TENDL-2021 LIBRARY; T=293.6K
Photon emission for (n,a)

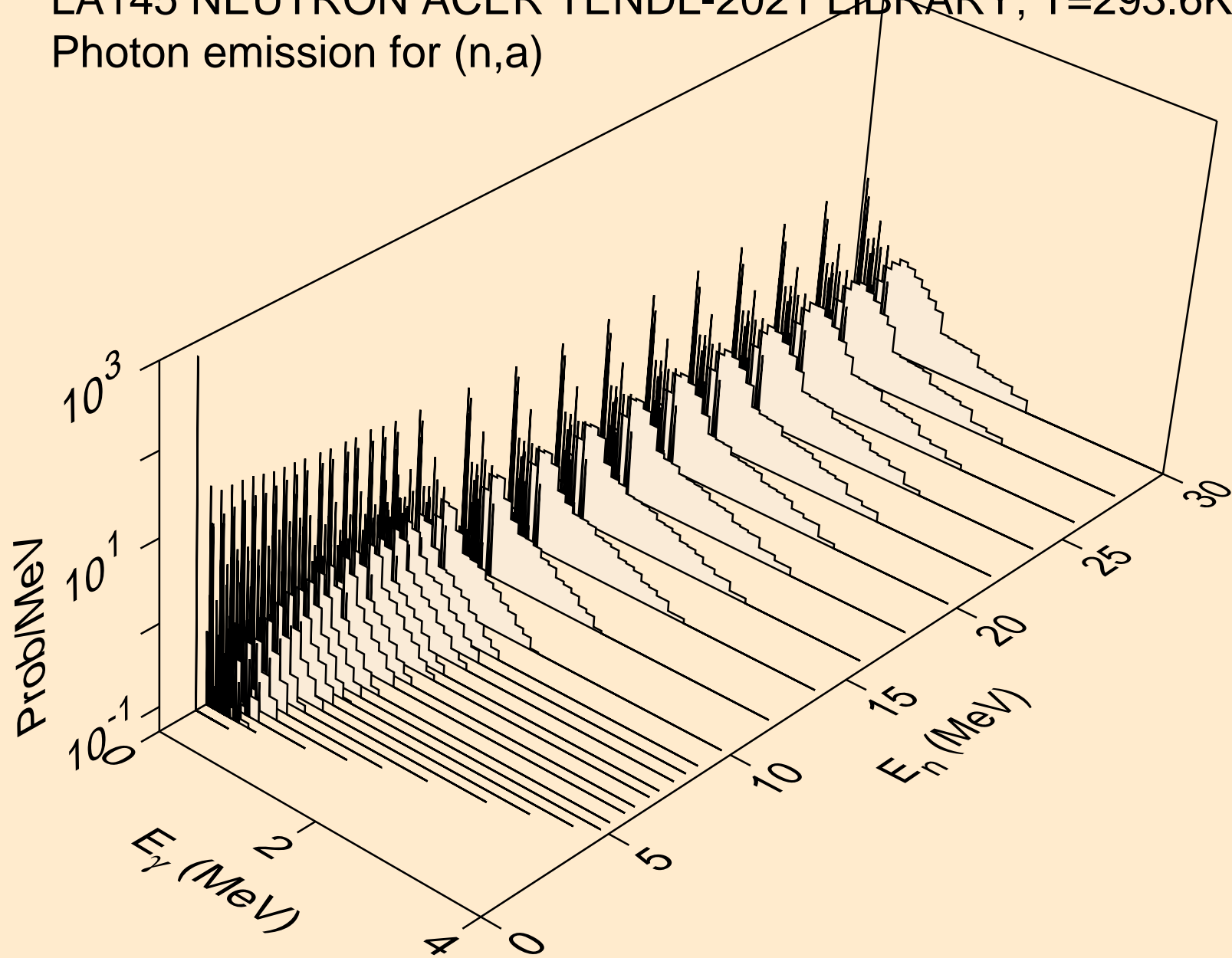

LA145 NEUTRON ACER TENDL-2021 LIBRARY; T=293.6K
Photon emission for (n,2a)

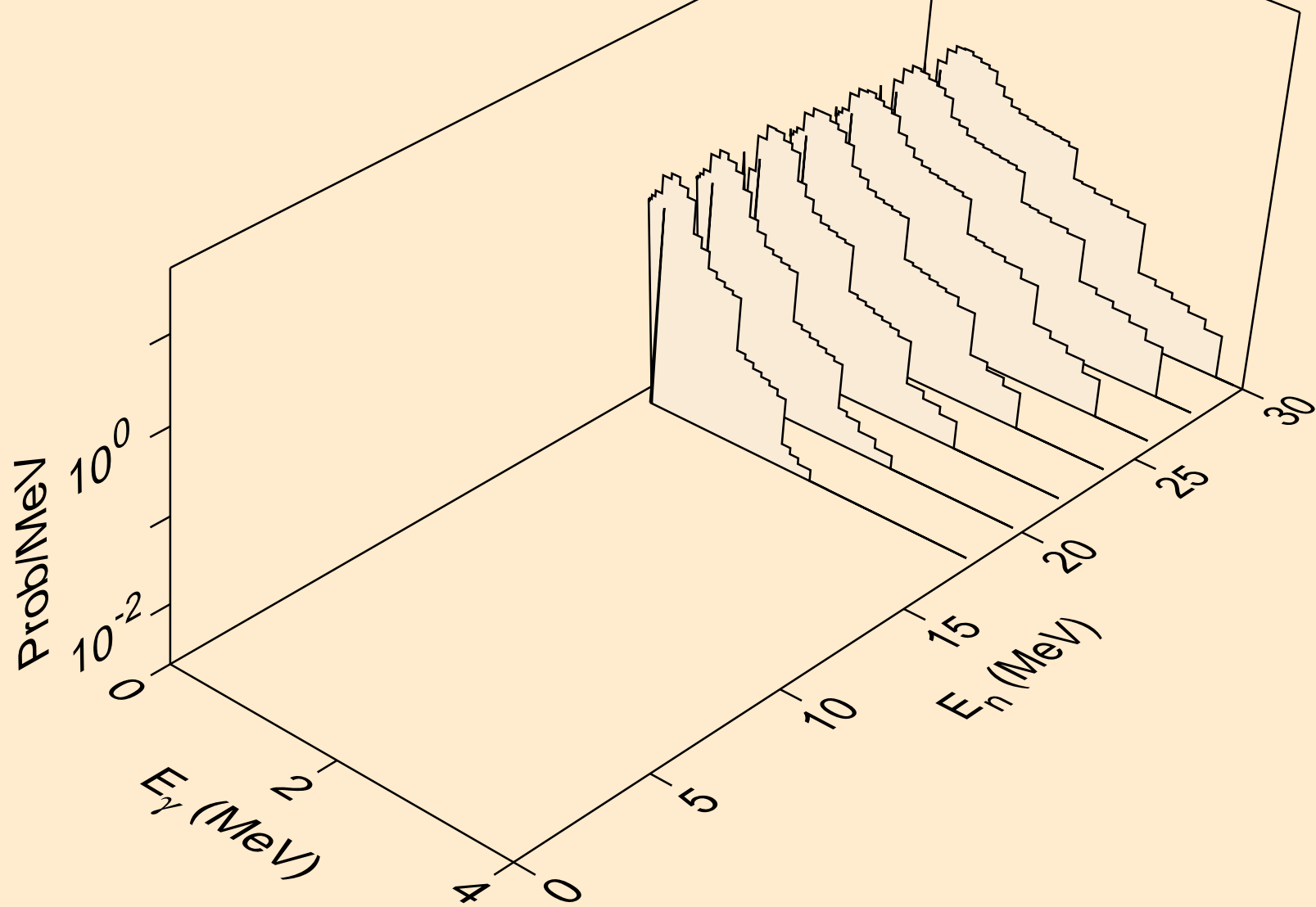

LA145 NEUTRON ACER TENDL-2021 LIBRARY; T=293.6K
Photon emission for (n,2p)

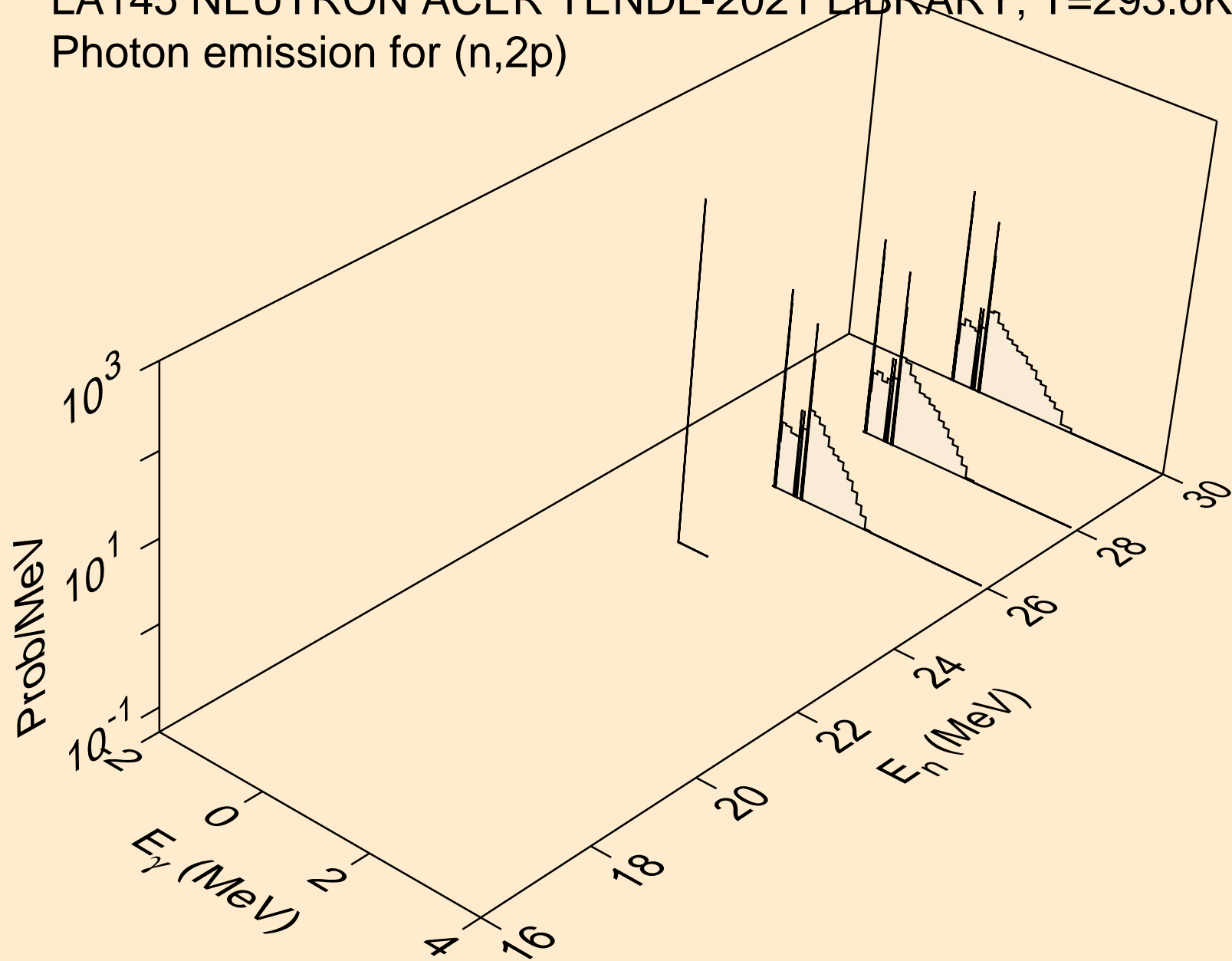

LA145 NEUTRON ACER TENDL-2021 LIBRARY; T=293.6K
thermal capture photon spectrum

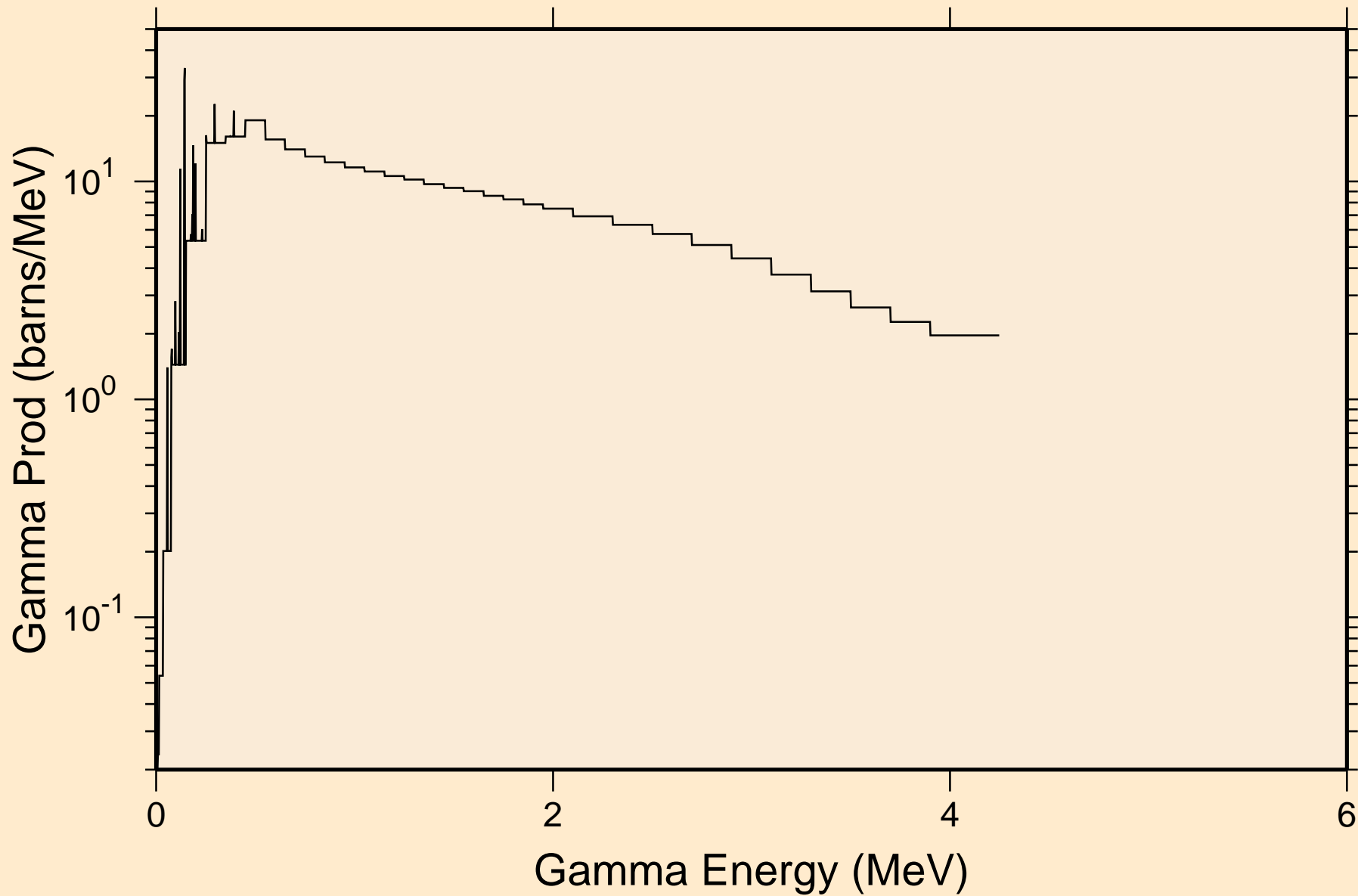

LA145 NEUTRON ACER TENDL-2021 LIBRARY; T=293.6K
14 MeV photon spectrum

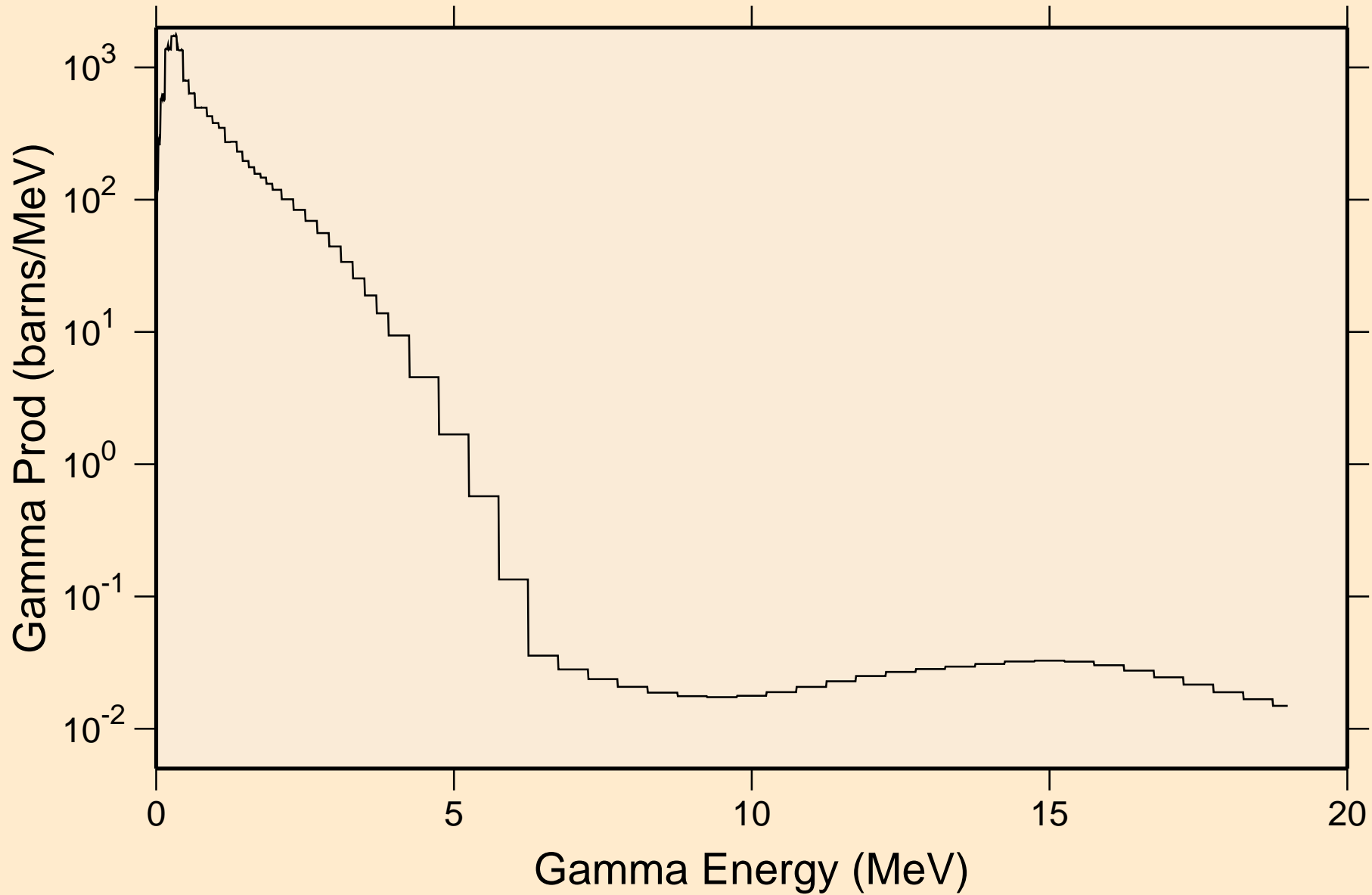

LA145 NEUTRON ACER TENDL-2021 LIBRARY; T=293.6K
Particle heating contributions

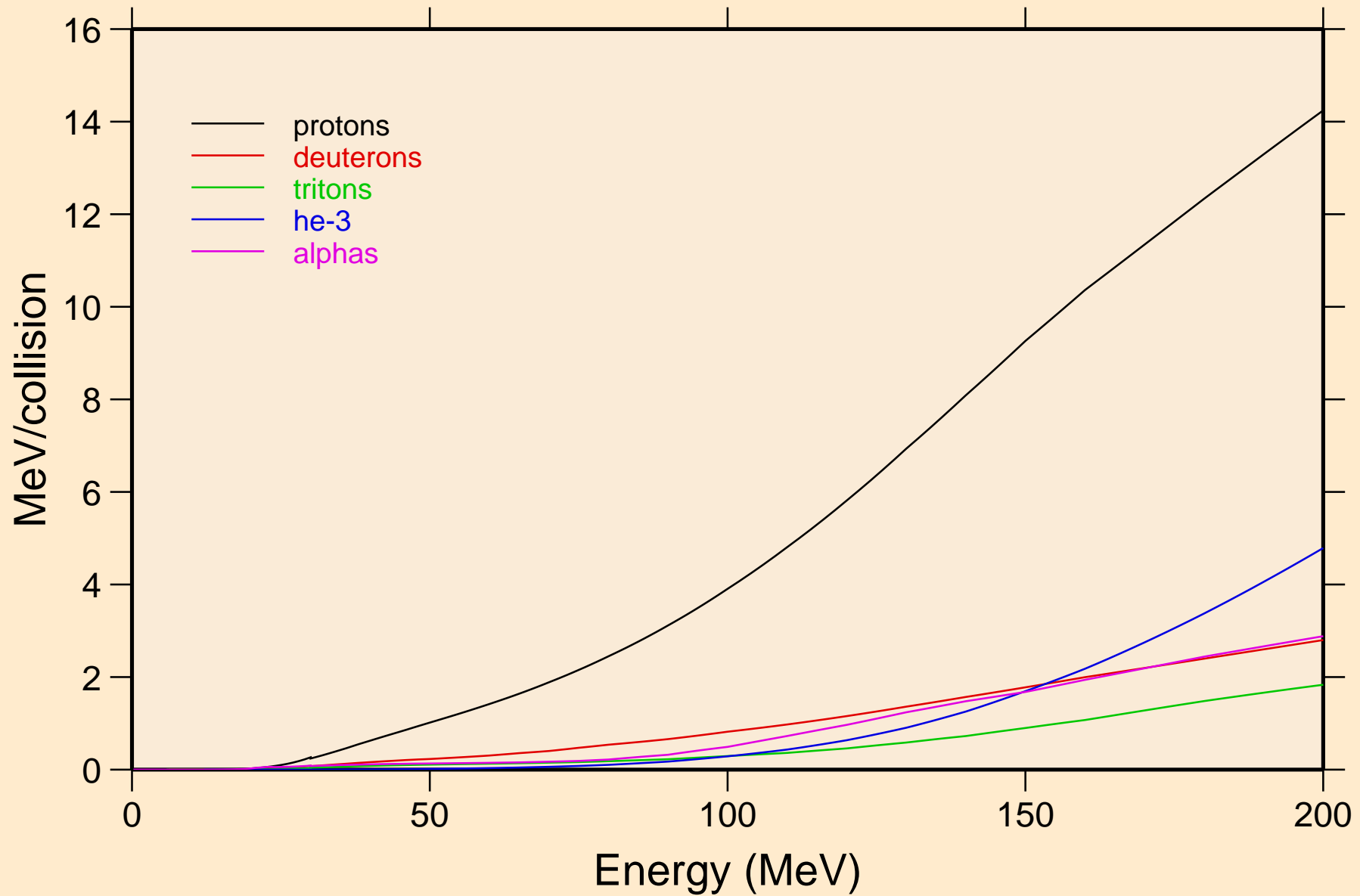

LA145 NEUTRON ACER TENDL-2021 LIBRARY; T=293.6K
Recoil Heating

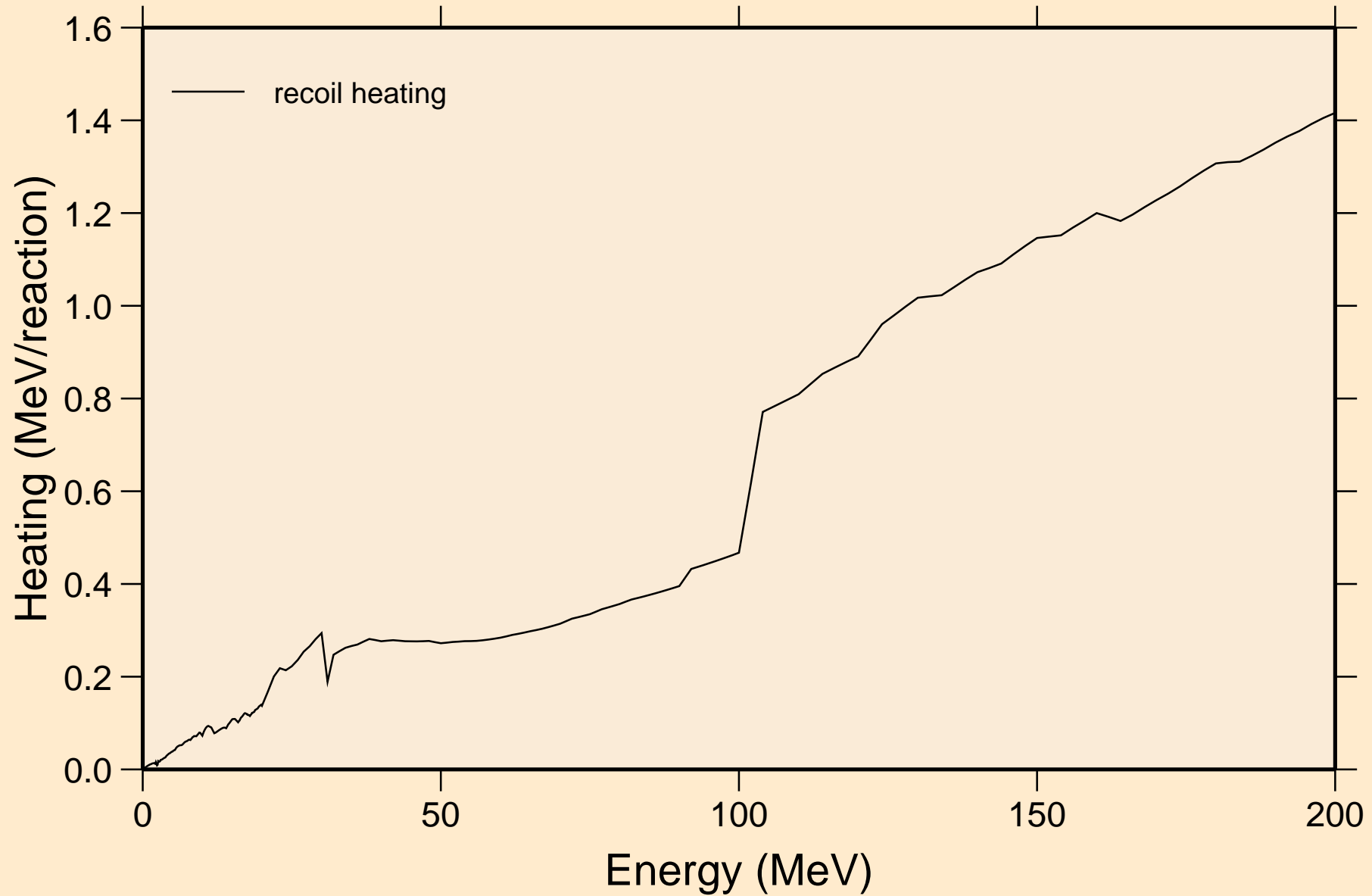

LA145 NEUTRON ACER TENDL-2021 LIBRARY; T=293.6K
Particle production cross sections

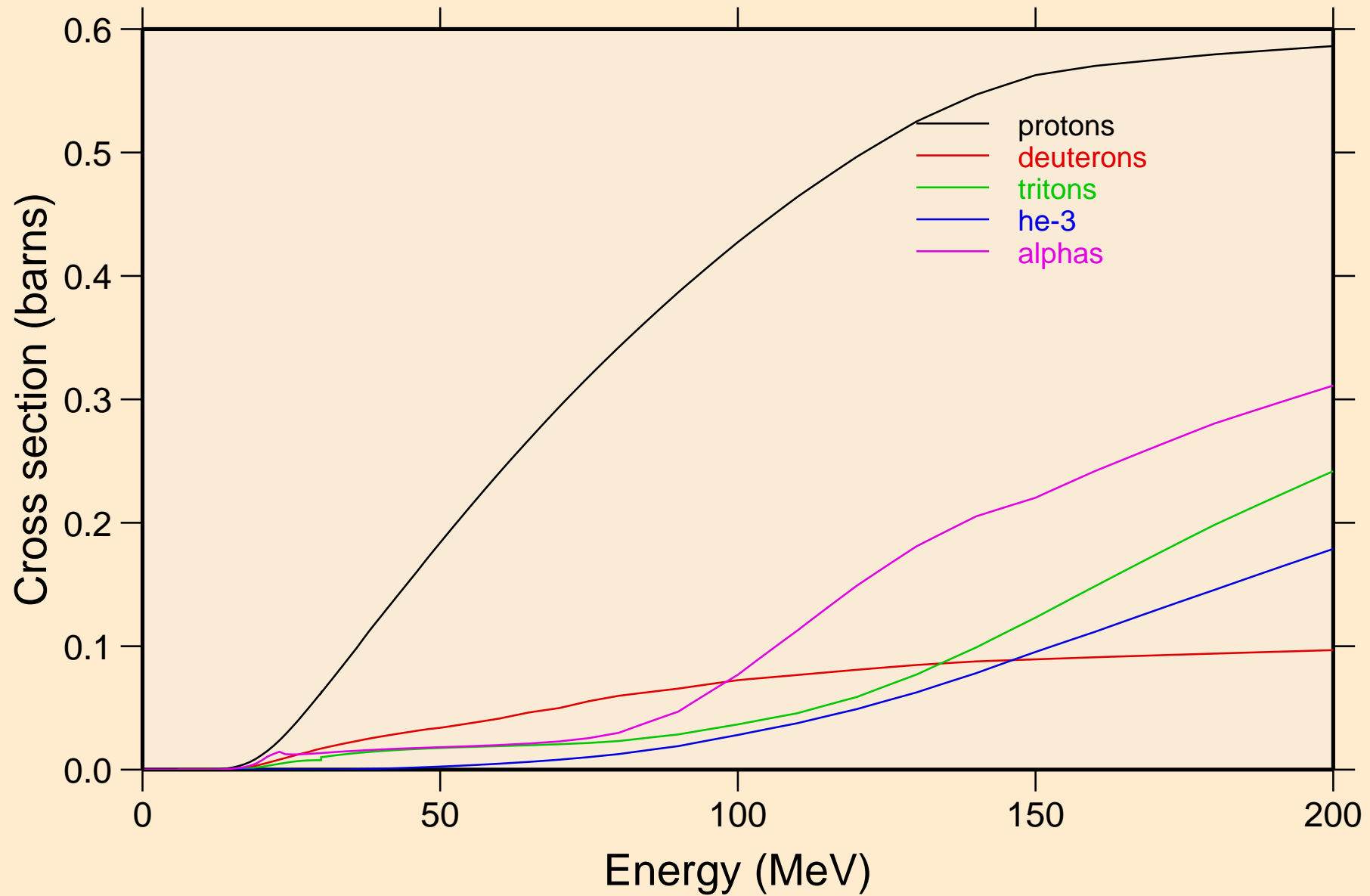

LA145 NEUTRON ACER TENDL-2021 LIBRARY; T=293.6K
protons from (n,x)

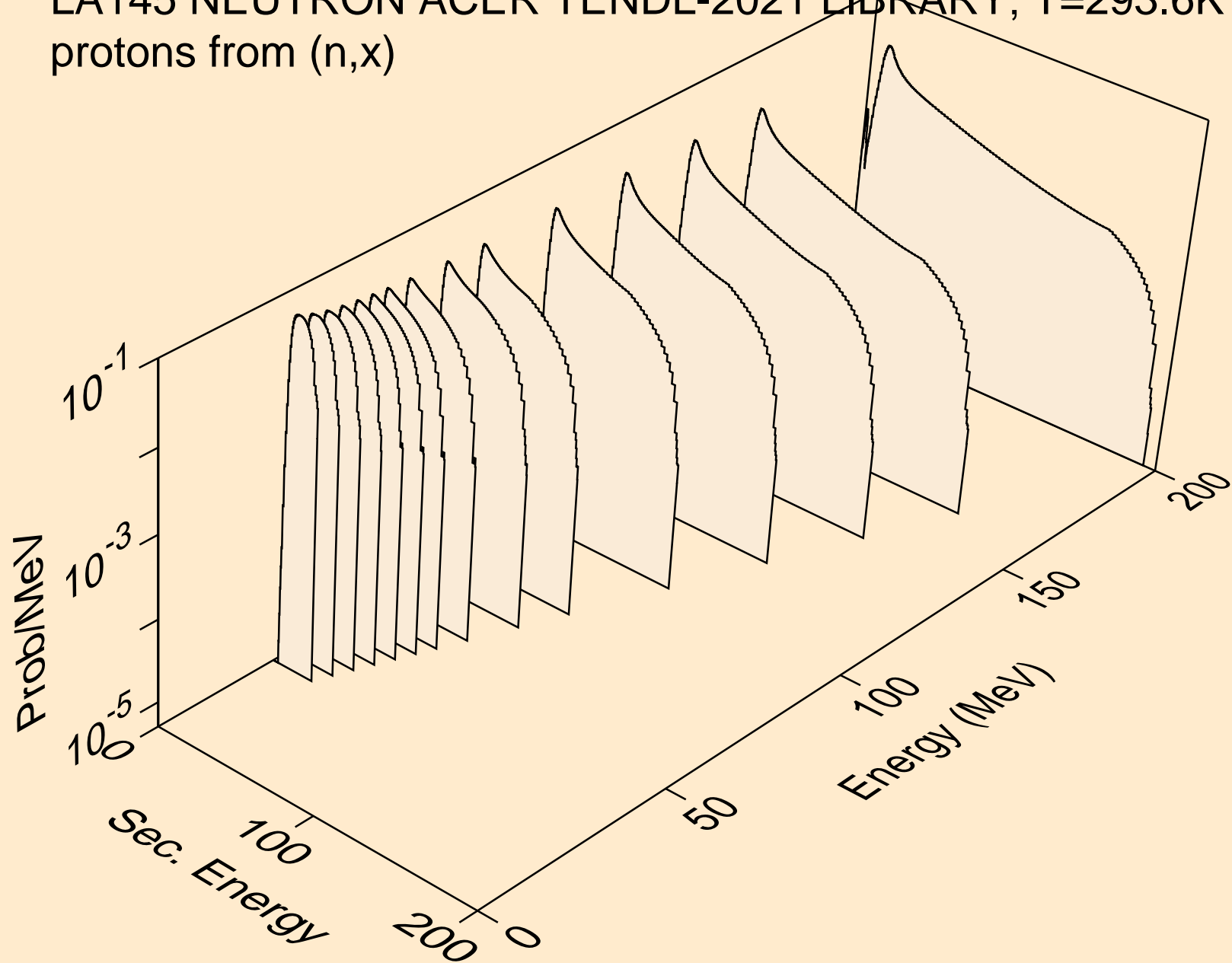

LA145 NEUTRON ACER TENDL-2021 LIBRARY; T=293.6K
protons from (n,n*)p

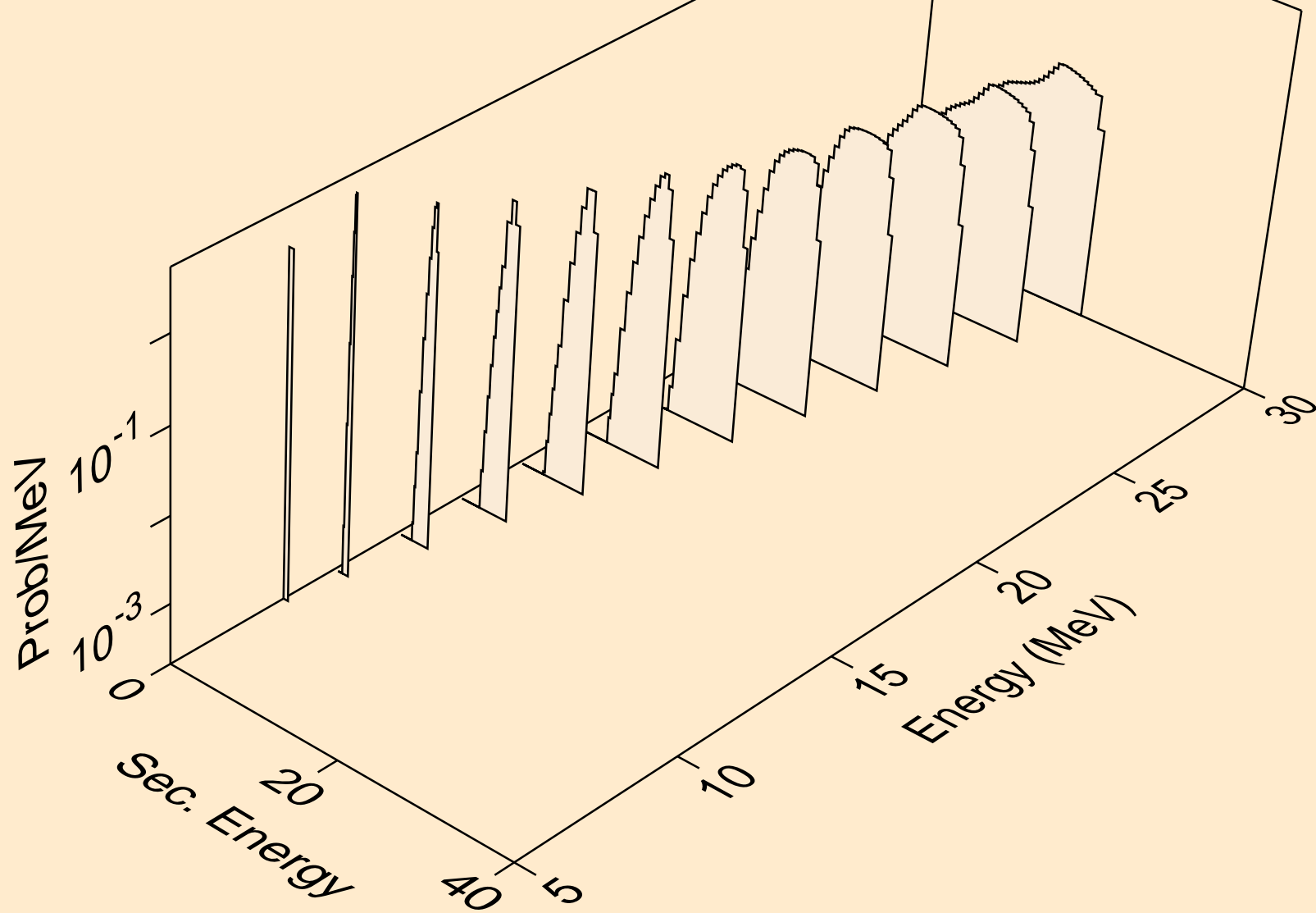

LA145 NEUTRON ACER TENDL-2021 LIBRARY; T=293.6K
protons from (n,2np)

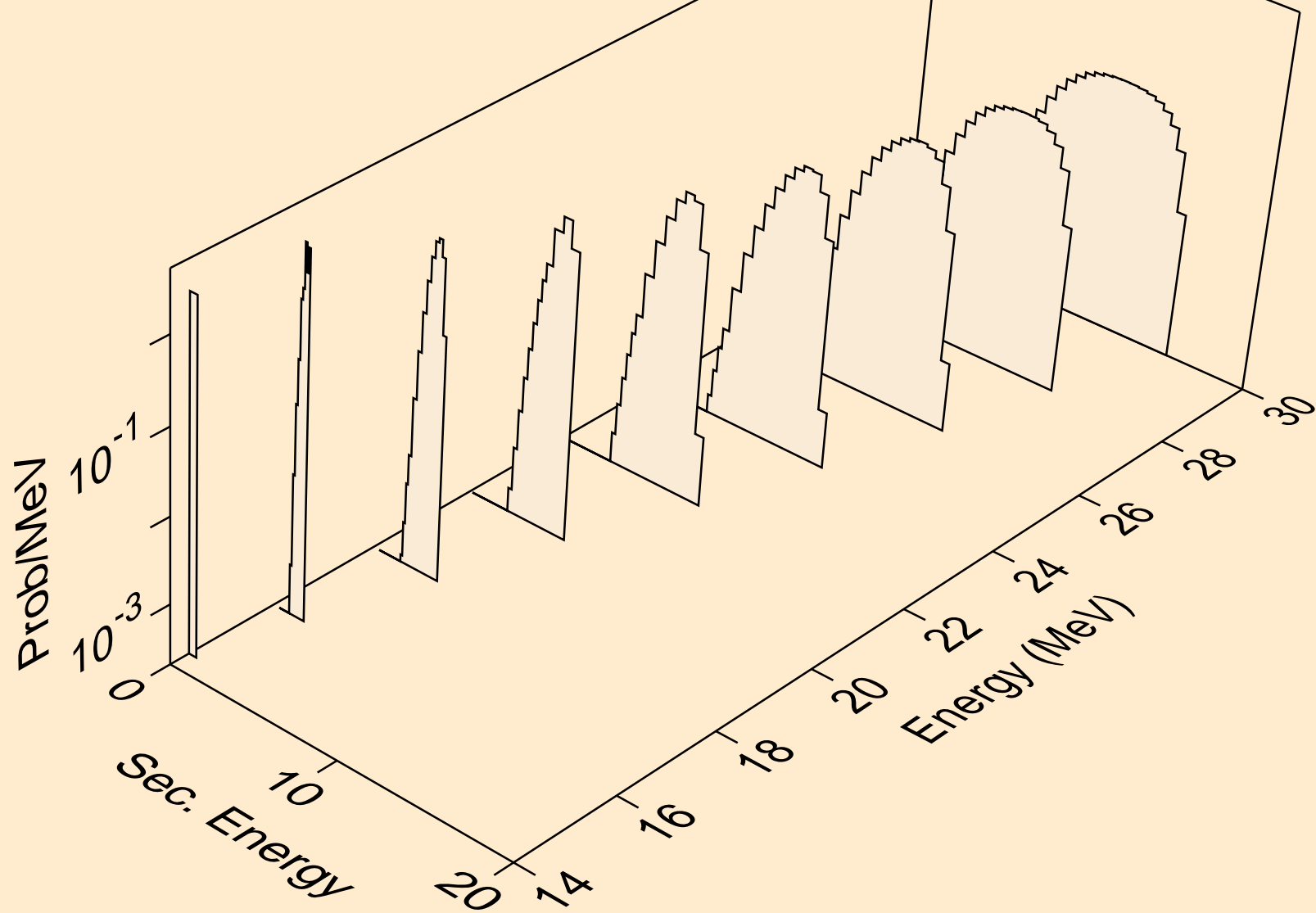

LA145 NEUTRON ACER TENDL-2021 LIBRARY; T=293.6K
protons from (n,3np)

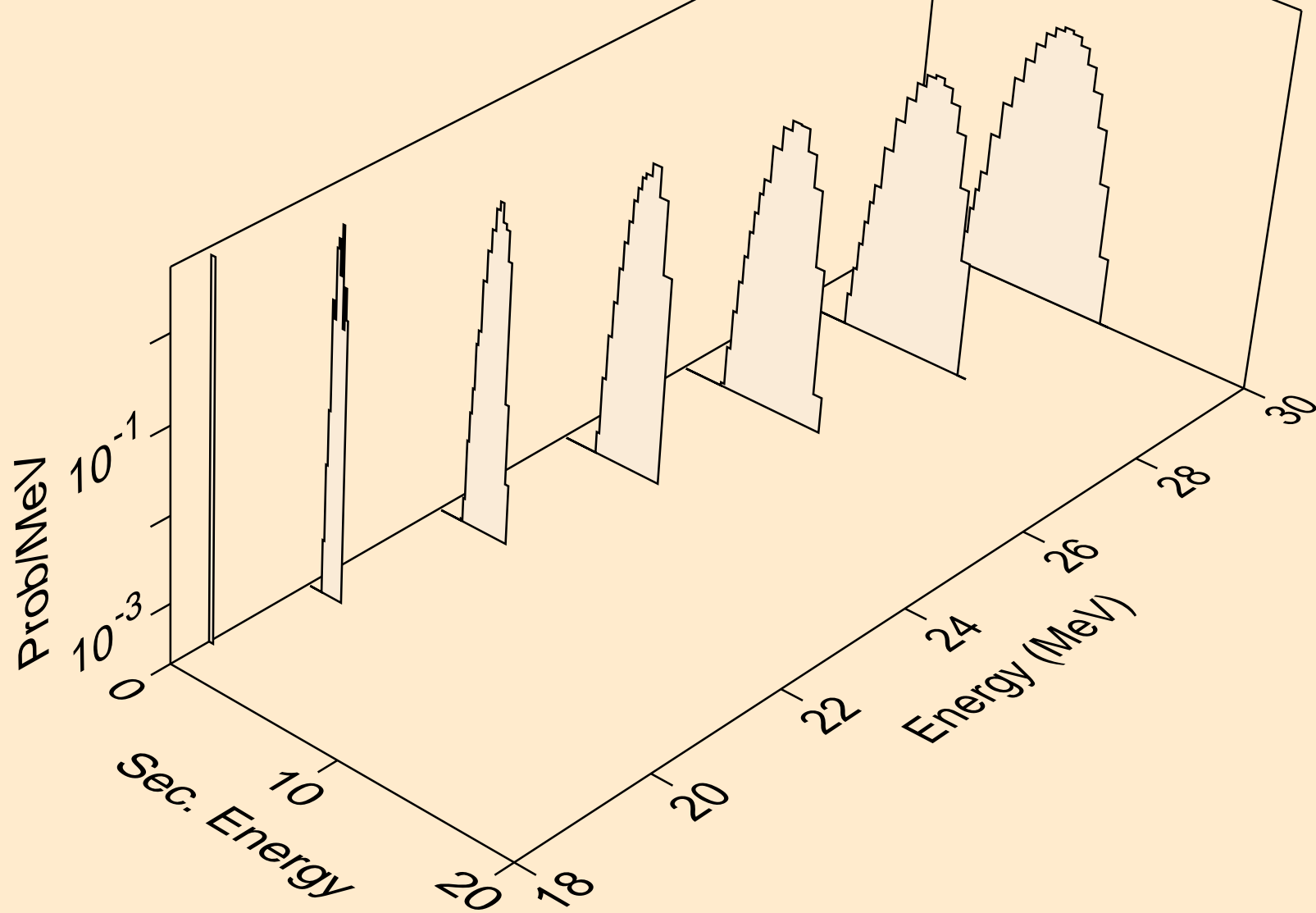

LA145 NEUTRON ACER TENDL-2021 LIBRARY; T=293.6K
protons from (n,p)

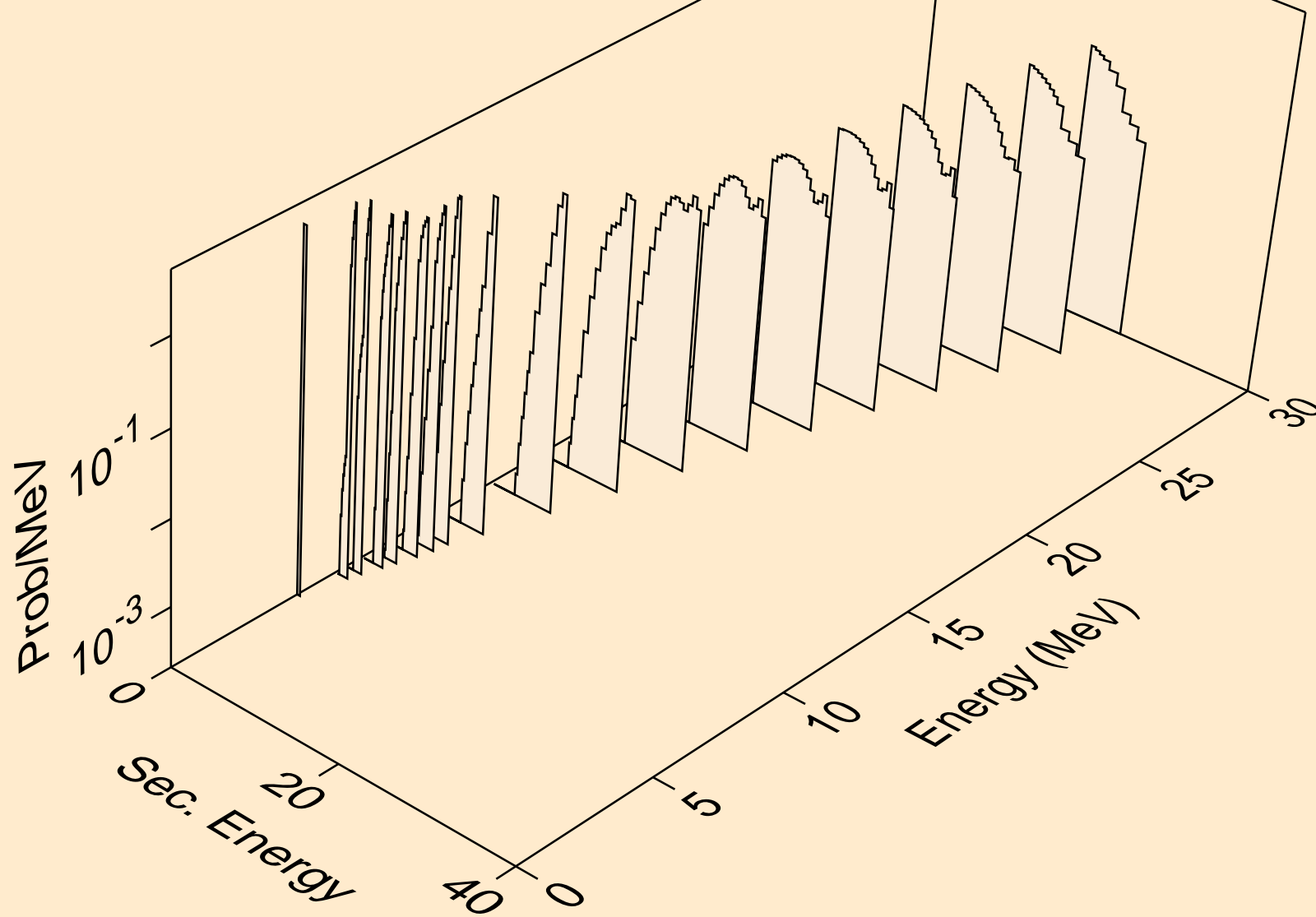

LA145 NEUTRON ACER TENDL-2021 LIBRARY; T=293.6K
protons from (n,2p)

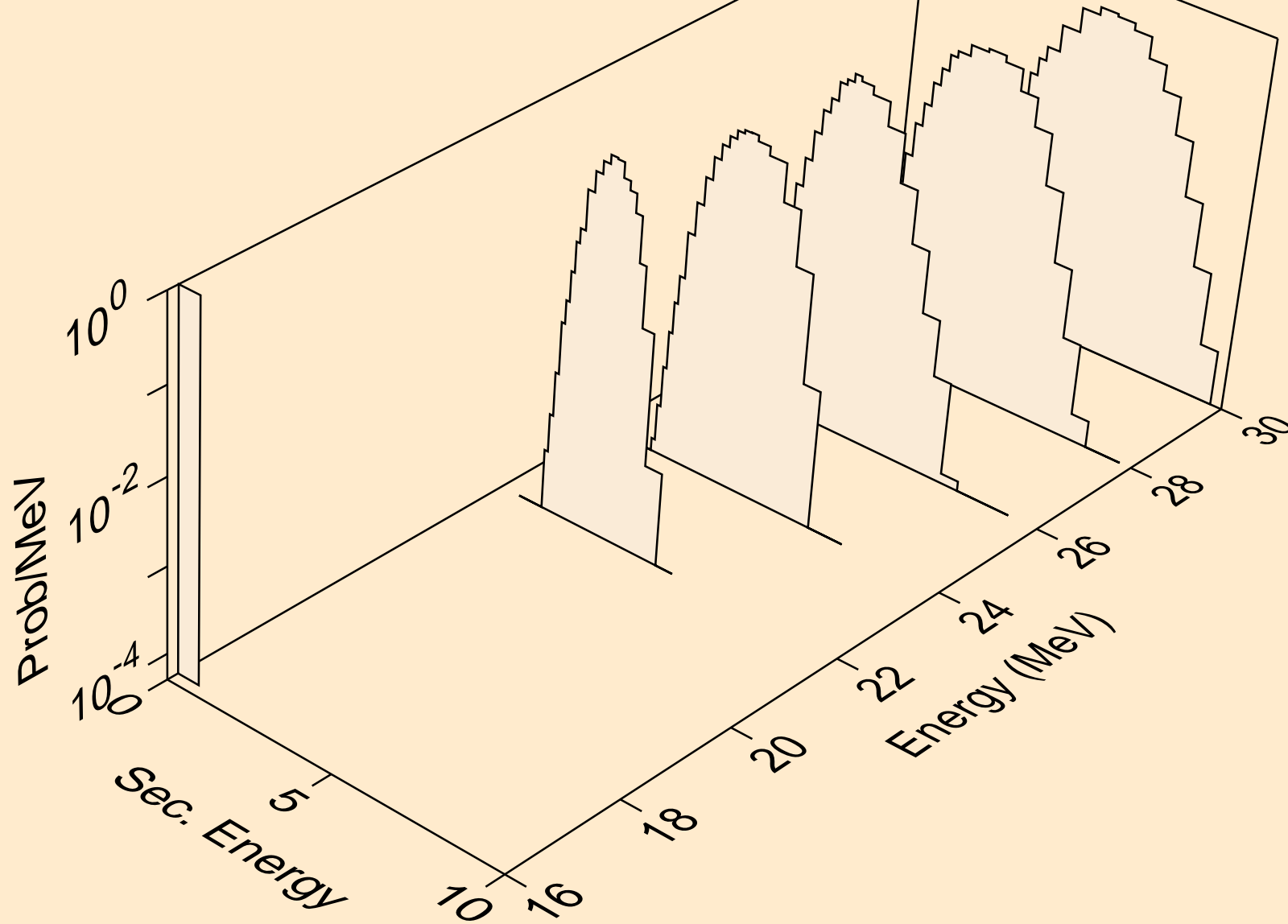

LA145 NEUTRON ACER TENDL-2021 LIBRARY; T=293.6K
deuterons from (n,x)

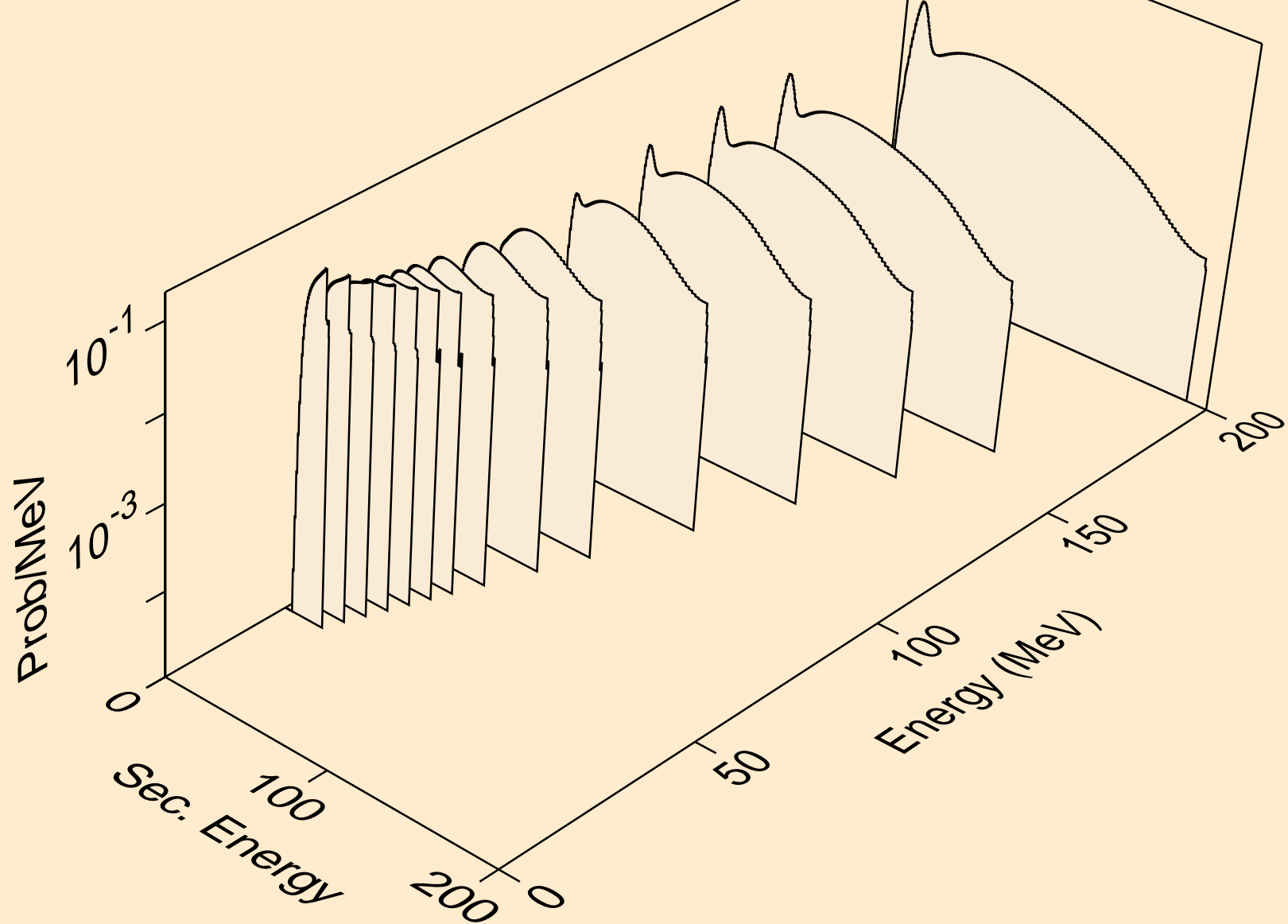

LA145 NEUTRON ACER TENDL-2021 LIBRARY; T=293.6K
deuterons from (n,2nd)

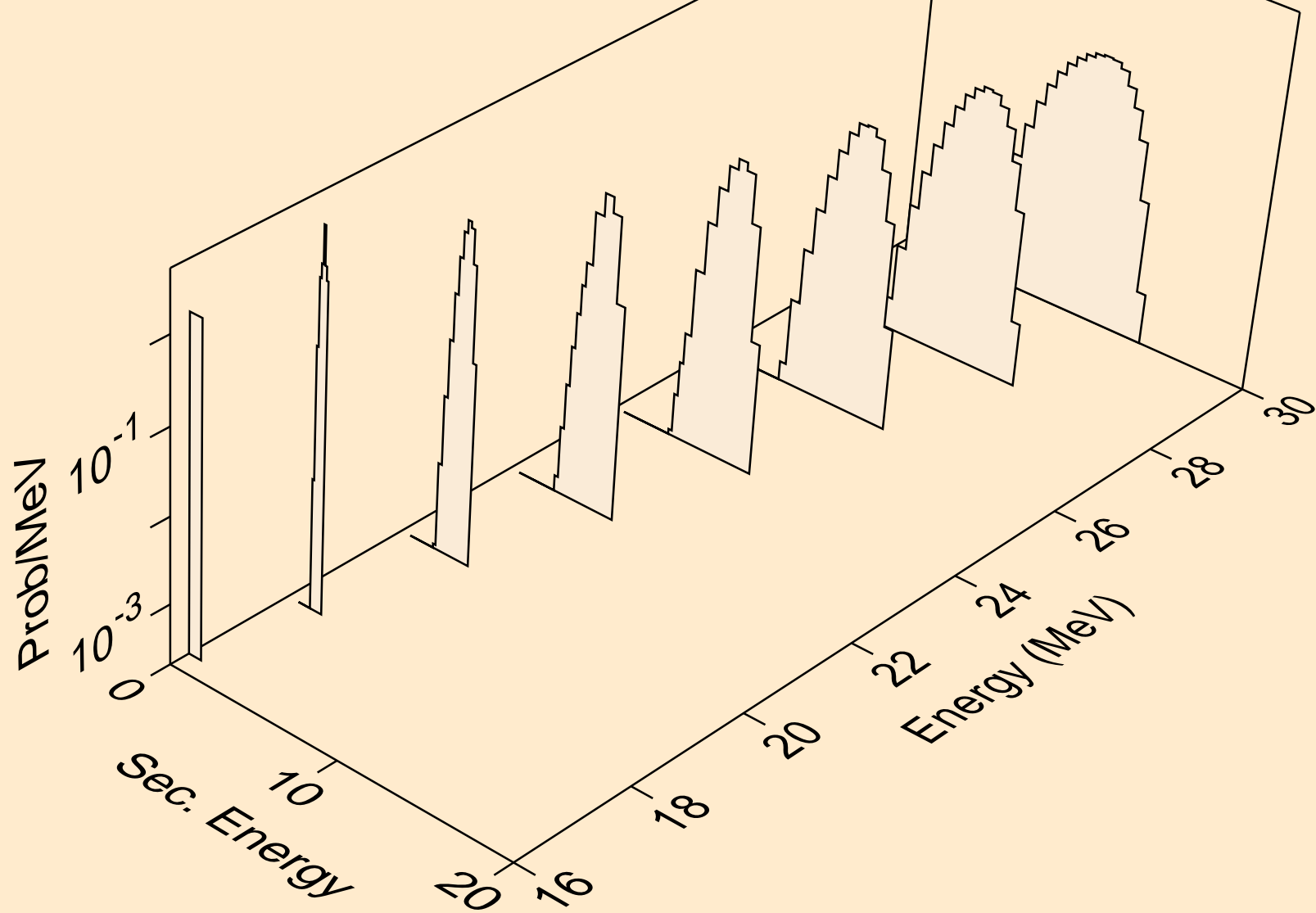

LA145 NEUTRON ACER TENDL-2021 LIBRARY; T=293.6K
deuterons from (n,n*)d

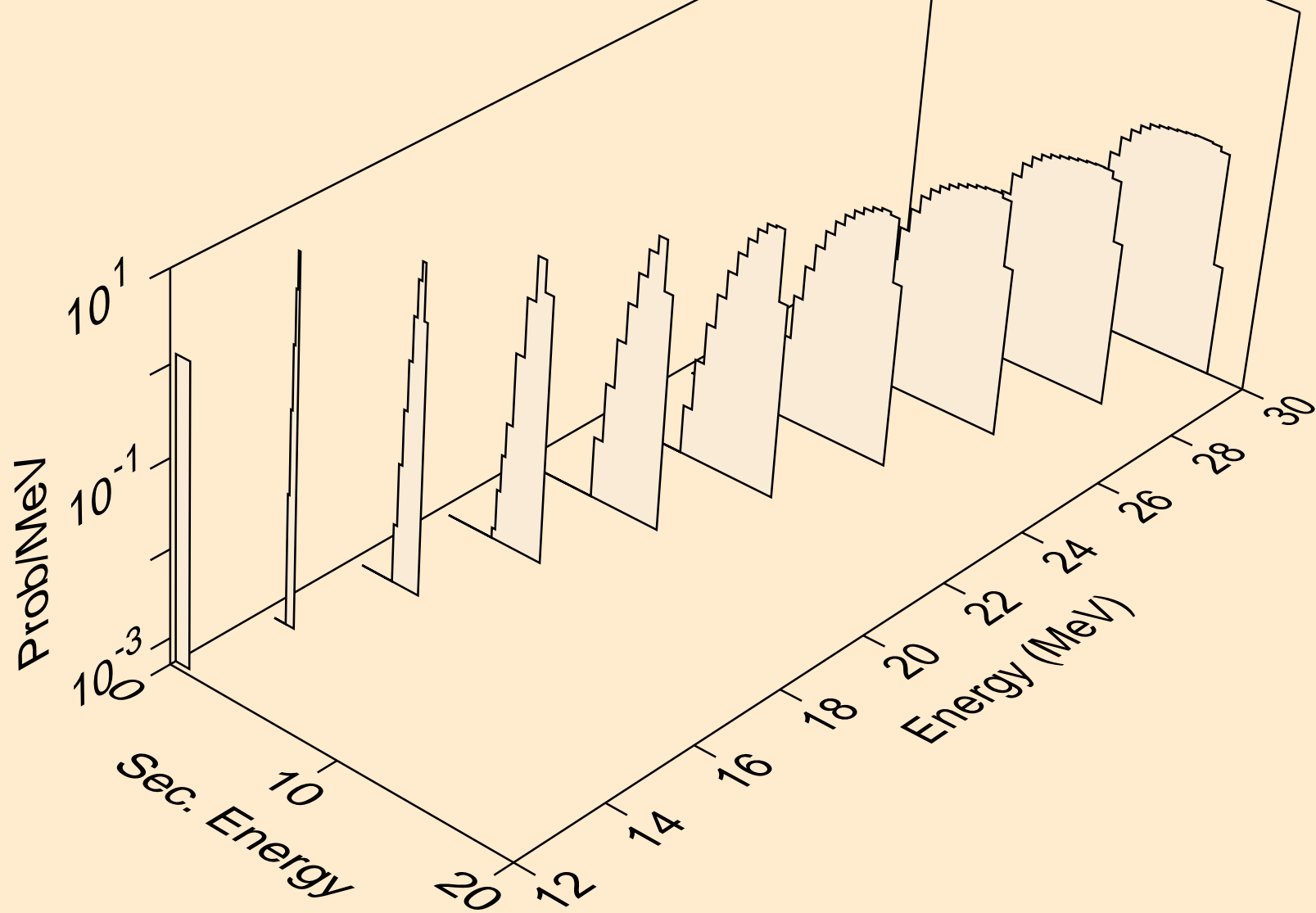

LA145 NEUTRON ACER TENDL-2021 LIBRARY; T=293.6K
deuterons from (n,d)

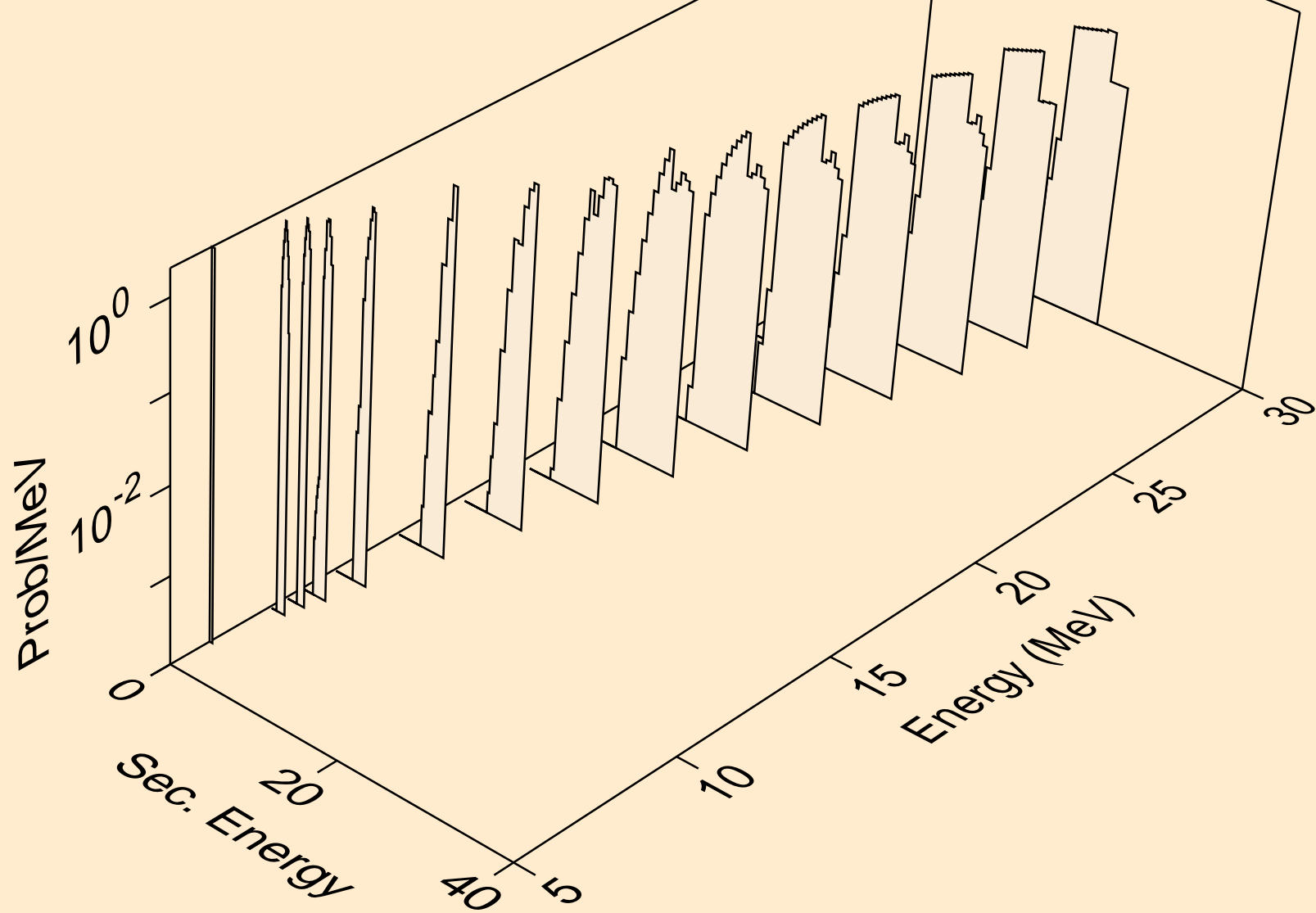

LA145 NEUTRON ACER TENDL-2021 LIBRARY; T=293.6K
tritons from (n,x)

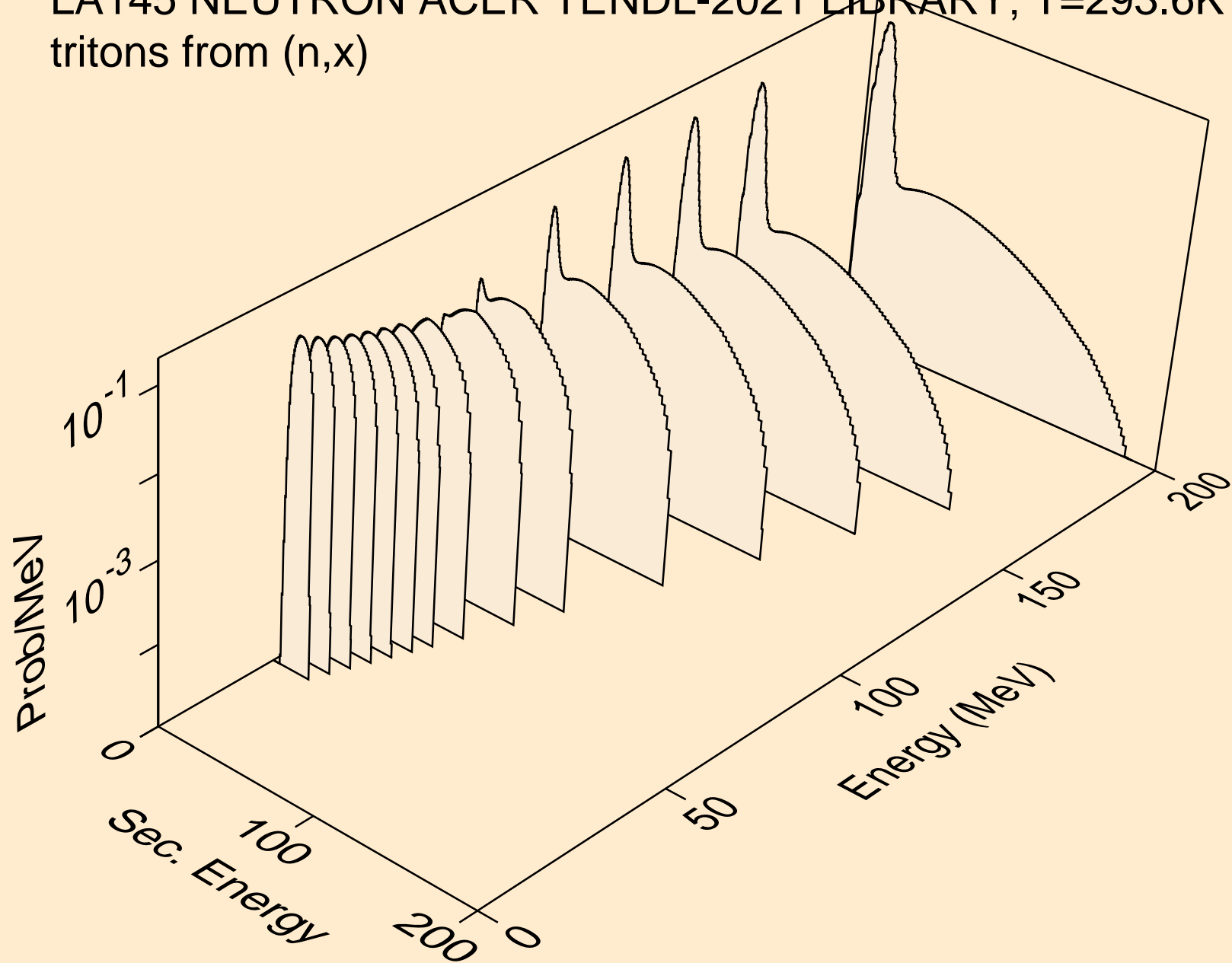

LA145 NEUTRON ACER TENDL-2021 LIBRARY; T=293.6K
tritons from (n,n*)t

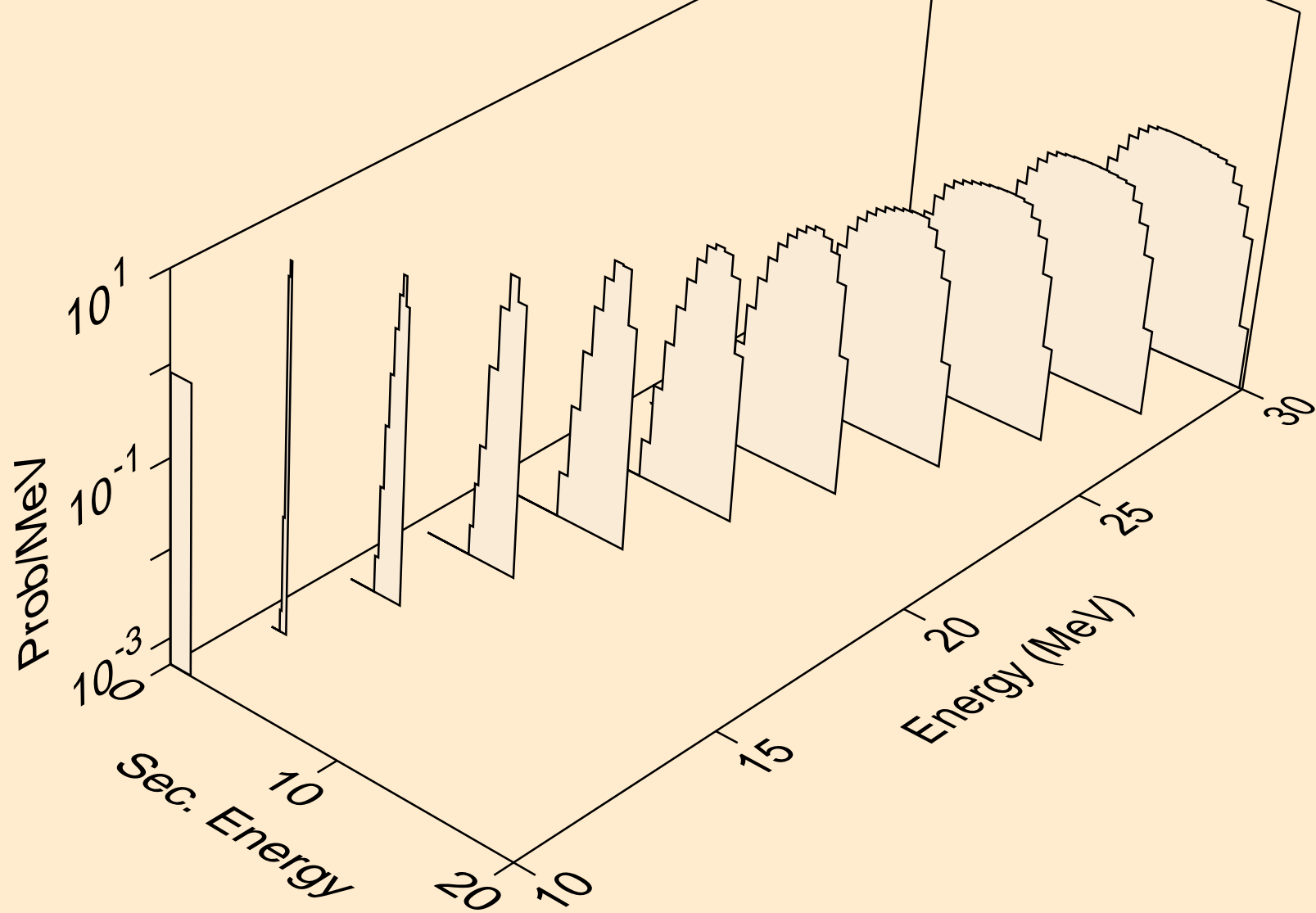

LA145 NEUTRON ACER TENDL-2021 LIBRARY; T=293.6K
tritons from (n,t)

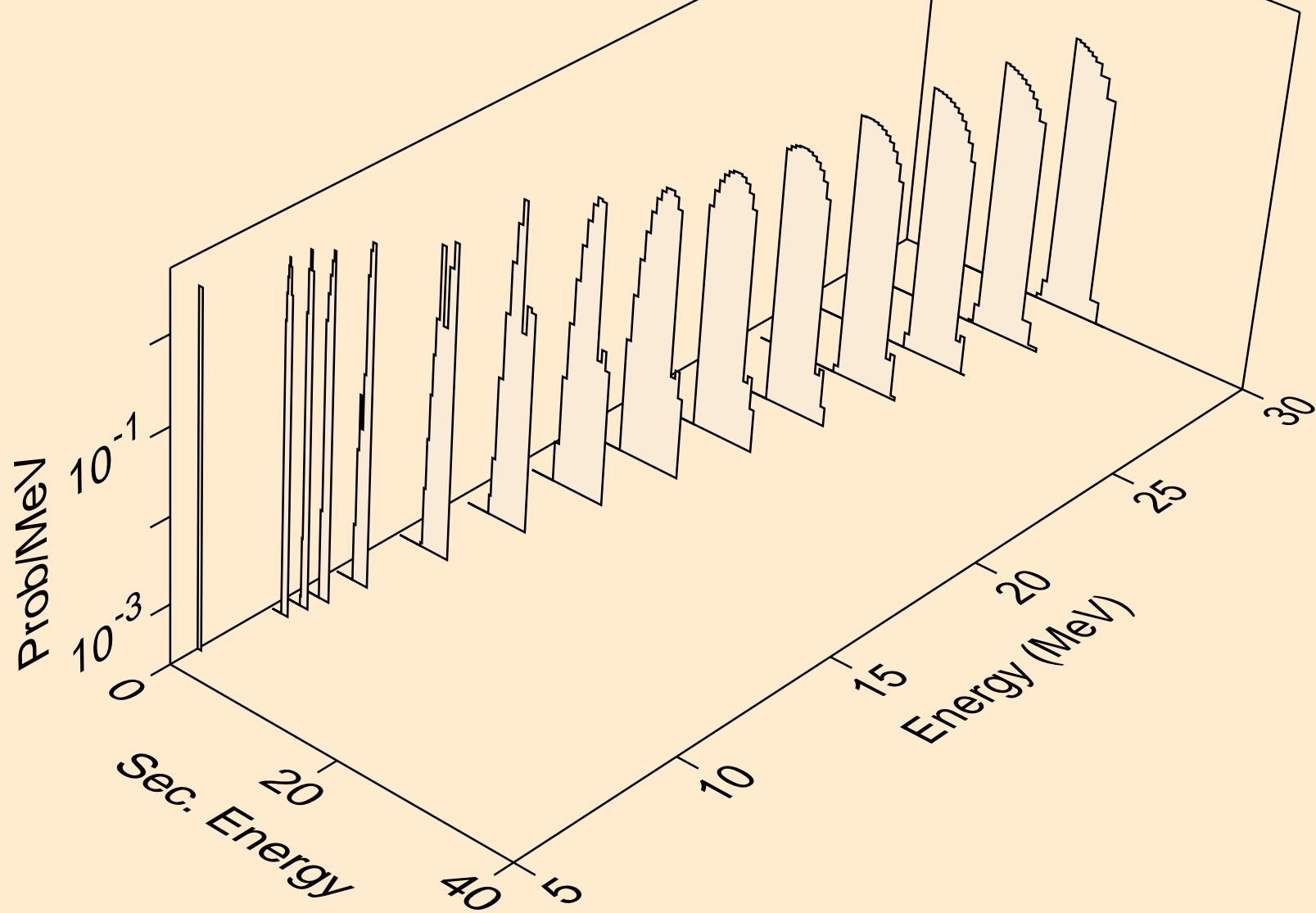

LA145 NEUTRON ACER TENDL-2021 LIBRARY; T=293.6K
he3s from (n,x)

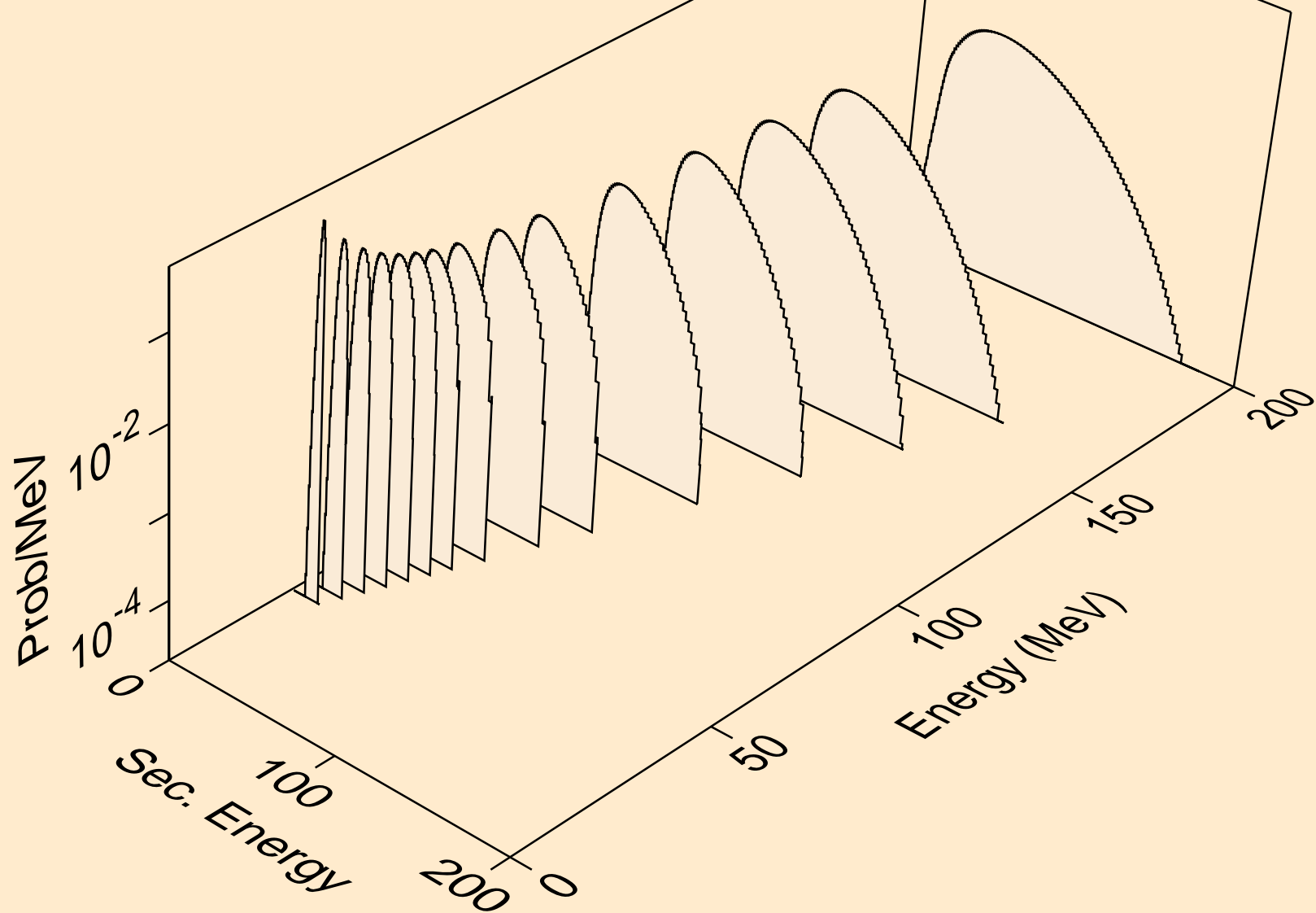

LA145 NEUTRON ACER TENDL-2021 LIBRARY; T=293.6K
he3s from (n,n*)he3

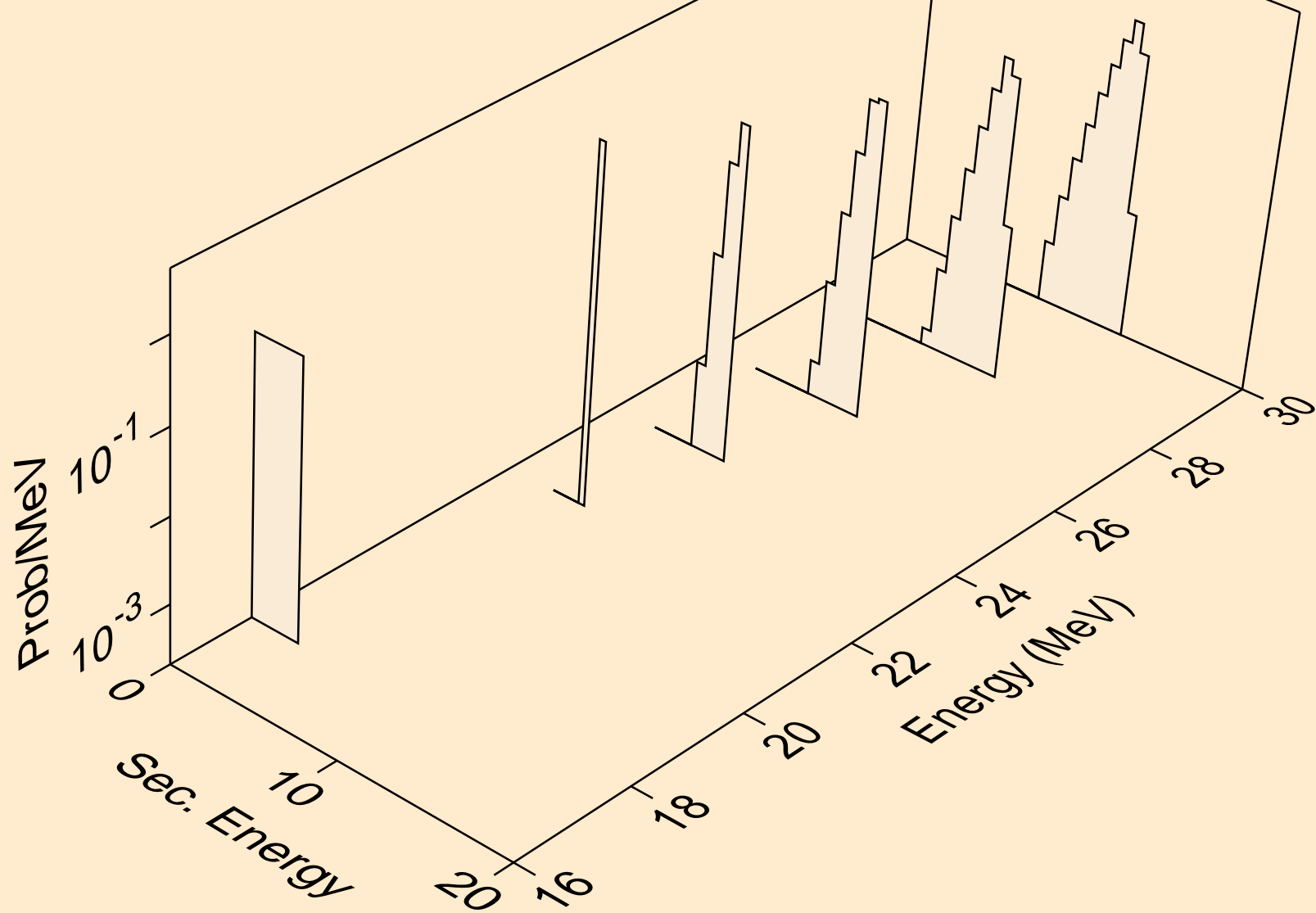

LA145 NEUTRON ACER TENDL-2021 LIBRARY; T=293.6K
he3s from (n,he3)

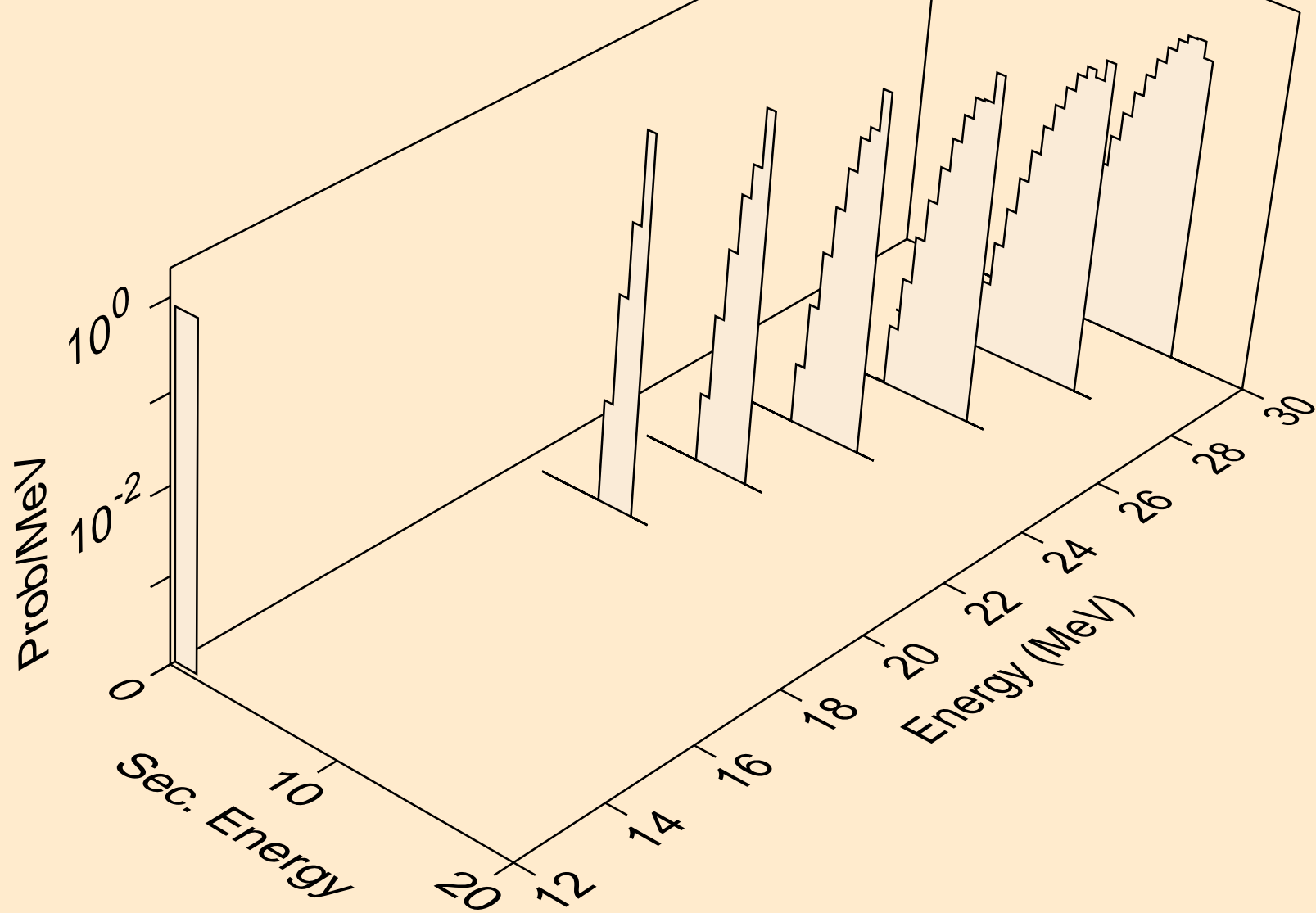

LA145 NEUTRON ACER TENDL-2021 LIBRARY; T=293.6K
alphas from (n,x)

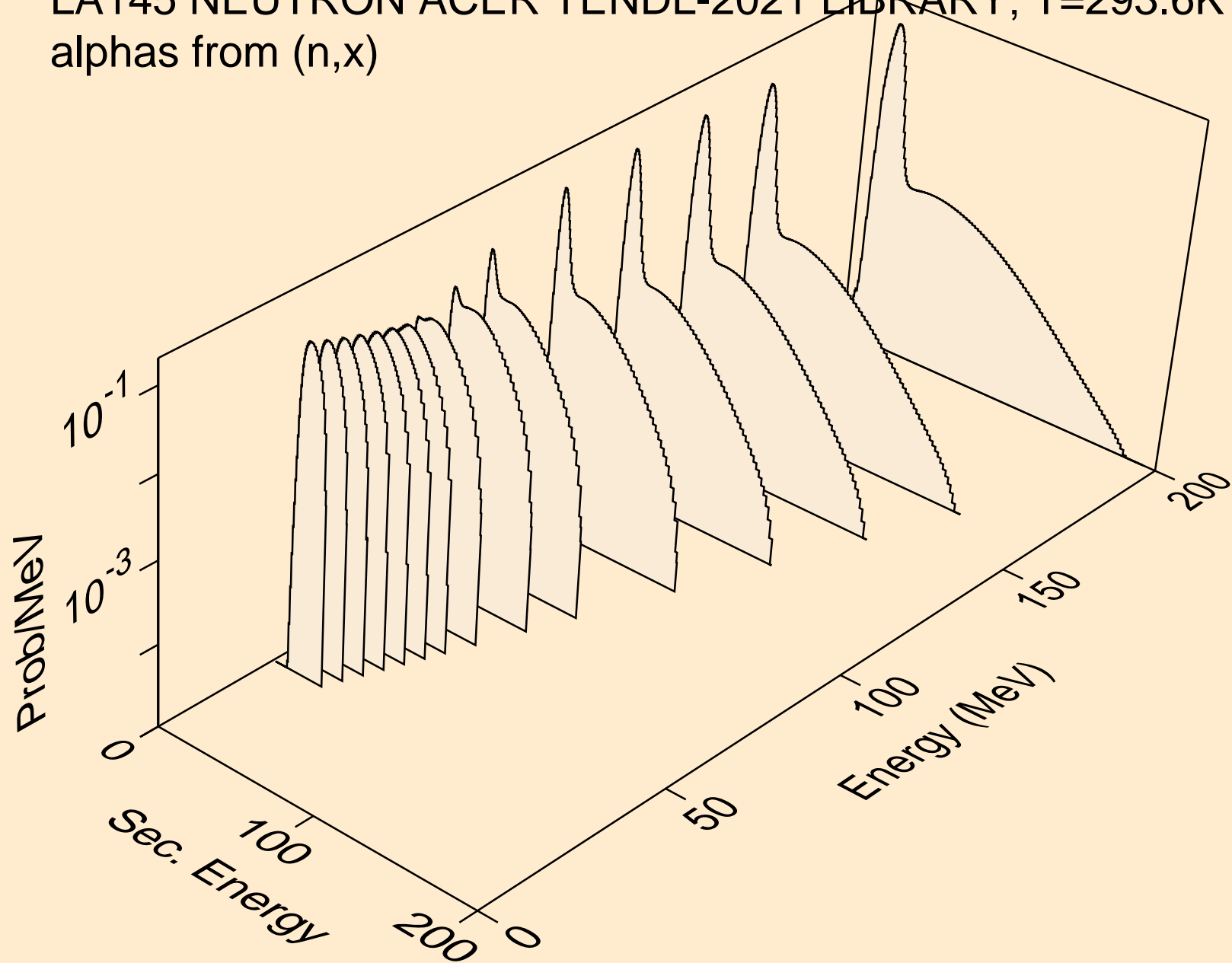

LA145 NEUTRON ACER TENDL-2021 LIBRARY; T=293.6K
alphas from (n,n*)a

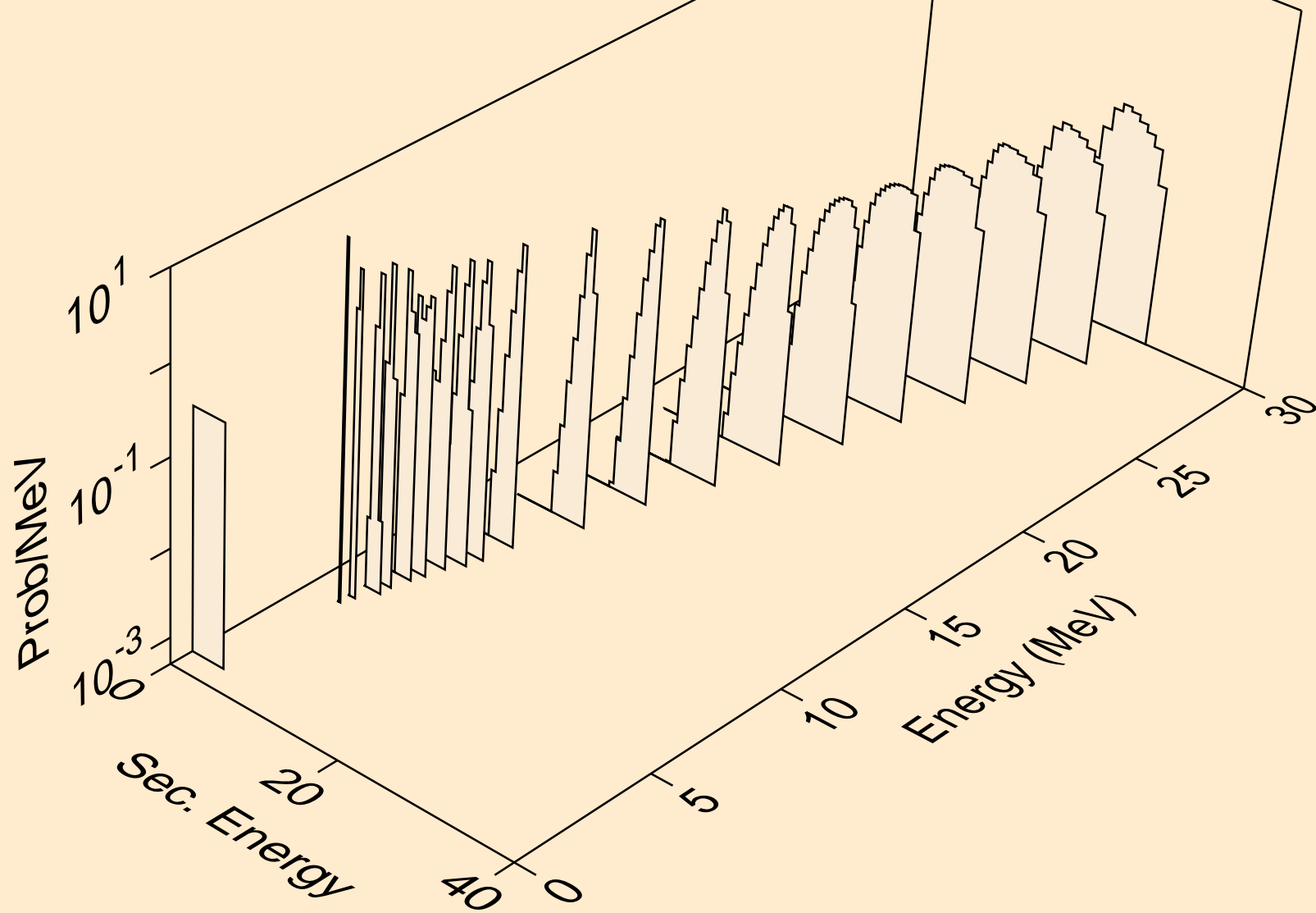

LA145 NEUTRON ACER TENDL-2021 LIBRARY; T=293.6K
alphas from (n,2n)a

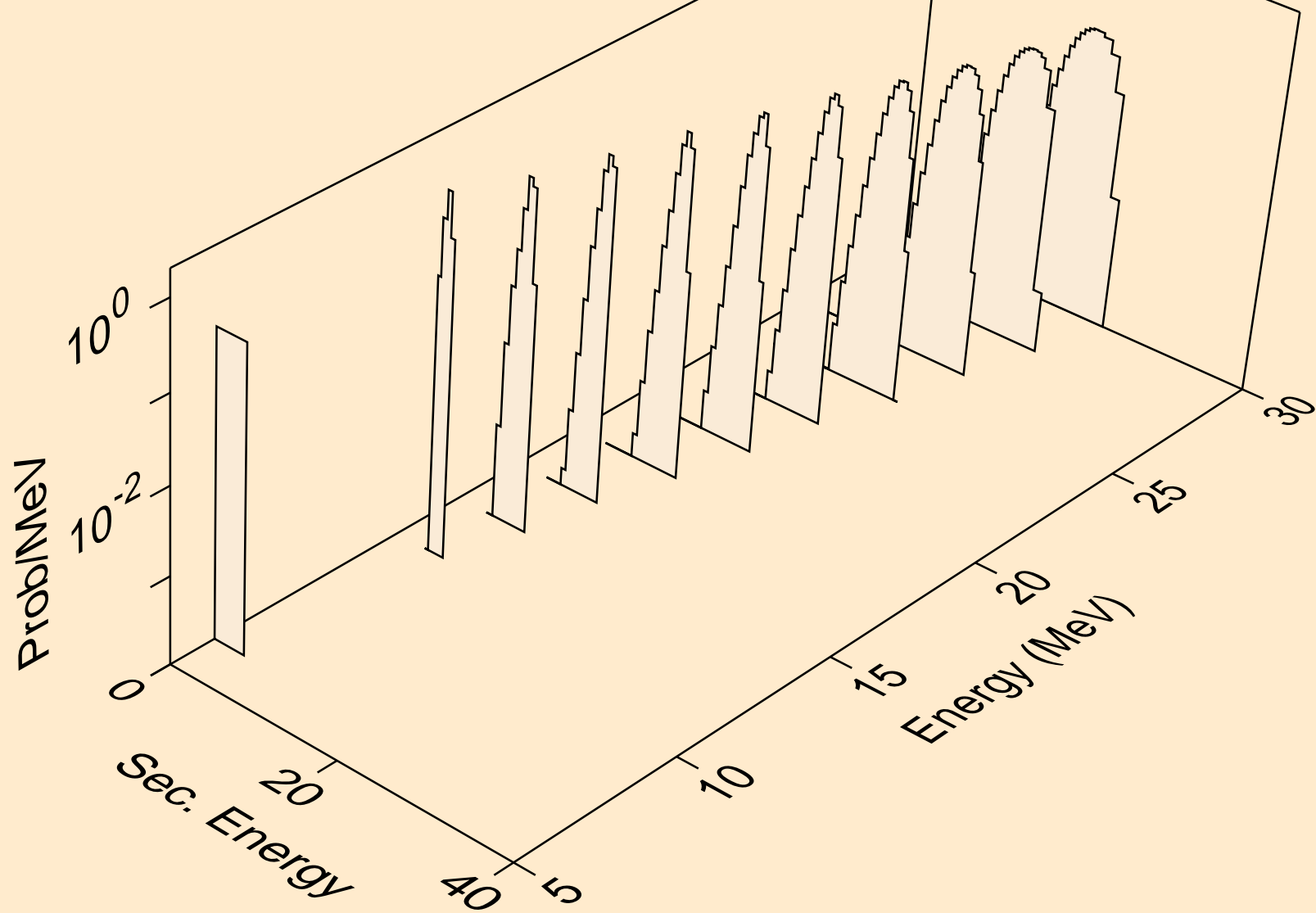

LA145 NEUTRON ACER TENDL-2021 LIBRARY; T=293.6K
alphas from (n,3n)a

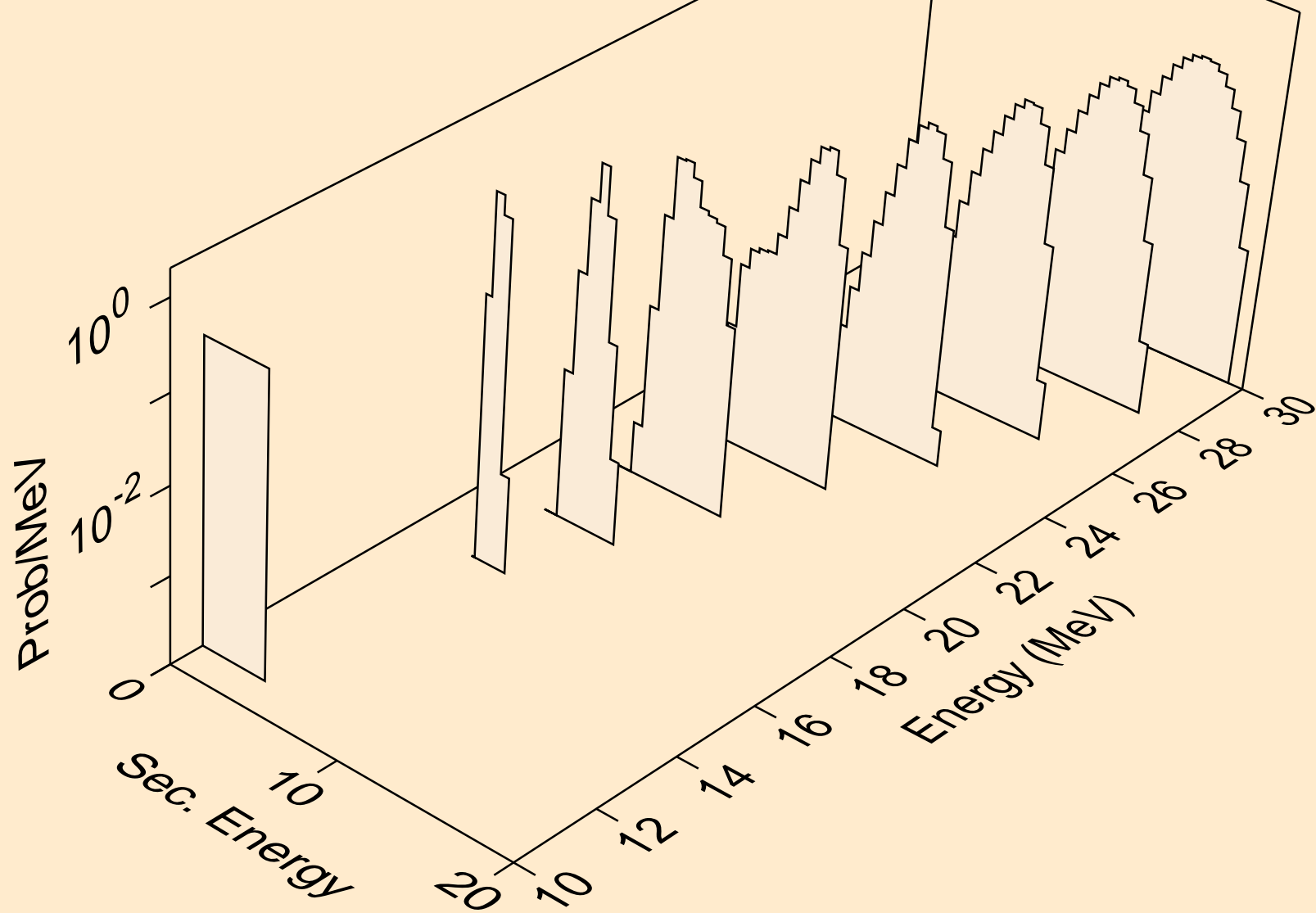

LA145 NEUTRON ACER TENDL-2021 LIBRARY; T=293.6K
alphas from (n,a)

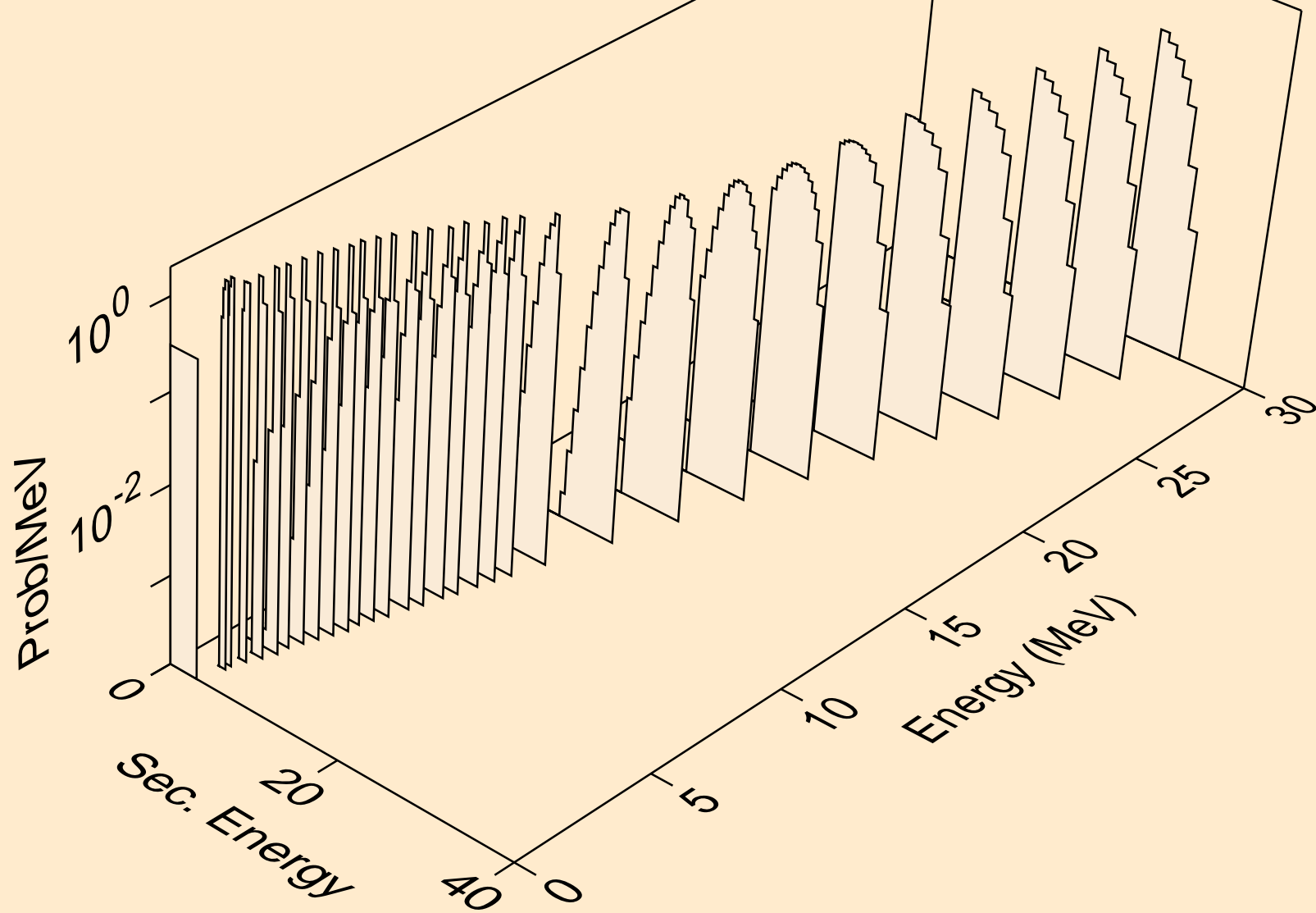

LA145 NEUTRON ACER TENDL-2021 LIBRARY; T=293.6K
alphas from (n,2a)

