

LR259 NEUTRON ACER TENDL-2021 LIBRARY; T=293.6K

Principal cross sections

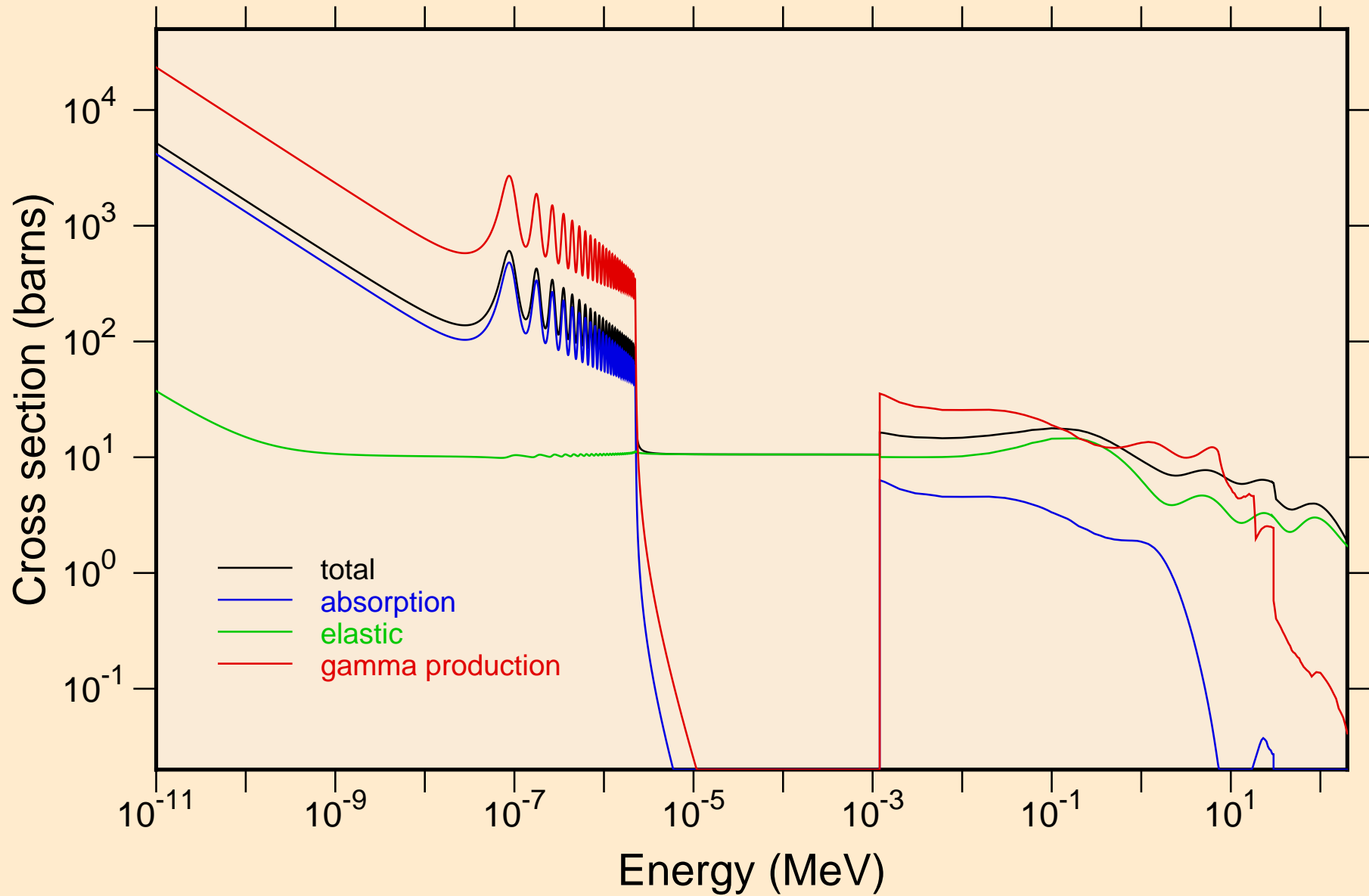

LR259 NEUTRON ACER TENDL-2021 LIBRARY; T=293.6K
resonance total cross section

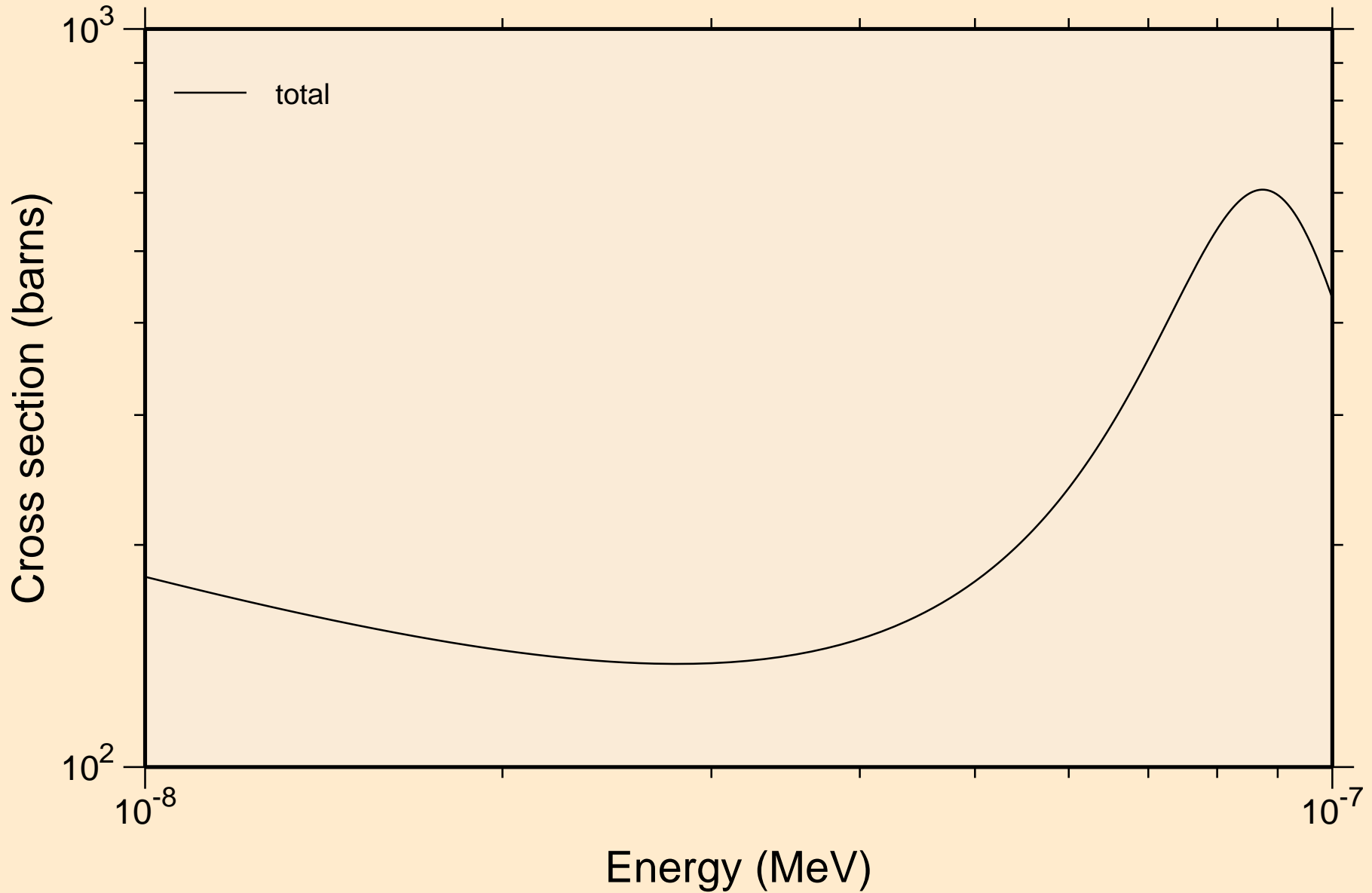

LR259 NEUTRON ACER TENDL-2021 LIBRARY; T=293.6K
resonance total cross section

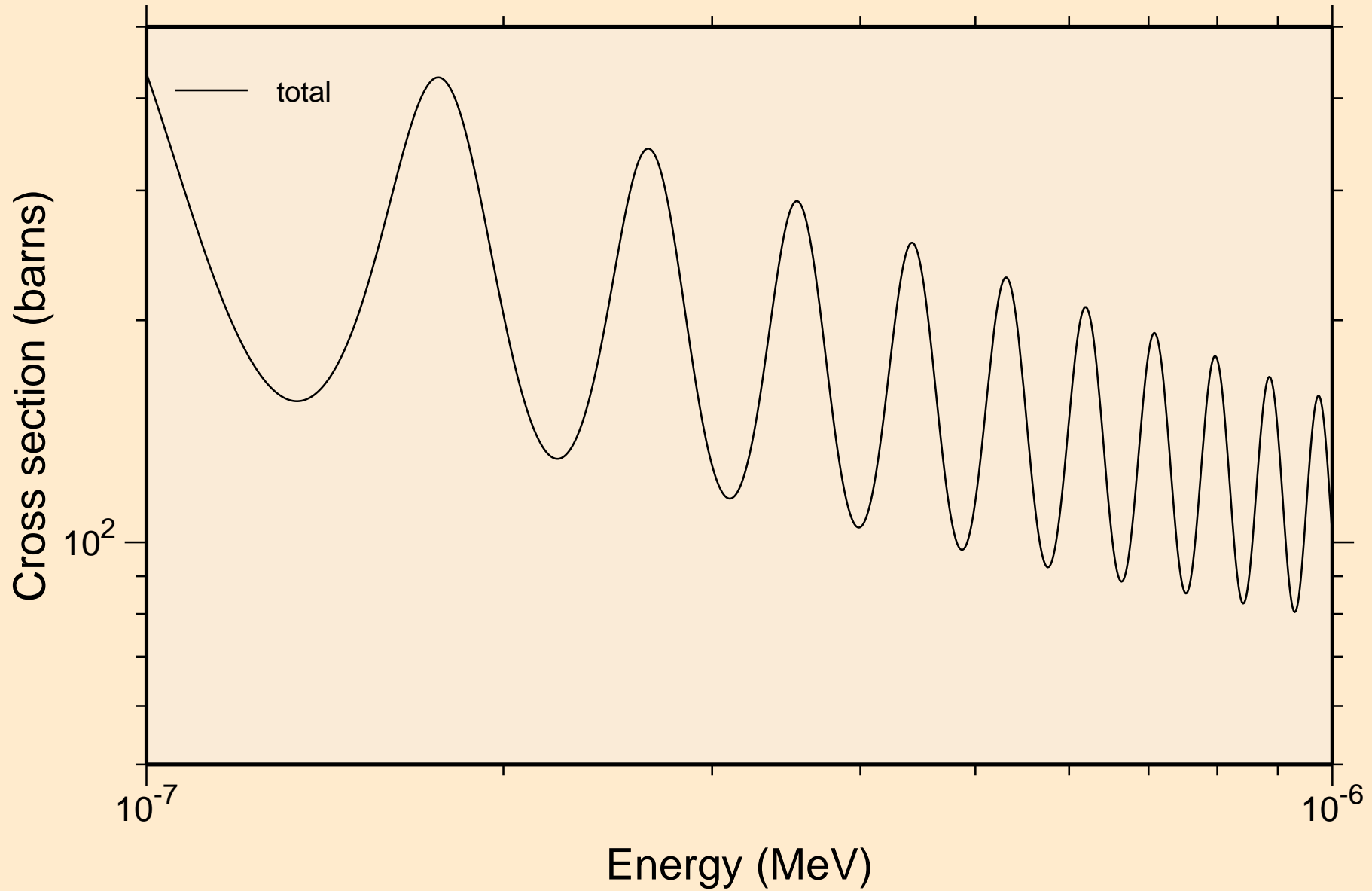

LR259 NEUTRON ACER TENDL-2021 LIBRARY; T=293.6K
resonance total cross section

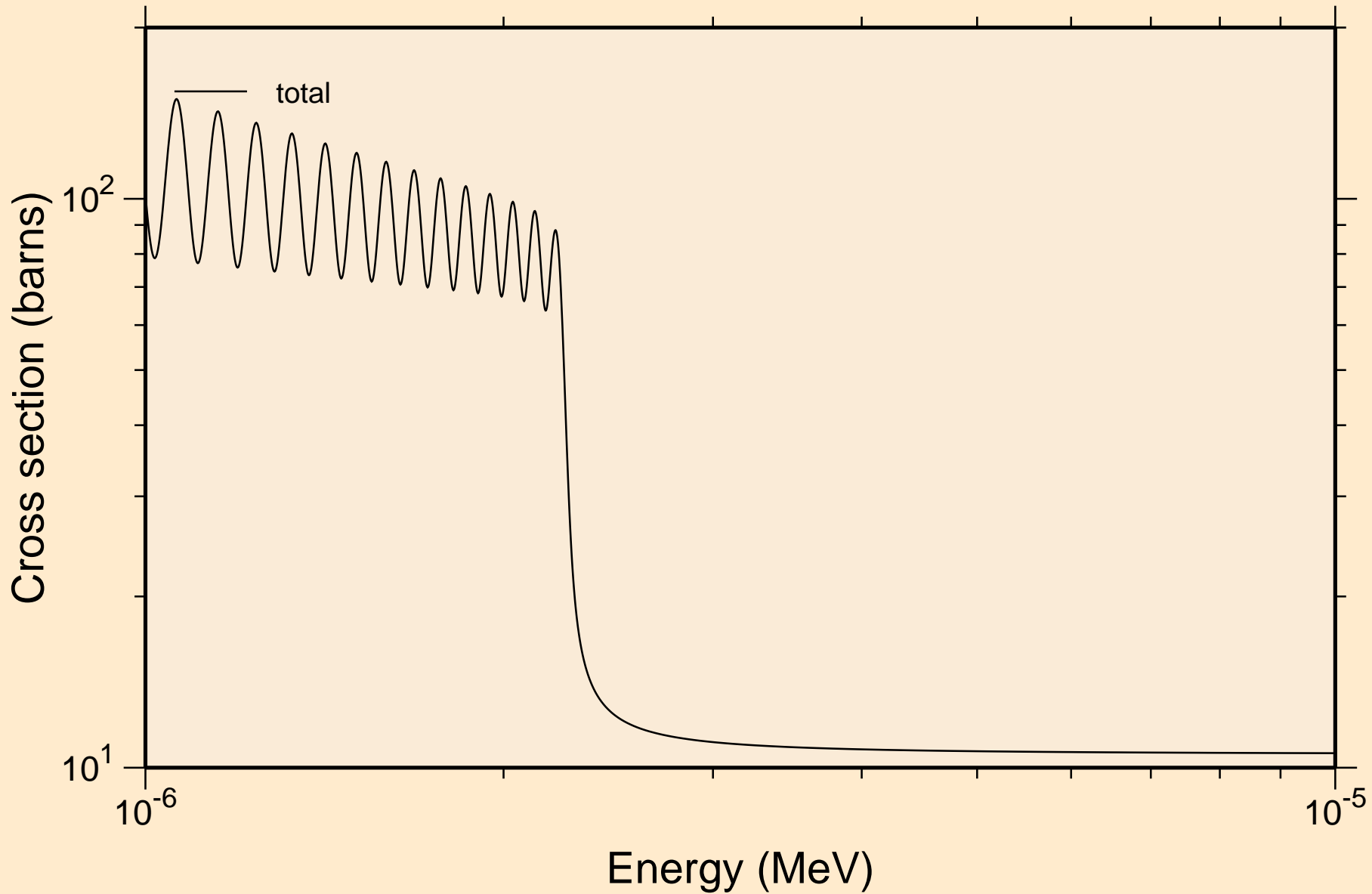

LR259 NEUTRON ACER TENDL-2021 LIBRARY; T=293.6K
resonance total cross section

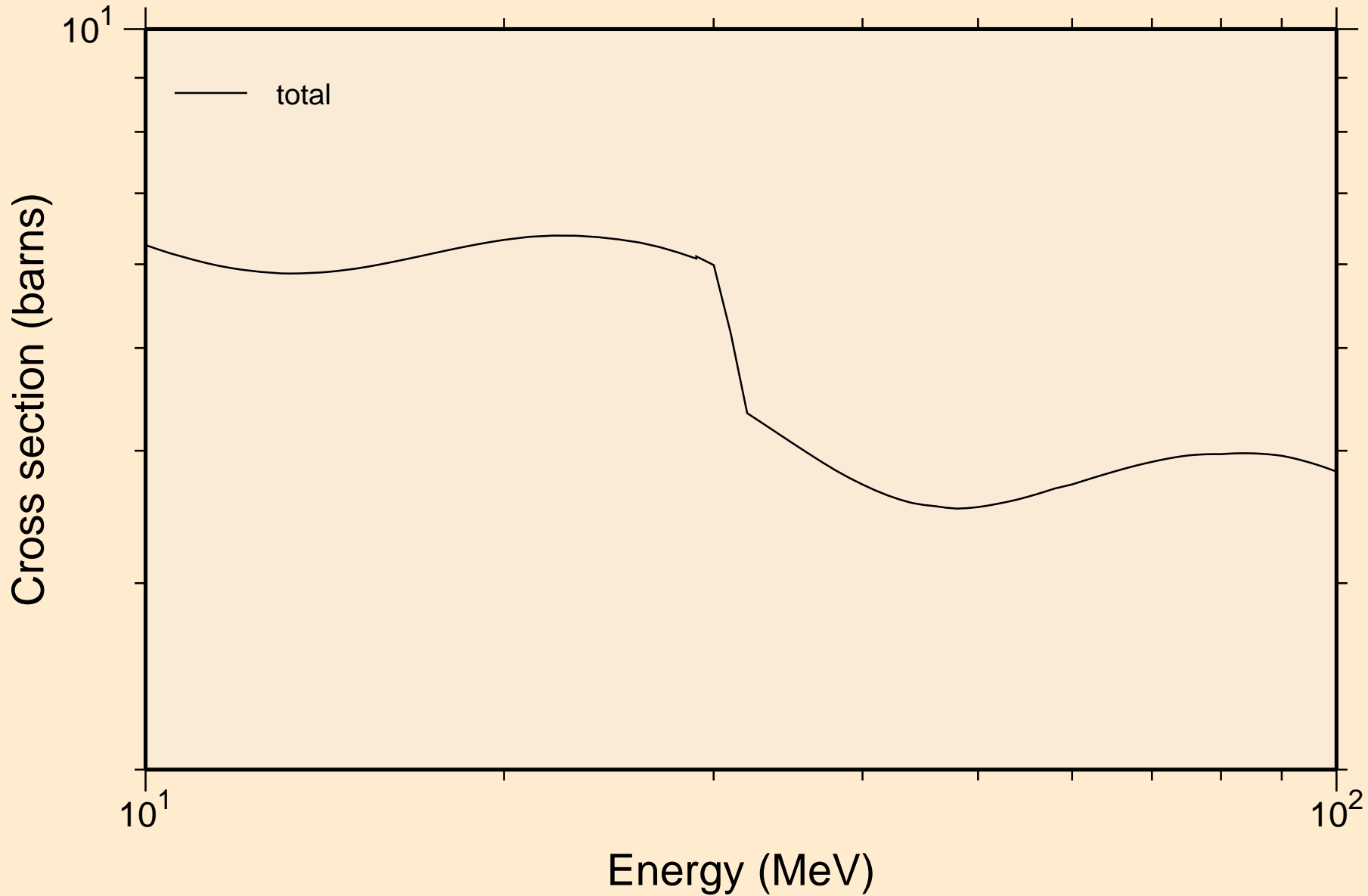

LR259 NEUTRON ACER TENDL-2021 LIBRARY; T=293.6K
resonance absorption cross sections

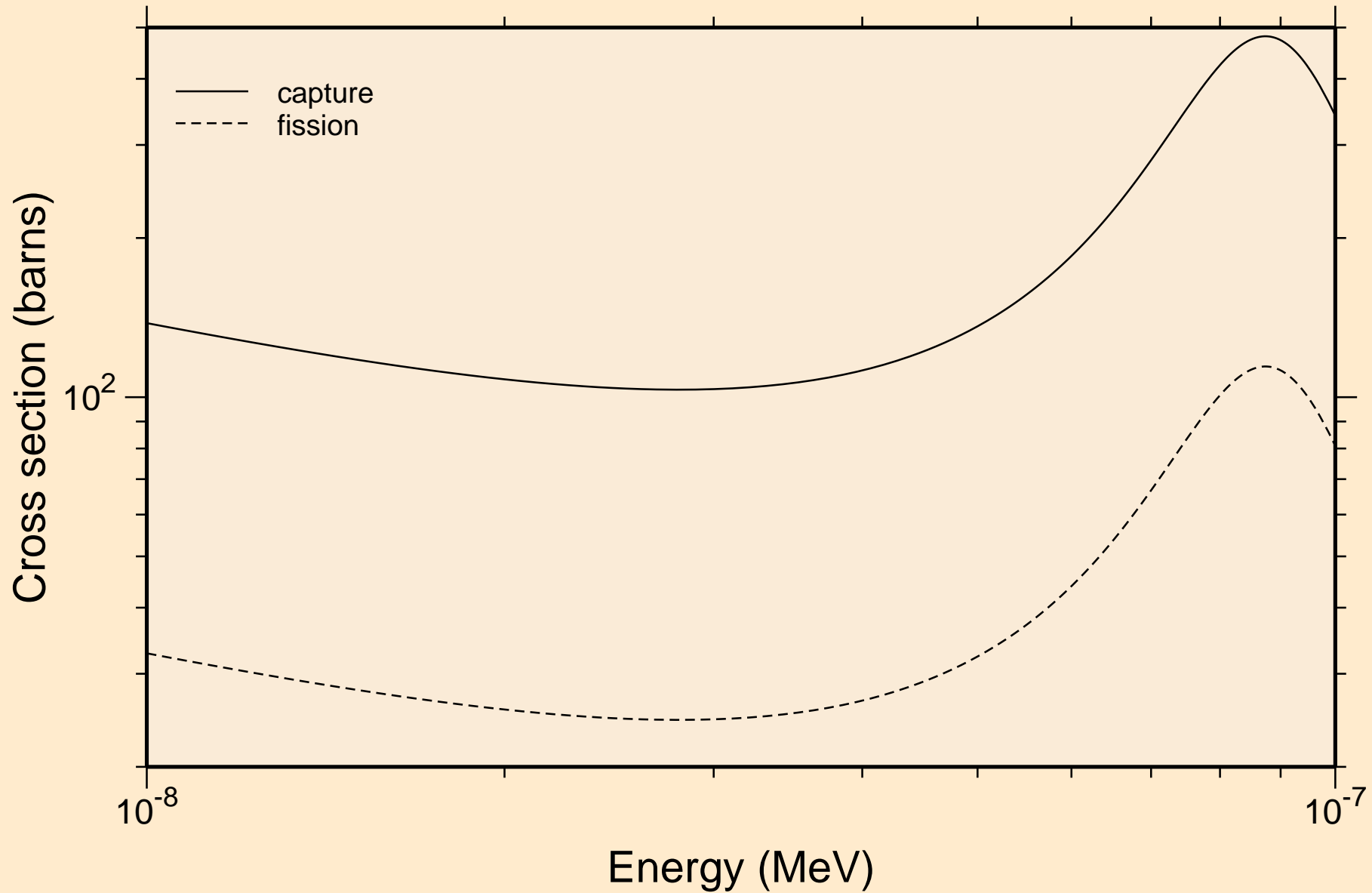

LR259 NEUTRON ACER TENDL-2021 LIBRARY; T=293.6K
resonance absorption cross sections

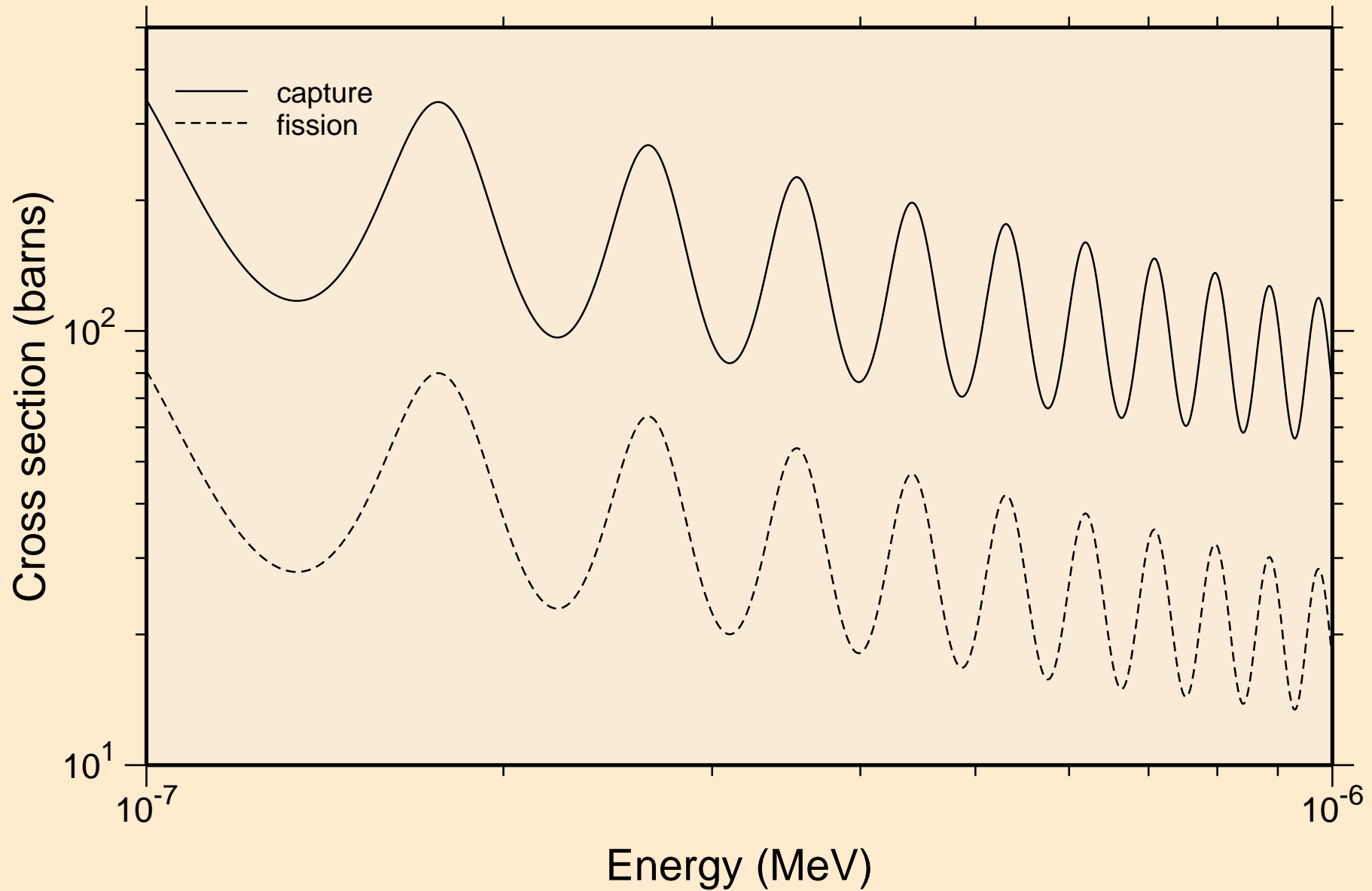

LR259 NEUTRON ACER TENDL-2021 LIBRARY; T=293.6K
resonance absorption cross sections

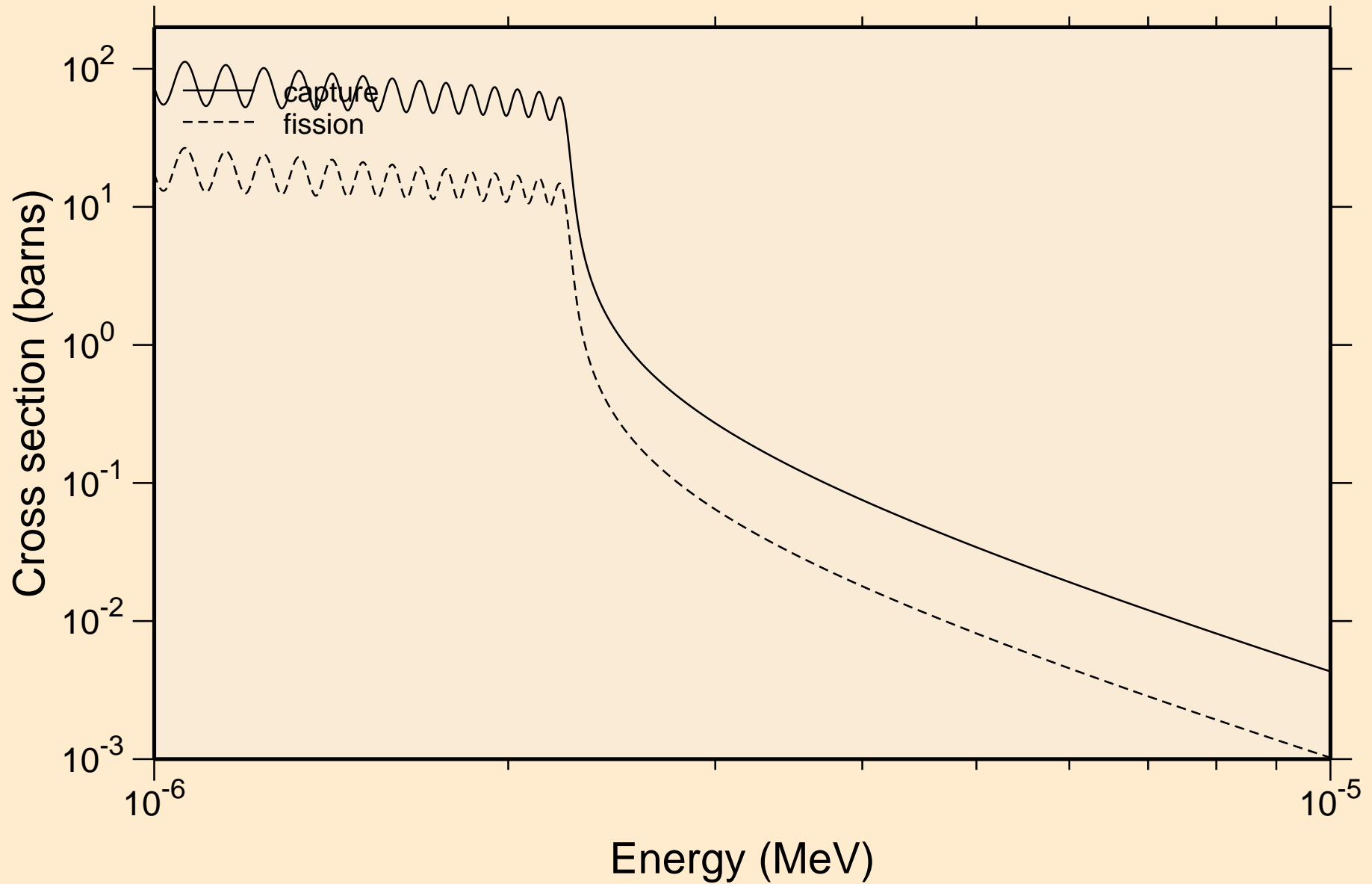

LR259 NEUTRON ACER TENDL-2021 LIBRARY; T=293.6K
resonance absorption cross sections

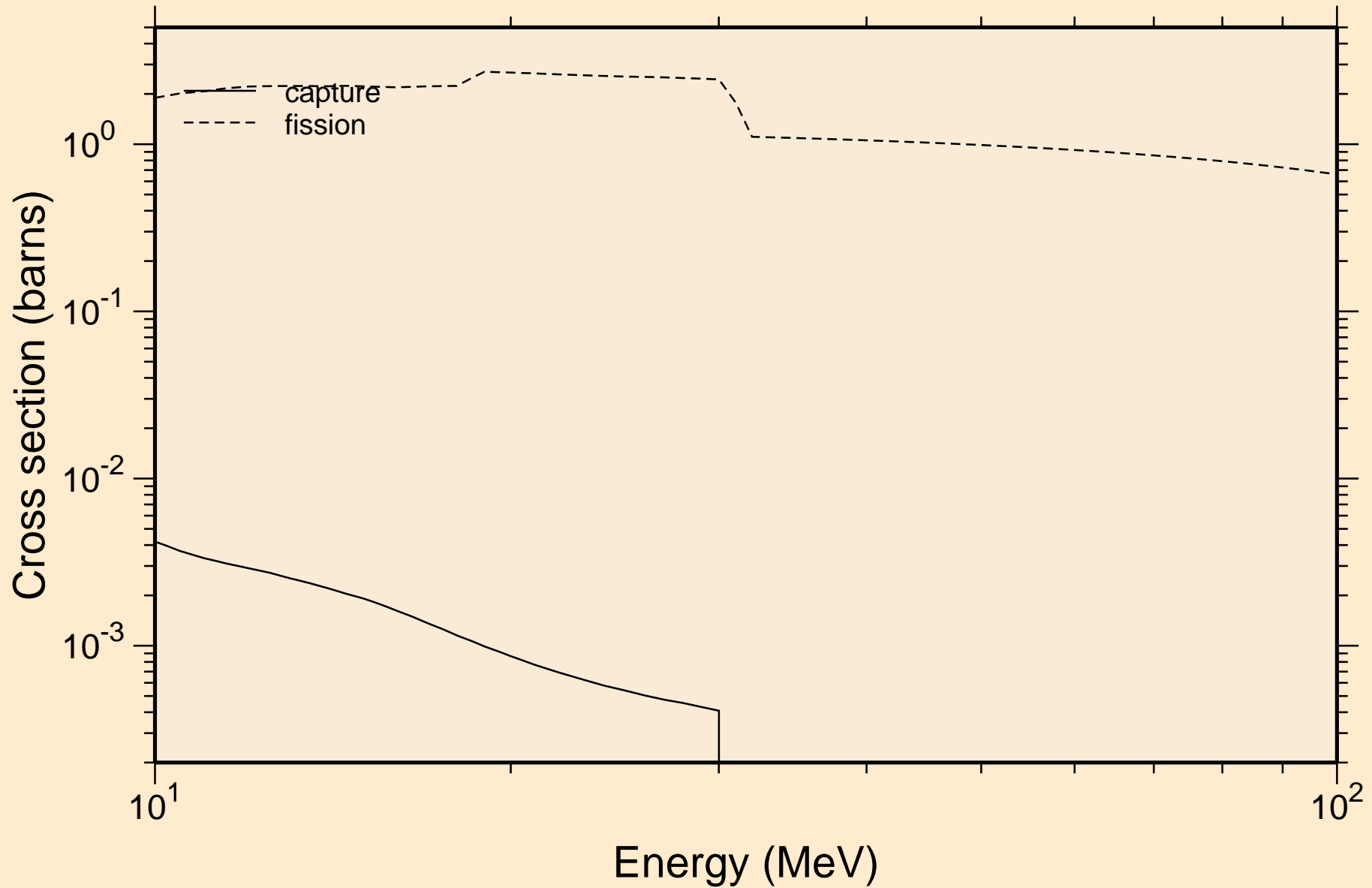

LR259 NEUTRON ACER TENDL-2021 LIBRARY; T=293.6K

Heating

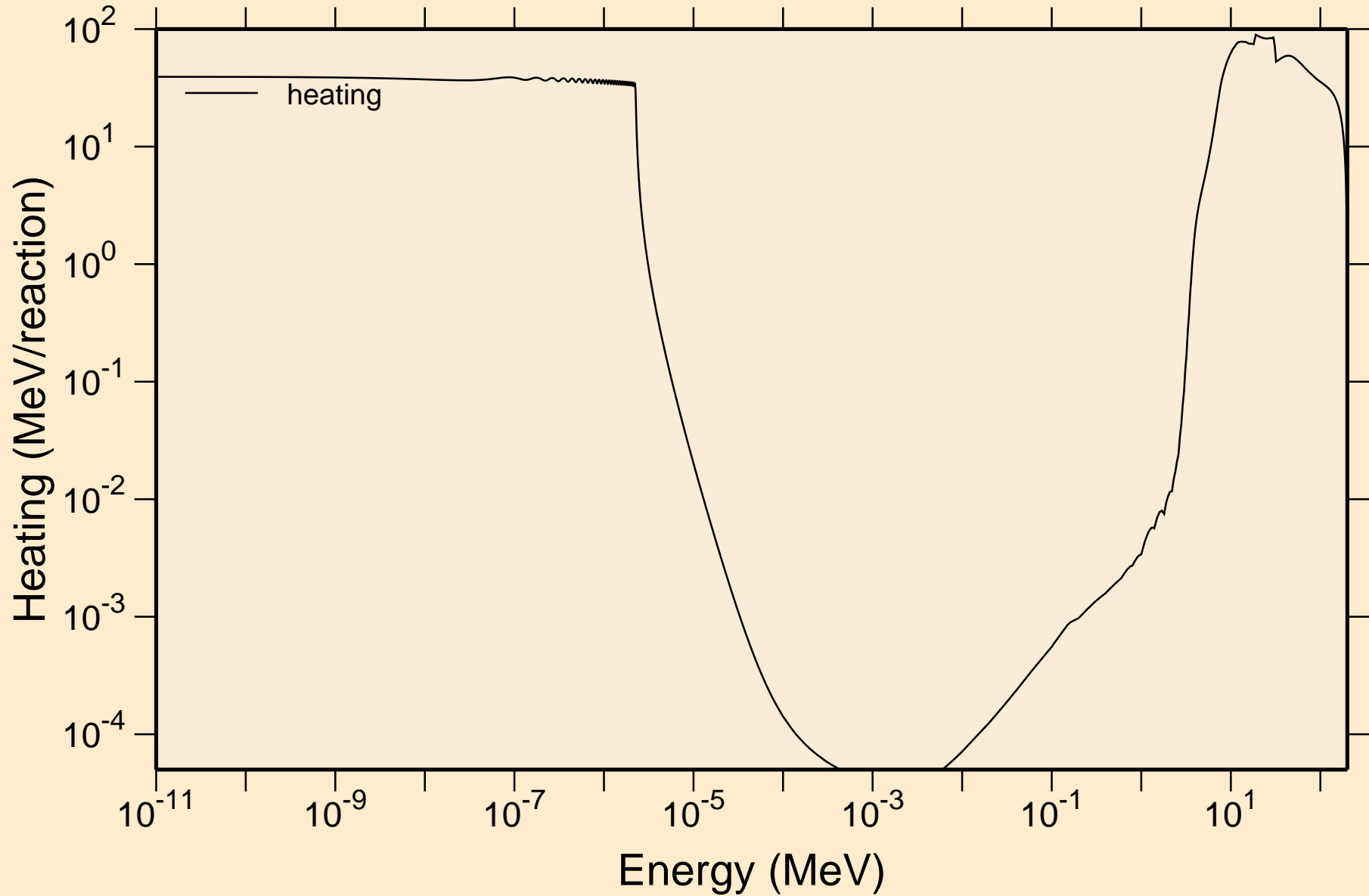

LR259 NEUTRON ACER TENDL-2021 LIBRARY; T=293.6K
Damage

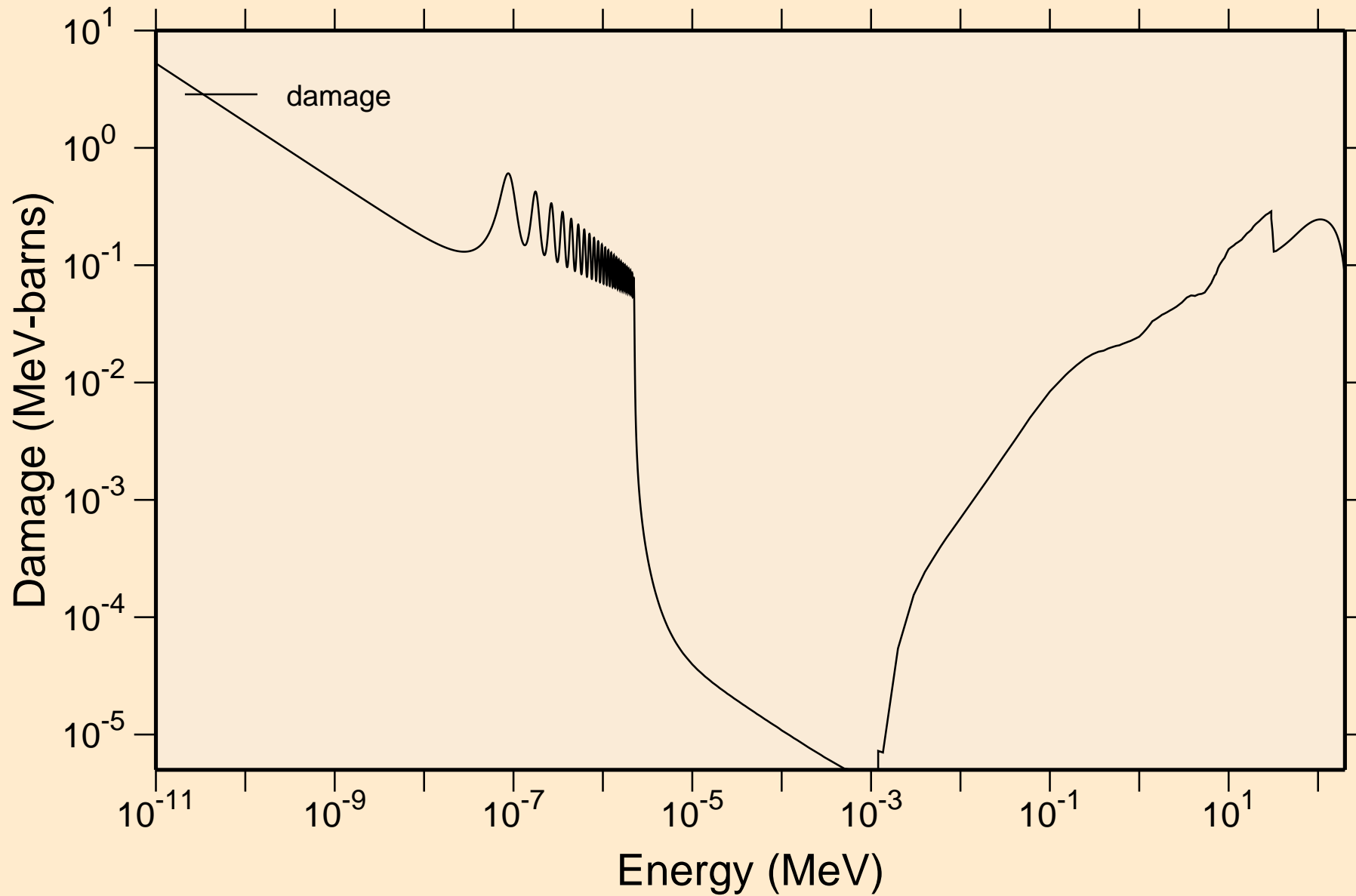

LR259 NEUTRON ACER TENDL-2021 LIBRARY; T=293.6K

Non-threshold reactions

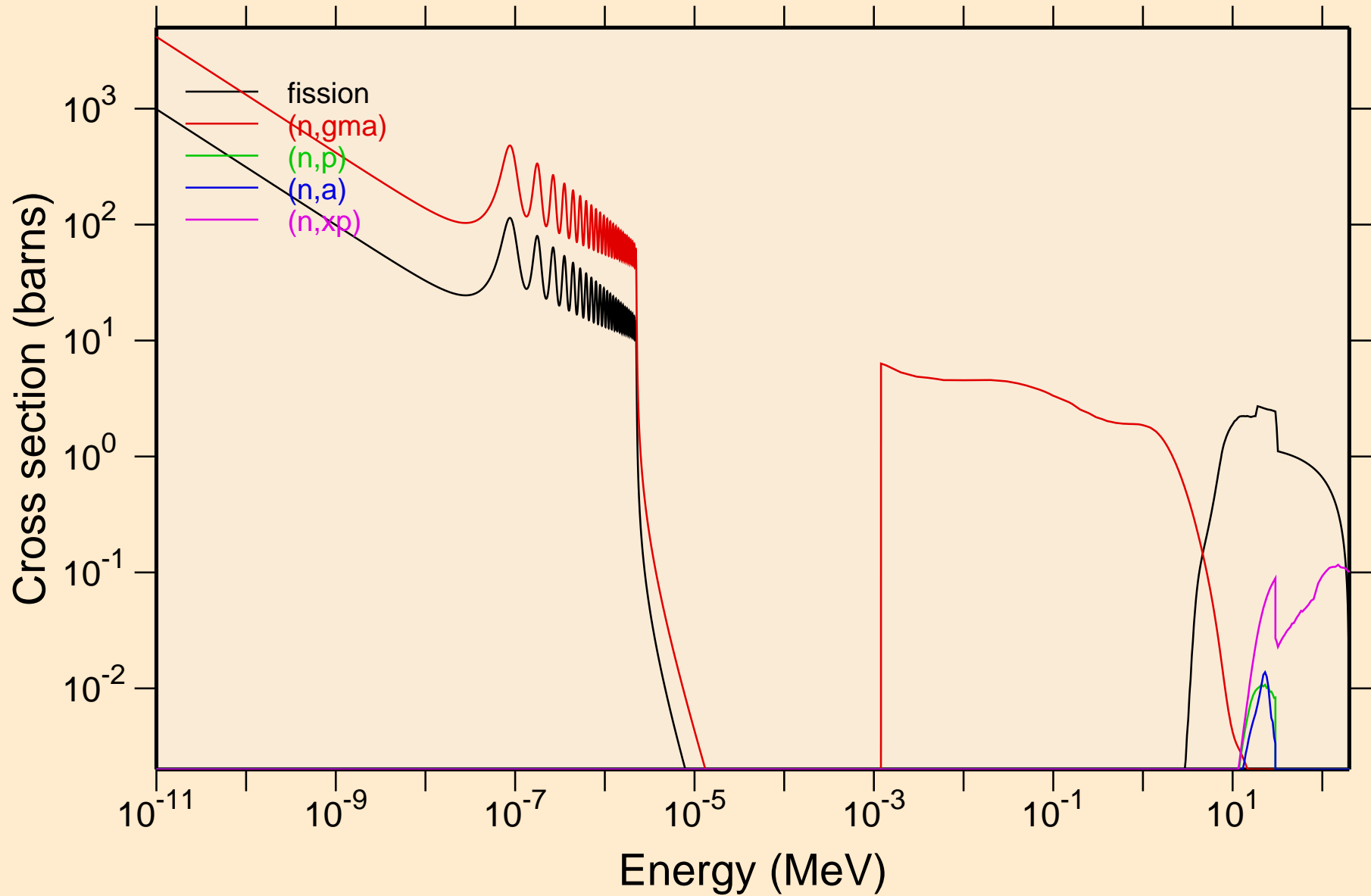

LR259 NEUTRON ACER TENDL-2021 LIBRARY; T=293.6K
Non-threshold reactions

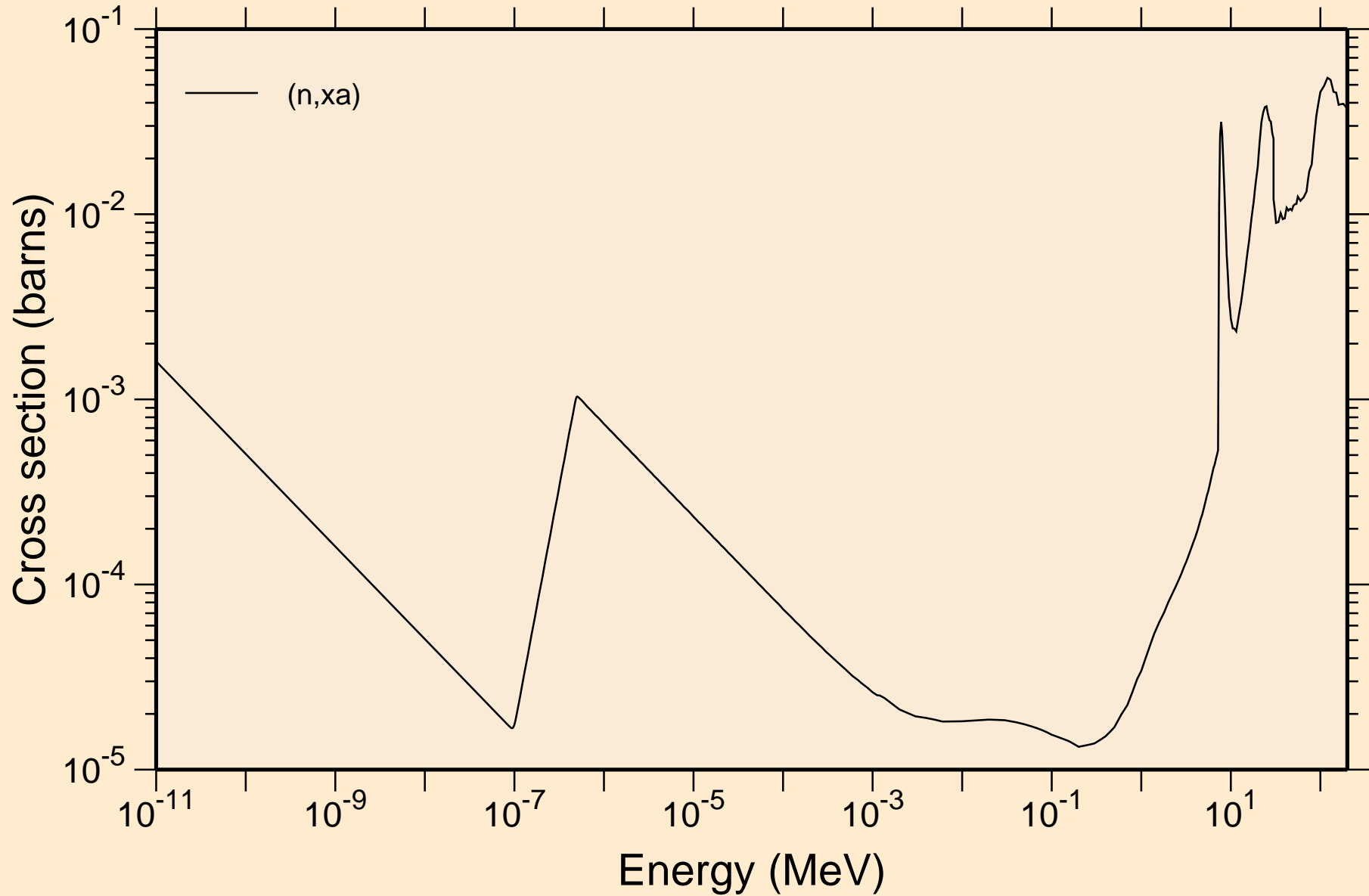

LR259 NEUTRON ACER TENDL-2021 LIBRARY; T=293.6K
Principal cross sections

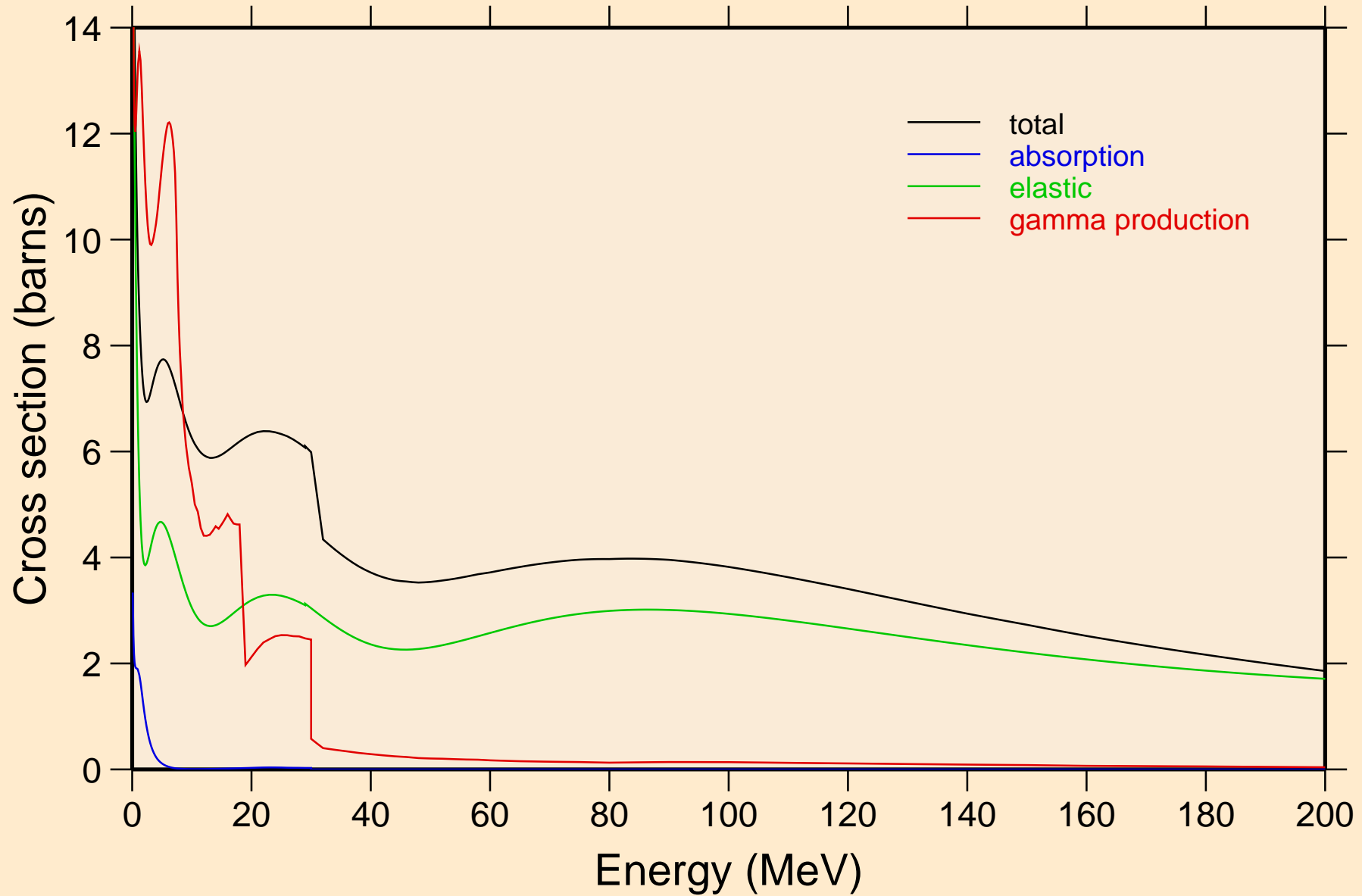

LR259 NEUTRON ACER TENDL-2021 LIBRARY; T=293.6K
Heating

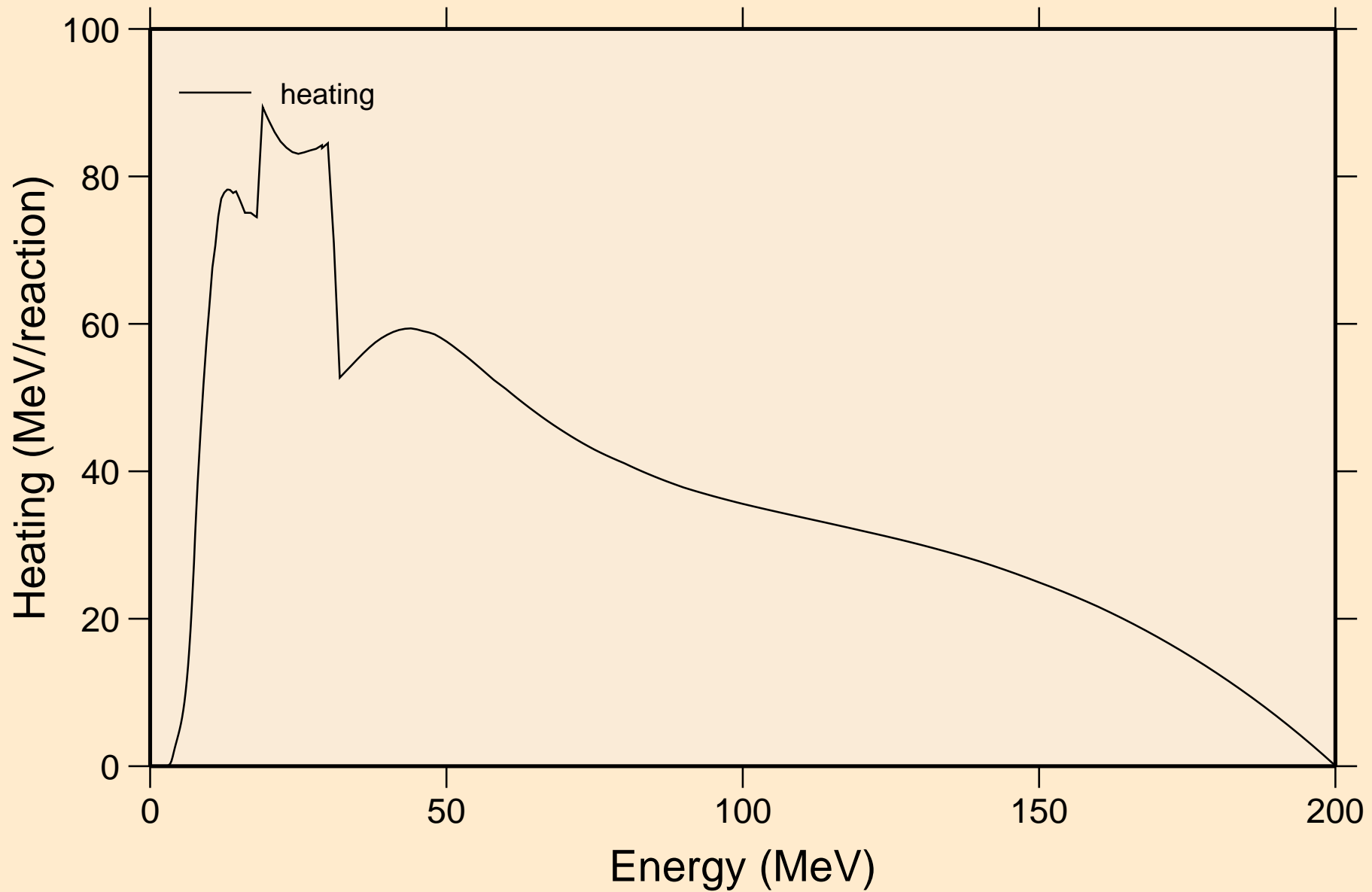

LR259 NEUTRON ACER TENDL-2021 LIBRARY; T=293.6K
Damage

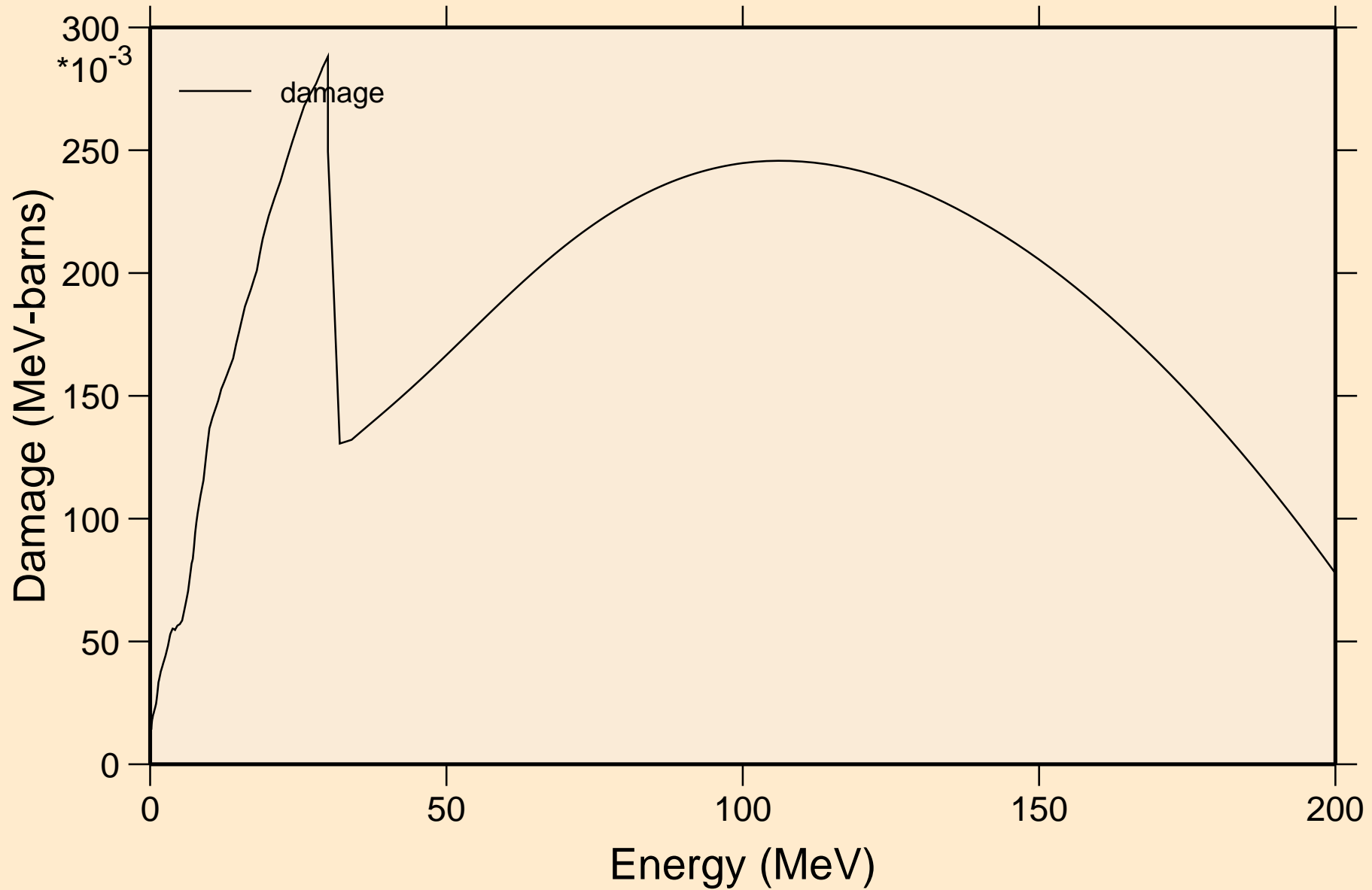

LR259 NEUTRON ACER TENDL-2021 LIBRARY; T=293.6K
Non-threshold reactions

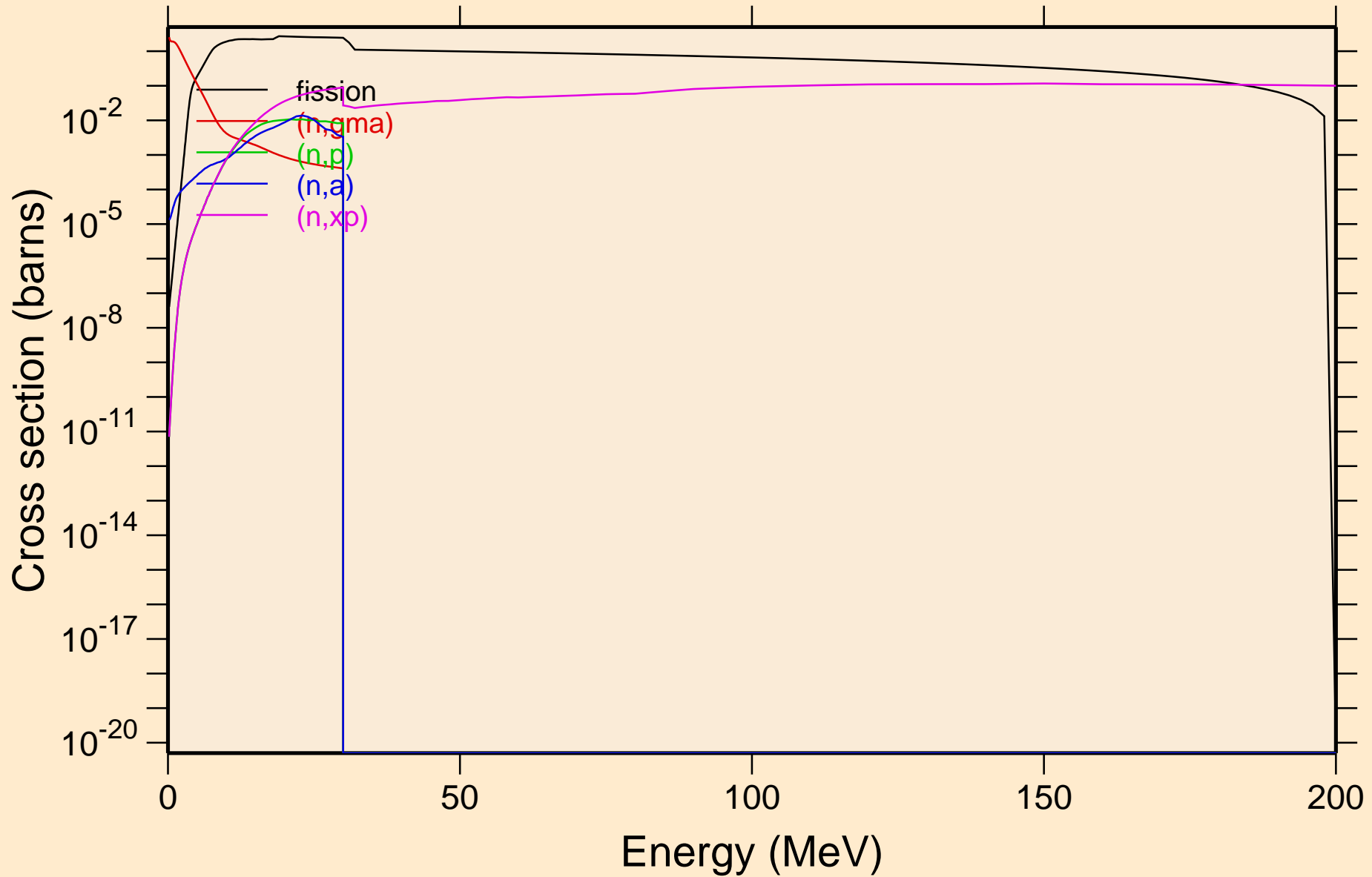

LR259 NEUTRON ACER TENDL-2021 LIBRARY; T=293.6K
Non-threshold reactions

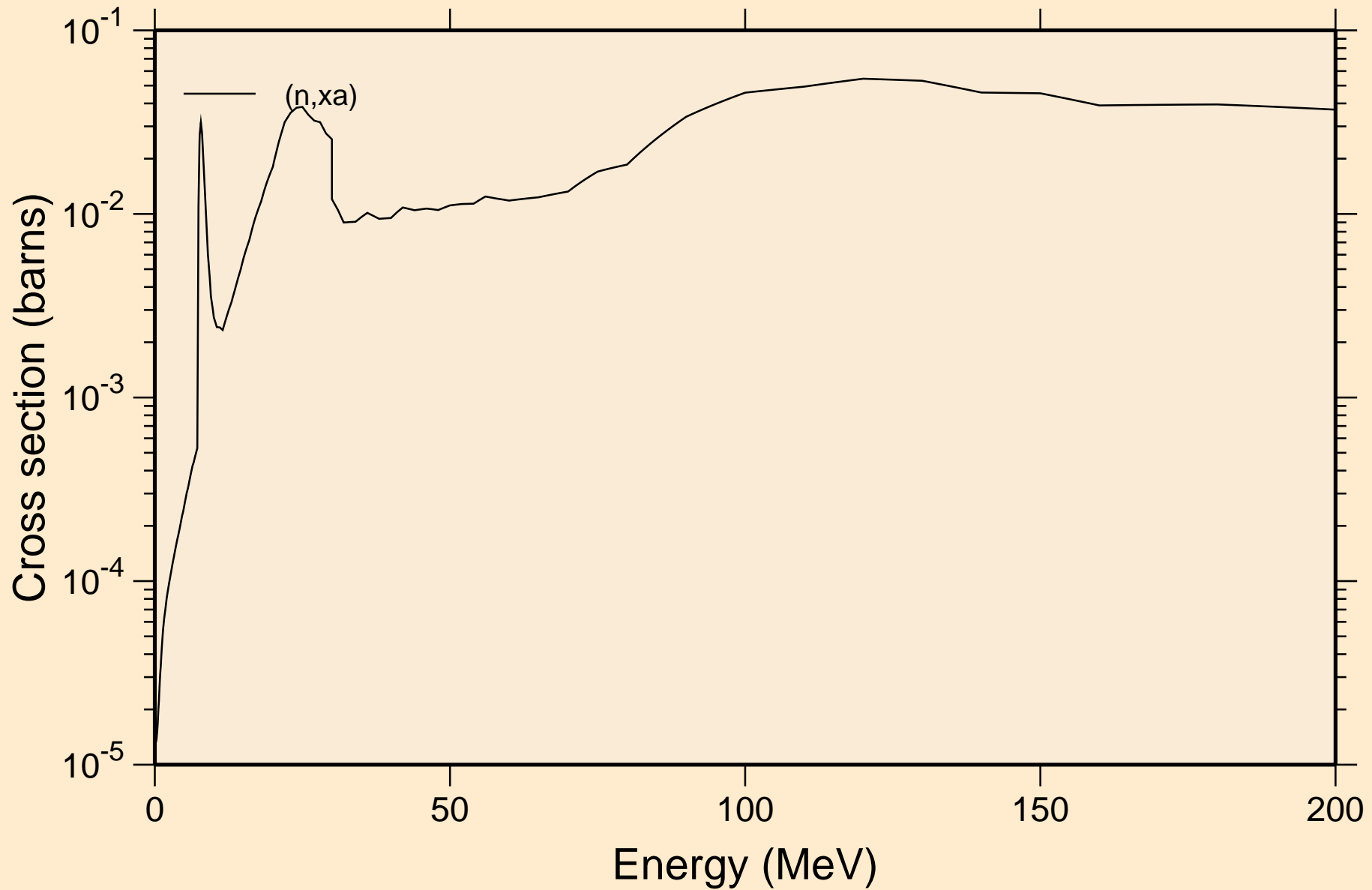

LR259 NEUTRON ACER TENDL-2021 LIBRARY; T=293.6K
Inelastic levels

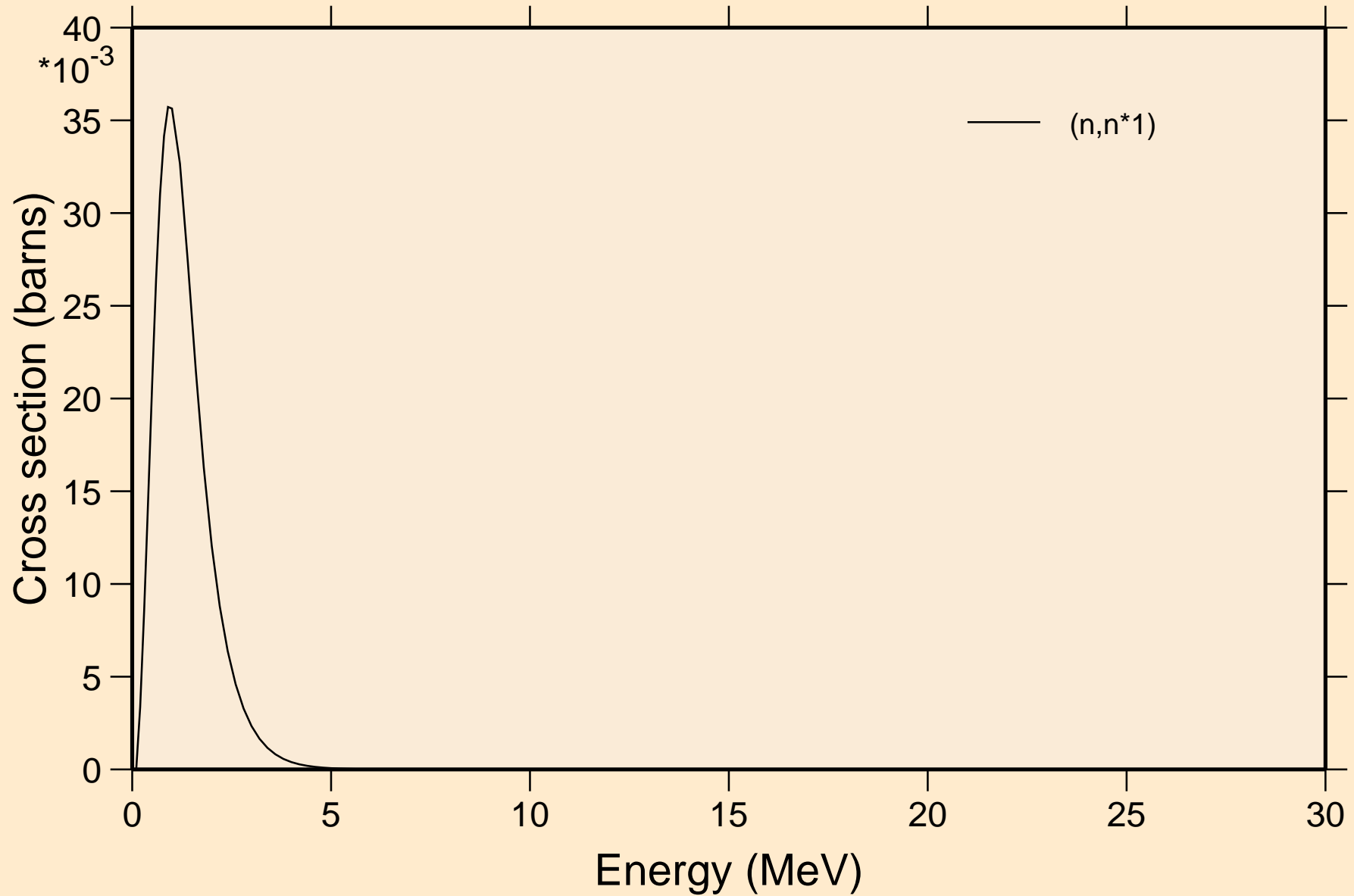

LR259 NEUTRON ACER TENDL-2021 LIBRARY; T=293.6K
Threshold reactions

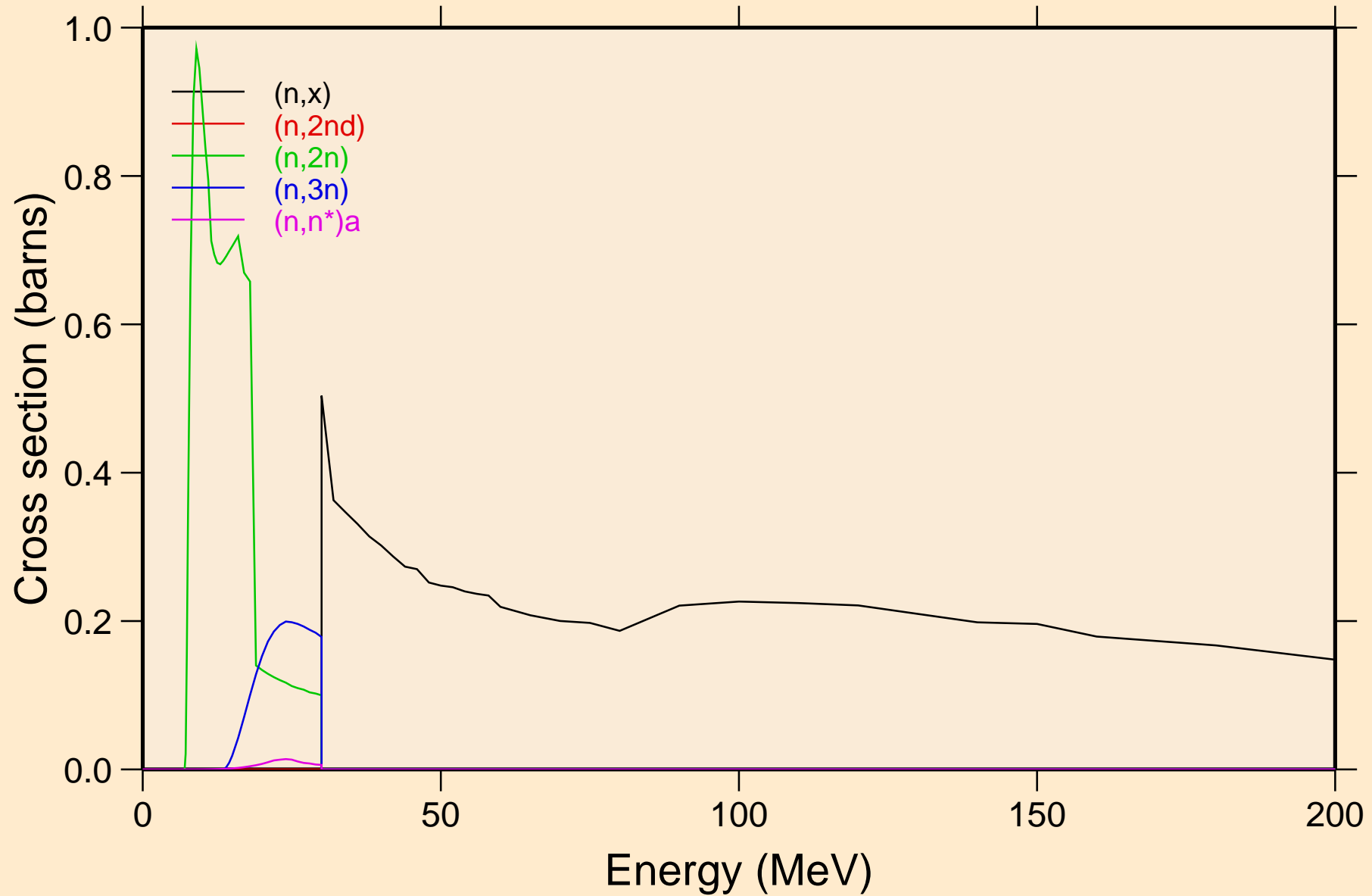

LR259 NEUTRON ACER TENDL-2021 LIBRARY; T=293.6K
Threshold reactions

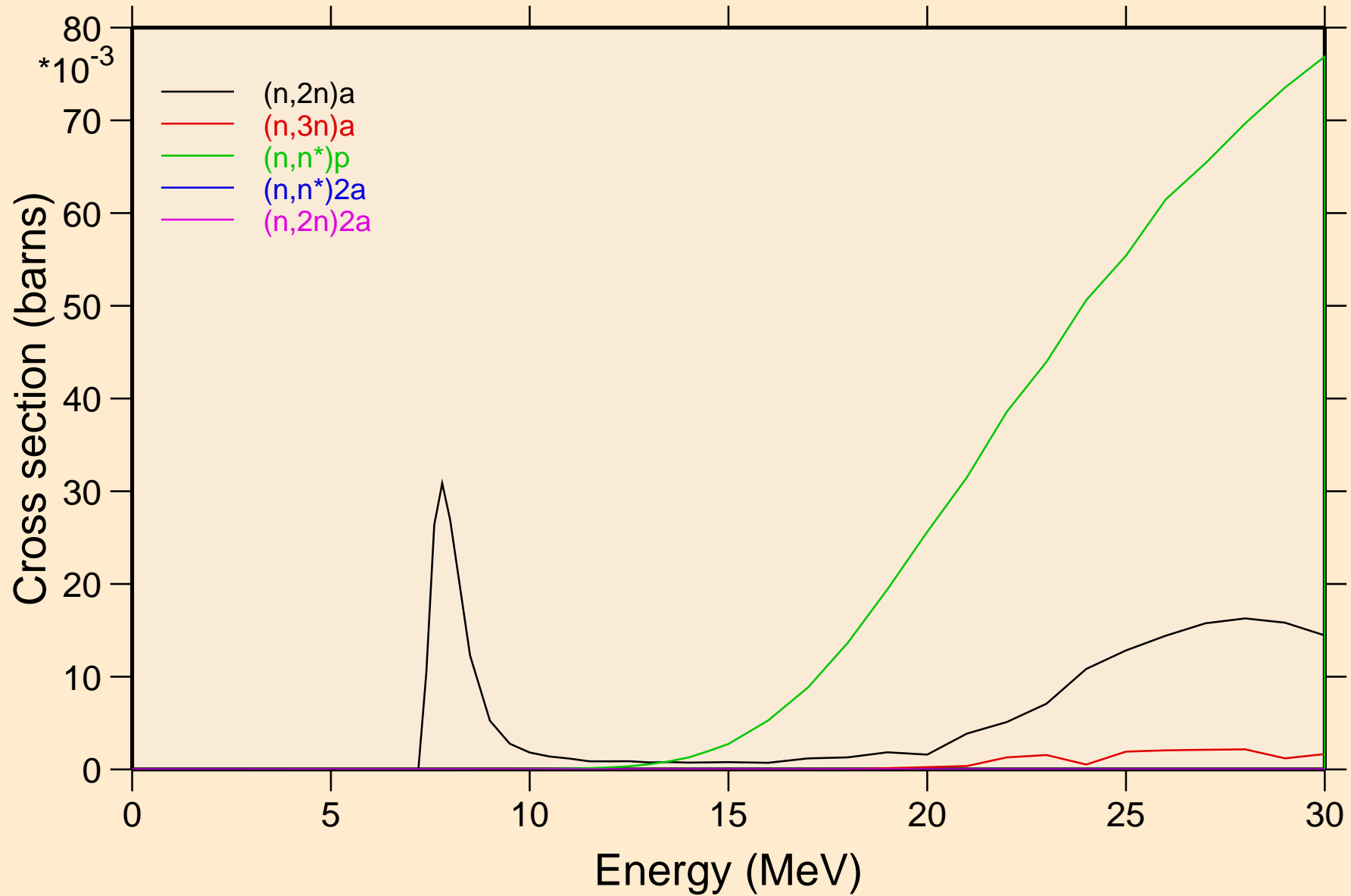

LR259 NEUTRON ACER TENDL-2021 LIBRARY; T=293.6K
Threshold reactions

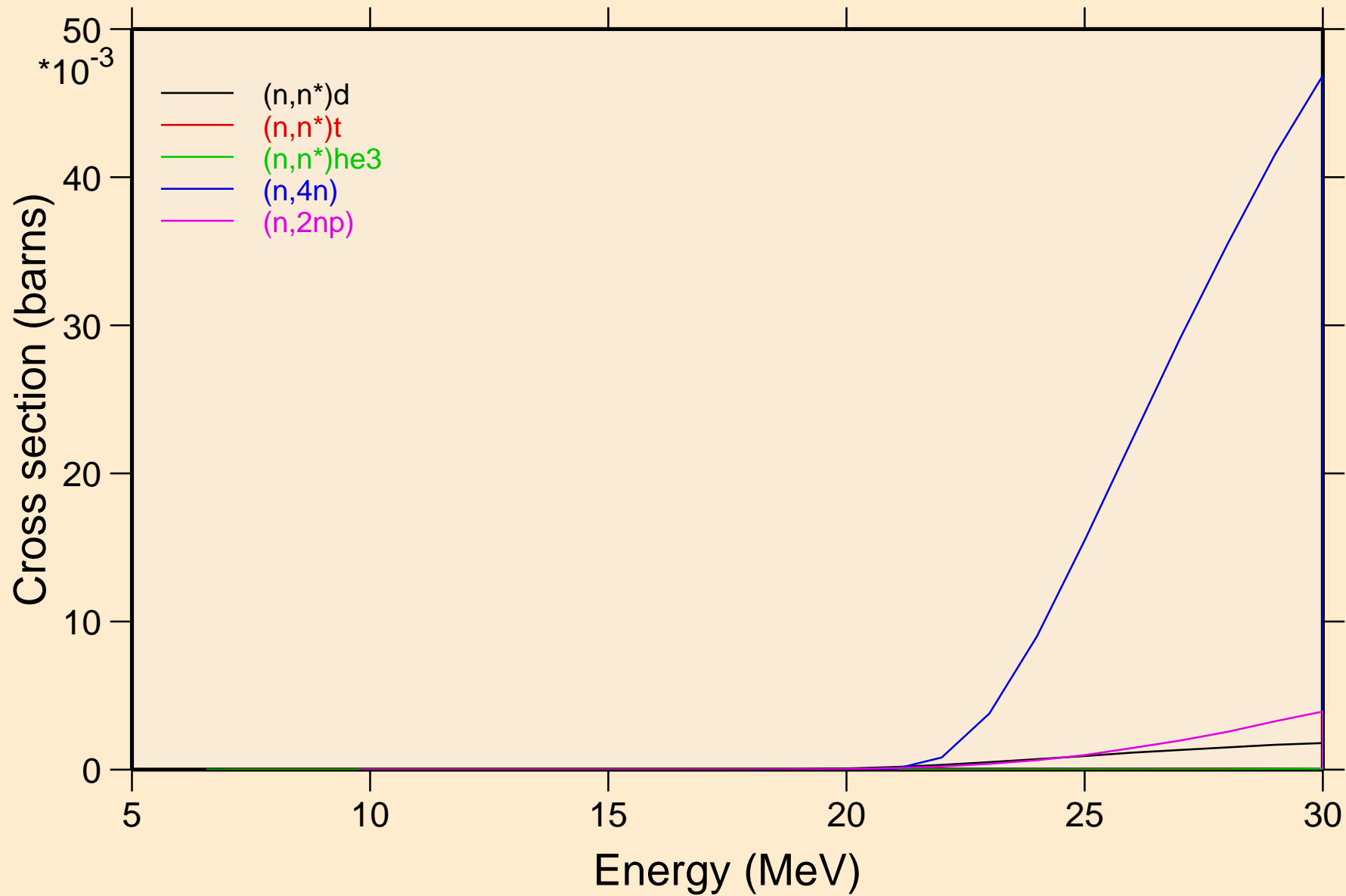

LR259 NEUTRON ACER TENDL-2021 LIBRARY; T=293.6K
Threshold reactions

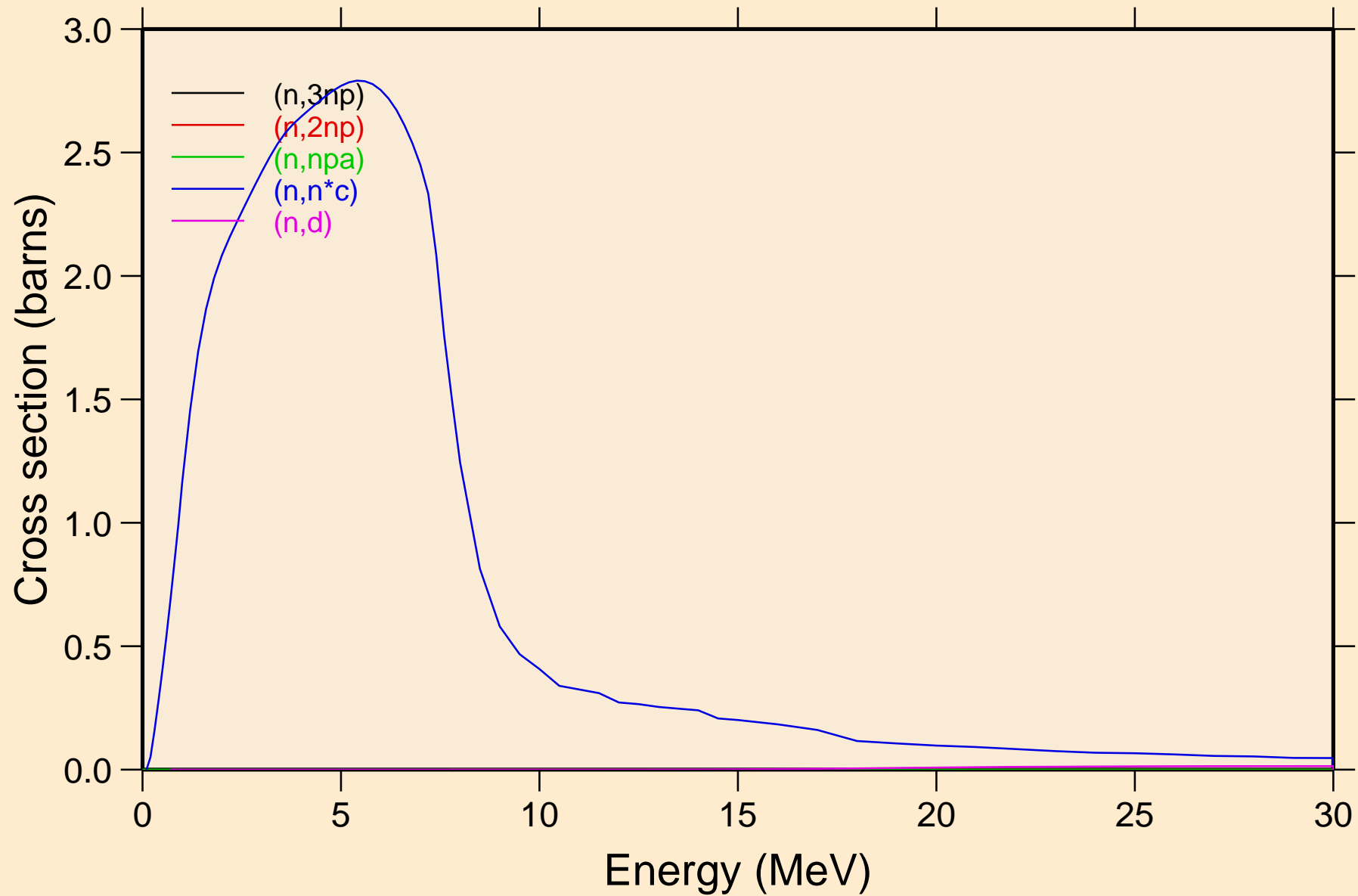

LR259 NEUTRON ACER TENDL-2021 LIBRARY; T=293.6K
Threshold reactions

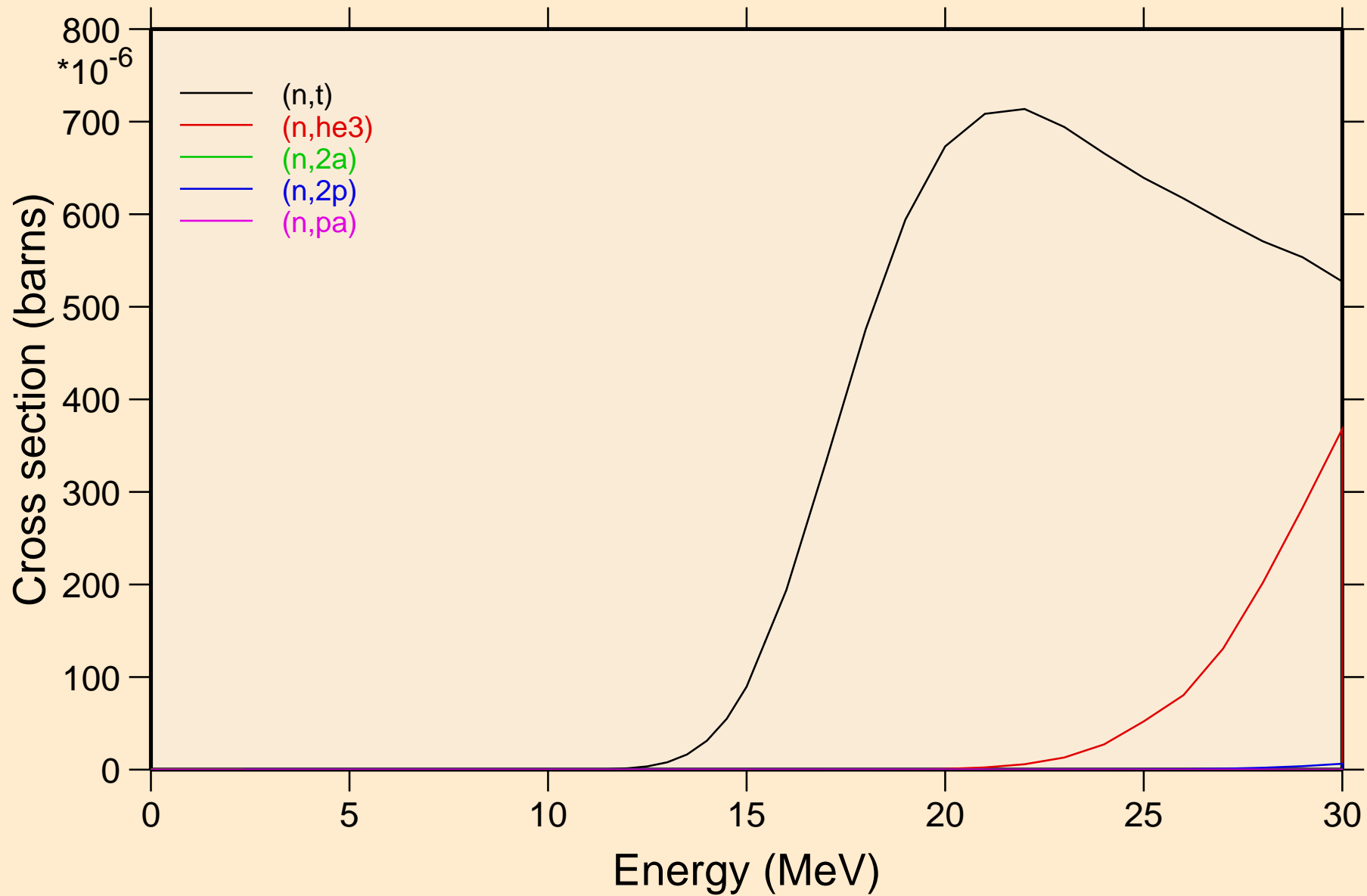

LR259 NEUTRON ACER TENDL-2021 LIBRARY; T=293.6K
Threshold reactions

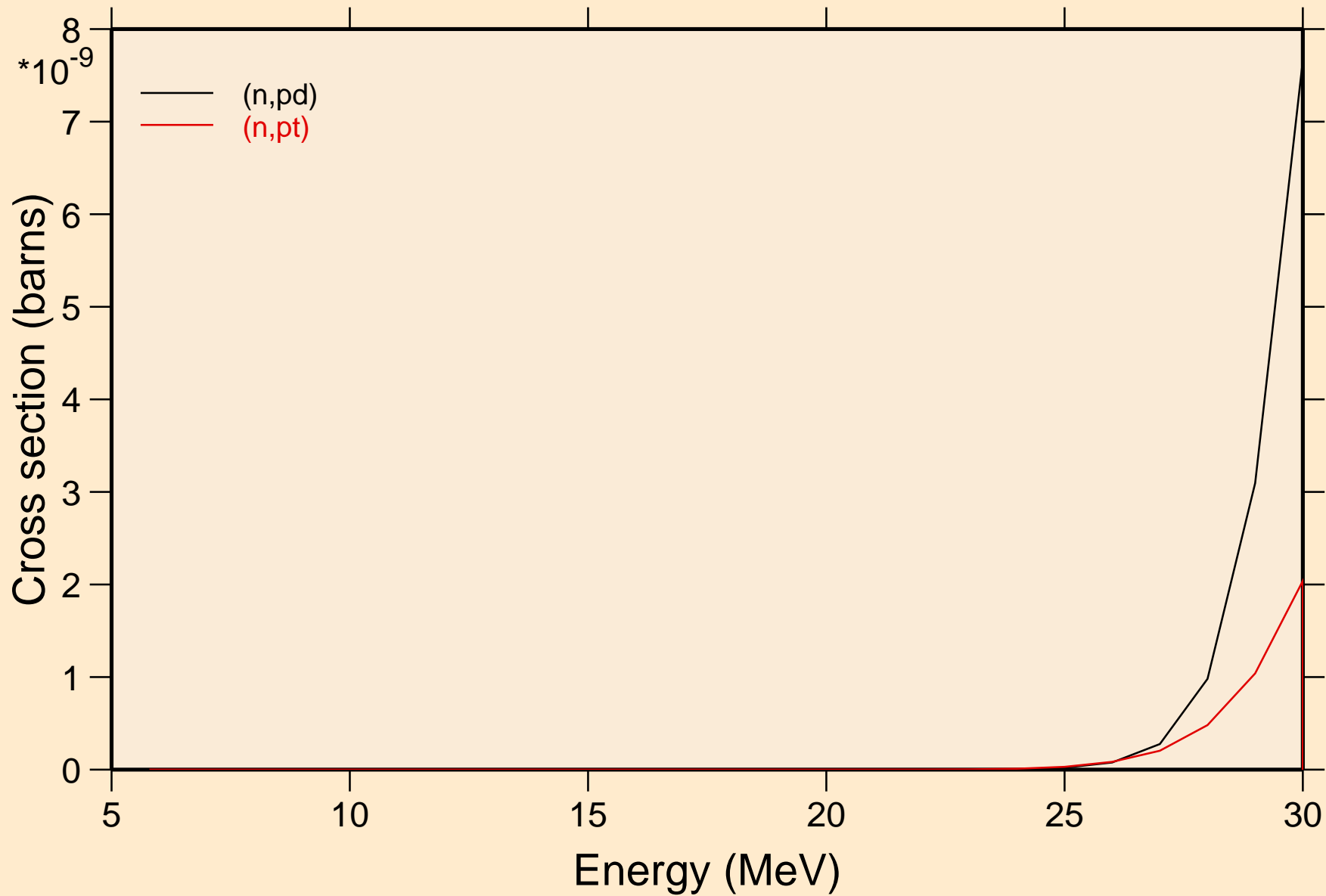

LR259 NEUTRON ACER TENDL-2021 LIBRARY; T=293.6K
Threshold reactions

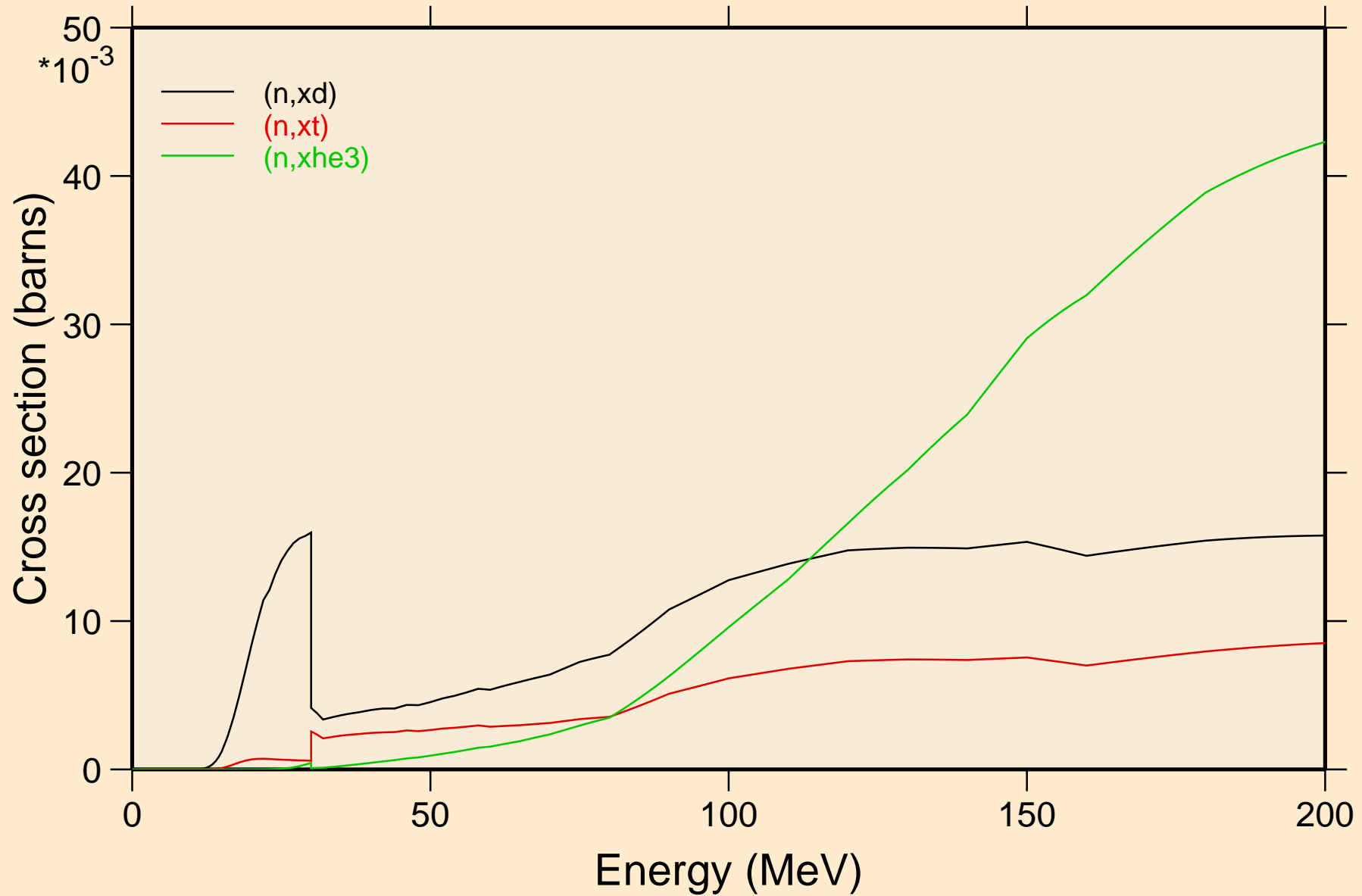

LR259 NEUTRON ACER TENDL-2021 LIBRARY; T=293.6K
angular distribution for elastic

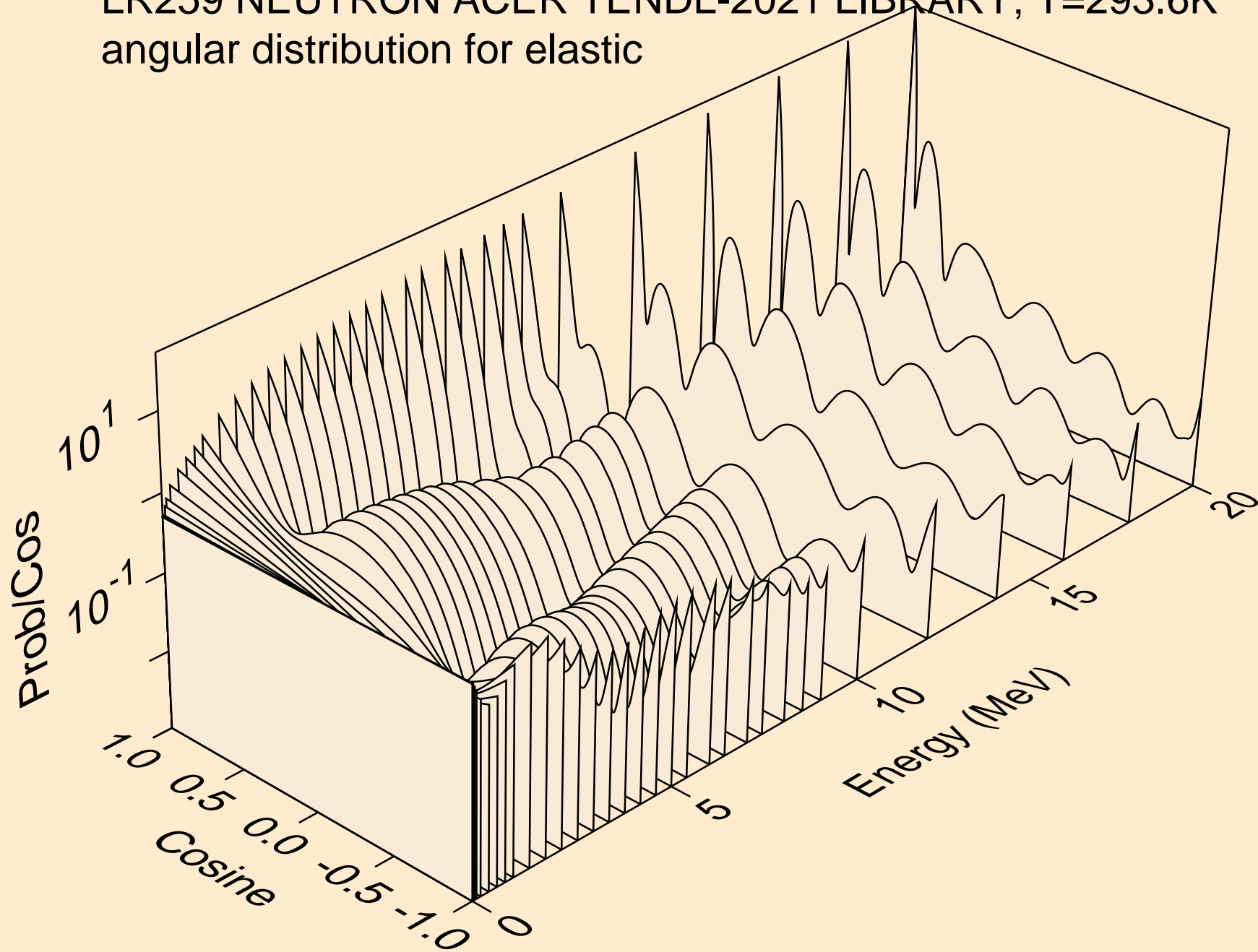

LR259 NEUTRON ACER TENDL-2021 LIBRARY; T=293.6K
angular distribution for elastic

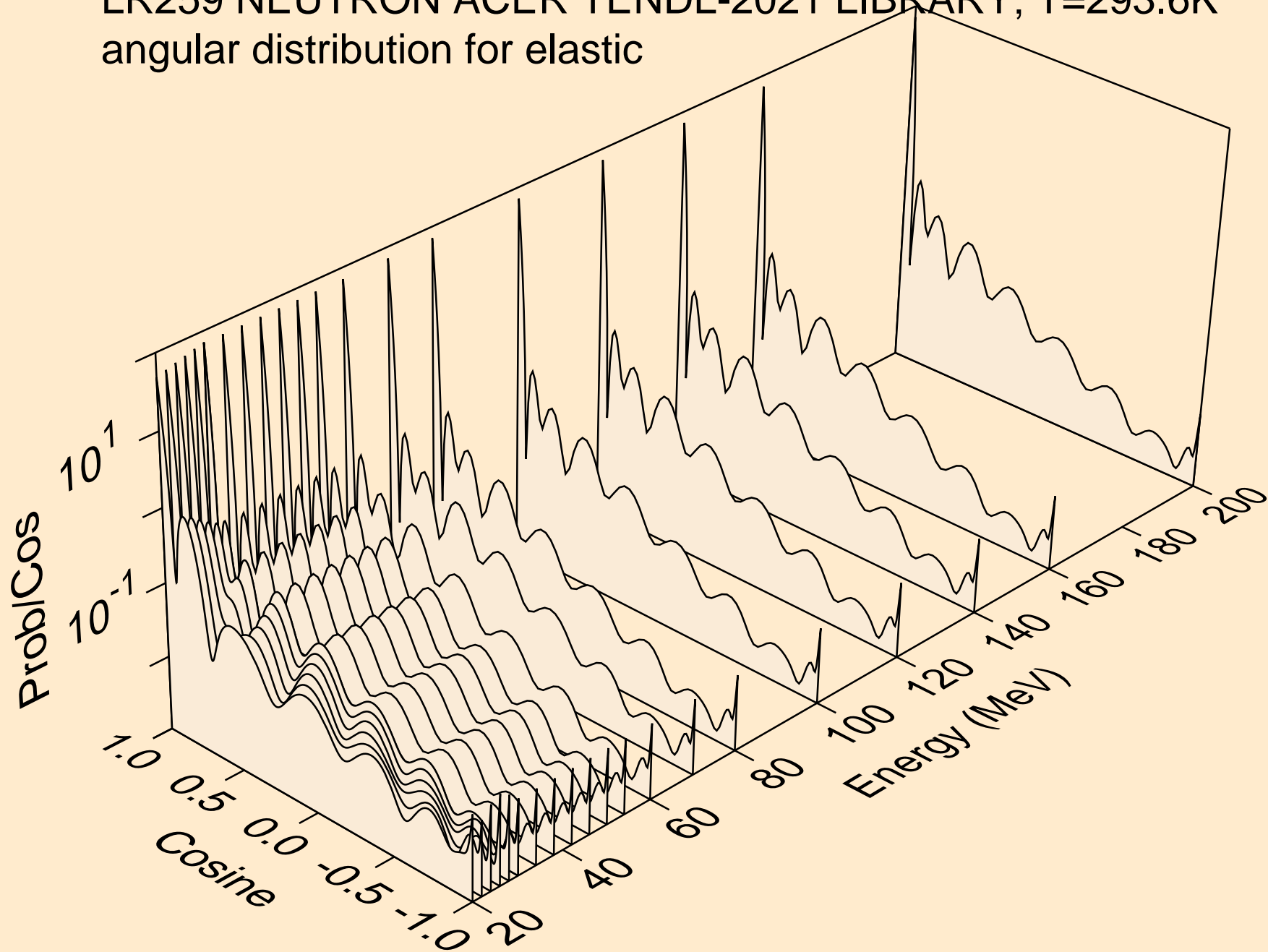

LR259 NEUTRON ACER TENDL-2021 LIBRARY; T=293.6K
angular distribution for (n,n*1)

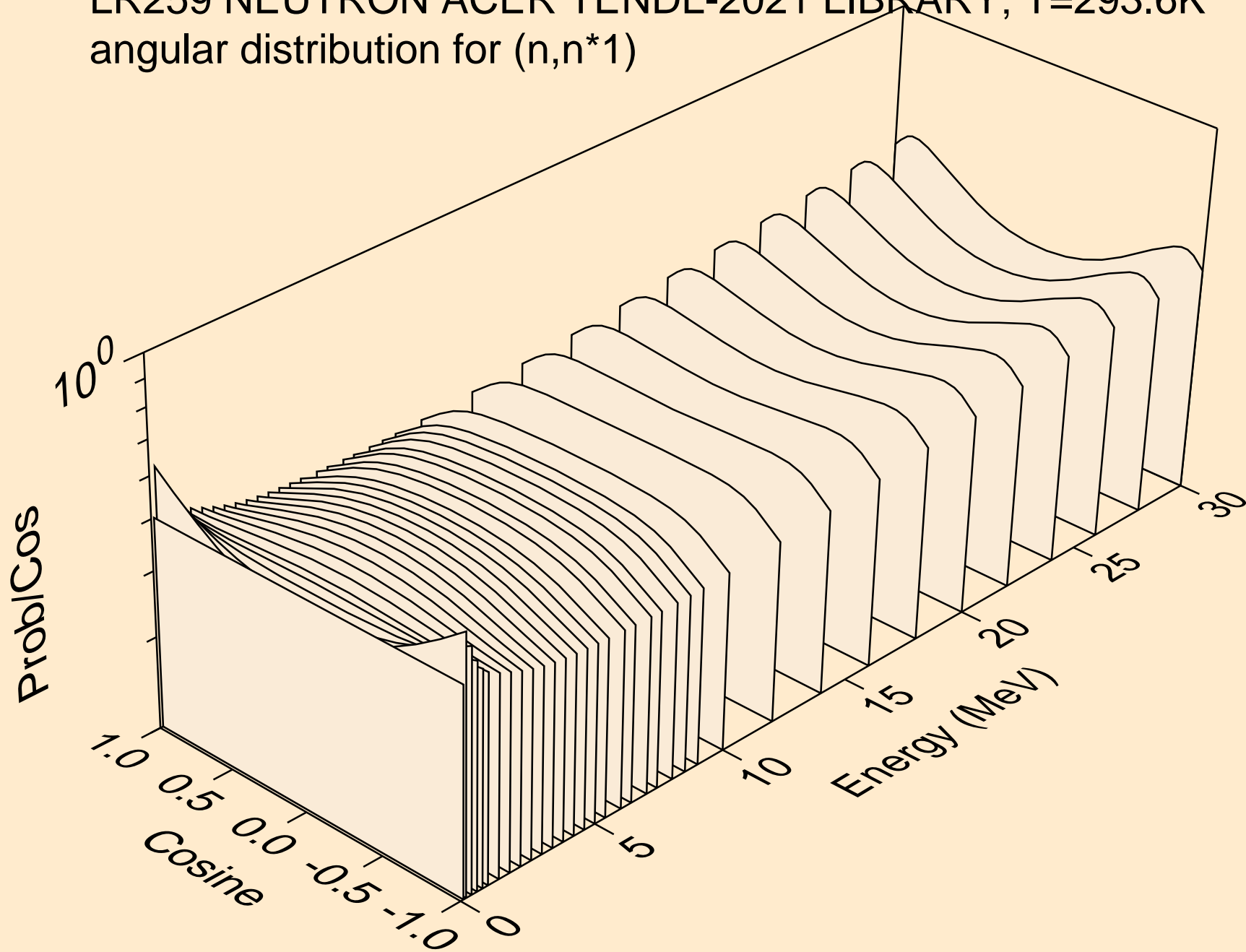

LR259 NEUTRON ACER TENDL-2021 LIBRARY; T=293.6K
Total fission nubar

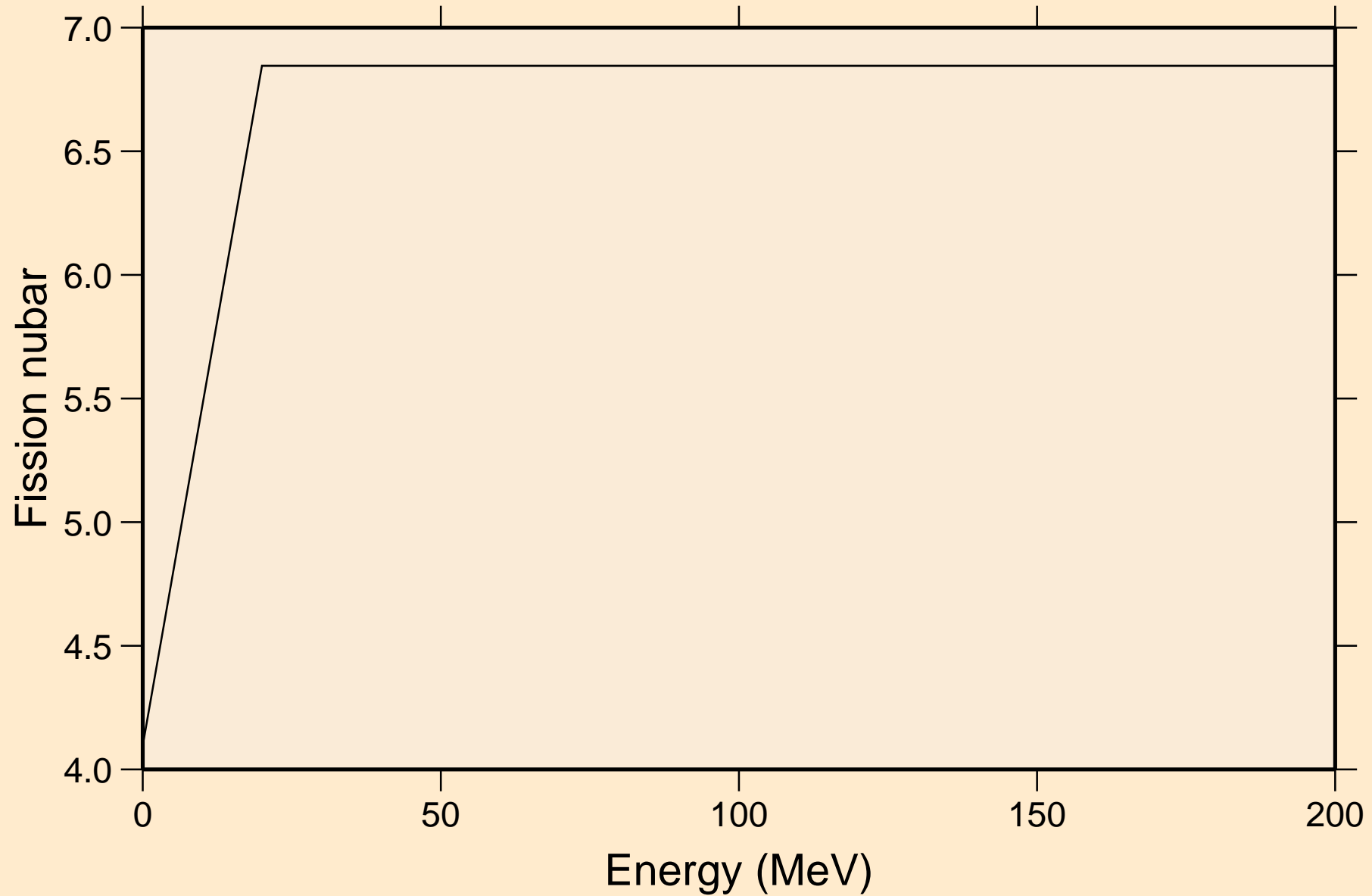

LR259 NEUTRON ACER TENDL-2021 LIBRARY; T=293.6K
Neutron emission for (n,x)

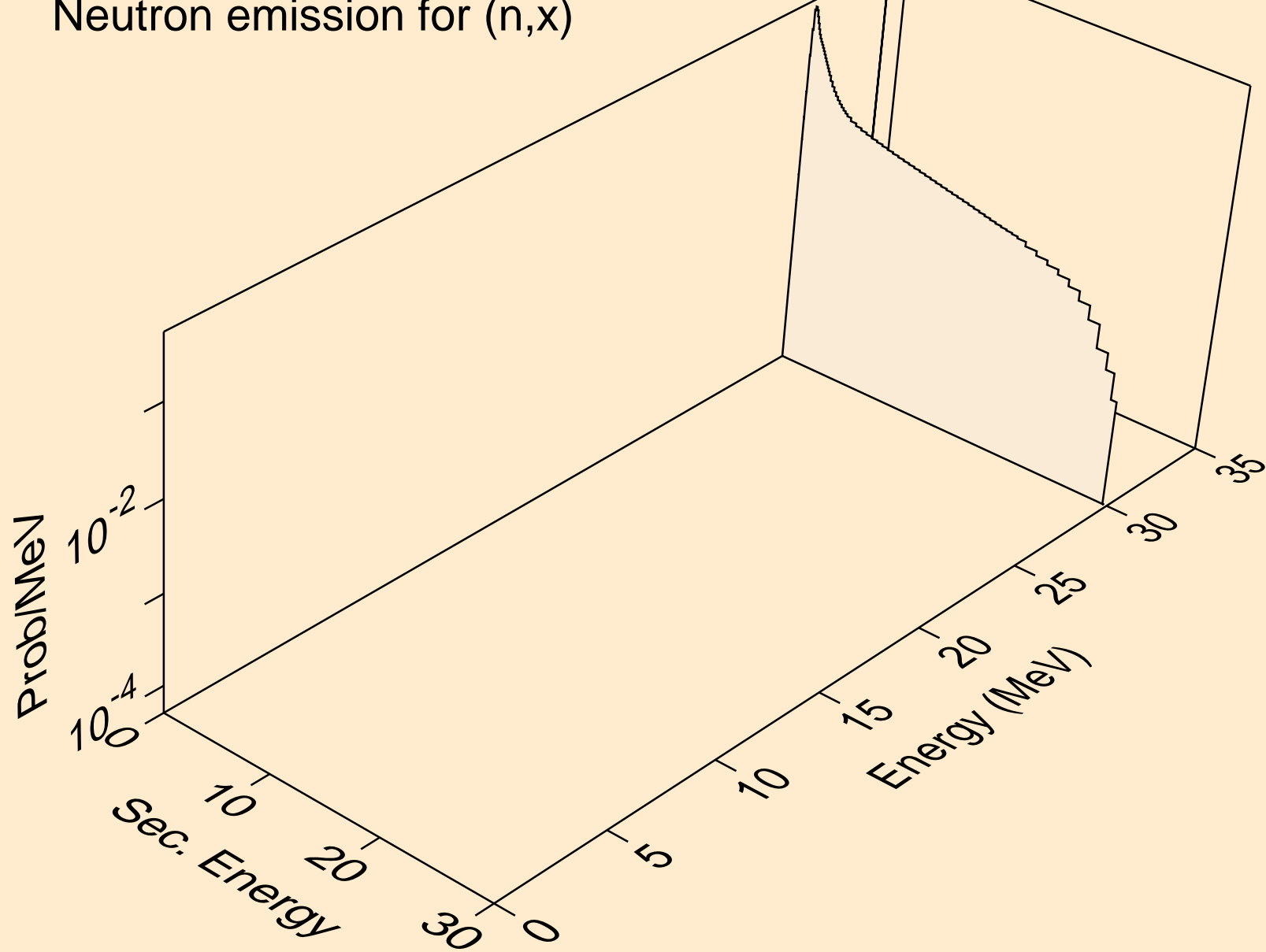

LR259 NEUTRON ACER TENDL-2021 LIBRARY; T=293.6K
Neutron emission for (n,2nd)

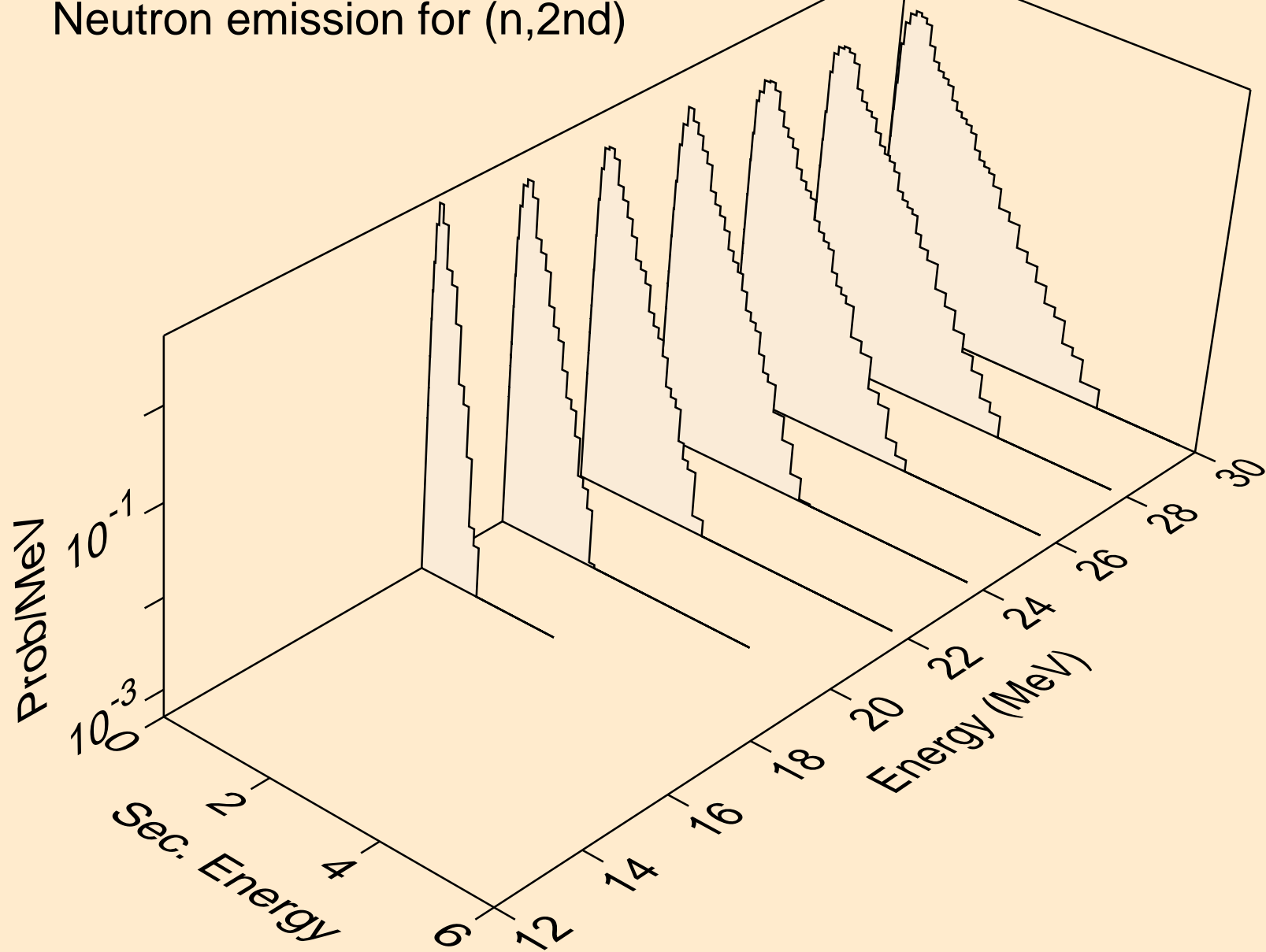

LR259 NEUTRON ACER TENDL-2021 LIBRARY; T=293.6K
Neutron emission for (n,2n)

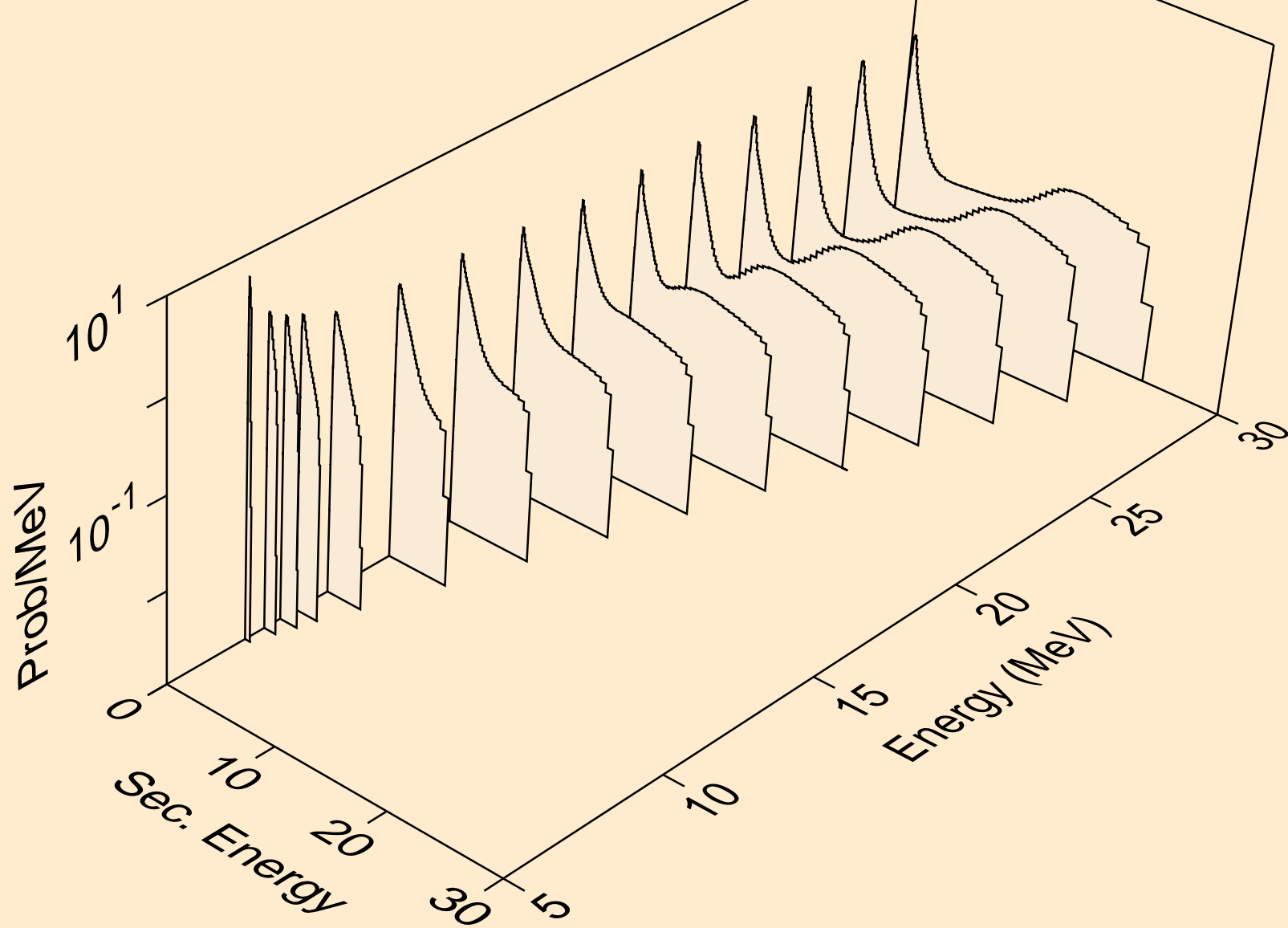

LR259 NEUTRON ACER TENDL-2021 LIBRARY; T=293.6K
Neutron emission for (n,3n)

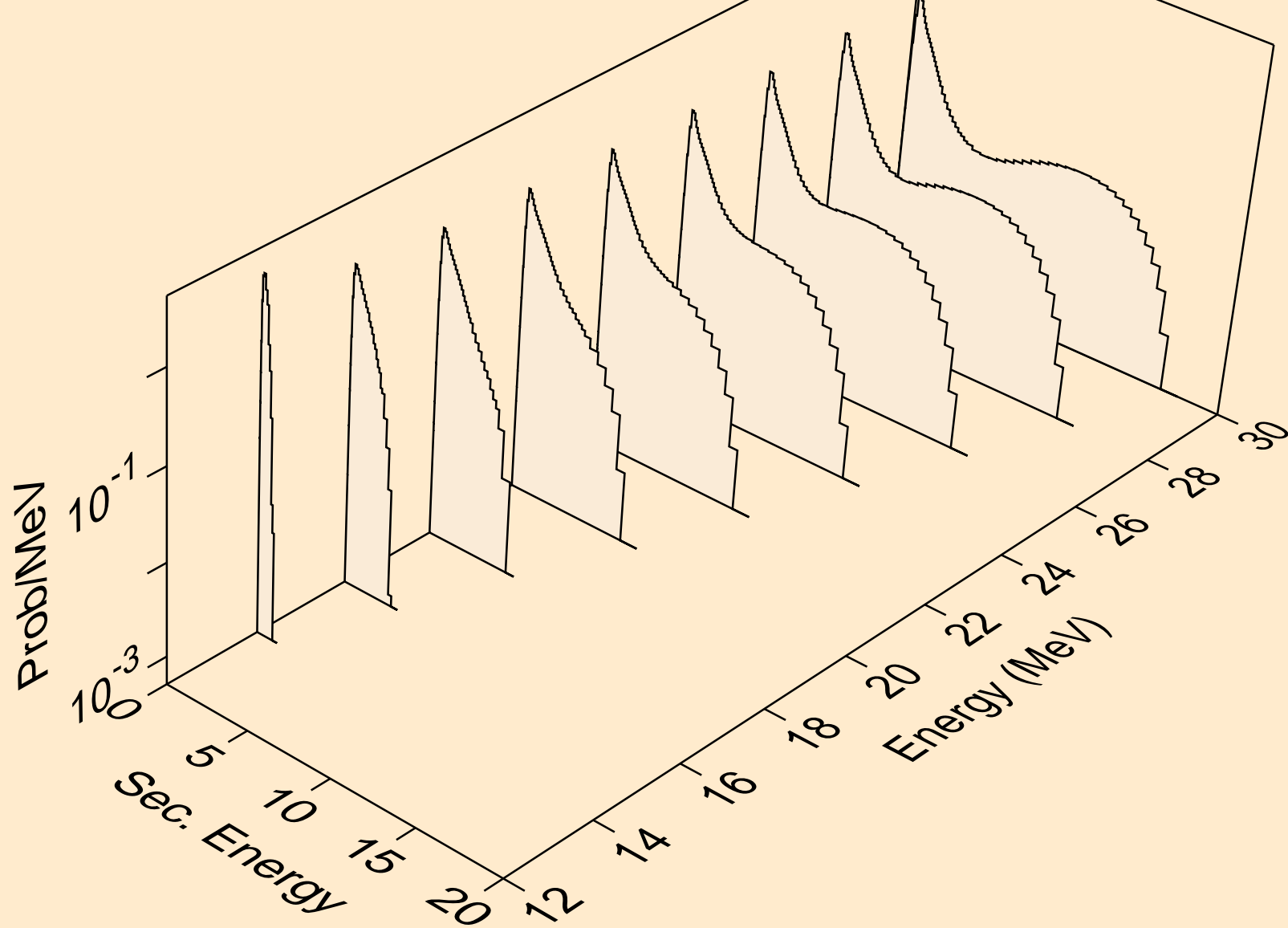

LR259 NEUTRON ACER TENDL-2021 LIBRARY; T=293.6K
Neutron emission for fission

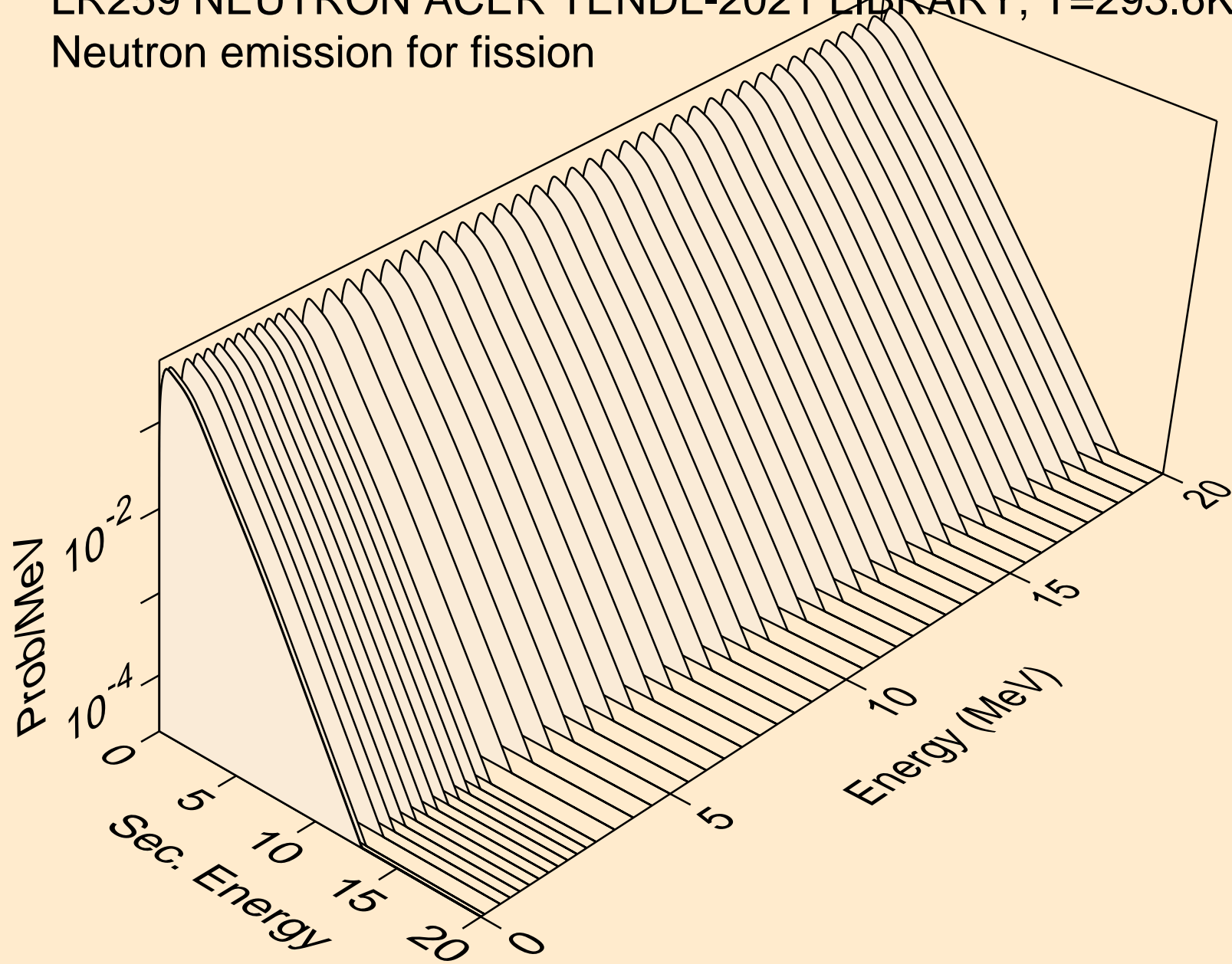

LR259 NEUTRON ACER TENDL-2021 LIBRARY; T=293.6K
Neutron emission for (n,n*)a

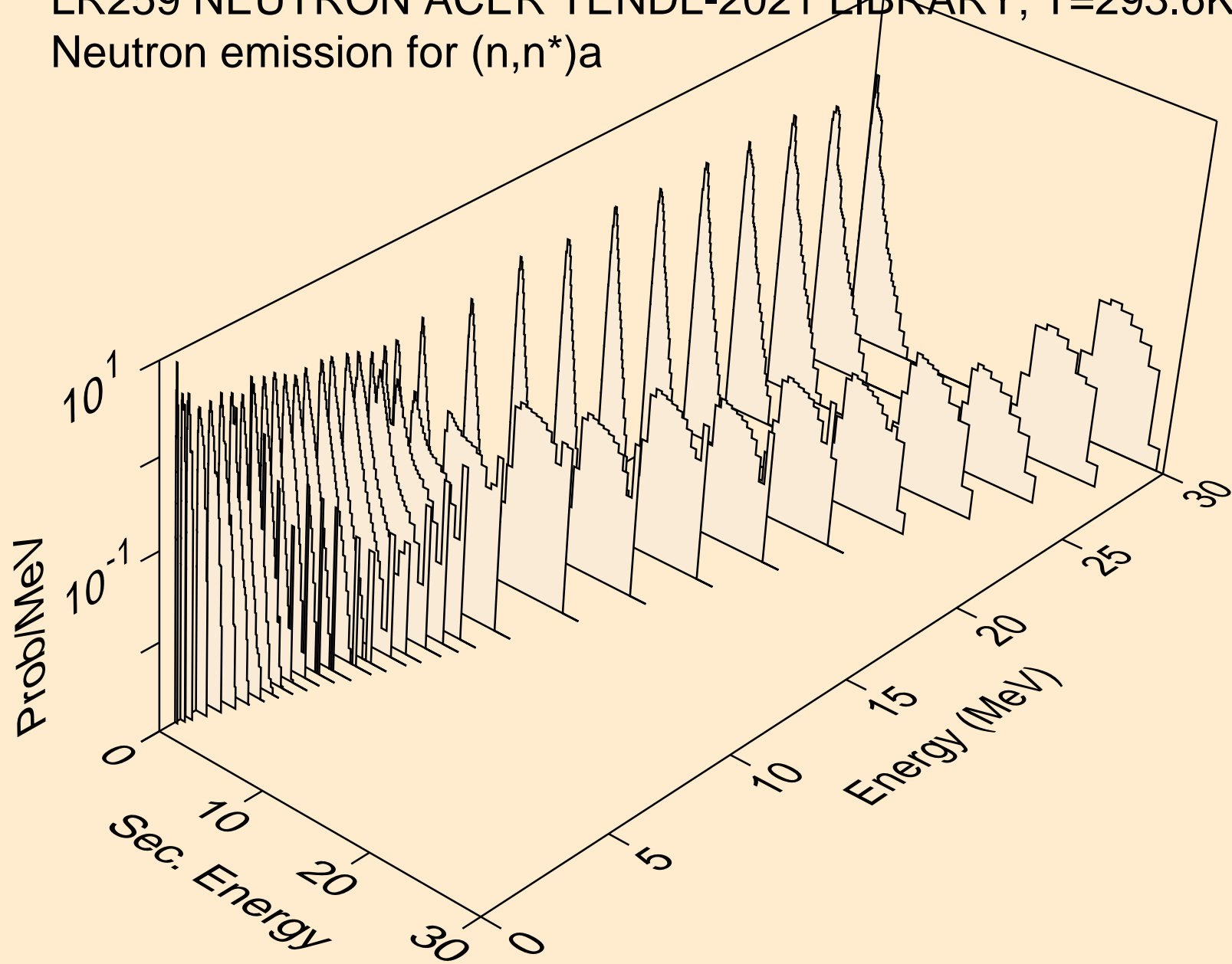

LR259 NEUTRON ACER TENDL-2021 LIBRARY; T=293.6K
Neutron emission for (n,2n)a

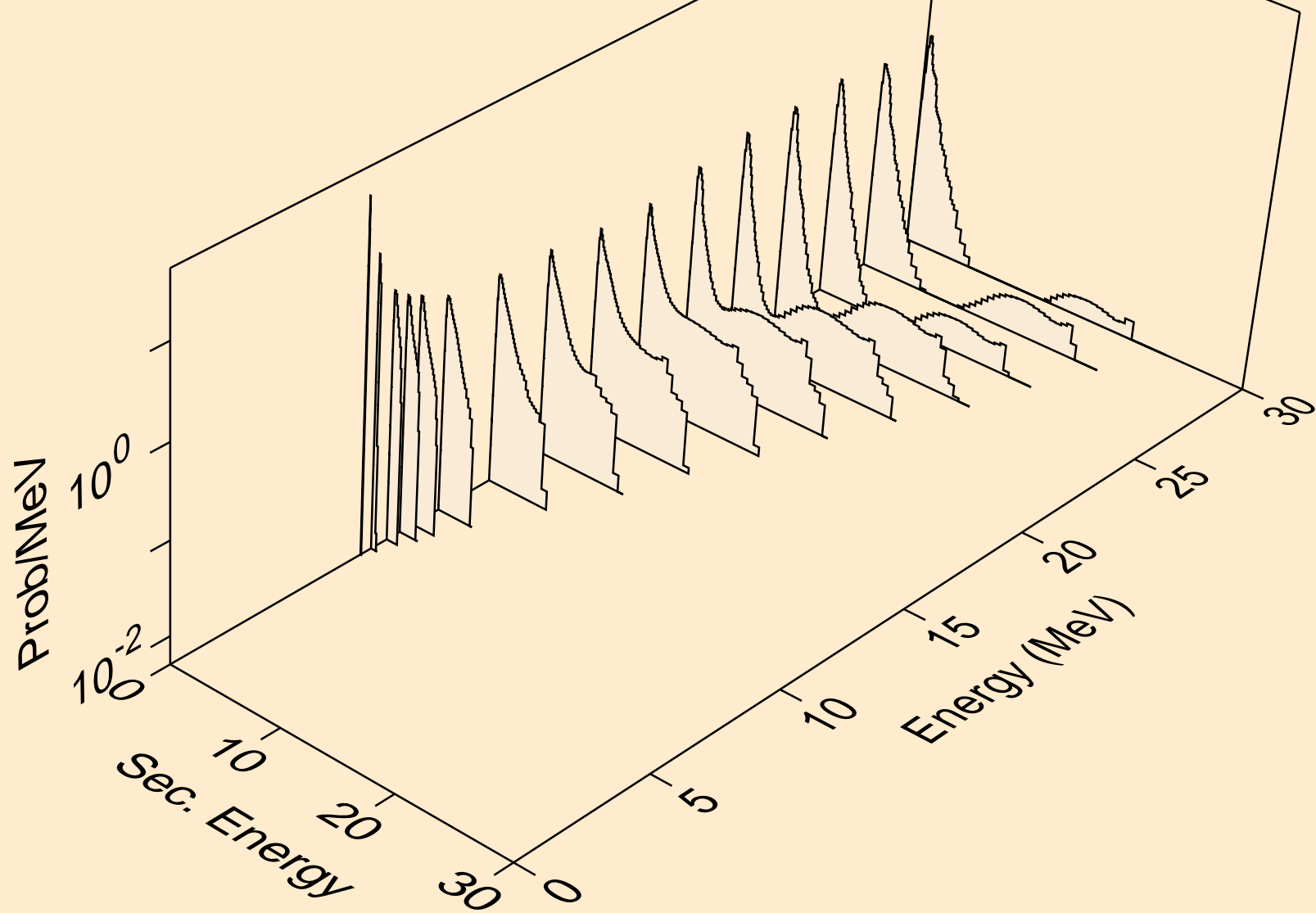

LR259 NEUTRON ACER TENDL-2021 LIBRARY; T=293.6K
Neutron emission for (n,3n)a

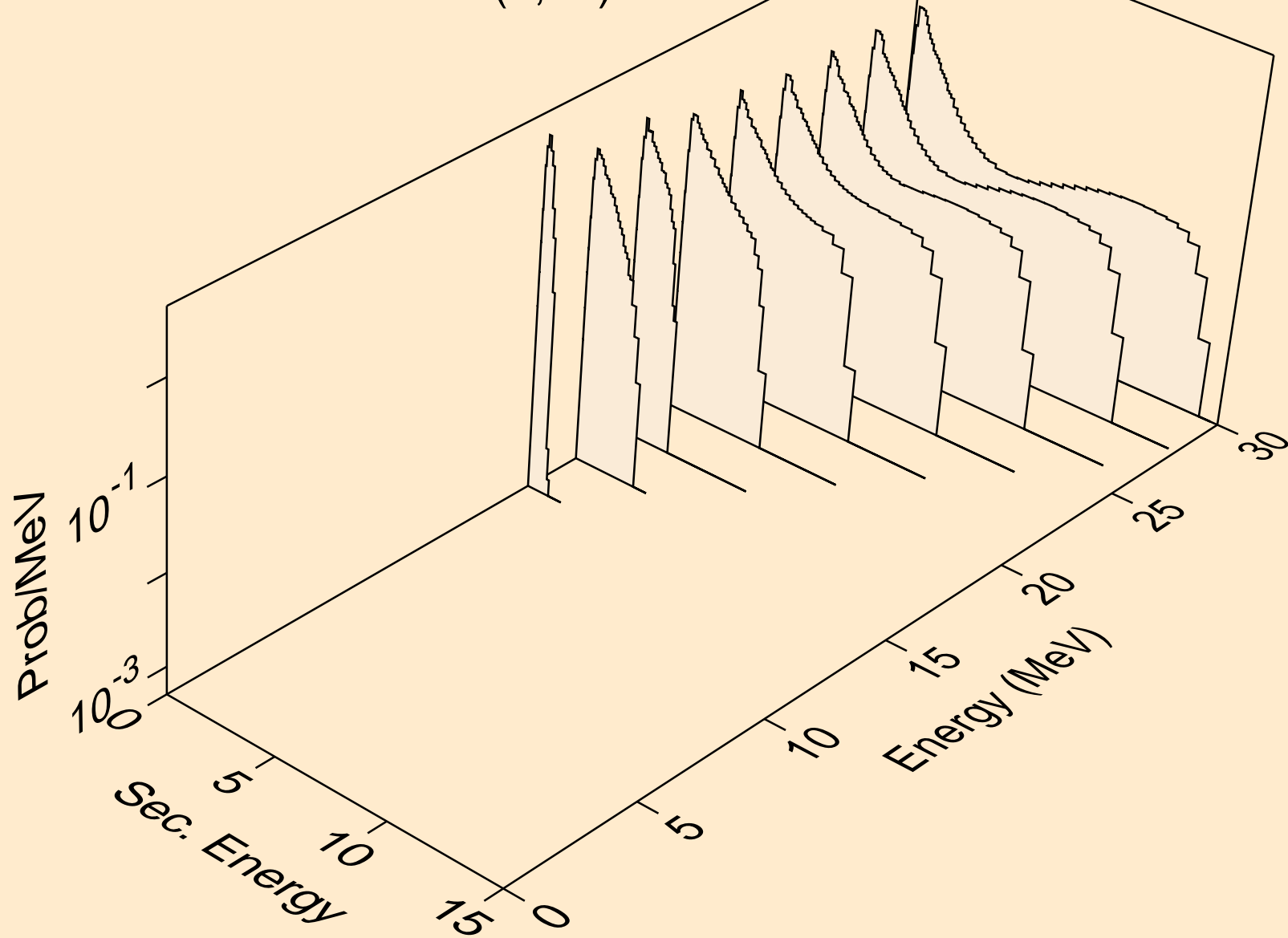

LR259 NEUTRON ACER TENDL-2021 LIBRARY; T=293.6K
Neutron emission for (n,n*)p

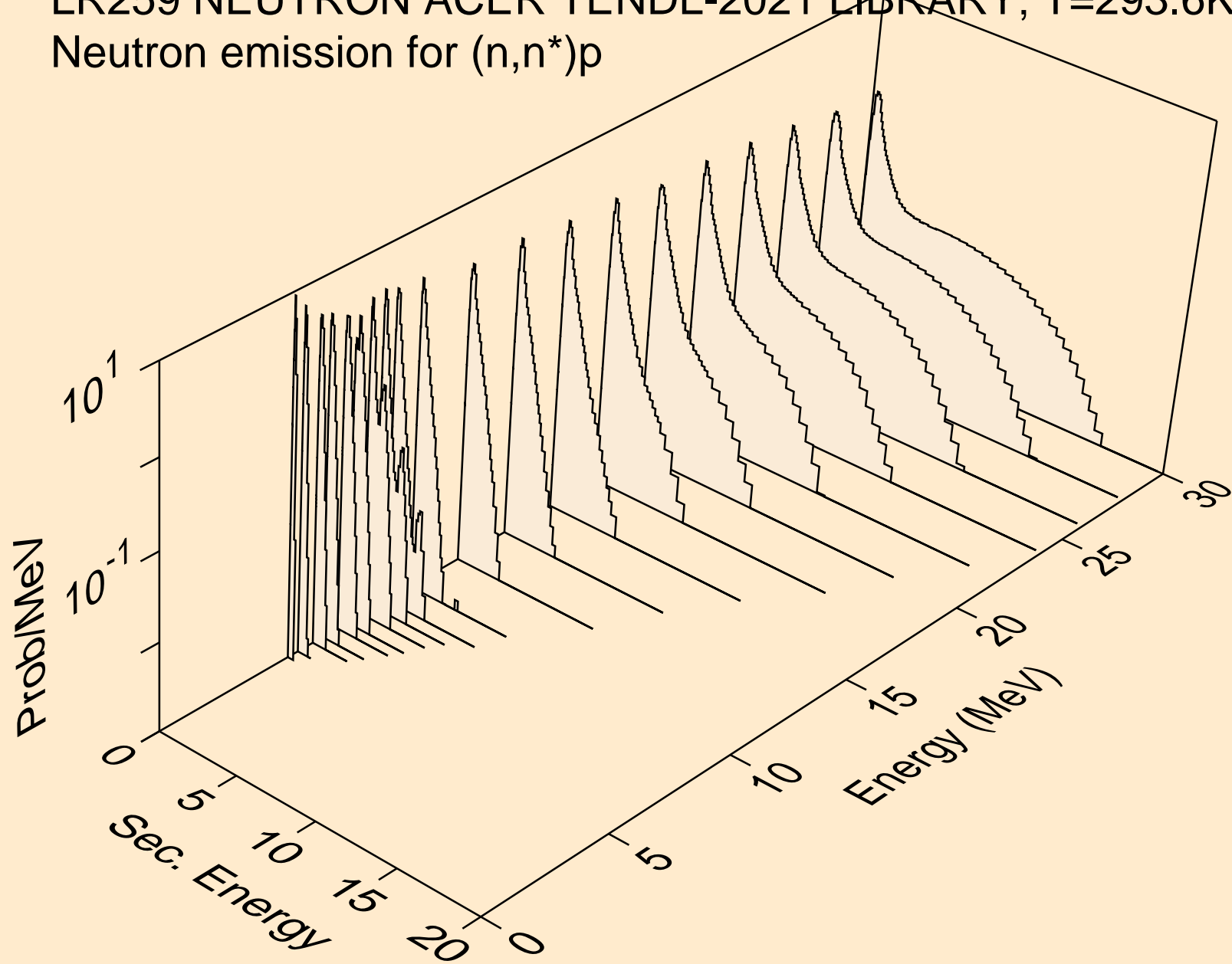

LR259 NEUTRON ACER TENDL-2021 LIBRARY; T=293.6K
Neutron emission for (n,n*)2a

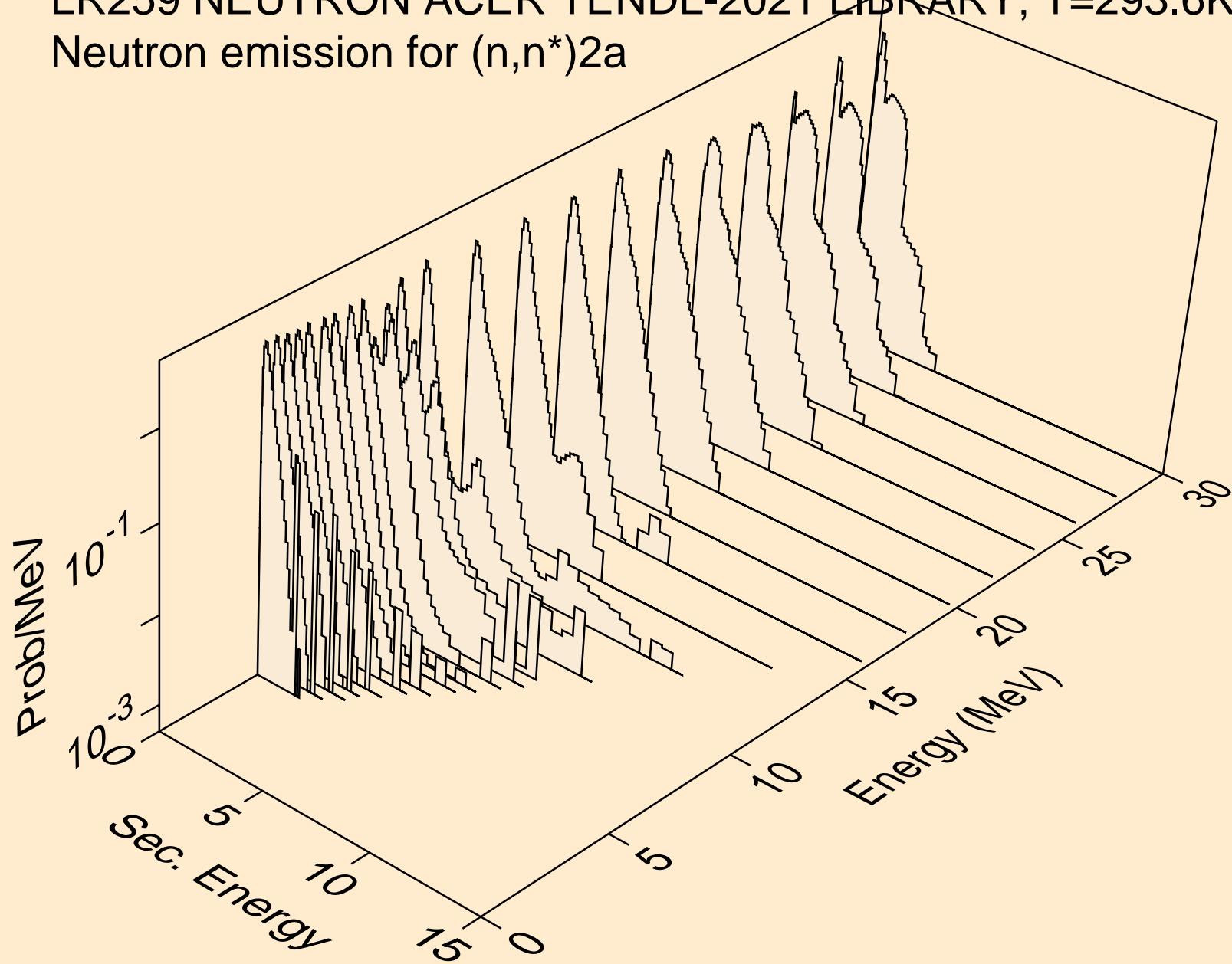

LR259 NEUTRON ACER TENDL-2021 LIBRARY; T=293.6K
Neutron emission for (n,2n)2a

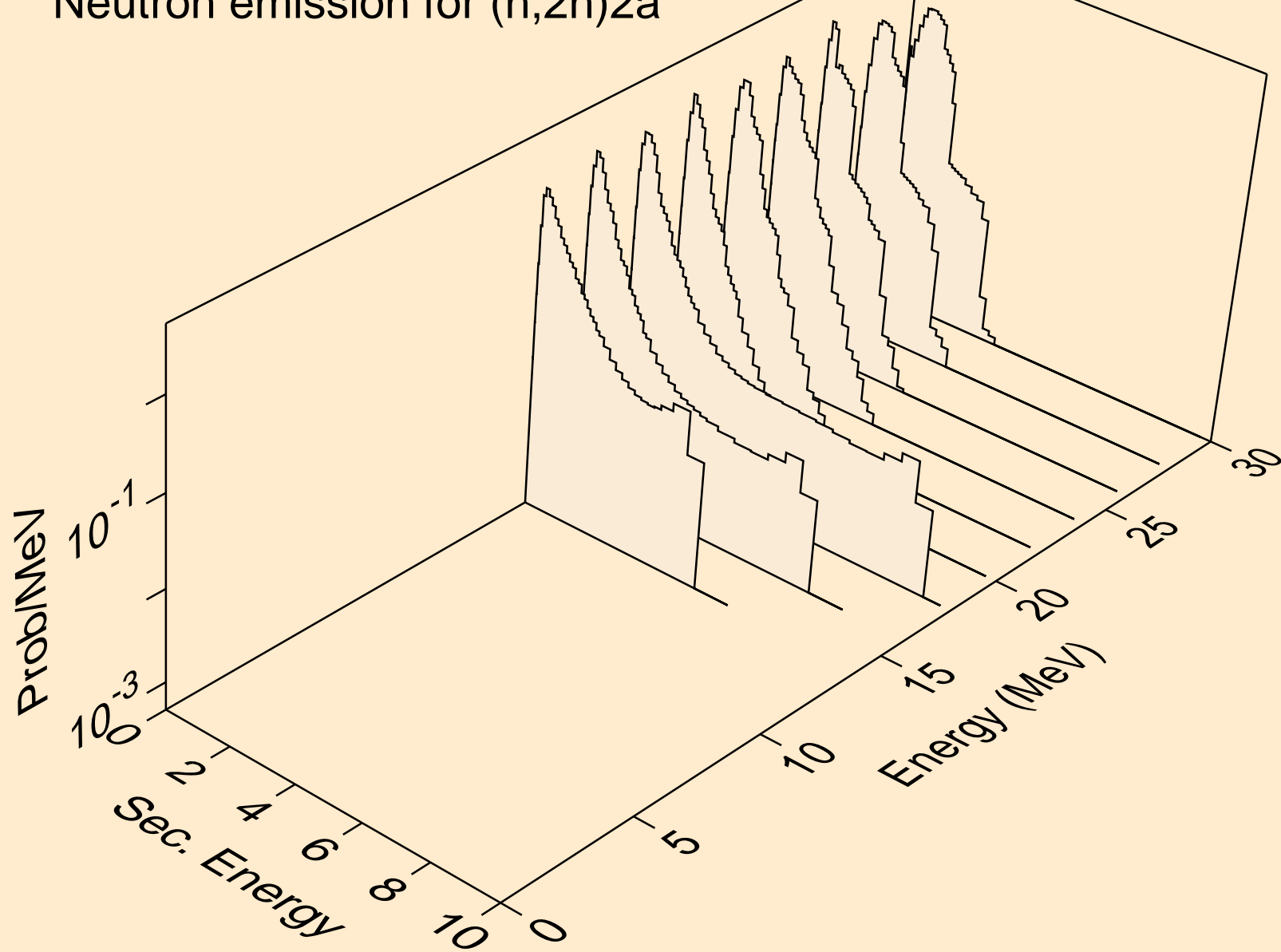

LR259 NEUTRON ACER TENDL-2021 LIBRARY; T=293.6K
Neutron emission for (n,n*)d

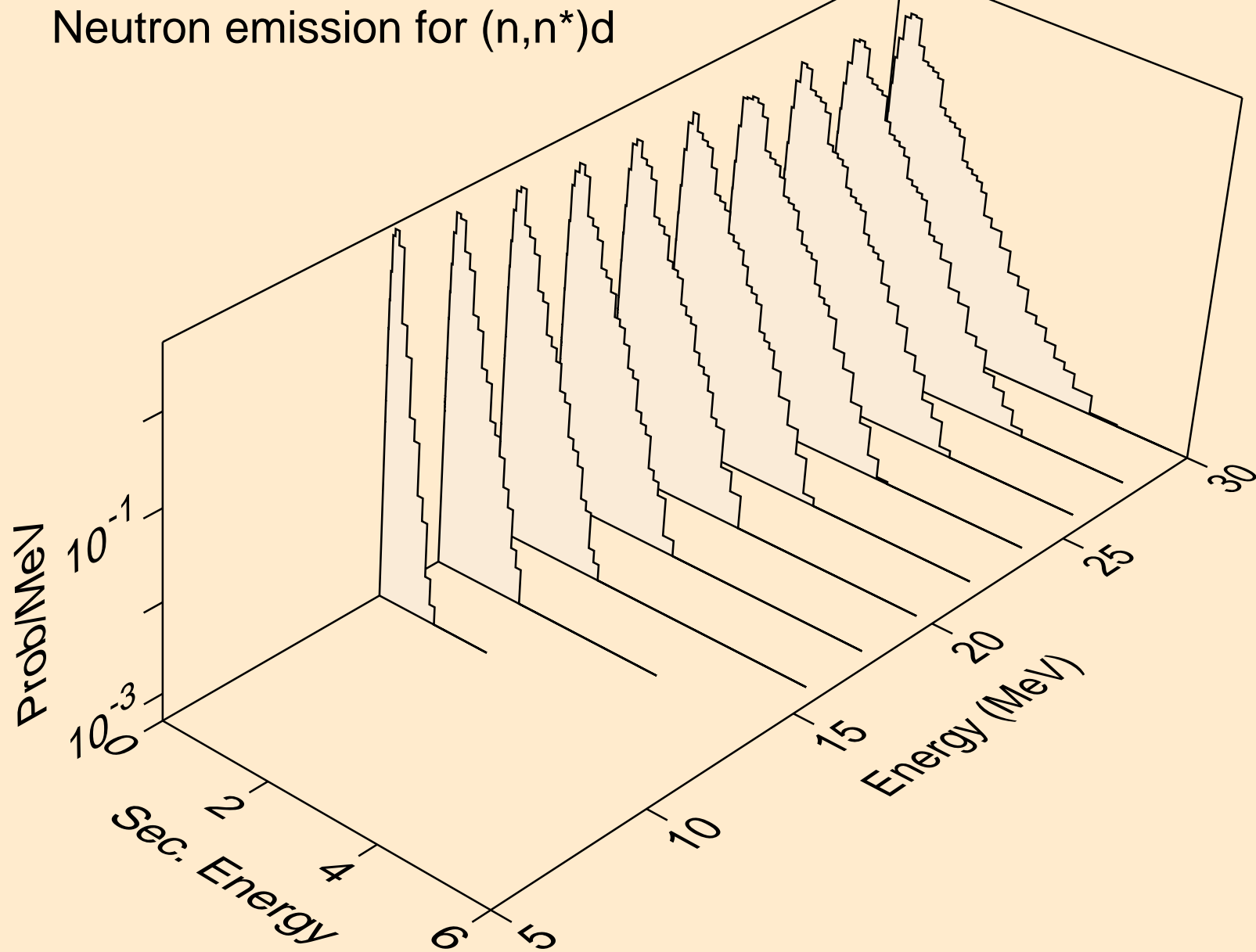

LR259 NEUTRON ACER TENDL-2021 LIBRARY; T=293.6K
Neutron emission for (n,n*)t

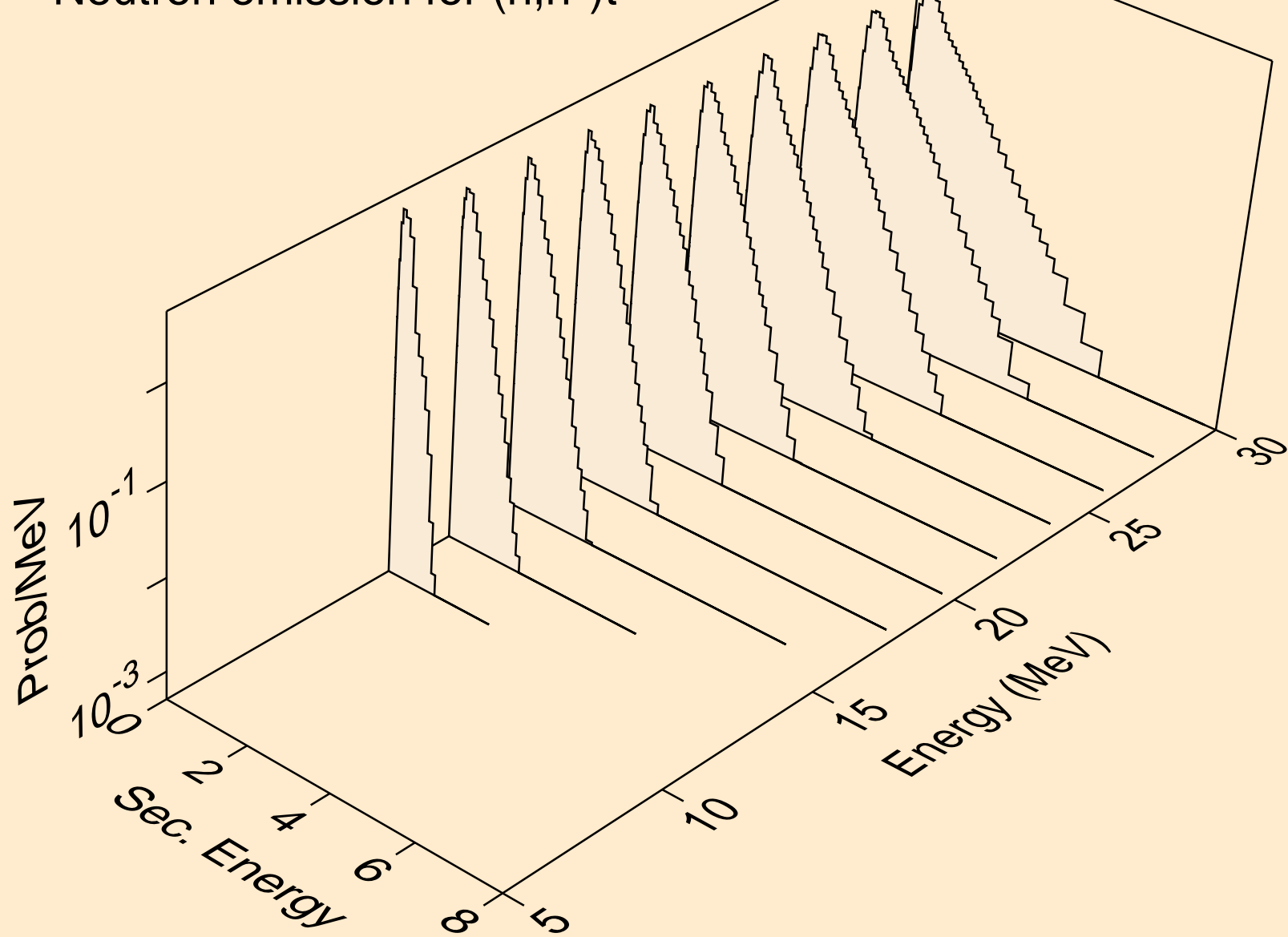

LR259 NEUTRON ACER TENDL-2021 LIBRARY; T=293.6K
Neutron emission for (n,n*)he3

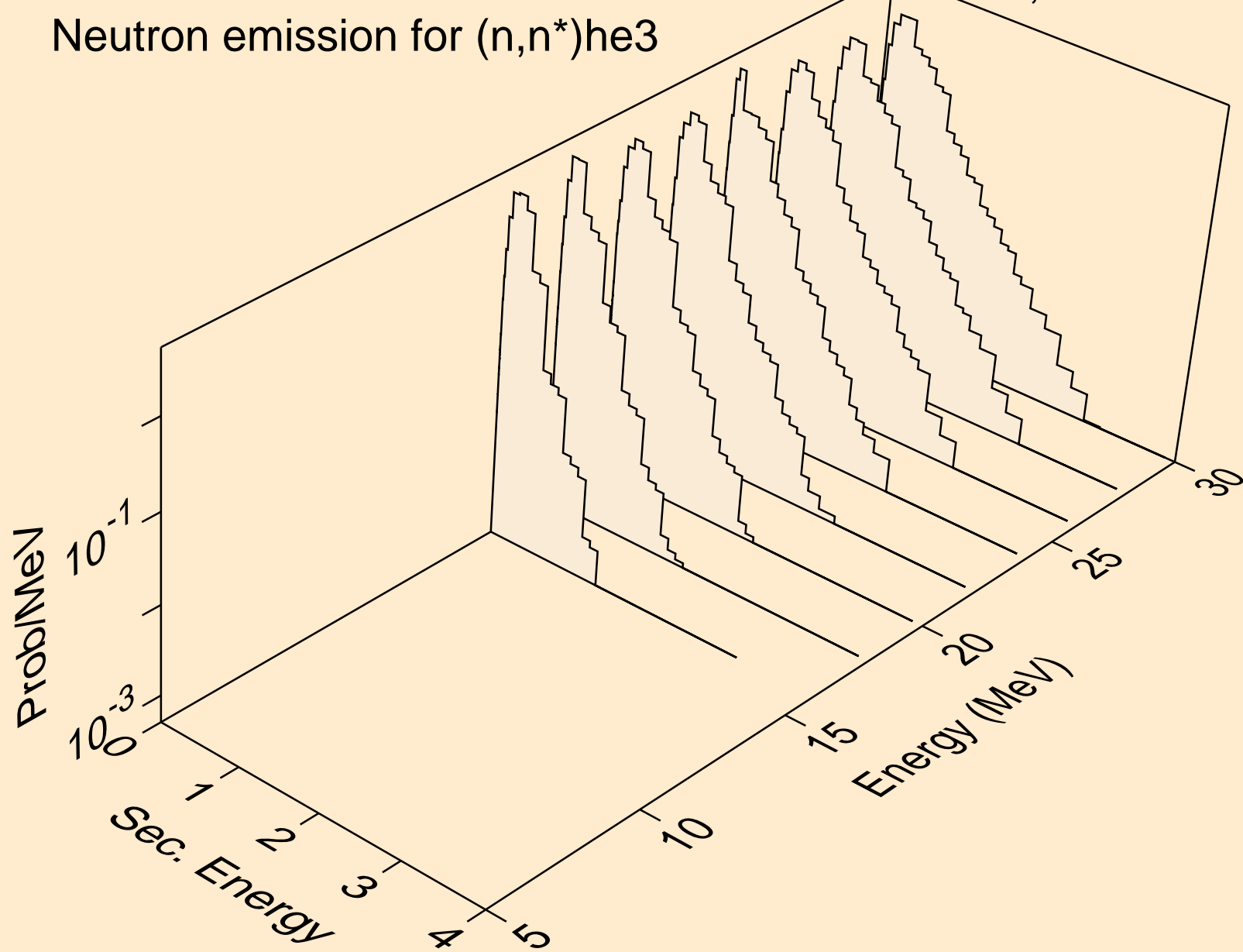

LR259 NEUTRON ACER TENDL-2021 LIBRARY; T=293.6K
Neutron emission for (n,4n)

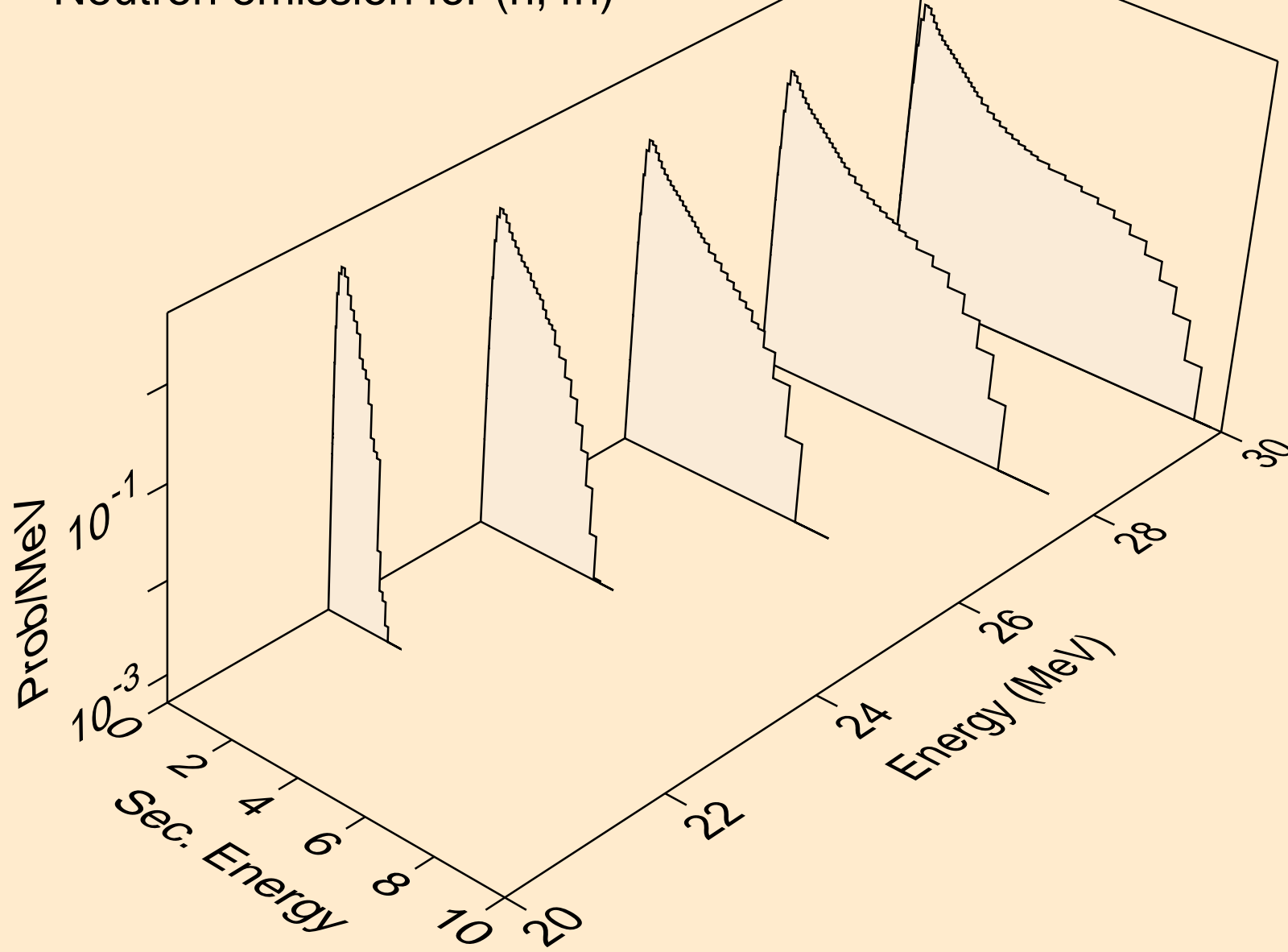

LR259 NEUTRON ACER TENDL-2021 LIBRARY; T=293.6K
Neutron emission for (n,2np)

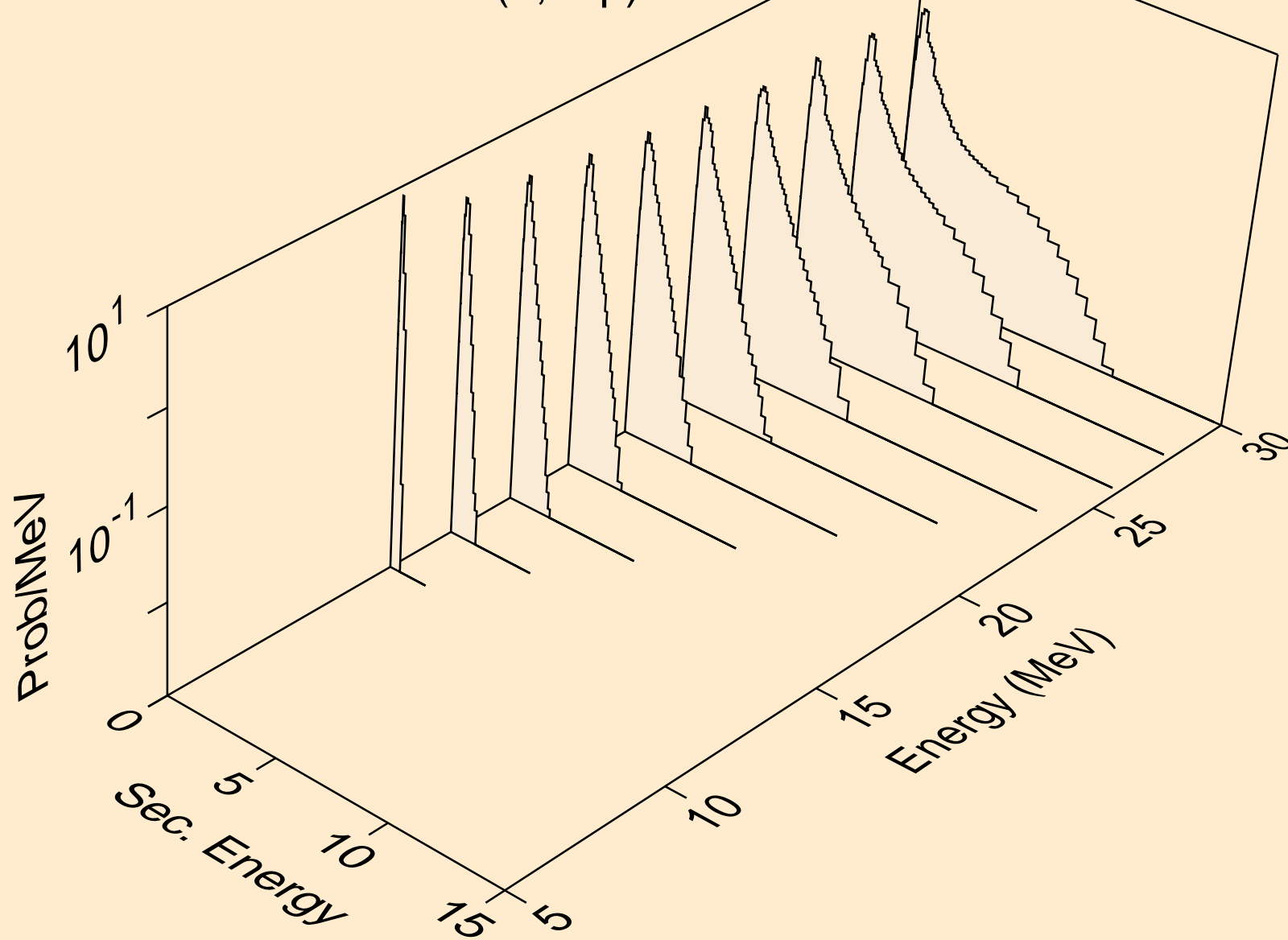

LR259 NEUTRON ACER TENDL-2021 LIBRARY; T=293.6K
Neutron emission for (n,3np)

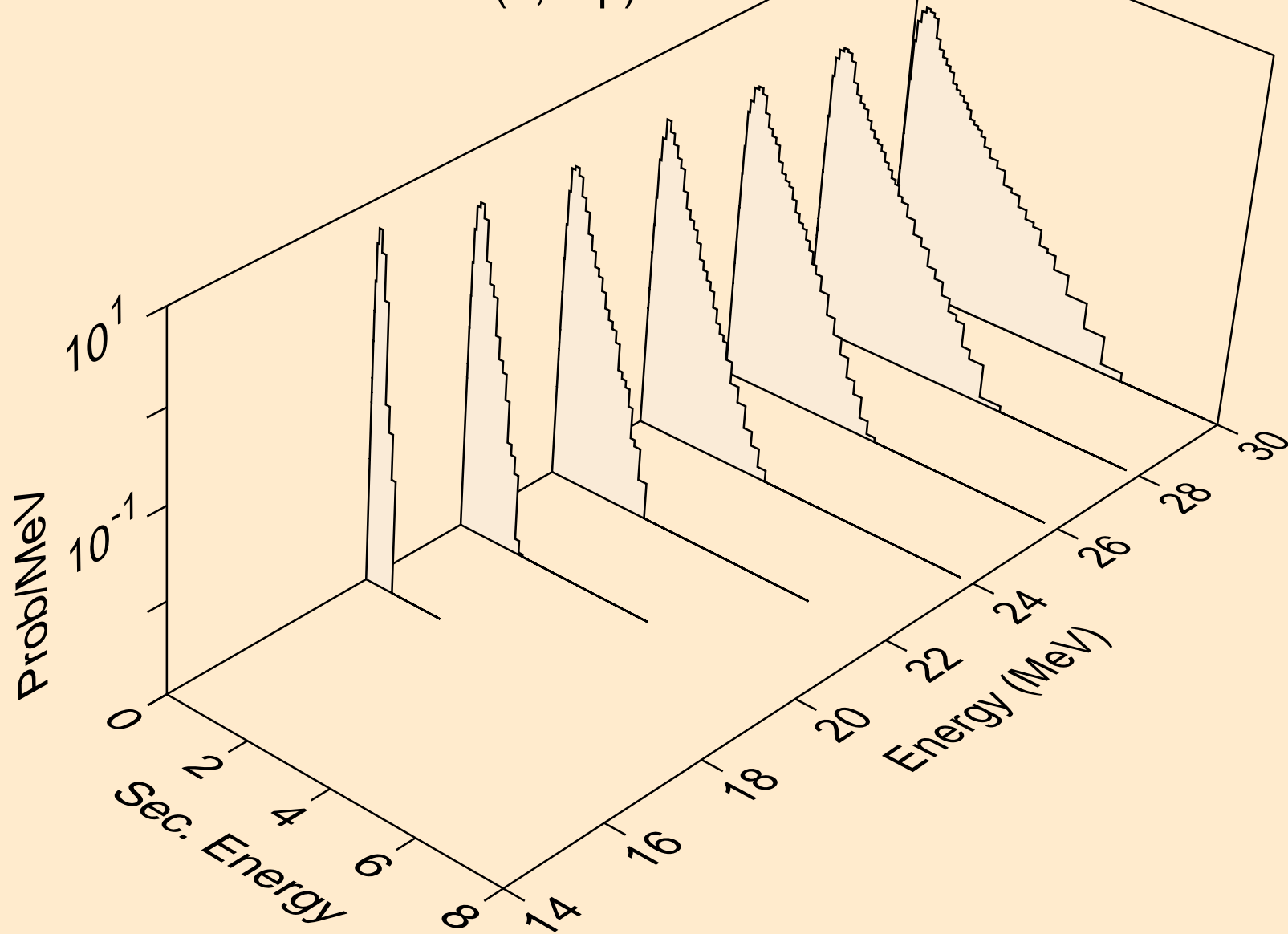

LR259 NEUTRON ACER TENDL-2021 LIBRARY; T=293.6K
Neutron emission for (n,2np)

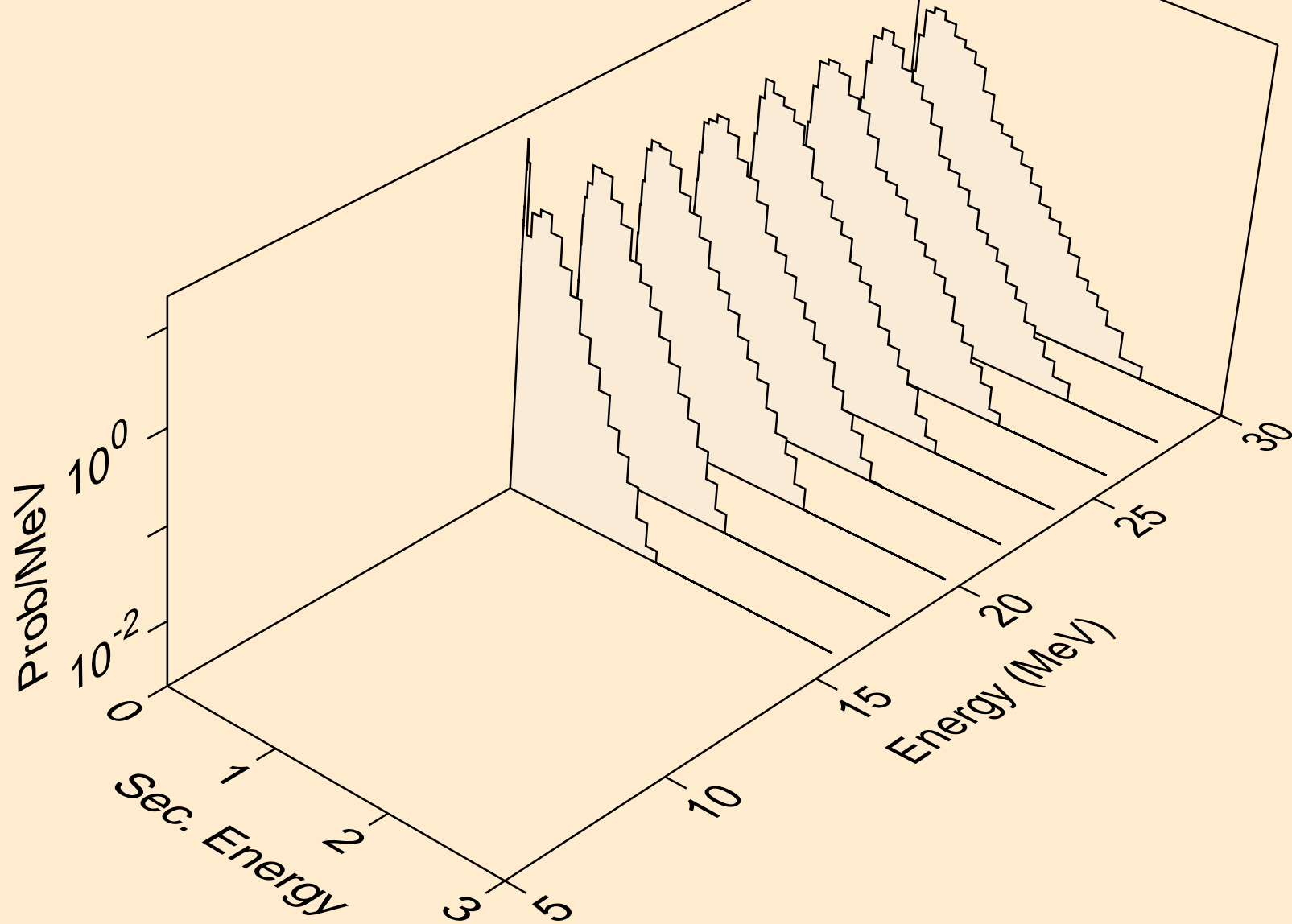

LR259 NEUTRON ACER TENDL-2021 LIBRARY; T=293.6K
Neutron emission for (n,npa)

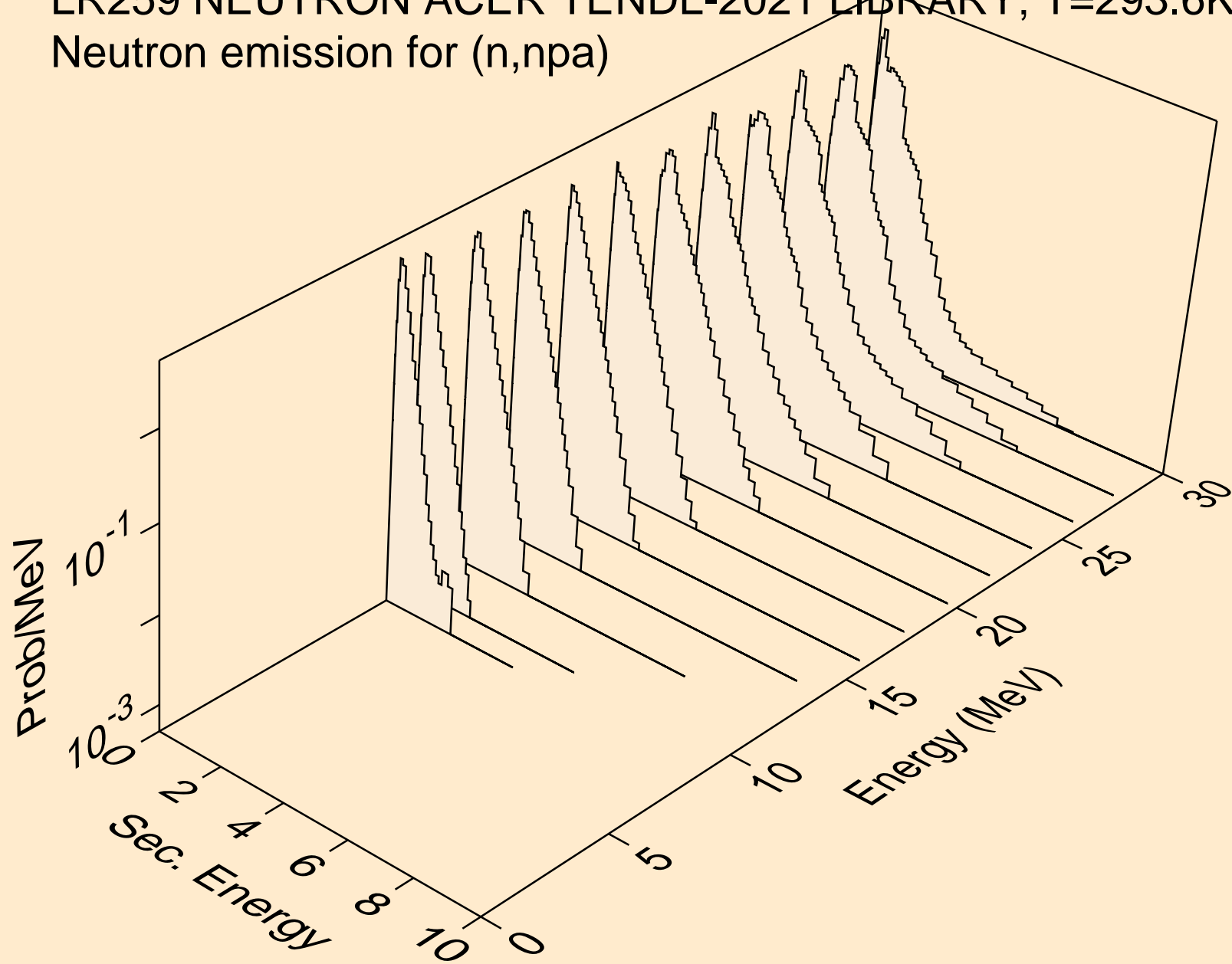

LR259 NEUTRON ACER TENDL-2021 LIBRARY; T=293.6K
Neutron emission for (n,n*c)

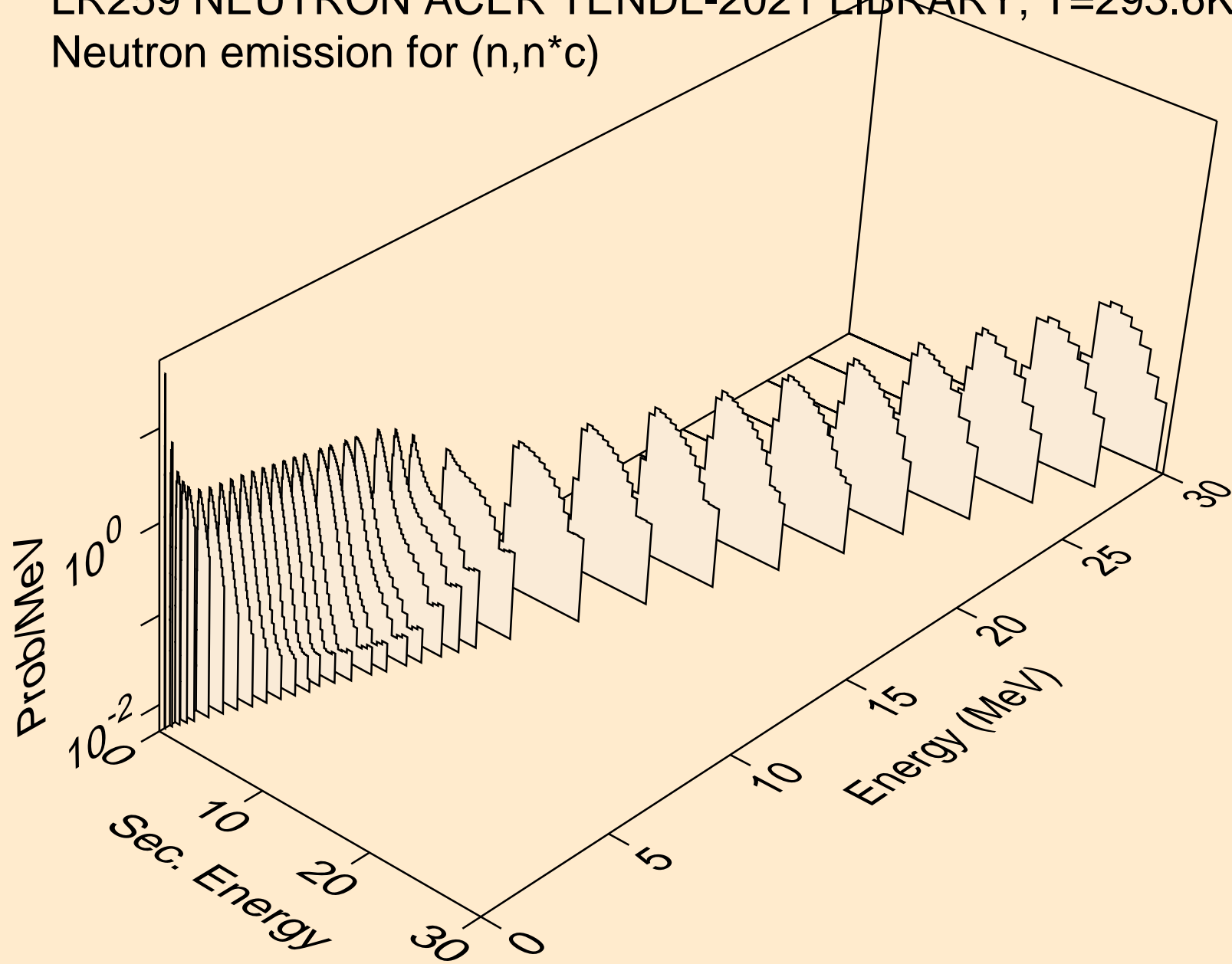

LR259 NEUTRON ACER TENDL-2021 LIBRARY; T=293.6K

Delayed nubar

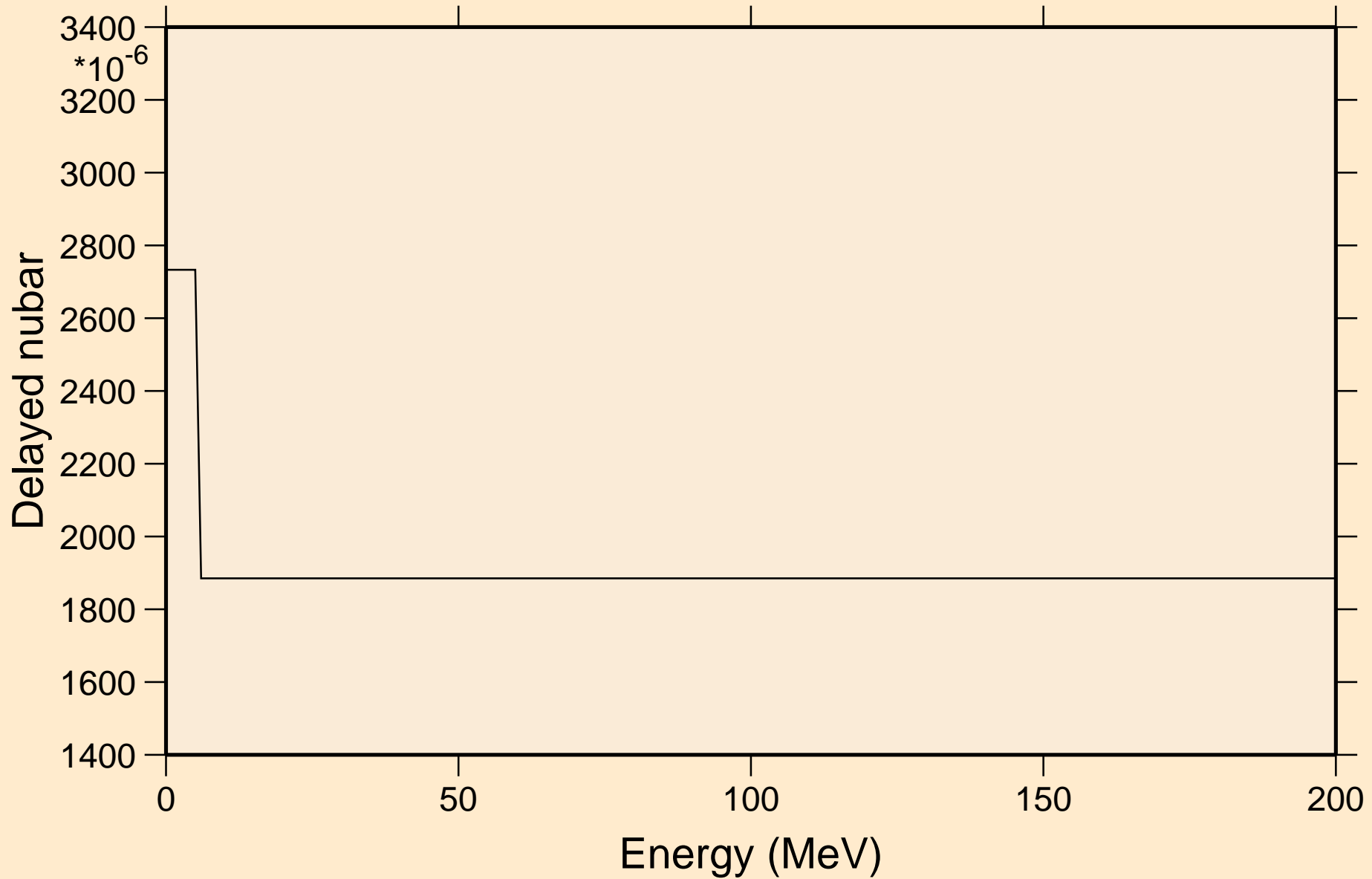

LR259 NEUTRON ACER TENDL-2021 LIBRARY; T=293.6K

Delayed neutron spectra

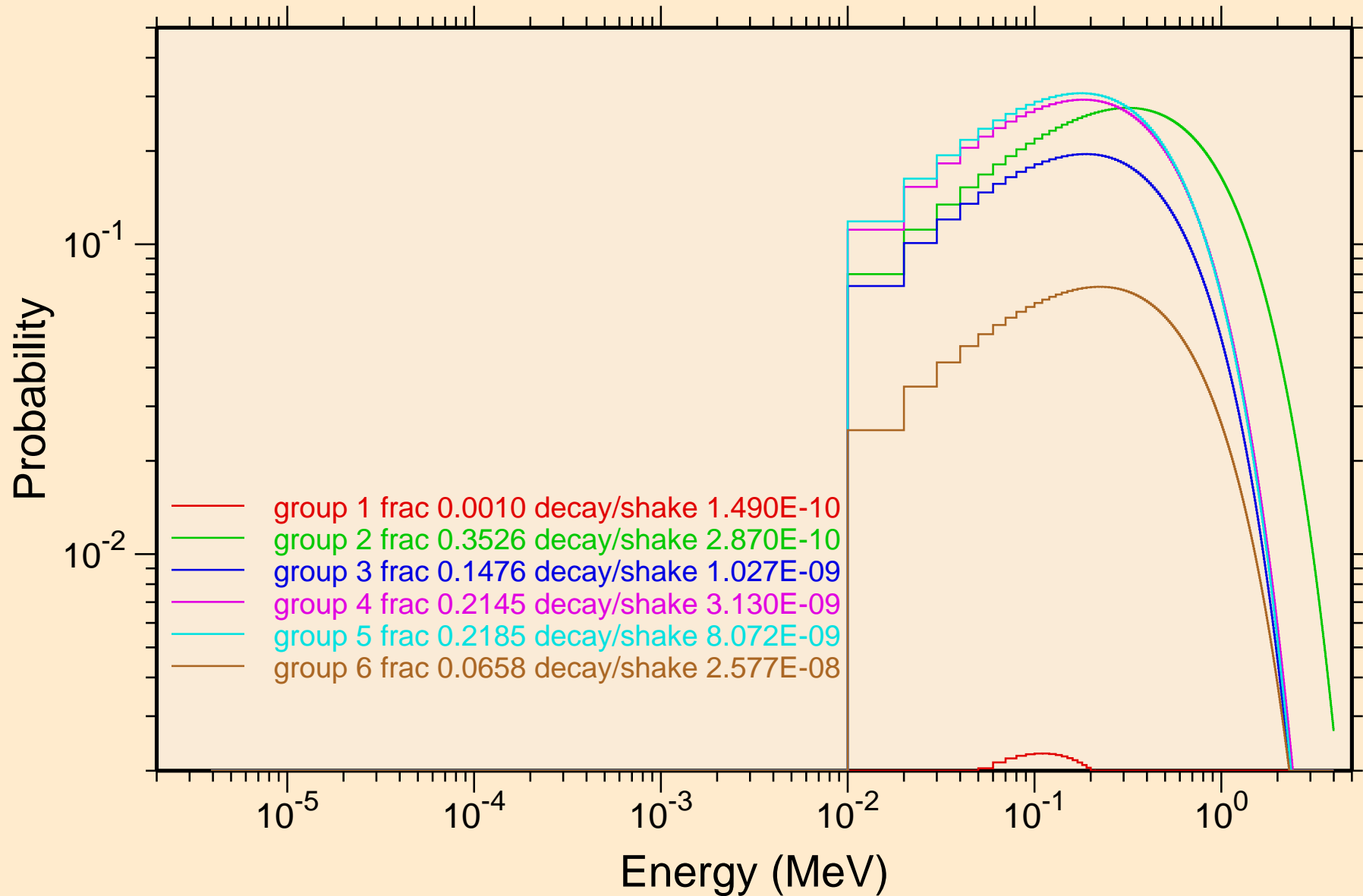

LR259 NEUTRON ACER TENDL-2021 LIBRARY; T=293.6K
Photon emission for (n,x)

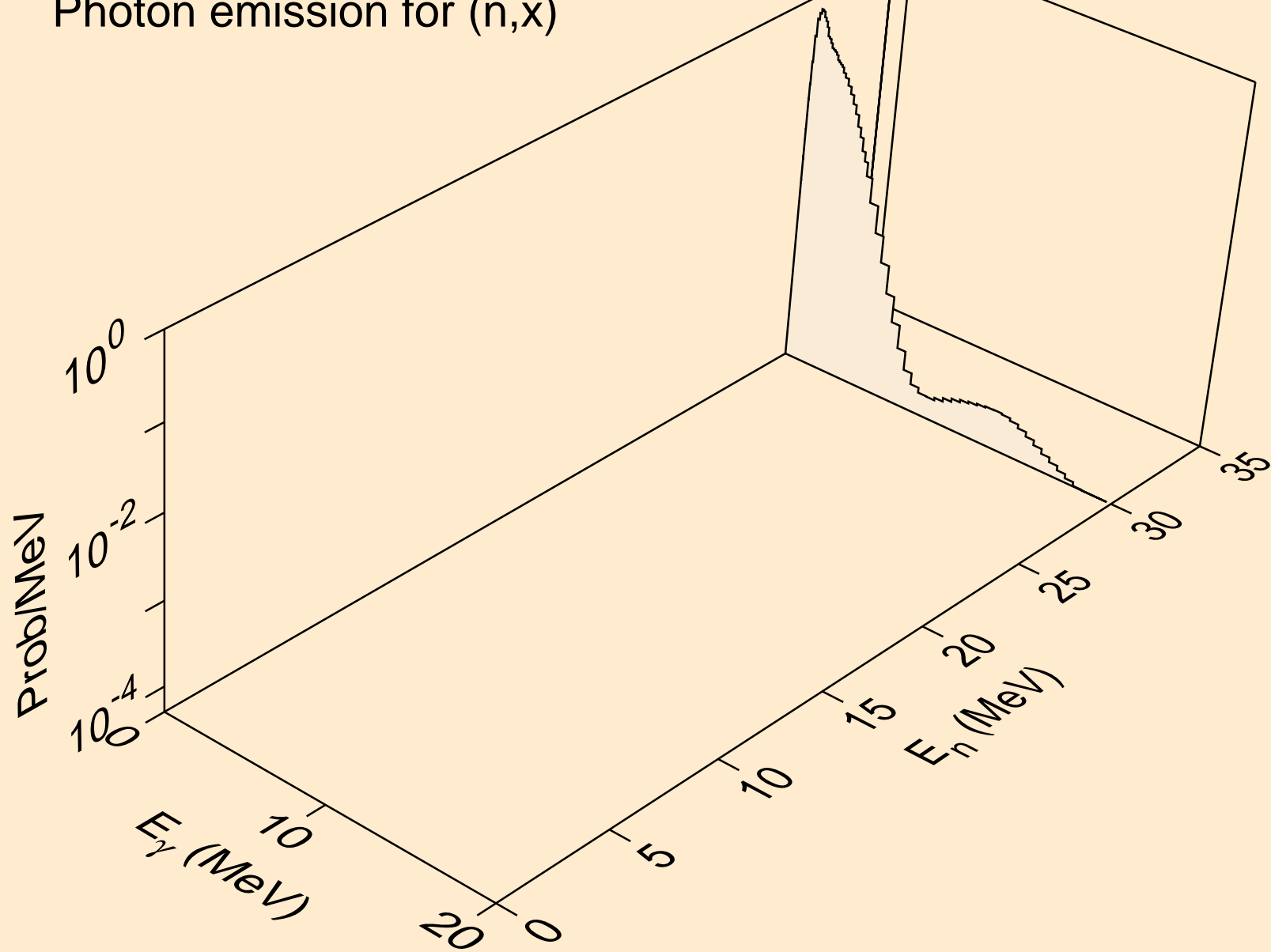

LR259 NEUTRON ACER TENDL-2021 LIBRARY; T=293.6K
Photon emission for (n,2nd)

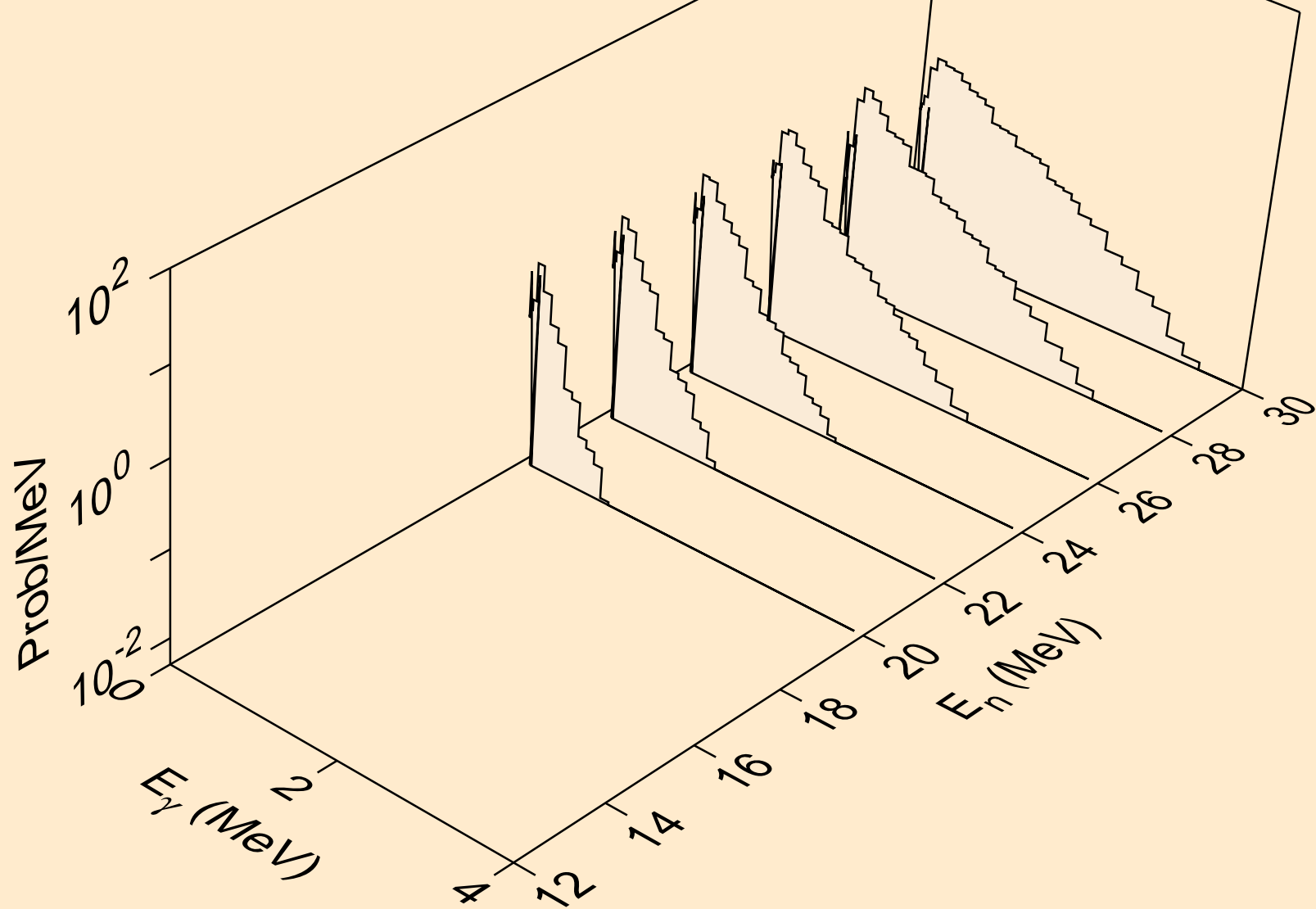

LR259 NEUTRON ACER TENDL-2021 LIBRARY; T=293.6K
Photon emission for (n,2n)

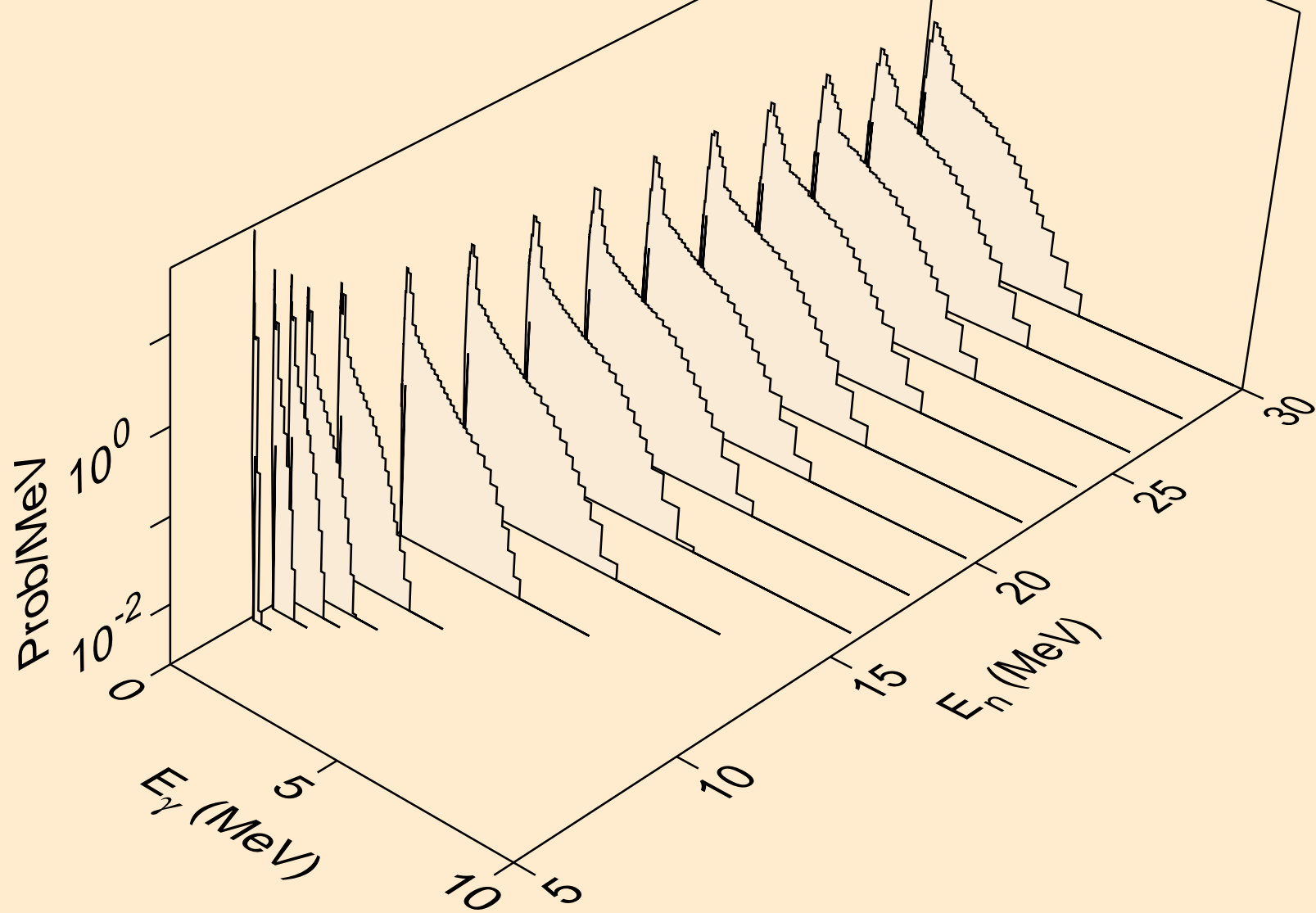

LR259 NEUTRON ACER TENDL-2021 LIBRARY; T=293.6K
Photon emission for (n,3n)

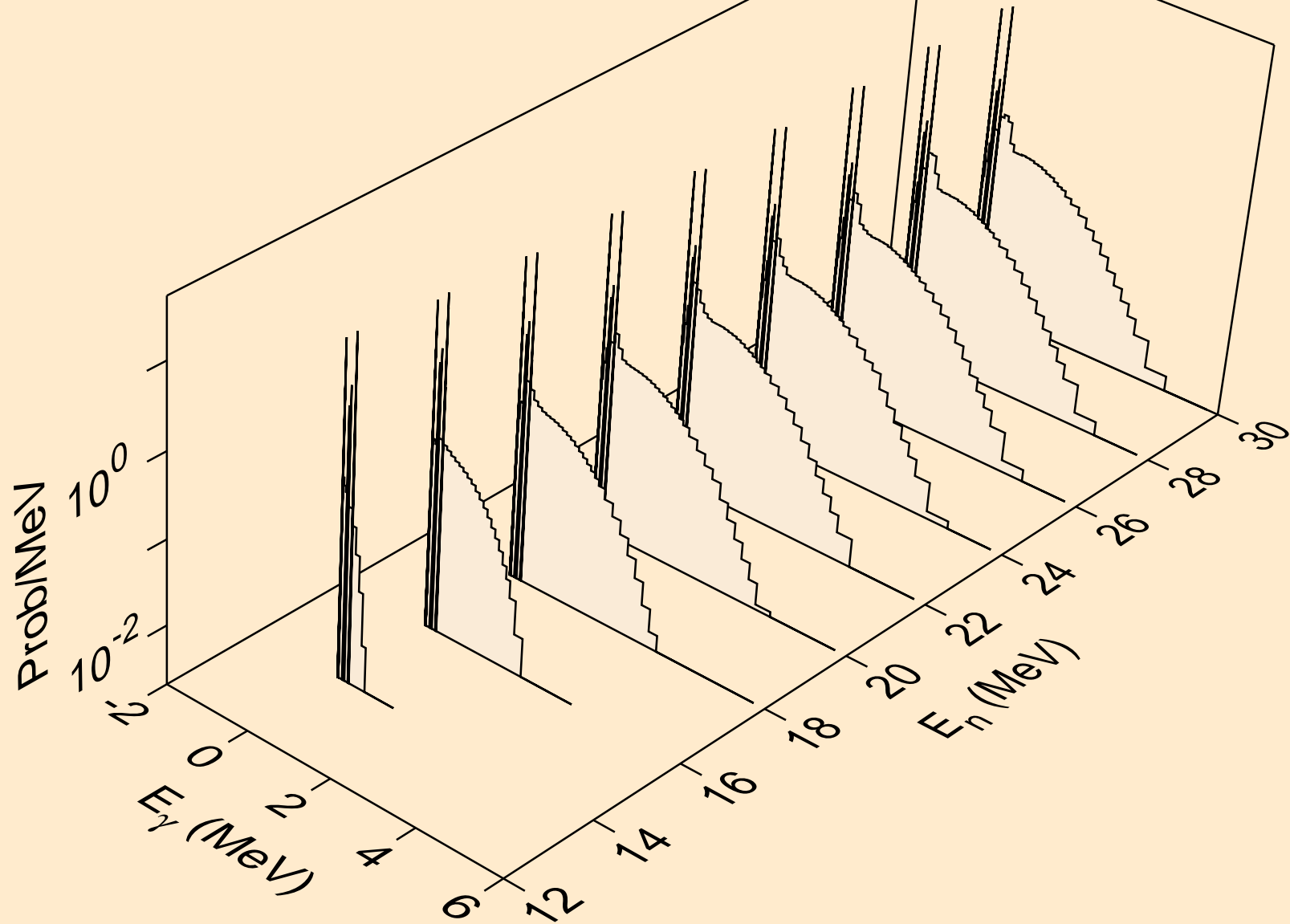

LR259 NEUTRON ACER TENDL-2021 LIBRARY; T=293.6K
Photon emission for (n,n*)a

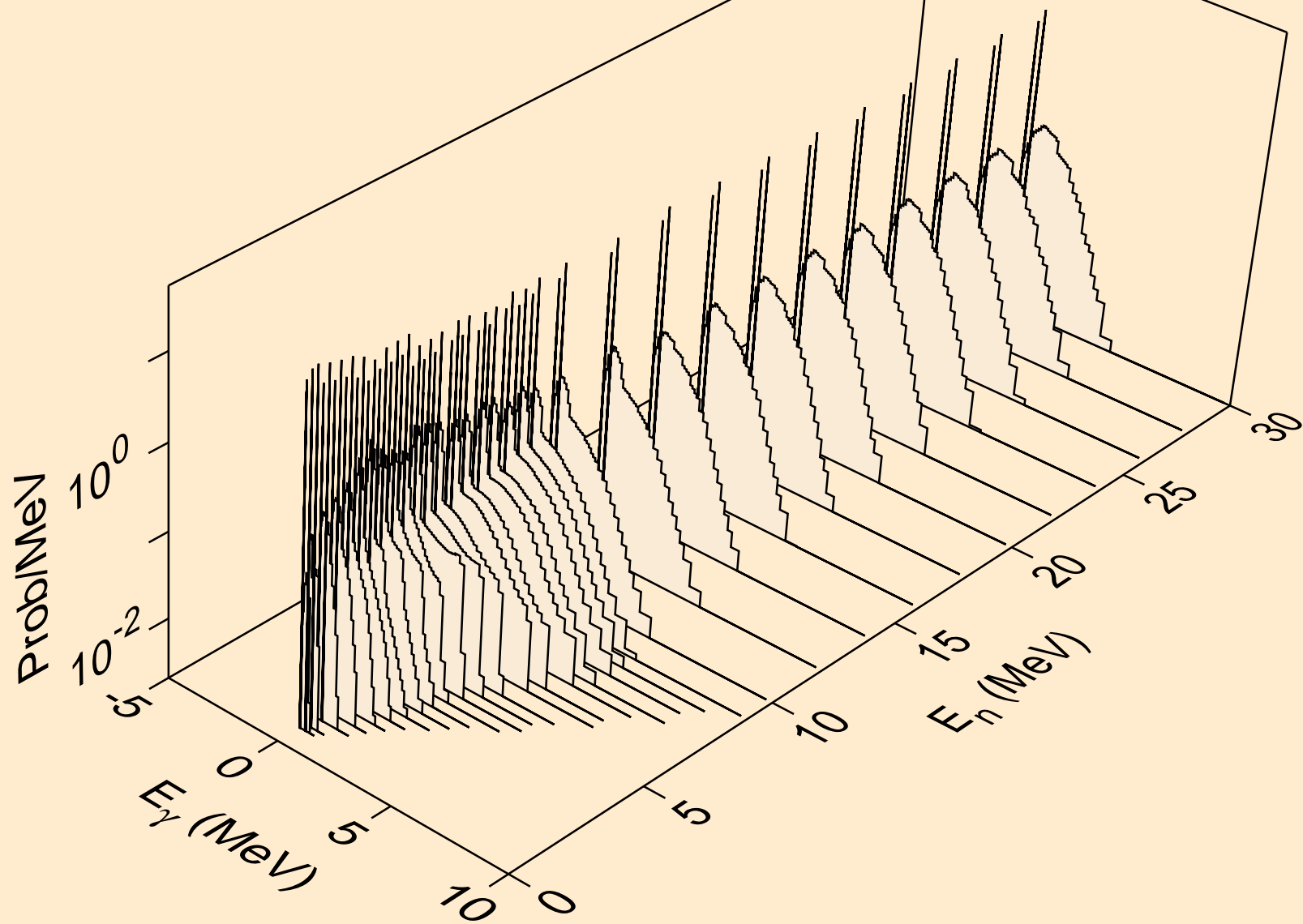

LR259 NEUTRON ACER TENDL-2021 LIBRARY; T=293.6K
Photon emission for (n,2n)a

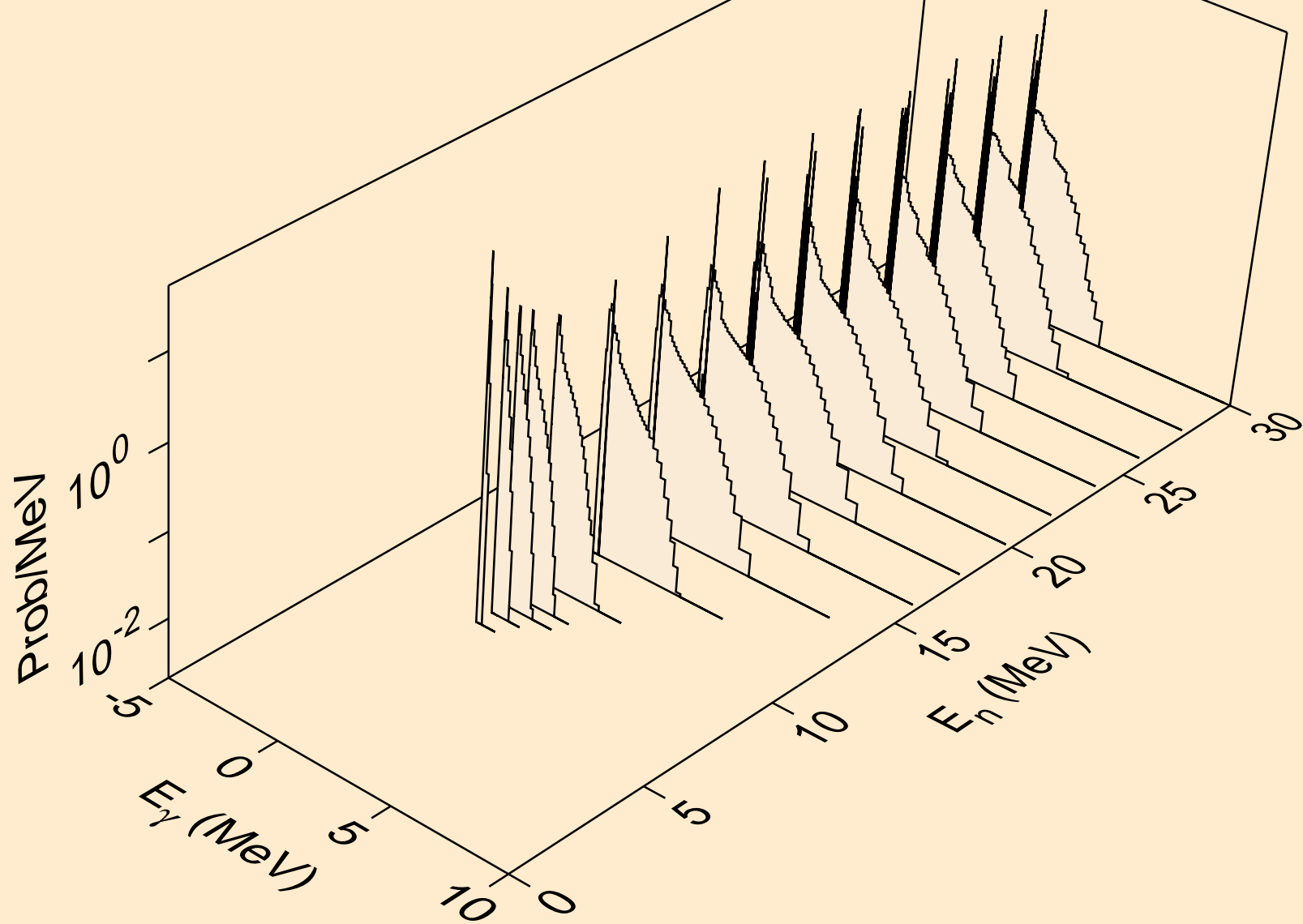

LR259 NEUTRON ACER TENDL-2021 LIBRARY; T=293.6K
Photon emission for (n,3n)a

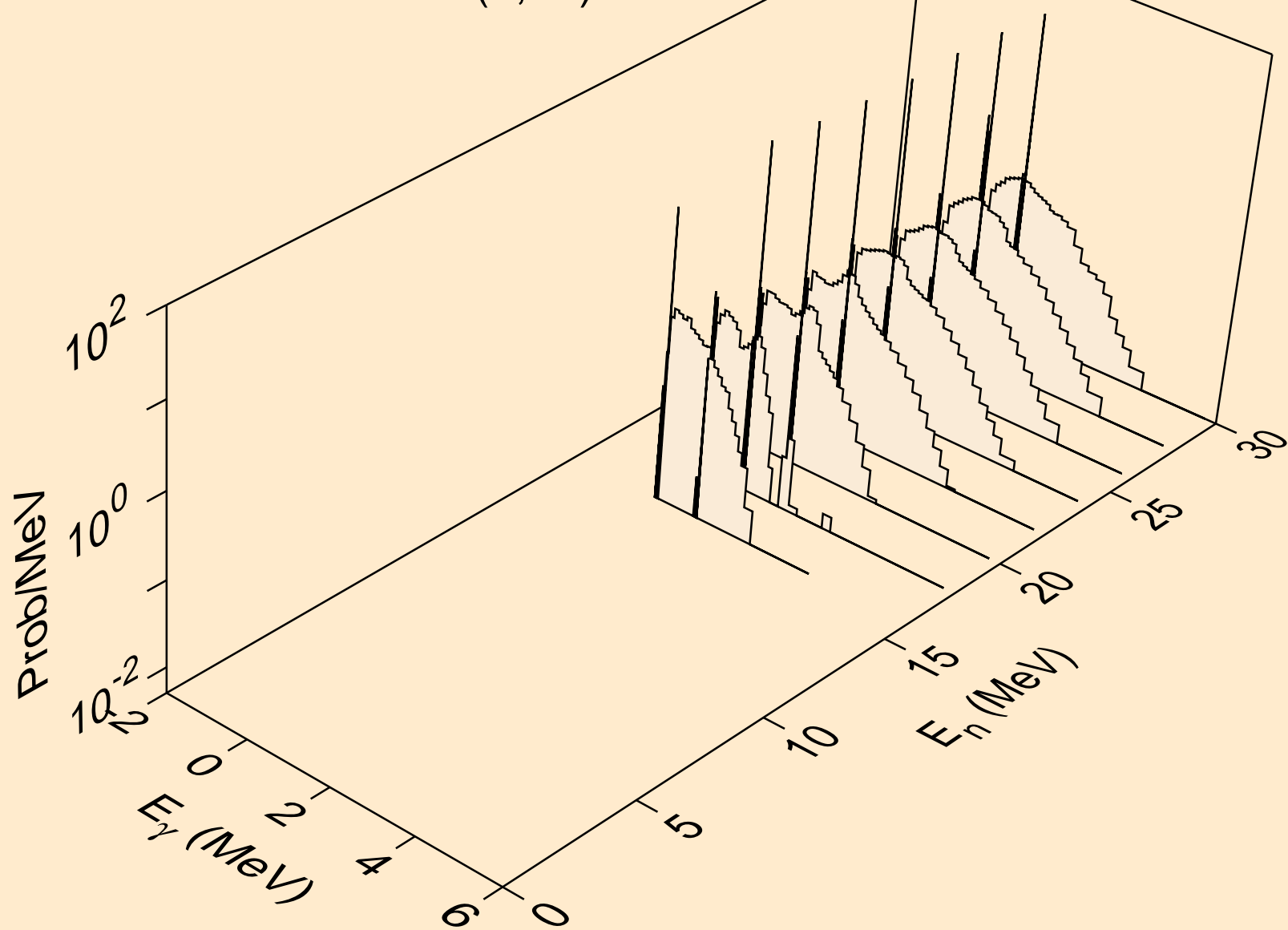

LR259 NEUTRON ACER TENDL-2021 LIBRARY; T=293.6K
Photon emission for (n,n*)p

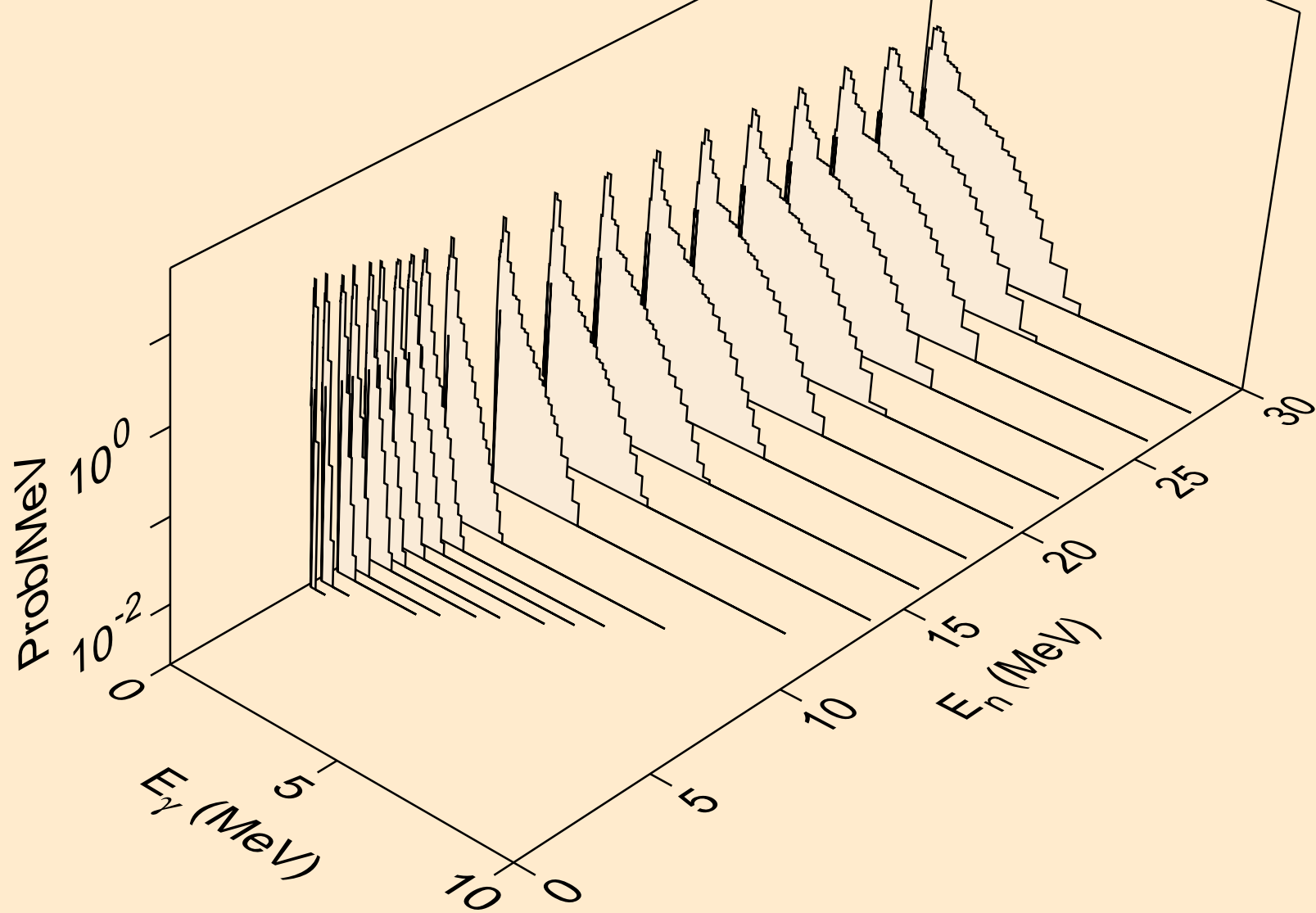

LR259 NEUTRON ACER TENDL-2021 LIBRARY; T=293.6K
Photon emission for (n,n*)2a

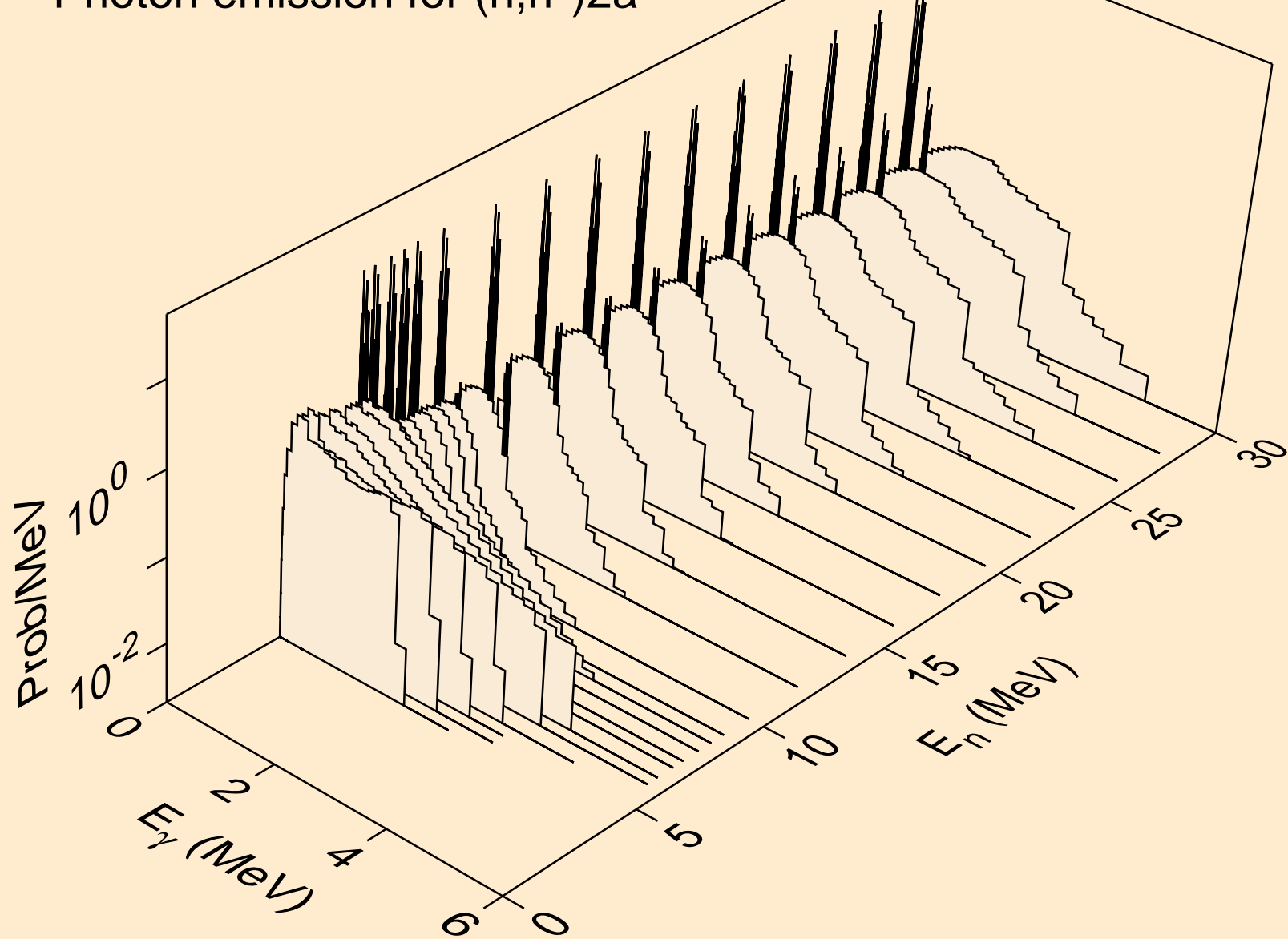

LR259 NEUTRON ACER TENDL-2021 LIBRARY; T=293.6K
Photon emission for (n,2n)2a

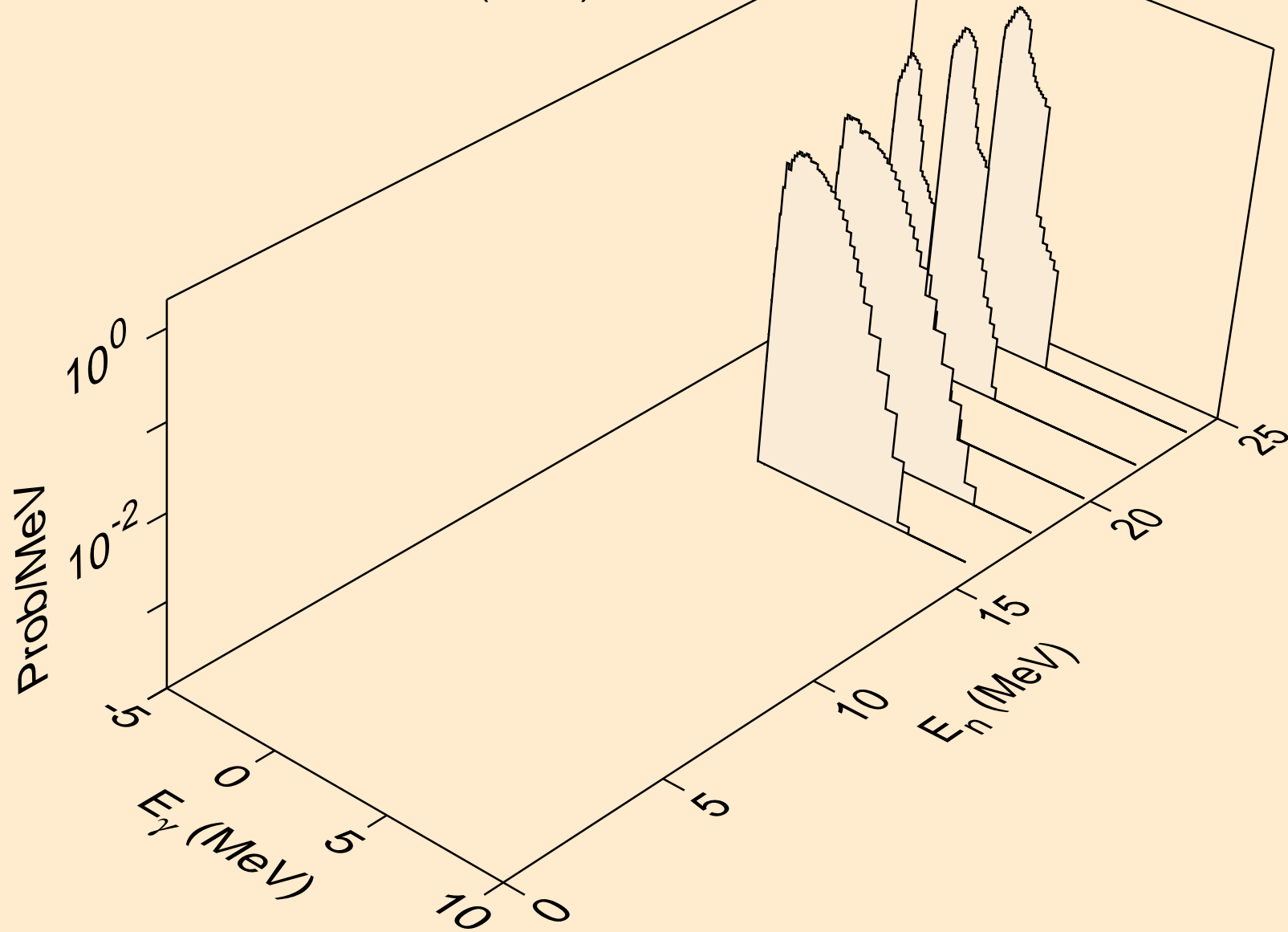

LR259 NEUTRON ACER TENDL-2021 LIBRARY; T=293.6K
Photon emission for (n,n*)d

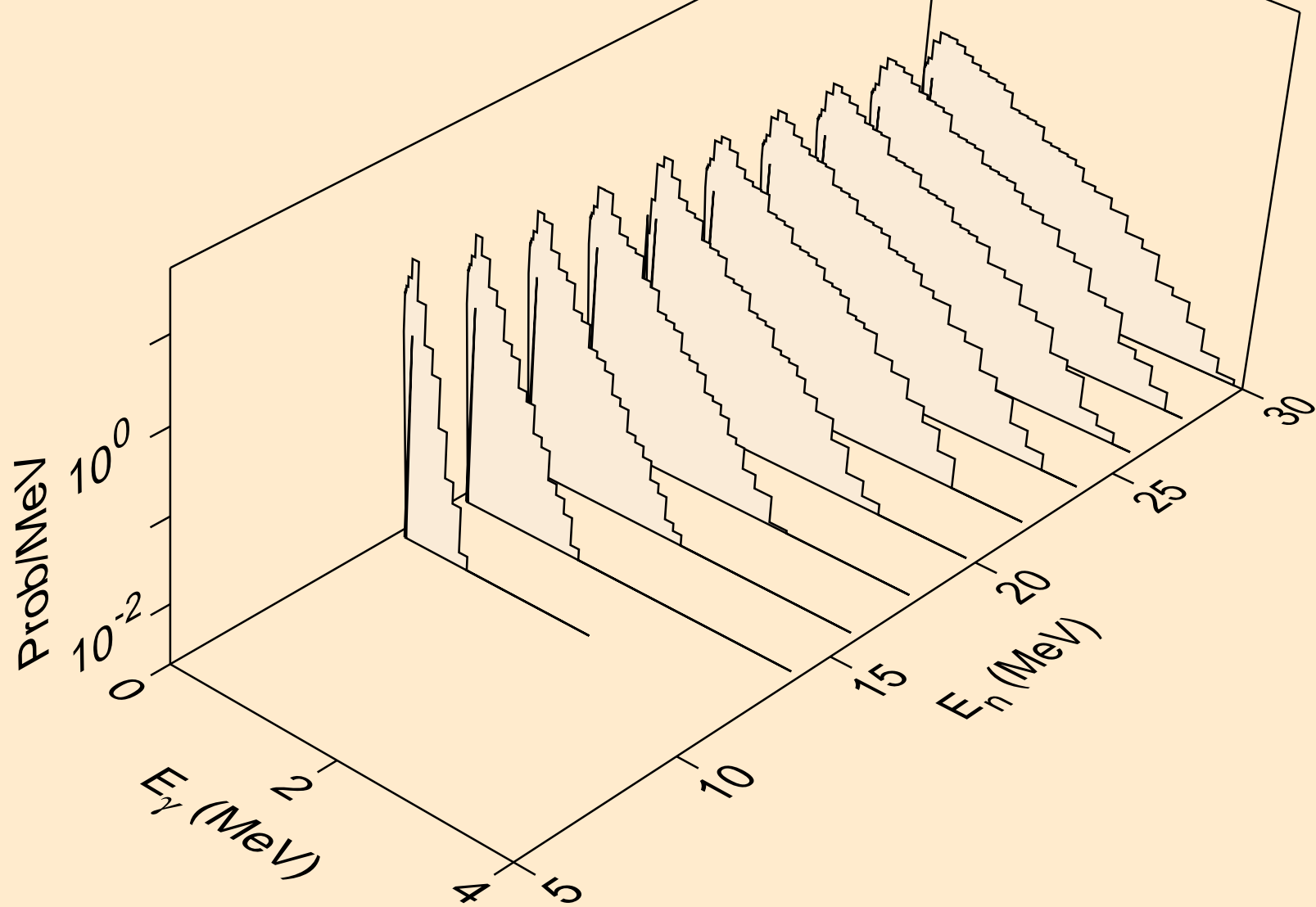

LR259 NEUTRON ACER TENDL-2021 LIBRARY; T=293.6K
Photon emission for (n,n*)t

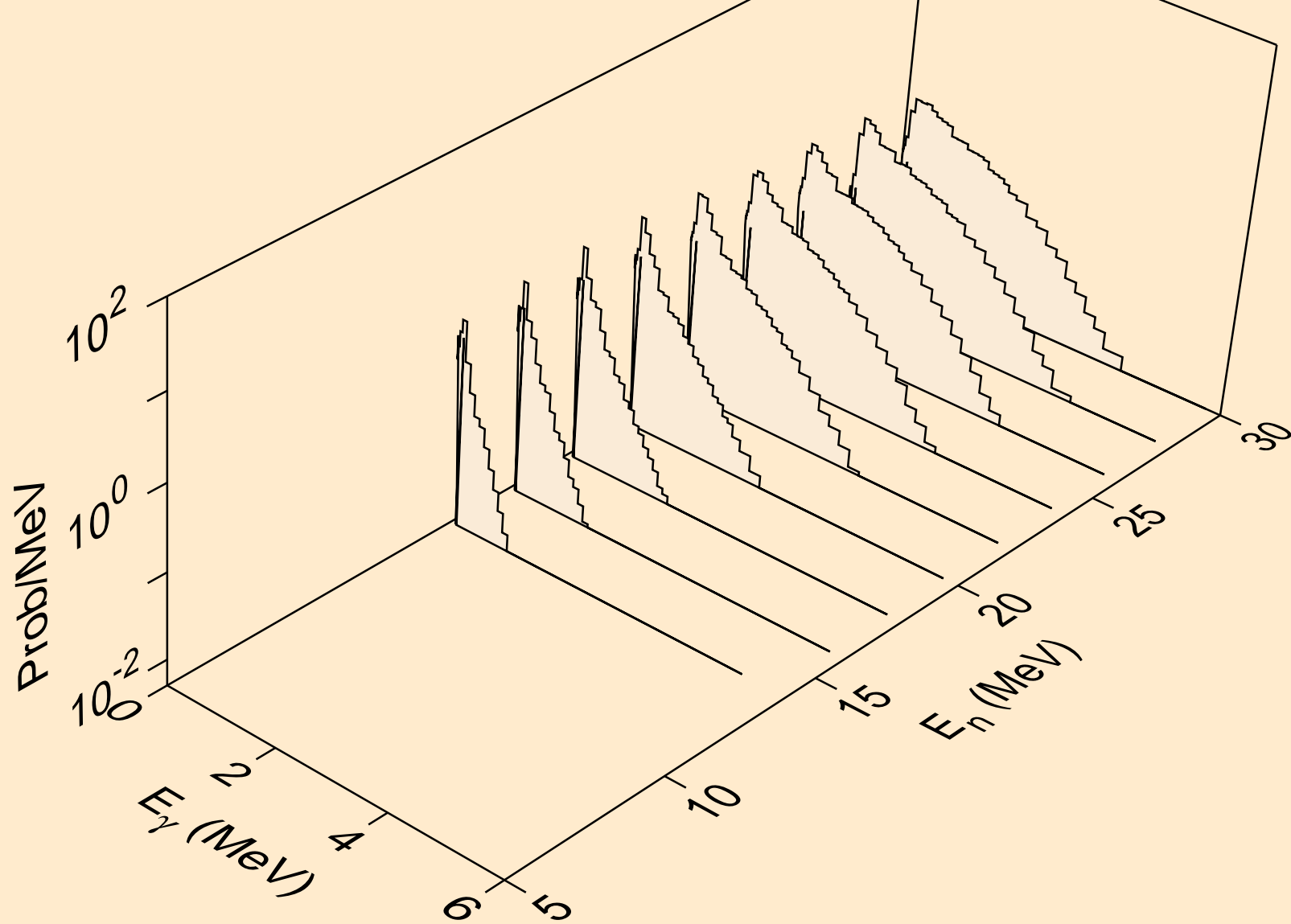

LR259 NEUTRON ACER TENDL-2021 LIBRARY; T=293.6K
Photon emission for (n,n*)he3

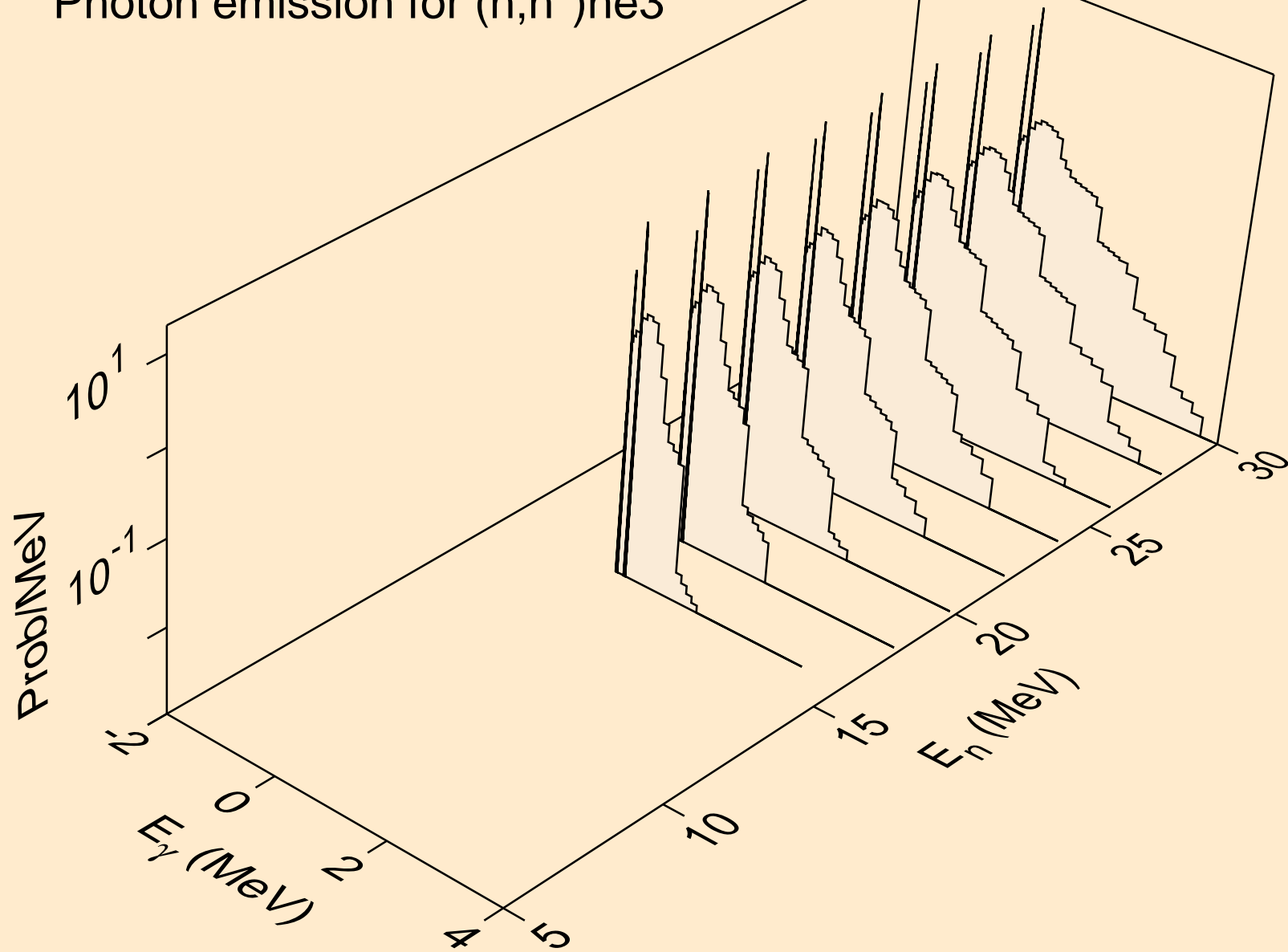

LR259 NEUTRON ACER TENDL-2021 LIBRARY; T=293.6K
Photon emission for (n,4n)

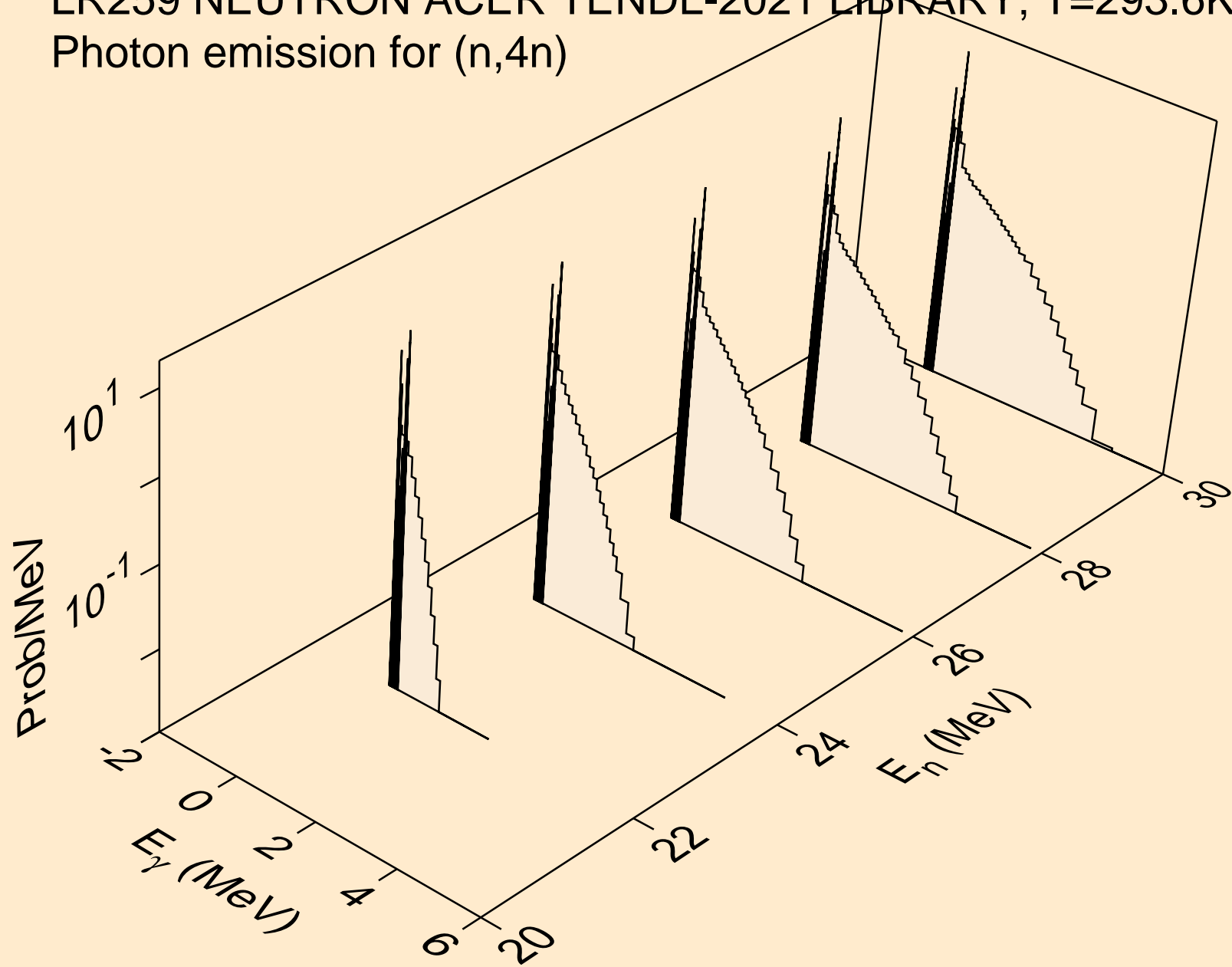

LR259 NEUTRON ACER TENDL-2021 LIBRARY; T=293.6K
Photon emission for (n,2np)

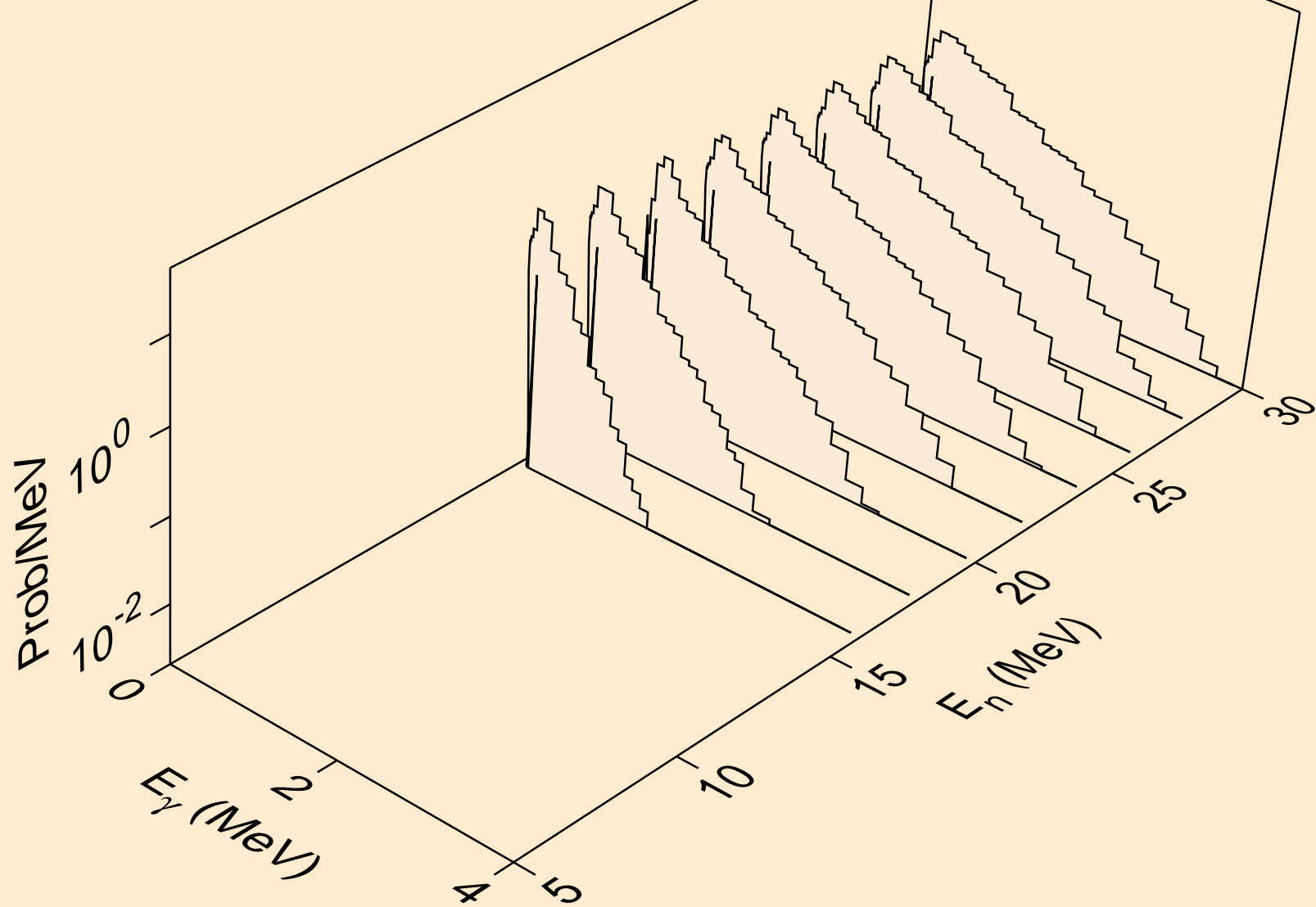

LR259 NEUTRON ACER TENDL-2021 LIBRARY; T=293.6K
Photon emission for (n,3np)

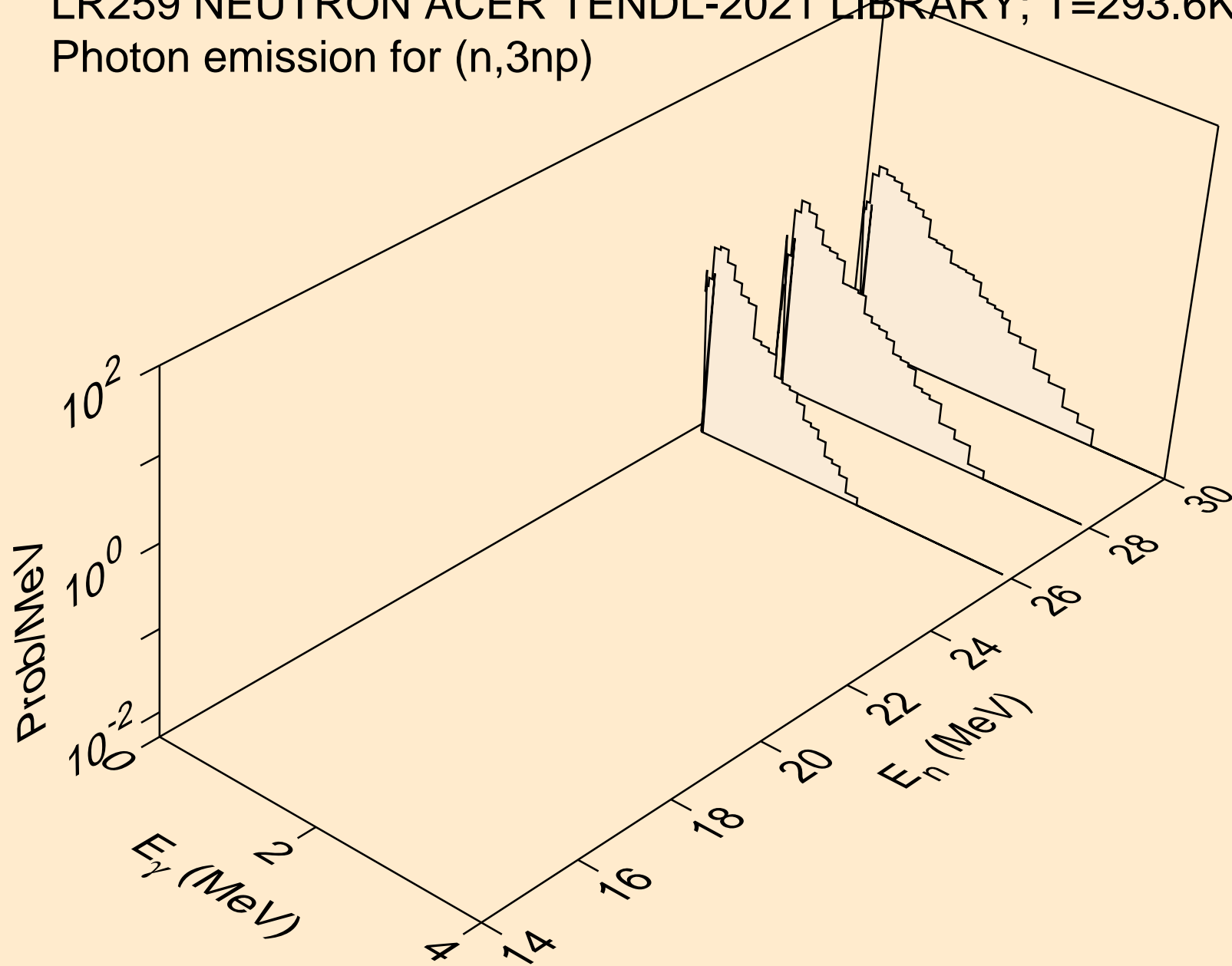

LR259 NEUTRON ACER TENDL-2021 LIBRARY; T=293.6K
Photon emission for (n,2np)

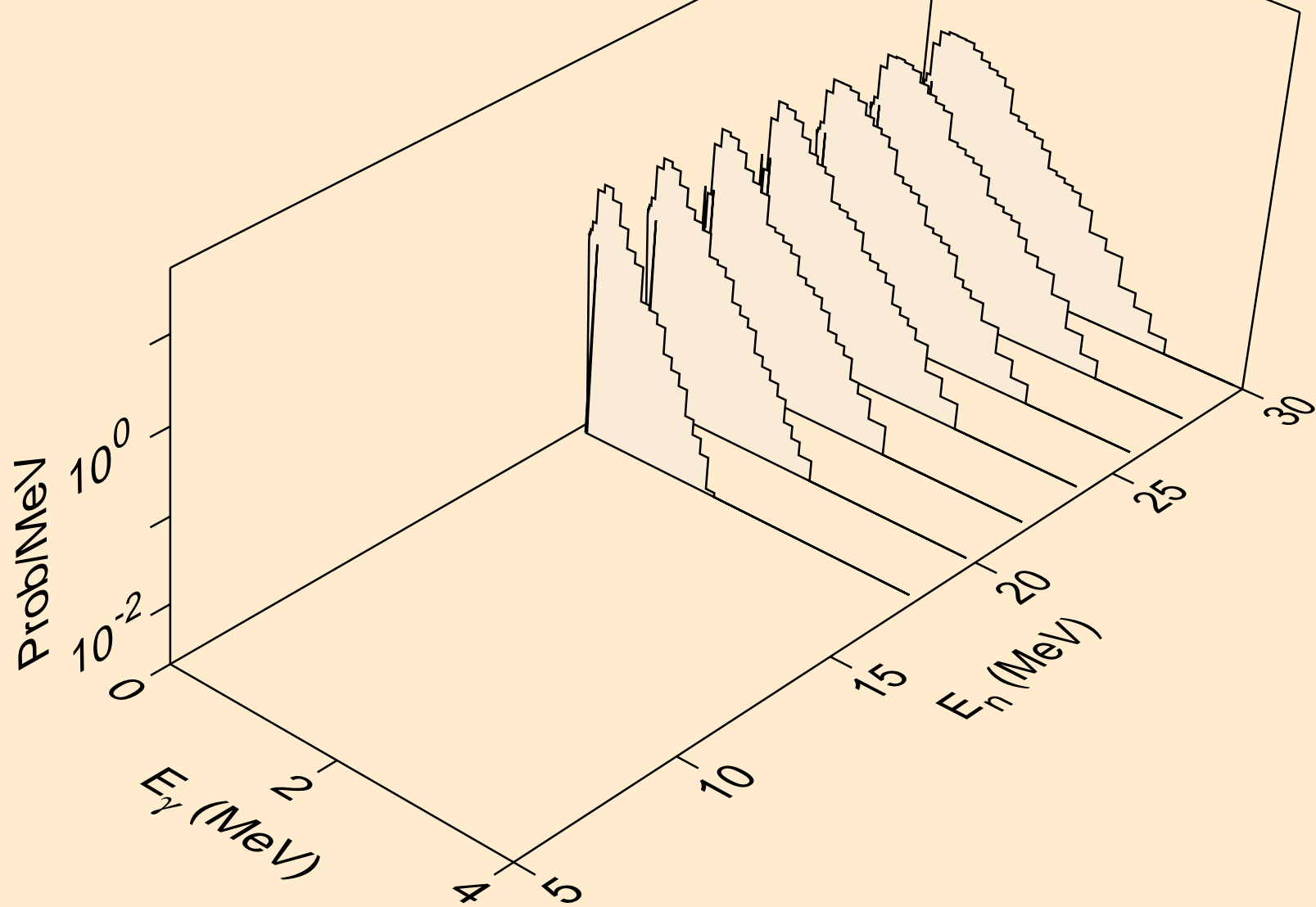

LR259 NEUTRON ACER TENDL-2021 LIBRARY; T=293.6K
Photon emission for (n,npa)

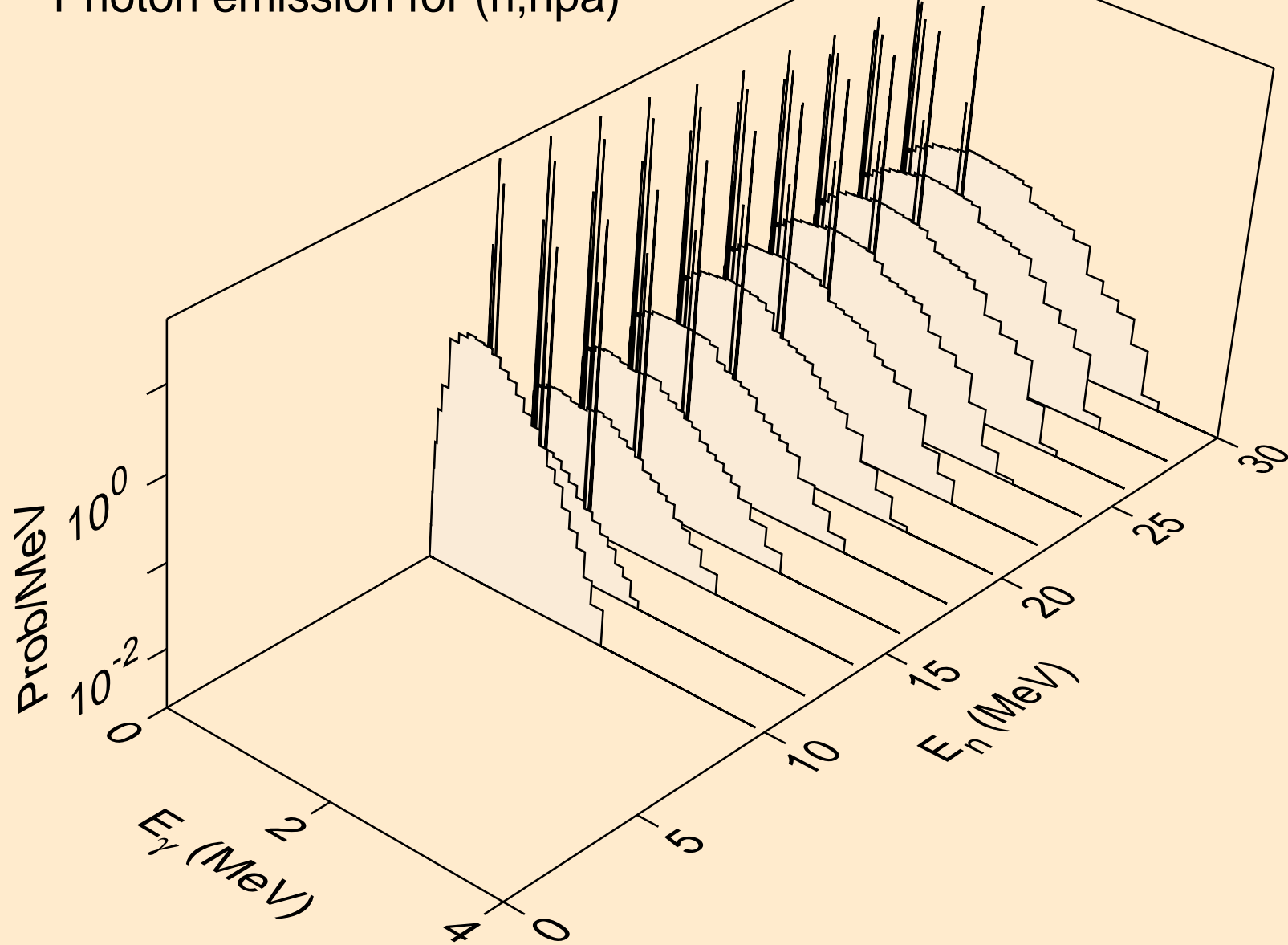

LR259 NEUTRON ACER TENDL-2021 LIBRARY; T=293.6K
Photon emission for (n,n*c)

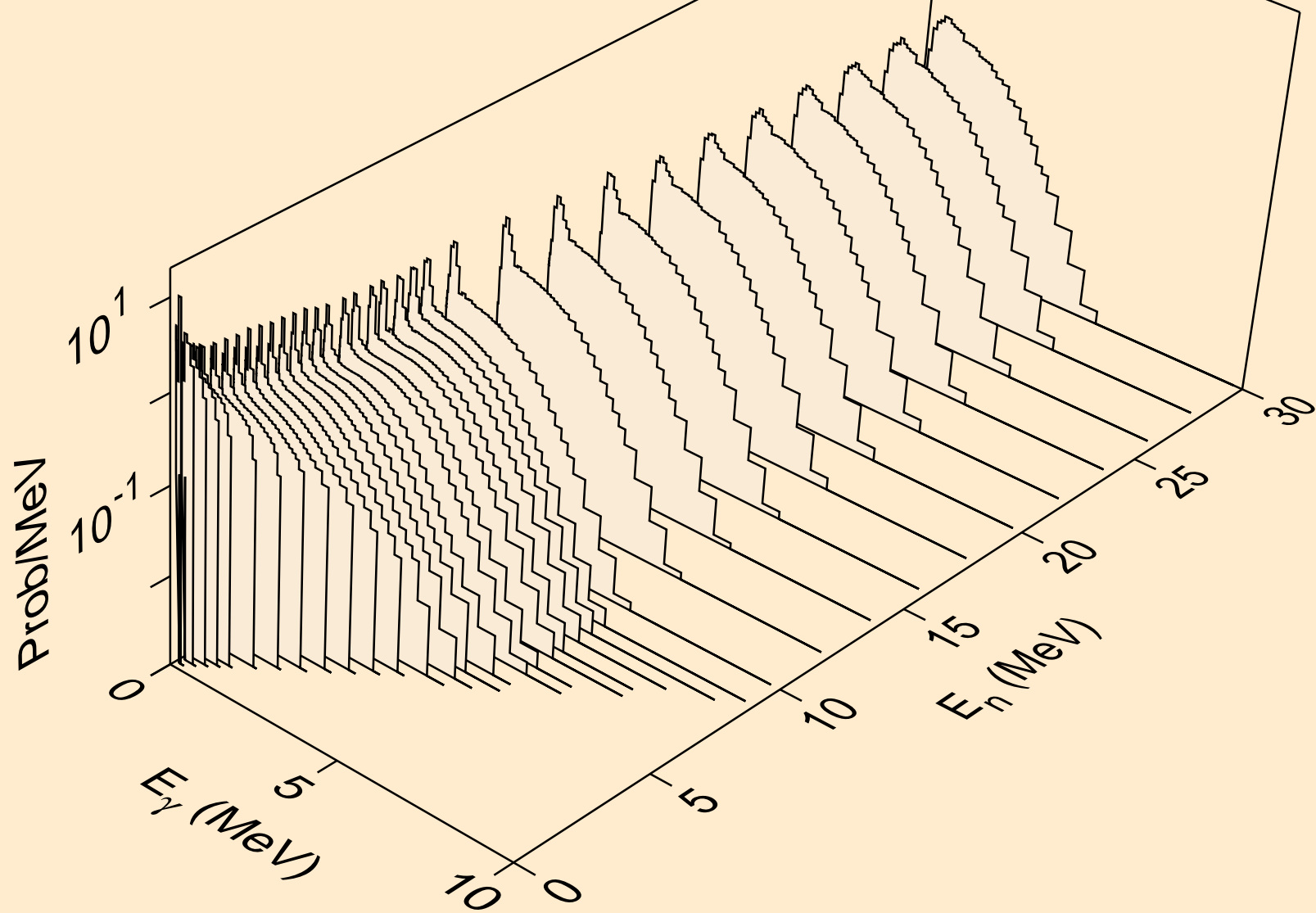

LR259 NEUTRON ACER TENDL-2021 LIBRARY; T=293.6K
Photon emission for (n,gma)

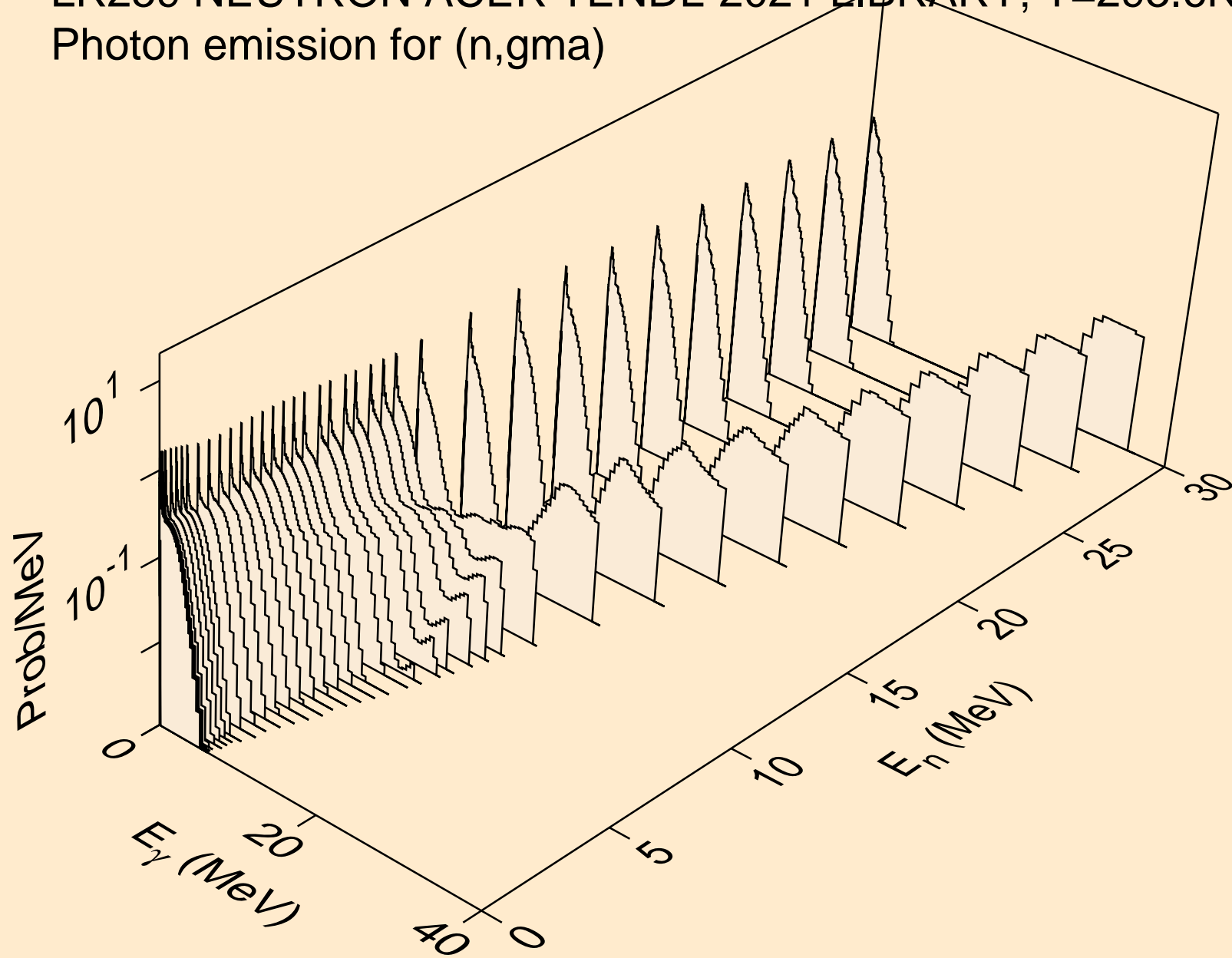

LR259 NEUTRON ACER TENDL-2021 LIBRARY; T=293.6K
Photon emission for (n,p)

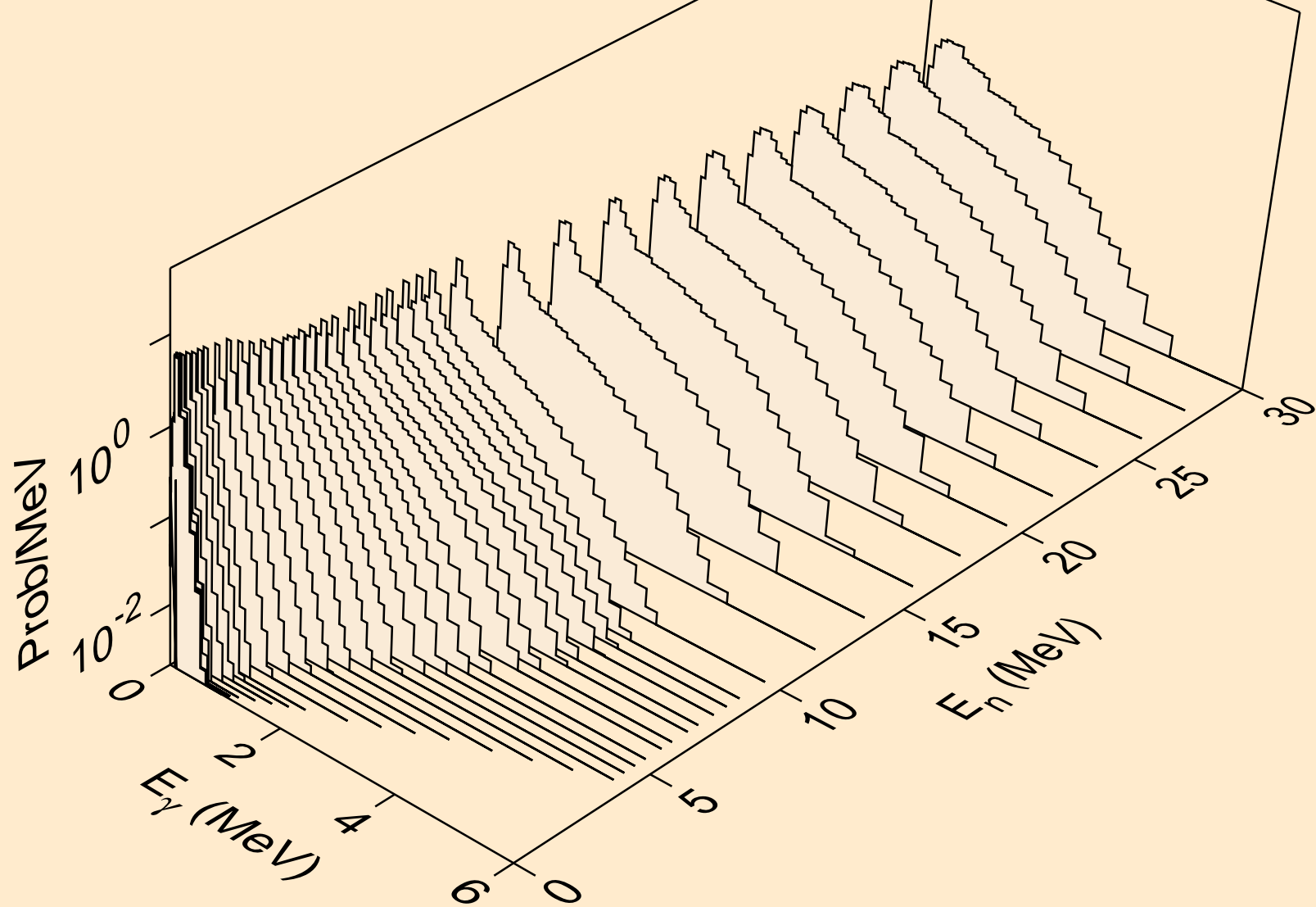

LR259 NEUTRON ACER TENDL-2021 LIBRARY; T=293.6K
Photon emission for (n,d)

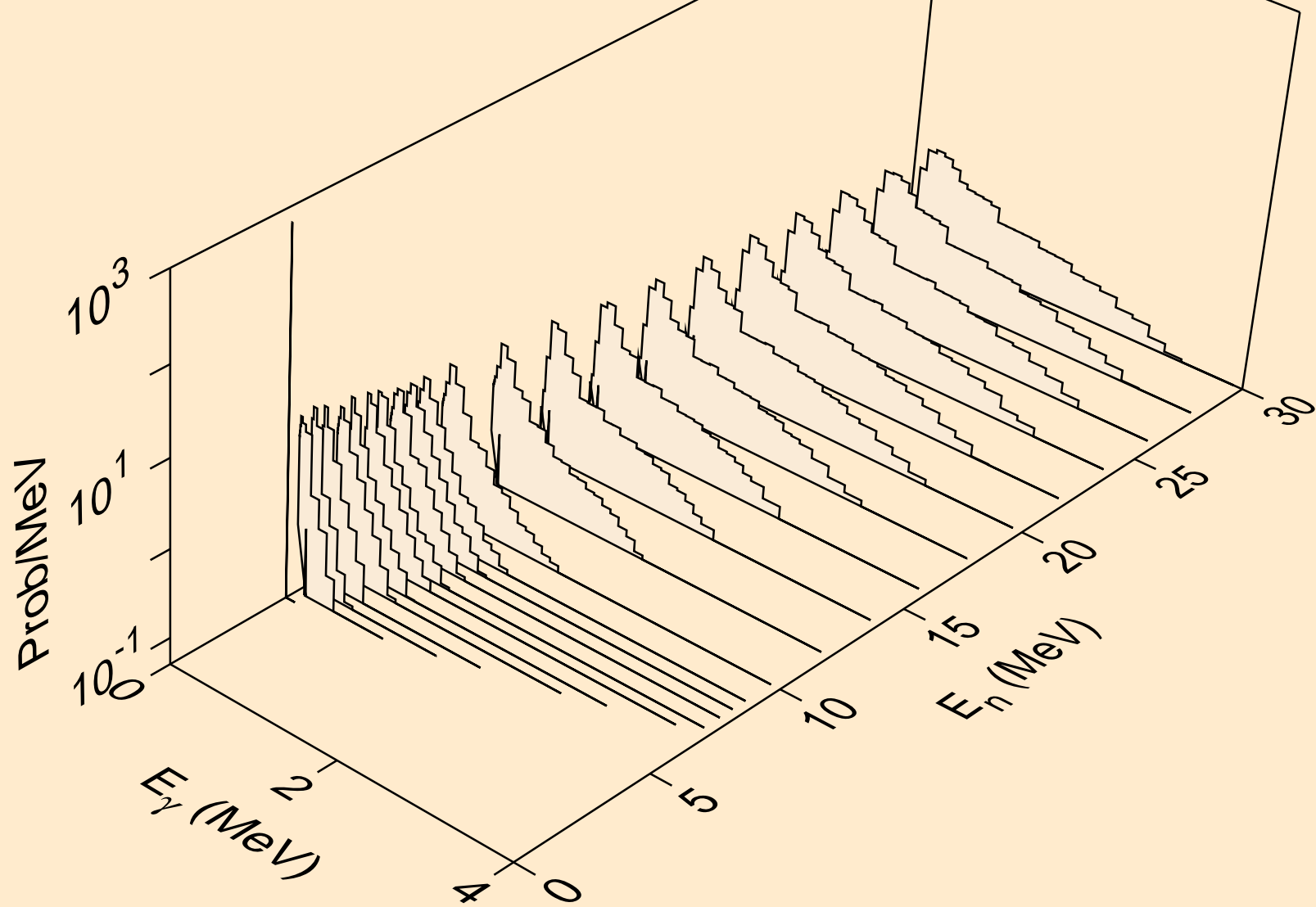

LR259 NEUTRON ACER TENDL-2021 LIBRARY; T=293.6K
Photon emission for (n,t)

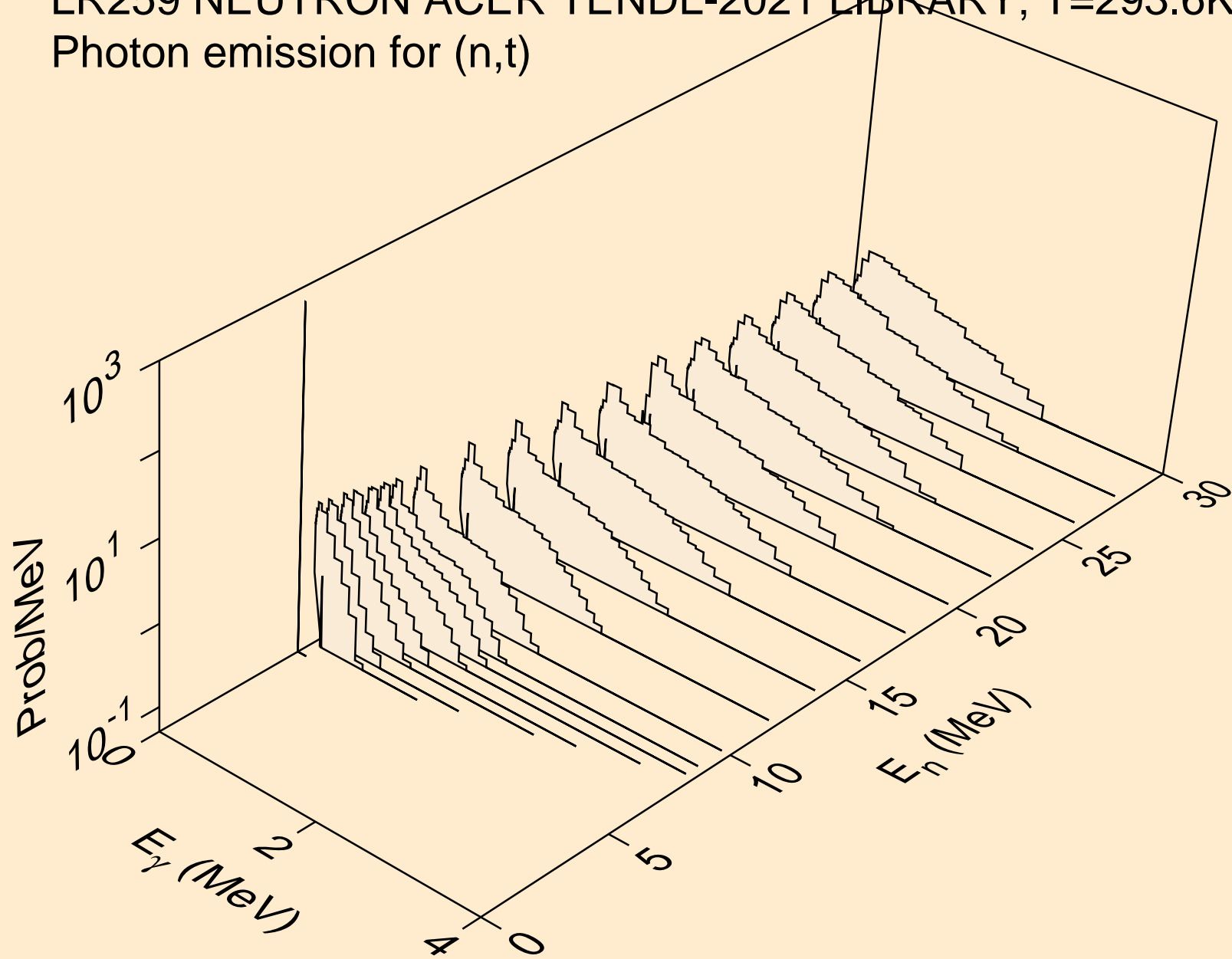

LR259 NEUTRON ACER TENDL-2021 LIBRARY; T=293.6K
Photon emission for (n,he3)

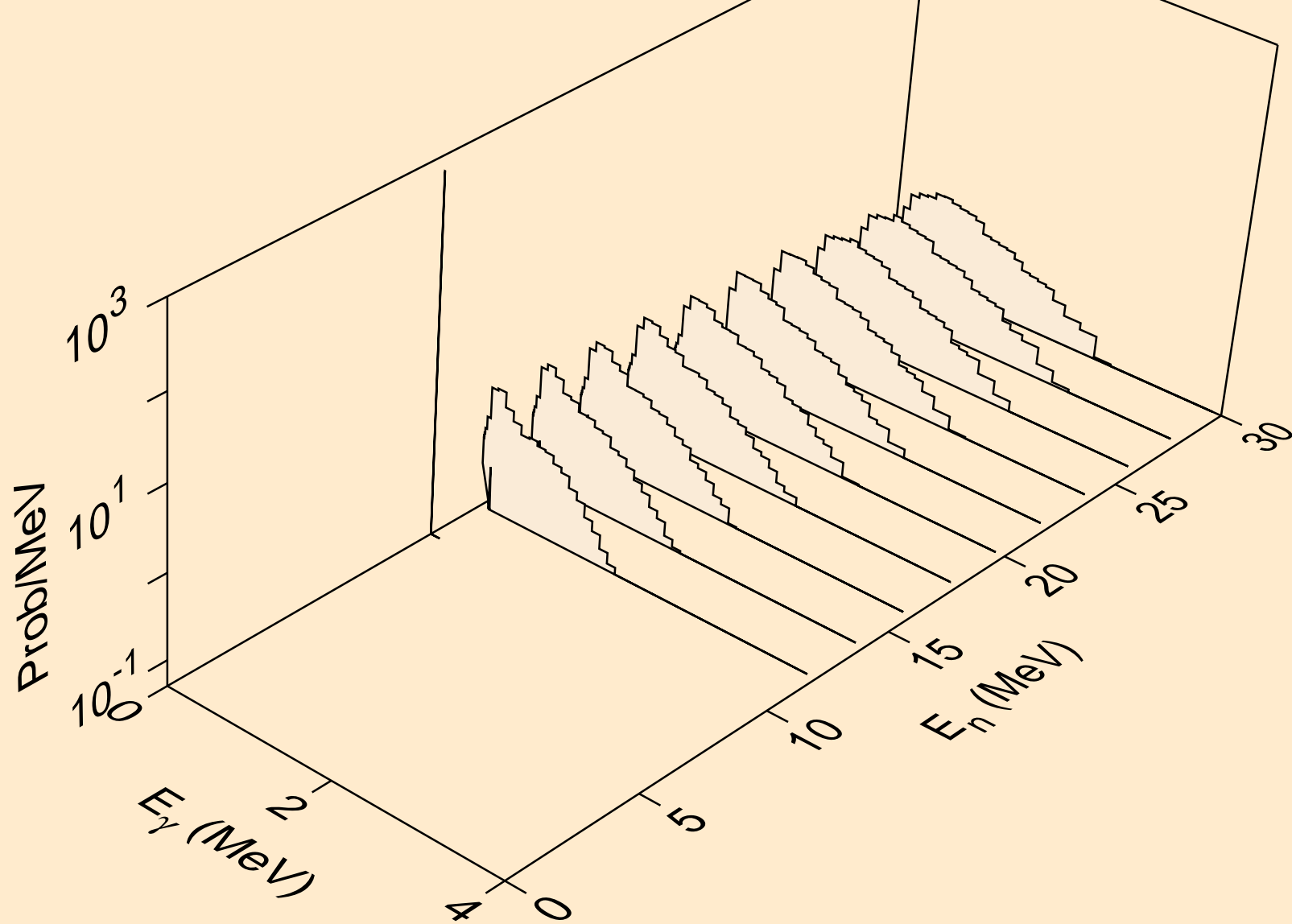

LR259 NEUTRON ACER TENDL-2021 LIBRARY; T=293.6K
Photon emission for (n,a)

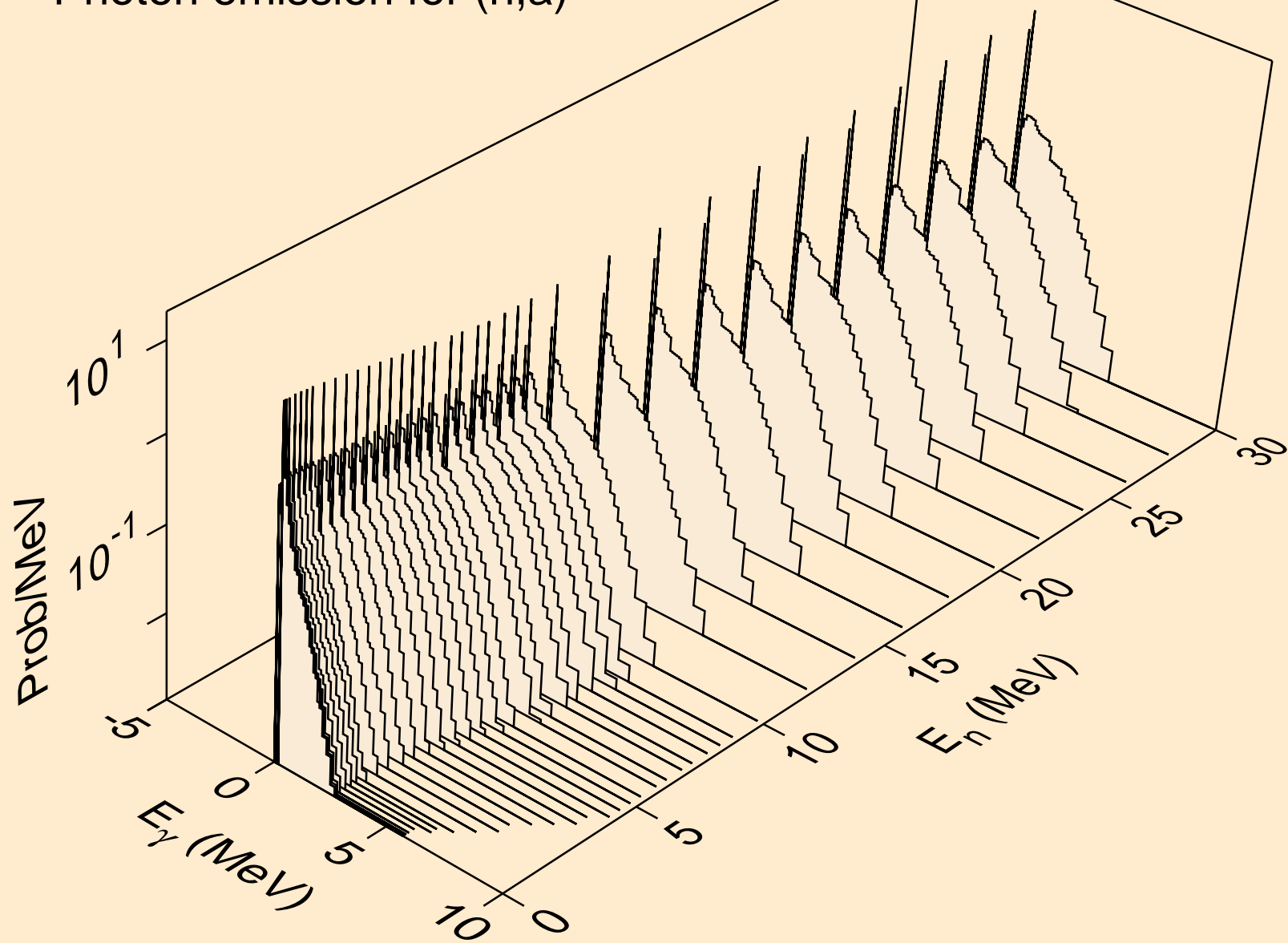

LR259 NEUTRON ACER TENDL-2021 LIBRARY; T=293.6K
Photon emission for (n,2a)

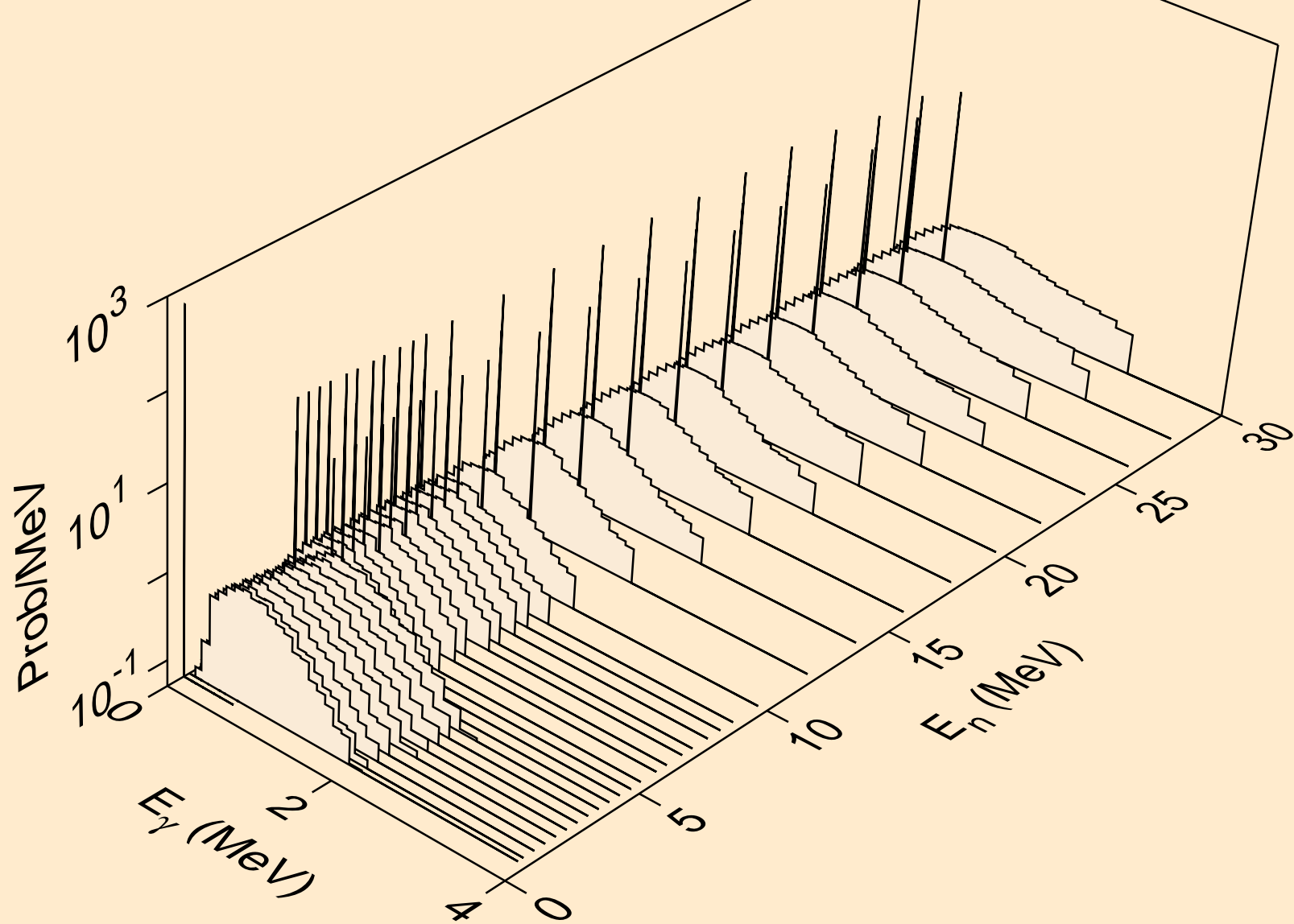

LR259 NEUTRON ACER TENDL-2021 LIBRARY; T=293.6K
Photon emission for (n,2p)

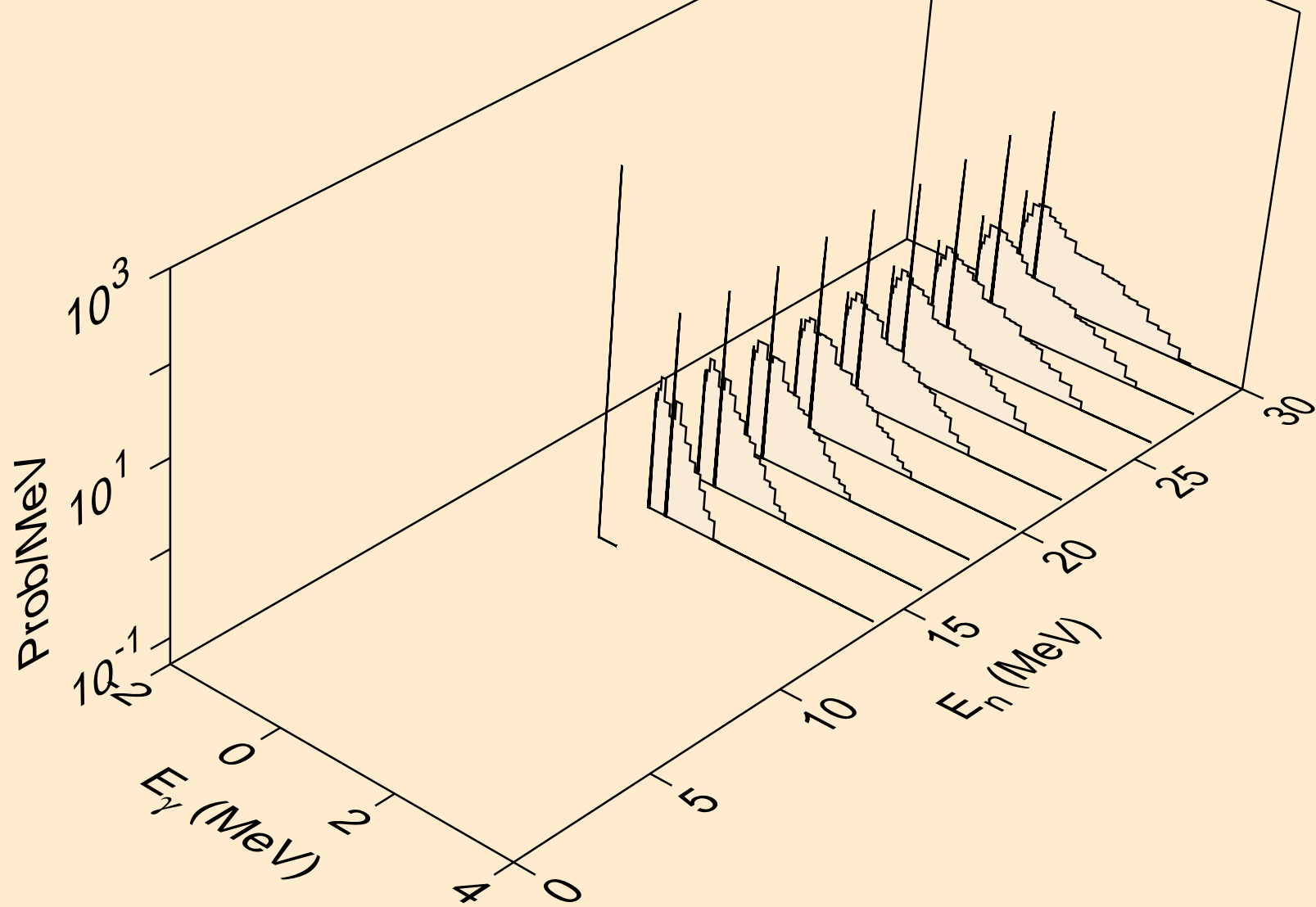

LR259 NEUTRON ACER TENDL-2021 LIBRARY; T=293.6K
Photon emission for (n,p α)

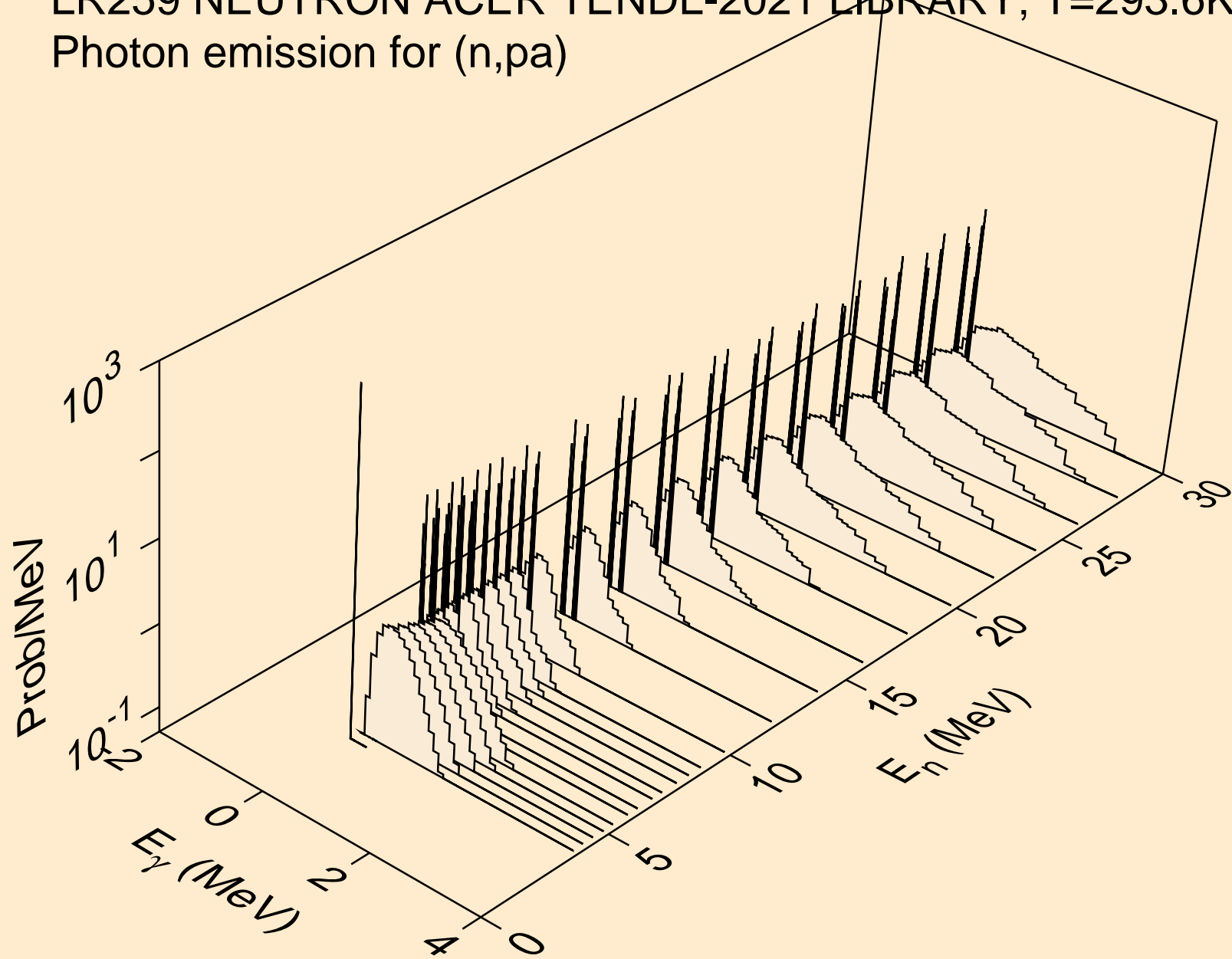

LR259 NEUTRON ACER TENDL-2021 LIBRARY; T=293.6K
Photon emission for (n,pd)

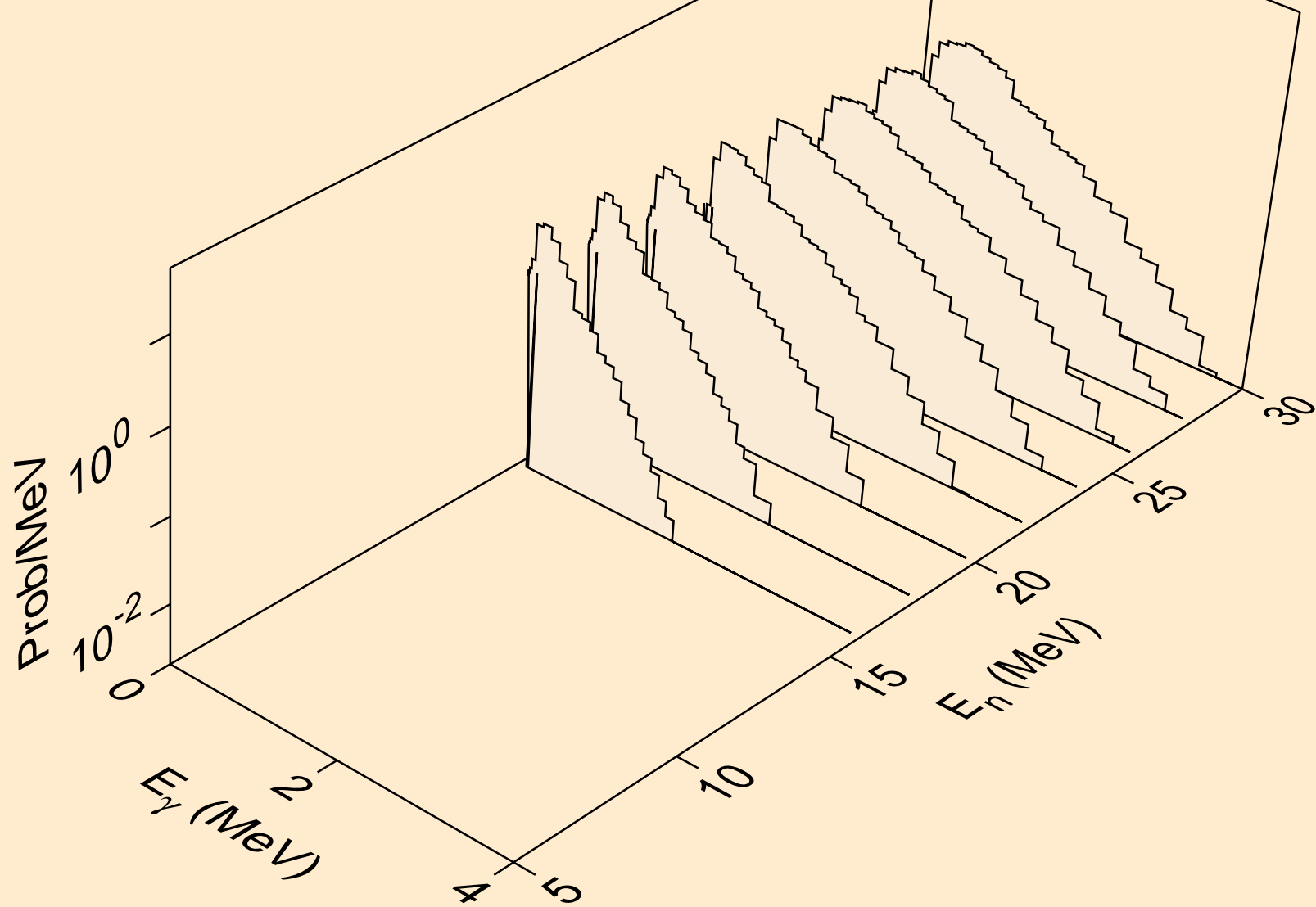

LR259 NEUTRON ACER TENDL-2021 LIBRARY; T=293.6K
Photon emission for (n,pt)

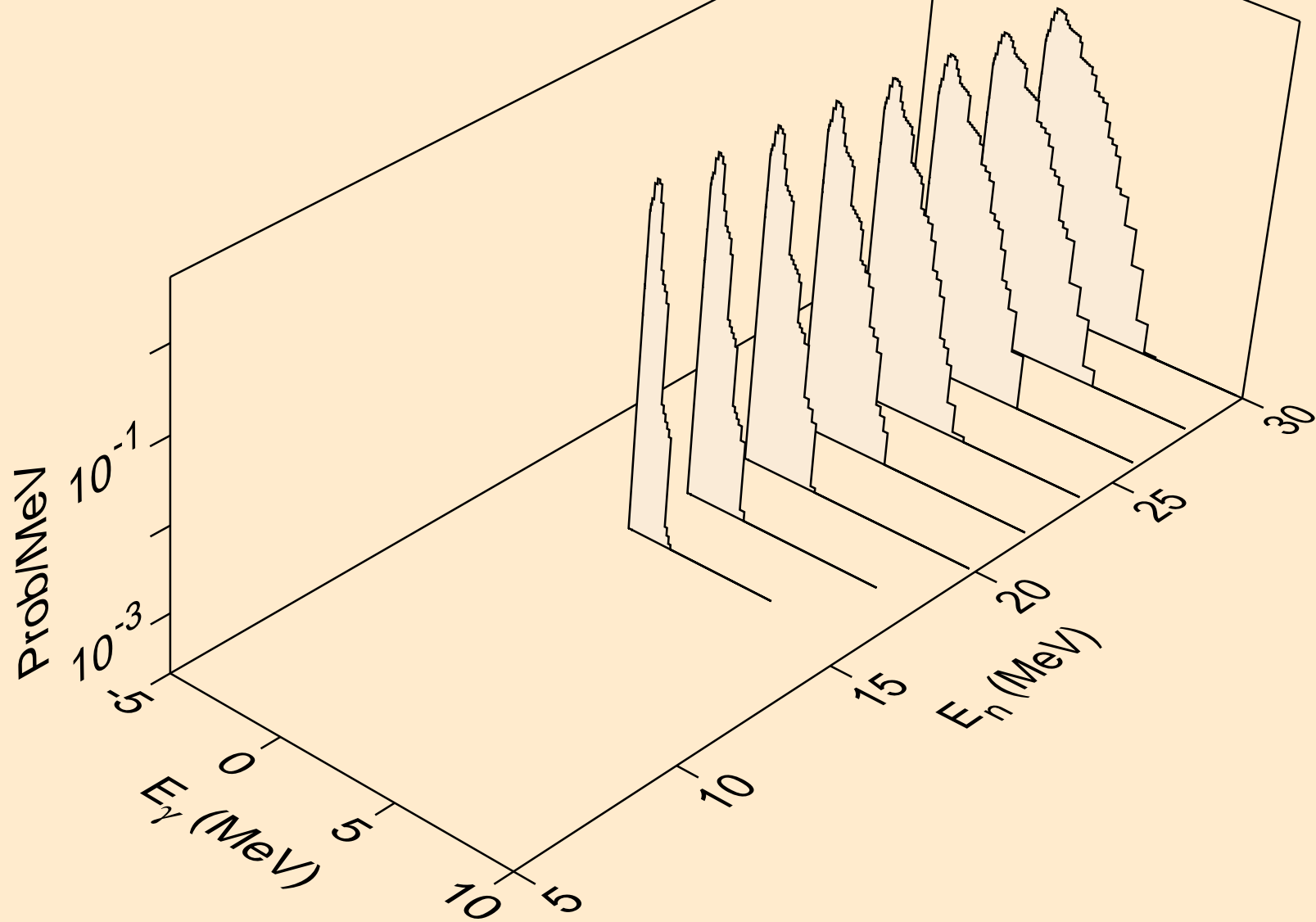

LR259 NEUTRON ACER TENDL-2021 LIBRARY; T=293.6K
thermal capture photon spectrum

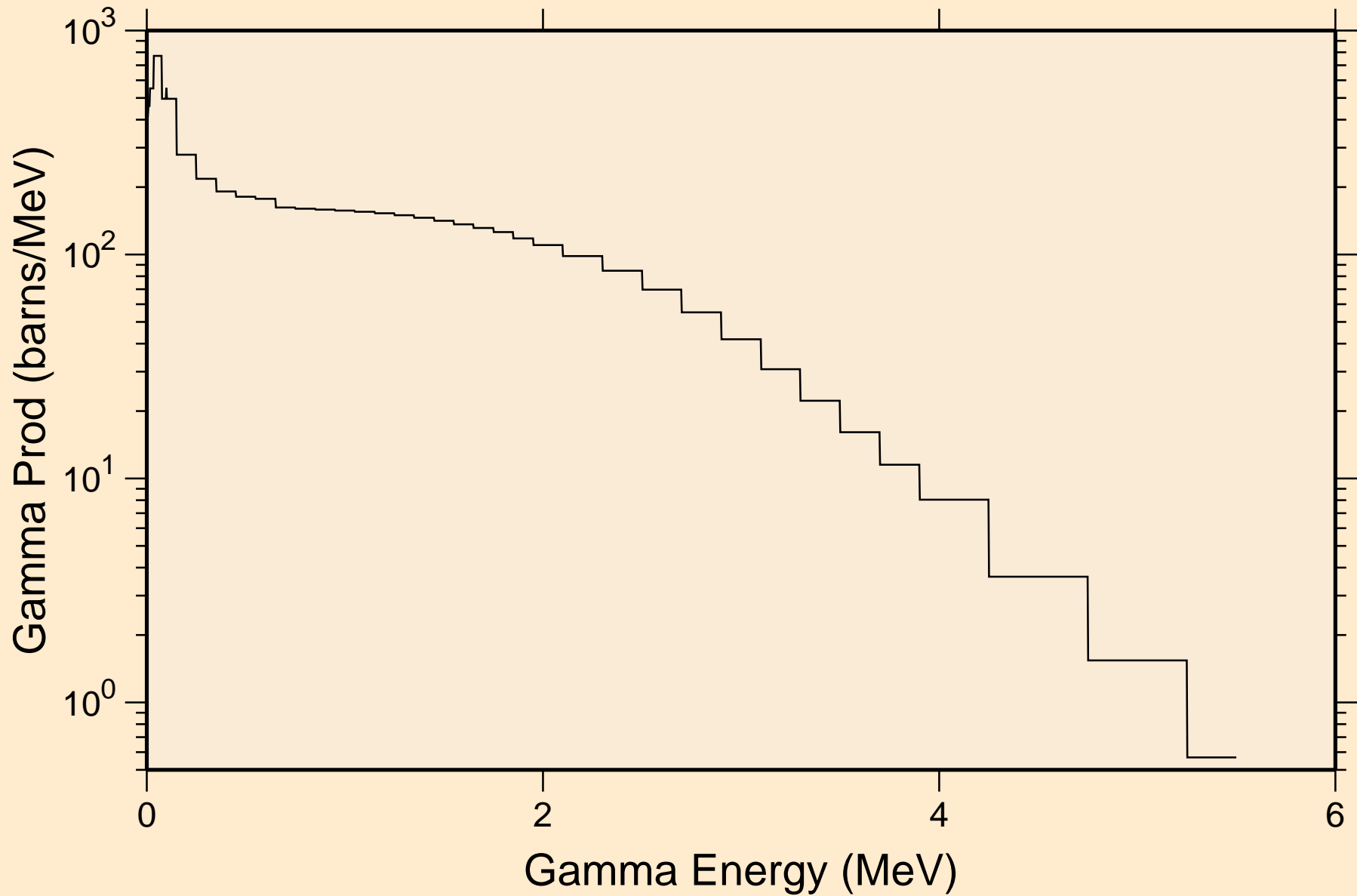

LR259 NEUTRON ACER TENDL-2021 LIBRARY; T=293.6K
14 MeV photon spectrum

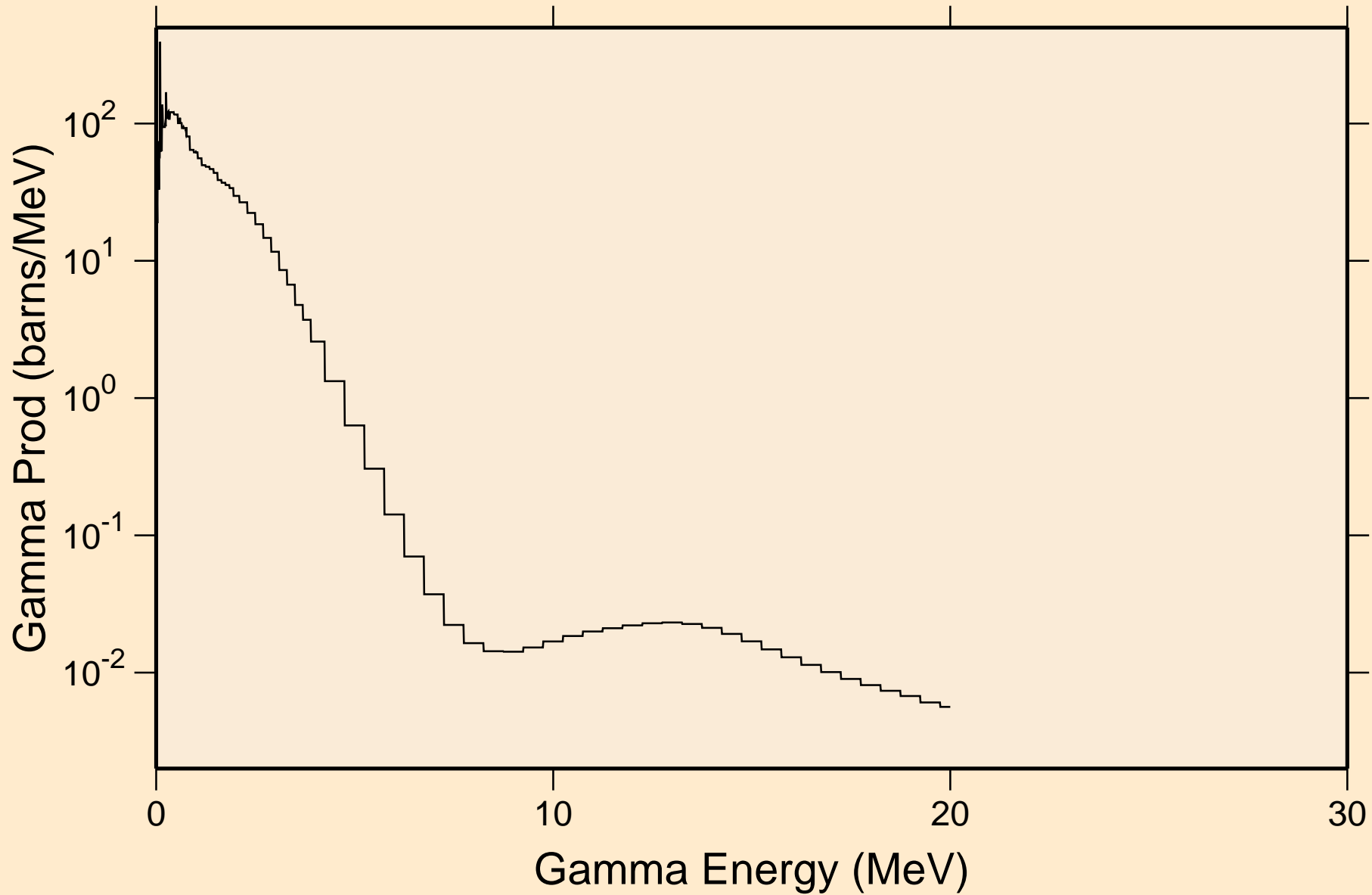

LR259 NEUTRON ACER TENDL-2021 LIBRARY; T=293.6K

Particle heating contributions

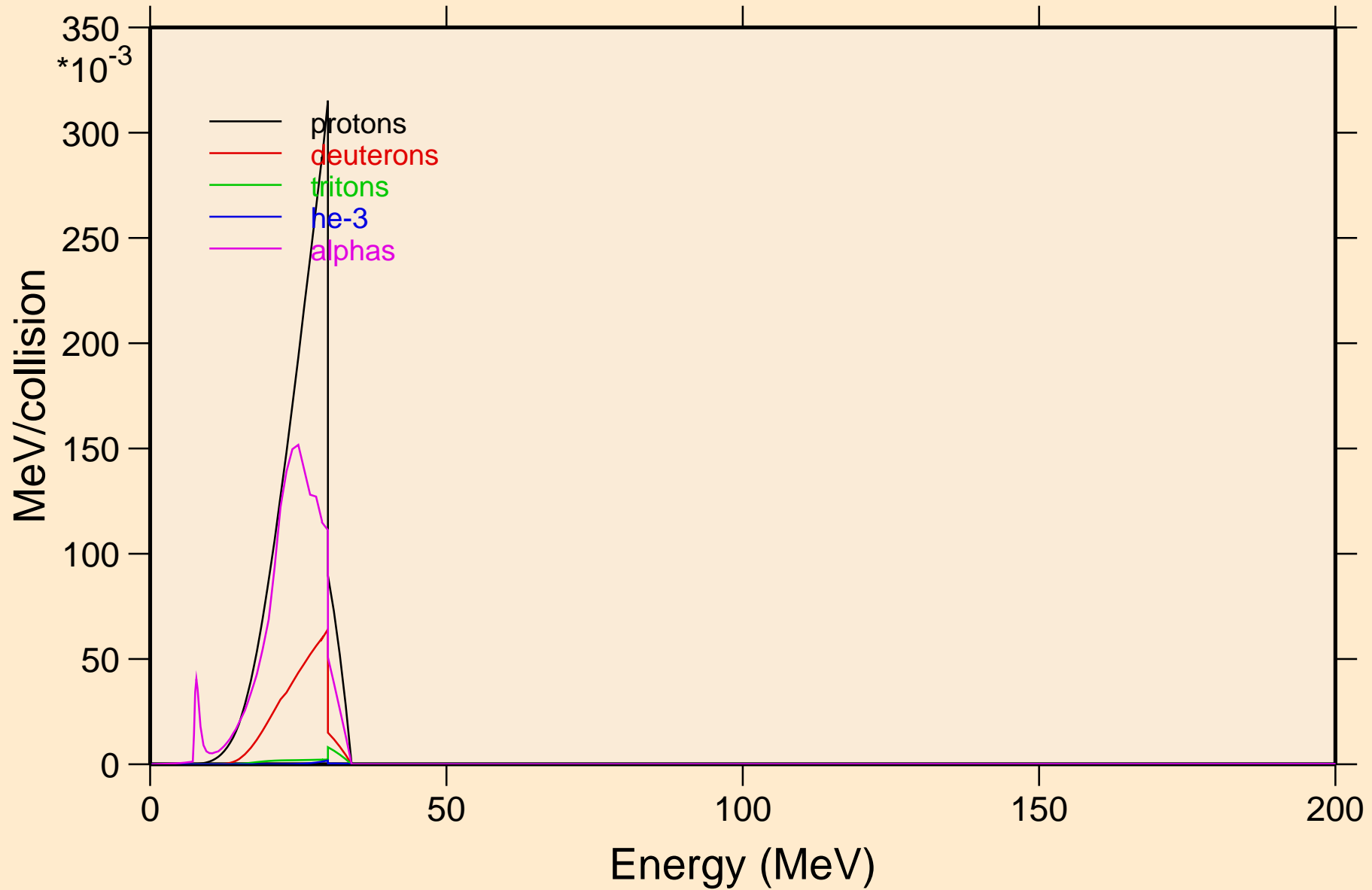

LR259 NEUTRON ACER TENDL-2021 LIBRARY; T=293.6K
Recoil Heating

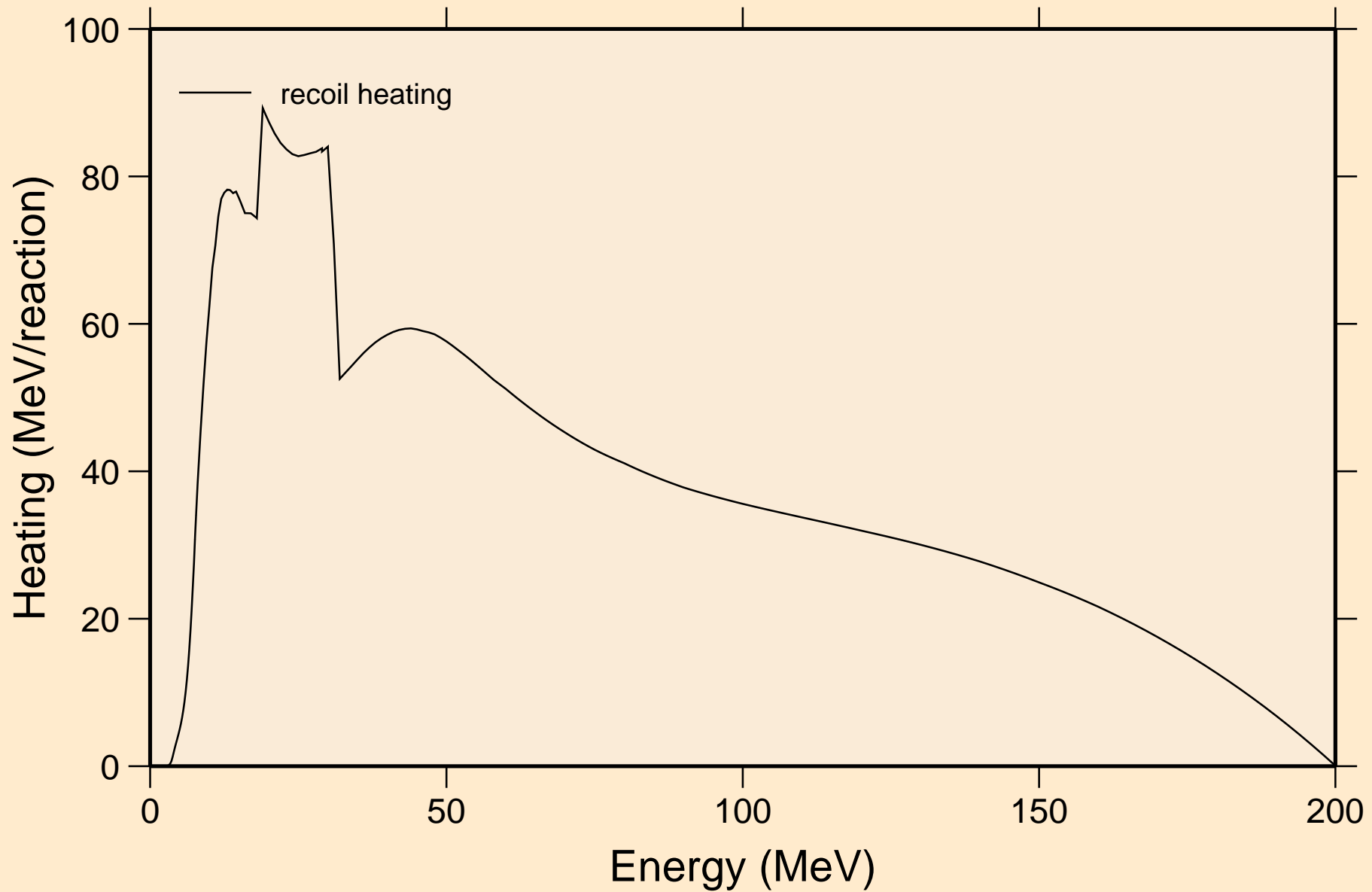

LR259 NEUTRON ACER TENDL-2021 LIBRARY; T=293.6K
Particle production cross sections

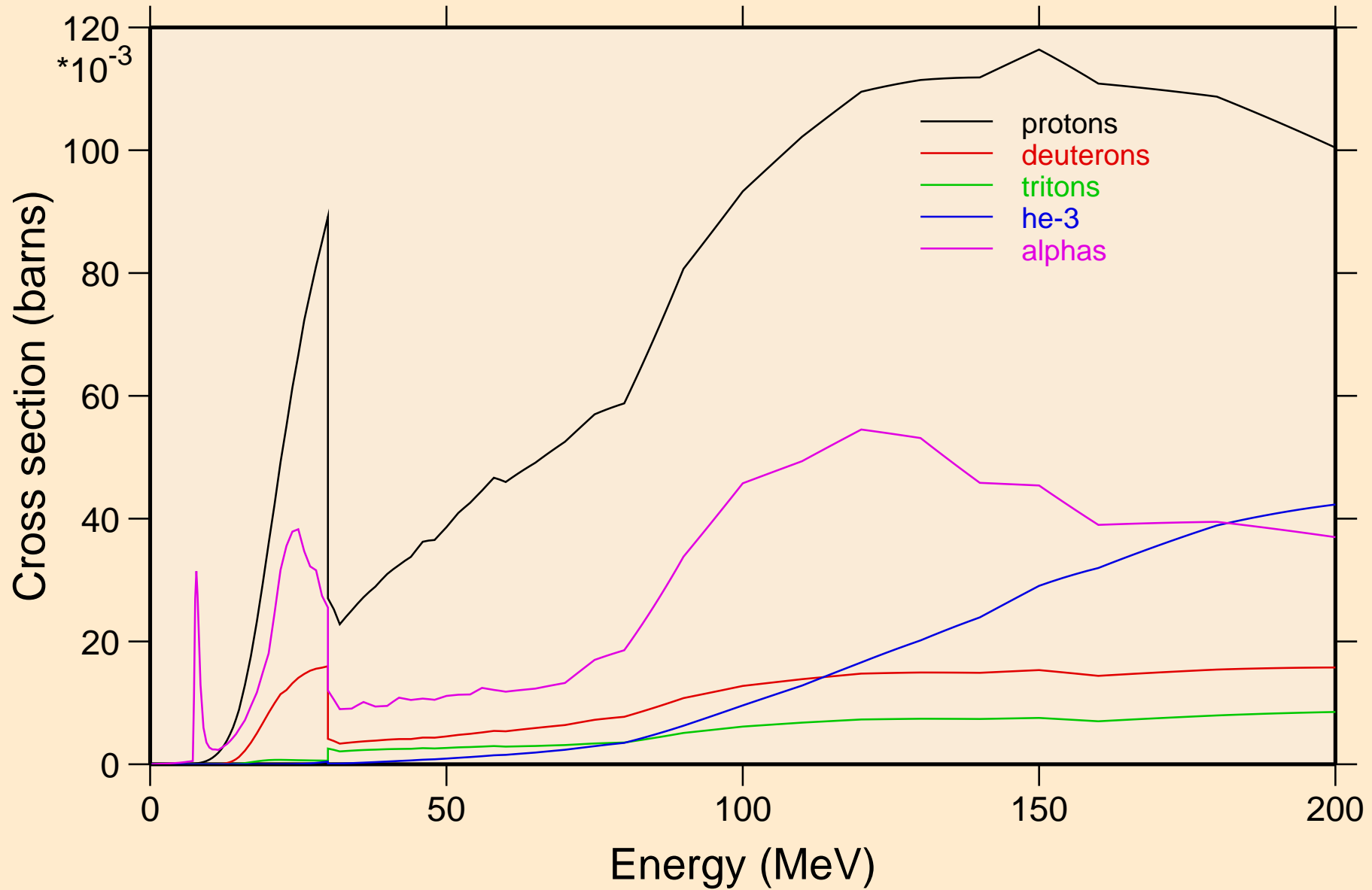

LR259 NEUTRON ACER TENDL-2021 LIBRARY; T=293.6K
protons from (n,x)

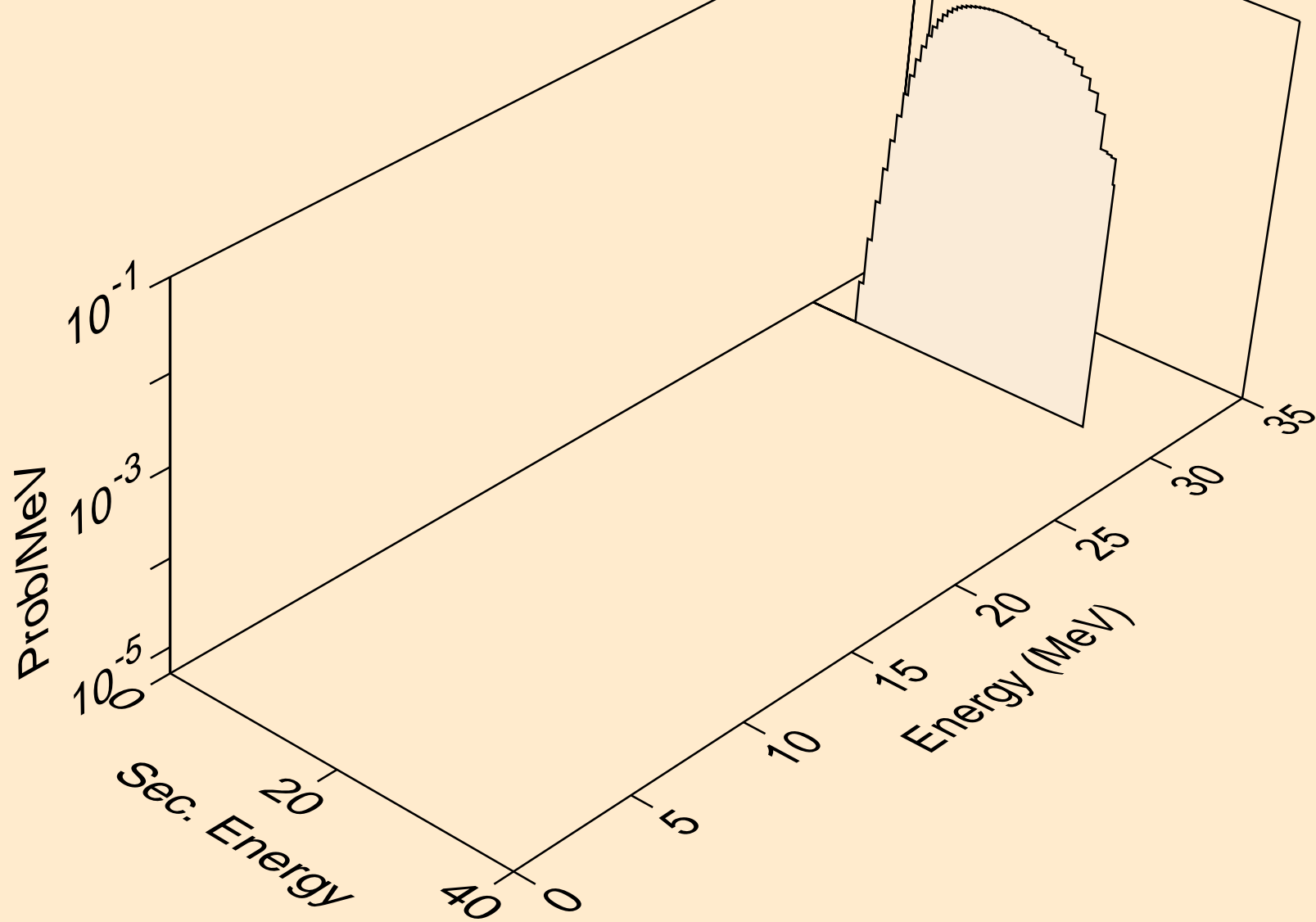

LR259 NEUTRON ACER TENDL-2021 LIBRARY; T=293.6K
protons from (n,n*)p

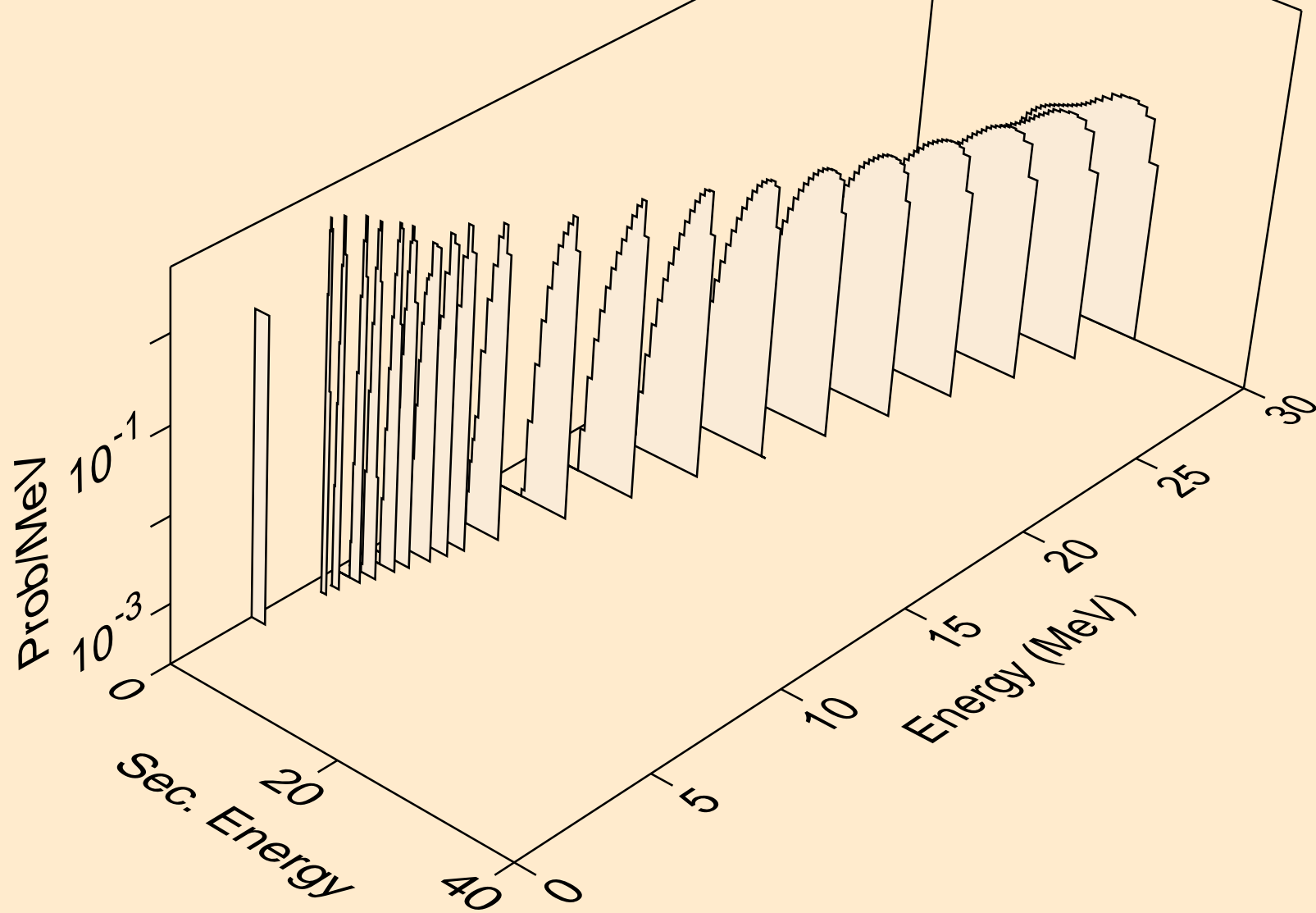

LR259 NEUTRON ACER TENDL-2021 LIBRARY; T=293.6K
protons from (n,2np)

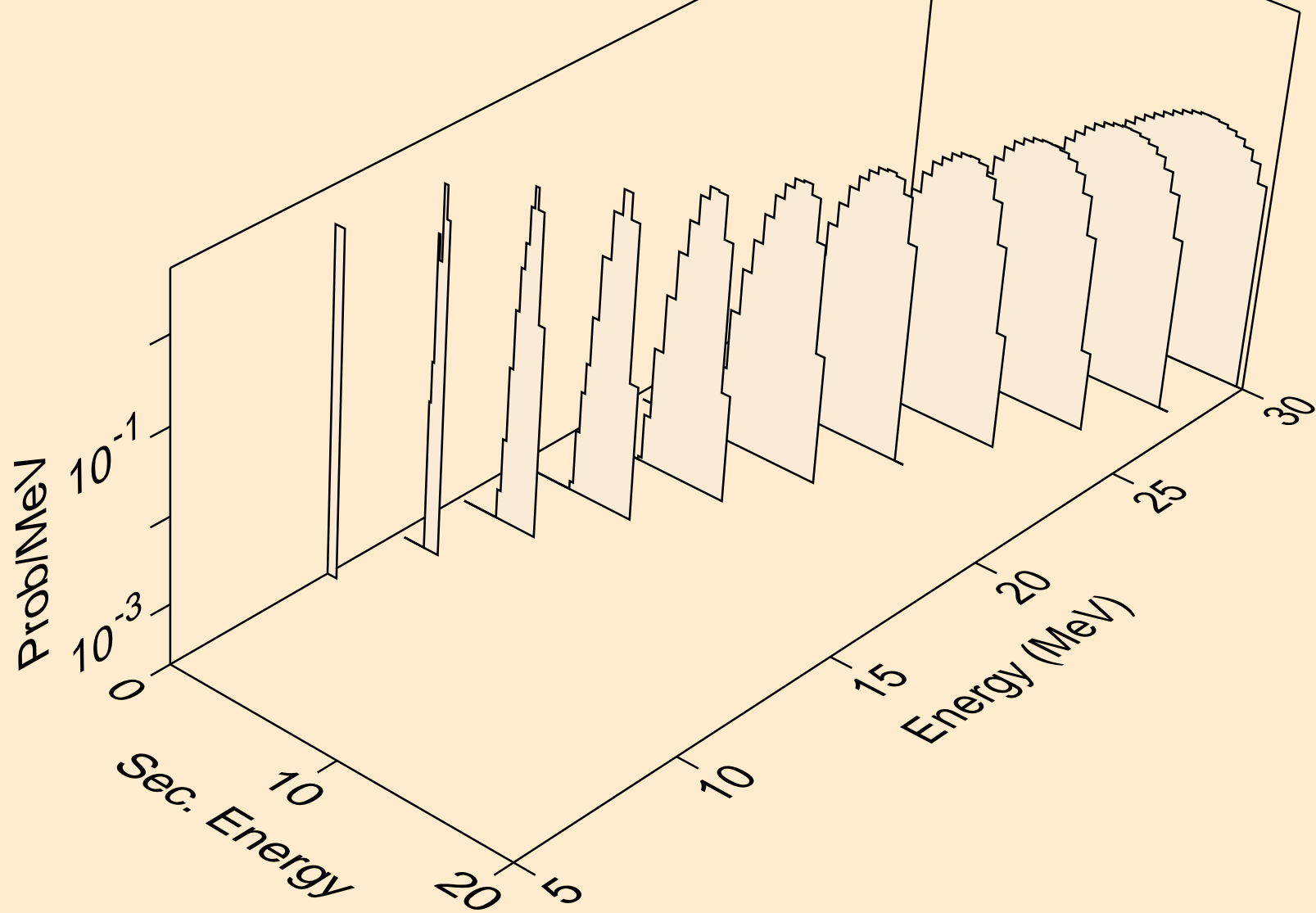

LR259 NEUTRON ACER TENDL-2021 LIBRARY; T=293.6K
protons from (n,3np)

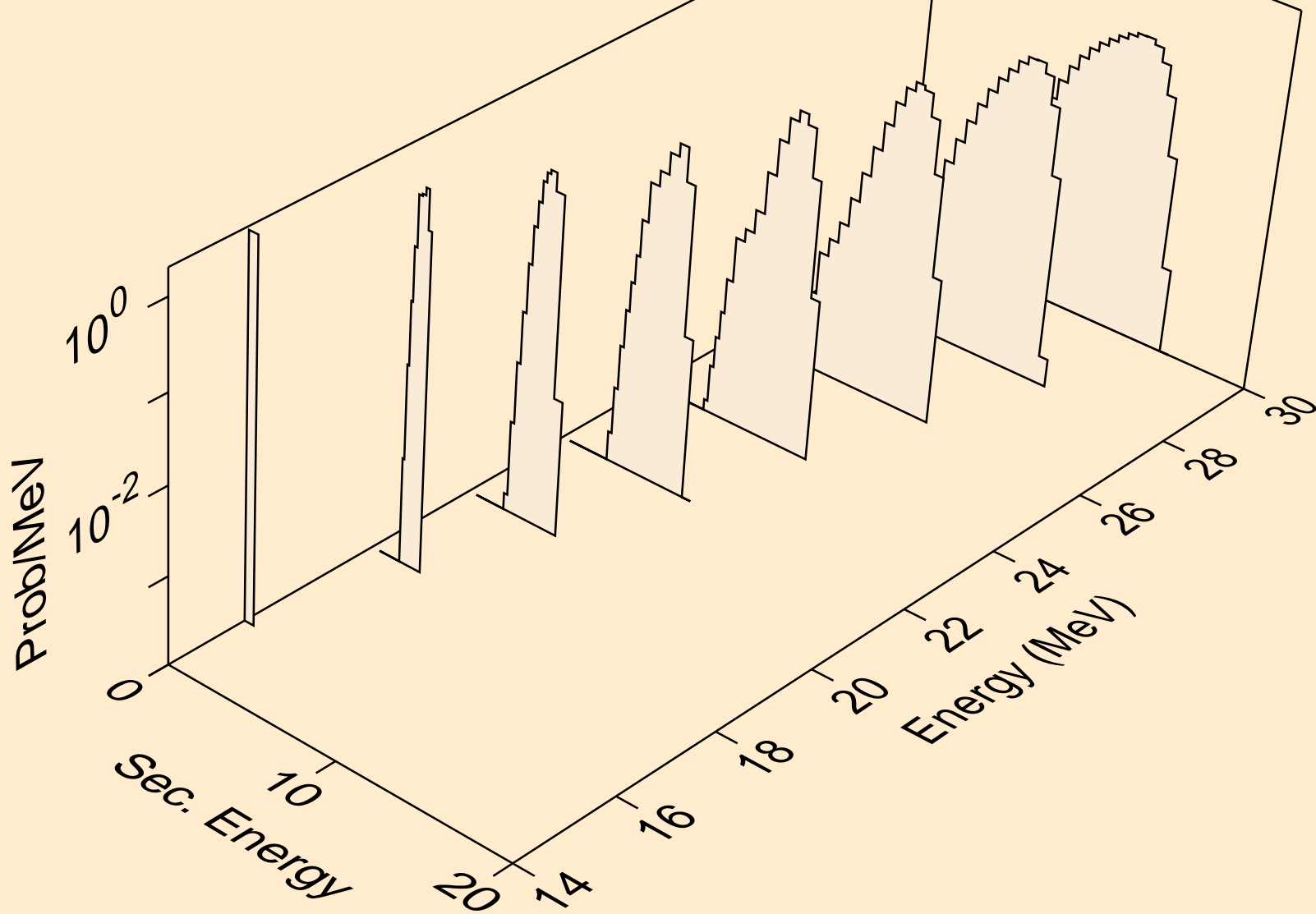

LR259 NEUTRON ACER TENDL-2021 LIBRARY; T=293.6K
protons from (n,2np)

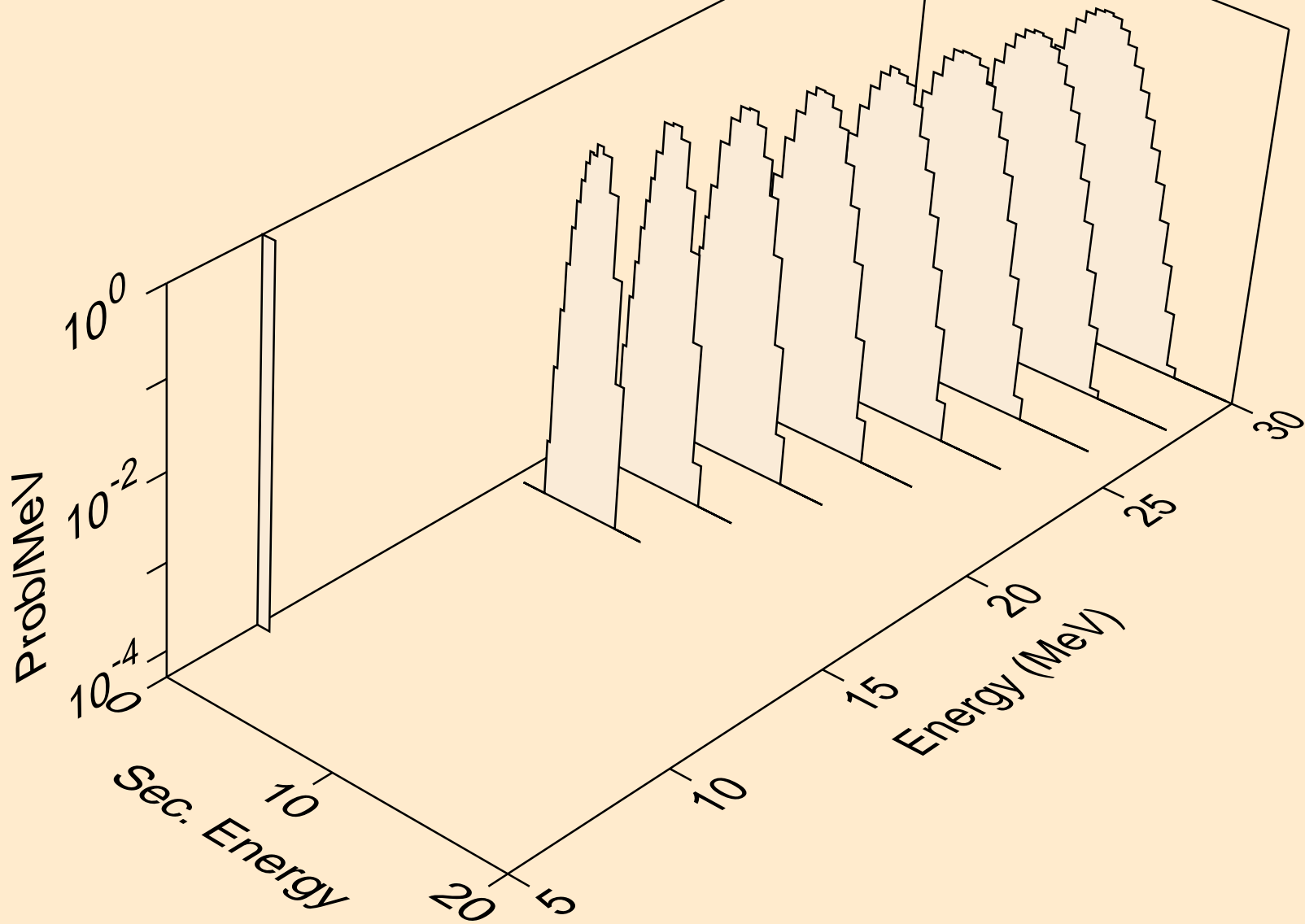

LR259 NEUTRON ACER TENDL-2021 LIBRARY; T=293.6K
protons from (n,npa)

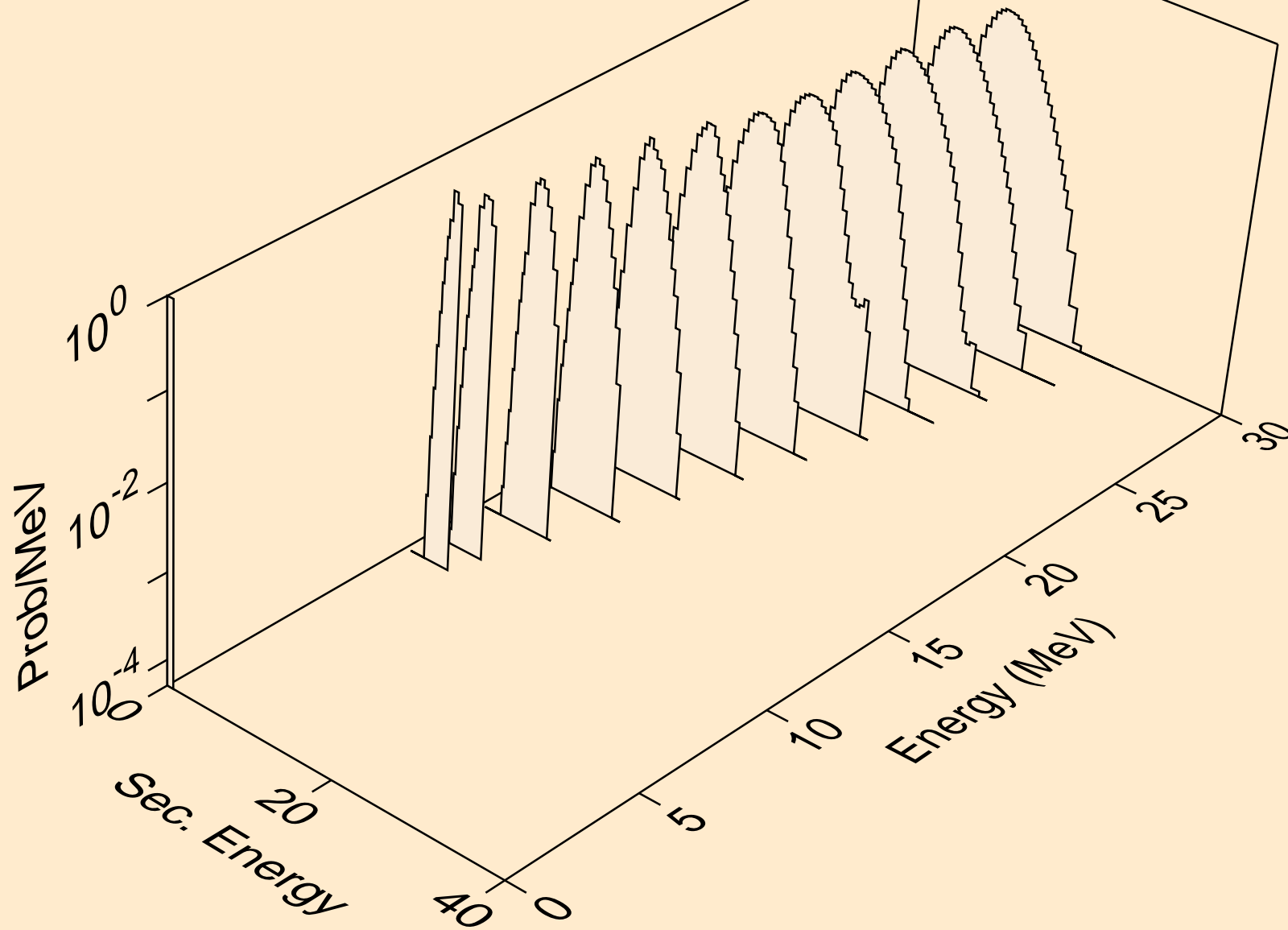

LR259 NEUTRON ACER TENDL-2021 LIBRARY; T=293.6K
protons from (n,p)

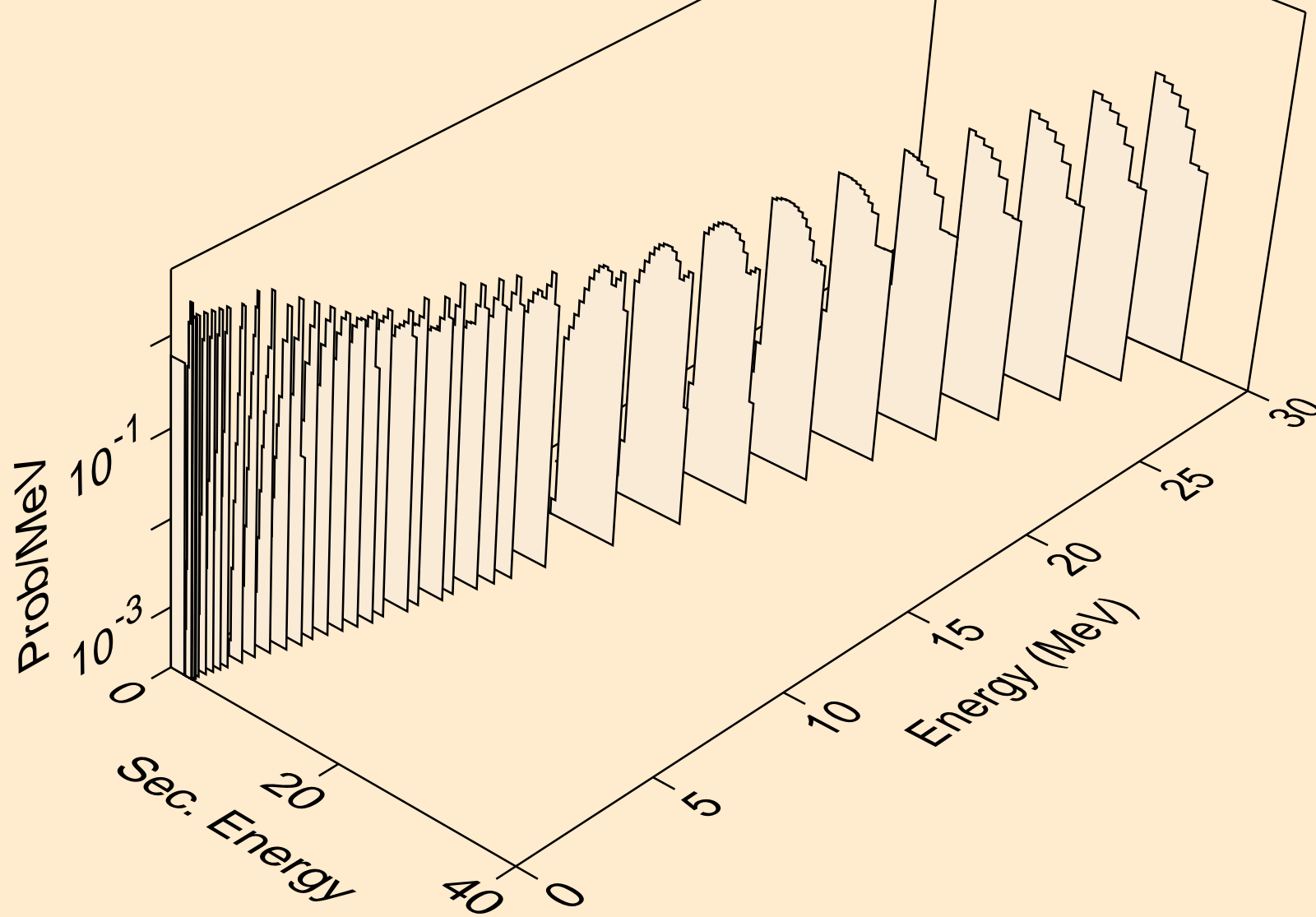

LR259 NEUTRON ACER TENDL-2021 LIBRARY; T=293.6K
protons from (n,2p)

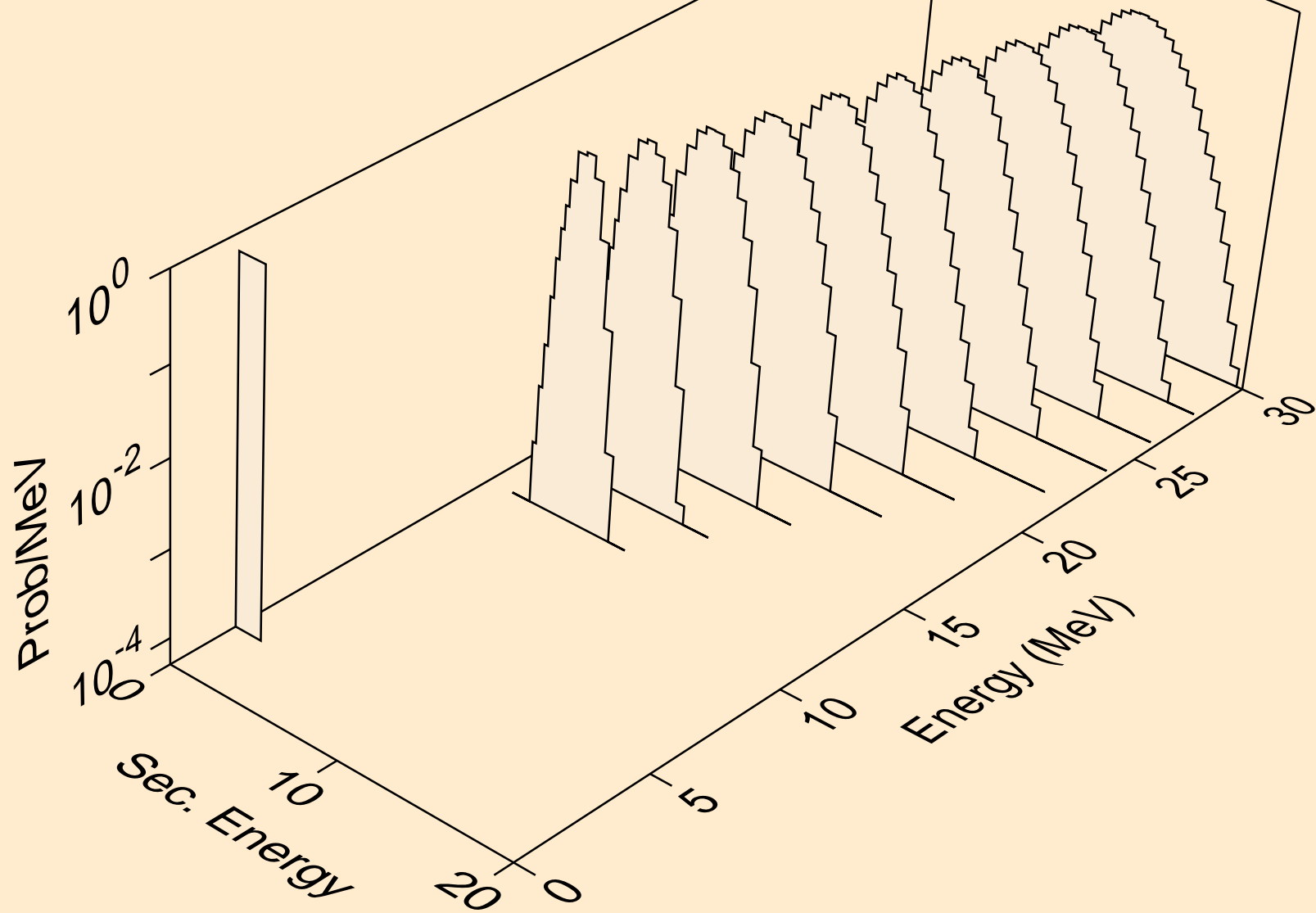

LR259 NEUTRON ACER TENDL-2021 LIBRARY; T=293.6K
protons from (n,p)

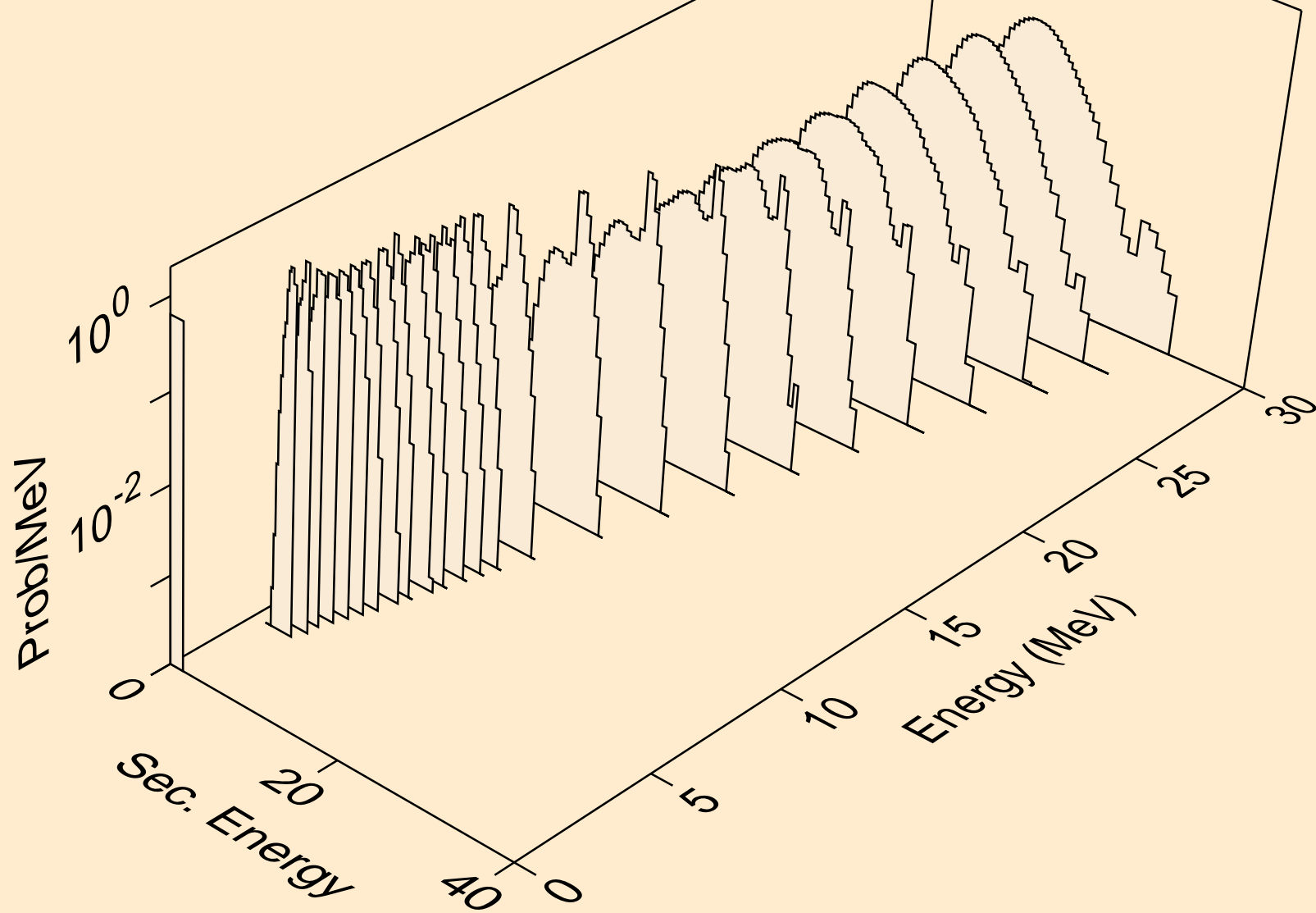

LR259 NEUTRON ACER TENDL-2021 LIBRARY; T=293.6K
protons from (n,pd)

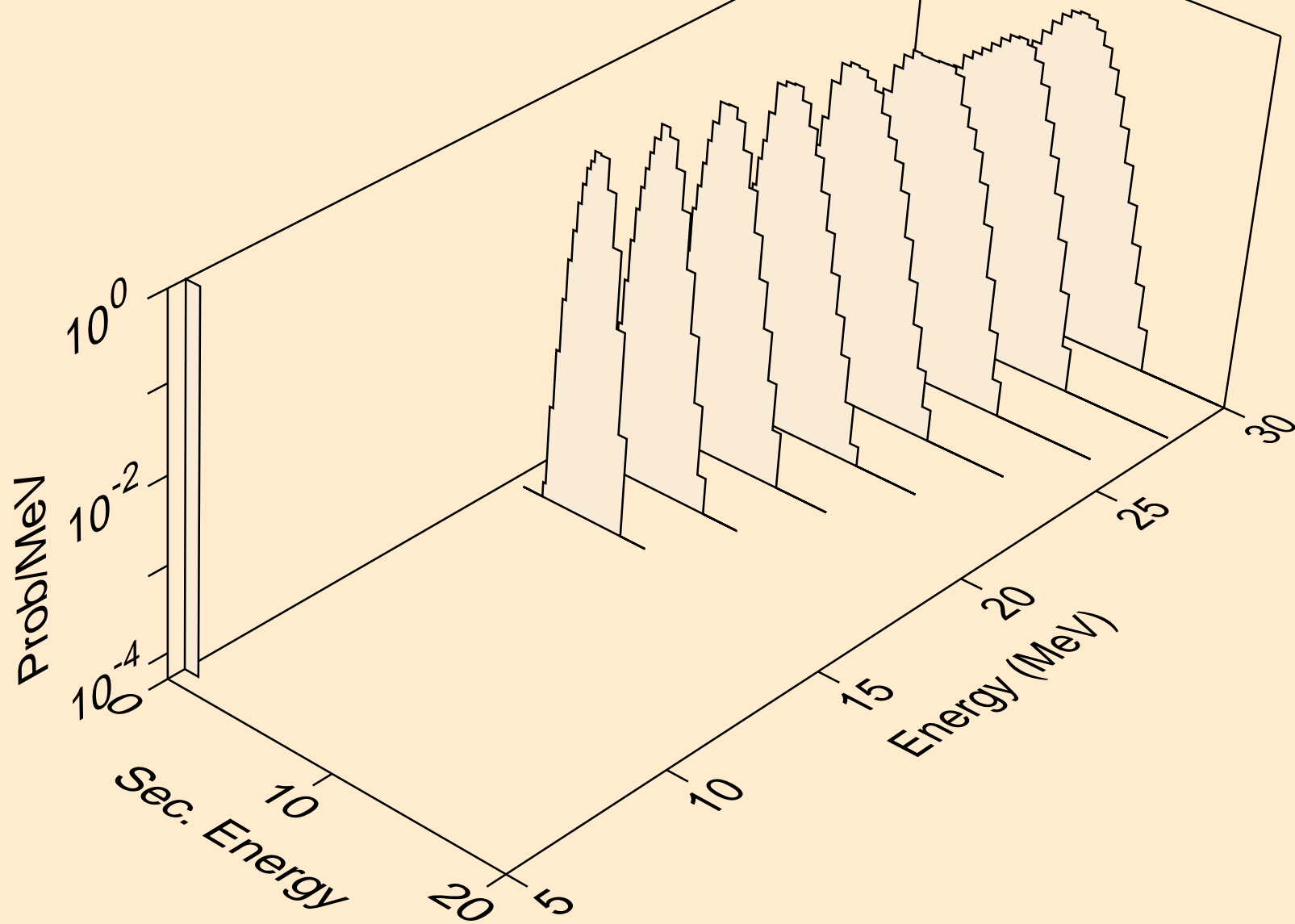

LR259 NEUTRON ACER TENDL-2021 LIBRARY; T=293.6K
protons from (n,pt)

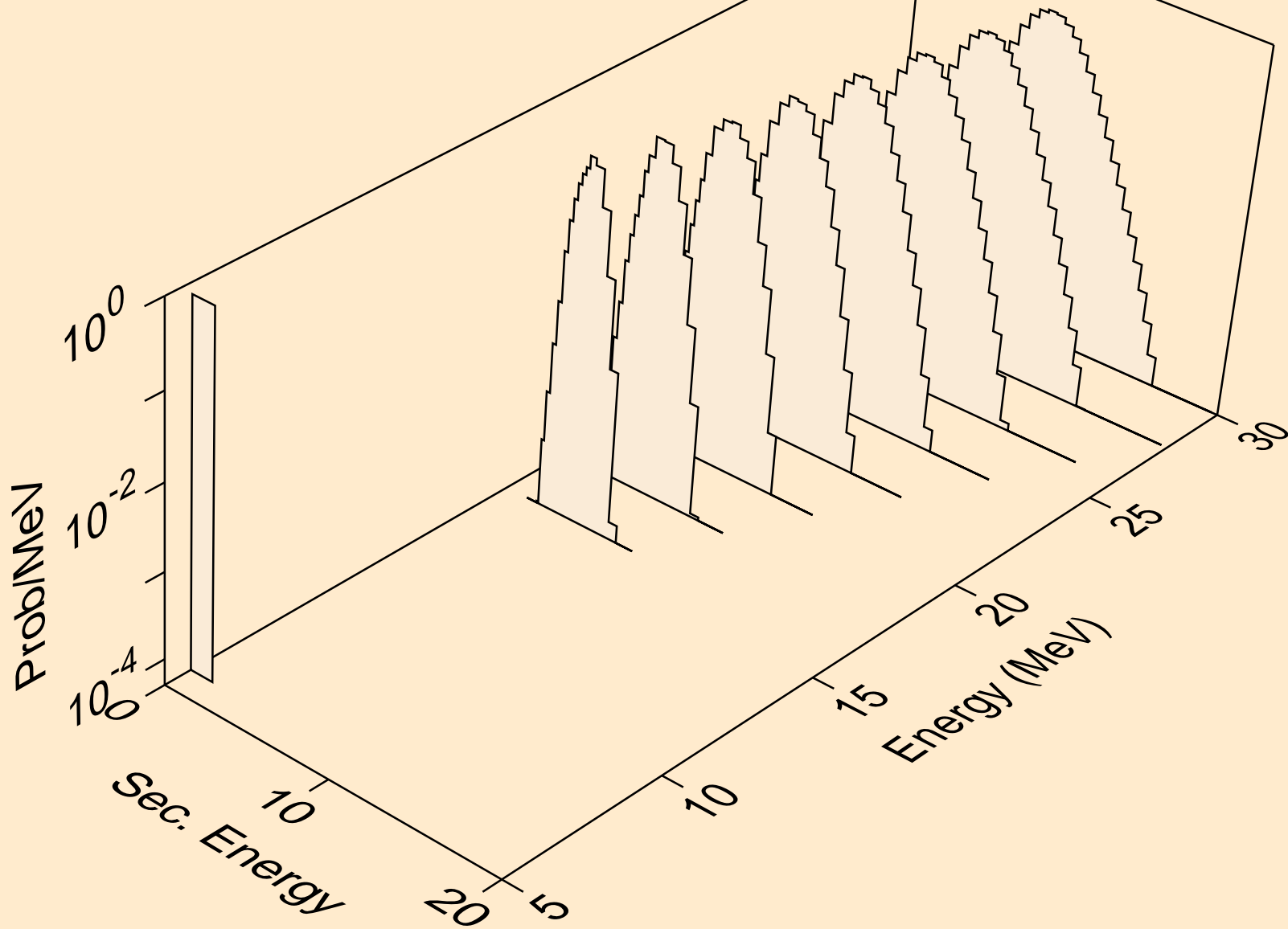

LR259 NEUTRON ACER TENDL-2021 LIBRARY; T=293.6K
deuterons from (n,x)

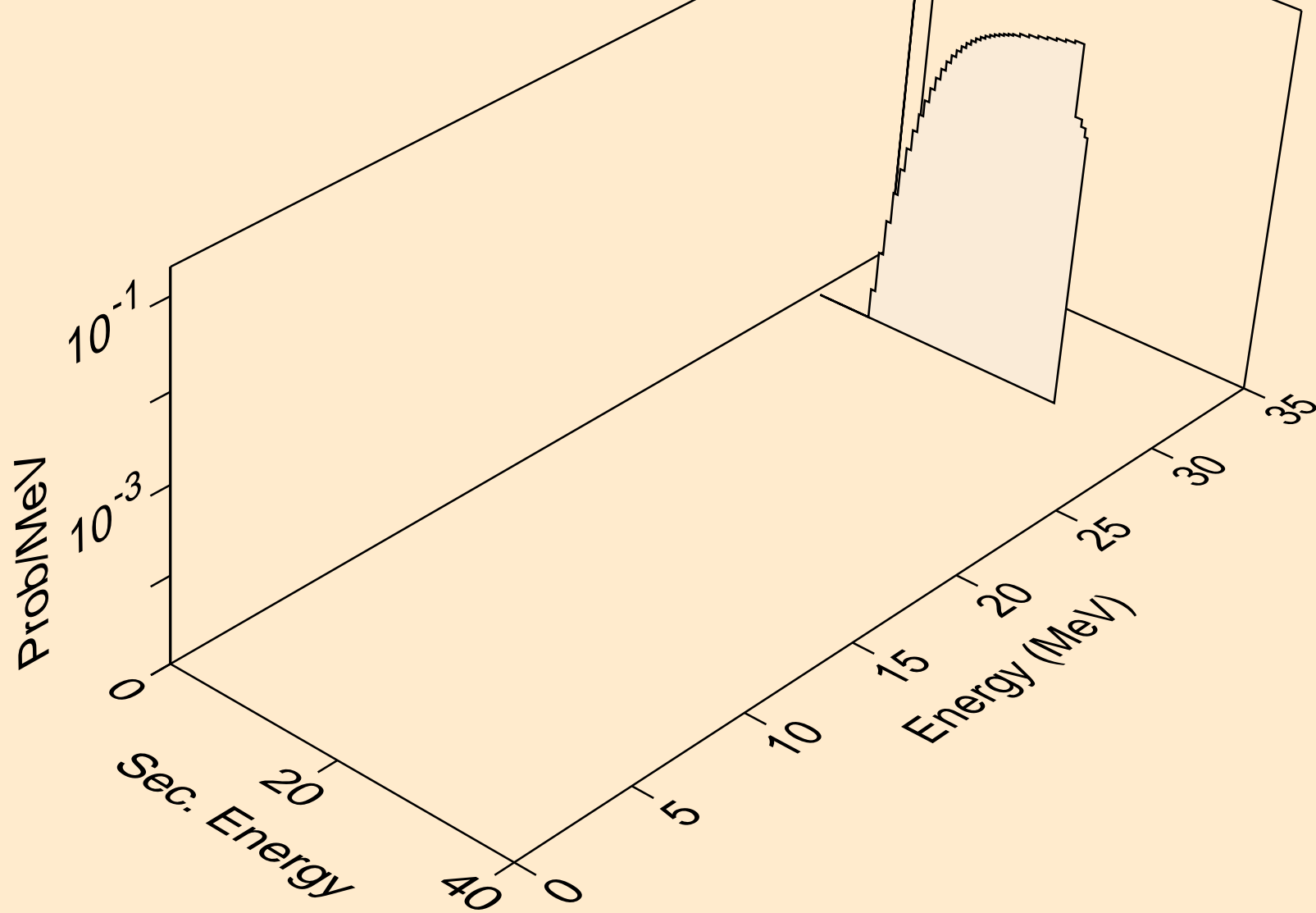

LR259 NEUTRON ACER TENDL-2021 LIBRARY; T=293.6K
deuterons from (n,2nd)

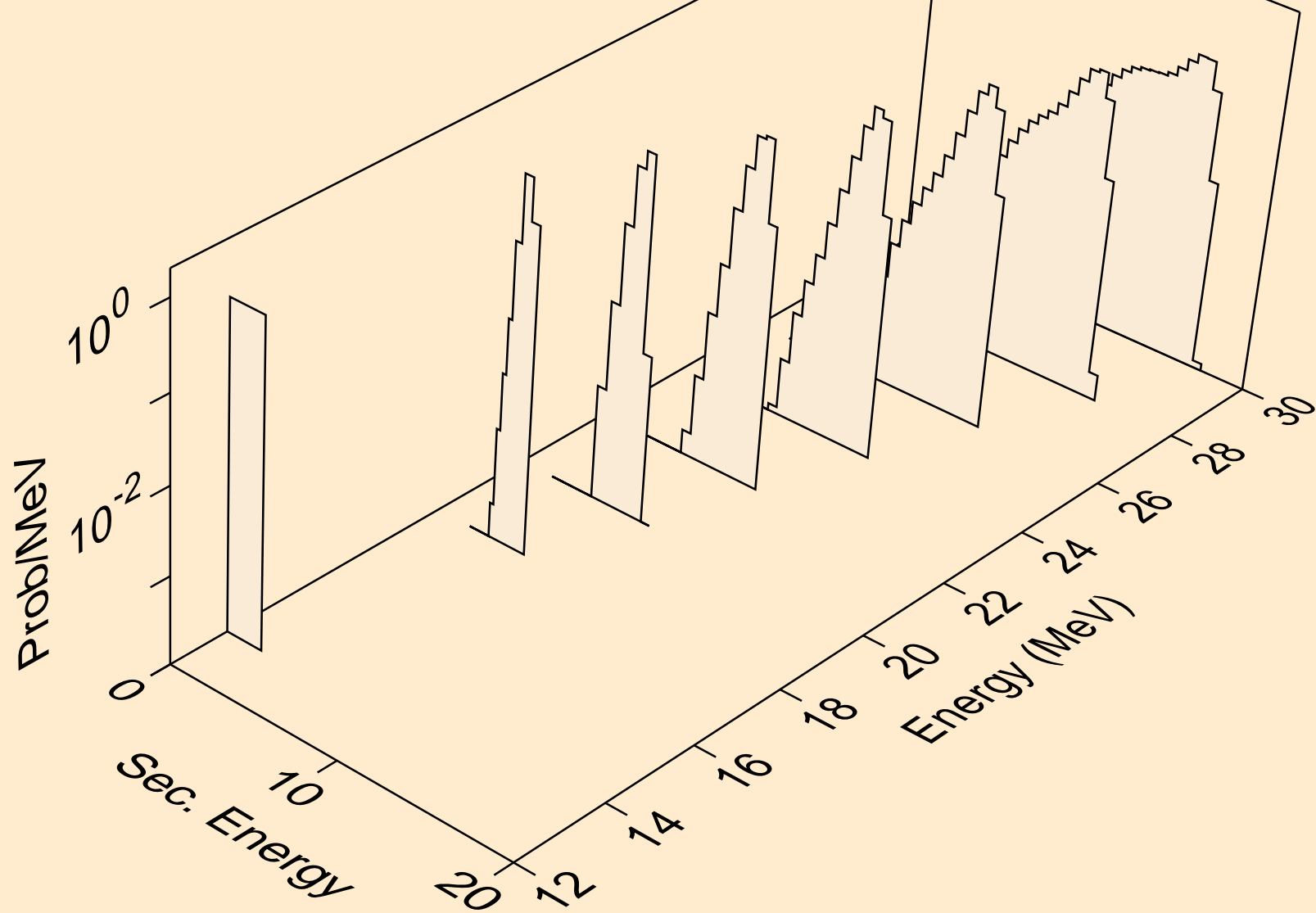

LR259 NEUTRON ACER TENDL-2021 LIBRARY; T=293.6K
deuterons from (n,n*)d

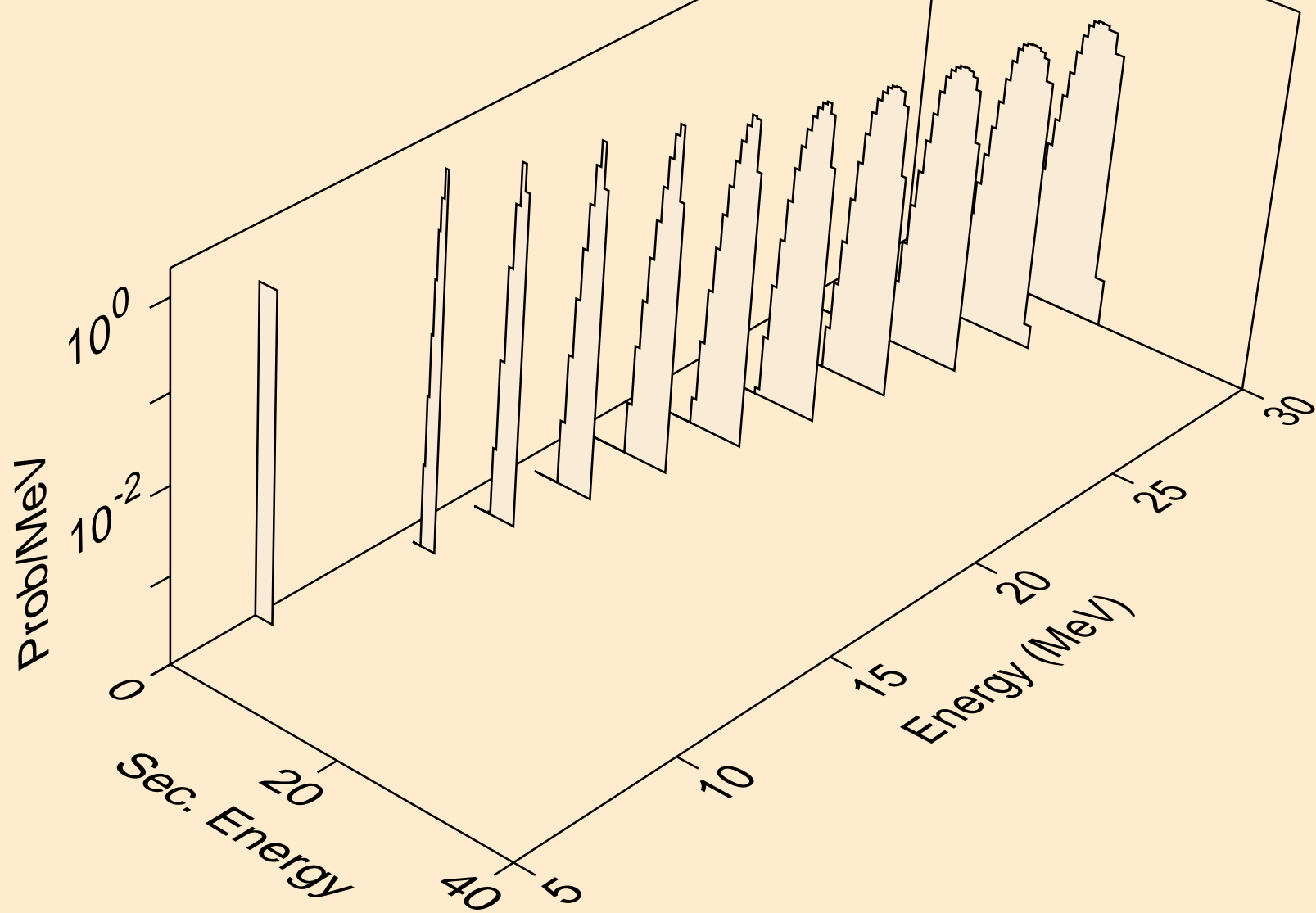

LR259 NEUTRON ACER TENDL-2021 LIBRARY; T=293.6K
deuterons from (n,d)

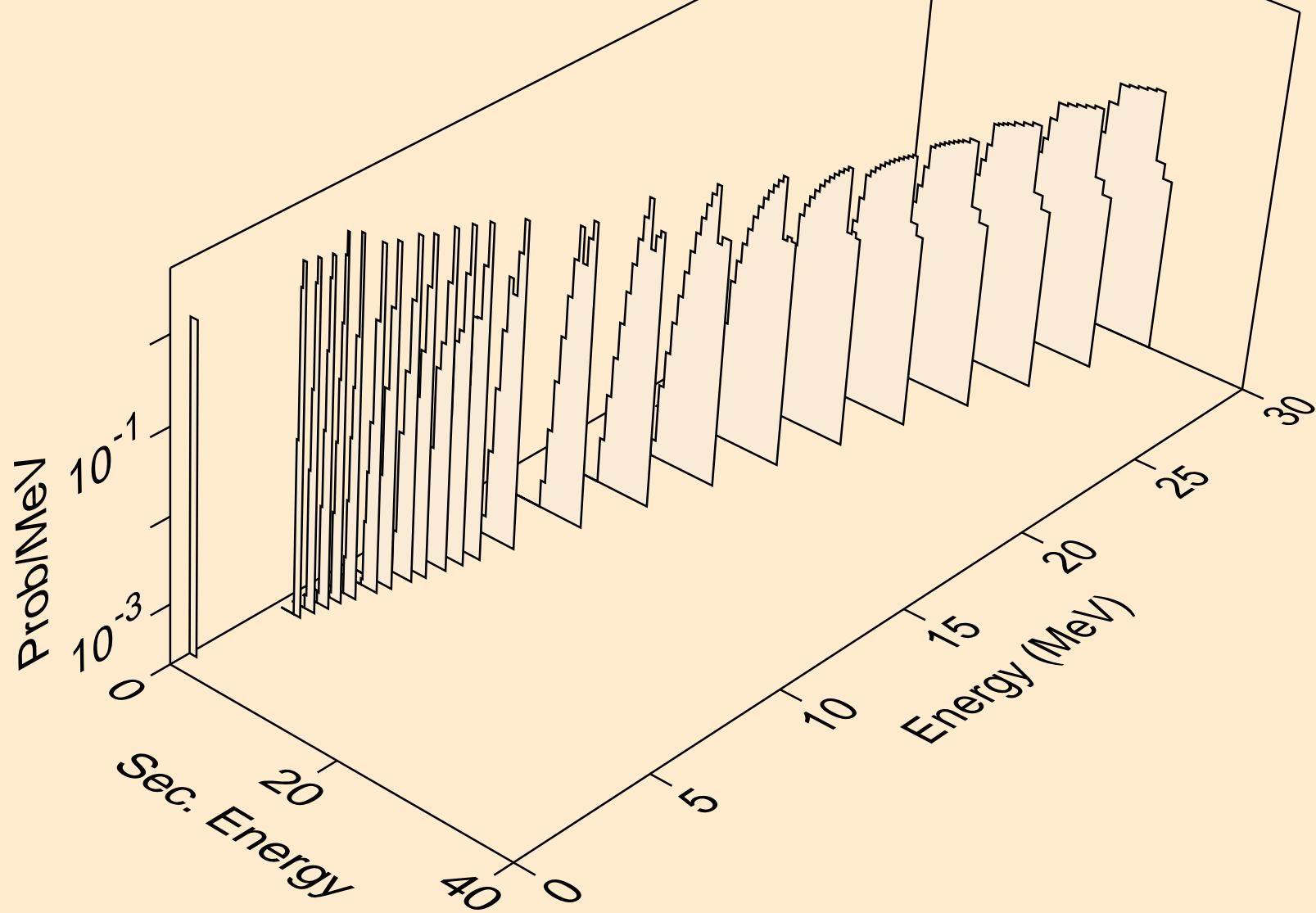

LR259 NEUTRON ACER TENDL-2021 LIBRARY; T=293.6K
deuterons from (n,pd)

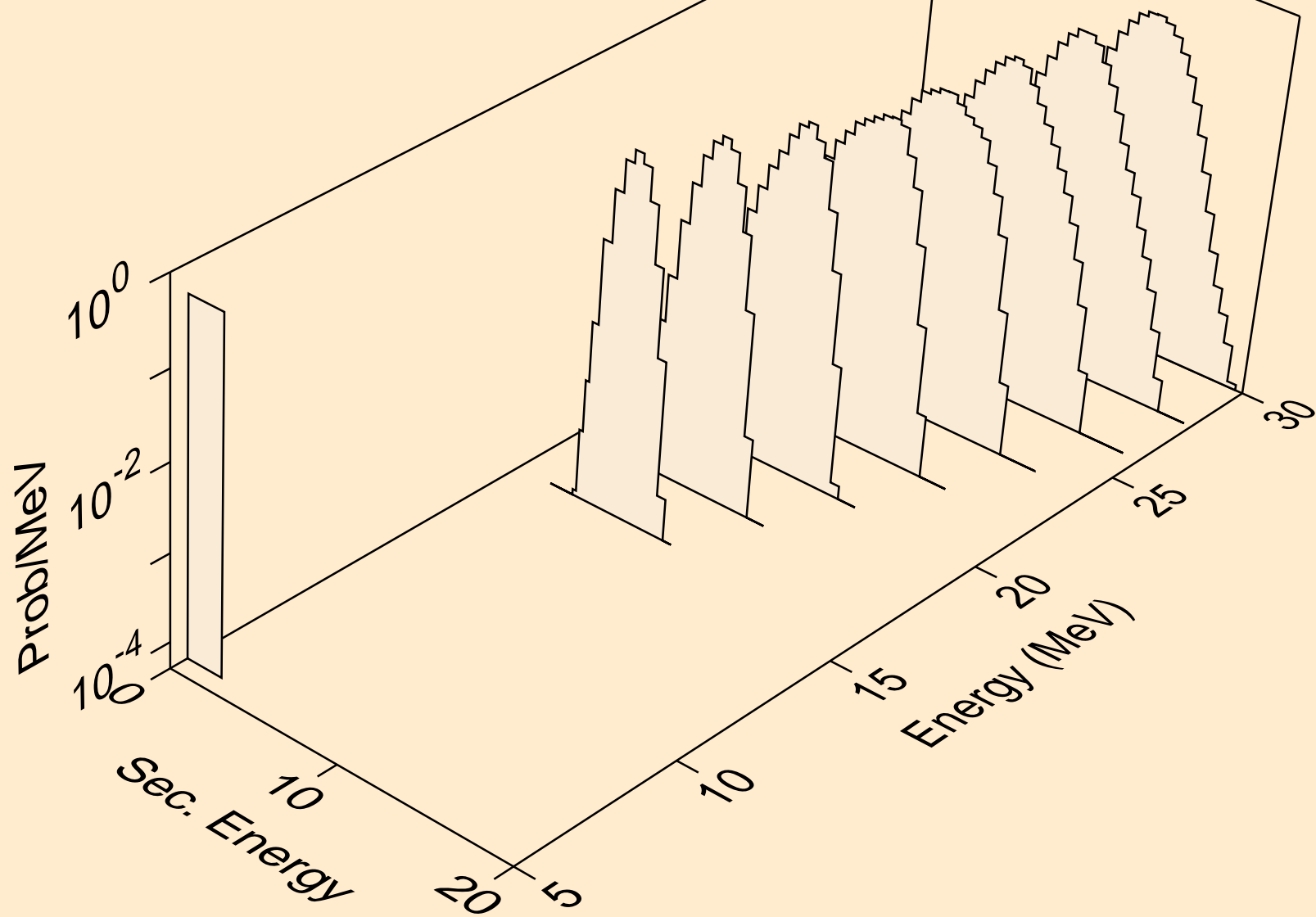

LR259 NEUTRON ACER TENDL-2021 LIBRARY; T=293.6K
tritons from (n,x)

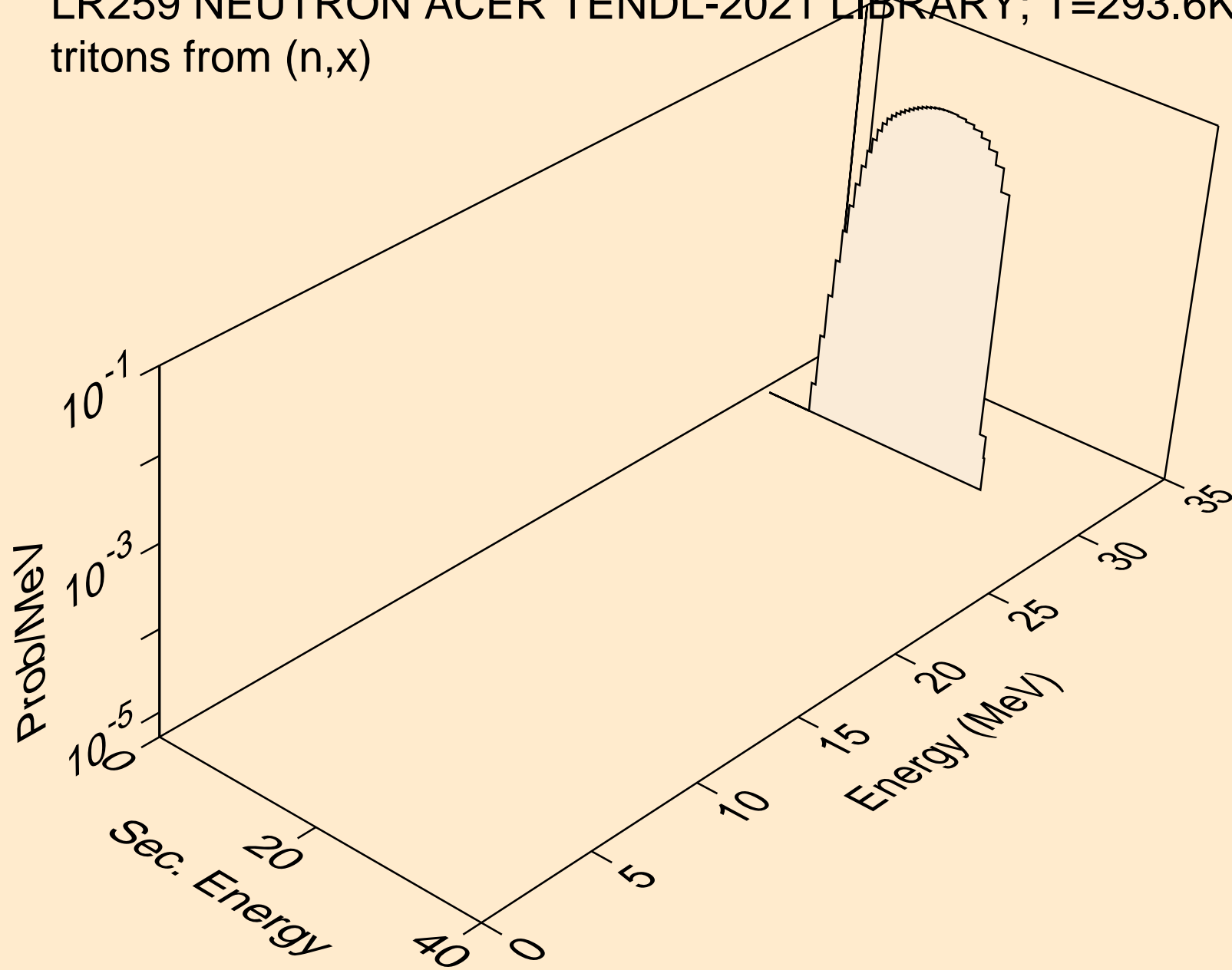

LR259 NEUTRON ACER TENDL-2021 LIBRARY; T=293.6K
tritons from (n,n*)t

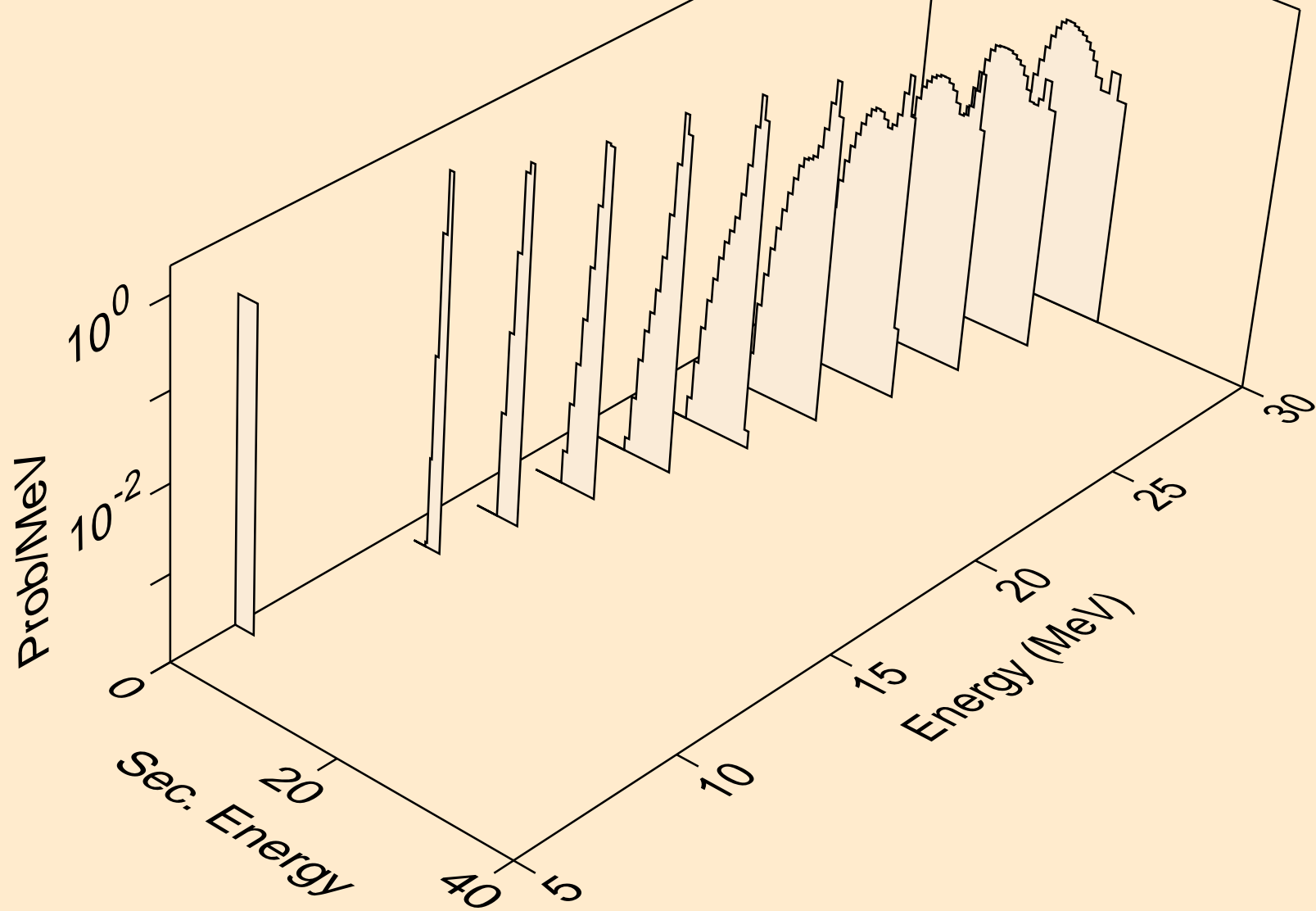

LR259 NEUTRON ACER TENDL-2021 LIBRARY; T=293.6K
tritons from (n,t)

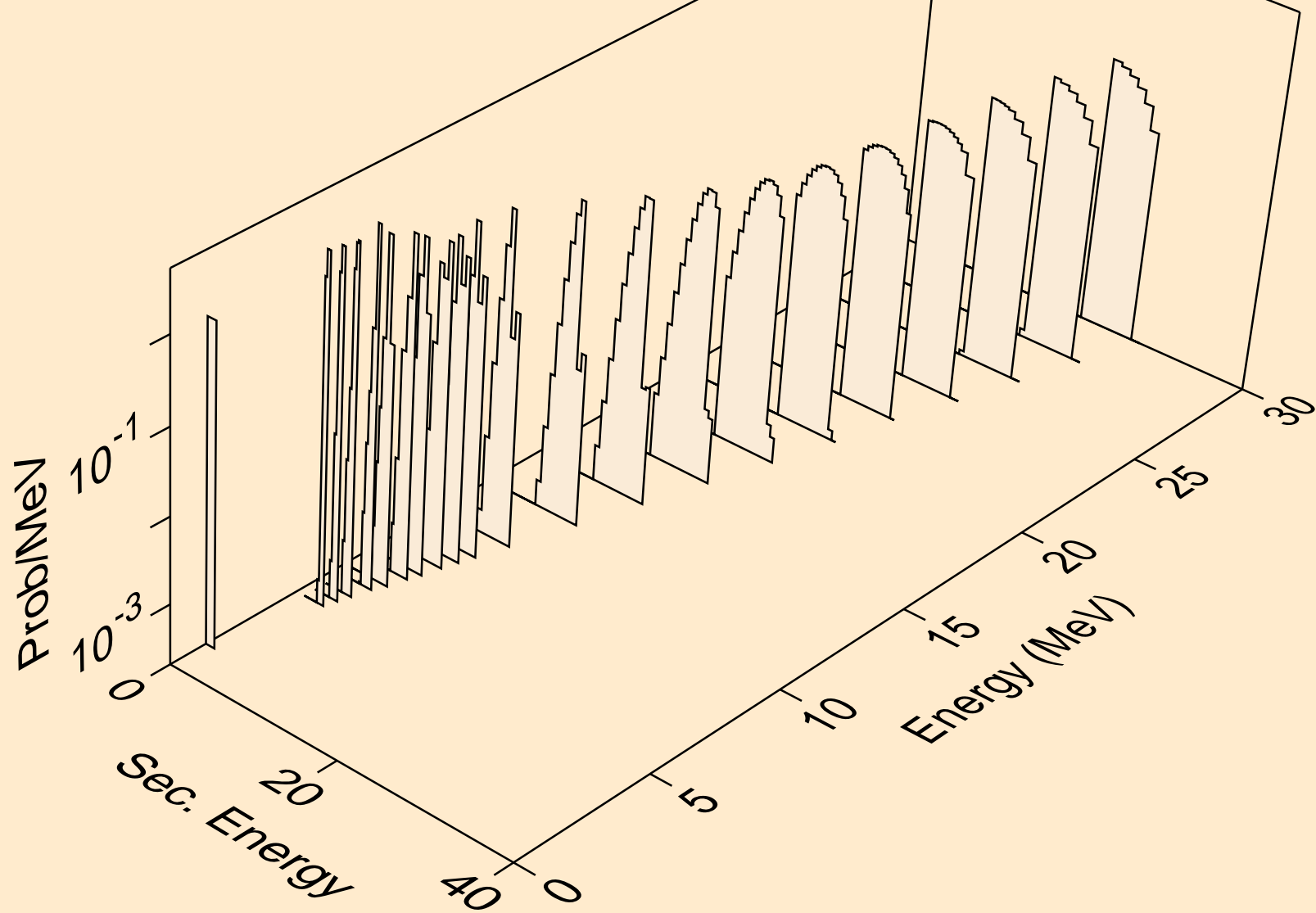

LR259 NEUTRON ACER TENDL-2021 LIBRARY; T=293.6K
tritons from (n,pt)

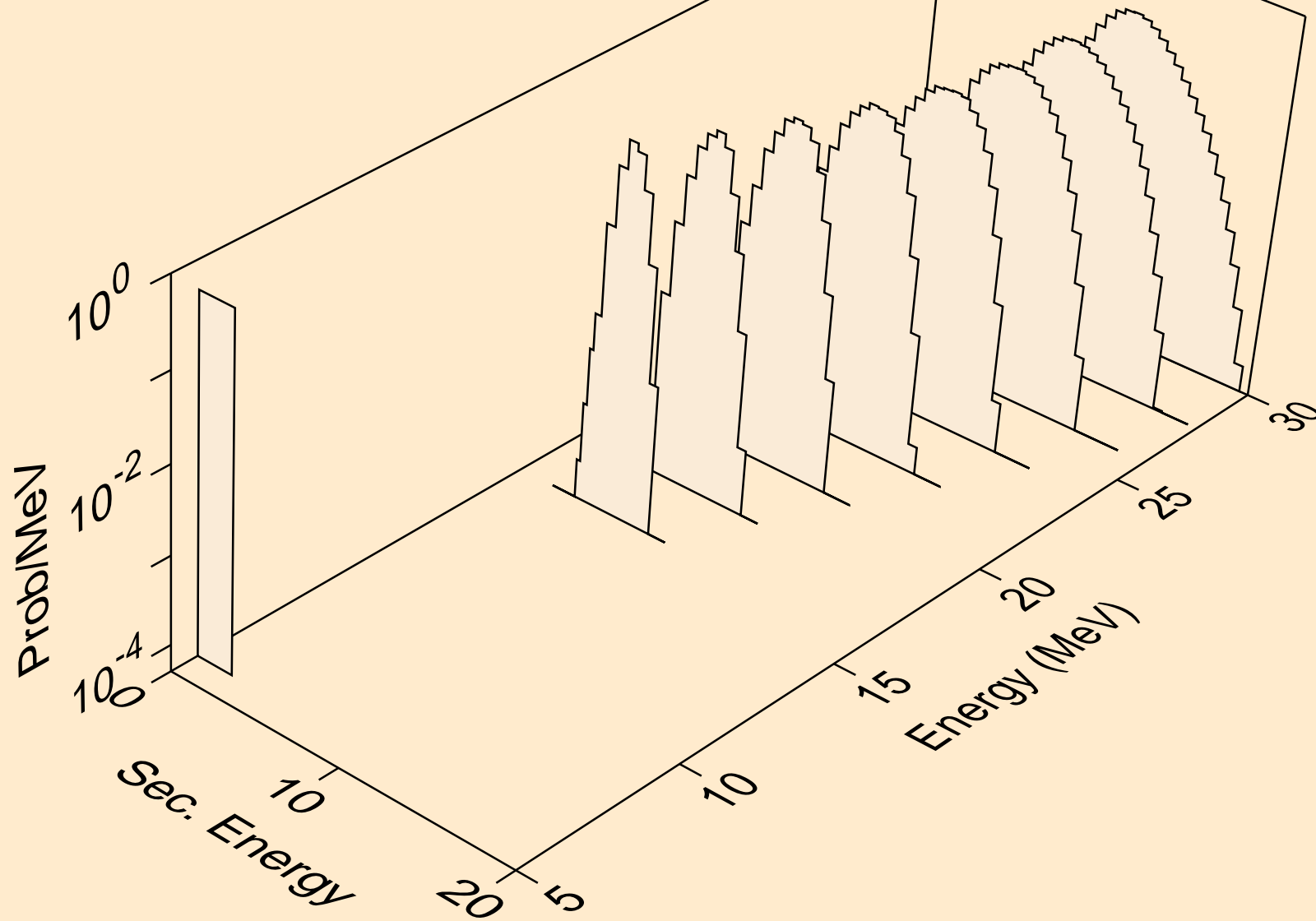

LR259 NEUTRON ACER TENDL-2021 LIBRARY; T=293.6K
he3s from (n,x)

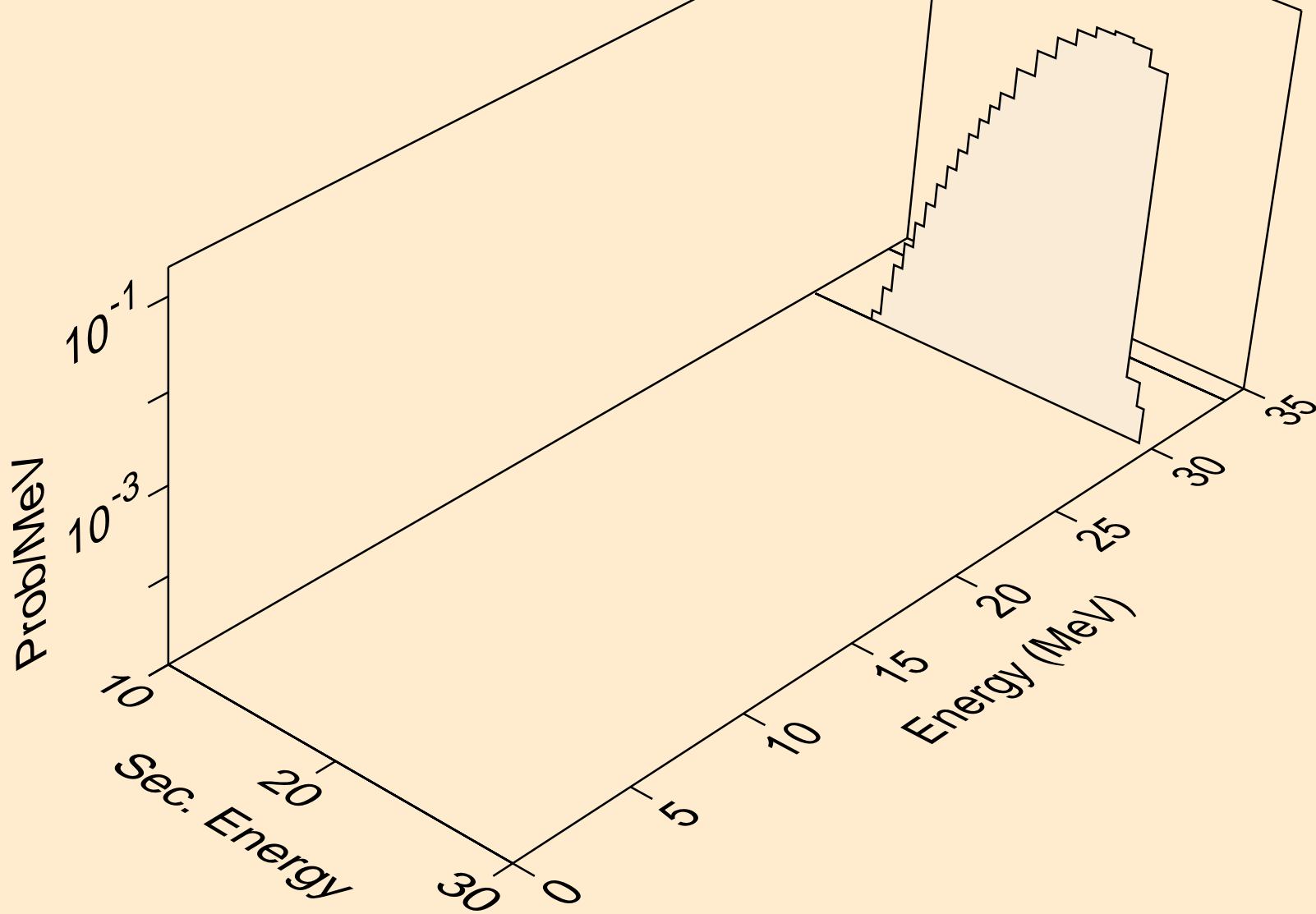

LR259 NEUTRON ACER TENDL-2021 LIBRARY; T=293.6K
he3s from (n,n*)he3

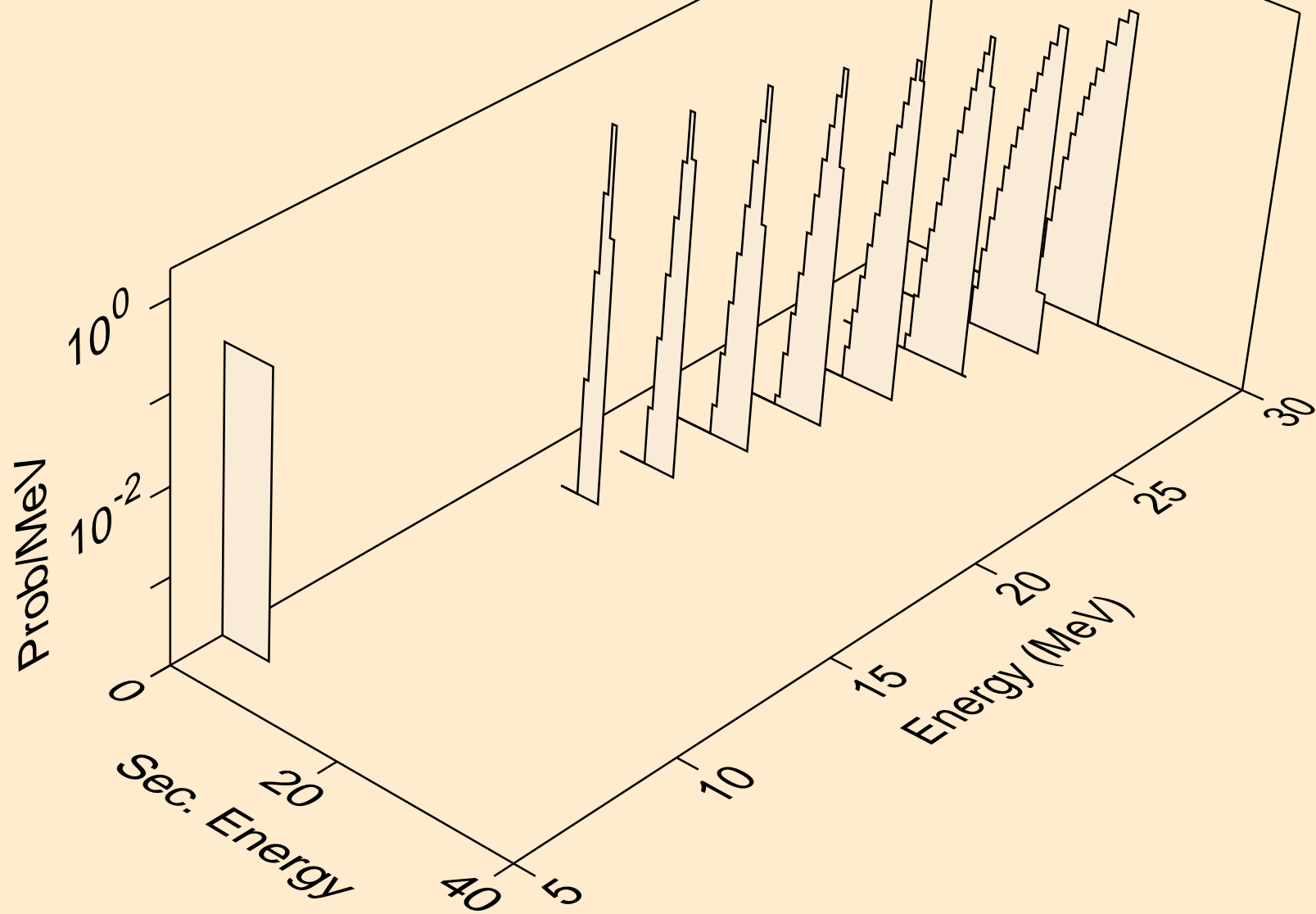

LR259 NEUTRON ACER TENDL-2021 LIBRARY; T=293.6K
he3s from (n,he3)

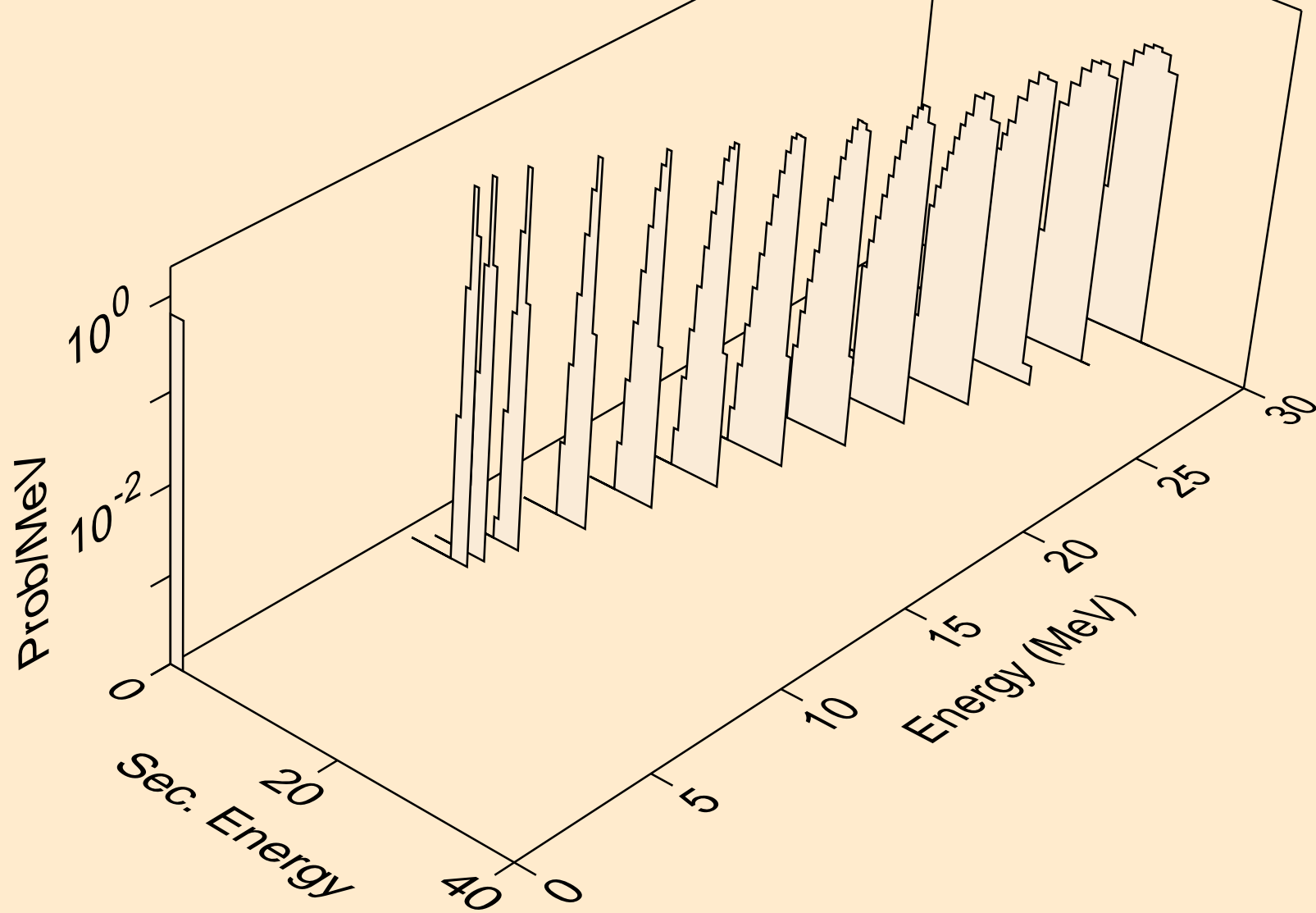

LR259 NEUTRON ACER TENDL-2021 LIBRARY; T=293.6K
alphas from (n,x)

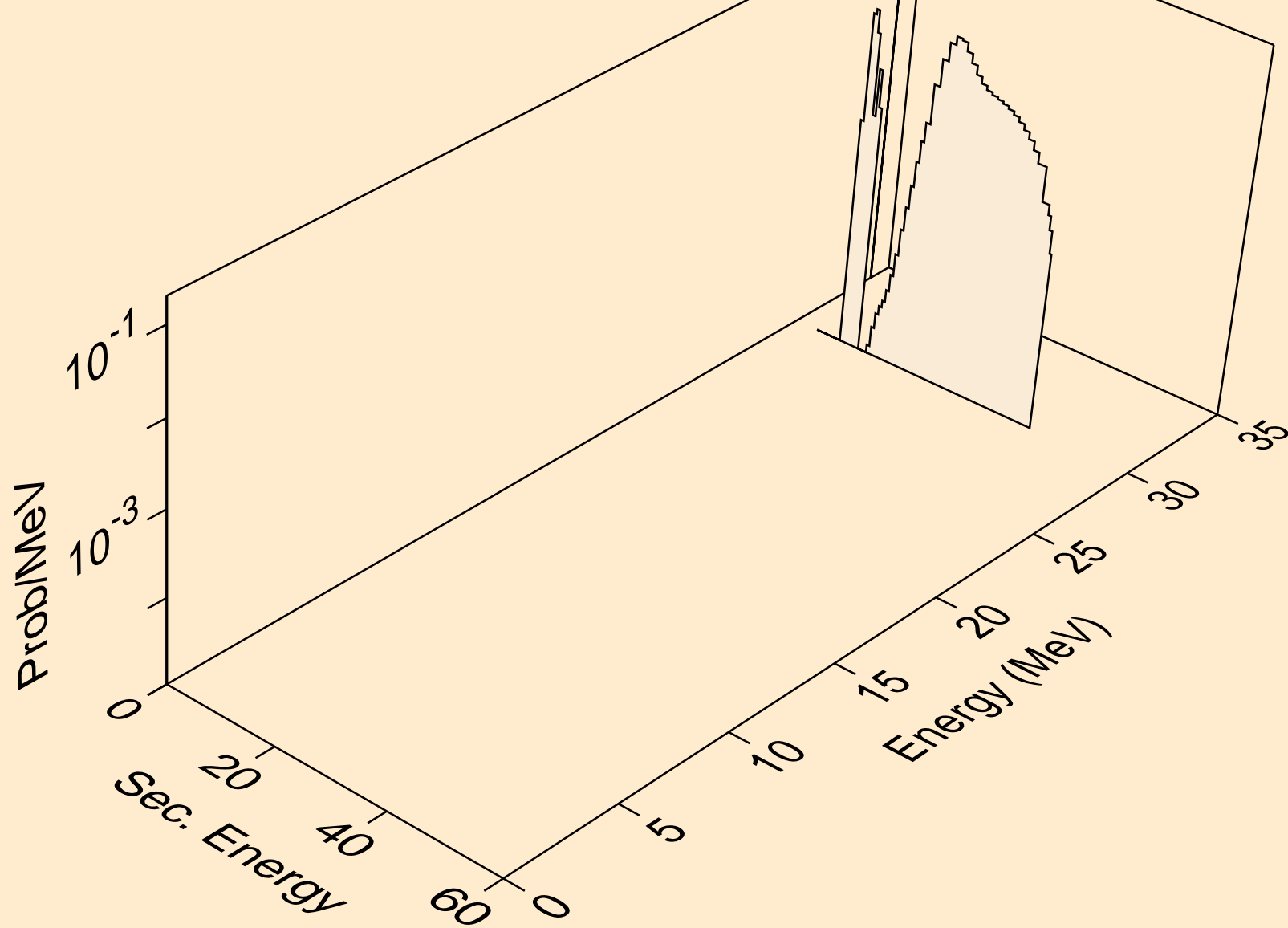

LR259 NEUTRON ACER TENDL-2021 LIBRARY; T=293.6K
alphas from (n,n*)a

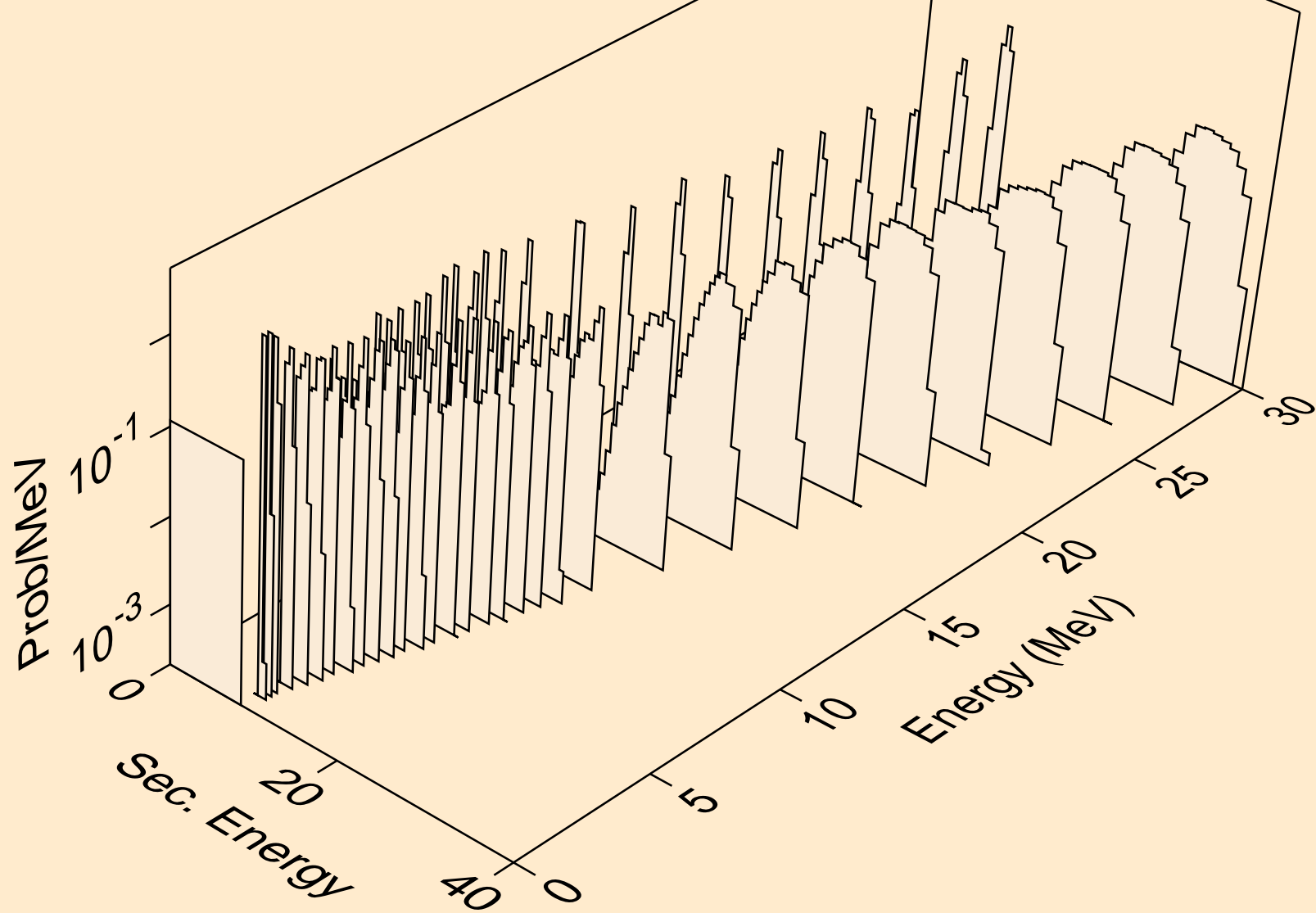

LR259 NEUTRON ACER TENDL-2021 LIBRARY; T=293.6K
alphas from (n,2n)a

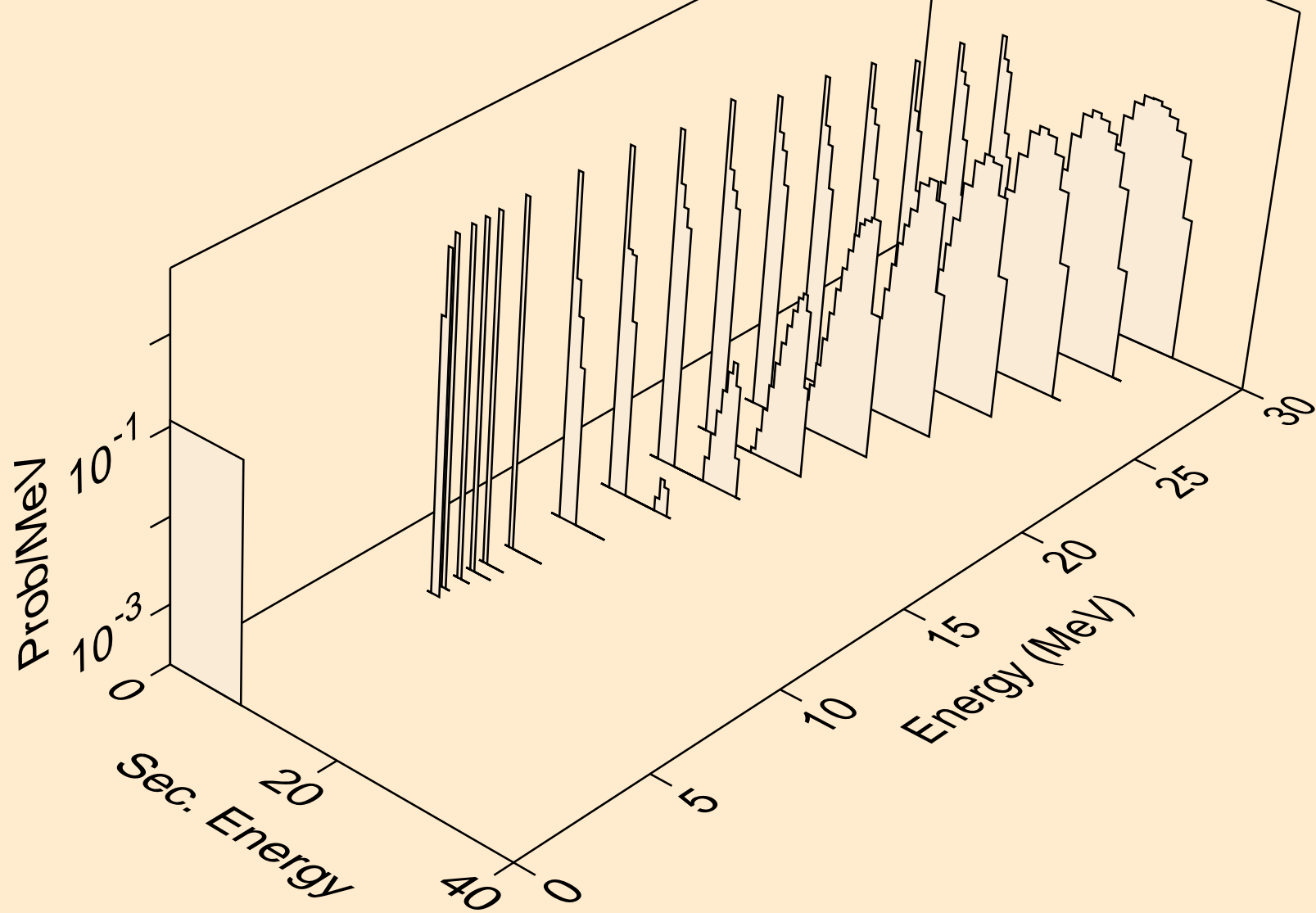

LR259 NEUTRON ACER TENDL-2021 LIBRARY; T=293.6K
alphas from (n,3n)a

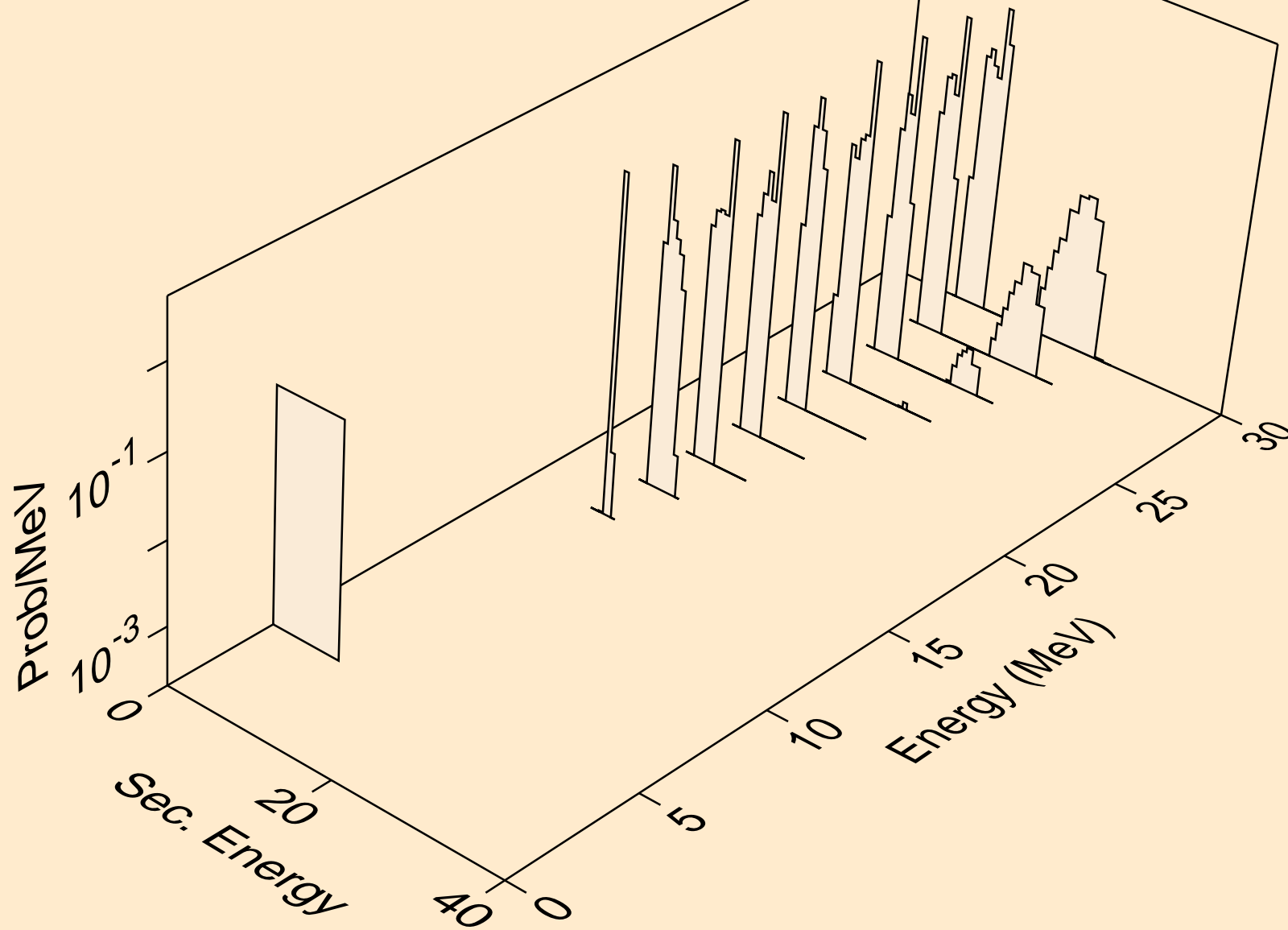

LR259 NEUTRON ACER TENDL-2021 LIBRARY; T=293.6K
alphas from (n,n*)2a

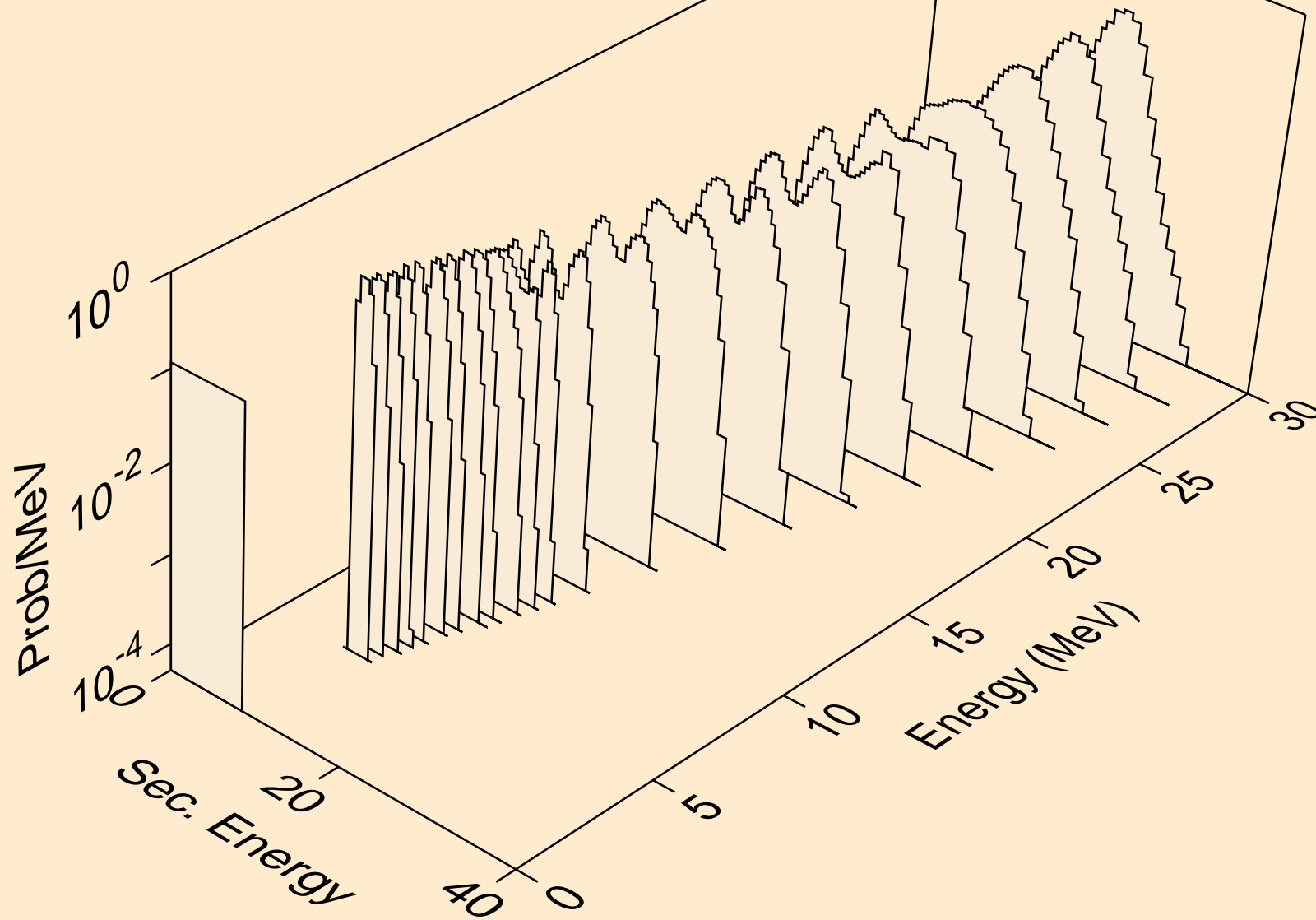

LR259 NEUTRON ACER TENDL-2021 LIBRARY; T=293.6K
alphas from (n,2n)2a

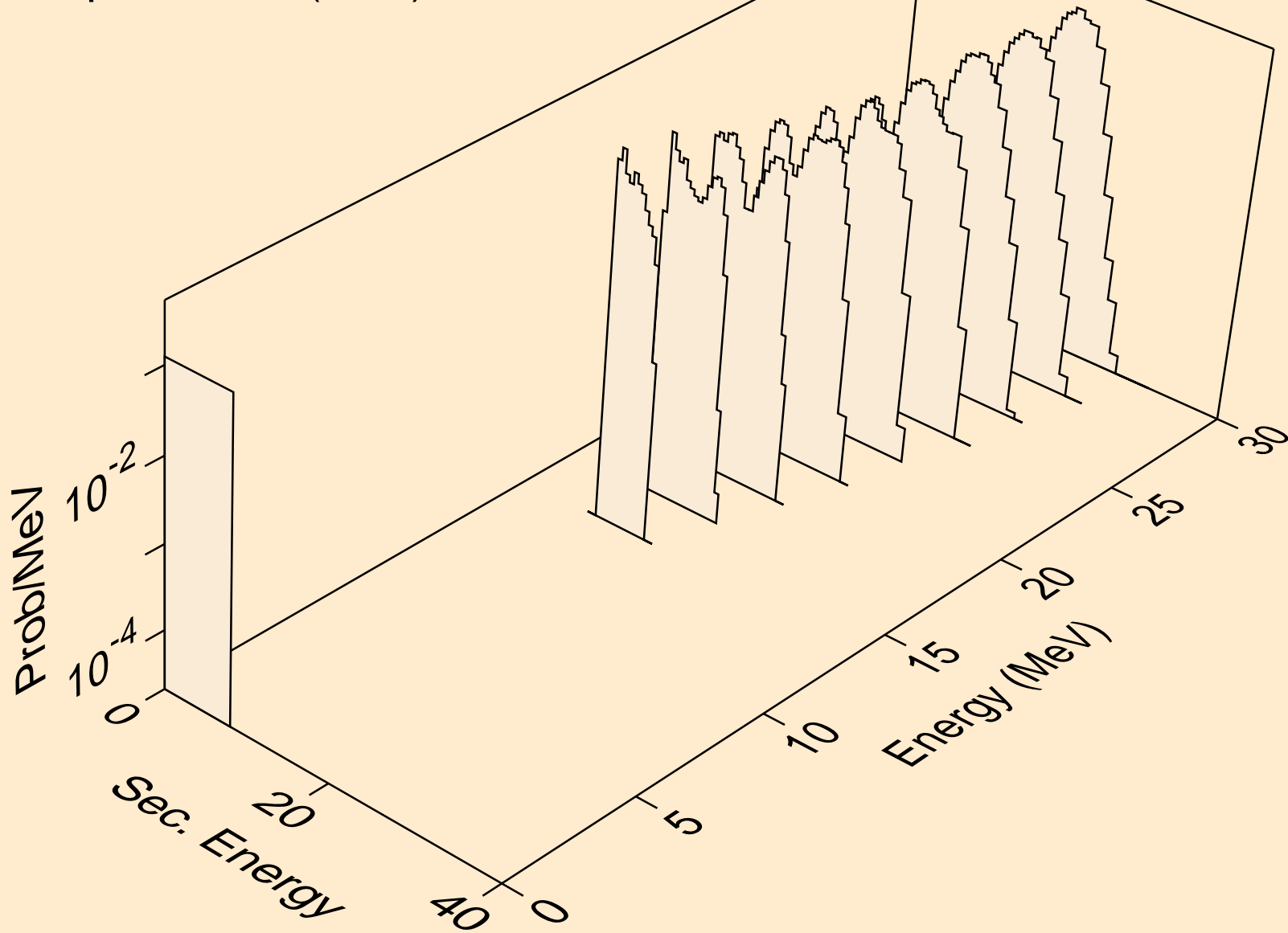

LR259 NEUTRON ACER TENDL-2021 LIBRARY; T=293.6K
alphas from (n,npa)

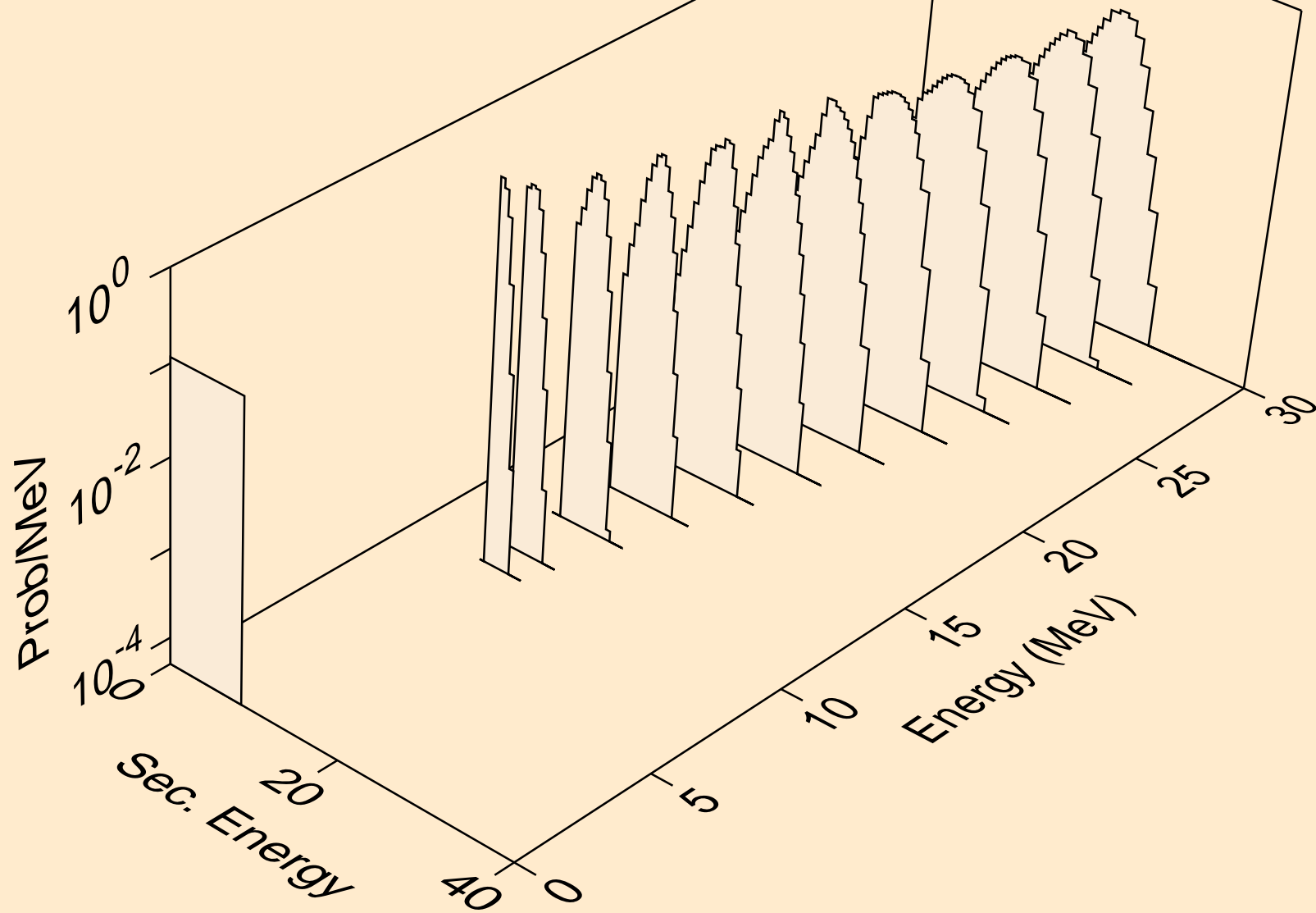

LR259 NEUTRON ACER TENDL-2021 LIBRARY; T=293.6K
alphas from (n,a)

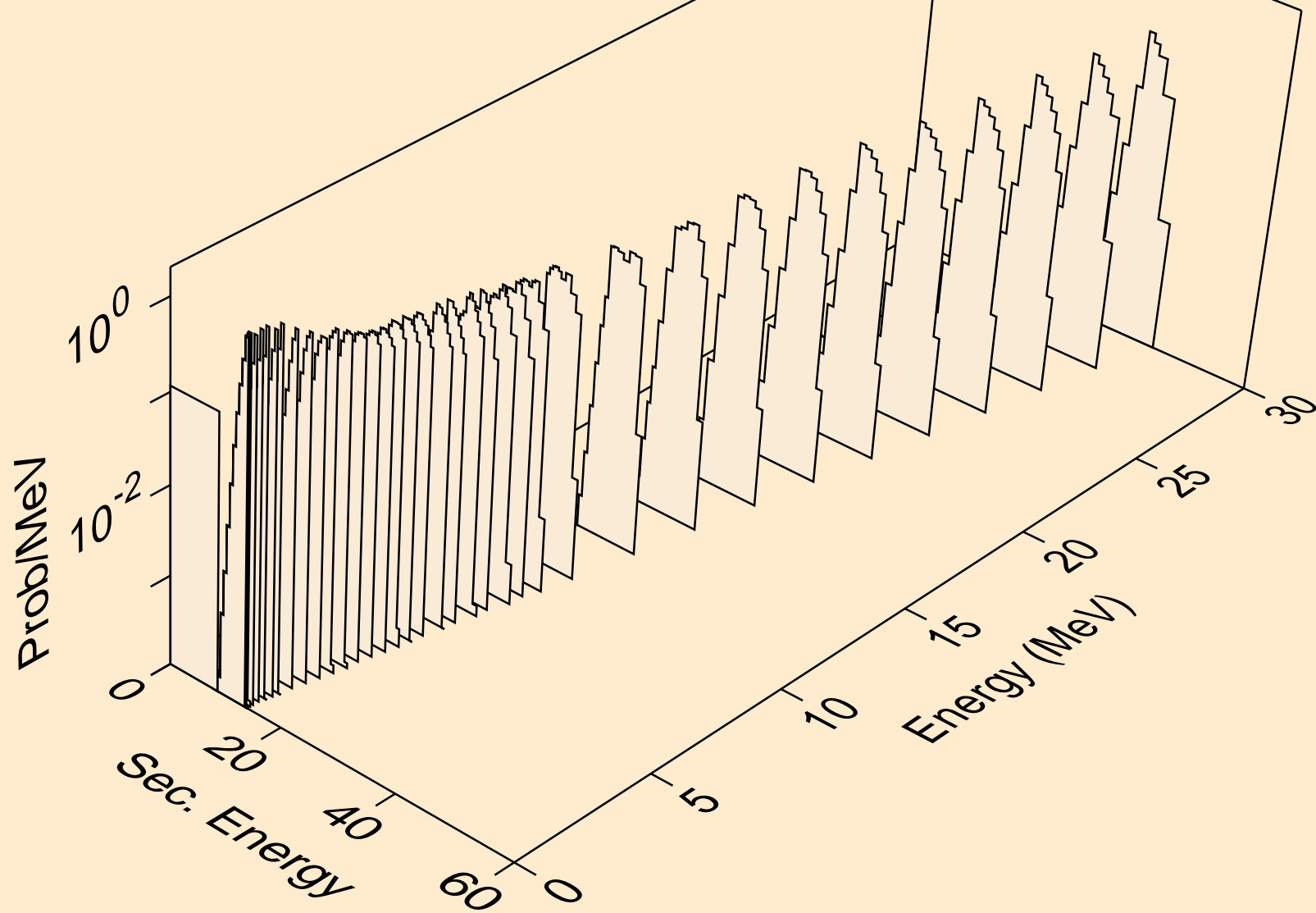

LR259 NEUTRON ACER TENDL-2021 LIBRARY; T=293.6K
alphas from (n,2a)

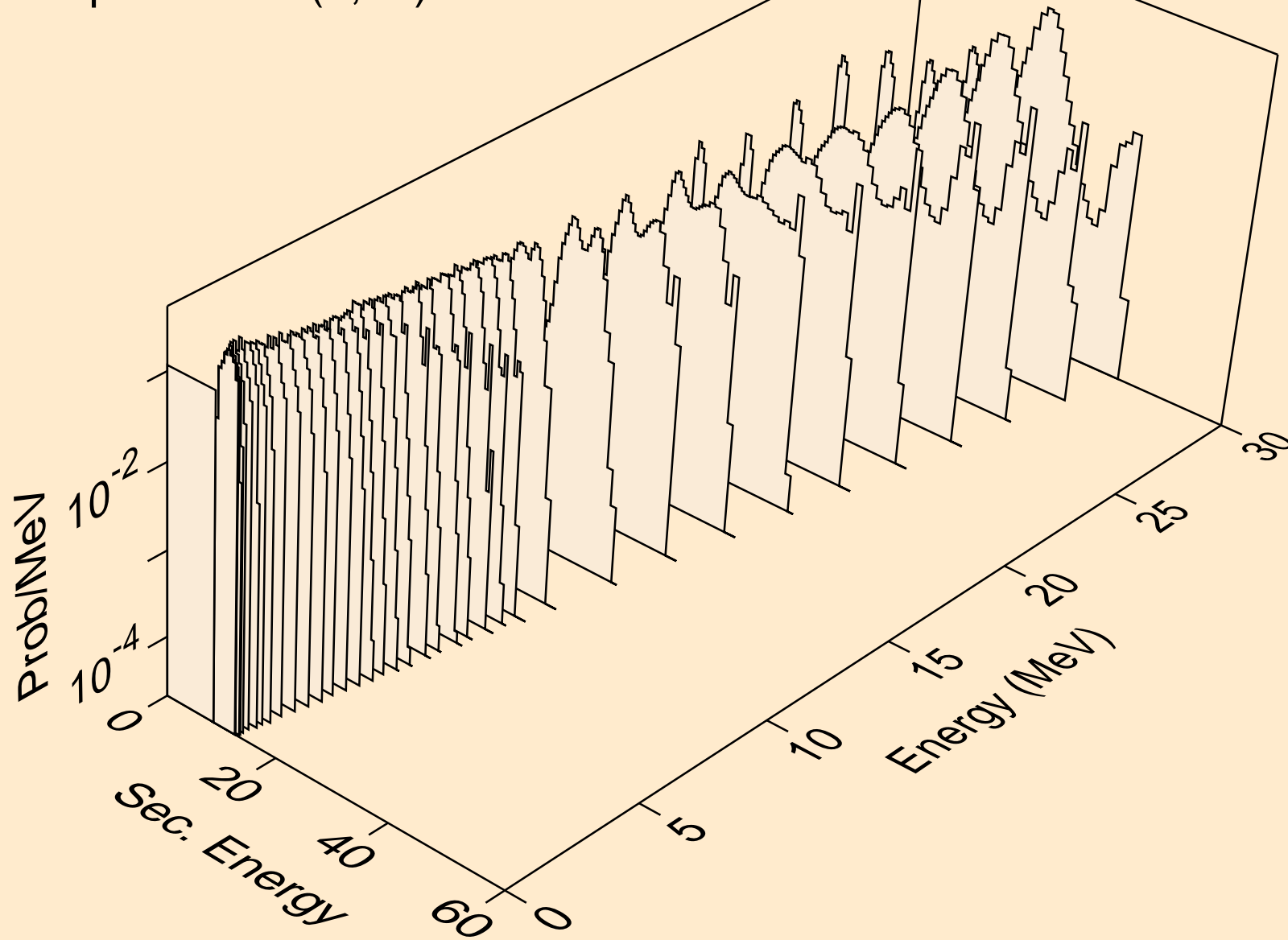

LR259 NEUTRON ACER TENDL-2021 LIBRARY; T=293.6K
alphas from (n,pa)

