

LR261 NEUTRON ACER TENDL-2021 LIBRARY; T=293.6K
Principal cross sections

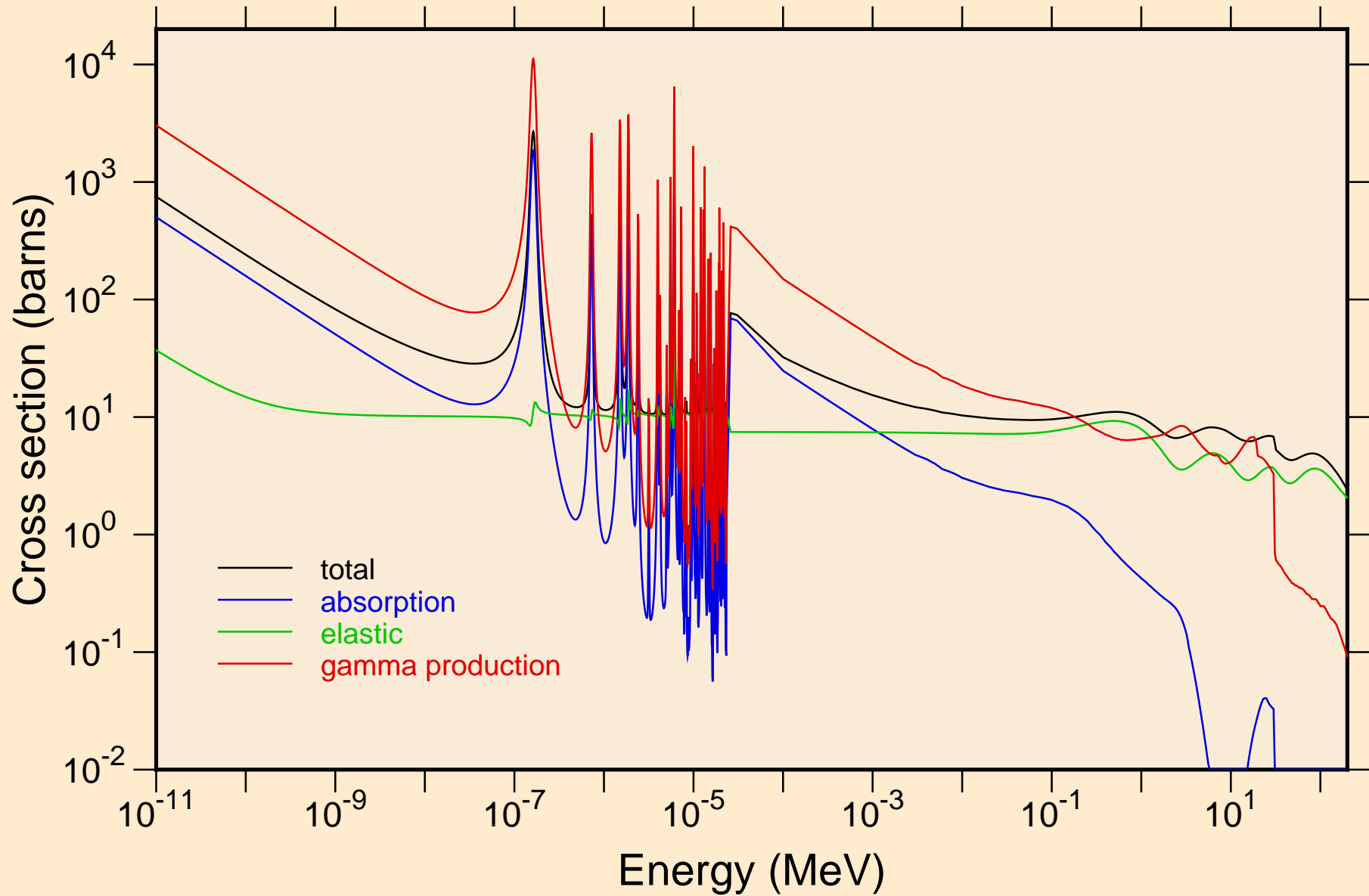

LR261 NEUTRON ACER TENDL-2021 LIBRARY; T=293.6K
resonance total cross section

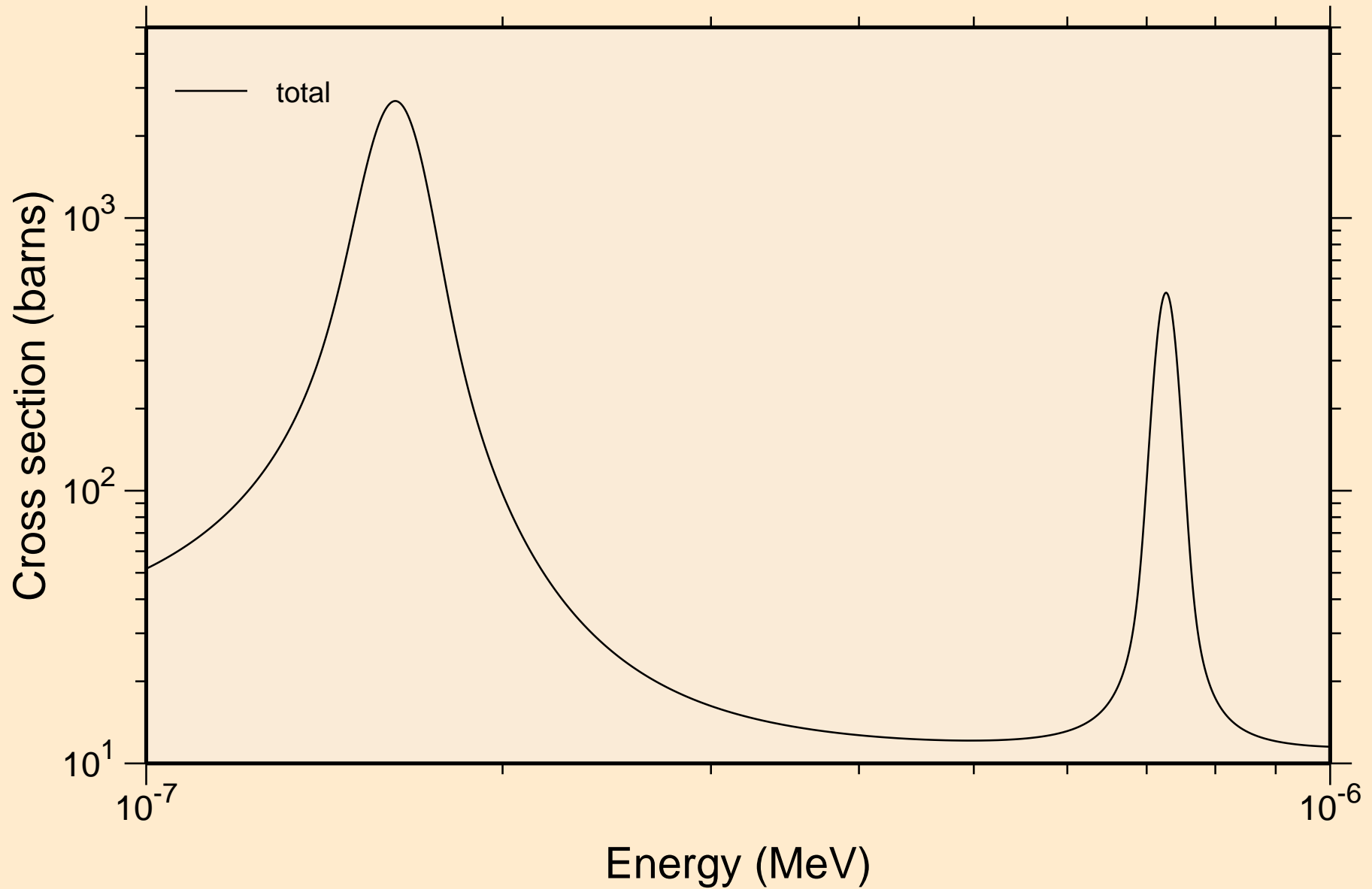

LR261 NEUTRON ACER TENDL-2021 LIBRARY; T=293.6K
resonance total cross section

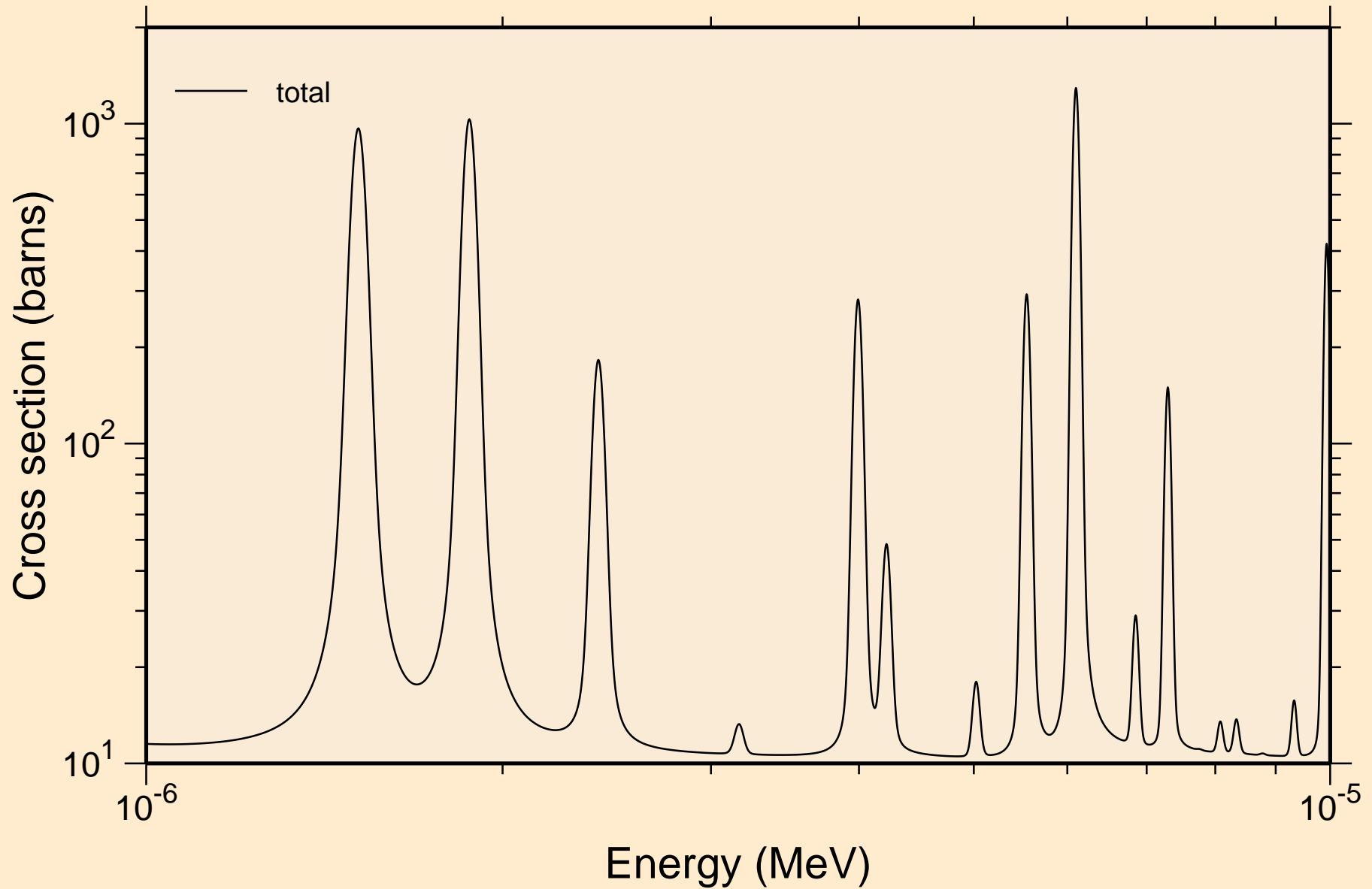

LR261 NEUTRON ACER TENDL-2021 LIBRARY; T=293.6K
resonance total cross section

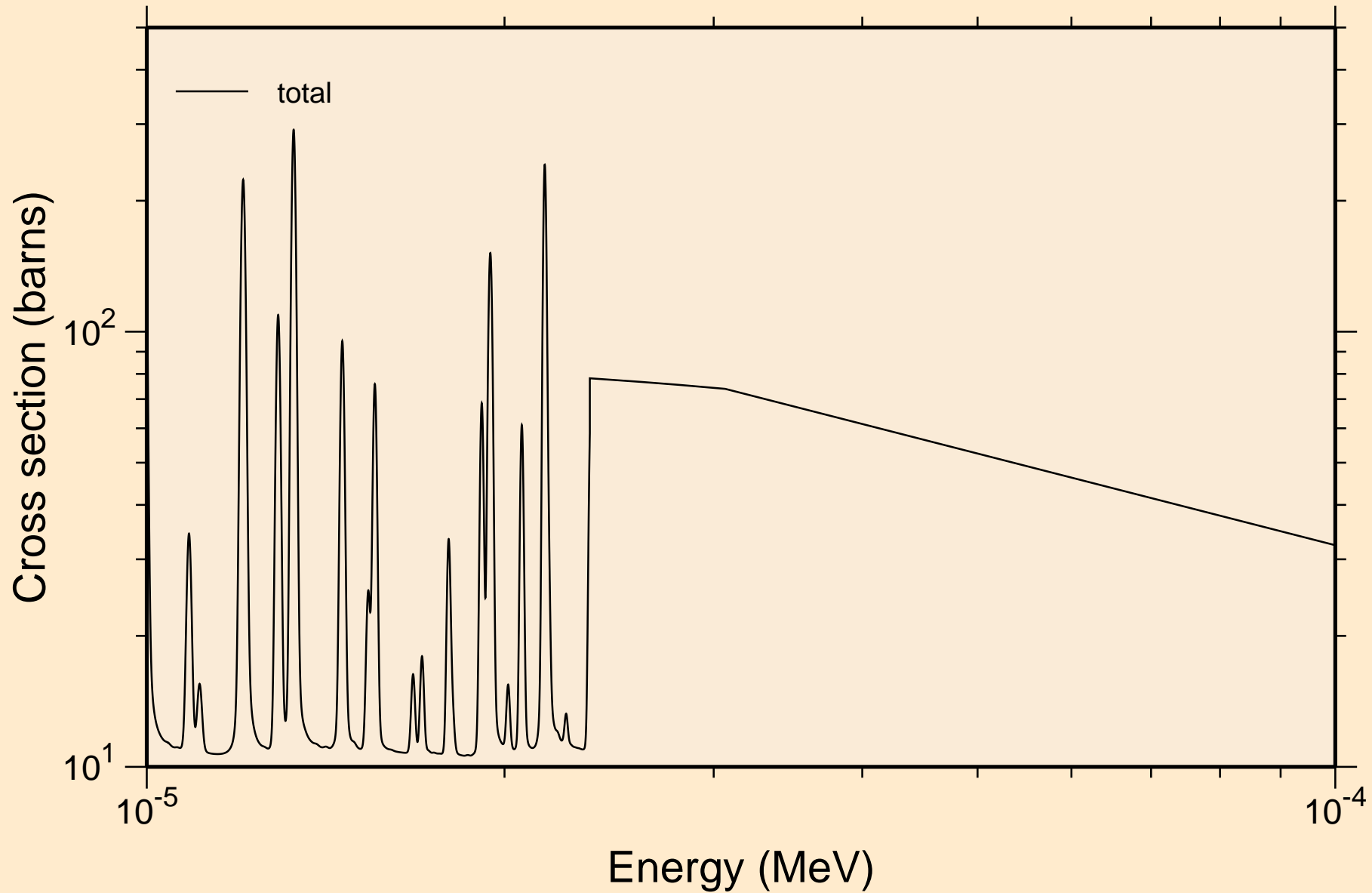

LR261 NEUTRON ACER TENDL-2021 LIBRARY; T=293.6K
resonance total cross section

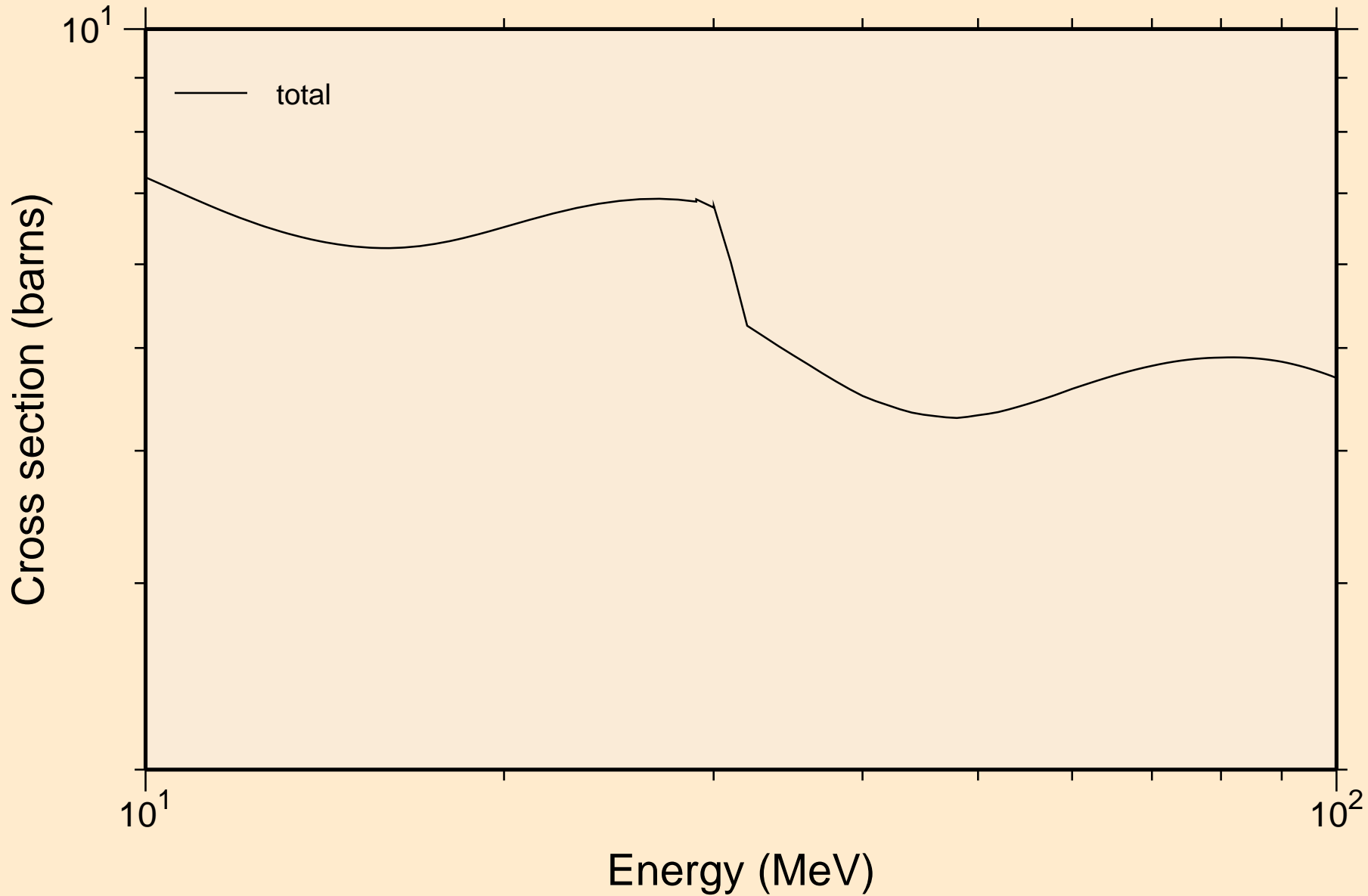

LR261 NEUTRON ACER TENDL-2021 LIBRARY; T=293.6K
resonance absorption cross sections

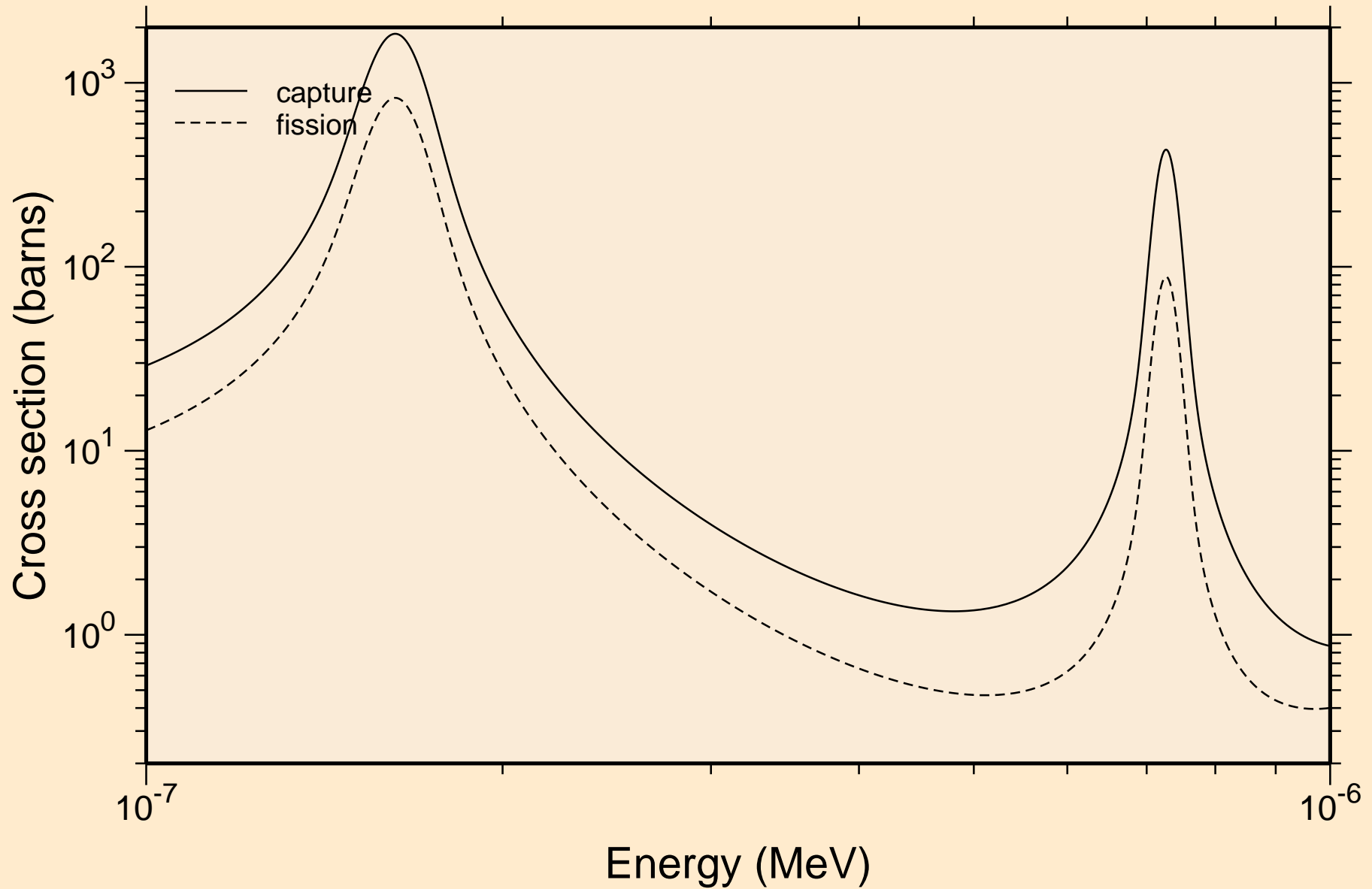

LR261 NEUTRON ACER TENDL-2021 LIBRARY; T=293.6K
resonance absorption cross sections

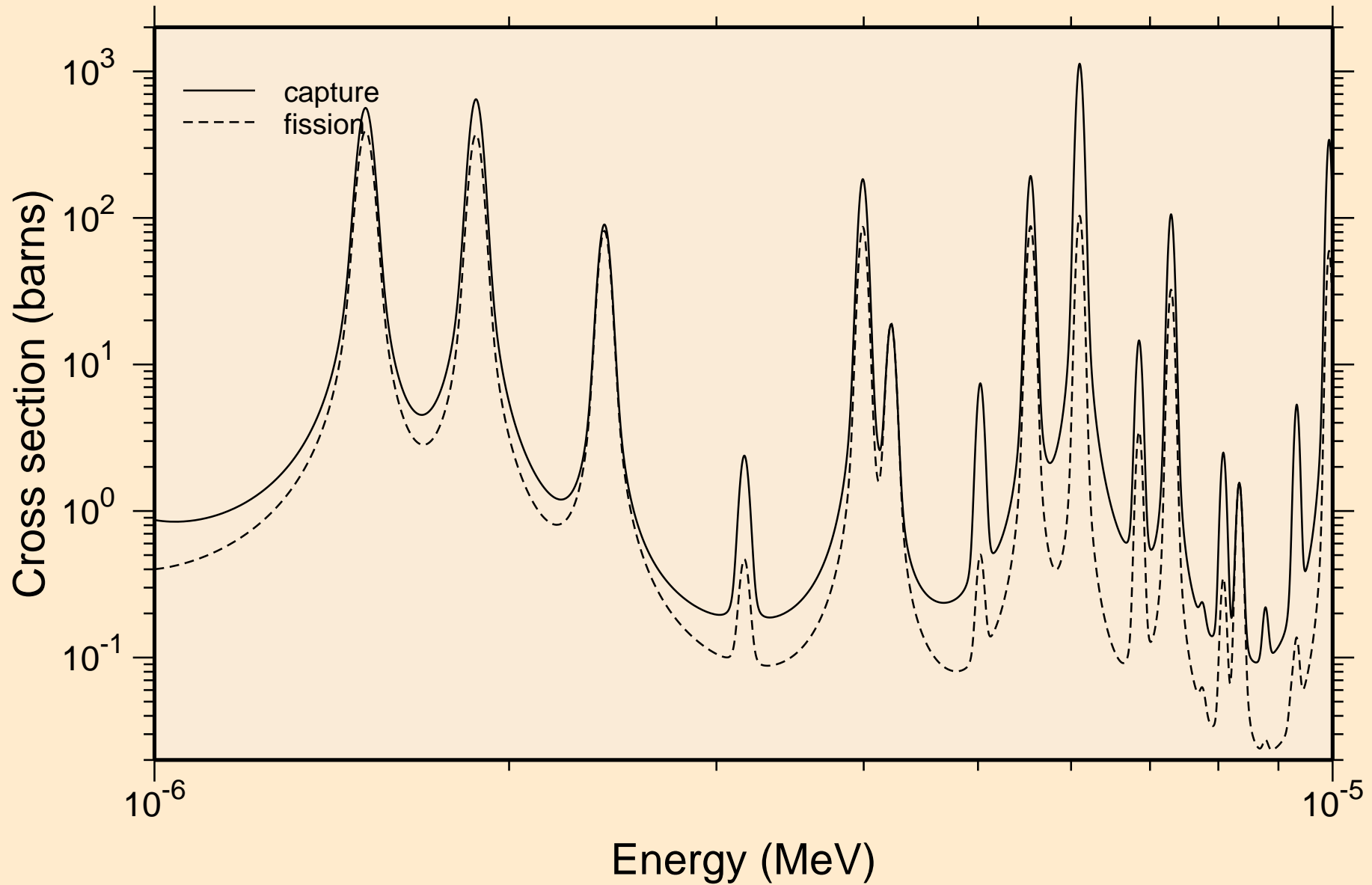

LR261 NEUTRON ACER TENDL-2021 LIBRARY; T=293.6K
resonance absorption cross sections

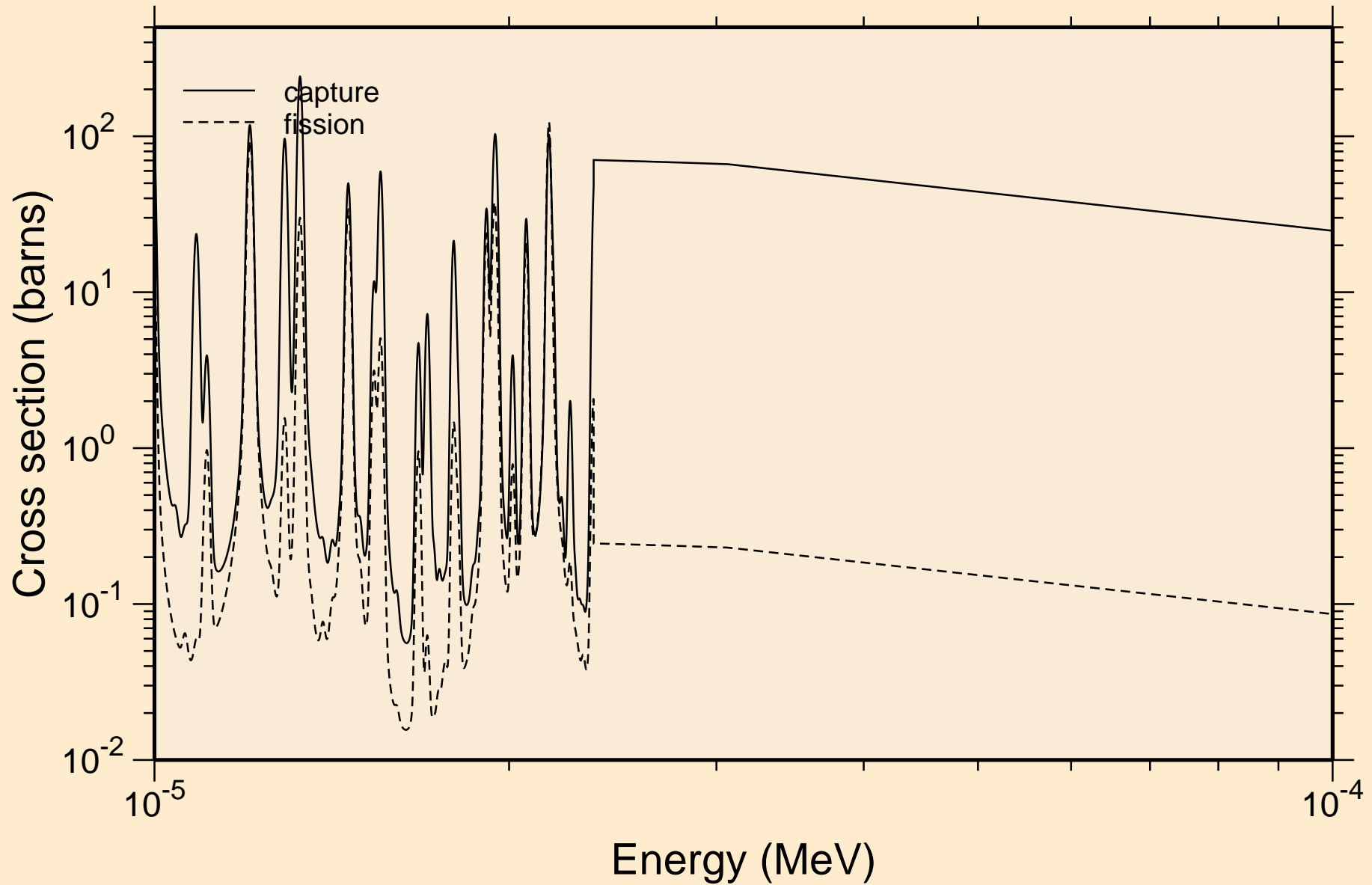

LR261 NEUTRON ACER TENDL-2021 LIBRARY; T=293.6K
resonance absorption cross sections

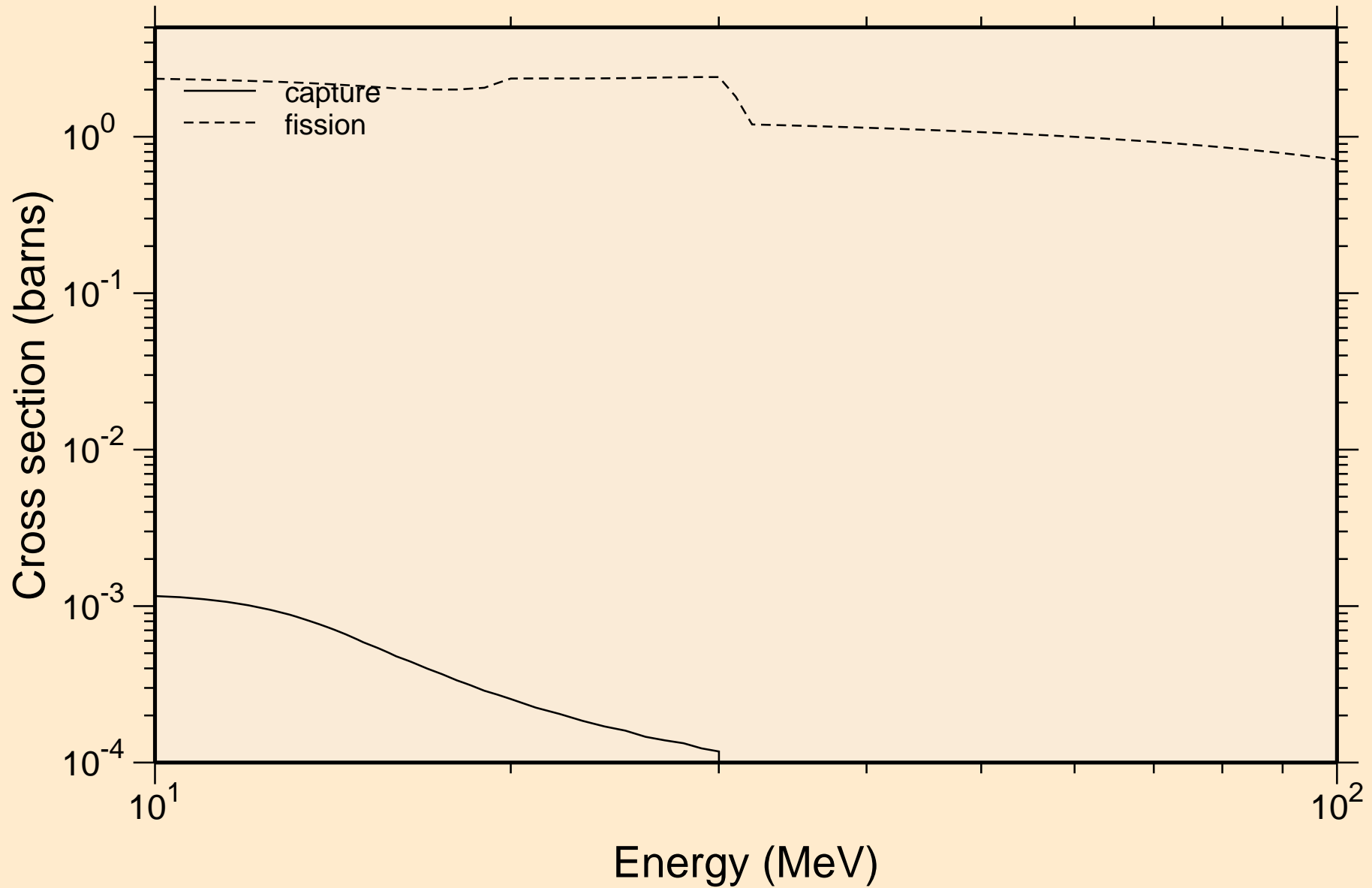

LR261 NEUTRON ACER TENDL-2021 LIBRARY; T=293.6K
Heating

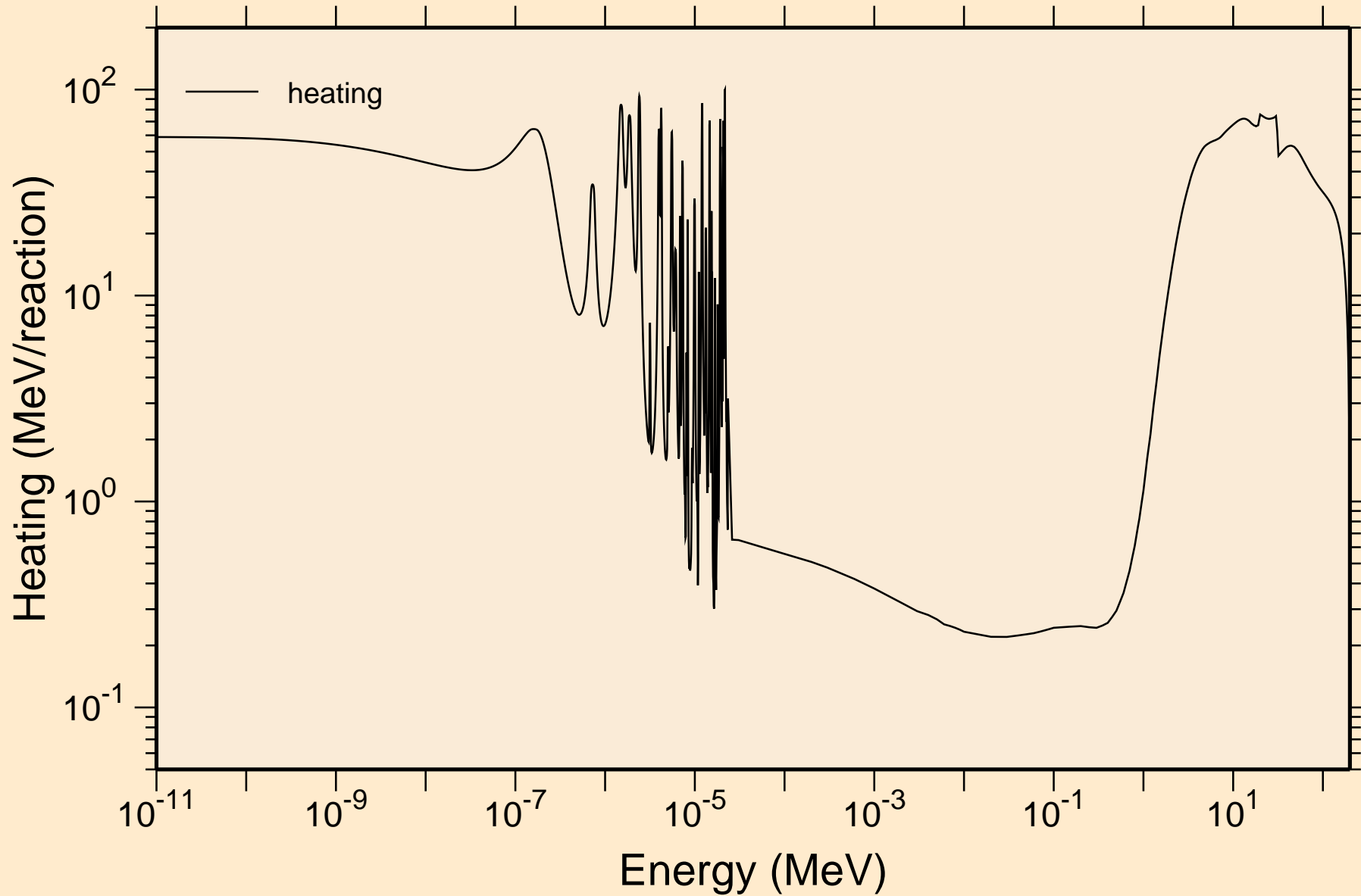

LR261 NEUTRON ACER TENDL-2021 LIBRARY; T=293.6K
Damage

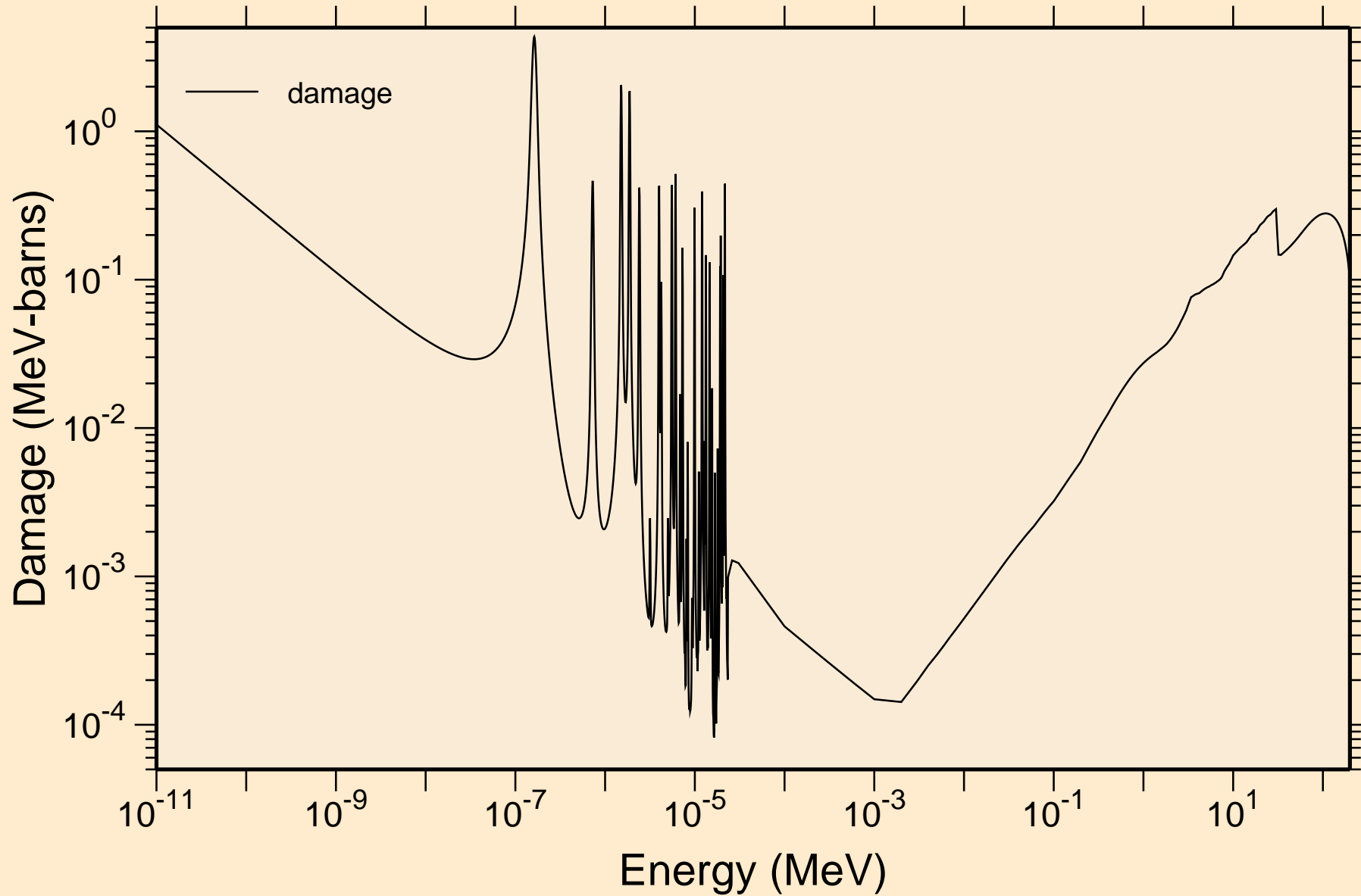

LR261 NEUTRON ACER TENDL-2021 LIBRARY; T=293.6K
Non-threshold reactions

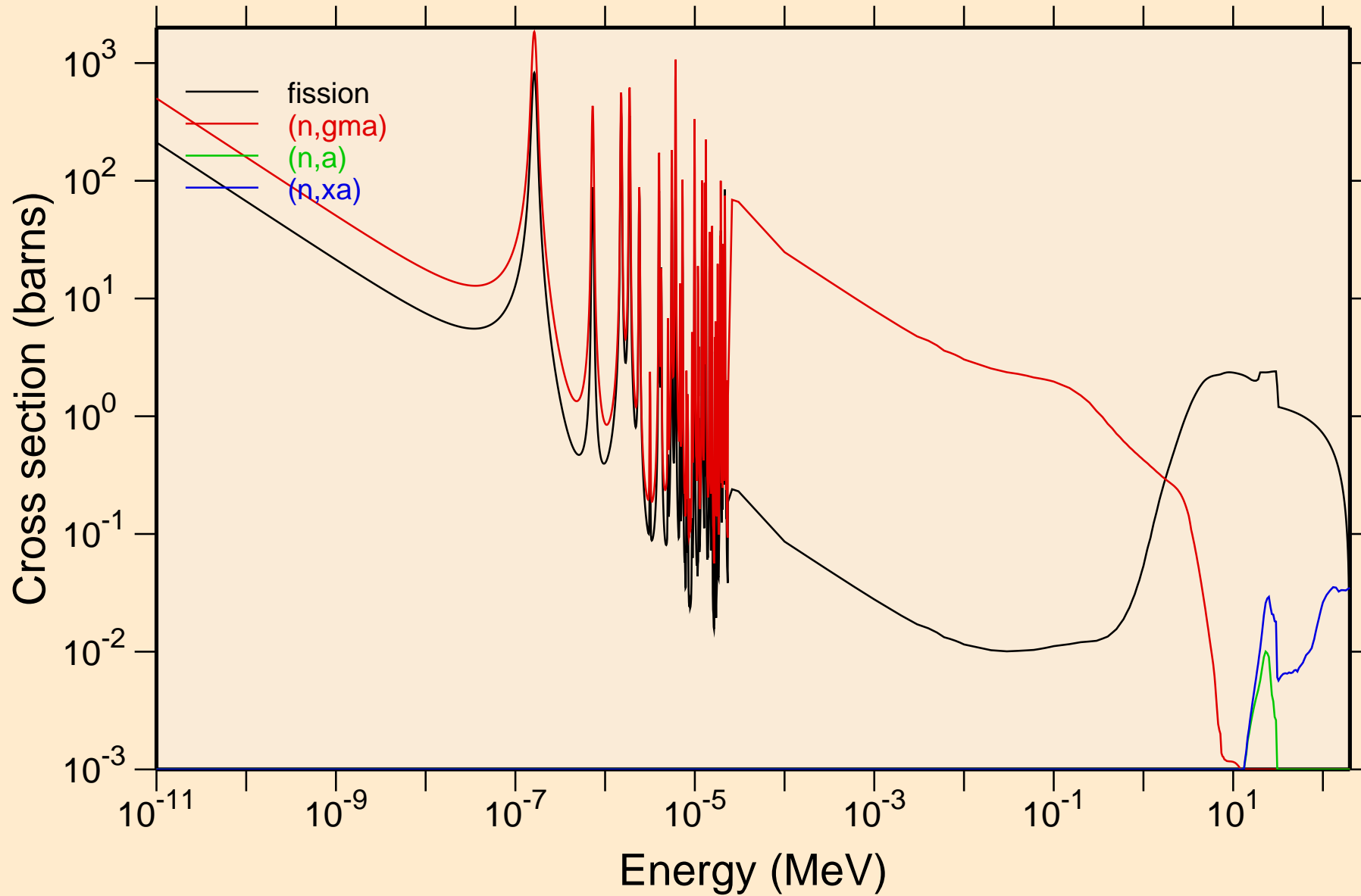

LR261 NEUTRON ACER TENDL-2021 LIBRARY; T=293.6K
Principal cross sections

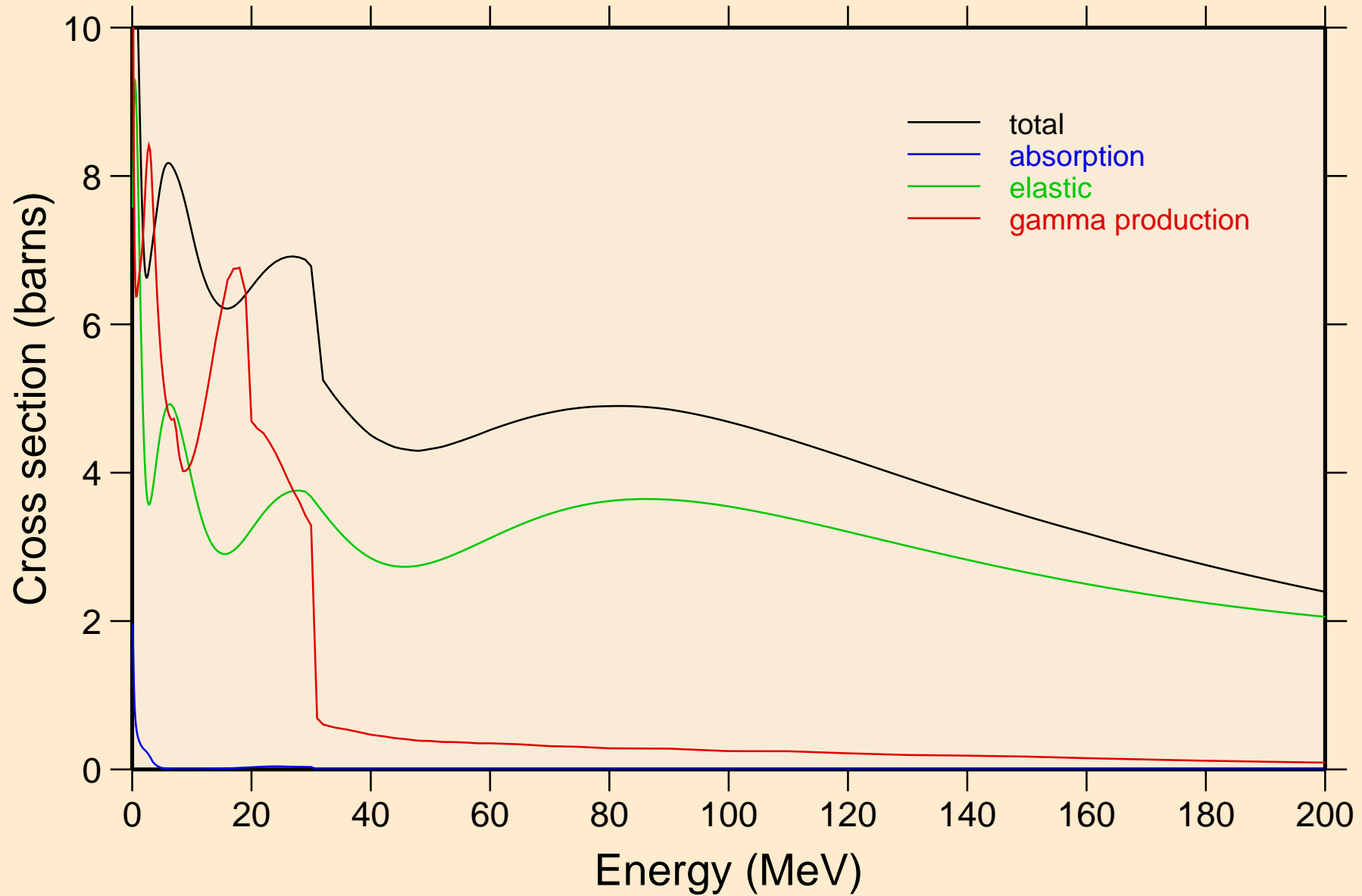

LR261 NEUTRON ACER TENDL-2021 LIBRARY; T=293.6K

Heating

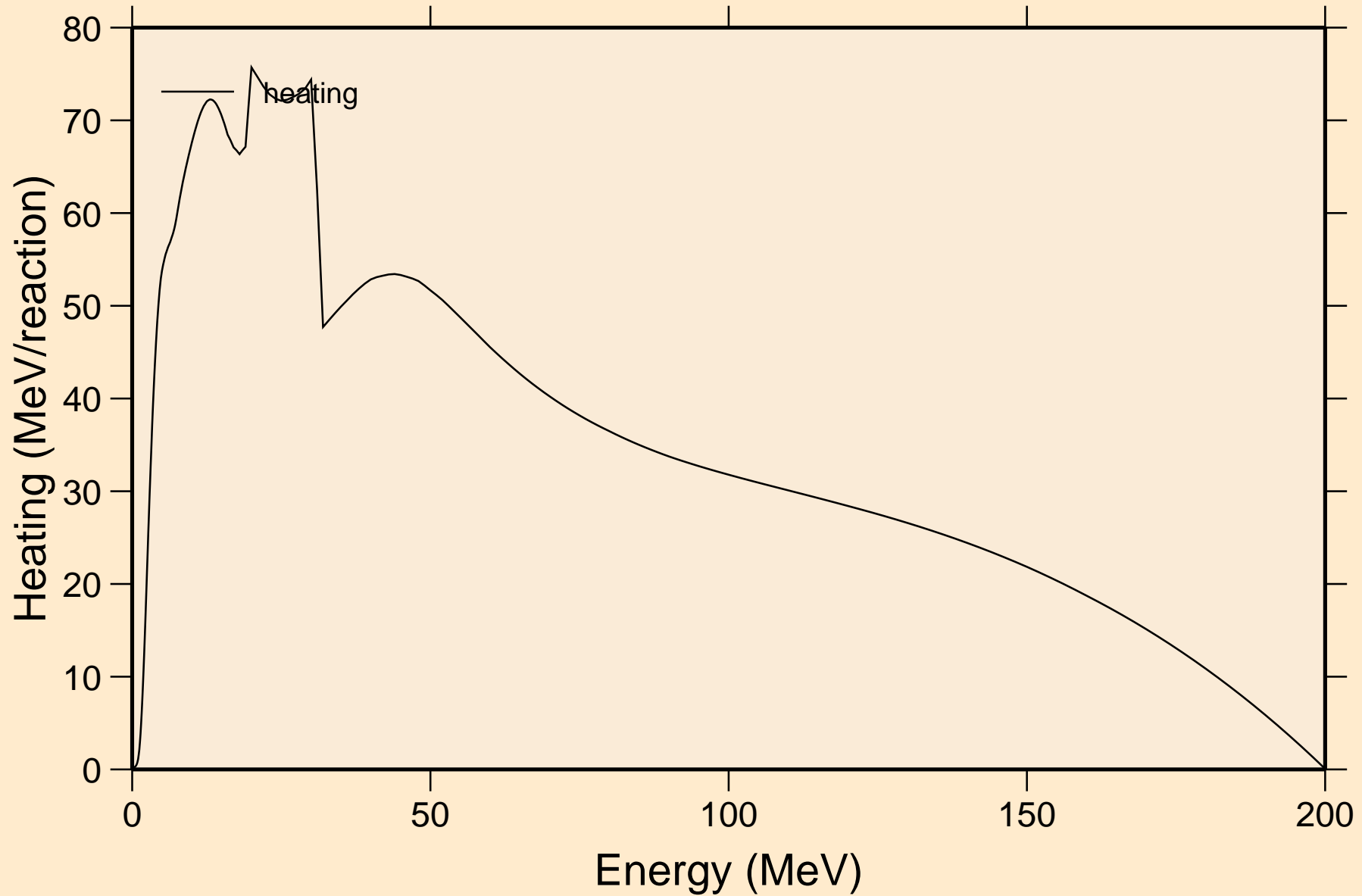

LR261 NEUTRON ACER TENDL-2021 LIBRARY; T=293.6K
Damage

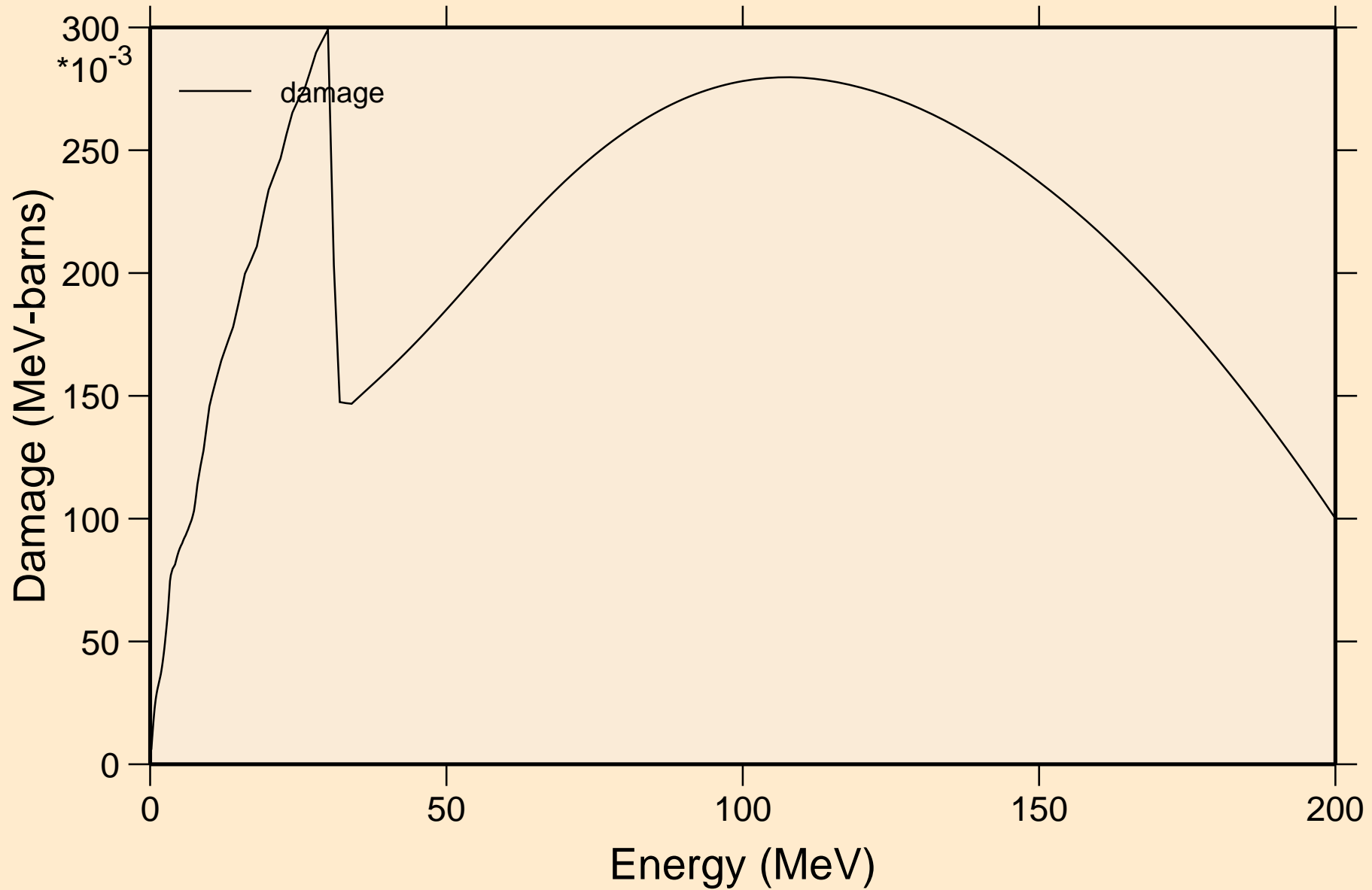

LR261 NEUTRON ACER TENDL-2021 LIBRARY; T=293.6K
Non-threshold reactions

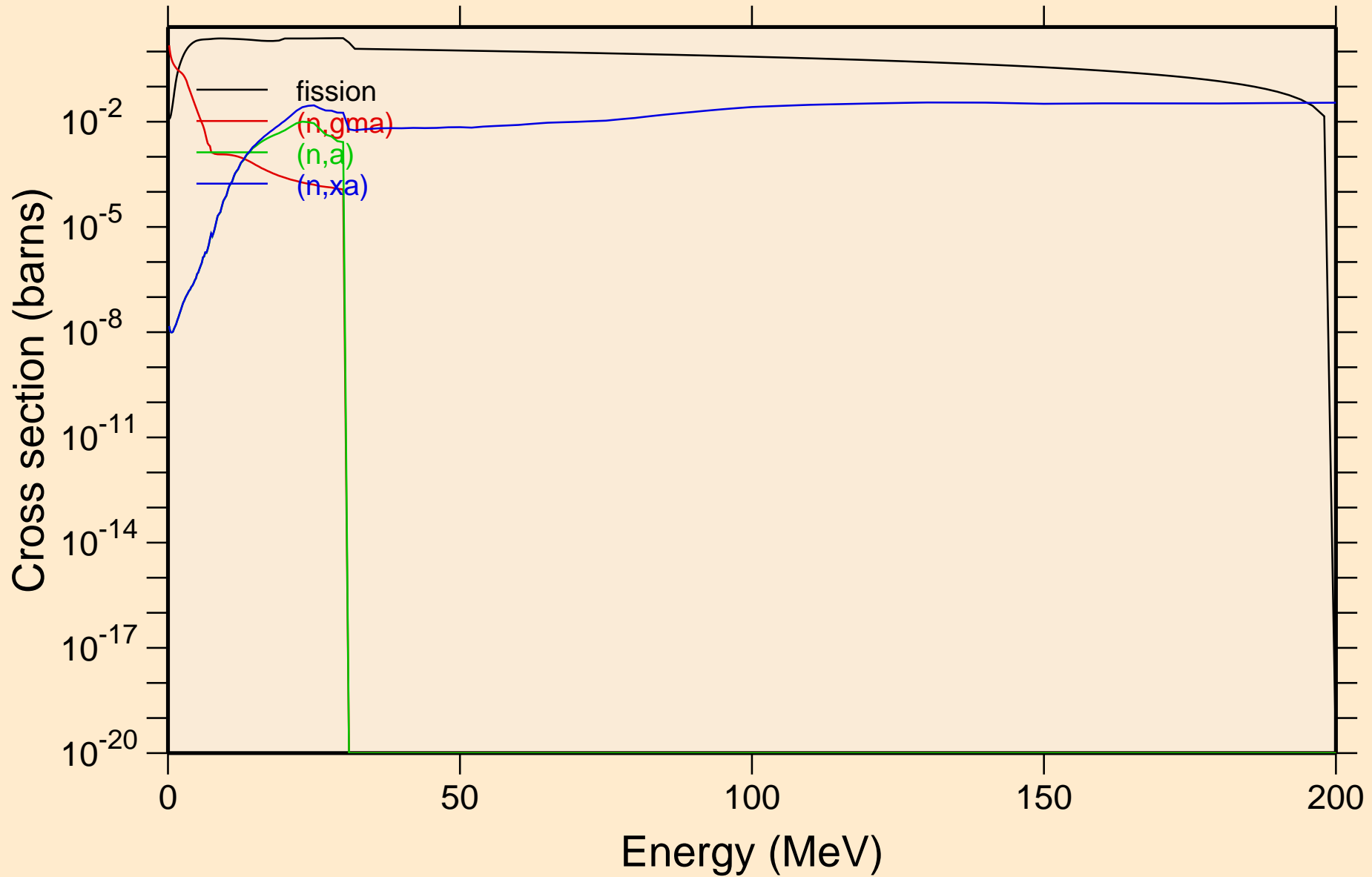

LR261 NEUTRON ACER TENDL-2021 LIBRARY; T=293.6K
Inelastic levels

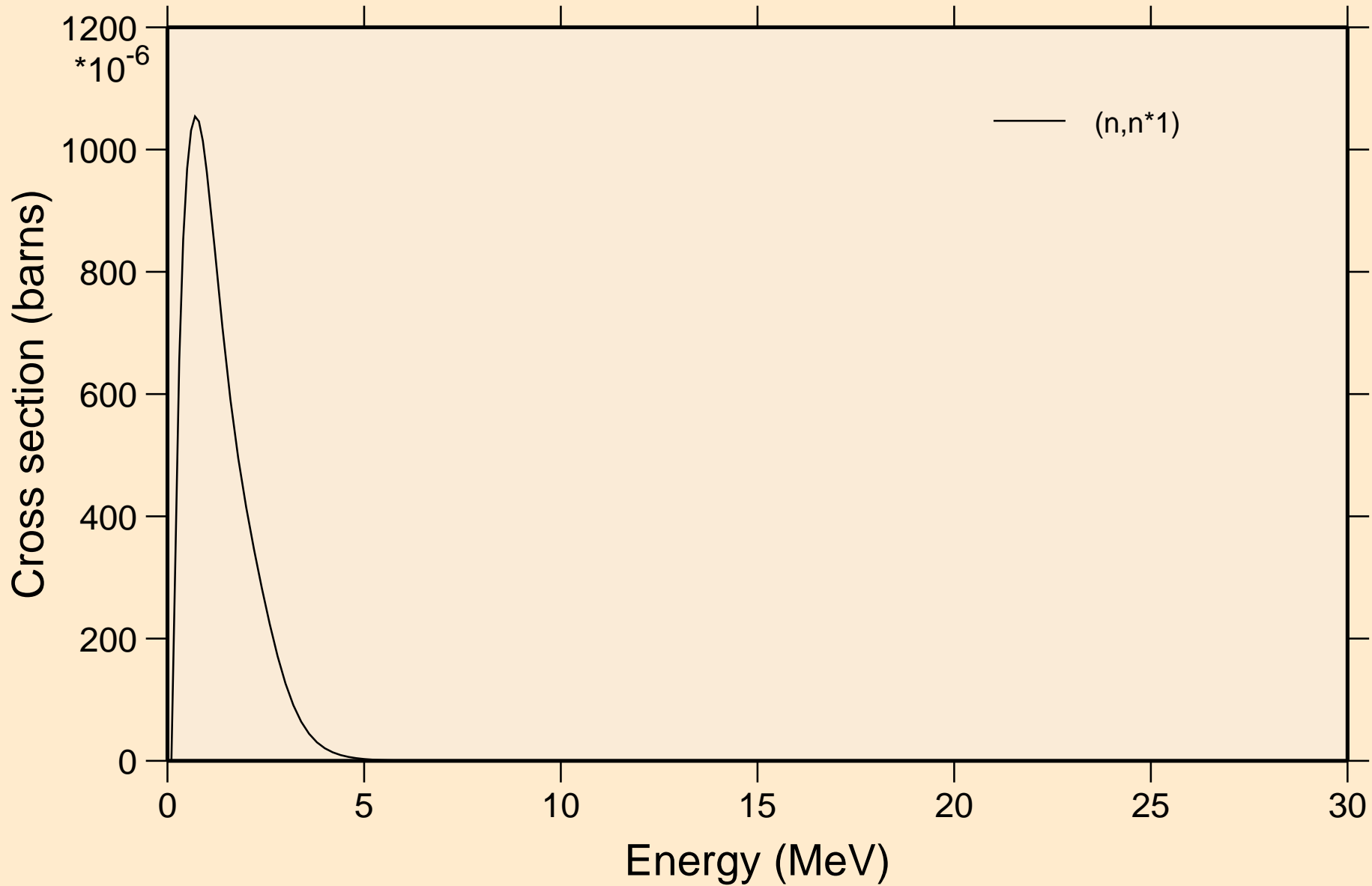

LR261 NEUTRON ACER TENDL-2021 LIBRARY; T=293.6K
Threshold reactions

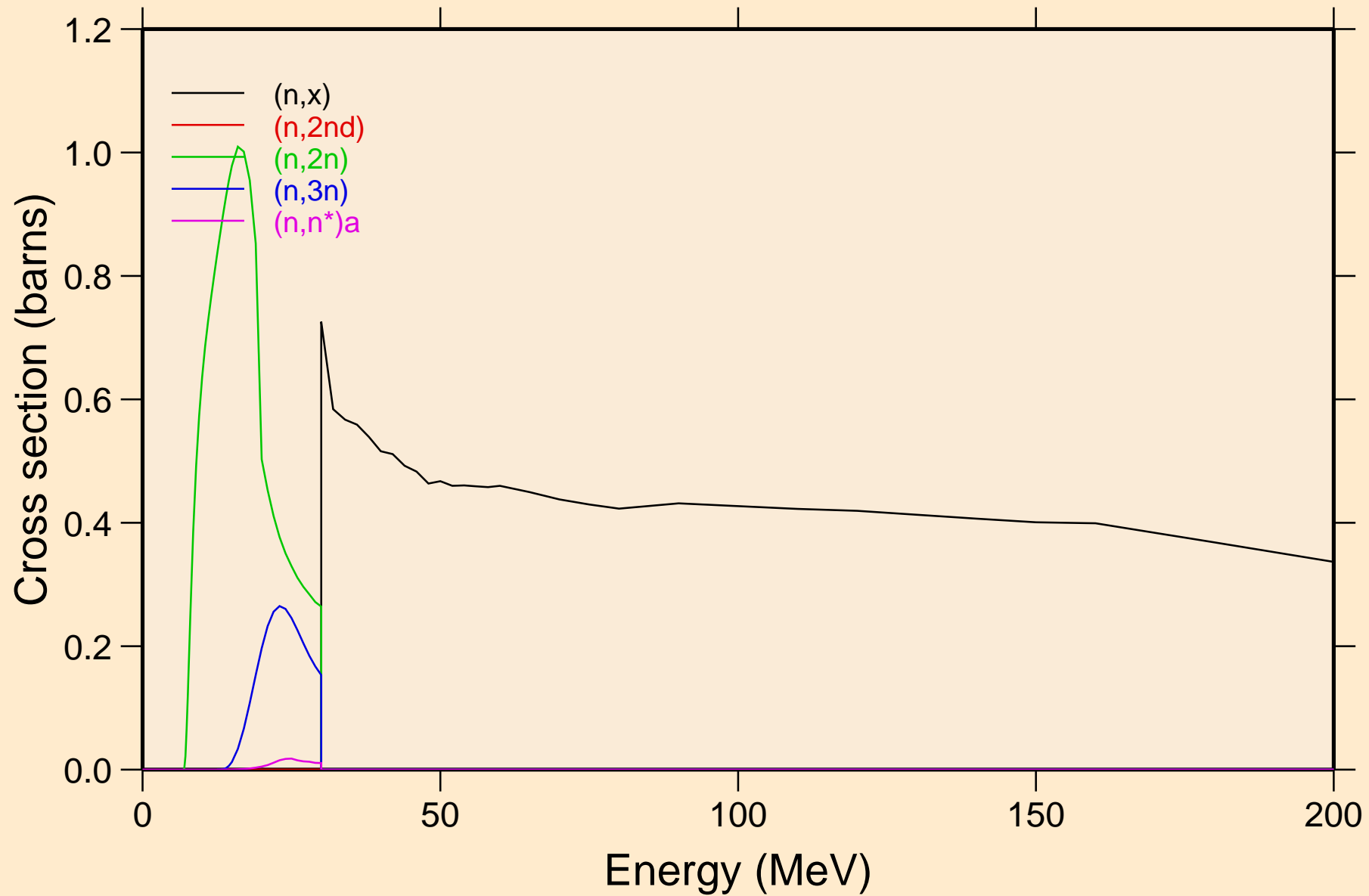

LR261 NEUTRON ACER TENDL-2021 LIBRARY; T=293.6K
Threshold reactions

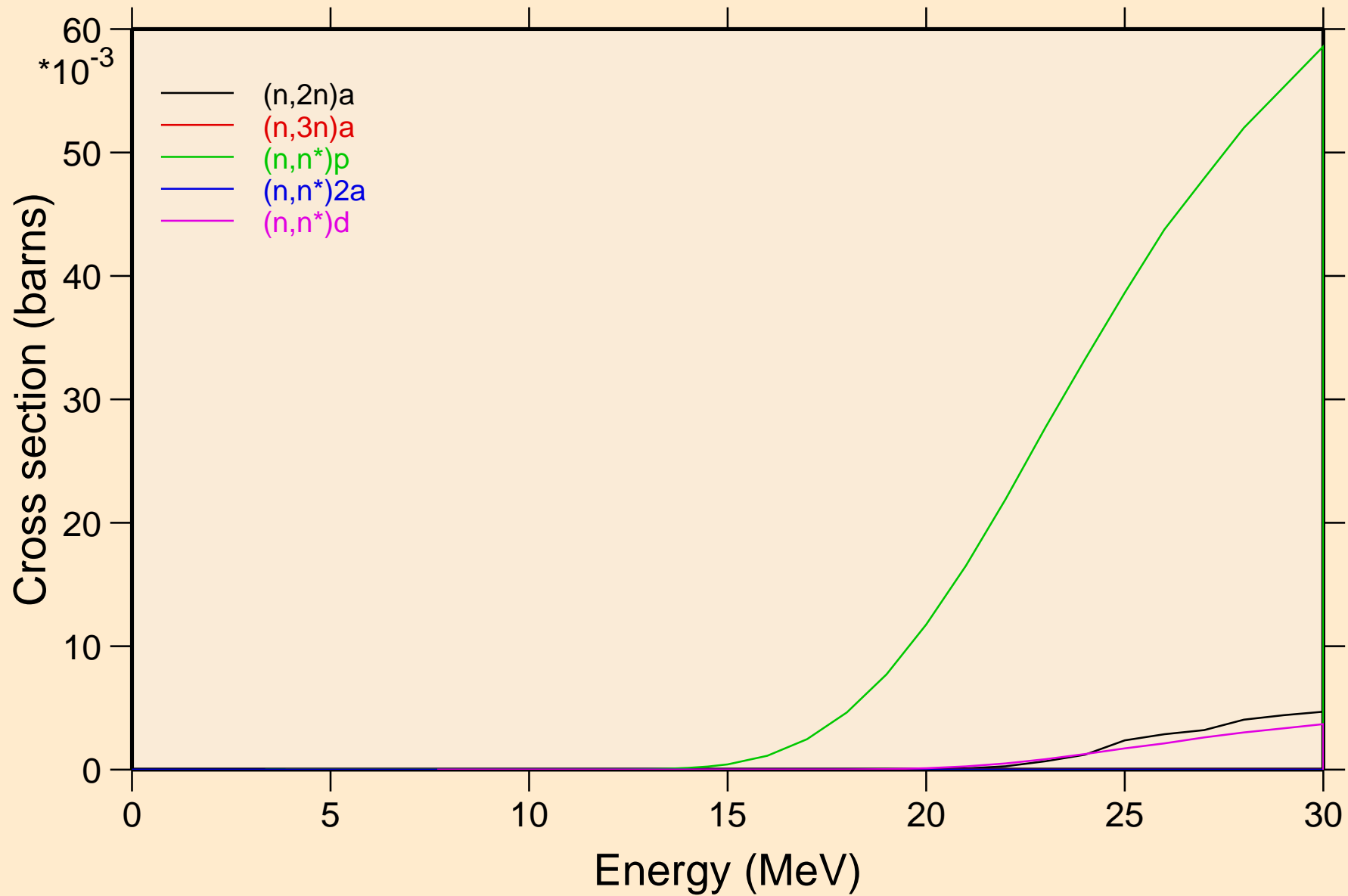

LR261 NEUTRON ACER TENDL-2021 LIBRARY; T=293.6K
Threshold reactions

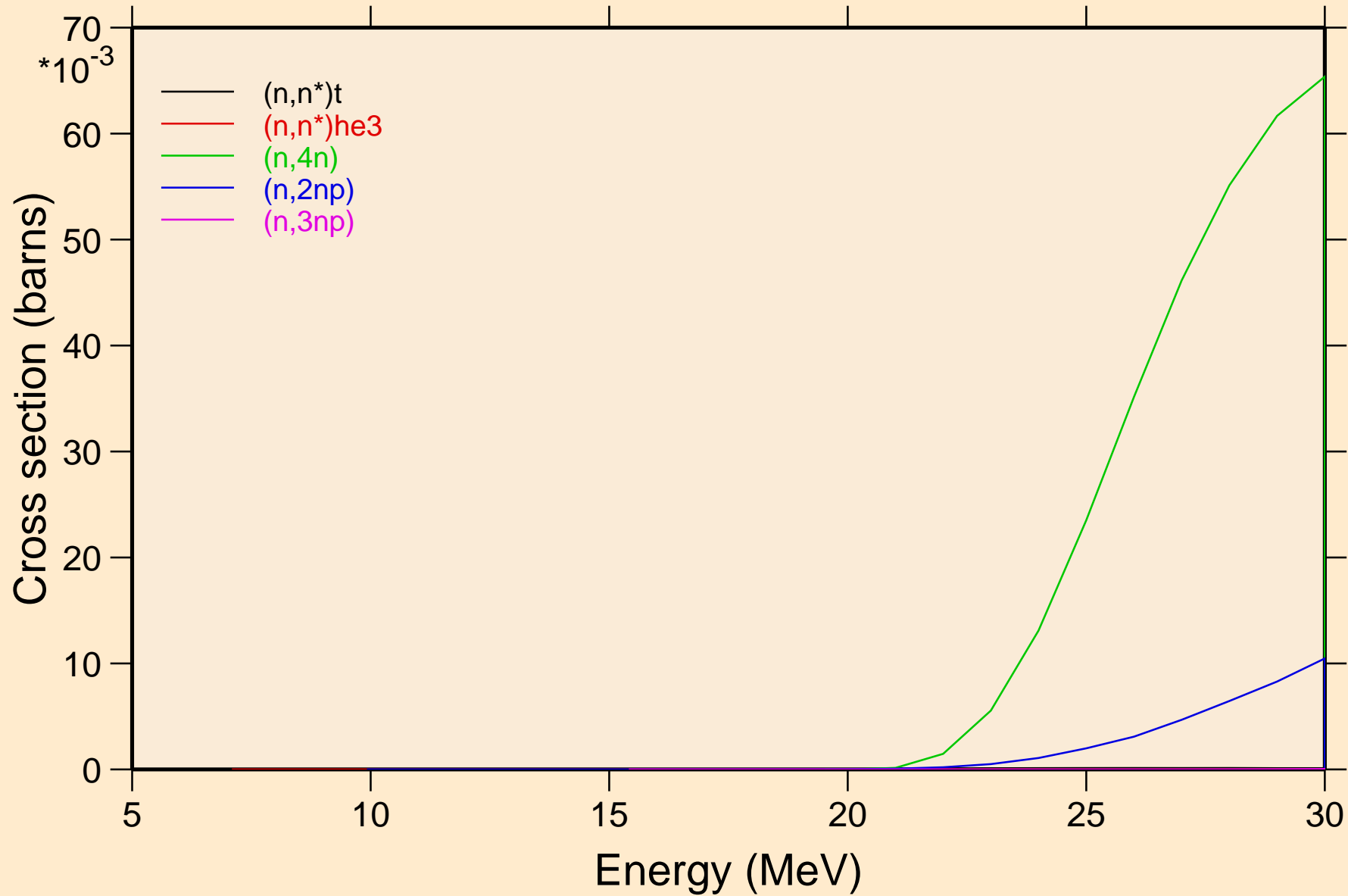

LR261 NEUTRON ACER TENDL-2021 LIBRARY; T=293.6K
Threshold reactions

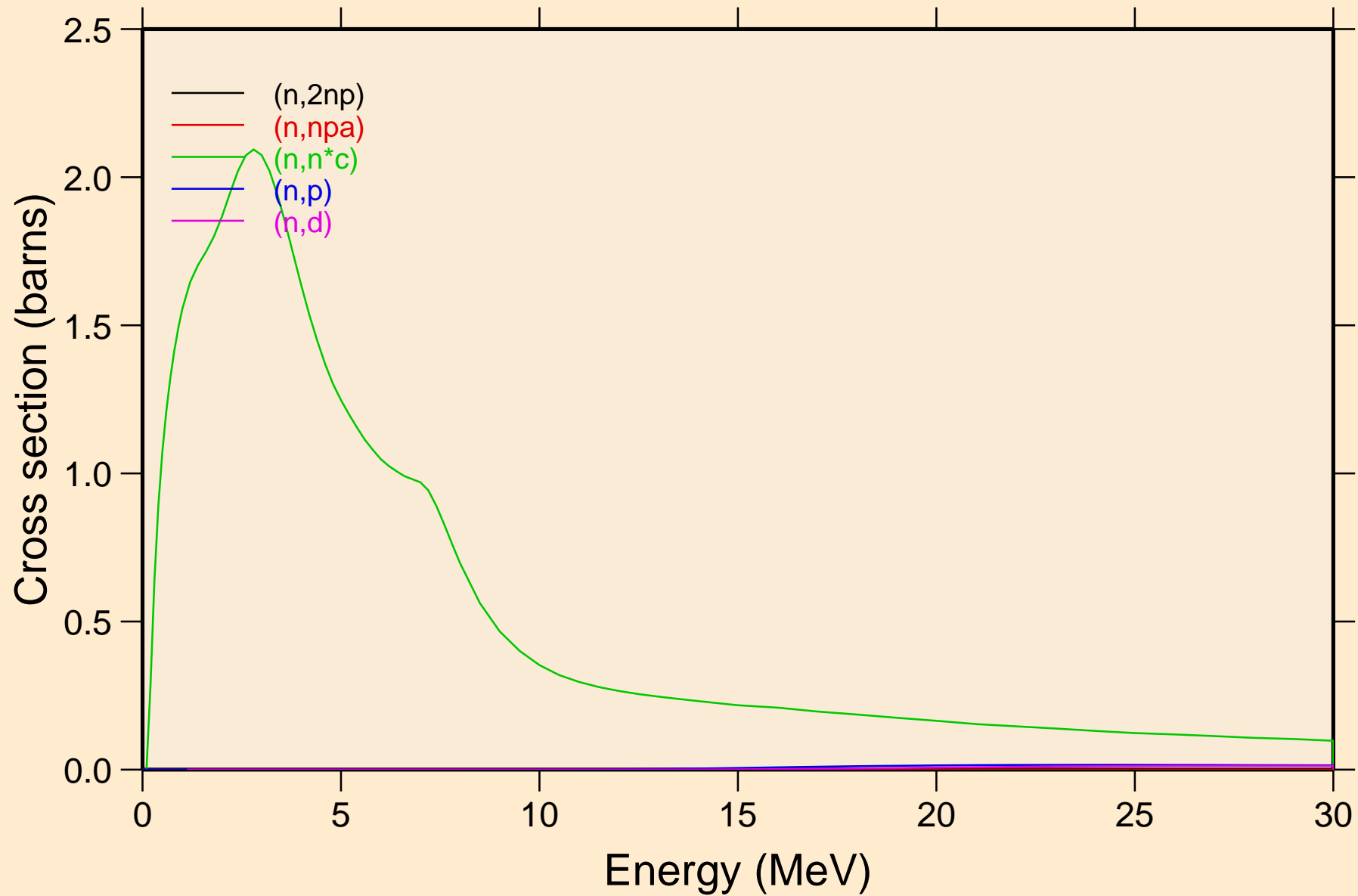

LR261 NEUTRON ACER TENDL-2021 LIBRARY; T=293.6K
Threshold reactions

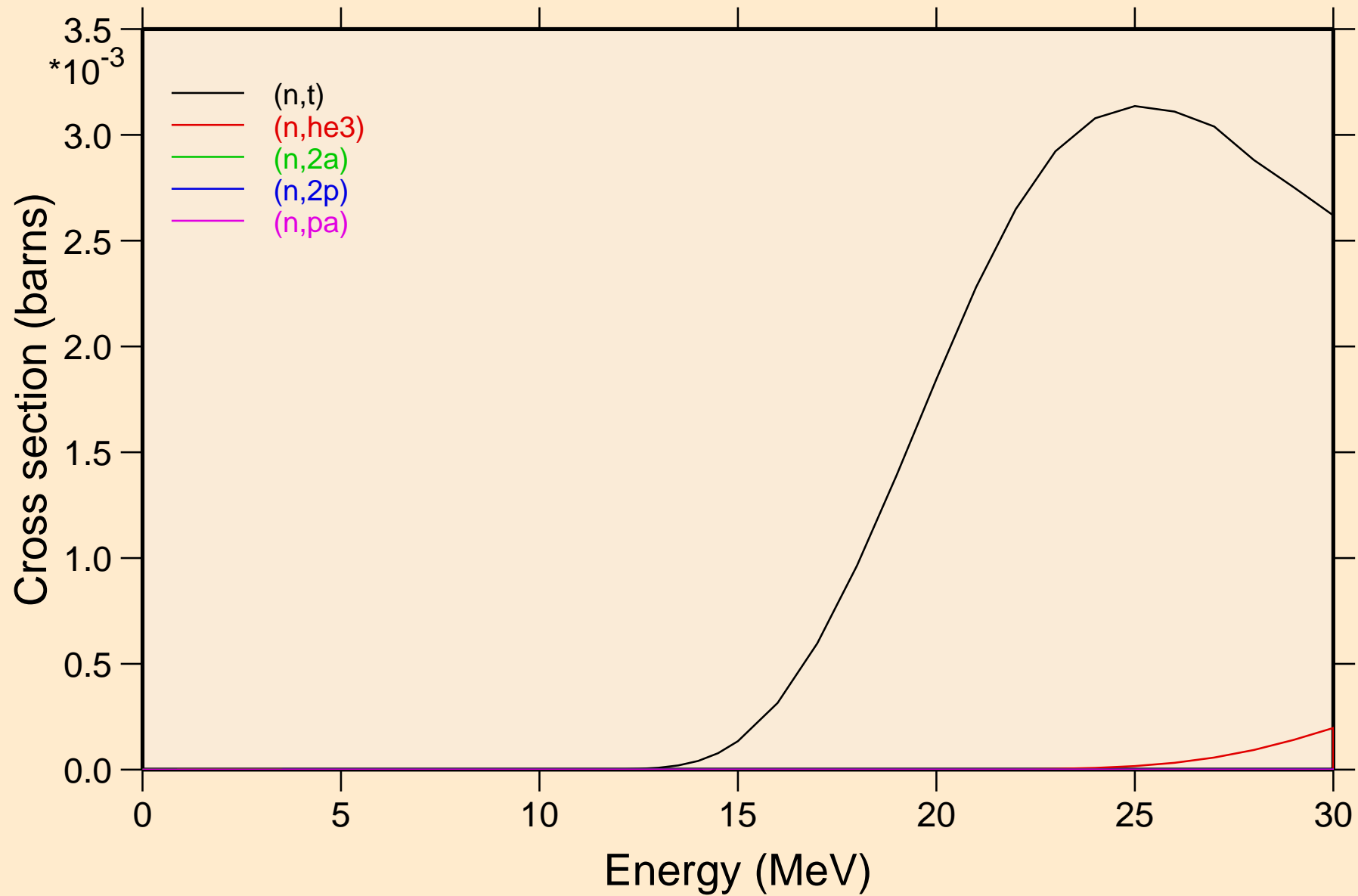

LR261 NEUTRON ACER TENDL-2021 LIBRARY; T=293.6K
Threshold reactions

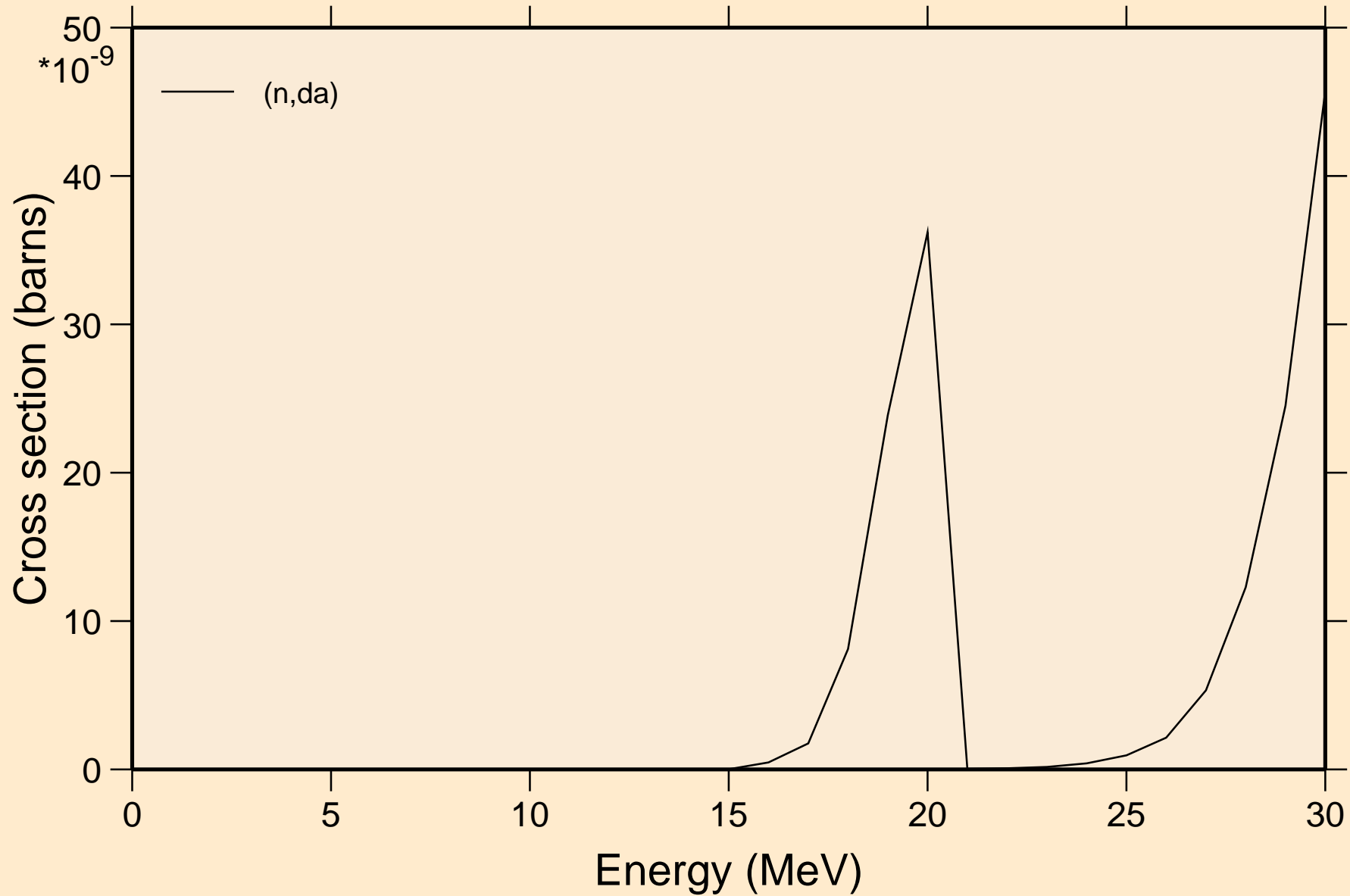

LR261 NEUTRON ACER TENDL-2021 LIBRARY; T=293.6K
Threshold reactions

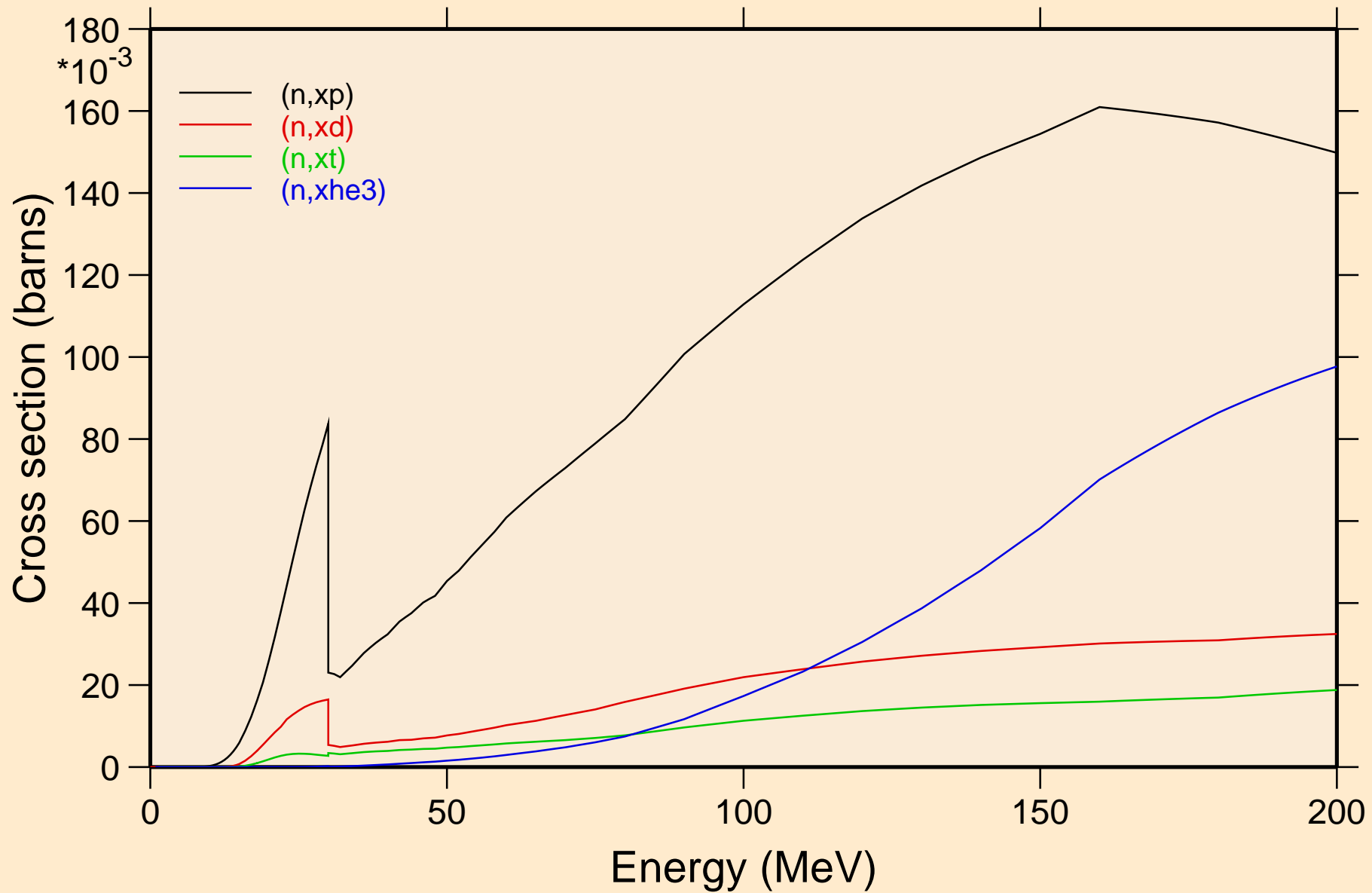

LR261 NEUTRON ACER TENDL-2021 LIBRARY; T=293.6K
angular distribution for elastic

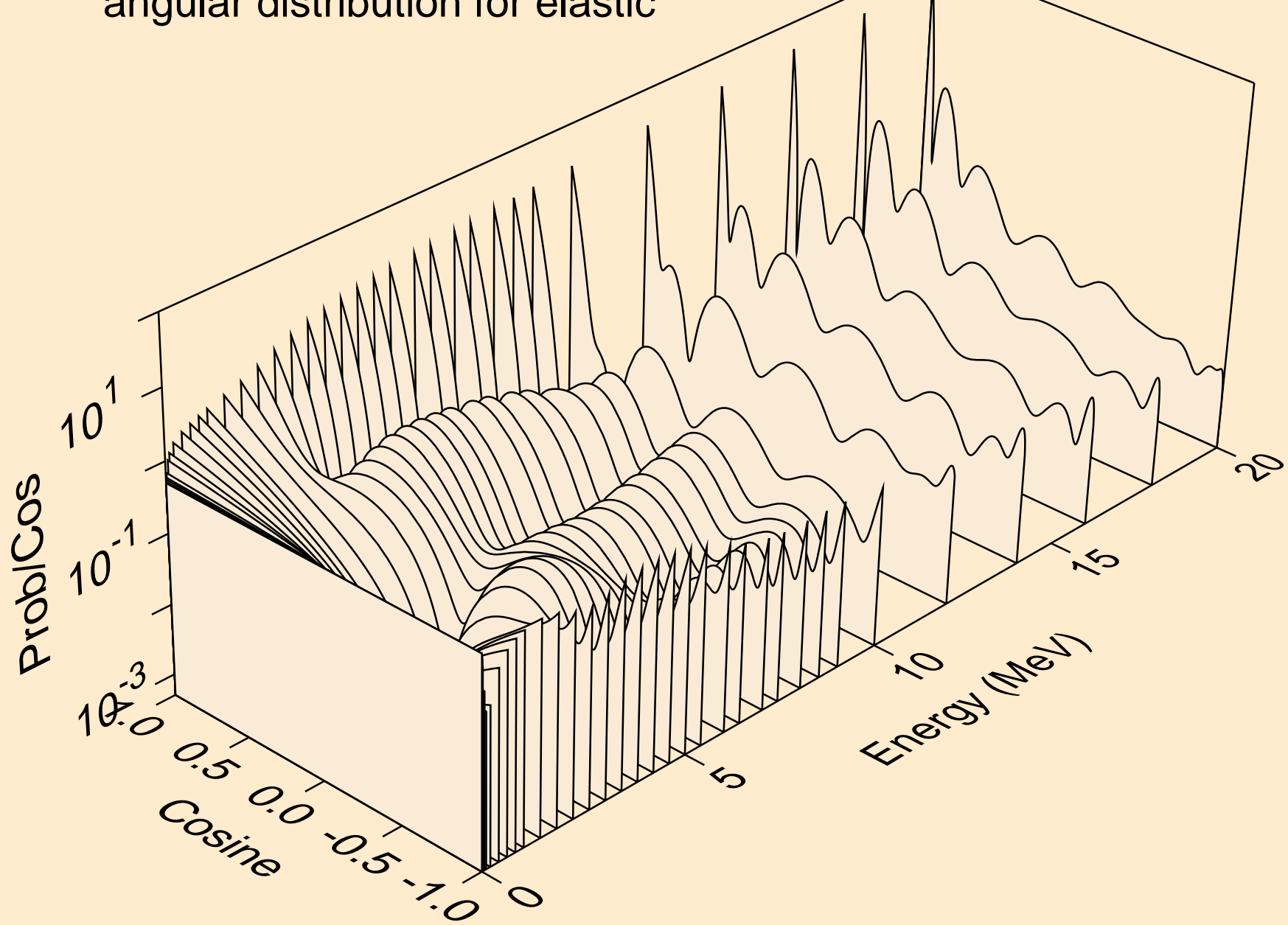

LR261 NEUTRON ACER TENDL-2021 LIBRARY; T=293.6K
angular distribution for elastic

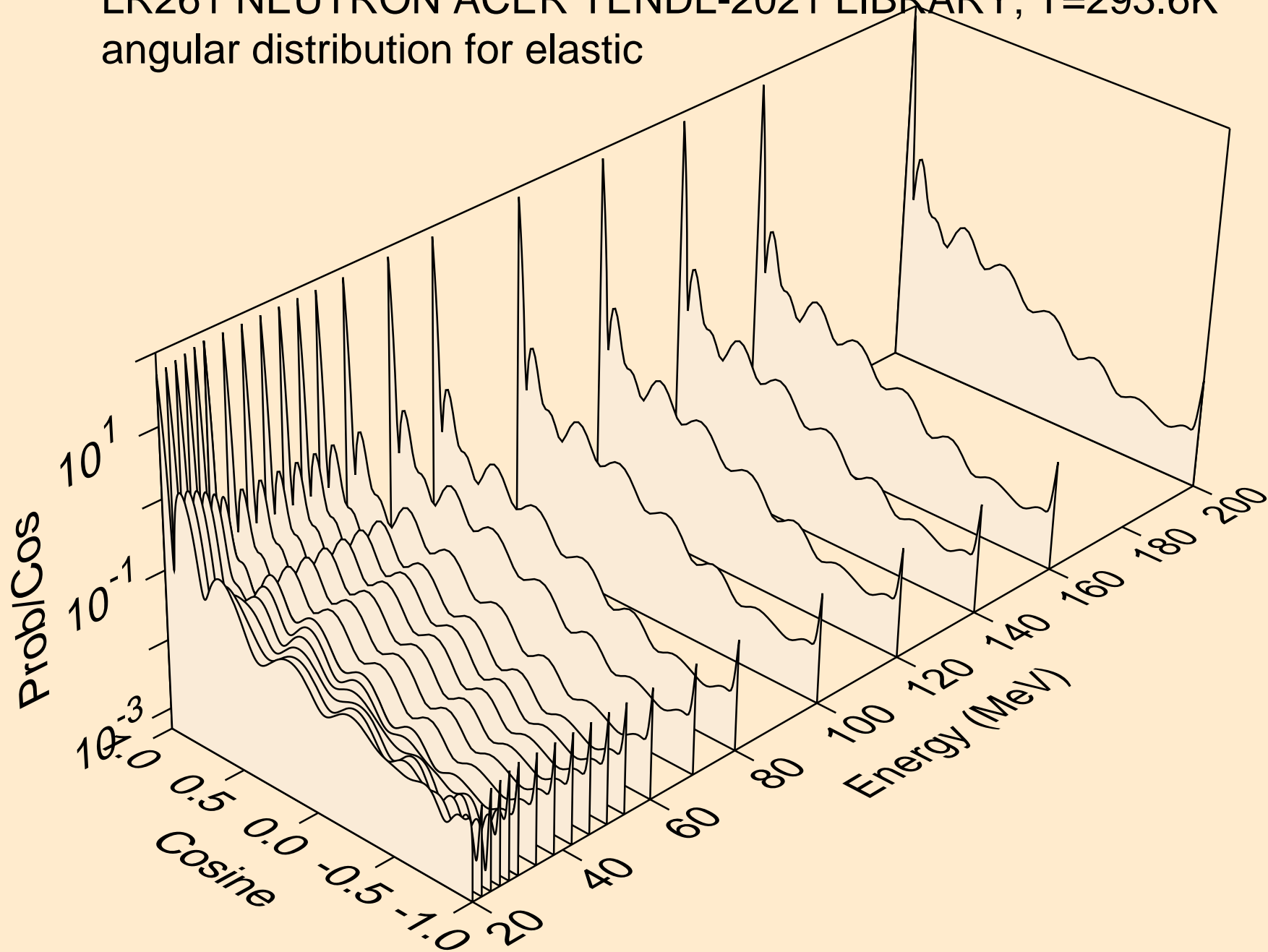

LR261 NEUTRON ACER TENDL-2021 LIBRARY; T=293.6K
angular distribution for (n,n*1)

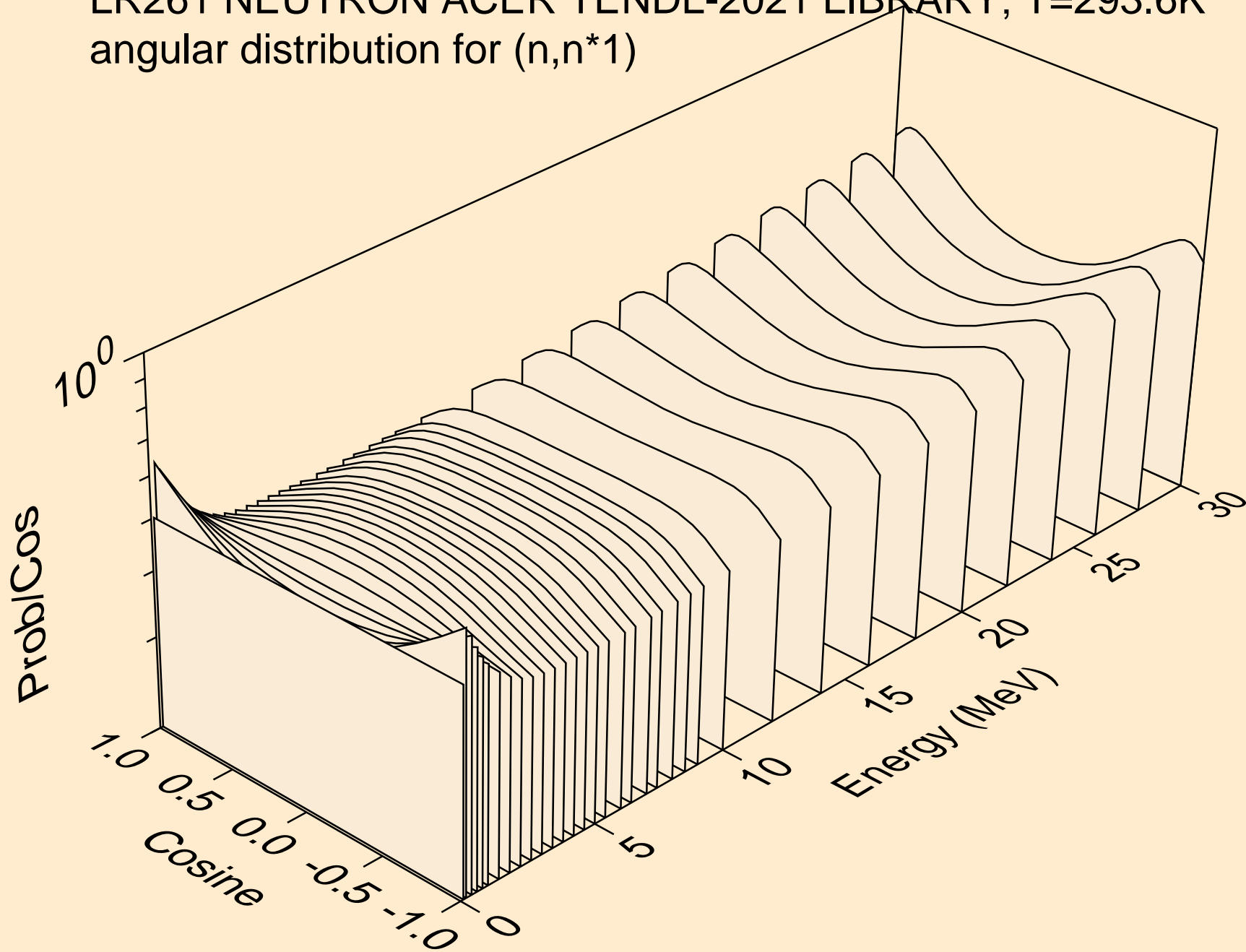

LR261 NEUTRON ACER TENDL-2021 LIBRARY; T=293.6K

Total fission nubar

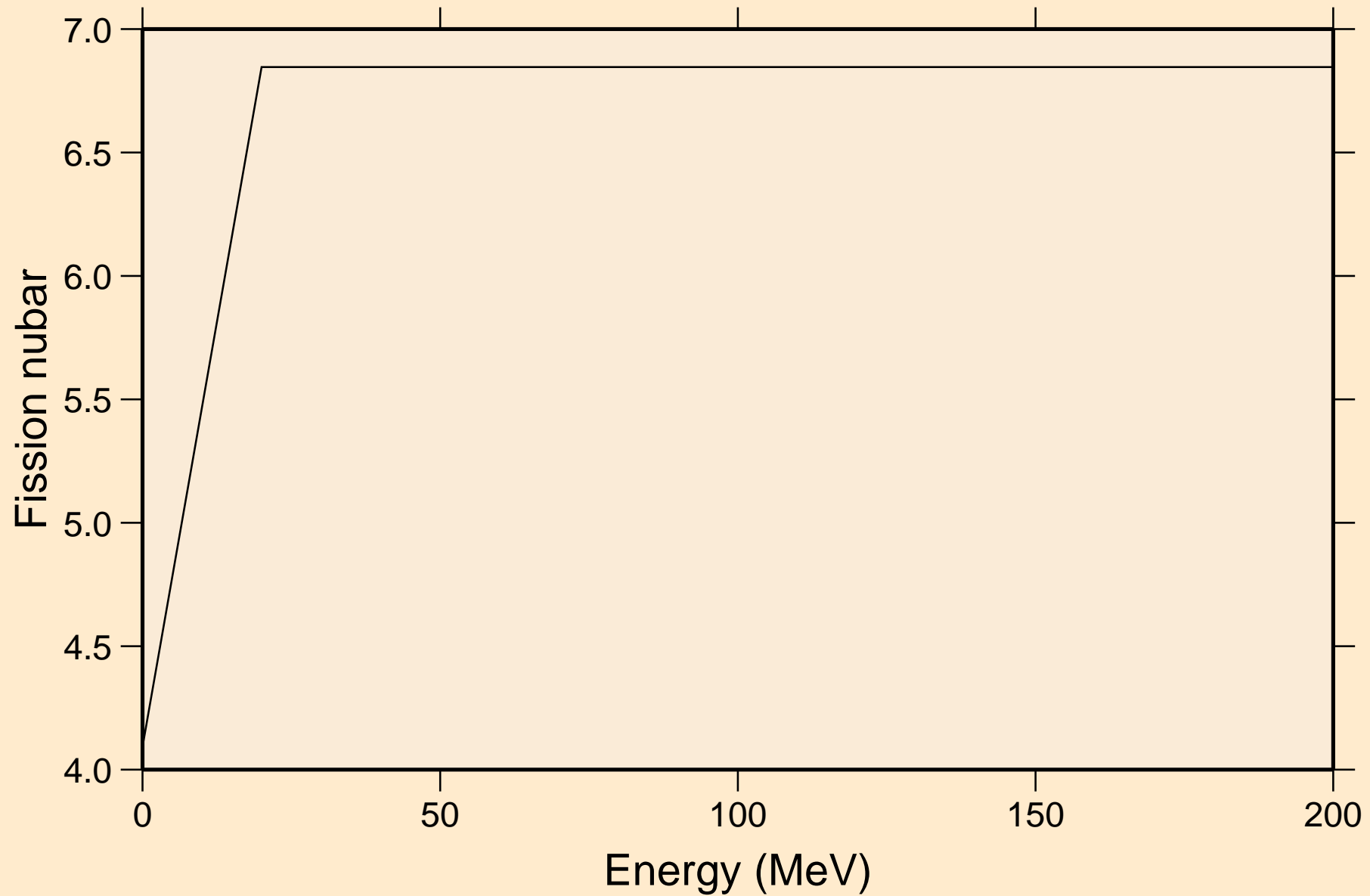

LR261 NEUTRON ACER TENDL-2021 LIBRARY; T=293.6K
Neutron emission for (n,x)

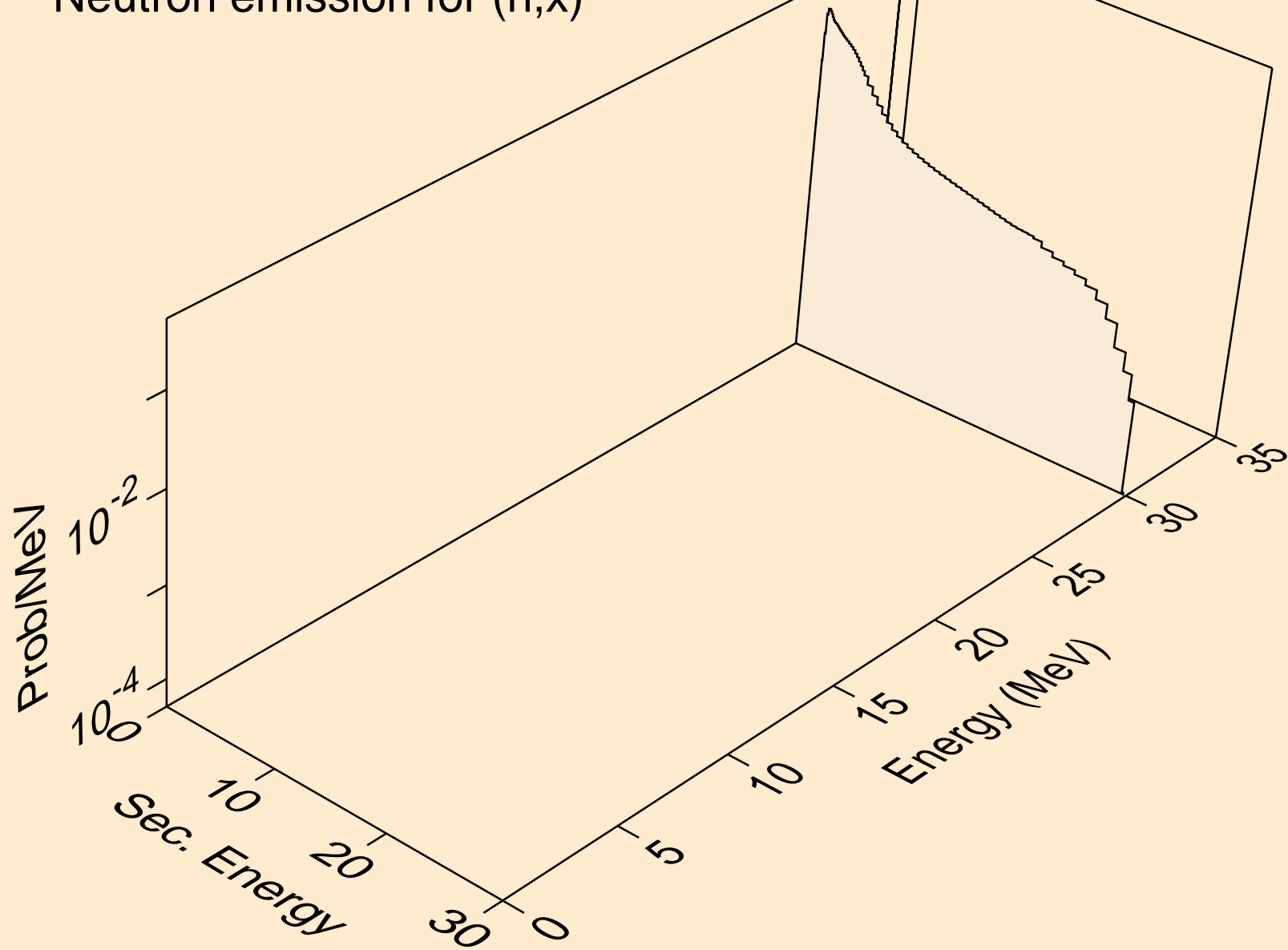

LR261 NEUTRON ACER TENDL-2021 LIBRARY; T=293.6K
Neutron emission for (n,2nd)

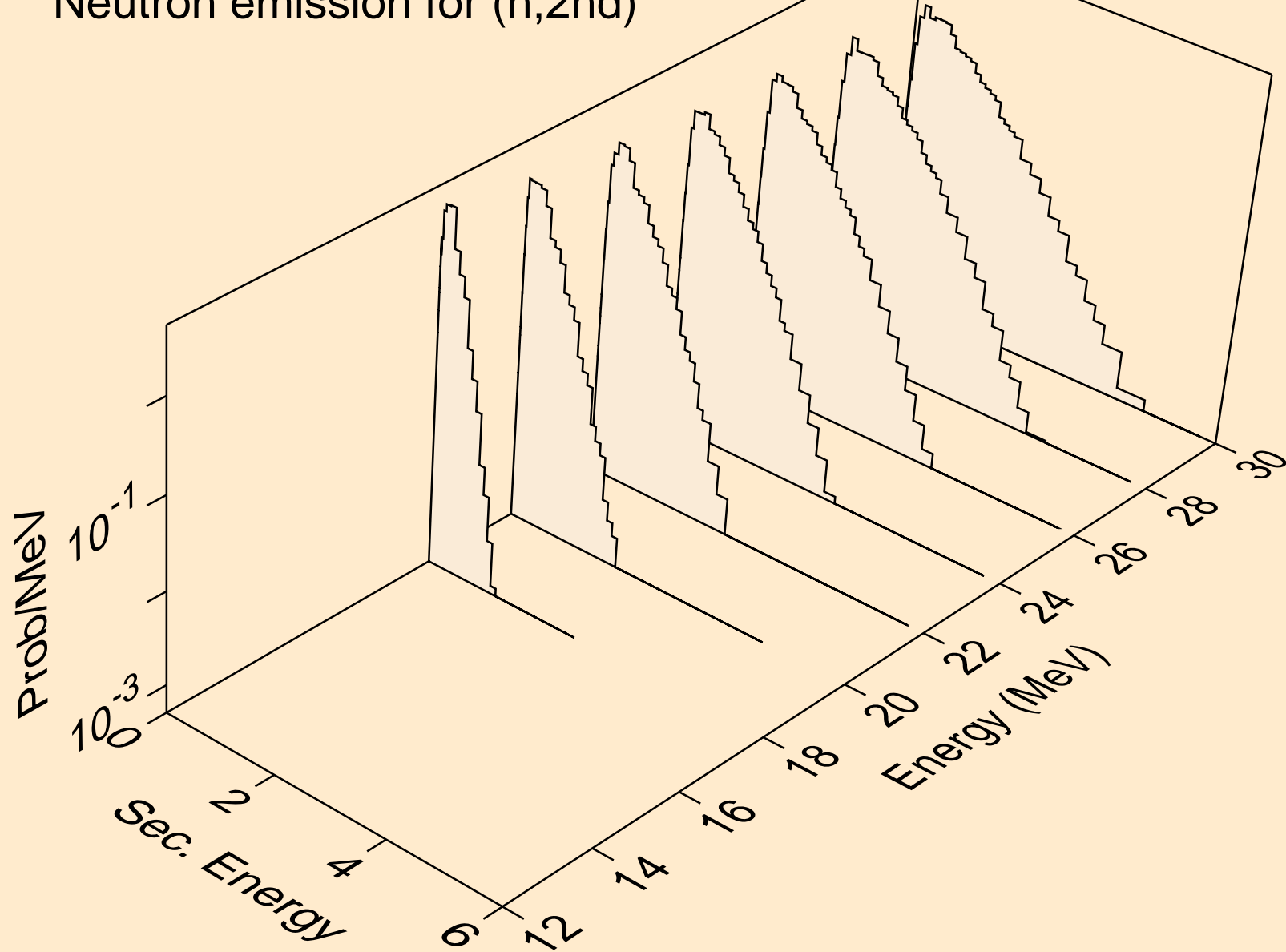

LR261 NEUTRON ACER TENDL-2021 LIBRARY; T=293.6K
Neutron emission for (n,2n)

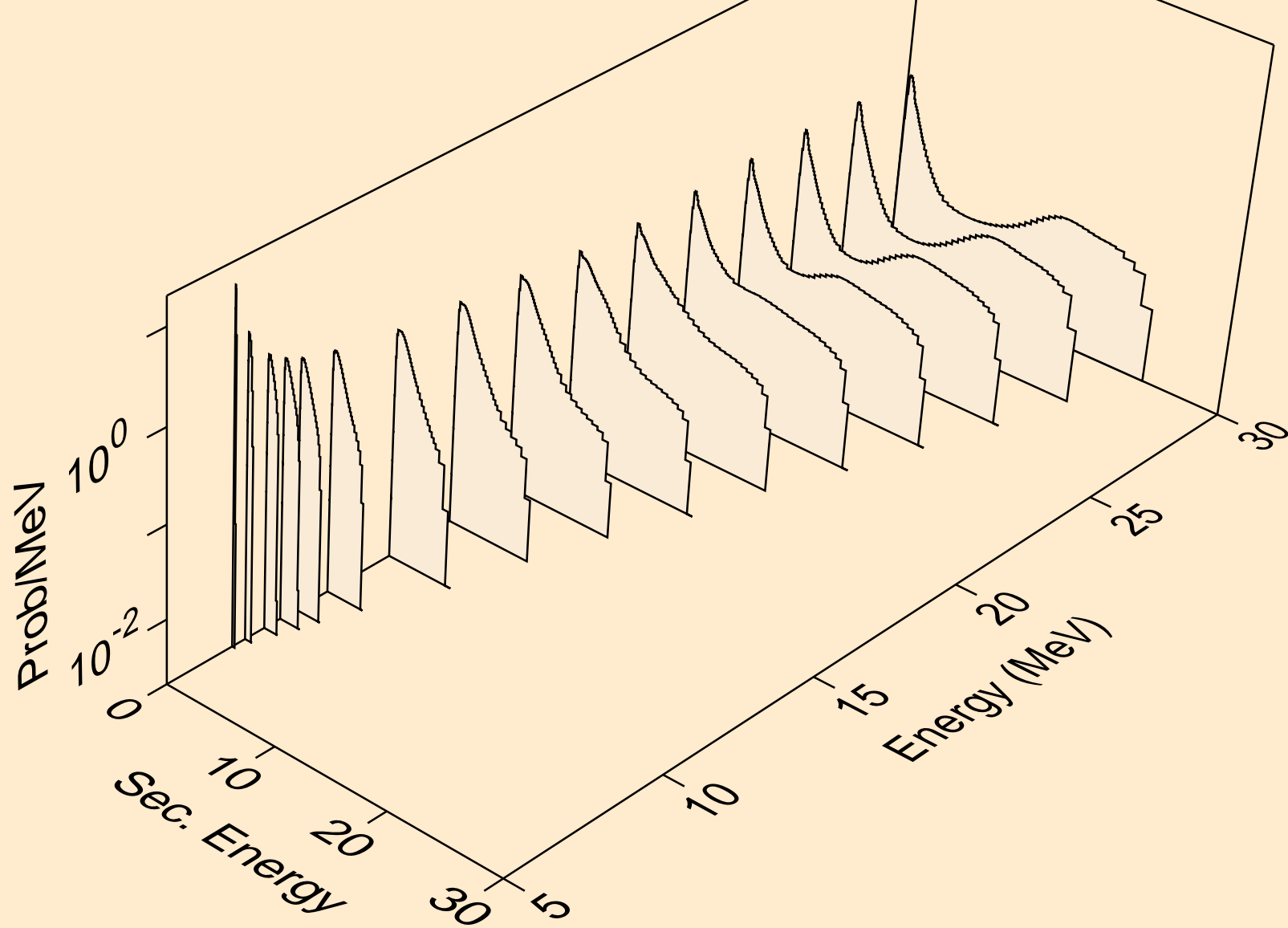

LR261 NEUTRON ACER TENDL-2021 LIBRARY; T=293.6K
Neutron emission for (n,3n)

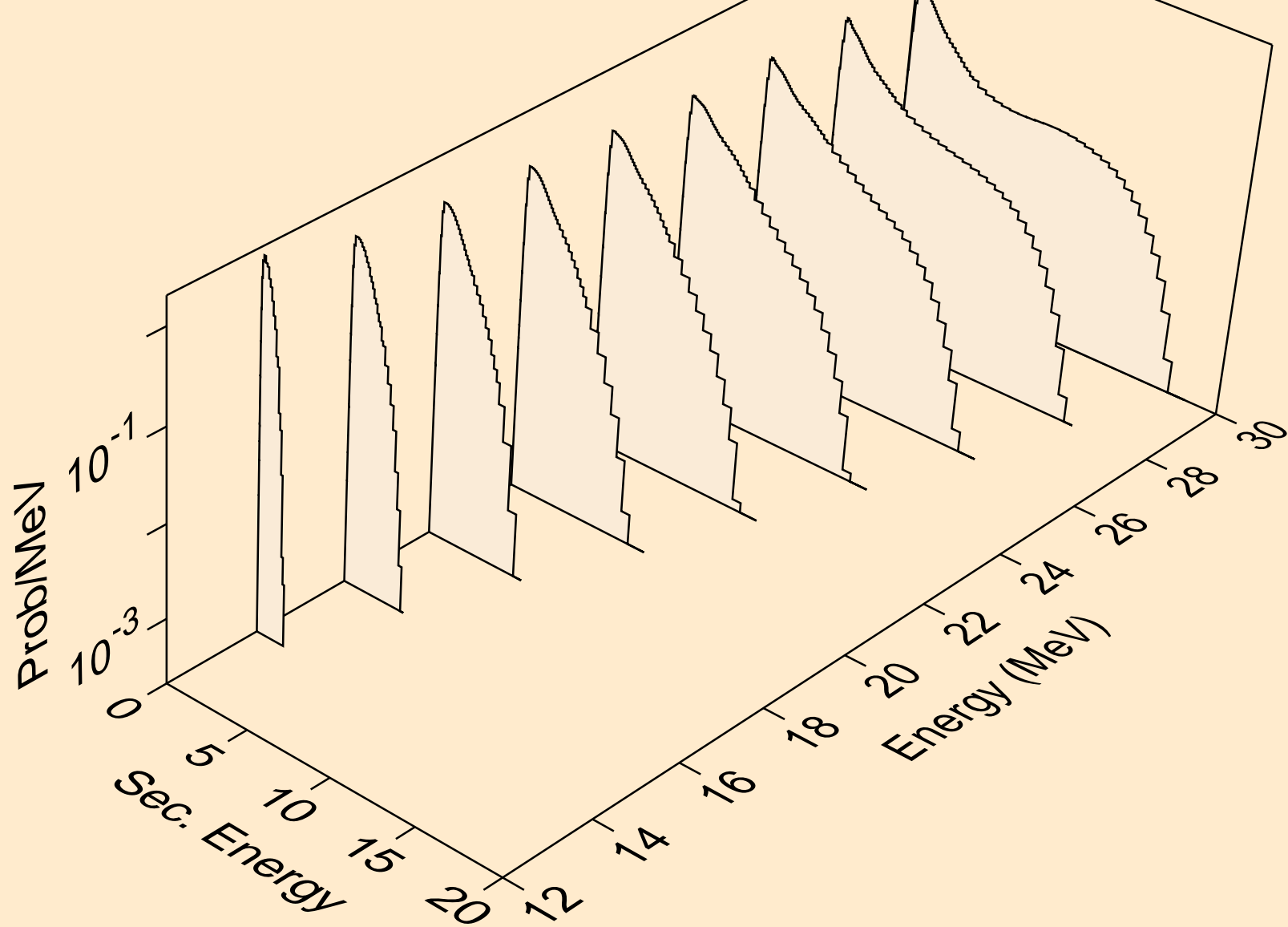

LR261 NEUTRON ACER TENDL-2021 LIBRARY; T=293.6K
Neutron emission for fission

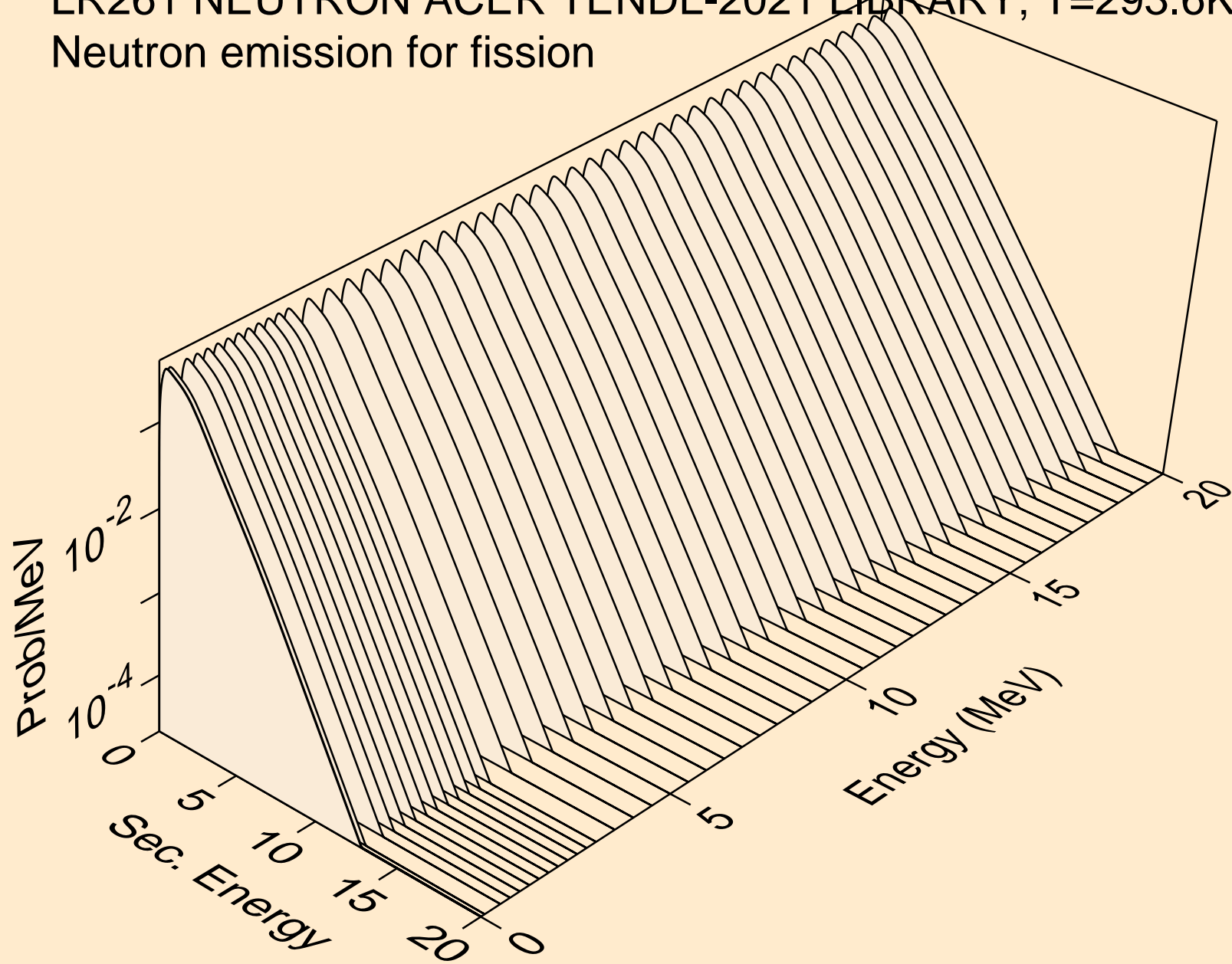

LR261 NEUTRON ACER TENDL-2021 LIBRARY; T=293.6K
Neutron emission for (n,n*)a

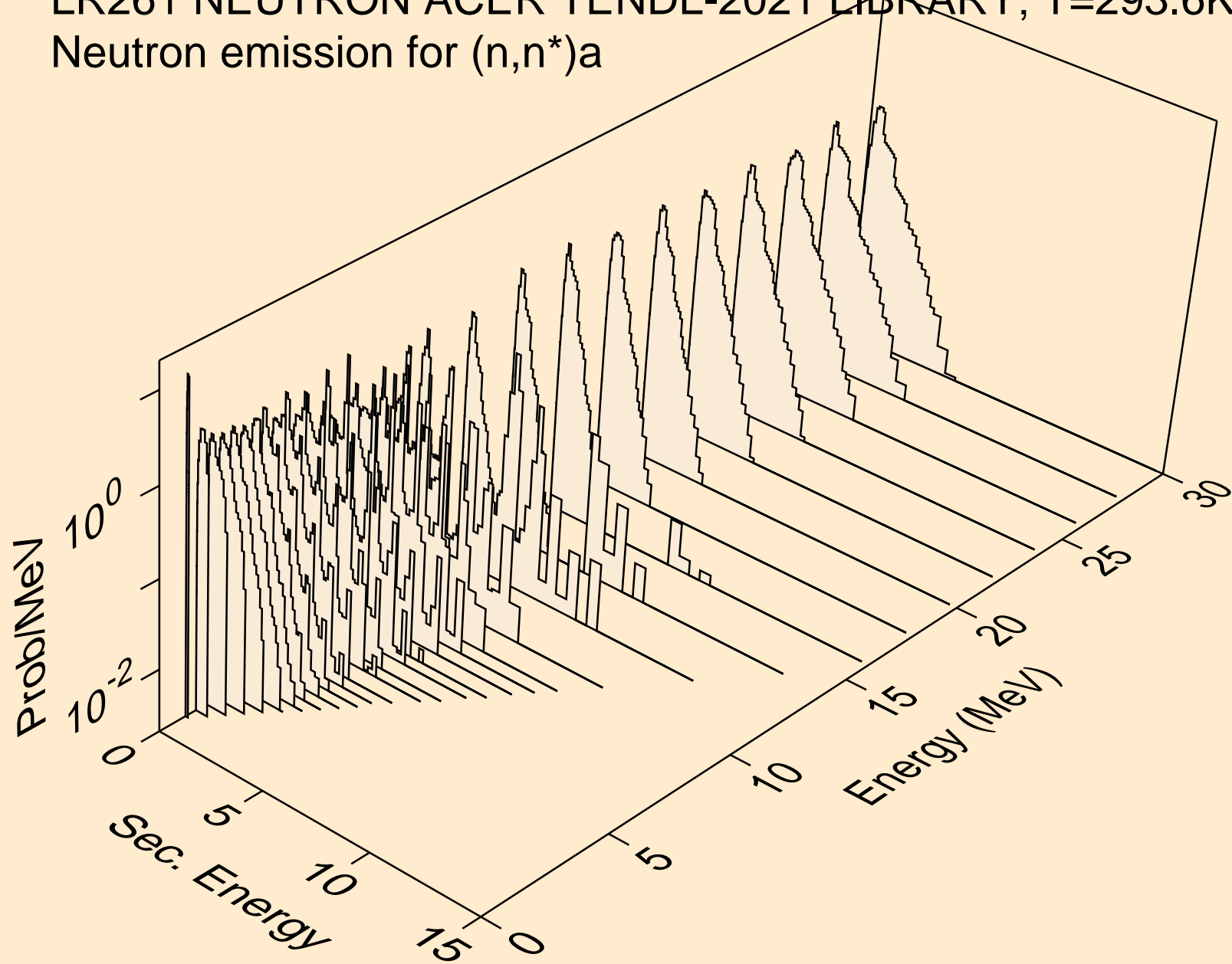

LR261 NEUTRON ACER TENDL-2021 LIBRARY; T=293.6K
Neutron emission for (n,2n)a

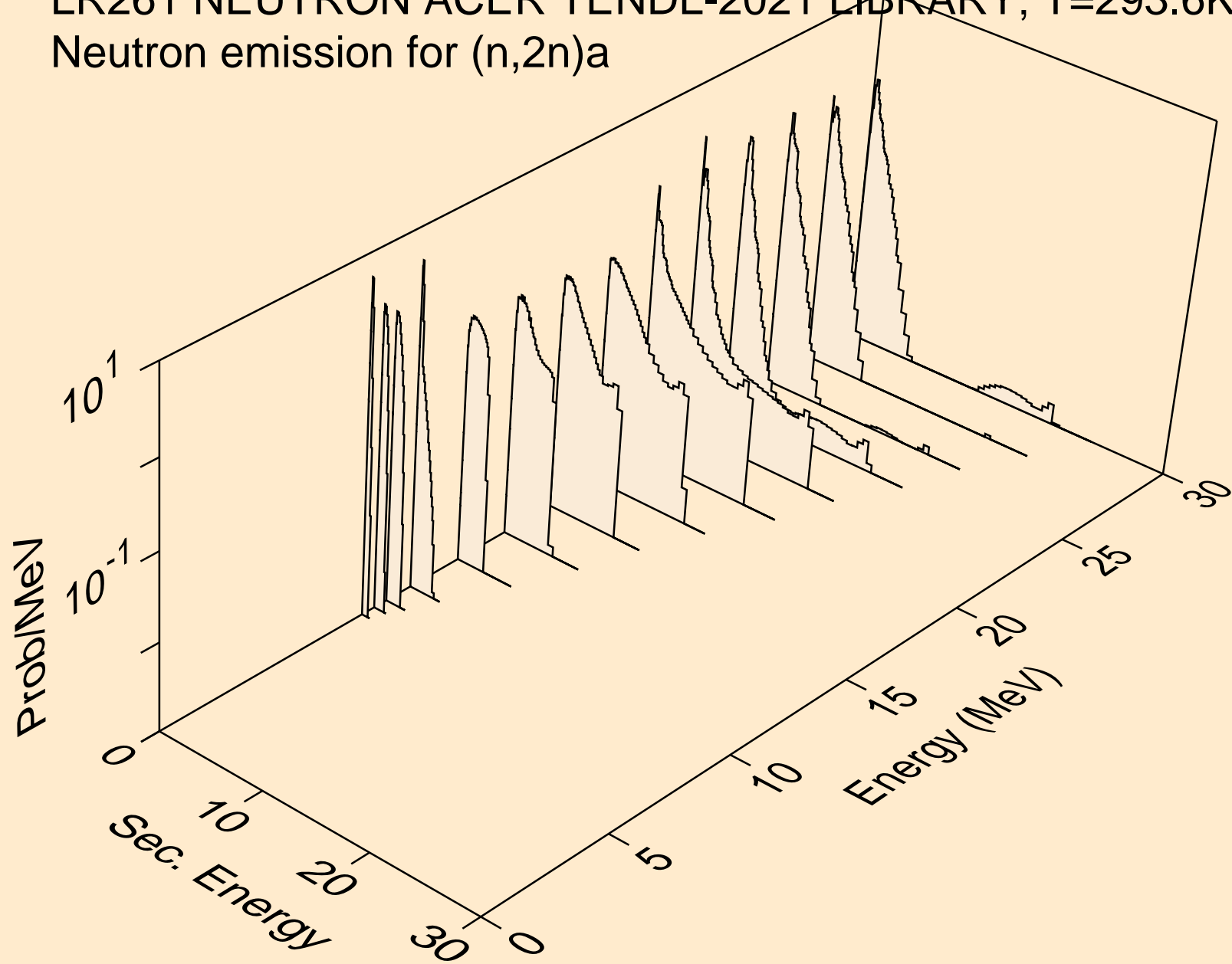

LR261 NEUTRON ACER TENDL-2021 LIBRARY; T=293.6K
Neutron emission for (n,3n)a

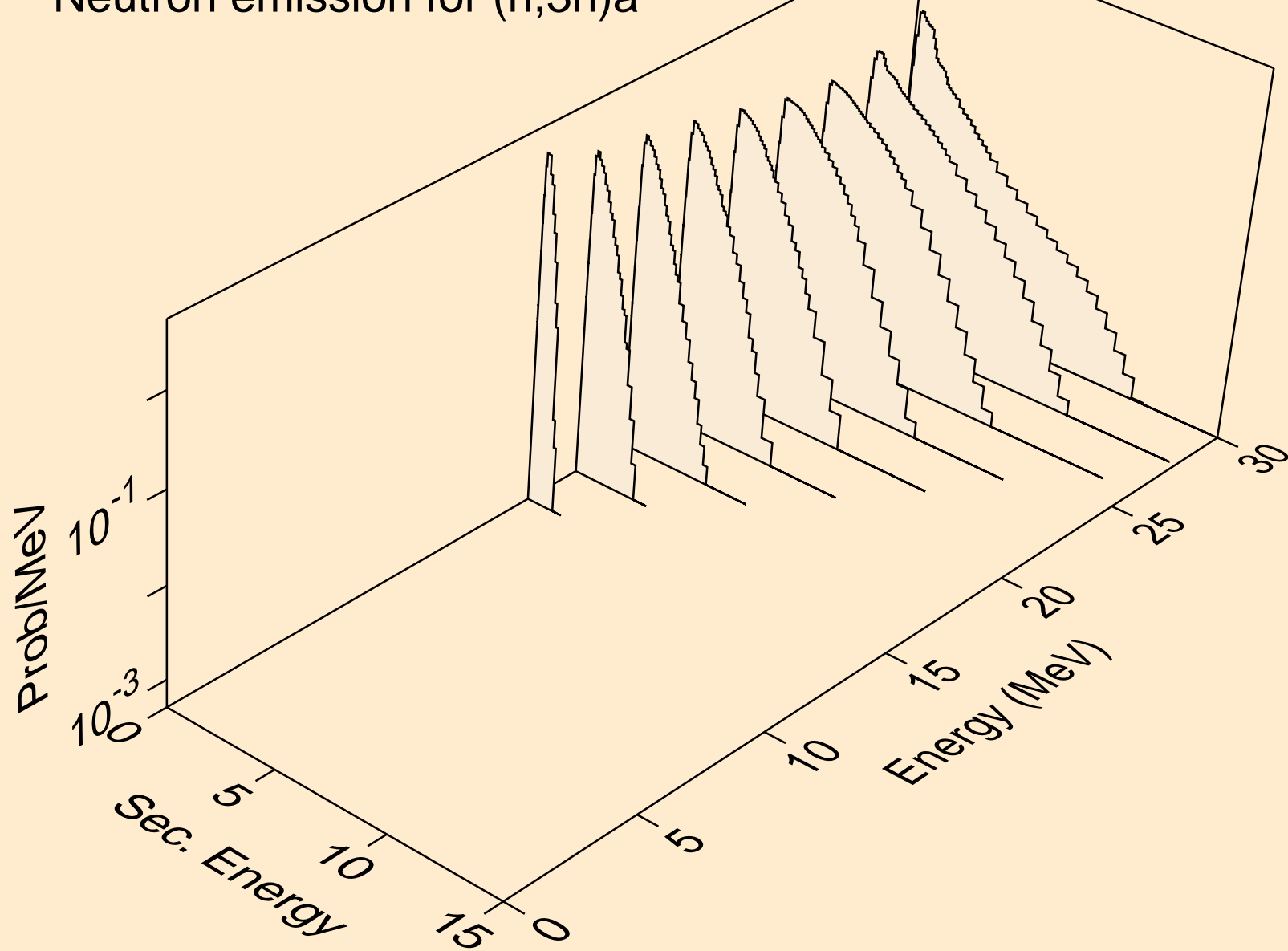

LR261 NEUTRON ACER TENDL-2021 LIBRARY; T=293.6K
Neutron emission for (n,n*)p

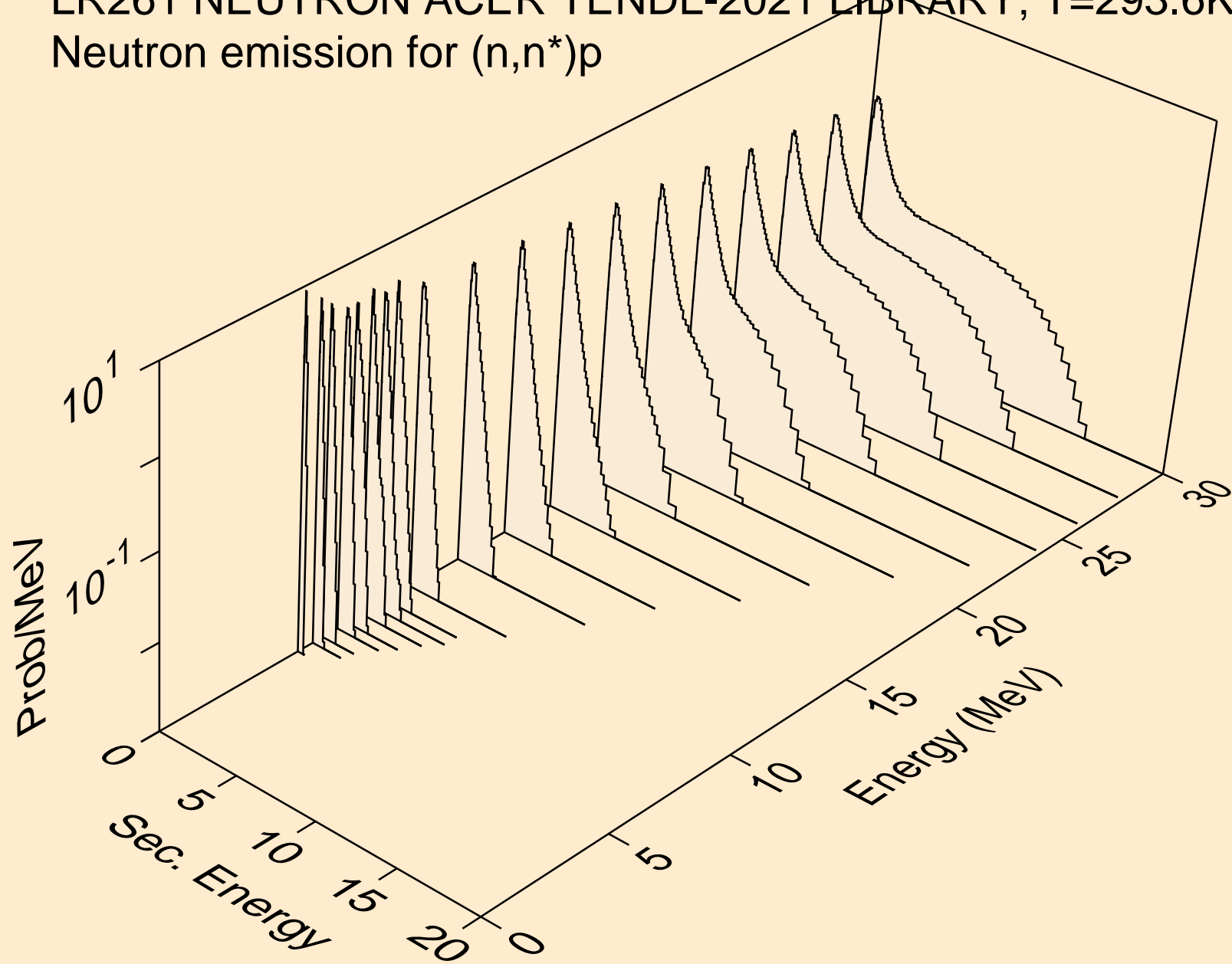

LR261 NEUTRON ACER TENDL-2021 LIBRARY; T=293.6K
Neutron emission for (n,n*)2a

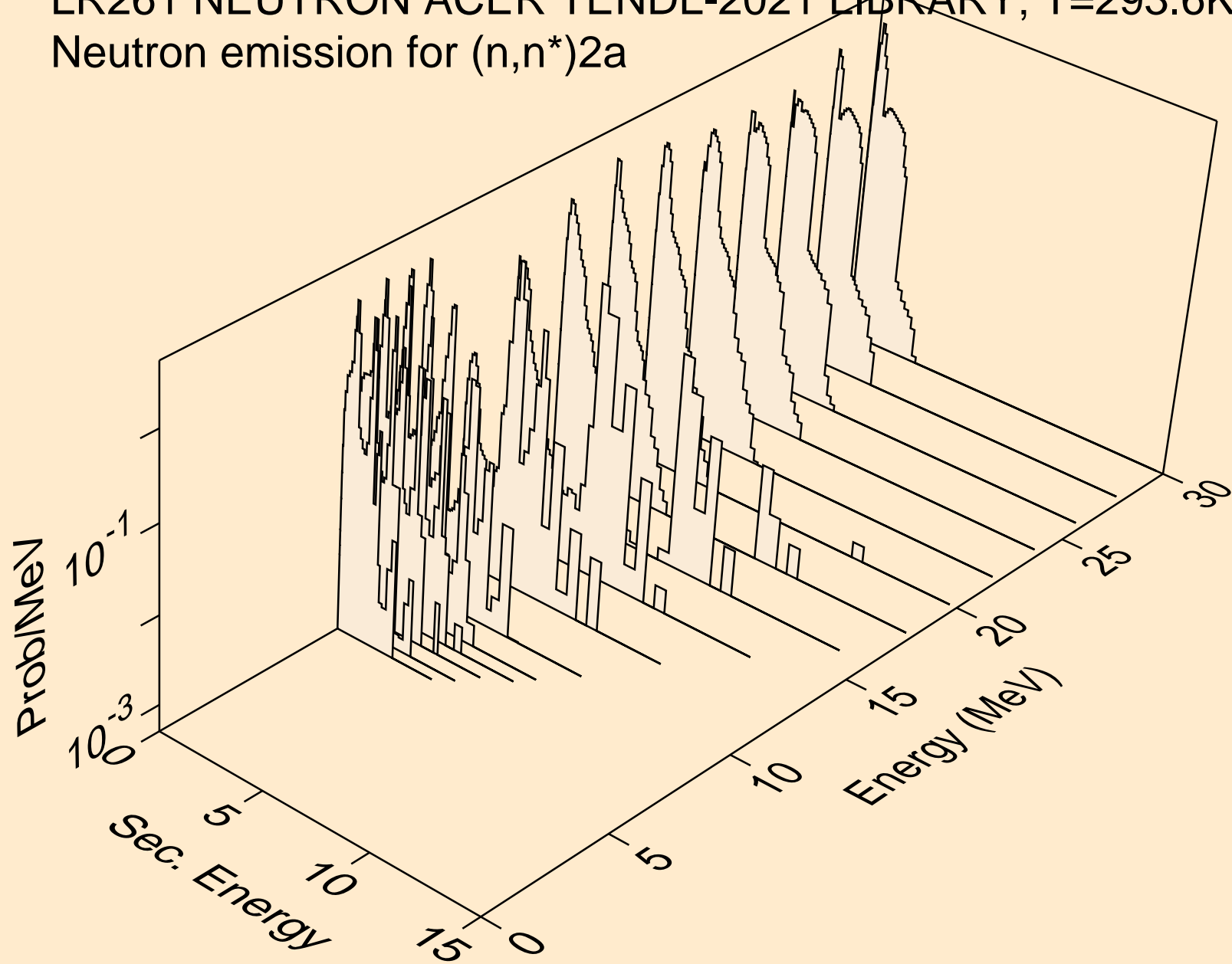

LR261 NEUTRON ACER TENDL-2021 LIBRARY; T=293.6K
Neutron emission for (n,n*)d

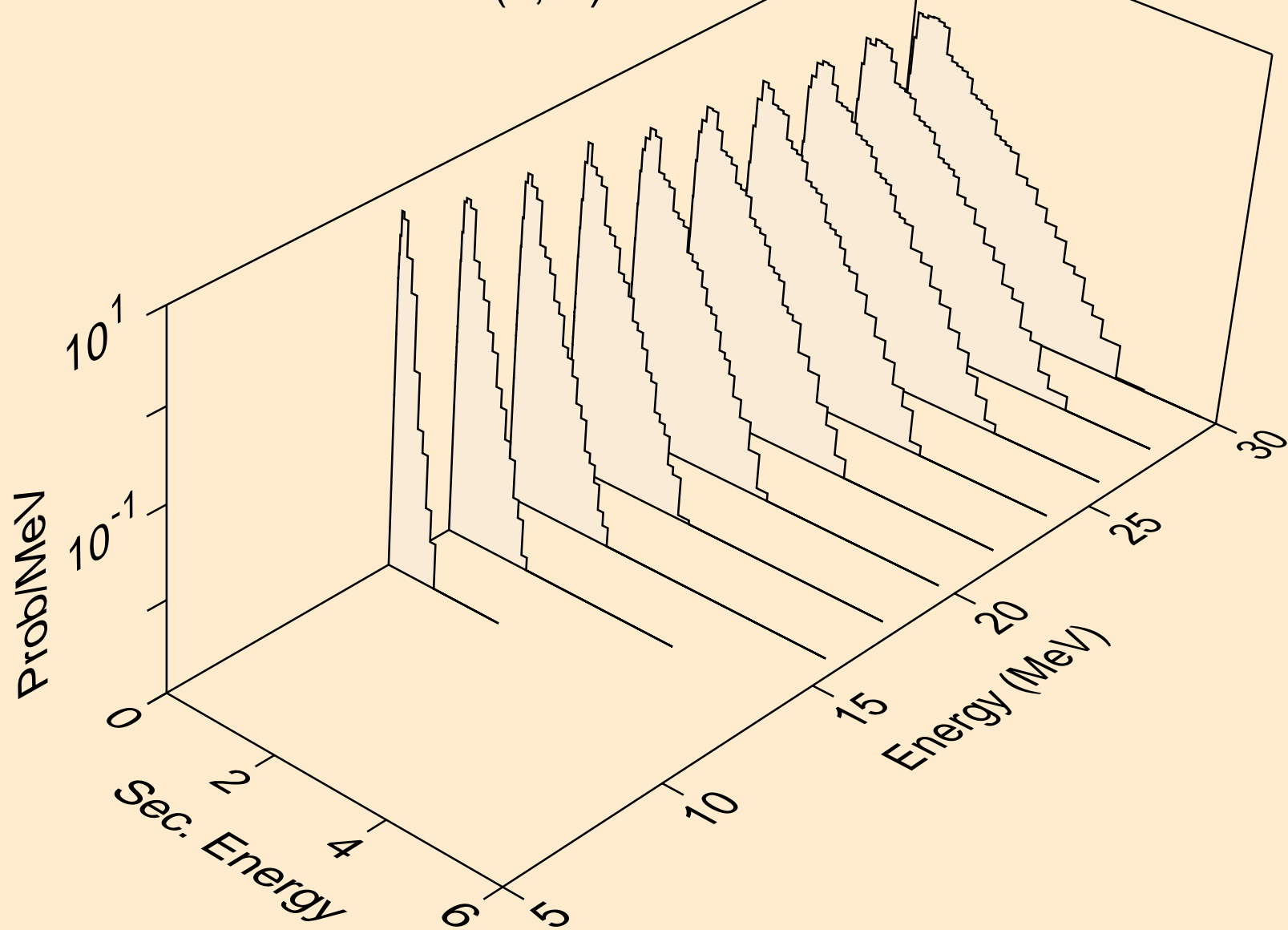

LR261 NEUTRON ACER TENDL-2021 LIBRARY; T=293.6K
Neutron emission for (n,n*)t

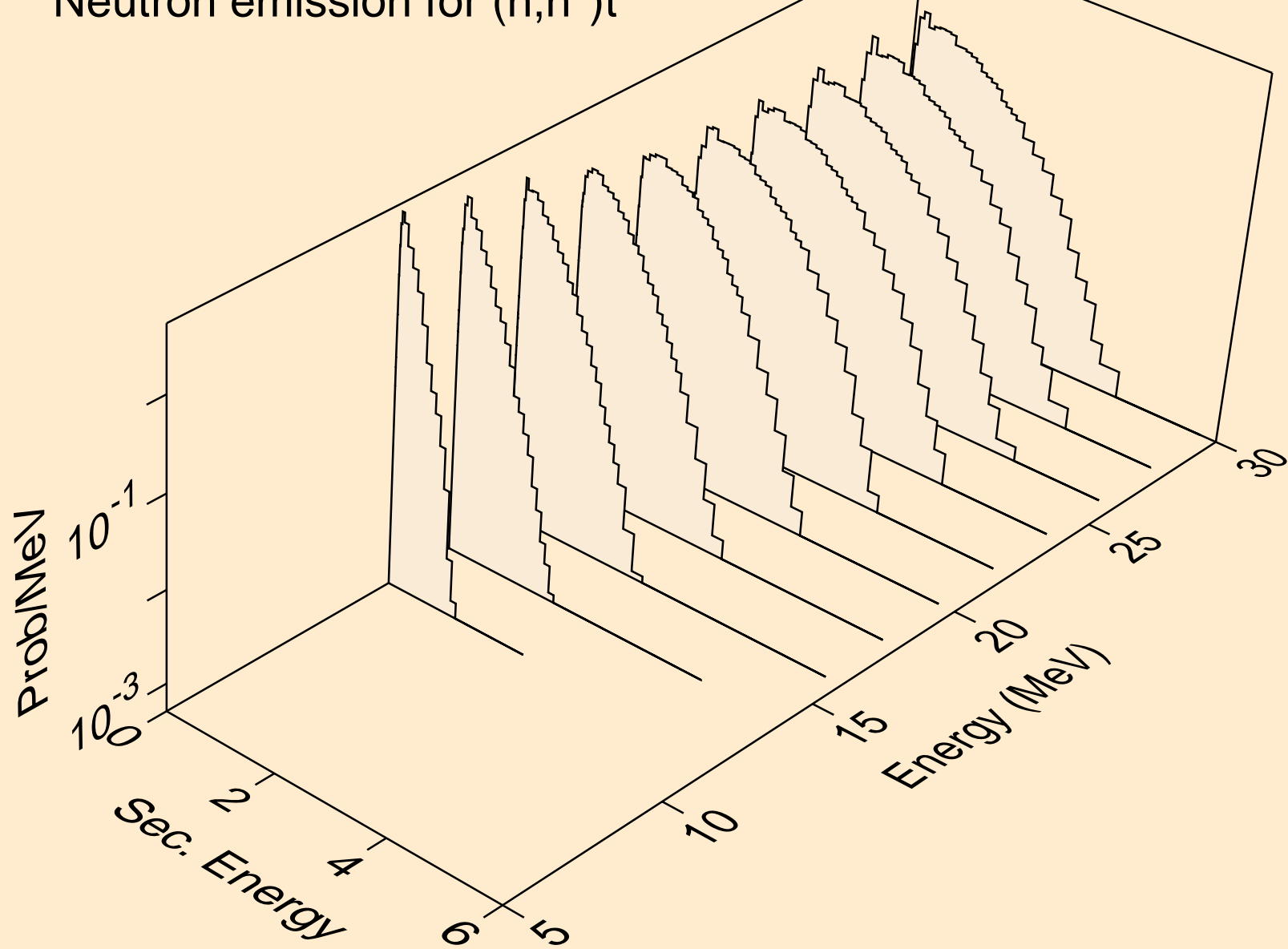

LR261 NEUTRON ACER TENDL-2021 LIBRARY; T=293.6K
Neutron emission for (n,n*)he3

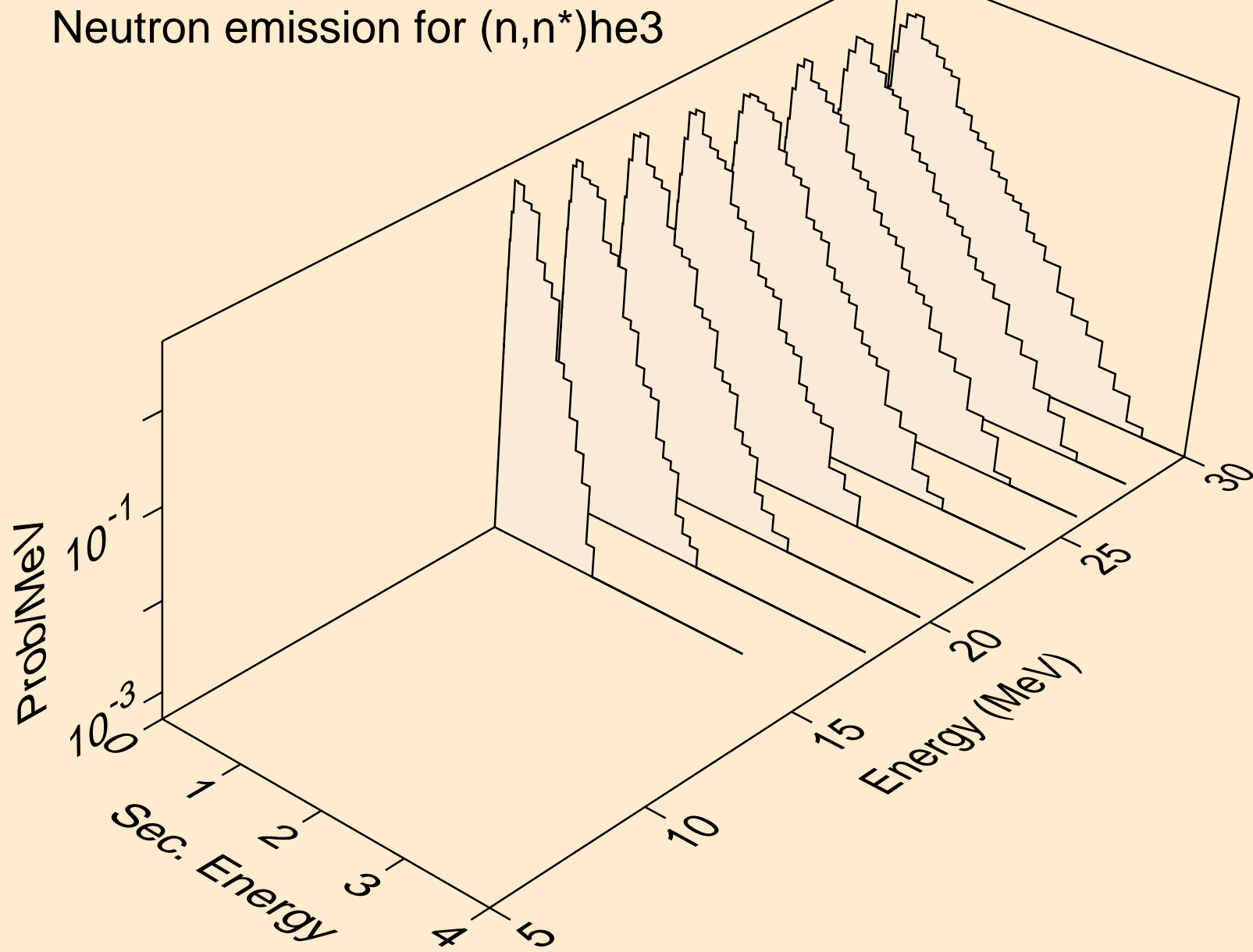

LR261 NEUTRON ACER TENDL-2021 LIBRARY; T=293.6K
Neutron emission for (n,4n)

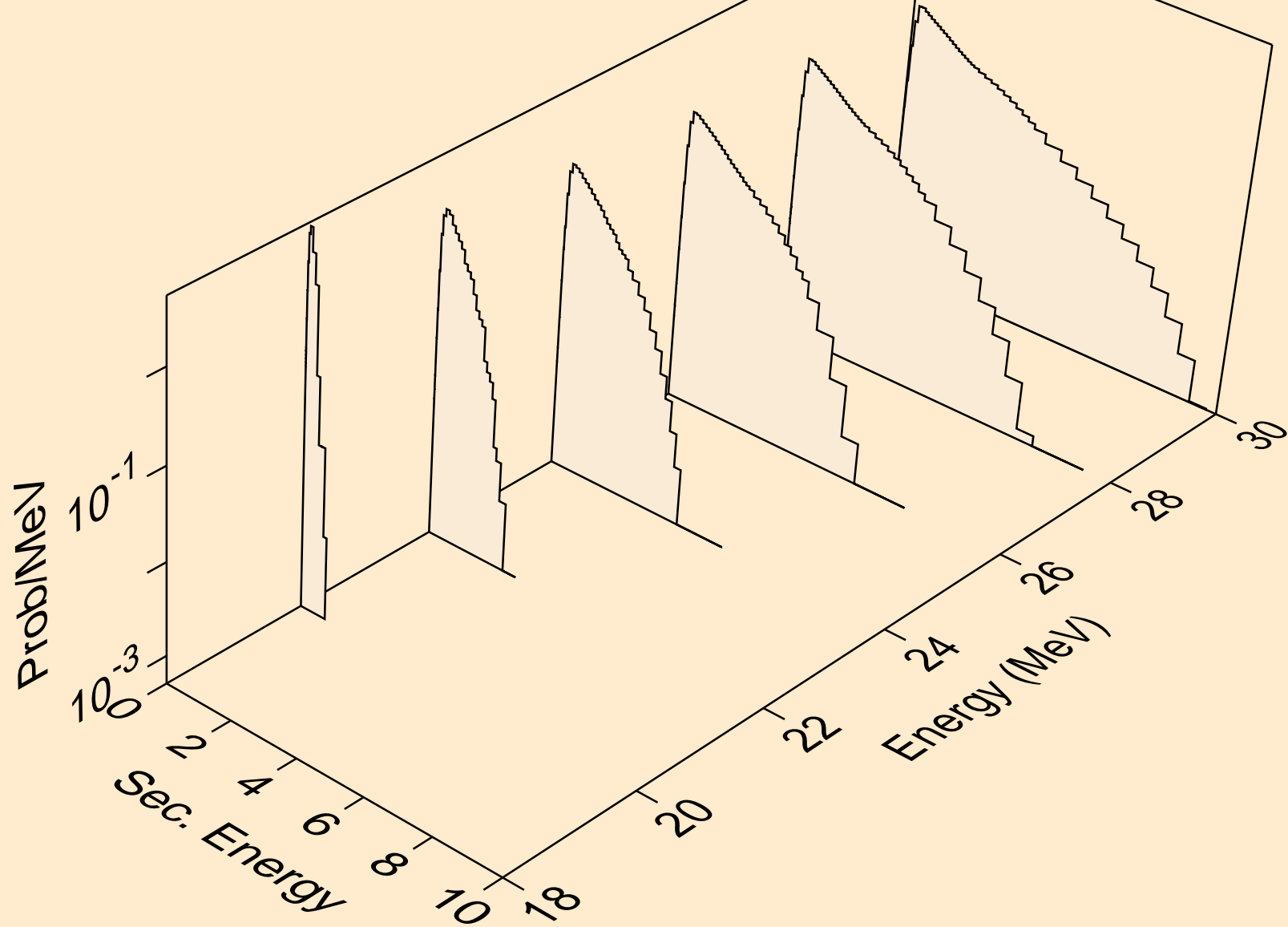

LR261 NEUTRON ACER TENDL-2021 LIBRARY; T=293.6K
Neutron emission for (n,2np)

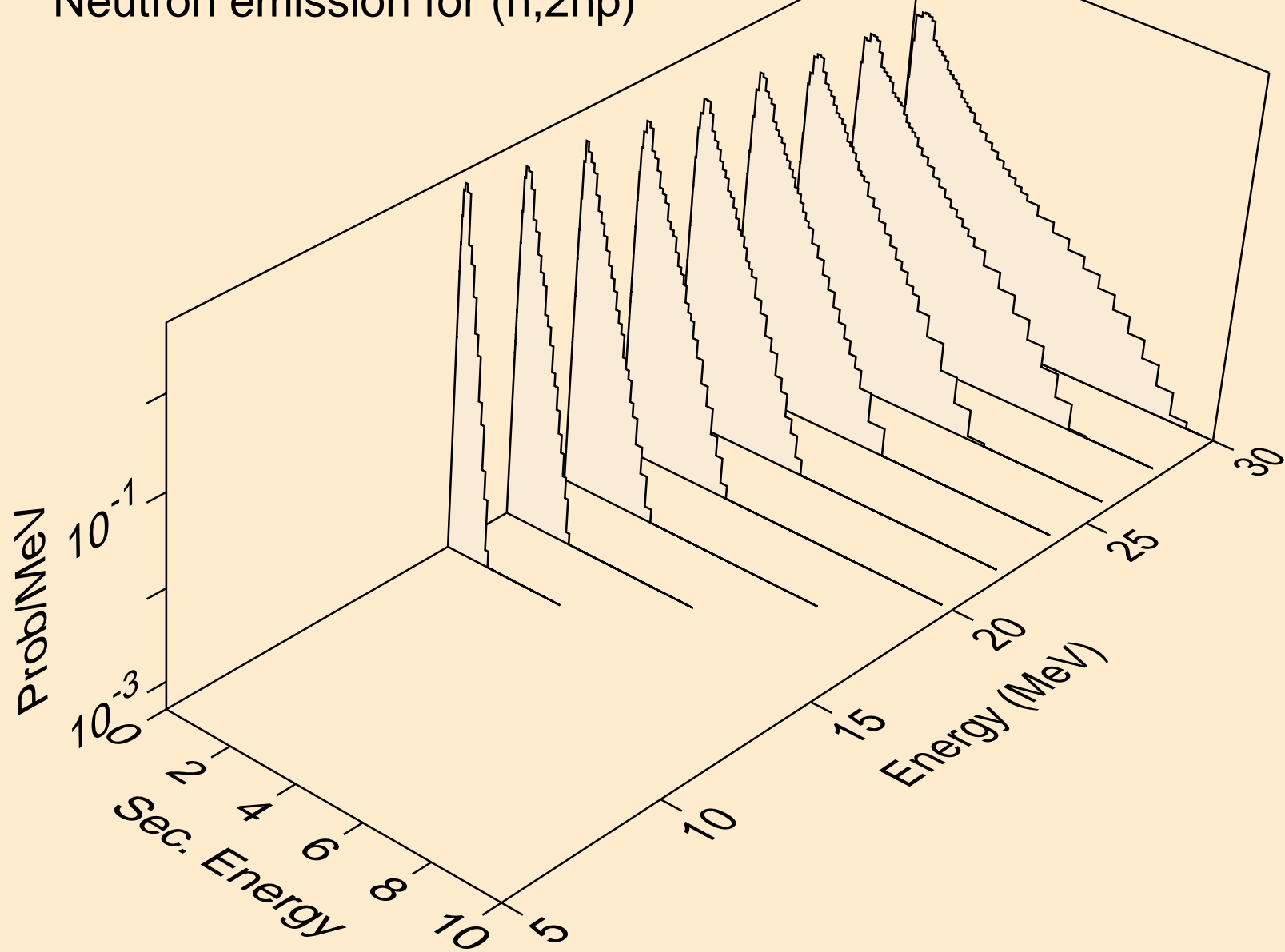

LR261 NEUTRON ACER TENDL-2021 LIBRARY; T=293.6K
Neutron emission for (n,3np)

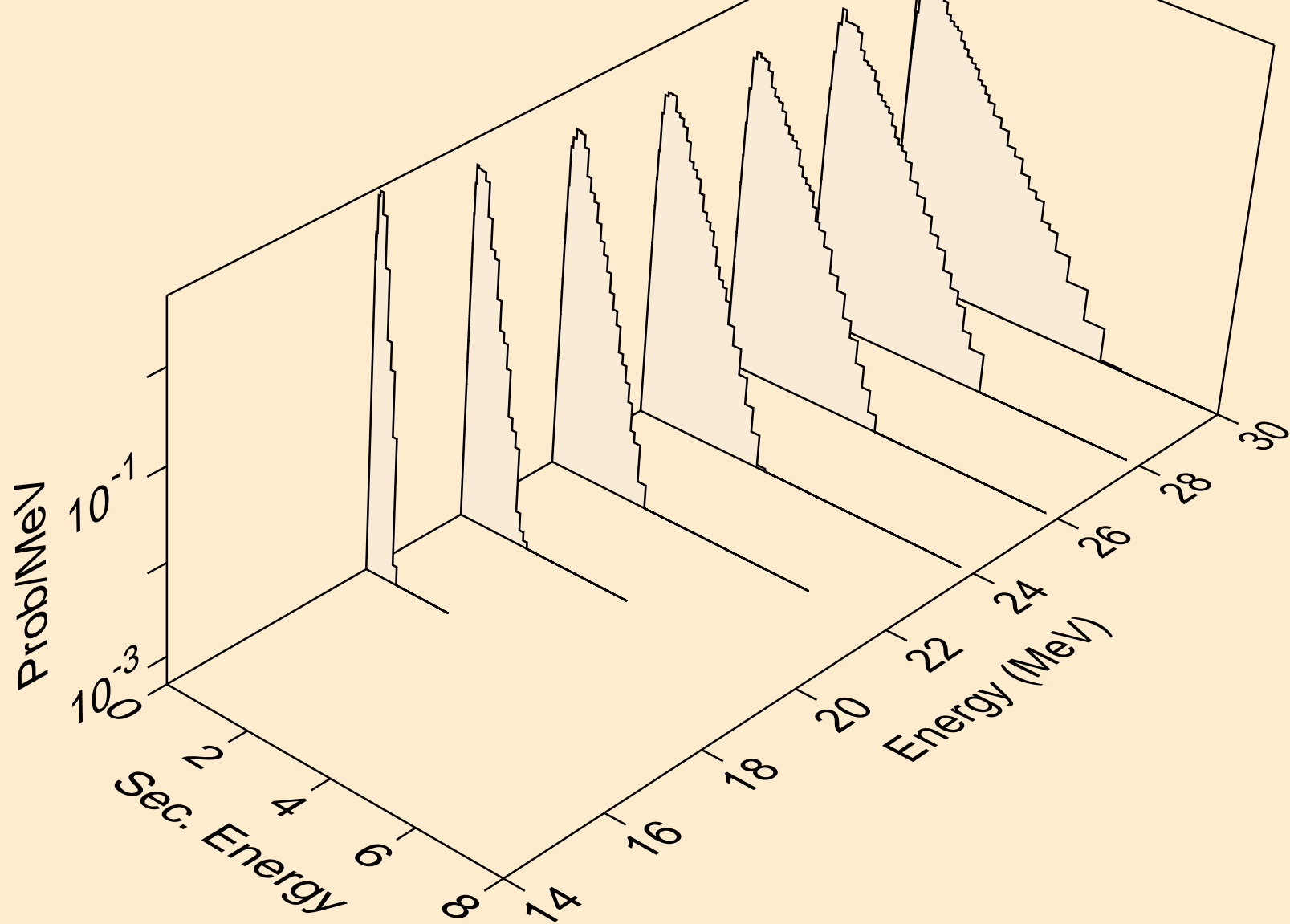

LR261 NEUTRON ACER TENDL-2021 LIBRARY; T=293.6K
Neutron emission for (n,2np)

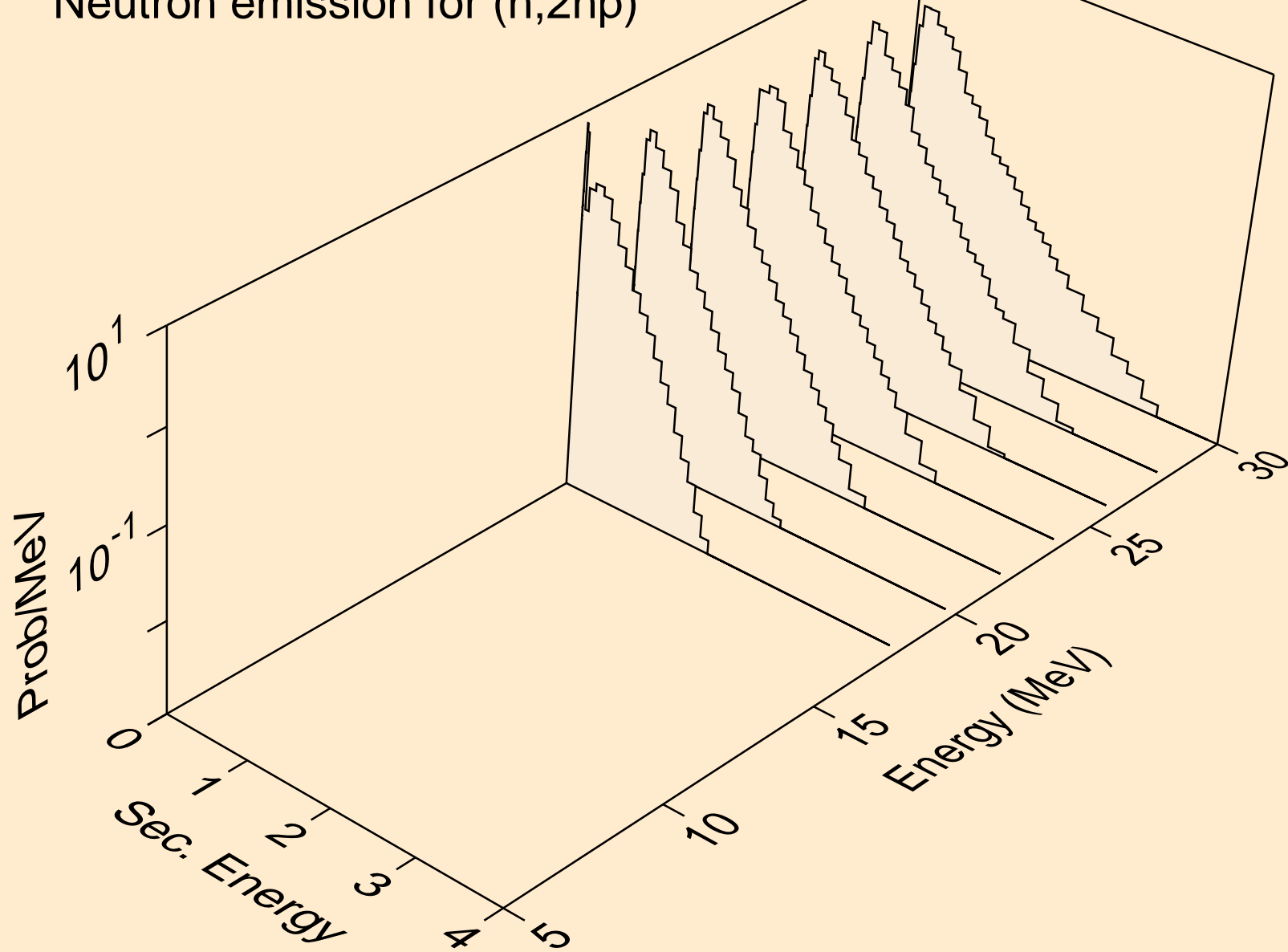

LR261 NEUTRON ACER TENDL-2021 LIBRARY; T=293.6K
Neutron emission for (n,npa)

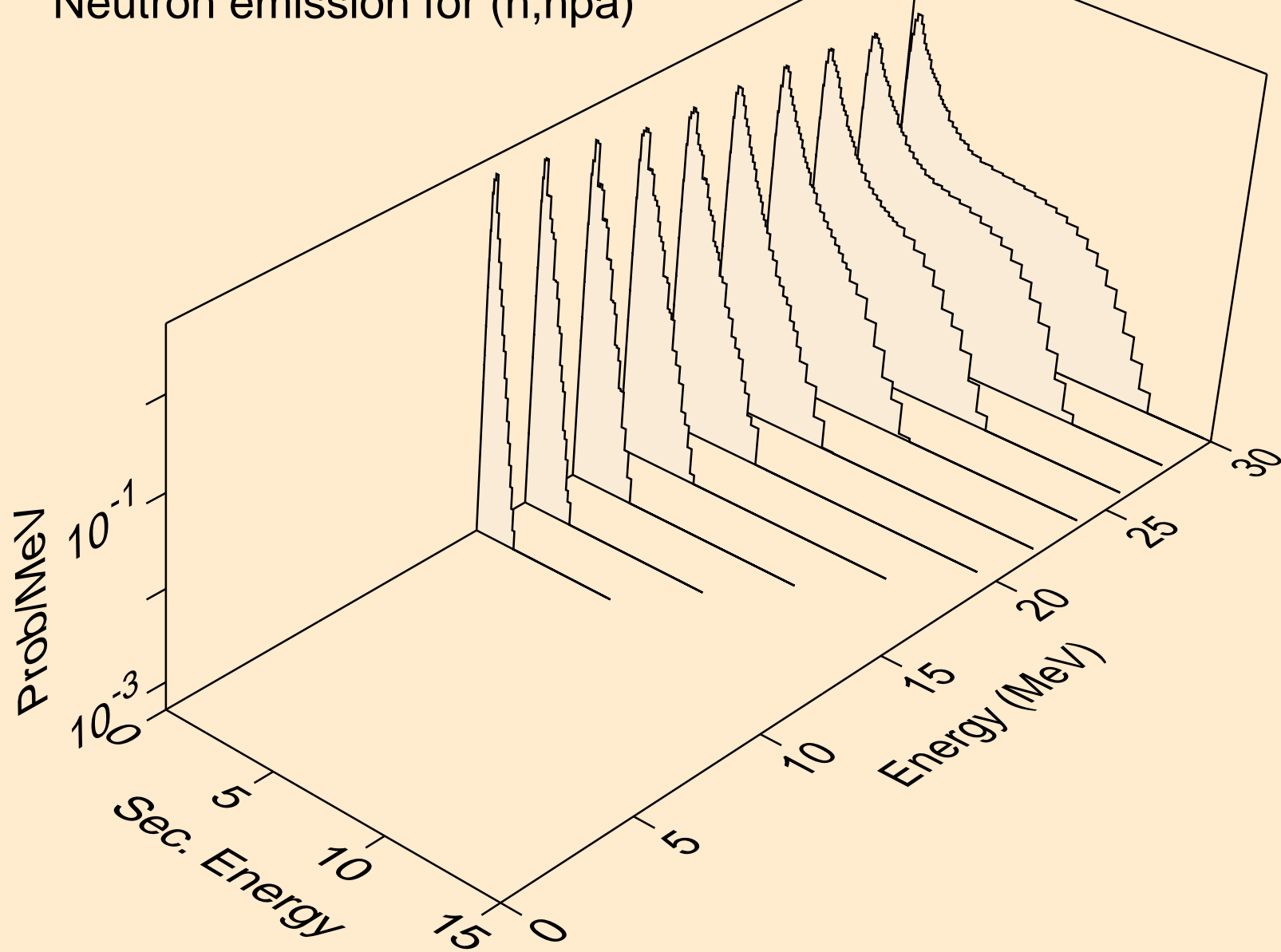

LR261 NEUTRON ACER TENDL-2021 LIBRARY; T=293.6K
Neutron emission for (n,n*c)

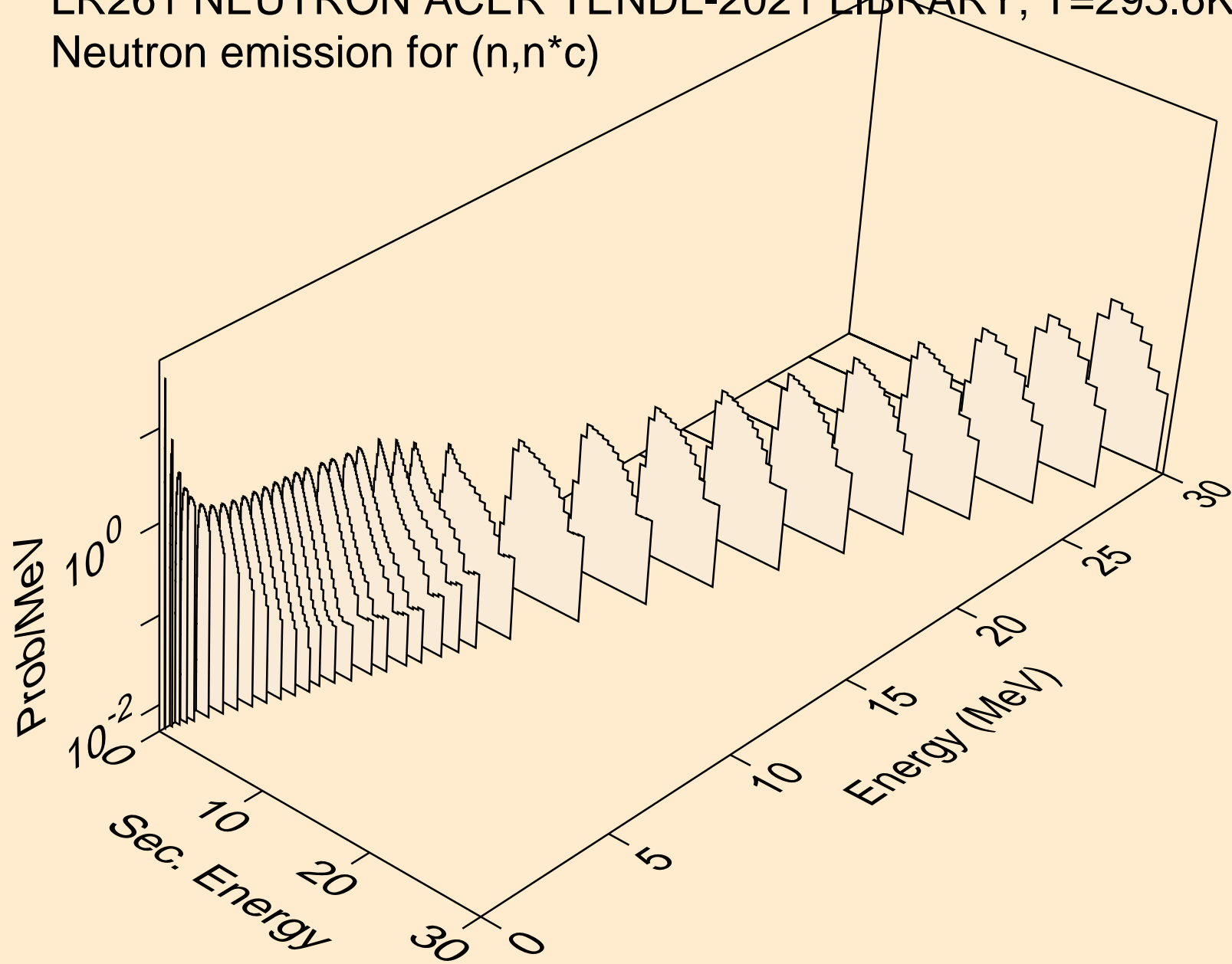

LR261 NEUTRON ACER TENDL-2021 LIBRARY; T=293.6K

Delayed nubar

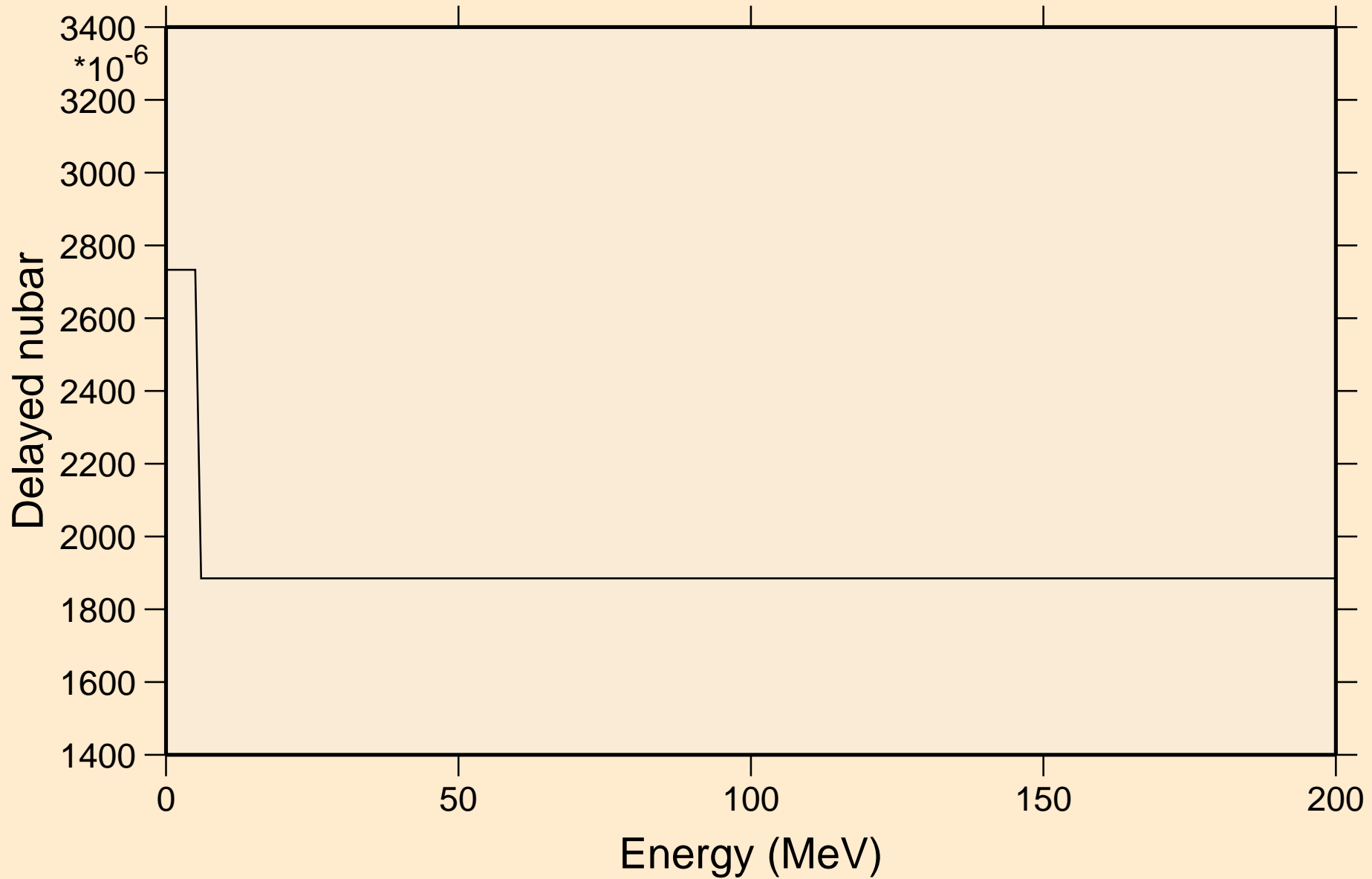

LR261 NEUTRON ACER TENDL-2021 LIBRARY; T=293.6K

Delayed neutron spectra

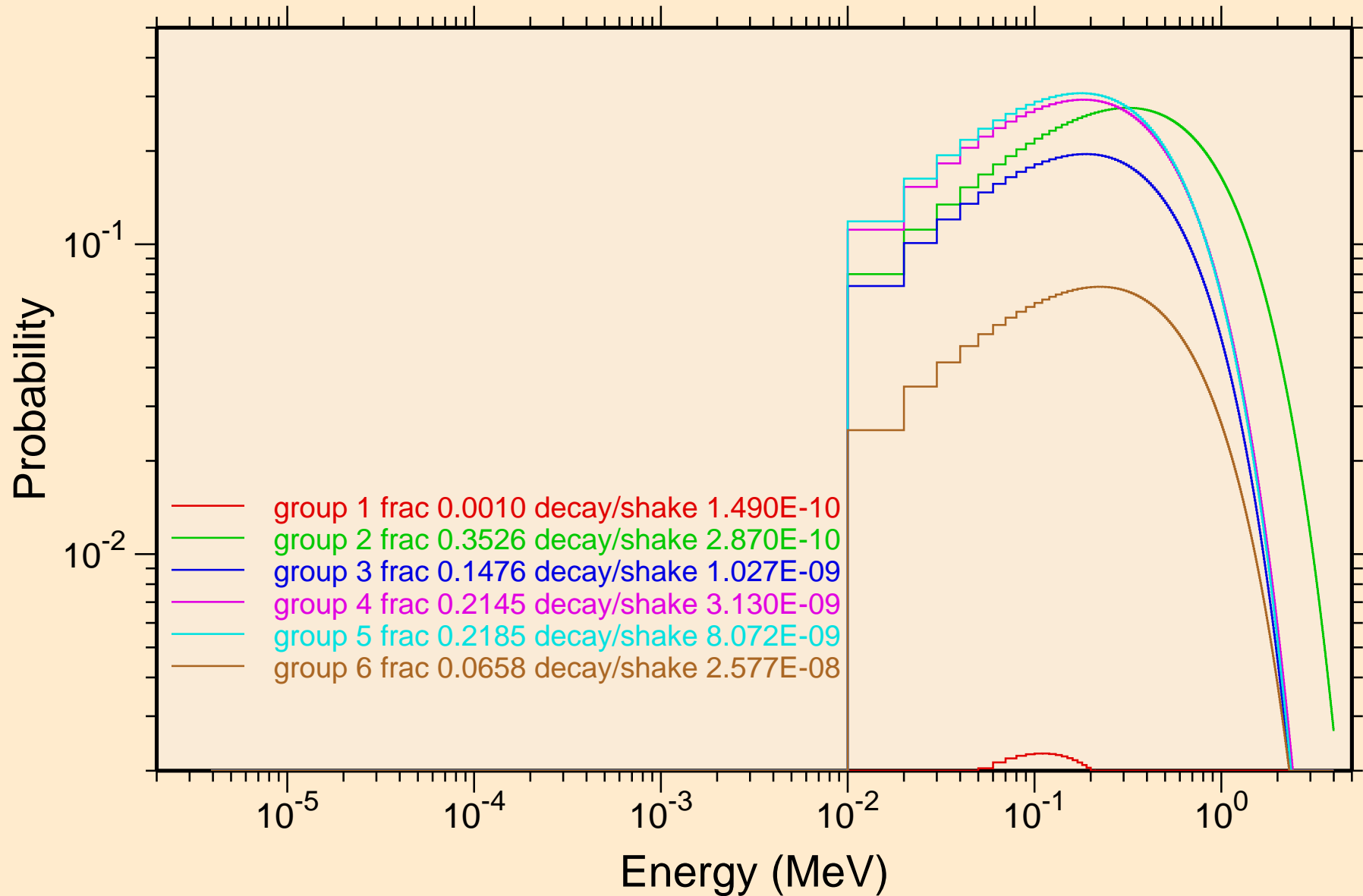

LR261 NEUTRON ACER TENDL-2021 LIBRARY; T=293.6K
Photon emission for (n,x)

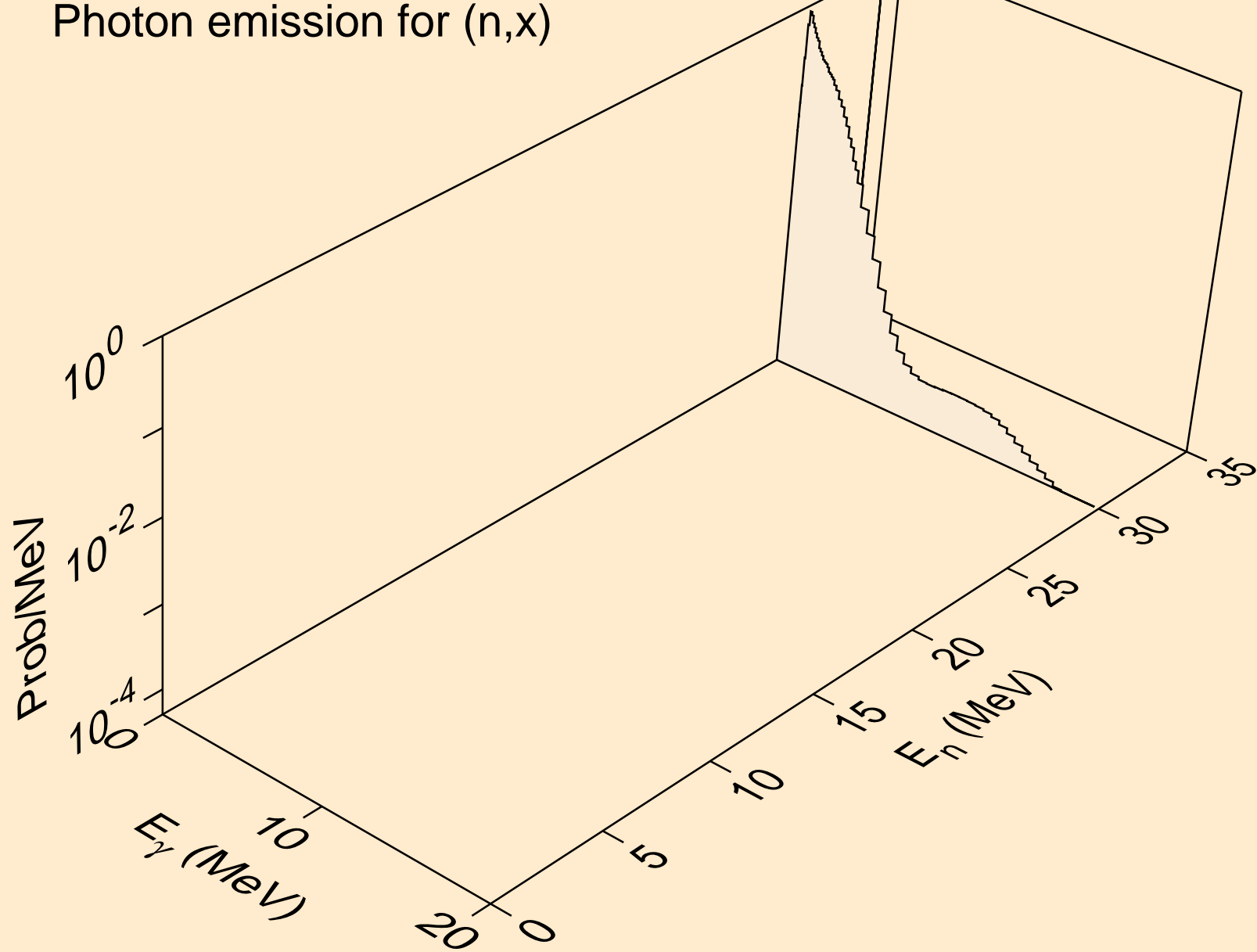

LR261 NEUTRON ACER TENDL-2021 LIBRARY; T=293.6K
Photon emission for (n,2nd)

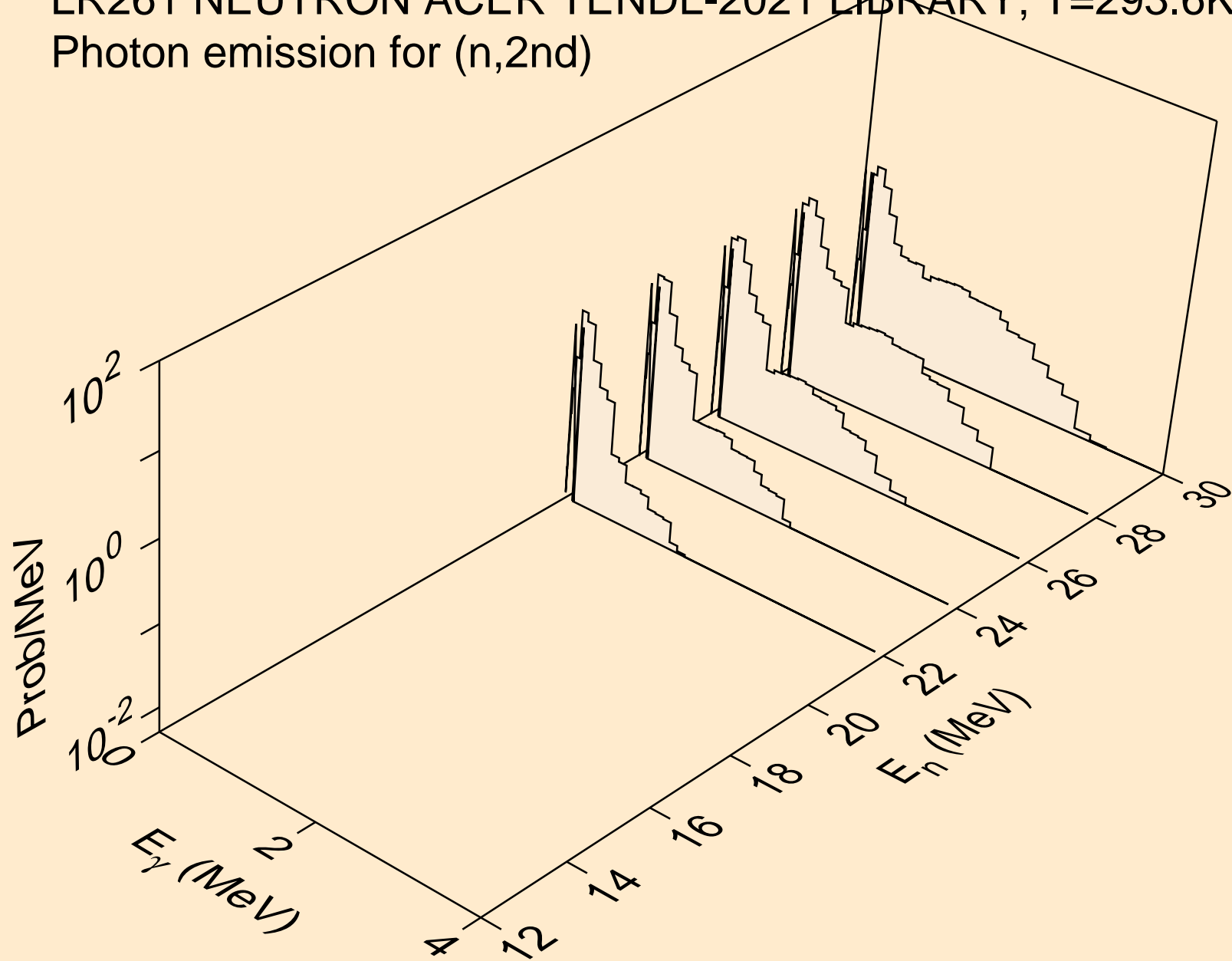

LR261 NEUTRON ACER TENDL-2021 LIBRARY; T=293.6K
Photon emission for (n,2n)

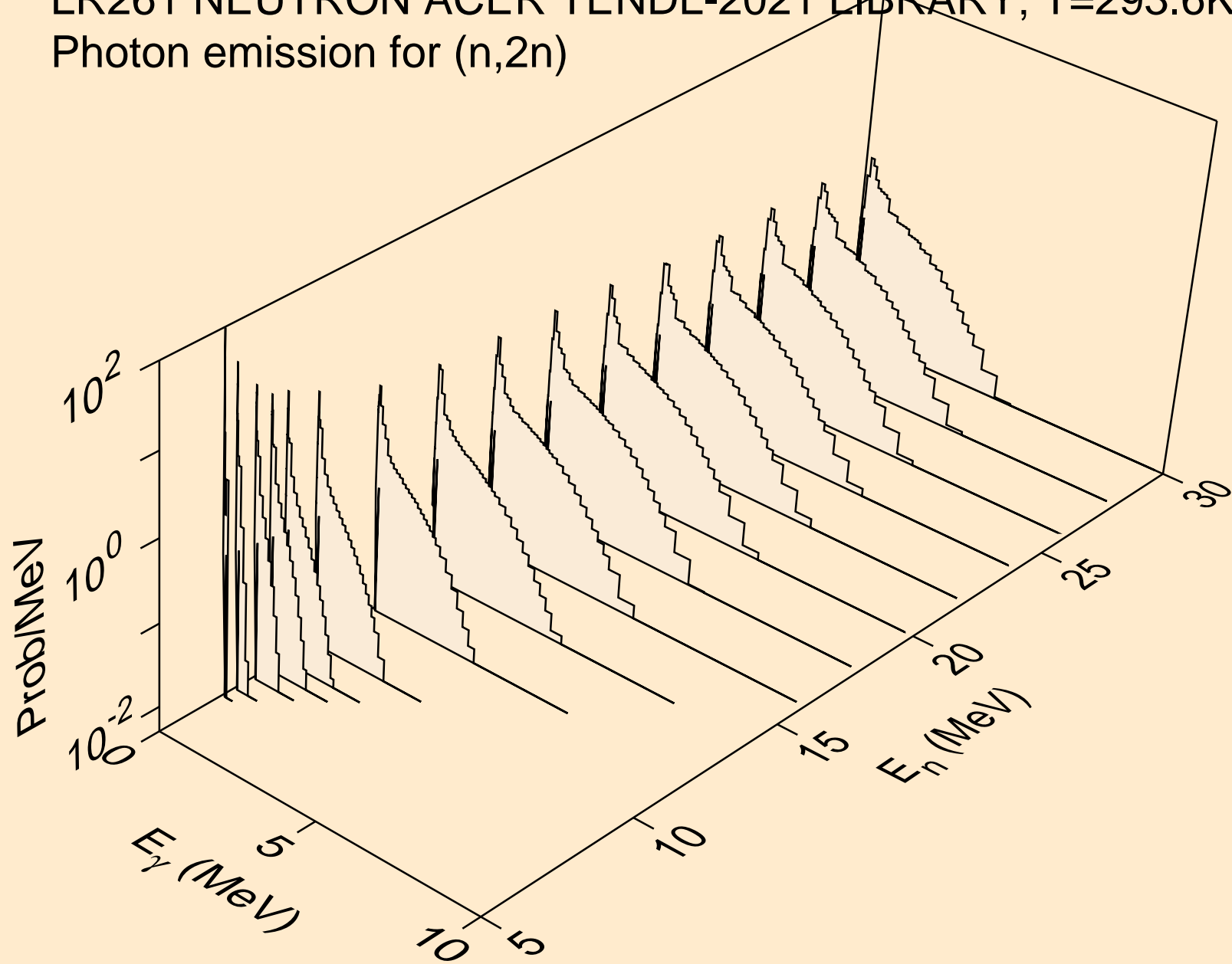

LR261 NEUTRON ACER TENDL-2021 LIBRARY; T=293.6K
Photon emission for (n,3n)

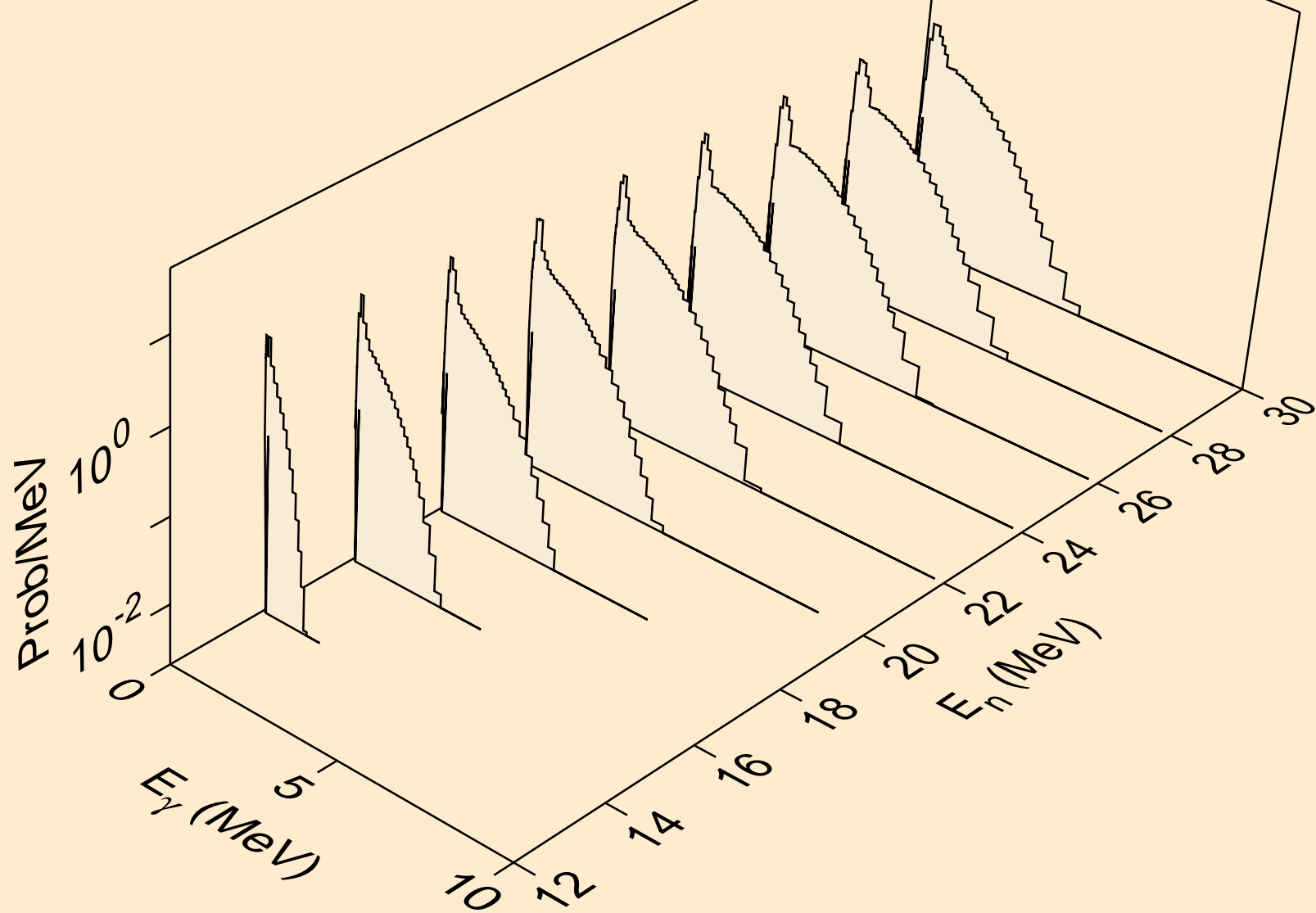

LR261 NEUTRON ACER TENDL-2021 LIBRARY; T=293.6K
Photon emission for (n,n*)a

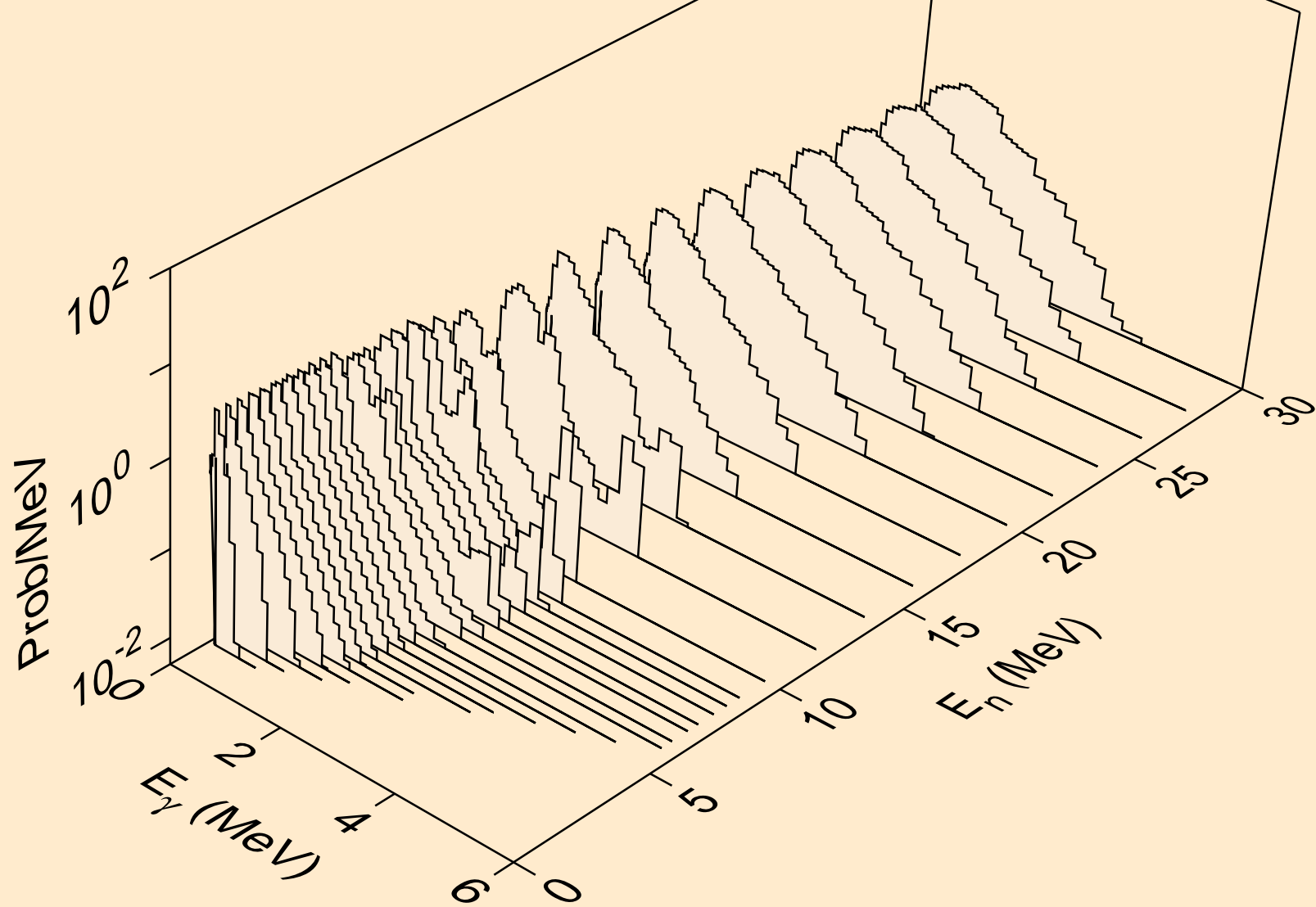

LR261 NEUTRON ACER TENDL-2021 LIBRARY; T=293.6K
Photon emission for (n,2n)a

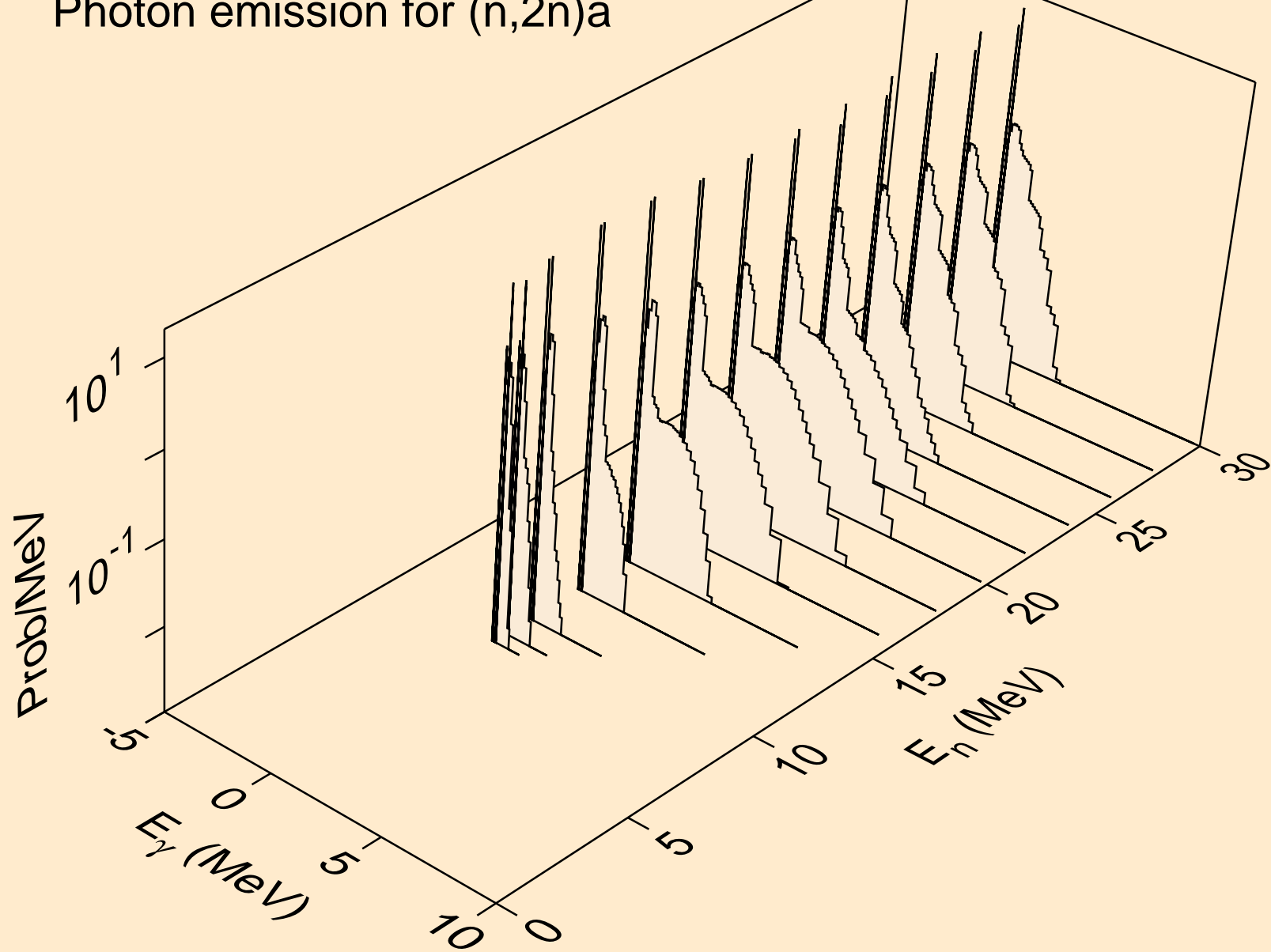

LR261 NEUTRON ACER TENDL-2021 LIBRARY; T=293.6K
Photon emission for (n,3n)a

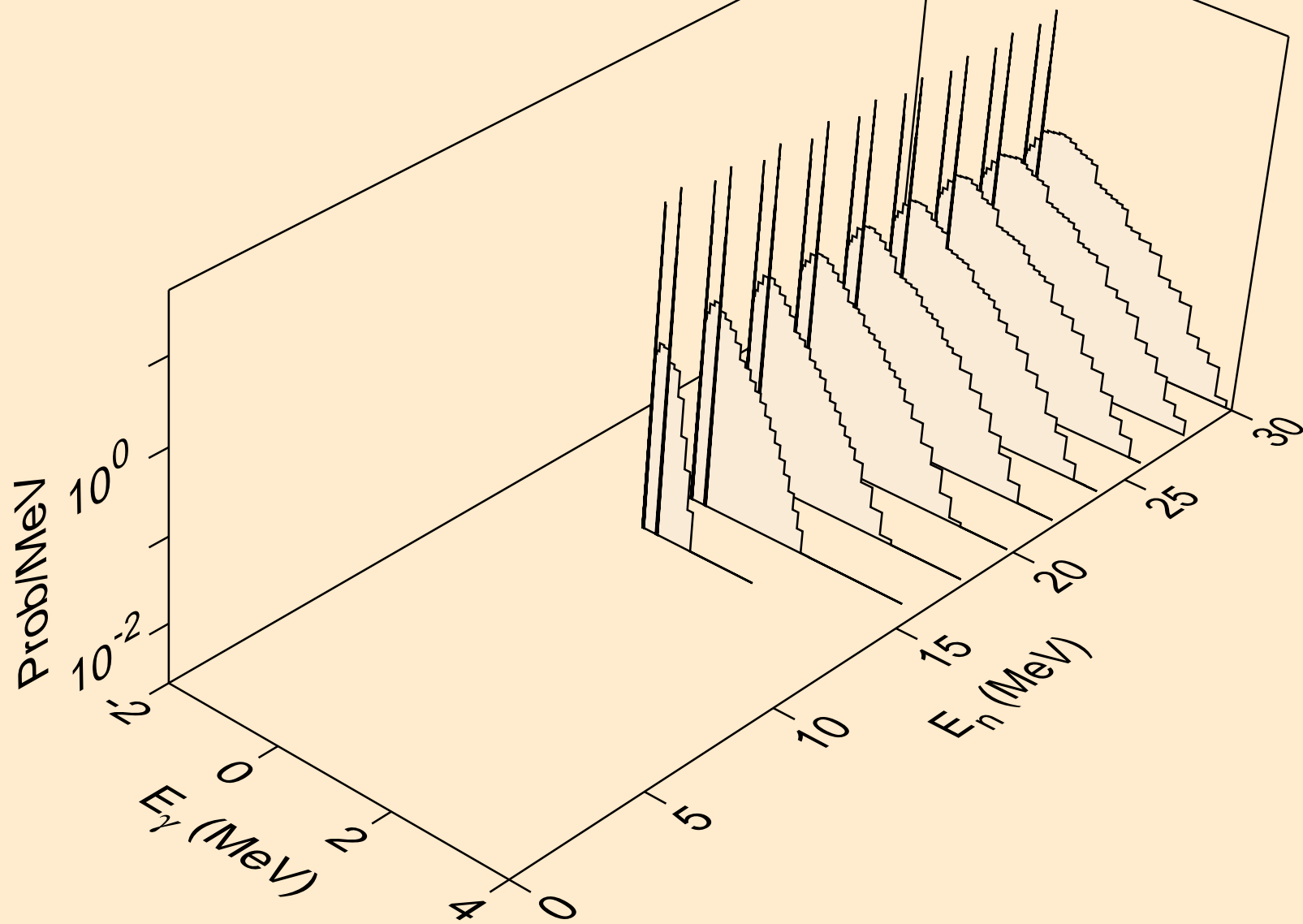

LR261 NEUTRON ACER TENDL-2021 LIBRARY; T=293.6K
Photon emission for (n,n*)p

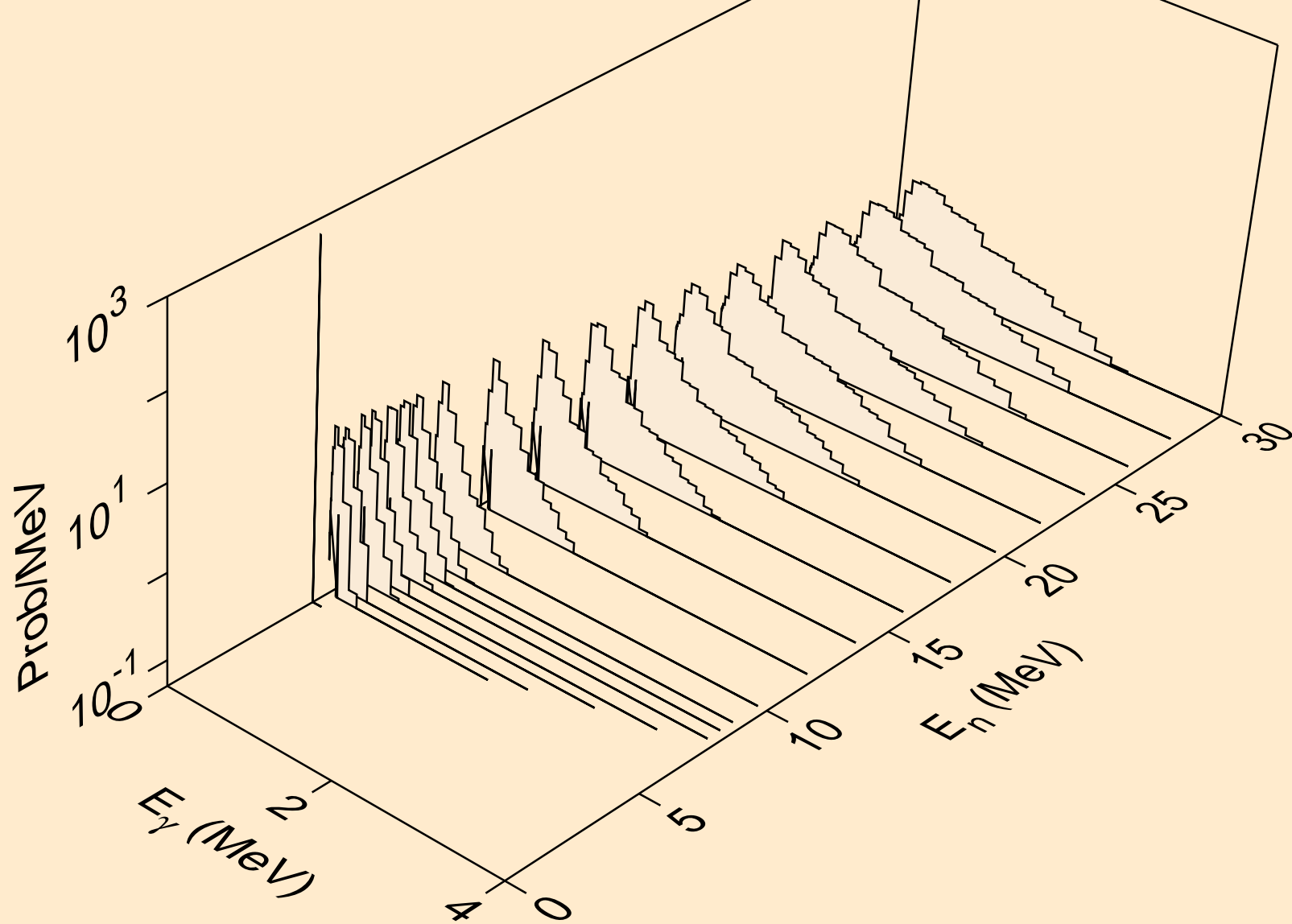

LR261 NEUTRON ACER TENDL-2021 LIBRARY; T=293.6K
Photon emission for (n,n*)2a

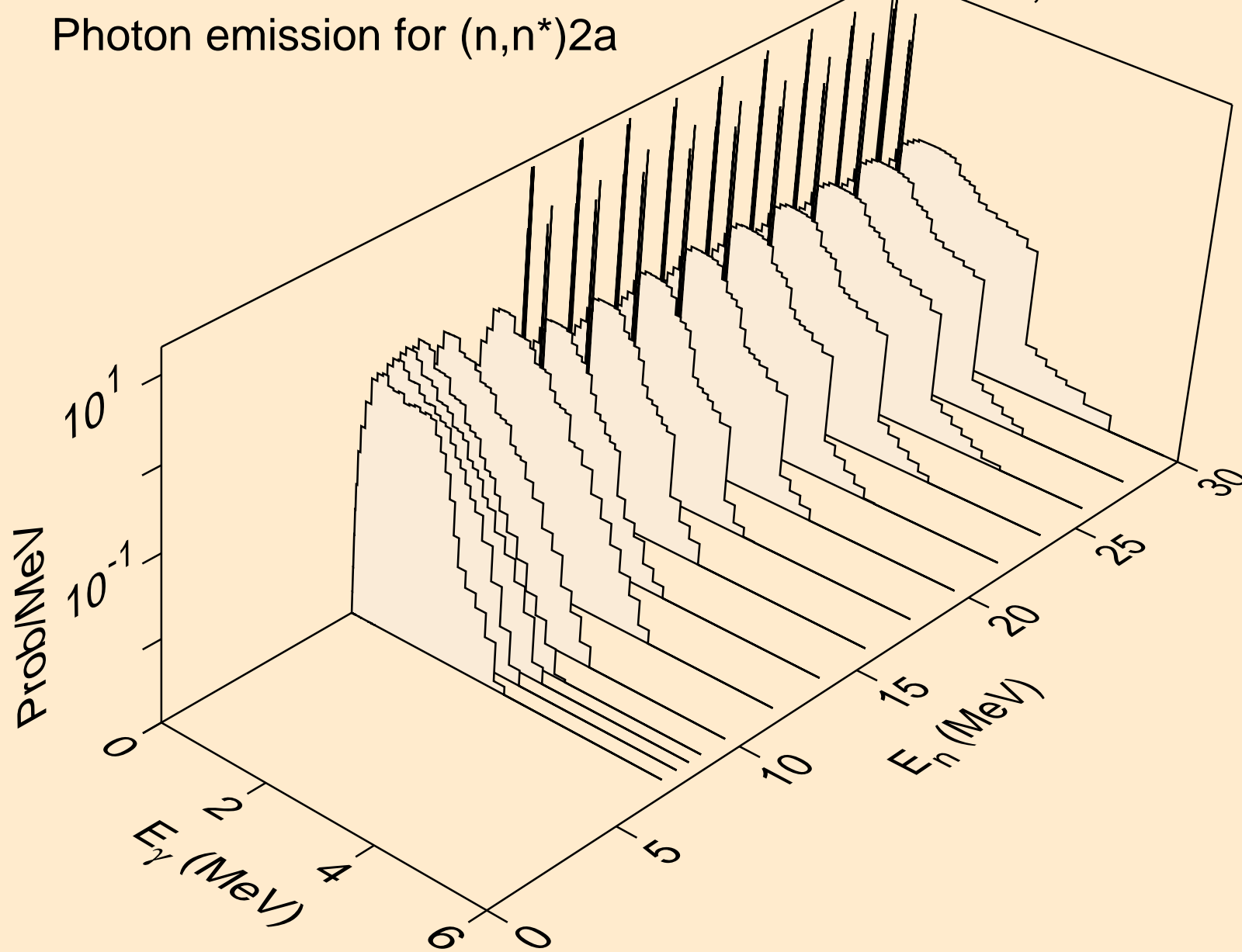

LR261 NEUTRON ACER TENDL-2021 LIBRARY; T=293.6K
Photon emission for (n,n*)d

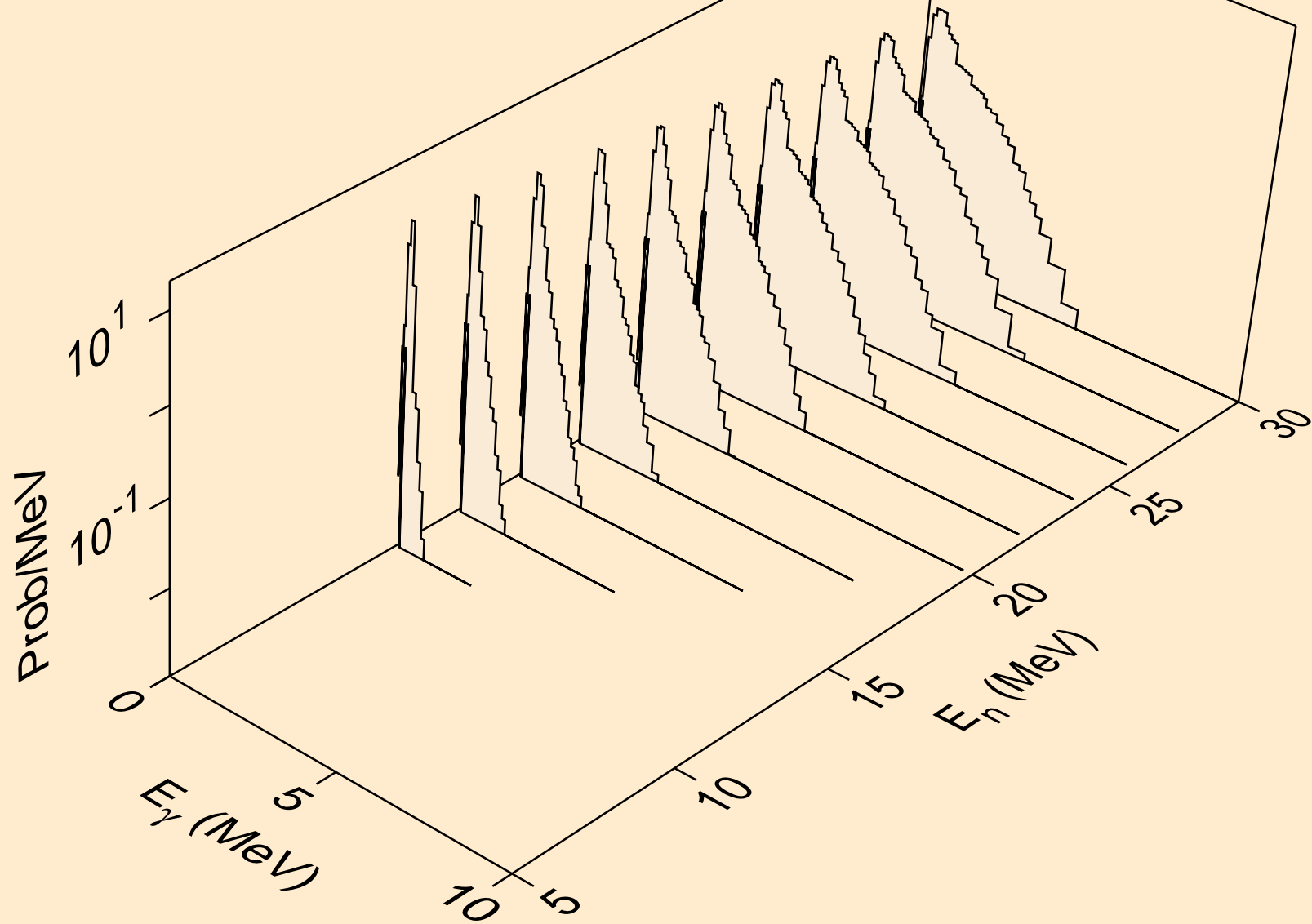

LR261 NEUTRON ACER TENDL-2021 LIBRARY; T=293.6K
Photon emission for (n,n*)t

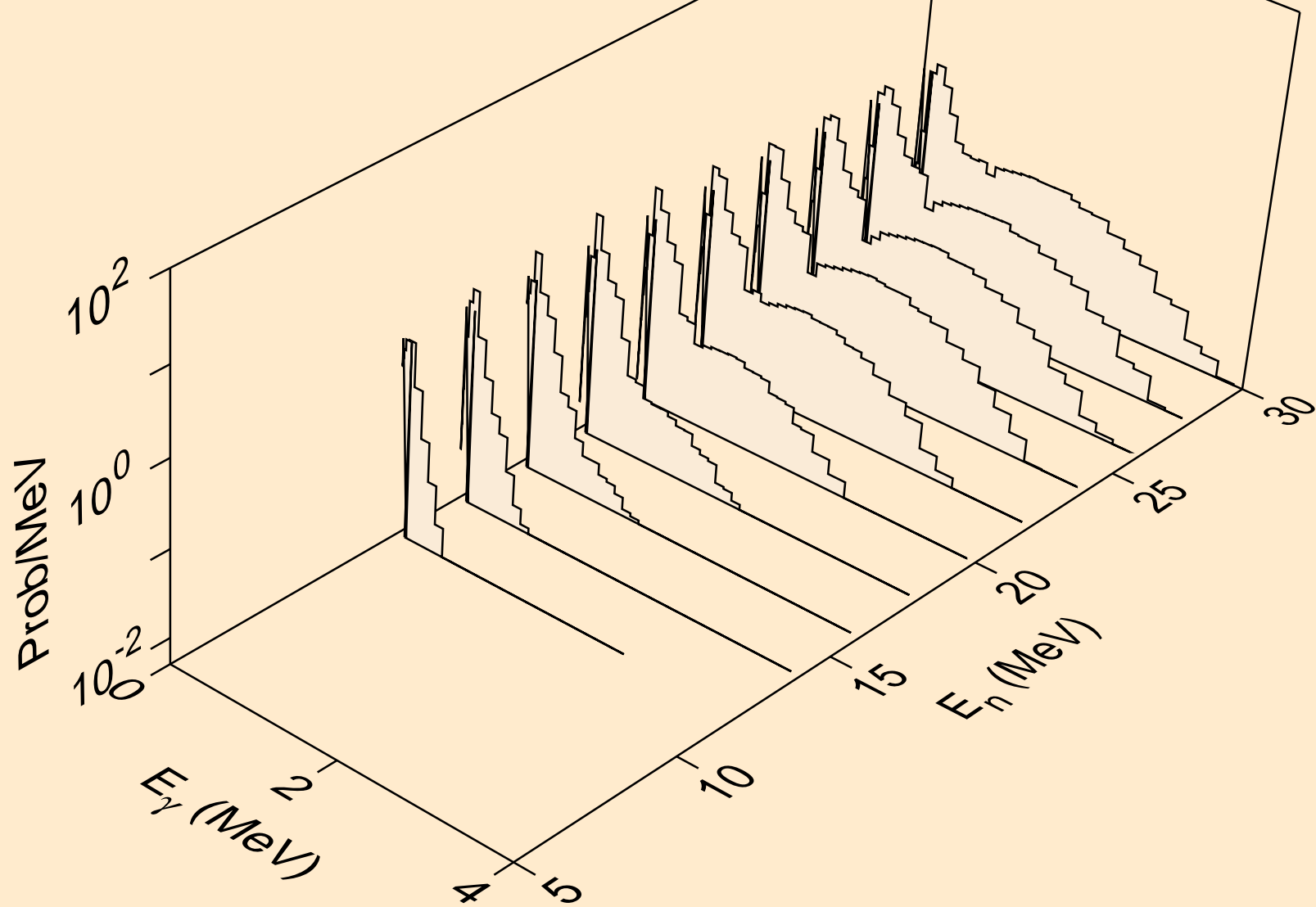

LR261 NEUTRON ACER TENDL-2021 LIBRARY; T=293.6K
Photon emission for (n,n*)he3

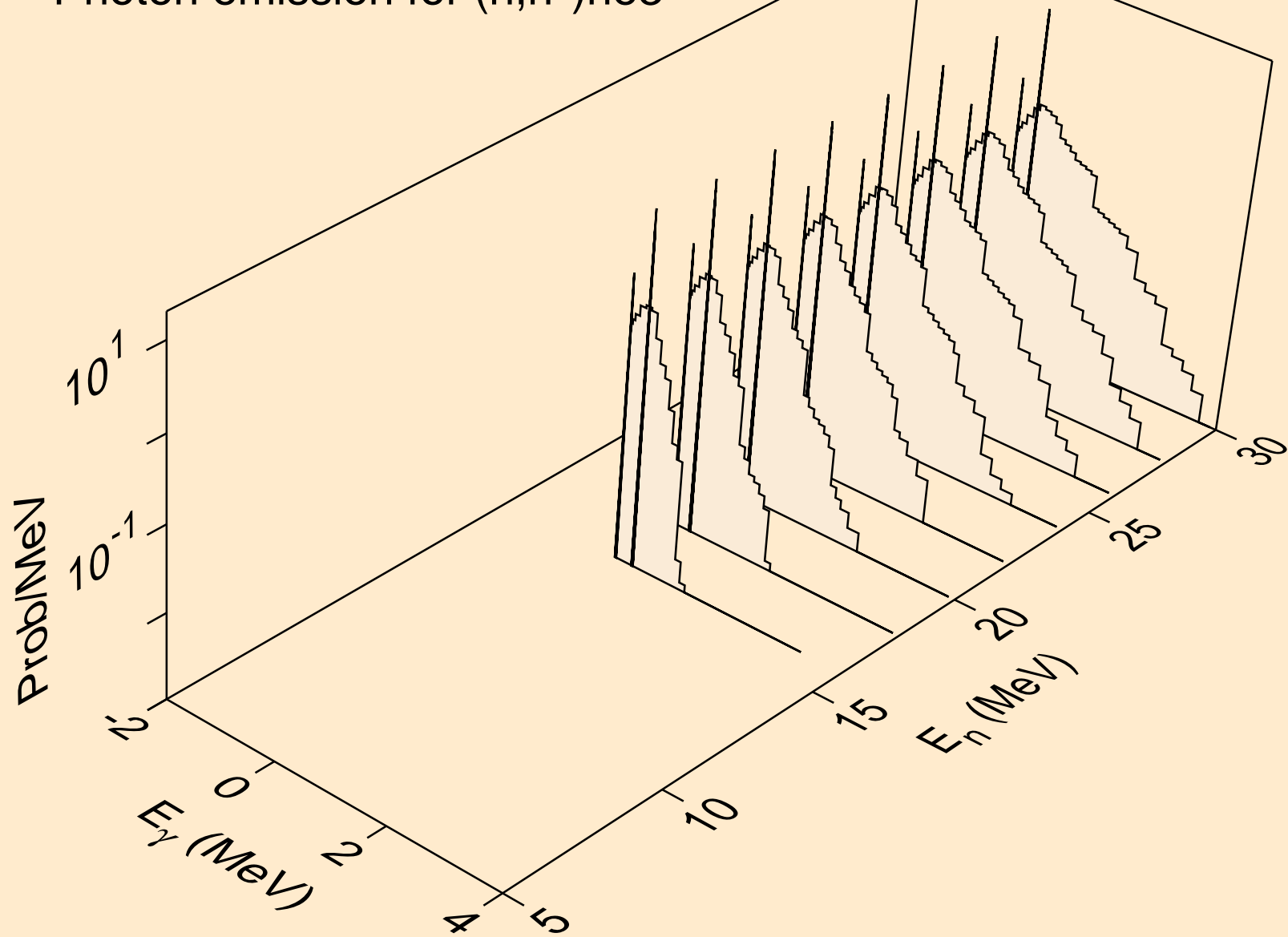

LR261 NEUTRON ACER TENDL-2021 LIBRARY; T=293.6K
Photon emission for (n,4n)

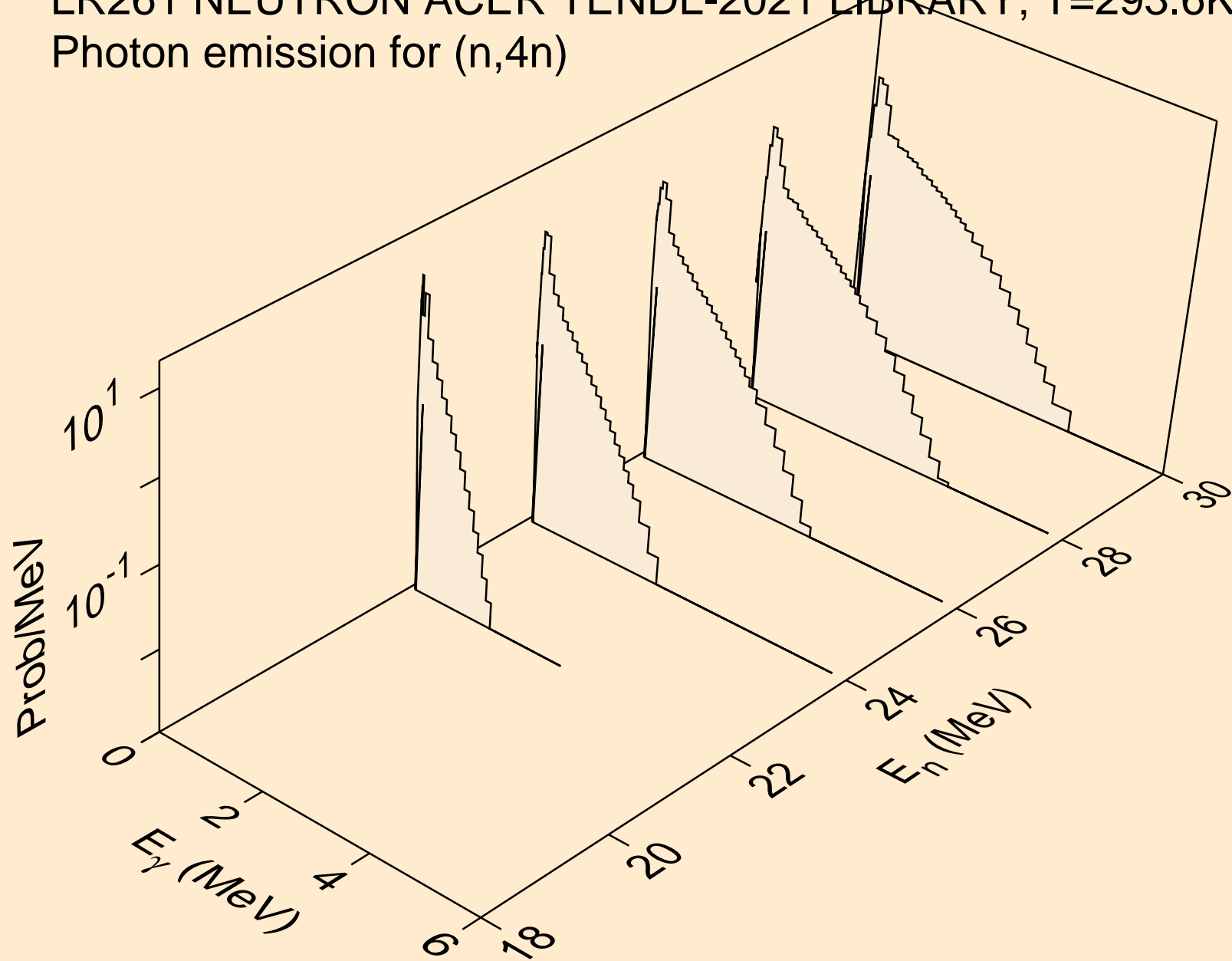

LR261 NEUTRON ACER TENDL-2021 LIBRARY; T=293.6K
Photon emission for (n,2np)

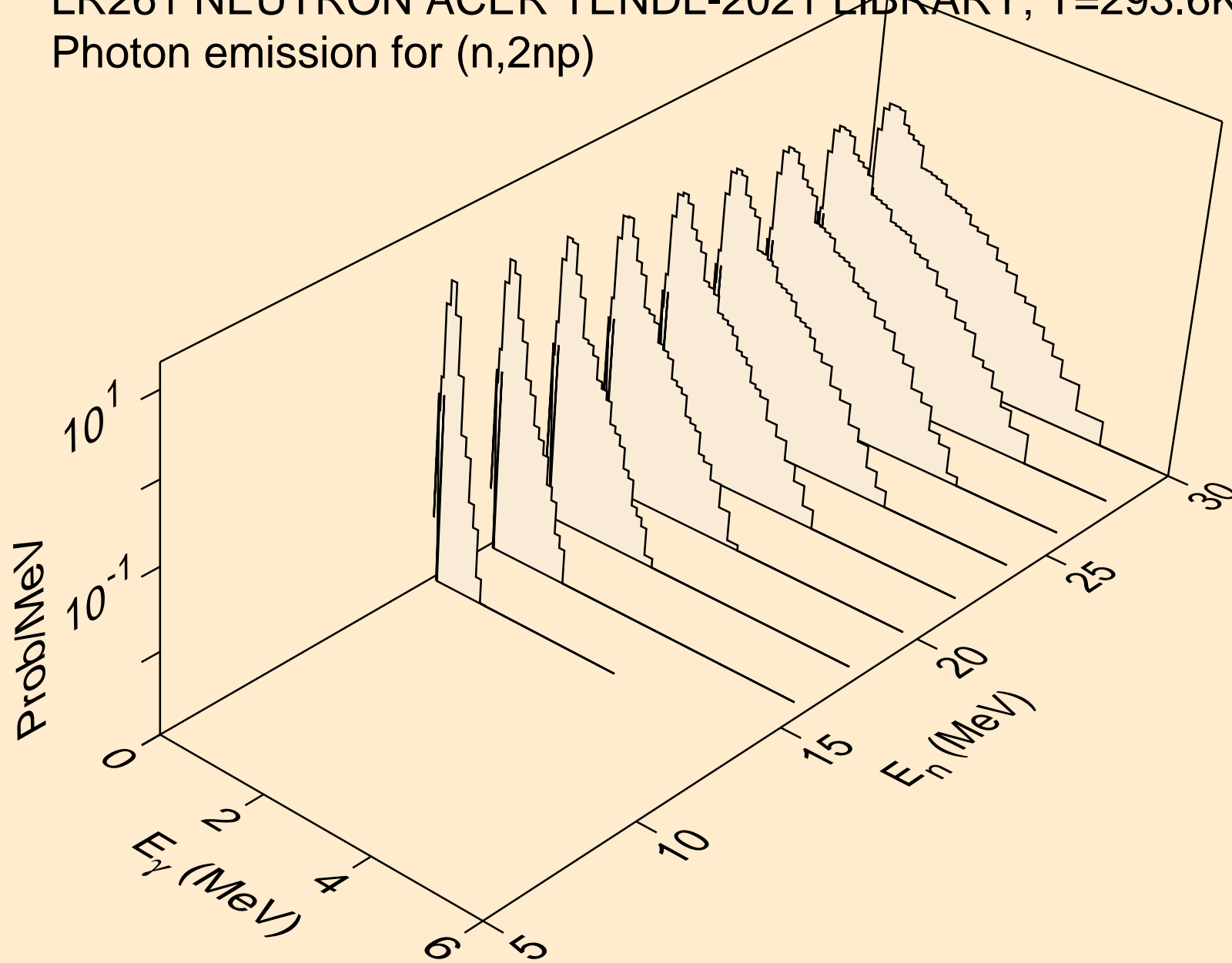

LR261 NEUTRON ACER TENDL-2021 LIBRARY; T=293.6K
Photon emission for (n,3np)

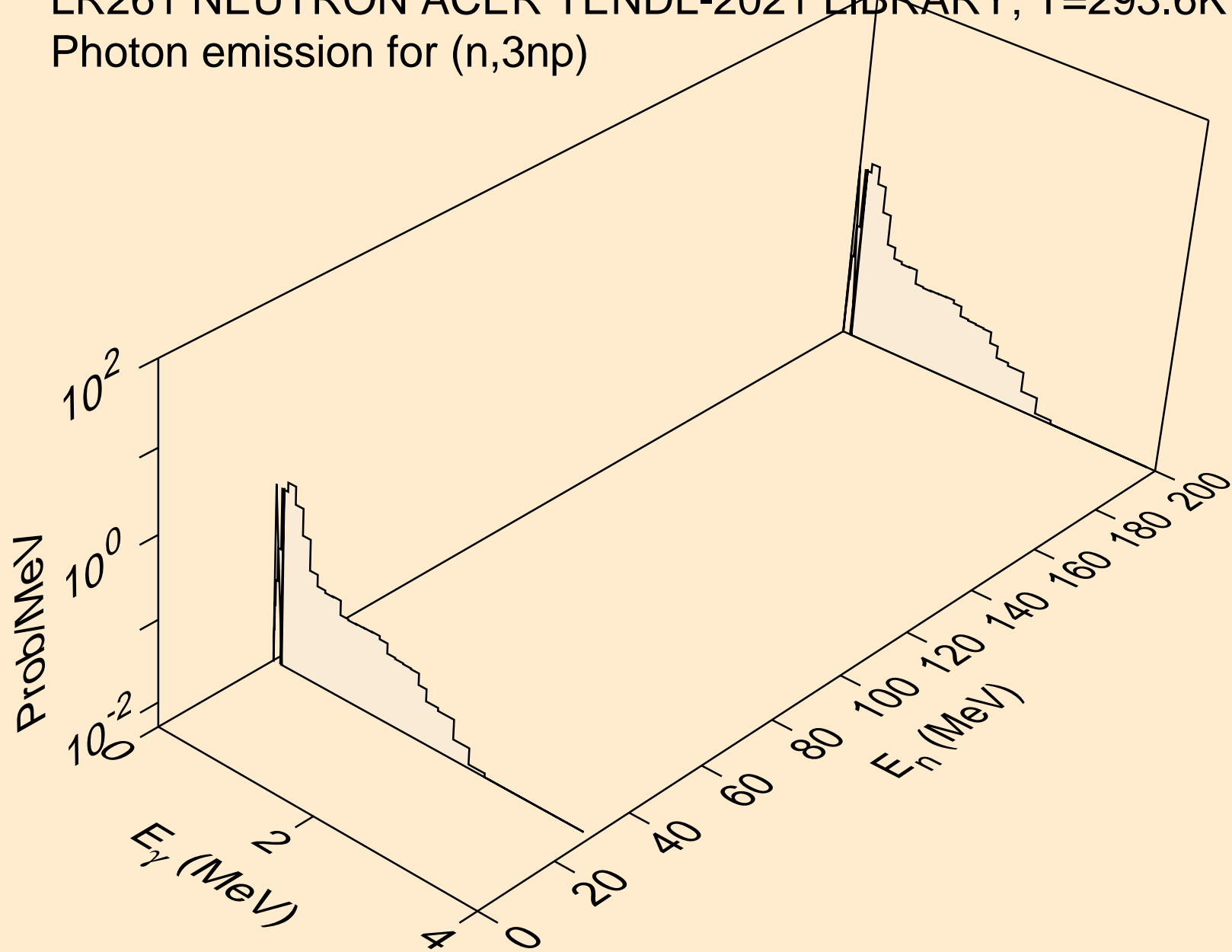

LR261 NEUTRON ACER TENDL-2021 LIBRARY; T=293.6K
Photon emission for (n,2np)

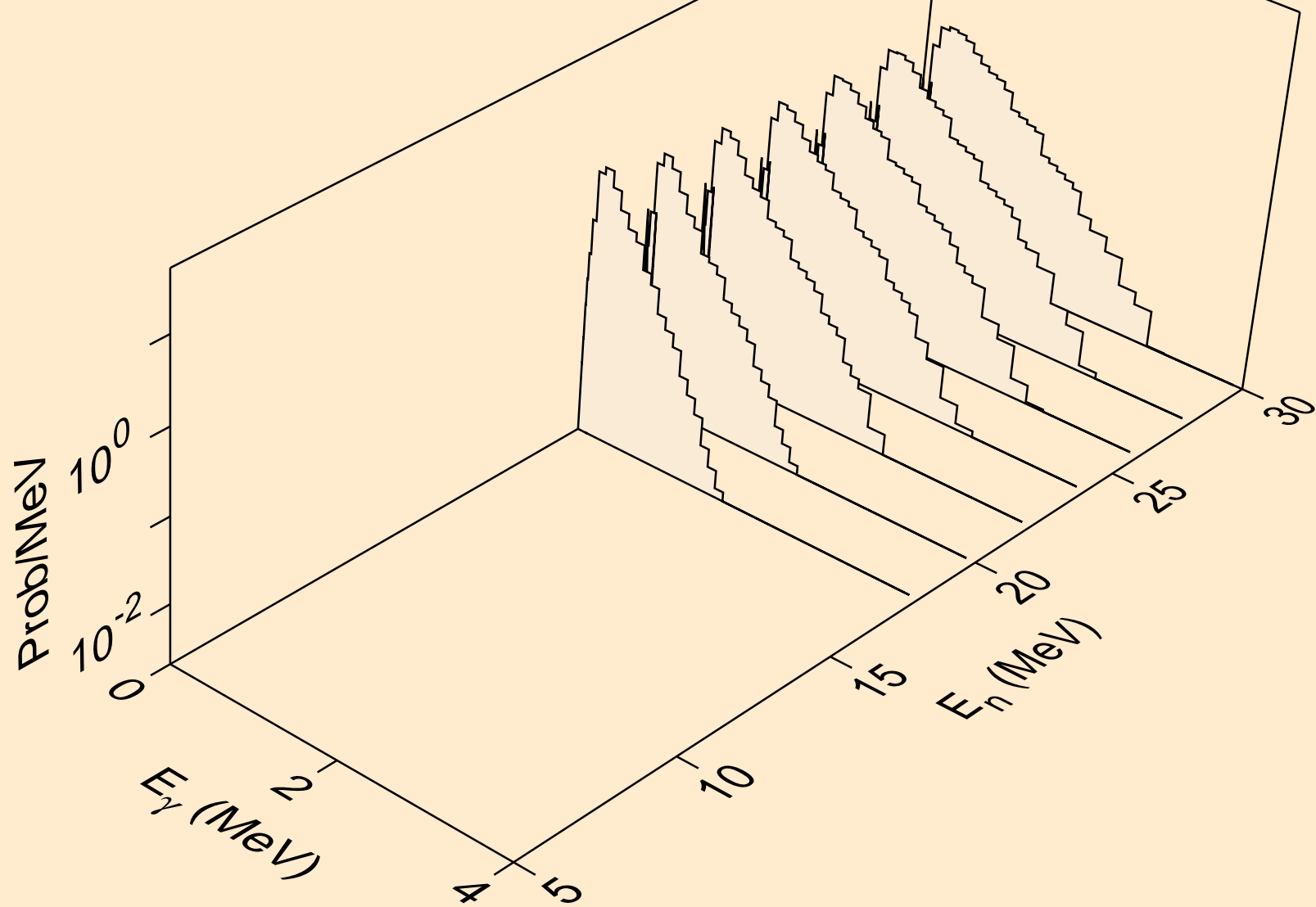

LR261 NEUTRON ACER TENDL-2021 LIBRARY; T=293.6K
Photon emission for (n,npa)

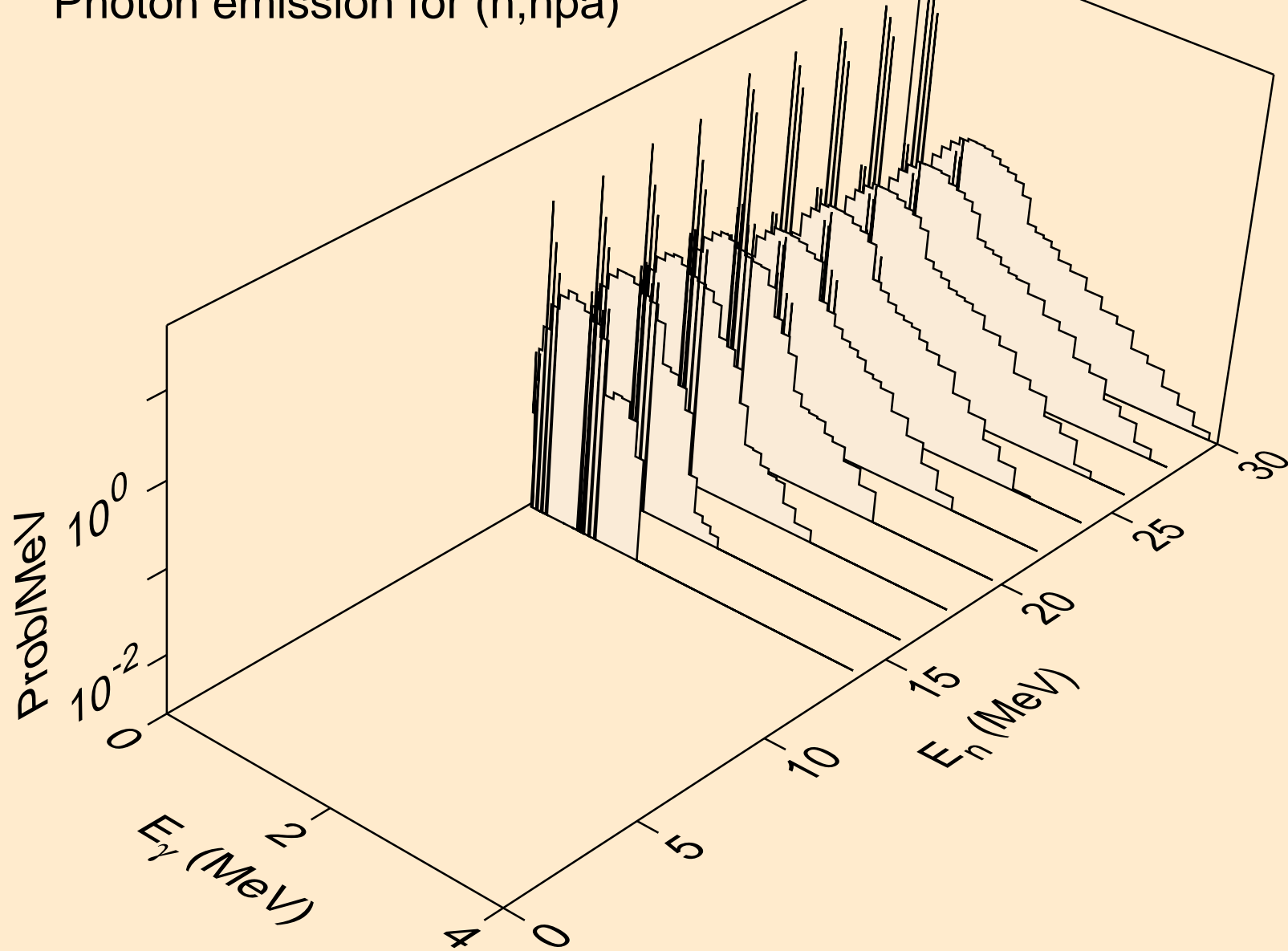

LR261 NEUTRON ACER TENDL-2021 LIBRARY; T=293.6K
Photon emission for (n,n*c)

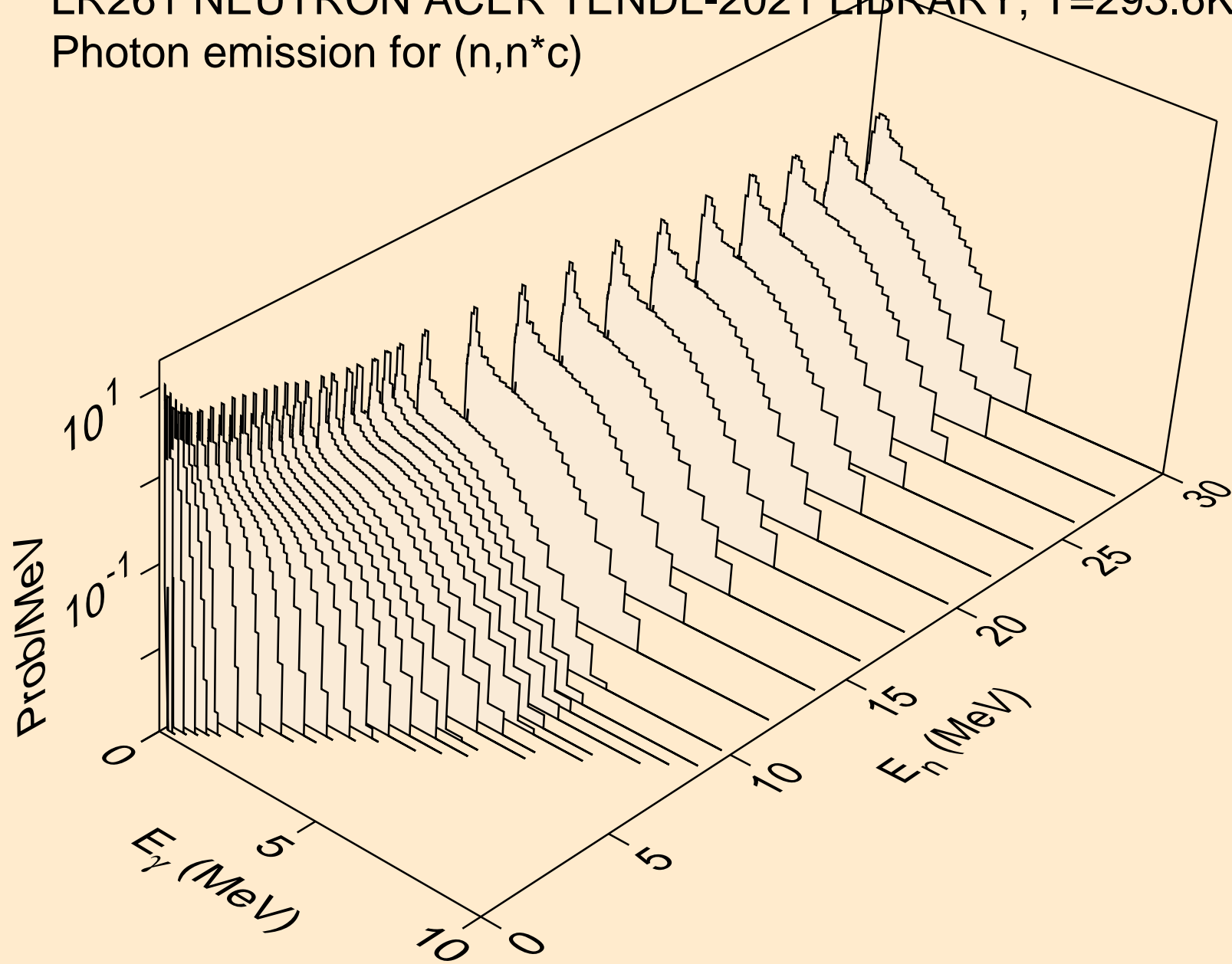

LR261 NEUTRON ACER TENDL-2021 LIBRARY; T=293.6K
Photon emission for (n,gma)

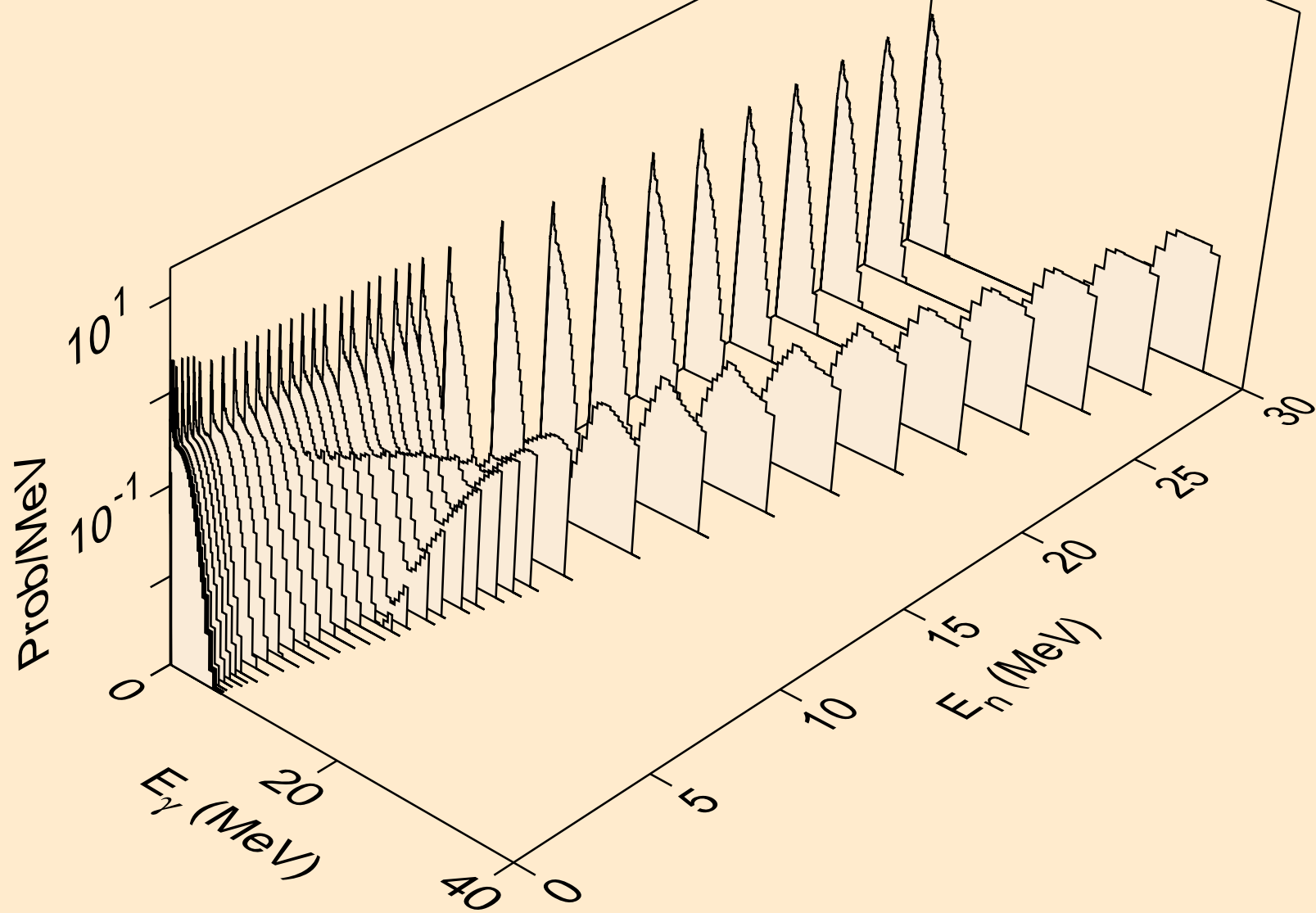

LR261 NEUTRON ACER TENDL-2021 LIBRARY; T=293.6K
Photon emission for (n,p)

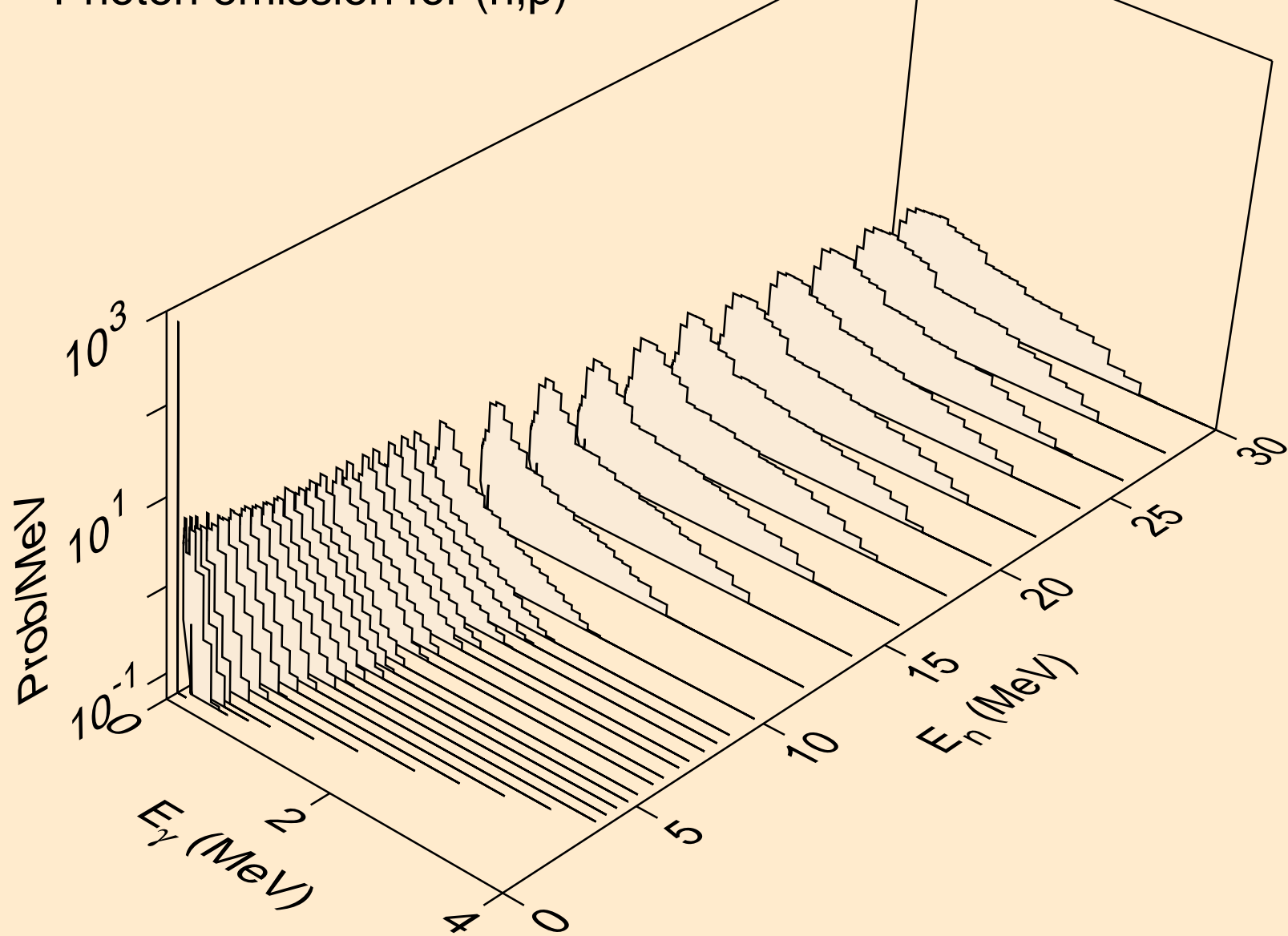

LR261 NEUTRON ACER TENDL-2021 LIBRARY; T=293.6K
Photon emission for (n,d)

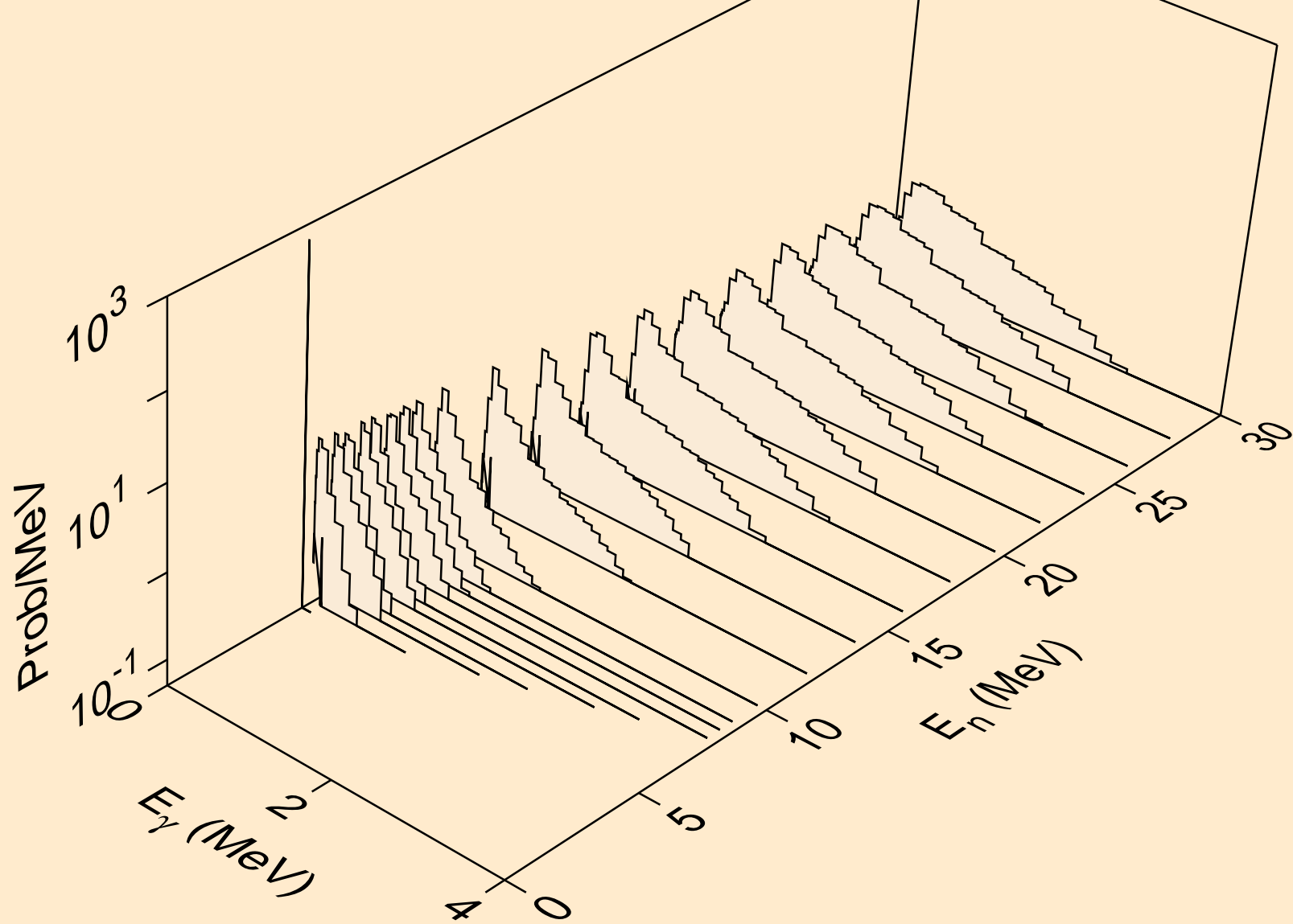

LR261 NEUTRON ACER TENDL-2021 LIBRARY; T=293.6K
Photon emission for (n,t)

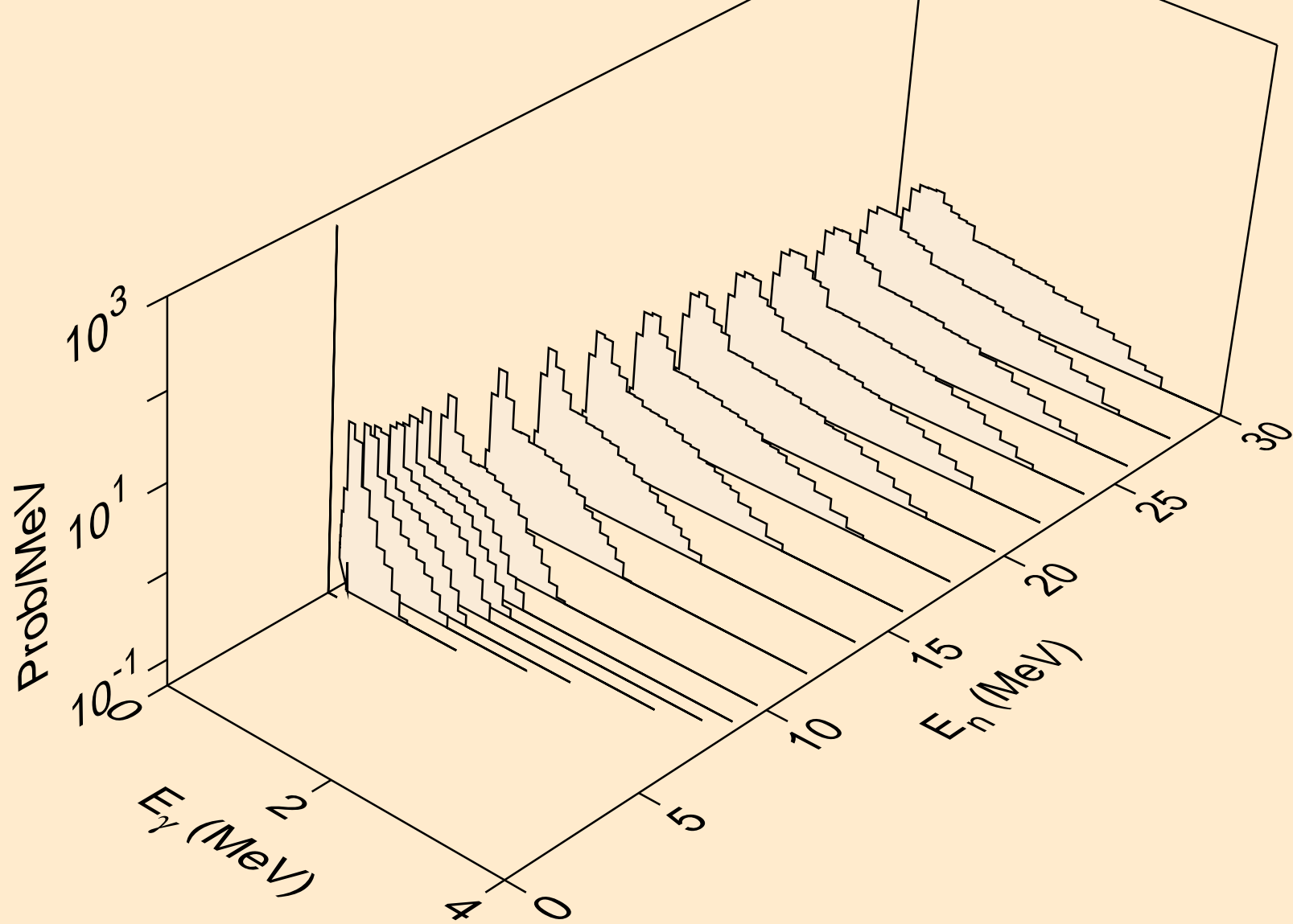

LR261 NEUTRON ACER TENDL-2021 LIBRARY; T=293.6K
Photon emission for (n,he3)

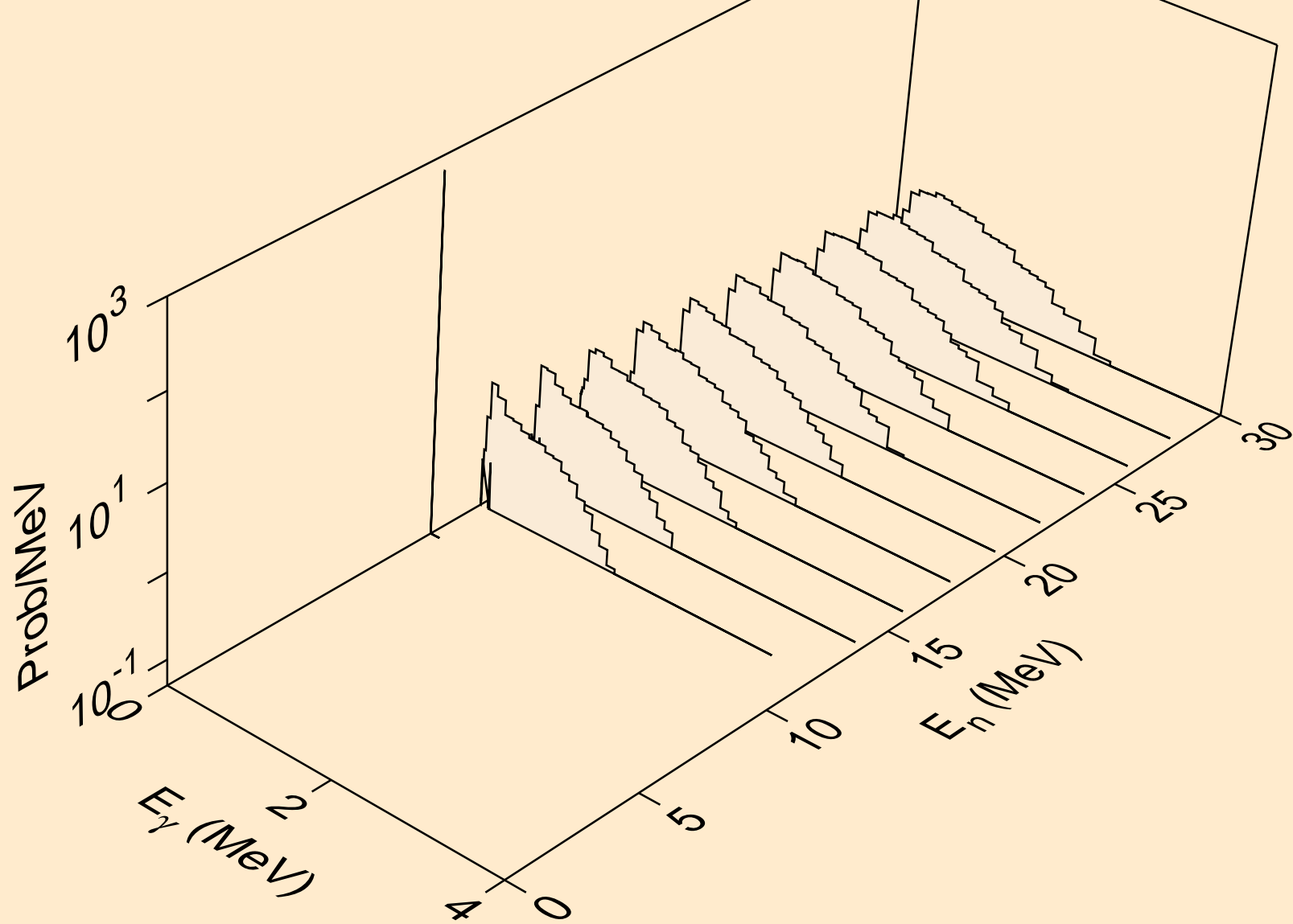

LR261 NEUTRON ACER TENDL-2021 LIBRARY; T=293.6K
Photon emission for (n,a)

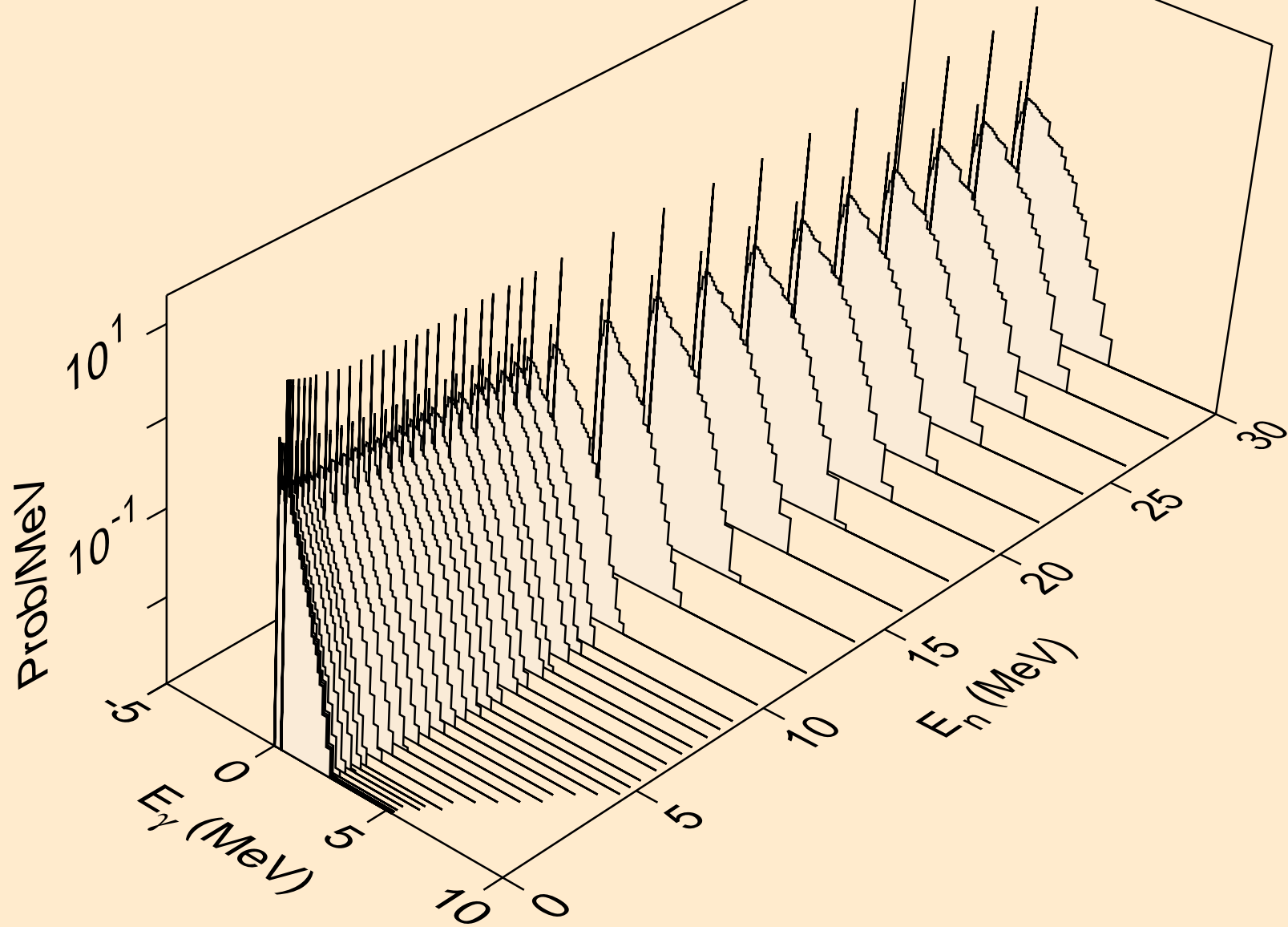

LR261 NEUTRON ACER TENDL-2021 LIBRARY; T=293.6K
Photon emission for (n,2a)

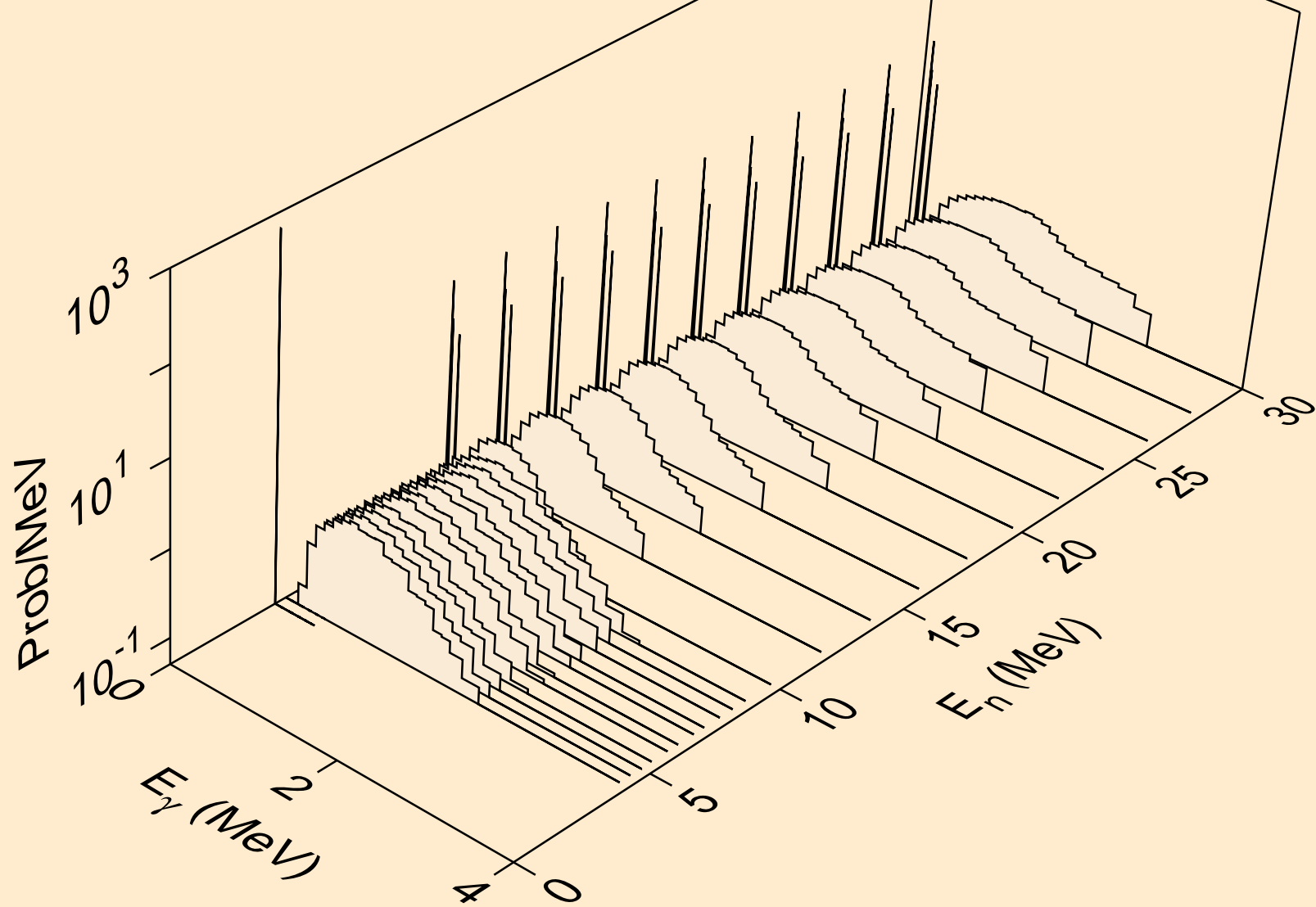

LR261 NEUTRON ACER TENDL-2021 LIBRARY; T=293.6K
Photon emission for (n,2p)

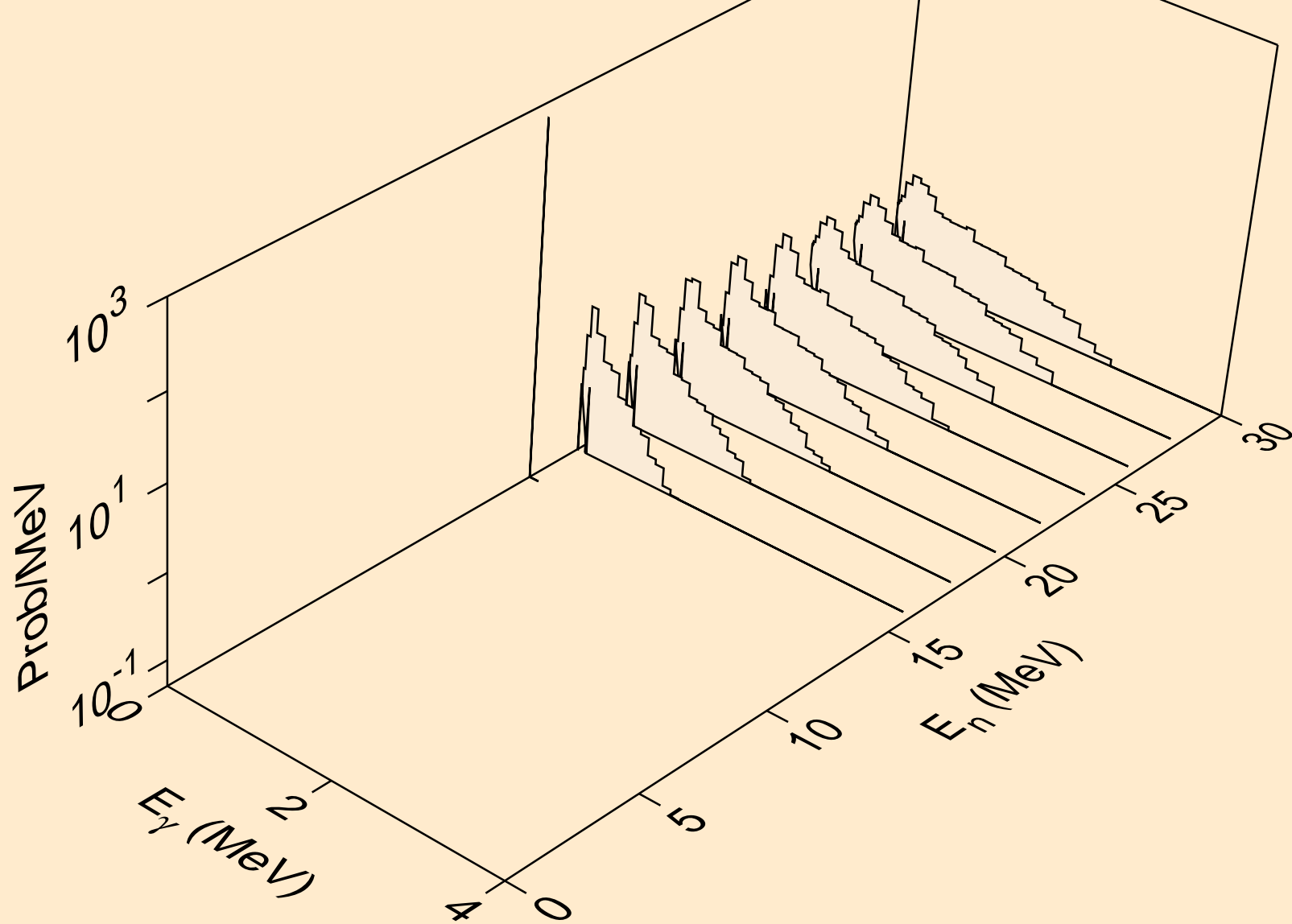

LR261 NEUTRON ACER TENDL-2021 LIBRARY; T=293.6K
Photon emission for (n,p)

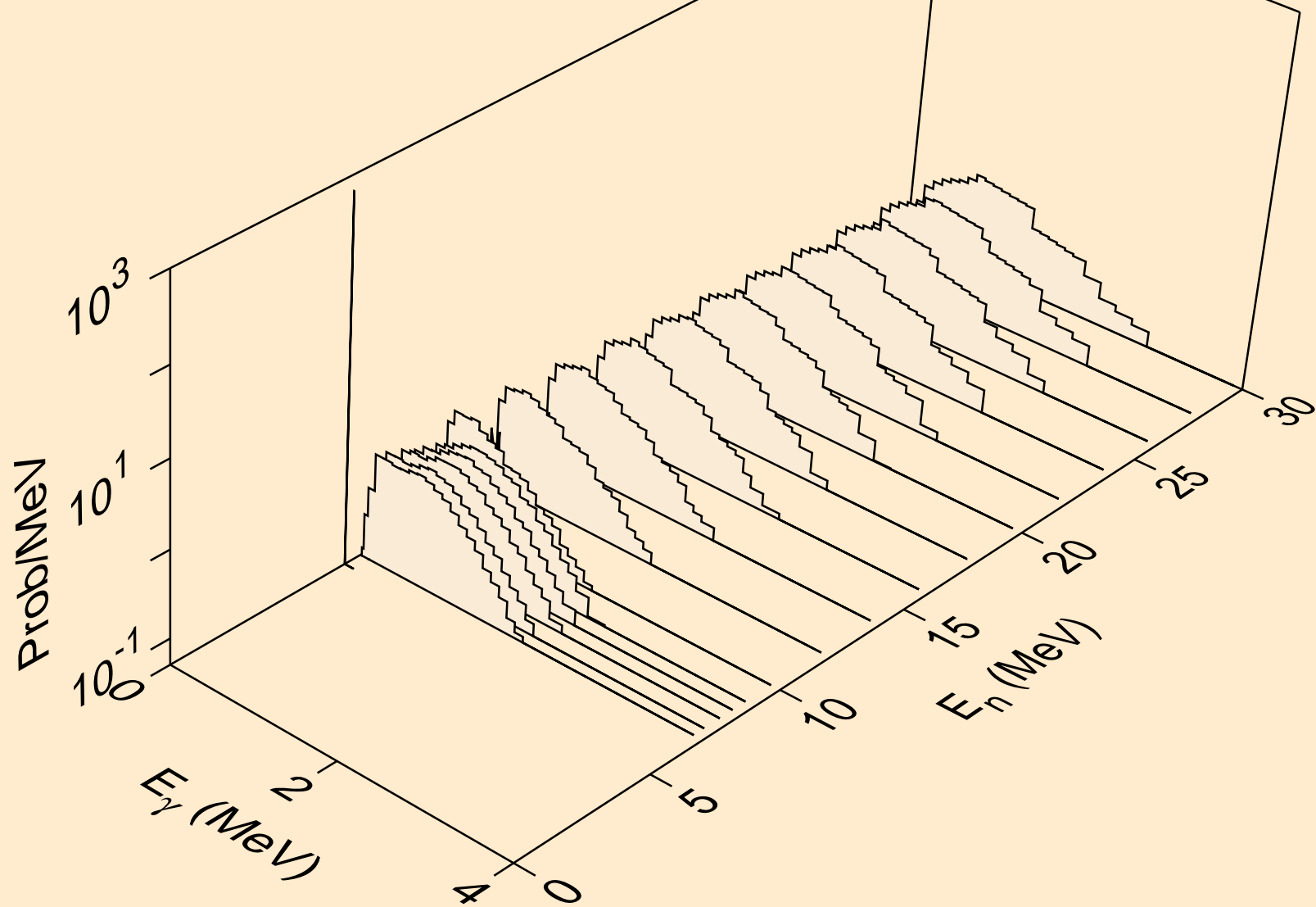

LR261 NEUTRON ACER TENDL-2021 LIBRARY; T=293.6K
Photon emission for (n,da)

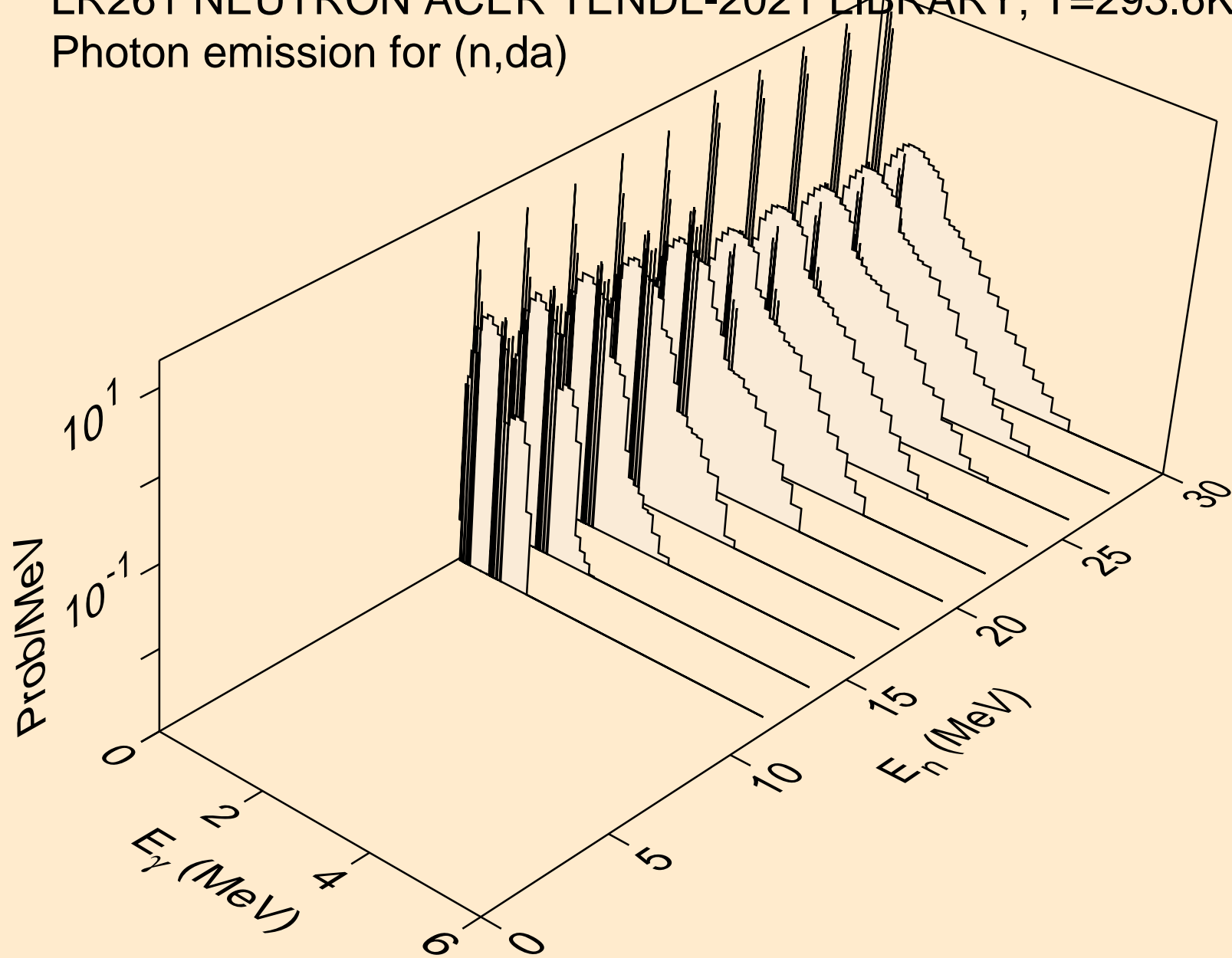

LR261 NEUTRON ACER TENDL-2021 LIBRARY; T=293.6K
thermal capture photon spectrum

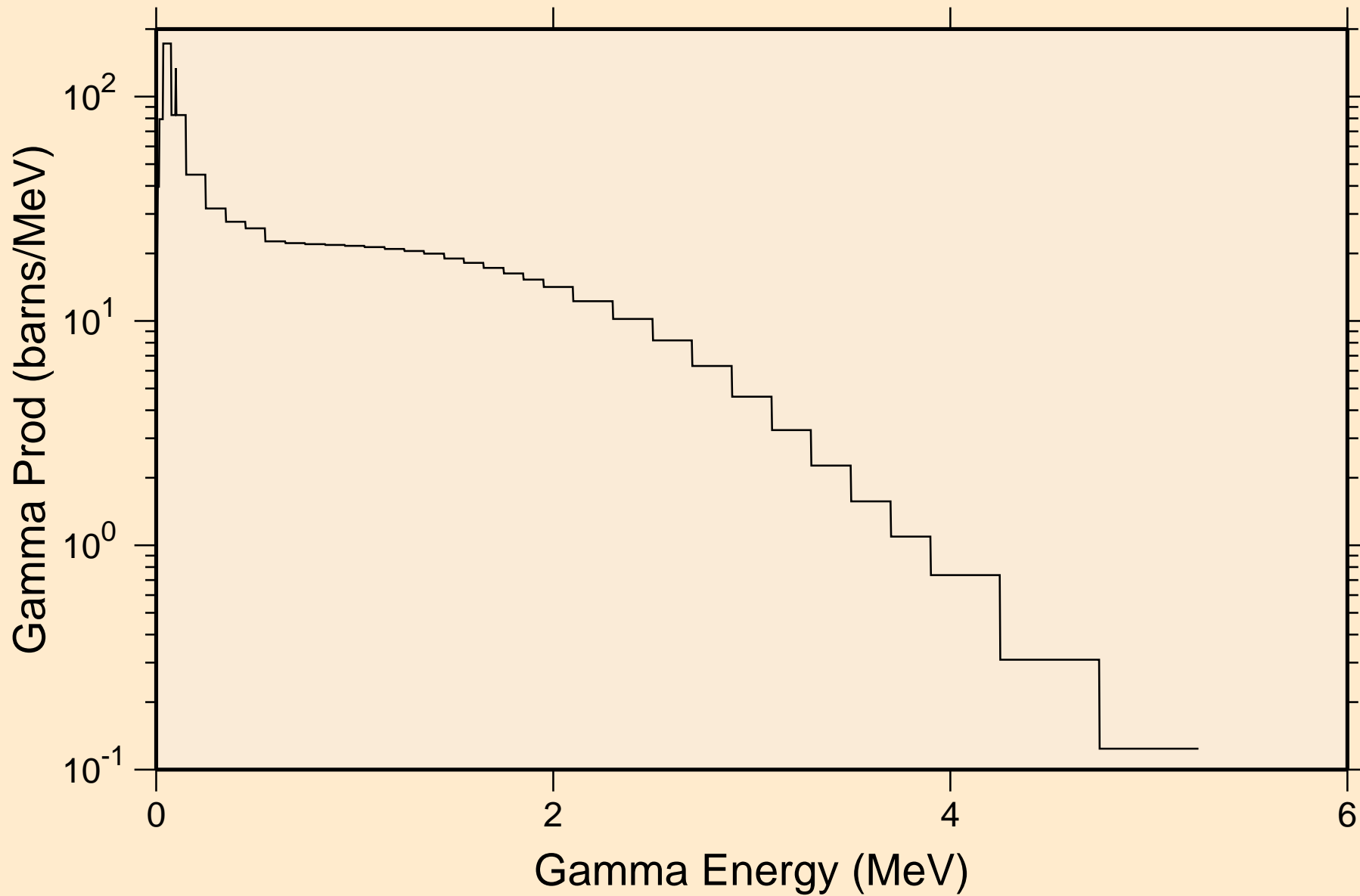

LR261 NEUTRON ACER TENDL-2021 LIBRARY; T=293.6K
14 MeV photon spectrum

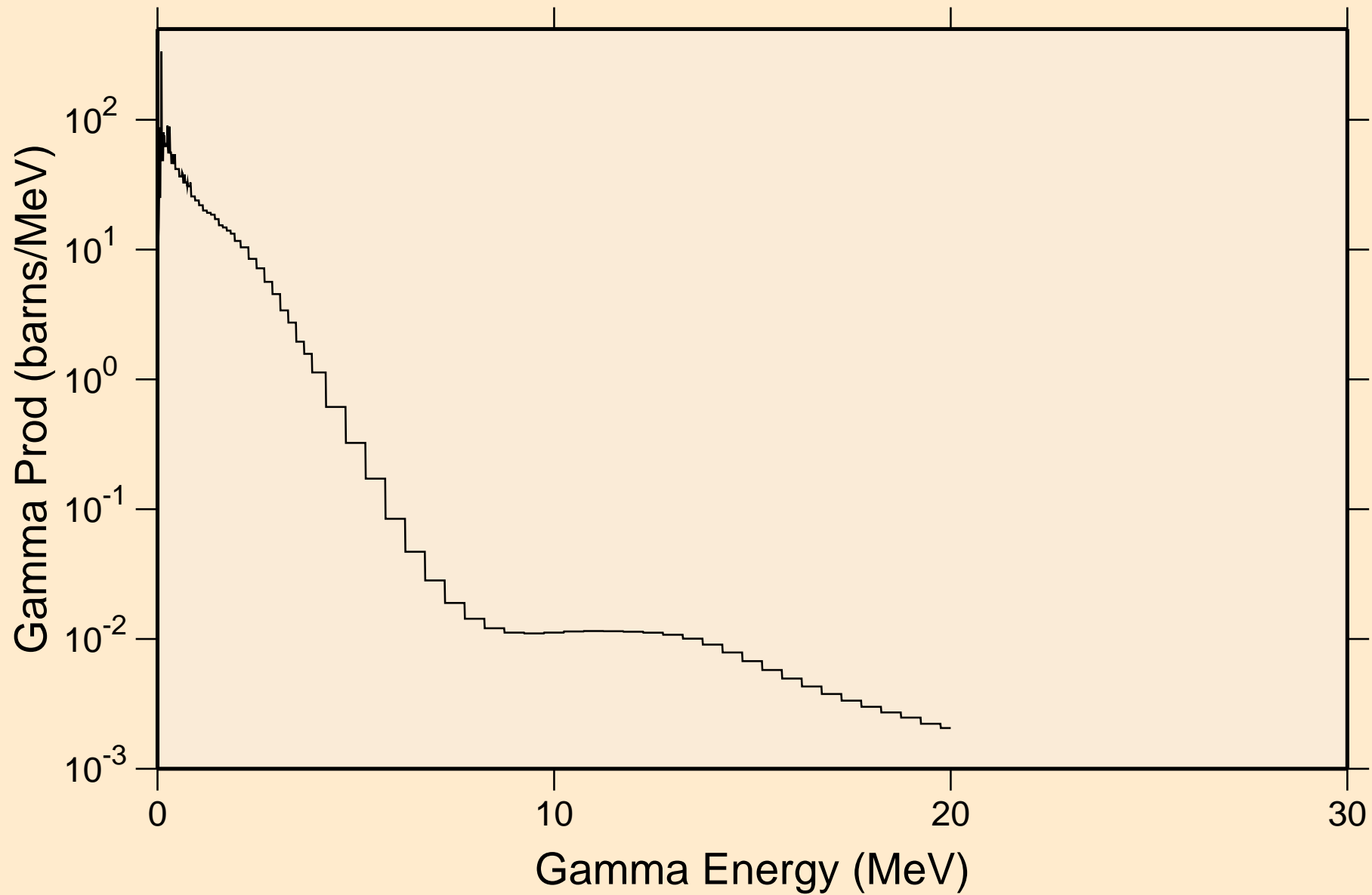

LR261 NEUTRON ACER TENDL-2021 LIBRARY; T=293.6K
Particle heating contributions

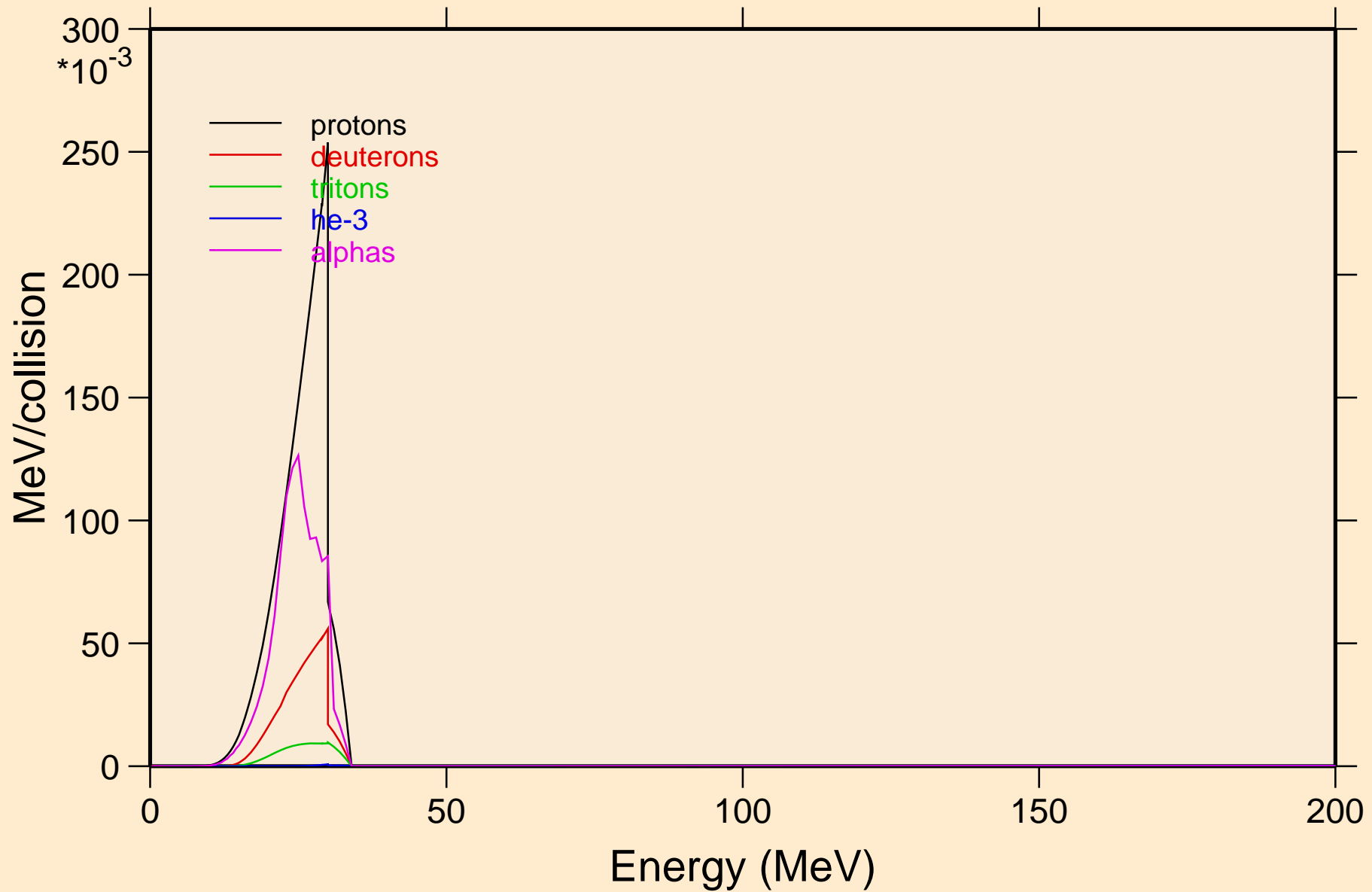

LR261 NEUTRON ACER TENDL-2021 LIBRARY; T=293.6K
Recoil Heating

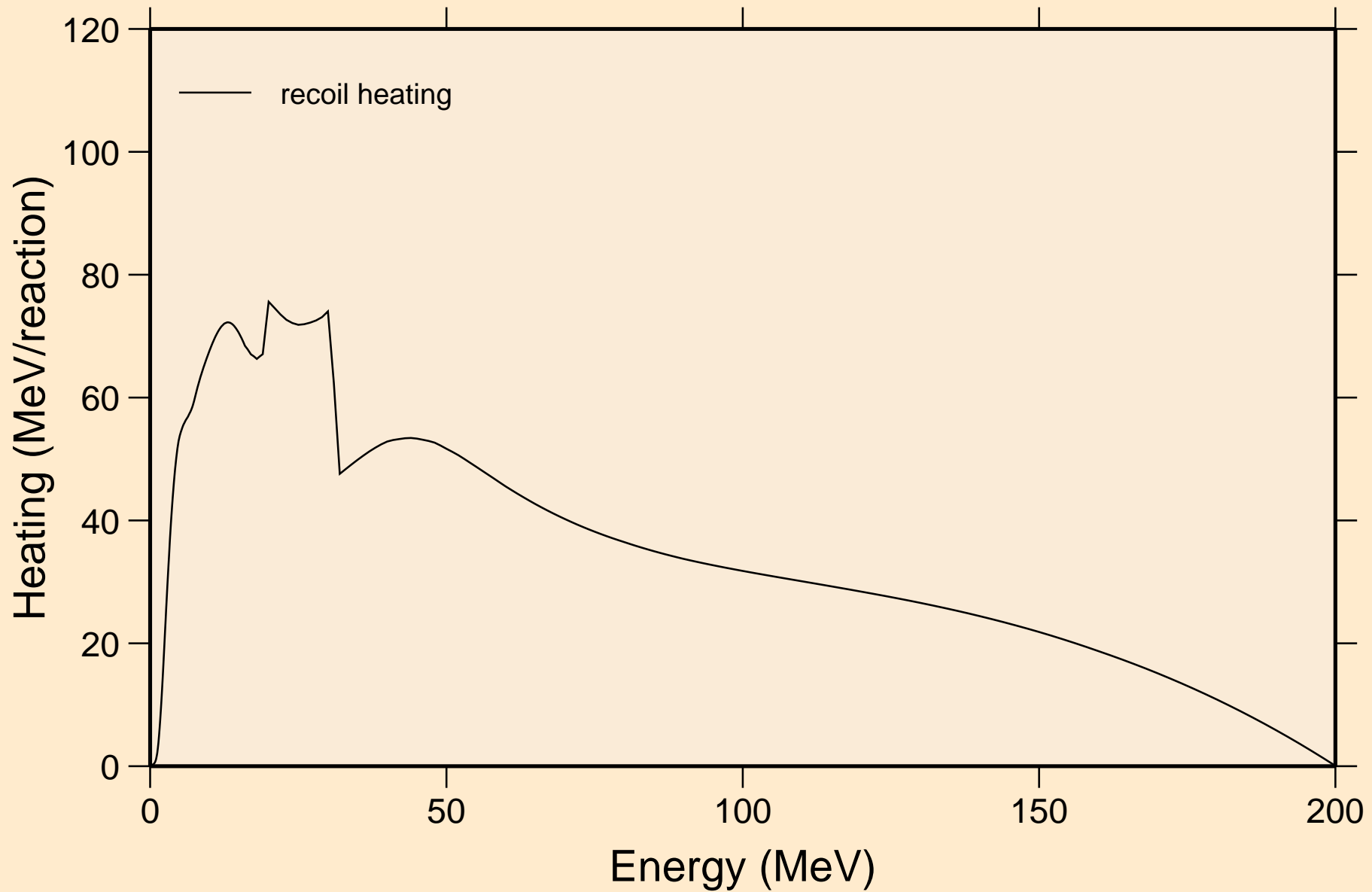

LR261 NEUTRON ACER TENDL-2021 LIBRARY; T=293.6K

Particle production cross sections

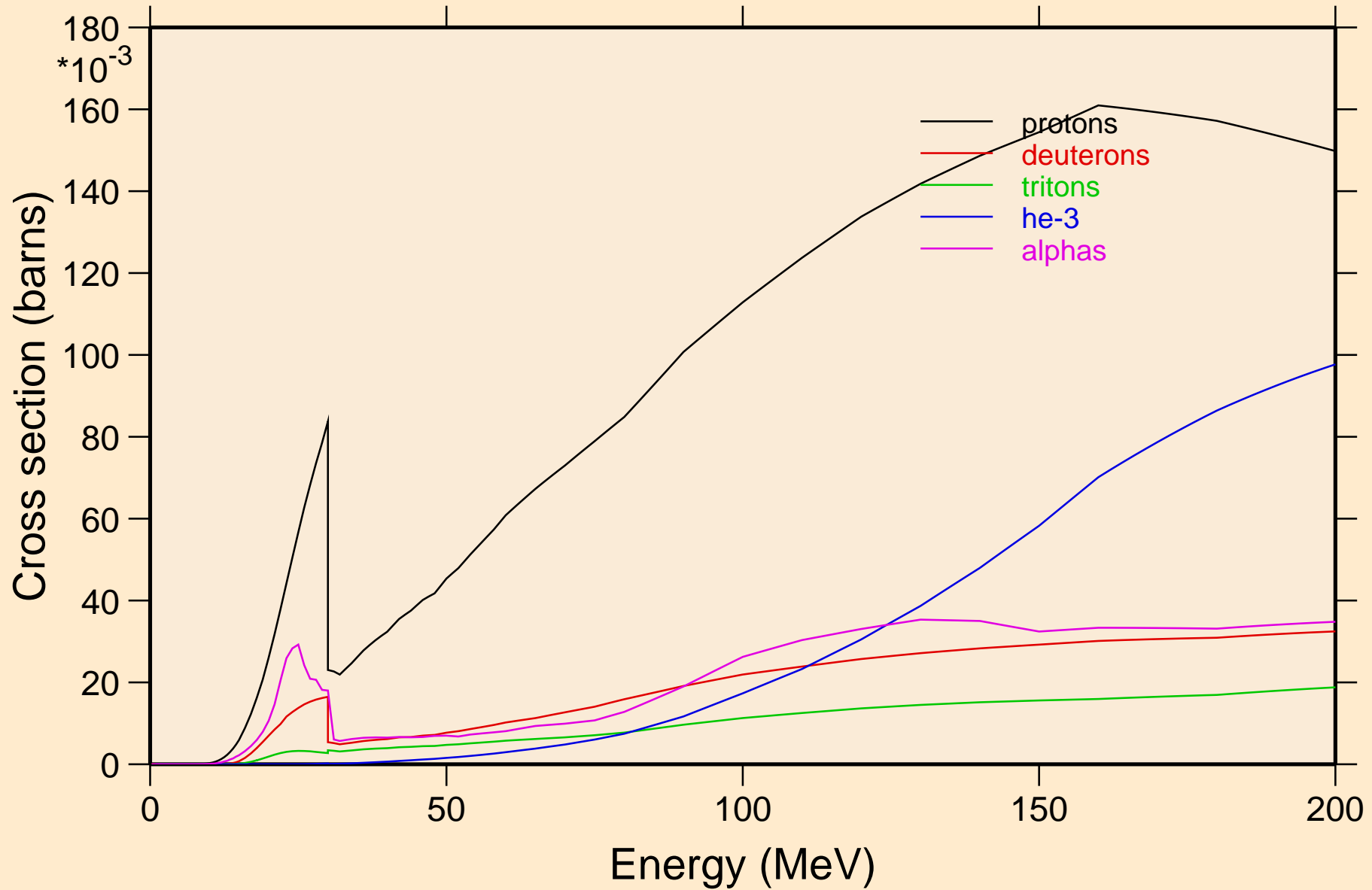

LR261 NEUTRON ACER TENDL-2021 LIBRARY; T=293.6K
protons from (n,x)

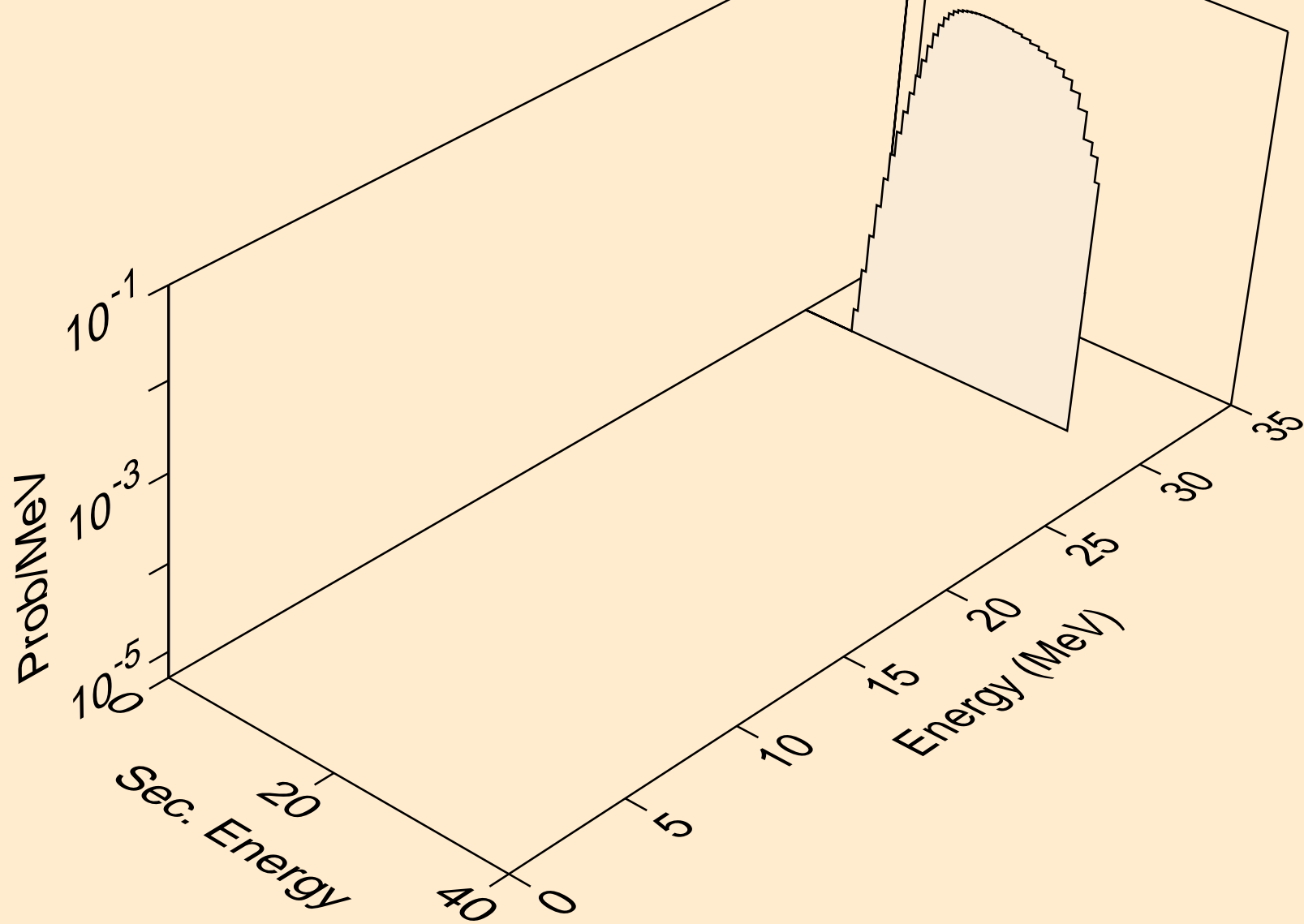

LR261 NEUTRON ACER TENDL-2021 LIBRARY; T=293.6K
protons from (n,n*)p

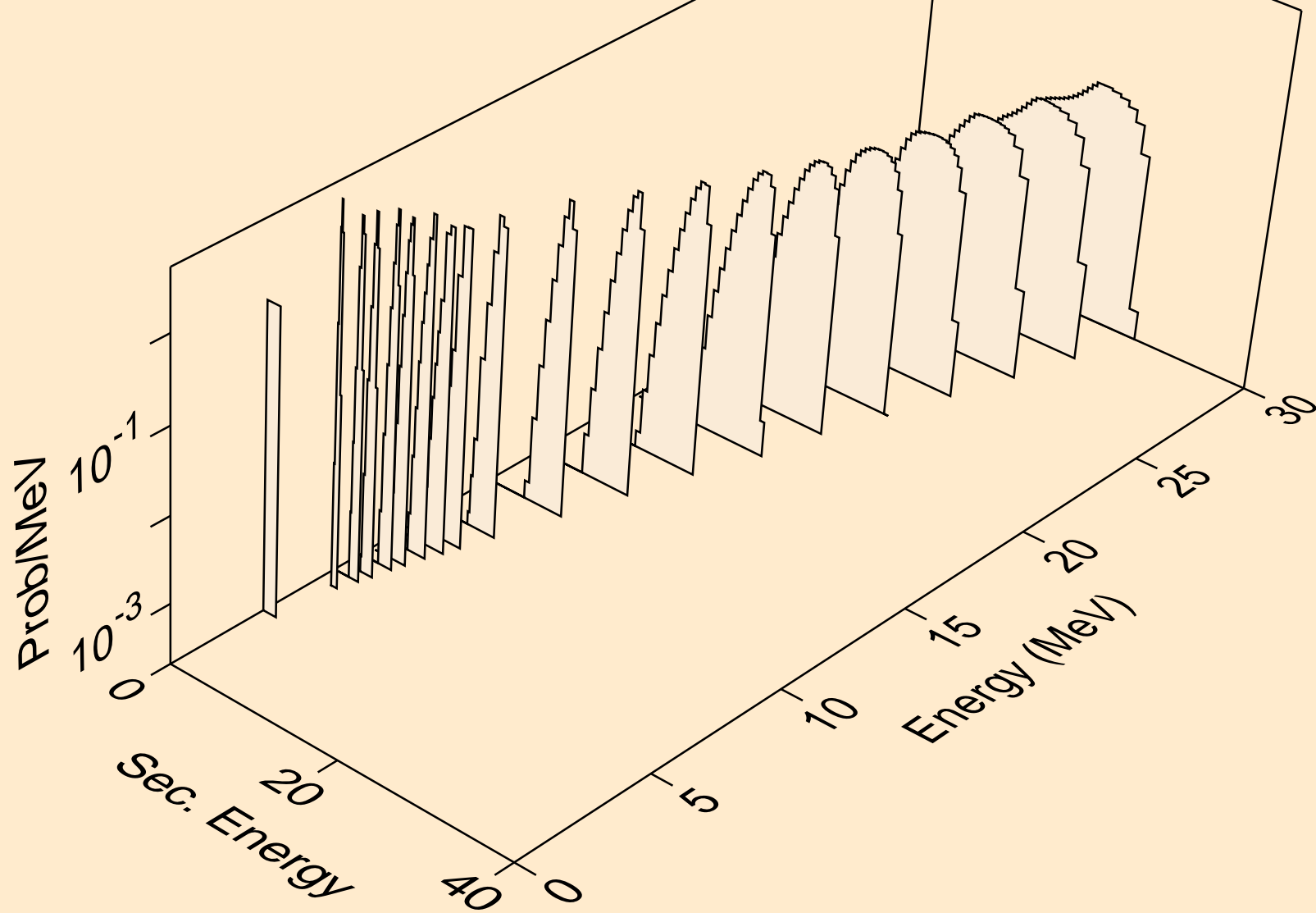

LR261 NEUTRON ACER TENDL-2021 LIBRARY; T=293.6K
protons from (n,2np)

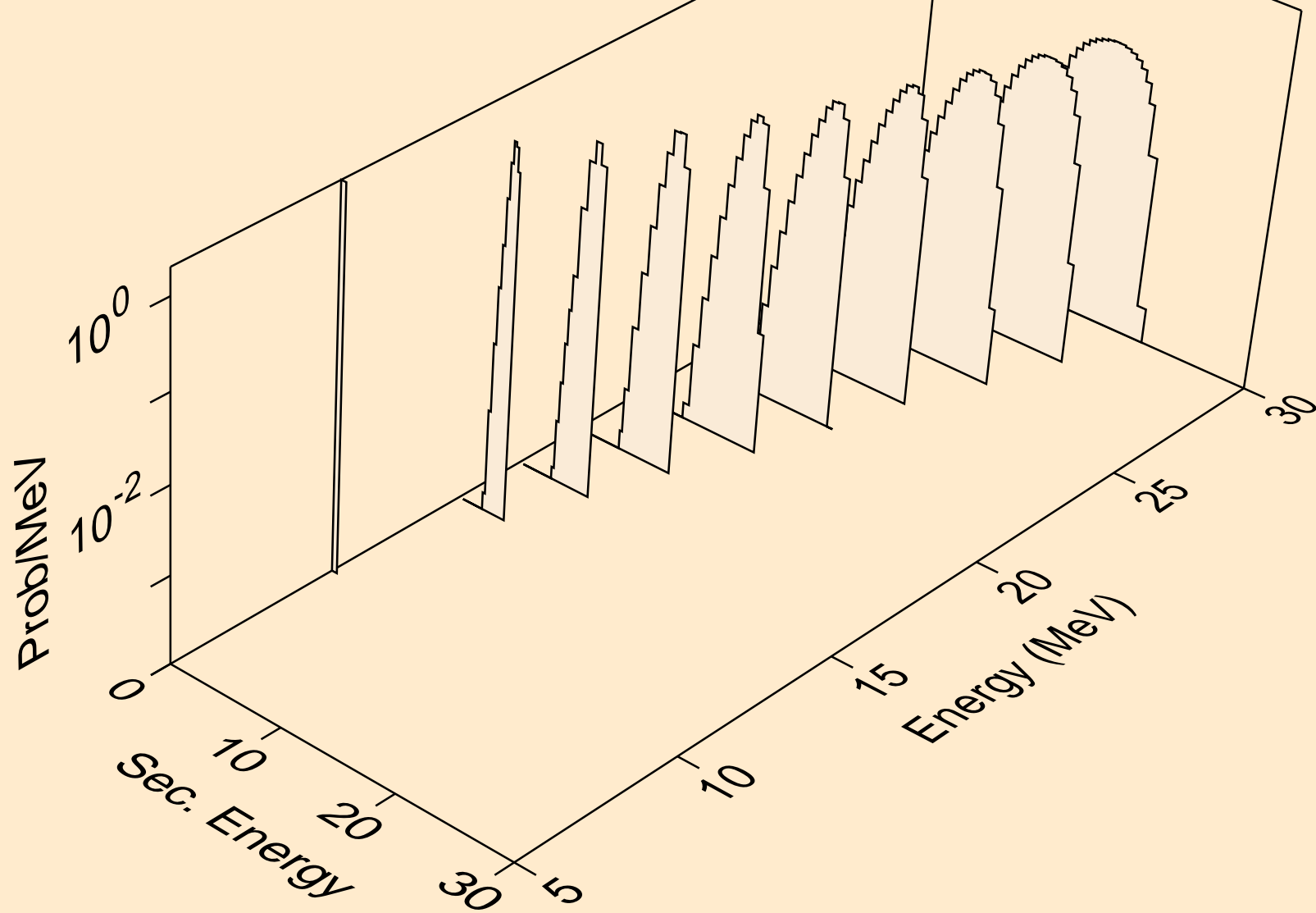

LR261 NEUTRON ACER TENDL-2021 LIBRARY; T=293.6K
protons from (n,3np)

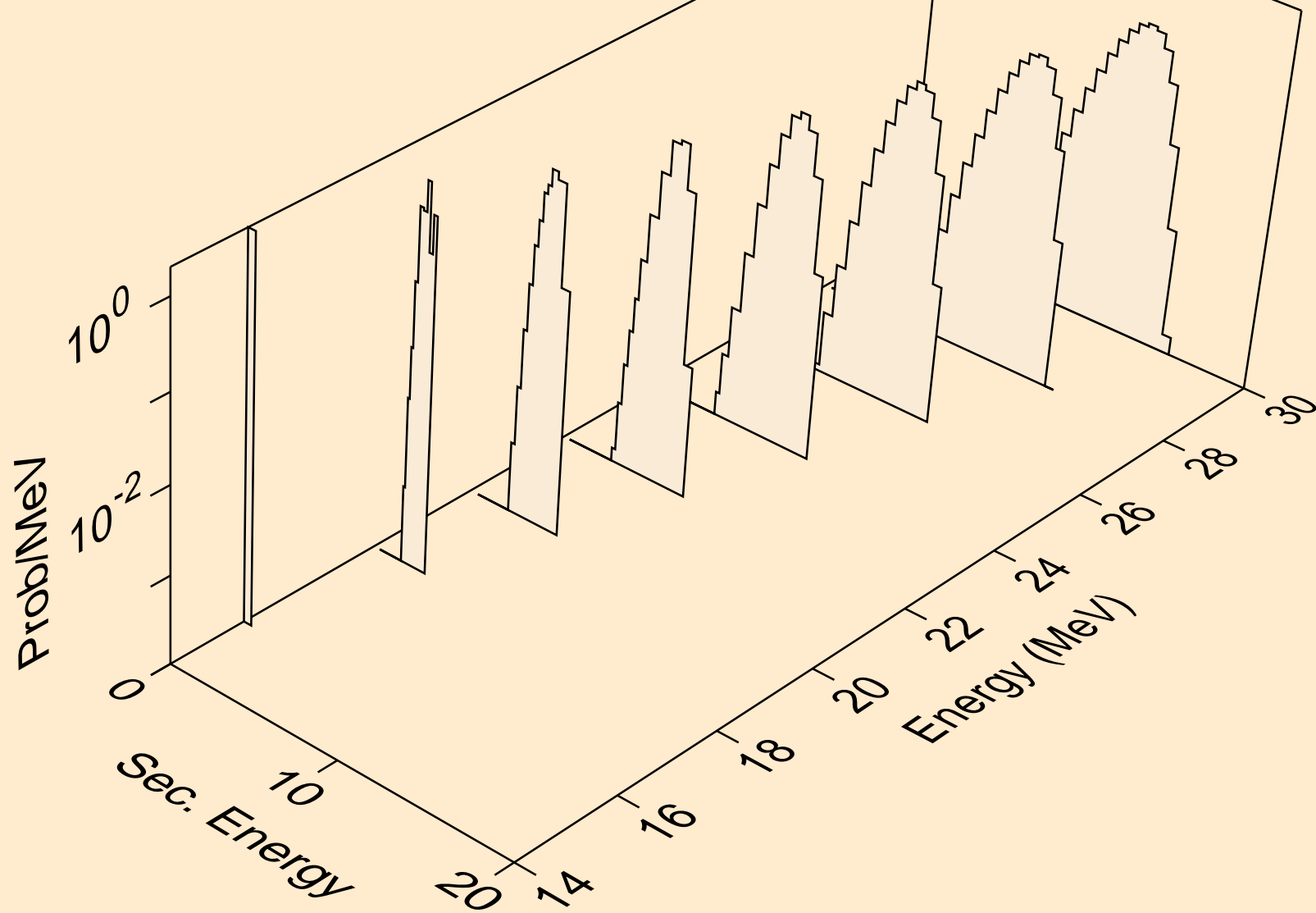

LR261 NEUTRON ACER TENDL-2021 LIBRARY; T=293.6K
protons from (n,2np)

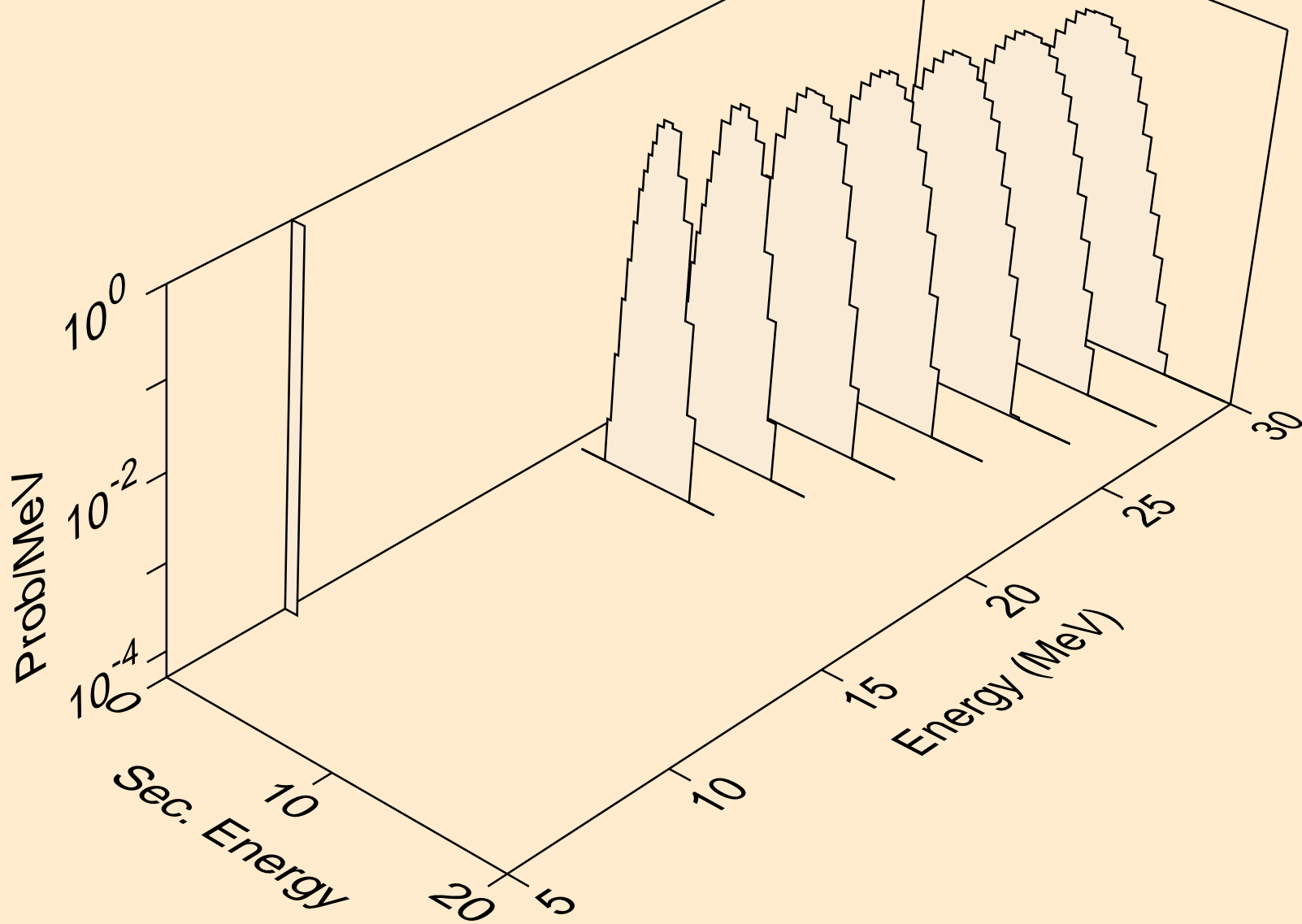

LR261 NEUTRON ACER TENDL-2021 LIBRARY; T=293.6K
protons from (n,npa)

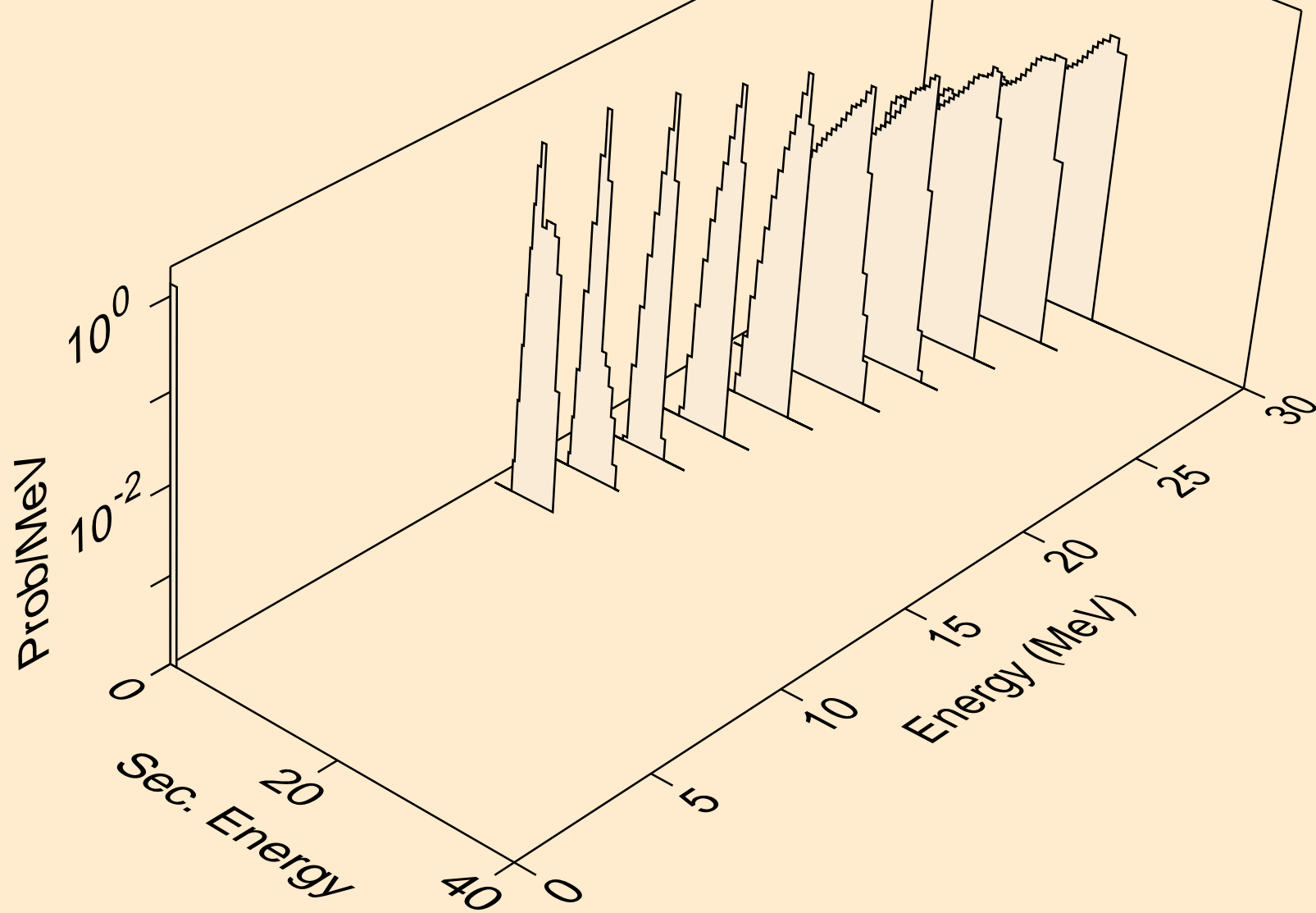

LR261 NEUTRON ACER TENDL-2021 LIBRARY; T=293.6K
protons from (n,p)

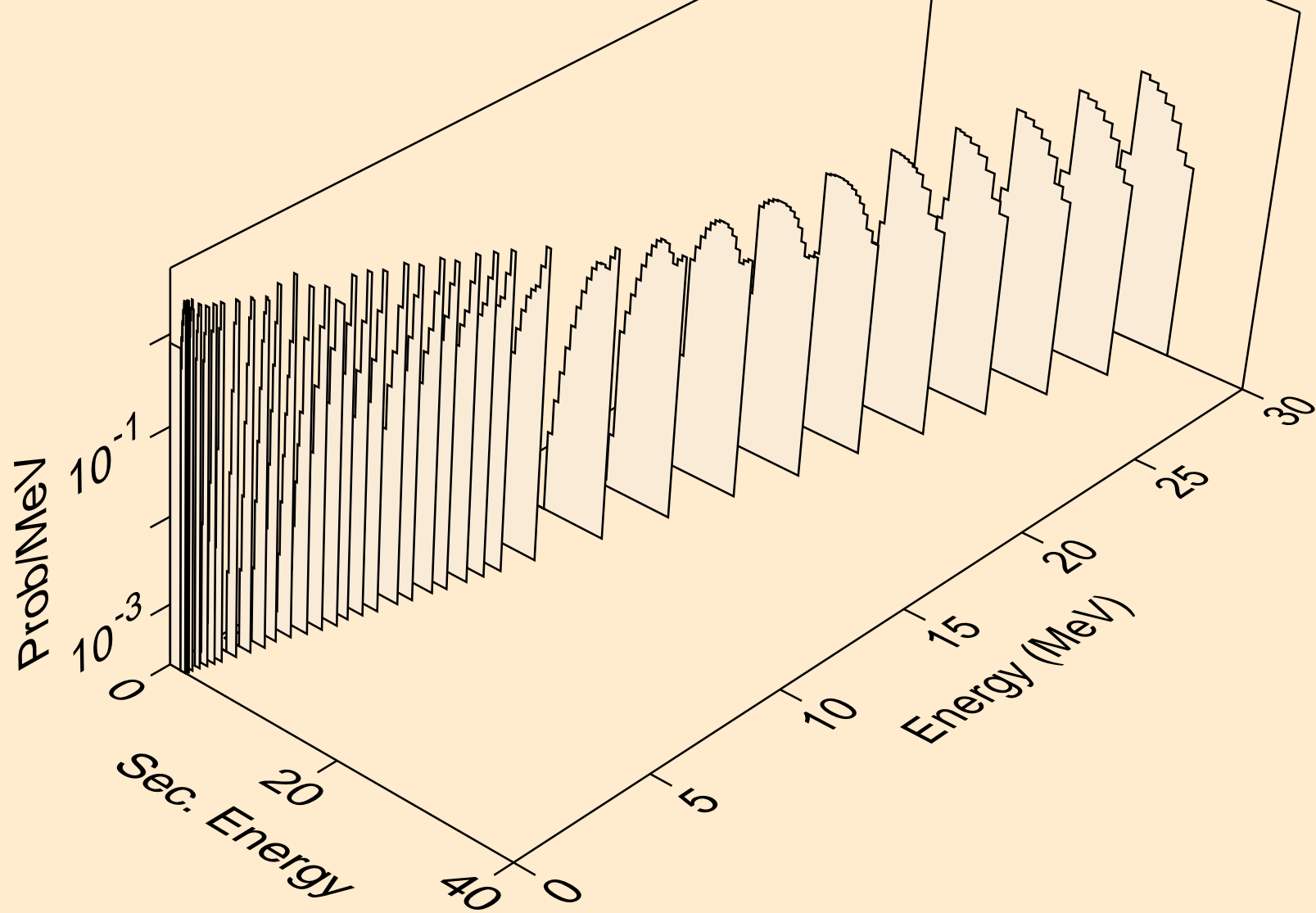

LR261 NEUTRON ACER TENDL-2021 LIBRARY; T=293.6K
protons from (n,2p)

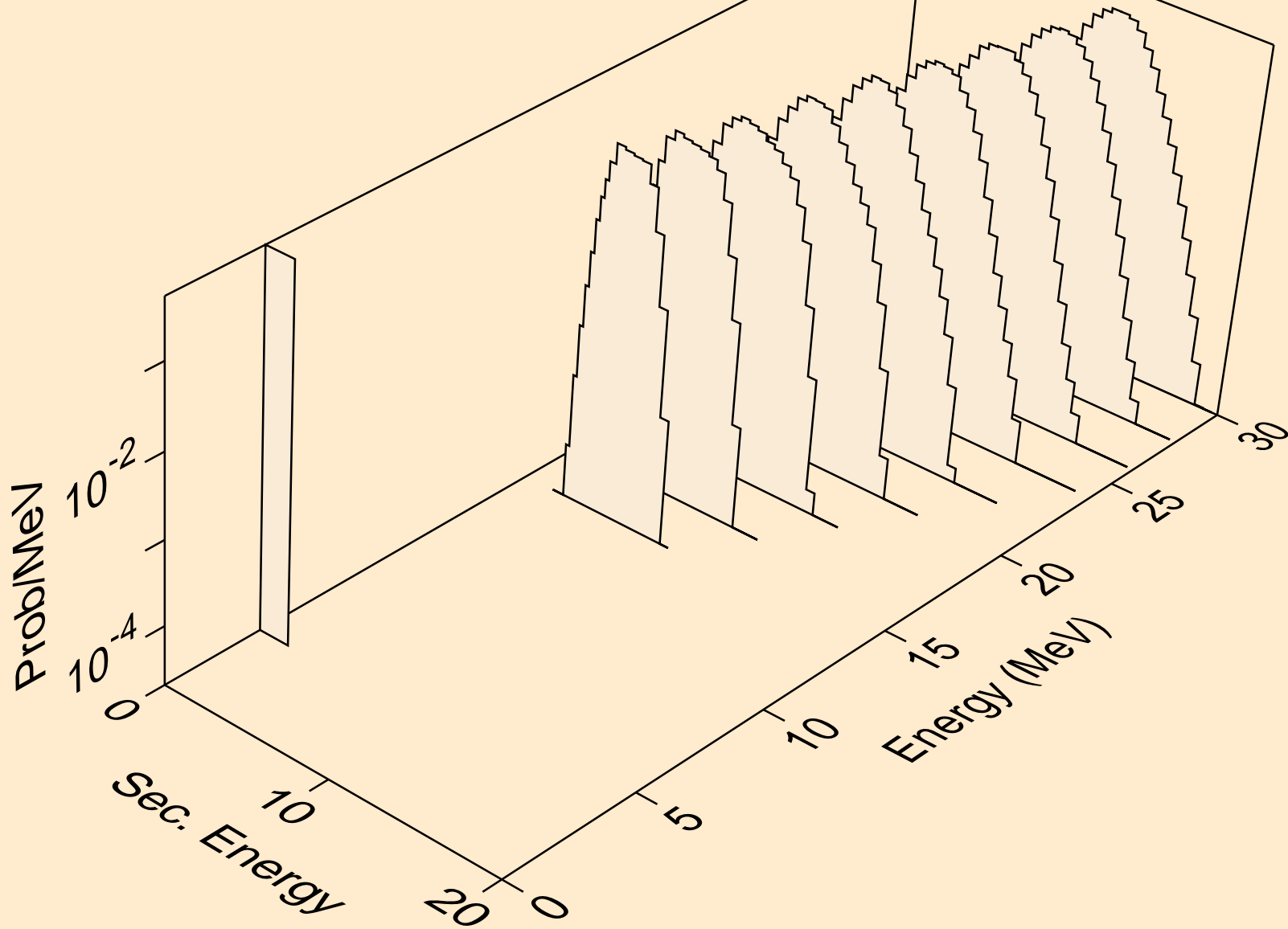

LR261 NEUTRON ACER TENDL-2021 LIBRARY; T=293.6K
protons from (n,p)

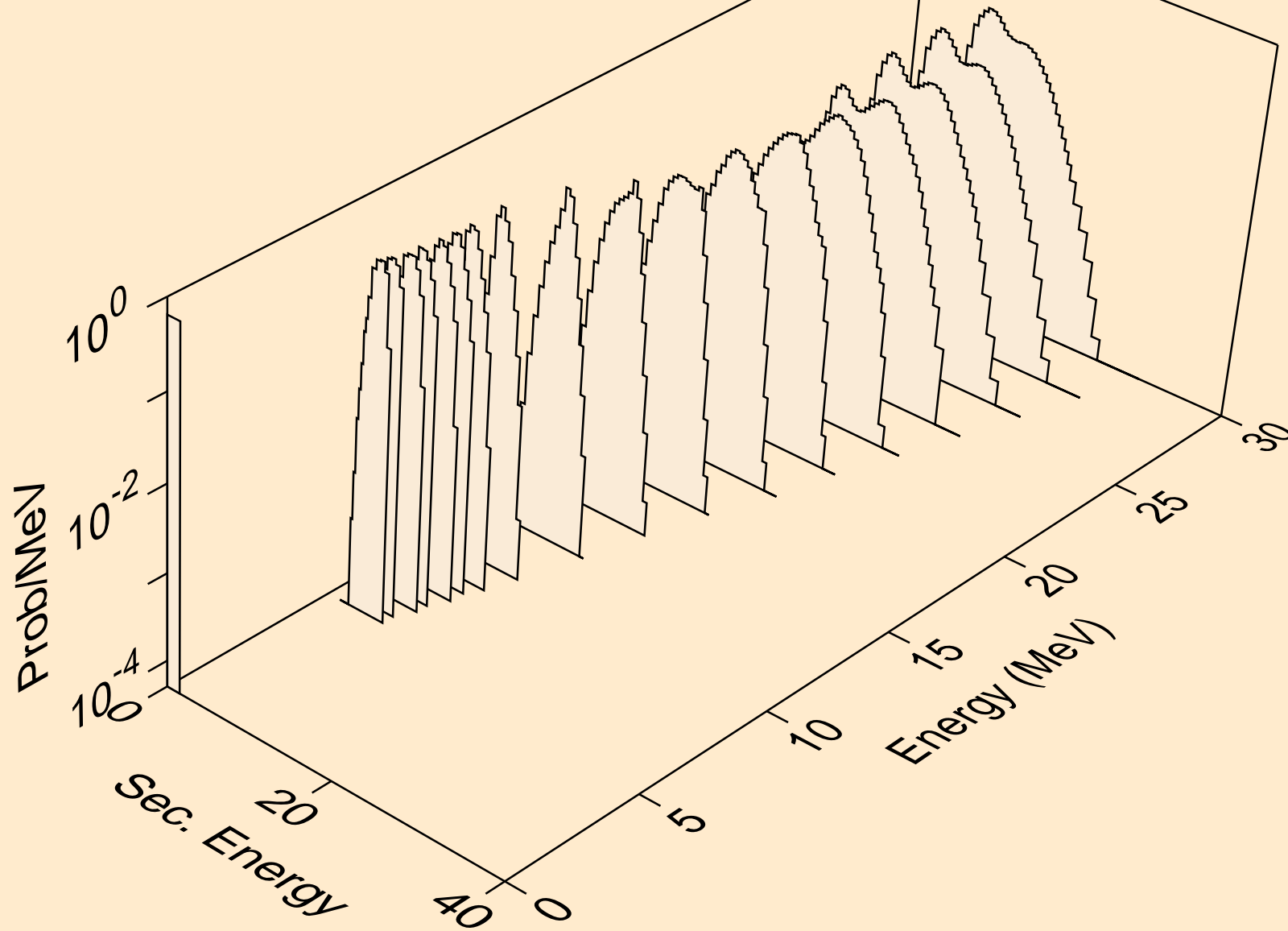

LR261 NEUTRON ACER TENDL-2021 LIBRARY; T=293.6K
deuterons from (n,x)

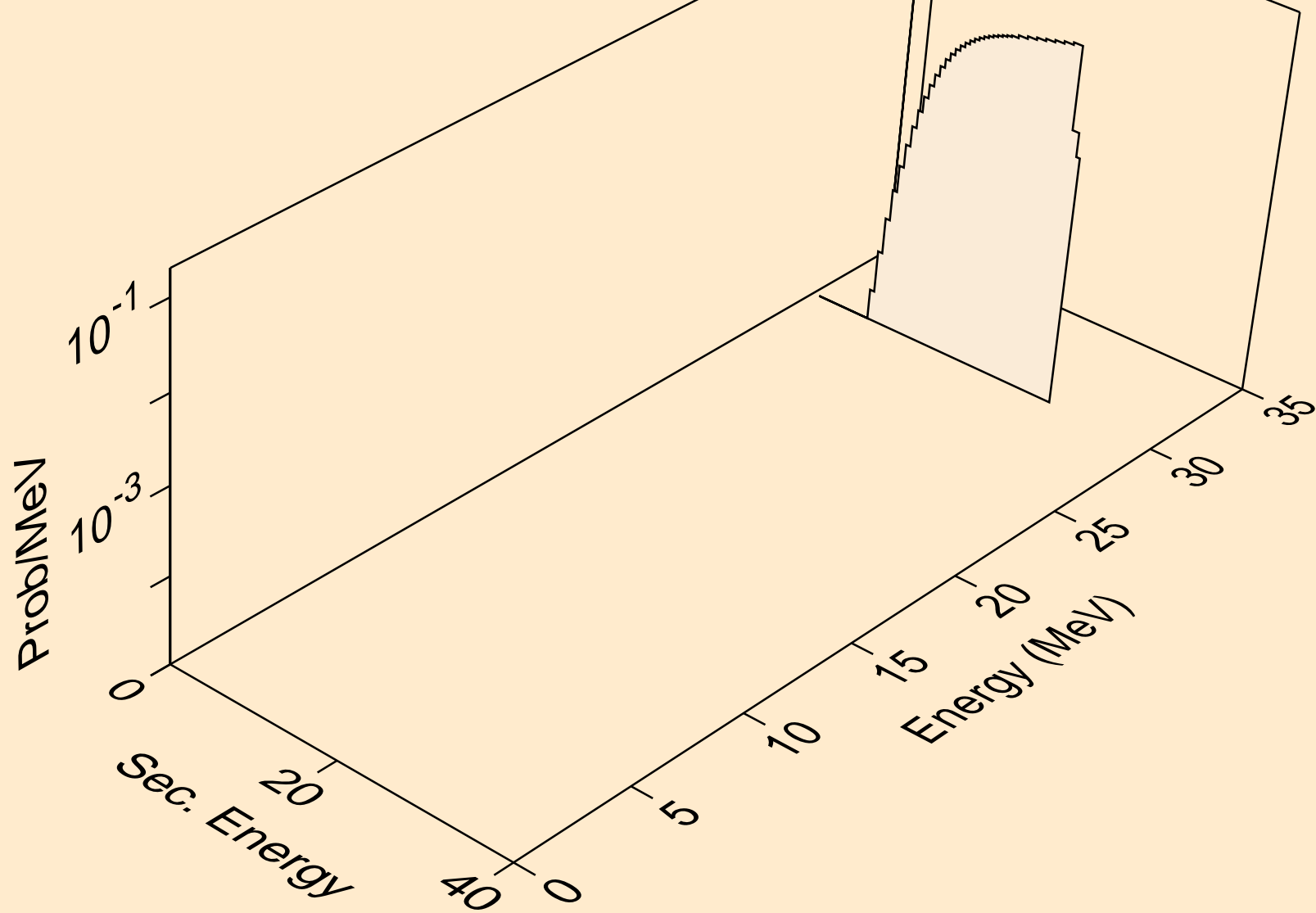

LR261 NEUTRON ACER TENDL-2021 LIBRARY; T=293.6K
deuterons from (n,2nd)

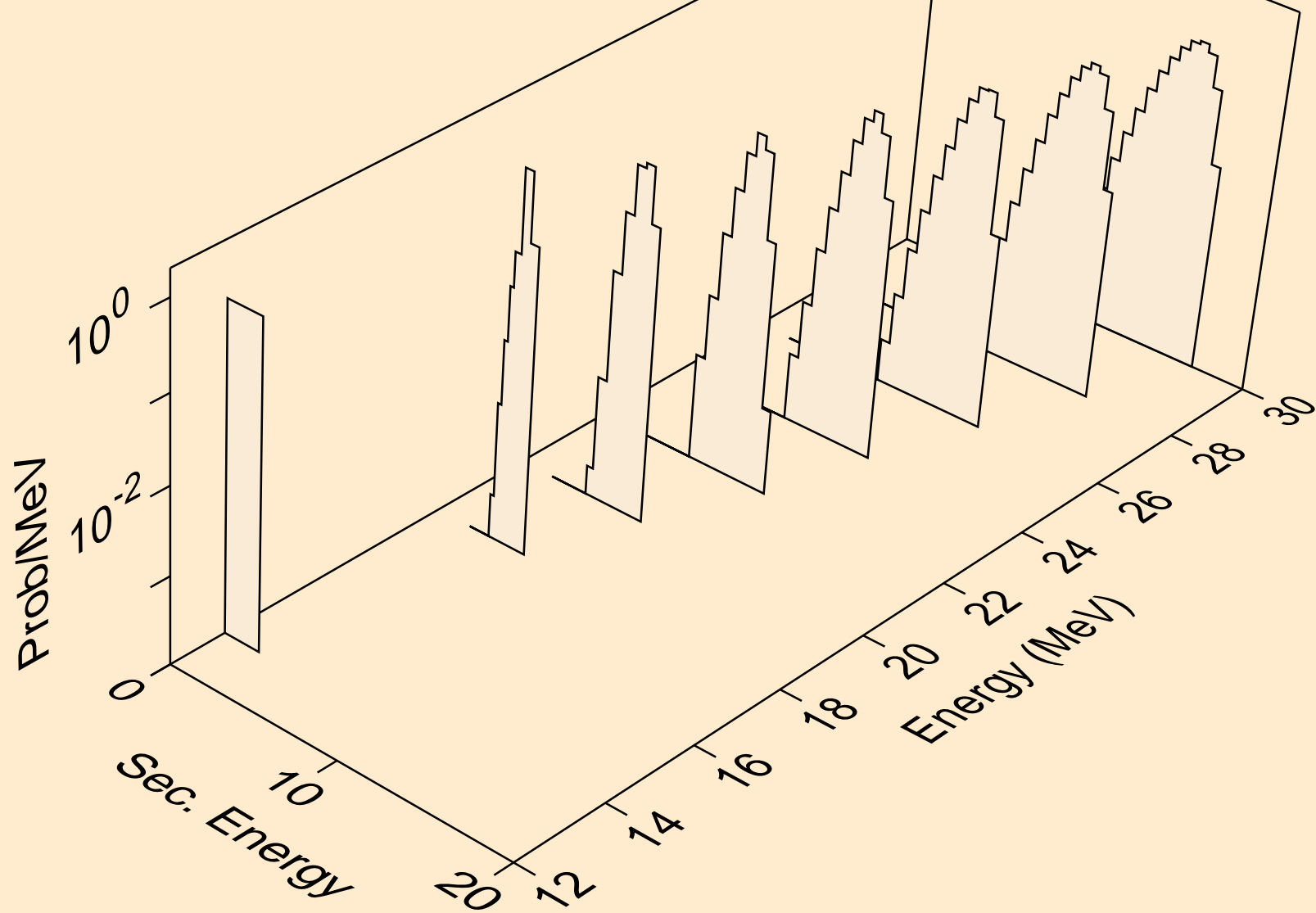

LR261 NEUTRON ACER TENDL-2021 LIBRARY; T=293.6K
deuterons from (n,n*)d

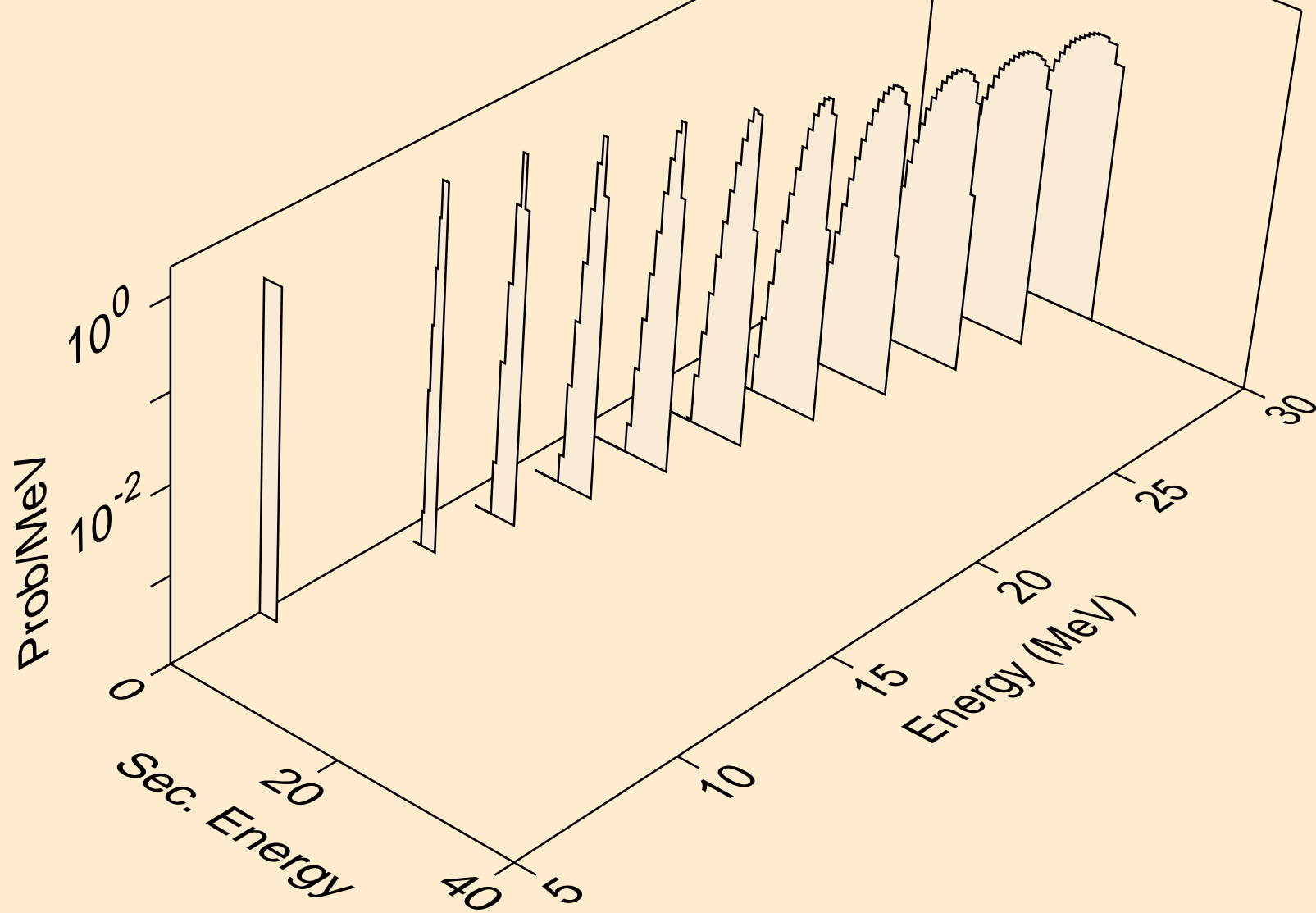

LR261 NEUTRON ACER TENDL-2021 LIBRARY; T=293.6K
deuterons from (n,d)

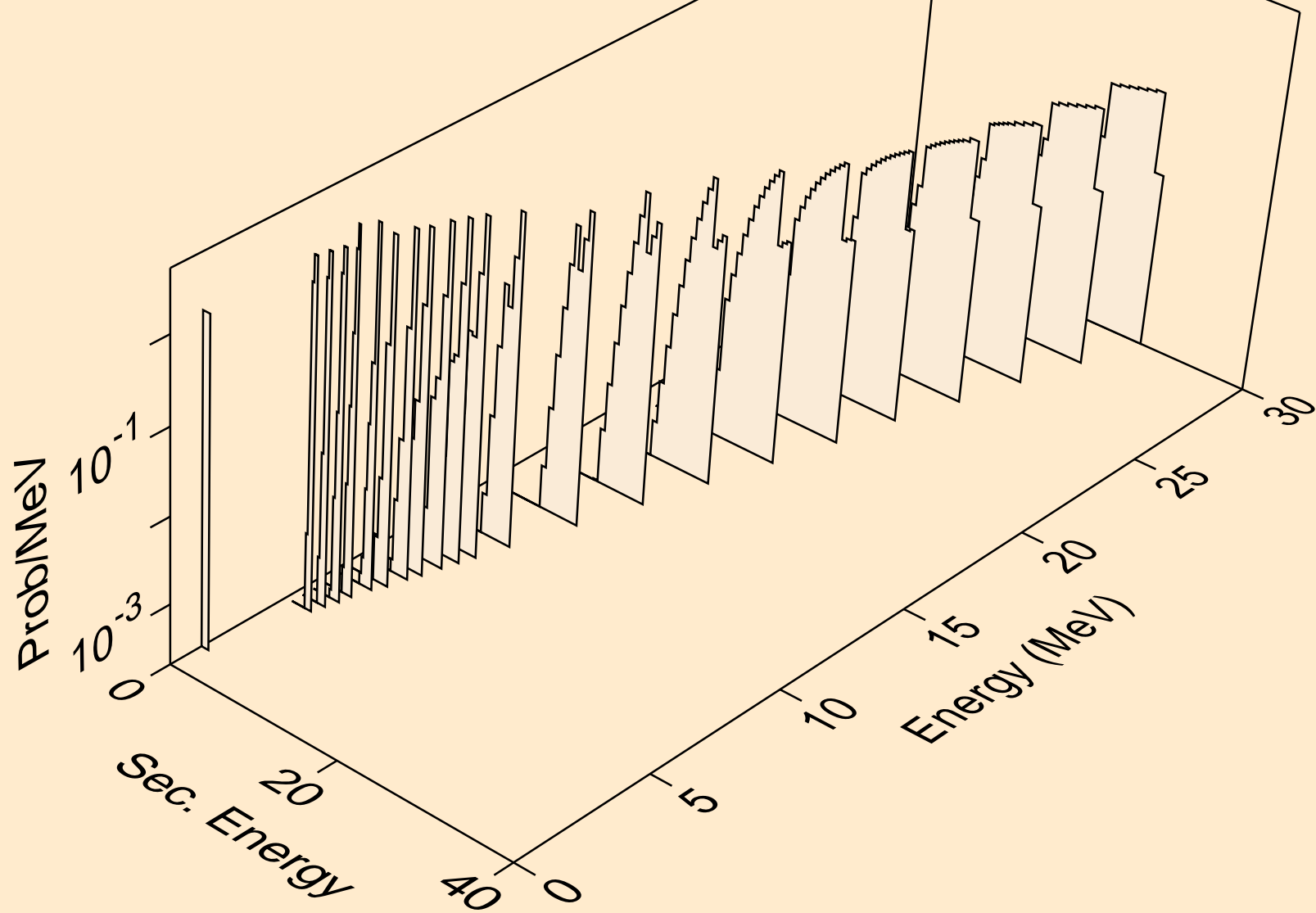

LR261 NEUTRON ACER TENDL-2021 LIBRARY; T=293.6K
deuterons from (n,da)

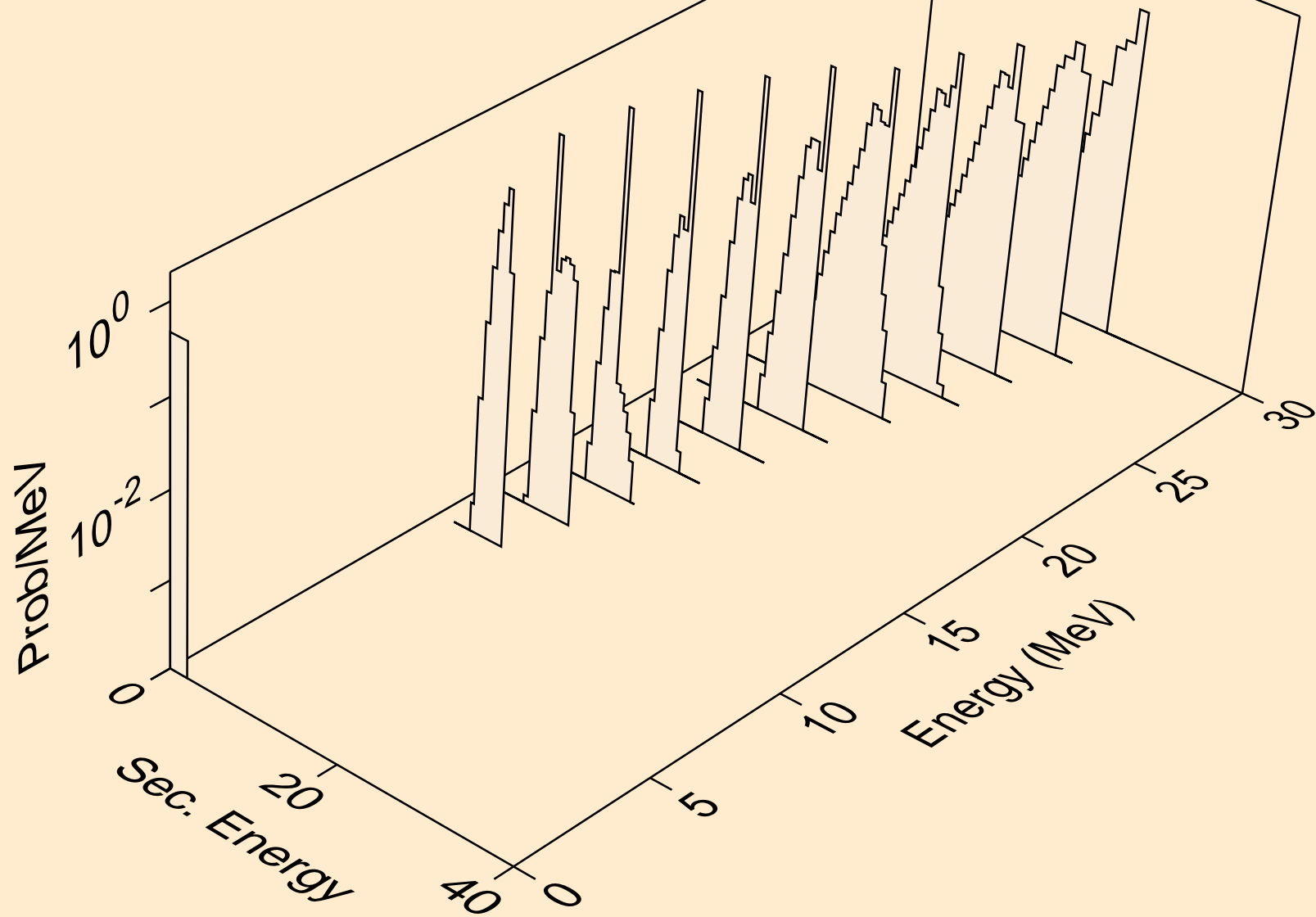

LR261 NEUTRON ACER TENDL-2021 LIBRARY; T=293.6K
tritons from (n,x)

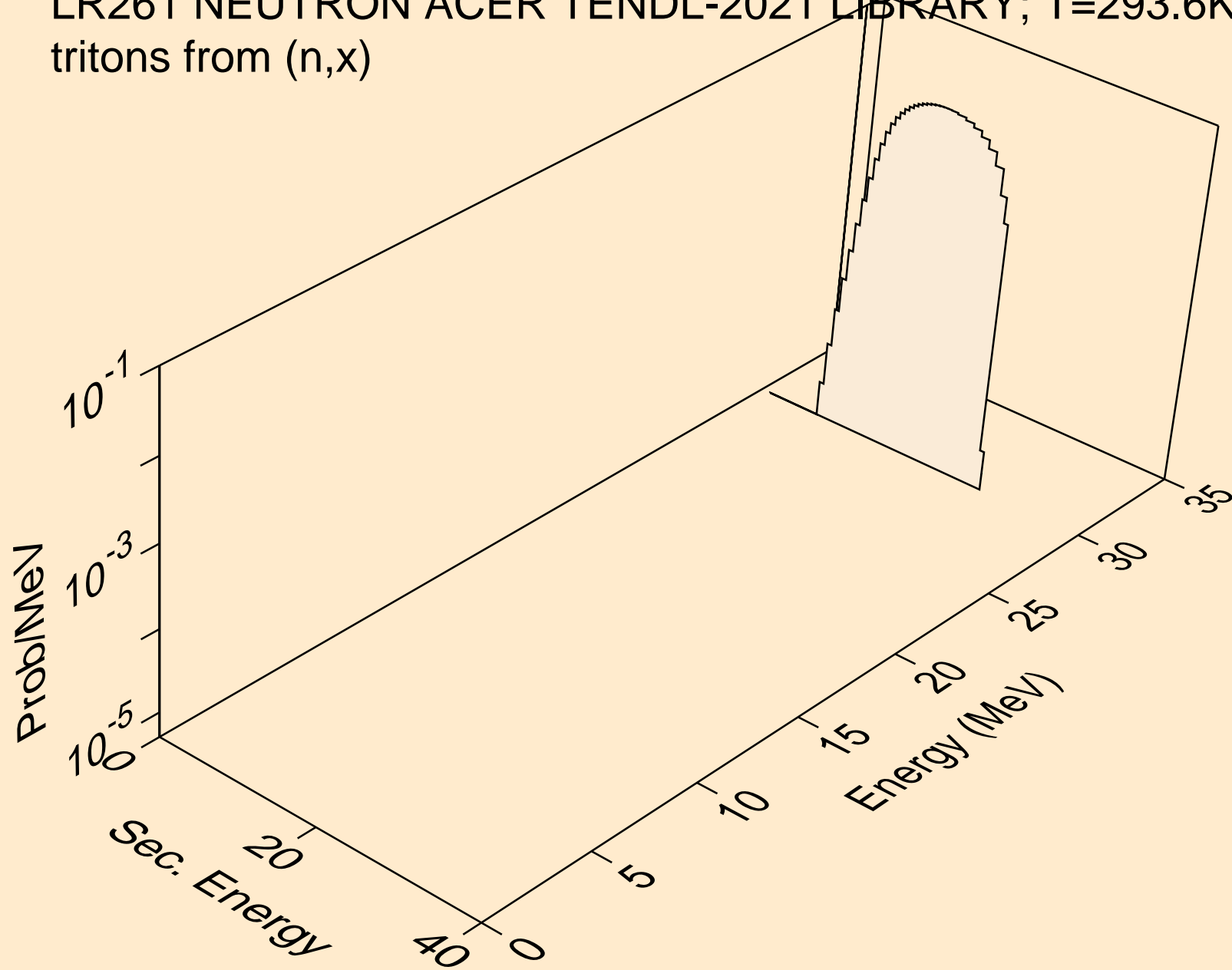

LR261 NEUTRON ACER TENDL-2021 LIBRARY; T=293.6K
tritons from (n,n*)t

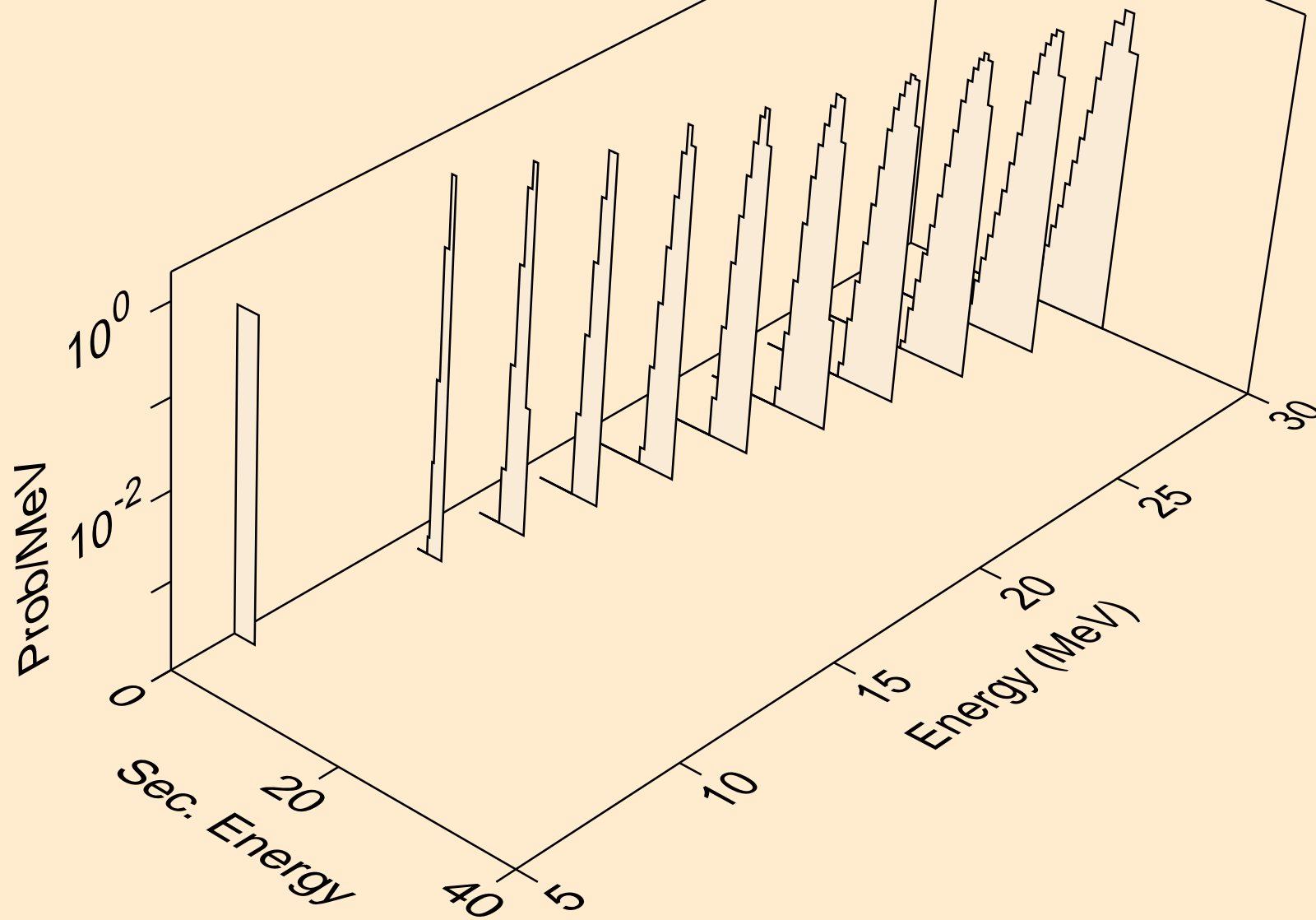

LR261 NEUTRON ACER TENDL-2021 LIBRARY; T=293.6K
tritons from (n,t)

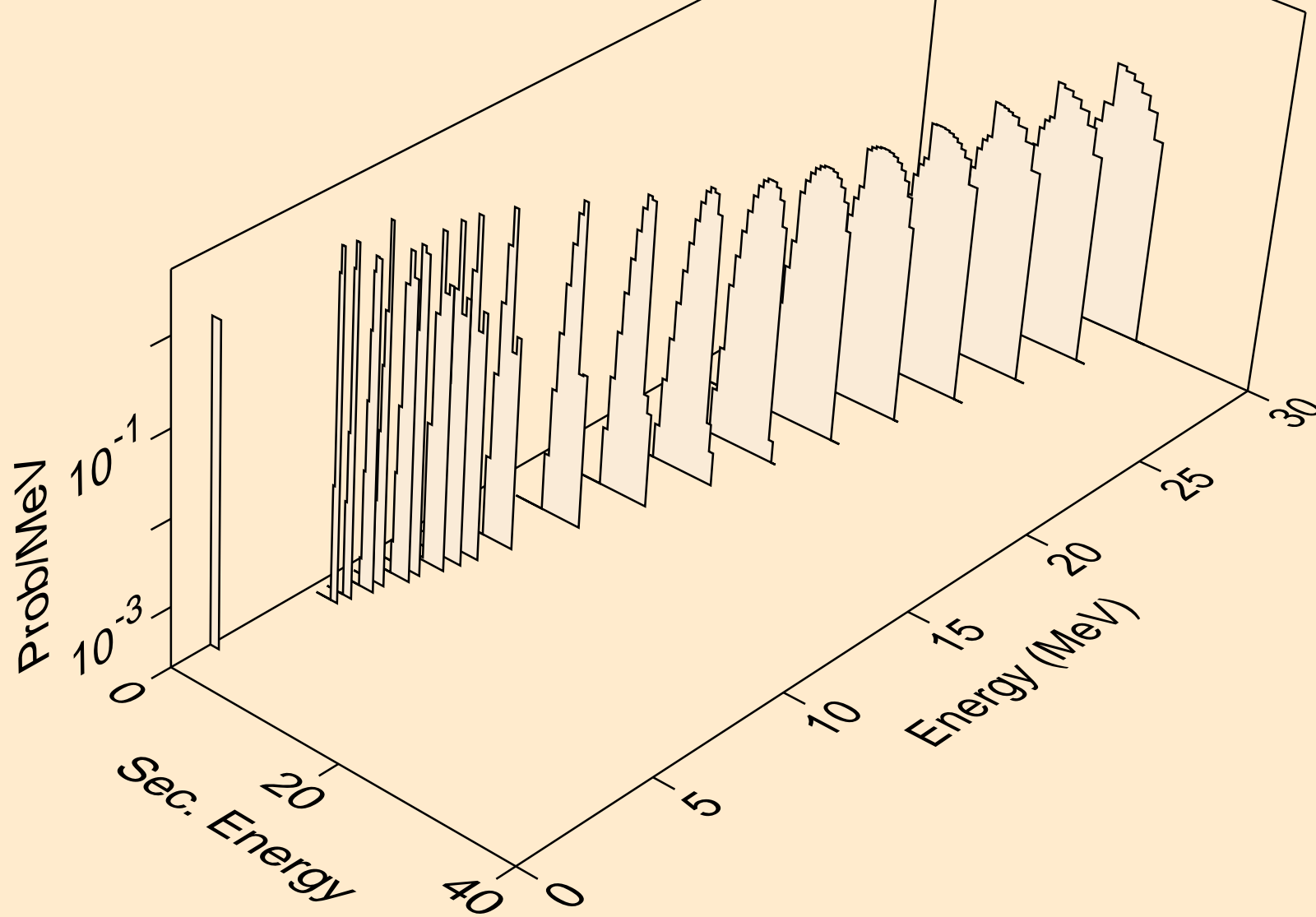

LR261 NEUTRON ACER TENDL-2021 LIBRARY; T=293.6K
he3s from (n,x)

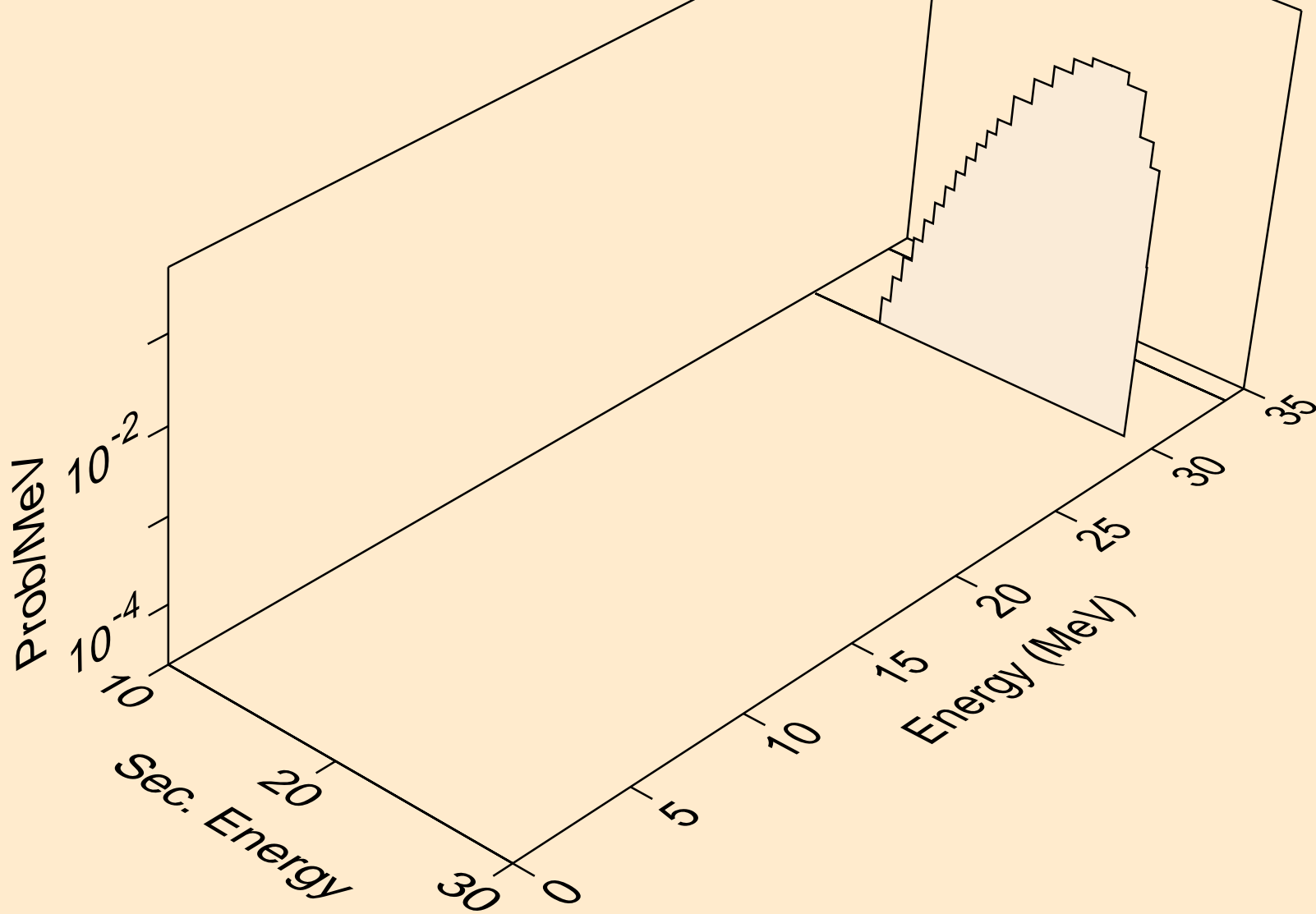

LR261 NEUTRON ACER TENDL-2021 LIBRARY; T=293.6K
he3s from (n,n*)he3

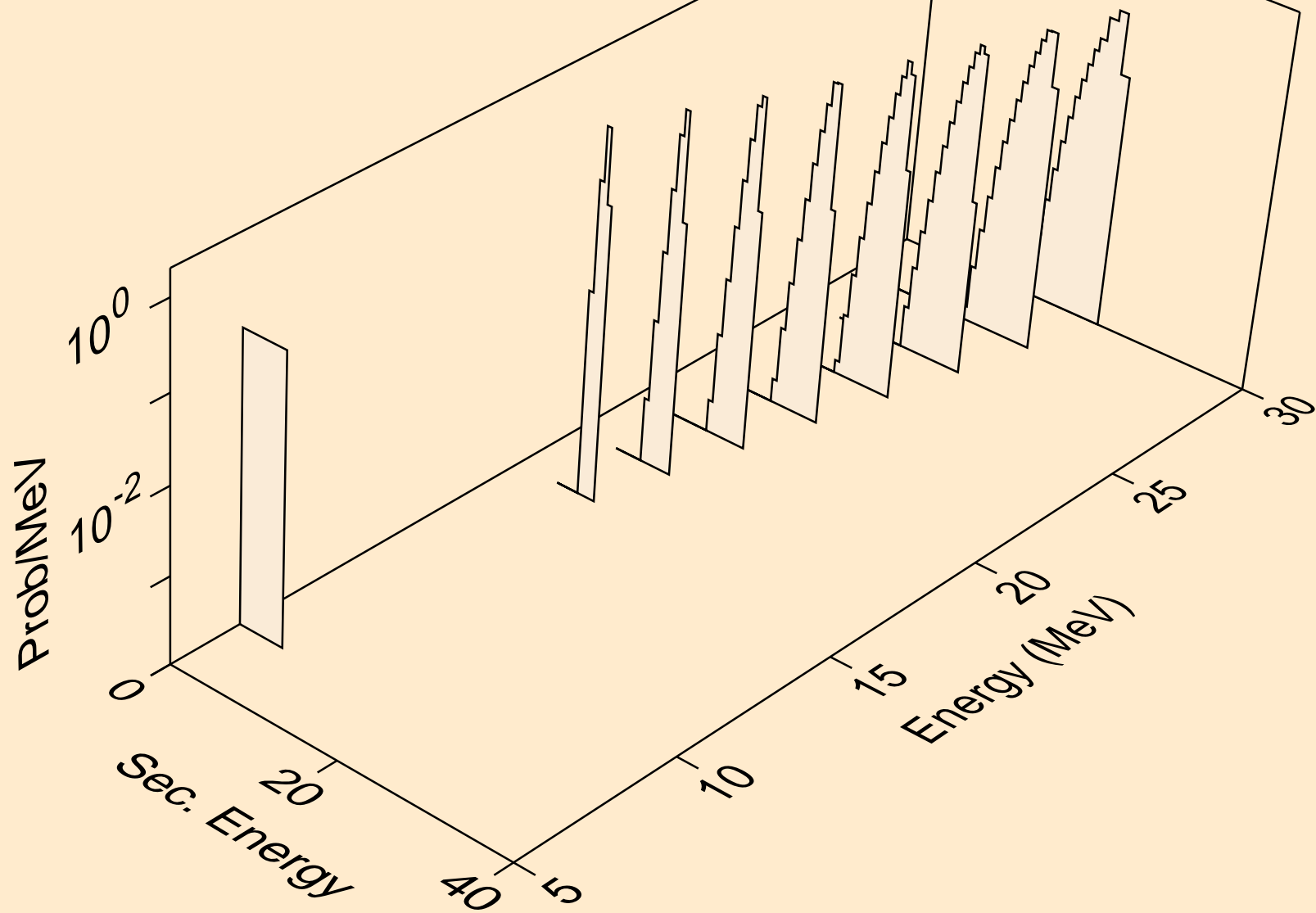

LR261 NEUTRON ACER TENDL-2021 LIBRARY; T=293.6K
he3s from (n,he3)

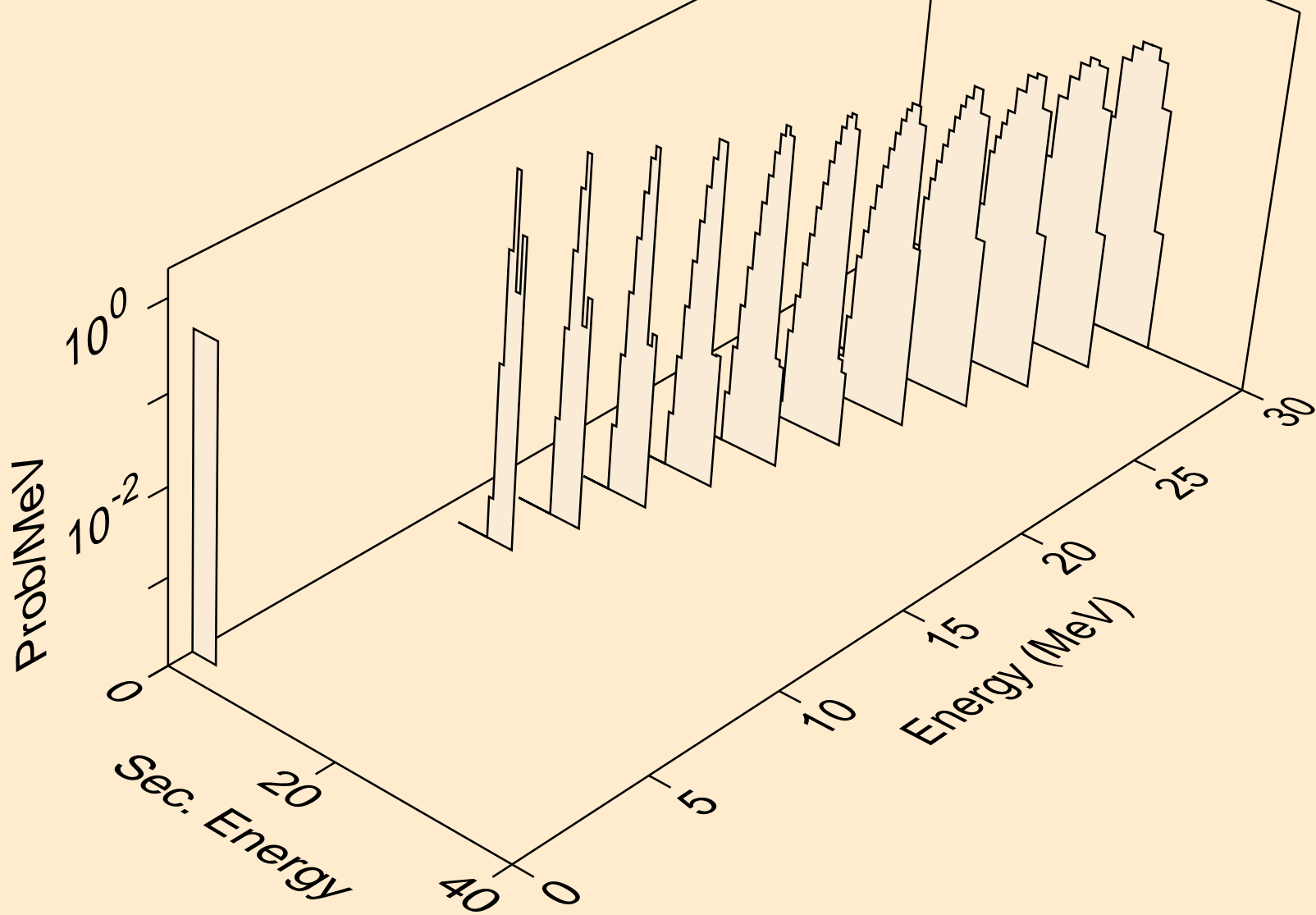

LR261 NEUTRON ACER TENDL-2021 LIBRARY; T=293.6K
alphas from (n,x)

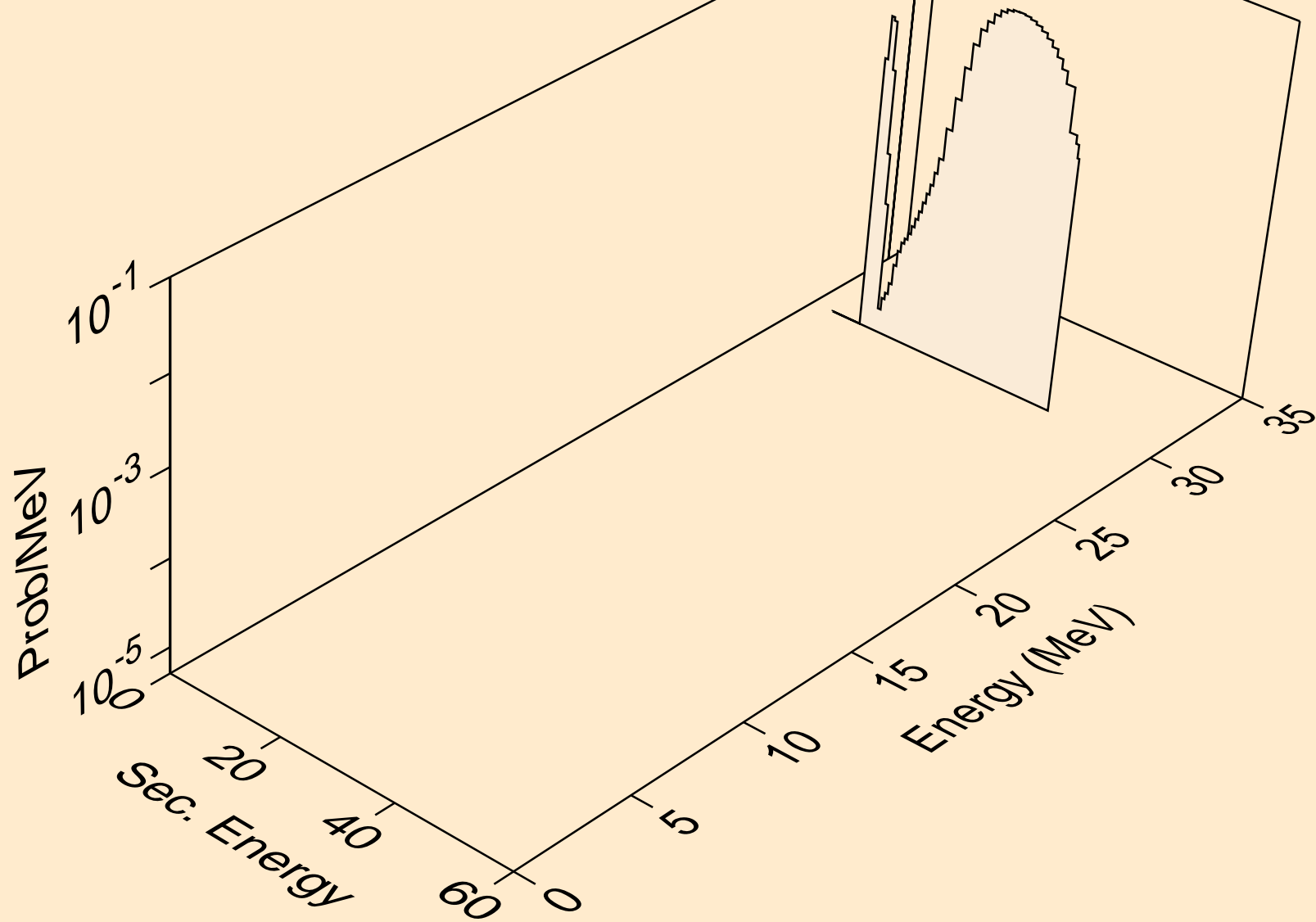

LR261 NEUTRON ACER TENDL-2021 LIBRARY; T=293.6K
alphas from (n,n*)a

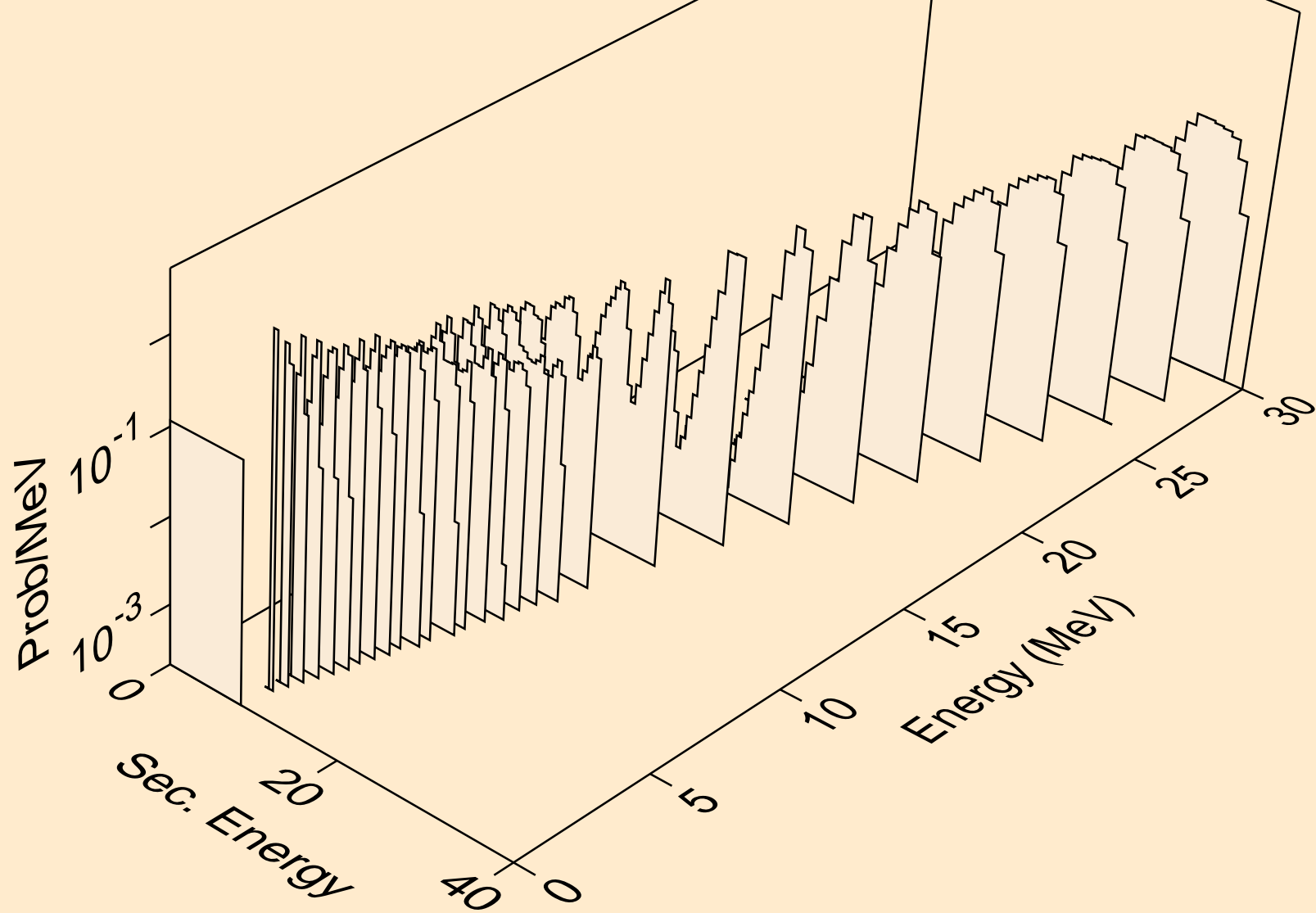

LR261 NEUTRON ACER TENDL-2021 LIBRARY; T=293.6K
alphas from (n,2n)a

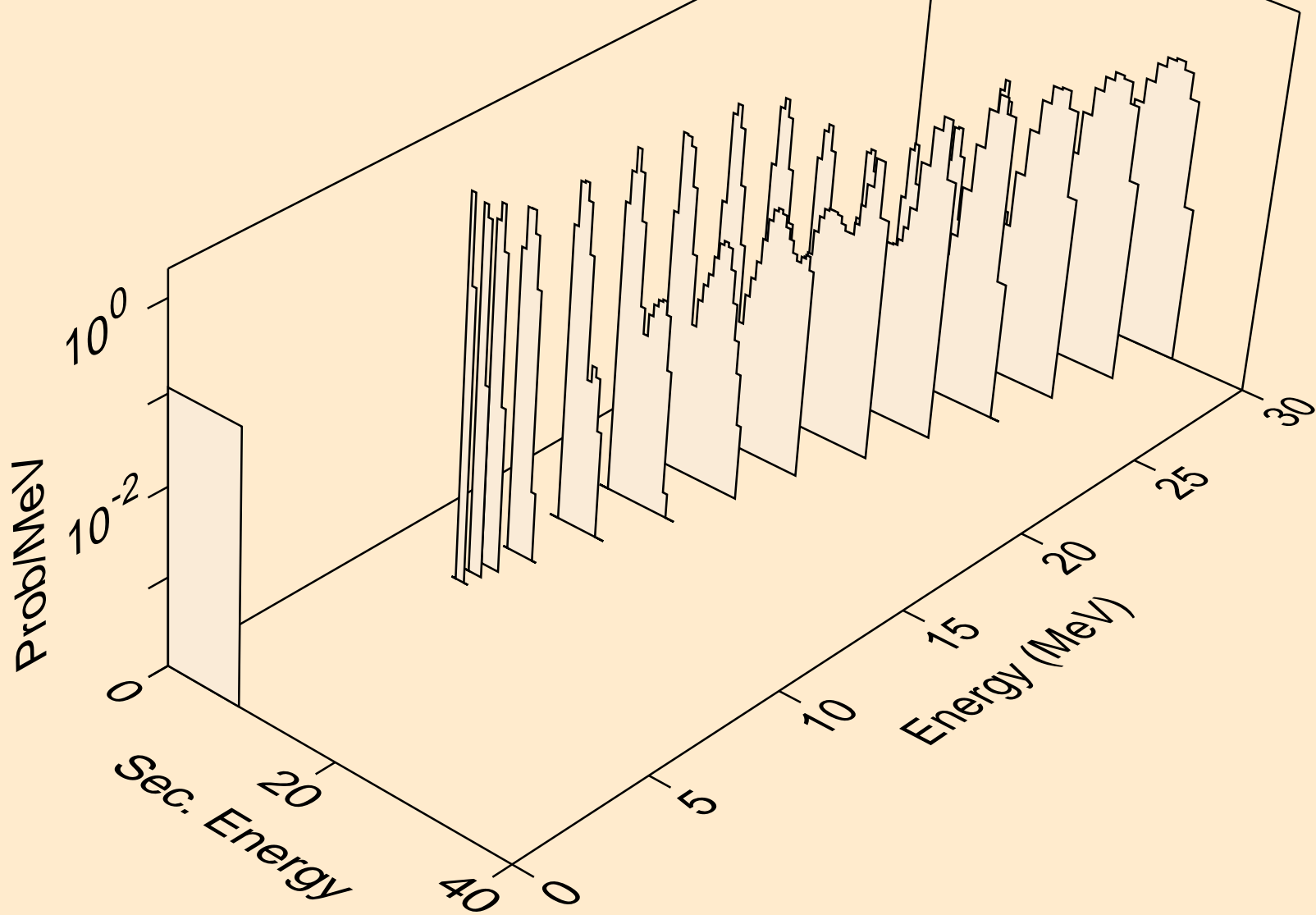

LR261 NEUTRON ACER TENDL-2021 LIBRARY; T=293.6K
alphas from (n,3n)a

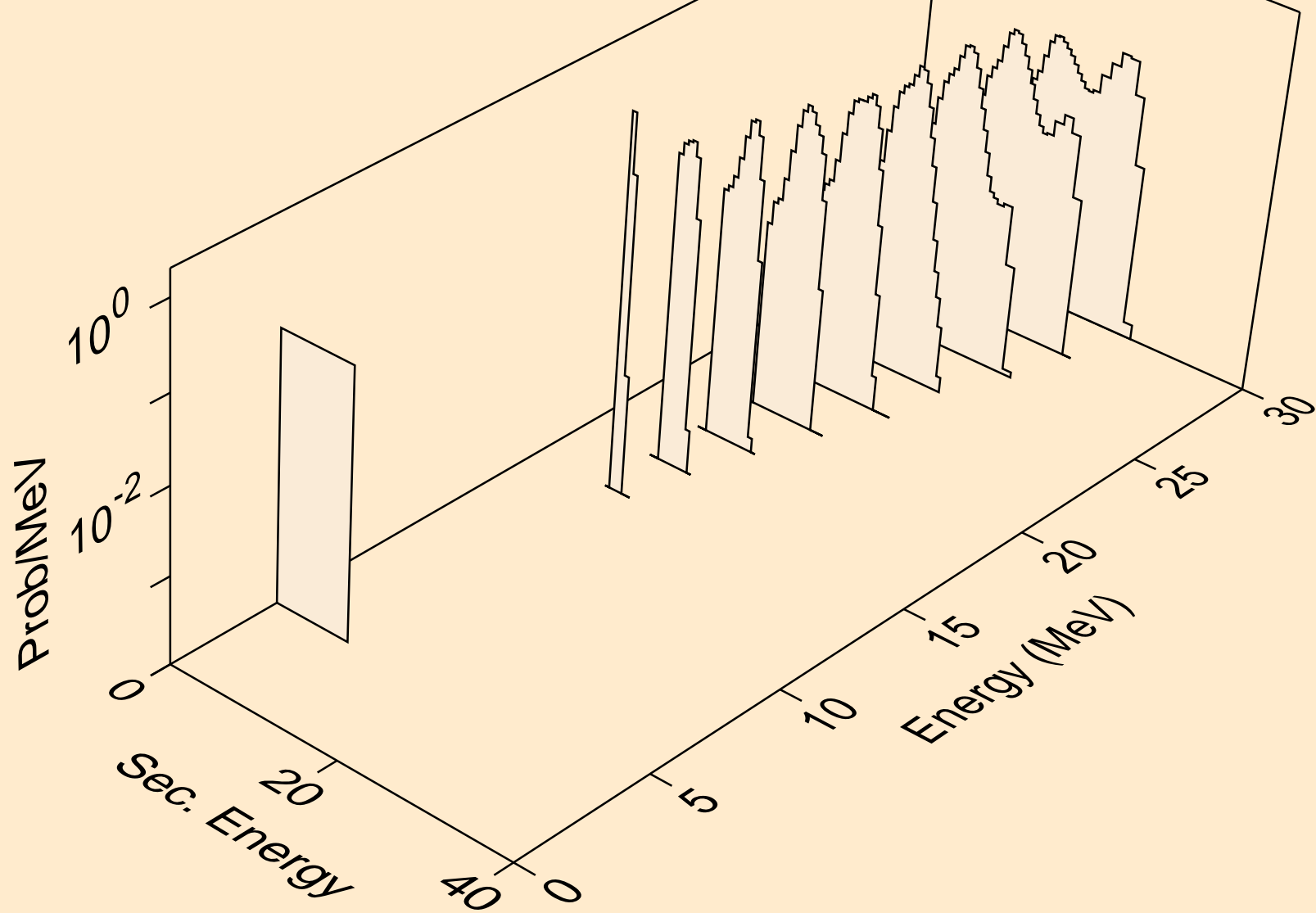

LR261 NEUTRON ACER TENDL-2021 LIBRARY; T=293.6K
alphas from (n,n*)2a

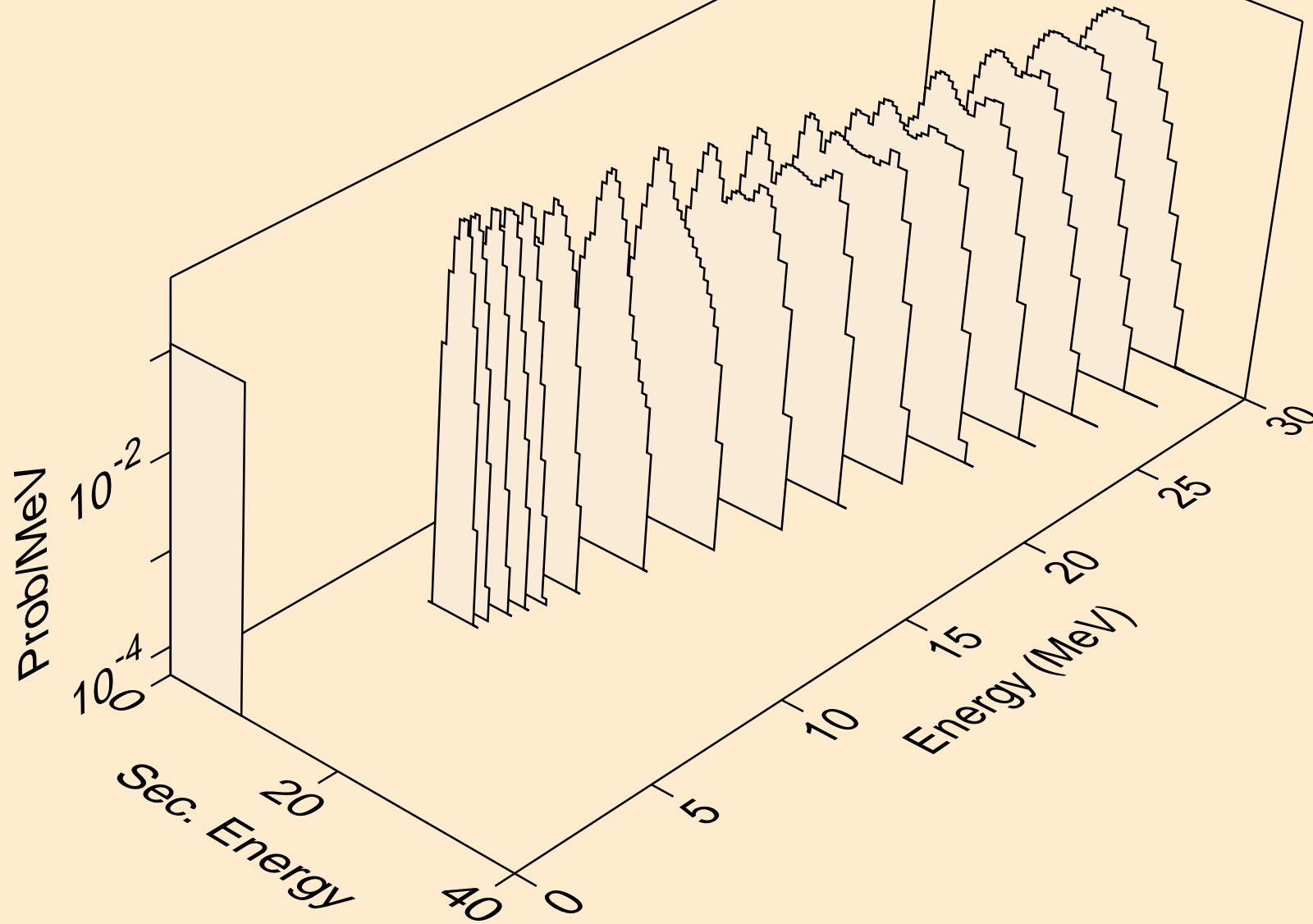

LR261 NEUTRON ACER TENDL-2021 LIBRARY; T=293.6K
alphas from (n,npa)

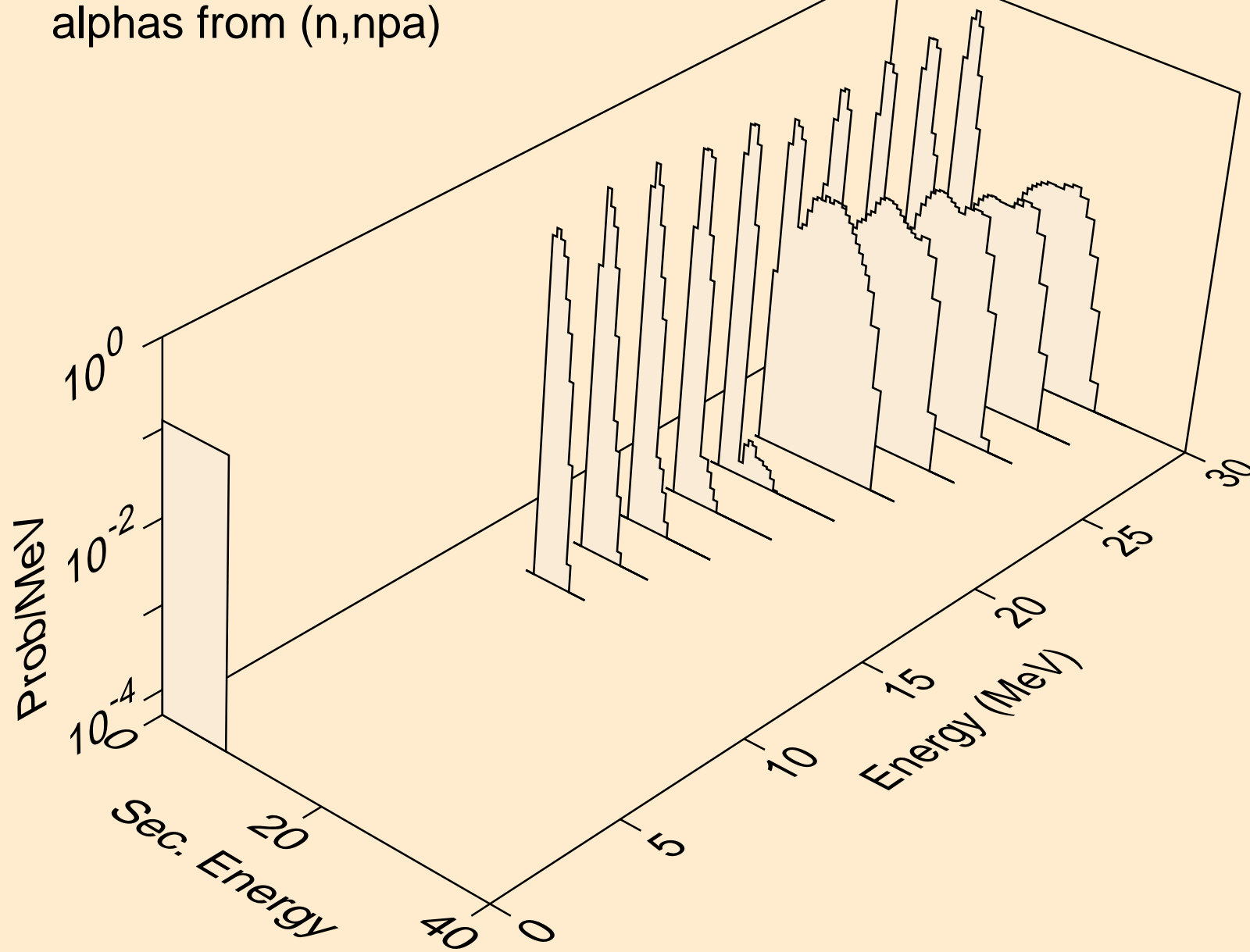

LR261 NEUTRON ACER TENDL-2021 LIBRARY; T=293.6K
alphas from (n,a)

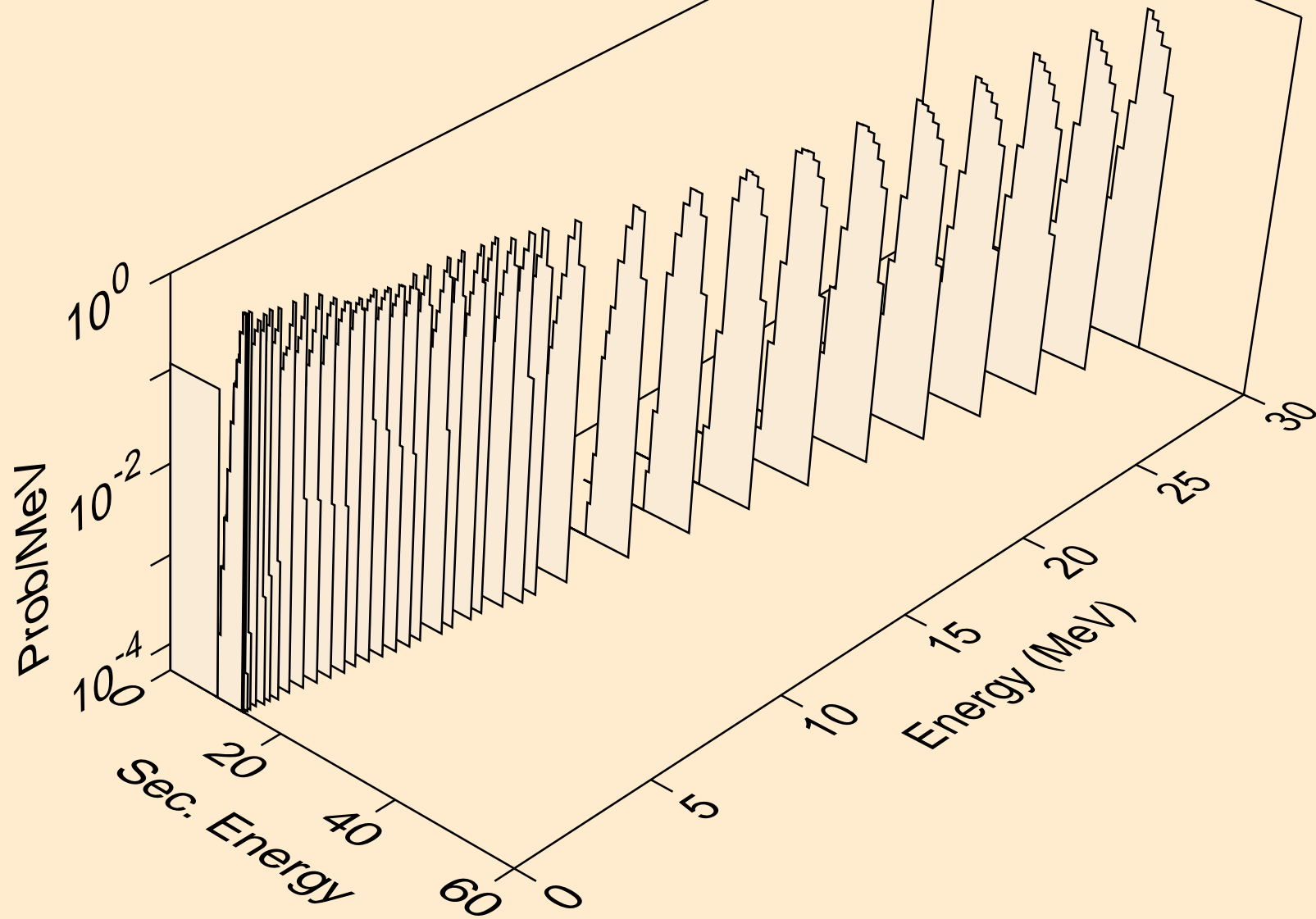

LR261 NEUTRON ACER TENDL-2021 LIBRARY; T=293.6K
alphas from (n,2a)

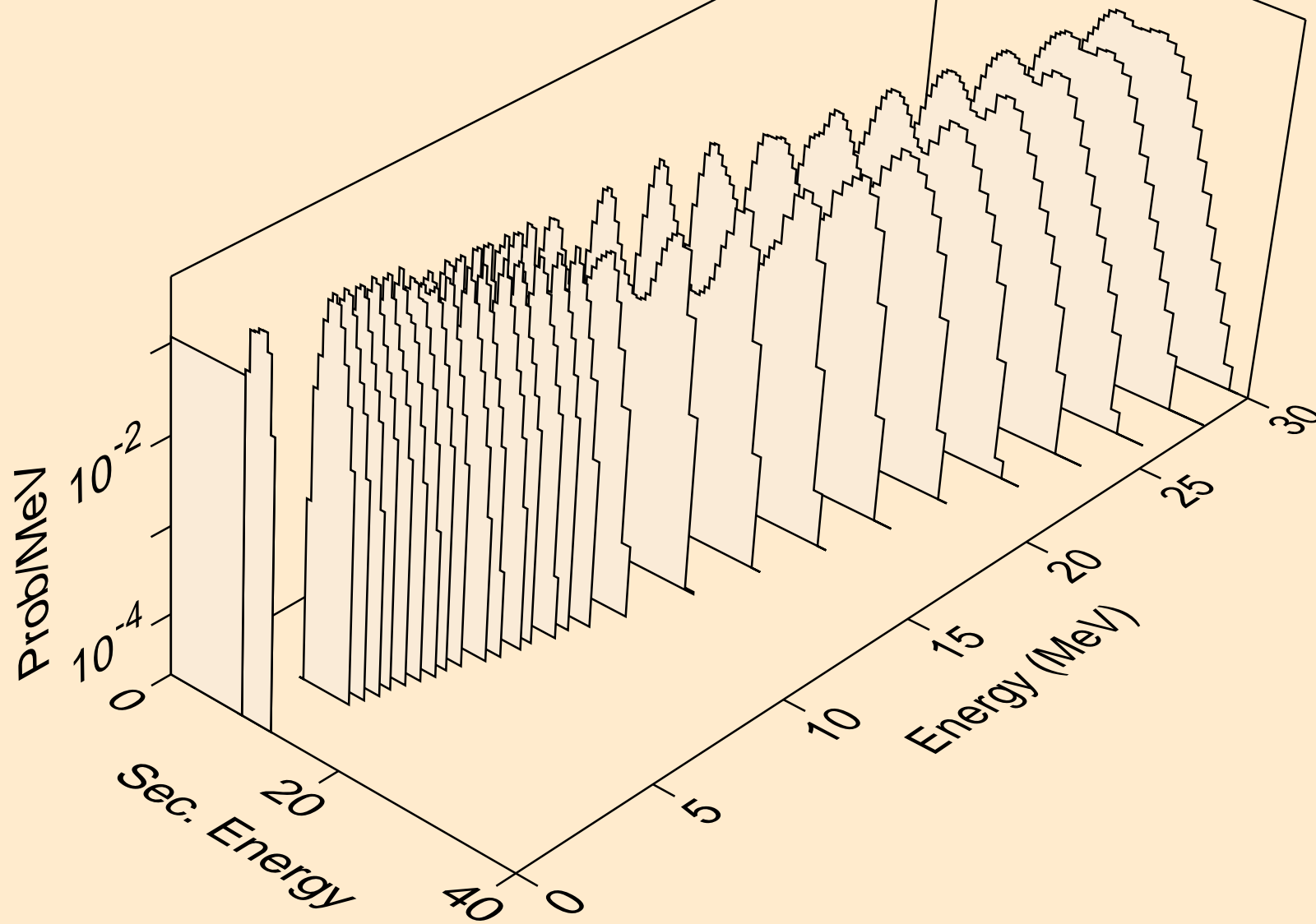

LR261 NEUTRON ACER TENDL-2021 LIBRARY; T=293.6K
alphas from (n,pa)

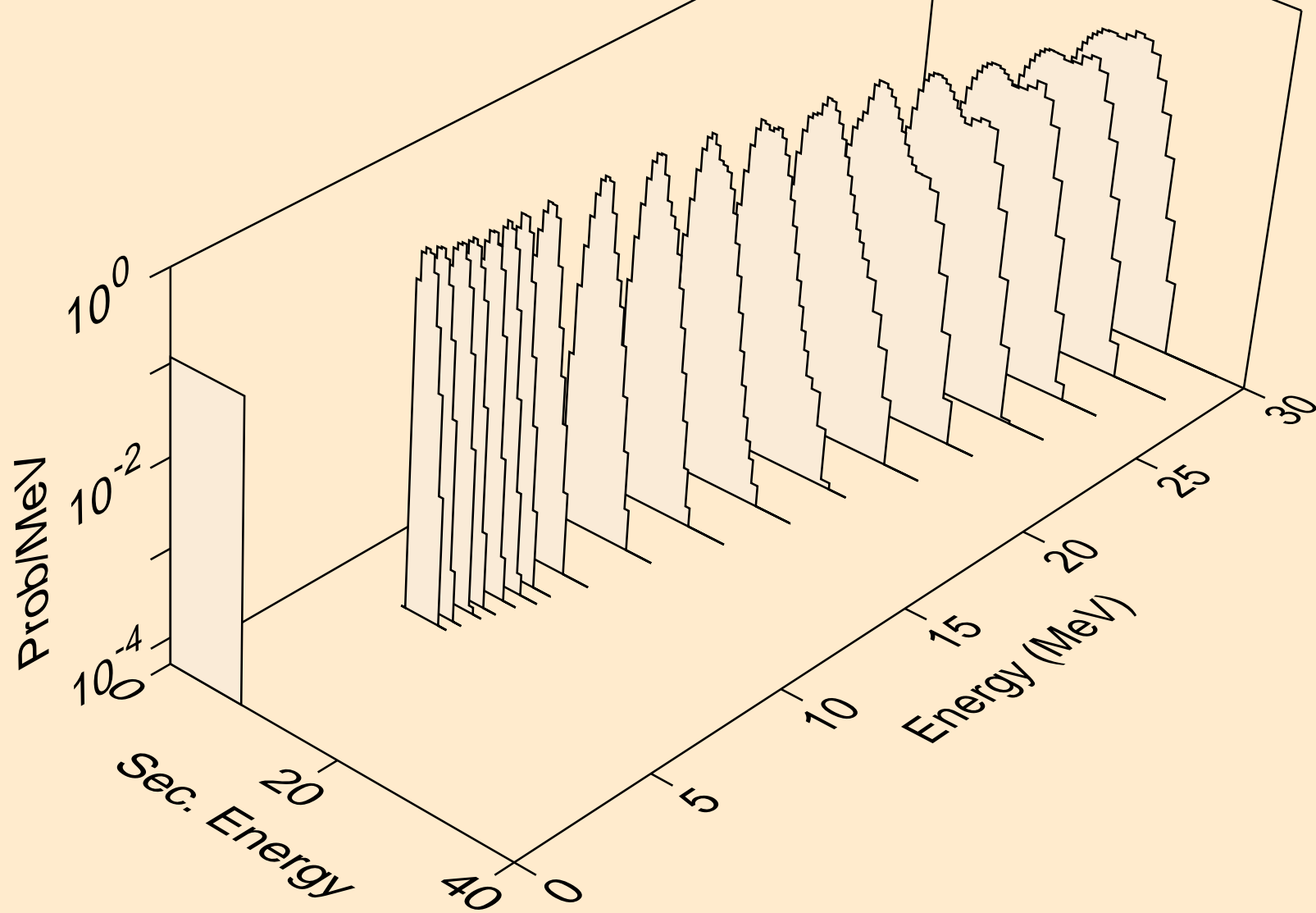

LR261 NEUTRON ACER TENDL-2021 LIBRARY; T=293.6K
alphas from (n,da)

