

LR264 NEUTRON ACER TENDL-2021 LIBRARY; T=293.6K

Principal cross sections

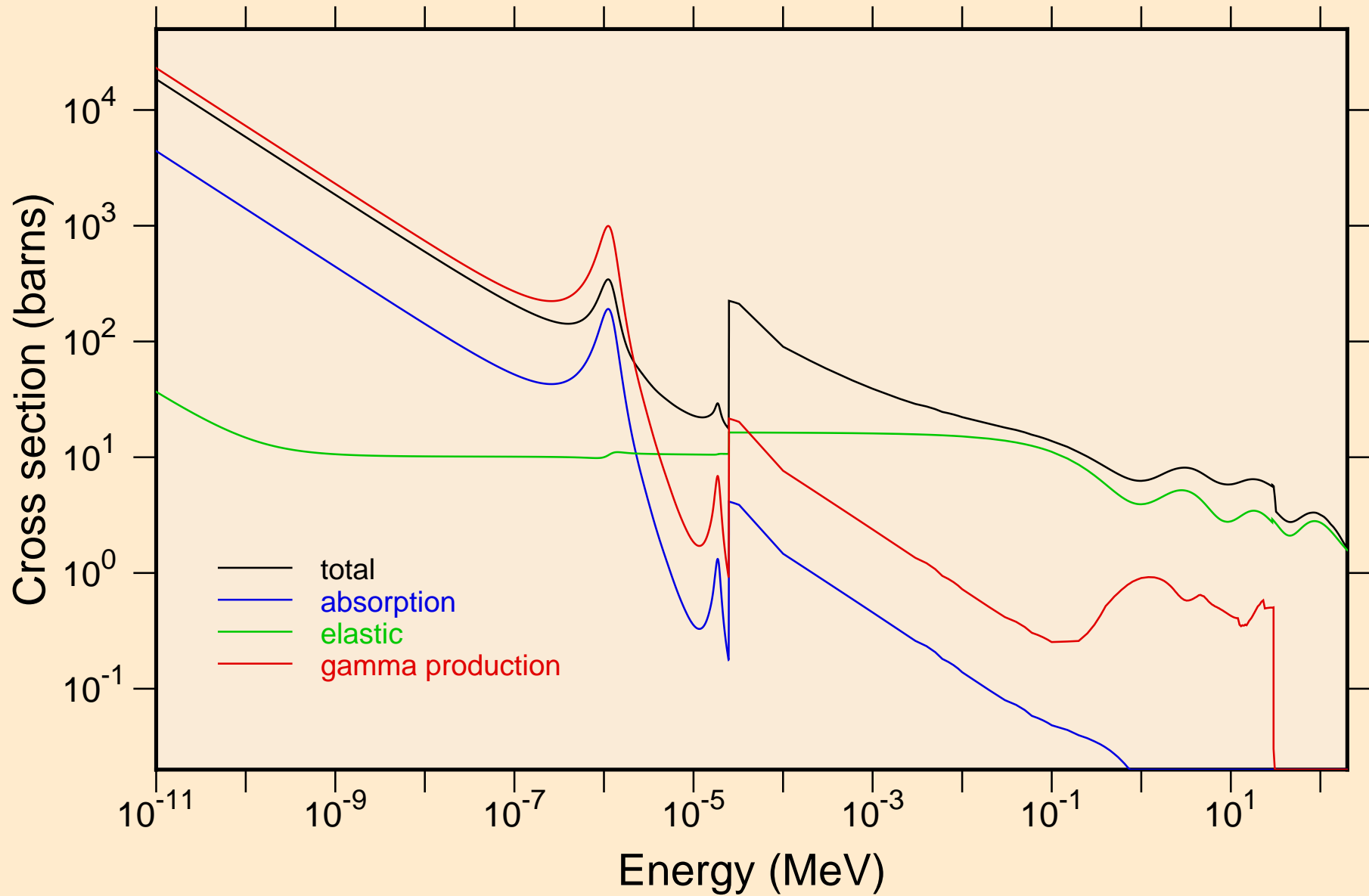

LR264 NEUTRON ACER TENDL-2021 LIBRARY; T=293.6K
Heating

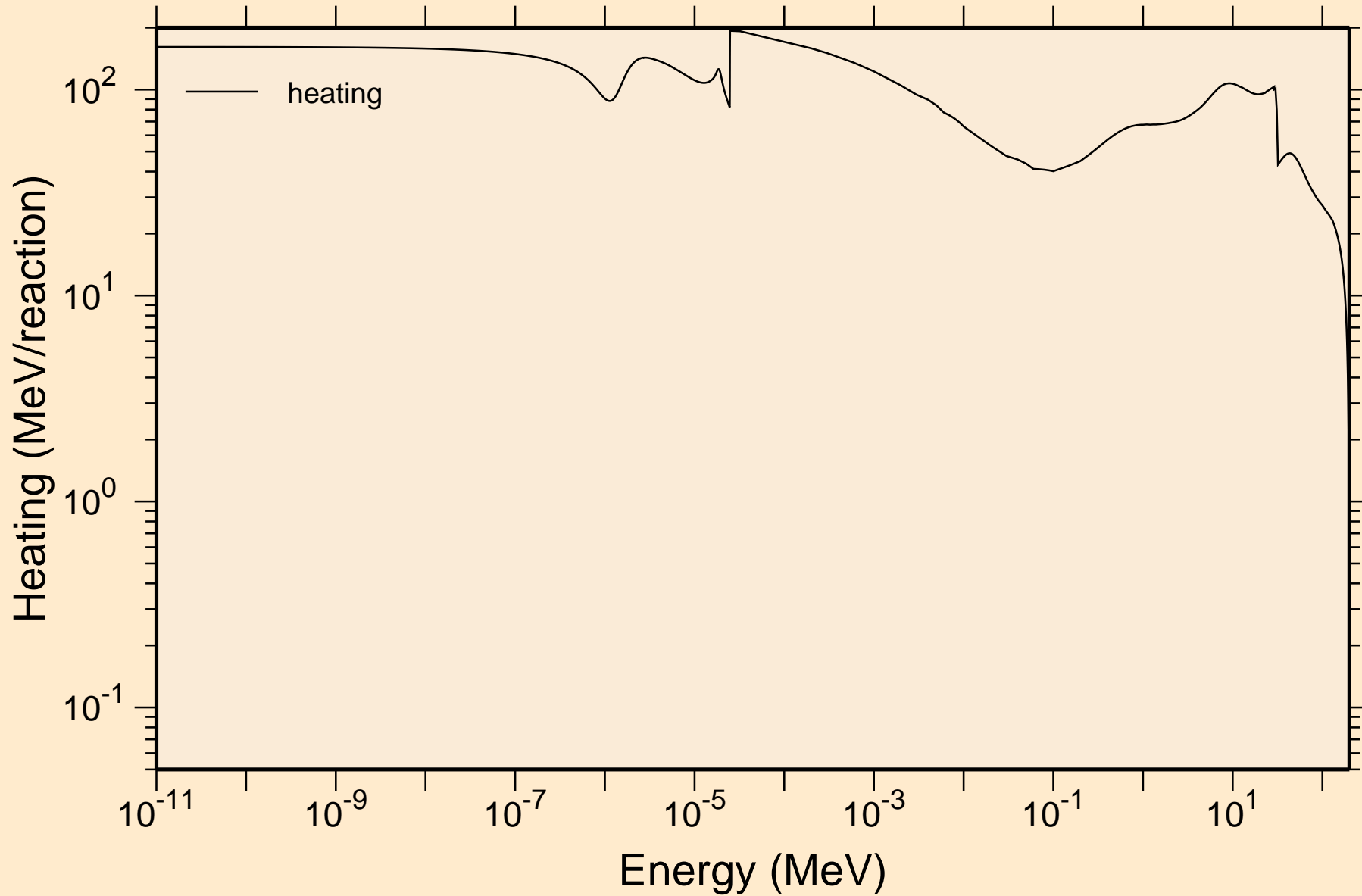

LR264 NEUTRON ACER TENDL-2021 LIBRARY; T=293.6K
Damage

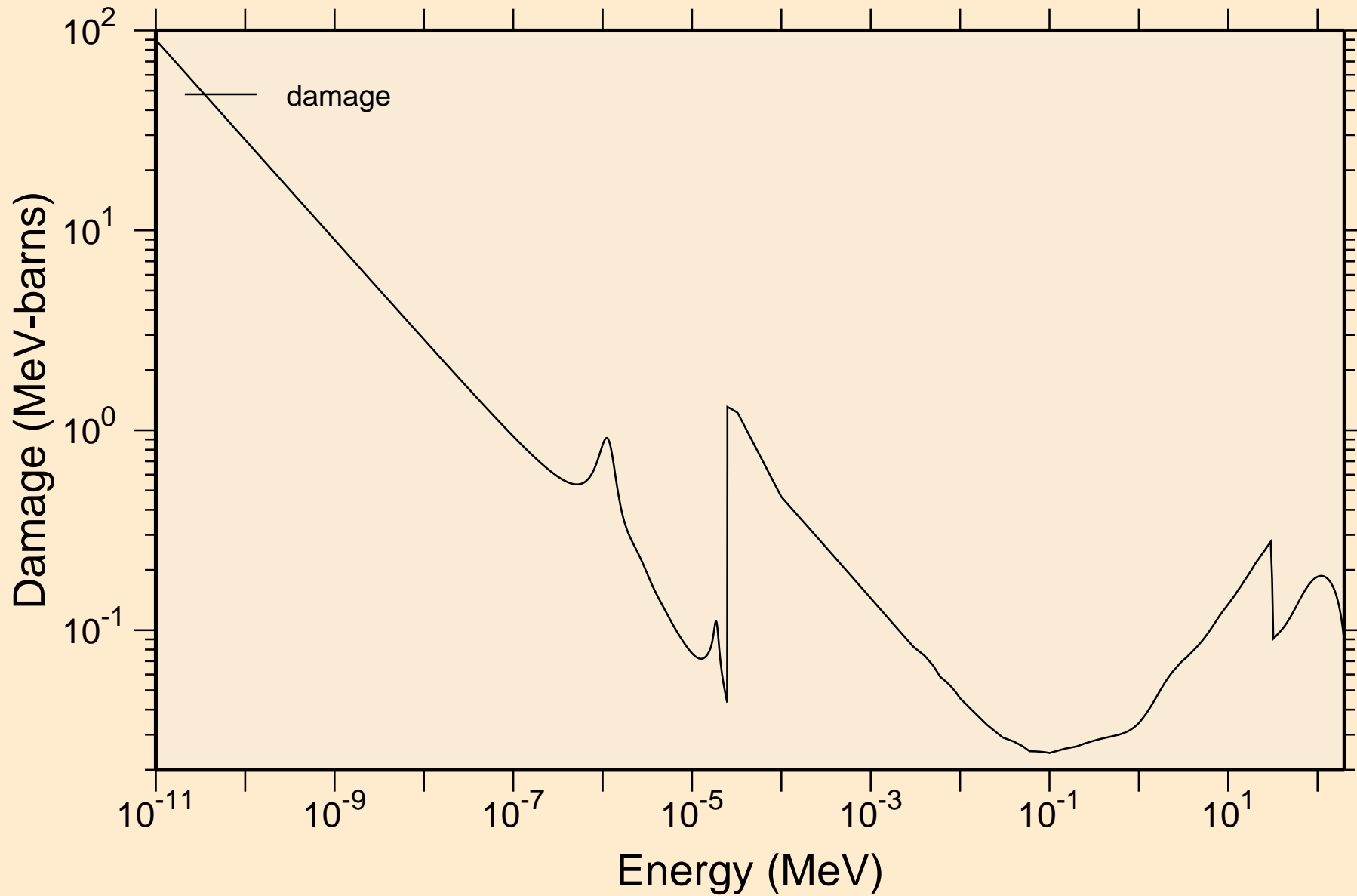

LR264 NEUTRON ACER TENDL-2021 LIBRARY; T=293.6K
Non-threshold reactions

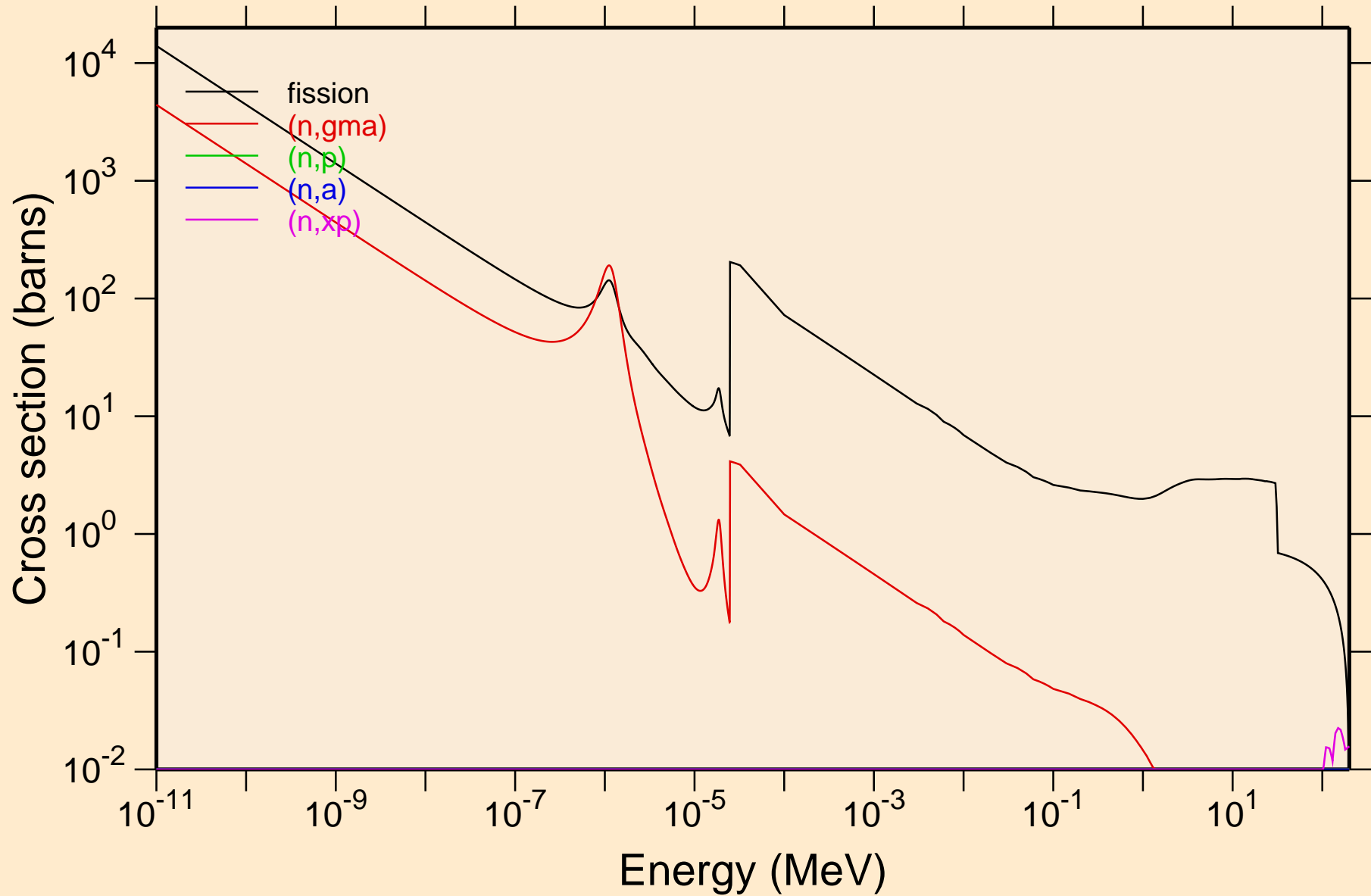

LR264 NEUTRON ACER TENDL-2021 LIBRARY; T=293.6K
Non-threshold reactions

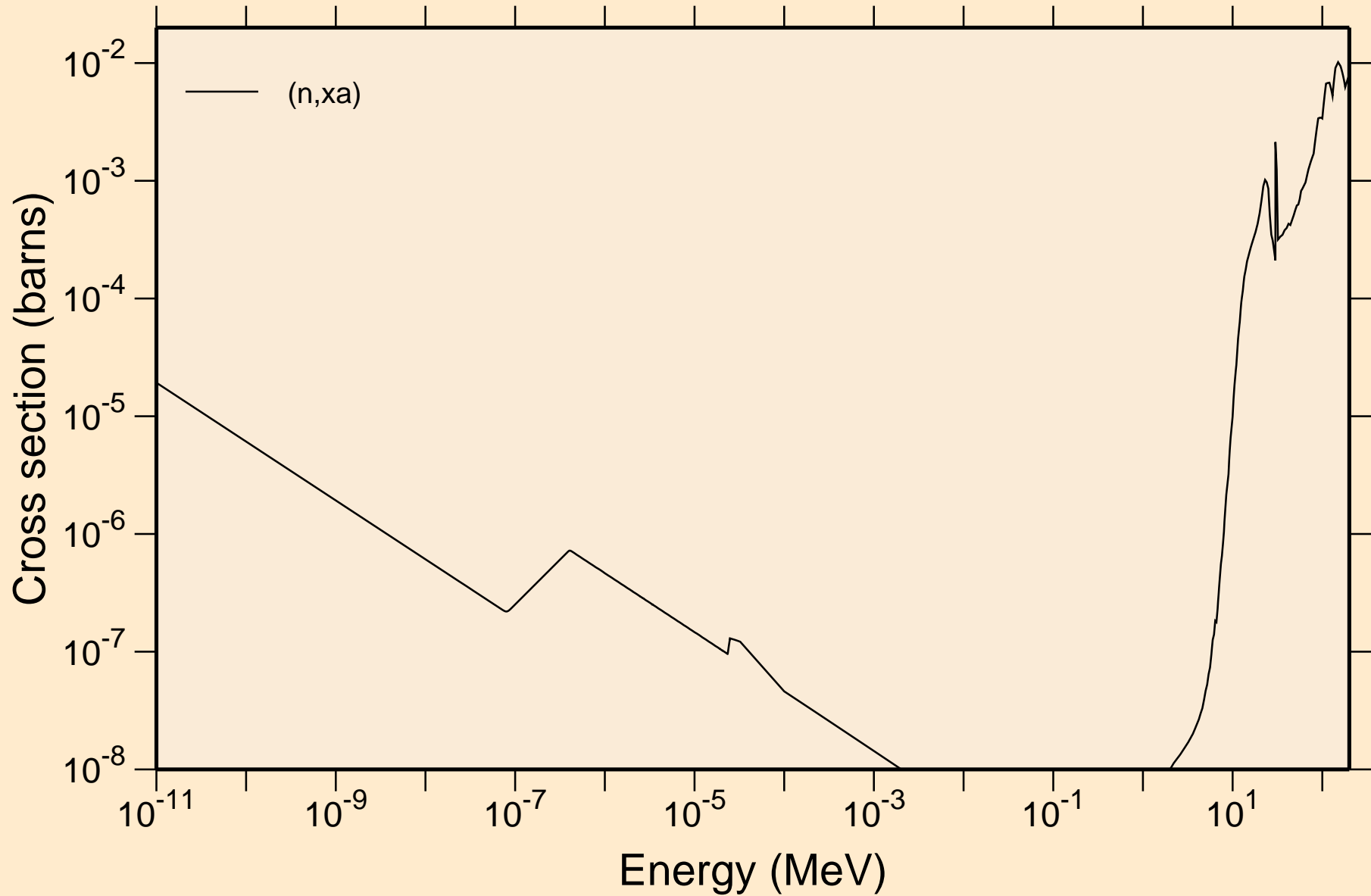

LR264 NEUTRON ACER TENDL-2021 LIBRARY; T=293.6K
Principal cross sections

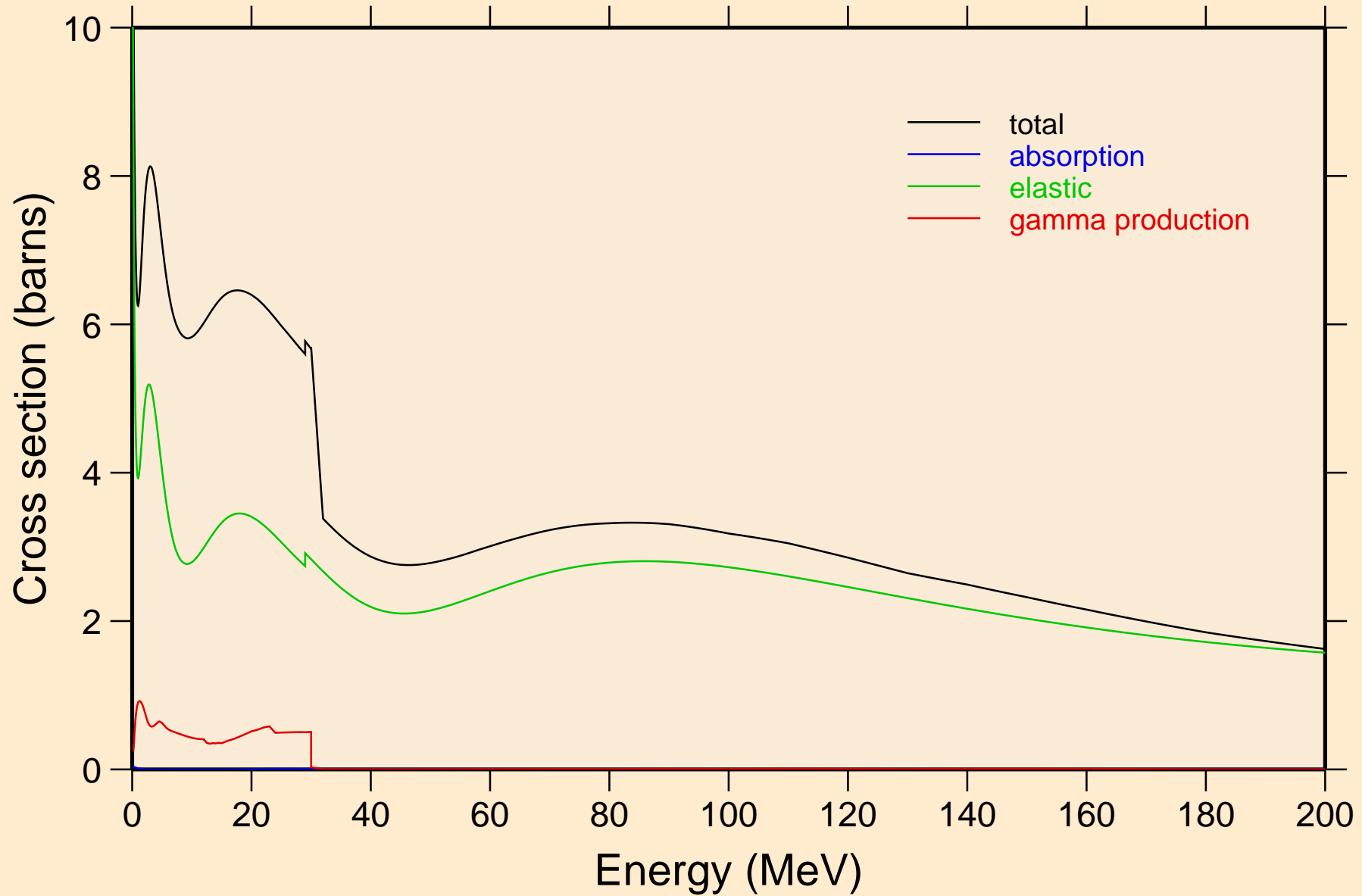

LR264 NEUTRON ACER TENDL-2021 LIBRARY; T=293.6K
Heating

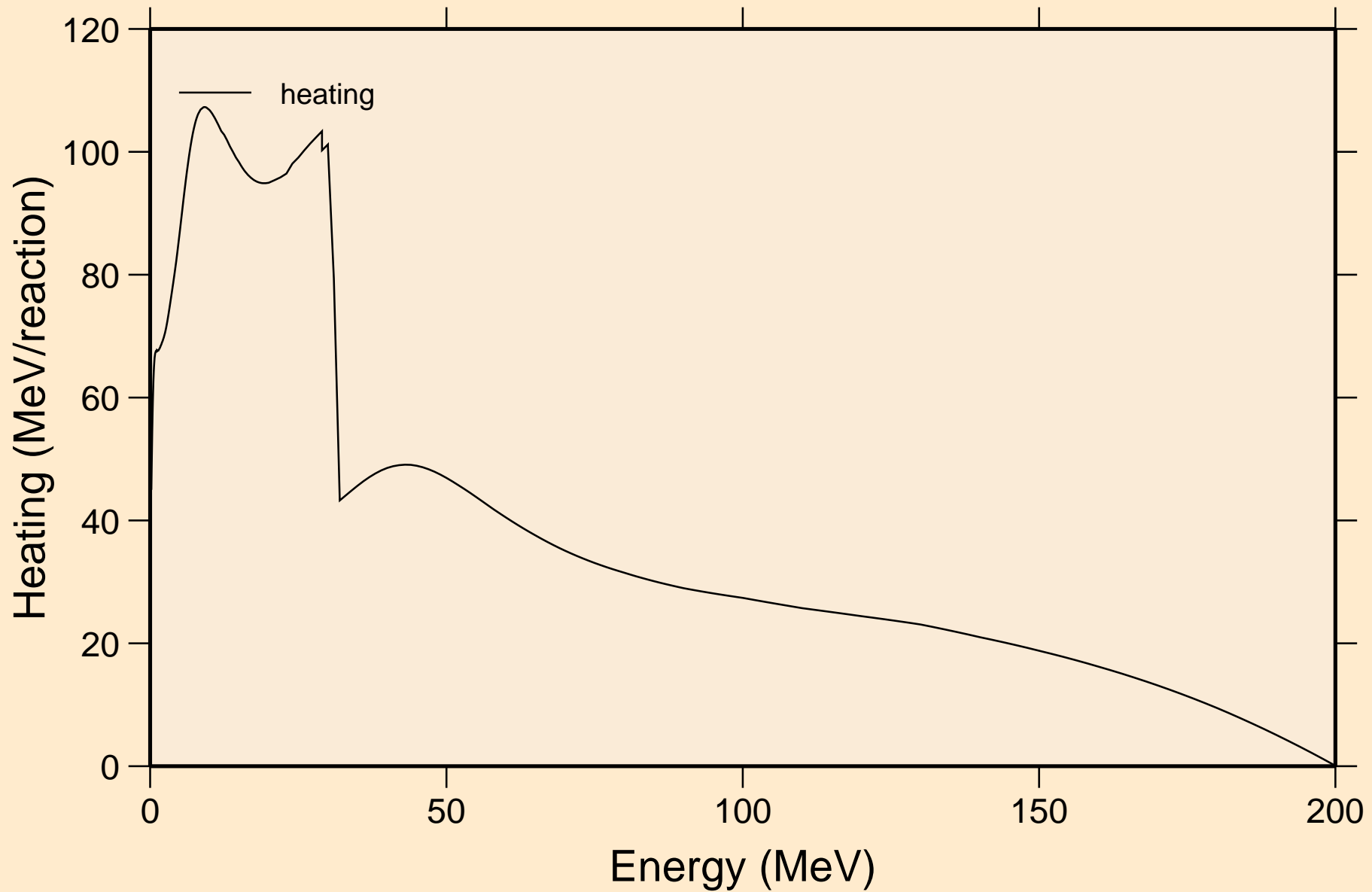

LR264 NEUTRON ACER TENDL-2021 LIBRARY; T=293.6K
Damage

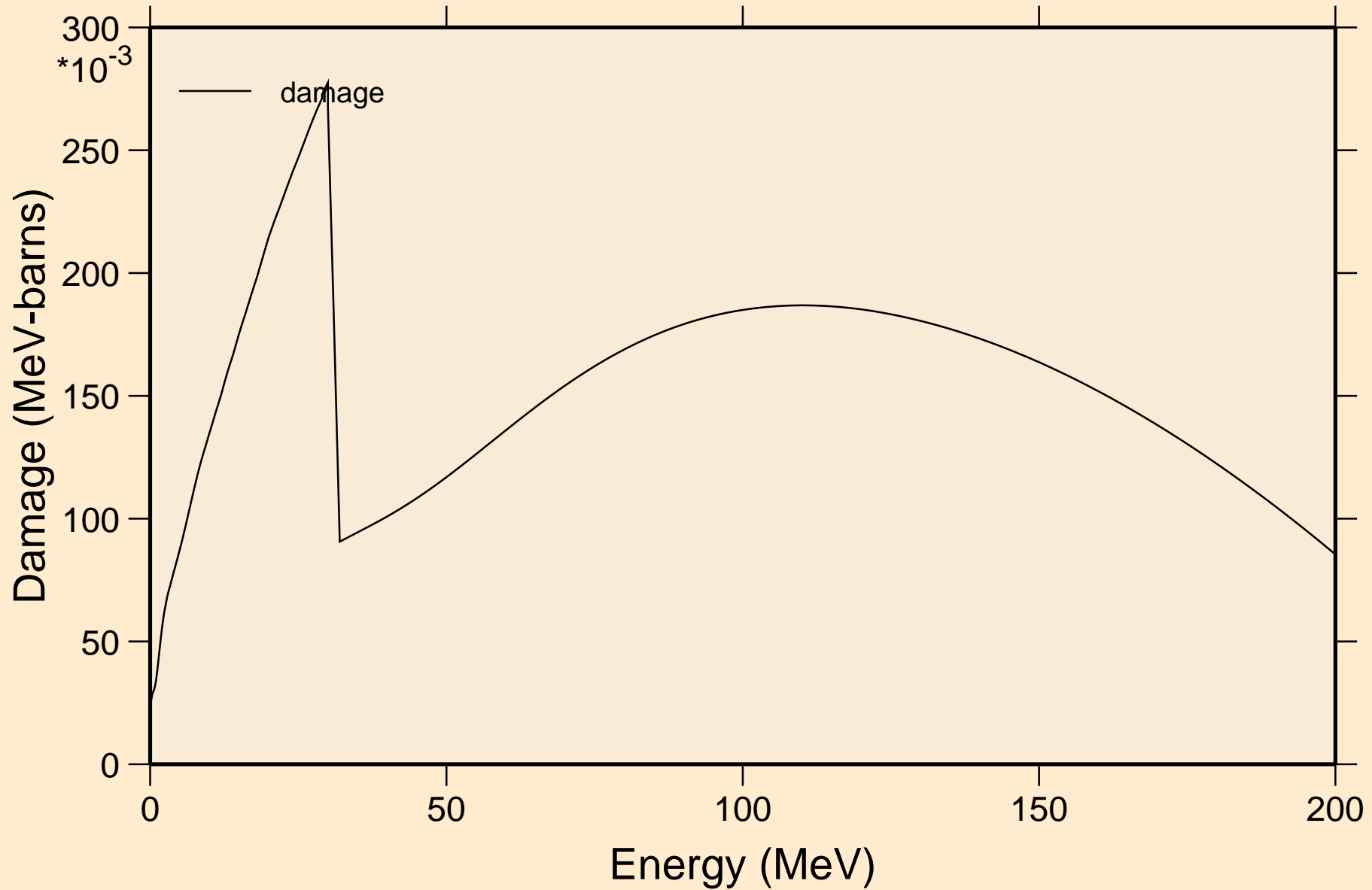

LR264 NEUTRON ACER TENDL-2021 LIBRARY; T=293.6K
Non-threshold reactions

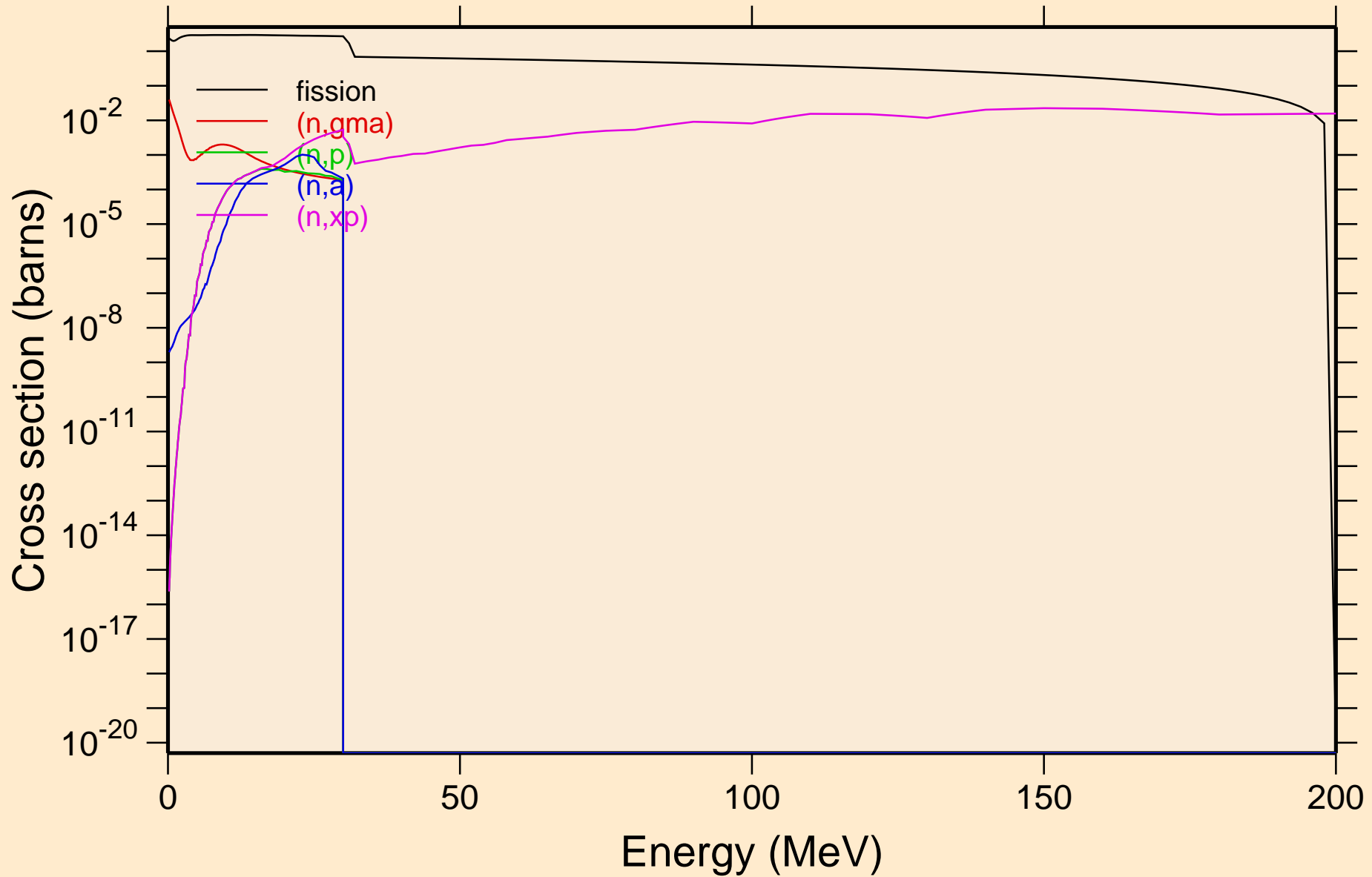

LR264 NEUTRON ACER TENDL-2021 LIBRARY; T=293.6K
Non-threshold reactions

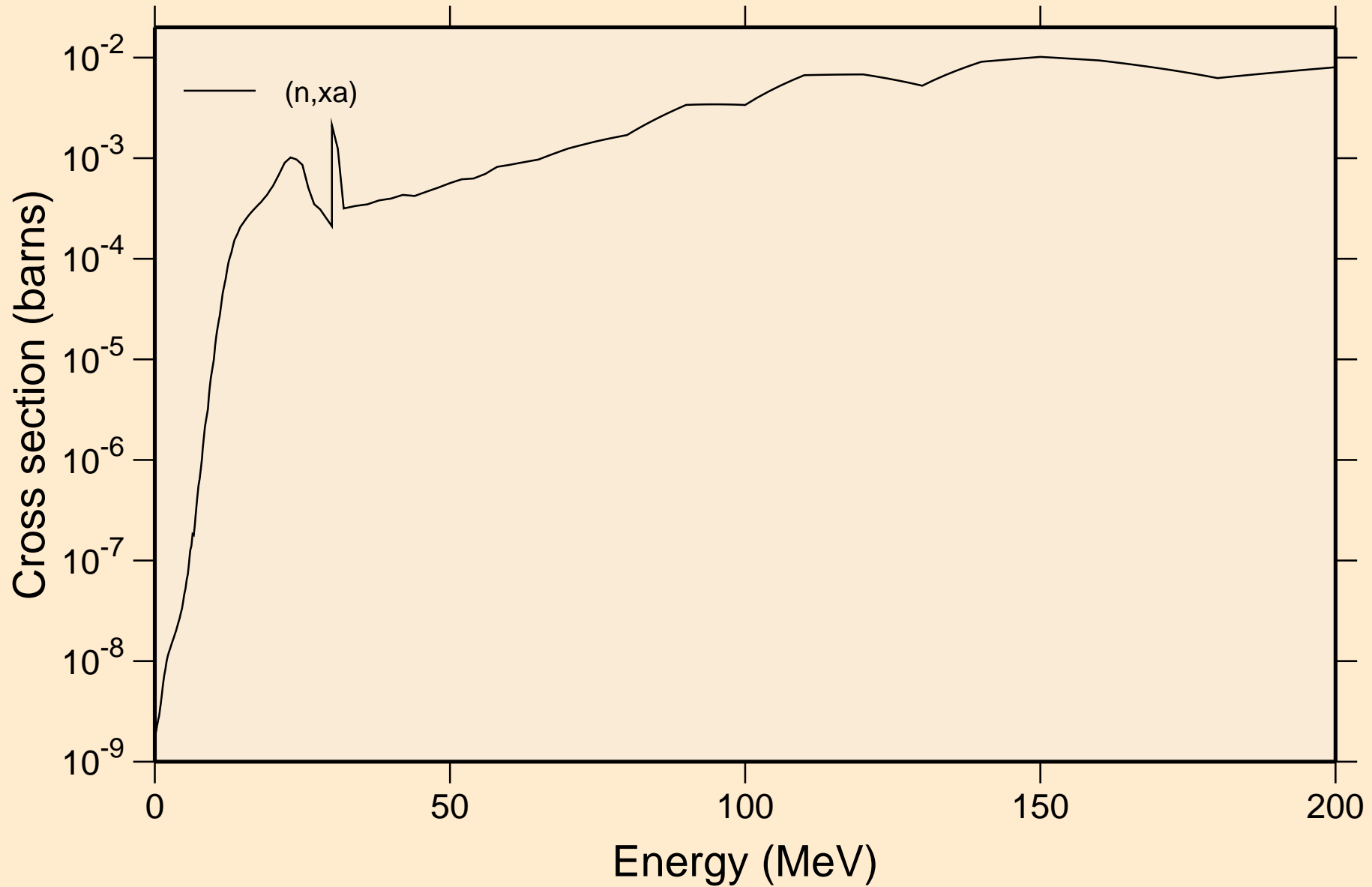

LR264 NEUTRON ACER TENDL-2021 LIBRARY; T=293.6K
Inelastic levels

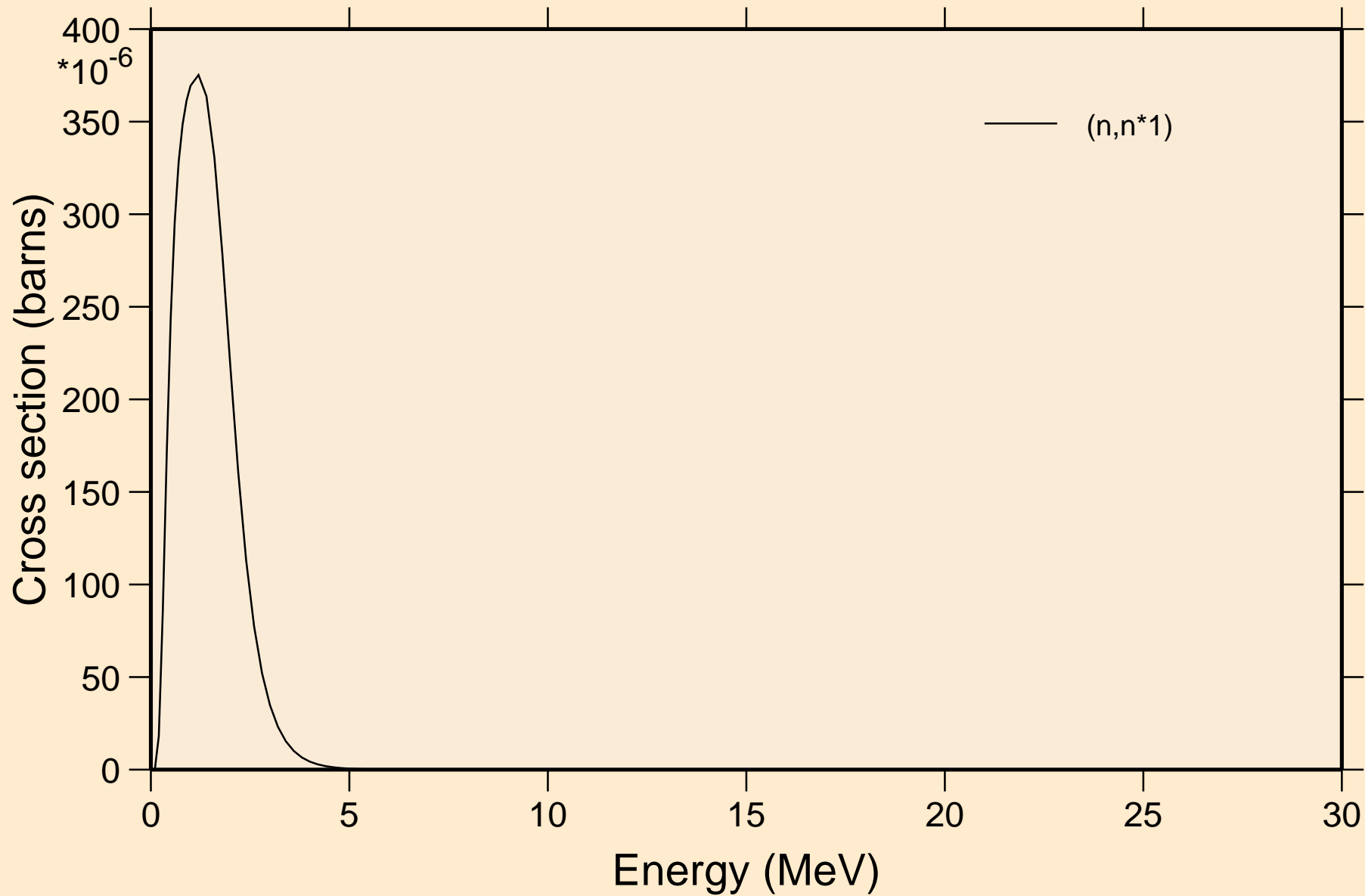

LR264 NEUTRON ACER TENDL-2021 LIBRARY; T=293.6K
Threshold reactions

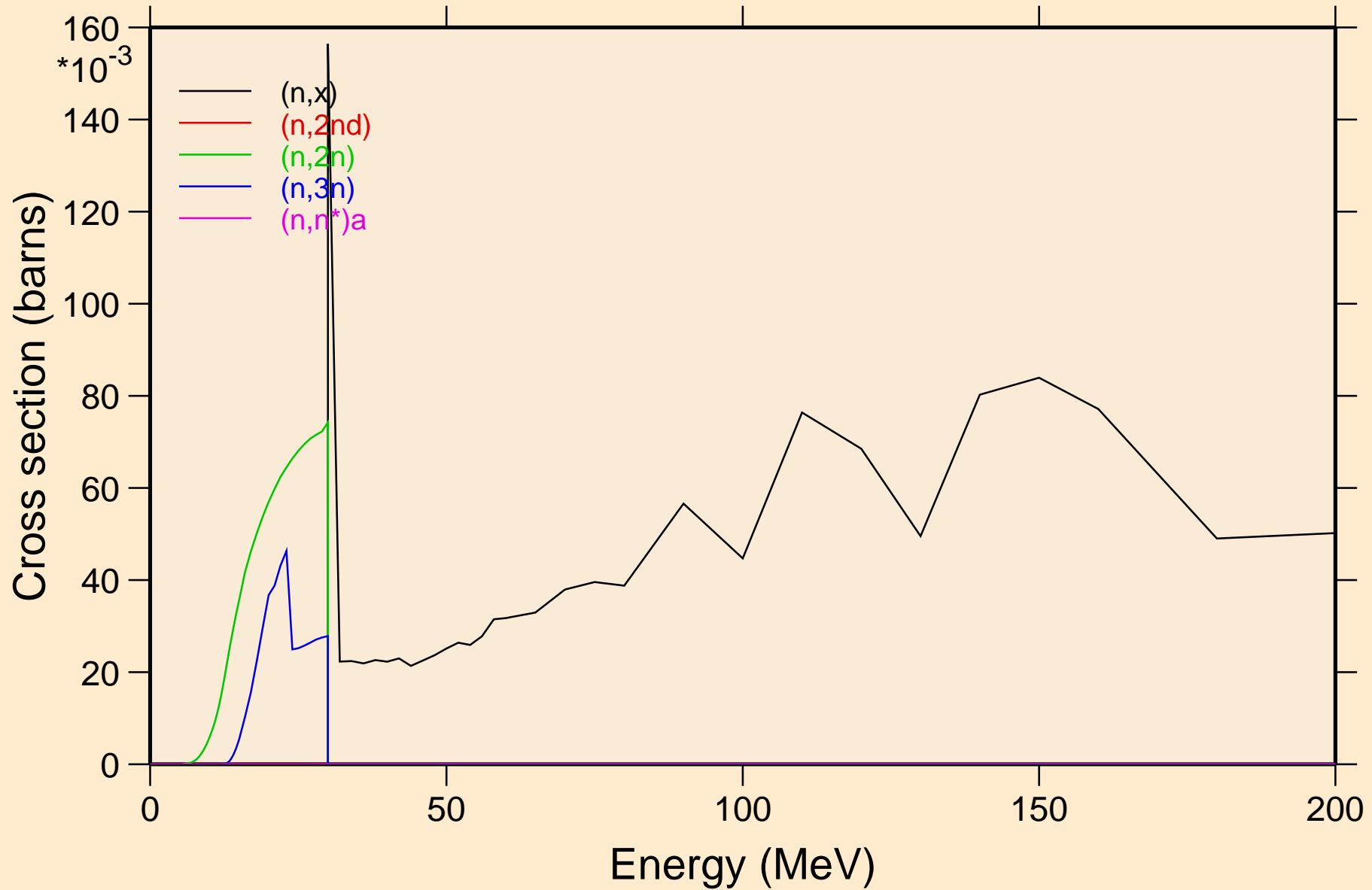

LR264 NEUTRON ACER TENDL-2021 LIBRARY; T=293.6K
Threshold reactions

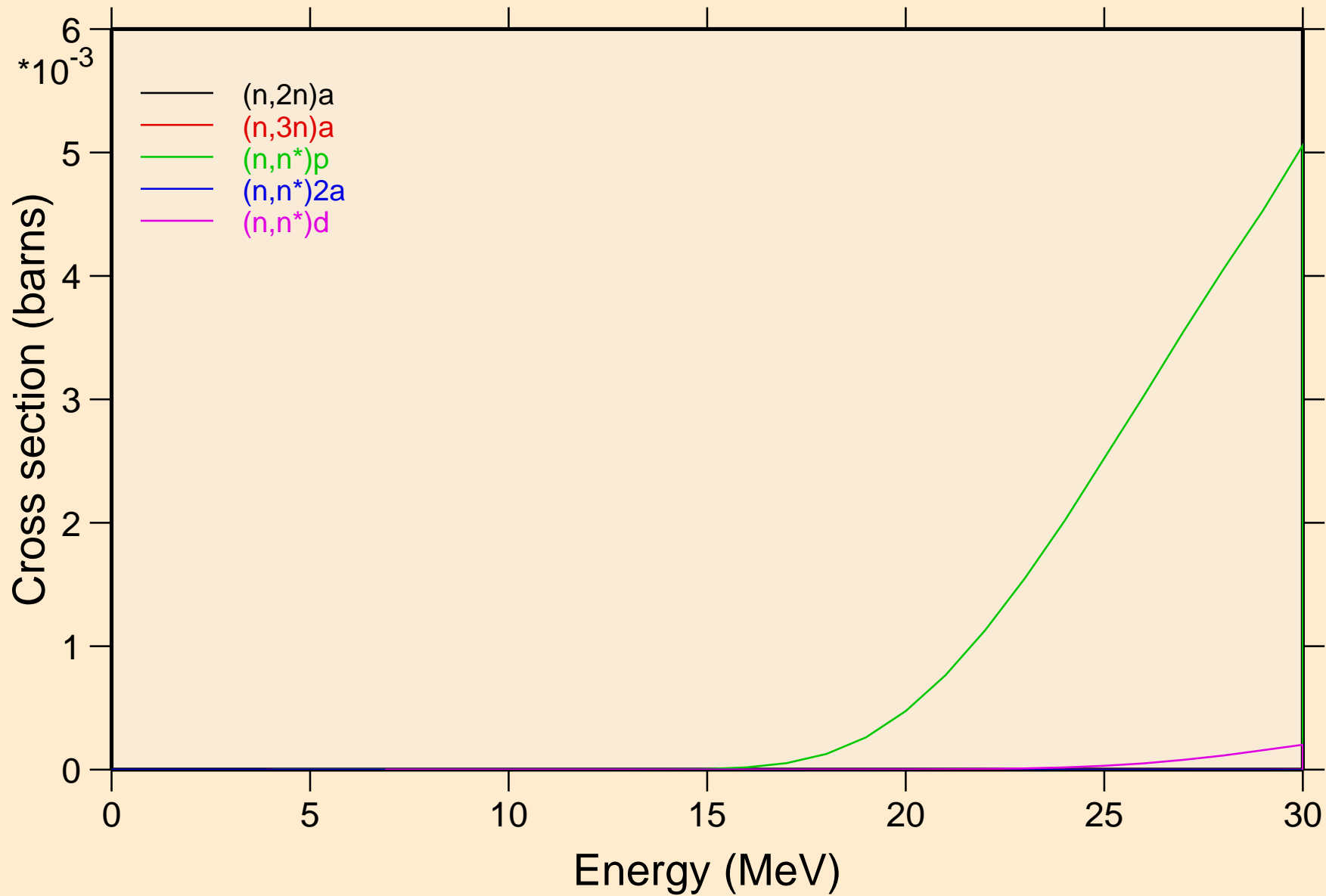

LR264 NEUTRON ACER TENDL-2021 LIBRARY; T=293.6K
Threshold reactions

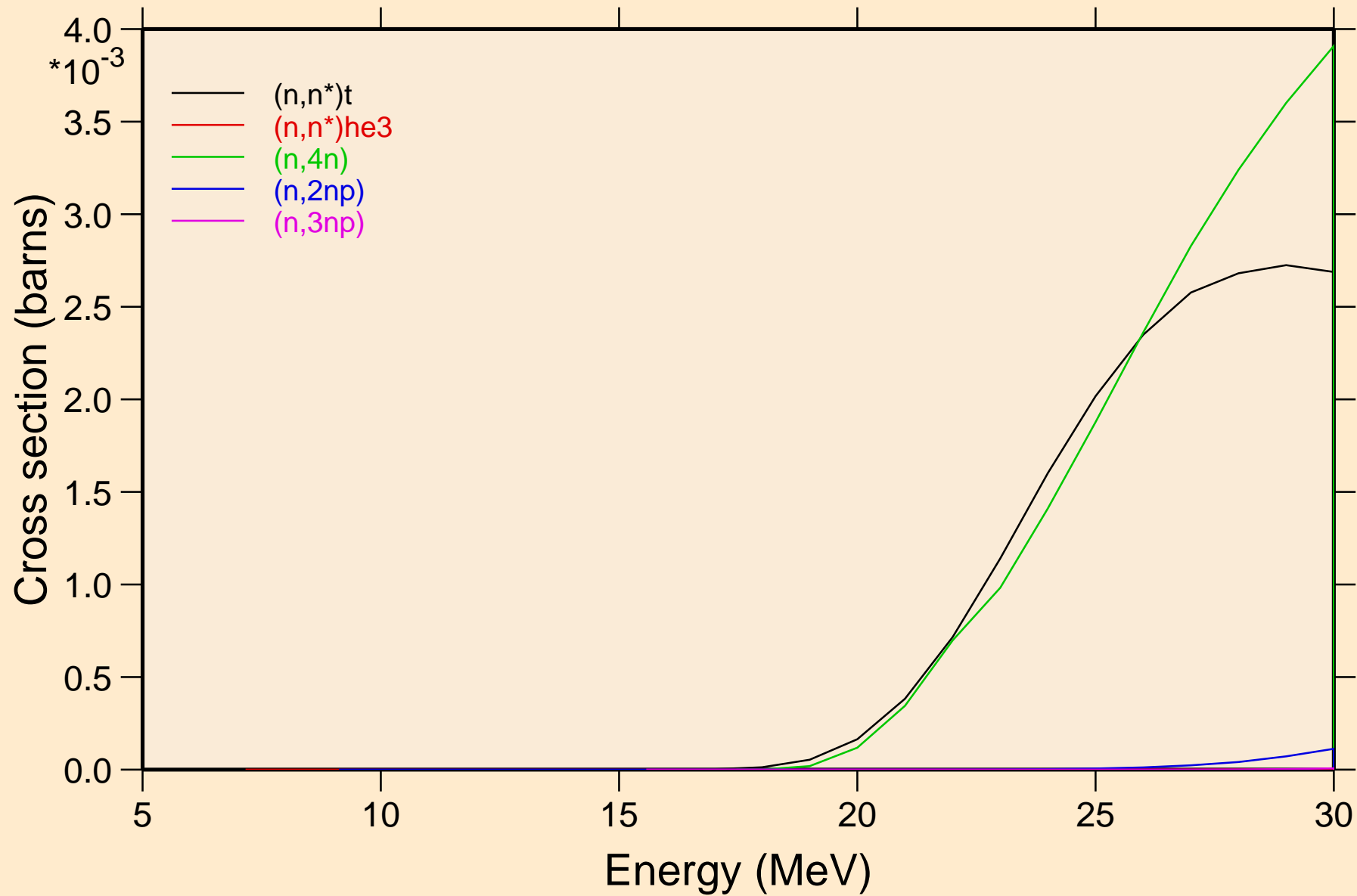

LR264 NEUTRON ACER TENDL-2021 LIBRARY; T=293.6K
Threshold reactions

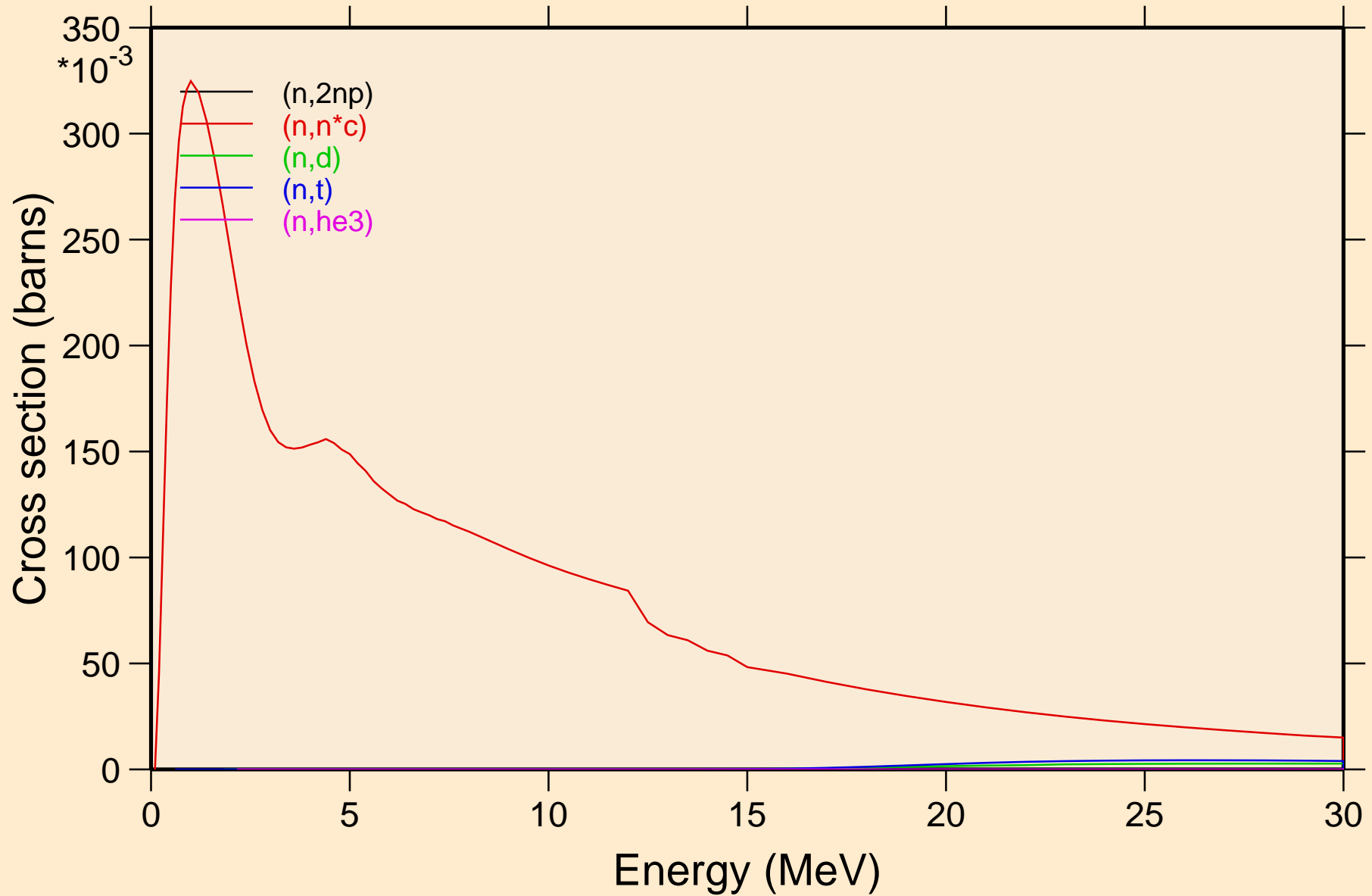

LR264 NEUTRON ACER TENDL-2021 LIBRARY; T=293.6K
Threshold reactions

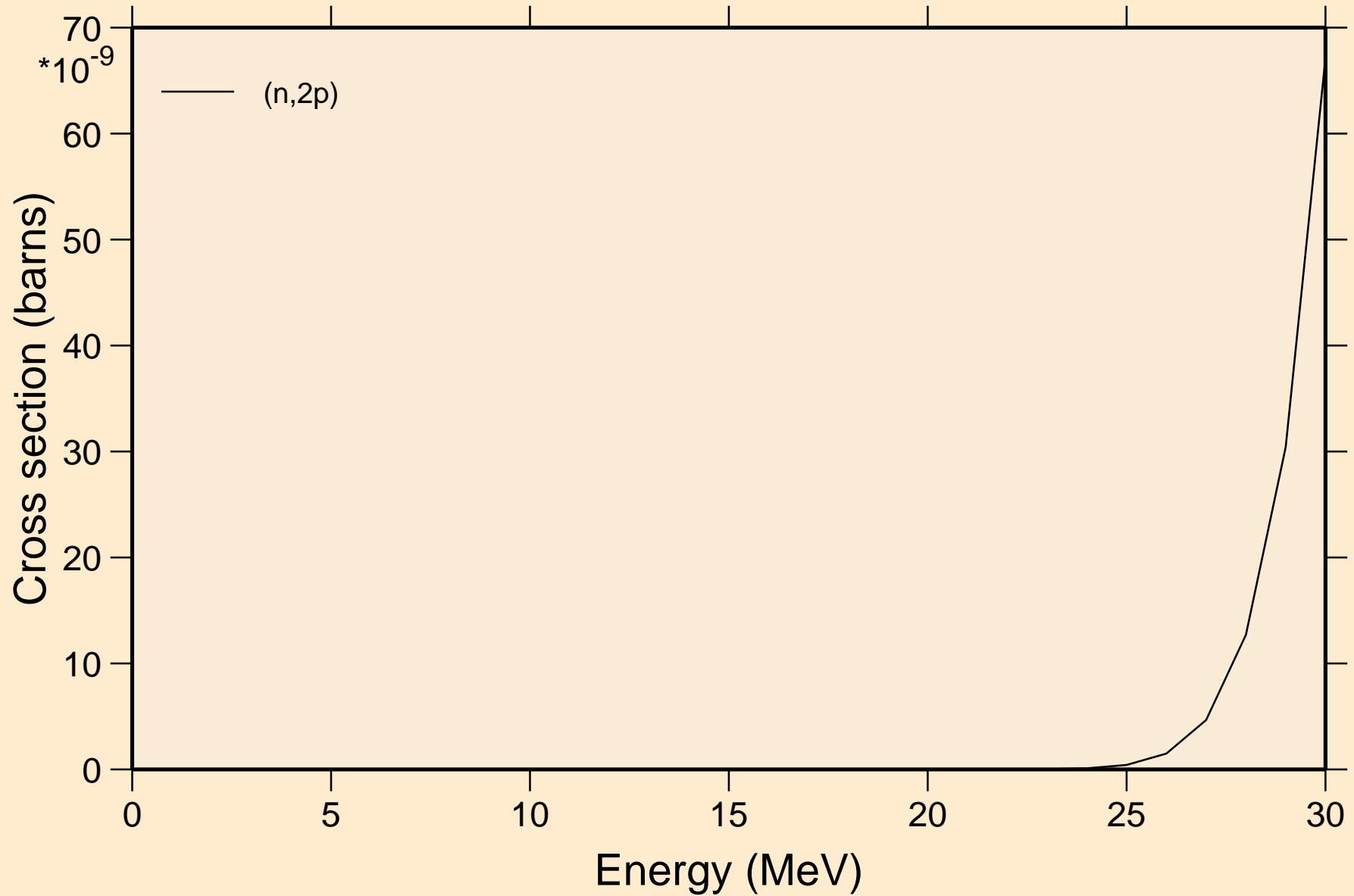

LR264 NEUTRON ACER TENDL-2021 LIBRARY; T=293.6K
Threshold reactions

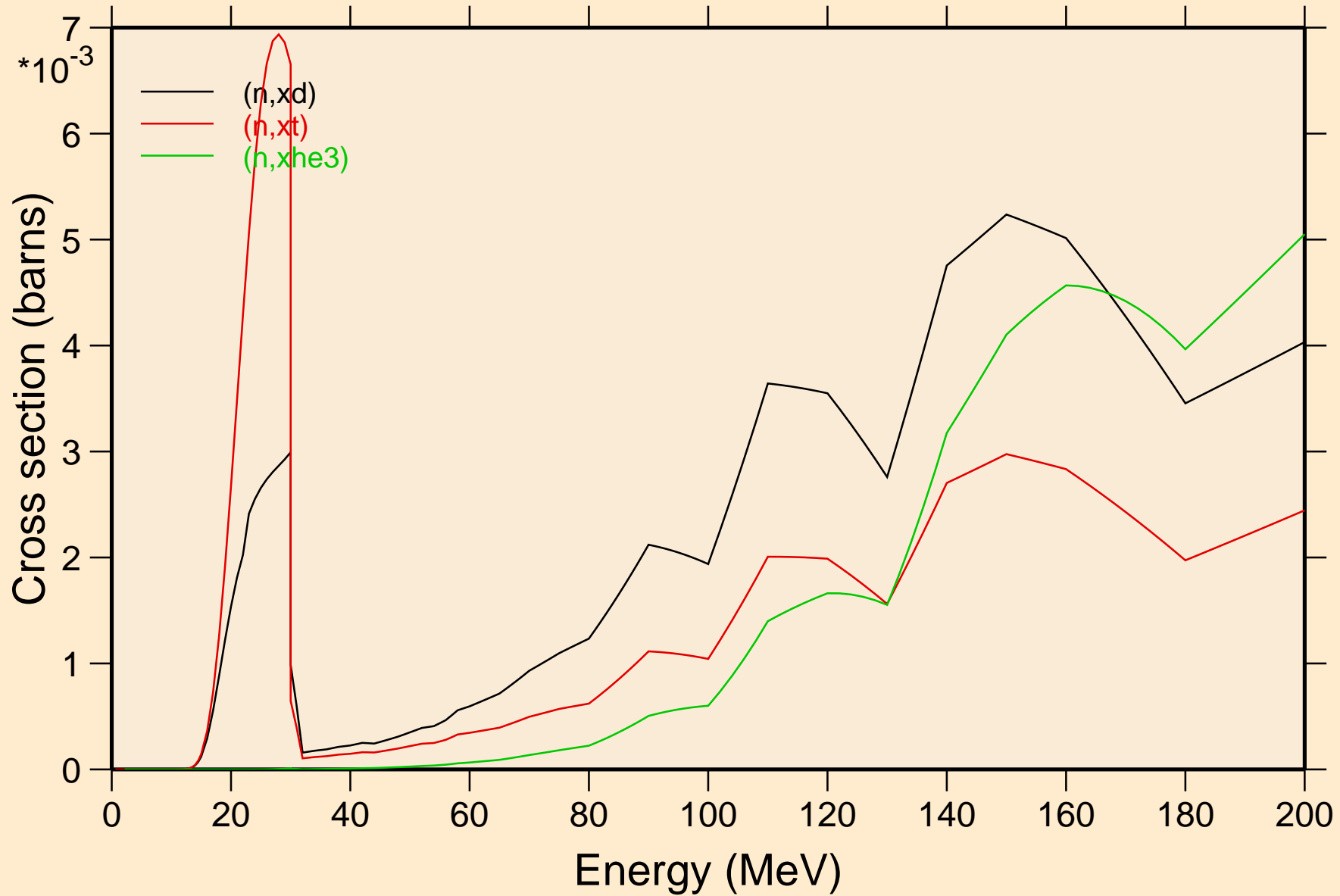

LR264 NEUTRON ACER TENDL-2021 LIBRARY; T=293.6K
angular distribution for elastic

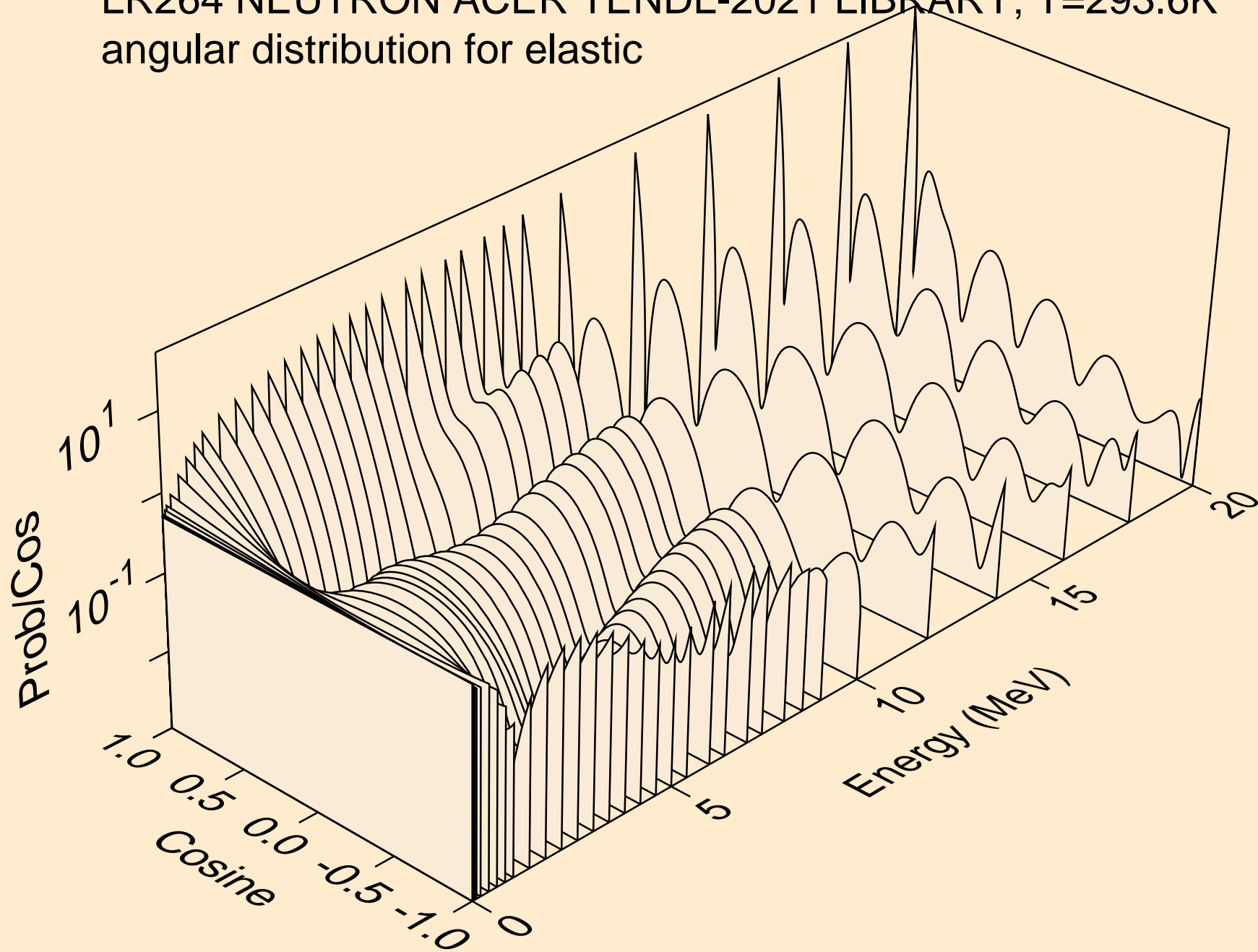

LR264 NEUTRON ACER TENDL-2021 LIBRARY; T=293.6K
angular distribution for elastic

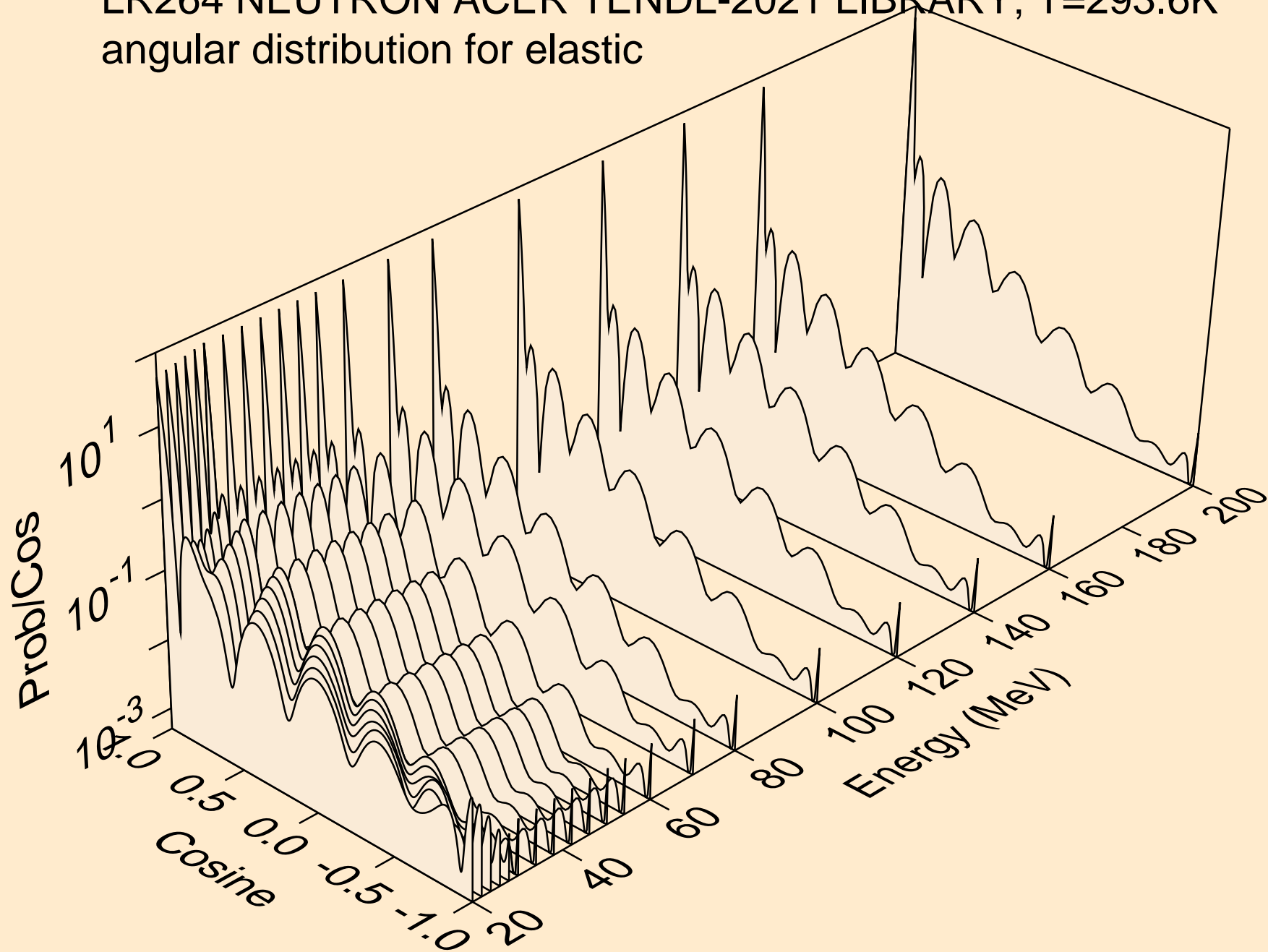

LR264 NEUTRON ACER TENDL-2021 LIBRARY; T=293.6K
angular distribution for (n,n*1)

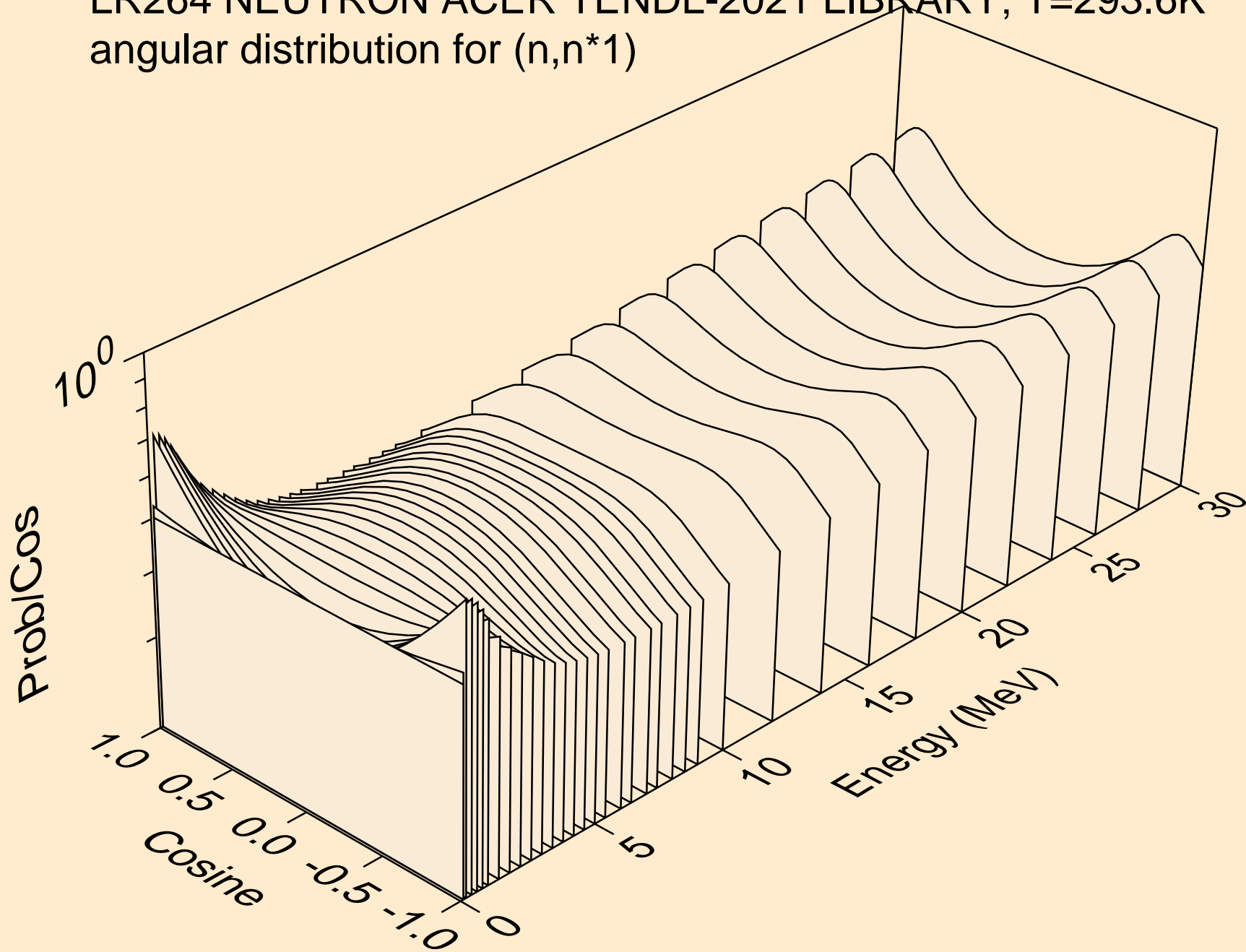

LR264 NEUTRON ACER TENDL-2021 LIBRARY; T=293.6K

Total fission nubar

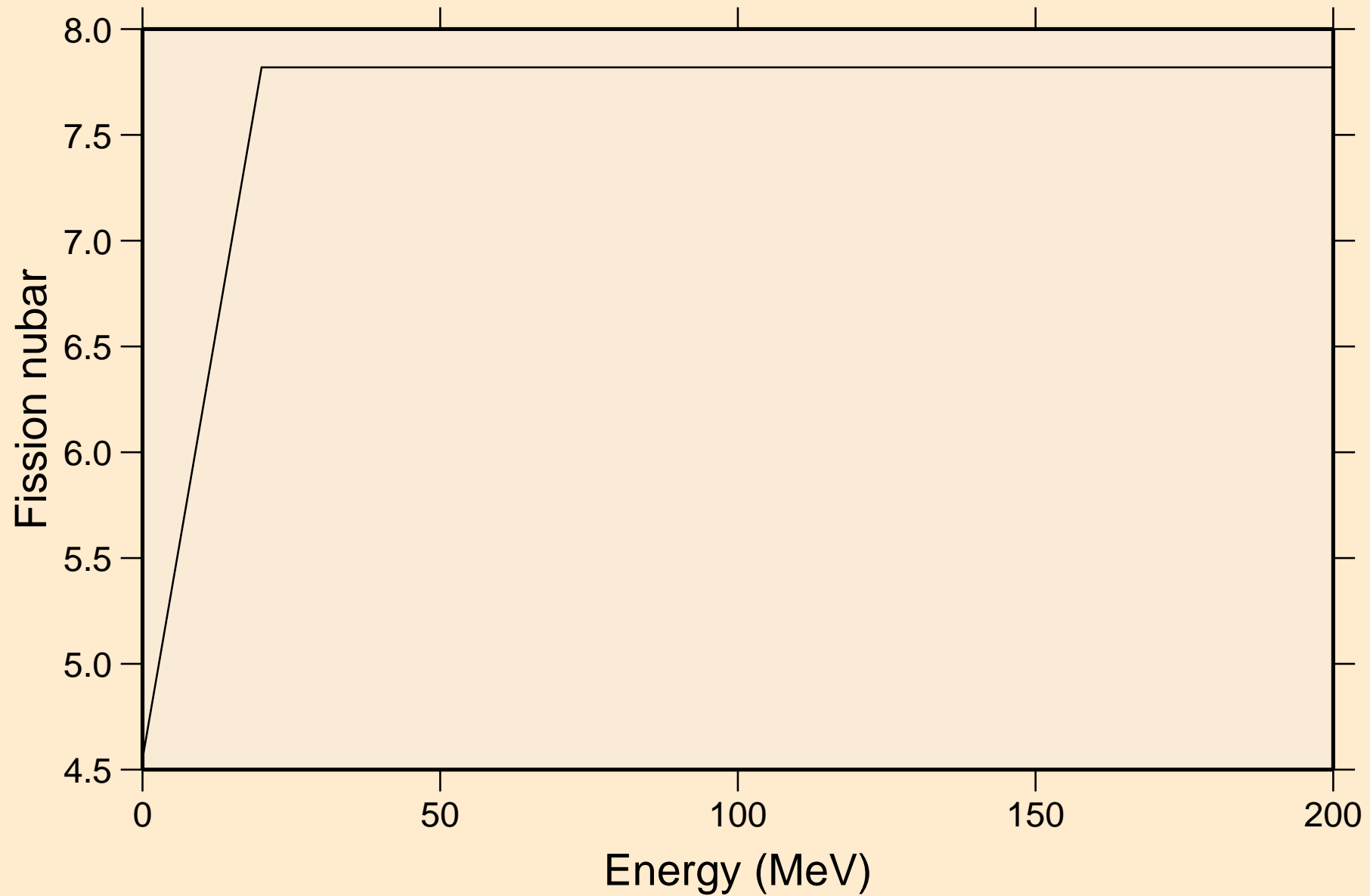

LR264 NEUTRON ACER TENDL-2021 LIBRARY; T=293.6K
Neutron emission for (n,x)

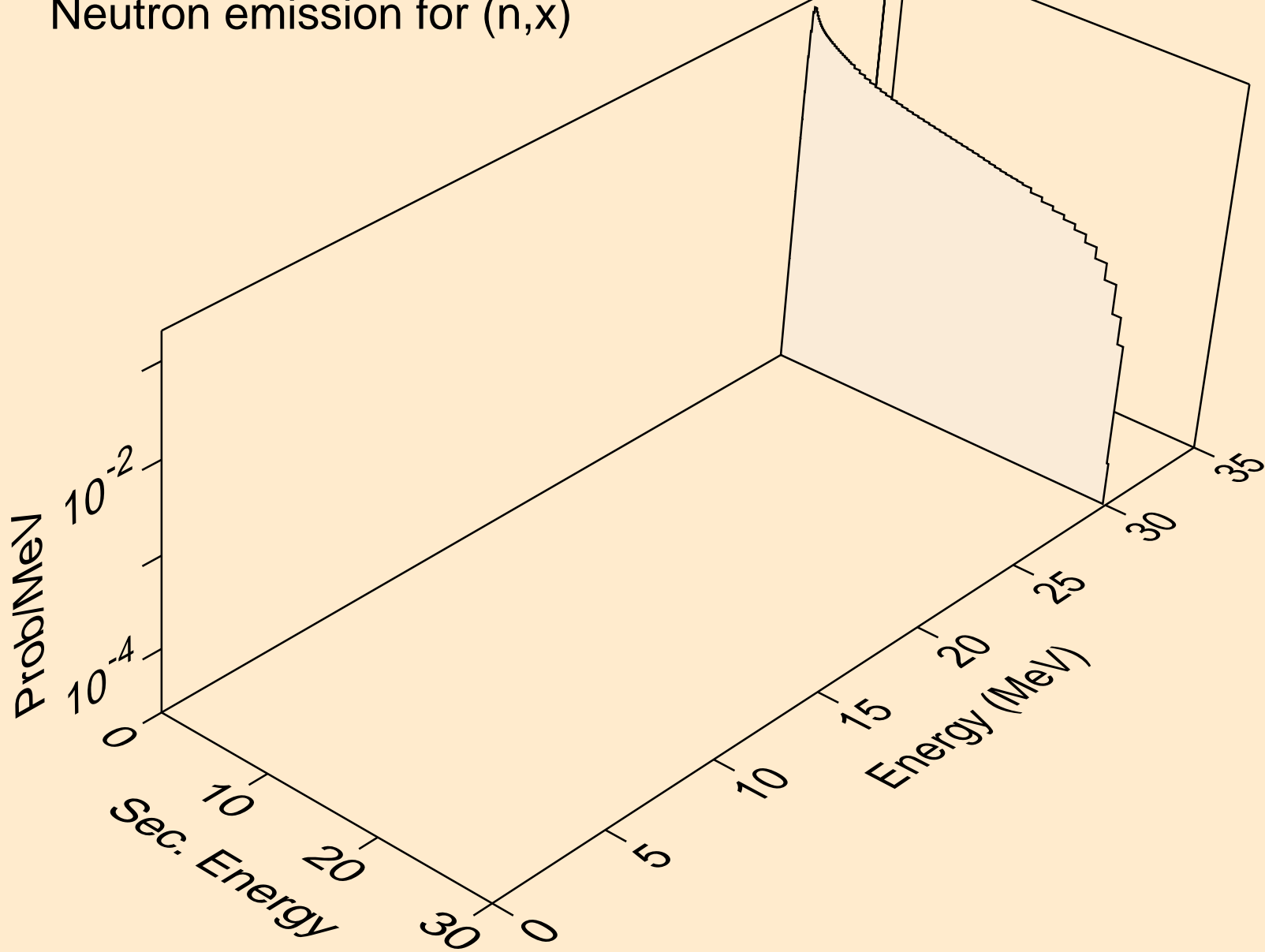

LR264 NEUTRON ACER TENDL-2021 LIBRARY; T=293.6K
Neutron emission for (n,2nd)

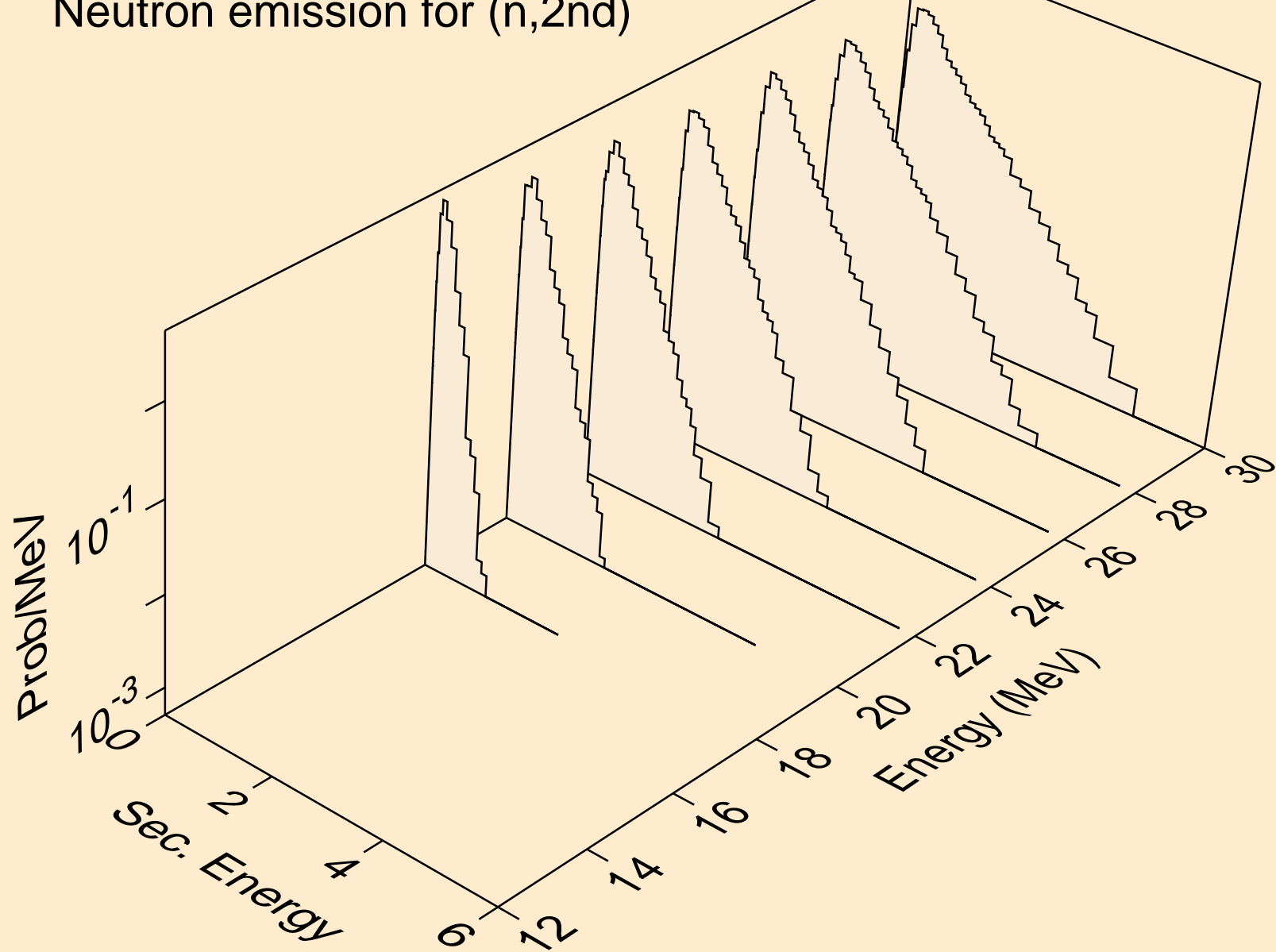

LR264 NEUTRON ACER TENDL-2021 LIBRARY; T=293.6K
Neutron emission for (n,2n)

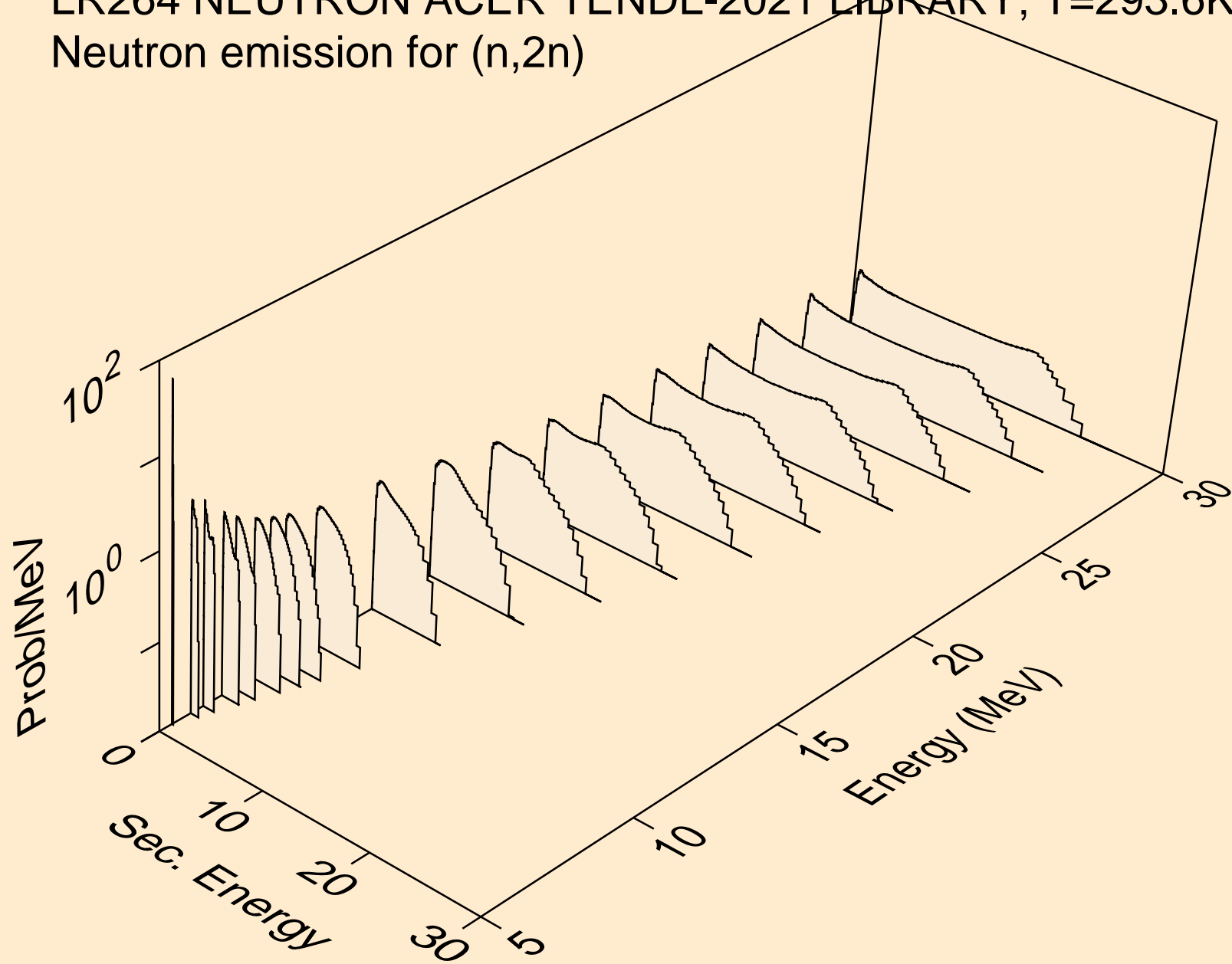

LR264 NEUTRON ACER TENDL-2021 LIBRARY; T=293.6K
Neutron emission for (n,3n)

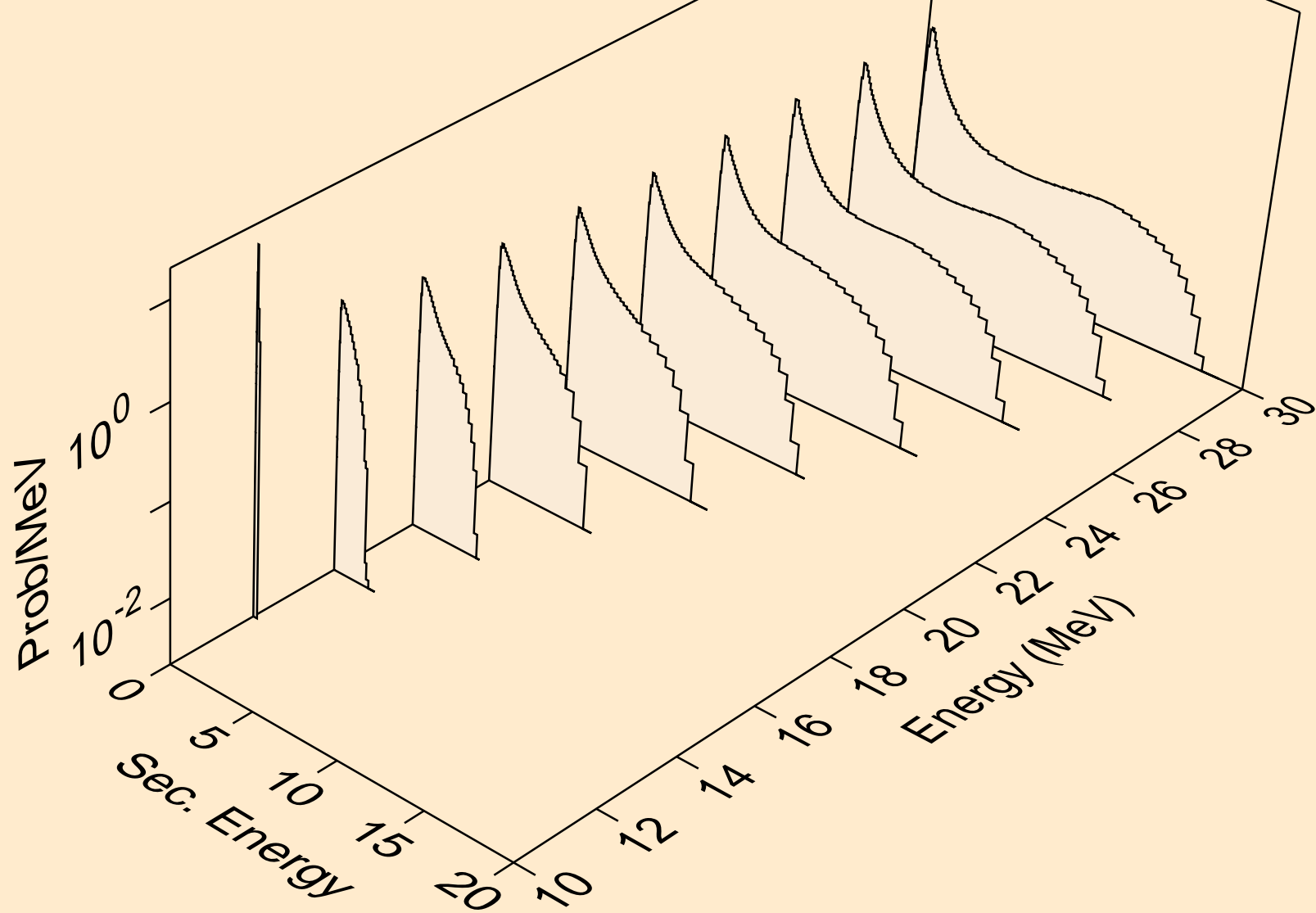

LR264 NEUTRON ACER TENDL-2021 LIBRARY; T=293.6K
Neutron emission for fission

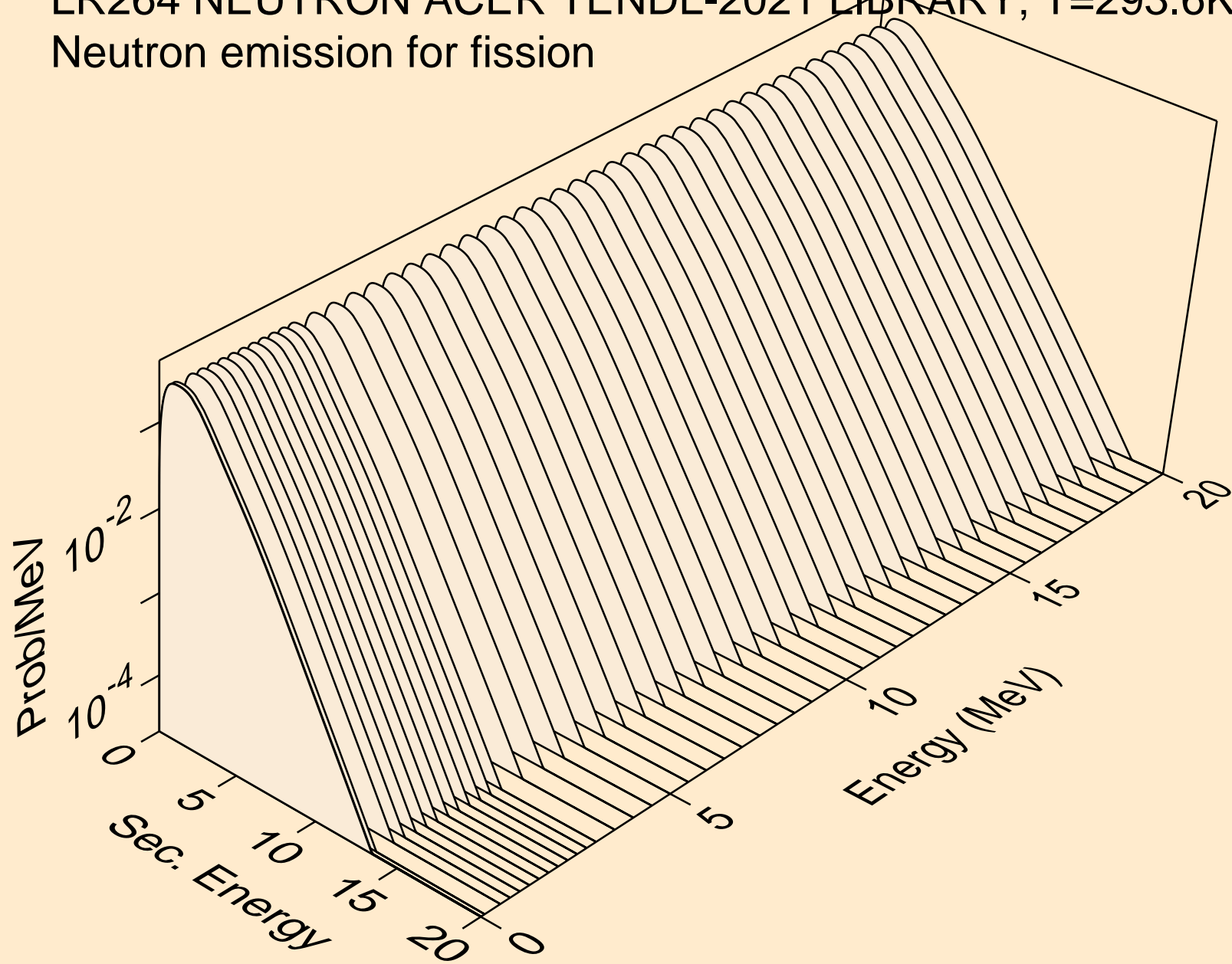

LR264 NEUTRON ACER TENDL-2021 LIBRARY; T=293.6K
Neutron emission for (n,n*)a

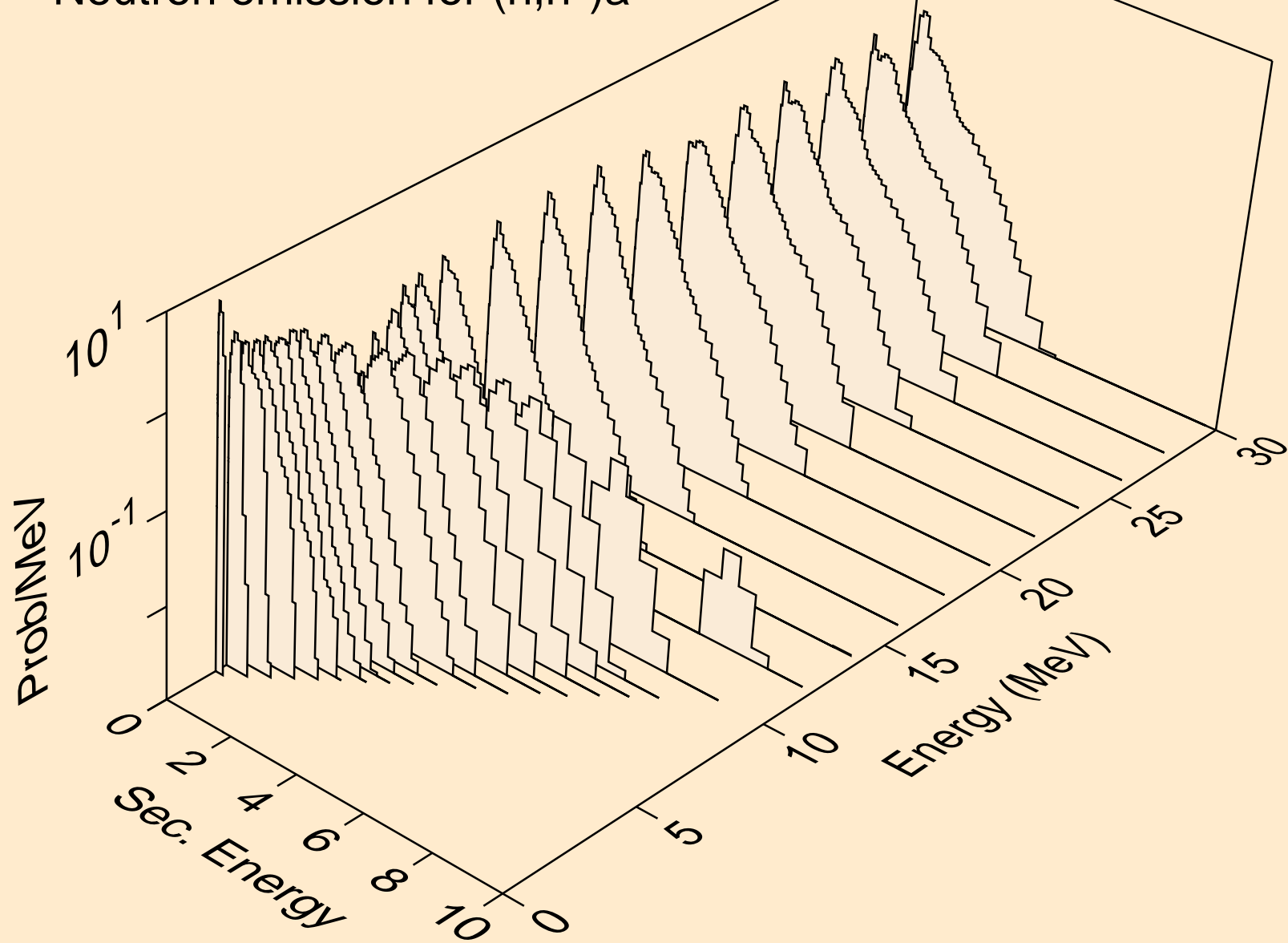

LR264 NEUTRON ACER TENDL-2021 LIBRARY; T=293.6K
Neutron emission for (n,2n)a

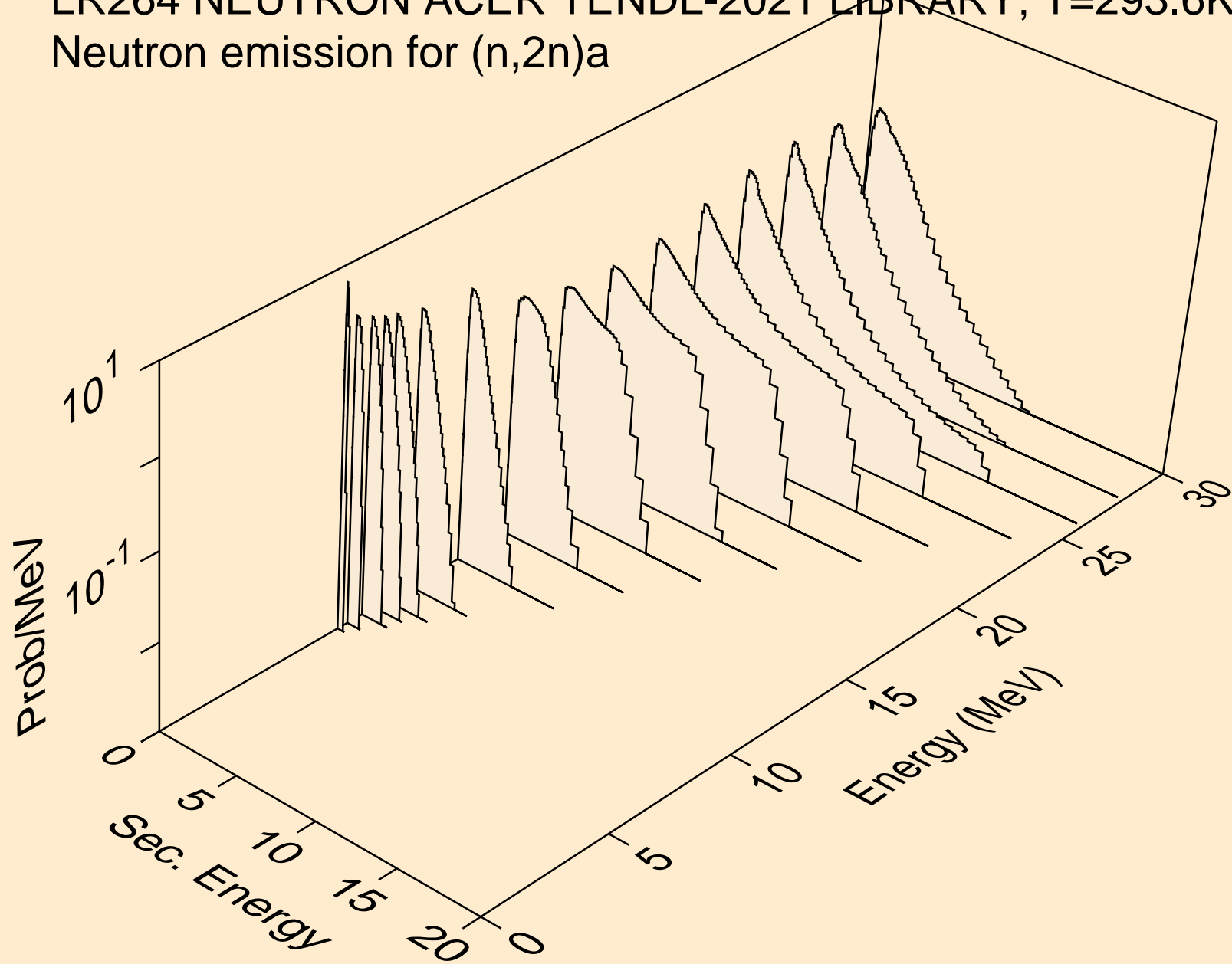

LR264 NEUTRON ACER TENDL-2021 LIBRARY; T=293.6K
Neutron emission for (n,3n)a

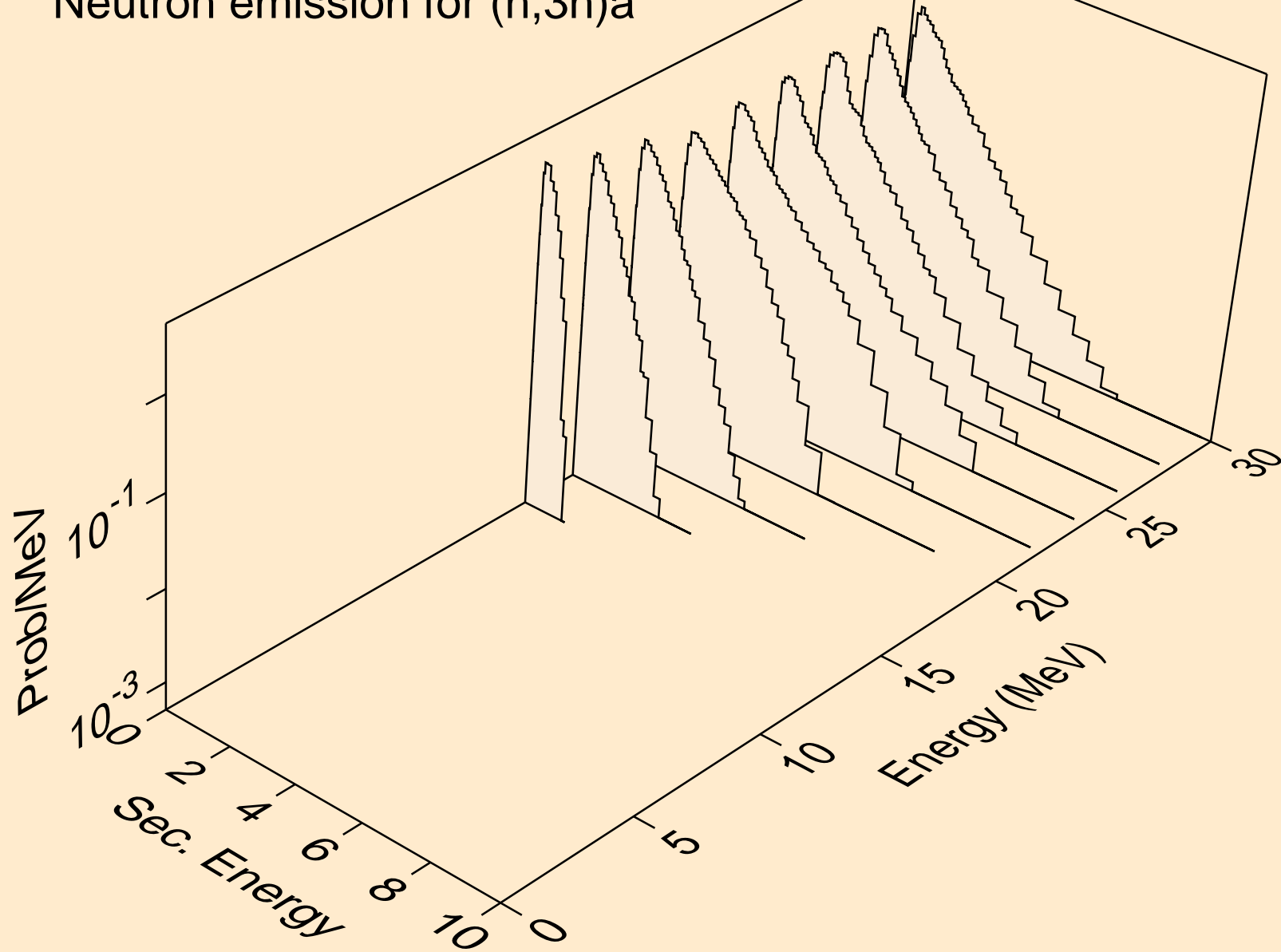

LR264 NEUTRON ACER TENDL-2021 LIBRARY; T=293.6K
Neutron emission for (n,n*)p

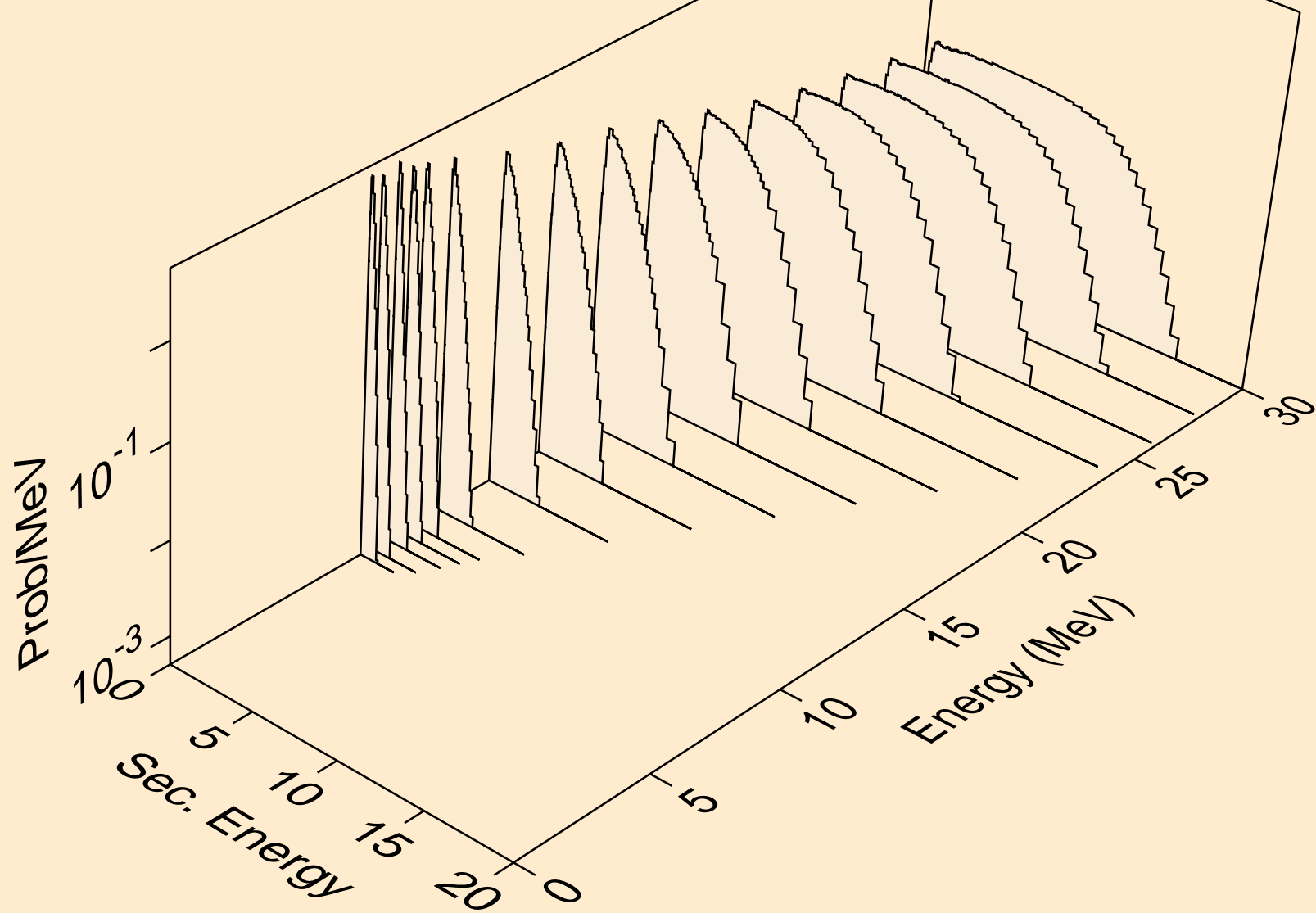

LR264 NEUTRON ACER TENDL-2021 LIBRARY; T=293.6K
Neutron emission for (n,n*)2a

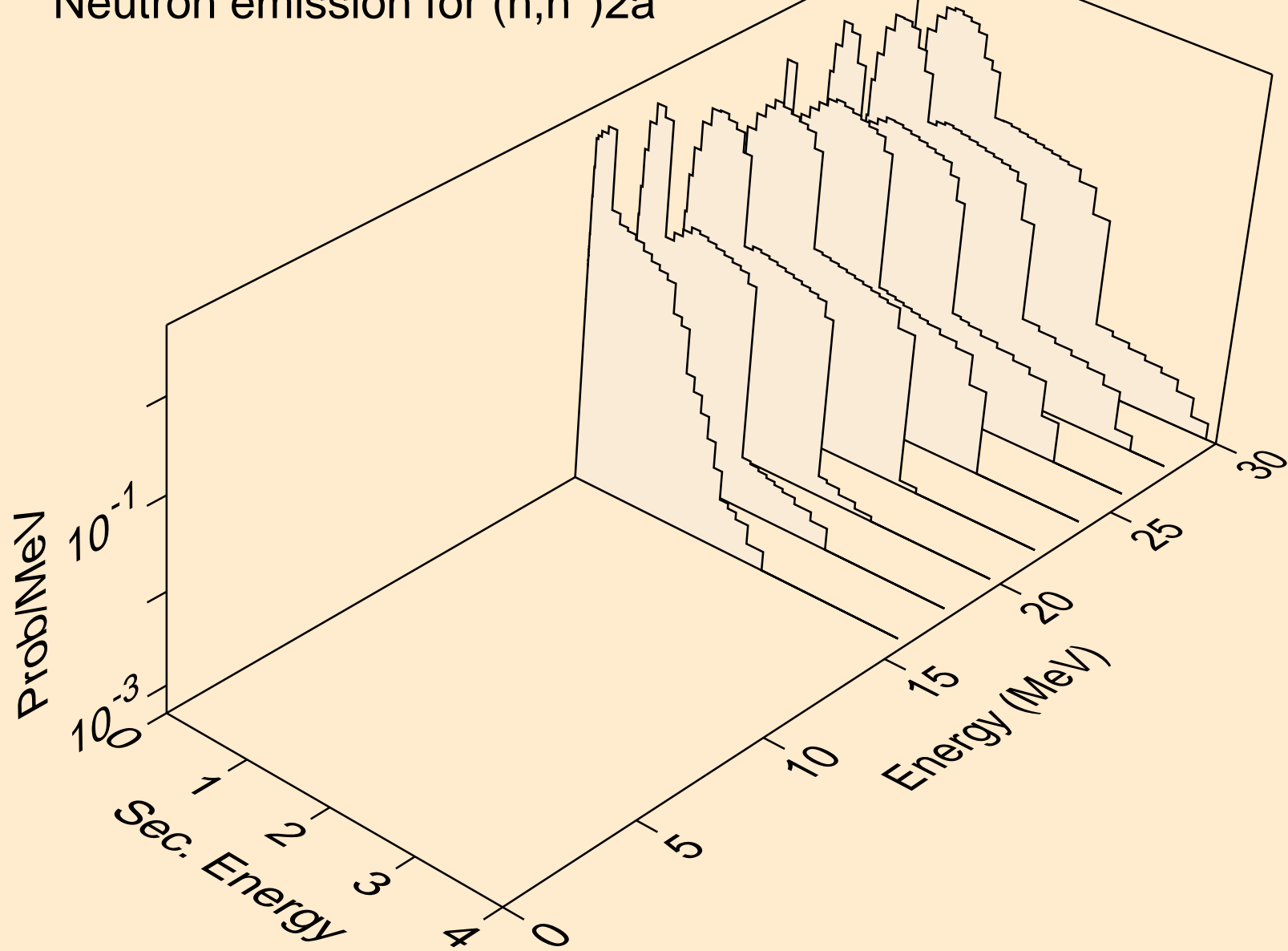

LR264 NEUTRON ACER TENDL-2021 LIBRARY; T=293.6K
Neutron emission for (n,n*)d

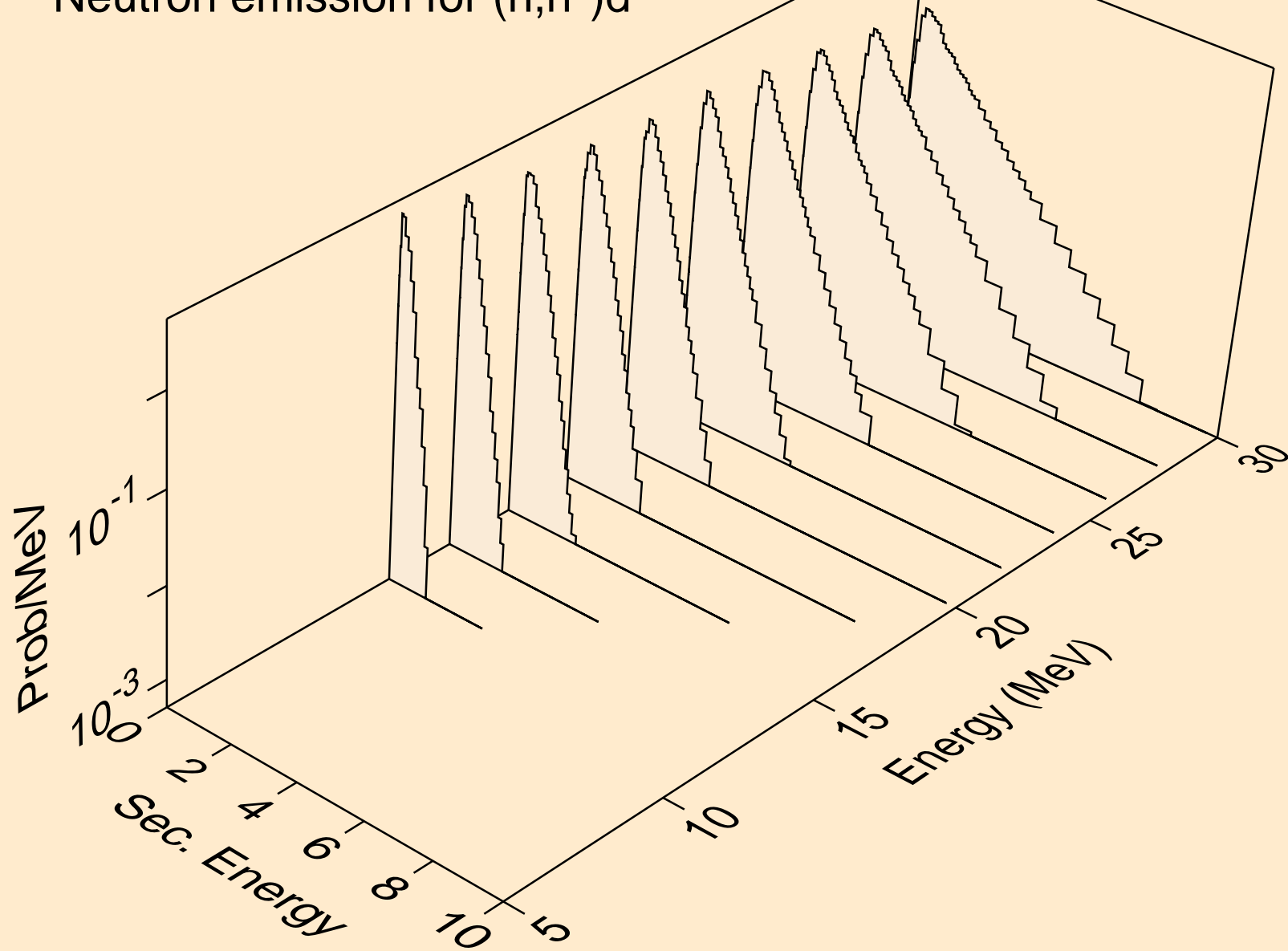

LR264 NEUTRON ACER TENDL-2021 LIBRARY; T=293.6K
Neutron emission for (n,n*)t

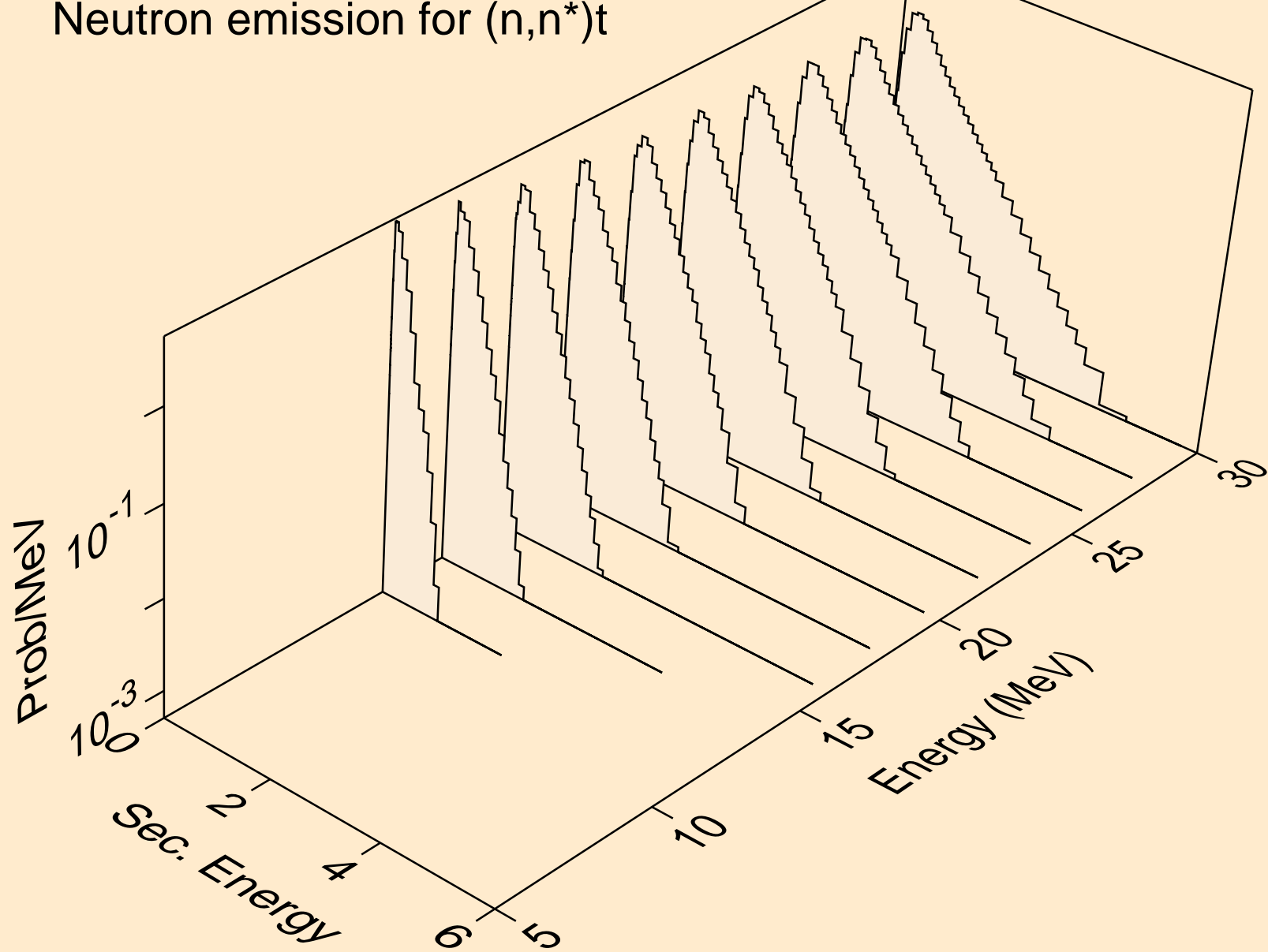

LR264 NEUTRON ACER TENDL-2021 LIBRARY; T=293.6K
Neutron emission for (n,n*)he3

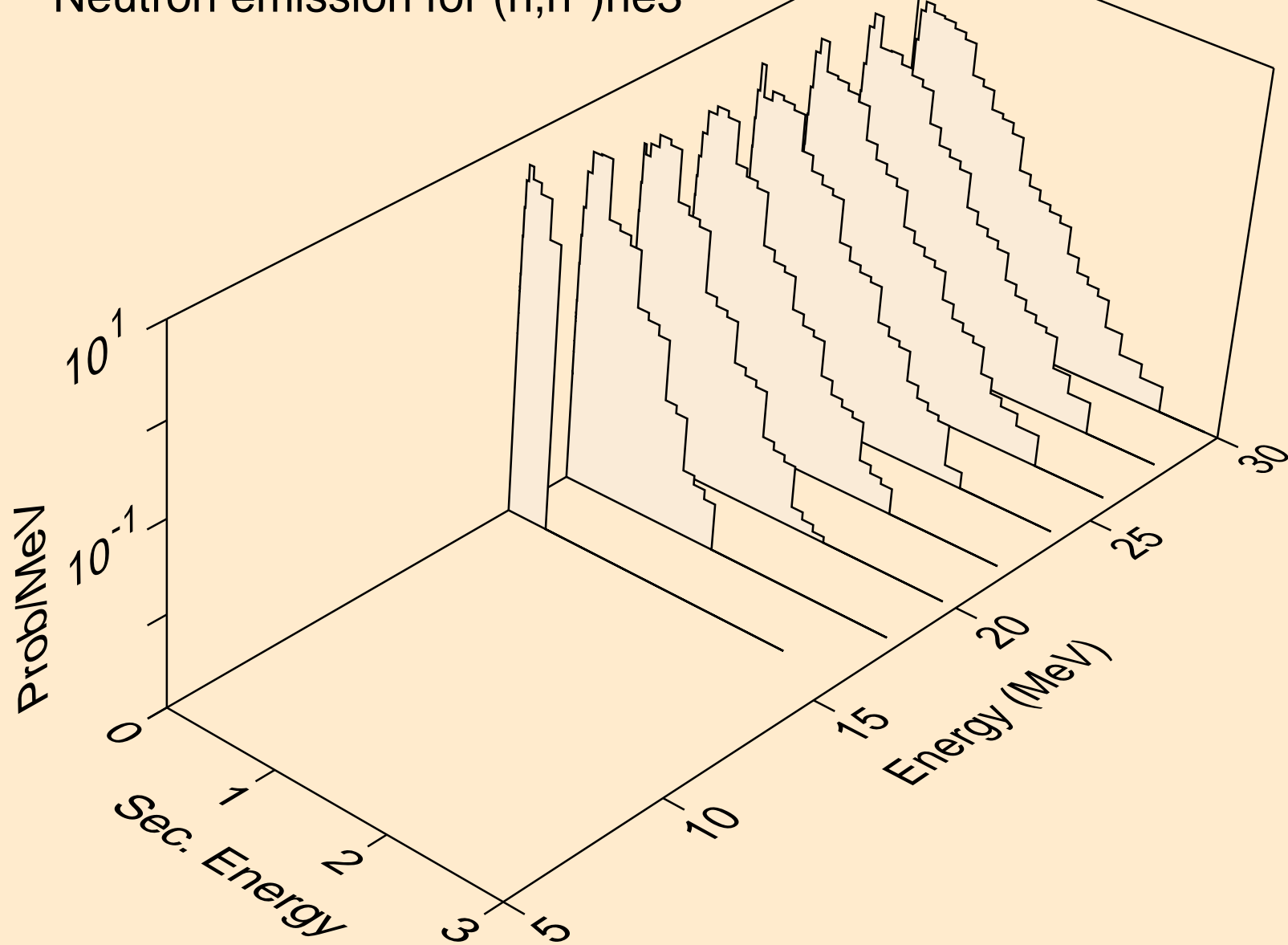

LR264 NEUTRON ACER TENDL-2021 LIBRARY; T=293.6K
Neutron emission for (n,4n)

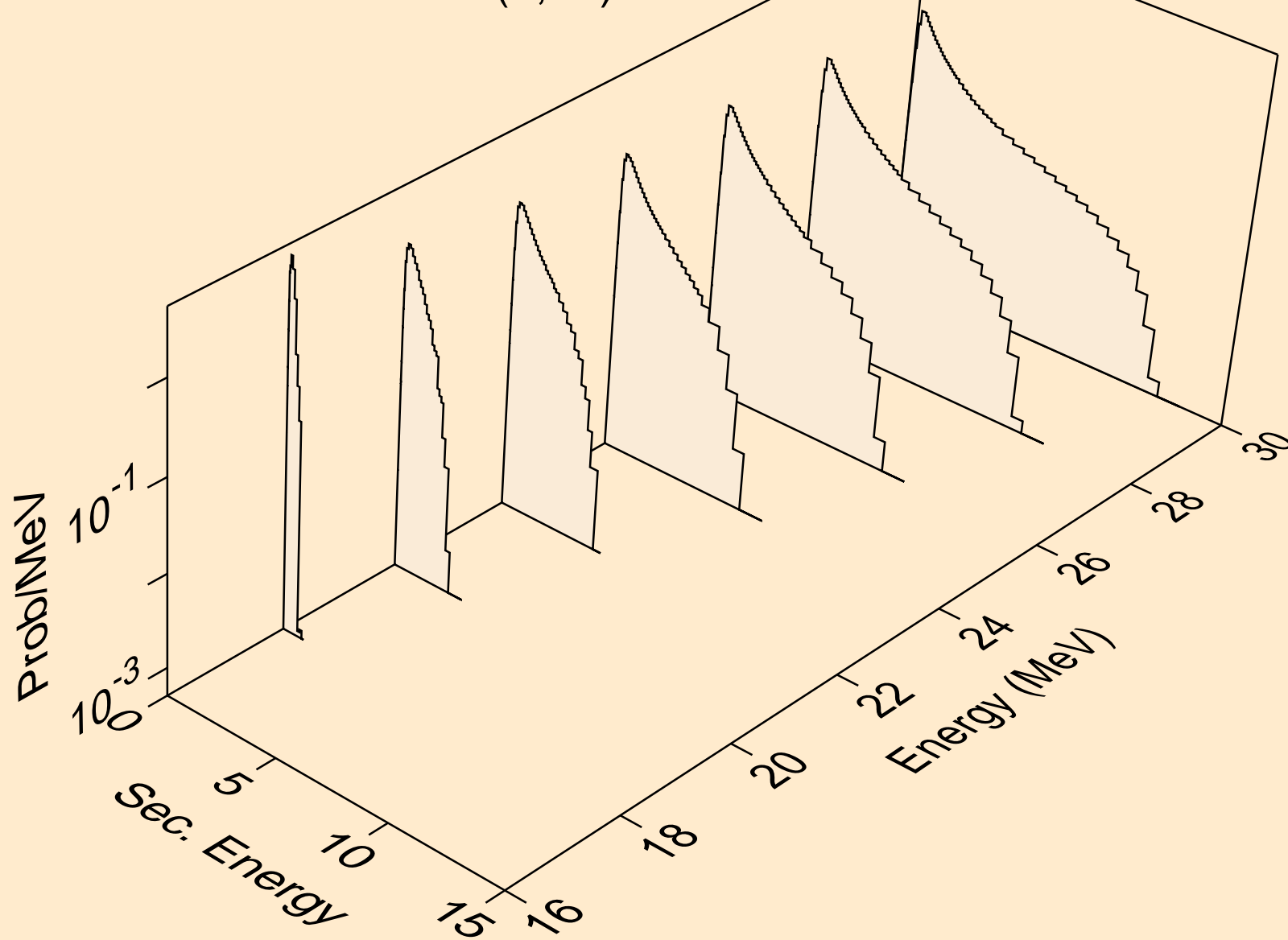

LR264 NEUTRON ACER TENDL-2021 LIBRARY; T=293.6K
Neutron emission for (n,2np)

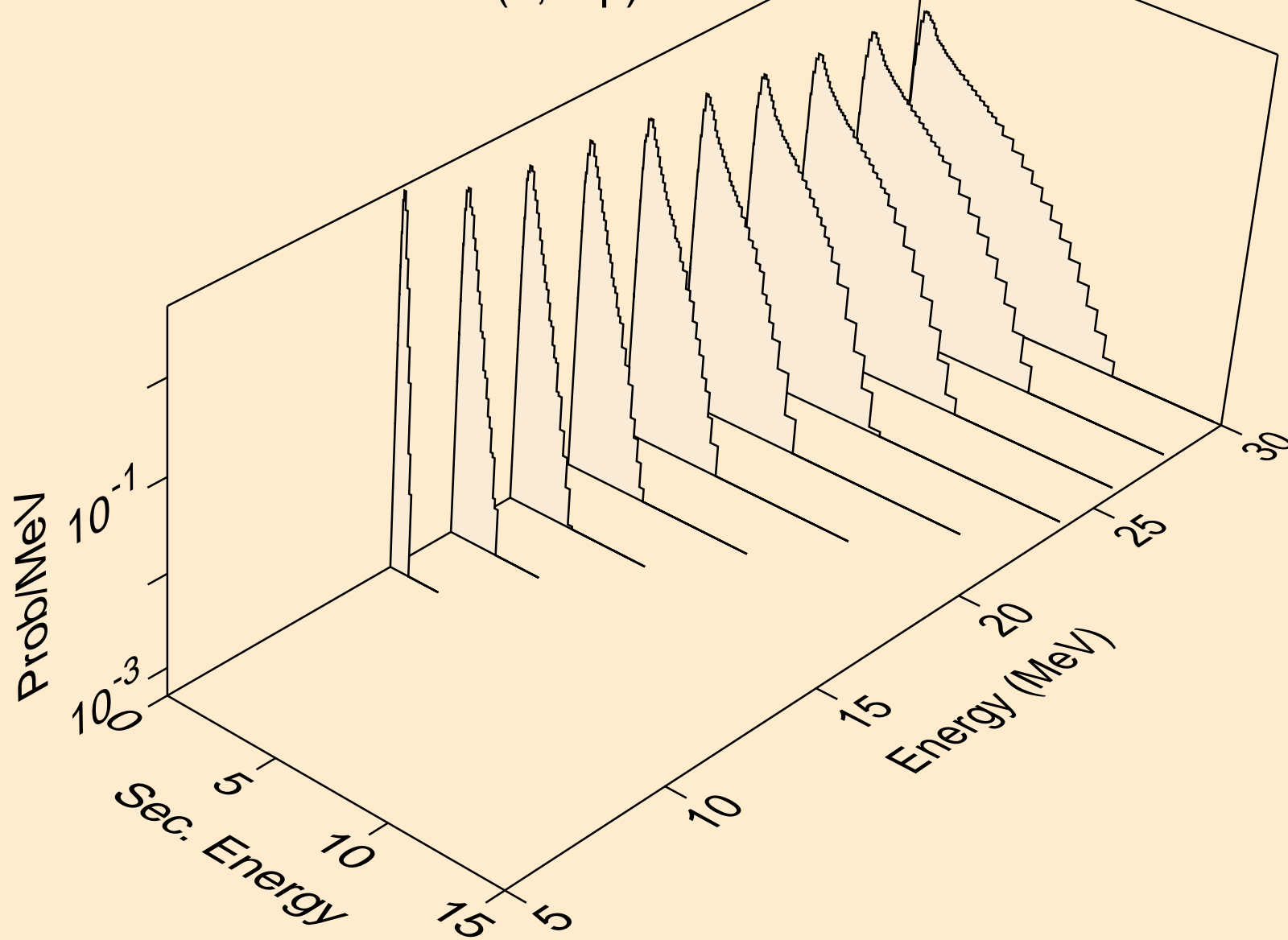

LR264 NEUTRON ACER TENDL-2021 LIBRARY; T=293.6K
Neutron emission for (n,3np)

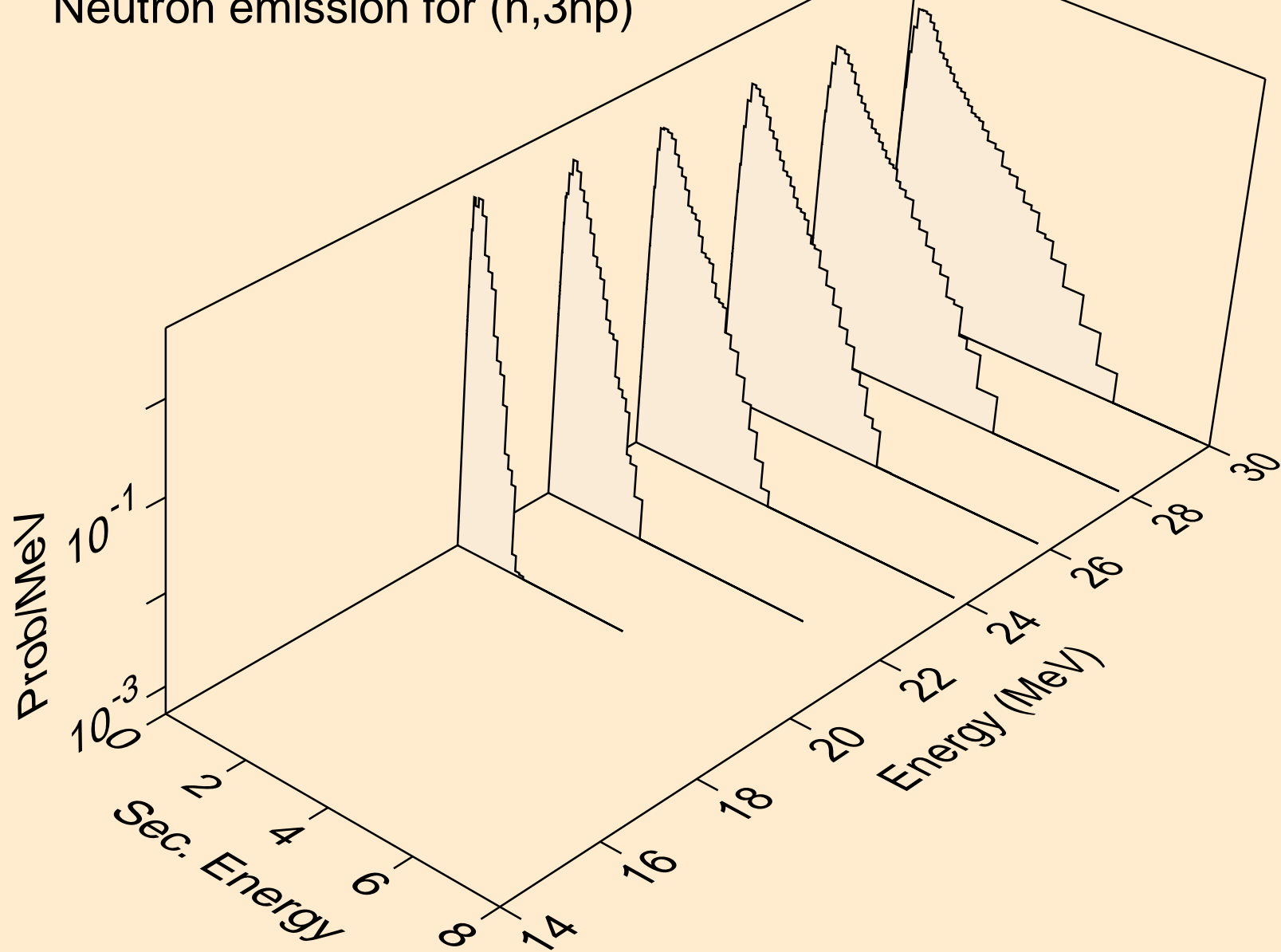

LR264 NEUTRON ACER TENDL-2021 LIBRARY; T=293.6K
Neutron emission for (n,2np)

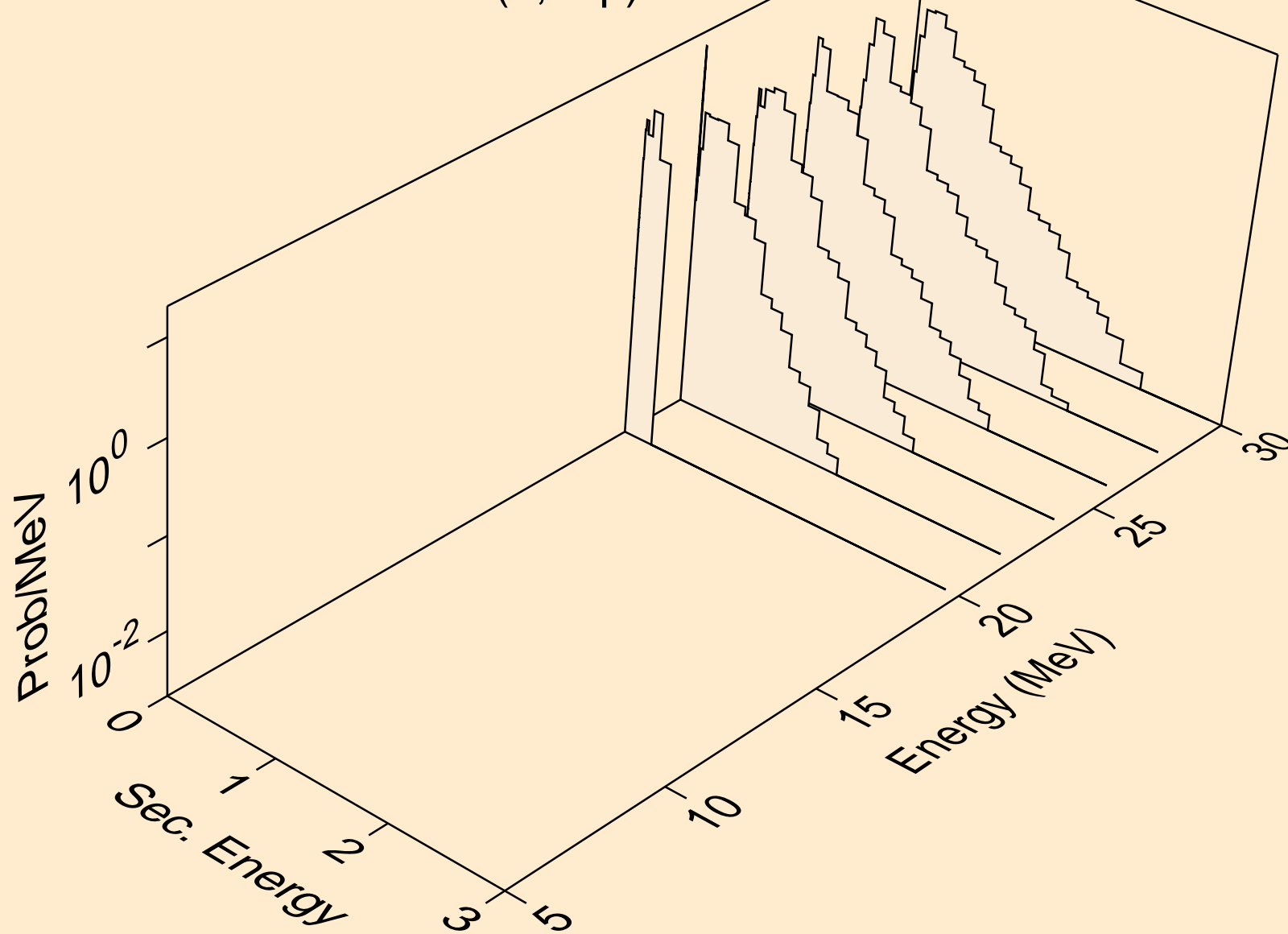

LR264 NEUTRON ACER TENDL-2021 LIBRARY; T=293.6K
Neutron emission for (n,n*c)

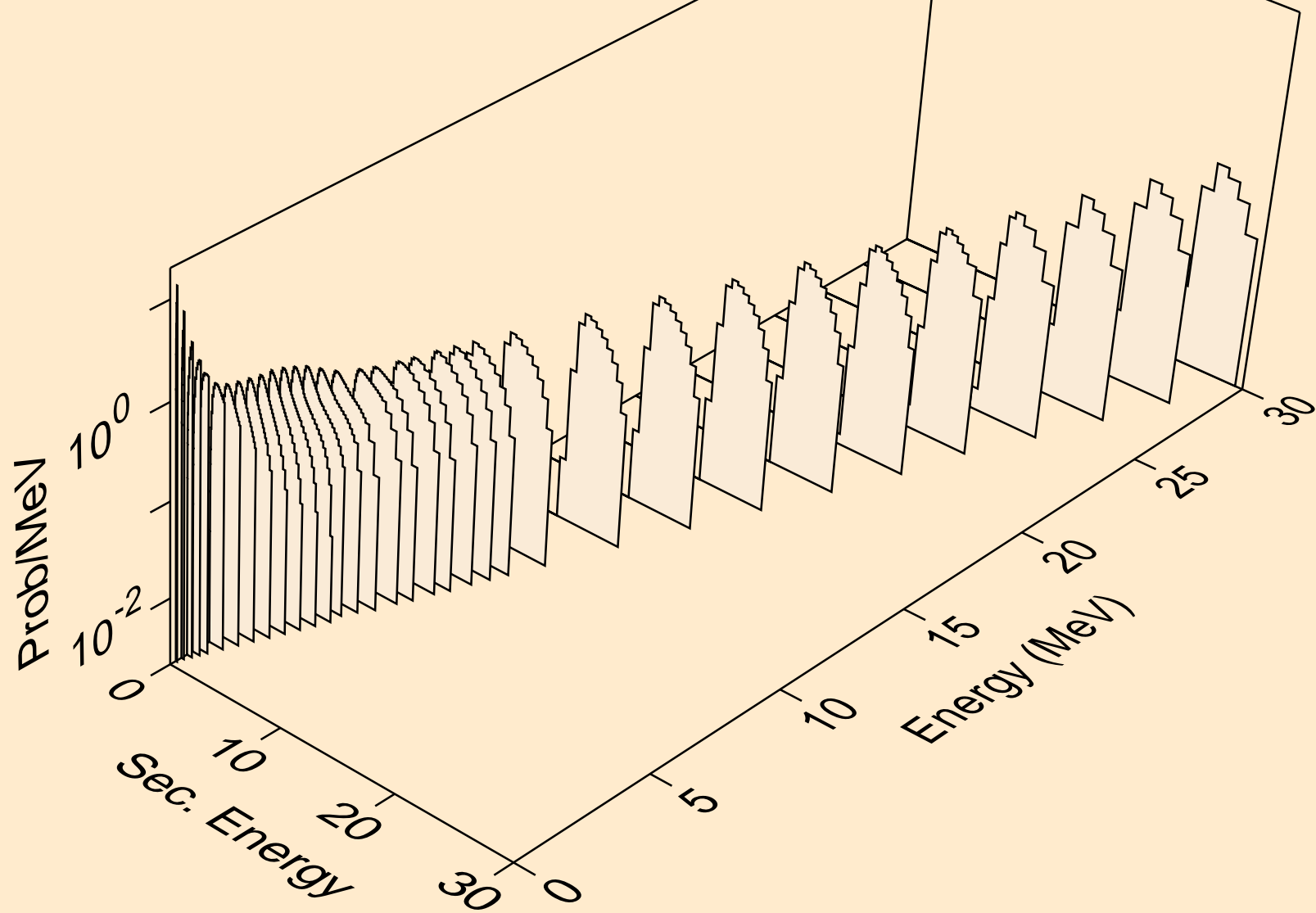

LR264 NEUTRON ACER TENDL-2021 LIBRARY; T=293.6K

Delayed nubar

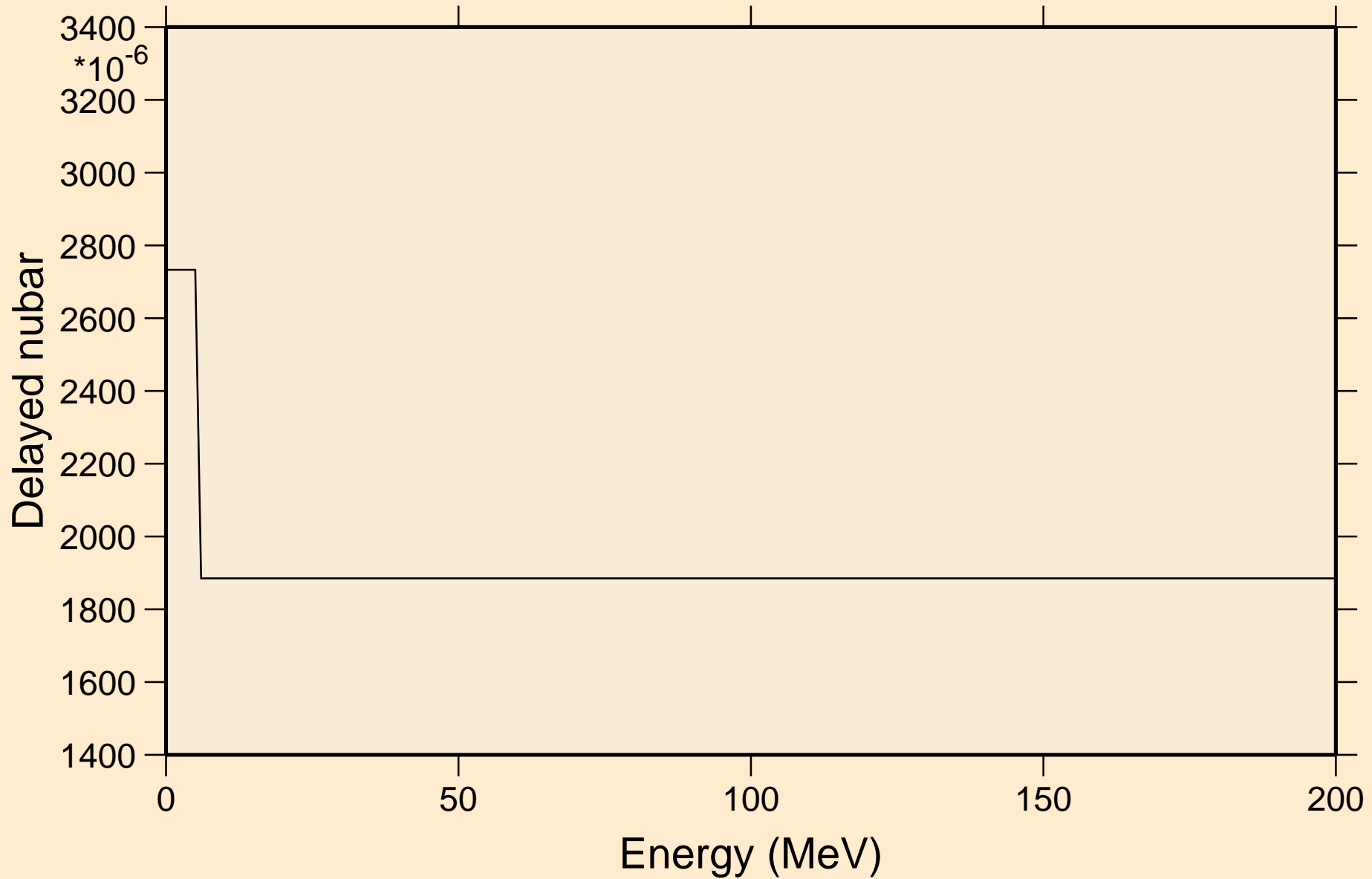

LR264 NEUTRON ACER TENDL-2021 LIBRARY; T=293.6K

Delayed neutron spectra

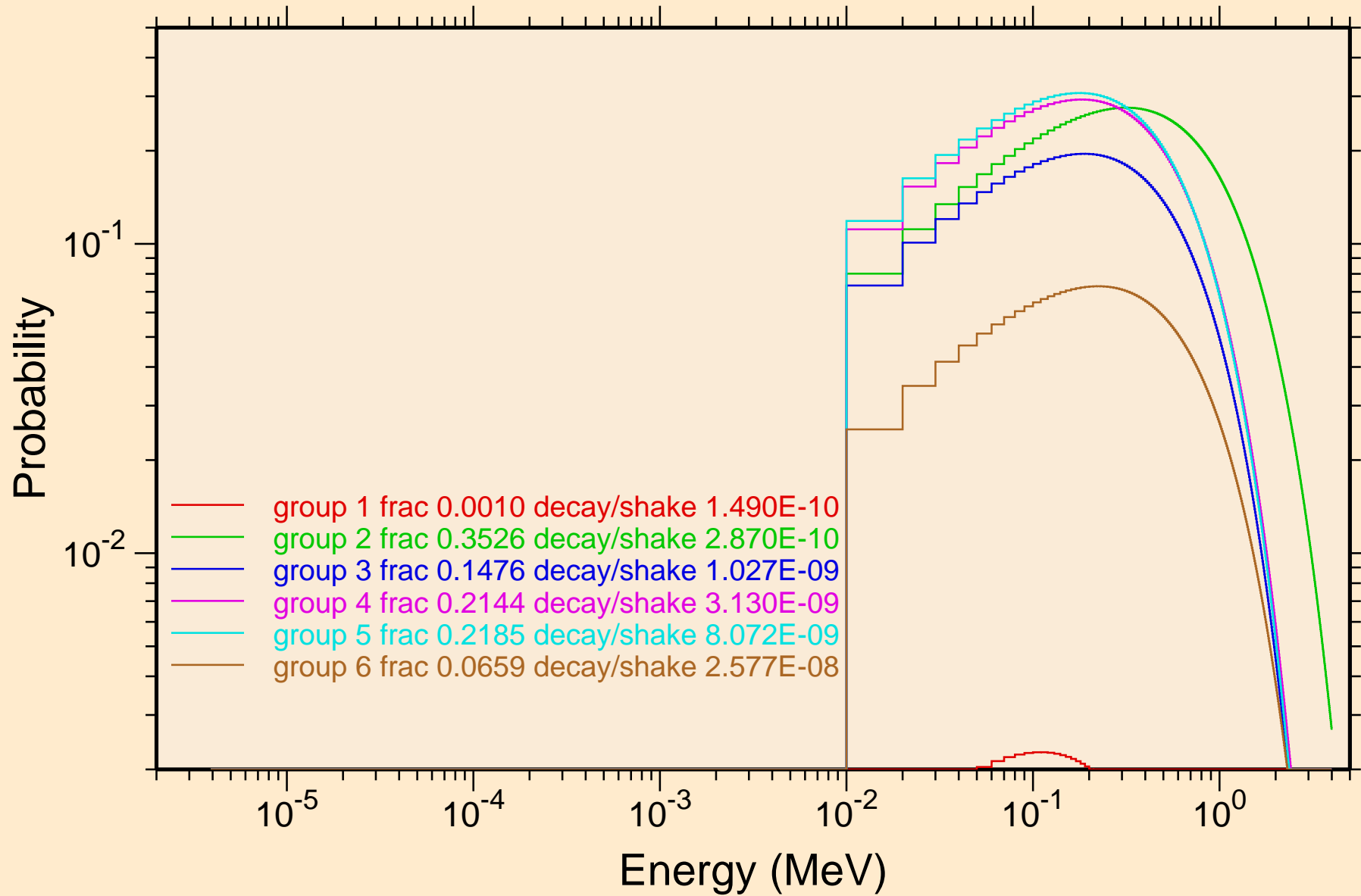

LR264 NEUTRON ACER TENDL-2021 LIBRARY; T=293.6K
Photon emission for (n,x)

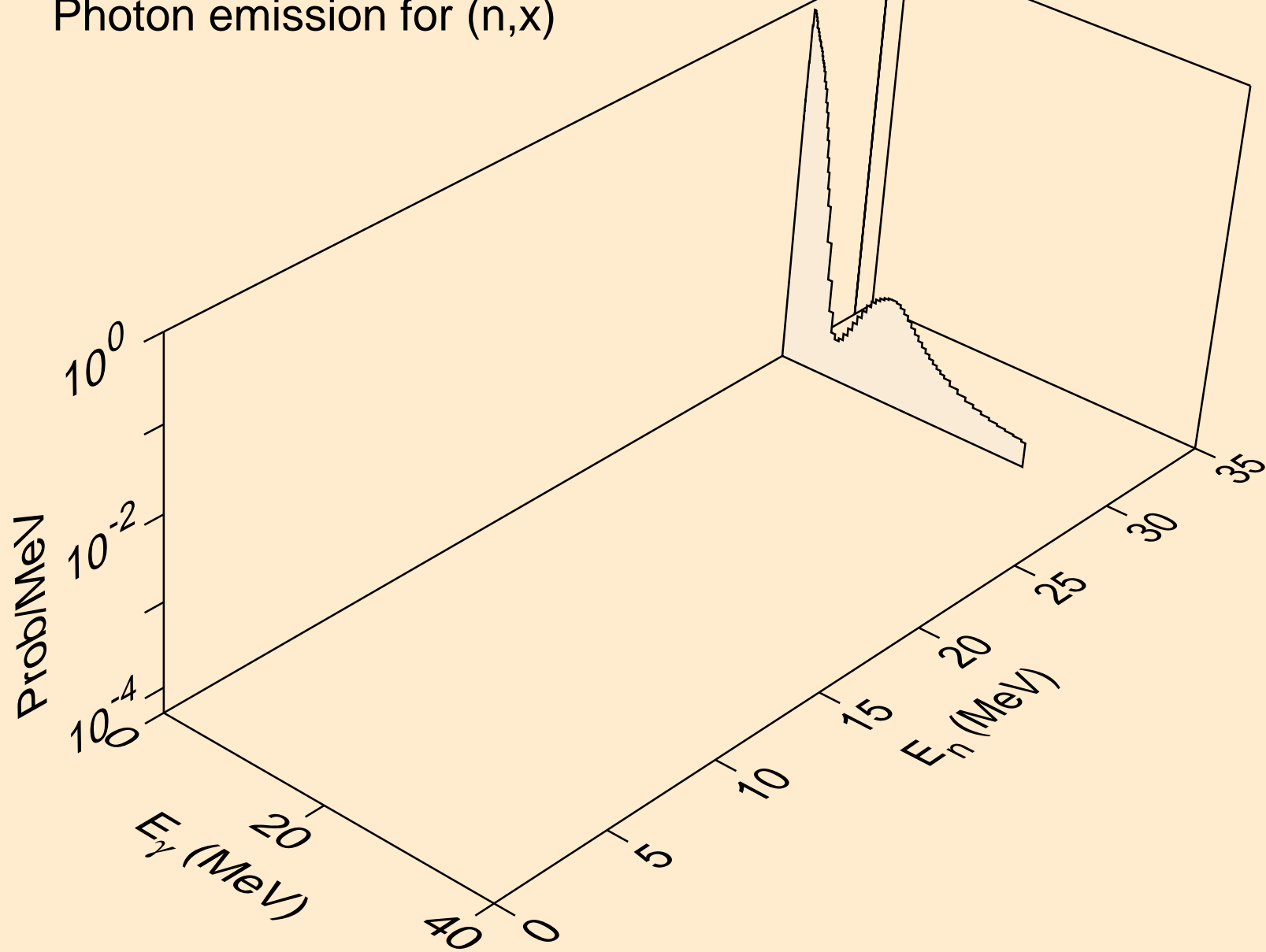

LR264 NEUTRON ACER TENDL-2021 LIBRARY; T=293.6K
Photon emission for (n,2nd)

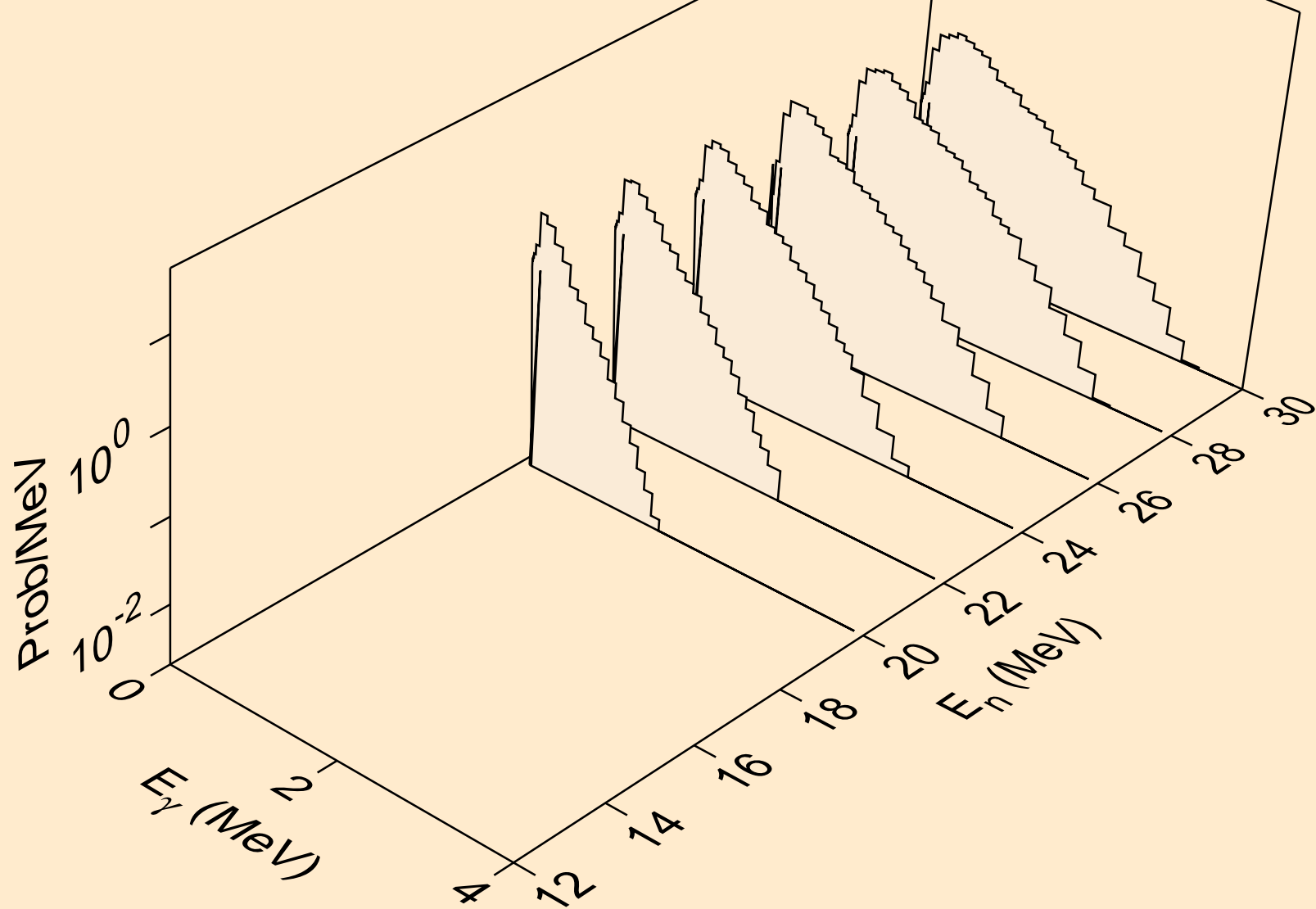

LR264 NEUTRON ACER TENDL-2021 LIBRARY; T=293.6K
Photon emission for (n,2n)

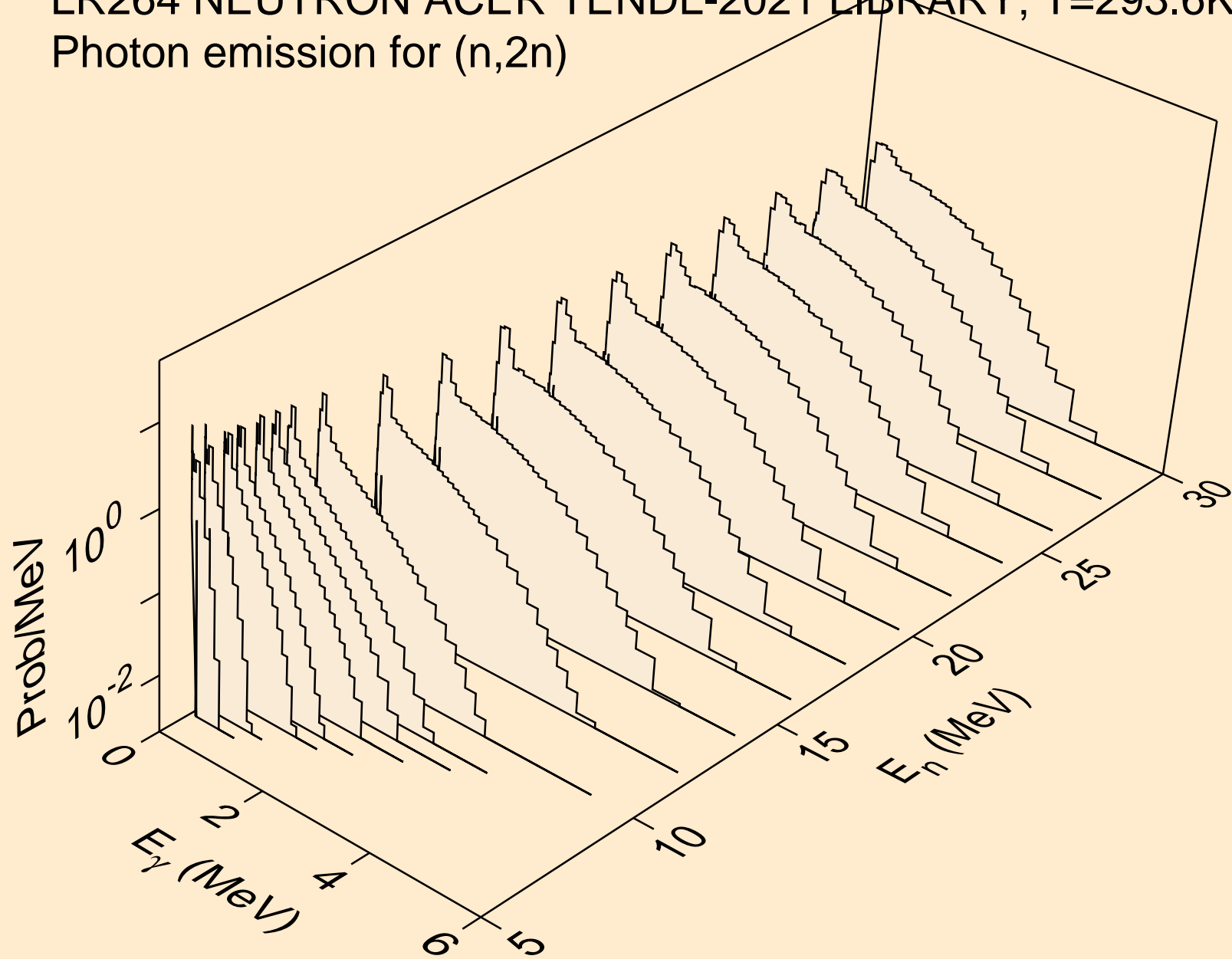

LR264 NEUTRON ACER TENDL-2021 LIBRARY; T=293.6K
Photon emission for (n,3n)

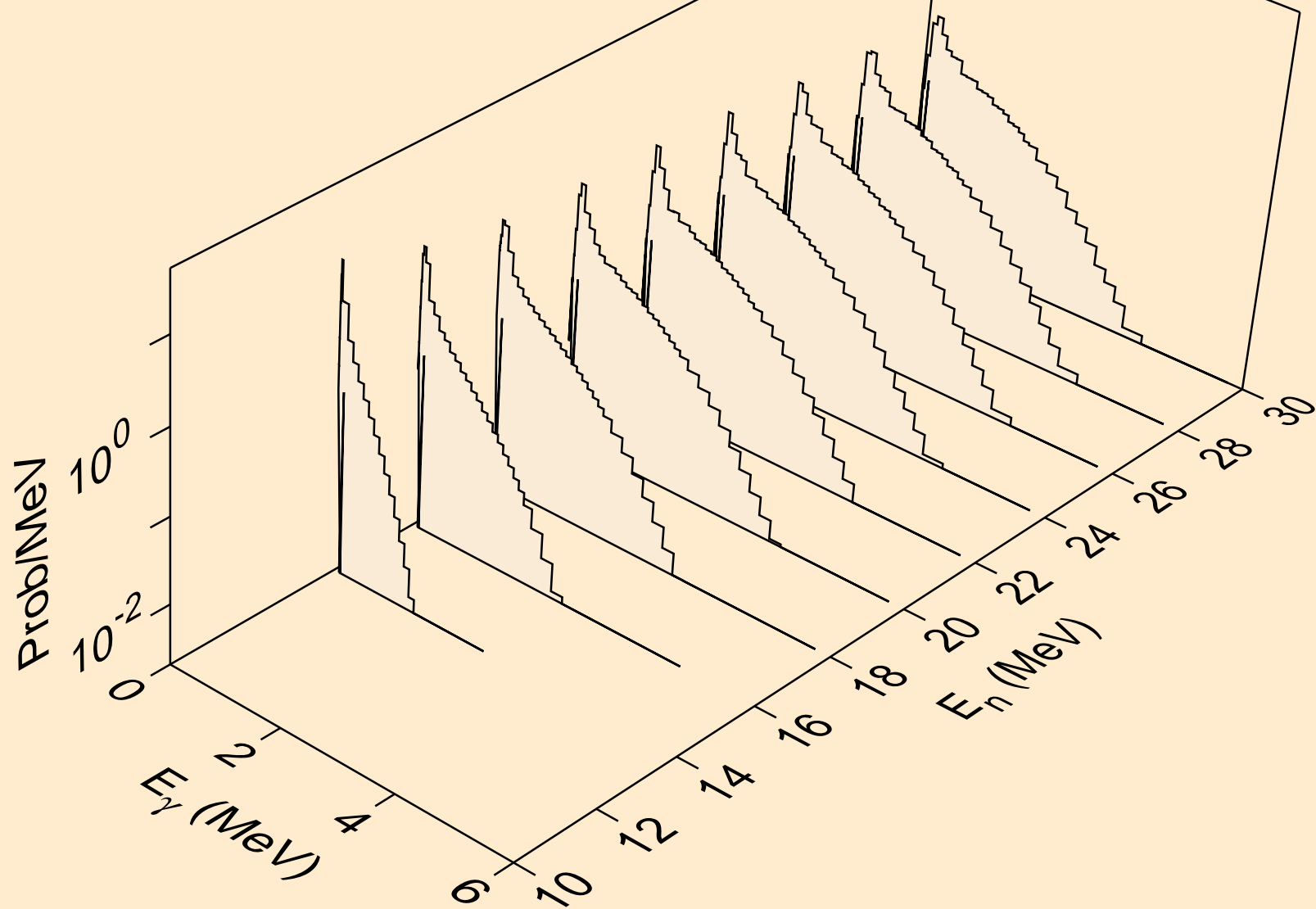

LR264 NEUTRON ACER TENDL-2021 LIBRARY; T=293.6K
Photon emission for (n,n*)a

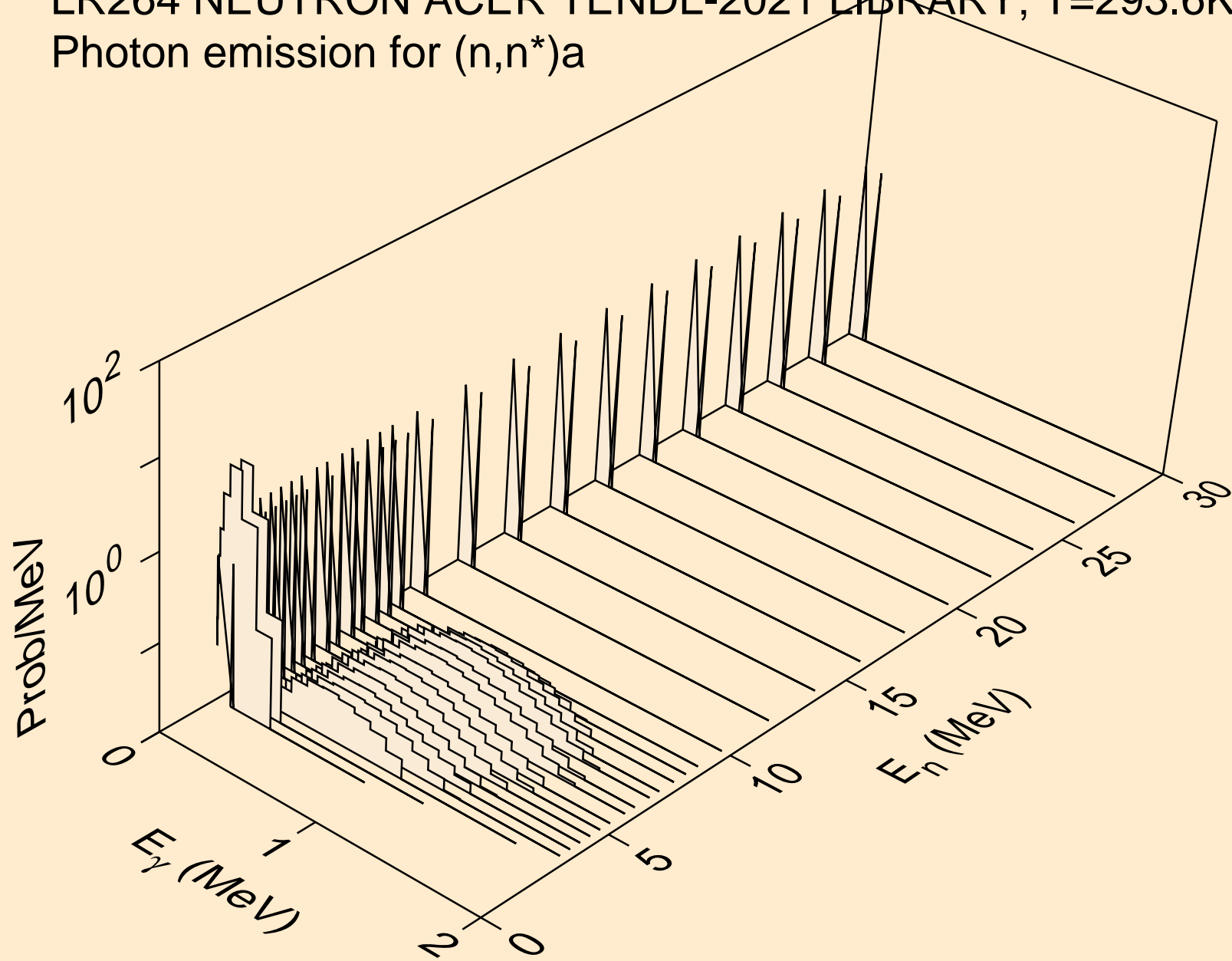

LR264 NEUTRON ACER TENDL-2021 LIBRARY; T=293.6K
Photon emission for (n,2n)a

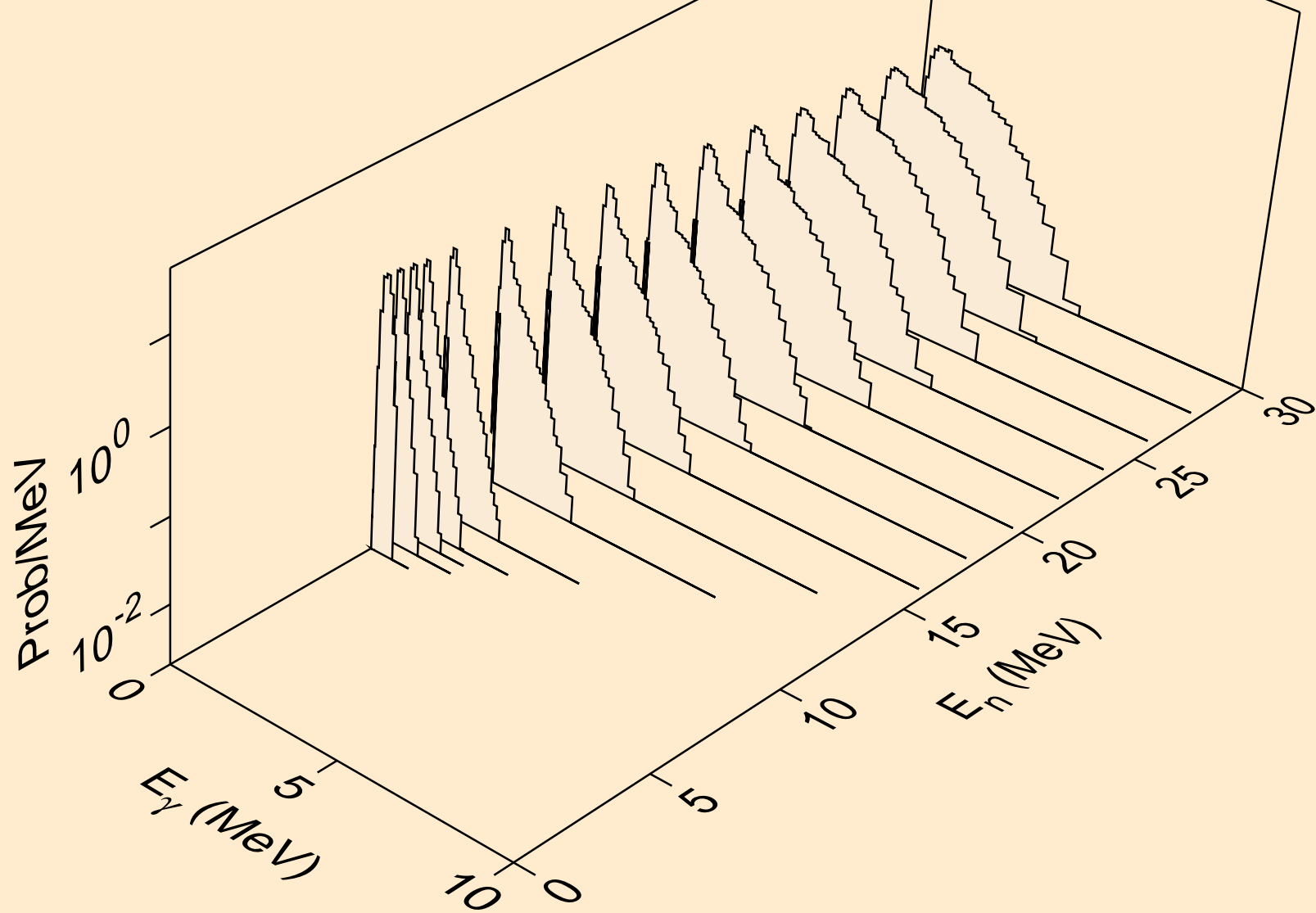

LR264 NEUTRON ACER TENDL-2021 LIBRARY; T=293.6K
Photon emission for (n,3n)a

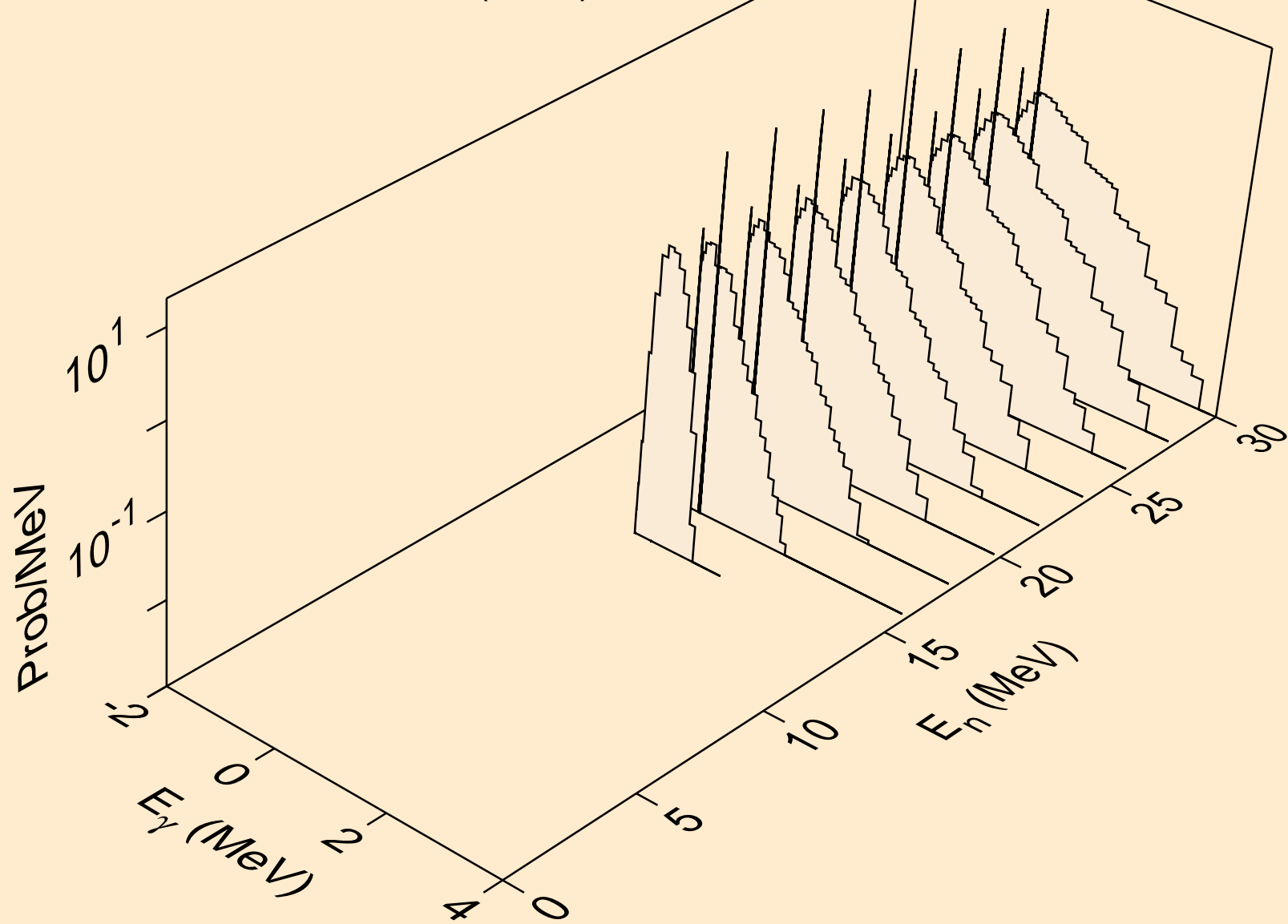

LR264 NEUTRON ACER TENDL-2021 LIBRARY; T=293.6K
Photon emission for (n,n*)p

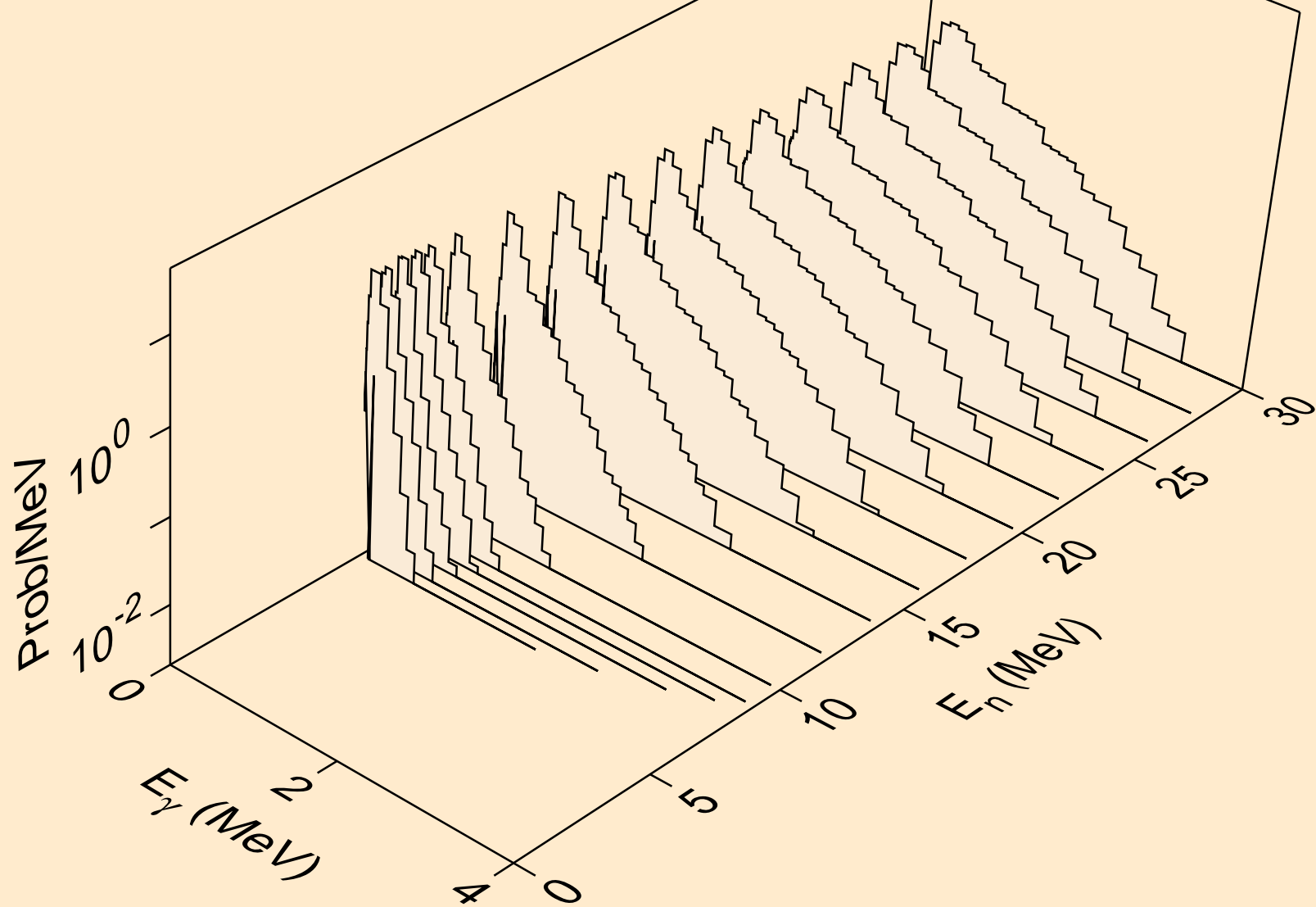

LR264 NEUTRON ACER TENDL-2021 LIBRARY; T=293.6K
Photon emission for (n,n*)2a

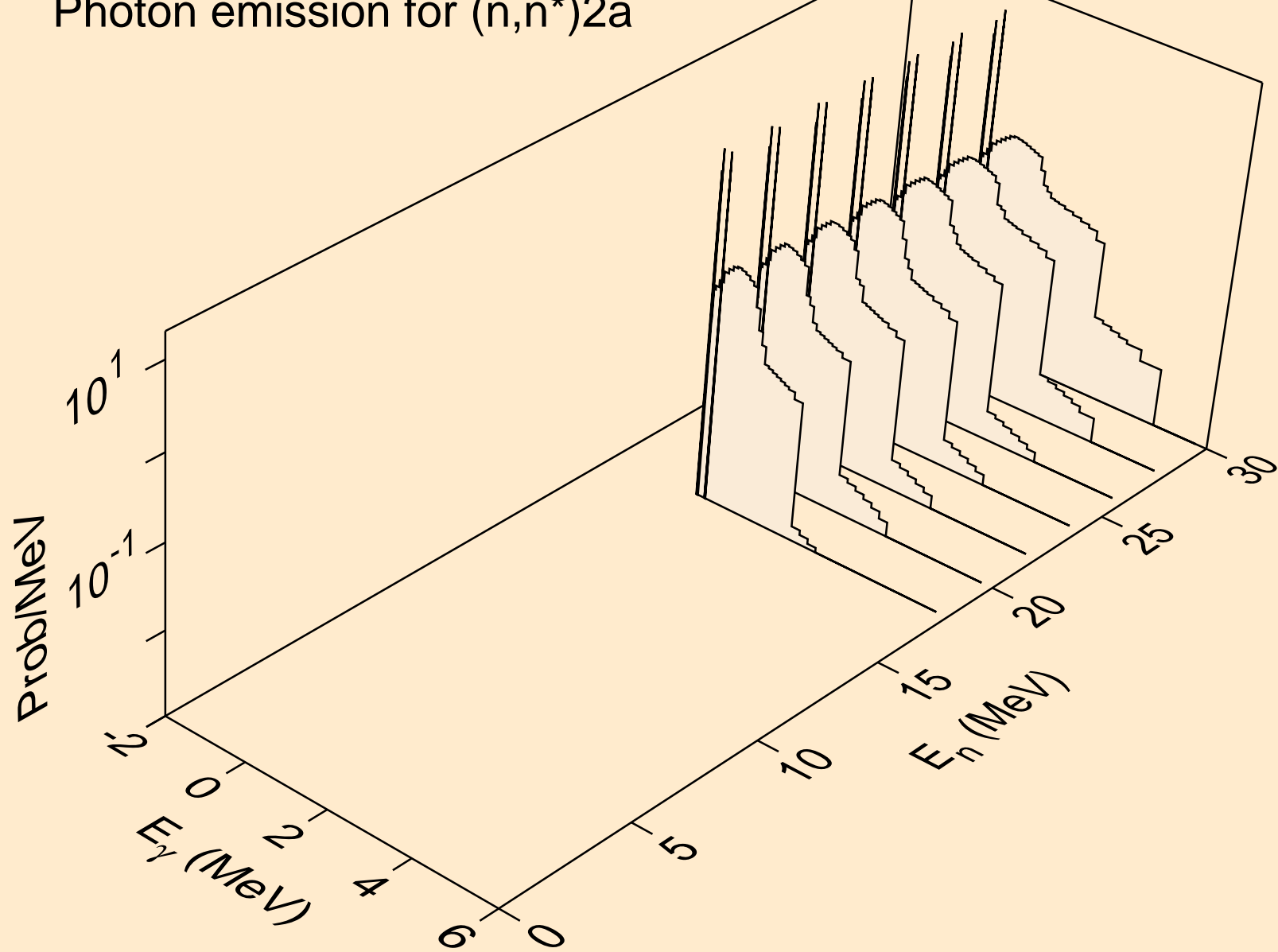

LR264 NEUTRON ACER TENDL-2021 LIBRARY; T=293.6K
Photon emission for (n,n*)d

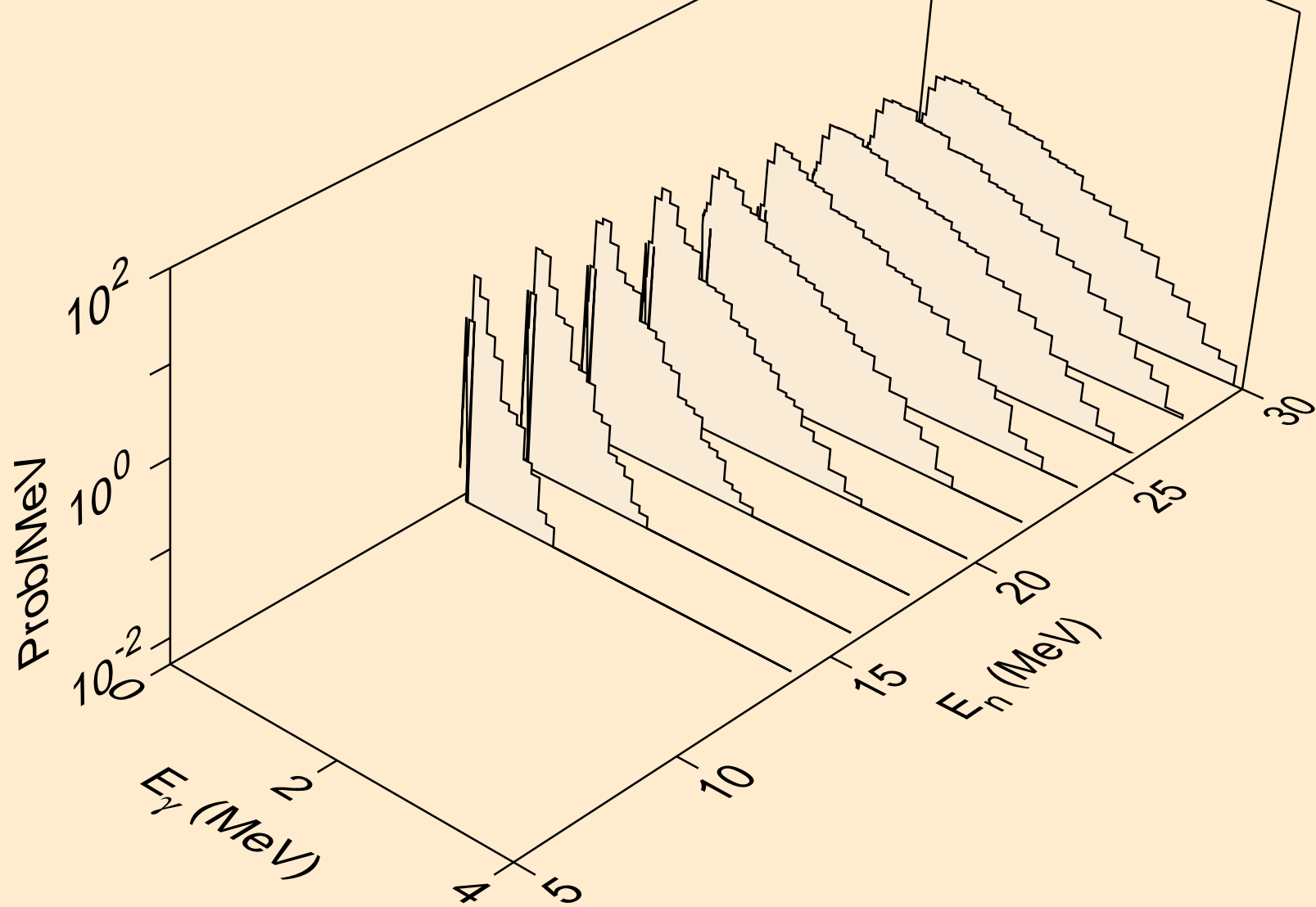

LR264 NEUTRON ACER TENDL-2021 LIBRARY; T=293.6K
Photon emission for (n,n*)t

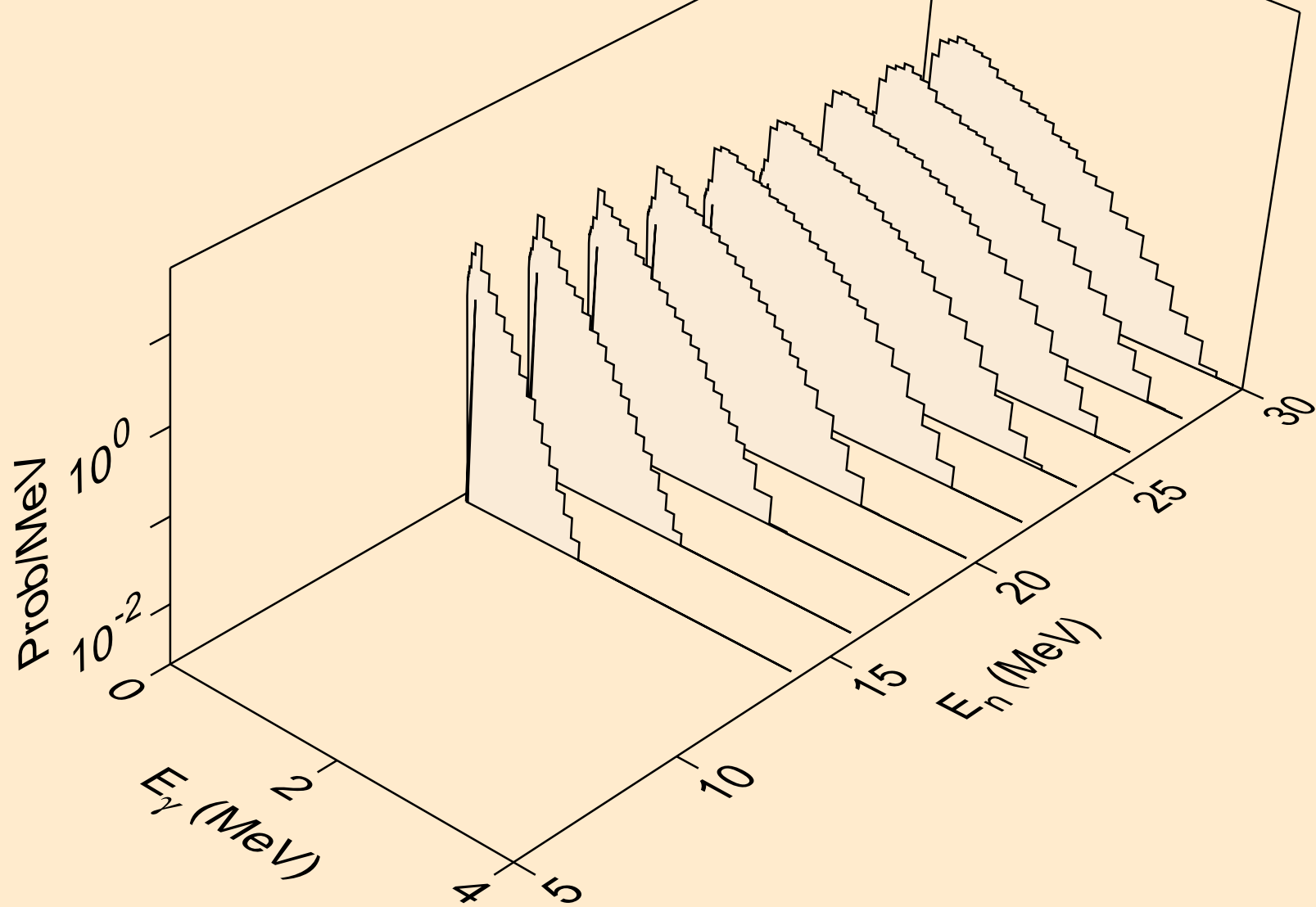

LR264 NEUTRON ACER TENDL-2021 LIBRARY; T=293.6K
Photon emission for (n,n*)he3

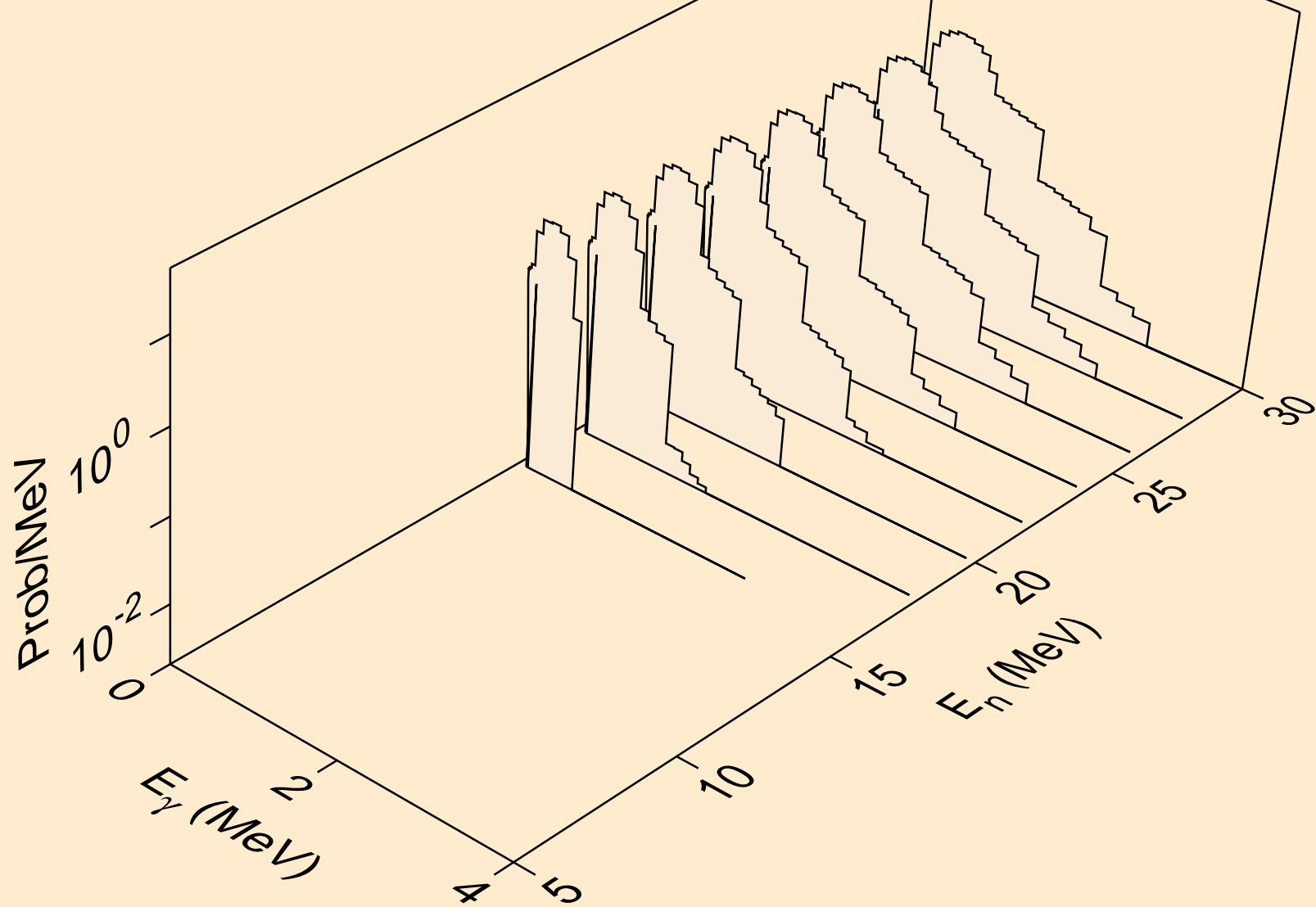

LR264 NEUTRON ACER TENDL-2021 LIBRARY; T=293.6K
Photon emission for (n,4n)

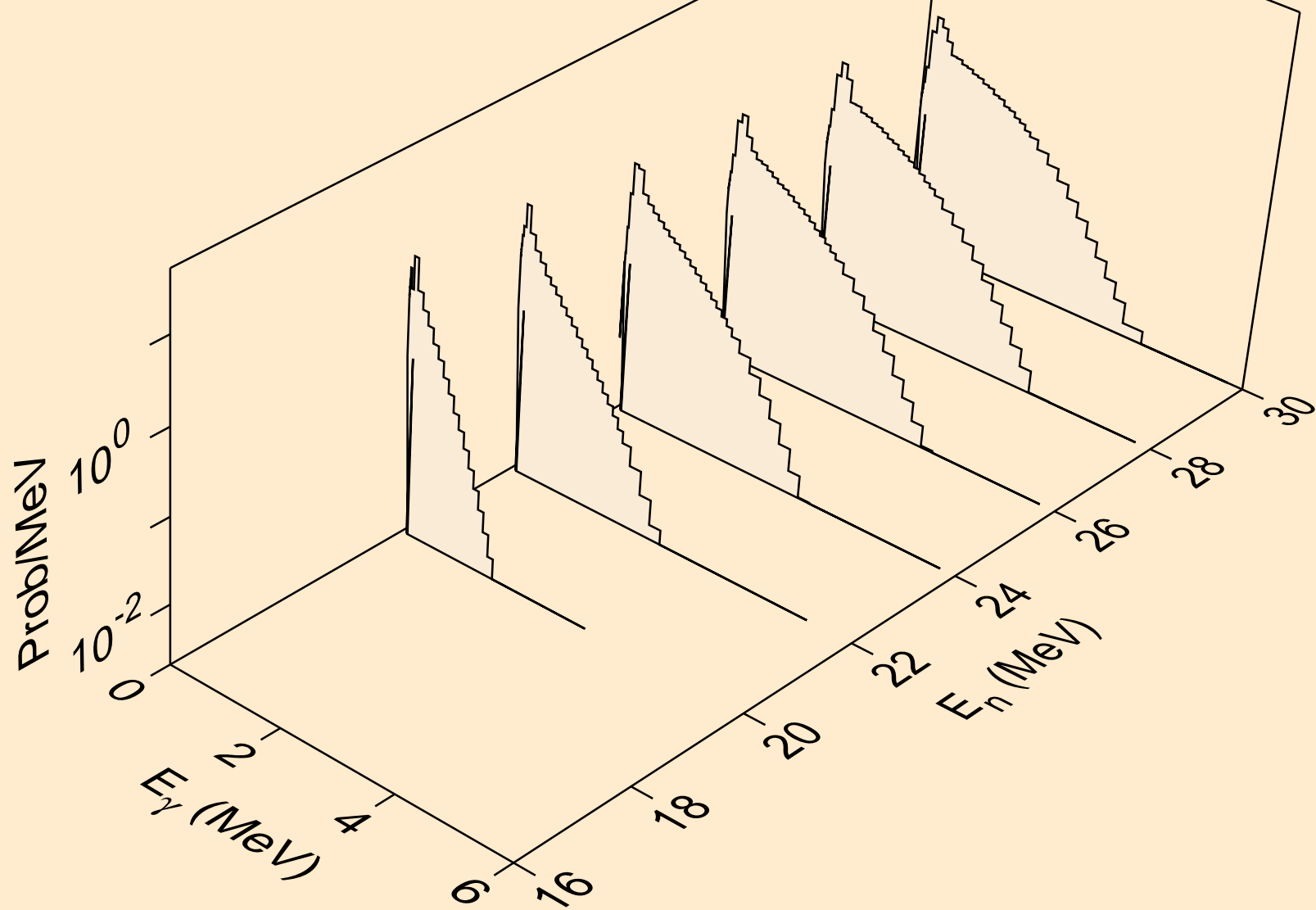

LR264 NEUTRON ACER TENDL-2021 LIBRARY; T=293.6K
Photon emission for (n,2np)

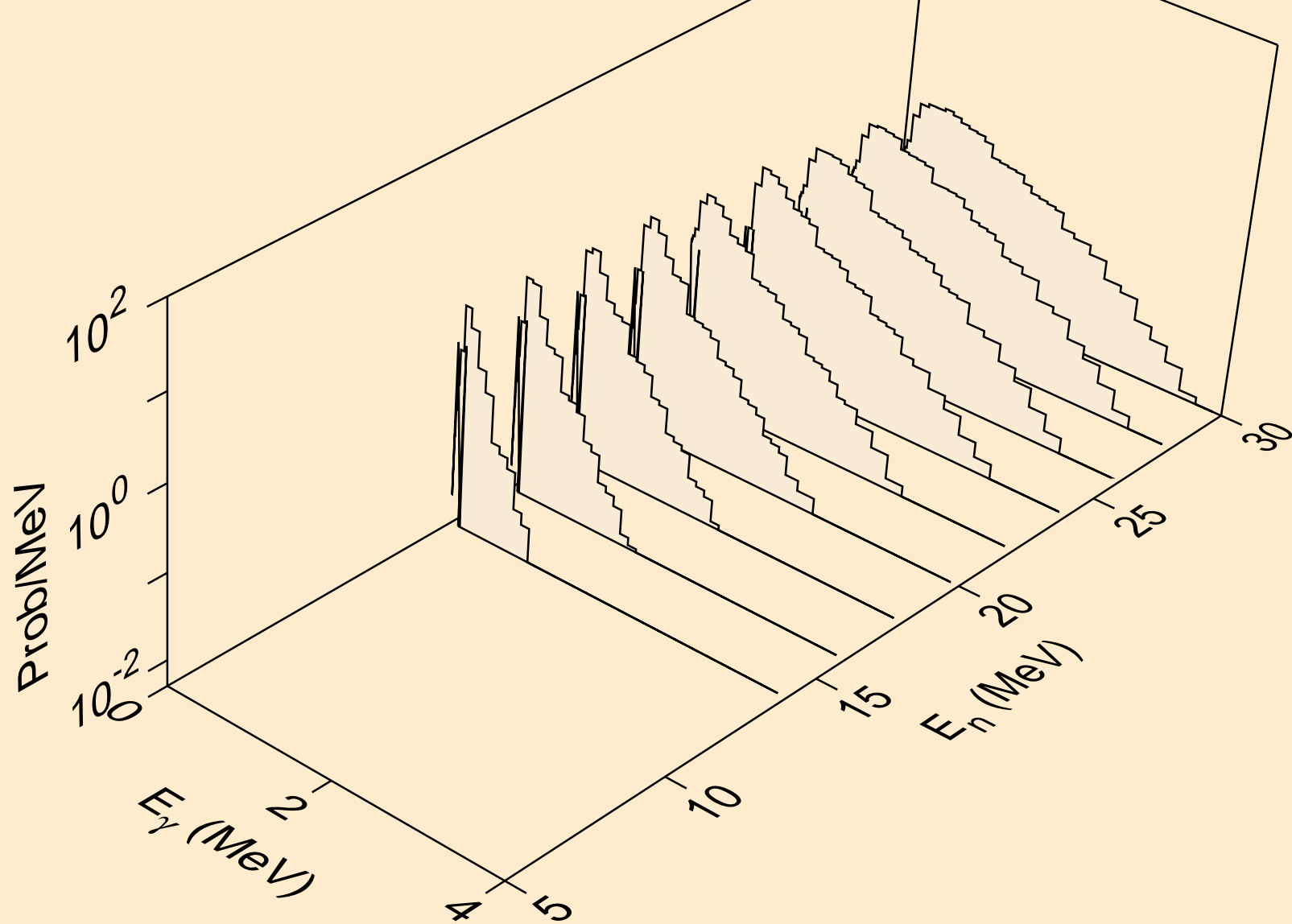

LR264 NEUTRON ACER TENDL-2021 LIBRARY; T=293.6K
Photon emission for (n,3np)

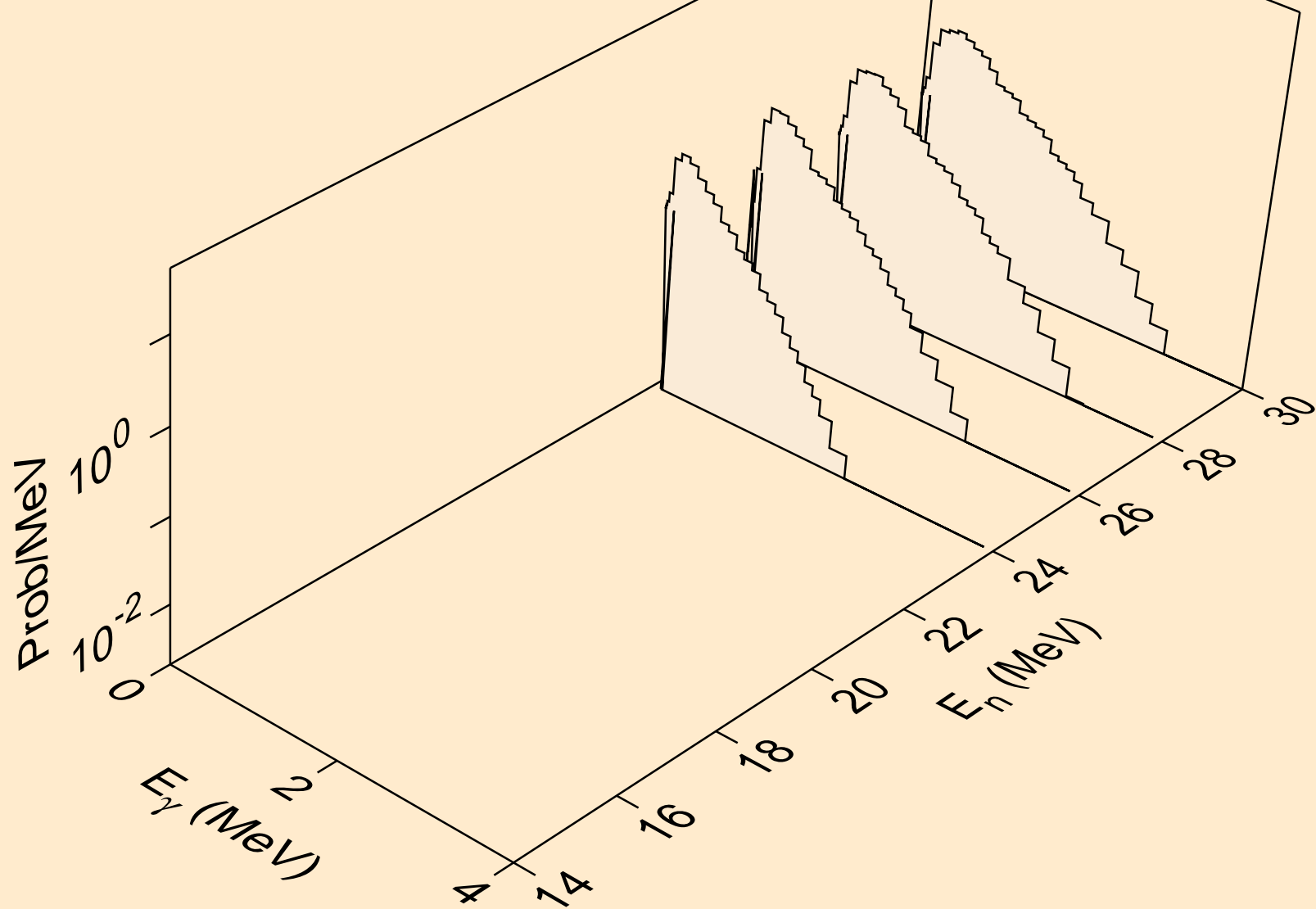

LR264 NEUTRON ACER TENDL-2021 LIBRARY; T=293.6K
Photon emission for (n,2np)

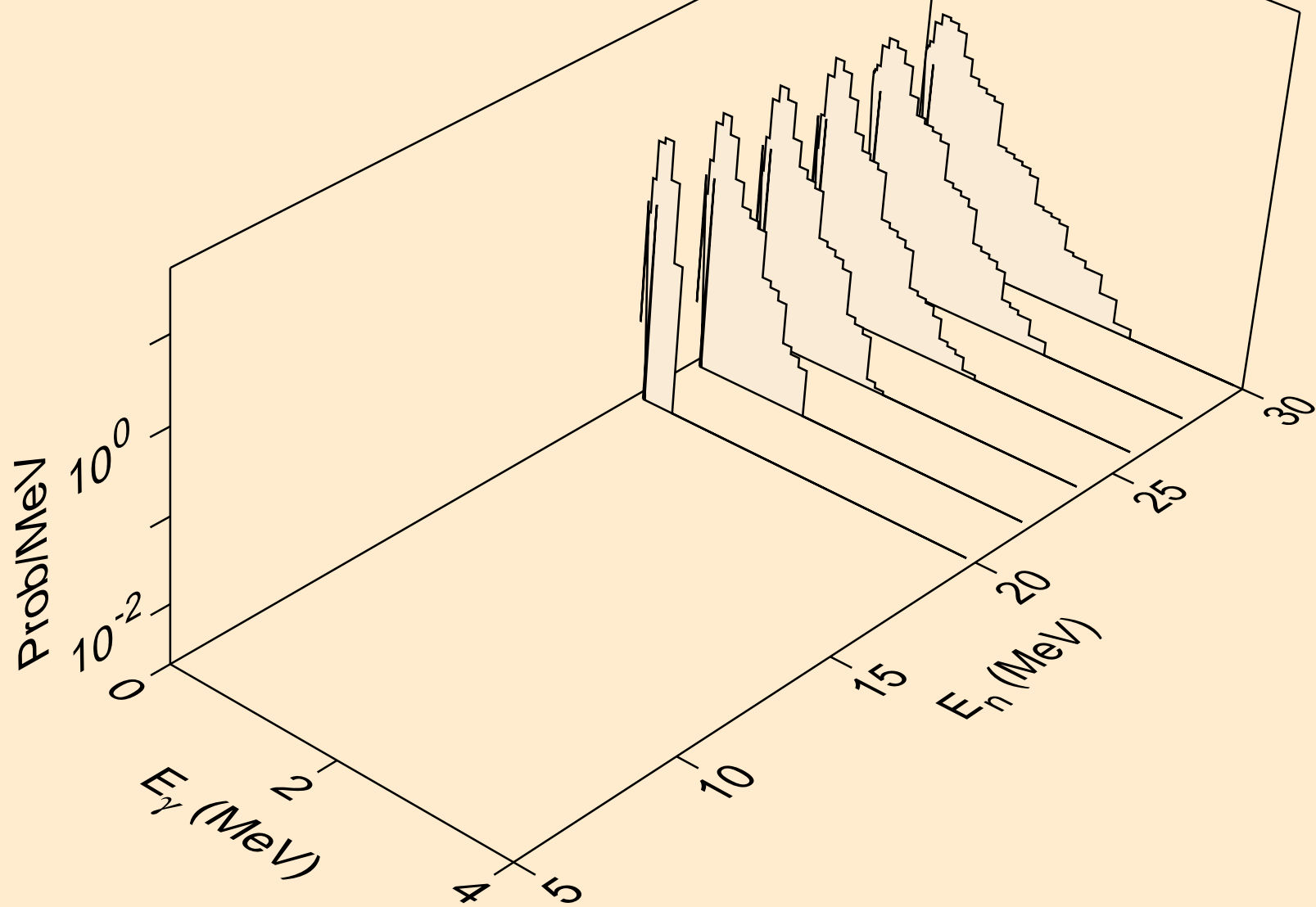

LR264 NEUTRON ACER TENDL-2021 LIBRARY; T=293.6K
Photon emission for (n,n*c)

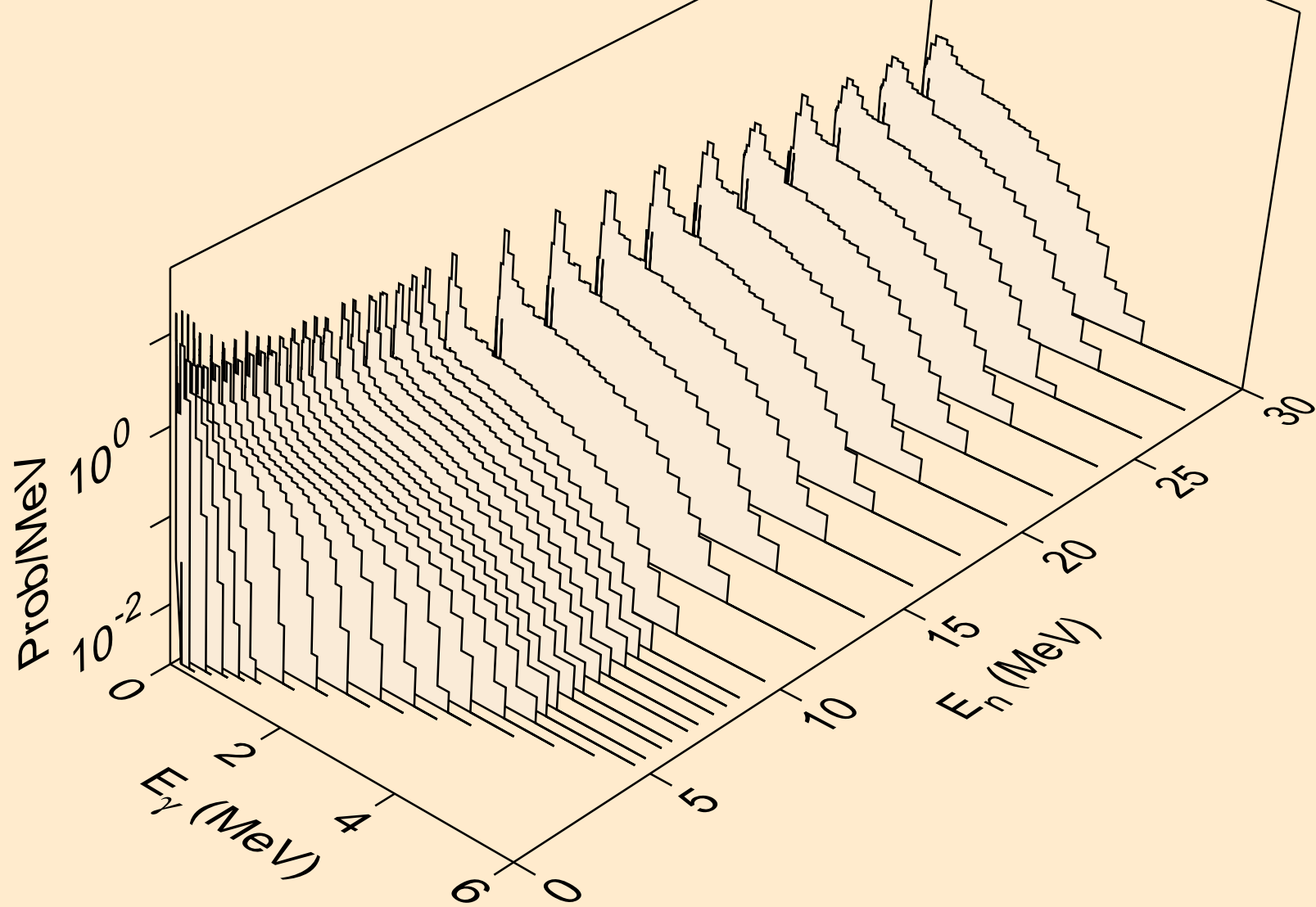

LR264 NEUTRON ACER TENDL-2021 LIBRARY; T=293.6K
Photon emission for (n,gma)

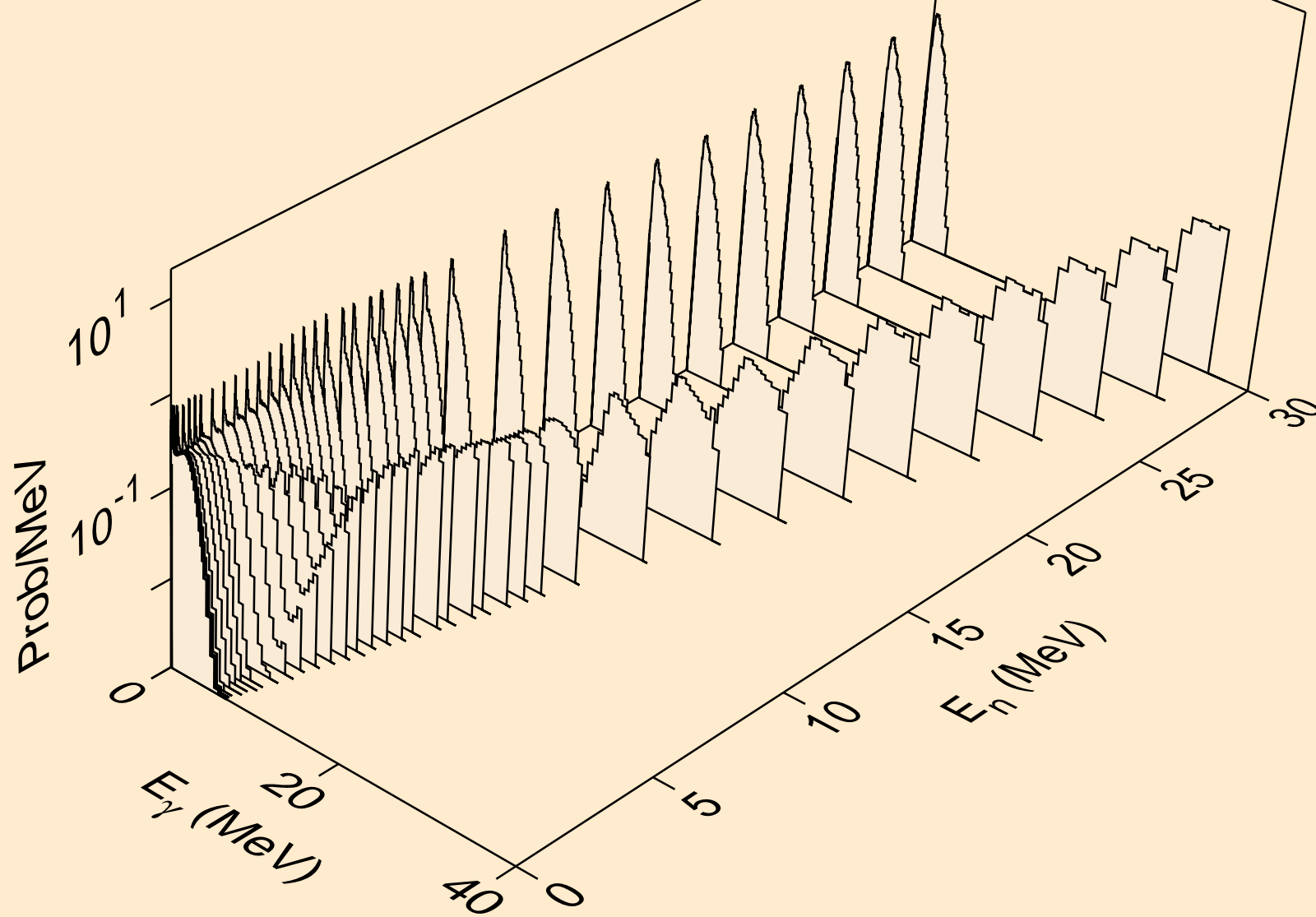

LR264 NEUTRON ACER TENDL-2021 LIBRARY; T=293.6K
Photon emission for (n,p)

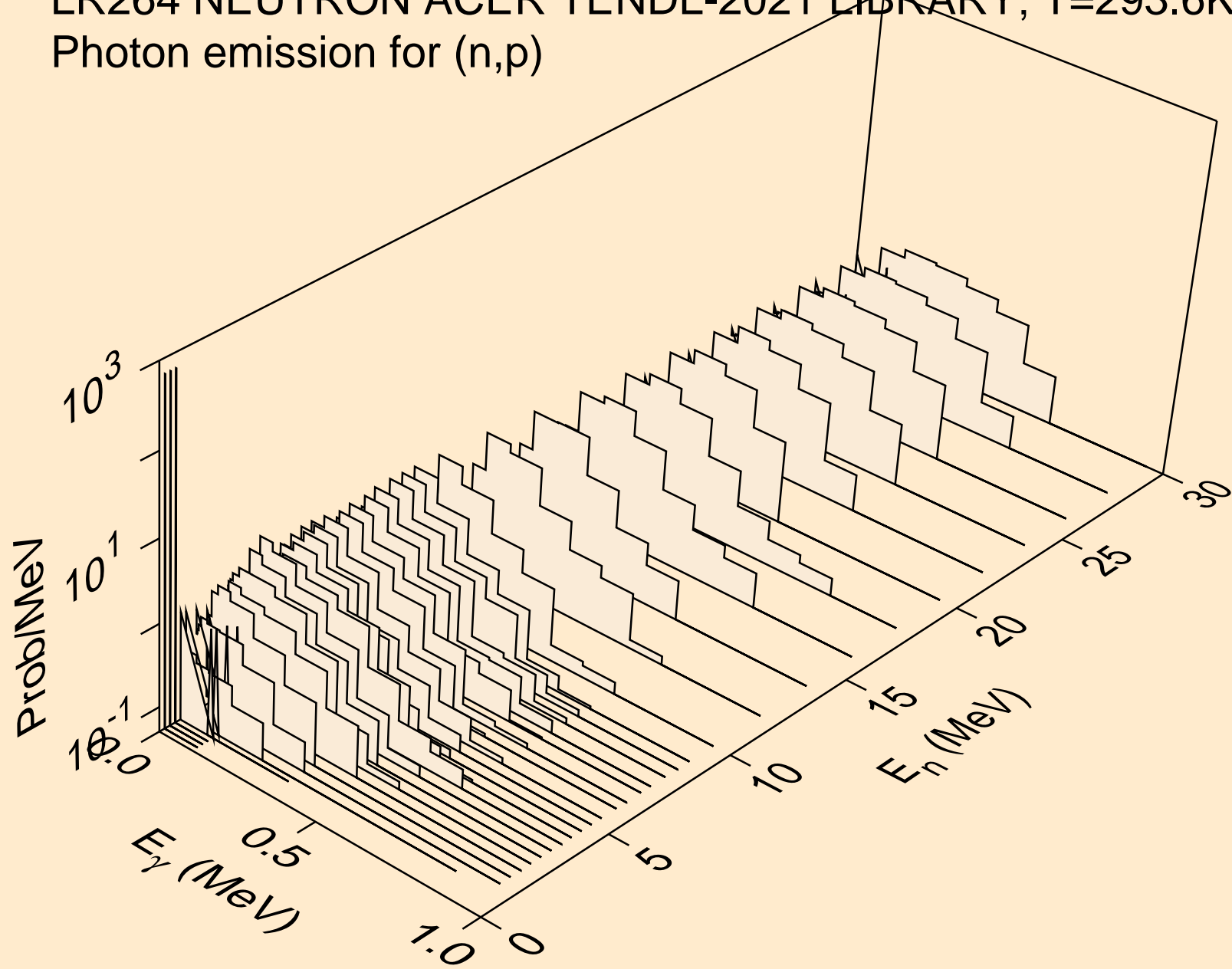

LR264 NEUTRON ACER TENDL-2021 LIBRARY; T=293.6K
Photon emission for (n,d)

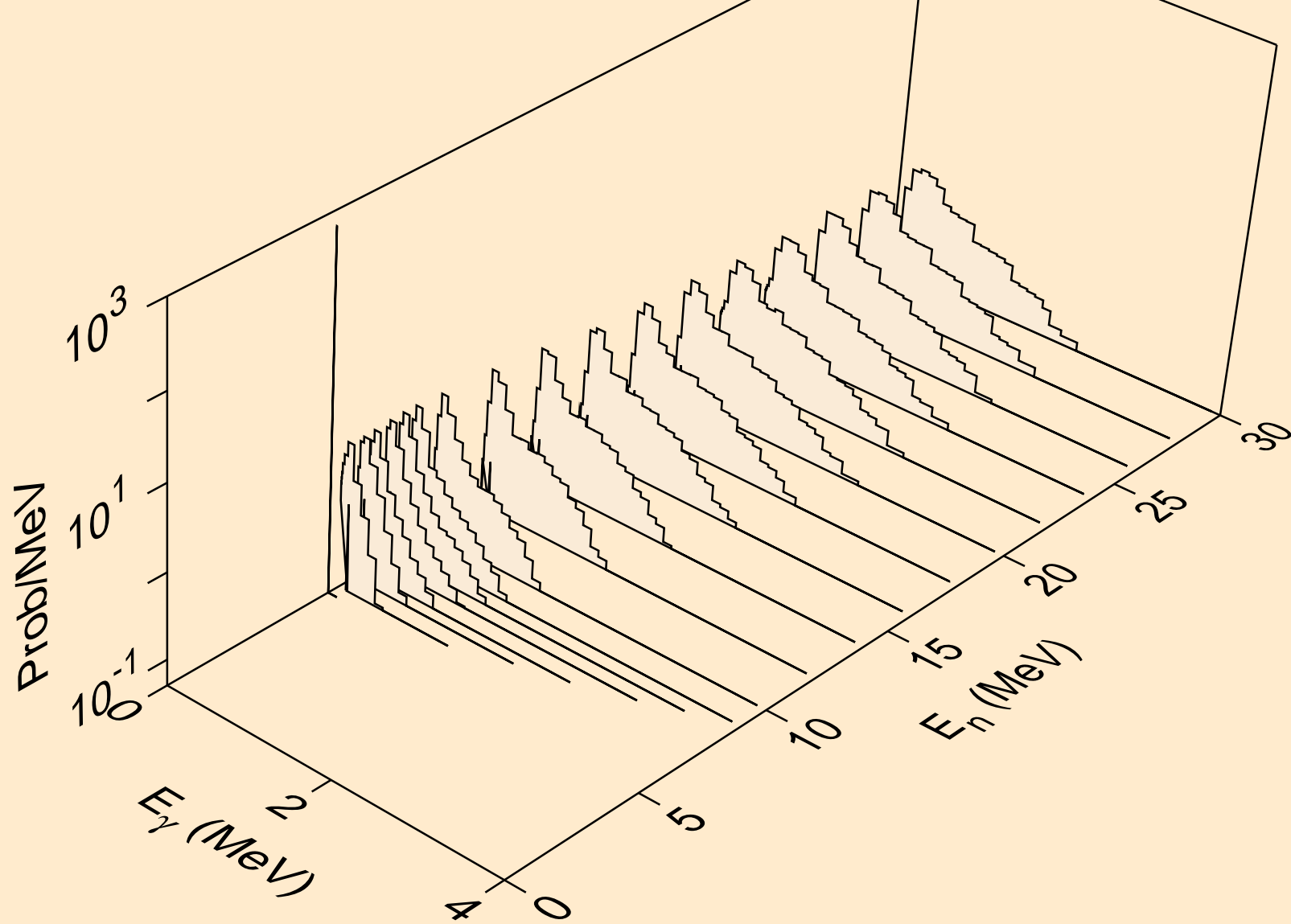

LR264 NEUTRON ACER TENDL-2021 LIBRARY; T=293.6K
Photon emission for (n,t)

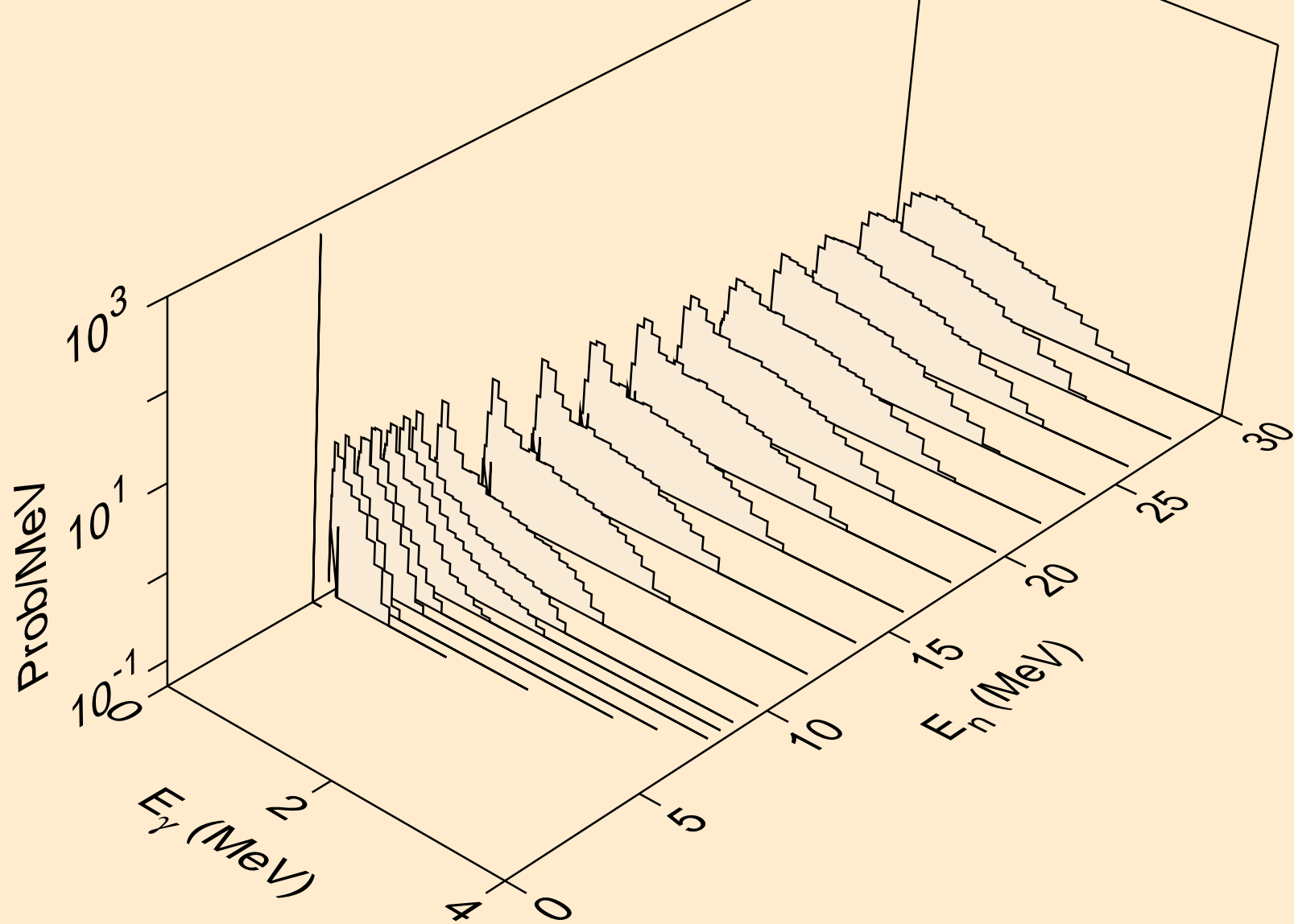

LR264 NEUTRON ACER TENDL-2021 LIBRARY; T=293.6K
Photon emission for (n,he3)

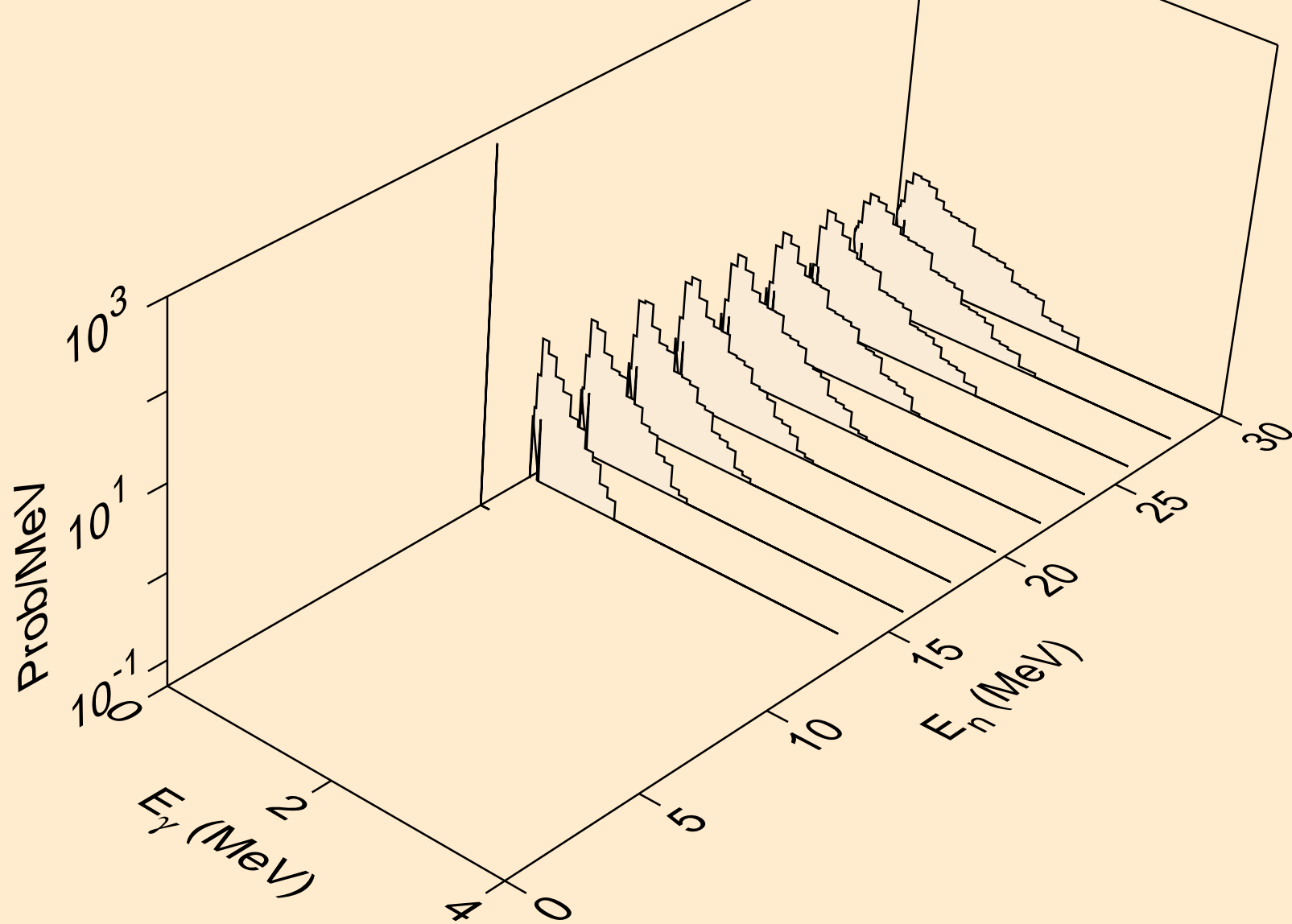

LR264 NEUTRON ACER TENDL-2021 LIBRARY; T=293.6K
Photon emission for (n,a)

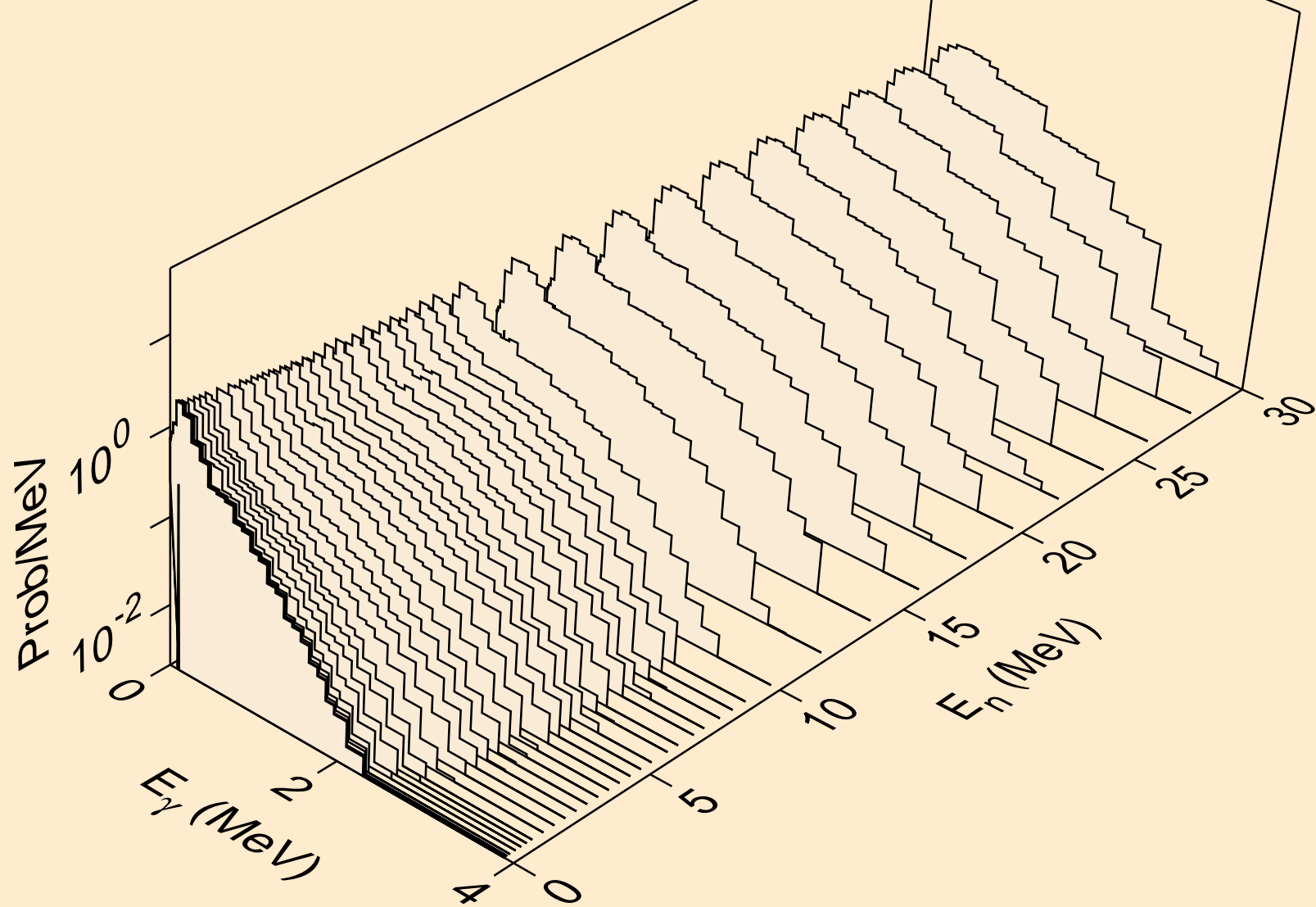

LR264 NEUTRON ACER TENDL-2021 LIBRARY; T=293.6K
Photon emission for (n,2p)

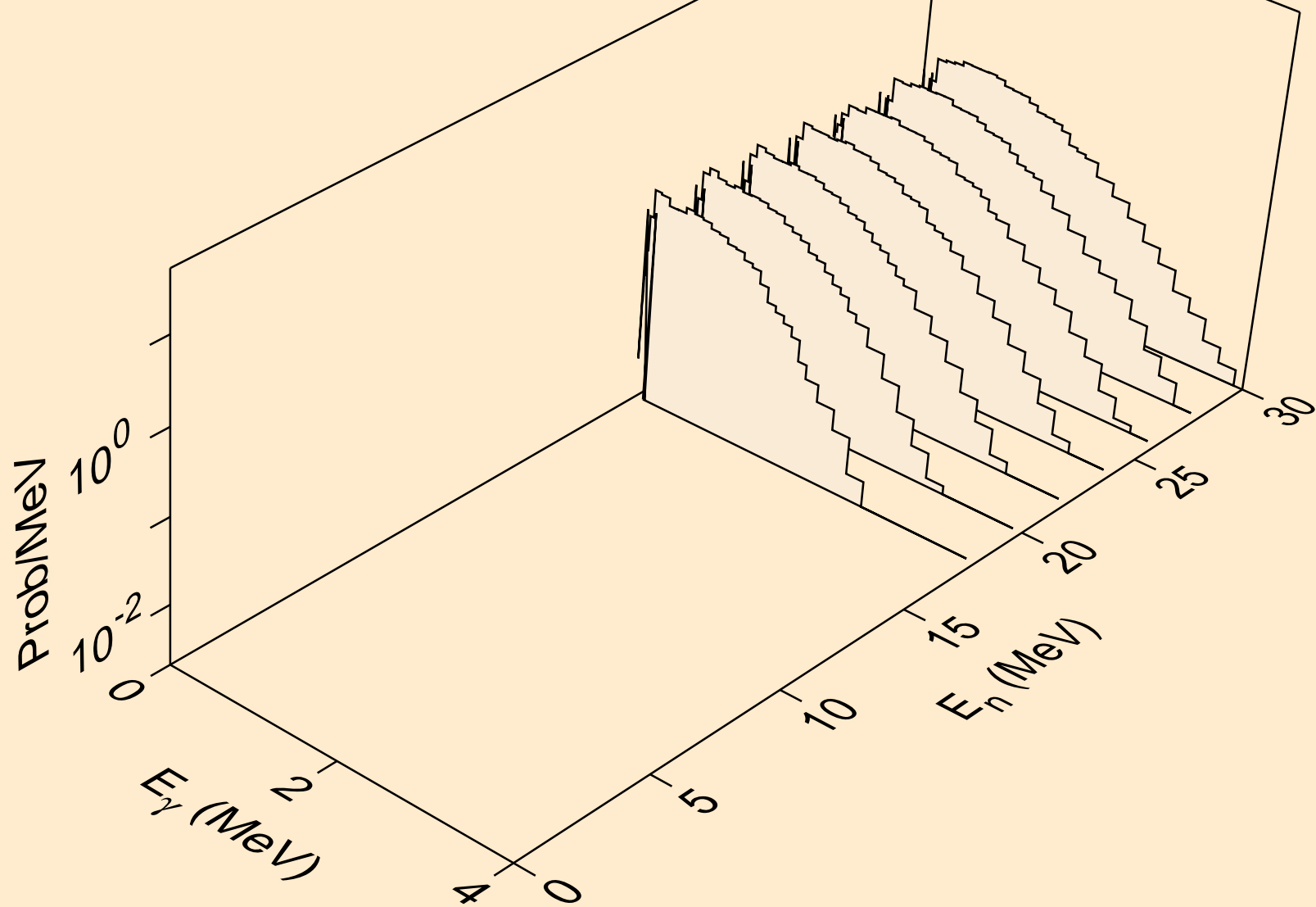

LR264 NEUTRON ACER TENDL-2021 LIBRARY; T=293.6K
thermal capture photon spectrum

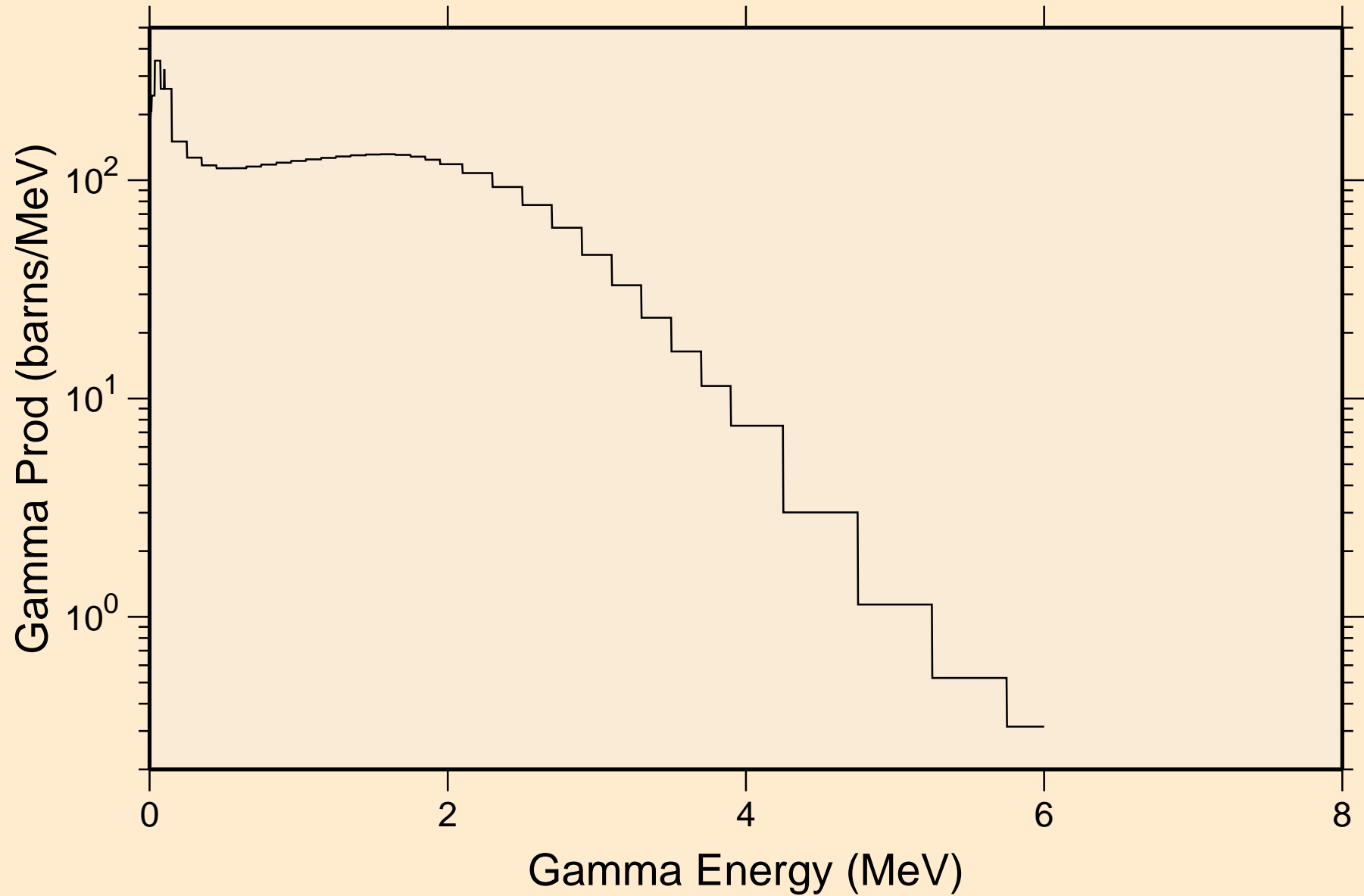

LR264 NEUTRON ACER TENDL-2021 LIBRARY; T=293.6K
14 MeV photon spectrum

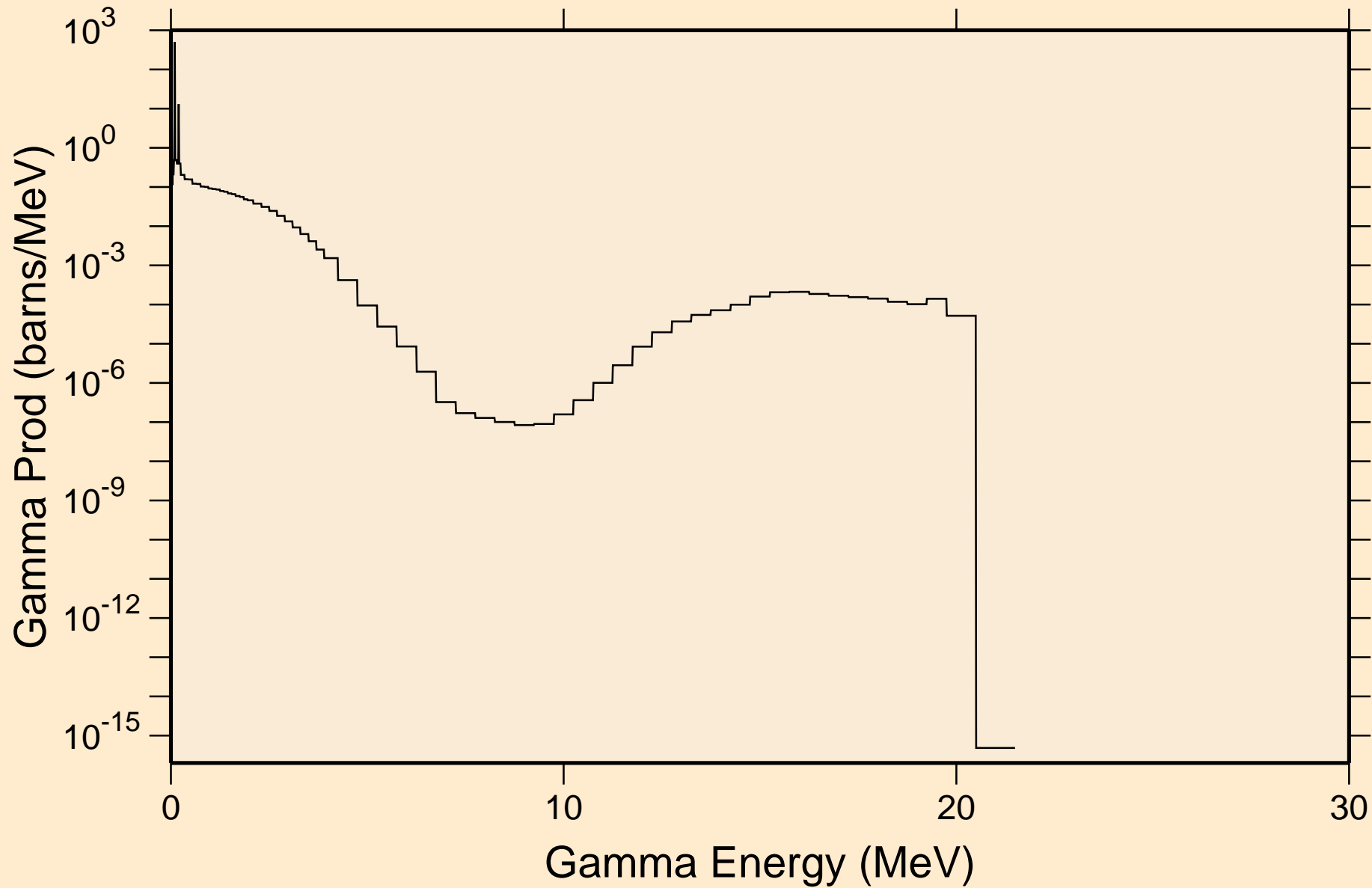

LR264 NEUTRON ACER TENDL-2021 LIBRARY; T=293.6K
Particle heating contributions

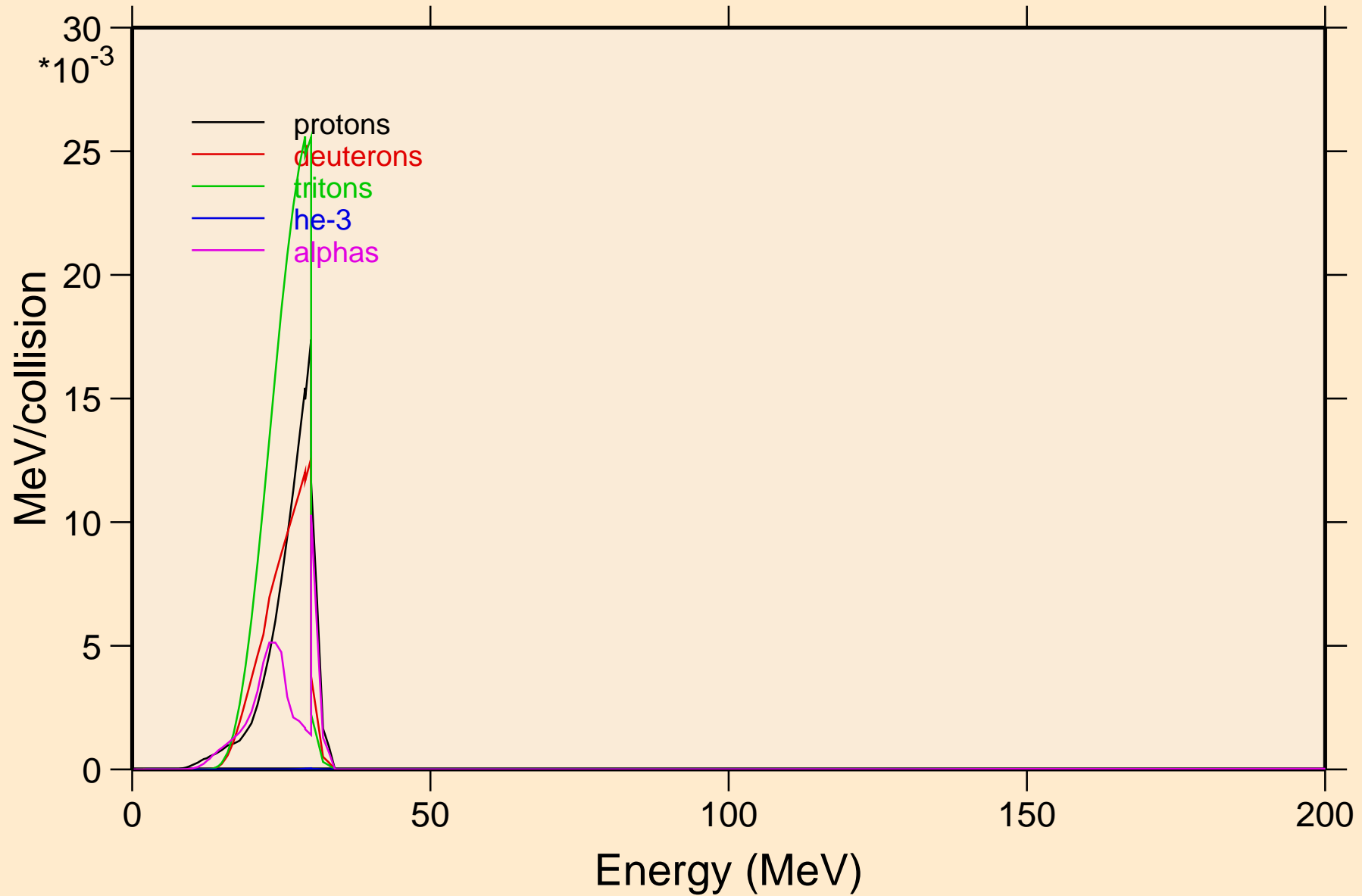

LR264 NEUTRON ACER TENDL-2021 LIBRARY; T=293.6K
Recoil Heating

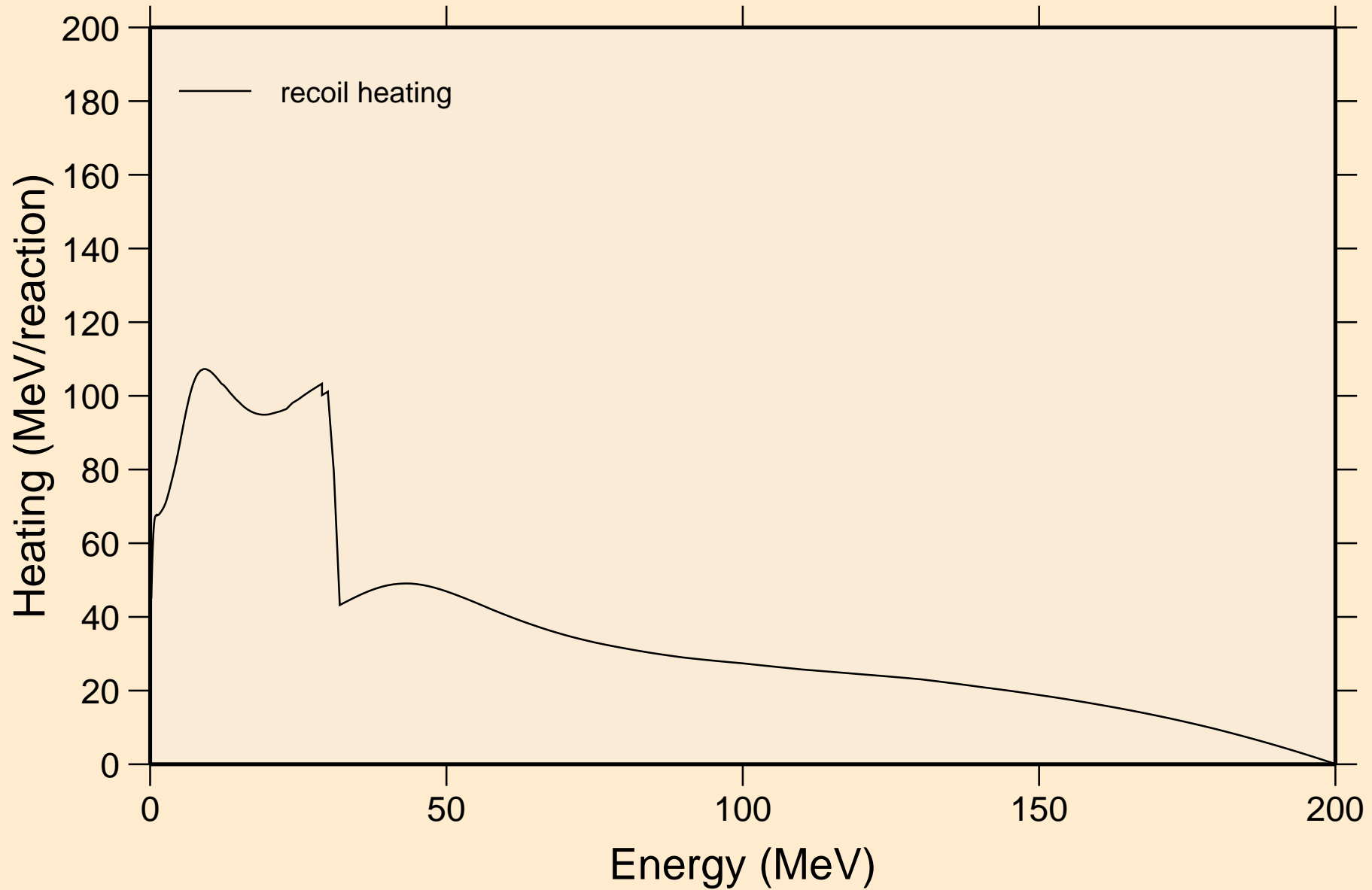

LR264 NEUTRON ACER TENDL-2021 LIBRARY; T=293.6K

Particle production cross sections

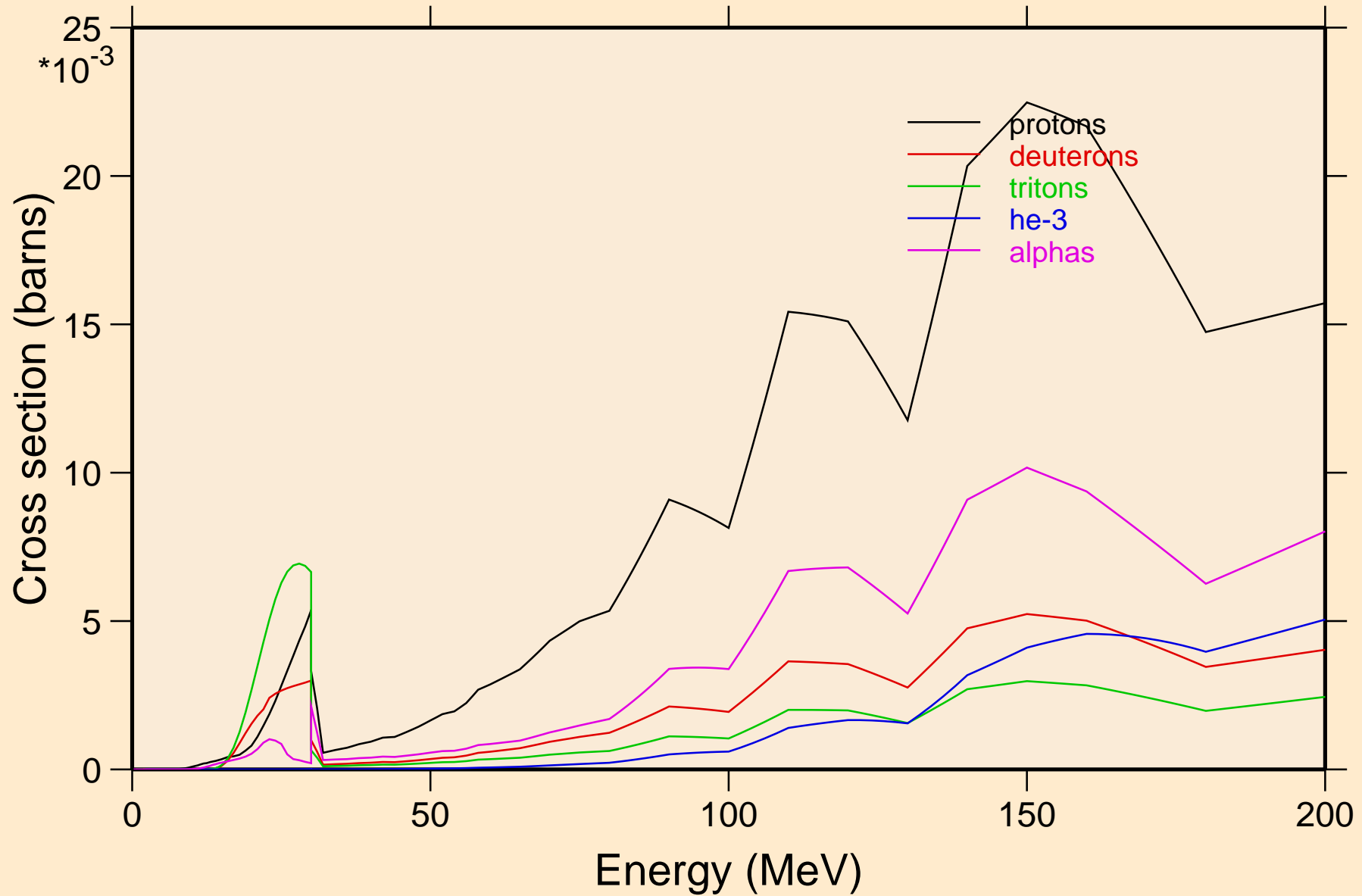

LR264 NEUTRON ACER TENDL-2021 LIBRARY; T=293.6K
protons from (n,x)

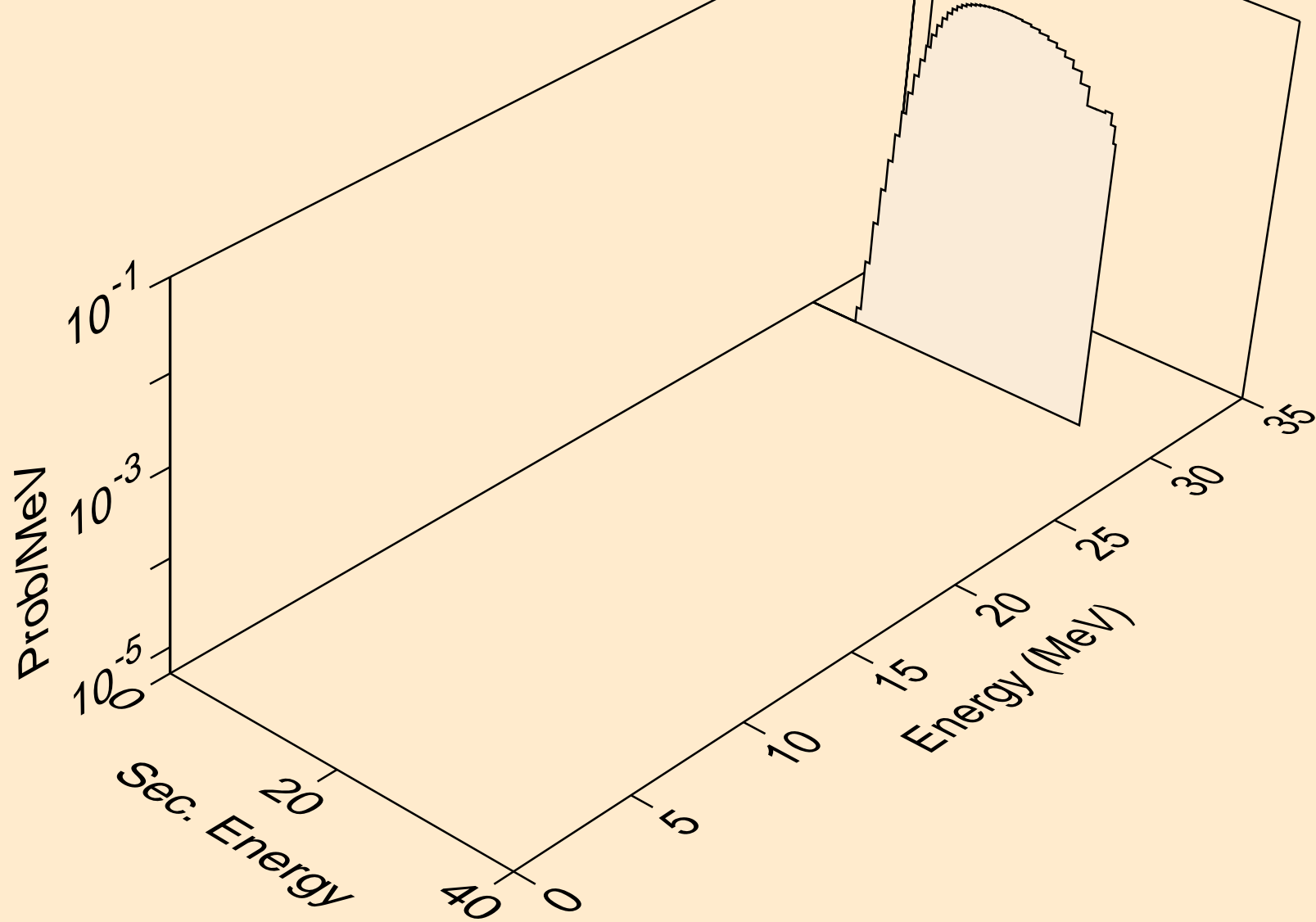

LR264 NEUTRON ACER TENDL-2021 LIBRARY; T=293.6K
protons from (n,n*)p

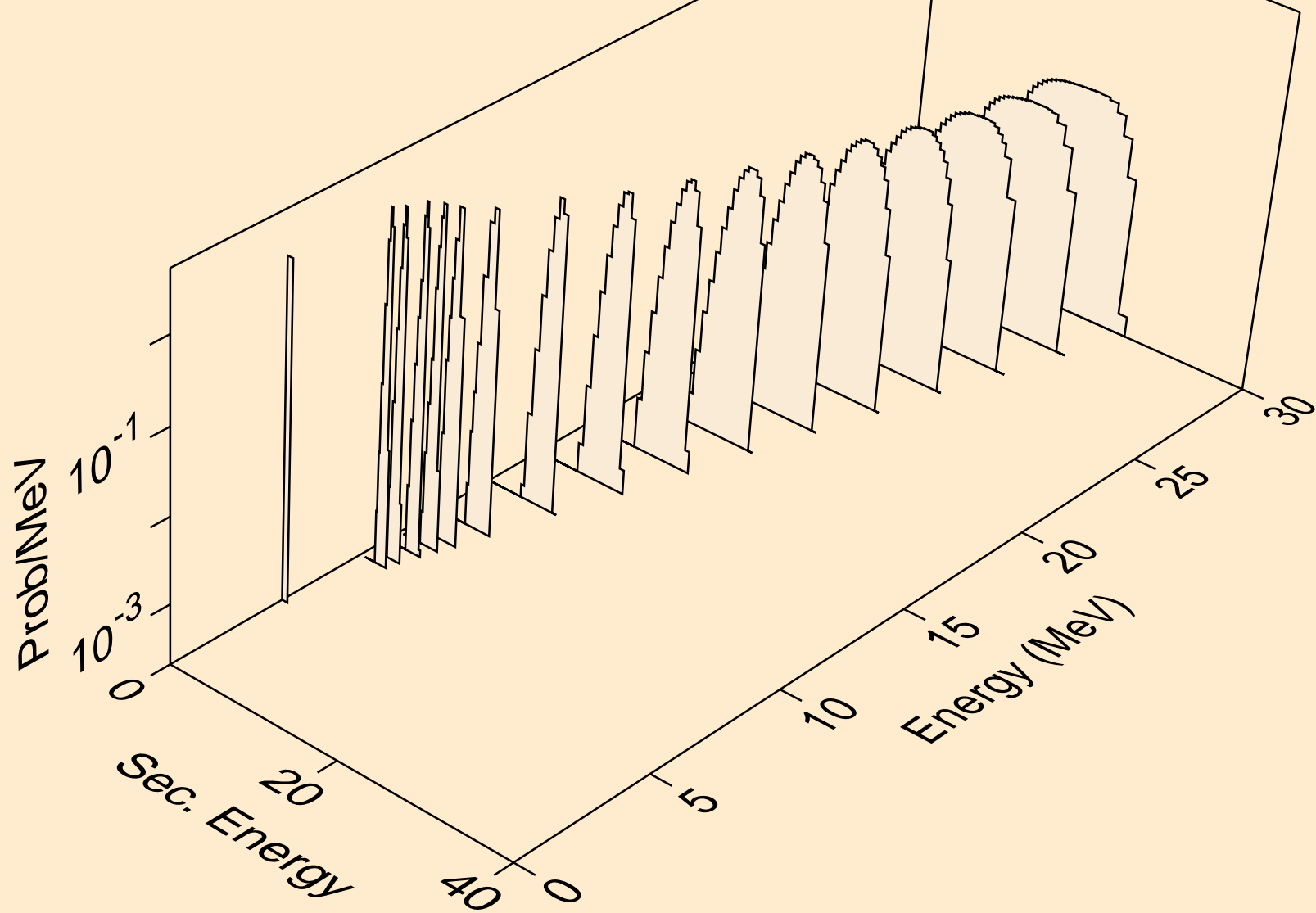

LR264 NEUTRON ACER TENDL-2021 LIBRARY; T=293.6K
protons from (n,2np)

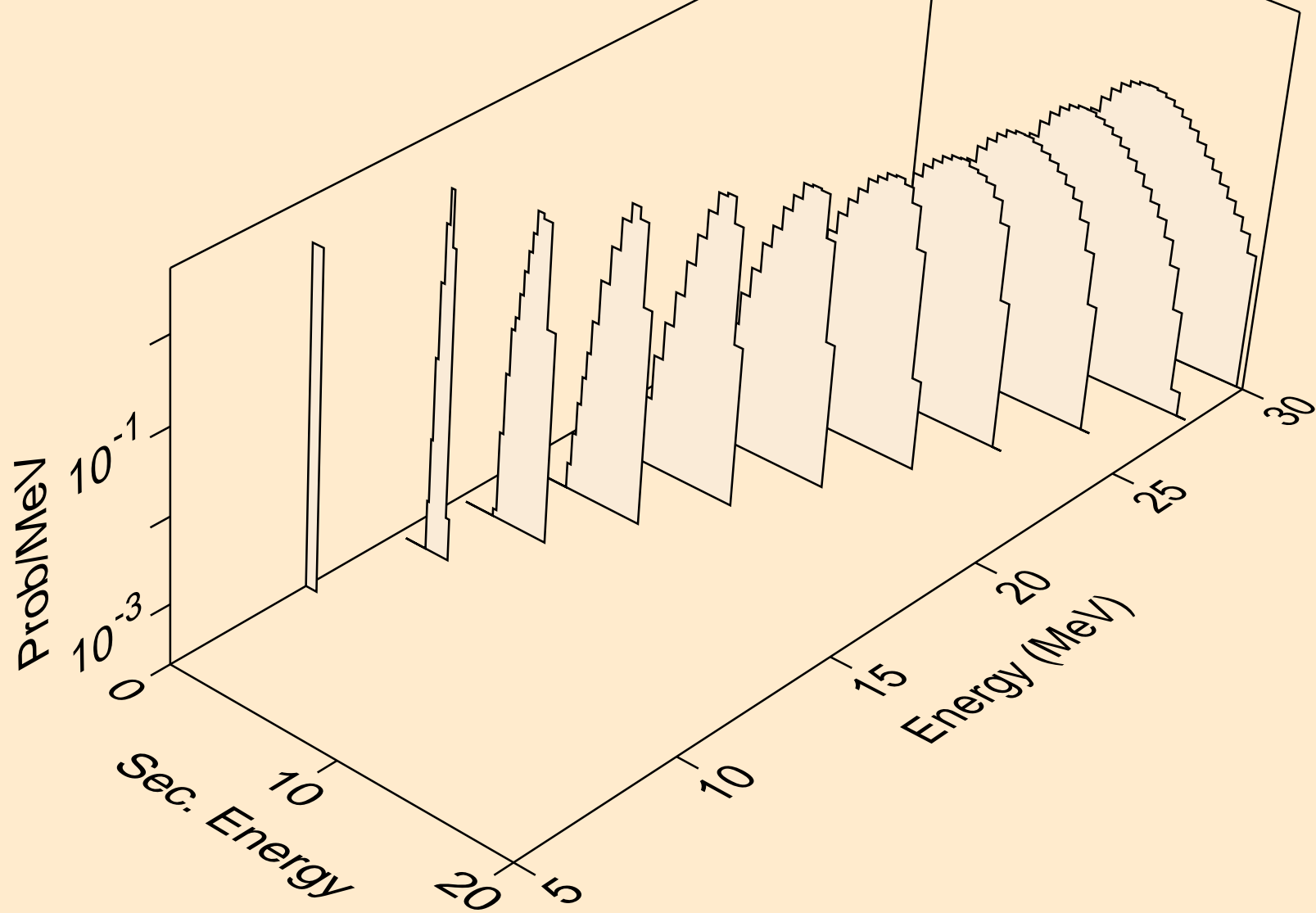

LR264 NEUTRON ACER TENDL-2021 LIBRARY; T=293.6K
protons from (n,3np)

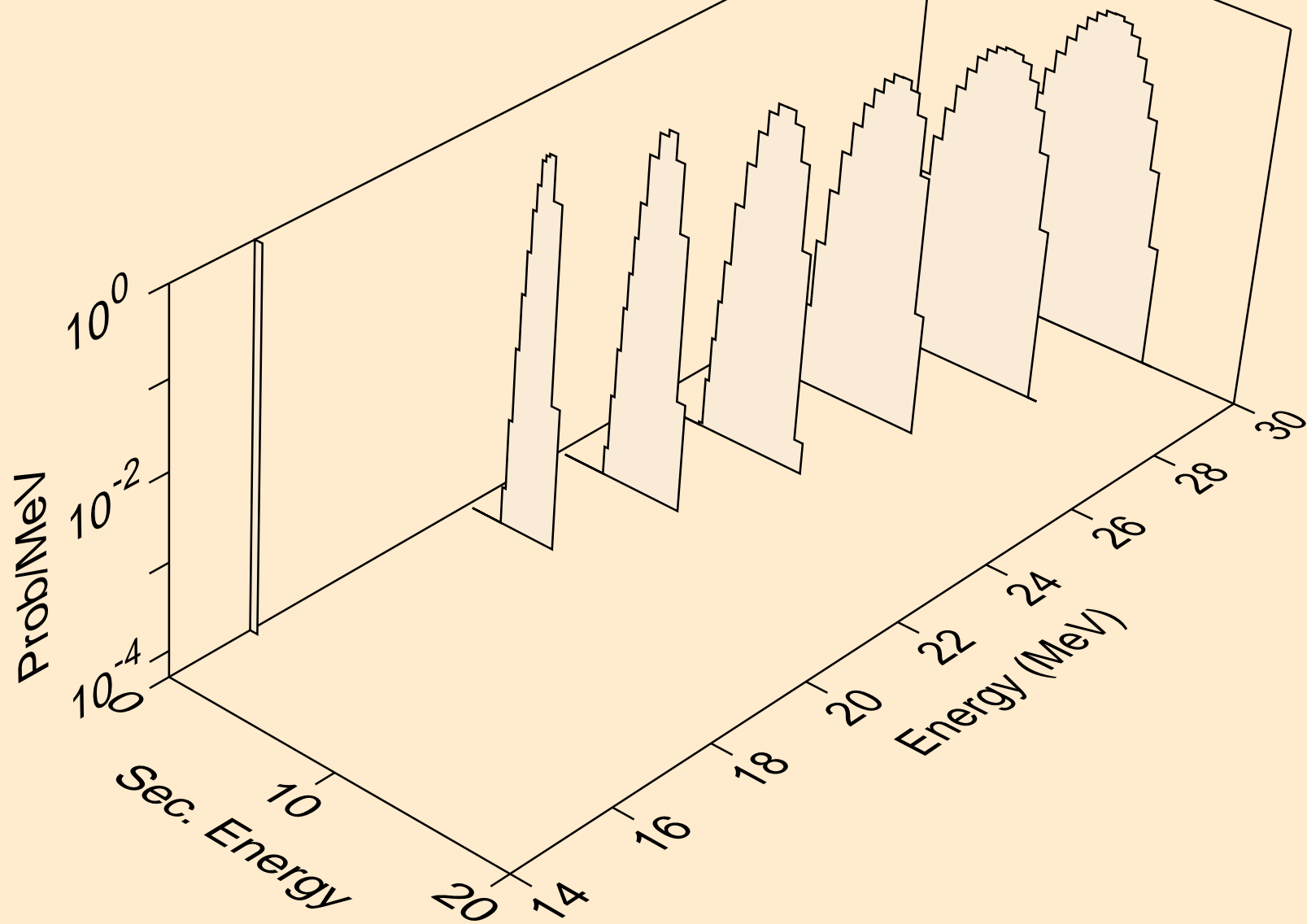

LR264 NEUTRON ACER TENDL-2021 LIBRARY; T=293.6K
protons from (n,2np)

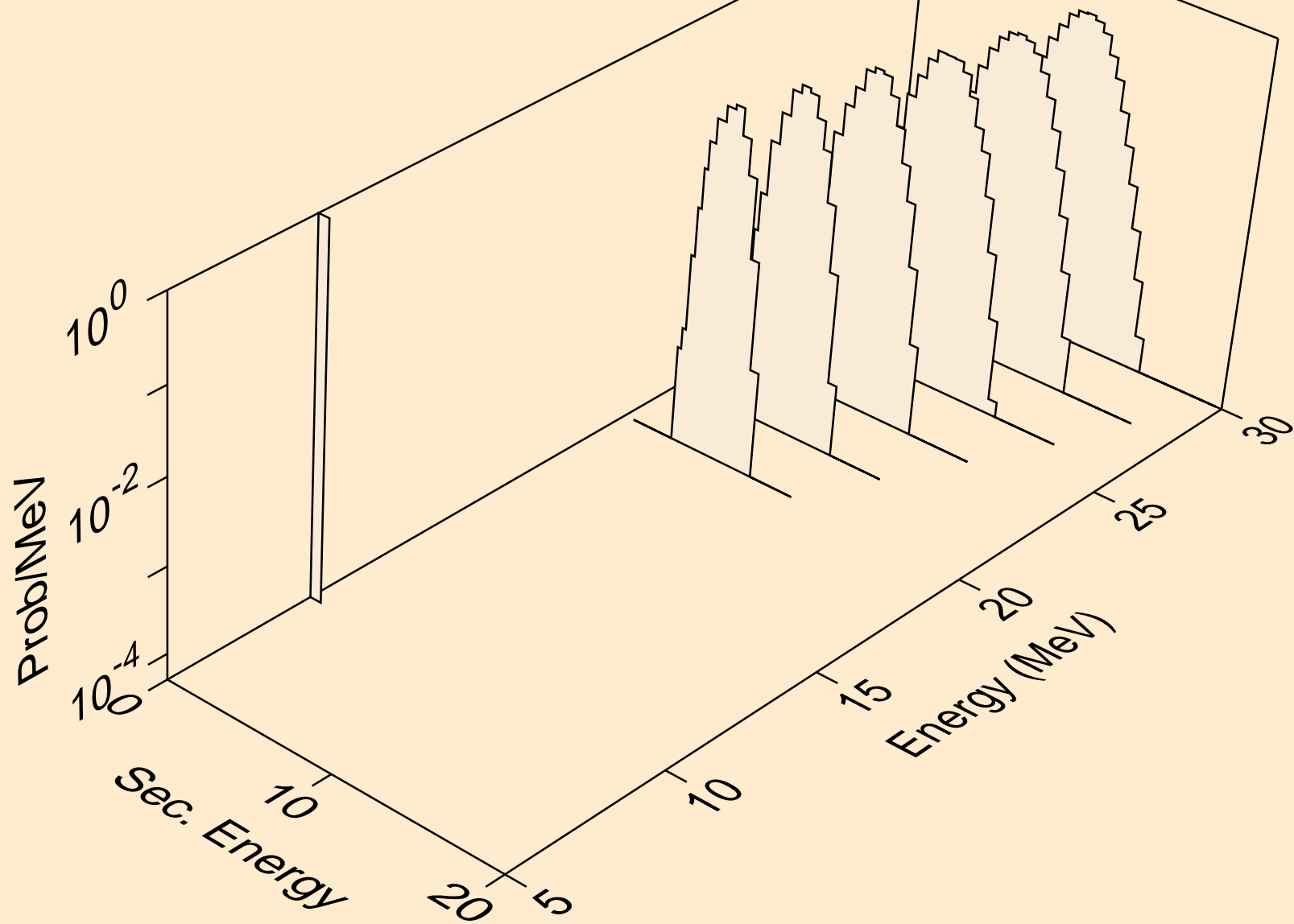

LR264 NEUTRON ACER TENDL-2021 LIBRARY; T=293.6K
protons from (n,p)

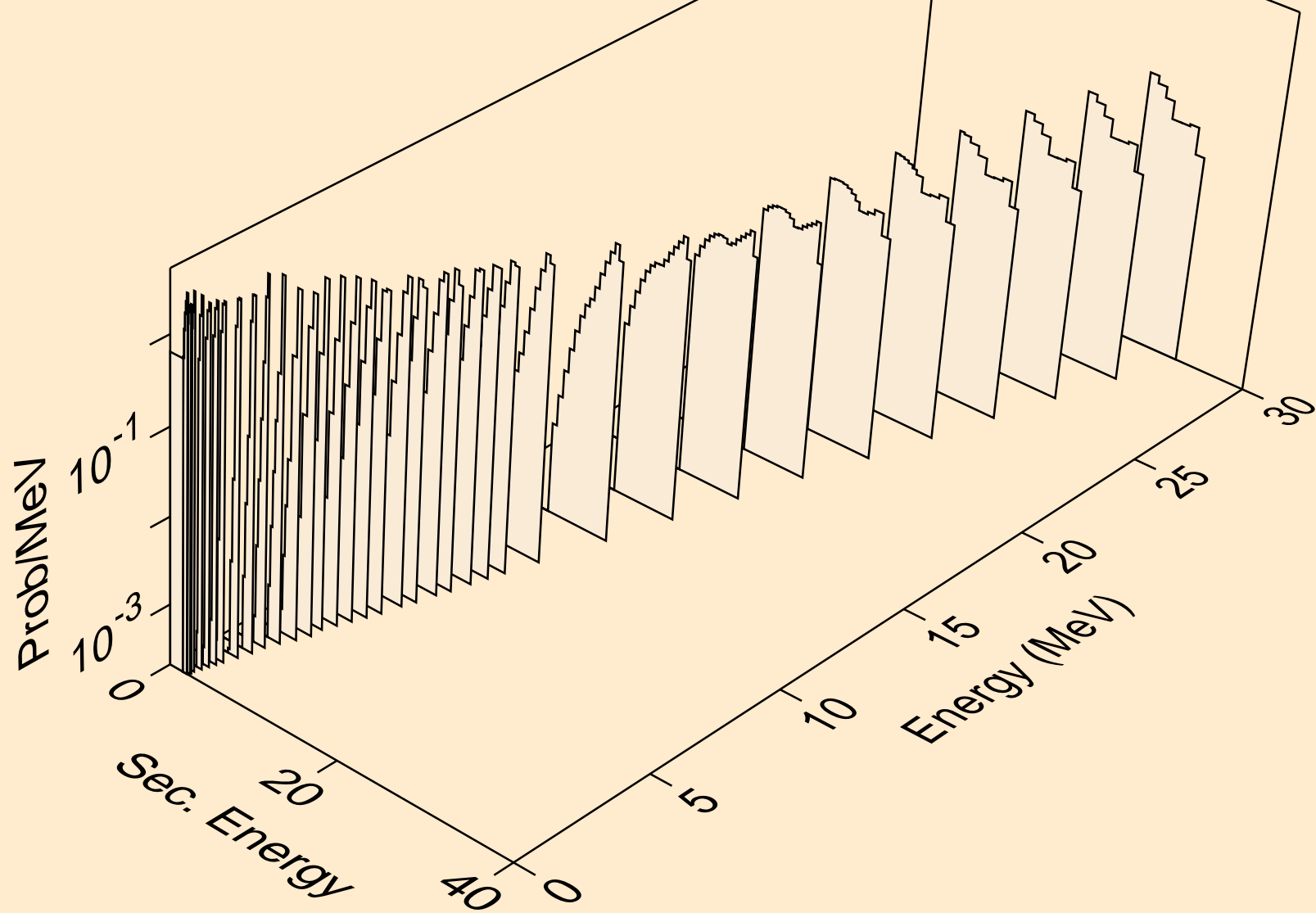

LR264 NEUTRON ACER TENDL-2021 LIBRARY; T=293.6K
protons from (n,2p)

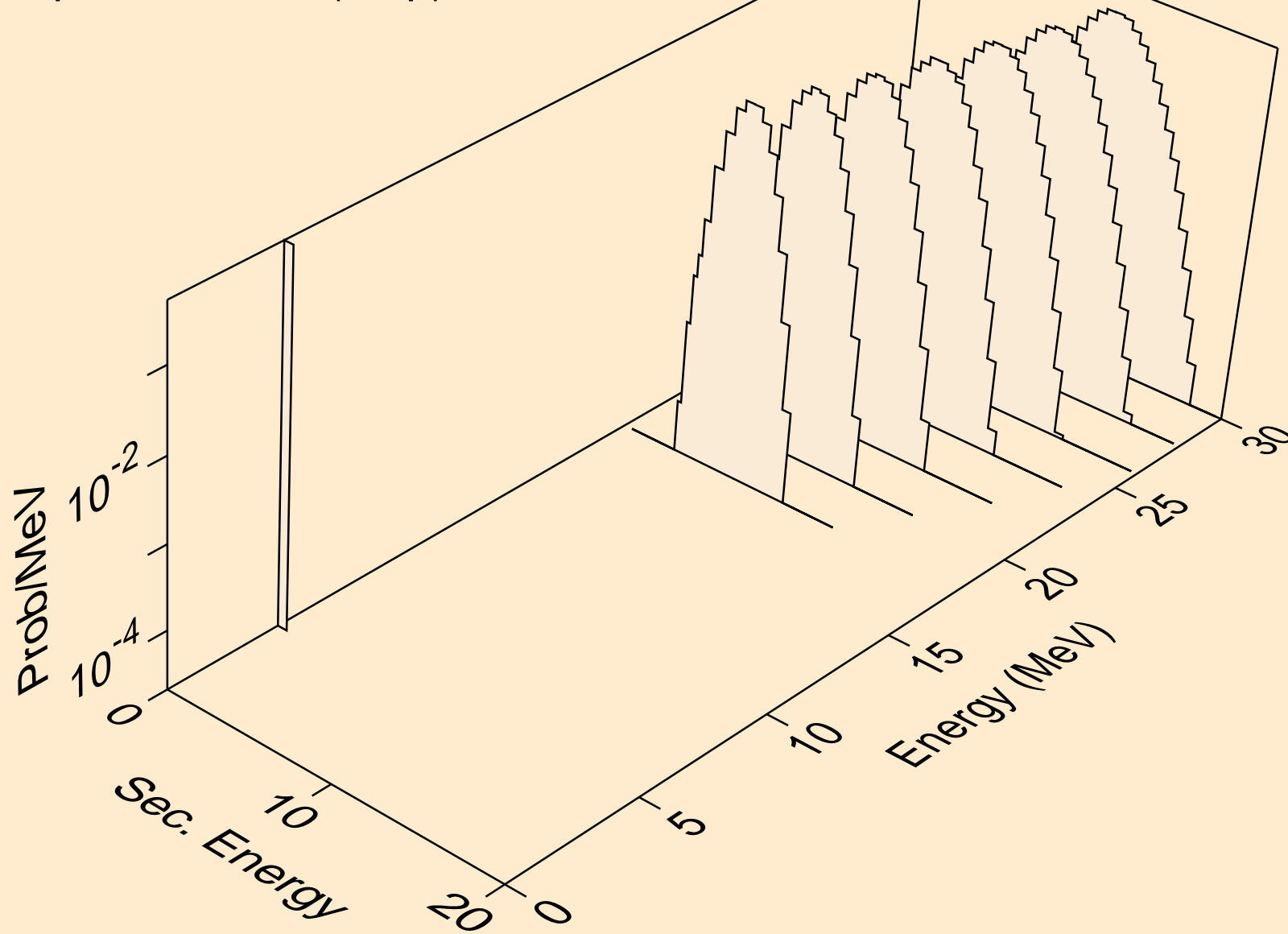

LR264 NEUTRON ACER TENDL-2021 LIBRARY; T=293.6K
deuterons from (n,x)

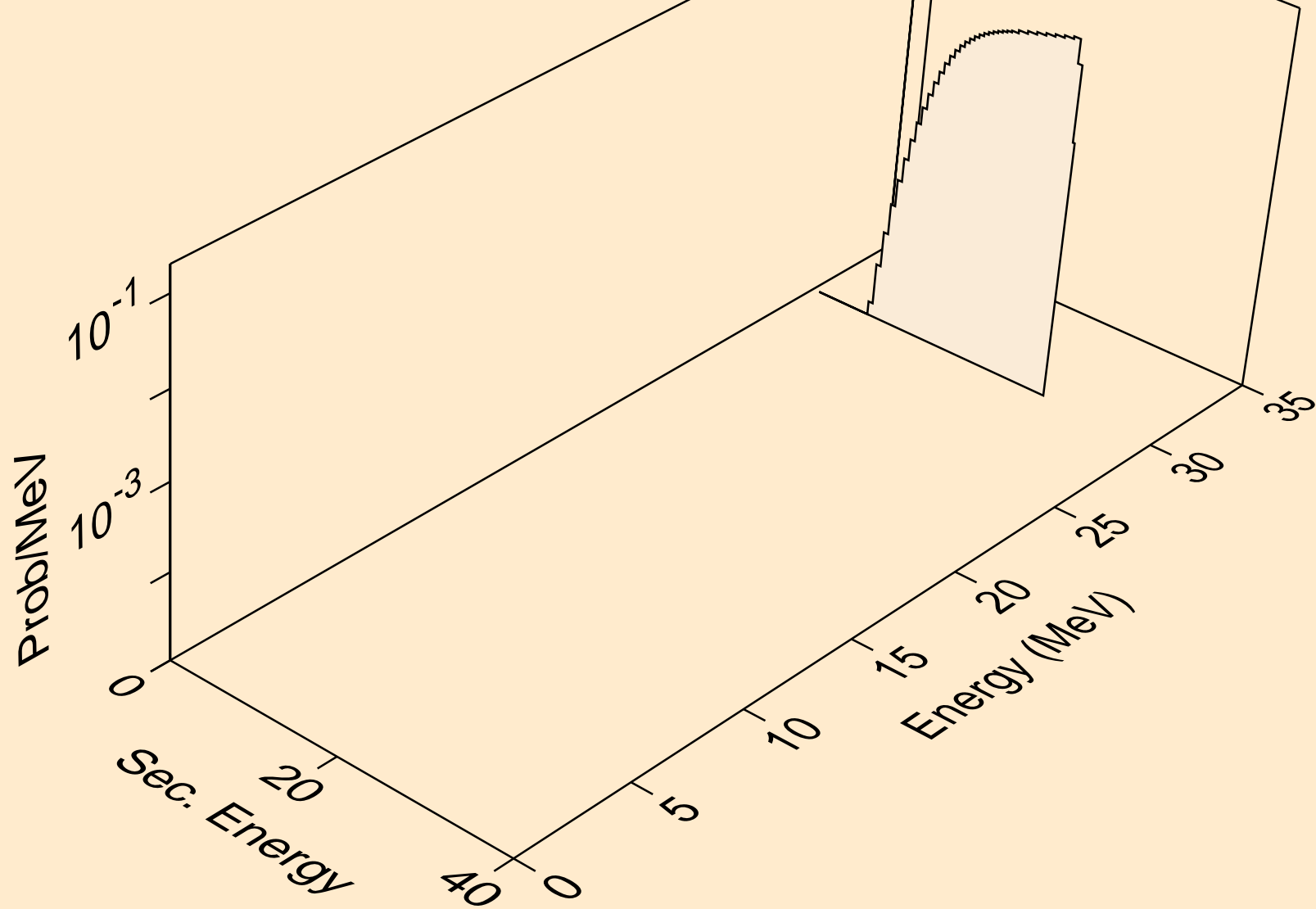

LR264 NEUTRON ACER TENDL-2021 LIBRARY; T=293.6K
deuterons from (n,2nd)

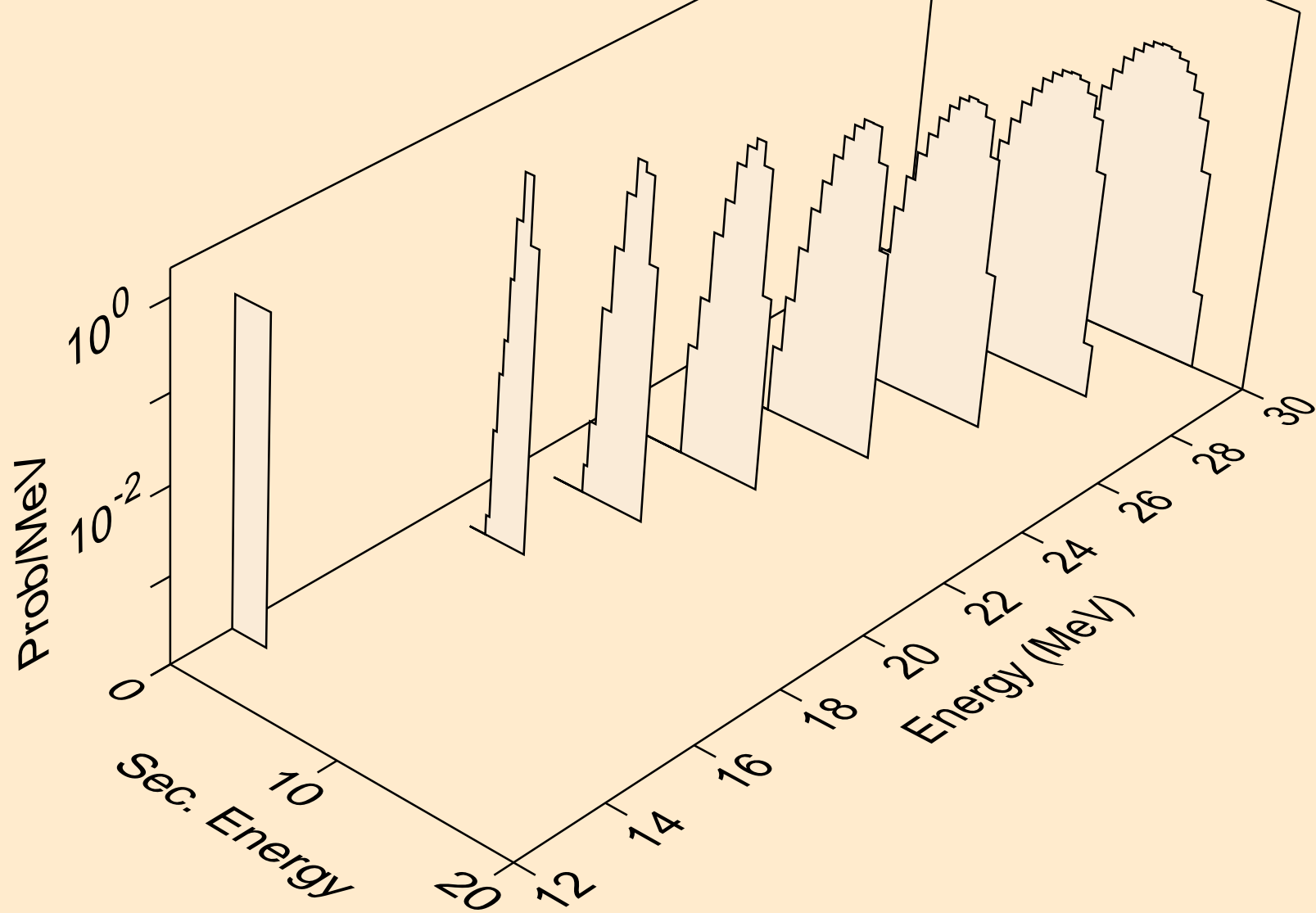

LR264 NEUTRON ACER TENDL-2021 LIBRARY; T=293.6K
deuterons from (n,n*)d

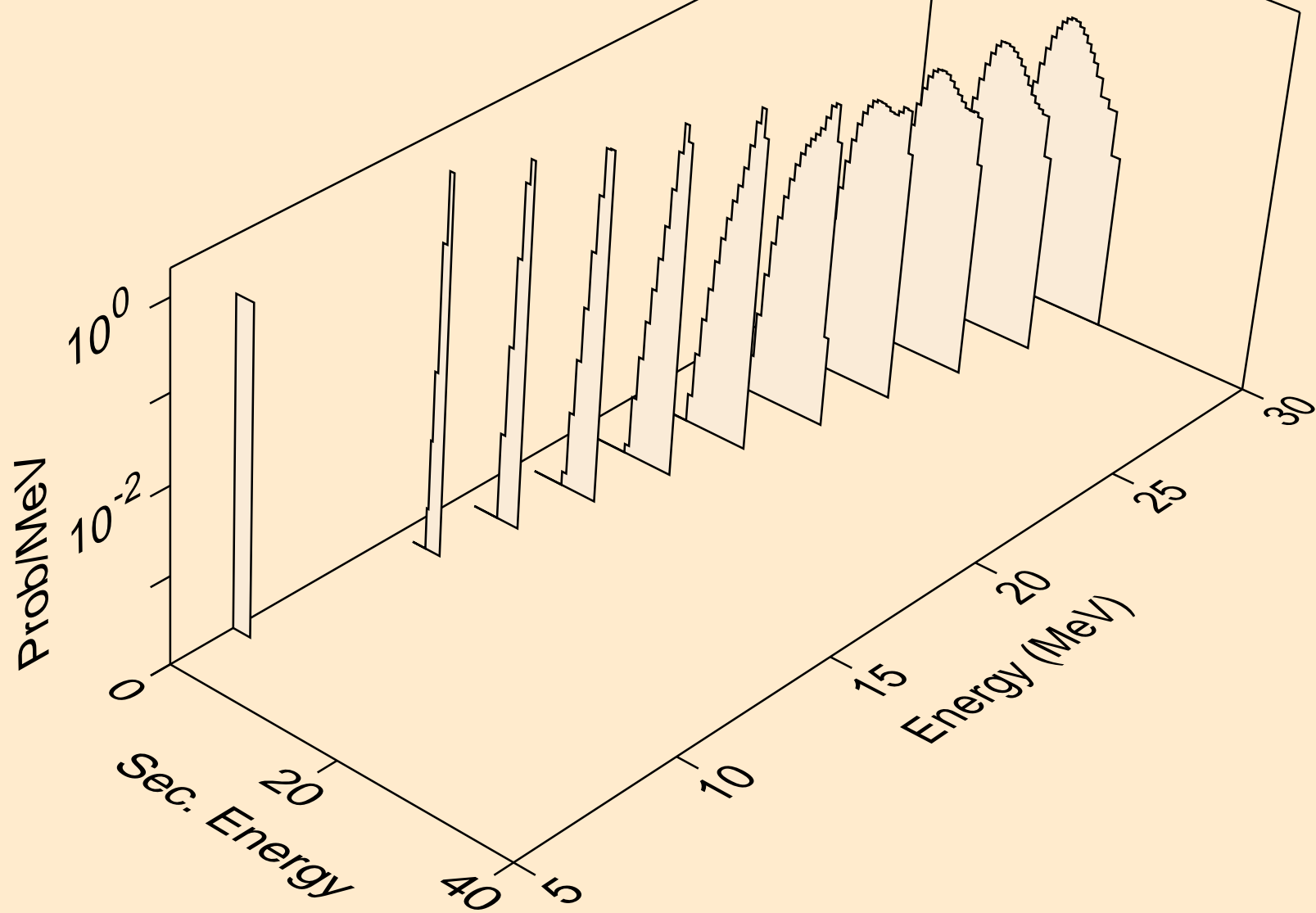

LR264 NEUTRON ACER TENDL-2021 LIBRARY; T=293.6K
deuterons from (n,d)

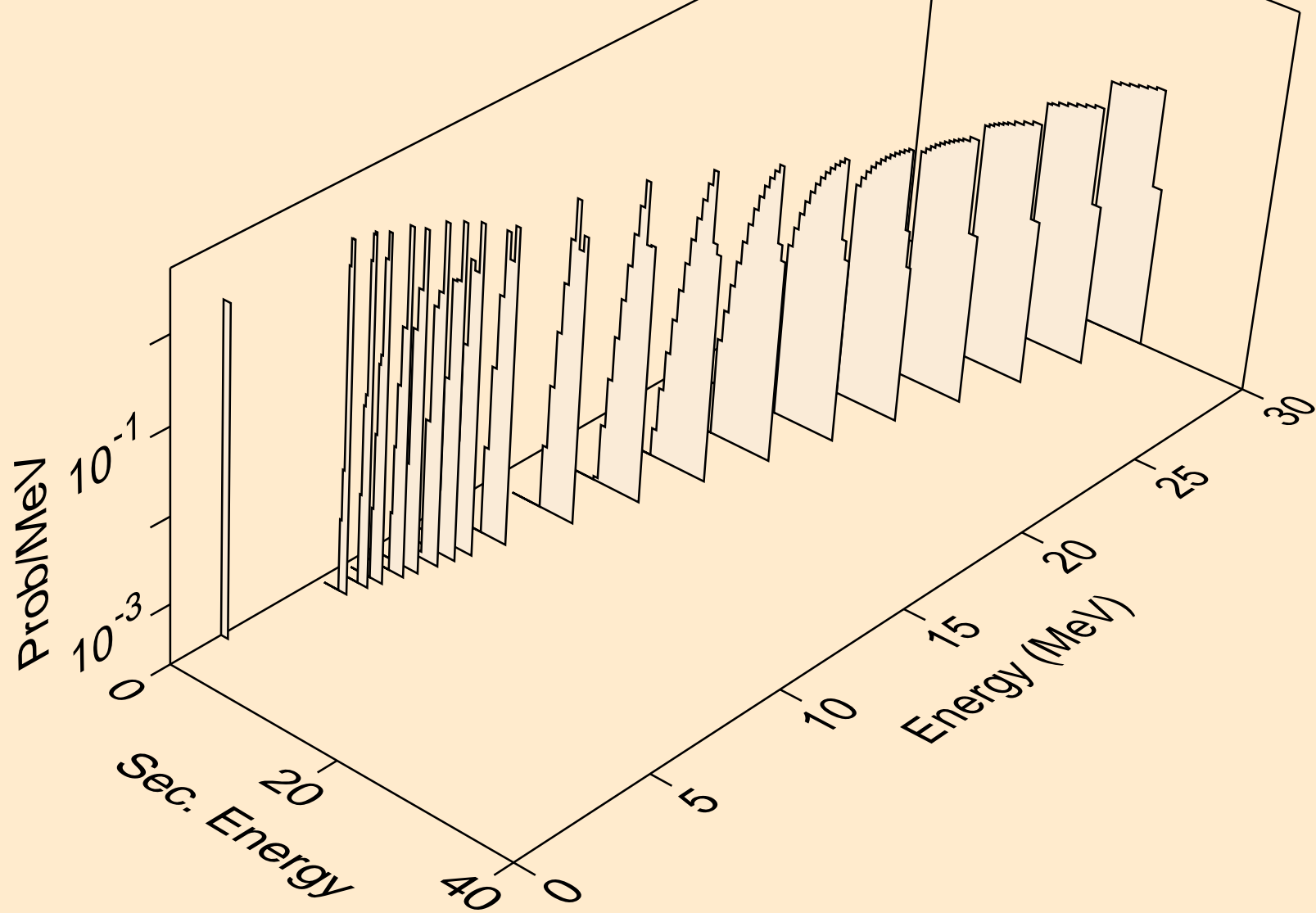

LR264 NEUTRON ACER TENDL-2021 LIBRARY; T=293.6K
tritons from (n,x)

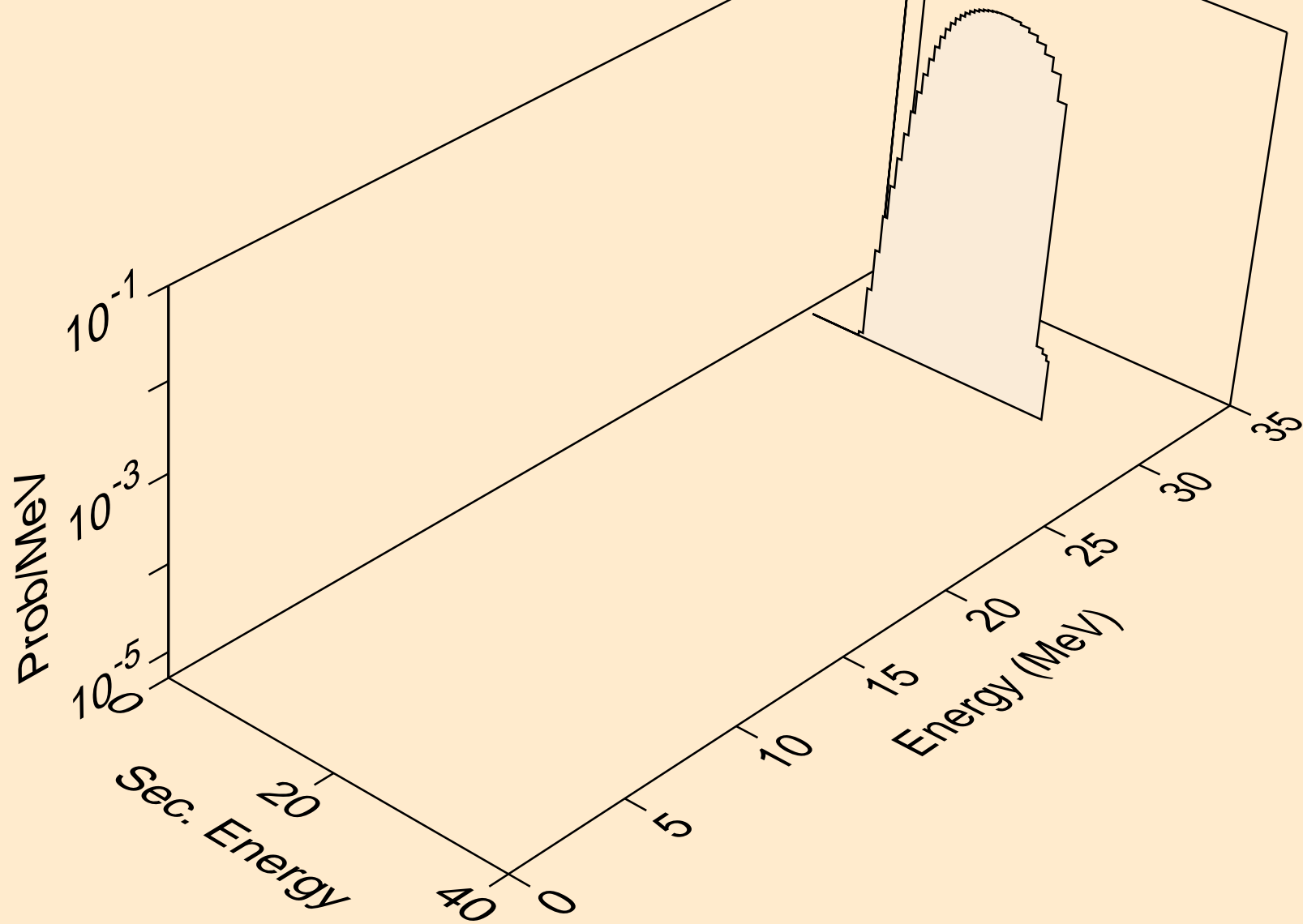

LR264 NEUTRON ACER TENDL-2021 LIBRARY; T=293.6K
tritons from (n,n*)t

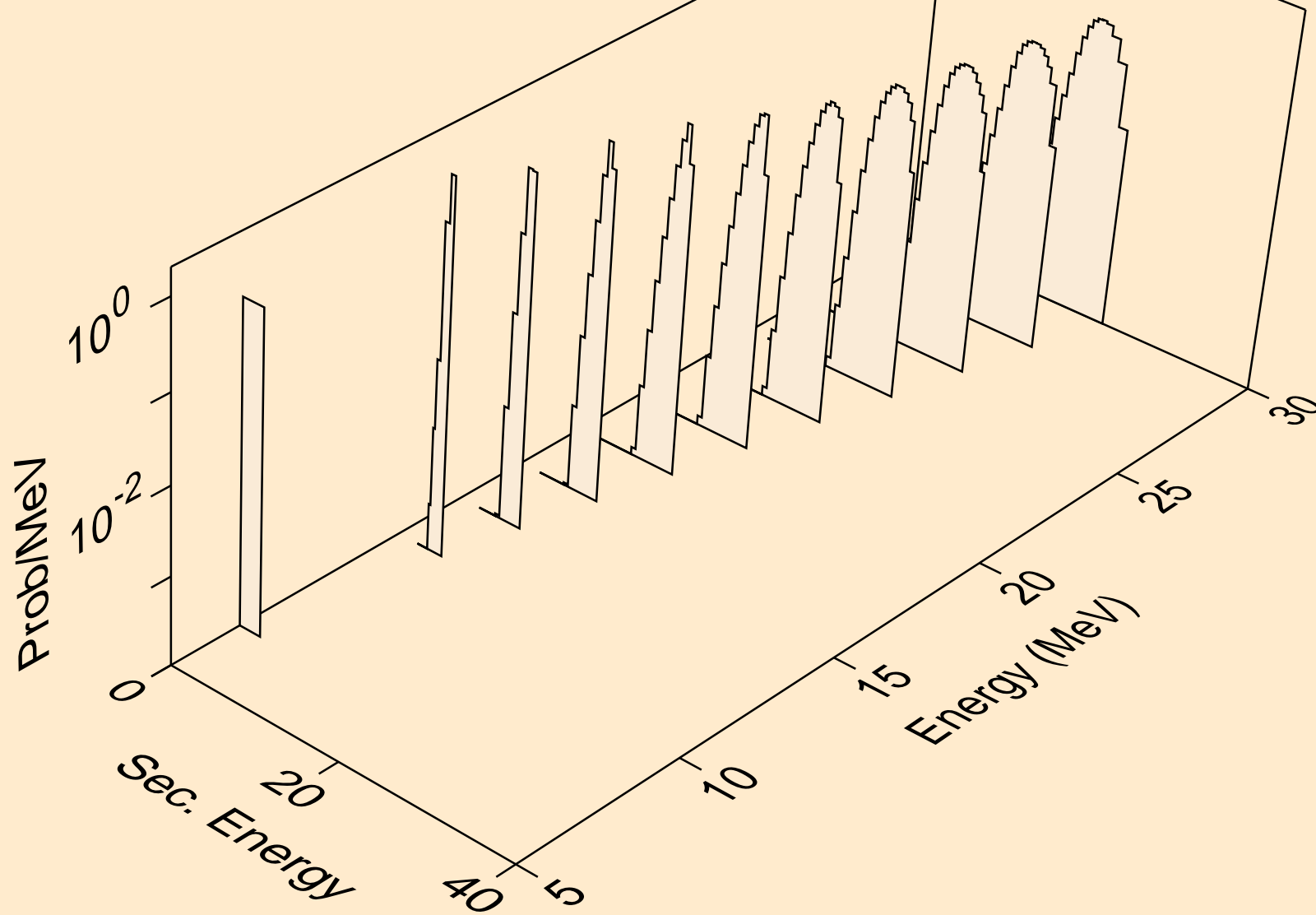

LR264 NEUTRON ACER TENDL-2021 LIBRARY; T=293.6K
tritons from (n,t)

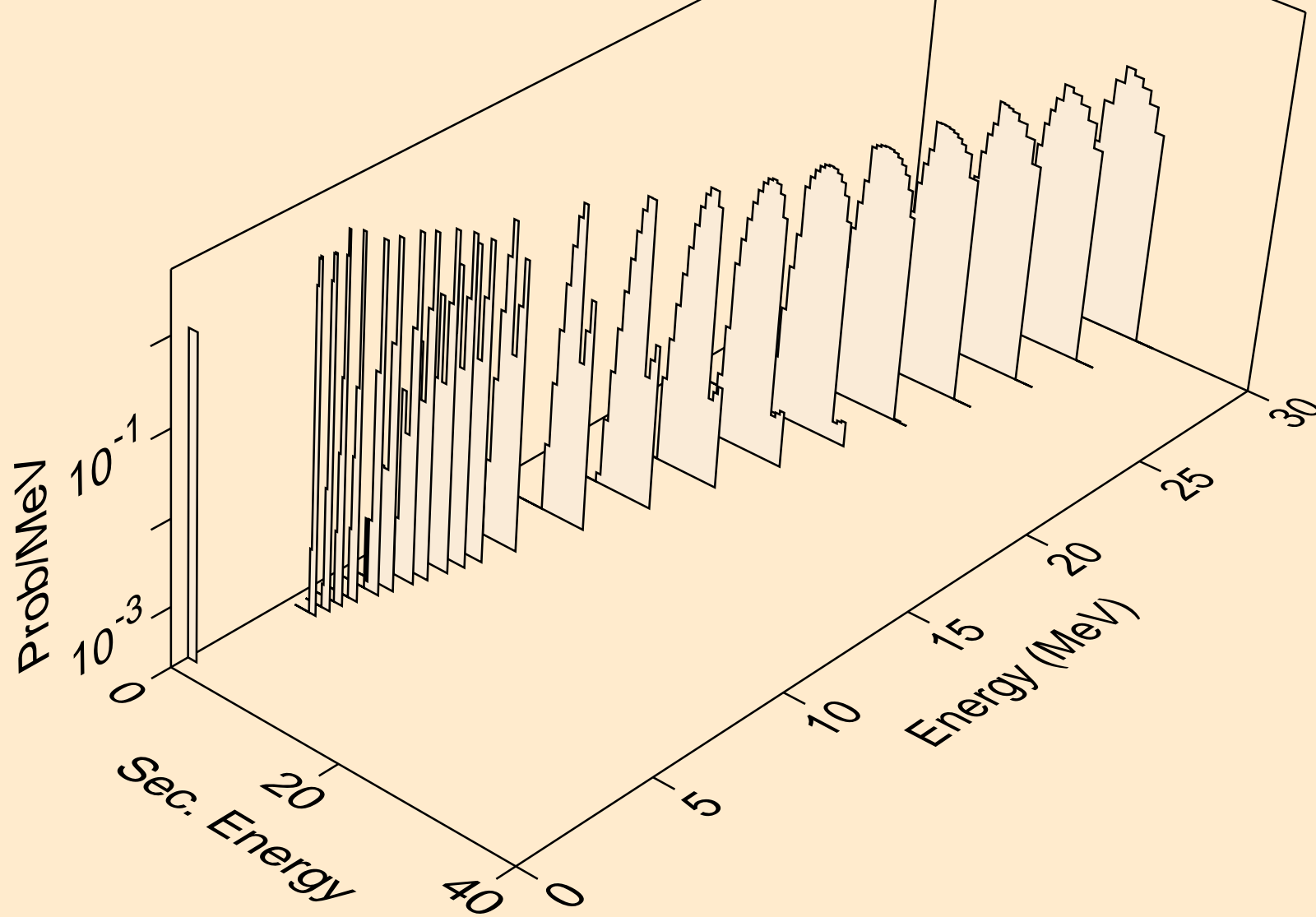

LR264 NEUTRON ACER TENDL-2021 LIBRARY; T=293.6K
he3s from (n,x)

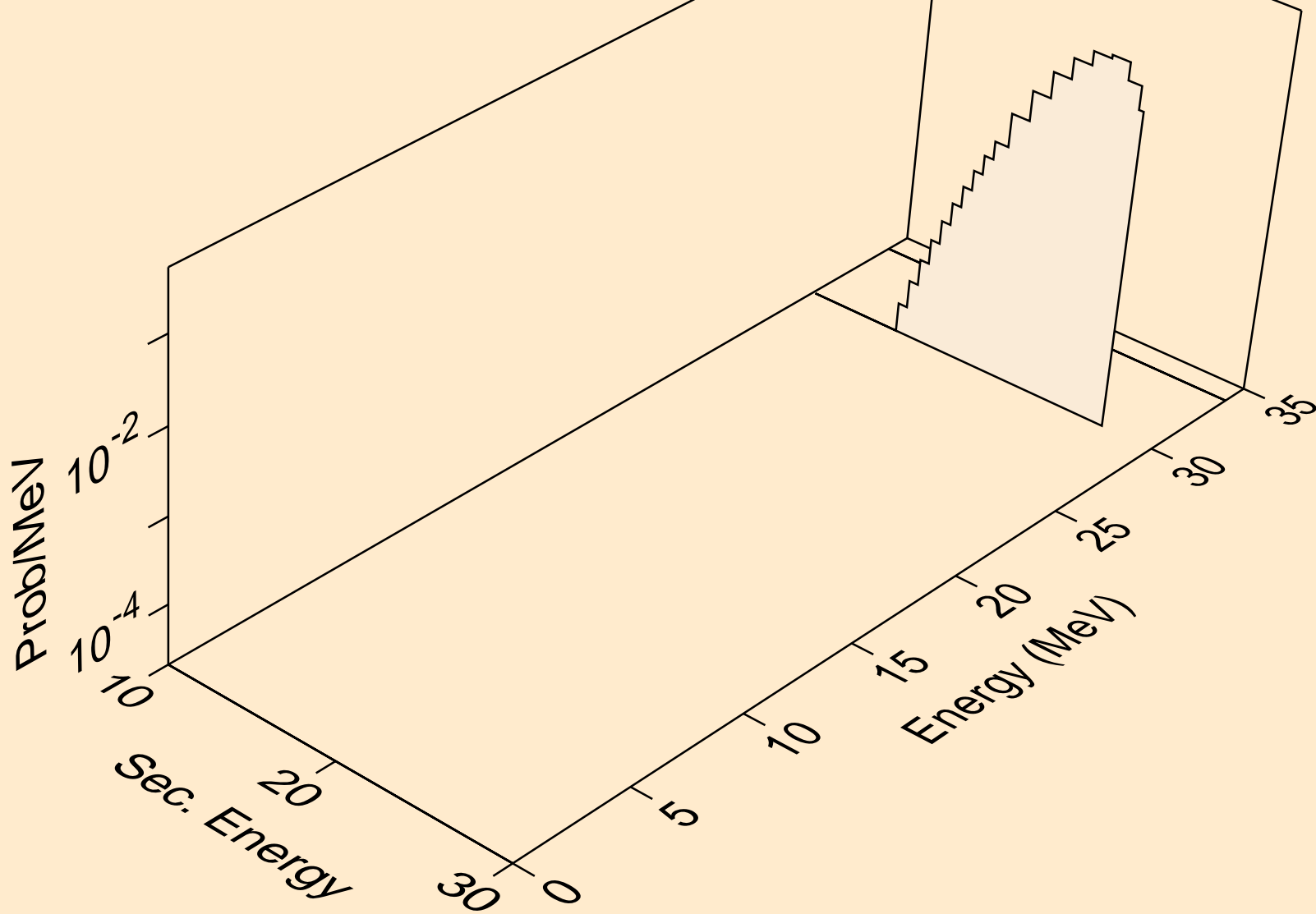

LR264 NEUTRON ACER TENDL-2021 LIBRARY; T=293.6K
he3s from (n,n*)he3

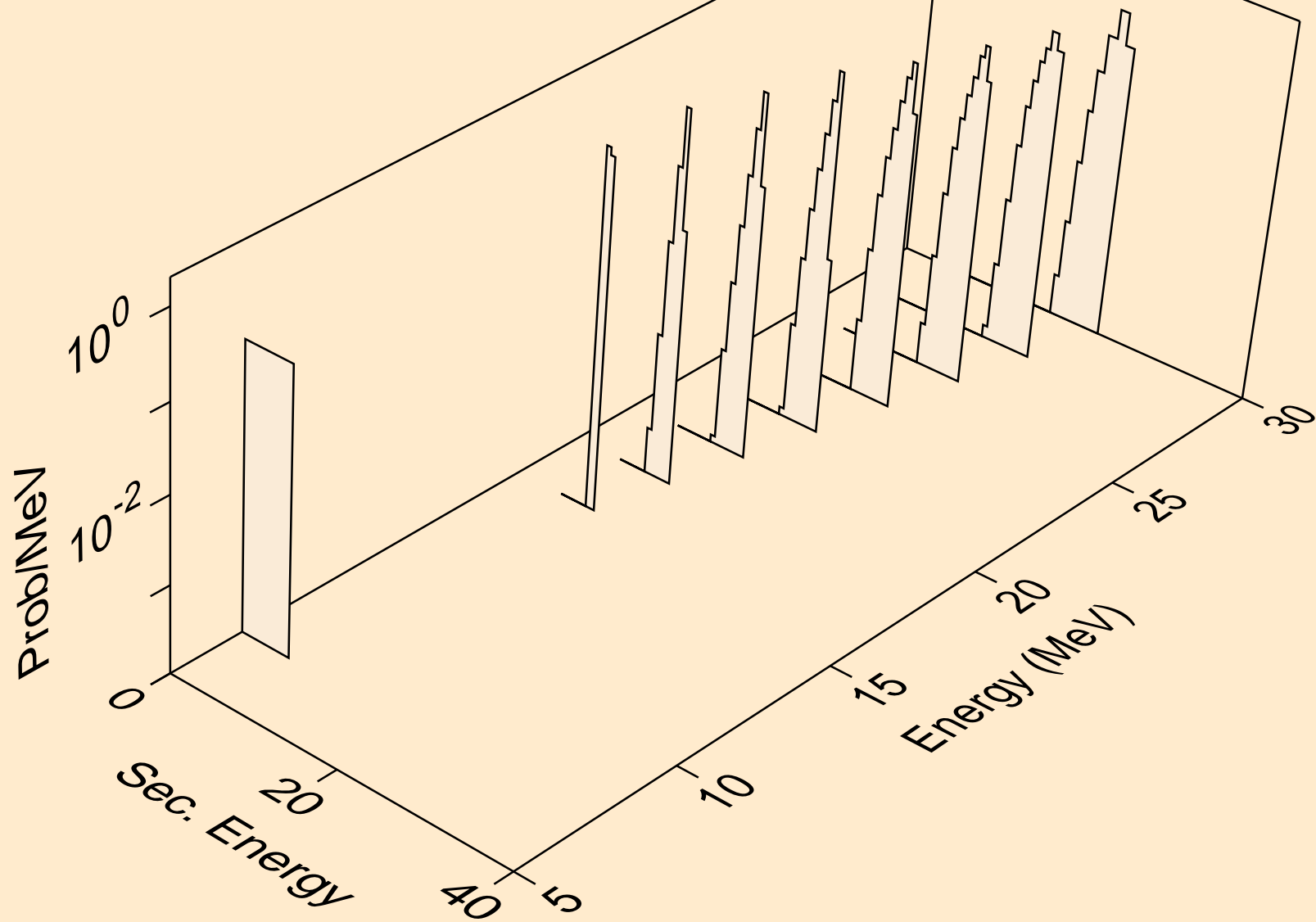

LR264 NEUTRON ACER TENDL-2021 LIBRARY; T=293.6K
he3s from (n,he3)

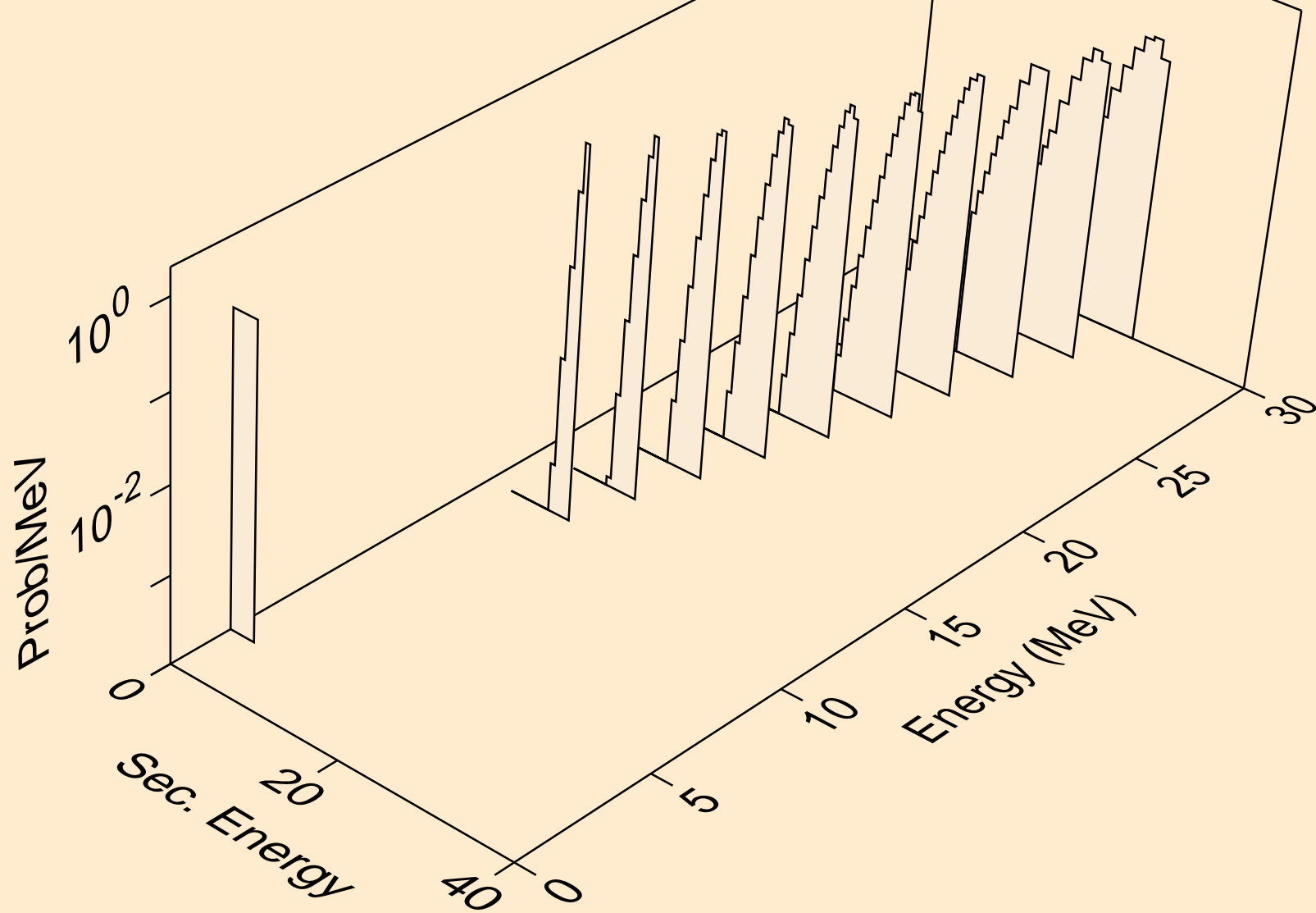

LR264 NEUTRON ACER TENDL-2021 LIBRARY; T=293.6K
alphas from (n,x)

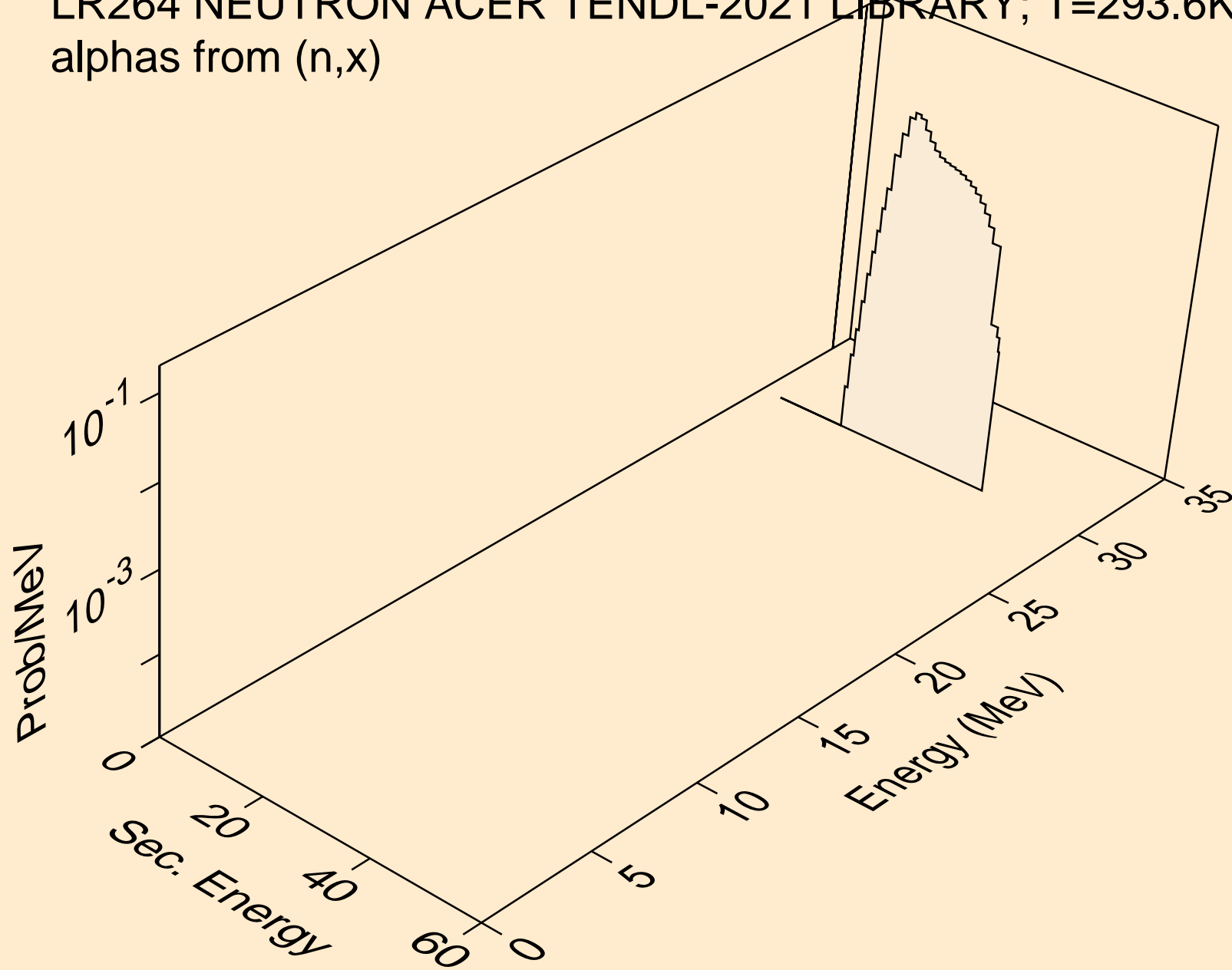

LR264 NEUTRON ACER TENDL-2021 LIBRARY; T=293.6K
alphas from (n,n*)a

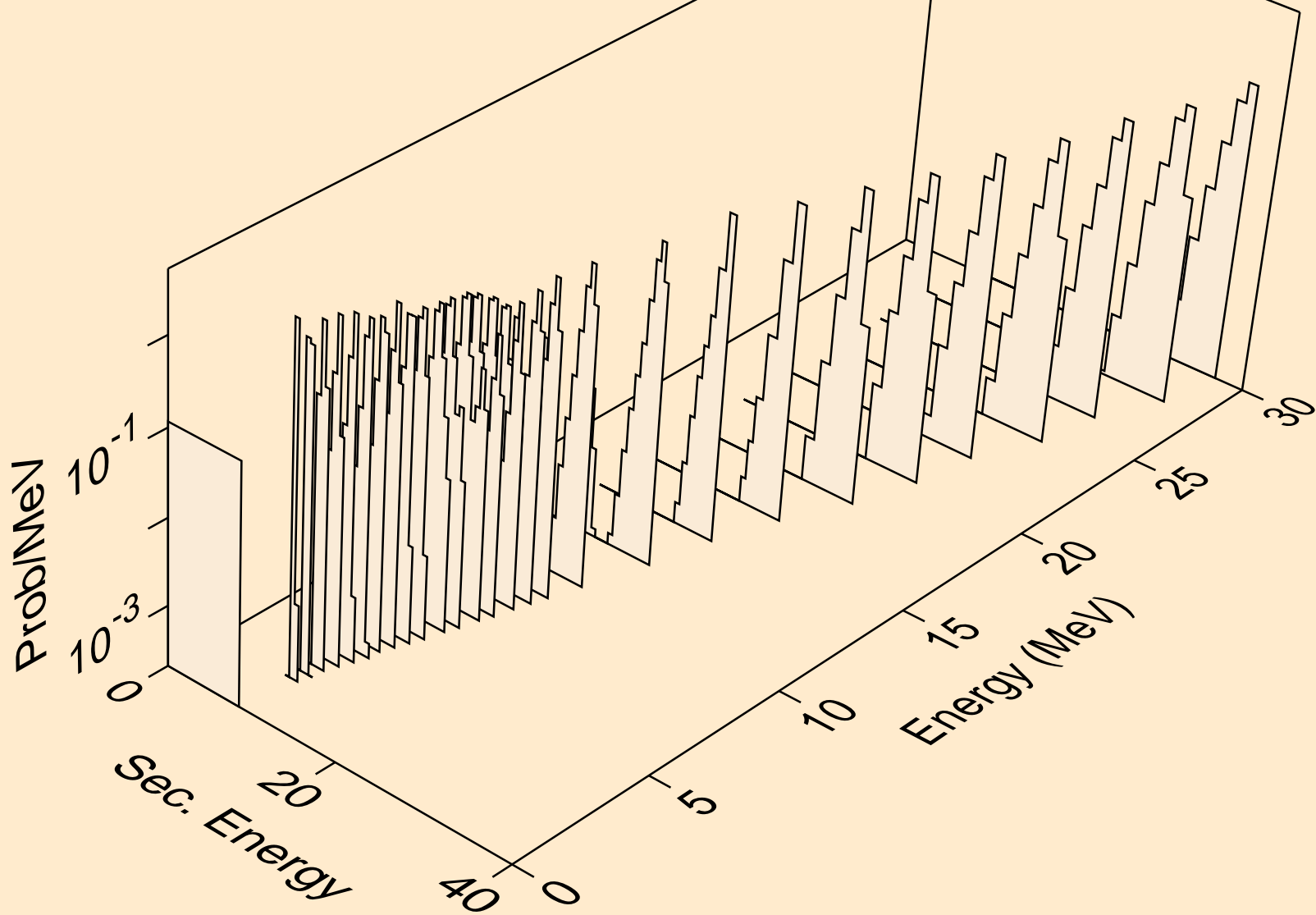

LR264 NEUTRON ACER TENDL-2021 LIBRARY; T=293.6K
alphas from (n,2n)a

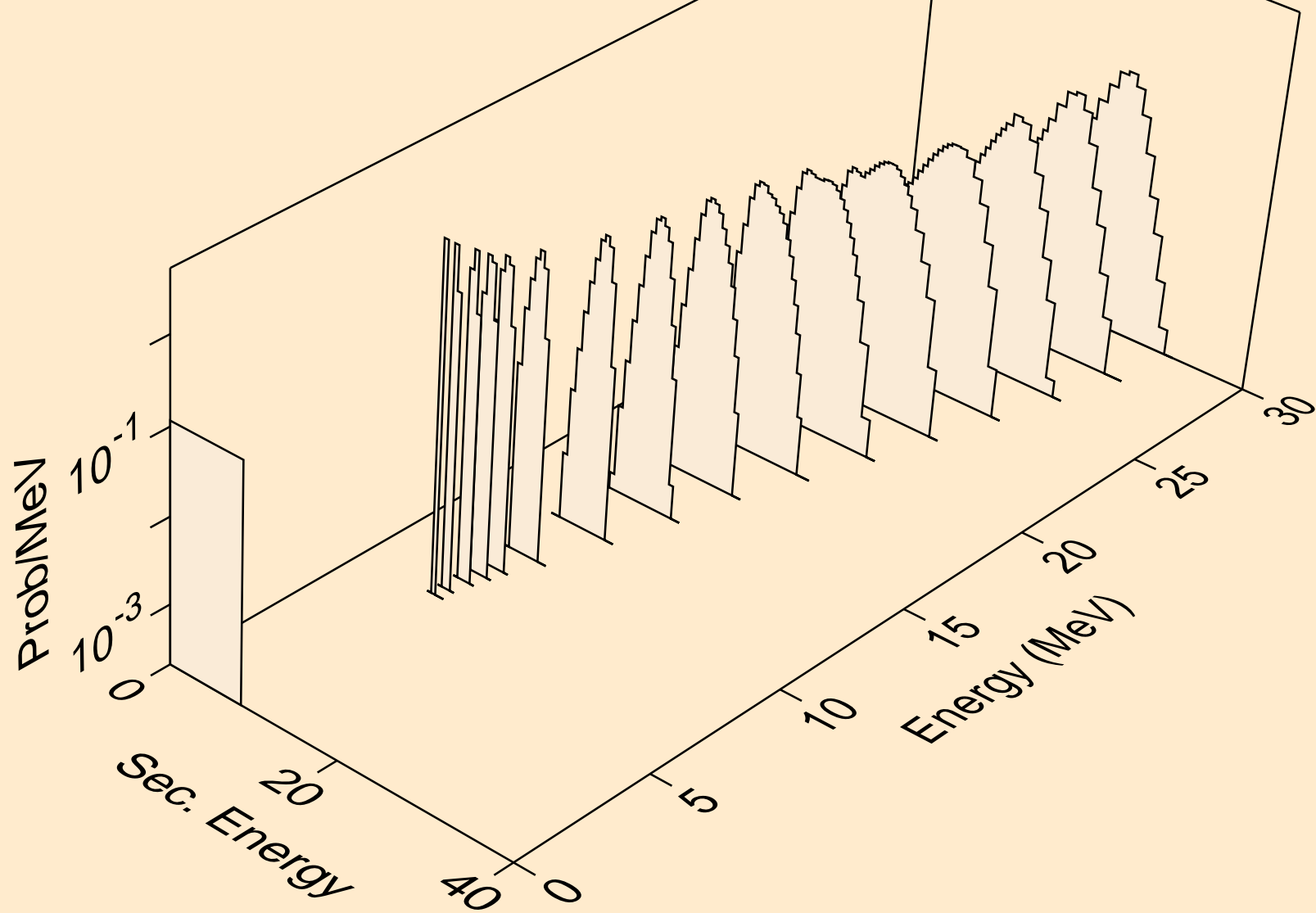

LR264 NEUTRON ACER TENDL-2021 LIBRARY; T=293.6K
alphas from (n,3n)a

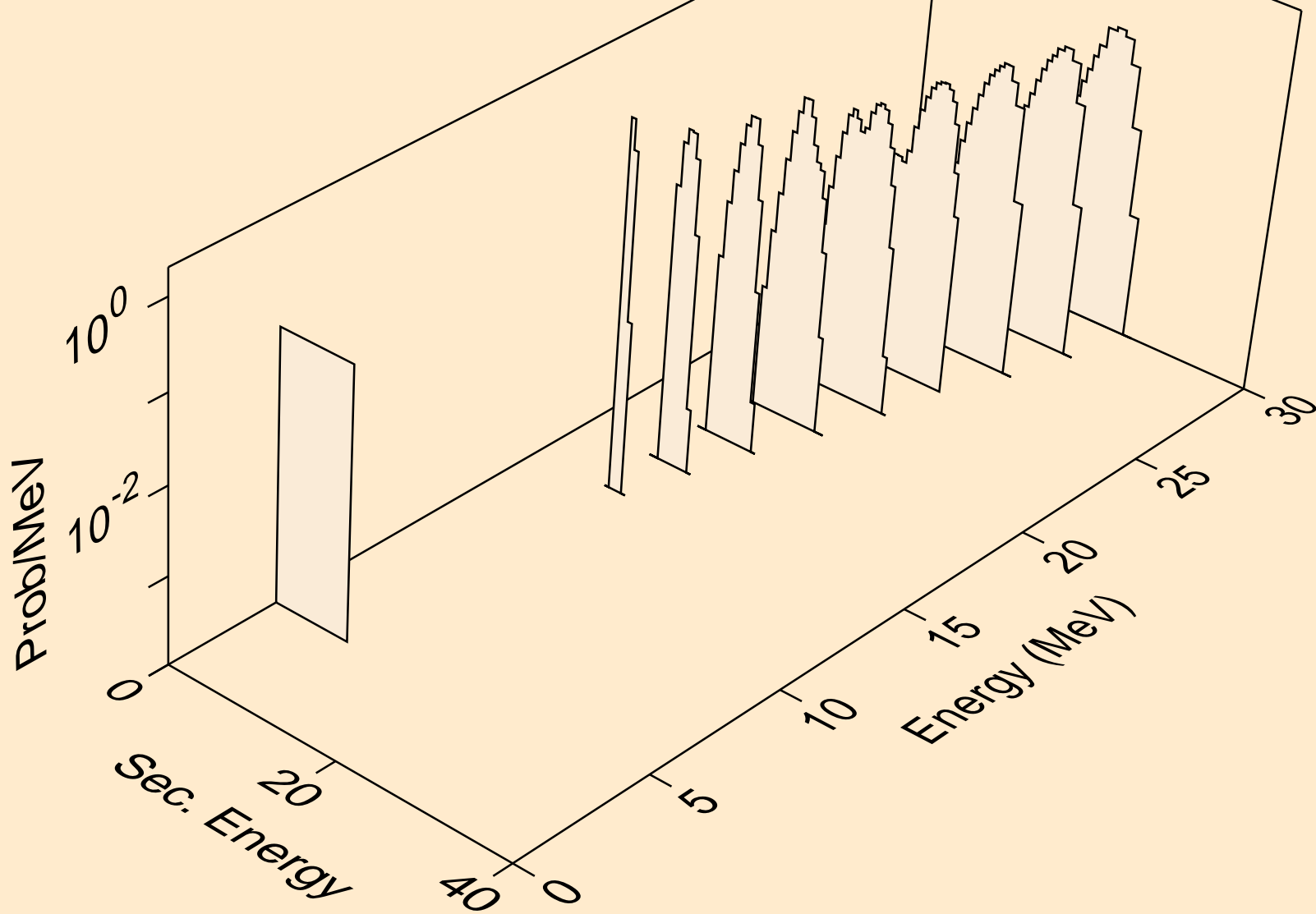

LR264 NEUTRON ACER TENDL-2021 LIBRARY; T=293.6K
alphas from (n,n*)2a

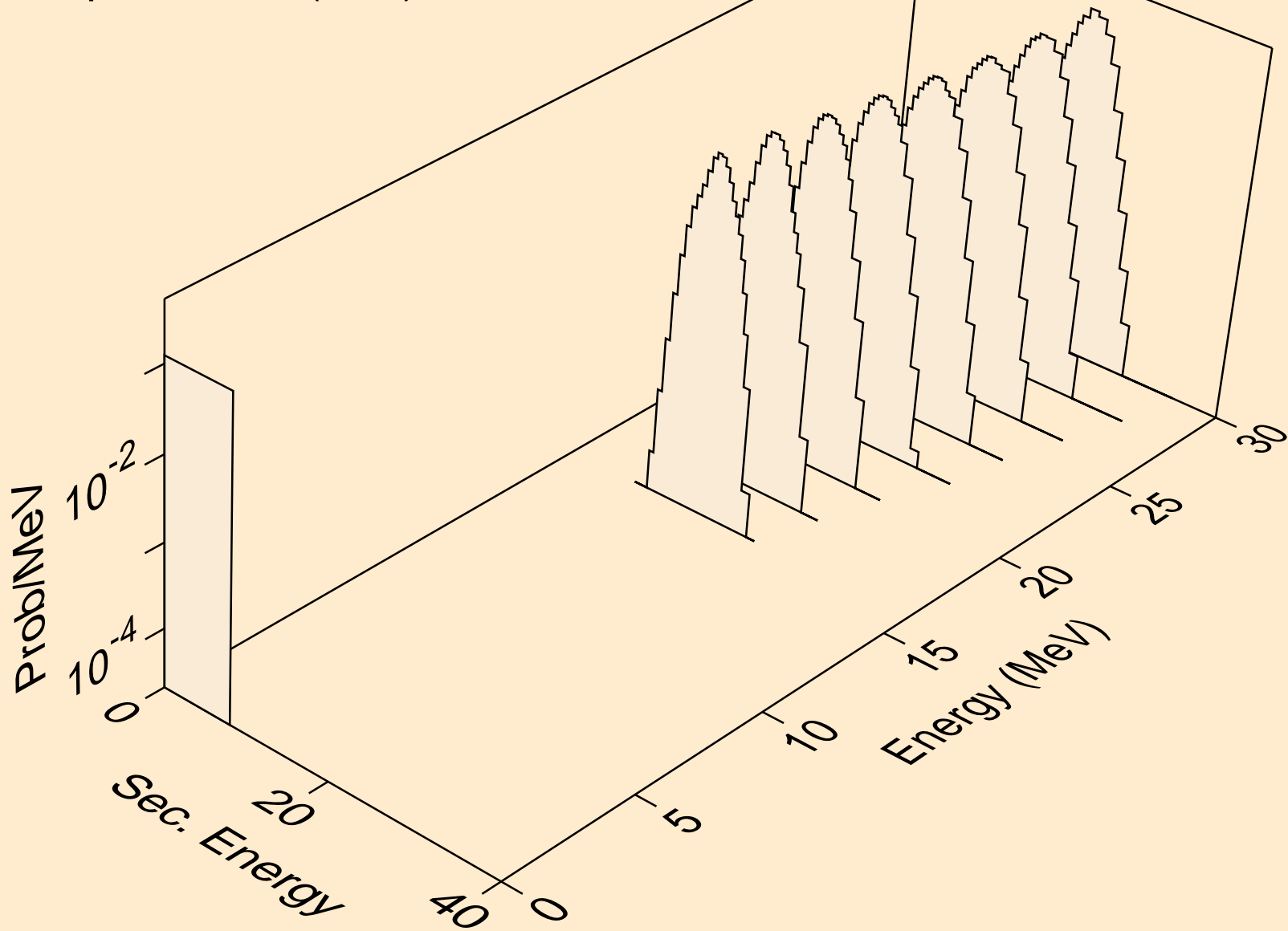

LR264 NEUTRON ACER TENDL-2021 LIBRARY; T=293.6K
alphas from (n,a)

