

LU185 NEUTRON ACER TENDL-2021 LIBRARY; T=293.6K
Principal cross sections

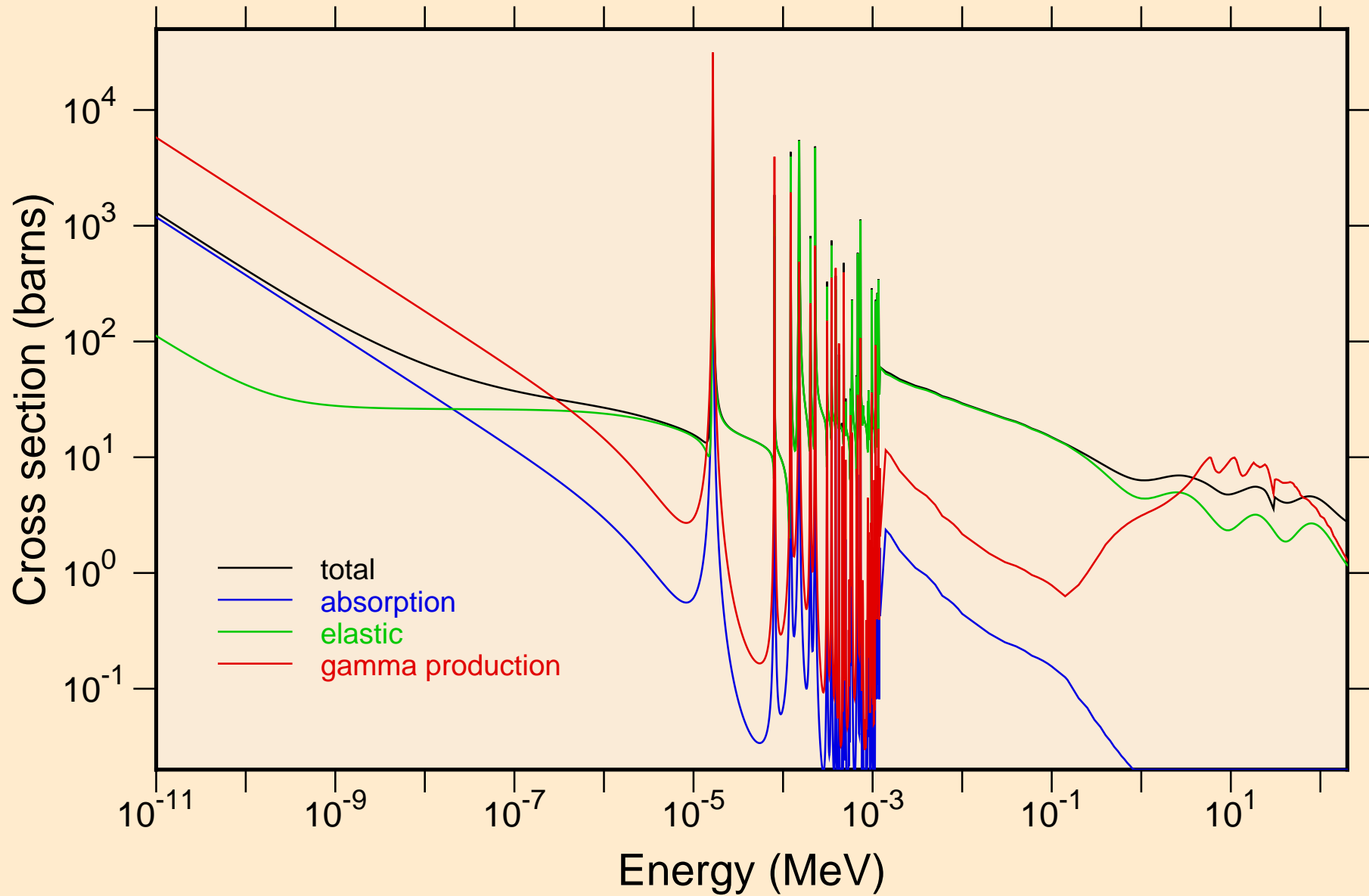

LU185 NEUTRON ACER TENDL-2021 LIBRARY; T=293.6K
resonance total cross section

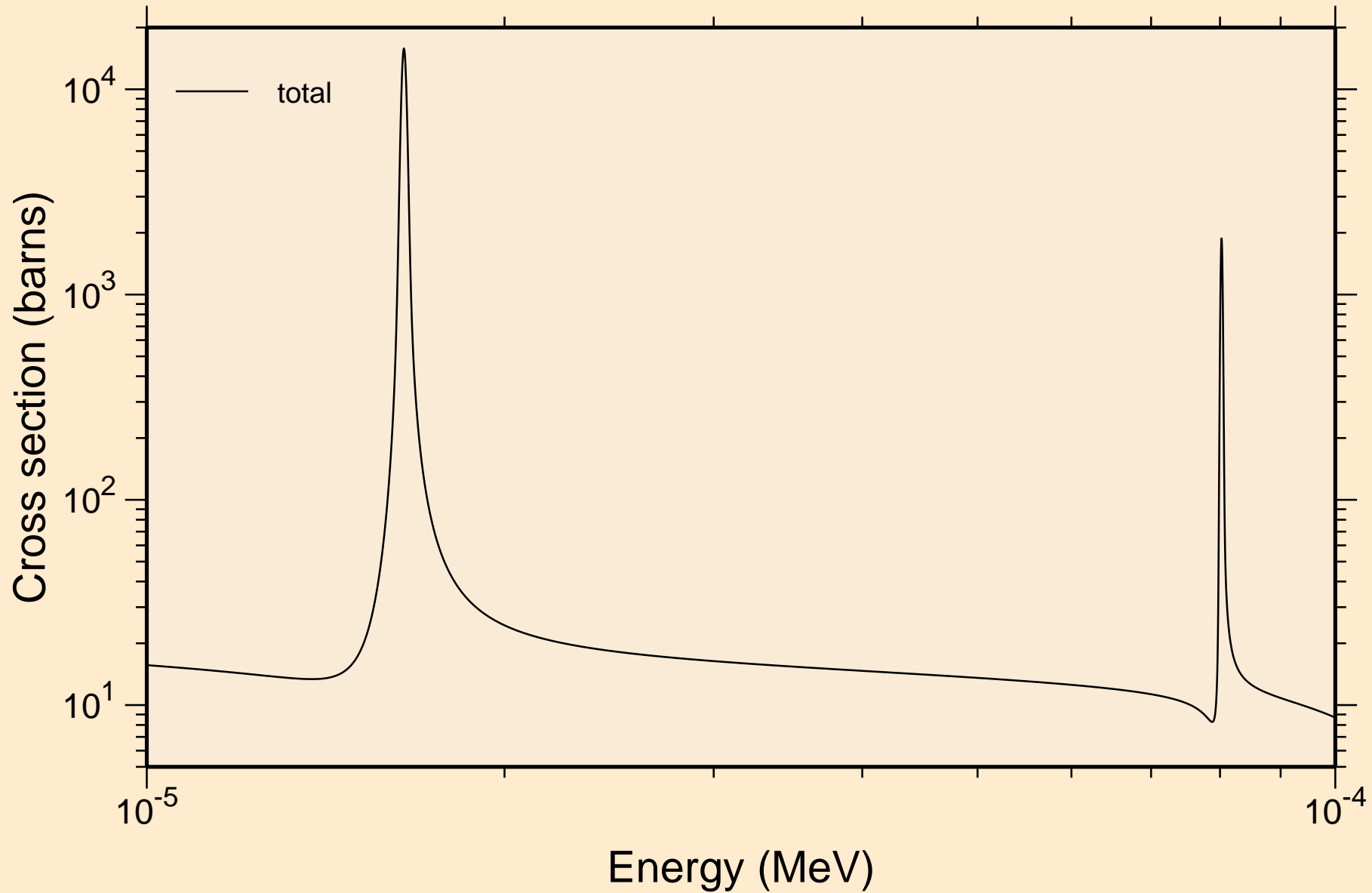

LU185 NEUTRON ACER TENDL-2021 LIBRARY; T=293.6K
resonance total cross section

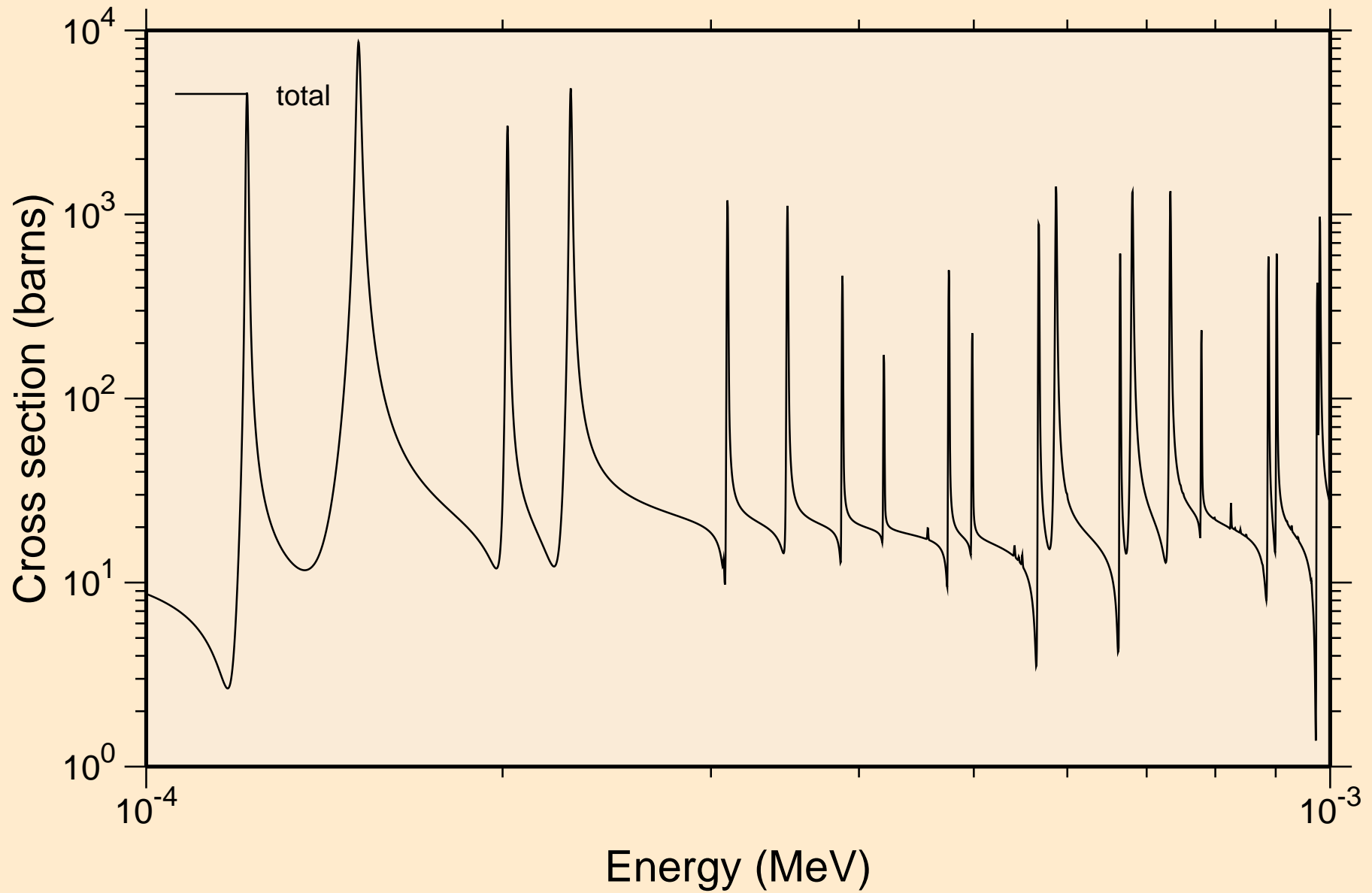

LU185 NEUTRON ACER TENDL-2021 LIBRARY; T=293.6K
resonance total cross section

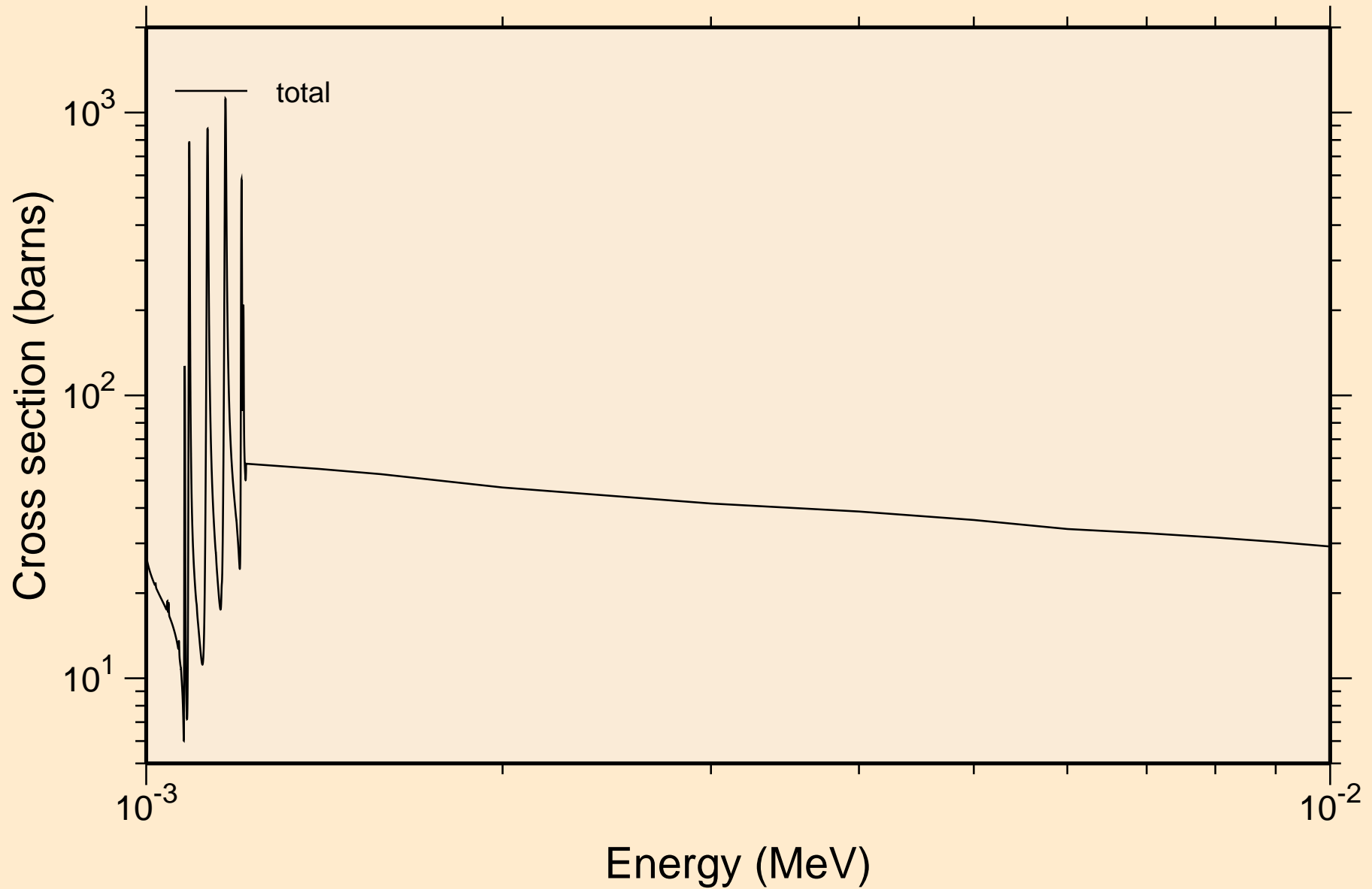

LU185 NEUTRON ACER TENDL-2021 LIBRARY; T=293.6K
resonance total cross section

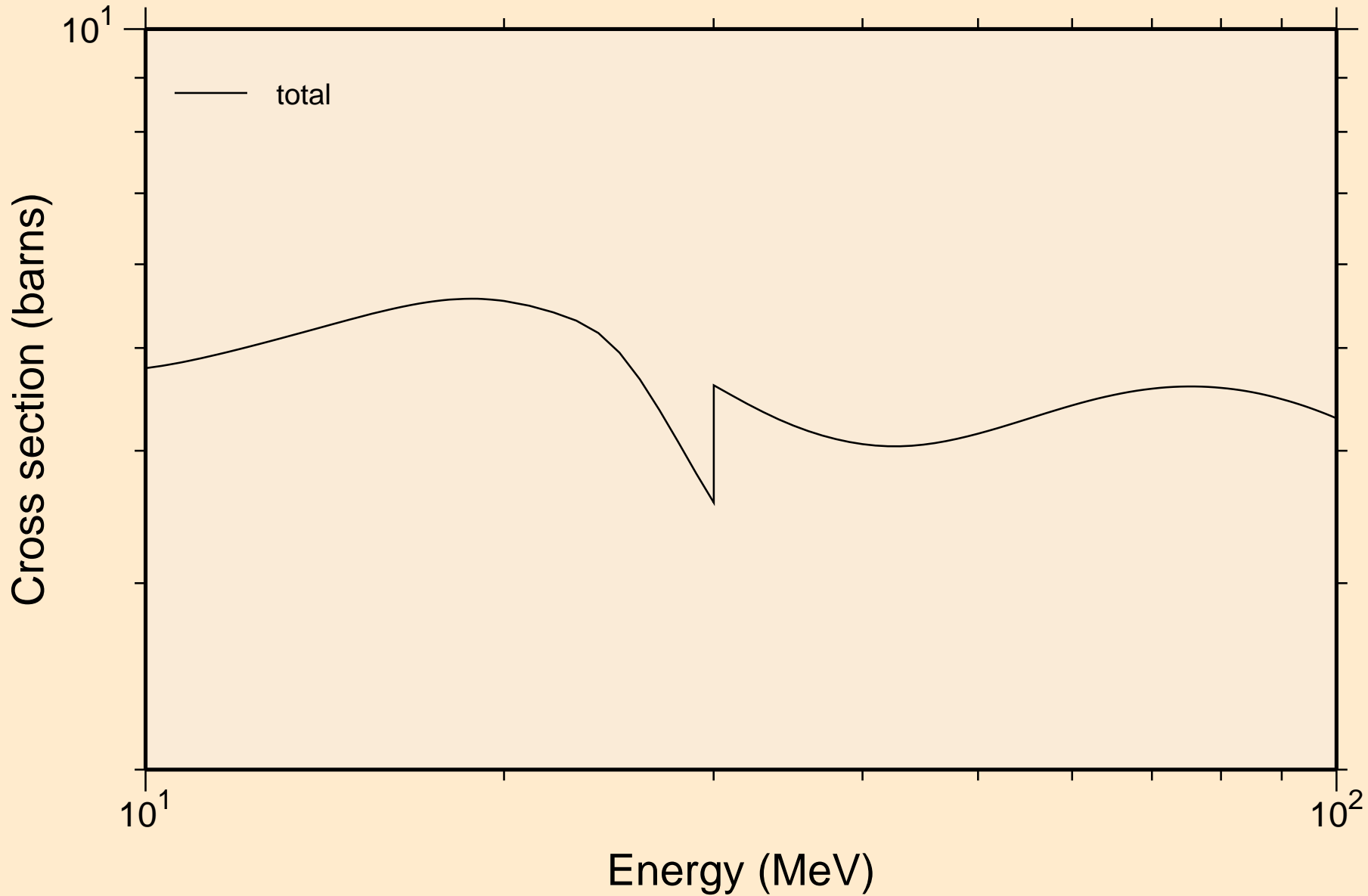

LU185 NEUTRON ACER TENDL-2021 LIBRARY; T=293.6K
resonance absorption cross sections

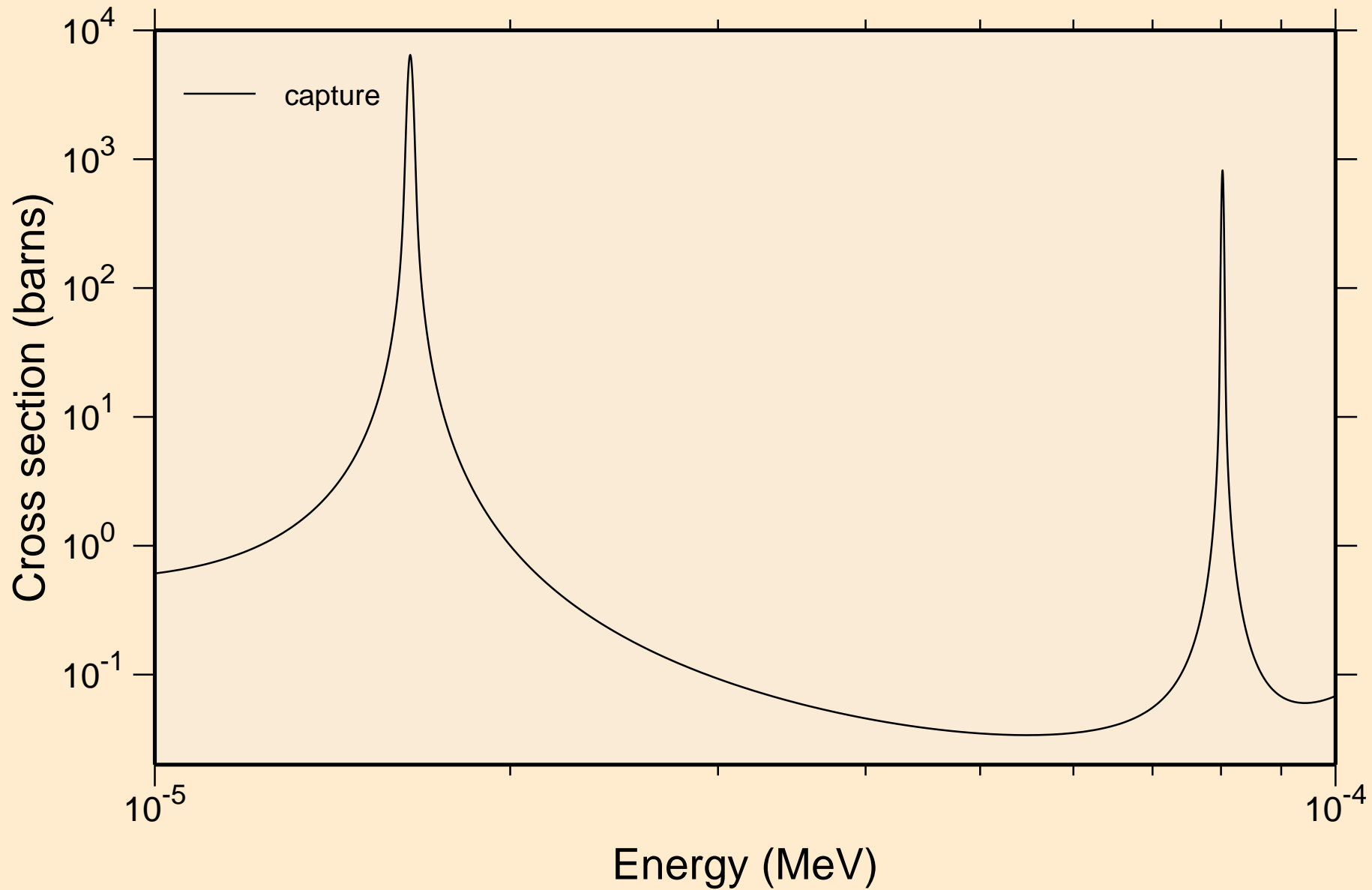

LU185 NEUTRON ACER TENDL-2021 LIBRARY; T=293.6K
resonance absorption cross sections

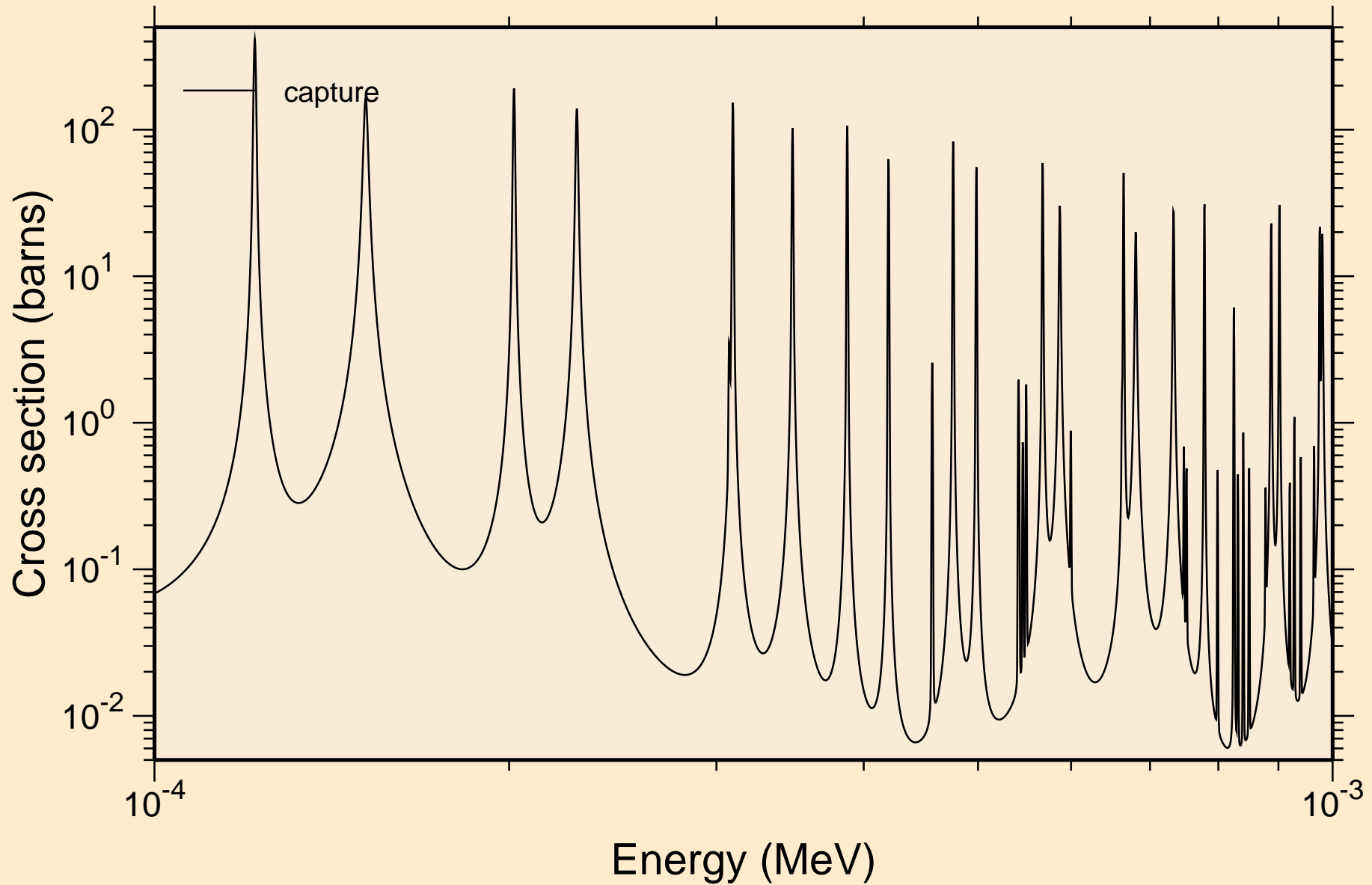

LU185 NEUTRON ACER TENDL-2021 LIBRARY; T=293.6K
resonance absorption cross sections

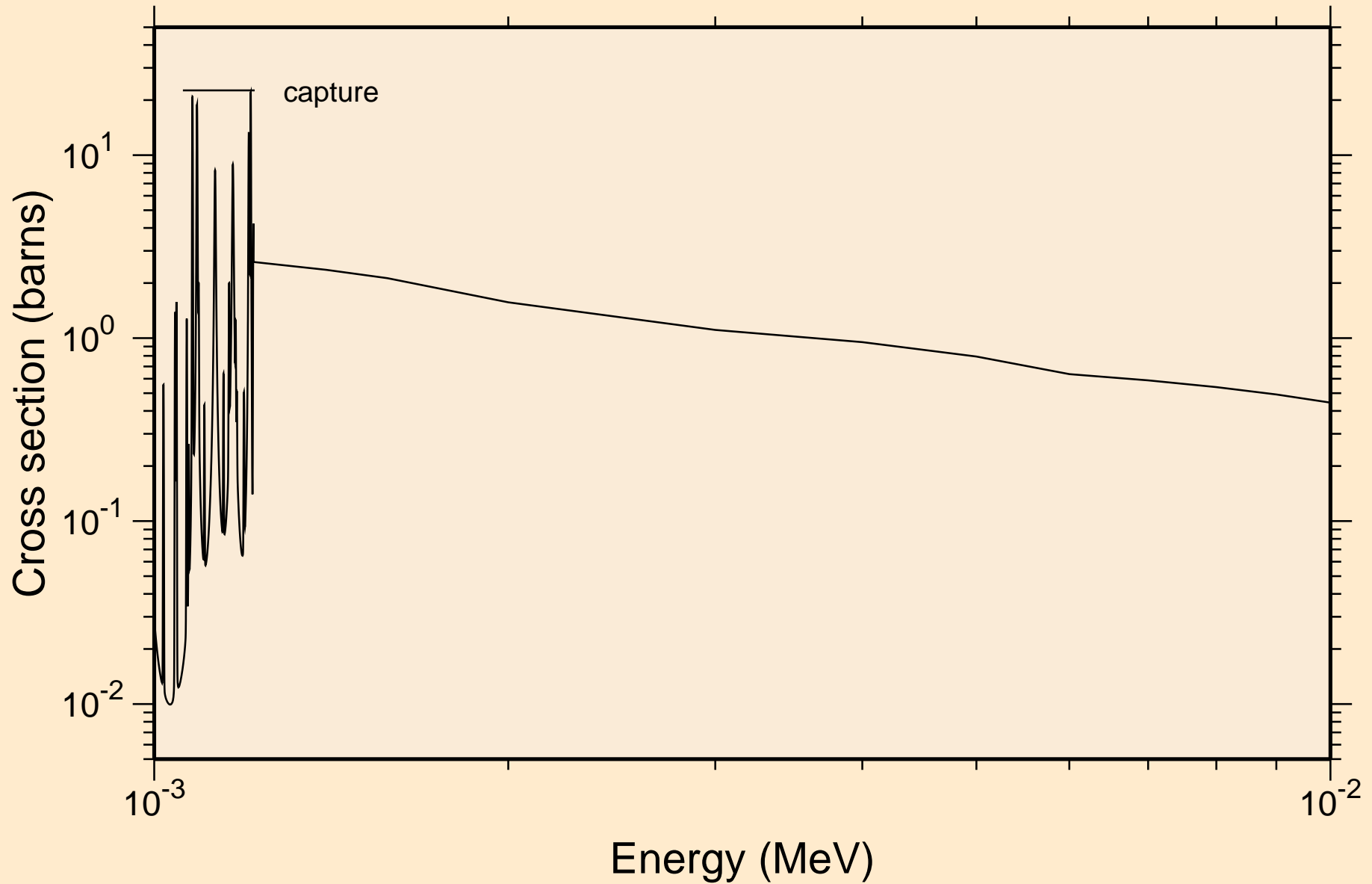

LU185 NEUTRON ACER TENDL-2021 LIBRARY; T=293.6K
resonance absorption cross sections

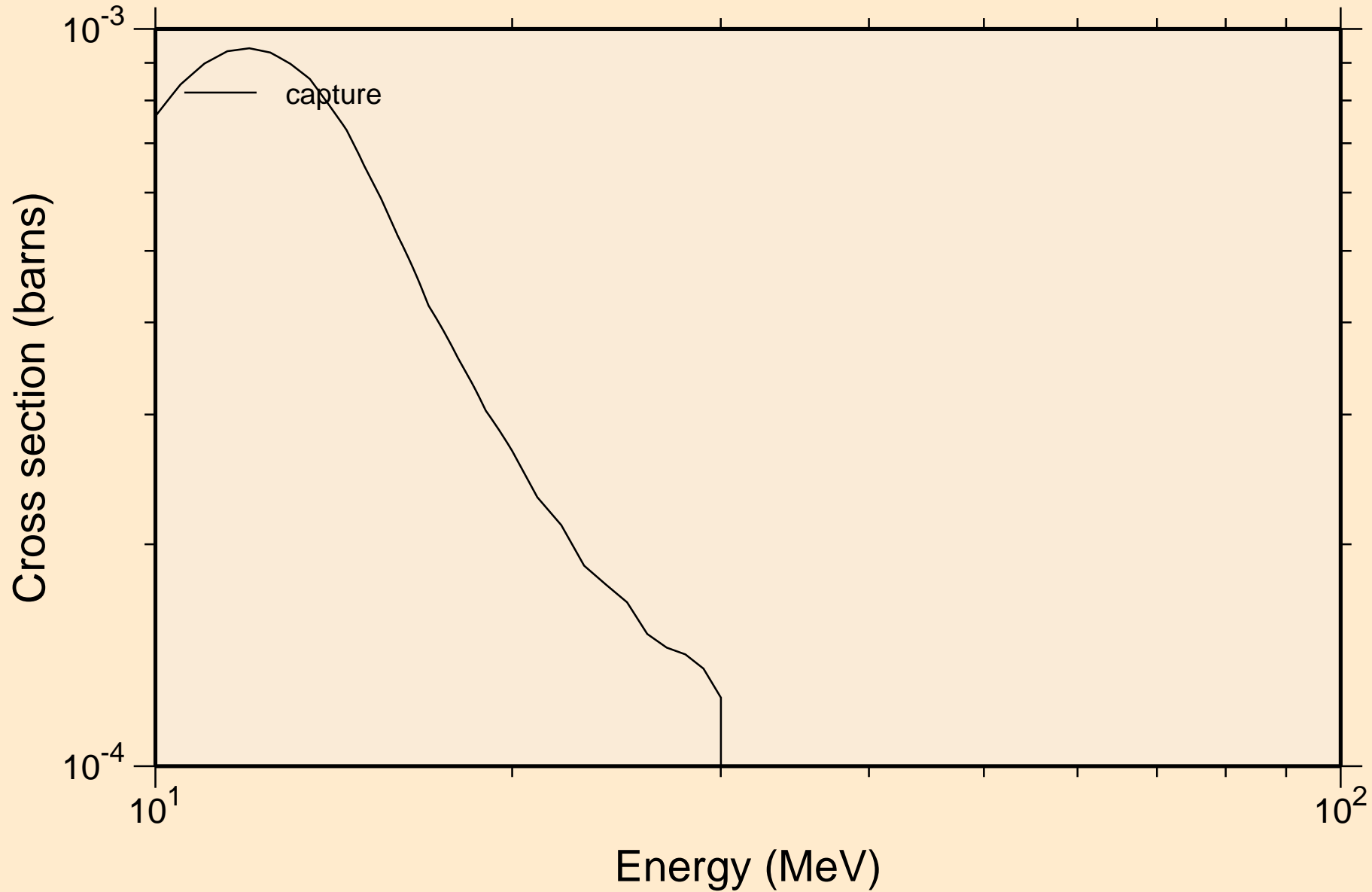

LU185 NEUTRON ACER TENDL-2021 LIBRARY; T=293.6K
Heating

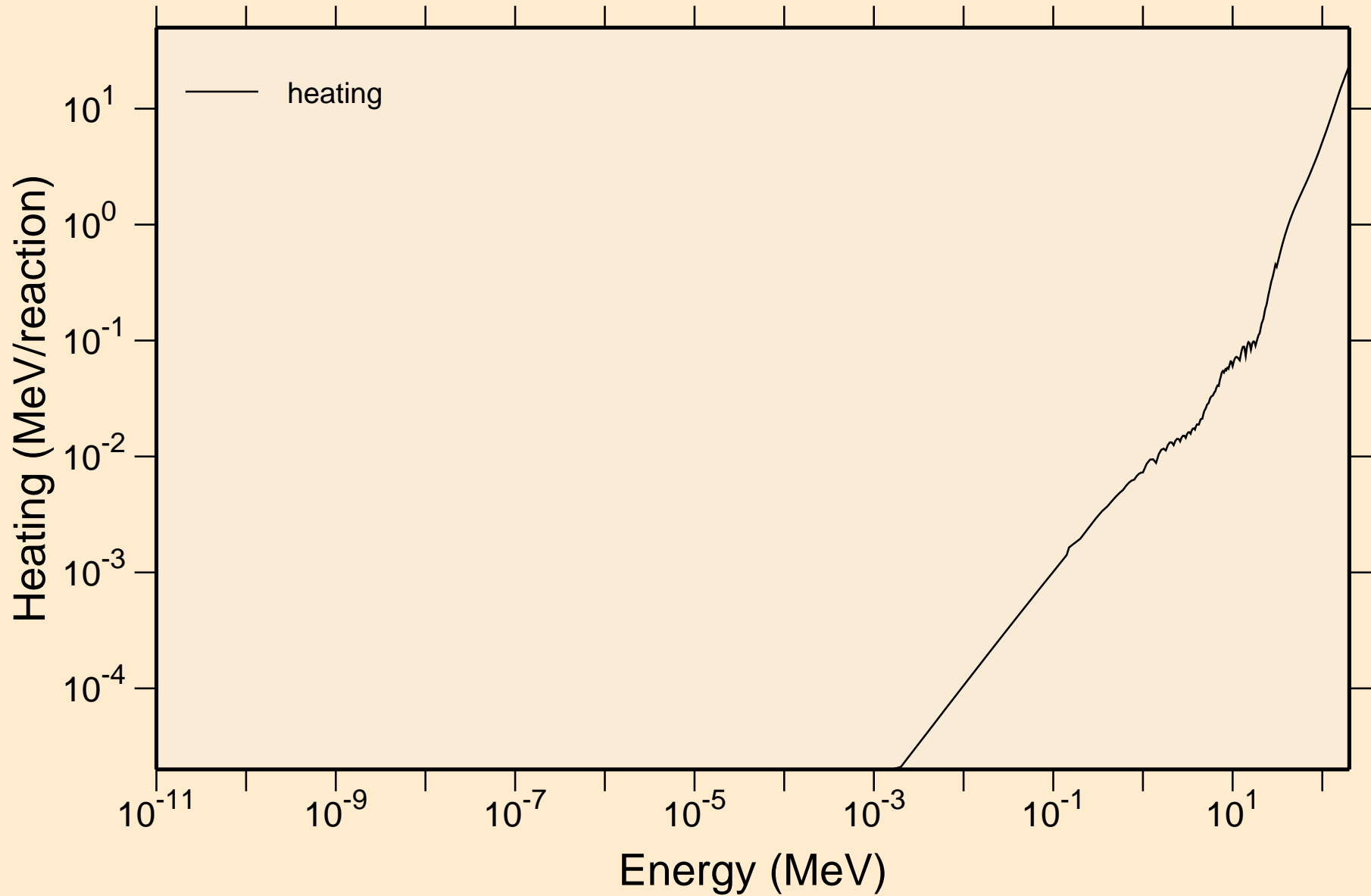

LU185 NEUTRON ACER TENDL-2021 LIBRARY; T=293.6K
Damage

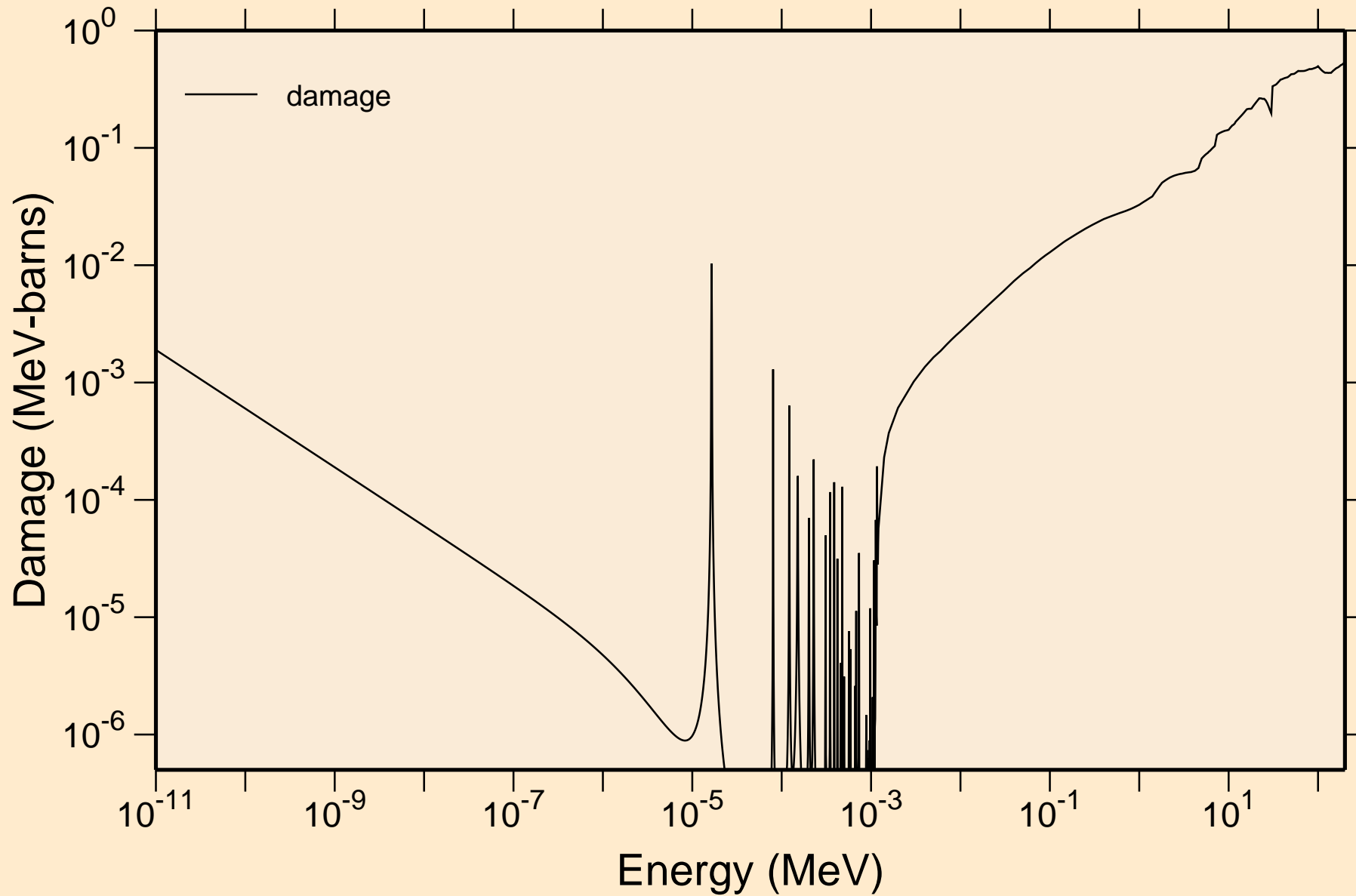

LU185 NEUTRON ACER TENDL-2021 LIBRARY; T=293.6K
Non-threshold reactions

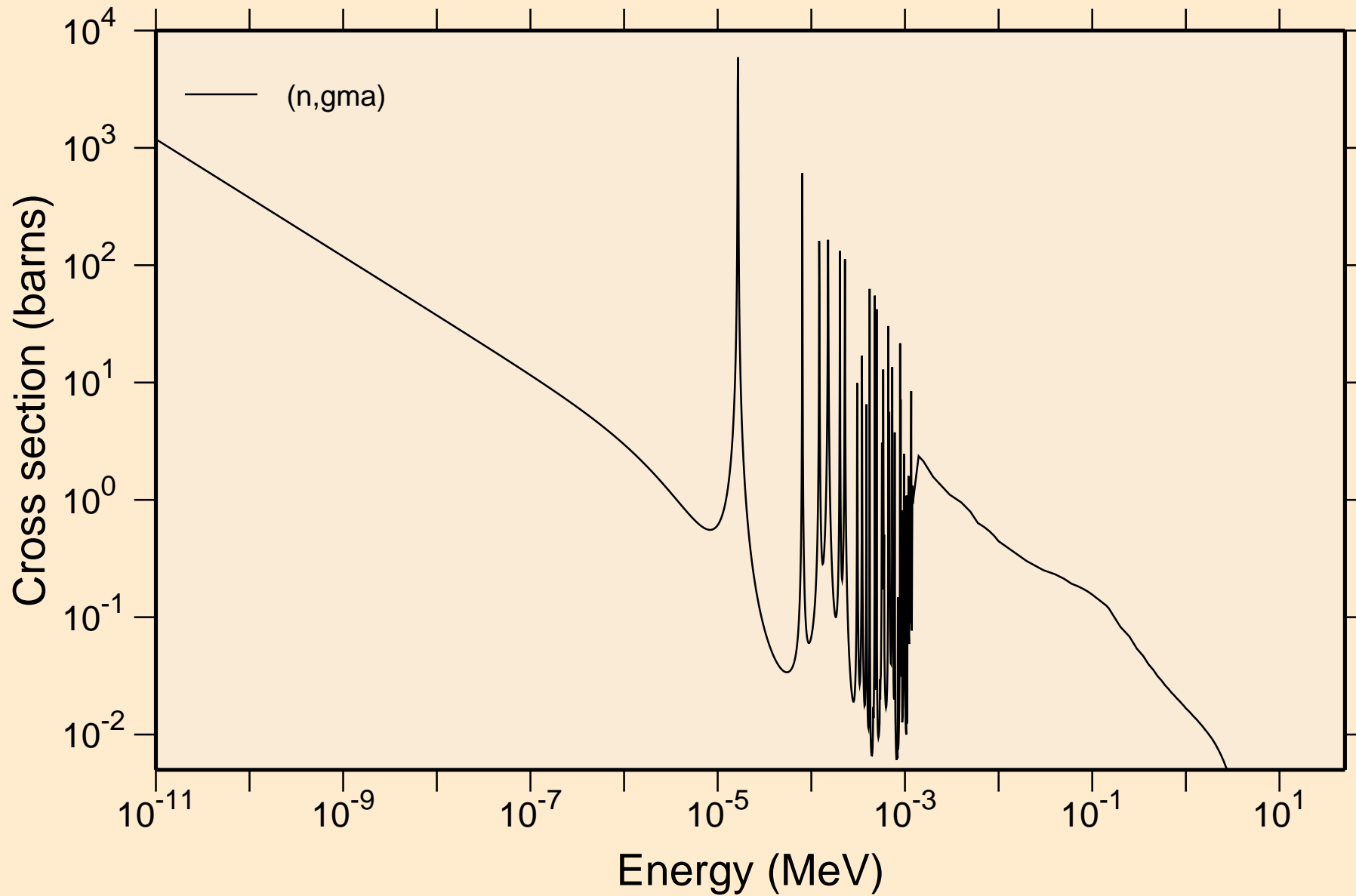

LU185 NEUTRON ACER TENDL-2021 LIBRARY; T=293.6K
Principal cross sections

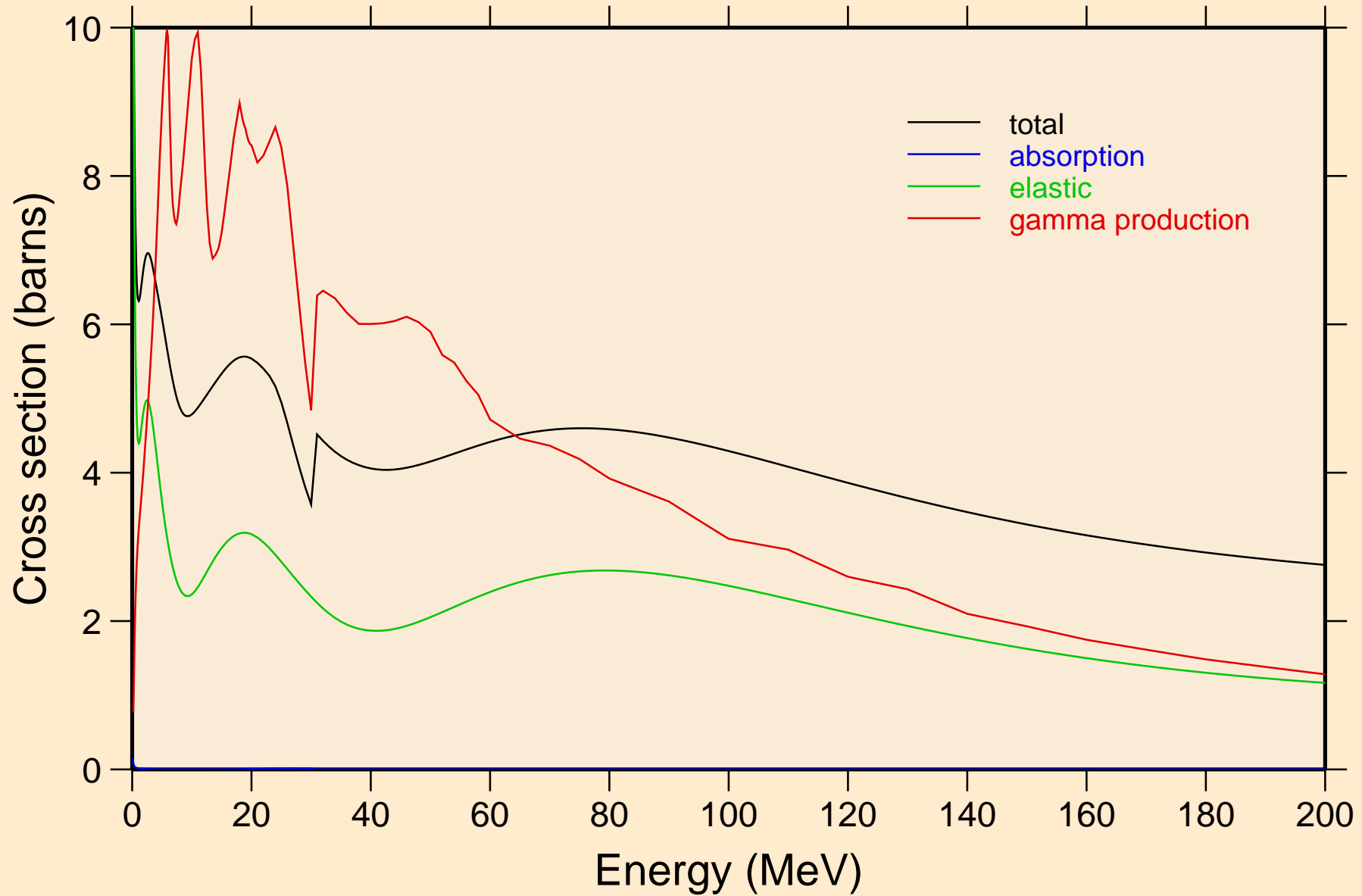

LU185 NEUTRON ACER TENDL-2021 LIBRARY; T=293.6K
Heating

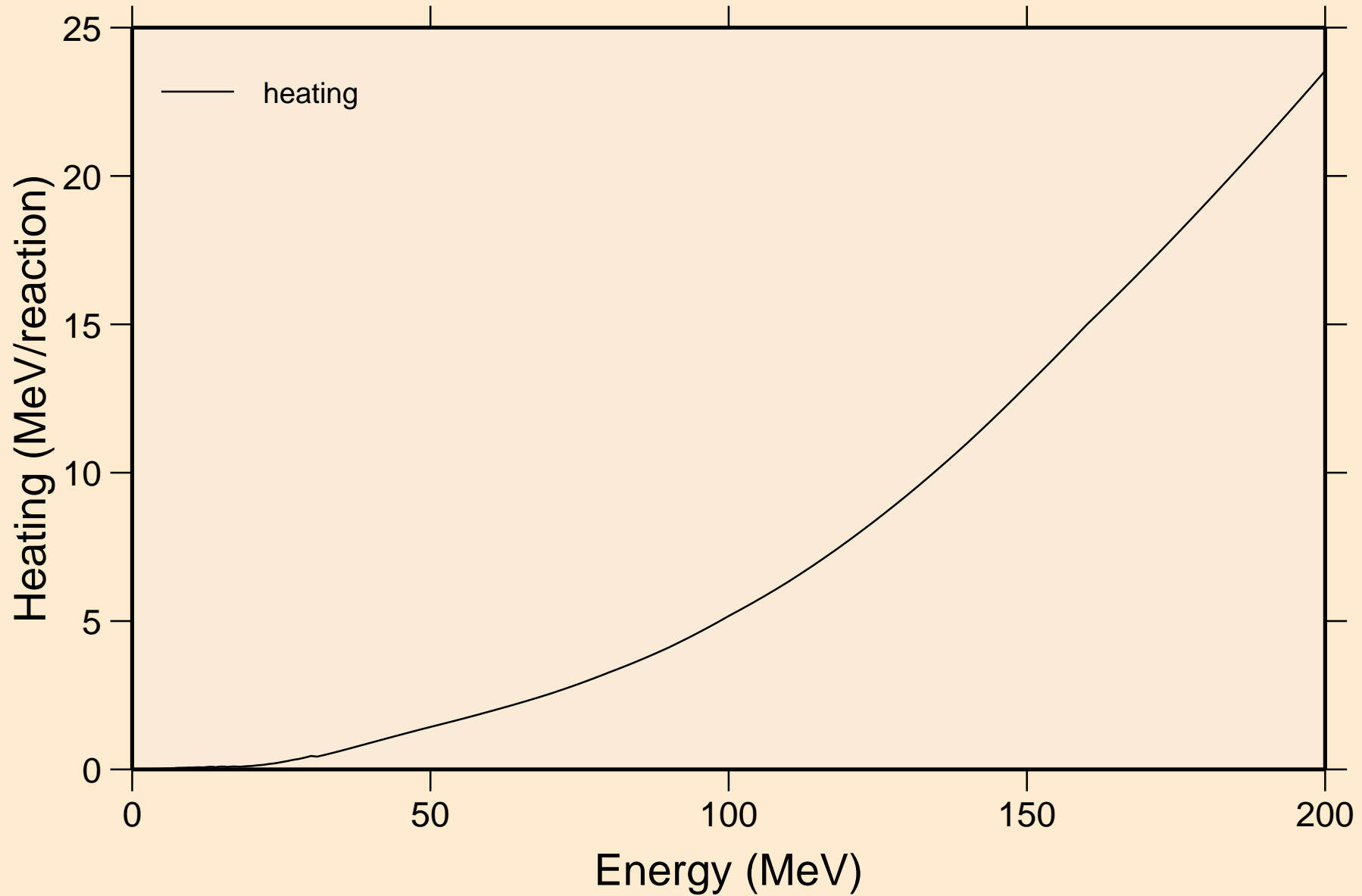

LU185 NEUTRON ACER TENDL-2021 LIBRARY; T=293.6K
Damage

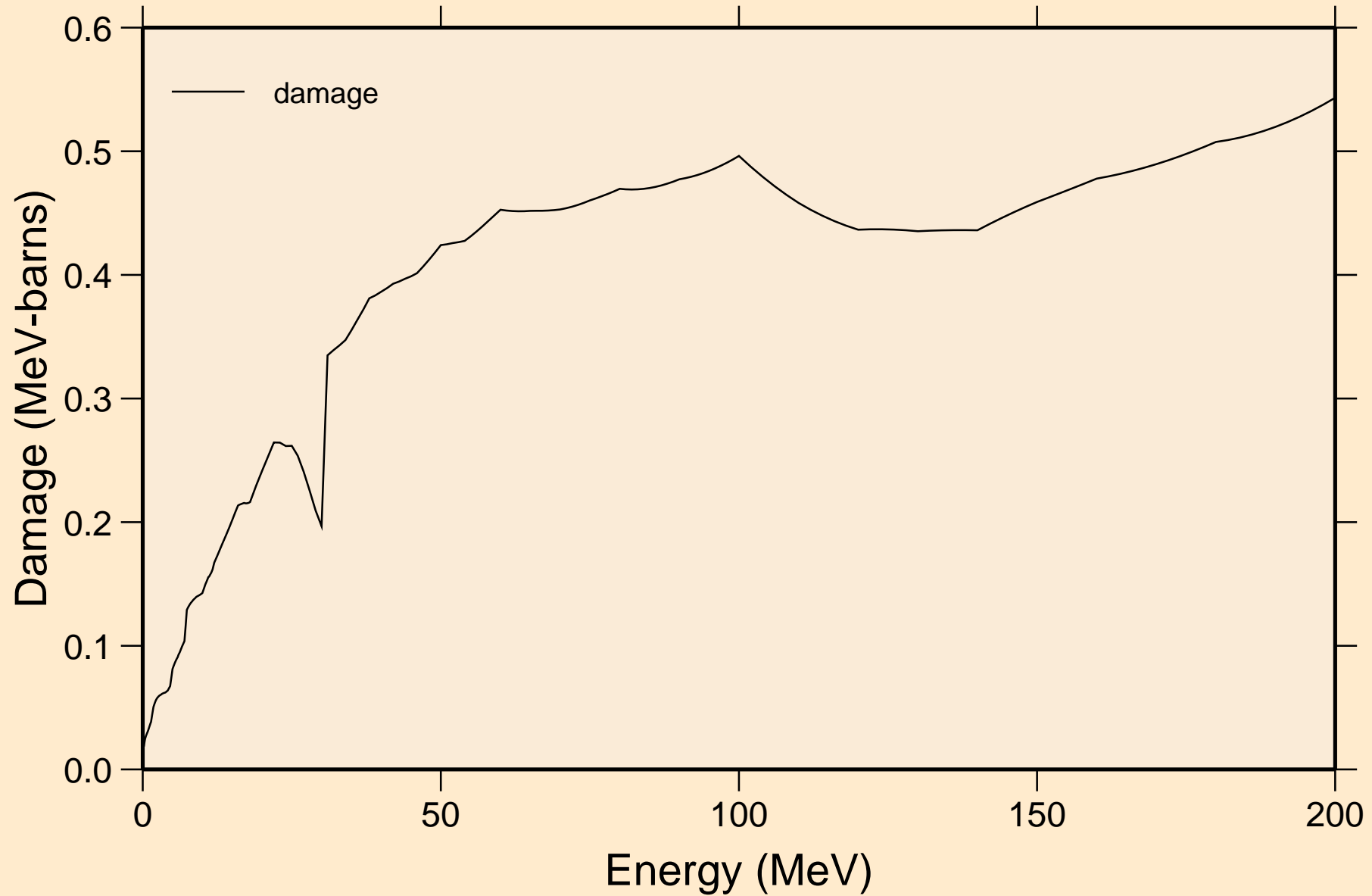

LU185 NEUTRON ACER TENDL-2021 LIBRARY; T=293.6K
Non-threshold reactions

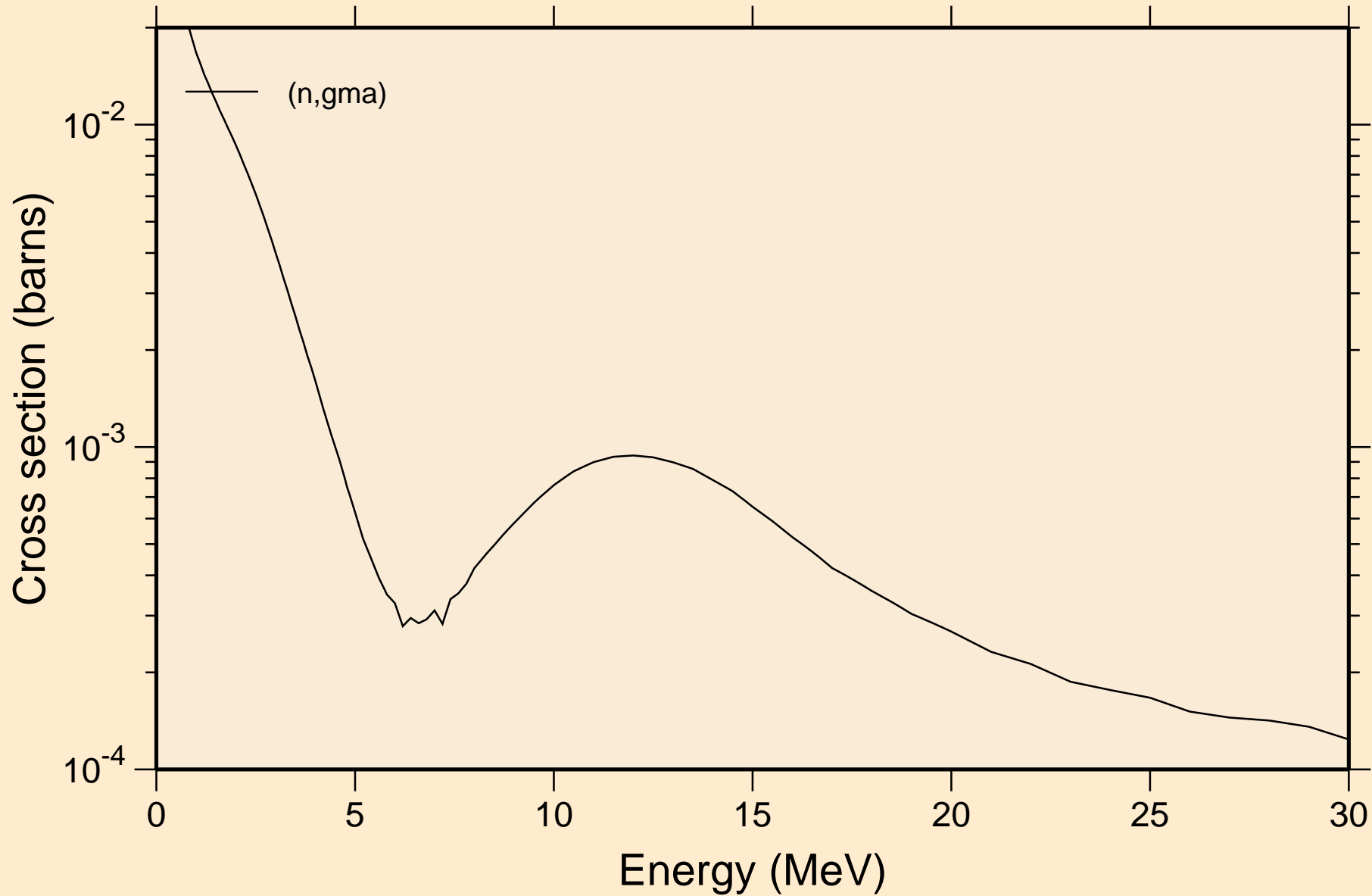

LU185 NEUTRON ACER TENDL-2021 LIBRARY; T=293.6K
Inelastic levels

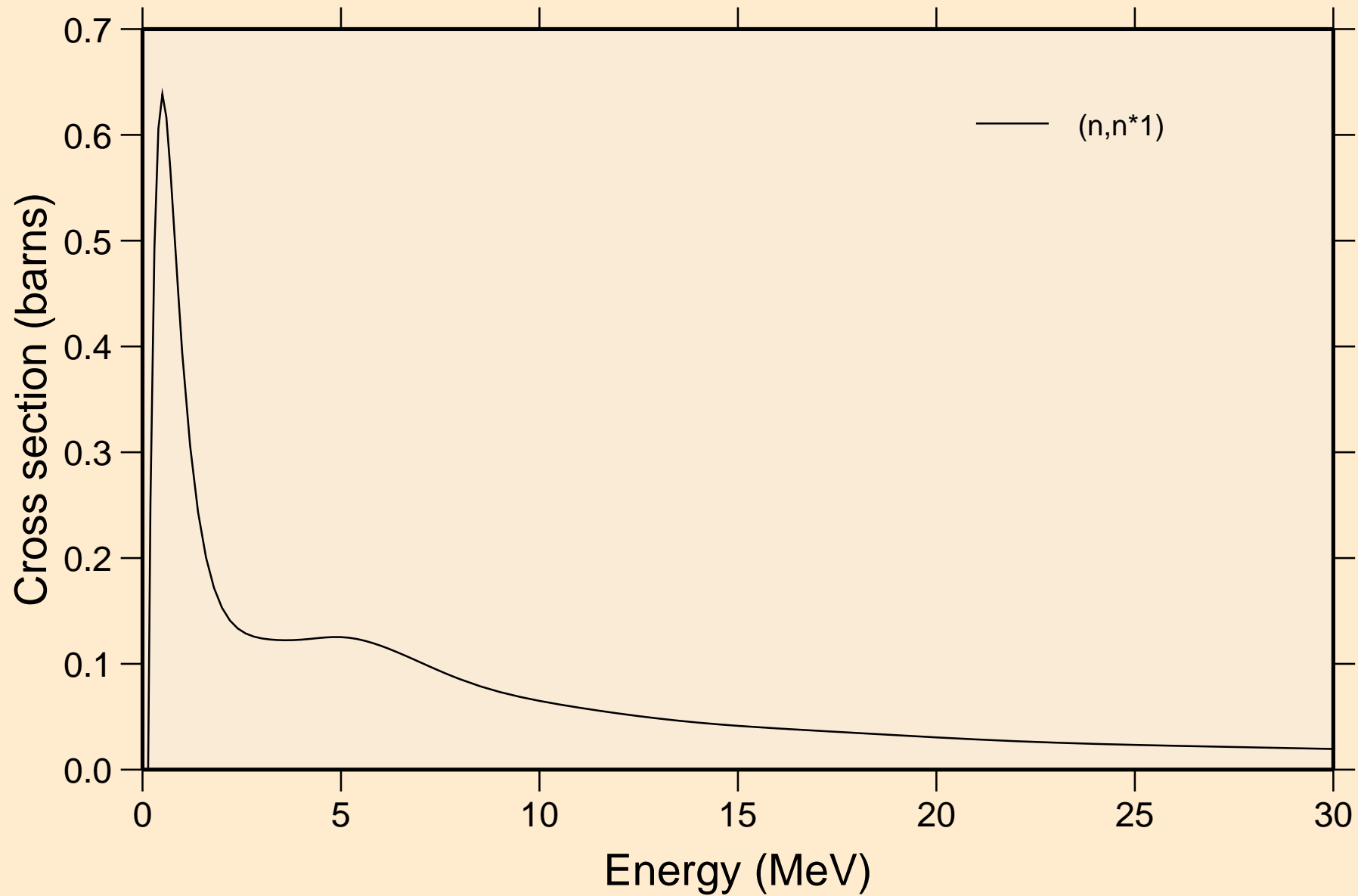

LU185 NEUTRON ACER TENDL-2021 LIBRARY; T=293.6K
Threshold reactions

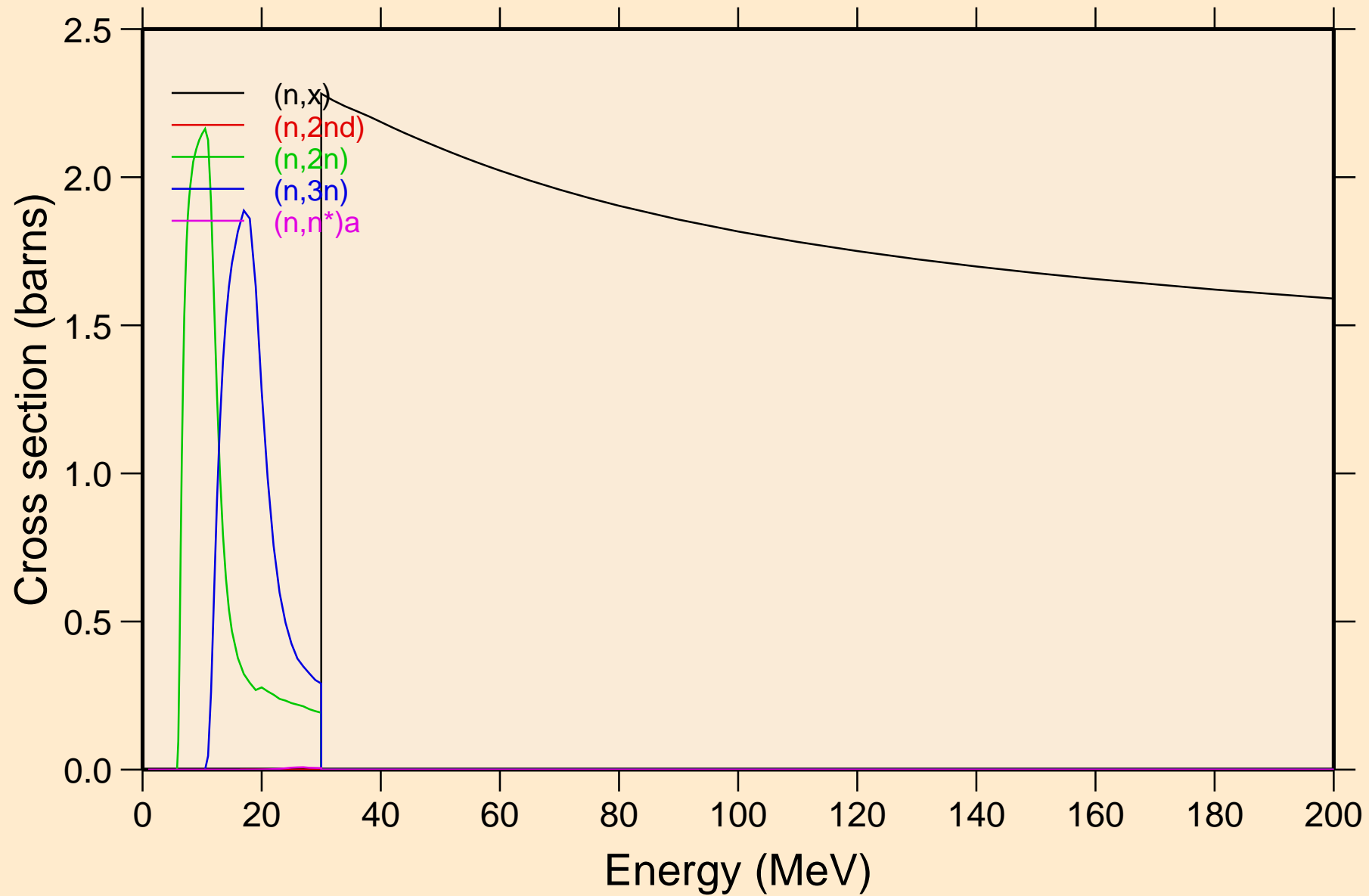

LU185 NEUTRON ACER TENDL-2021 LIBRARY; T=293.6K
Threshold reactions

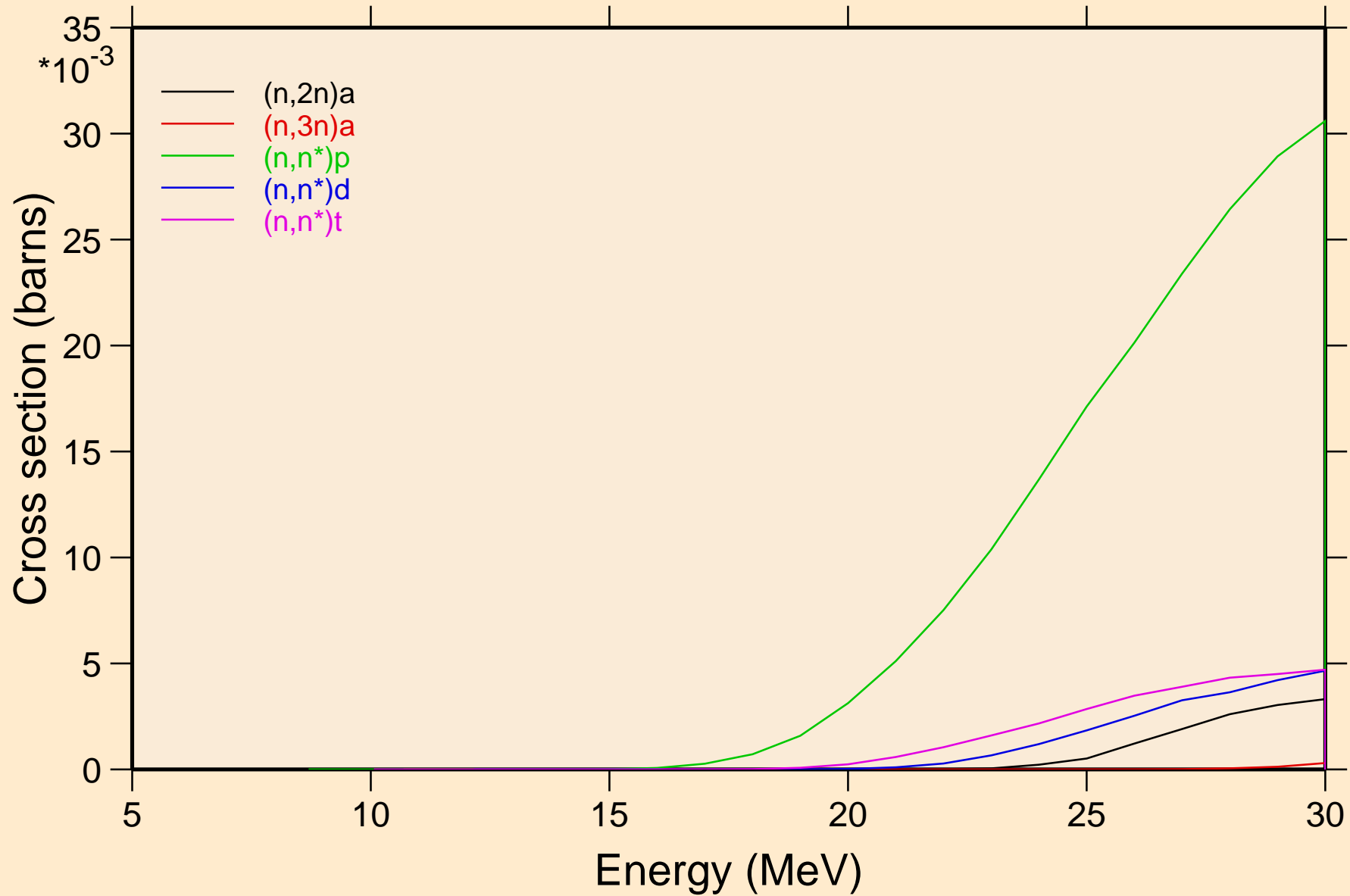

LU185 NEUTRON ACER TENDL-2021 LIBRARY; T=293.6K
Threshold reactions

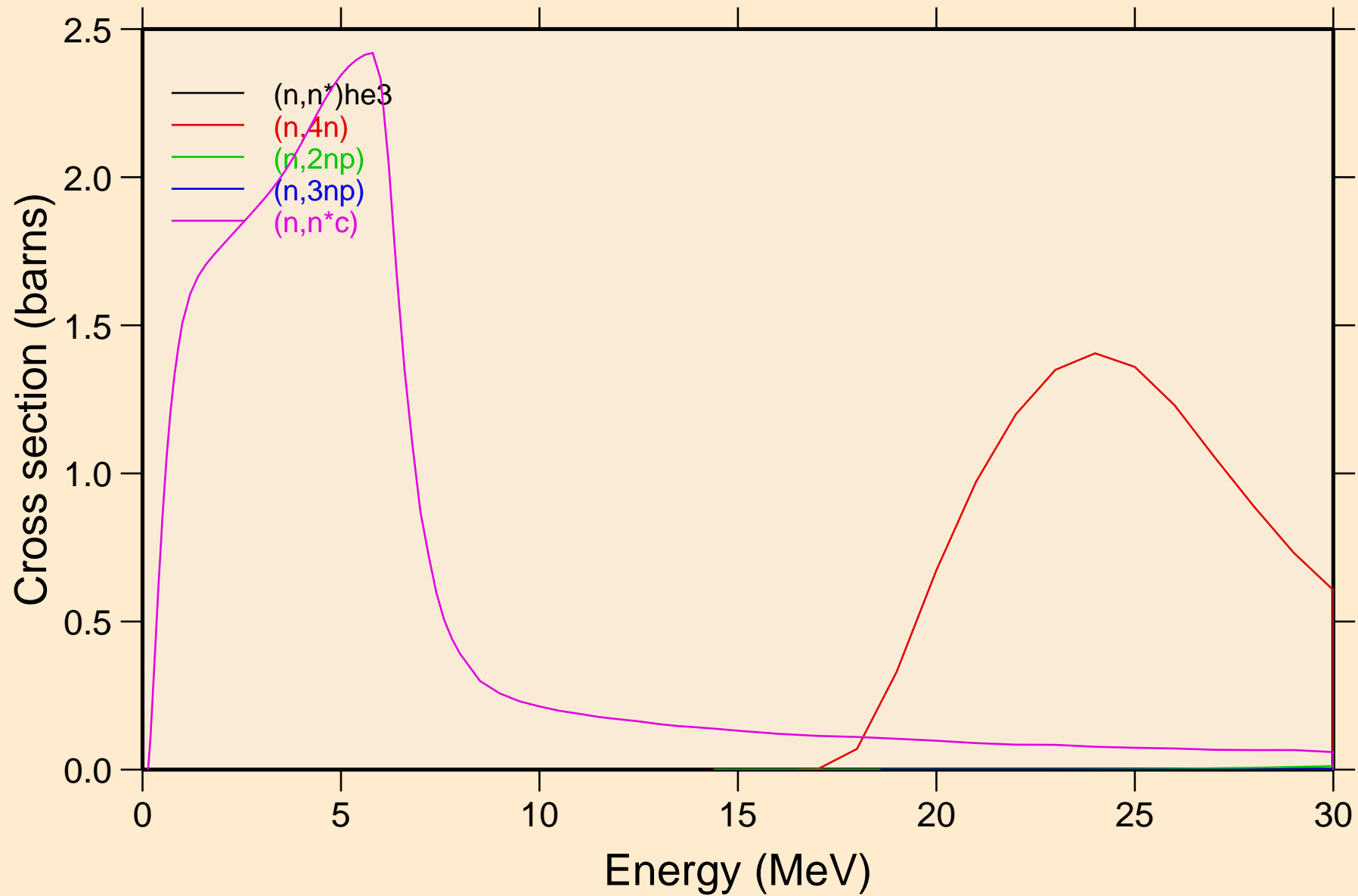

LU185 NEUTRON ACER TENDL-2021 LIBRARY; T=293.6K
Threshold reactions

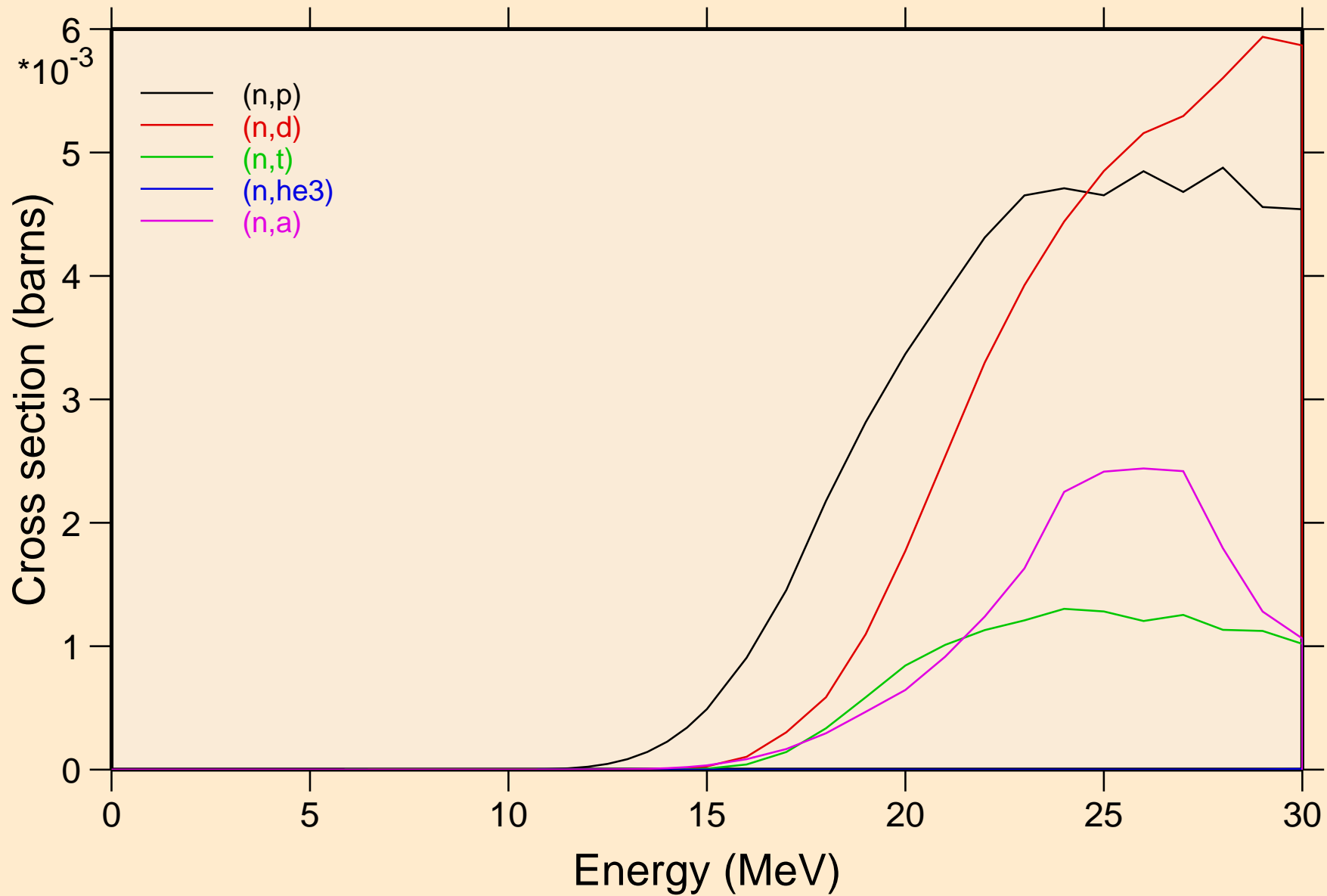

LU185 NEUTRON ACER TENDL-2021 LIBRARY; T=293.6K
Threshold reactions

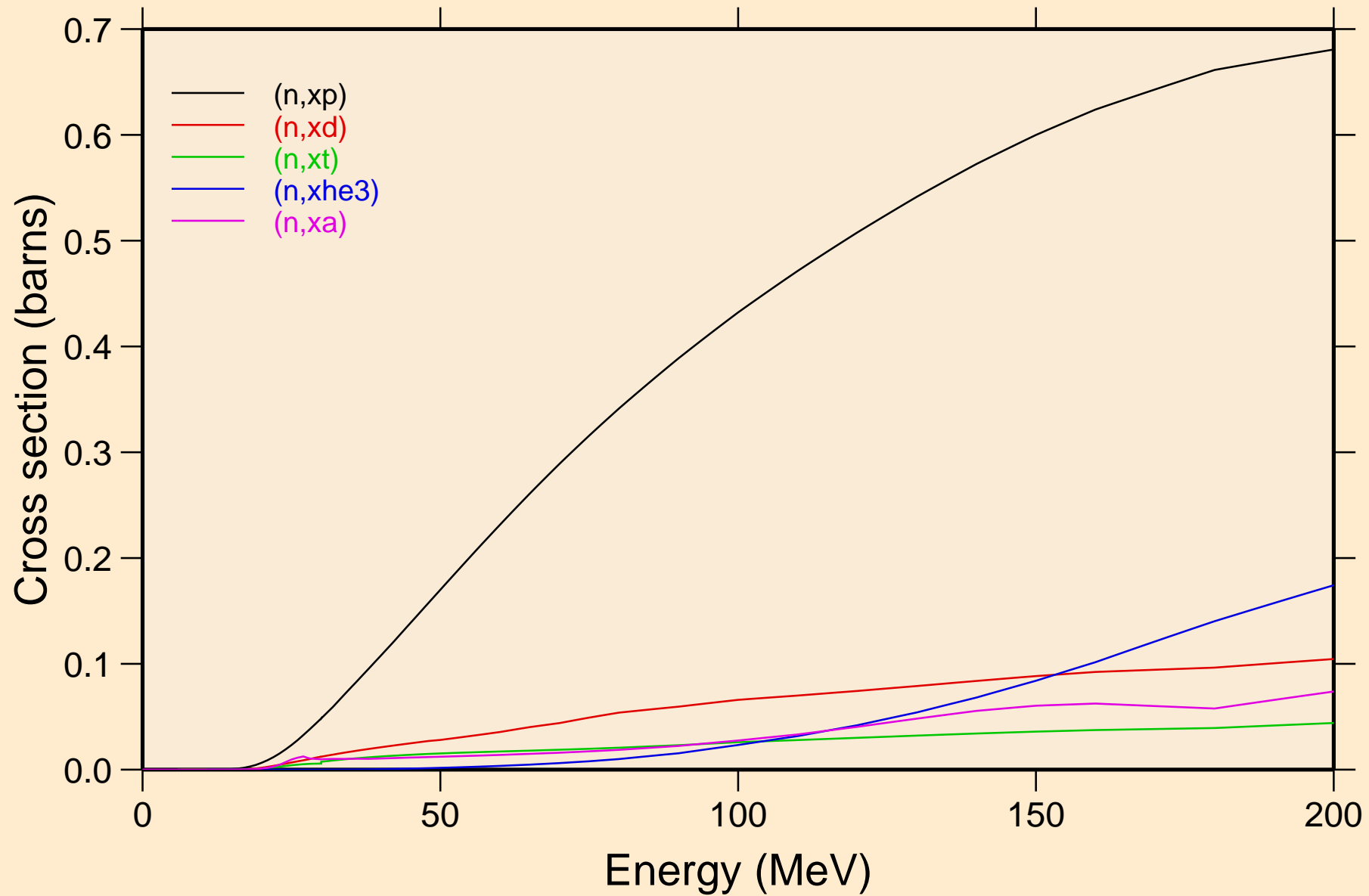

LU185 NEUTRON ACER TENDL-2021 LIBRARY; T=293.6K
angular distribution for elastic

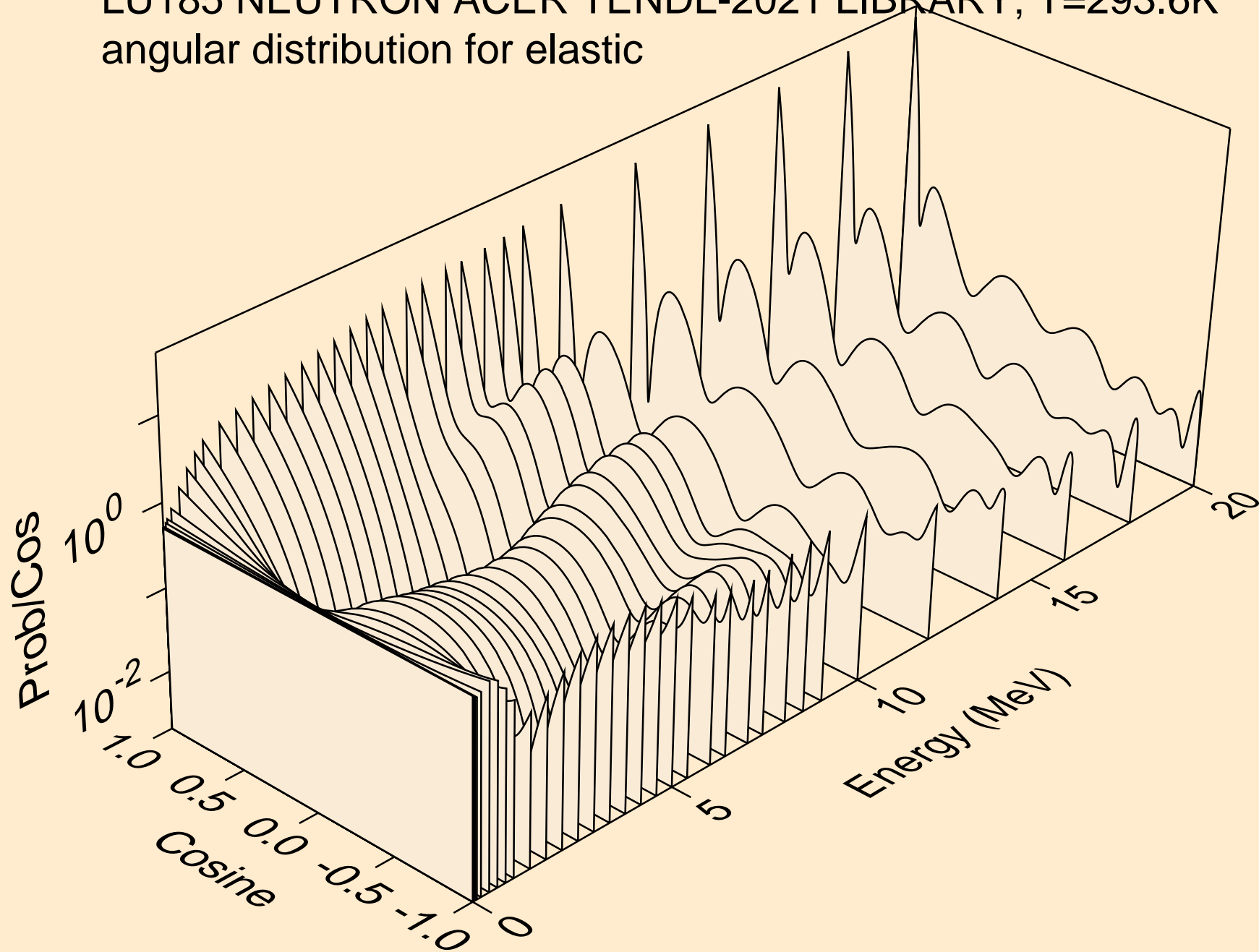

LU185 NEUTRON ACER TENDL-2021 LIBRARY; T=293.6K
angular distribution for elastic

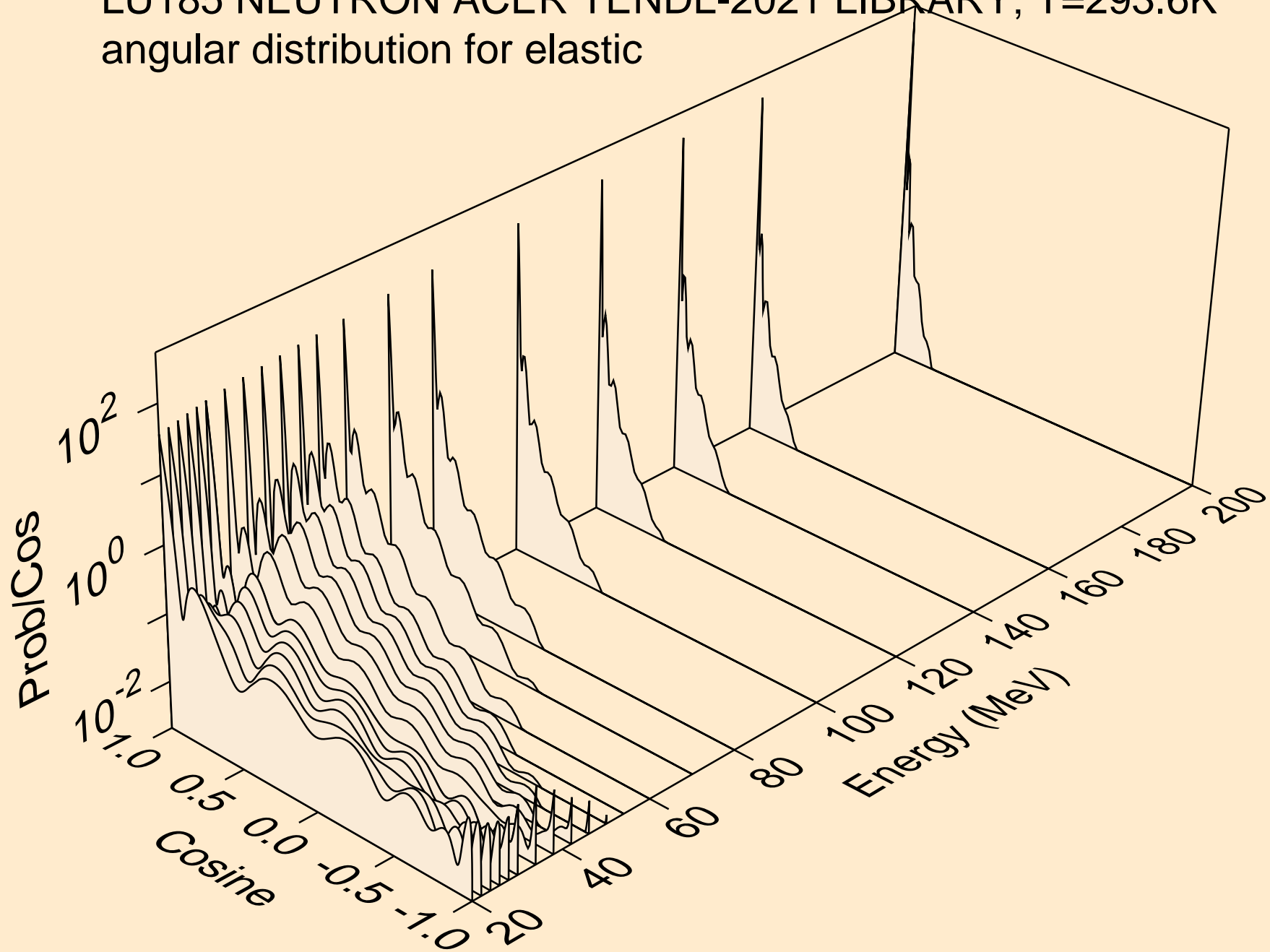

LU185 NEUTRON ACER TENDL-2021 LIBRARY; T=293.6K
angular distribution for (n,n*1)

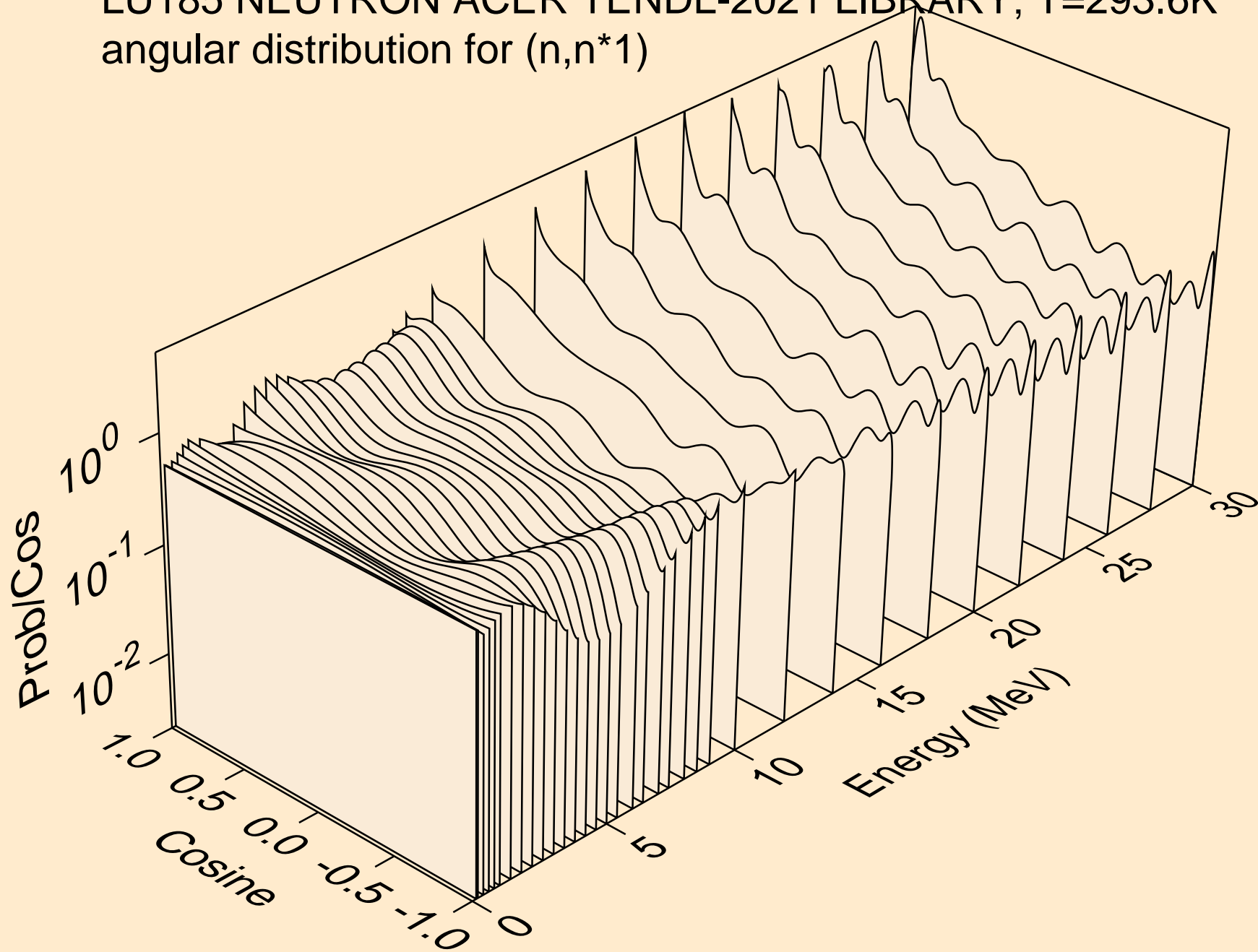

LU185 NEUTRON ACER TENDL-2021 LIBRARY; T=293.6K
Neutron emission for (n,x)

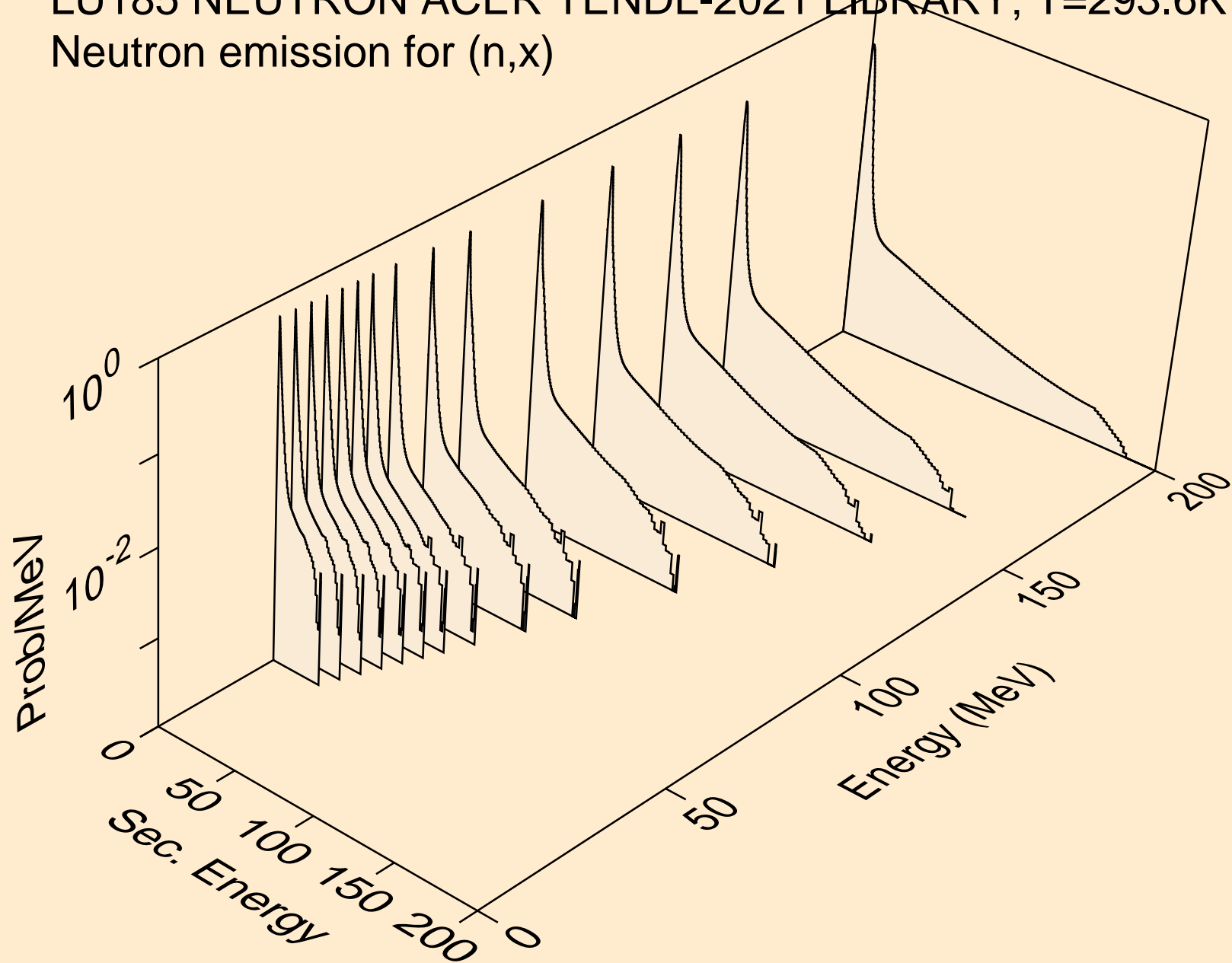

LU185 NEUTRON ACER TENDL-2021 LIBRARY; T=293.6K
Neutron emission for (n,2nd)

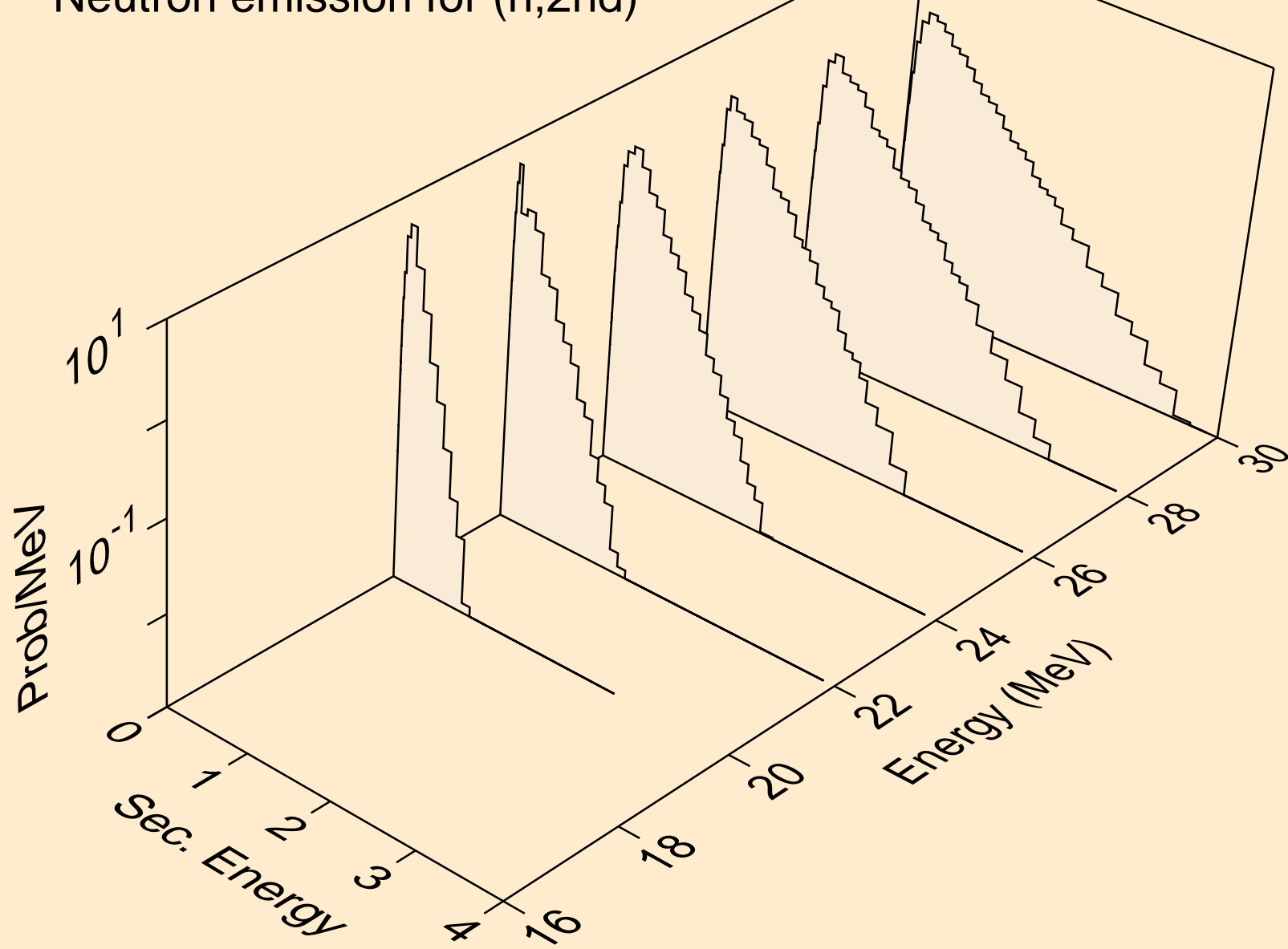

LU185 NEUTRON ACER TENDL-2021 LIBRARY; T=293.6K
Neutron emission for (n,2n)

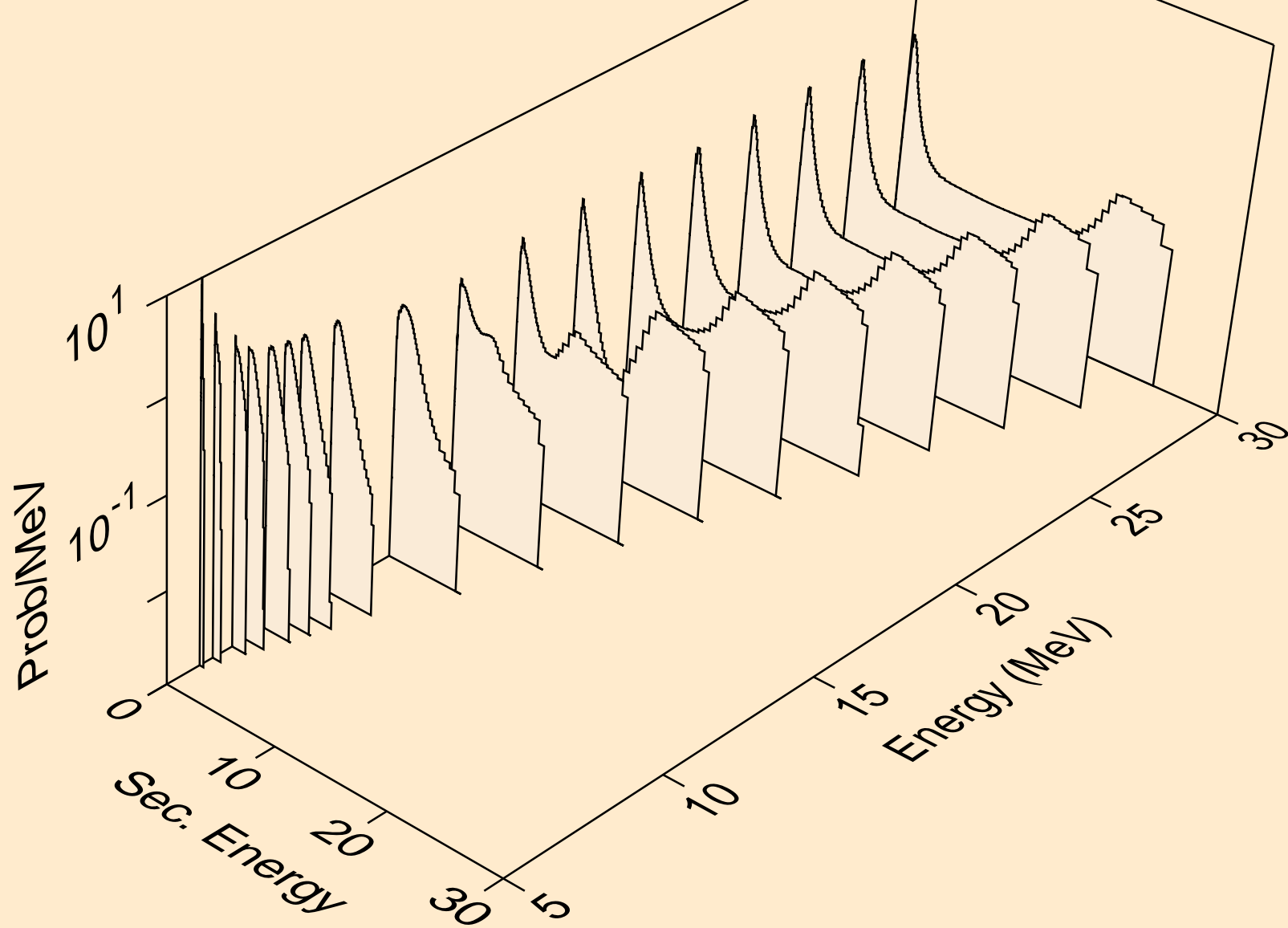

LU185 NEUTRON ACER TENDL-2021 LIBRARY; T=293.6K
Neutron emission for (n,3n)

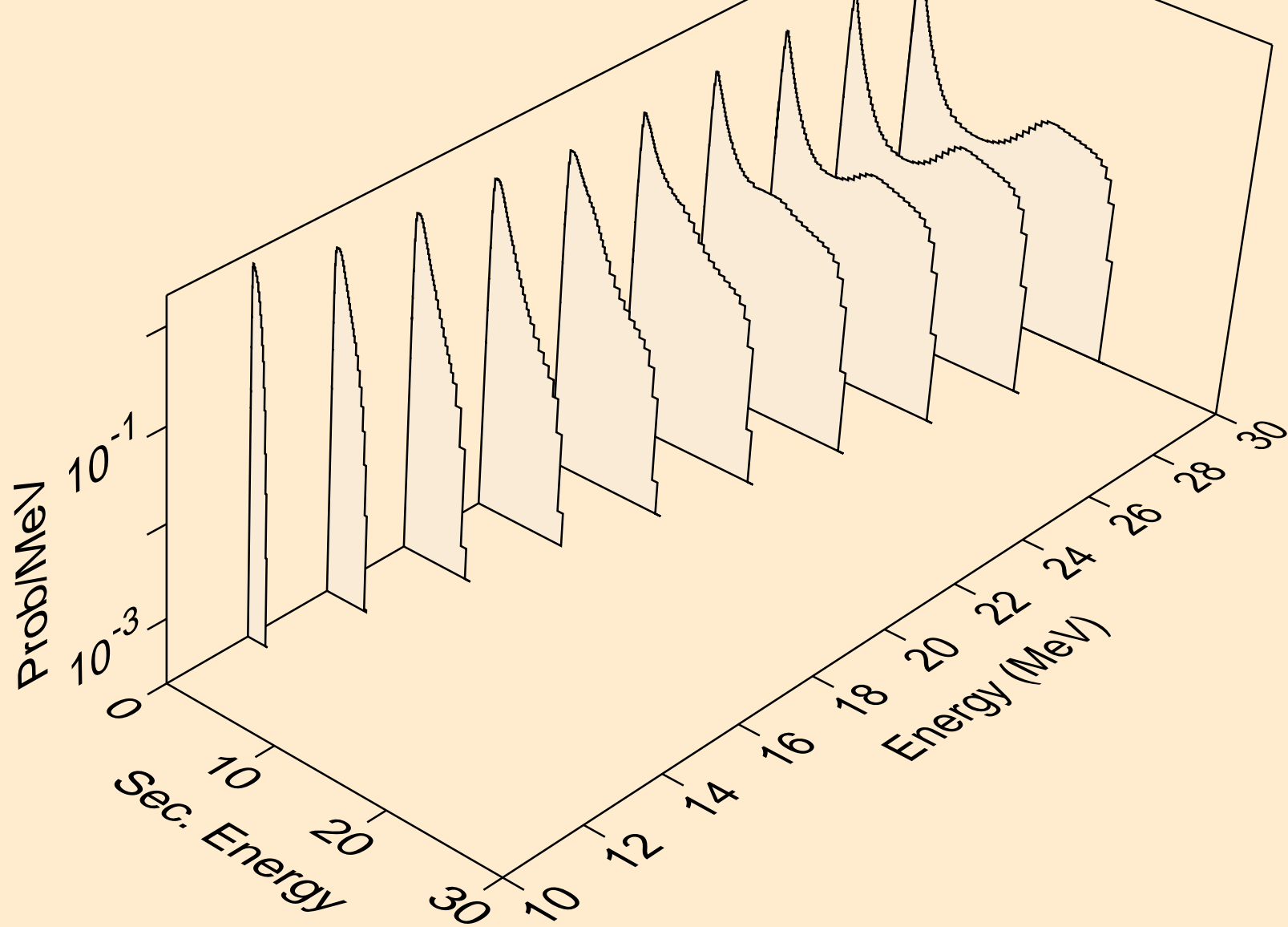

LU185 NEUTRON ACER TENDL-2021 LIBRARY; T=293.6K
Neutron emission for (n,n*)a

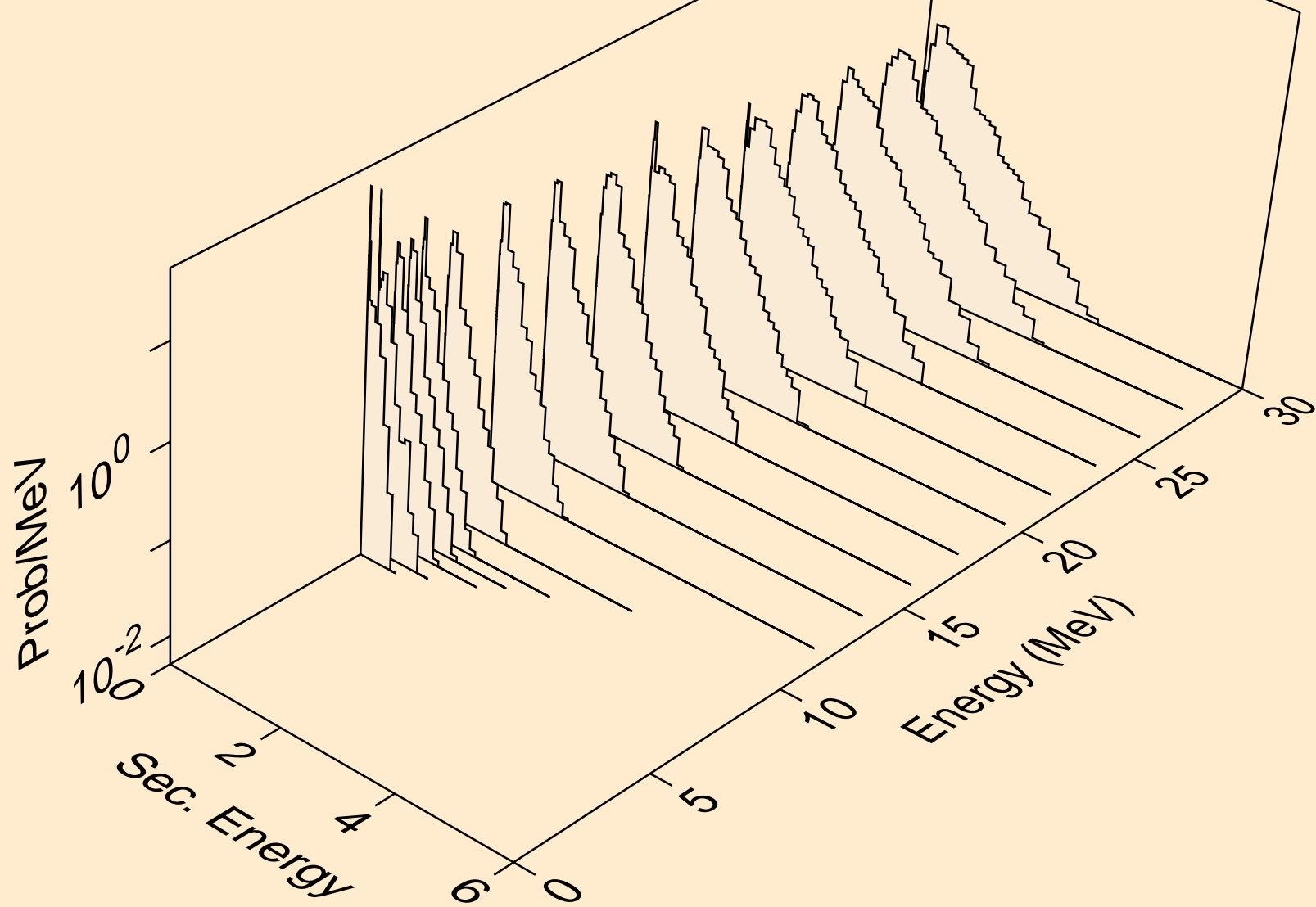

LU185 NEUTRON ACER TENDL-2021 LIBRARY; T=293.6K
Neutron emission for (n,2n)_a

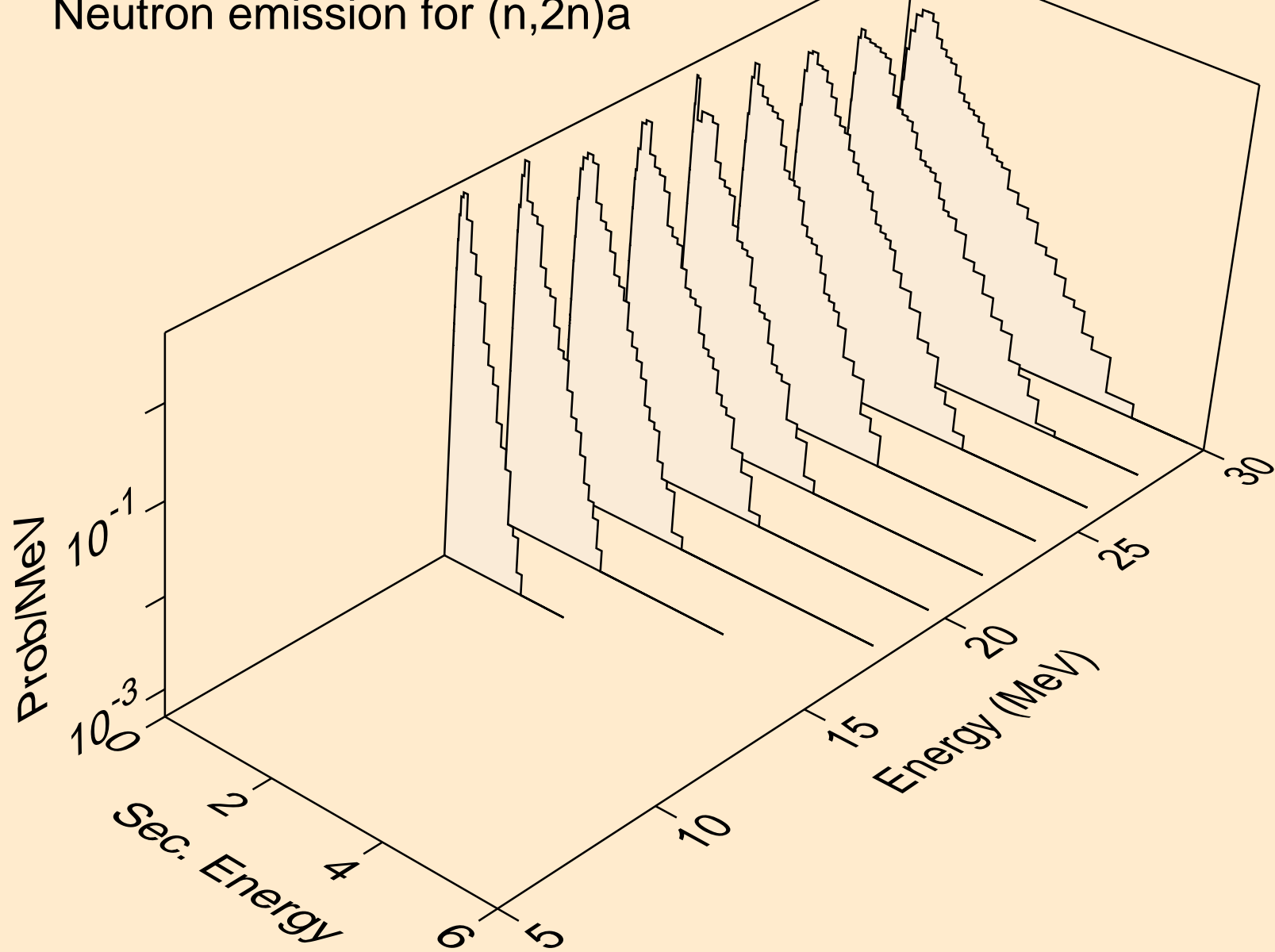

LU185 NEUTRON ACER TENDL-2021 LIBRARY; T=293.6K
Neutron emission for (n,3n)a

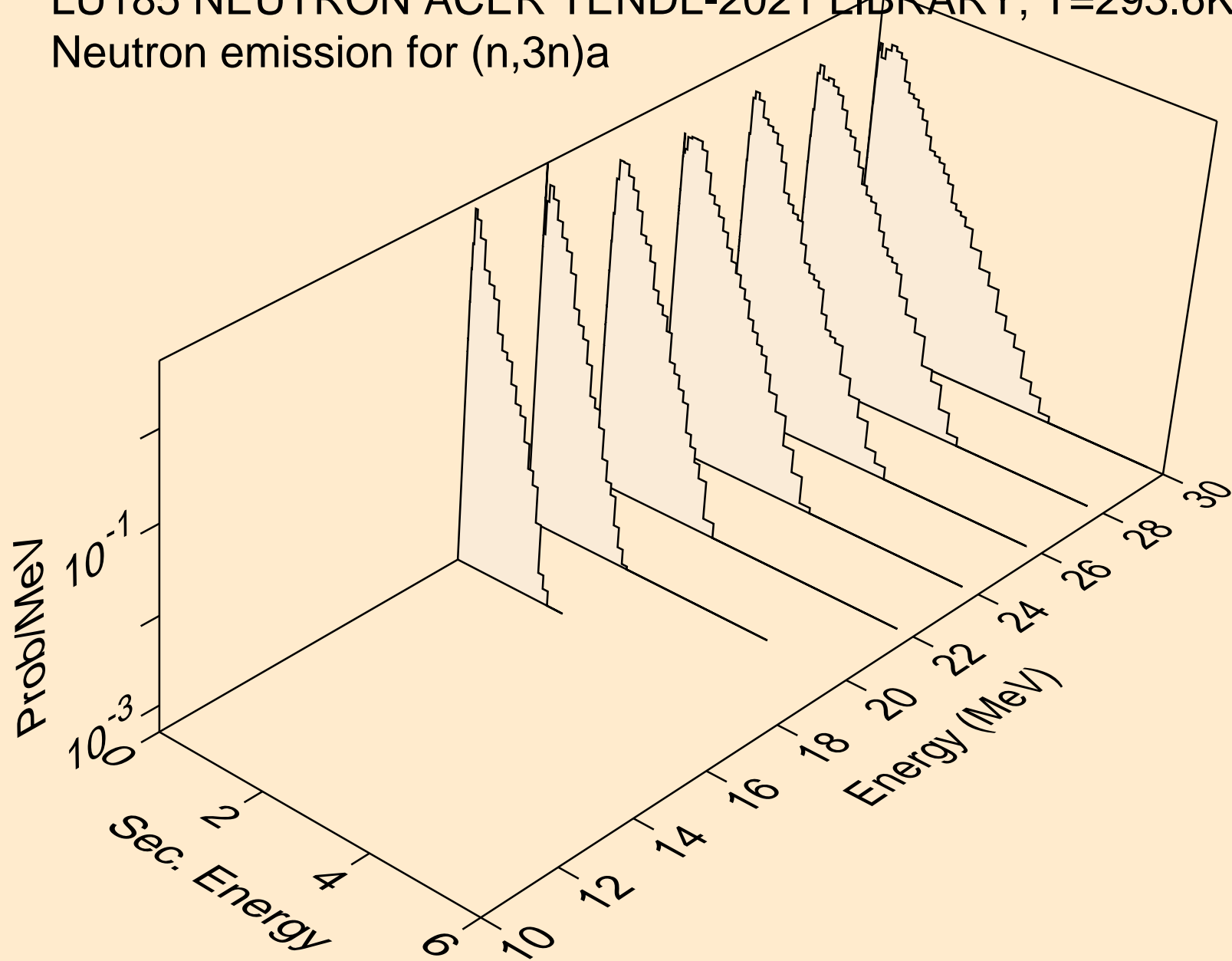

LU185 NEUTRON ACER TENDL-2021 LIBRARY; T=293.6K
Neutron emission for (n,n*)p

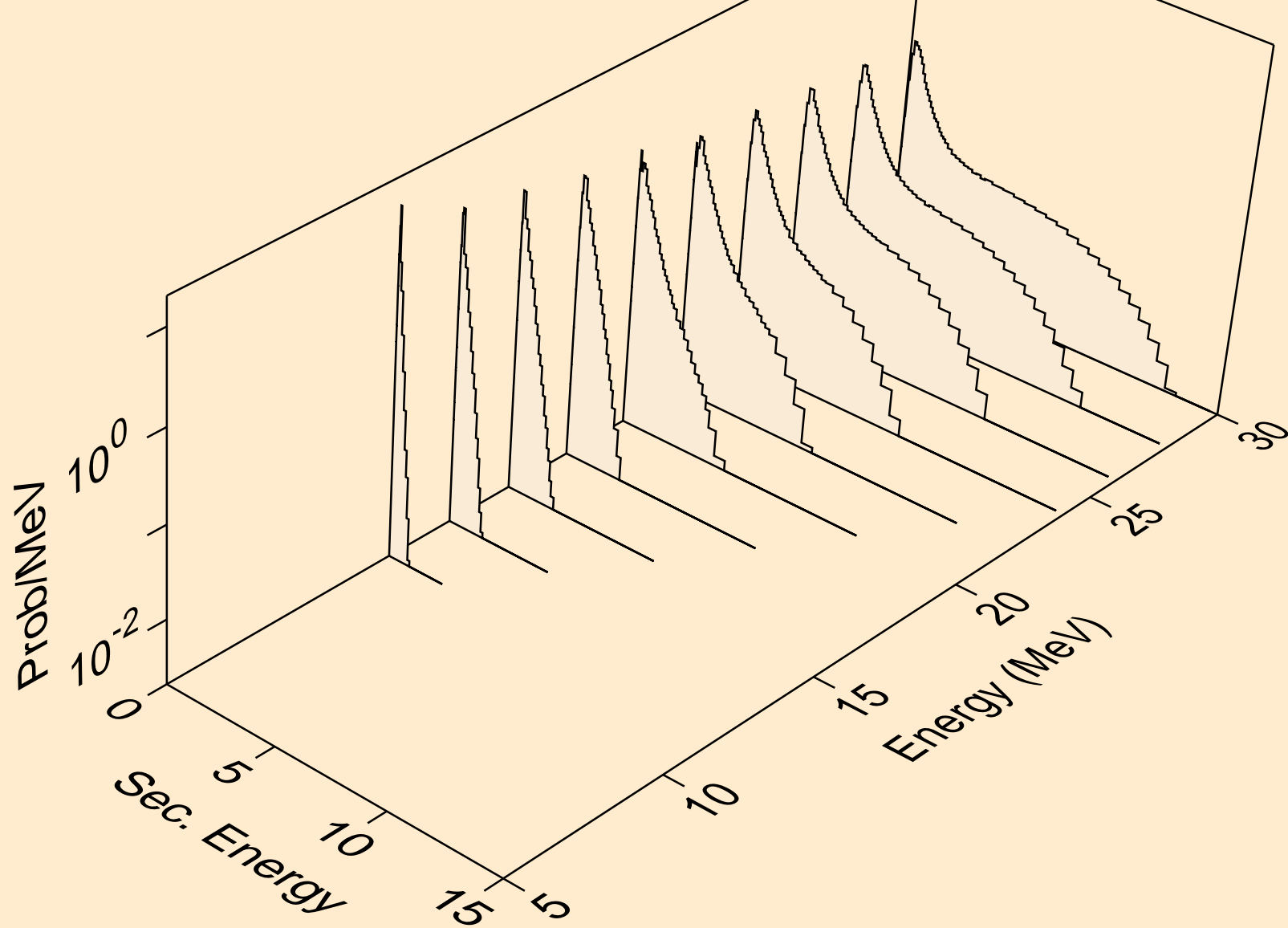

LU185 NEUTRON ACER TENDL-2021 LIBRARY; T=293.6K
Neutron emission for (n,n*)d

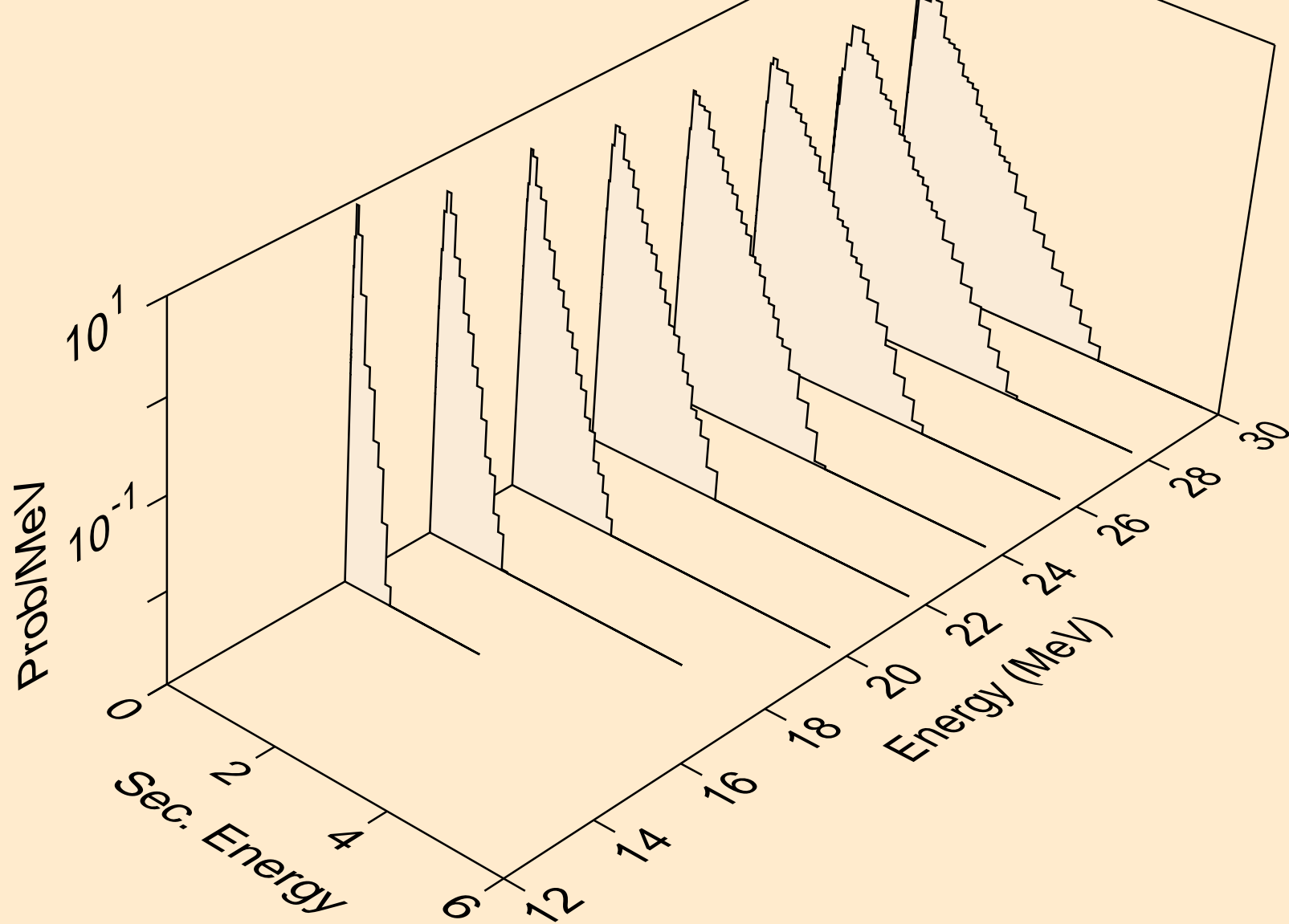

LU185 NEUTRON ACER TENDL-2021 LIBRARY; T=293.6K
Neutron emission for (n,n*)t

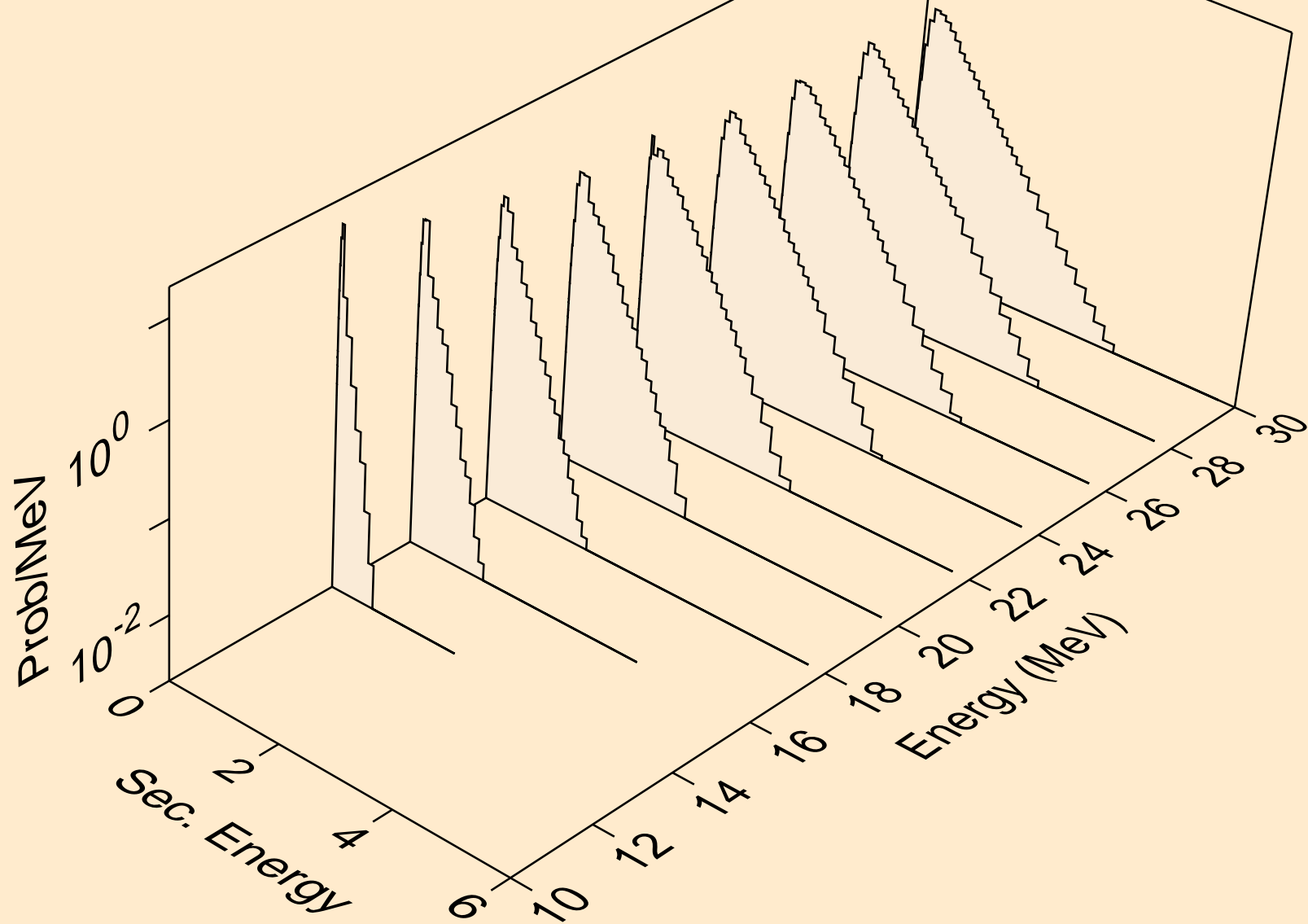

LU185 NEUTRON ACER TENDL-2021 LIBRARY; T=293.6K
Neutron emission for (n,n*)he3

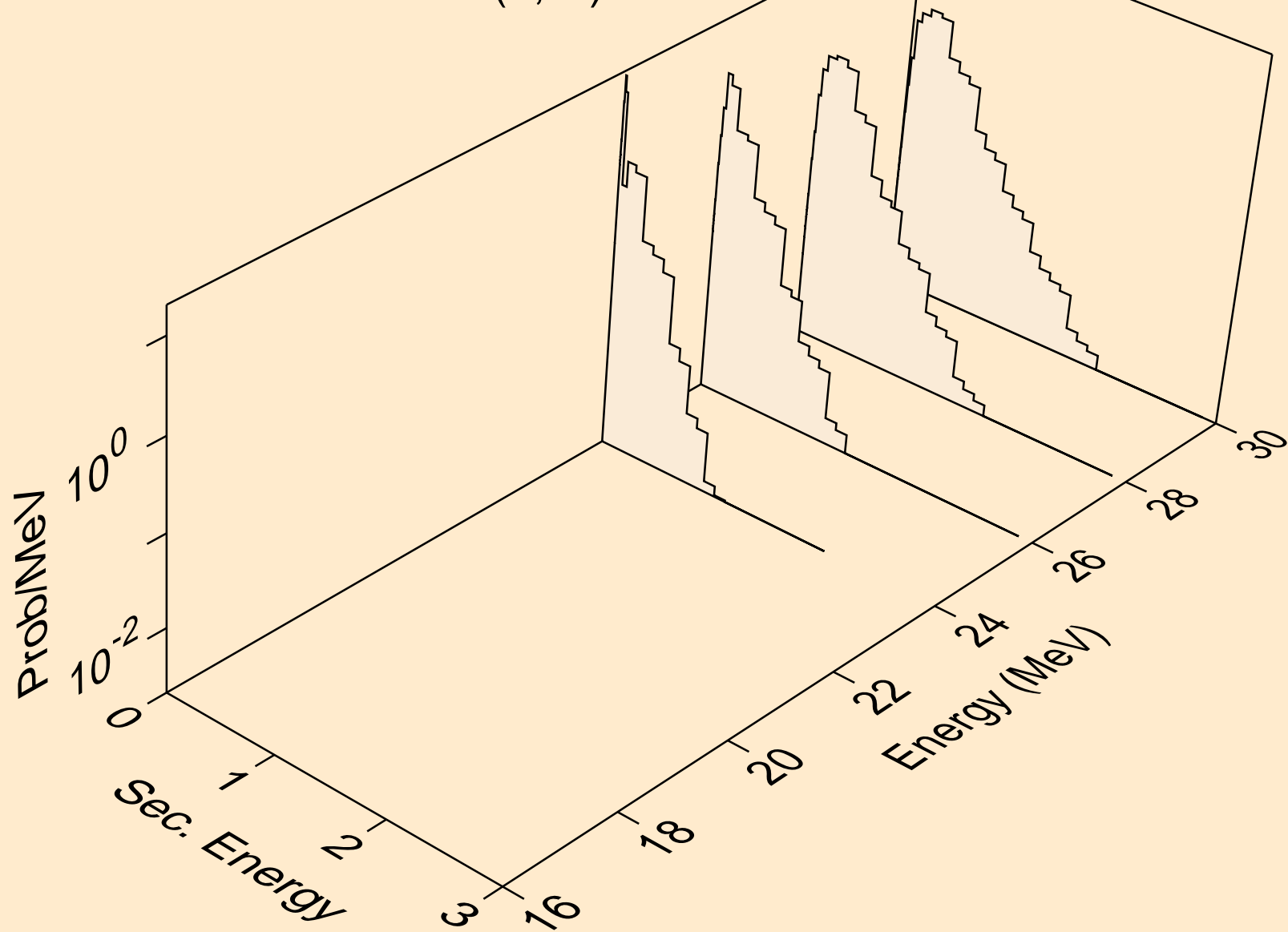

LU185 NEUTRON ACER TENDL-2021 LIBRARY; T=293.6K
Neutron emission for (n,4n)

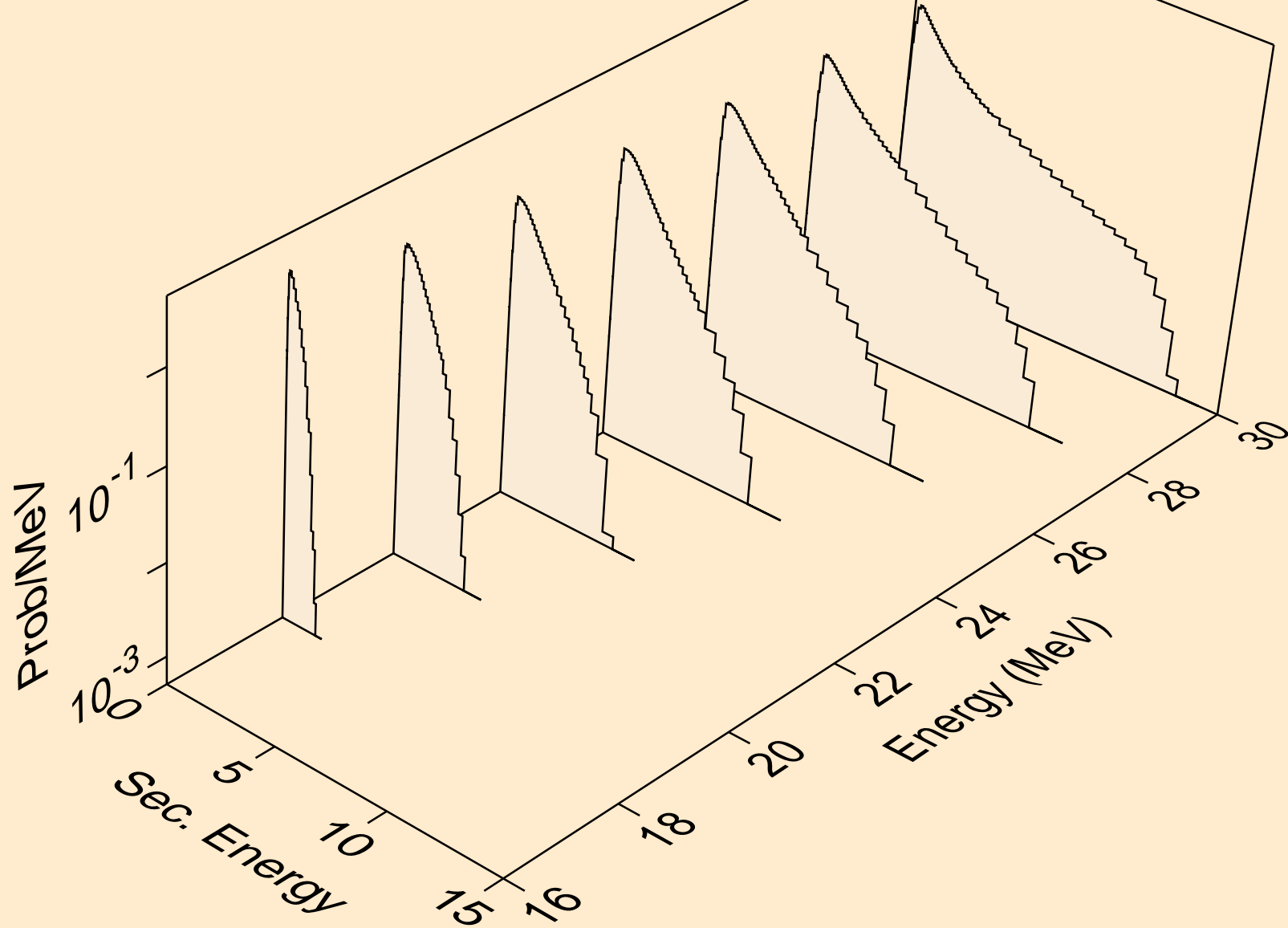

LU185 NEUTRON ACER TENDL-2021 LIBRARY; T=293.6K
Neutron emission for (n,2np)

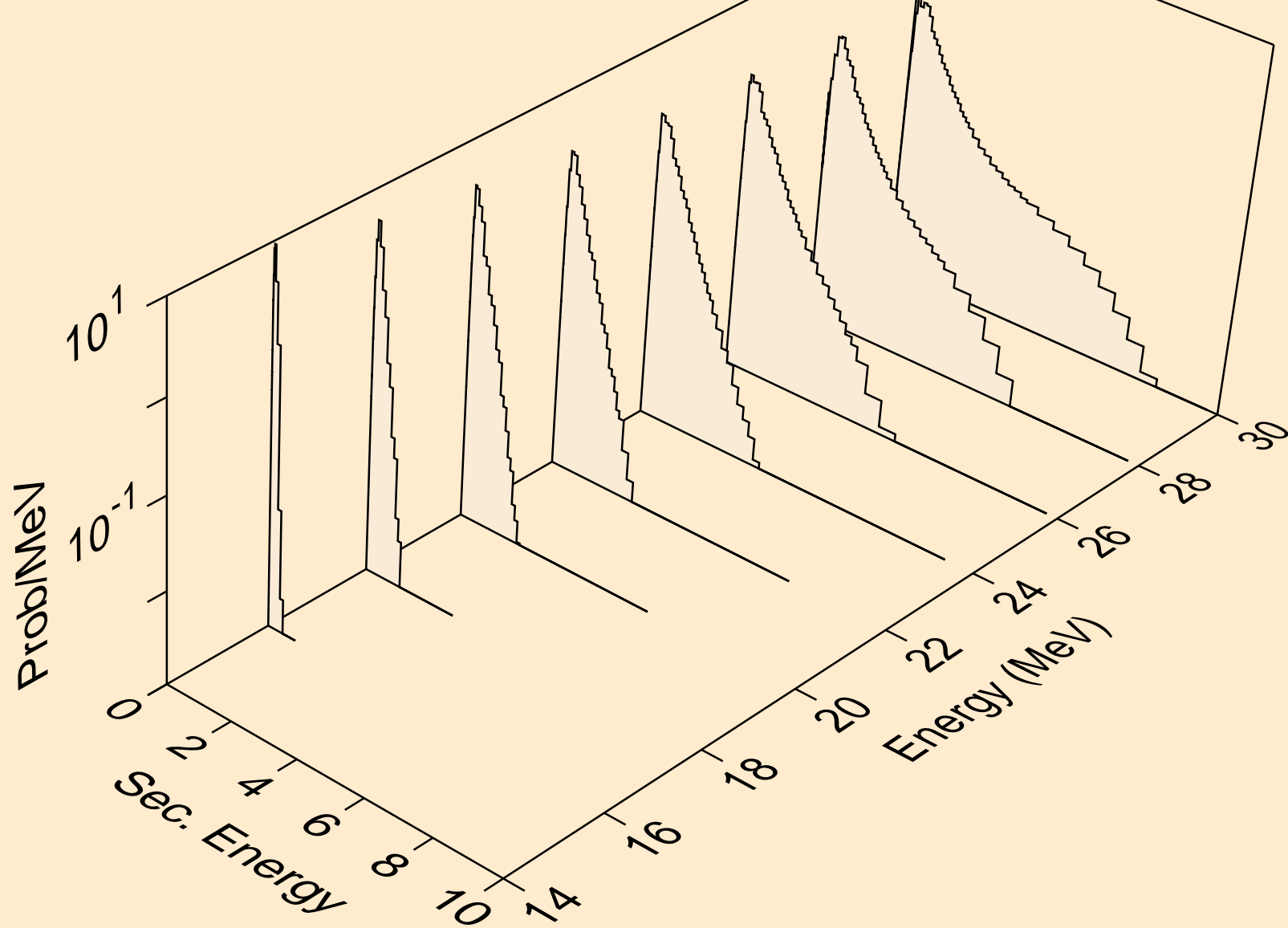

LU185 NEUTRON ACER TENDL-2021 LIBRARY; T=293.6K
Neutron emission for (n,3np)

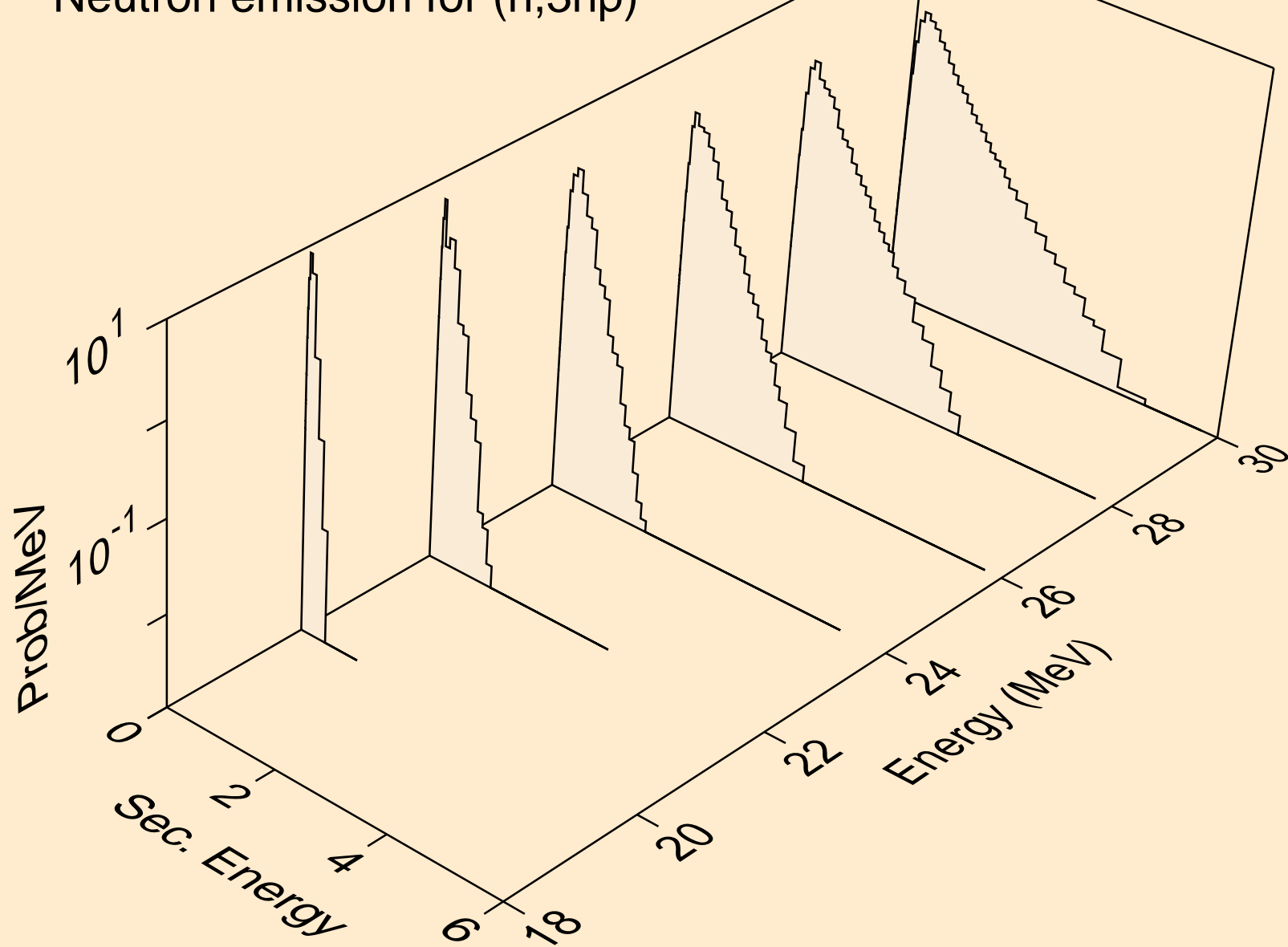

LU185 NEUTRON ACER TENDL-2021 LIBRARY; T=293.6K
Neutron emission for (n,n*c)

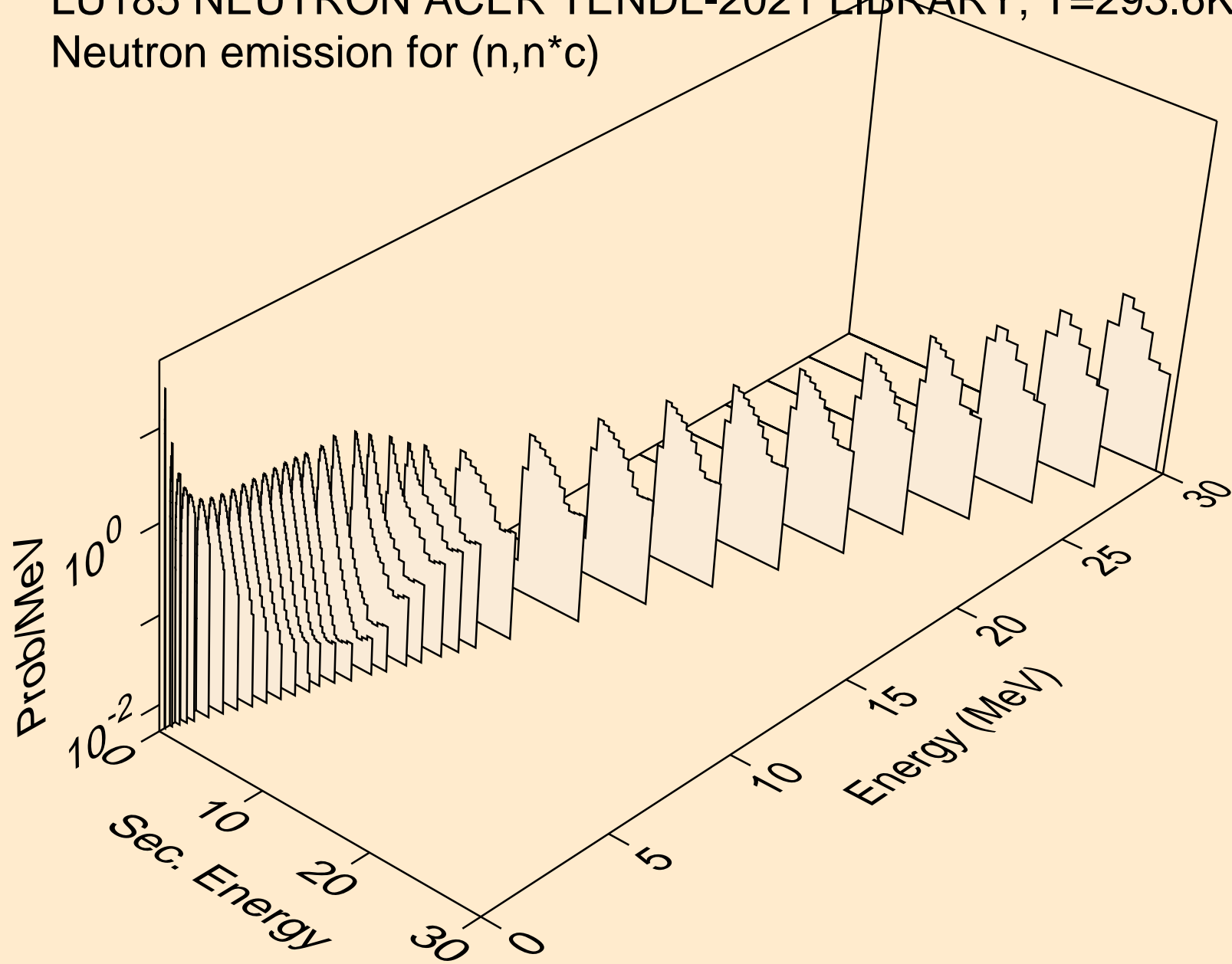

LU185 NEUTRON ACER TENDL-2021 LIBRARY; T=293.6K
Photon emission for (n,x)

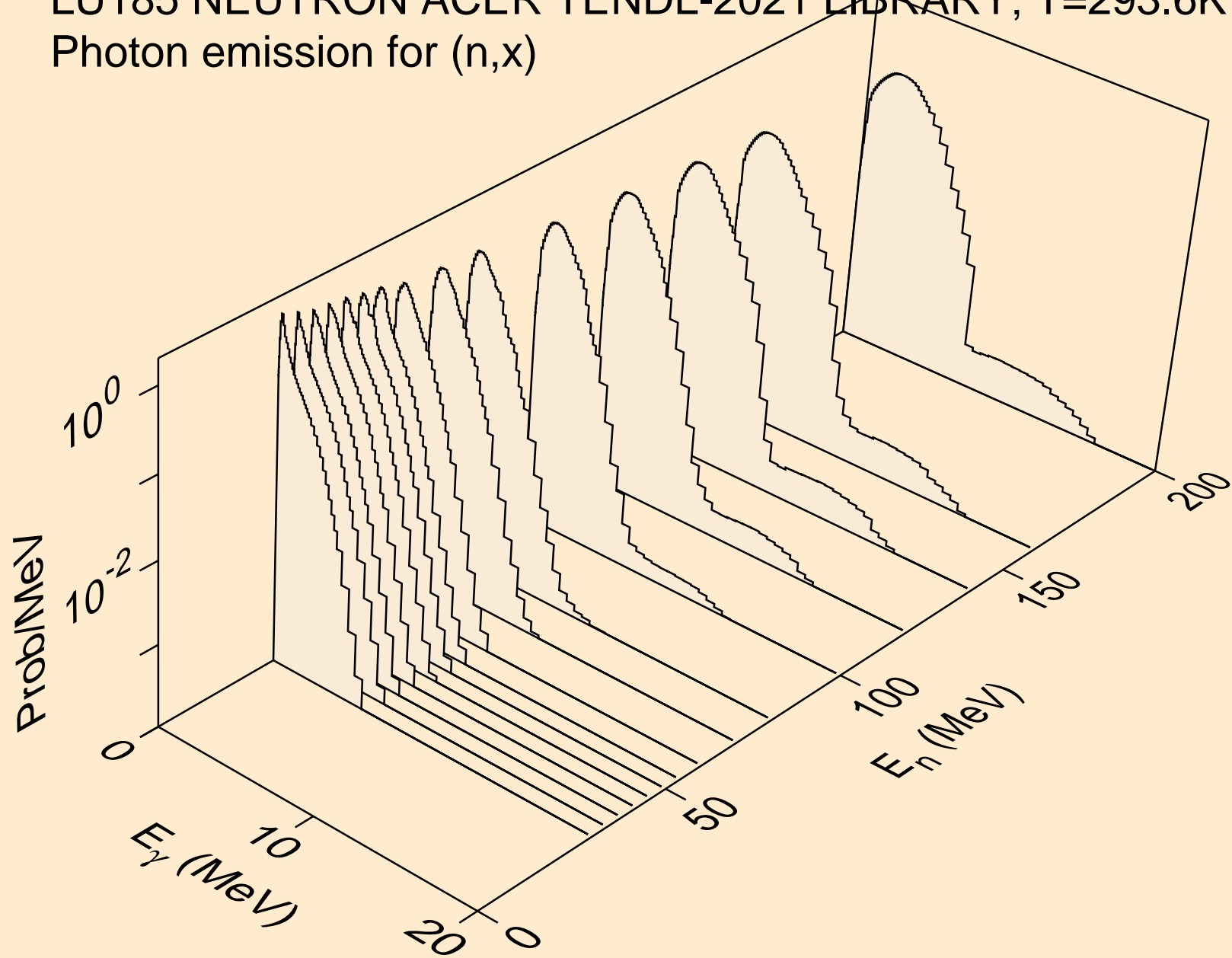

LU185 NEUTRON ACER TENDL-2021 LIBRARY; T=293.6K
Photon emission for (n,2nd)

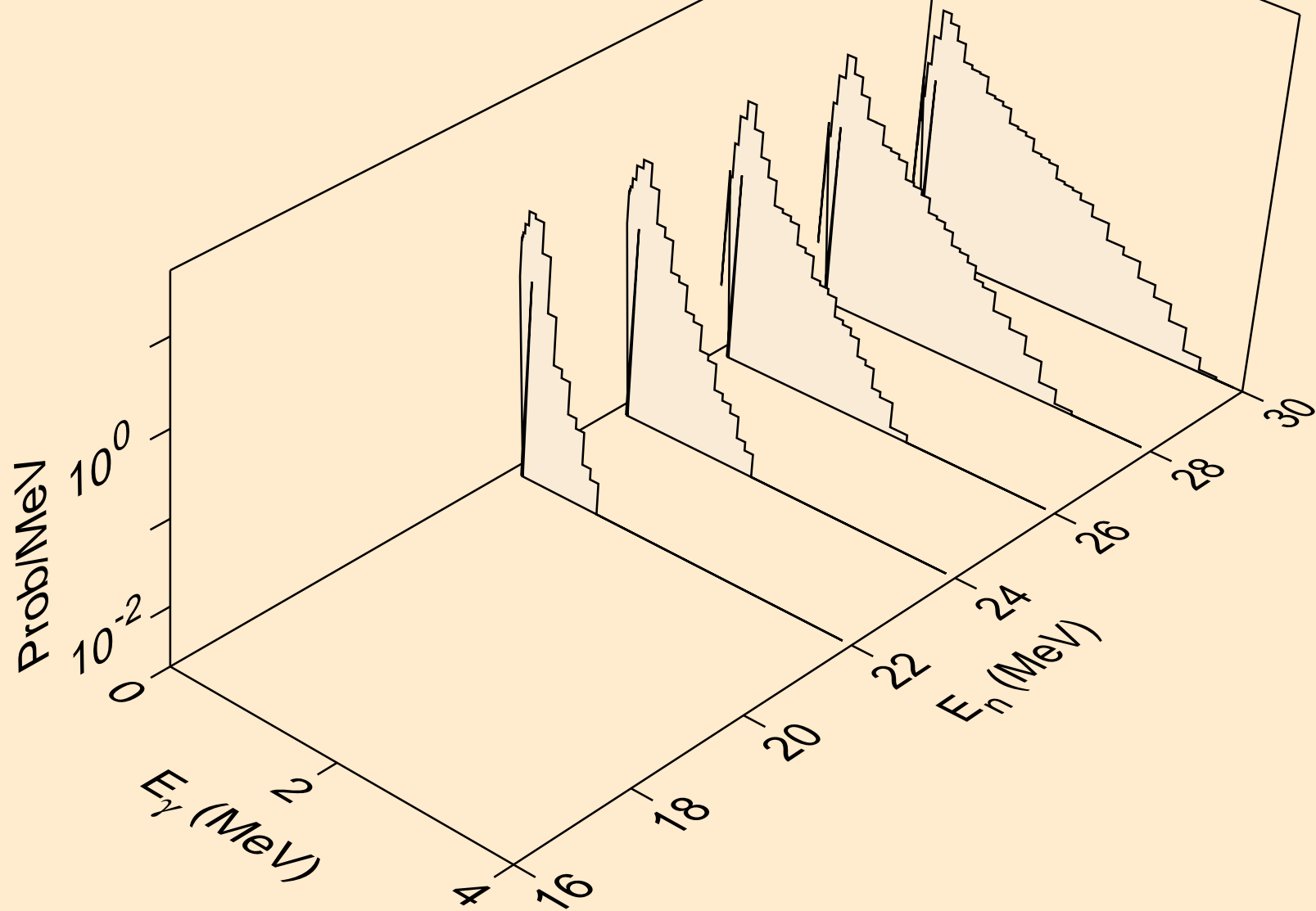

LU185 NEUTRON ACER TENDL-2021 LIBRARY; T=293.6K
Photon emission for (n,2n)

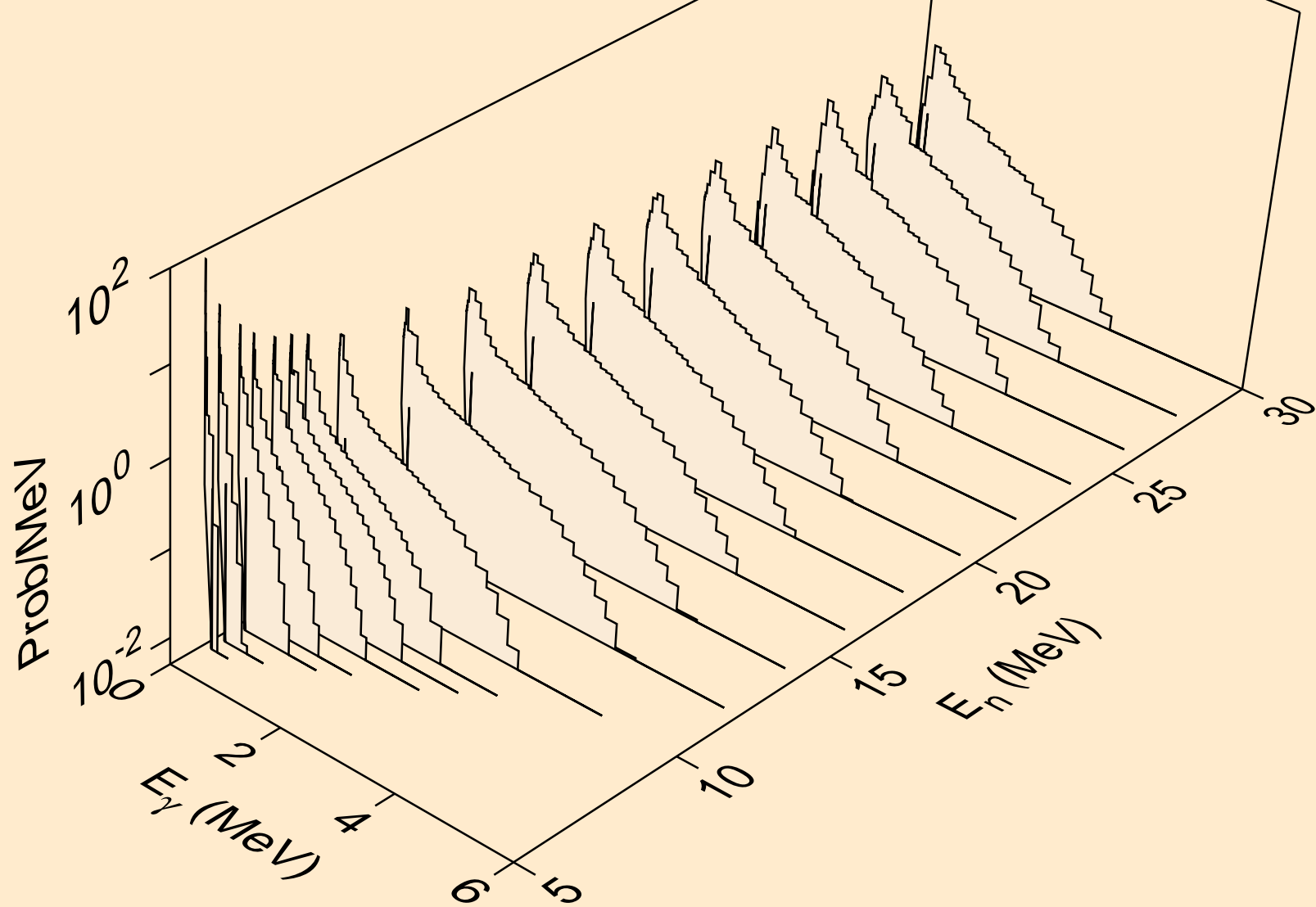

LU185 NEUTRON ACER TENDL-2021 LIBRARY; T=293.6K
Photon emission for (n,3n)

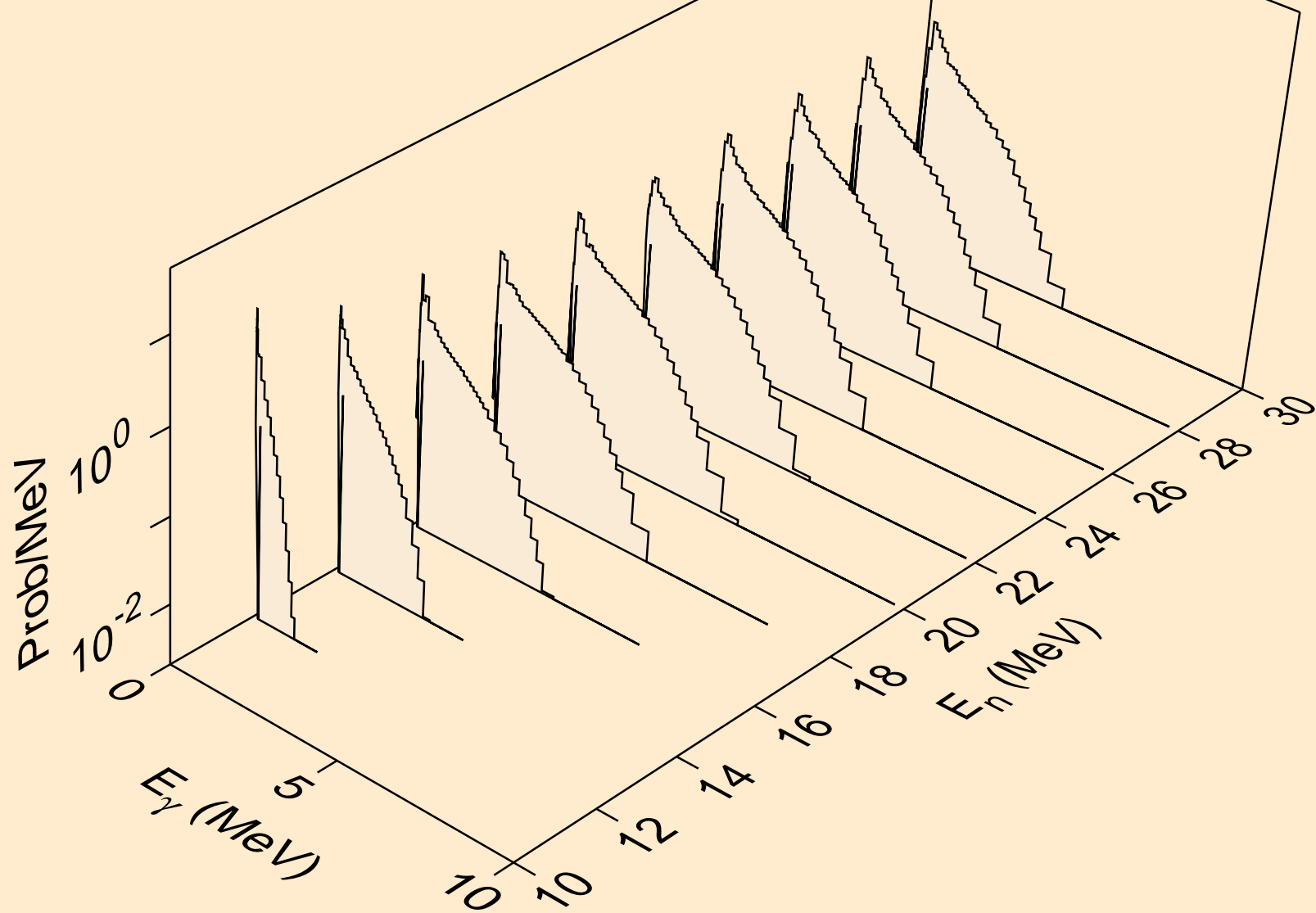

LU185 NEUTRON ACER TENDL-2021 LIBRARY; T=293.6K
Photon emission for (n,n*)a

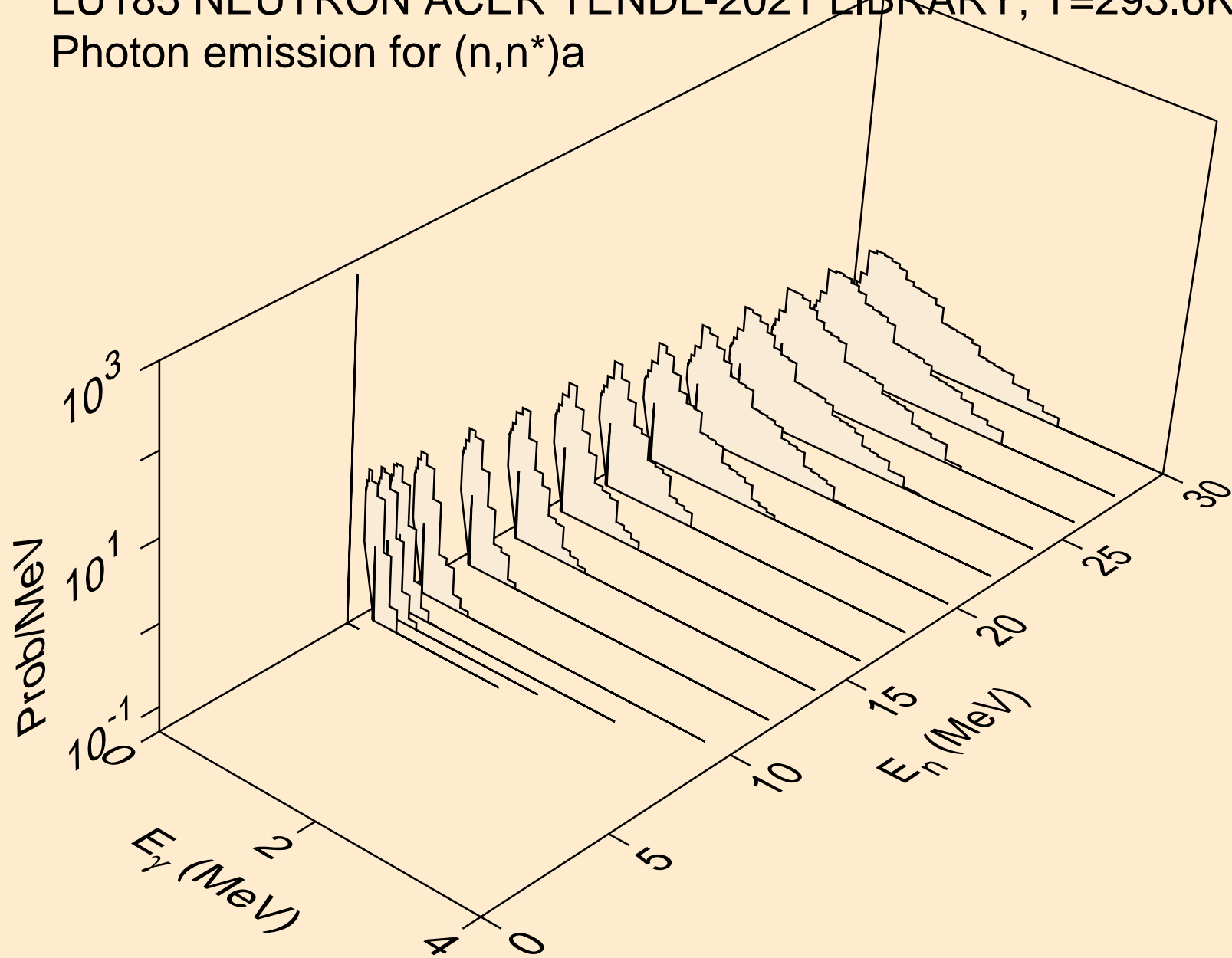

LU185 NEUTRON ACER TENDL-2021 LIBRARY; T=293.6K
Photon emission for (n,2n)a

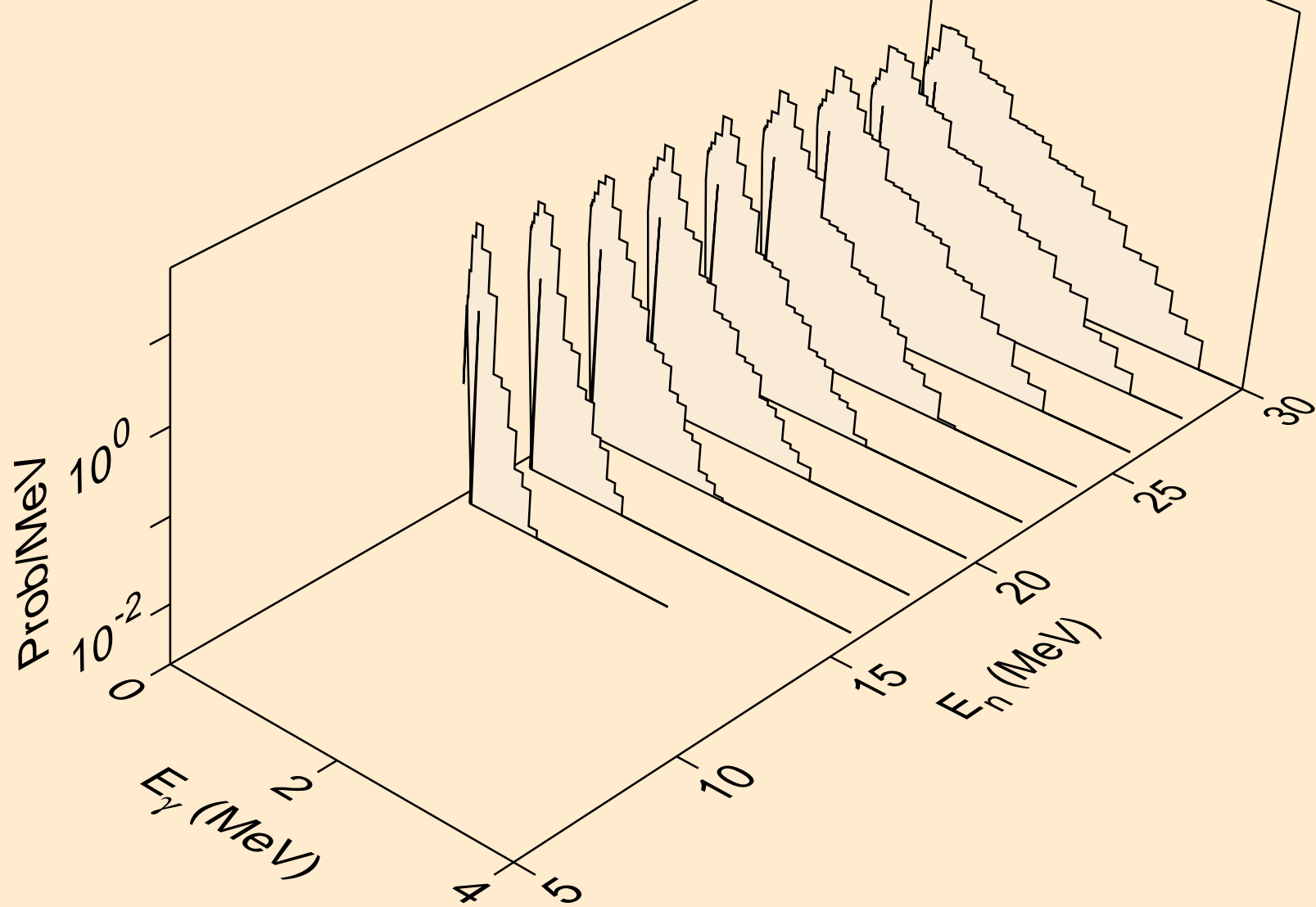

LU185 NEUTRON ACER TENDL-2021 LIBRARY; T=293.6K
Photon emission for (n,3n)a

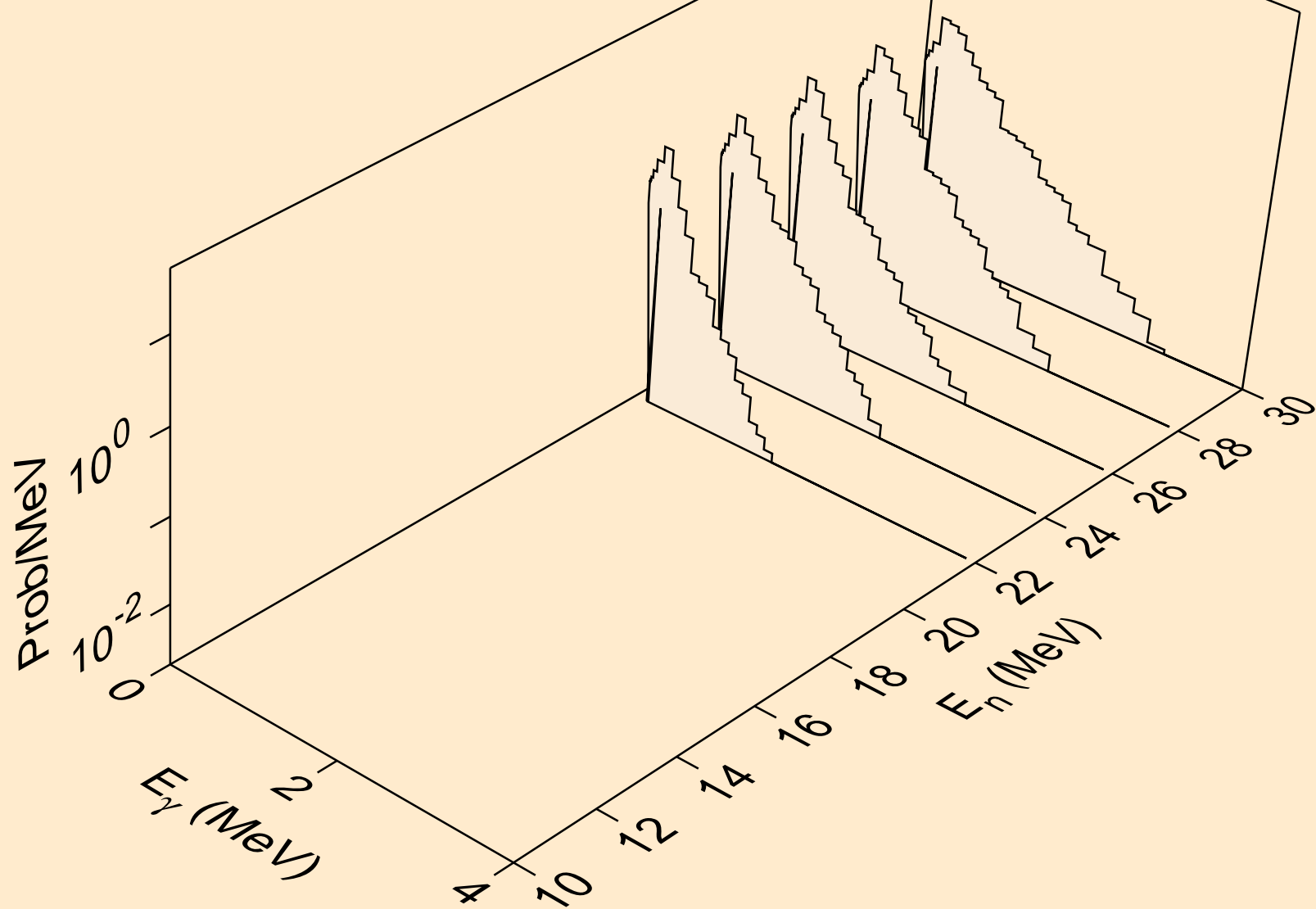

LU185 NEUTRON ACER TENDL-2021 LIBRARY; T=293.6K
Photon emission for (n,n*)p

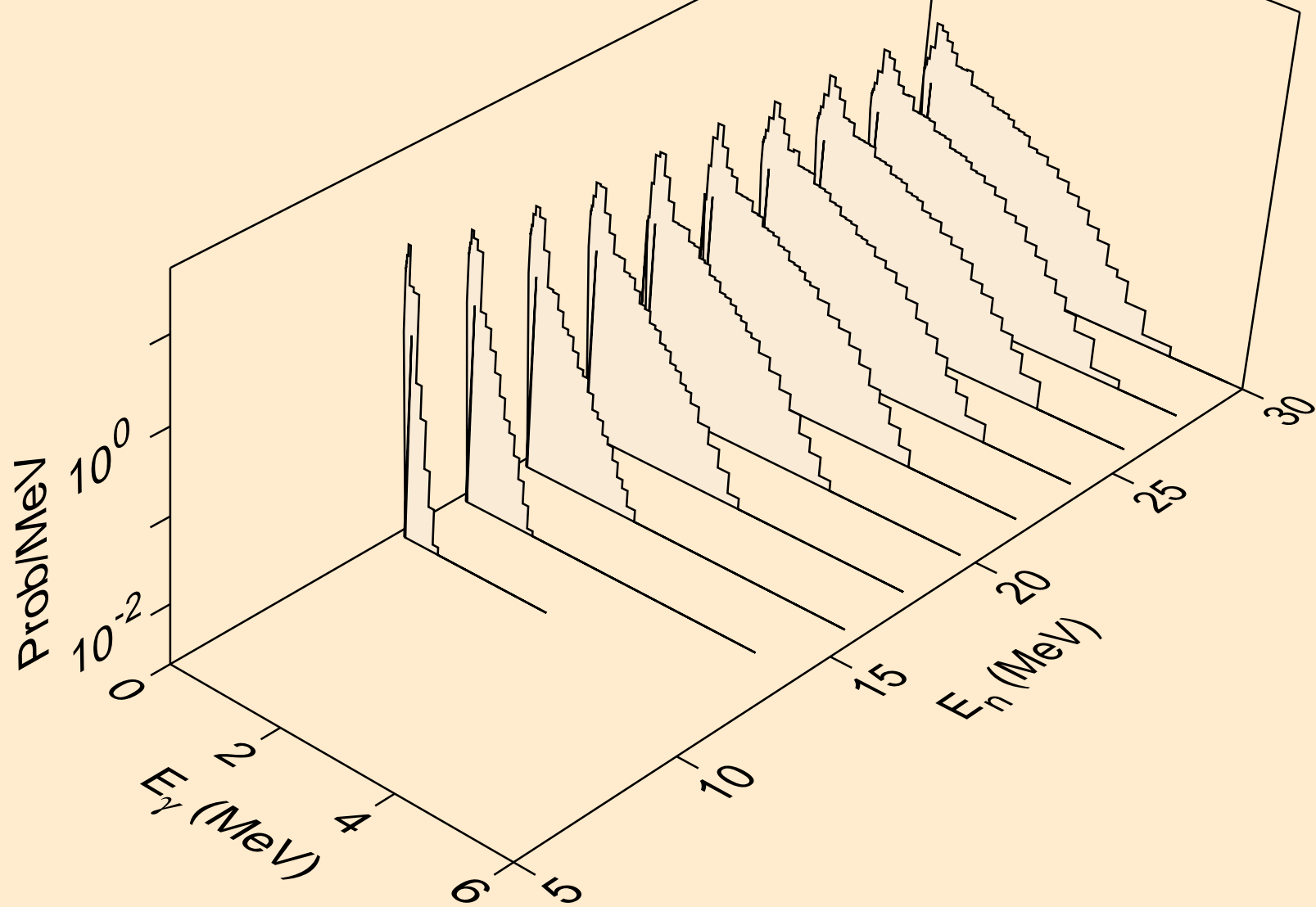

LU185 NEUTRON ACER TENDL-2021 LIBRARY; T=293.6K
Photon emission for (n,n*)d

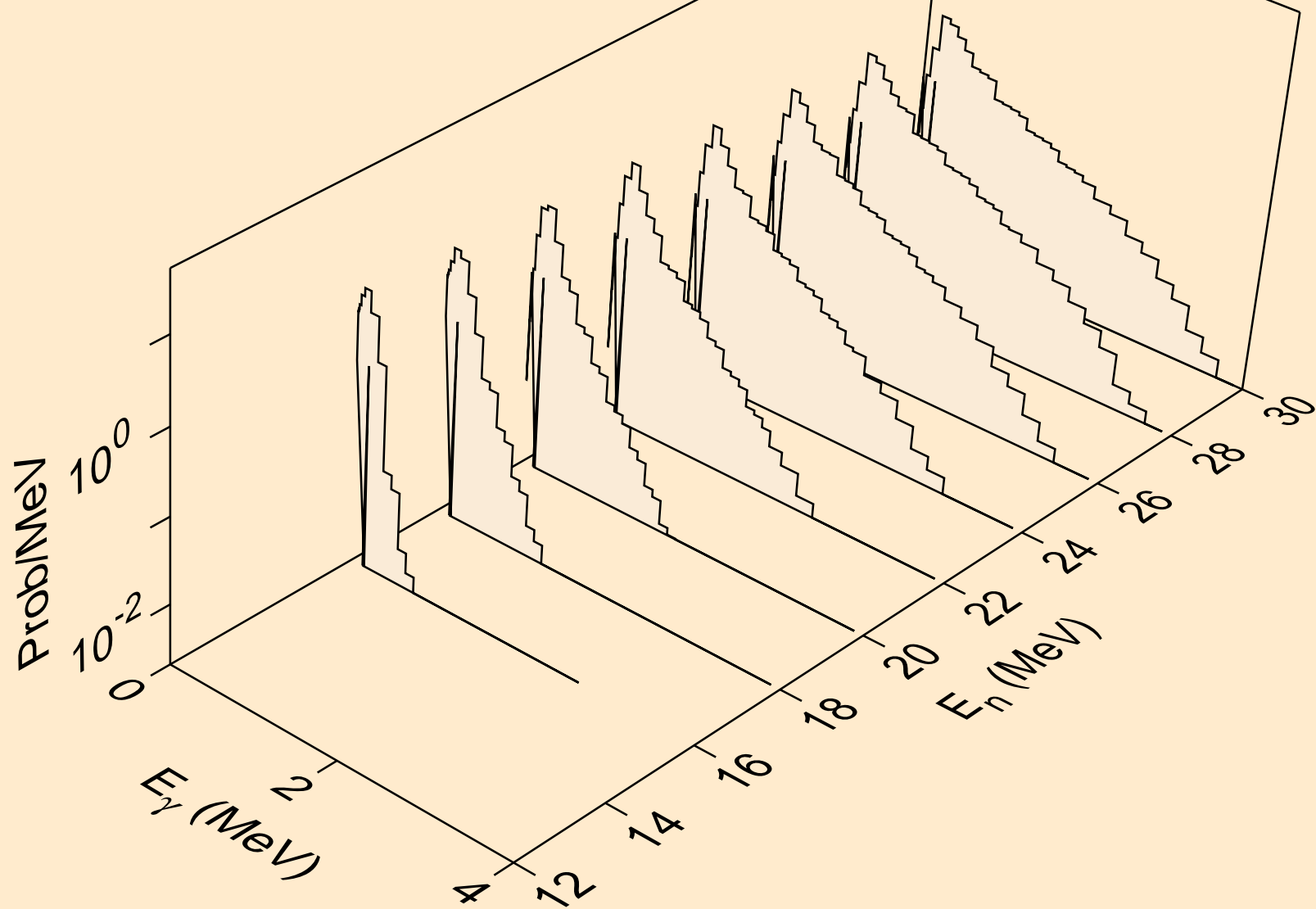

LU185 NEUTRON ACER TENDL-2021 LIBRARY; T=293.6K
Photon emission for (n,n*)t

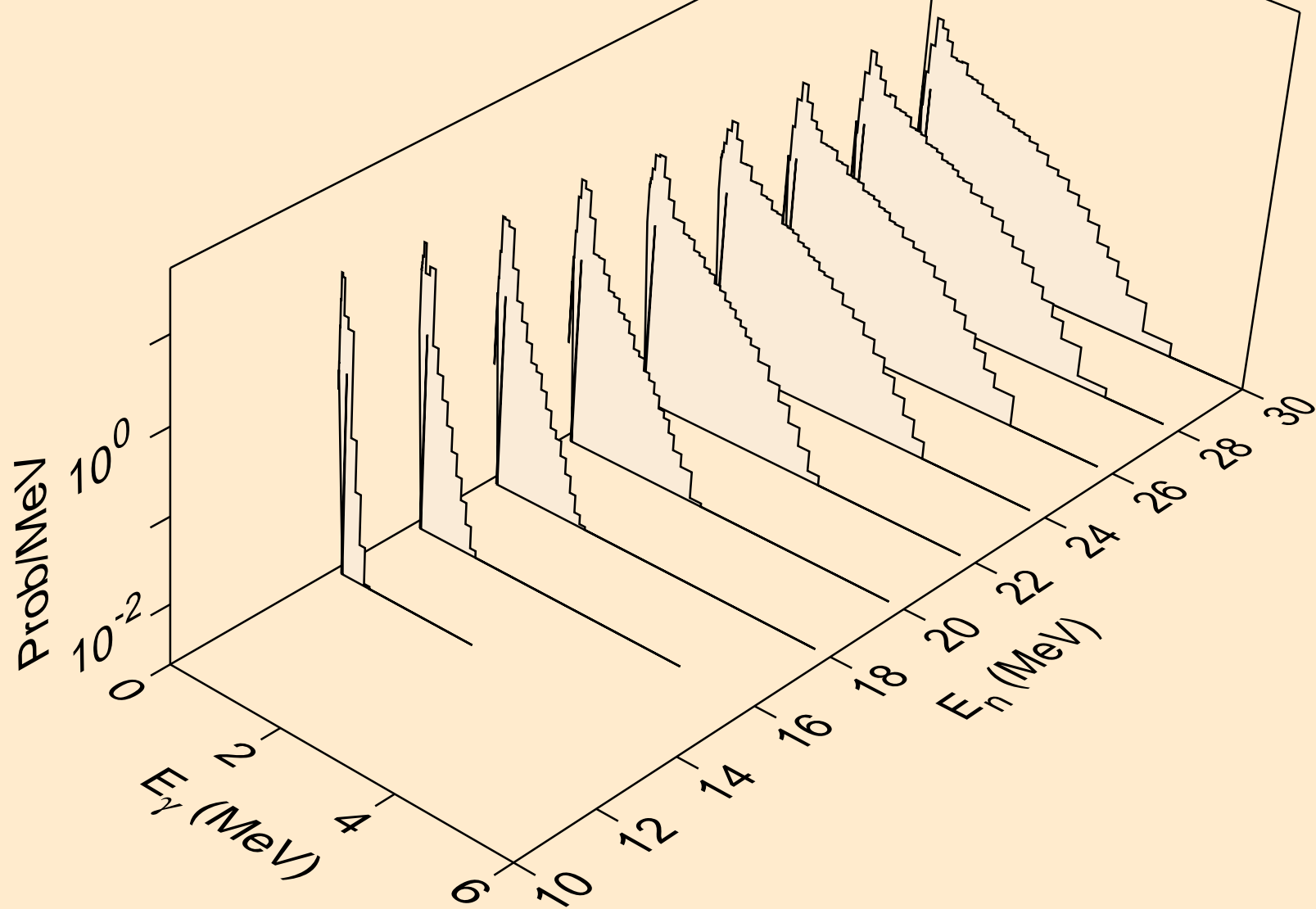

LU185 NEUTRON ACER TENDL-2021 LIBRARY; T=293.6K
Photon emission for (n,n*)he3

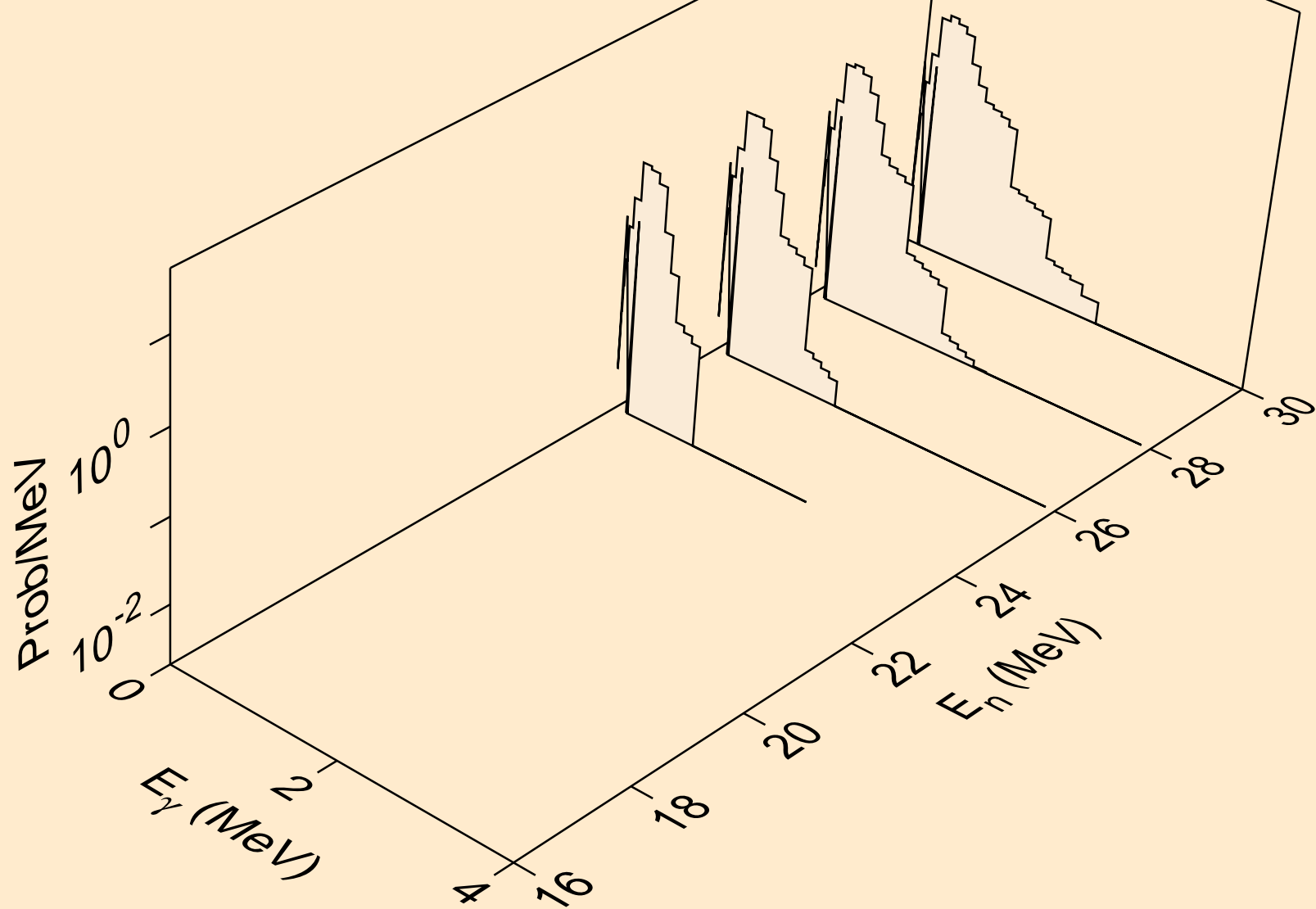

LU185 NEUTRON ACER TENDL-2021 LIBRARY; T=293.6K
Photon emission for (n,4n)

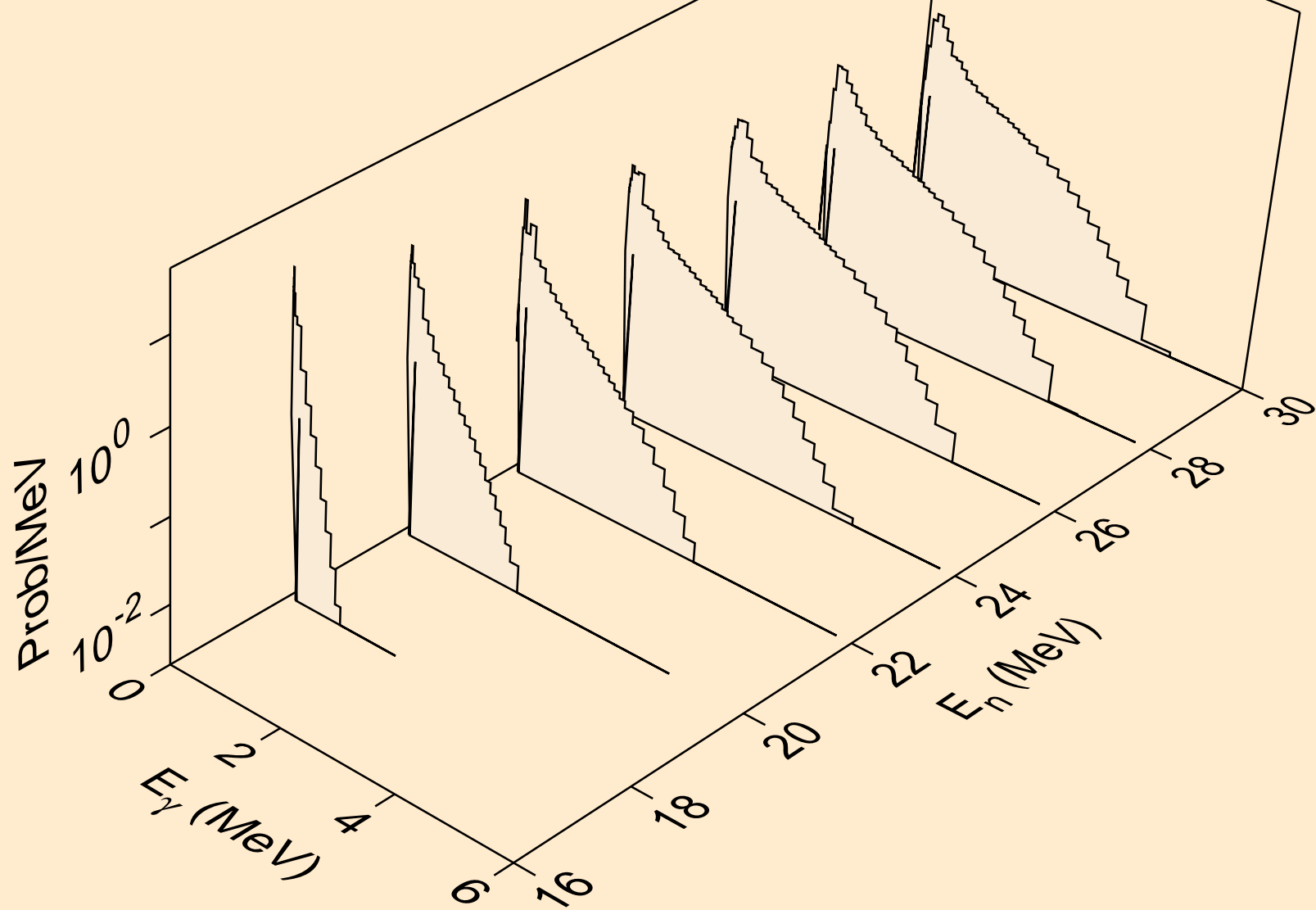

LU185 NEUTRON ACER TENDL-2021 LIBRARY; T=293.6K
Photon emission for (n,2np)

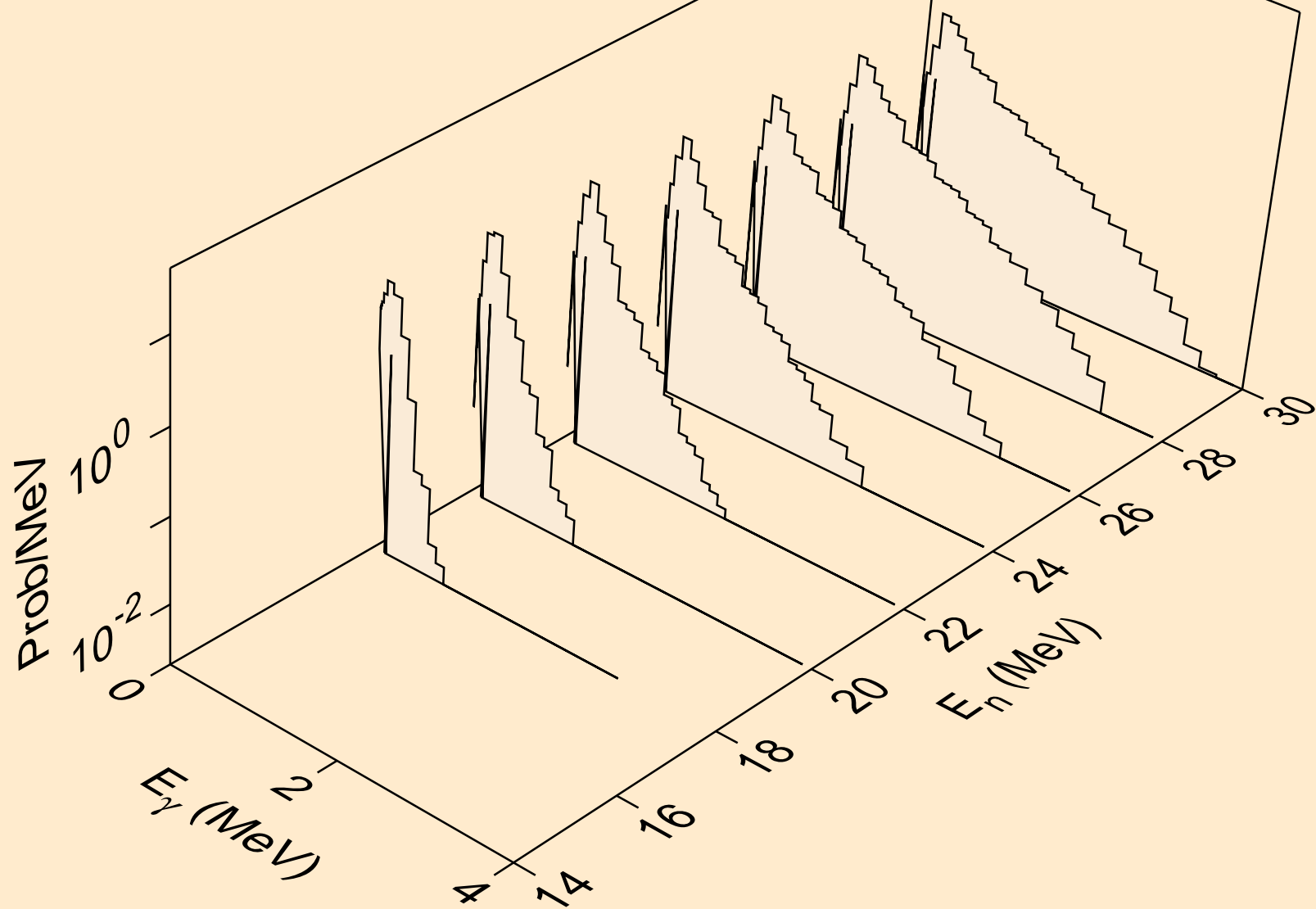

LU185 NEUTRON ACER TENDL-2021 LIBRARY; T=293.6K
Photon emission for (n,3np)

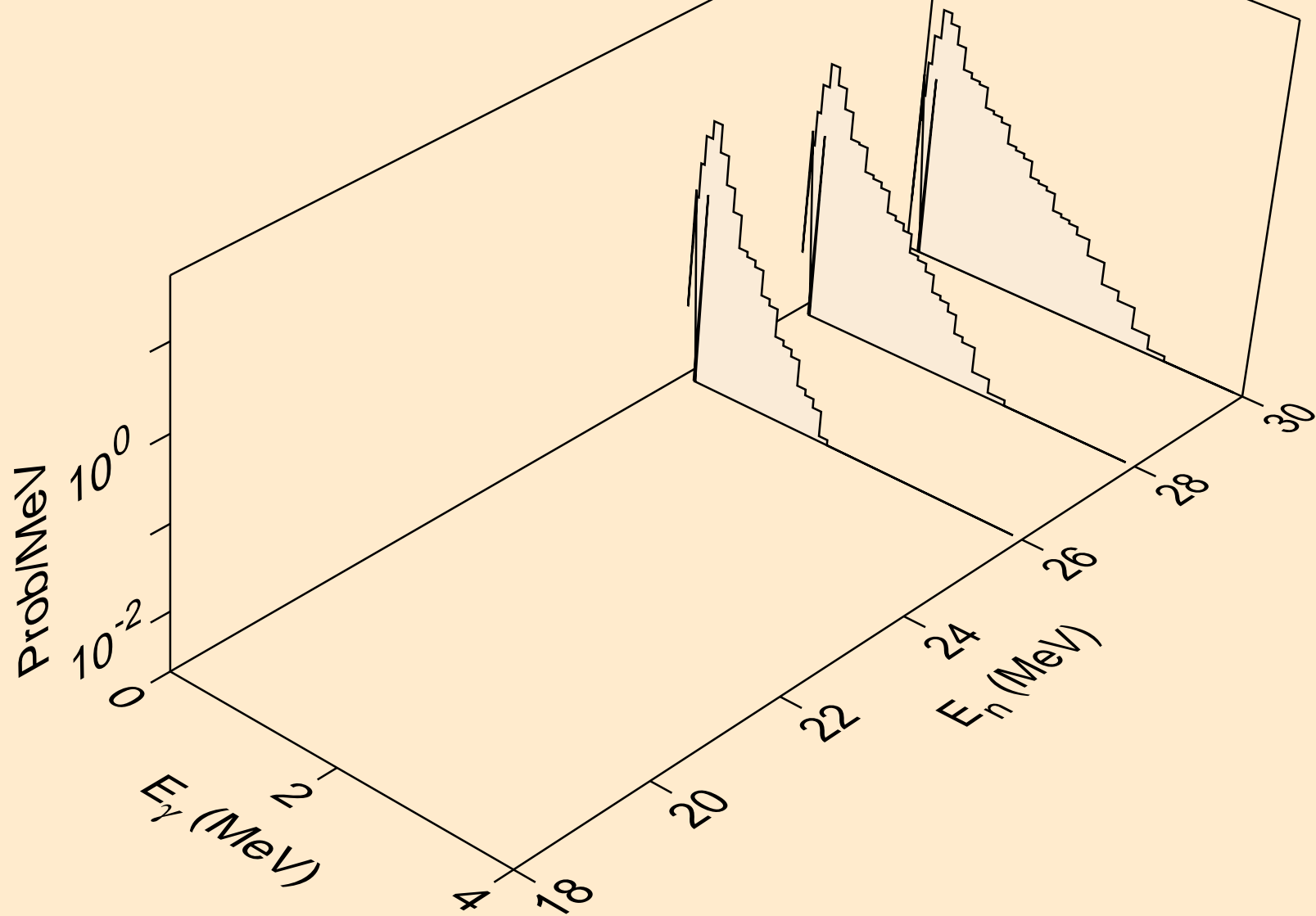

LU185 NEUTRON ACER TENDL-2021 LIBRARY; T=293.6K
Photon emission for (n,n*c)

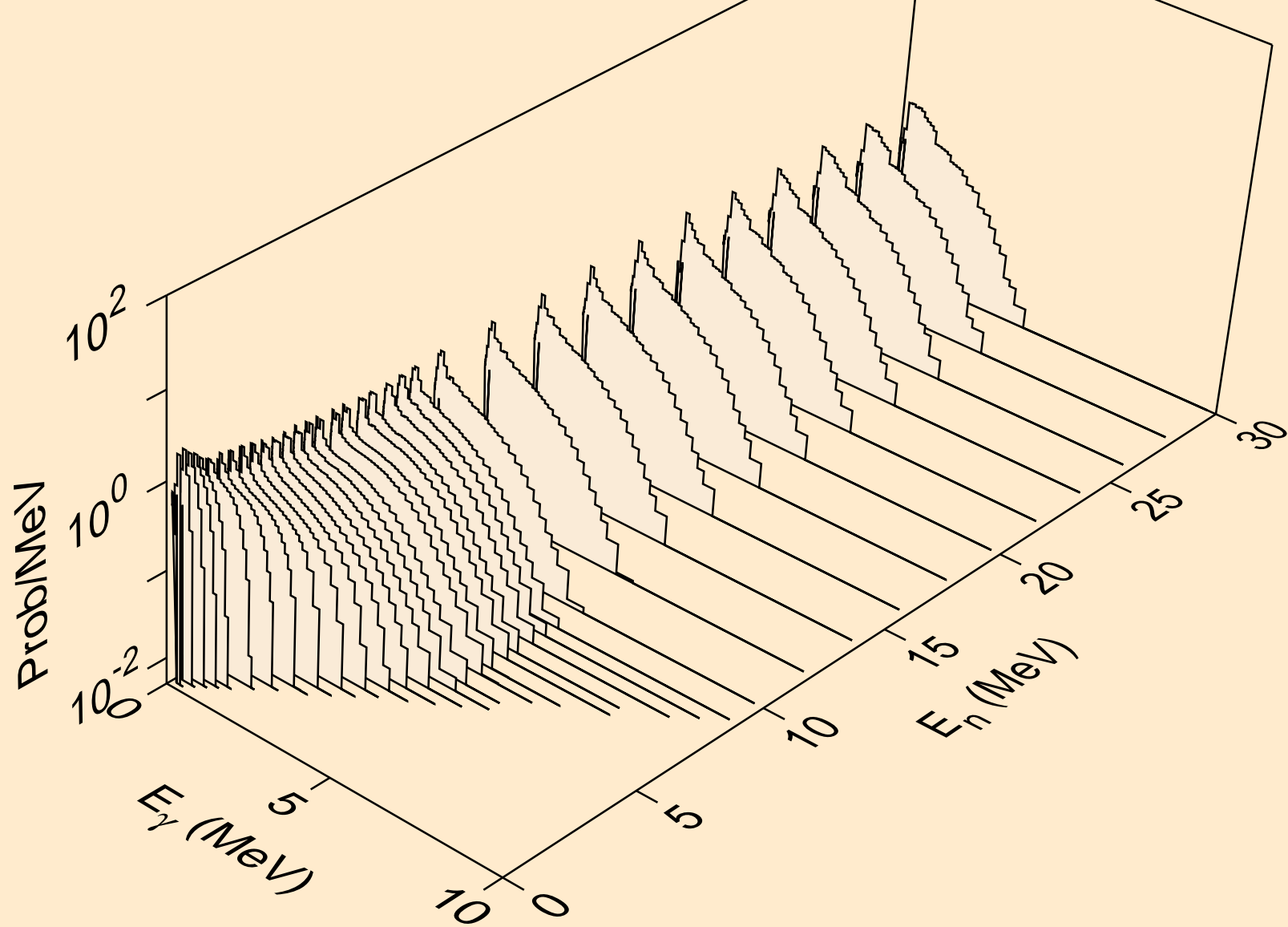

LU185 NEUTRON ACER TENDL-2021 LIBRARY; T=293.6K
Photon emission for (n,gma)

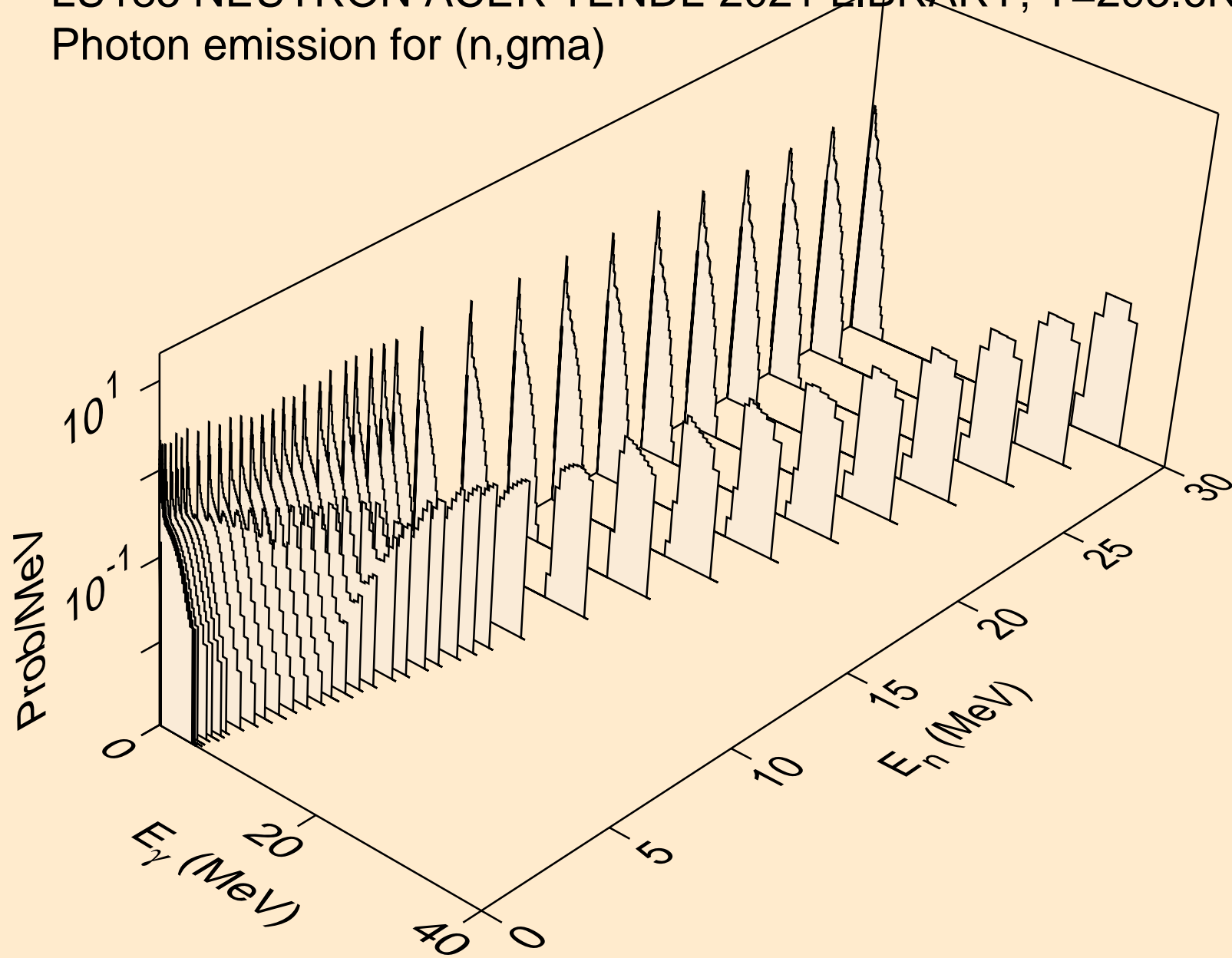

LU185 NEUTRON ACER TENDL-2021 LIBRARY; T=293.6K
Photon emission for (n,p)

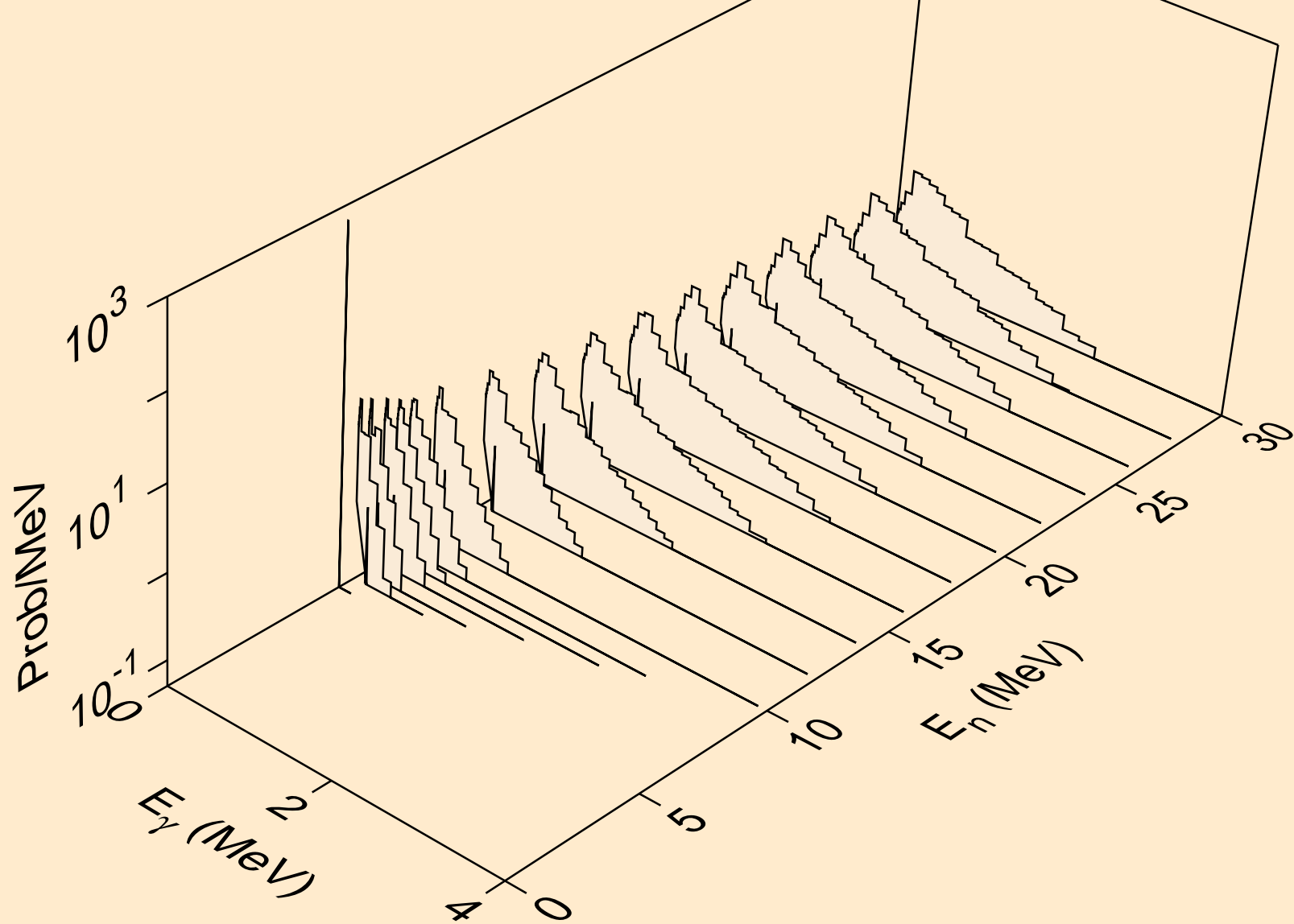

LU185 NEUTRON ACER TENDL-2021 LIBRARY; T=293.6K
Photon emission for (n,d)

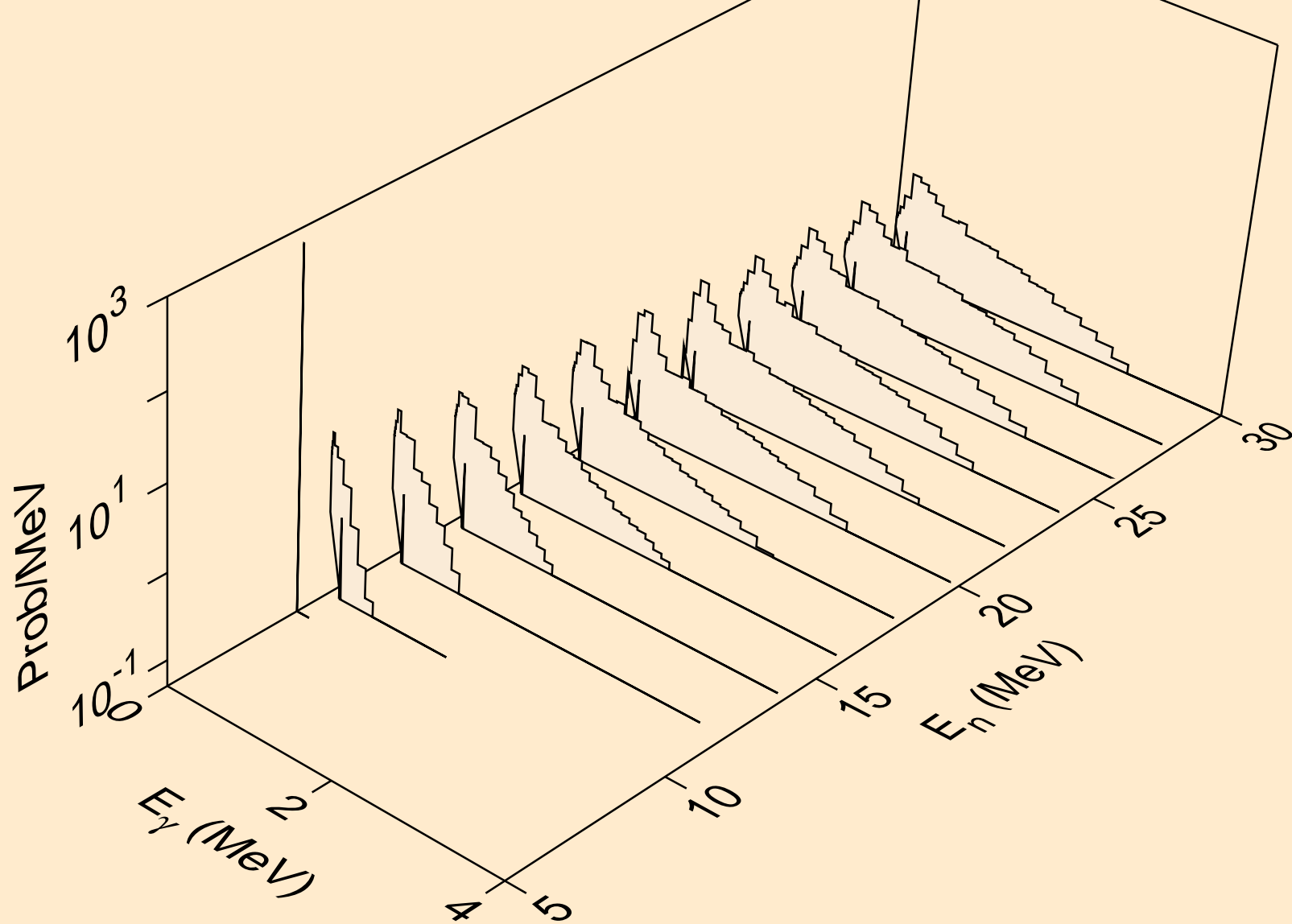

LU185 NEUTRON ACER TENDL-2021 LIBRARY; T=293.6K
Photon emission for (n,t)

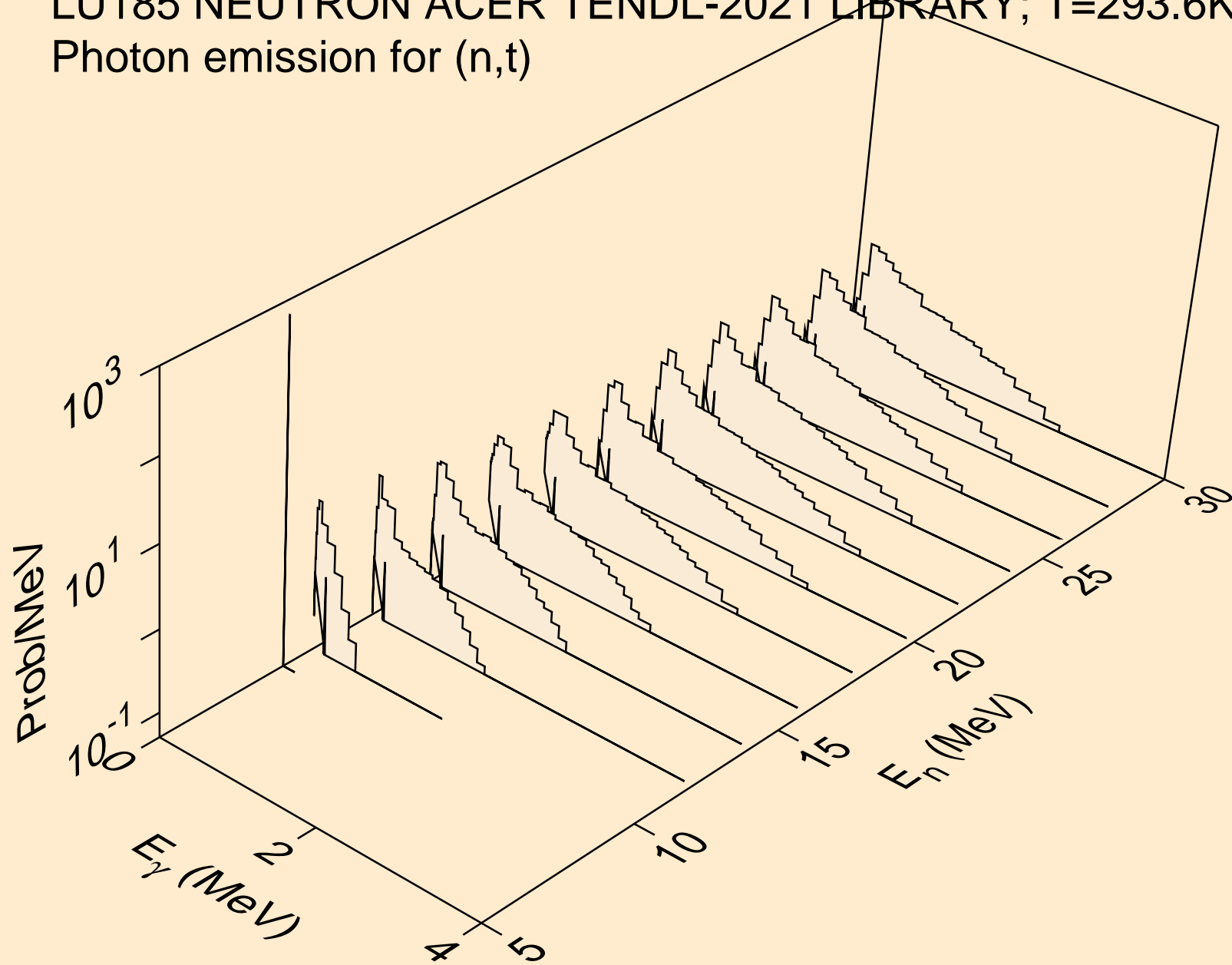

LU185 NEUTRON ACER TENDL-2021 LIBRARY; T=293.6K
Photon emission for (n,he3)

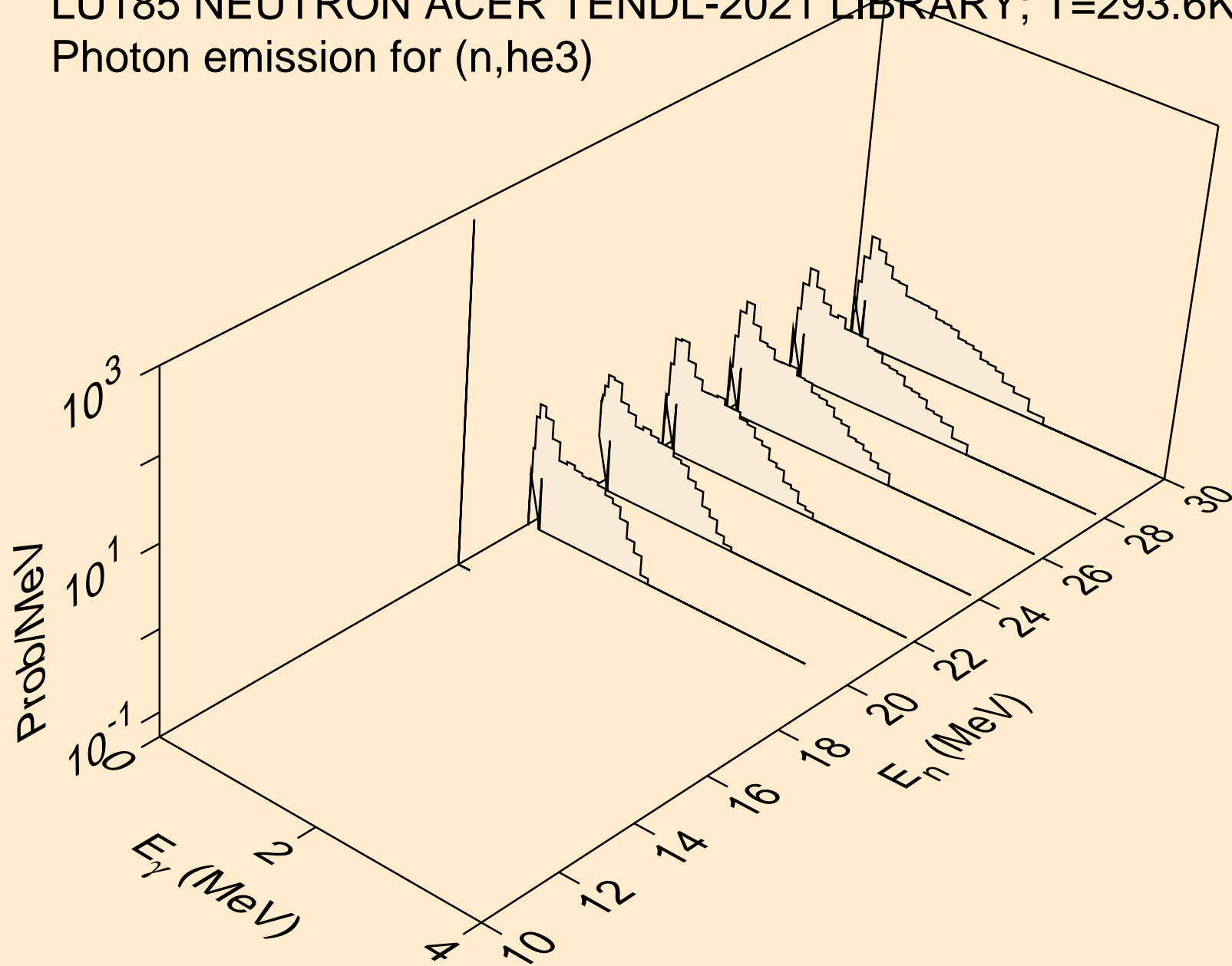

LU185 NEUTRON ACER TENDL-2021 LIBRARY; T=293.6K
Photon emission for (n,a)

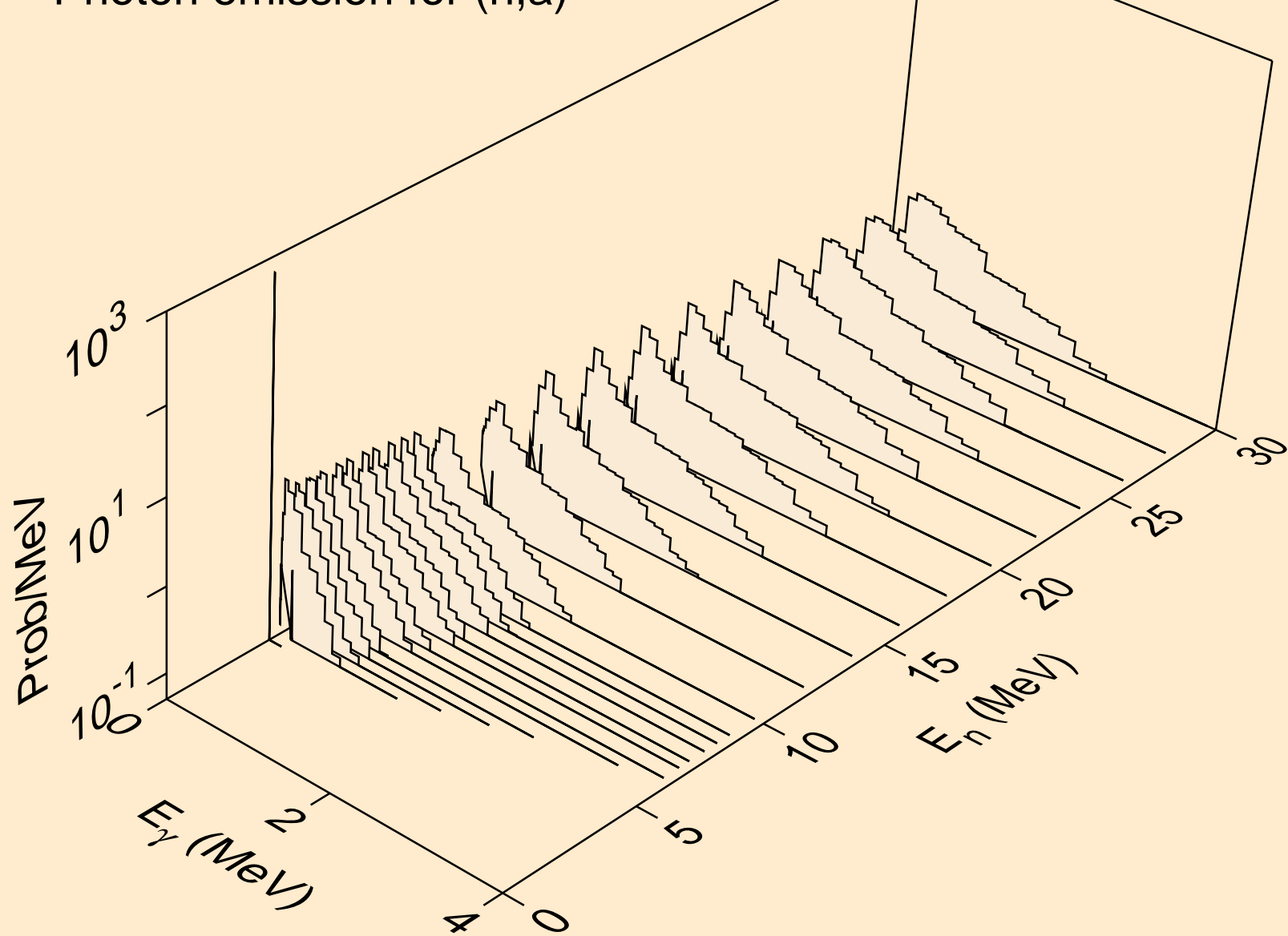

LU185 NEUTRON ACER TENDL-2021 LIBRARY; T=293.6K
thermal capture photon spectrum

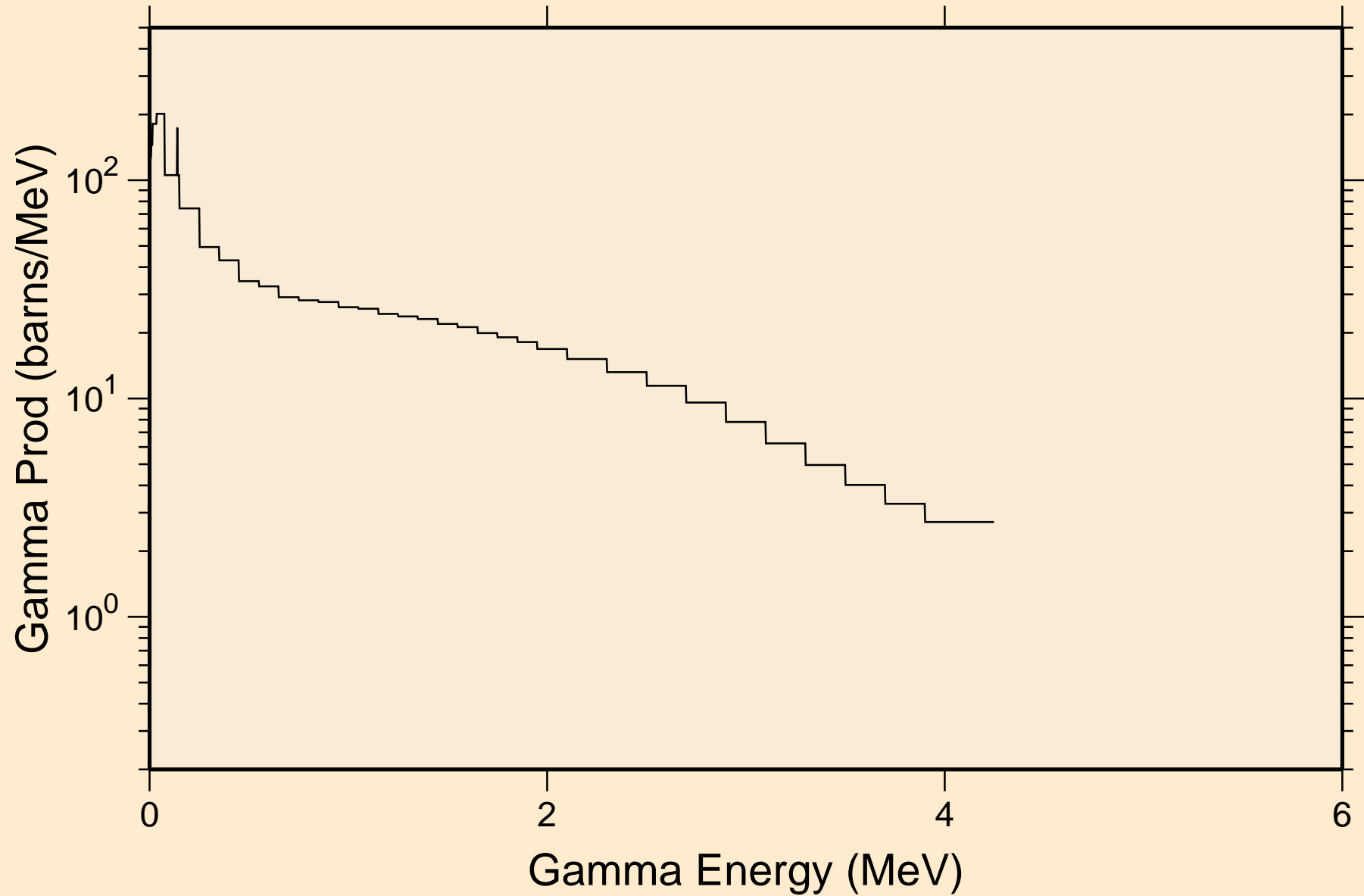

LU185 NEUTRON ACER TENDL-2021 LIBRARY; T=293.6K
14 MeV photon spectrum

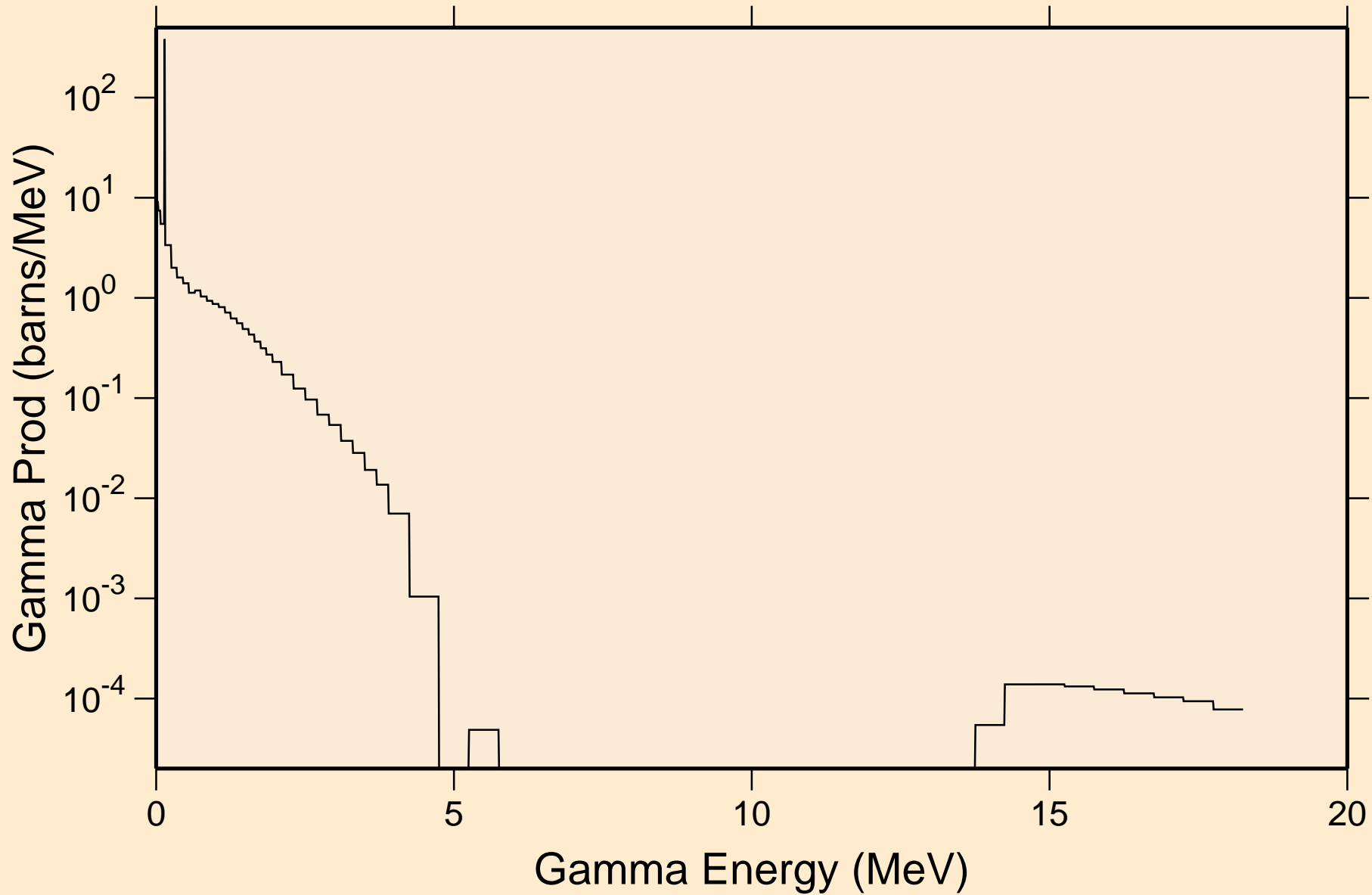

LU185 NEUTRON ACER TENDL-2021 LIBRARY; T=293.6K
Particle heating contributions

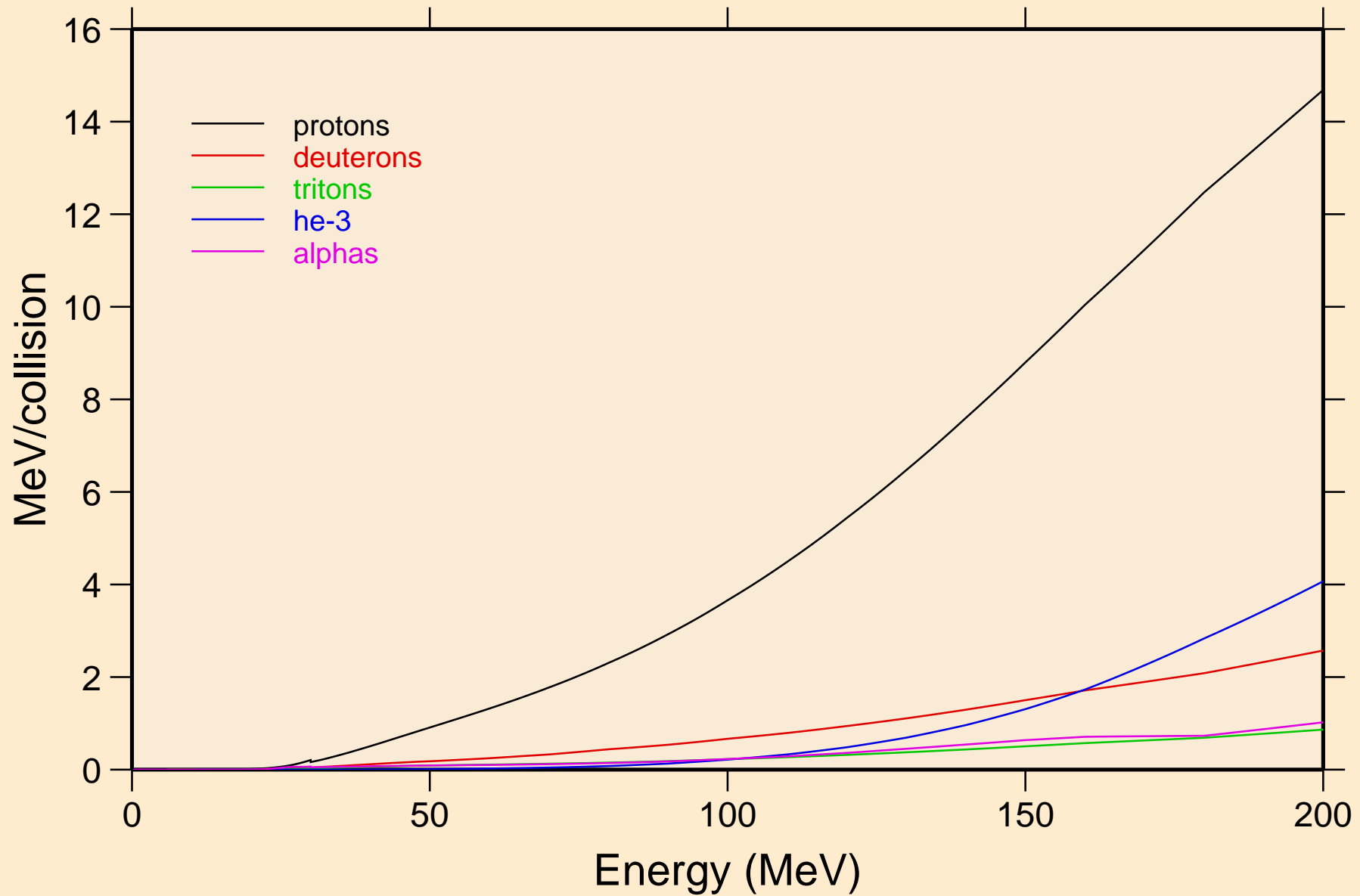

LU185 NEUTRON ACER TENDL-2021 LIBRARY; T=293.6K
Recoil Heating

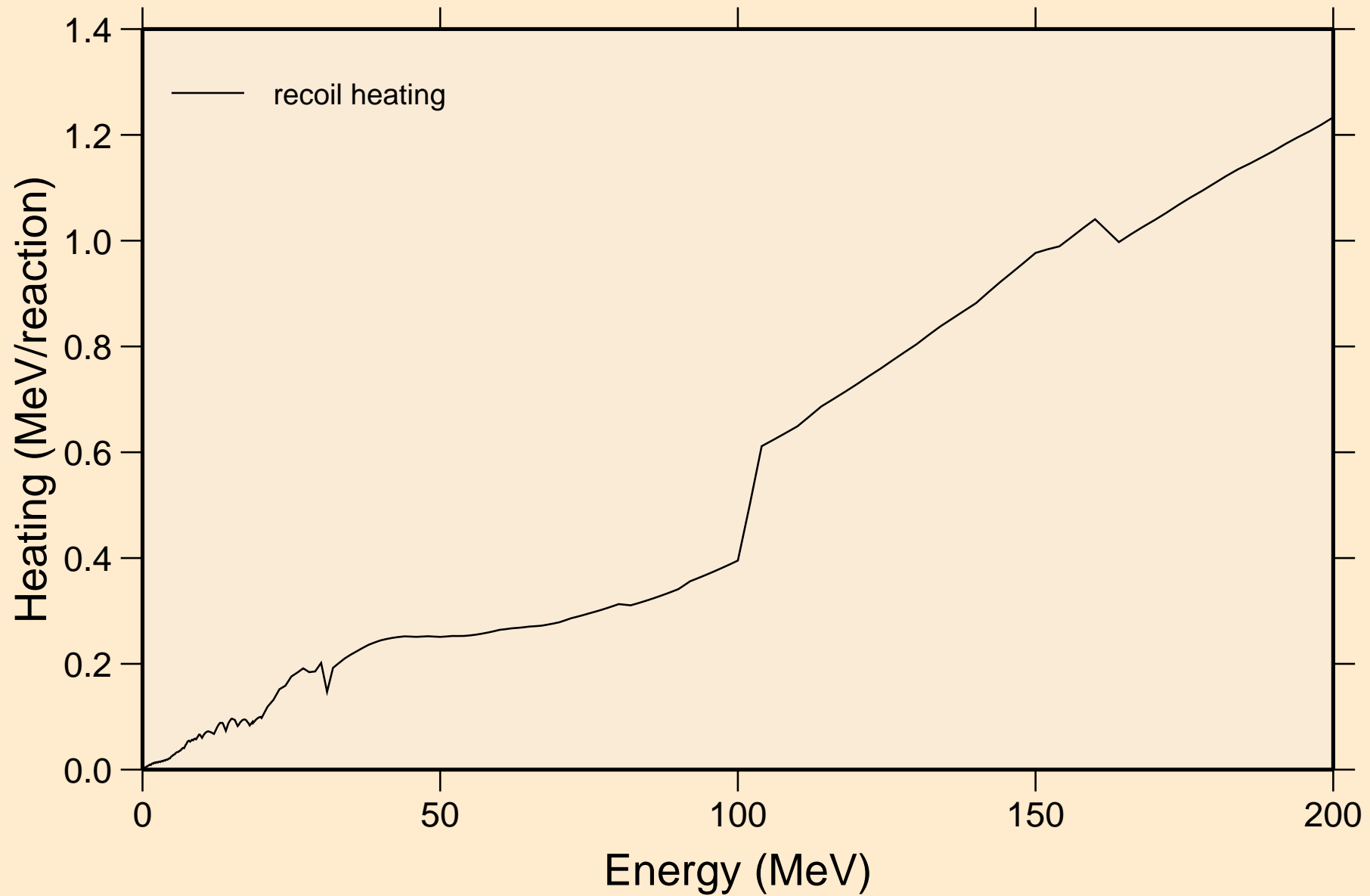

LU185 NEUTRON ACER TENDL-2021 LIBRARY; T=293.6K
Particle production cross sections

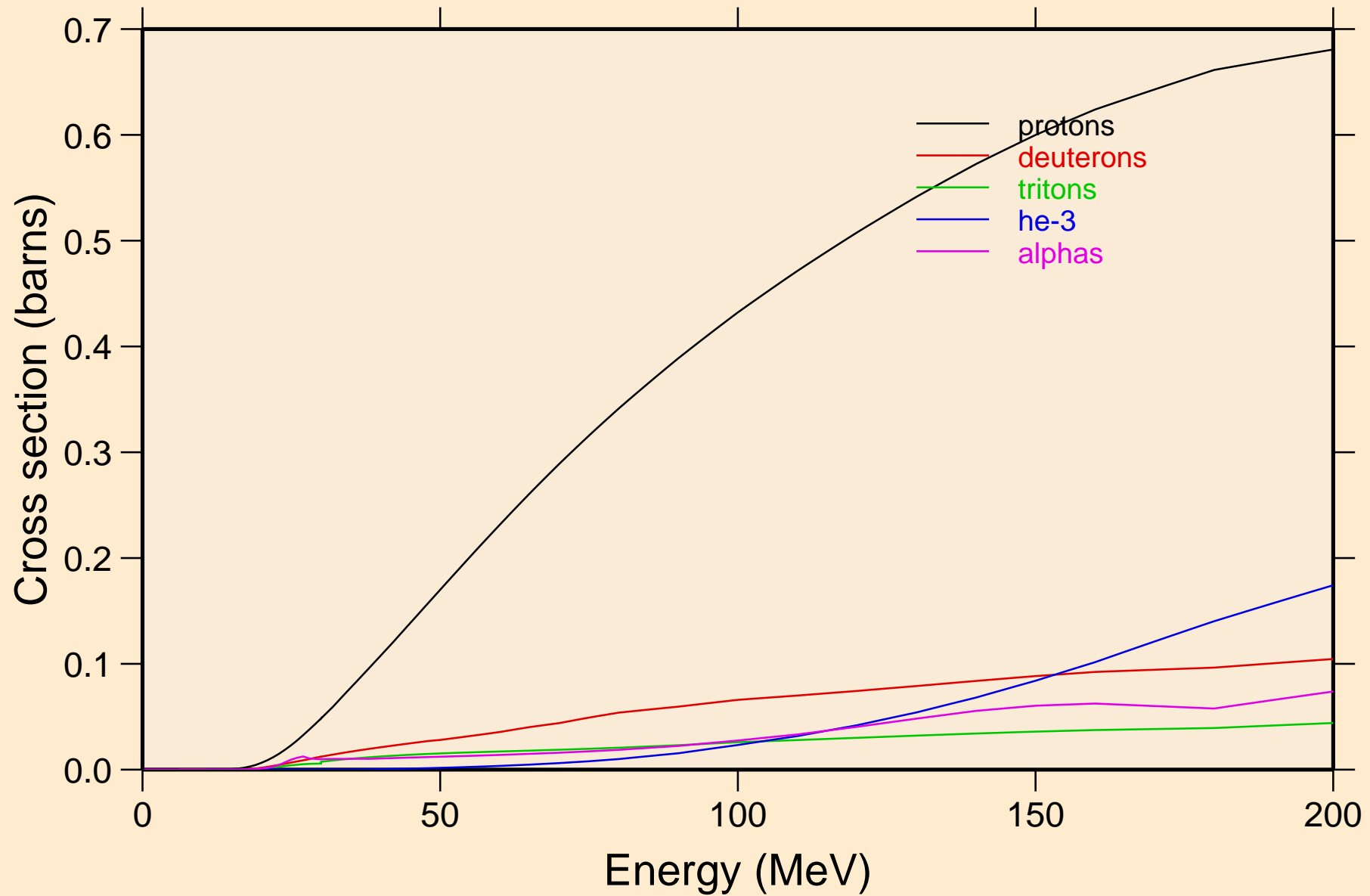

LU185 NEUTRON ACER TENDL-2021 LIBRARY; T=293.6K
protons from (n,x)

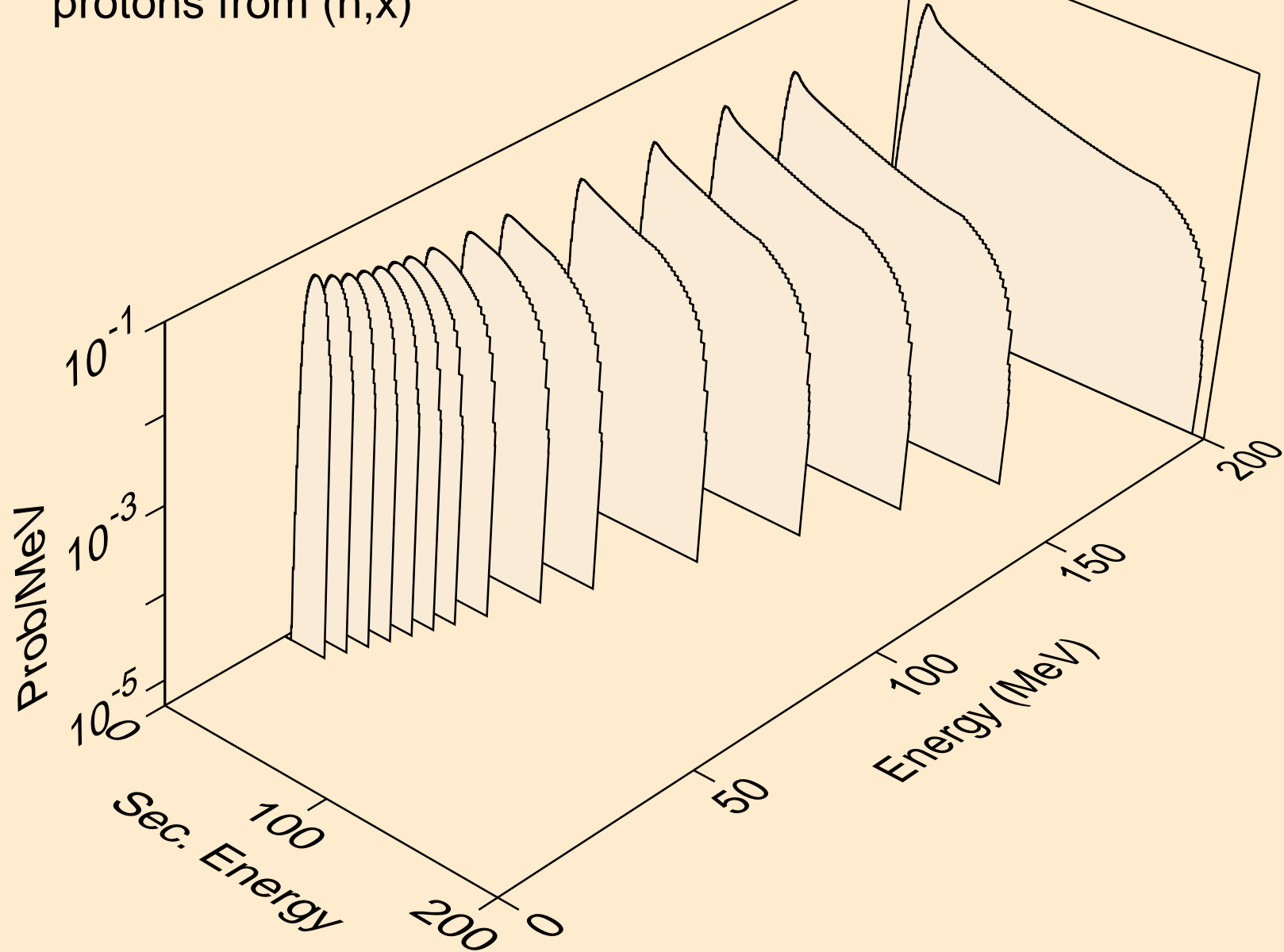

LU185 NEUTRON ACER TENDL-2021 LIBRARY; T=293.6K
protons from (n,n*)p

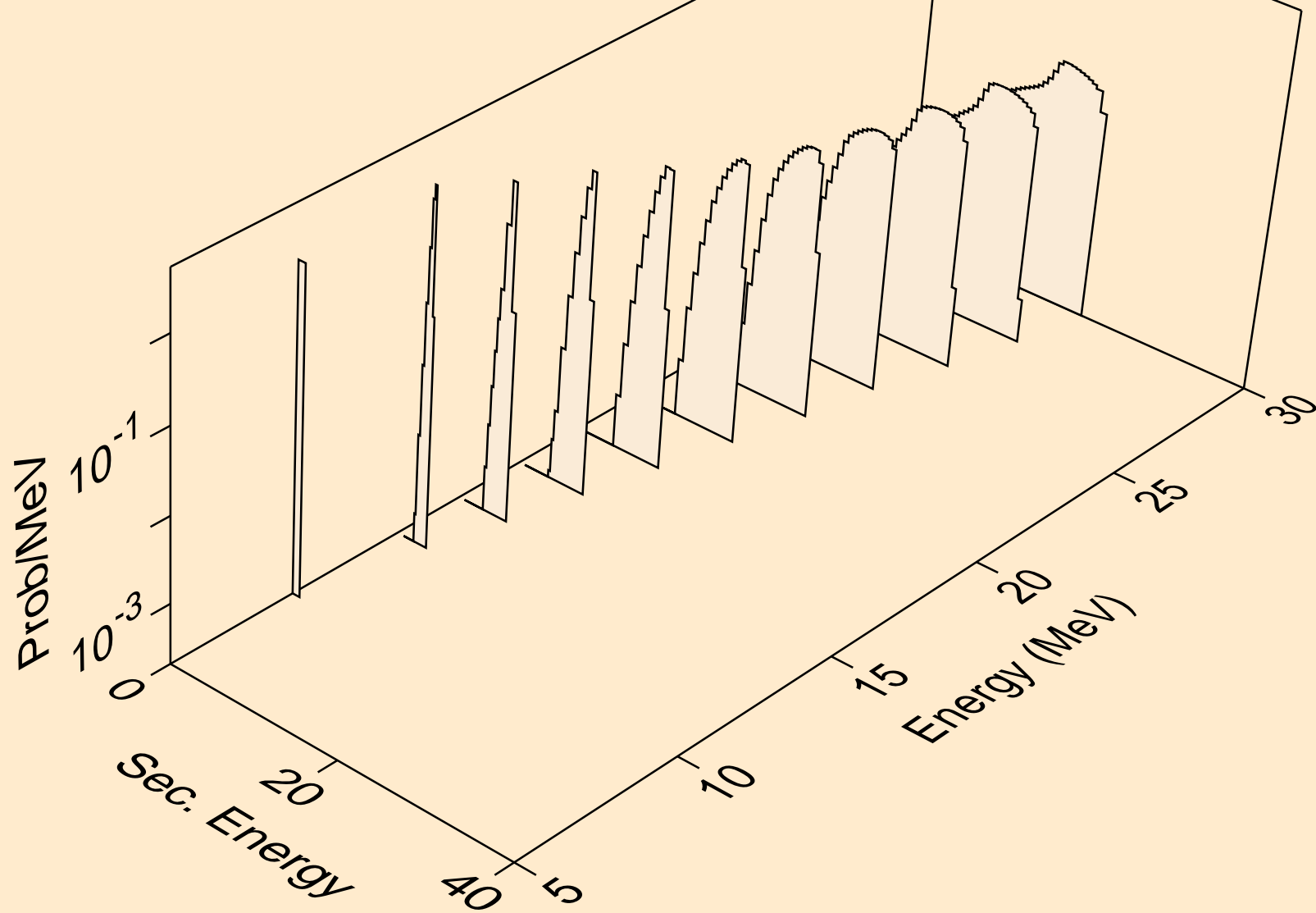

LU185 NEUTRON ACER TENDL-2021 LIBRARY; T=293.6K
protons from (n,2np)

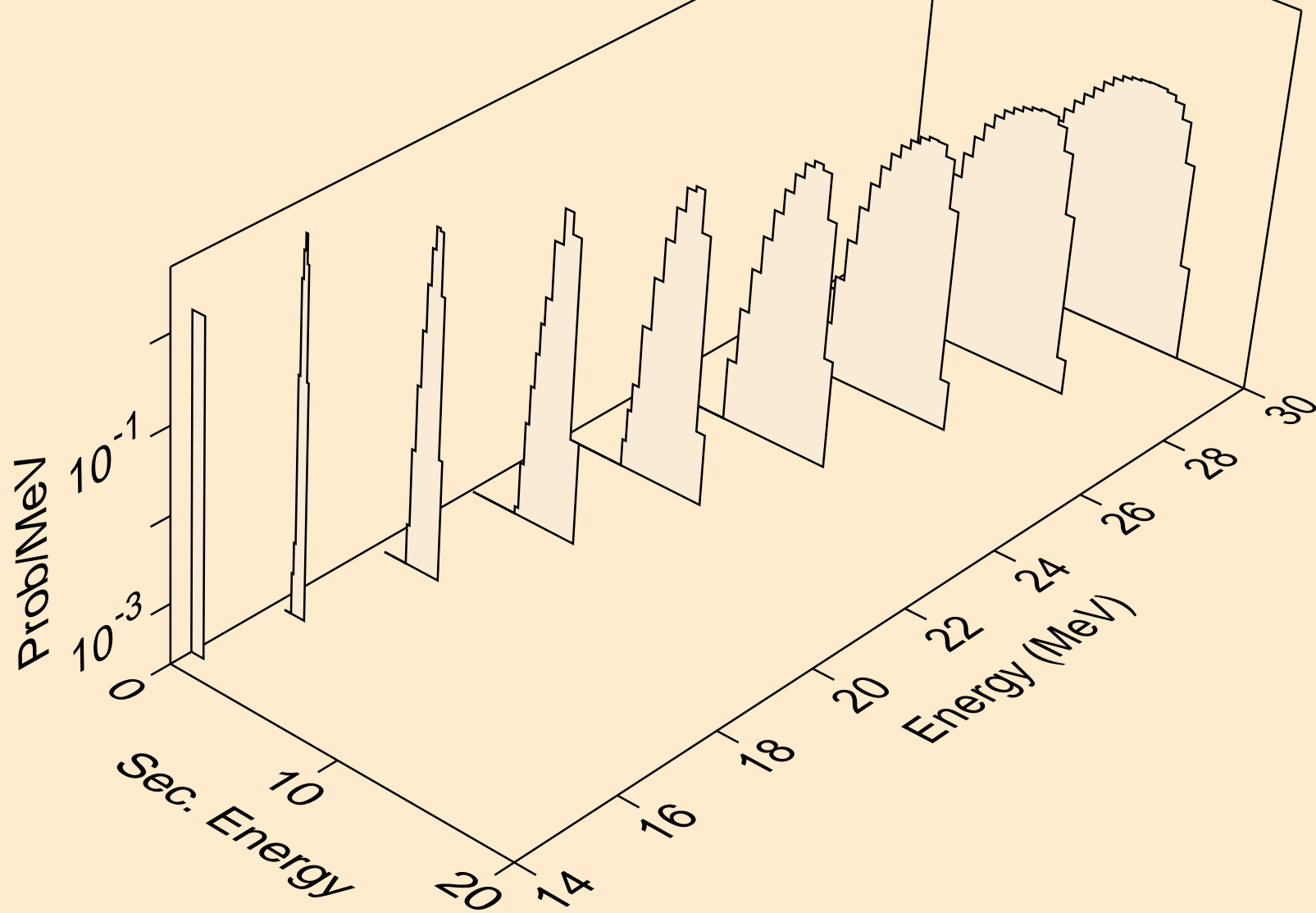

LU185 NEUTRON ACER TENDL-2021 LIBRARY; T=293.6K
protons from (n,3np)

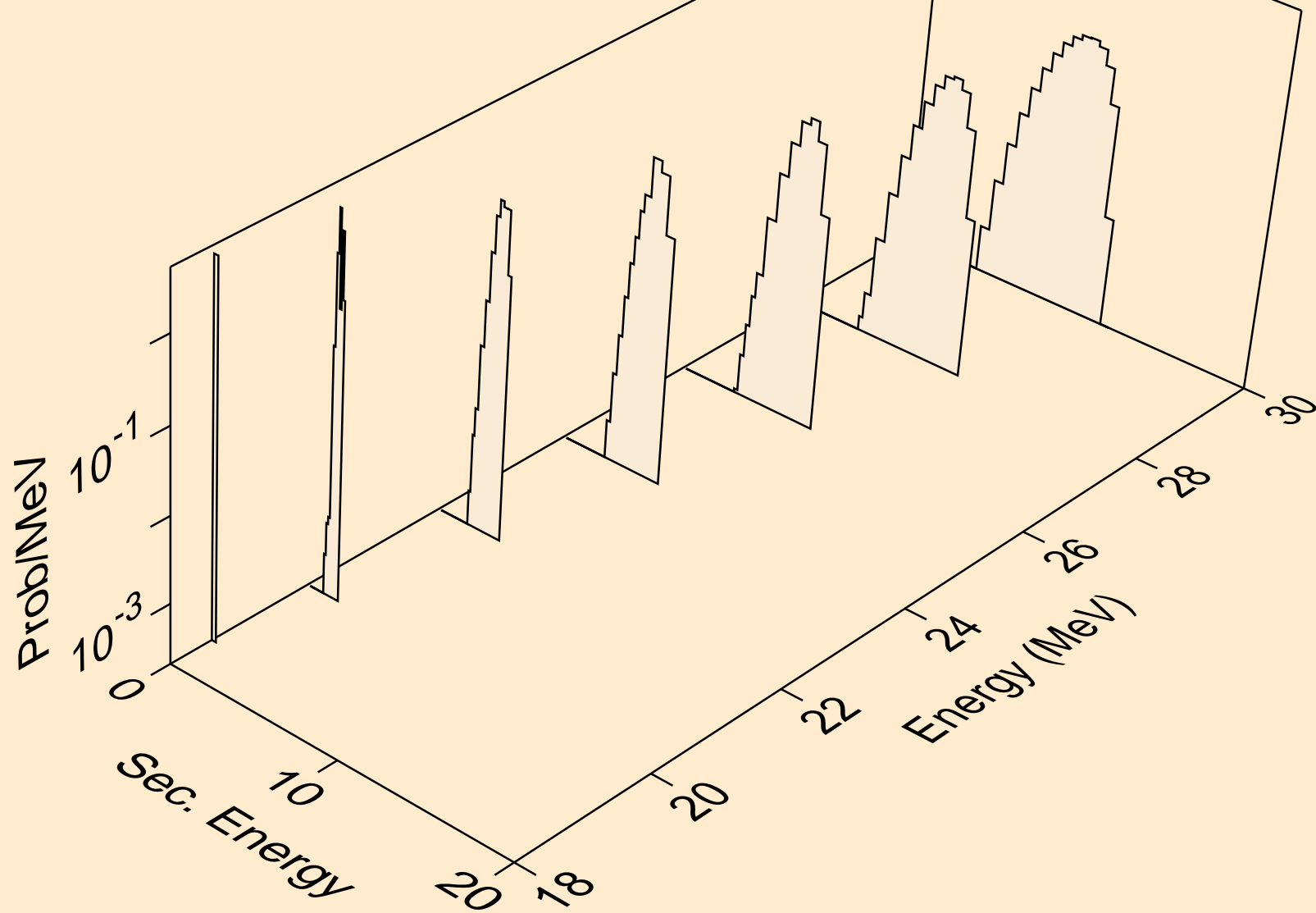

LU185 NEUTRON ACER TENDL-2021 LIBRARY; T=293.6K
protons from (n,p)

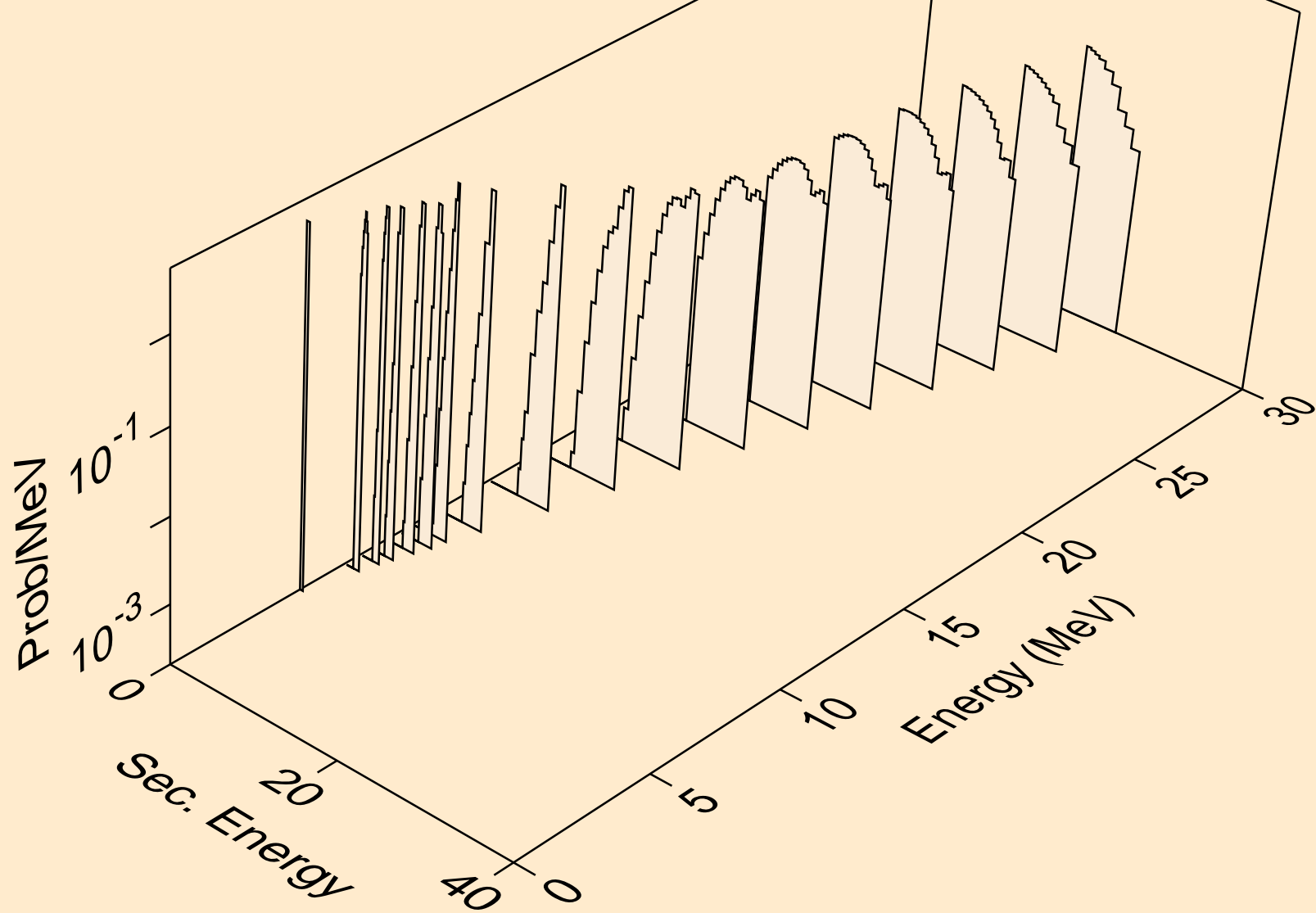

LU185 NEUTRON ACER TENDL-2021 LIBRARY; T=293.6K
deuterons from (n,x)

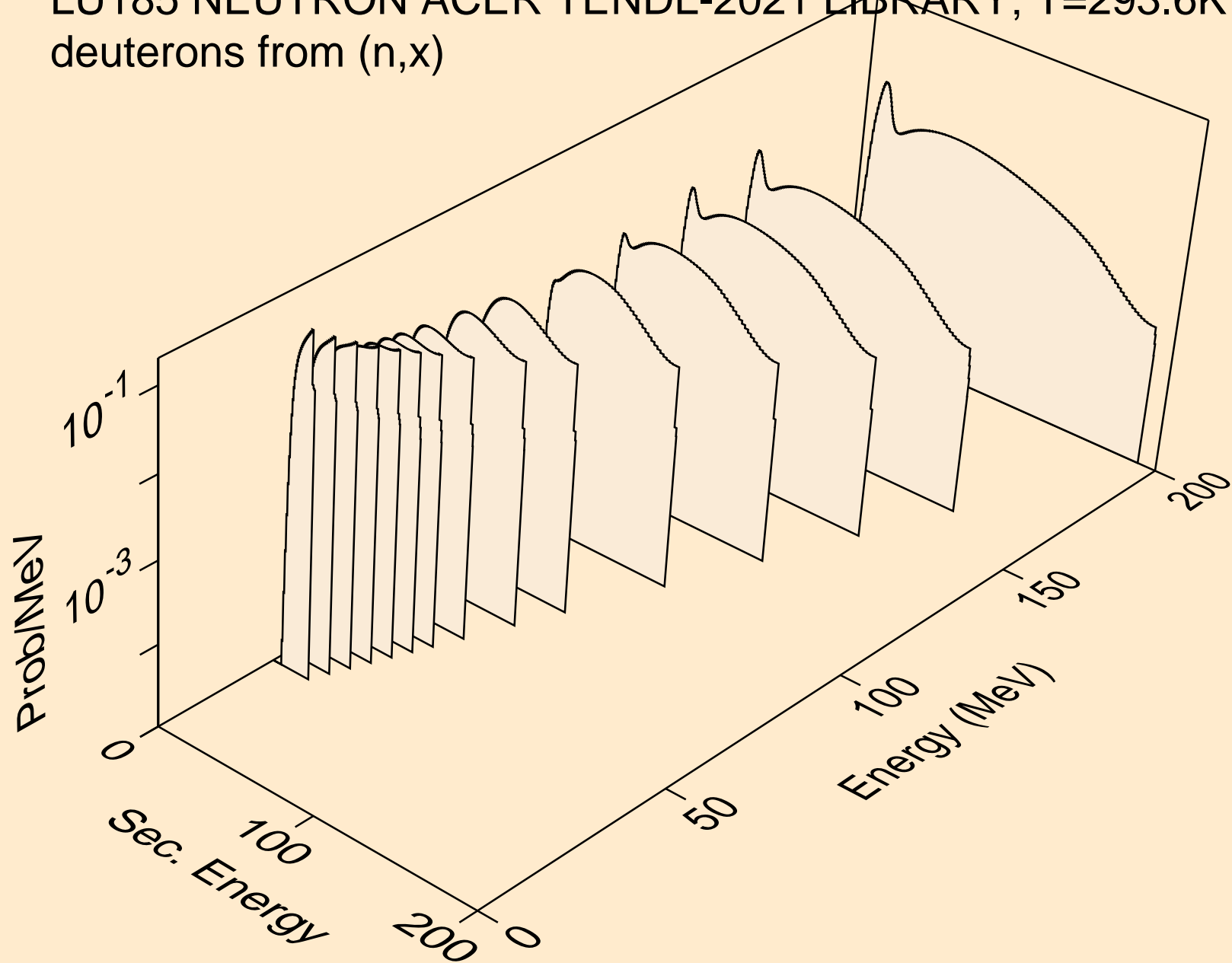

LU185 NEUTRON ACER TENDL-2021 LIBRARY; T=293.6K
deuterons from (n,2nd)

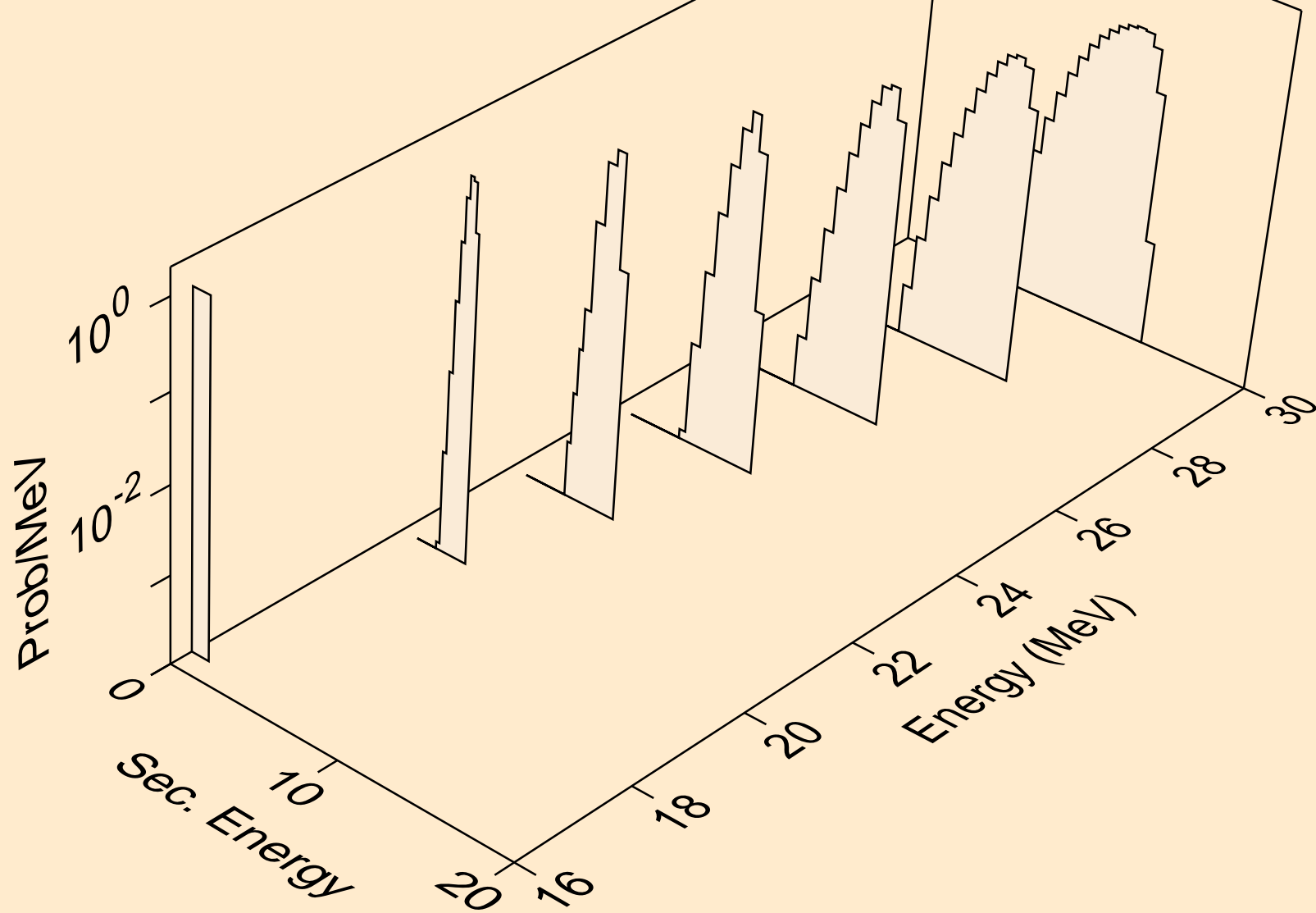

LU185 NEUTRON ACER TENDL-2021 LIBRARY; T=293.6K
deuterons from (n,n*)d

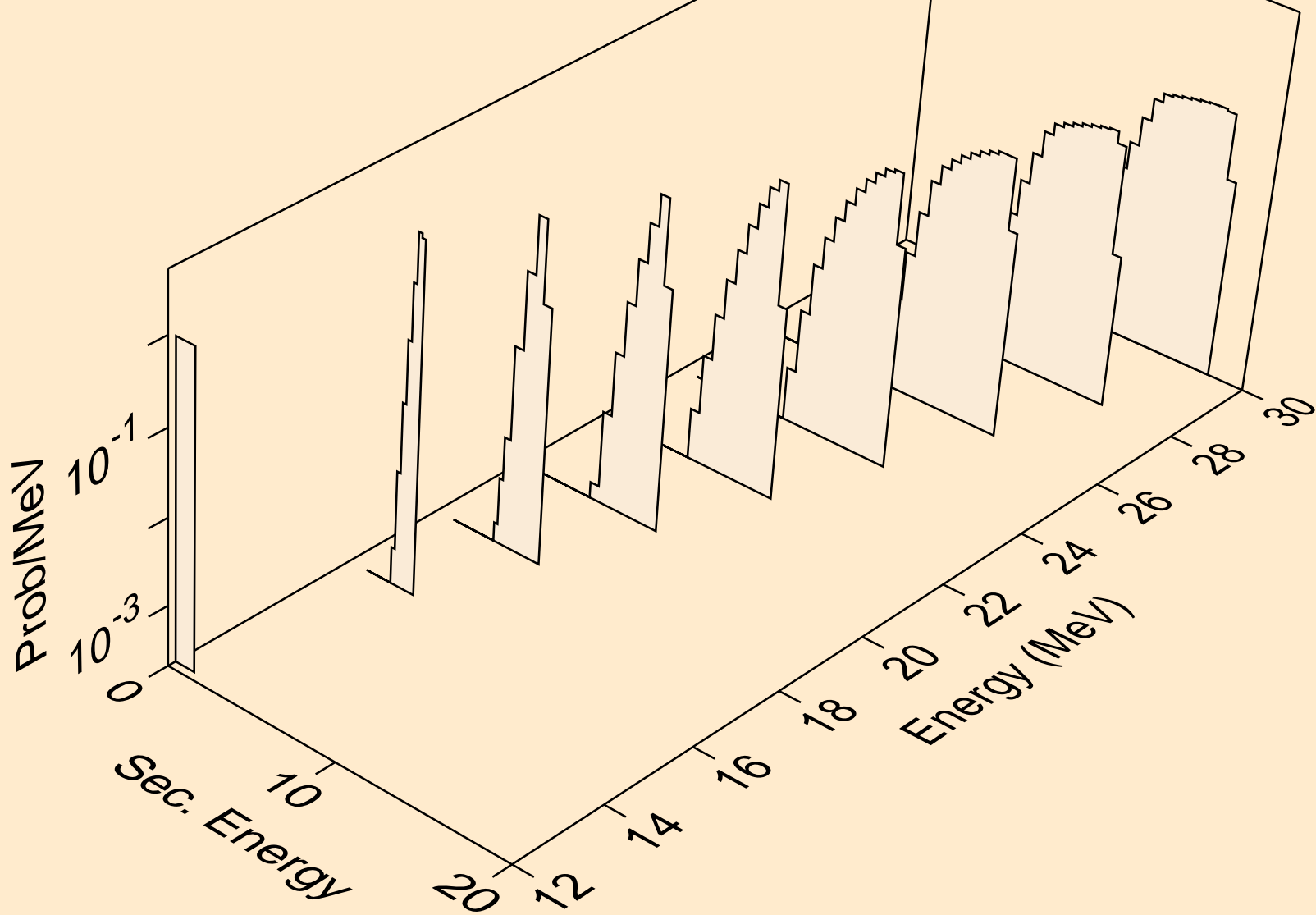

LU185 NEUTRON ACER TENDL-2021 LIBRARY; T=293.6K
deuterons from (n,d)

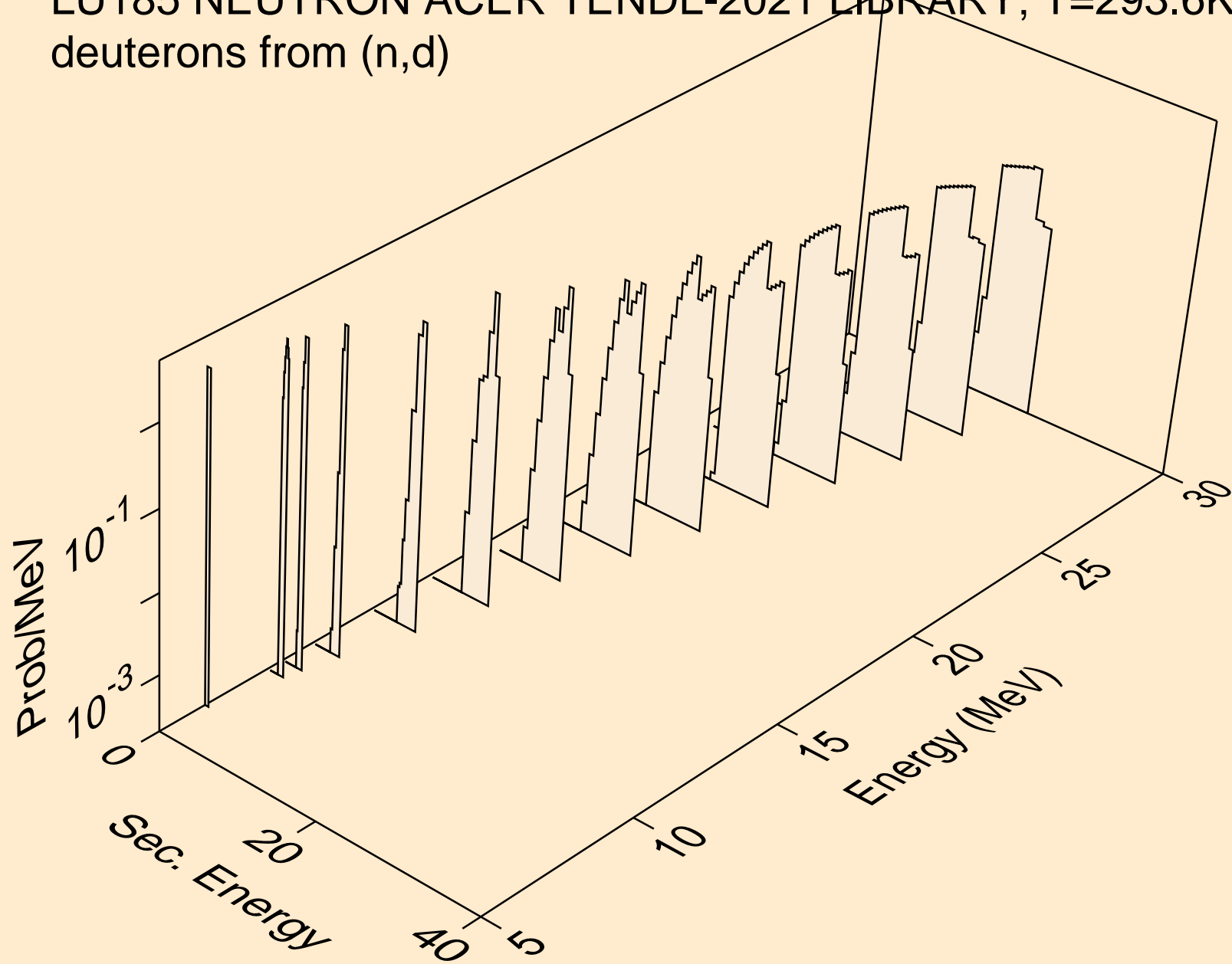

LU185 NEUTRON ACER TENDL-2021 LIBRARY; T=293.6K
tritons from (n,x)

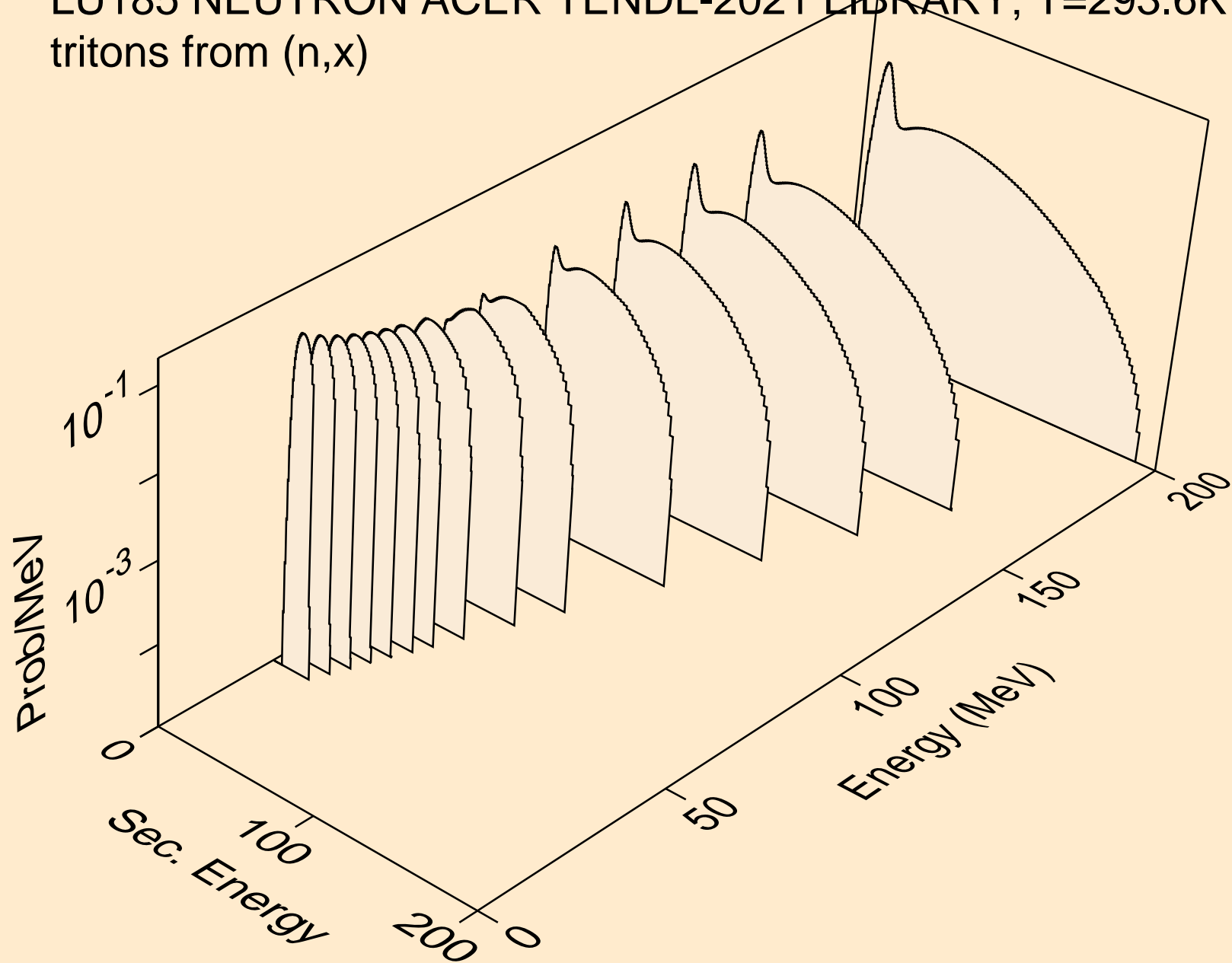

LU185 NEUTRON ACER TENDL-2021 LIBRARY; T=293.6K
tritons from (n,n*)t

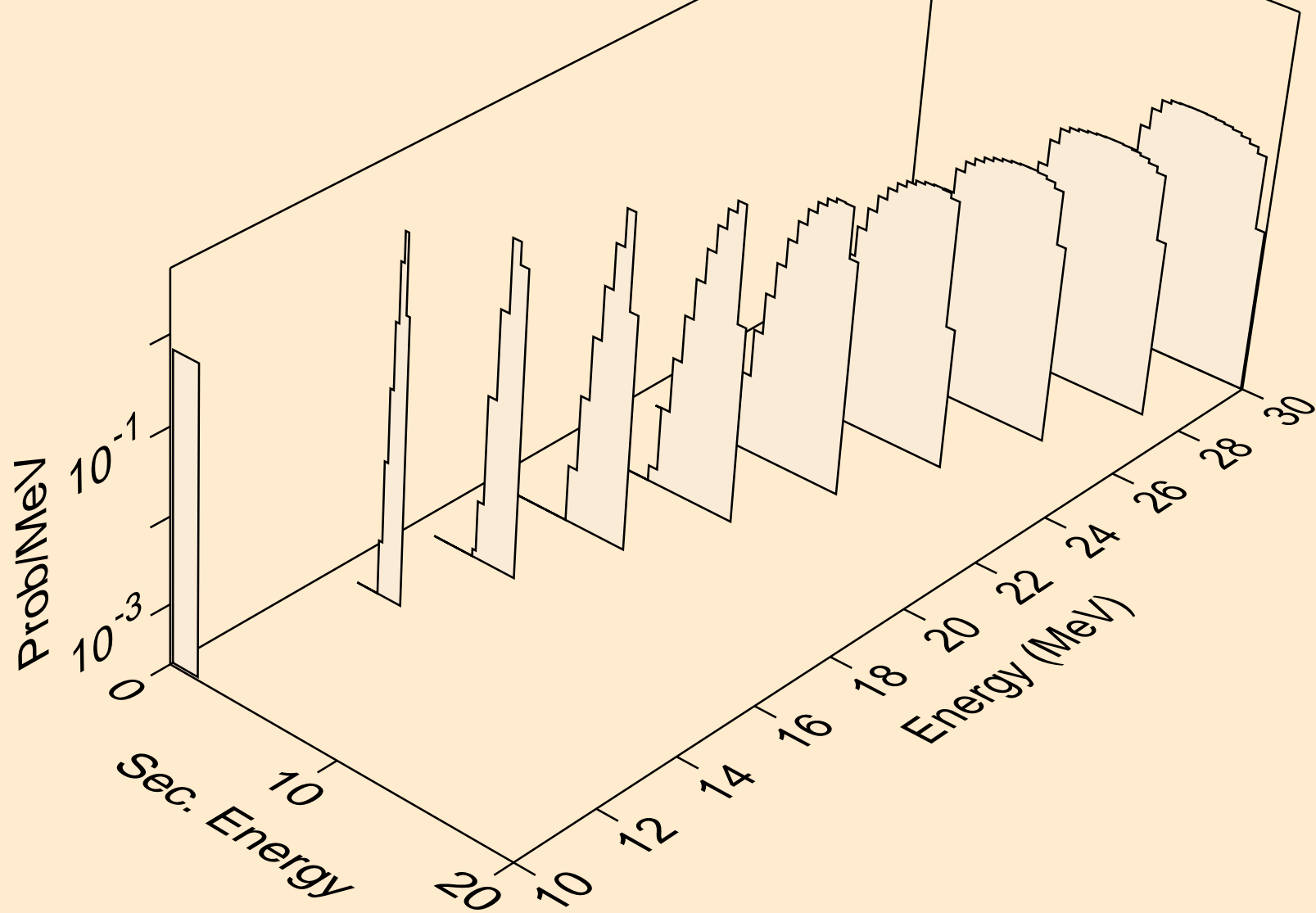

LU185 NEUTRON ACER TENDL-2021 LIBRARY; T=293.6K
tritons from (n,t)

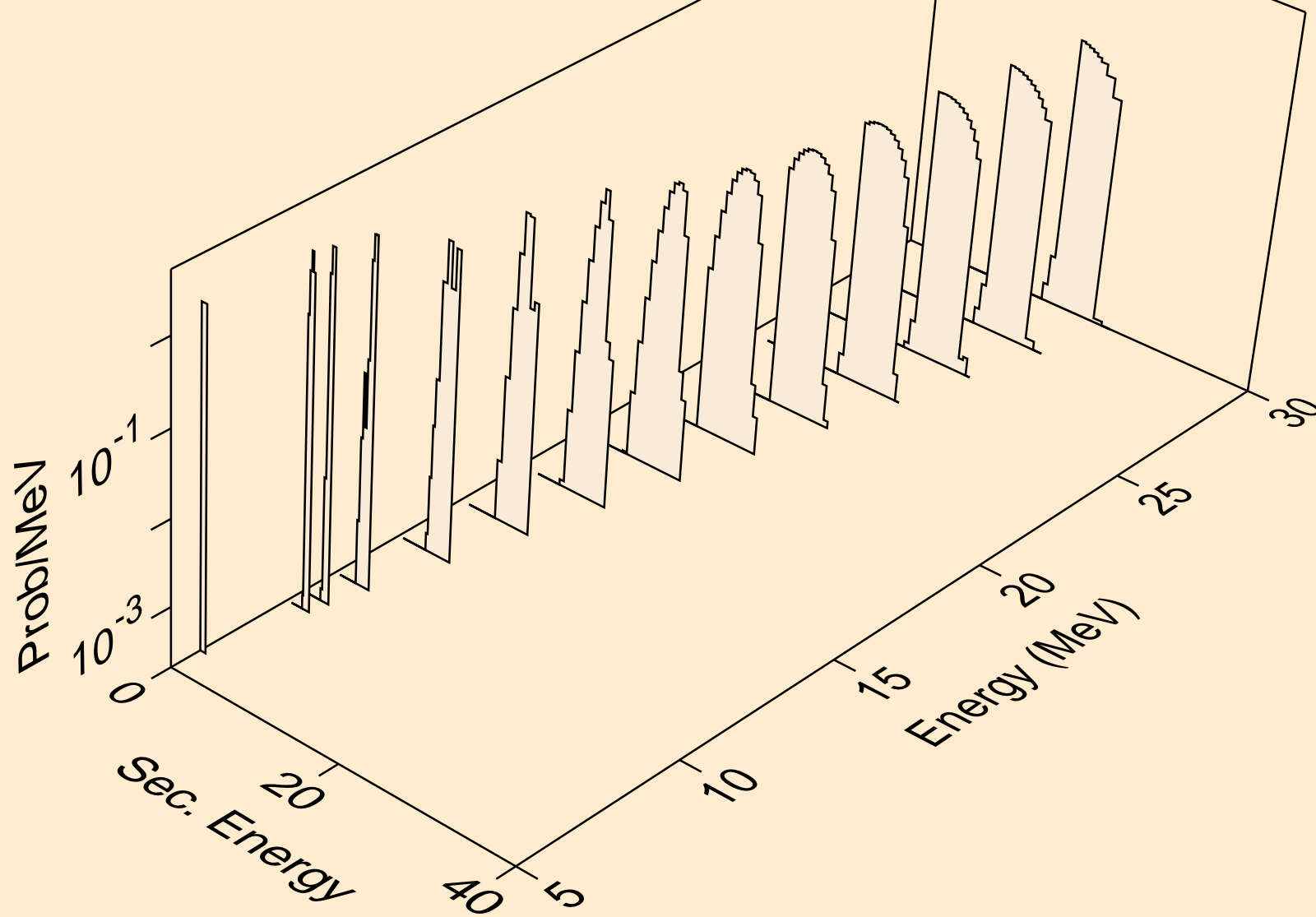

LU185 NEUTRON ACER TENDL-2021 LIBRARY; T=293.6K
he3s from (n,x)

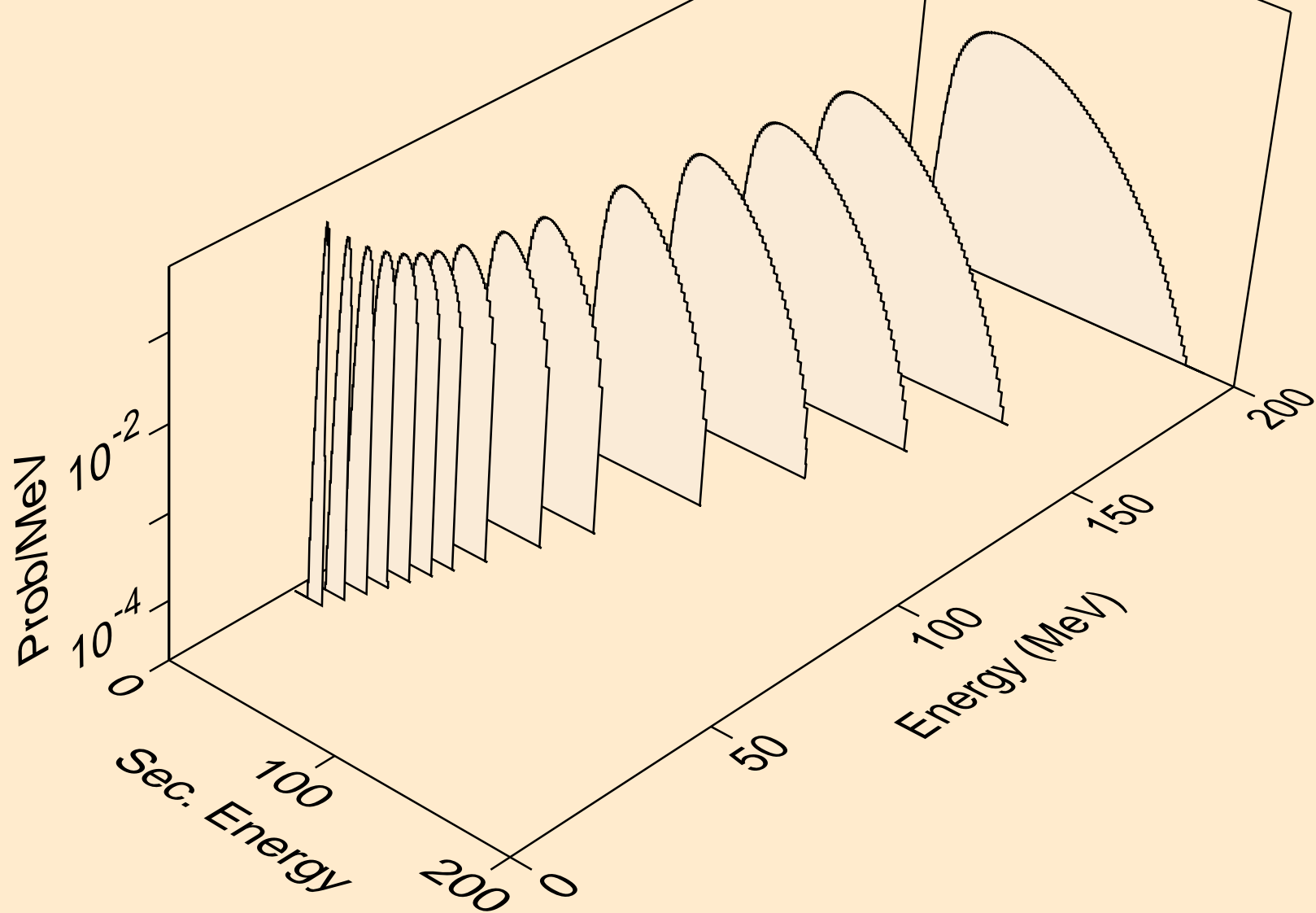

LU185 NEUTRON ACER TENDL-2021 LIBRARY; T=293.6K
he3s from (n,n*)he3

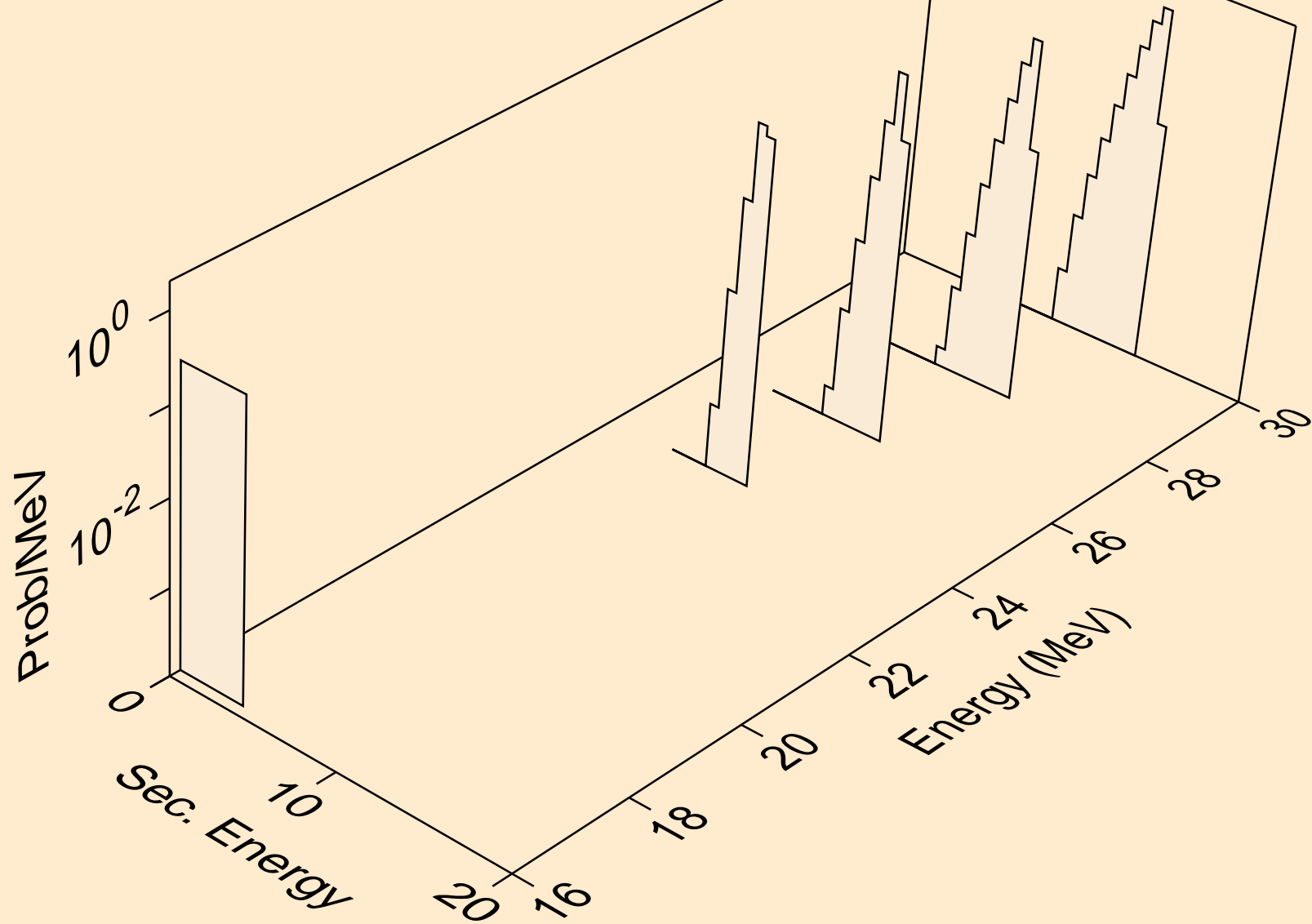

LU185 NEUTRON ACER TENDL-2021 LIBRARY; T=293.6K
he3s from (n,he3)

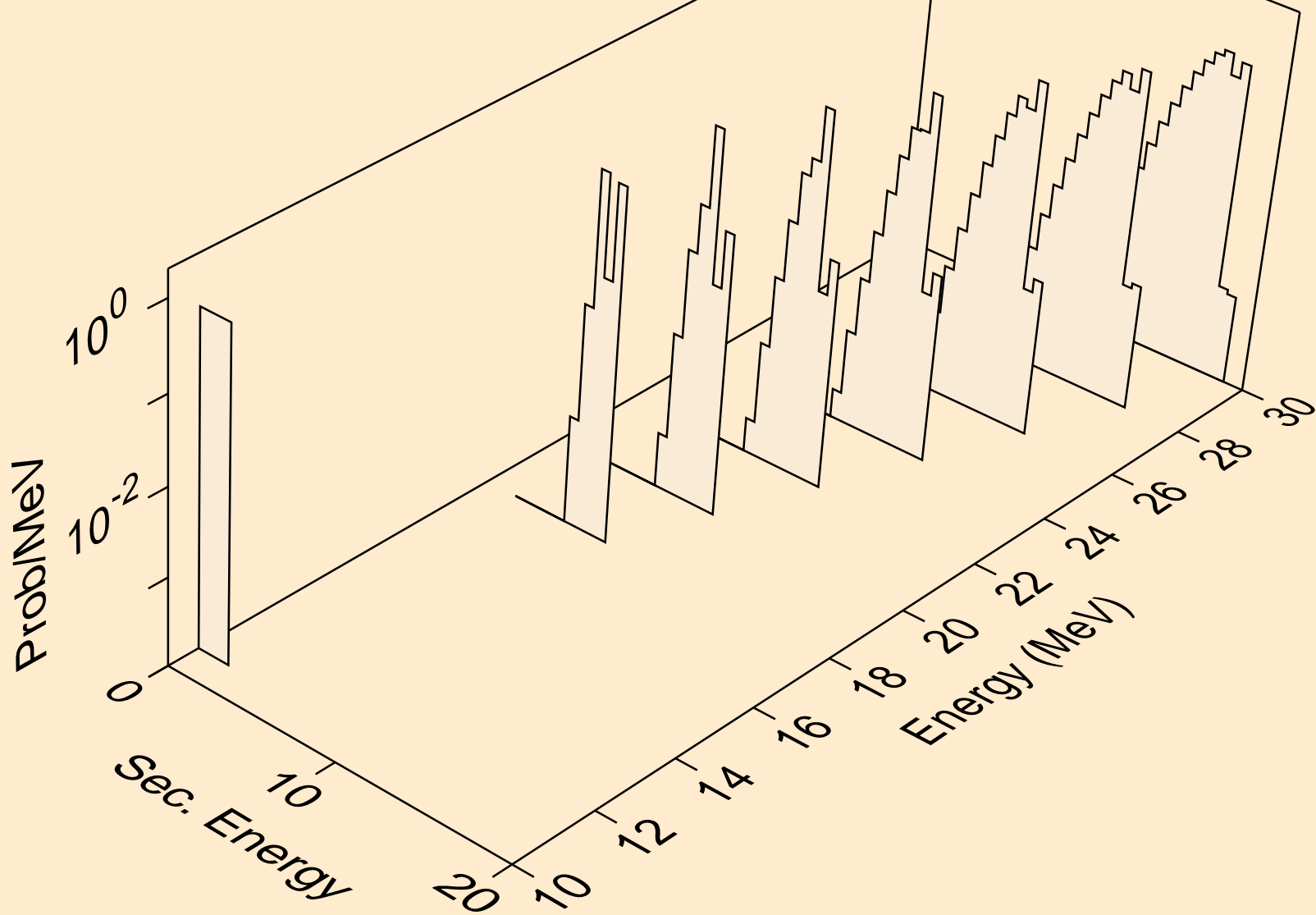

LU185 NEUTRON ACER TENDL-2021 LIBRARY; T=293.6K
alphas from (n,x)

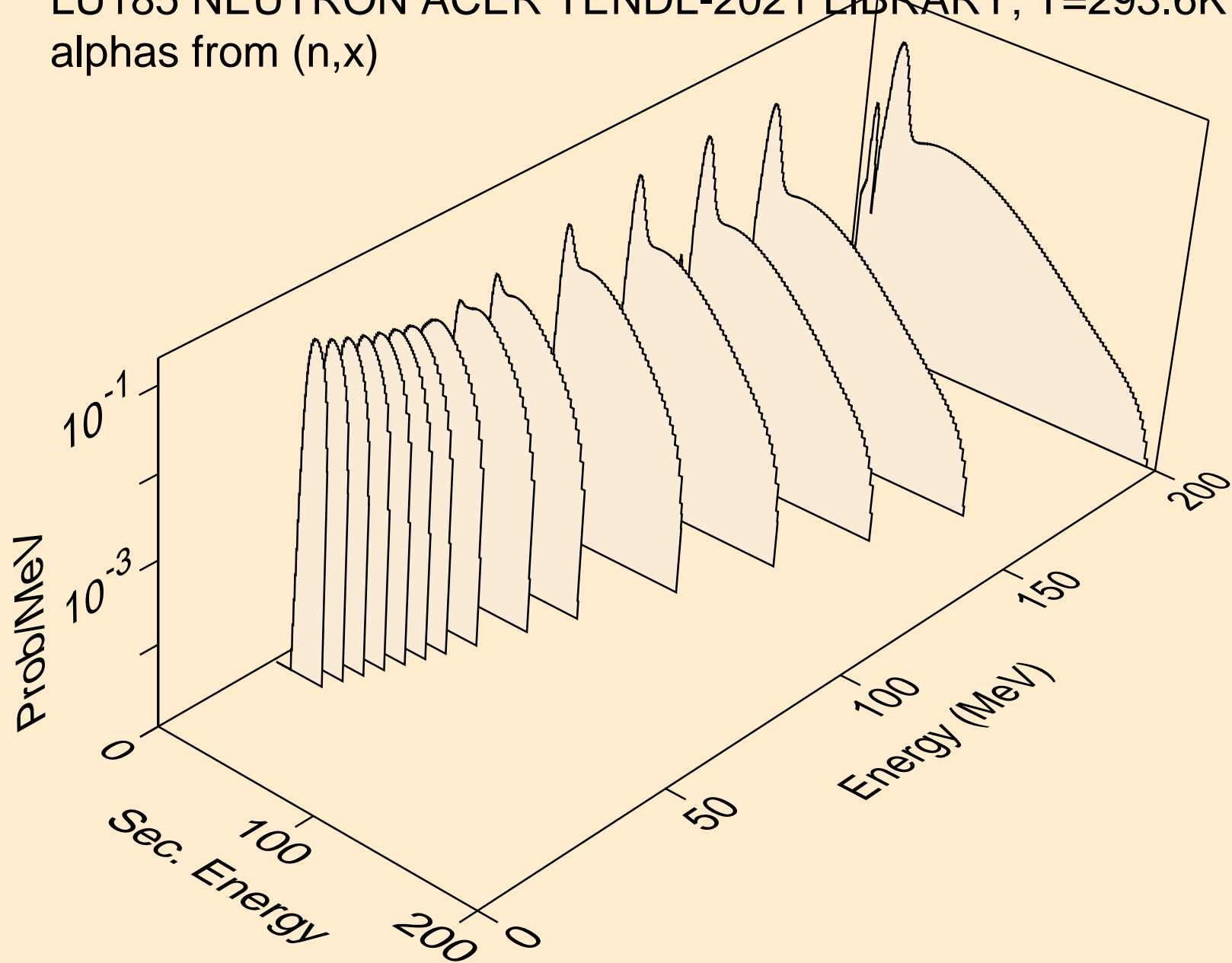

LU185 NEUTRON ACER TENDL-2021 LIBRARY; T=293.6K
alphas from (n,n*)a

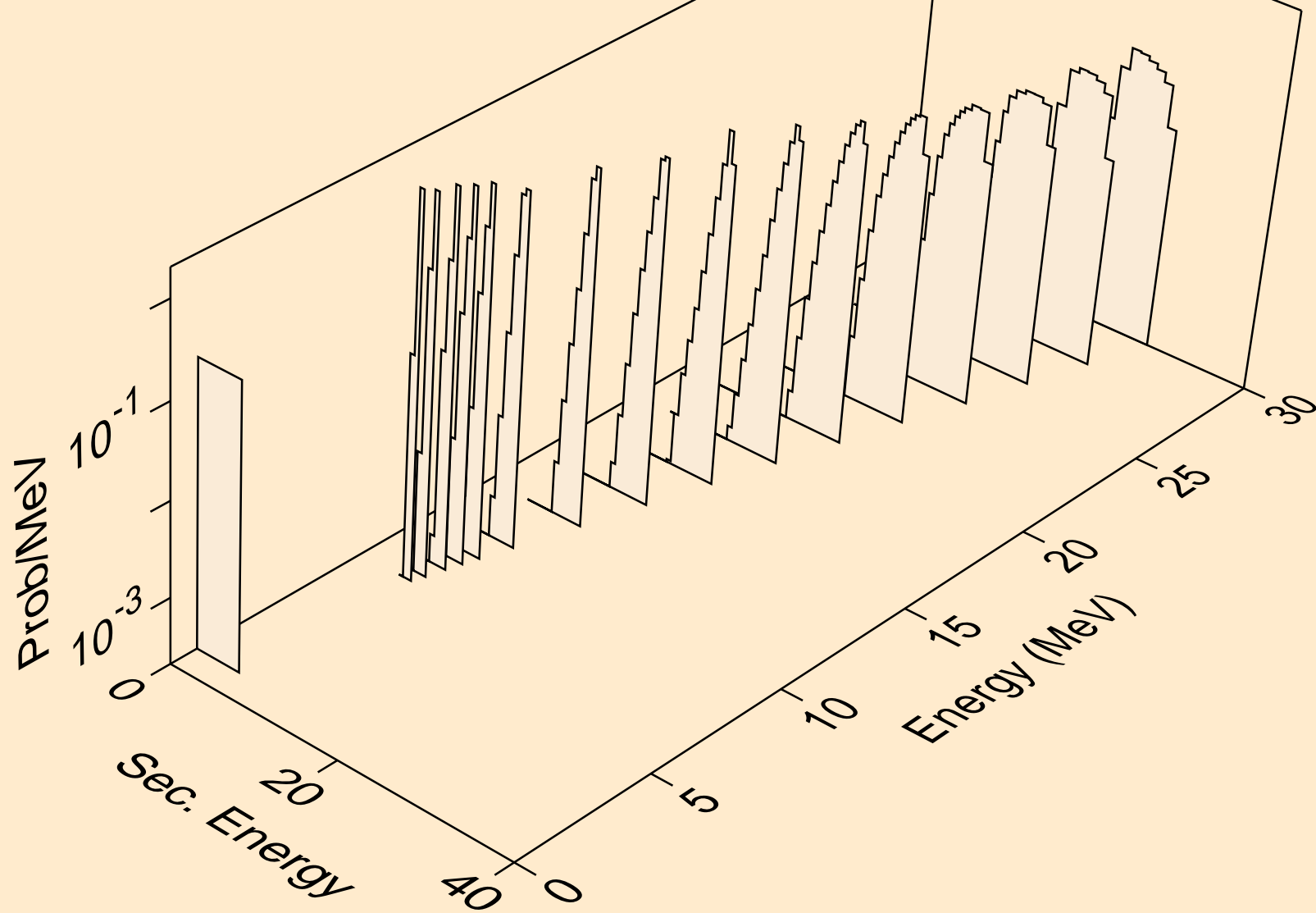

LU185 NEUTRON ACER TENDL-2021 LIBRARY; T=293.6K
alphas from (n,2n)a

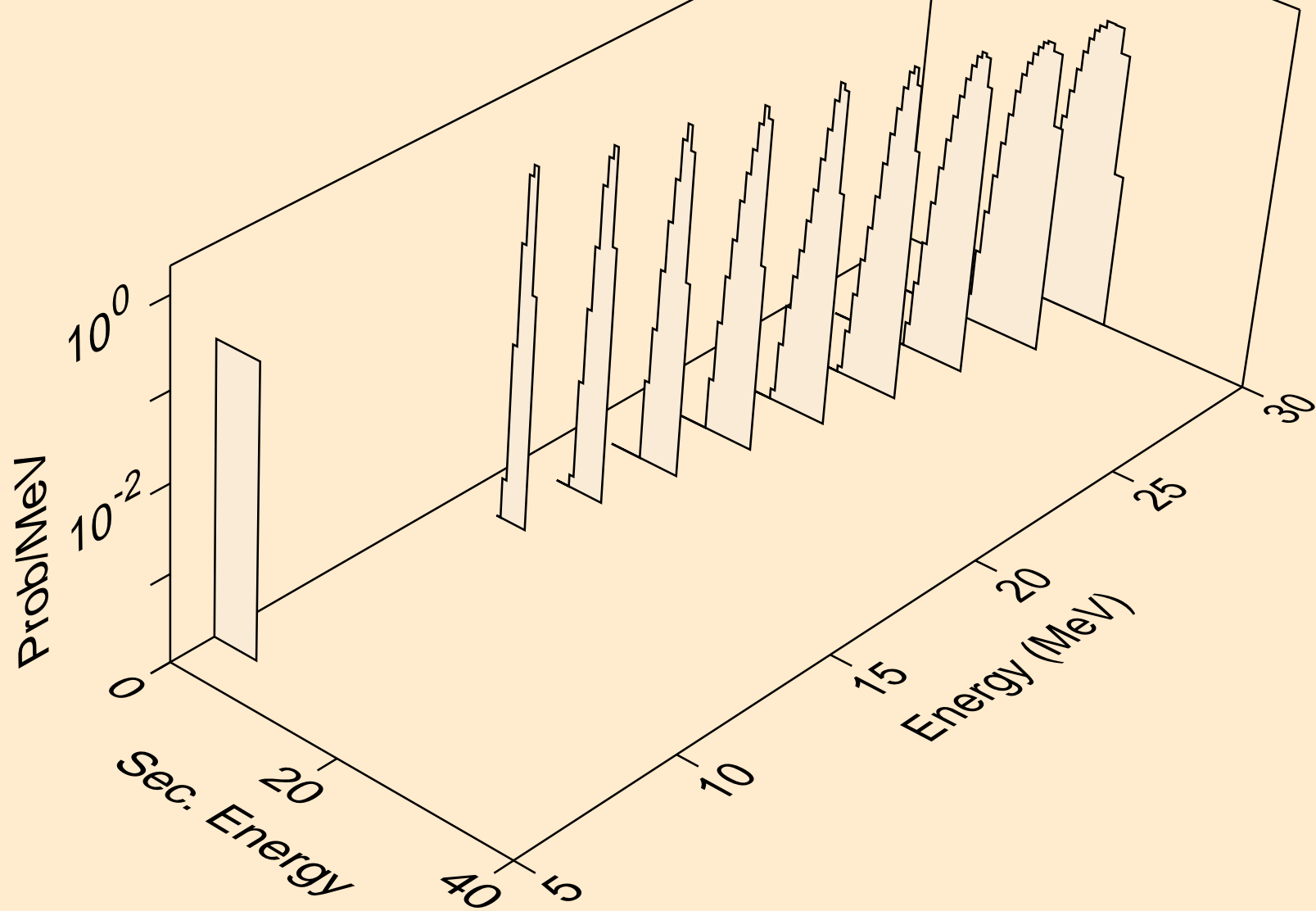

LU185 NEUTRON ACER TENDL-2021 LIBRARY; T=293.6K
alphas from (n,3n)a

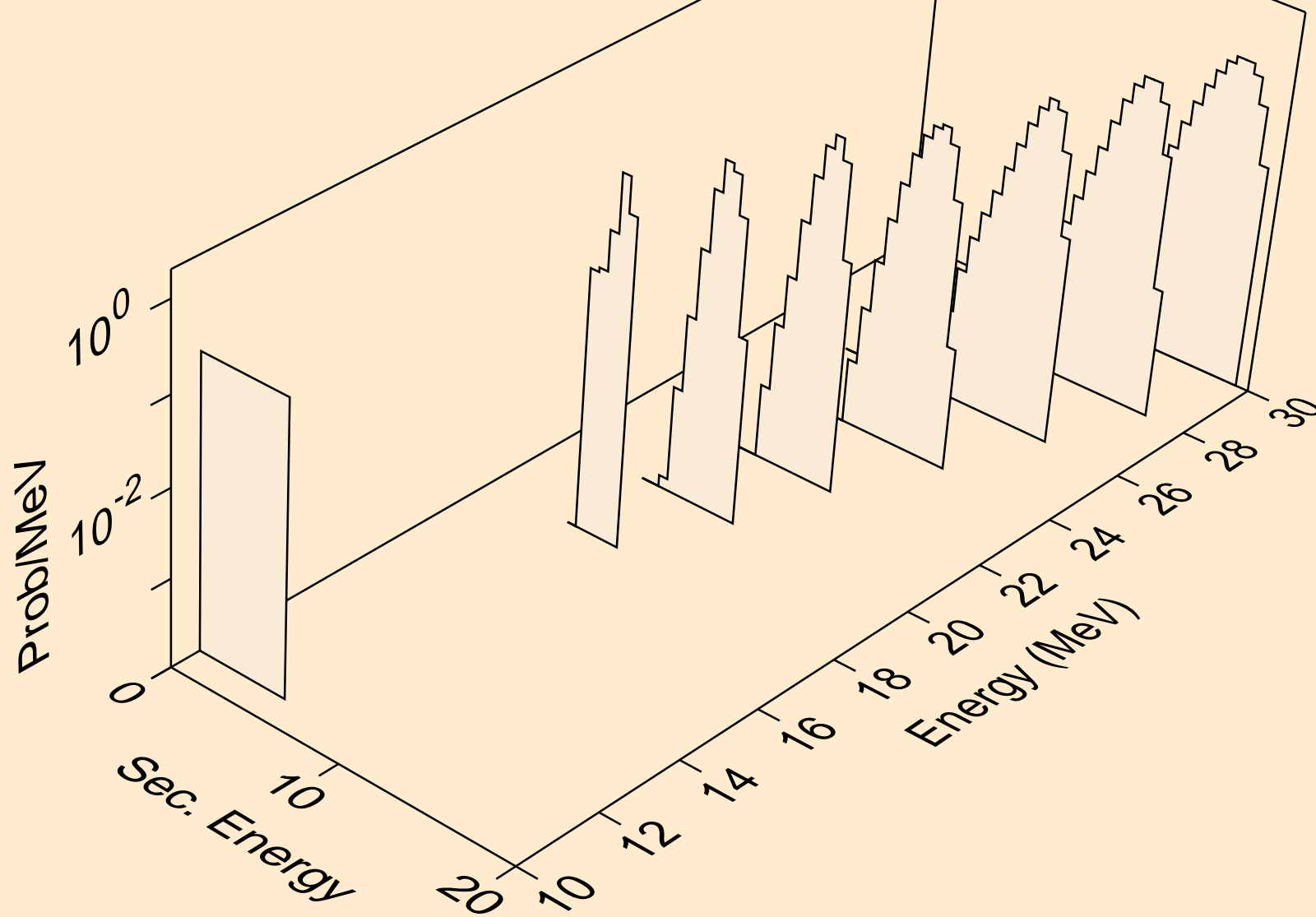

LU185 NEUTRON ACER TENDL-2021 LIBRARY; T=293.6K
alphas from (n,a)

