

MD254M NEUTRON ACER TENDL-2021 LIBRARY; T=293.6K

Principal cross sections

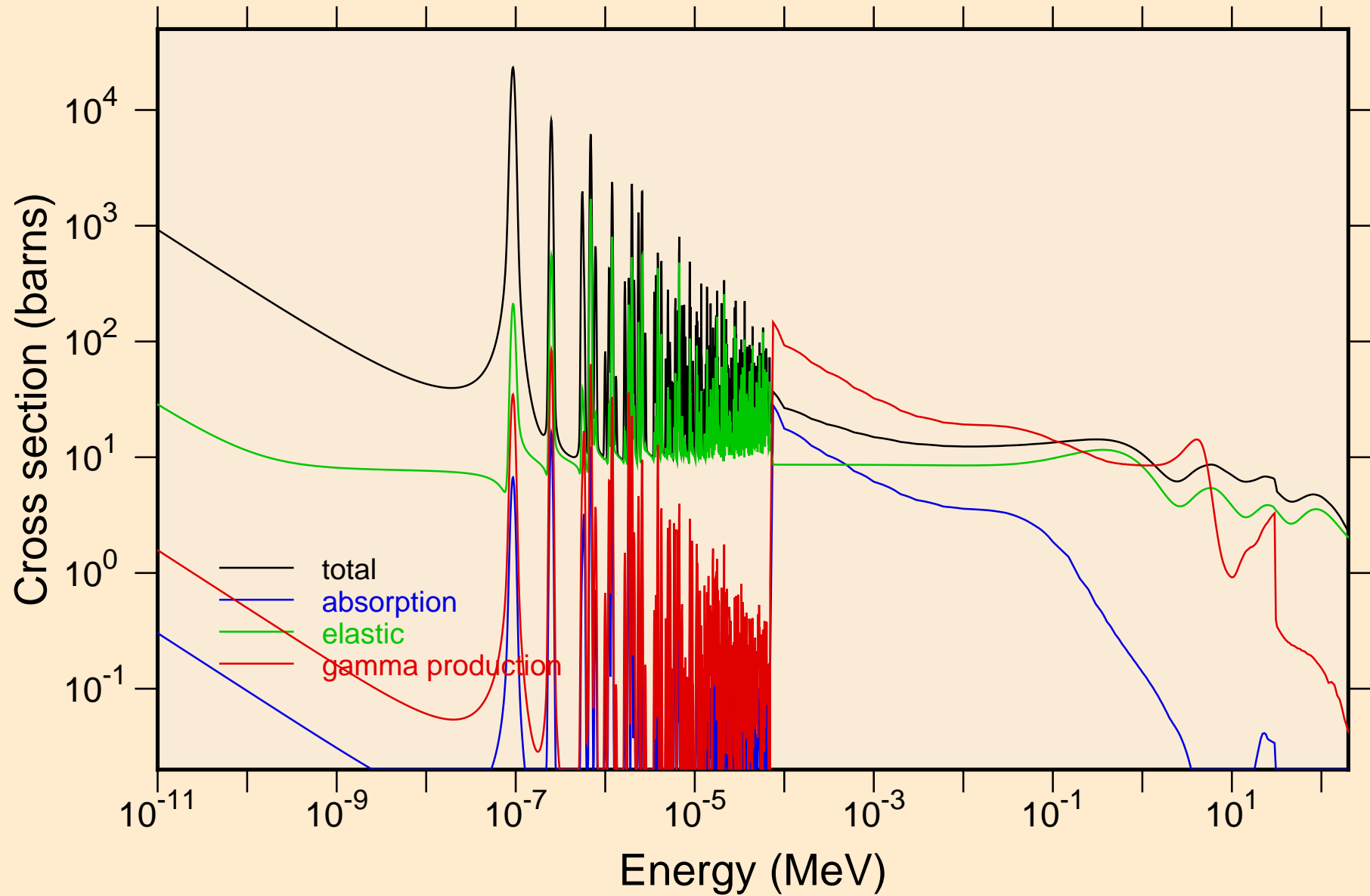

MD254M NEUTRON ACER TENDL-2021 LIBRARY; T=293.6K
resonance total cross section

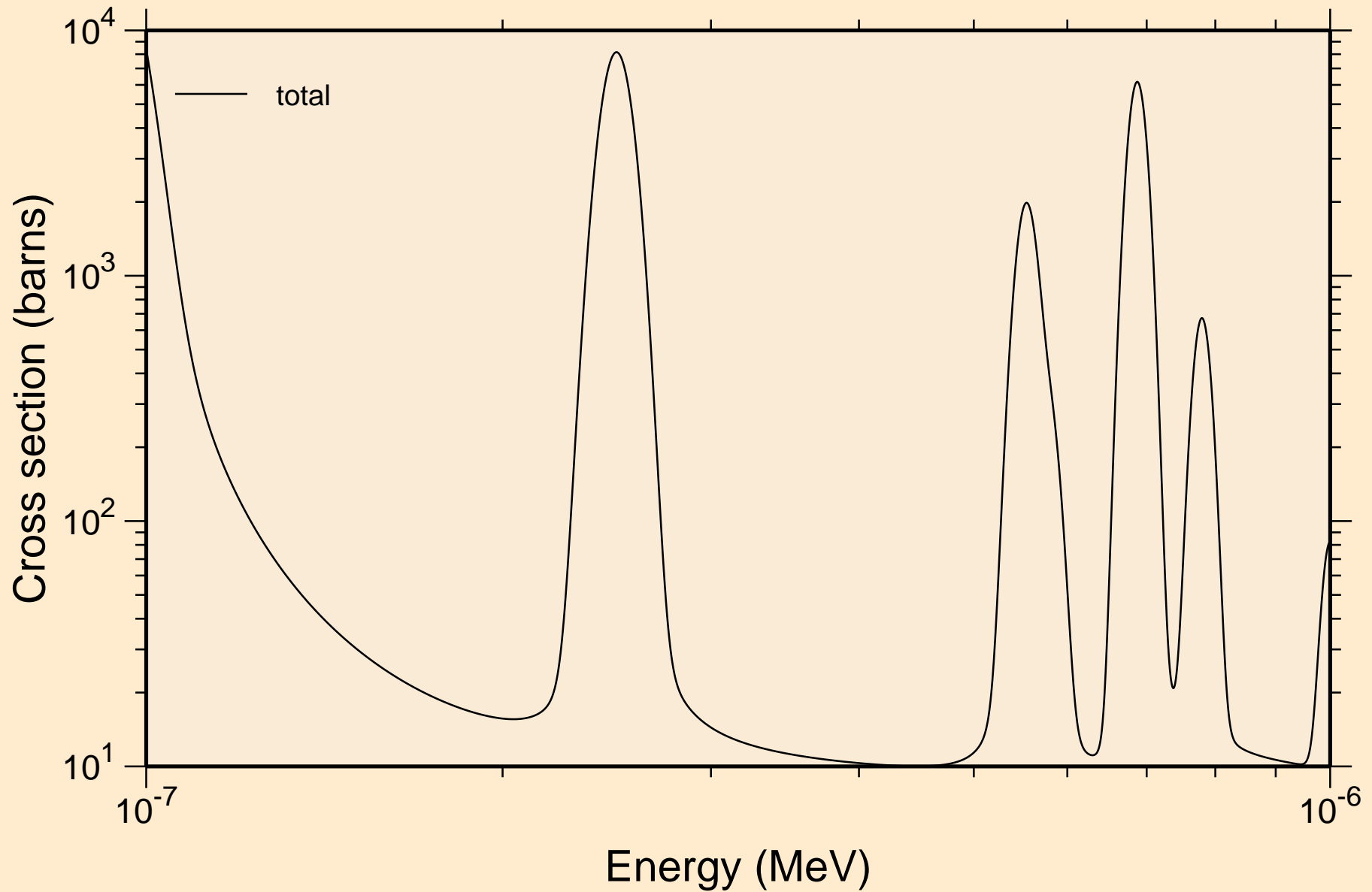

MD254M NEUTRON ACER TENDL-2021 LIBRARY; T=293.6K
resonance total cross section

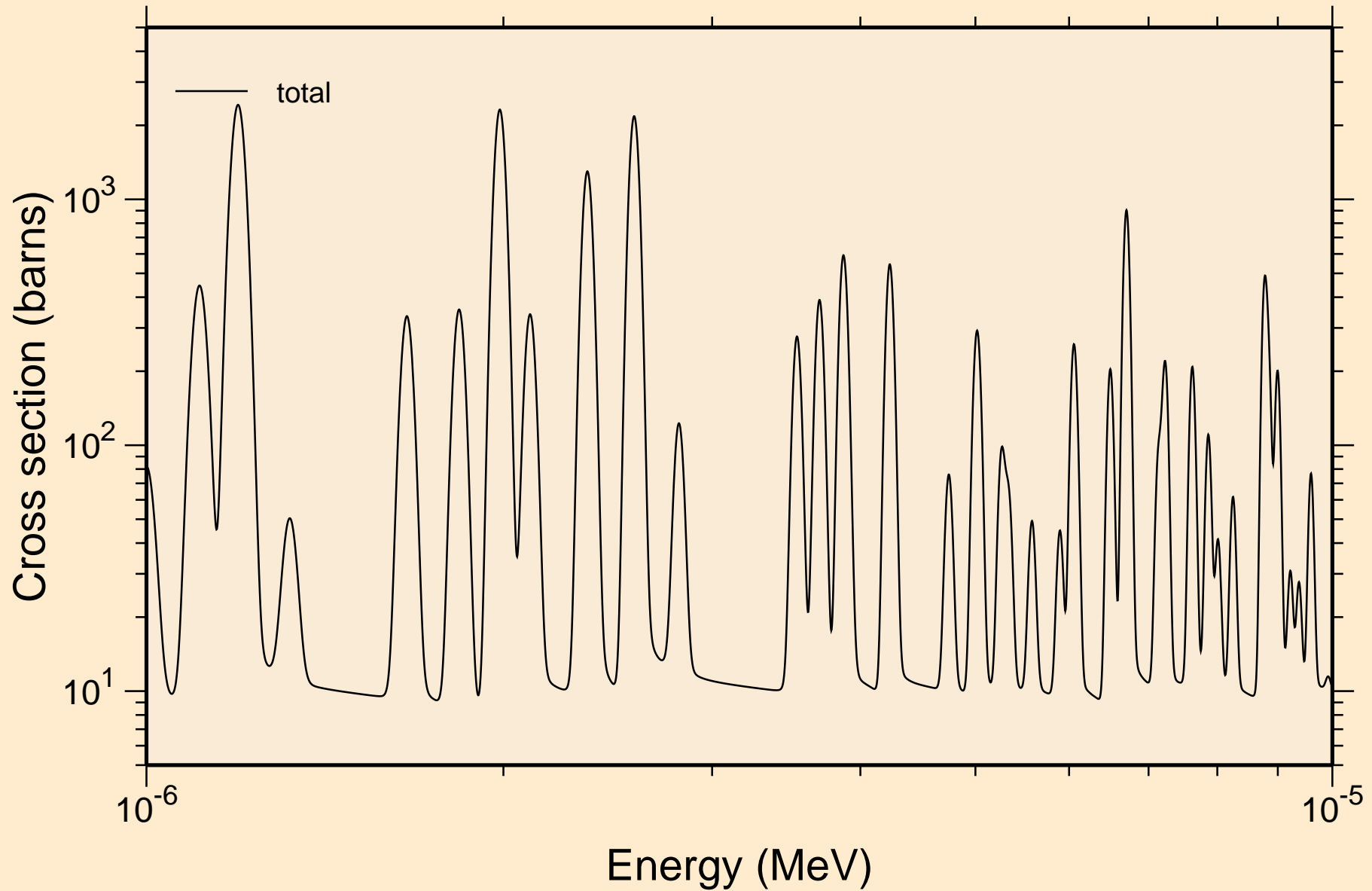

MD254M NEUTRON ACER TENDL-2021 LIBRARY; T=293.6K
resonance total cross section

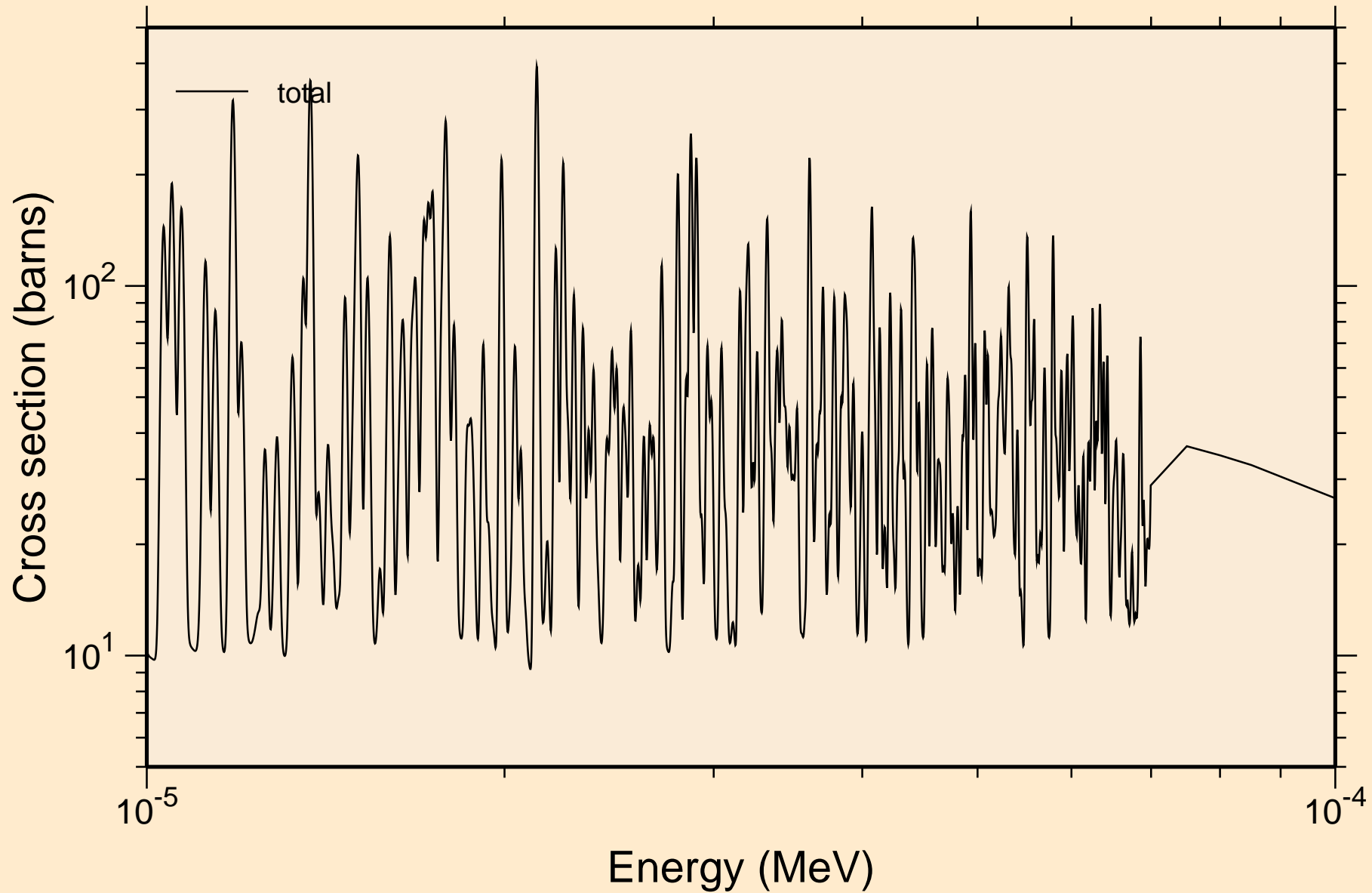

MD254M NEUTRON ACER TENDL-2021 LIBRARY; T=293.6K
resonance total cross section

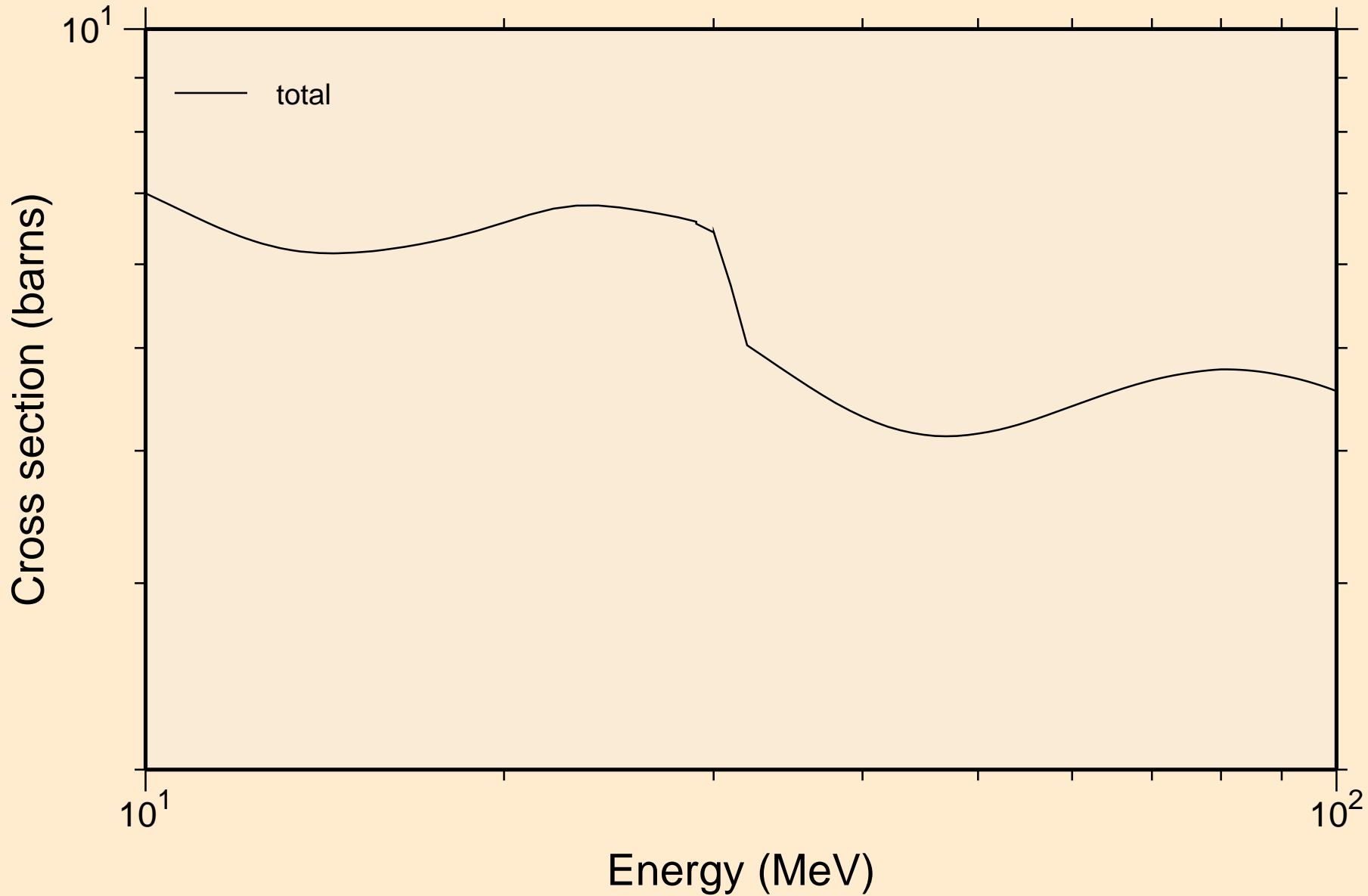

MD254M NEUTRON ACER TENDL-2021 LIBRARY; T=293.6K
resonance absorption cross sections

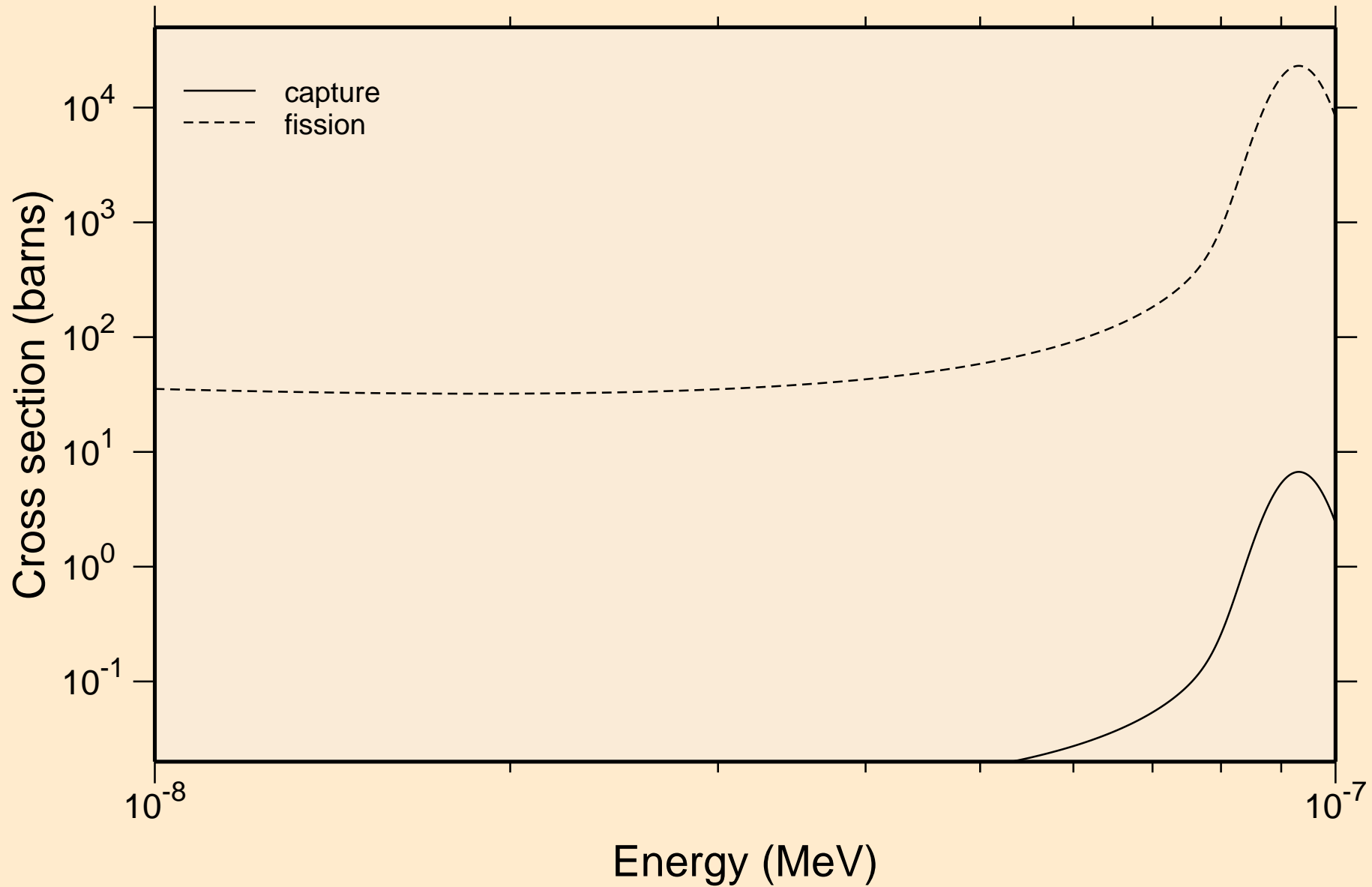

MD254M NEUTRON ACER TENDL-2021 LIBRARY; T=293.6K
resonance absorption cross sections

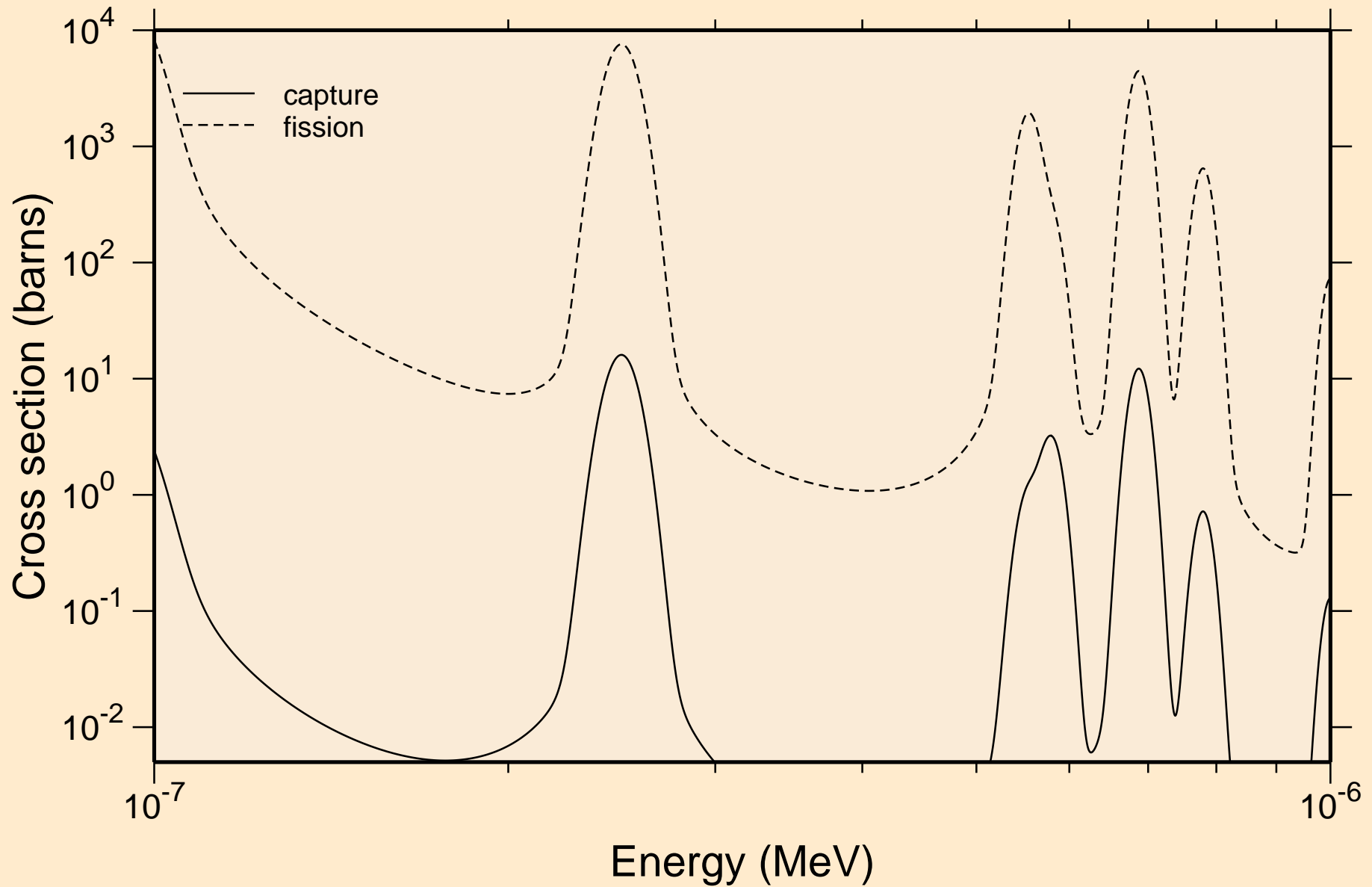

MD254M NEUTRON ACER TENDL-2021 LIBRARY; T=293.6K
resonance absorption cross sections

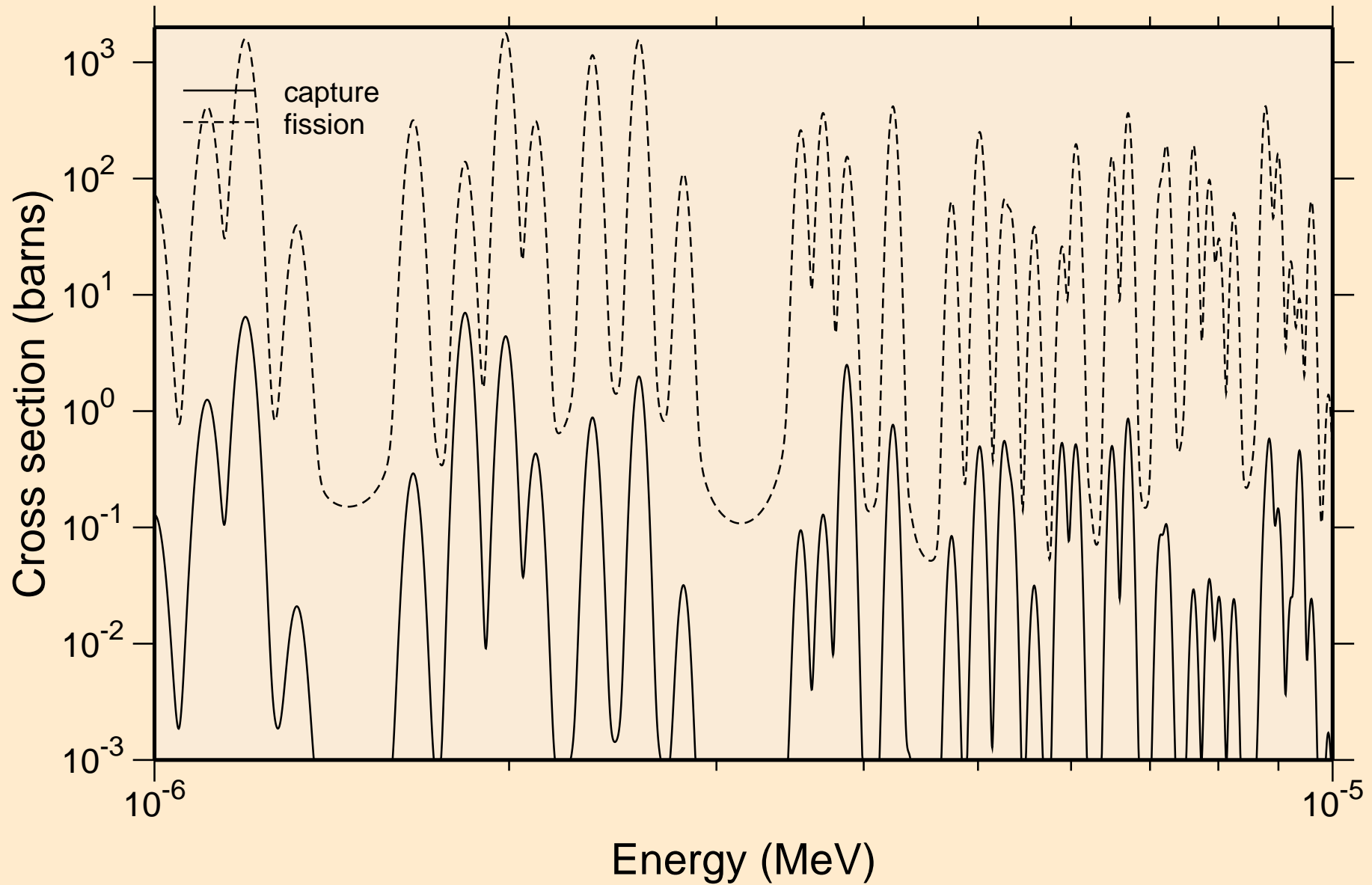

MD254M NEUTRON ACER TENDL-2021 LIBRARY; T=293.6K
resonance absorption cross sections

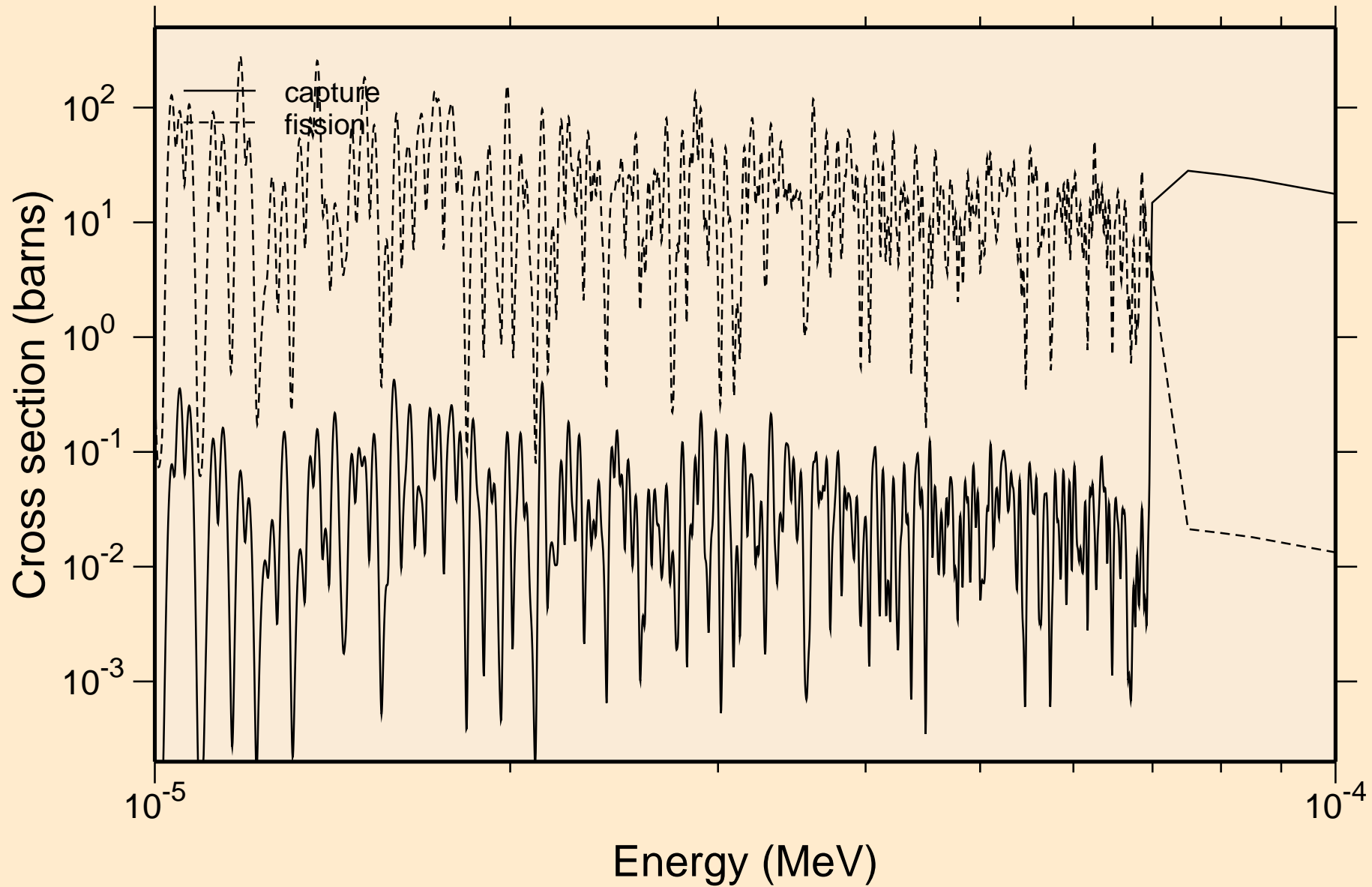

MD254M NEUTRON ACER TENDL-2021 LIBRARY; T=293.6K
resonance absorption cross sections

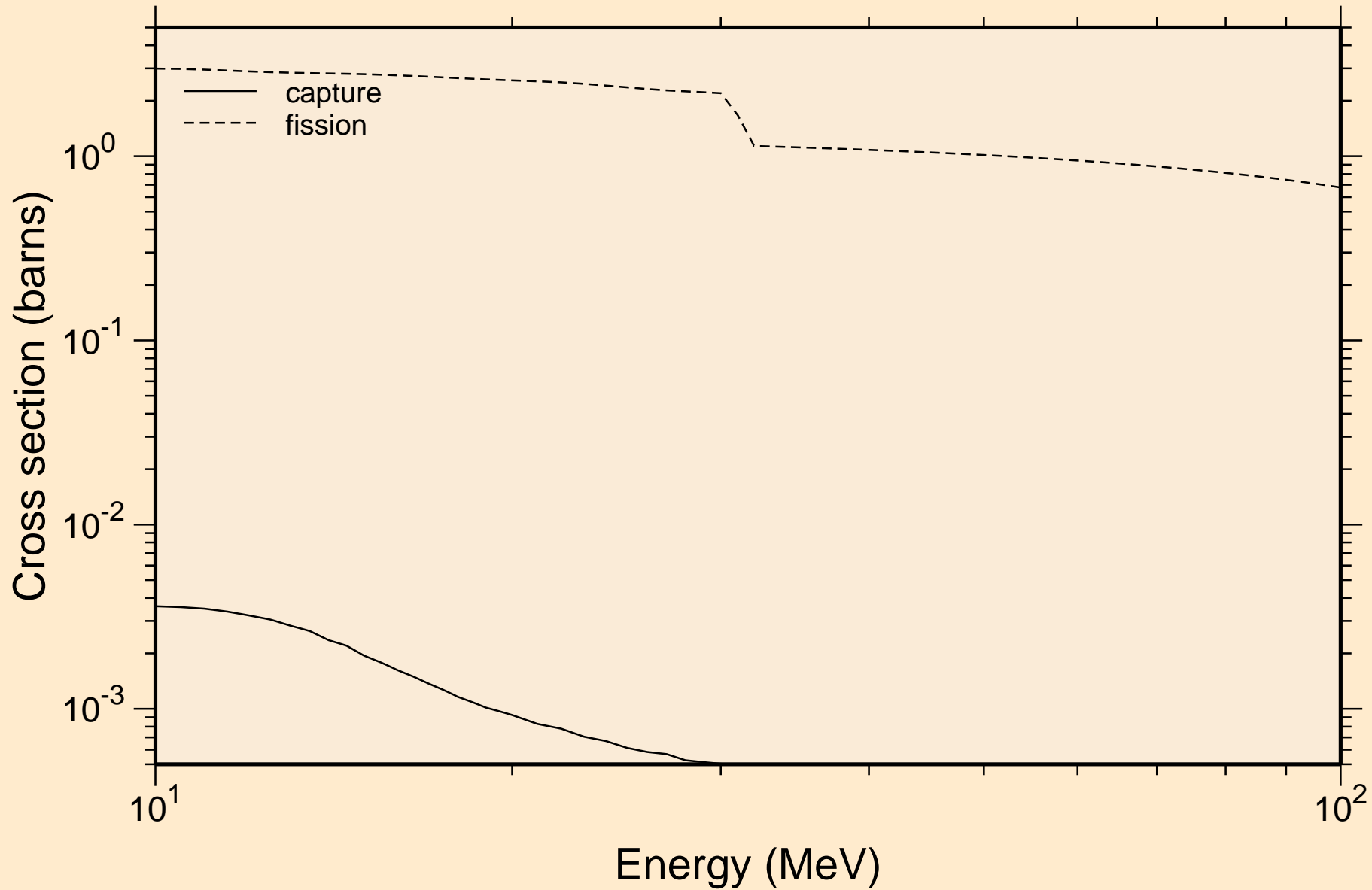

MD254M NEUTRON ACER TENDL-2021 LIBRARY; T=293.6K
Heating

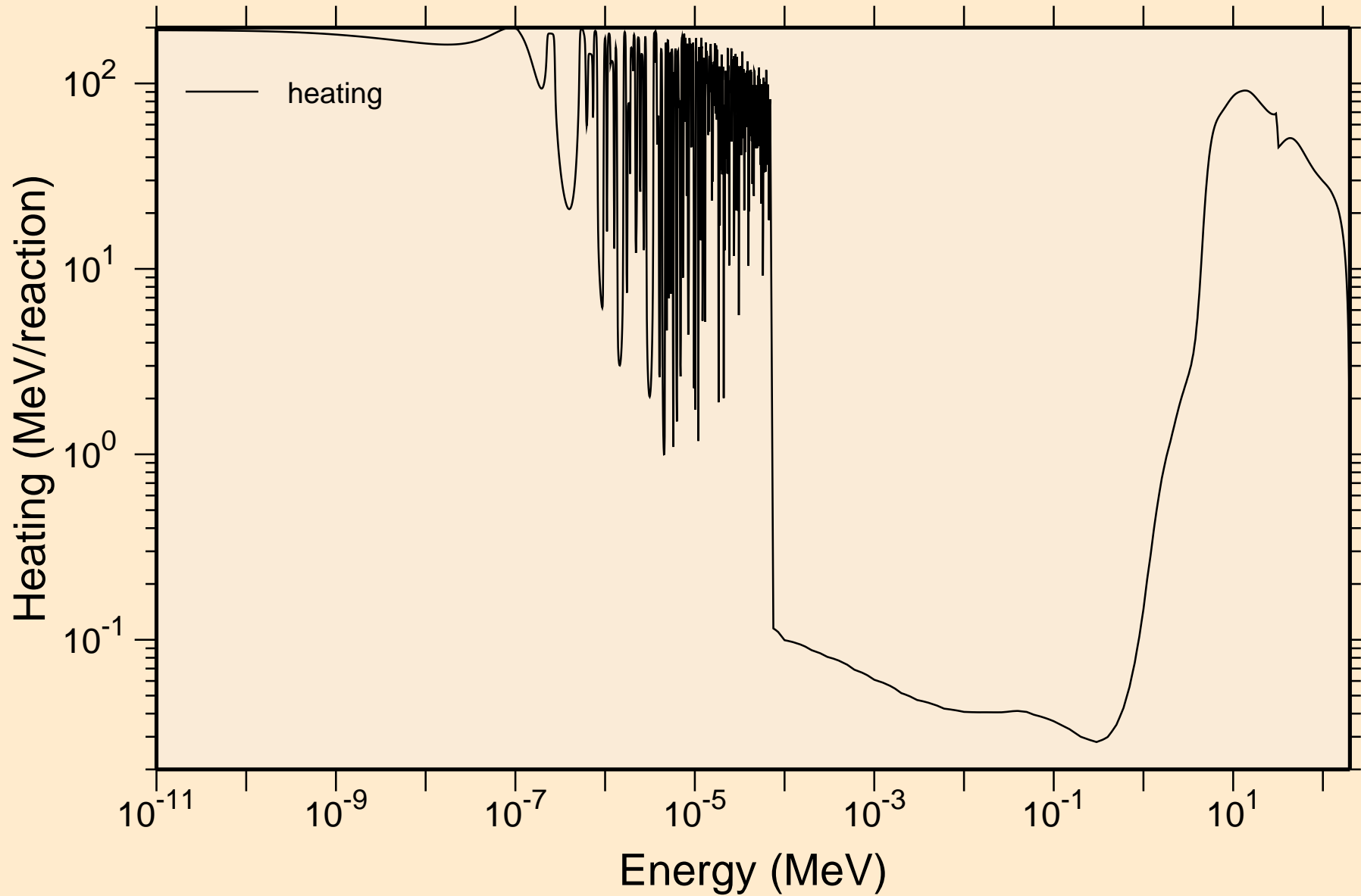

MD254M NEUTRON ACER TENDL-2021 LIBRARY; T=293.6K
Damage

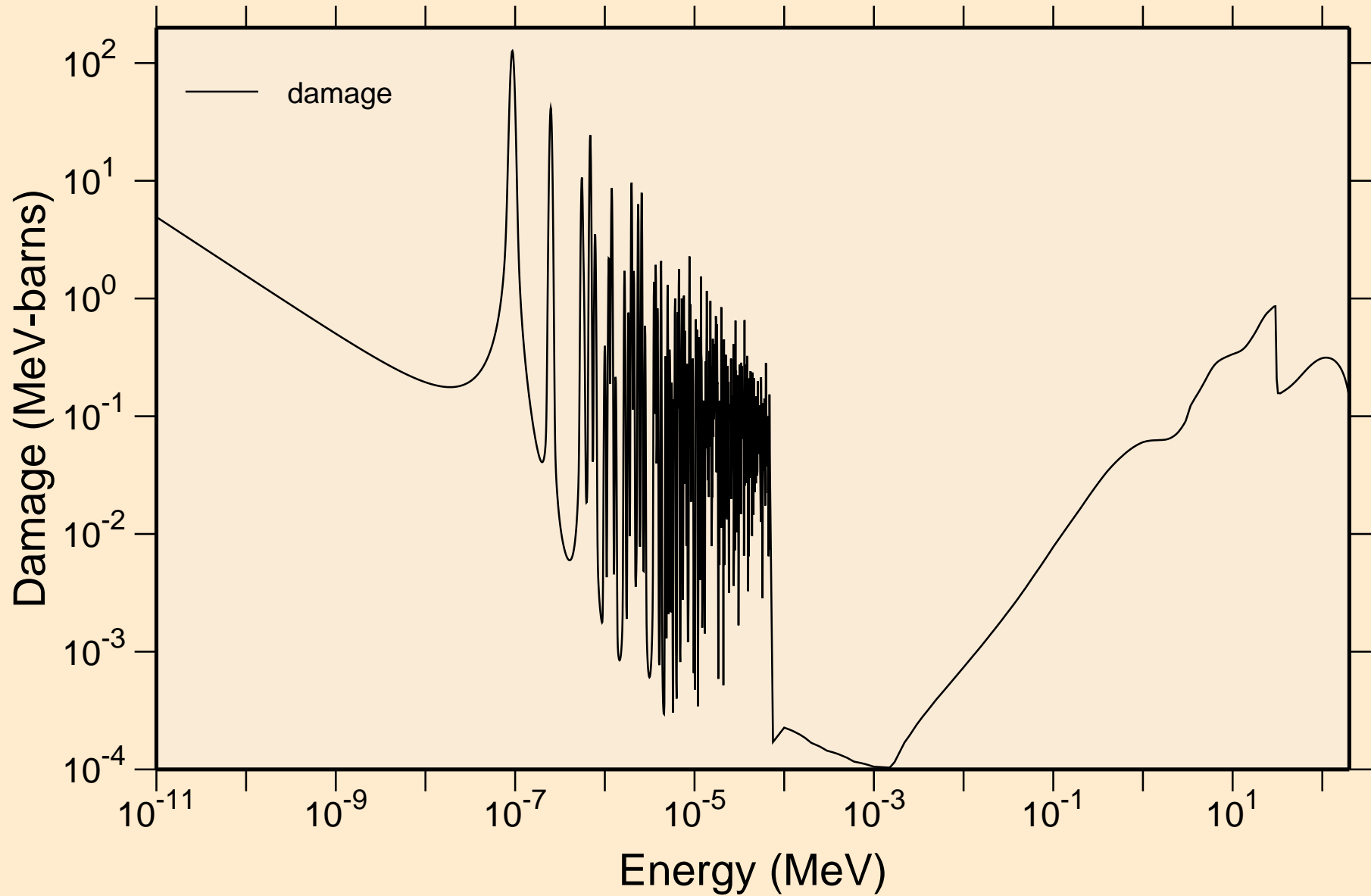

MD254M NEUTRON ACER TENDL-2021 LIBRARY; T=293.6K

Non-threshold reactions

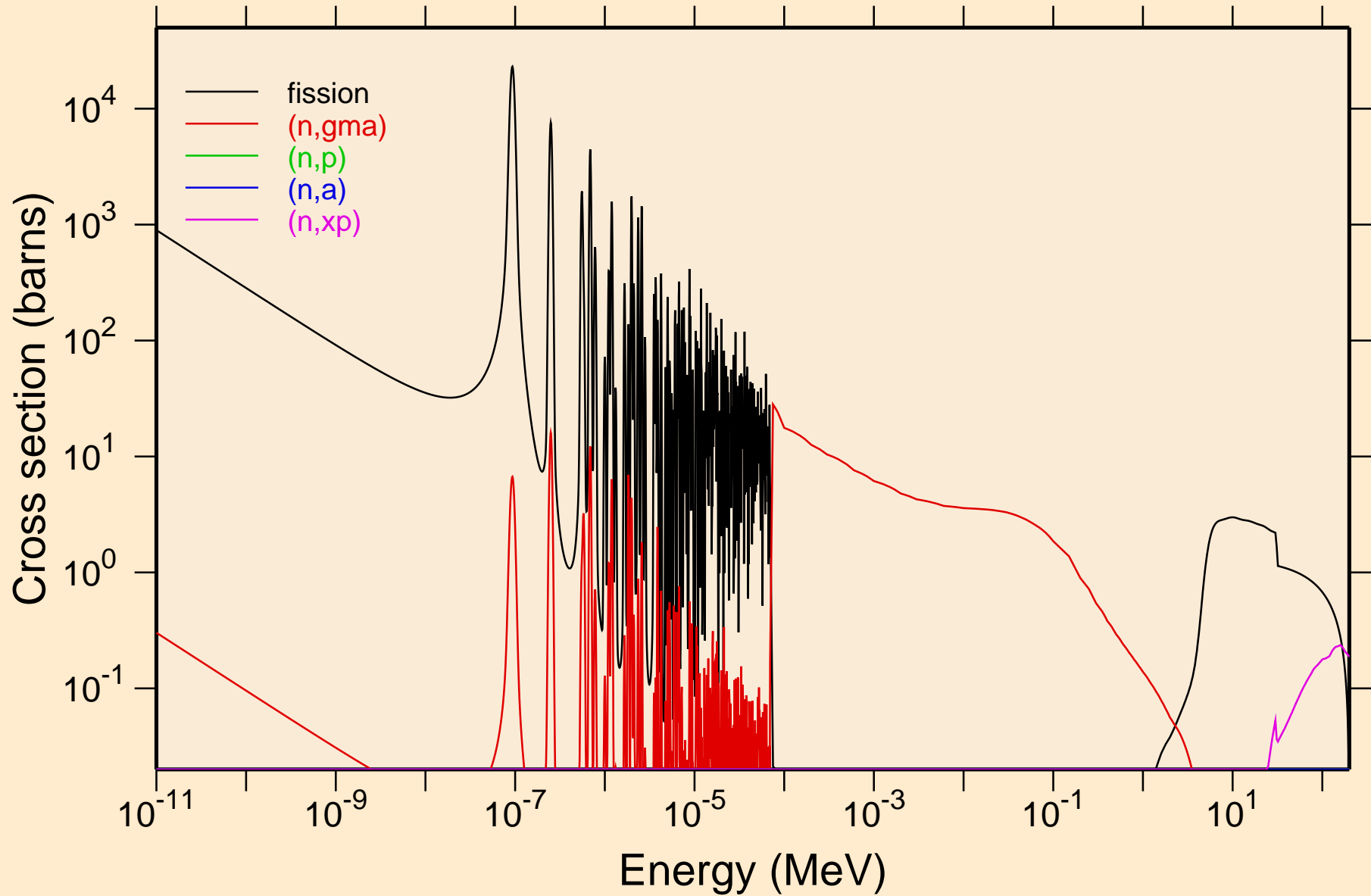

MD254M NEUTRON ACER TENDL-2021 LIBRARY; T=293.6K
Non-threshold reactions

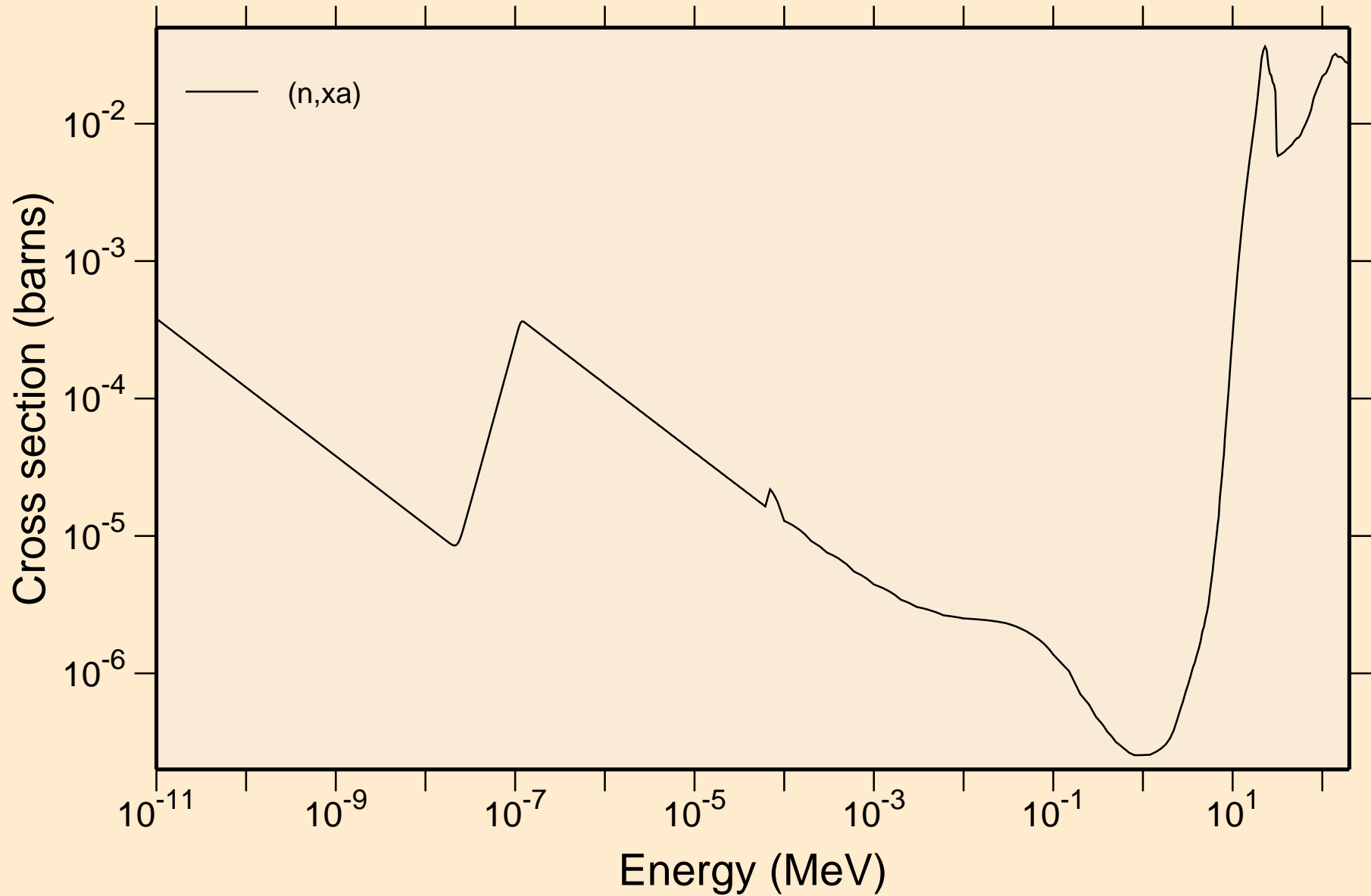

MD254M NEUTRON ACER TENDL-2021 LIBRARY; T=293.6K

Principal cross sections

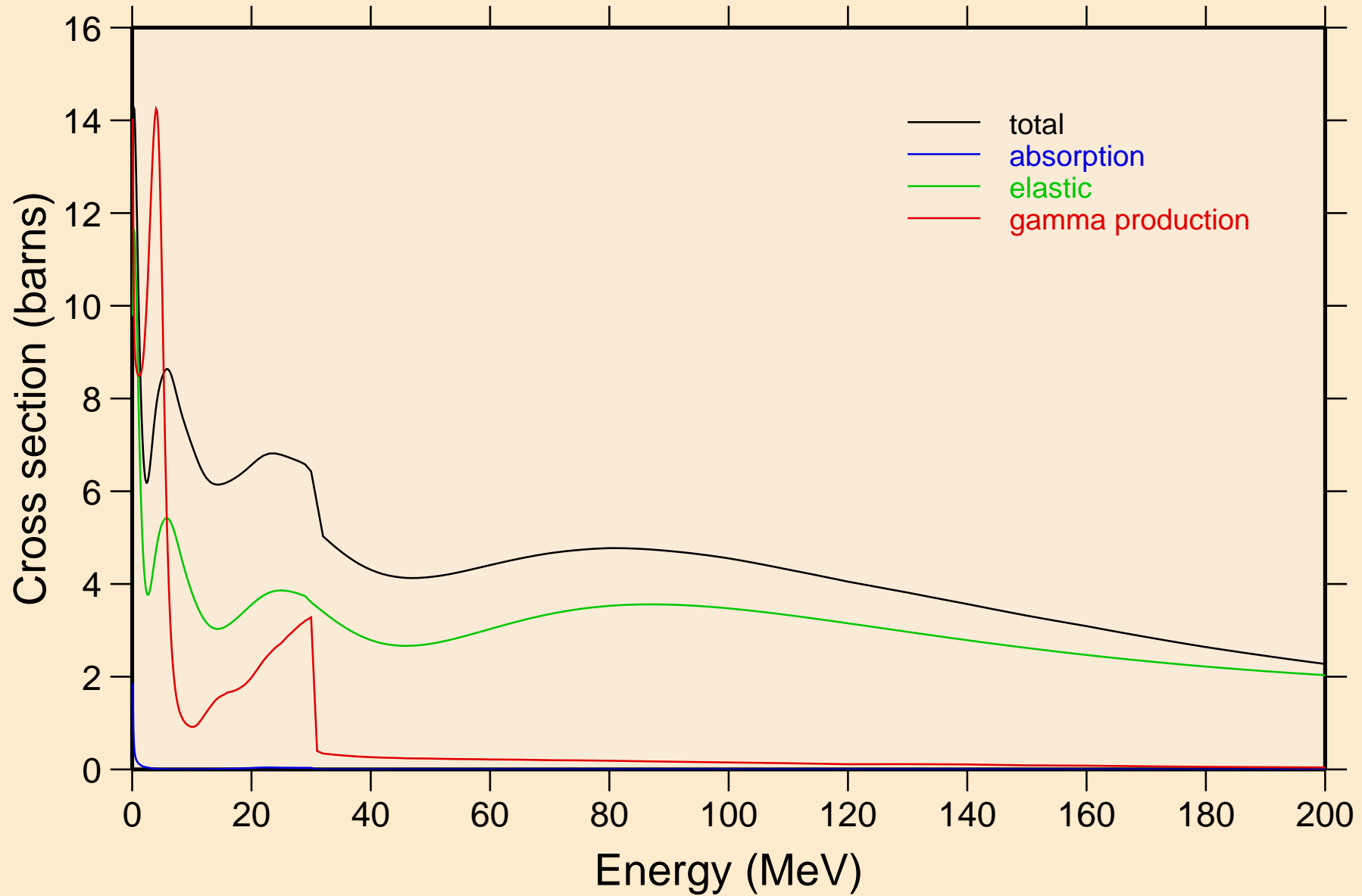

MD254M NEUTRON ACER TENDL-2021 LIBRARY; T=293.6K
Heating

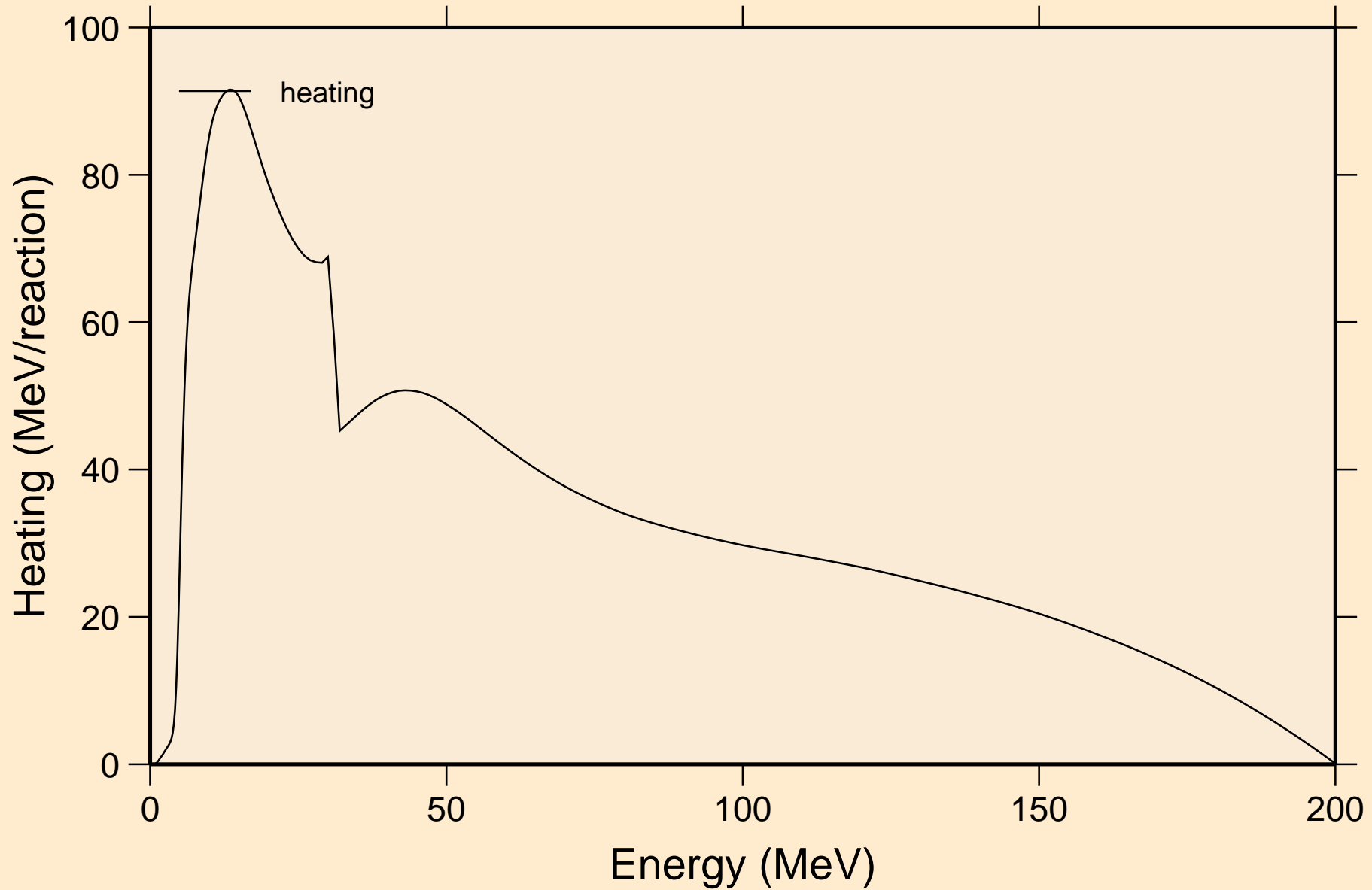

MD254M NEUTRON ACER TENDL-2021 LIBRARY; T=293.6K
Damage

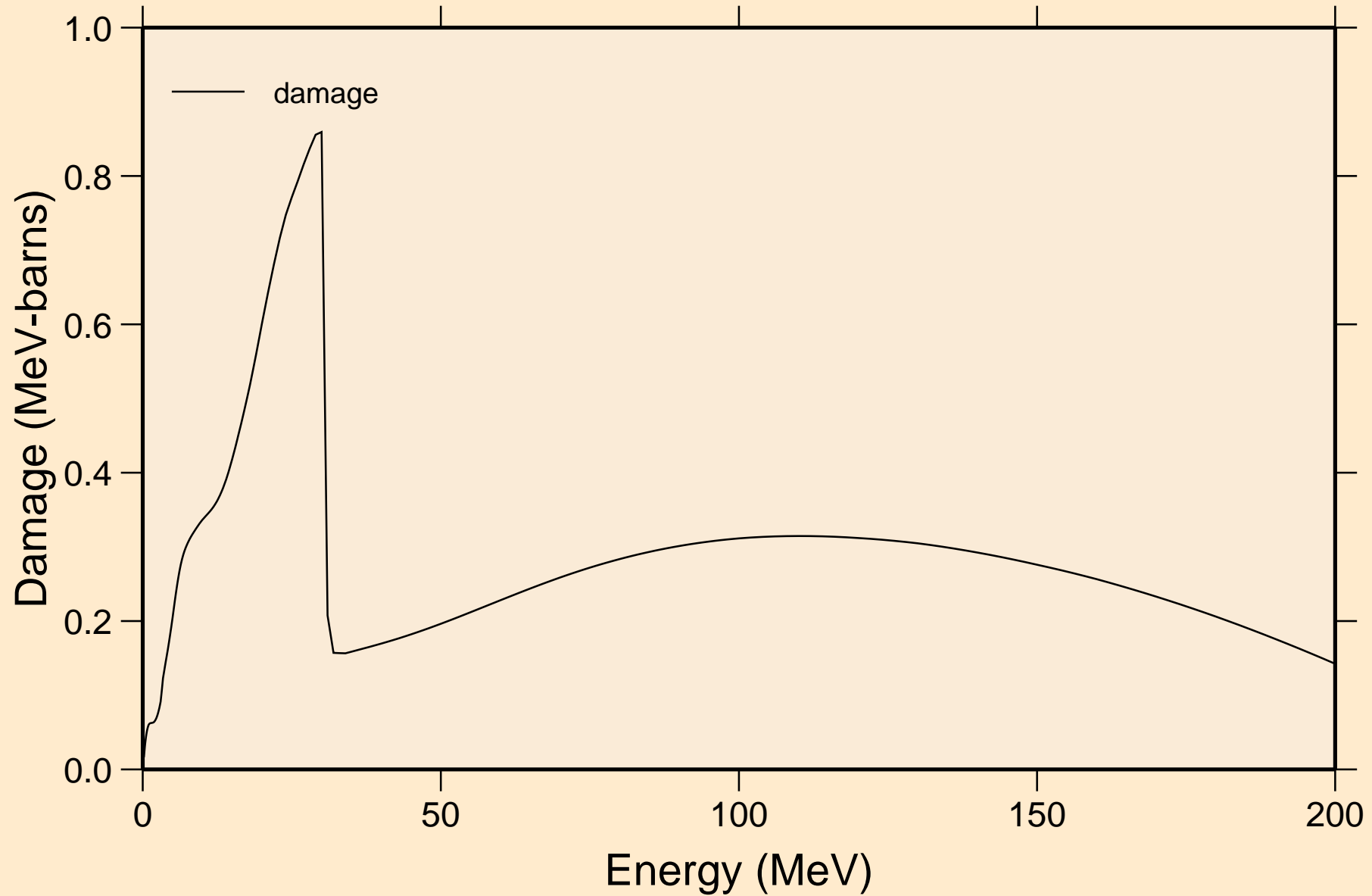

MD254M NEUTRON ACER TENDL-2021 LIBRARY; T=293.6K

Non-threshold reactions

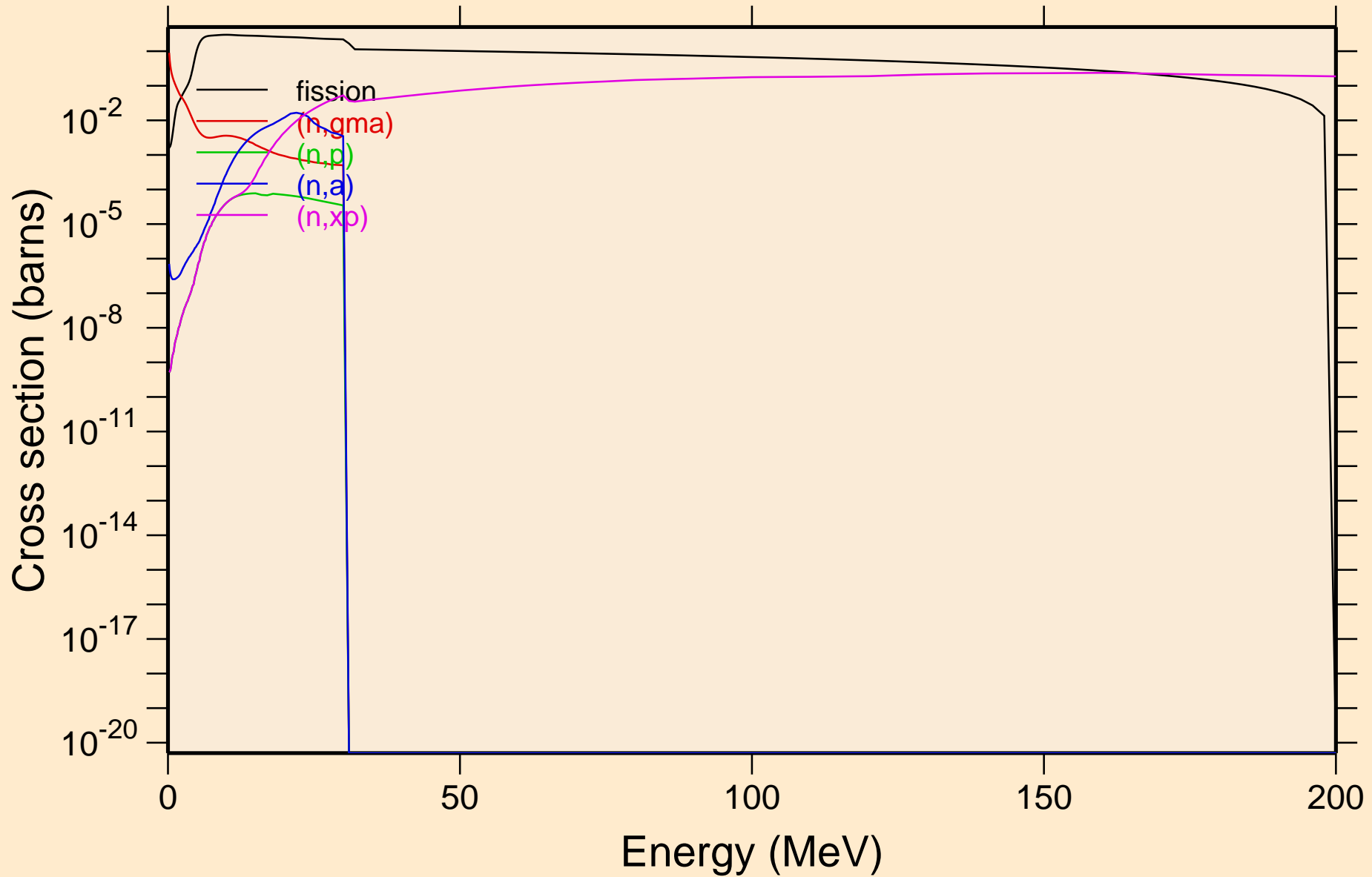

MD254M NEUTRON ACER TENDL-2021 LIBRARY; T=293.6K
Non-threshold reactions

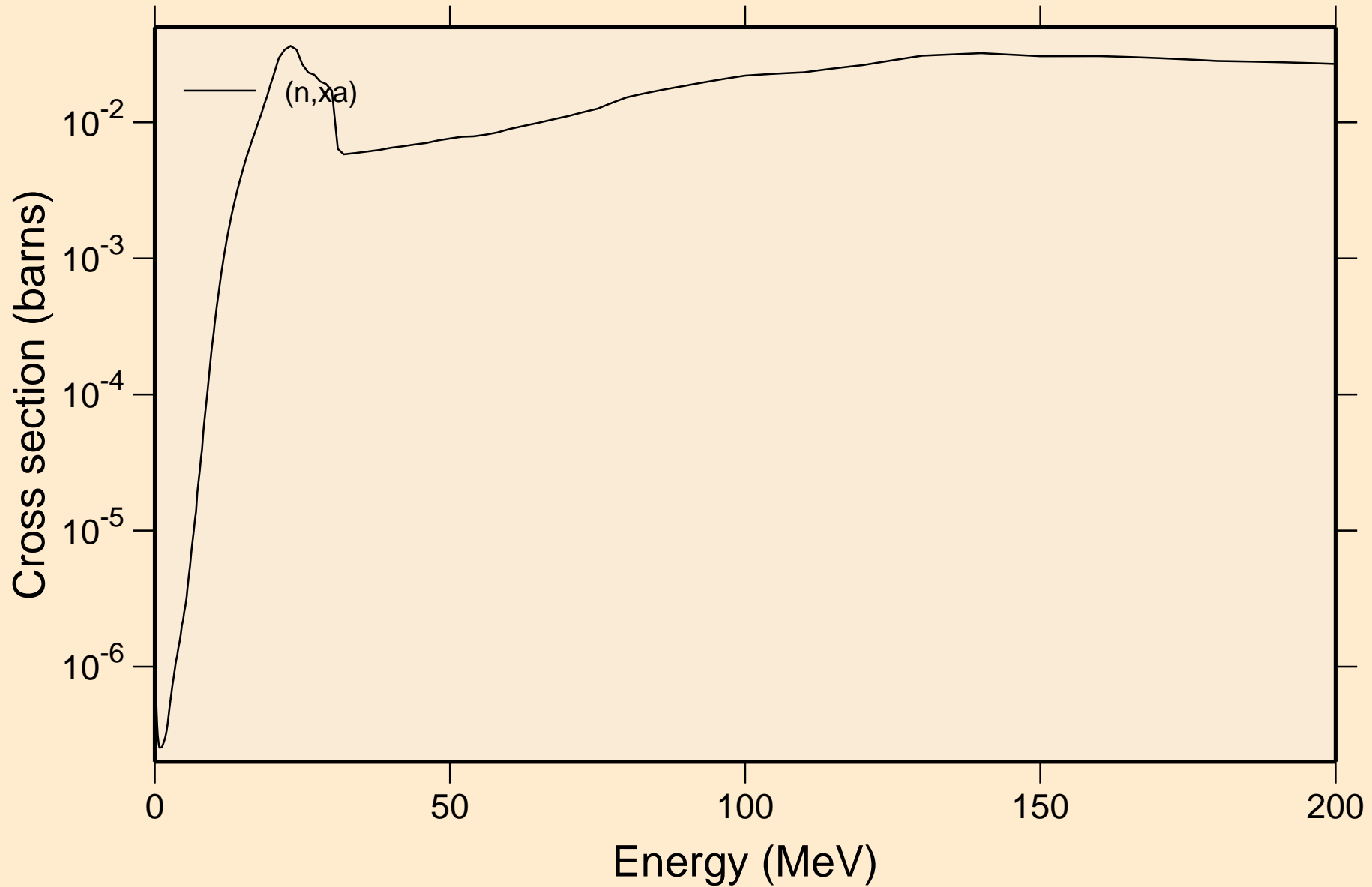

MD254M NEUTRON ACER TENDL-2021 LIBRARY; T=293.6K
Inelastic levels

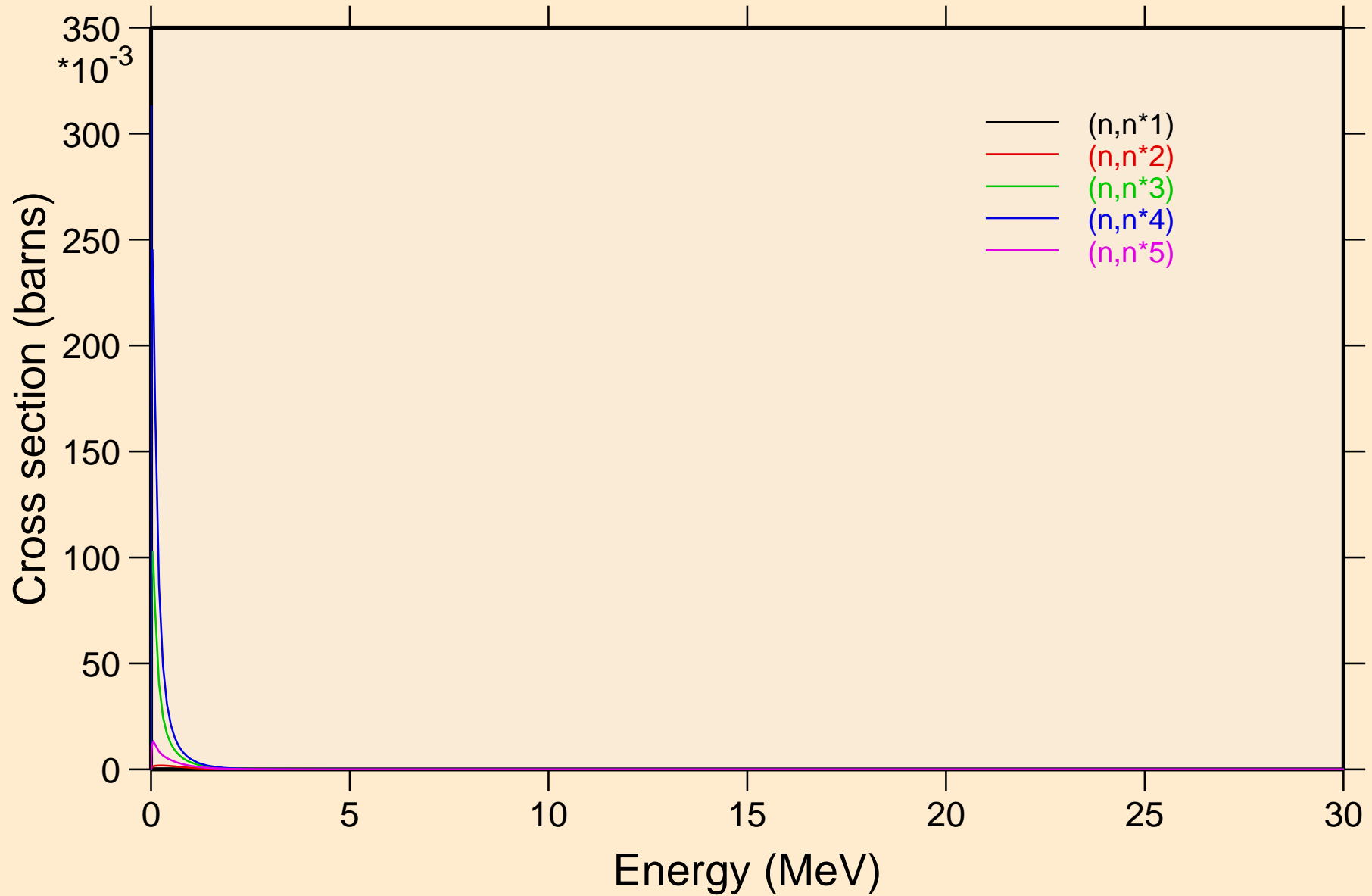

MD254M NEUTRON ACER TENDL-2021 LIBRARY; T=293.6K
Inelastic levels

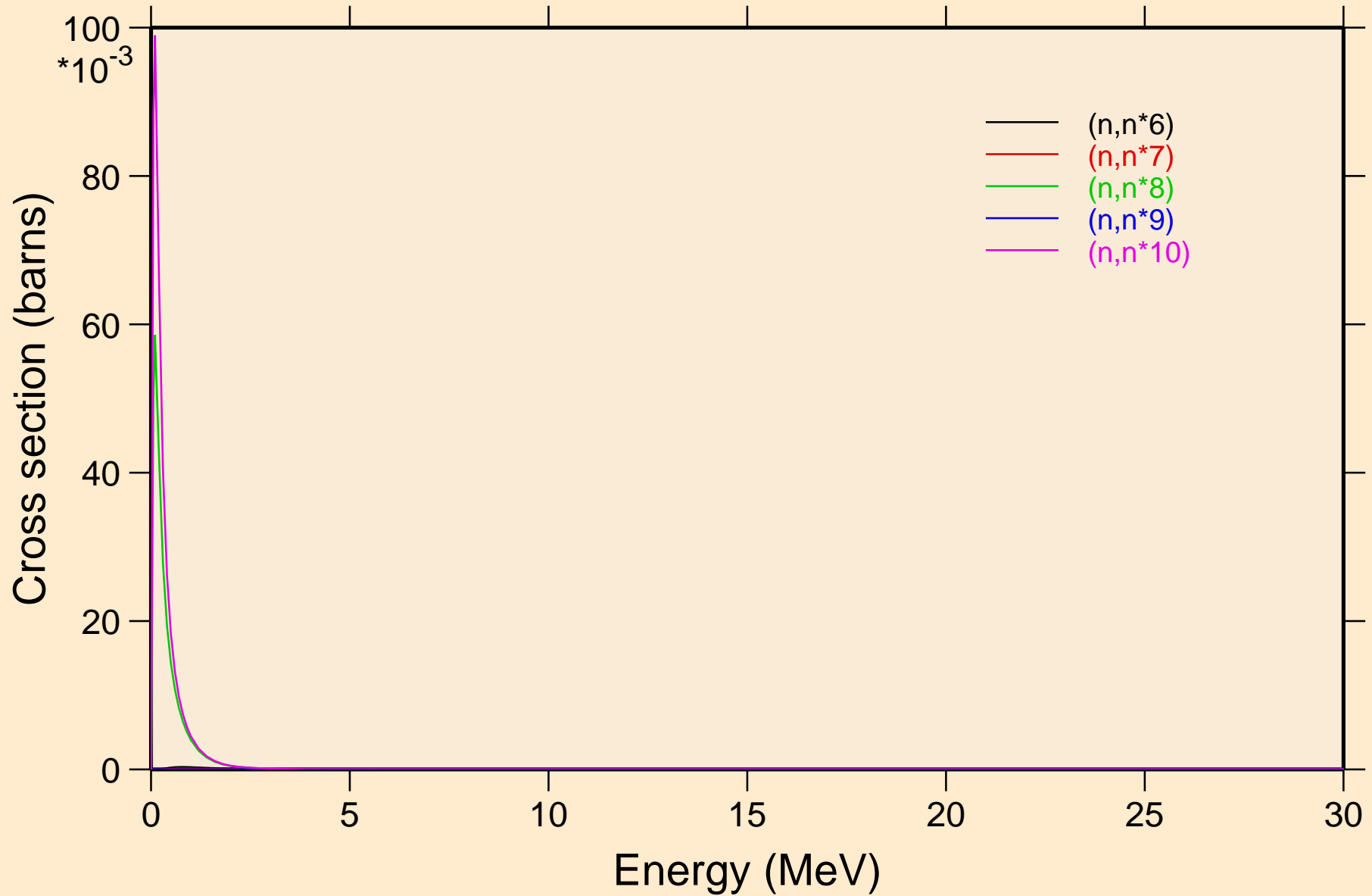

MD254M NEUTRON ACER TENDL-2021 LIBRARY; T=293.6K
Inelastic levels

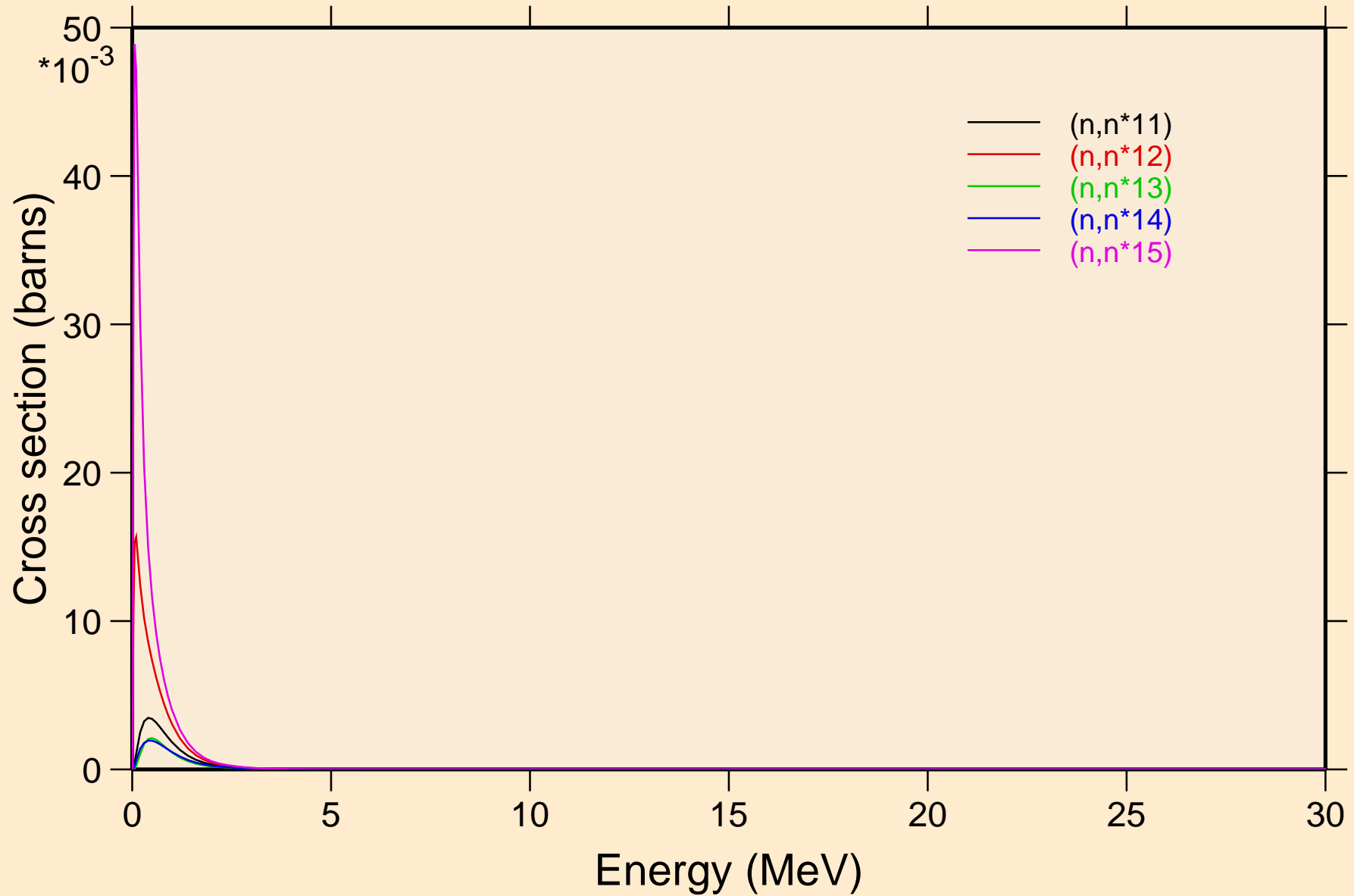

MD254M NEUTRON ACER TENDL-2021 LIBRARY; T=293.6K
Inelastic levels

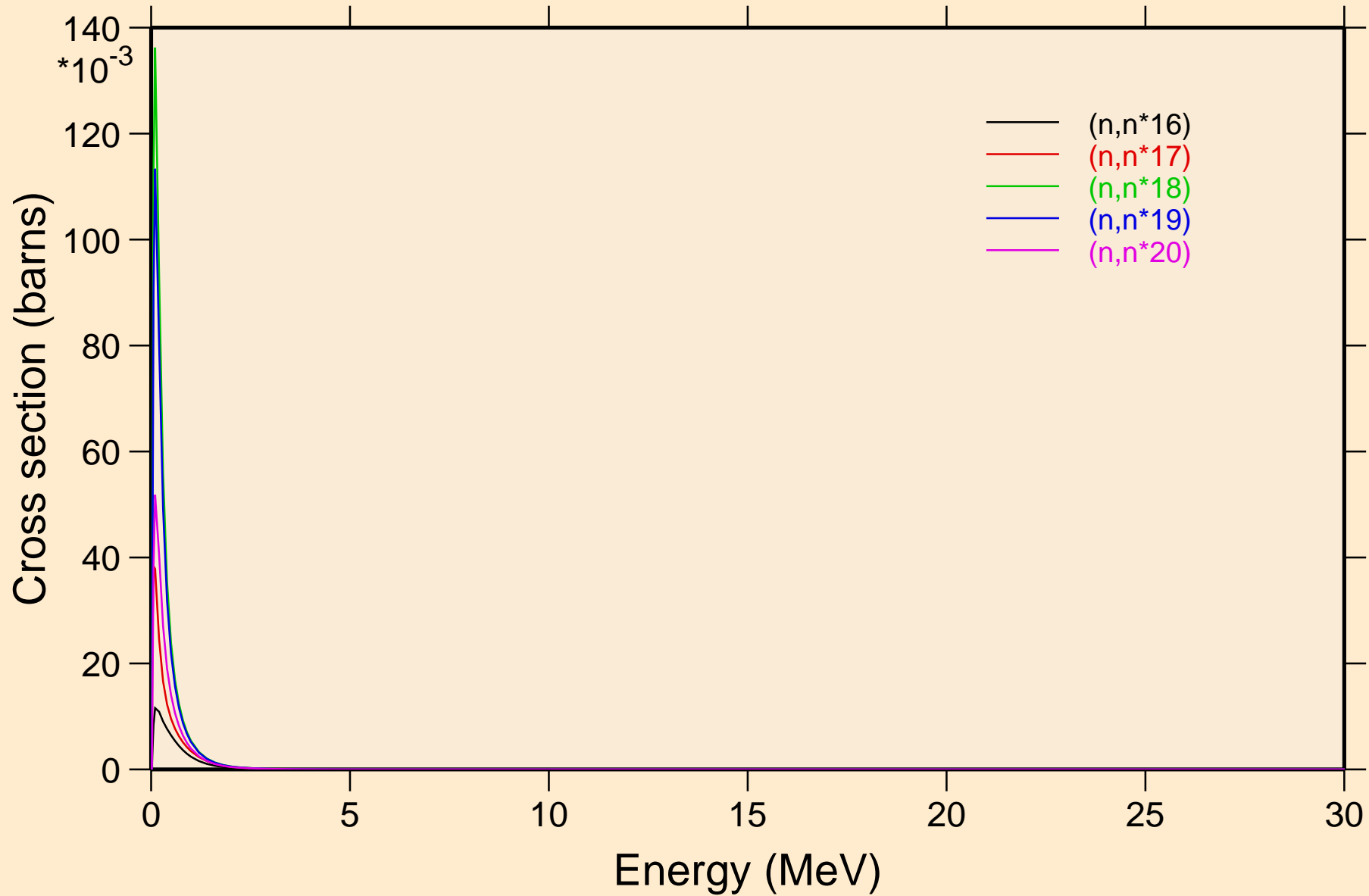

MD254M NEUTRON ACER TENDL-2021 LIBRARY; T=293.6K
Inelastic levels

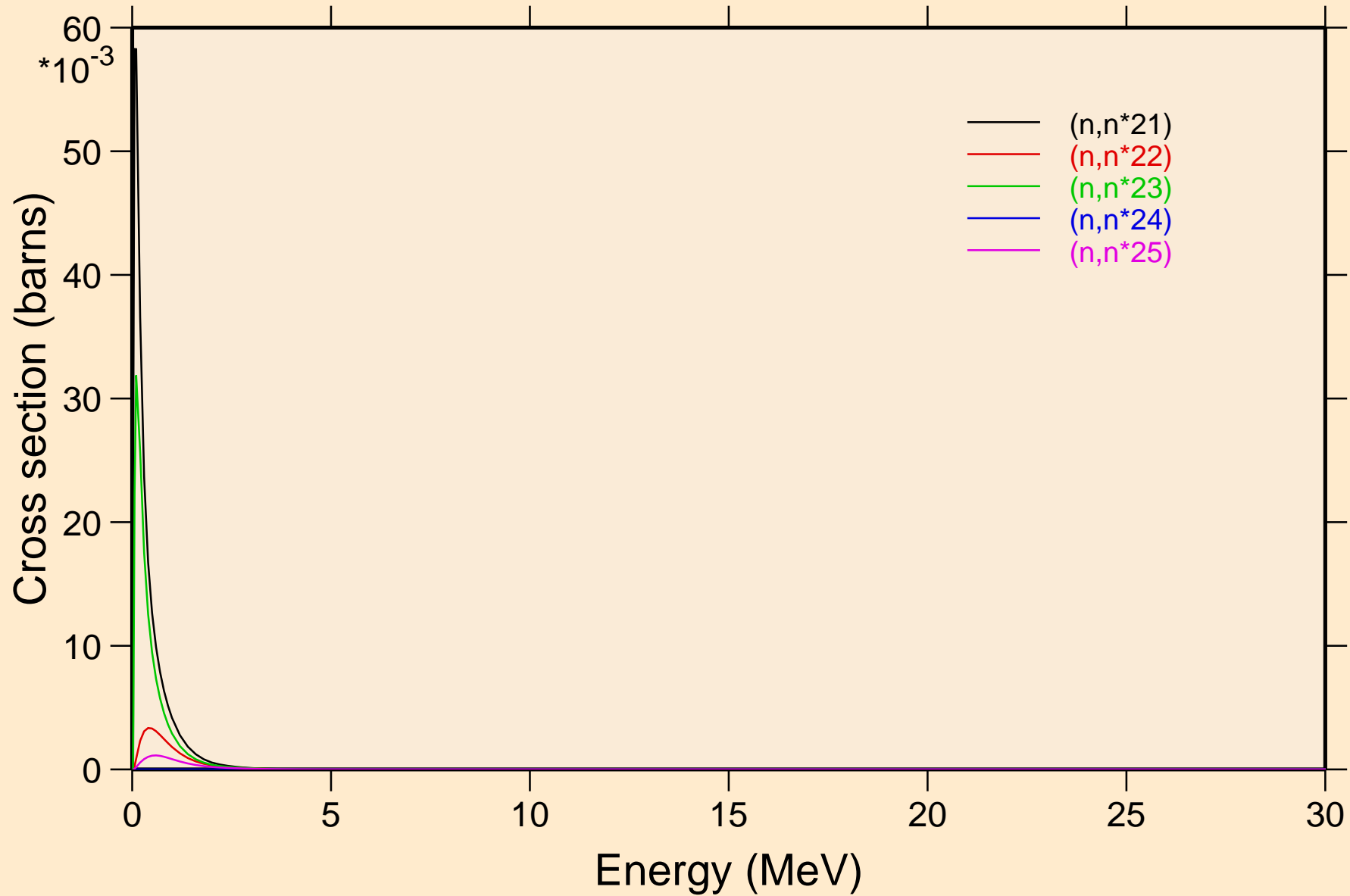

MD254M NEUTRON ACER TENDL-2021 LIBRARY; T=293.6K
Inelastic levels

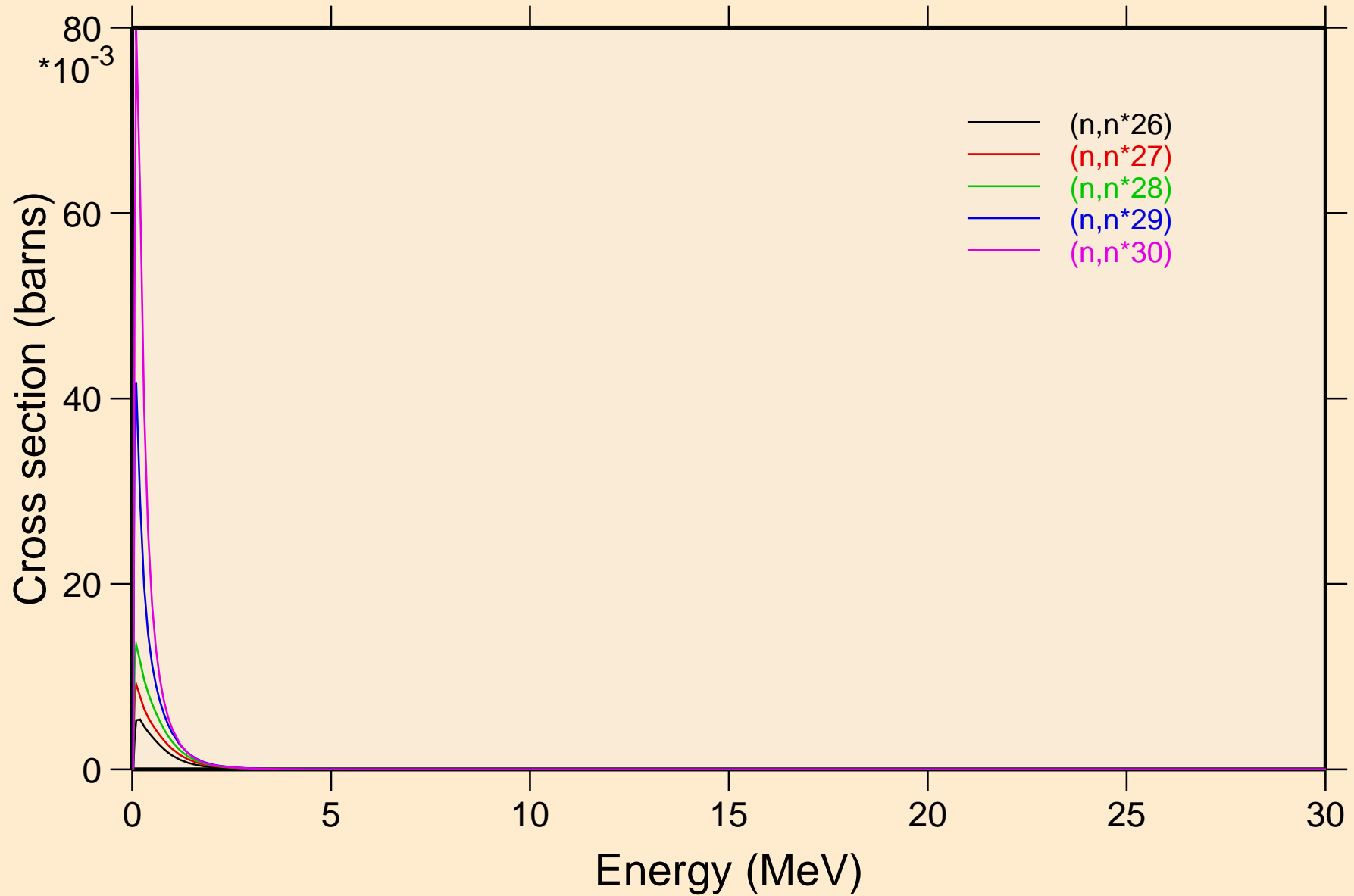

MD254M NEUTRON ACER TENDL-2021 LIBRARY; T=293.6K
Threshold reactions

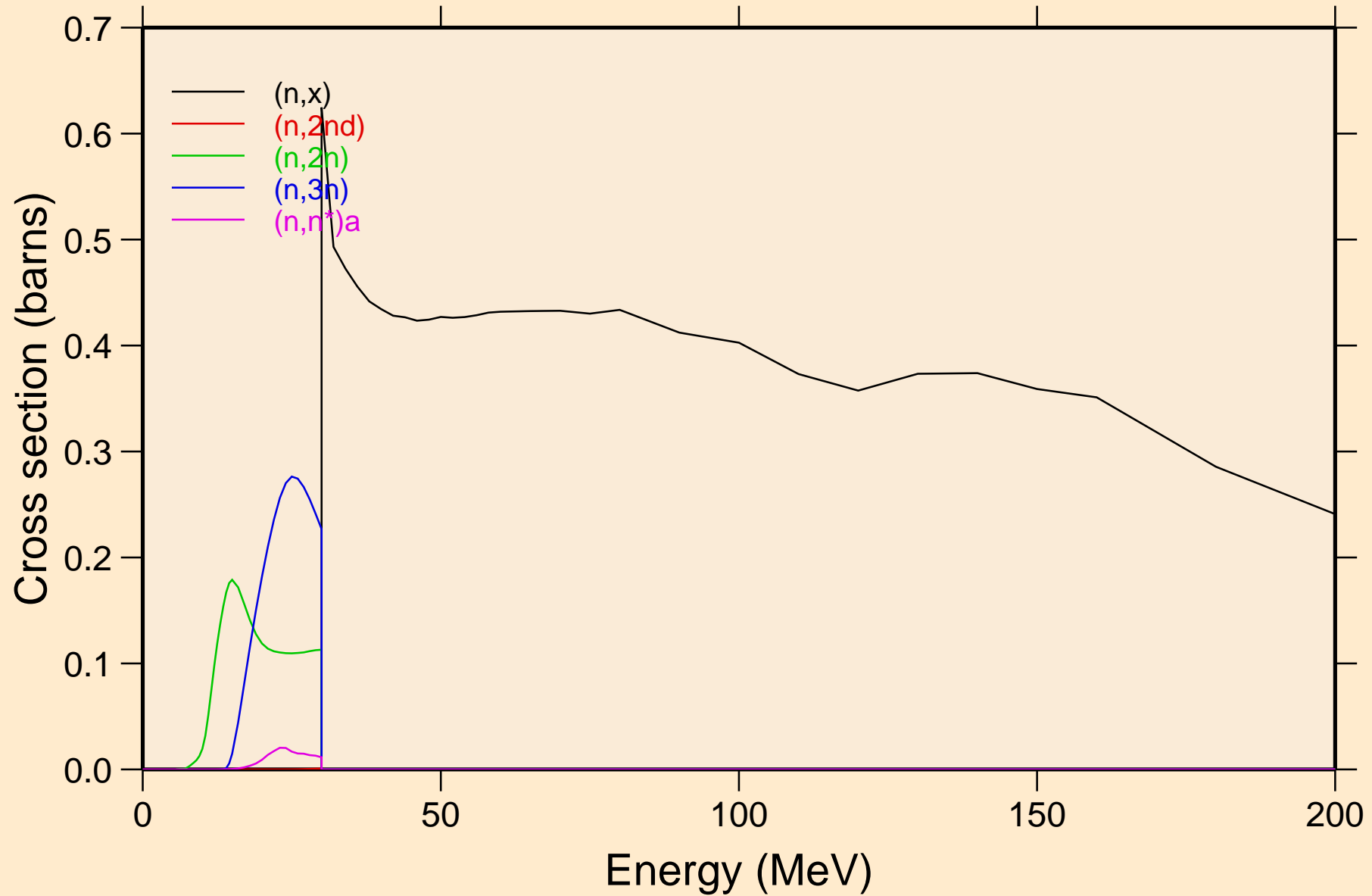

MD254M NEUTRON ACER TENDL-2021 LIBRARY; T=293.6K
Threshold reactions

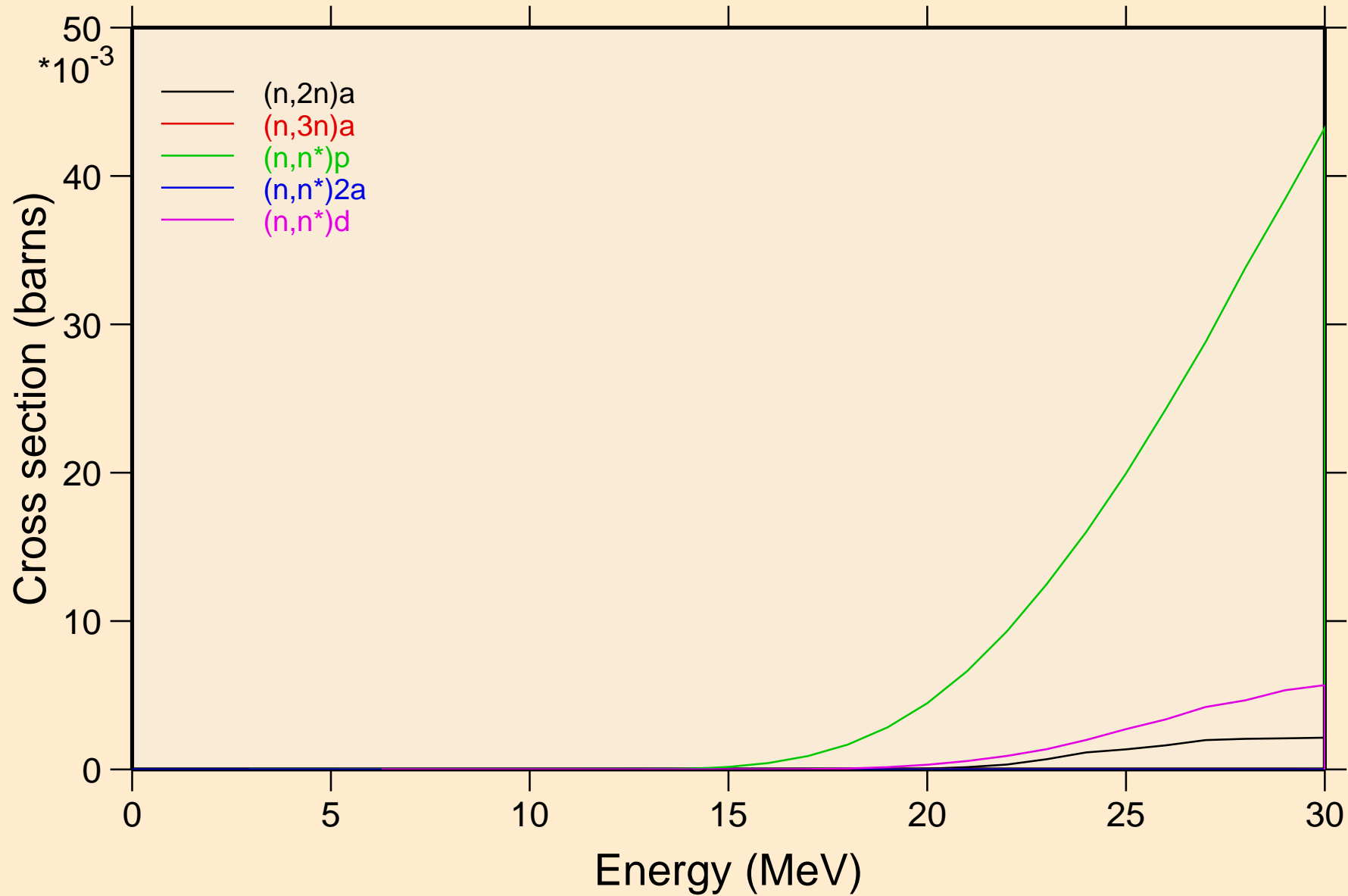

MD254M NEUTRON ACER TENDL-2021 LIBRARY; T=293.6K
Threshold reactions

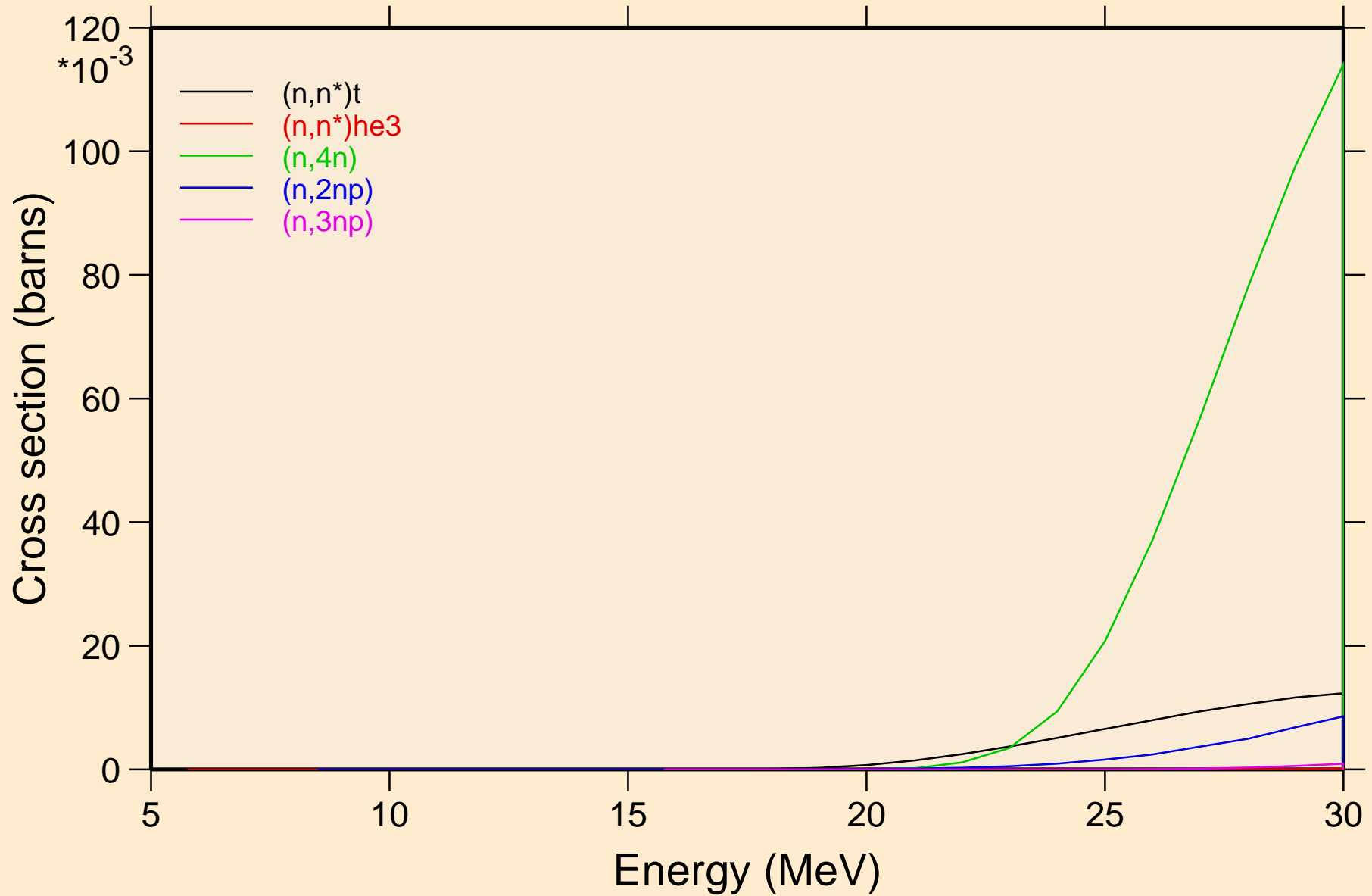

MD254M NEUTRON ACER TENDL-2021 LIBRARY; T=293.6K
Threshold reactions

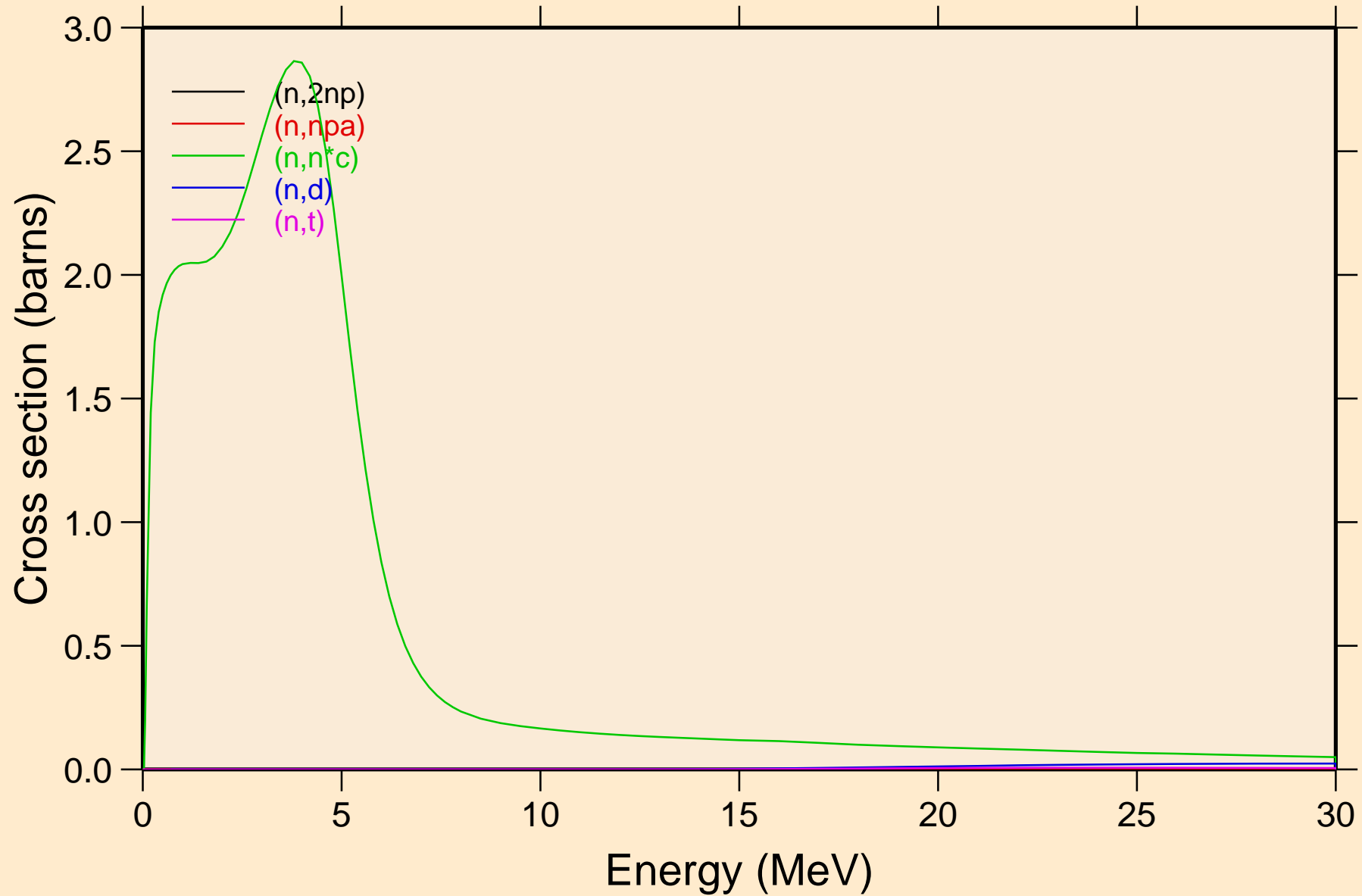

MD254M NEUTRON ACER TENDL-2021 LIBRARY; T=293.6K
Threshold reactions

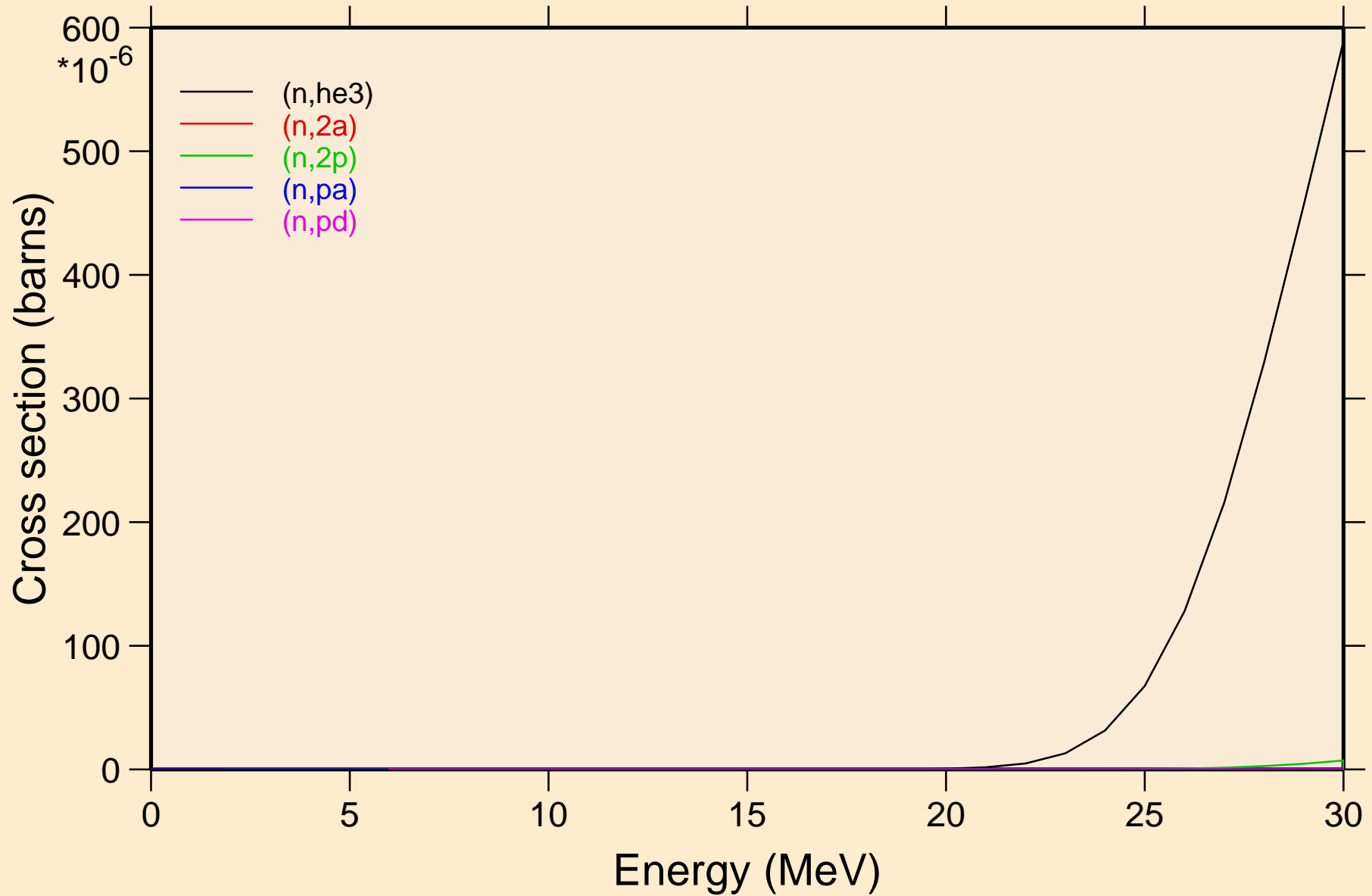

MD254M NEUTRON ACER TENDL-2021 LIBRARY; T=293.6K
Threshold reactions

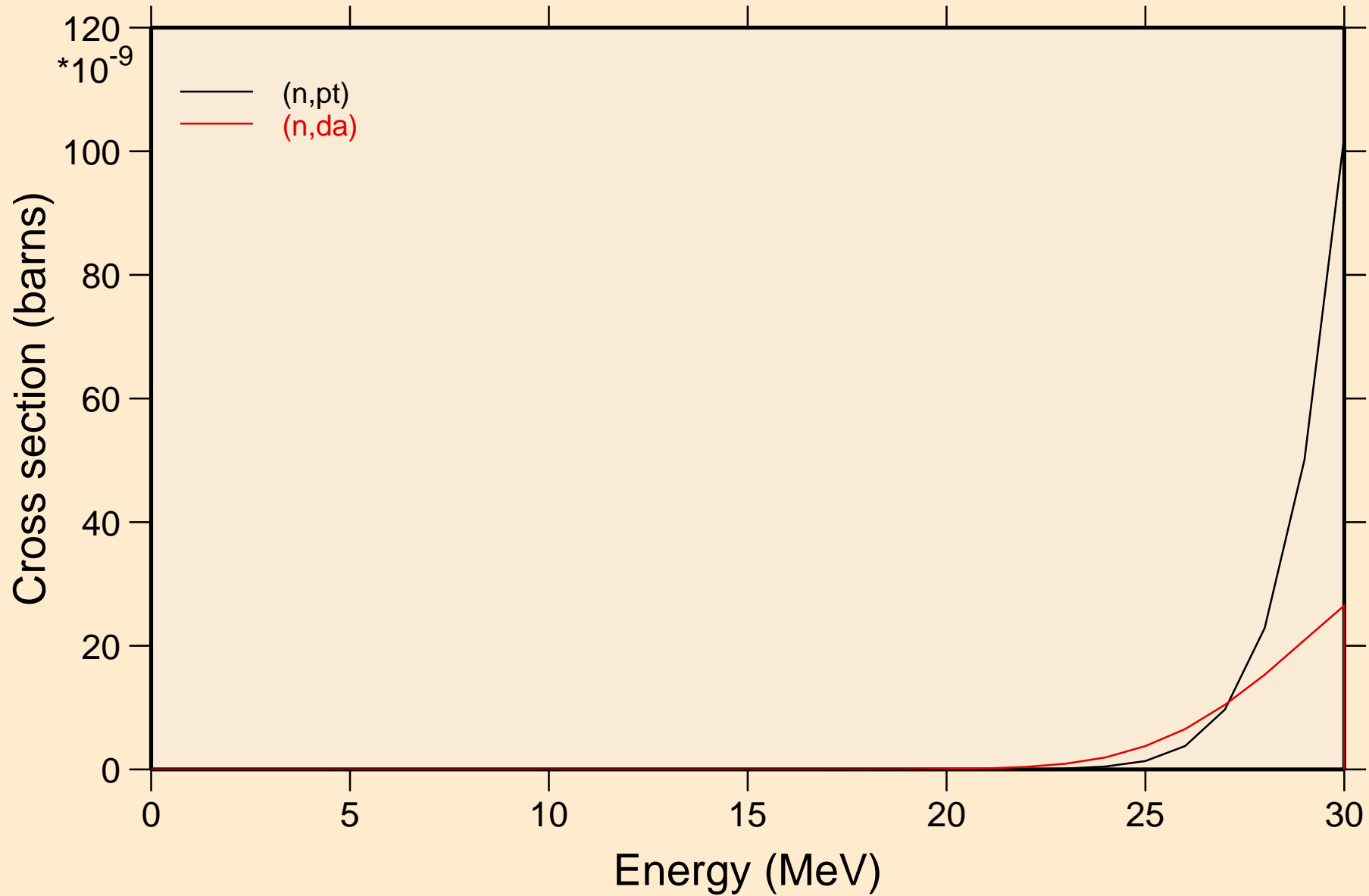

MD254M NEUTRON ACER TENDL-2021 LIBRARY; T=293.6K
Threshold reactions

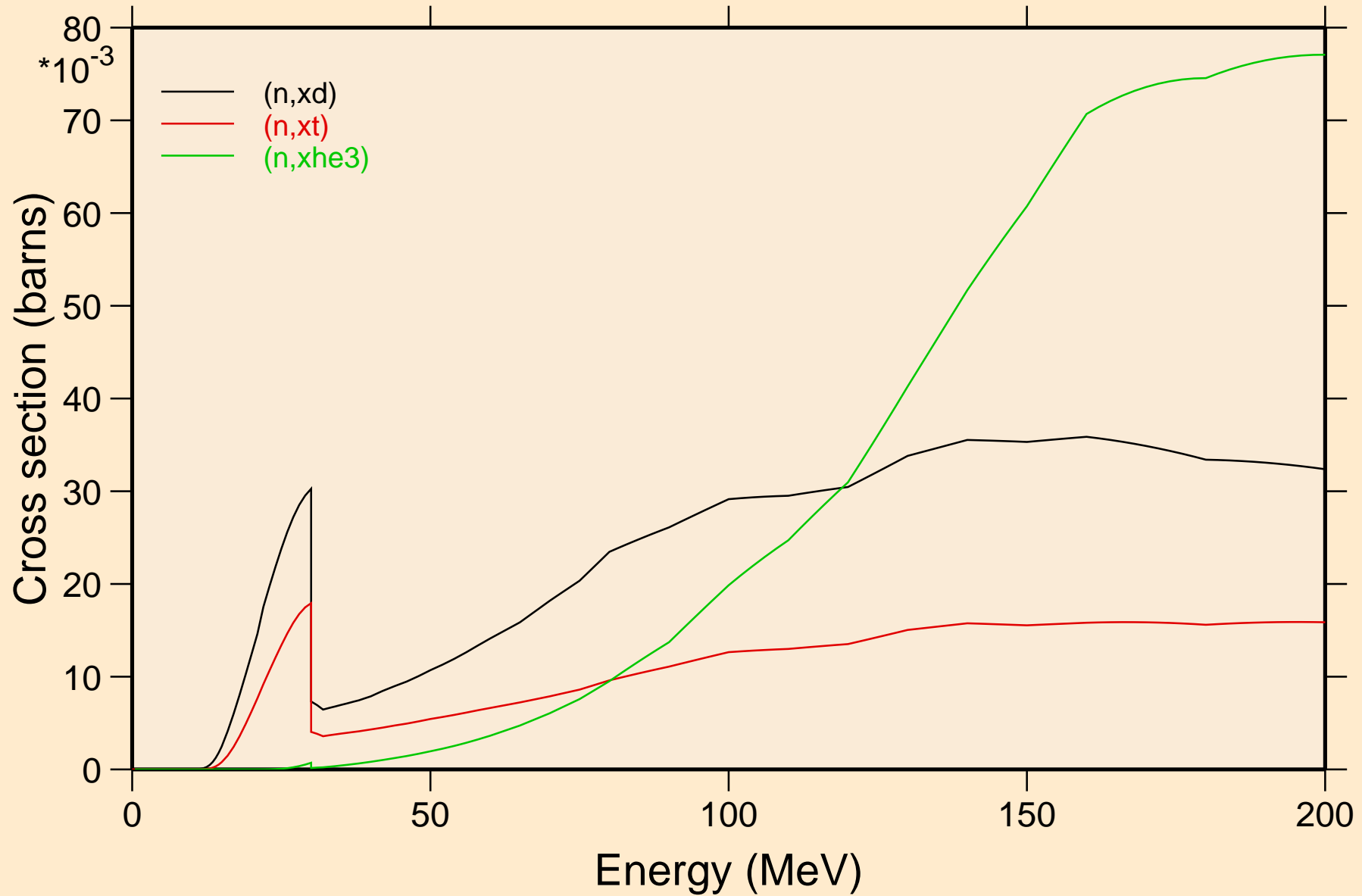

MD254M NEUTRON ACER TENDL-2021 LIBRARY; T=293.6K
angular distribution for elastic

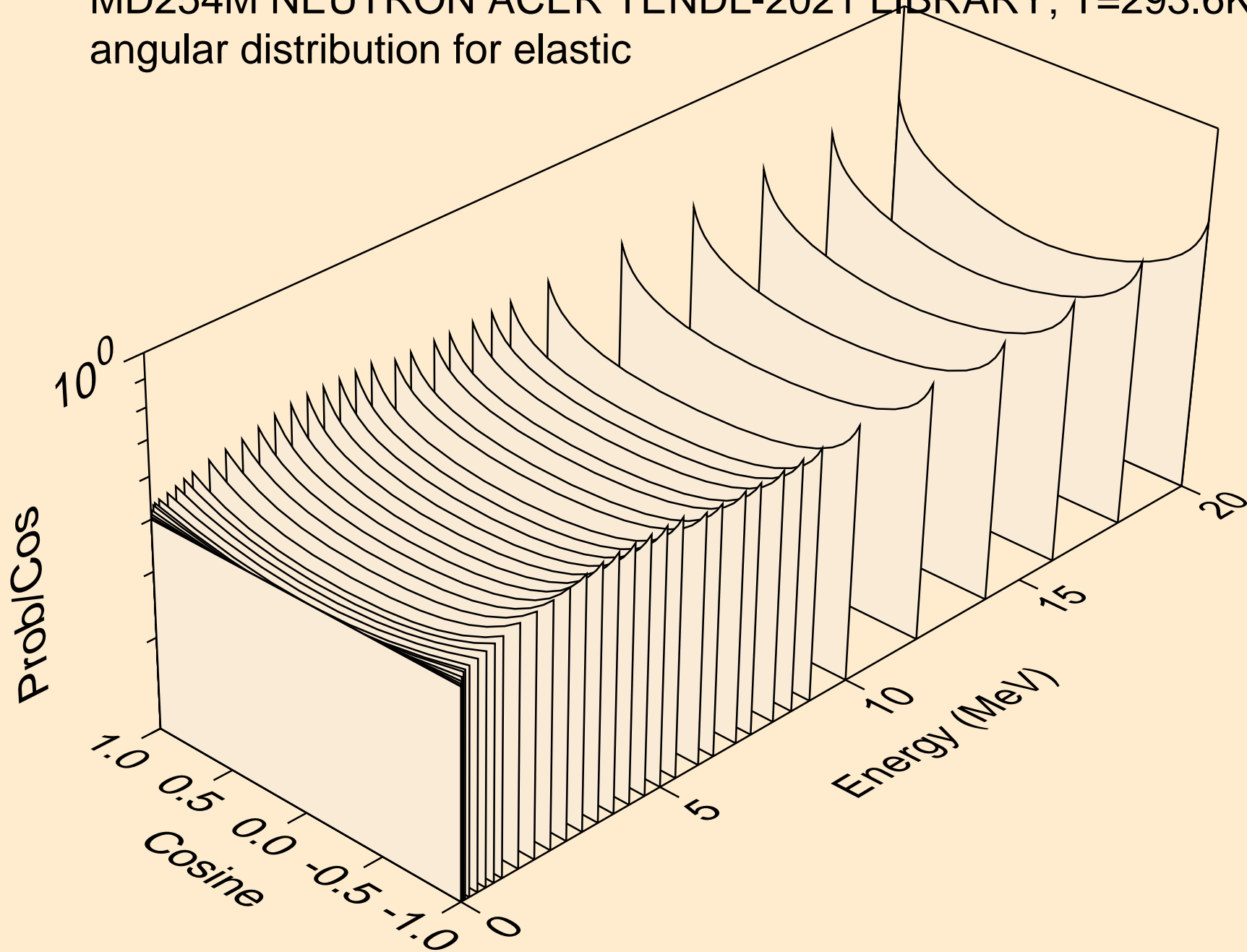

MD254M NEUTRON ACER TENDL-2021 LIBRARY; T=293.6K
angular distribution for elastic

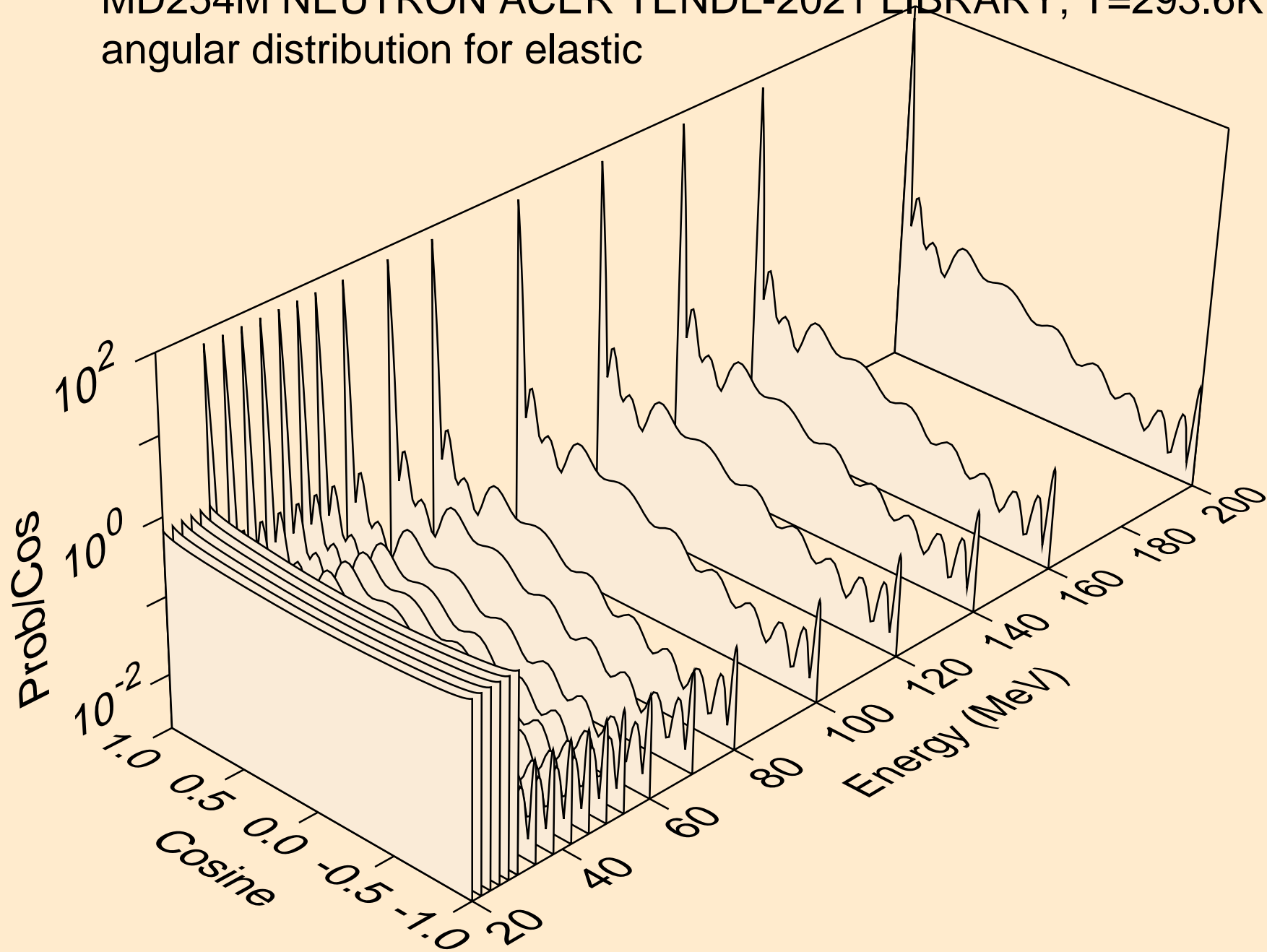

MD254M NEUTRON ACER TENDL-2021 LIBRARY; T=293.6K
angular distribution for (n,n*1)

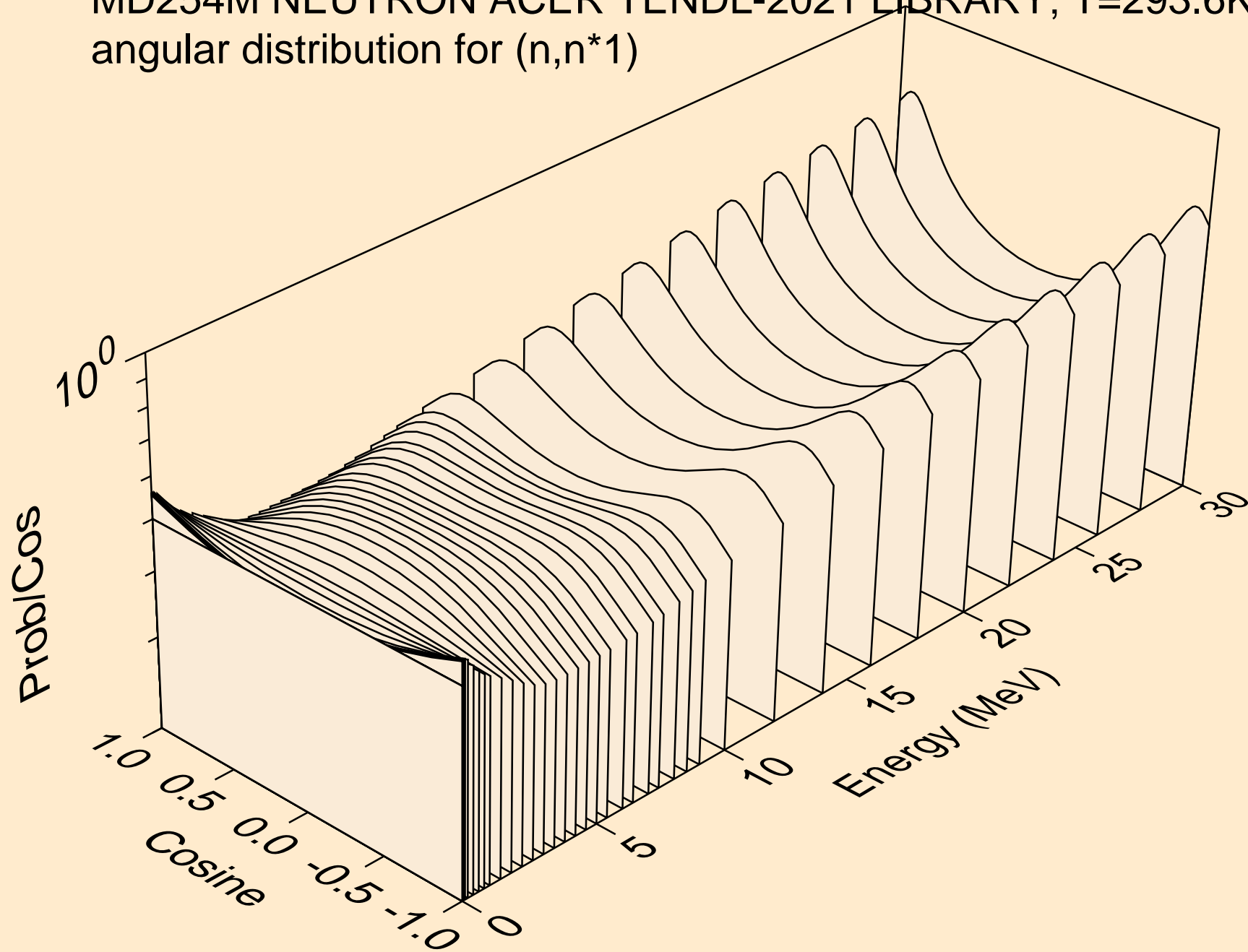

MD254M NEUTRON ACER TENDL-2021 LIBRARY; T=293.6K
angular distribution for (n,n*2)

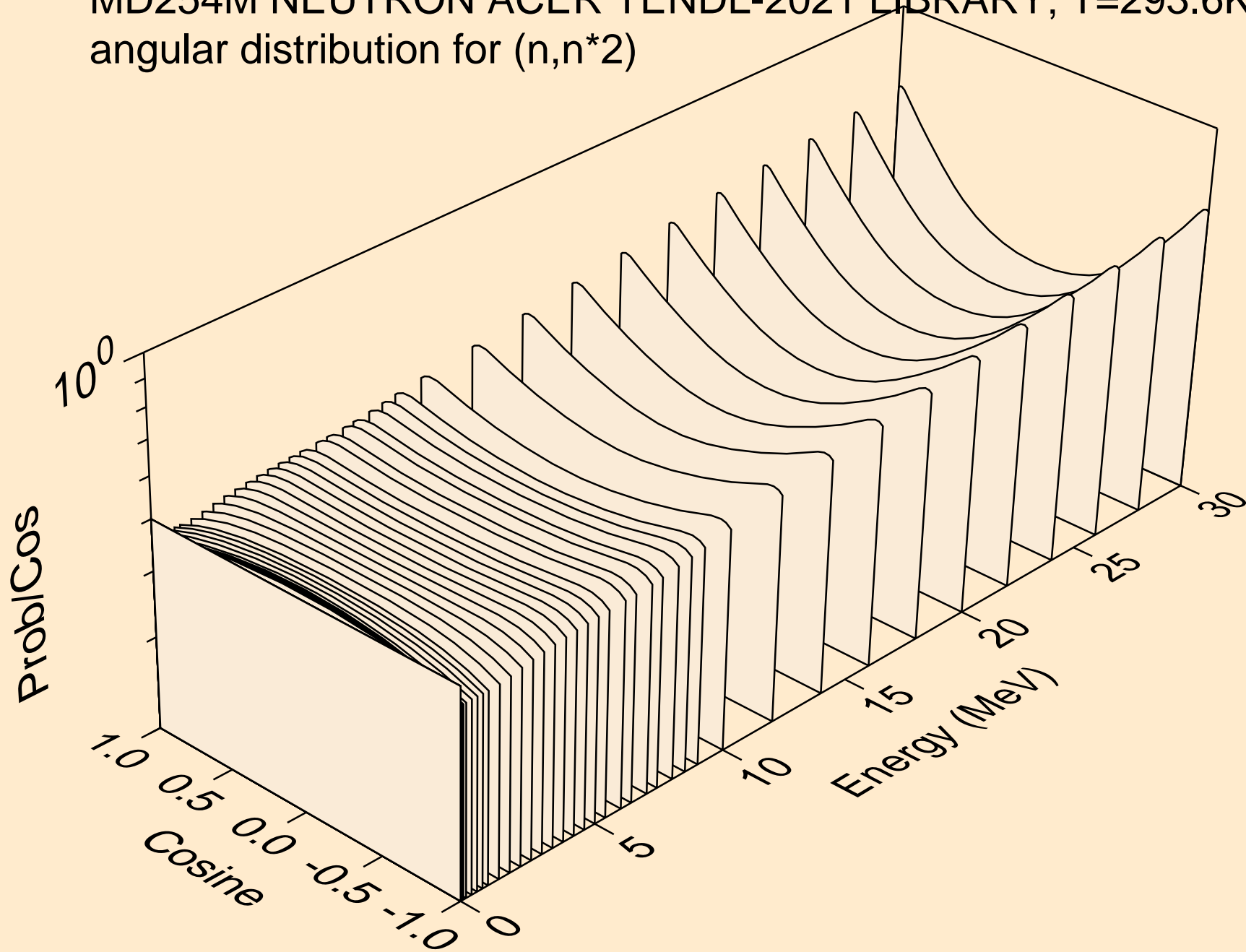

MD254M NEUTRON ACER TENDL-2021 LIBRARY; T=293.6K
angular distribution for (n,n*3)

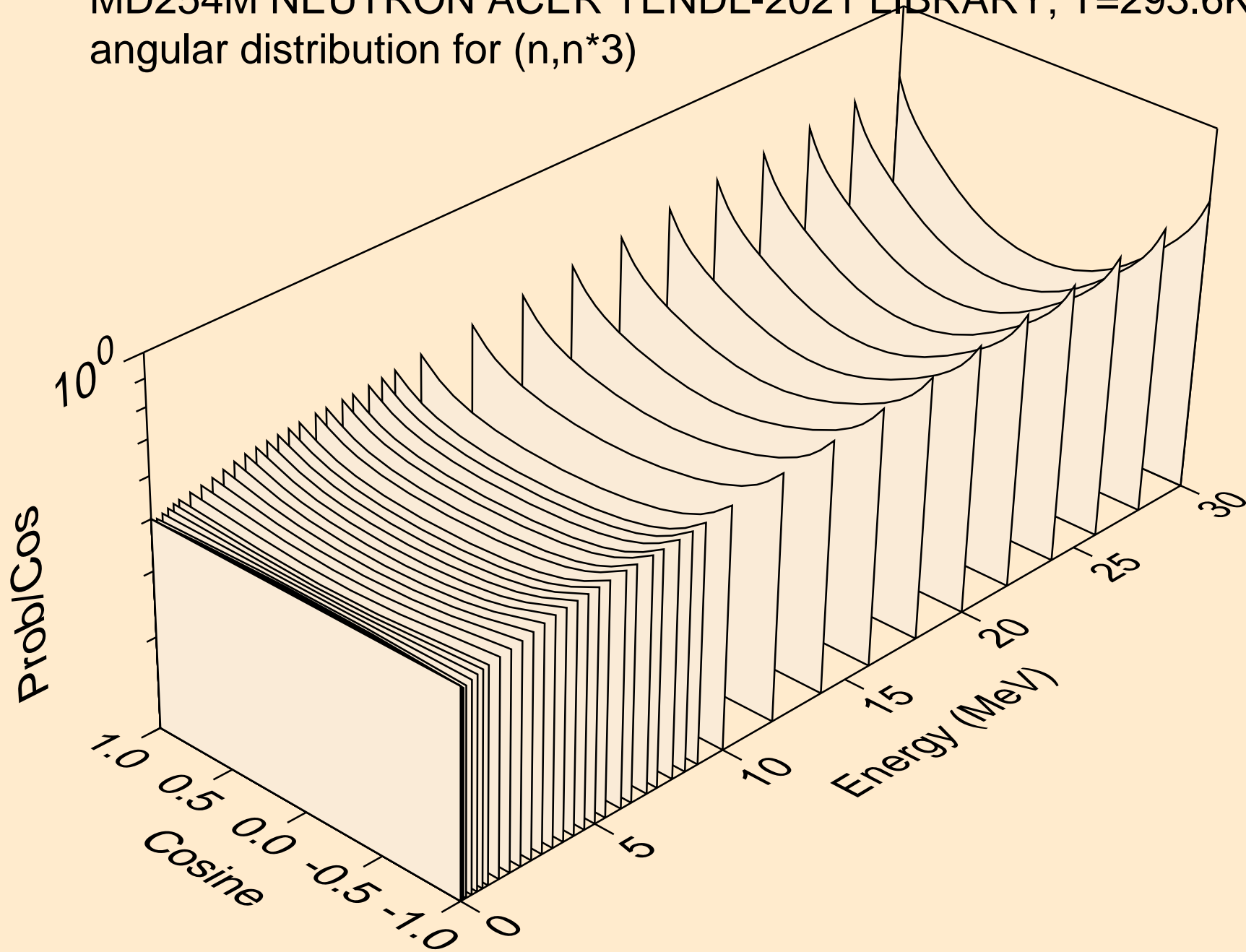

MD254M NEUTRON ACER TENDL-2021 LIBRARY; T=293.6K
angular distribution for (n,n*4)

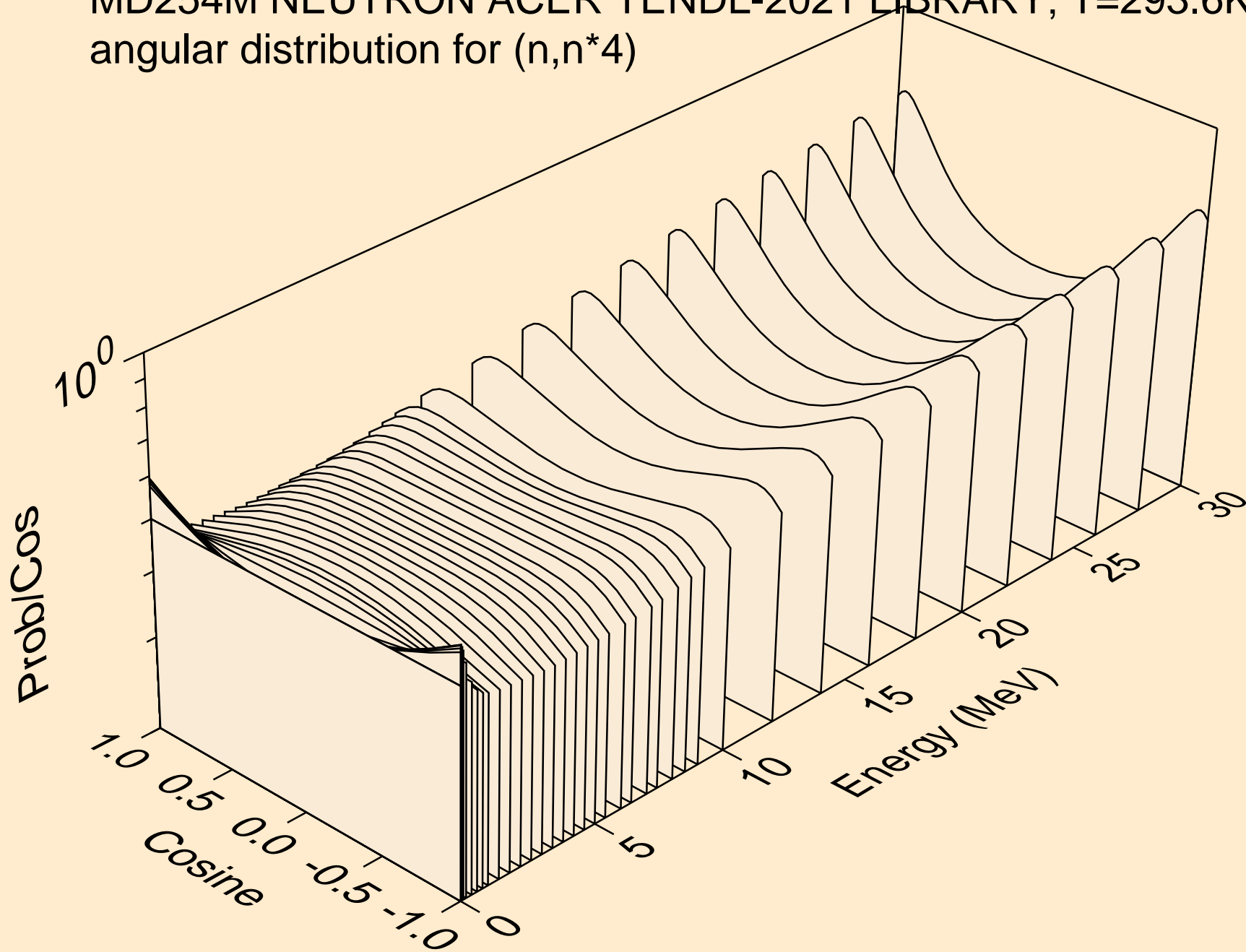

MD254M NEUTRON ACER TENDL-2021 LIBRARY; T=293.6K
angular distribution for (n,n*5)

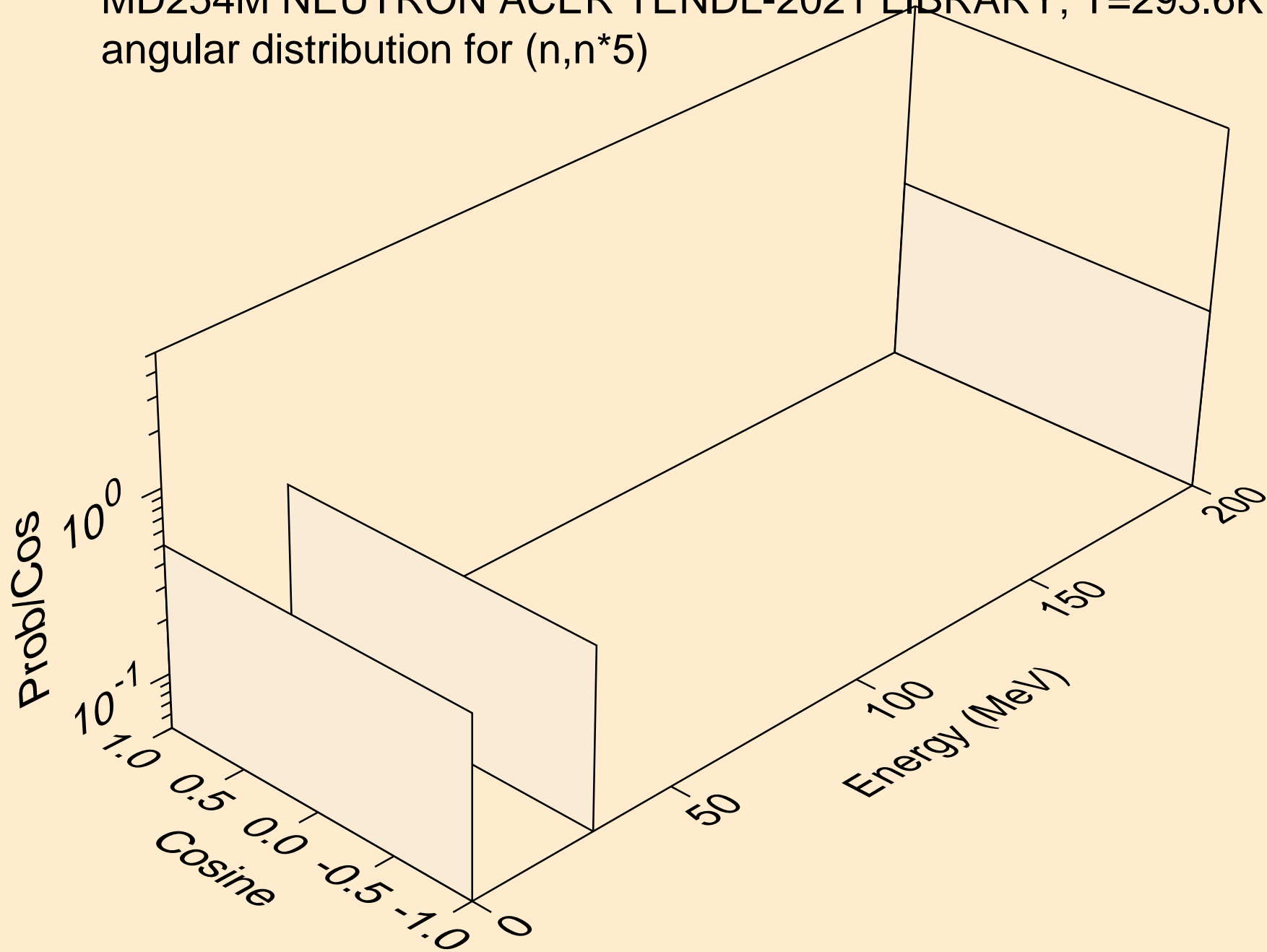

MD254M NEUTRON ACER TENDL-2021 LIBRARY; T=293.6K
angular distribution for (n,n*6)

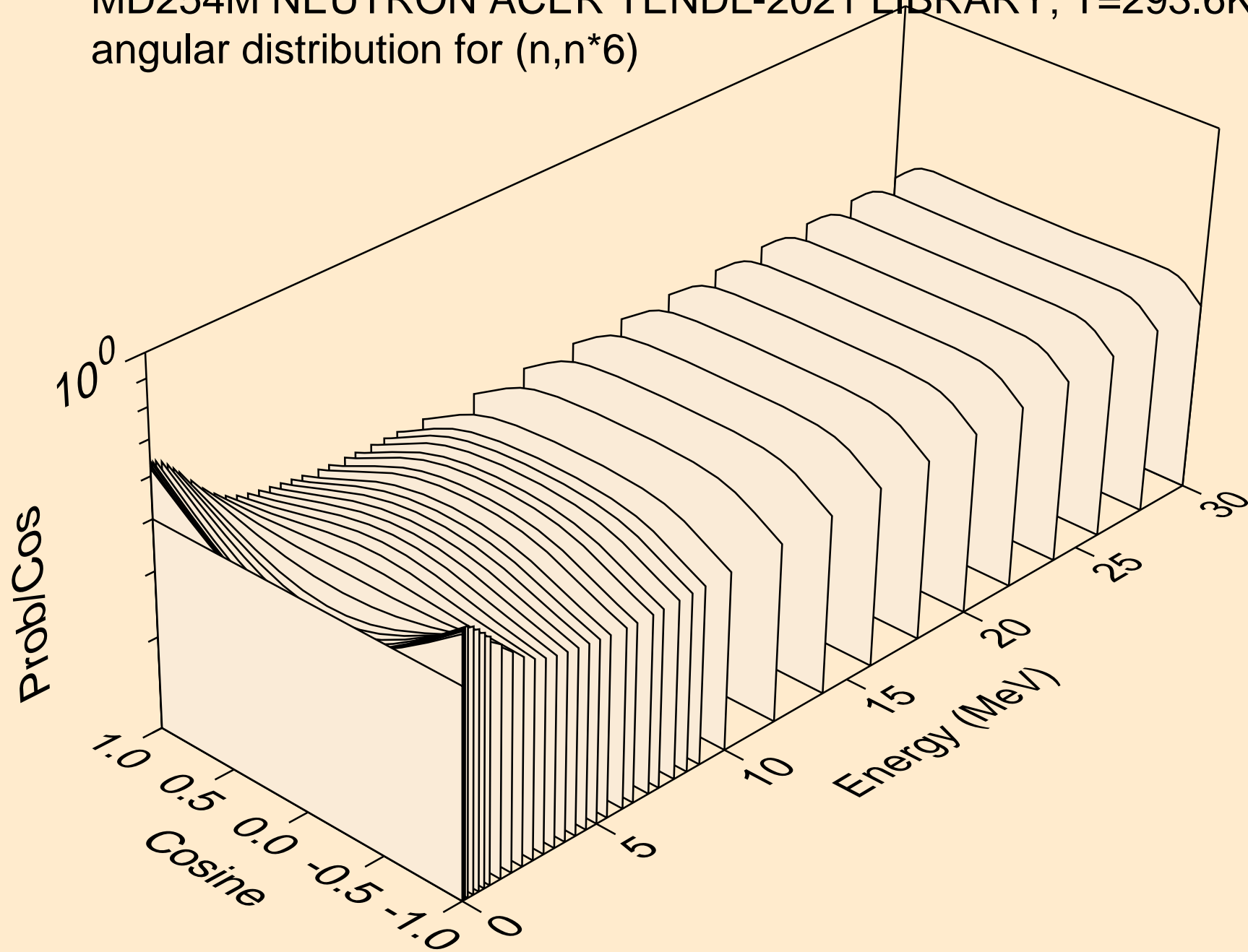

MD254M NEUTRON ACER TENDL-2021 LIBRARY; T=293.6K
angular distribution for (n,n*7)

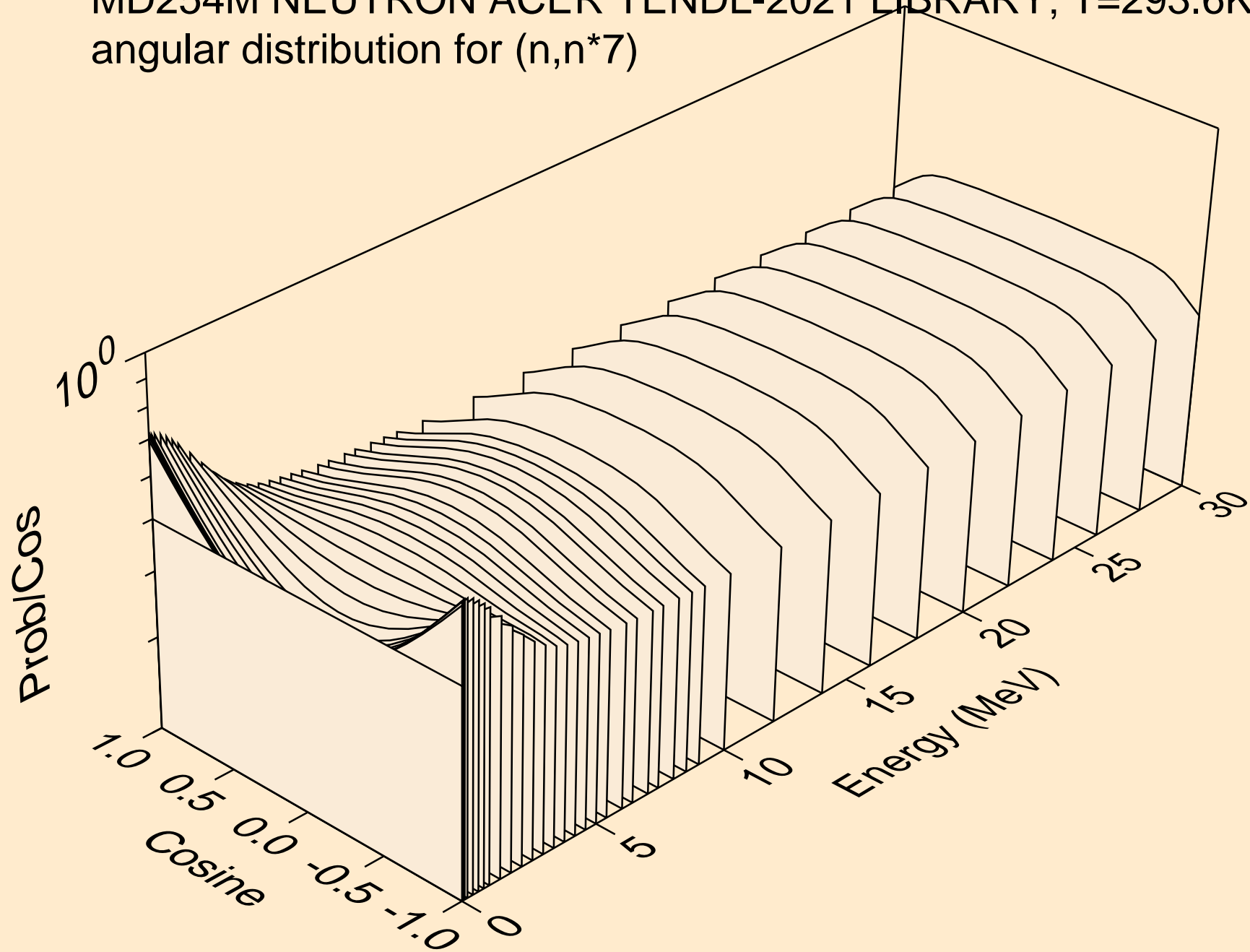

MD254M NEUTRON ACER TENDL-2021 LIBRARY; T=293.6K
angular distribution for (n,n*8)

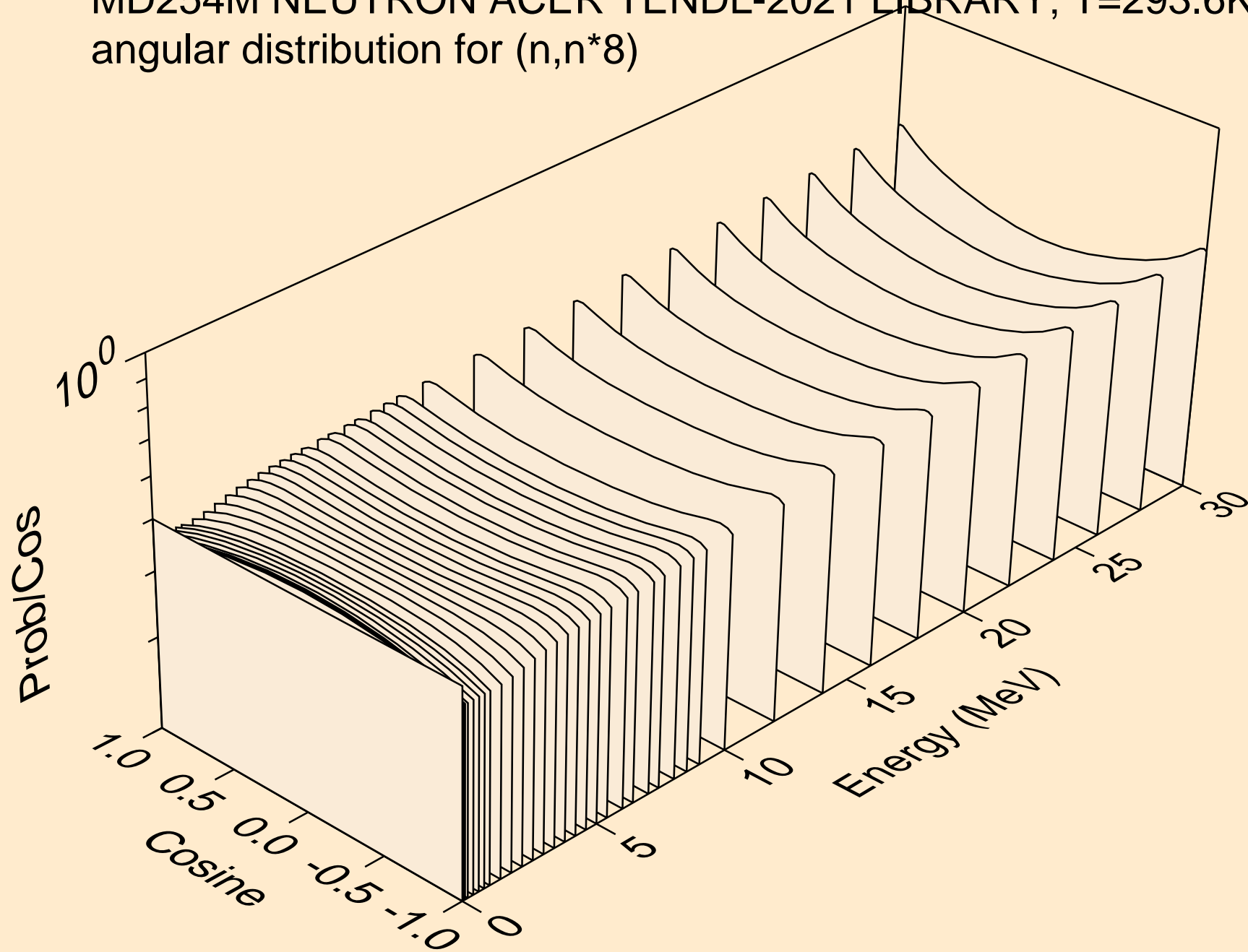

MD254M NEUTRON ACER TENDL-2021 LIBRARY; T=293.6K
angular distribution for (n,n*9)

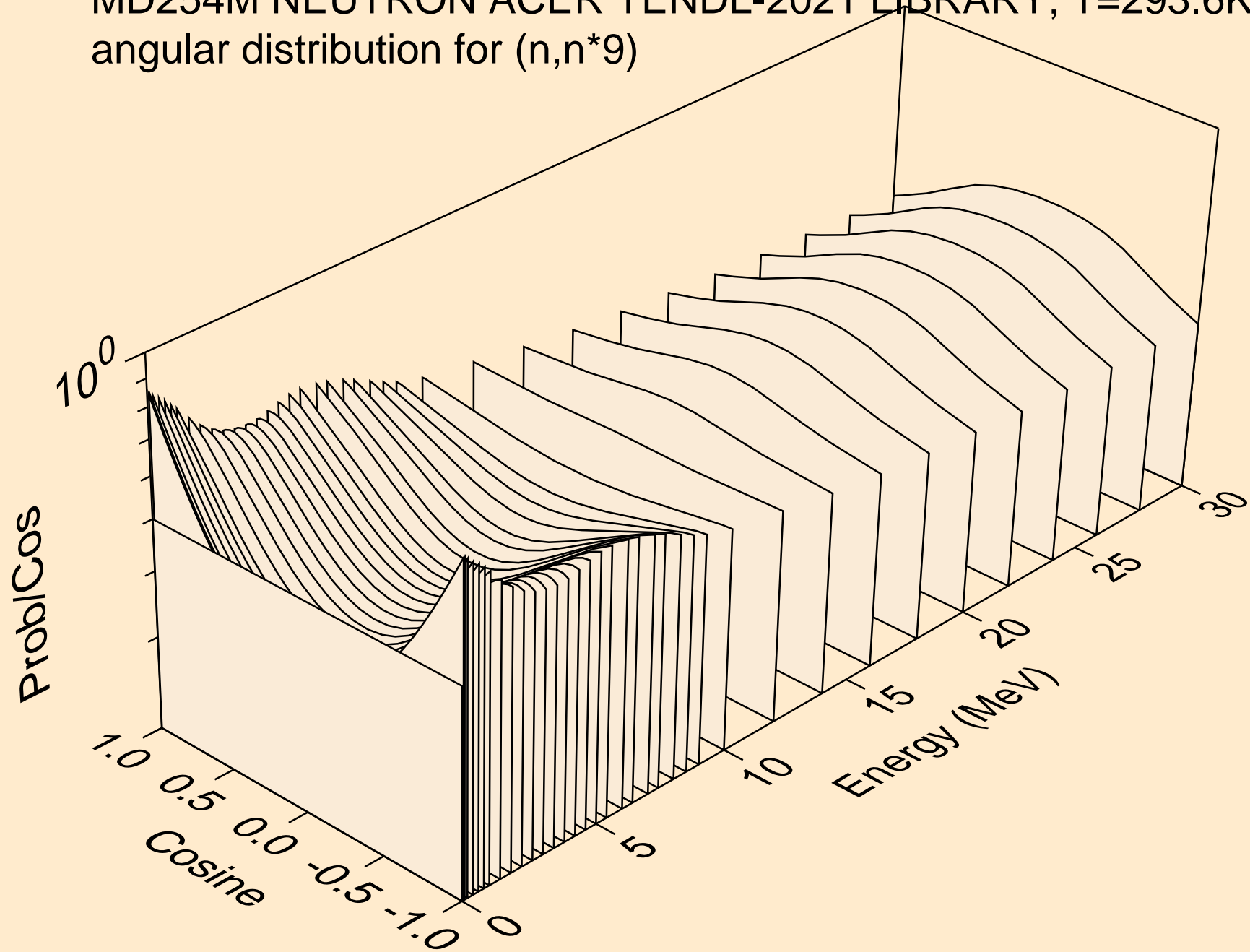

MD254M NEUTRON ACER TENDL-2021 LIBRARY; T=293.6K
angular distribution for (n,n*10)

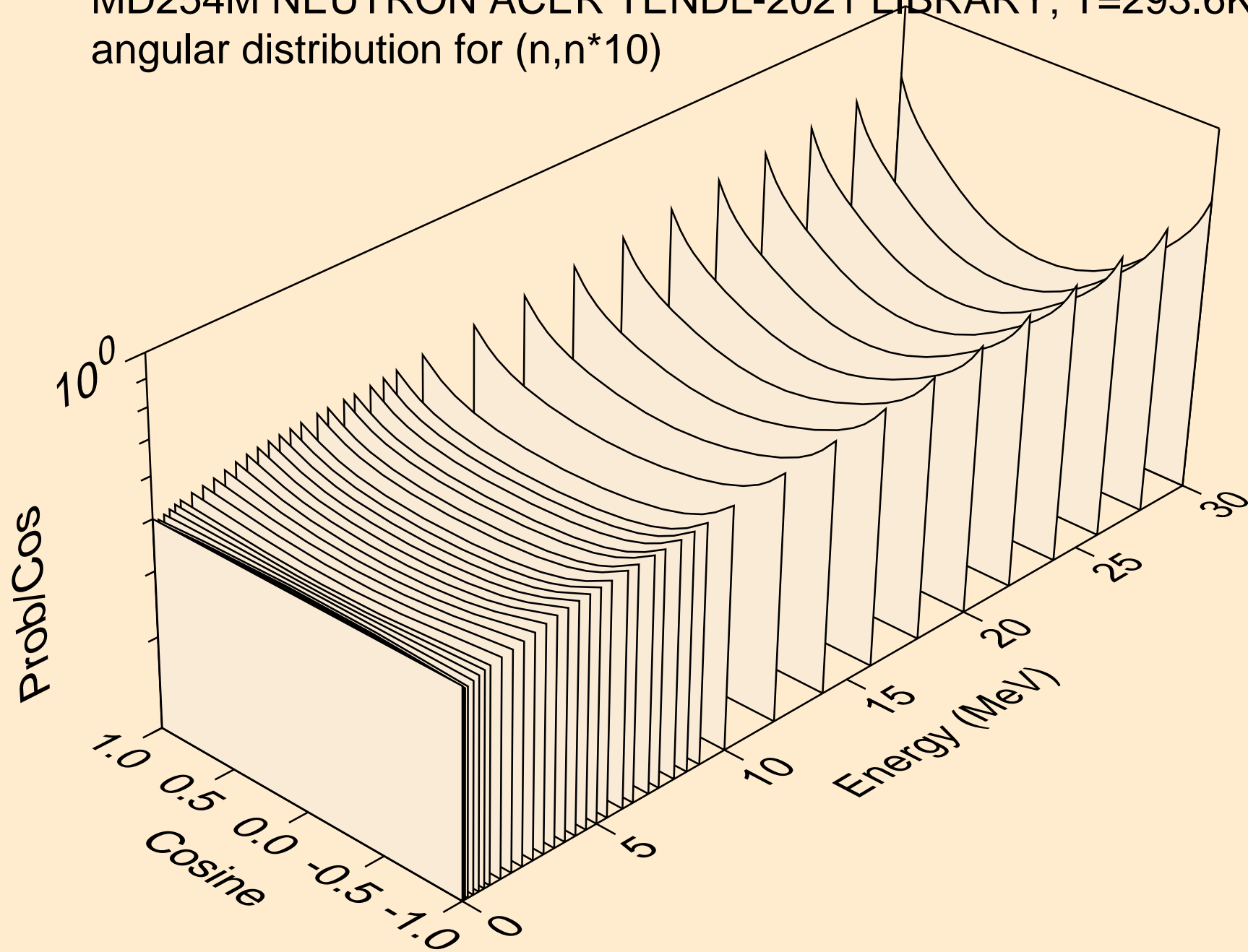

MD254M NEUTRON ACER TENDL-2021 LIBRARY; T=293.6K
angular distribution for (n,n*11)

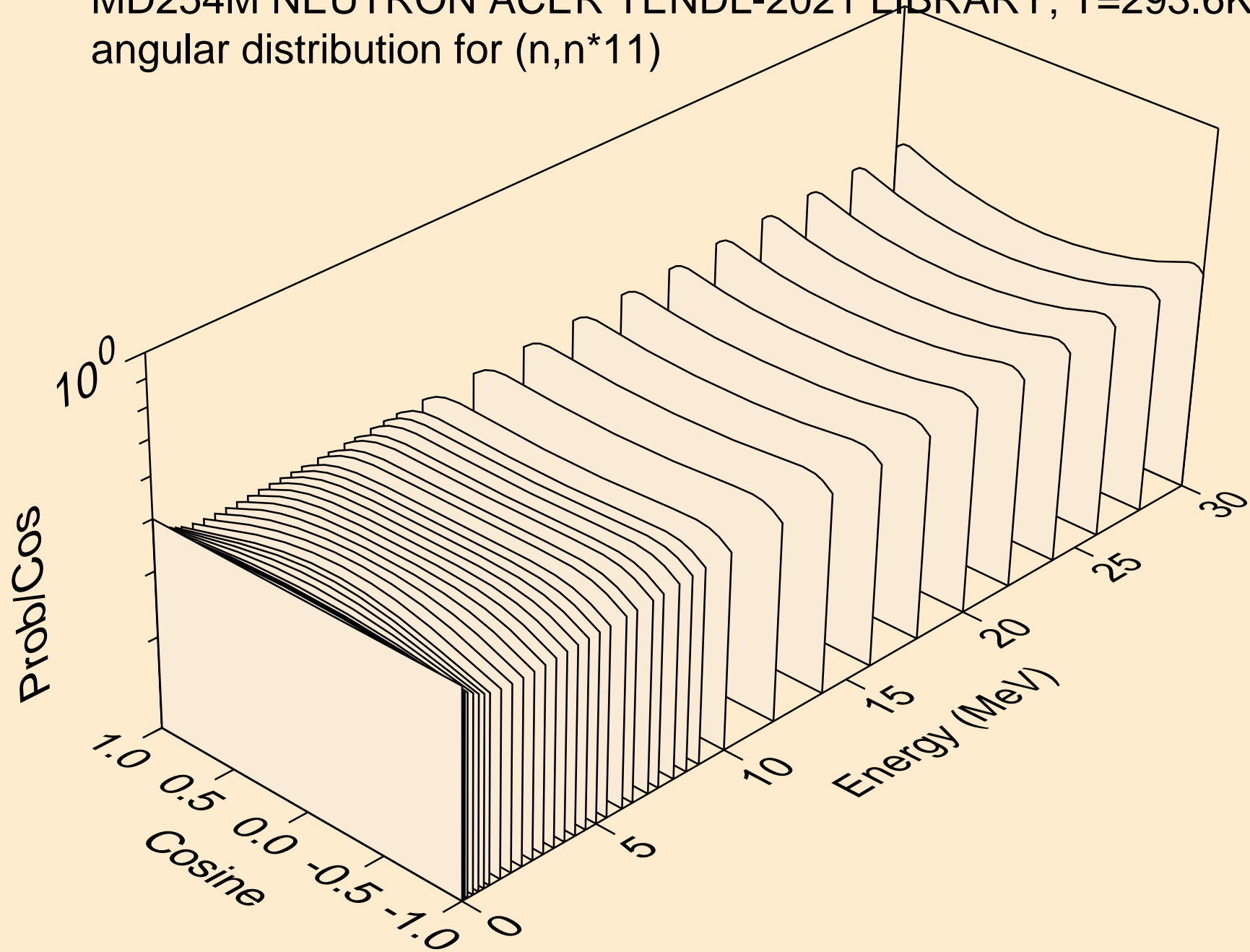

MD254M NEUTRON ACER TENDL-2021 LIBRARY; T=293.6K
angular distribution for (n,n*12)

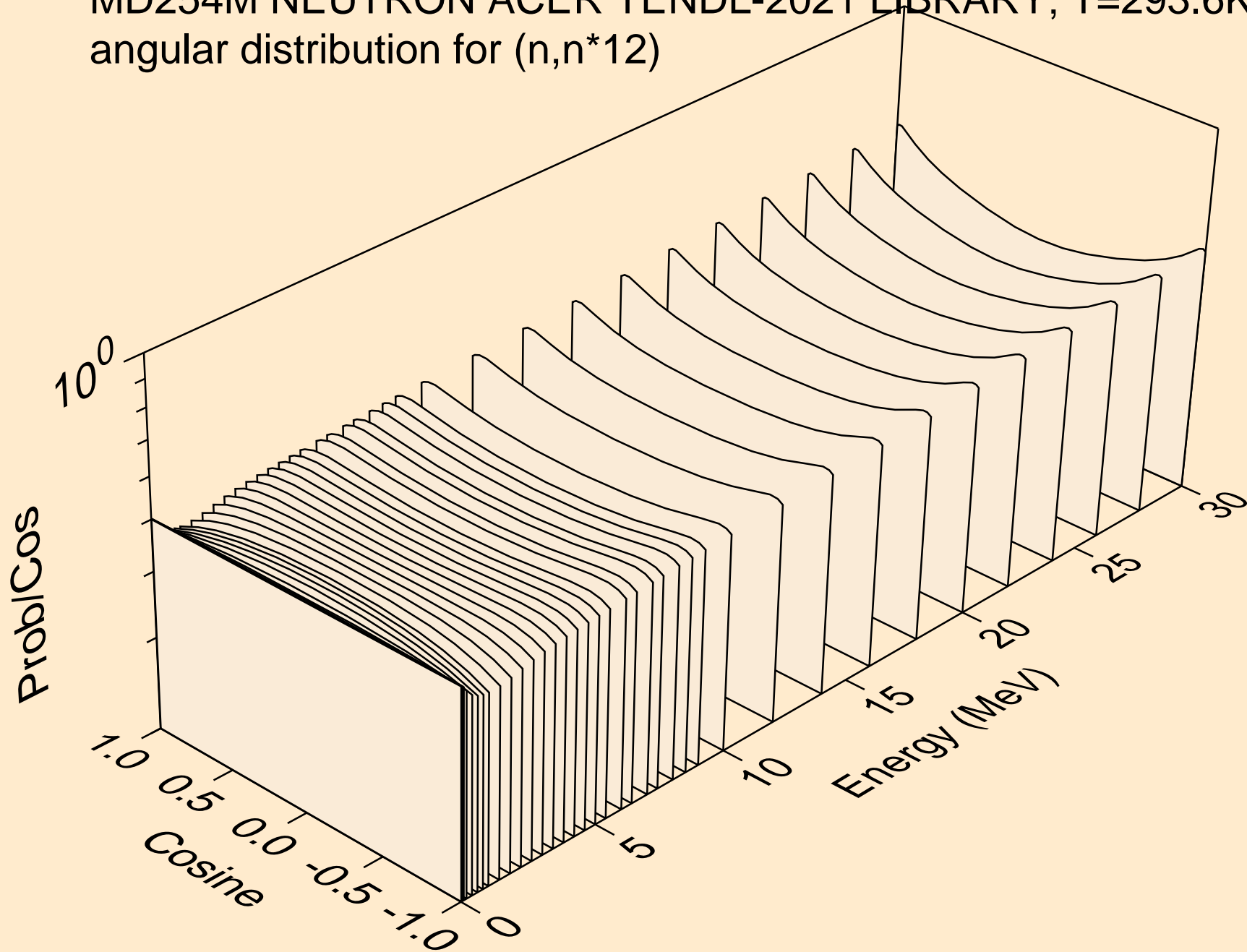

MD254M NEUTRON ACER TENDL-2021 LIBRARY; T=293.6K
angular distribution for (n,n*13)

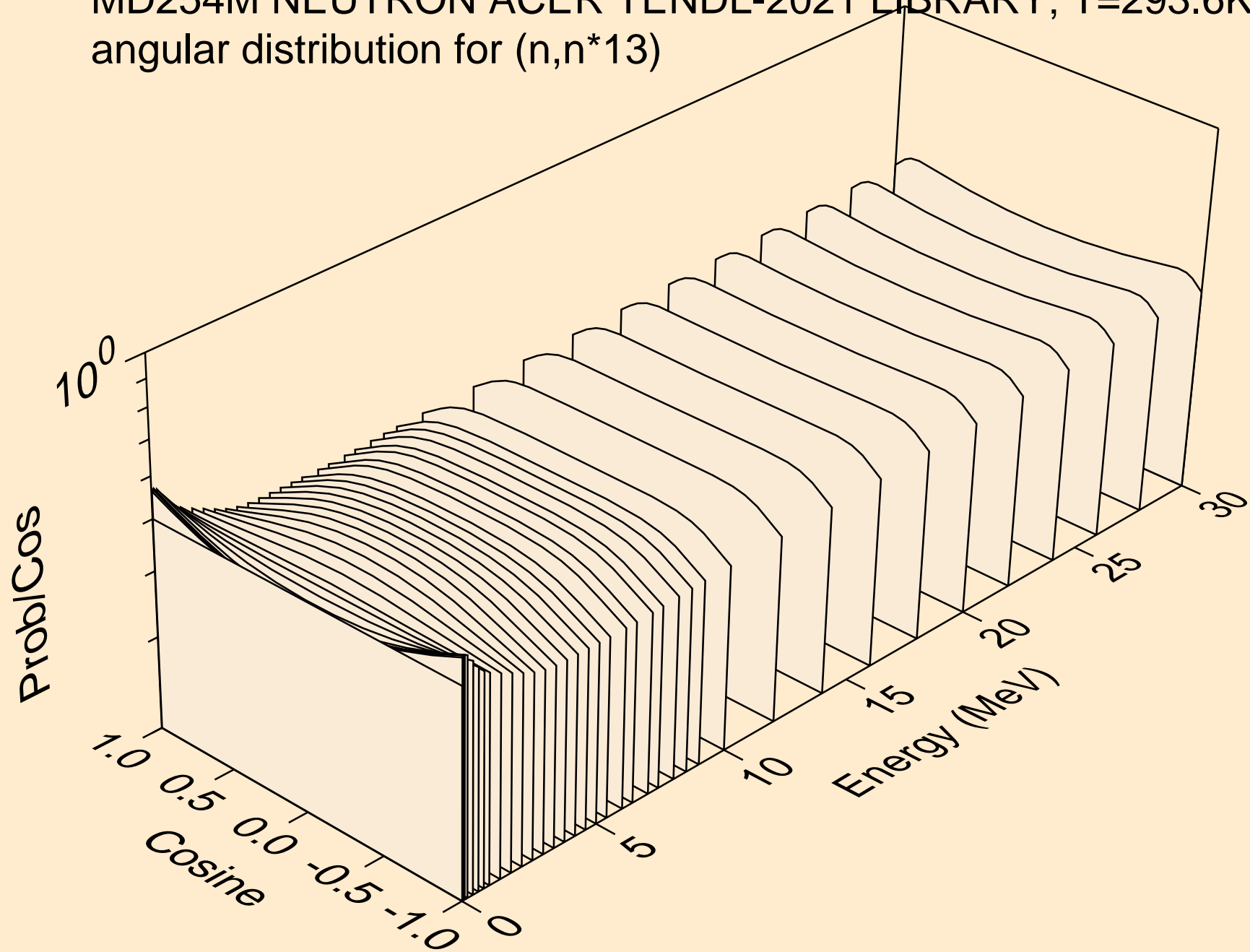

MD254M NEUTRON ACER TENDL-2021 LIBRARY; T=293.6K
angular distribution for (n,n*14)

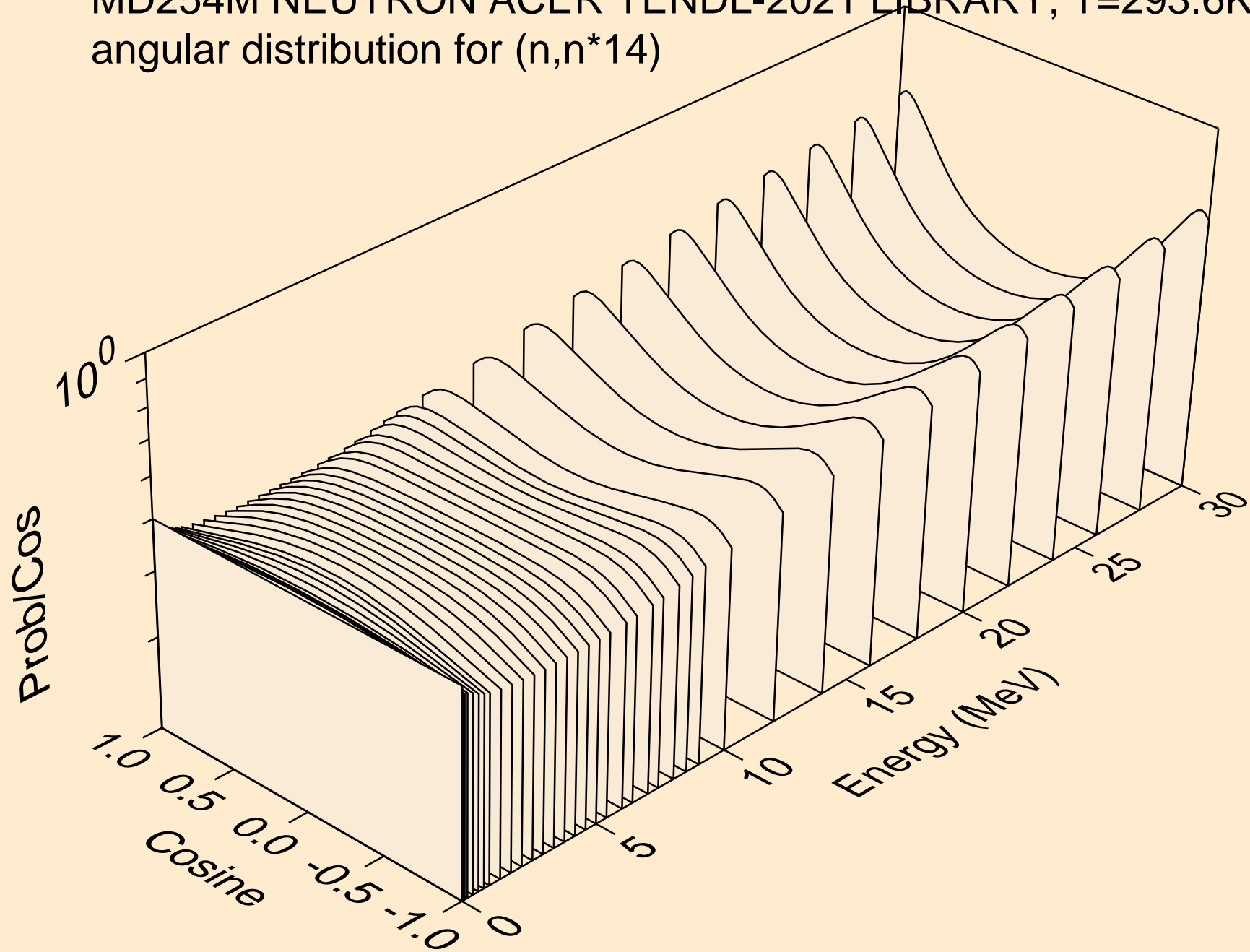

MD254M NEUTRON ACER TENDL-2021 LIBRARY; T=293.6K
angular distribution for (n,n*15)

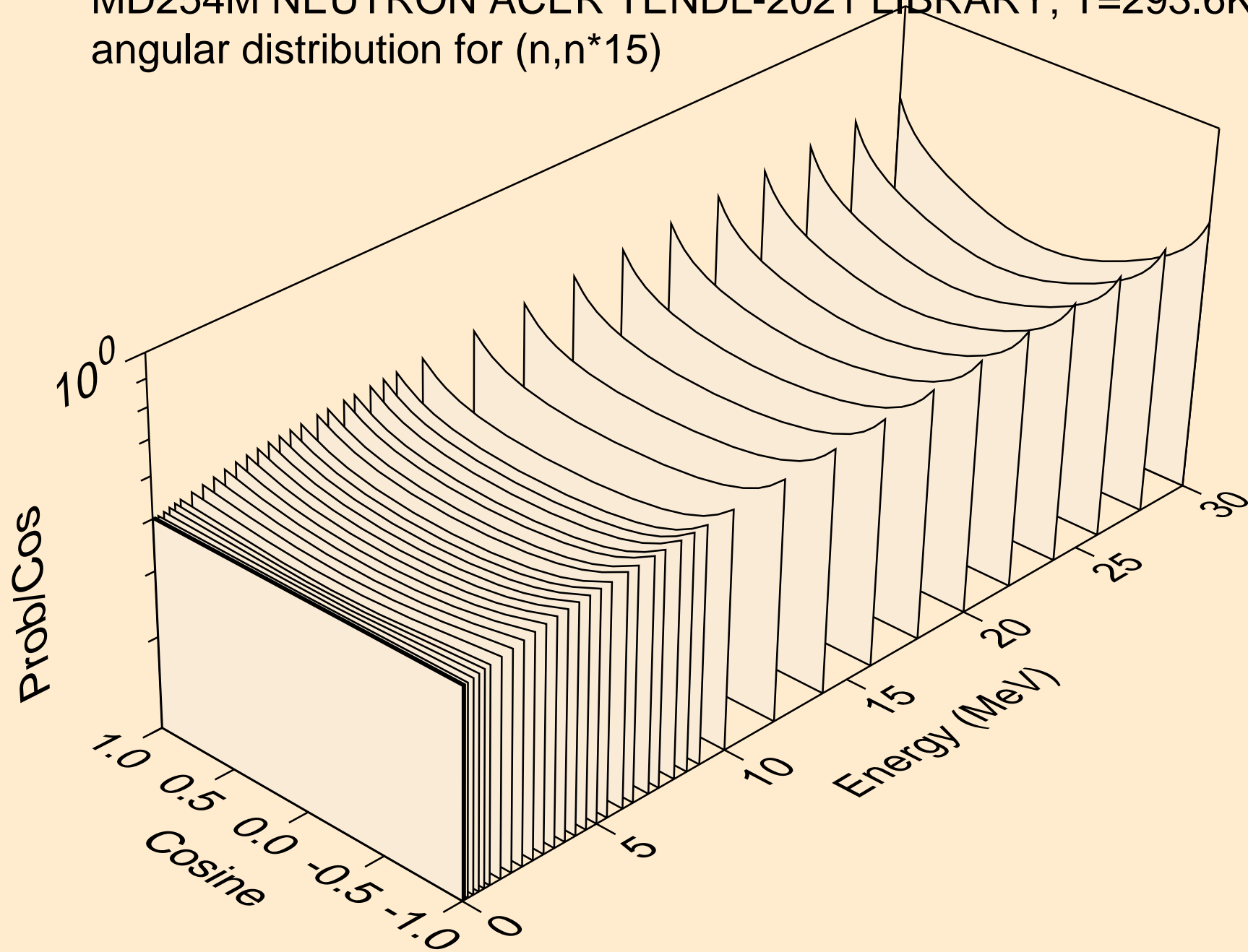

MD254M NEUTRON ACER TENDL-2021 LIBRARY; T=293.6K
angular distribution for (n,n*16)

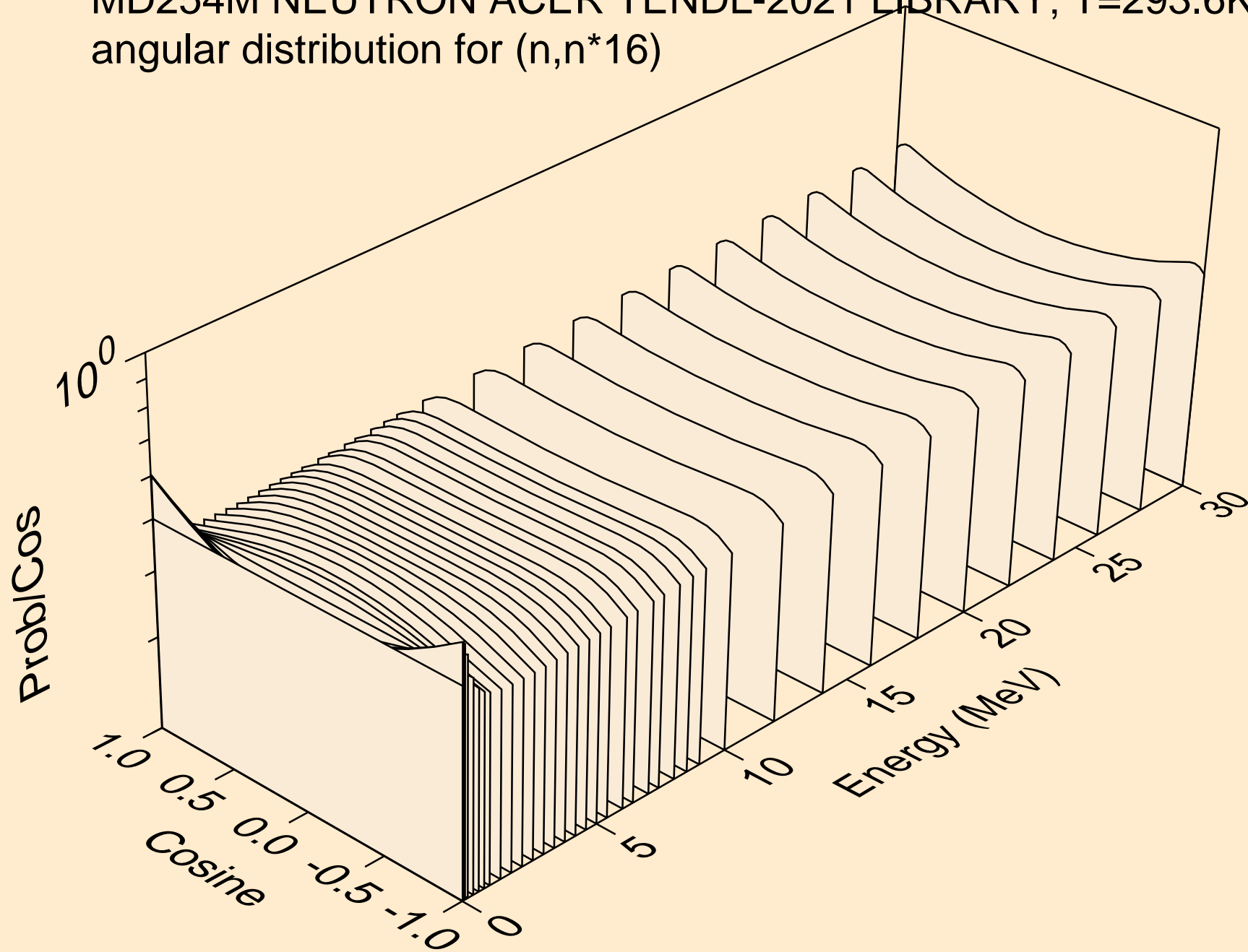

MD254M NEUTRON ACER TENDL-2021 LIBRARY; T=293.6K
angular distribution for (n,n*17)

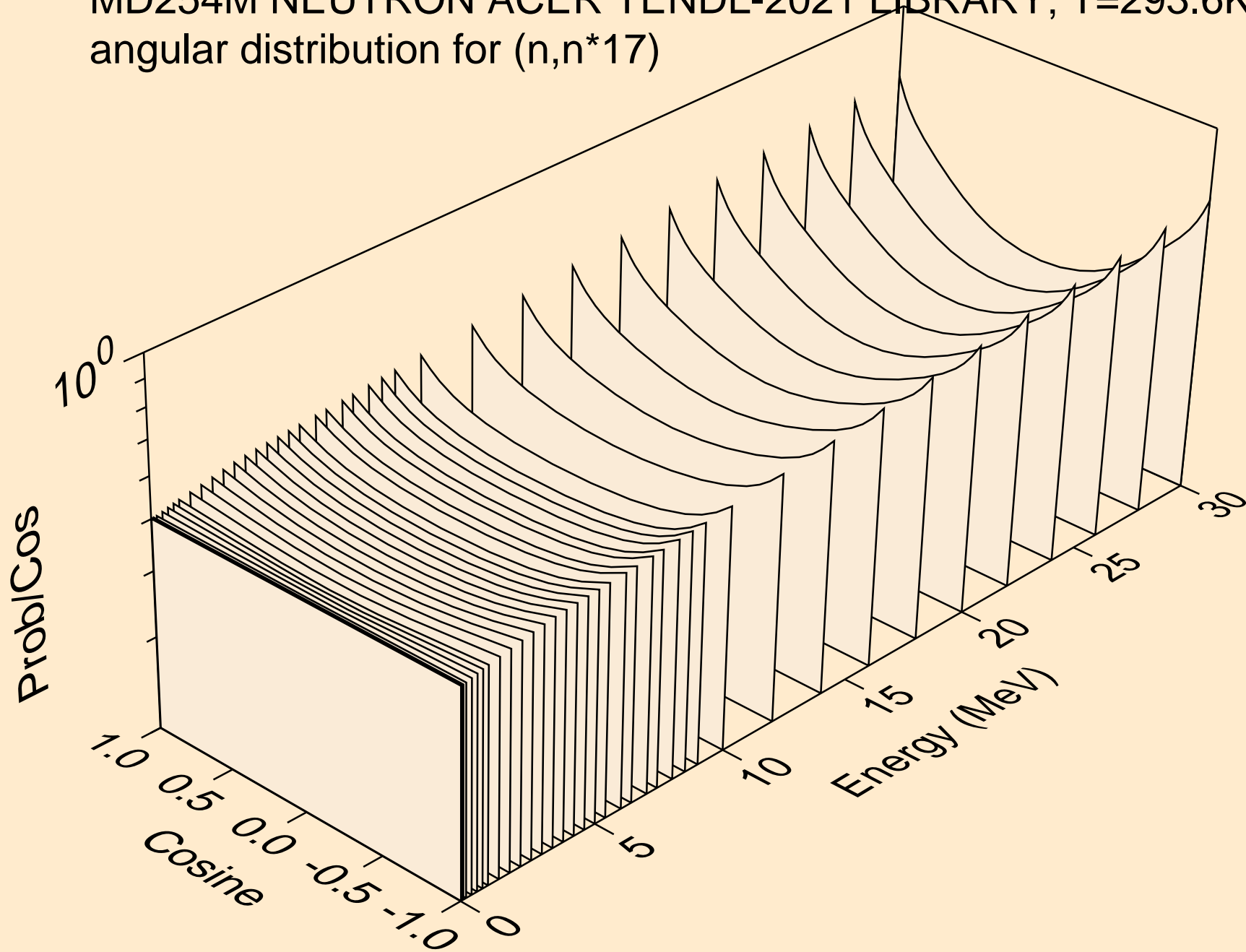

MD254M NEUTRON ACER TENDL-2021 LIBRARY; T=293.6K
angular distribution for (n,n*18)

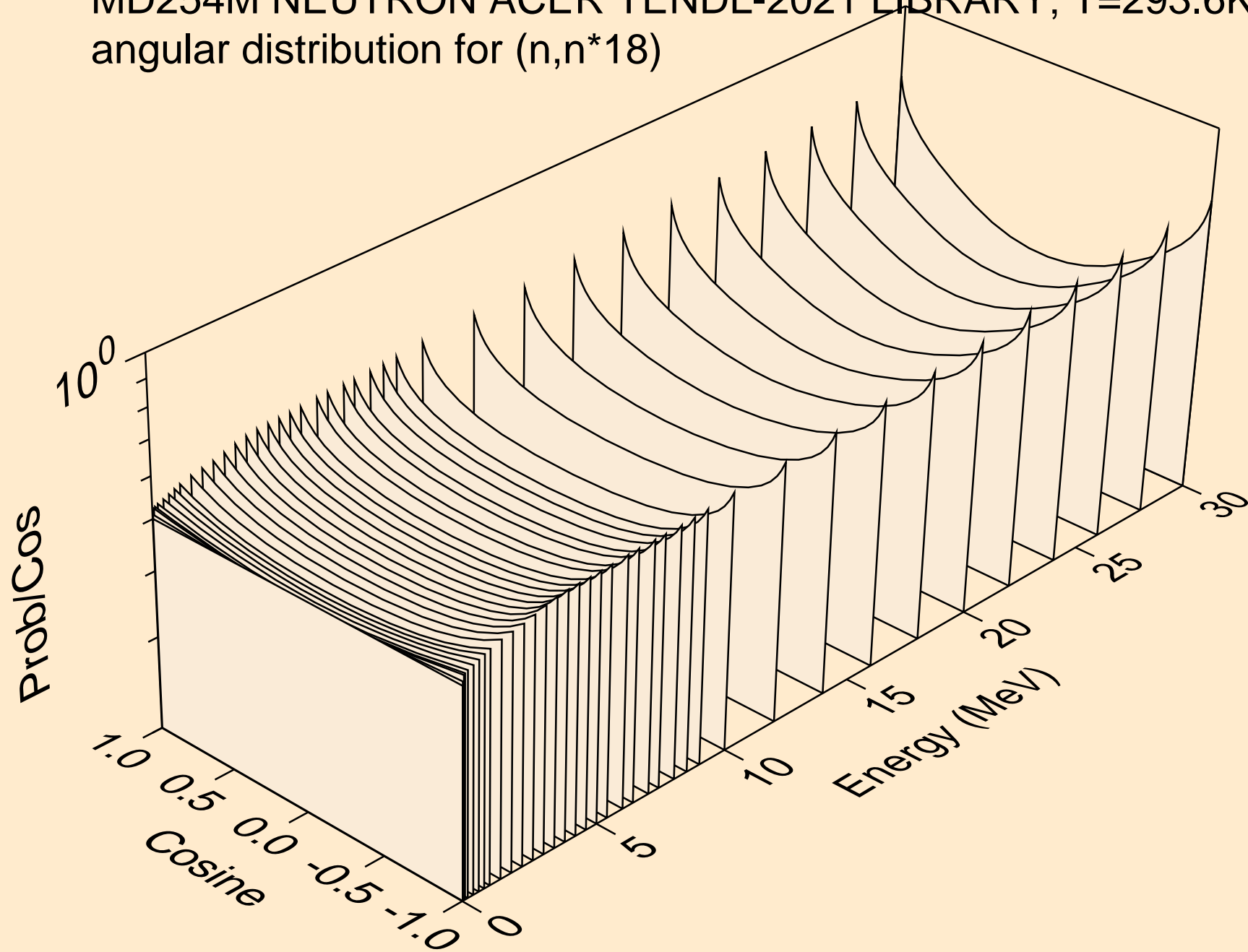

MD254M NEUTRON ACER TENDL-2021 LIBRARY; T=293.6K
angular distribution for (n,n*19)

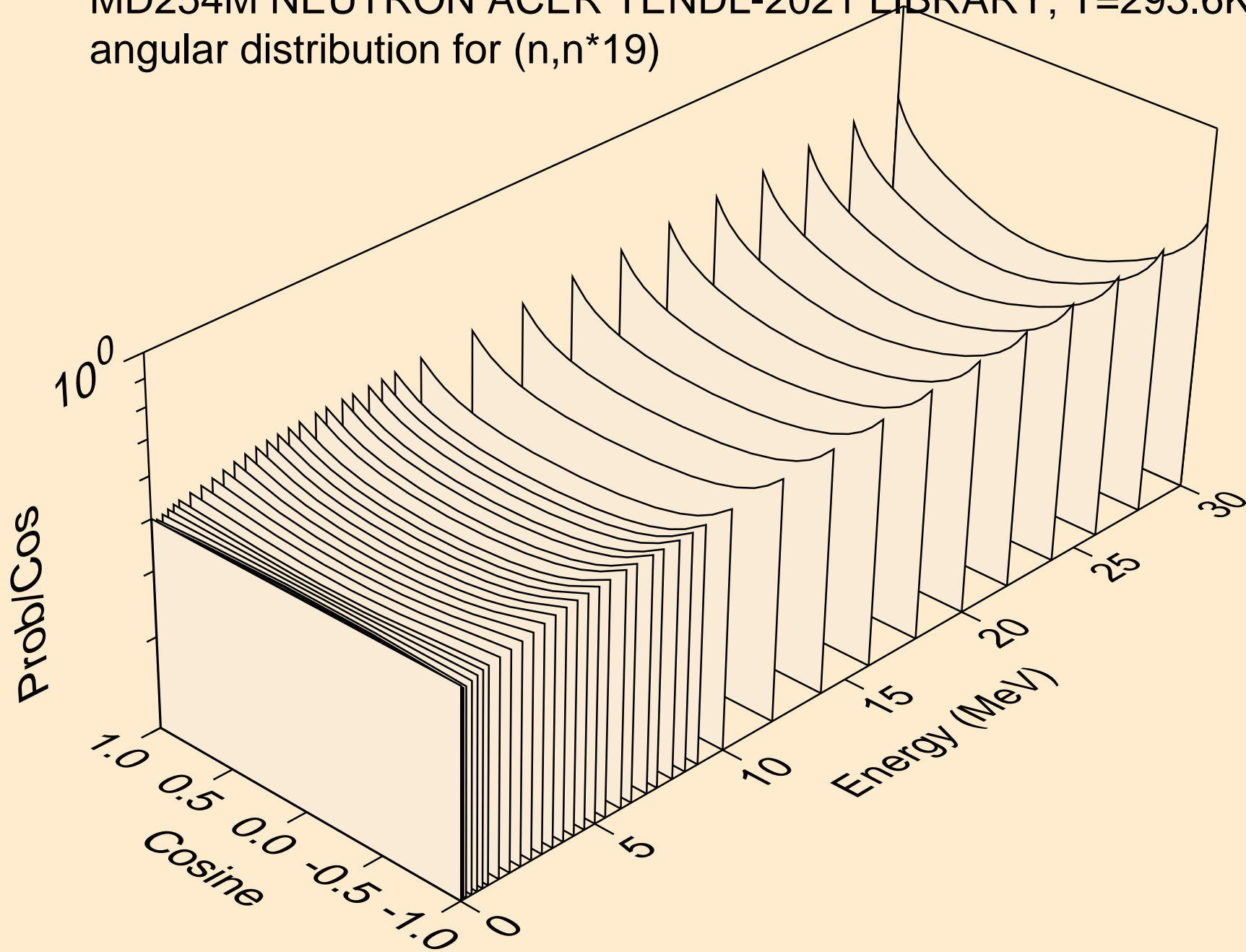

MD254M NEUTRON ACER TENDL-2021 LIBRARY; T=293.6K
angular distribution for (n,n*20)

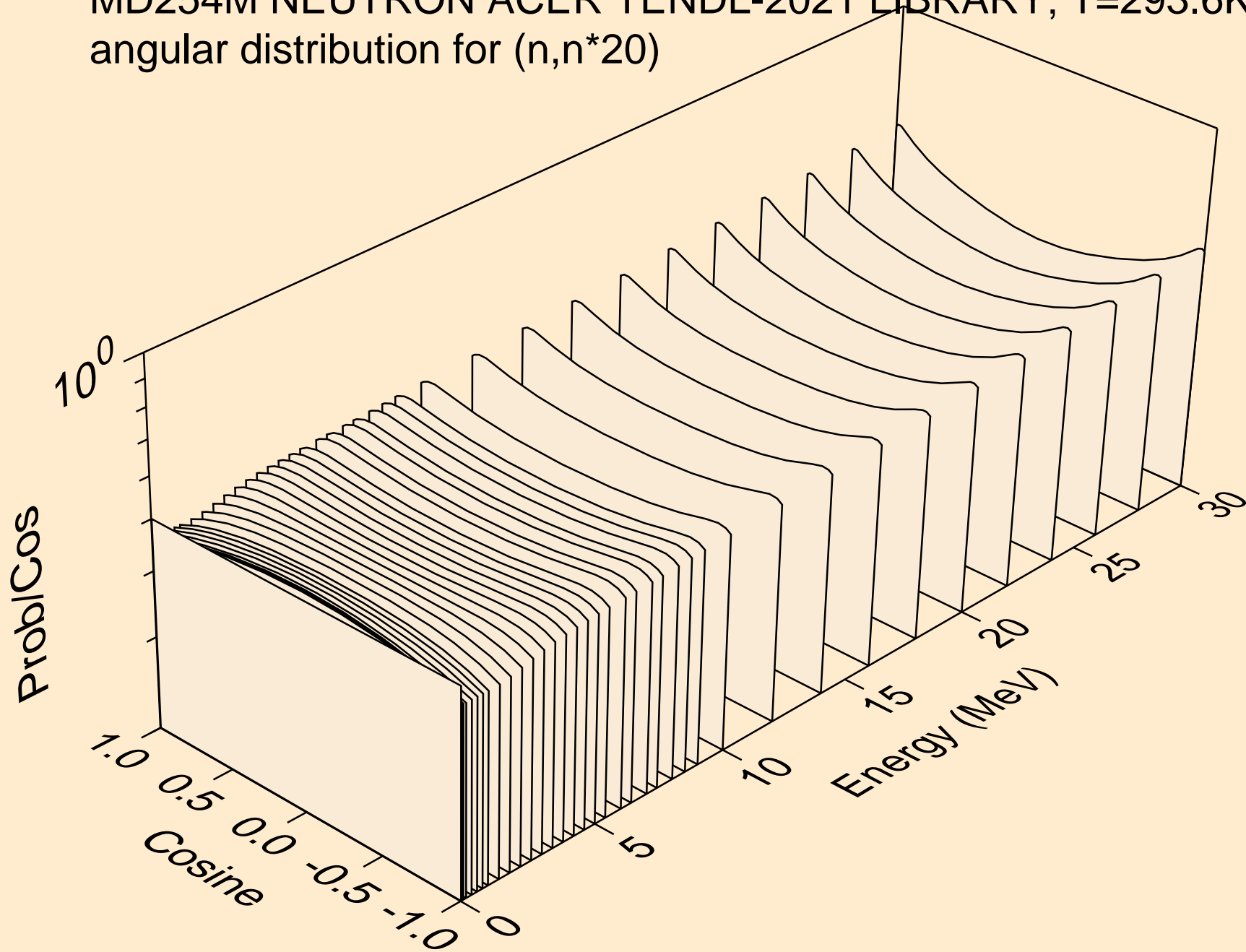

MD254M NEUTRON ACER TENDL-2021 LIBRARY; T=293.6K
angular distribution for (n,n*21)

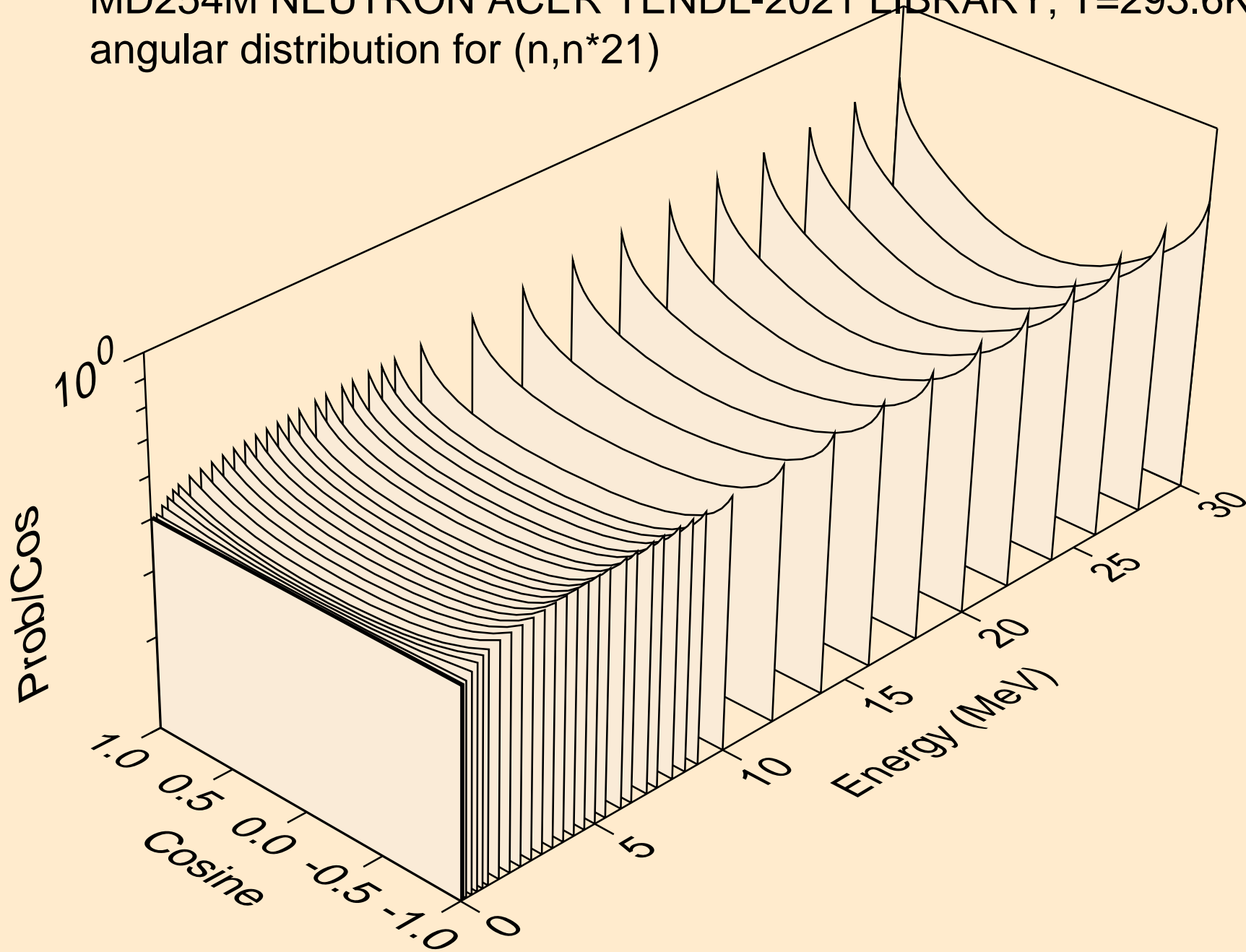

MD254M NEUTRON ACER TENDL-2021 LIBRARY; T=293.6K
angular distribution for (n,n*22)

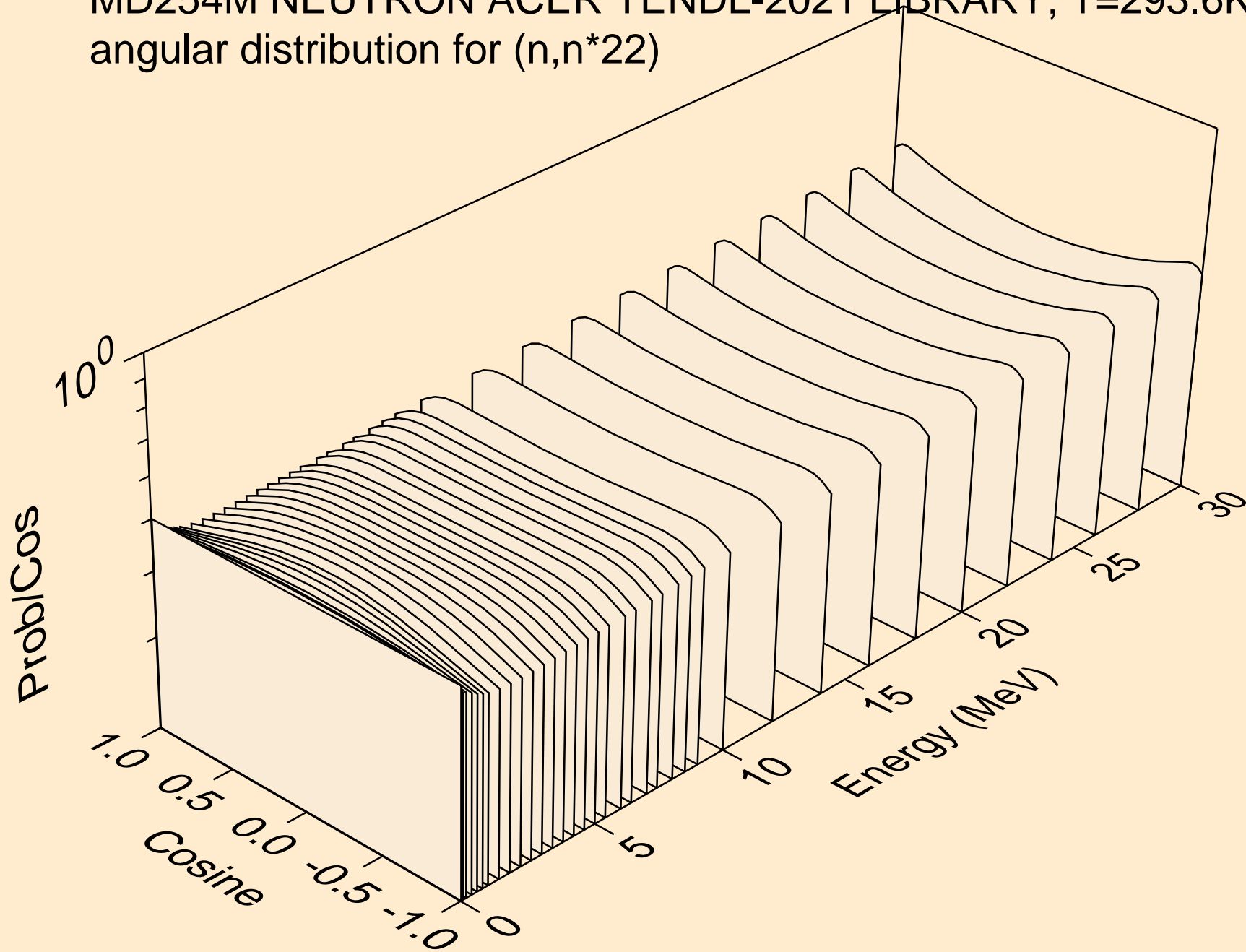

MD254M NEUTRON ACER TENDL-2021 LIBRARY; T=293.6K
angular distribution for (n,n*23)

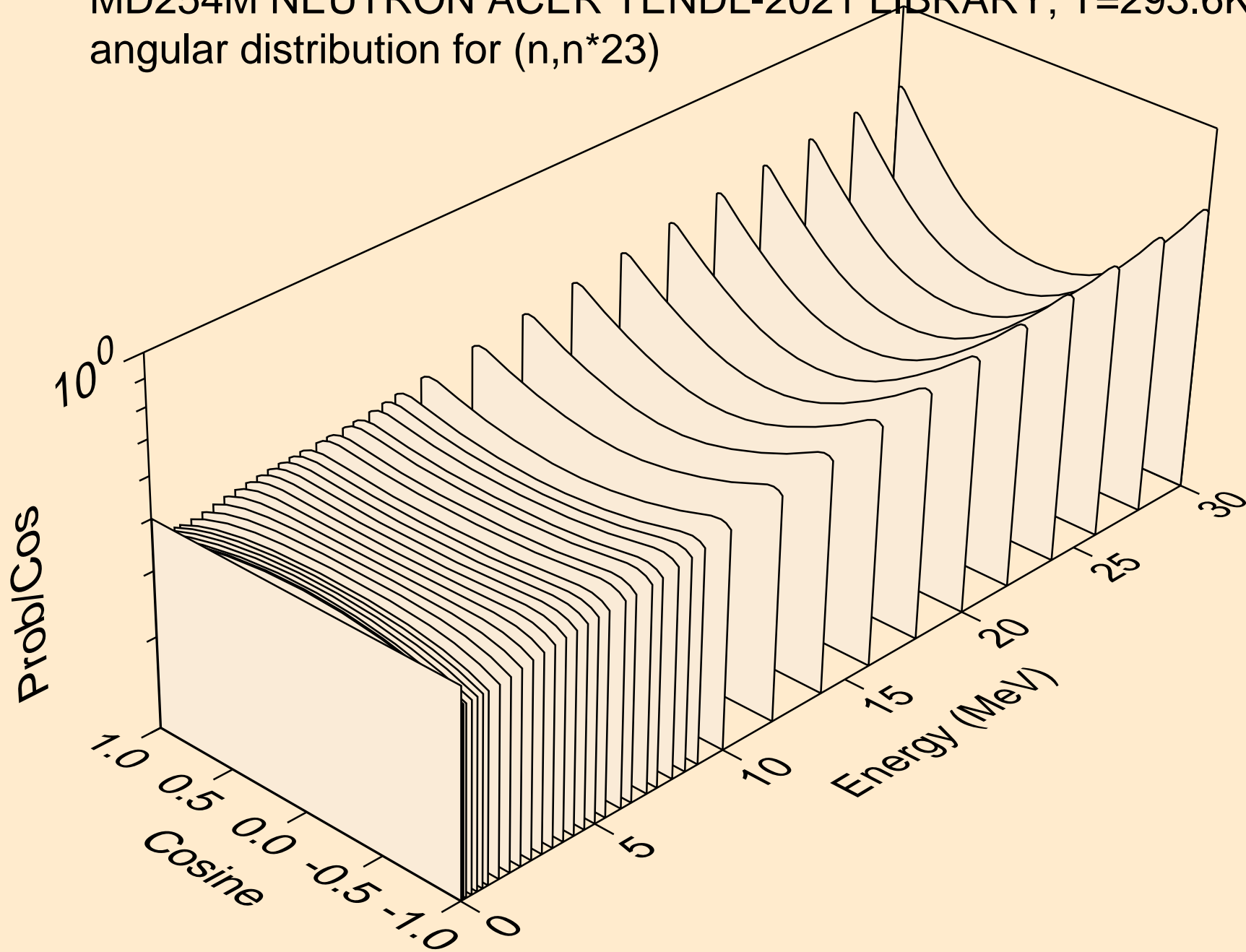

MD254M NEUTRON ACER TENDL-2021 LIBRARY; T=293.6K
angular distribution for (n,n*24)

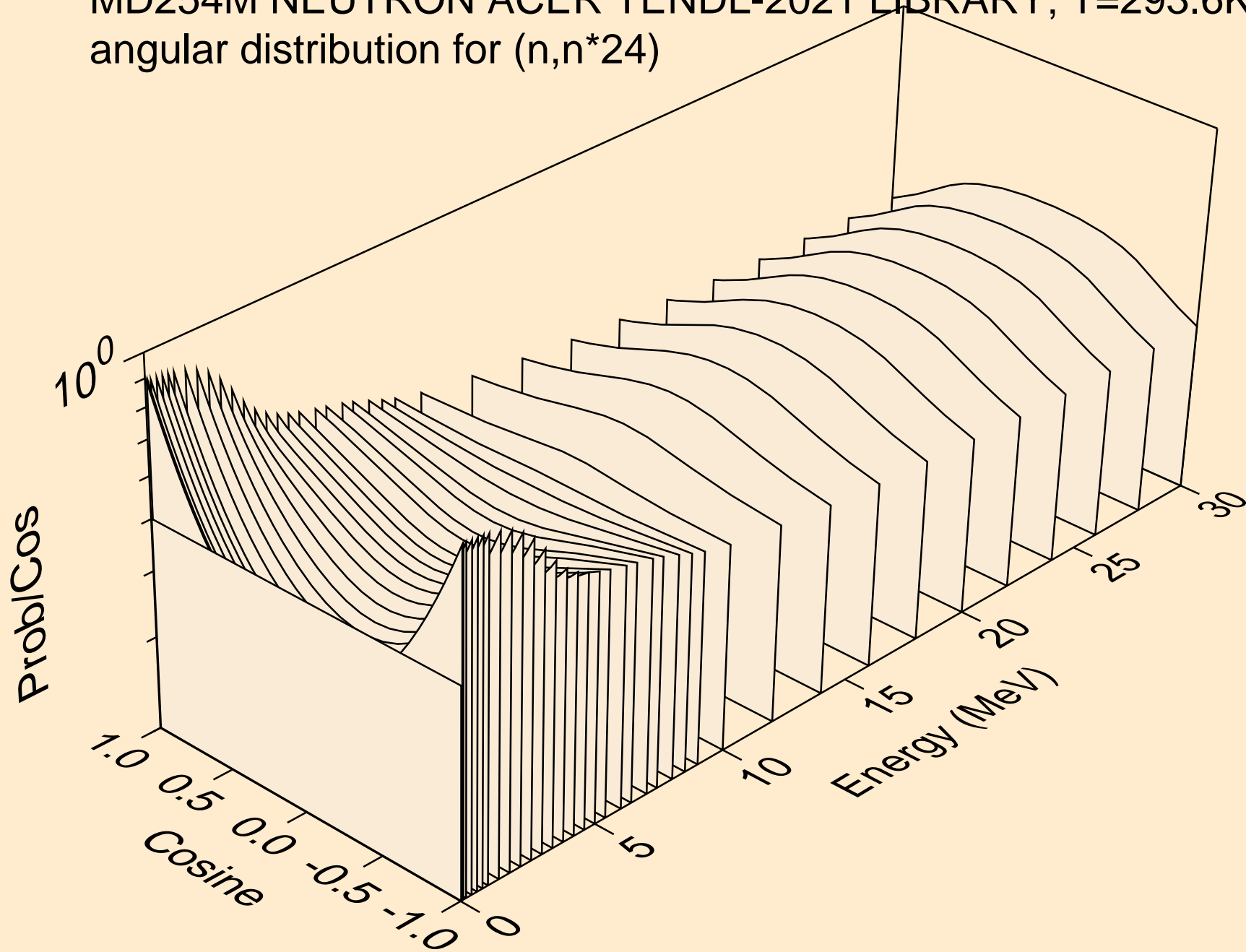

MD254M NEUTRON ACER TENDL-2021 LIBRARY; T=293.6K
angular distribution for (n,n*25)

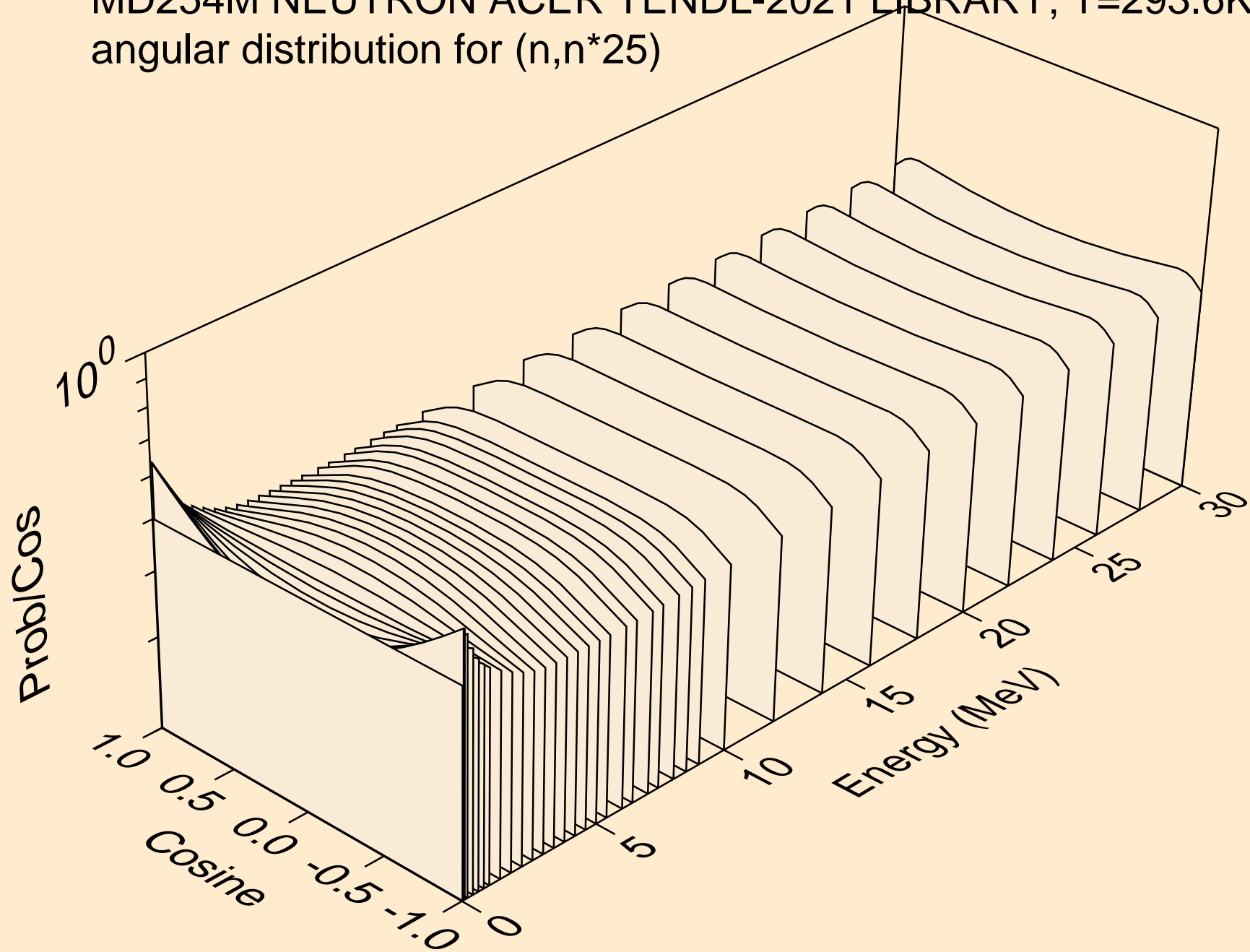

MD254M NEUTRON ACER TENDL-2021 LIBRARY; T=293.6K
angular distribution for (n,n*26)

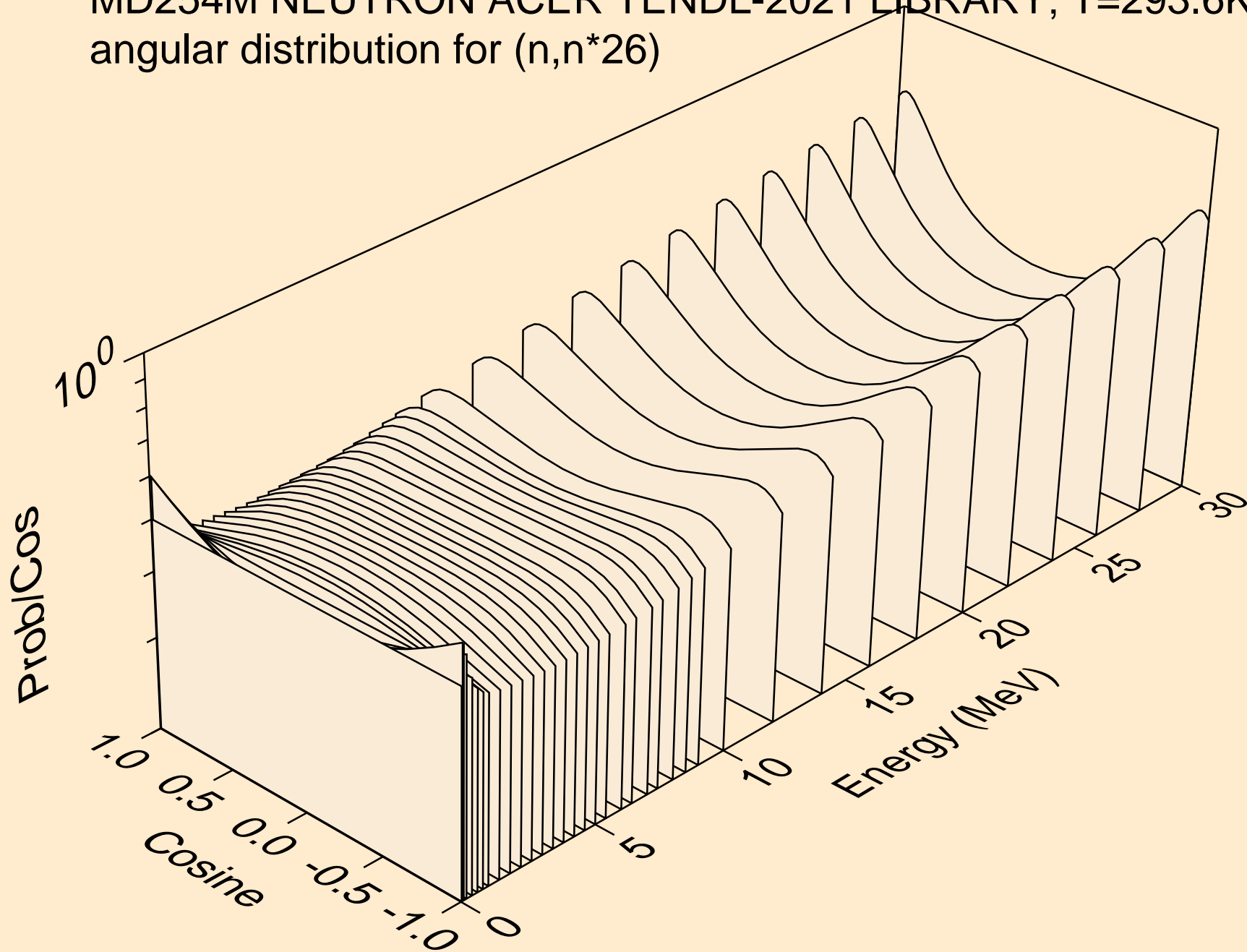

MD254M NEUTRON ACER TENDL-2021 LIBRARY; T=293.6K
angular distribution for (n,n*27)

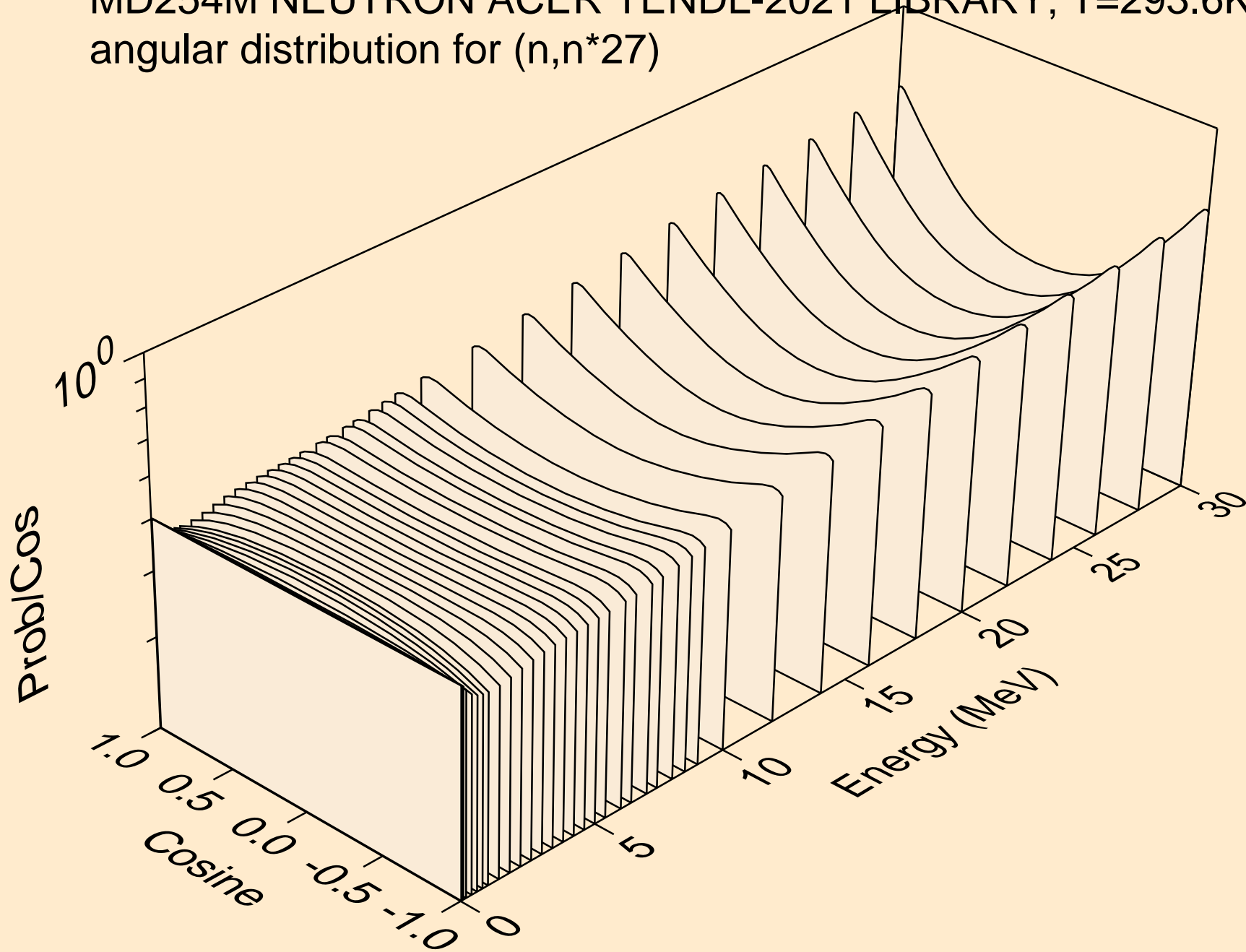

MD254M NEUTRON ACER TENDL-2021 LIBRARY; T=293.6K
angular distribution for (n,n*28)

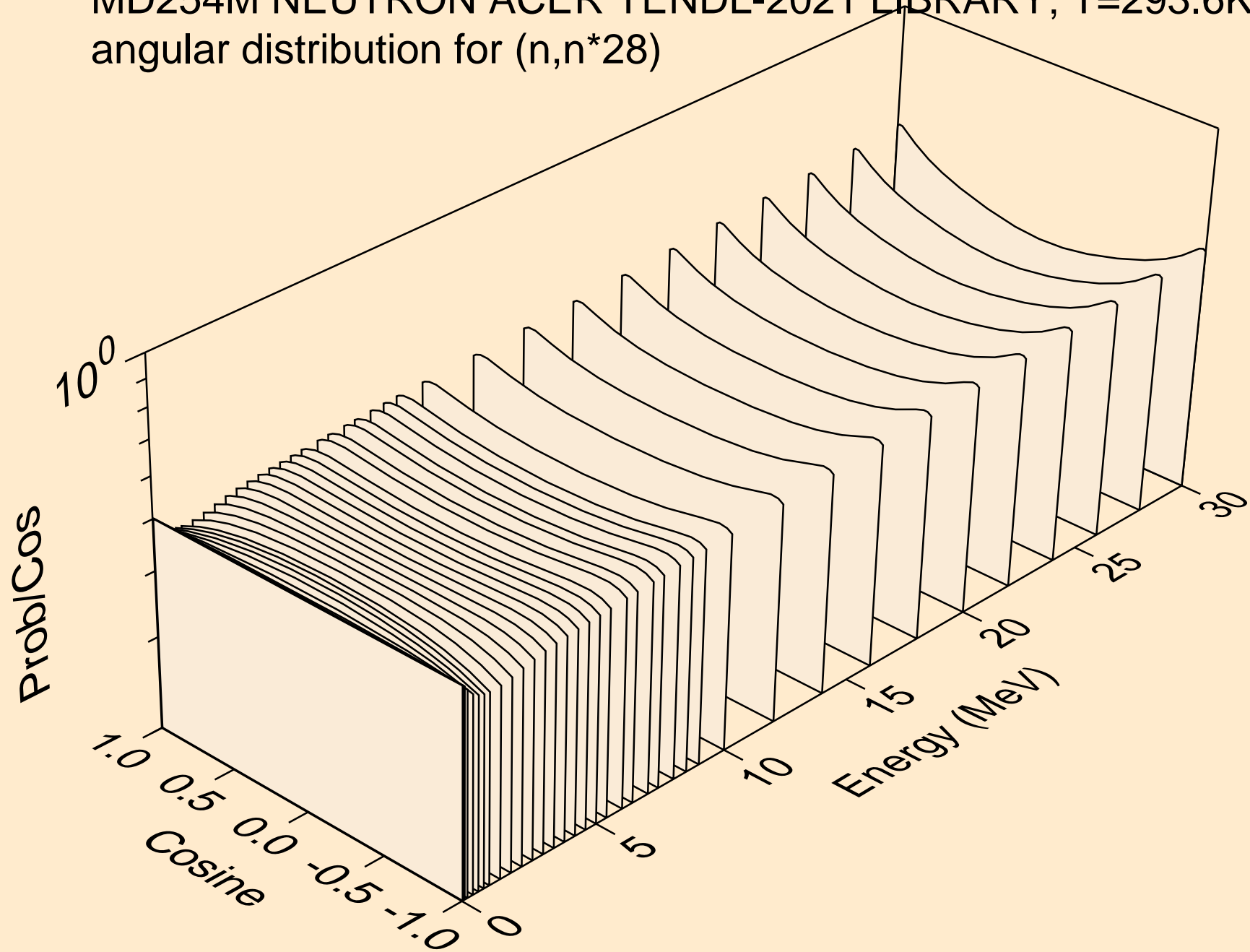

MD254M NEUTRON ACER TENDL-2021 LIBRARY; T=293.6K
angular distribution for (n,n*29)

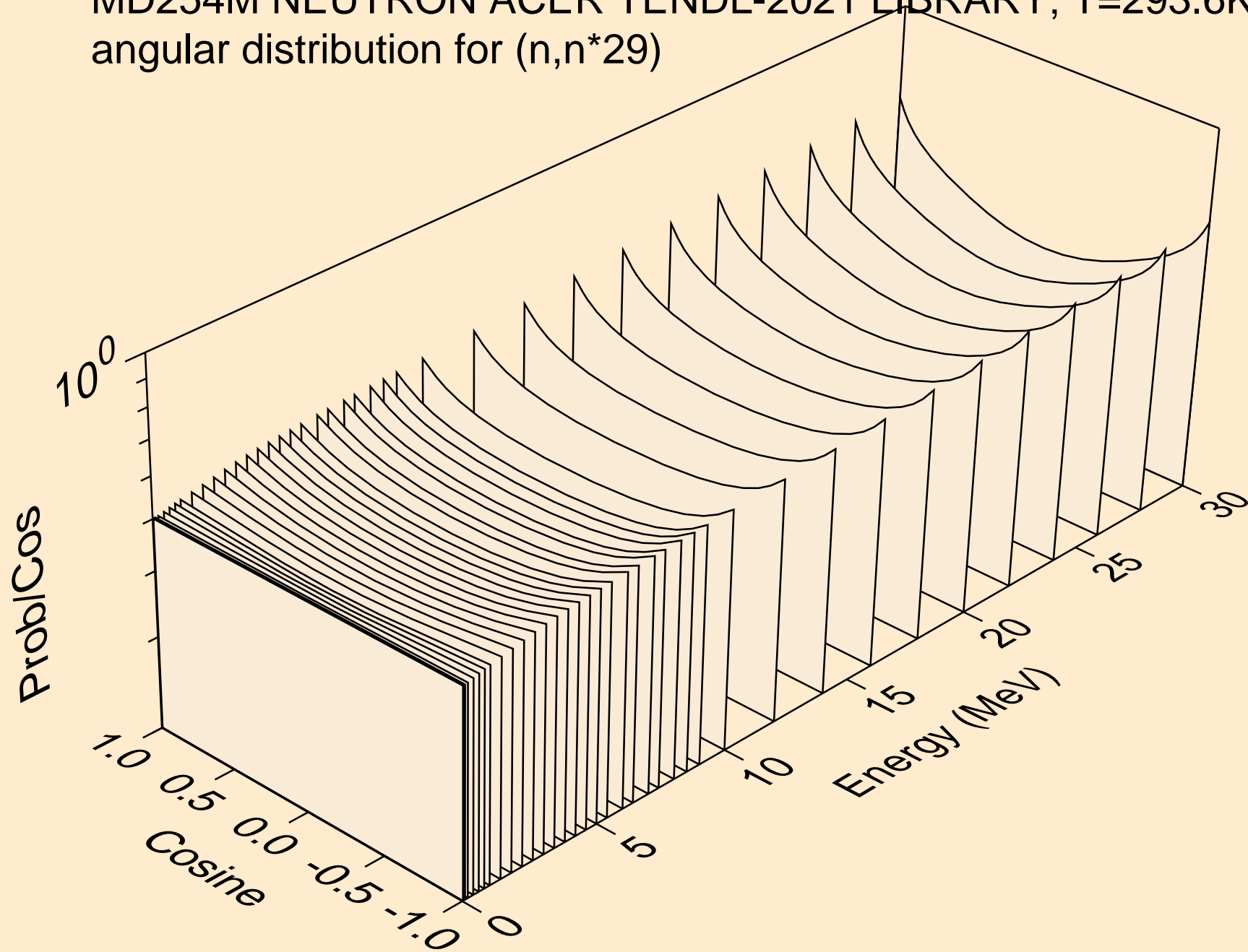

MD254M NEUTRON ACER TENDL-2021 LIBRARY; T=293.6K
angular distribution for (n,n*30)

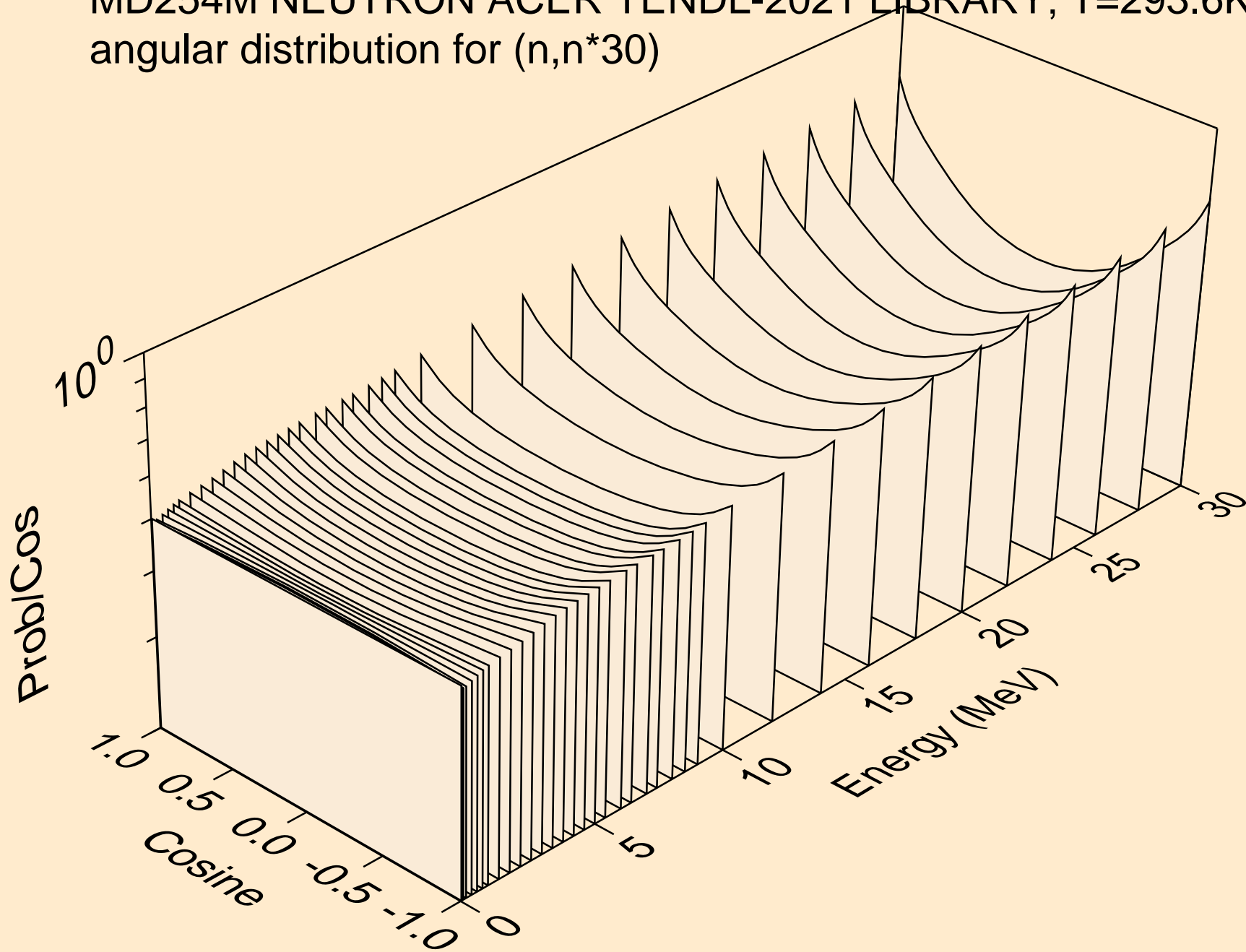

MD254M NEUTRON ACER TENDL-2021 LIBRARY; T=293.6K
Total fission nubar

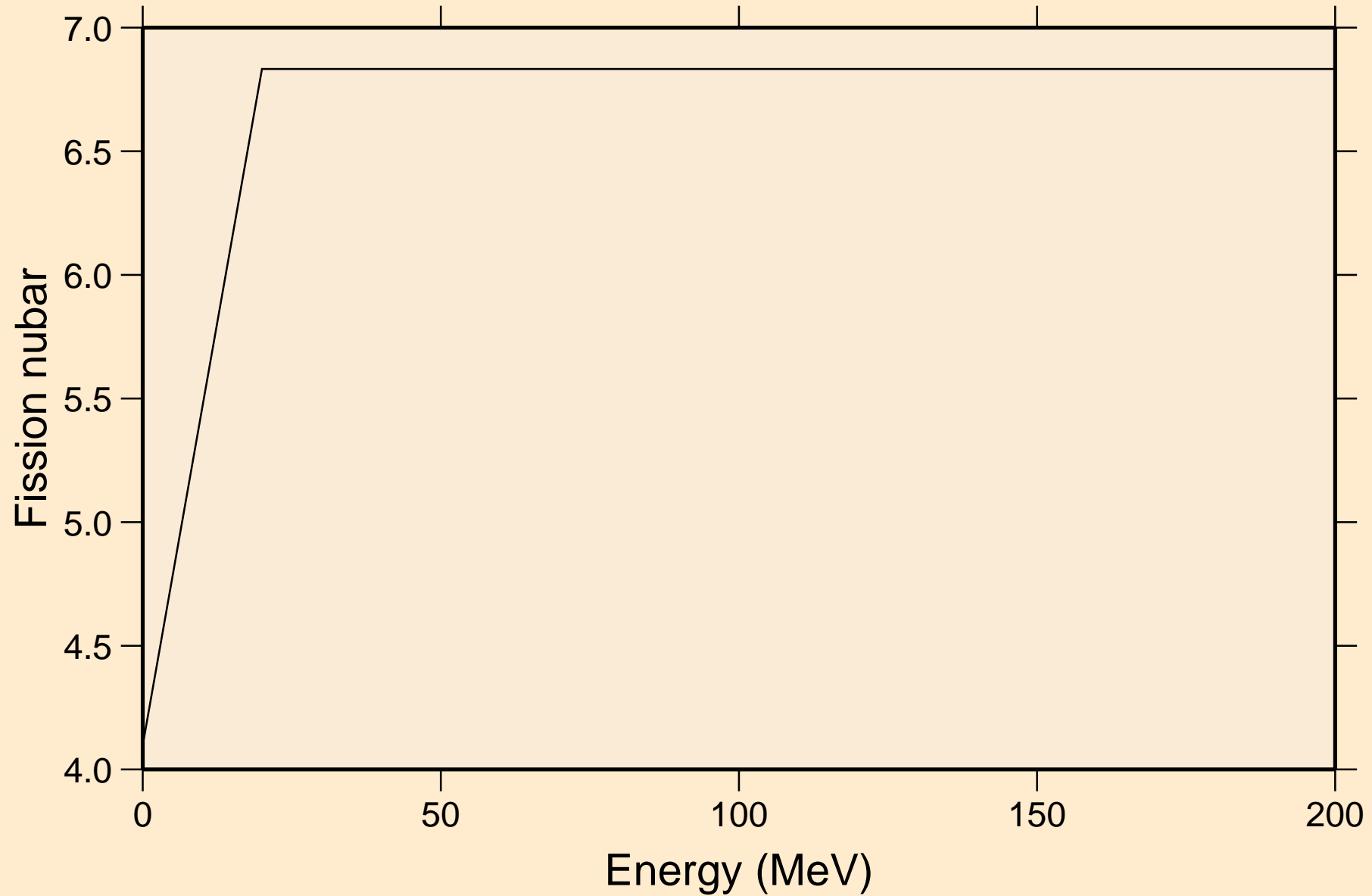

MD254M NEUTRON ACER TENDL-2021 LIBRARY; T=293.6K
Neutron emission for (n,x)

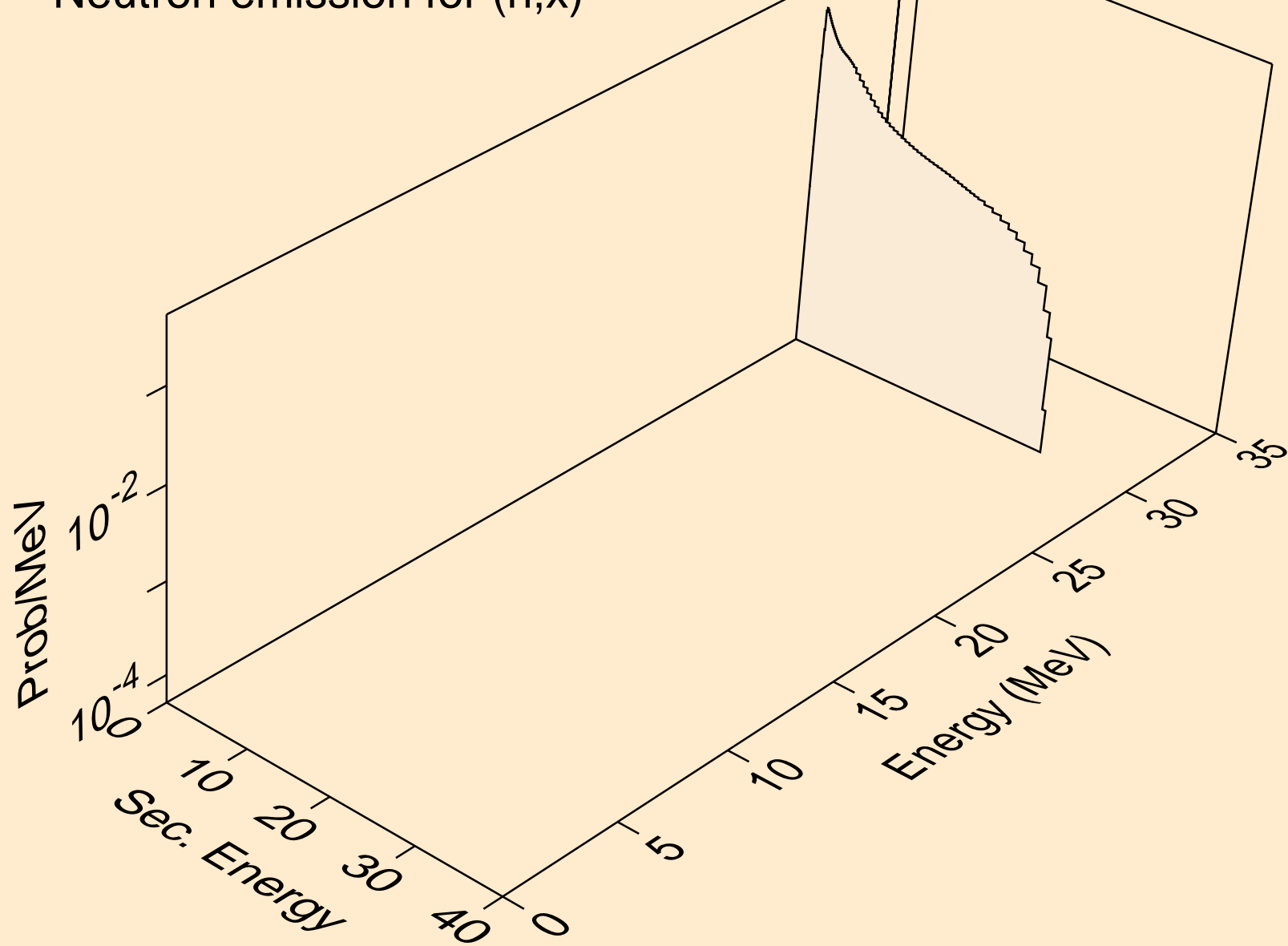

MD254M NEUTRON ACER TENDL-2021 LIBRARY; T=293.6K
Neutron emission for (n,2nd)

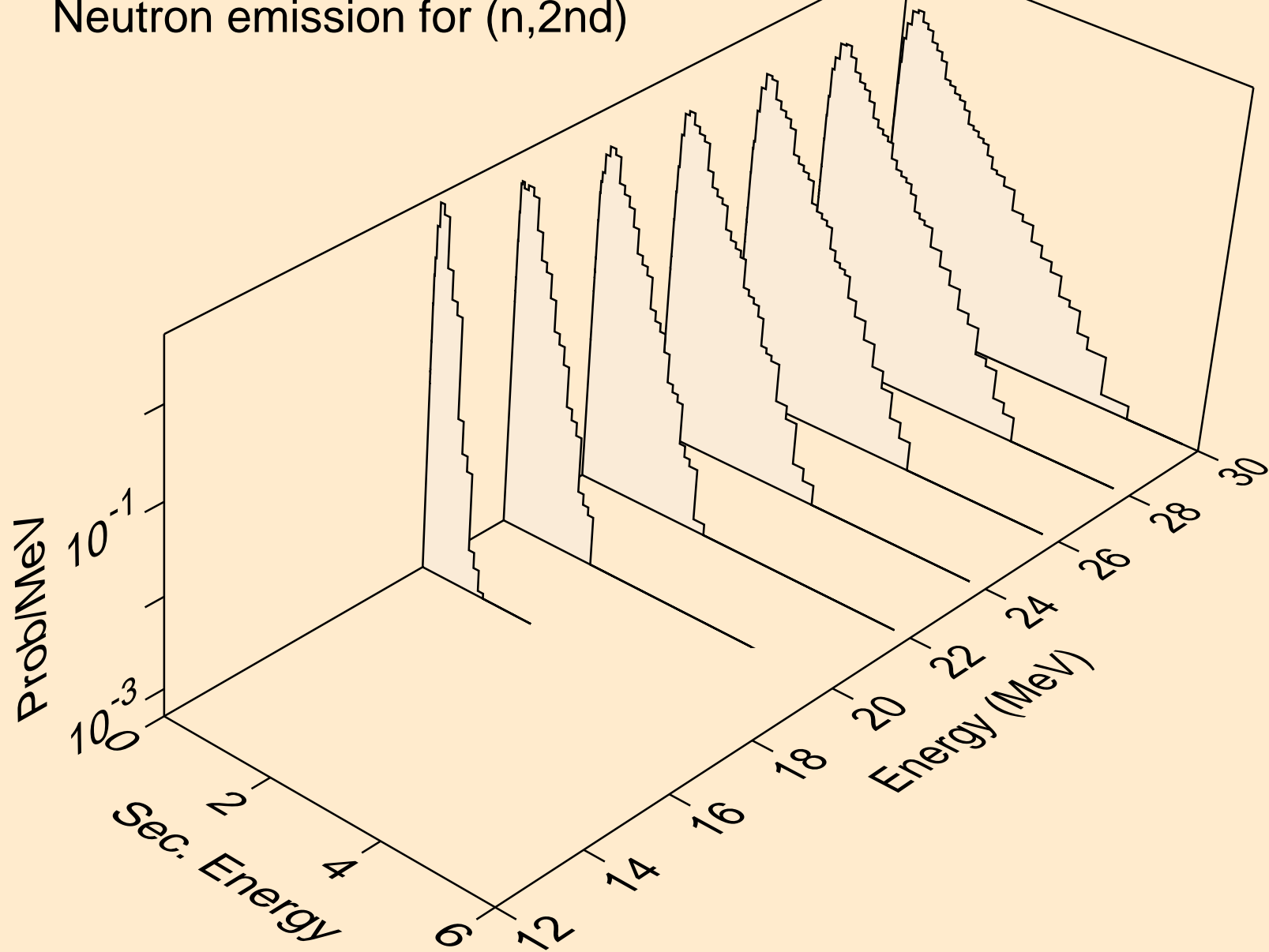

MD254M NEUTRON ACER TENDL-2021 LIBRARY; T=293.6K
Neutron emission for (n,2n)

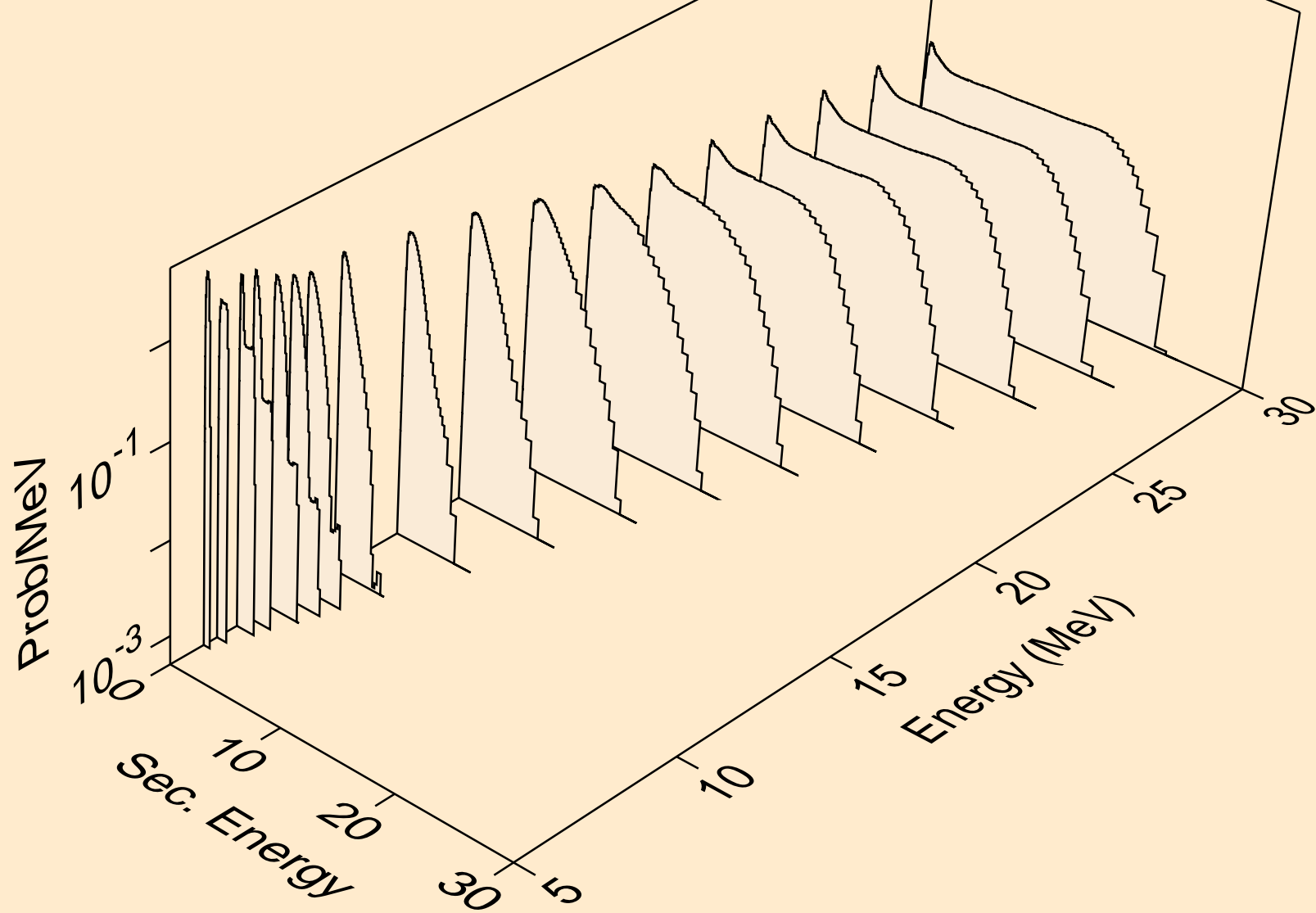

MD254M NEUTRON ACER TENDL-2021 LIBRARY; T=293.6K
Neutron emission for (n,3n)

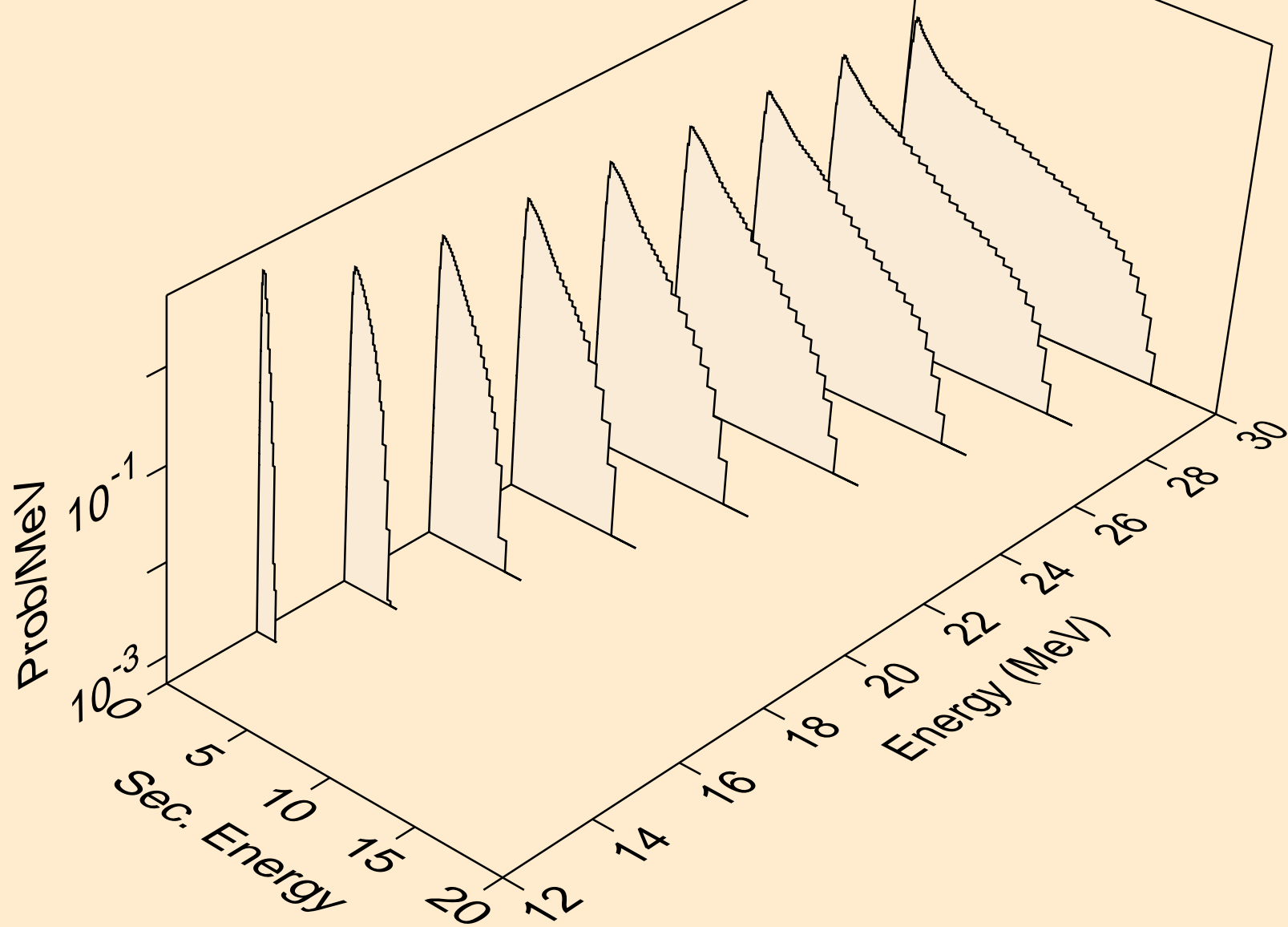

MD254M NEUTRON ACER TENDL-2021 LIBRARY; T=293.6K
Neutron emission for fission

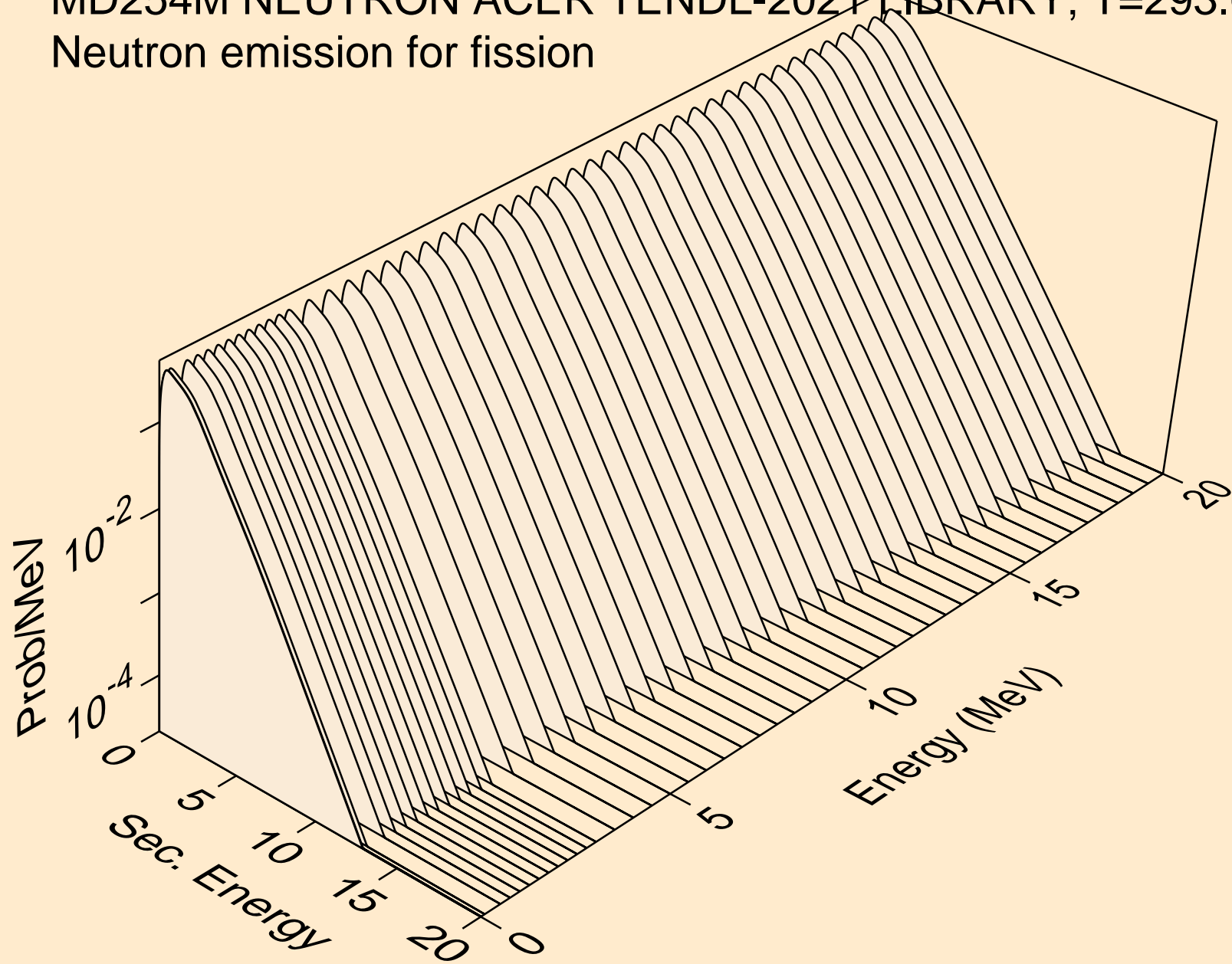

MD254M NEUTRON ACER TENDL-2021 LIBRARY; T=293.6K
Neutron emission for (n,n*)a

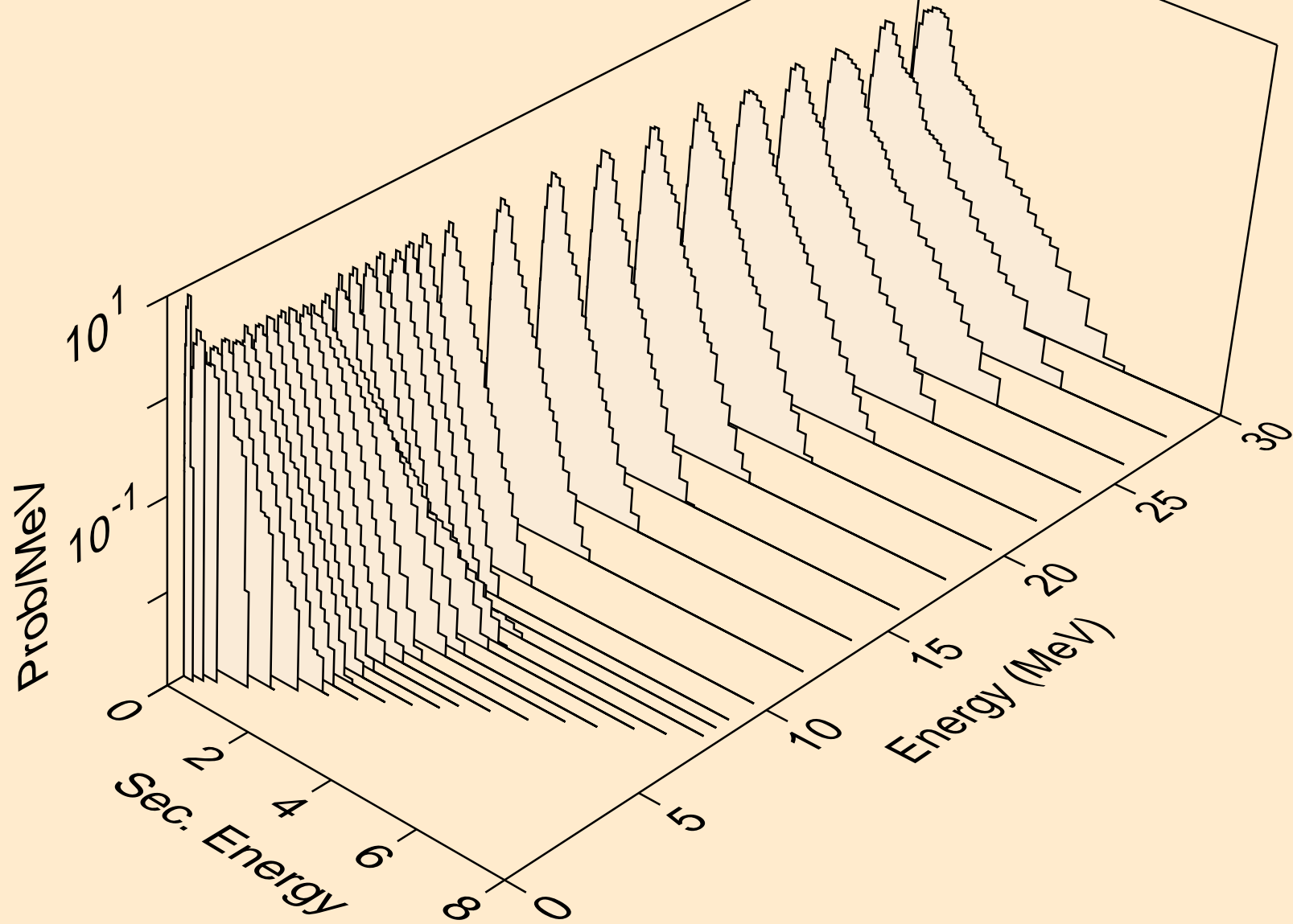

MD254M NEUTRON ACER TENDL-2021 LIBRARY; T=293.6K
Neutron emission for (n,2n)a

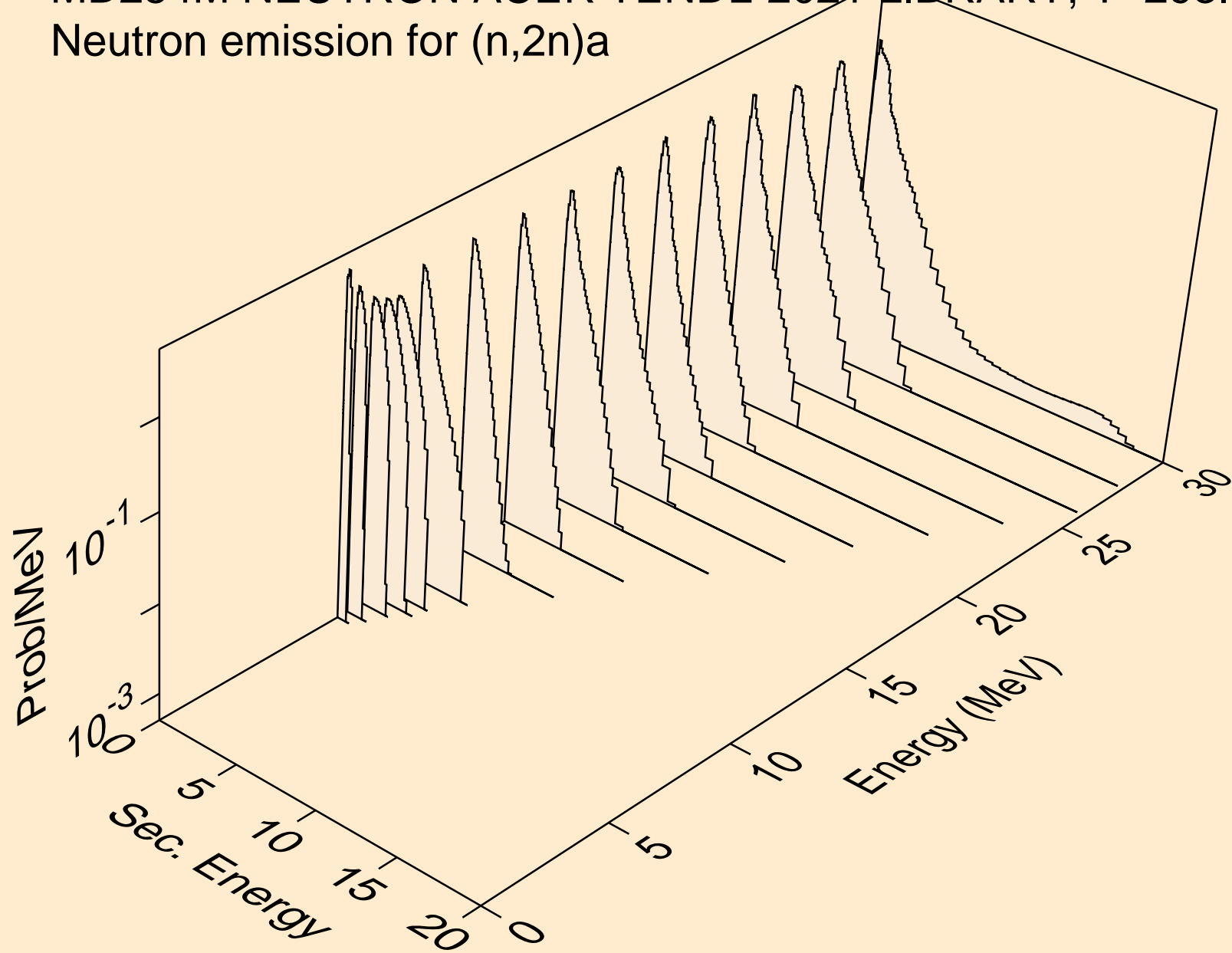

MD254M NEUTRON ACER TENDL-2021 LIBRARY; T=293.6K
Neutron emission for (n,3n)a

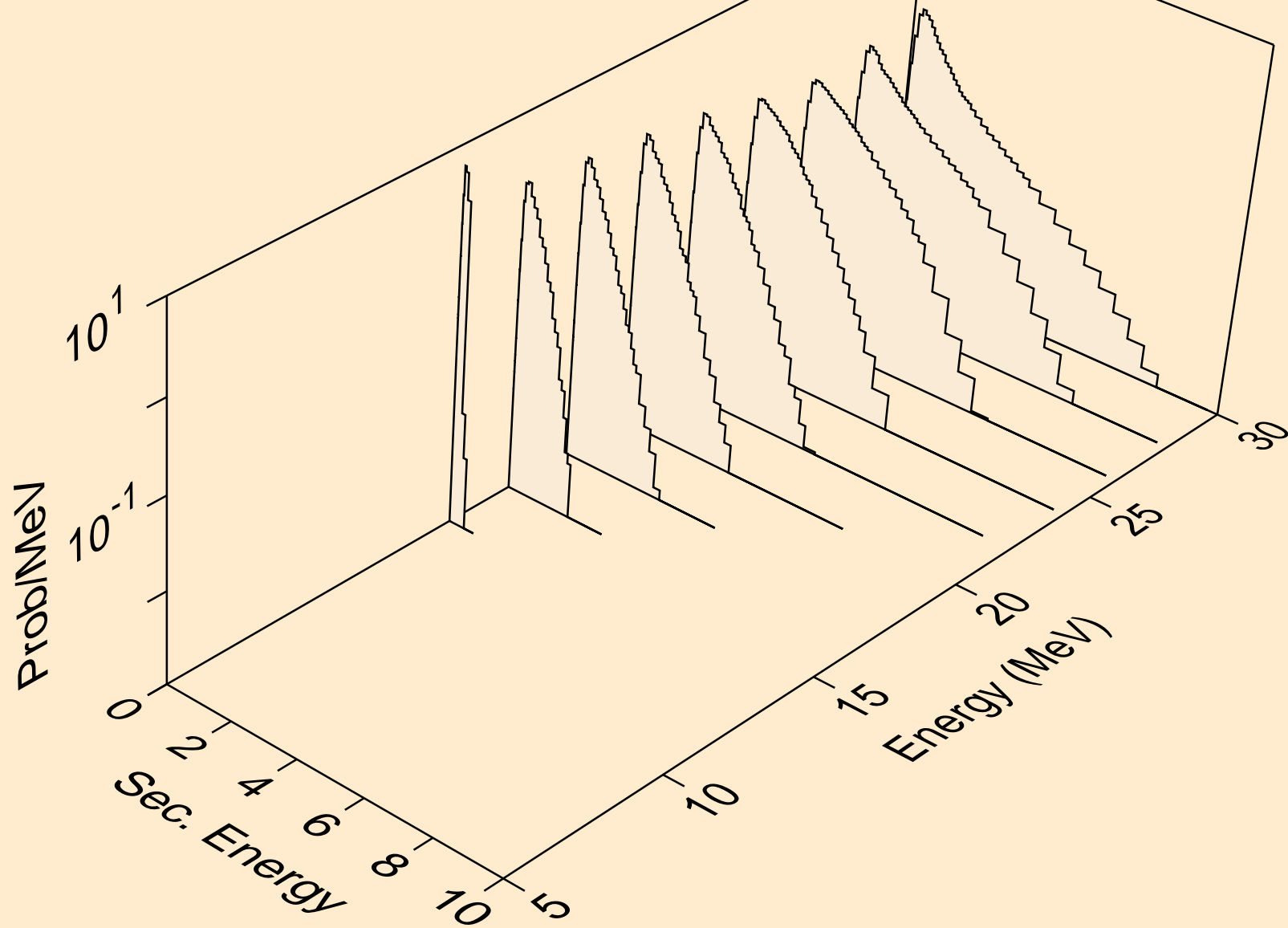

MD254M NEUTRON ACER TENDL-2021 LIBRARY; T=293.6K
Neutron emission for (n,n*)p

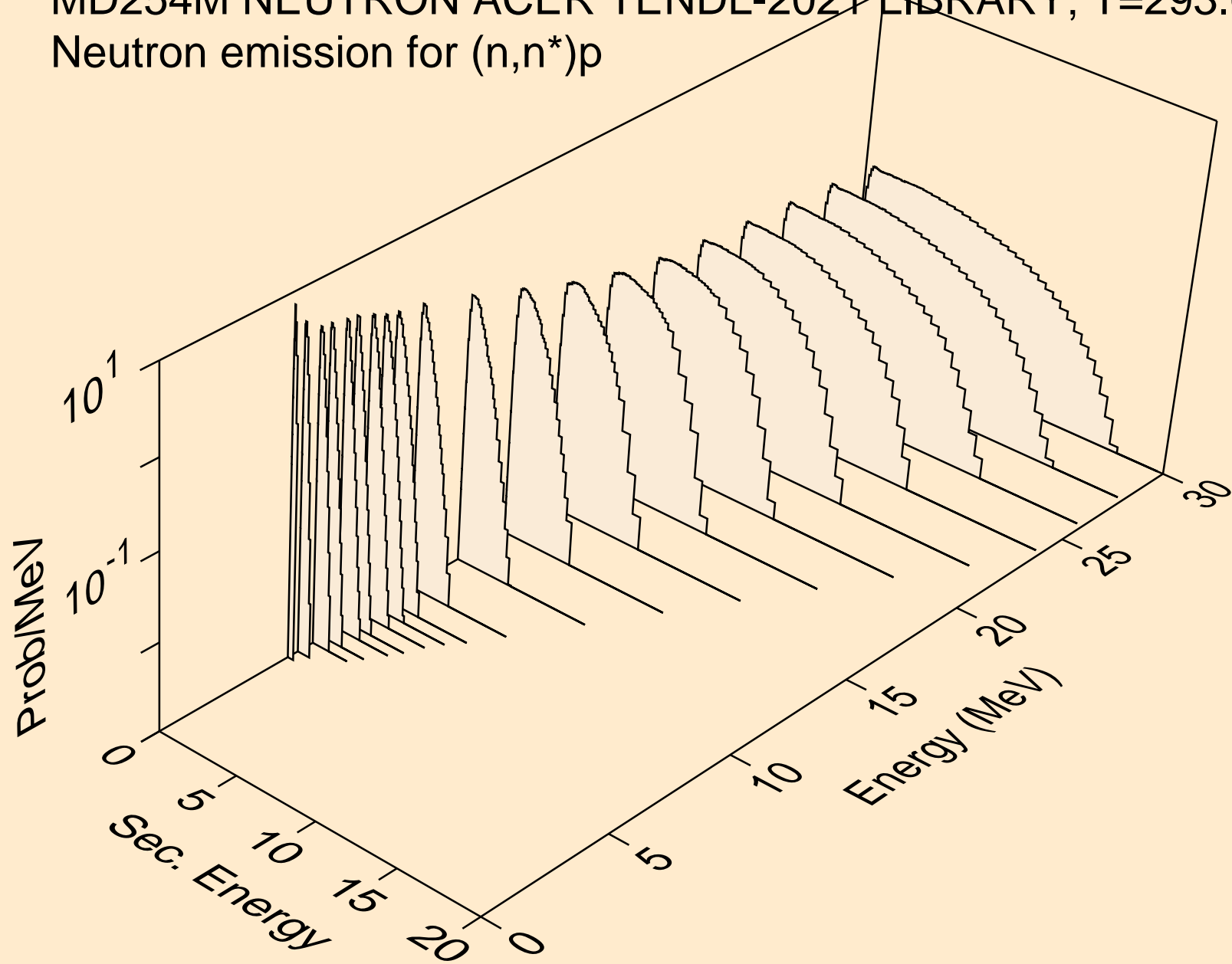

MD254M NEUTRON ACER TENDL-2021 LIBRARY; T=293.6K
Neutron emission for (n,n*)2a

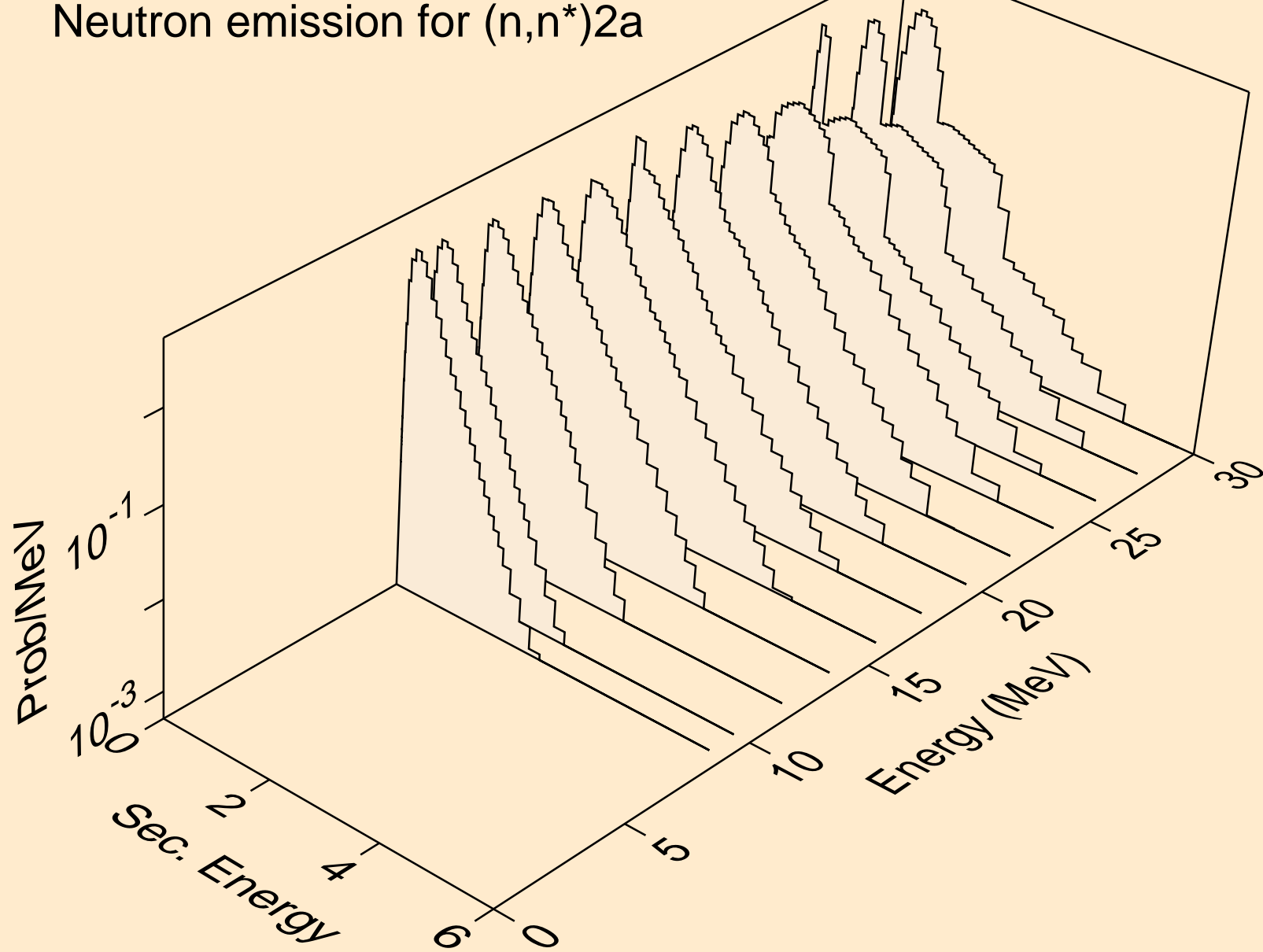

MD254M NEUTRON ACER TENDL-2021 LIBRARY; T=293.6K
Neutron emission for (n,n*)d

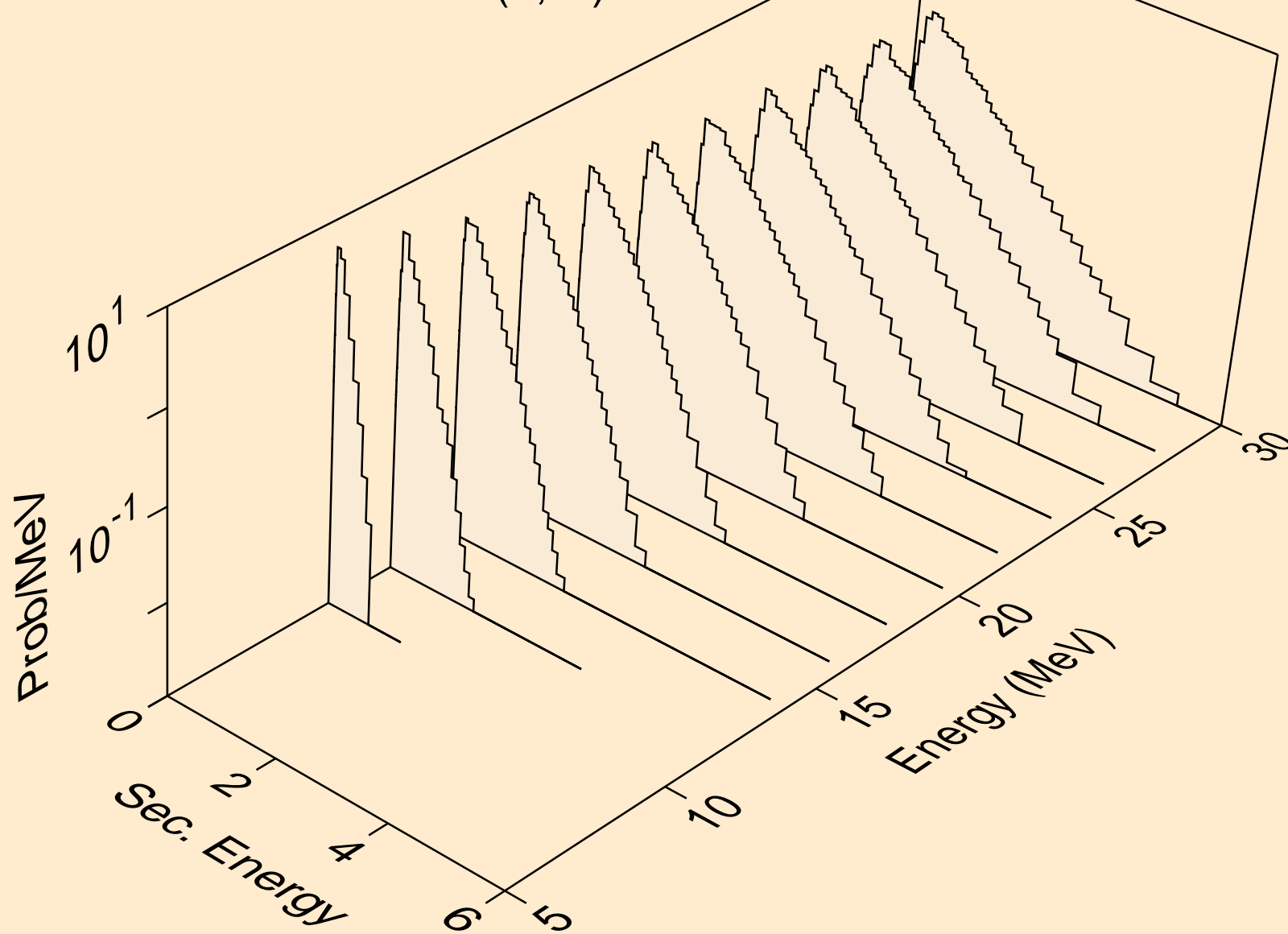

MD254M NEUTRON ACER TENDL-2021 LIBRARY; T=293.6K
Neutron emission for (n,n*)t

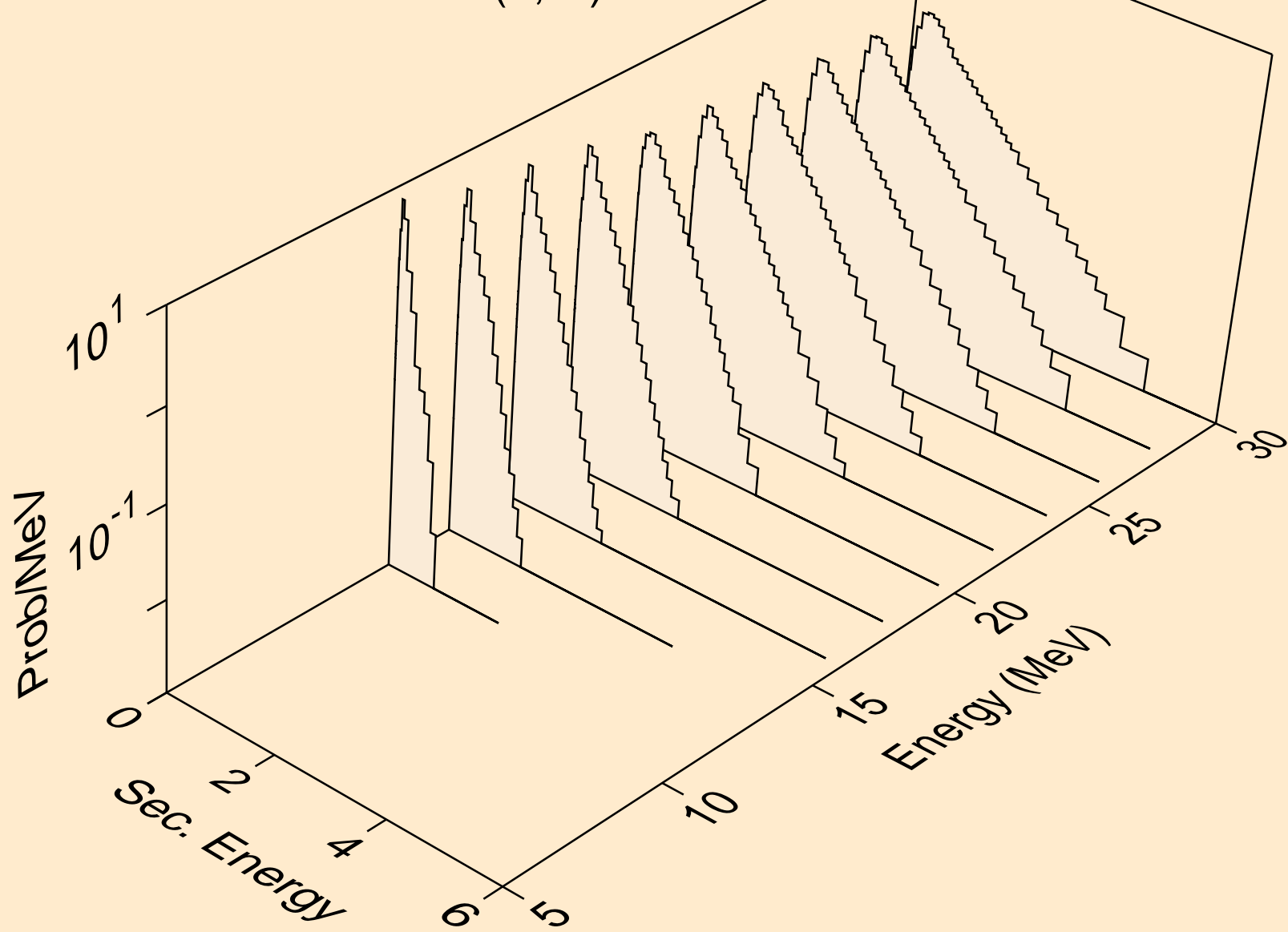

MD254M NEUTRON ACER TENDL-2021 LIBRARY; T=293.6K
Neutron emission for (n,n*)he3

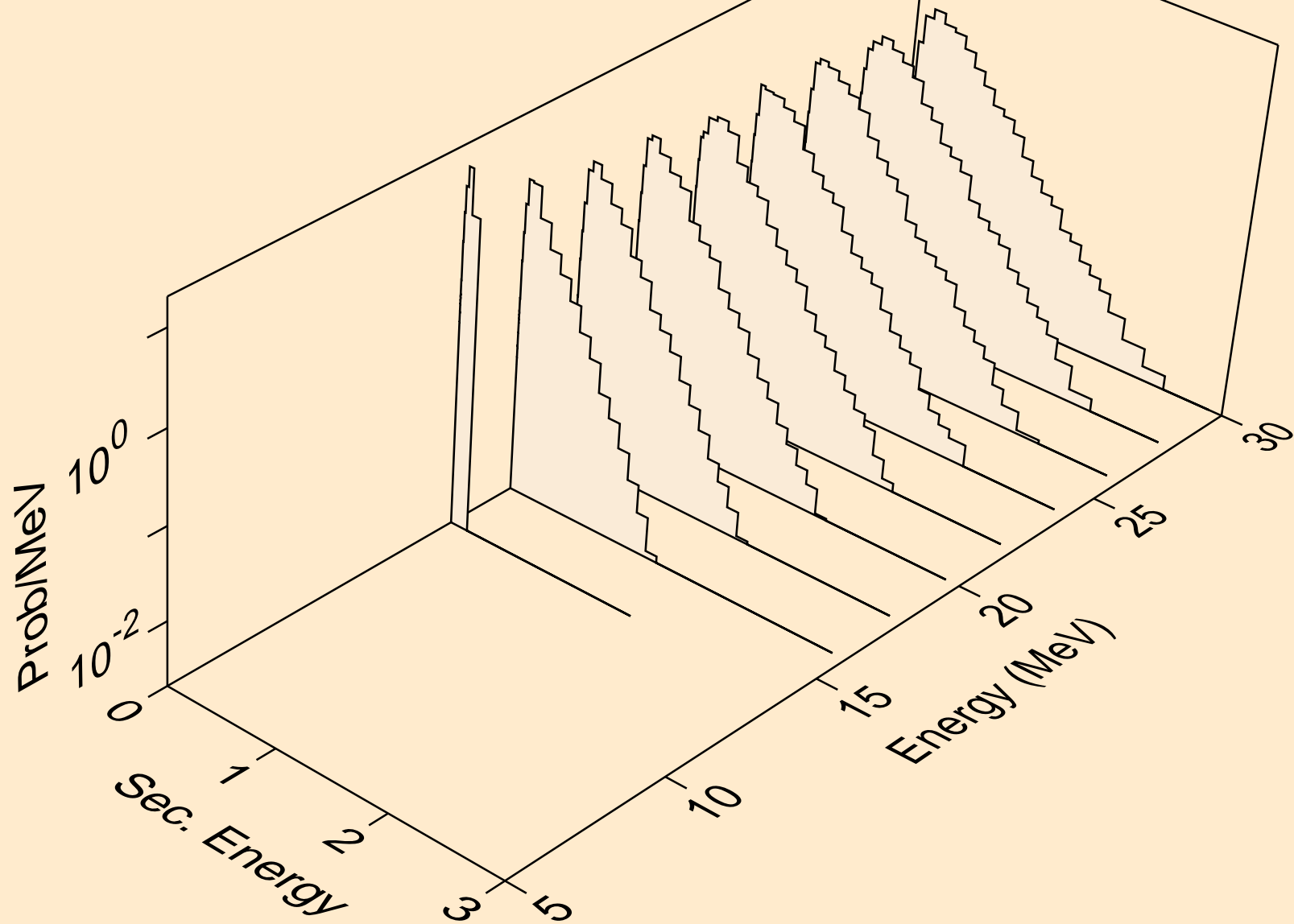

MD254M NEUTRON ACER TENDL-2021 LIBRARY; T=293.6K
Neutron emission for (n,4n)

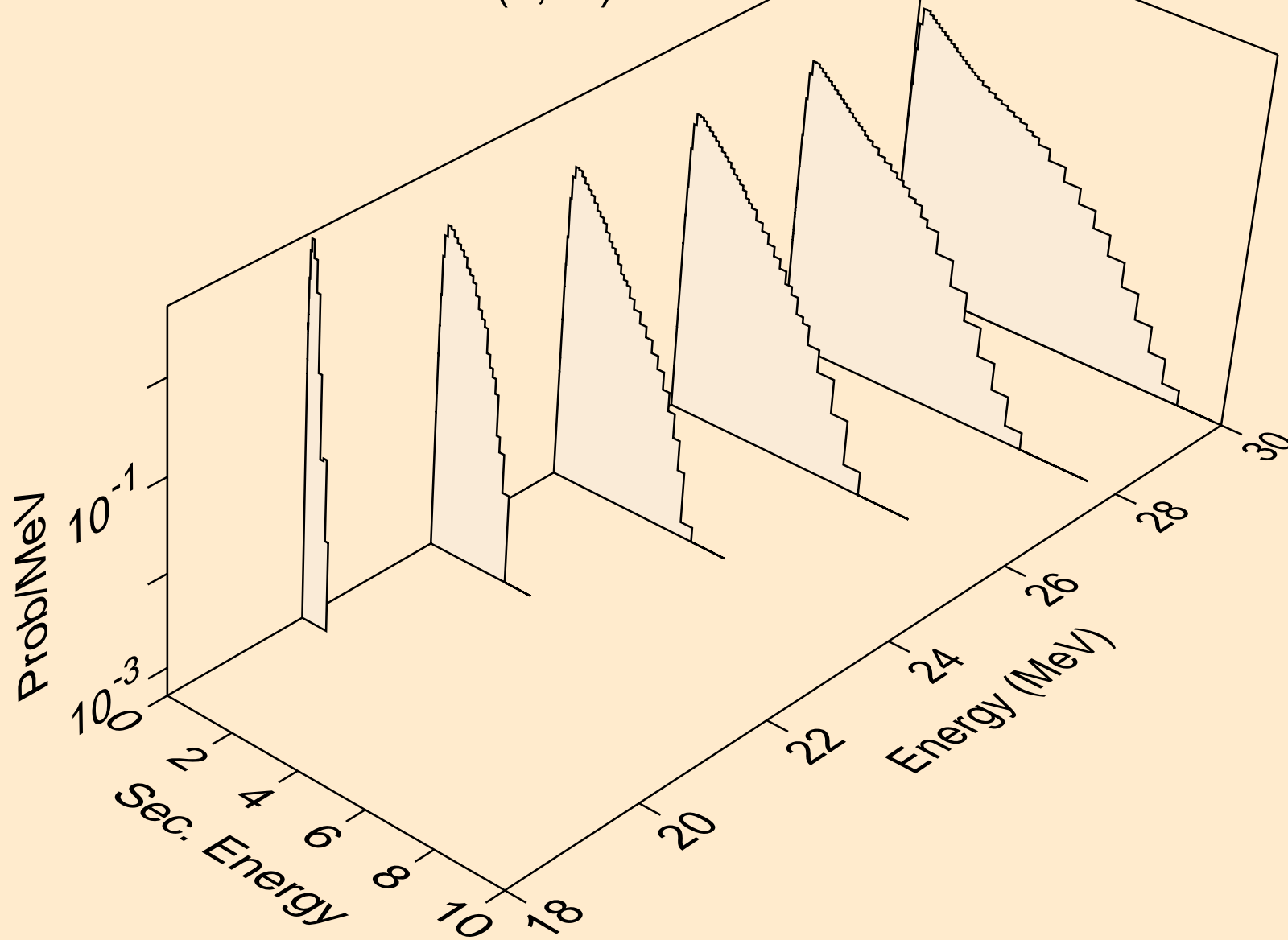

MD254M NEUTRON ACER TENDL-2021 LIBRARY; T=293.6K
Neutron emission for (n,2np)

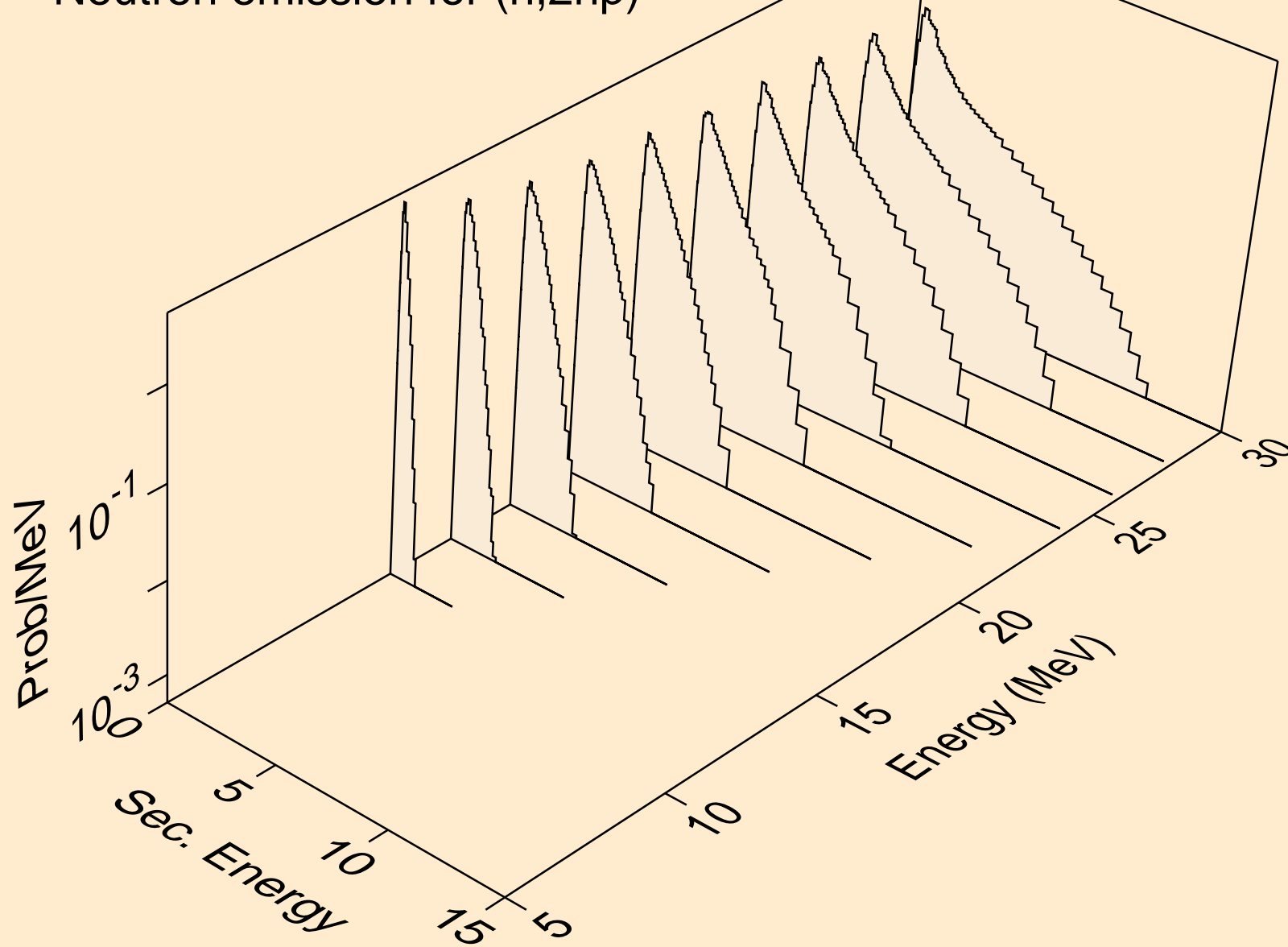

MD254M NEUTRON ACER TENDL-2021 LIBRARY; T=293.6K
Neutron emission for (n,3np)

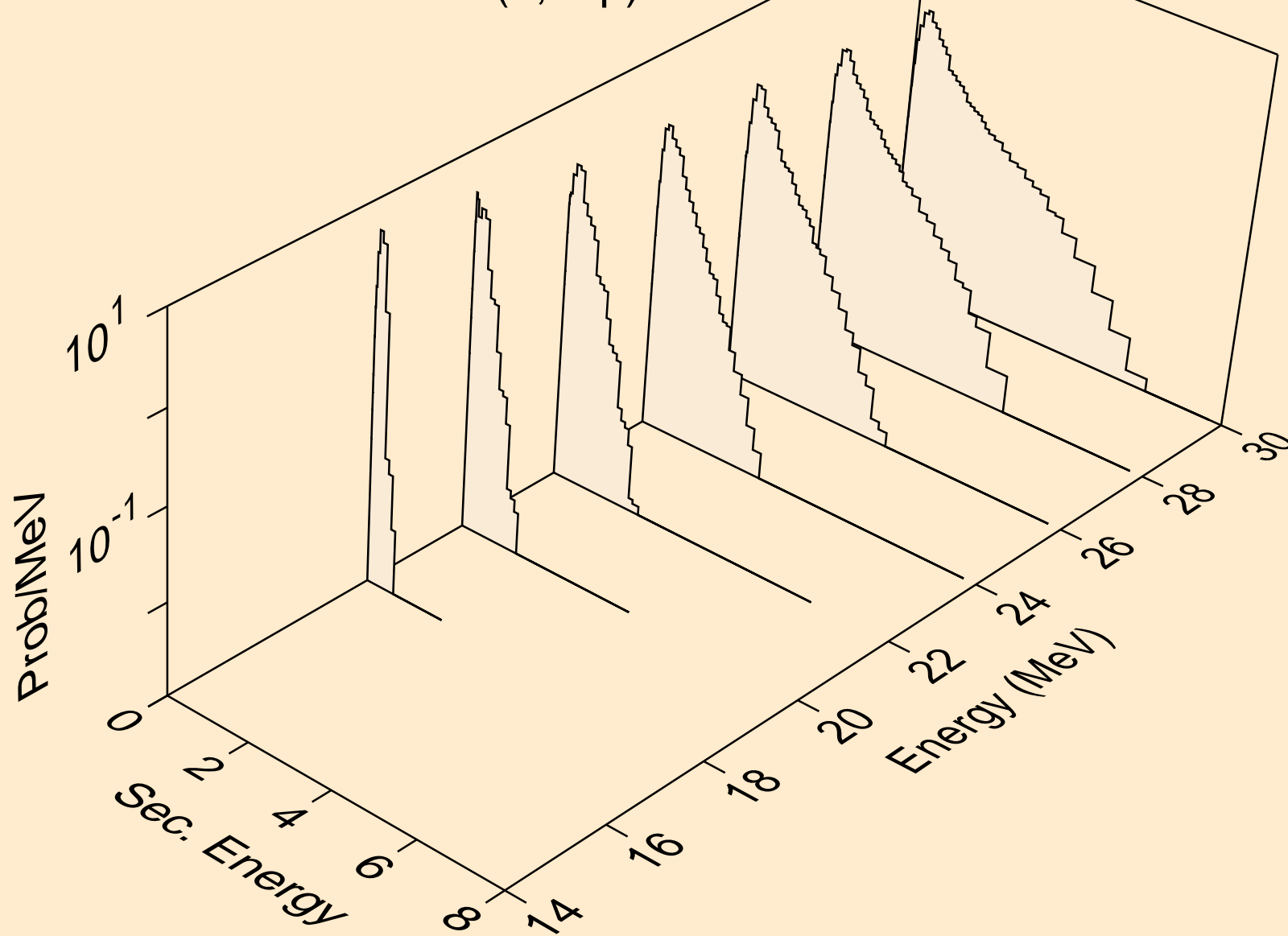

MD254M NEUTRON ACER TENDL-2021 LIBRARY; T=293.6K
Neutron emission for (n,2np)

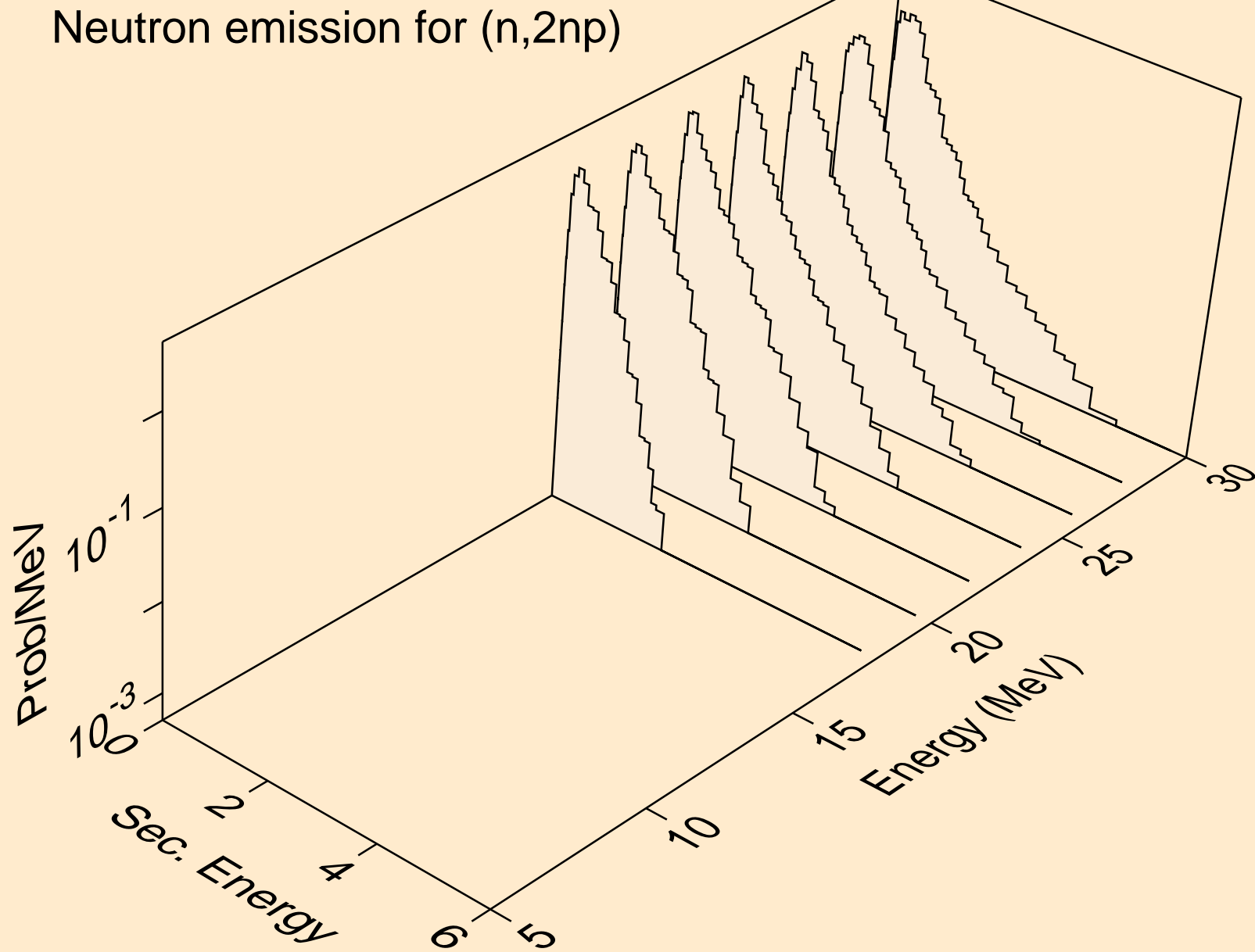

MD254M NEUTRON ACER TENDL-2021 LIBRARY; T=293.6K
Neutron emission for (n,npa)

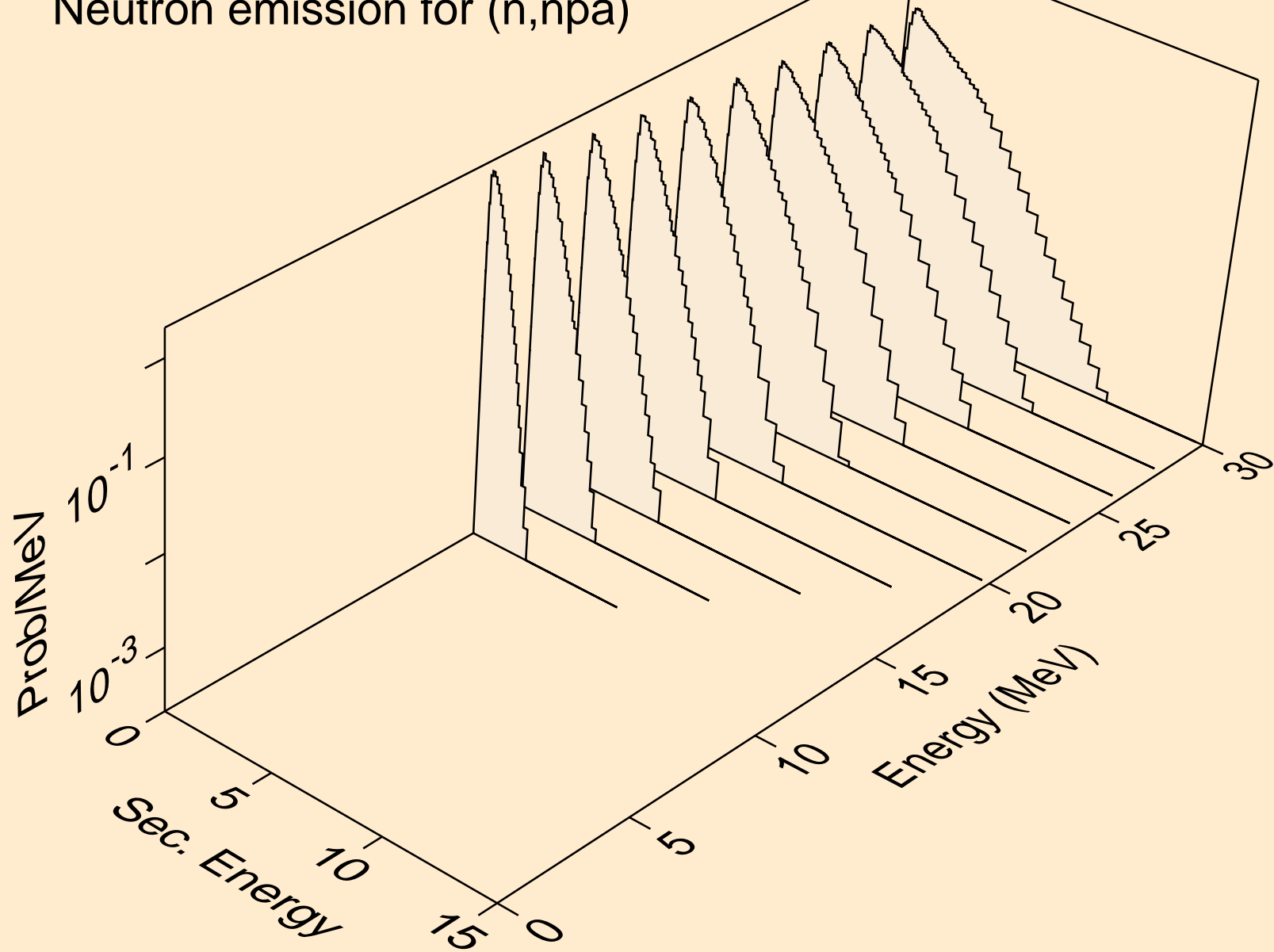

MD254M NEUTRON ACER TENDL-2021 LIBRARY; T=293.6K
Neutron emission for (n,n*c)

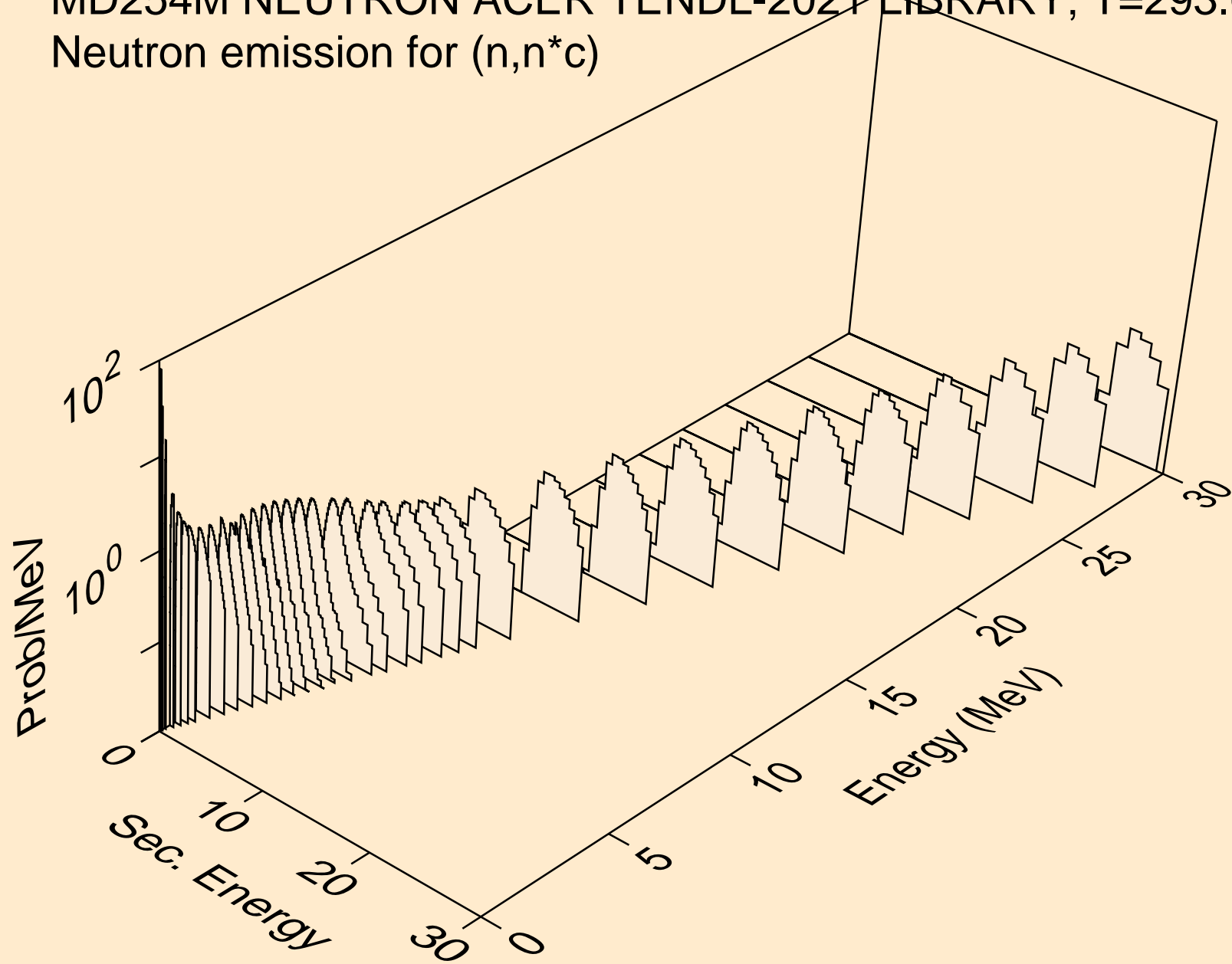

MD254M NEUTRON ACER TENDL-2021 LIBRARY; T=293.6K

Delayed nubar

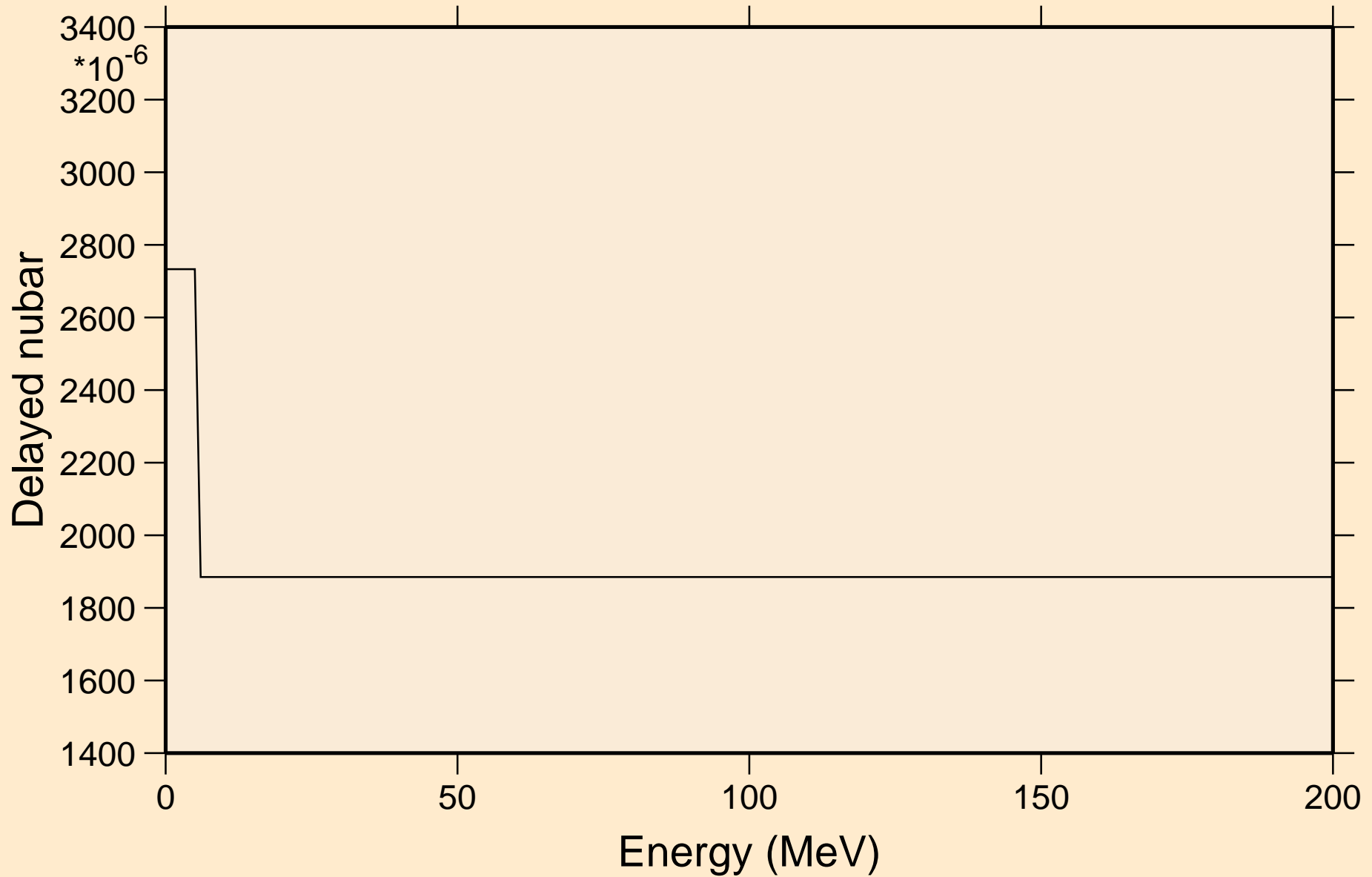

MD254M NEUTRON ACER TENDL-2021 LIBRARY; T=293.6K

Delayed neutron spectra

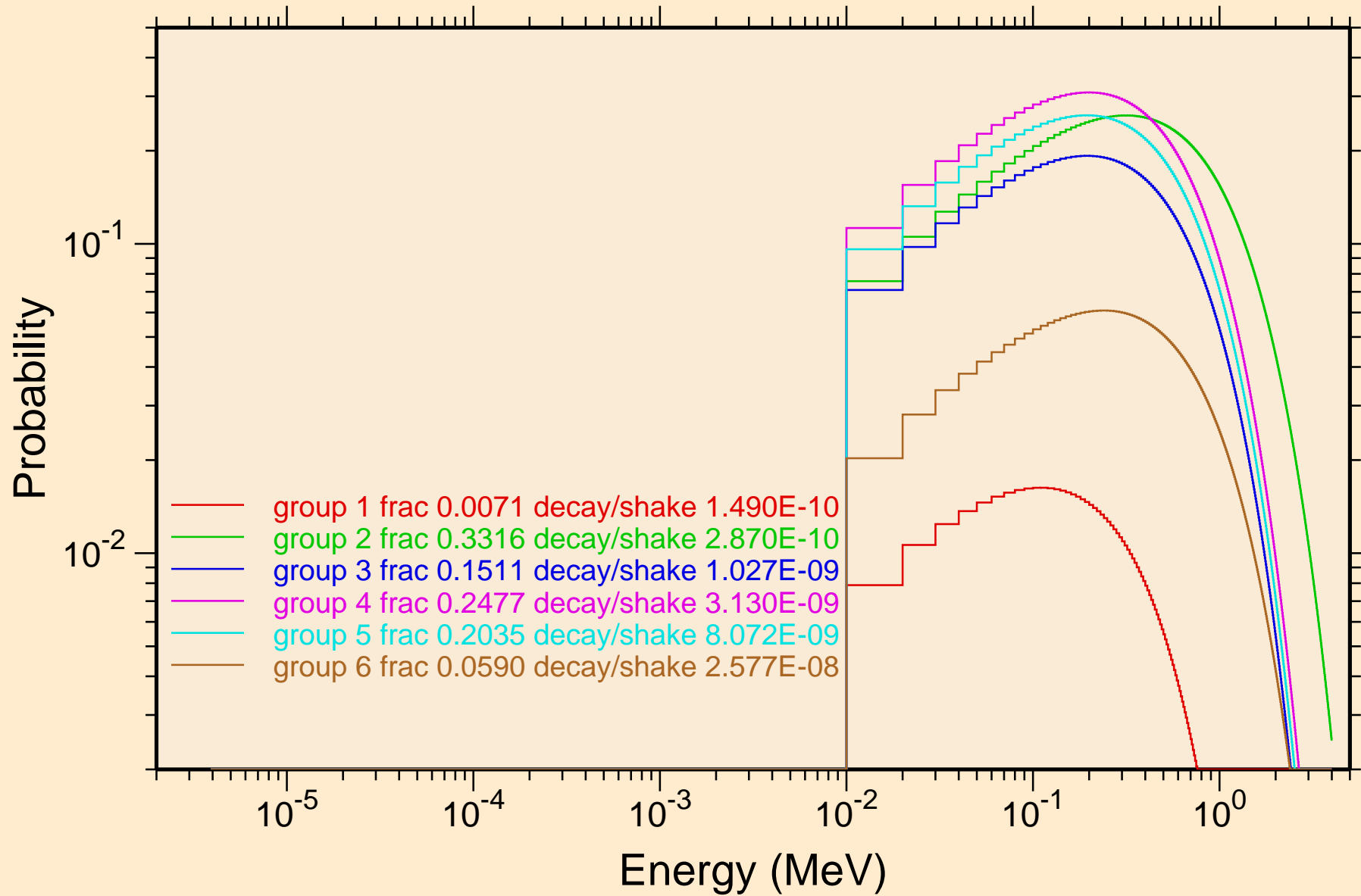

MD254M NEUTRON ACER TENDL-2021 LIBRARY; T=293.6K
Photon emission for (n,x)

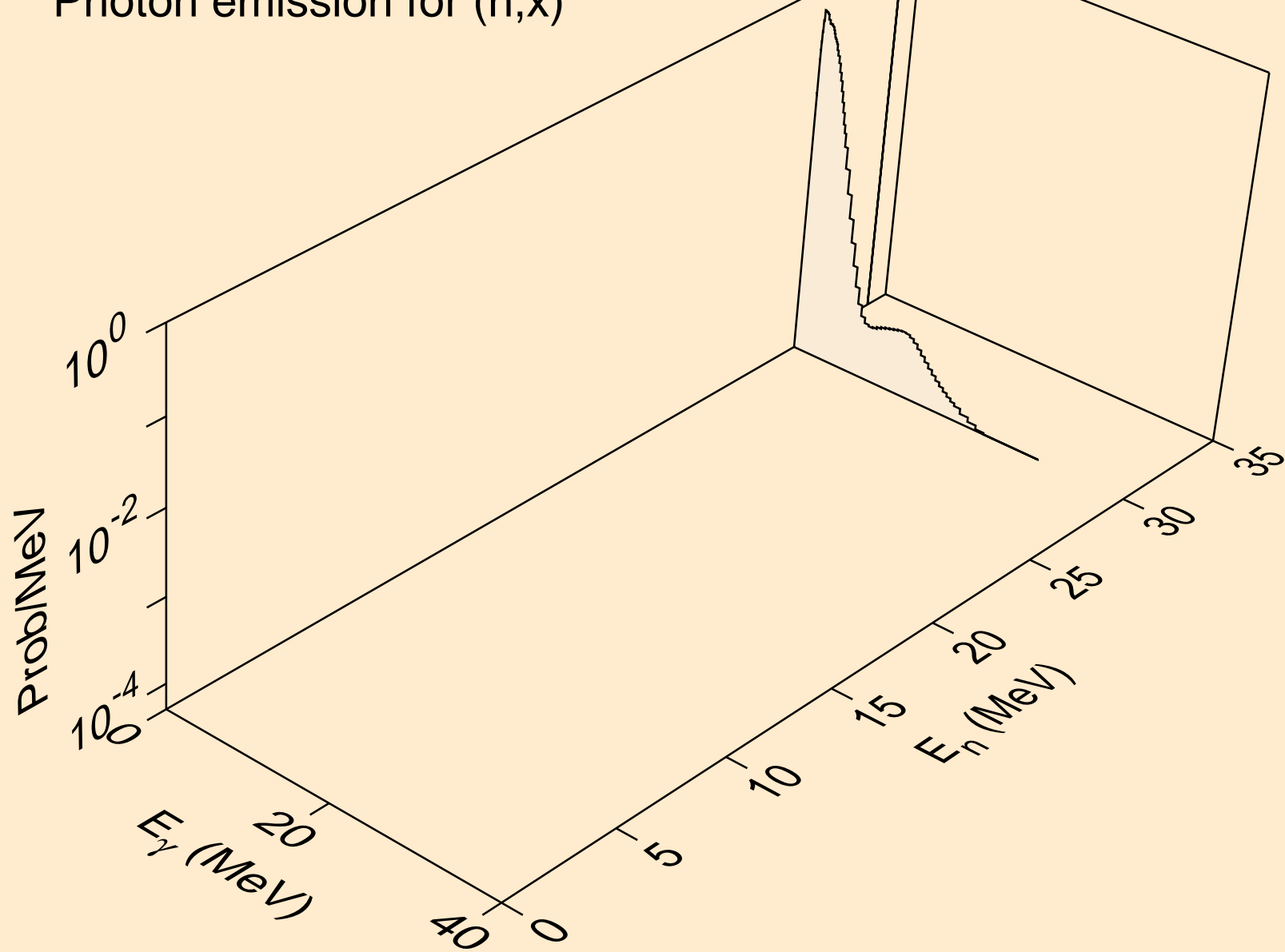

MD254M NEUTRON ACER TENDL-2021 LIBRARY; T=293.6K
Photon emission for (n,2nd)

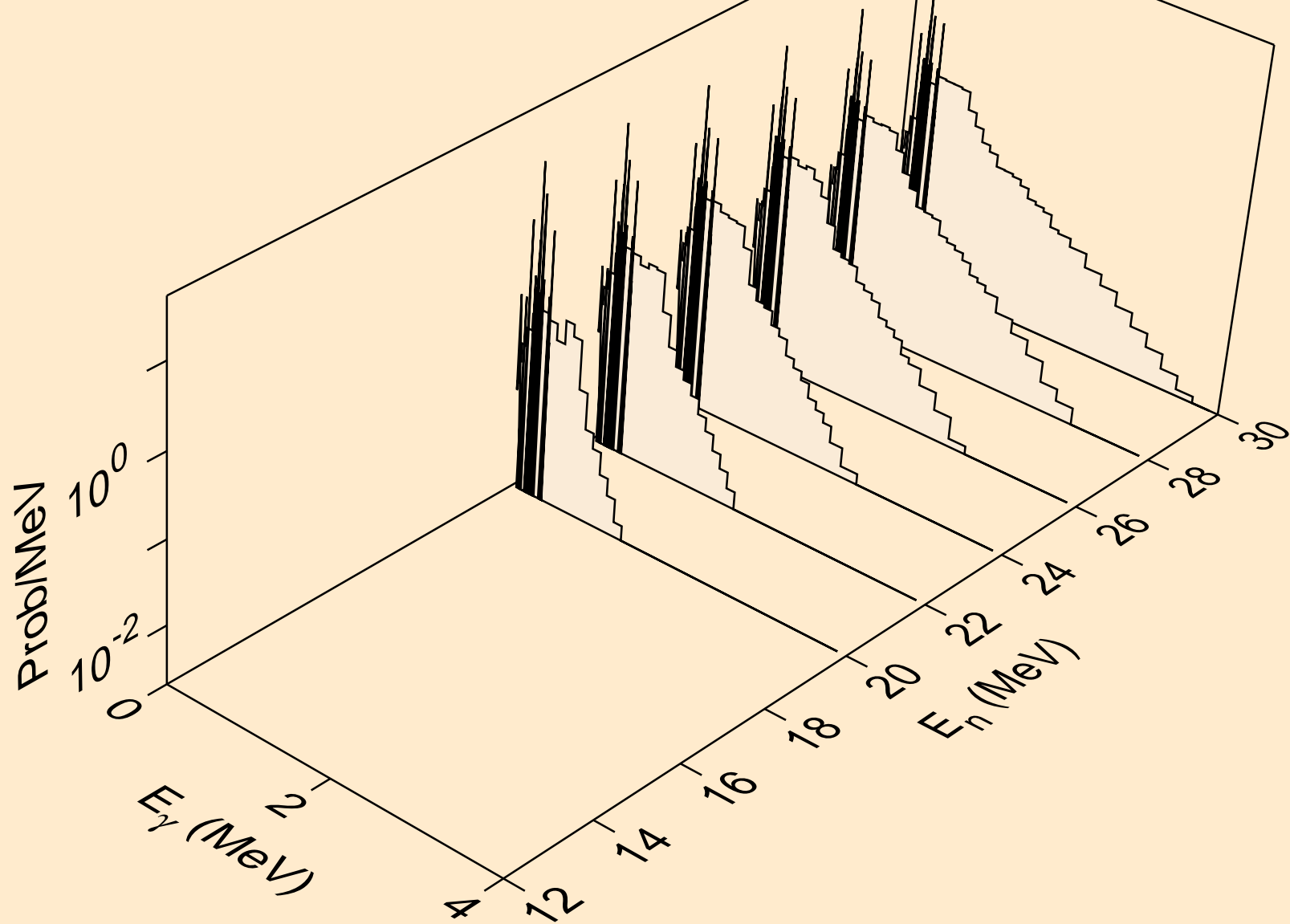

MD254M NEUTRON ACER TENDL-2021 LIBRARY; T=293.6K
Photon emission for (n,2n)

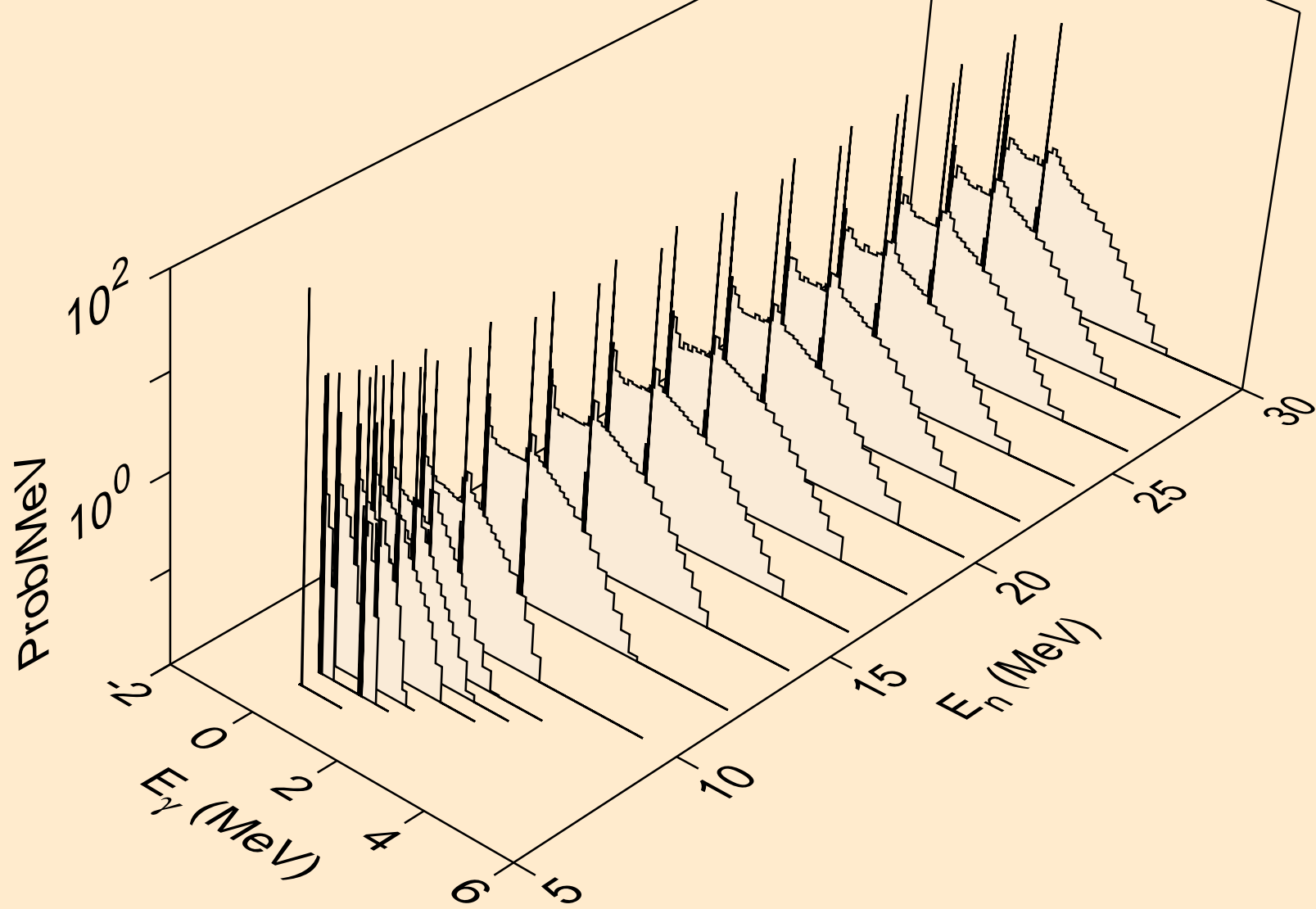

MD254M NEUTRON ACER TENDL-2021 LIBRARY; T=293.6K
Photon emission for (n,3n)

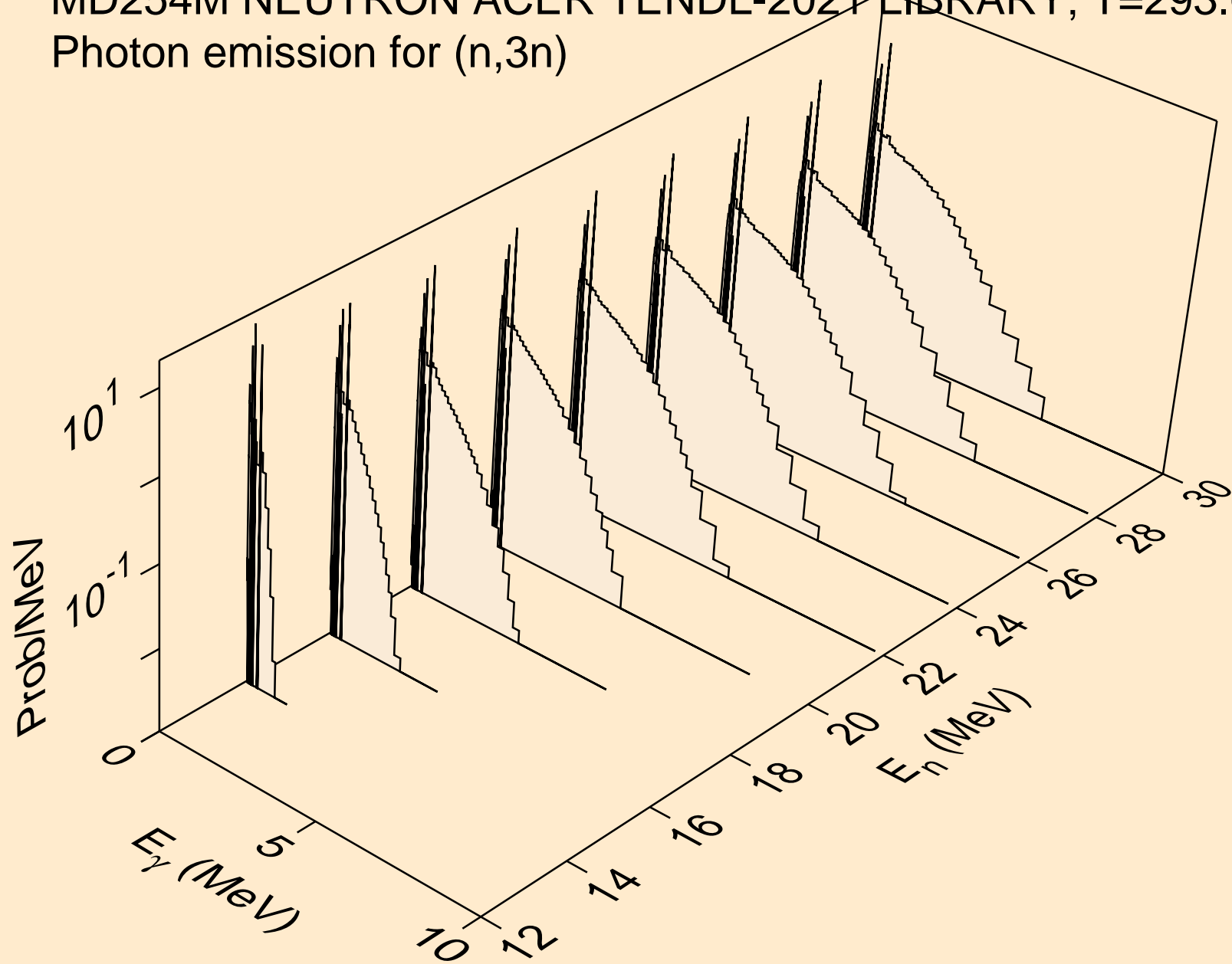

MD254M NEUTRON ACER TENDL-2021 LIBRARY; T=293.6K
Photon emission for (n,n*)a

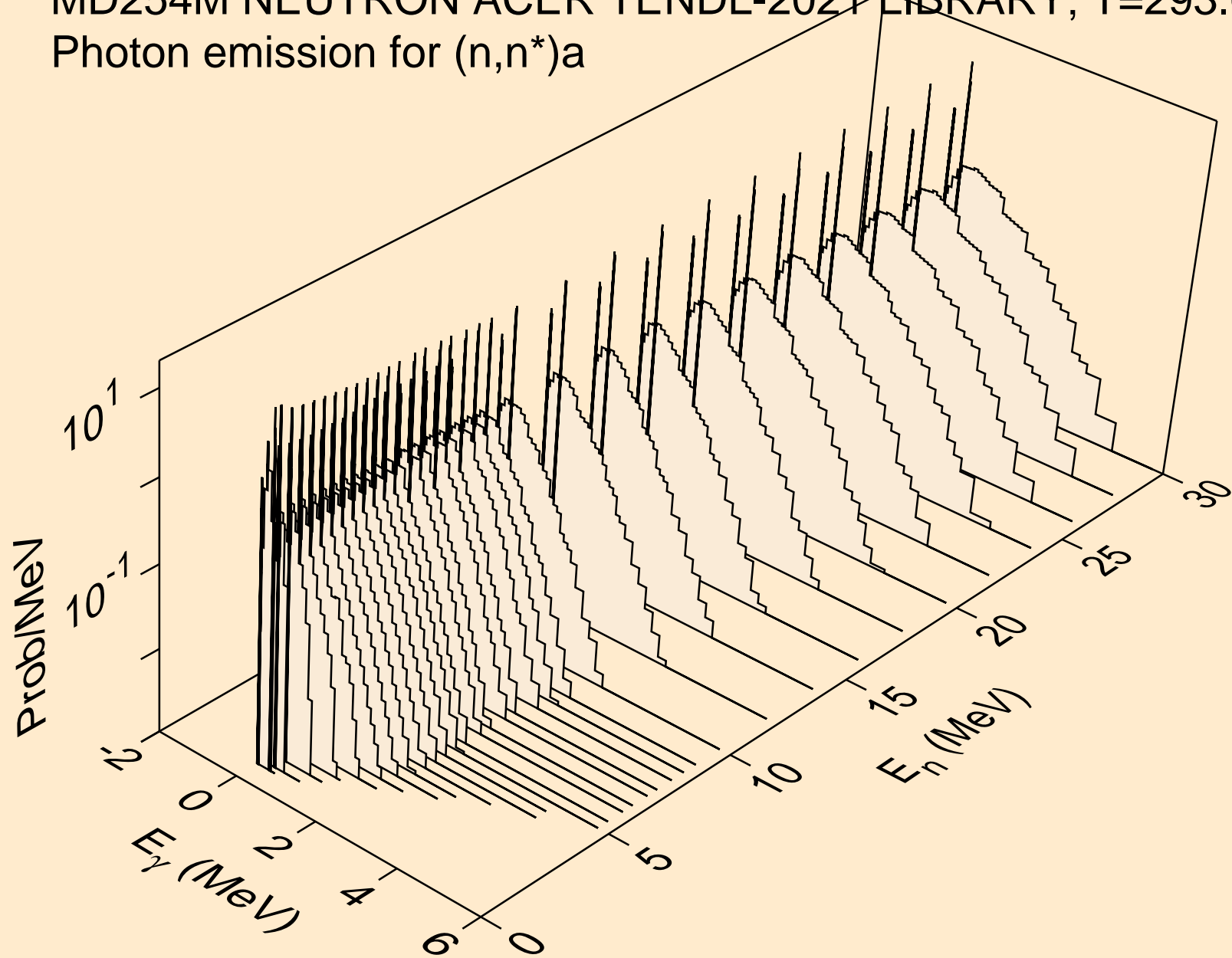

MD254M NEUTRON ACER TENDL-2021 LIBRARY; T=293.6K
Photon emission for (n,2n) α

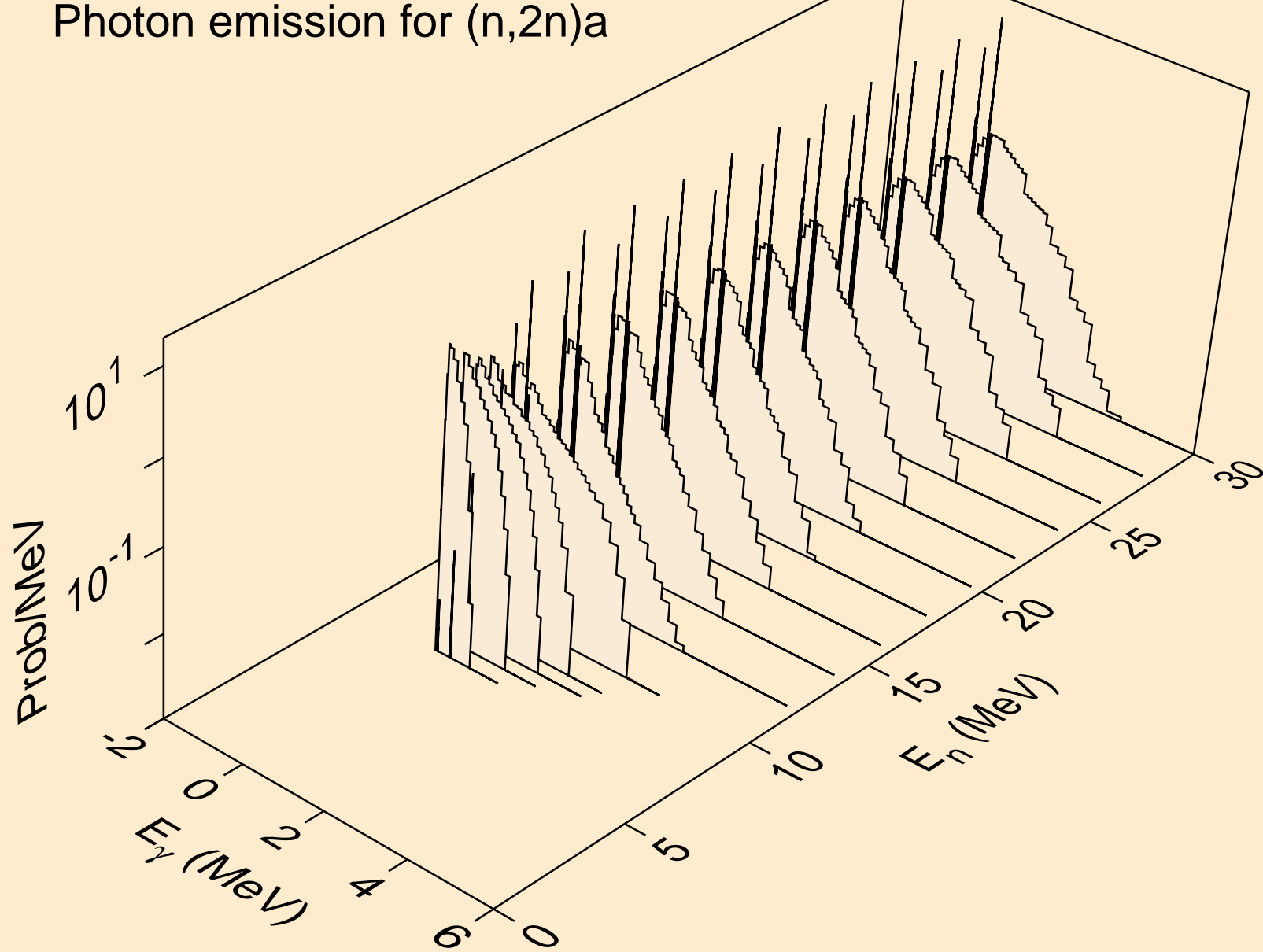

MD254M NEUTRON ACER TENDL-2021 LIBRARY; T=293.6K
Photon emission for (n,3n)a

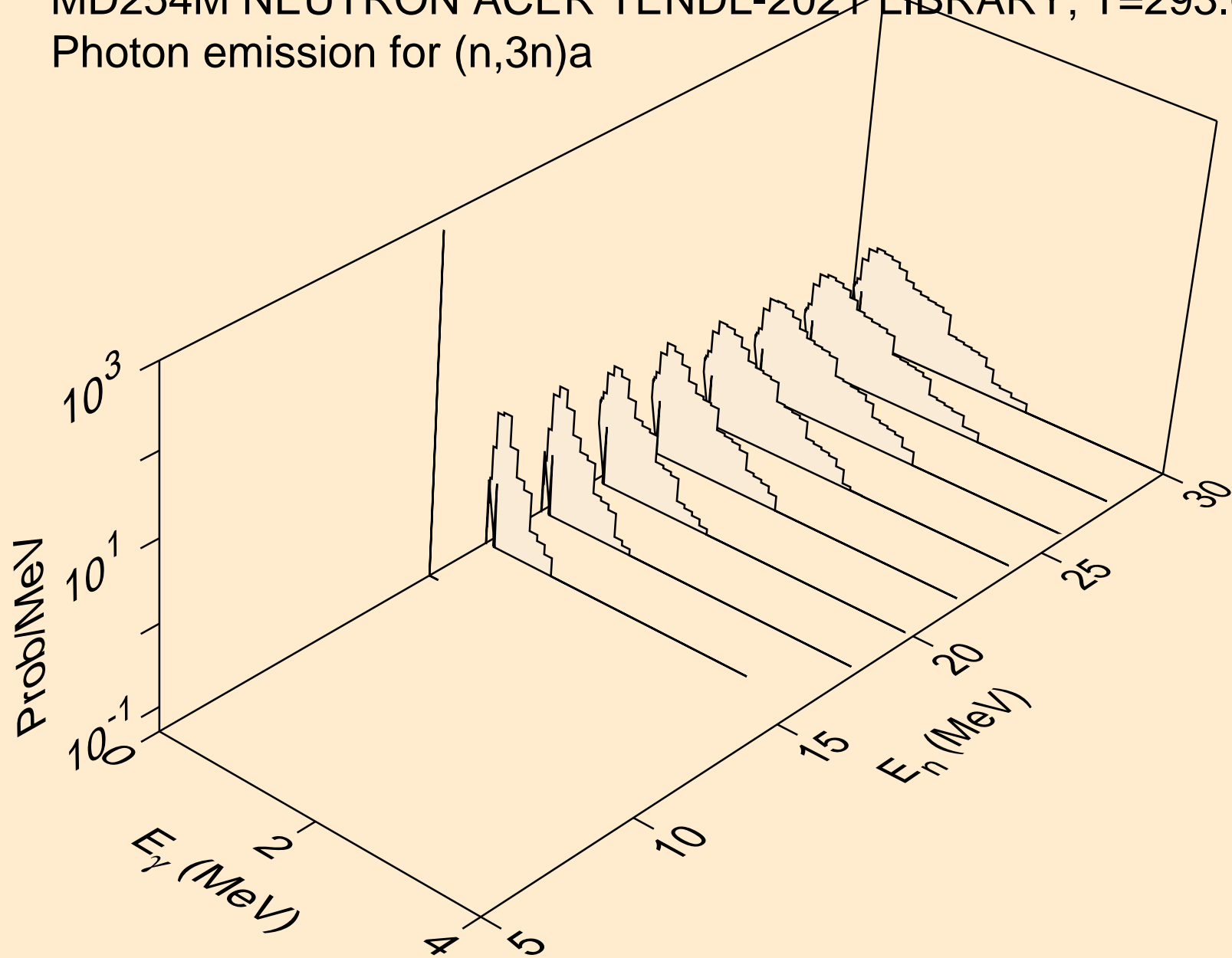

MD254M NEUTRON ACER TENDL-2021 LIBRARY; T=293.6K
Photon emission for (n,n*)p

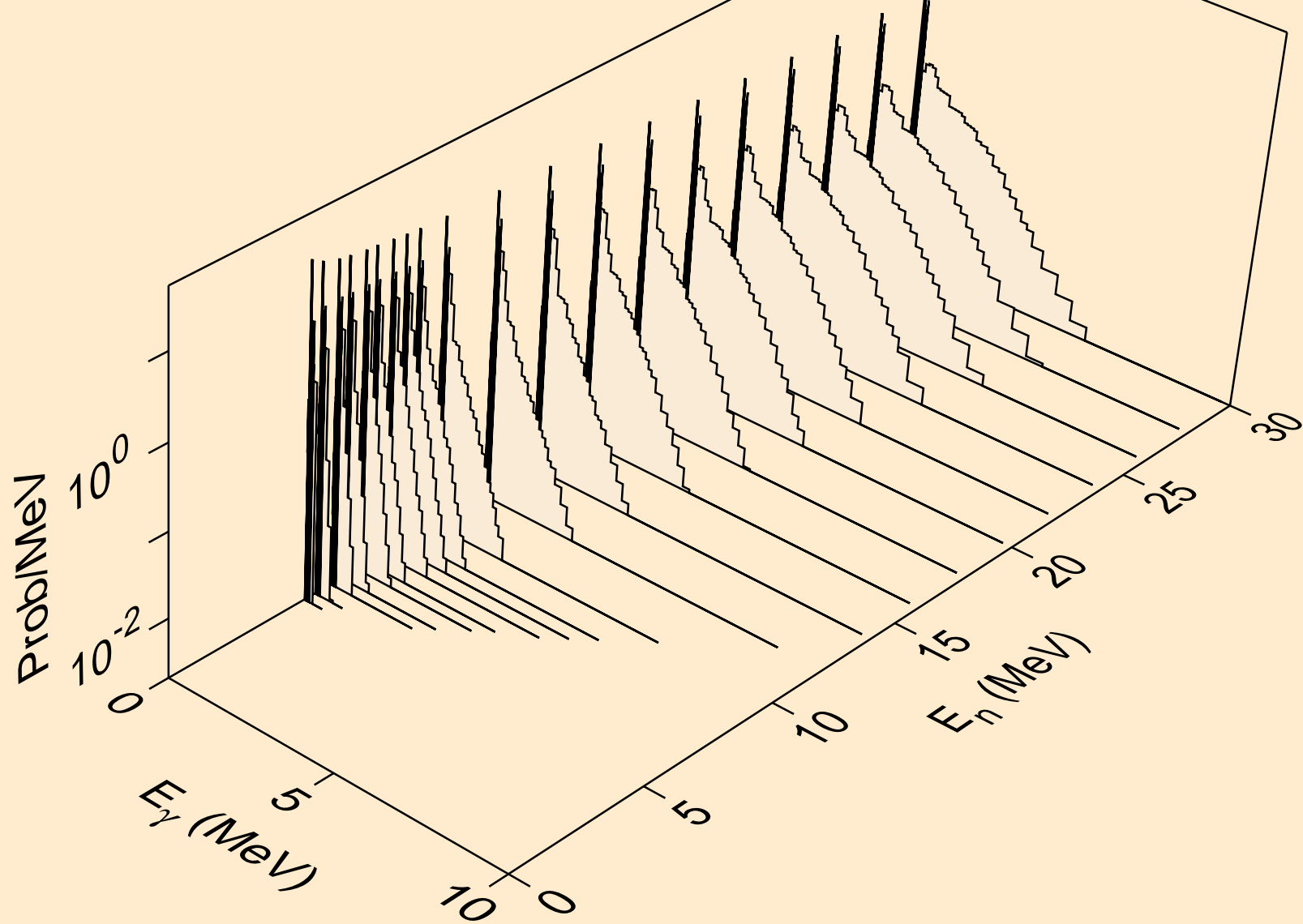

MD254M NEUTRON ACER TENDL-2021 LIBRARY; T=293.6K
Photon emission for (n,n*)2a

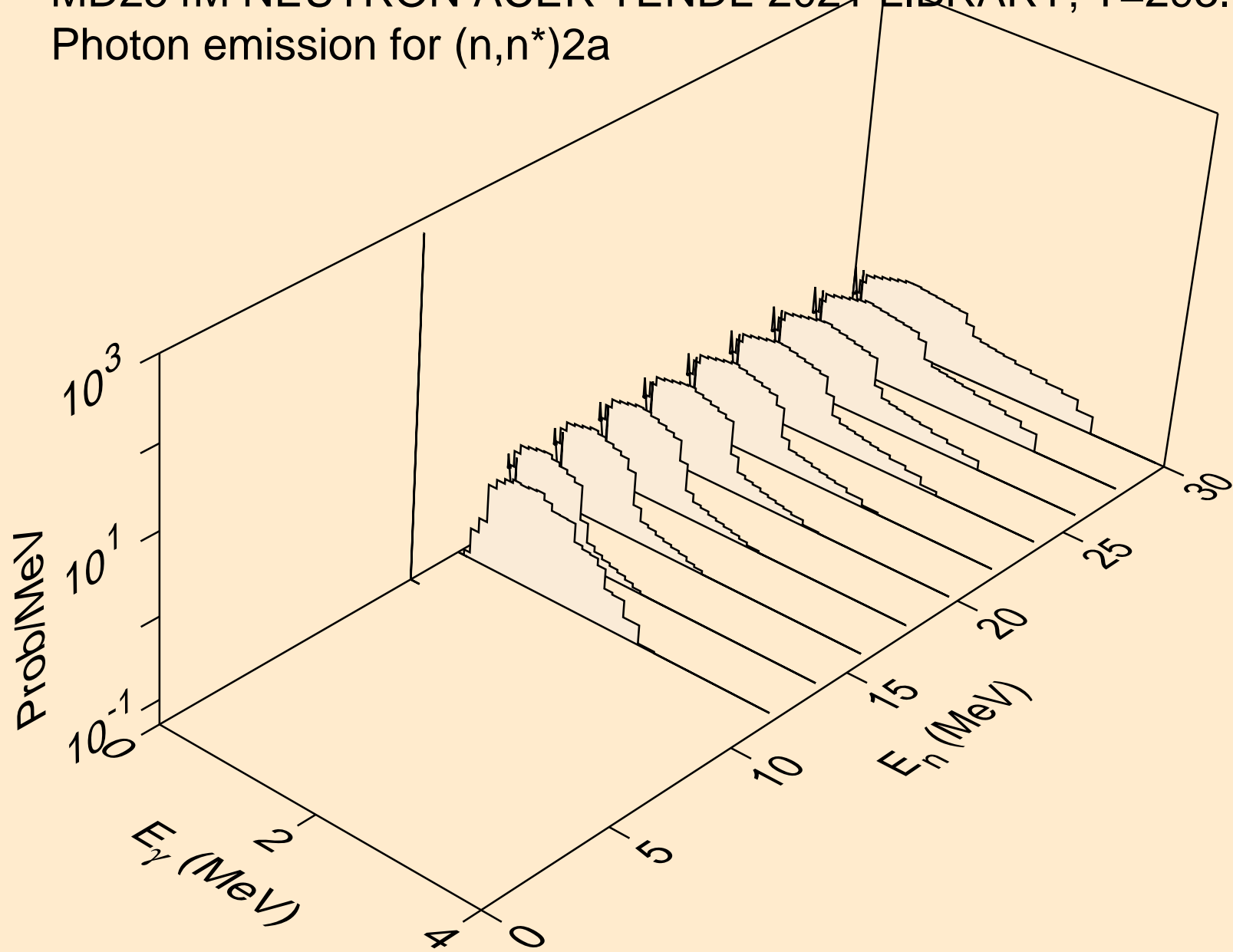

MD254M NEUTRON ACER TENDL-2021 LIBRARY; T=293.6K
Photon emission for (n,n*)d

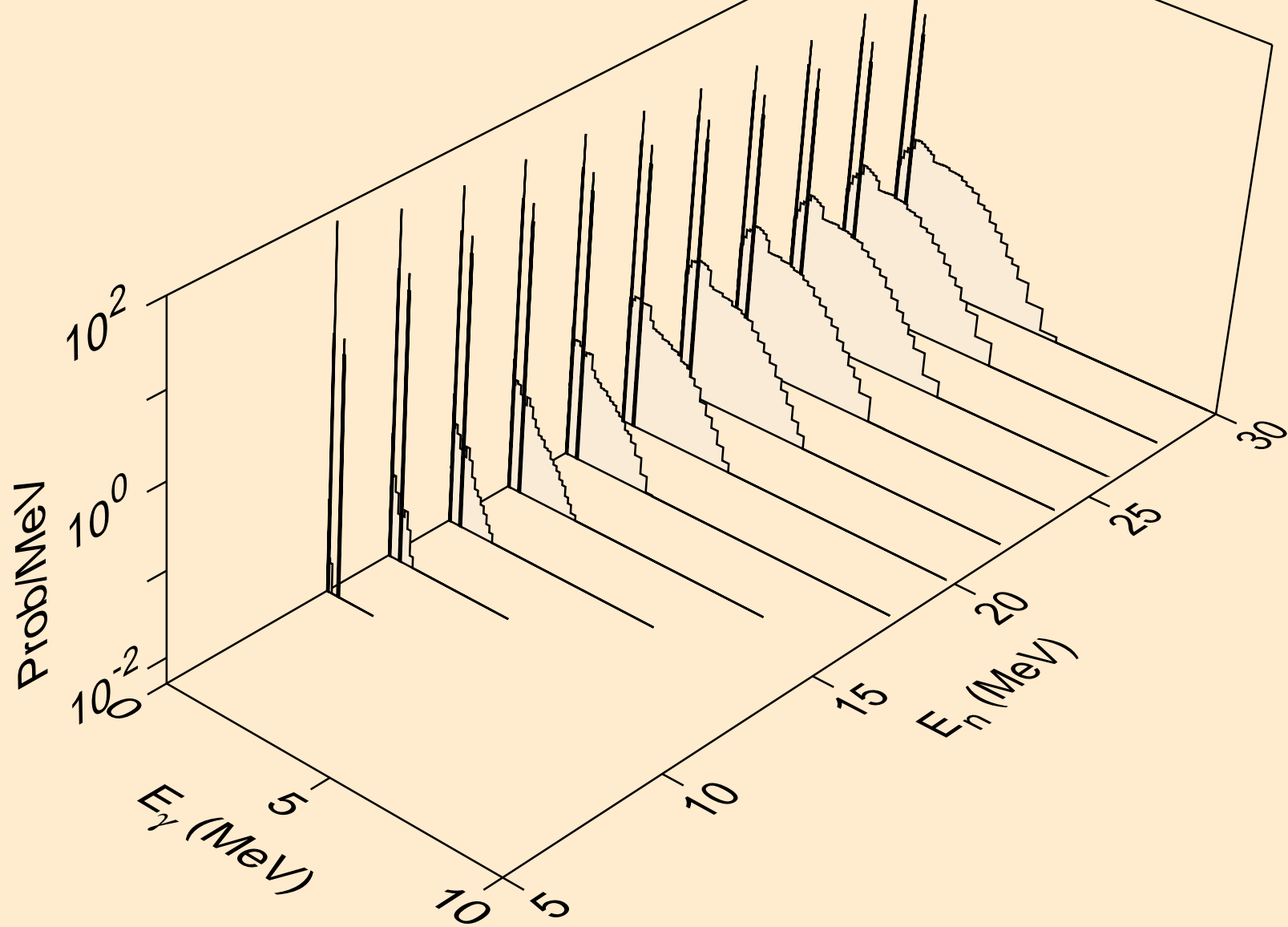

MD254M NEUTRON ACER TENDL-2021 LIBRARY; T=293.6K
Photon emission for (n,n*)t

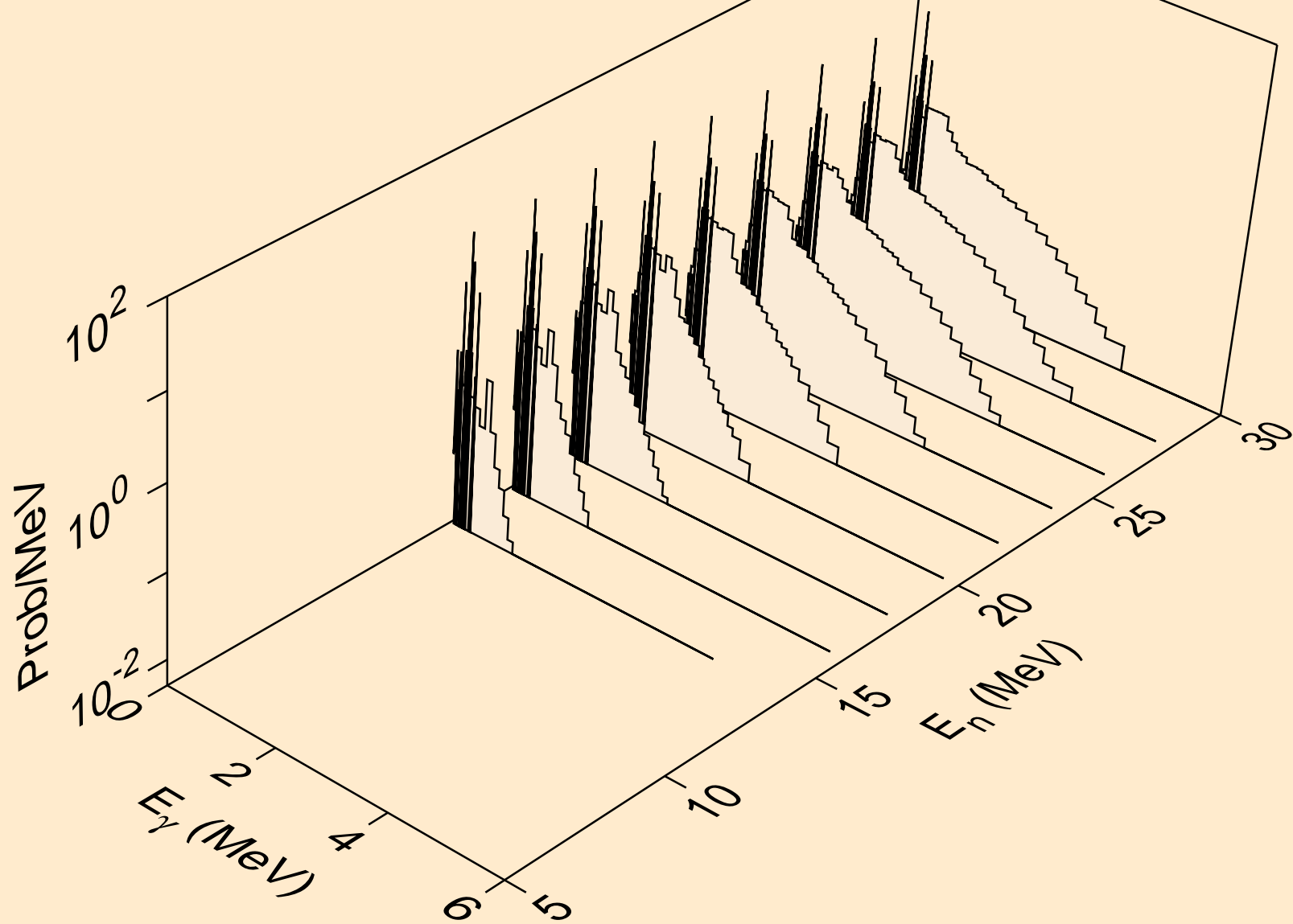

MD254M NEUTRON ACER TENDL-2021 LIBRARY; T=293.6K
Photon emission for (n,n*)he3

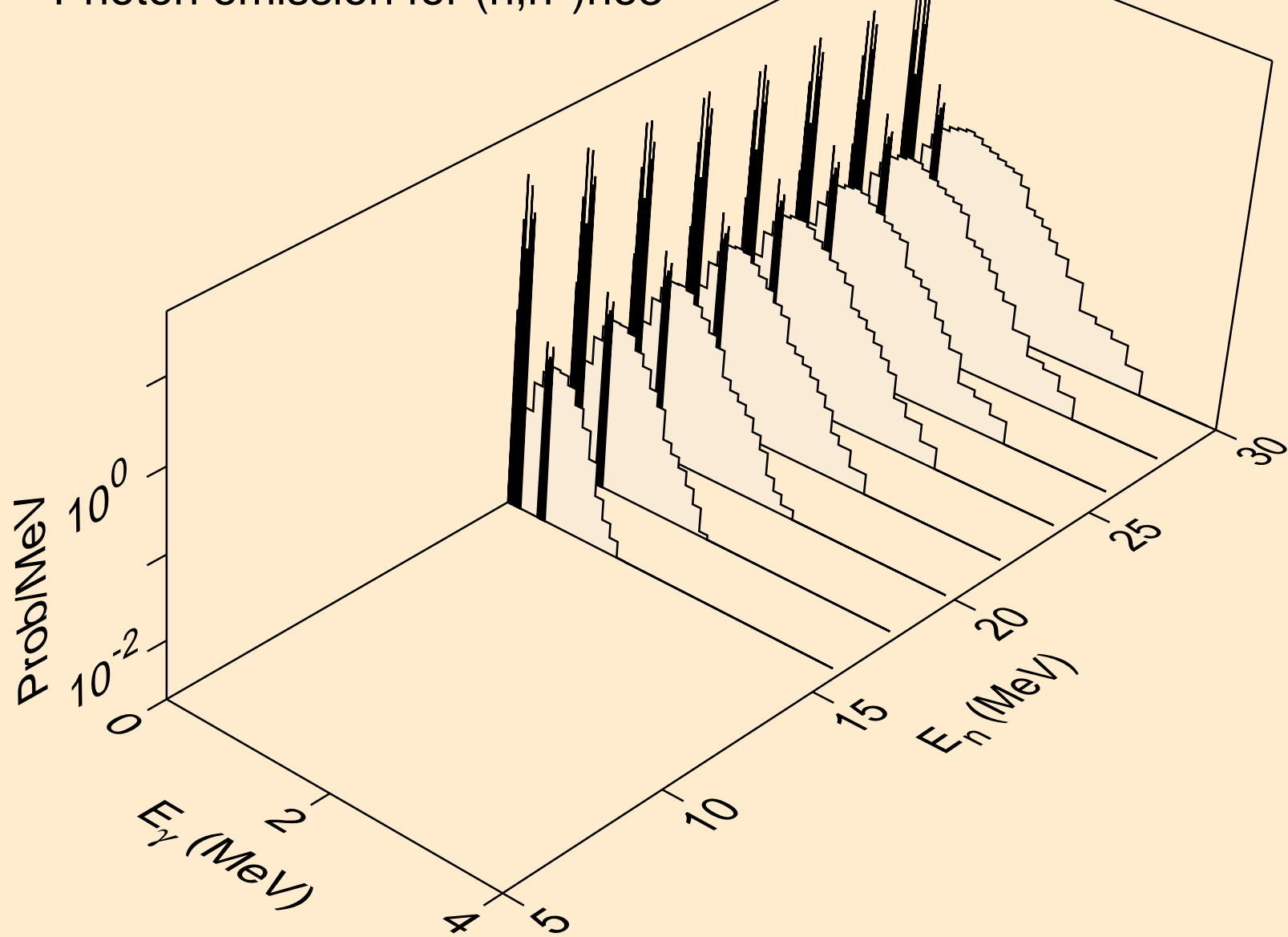

MD254M NEUTRON ACER TENDL-2021 LIBRARY; T=293.6K
Photon emission for (n,4n)

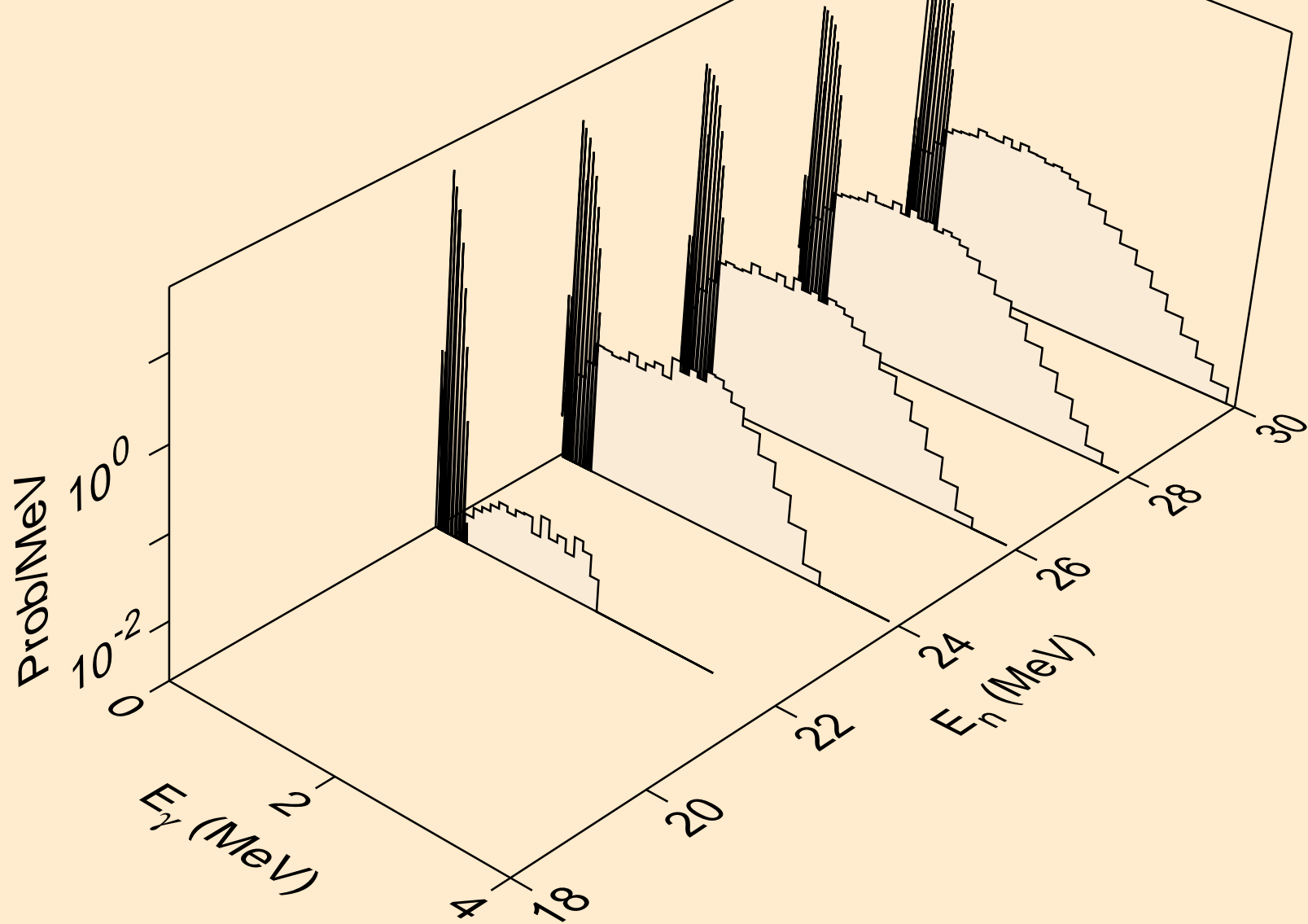

MD254M NEUTRON ACER TENDL-2021 LIBRARY; T=293.6K
Photon emission for (n,2np)

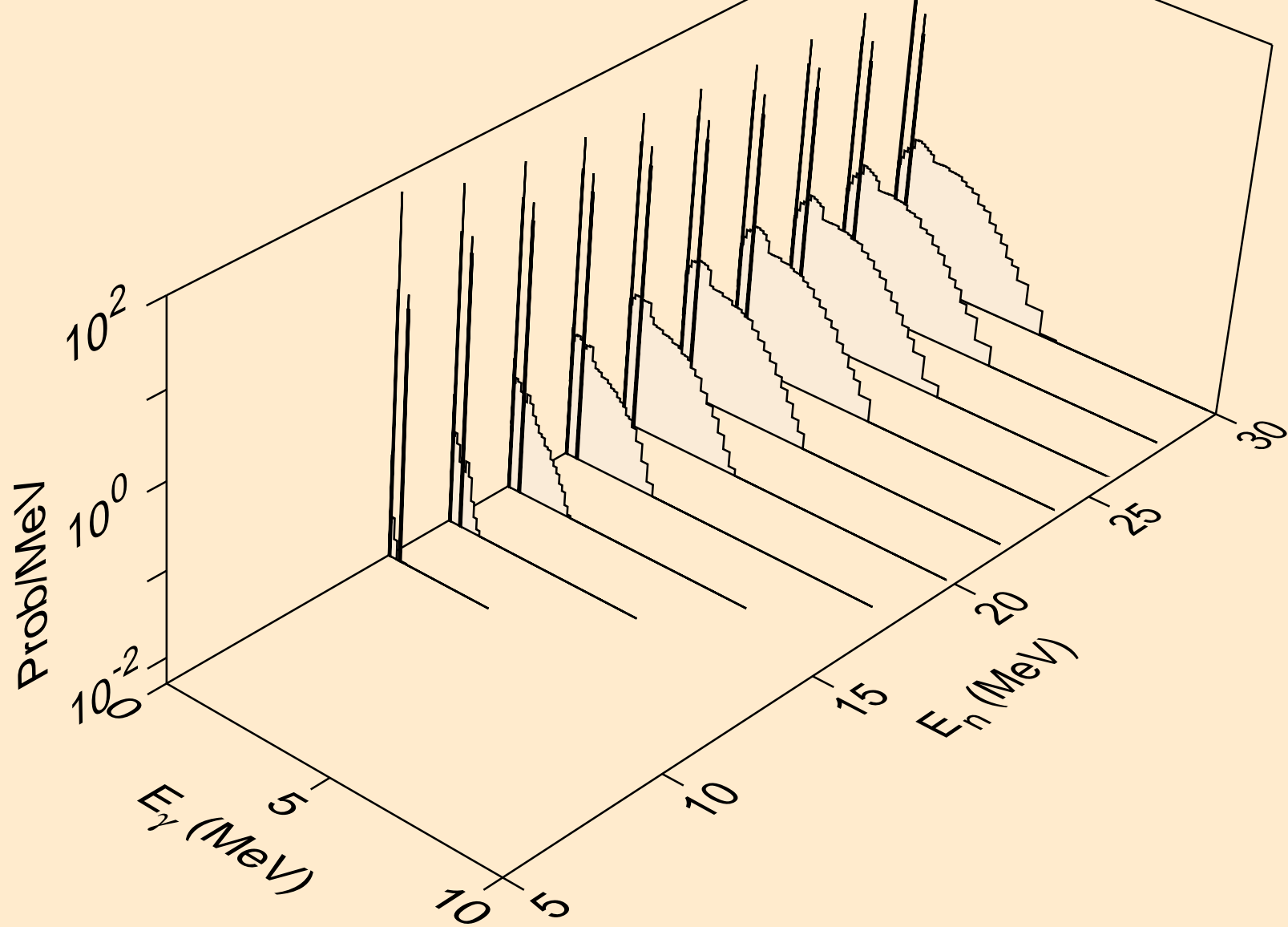

MD254M NEUTRON ACER TENDL-2021 LIBRARY; T=293.6K
Photon emission for (n,3np)

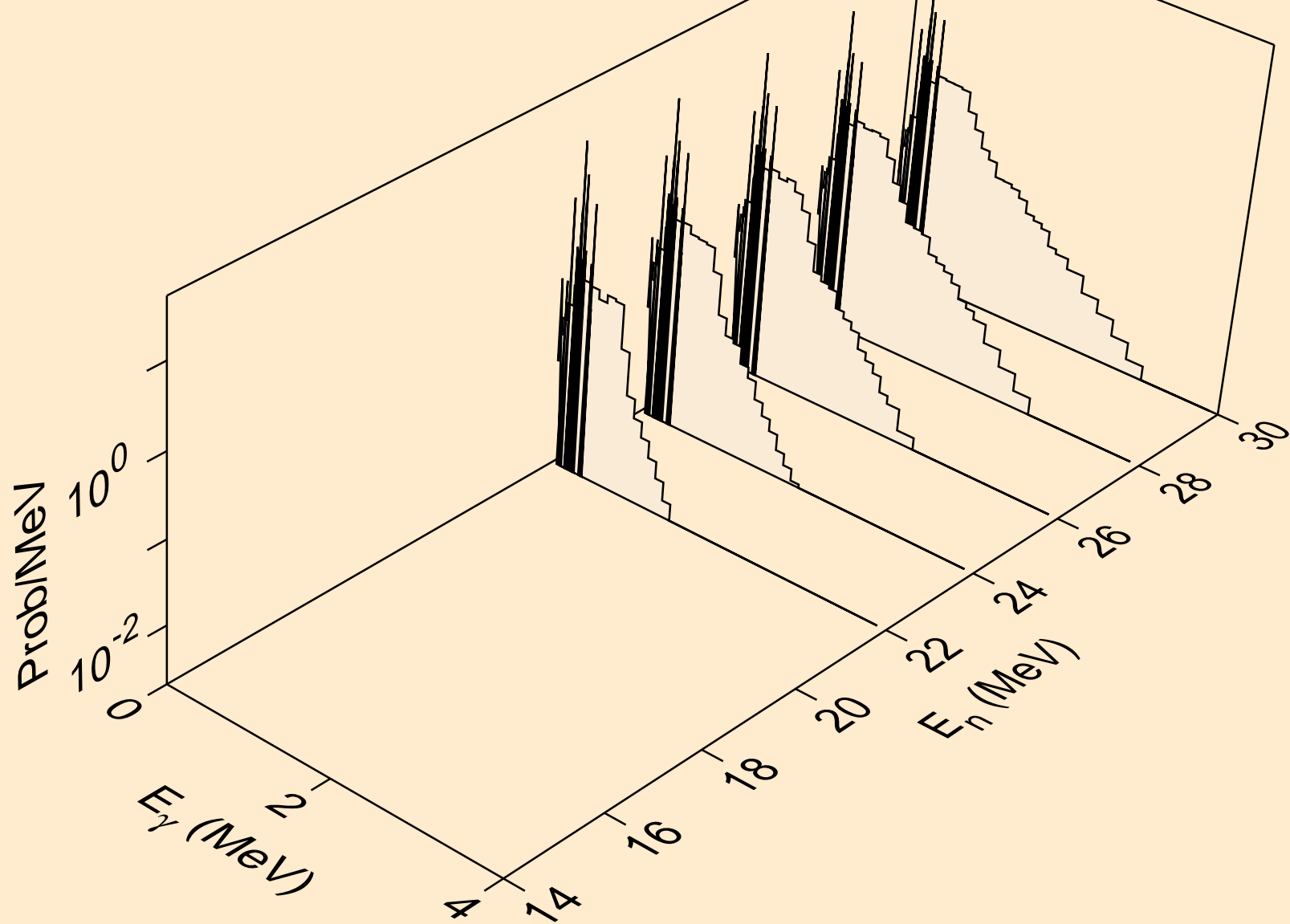

MD254M NEUTRON ACER TENDL-2021 LIBRARY; T=293.6K
Photon emission for (n,2np)

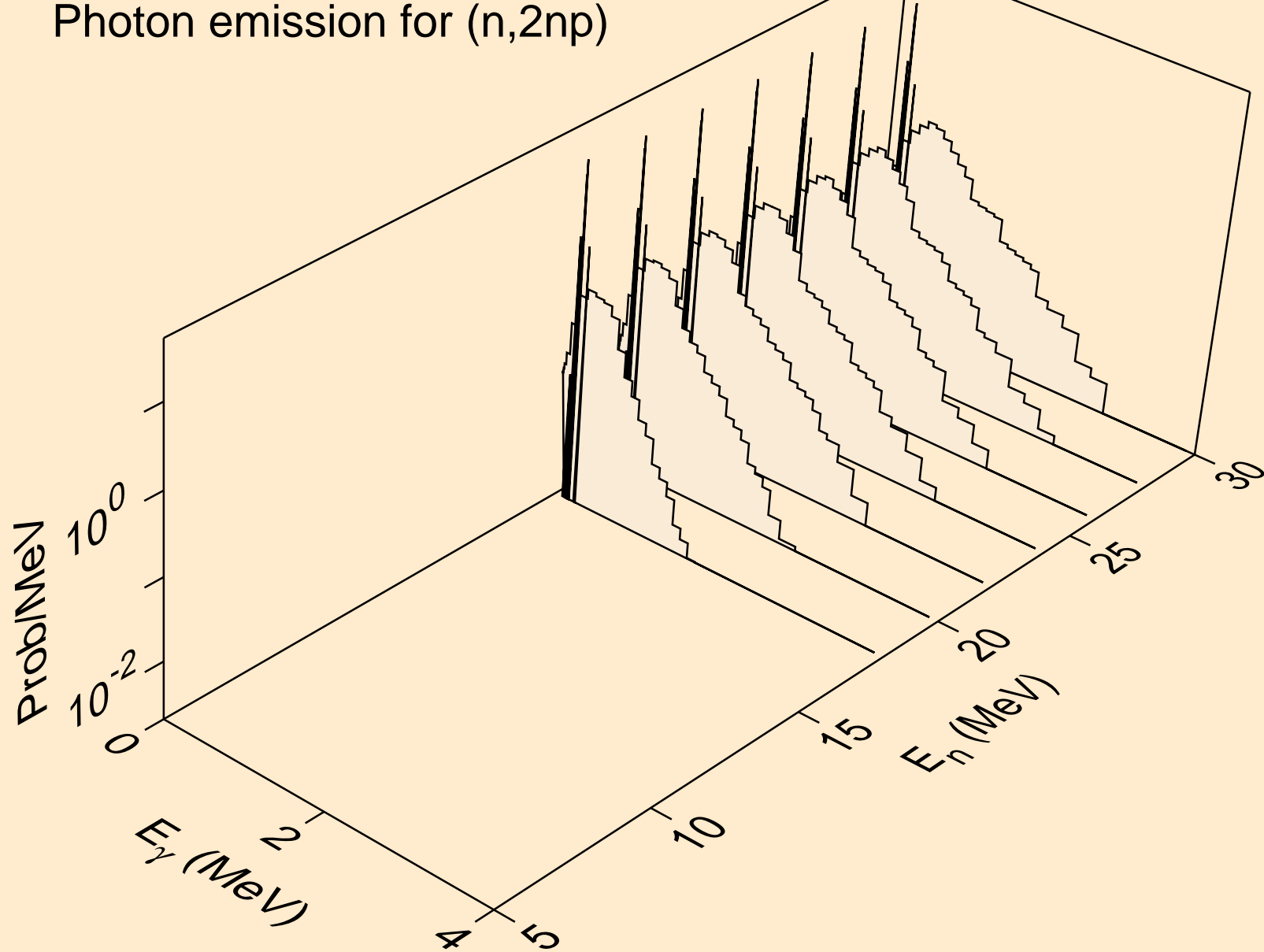

MD254M NEUTRON ACER TENDL-2021 LIBRARY; T=293.6K
Photon emission for (n,npa)

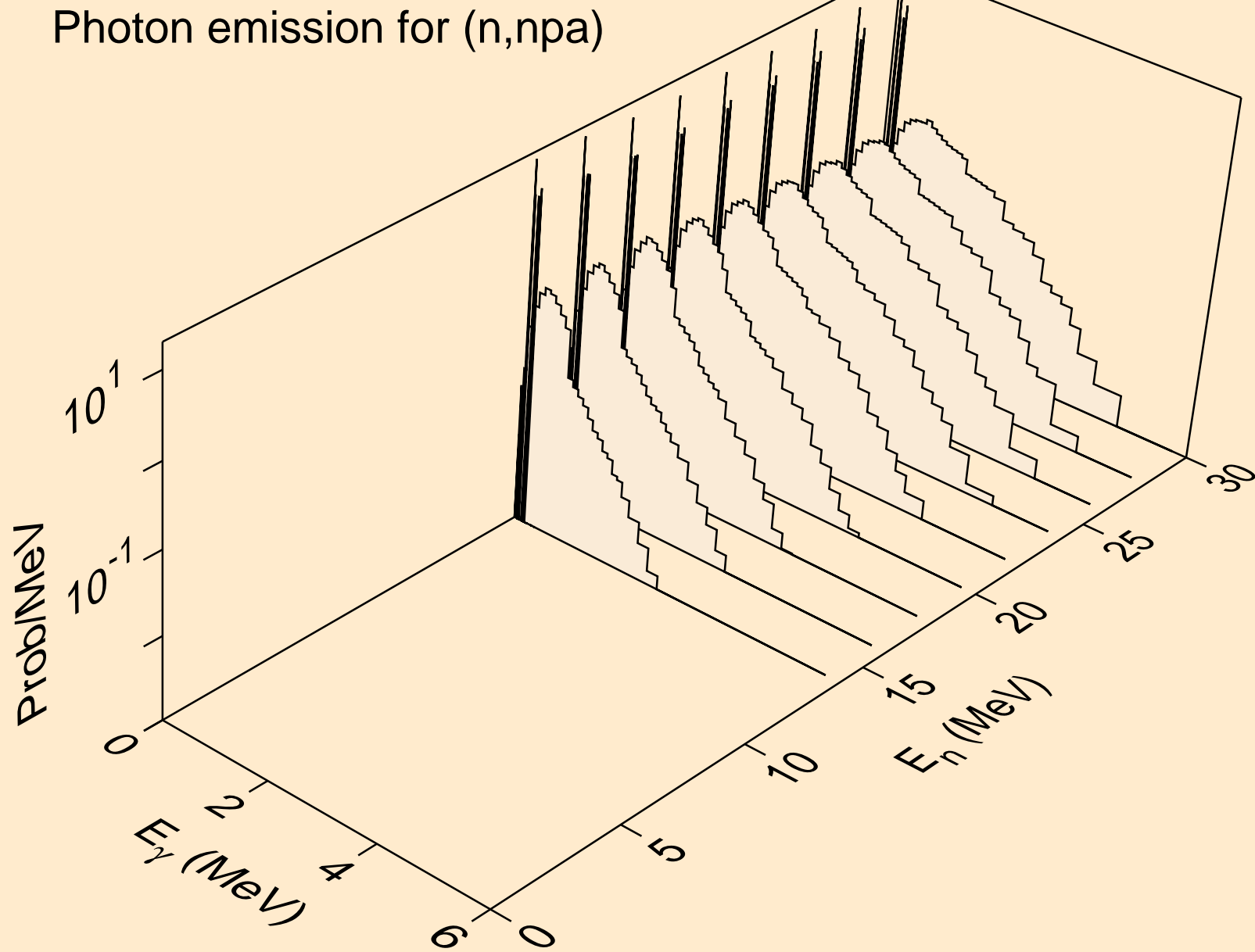

MD254M NEUTRON ACER TENDL-2021 LIBRARY; T=293.6K
Photon emission for (n,n*1)

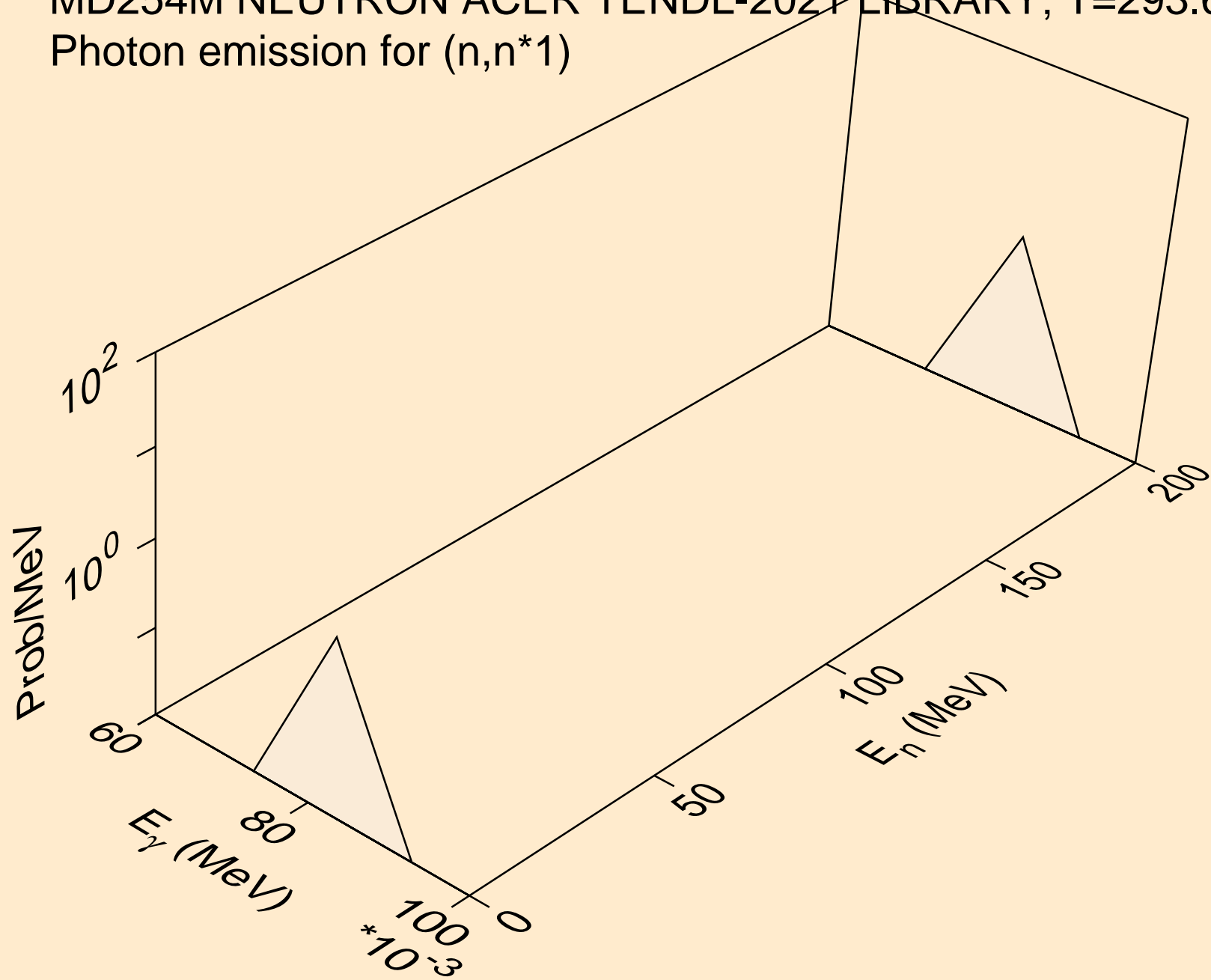

MD254M NEUTRON ACER TENDL-2021 LIBRARY; T=293.6K
Photon emission for (n,n*2)

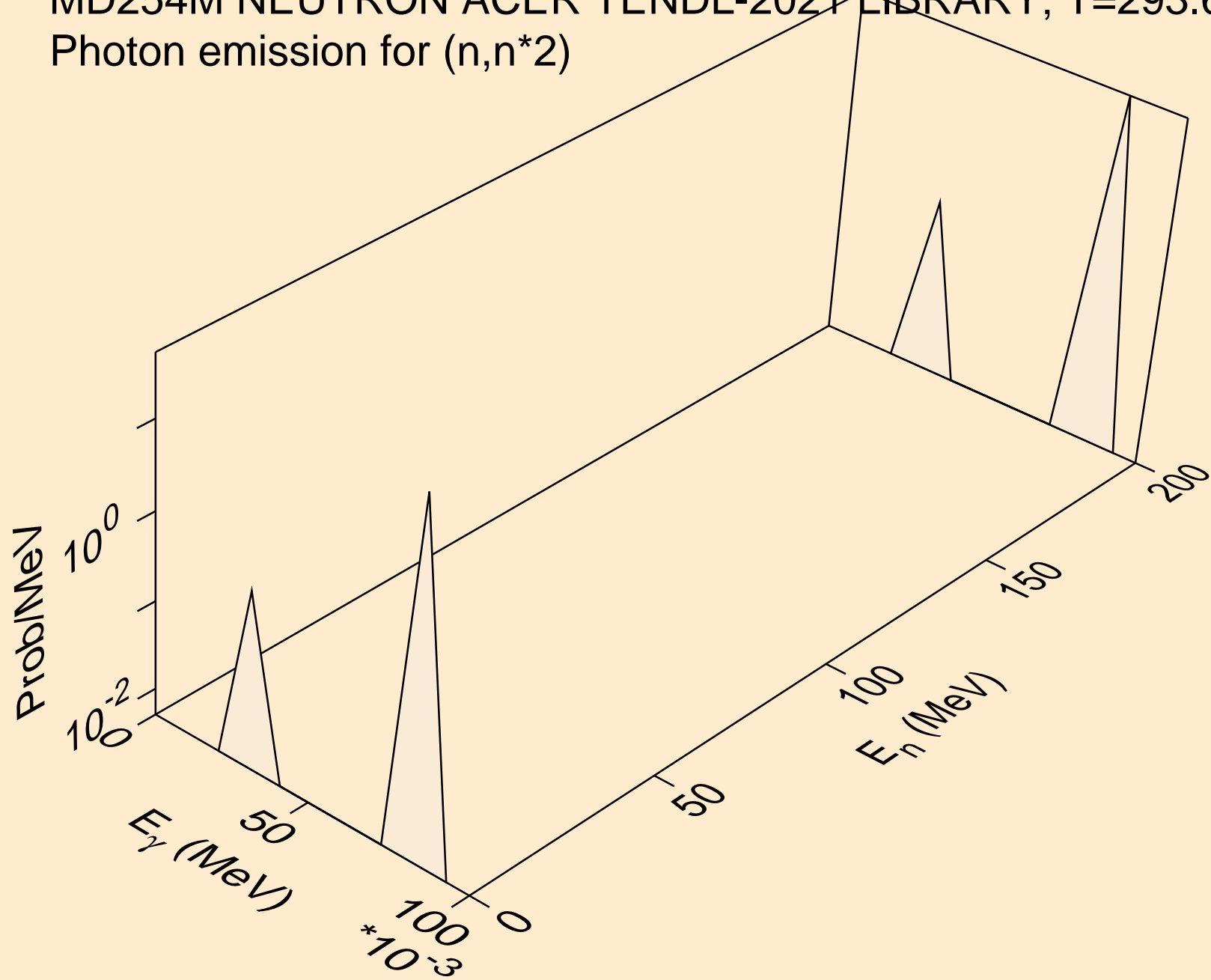

MD254M NEUTRON ACER TENDL-2021 LIBRARY; T=293.6K
Photon emission for (n,n*3)

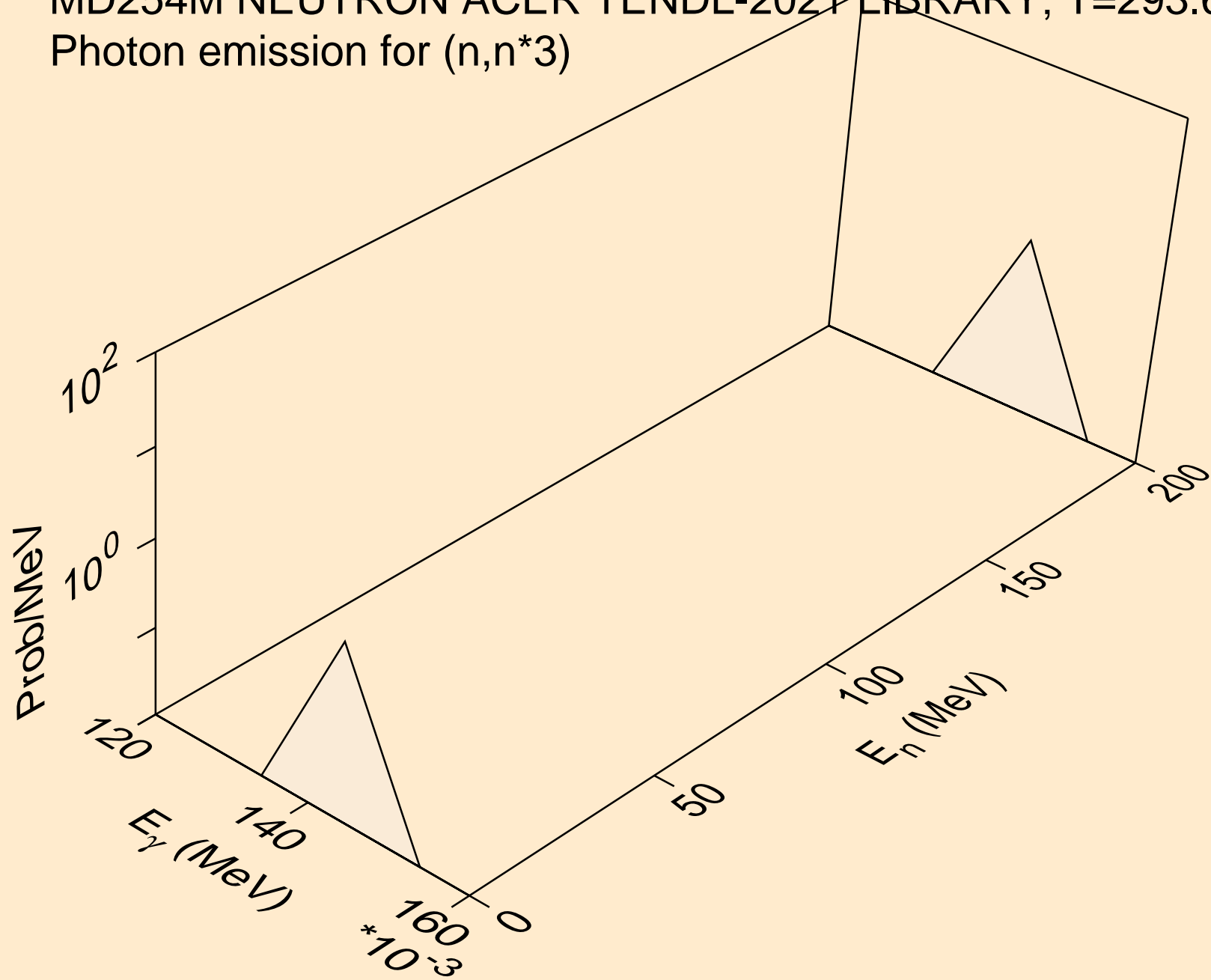

MD254M NEUTRON ACER TENDL-2021 LIBRARY; T=293.6K
Photon emission for (n,n*4)

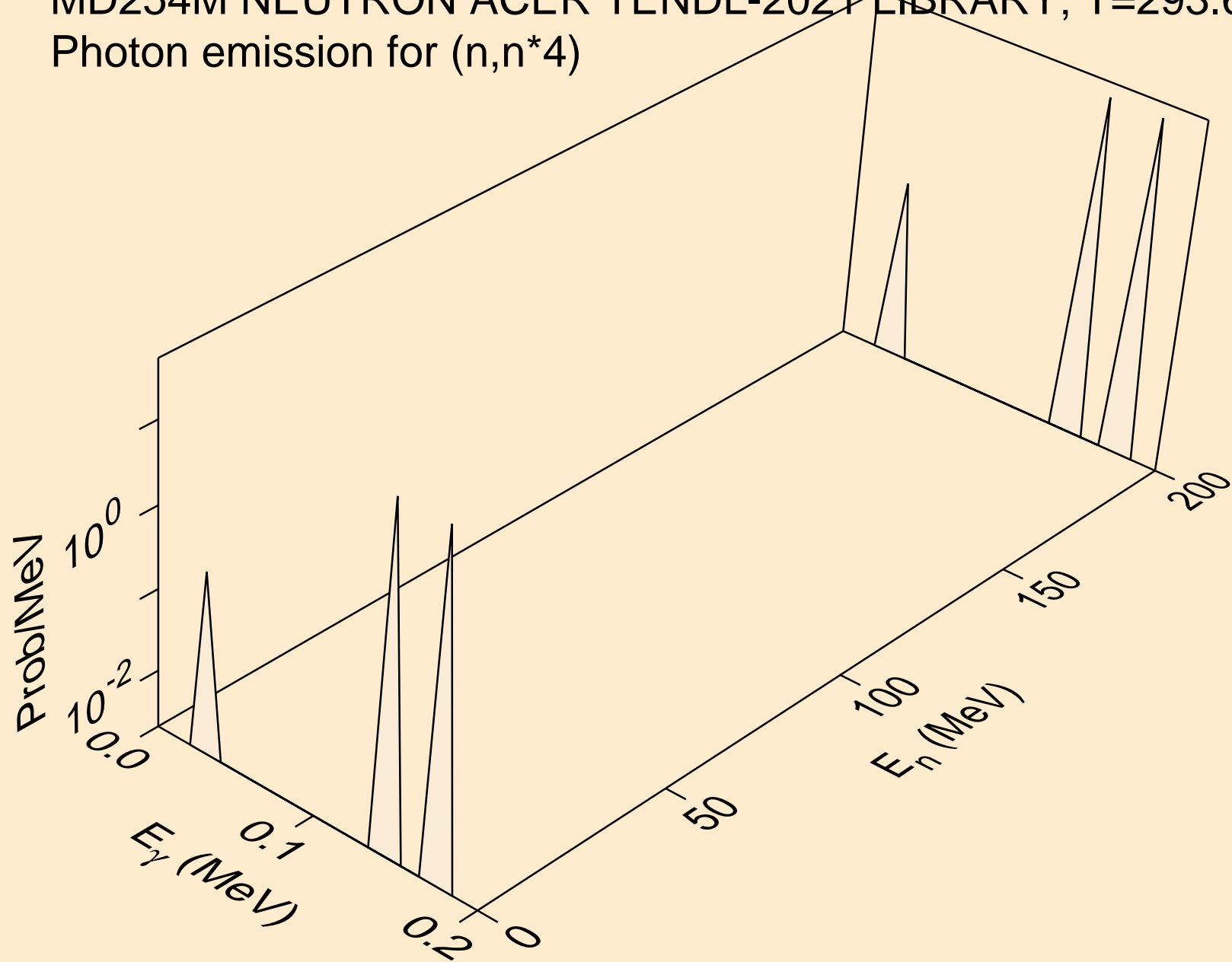

MD254M NEUTRON ACER TENDL-2021 LIBRARY; T=293.6K
Photon emission for (n,n*6)

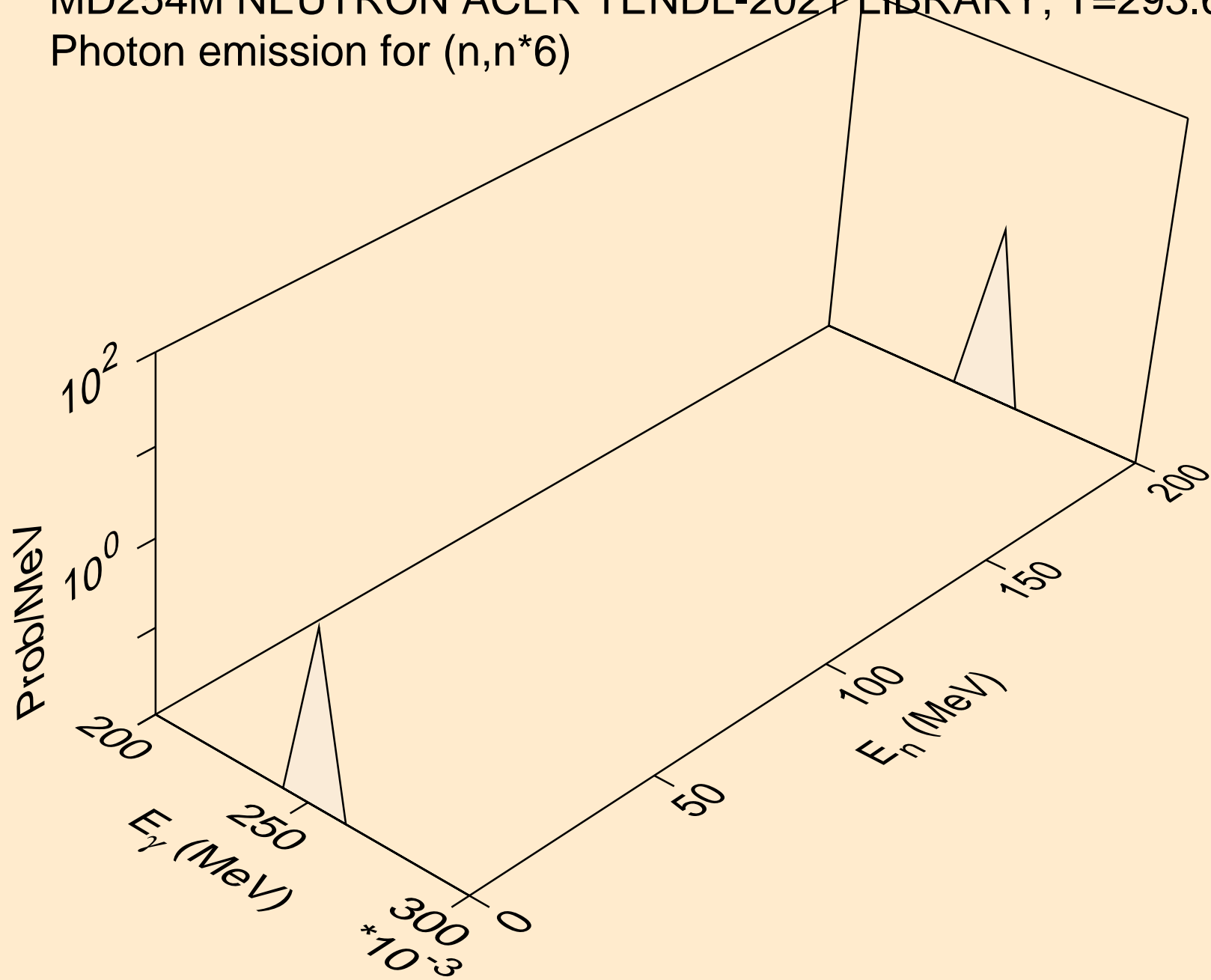

MD254M NEUTRON ACER TENDL-2021 LIBRARY; T=293.6K
Photon emission for (n,n*7)

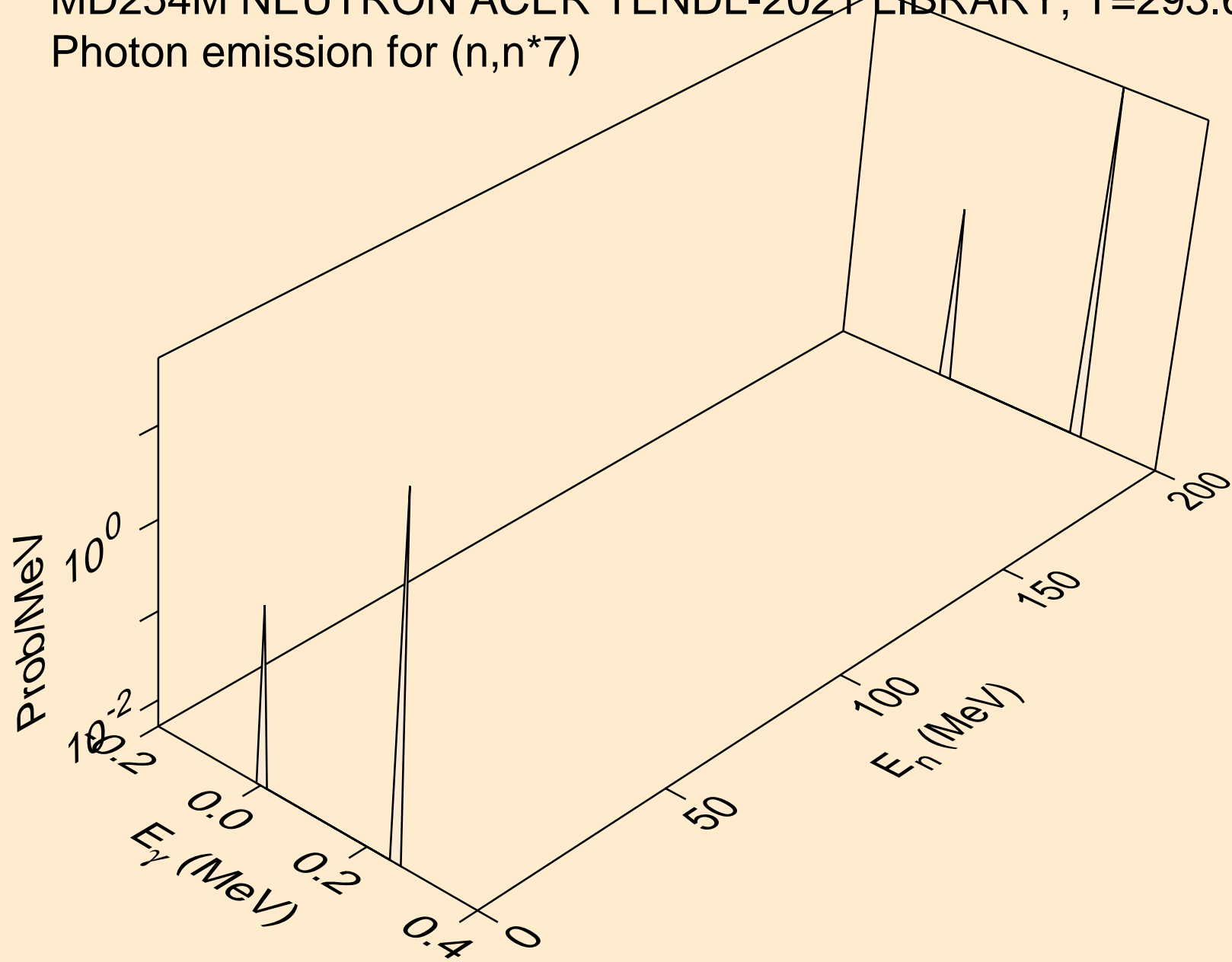

MD254M NEUTRON ACER TENDL-2021 LIBRARY; T=293.6K
Photon emission for (n,n*8)

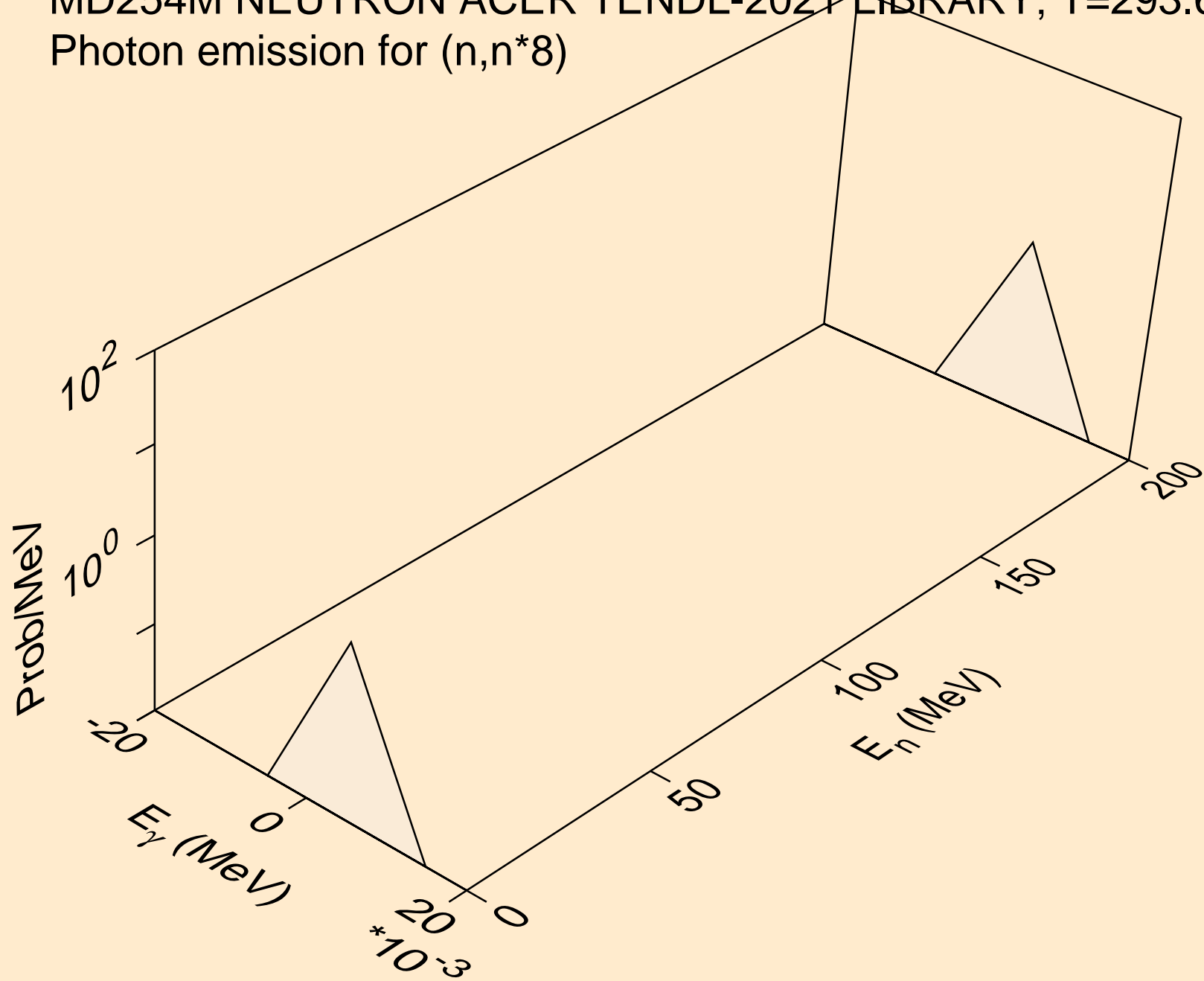

MD254M NEUTRON ACER TENDL-2021 LIBRARY; T=293.6K
Photon emission for (n,n*9)

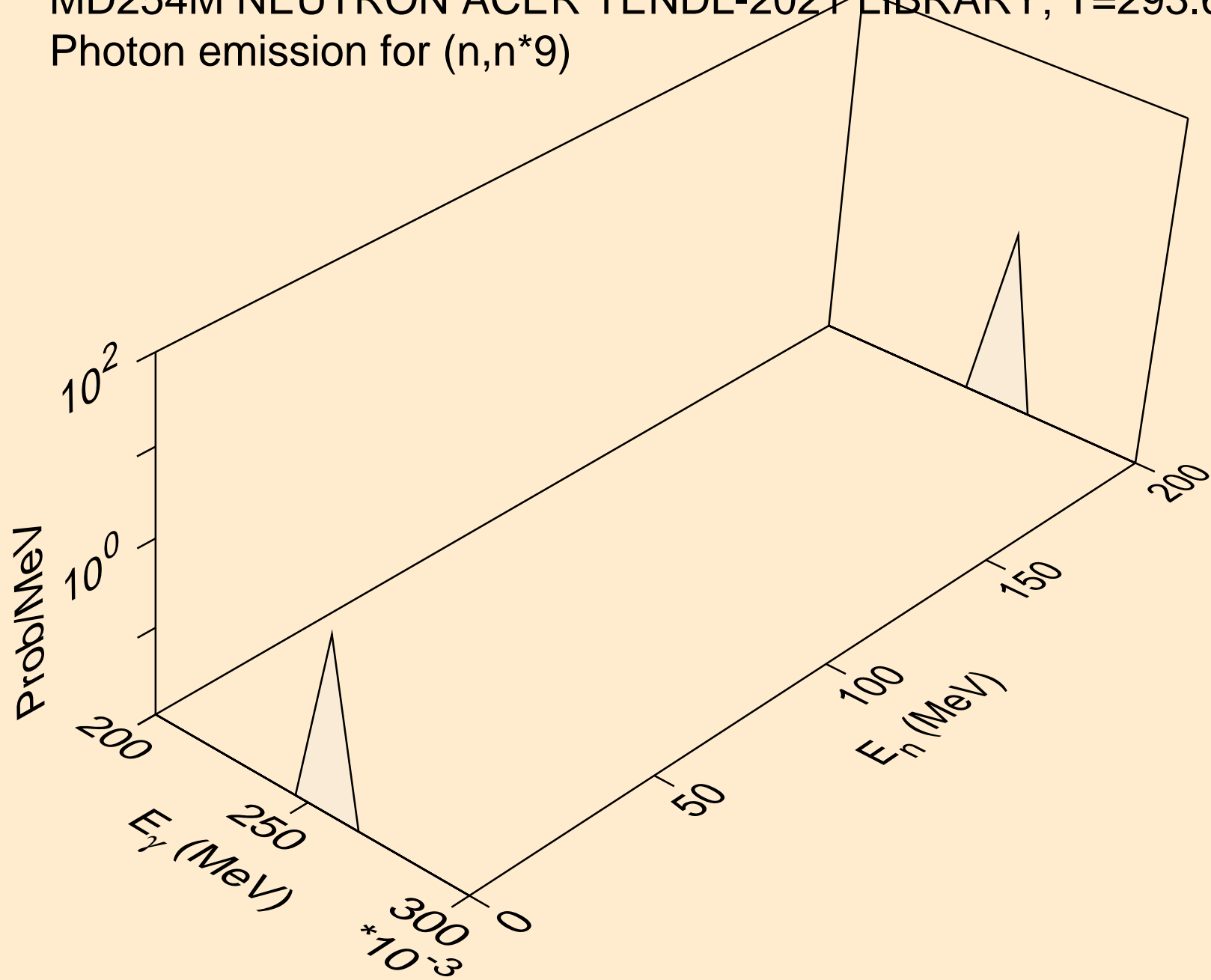

MD254M NEUTRON ACER TENDL-2021 LIBRARY; T=293.6K
Photon emission for (n,n*10)

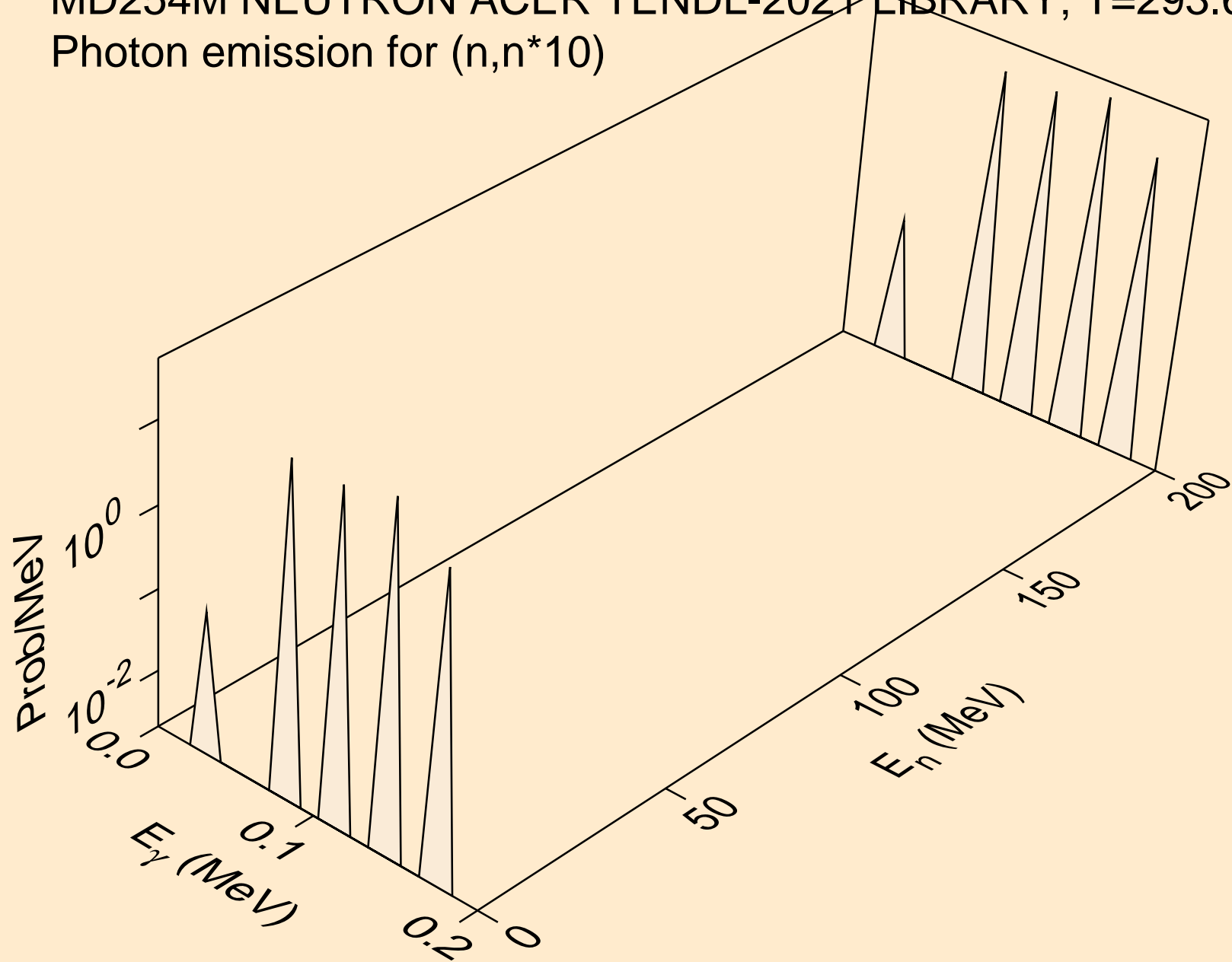

MD254M NEUTRON ACER TENDL-2021 LIBRARY; T=293.6K
Photon emission for (n,n*11)

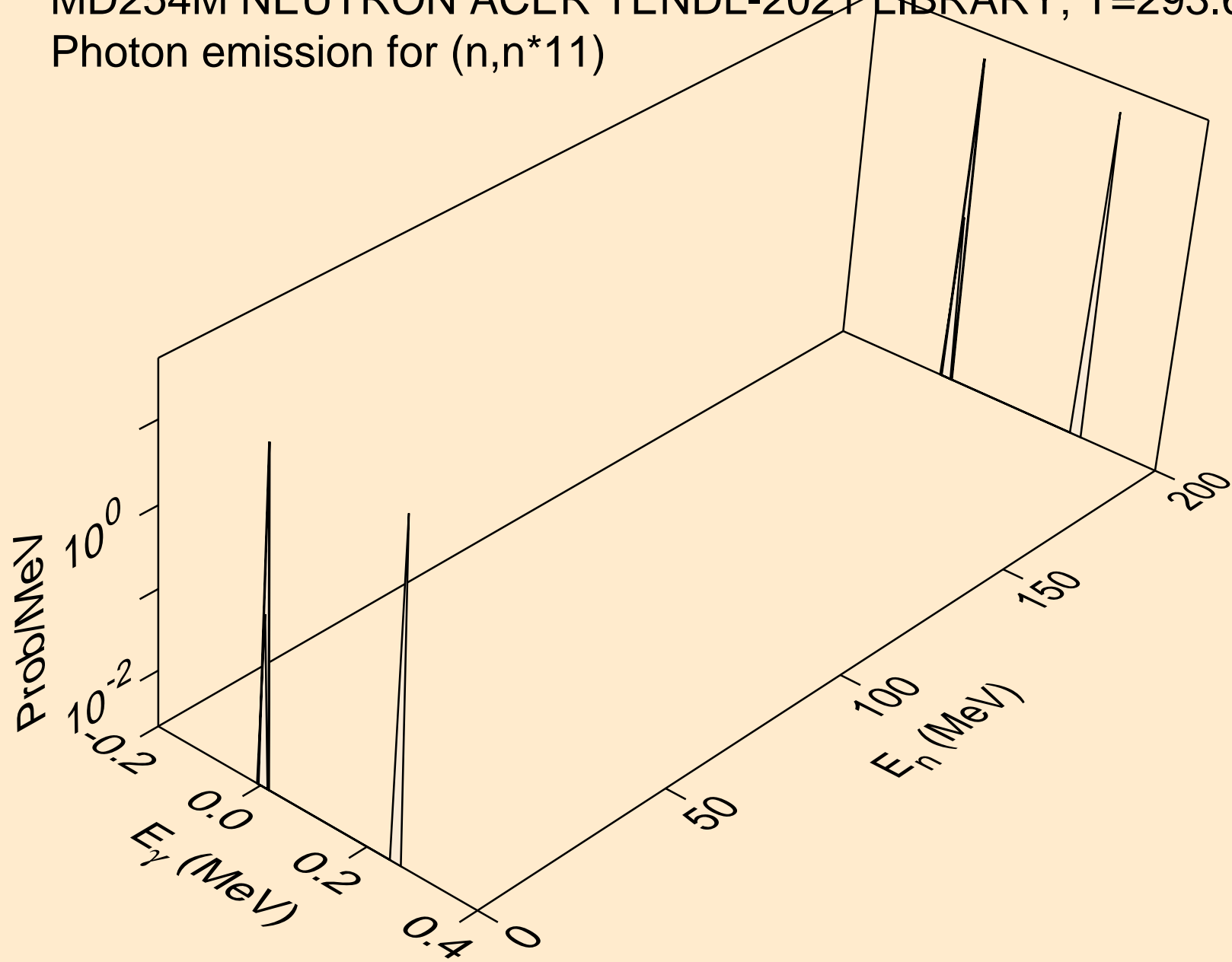

MD254M NEUTRON ACER TENDL-2021 LIBRARY; T=293.6K
Photon emission for (n,n*12)

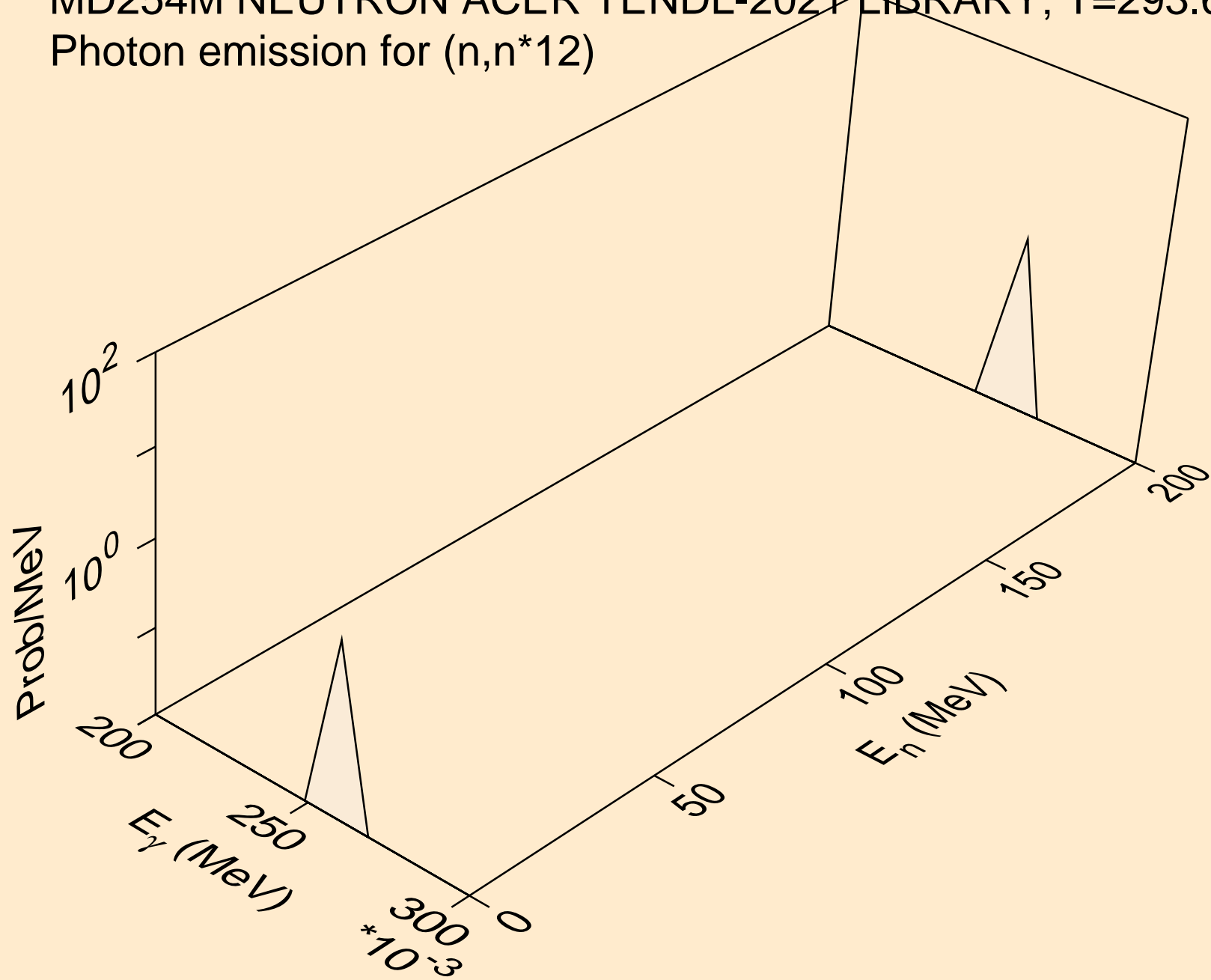

MD254M NEUTRON ACER TENDL-2021 LIBRARY; T=293.6K
Photon emission for (n,n*13)

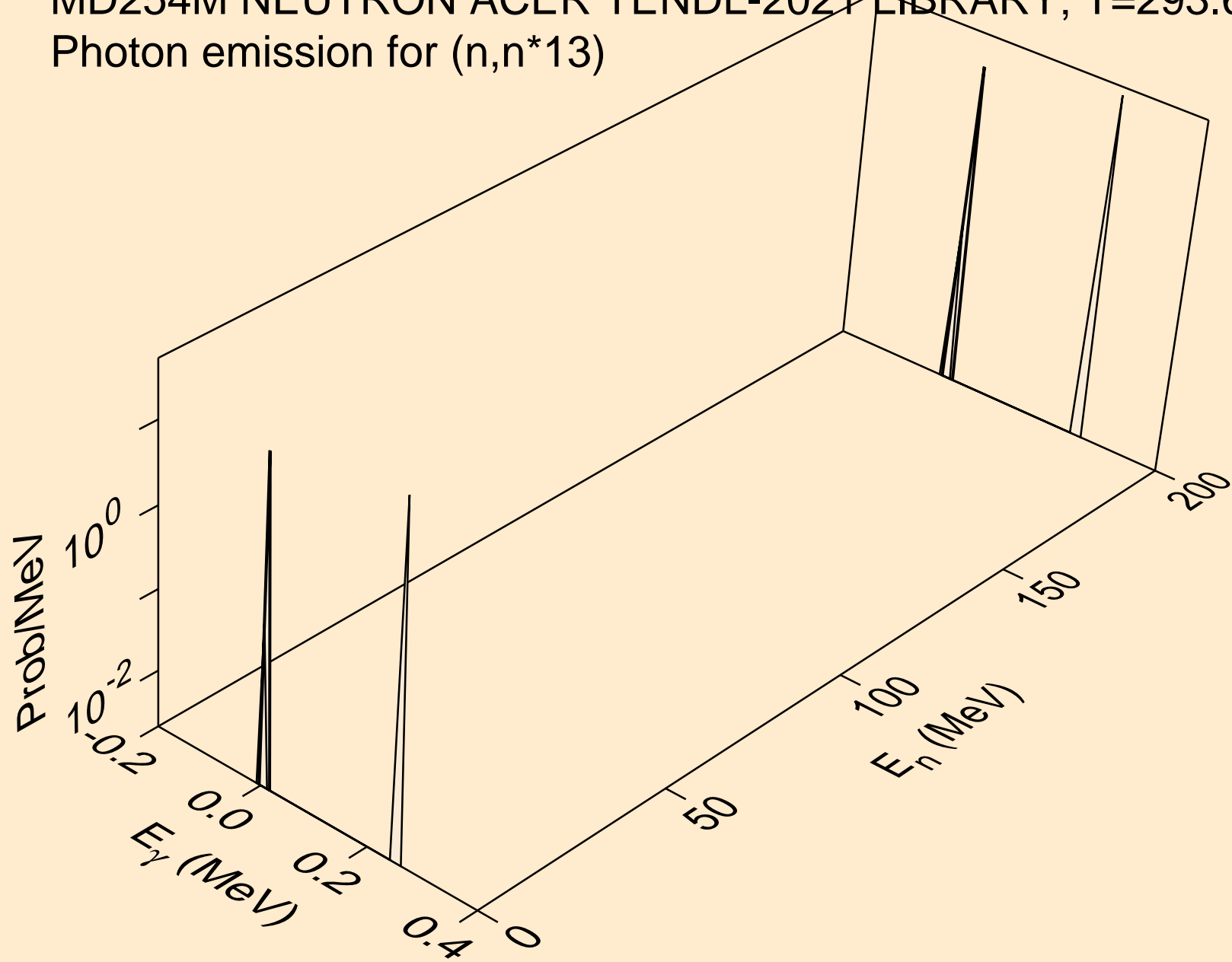

MD254M NEUTRON ACER TENDL-2021 LIBRARY; T=293.6K
Photon emission for (n,n*14)

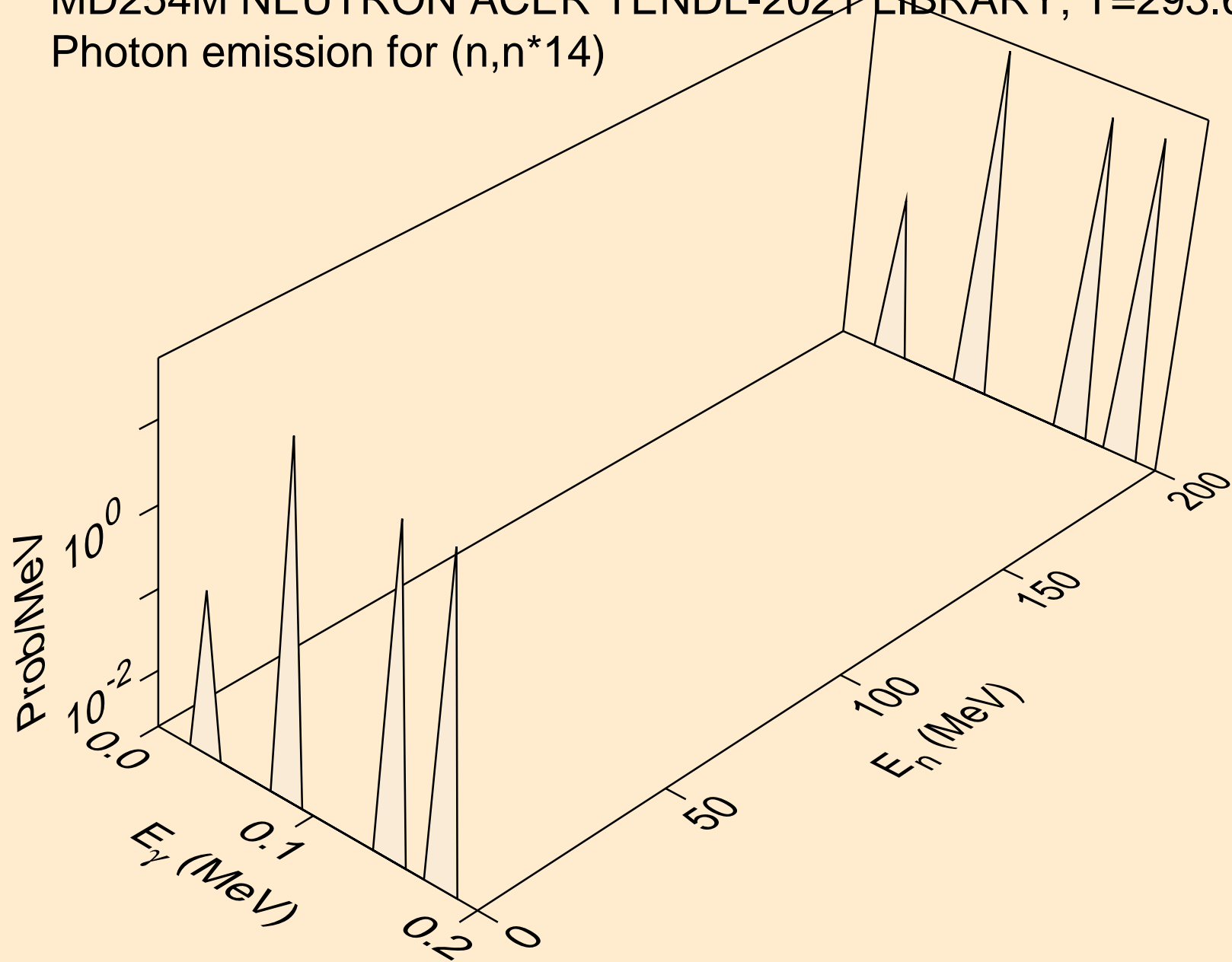

MD254M NEUTRON ACER TENDL-2021 LIBRARY; T=293.6K
Photon emission for (n,n*15)

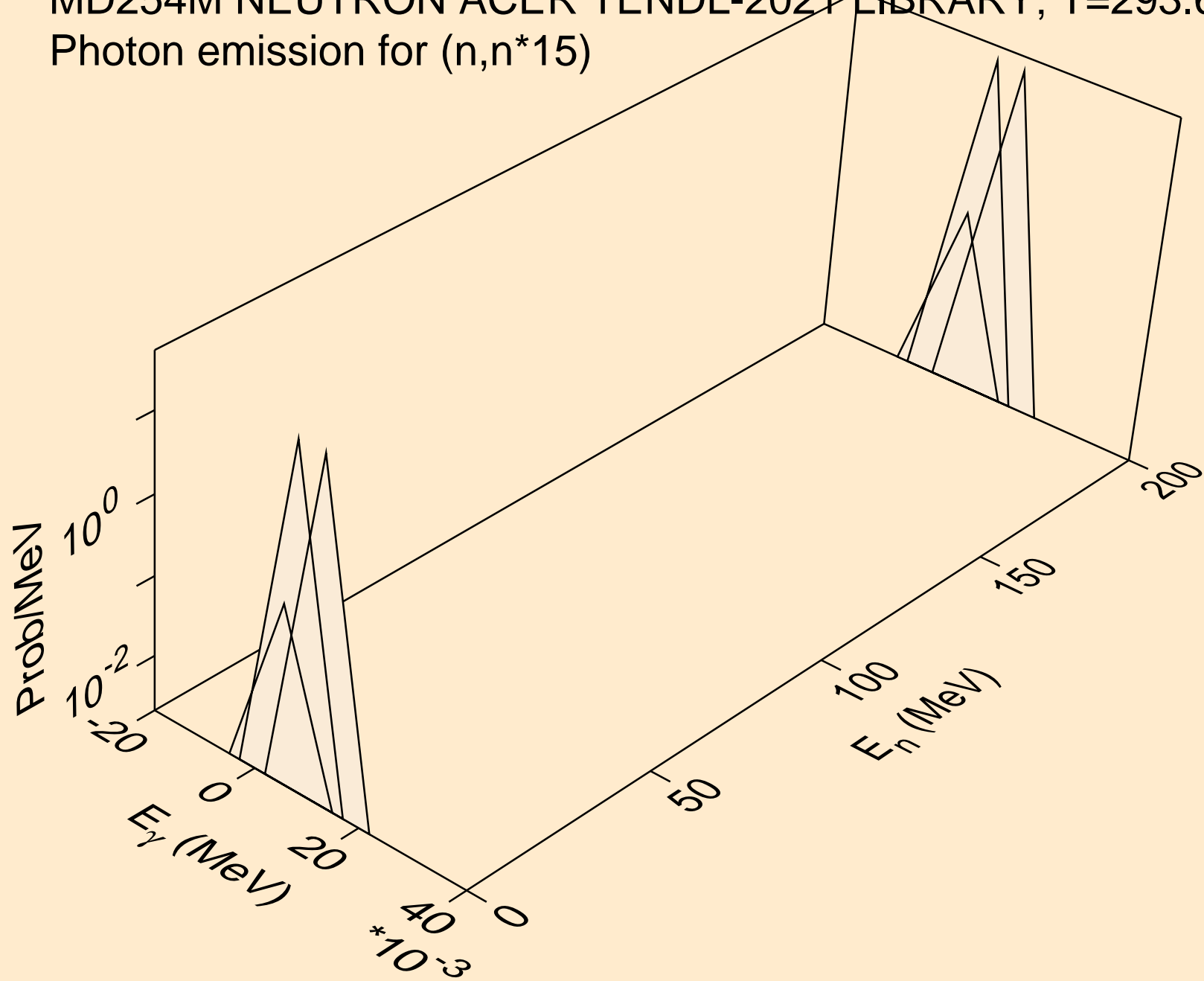

MD254M NEUTRON ACER TENDL-2021 LIBRARY; T=293.6K
Photon emission for (n,n*16)

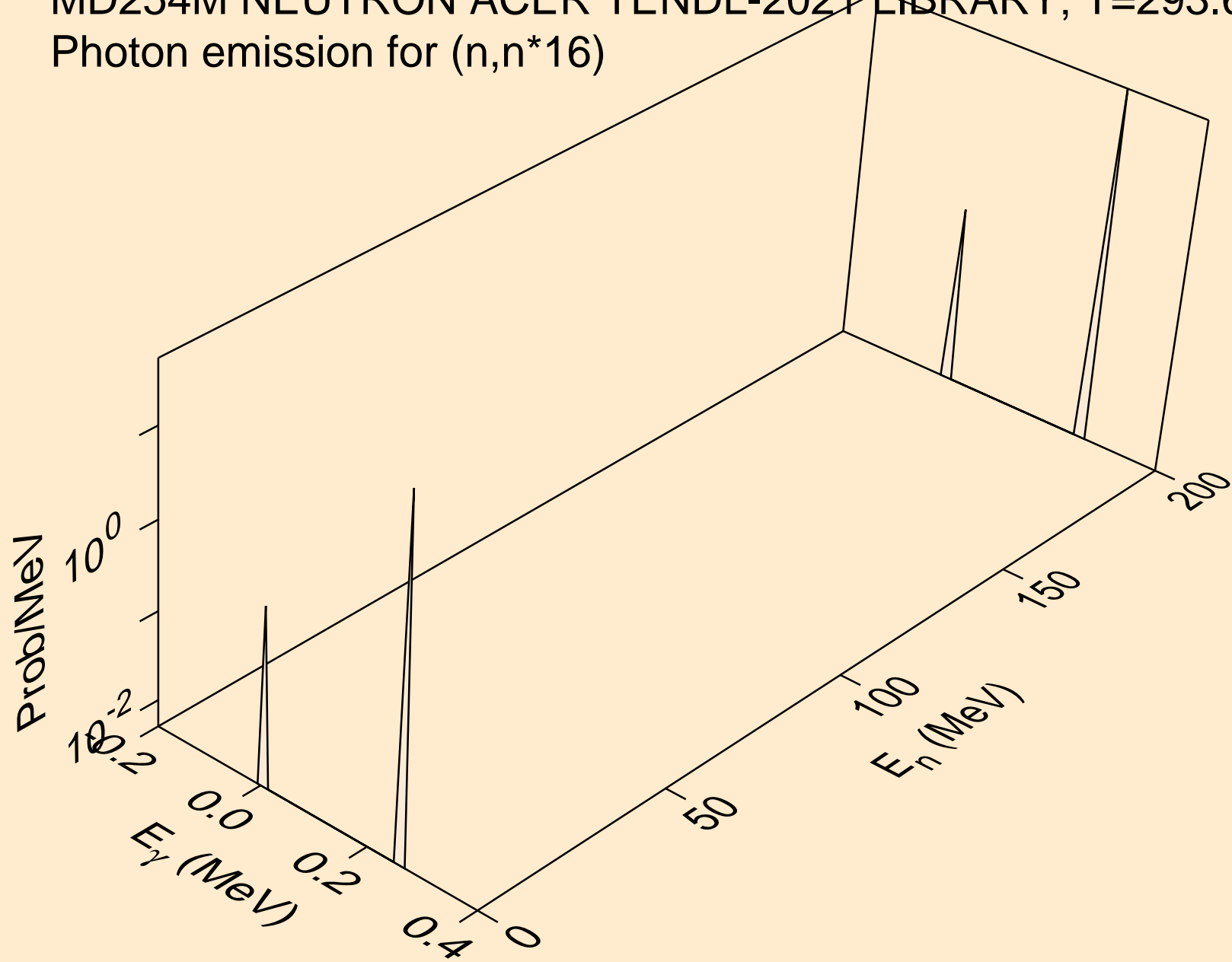

MD254M NEUTRON ACER TENDL-2021 LIBRARY; T=293.6K
Photon emission for (n,n*17)

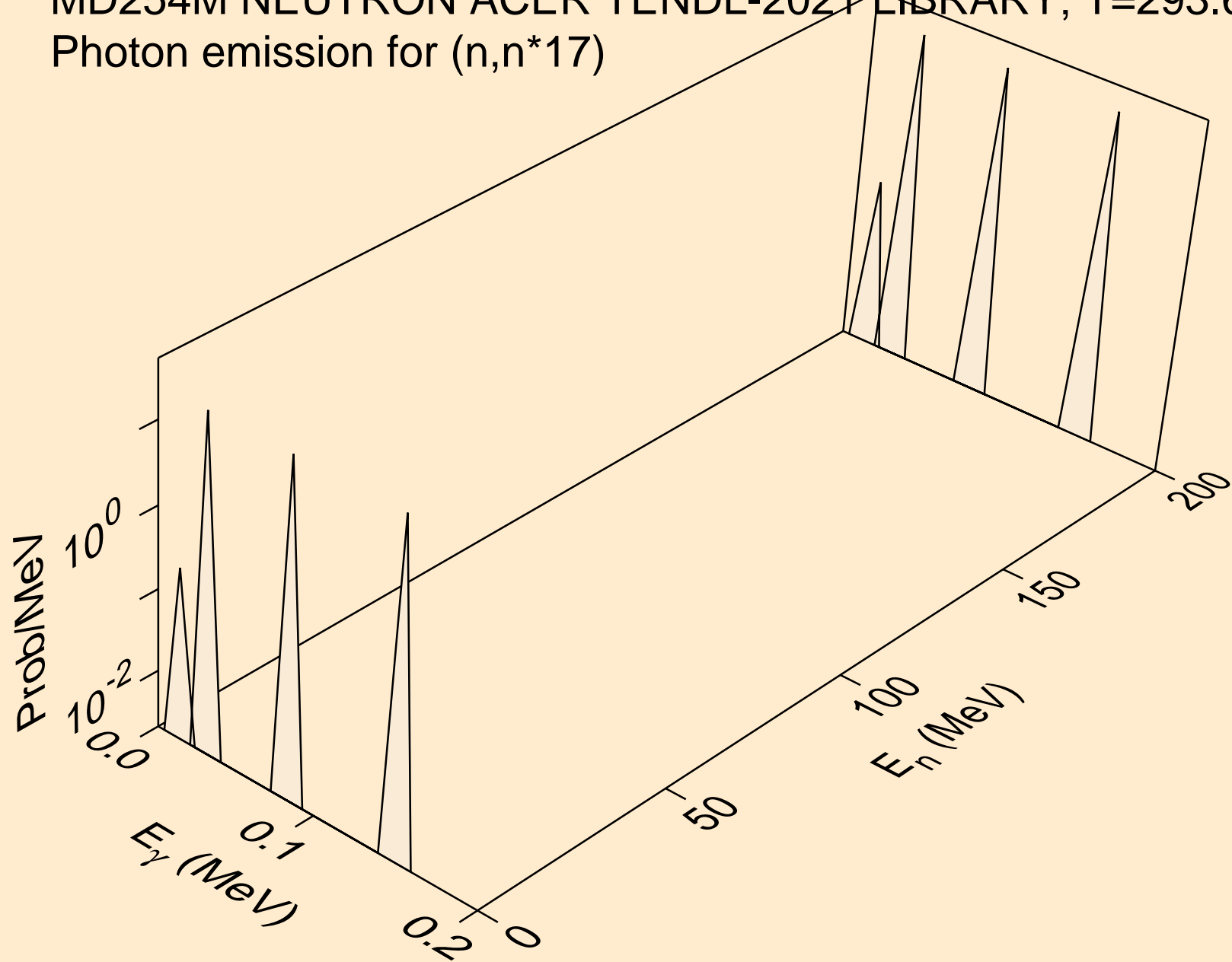

MD254M NEUTRON ACER TENDL-2021 LIBRARY; T=293.6K
Photon emission for (n,n*18)

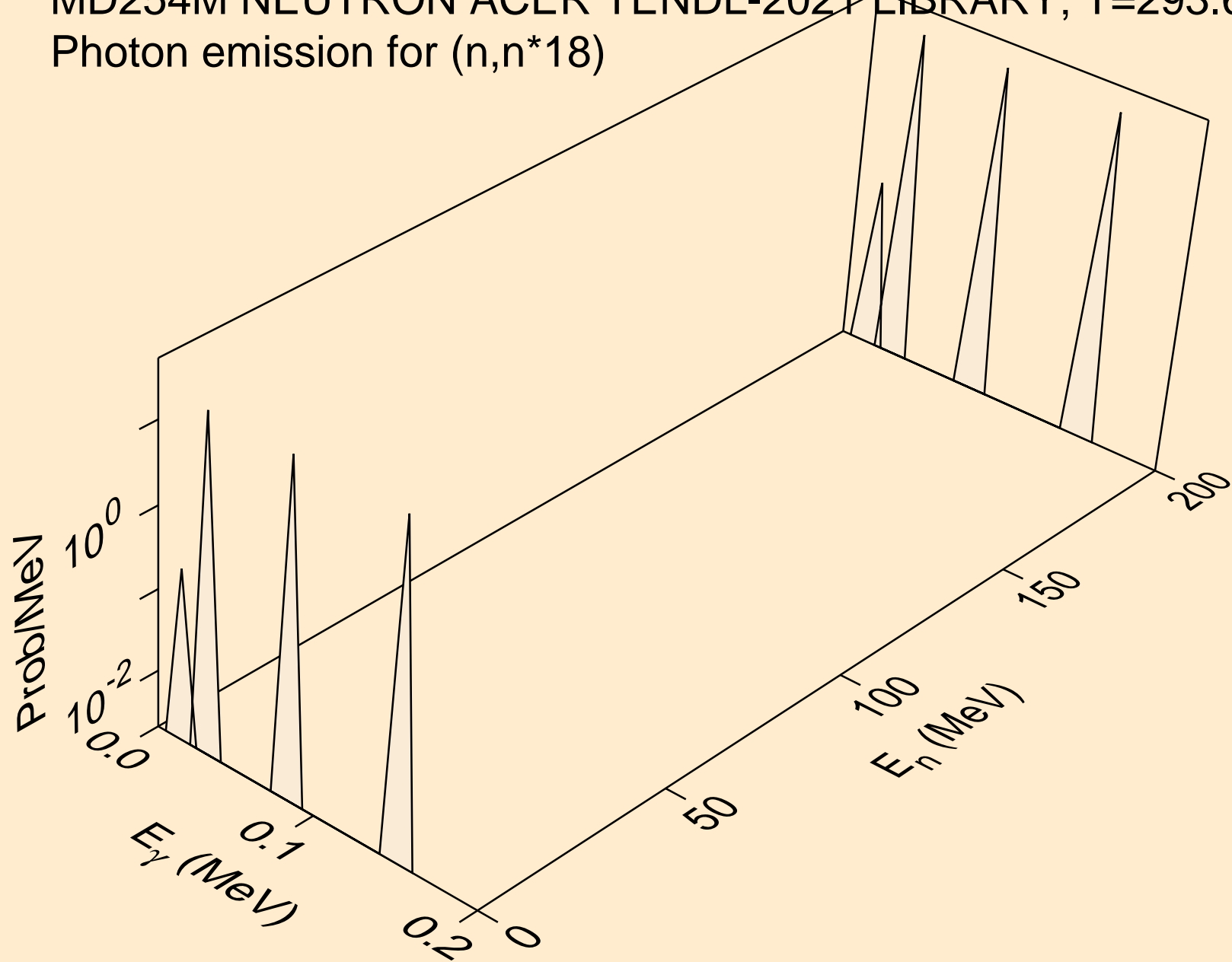

MD254M NEUTRON ACER TENDL-2021 LIBRARY; T=293.6K
Photon emission for (n,n*19)

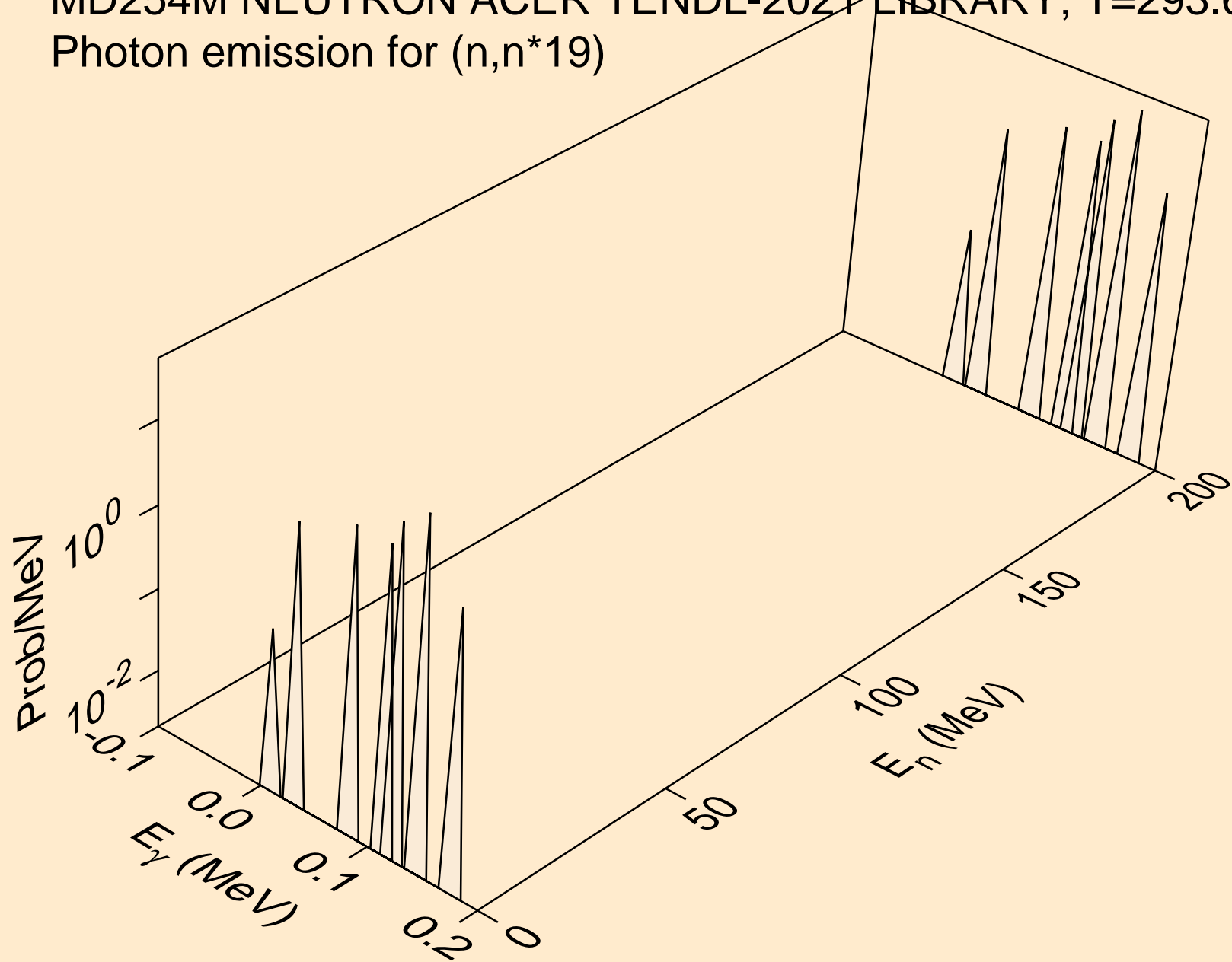

MD254M NEUTRON ACER TENDL-2021 LIBRARY; T=293.6K
Photon emission for (n,n*20)

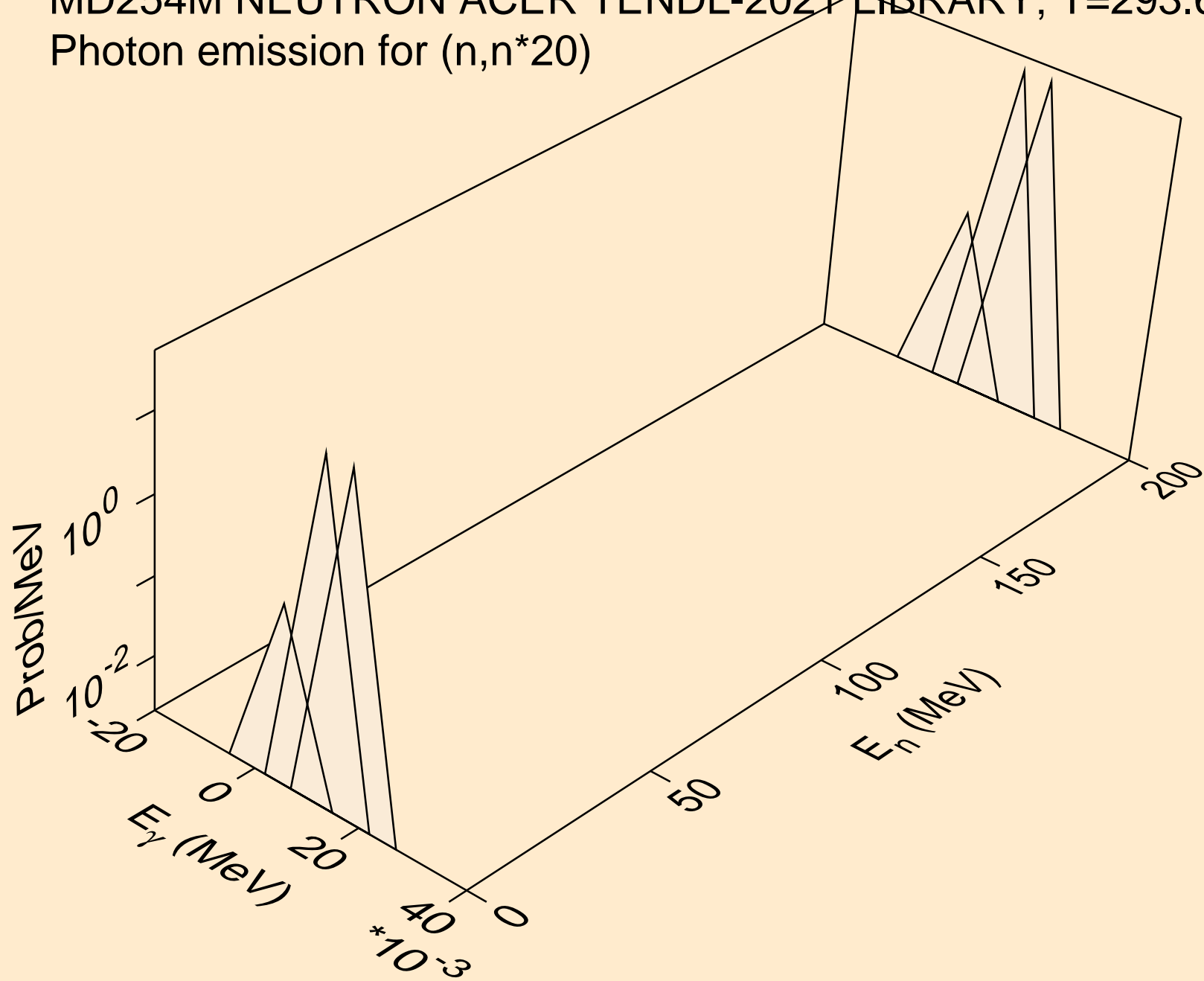

MD254M NEUTRON ACER TENDL-2021 LIBRARY; T=293.6K
Photon emission for (n,n*21)

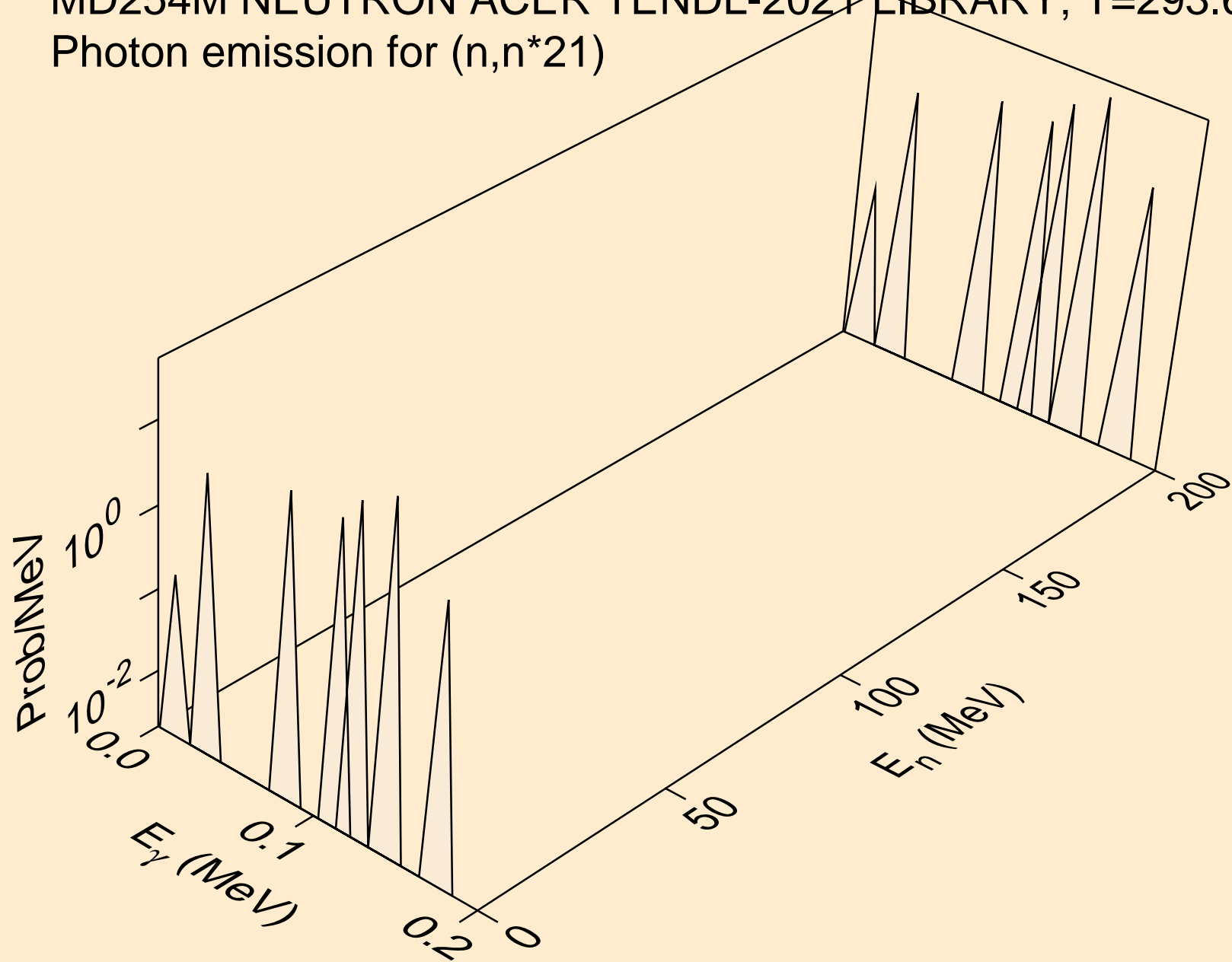

MD254M NEUTRON ACER TENDL-2021 LIBRARY; T=293.6K
Photon emission for (n,n*22)

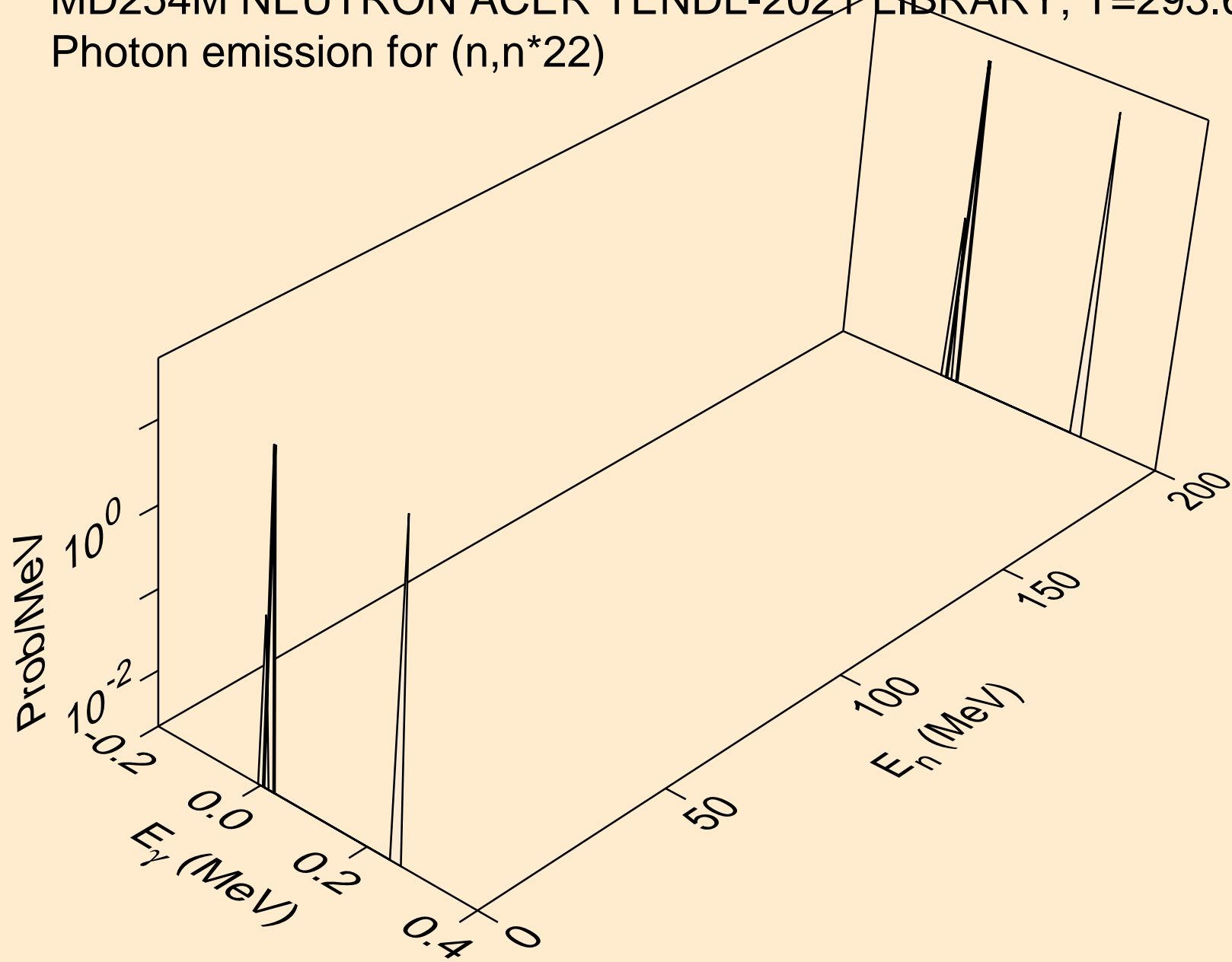

MD254M NEUTRON ACER TENDL-2021 LIBRARY; T=293.6K
Photon emission for (n,n*23)

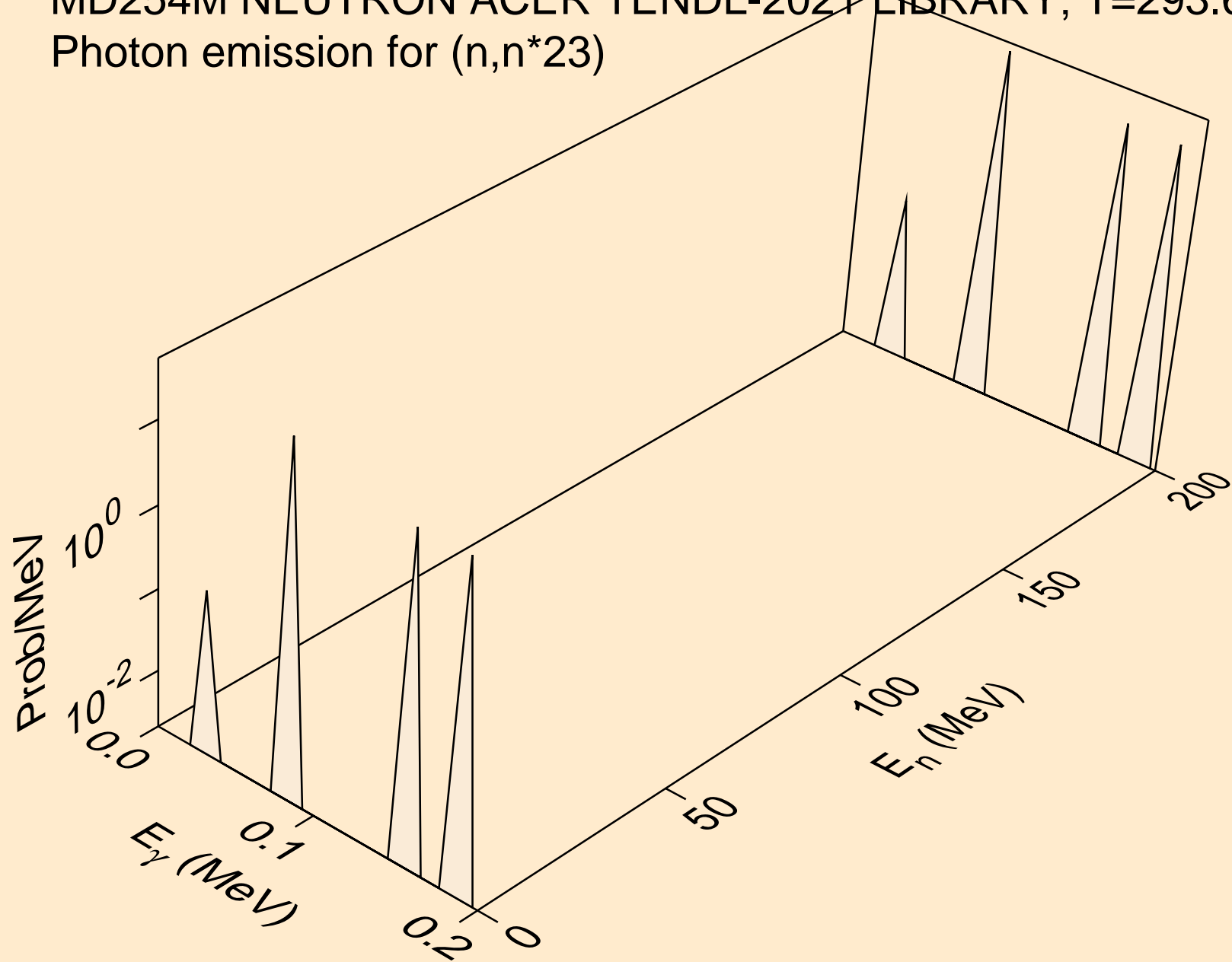

MD254M NEUTRON ACER TENDL-2021 LIBRARY; T=293.6K
Photon emission for (n,n*24)

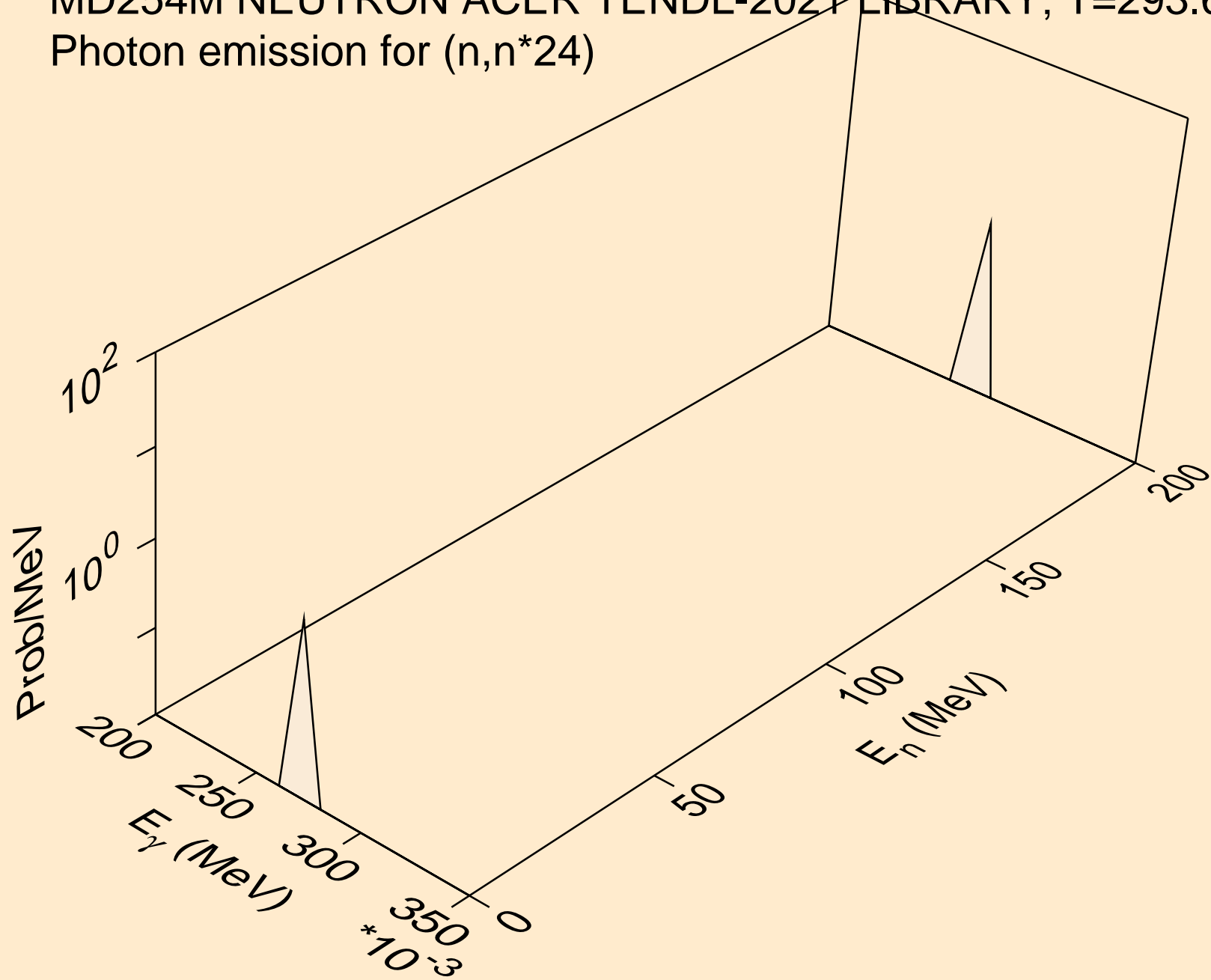

MD254M NEUTRON ACER TENDL-2021 LIBRARY; T=293.6K
Photon emission for (n,n*25)

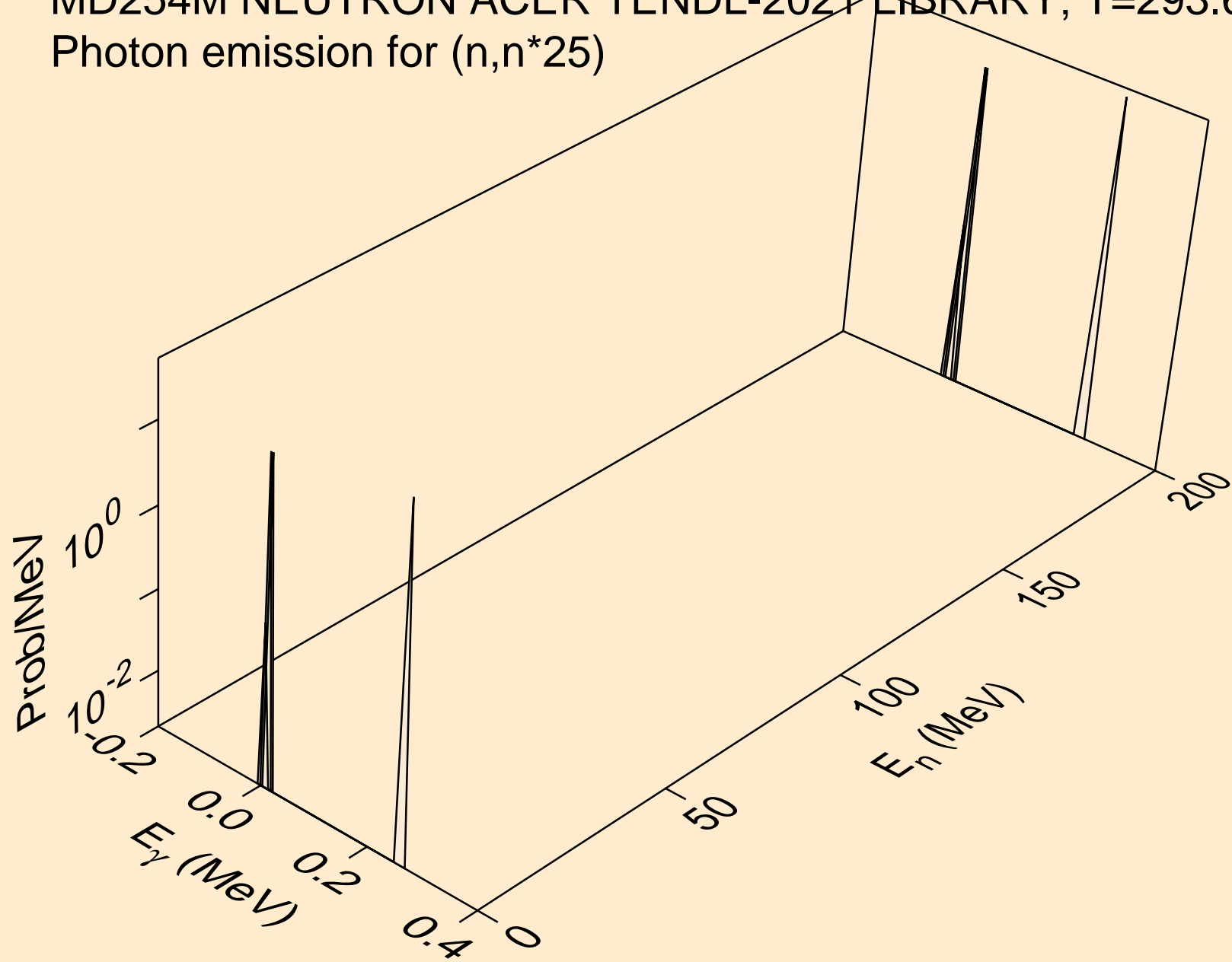

MD254M NEUTRON ACER TENDL-2021 LIBRARY; T=293.6K
Photon emission for (n,n*26)

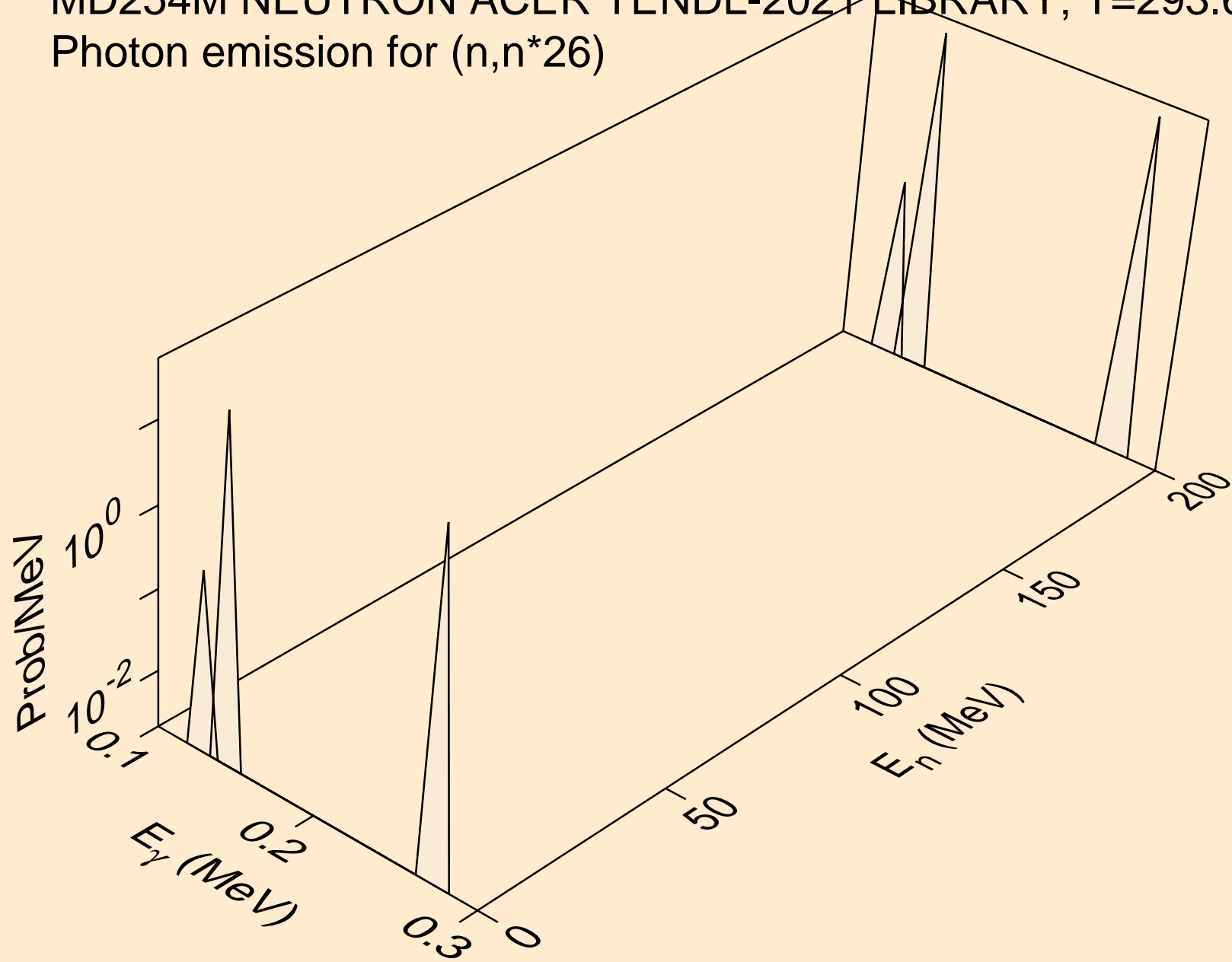

MD254M NEUTRON ACER TENDL-2021 LIBRARY; T=293.6K
Photon emission for (n,n*27)

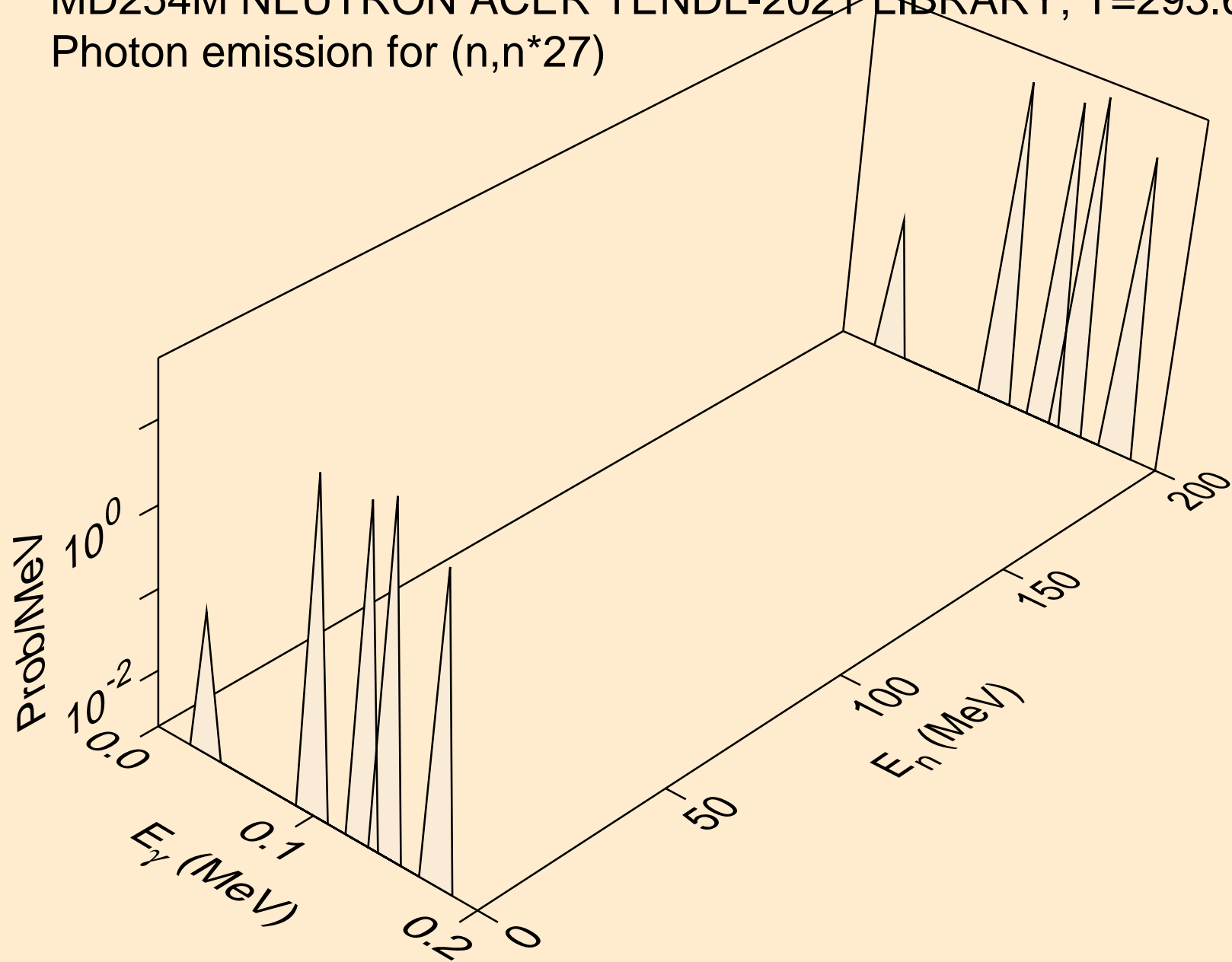

MD254M NEUTRON ACER TENDL-2021 LIBRARY; T=293.6K
Photon emission for (n,n*28)

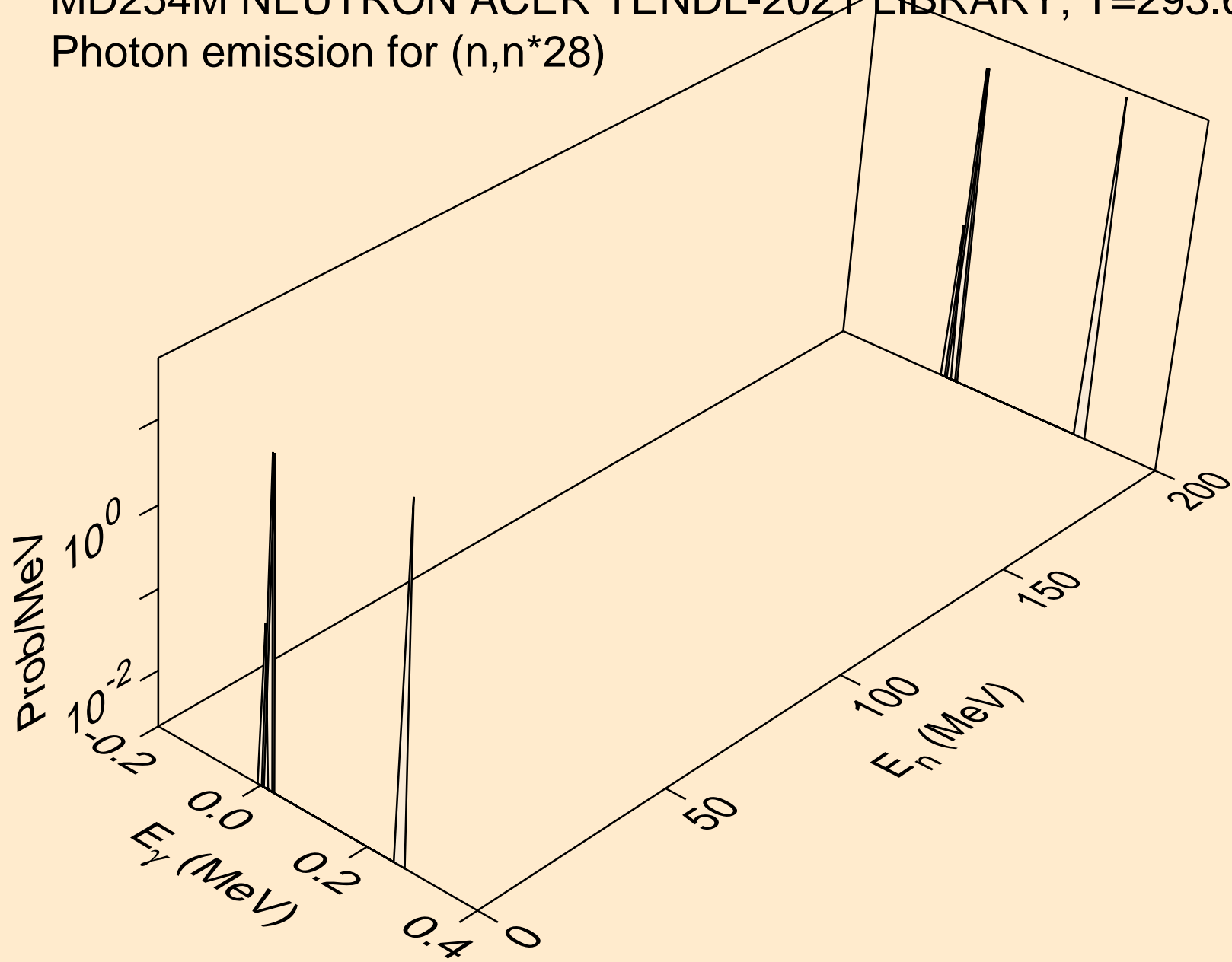

MD254M NEUTRON ACER TENDL-2021 LIBRARY; T=293.6K
Photon emission for (n,n*29)

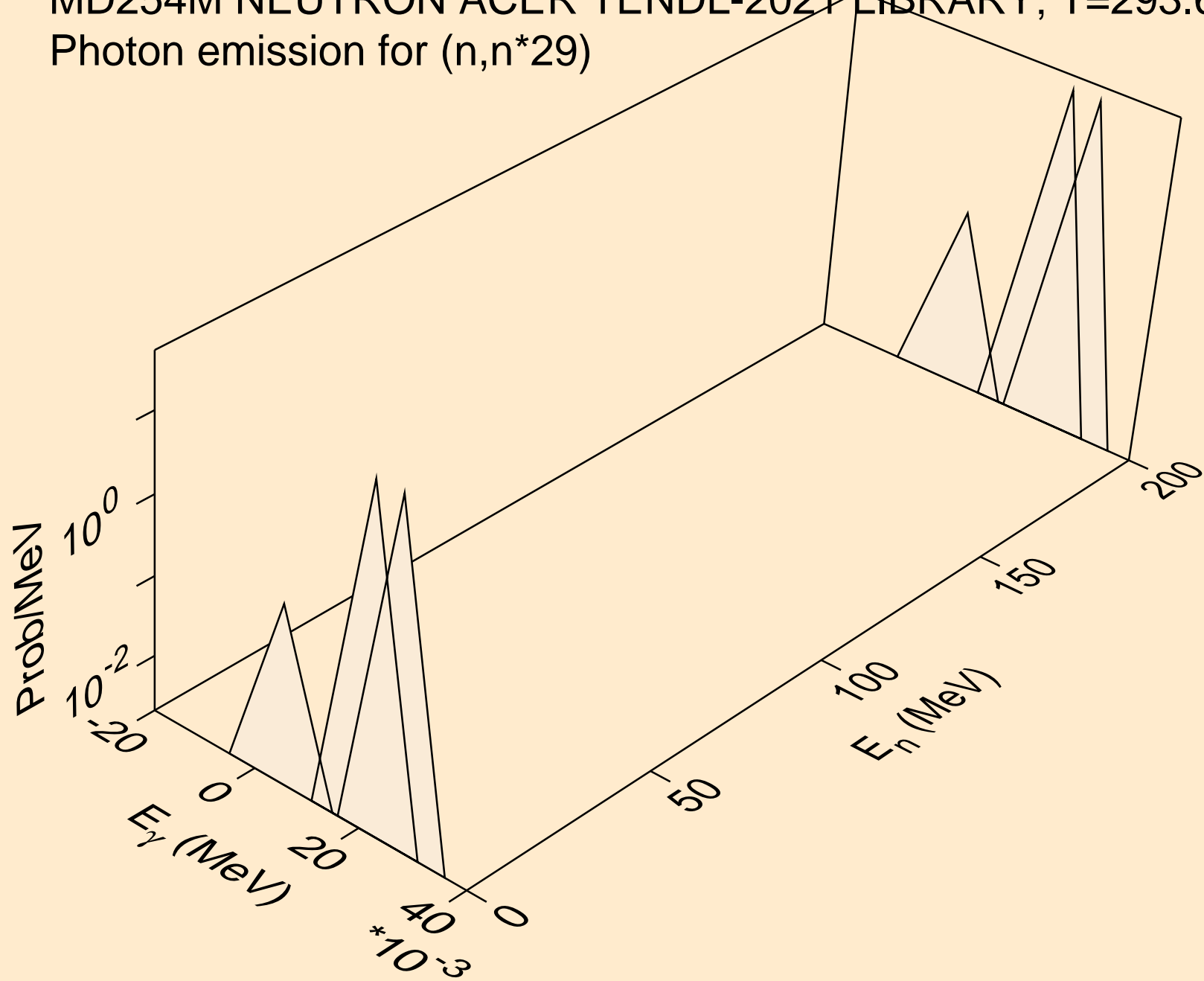

MD254M NEUTRON ACER TENDL-2021 LIBRARY; T=293.6K
Photon emission for (n,n*30)

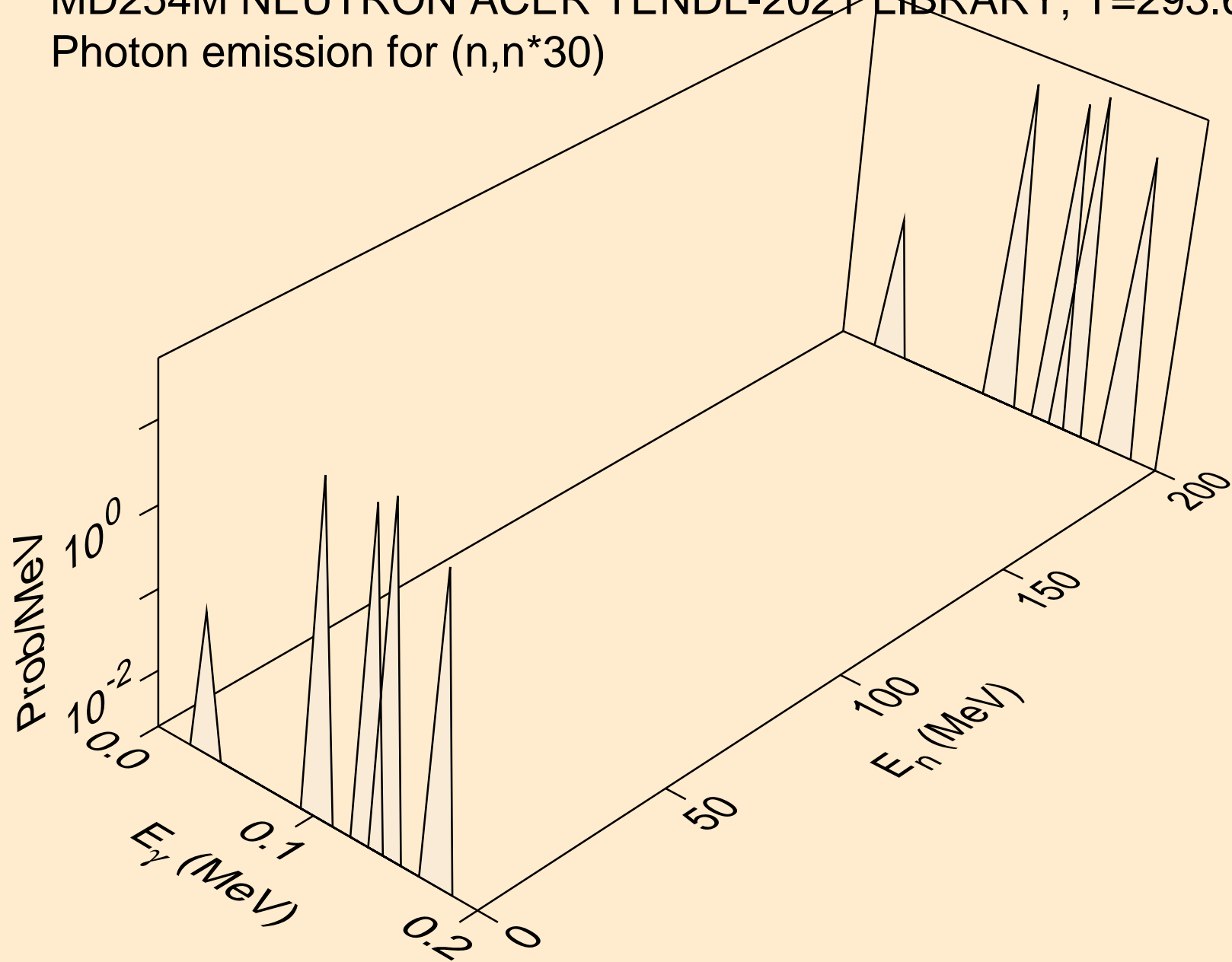

MD254M NEUTRON ACER TENDL-2021 LIBRARY; T=293.6K
Photon emission for (n,n*c)

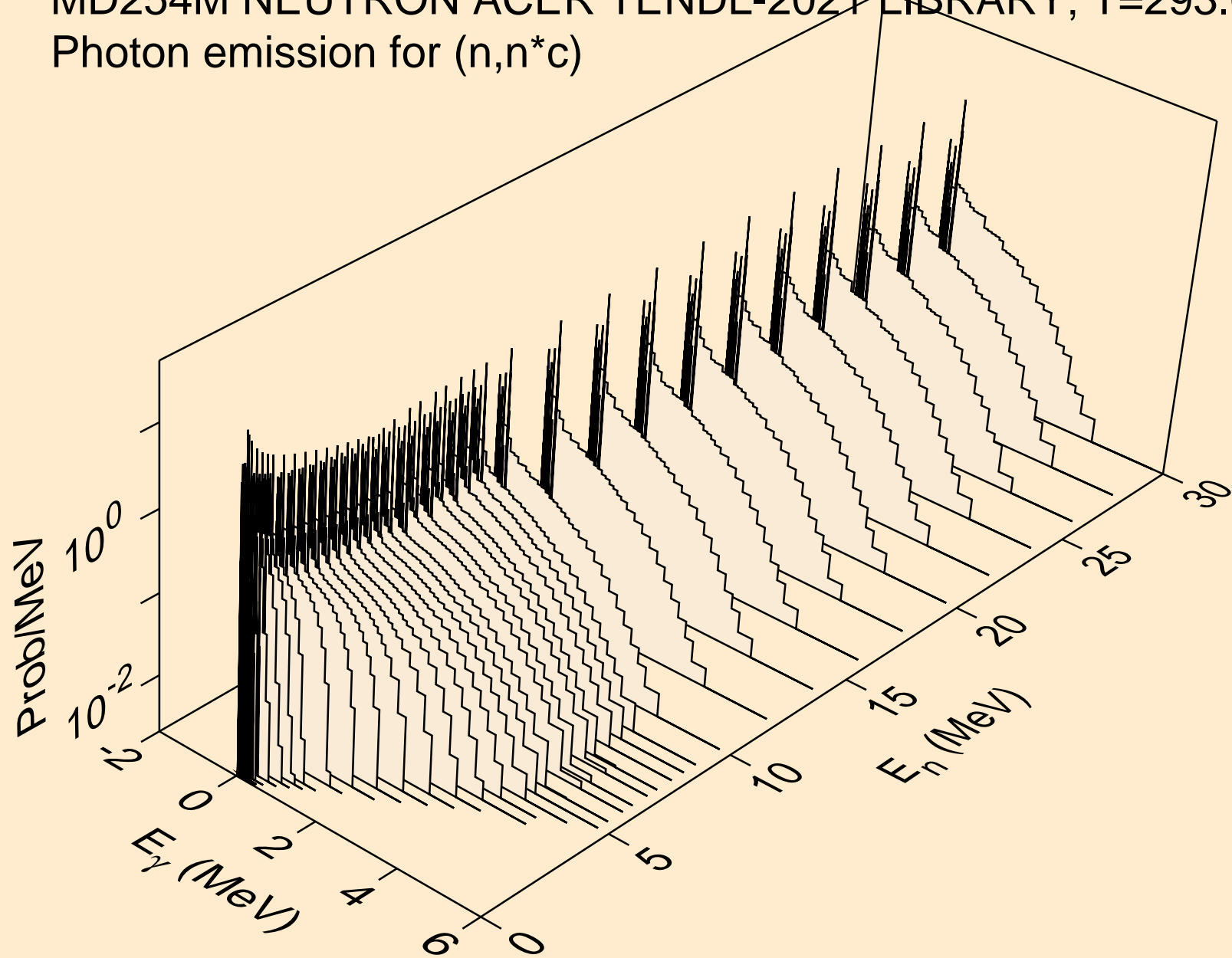

MD254M NEUTRON ACER TENDL-2021 LIBRARY; T=293.6K
Photon emission for (n,gma)

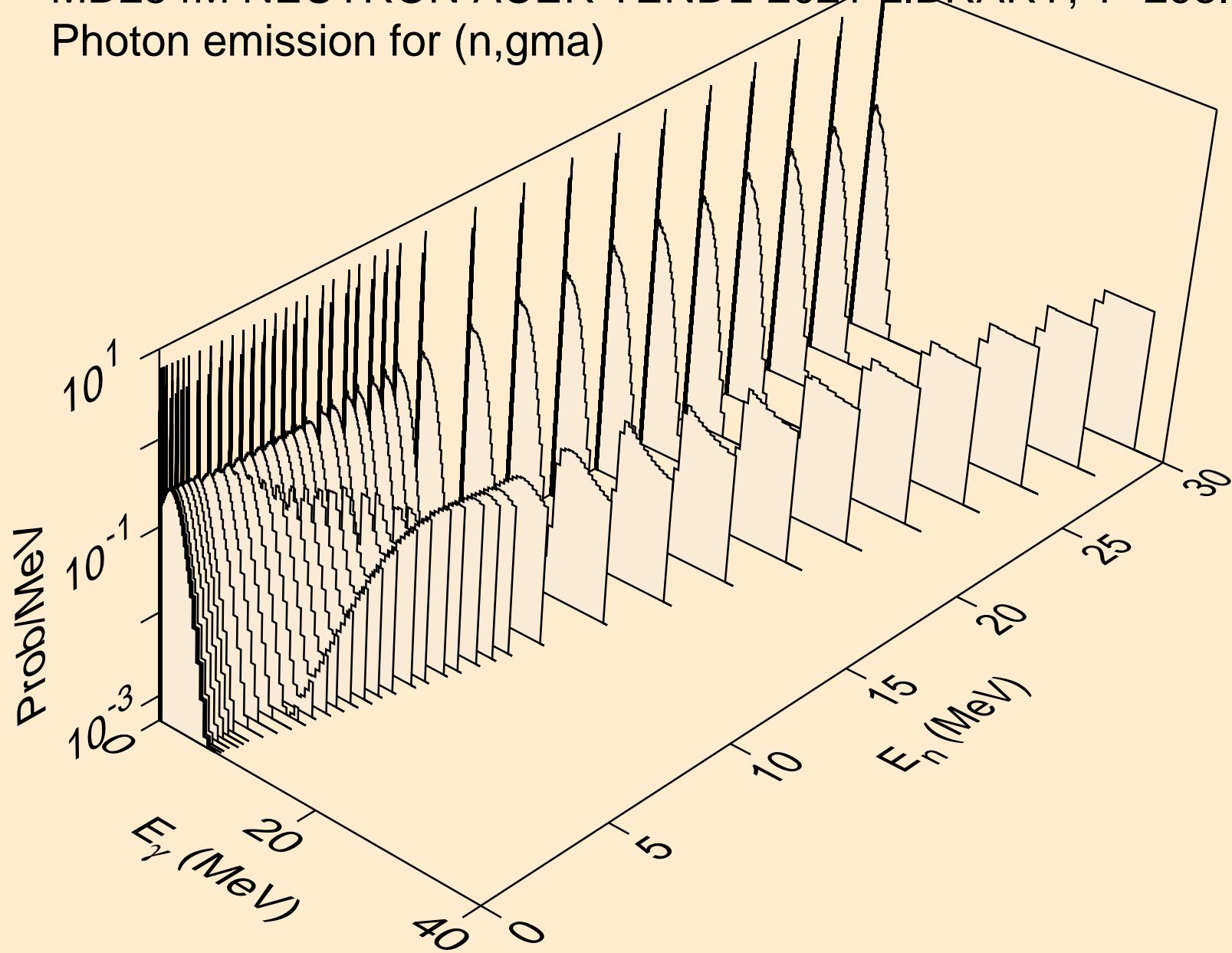

MD254M NEUTRON ACER TENDL-2021 LIBRARY; T=293.6K
Photon emission for (n,p)

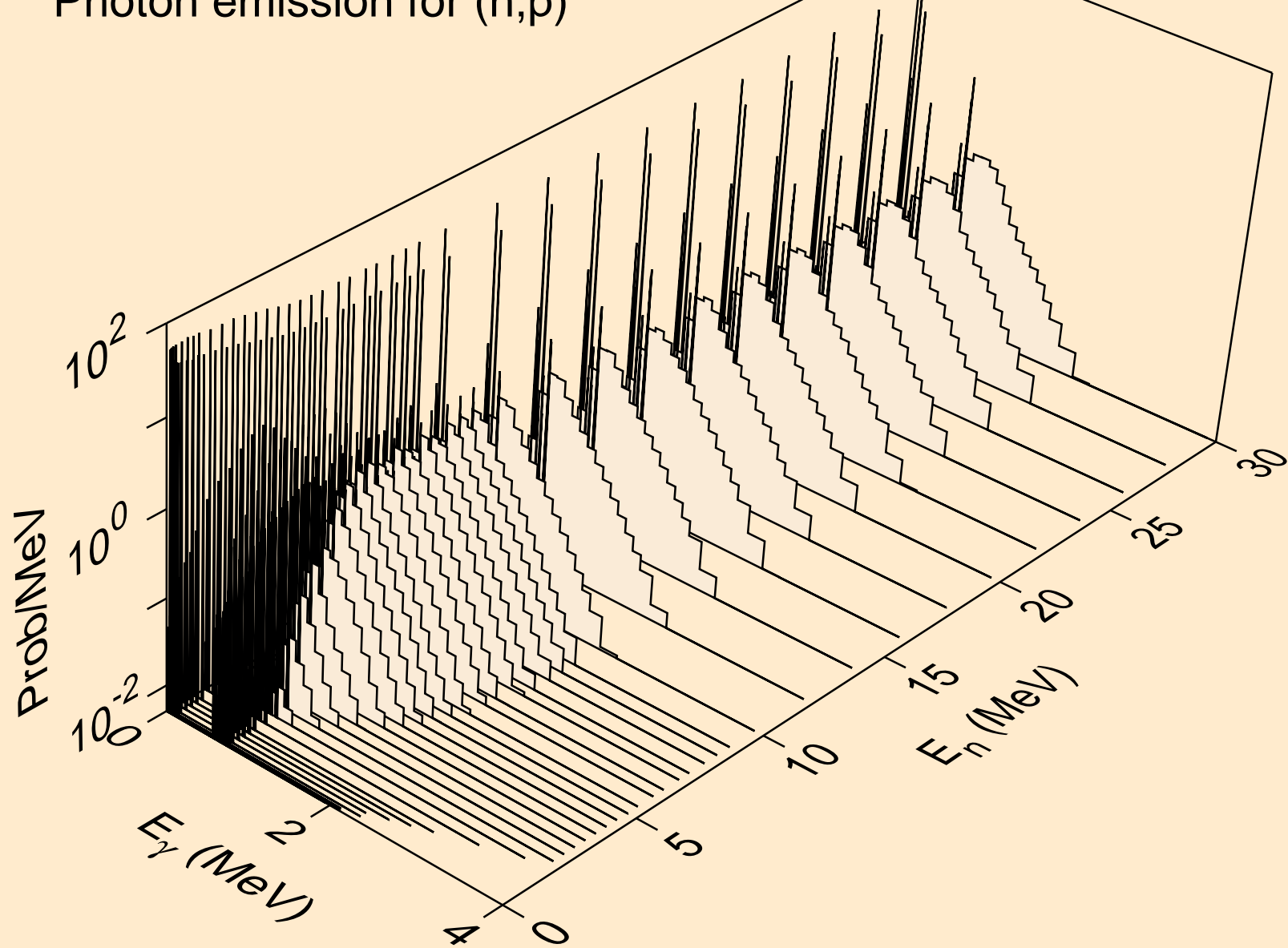

MD254M NEUTRON ACER TENDL-2021 LIBRARY; T=293.6K
Photon emission for (n,d)

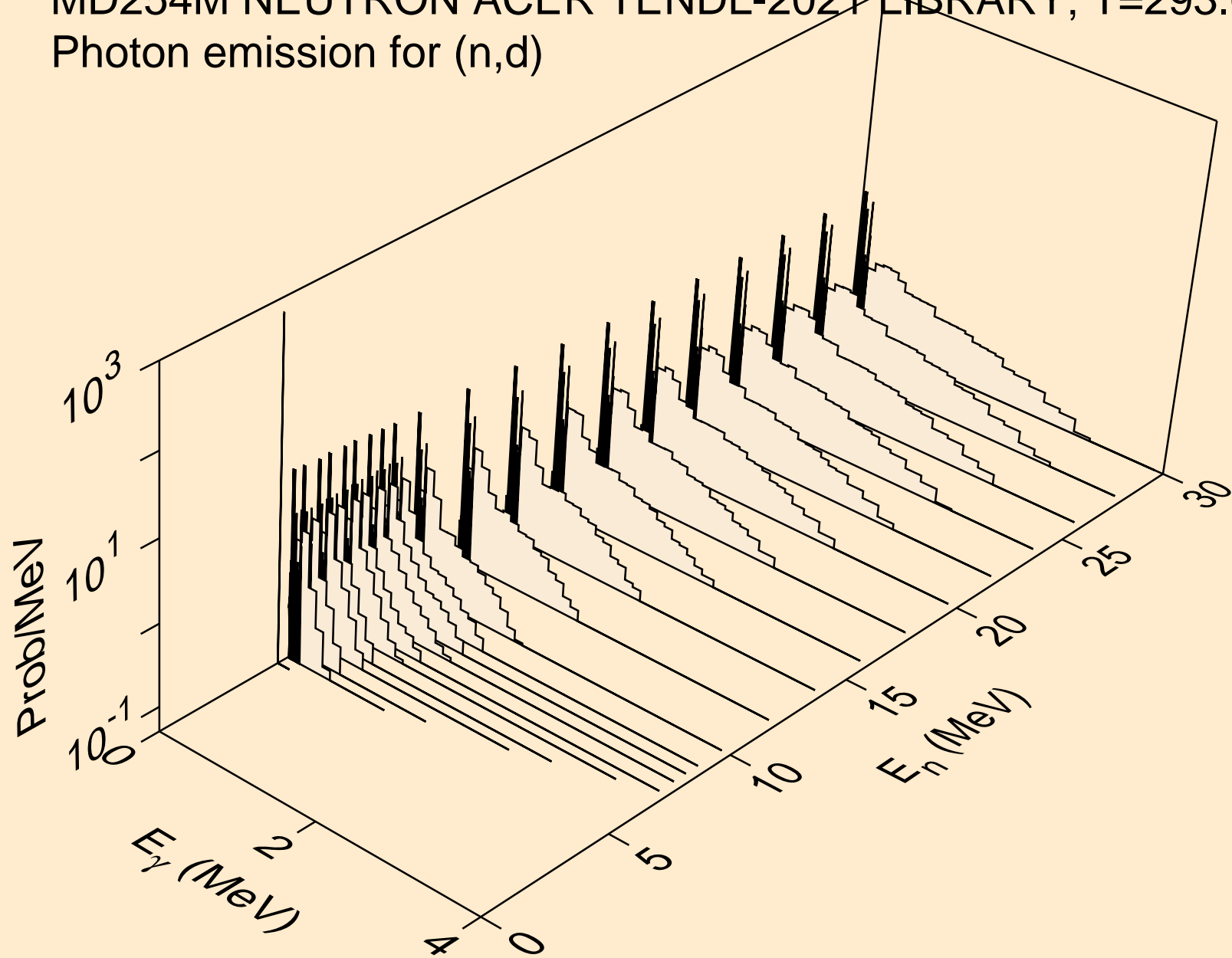

MD254M NEUTRON ACER TENDL-2021 LIBRARY; T=293.6K
Photon emission for (n,t)

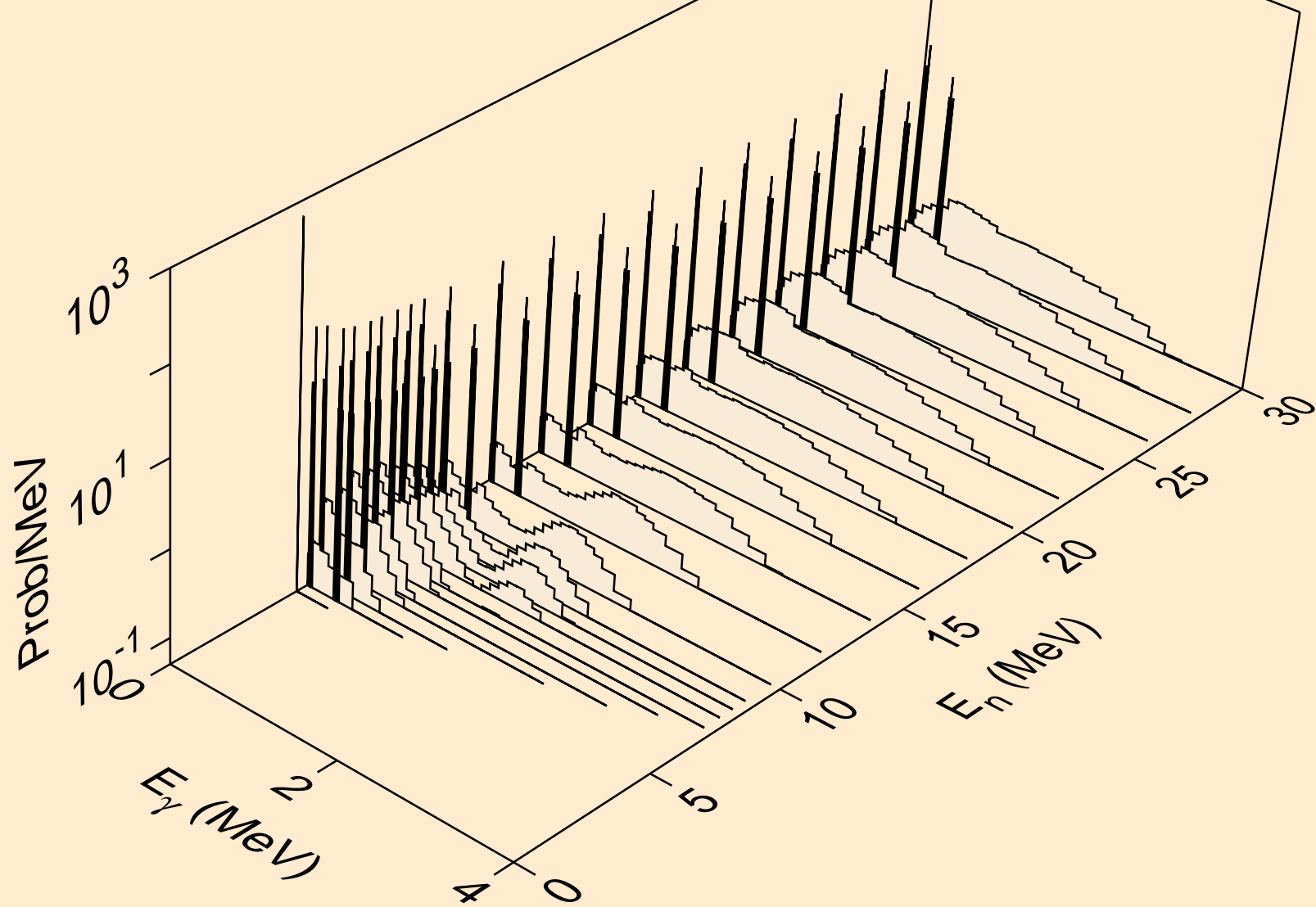

MD254M NEUTRON ACER TENDL-2021 LIBRARY; T=293.6K
Photon emission for (n,he3)

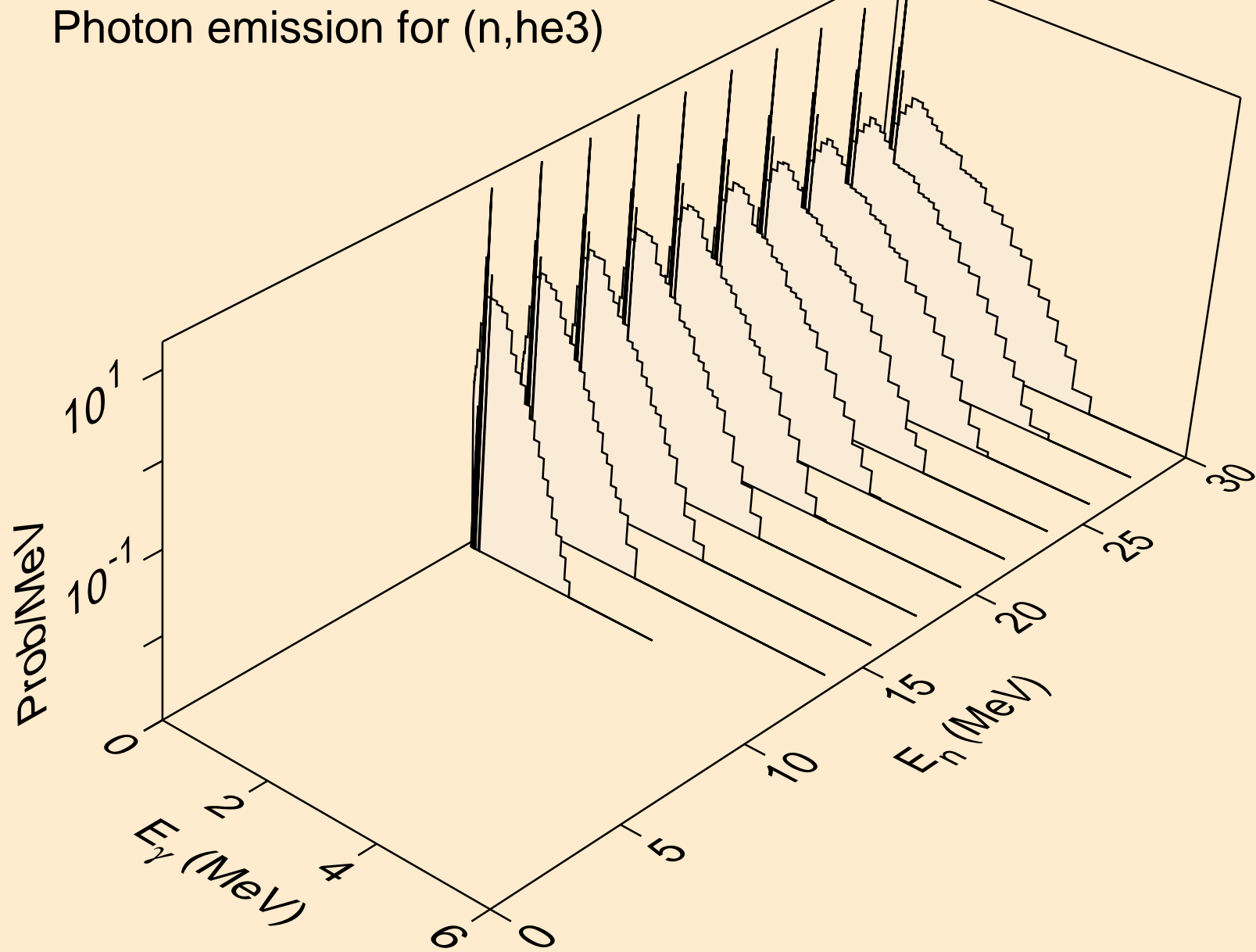

MD254M NEUTRON ACER TENDL-2021 LIBRARY; T=293.6K
Photon emission for (n,a)

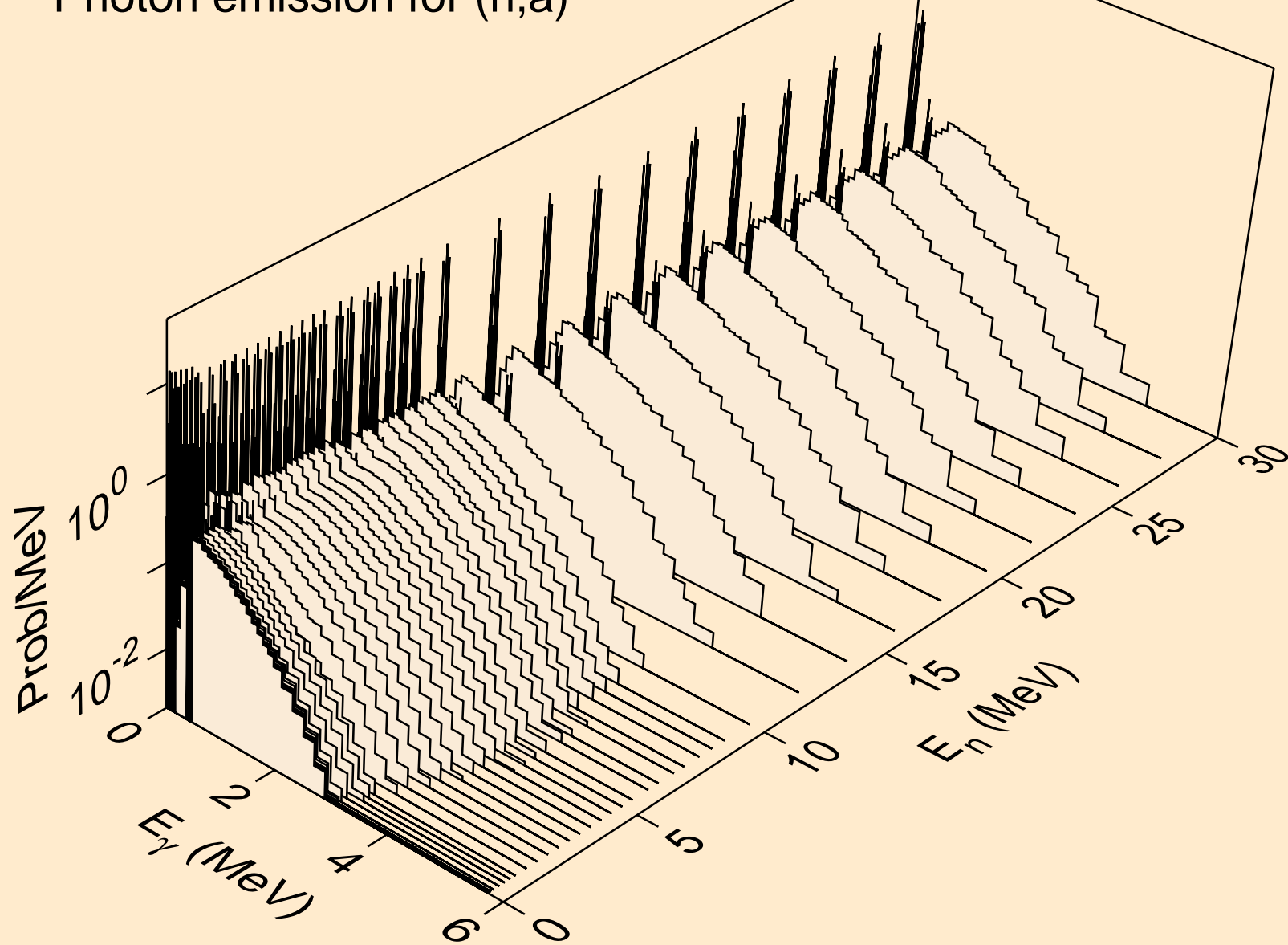

MD254M NEUTRON ACER TENDL-2021 LIBRARY; T=293.6K
Photon emission for (n,2a)

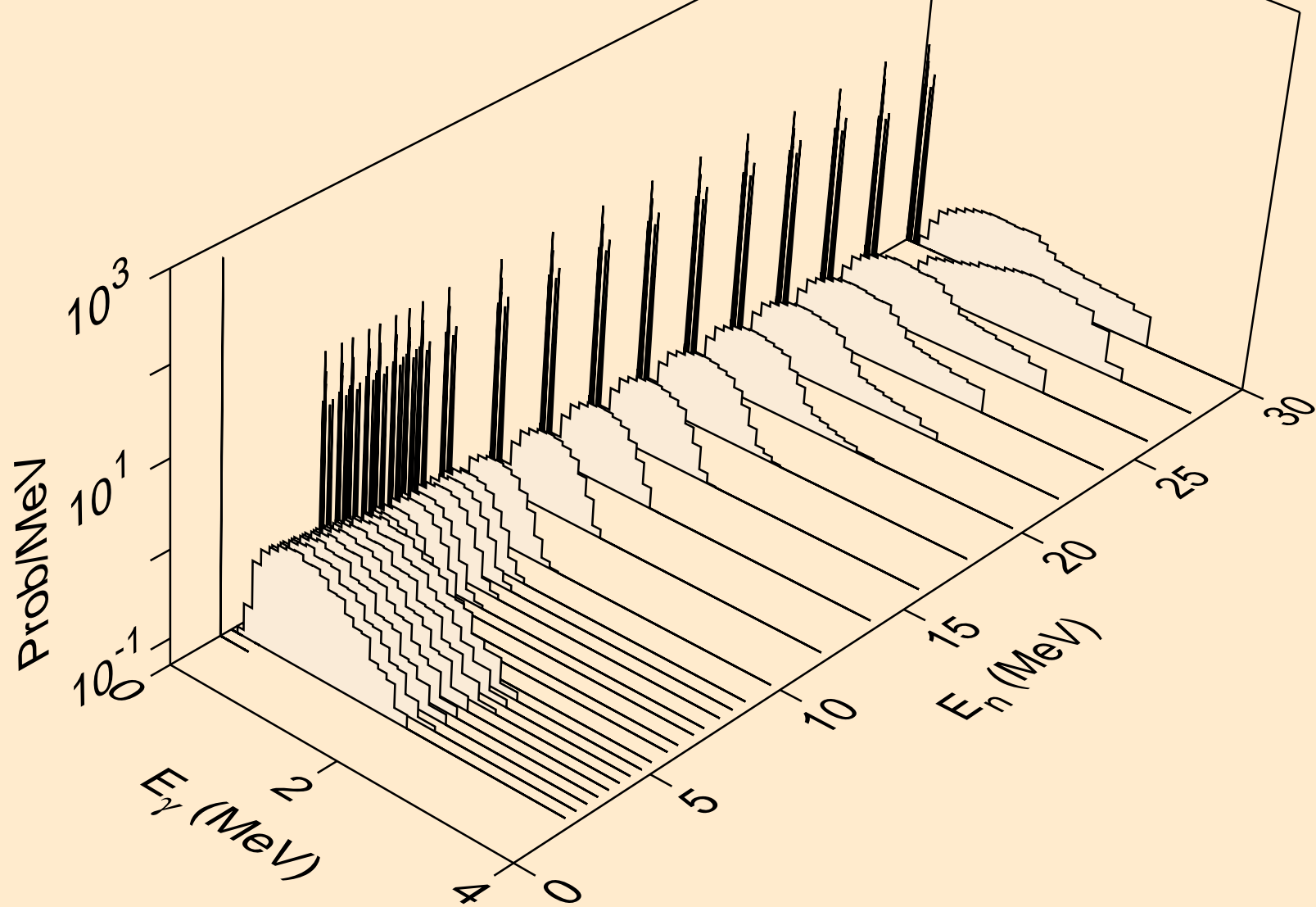

MD254M NEUTRON ACER TENDL-2021 LIBRARY; T=293.6K
Photon emission for (n,2p)

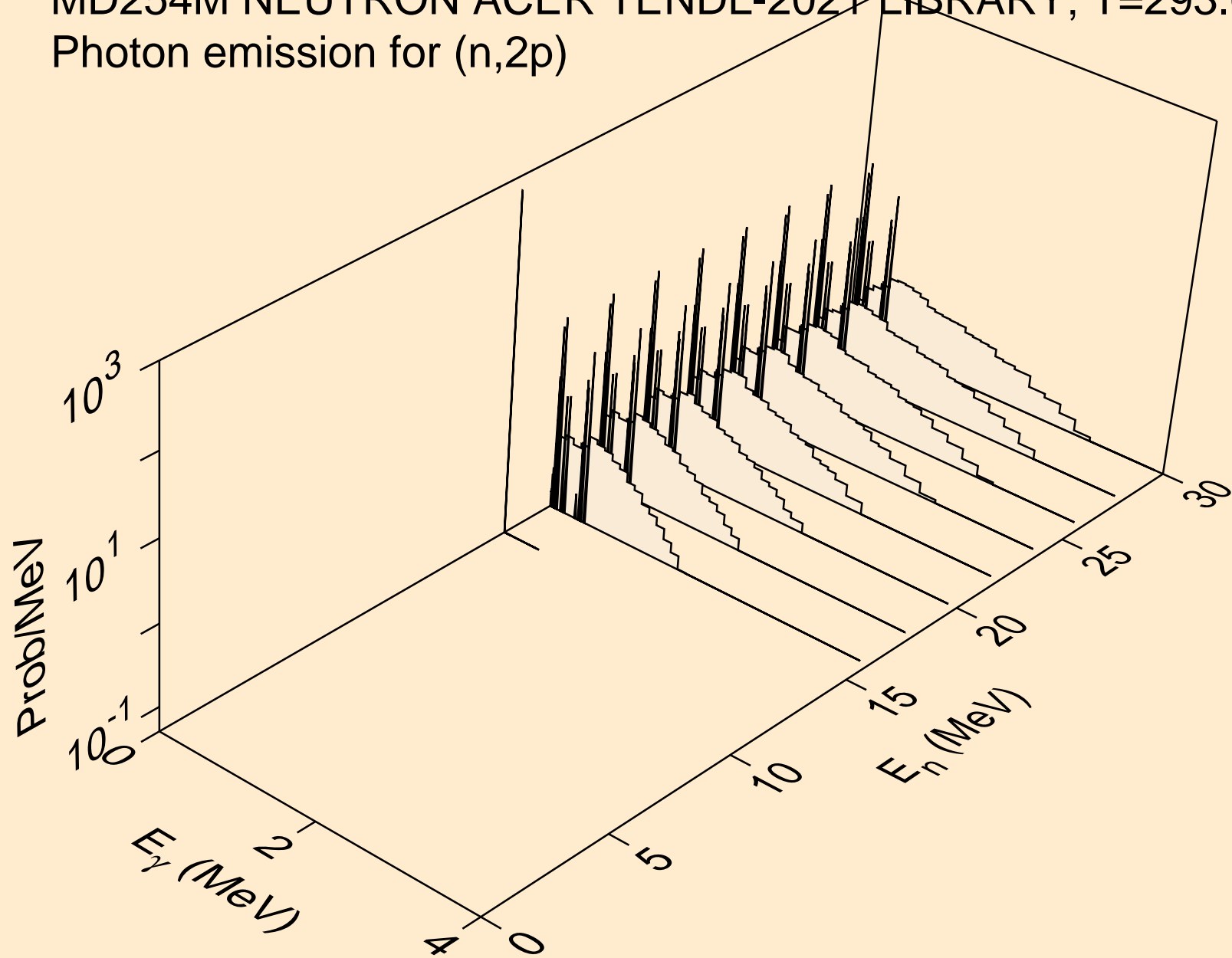

MD254M NEUTRON ACER TENDL-2021 LIBRARY; T=293.6K
Photon emission for (n,p)

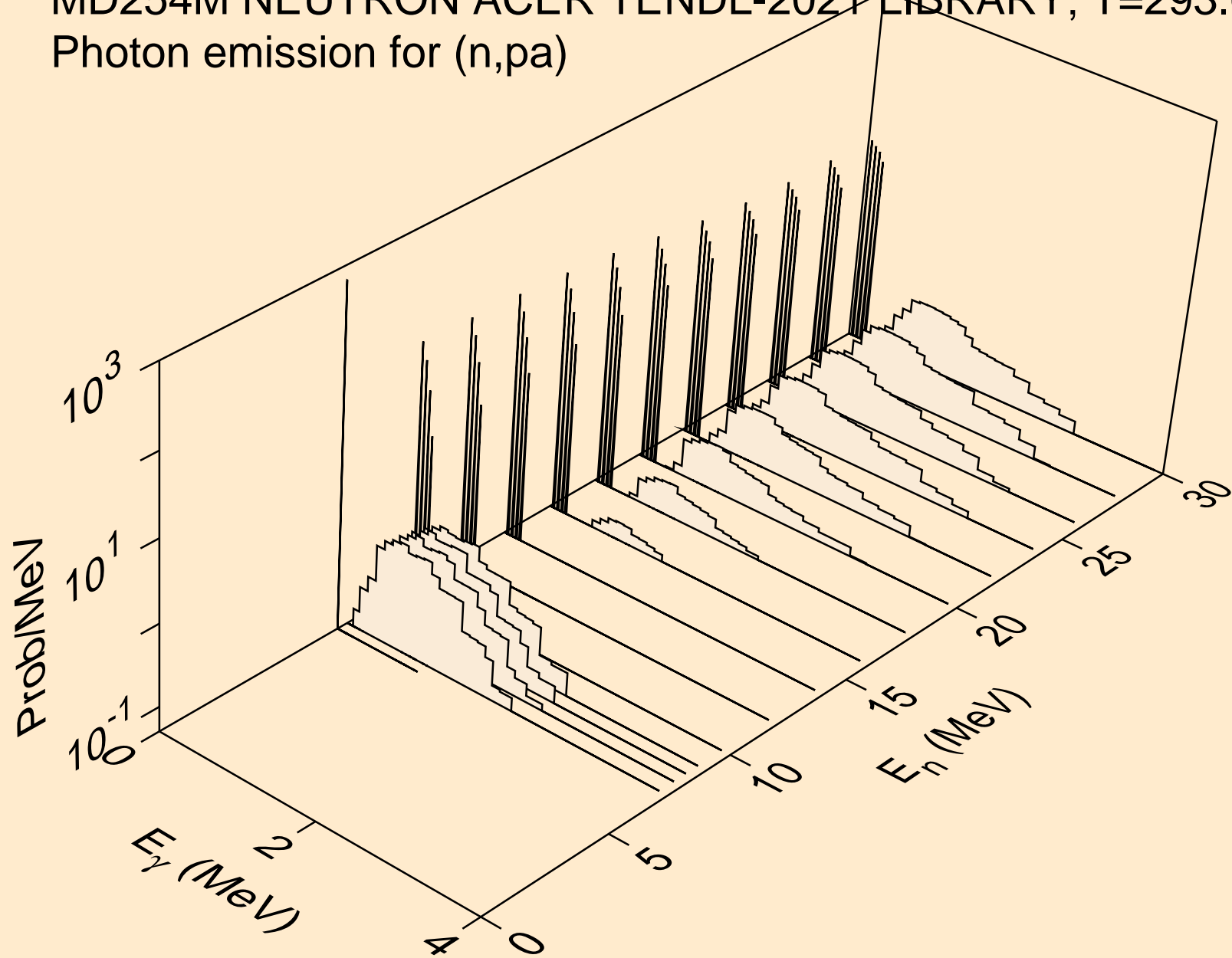

MD254M NEUTRON ACER TENDL-2021 LIBRARY; T=293.6K
Photon emission for (n,pd)

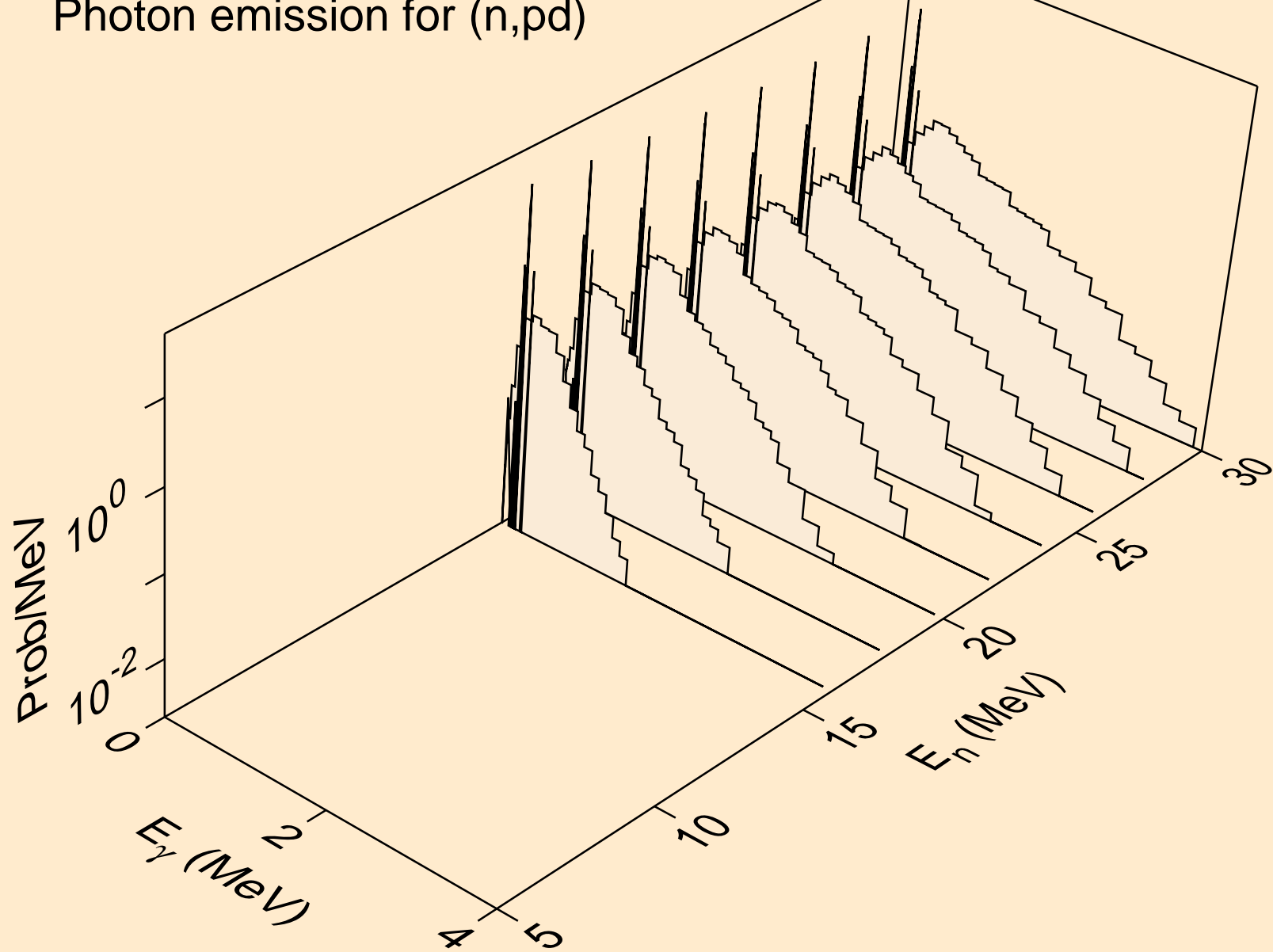

MD254M NEUTRON ACER TENDL-2021 LIBRARY; T=293.6K
Photon emission for (n,pt)

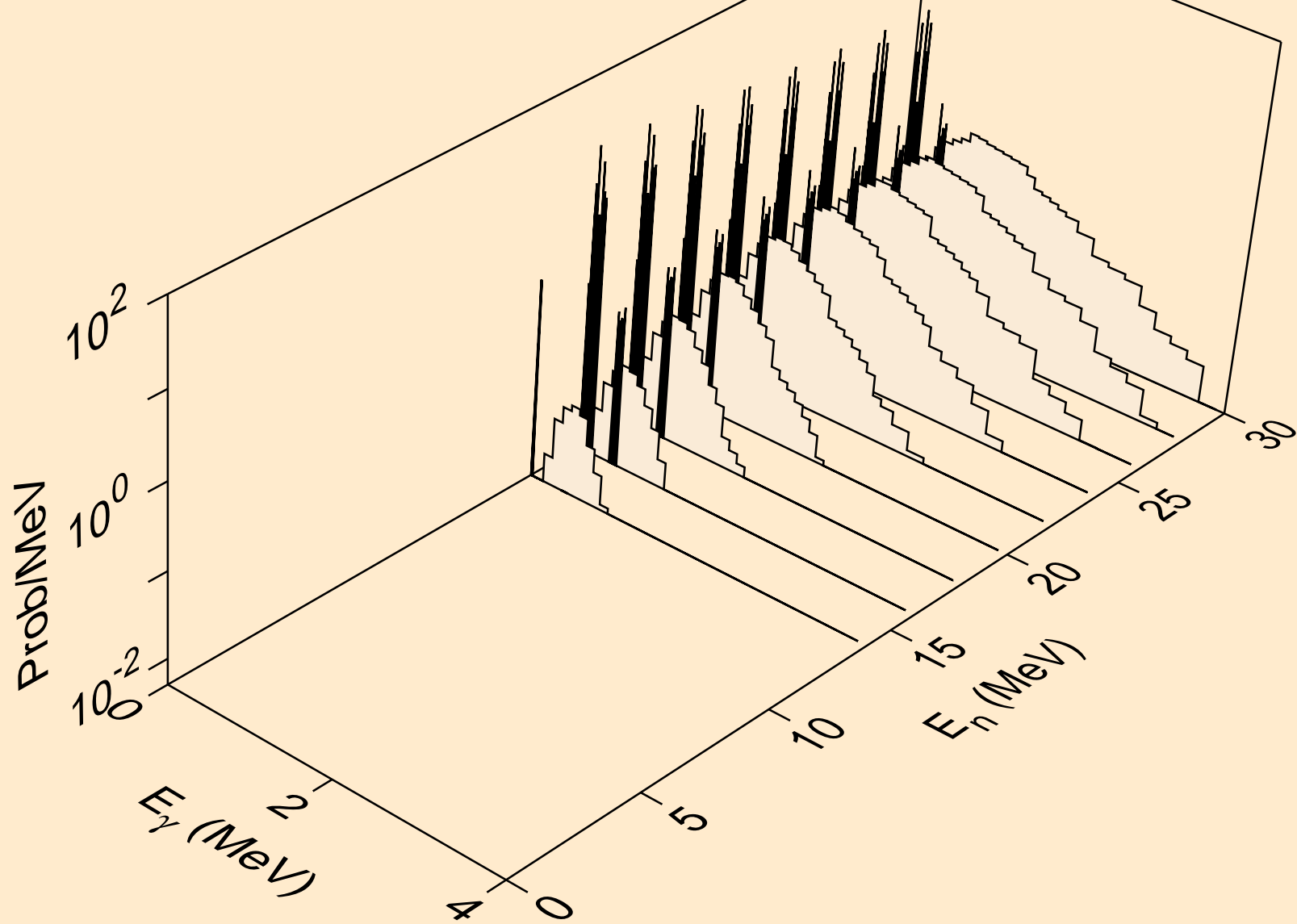

MD254M NEUTRON ACER TENDL-2021 LIBRARY; T=293.6K
Photon emission for (n,da)

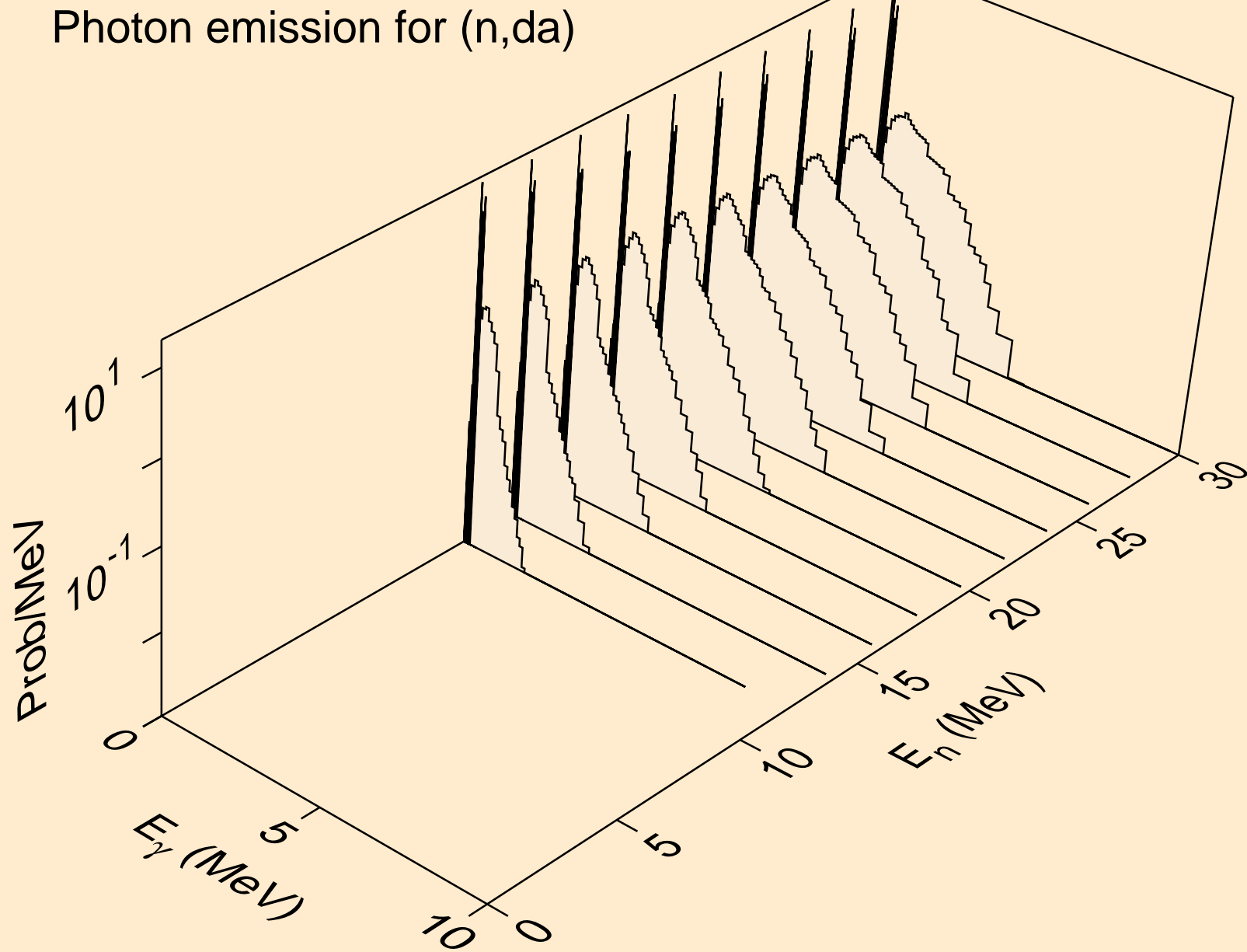

MD254M NEUTRON ACER TENDL-2021 LIBRARY; T=293.6K
thermal capture photon spectrum

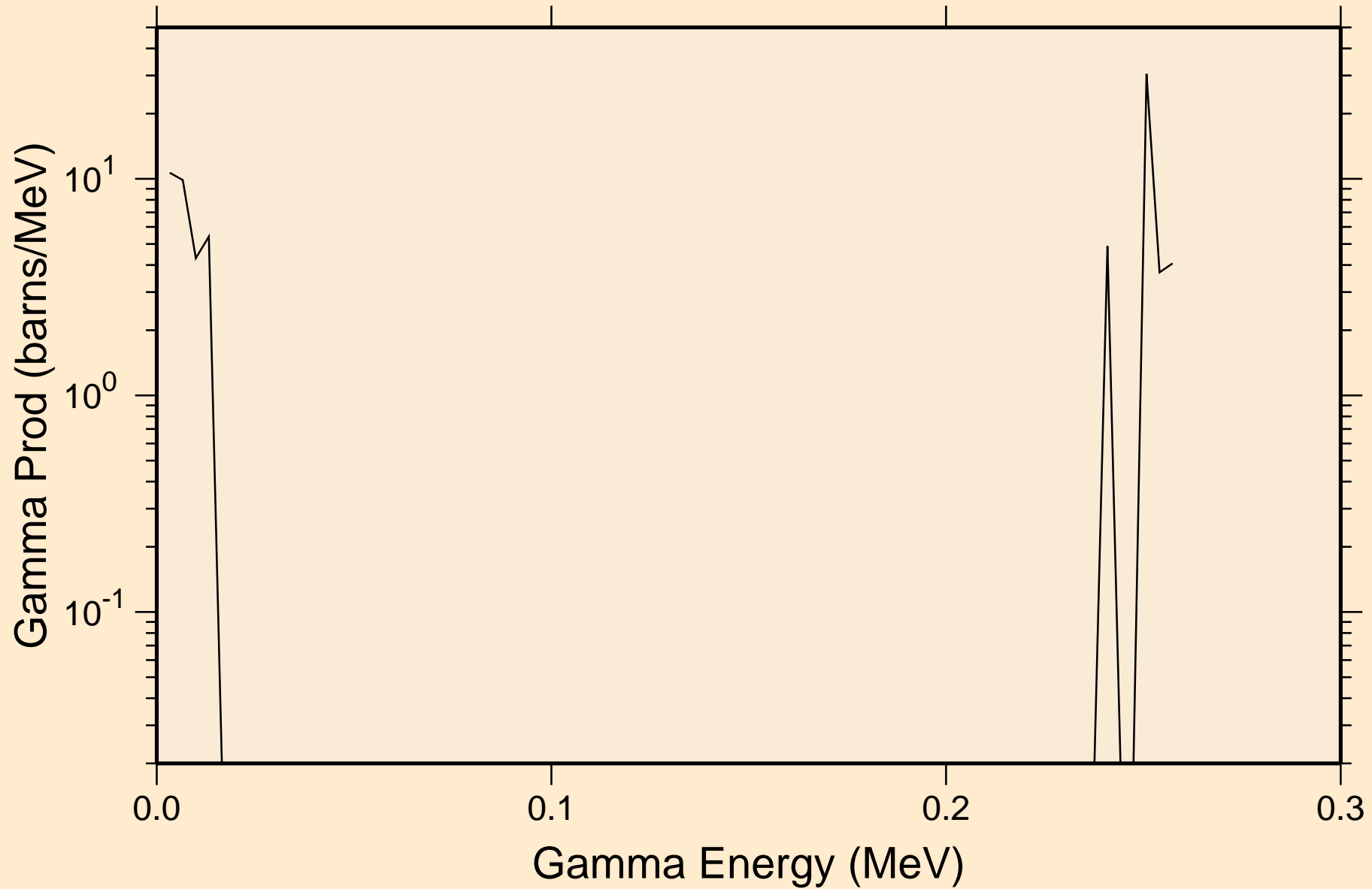

MD254M NEUTRON ACER TENDL-2021 LIBRARY; T=293.6K
14 MeV photon spectrum

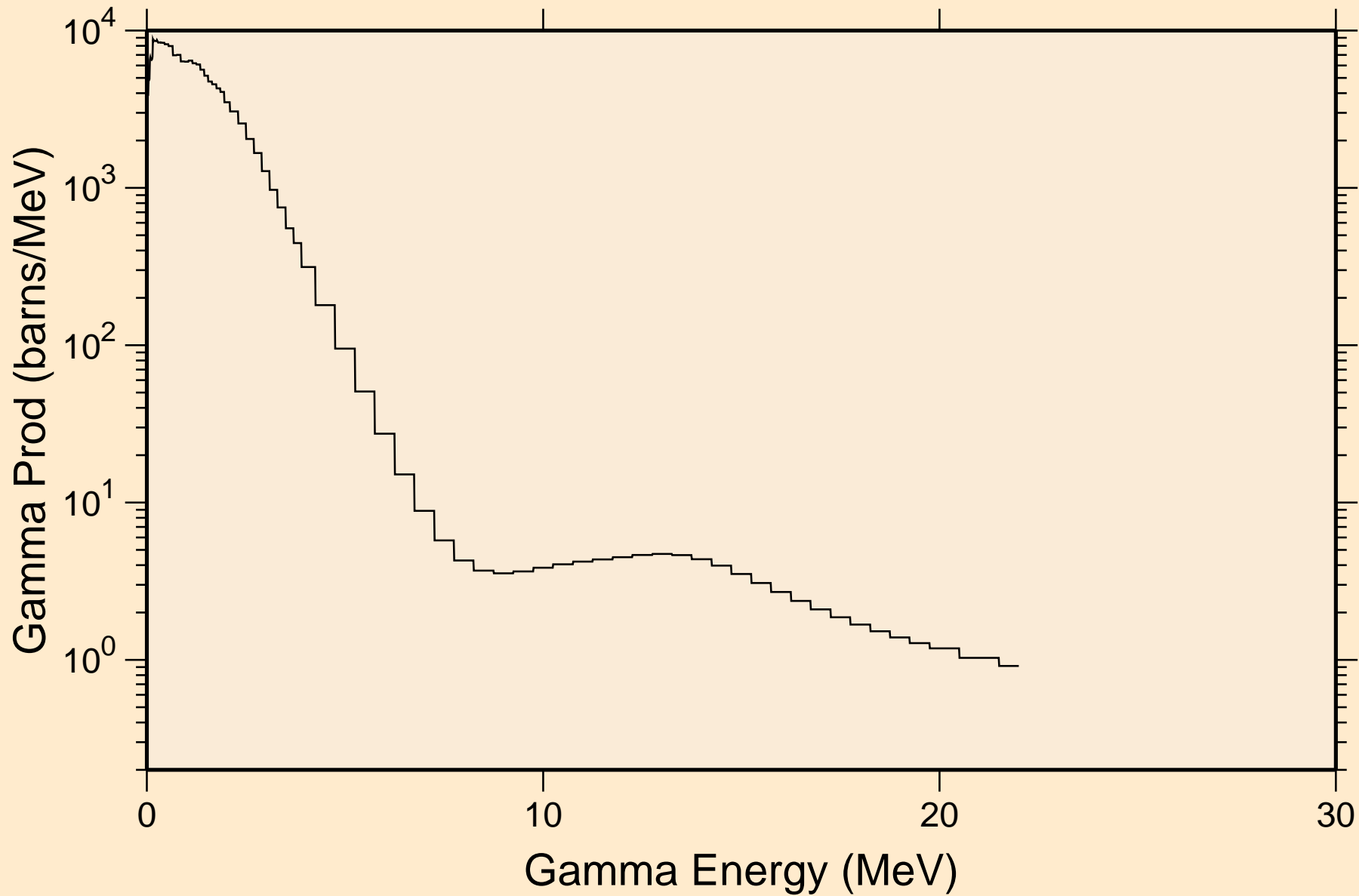

MD254M NEUTRON ACER TENDL-2021 LIBRARY; T=293.6K

Particle heating contributions

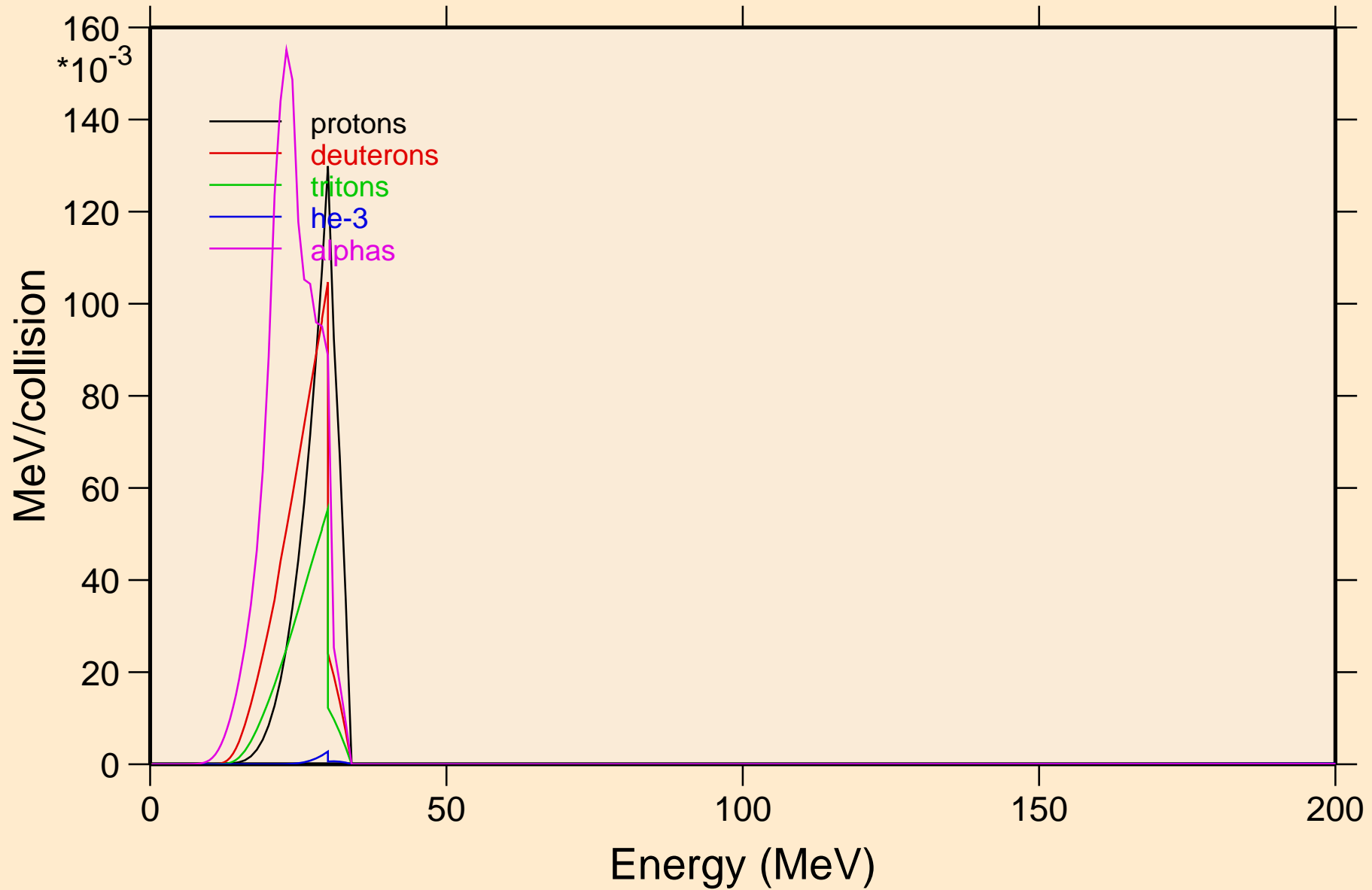

MD254M NEUTRON ACER TENDL-2021 LIBRARY; T=293.6K
Recoil Heating

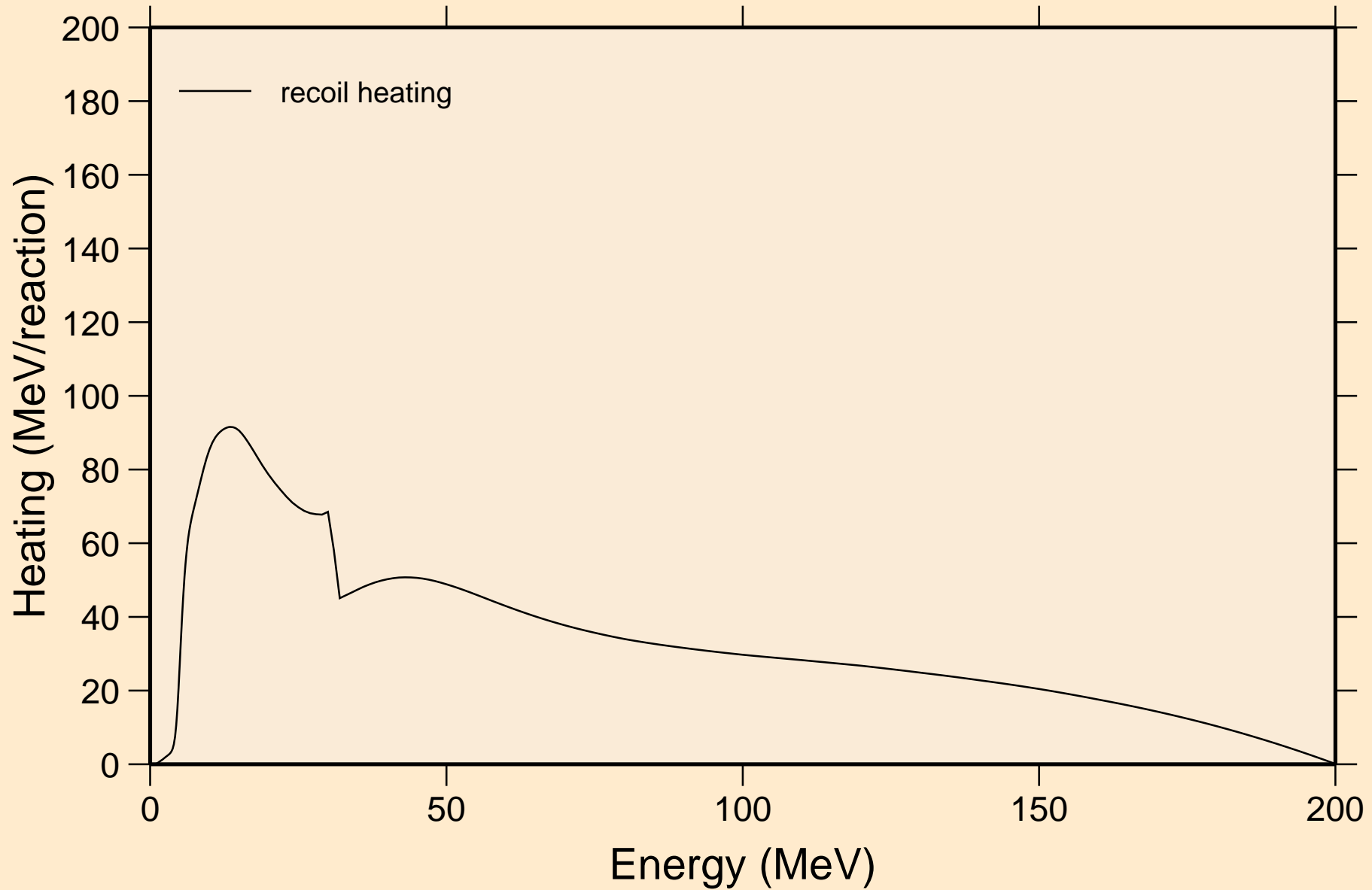

MD254M NEUTRON ACER TENDL-2021 LIBRARY; T=293.6K

Particle production cross sections

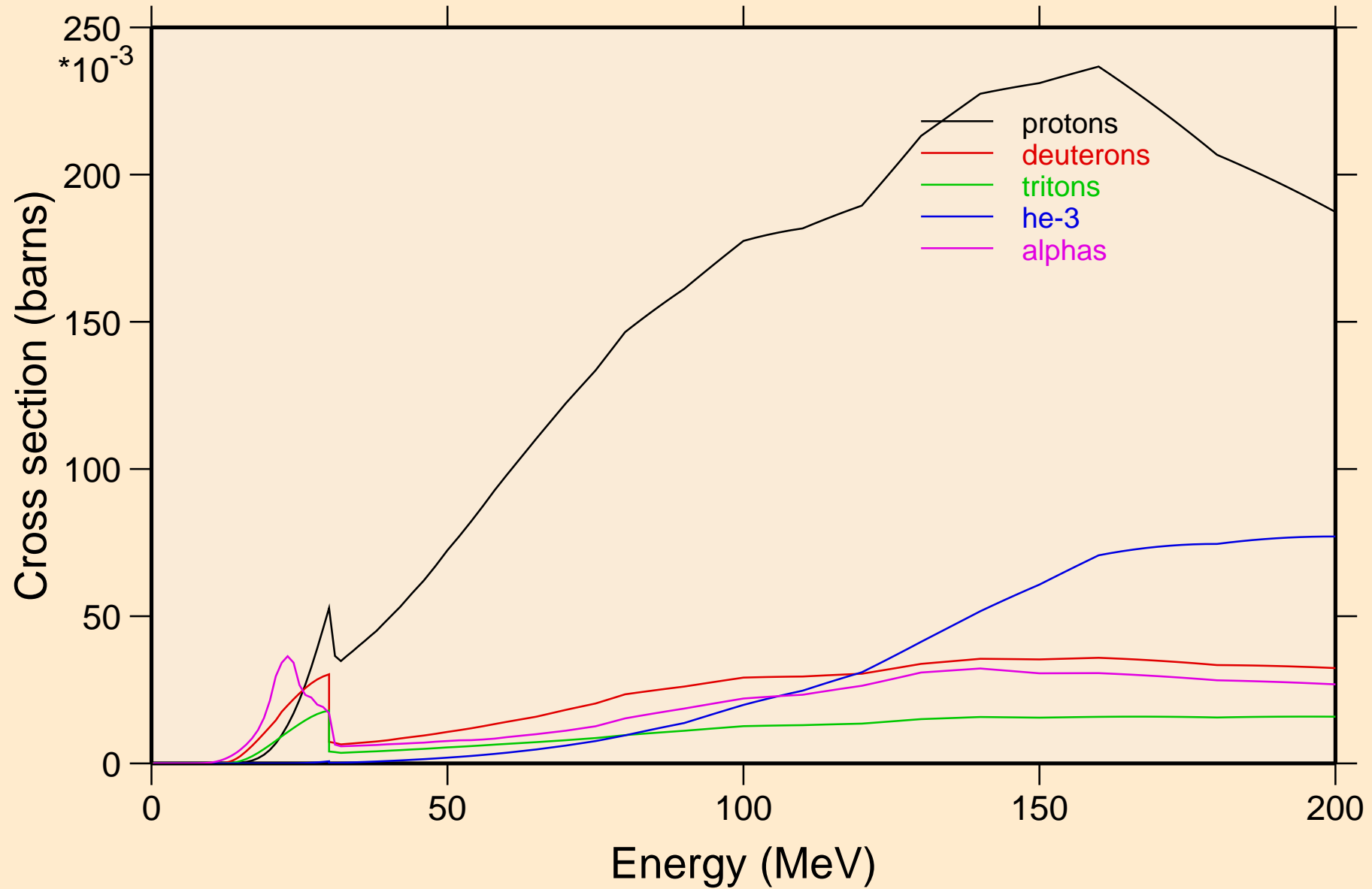

MD254M NEUTRON ACER TENDL-2021 LIBRARY; T=293.6K
protons from (n,x)

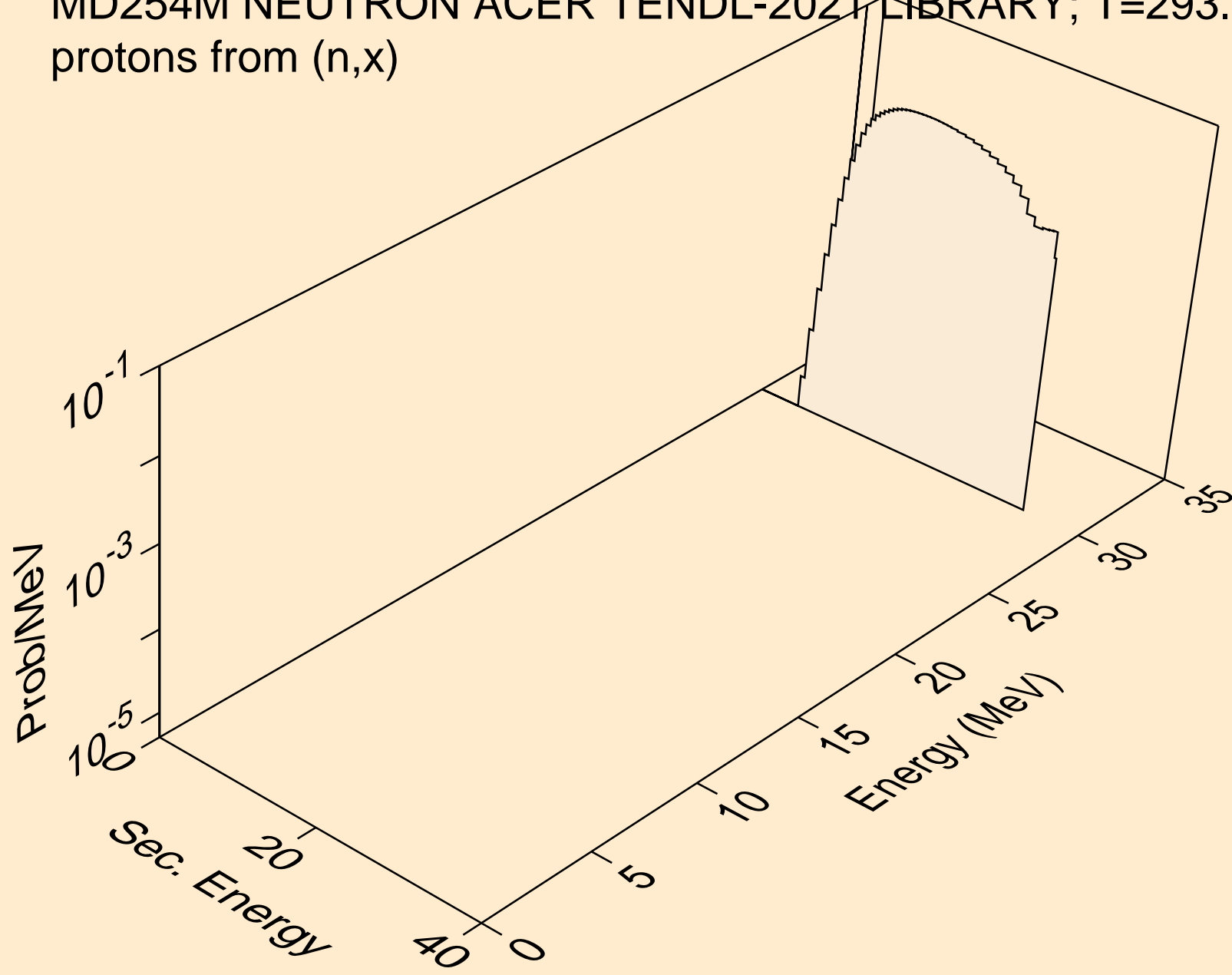

MD254M NEUTRON ACER TENDL-2021 LIBRARY; T=293.6K
protons from (n,n*)p

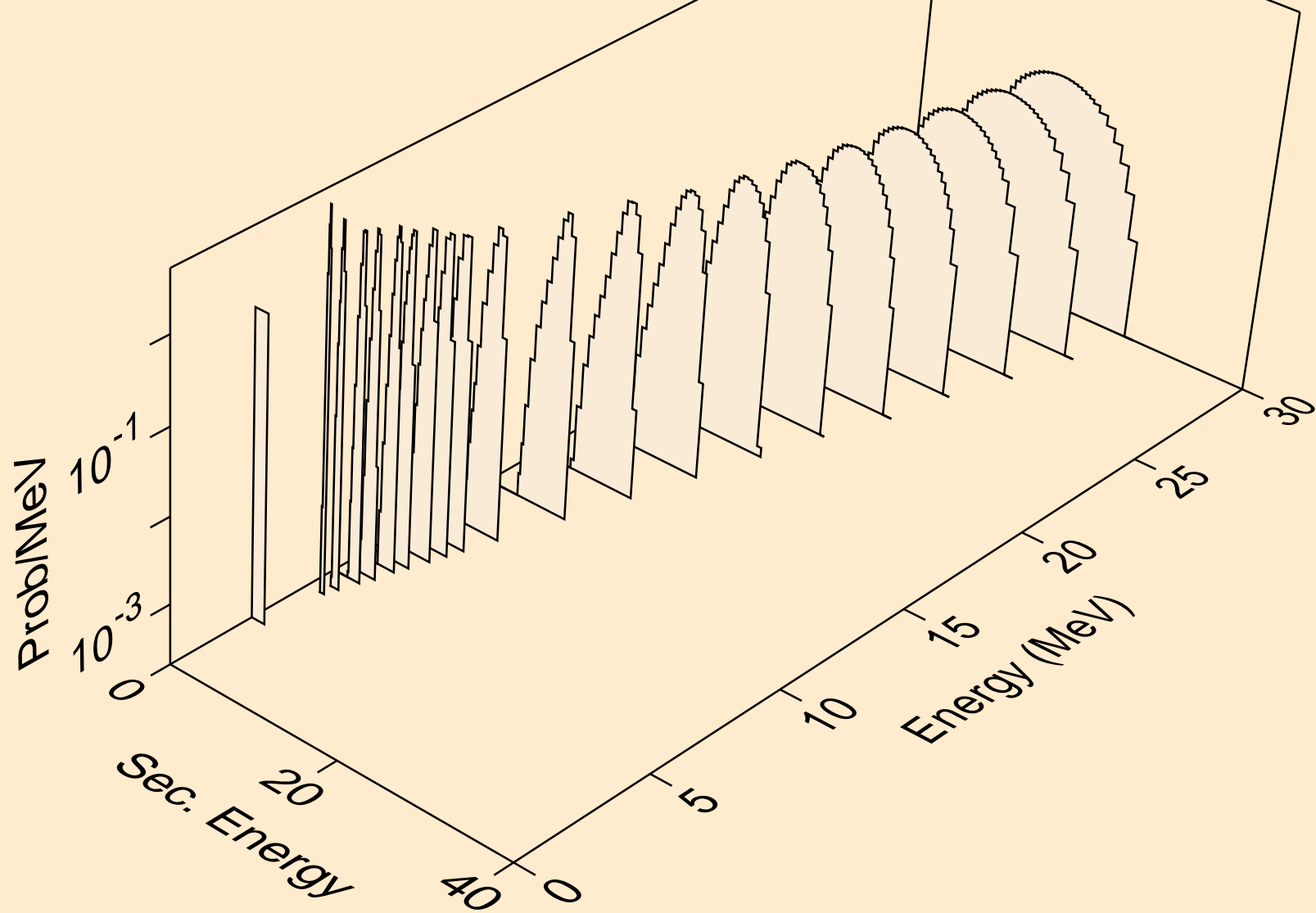

MD254M NEUTRON ACER TENDL-2021 LIBRARY; T=293.6K
protons from (n,2np)

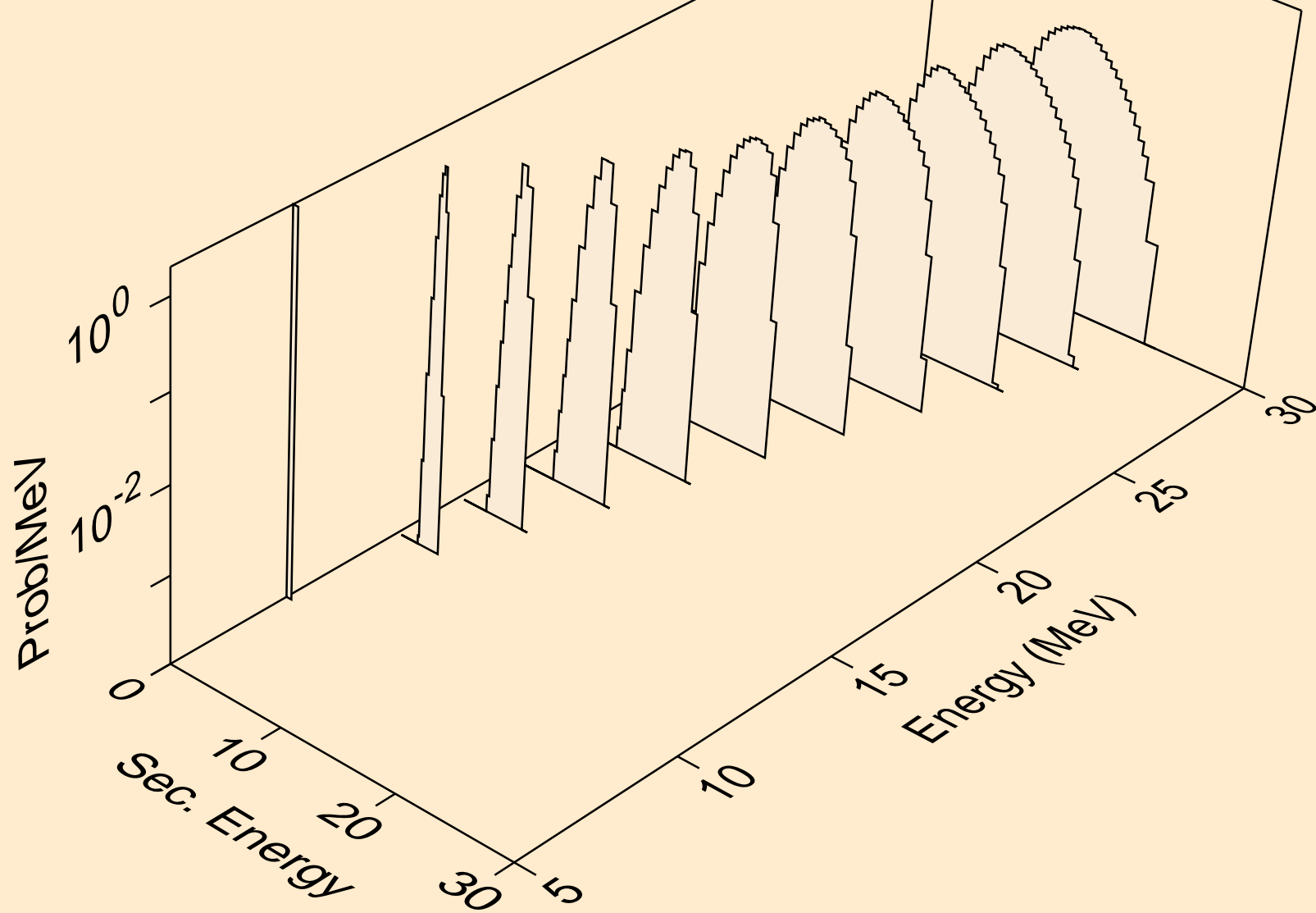

MD254M NEUTRON ACER TENDL-2021 LIBRARY; T=293.6K
protons from (n,3np)

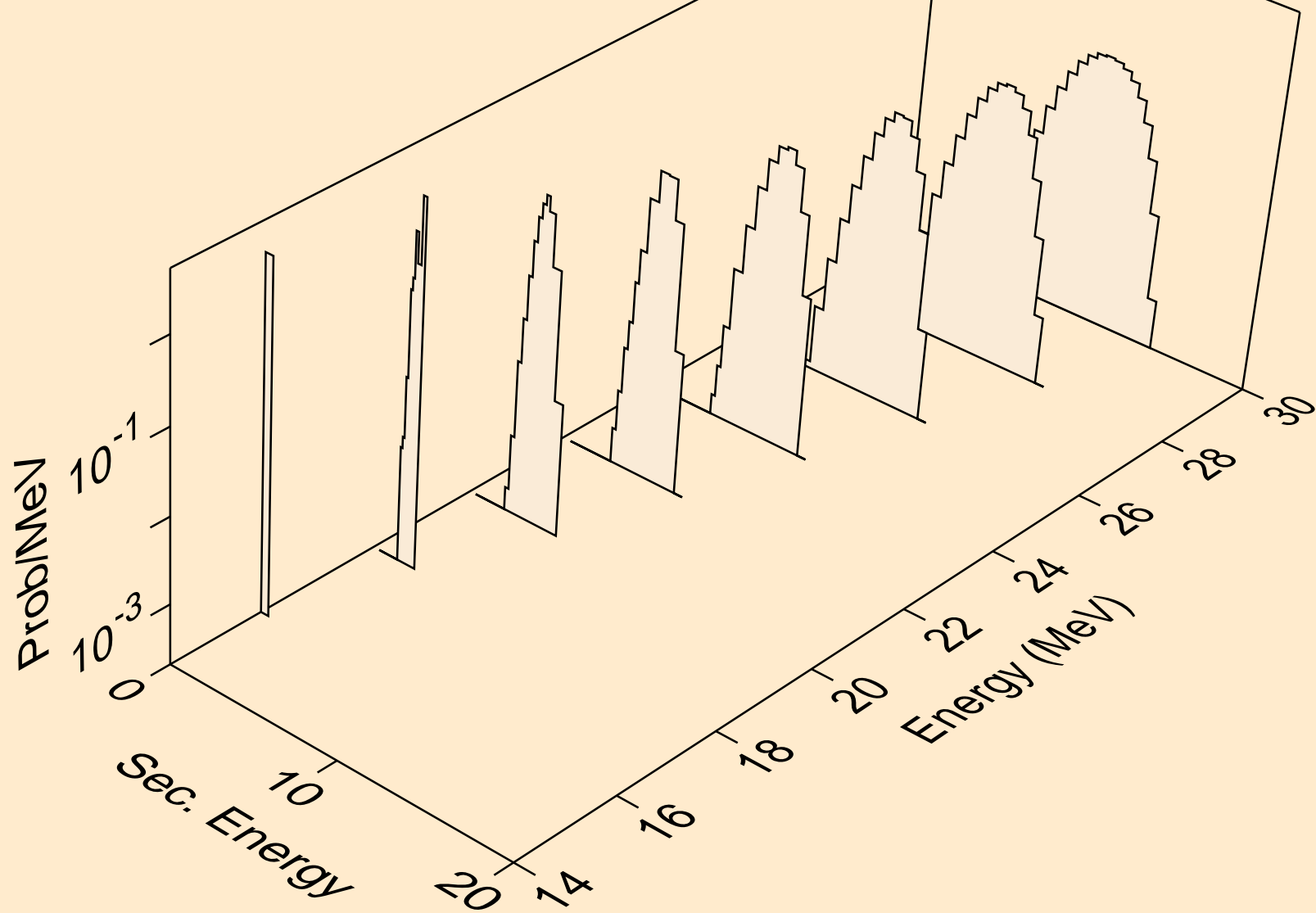

MD254M NEUTRON ACER TENDL-2021 LIBRARY; T=293.6K
protons from (n,2np)

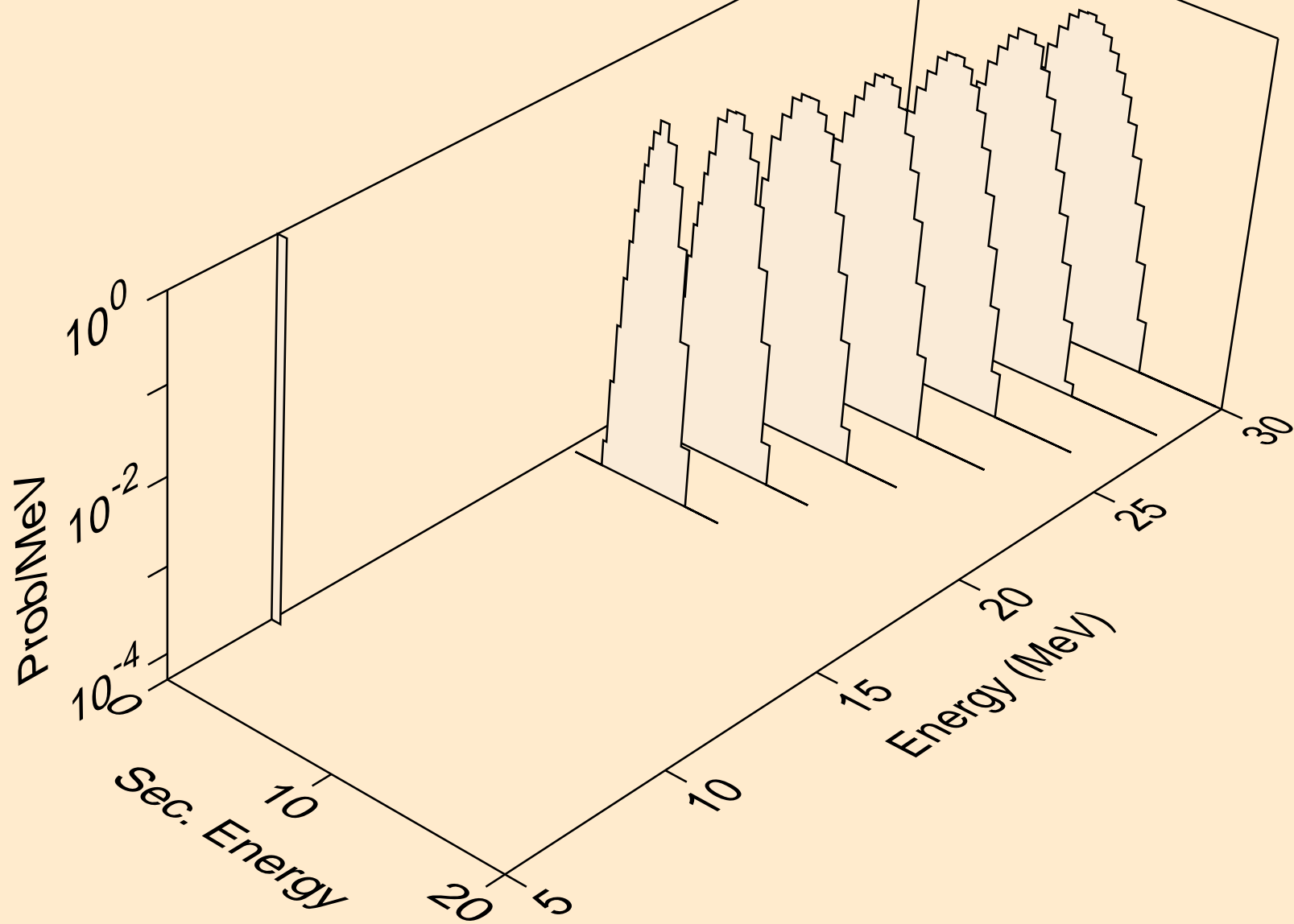

MD254M NEUTRON ACER TENDL-2021 LIBRARY; T=293.6K
protons from (n,npa)

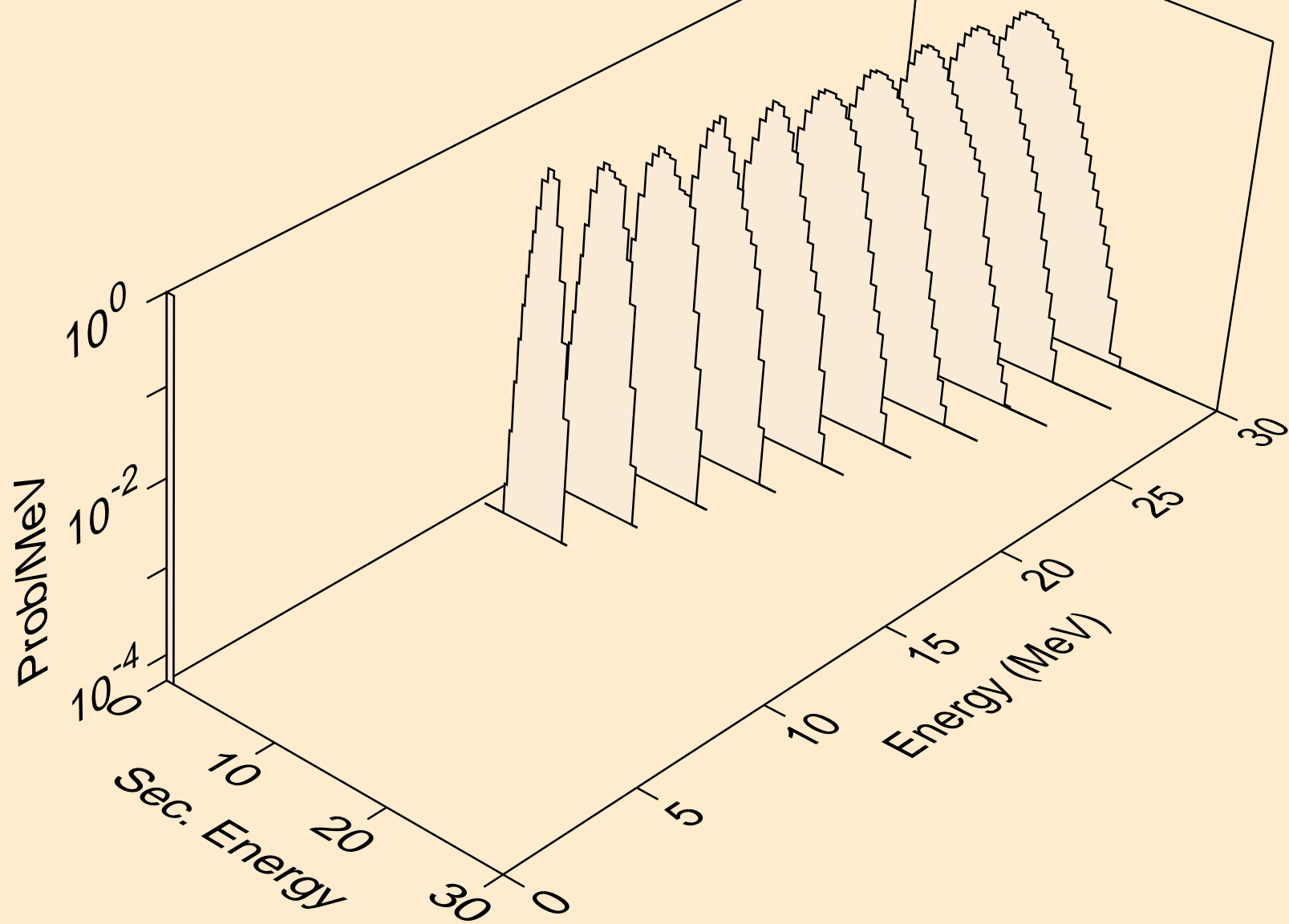

MD254M NEUTRON ACER TENDL-2021 LIBRARY; T=293.6K
protons from (n,p)

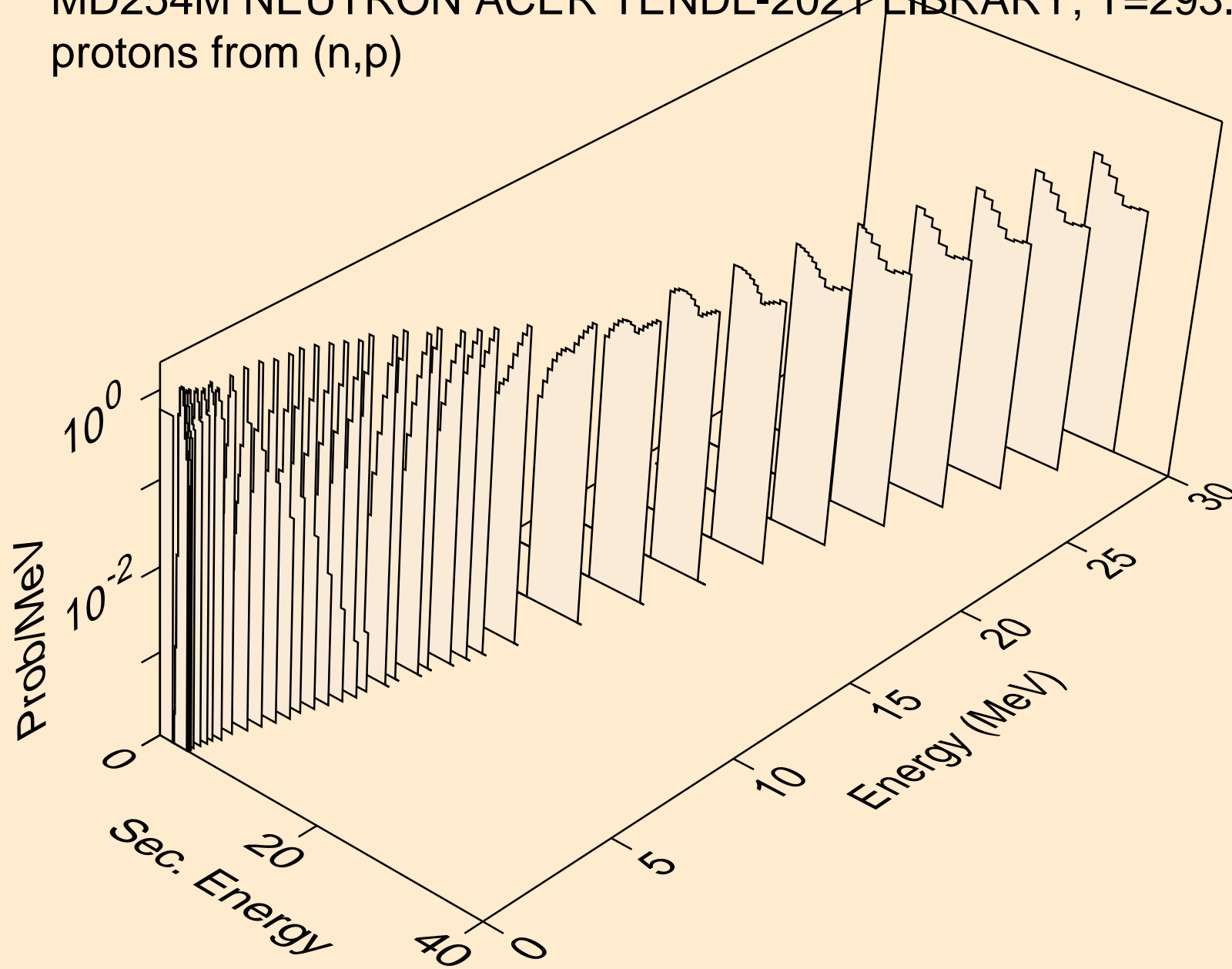

MD254M NEUTRON ACER TENDL-2021 LIBRARY; T=293.6K
protons from (n,2p)

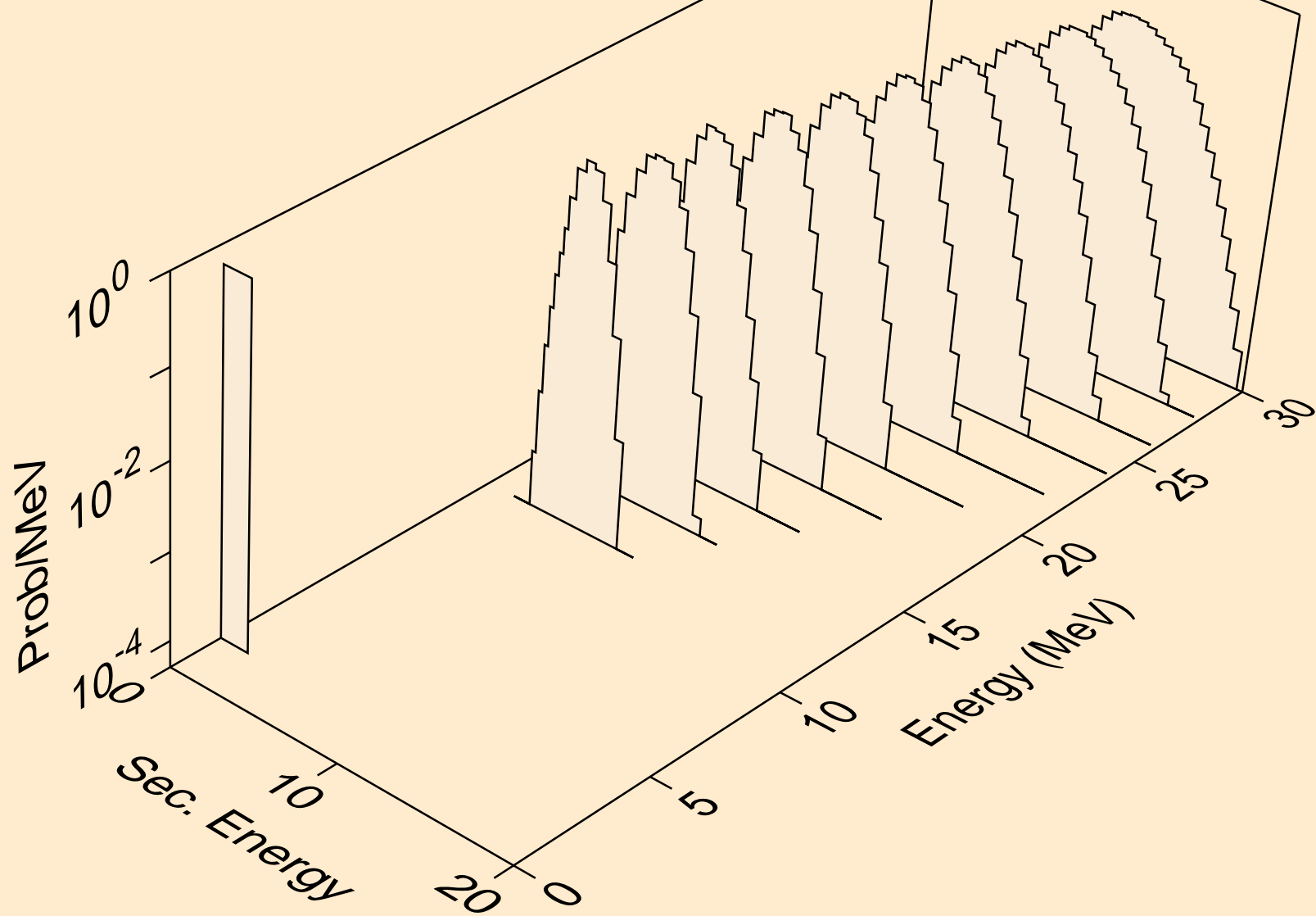

MD254M NEUTRON ACER TENDL-2021 LIBRARY; T=293.6K
protons from (n,p)

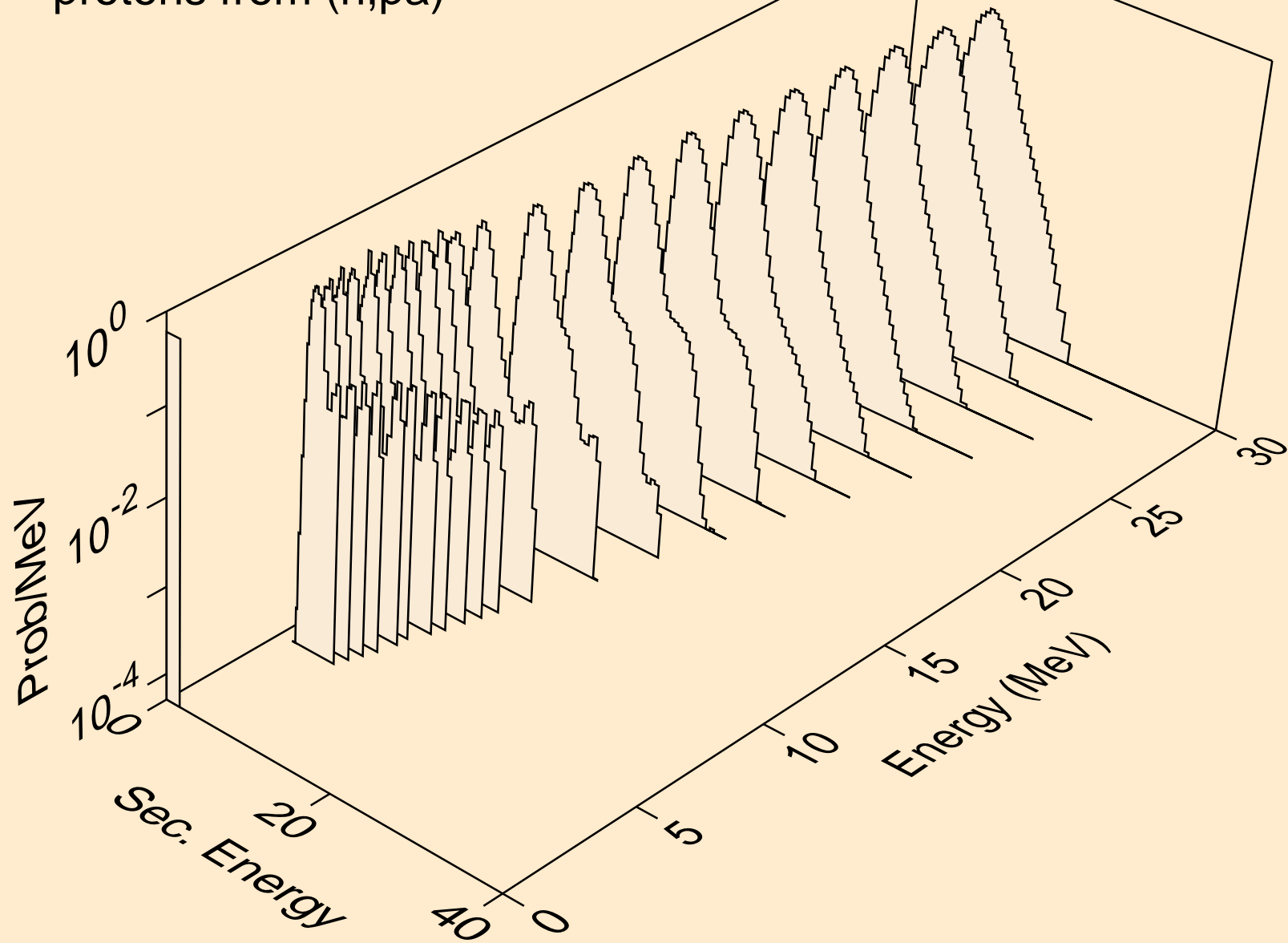

MD254M NEUTRON ACER TENDL-2021 LIBRARY; T=293.6K
protons from (n,pd)

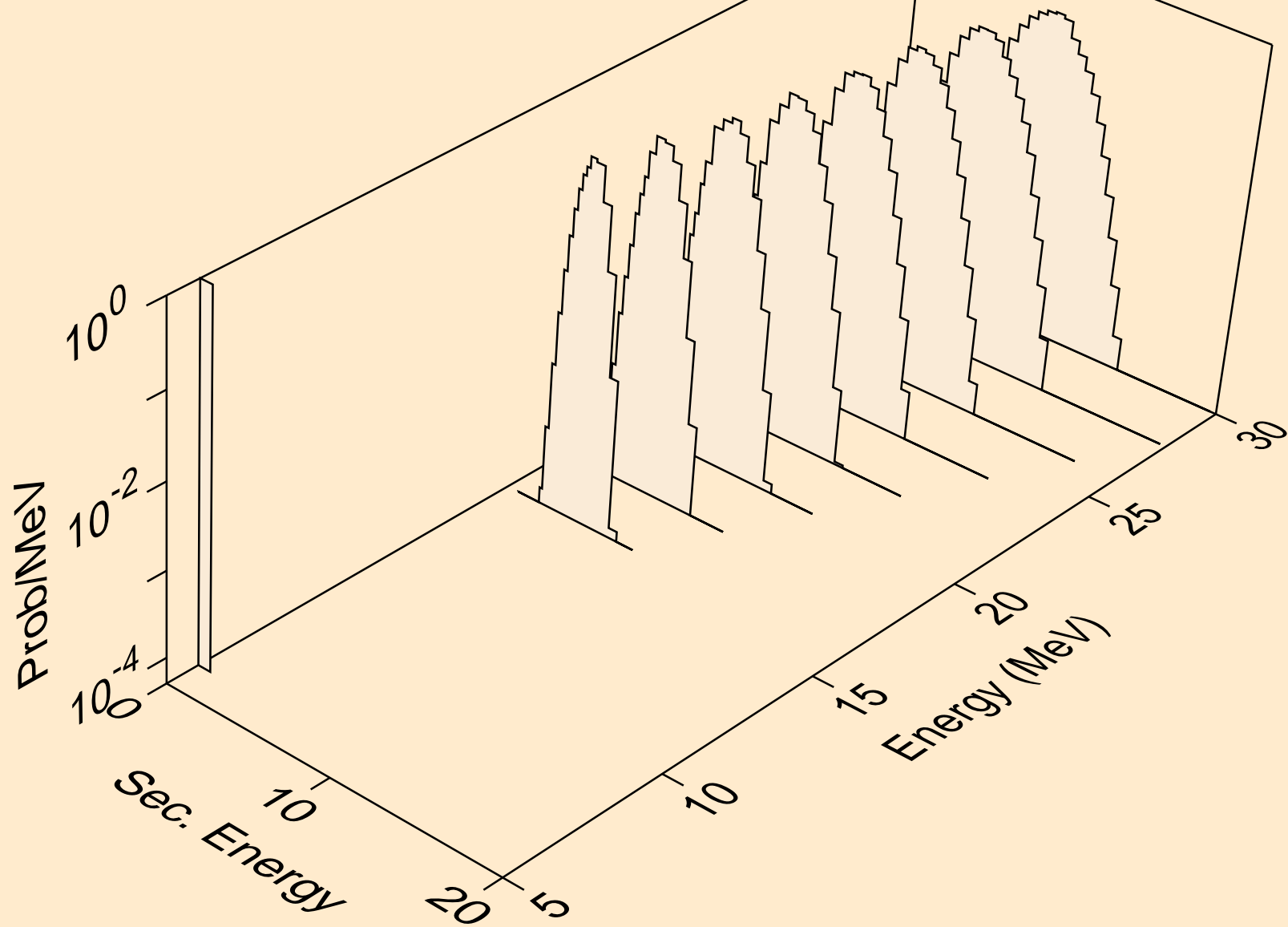

MD254M NEUTRON ACER TENDL-2021 LIBRARY; T=293.6K
protons from (n,pt)

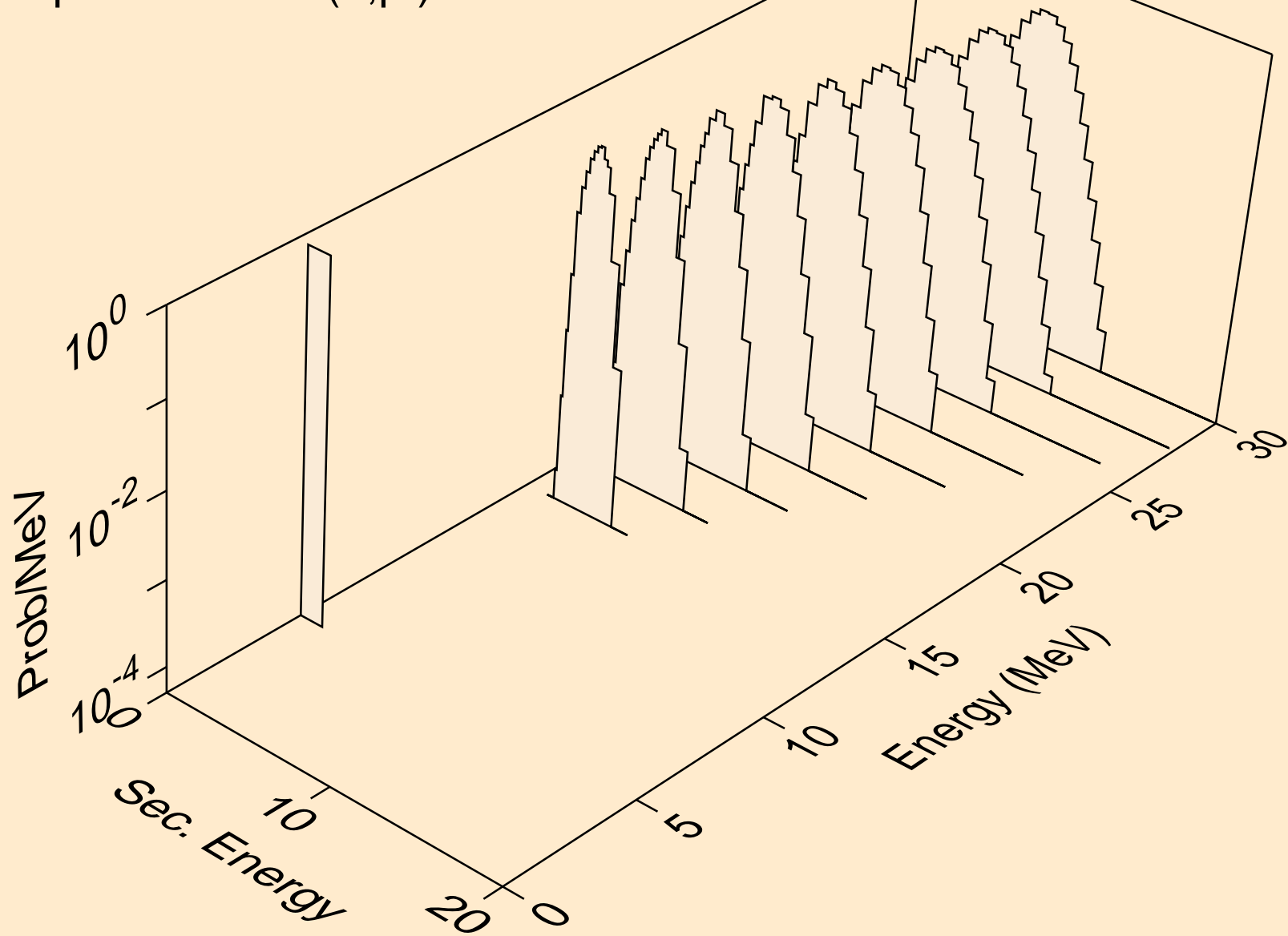

MD254M NEUTRON ACER TENDL-2021 LIBRARY; T=293.6K
deuterons from (n,x)

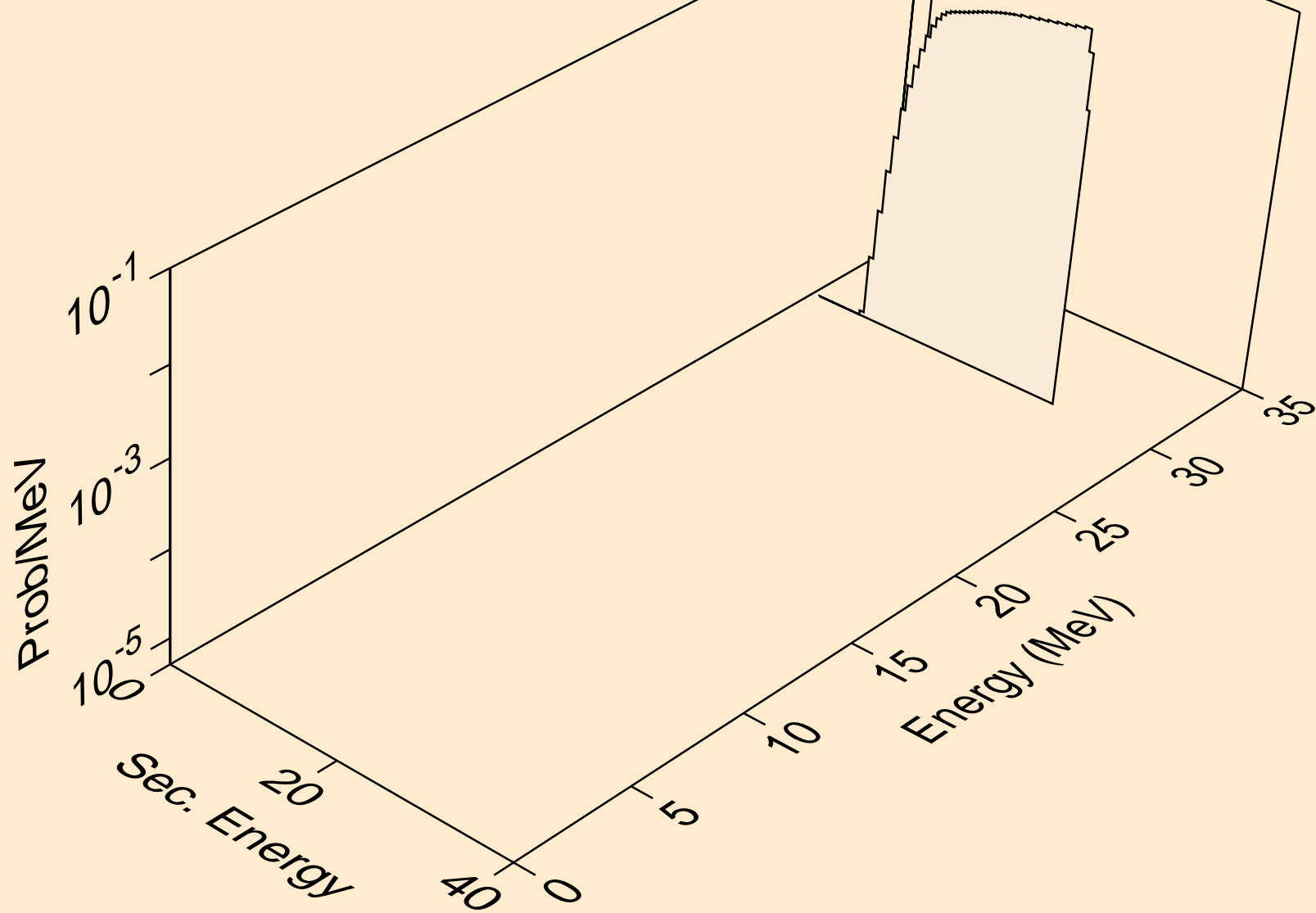

MD254M NEUTRON ACER TENDL-2021 LIBRARY; T=293.6K
deuterons from (n,2nd)

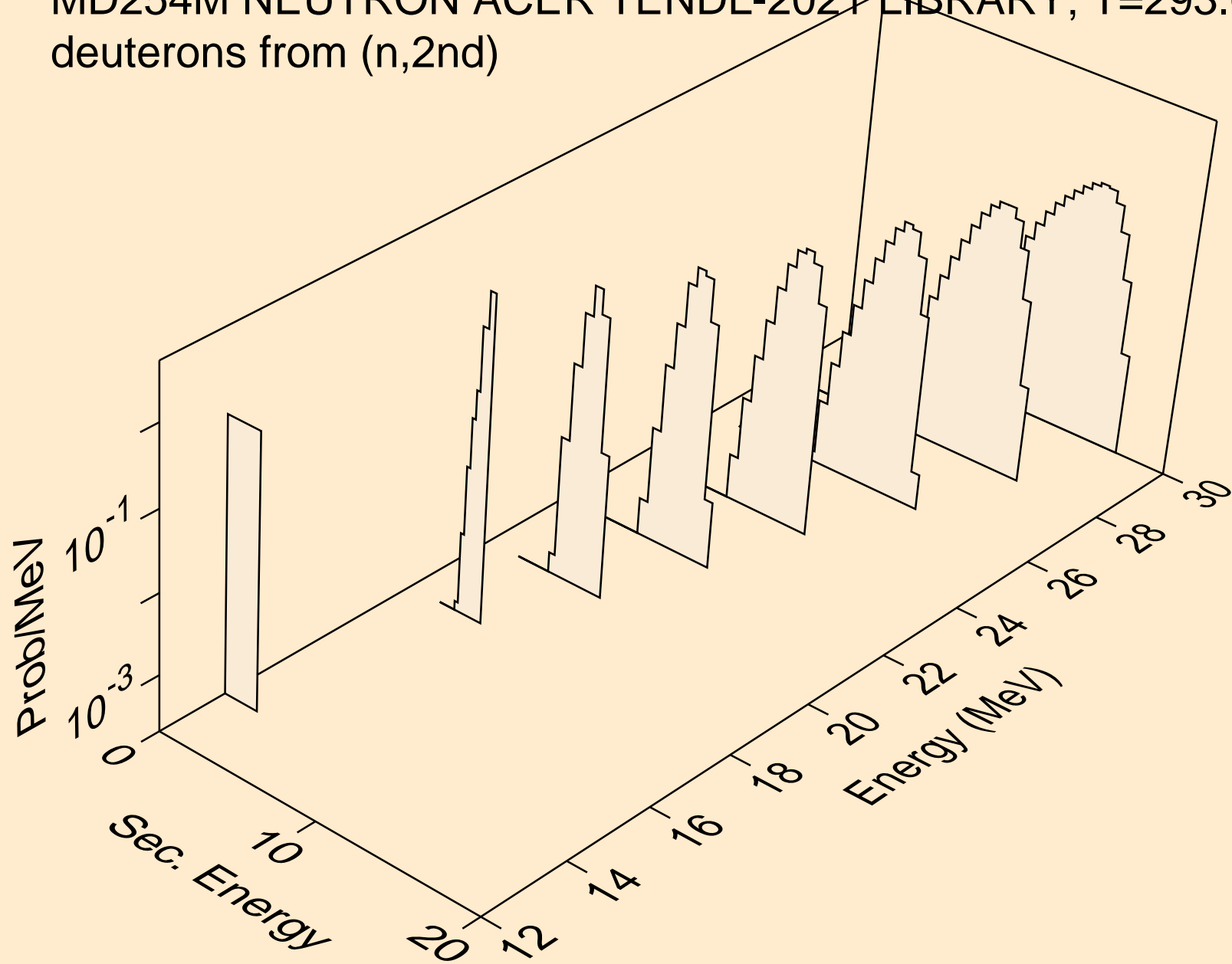

MD254M NEUTRON ACER TENDL-2021 LIBRARY; T=293.6K
deuterons from (n,n*)d

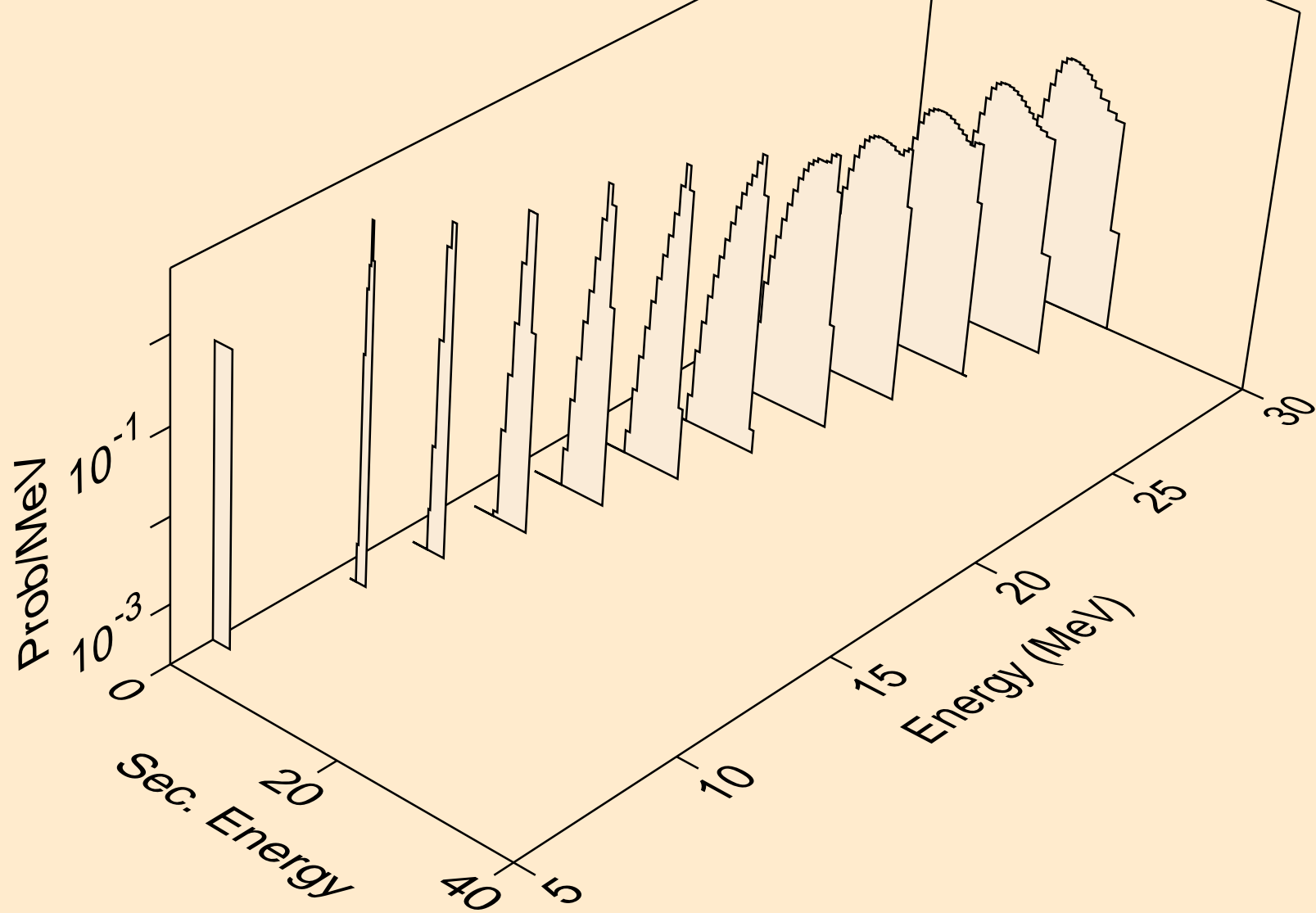

MD254M NEUTRON ACER TENDL-2021 LIBRARY; T=293.6K
deuterons from (n,d)

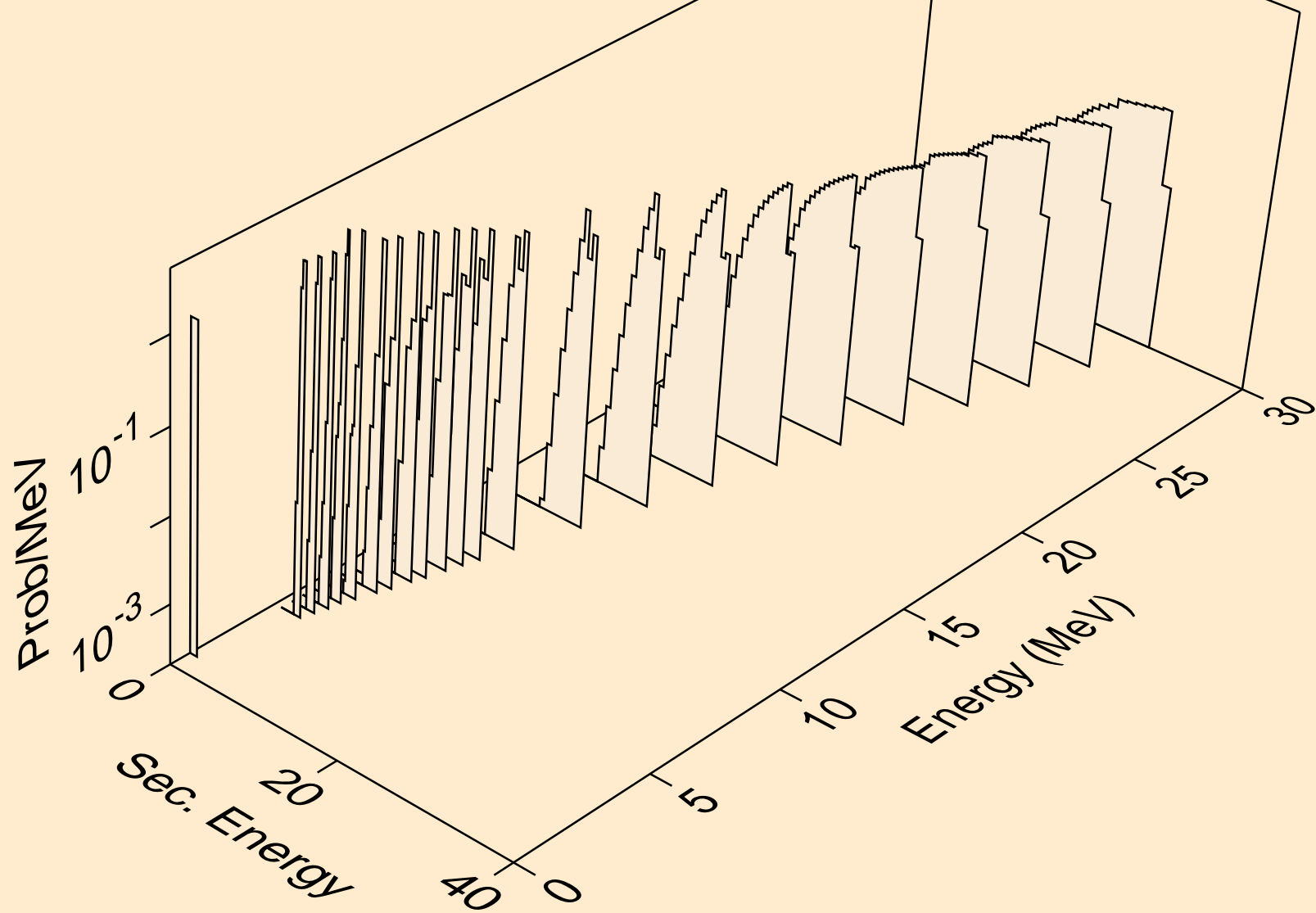

MD254M NEUTRON ACER TENDL-2021 LIBRARY; T=293.6K
deuterons from (n,pd)

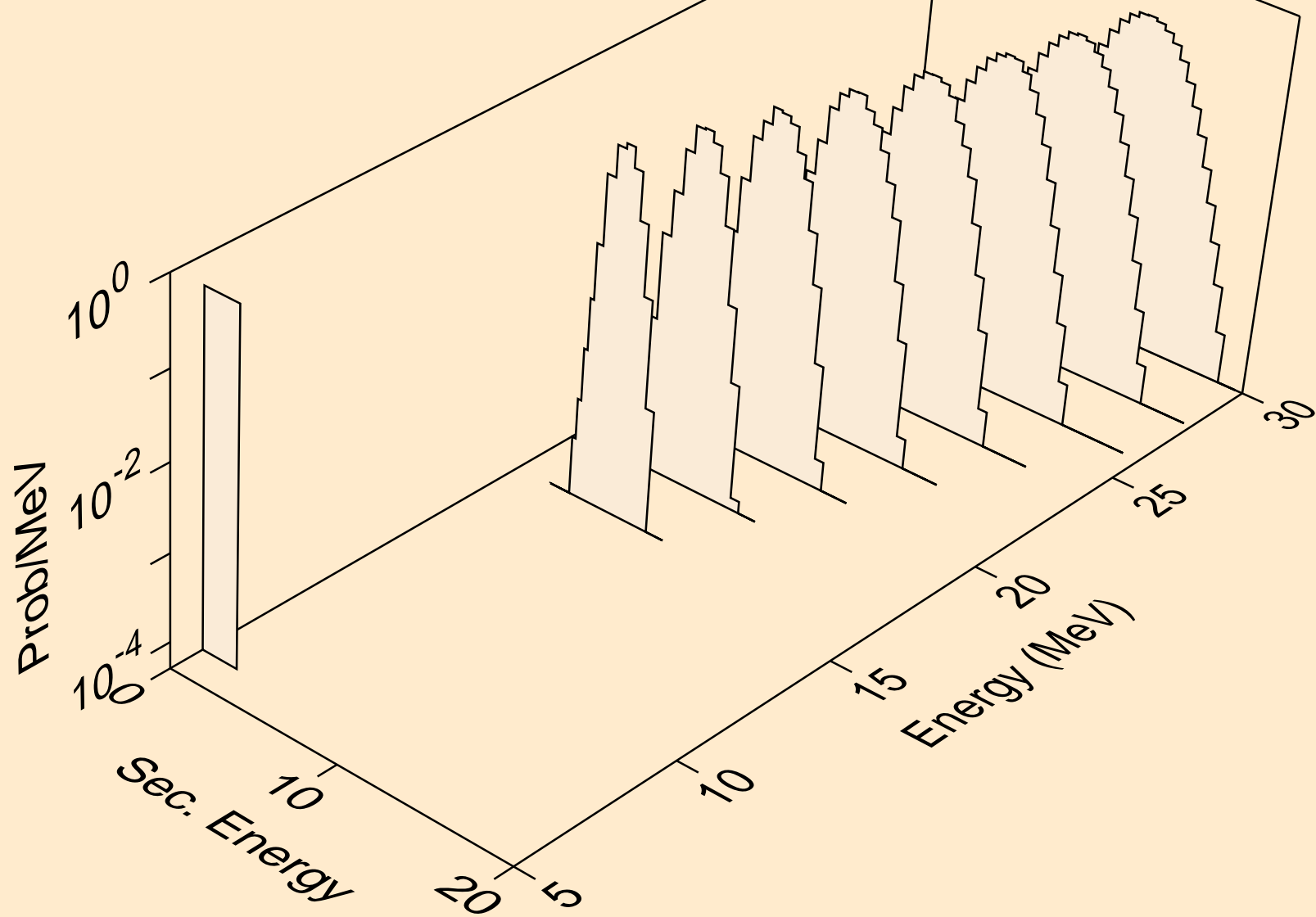

MD254M NEUTRON ACER TENDL-2021 LIBRARY; T=293.6K
deuterons from (n,da)

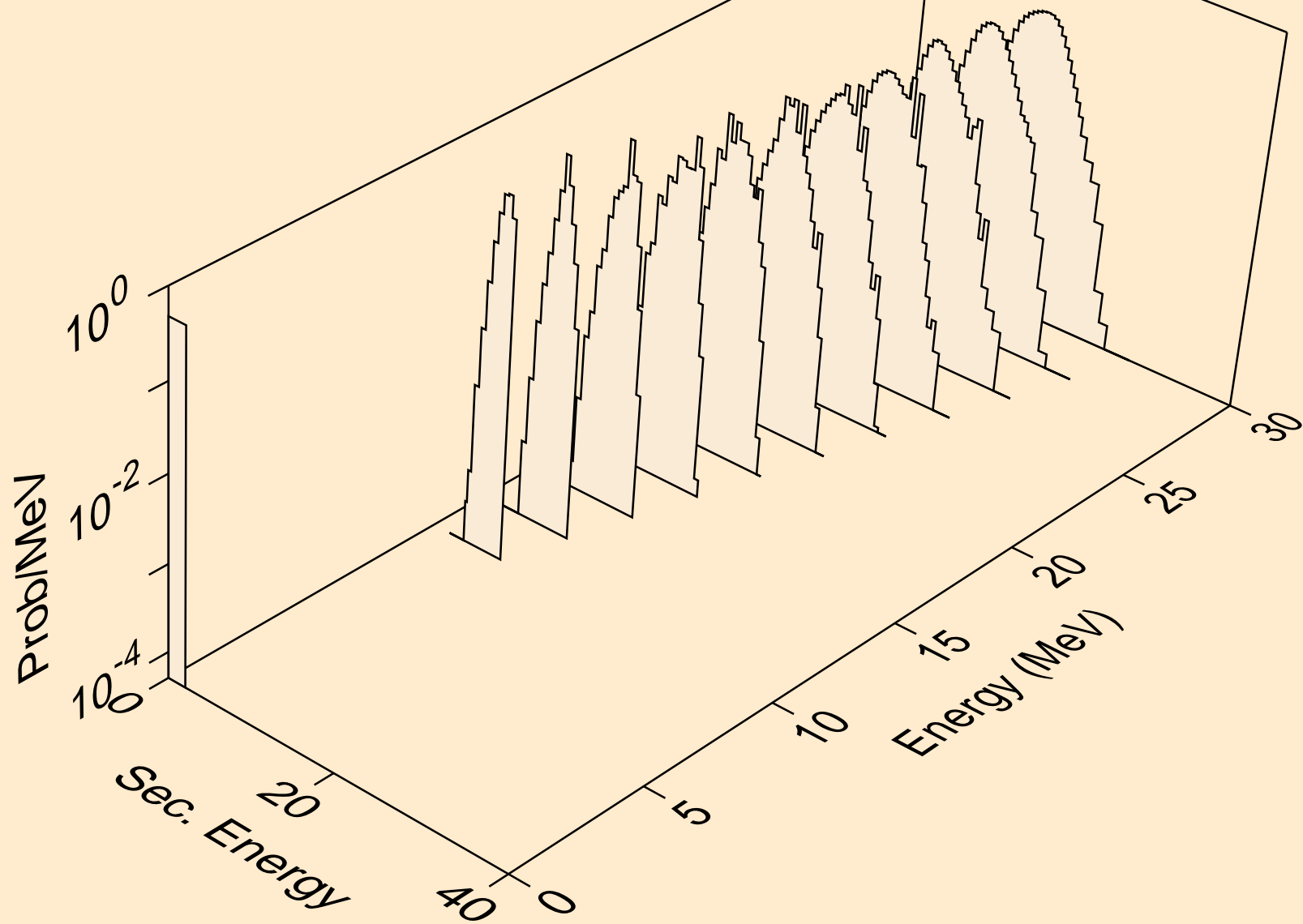

MD254M NEUTRON ACER TENDL-2021 LIBRARY; T=293.6K
tritons from (n,x)

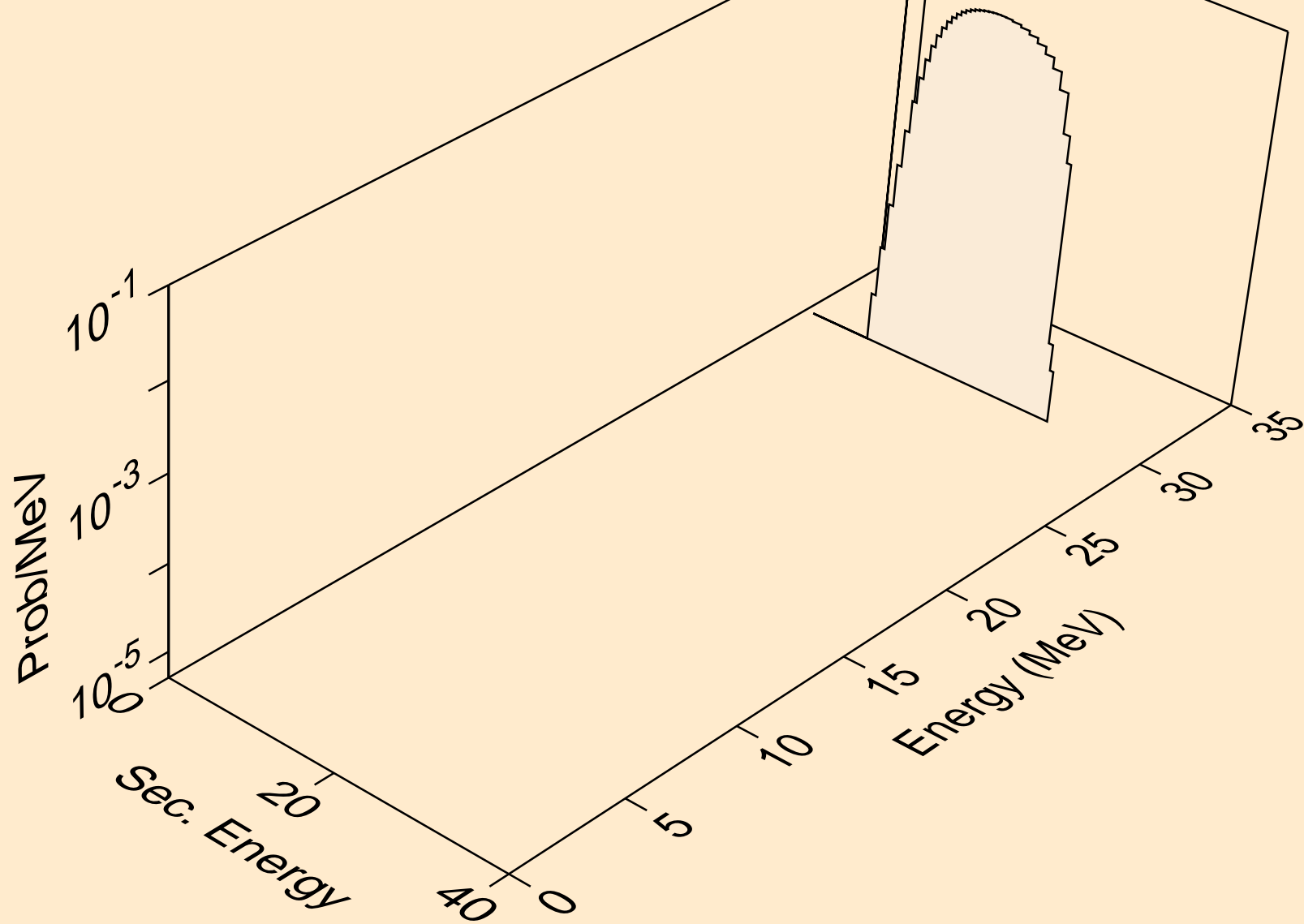

MD254M NEUTRON ACER TENDL-2021 LIBRARY; T=293.6K
tritons from (n,n*)t

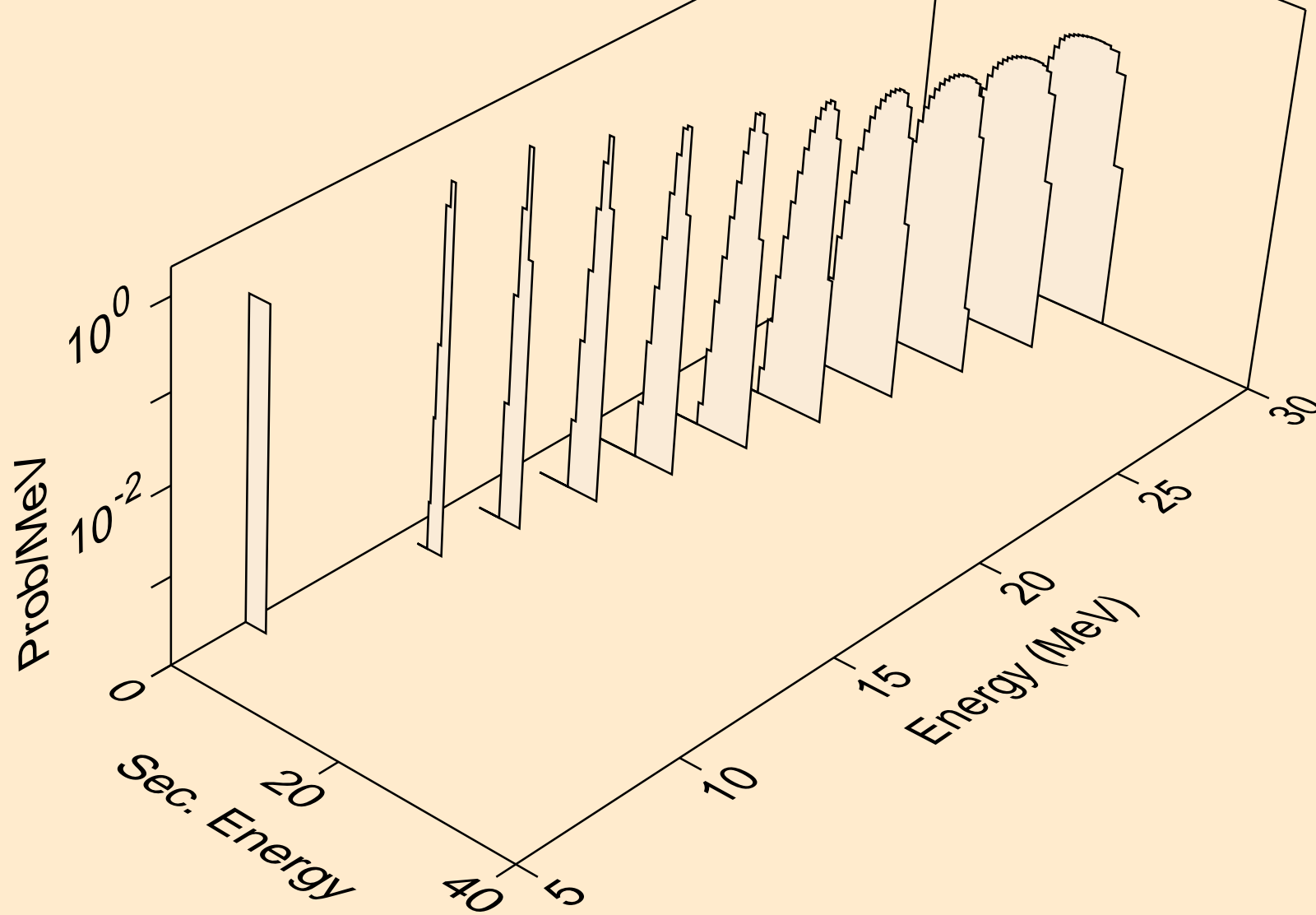

MD254M NEUTRON ACER TENDL-2021 LIBRARY; T=293.6K
tritons from (n,t)

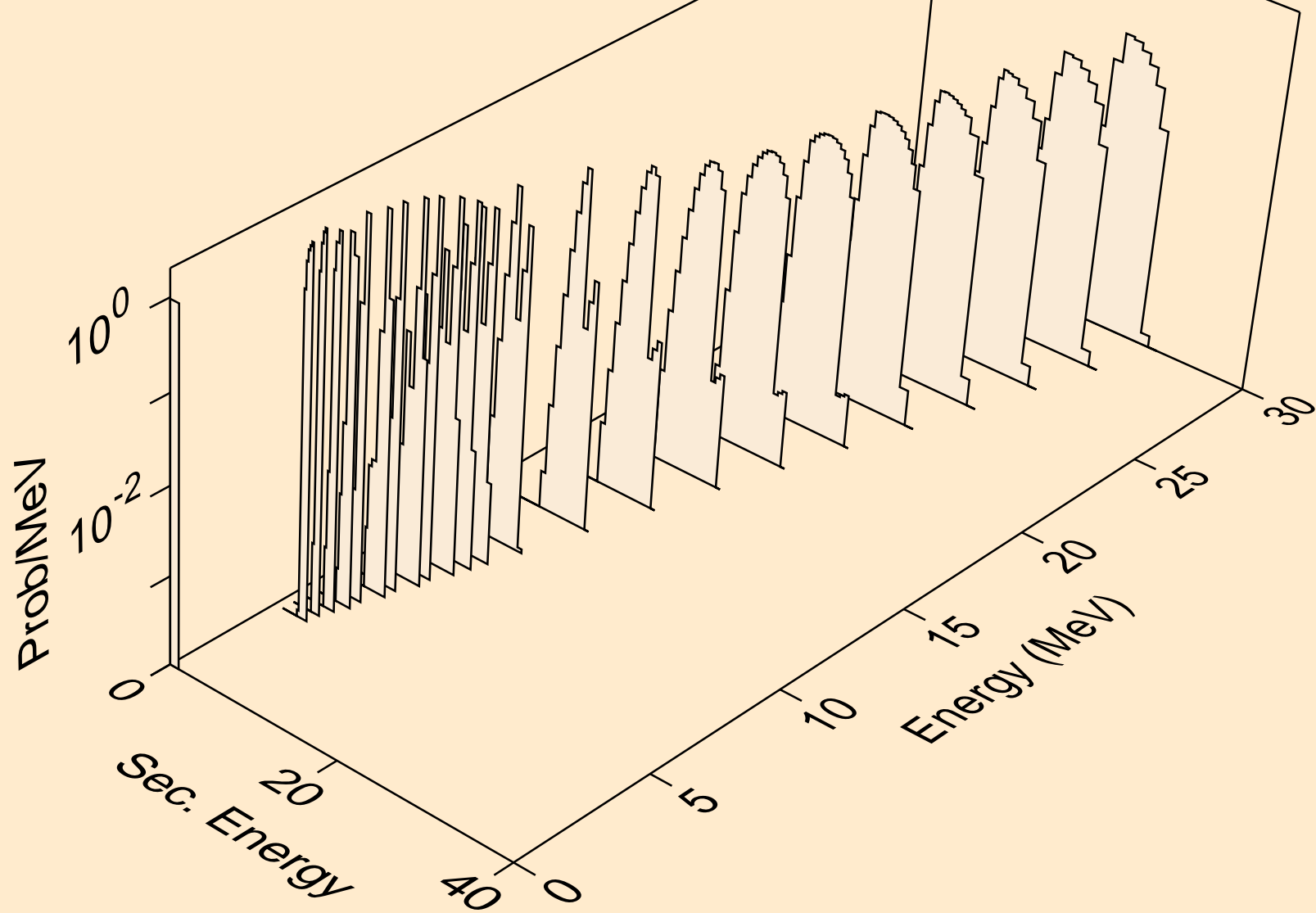

MD254M NEUTRON ACER TENDL-2021 LIBRARY; T=293.6K
tritons from (n,pt)

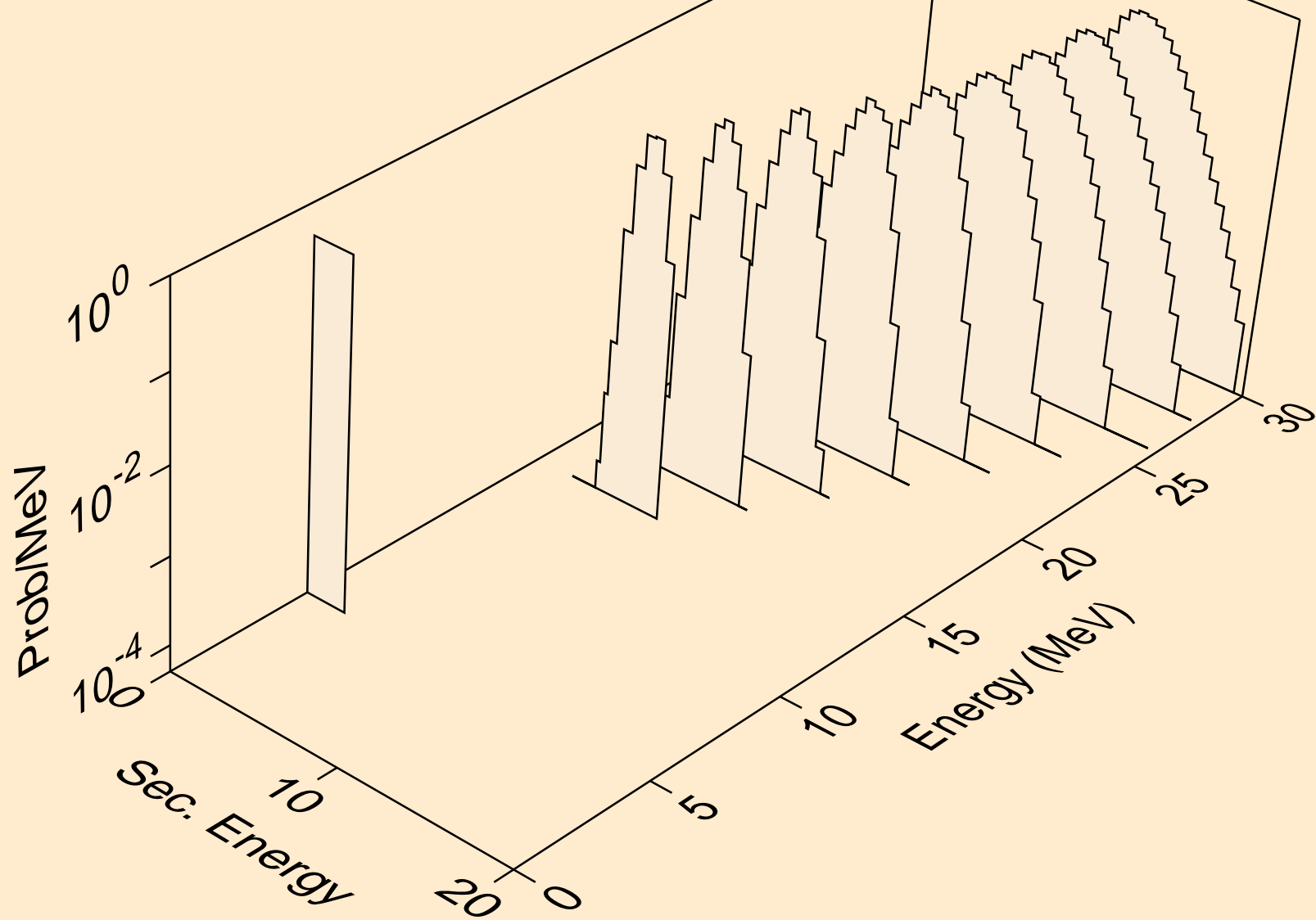

MD254M NEUTRON ACER TENDL-2021 LIBRARY; T=293.6K
he3s from (n,x)

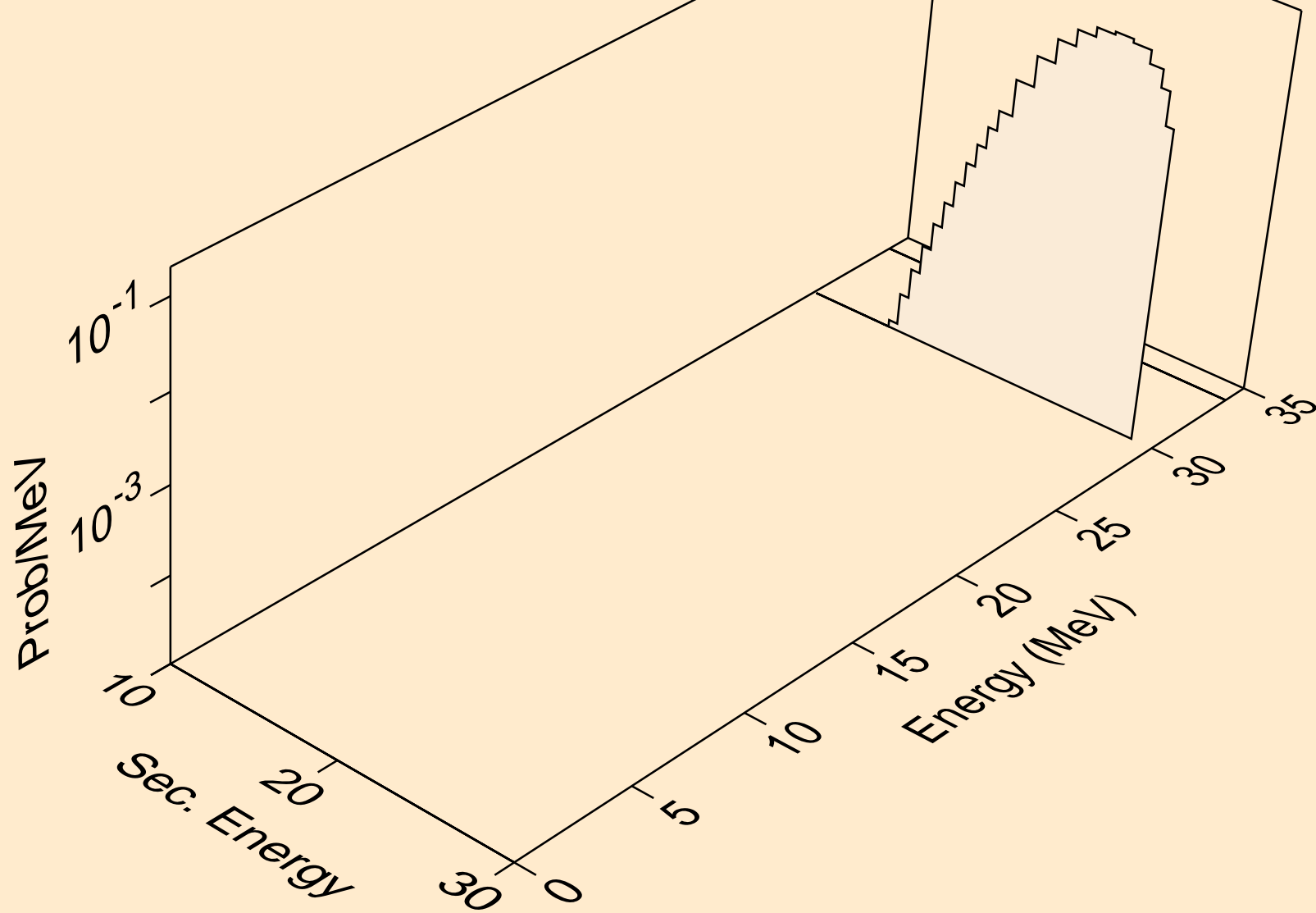

MD254M NEUTRON ACER TENDL-2021 LIBRARY; T=293.6K
he3s from (n,n*)he3

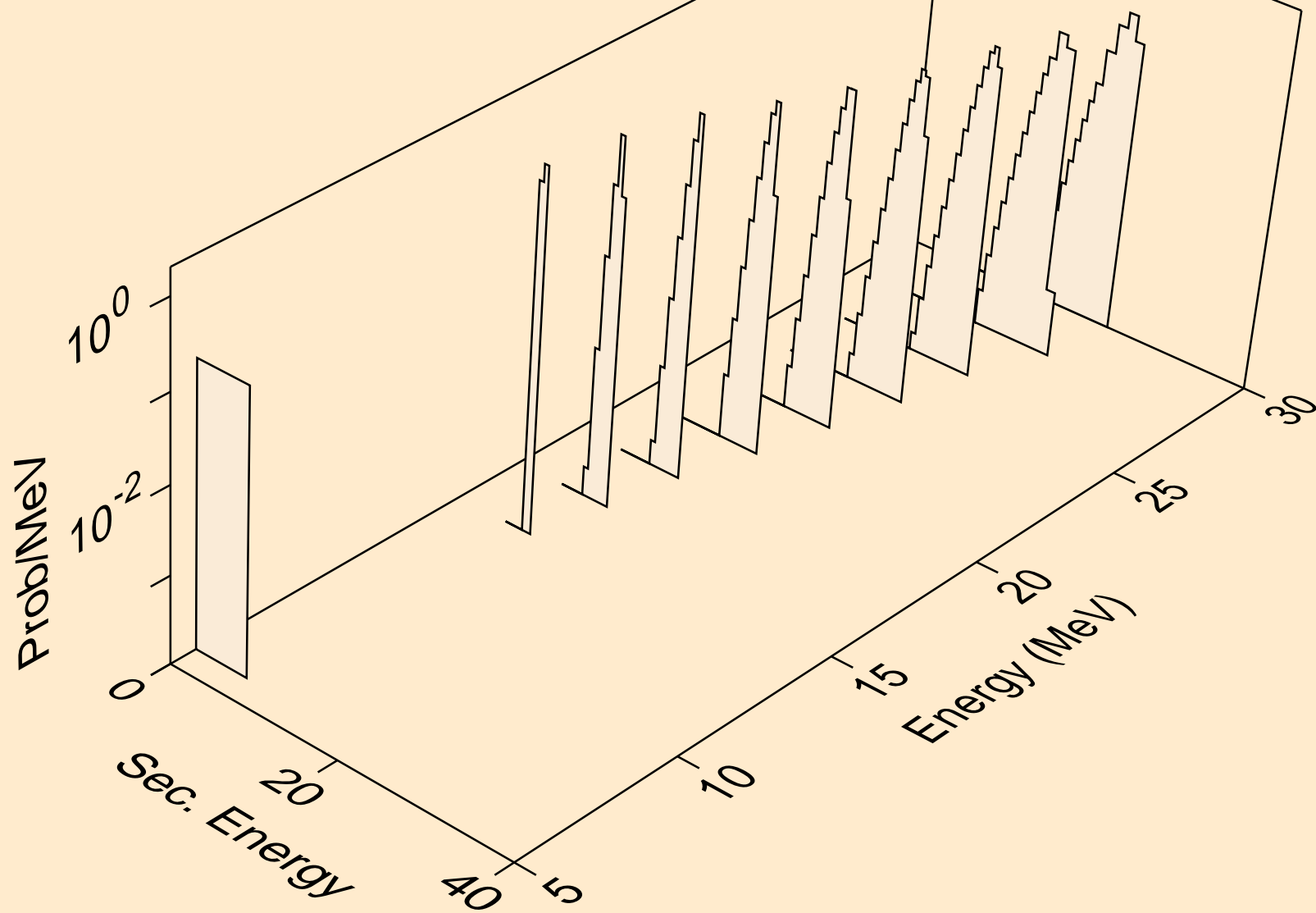

MD254M NEUTRON ACER TENDL-2021 LIBRARY; T=293.6K
he3s from (n,he3)

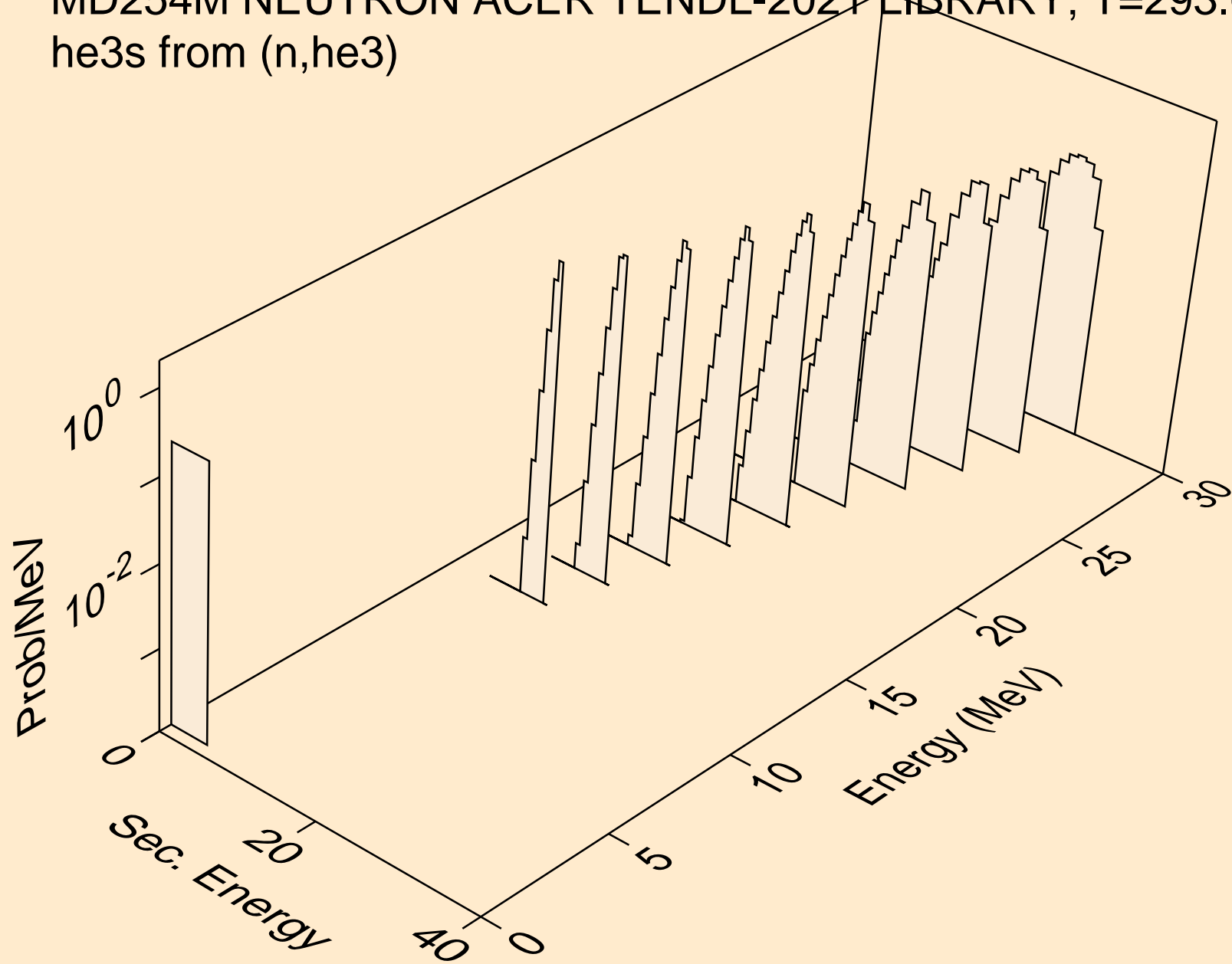

MD254M NEUTRON ACER TENDL-2021 LIBRARY; T=293.6K
alphas from (n,x)

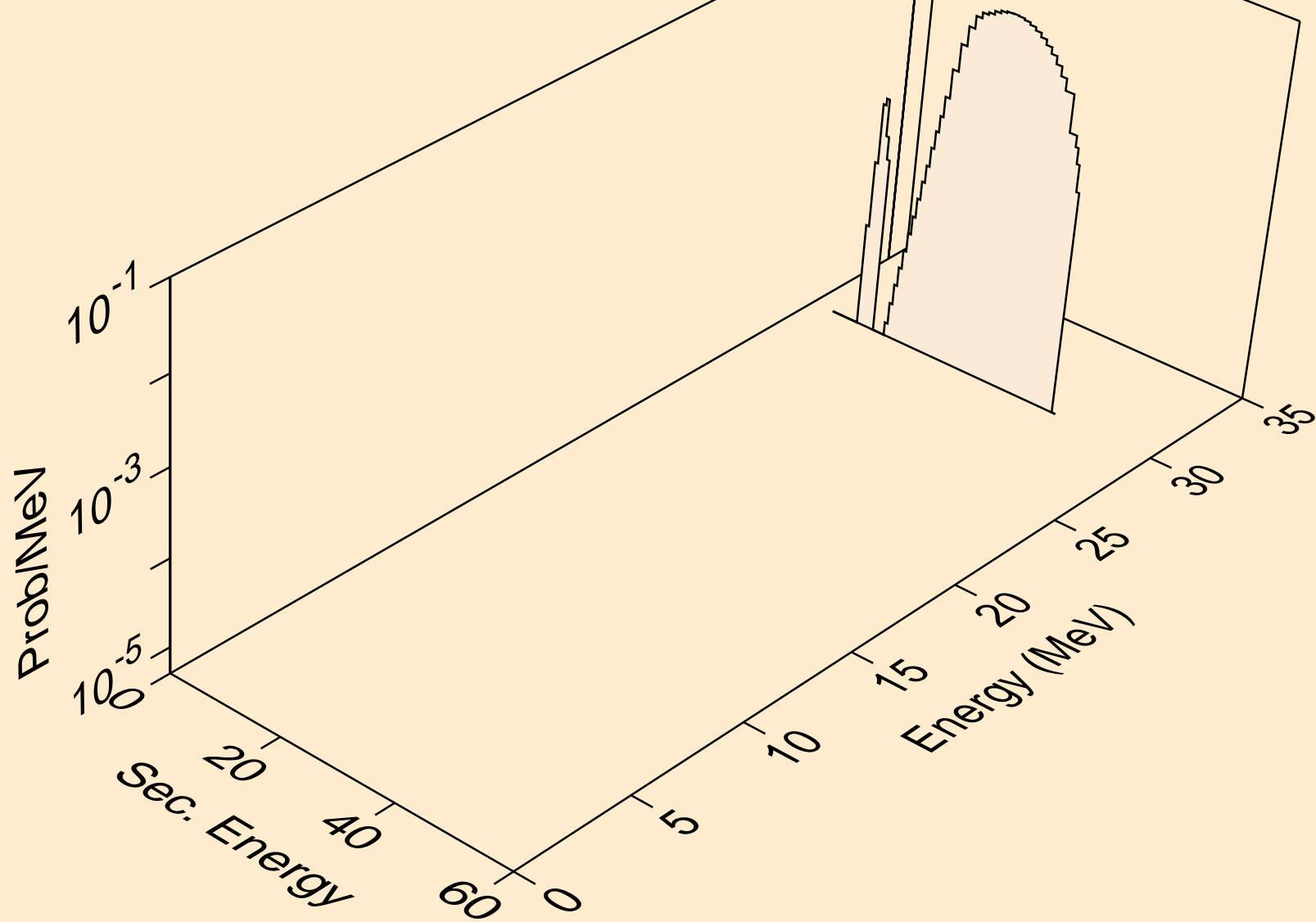

MD254M NEUTRON ACER TENDL-2021 LIBRARY; T=293.6K
alphas from (n,n*)a

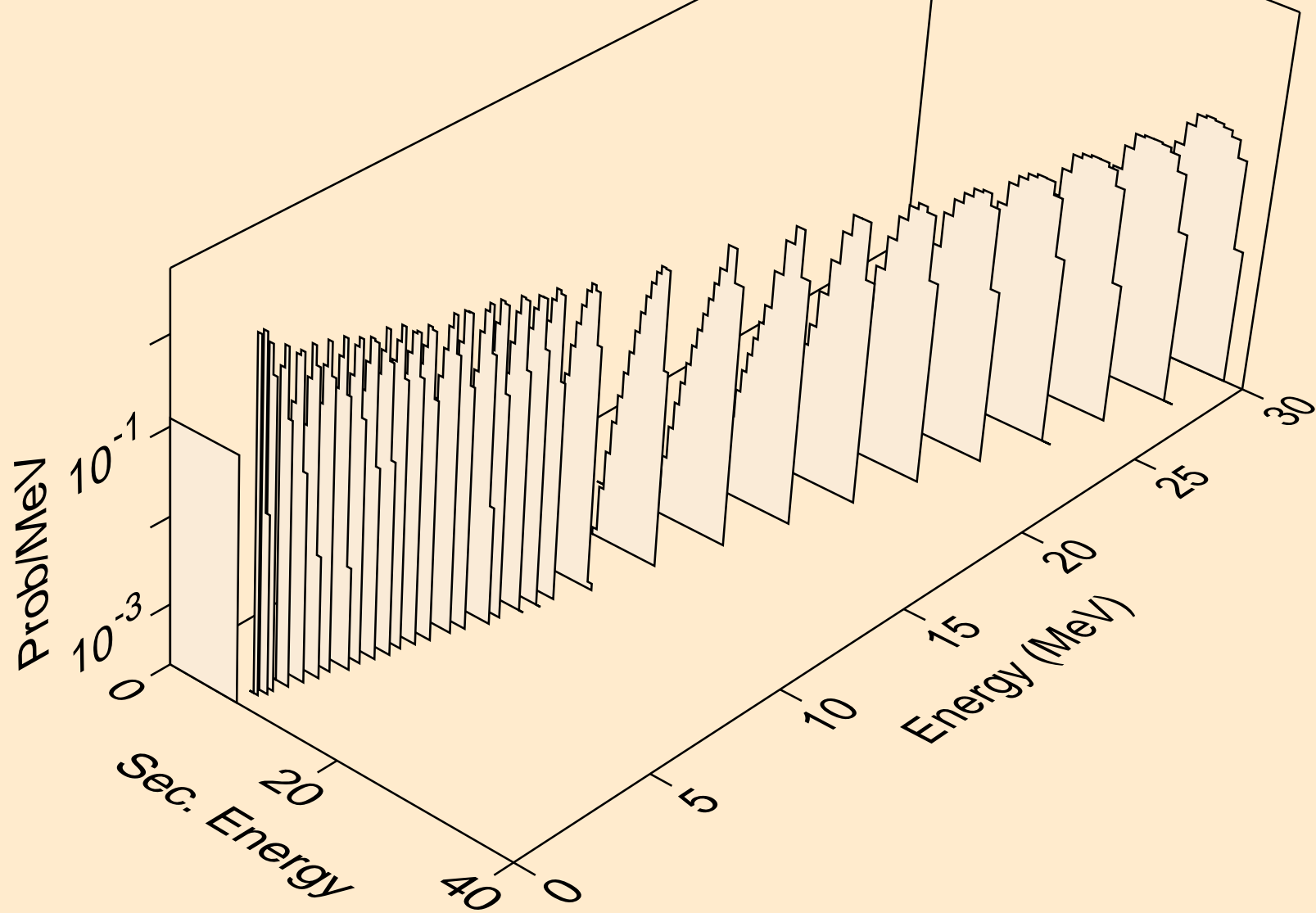

MD254M NEUTRON ACER TENDL-2021 LIBRARY; T=293.6K
alphas from (n,2n)a

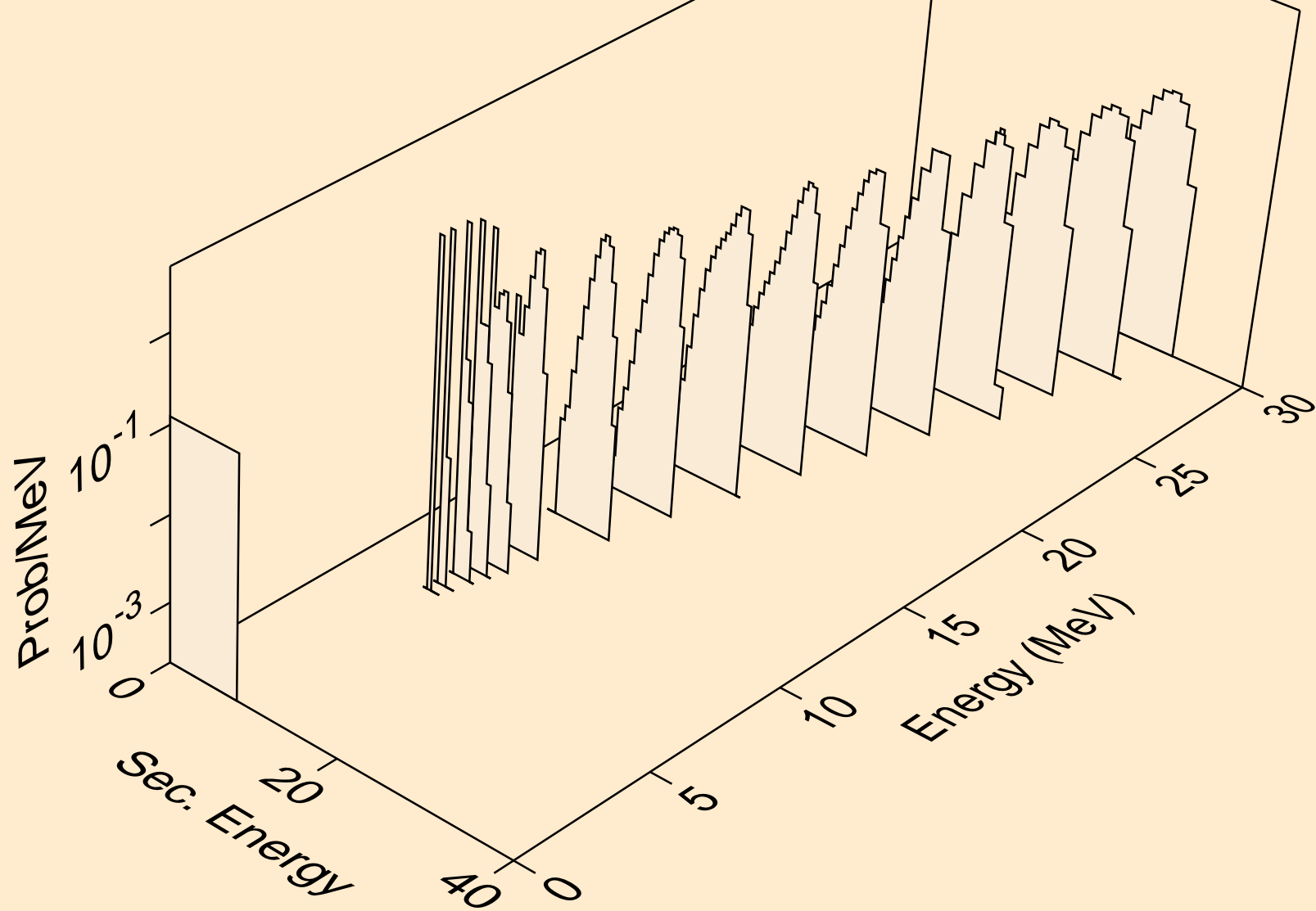

MD254M NEUTRON ACER TENDL-2021 LIBRARY; T=293.6K
alphas from (n,3n)a

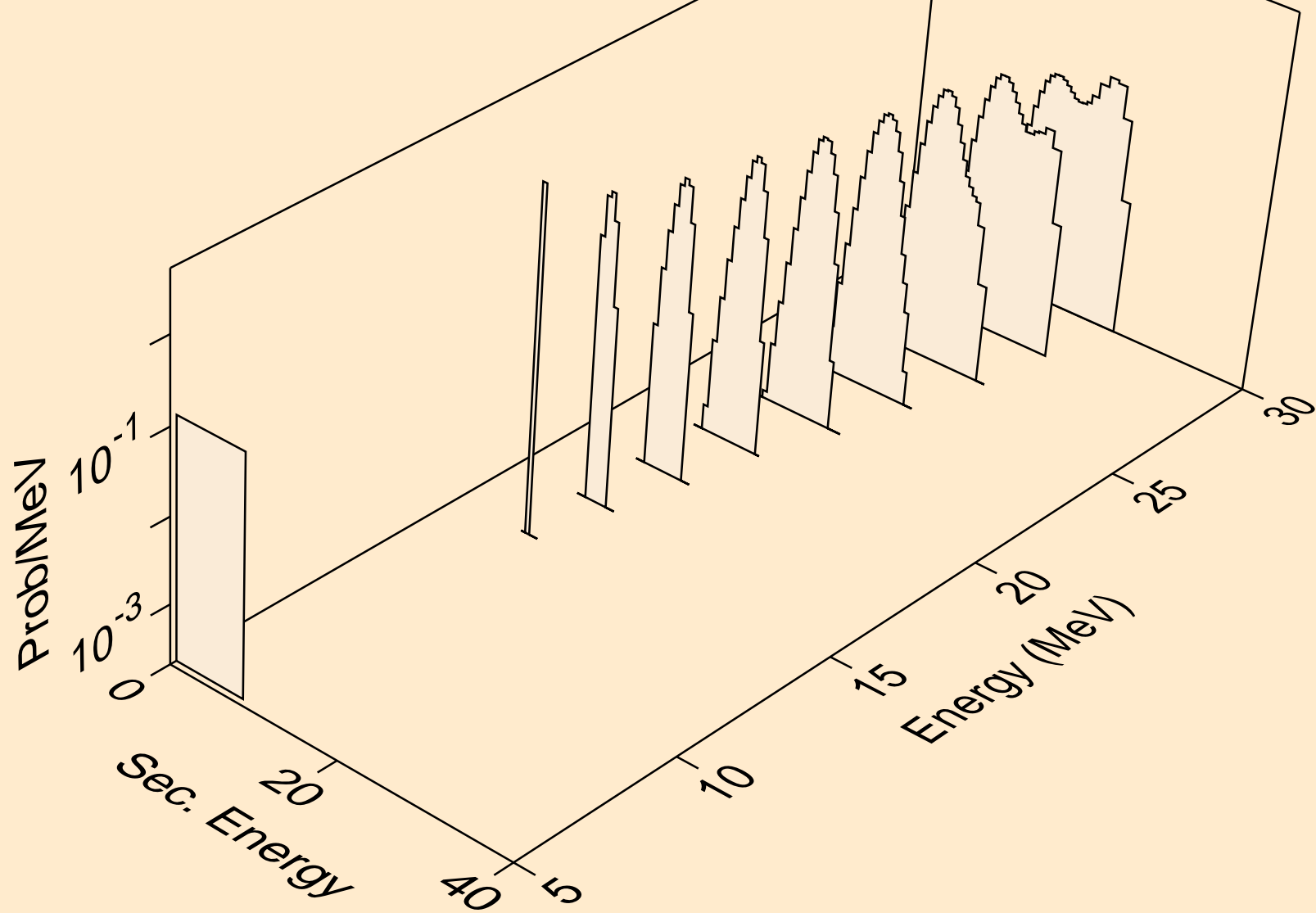

MD254M NEUTRON ACER TENDL-2021 LIBRARY; T=293.6K
alphas from (n,n*)2a

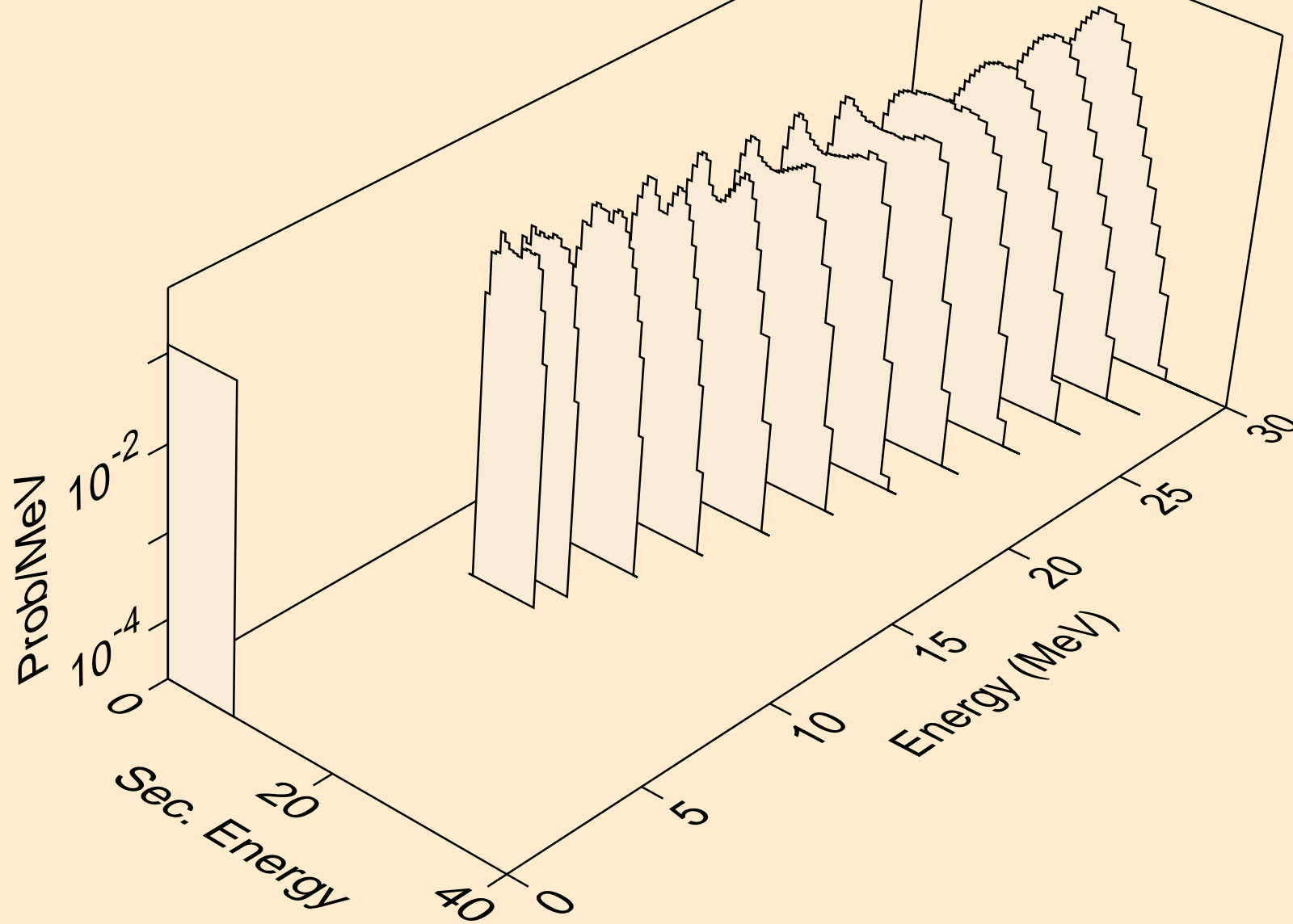

MD254M NEUTRON ACER TENDL-2021 LIBRARY; T=293.6K
alphas from (n,npa)

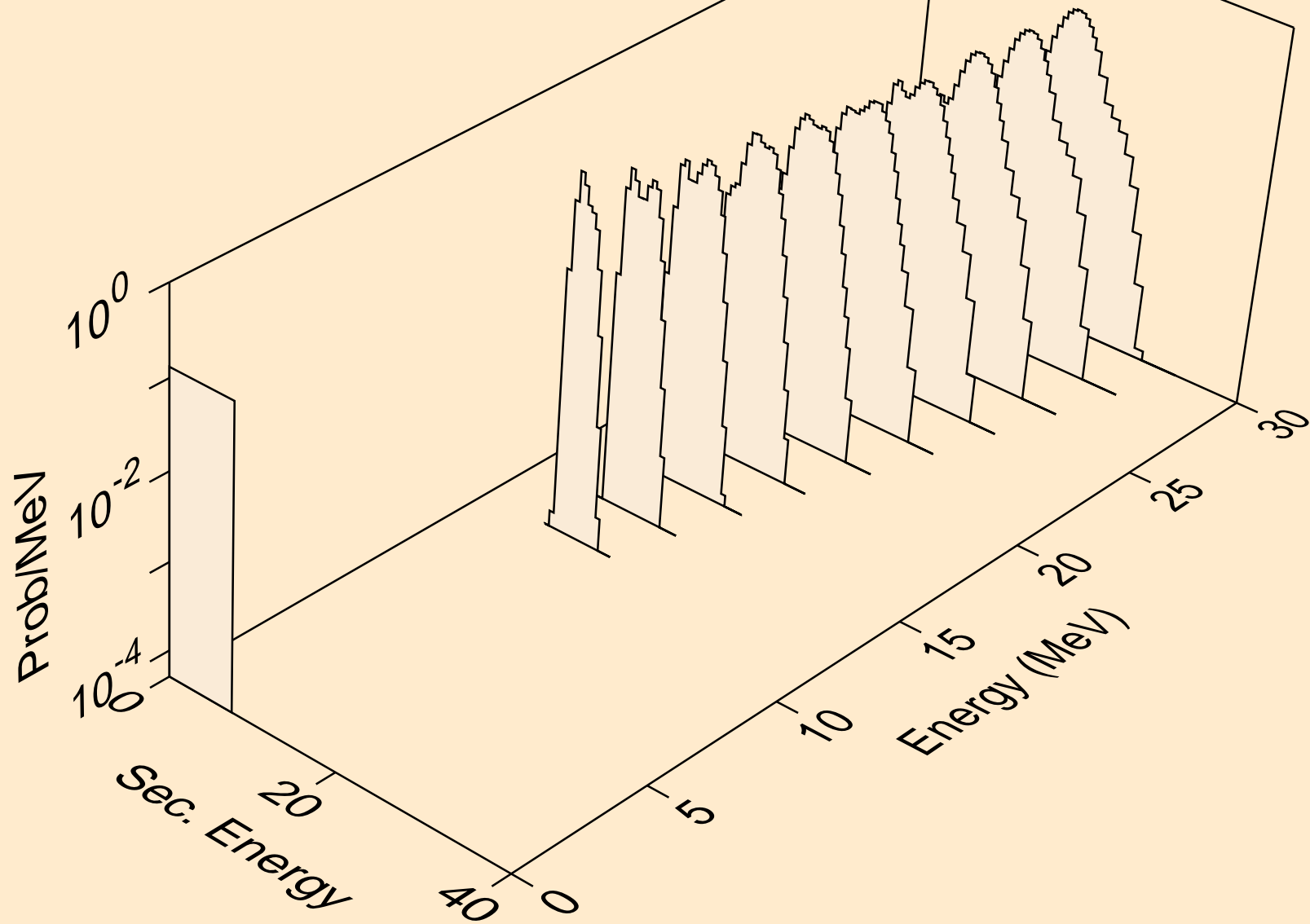

MD254M NEUTRON ACER TENDL-2021 LIBRARY; T=293.6K
alphas from (n,a)

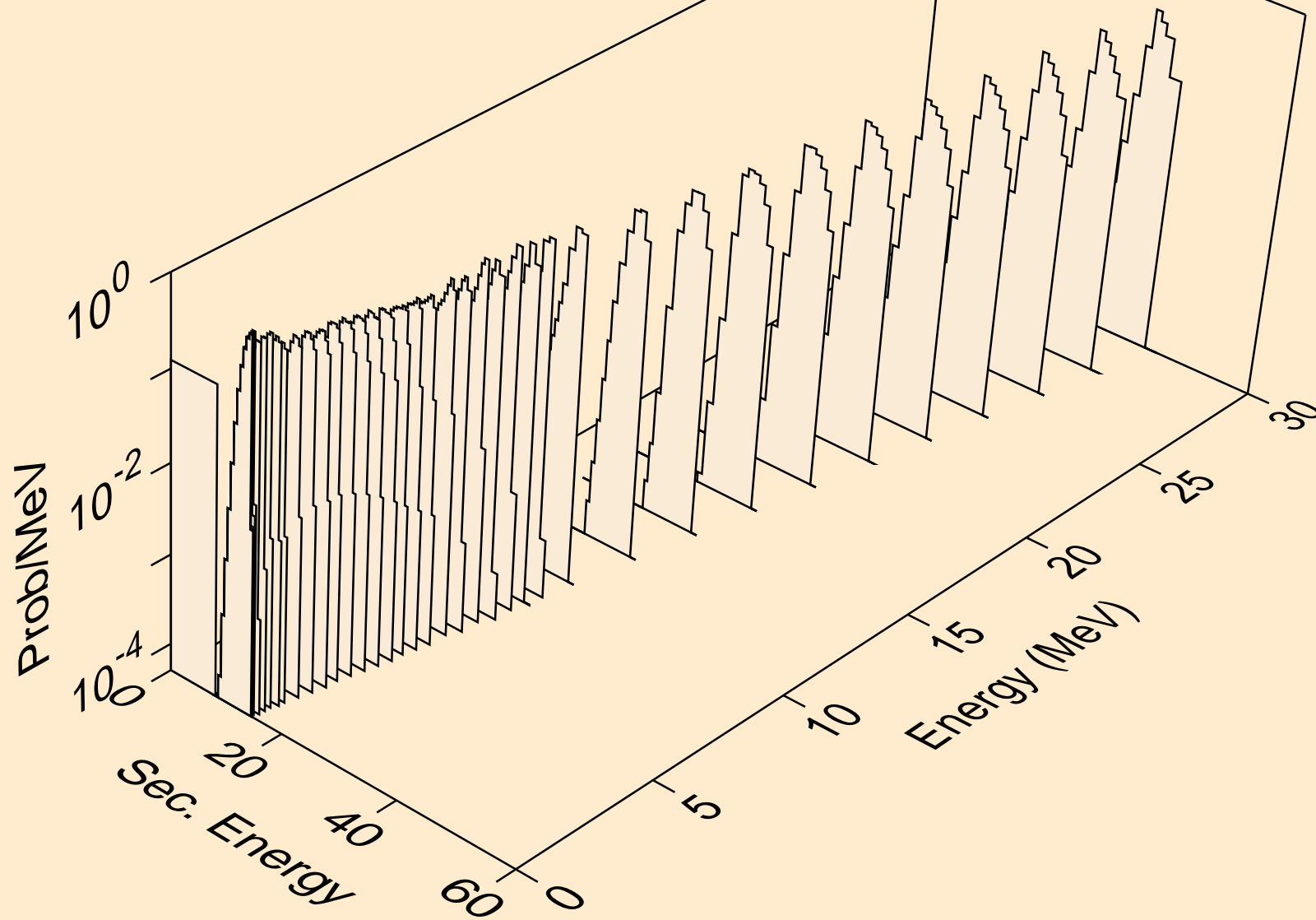

MD254M NEUTRON ACER TENDL-2021 LIBRARY; T=293.6K
alphas from (n,2a)

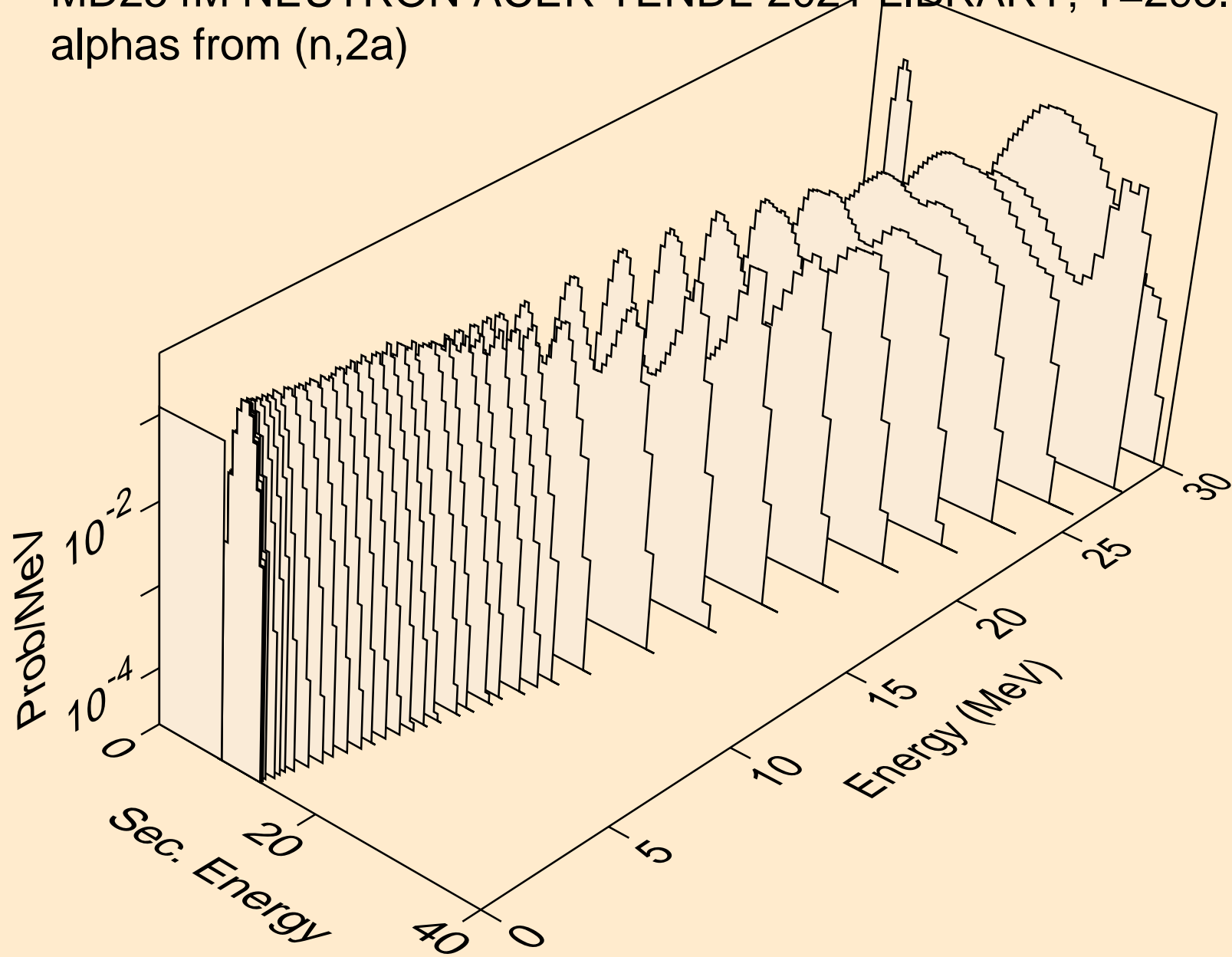

MD254M NEUTRON ACER TENDL-2021 LIBRARY; T=293.6K
alphas from (n,pa)

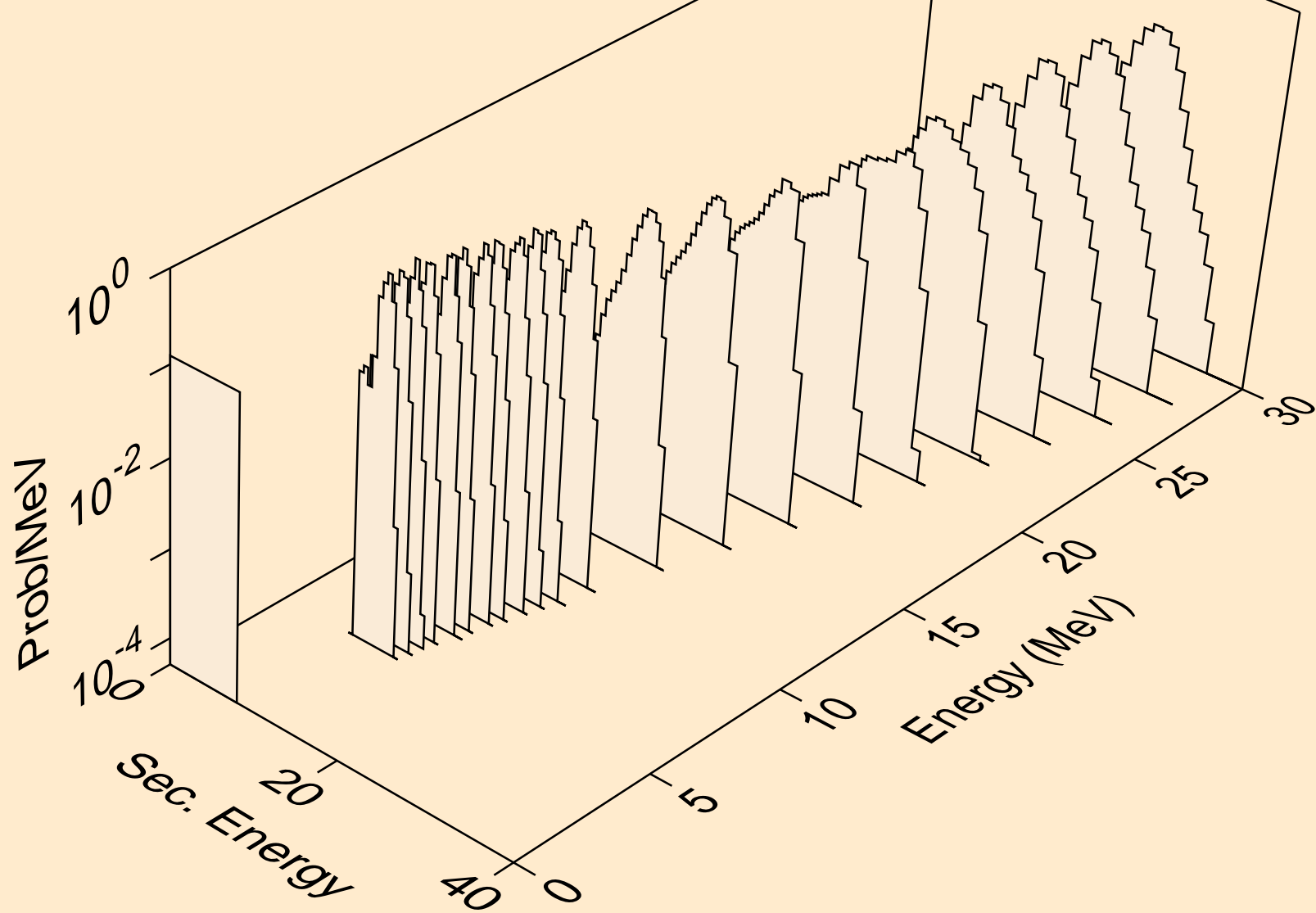

MD254M NEUTRON ACER TENDL-2021 LIBRARY; T=293.6K
alphas from (n,da)

