

MD258M NEUTRON ACER TENDL-2021 LIBRARY; T=293.6K

Principal cross sections

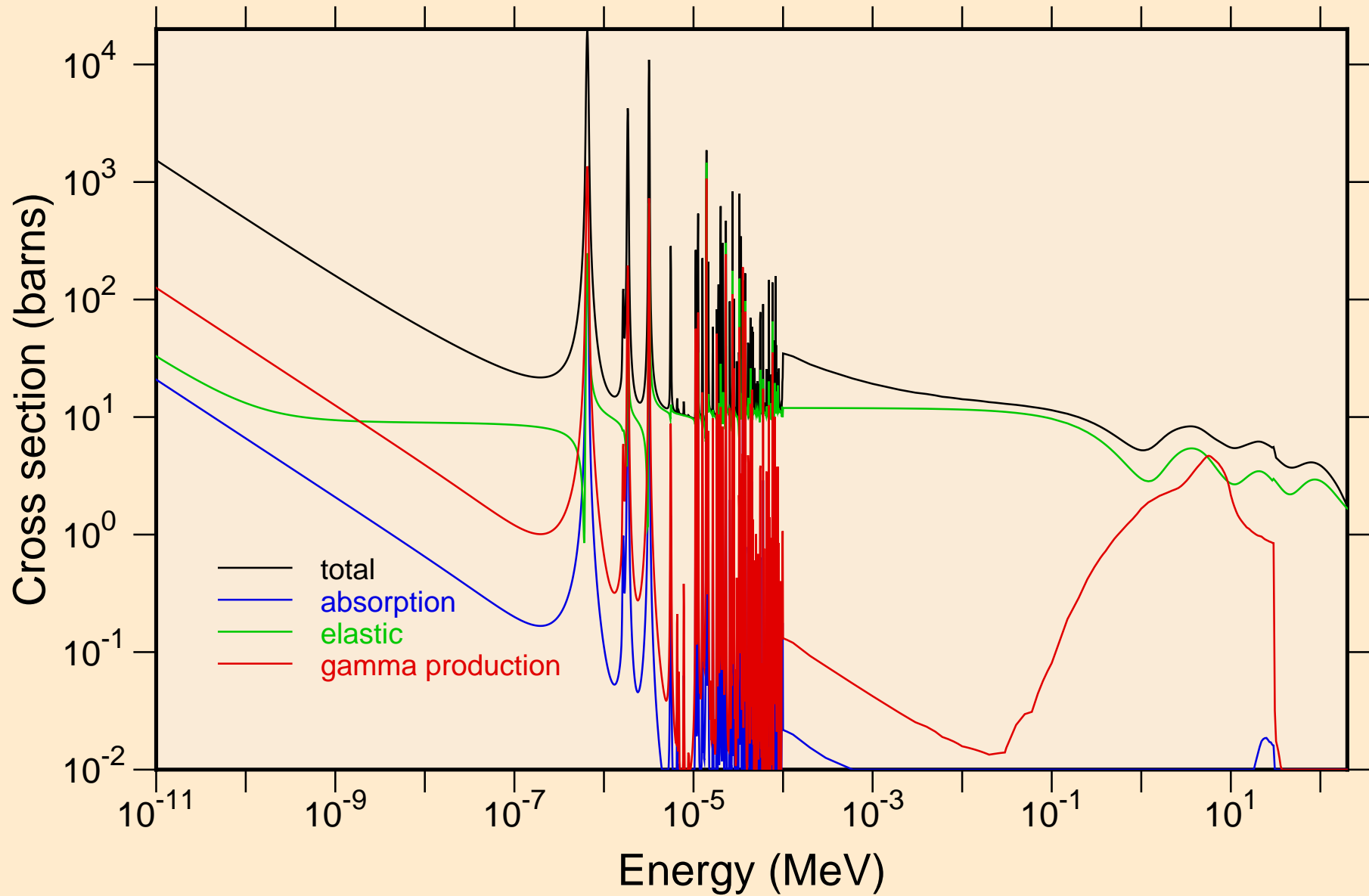

MD258M NEUTRON ACER TENDL-2021 LIBRARY; T=293.6K
resonance total cross section

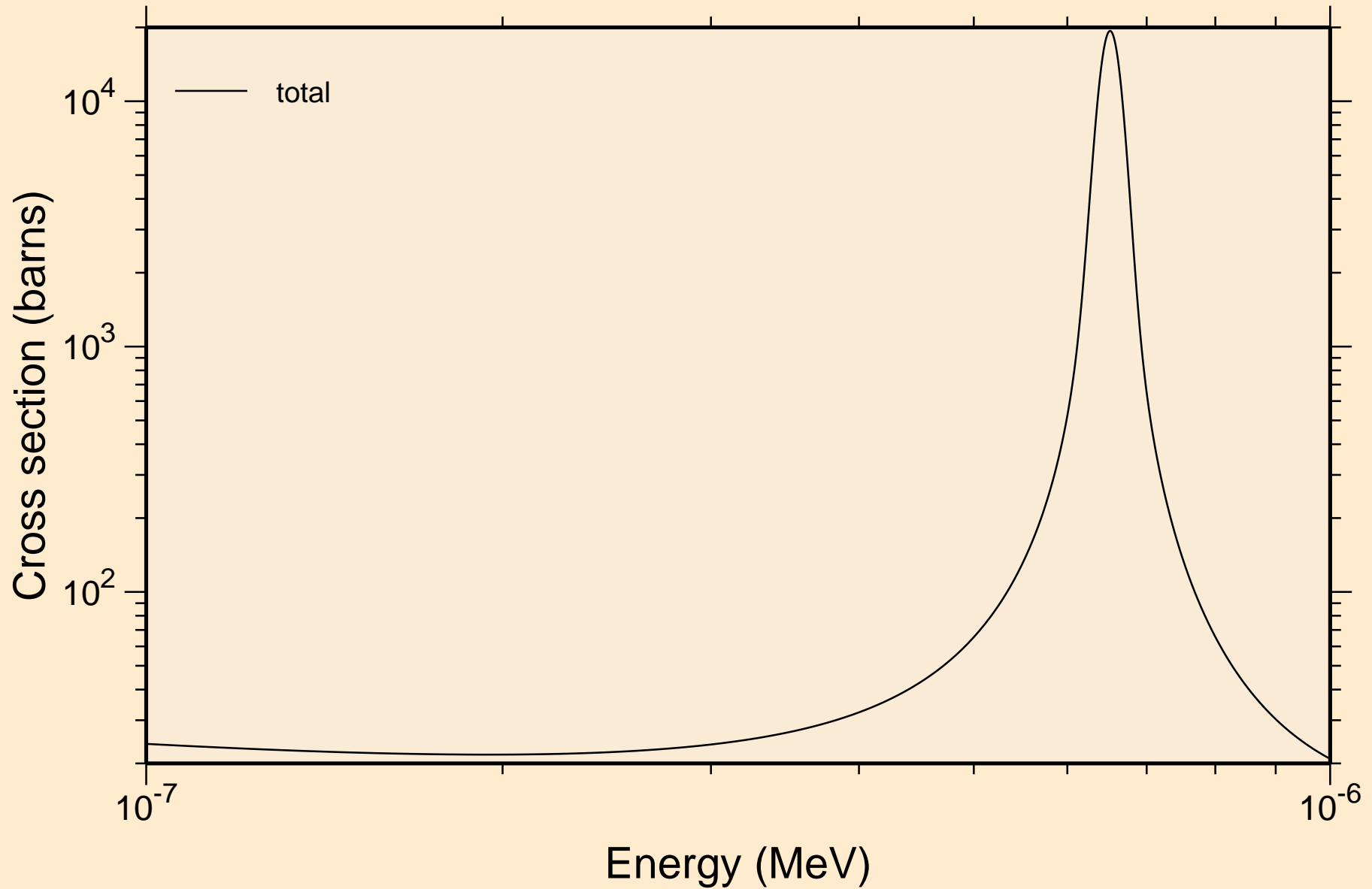

MD258M NEUTRON ACER TENDL-2021 LIBRARY; T=293.6K
resonance total cross section

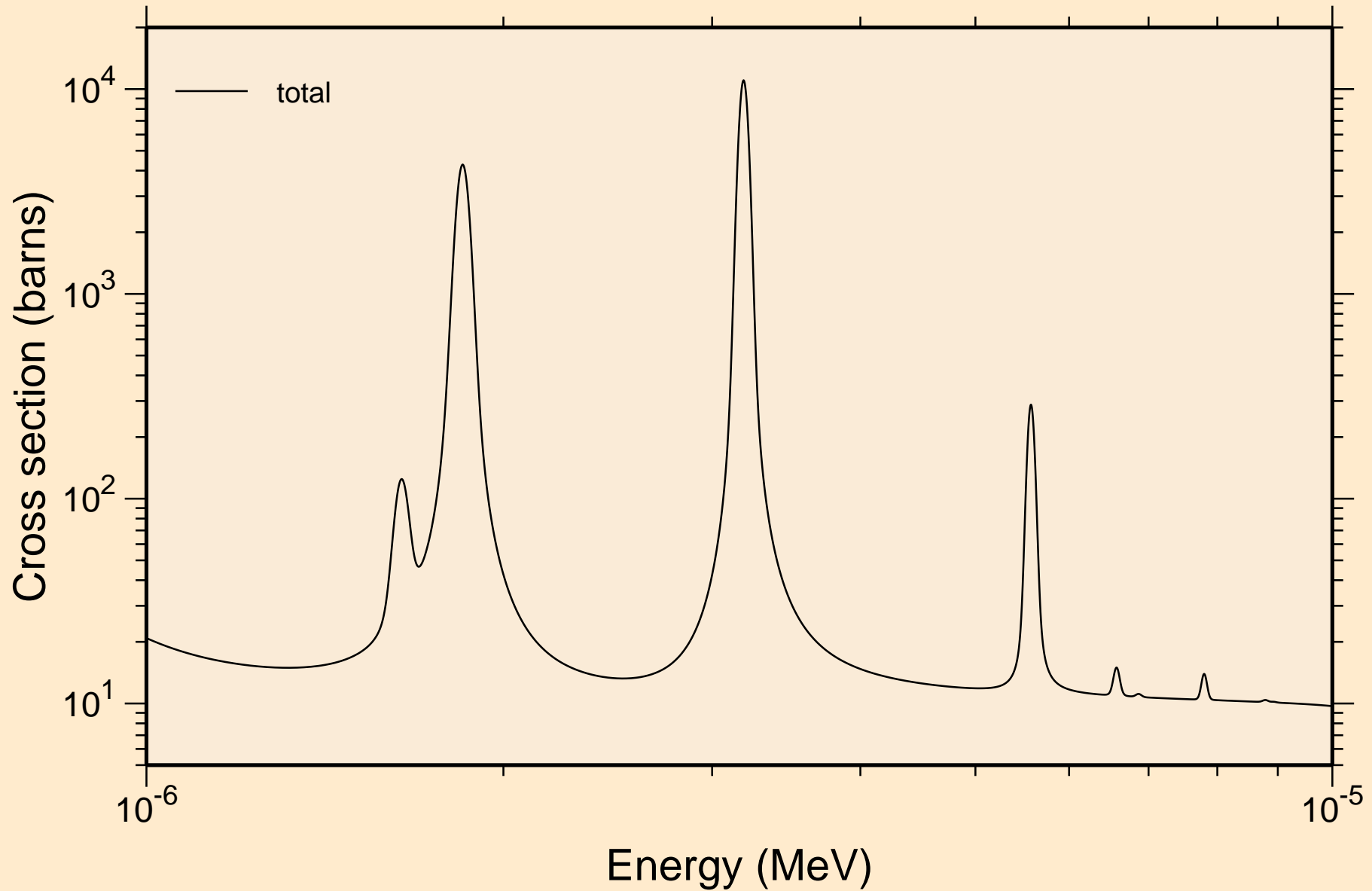

MD258M NEUTRON ACER TENDL-2021 LIBRARY; T=293.6K
resonance total cross section

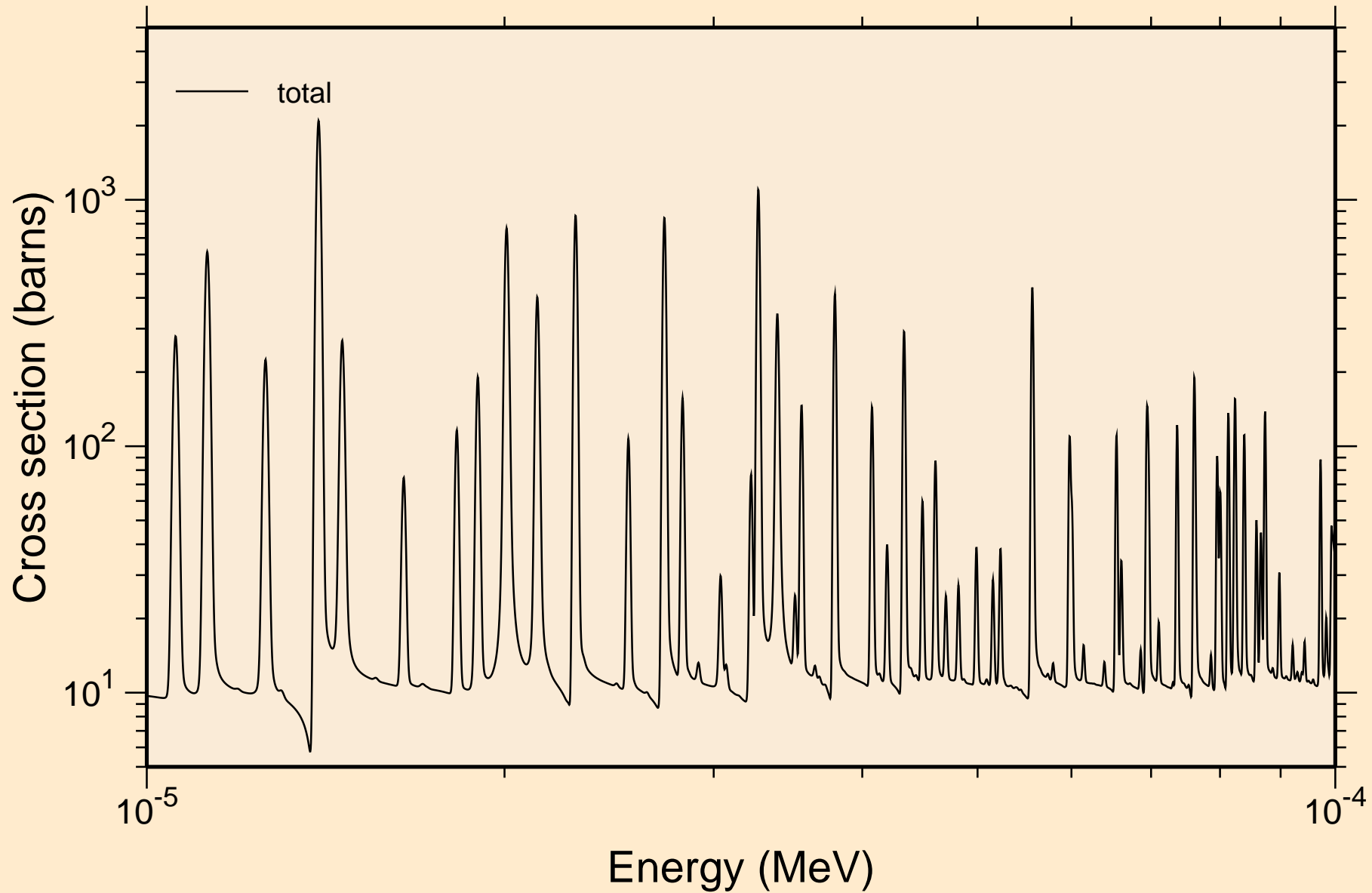

MD258M NEUTRON ACER TENDL-2021 LIBRARY; T=293.6K
resonance total cross section

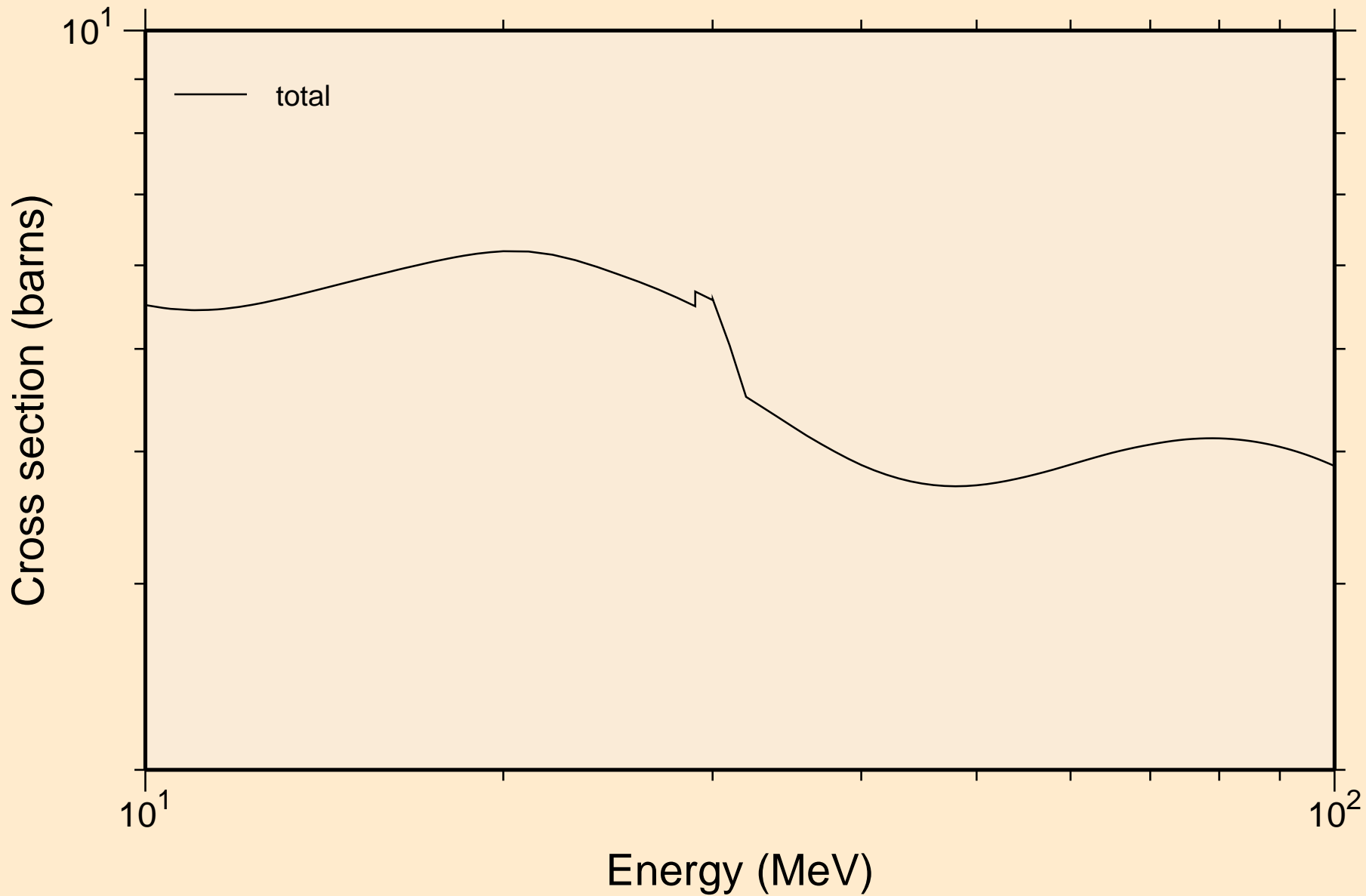

MD258M NEUTRON ACER TENDL-2021 LIBRARY; T=293.6K
resonance absorption cross sections

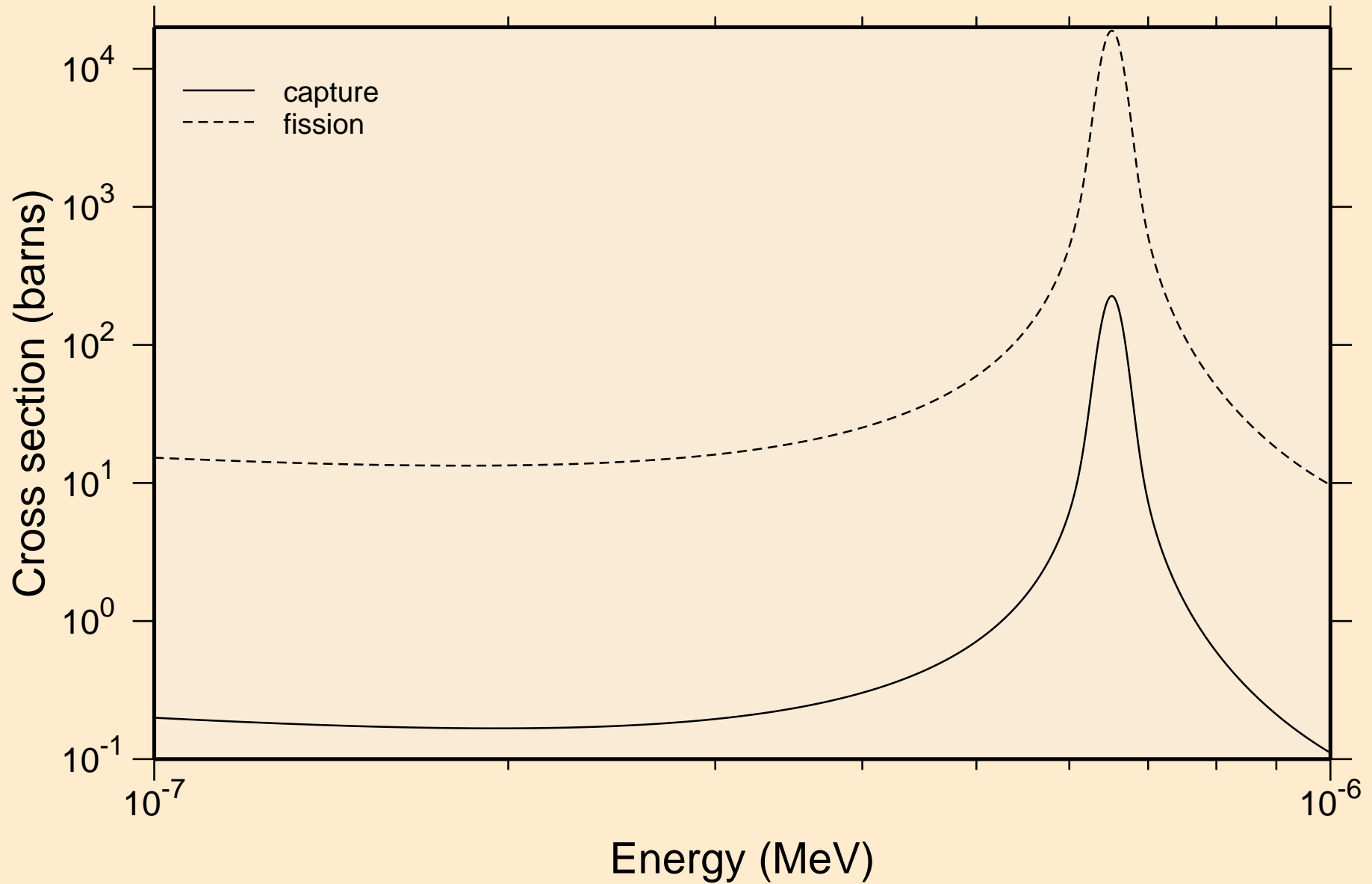

MD258M NEUTRON ACER TENDL-2021 LIBRARY; T=293.6K
resonance absorption cross sections

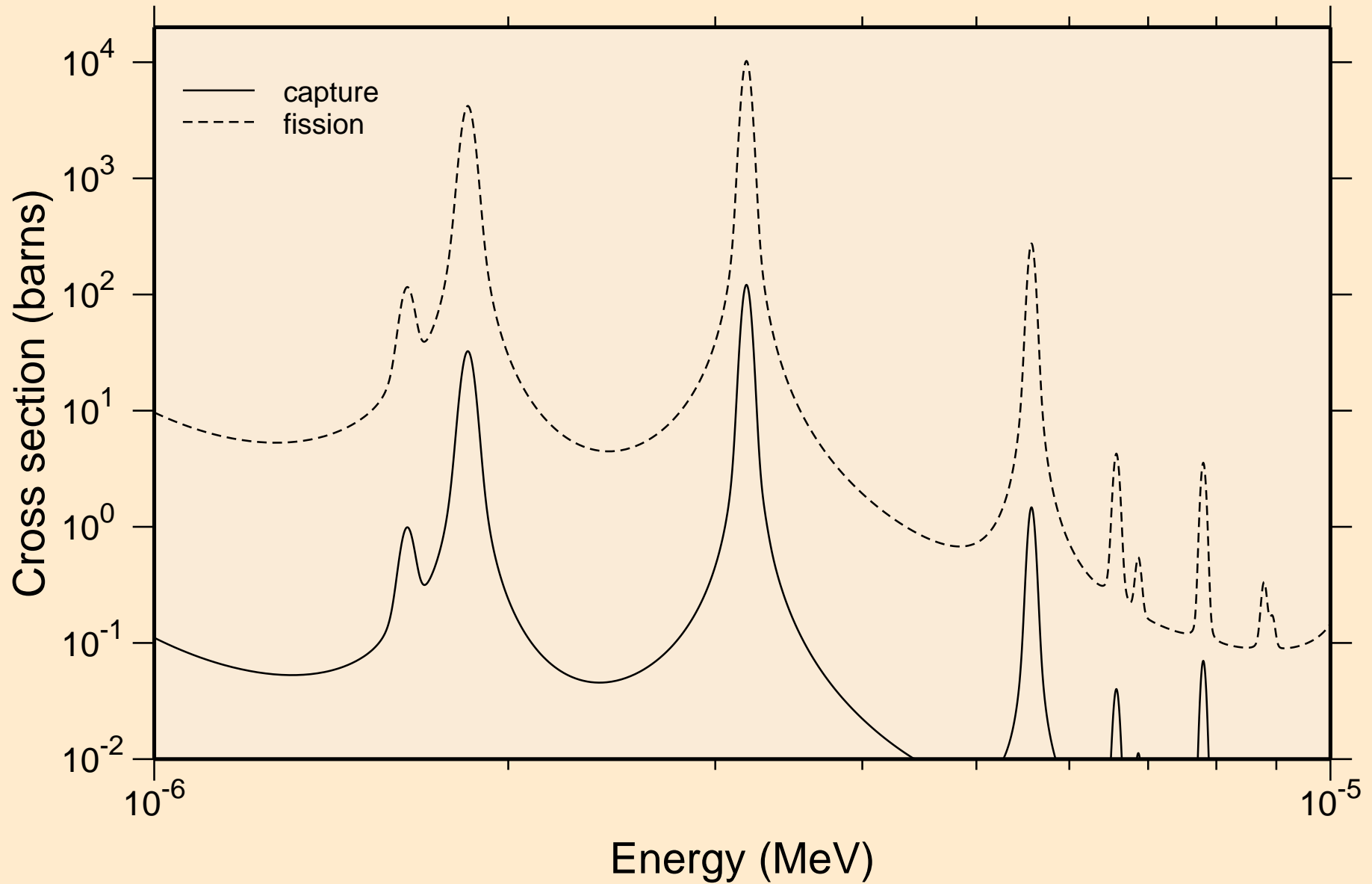

MD258M NEUTRON ACER TENDL-2021 LIBRARY; T=293.6K
resonance absorption cross sections

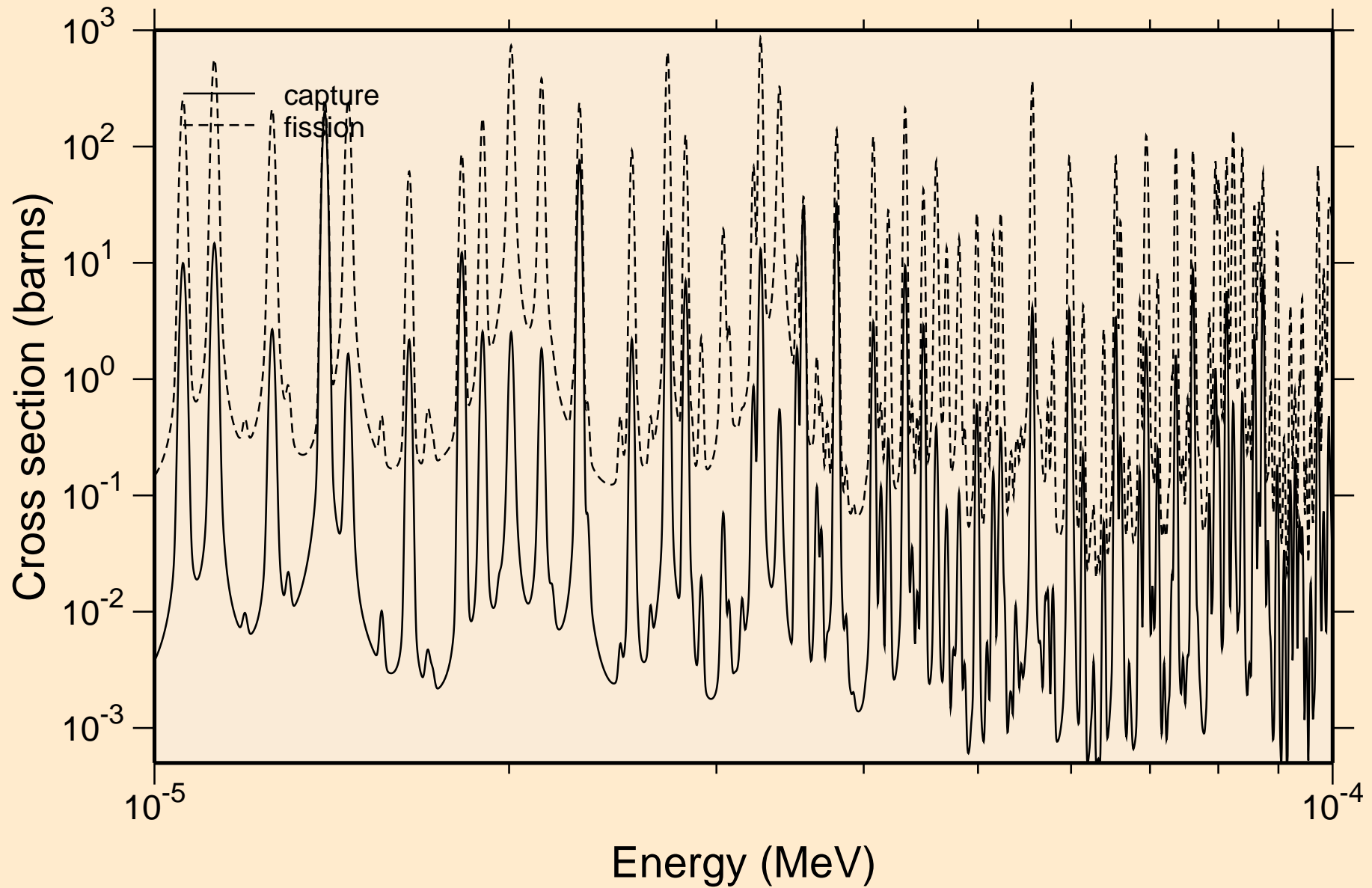

MD258M NEUTRON ACER TENDL-2021 LIBRARY; T=293.6K
resonance absorption cross sections

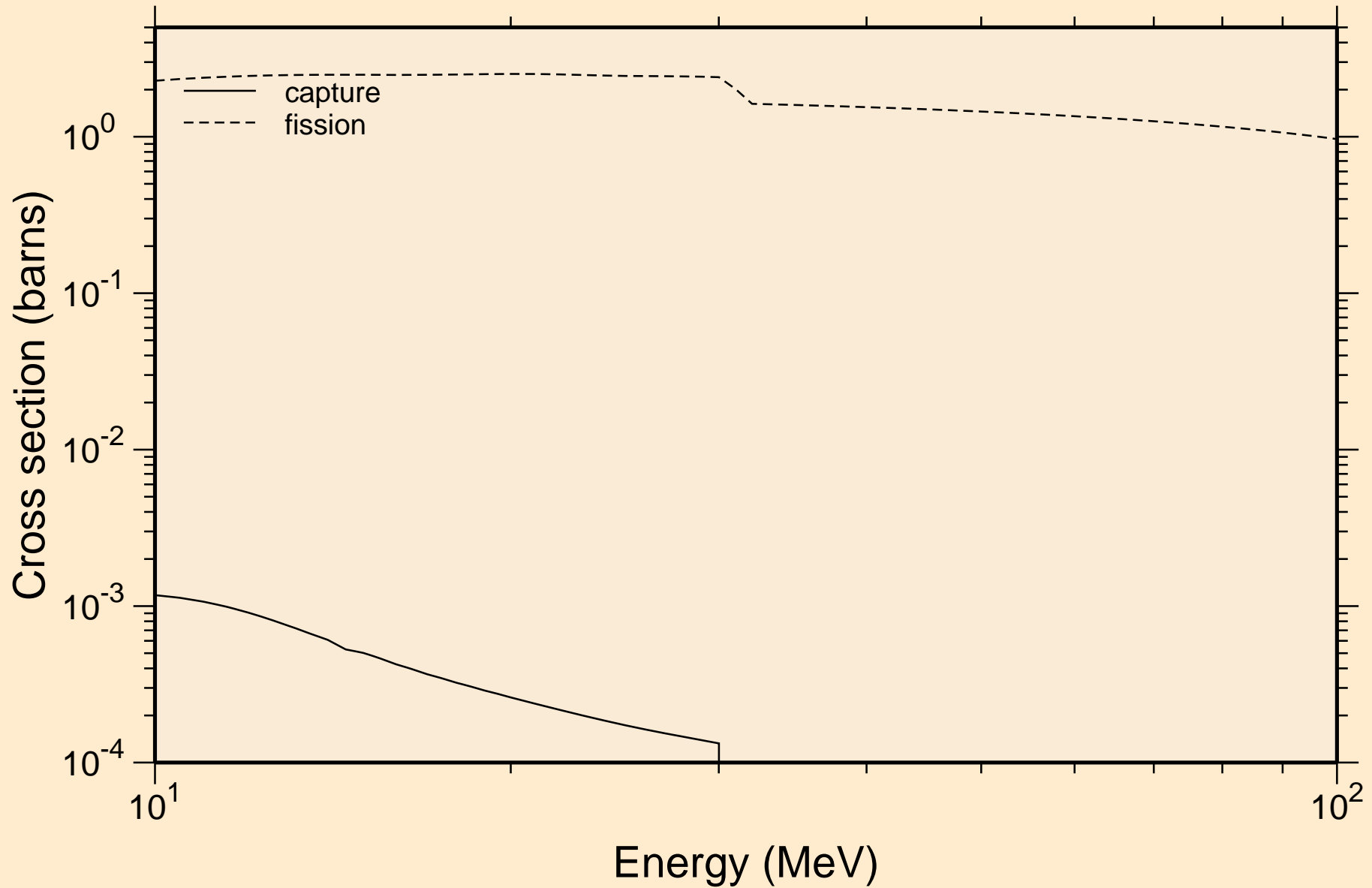

MD258M NEUTRON ACER TENDL-2021 LIBRARY; T=293.6K
Heating

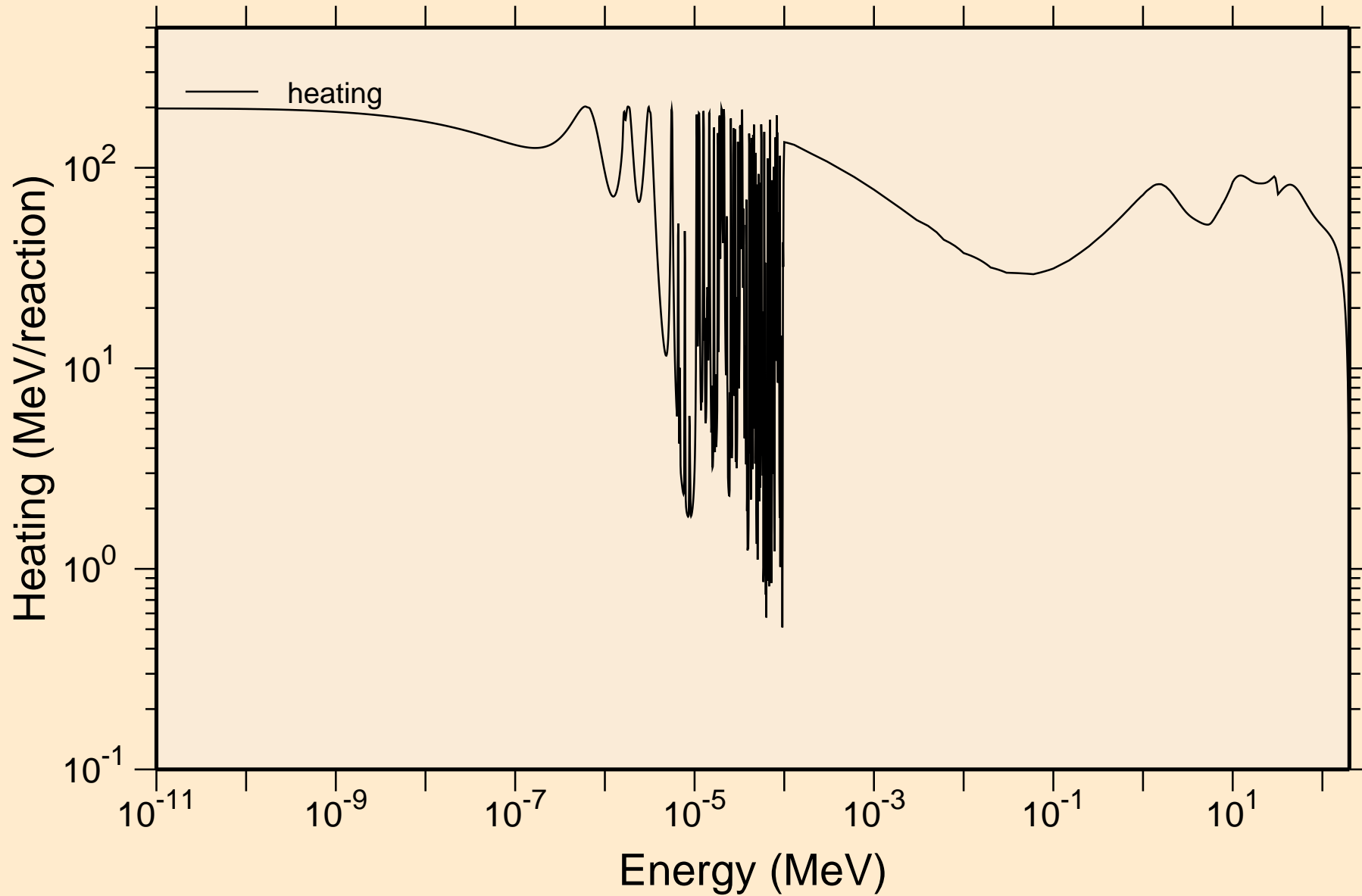

MD258M NEUTRON ACER TENDL-2021 LIBRARY; T=293.6K
Damage

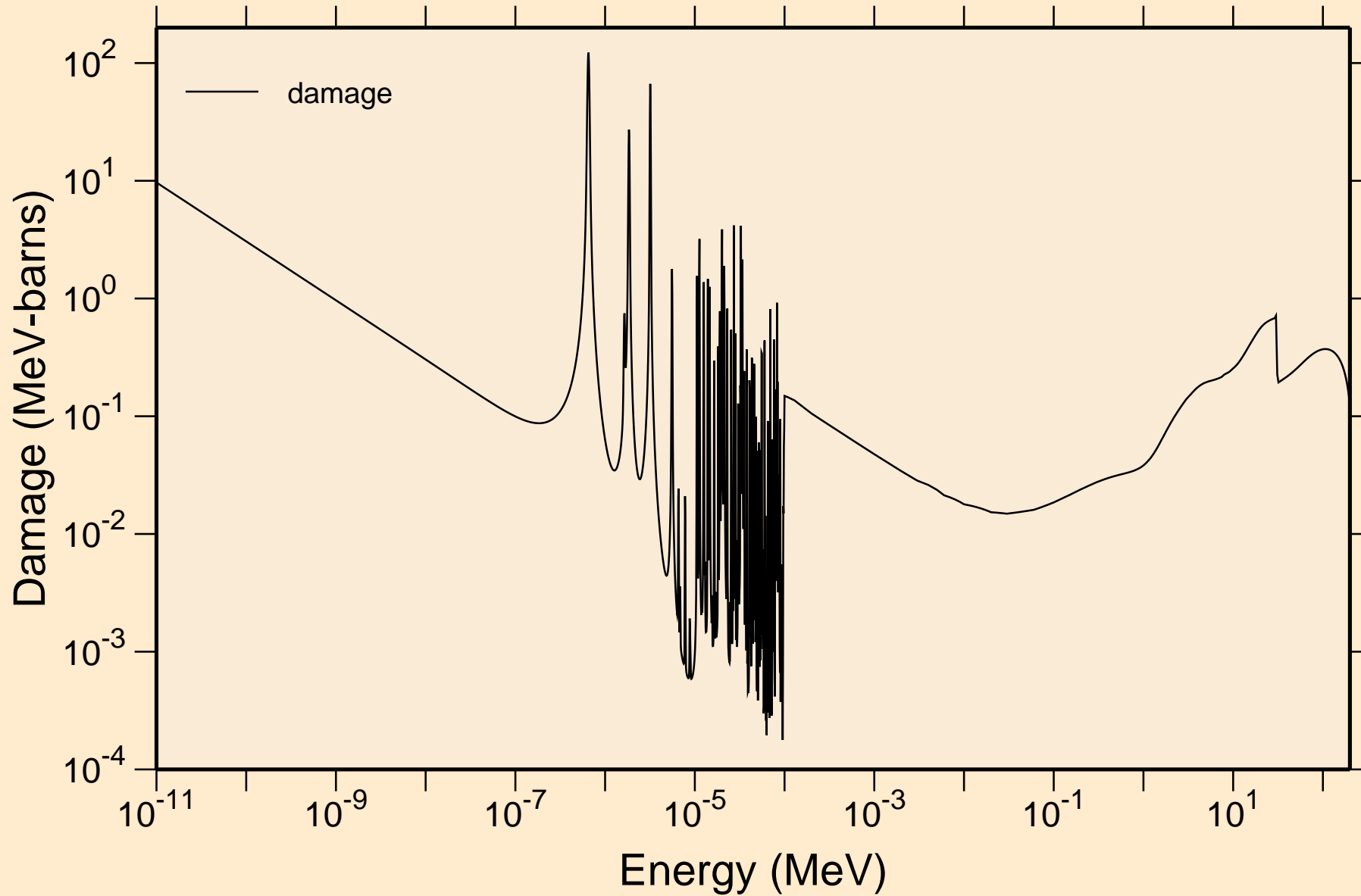

MD258M NEUTRON ACER TENDL-2021 LIBRARY; T=293.6K
Non-threshold reactions

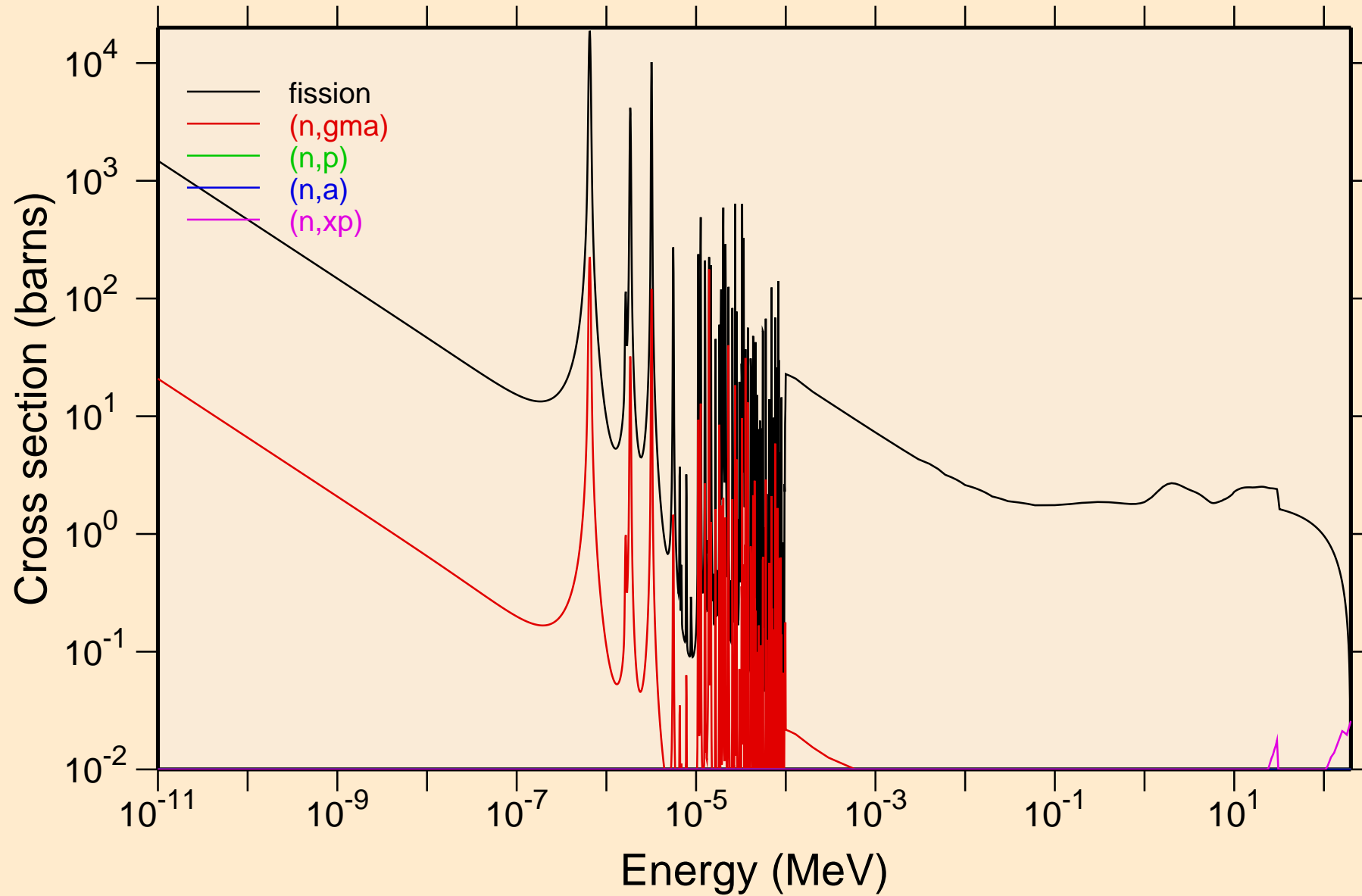

MD258M NEUTRON ACER TENDL-2021 LIBRARY; T=293.6K
Non-threshold reactions

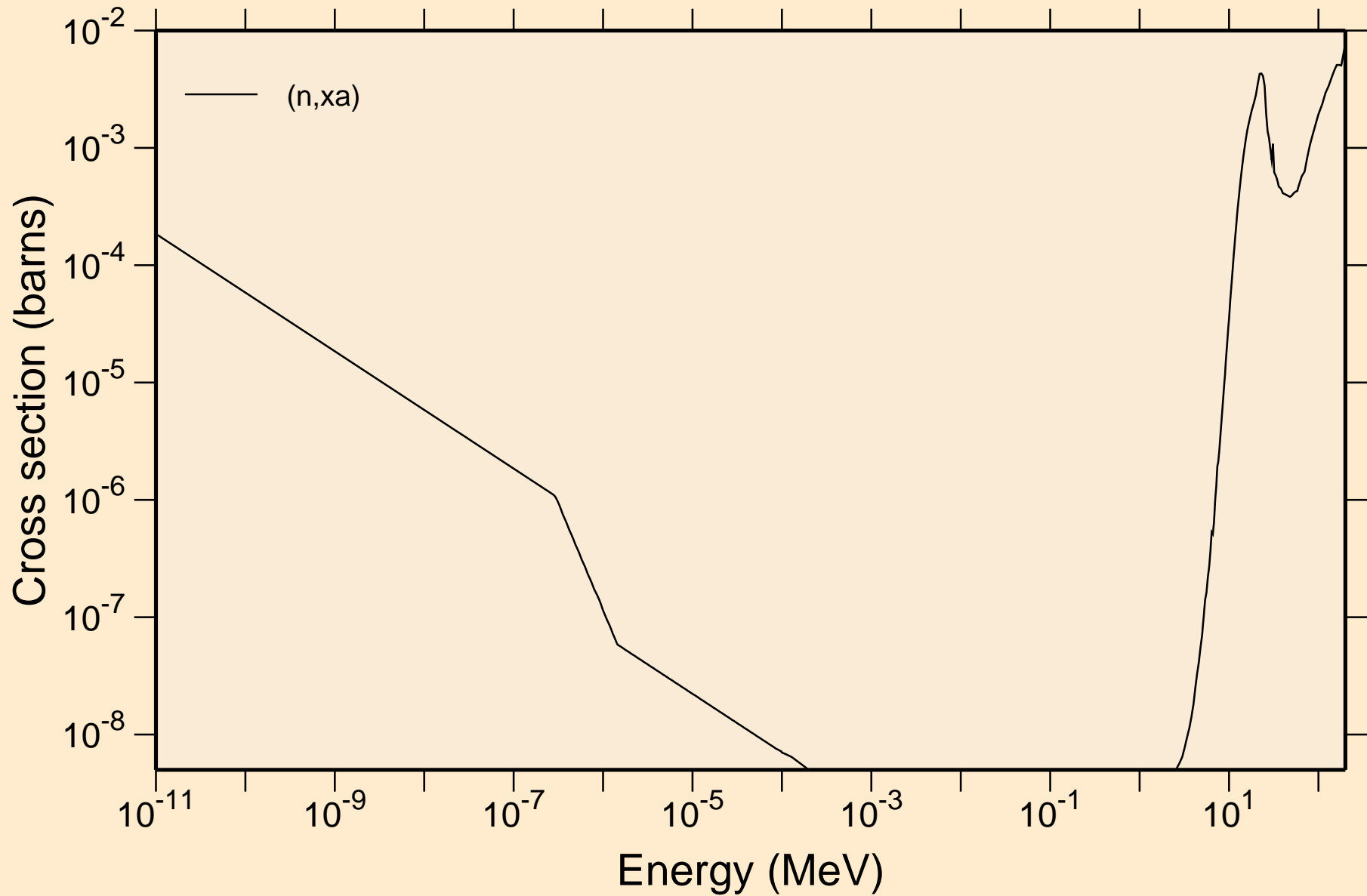

MD258M NEUTRON ACER TENDL-2021 LIBRARY; T=293.6K
Principal cross sections

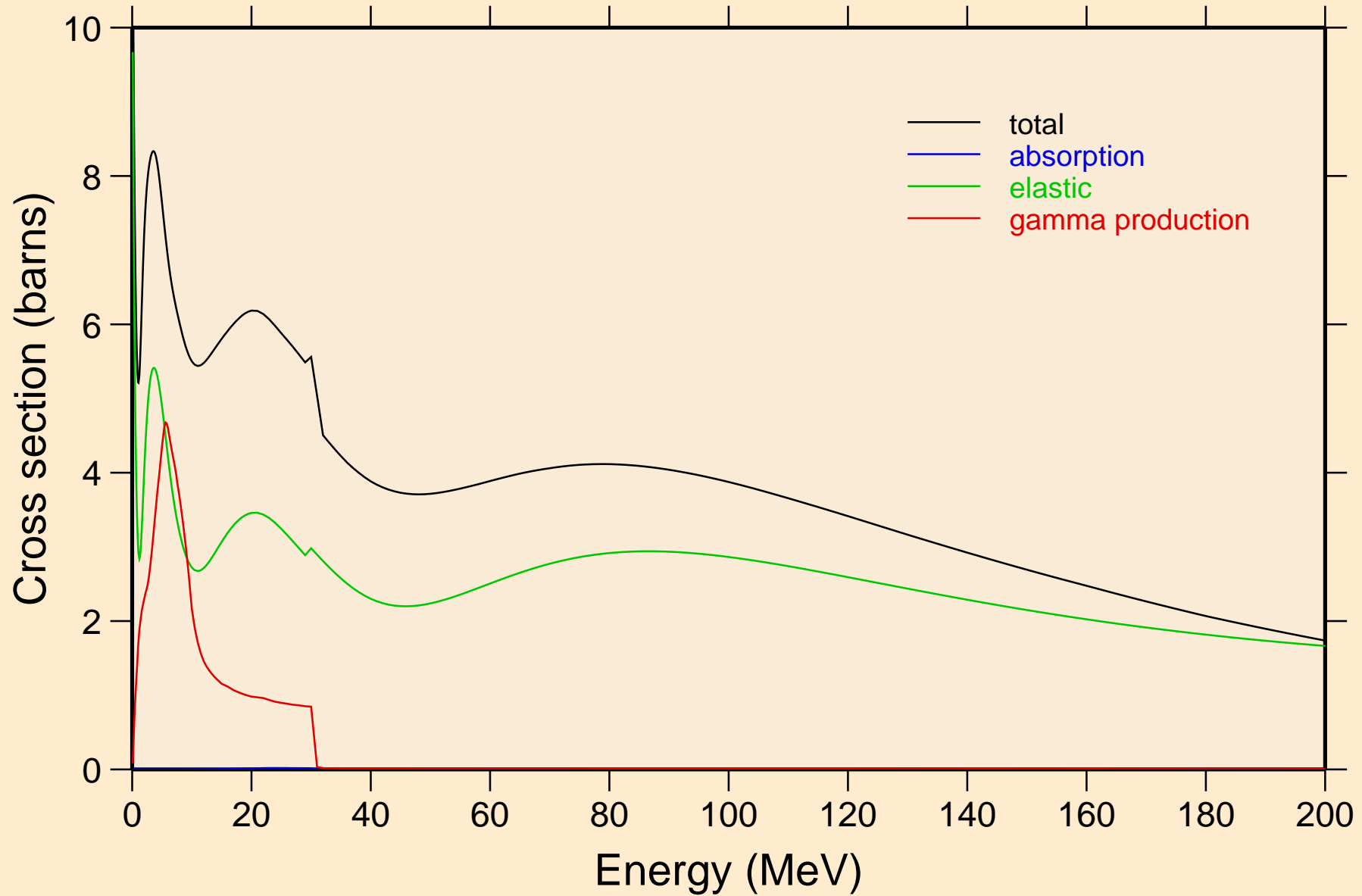

MD258M NEUTRON ACER TENDL-2021 LIBRARY; T=293.6K
Heating

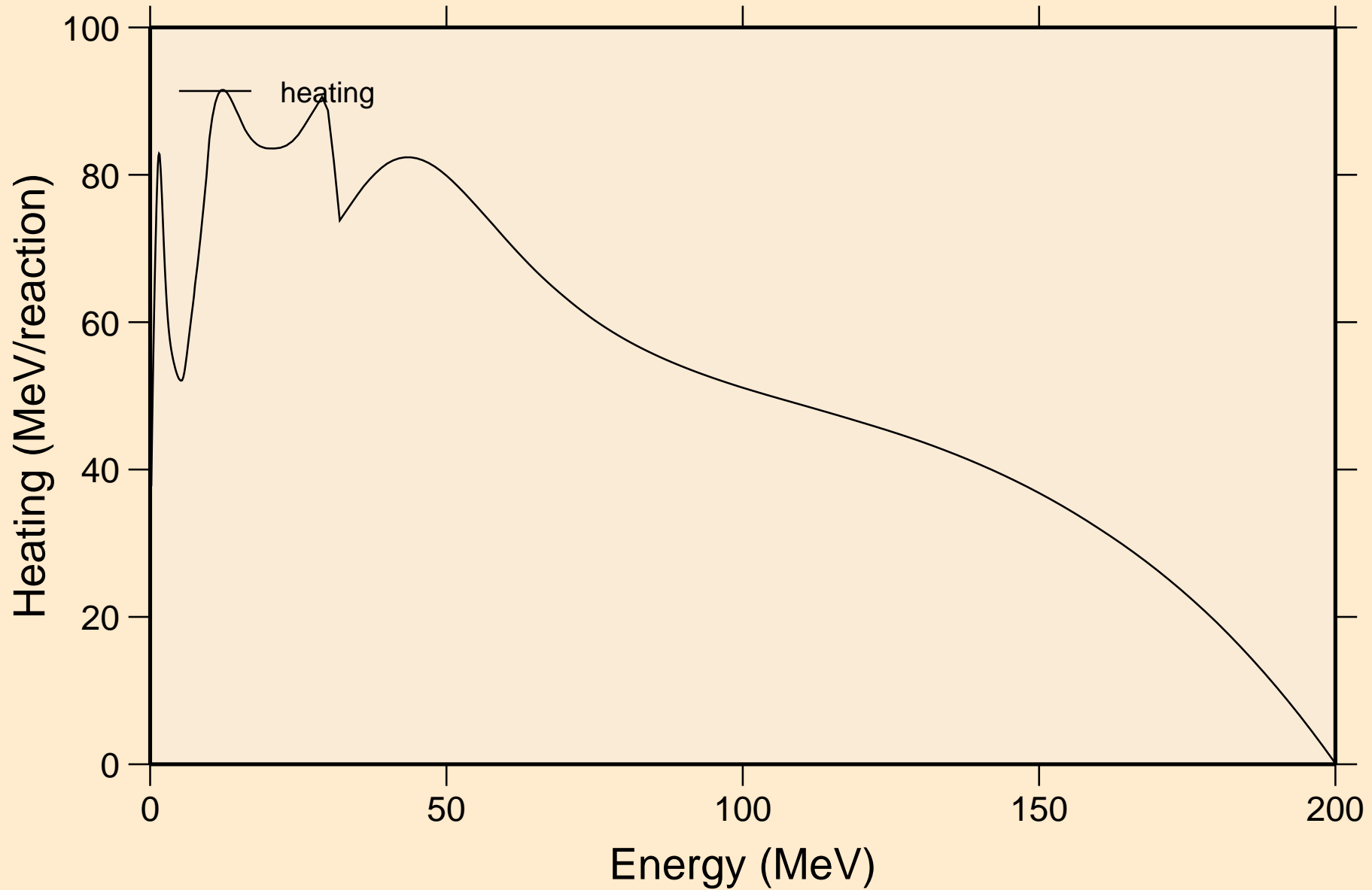

MD258M NEUTRON ACER TENDL-2021 LIBRARY; T=293.6K
Damage

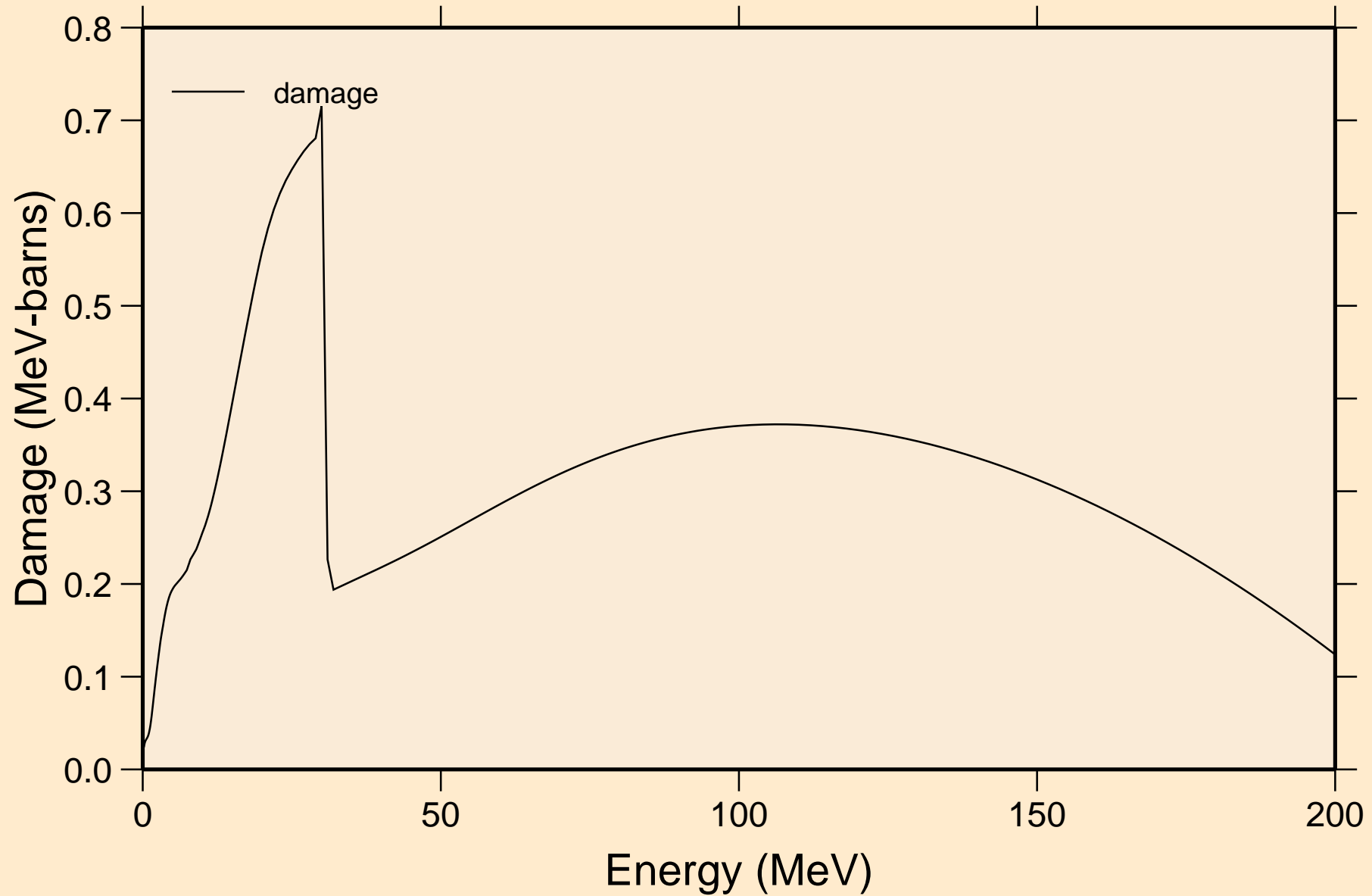

MD258M NEUTRON ACER TENDL-2021 LIBRARY; T=293.6K

Non-threshold reactions

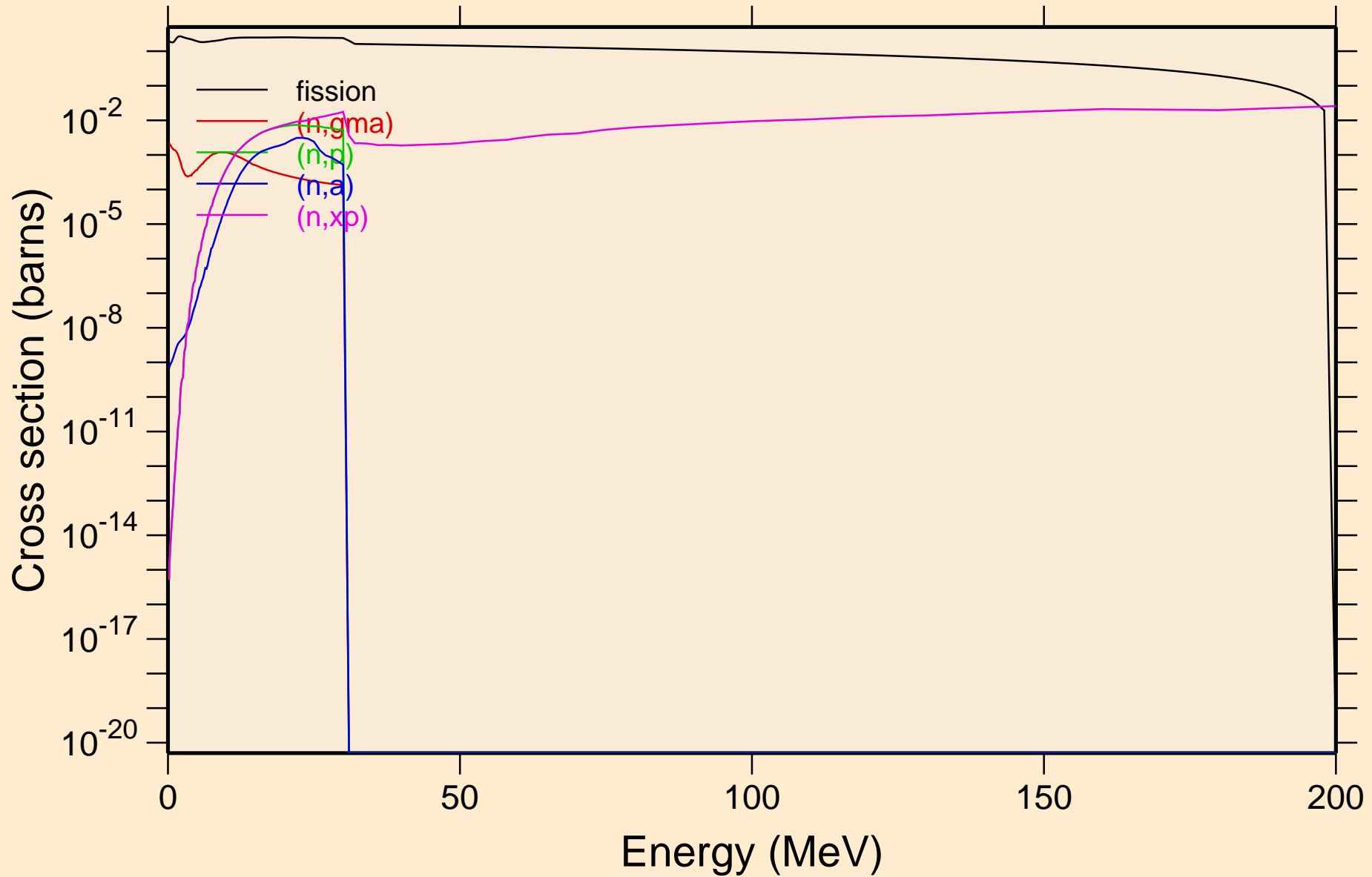

MD258M NEUTRON ACER TENDL-2021 LIBRARY; T=293.6K
Non-threshold reactions

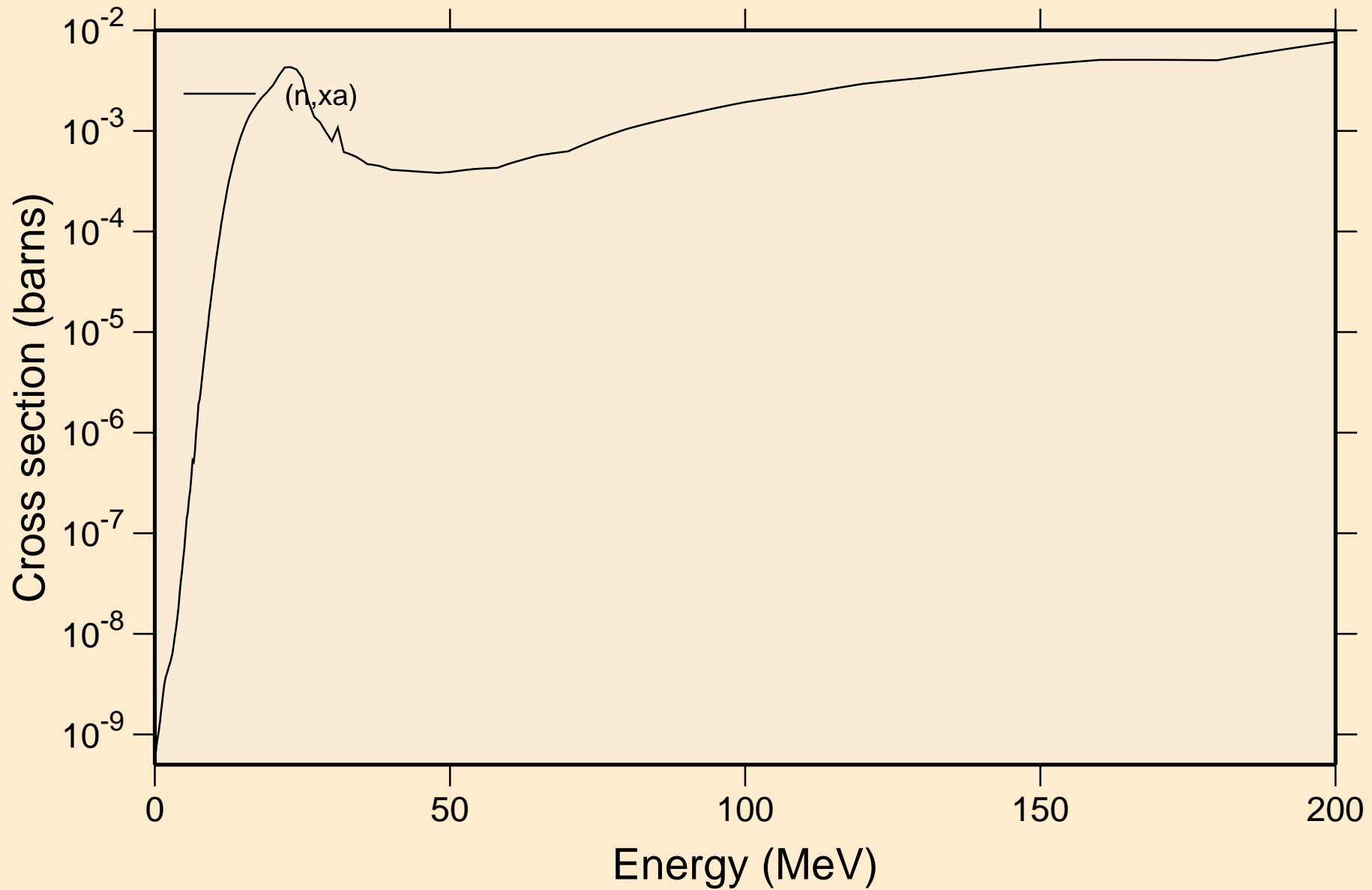

MD258M NEUTRON ACER TENDL-2021 LIBRARY; T=293.6K
Inelastic levels

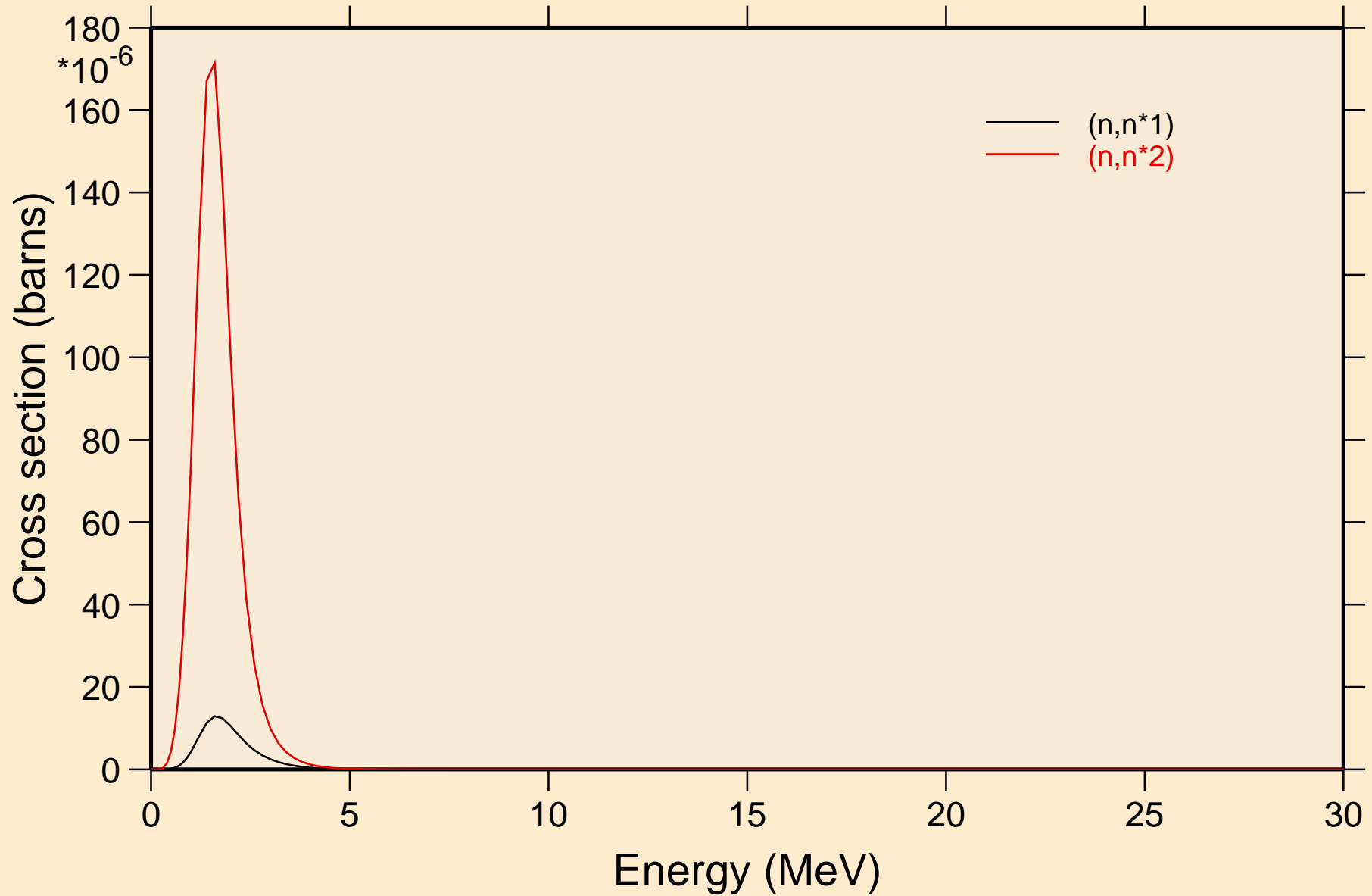

MD258M NEUTRON ACER TENDL-2021 LIBRARY; T=293.6K

Threshold reactions

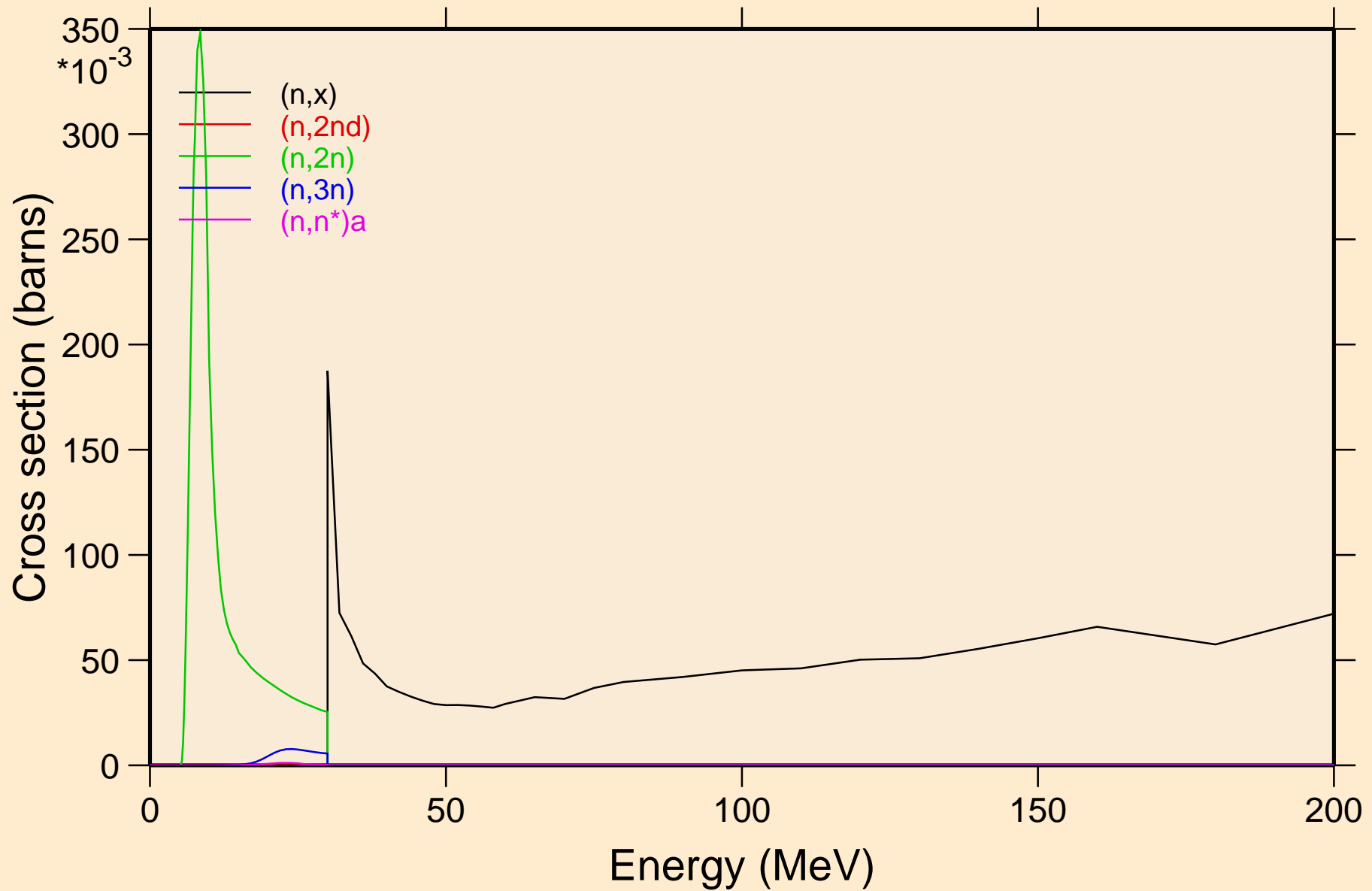

MD258M NEUTRON ACER TENDL-2021 LIBRARY; T=293.6K
Threshold reactions

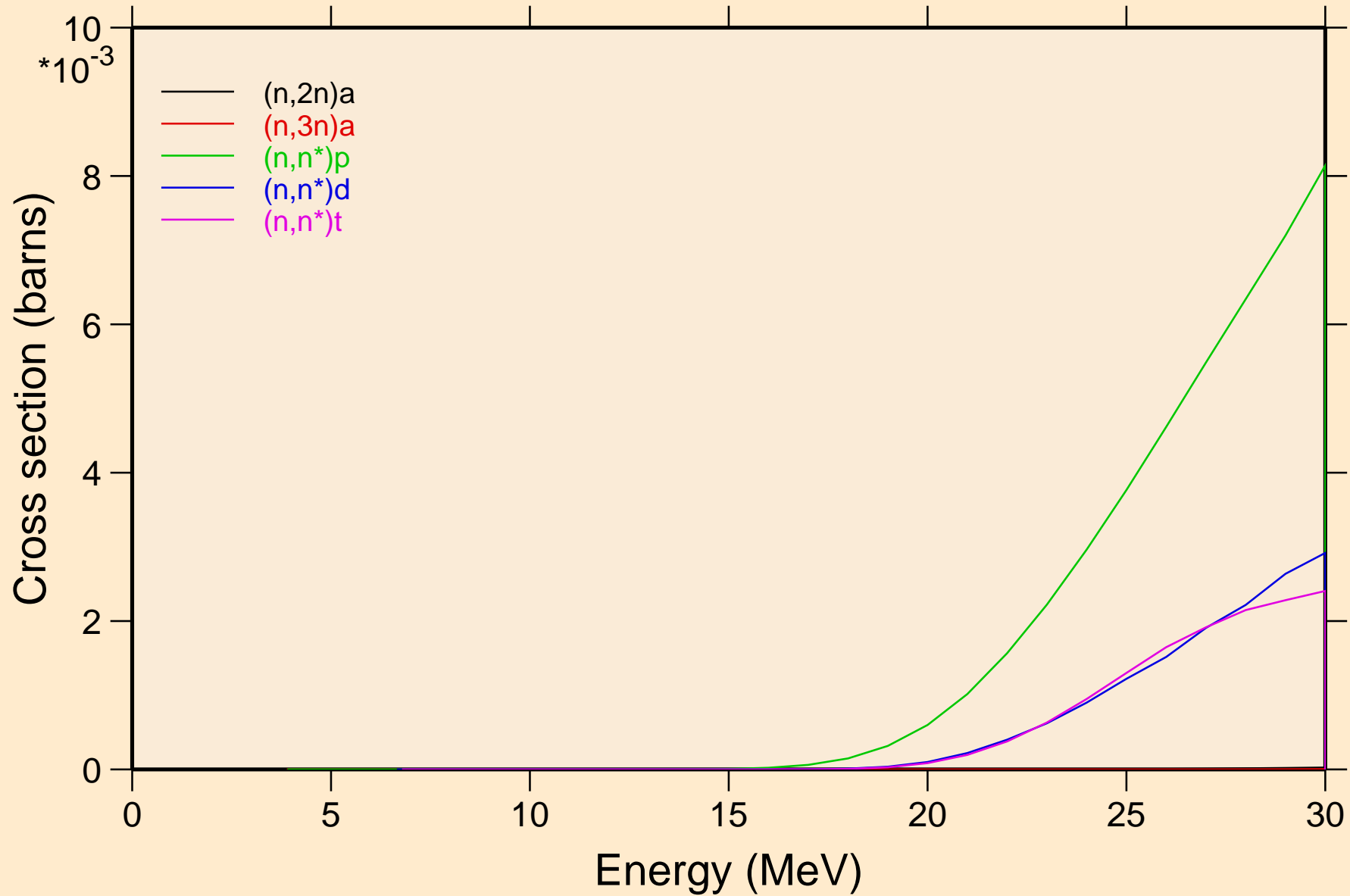

MD258M NEUTRON ACER TENDL-2021 LIBRARY; T=293.6K
Threshold reactions

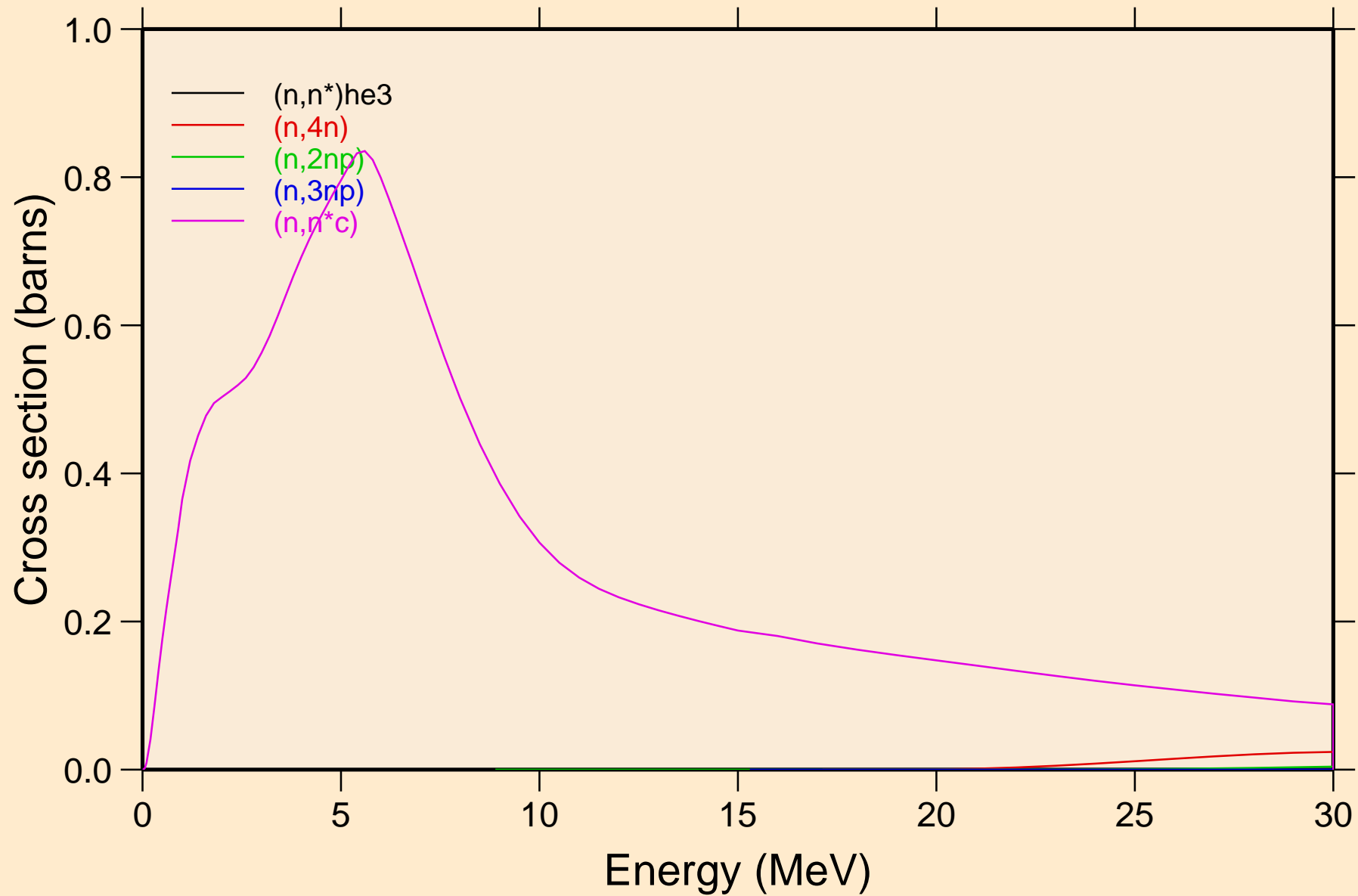

MD258M NEUTRON ACER TENDL-2021 LIBRARY; T=293.6K
Threshold reactions

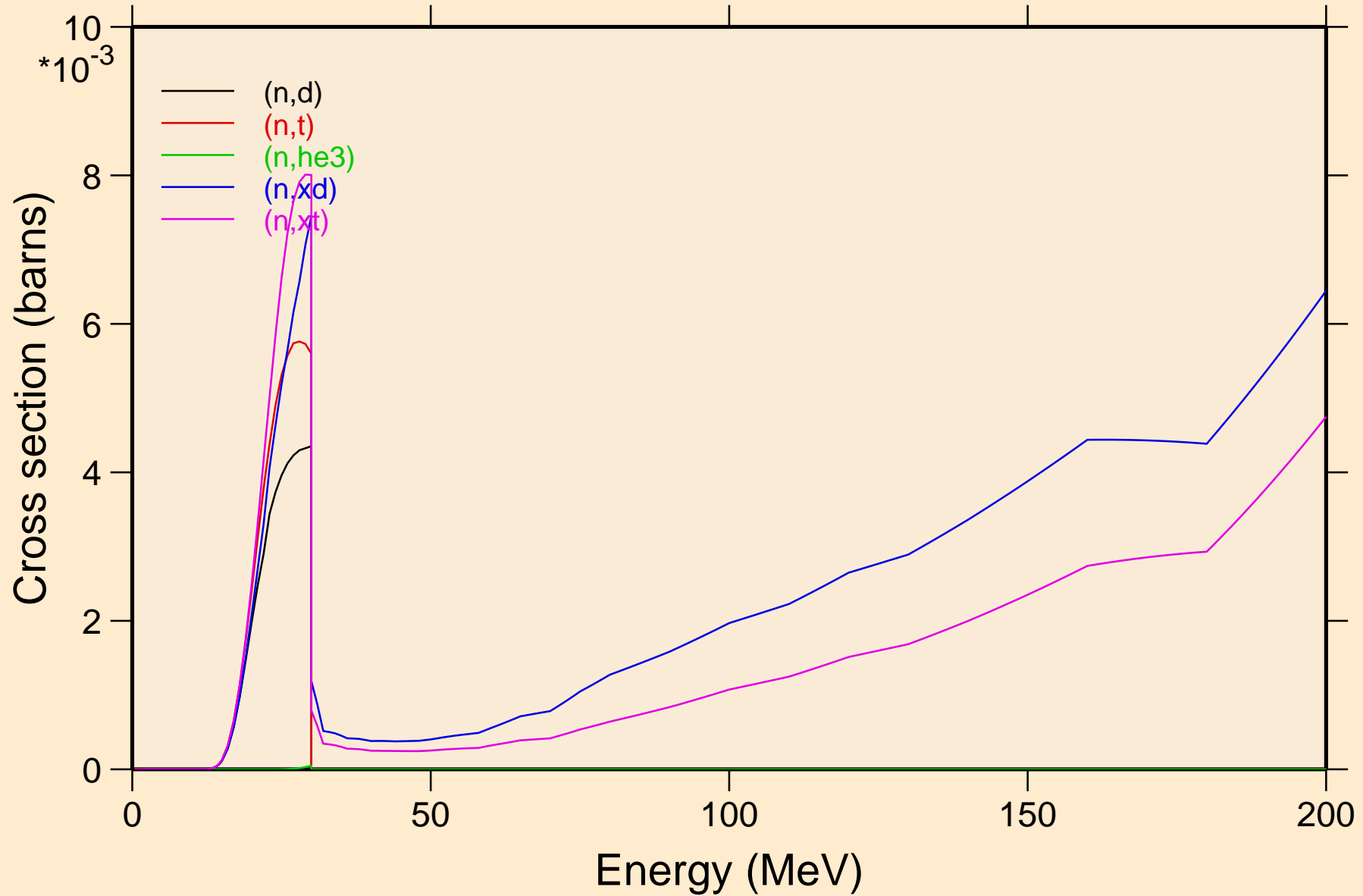

MD258M NEUTRON ACER TENDL-2021 LIBRARY; T=293.6K
Threshold reactions

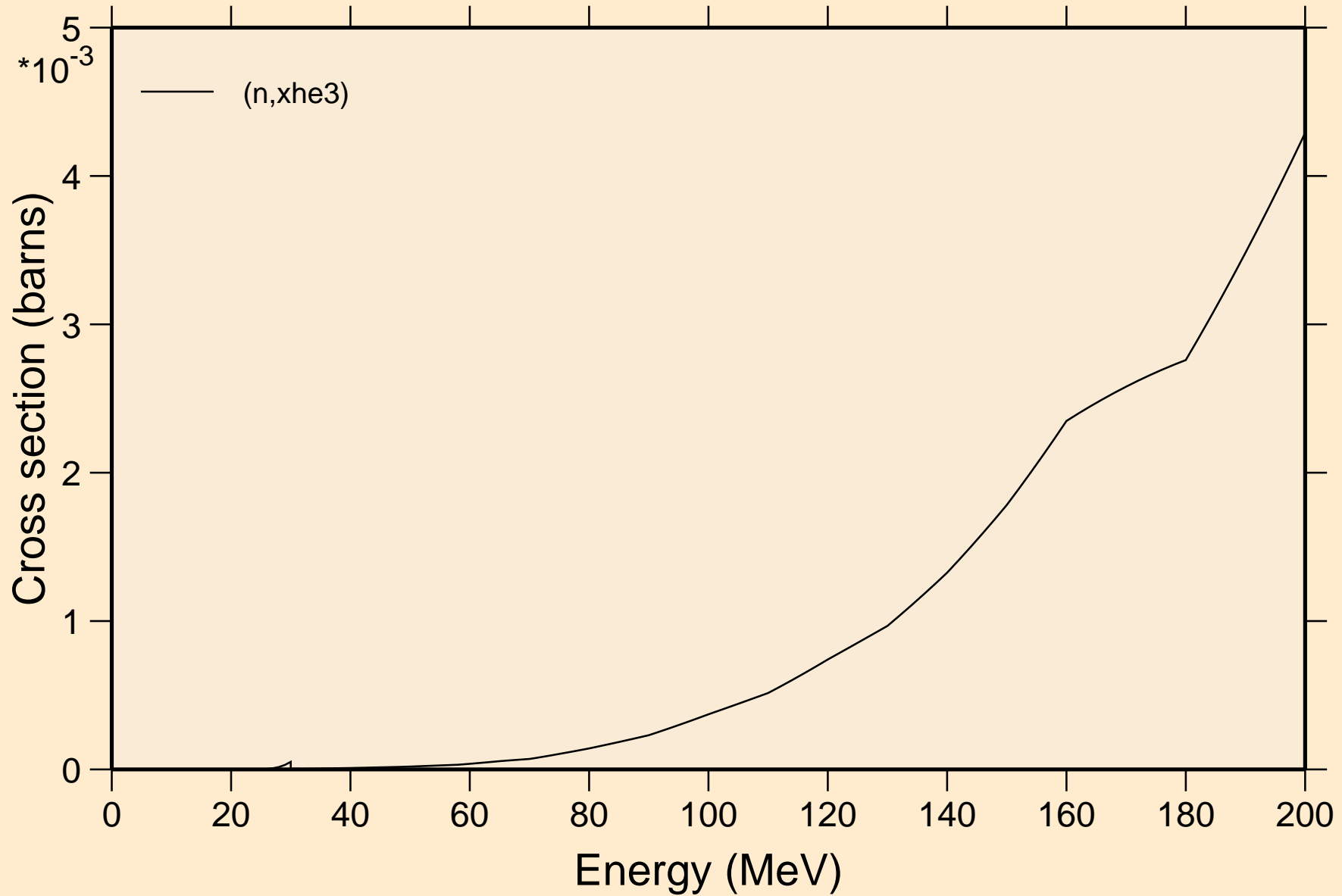

MD258M NEUTRON ACER TENDL-2021 LIBRARY; T=293.6K
angular distribution for elastic

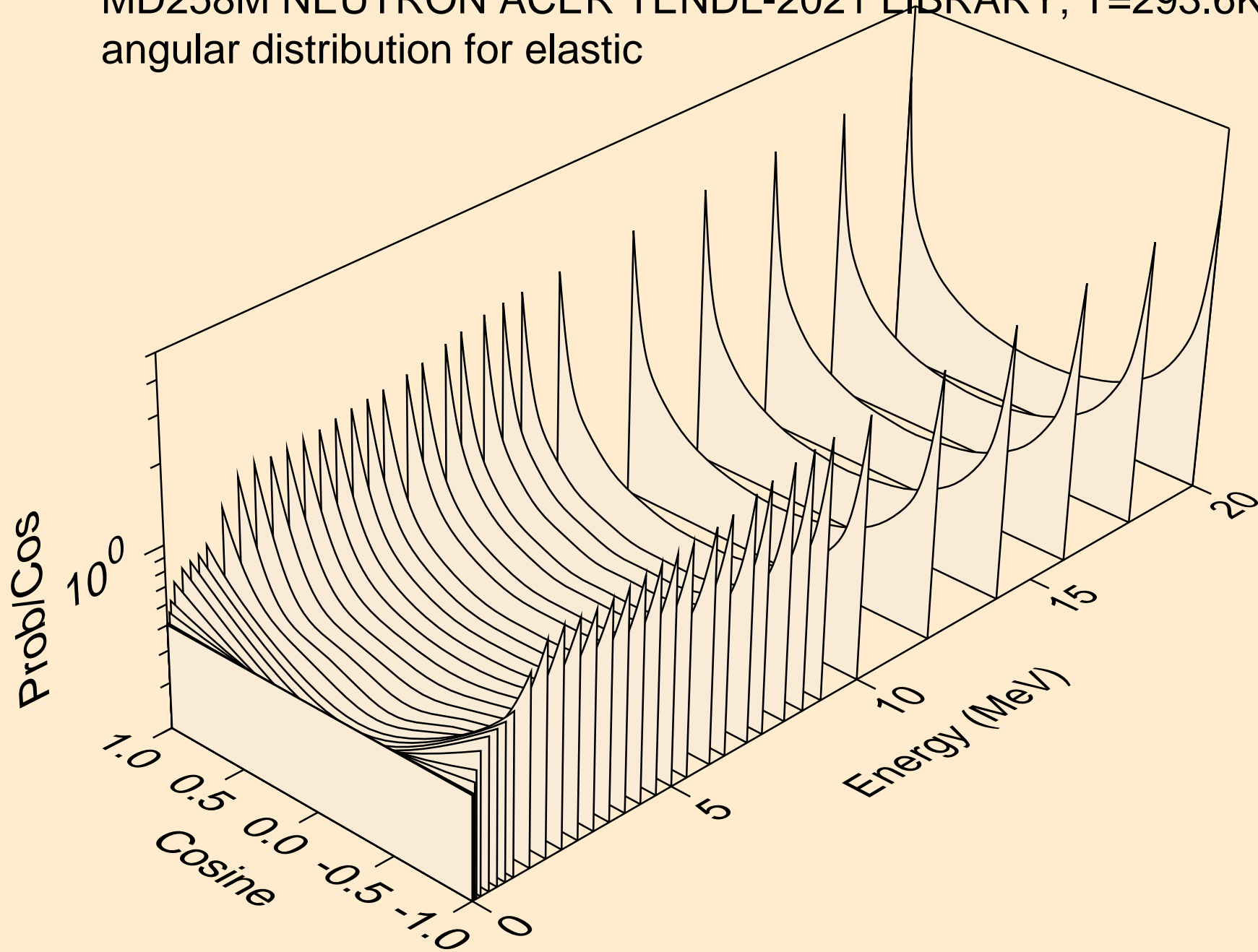

MD258M NEUTRON ACER TENDL-2021 LIBRARY; T=293.6K
angular distribution for elastic

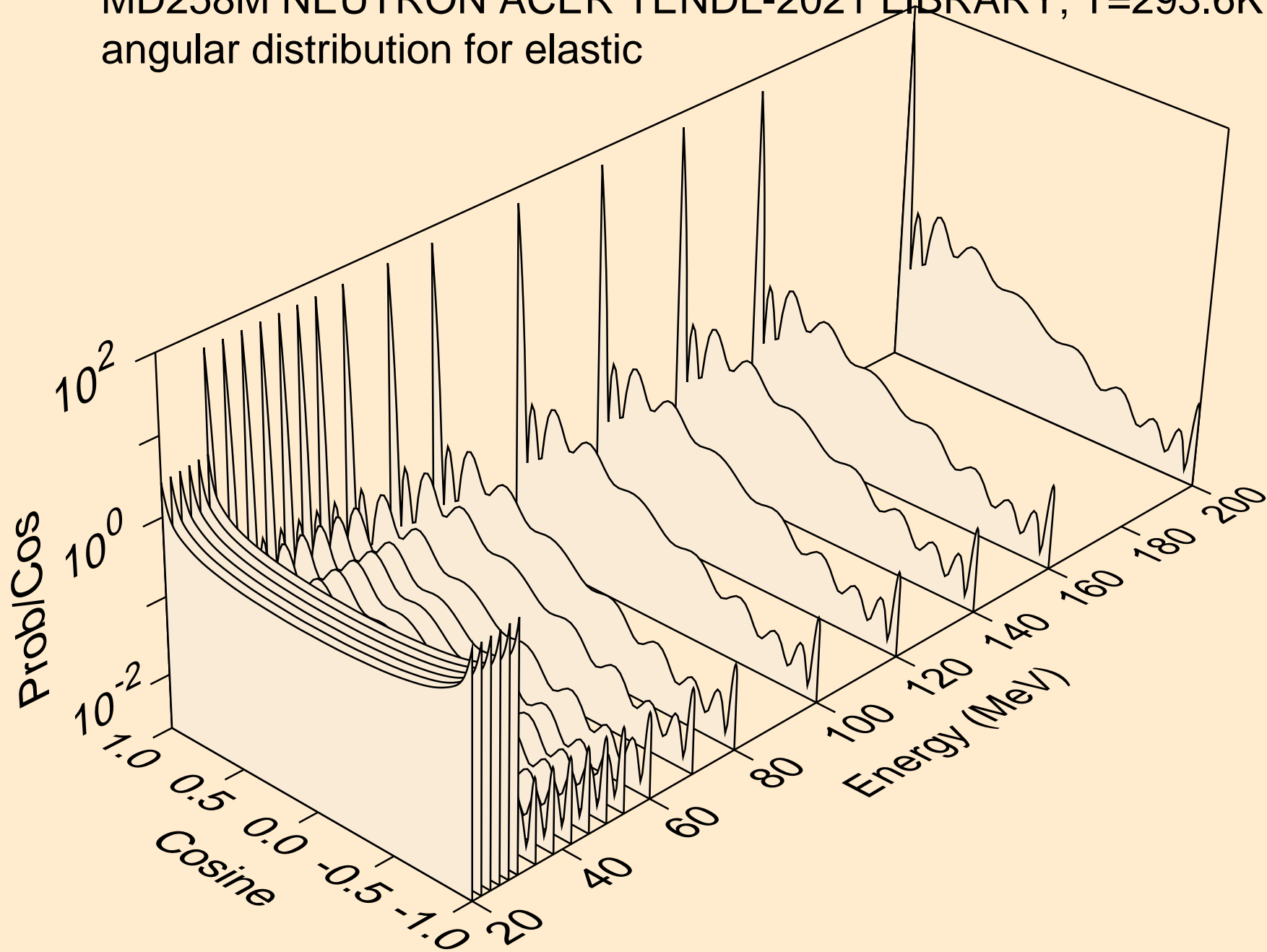

MD258M NEUTRON ACER TENDL-2021 LIBRARY; T=293.6K
angular distribution for (n,n*1)

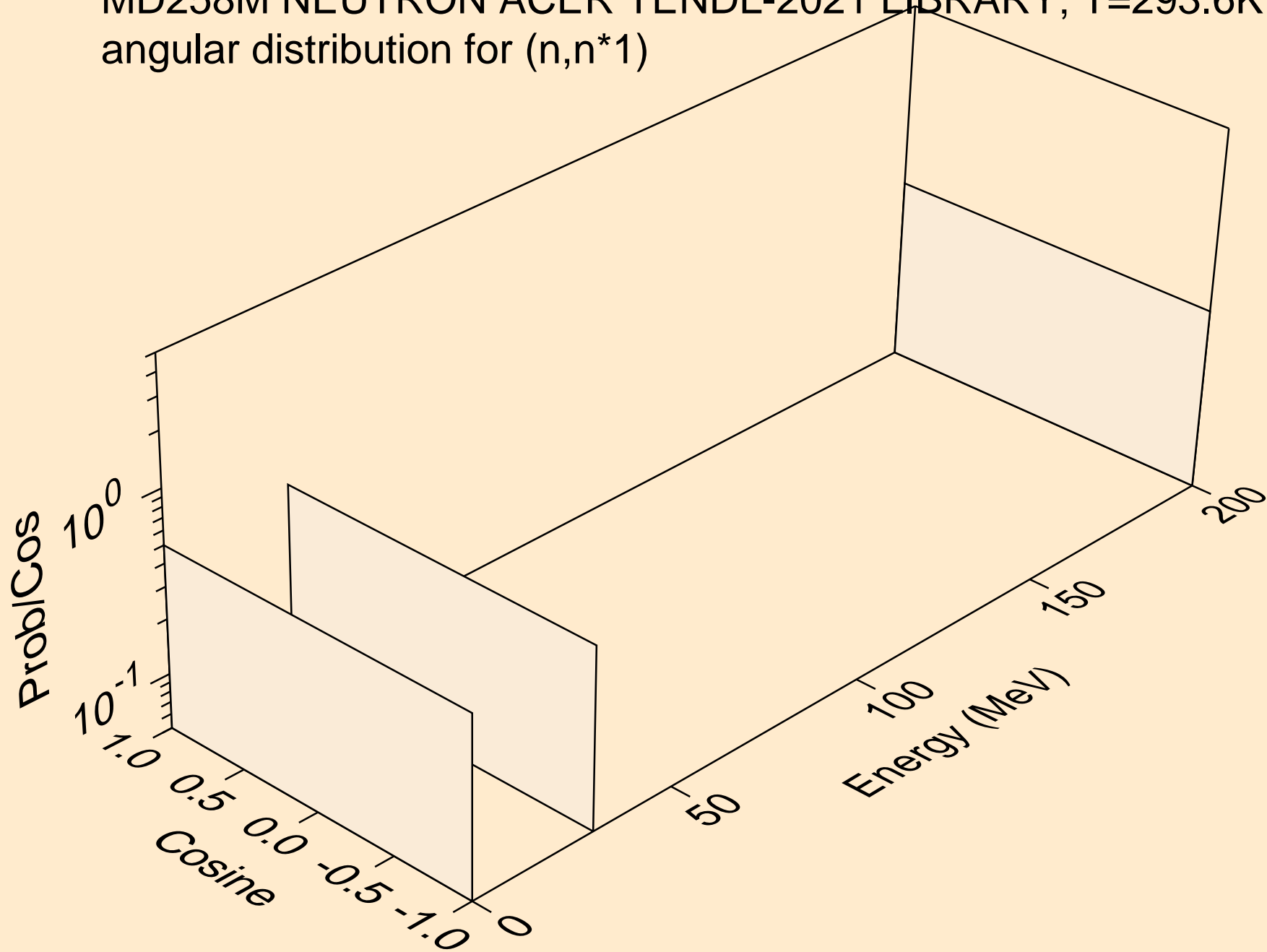

MD258M NEUTRON ACER TENDL-2021 LIBRARY; T=293.6K
angular distribution for (n,n*2)

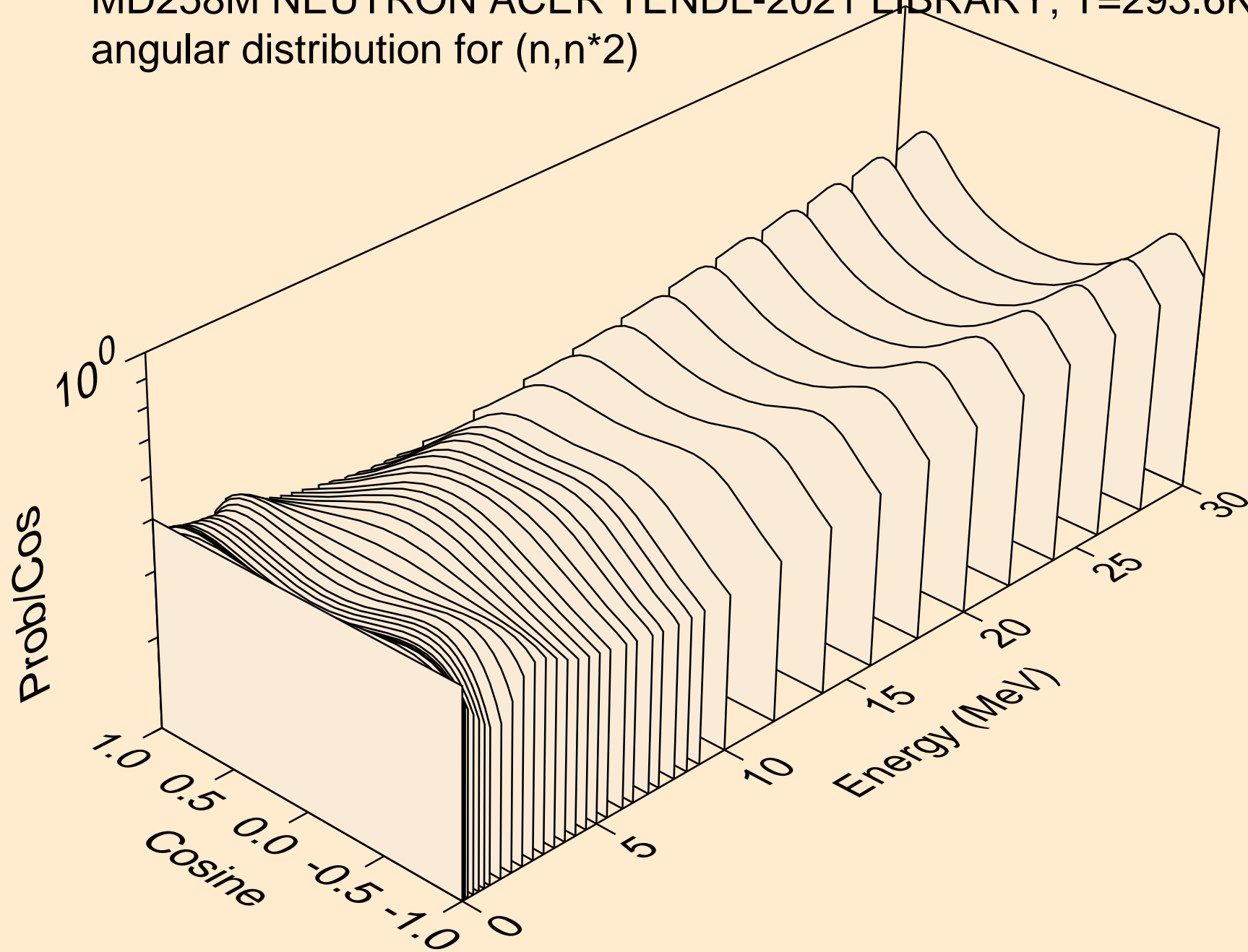

MD258M NEUTRON ACER TENDL-2021 LIBRARY; T=293.6K
Total fission nubar

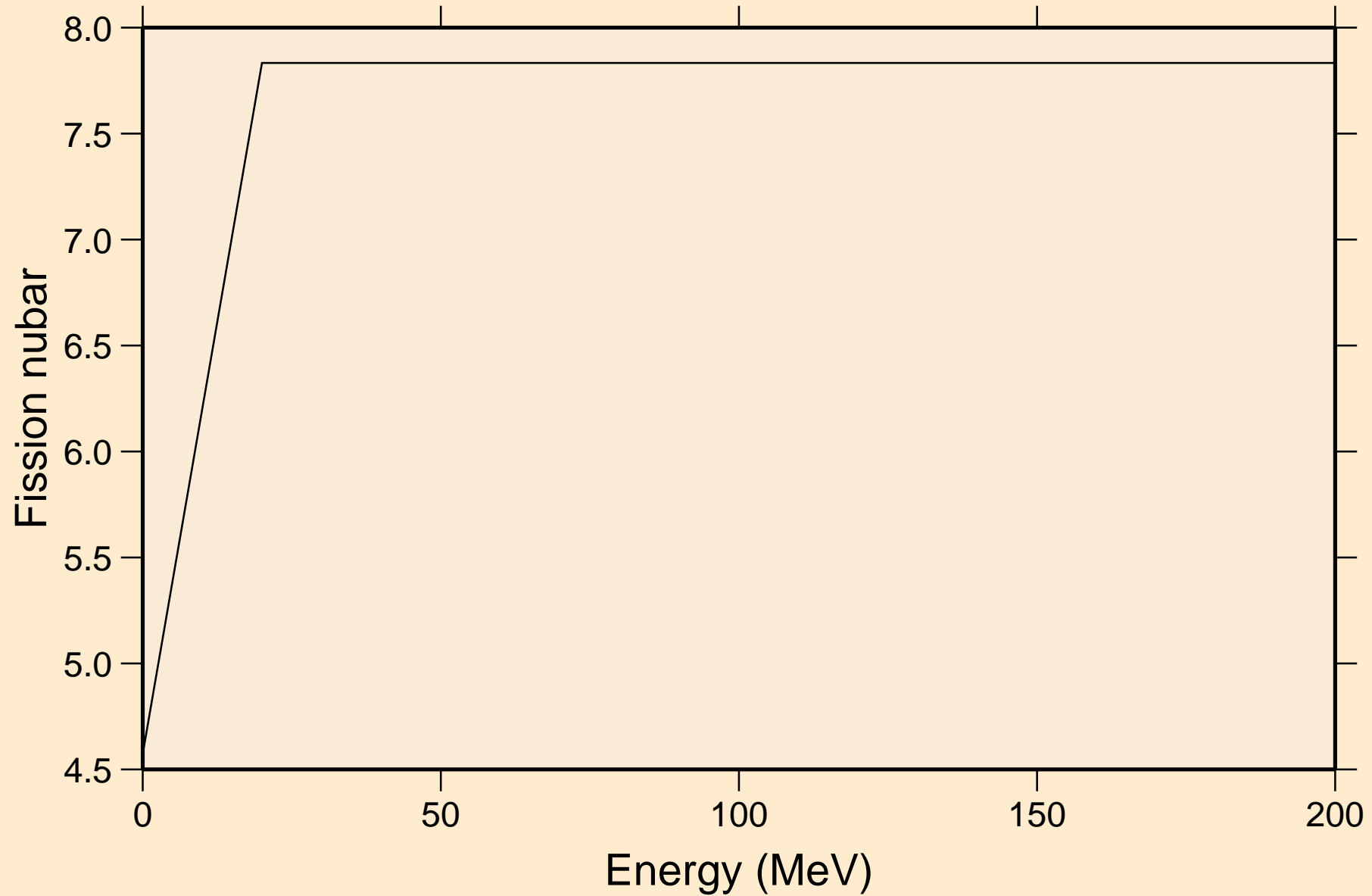

MD258M NEUTRON ACER TENDL-2021 LIBRARY; T=293.6K
Neutron emission for (n,x)

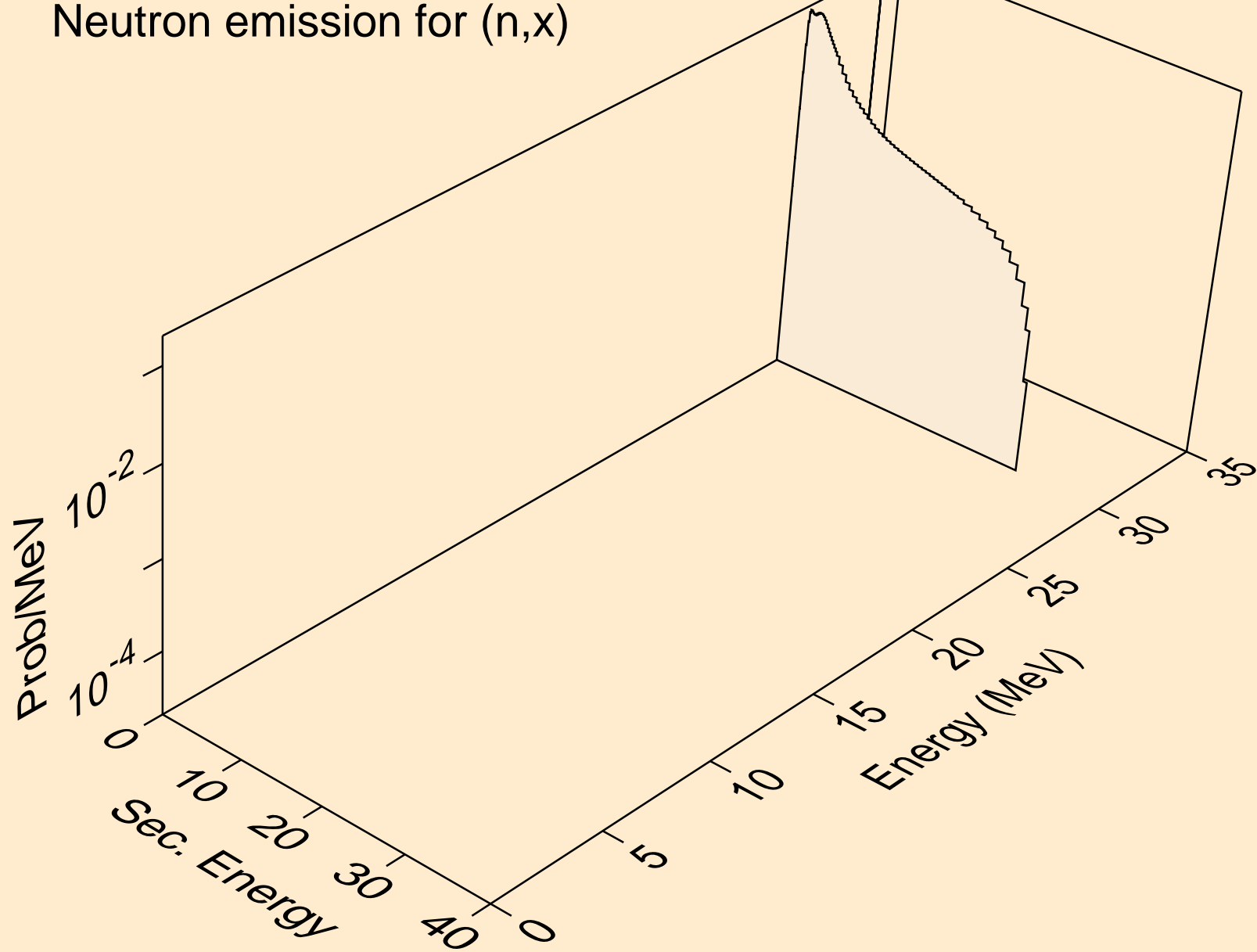

MD258M NEUTRON ACER TENDL-2021 LIBRARY; T=293.6K
Neutron emission for (n,2nd)

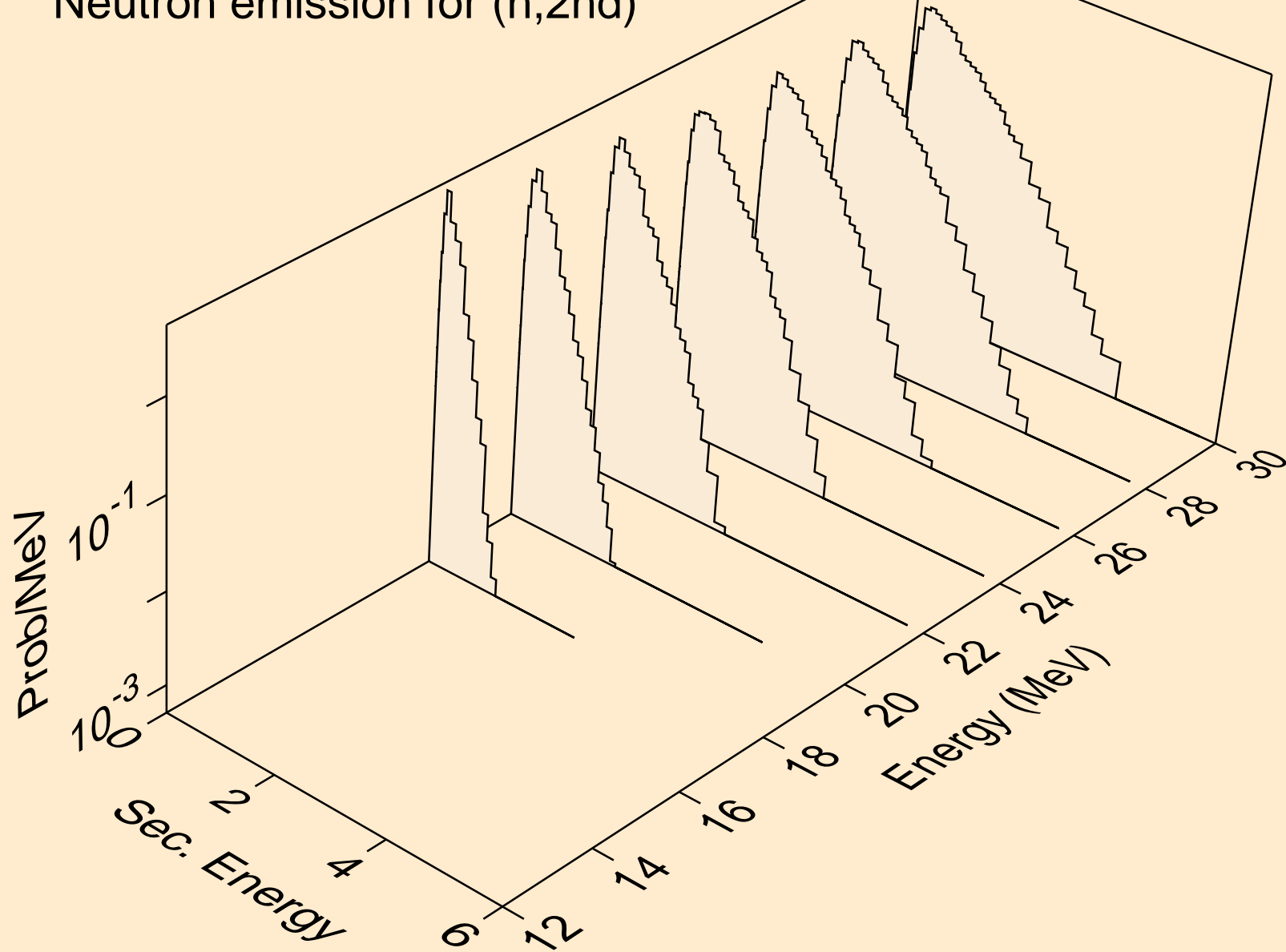

MD258M NEUTRON ACER TENDL-2021 LIBRARY; T=293.6K
Neutron emission for (n,2n)

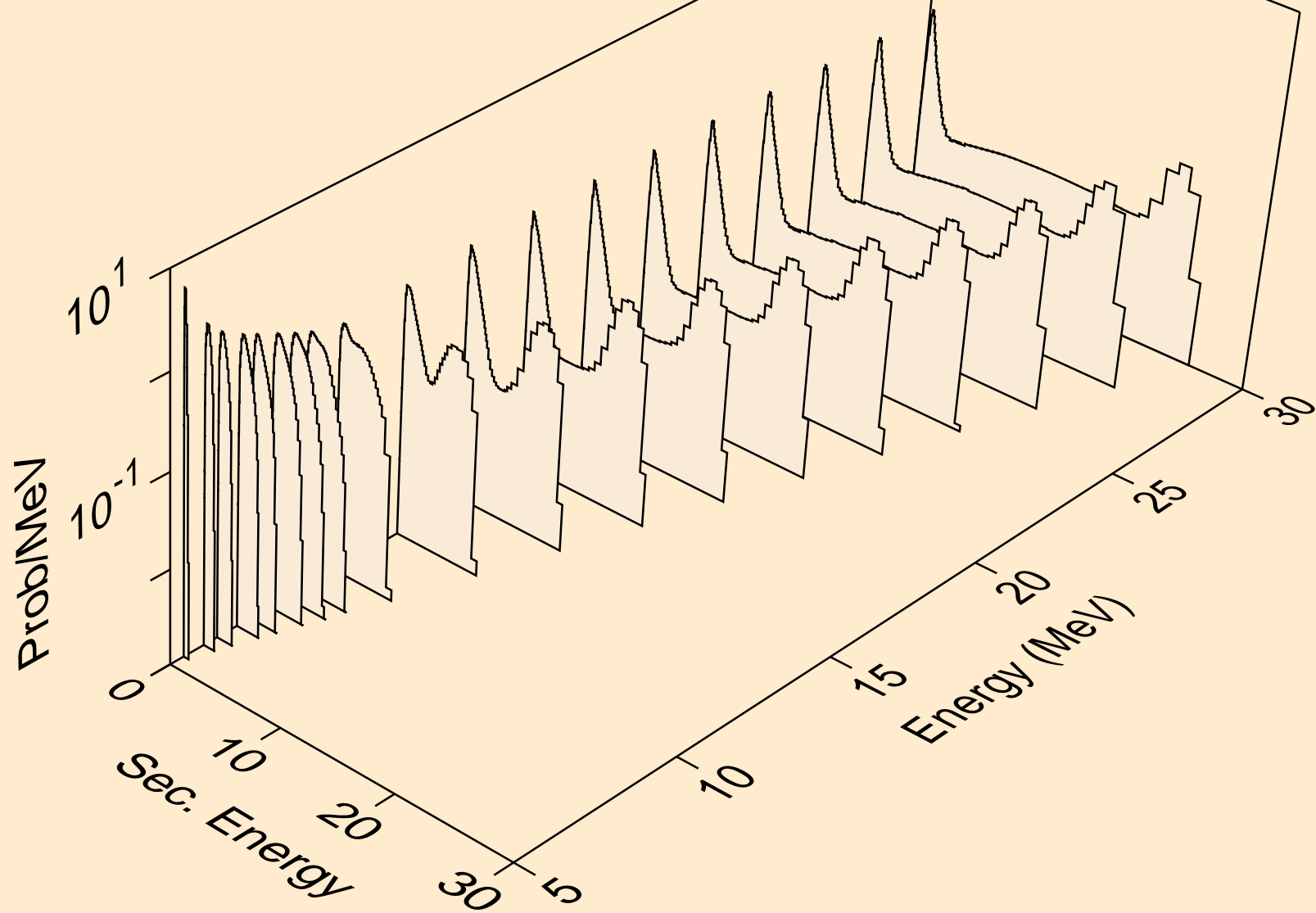

MD258M NEUTRON ACER TENDL-2021 LIBRARY; T=293.6K
Neutron emission for (n,3n)

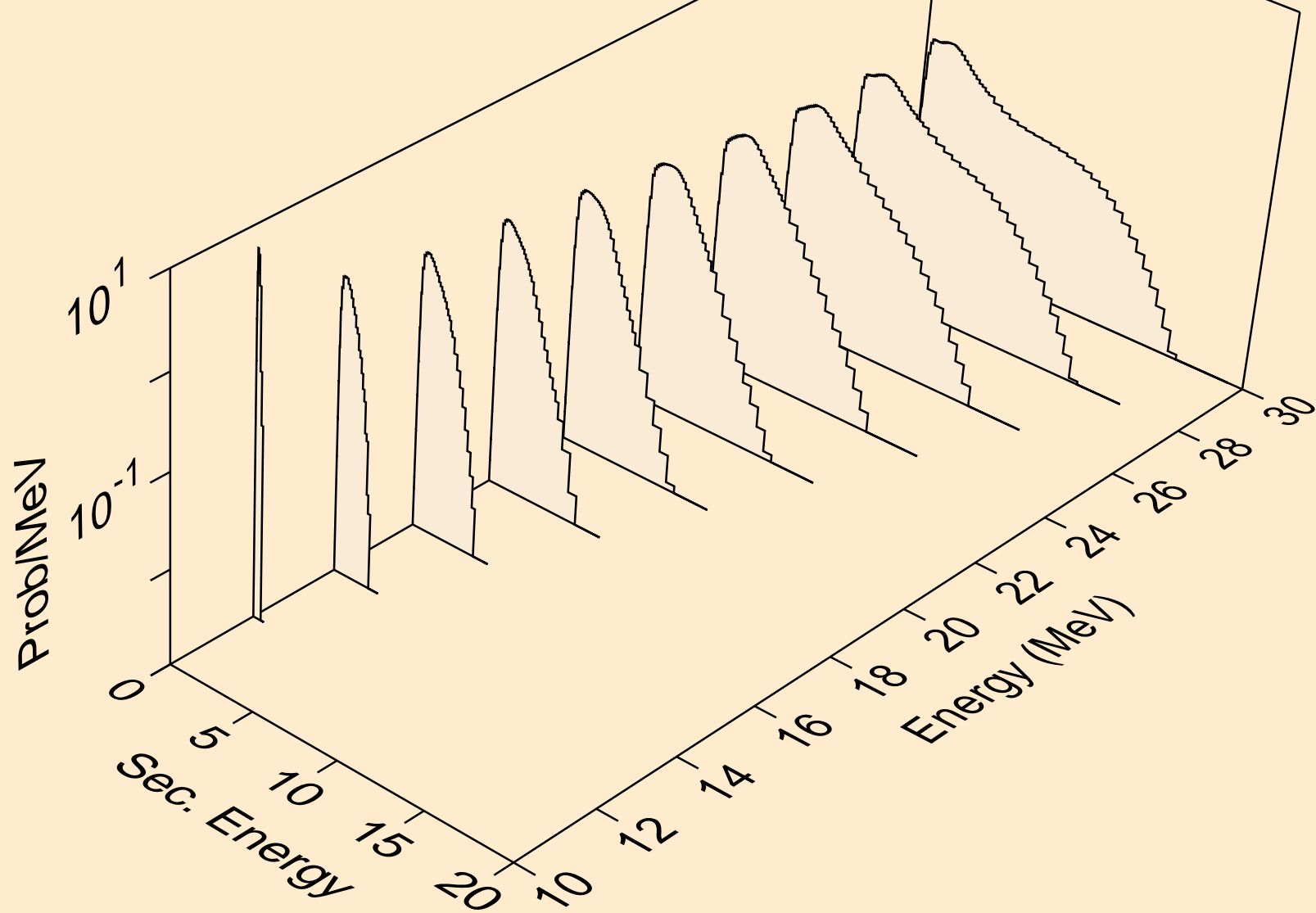

MD258M NEUTRON ACER TENDL-2021 LIBRARY; T=293.6K
Neutron emission for fission

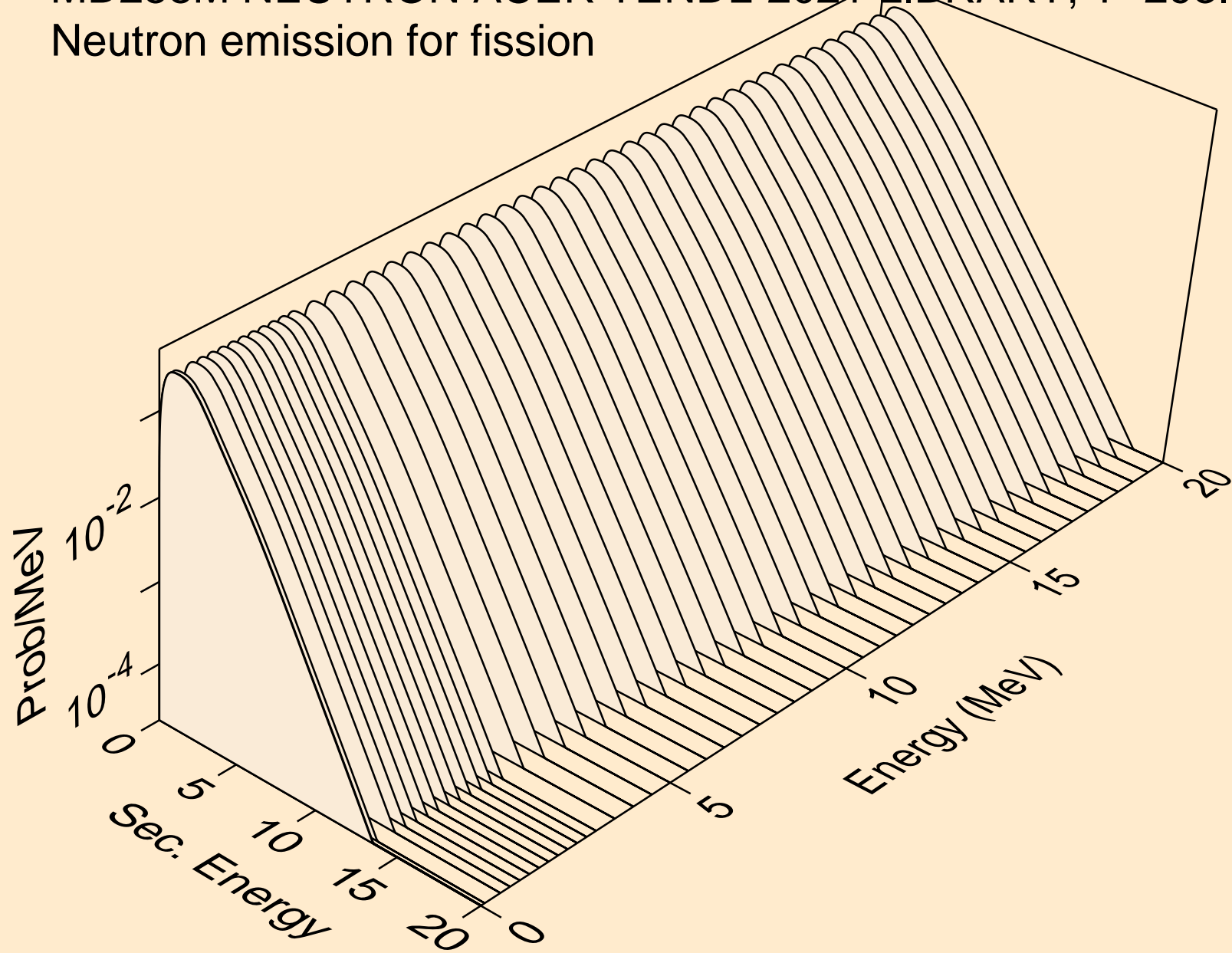

MD258M NEUTRON ACER TENDL-2021 LIBRARY; T=293.6K
Neutron emission for (n,n*)a

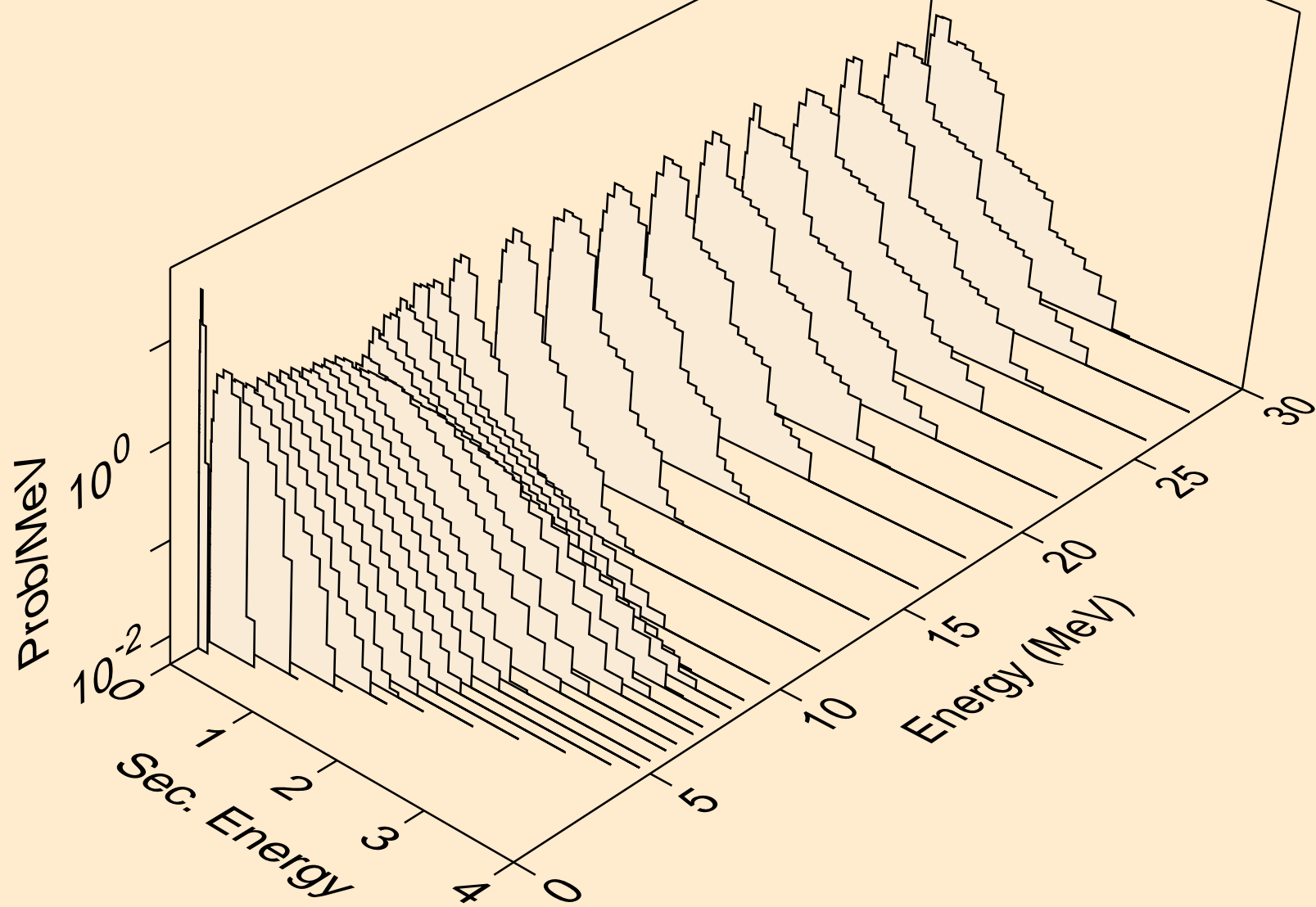

MD258M NEUTRON ACER TENDL-2021 LIBRARY; T=293.6K
Neutron emission for (n,2n)a

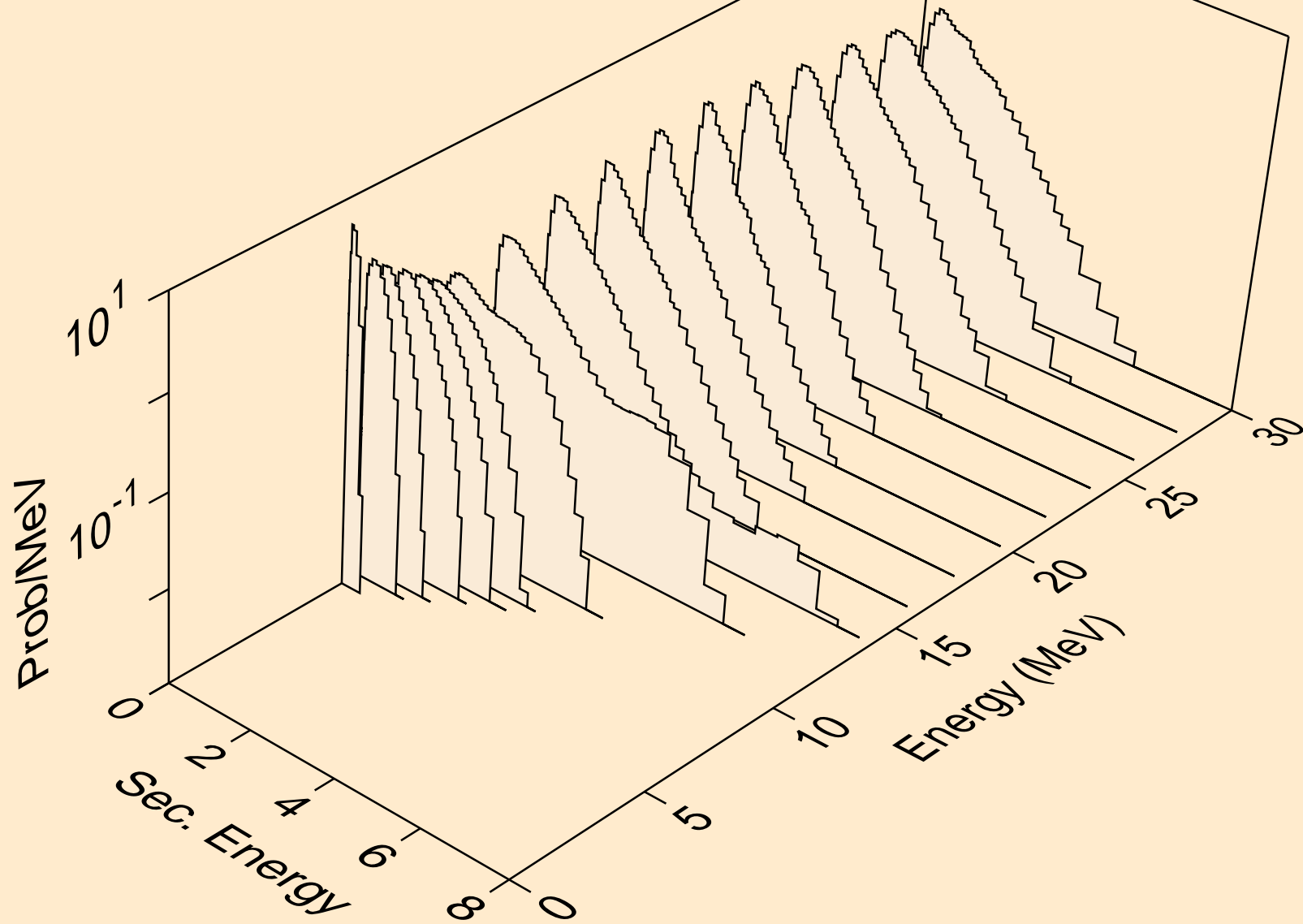

MD258M NEUTRON ACER TENDL-2021 LIBRARY; T=293.6K
Neutron emission for (n,3n)a

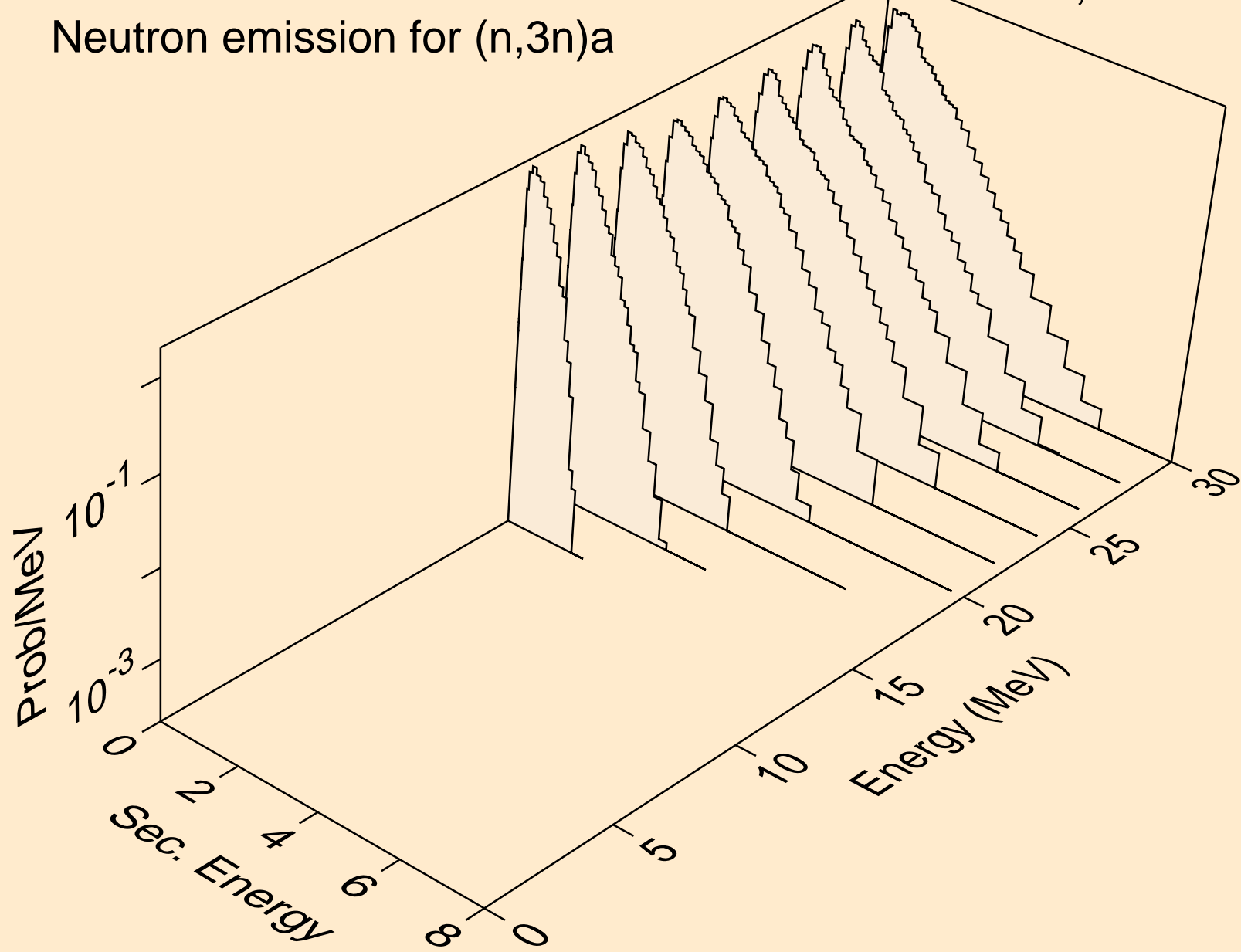

MD258M NEUTRON ACER TENDL-2021 LIBRARY; T=293.6K
Neutron emission for (n,n*)p

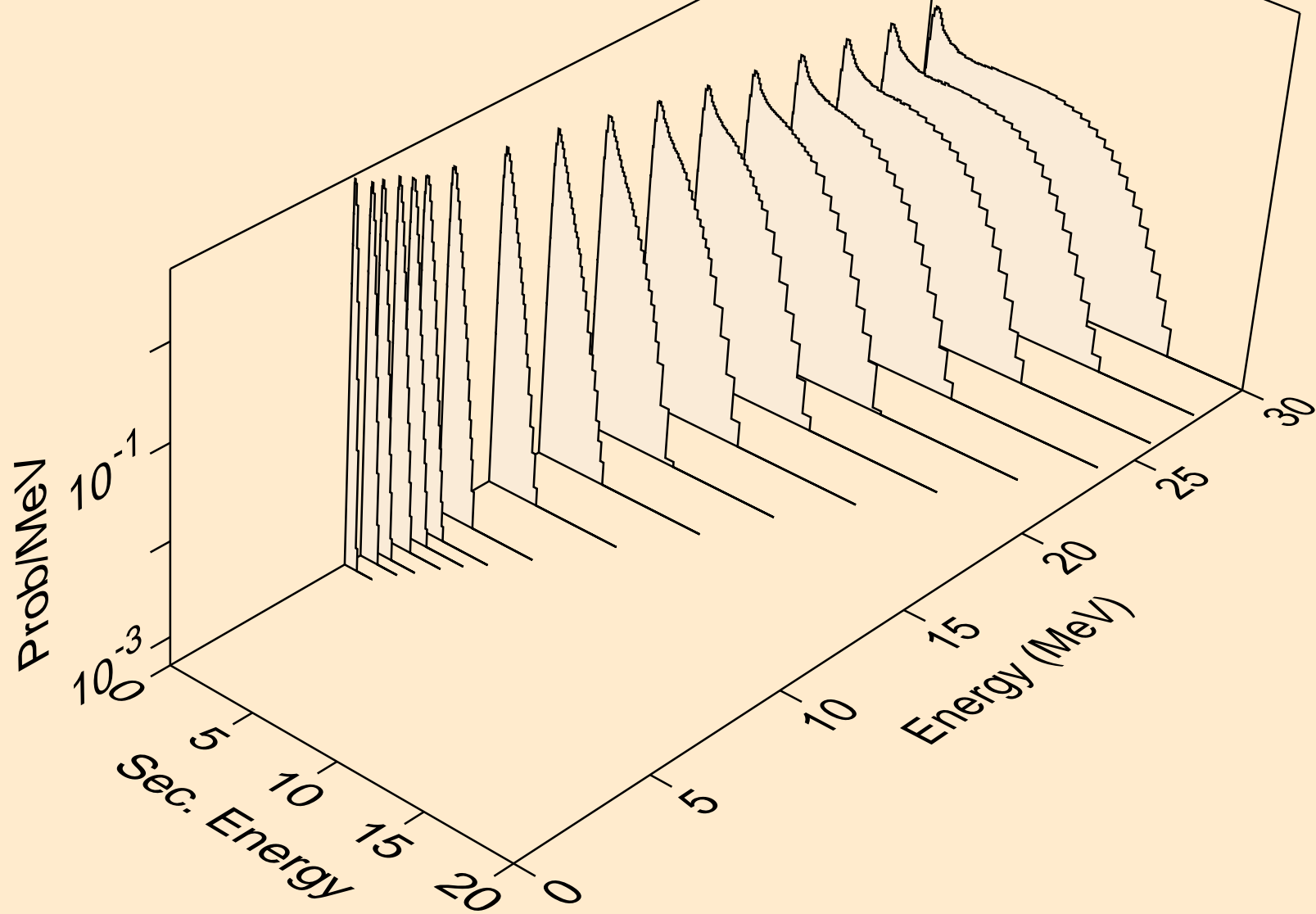

MD258M NEUTRON ACER TENDL-2021 LIBRARY; T=293.6K
Neutron emission for (n,n*)d

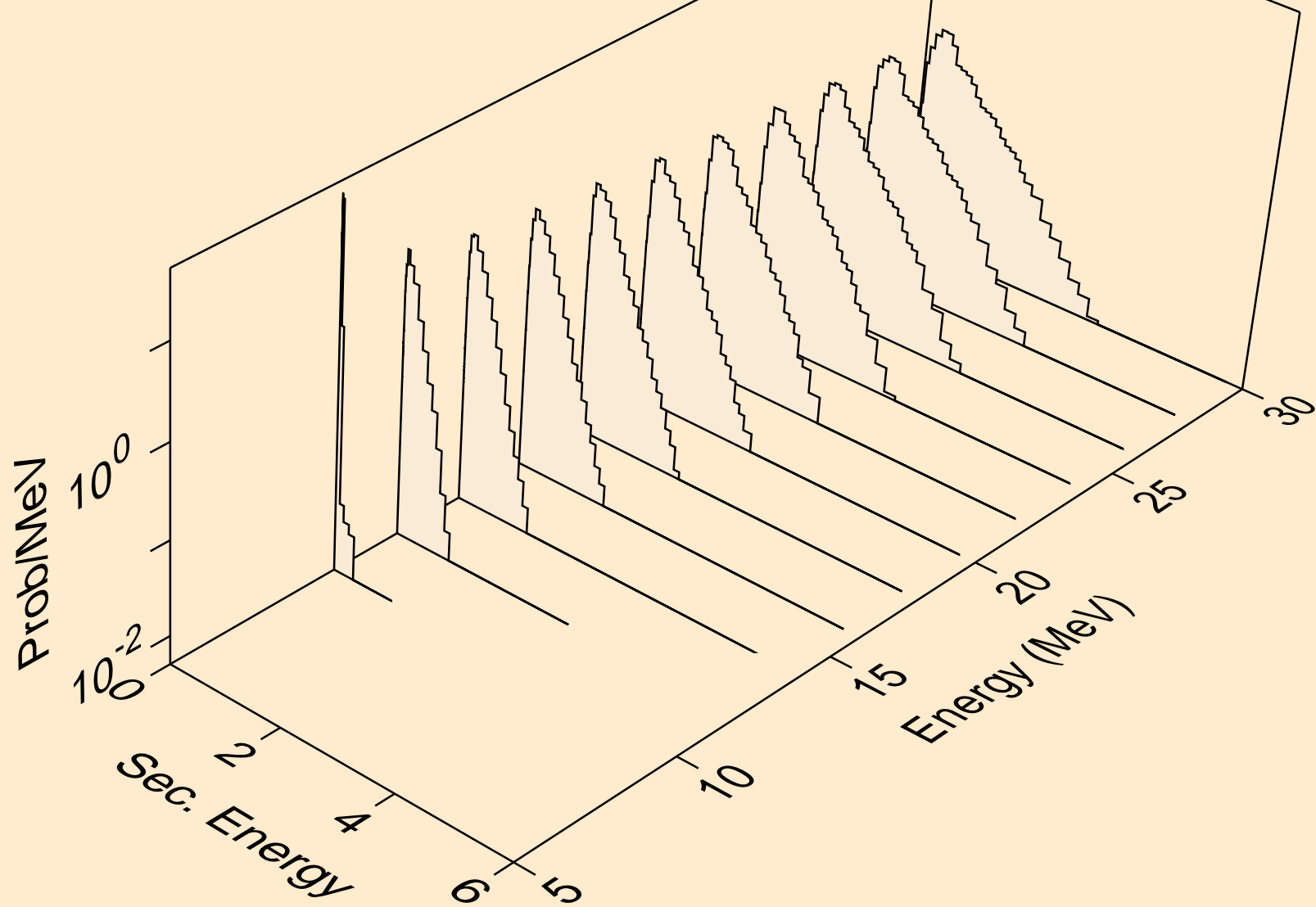

MD258M NEUTRON ACER TENDL-2021 LIBRARY; T=293.6K
Neutron emission for (n,n*)t

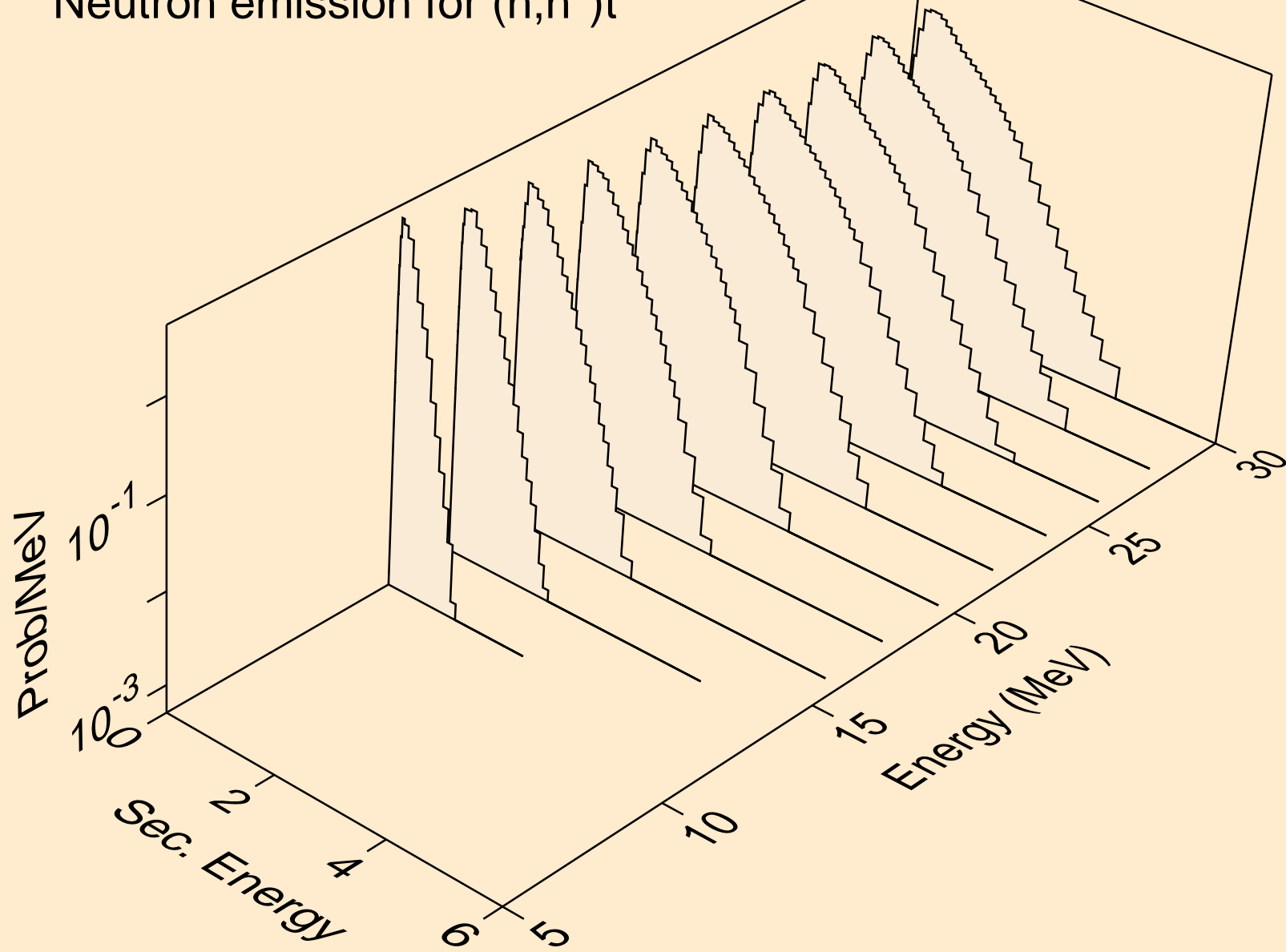

MD258M NEUTRON ACER TENDL-2021 LIBRARY; T=293.6K
Neutron emission for (n,n*)he3

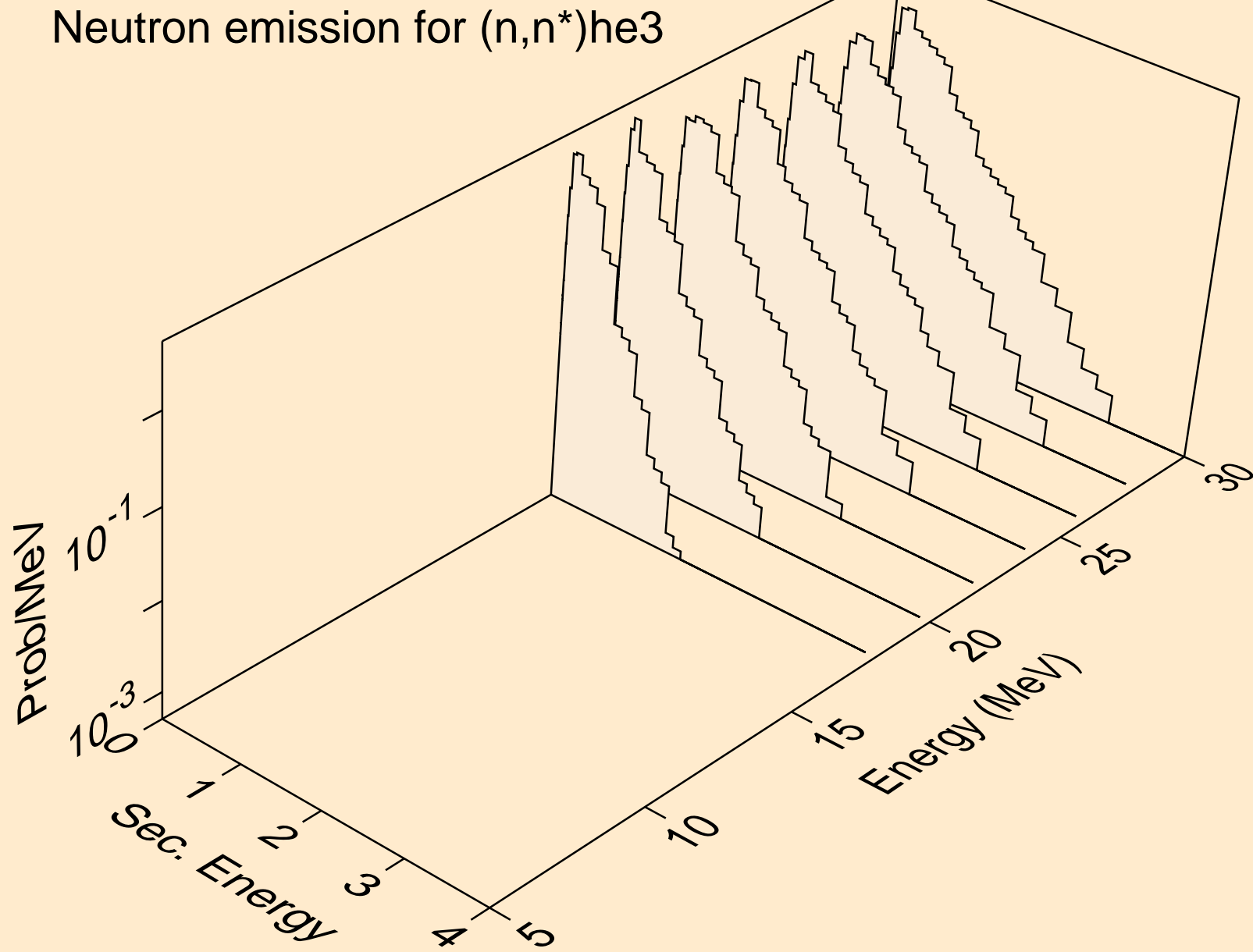

MD258M NEUTRON ACER TENDL-2021 LIBRARY; T=293.6K
Neutron emission for (n,4n)

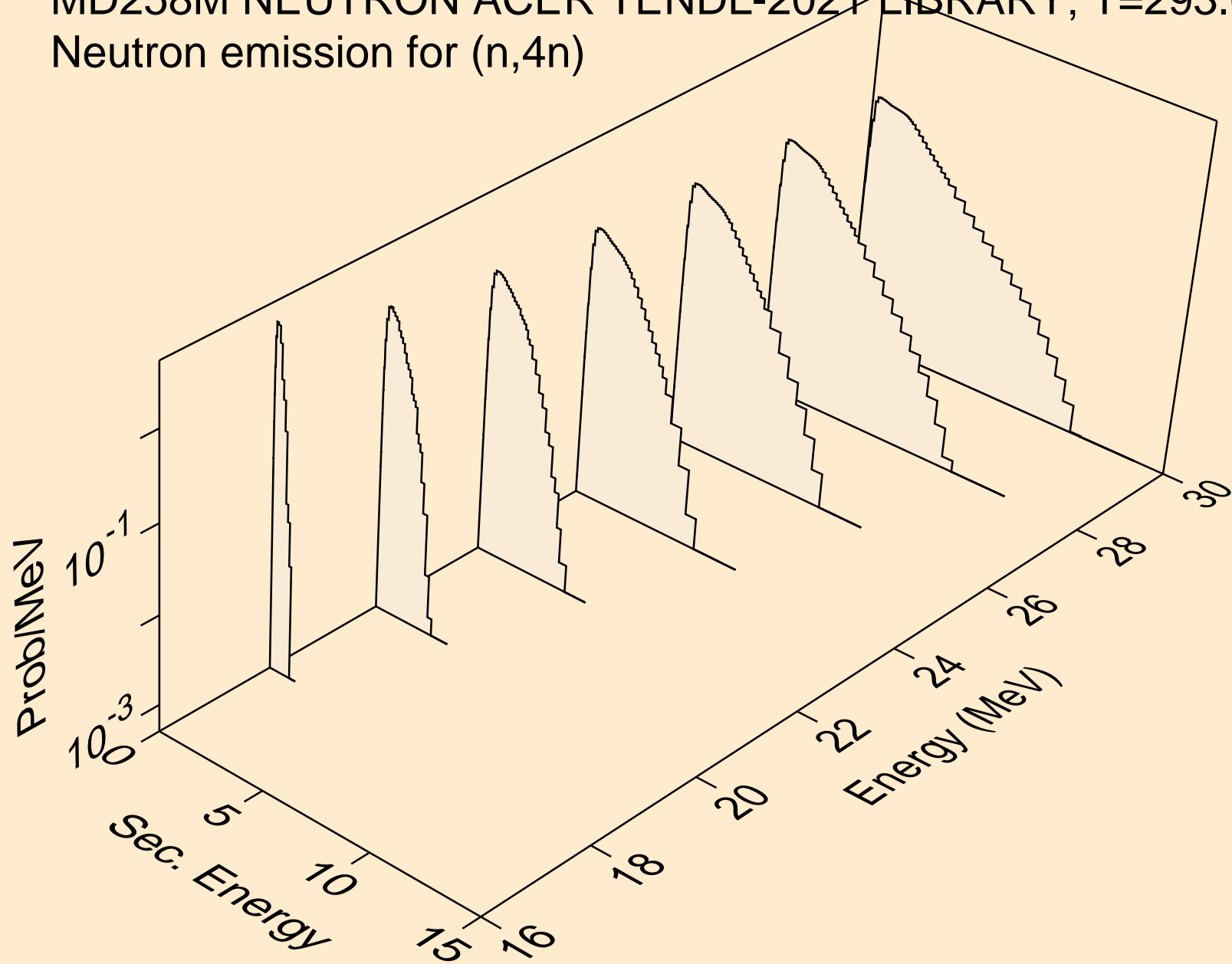

MD258M NEUTRON ACER TENDL-2021 LIBRARY; T=293.6K
Neutron emission for (n,2np)

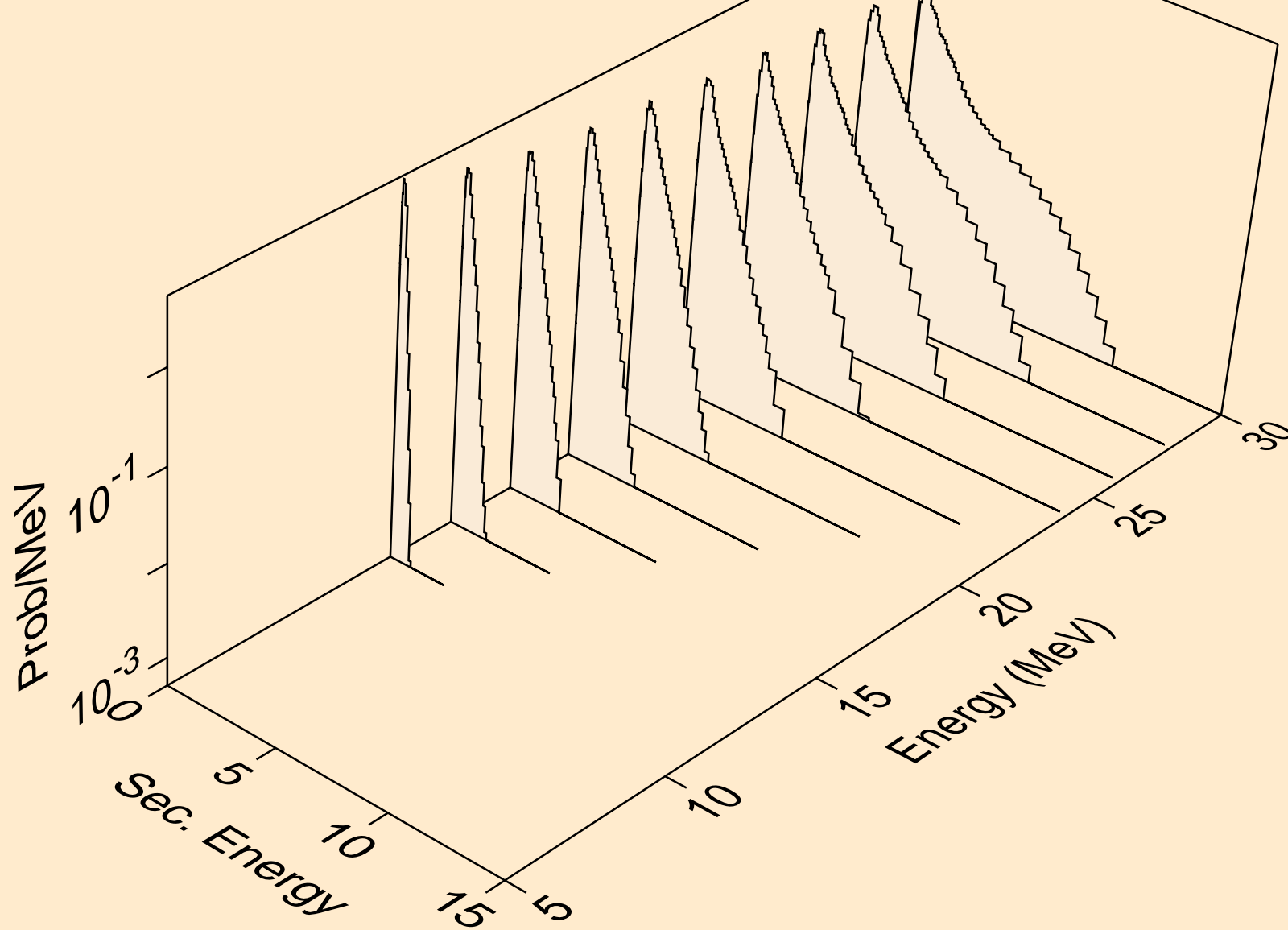

MD258M NEUTRON ACER TENDL-2021 LIBRARY; T=293.6K
Neutron emission for (n,3np)

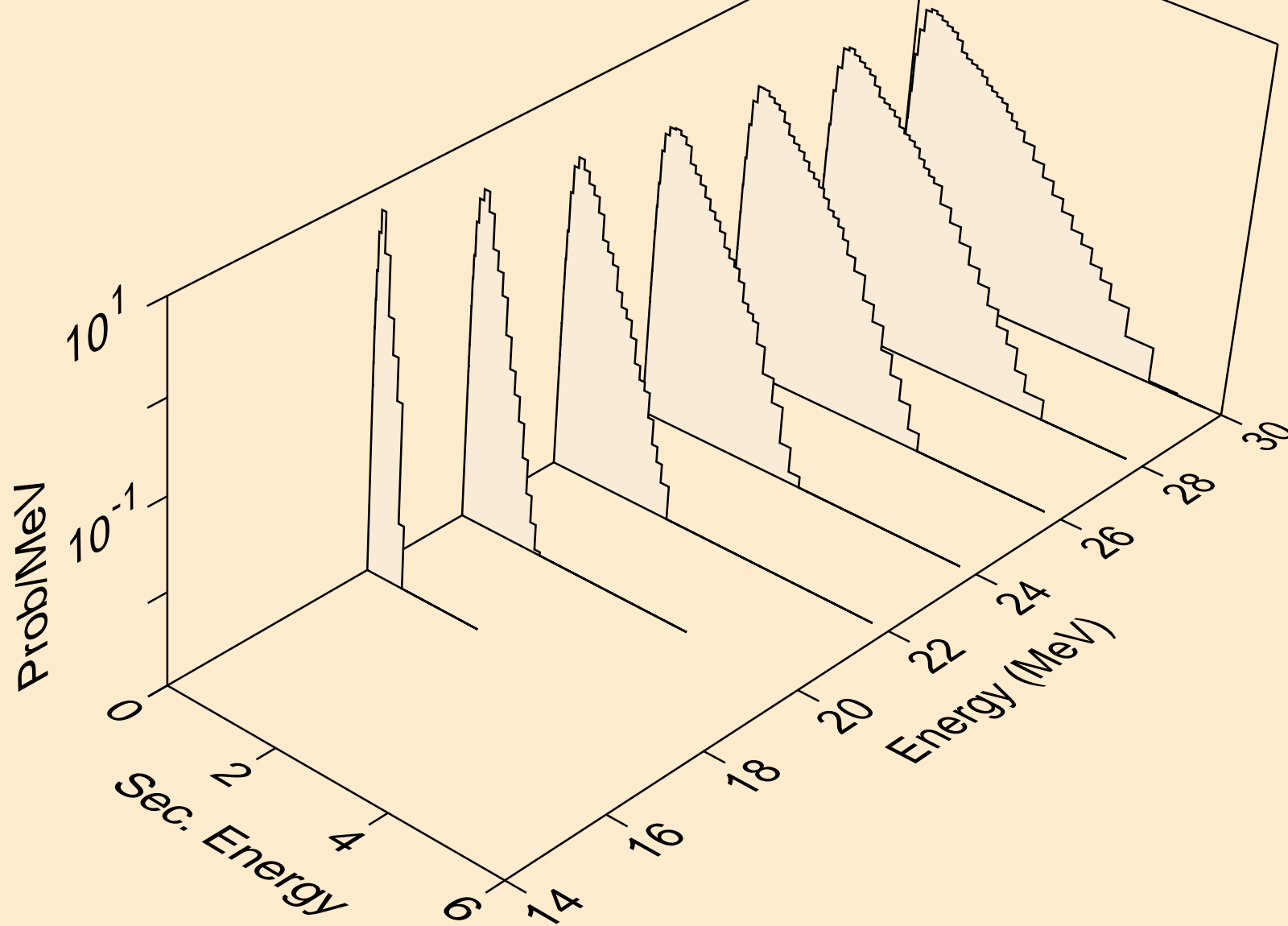

MD258M NEUTRON ACER TENDL-2021 LIBRARY; T=293.6K
Neutron emission for (n,n*c)

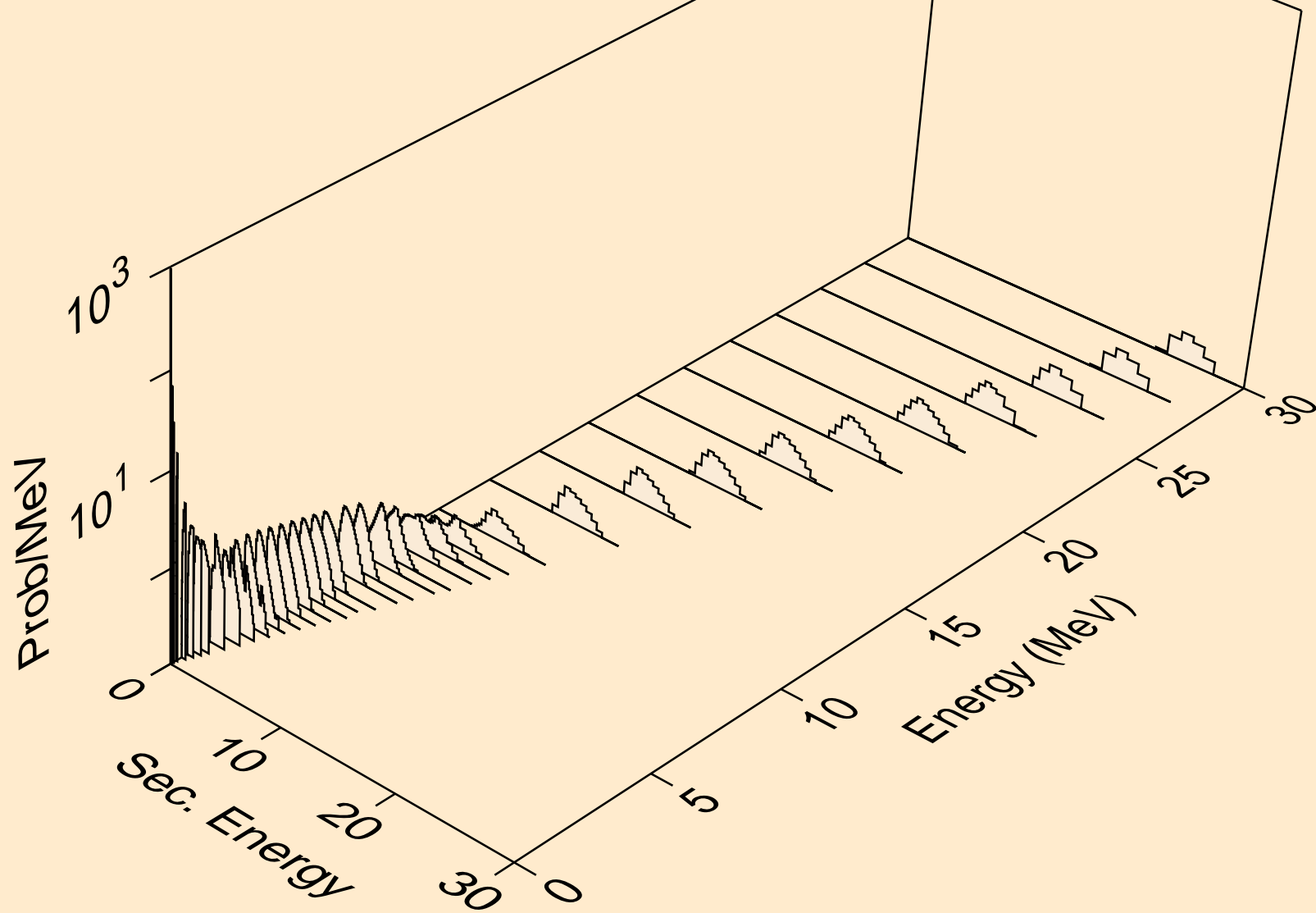

MD258M NEUTRON ACER TENDL-2021 LIBRARY; T=293.6K
Delayed nubar

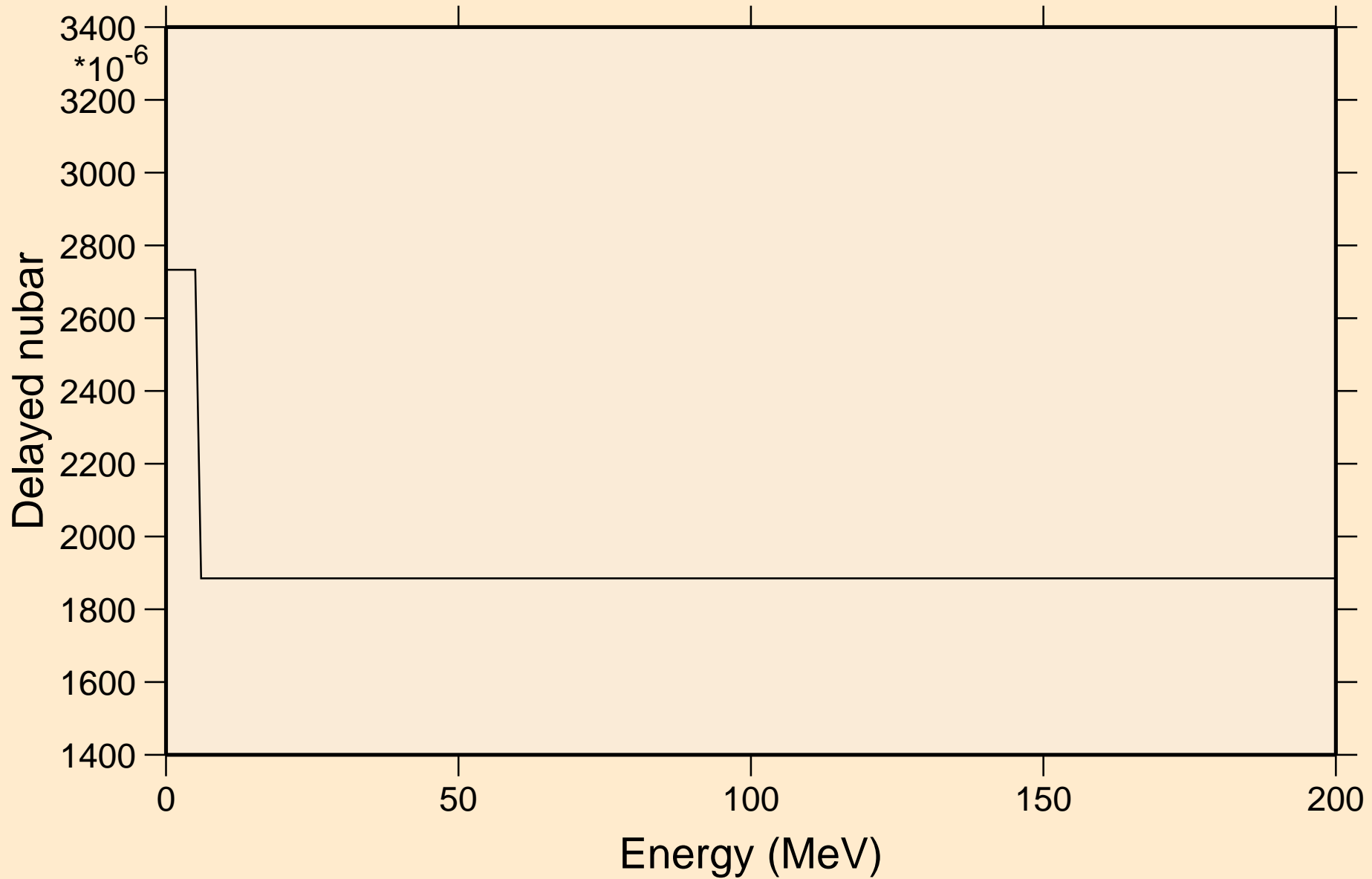

MD258M NEUTRON ACER TENDL-2021 LIBRARY; T=293.6K

Delayed neutron spectra

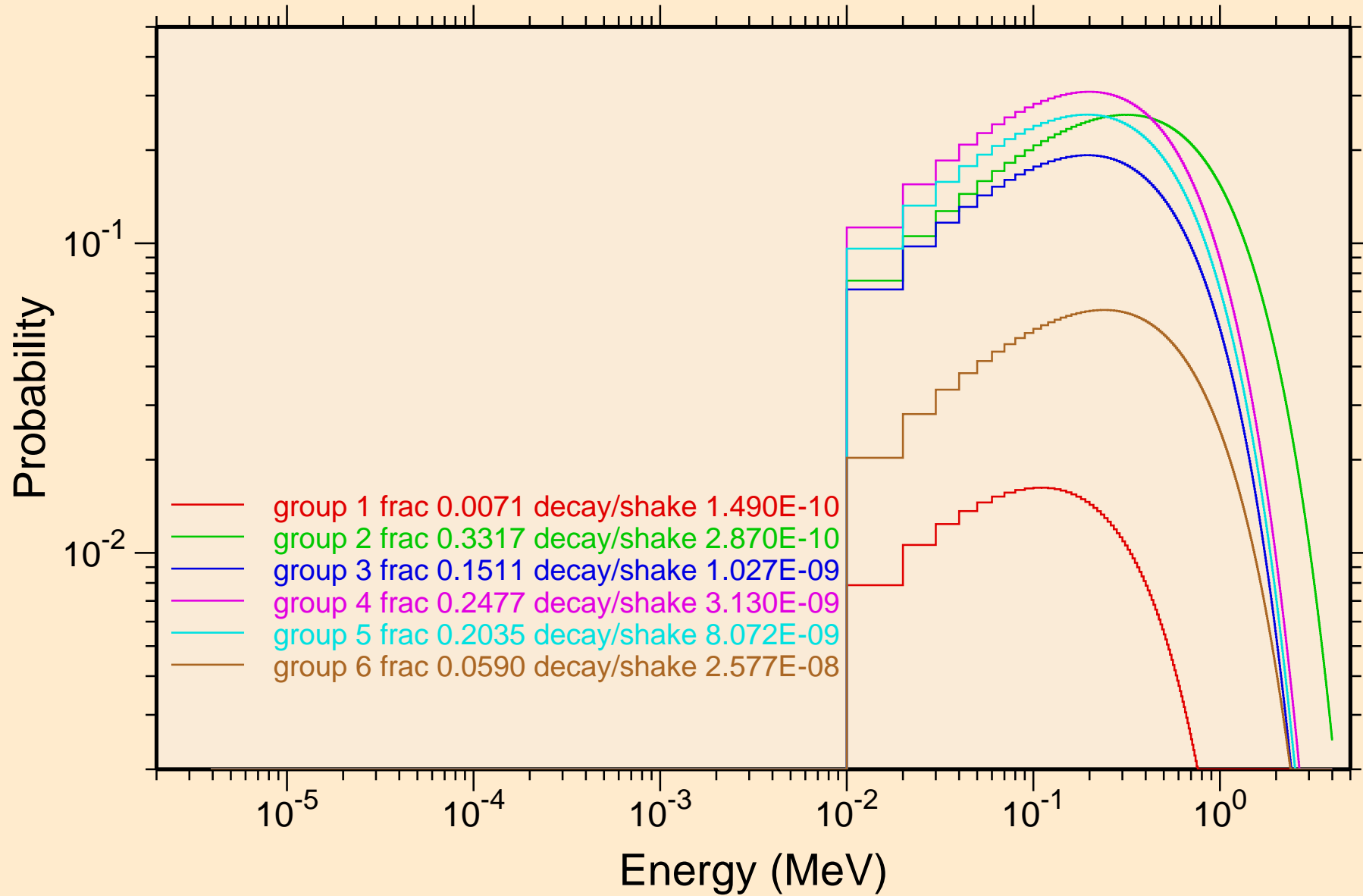

MD258M NEUTRON ACER TENDL-2021 LIBRARY; T=293.6K
Photon emission for (n,x)

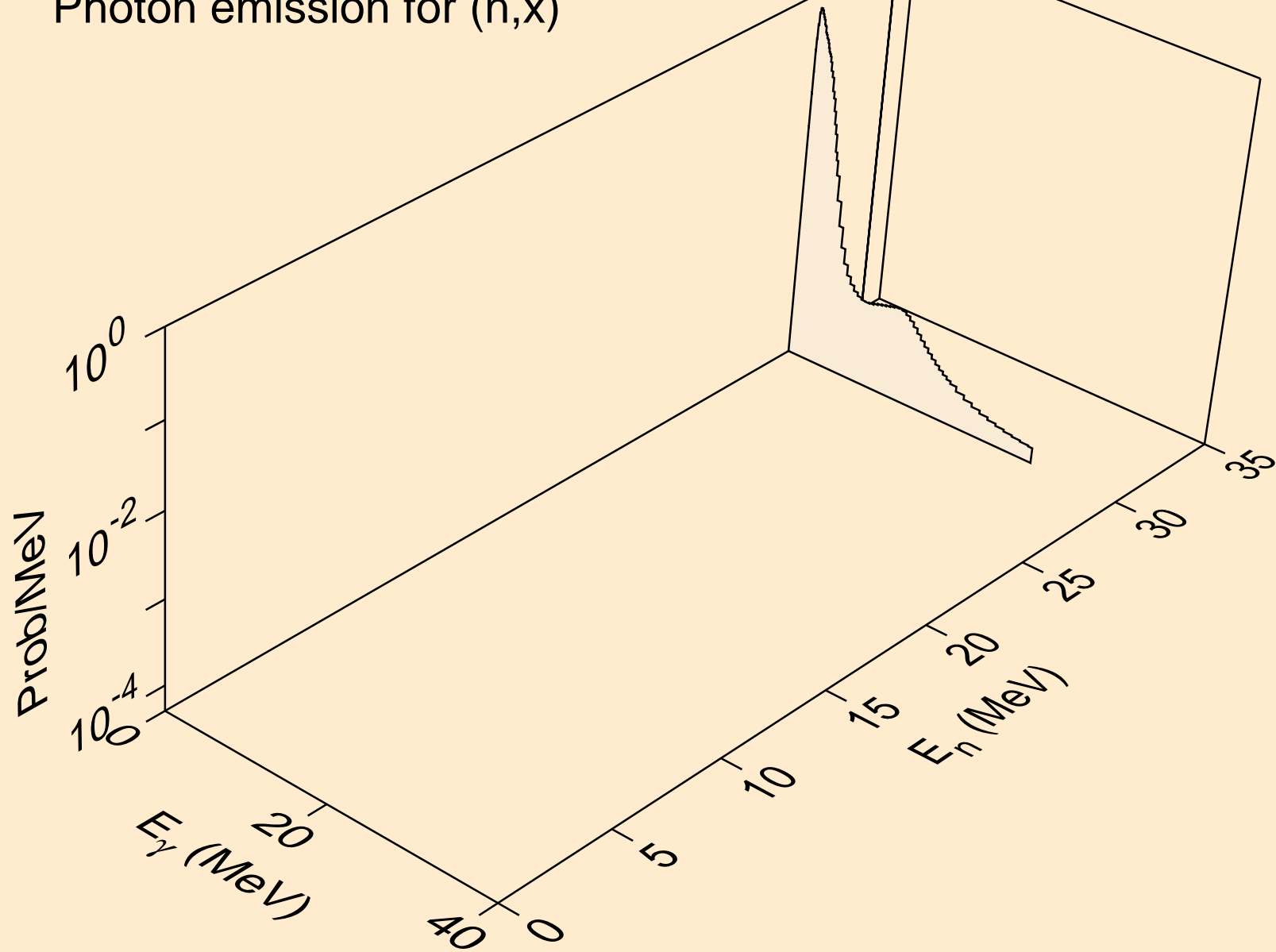

MD258M NEUTRON ACER TENDL-2021 LIBRARY; T=293.6K
Photon emission for (n,2nd)

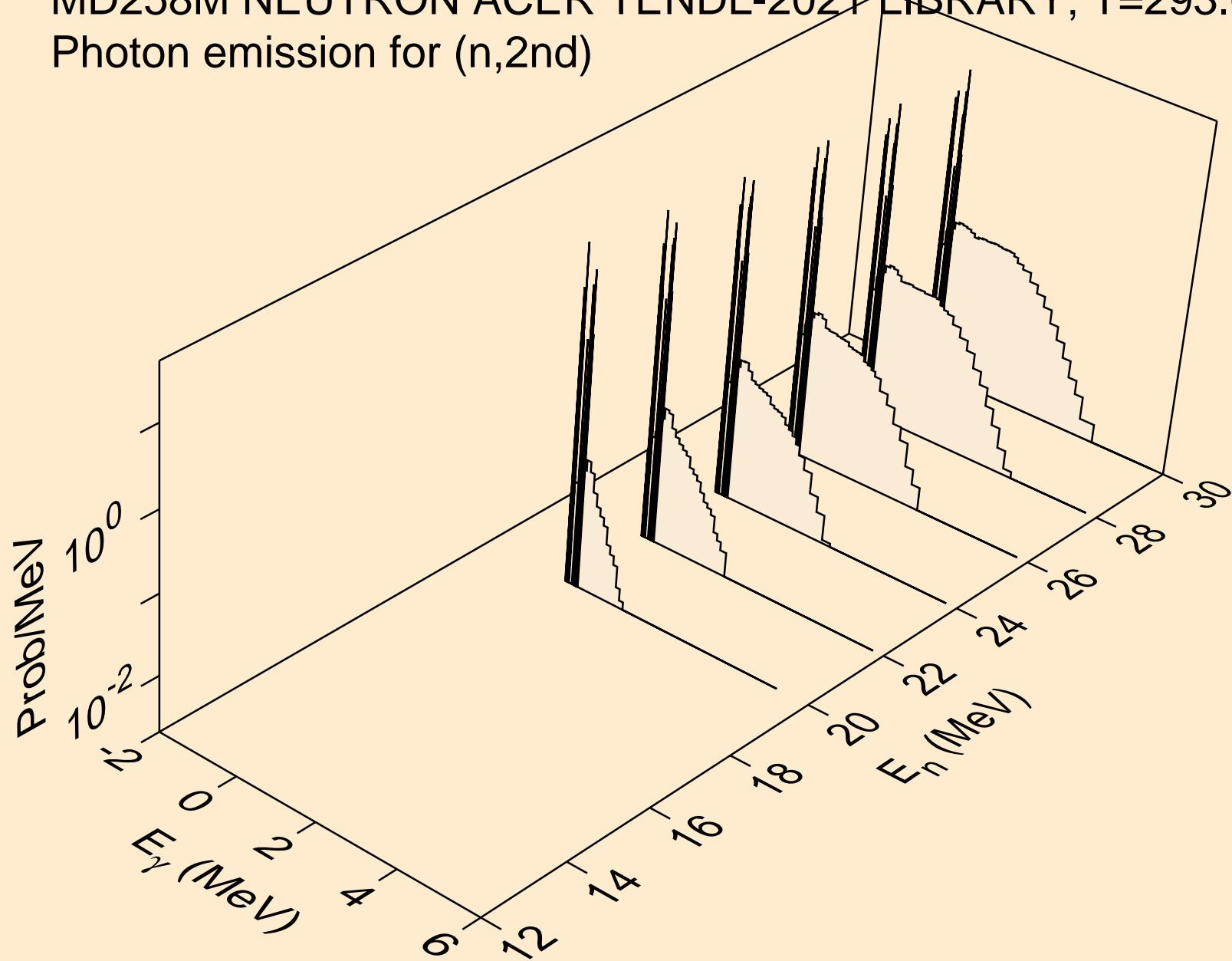

MD258M NEUTRON ACER TENDL-2021 LIBRARY; T=293.6K
Photon emission for (n,2n)

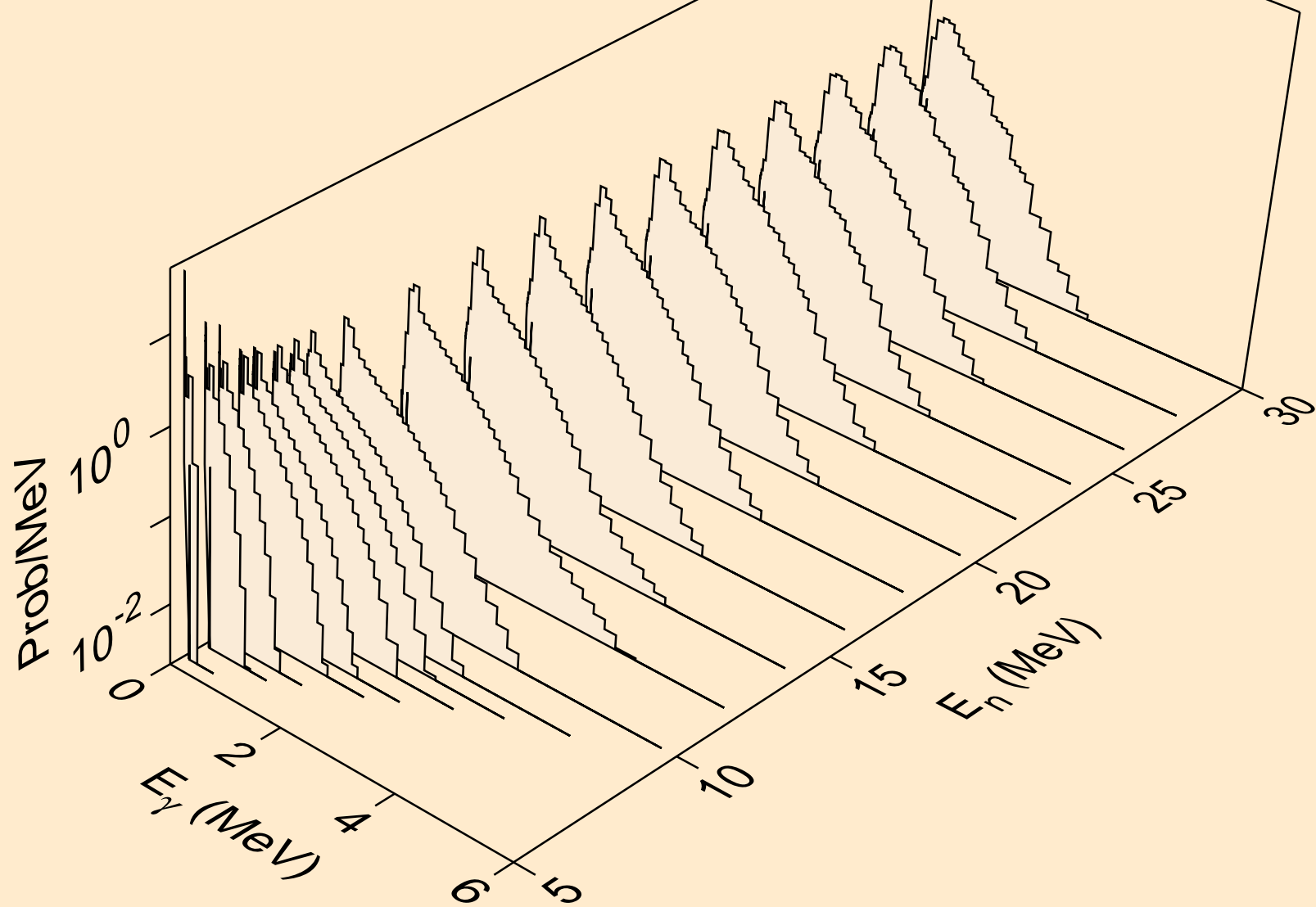

MD258M NEUTRON ACER TENDL-2021 LIBRARY; T=293.6K
Photon emission for (n,3n)

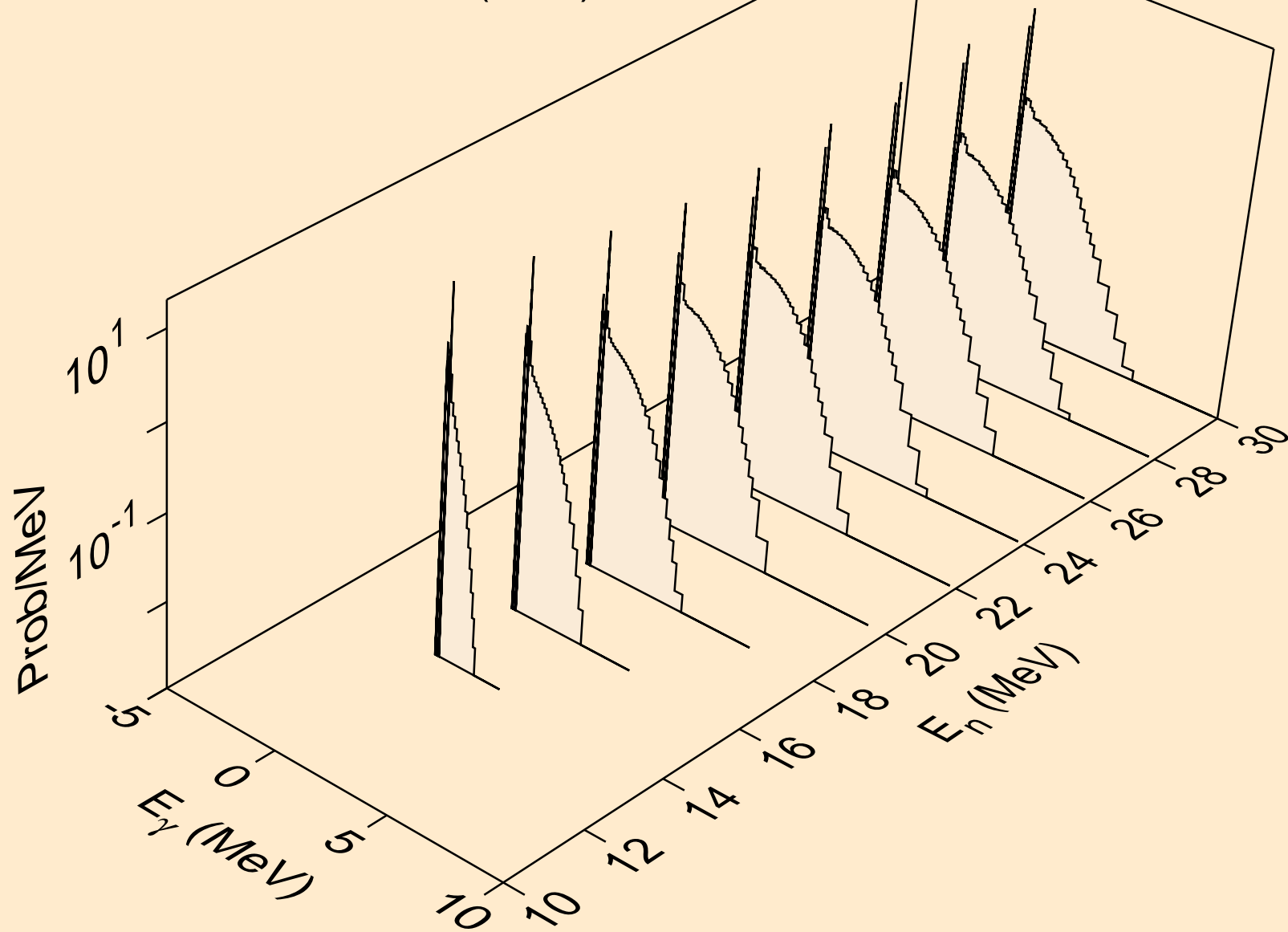

MD258M NEUTRON ACER TENDL-2021 LIBRARY; T=293.6K
Photon emission for (n,n*)a

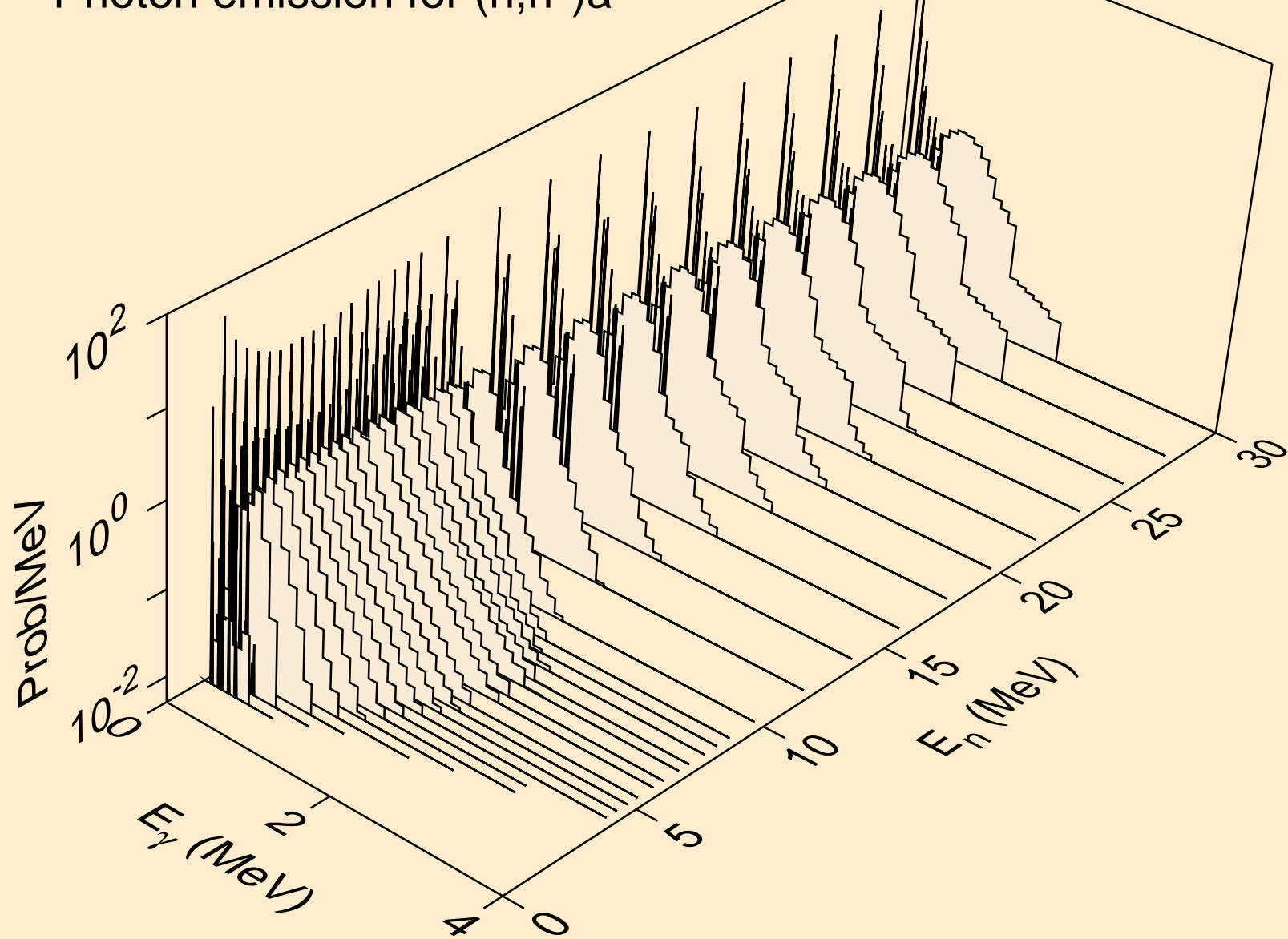

MD258M NEUTRON ACER TENDL-2021 LIBRARY; T=293.6K
Photon emission for (n,2n)a

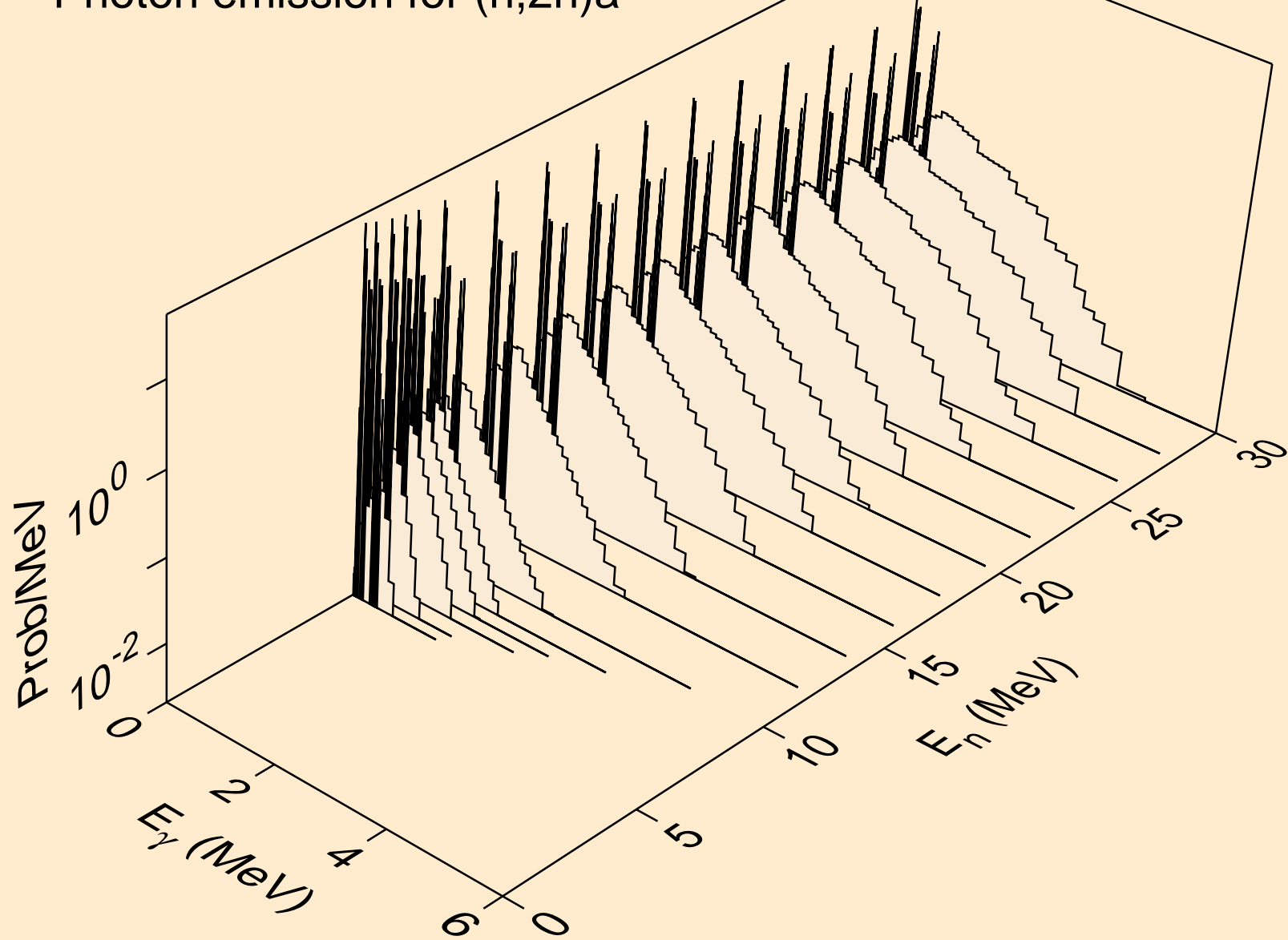

MD258M NEUTRON ACER TENDL-2021 LIBRARY; T=293.6K
Photon emission for (n,3n)a

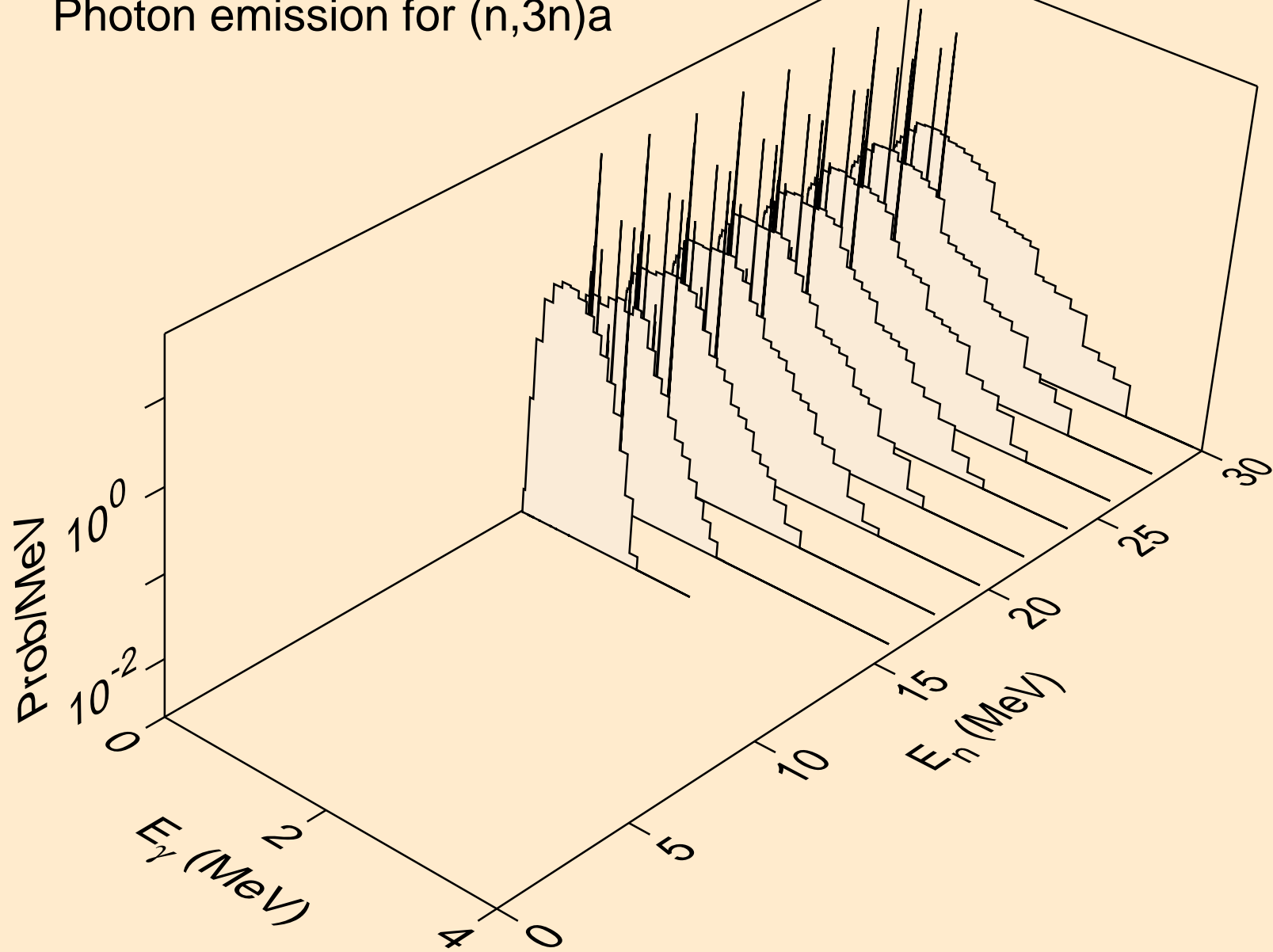

MD258M NEUTRON ACER TENDL-2021 LIBRARY; T=293.6K
Photon emission for (n,n*)p

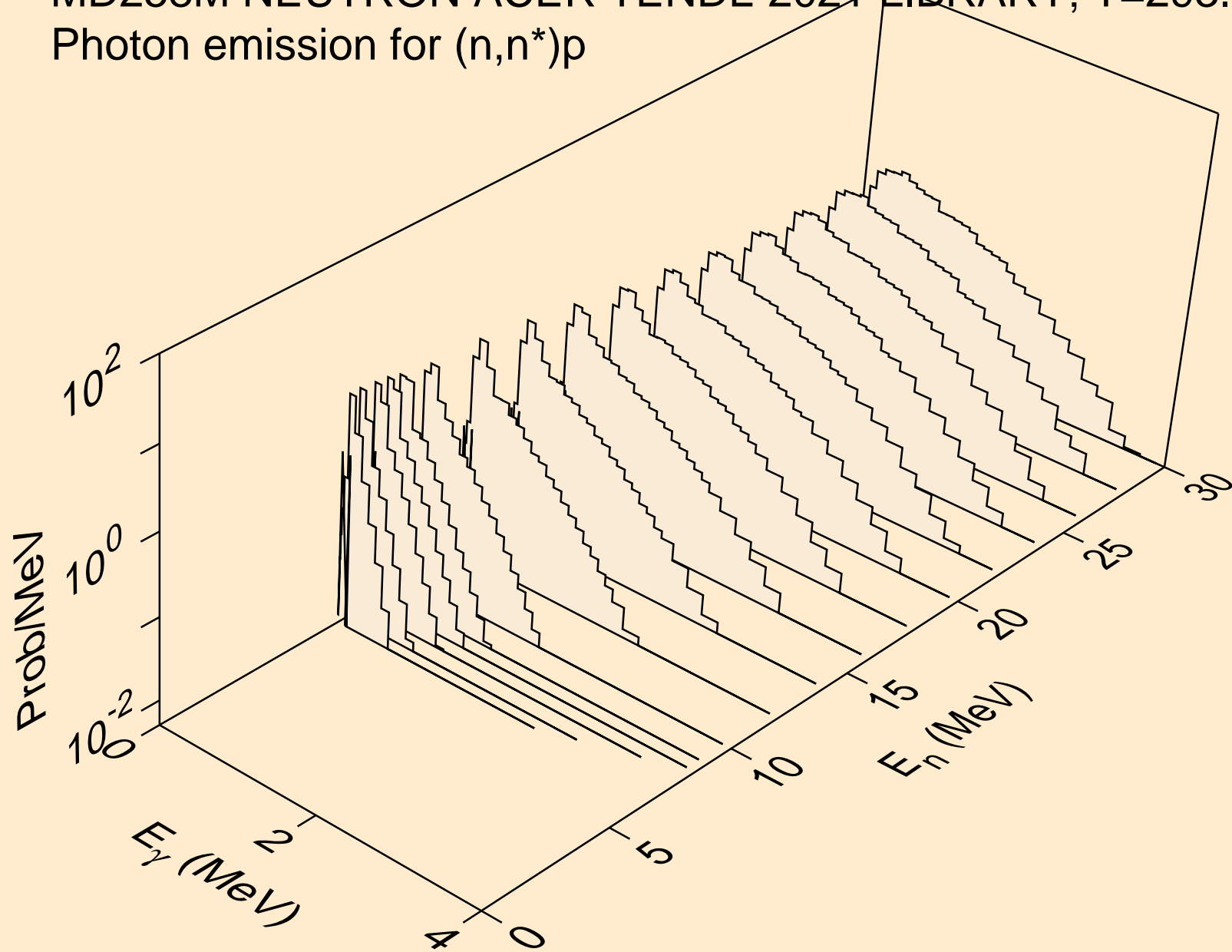

MD258M NEUTRON ACER TENDL-2021 LIBRARY; T=293.6K
Photon emission for (n,n*)d

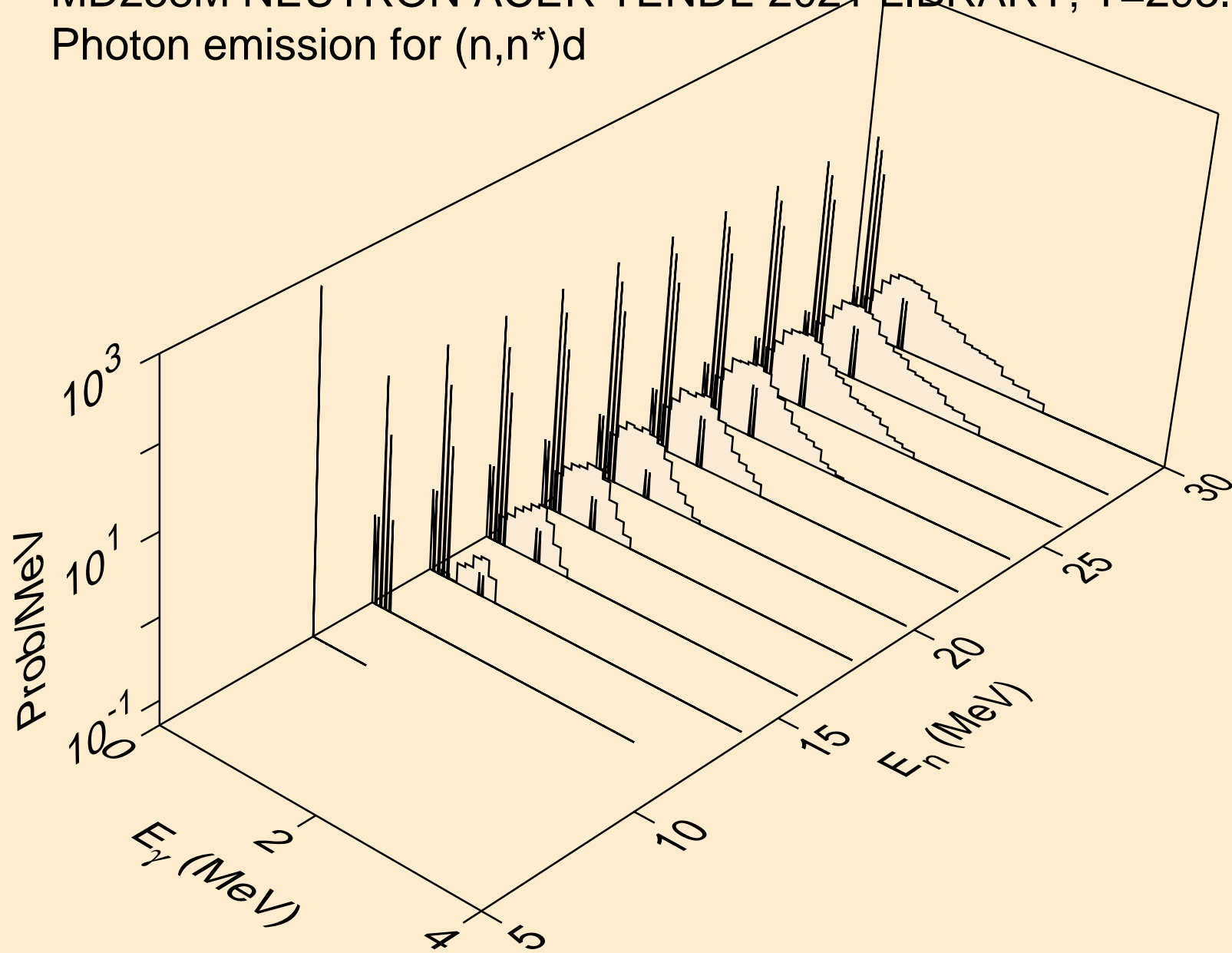

MD258M NEUTRON ACER TENDL-2021 LIBRARY; T=293.6K
Photon emission for (n,n*)t

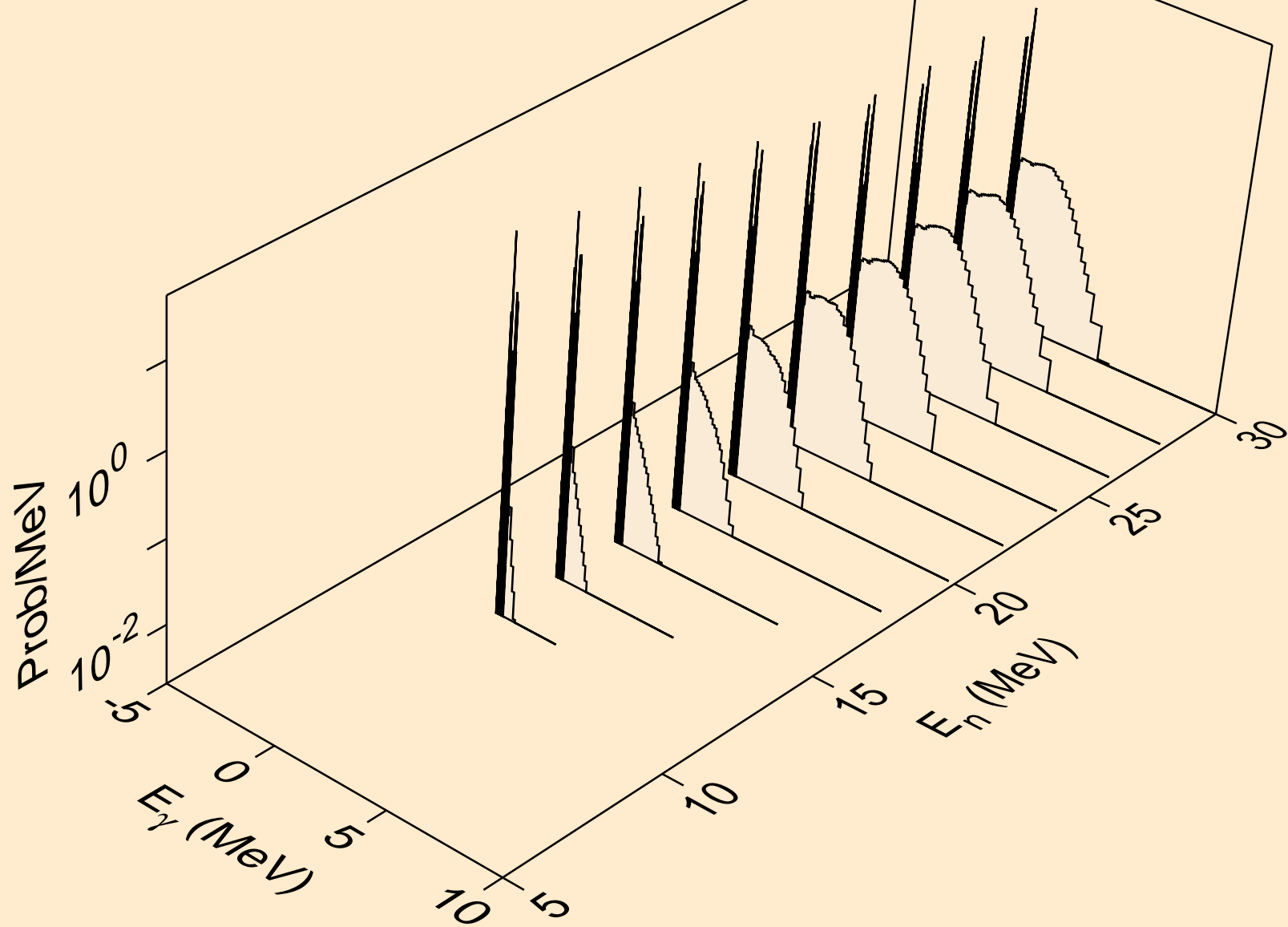

MD258M NEUTRON ACER TENDL-2021 LIBRARY; T=293.6K
Photon emission for (n,n*)he3

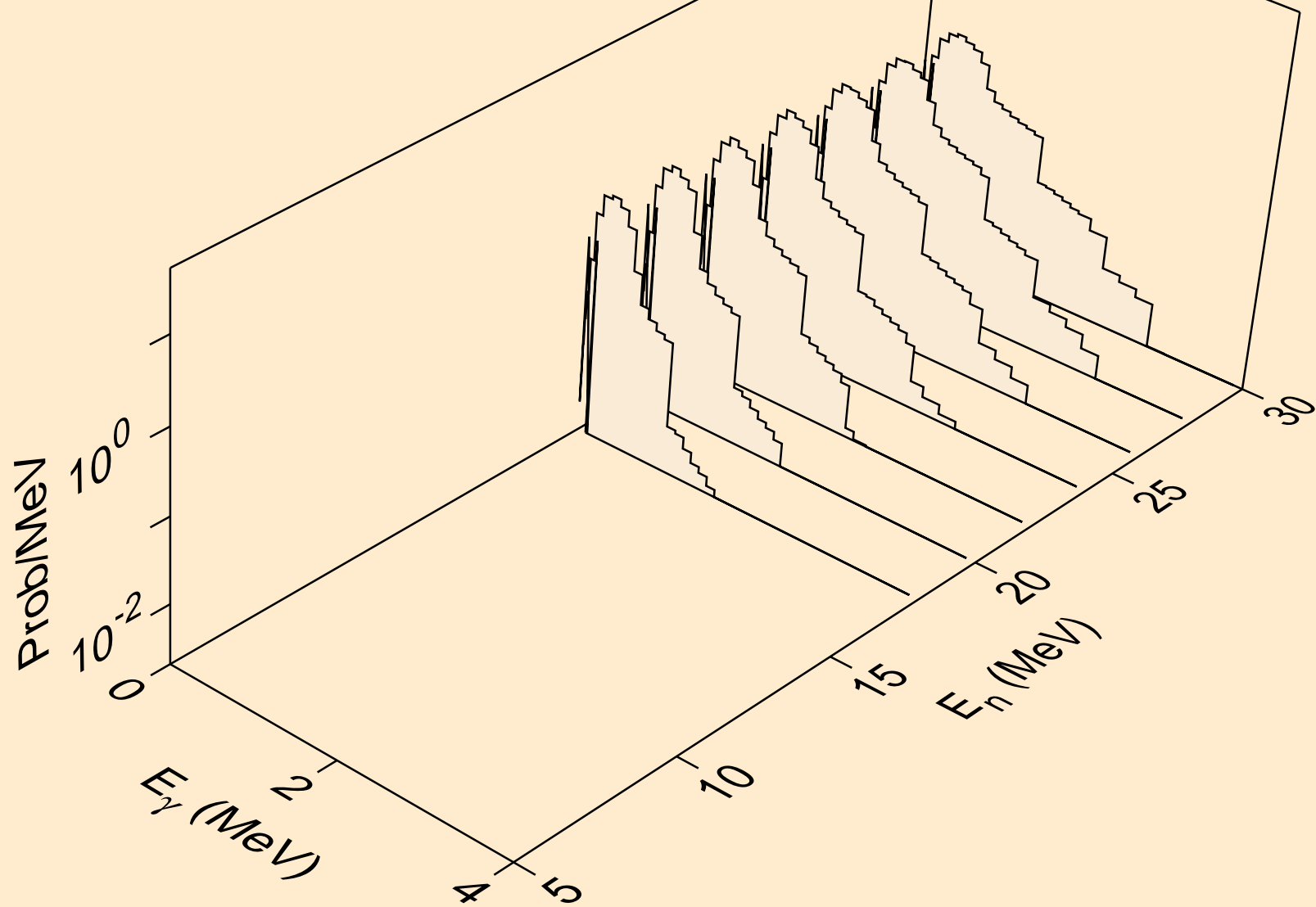

MD258M NEUTRON ACER TENDL-2021 LIBRARY; T=293.6K
Photon emission for (n,4n)

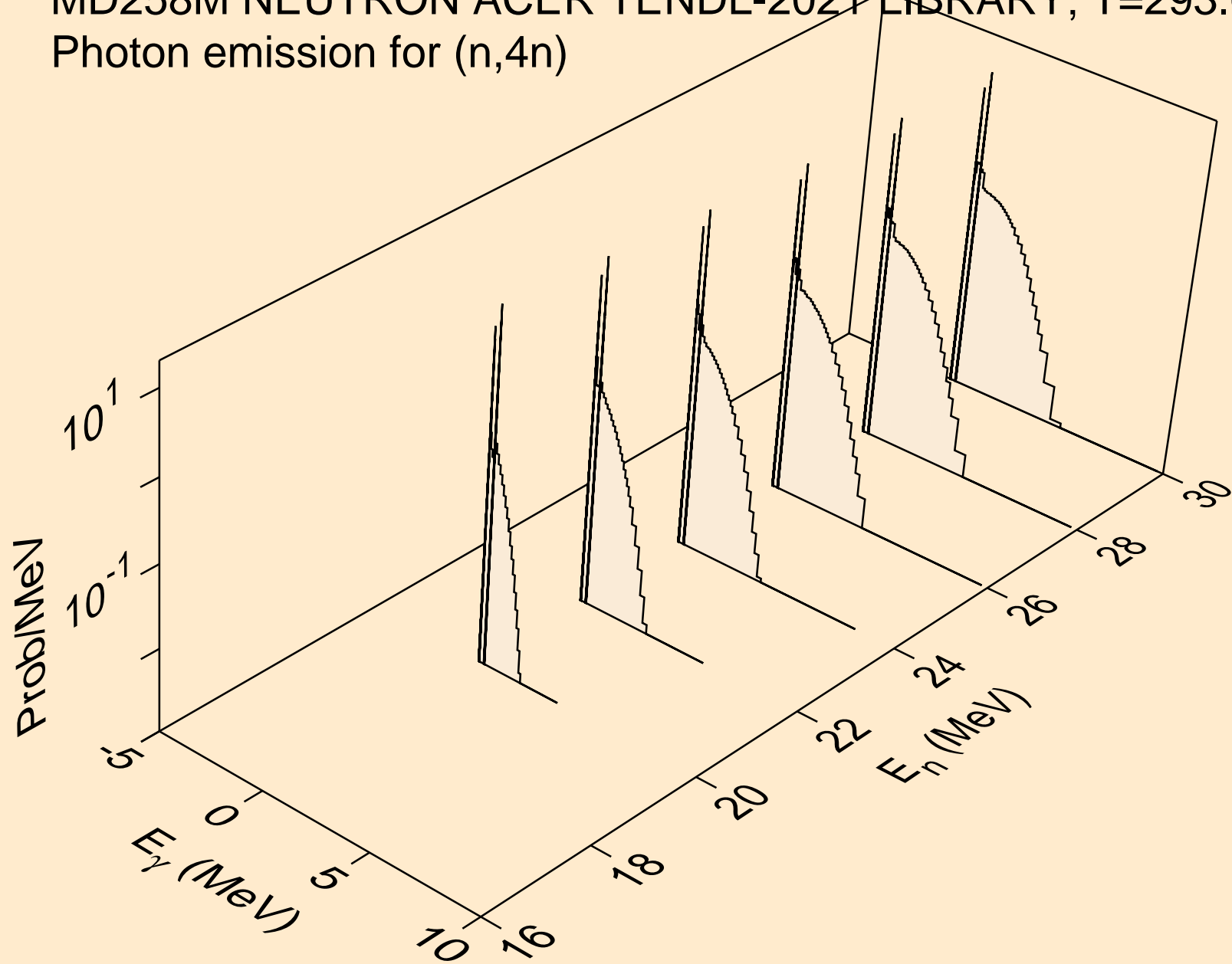

MD258M NEUTRON ACER TENDL-2021 LIBRARY; T=293.6K
Photon emission for (n,2np)

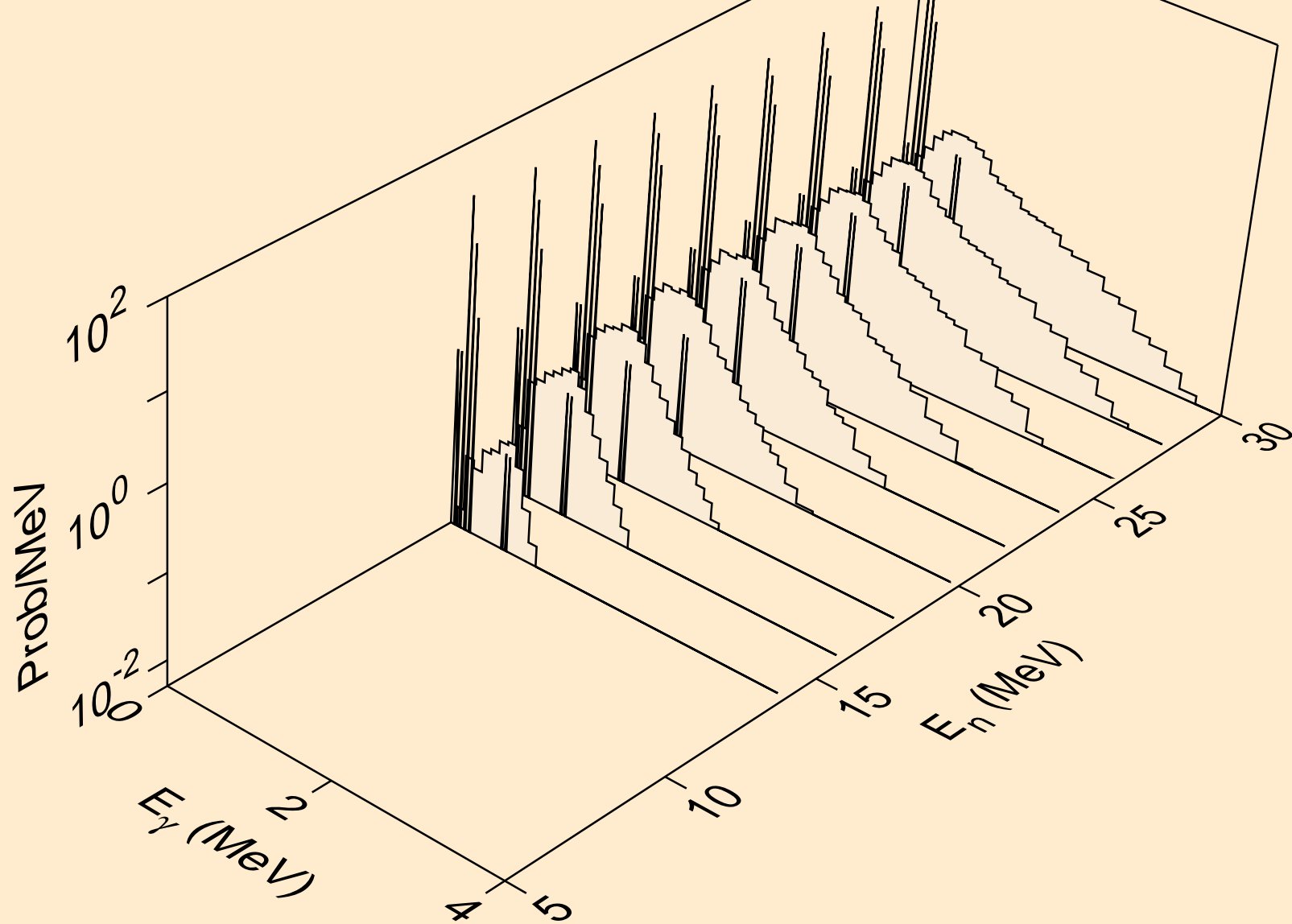

MD258M NEUTRON ACER TENDL-2021 LIBRARY; T=293.6K
Photon emission for (n,3np)

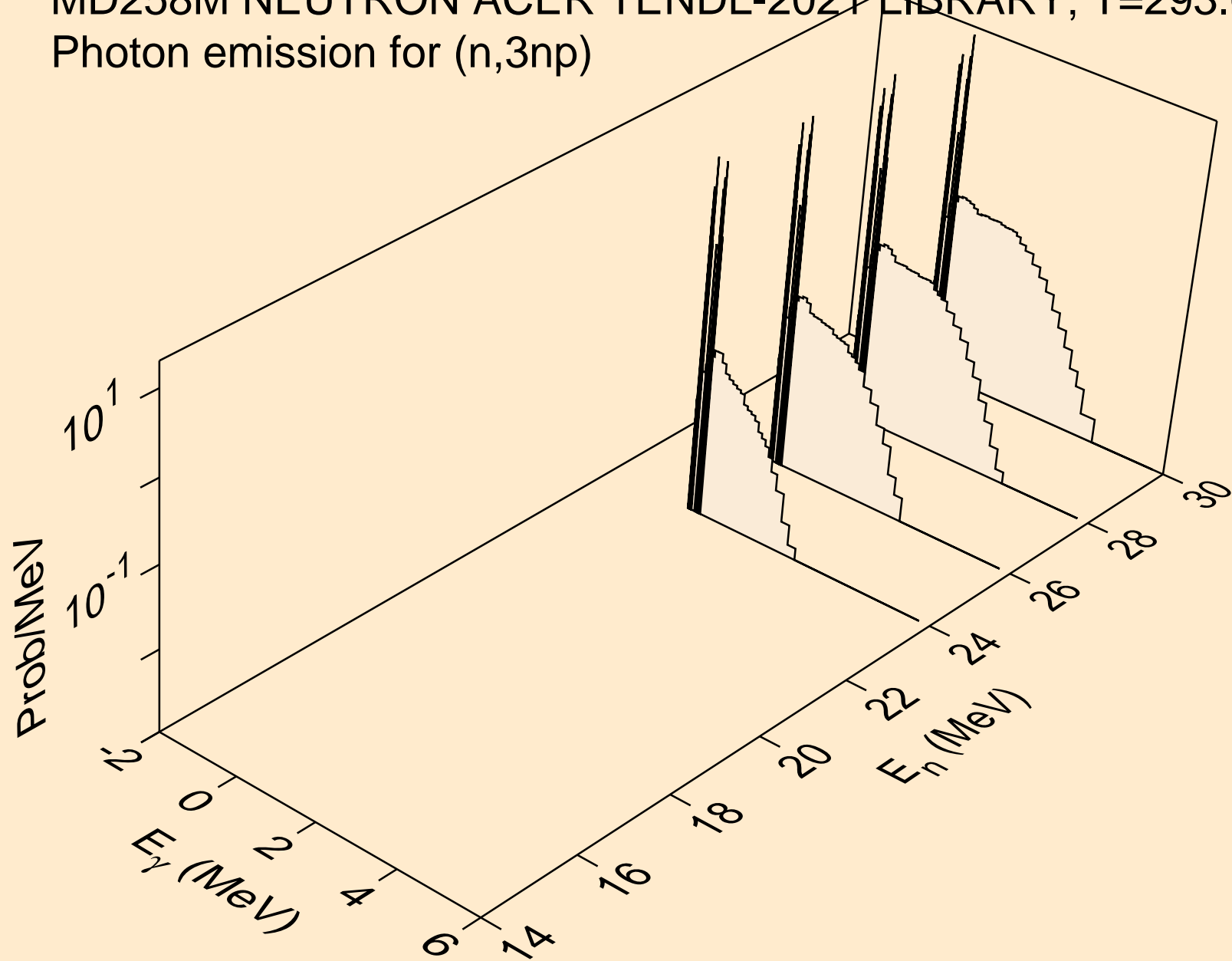

MD258M NEUTRON ACER TENDL-2021 LIBRARY; T=293.6K
Photon emission for (n,n*2)

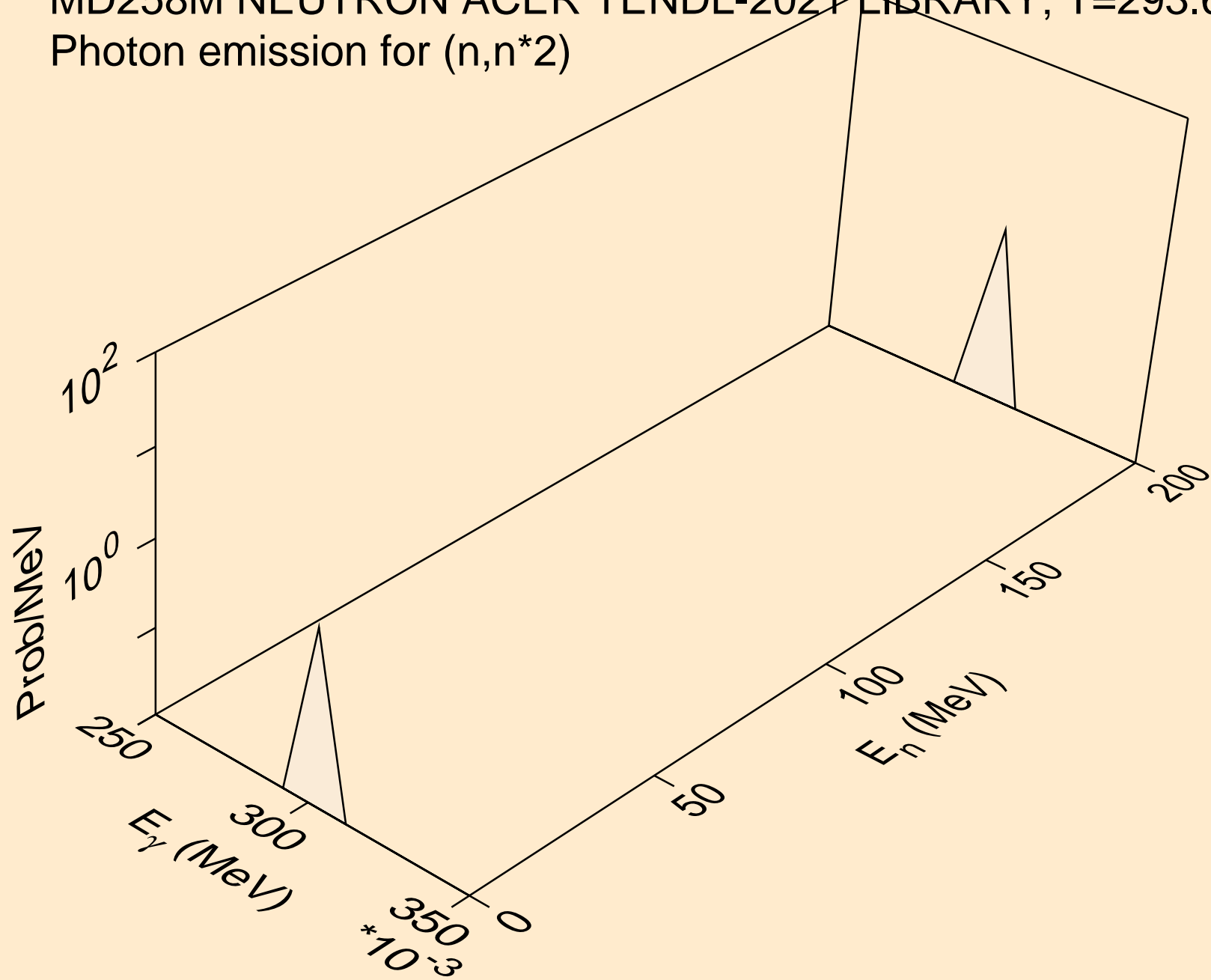

MD258M NEUTRON ACER TENDL-2021 LIBRARY; T=293.6K
Photon emission for (n,n*c)

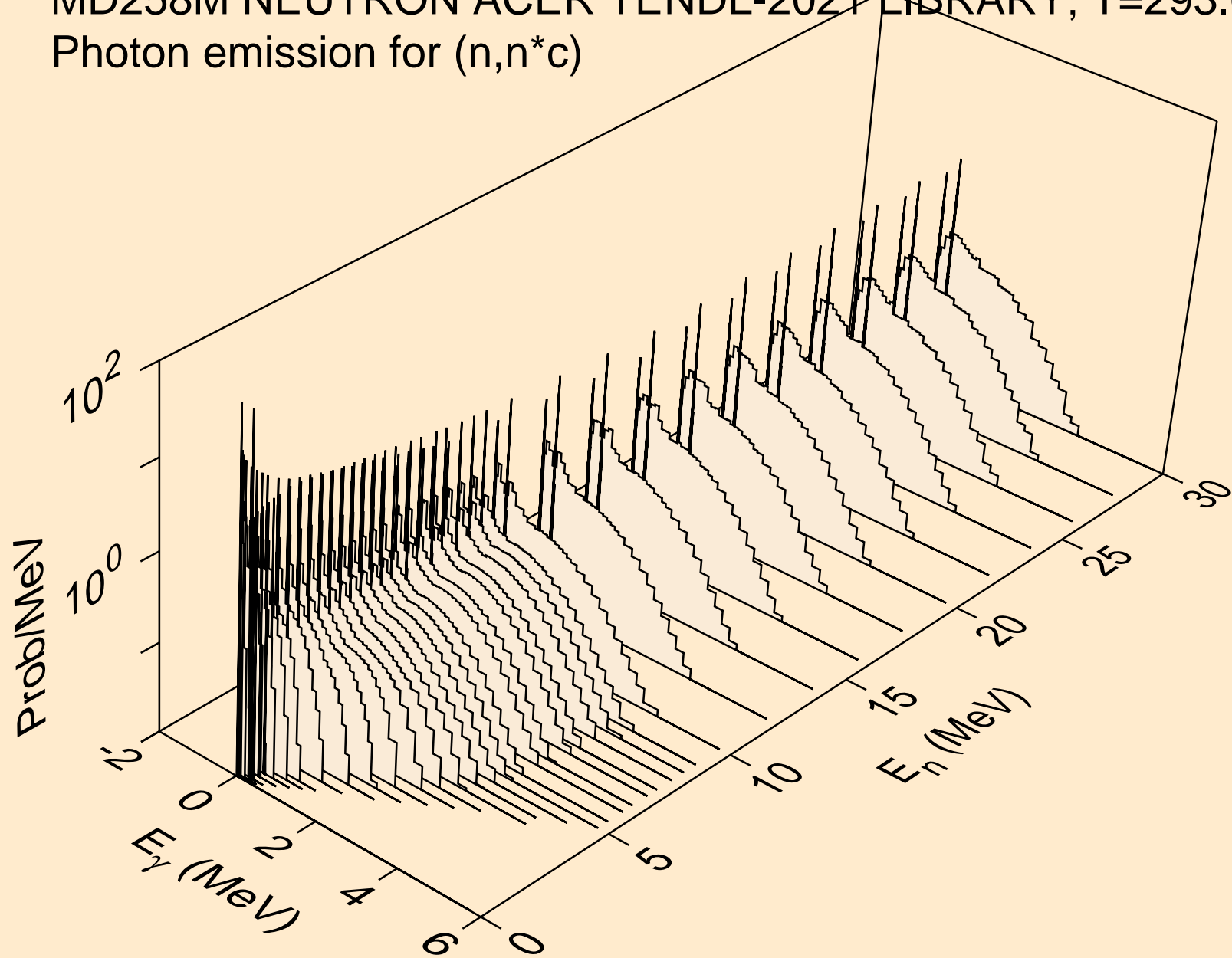

MD258M NEUTRON ACER TENDL-2021 LIBRARY; T=293.6K
Photon emission for (n,gma)

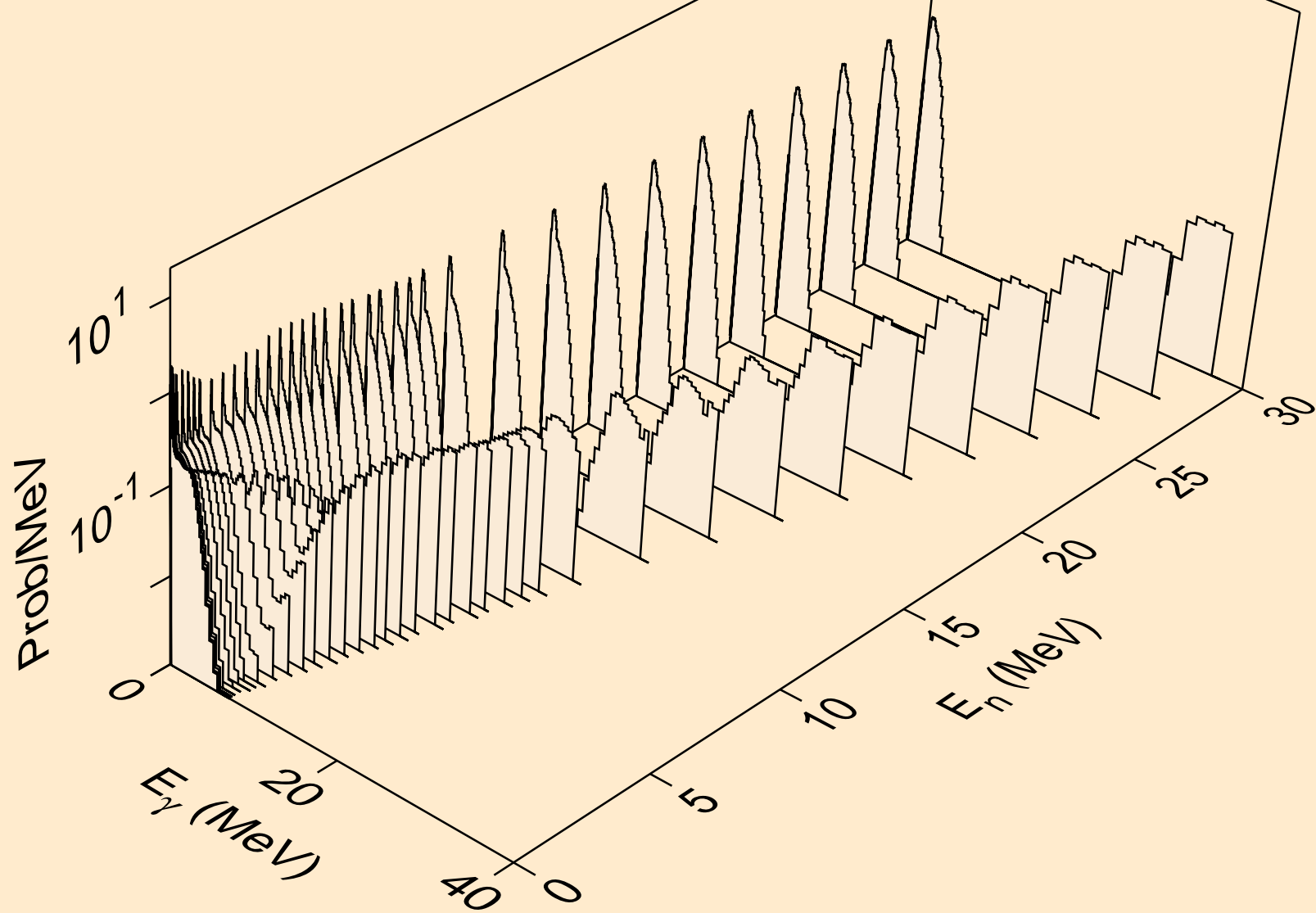

MD258M NEUTRON ACER TENDL-2021 LIBRARY; T=293.6K
Photon emission for (n,p)

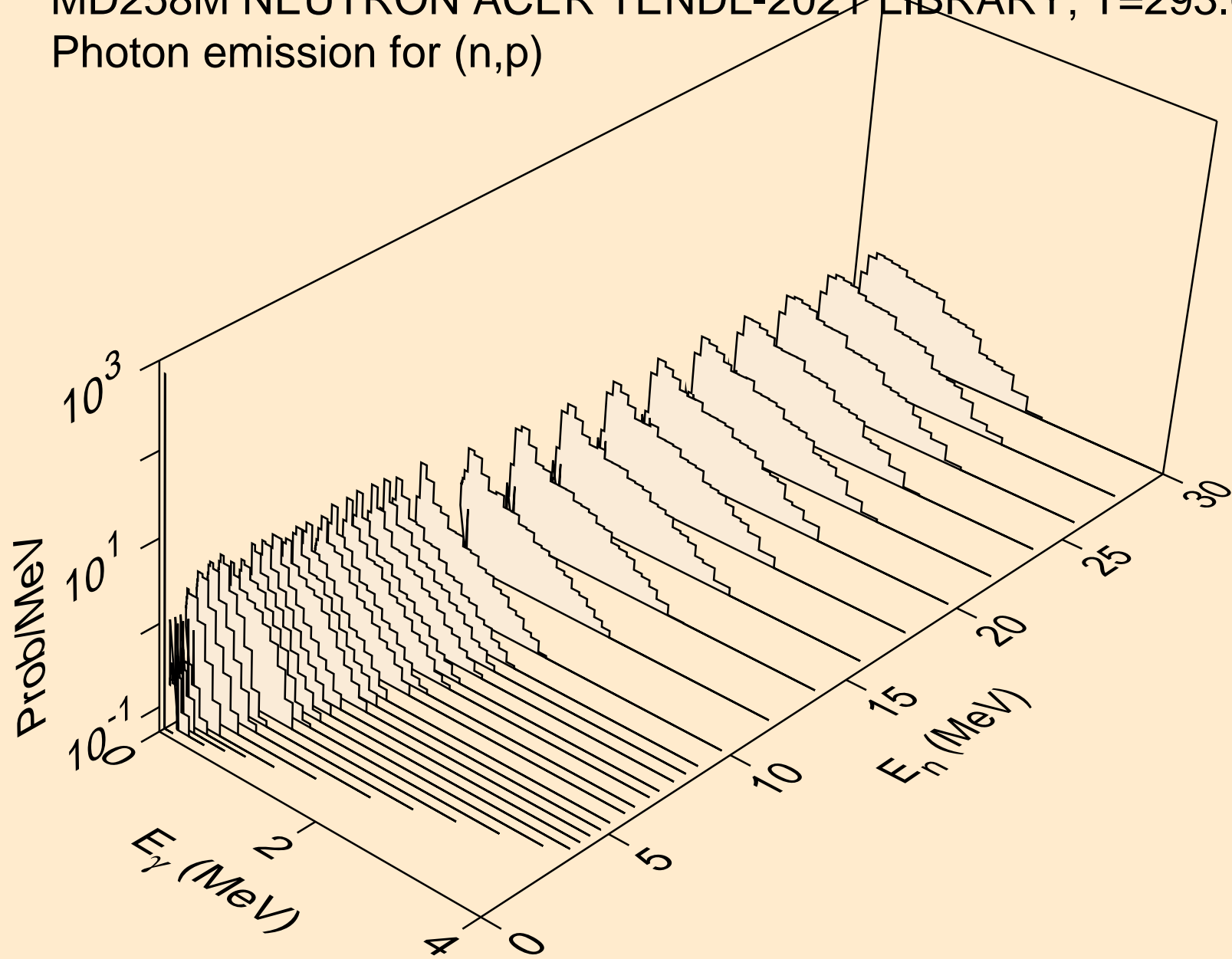

MD258M NEUTRON ACER TENDL-2021 LIBRARY; T=293.6K
Photon emission for (n,d)

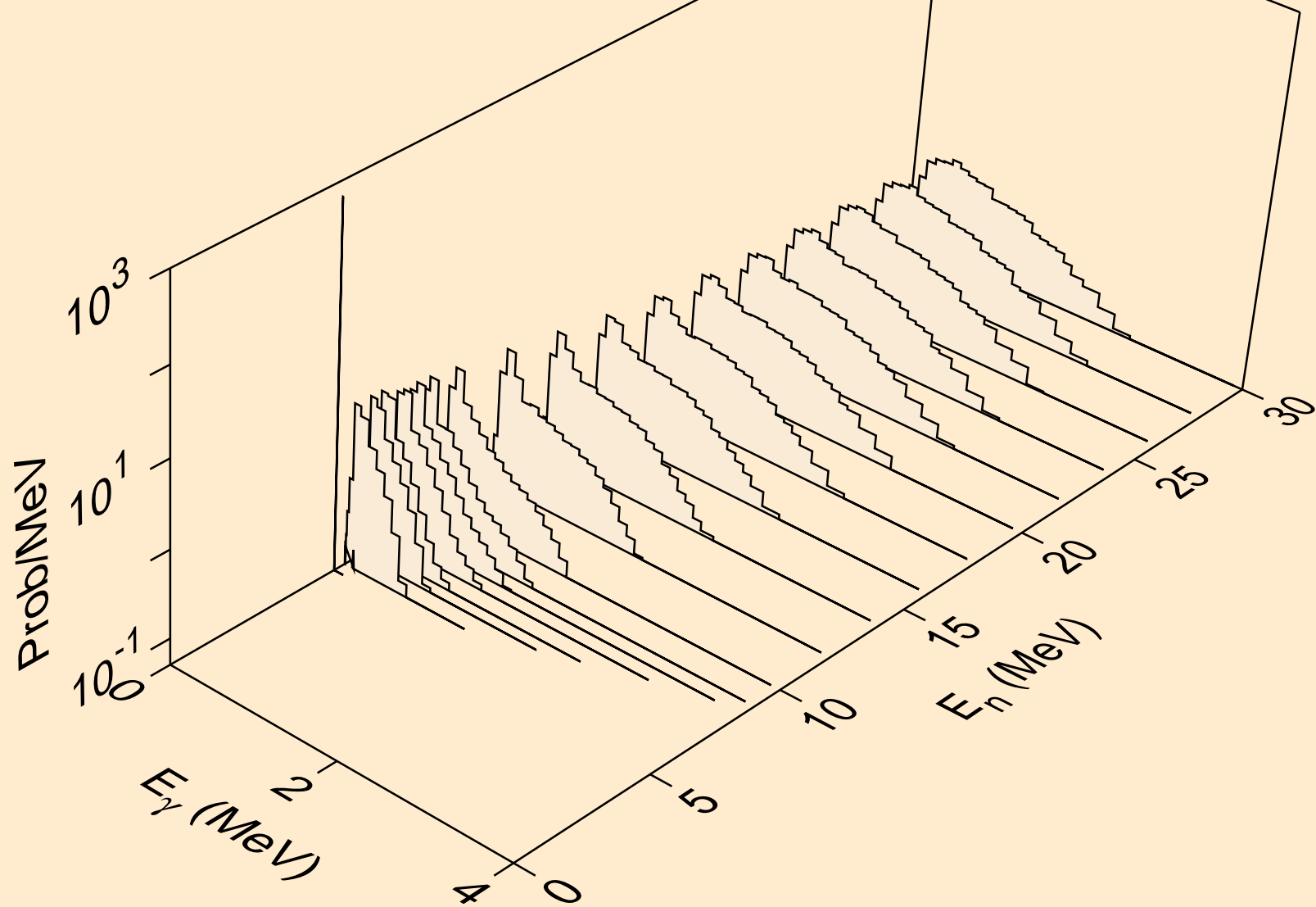

MD258M NEUTRON ACER TENDL-2021 LIBRARY; T=293.6K
Photon emission for (n,t)

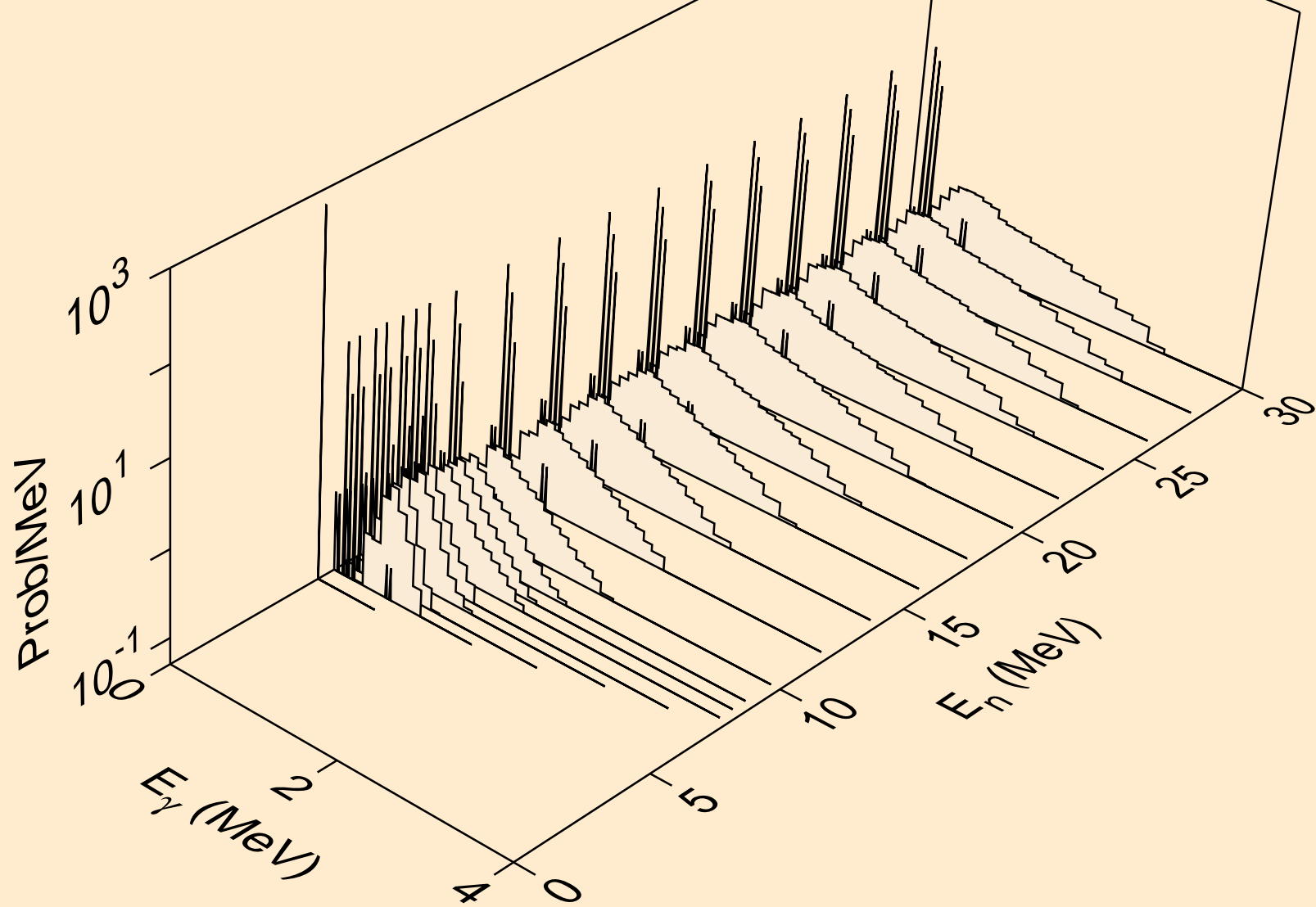

MD258M NEUTRON ACER TENDL-2021 LIBRARY; T=293.6K
Photon emission for (n,he3)

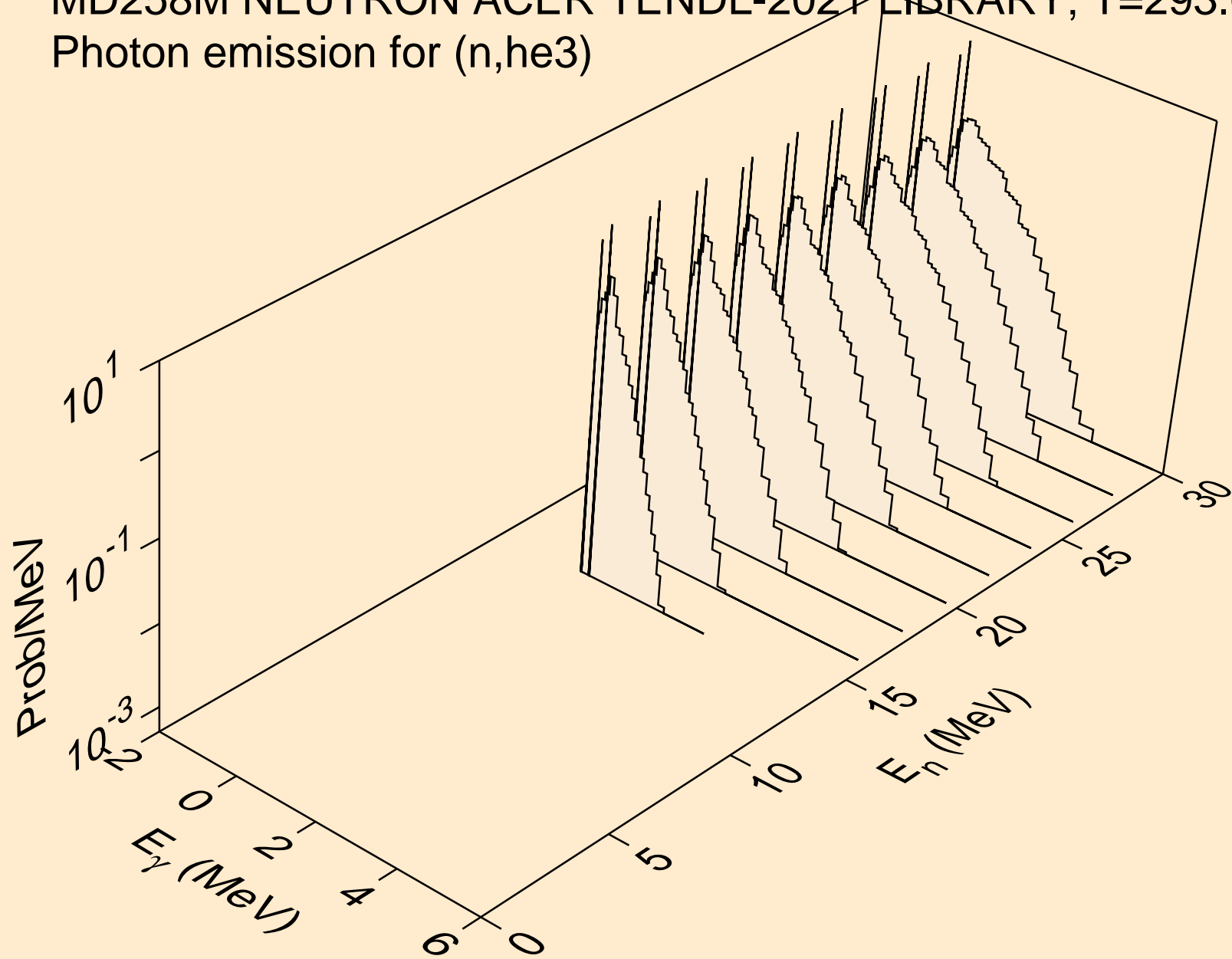

MD258M NEUTRON ACER TENDL-2021 LIBRARY; T=293.6K
Photon emission for (n,a)

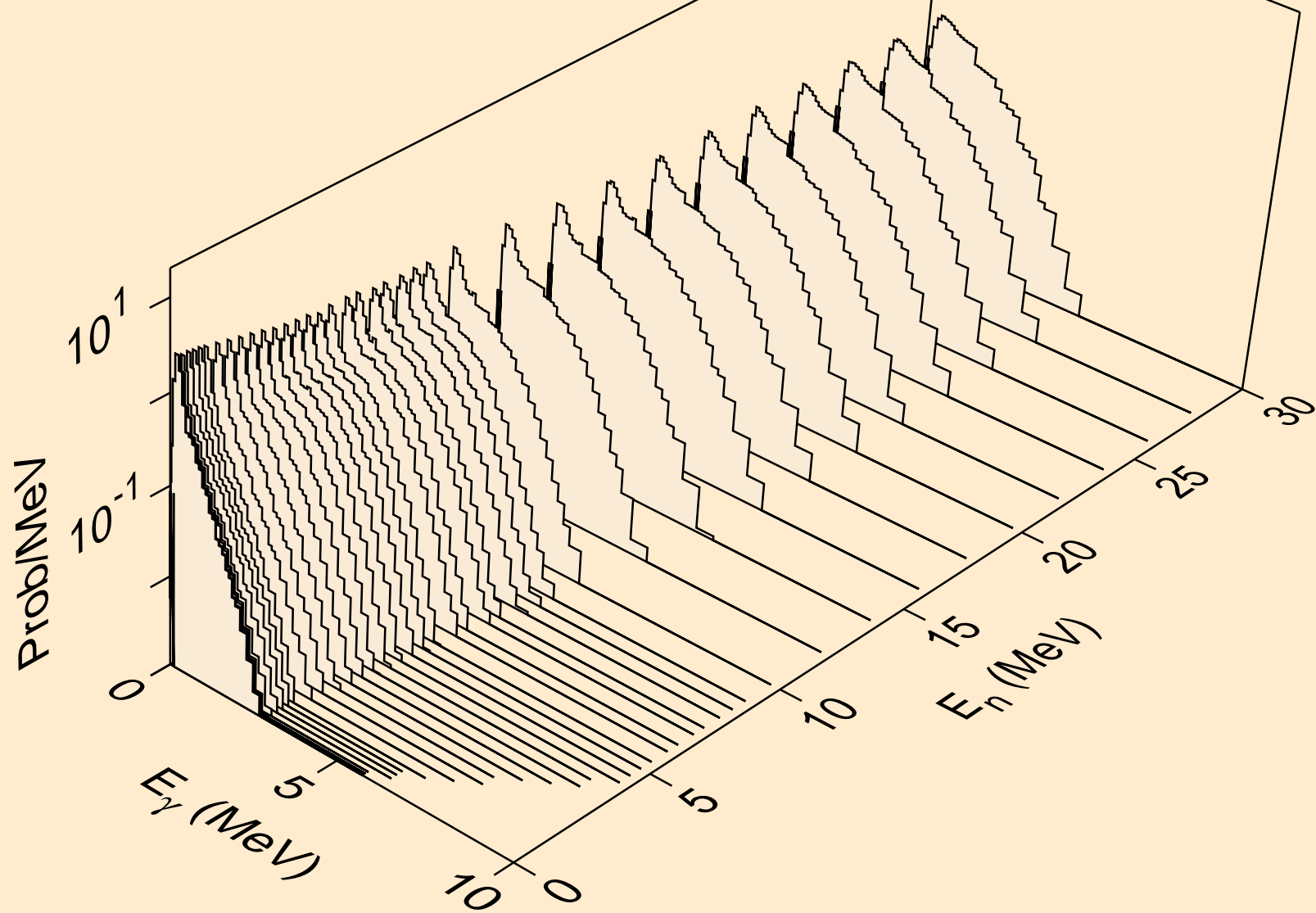

MD258M NEUTRON ACER TENDL-2021 LIBRARY; T=293.6K
thermal capture photon spectrum

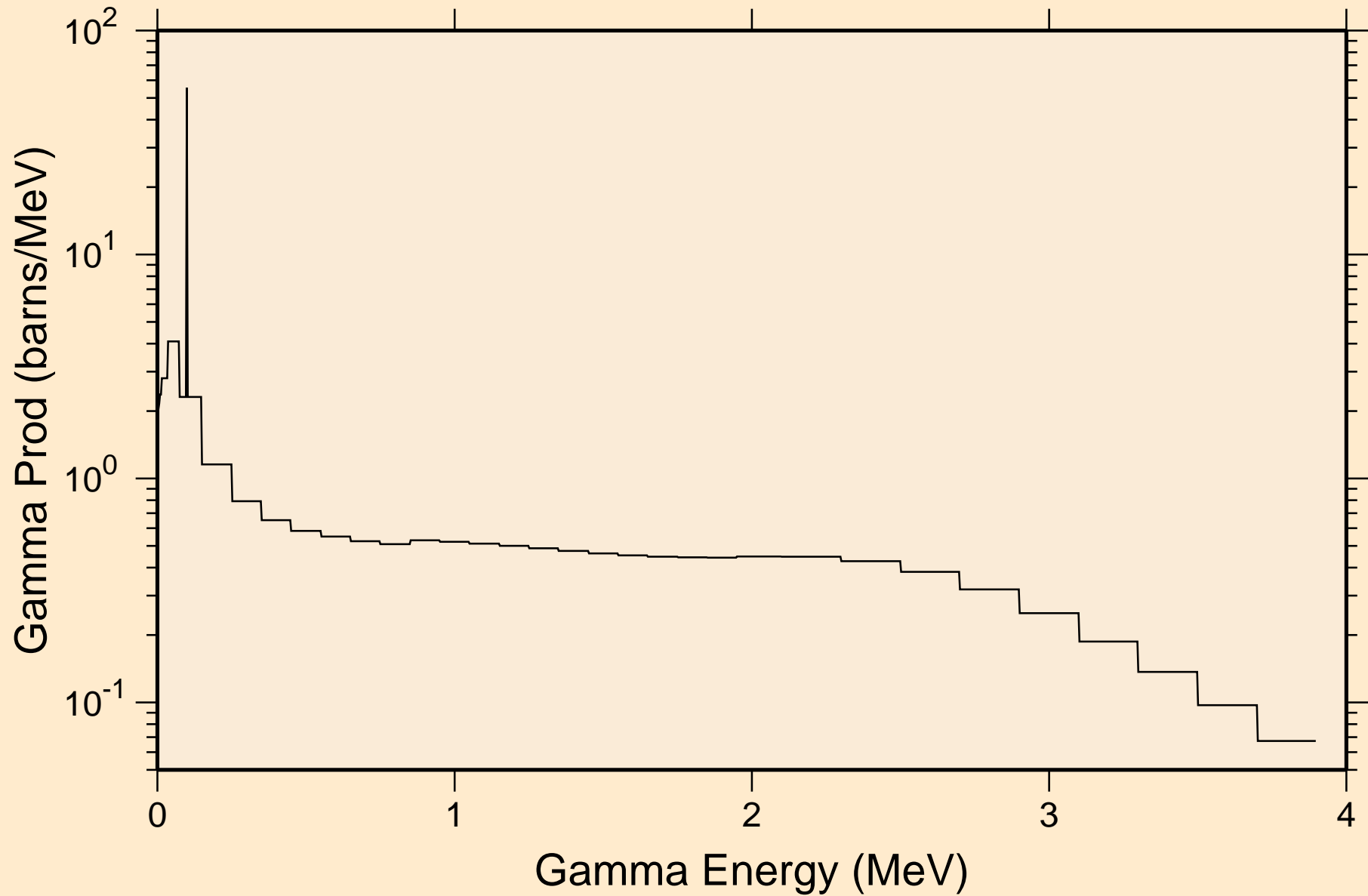

MD258M NEUTRON ACER TENDL-2021 LIBRARY; T=293.6K
14 MeV photon spectrum

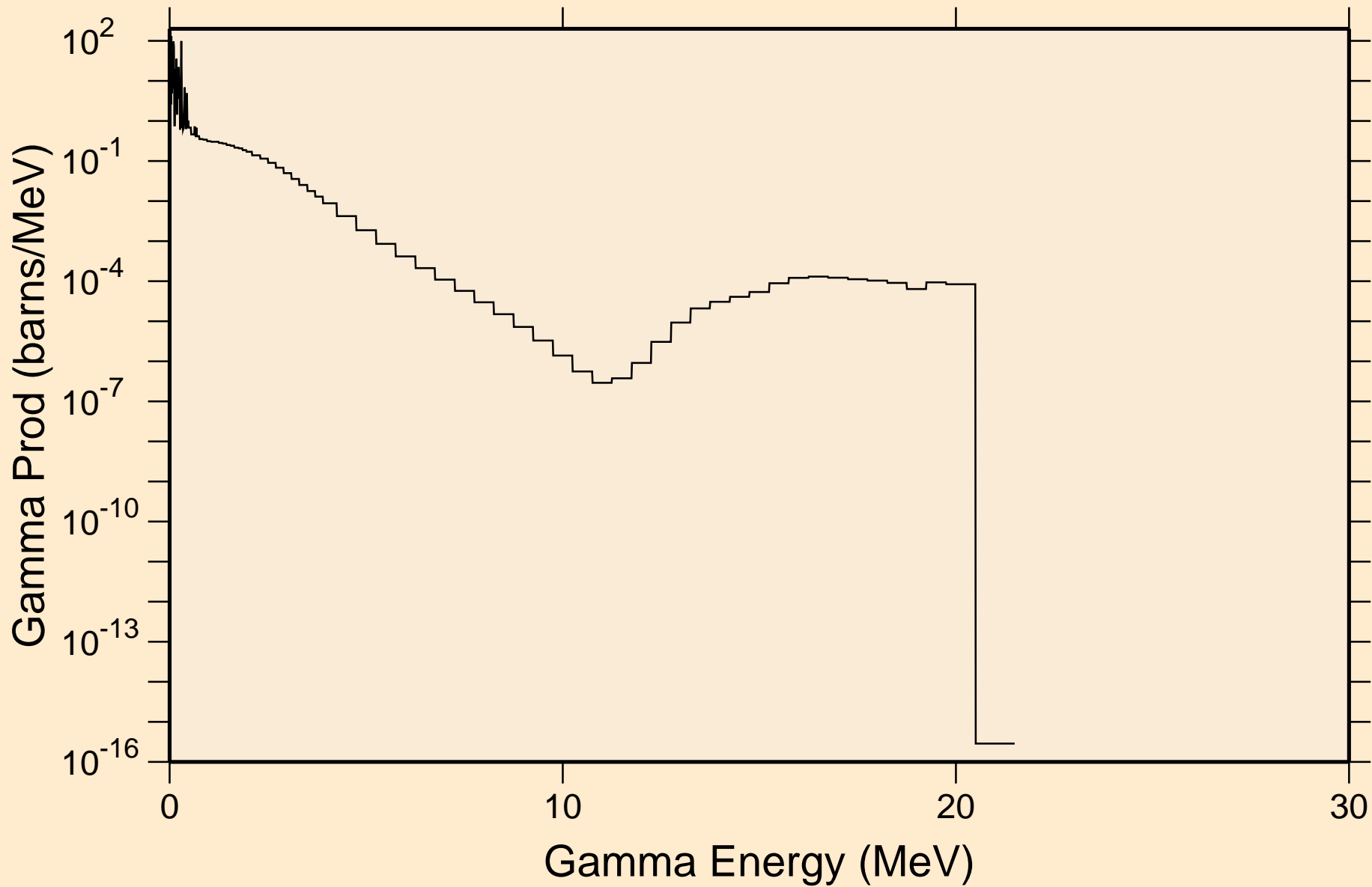

MD258M NEUTRON ACER TENDL-2021 LIBRARY; T=293.6K
Particle heating contributions

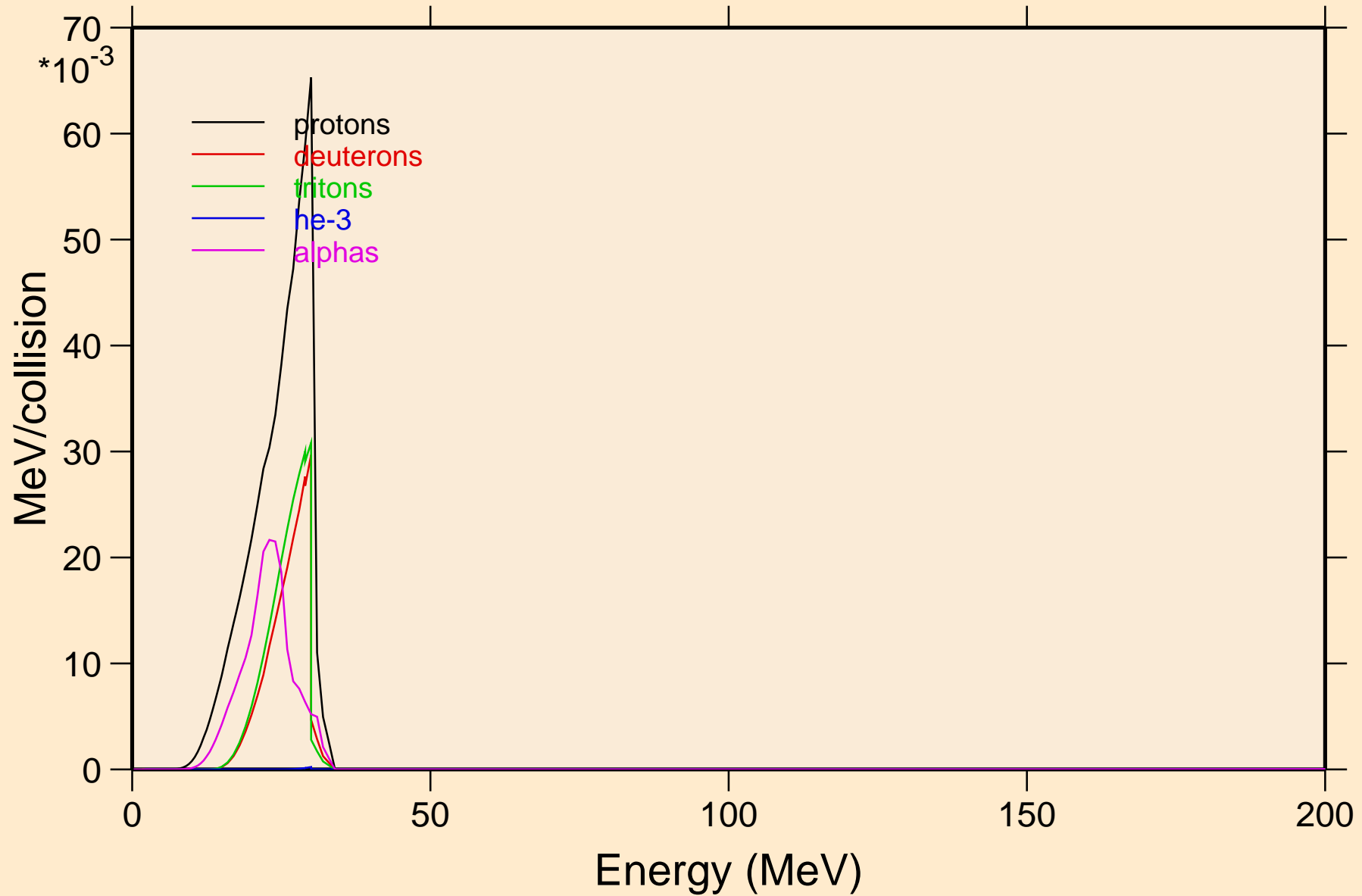

MD258M NEUTRON ACER TENDL-2021 LIBRARY; T=293.6K
Recoil Heating

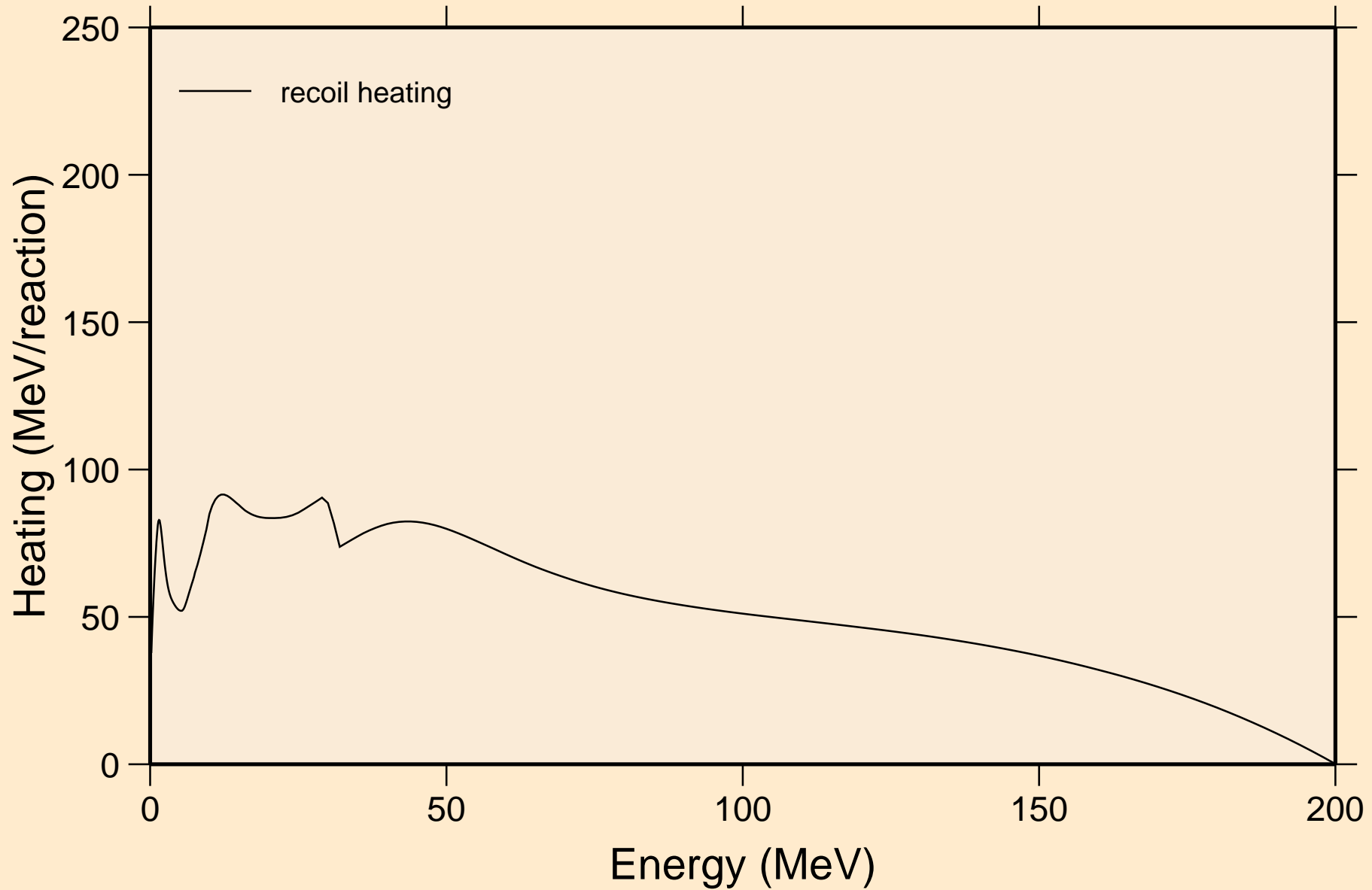

MD258M NEUTRON ACER TENDL-2021 LIBRARY; T=293.6K
Particle production cross sections

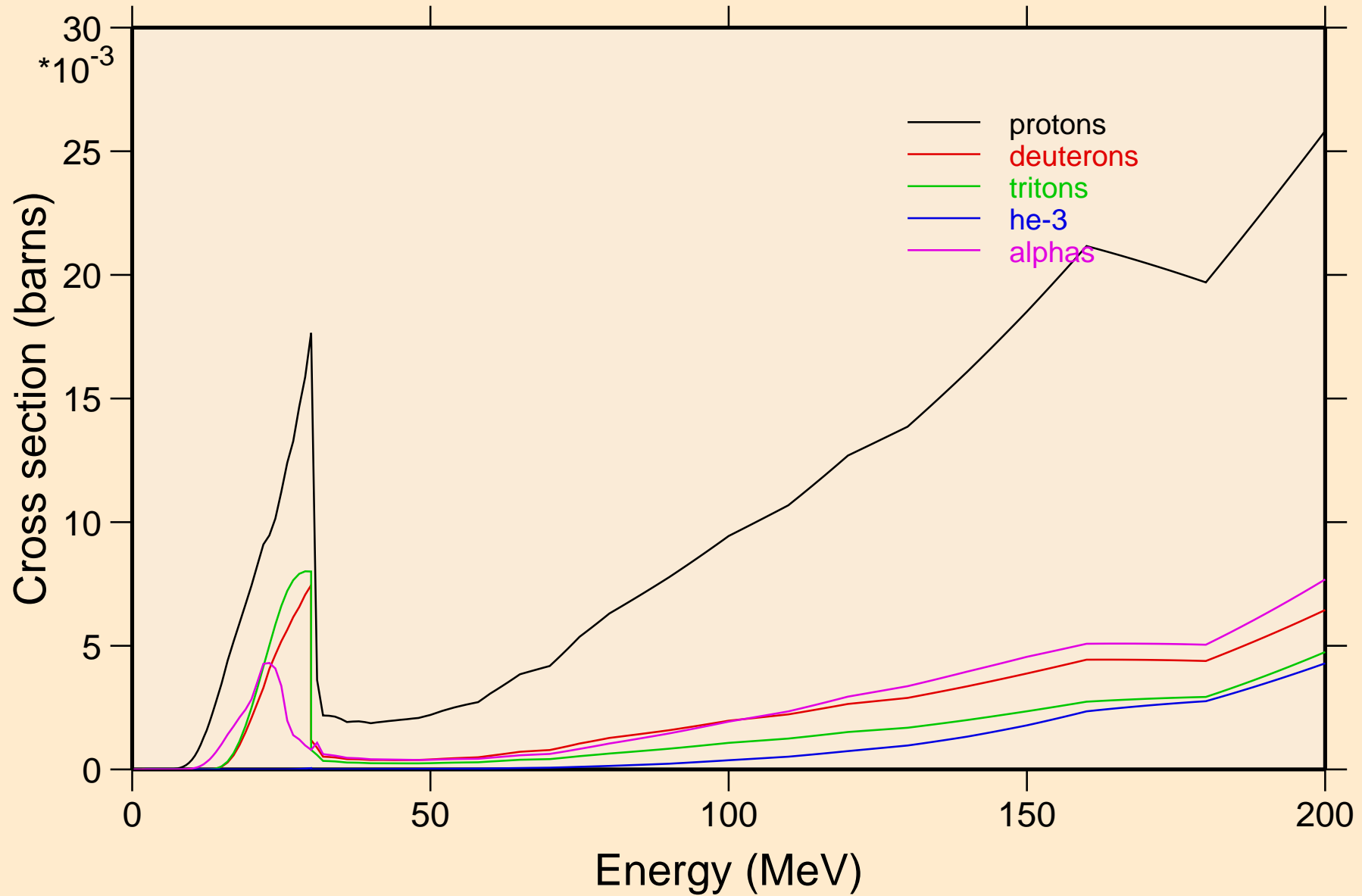

MD258M NEUTRON ACER TENDL-2021 LIBRARY; T=293.6K
protons from (n,x)

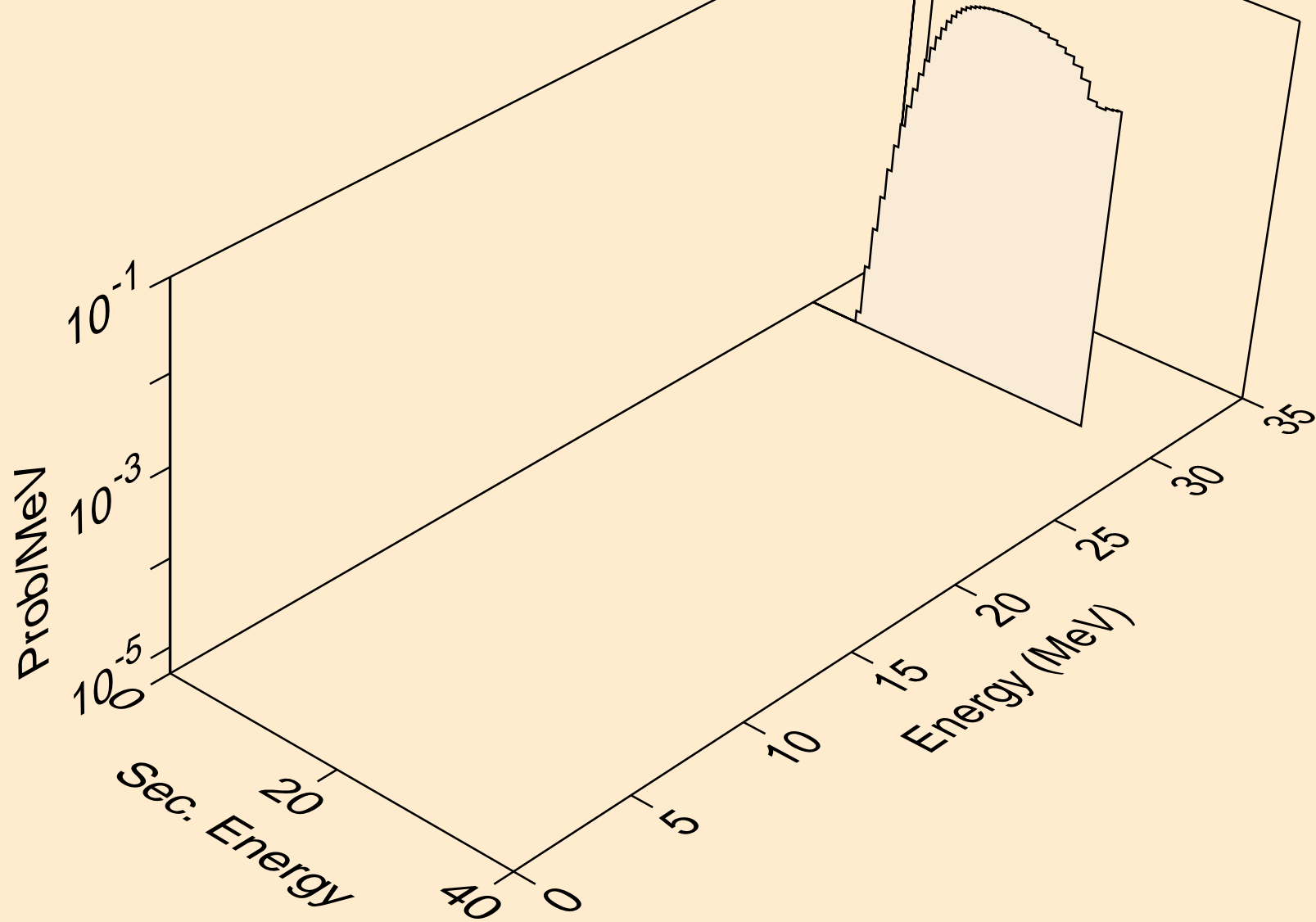

MD258M NEUTRON ACER TENDL-2021 LIBRARY; T=293.6K
protons from (n,n*)p

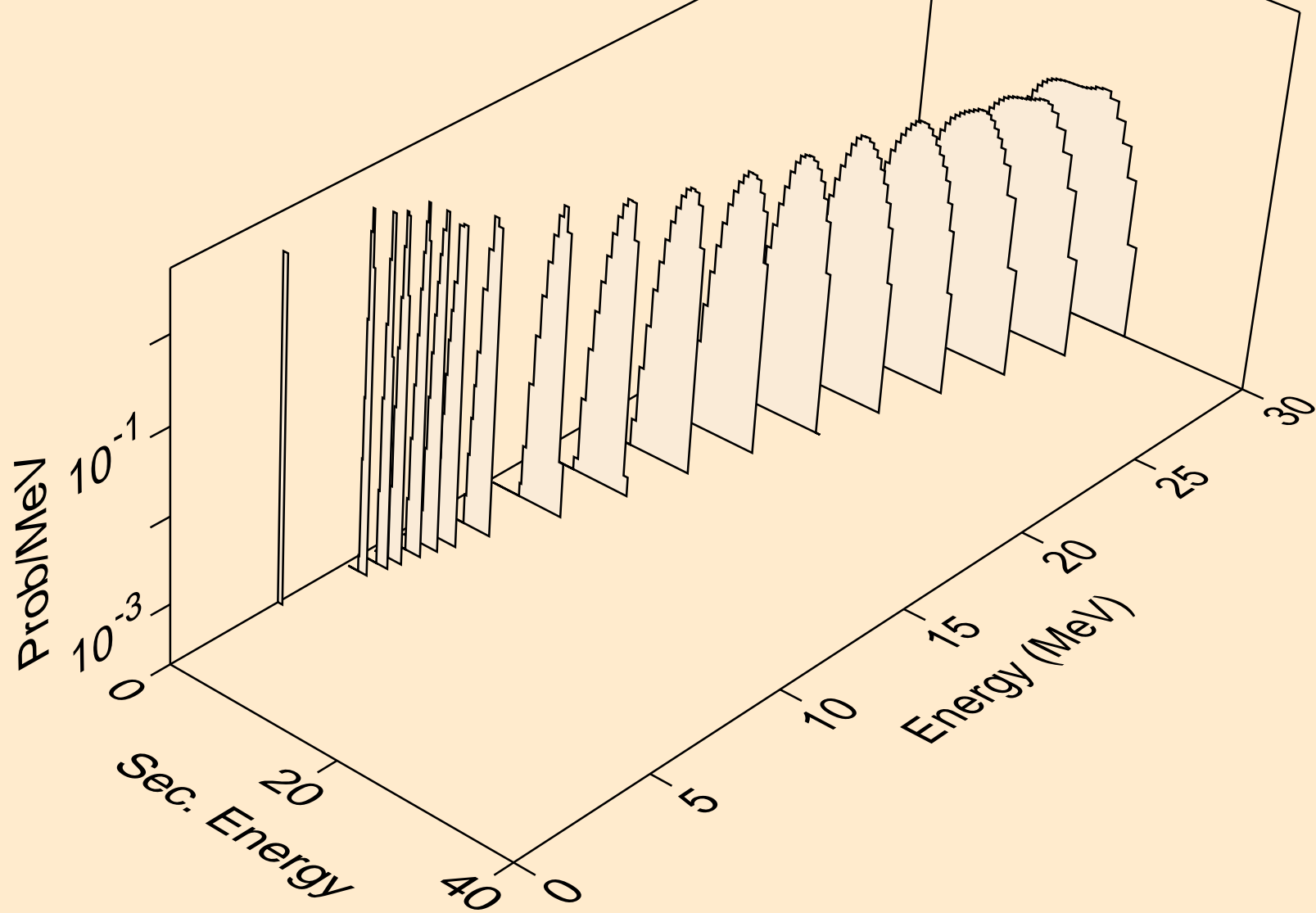

MD258M NEUTRON ACER TENDL-2021 LIBRARY; T=293.6K
protons from (n,2np)

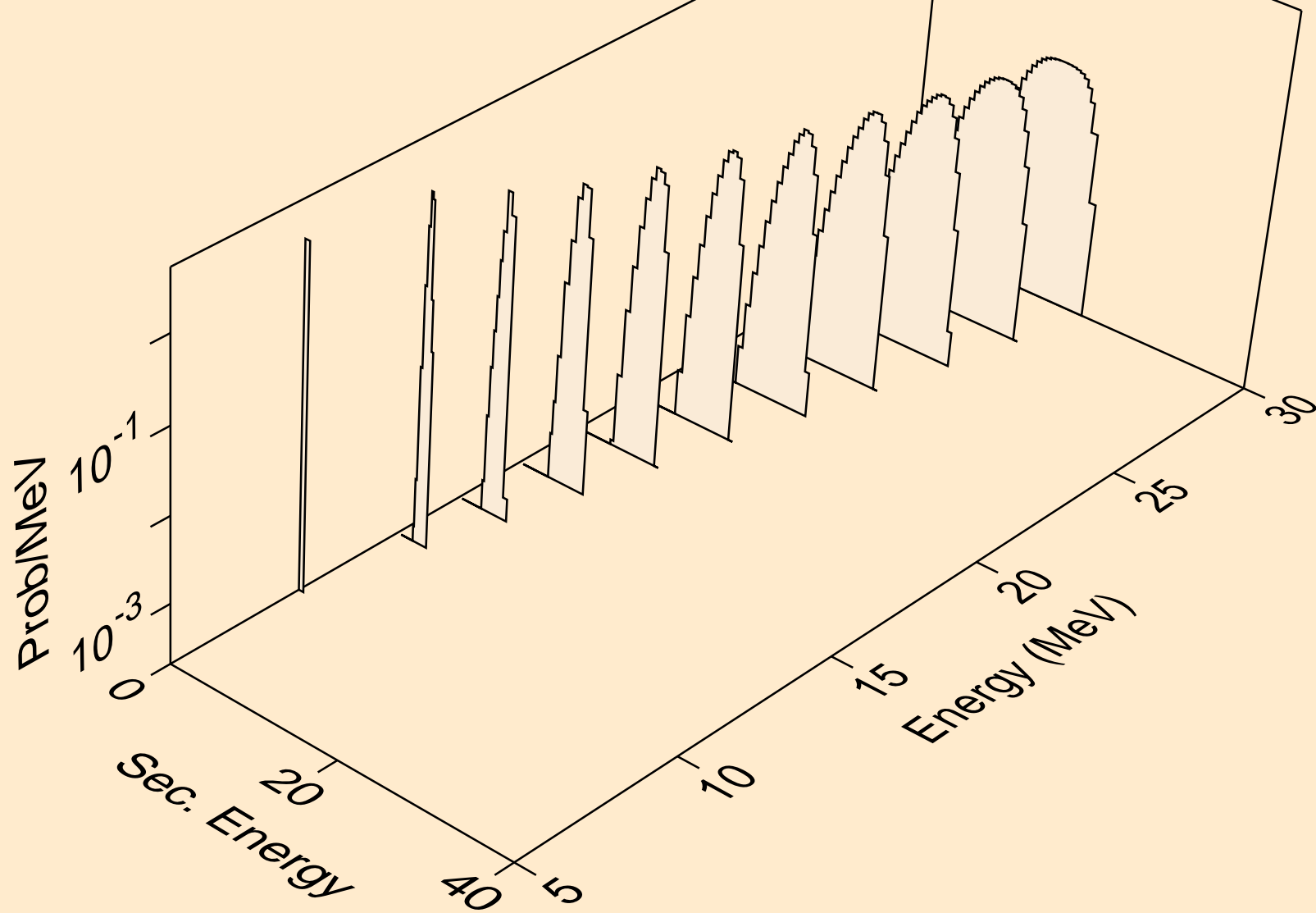

MD258M NEUTRON ACER TENDL-2021 LIBRARY; T=293.6K
protons from (n,3np)

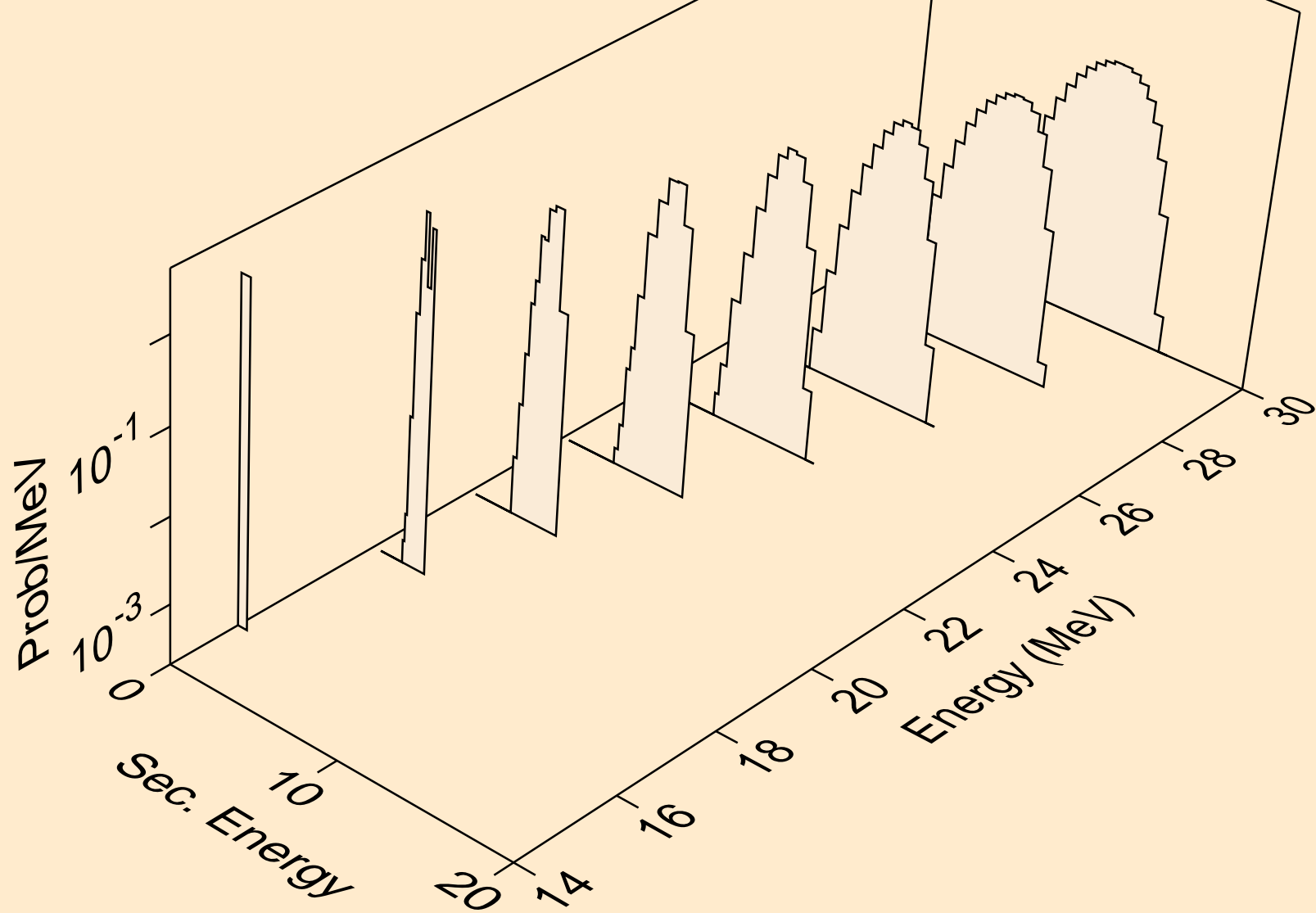

MD258M NEUTRON ACER TENDL-2021 LIBRARY; T=293.6K
protons from (n,p)

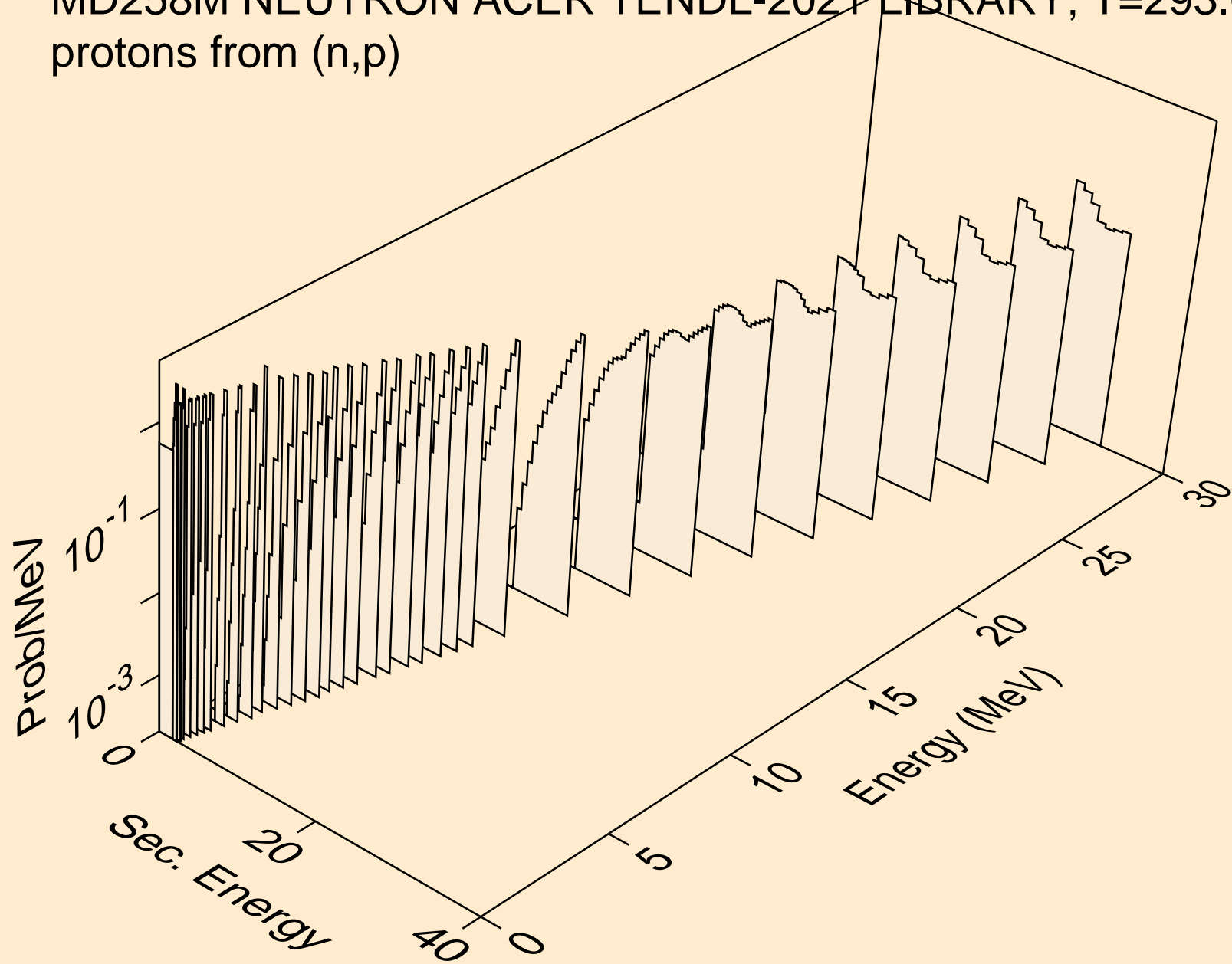

MD258M NEUTRON ACER TENDL-2021 LIBRARY; T=293.6K
deuterons from (n,x)

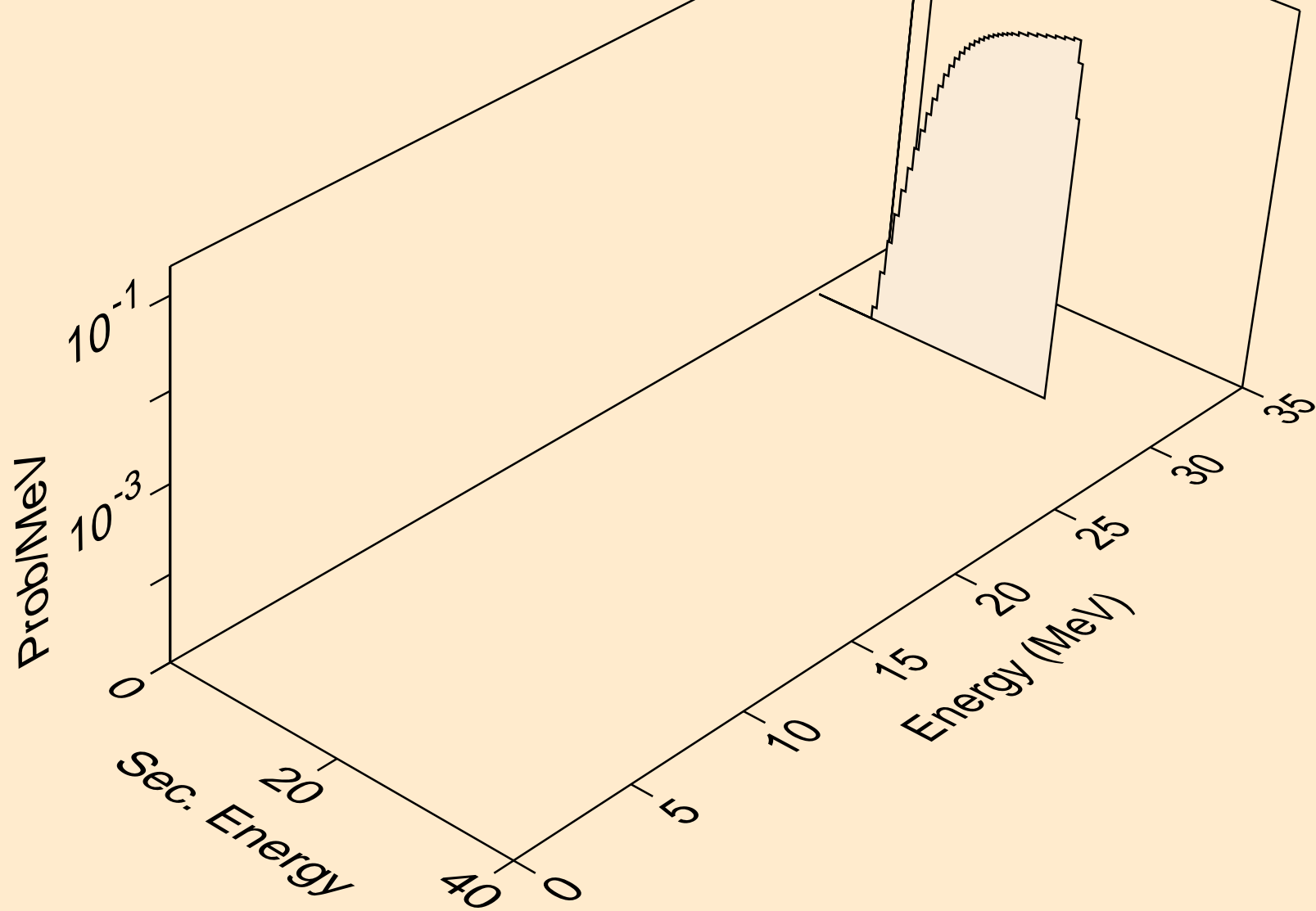

MD258M NEUTRON ACER TENDL-2021 LIBRARY; T=293.6K
deuterons from (n,2nd)

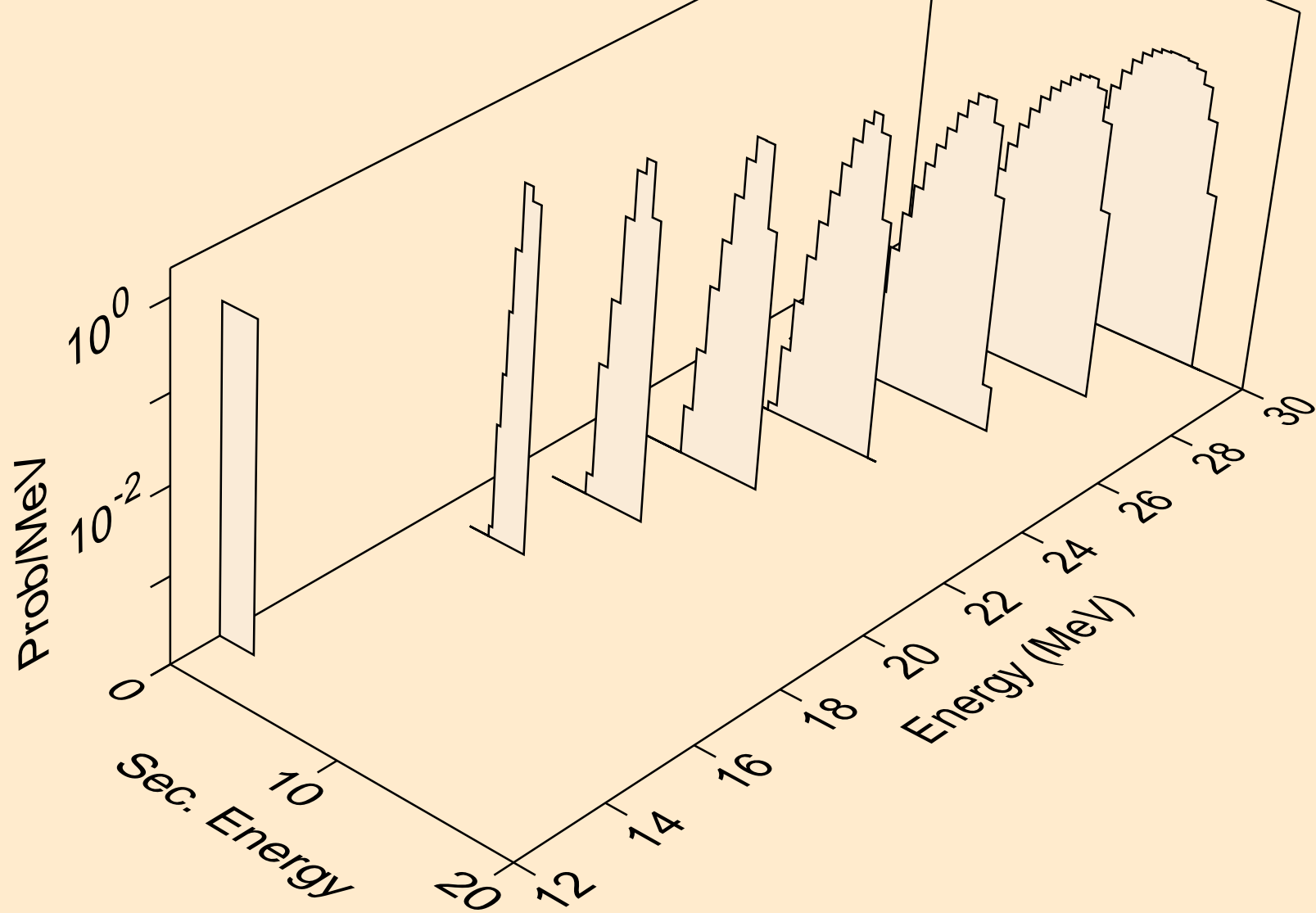

MD258M NEUTRON ACER TENDL-2021 LIBRARY; T=293.6K
deuterons from (n,n*)d

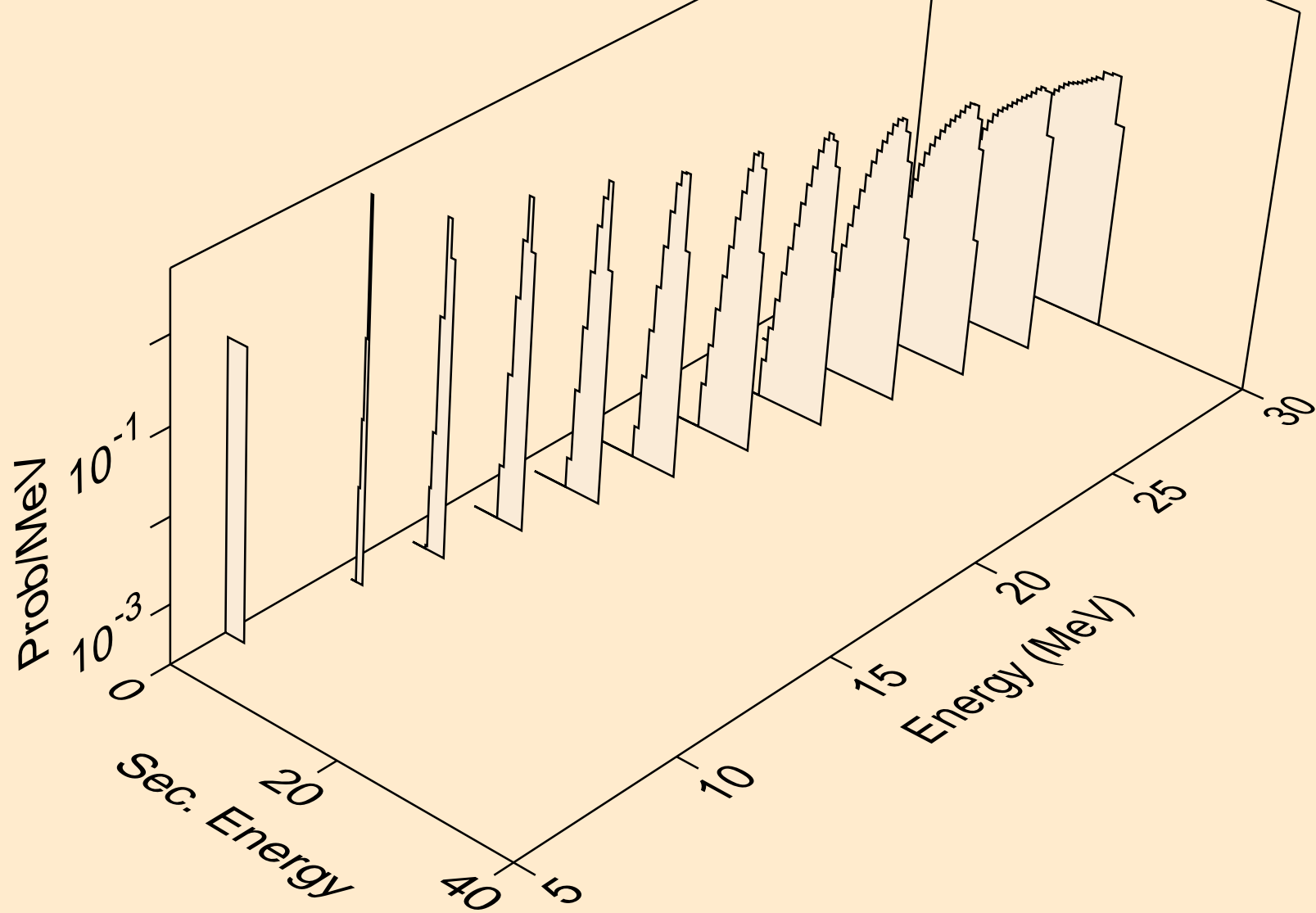

MD258M NEUTRON ACER TENDL-2021 LIBRARY; T=293.6K
deuterons from (n,d)

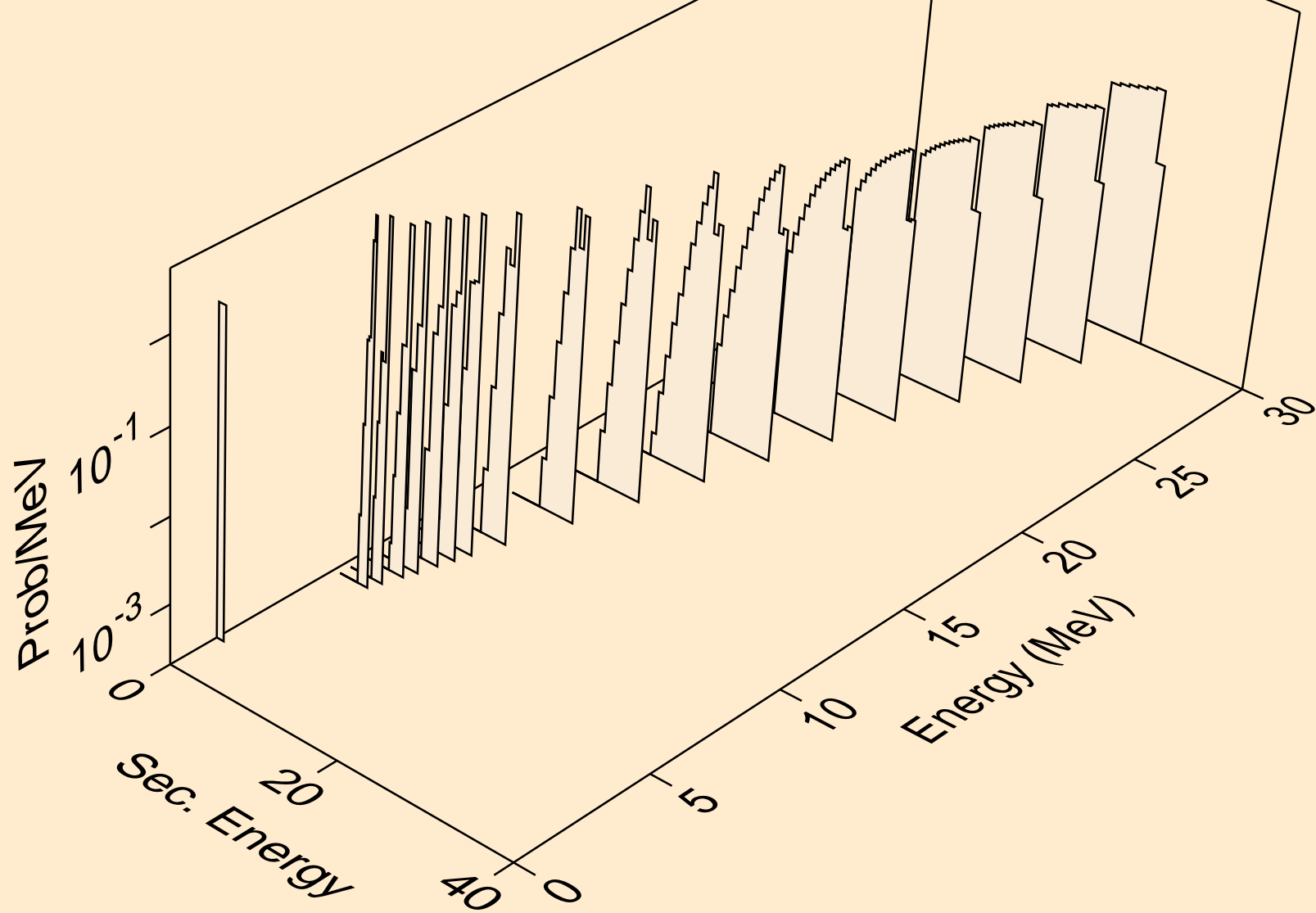

MD258M NEUTRON ACER TENDL-2021 LIBRARY; T=293.6K
tritons from (n,x)

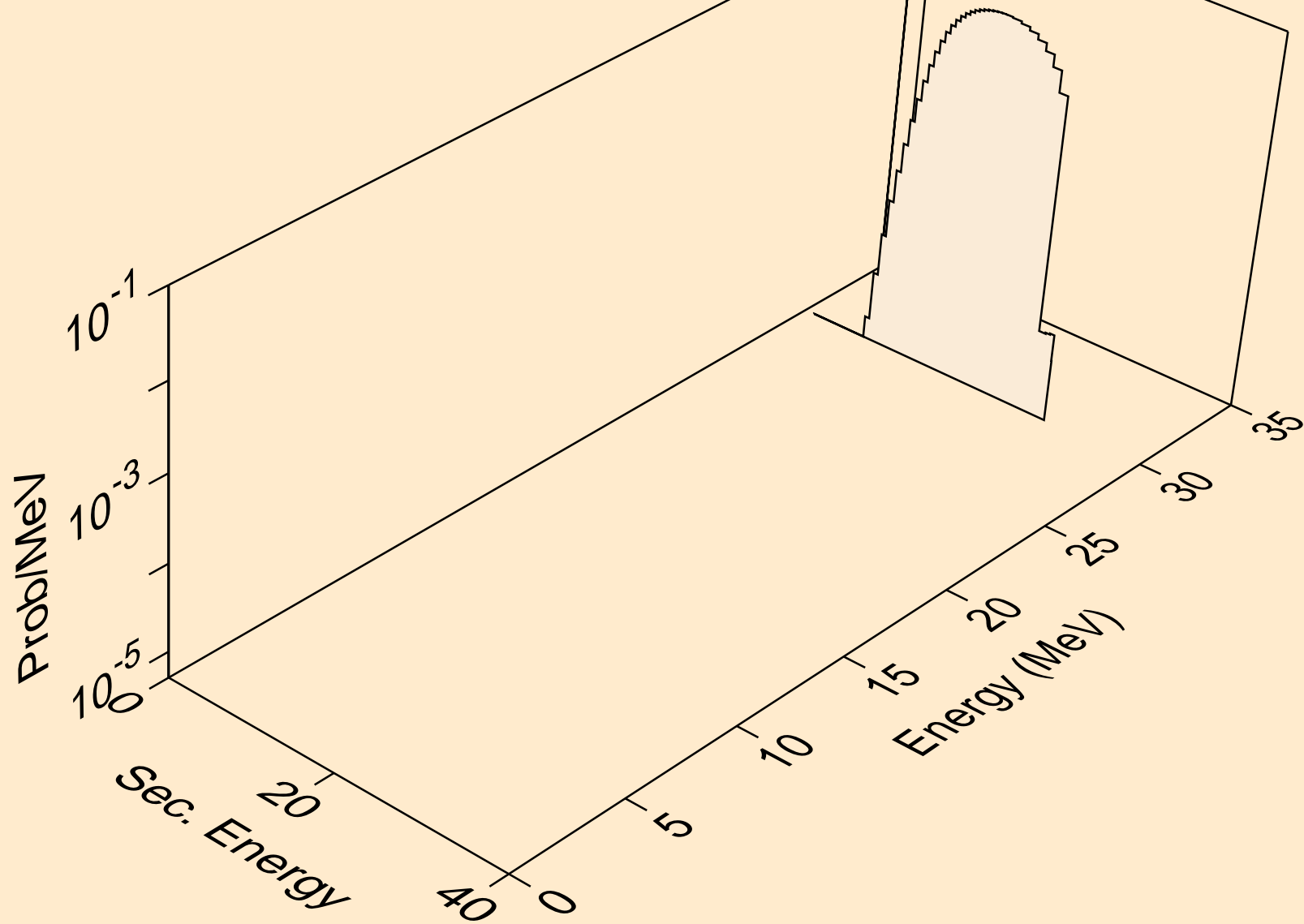

MD258M NEUTRON ACER TENDL-2021 LIBRARY; T=293.6K
tritons from (n,n*)t

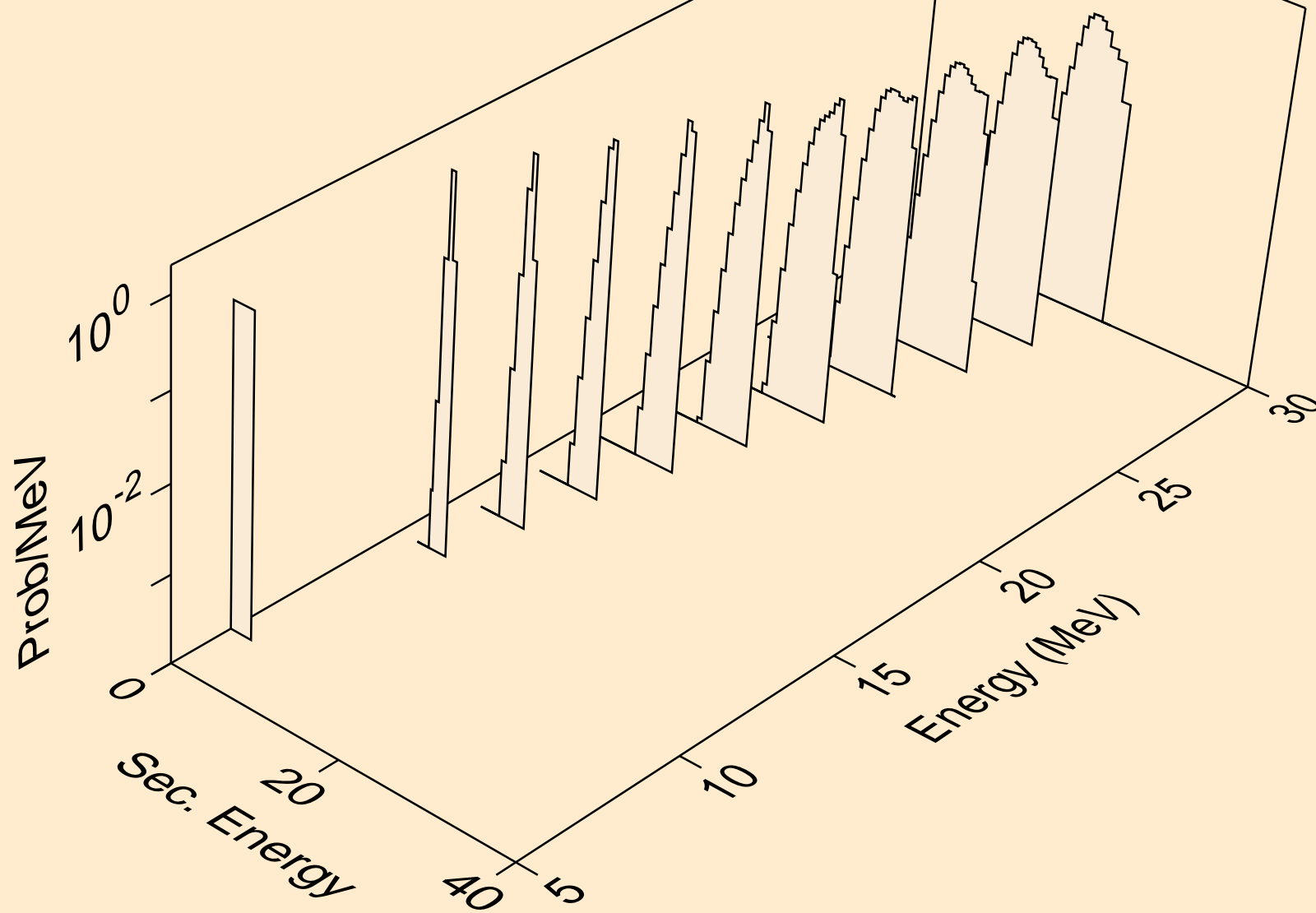

MD258M NEUTRON ACER TENDL-2021 LIBRARY; T=293.6K
tritons from (n,t)

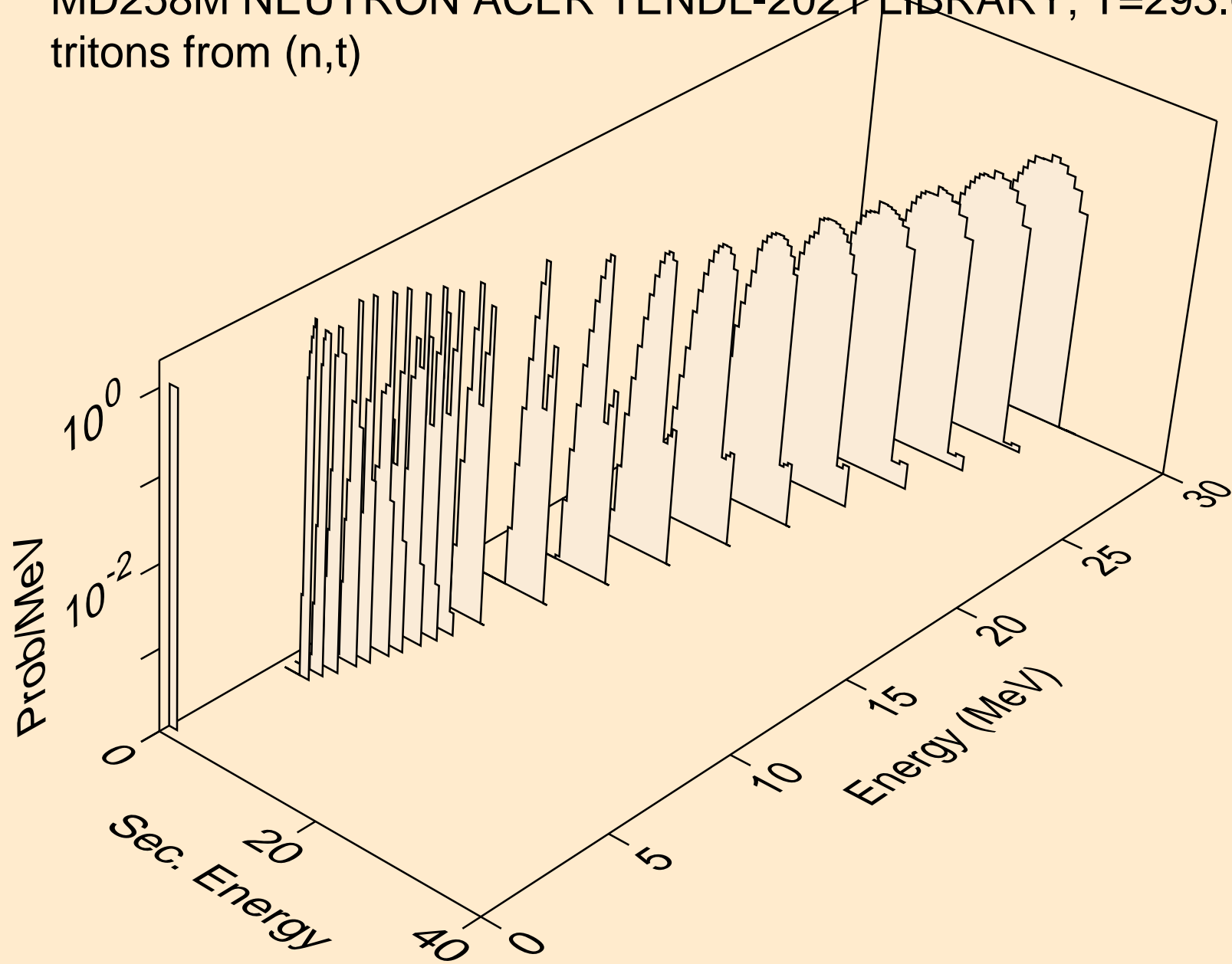

MD258M NEUTRON ACER TENDL-2021 LIBRARY; T=293.6K
he3s from (n,x)

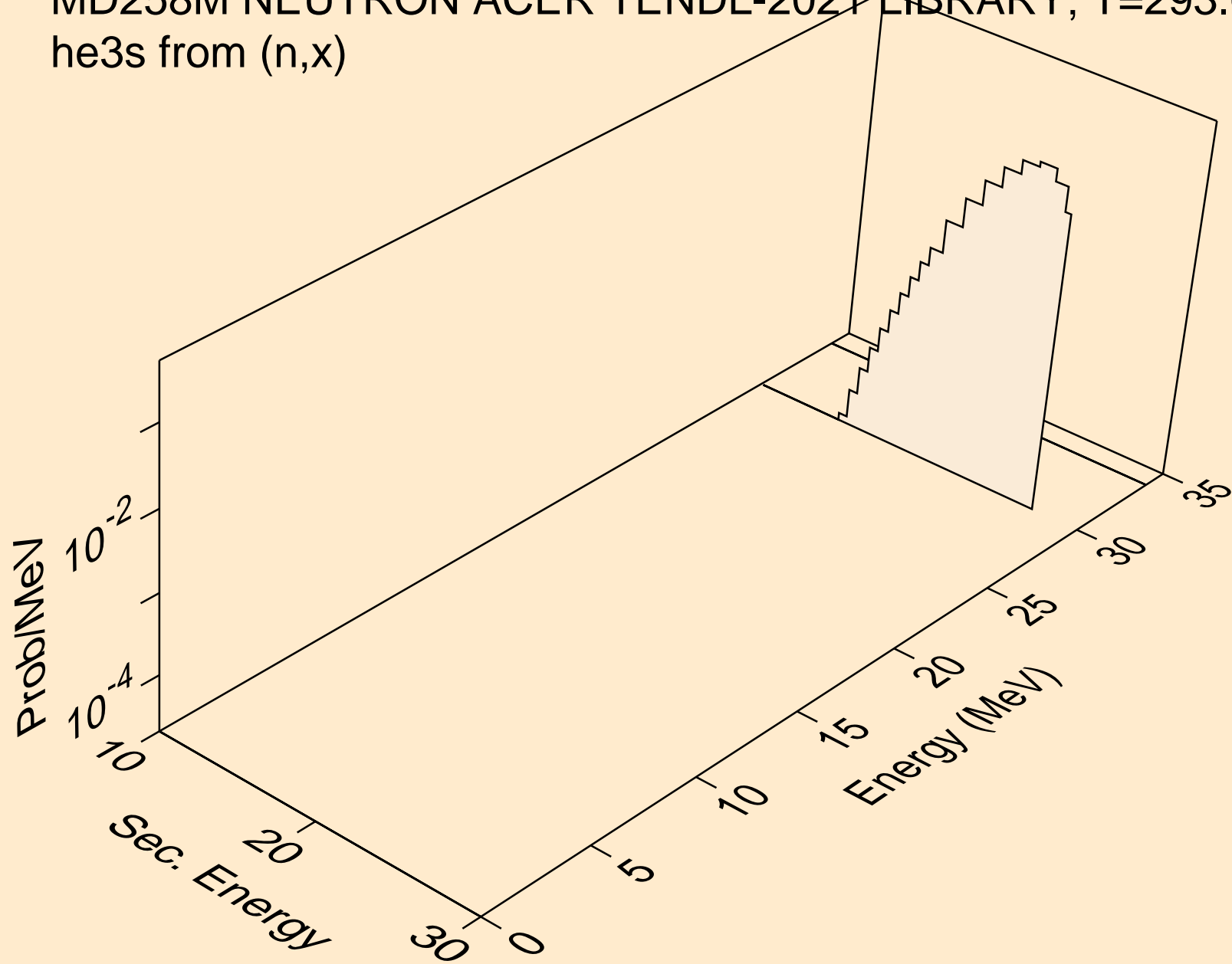

MD258M NEUTRON ACER TENDL-2021 LIBRARY; T=293.6K
he3s from (n,n*)he3

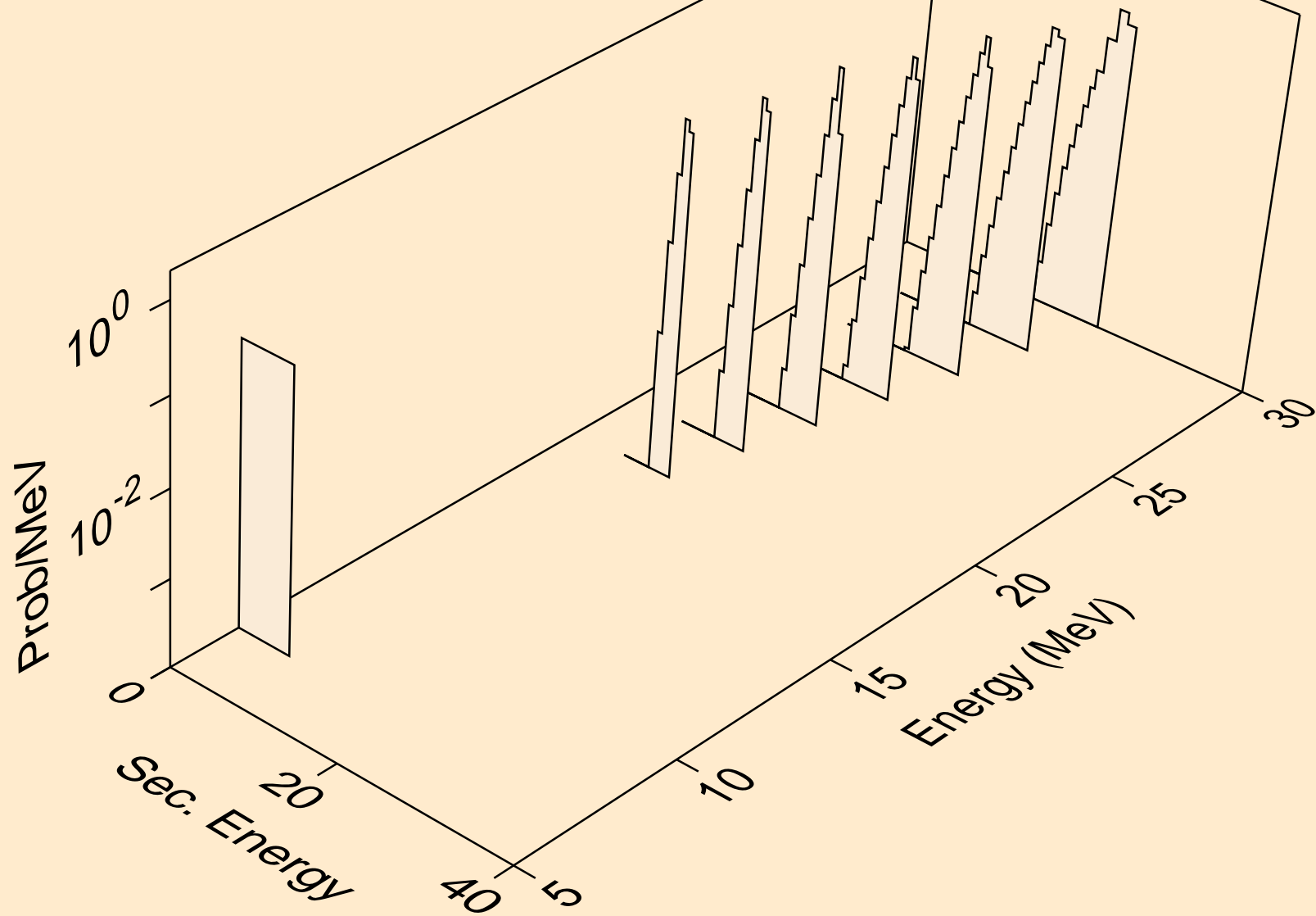

MD258M NEUTRON ACER TENDL-2021 LIBRARY; T=293.6K
he3s from (n,he3)

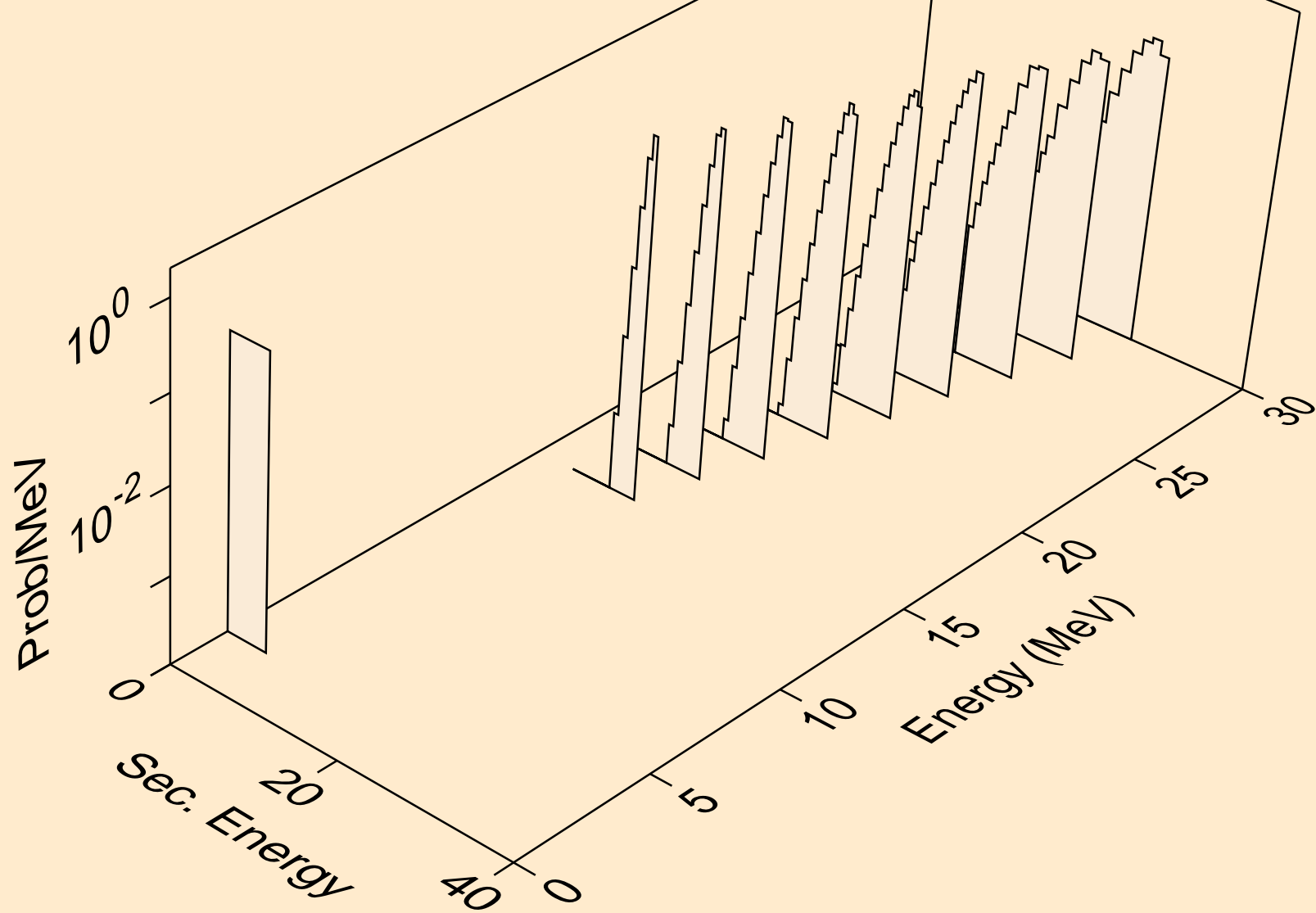

MD258M NEUTRON ACER TENDL-2021 LIBRARY; T=293.6K
alphas from (n,x)

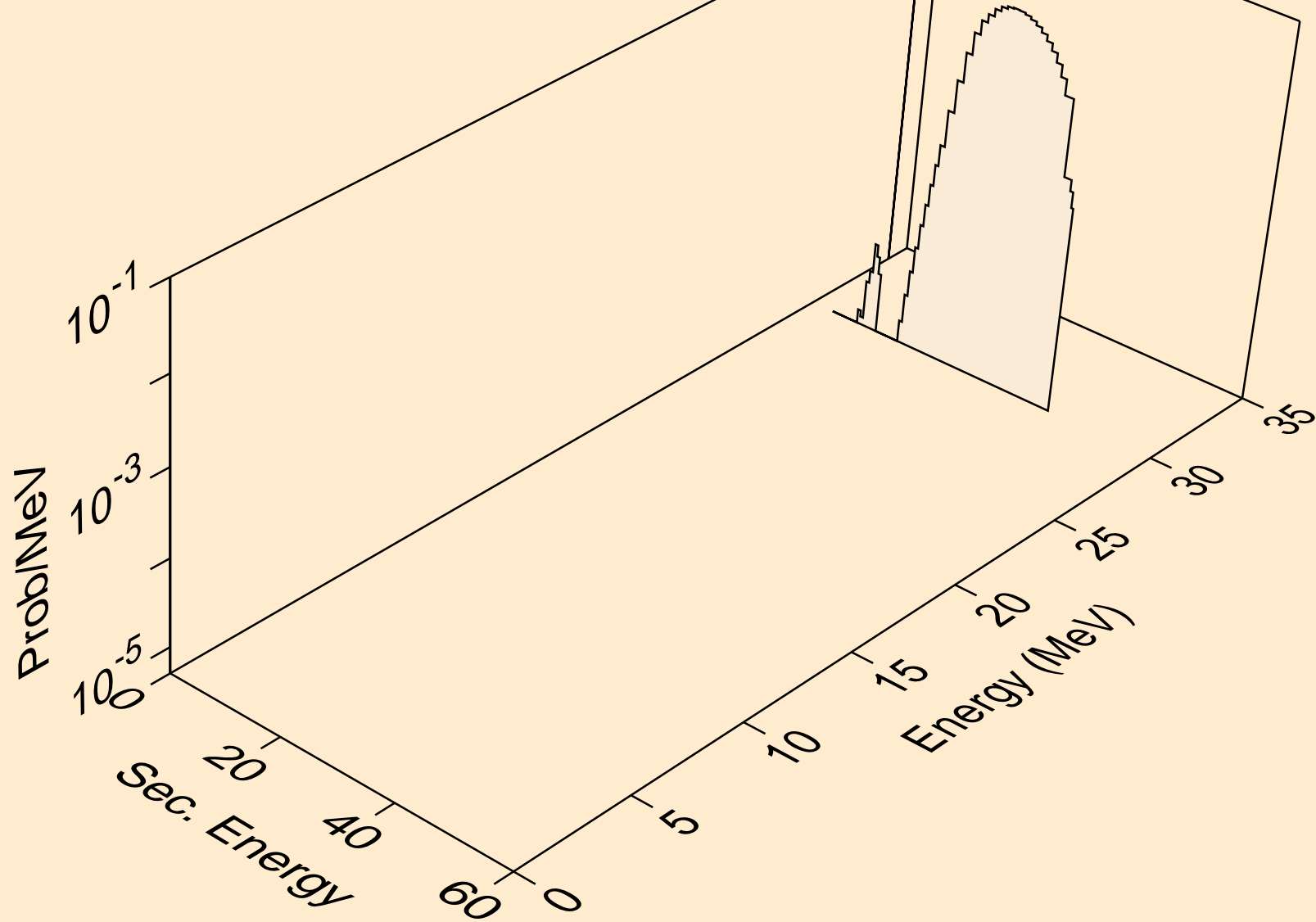

MD258M NEUTRON ACER TENDL-2021 LIBRARY; T=293.6K
alphas from (n,n*)a

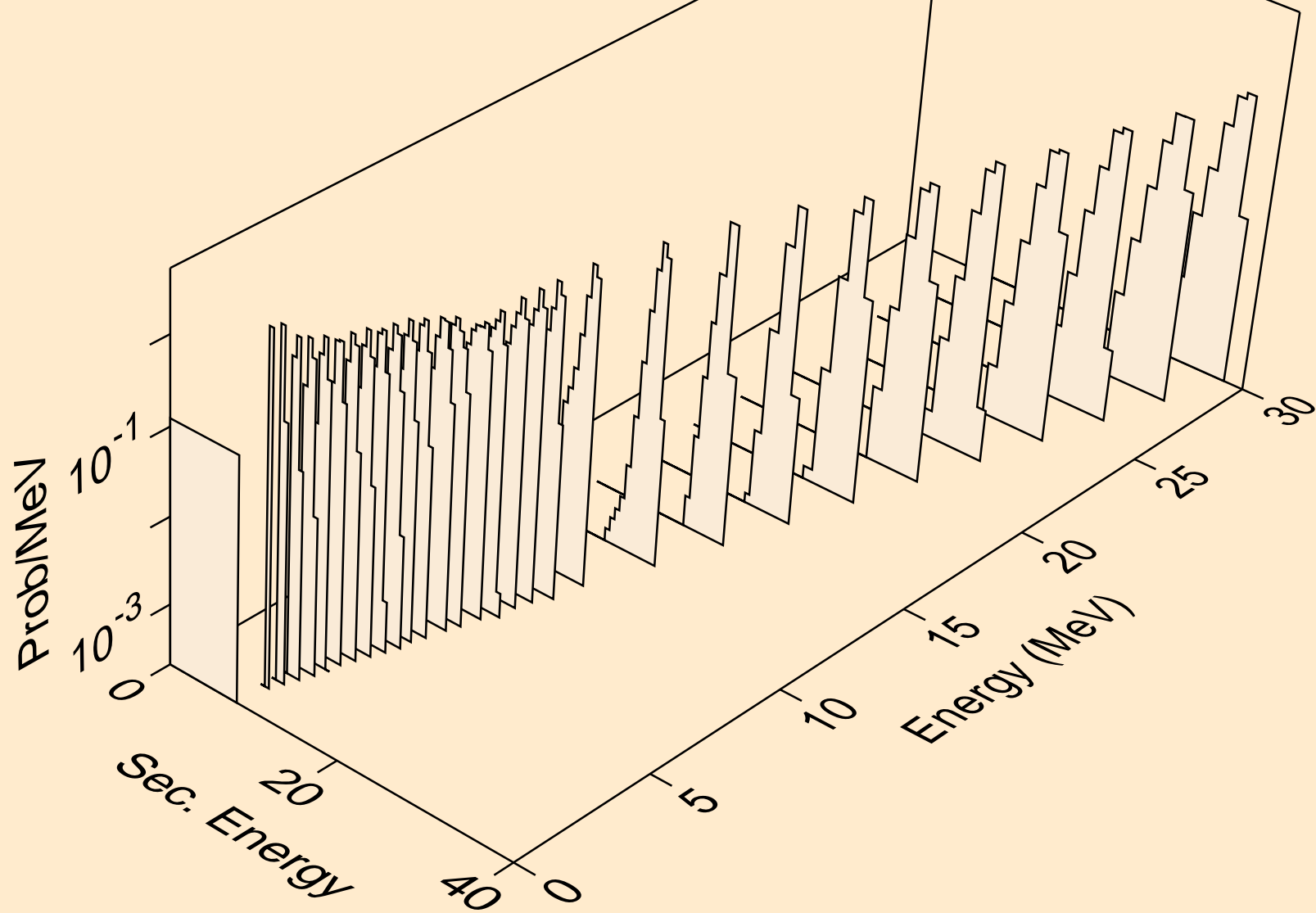

MD258M NEUTRON ACER TENDL-2021 LIBRARY; T=293.6K
alphas from (n,2n)a

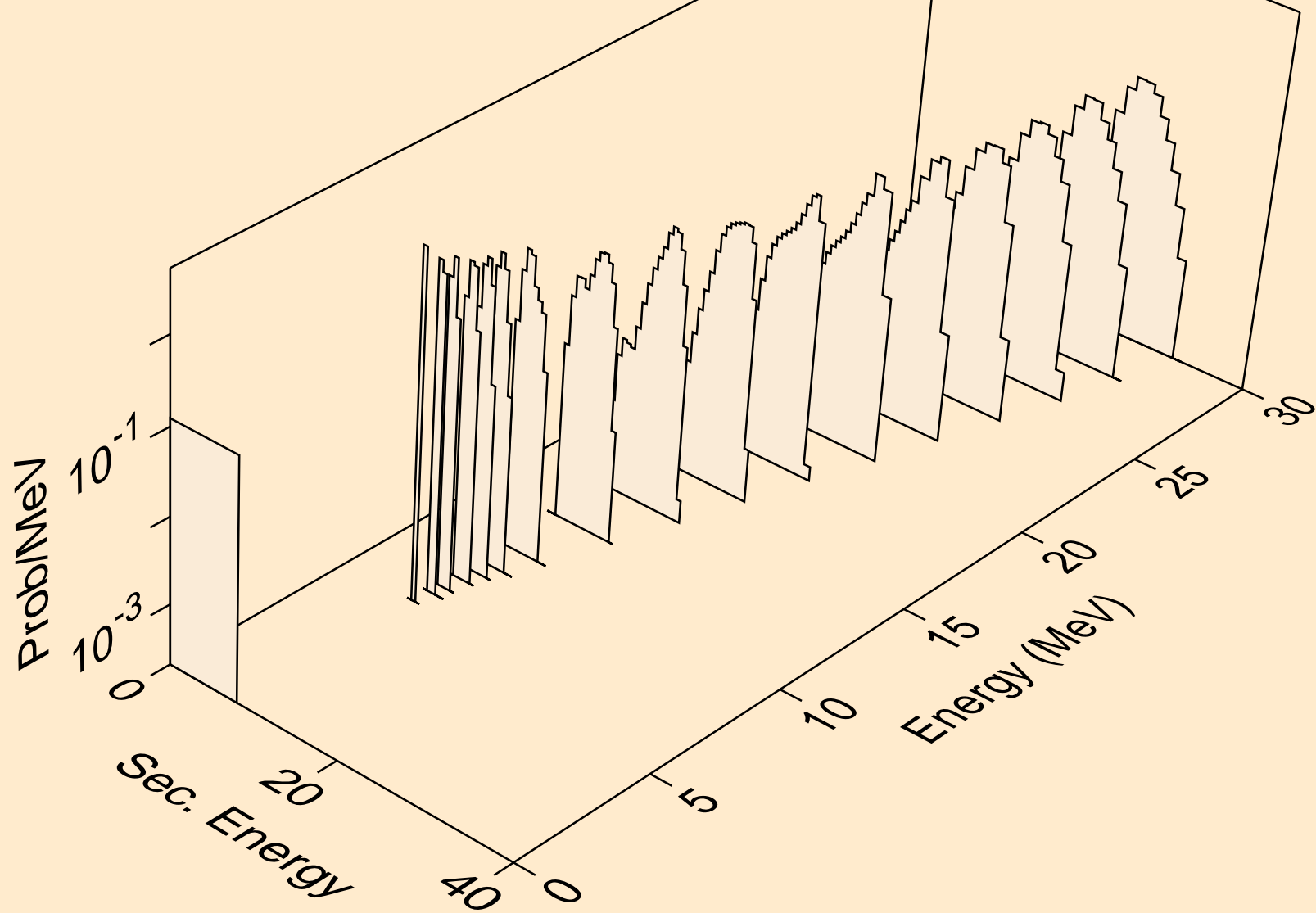

MD258M NEUTRON ACER TENDL-2021 LIBRARY; T=293.6K
alphas from (n,3n)a

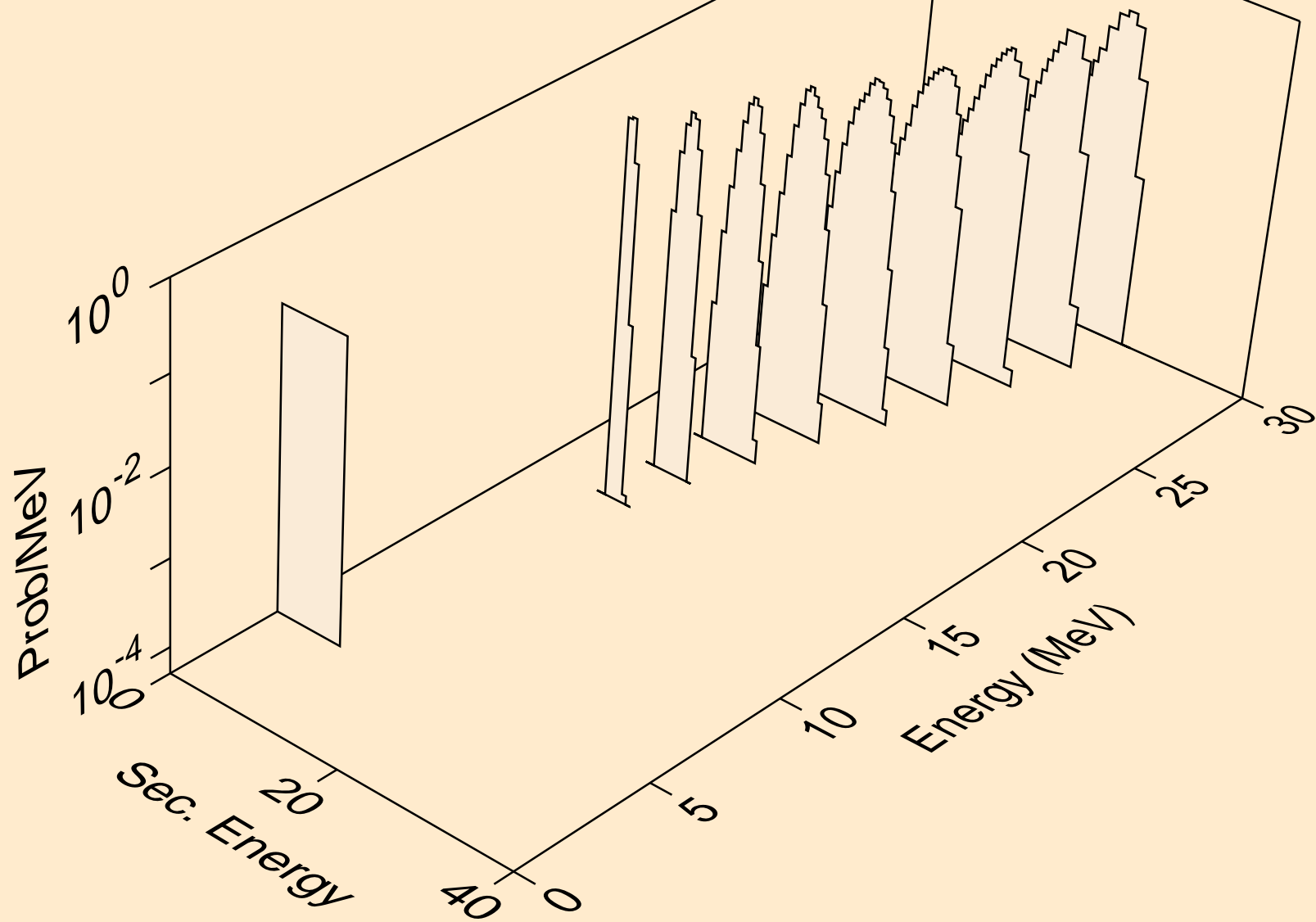

MD258M NEUTRON ACER TENDL-2021 LIBRARY; T=293.6K
alphas from (n,a)

