

MD259 NEUTRON ACER TENDL-2021 LIBRARY; T=293.6K
Principal cross sections

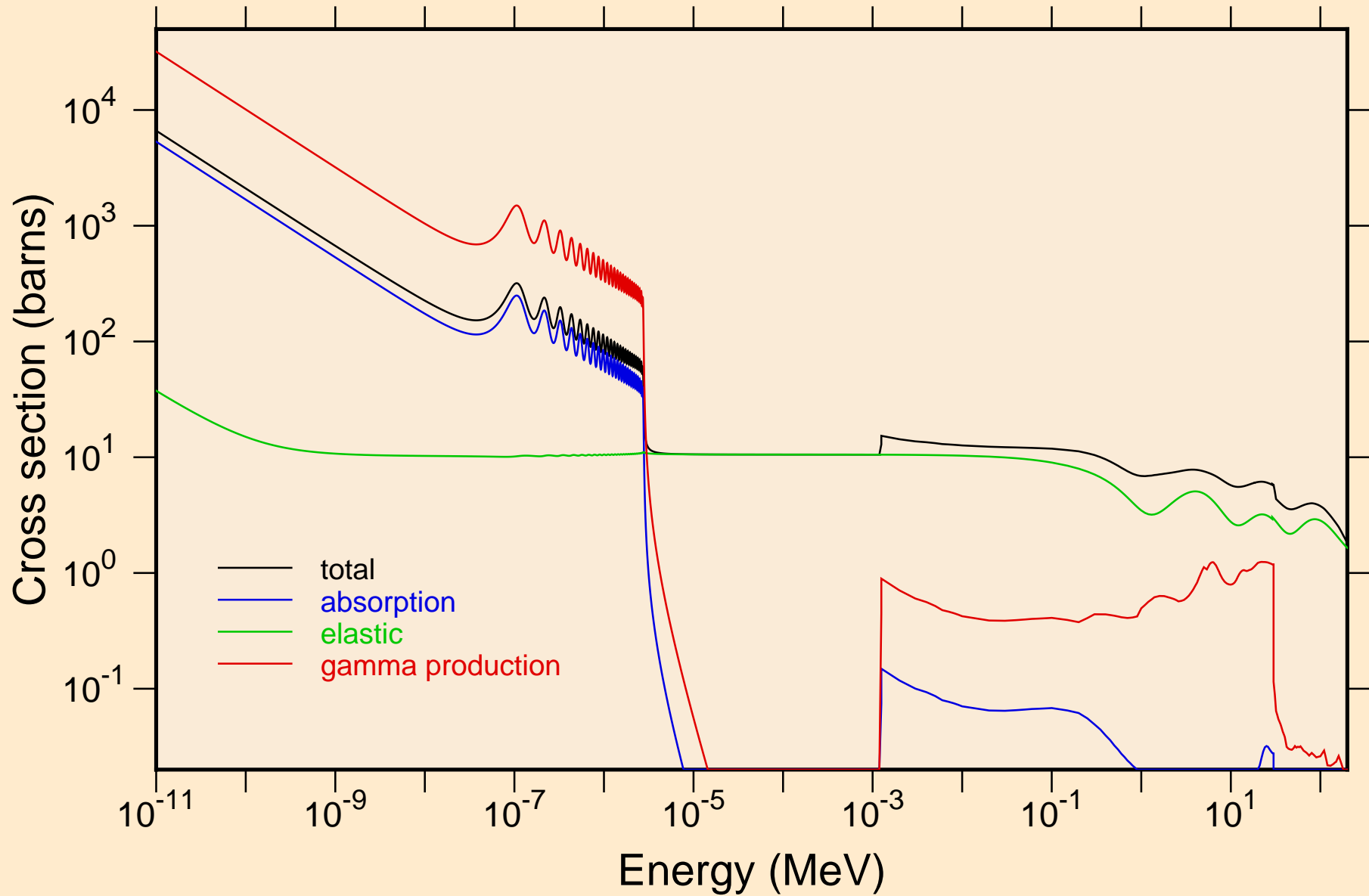

MD259 NEUTRON ACER TENDL-2021 LIBRARY; T=293.6K
resonance total cross section

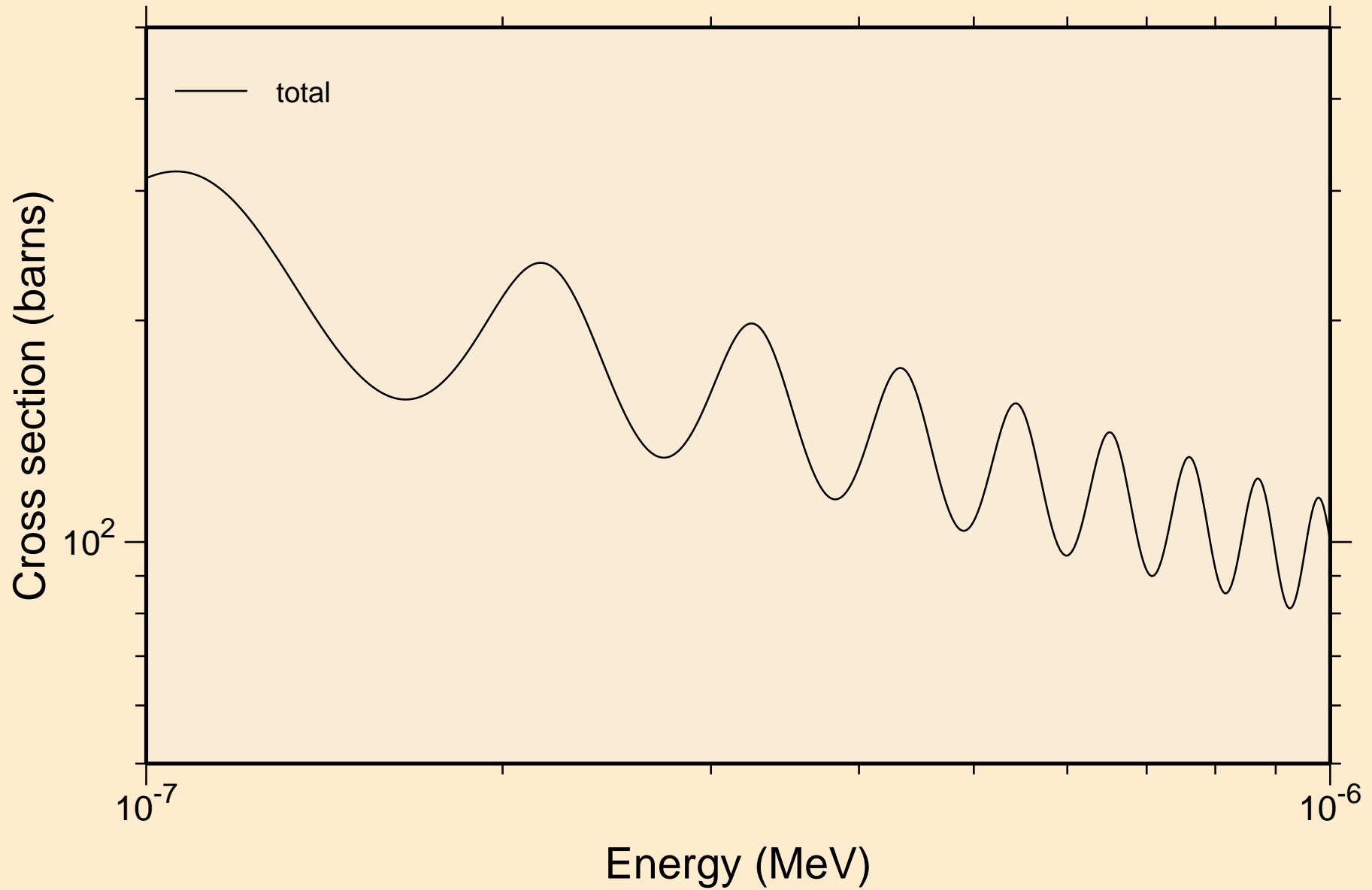

MD259 NEUTRON ACER TENDL-2021 LIBRARY; T=293.6K
resonance total cross section

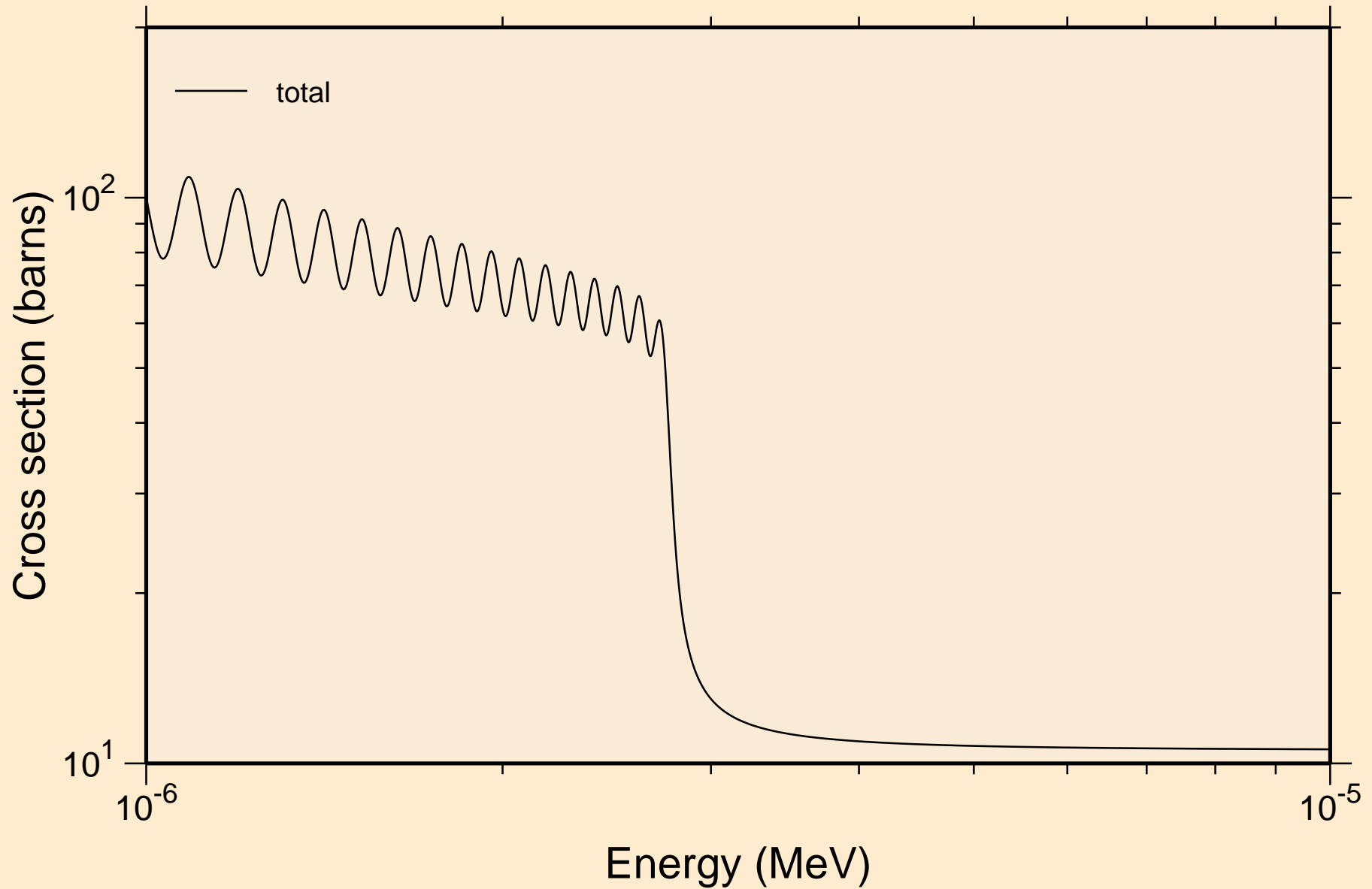

MD259 NEUTRON ACER TENDL-2021 LIBRARY; T=293.6K
resonance total cross section

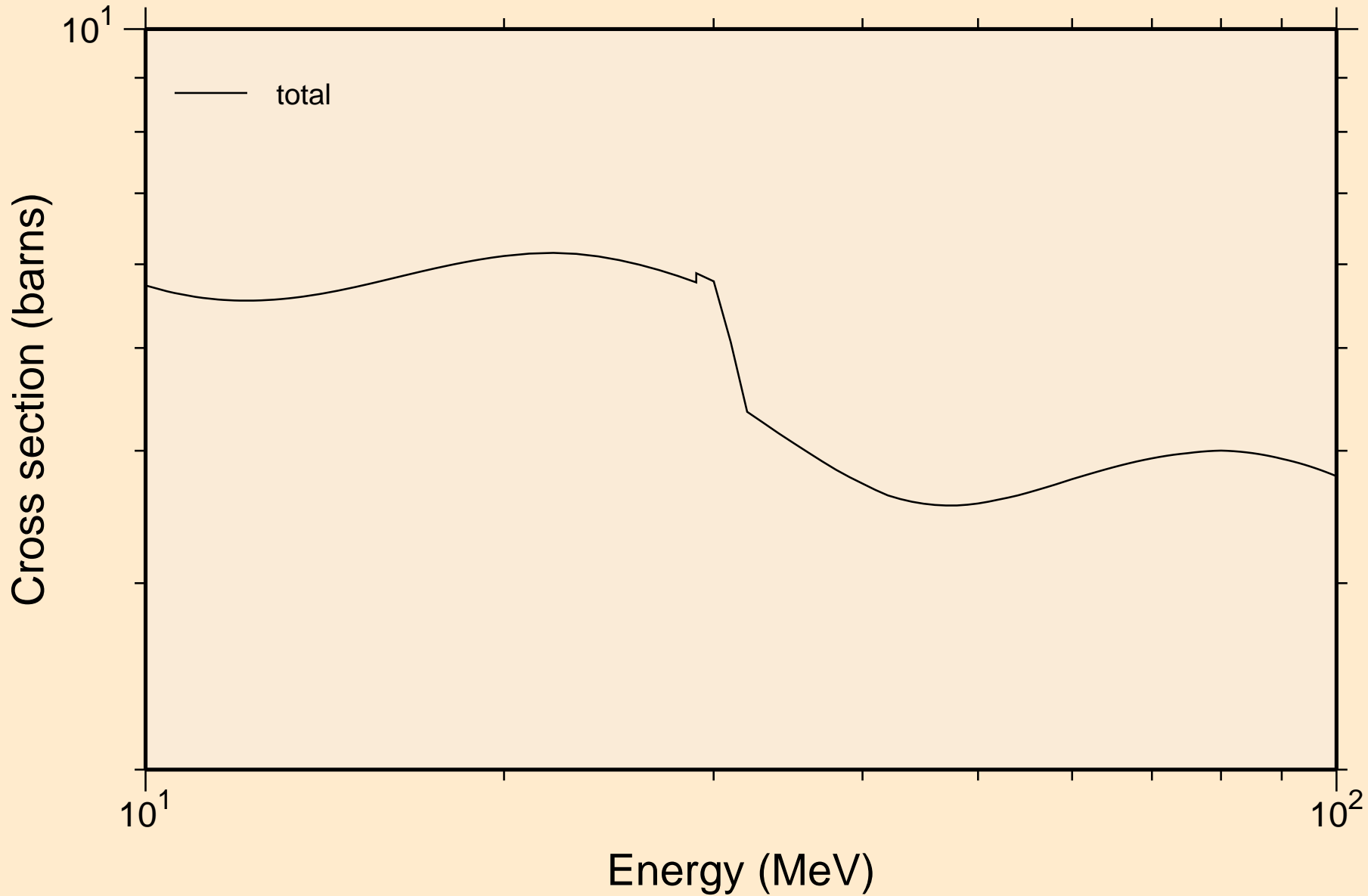

MD259 NEUTRON ACER TENDL-2021 LIBRARY; T=293.6K
resonance absorption cross sections

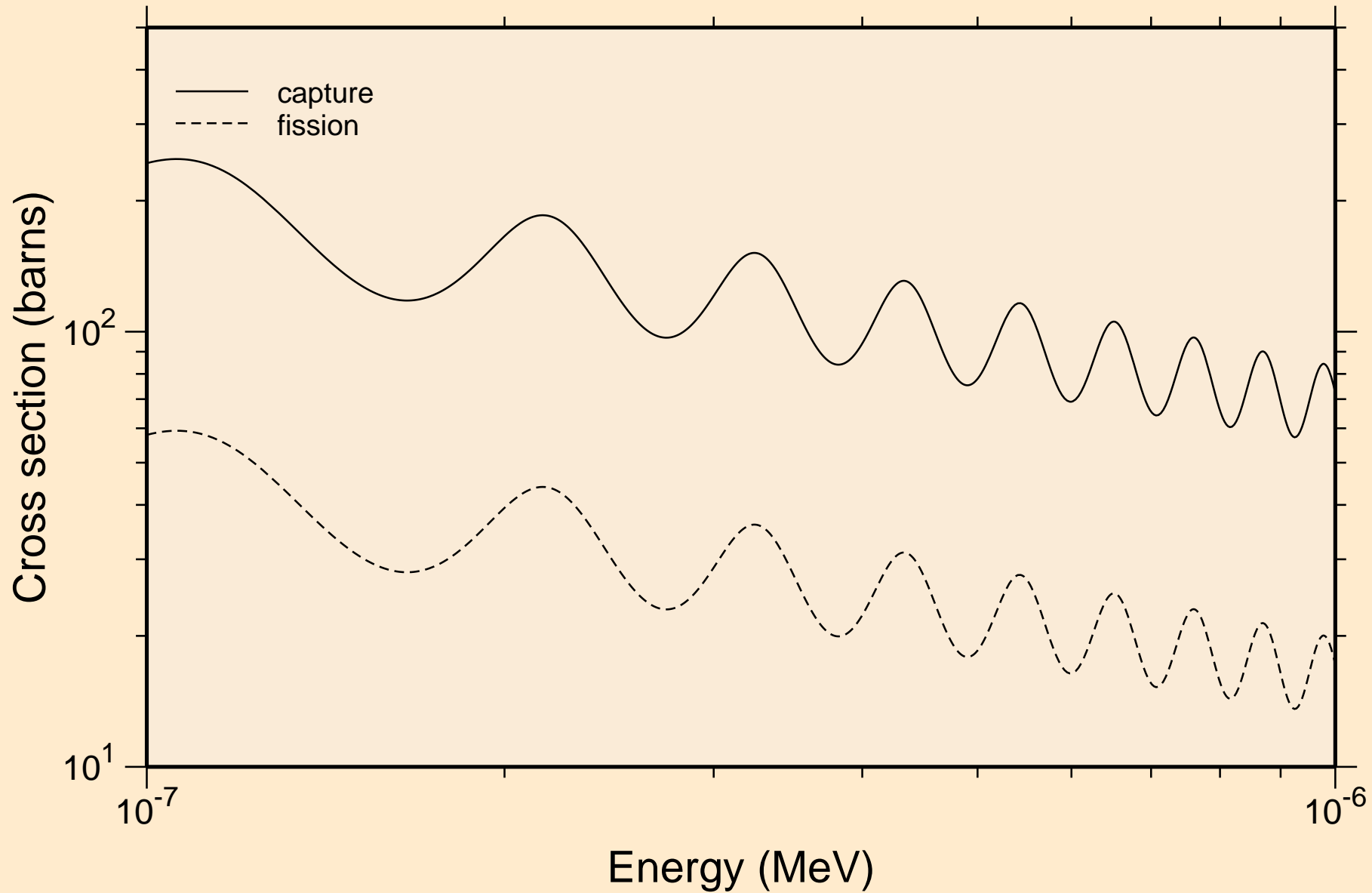

MD259 NEUTRON ACER TENDL-2021 LIBRARY; T=293.6K
resonance absorption cross sections

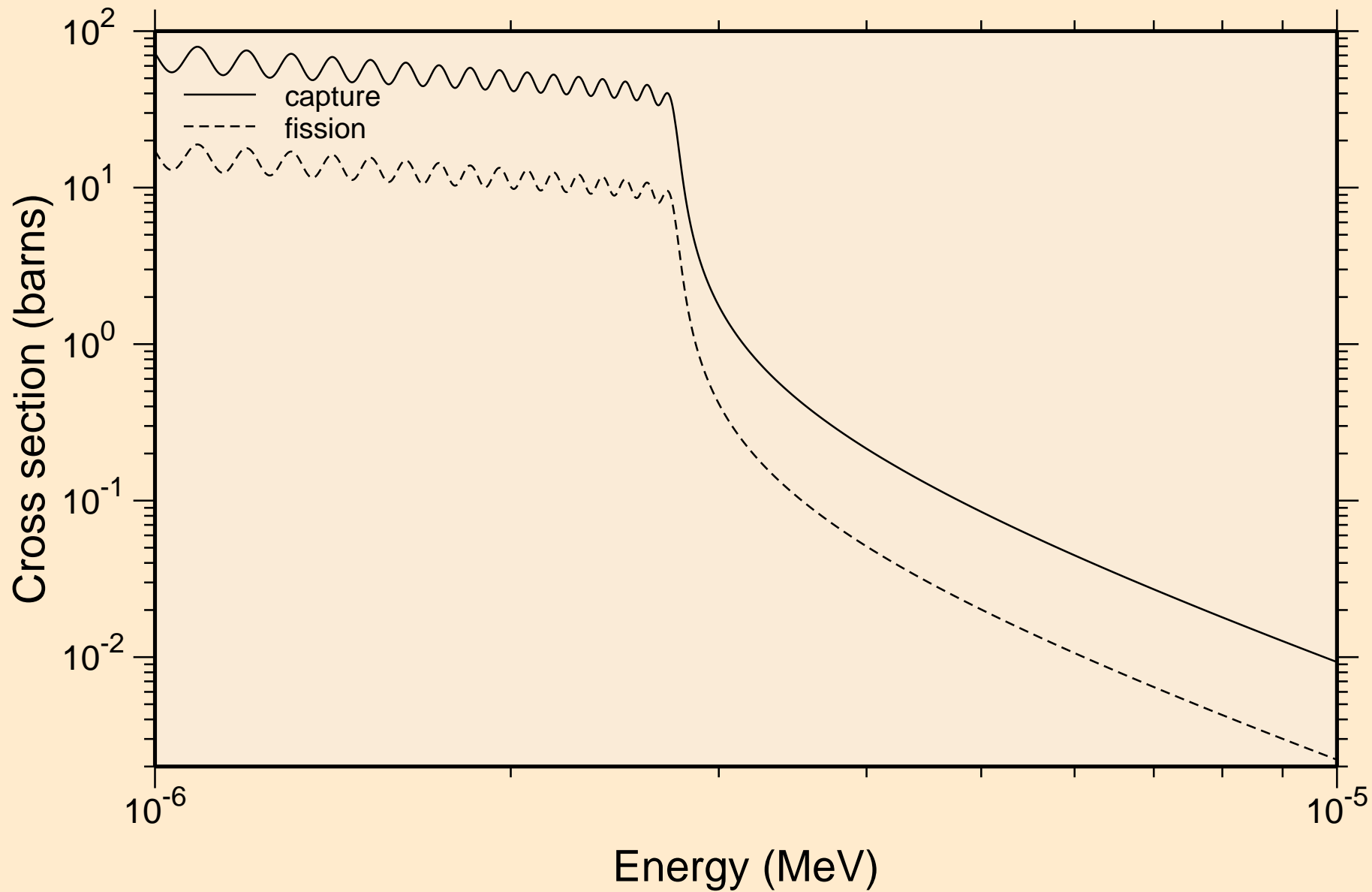

MD259 NEUTRON ACER TENDL-2021 LIBRARY; T=293.6K
resonance absorption cross sections

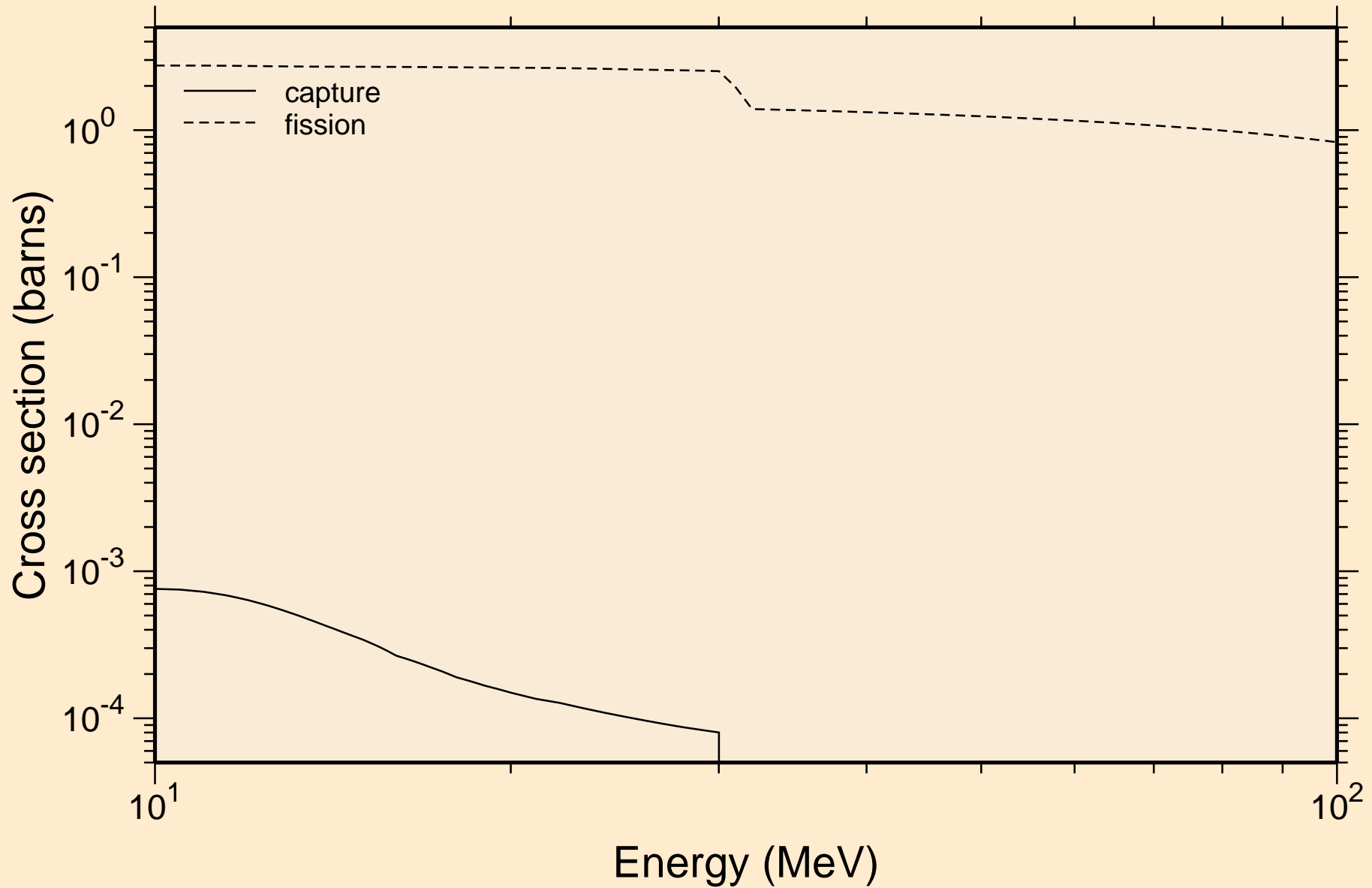

MD259 NEUTRON ACER TENDL-2021 LIBRARY; T=293.6K
Heating

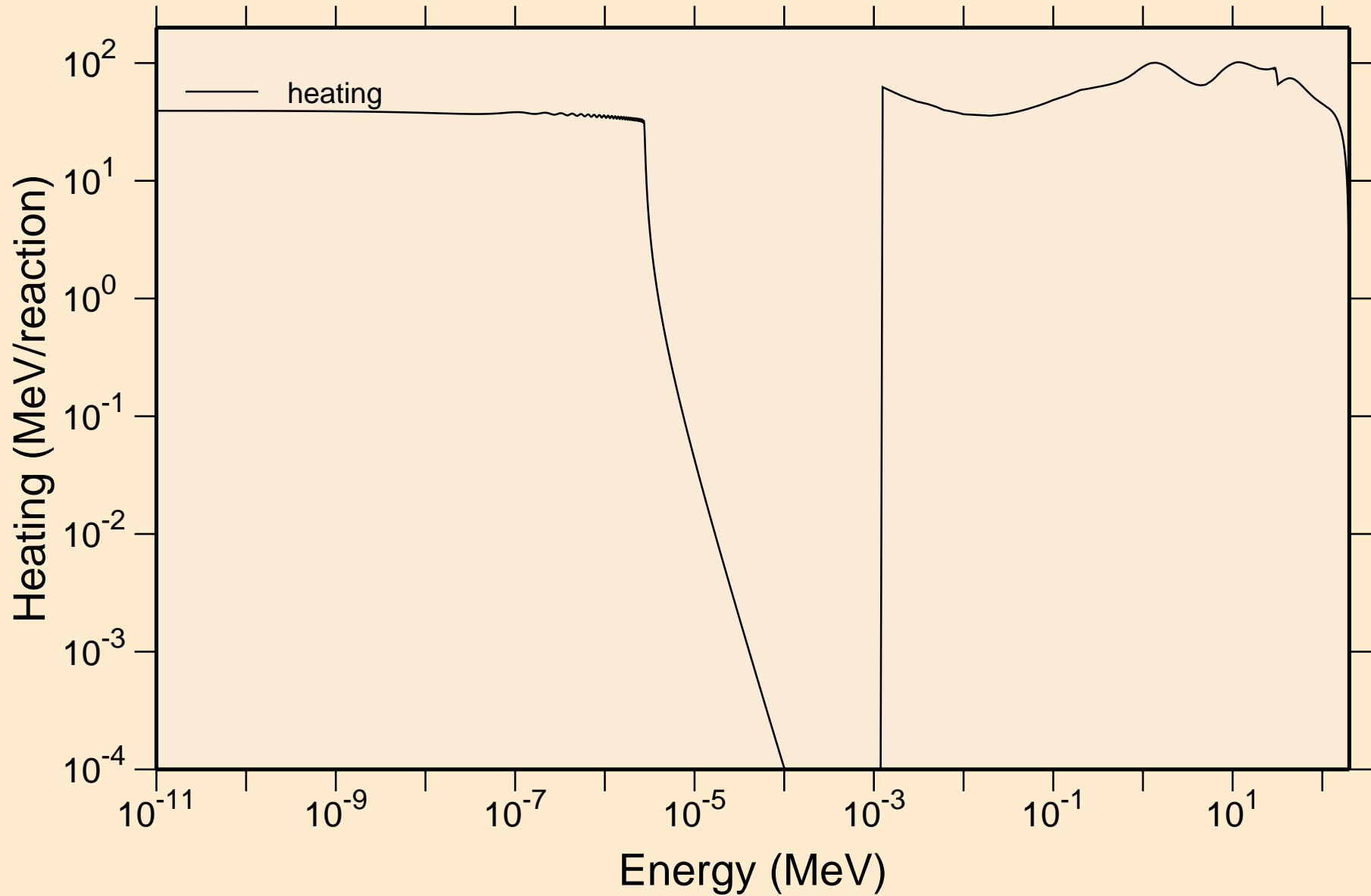

MD259 NEUTRON ACER TENDL-2021 LIBRARY; T=293.6K
Damage

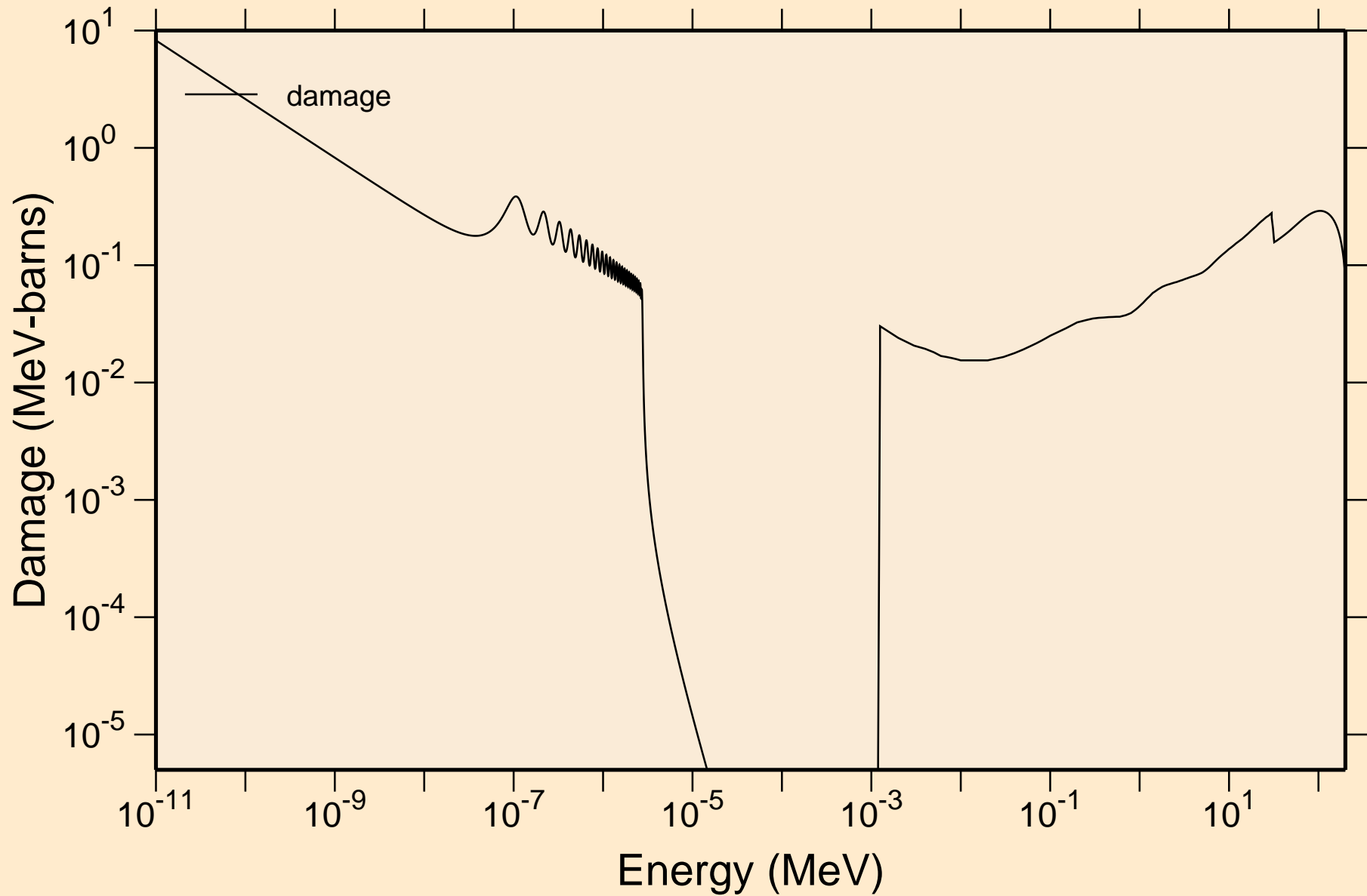

MD259 NEUTRON ACER TENDL-2021 LIBRARY; T=293.6K
Non-threshold reactions

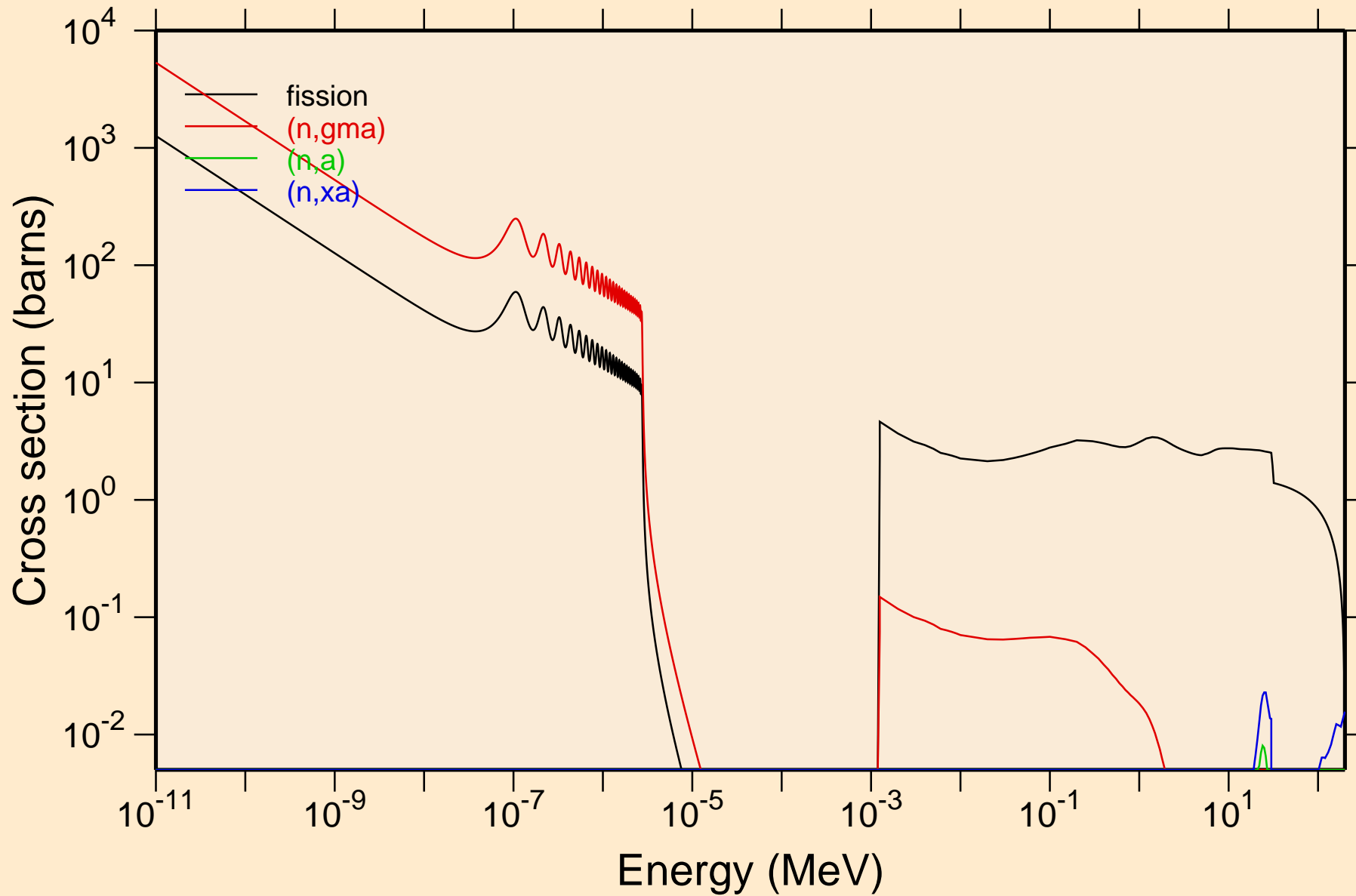

MD259 NEUTRON ACER TENDL-2021 LIBRARY; T=293.6K
Principal cross sections

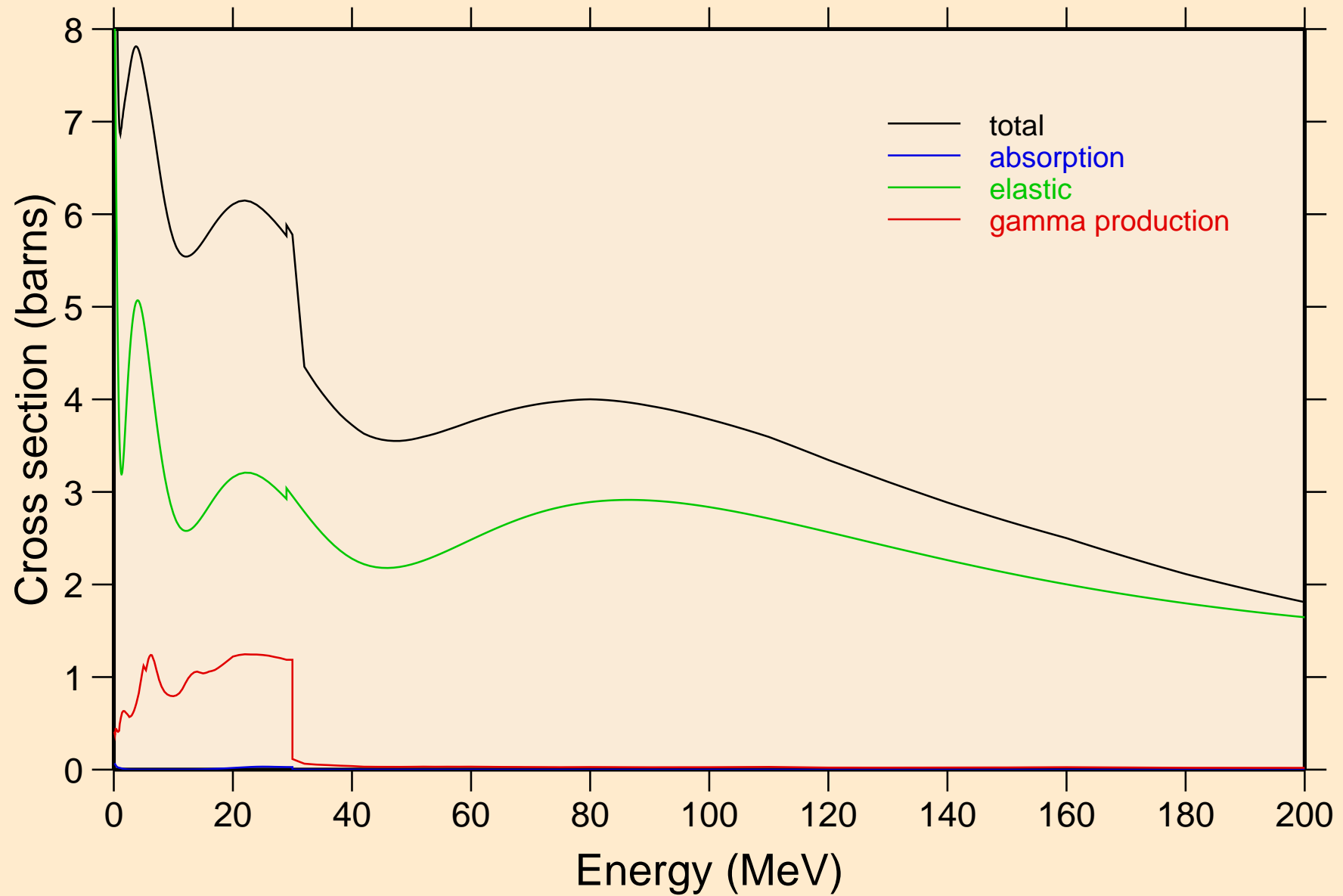

MD259 NEUTRON ACER TENDL-2021 LIBRARY; T=293.6K
Heating

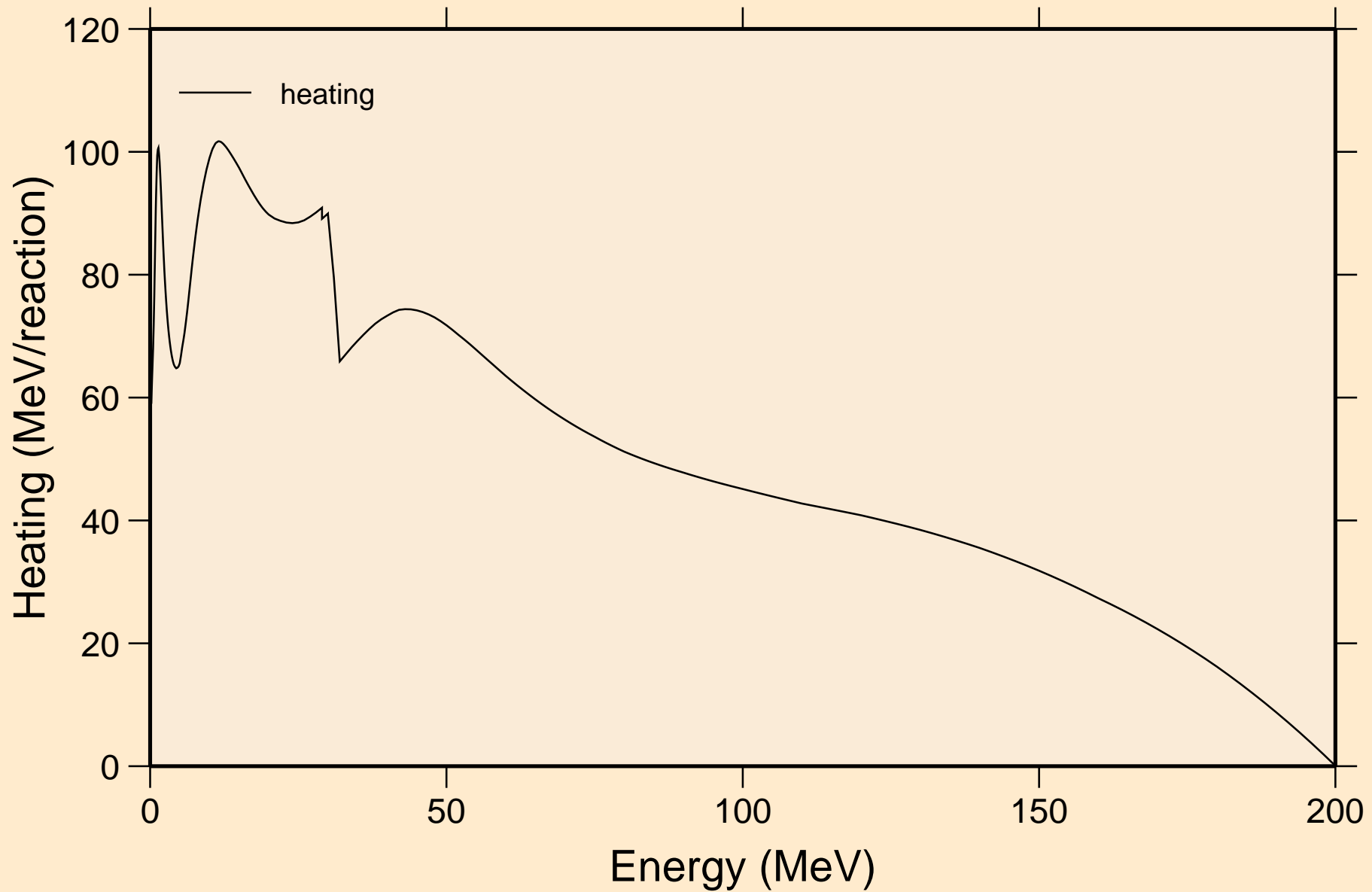

MD259 NEUTRON ACER TENDL-2021 LIBRARY; T=293.6K
Damage

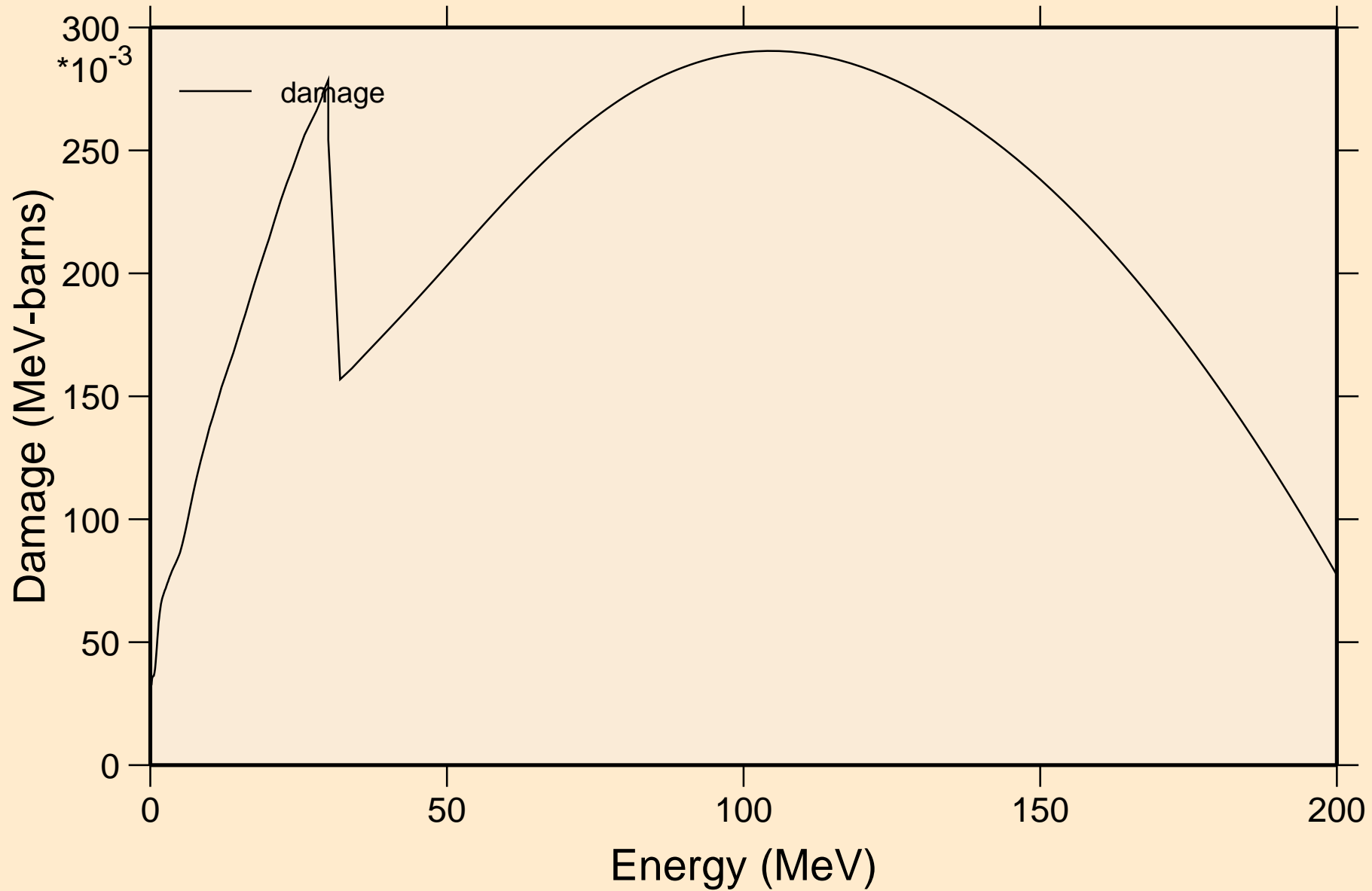

MD259 NEUTRON ACER TENDL-2021 LIBRARY; T=293.6K
Non-threshold reactions

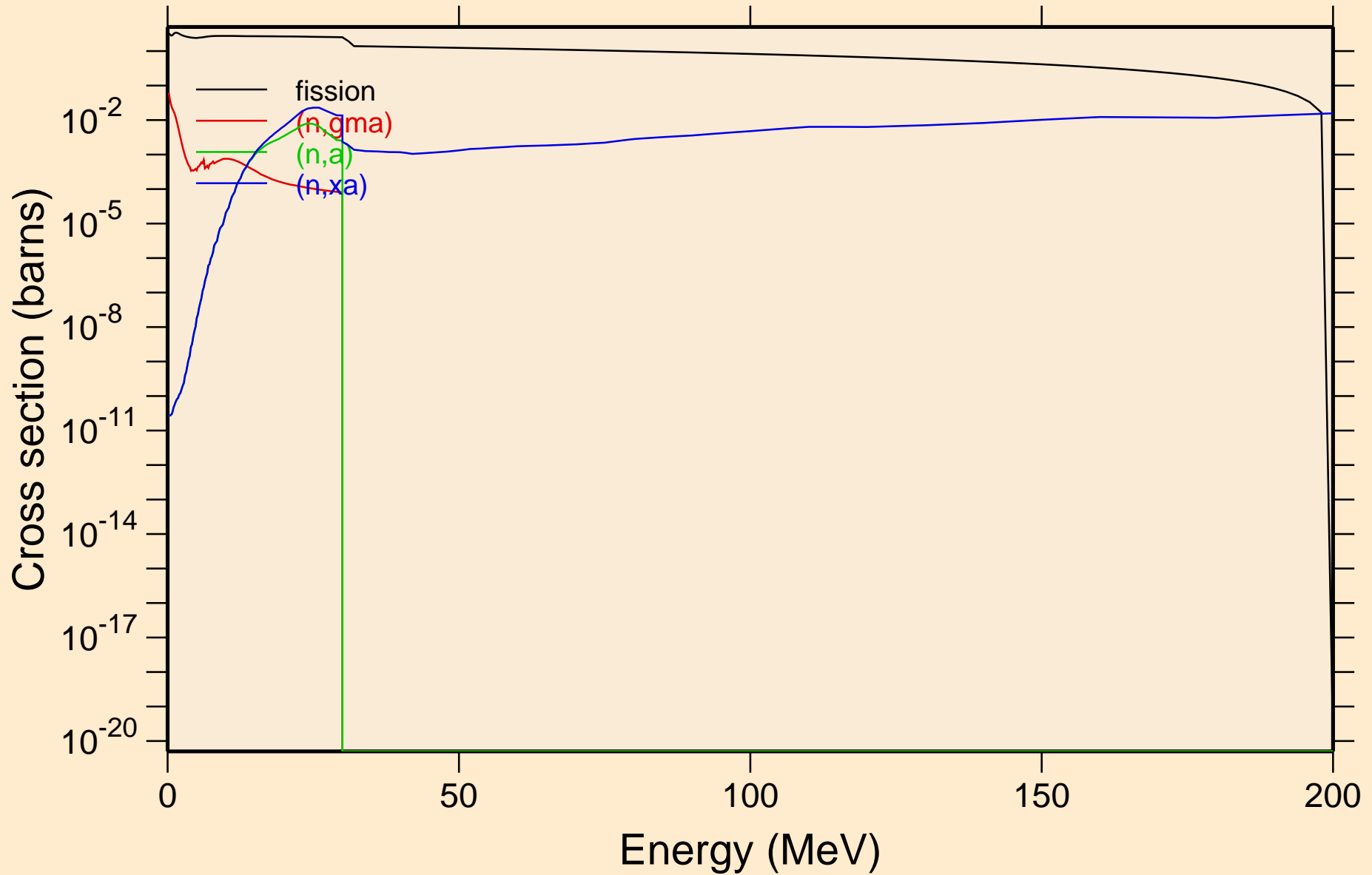

MD259 NEUTRON ACER TENDL-2021 LIBRARY; T=293.6K
Inelastic levels

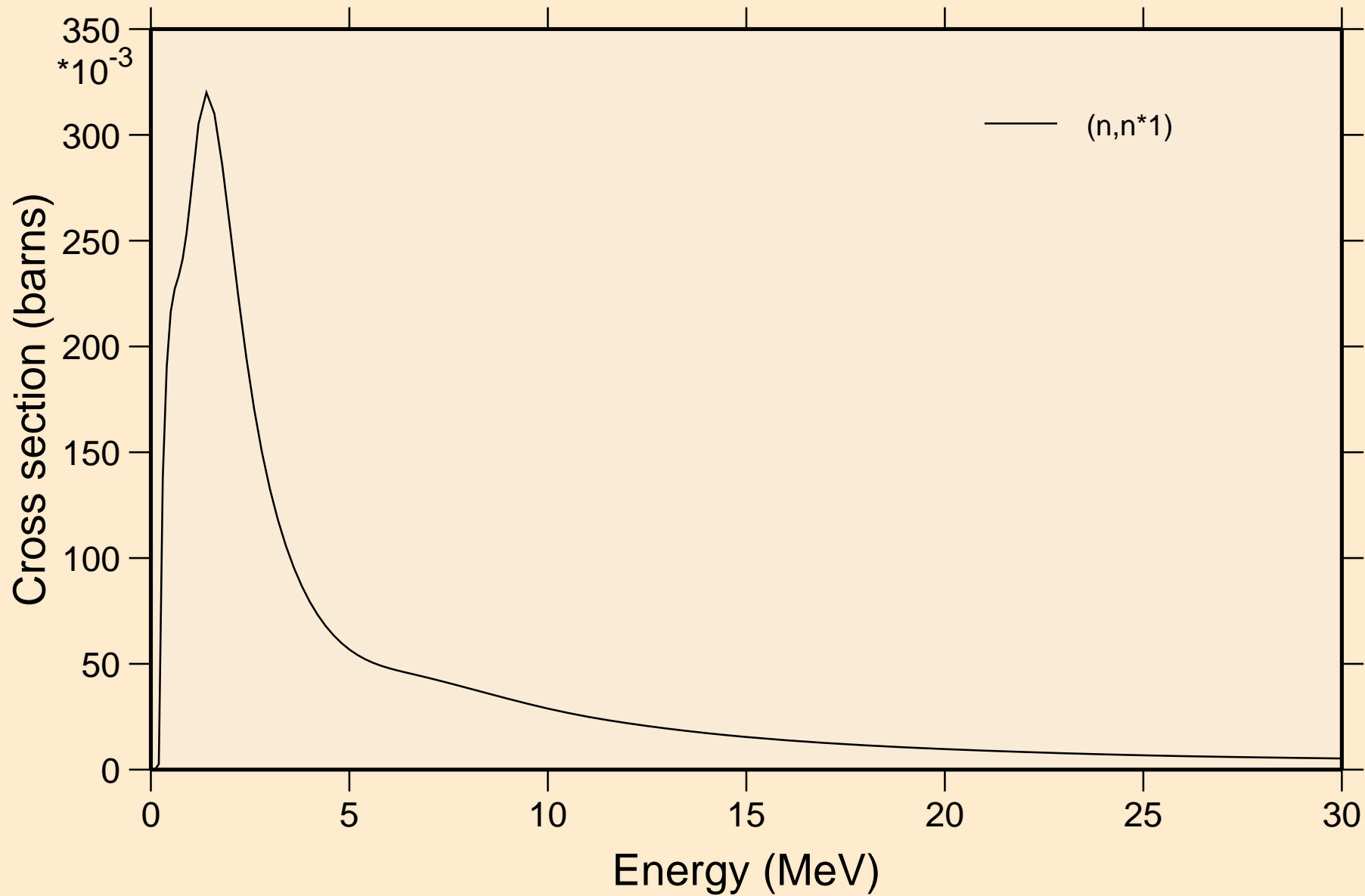

MD259 NEUTRON ACER TENDL-2021 LIBRARY; T=293.6K

Threshold reactions

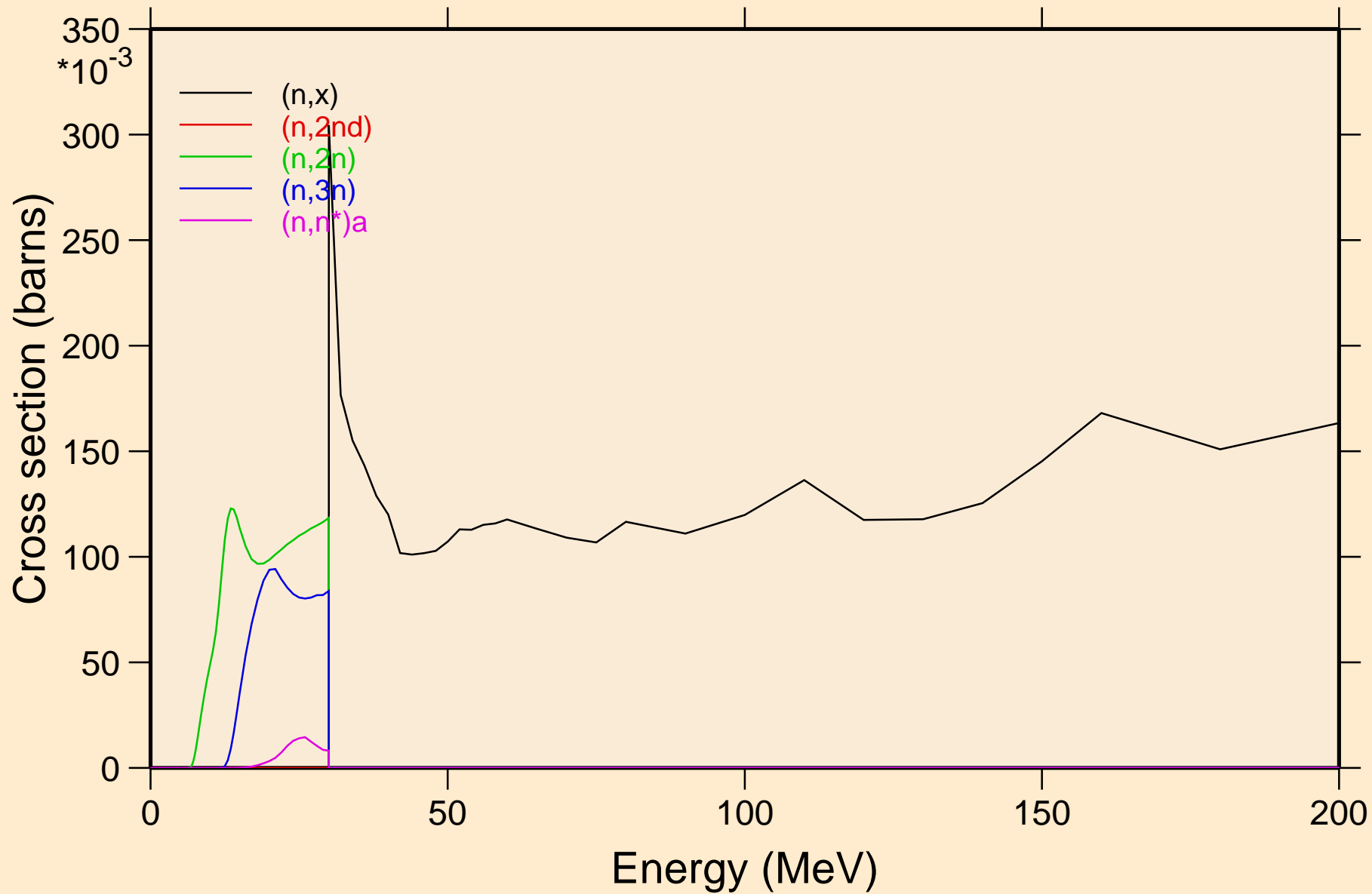

MD259 NEUTRON ACER TENDL-2021 LIBRARY; T=293.6K
Threshold reactions

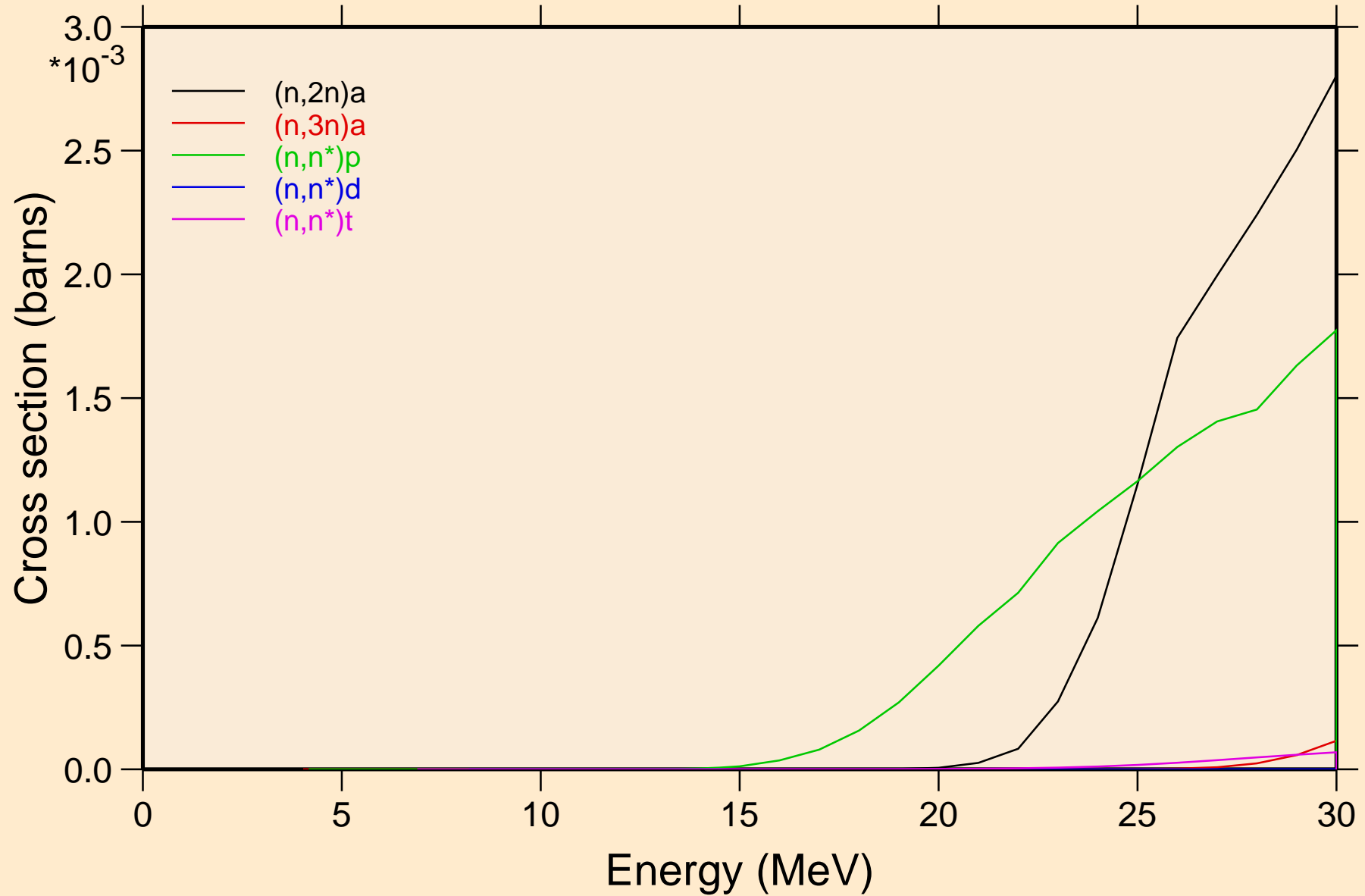

MD259 NEUTRON ACER TENDL-2021 LIBRARY; T=293.6K
Threshold reactions

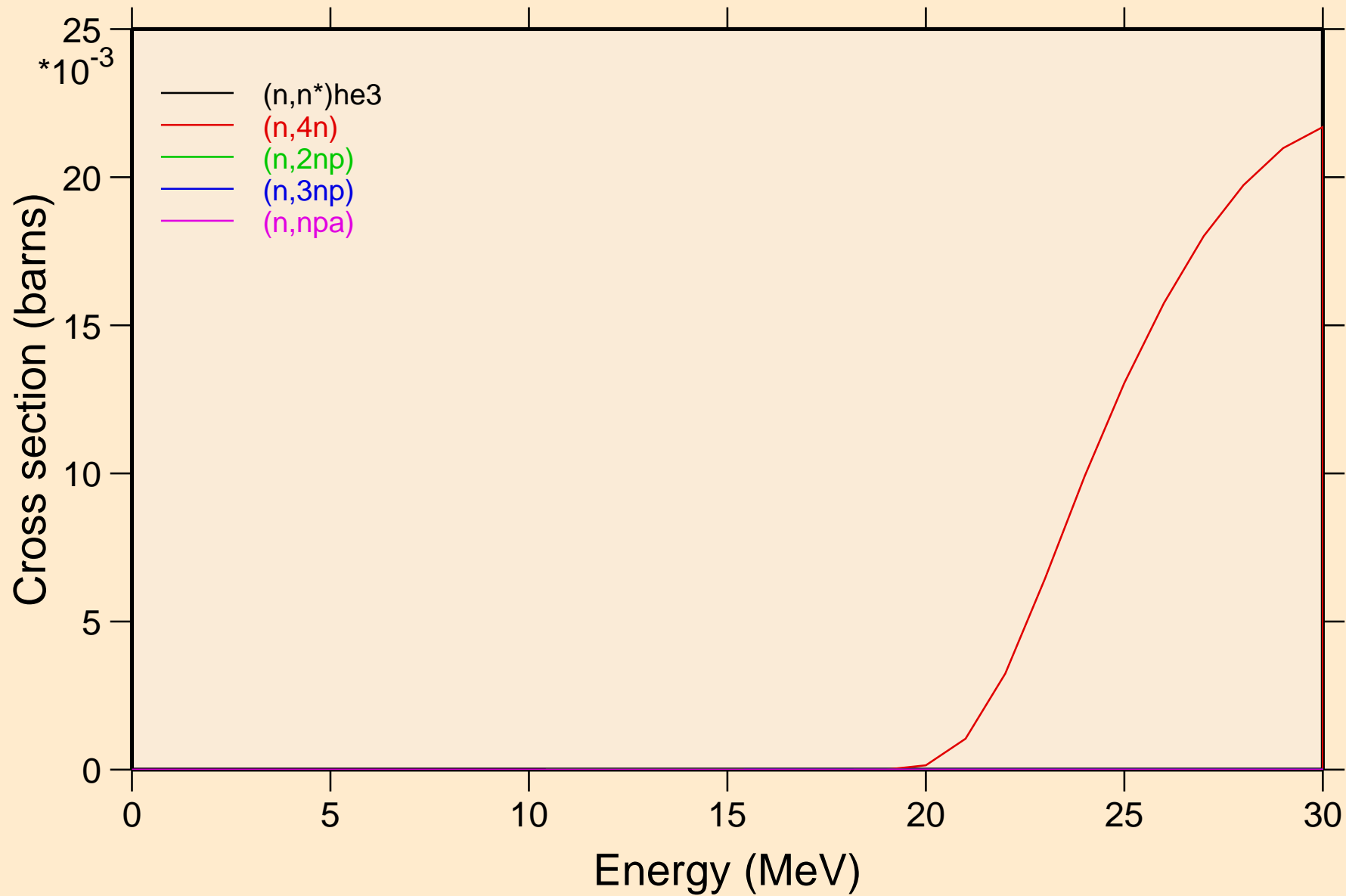

MD259 NEUTRON ACER TENDL-2021 LIBRARY; T=293.6K
Threshold reactions

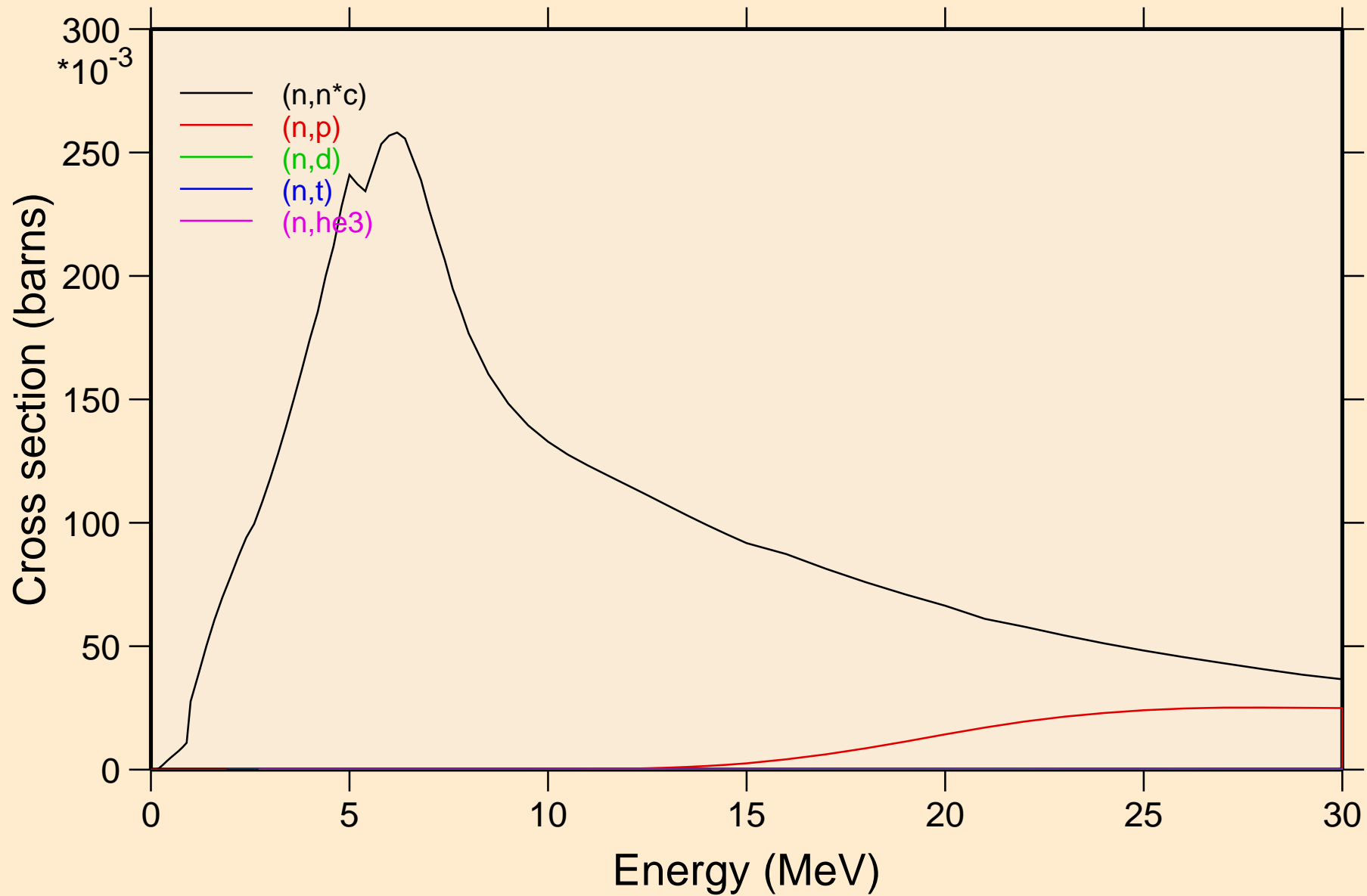

MD259 NEUTRON ACER TENDL-2021 LIBRARY; T=293.6K
Threshold reactions

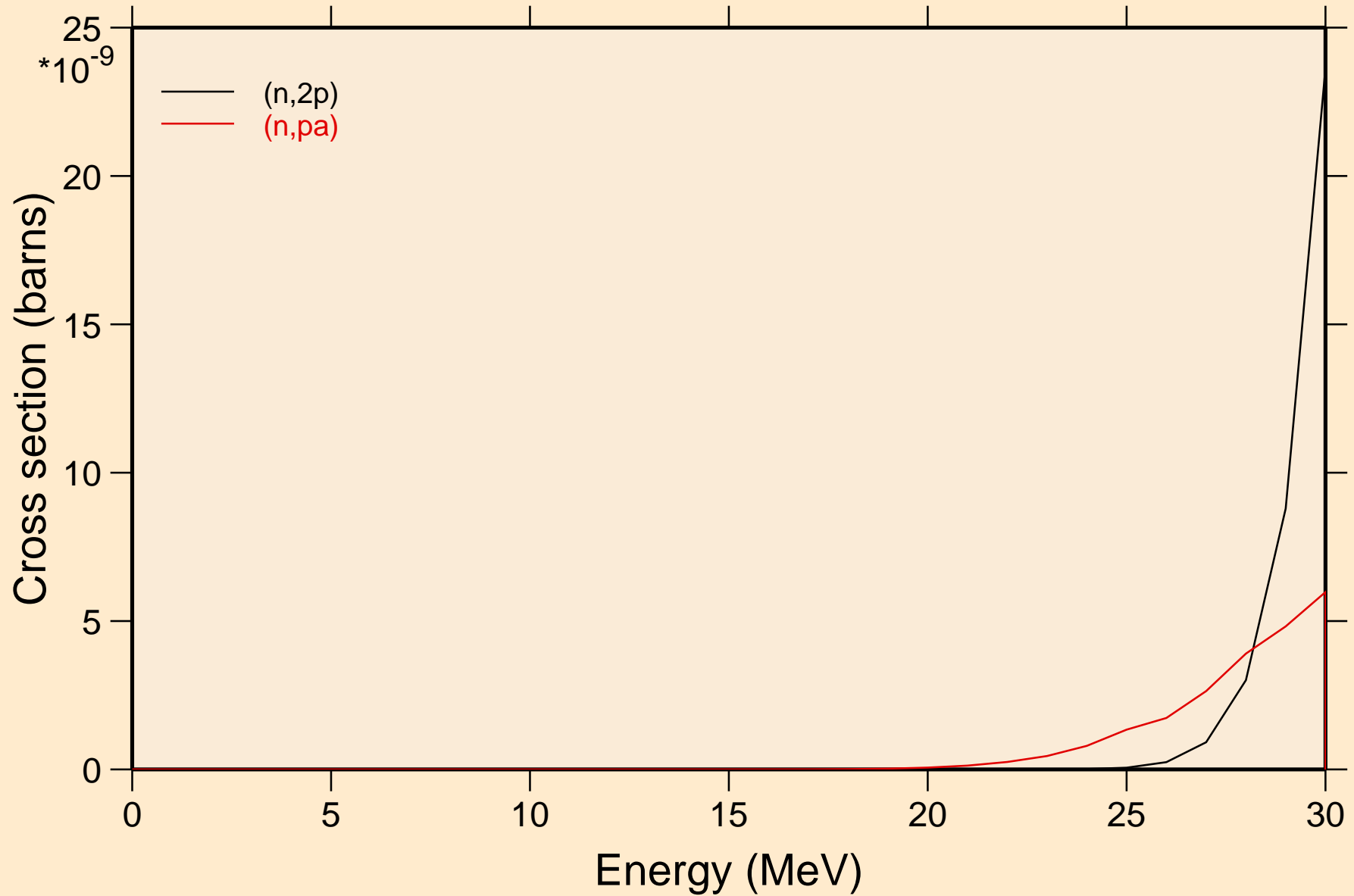

MD259 NEUTRON ACER TENDL-2021 LIBRARY; T=293.6K
Threshold reactions

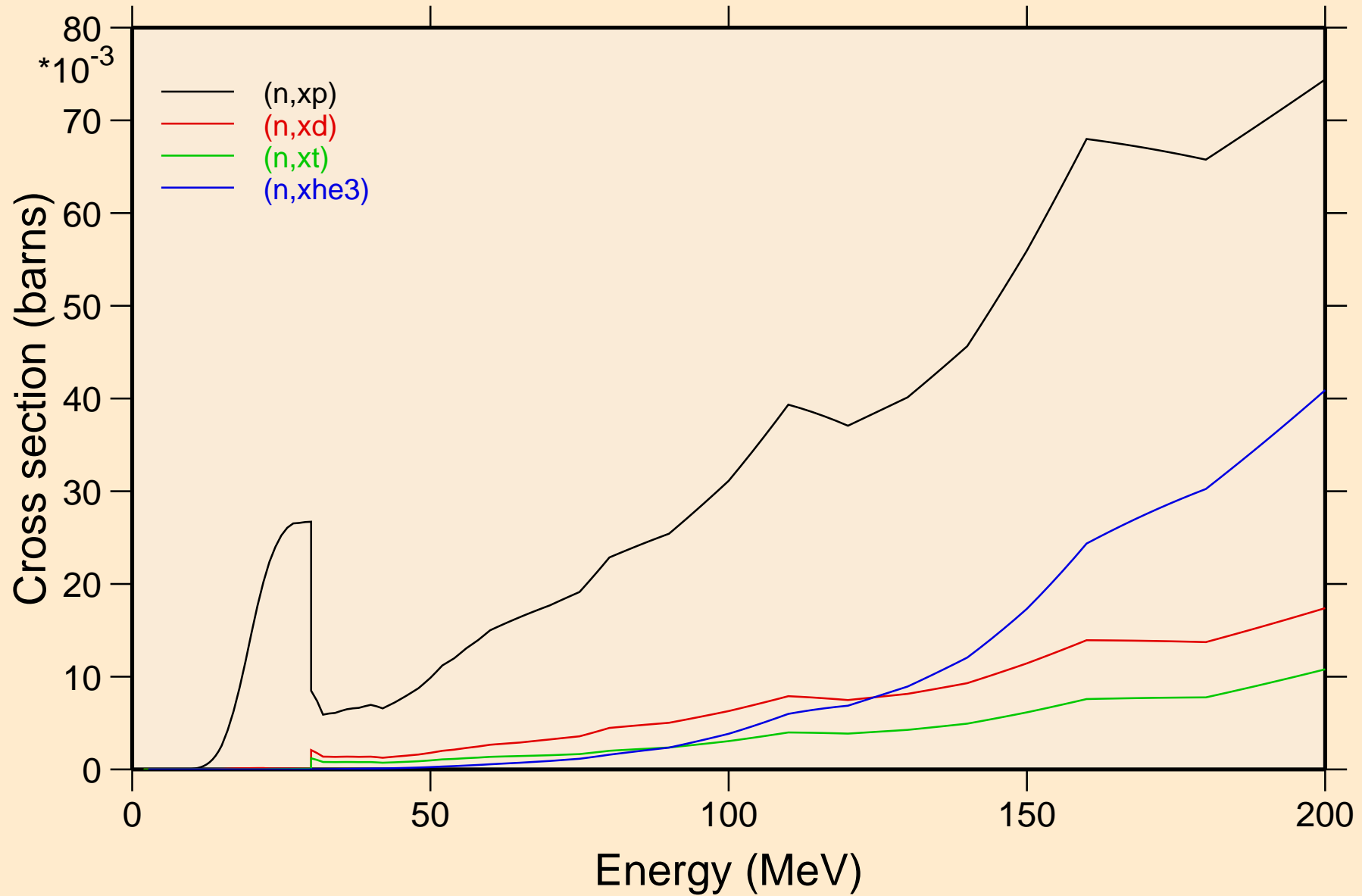

MD259 NEUTRON ACER TENDL-2021 LIBRARY; T=293.6K
angular distribution for elastic

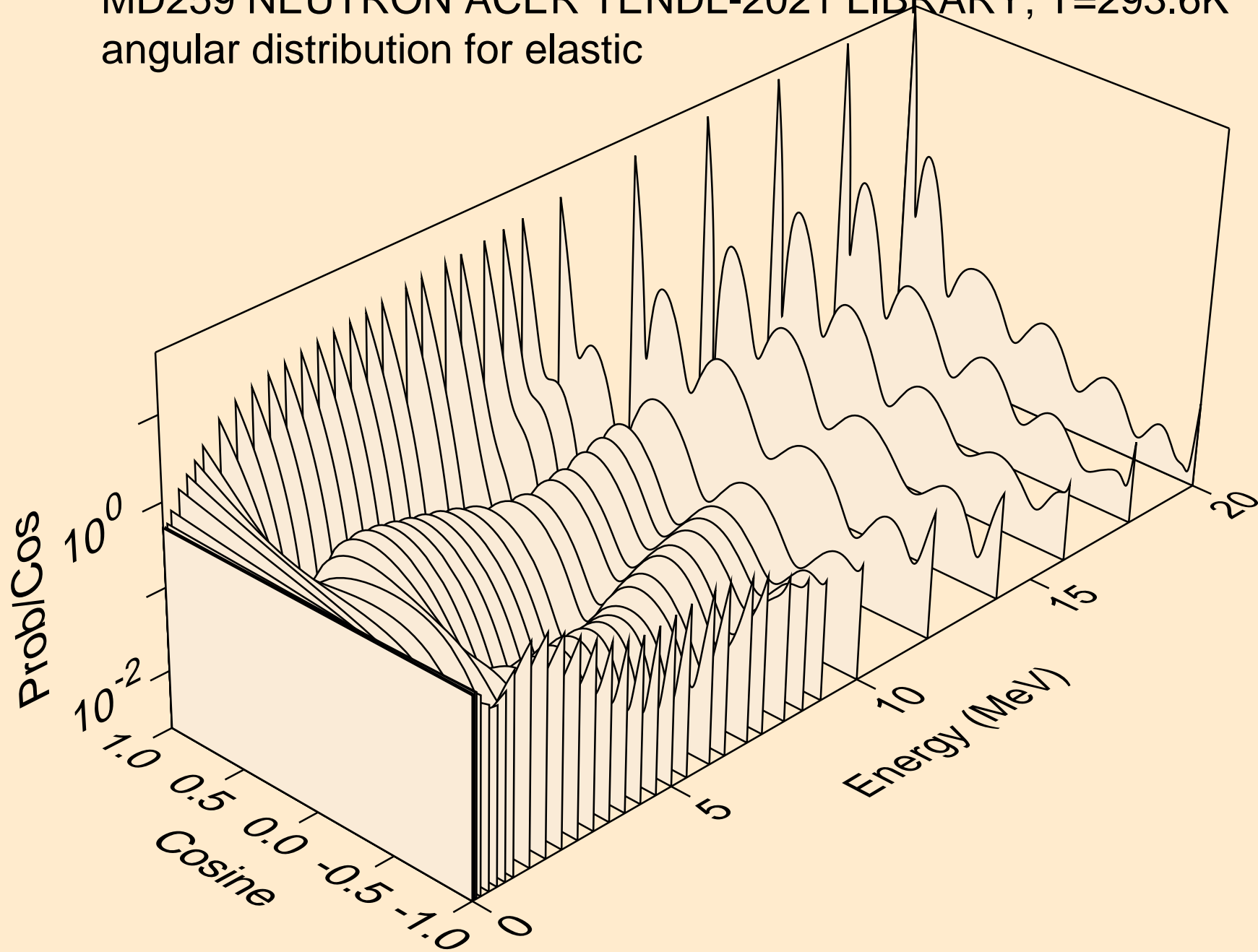

MD259 NEUTRON ACER TENDL-2021 LIBRARY; T=293.6K
angular distribution for elastic

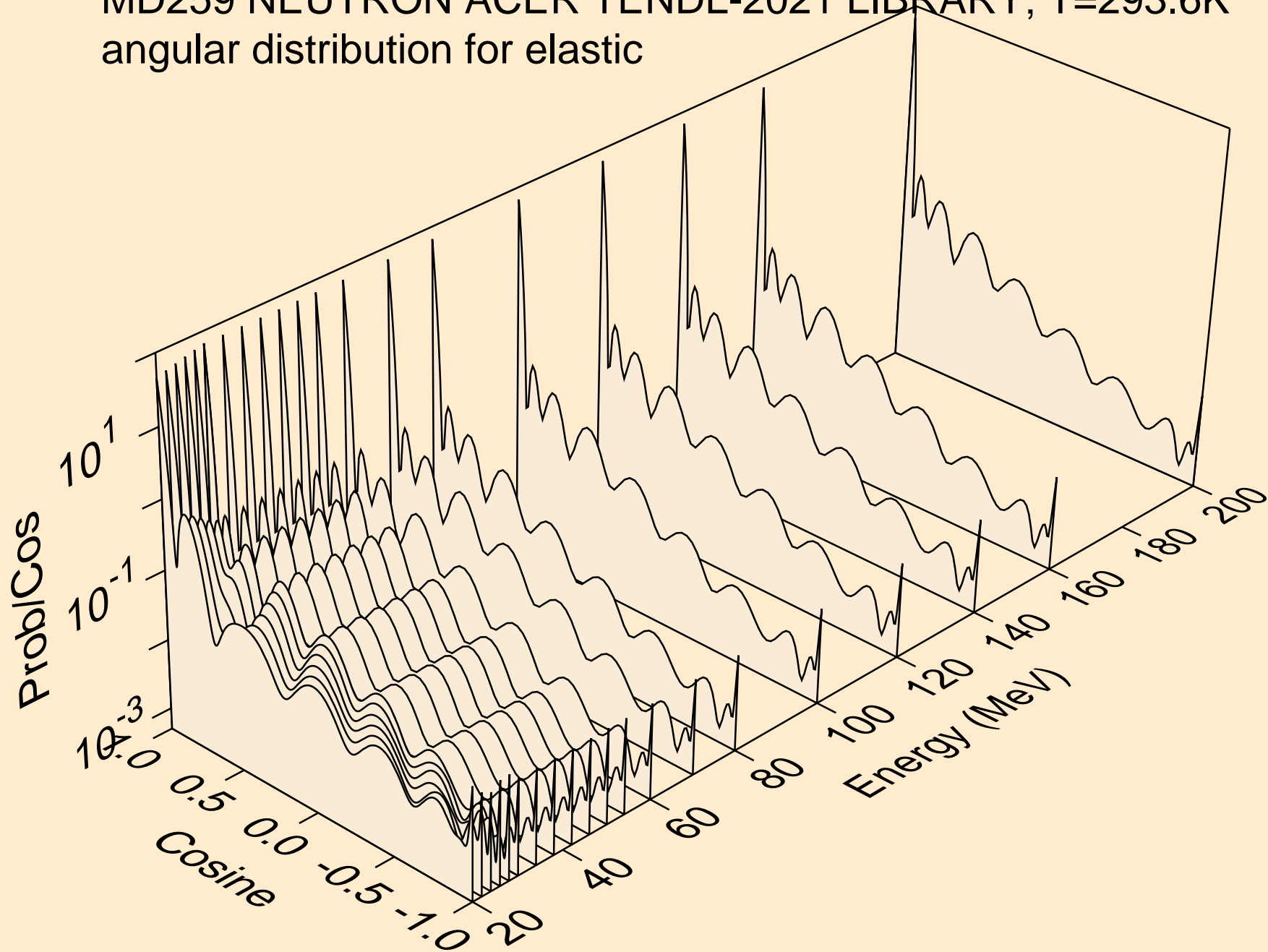

MD259 NEUTRON ACER TENDL-2021 LIBRARY; T=293.6K
angular distribution for (n,n*1)

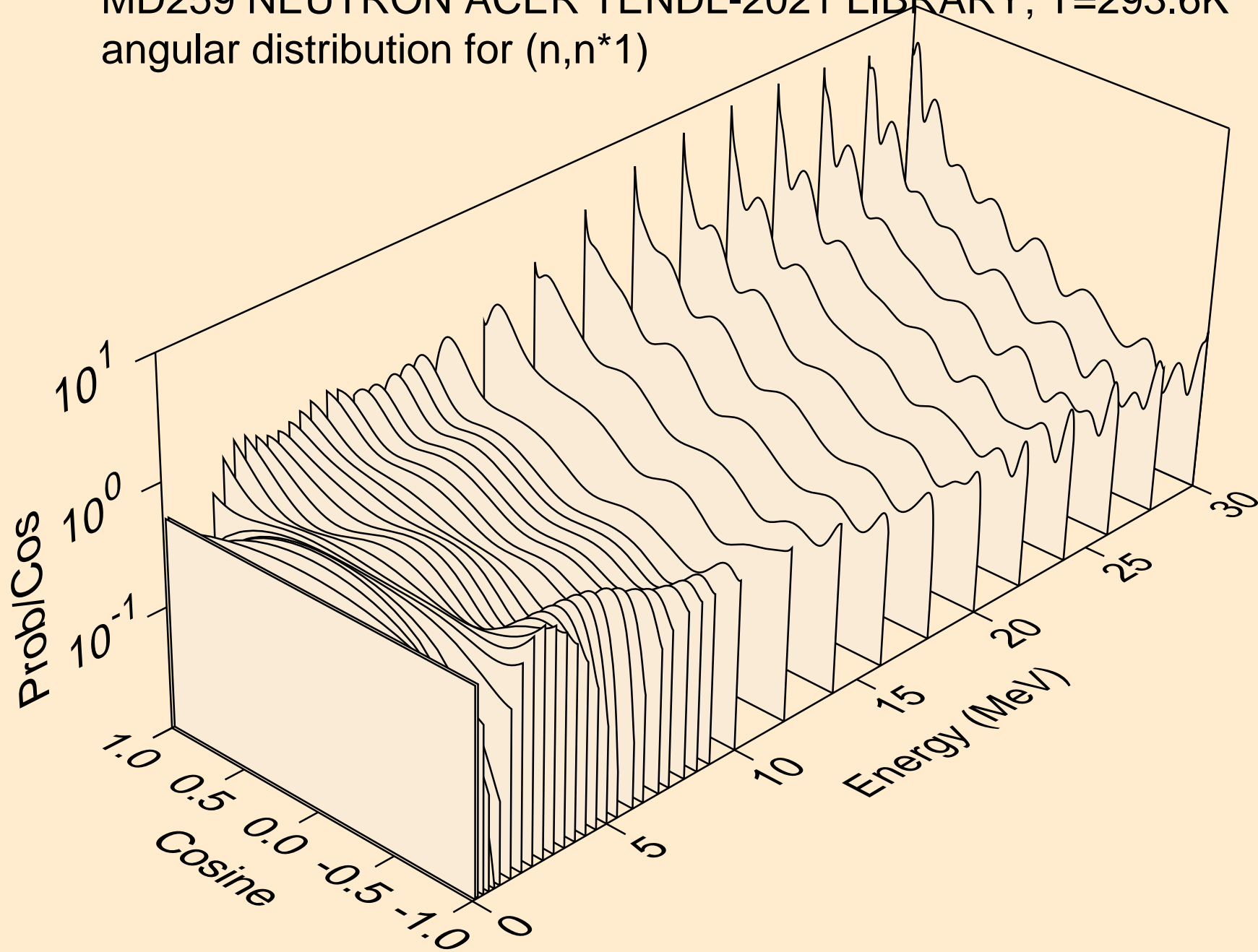

MD259 NEUTRON ACER TENDL-2021 LIBRARY; T=293.6K
Total fission nubar

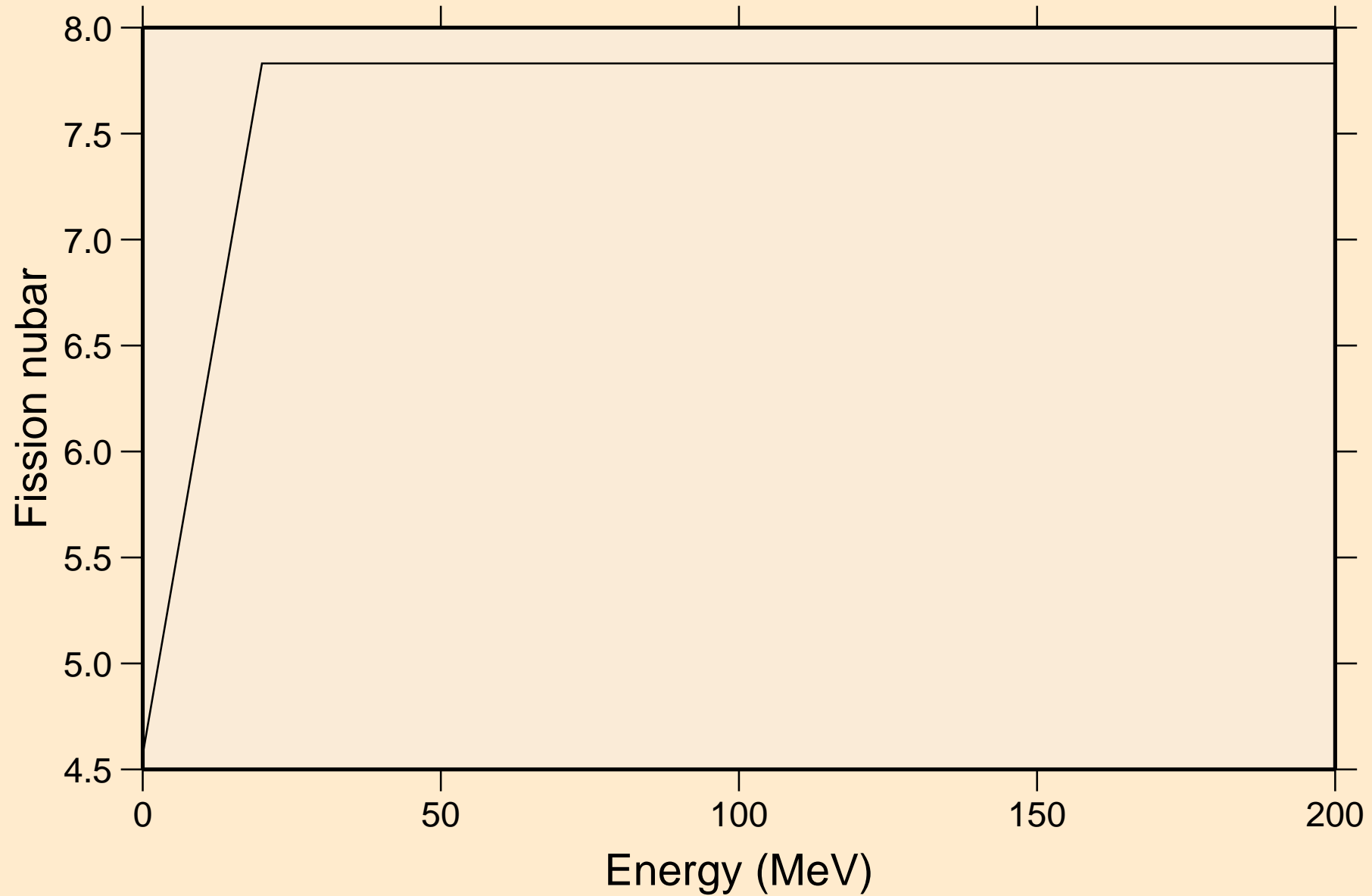

MD259 NEUTRON ACER TENDL-2021 LIBRARY; T=293.6K
Neutron emission for (n,x)

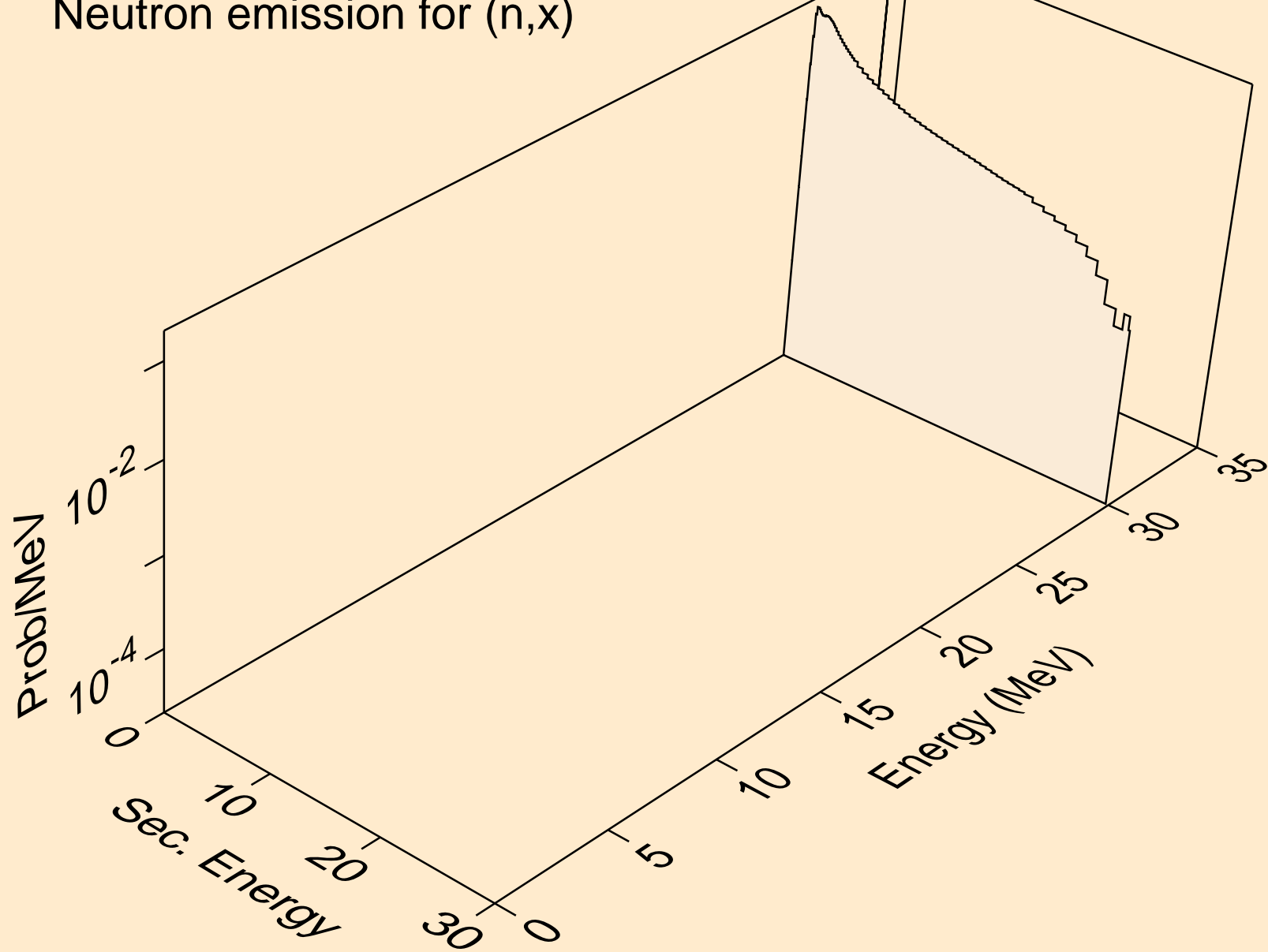

MD259 NEUTRON ACER TENDL-2021 LIBRARY; T=293.6K
Neutron emission for (n,2nd)

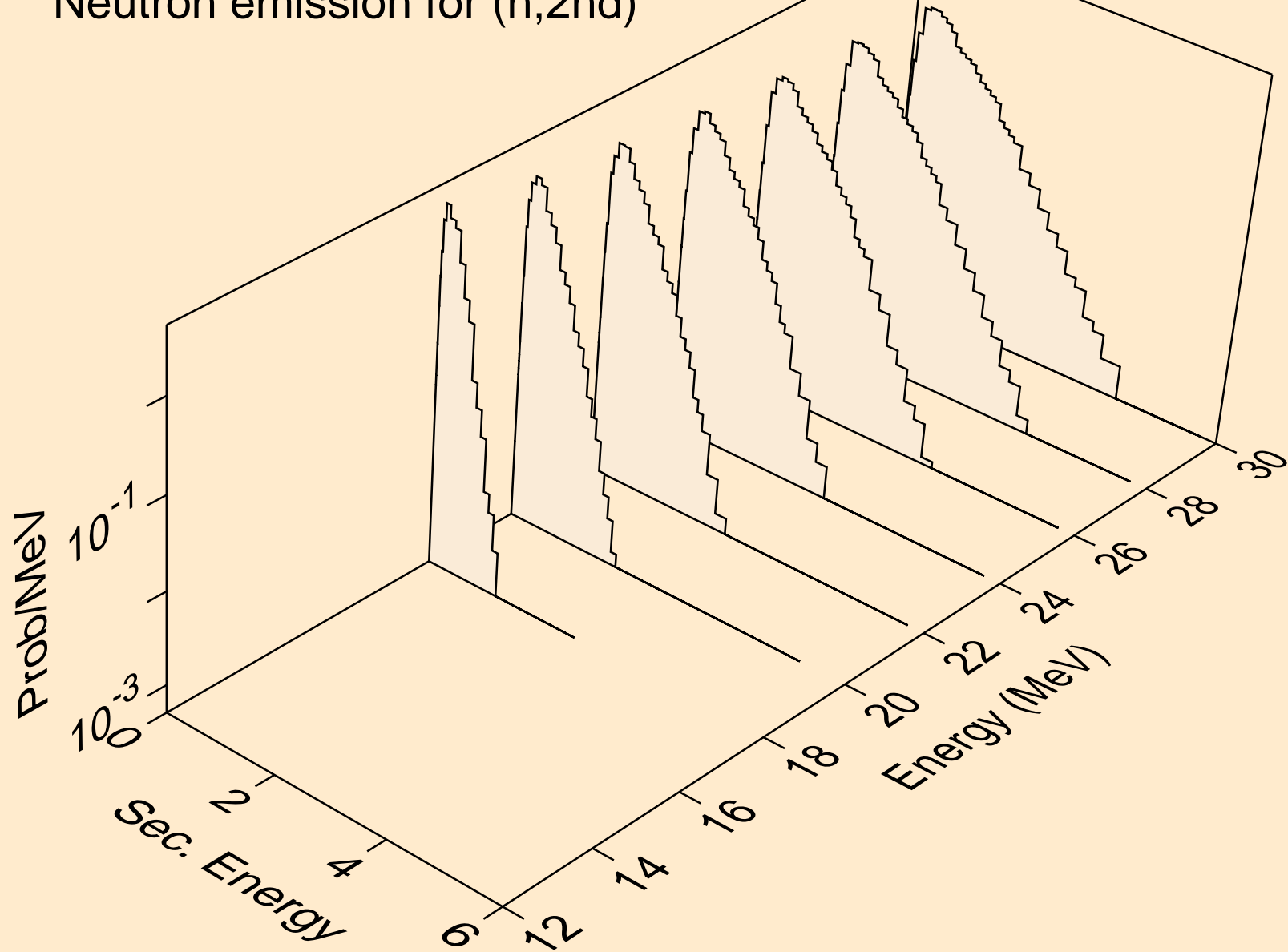

MD259 NEUTRON ACER TENDL-2021 LIBRARY; T=293.6K
Neutron emission for (n,2n)

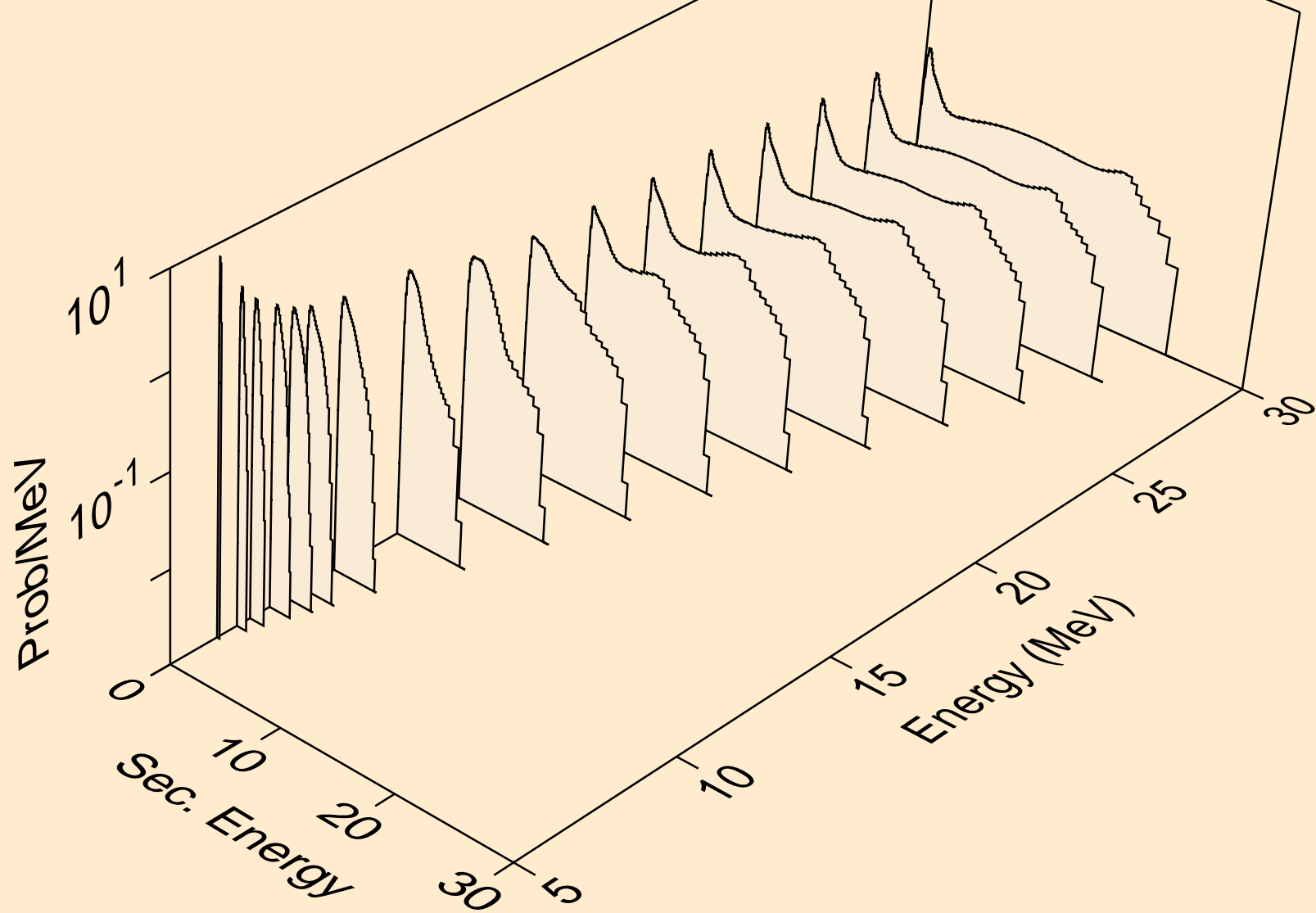

MD259 NEUTRON ACER TENDL-2021 LIBRARY; T=293.6K
Neutron emission for (n,3n)

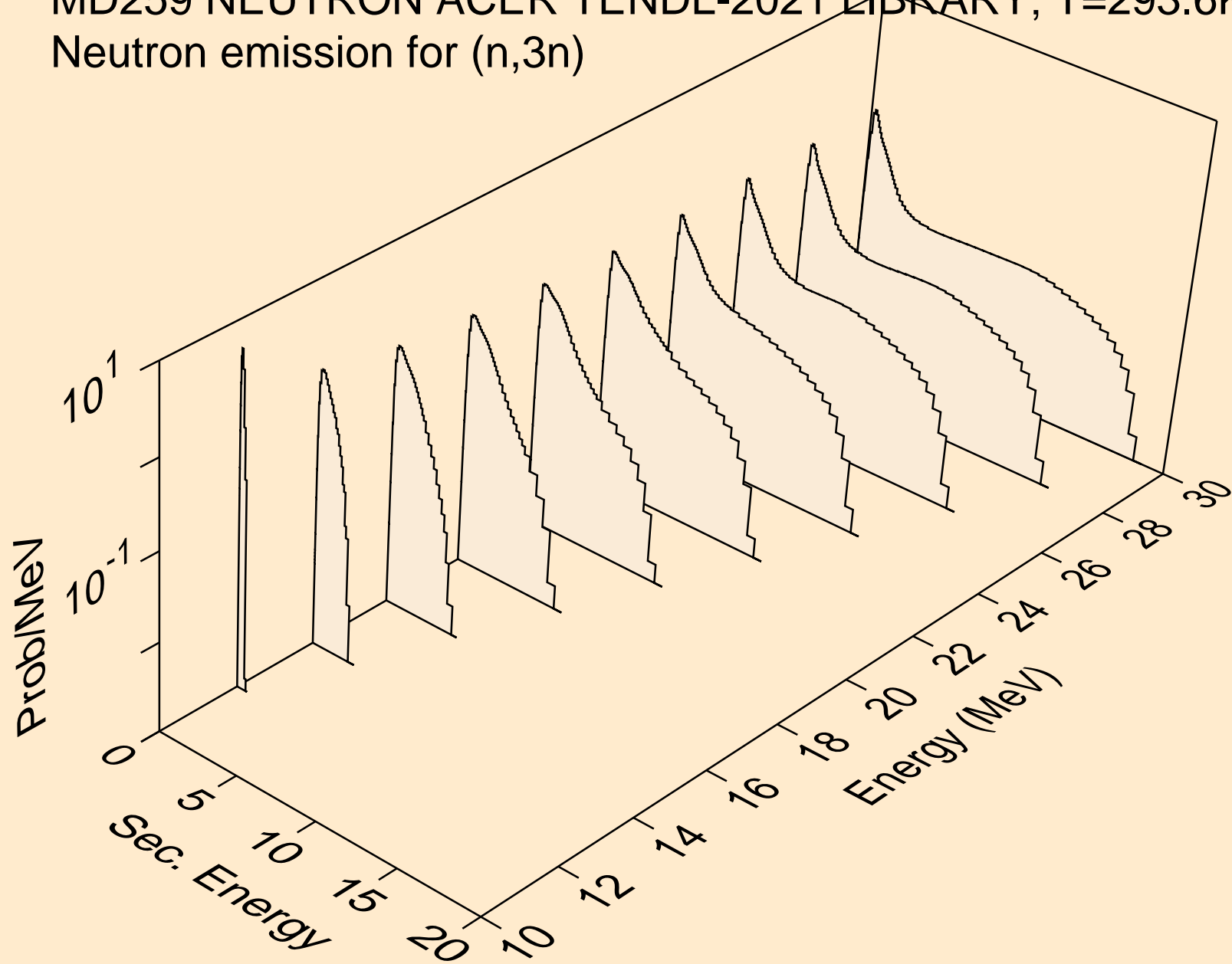

MD259 NEUTRON ACER TENDL-2021 LIBRARY; T=293.6K
Neutron emission for fission

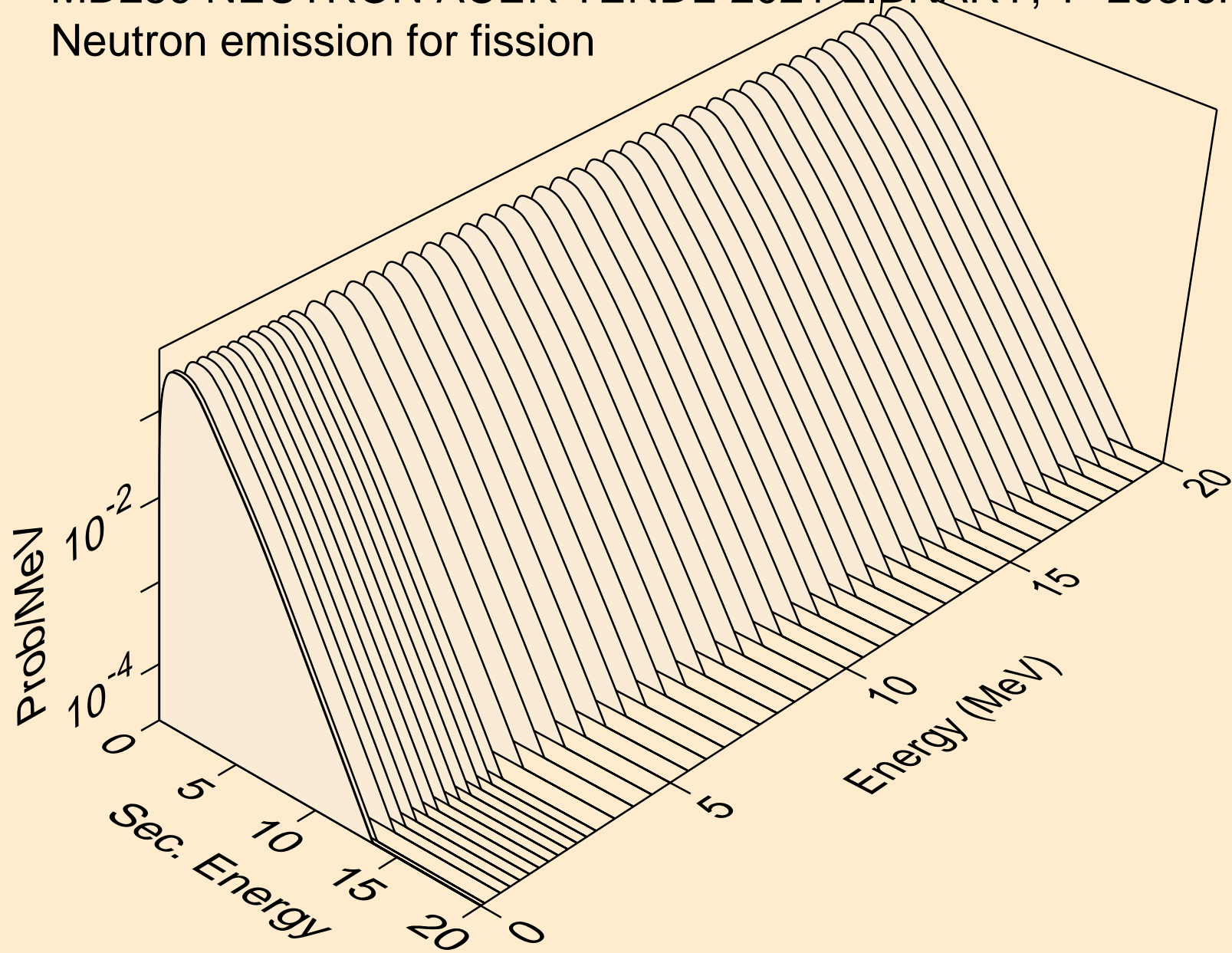

MD259 NEUTRON ACER TENDL-2021 LIBRARY; T=293.6K
Neutron emission for (n,n*)a

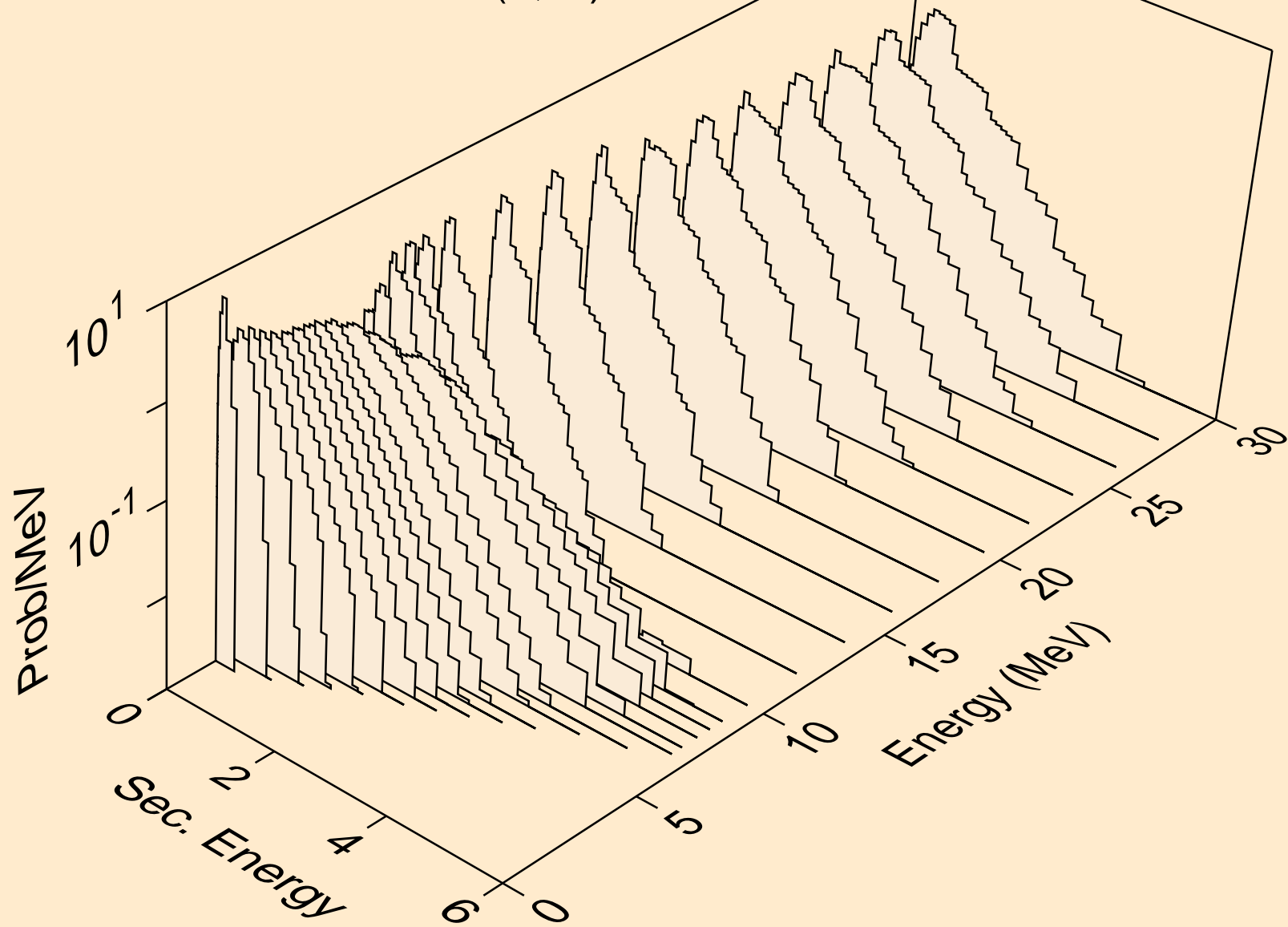

MD259 NEUTRON ACER TENDL-2021 LIBRARY; T=293.6K
Neutron emission for (n,2n)a

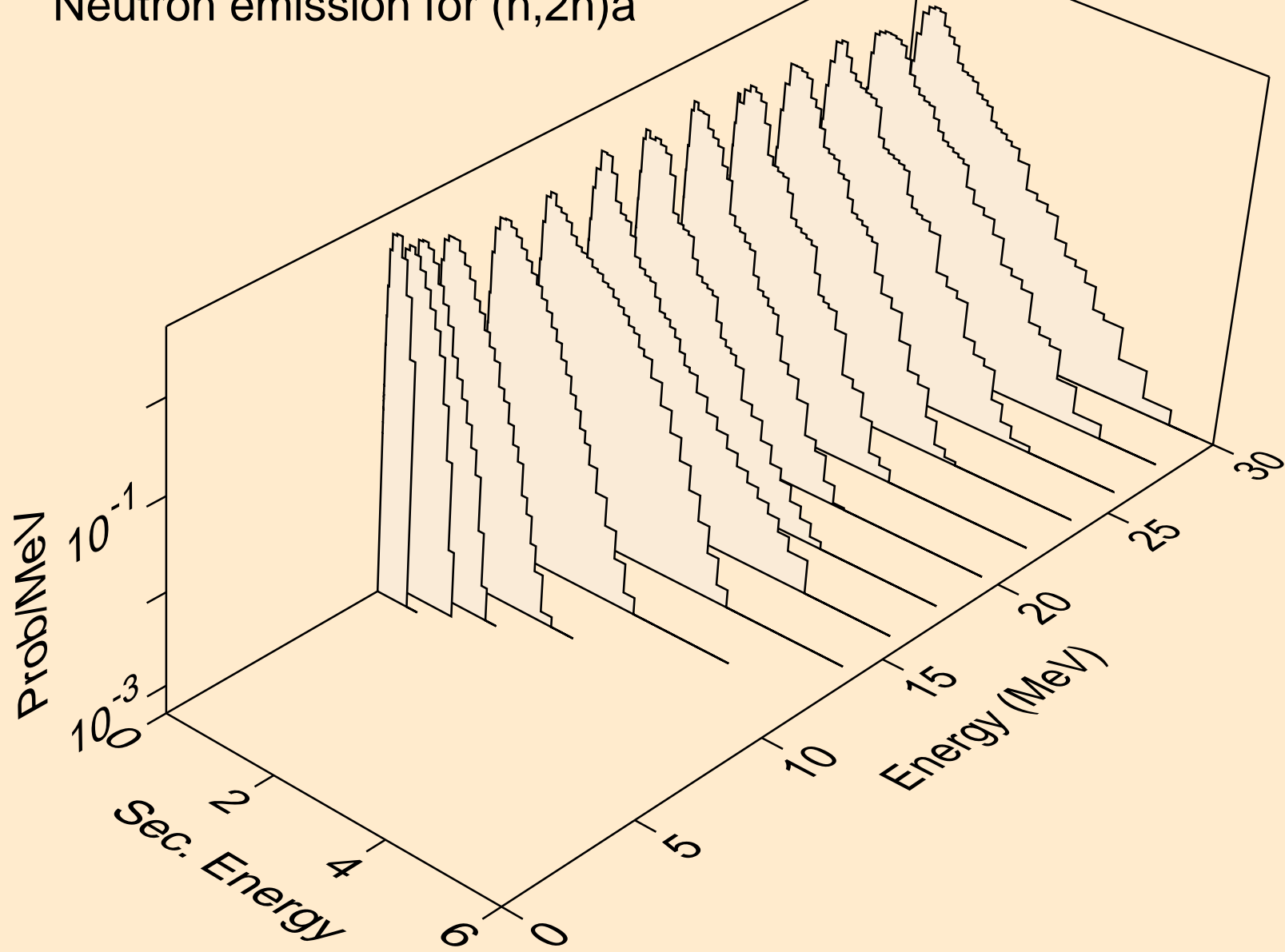

MD259 NEUTRON ACER TENDL-2021 LIBRARY; T=293.6K
Neutron emission for (n,3n)a

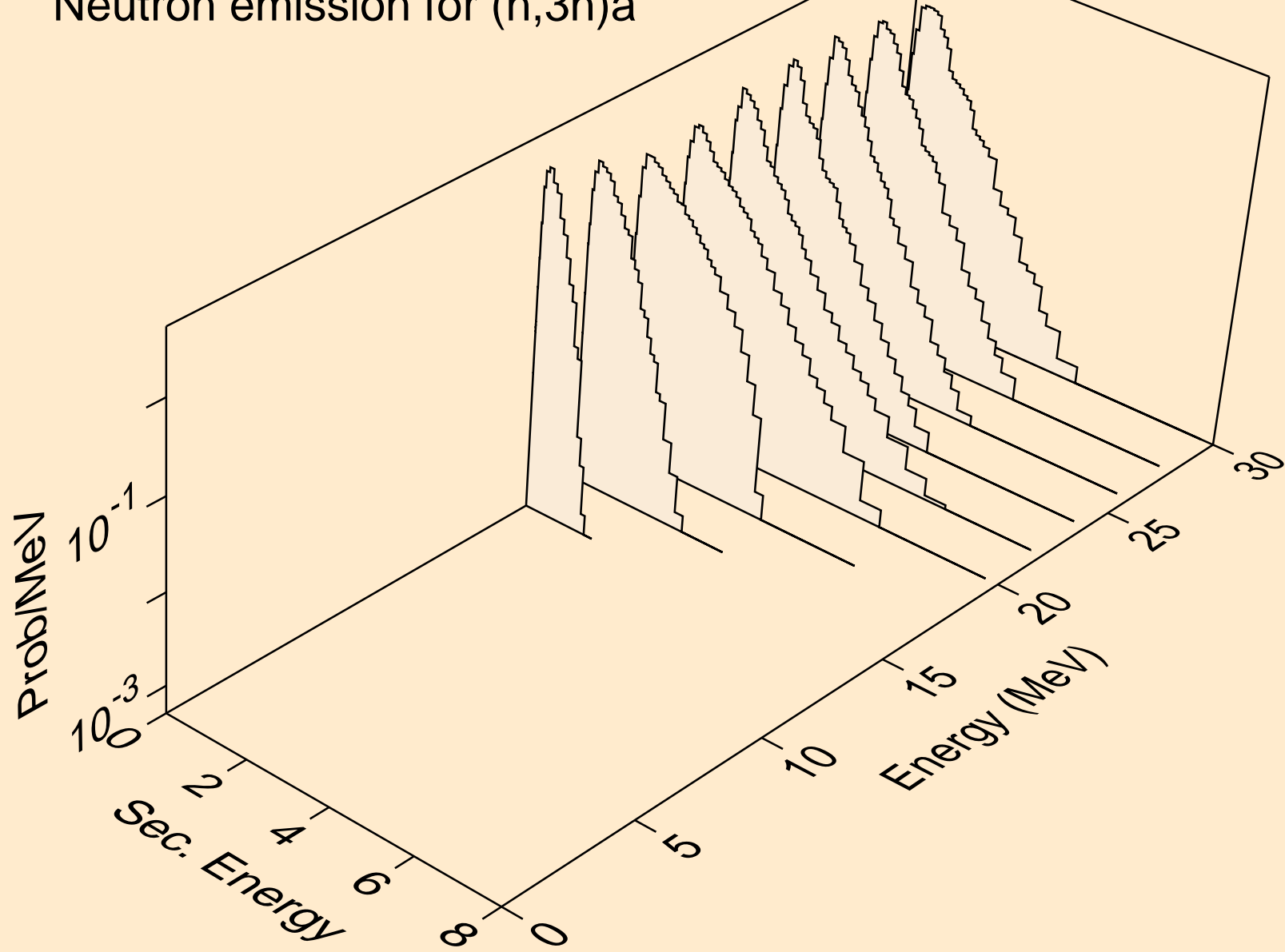

MD259 NEUTRON ACER TENDL-2021 LIBRARY; T=293.6K
Neutron emission for (n,n*)p

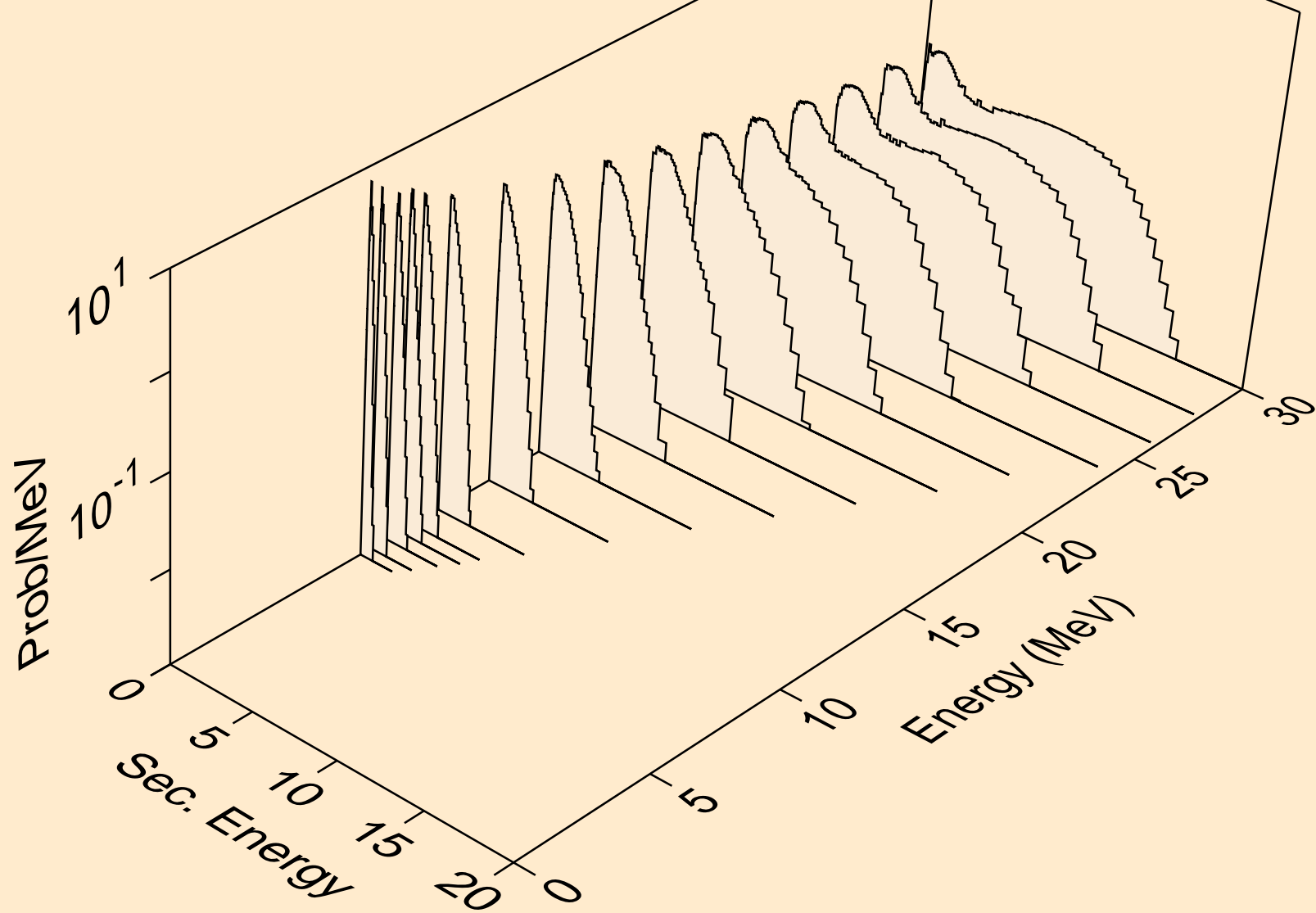

MD259 NEUTRON ACER TENDL-2021 LIBRARY; T=293.6K
Neutron emission for (n,n*)d

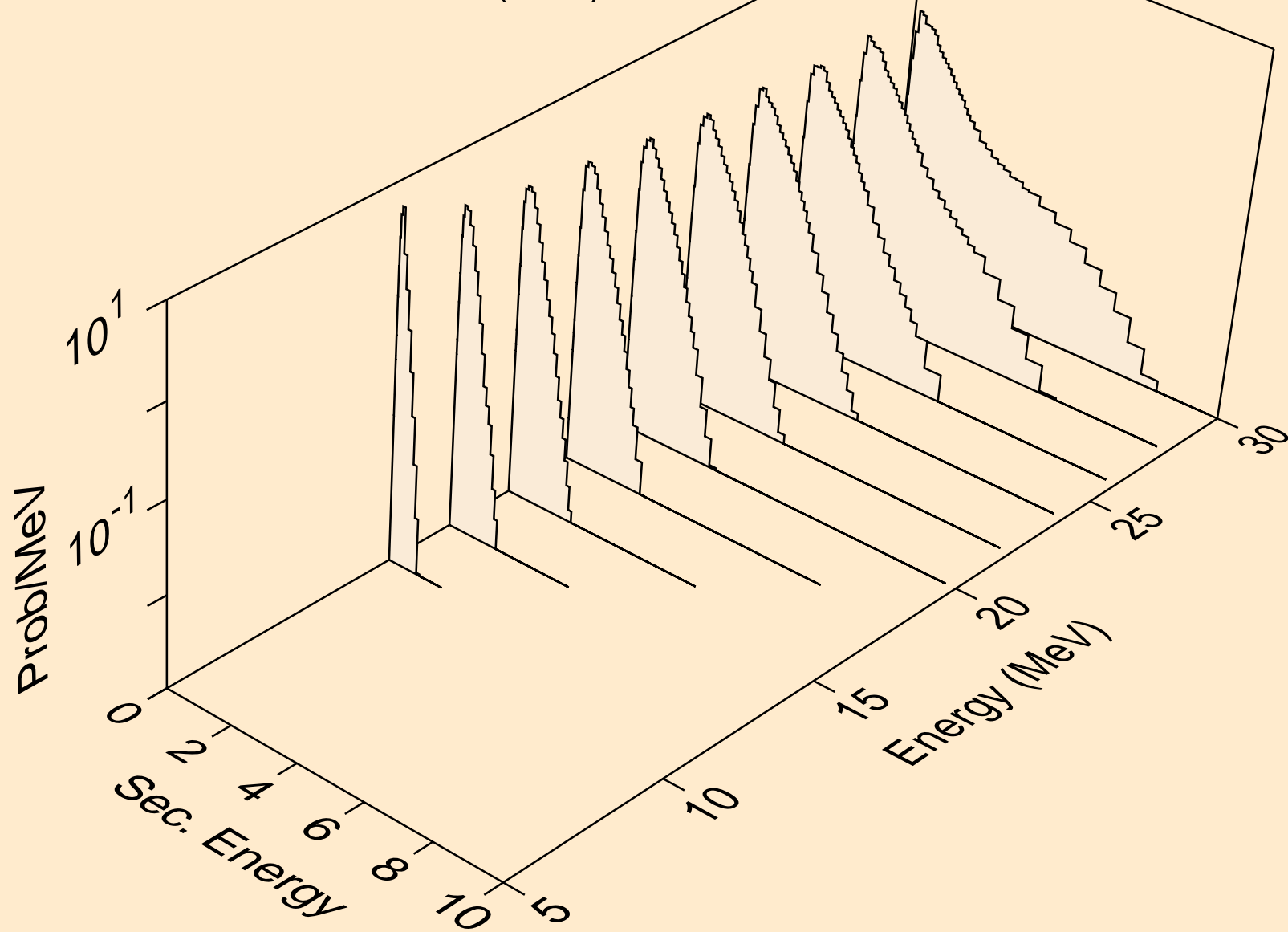

MD259 NEUTRON ACER TENDL-2021 LIBRARY; T=293.6K
Neutron emission for (n,n*)t

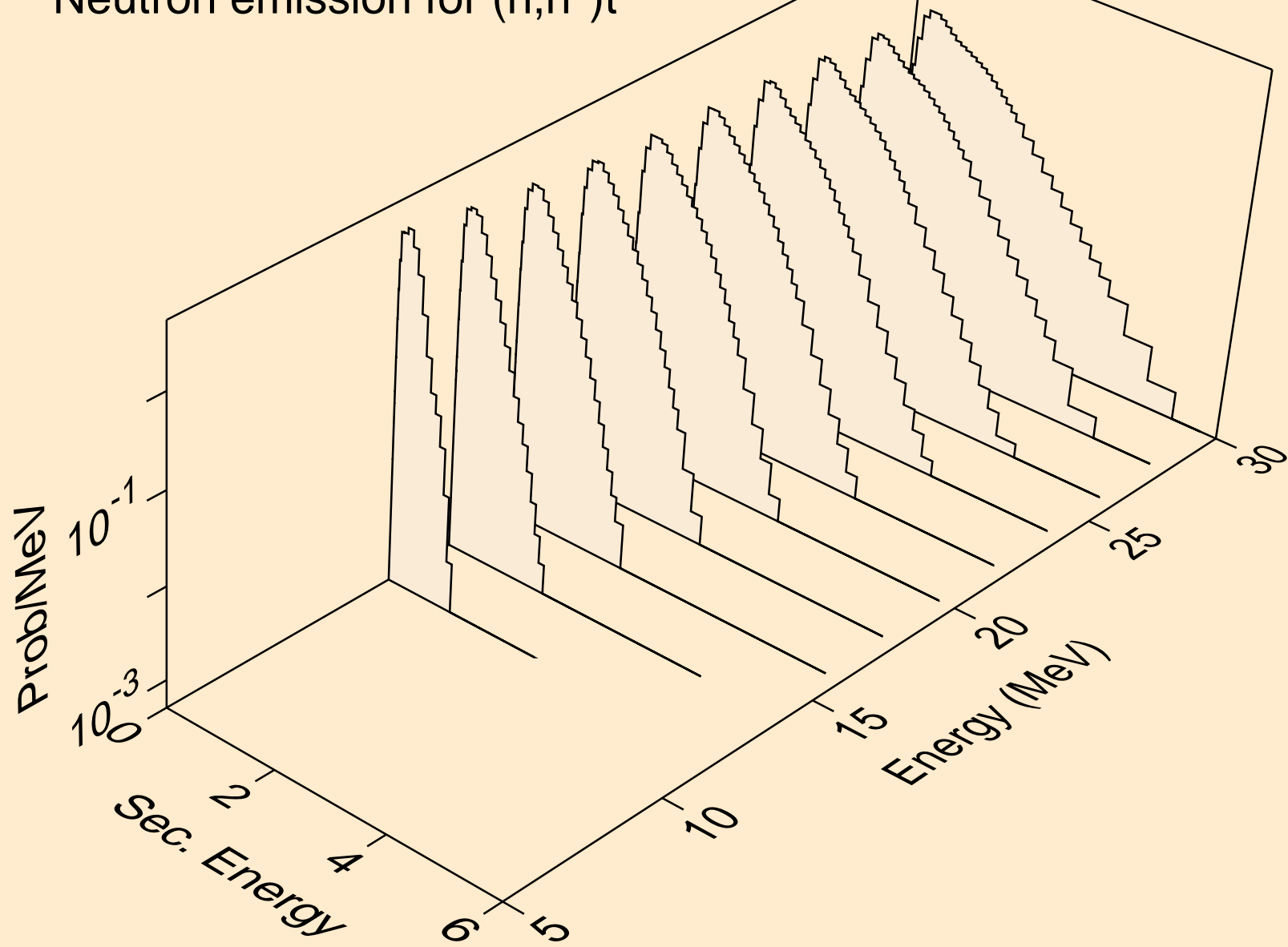

MD259 NEUTRON ACER TENDL-2021 LIBRARY; T=293.6K
Neutron emission for (n,n*)he3

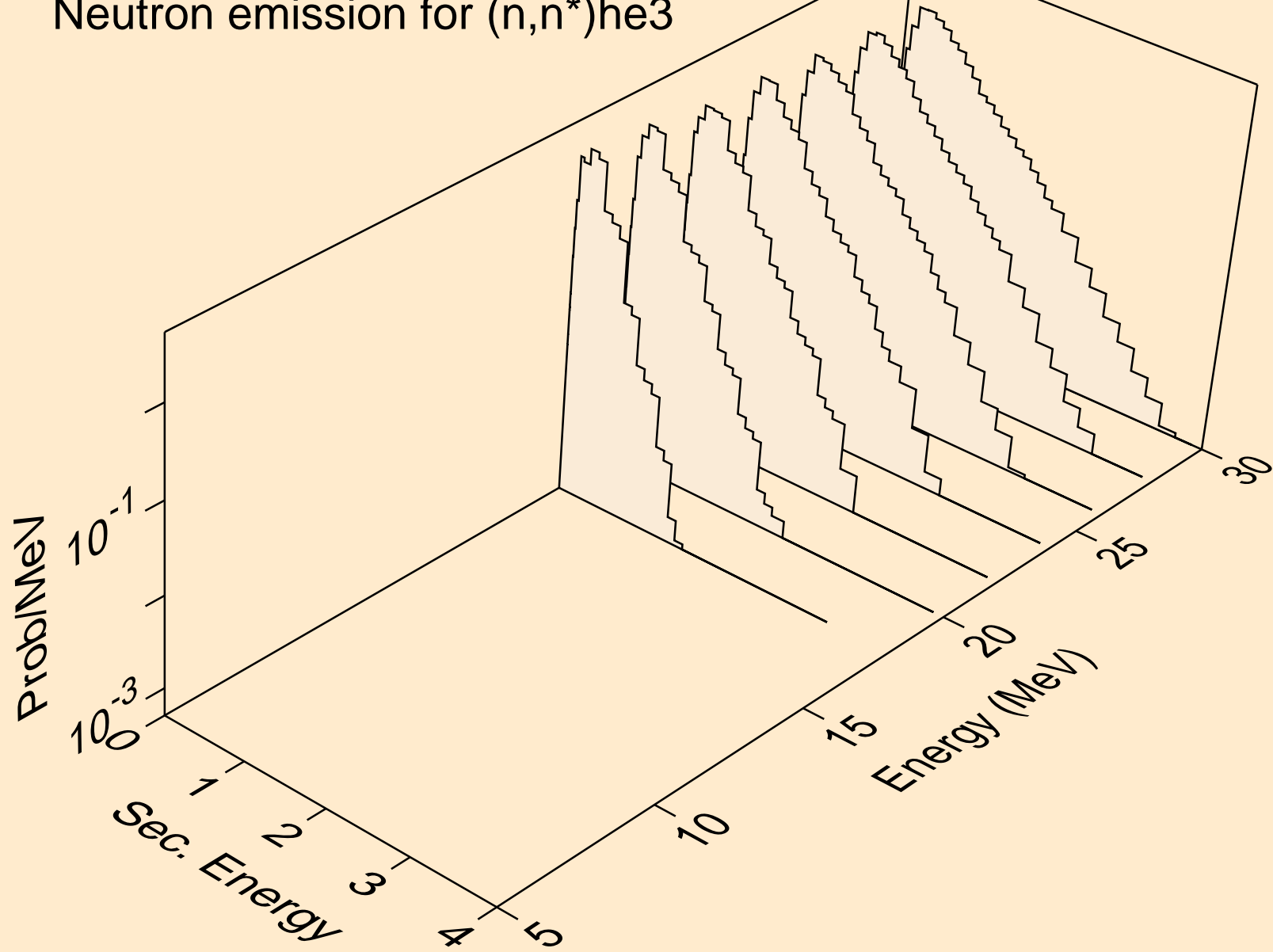

MD259 NEUTRON ACER TENDL-2021 LIBRARY; T=293.6K
Neutron emission for (n,4n)

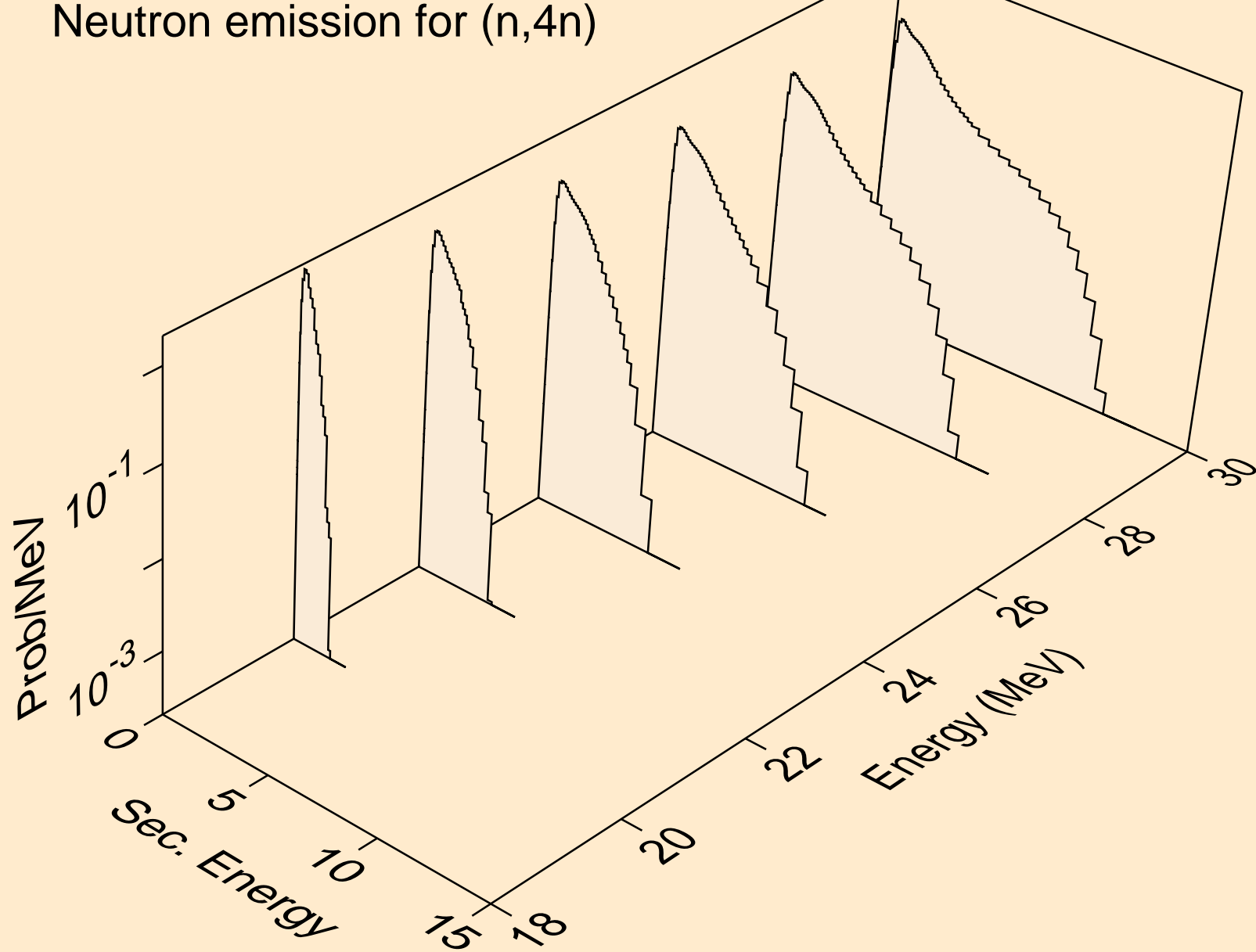

MD259 NEUTRON ACER TENDL-2021 LIBRARY; T=293.6K
Neutron emission for (n,2np)

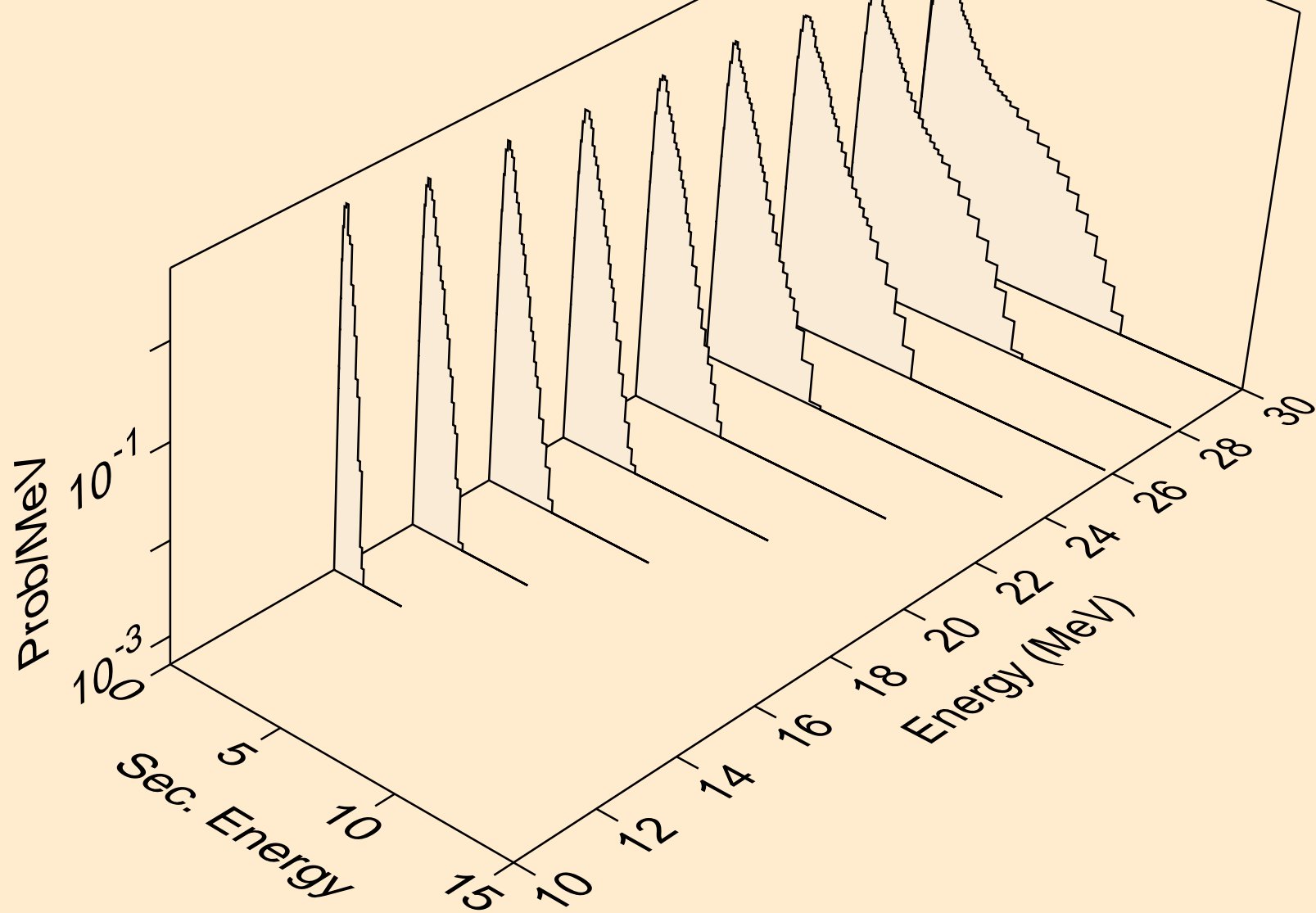

MD259 NEUTRON ACER TENDL-2021 LIBRARY; T=293.6K
Neutron emission for (n,3np)

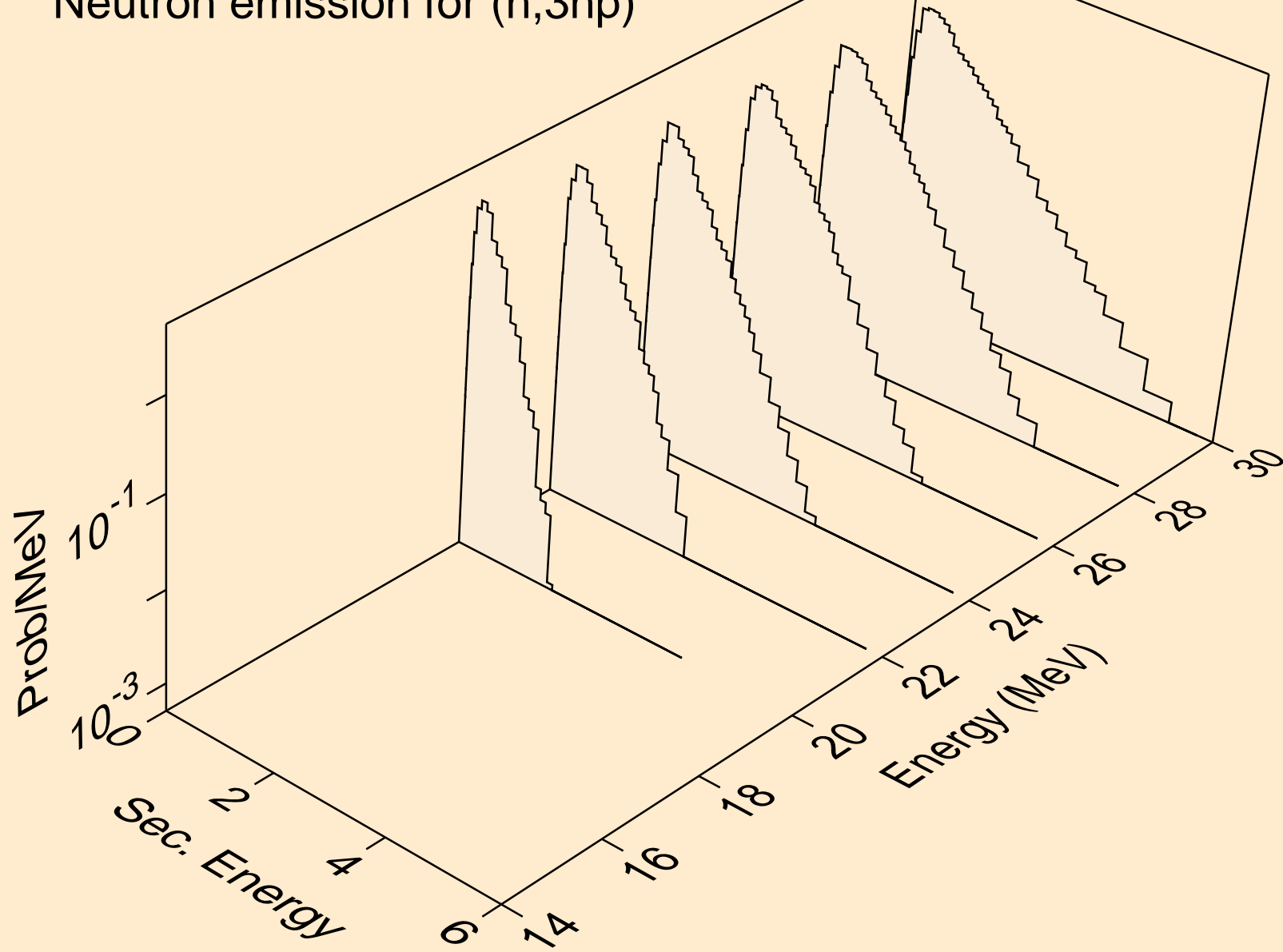

MD259 NEUTRON ACER TENDL-2021 LIBRARY; T=293.6K
Neutron emission for (n,npa)

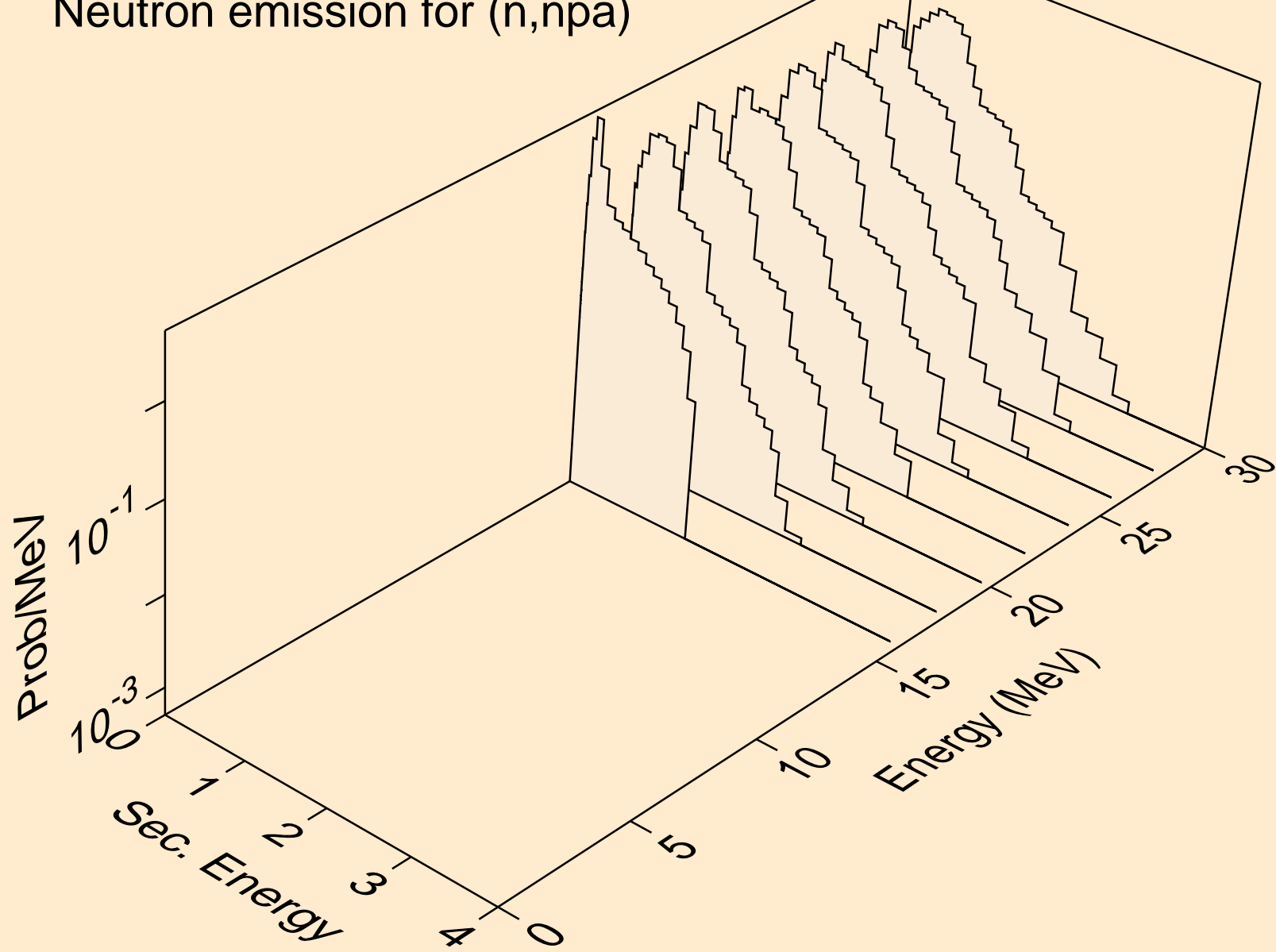

MD259 NEUTRON ACER TENDL-2021 LIBRARY; T=293.6K
Neutron emission for (n,n*c)

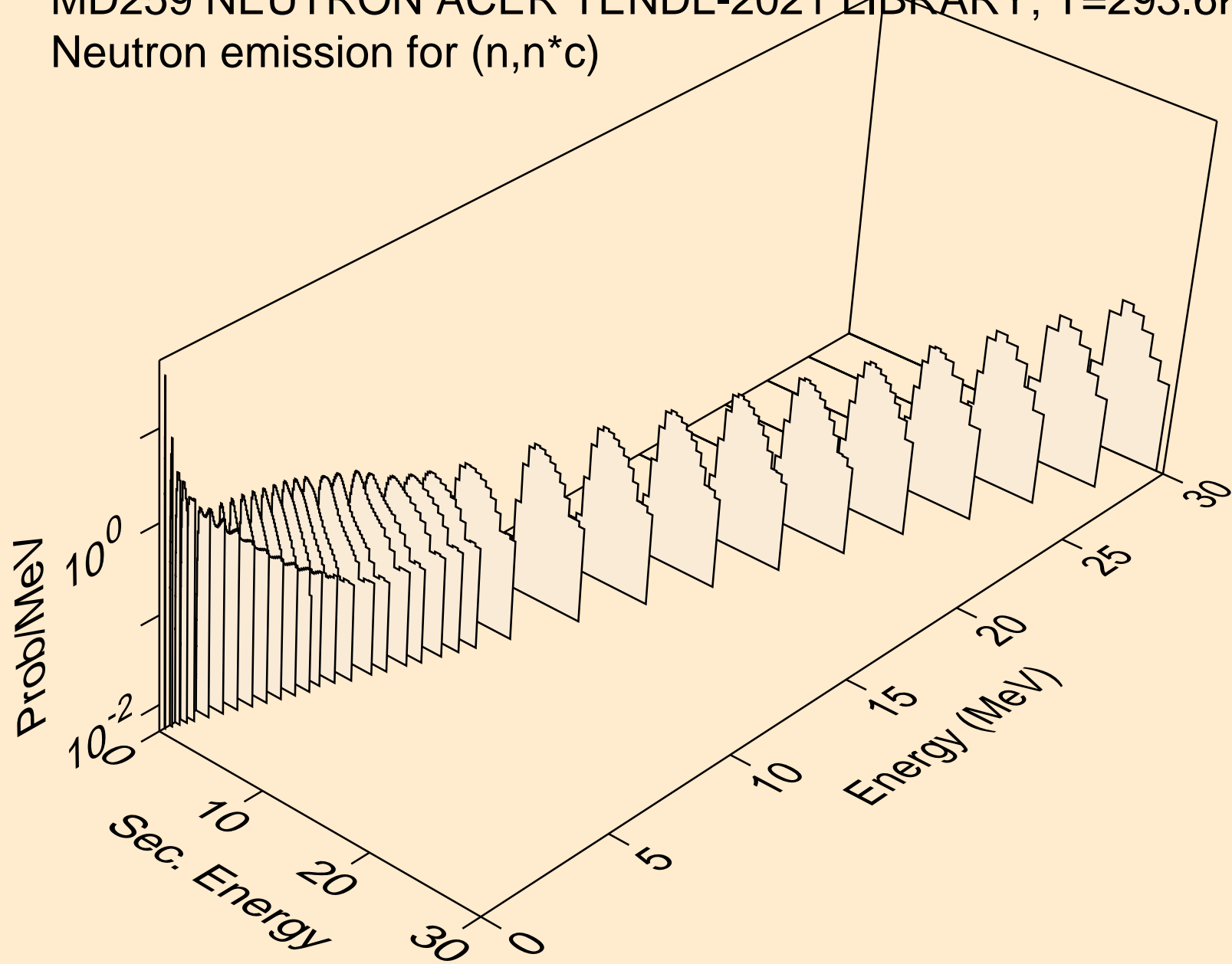

MD259 NEUTRON ACER TENDL-2021 LIBRARY; T=293.6K

Delayed nubar

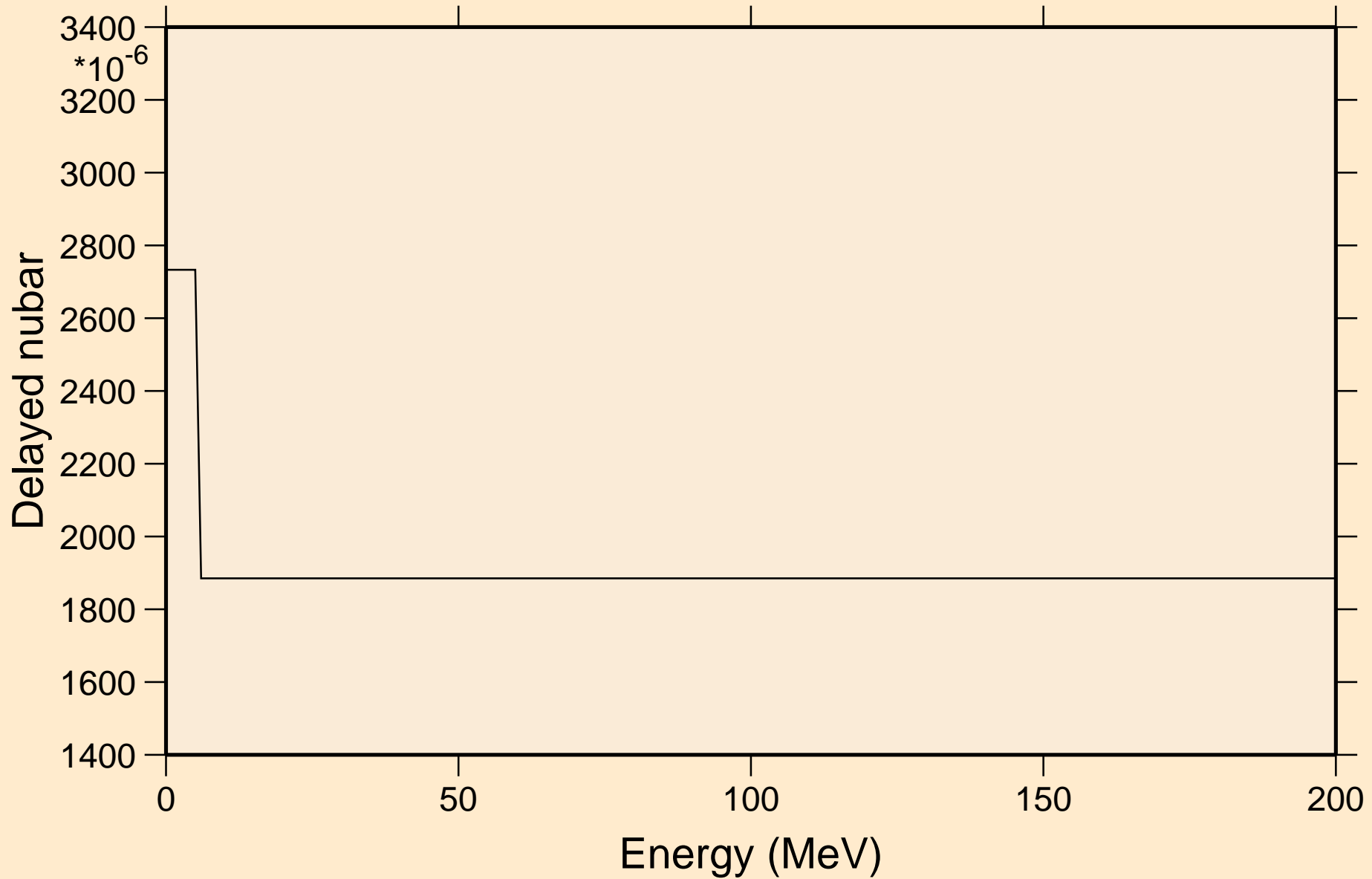

MD259 NEUTRON ACER TENDL-2021 LIBRARY; T=293.6K

Delayed neutron spectra

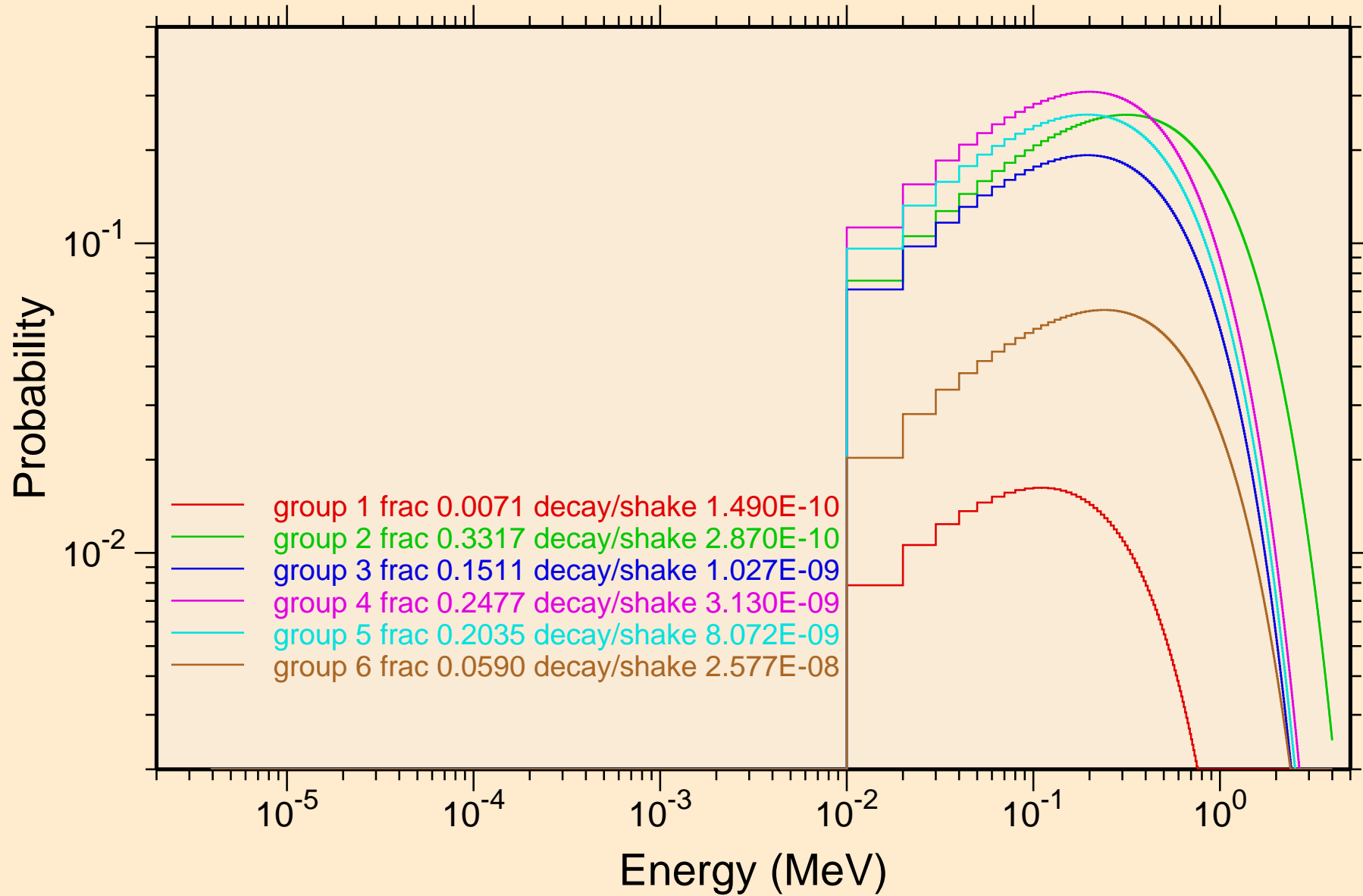

MD259 NEUTRON ACER TENDL-2021 LIBRARY; T=293.6K
Photon emission for (n,x)

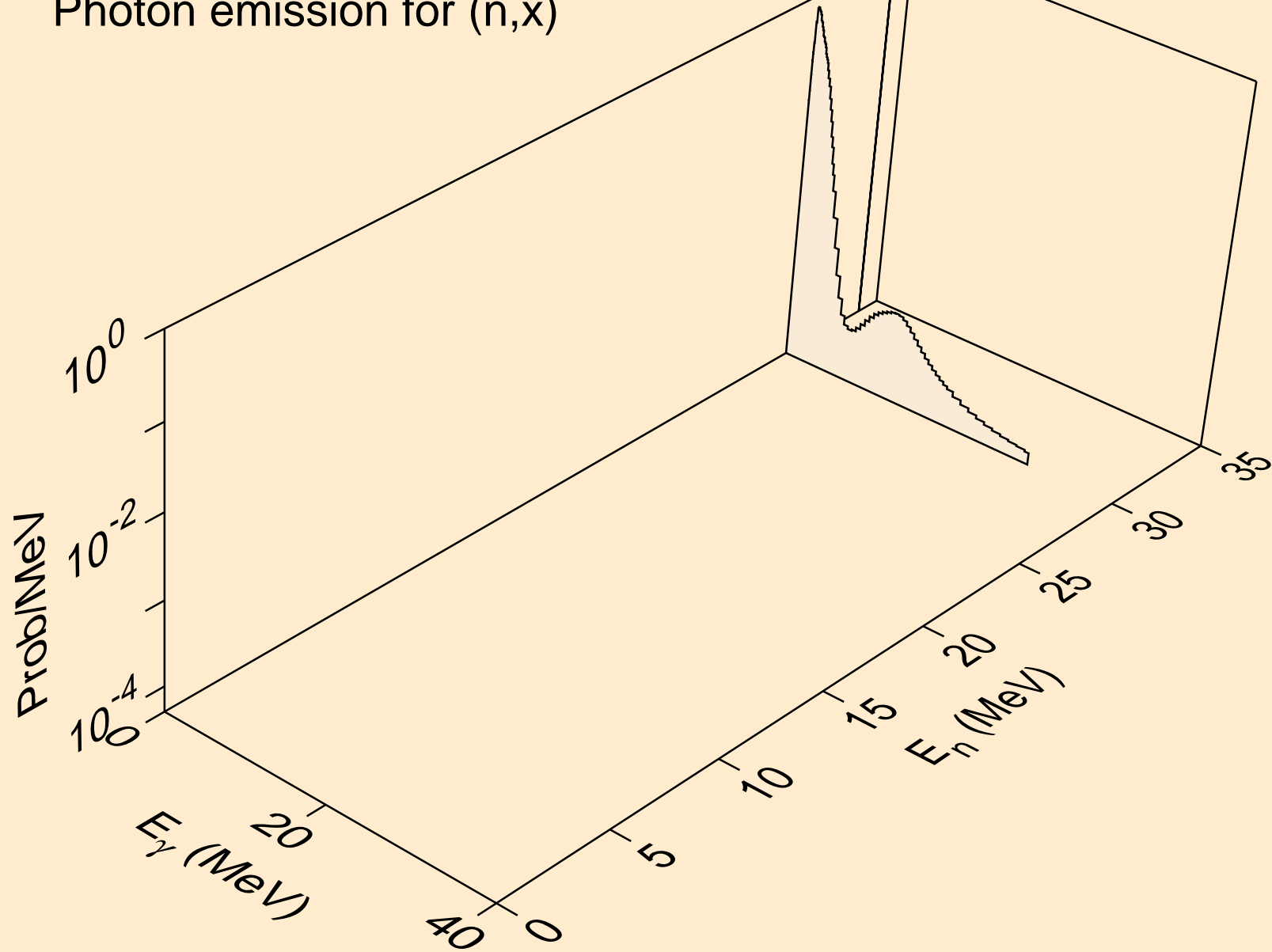

MD259 NEUTRON ACER TENDL-2021 LIBRARY; T=293.6K
Photon emission for (n,2nd)

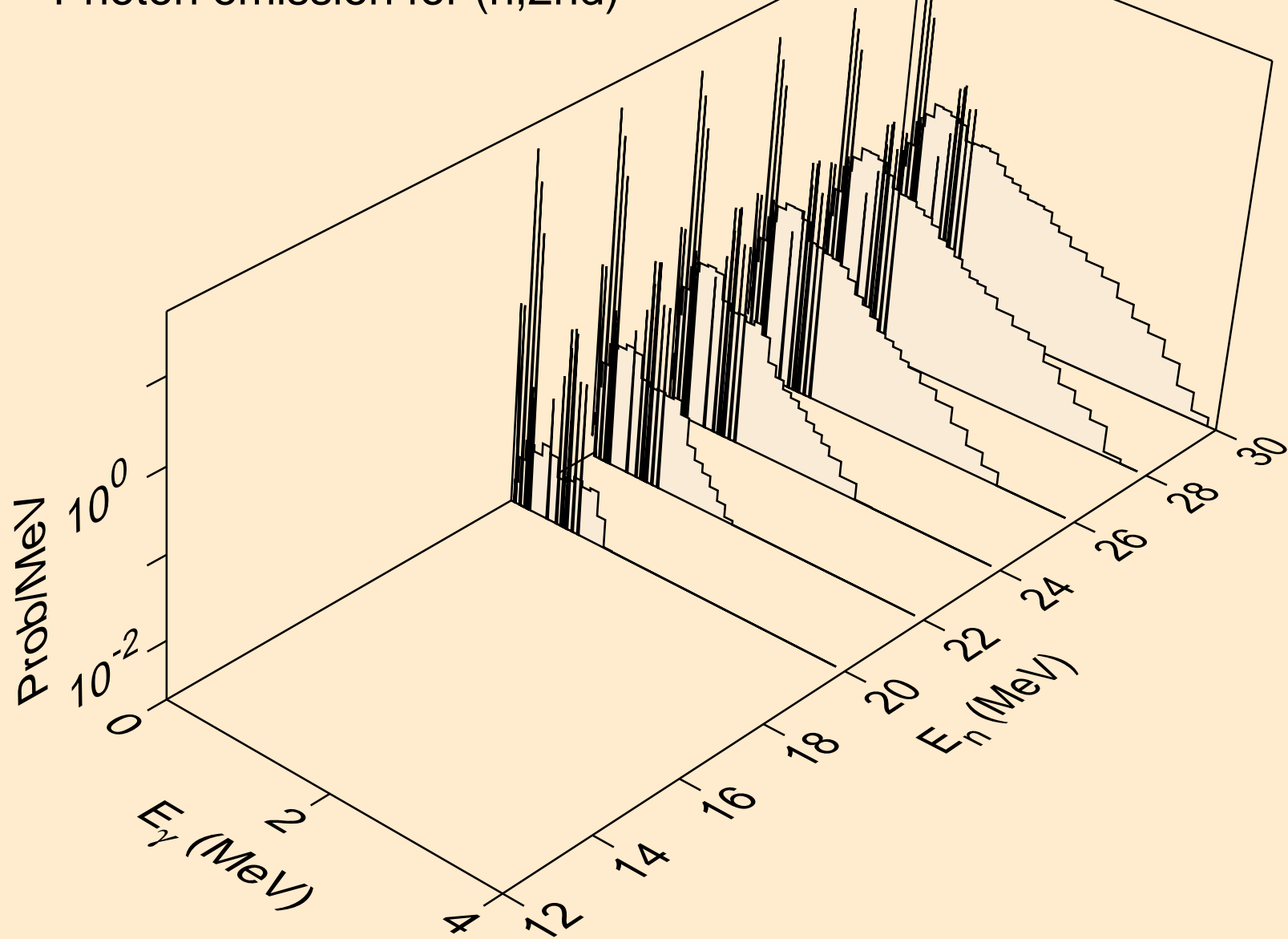

MD259 NEUTRON ACER TENDL-2021 LIBRARY; T=293.6K
Photon emission for (n,2n)

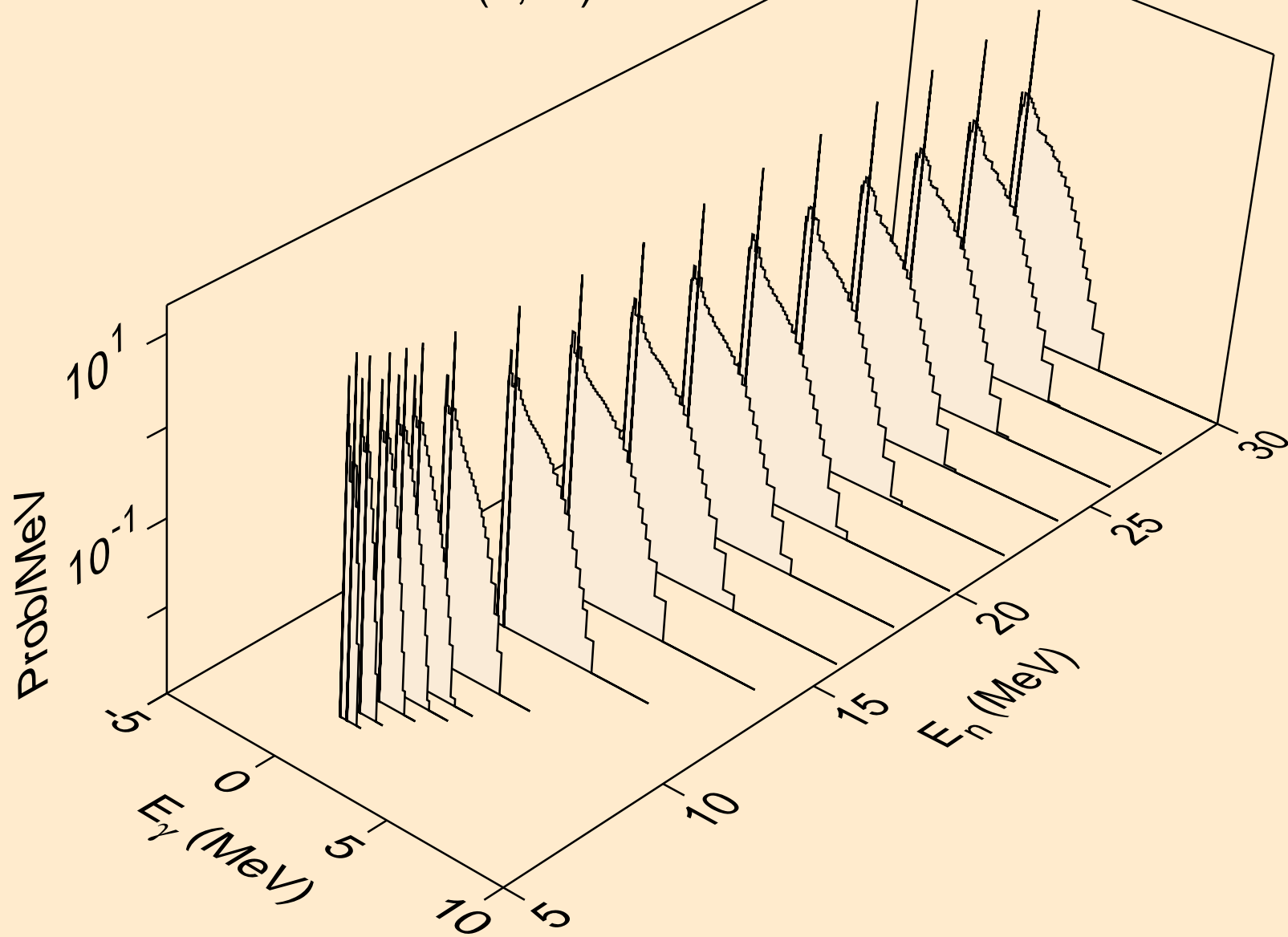

MD259 NEUTRON ACER TENDL-2021 LIBRARY; T=293.6K
Photon emission for (n,3n)

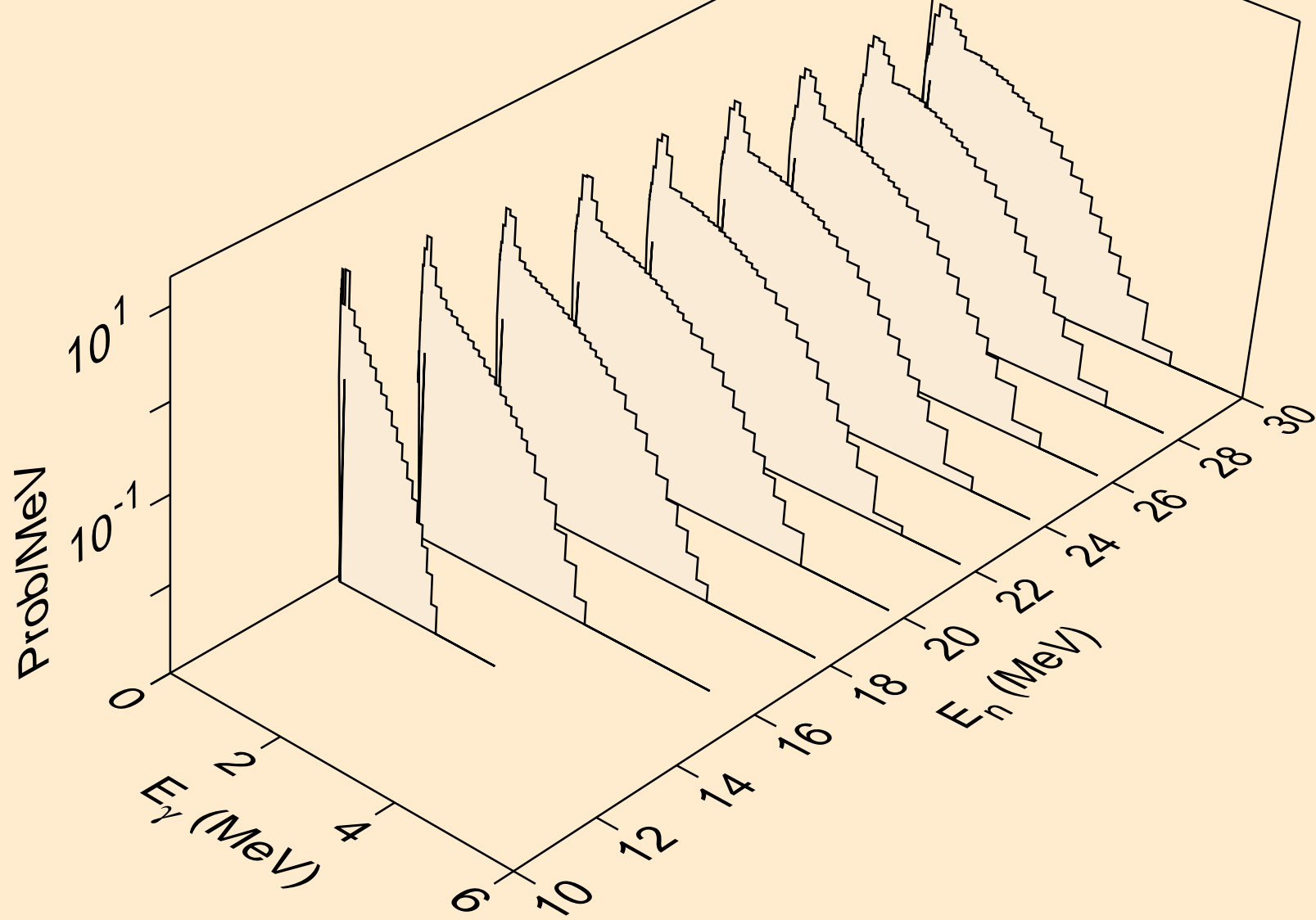

MD259 NEUTRON ACER TENDL-2021 LIBRARY; T=293.6K
Photon emission for (n,n*)a

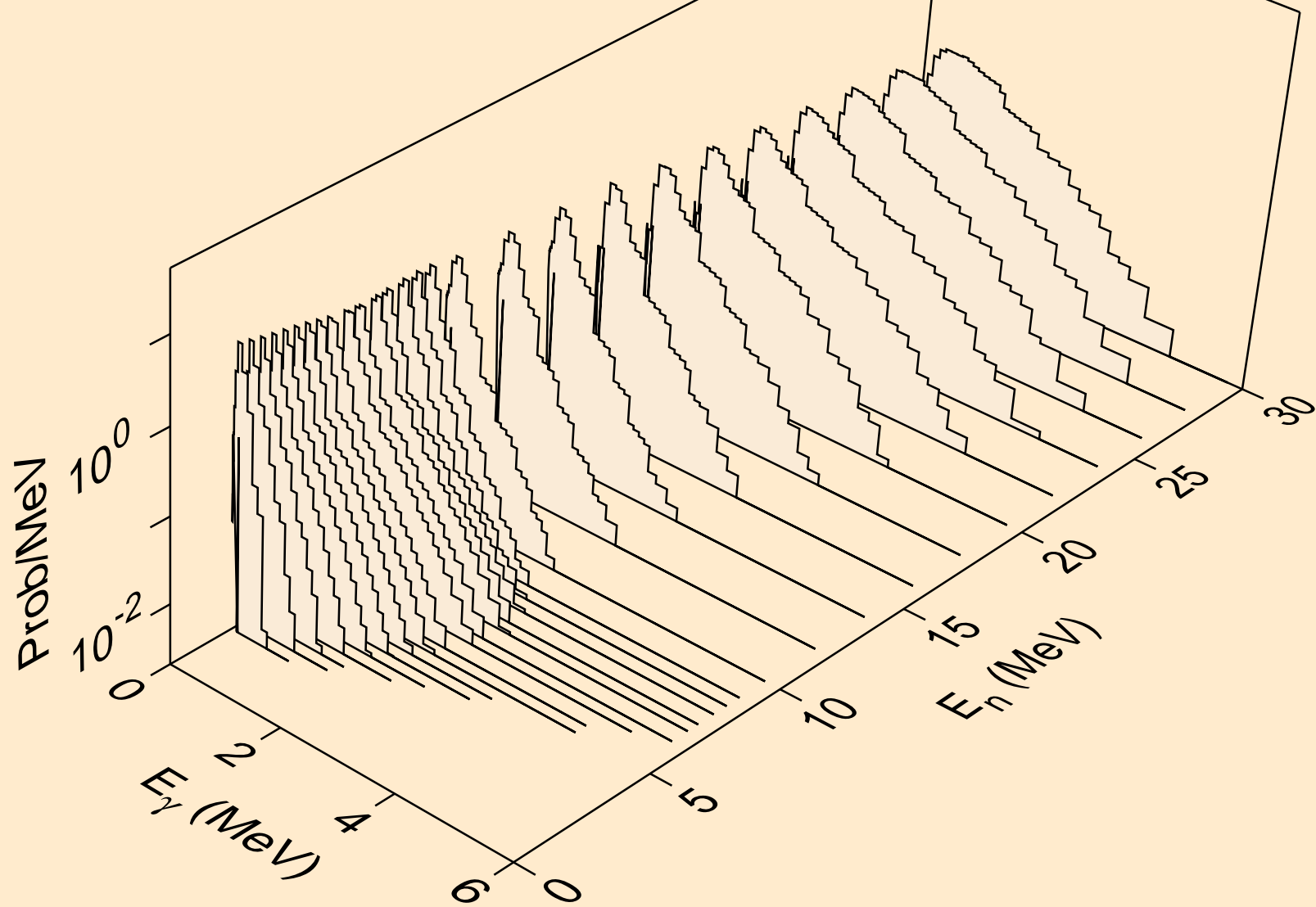

MD259 NEUTRON ACER TENDL-2021 LIBRARY; T=293.6K
Photon emission for (n,2n)a

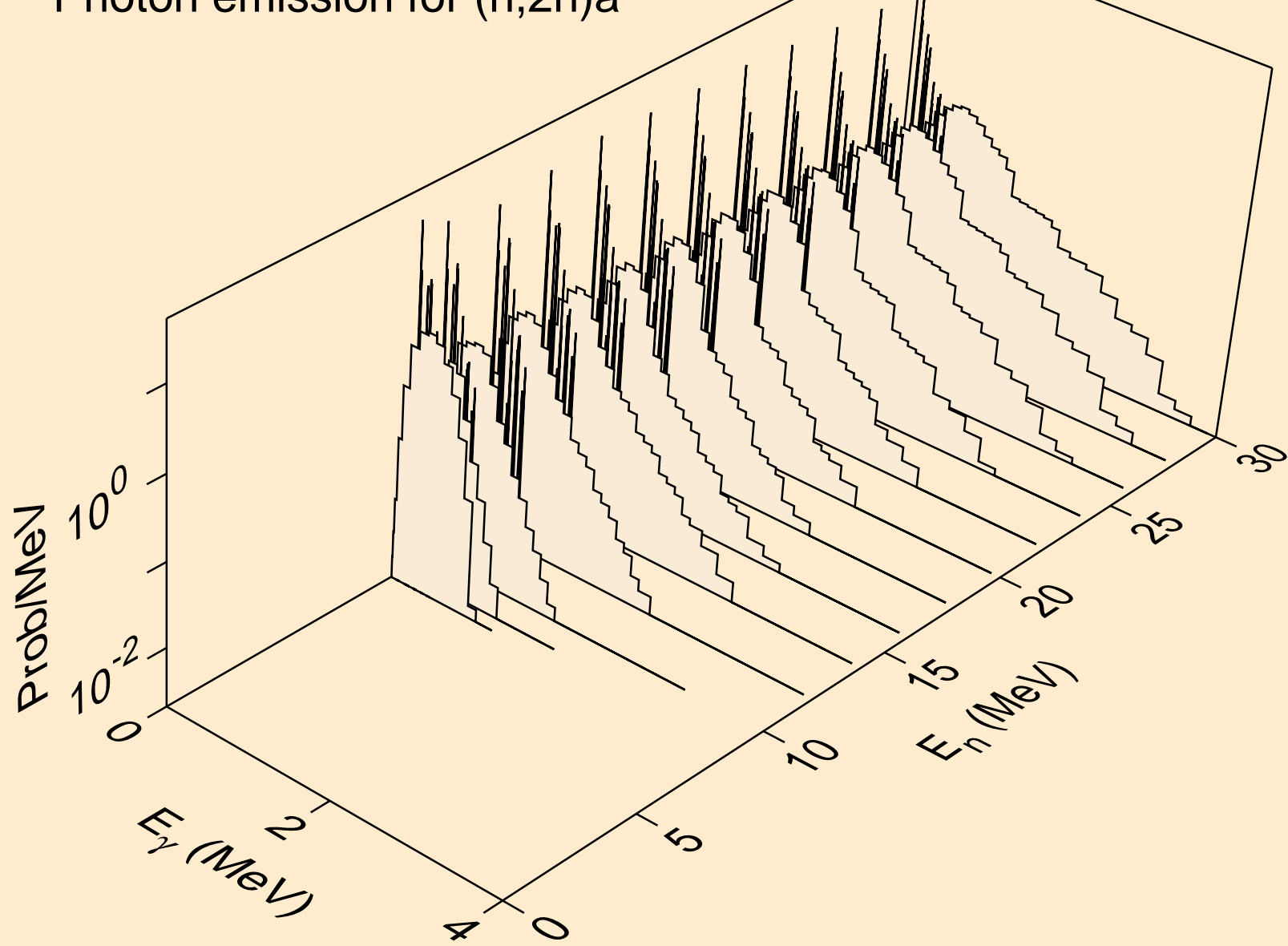

MD259 NEUTRON ACER TENDL-2021 LIBRARY; T=293.6K
Photon emission for (n,3n)a

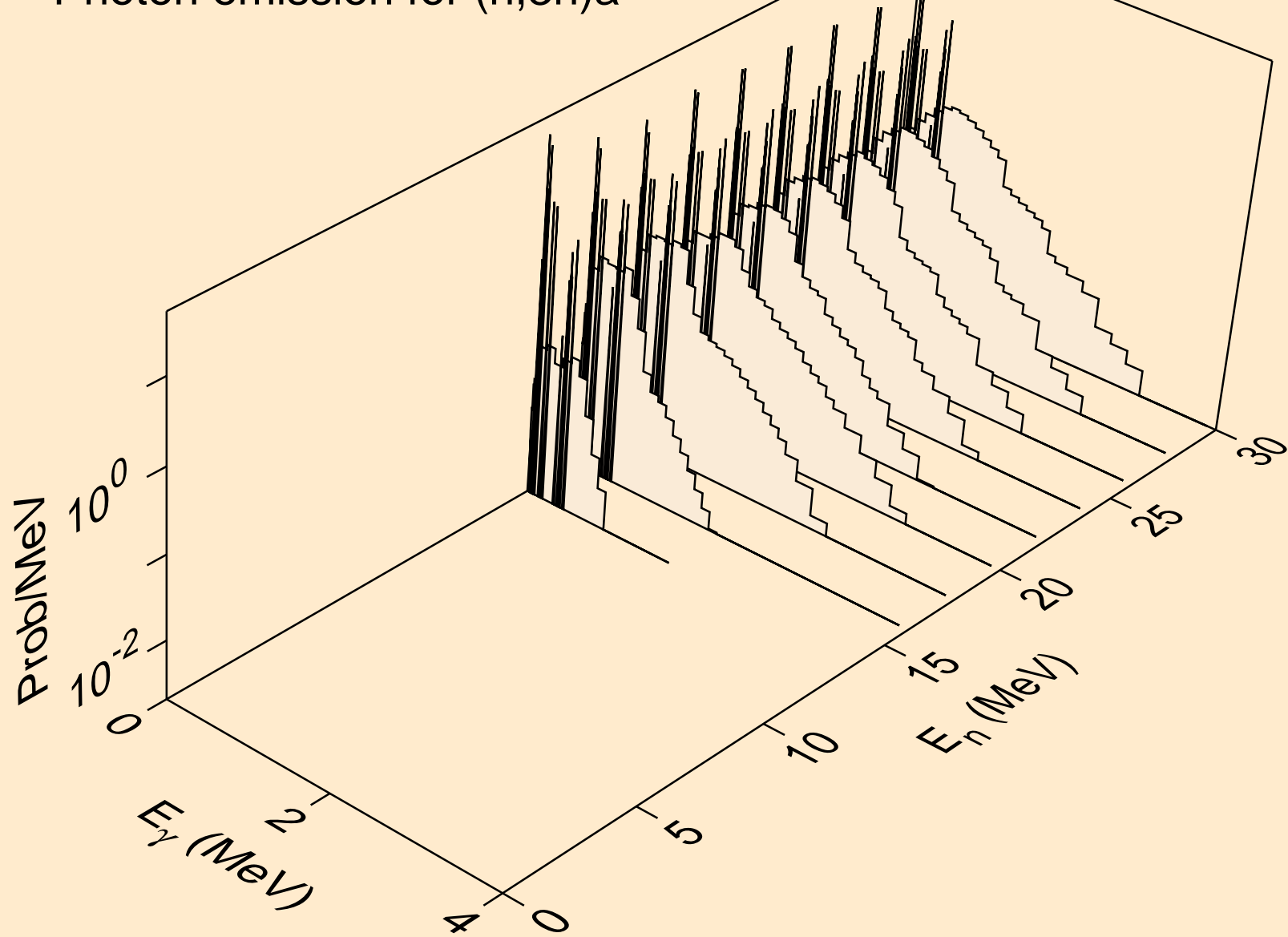

MD259 NEUTRON ACER TENDL-2021 LIBRARY; T=293.6K
Photon emission for (n,n*)p

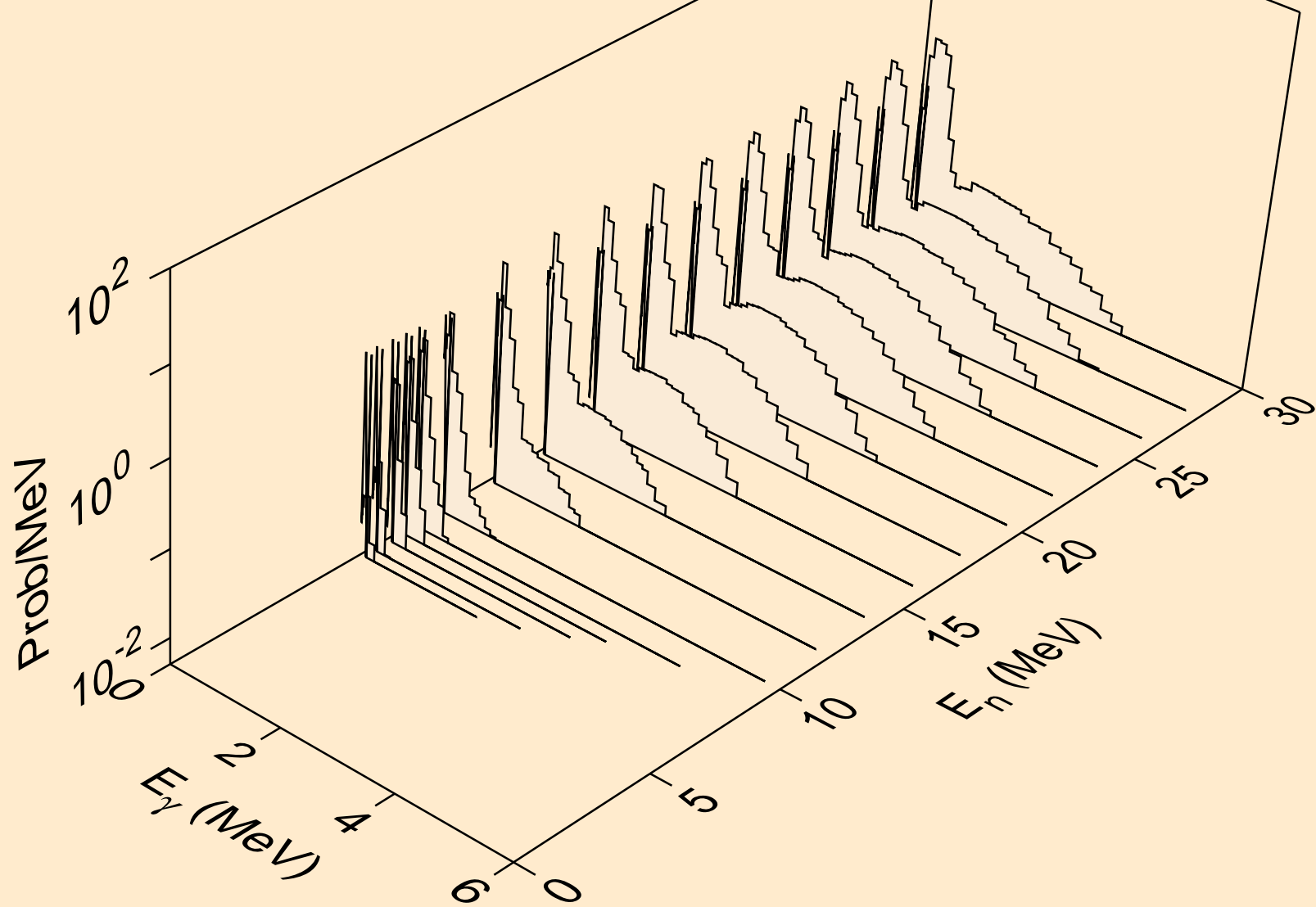

MD259 NEUTRON ACER TENDL-2021 LIBRARY; T=293.6K
Photon emission for (n,n*)d

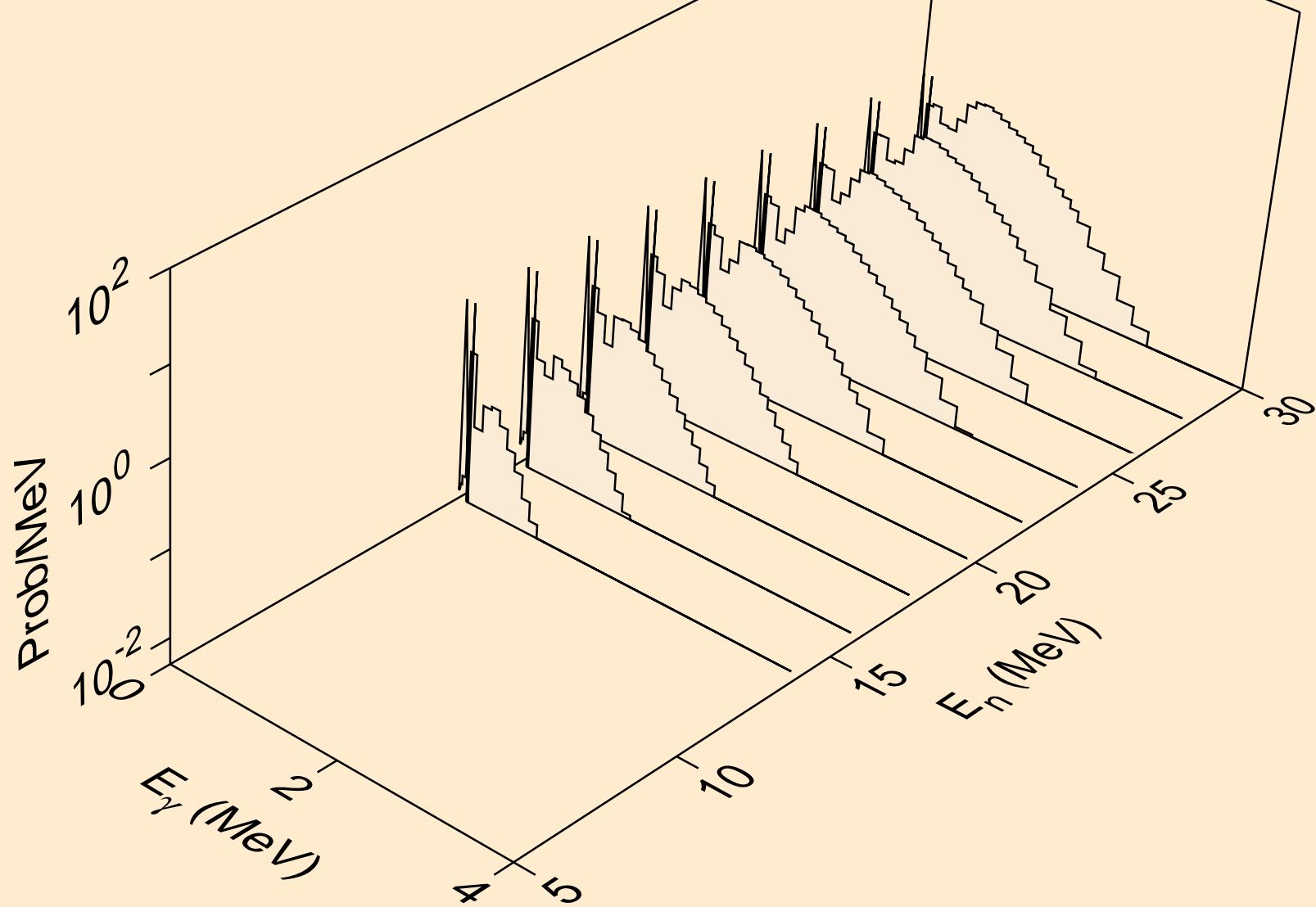

MD259 NEUTRON ACER TENDL-2021 LIBRARY; T=293.6K
Photon emission for (n,n*)t

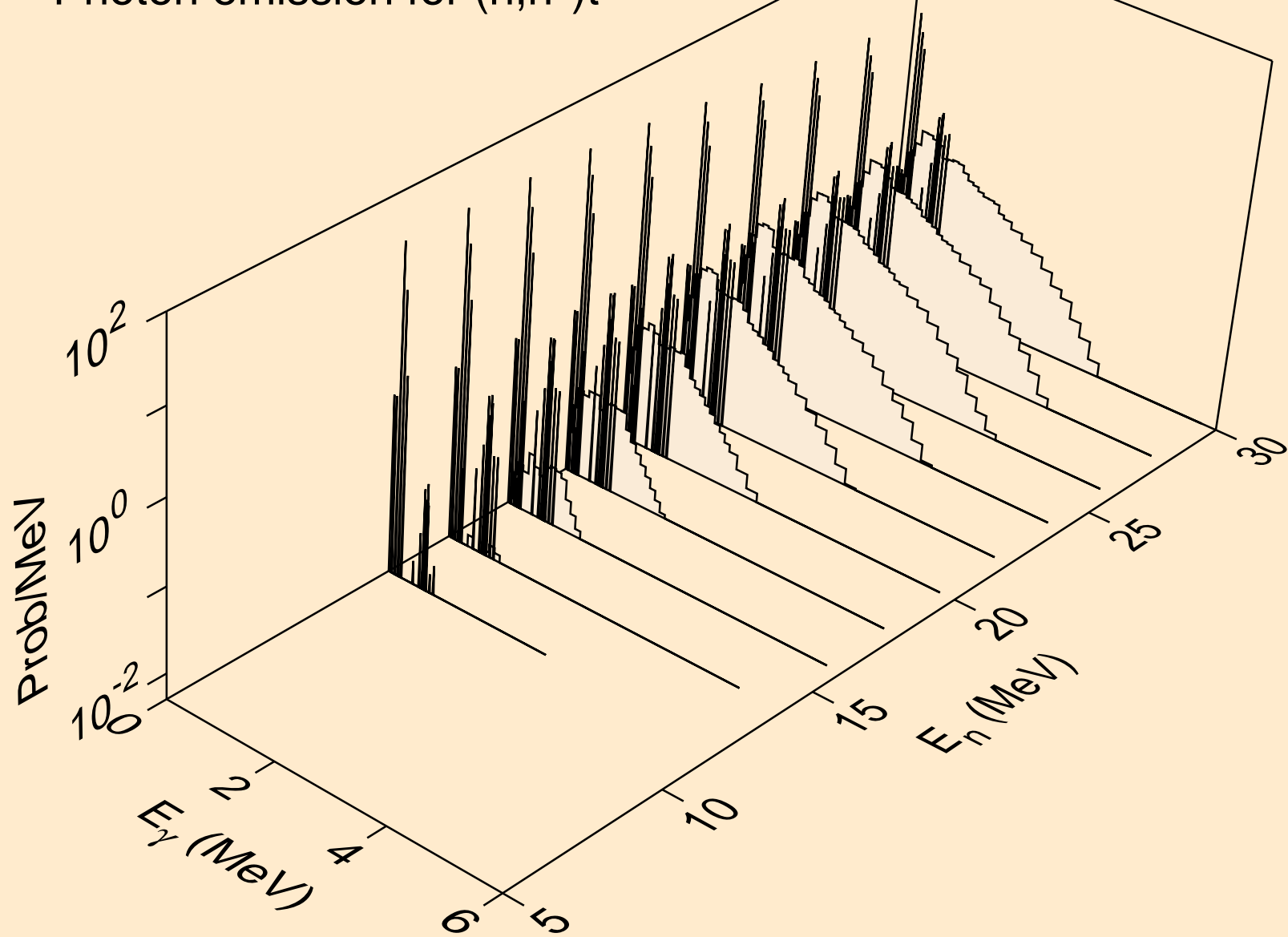

MD259 NEUTRON ACER TENDL-2021 LIBRARY; T=293.6K
Photon emission for (n,n*)he3

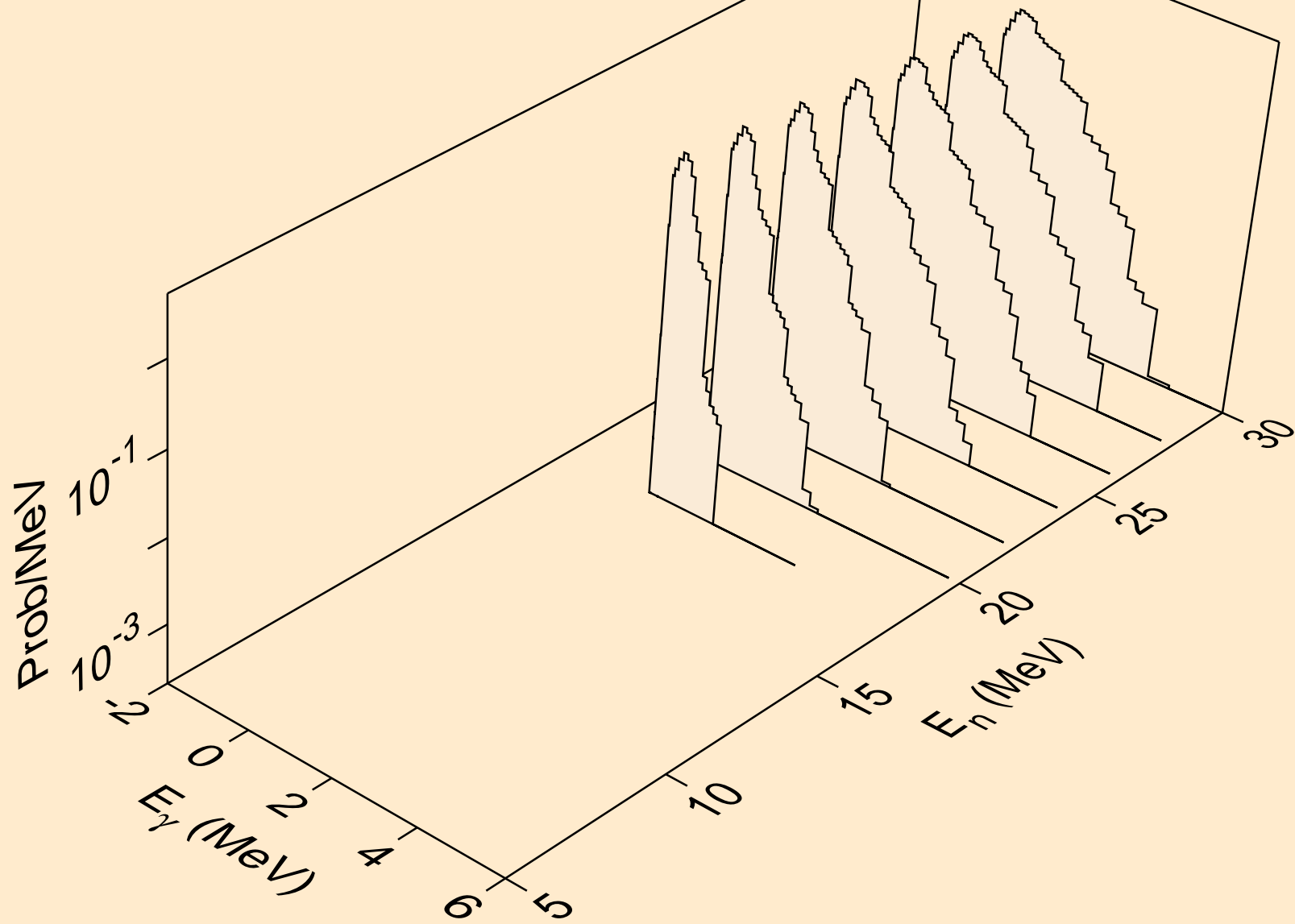

MD259 NEUTRON ACER TENDL-2021 LIBRARY; T=293.6K
Photon emission for (n,4n)

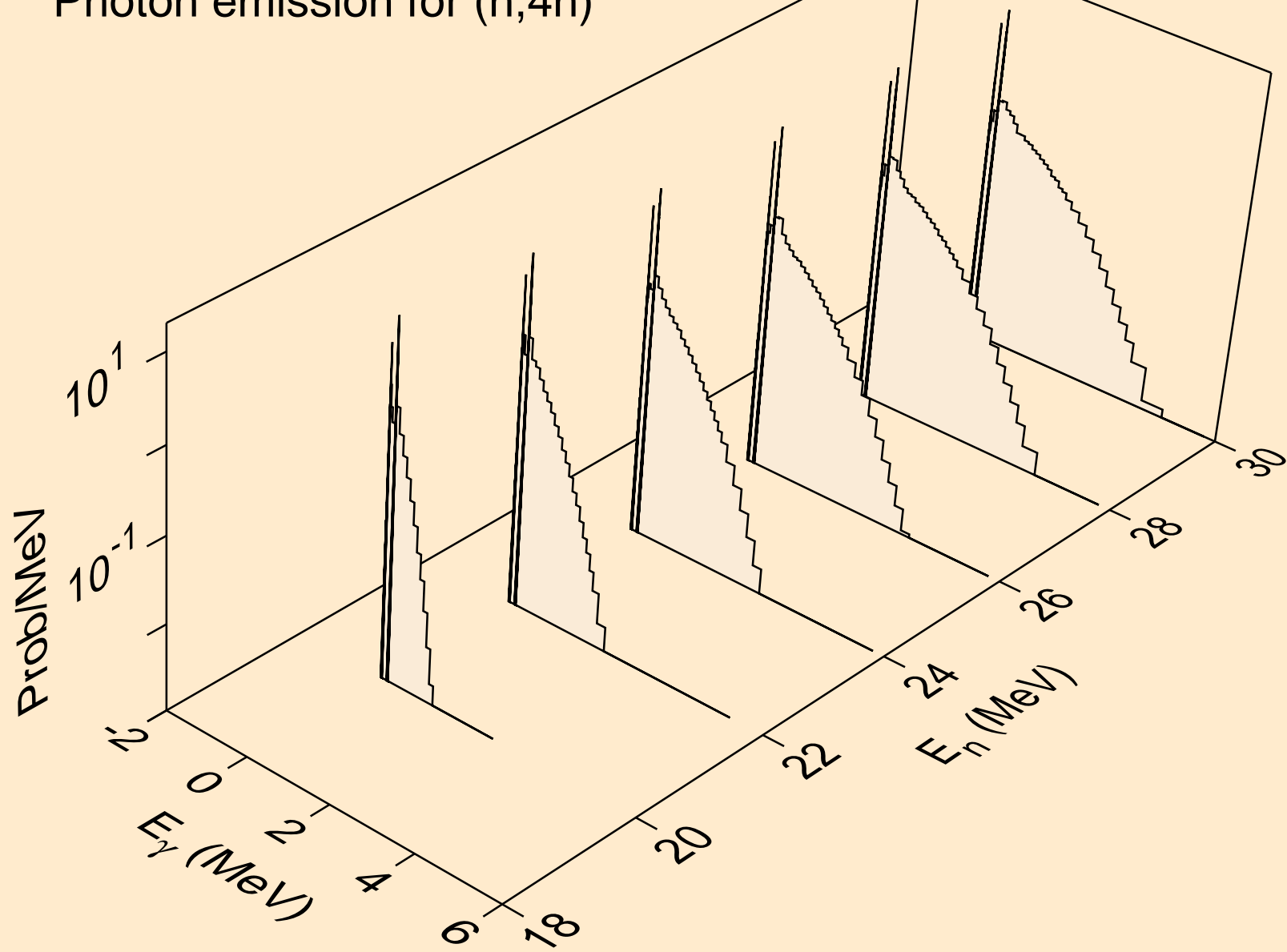

MD259 NEUTRON ACER TENDL-2021 LIBRARY; T=293.6K
Photon emission for (n,2np)

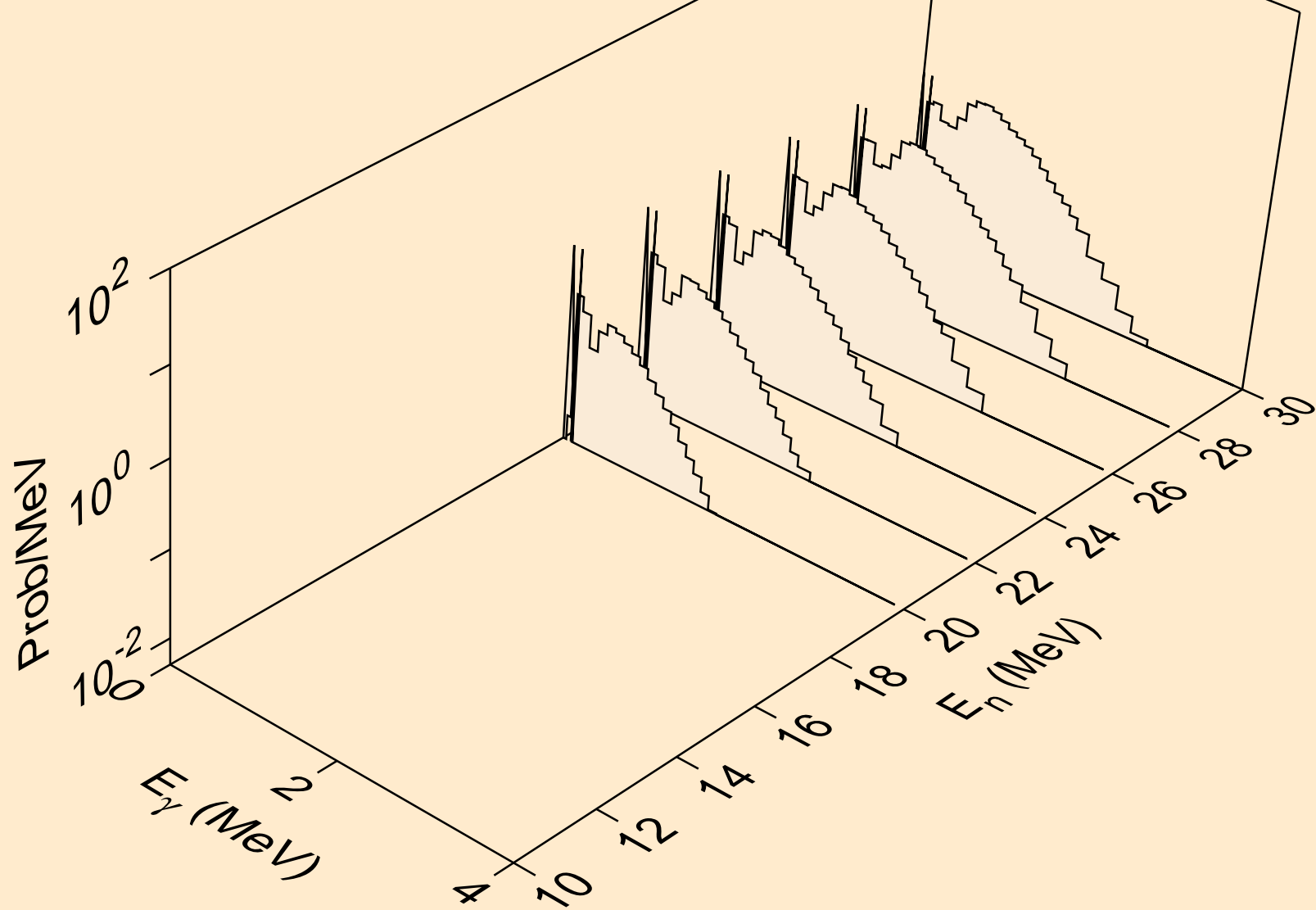

MD259 NEUTRON ACER TENDL-2021 LIBRARY; T=293.6K
Photon emission for (n,3np)

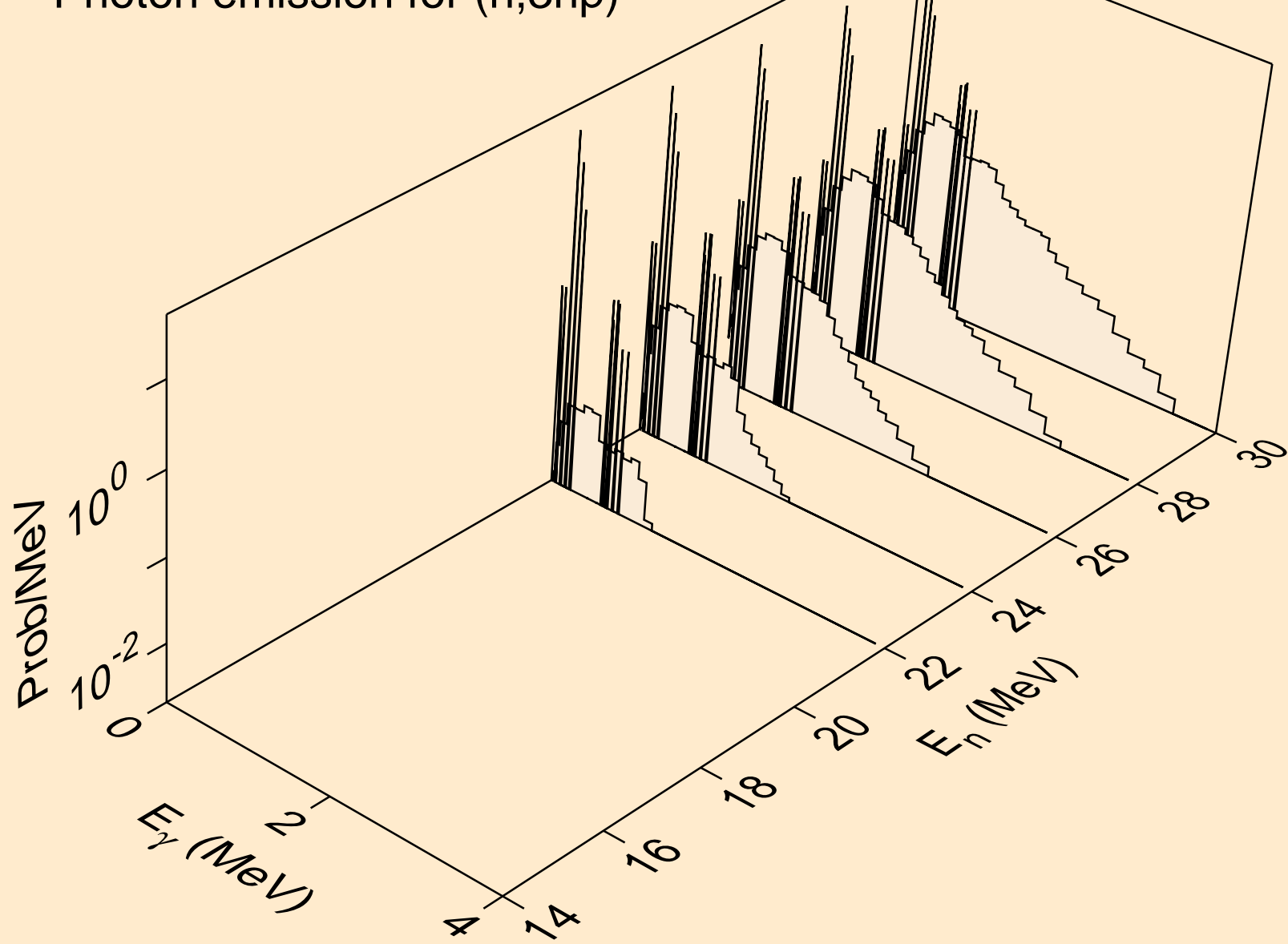

MD259 NEUTRON ACER TENDL-2021 LIBRARY; T=293.6K
Photon emission for (n,npa)

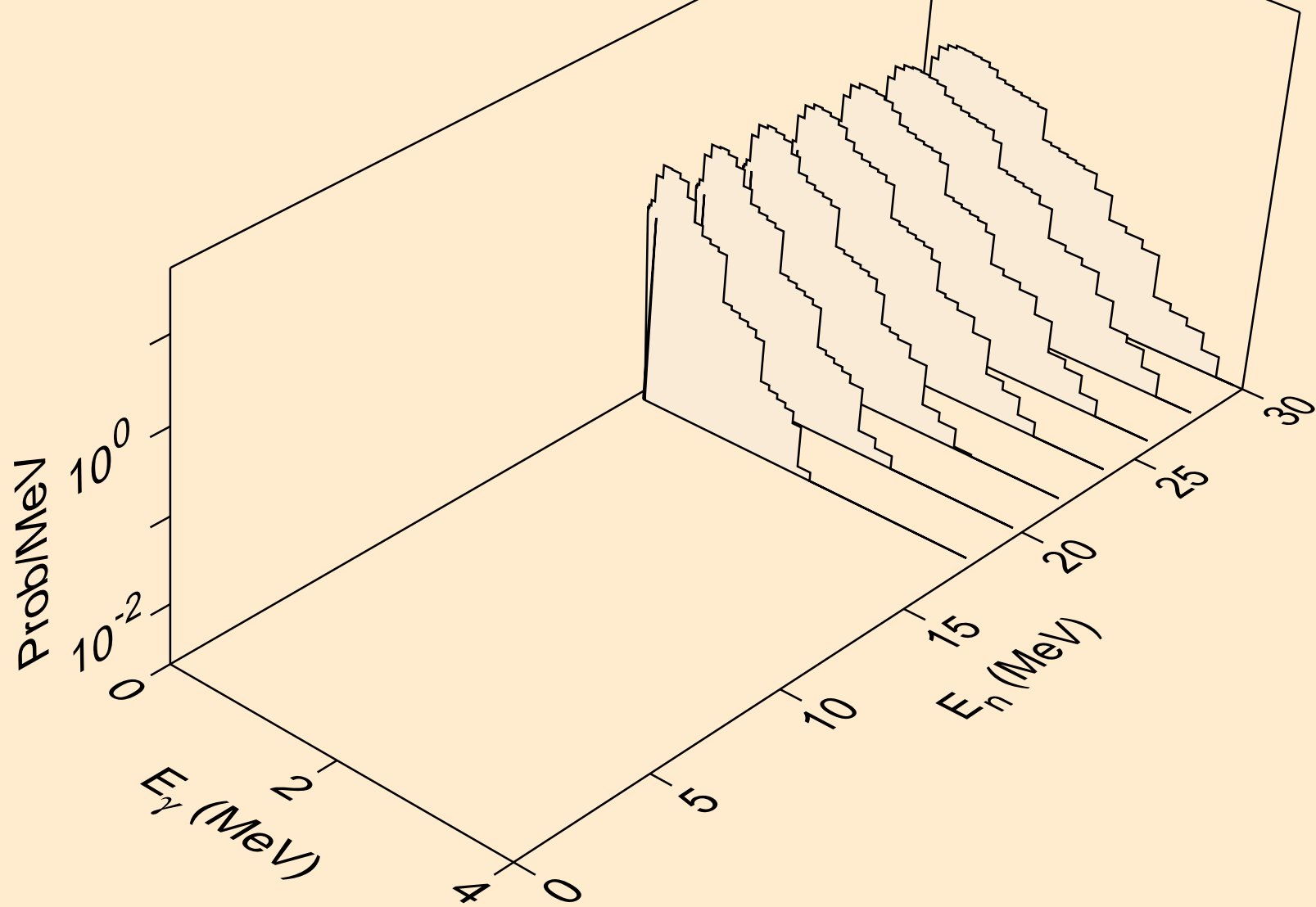

MD259 NEUTRON ACER TENDL-2021 LIBRARY; T=293.6K
Photon emission for (n,n*c)

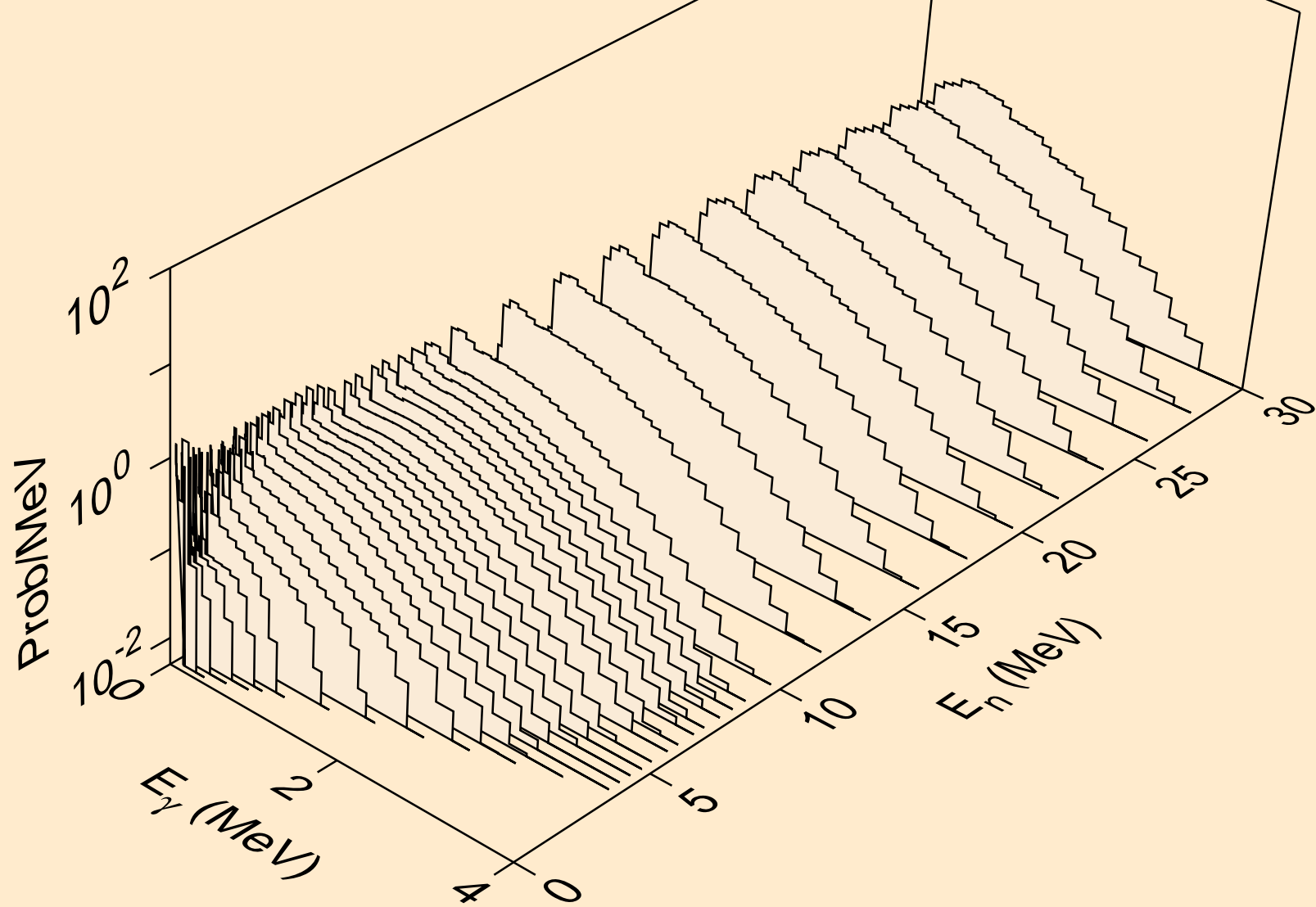

MD259 NEUTRON ACER TENDL-2021 LIBRARY; T=293.6K
Photon emission for (n,gma)

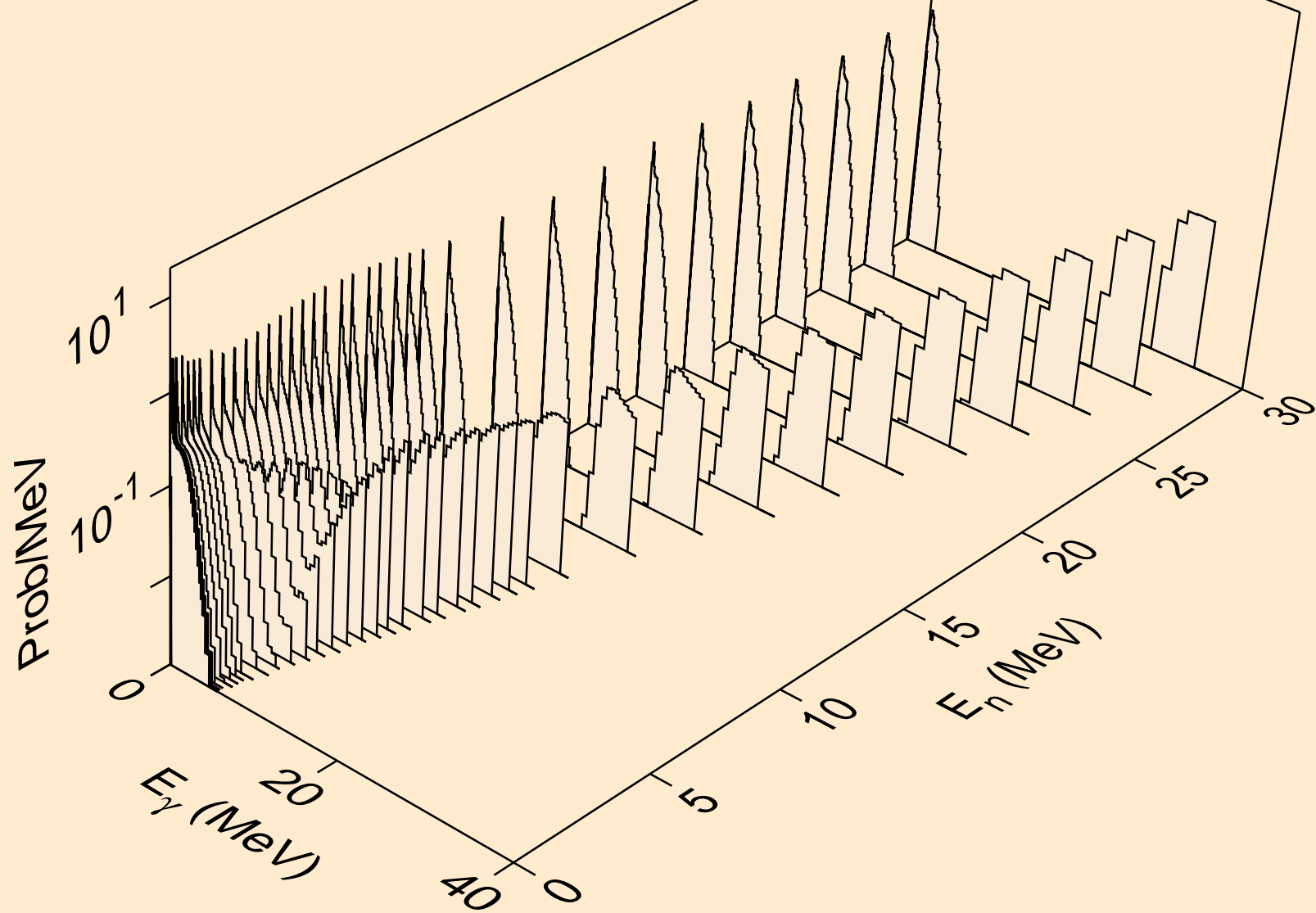

MD259 NEUTRON ACER TENDL-2021 LIBRARY; T=293.6K
Photon emission for (n,p)

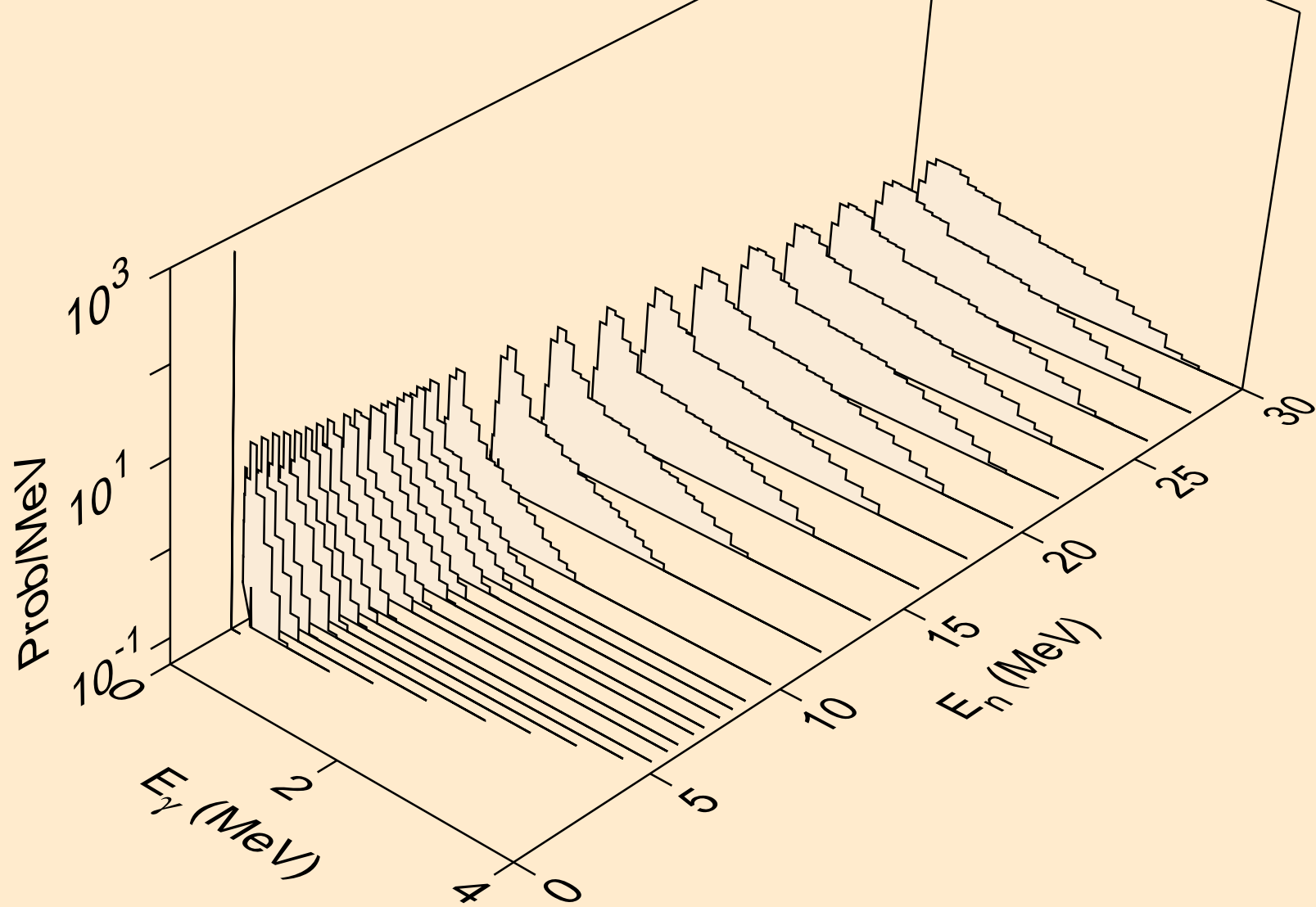

MD259 NEUTRON ACER TENDL-2021 LIBRARY; T=293.6K
Photon emission for (n,d)

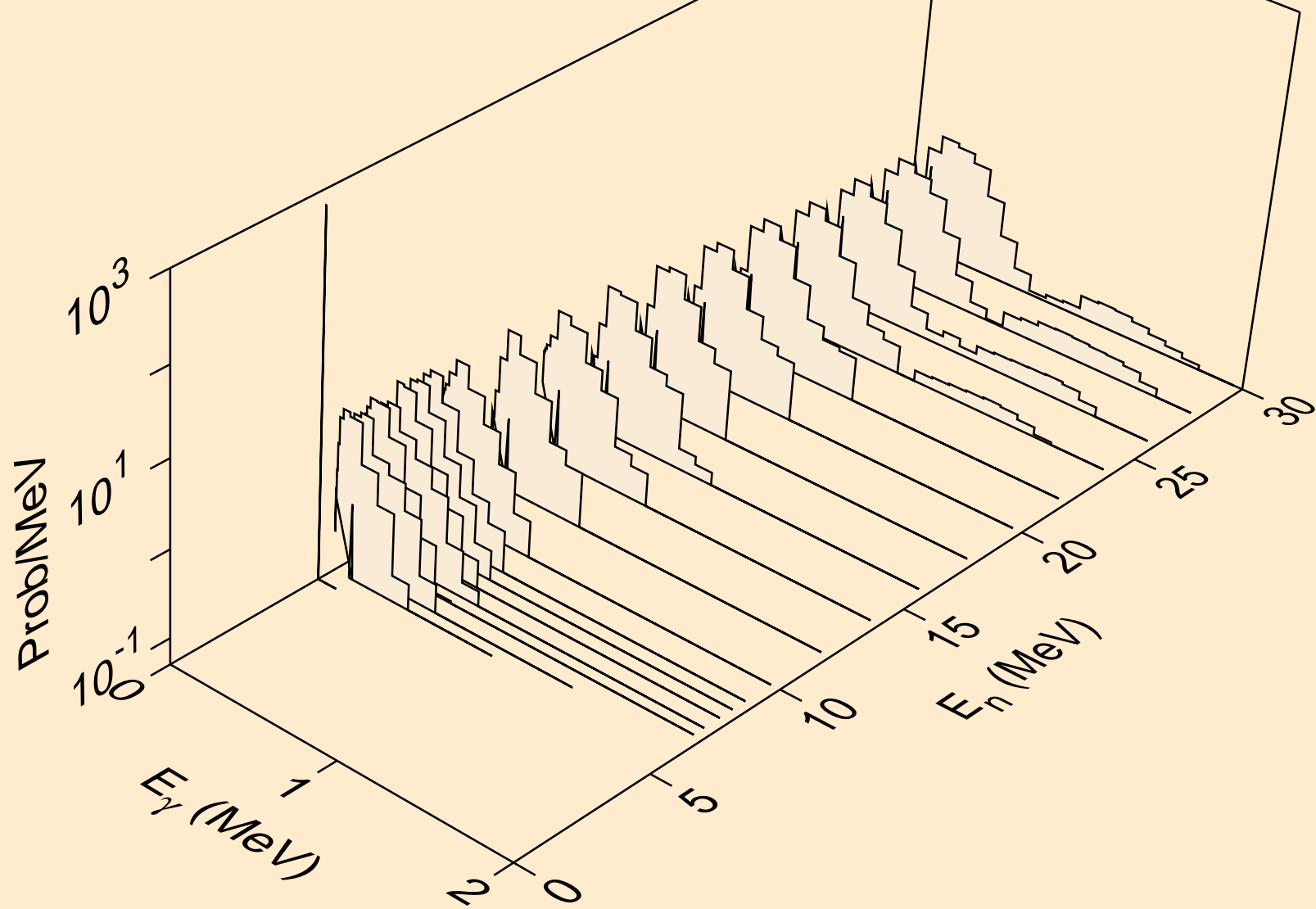

MD259 NEUTRON ACER TENDL-2021 LIBRARY; T=293.6K
Photon emission for (n,t)

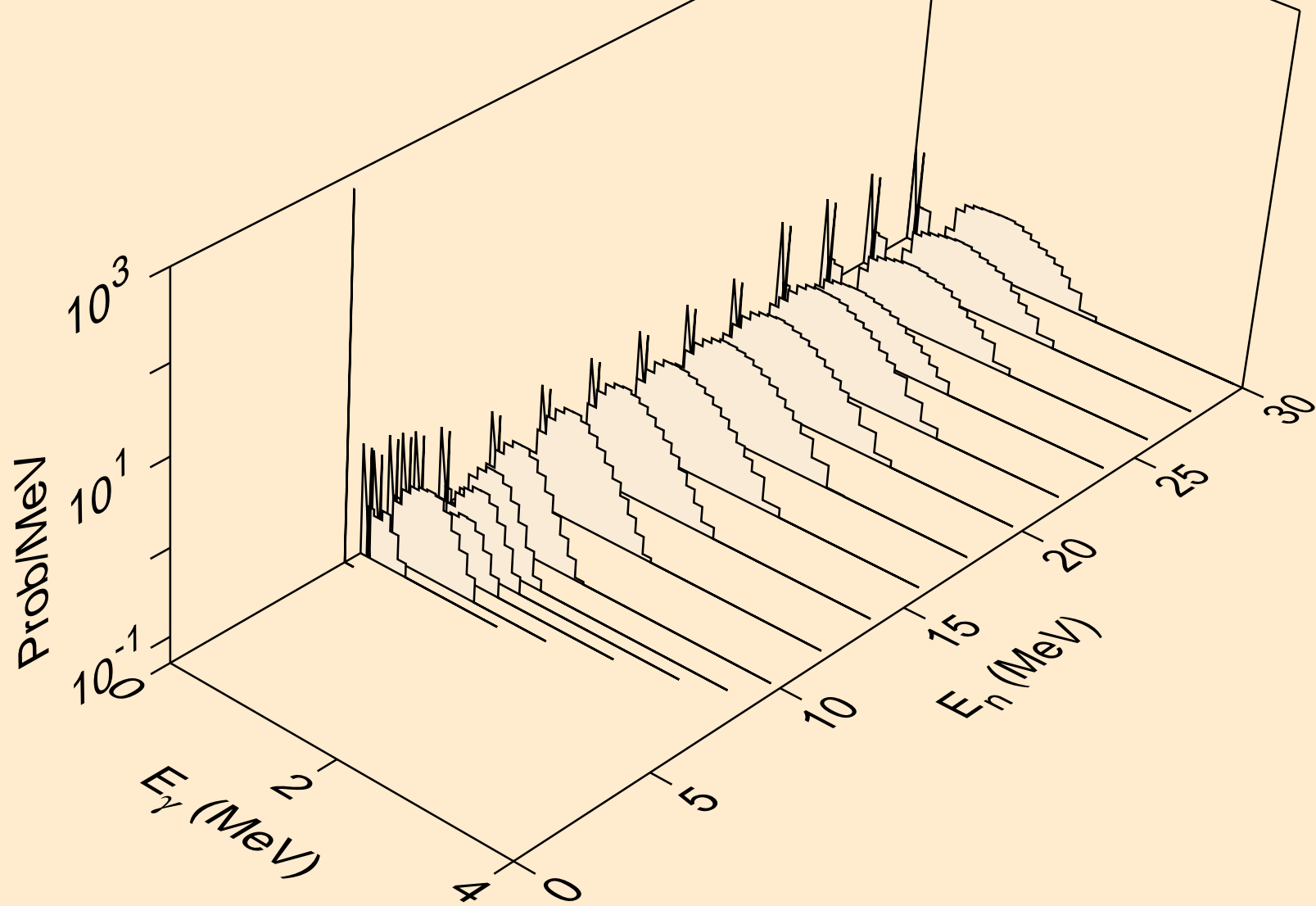

MD259 NEUTRON ACER TENDL-2021 LIBRARY; T=293.6K
Photon emission for (n,he3)

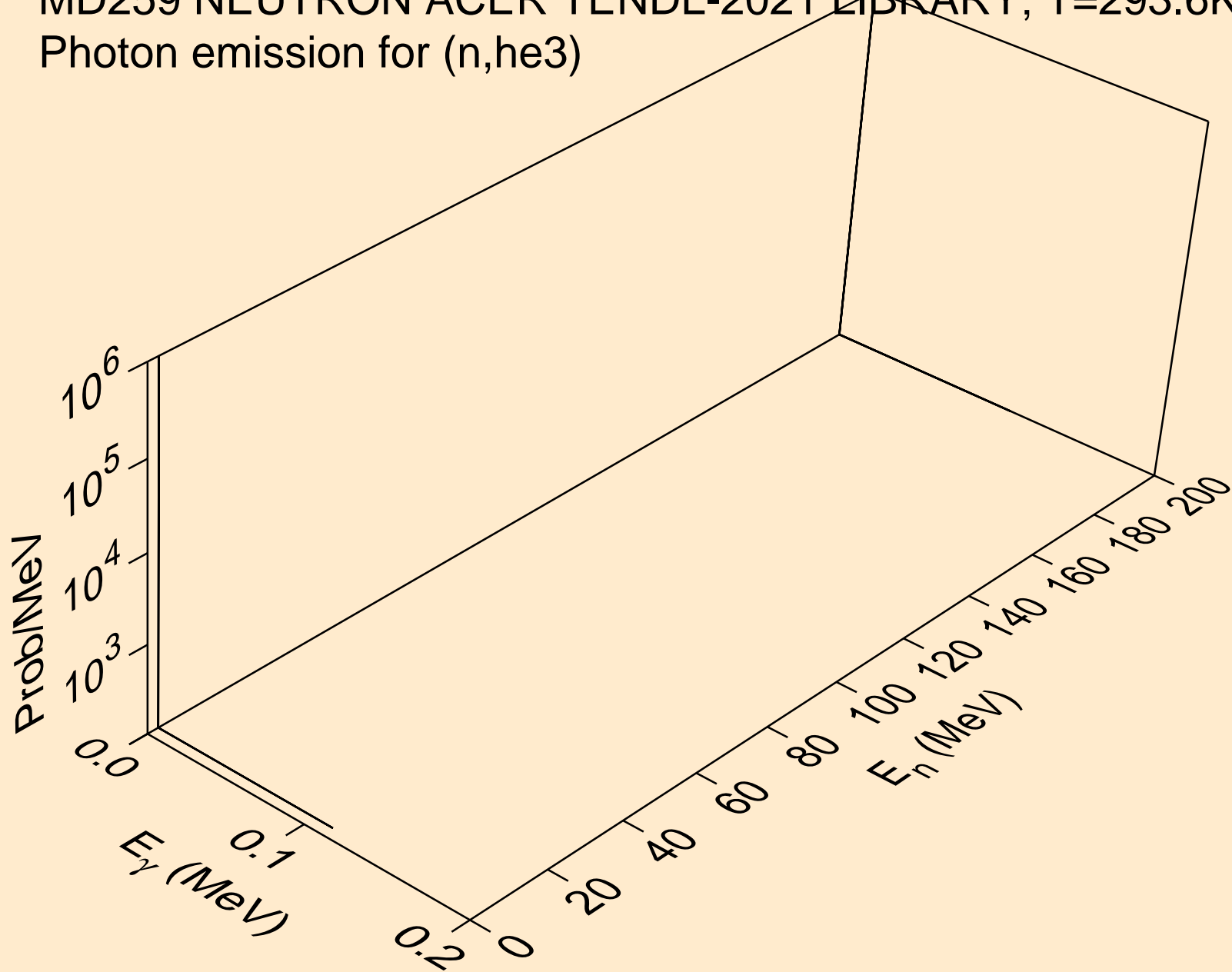

MD259 NEUTRON ACER TENDL-2021 LIBRARY; T=293.6K
Photon emission for (n,a)

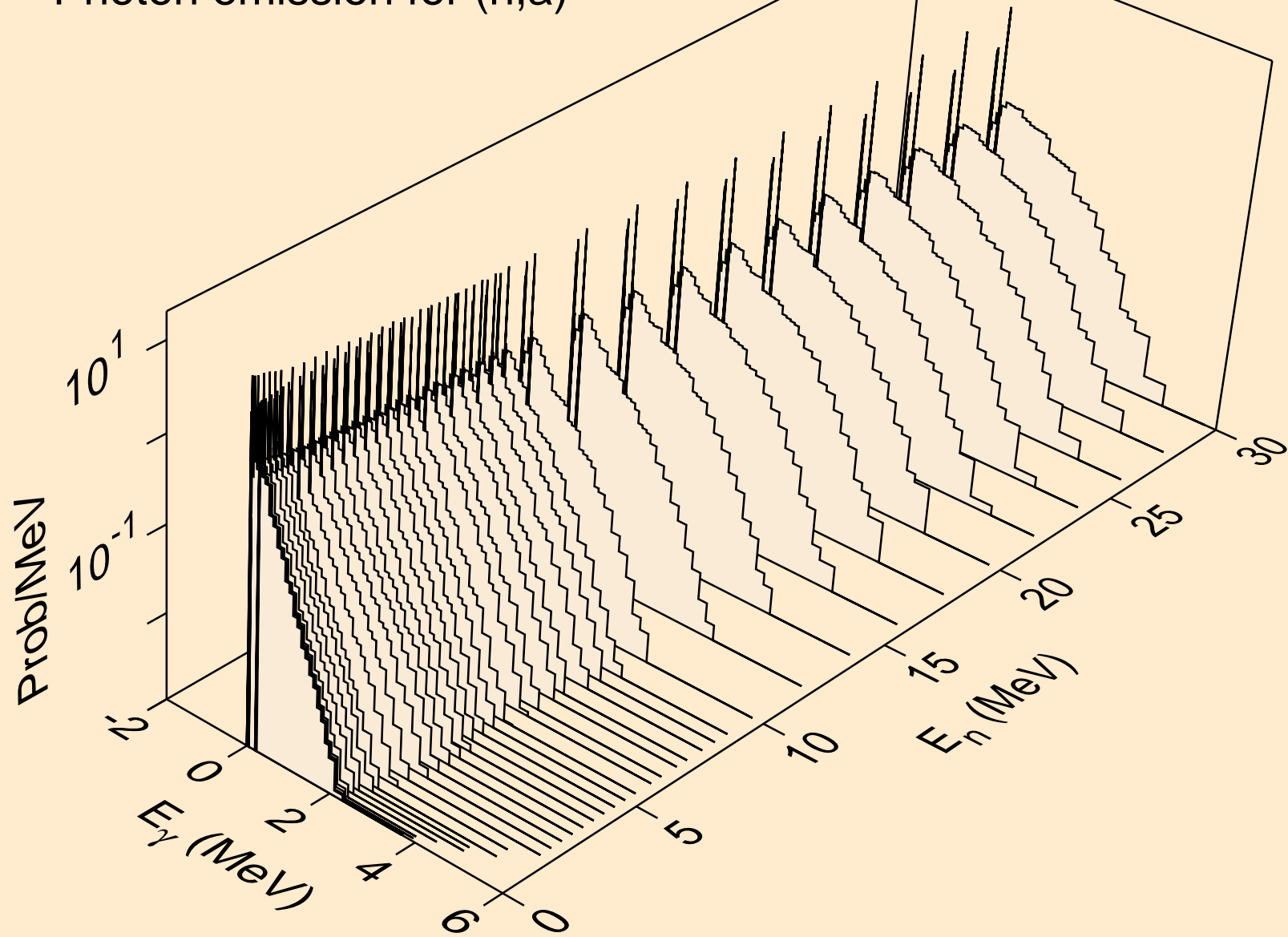

MD259 NEUTRON ACER TENDL-2021 LIBRARY; T=293.6K
Photon emission for (n,2p)

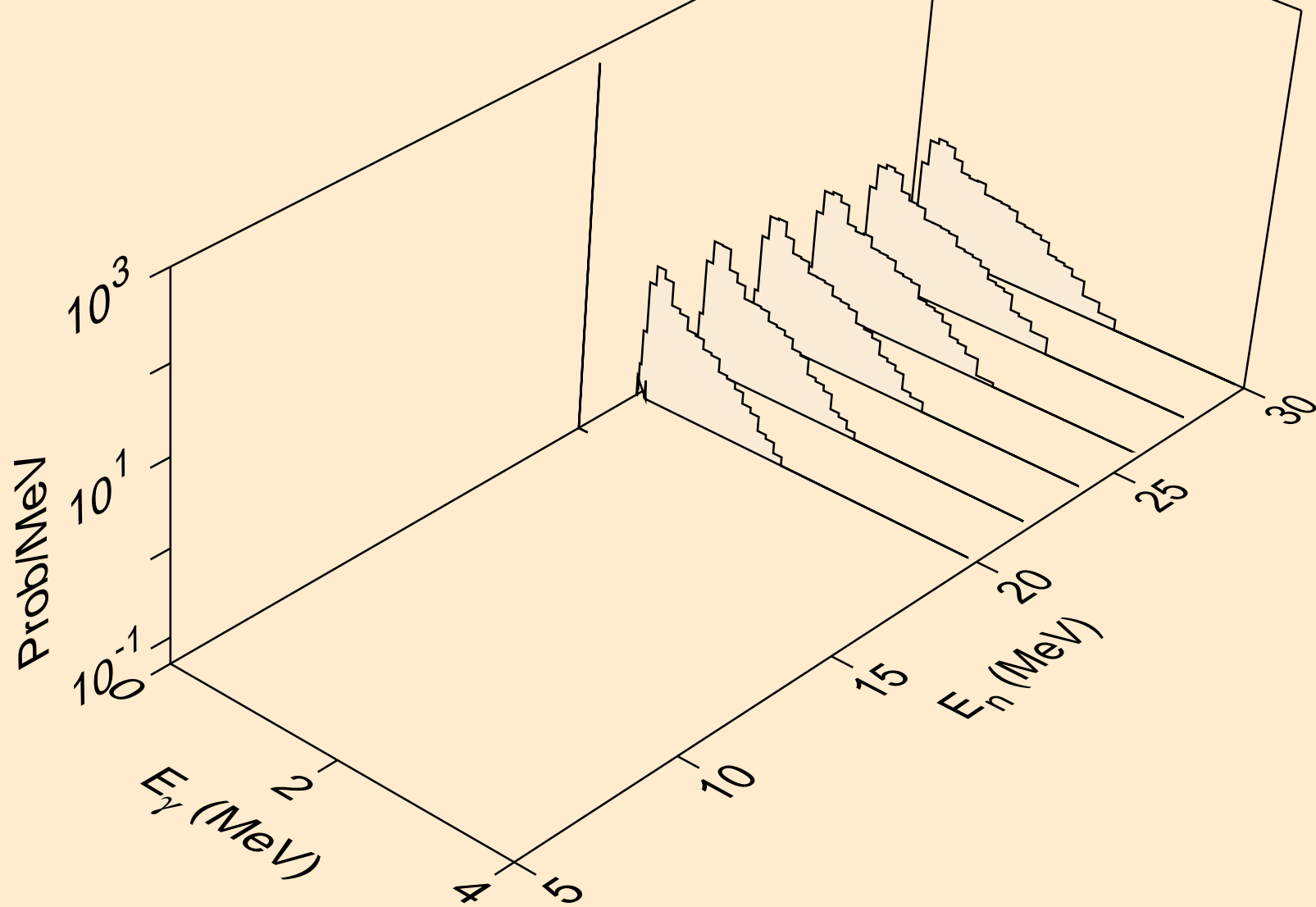

MD259 NEUTRON ACER TENDL-2021 LIBRARY; T=293.6K
Photon emission for (n,p)

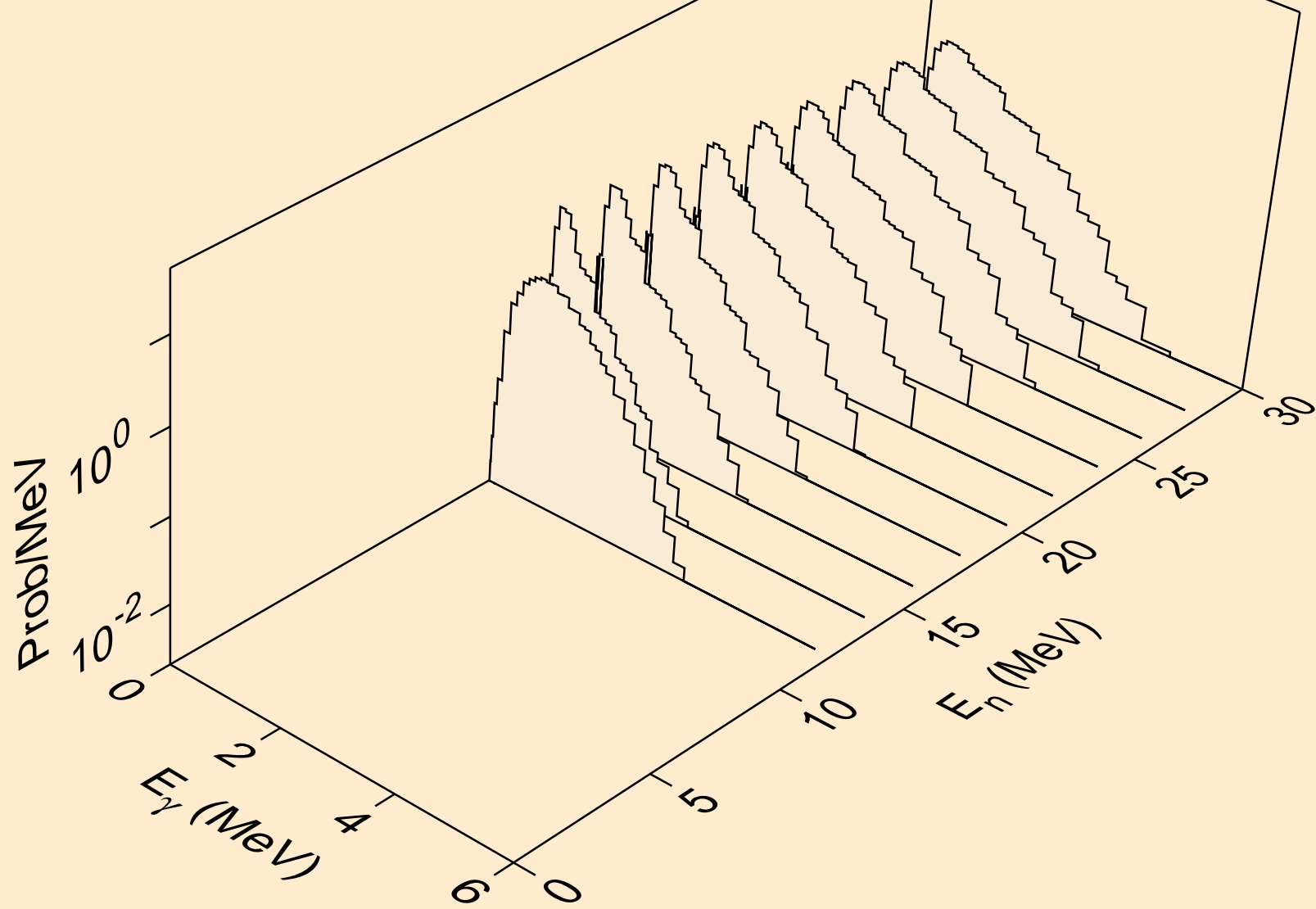

MD259 NEUTRON ACER TENDL-2021 LIBRARY; T=293.6K
thermal capture photon spectrum

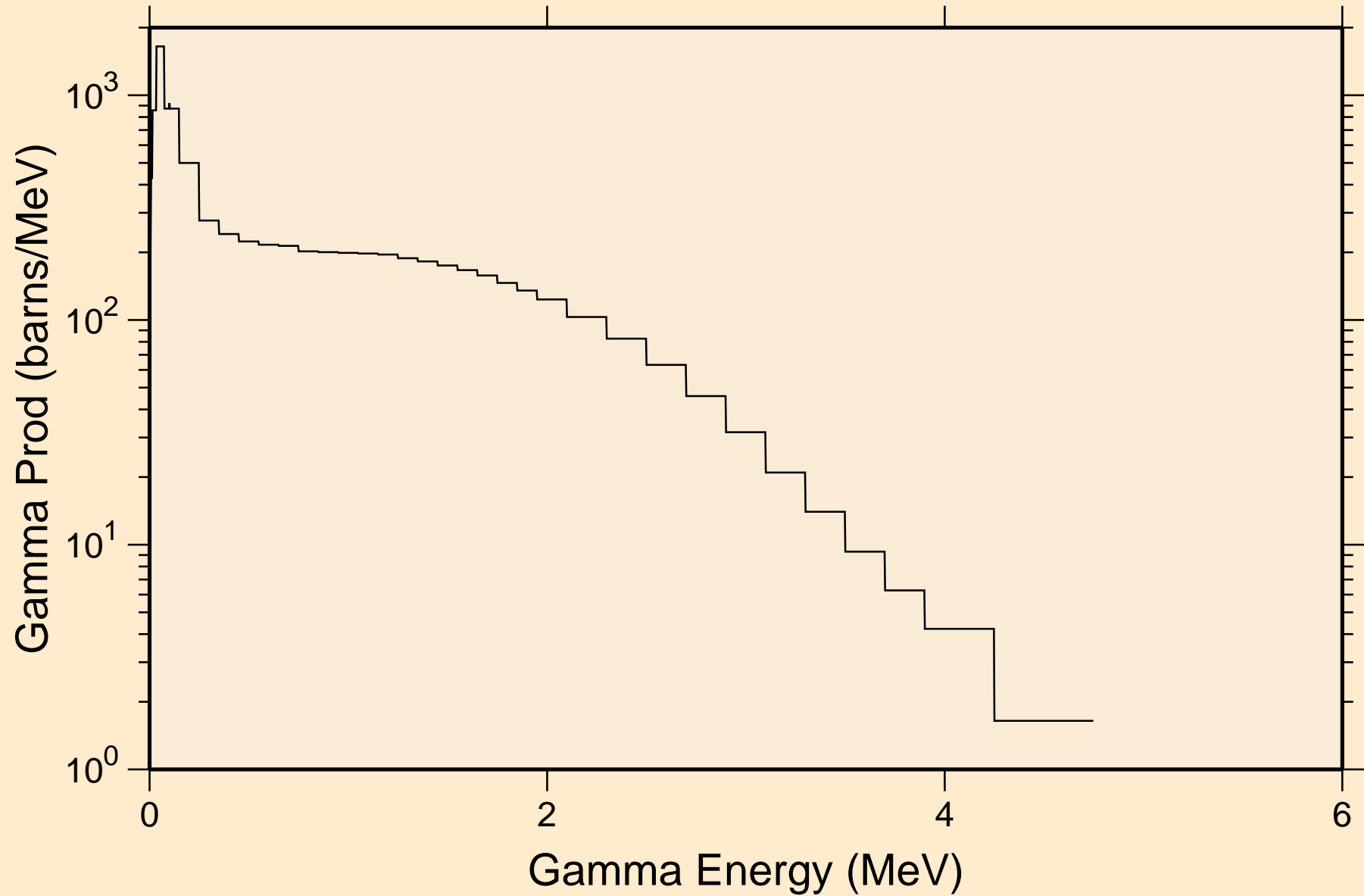

MD259 NEUTRON ACER TENDL-2021 LIBRARY; T=293.6K
14 MeV photon spectrum

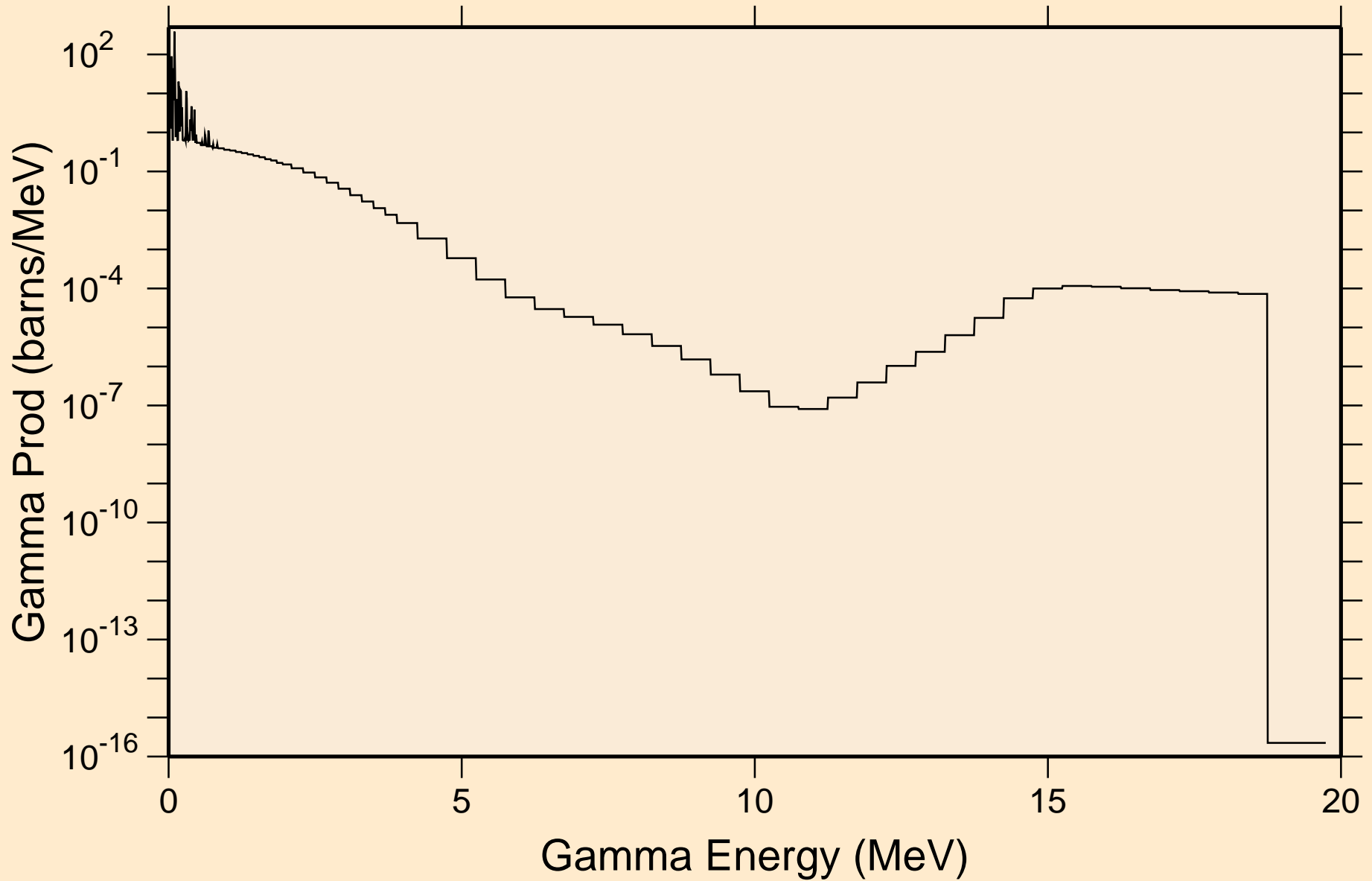

MD259 NEUTRON ACER TENDL-2021 LIBRARY; T=293.6K
Particle heating contributions

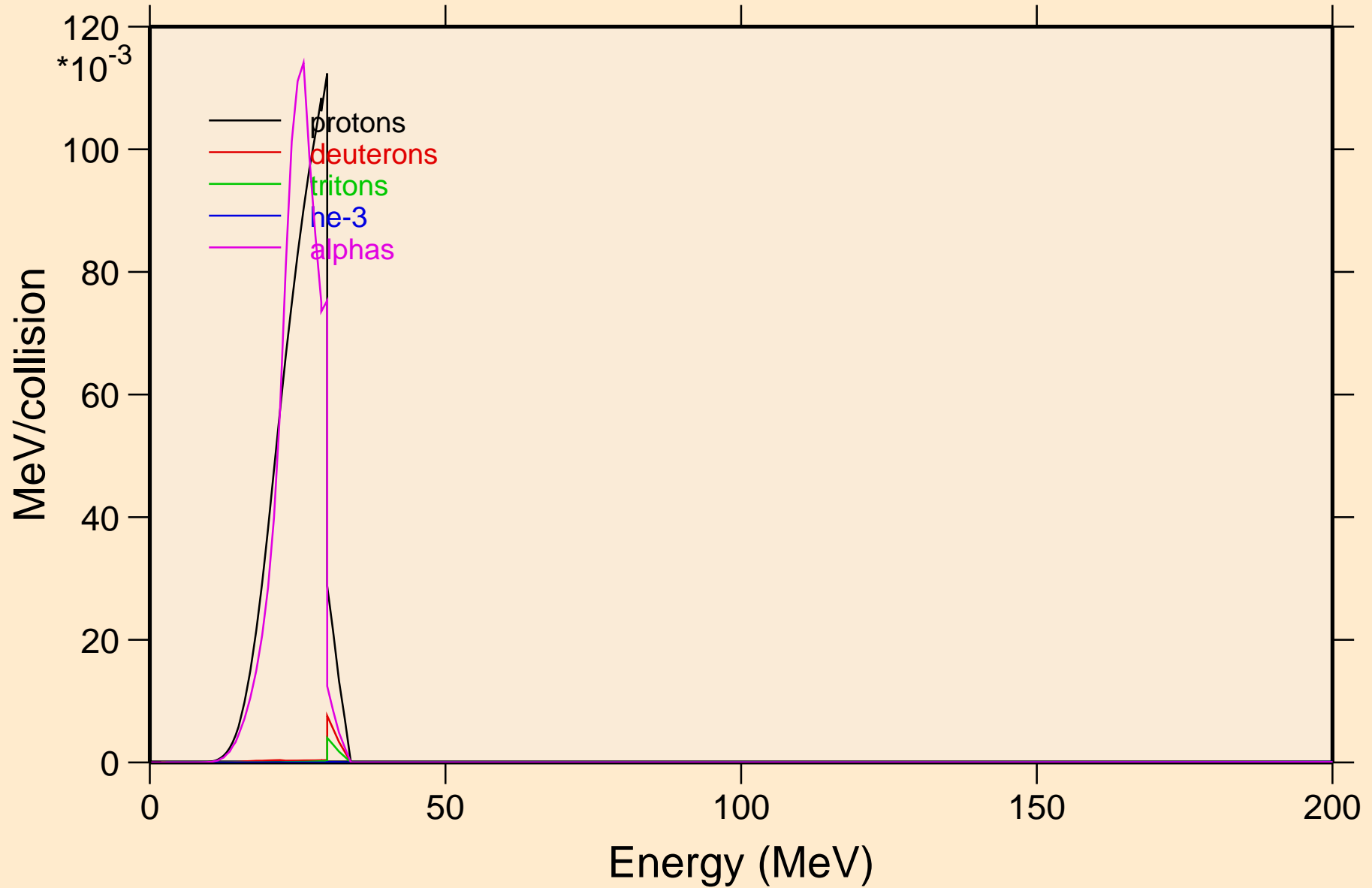

MD259 NEUTRON ACER TENDL-2021 LIBRARY; T=293.6K
Recoil Heating

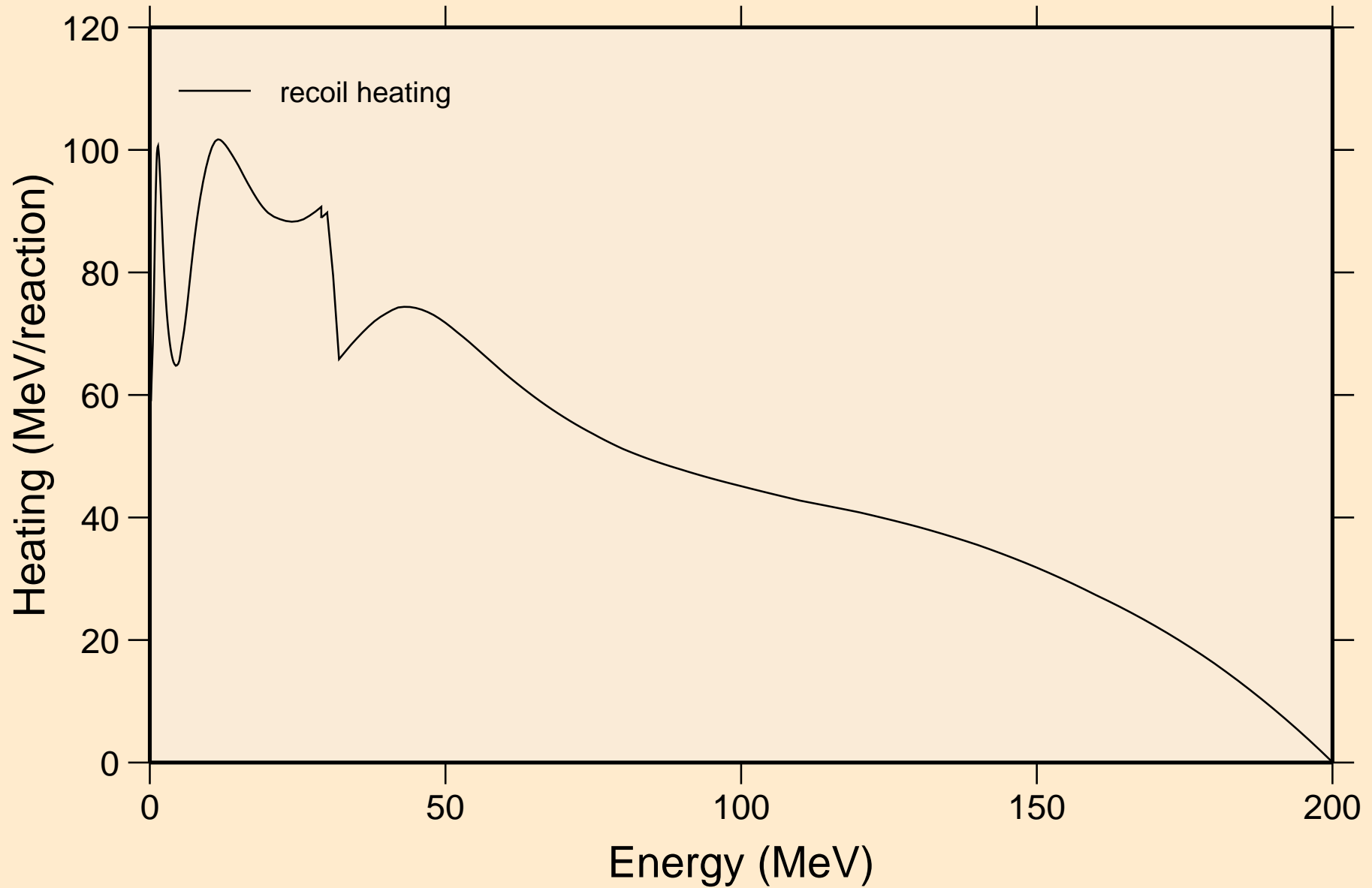

MD259 NEUTRON ACER TENDL-2021 LIBRARY; T=293.6K

Particle production cross sections

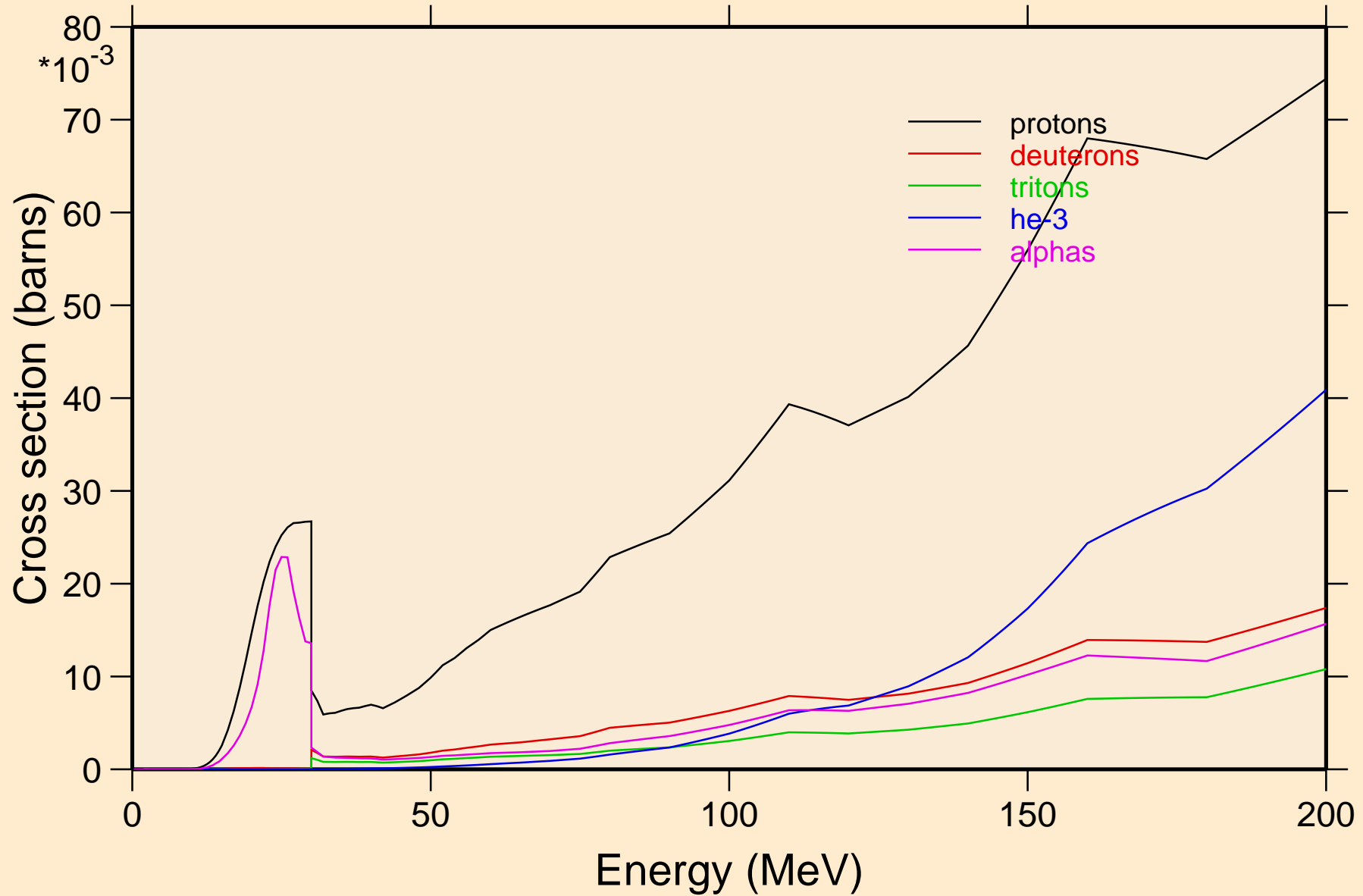

MD259 NEUTRON ACER TENDL-2021 LIBRARY; T=293.6K
protons from (n,x)

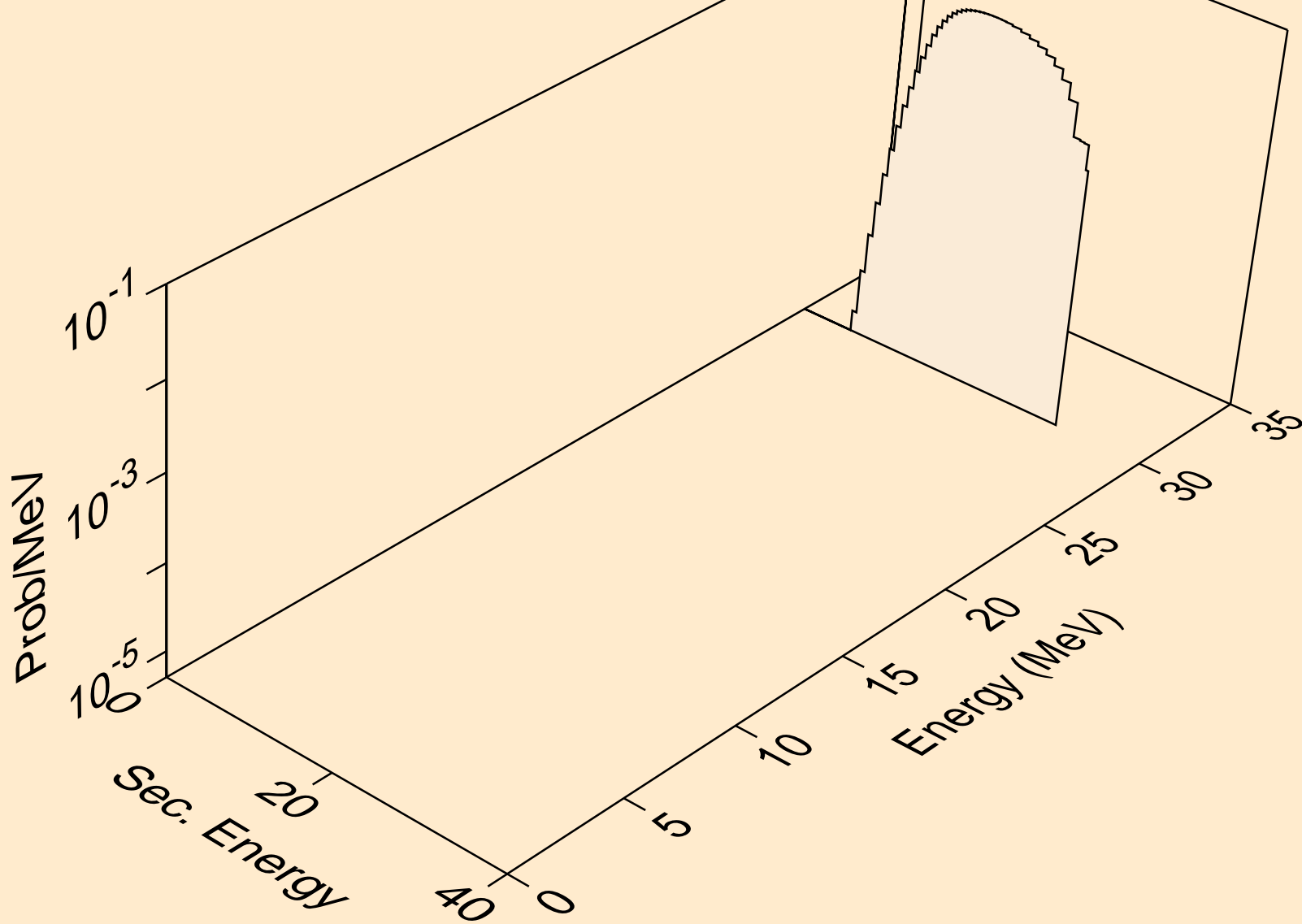

MD259 NEUTRON ACER TENDL-2021 LIBRARY; T=293.6K
protons from (n,n*)p

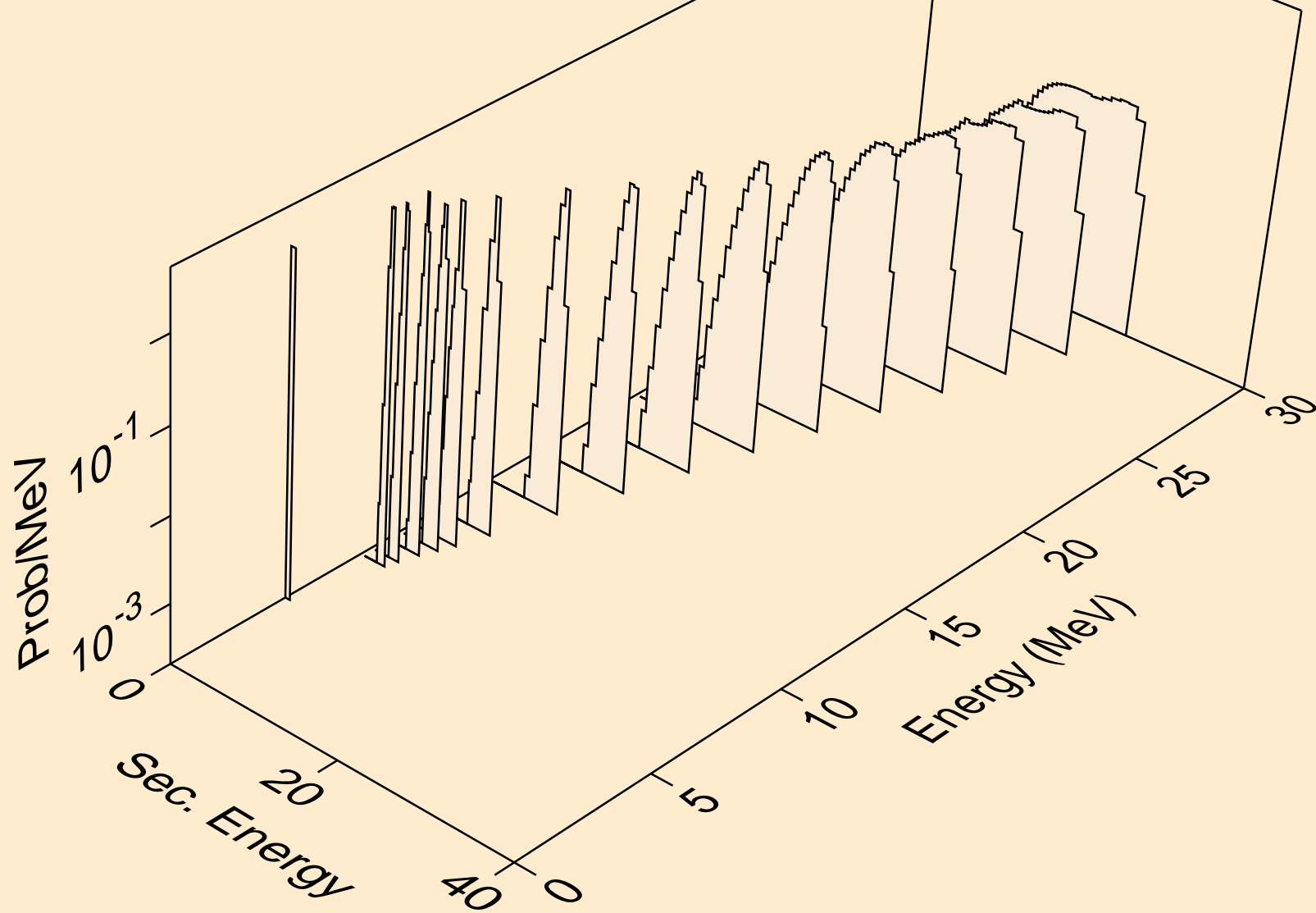

MD259 NEUTRON ACER TENDL-2021 LIBRARY; T=293.6K
protons from (n,2np)

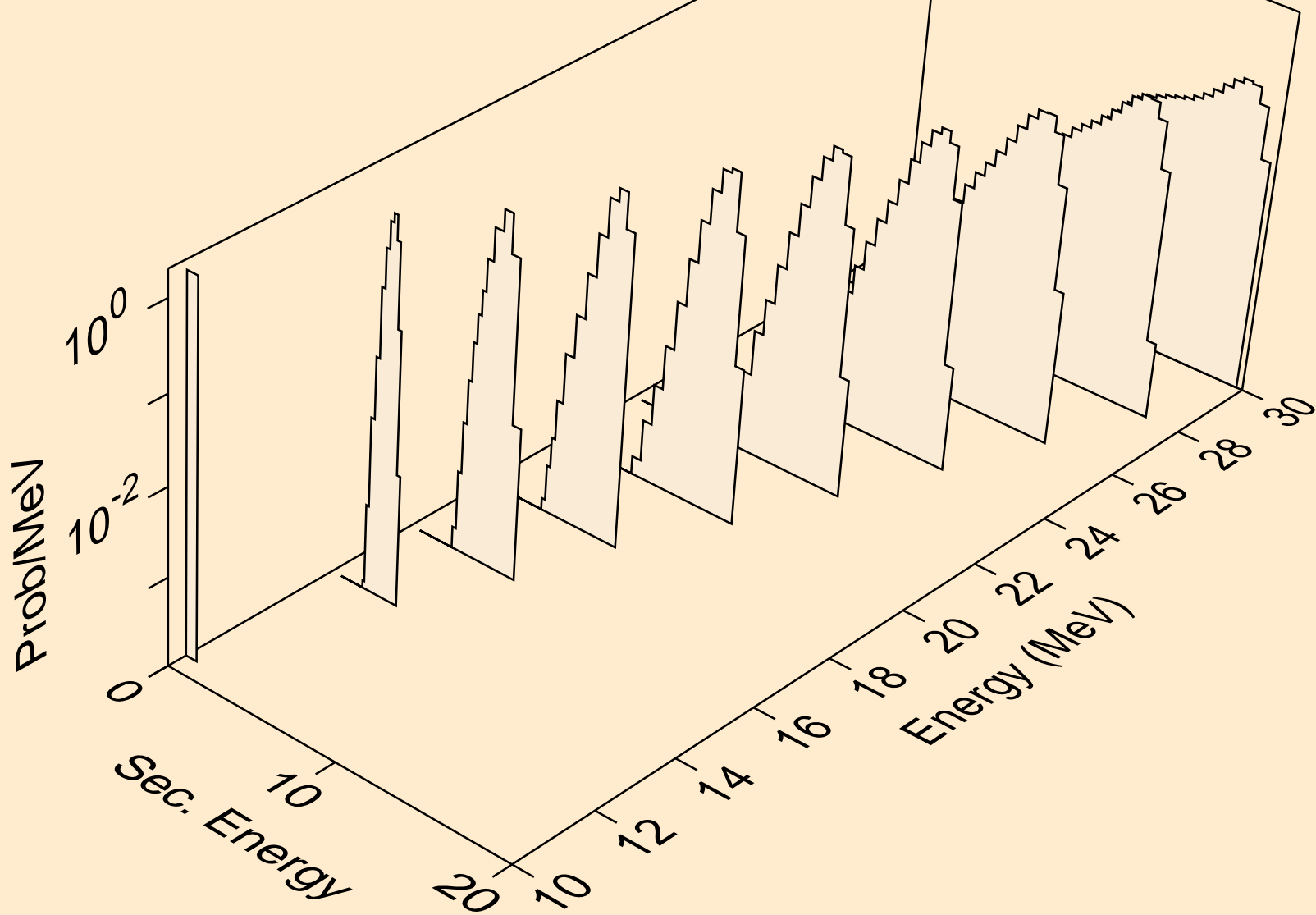

MD259 NEUTRON ACER TENDL-2021 LIBRARY; T=293.6K
protons from (n,3np)

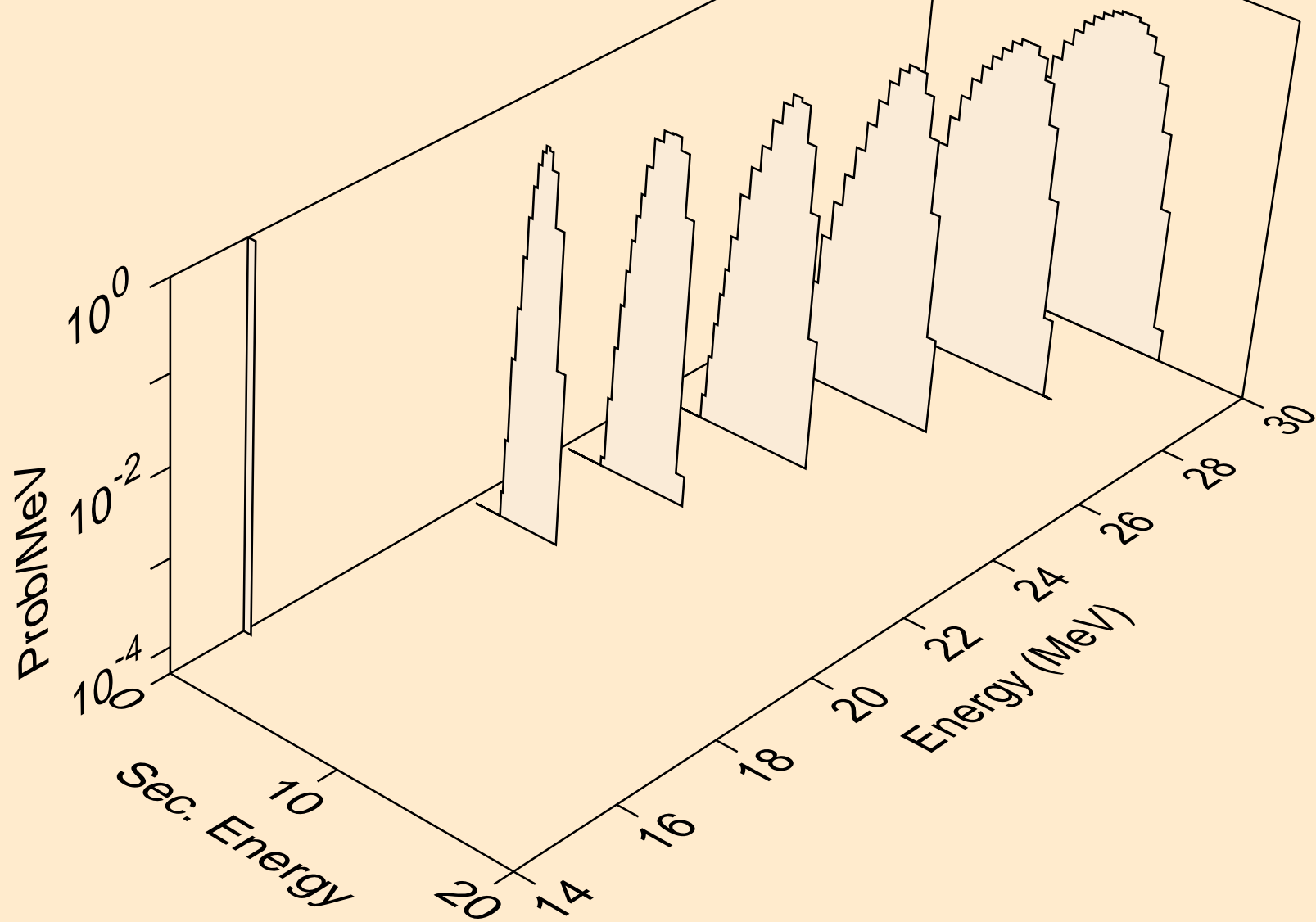

MD259 NEUTRON ACER TENDL-2021 LIBRARY; T=293.6K
protons from (n,npa)

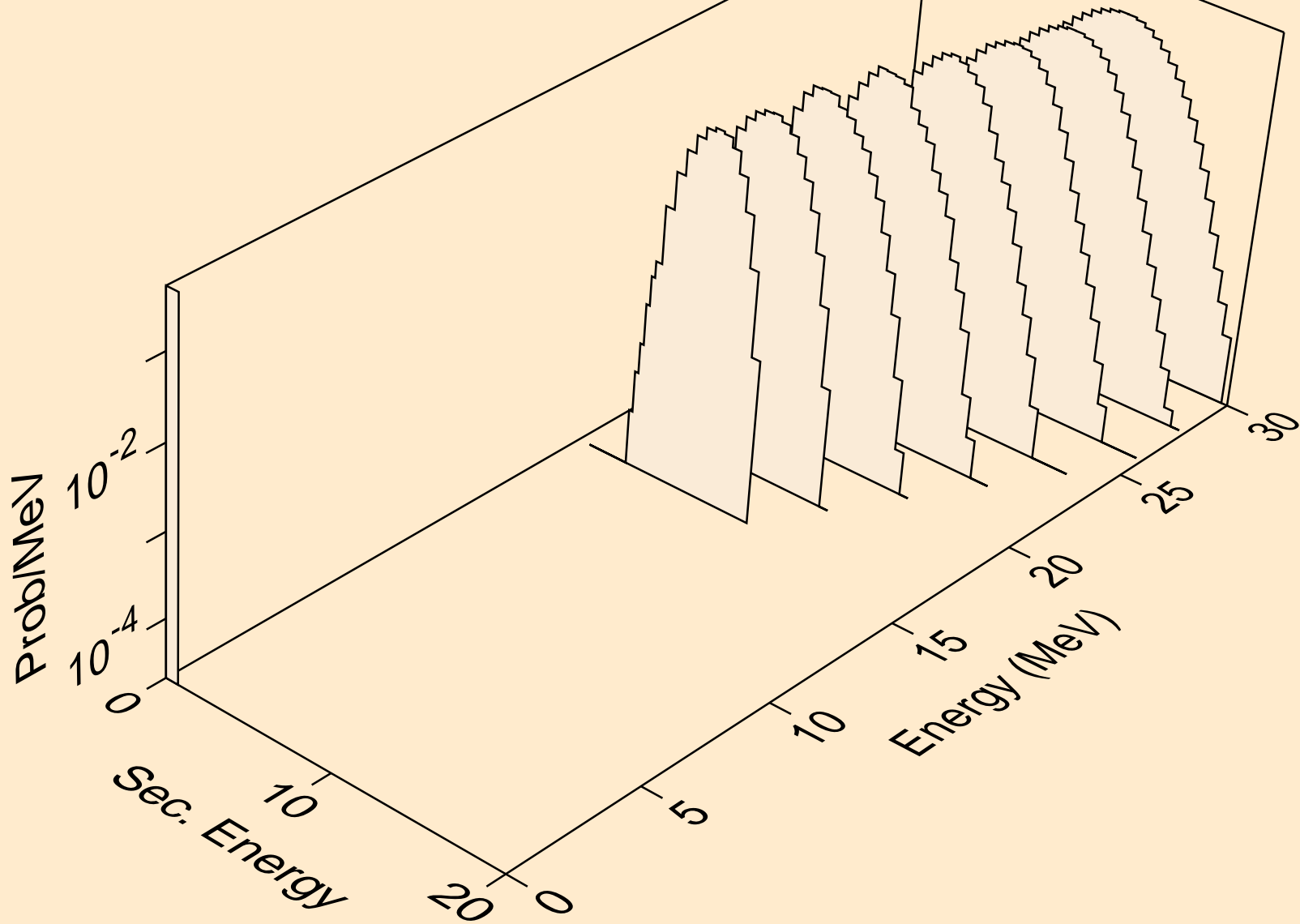

MD259 NEUTRON ACER TENDL-2021 LIBRARY; T=293.6K
protons from (n,p)

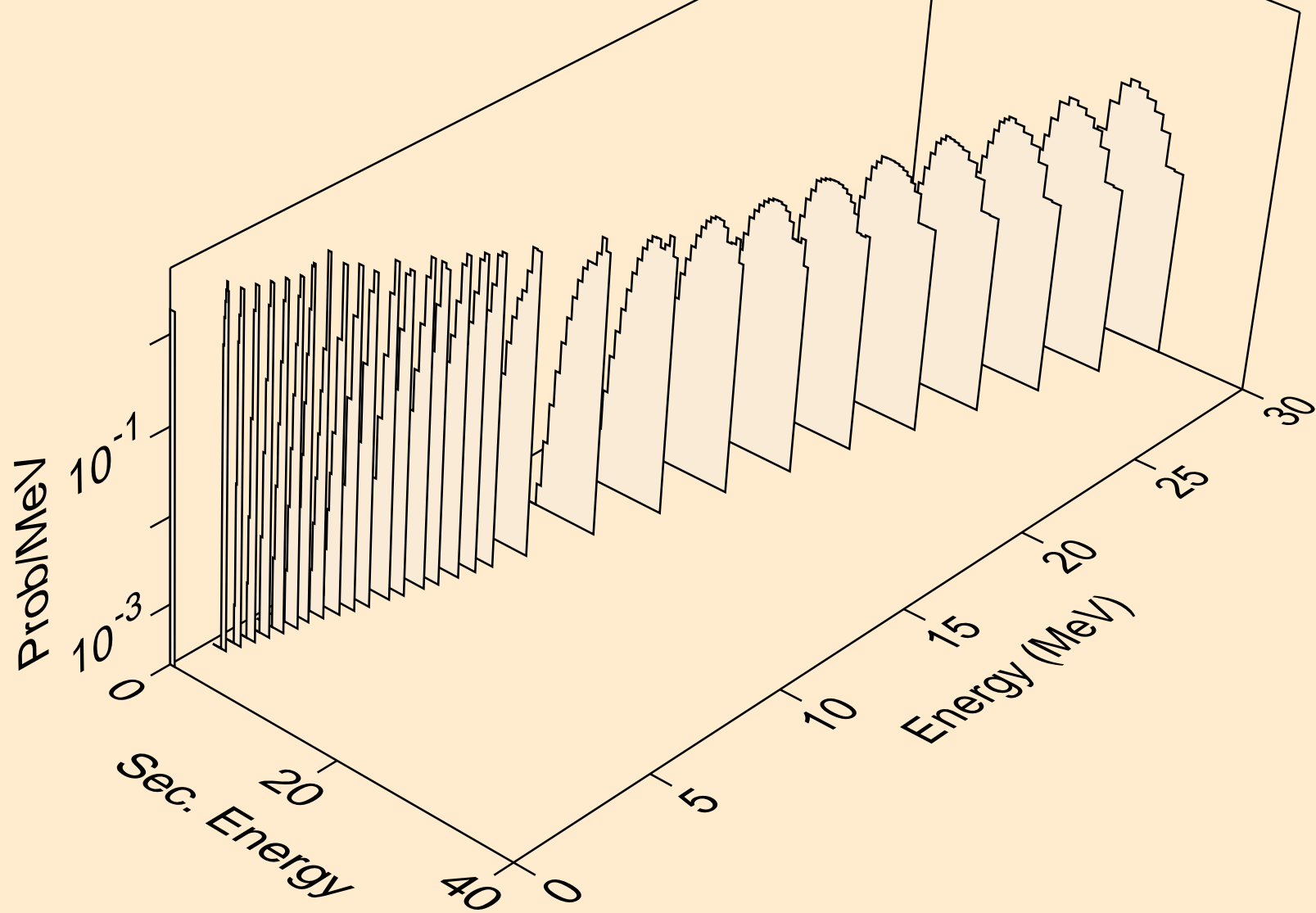

MD259 NEUTRON ACER TENDL-2021 LIBRARY; T=293.6K
protons from (n,2p)

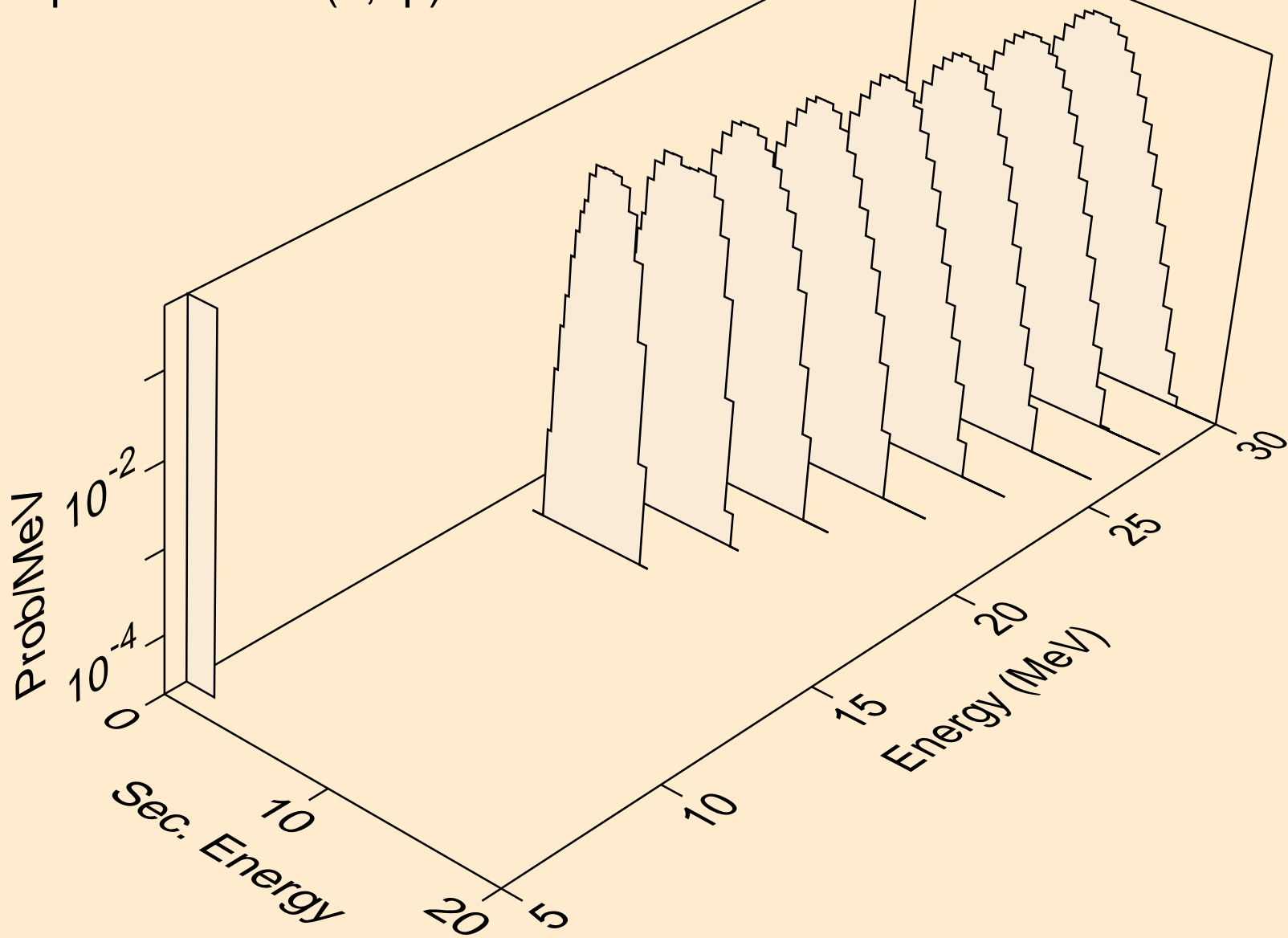

MD259 NEUTRON ACER TENDL-2021 LIBRARY; T=293.6K
protons from (n,p)

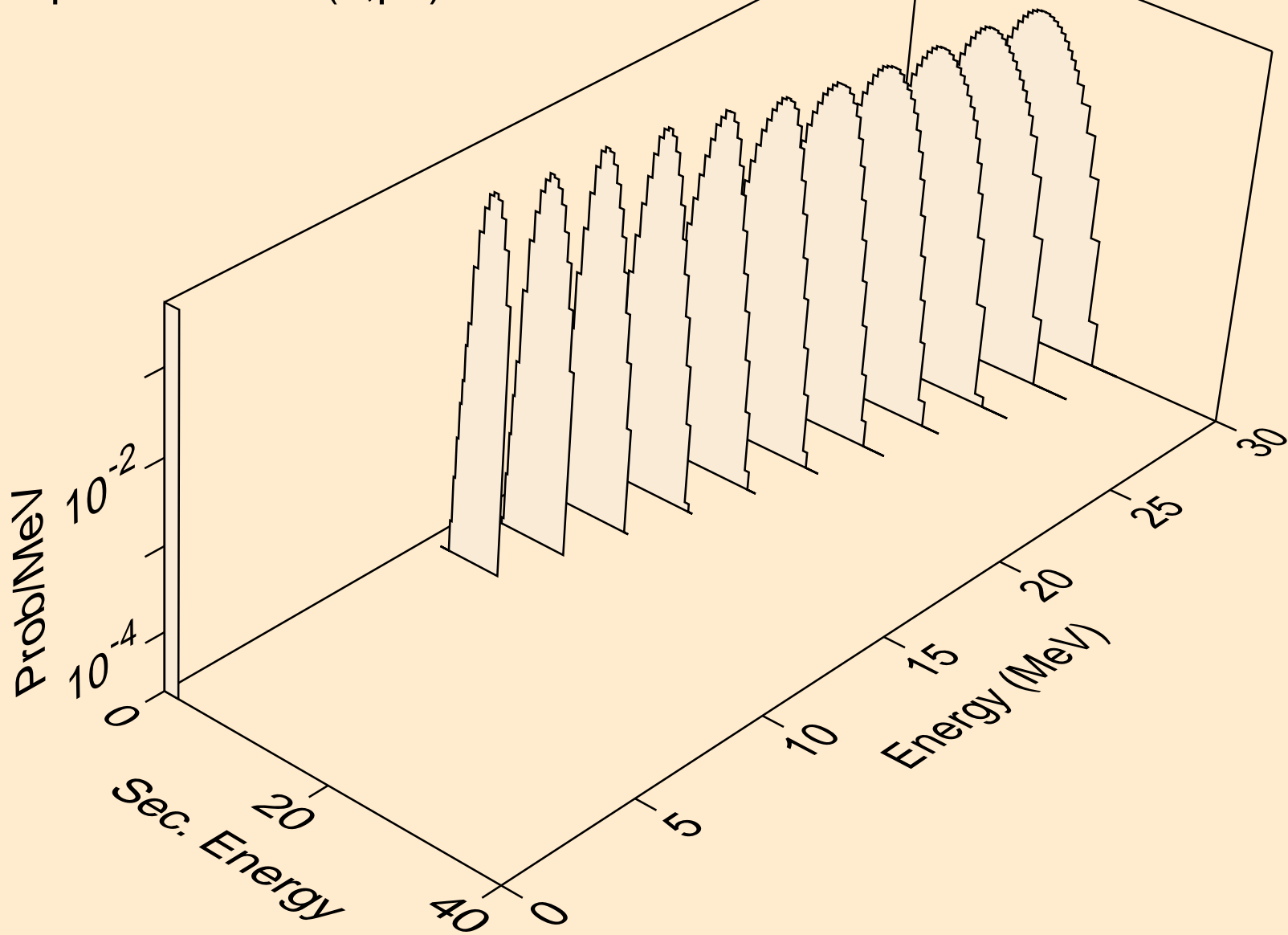

MD259 NEUTRON ACER TENDL-2021 LIBRARY; T=293.6K
deuterons from (n,x)

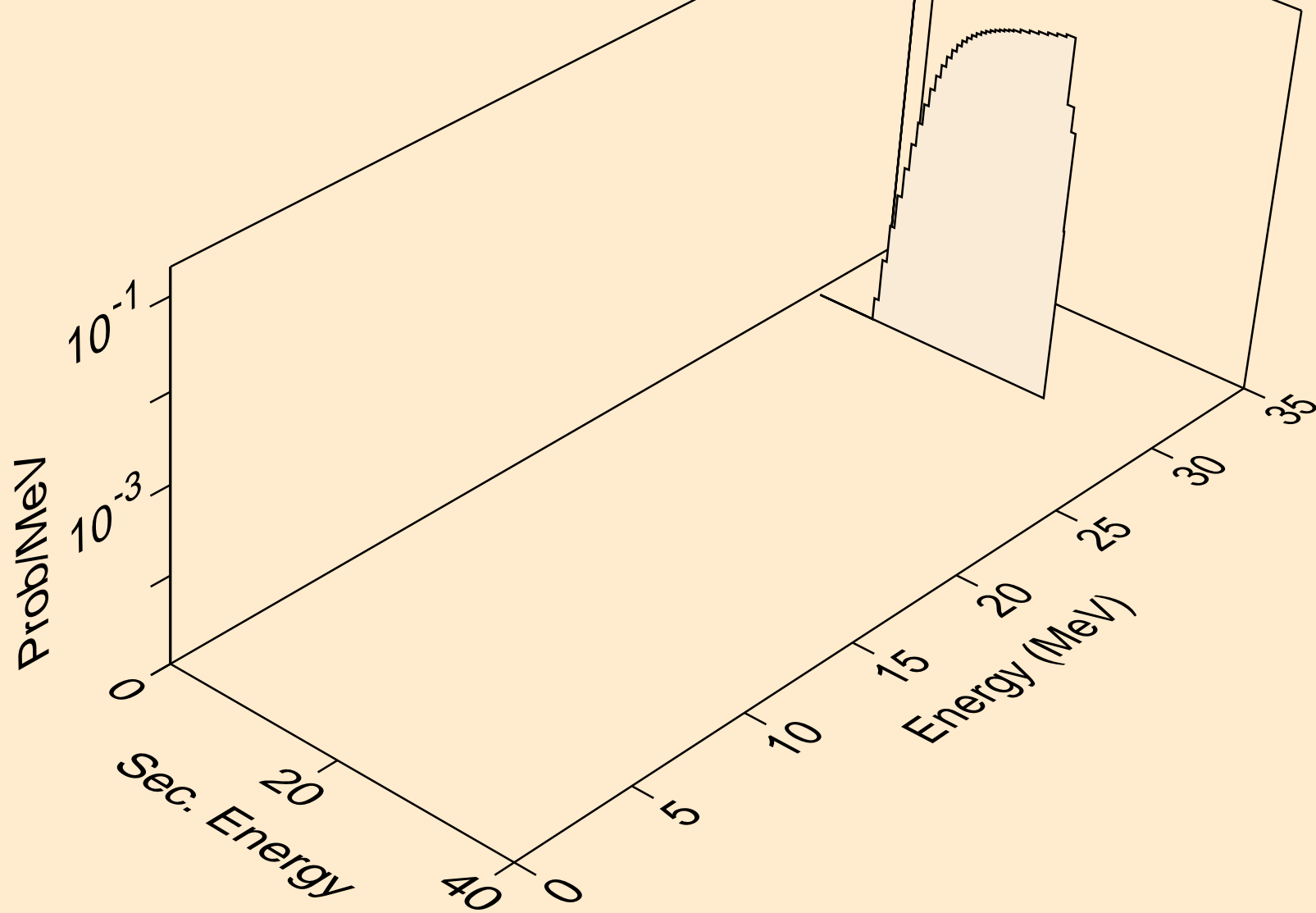

MD259 NEUTRON ACER TENDL-2021 LIBRARY; T=293.6K
deuterons from (n,2nd)

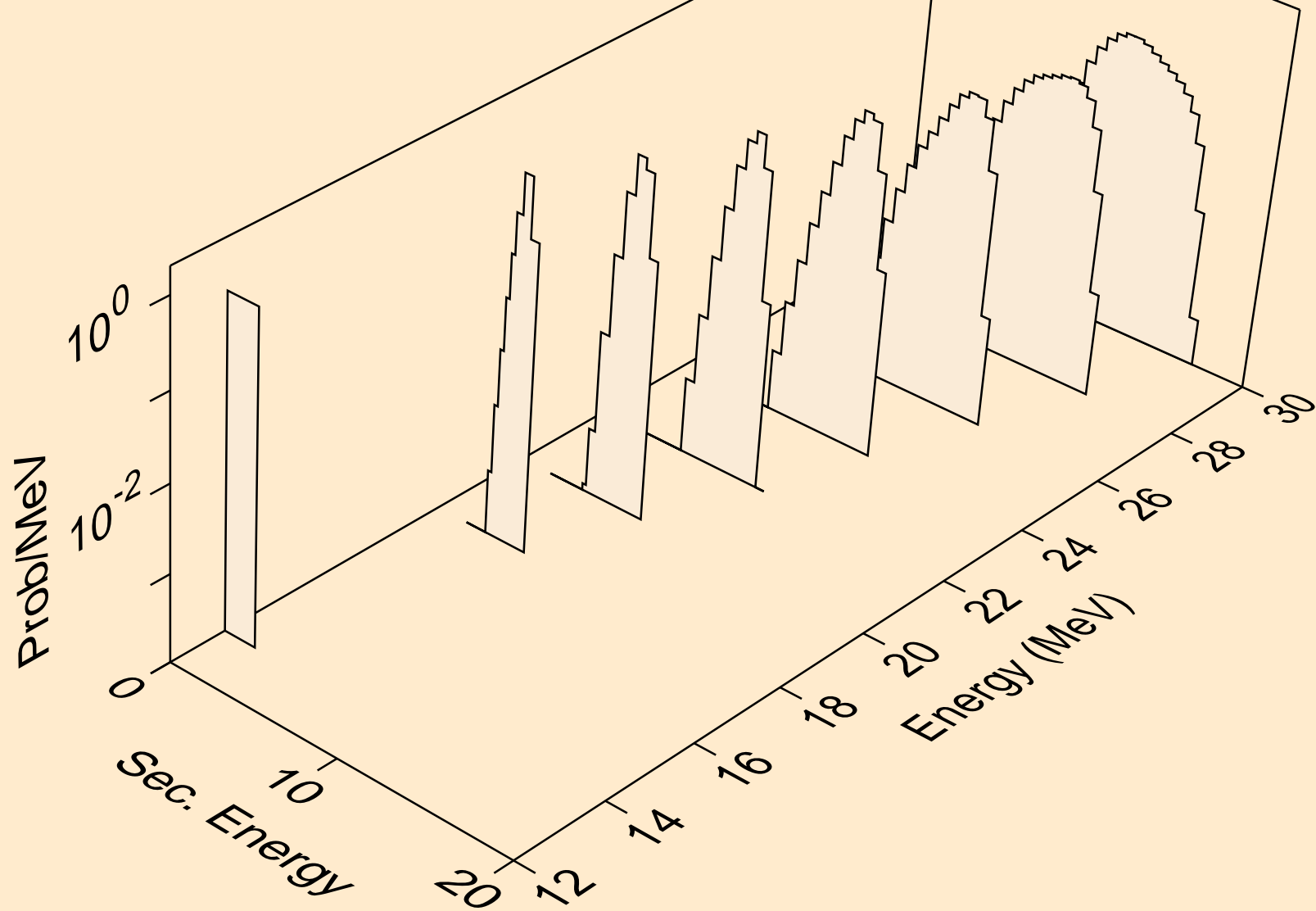

MD259 NEUTRON ACER TENDL-2021 LIBRARY; T=293.6K
deuterons from (n,n*)d

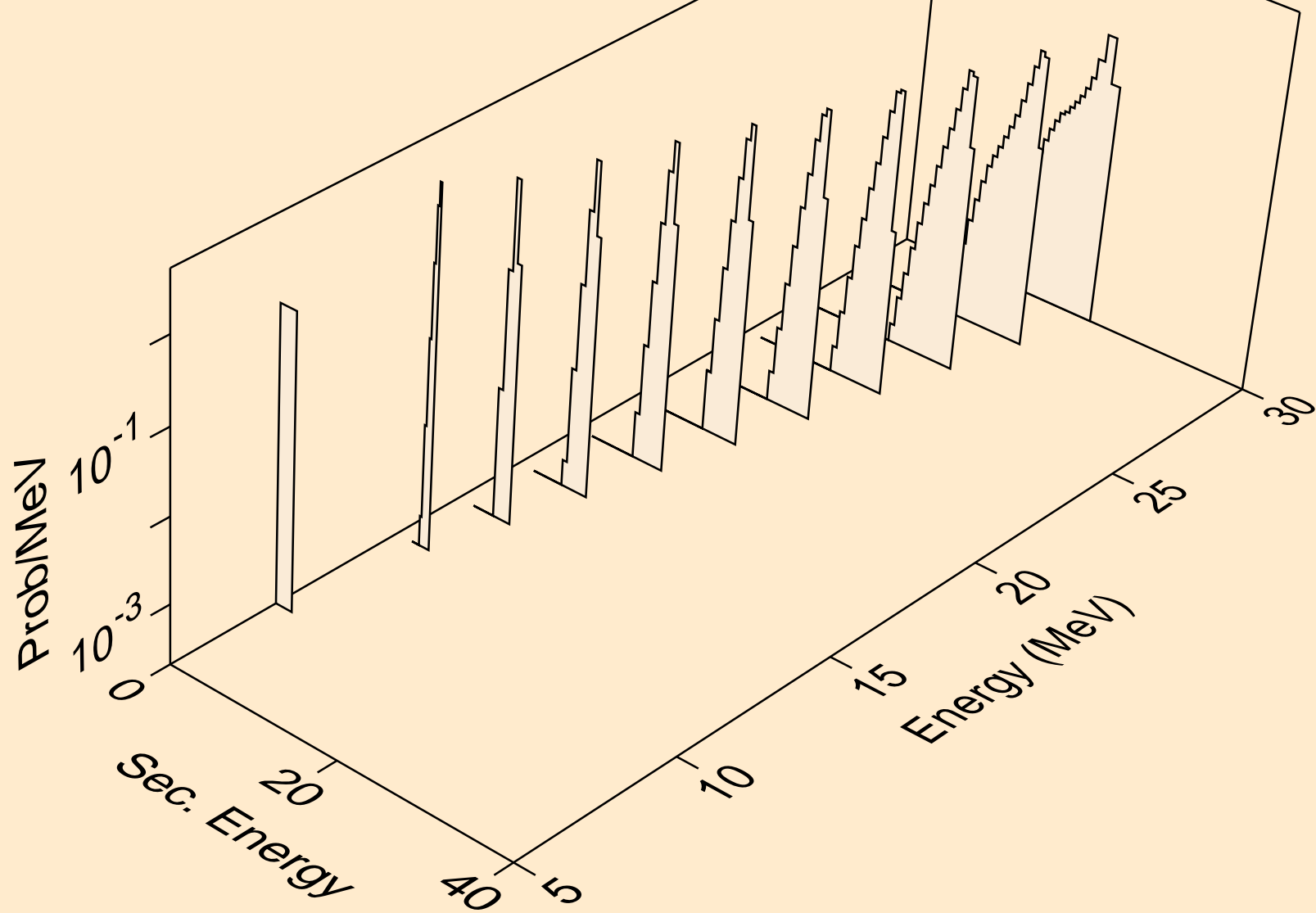

MD259 NEUTRON ACER TENDL-2021 LIBRARY; T=293.6K
deuterons from (n,d)

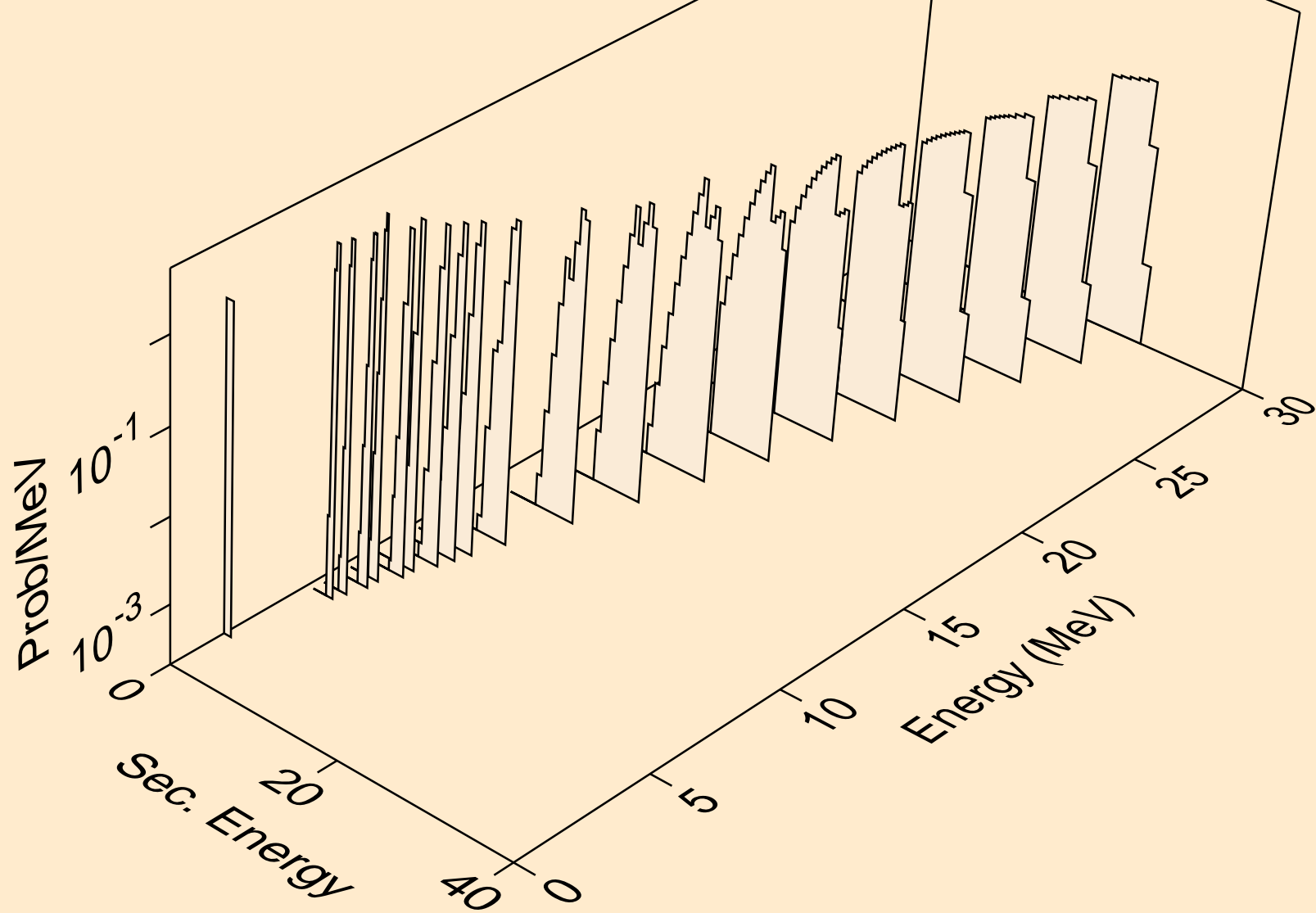

MD259 NEUTRON ACER TENDL-2021 LIBRARY; T=293.6K
tritons from (n,x)

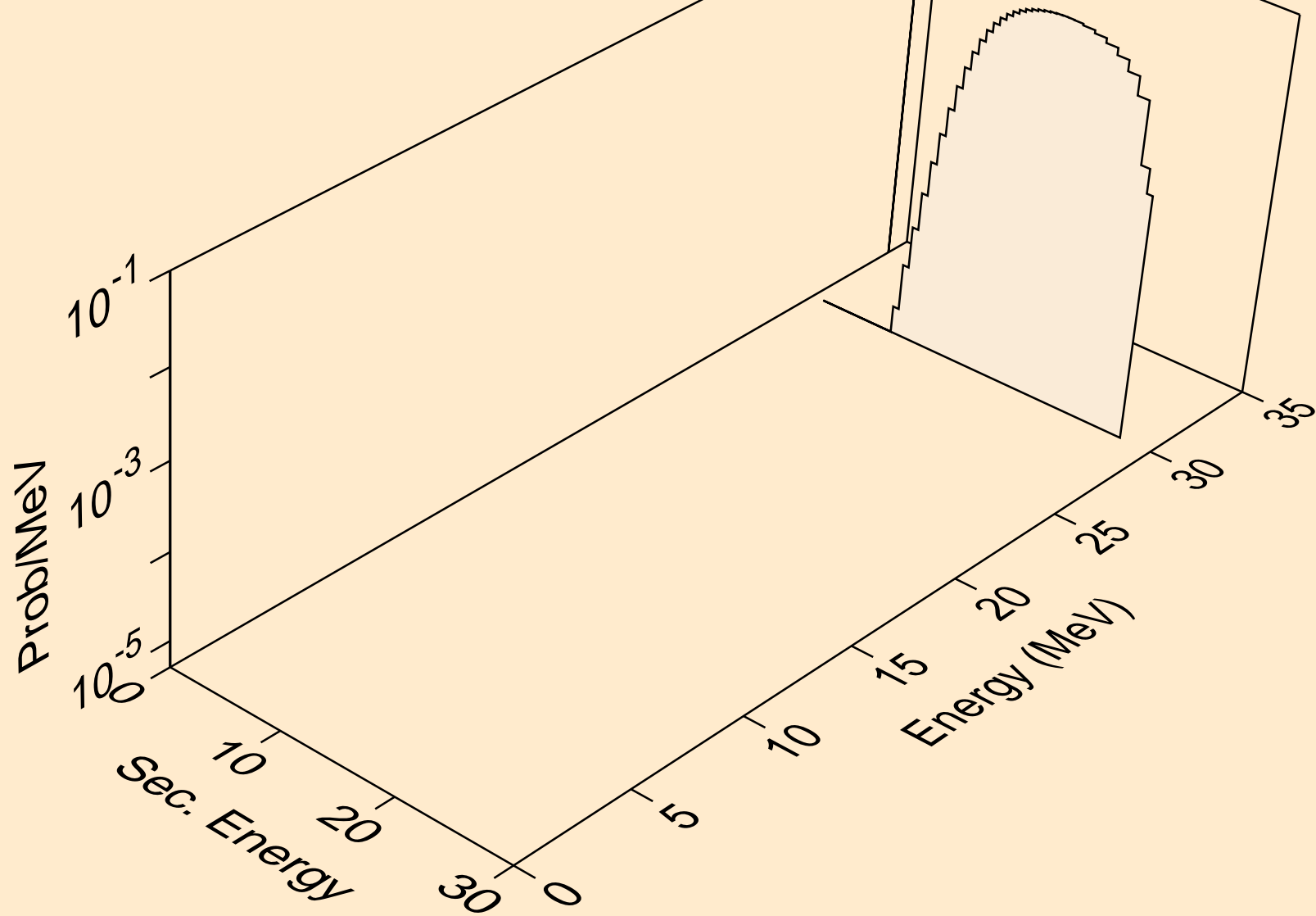

MD259 NEUTRON ACER TENDL-2021 LIBRARY; T=293.6K
tritons from (n,n*)t

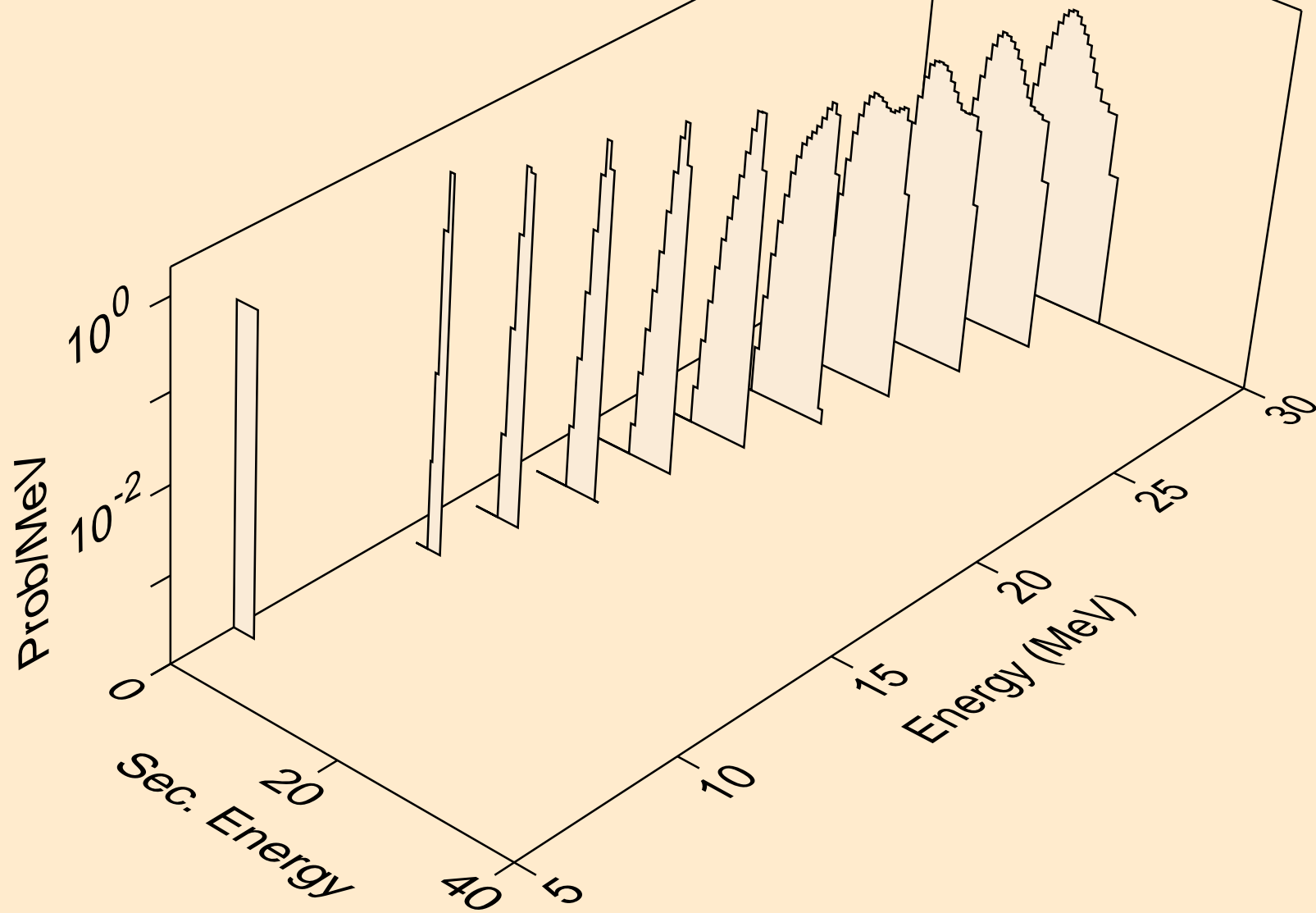

MD259 NEUTRON ACER TENDL-2021 LIBRARY; T=293.6K
tritons from (n,t)

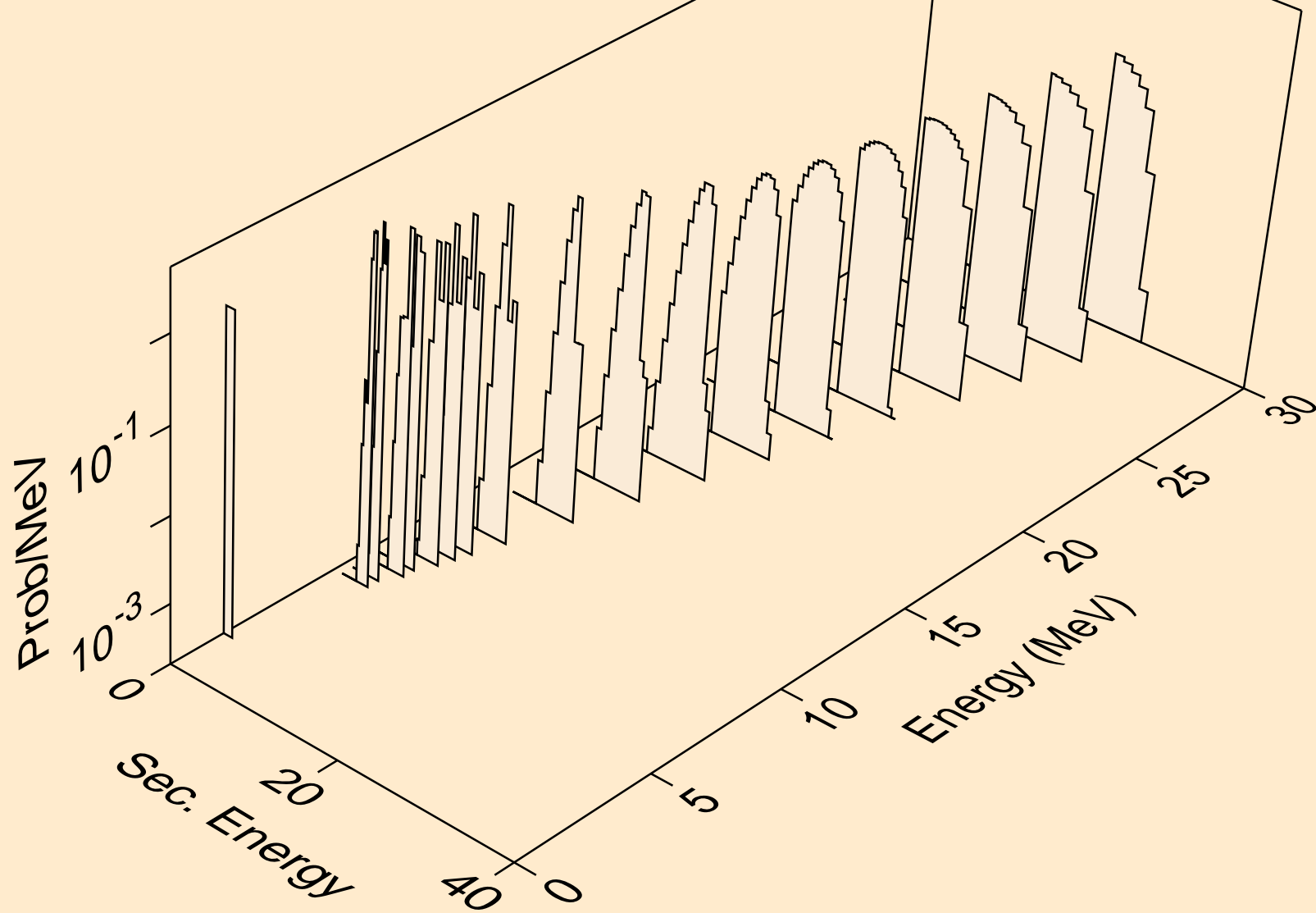

MD259 NEUTRON ACER TENDL-2021 LIBRARY; T=293.6K
he3s from (n,x)

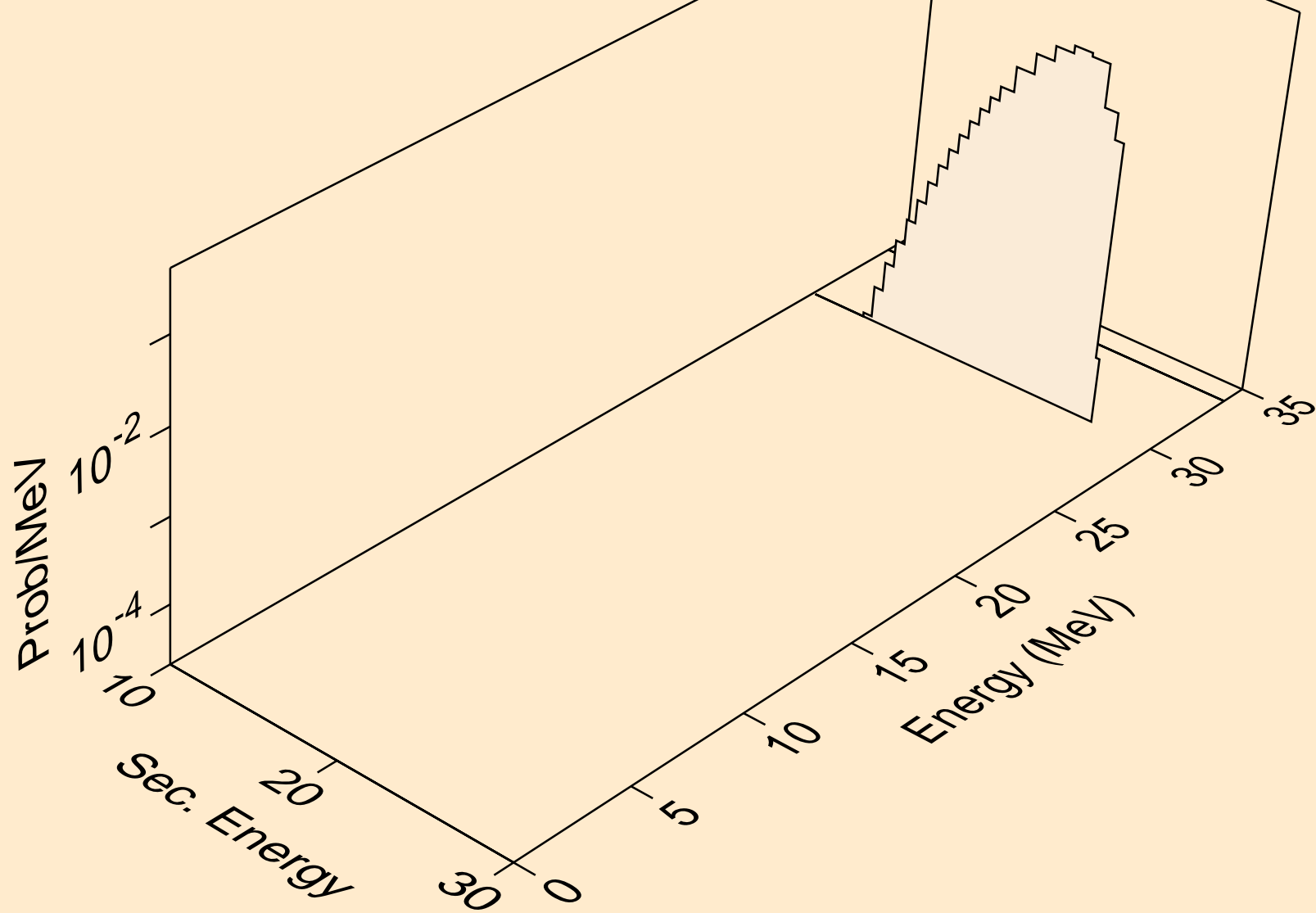

MD259 NEUTRON ACER TENDL-2021 LIBRARY; T=293.6K
he3s from (n,n*)he3

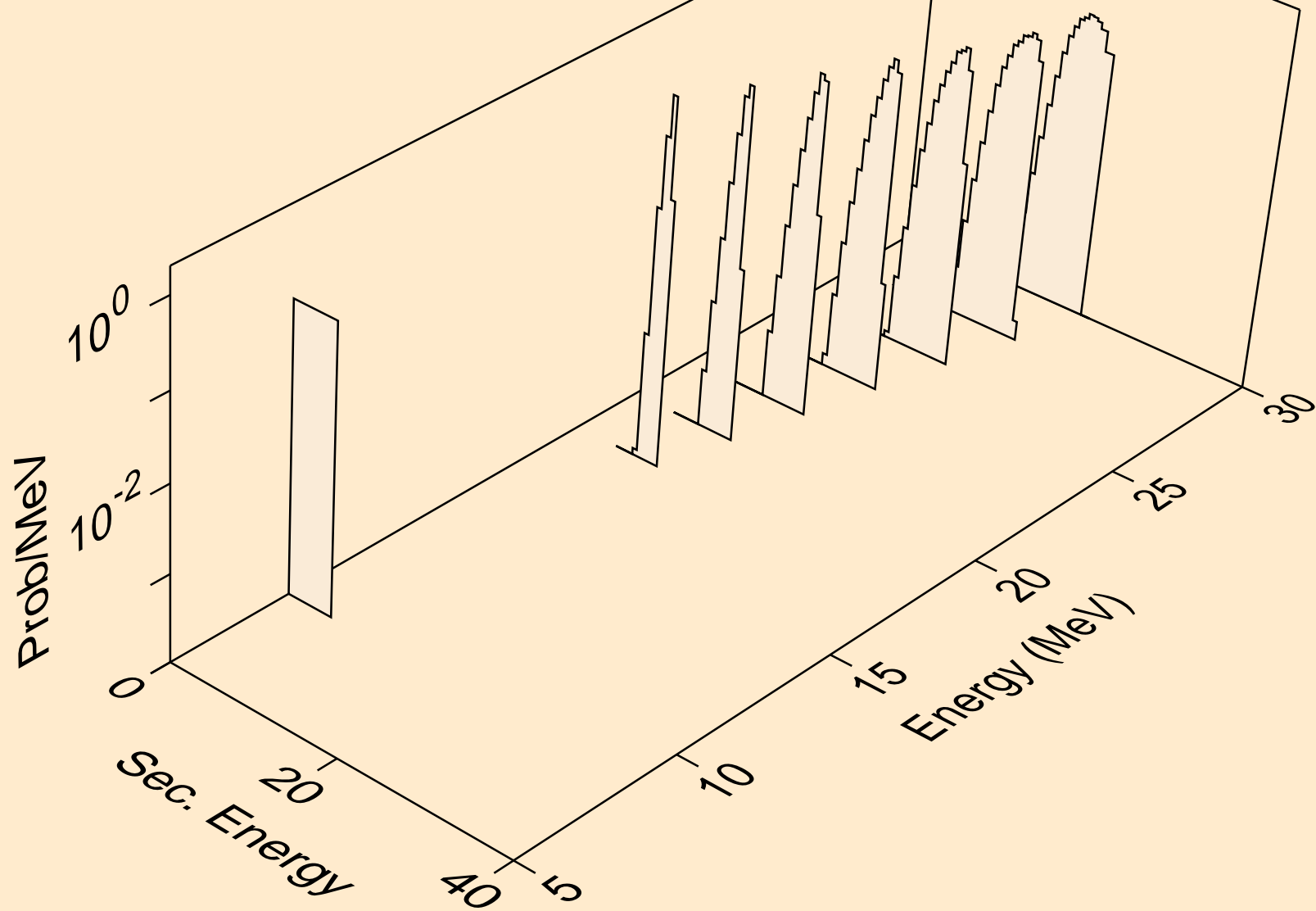

MD259 NEUTRON ACER TENDL-2021 LIBRARY; T=293.6K
he3s from (n,he3)

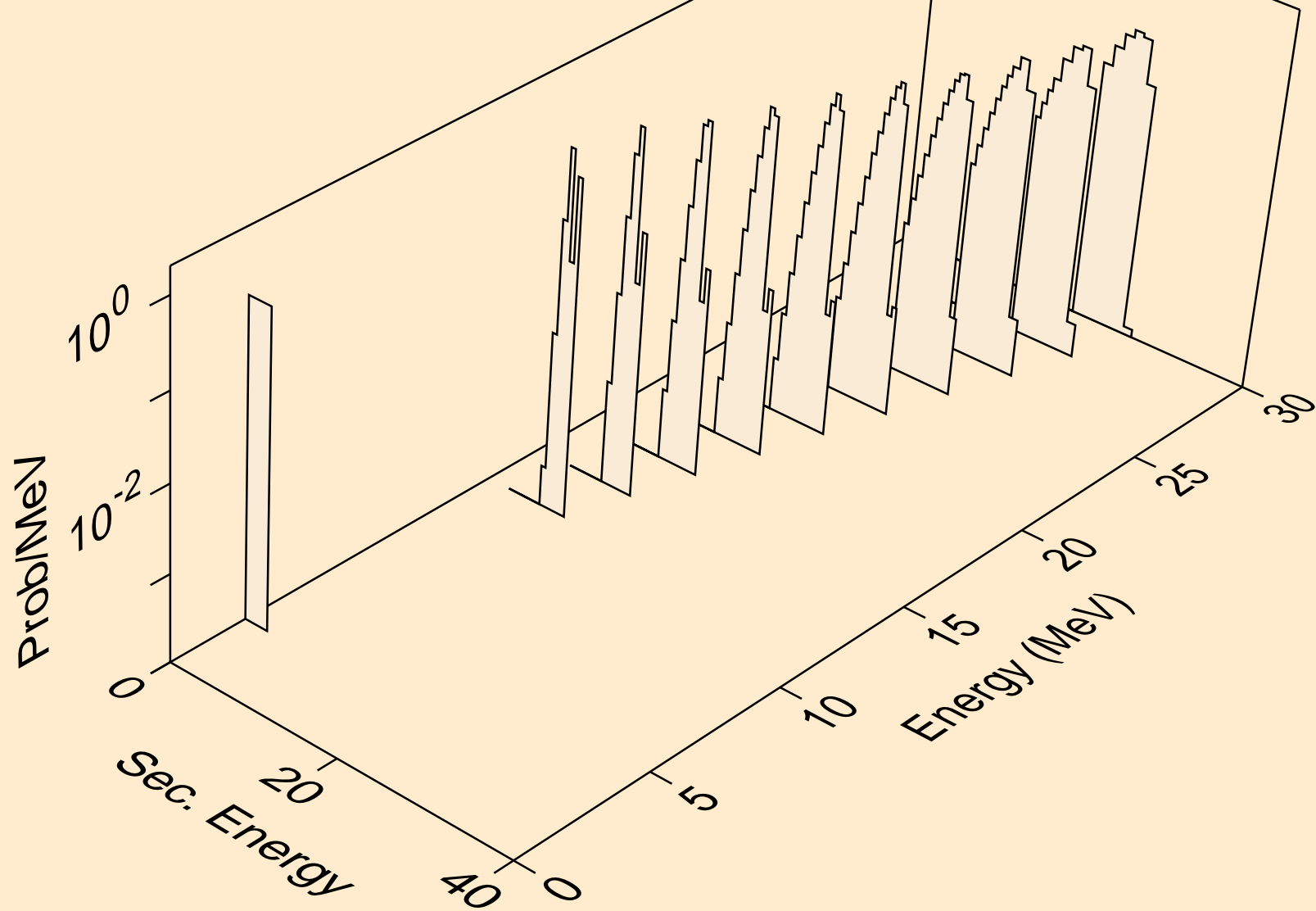

MD259 NEUTRON ACER TENDL-2021 LIBRARY; T=293.6K
alphas from (n,x)

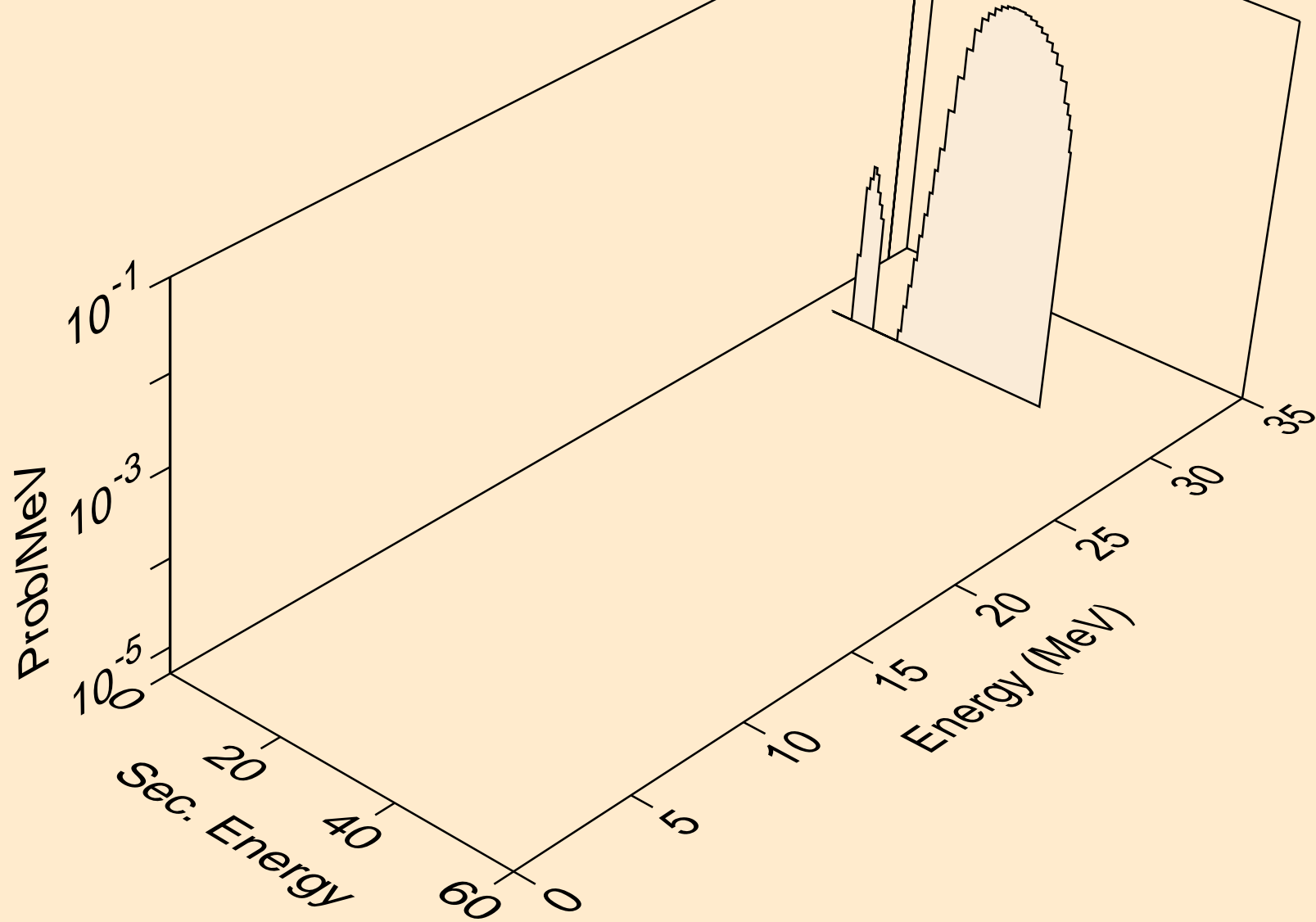

MD259 NEUTRON ACER TENDL-2021 LIBRARY; T=293.6K
alphas from (n,n*)a

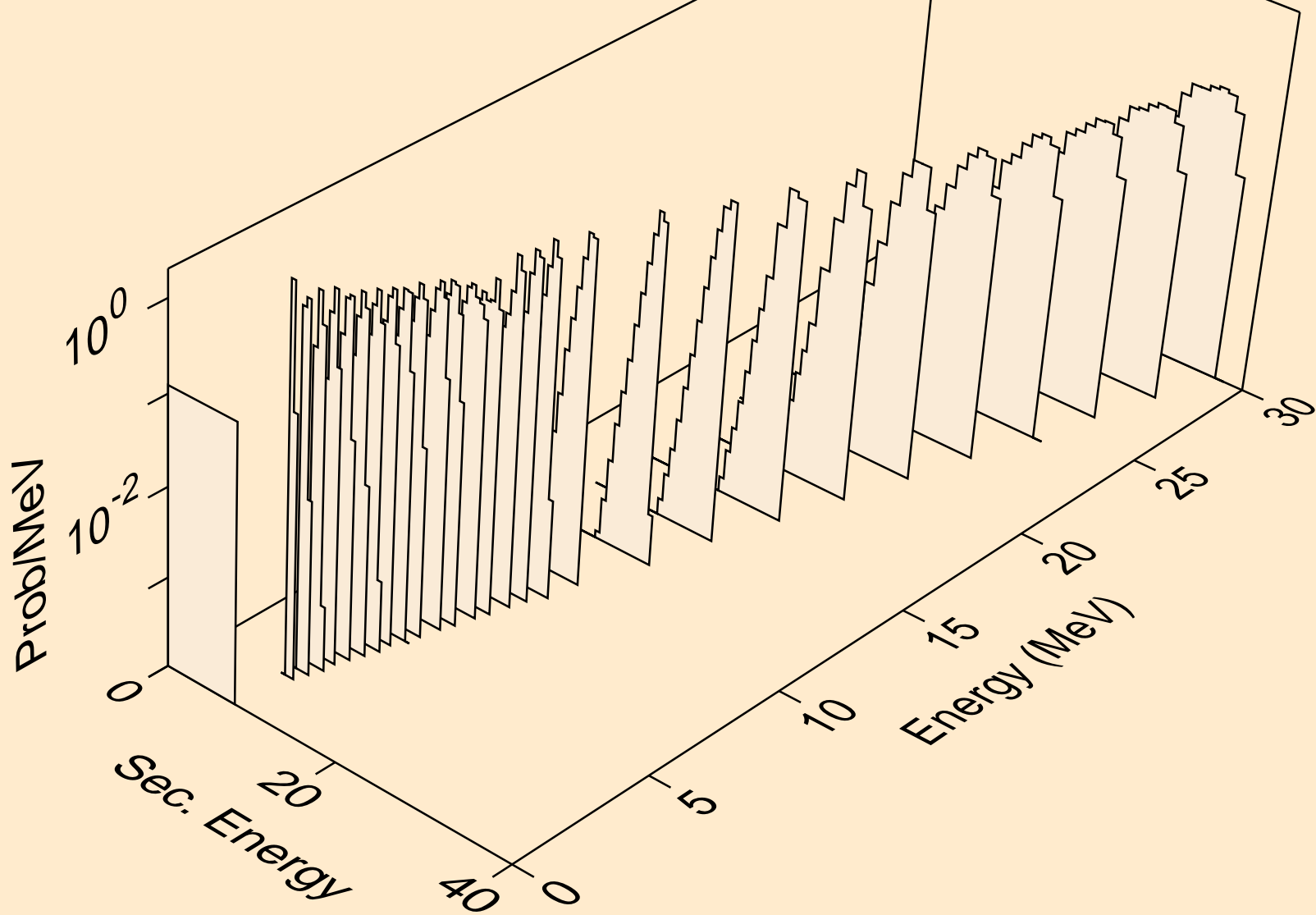

MD259 NEUTRON ACER TENDL-2021 LIBRARY; T=293.6K
alphas from (n,2n)a

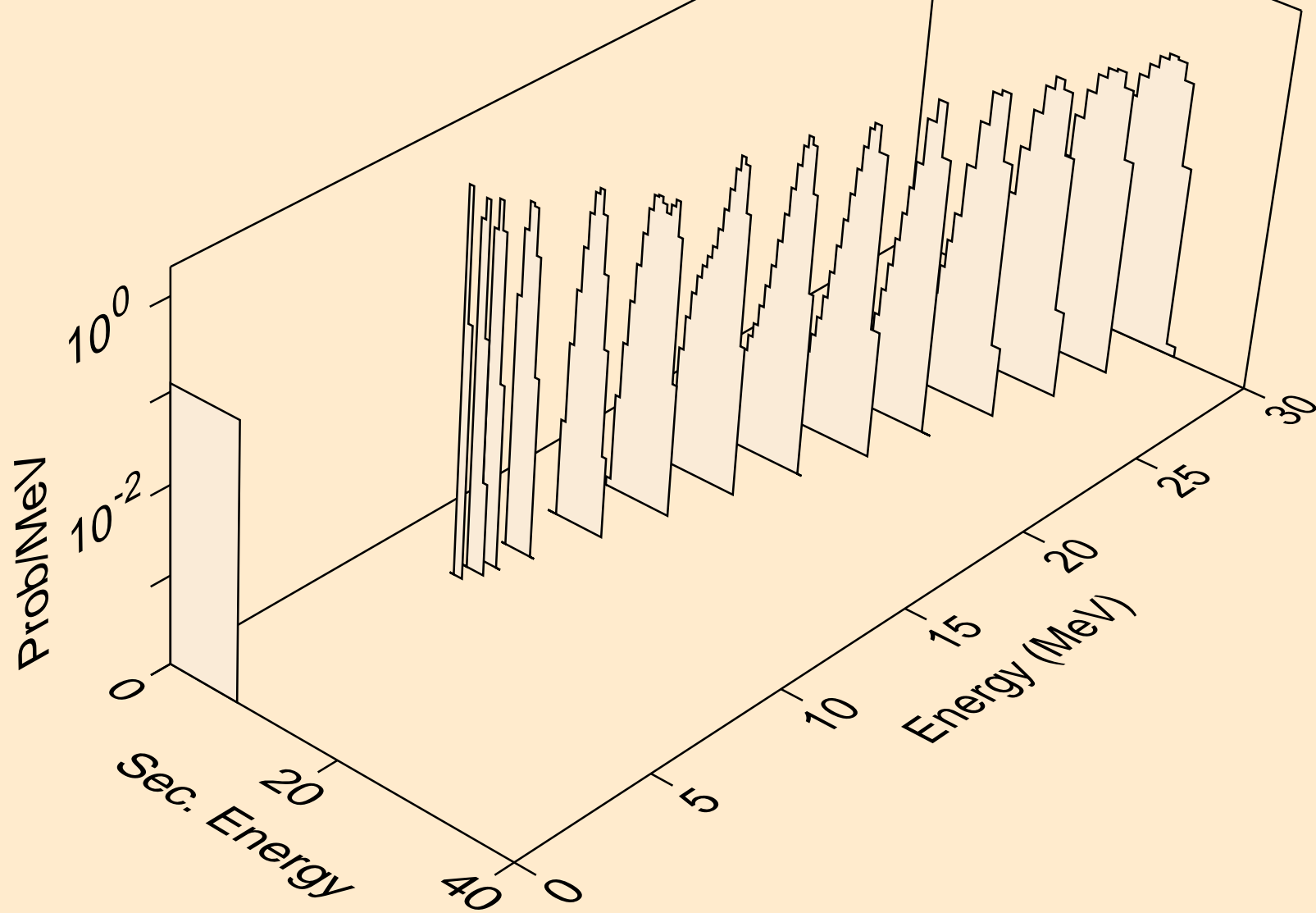

MD259 NEUTRON ACER TENDL-2021 LIBRARY; T=293.6K
alphas from (n,3n)a

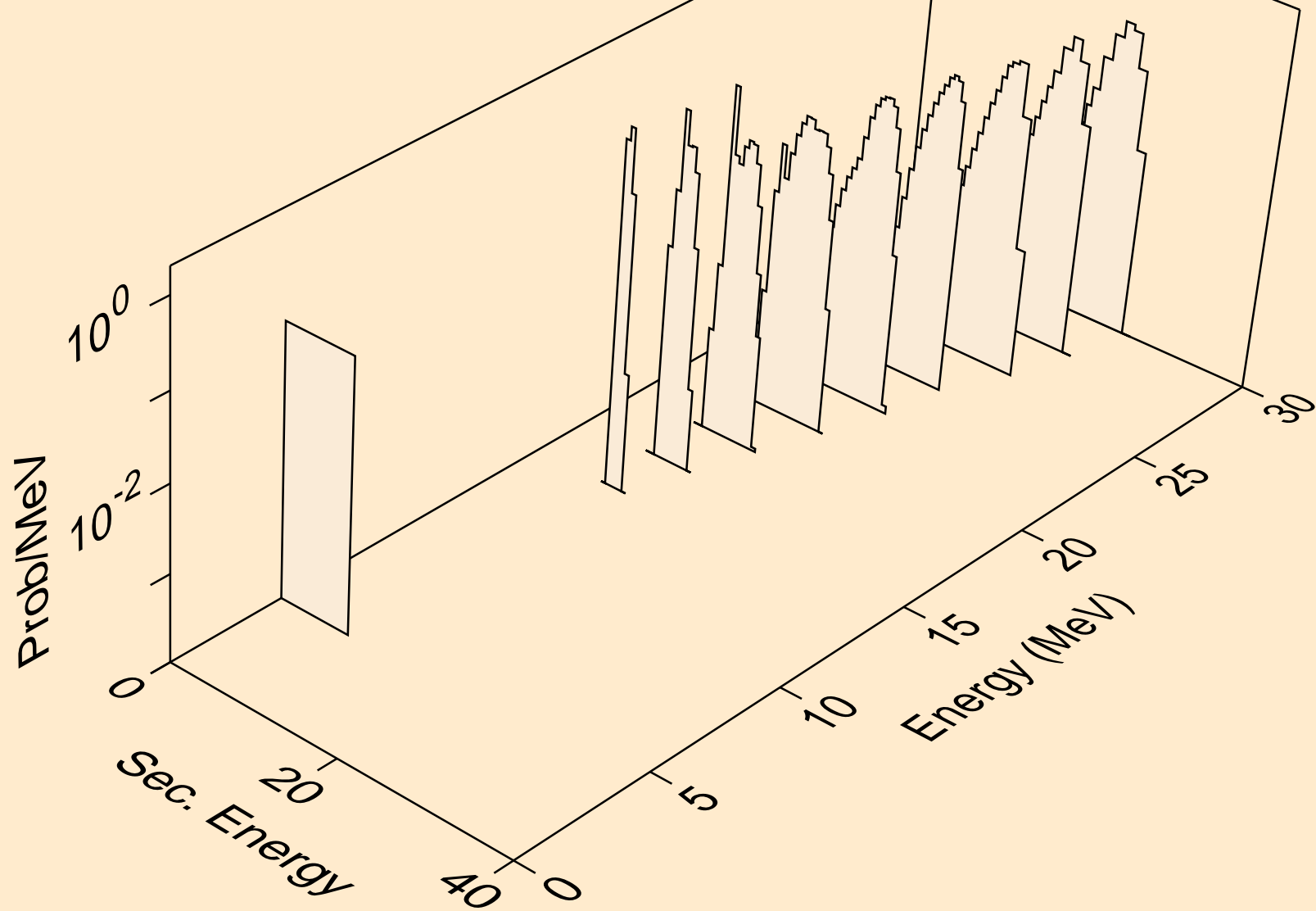

MD259 NEUTRON ACER TENDL-2021 LIBRARY; T=293.6K
alphas from (n,npa)

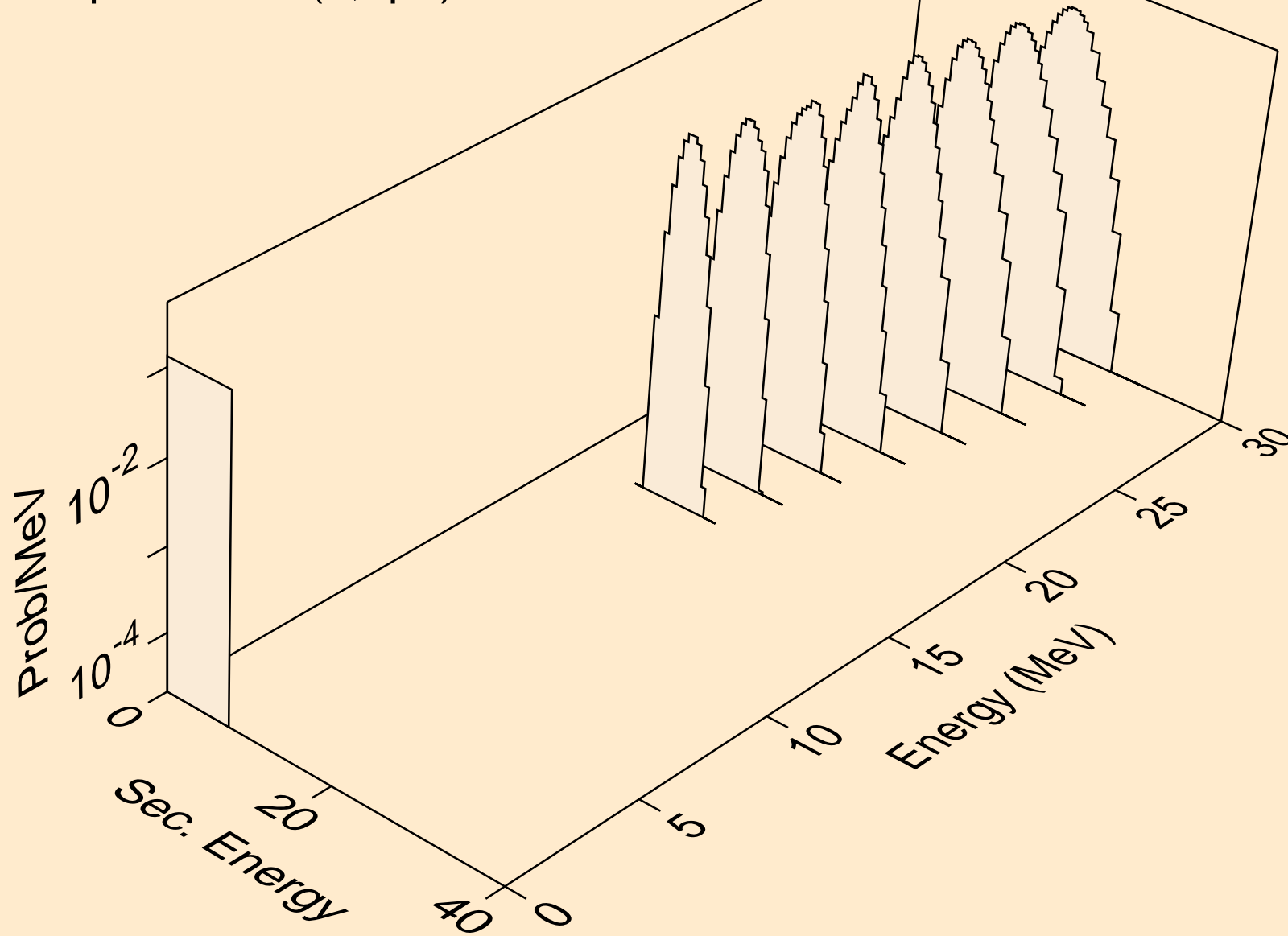

MD259 NEUTRON ACER TENDL-2021 LIBRARY; T=293.6K
alphas from (n,a)

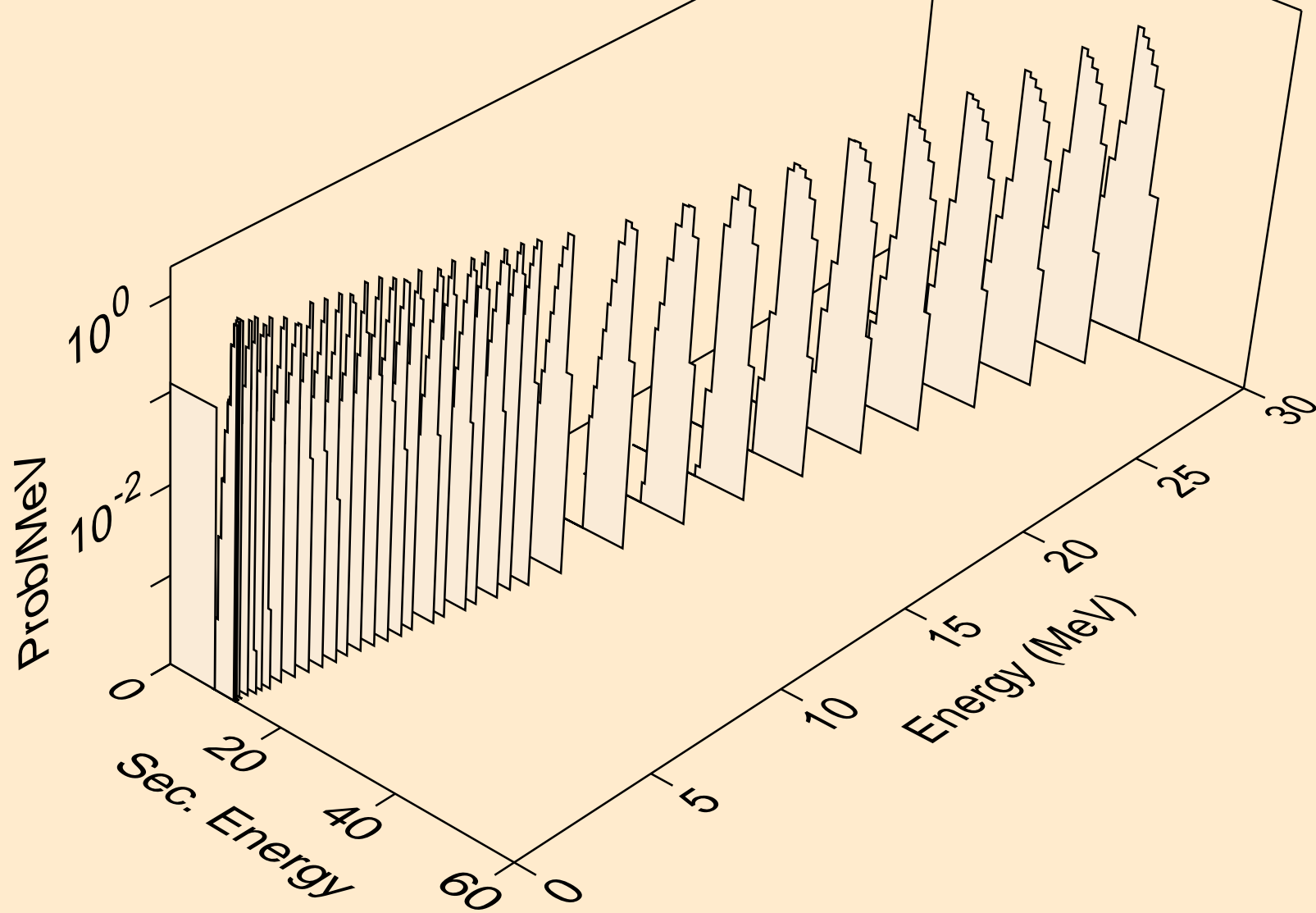

MD259 NEUTRON ACER TENDL-2021 LIBRARY; T=293.6K
alphas from (n,pa)

