

MD261 NEUTRON ACER TENDL-2021 LIBRARY; T=293.6K

Principal cross sections

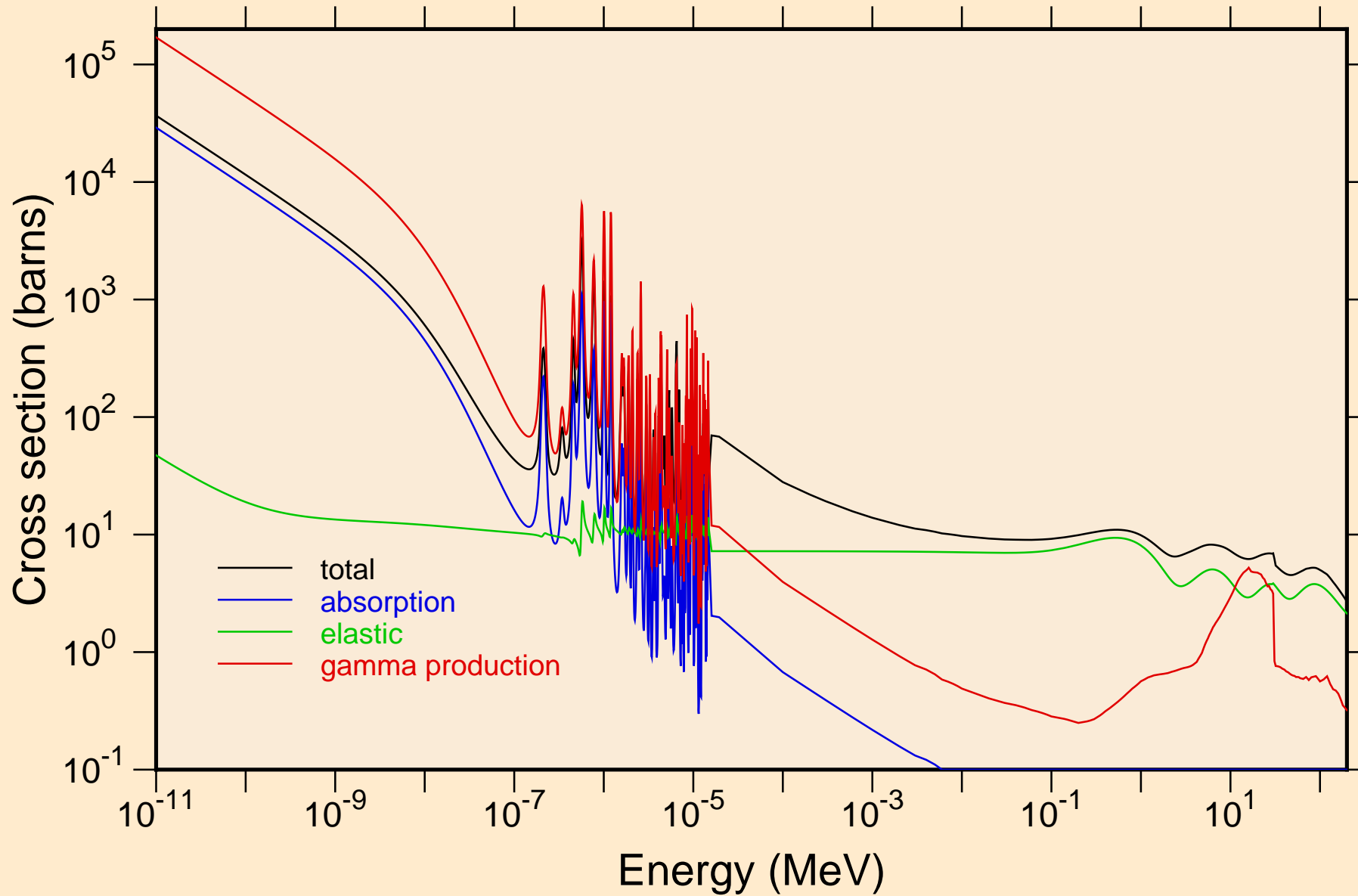

MD261 NEUTRON ACER TENDL-2021 LIBRARY; T=293.6K
resonance total cross section

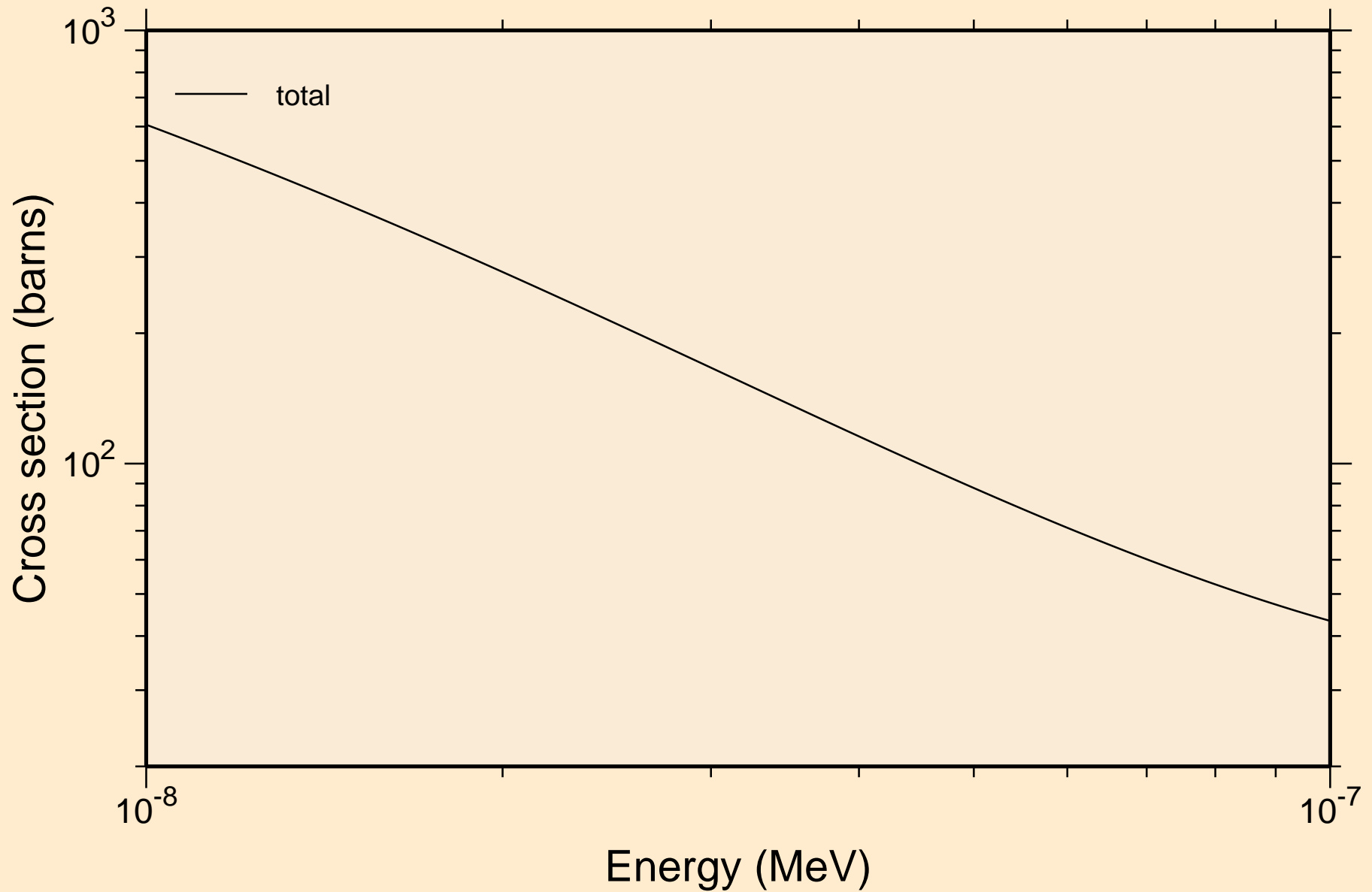

MD261 NEUTRON ACER TENDL-2021 LIBRARY; T=293.6K
resonance total cross section

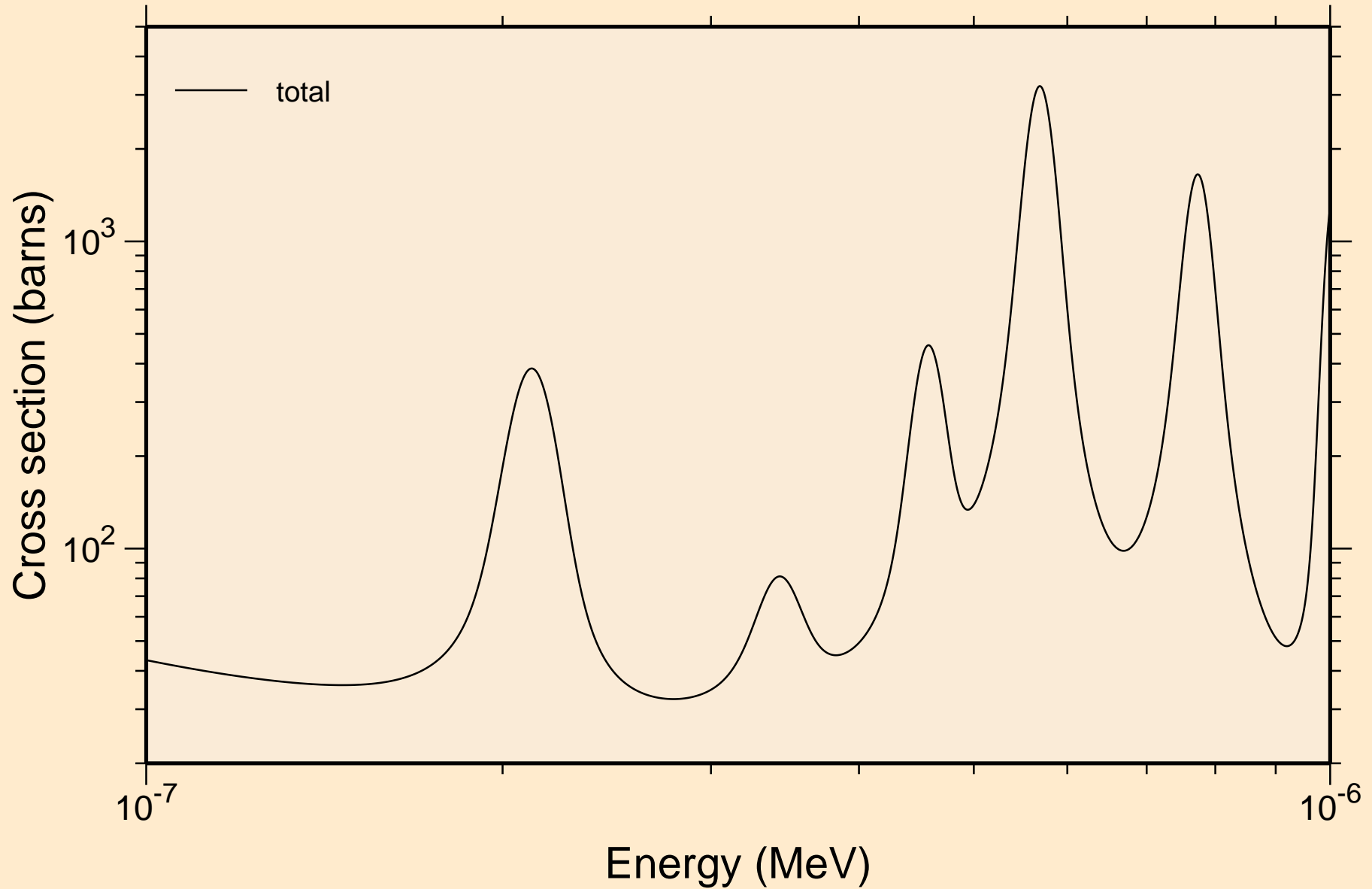

MD261 NEUTRON ACER TENDL-2021 LIBRARY; T=293.6K
resonance total cross section

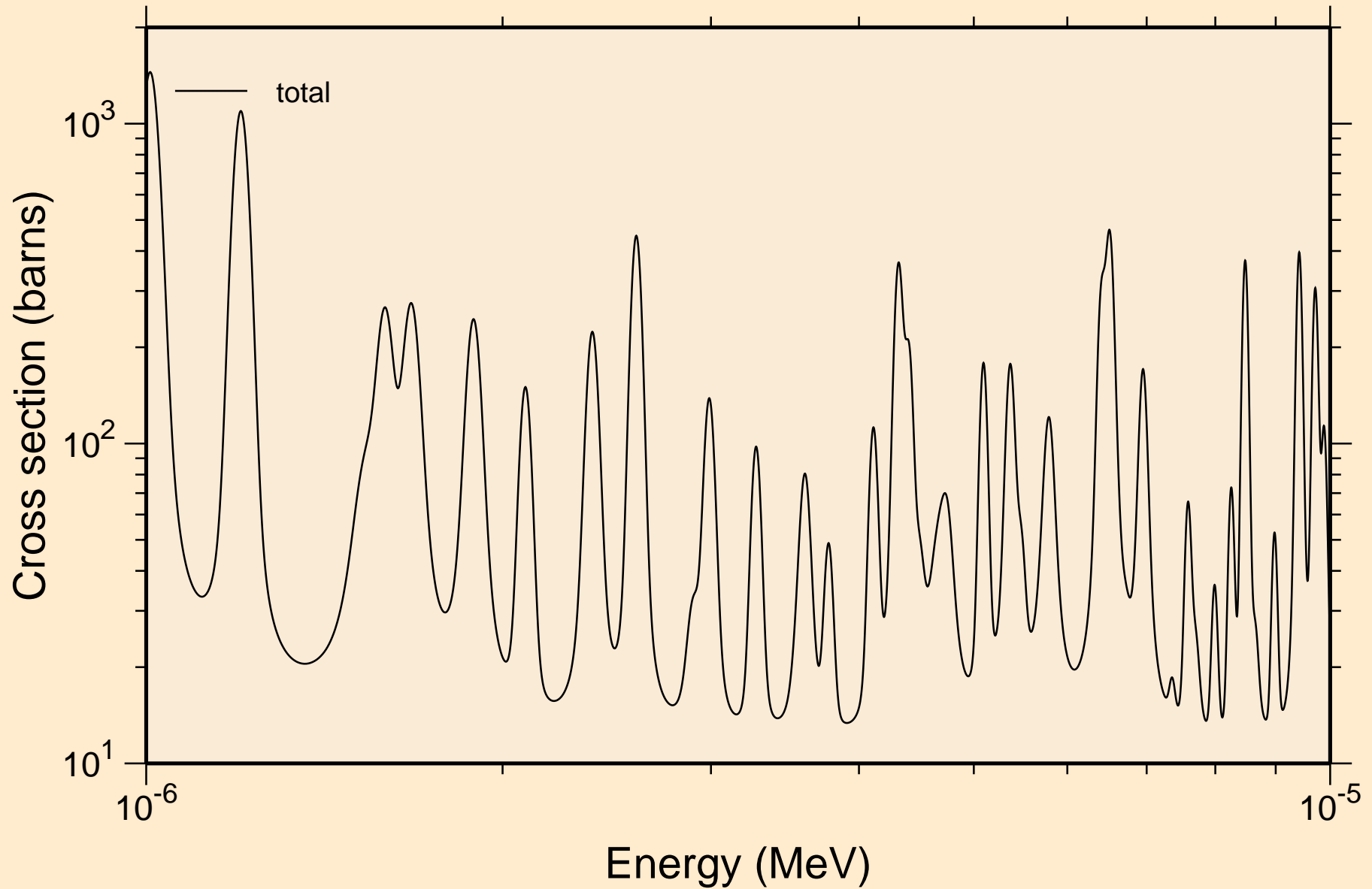

MD261 NEUTRON ACER TENDL-2021 LIBRARY; T=293.6K
resonance total cross section

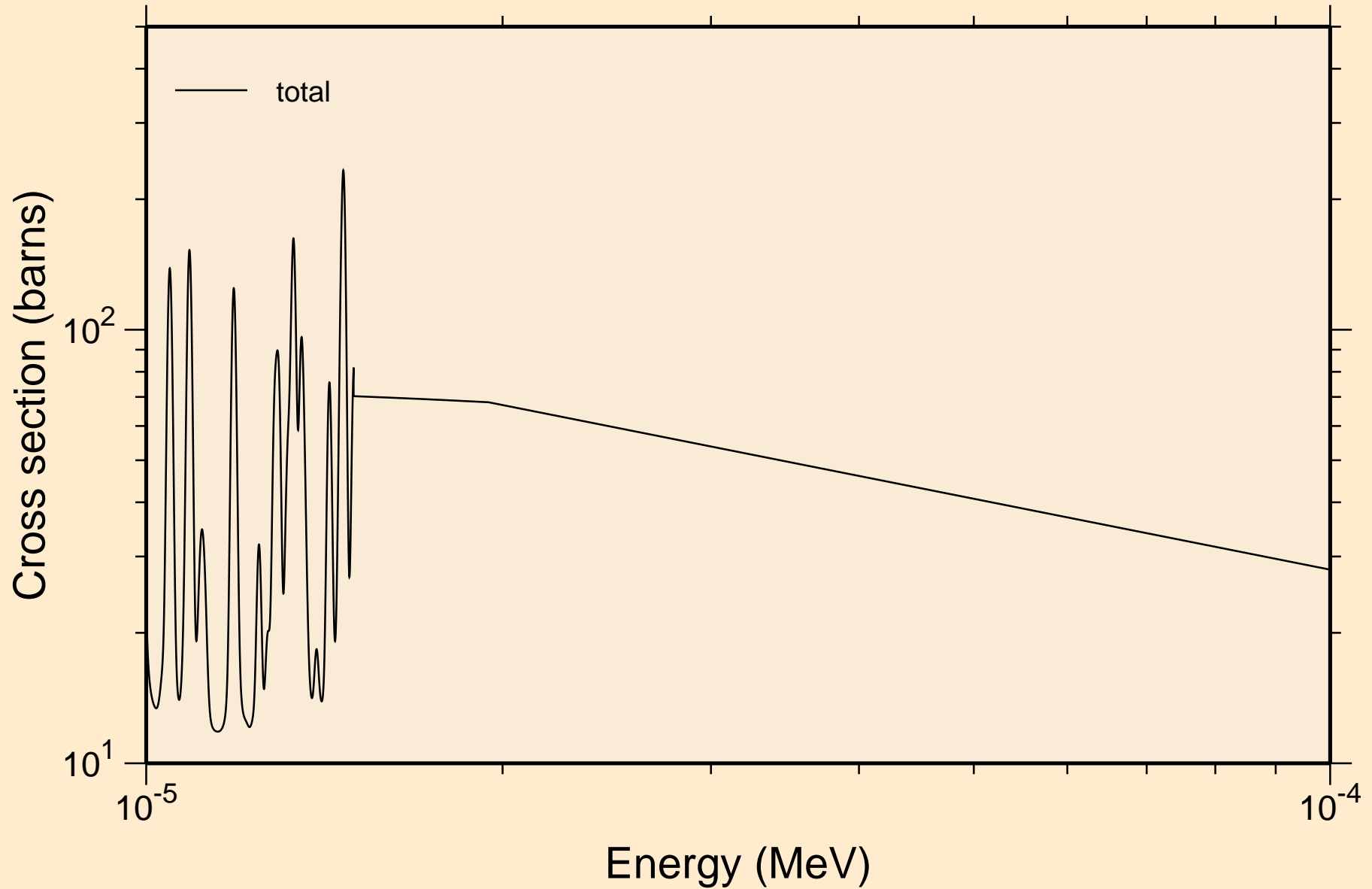

MD261 NEUTRON ACER TENDL-2021 LIBRARY; T=293.6K
resonance total cross section

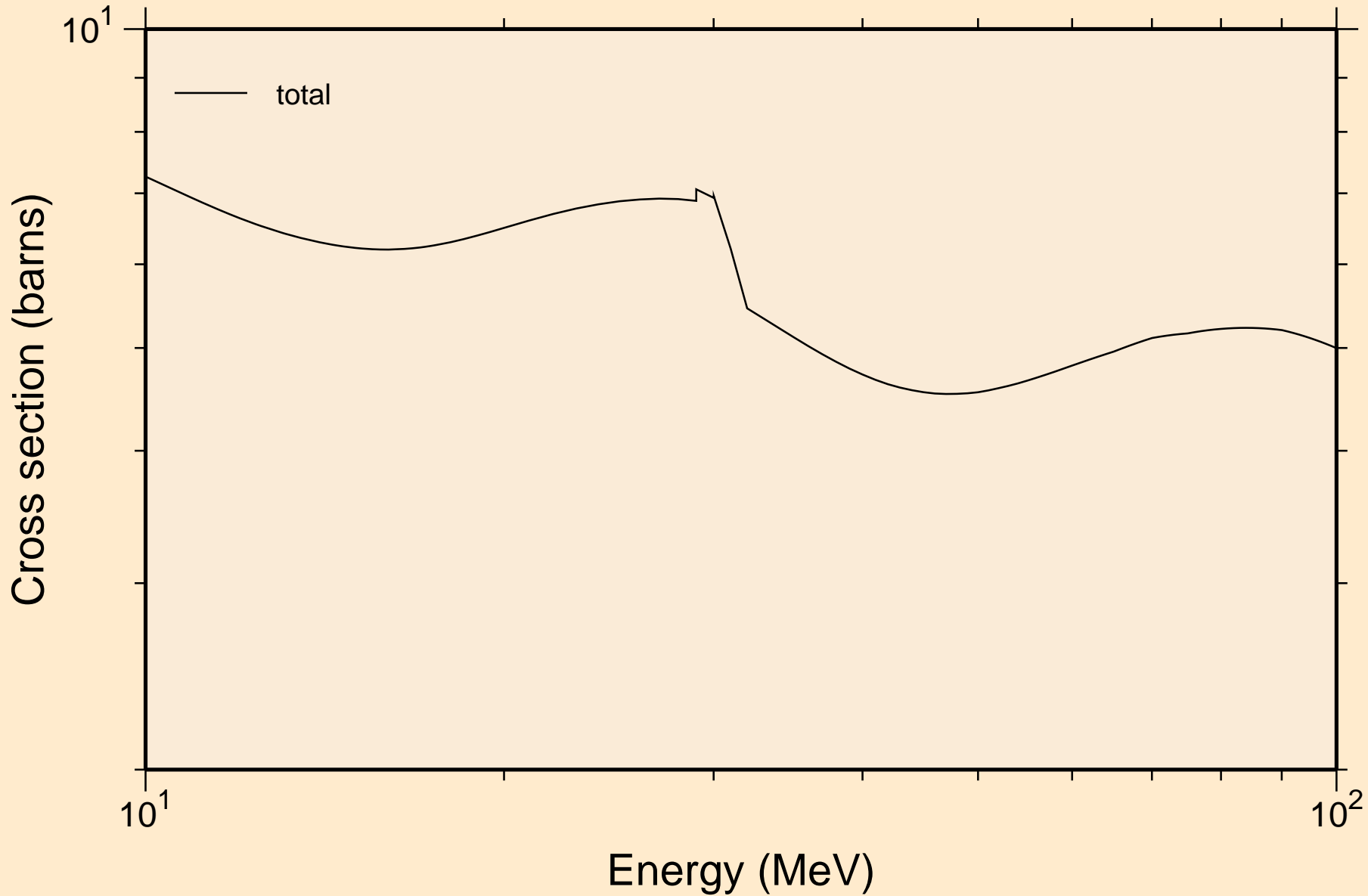

MD261 NEUTRON ACER TENDL-2021 LIBRARY; T=293.6K
resonance absorption cross sections

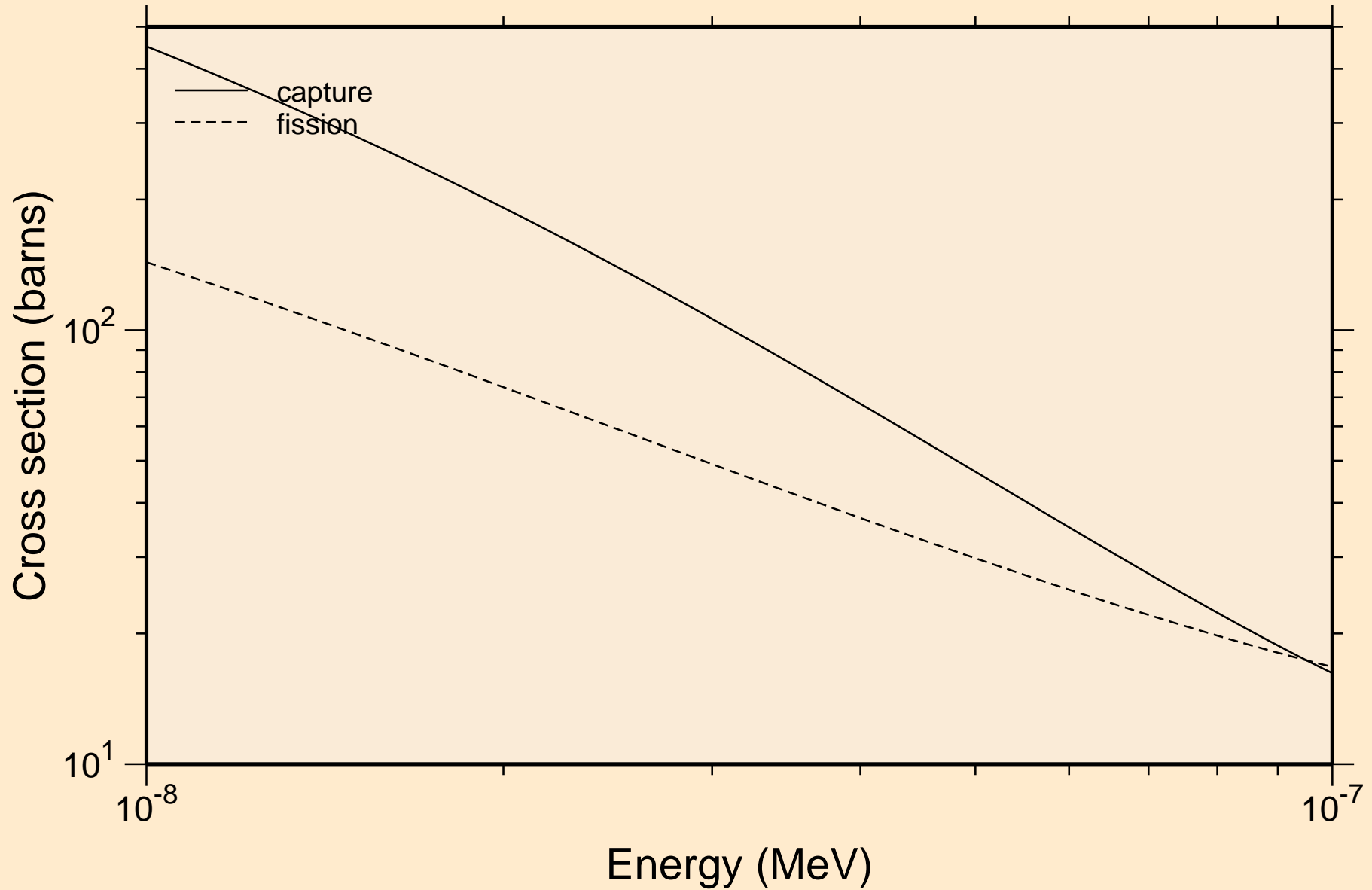

MD261 NEUTRON ACER TENDL-2021 LIBRARY; T=293.6K
resonance absorption cross sections

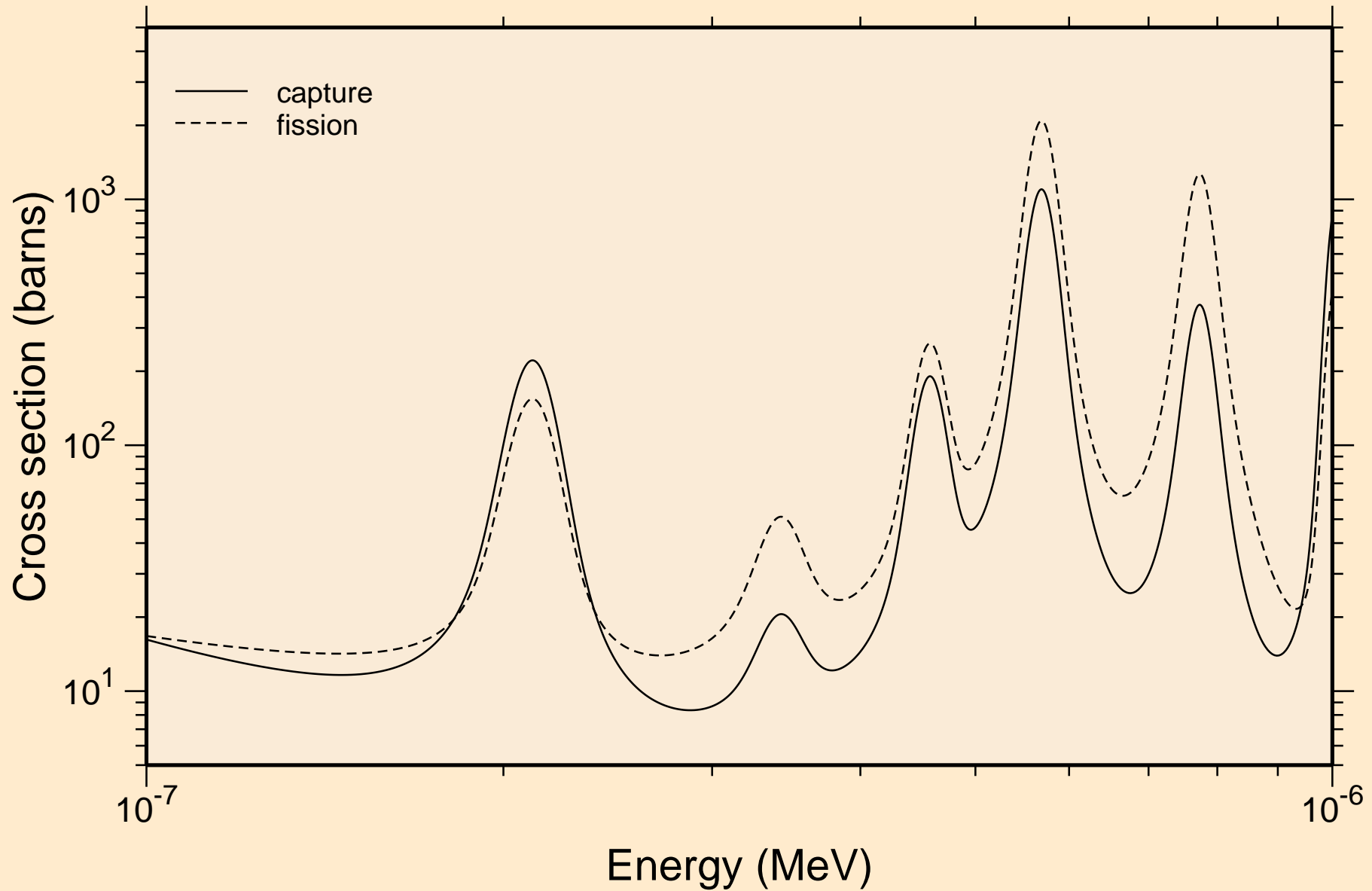

MD261 NEUTRON ACER TENDL-2021 LIBRARY; T=293.6K
resonance absorption cross sections

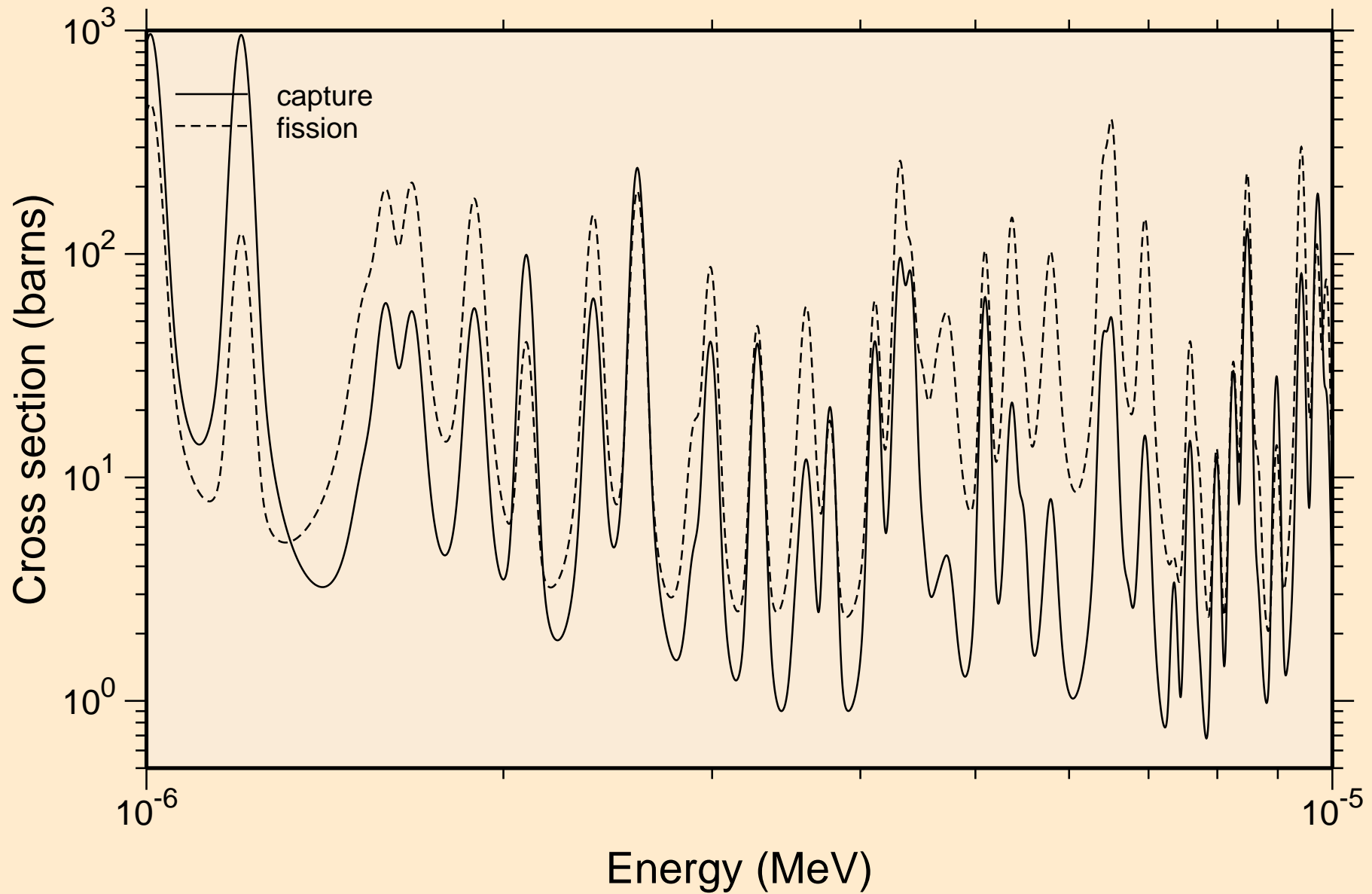

MD261 NEUTRON ACER TENDL-2021 LIBRARY; T=293.6K
resonance absorption cross sections

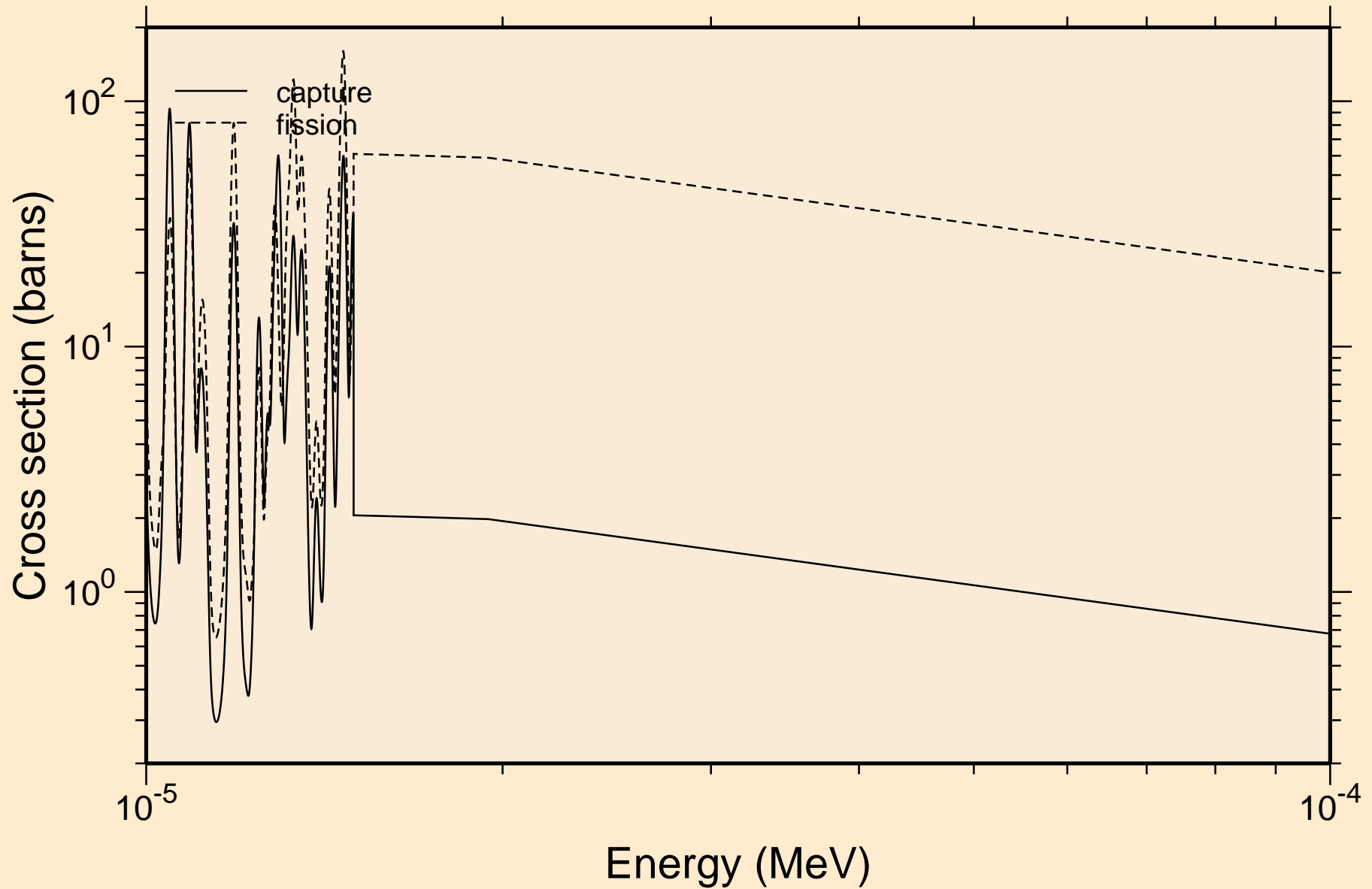

MD261 NEUTRON ACER TENDL-2021 LIBRARY; T=293.6K
resonance absorption cross sections

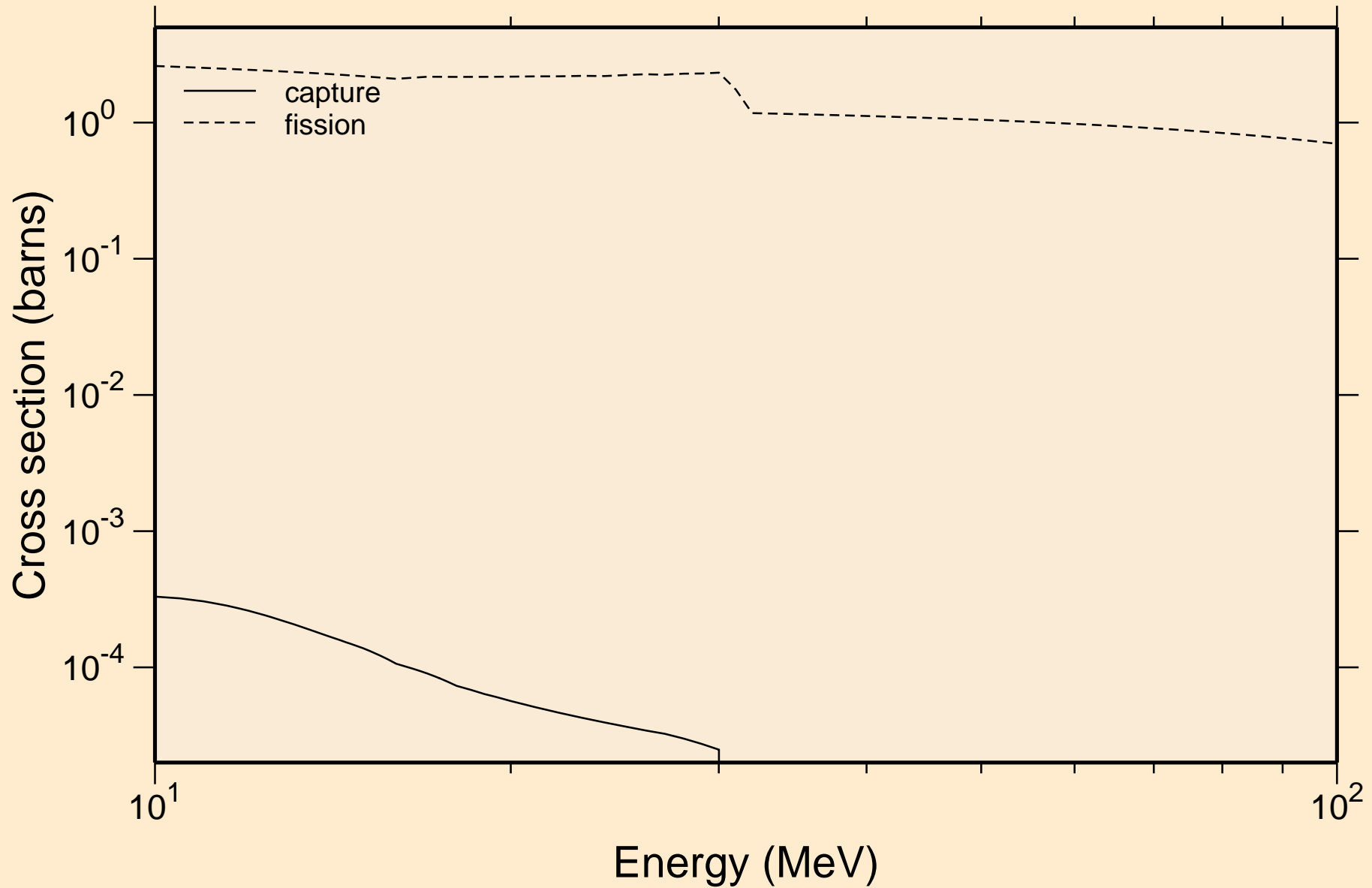

MD261 NEUTRON ACER TENDL-2021 LIBRARY; T=293.6K
Heating

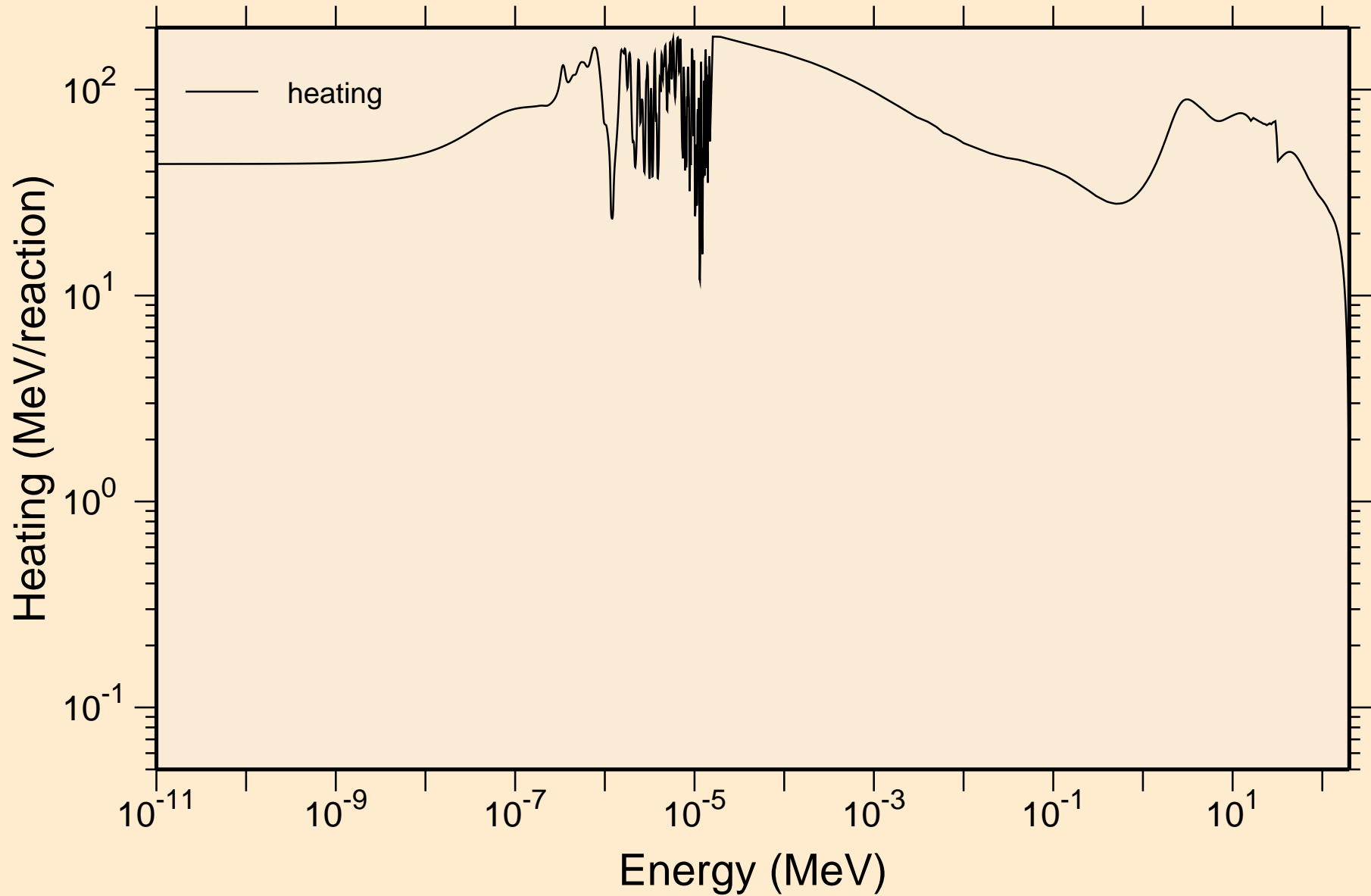

MD261 NEUTRON ACER TENDL-2021 LIBRARY; T=293.6K
Damage

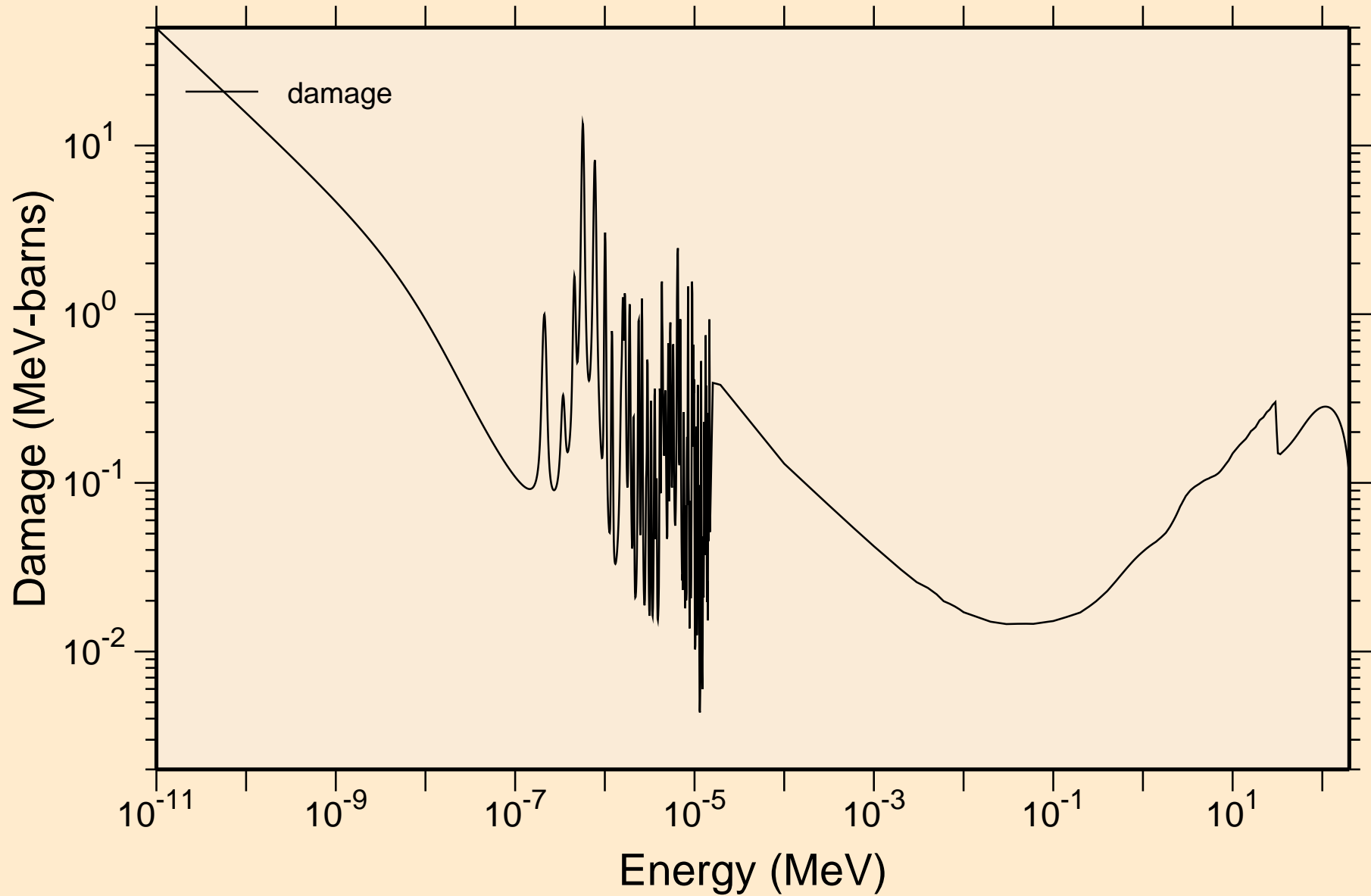

MD261 NEUTRON ACER TENDL-2021 LIBRARY; T=293.6K
Non-threshold reactions

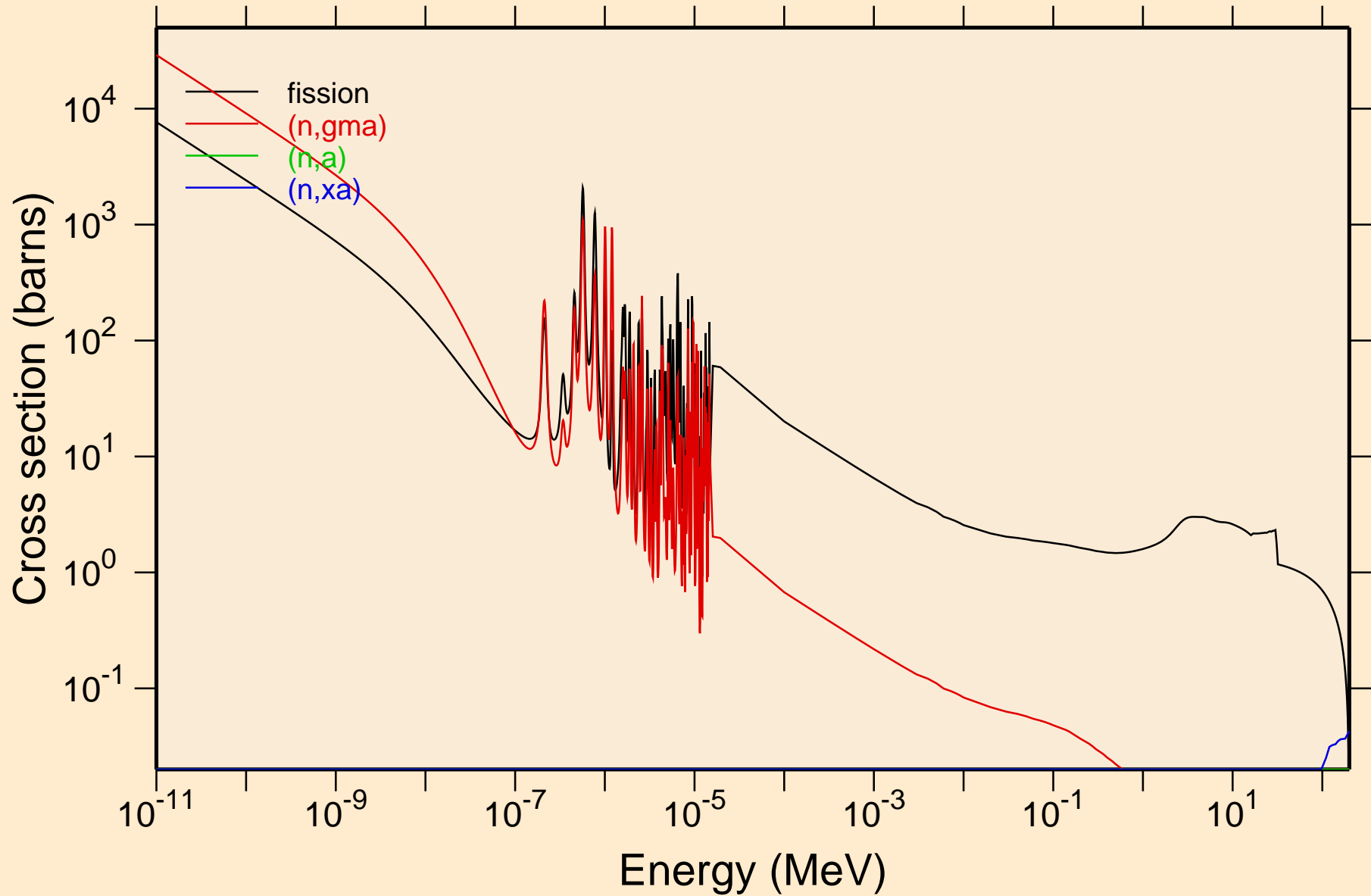

MD261 NEUTRON ACER TENDL-2021 LIBRARY; T=293.6K
Principal cross sections

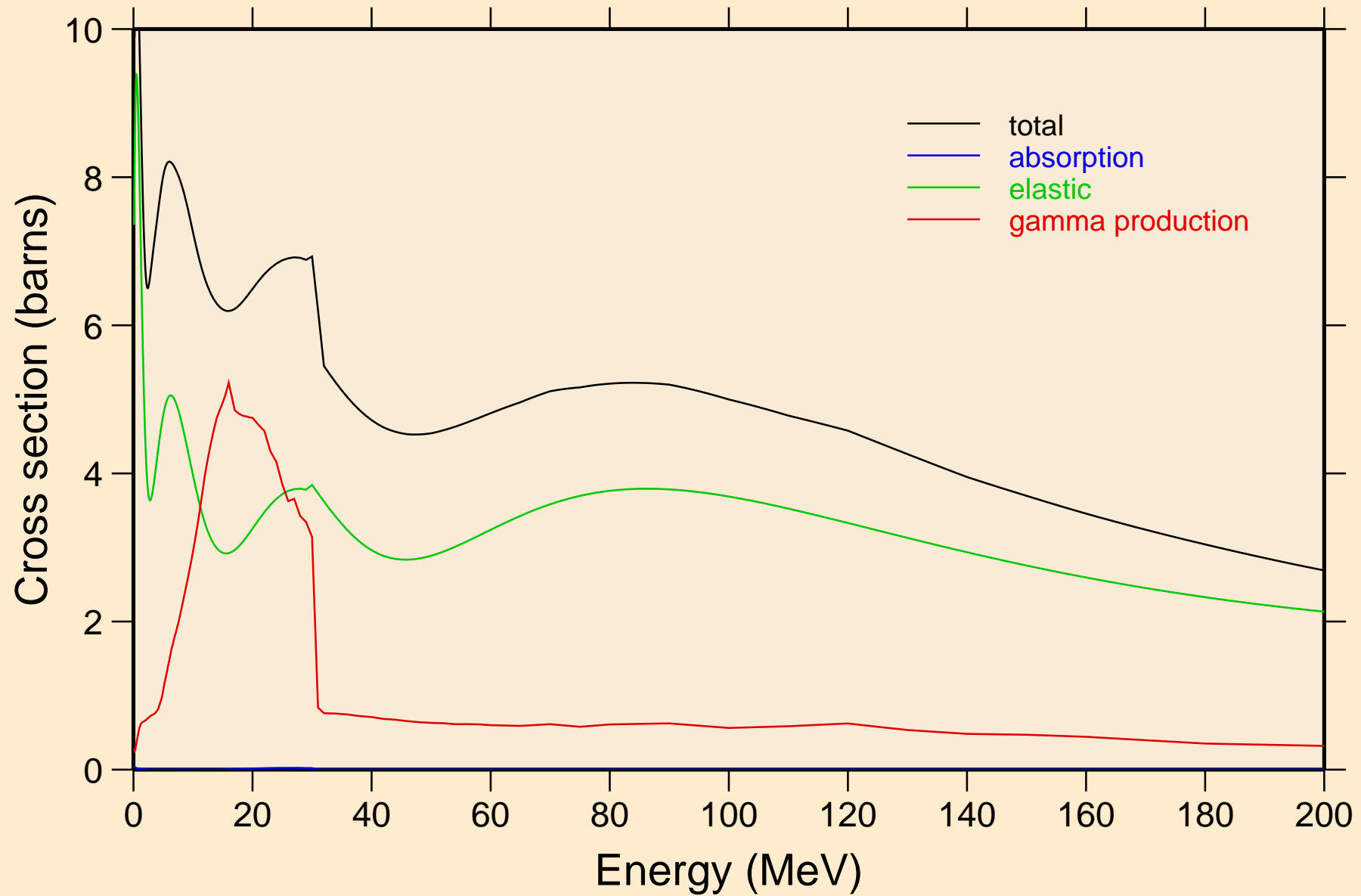

MD261 NEUTRON ACER TENDL-2021 LIBRARY; T=293.6K
Heating

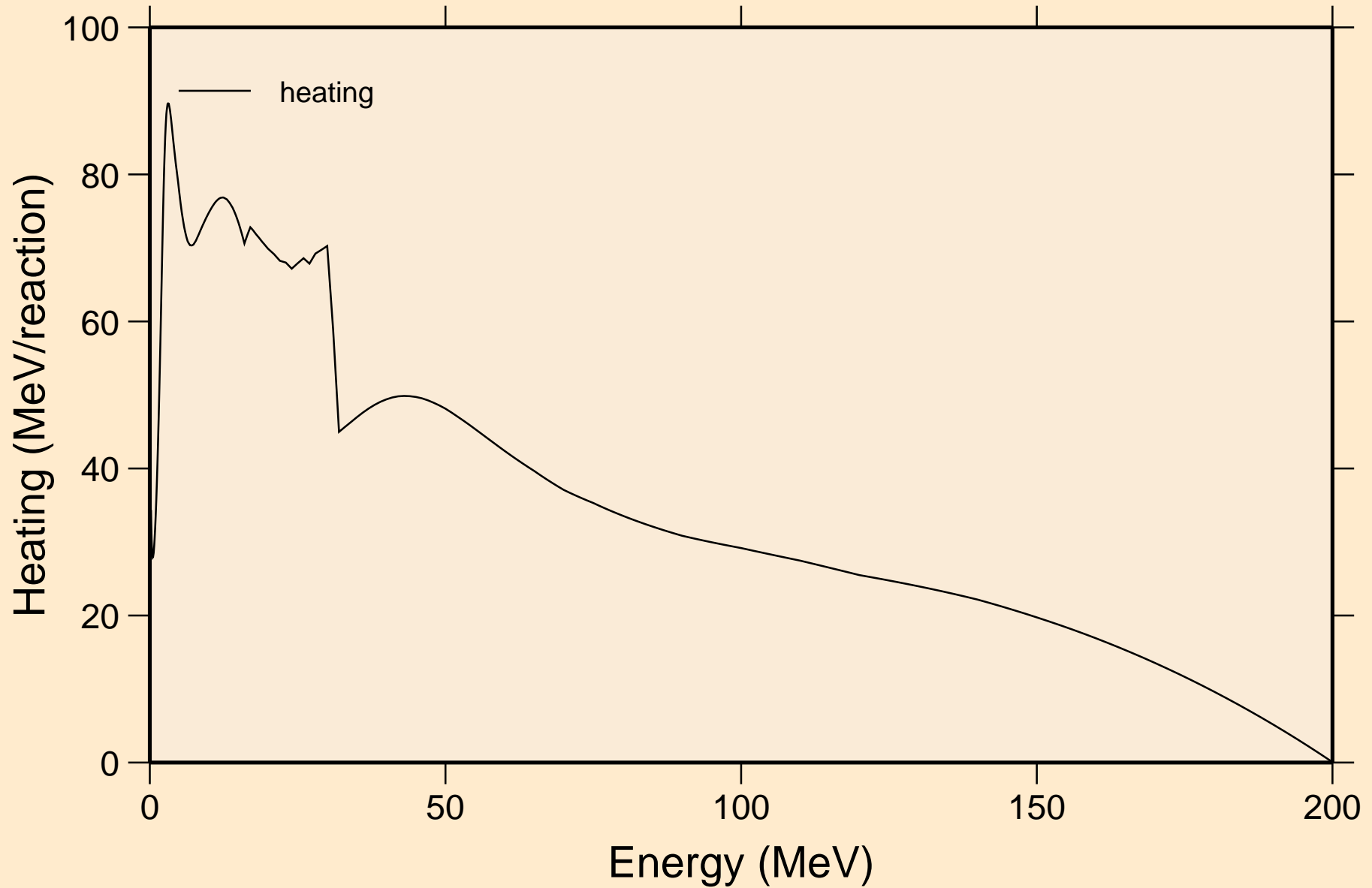

MD261 NEUTRON ACER TENDL-2021 LIBRARY; T=293.6K
Damage

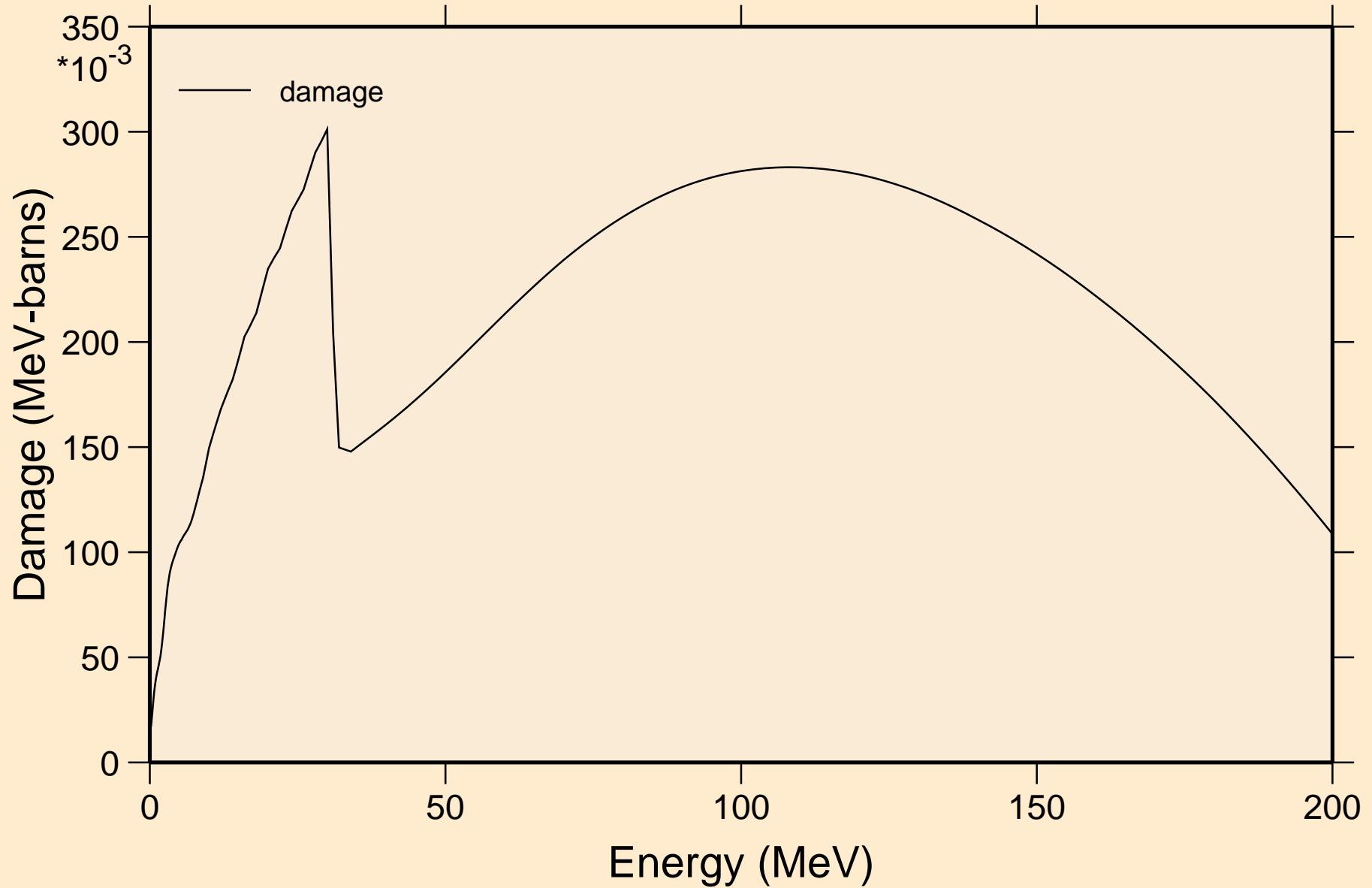

MD261 NEUTRON ACER TENDL-2021 LIBRARY; T=293.6K
Non-threshold reactions

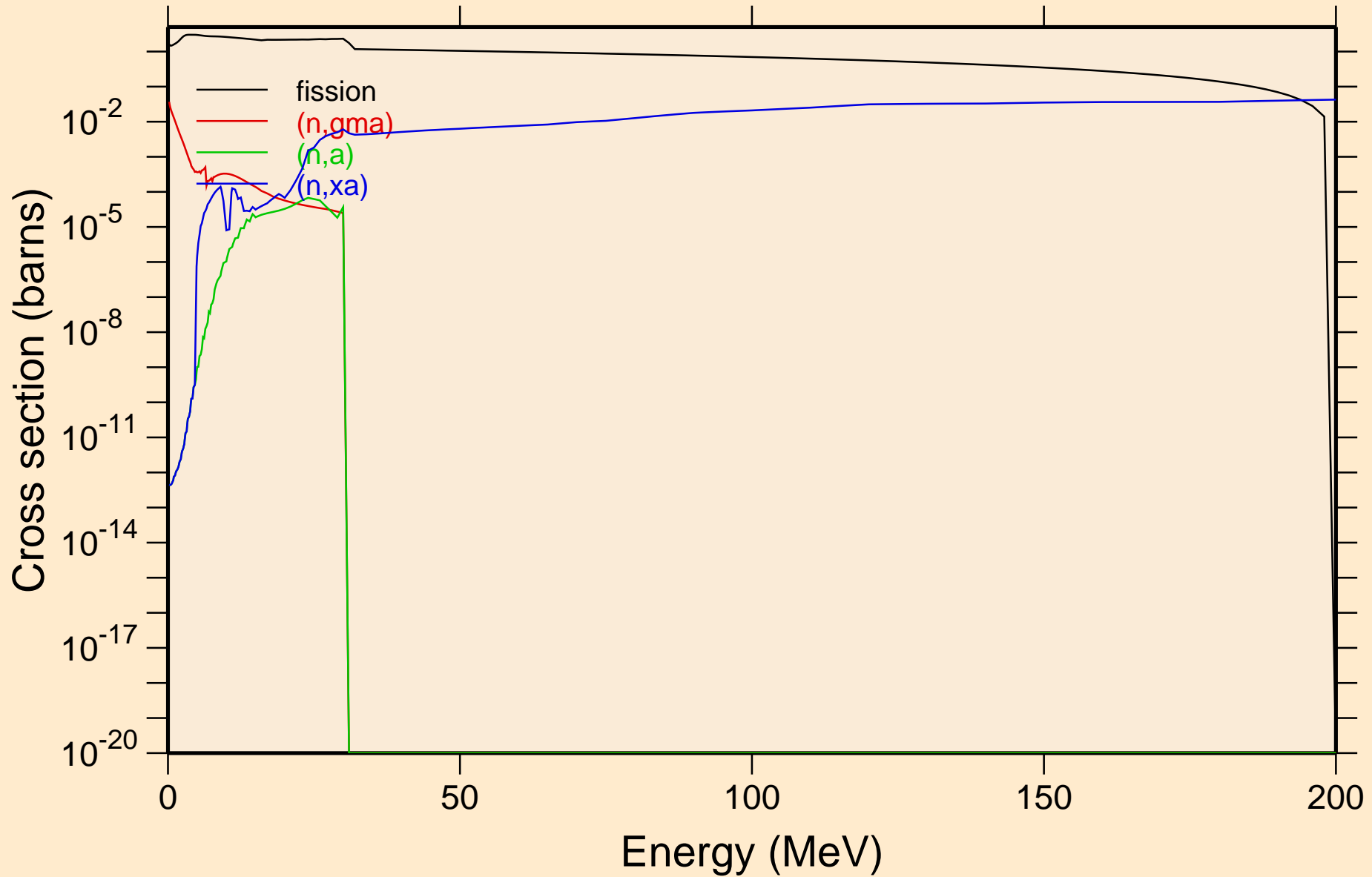

MD261 NEUTRON ACER TENDL-2021 LIBRARY; T=293.6K
Inelastic levels

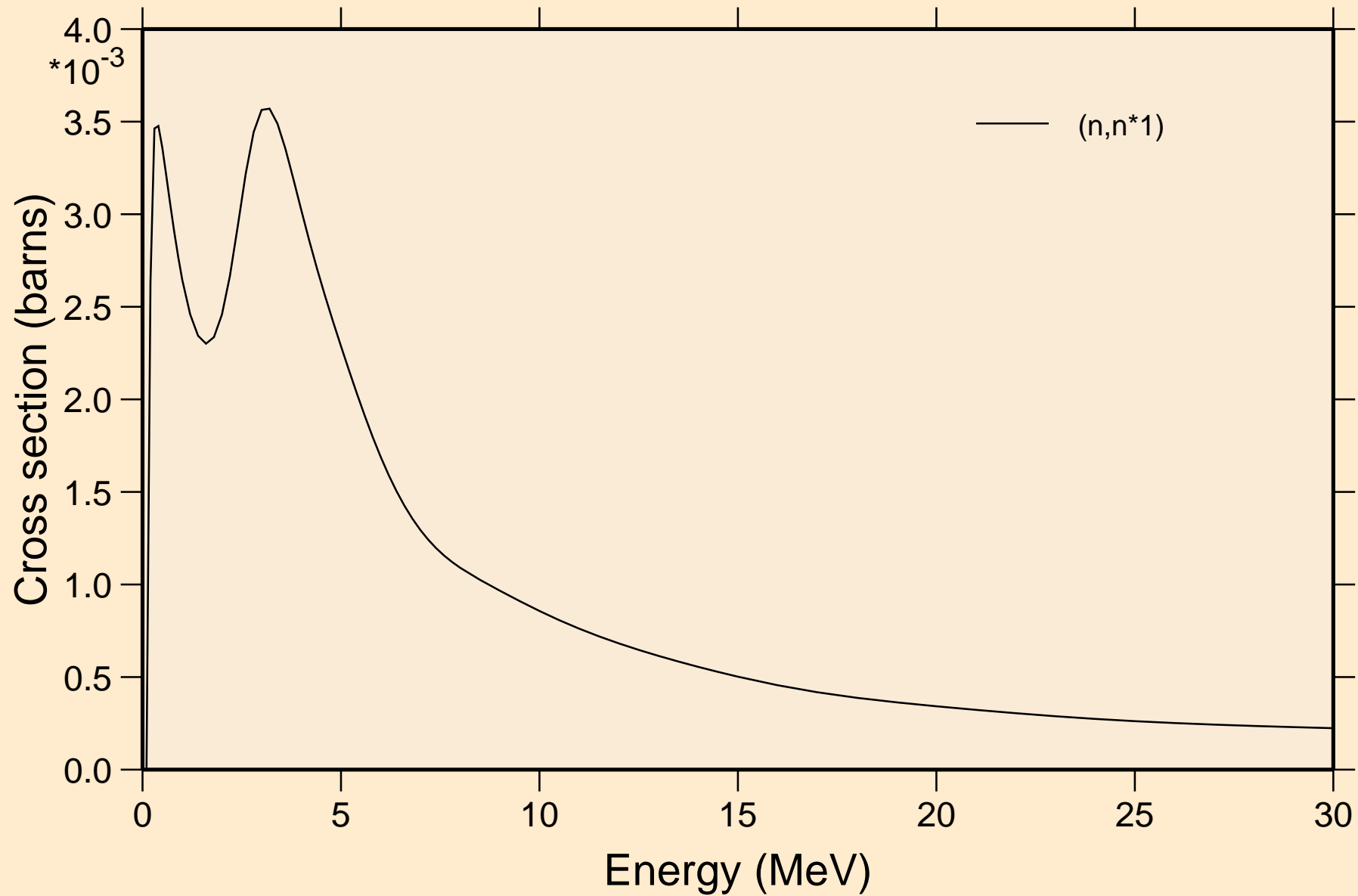

MD261 NEUTRON ACER TENDL-2021 LIBRARY; T=293.6K
Threshold reactions

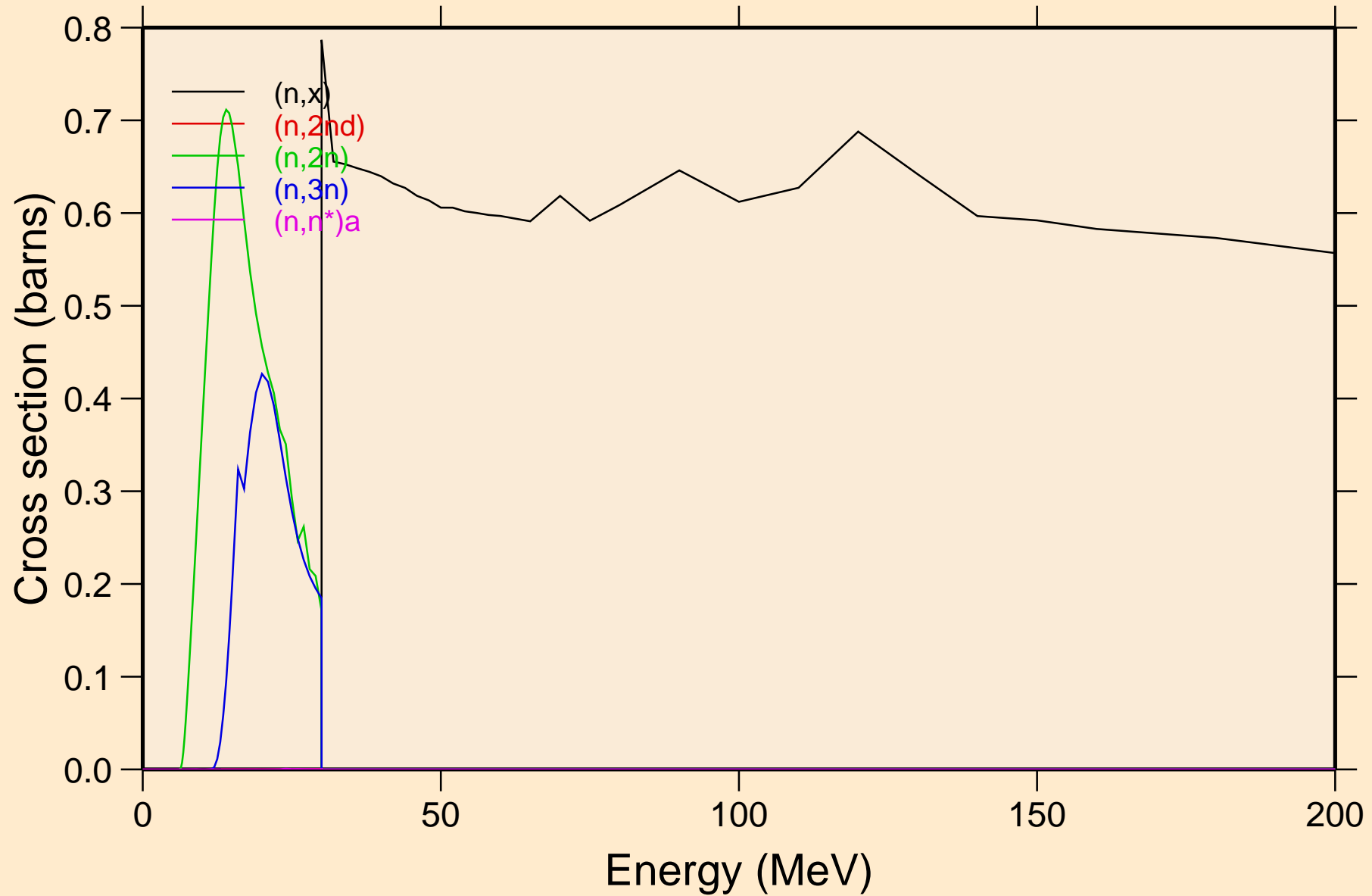

MD261 NEUTRON ACER TENDL-2021 LIBRARY; T=293.6K
Threshold reactions

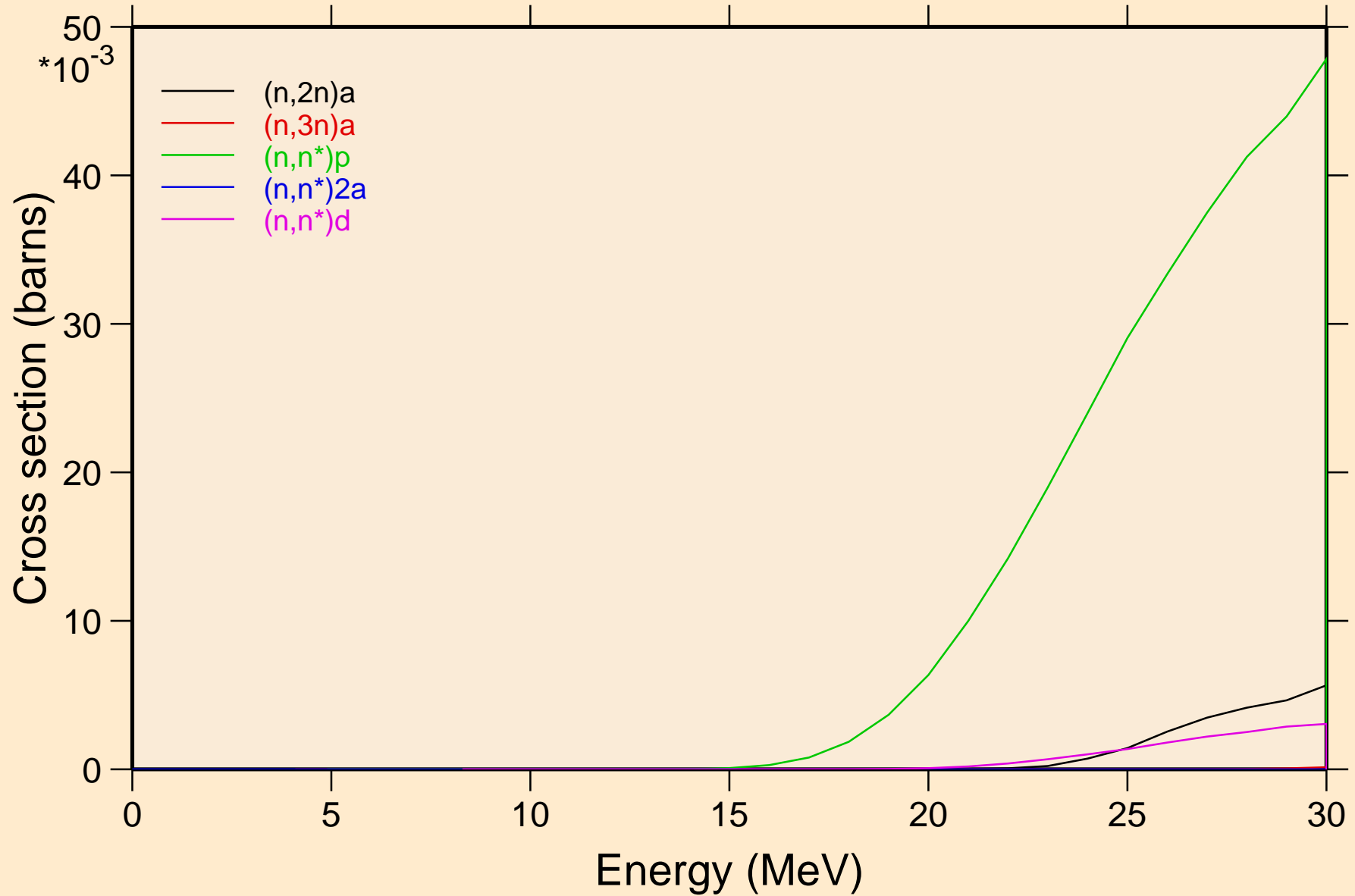

MD261 NEUTRON ACER TENDL-2021 LIBRARY; T=293.6K
Threshold reactions

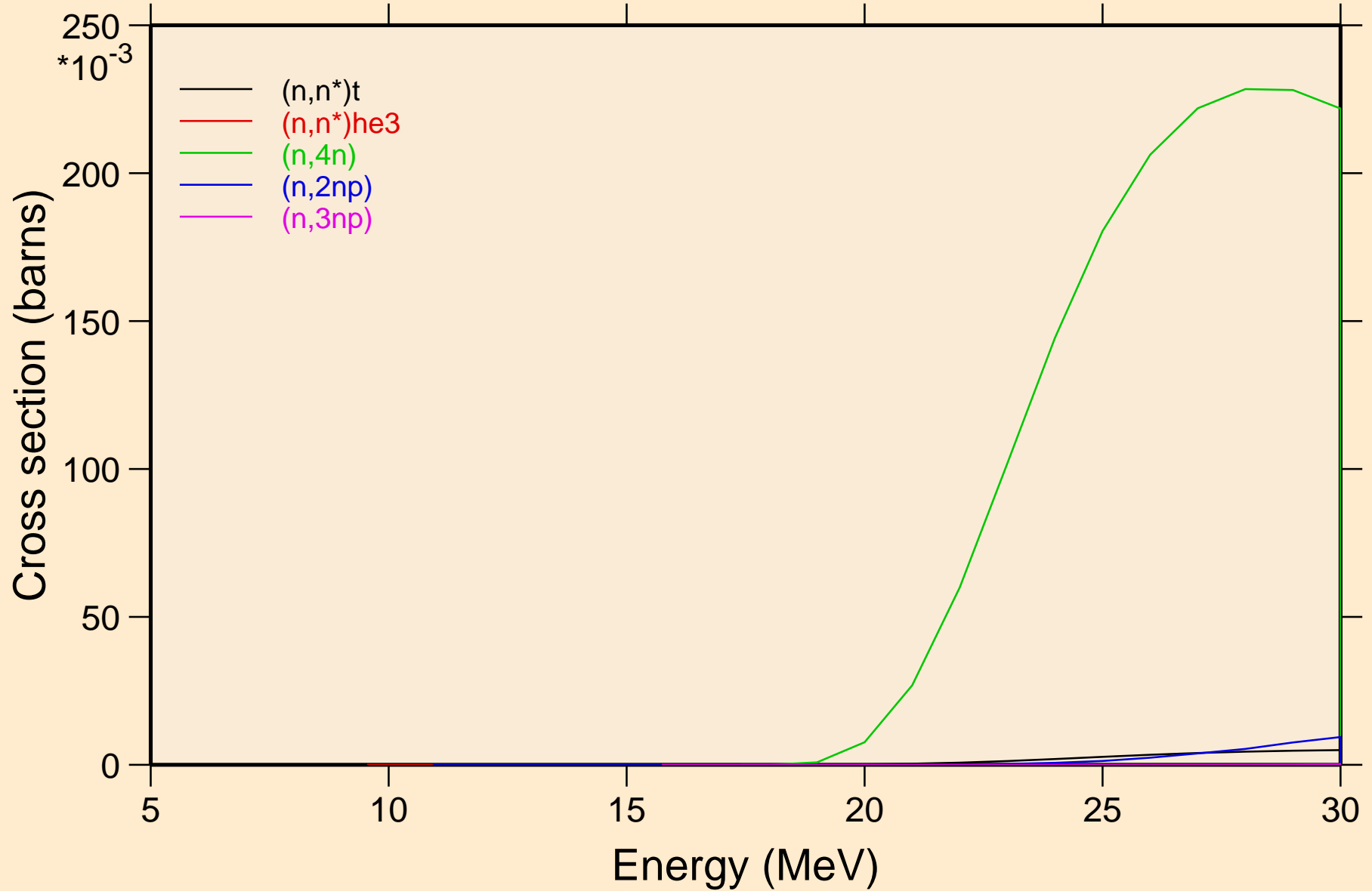

MD261 NEUTRON ACER TENDL-2021 LIBRARY; T=293.6K
Threshold reactions

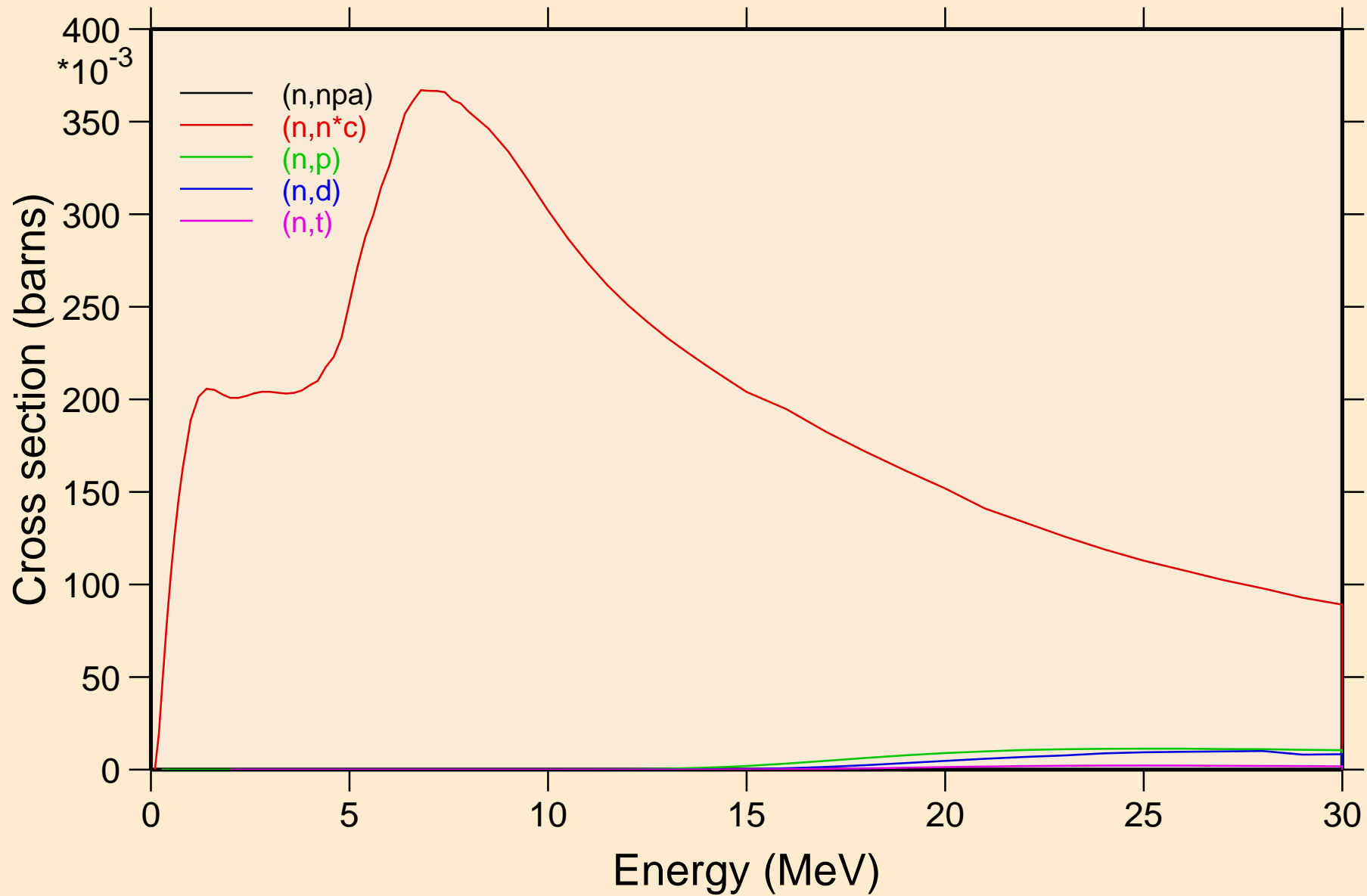

MD261 NEUTRON ACER TENDL-2021 LIBRARY; T=293.6K
Threshold reactions

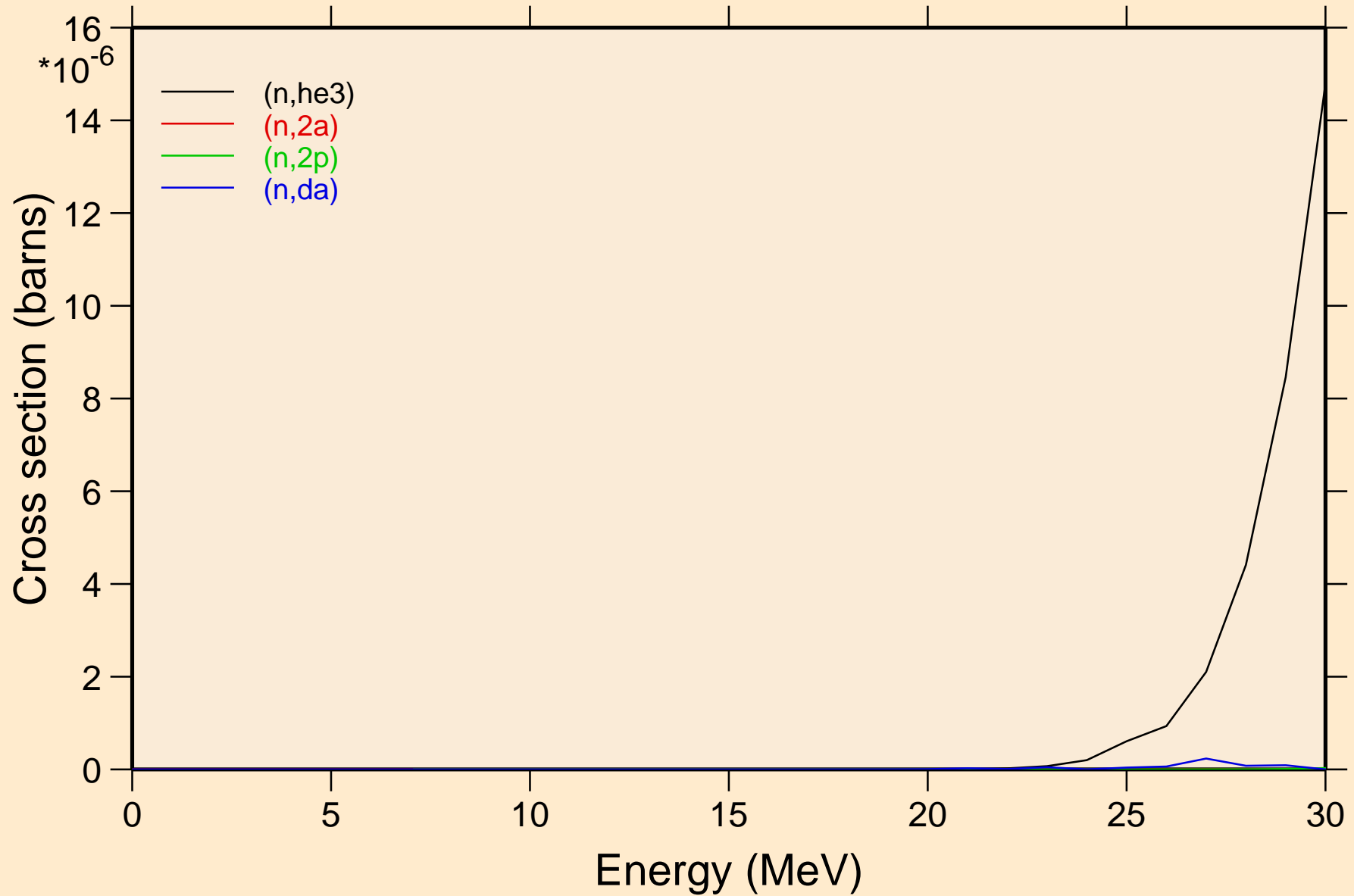

MD261 NEUTRON ACER TENDL-2021 LIBRARY; T=293.6K

Threshold reactions

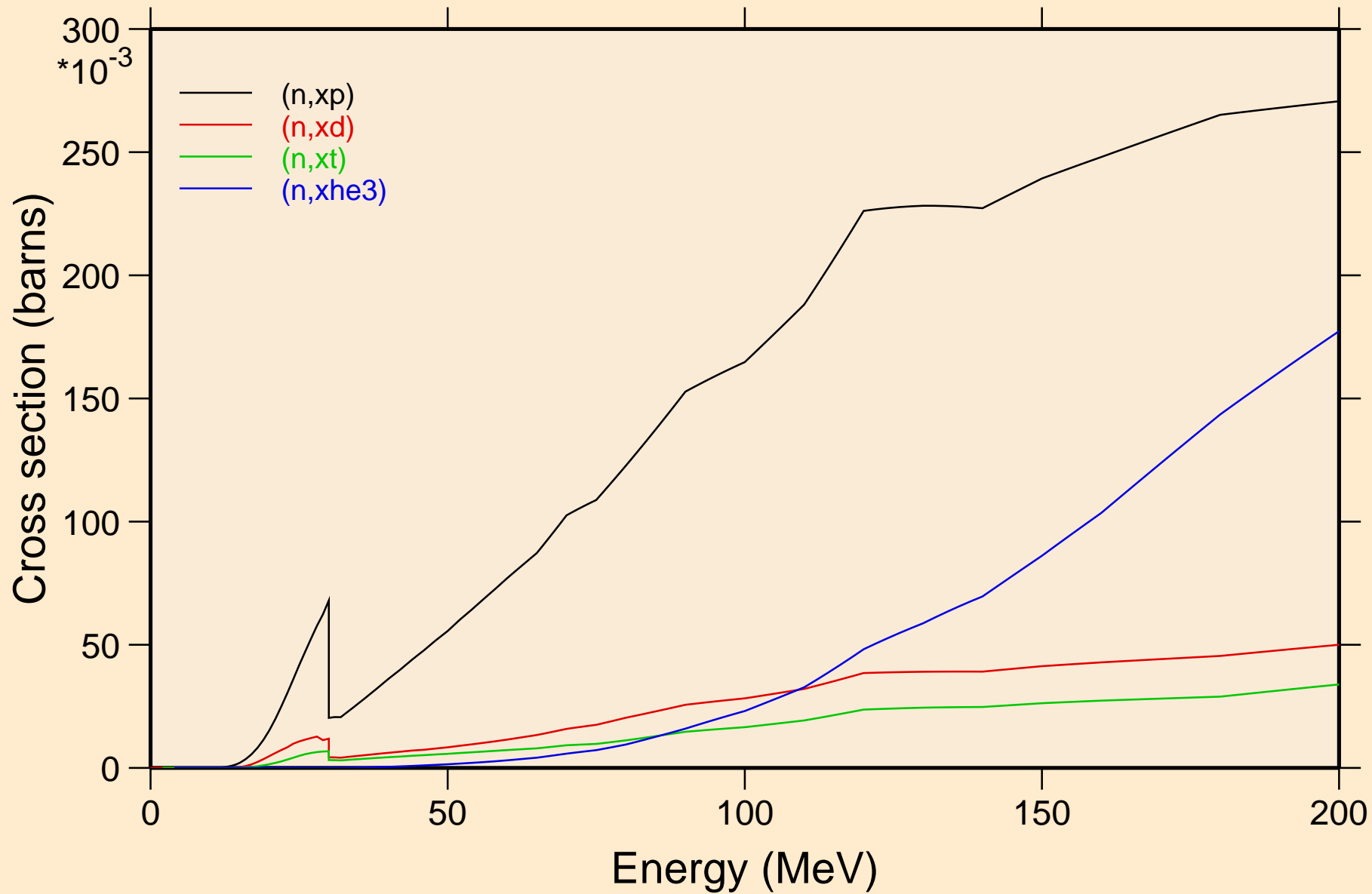

MD261 NEUTRON ACER TENDL-2021 LIBRARY; T=293.6K
angular distribution for elastic

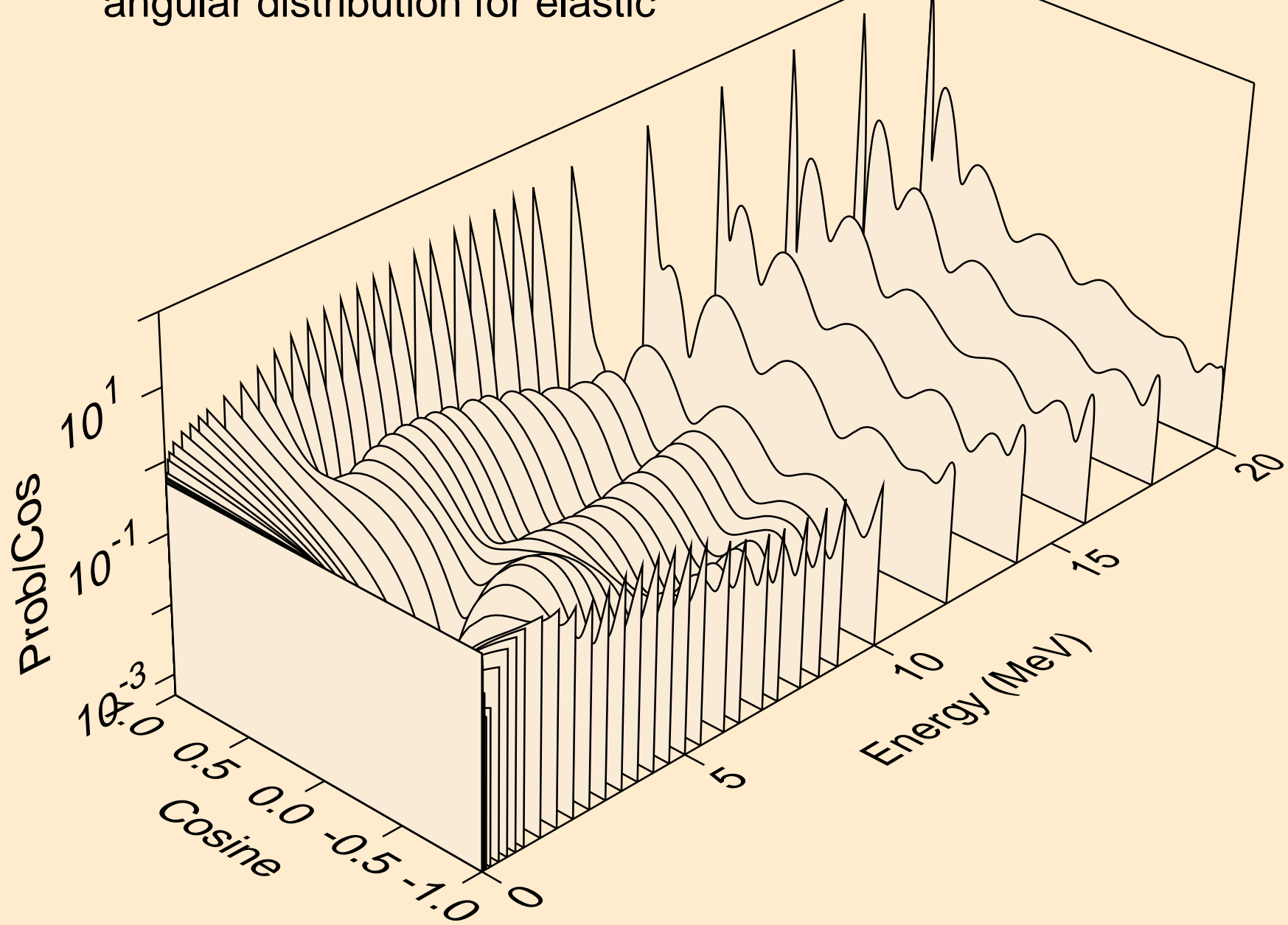

MD261 NEUTRON ACER TENDL-2021 LIBRARY; T=293.6K
angular distribution for elastic

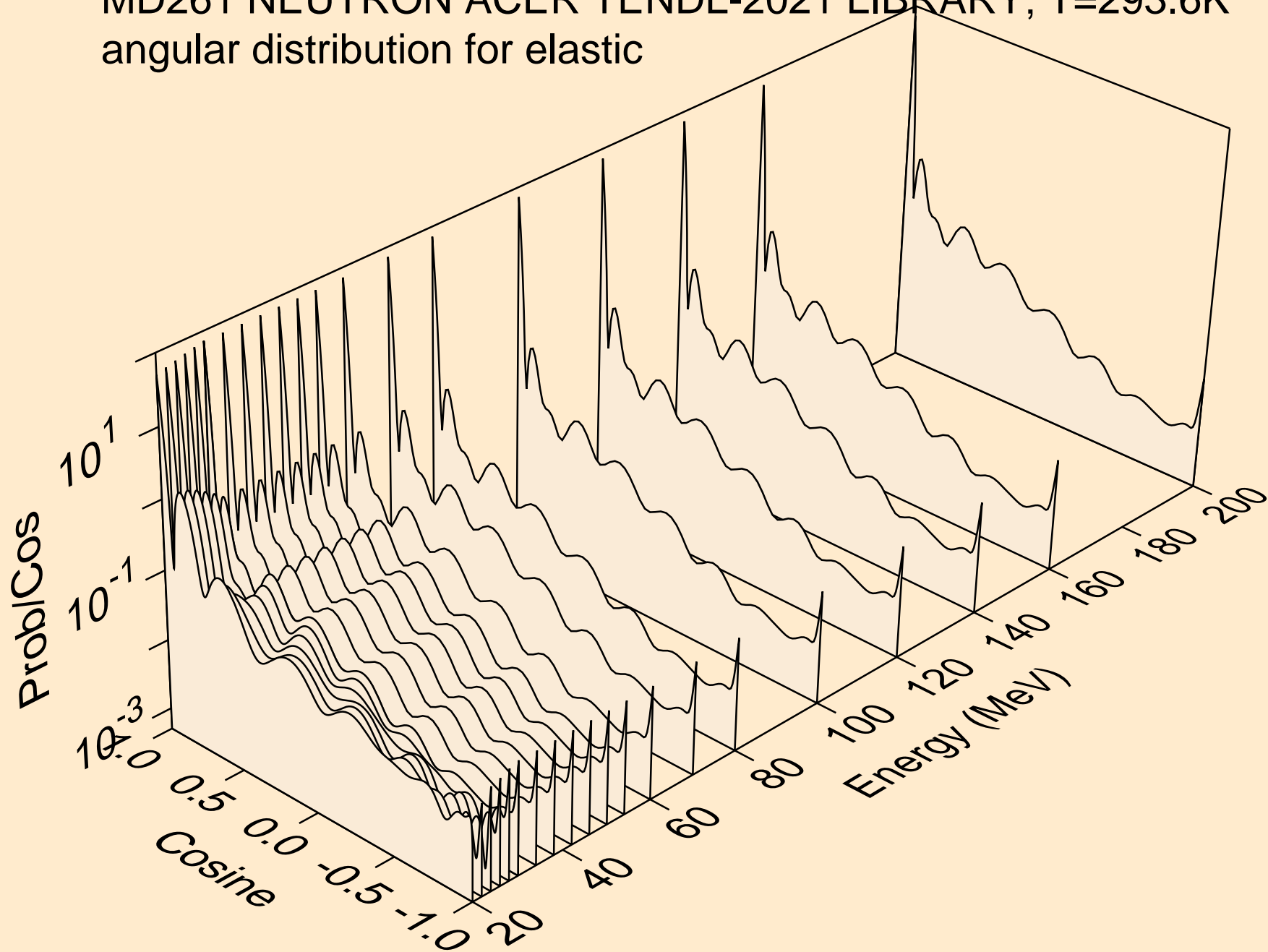

MD261 NEUTRON ACER TENDL-2021 LIBRARY; T=293.6K
angular distribution for (n,n*1)

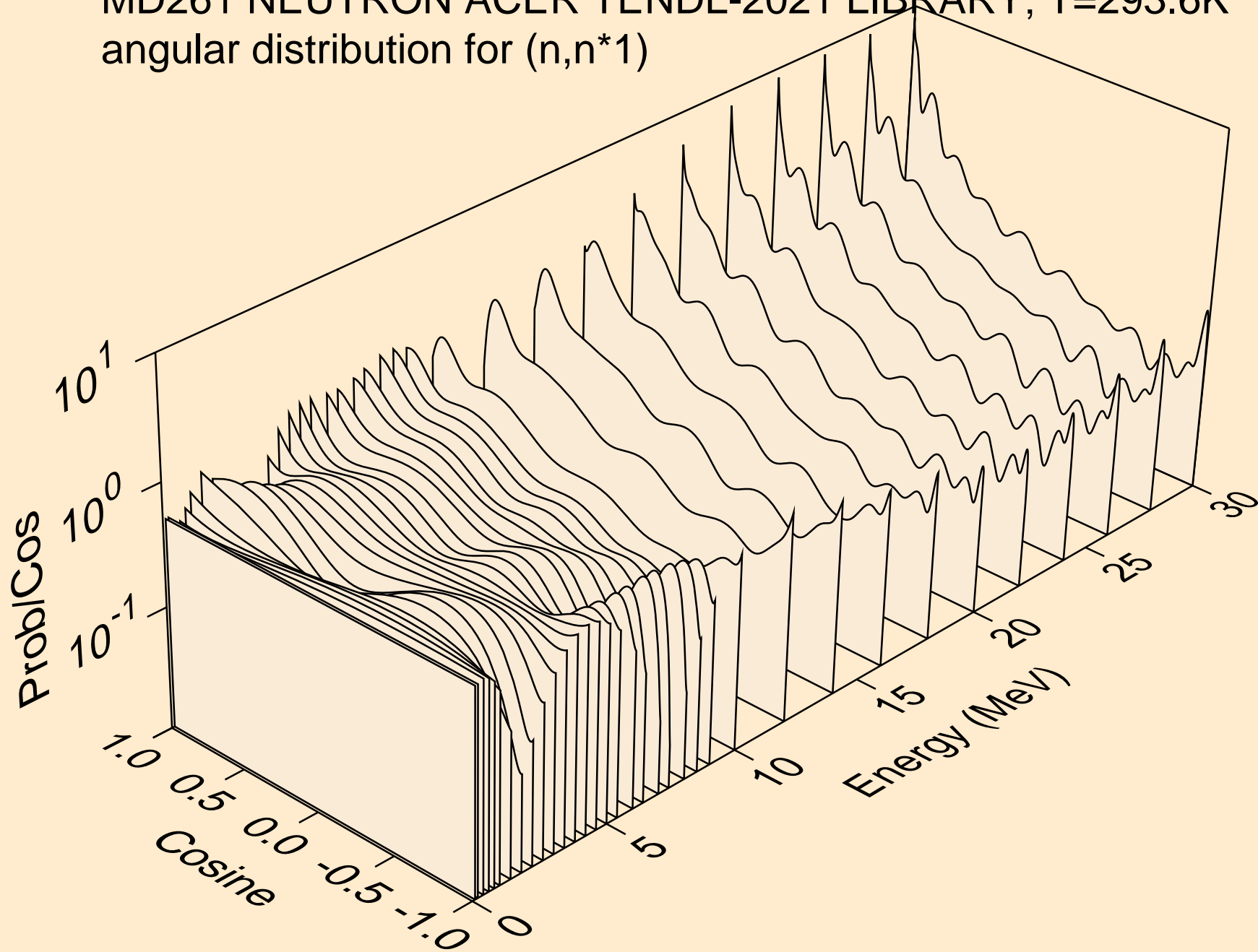

MD261 NEUTRON ACER TENDL-2021 LIBRARY; T=293.6K
Total fission nubar

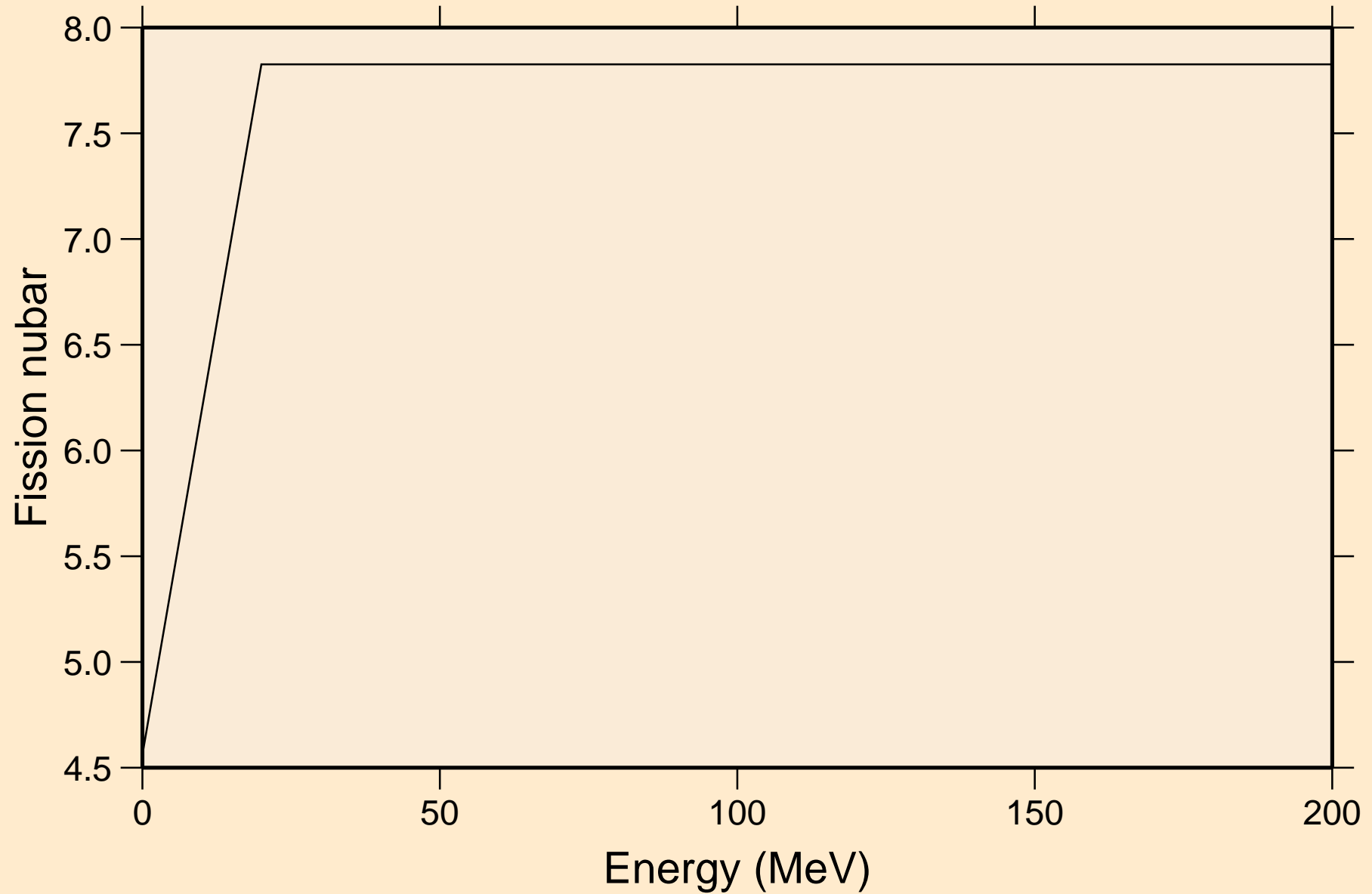

MD261 NEUTRON ACER TENDL-2021 LIBRARY; T=293.6K
Neutron emission for (n,x)

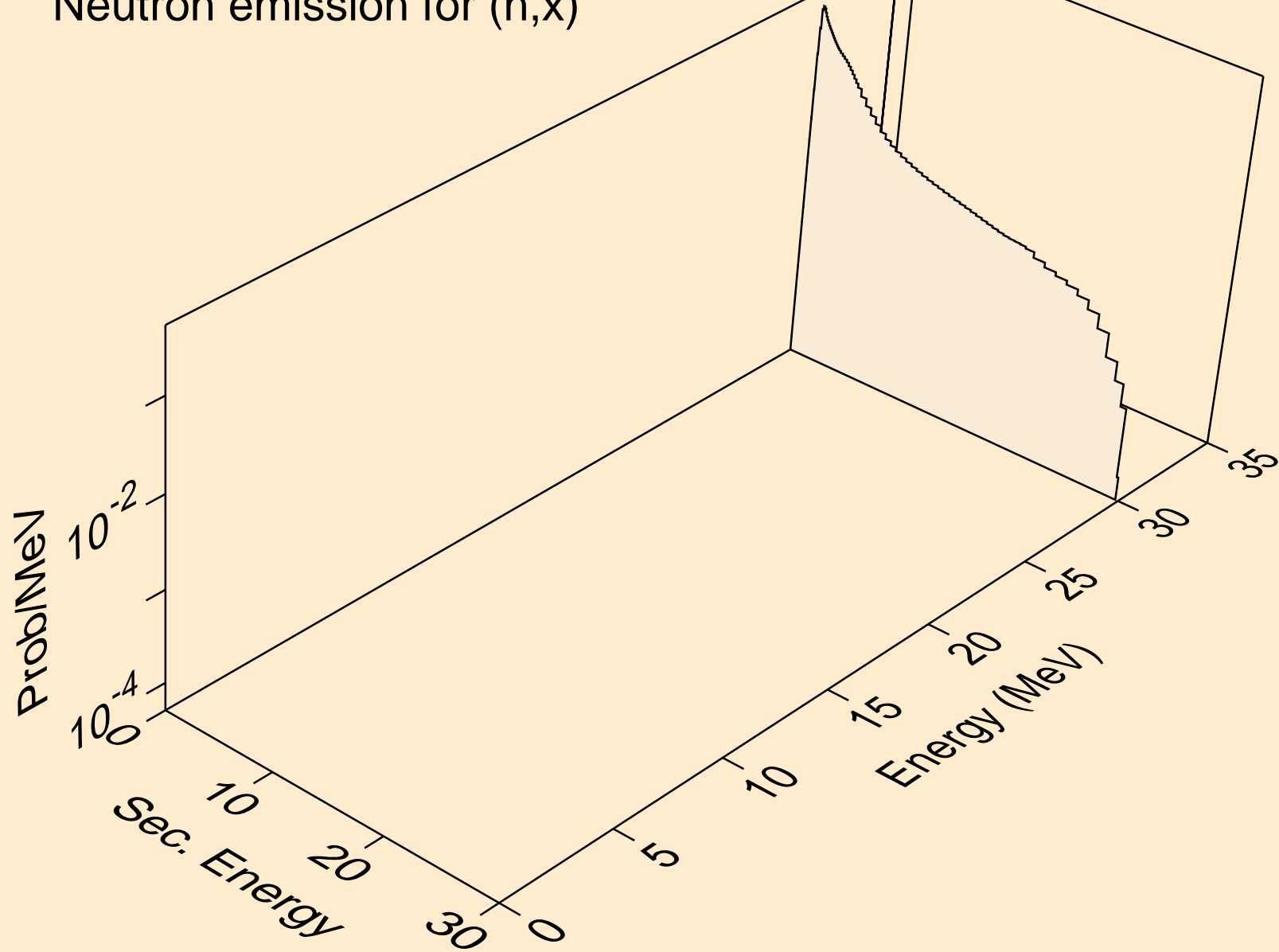

MD261 NEUTRON ACER TENDL-2021 LIBRARY; T=293.6K
Neutron emission for (n,2nd)

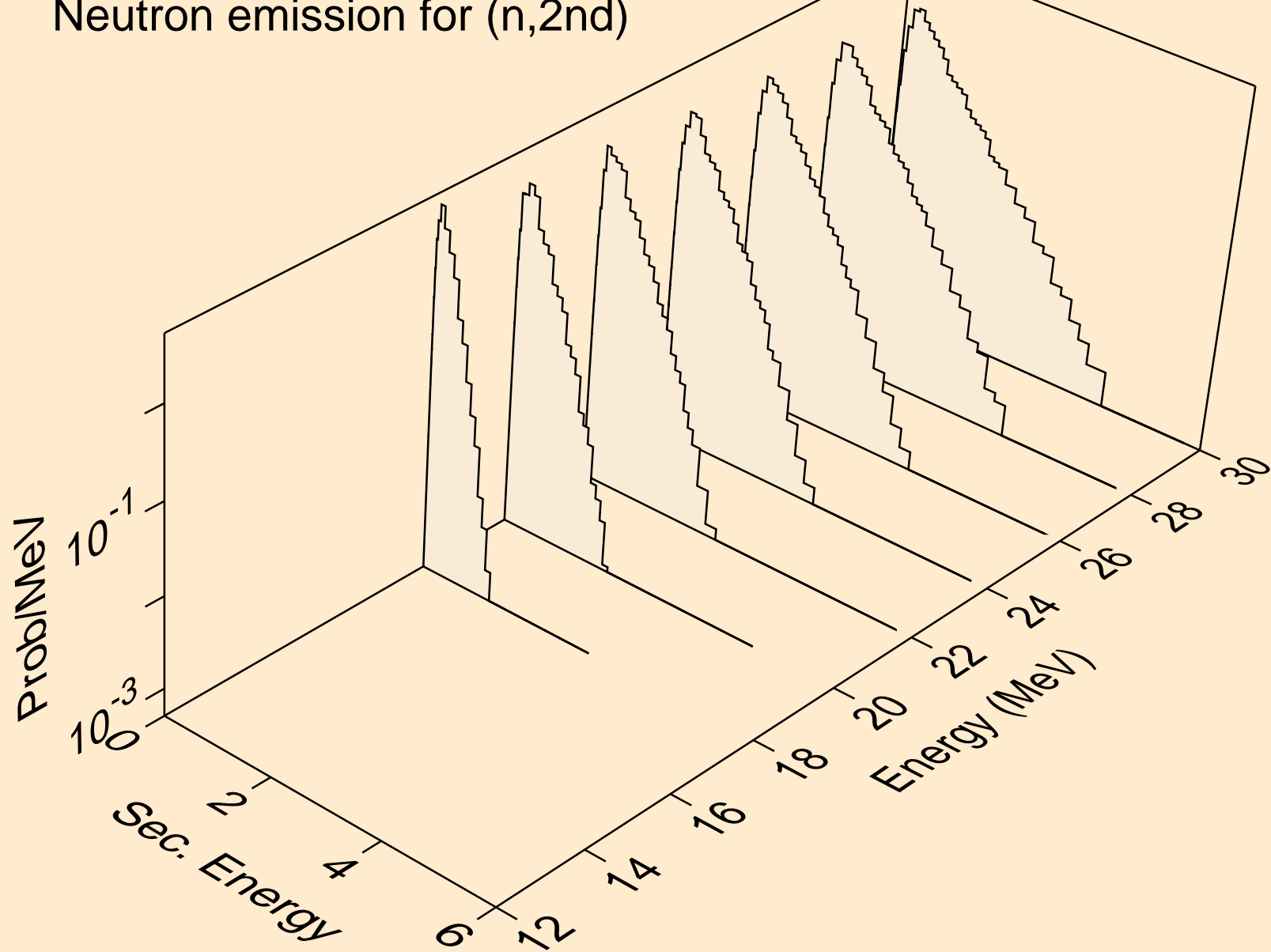

MD261 NEUTRON ACER TENDL-2021 LIBRARY; T=293.6K
Neutron emission for (n,2n)

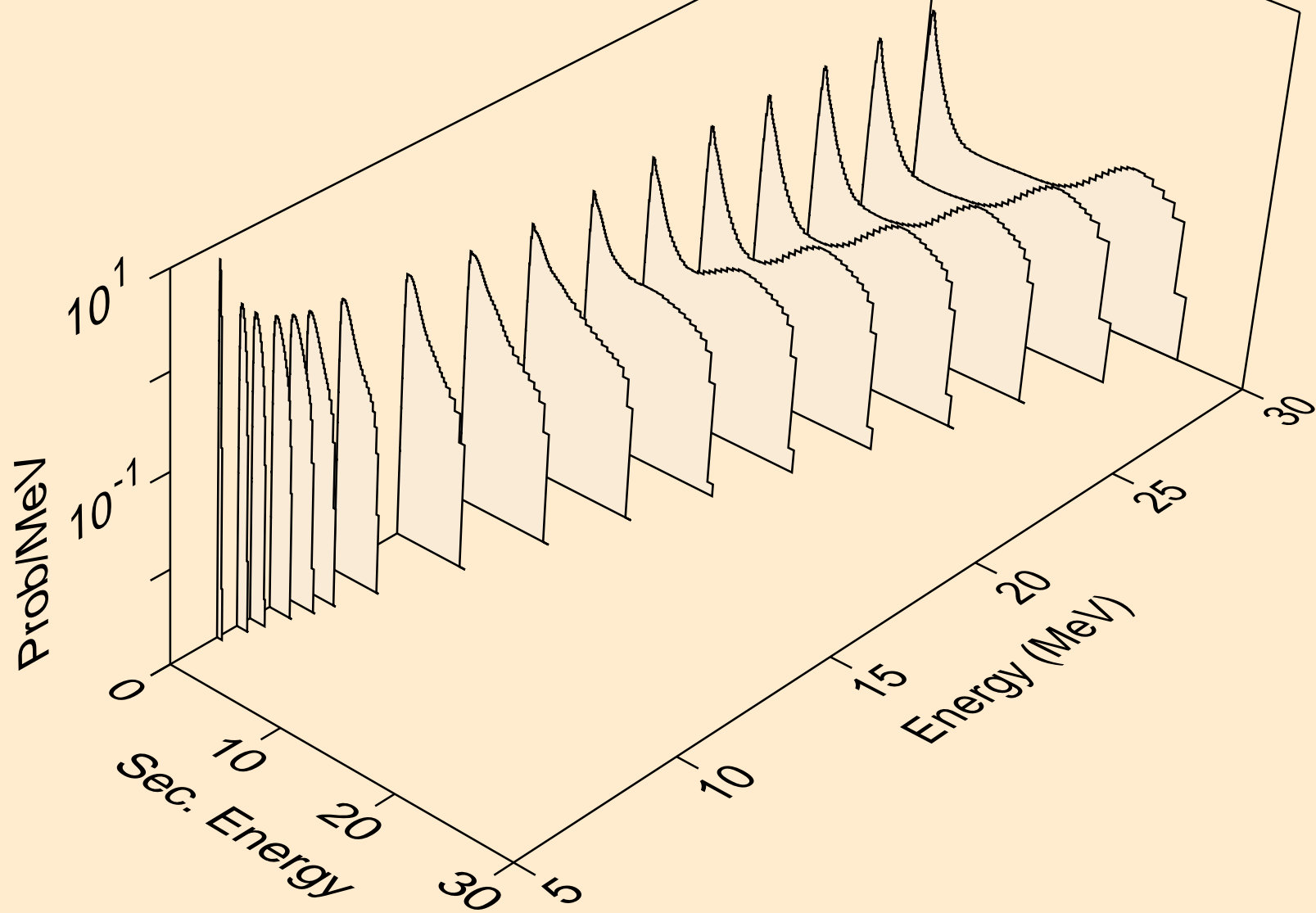

MD261 NEUTRON ACER TENDL-2021 LIBRARY; T=293.6K
Neutron emission for (n,3n)

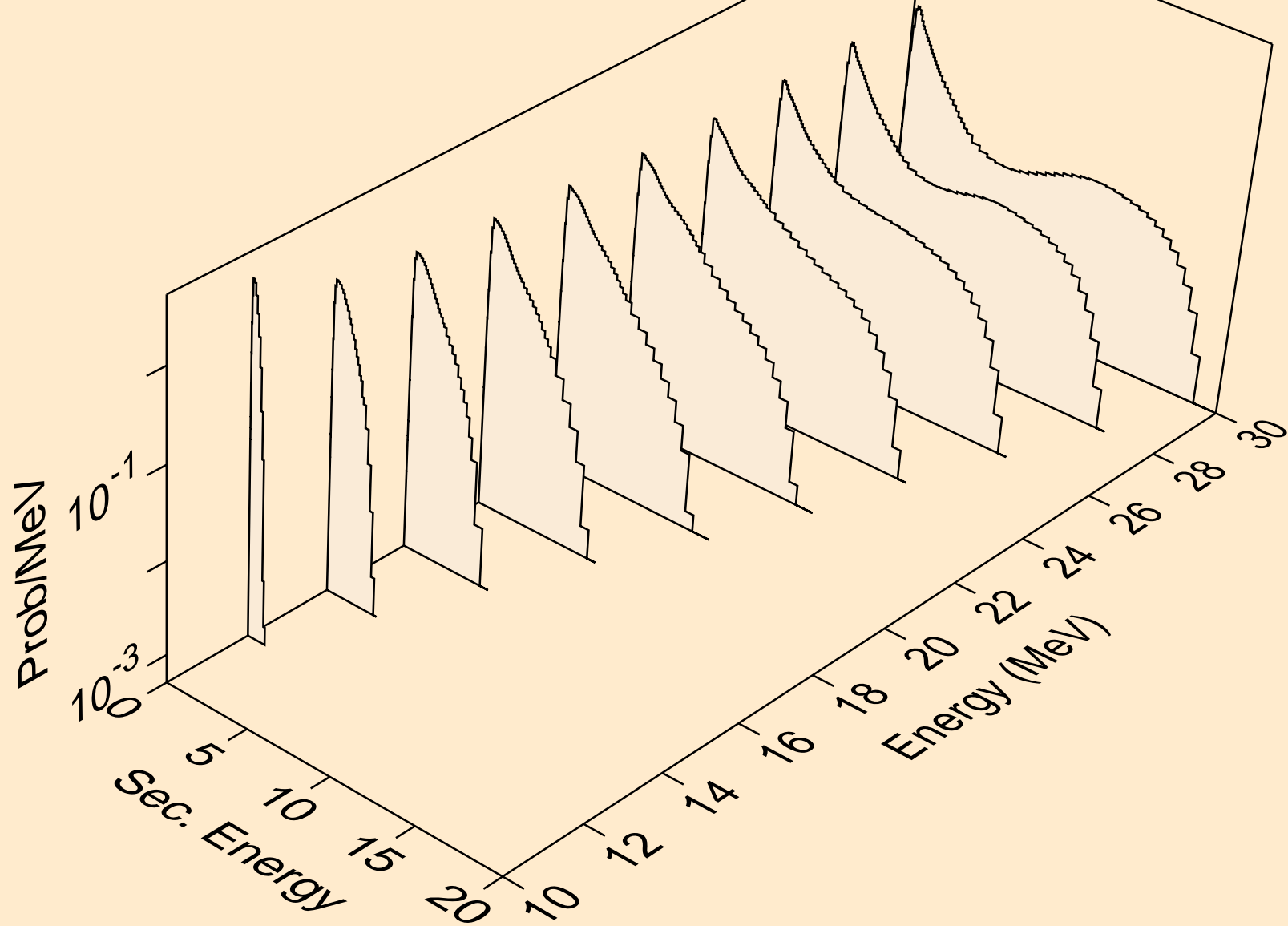

MD261 NEUTRON ACER TENDL-2021 LIBRARY; T=293.6K
Neutron emission for fission

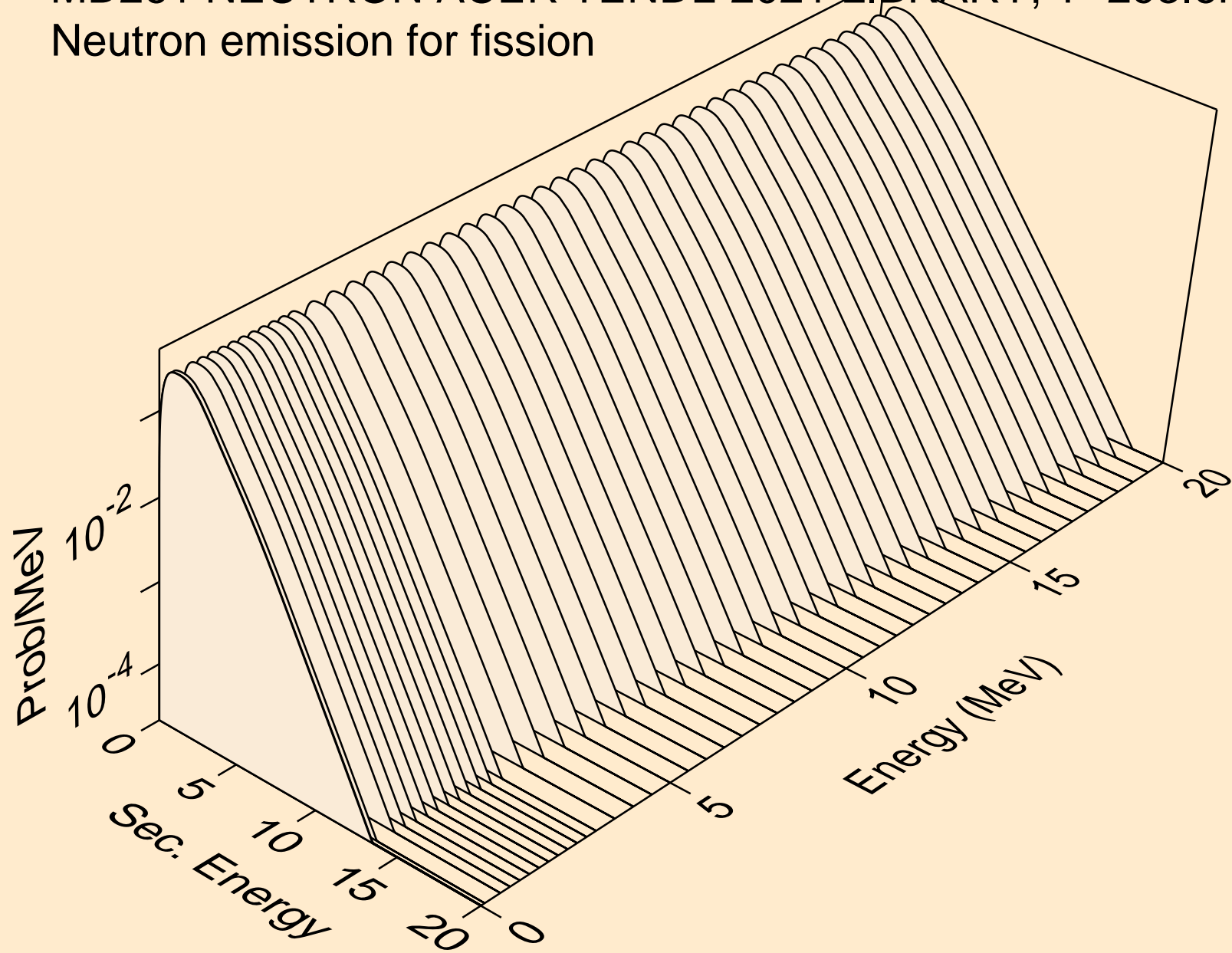

MD261 NEUTRON ACER TENDL-2021 LIBRARY; T=293.6K
Neutron emission for (n,n*)a

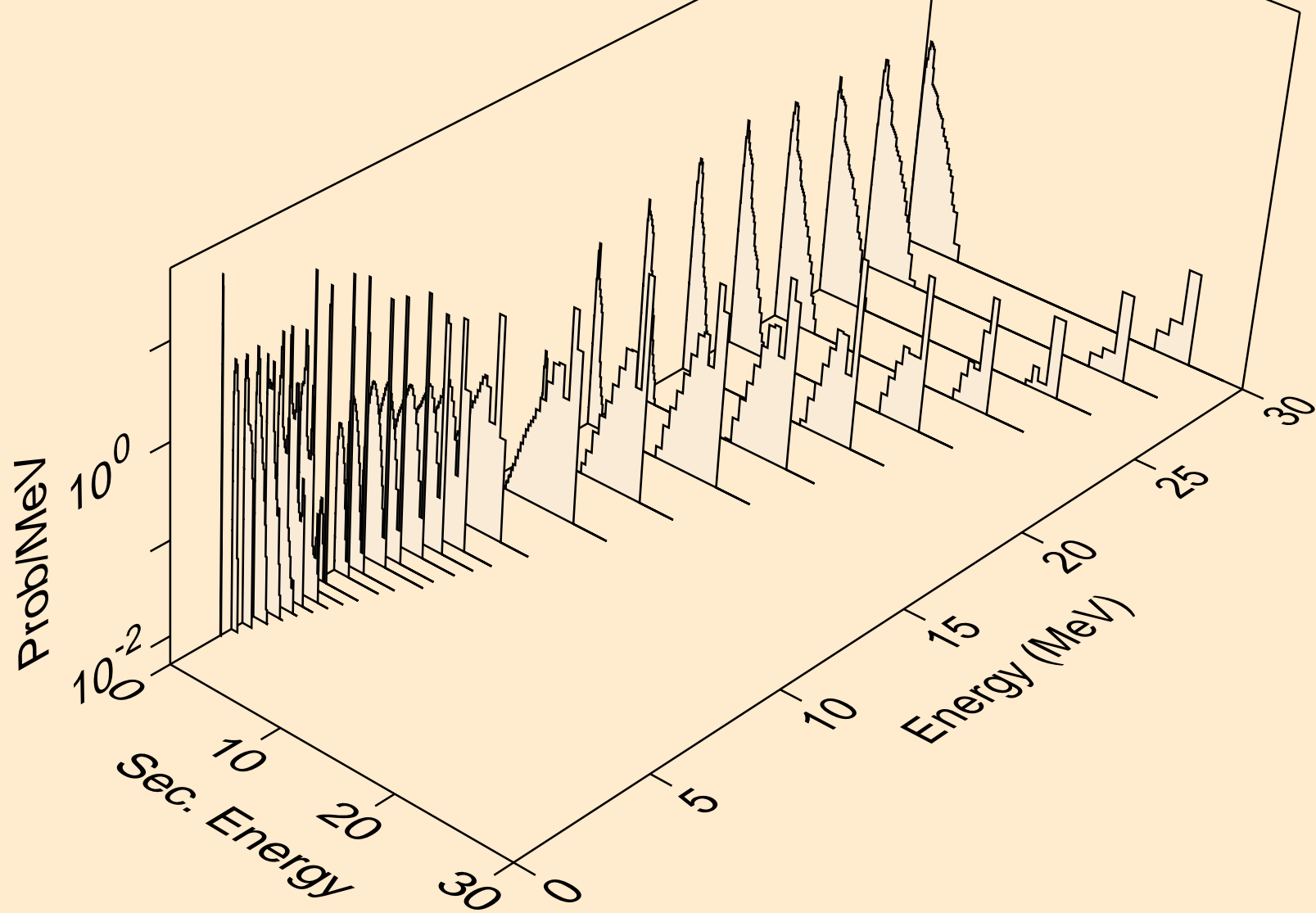

MD261 NEUTRON ACER TENDL-2021 LIBRARY; T=293.6K
Neutron emission for (n,2n)a

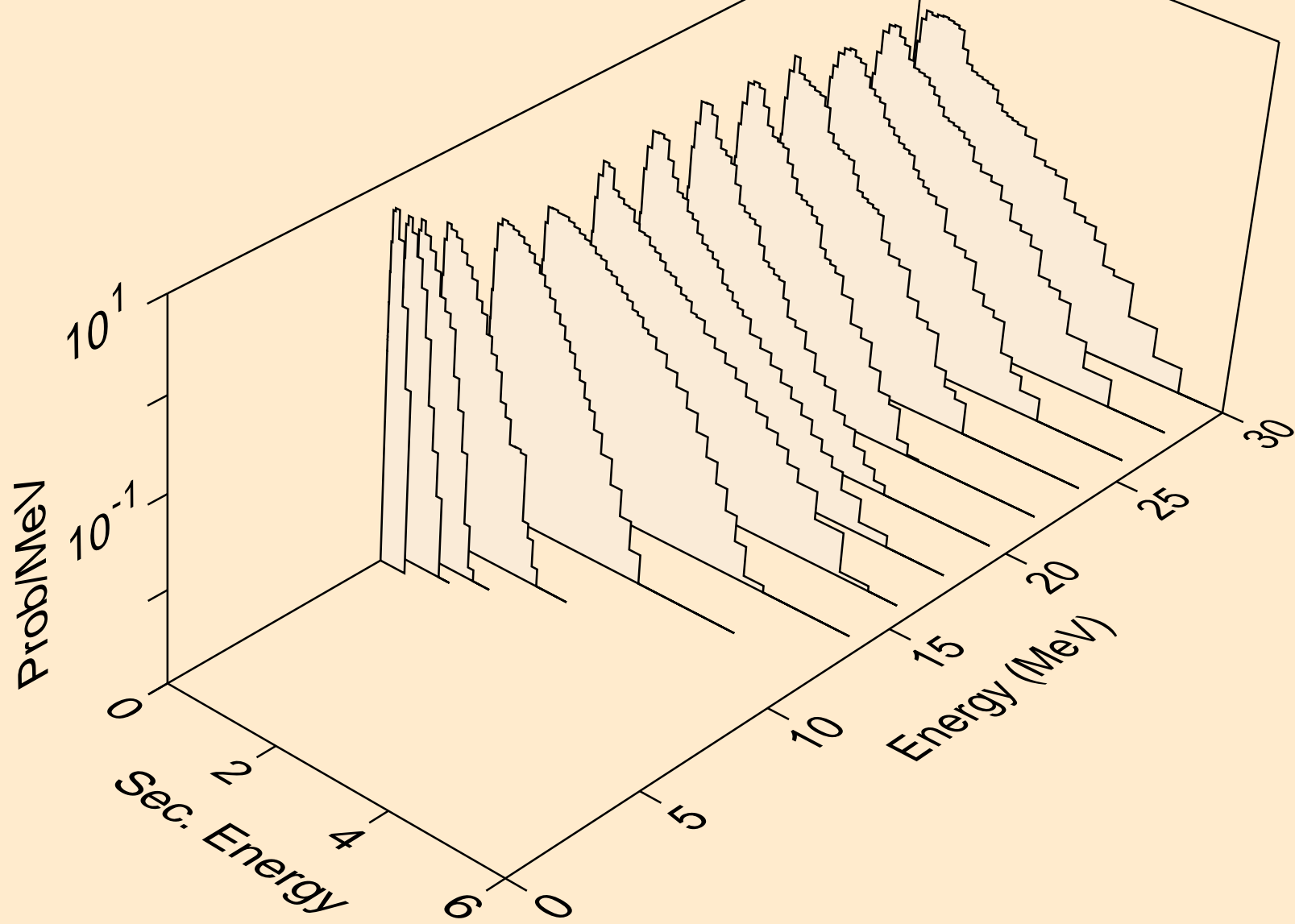

MD261 NEUTRON ACER TENDL-2021 LIBRARY; T=293.6K
Neutron emission for (n,3n)a

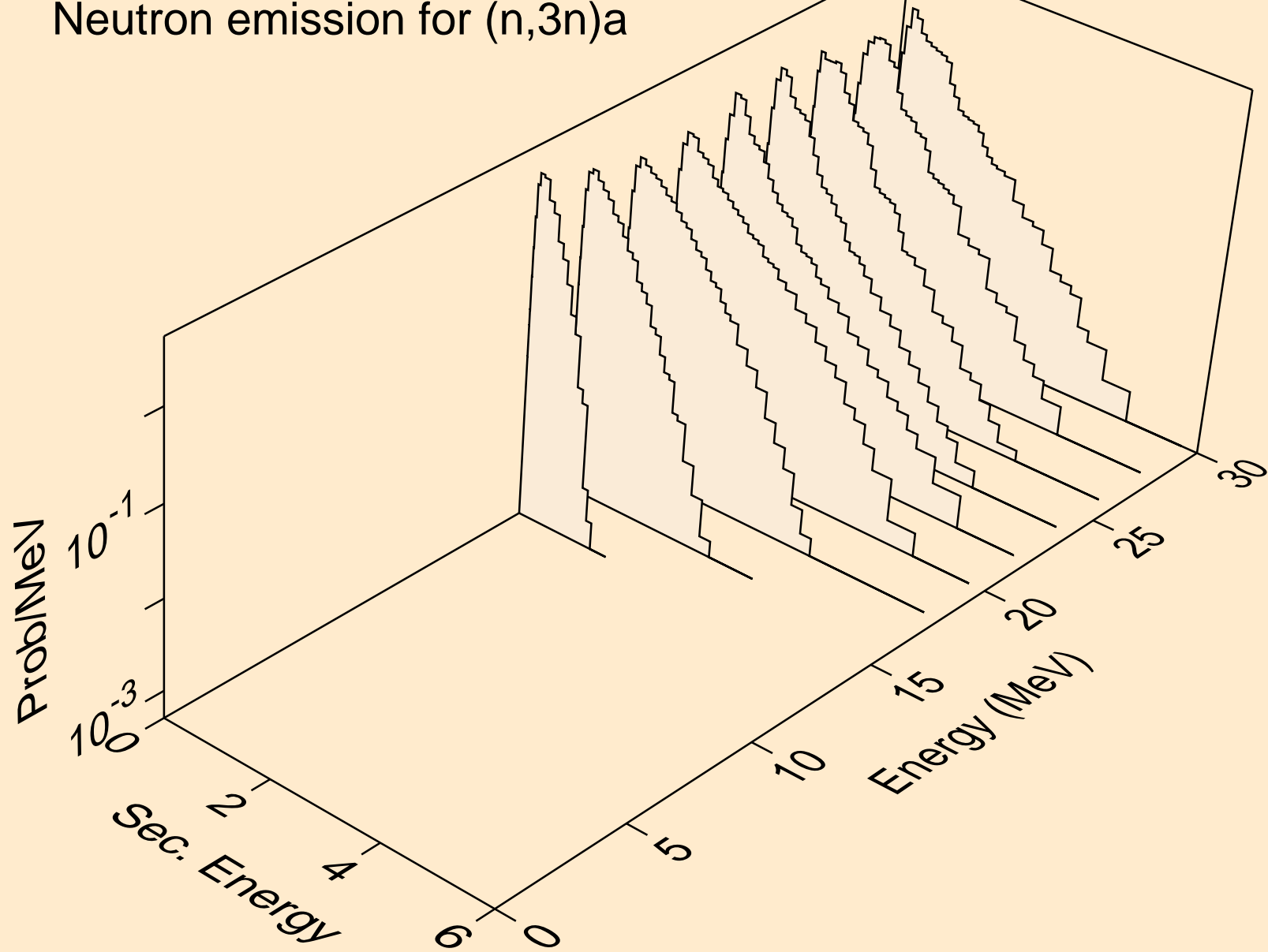

MD261 NEUTRON ACER TENDL-2021 LIBRARY; T=293.6K
Neutron emission for (n,n*)p

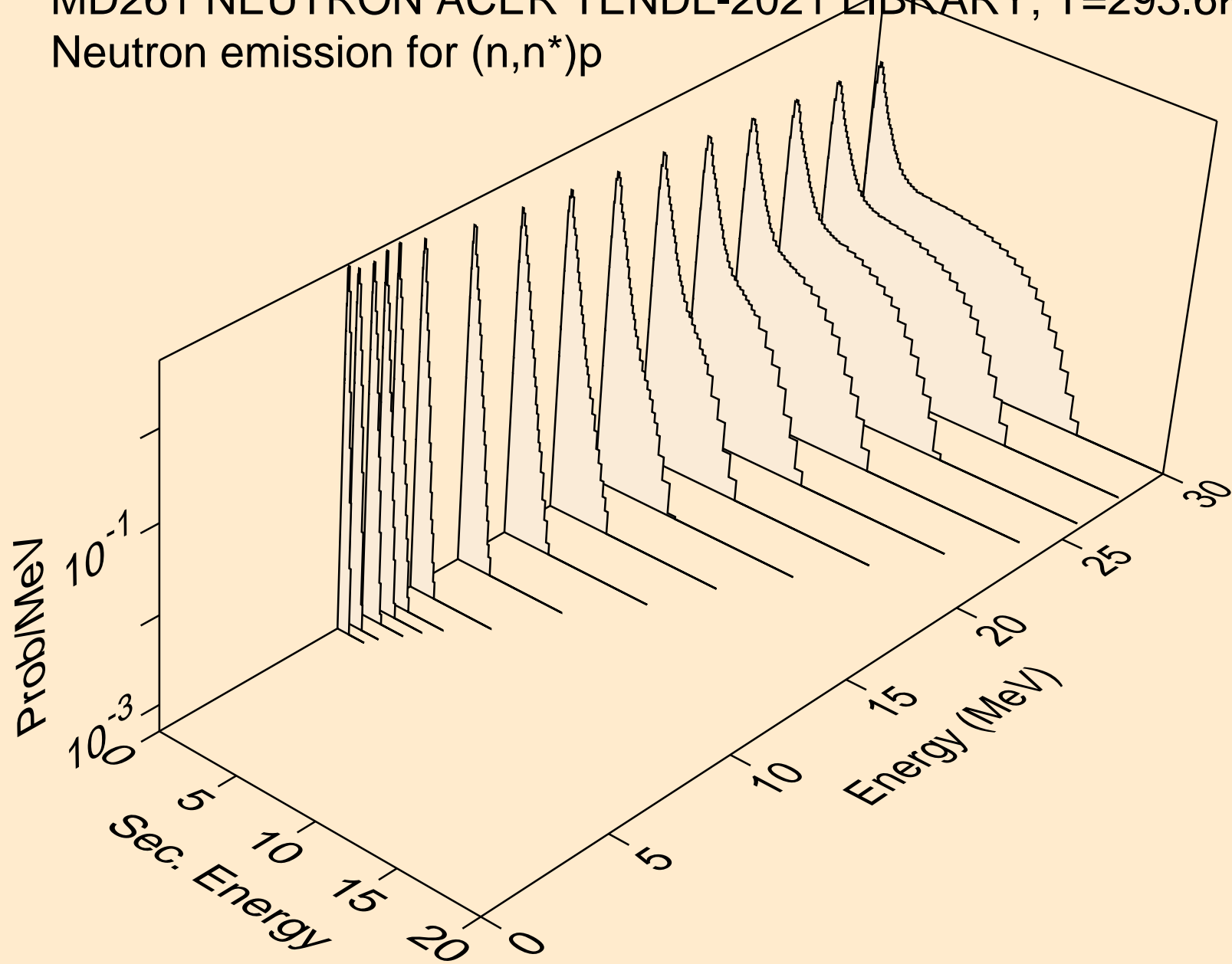

MD261 NEUTRON ACER TENDL-2021 LIBRARY; T=293.6K
Neutron emission for (n,n*)2a

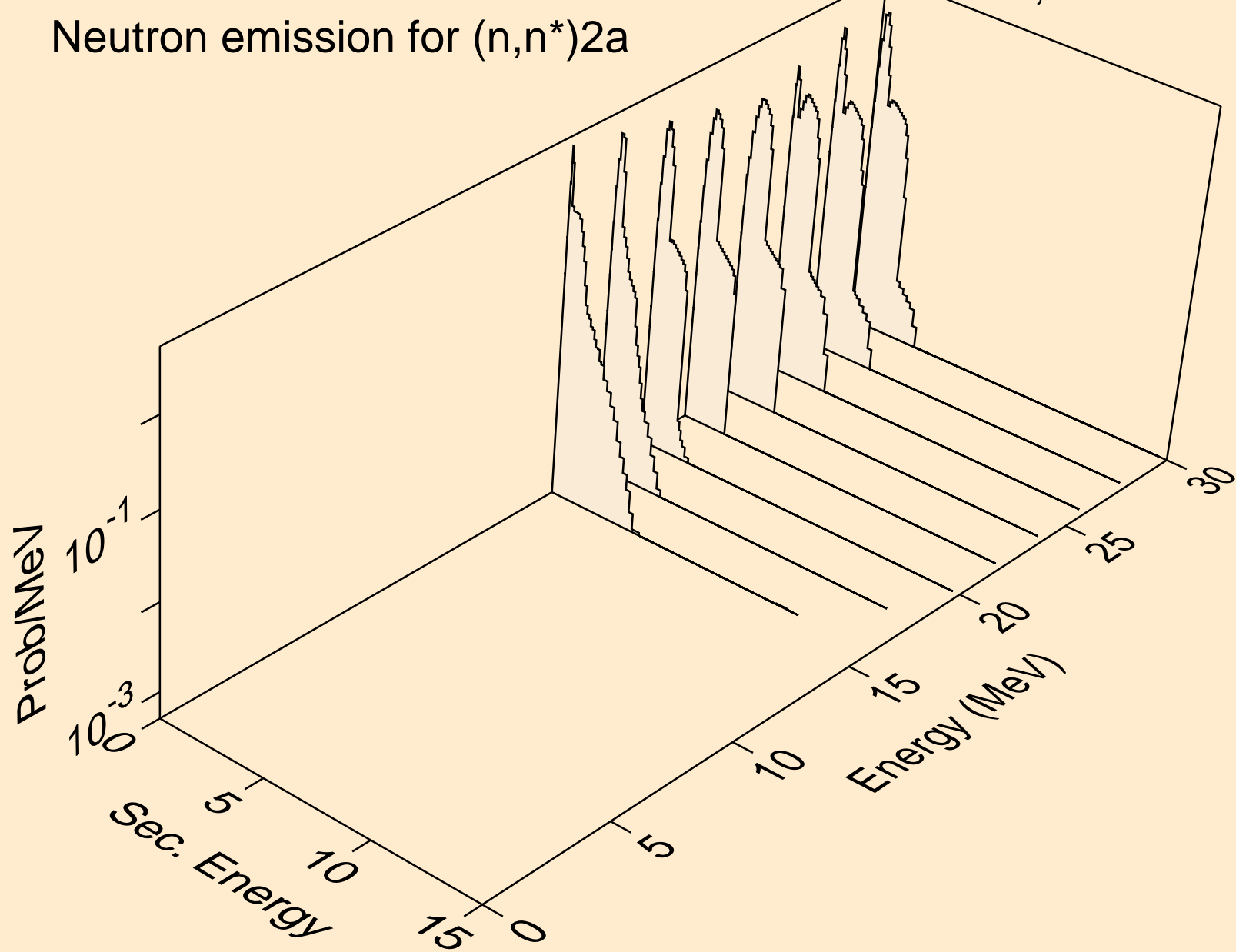

MD261 NEUTRON ACER TENDL-2021 LIBRARY; T=293.6K
Neutron emission for (n,n*)d

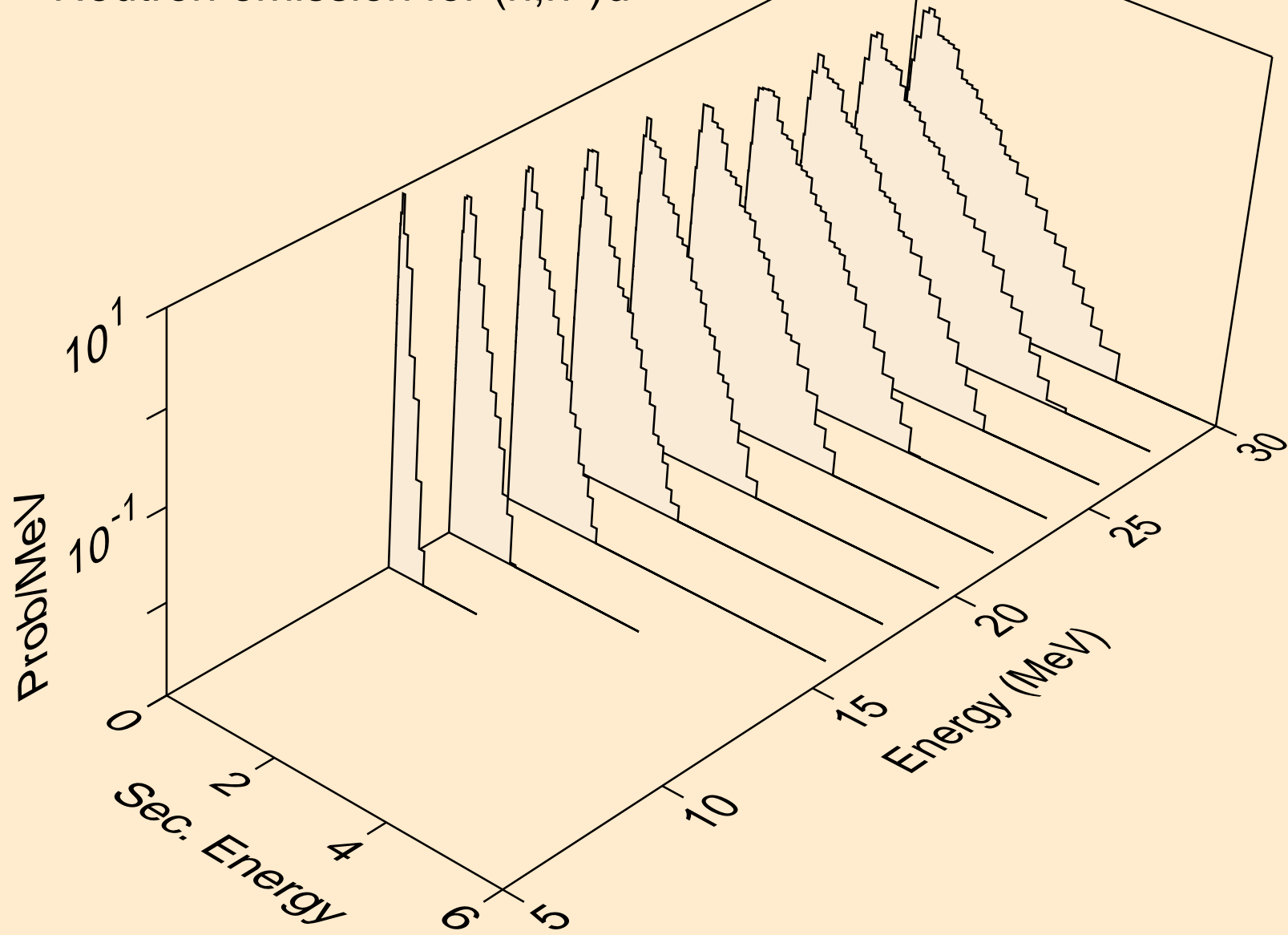

MD261 NEUTRON ACER TENDL-2021 LIBRARY; T=293.6K
Neutron emission for (n,n*)t

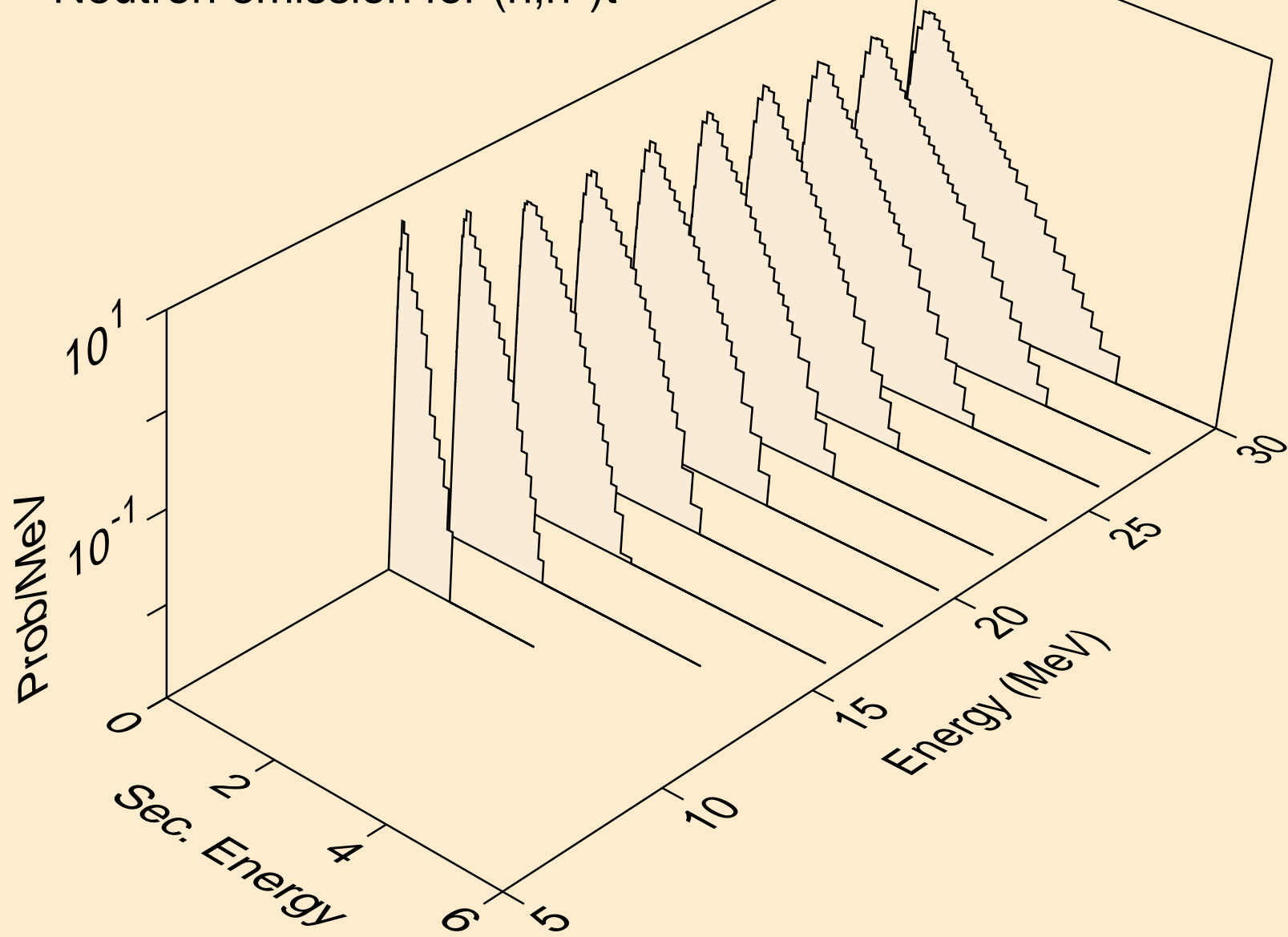

MD261 NEUTRON ACER TENDL-2021 LIBRARY; T=293.6K
Neutron emission for (n,n*)he3

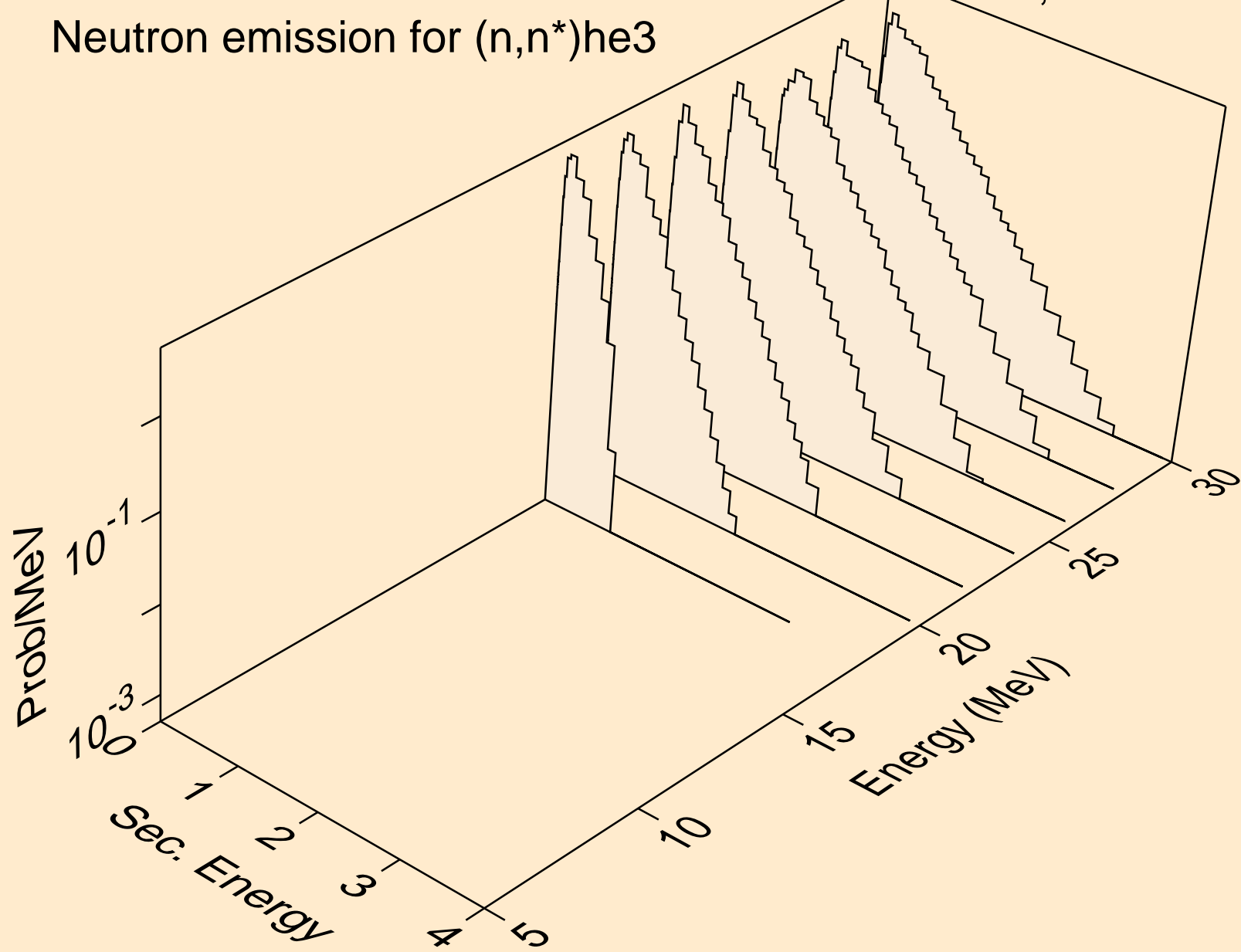

MD261 NEUTRON ACER TENDL-2021 LIBRARY; T=293.6K
Neutron emission for (n,4n)

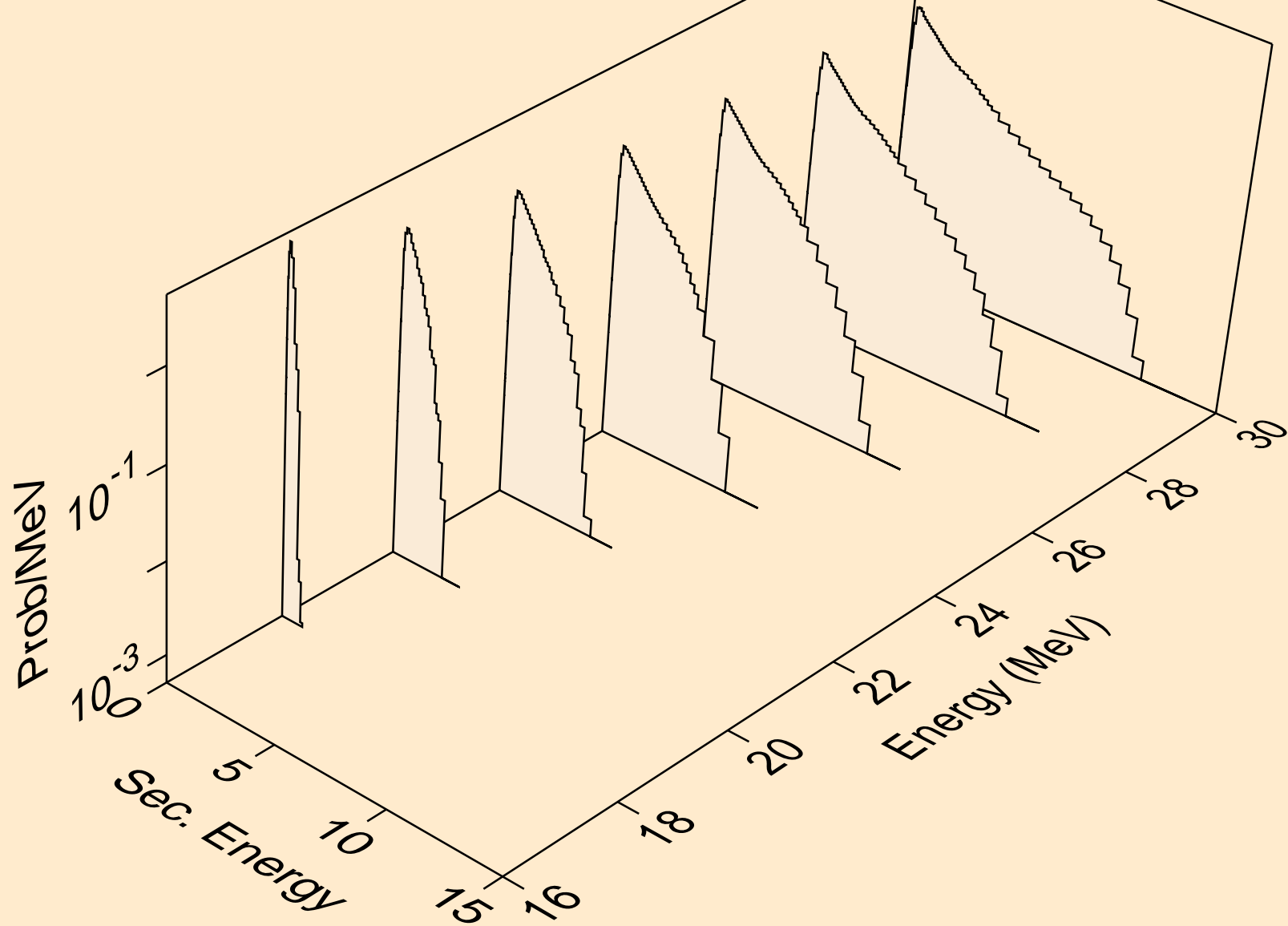

MD261 NEUTRON ACER TENDL-2021 LIBRARY; T=293.6K
Neutron emission for (n,2np)

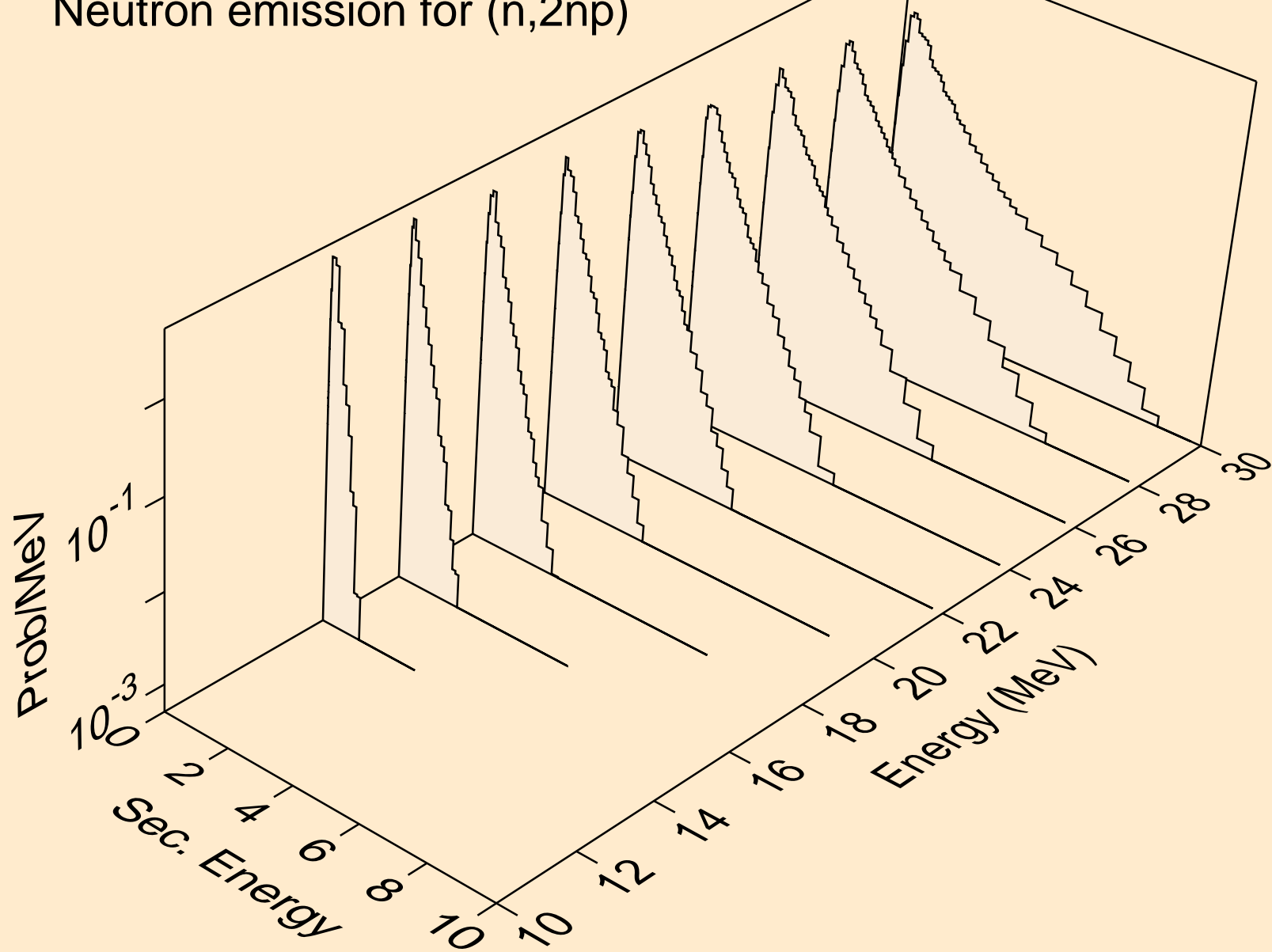

MD261 NEUTRON ACER TENDL-2021 LIBRARY; T=293.6K
Neutron emission for (n,3np)

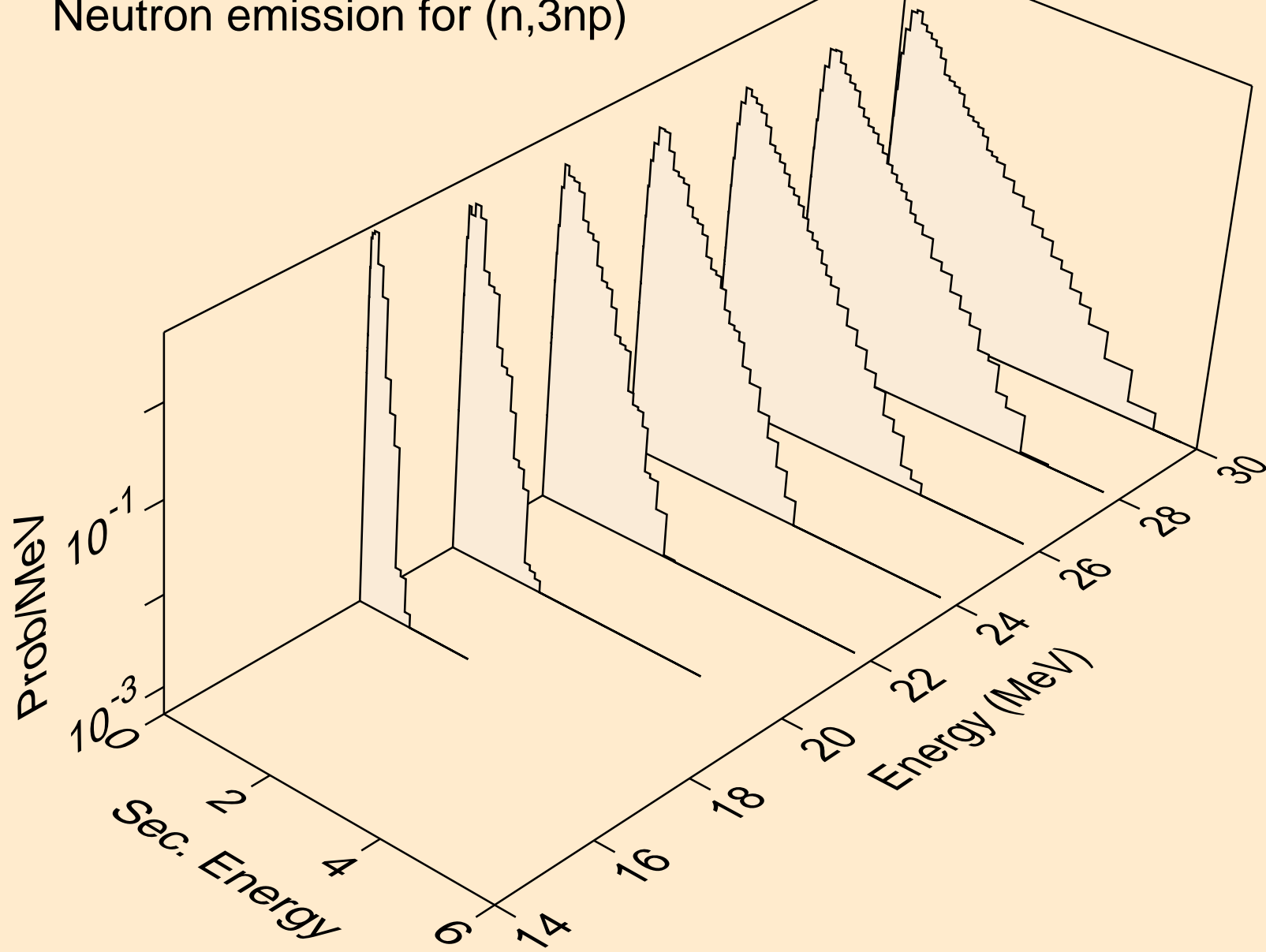

MD261 NEUTRON ACER TENDL-2021 LIBRARY; T=293.6K
Neutron emission for (n,npa)

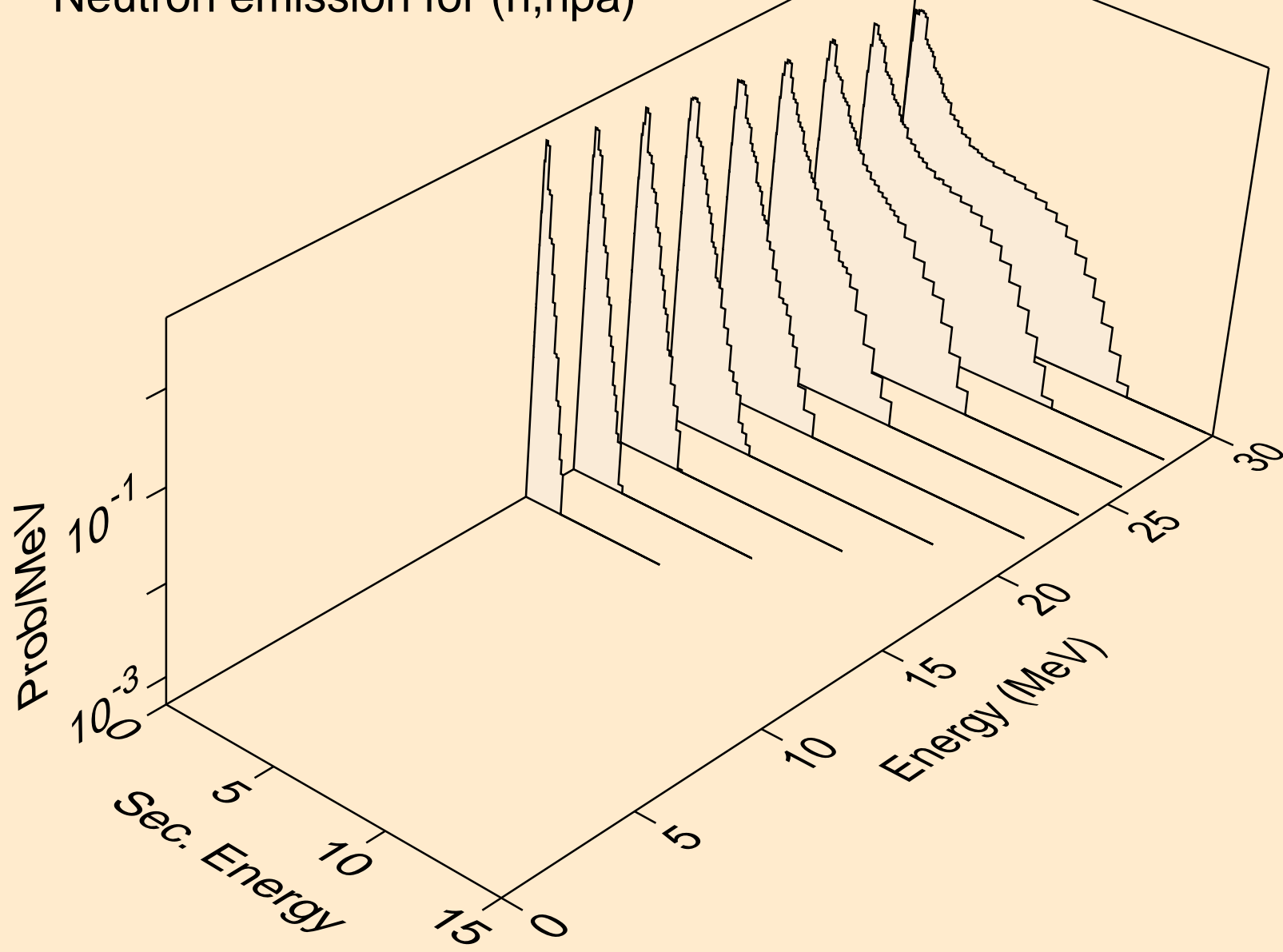

MD261 NEUTRON ACER TENDL-2021 LIBRARY; T=293.6K
Neutron emission for (n,n*c)

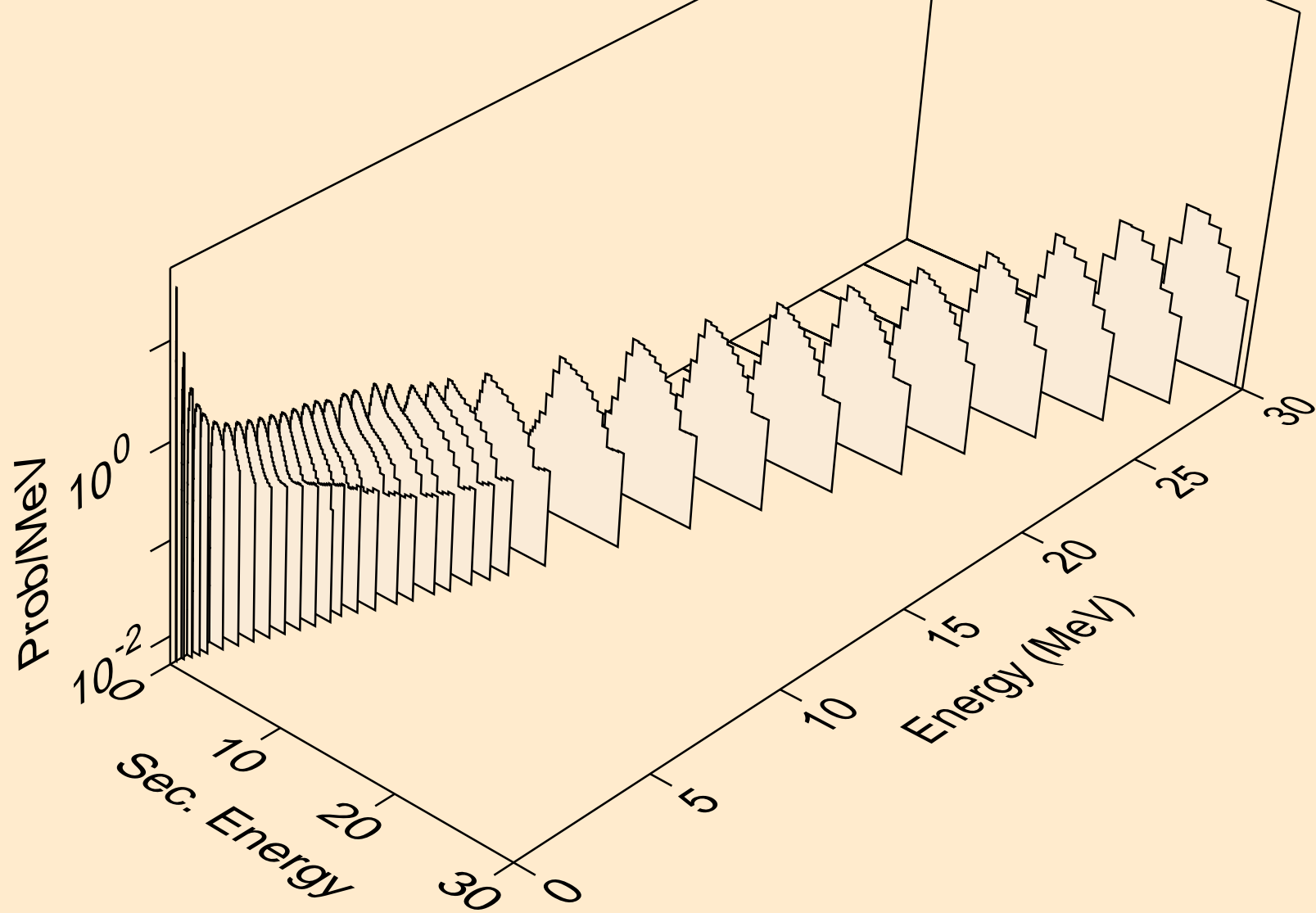

MD261 NEUTRON ACER TENDL-2021 LIBRARY; T=293.6K

Delayed nubar

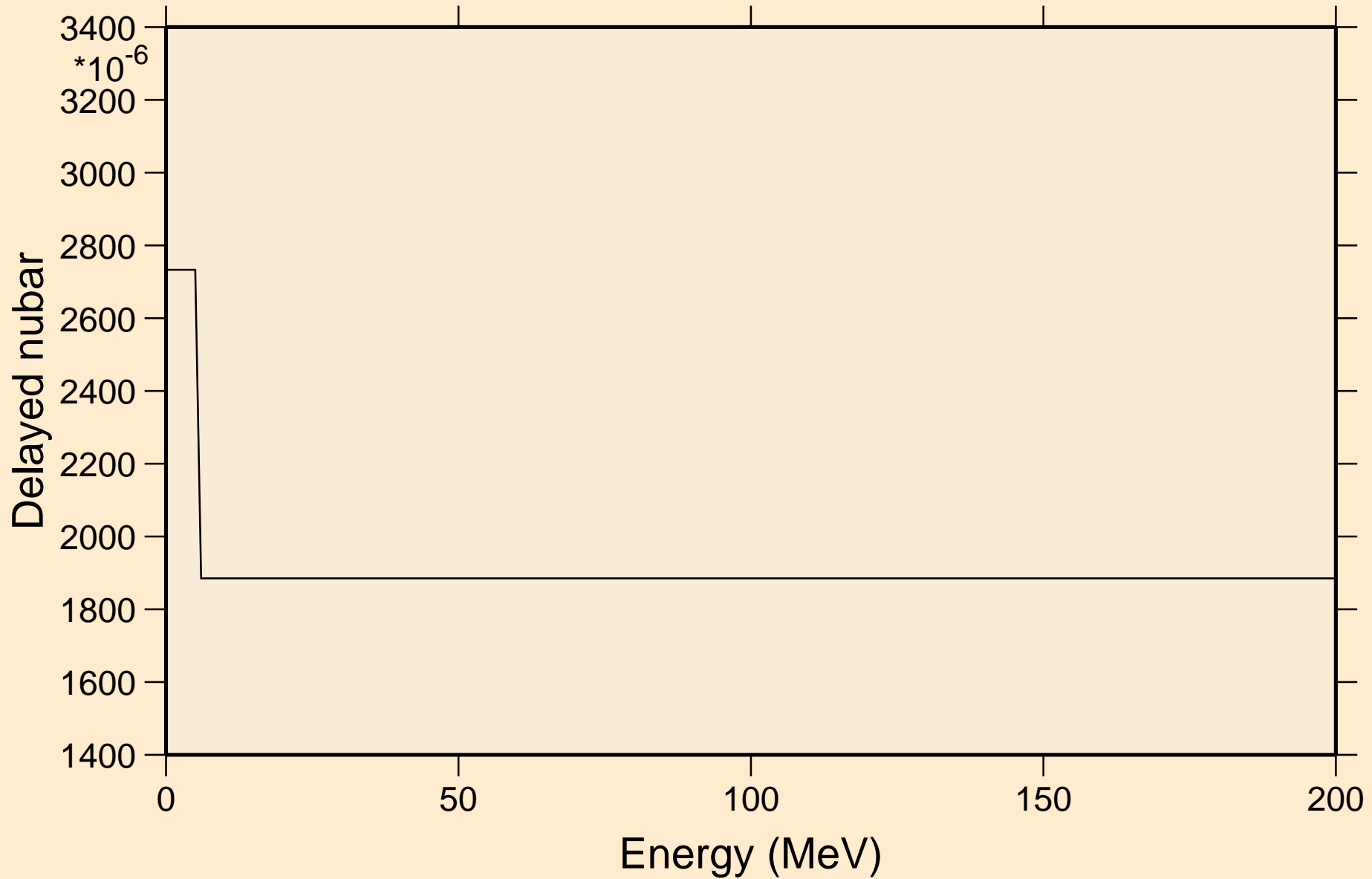

MD261 NEUTRON ACER TENDL-2021 LIBRARY; T=293.6K

Delayed neutron spectra

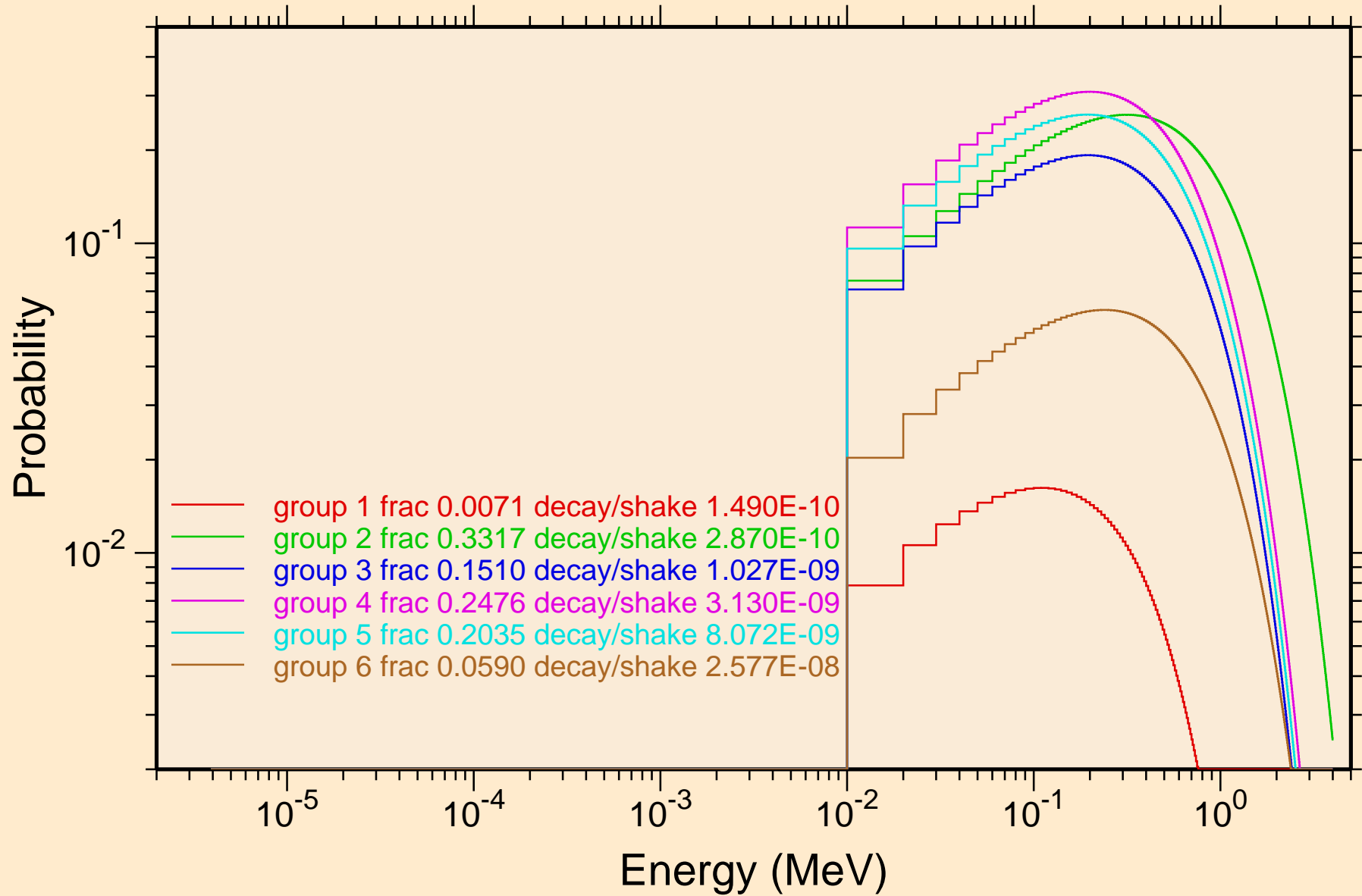

MD261 NEUTRON ACER TENDL-2021 LIBRARY; T=293.6K
Photon emission for (n,x)

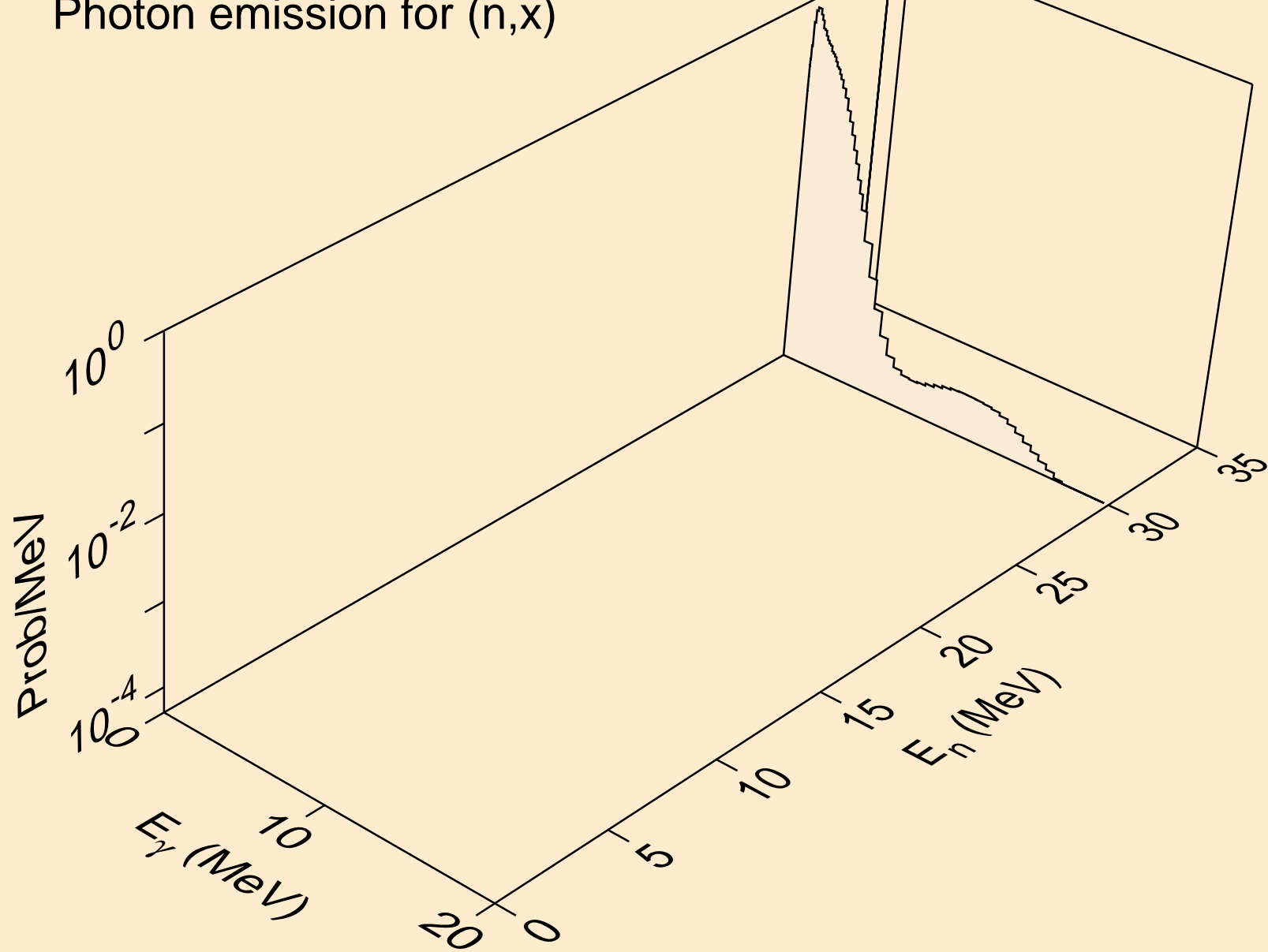

MD261 NEUTRON ACER TENDL-2021 LIBRARY; T=293.6K
Photon emission for (n,2nd)

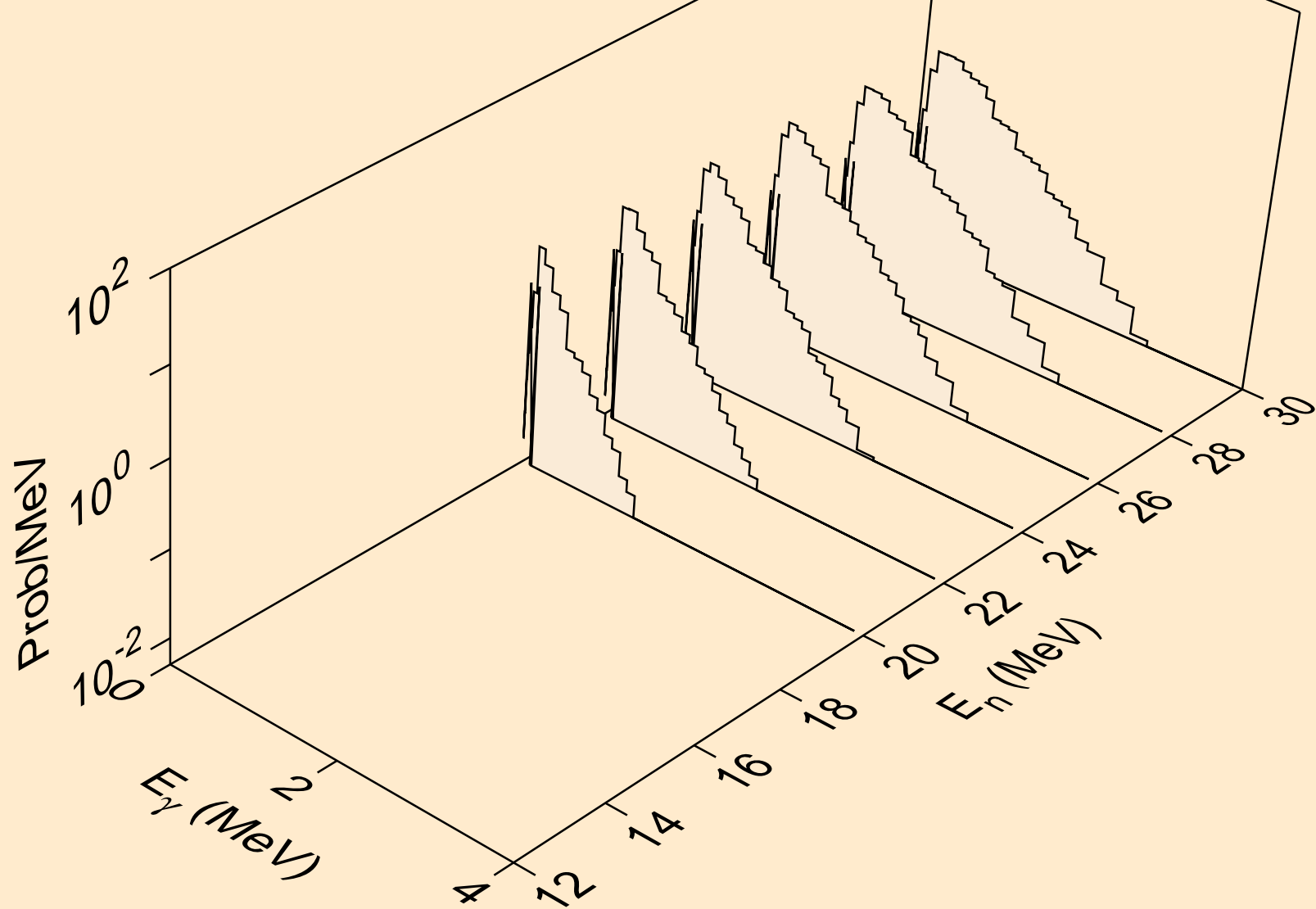

MD261 NEUTRON ACER TENDL-2021 LIBRARY; T=293.6K
Photon emission for (n,2n)

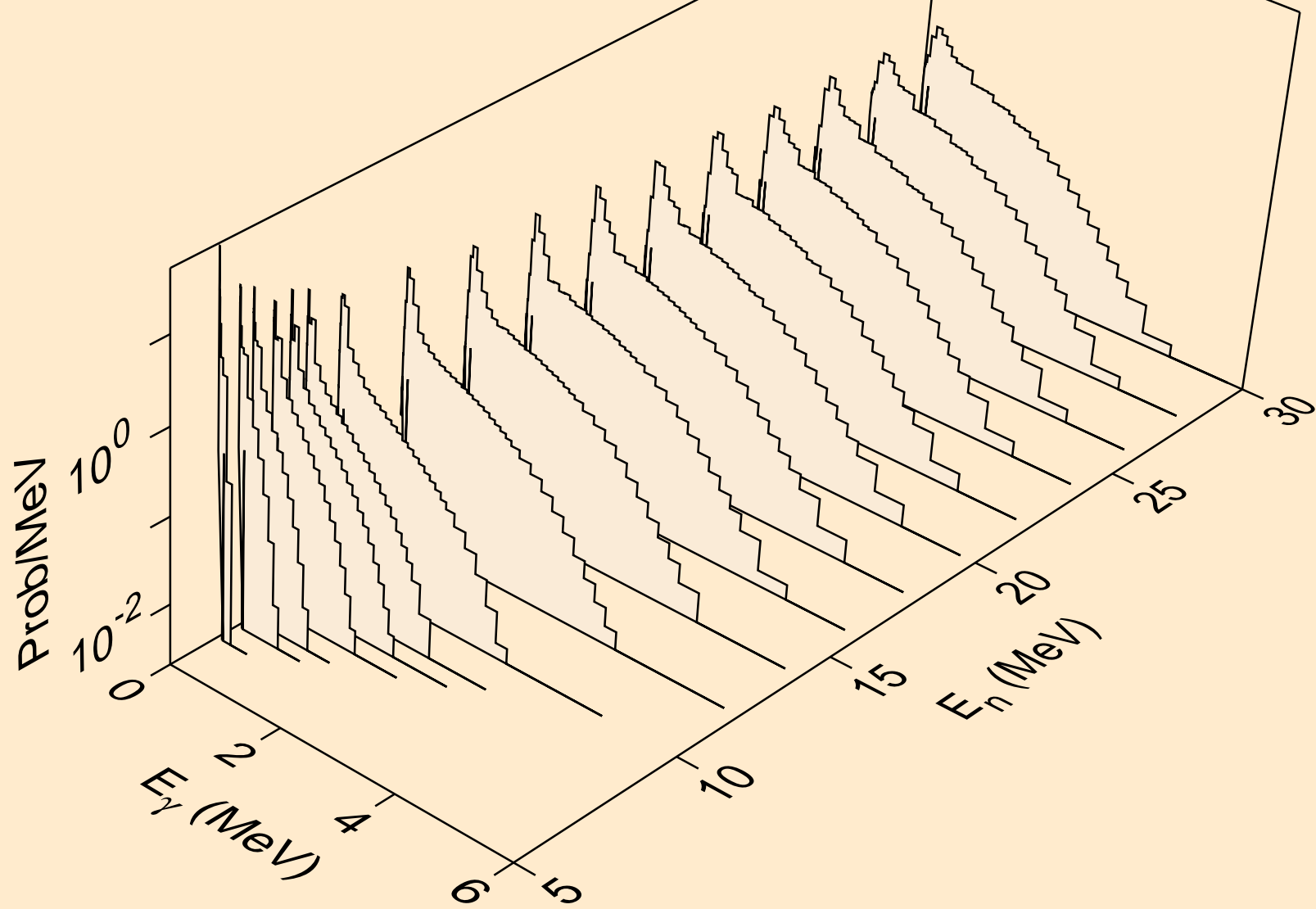

MD261 NEUTRON ACER TENDL-2021 LIBRARY; T=293.6K
Photon emission for (n,3n)

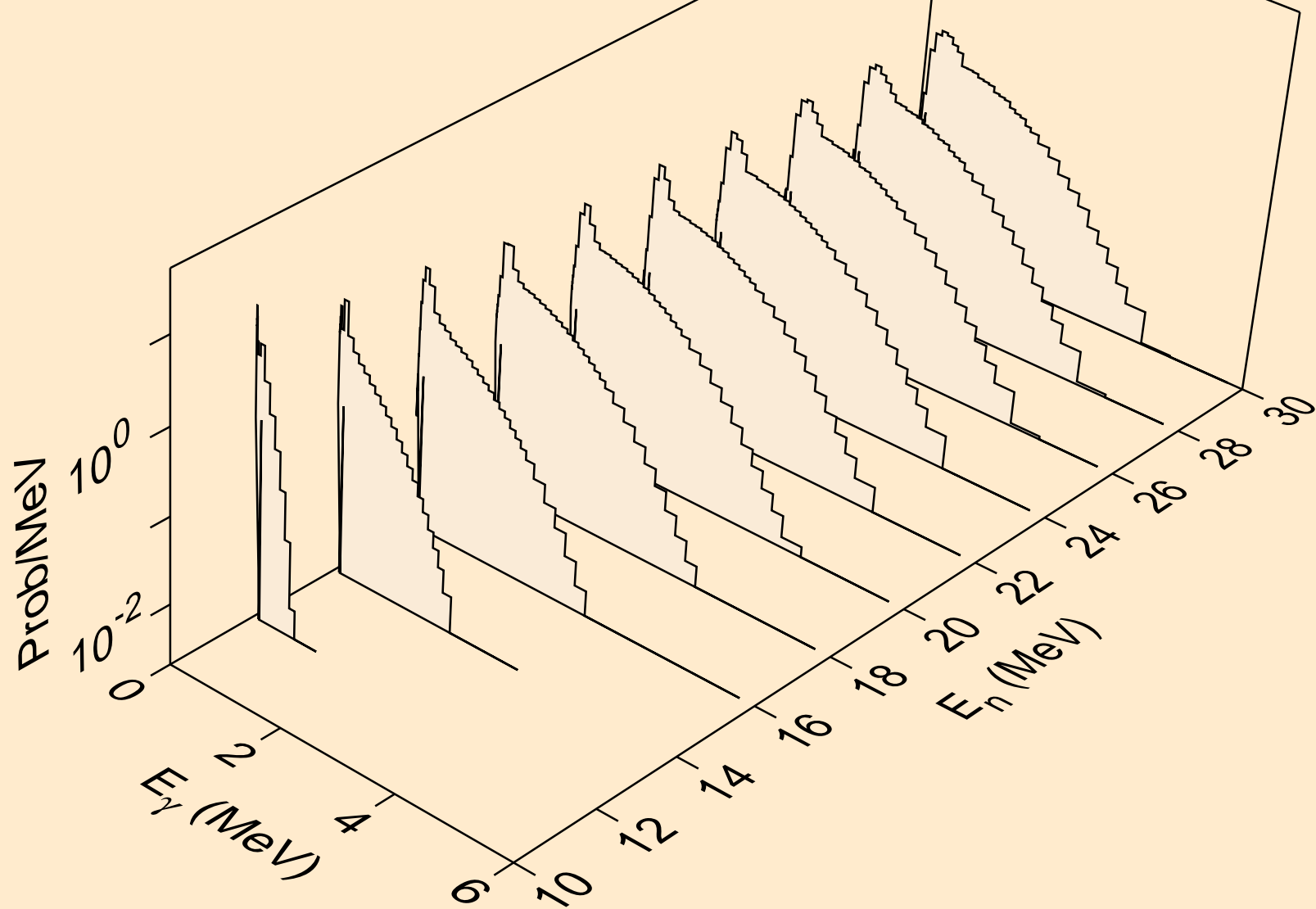

MD261 NEUTRON ACER TENDL-2021 LIBRARY; T=293.6K
Photon emission for (n,n*)a

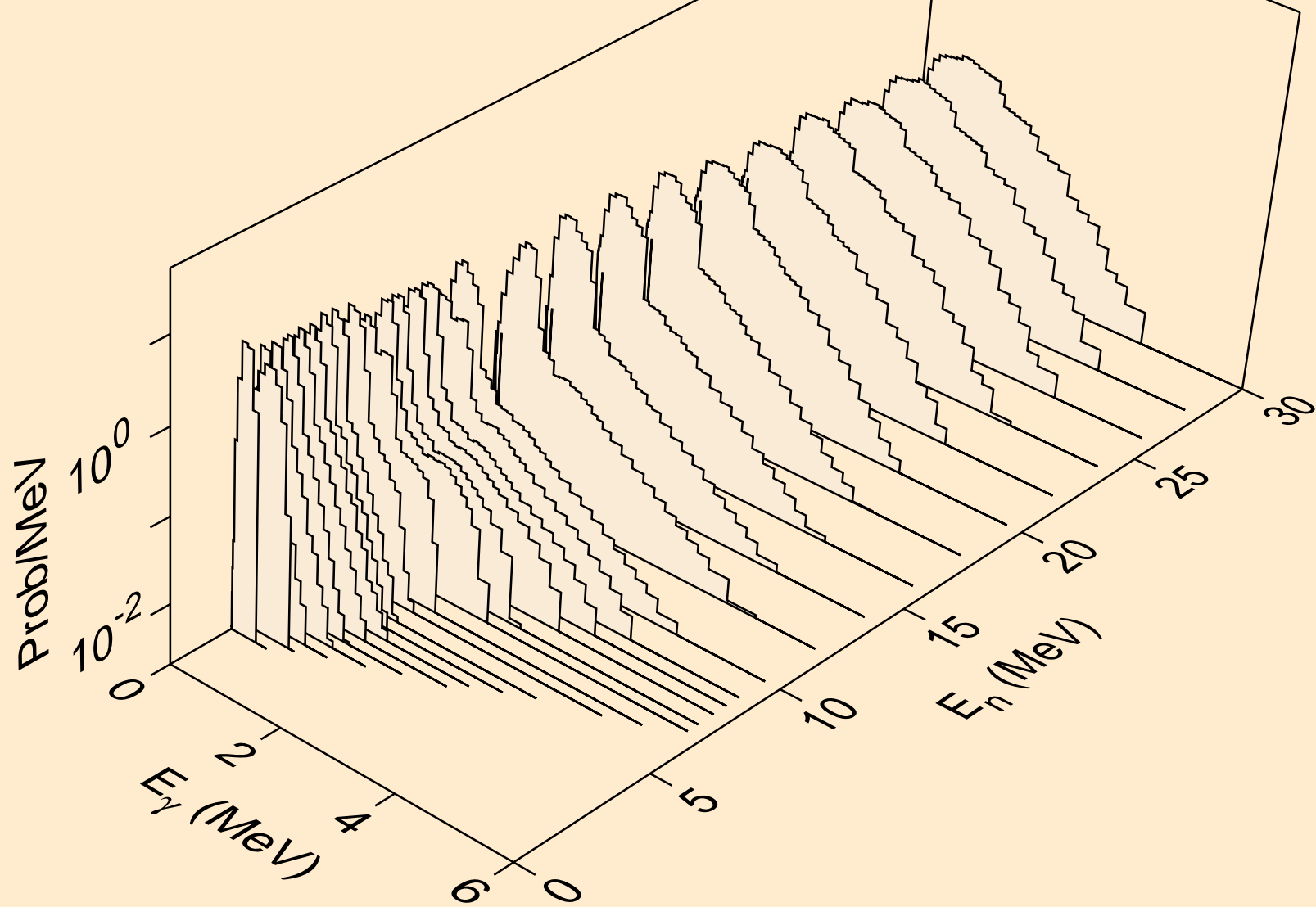

MD261 NEUTRON ACER TENDL-2021 LIBRARY; T=293.6K
Photon emission for (n,2n)a

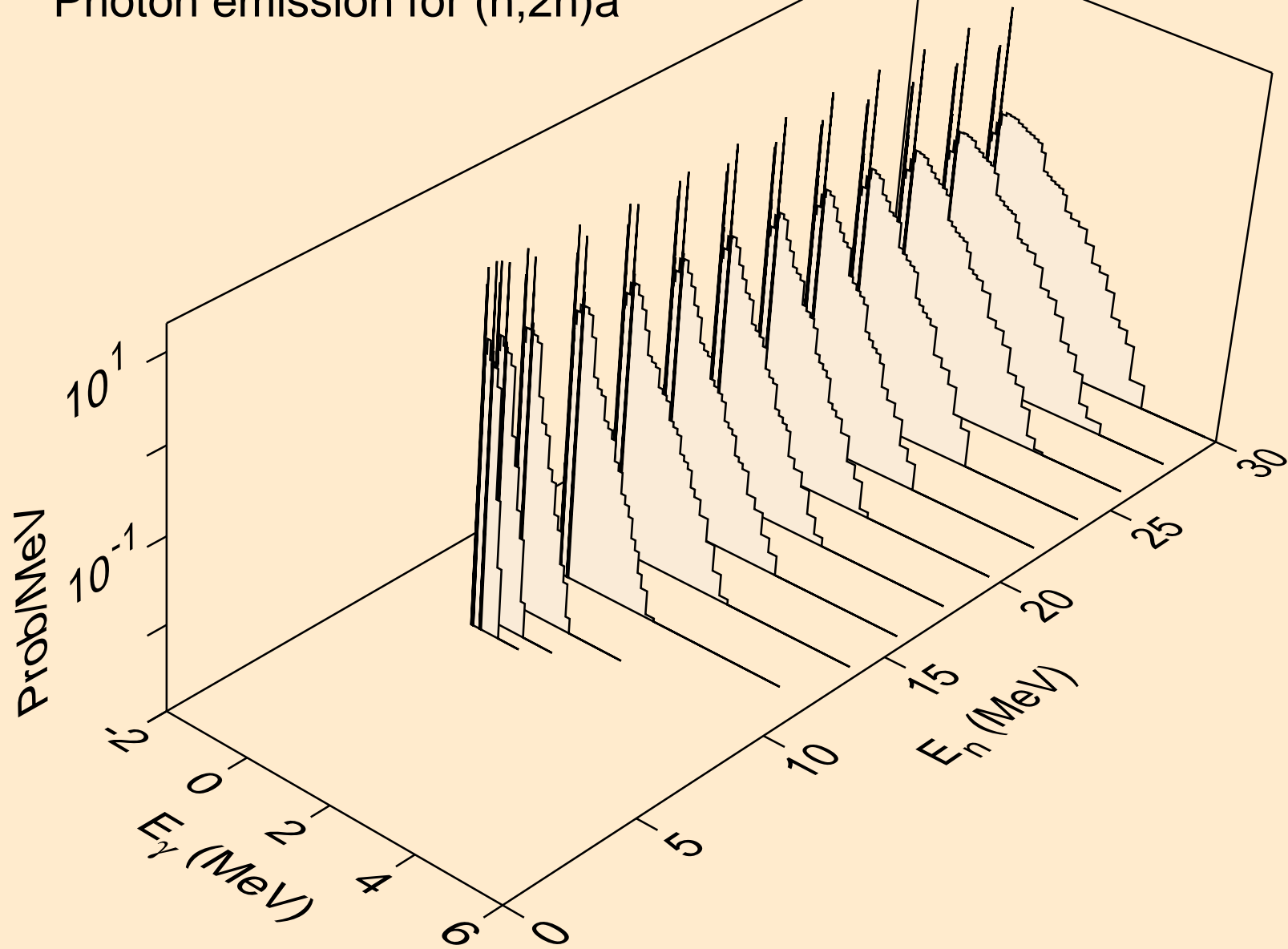

MD261 NEUTRON ACER TENDL-2021 LIBRARY; T=293.6K
Photon emission for (n,3n)a

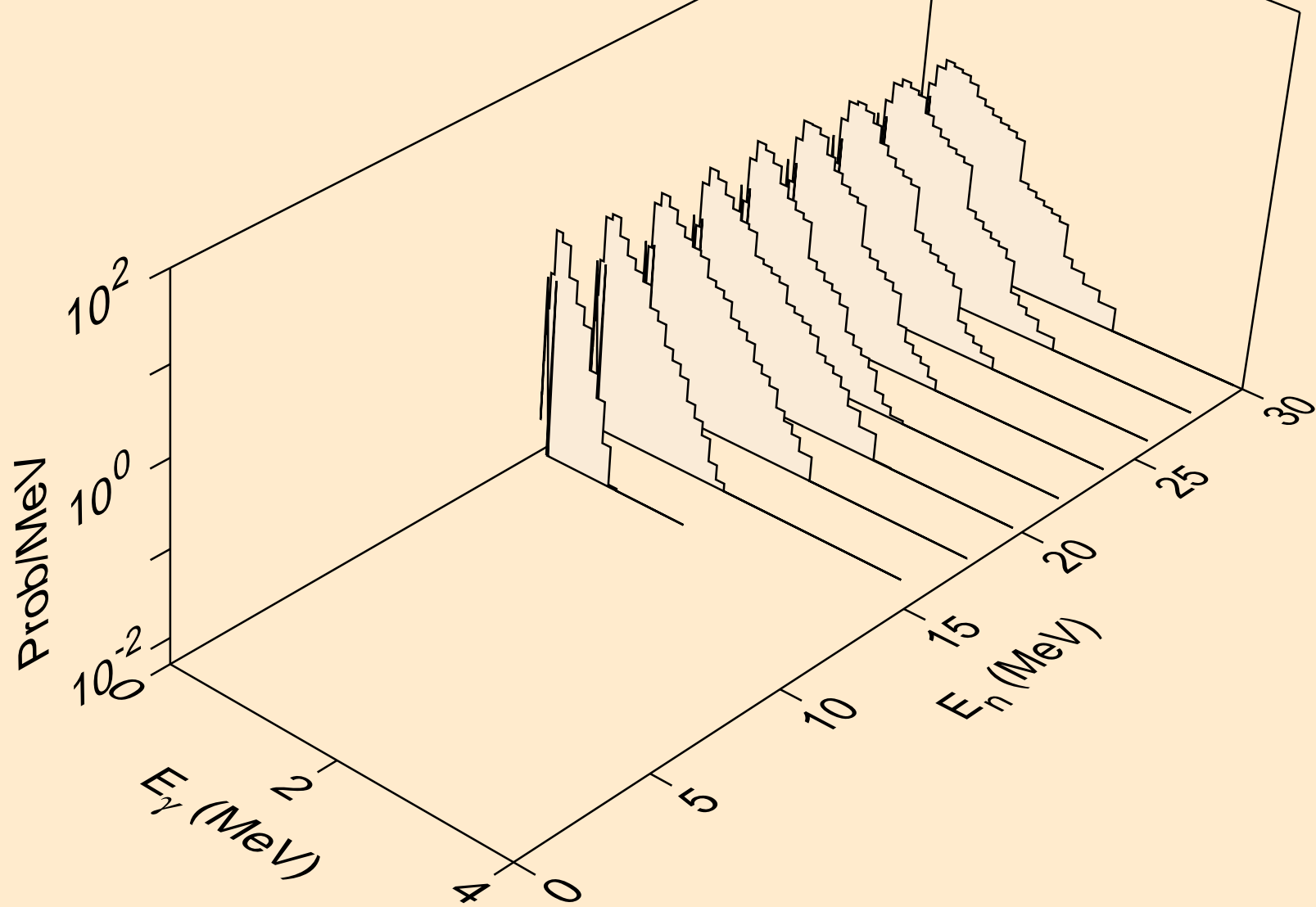

MD261 NEUTRON ACER TENDL-2021 LIBRARY; T=293.6K
Photon emission for (n,n*)p

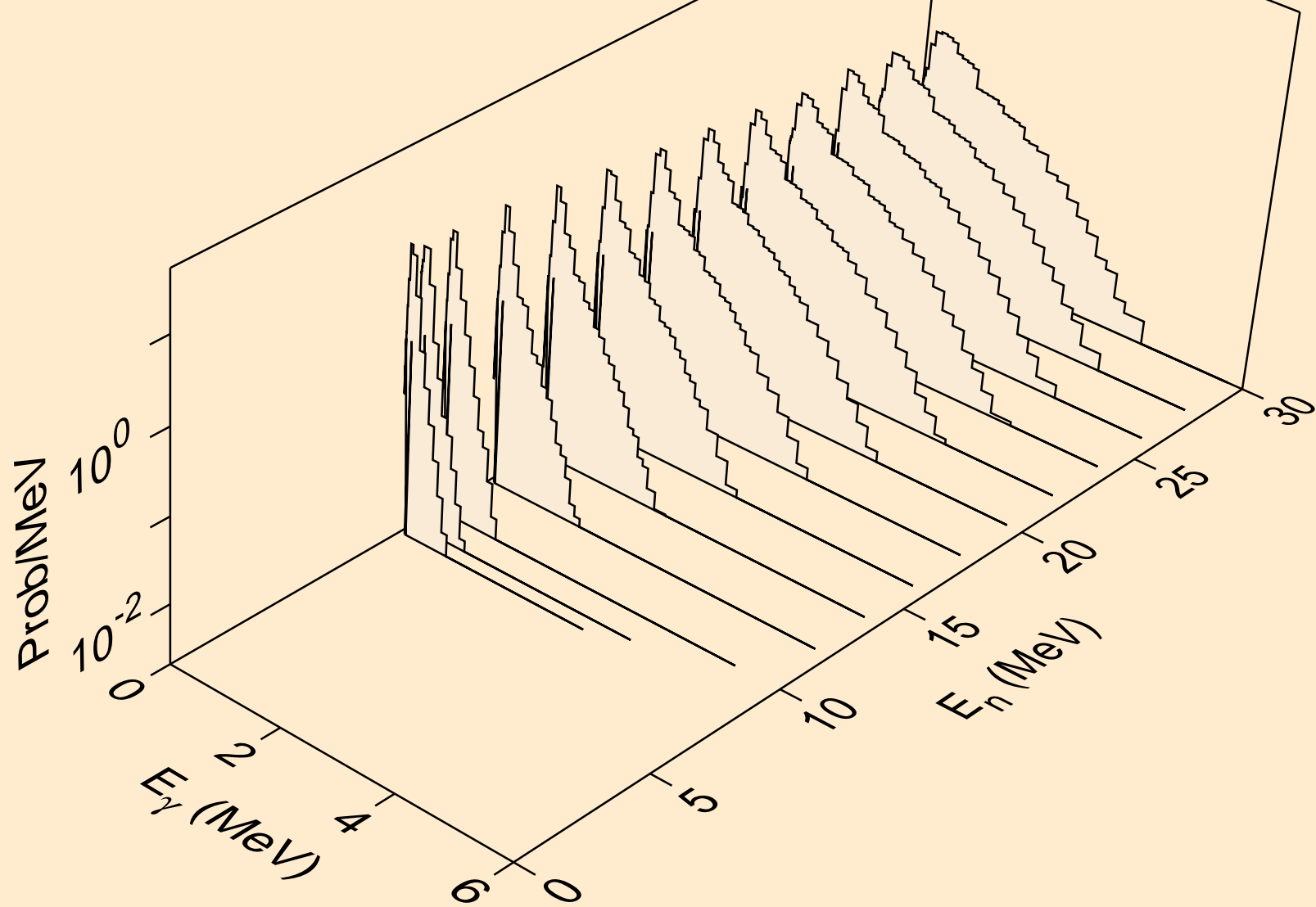

MD261 NEUTRON ACER TENDL-2021 LIBRARY; T=293.6K
Photon emission for (n,n*)2a

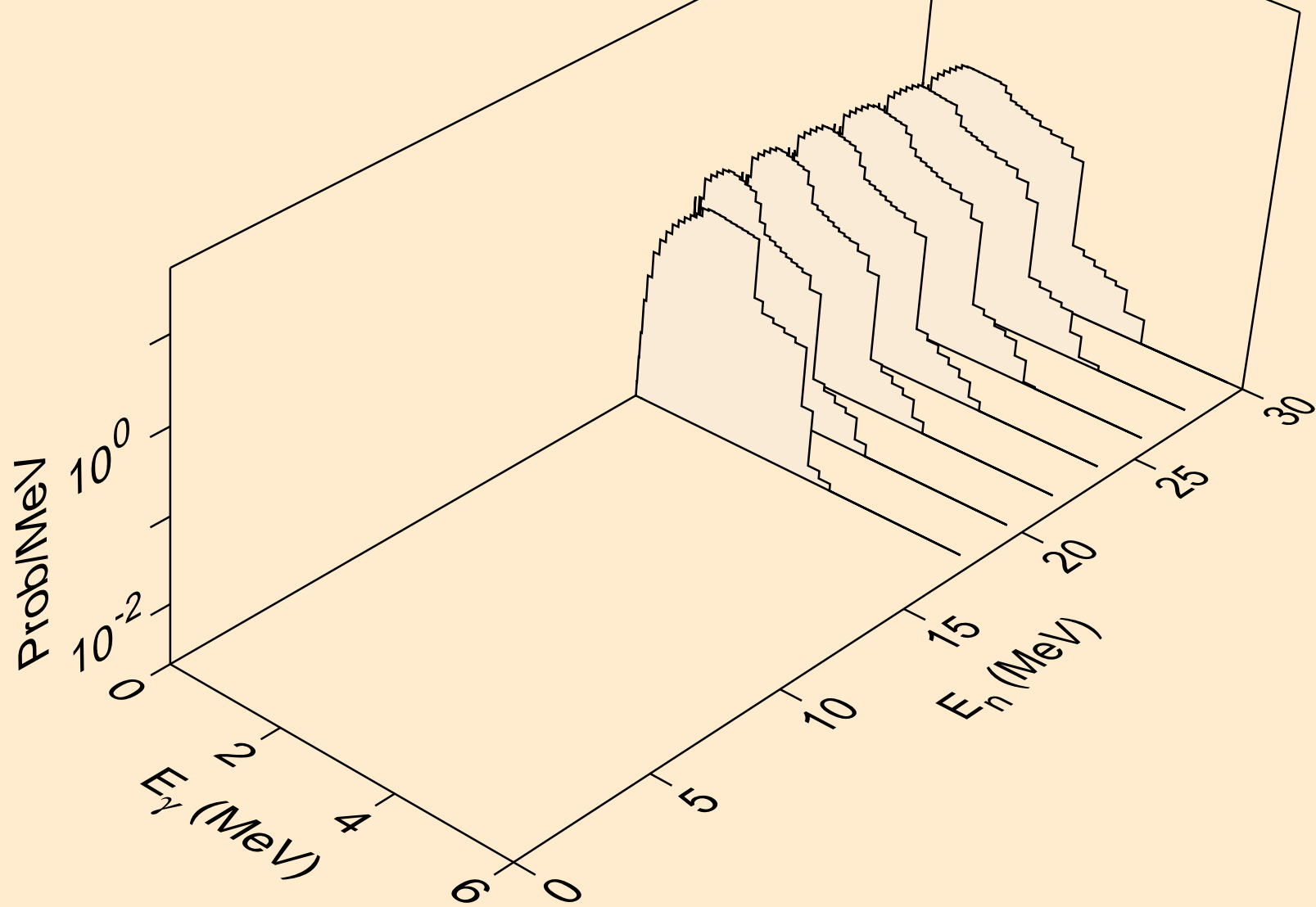

MD261 NEUTRON ACER TENDL-2021 LIBRARY; T=293.6K
Photon emission for (n,n*)d

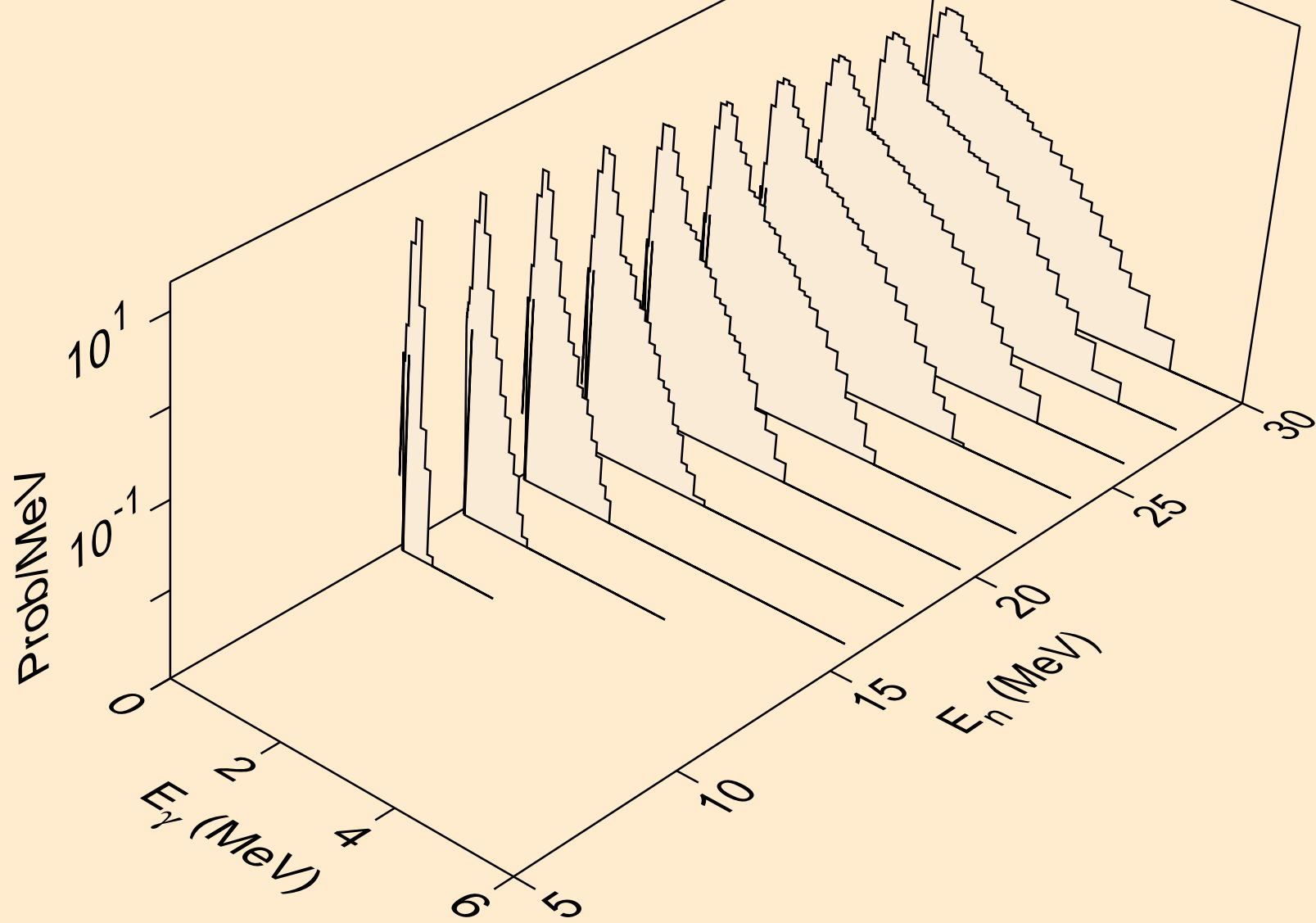

MD261 NEUTRON ACER TENDL-2021 LIBRARY; T=293.6K
Photon emission for (n,n*)t

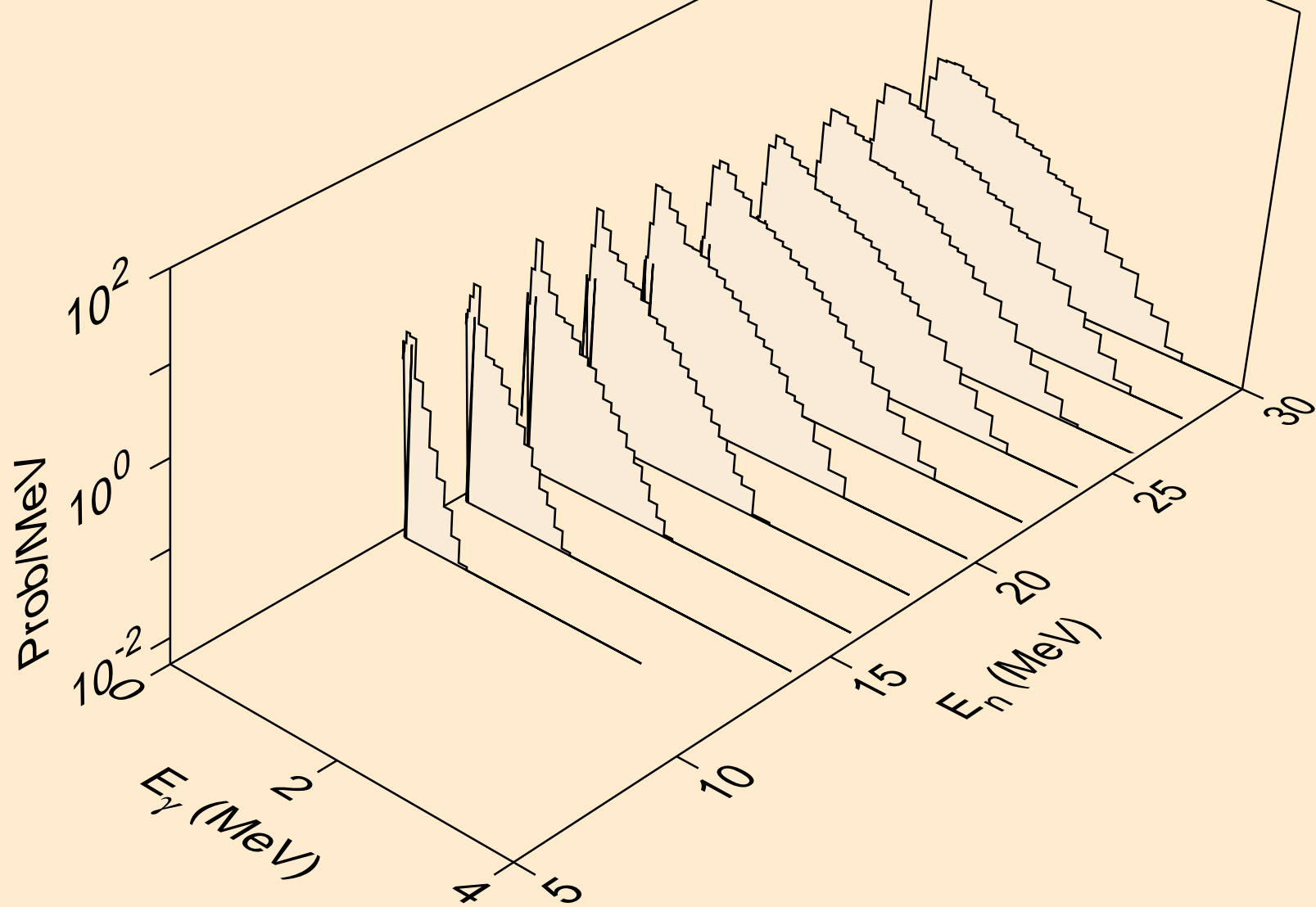

MD261 NEUTRON ACER TENDL-2021 LIBRARY; T=293.6K
Photon emission for (n,n*)he3

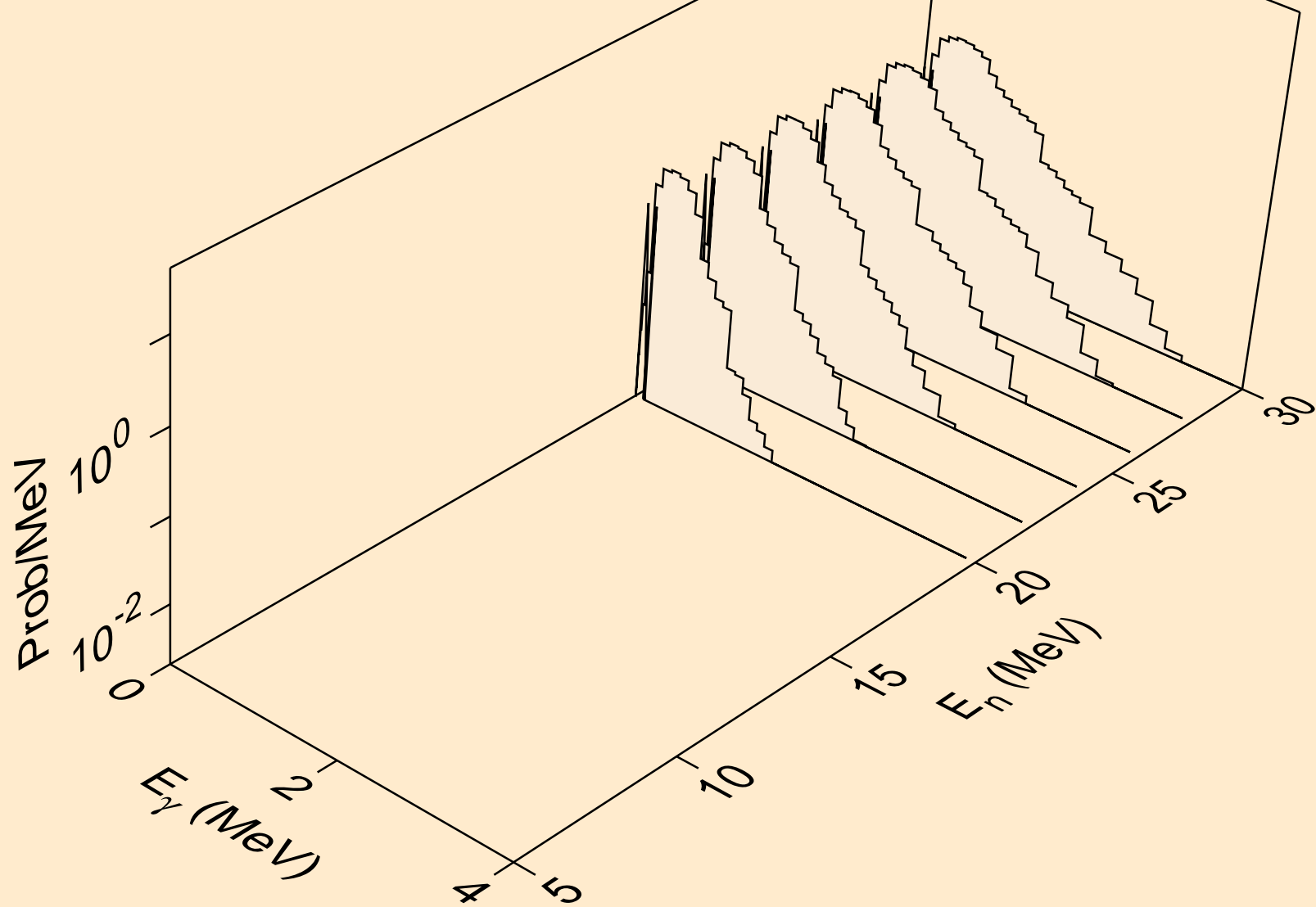

MD261 NEUTRON ACER TENDL-2021 LIBRARY; T=293.6K
Photon emission for (n,4n)

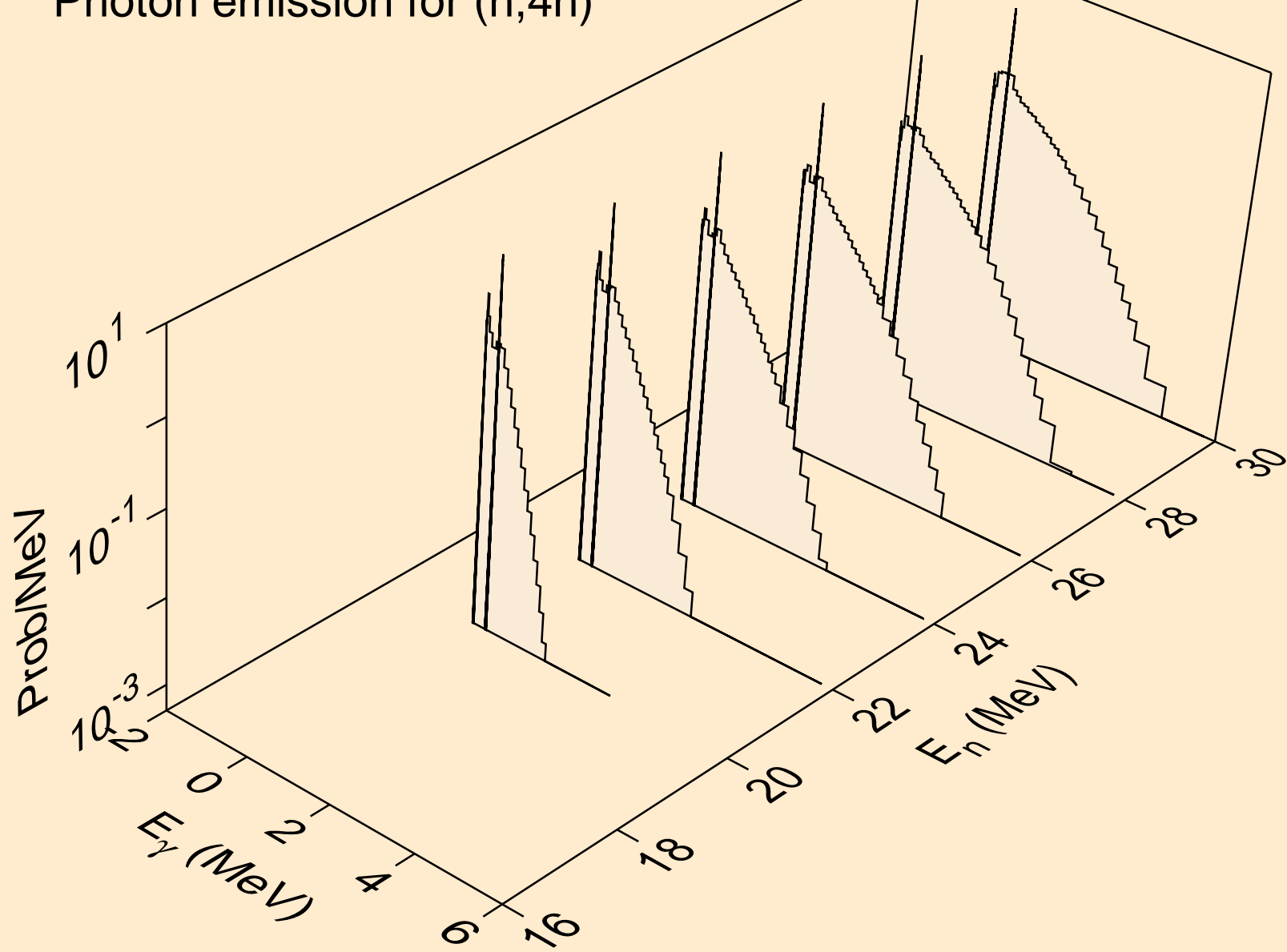

MD261 NEUTRON ACER TENDL-2021 LIBRARY; T=293.6K
Photon emission for (n,2np)

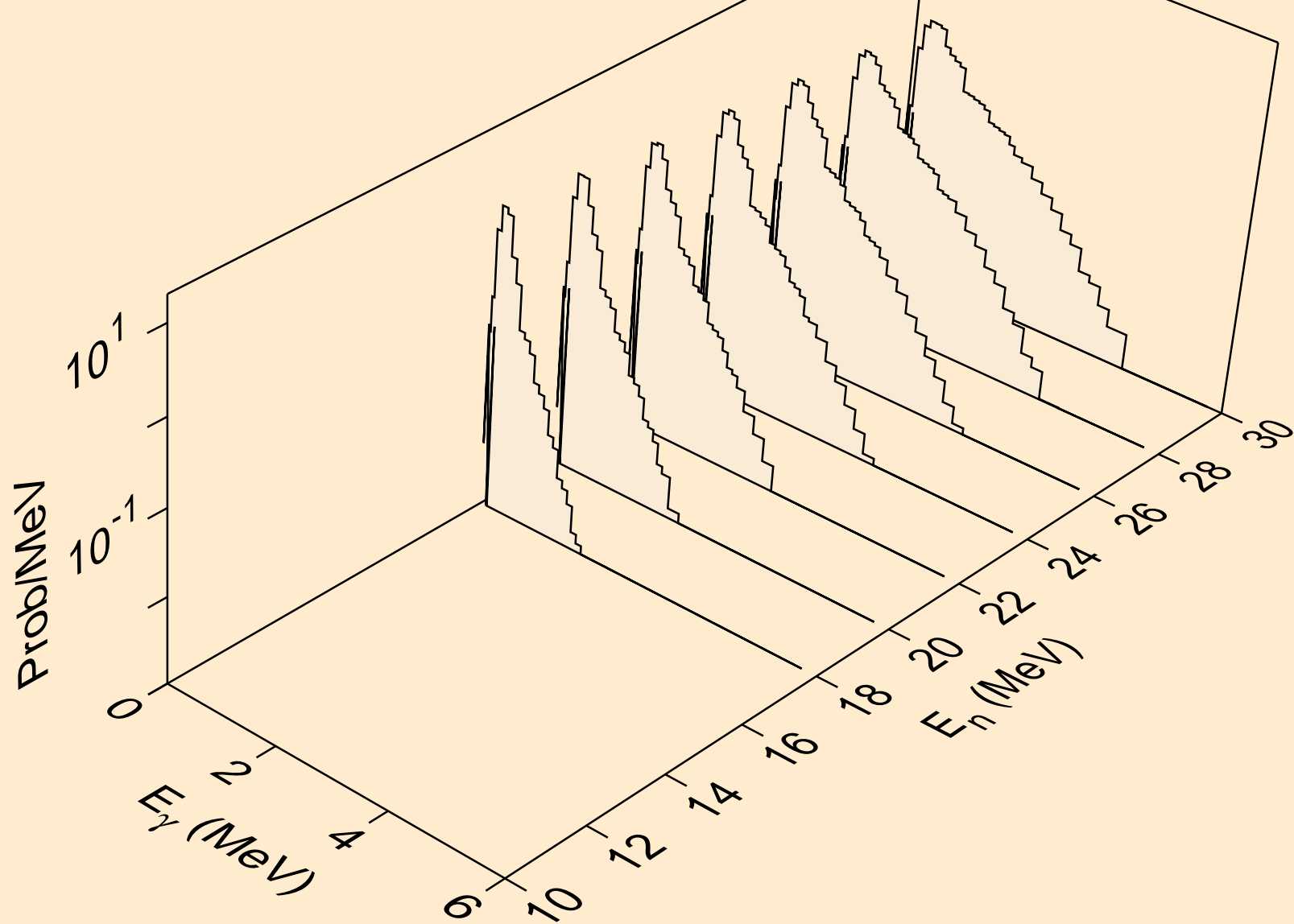

MD261 NEUTRON ACER TENDL-2021 LIBRARY; T=293.6K
Photon emission for (n,3np)

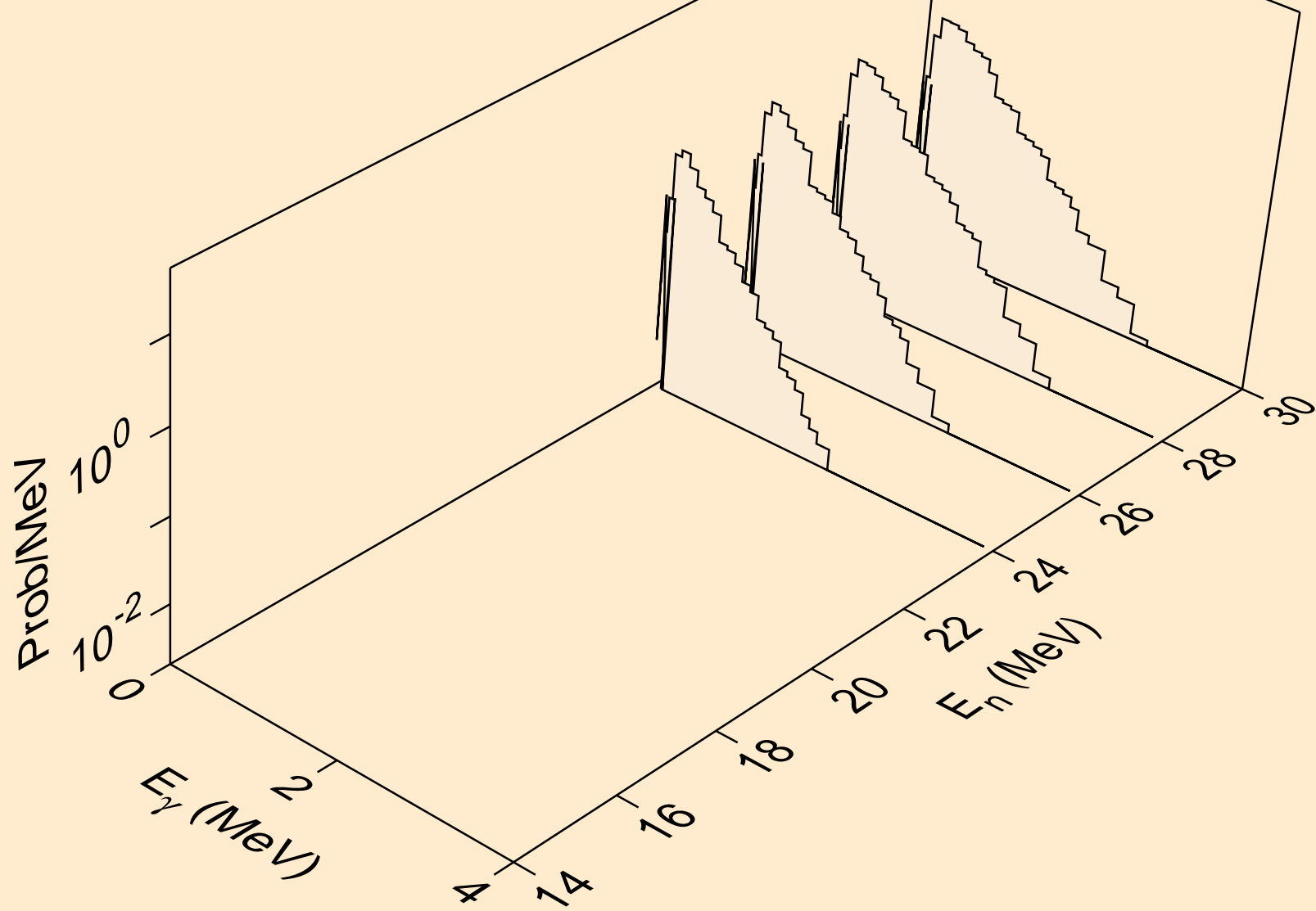

MD261 NEUTRON ACER TENDL-2021 LIBRARY; T=293.6K
Photon emission for (n,npa)

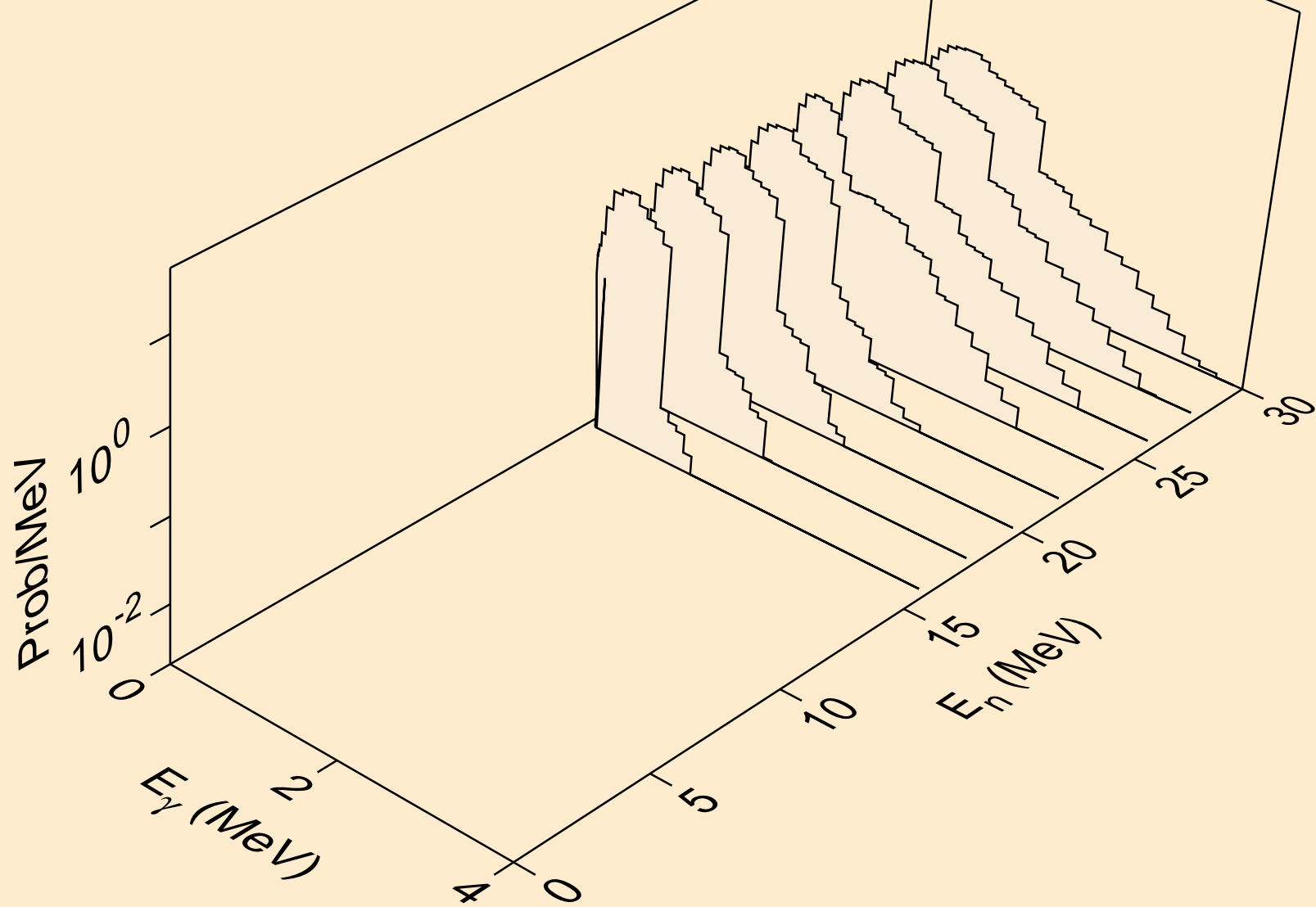

MD261 NEUTRON ACER TENDL-2021 LIBRARY; T=293.6K
Photon emission for (n,n*c)

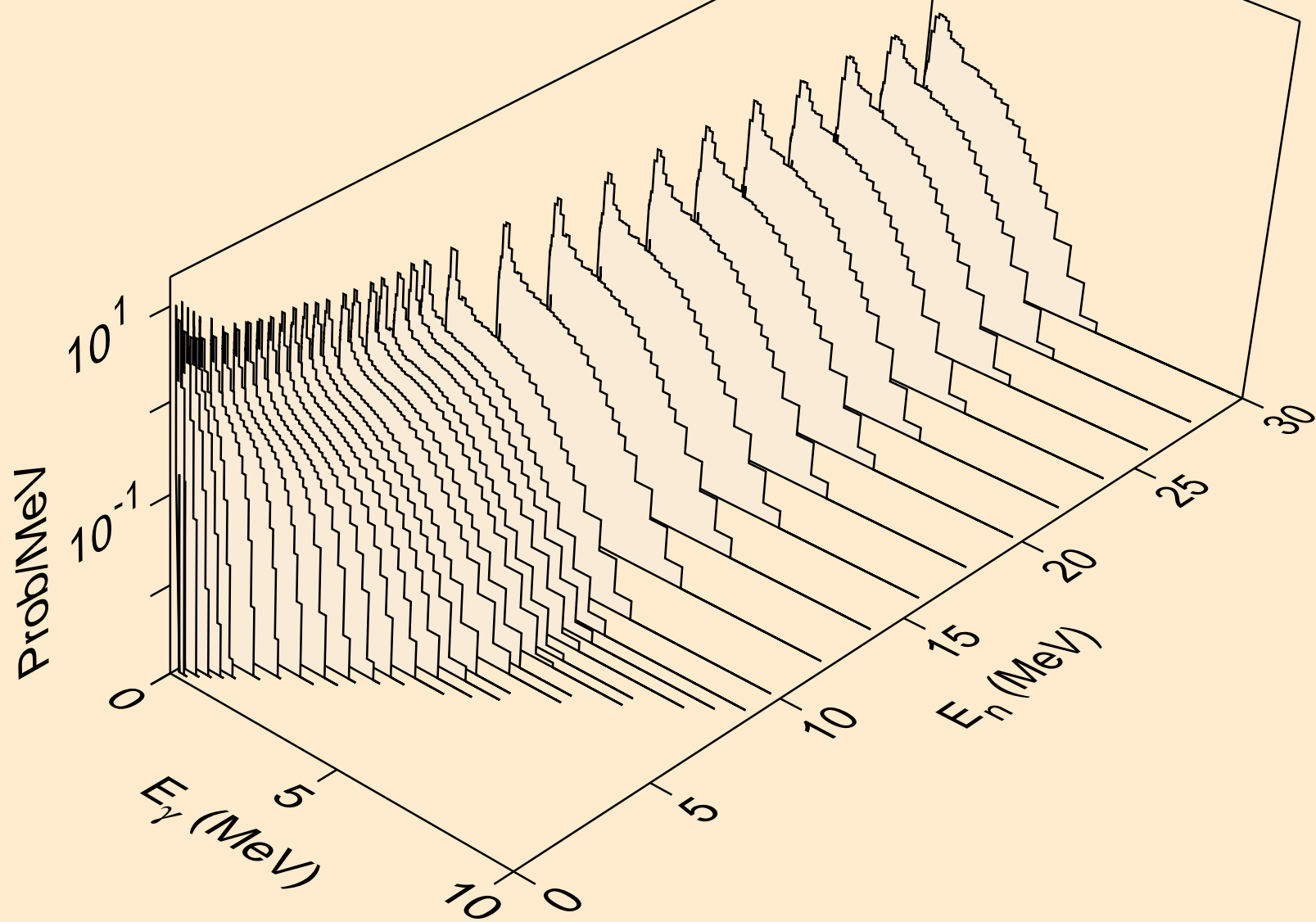

MD261 NEUTRON ACER TENDL-2021 LIBRARY; T=293.6K
Photon emission for (n,gma)

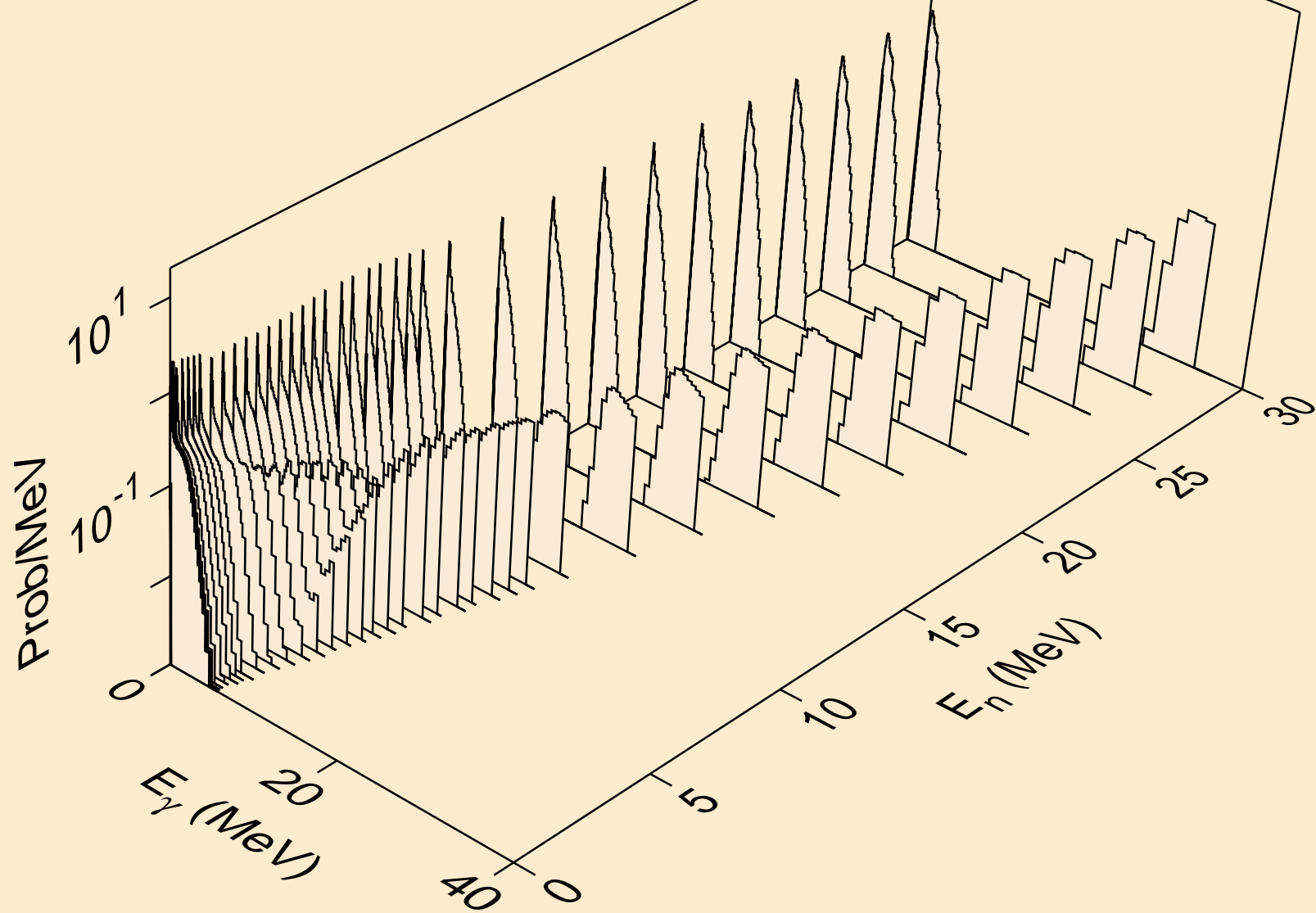

MD261 NEUTRON ACER TENDL-2021 LIBRARY; T=293.6K
Photon emission for (n,p)

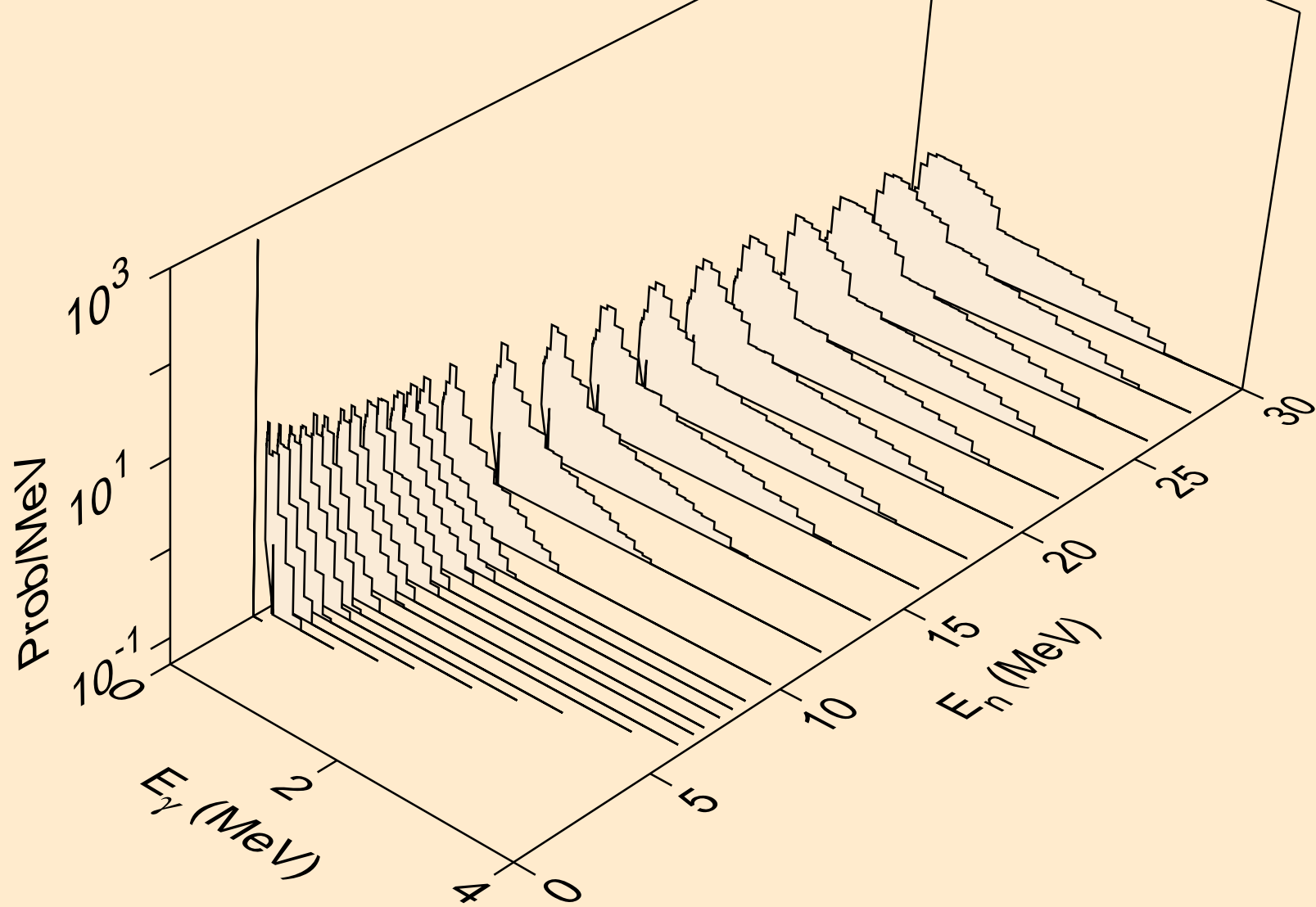

MD261 NEUTRON ACER TENDL-2021 LIBRARY; T=293.6K
Photon emission for (n,d)

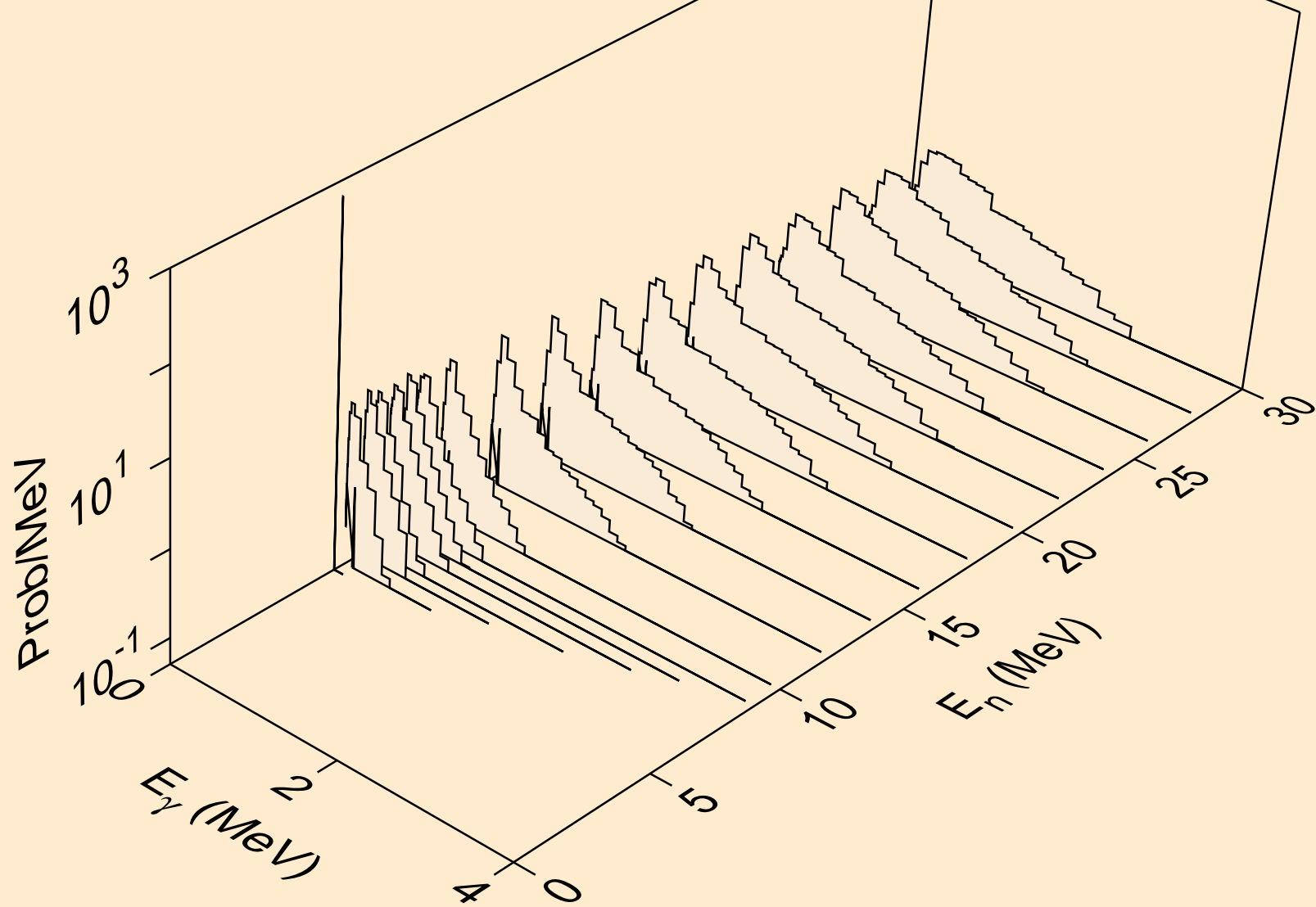

MD261 NEUTRON ACER TENDL-2021 LIBRARY; T=293.6K
Photon emission for (n,t)

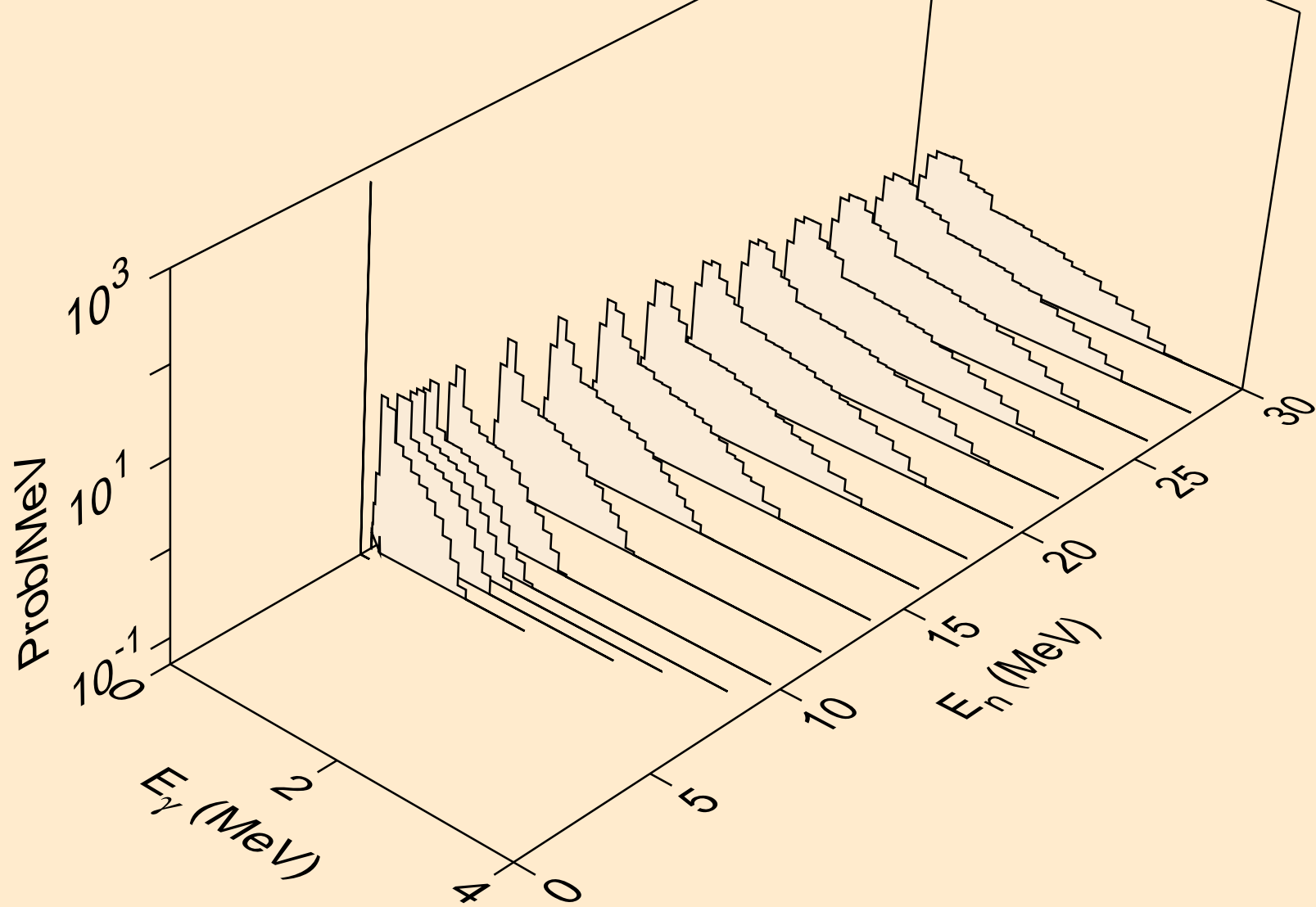

MD261 NEUTRON ACER TENDL-2021 LIBRARY; T=293.6K
Photon emission for (n,he3)

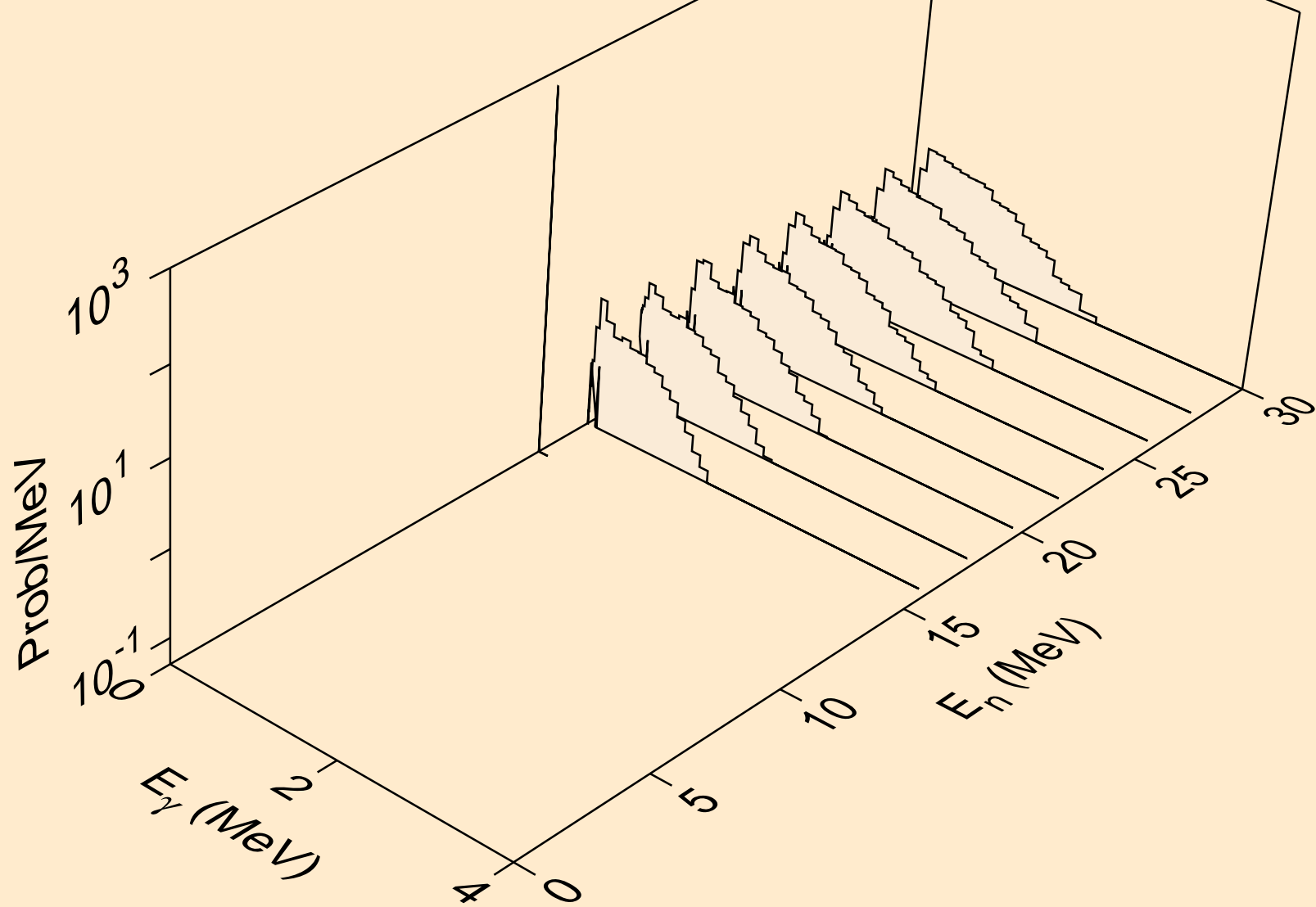

MD261 NEUTRON ACER TENDL-2021 LIBRARY; T=293.6K
Photon emission for (n,a)

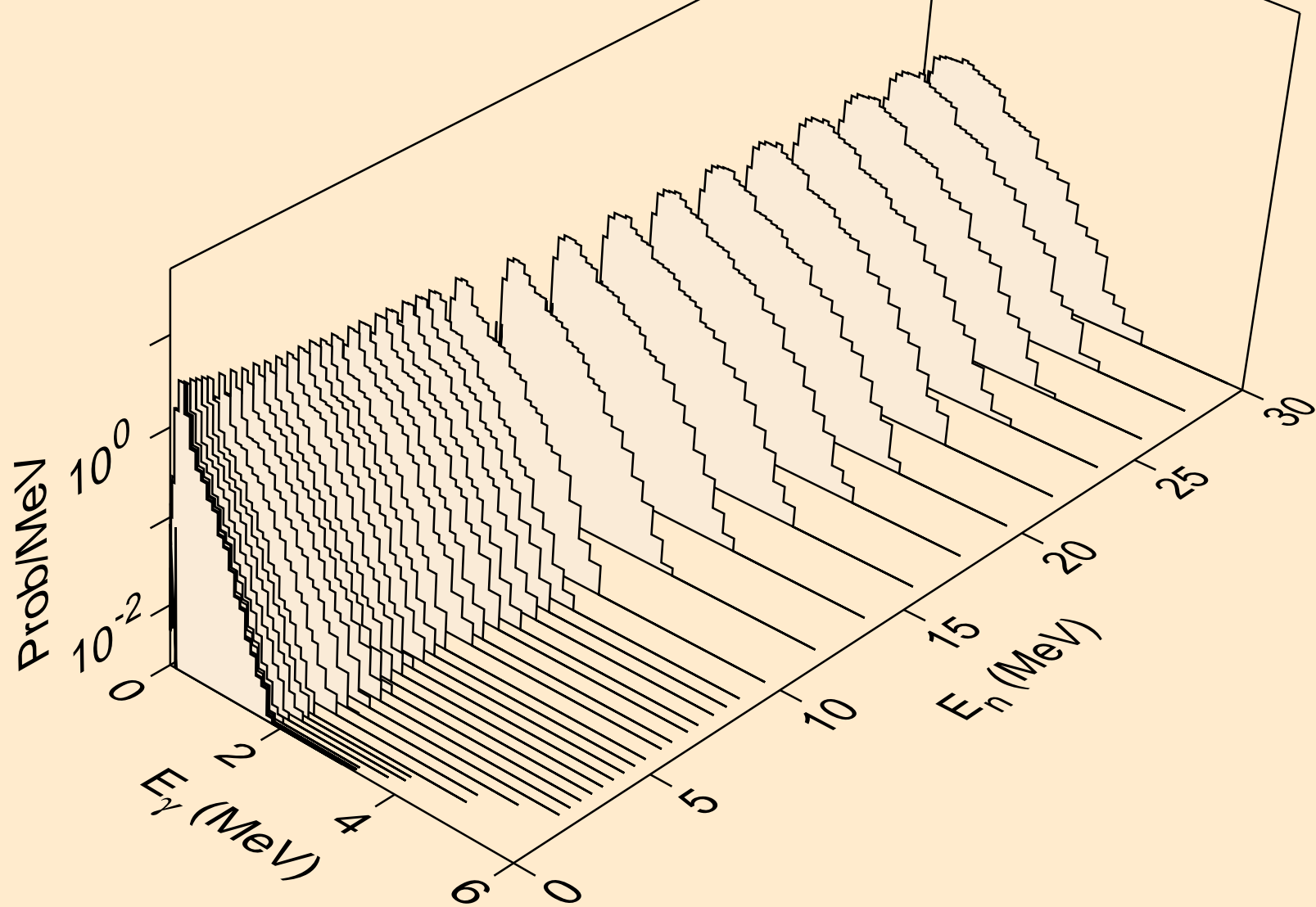

MD261 NEUTRON ACER TENDL-2021 LIBRARY; T=293.6K
Photon emission for (n,2a)

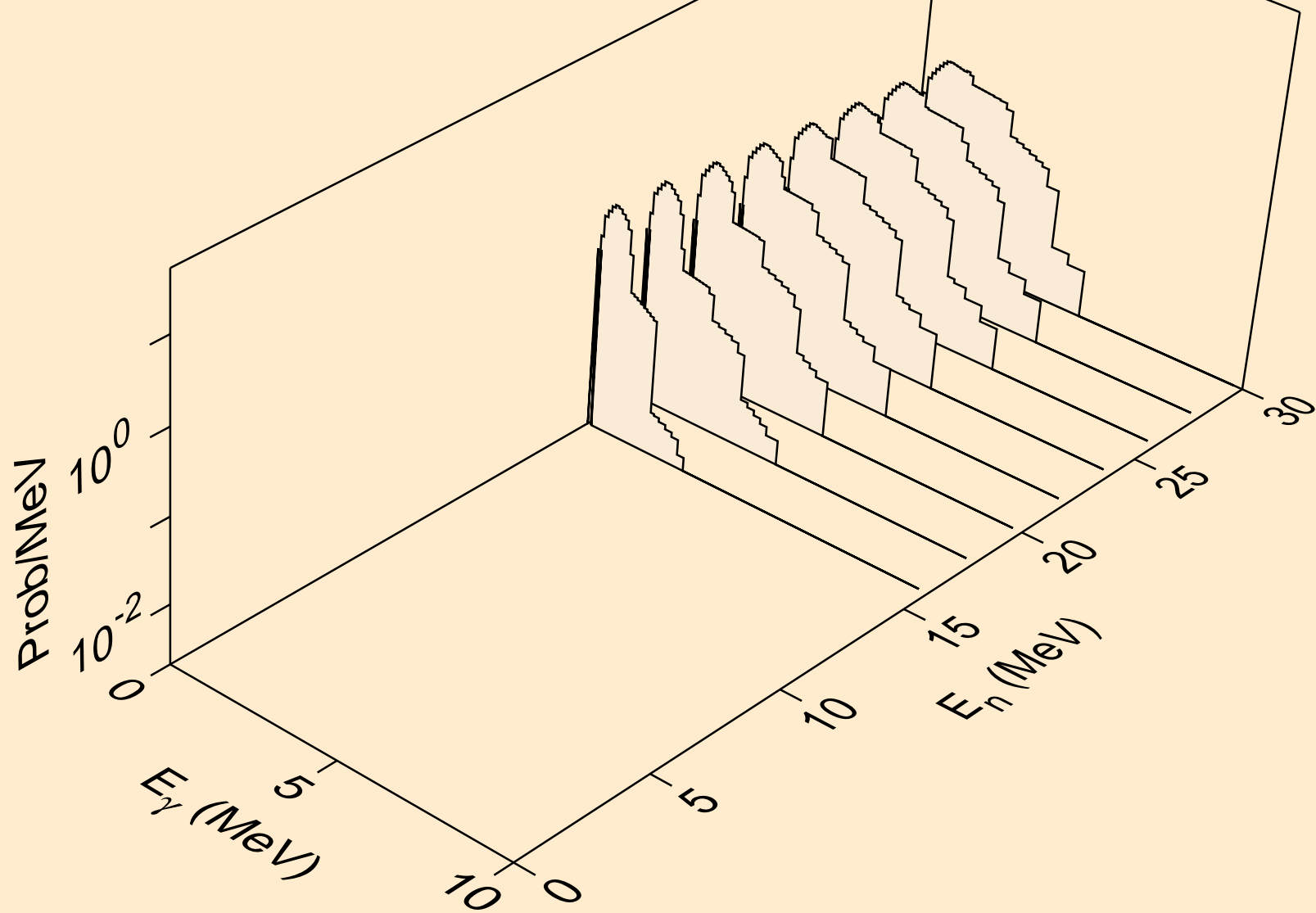

MD261 NEUTRON ACER TENDL-2021 LIBRARY; T=293.6K
Photon emission for (n,2p)

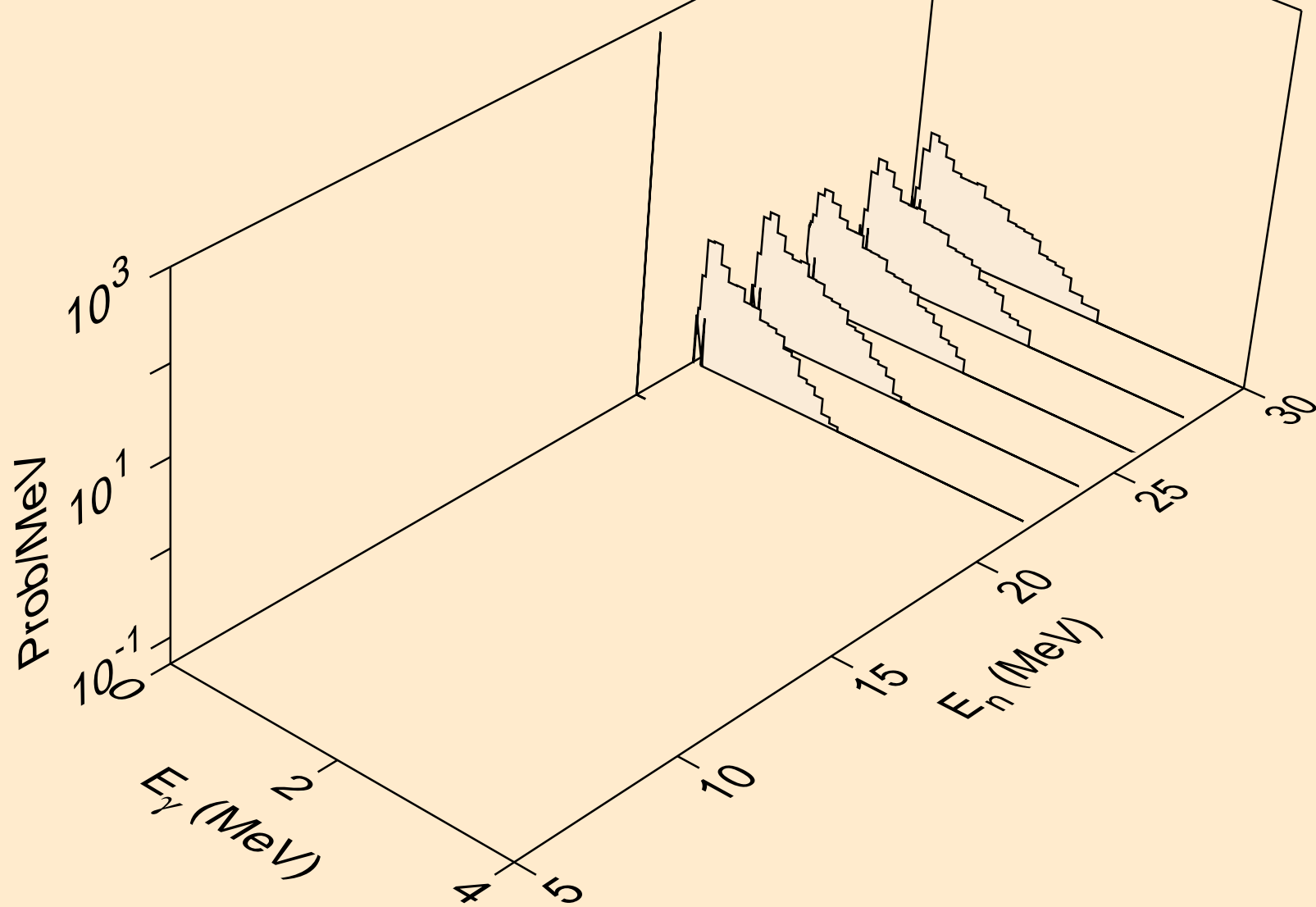

MD261 NEUTRON ACER TENDL-2021 LIBRARY; T=293.6K
Photon emission for (n,da)

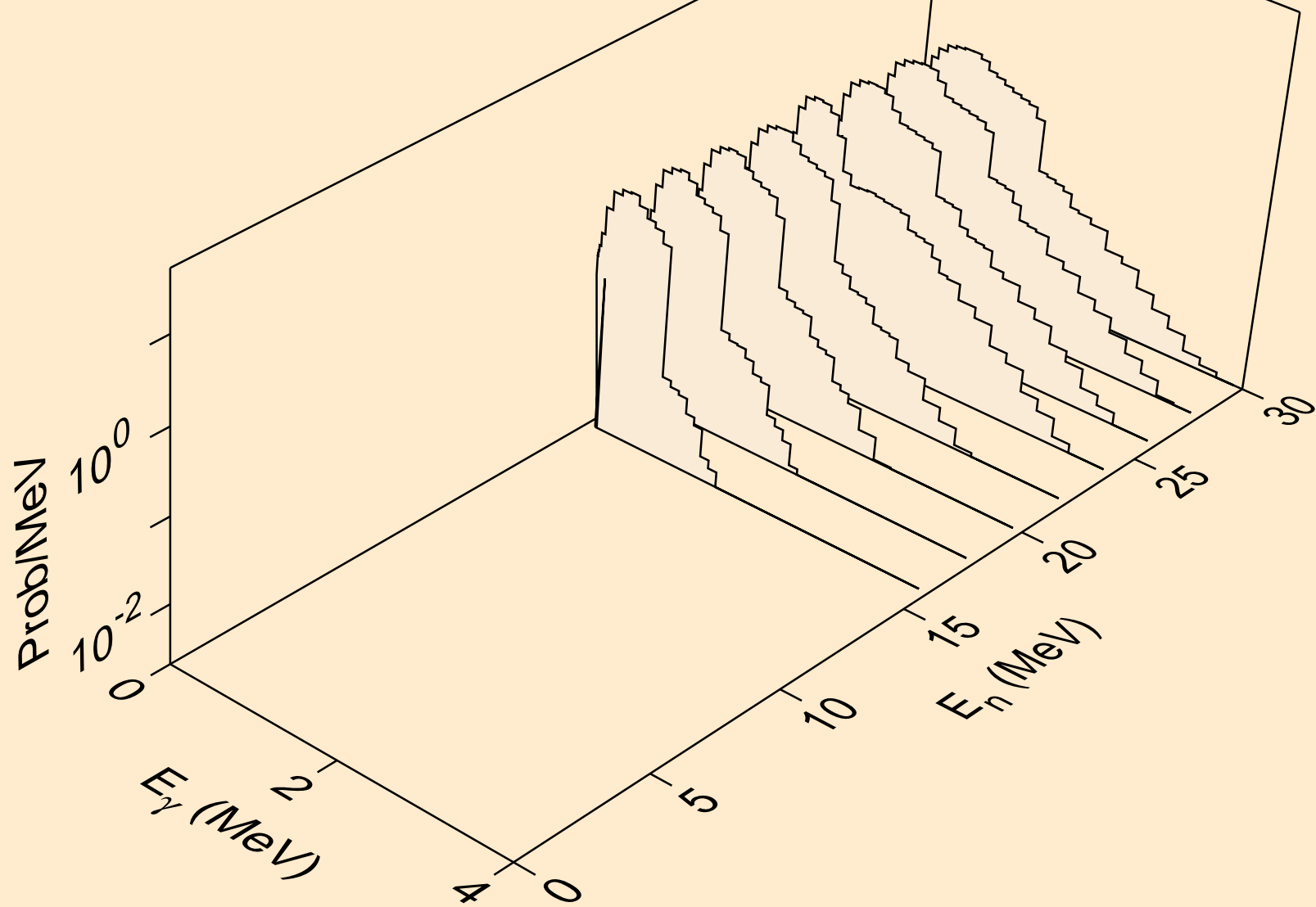

MD261 NEUTRON ACER TENDL-2021 LIBRARY; T=293.6K
thermal capture photon spectrum

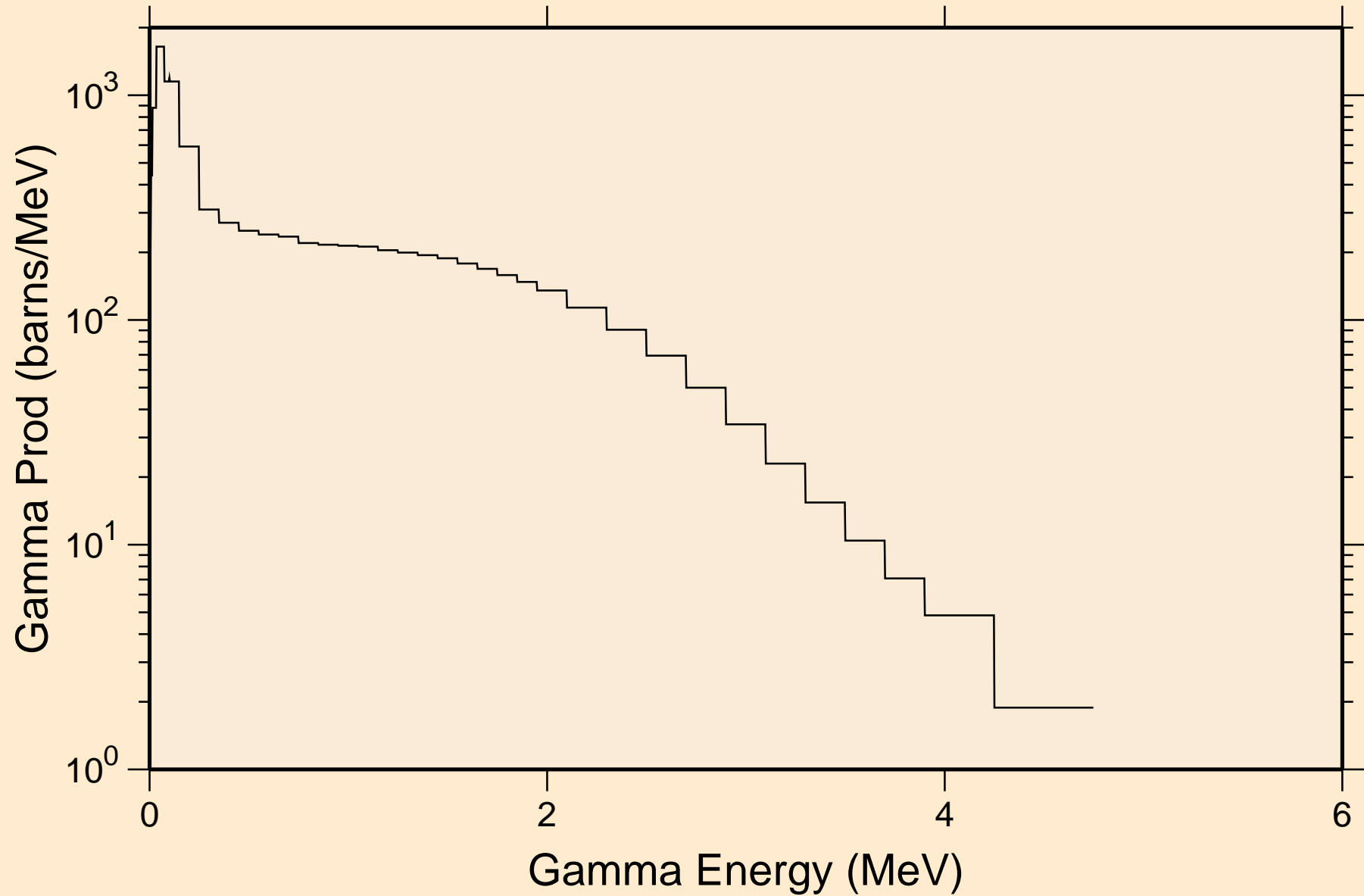

MD261 NEUTRON ACER TENDL-2021 LIBRARY; T=293.6K
14 MeV photon spectrum

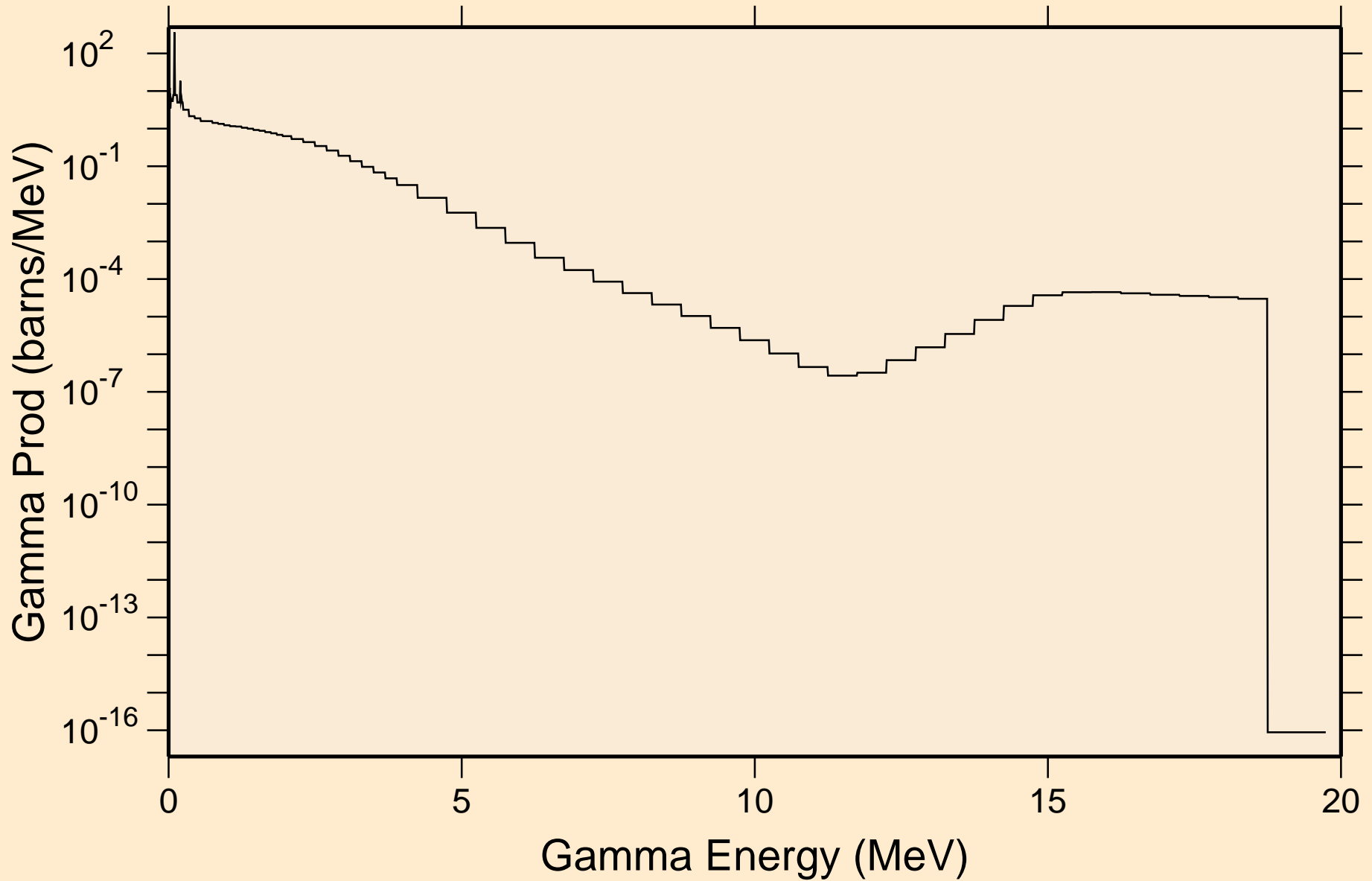

MD261 NEUTRON ACER TENDL-2021 LIBRARY; T=293.6K

Particle heating contributions

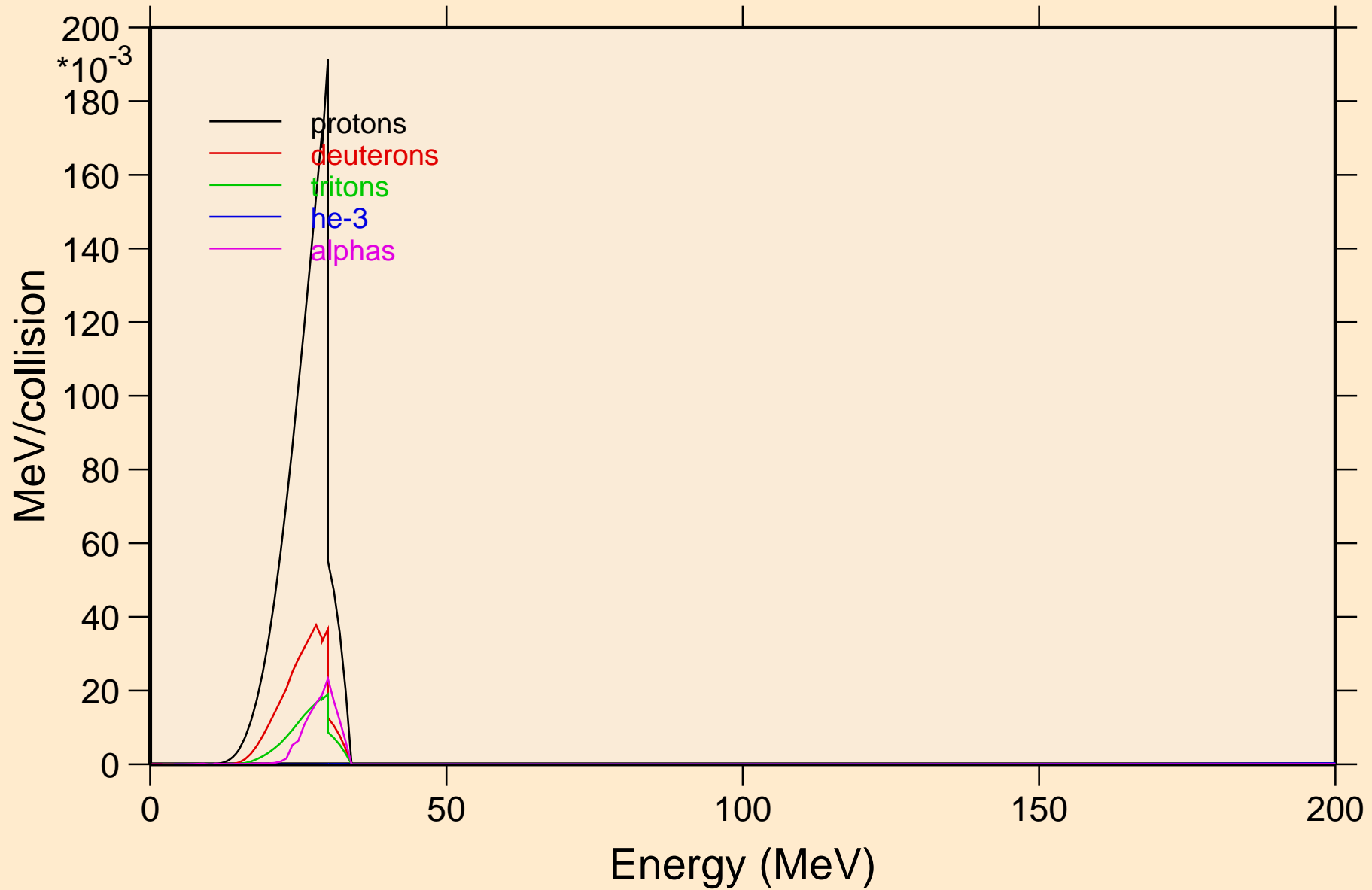

MD261 NEUTRON ACER TENDL-2021 LIBRARY; T=293.6K
Recoil Heating

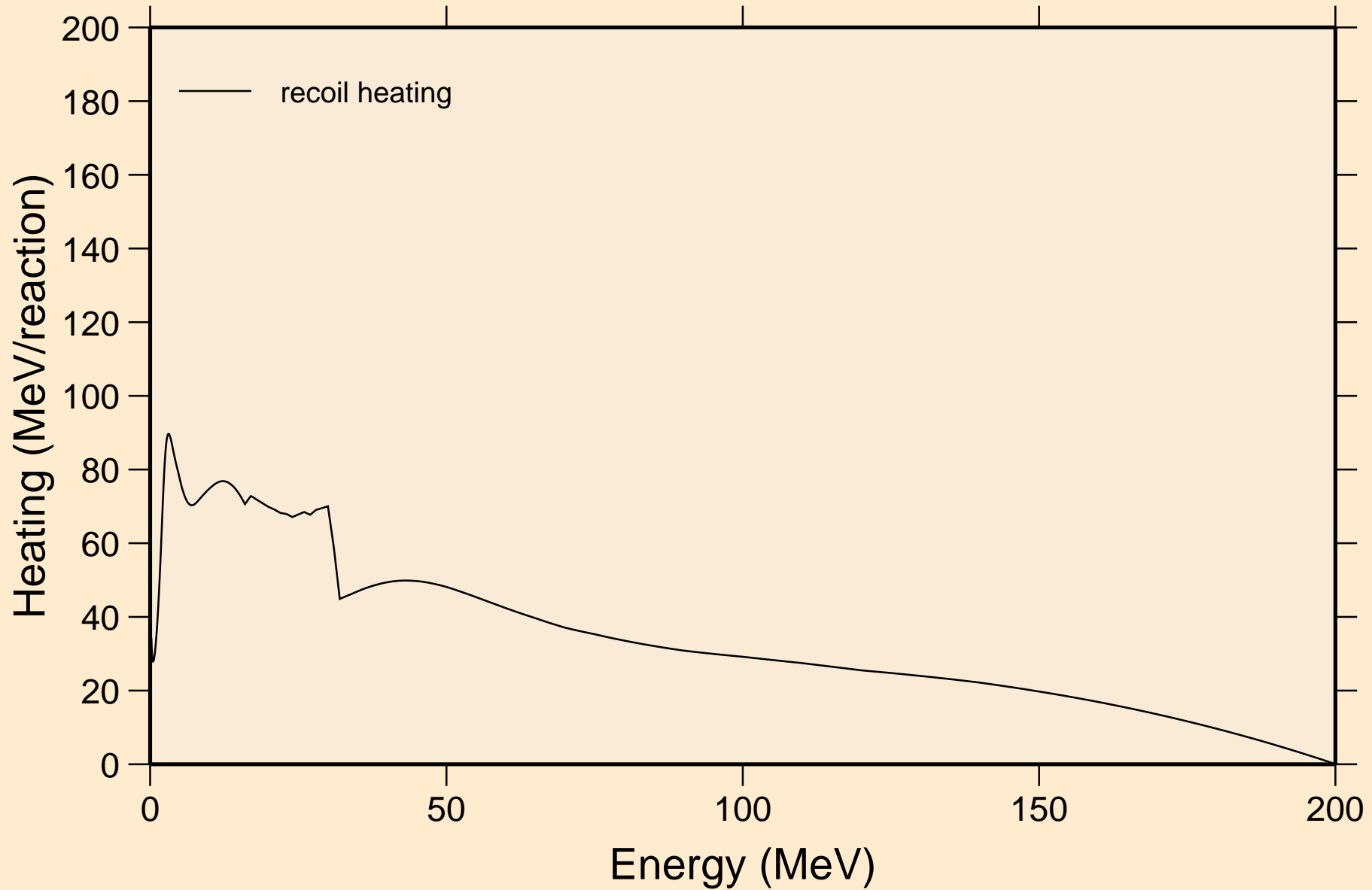

MD261 NEUTRON ACER TENDL-2021 LIBRARY; T=293.6K
Particle production cross sections

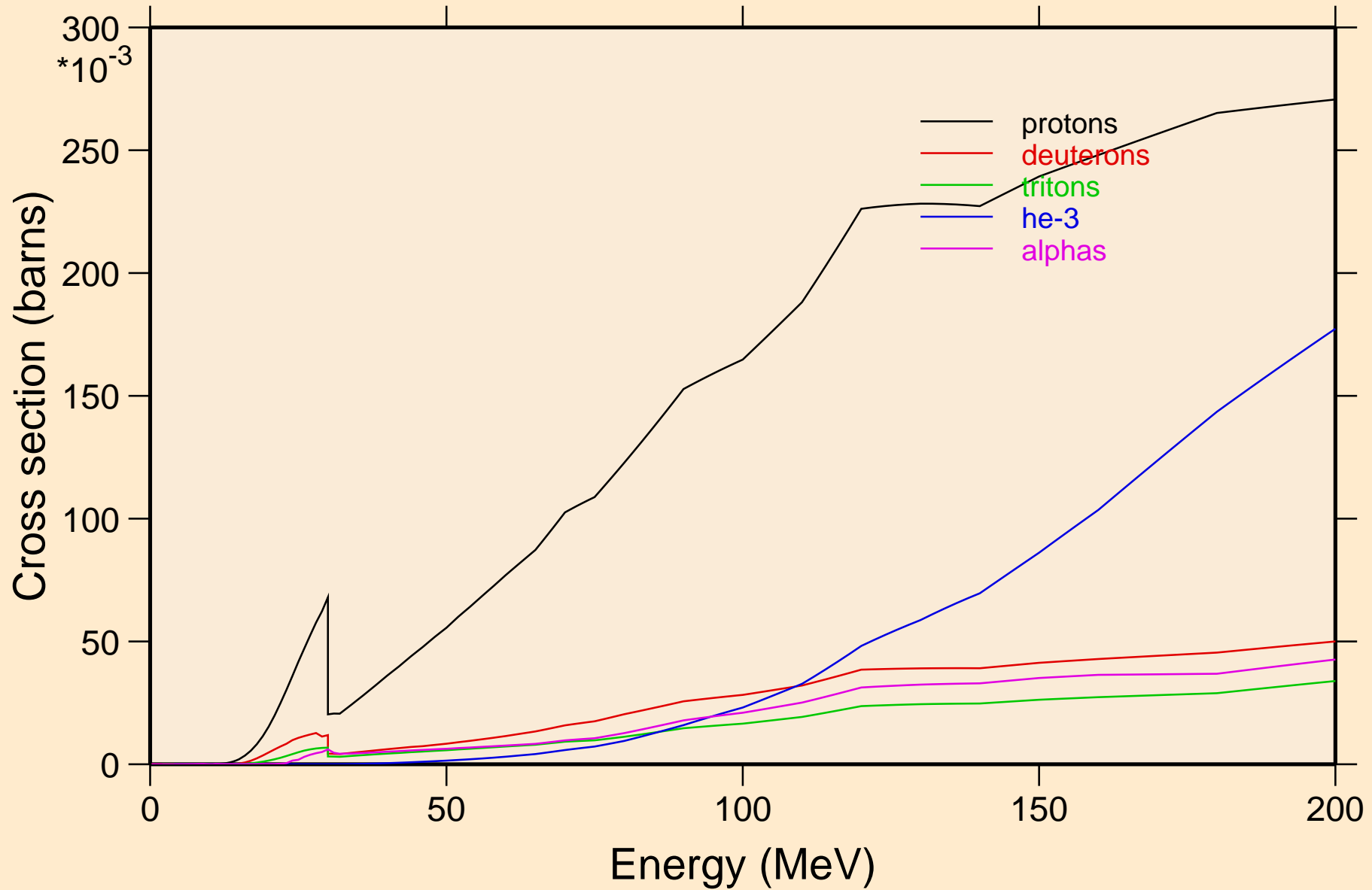

MD261 NEUTRON ACER TENDL-2021 LIBRARY; T=293.6K
protons from (n,x)

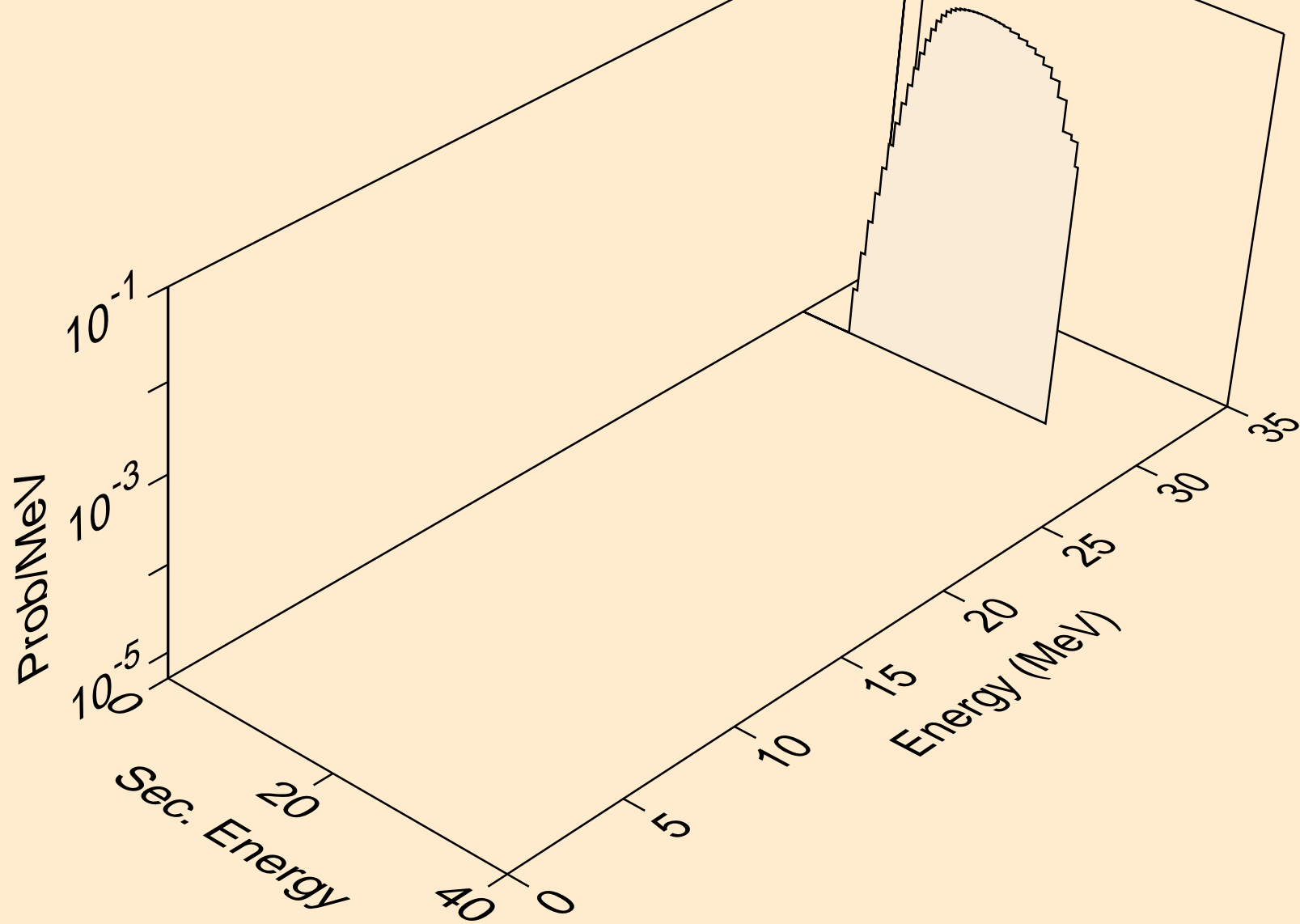

MD261 NEUTRON ACER TENDL-2021 LIBRARY; T=293.6K
protons from (n,n*)p

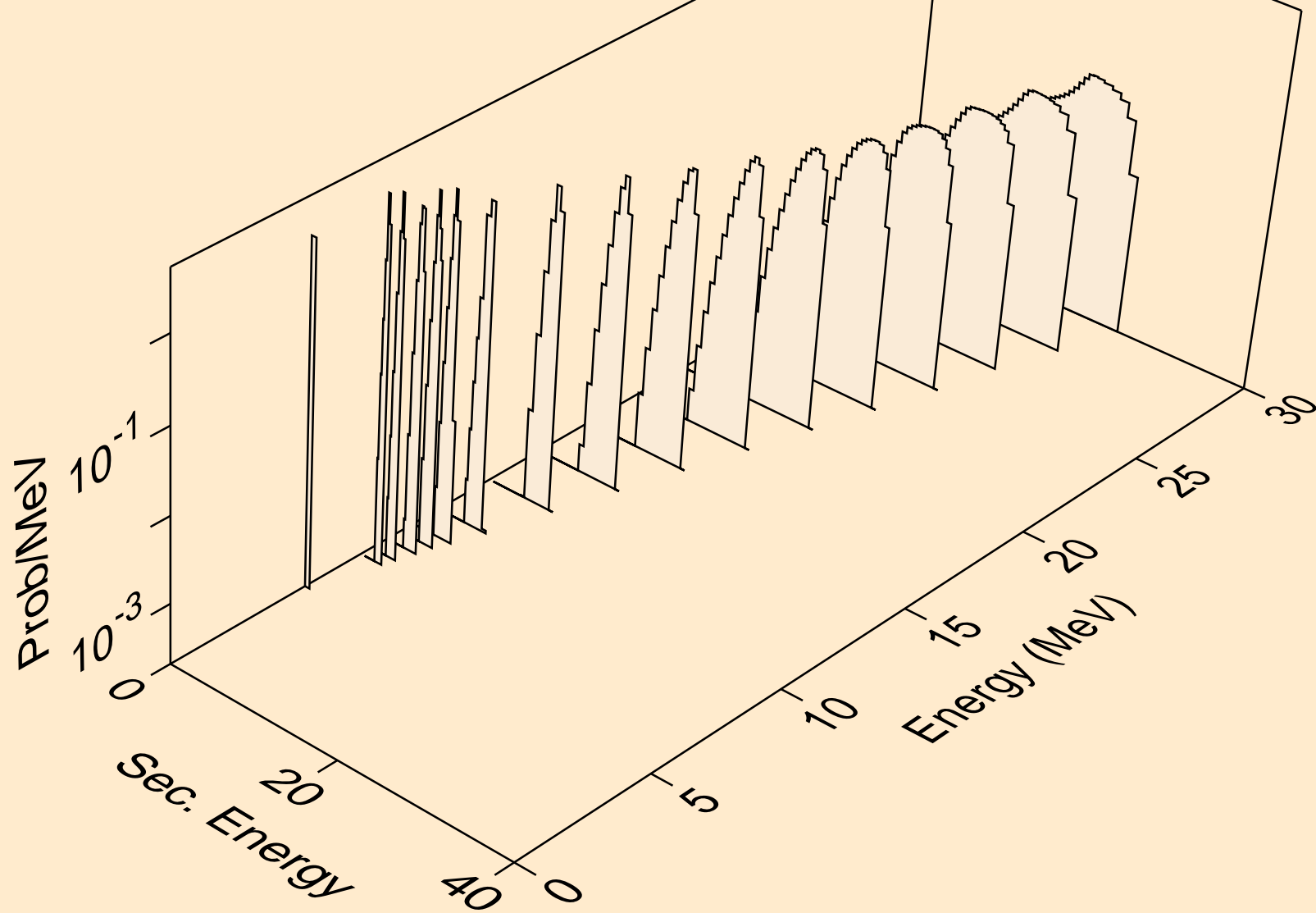

MD261 NEUTRON ACER TENDL-2021 LIBRARY; T=293.6K
protons from (n,2np)

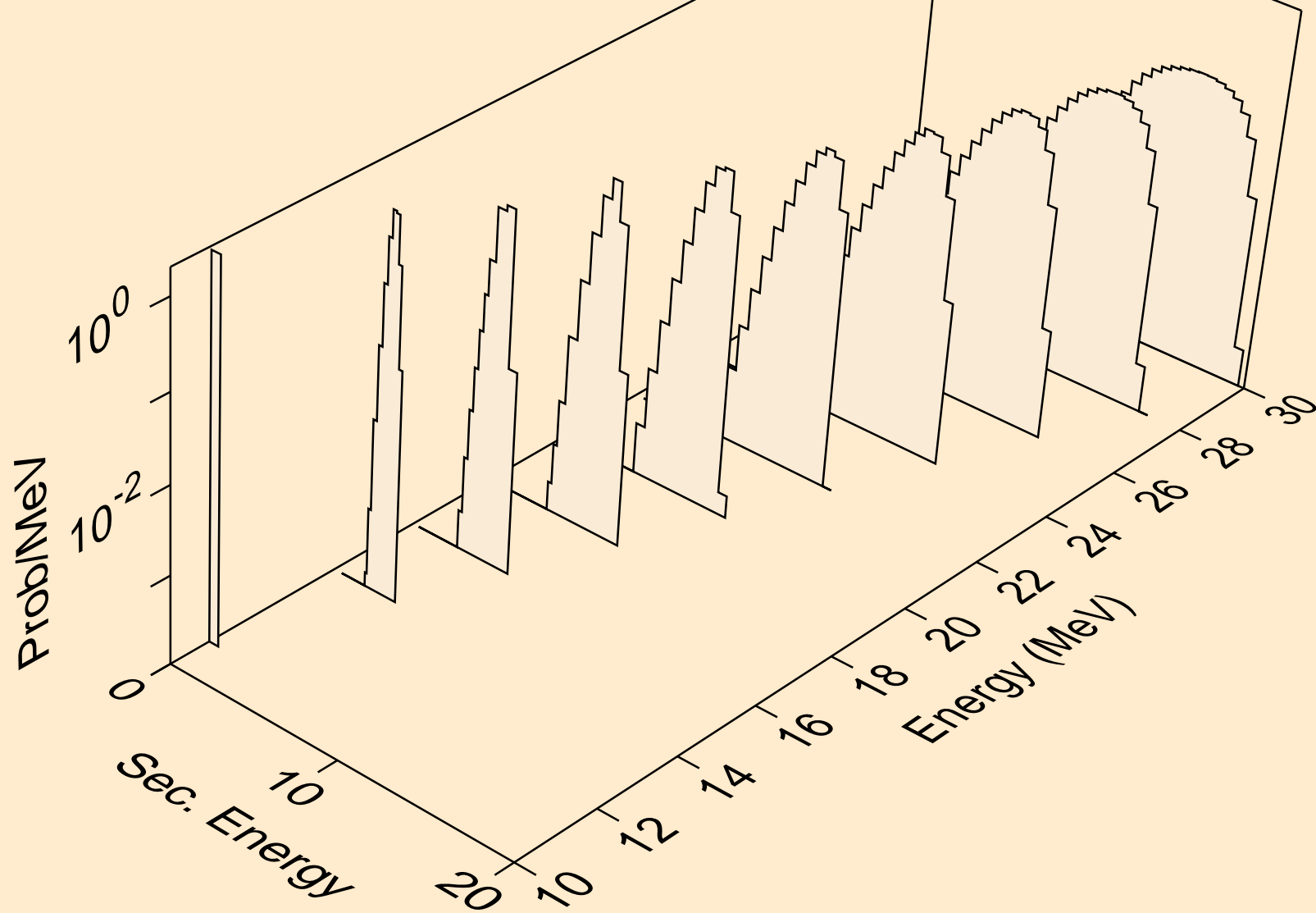

MD261 NEUTRON ACER TENDL-2021 LIBRARY; T=293.6K
protons from (n,3np)

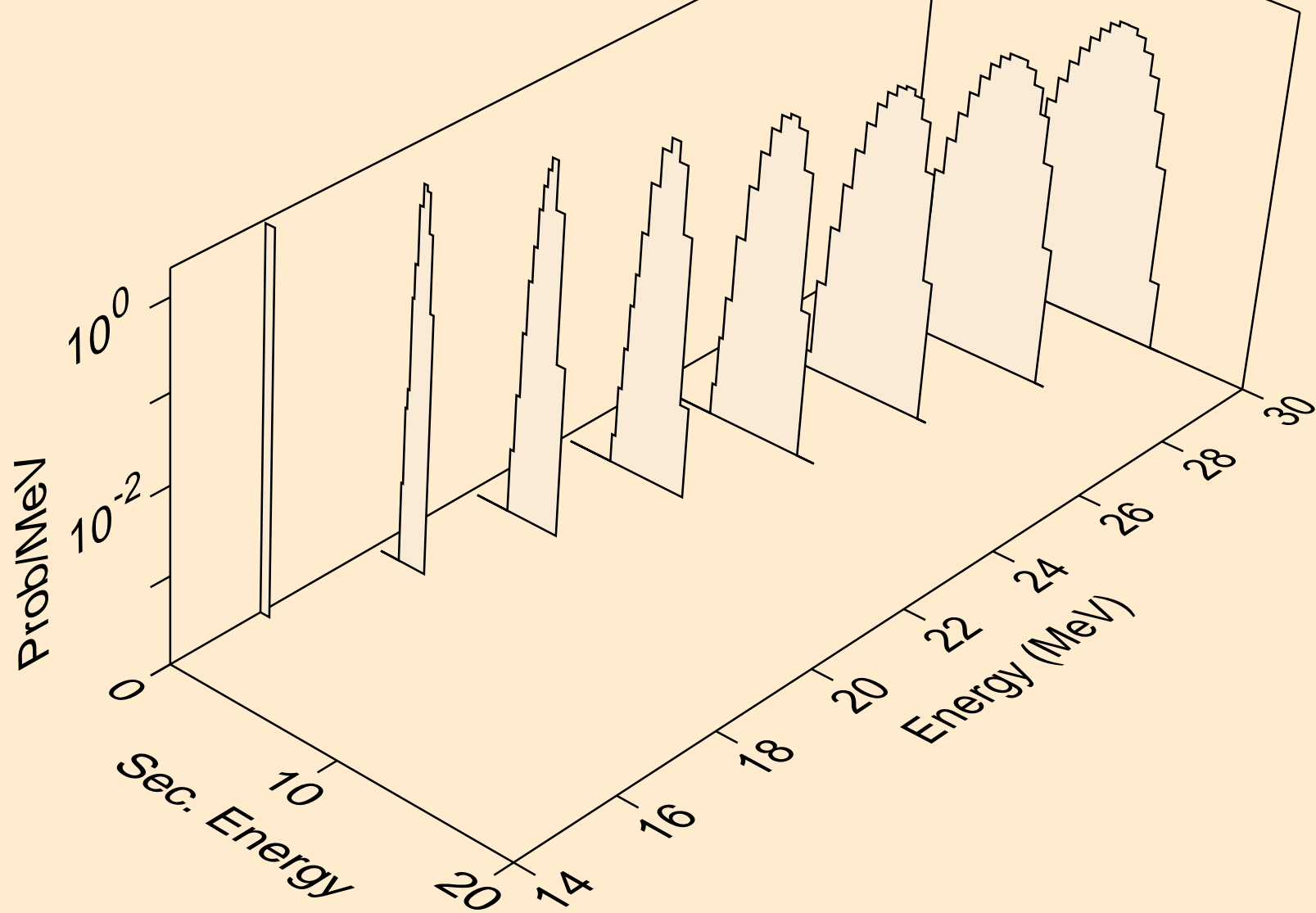

MD261 NEUTRON ACER TENDL-2021 LIBRARY; T=293.6K
protons from (n,npa)

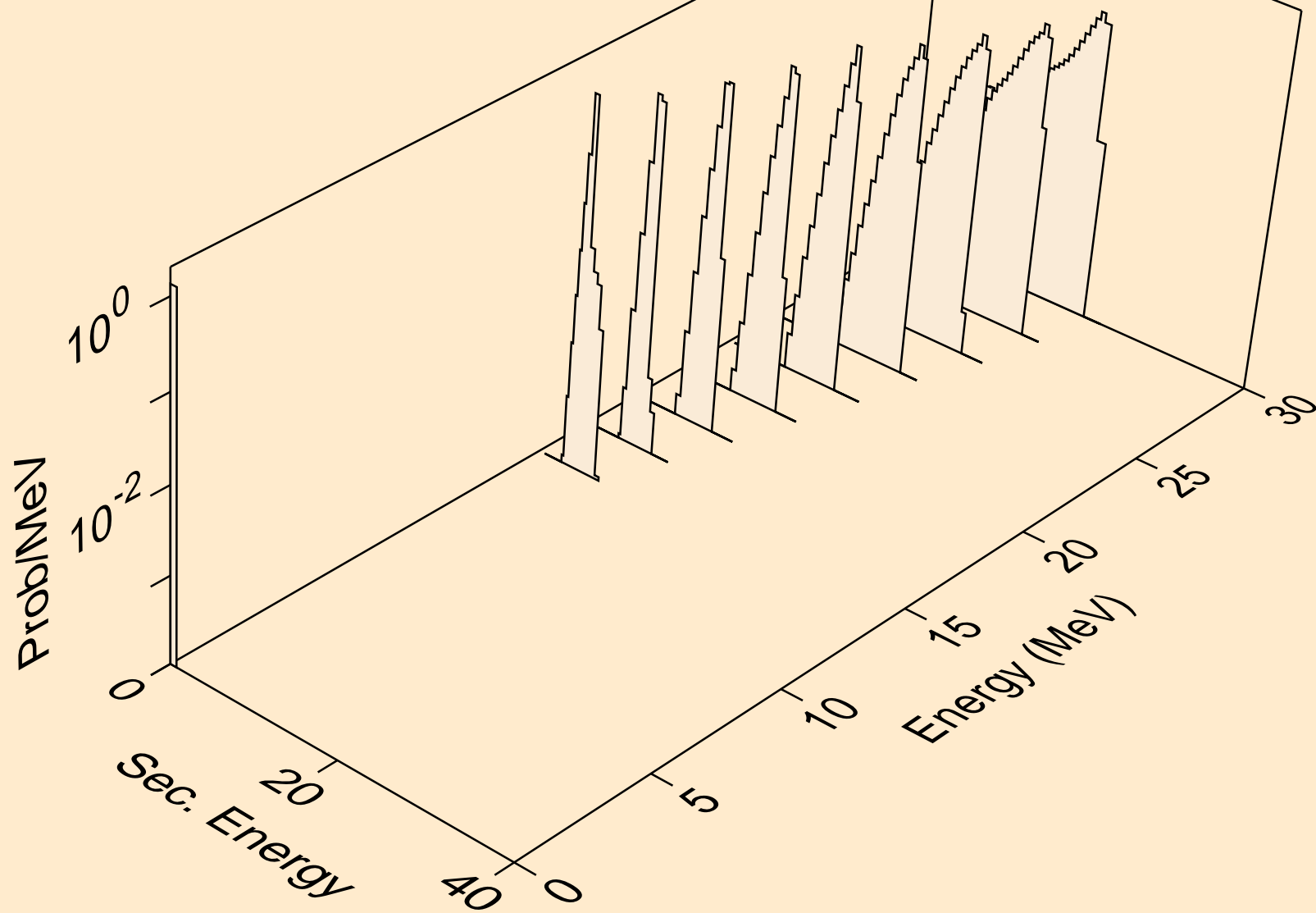

MD261 NEUTRON ACER TENDL-2021 LIBRARY; T=293.6K
protons from (n,p)

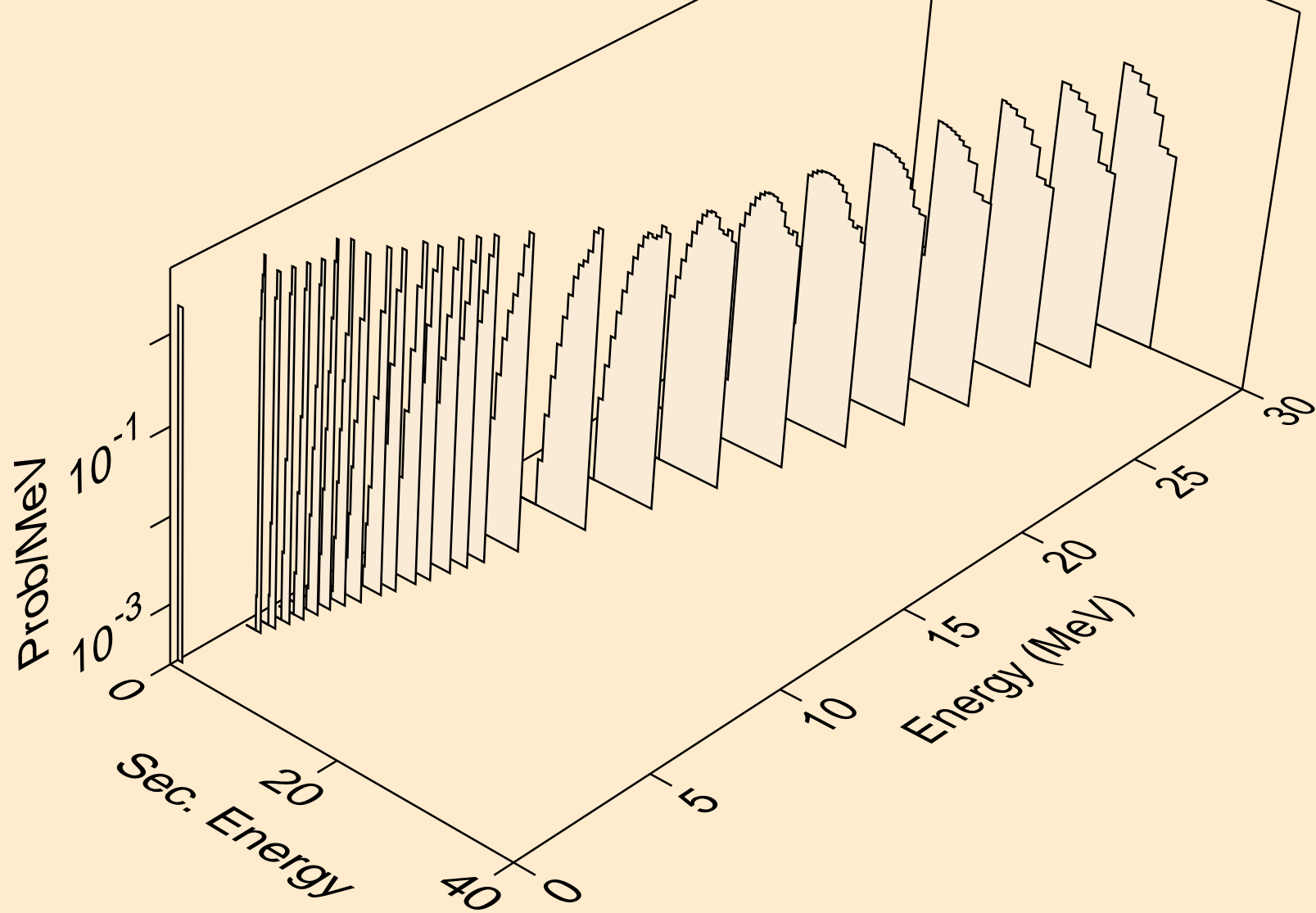

MD261 NEUTRON ACER TENDL-2021 LIBRARY; T=293.6K
protons from (n,2p)

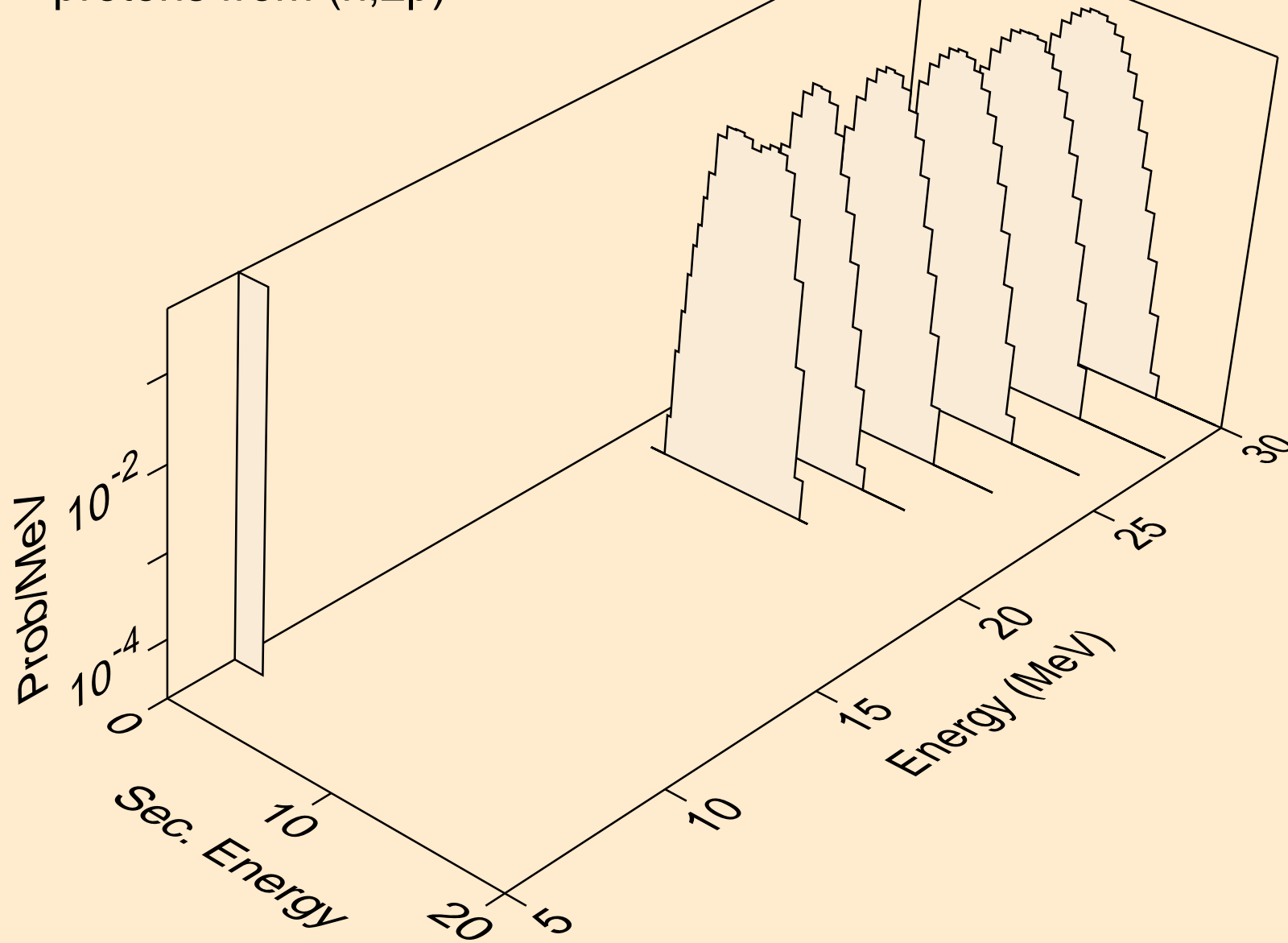

MD261 NEUTRON ACER TENDL-2021 LIBRARY; T=293.6K
deuterons from (n,x)

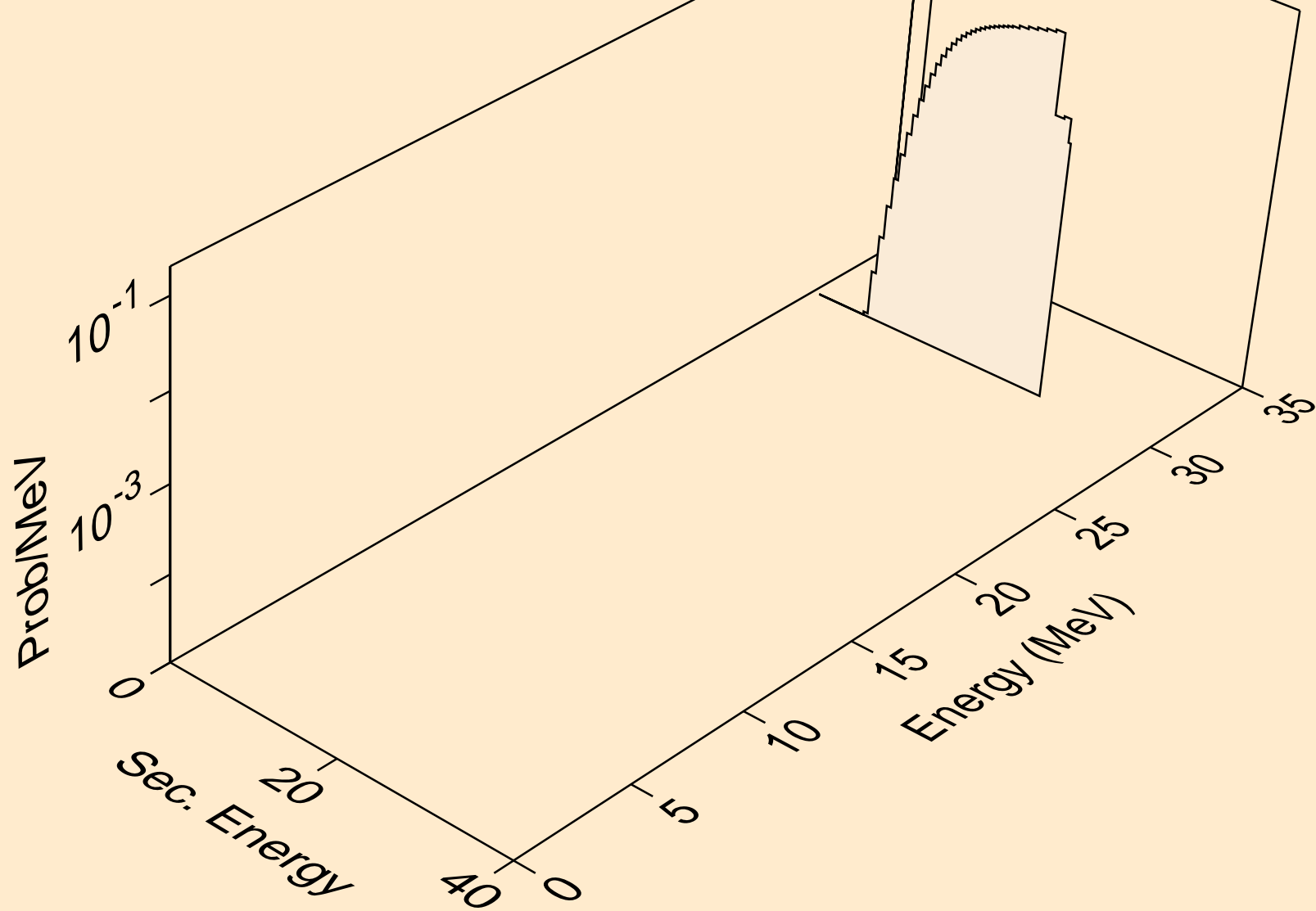

MD261 NEUTRON ACER TENDL-2021 LIBRARY; T=293.6K
deuterons from (n,2nd)

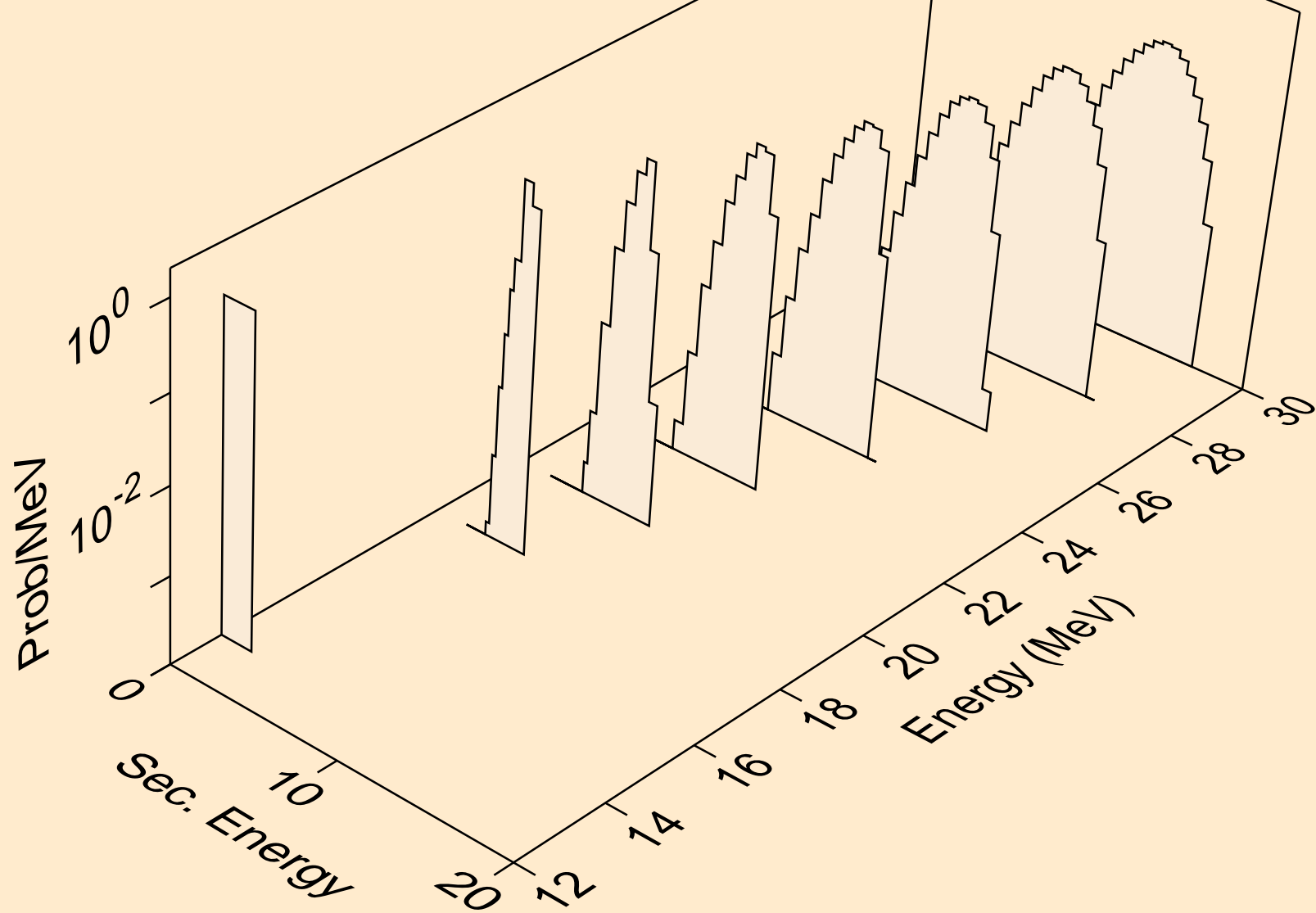

MD261 NEUTRON ACER TENDL-2021 LIBRARY; T=293.6K
deuterons from (n,n*)d

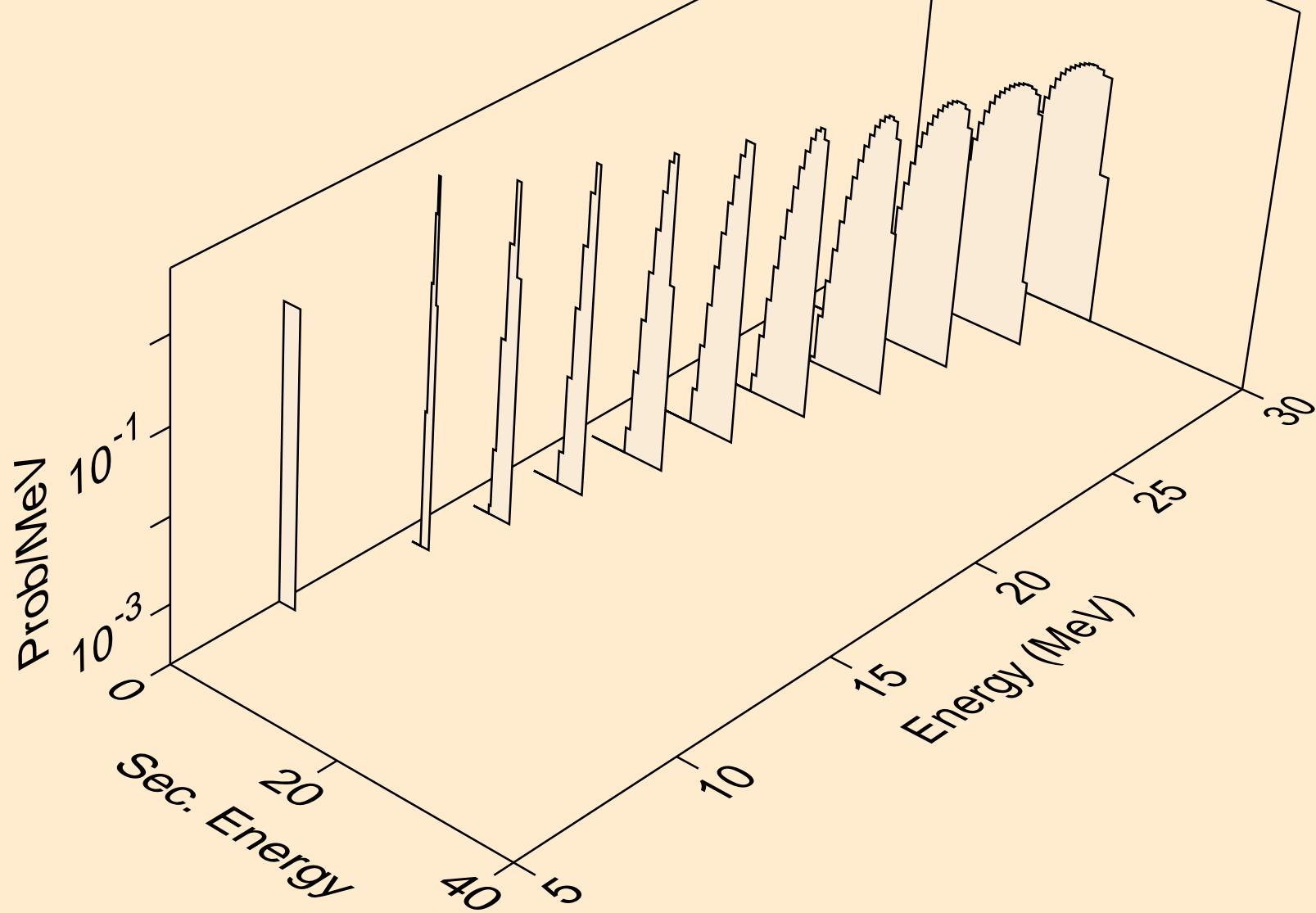

MD261 NEUTRON ACER TENDL-2021 LIBRARY; T=293.6K
deuterons from (n,d)

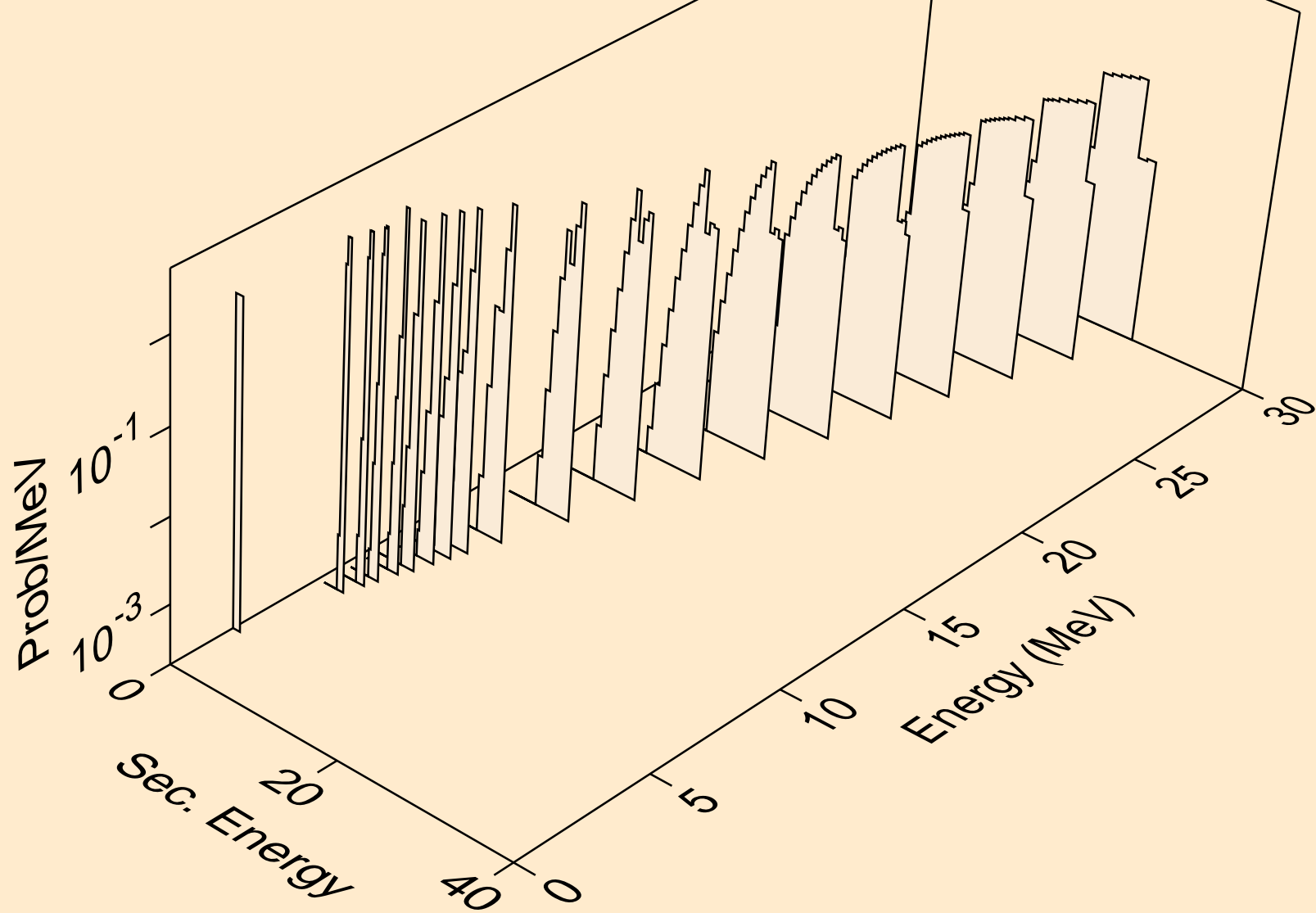

MD261 NEUTRON ACER TENDL-2021 LIBRARY; T=293.6K
deuterons from (n,da)

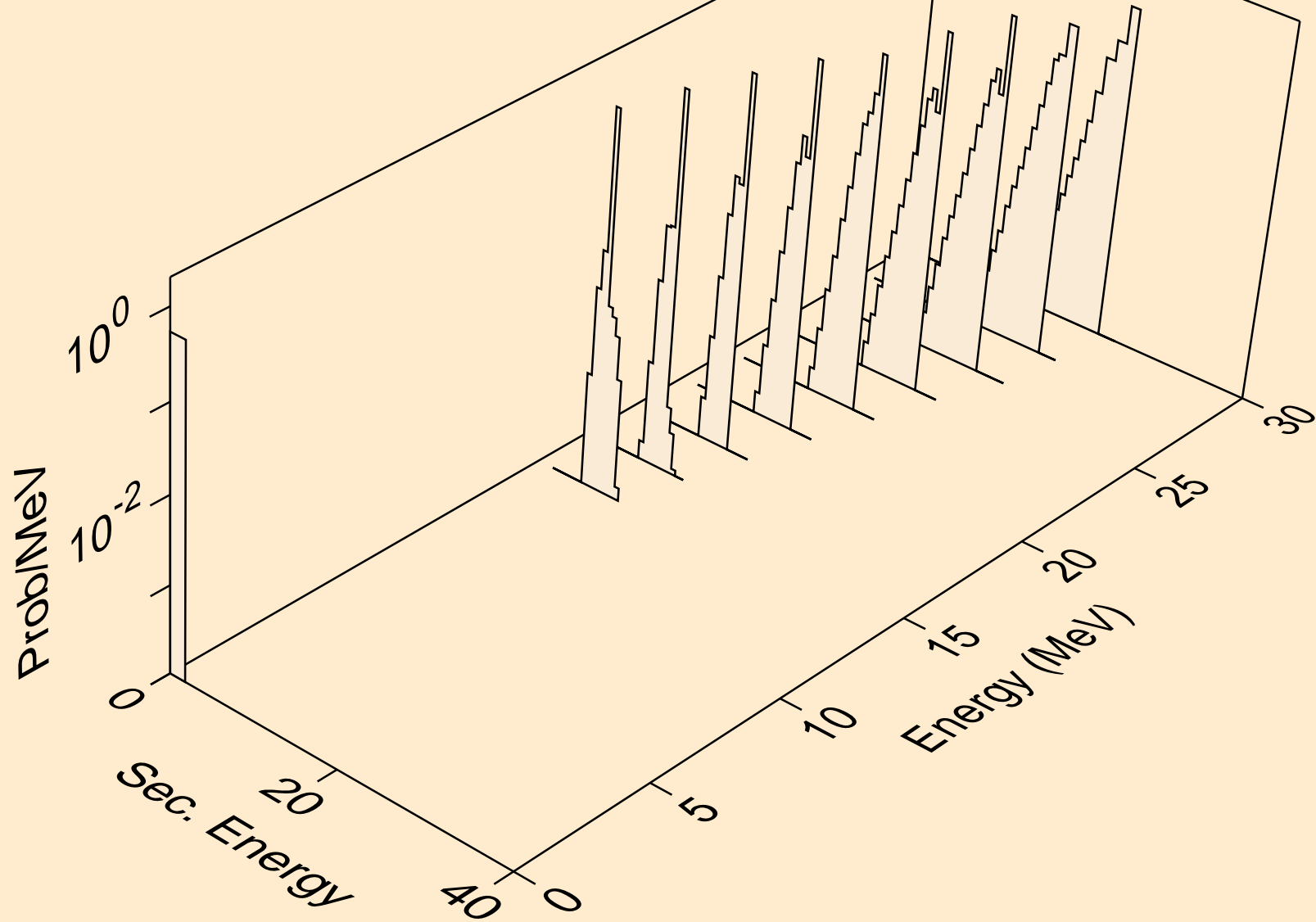

MD261 NEUTRON ACER TENDL-2021 LIBRARY; T=293.6K
tritons from (n,x)

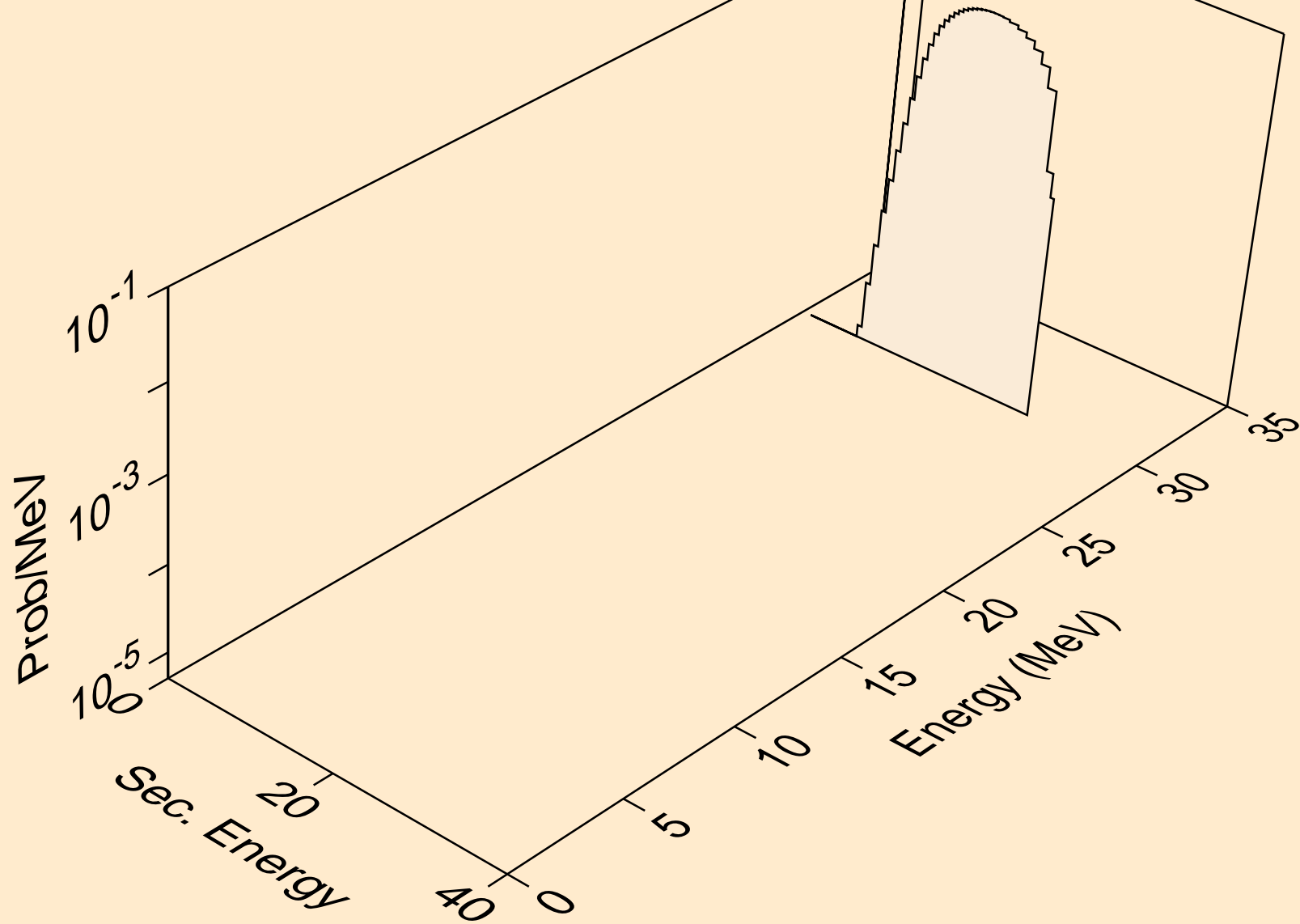

MD261 NEUTRON ACER TENDL-2021 LIBRARY; T=293.6K
tritons from (n,n*)t

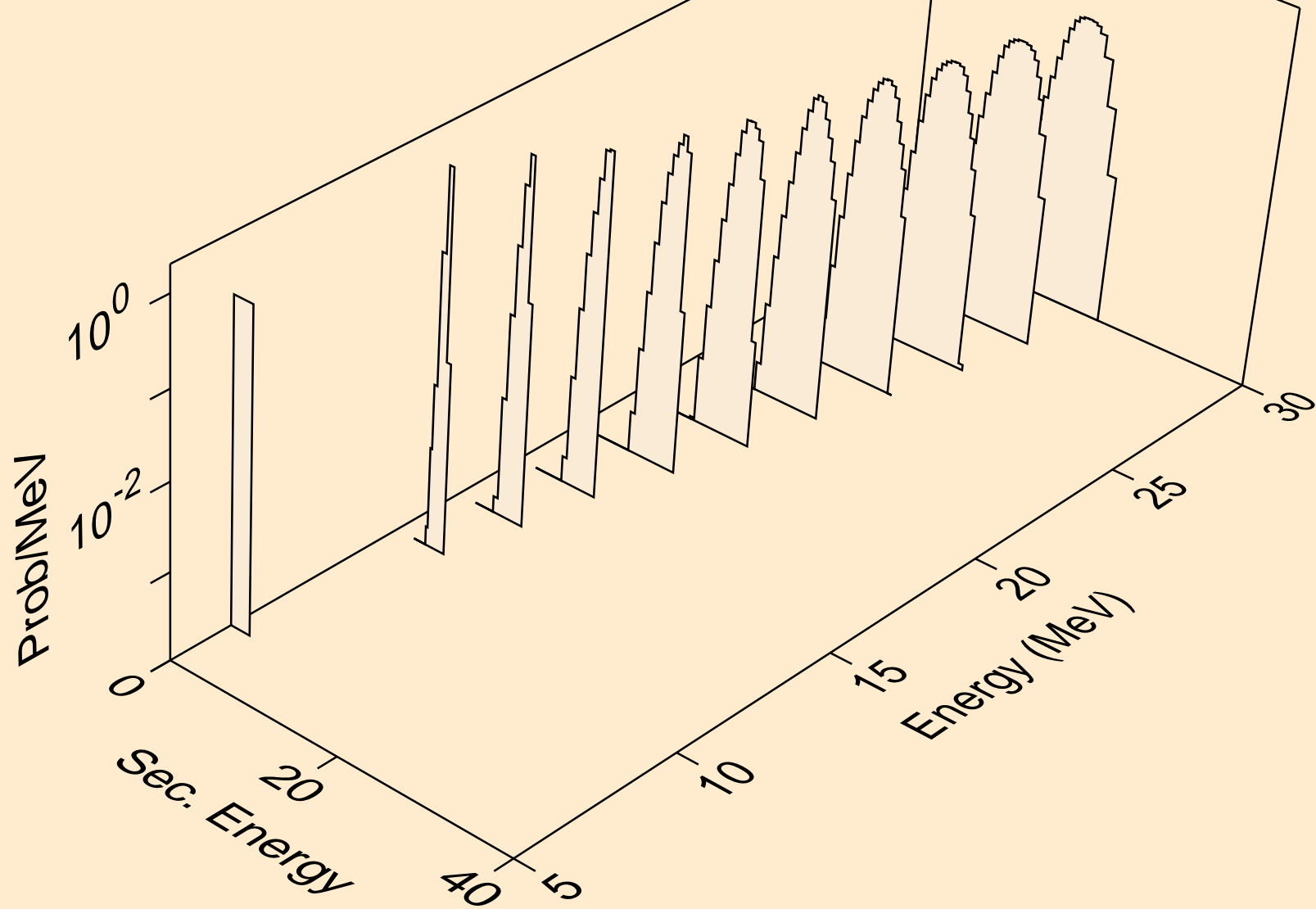

MD261 NEUTRON ACER TENDL-2021 LIBRARY; T=293.6K
tritons from (n,t)

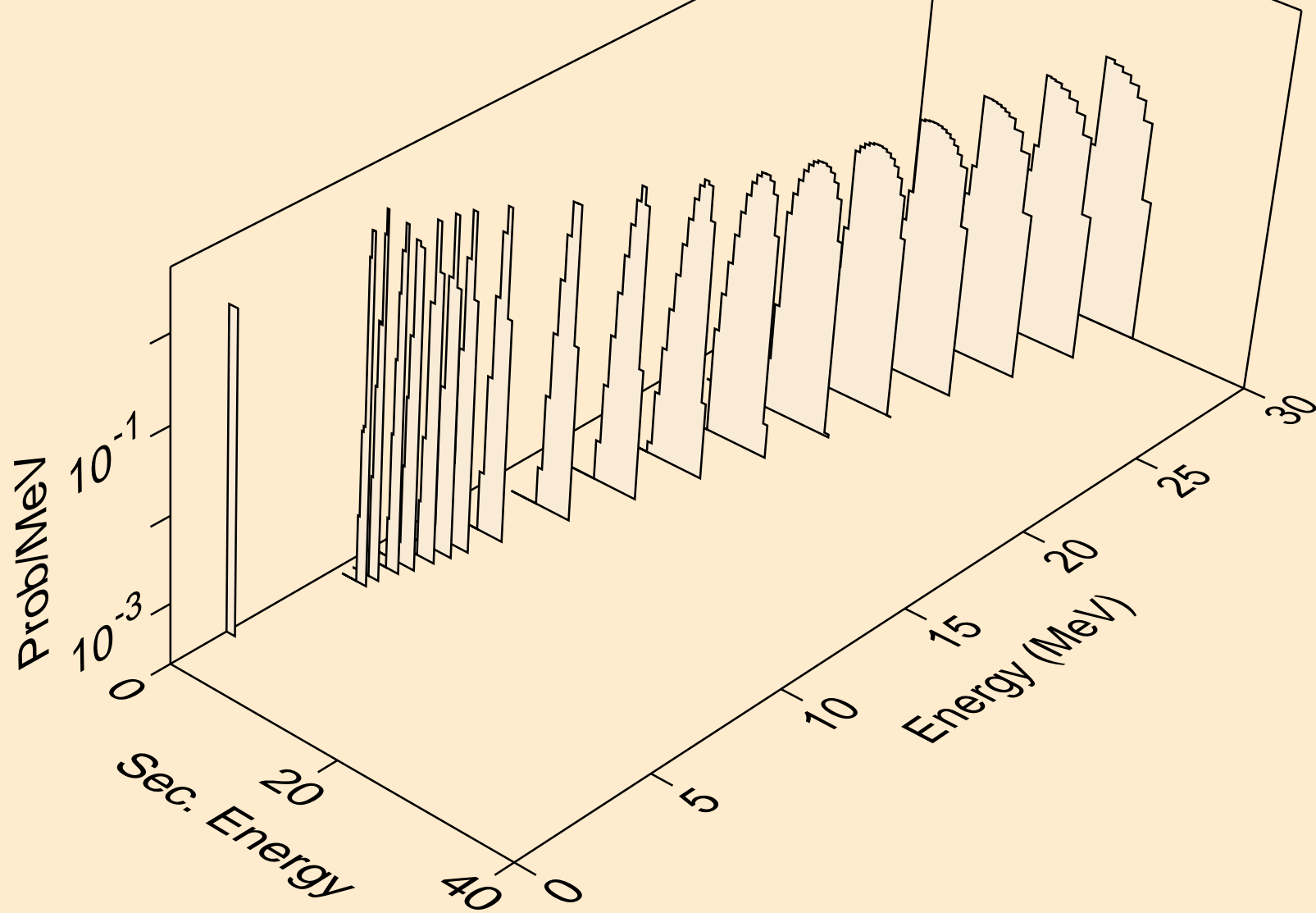

MD261 NEUTRON ACER TENDL-2021 LIBRARY; T=293.6K
he3s from (n,x)

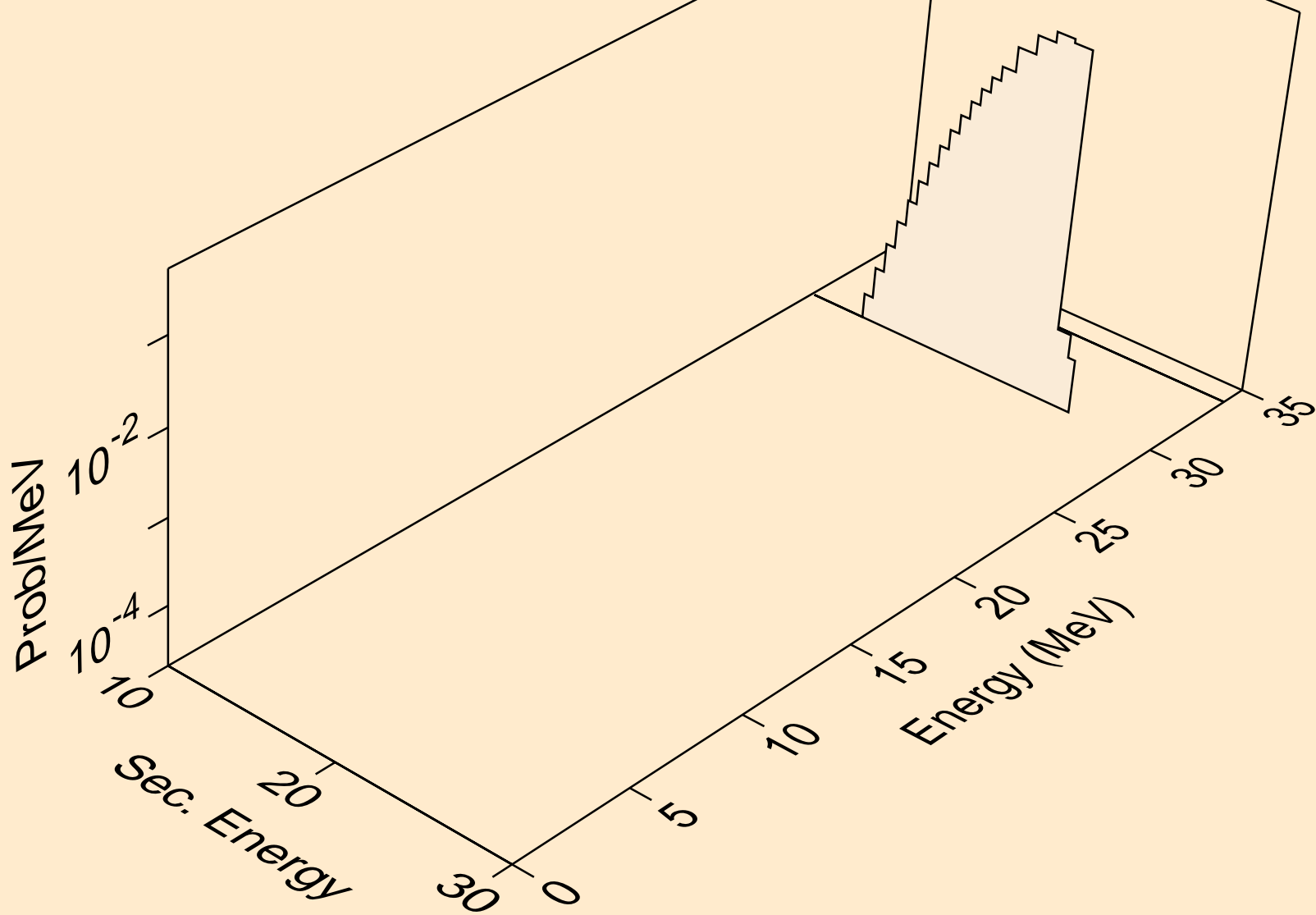

MD261 NEUTRON ACER TENDL-2021 LIBRARY; T=293.6K
he3s from (n,n*)he3

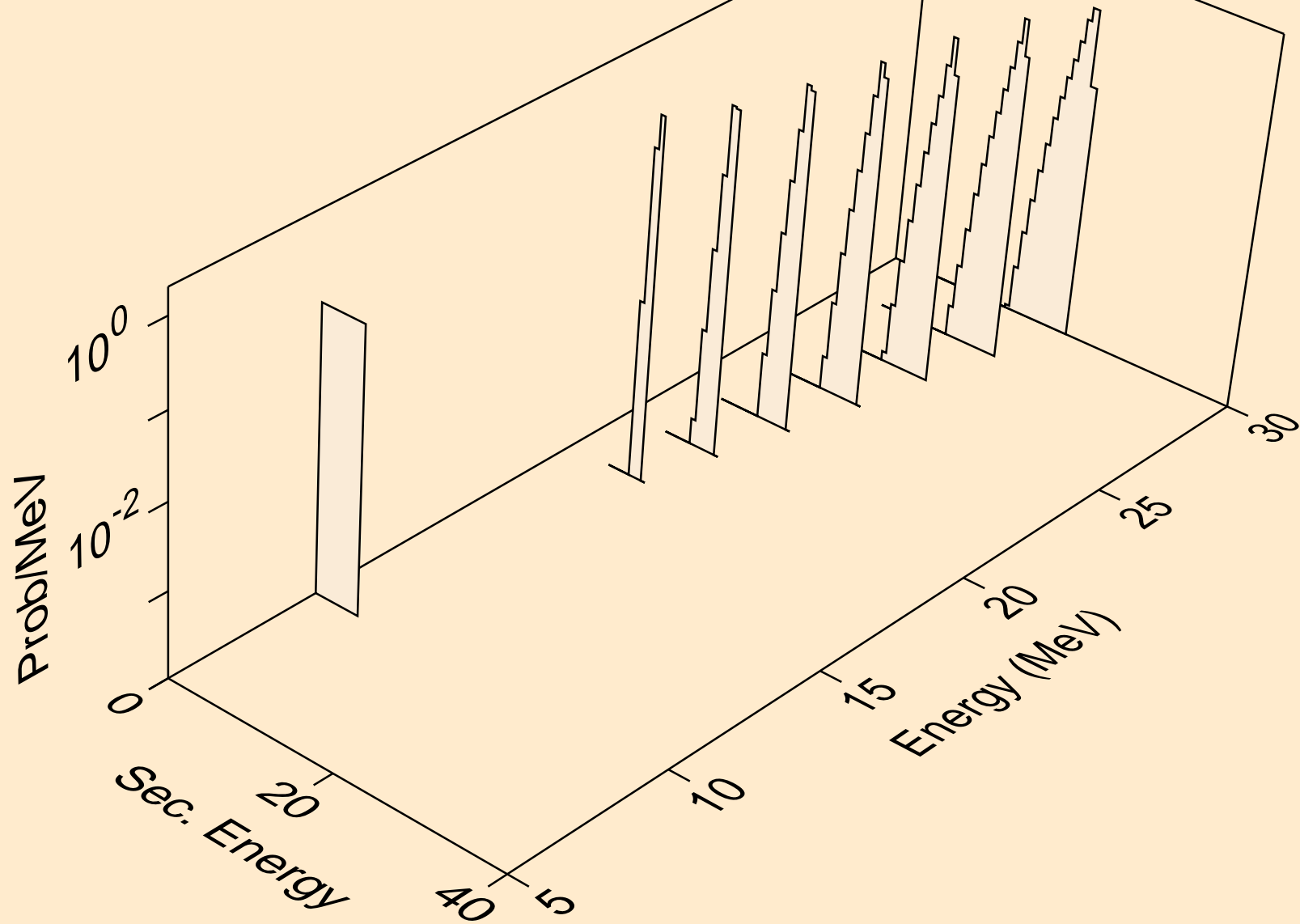

MD261 NEUTRON ACER TENDL-2021 LIBRARY; T=293.6K
he3s from (n,he3)

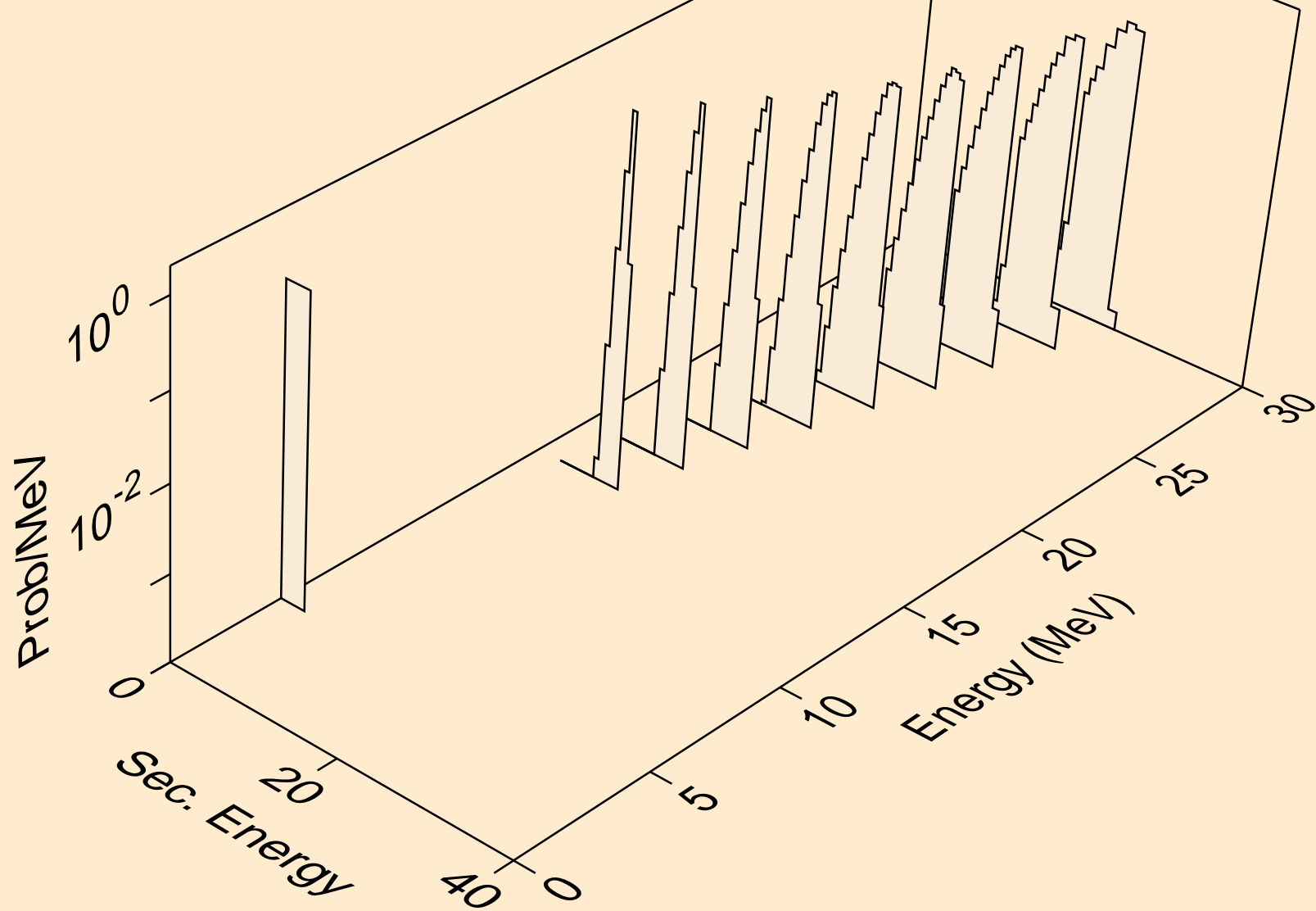

MD261 NEUTRON ACER TENDL-2021 LIBRARY; T=293.6K
alphas from (n,x)

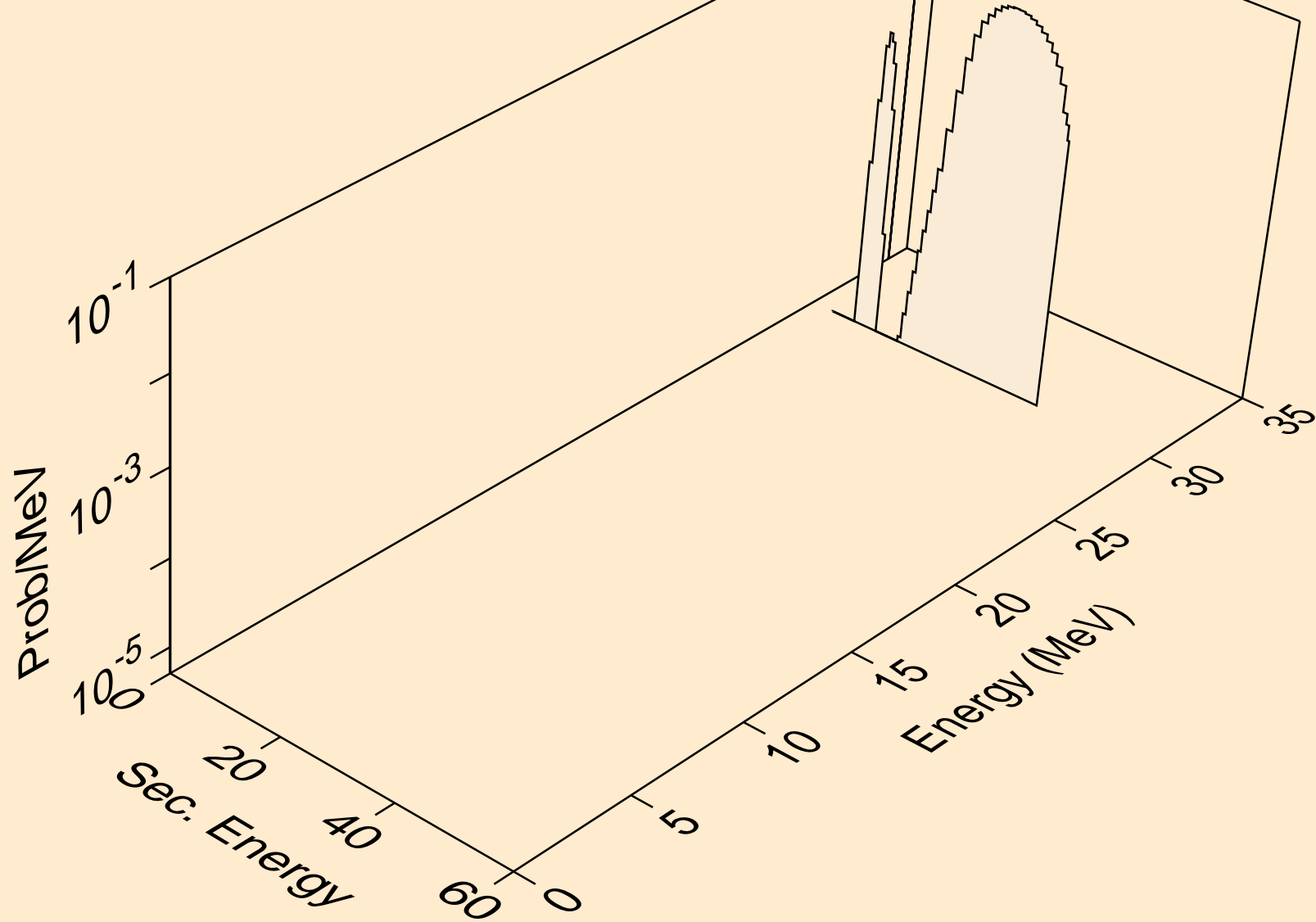

MD261 NEUTRON ACER TENDL-2021 LIBRARY; T=293.6K
alphas from (n,n*)a

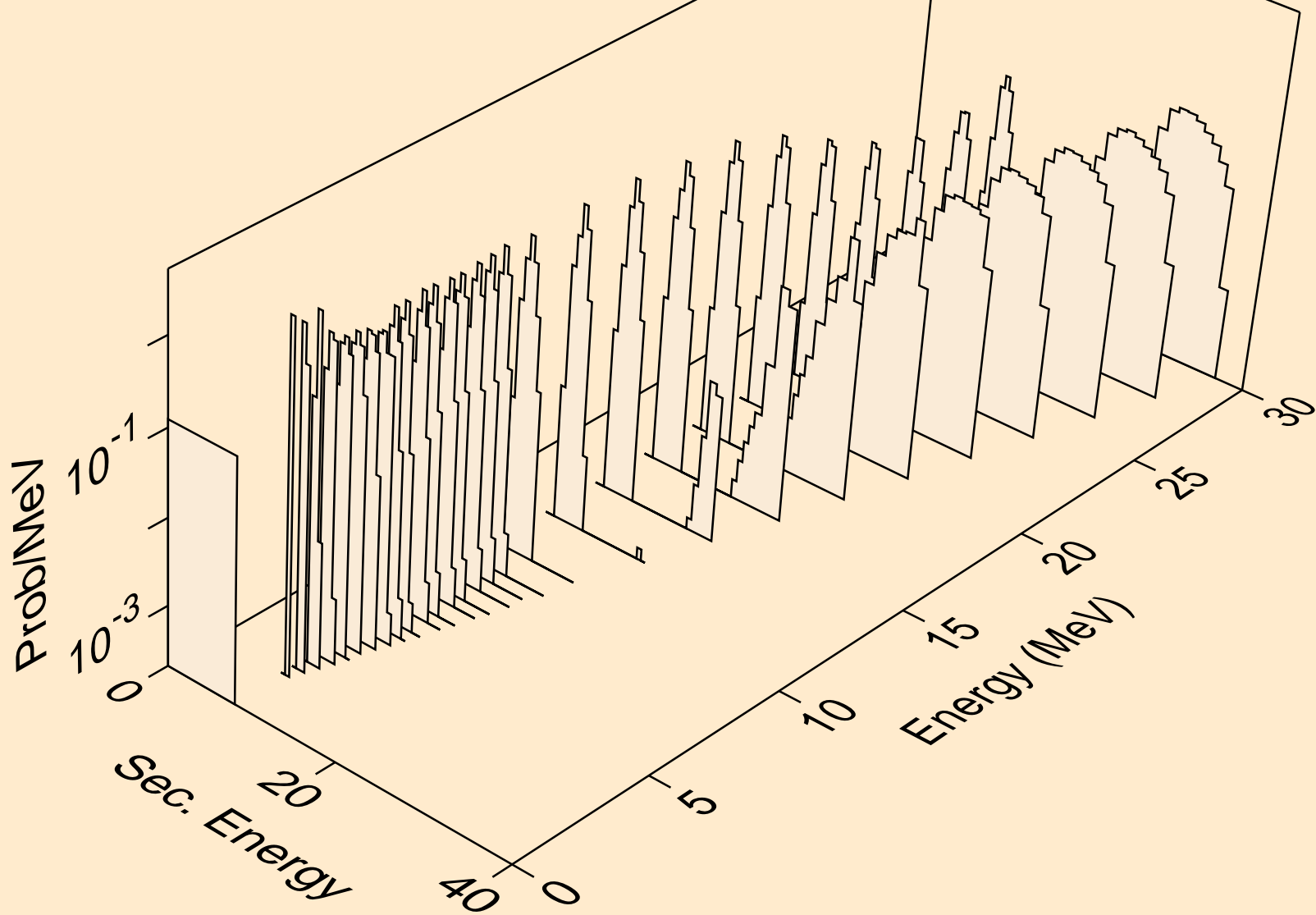

MD261 NEUTRON ACER TENDL-2021 LIBRARY; T=293.6K
alphas from (n,2n)a

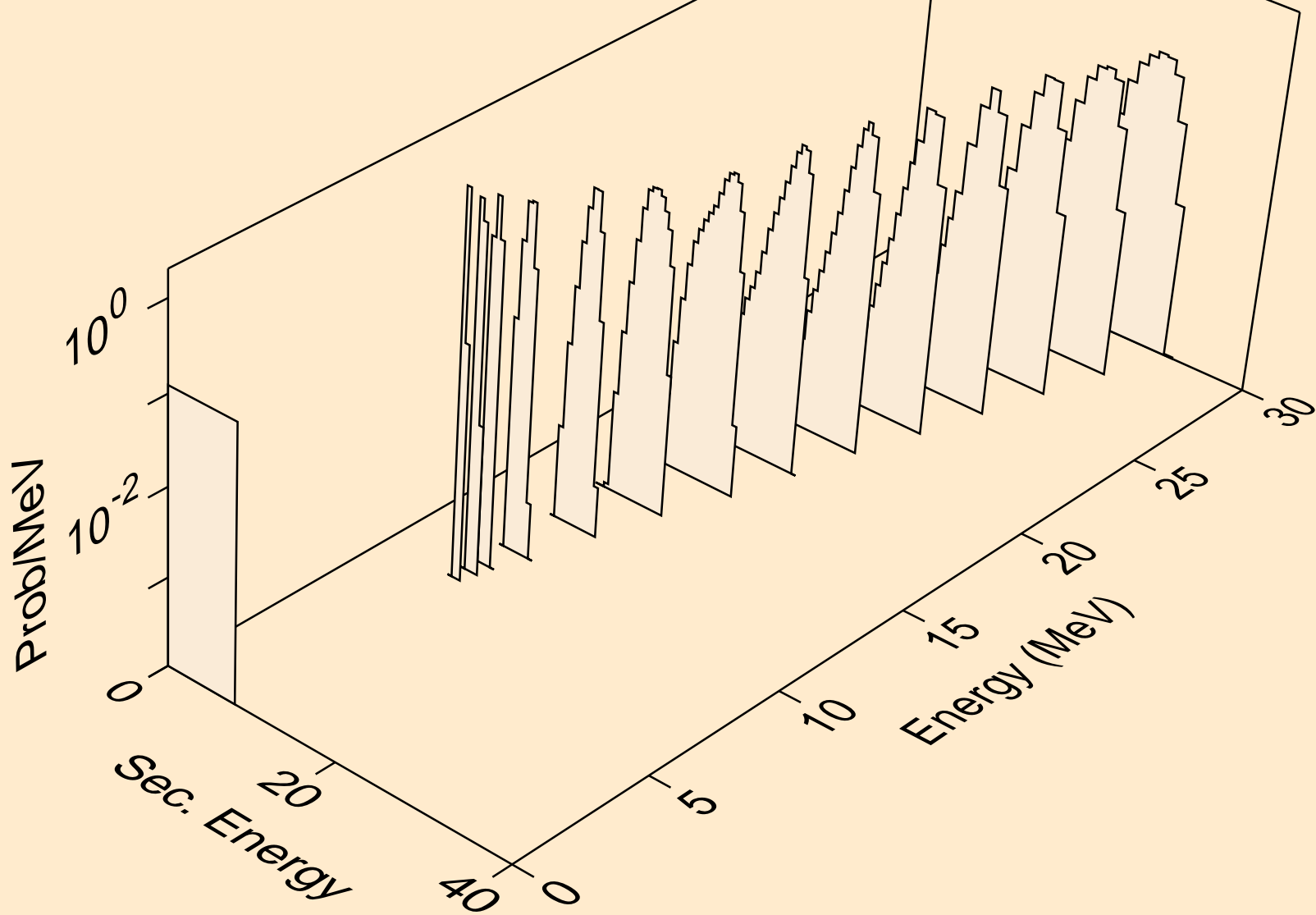

MD261 NEUTRON ACER TENDL-2021 LIBRARY; T=293.6K
alphas from (n,3n)a

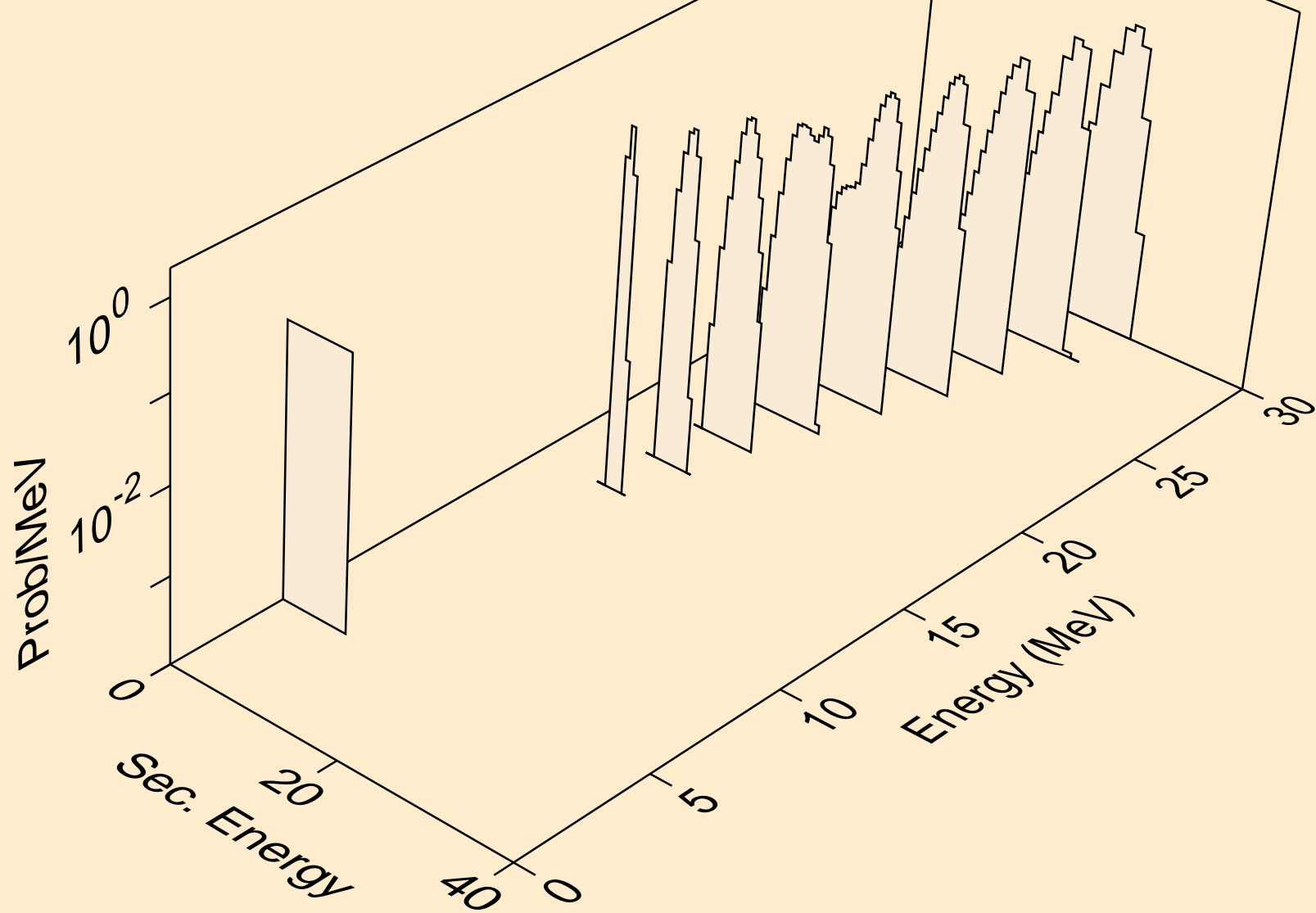

MD261 NEUTRON ACER TENDL-2021 LIBRARY; T=293.6K
alphas from (n,n*)2a

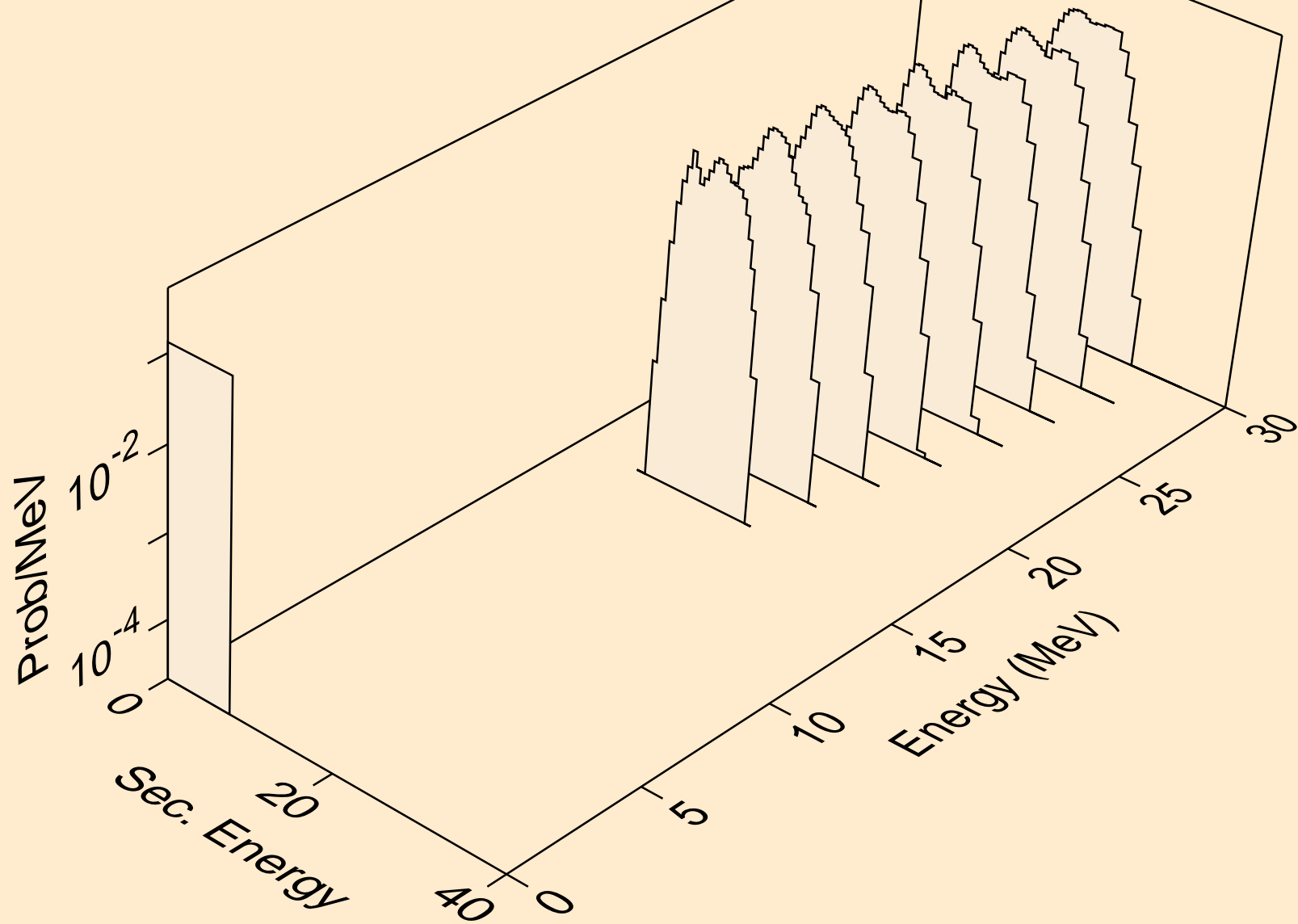

MD261 NEUTRON ACER TENDL-2021 LIBRARY; T=293.6K
alphas from (n,npa)

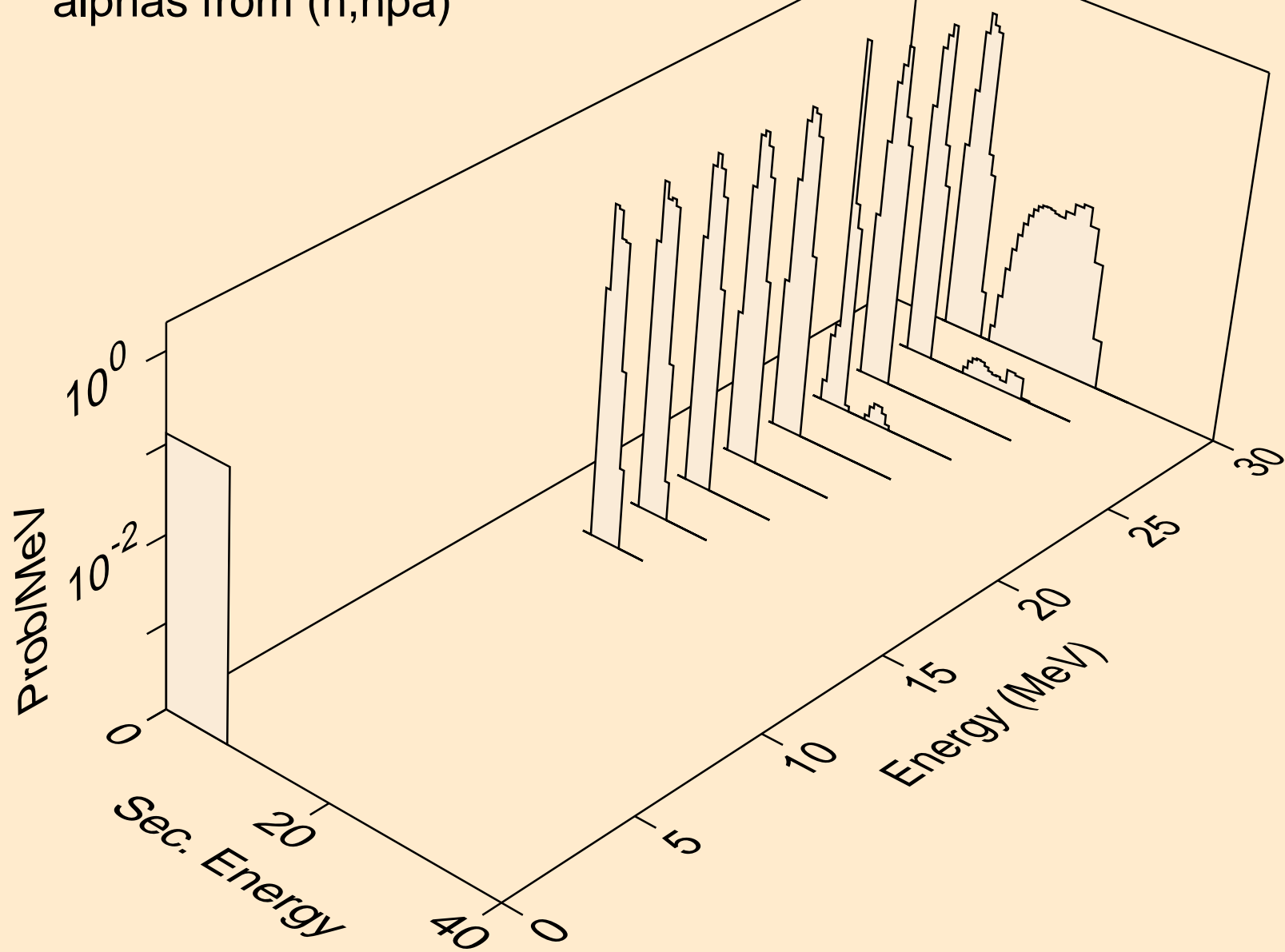

MD261 NEUTRON ACER TENDL-2021 LIBRARY; T=293.6K
alphas from (n,a)

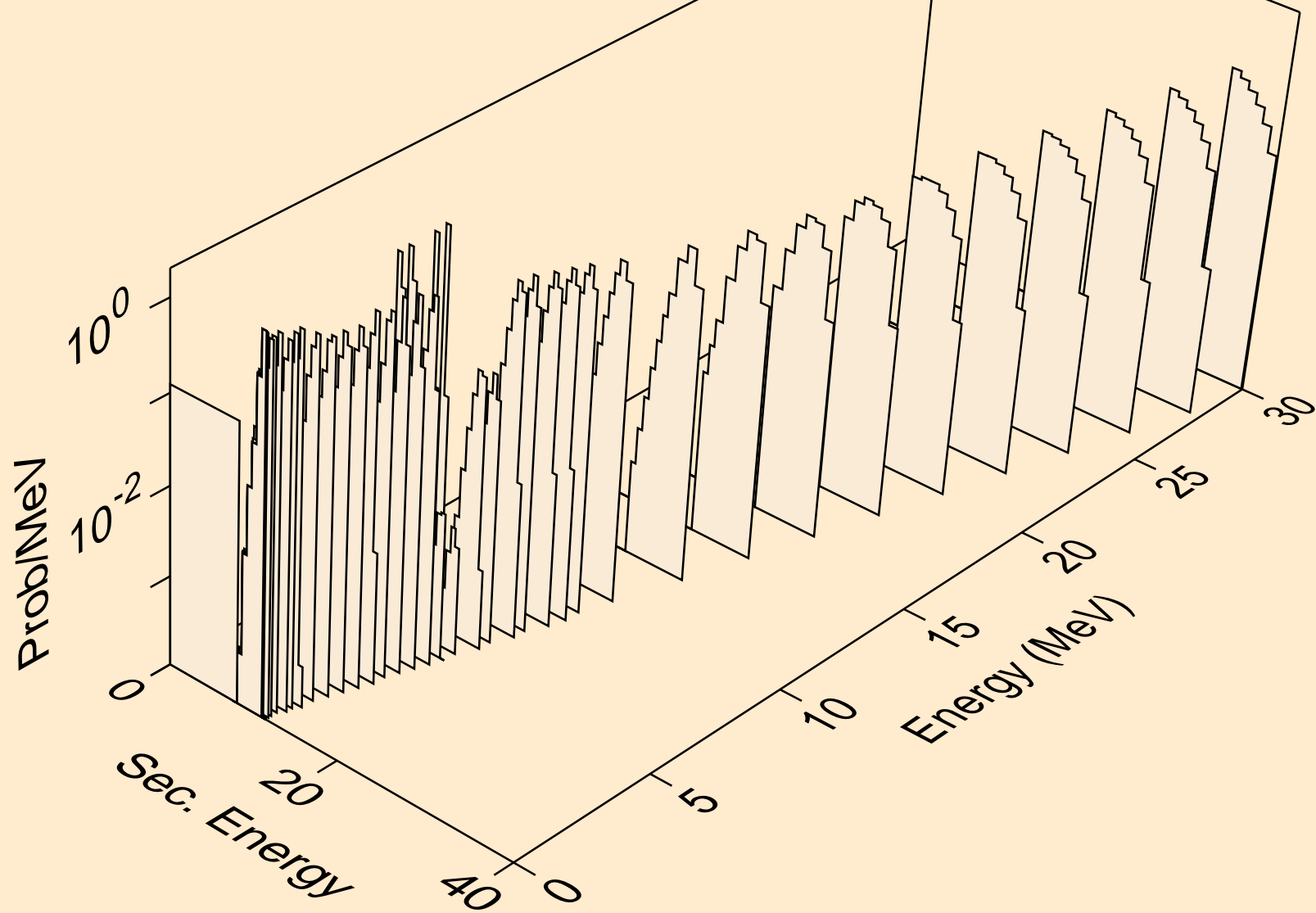

MD261 NEUTRON ACER TENDL-2021 LIBRARY; T=293.6K
alphas from (n,2a)

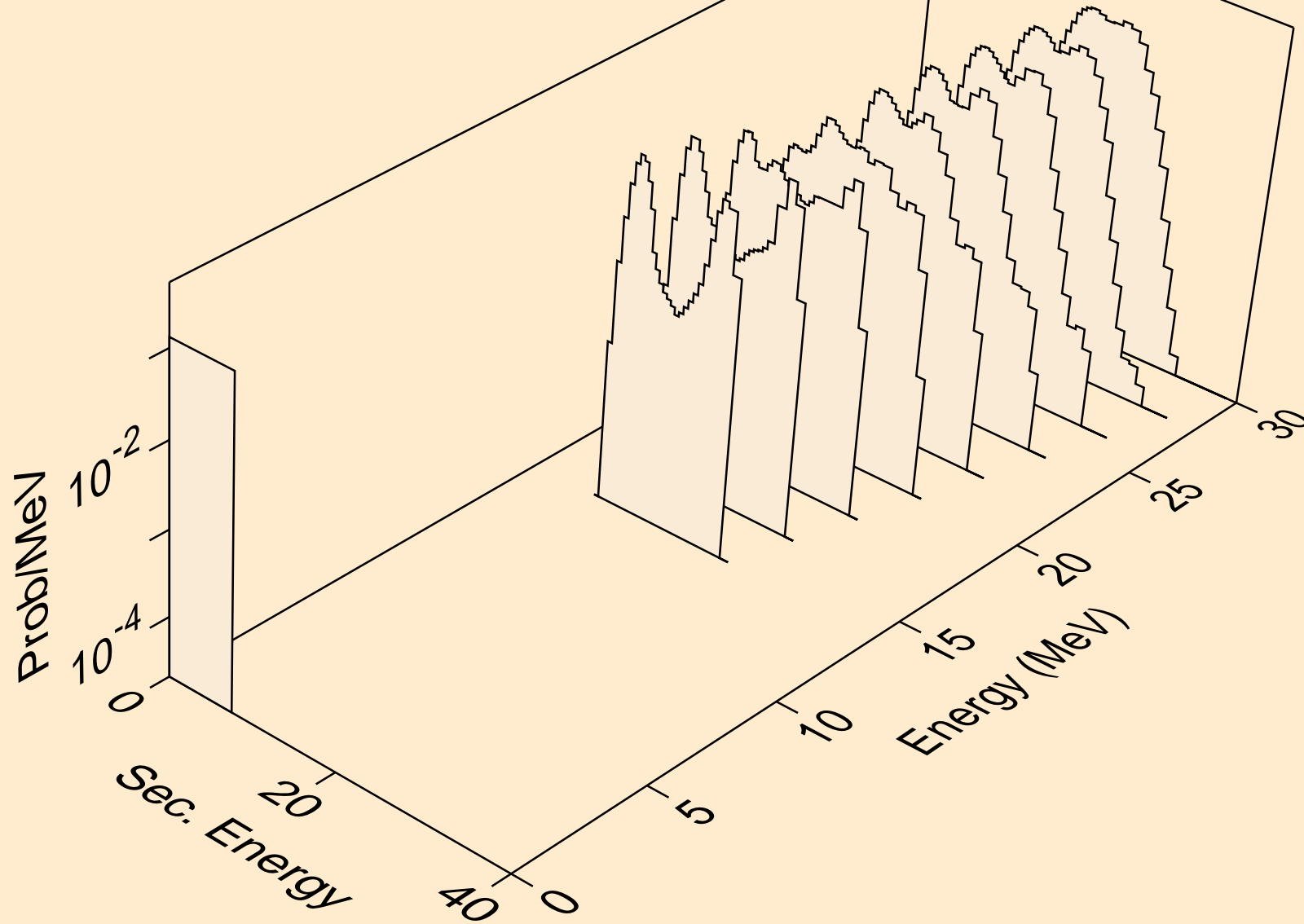

MD261 NEUTRON ACER TENDL-2021 LIBRARY; T=293.6K
alphas from (n,da)

