

# MG028 NEUTRON ACER TENDL-2021 LIBRARY; T=293.6K

## Principal cross sections

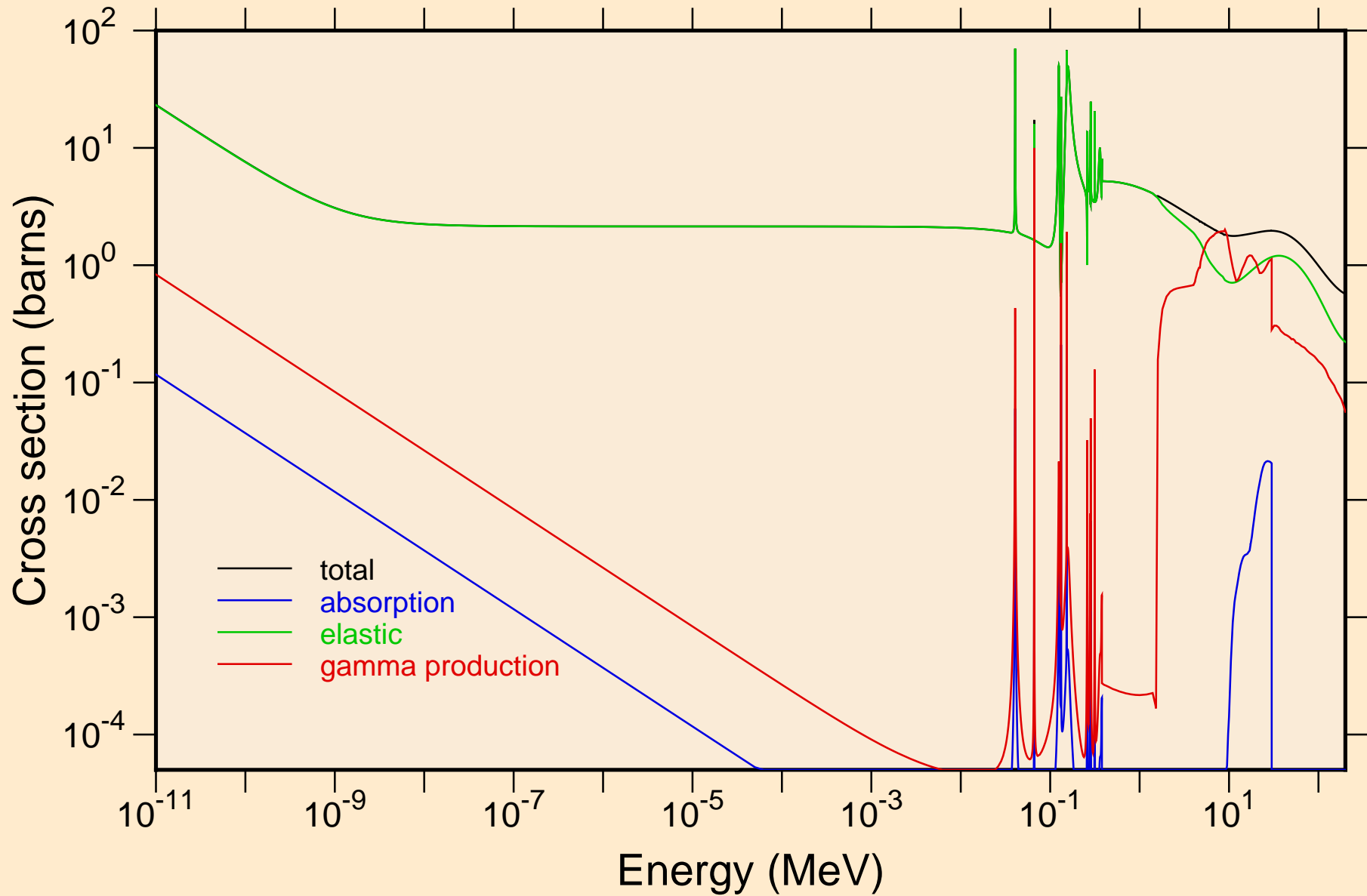

MG028 NEUTRON ACER TENDL-2021 LIBRARY; T=293.6K  
resonance total cross section

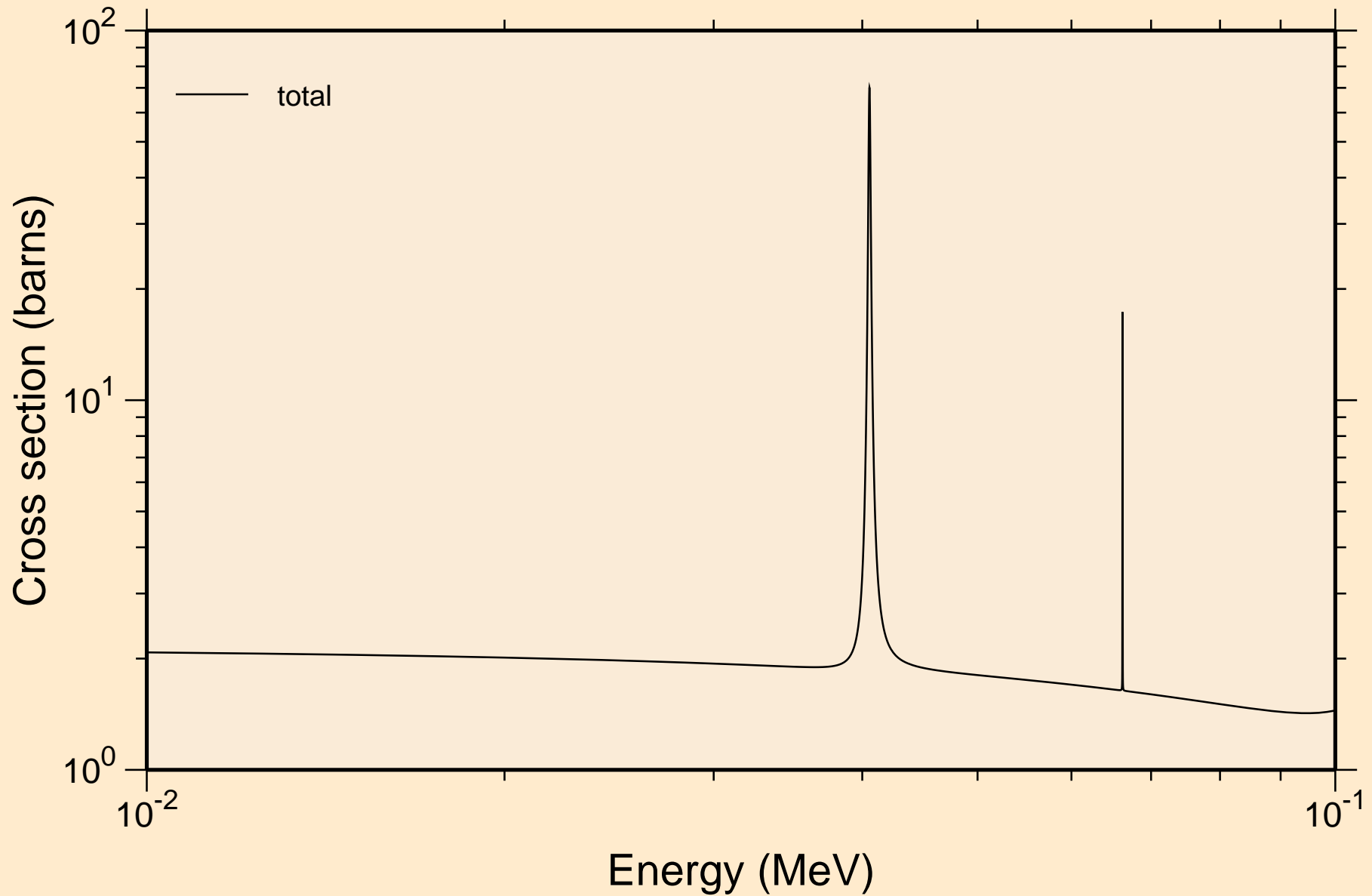

MG028 NEUTRON ACER TENDL-2021 LIBRARY; T=293.6K  
resonance total cross section

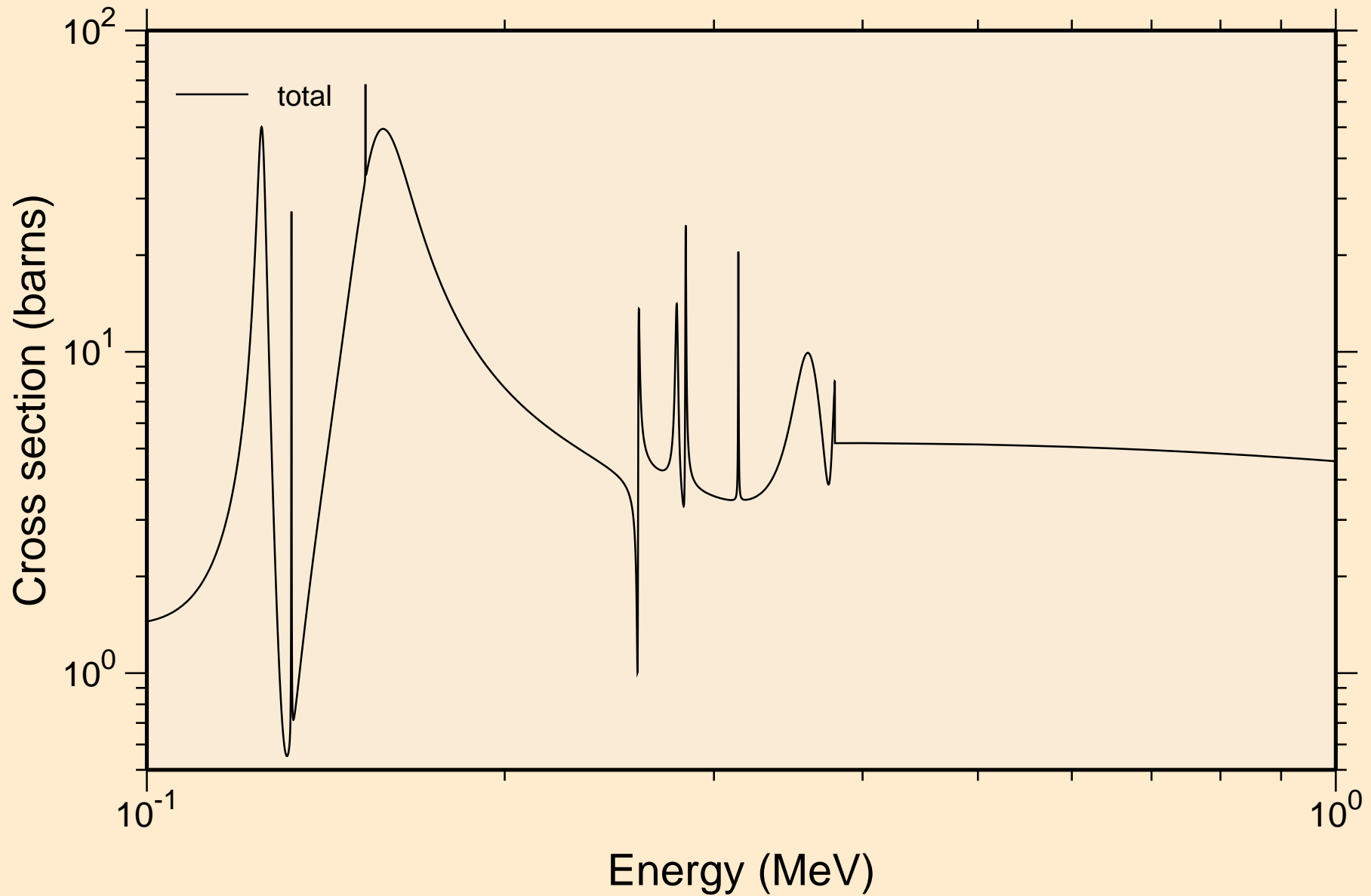

MG028 NEUTRON ACER TENDL-2021 LIBRARY; T=293.6K  
resonance total cross section

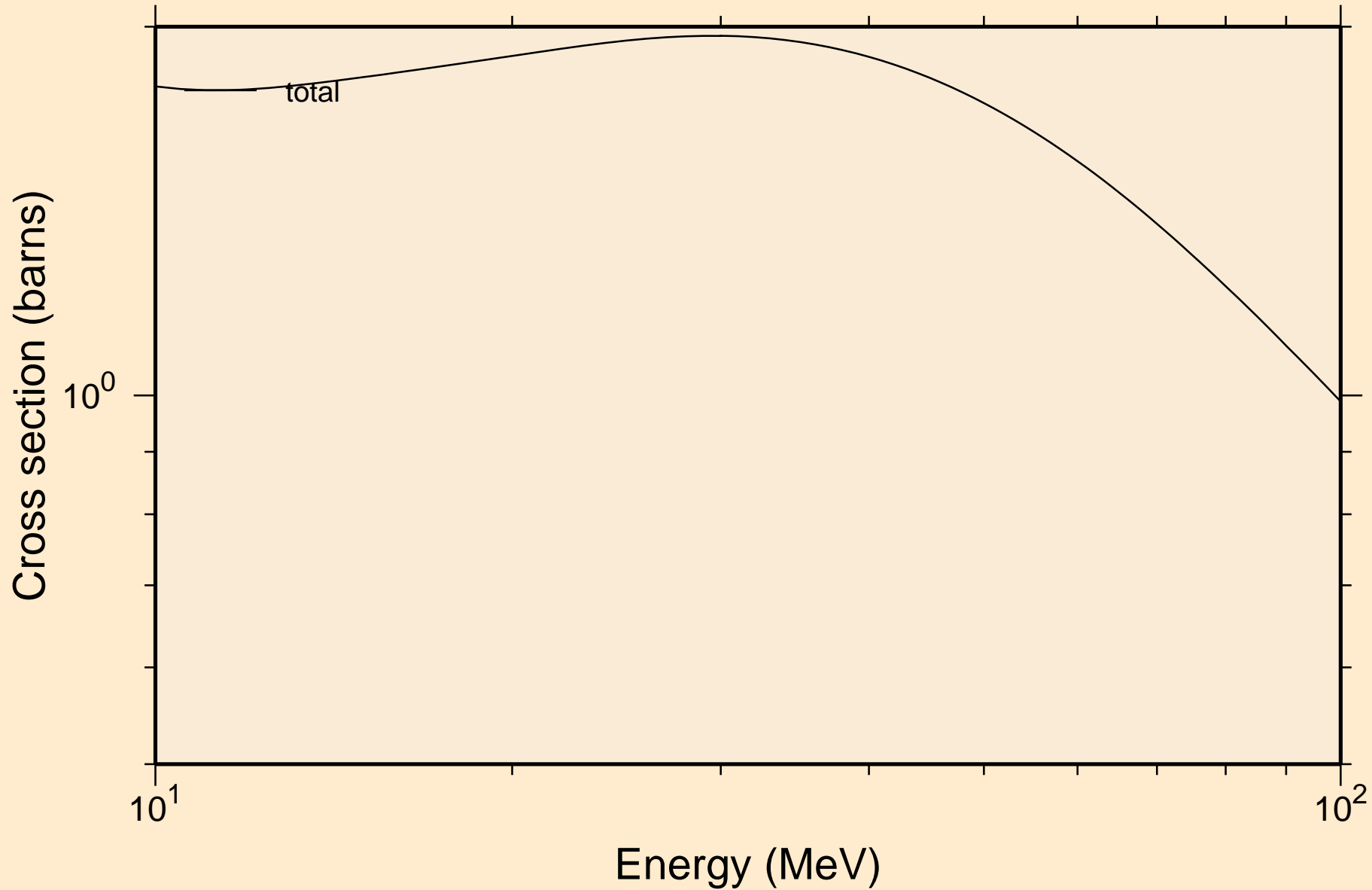

MG028 NEUTRON ACER TENDL-2021 LIBRARY; T=293.6K  
resonance absorption cross sections

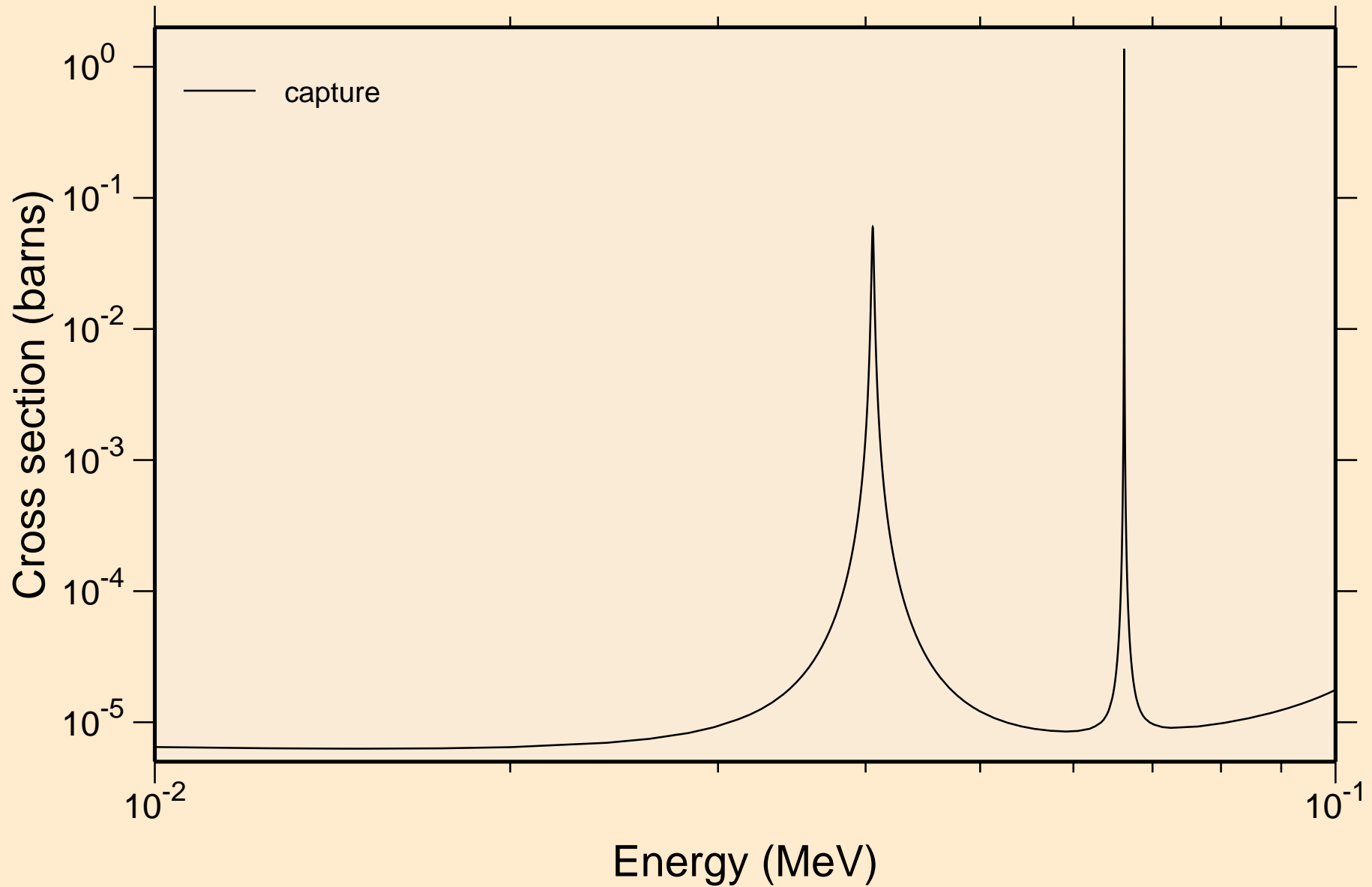

MG028 NEUTRON ACER TENDL-2021 LIBRARY; T=293.6K  
resonance absorption cross sections

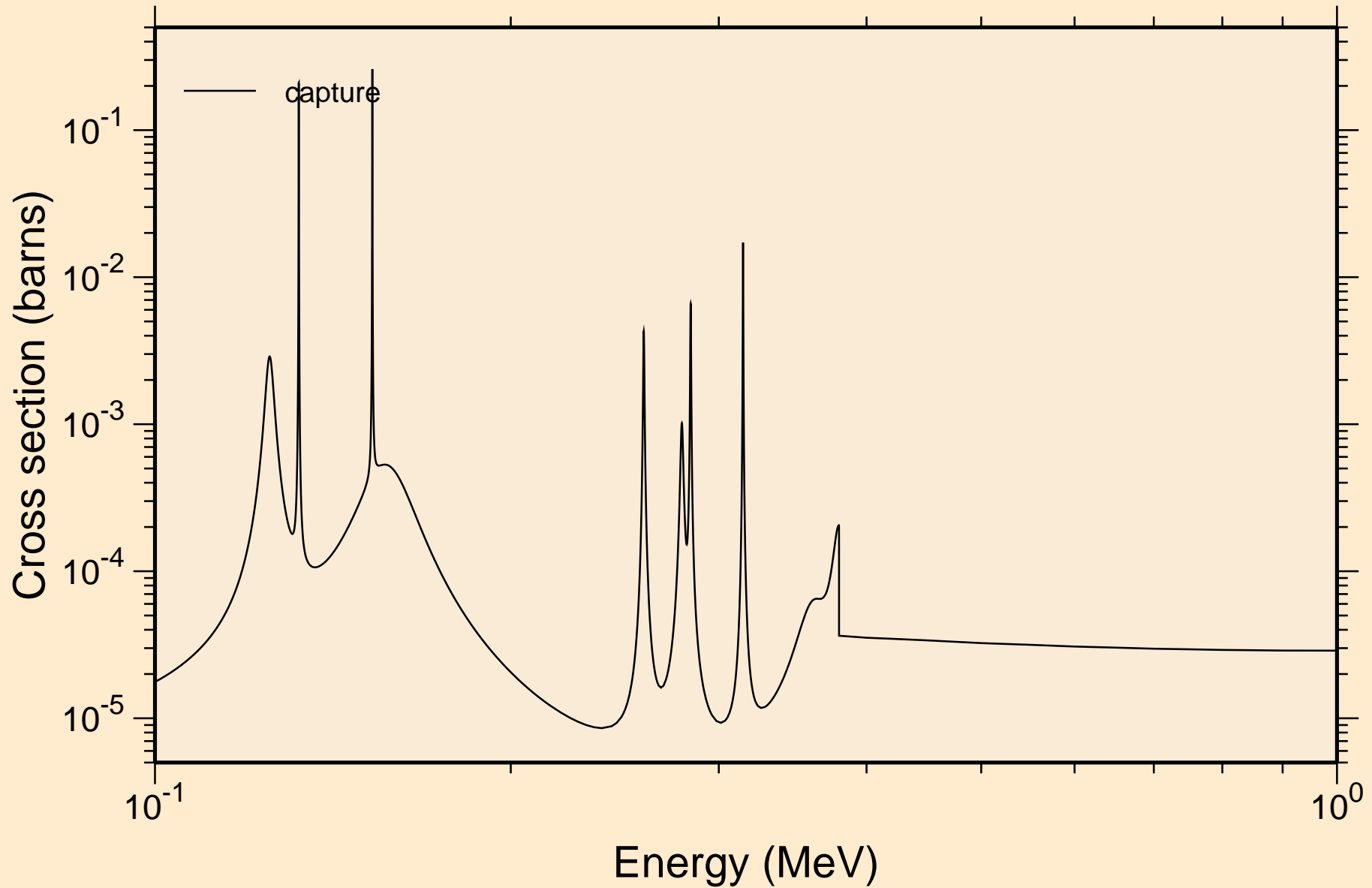

MG028 NEUTRON ACER TENDL-2021 LIBRARY; T=293.6K  
resonance absorption cross sections

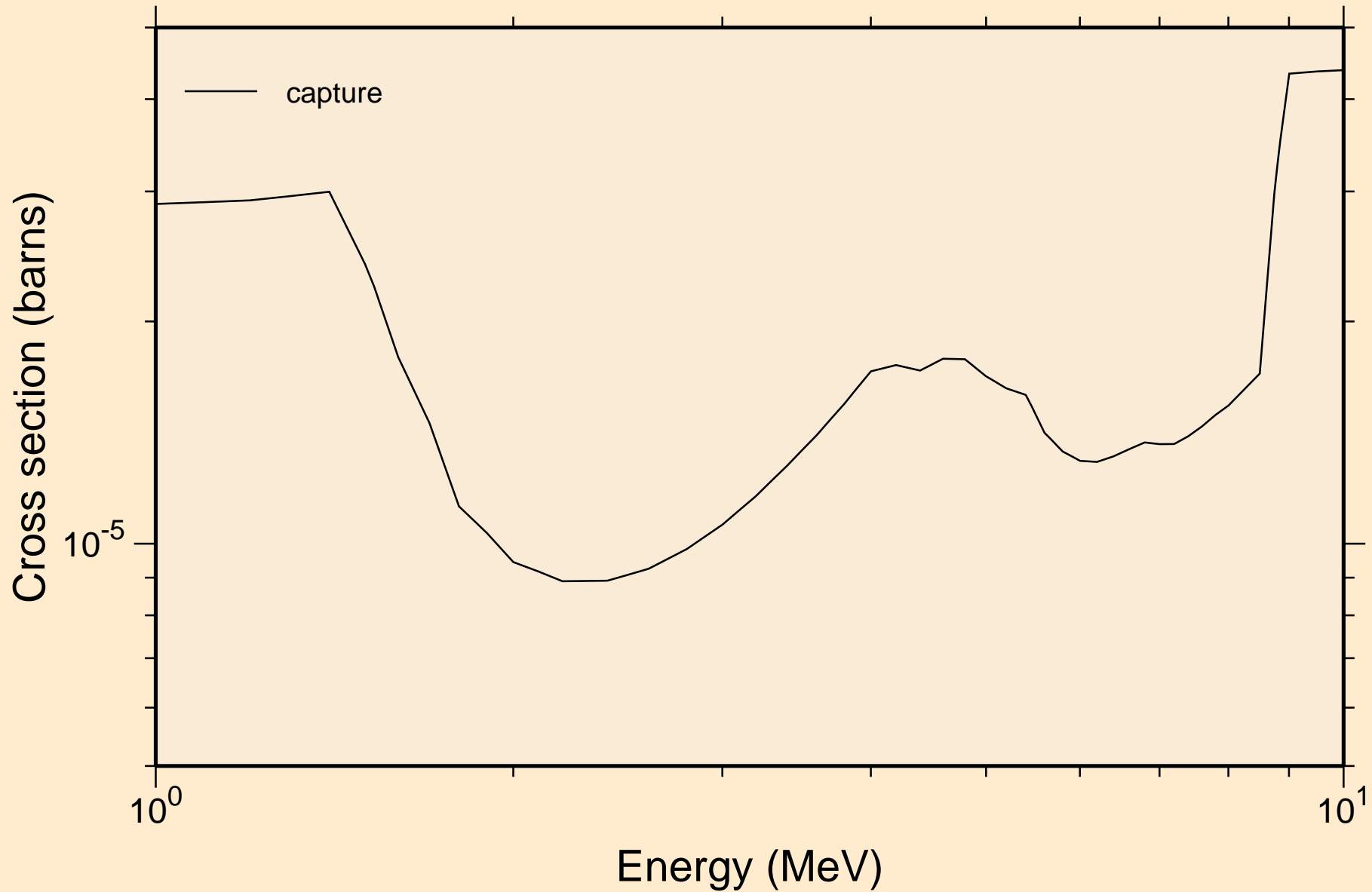

MG028 NEUTRON ACER TENDL-2021 LIBRARY; T=293.6K  
Heating

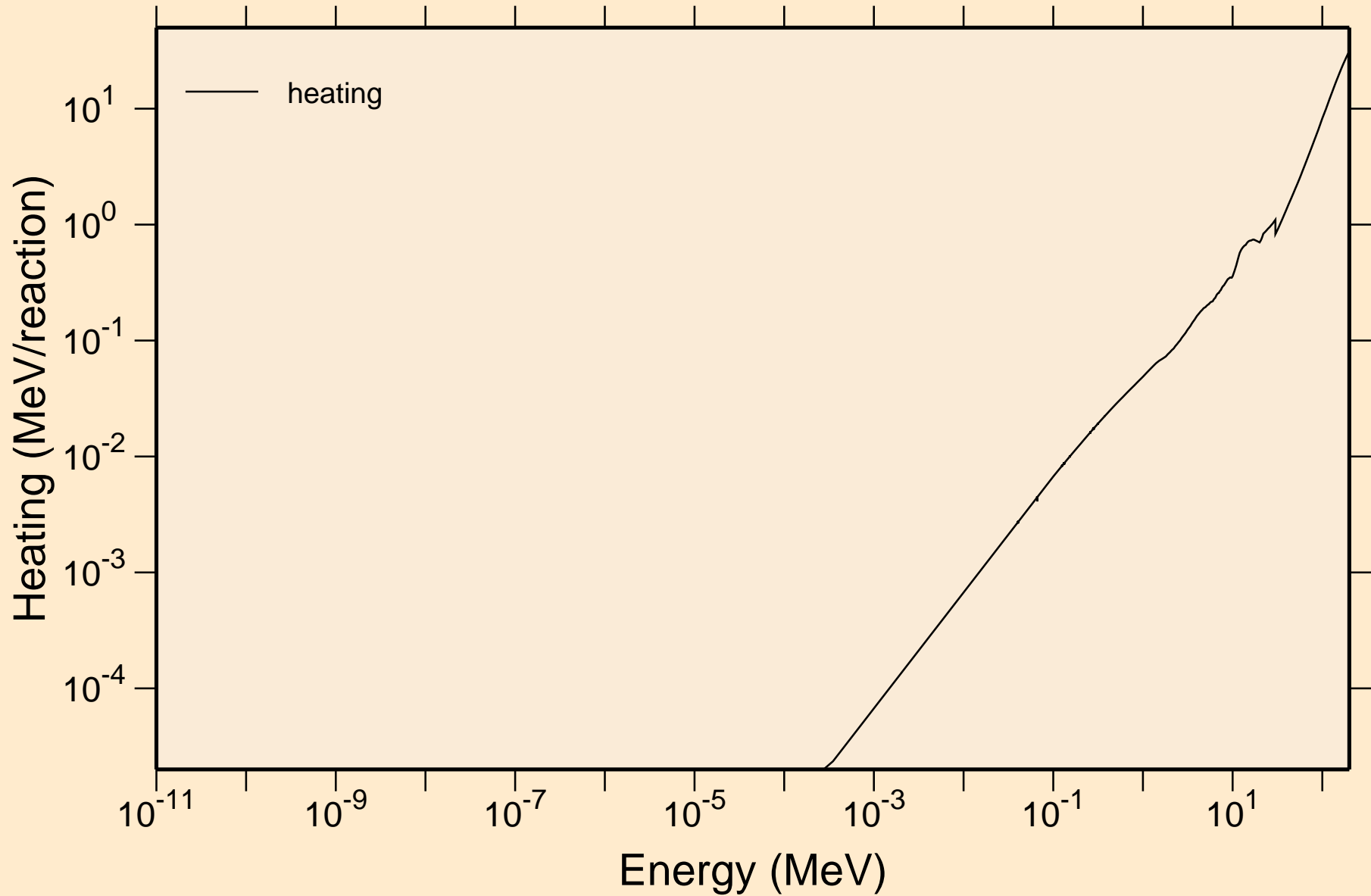



# MG028 NEUTRON ACER TENDL-2021 LIBRARY; T=293.6K Damage

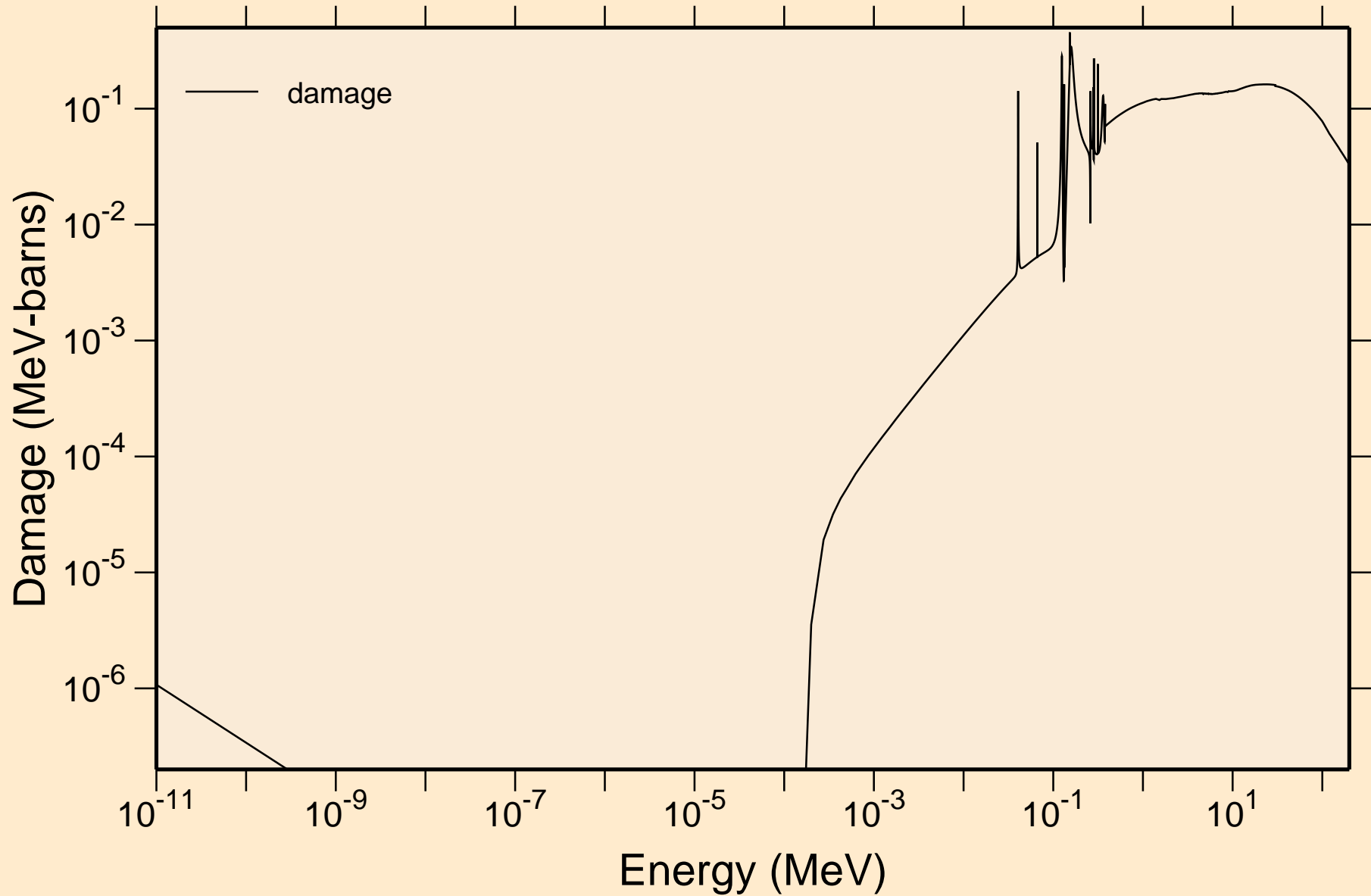

MG028 NEUTRON ACER TENDL-2021 LIBRARY; T=293.6K  
Non-threshold reactions

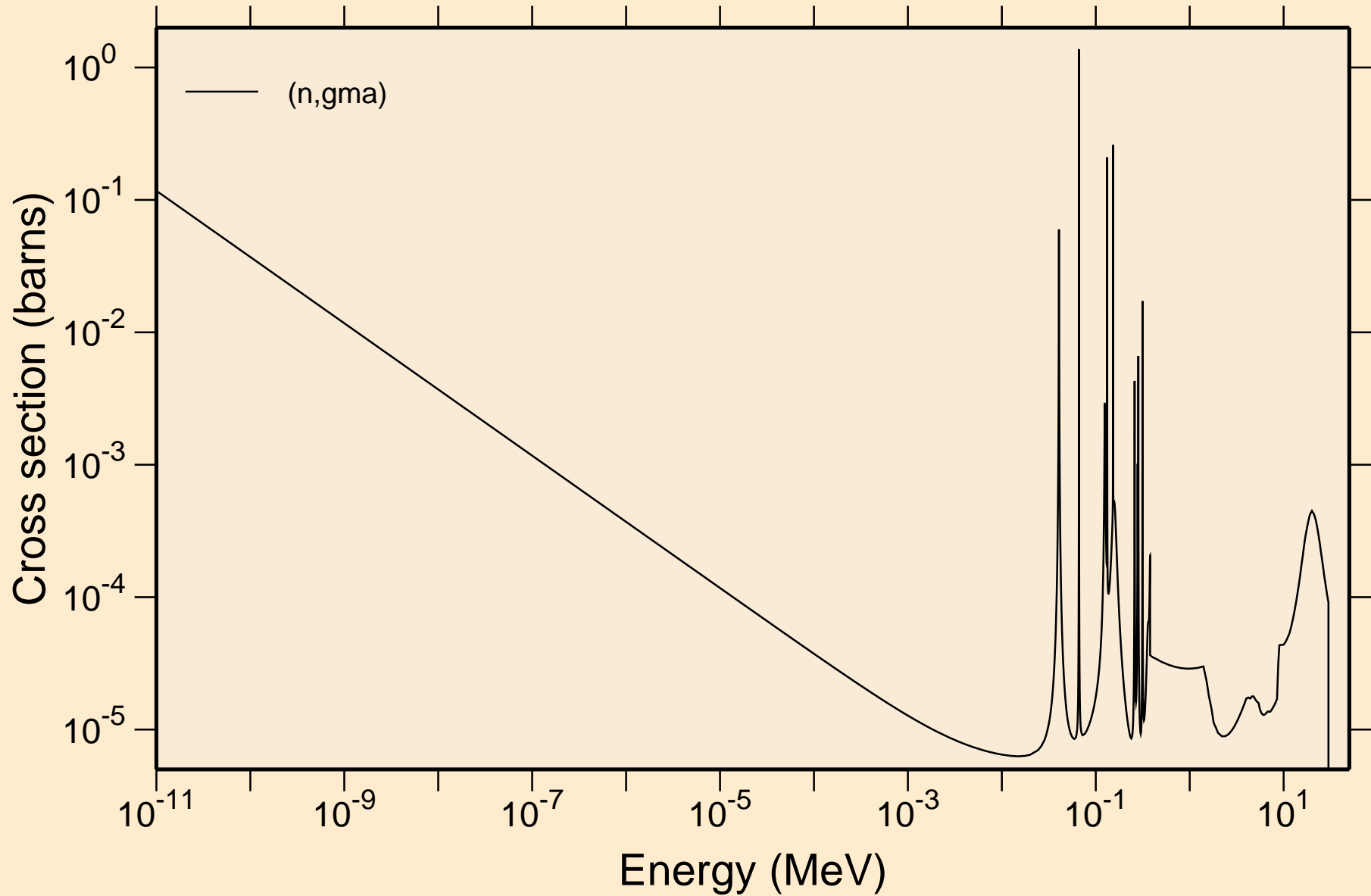

# MG028 NEUTRON ACER TENDL-2021 LIBRARY; T=293.6K

## Principal cross sections

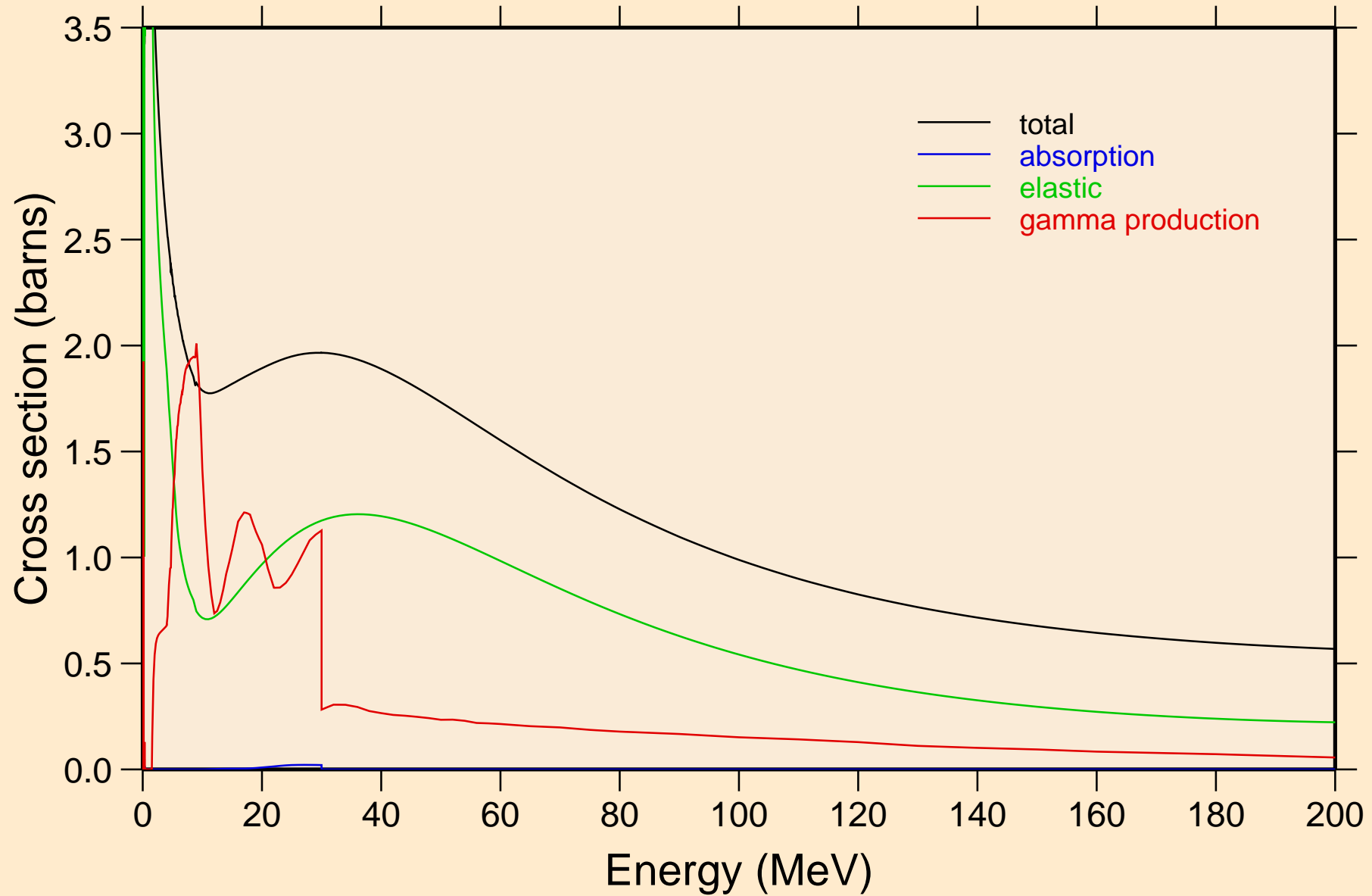

MG028 NEUTRON ACER TENDL-2021 LIBRARY; T=293.6K  
Heating

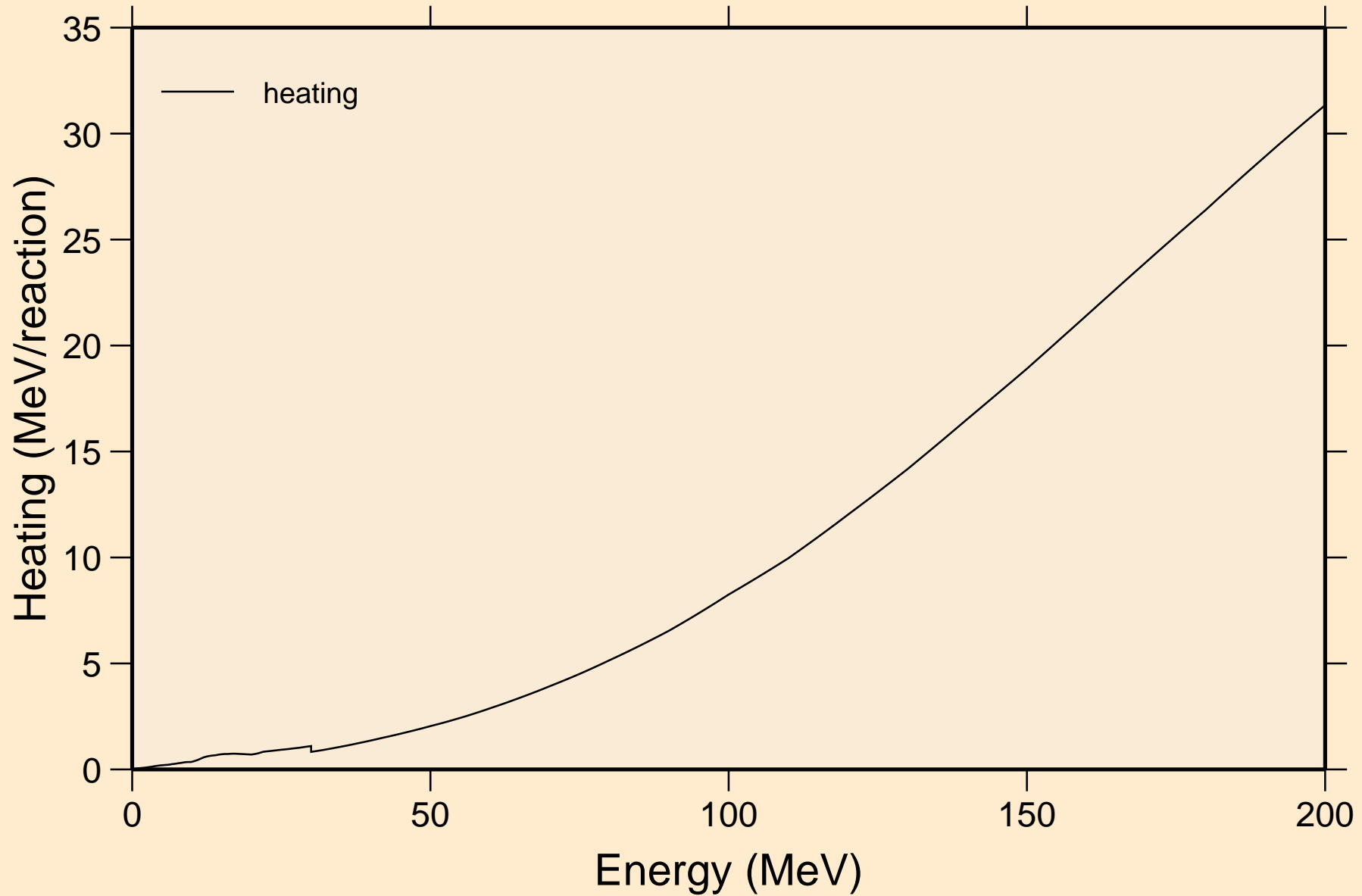

MG028 NEUTRON ACER TENDL-2021 LIBRARY; T=293.6K  
Damage

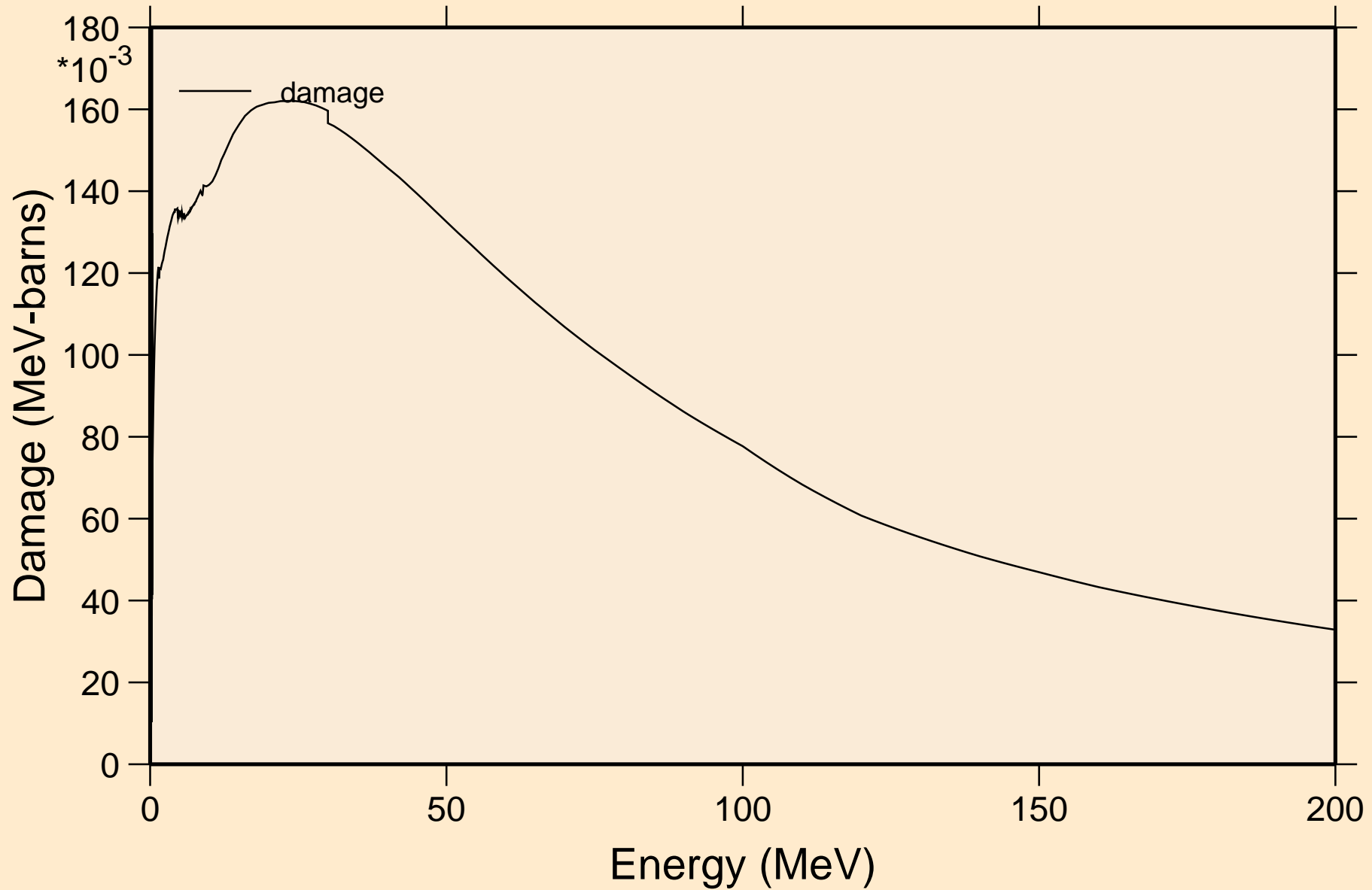

MG028 NEUTRON ACER TENDL-2021 LIBRARY; T=293.6K  
Non-threshold reactions

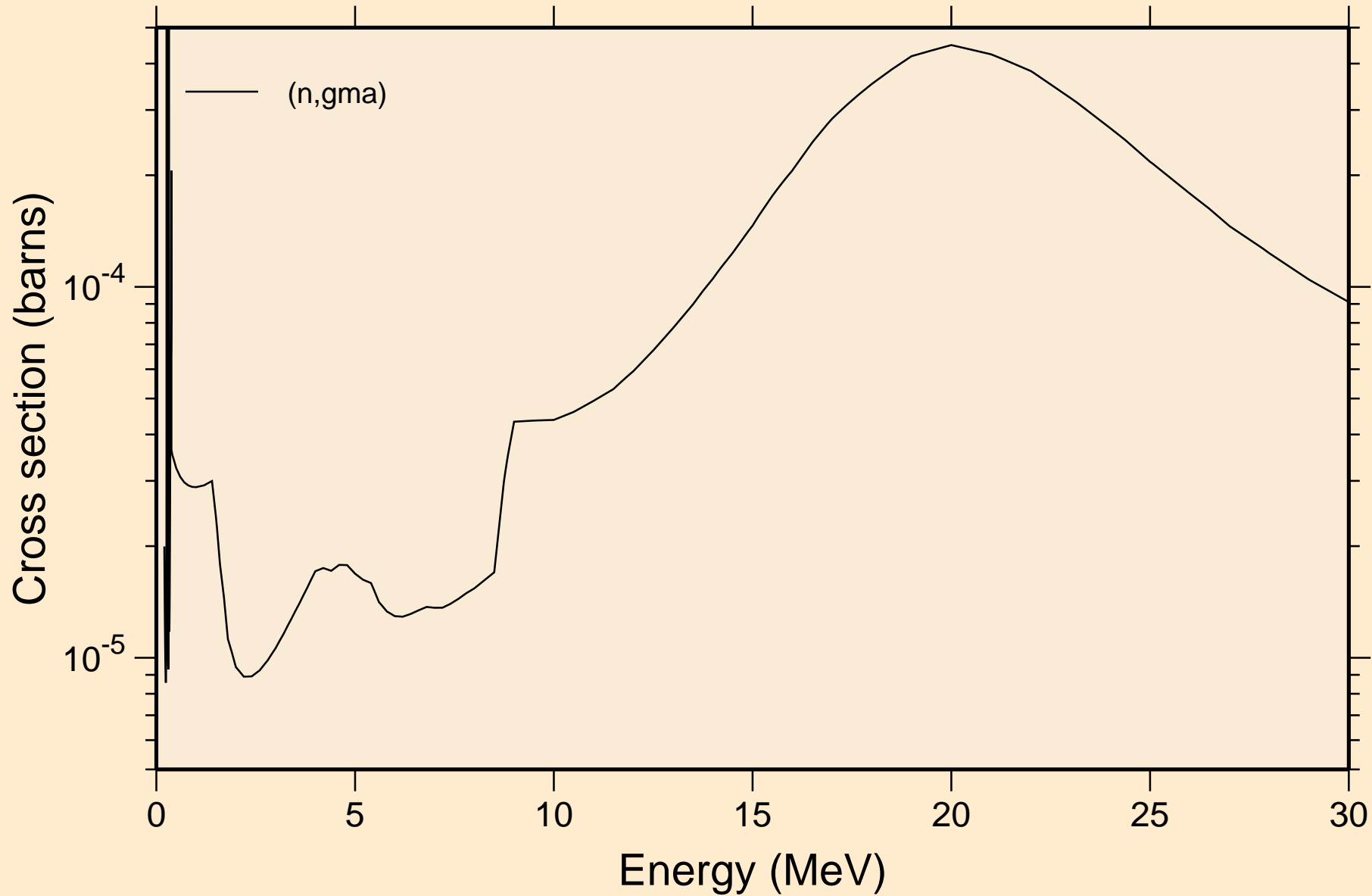

MG028 NEUTRON ACER TENDL-2021 LIBRARY; T=293.6K  
Inelastic levels

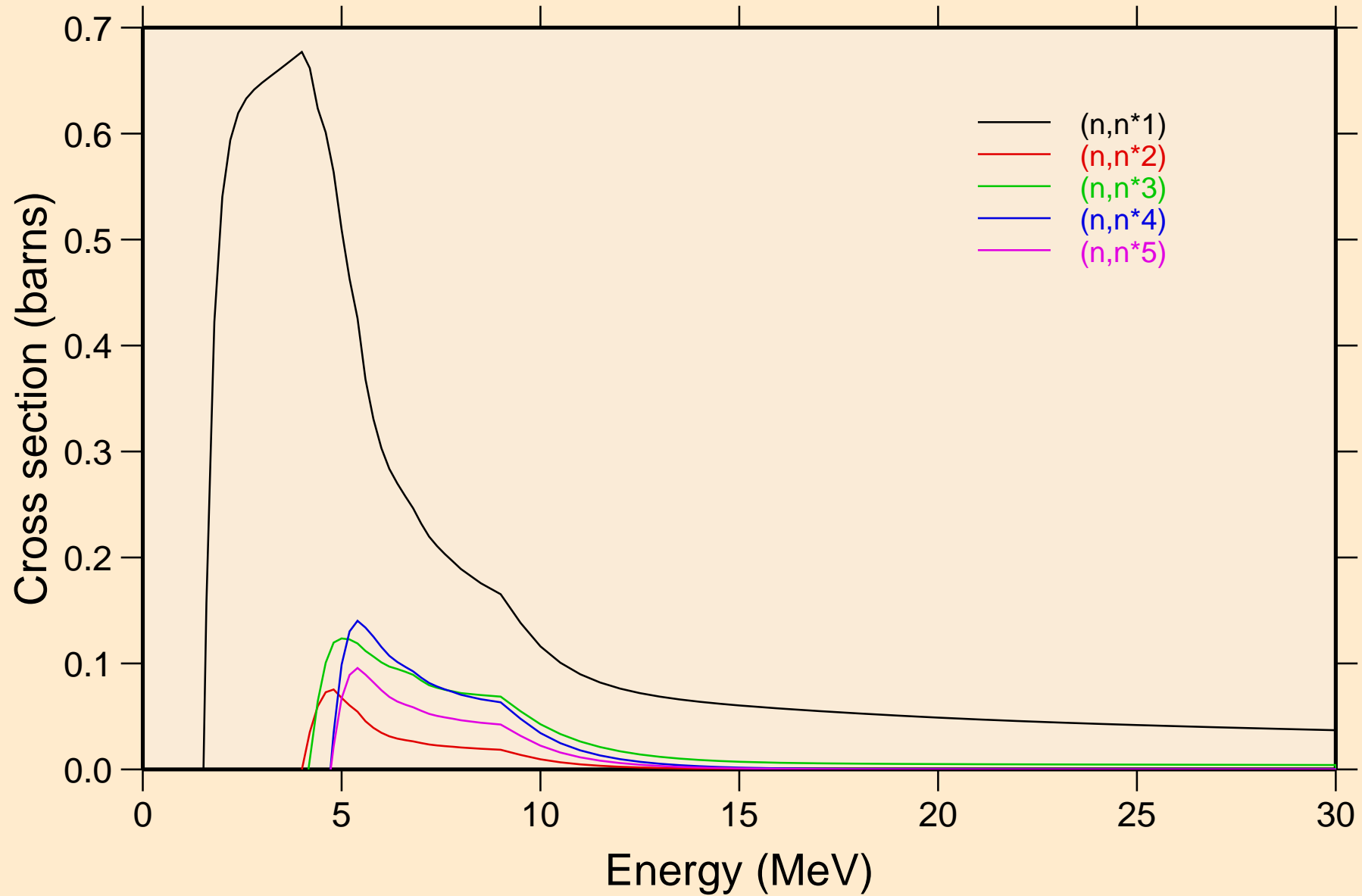

MG028 NEUTRON ACER TENDL-2021 LIBRARY; T=293.6K  
Inelastic levels

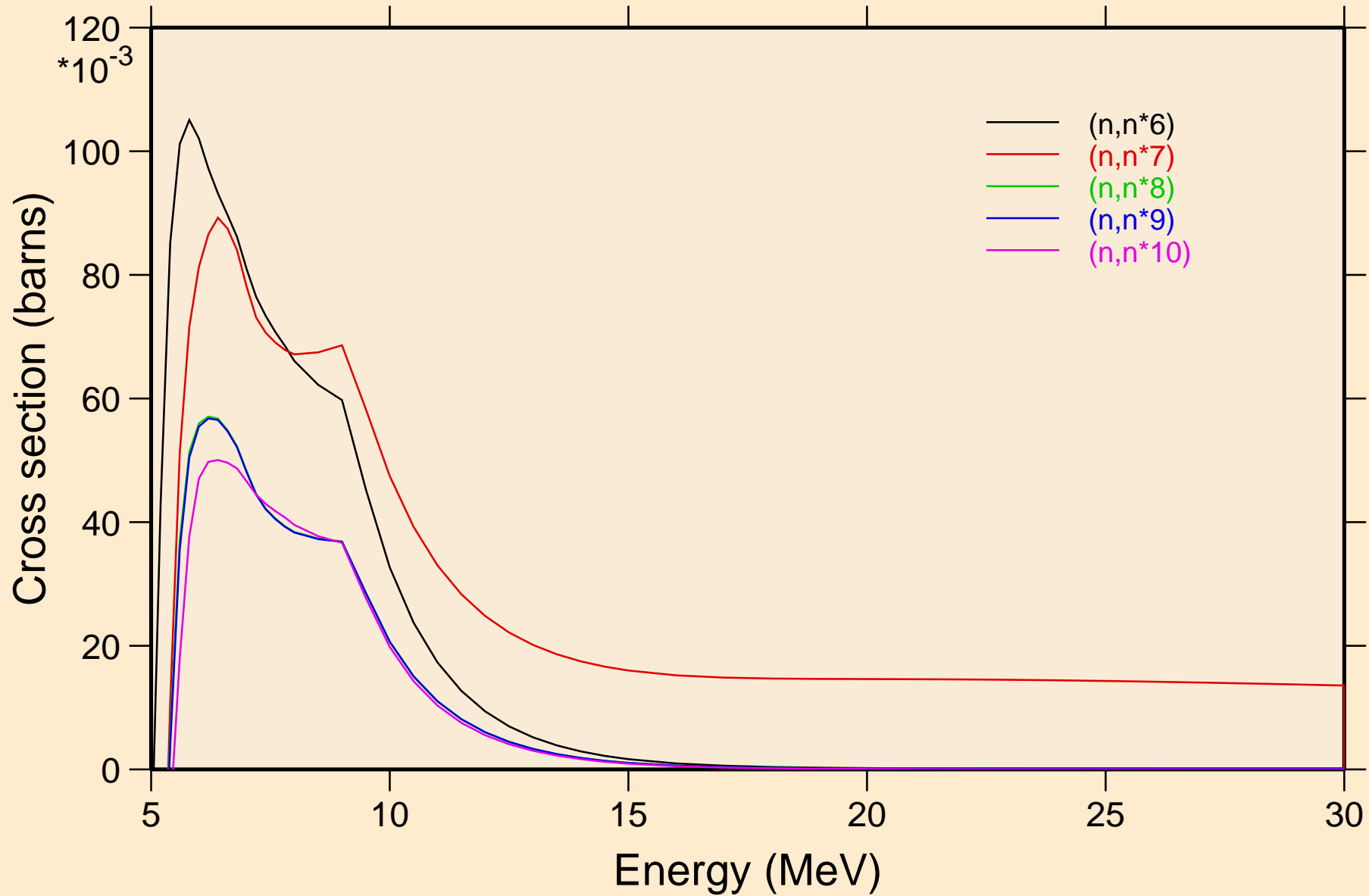



MG028 NEUTRON ACER TENDL-2021 LIBRARY; T=293.6K  
Inelastic levels

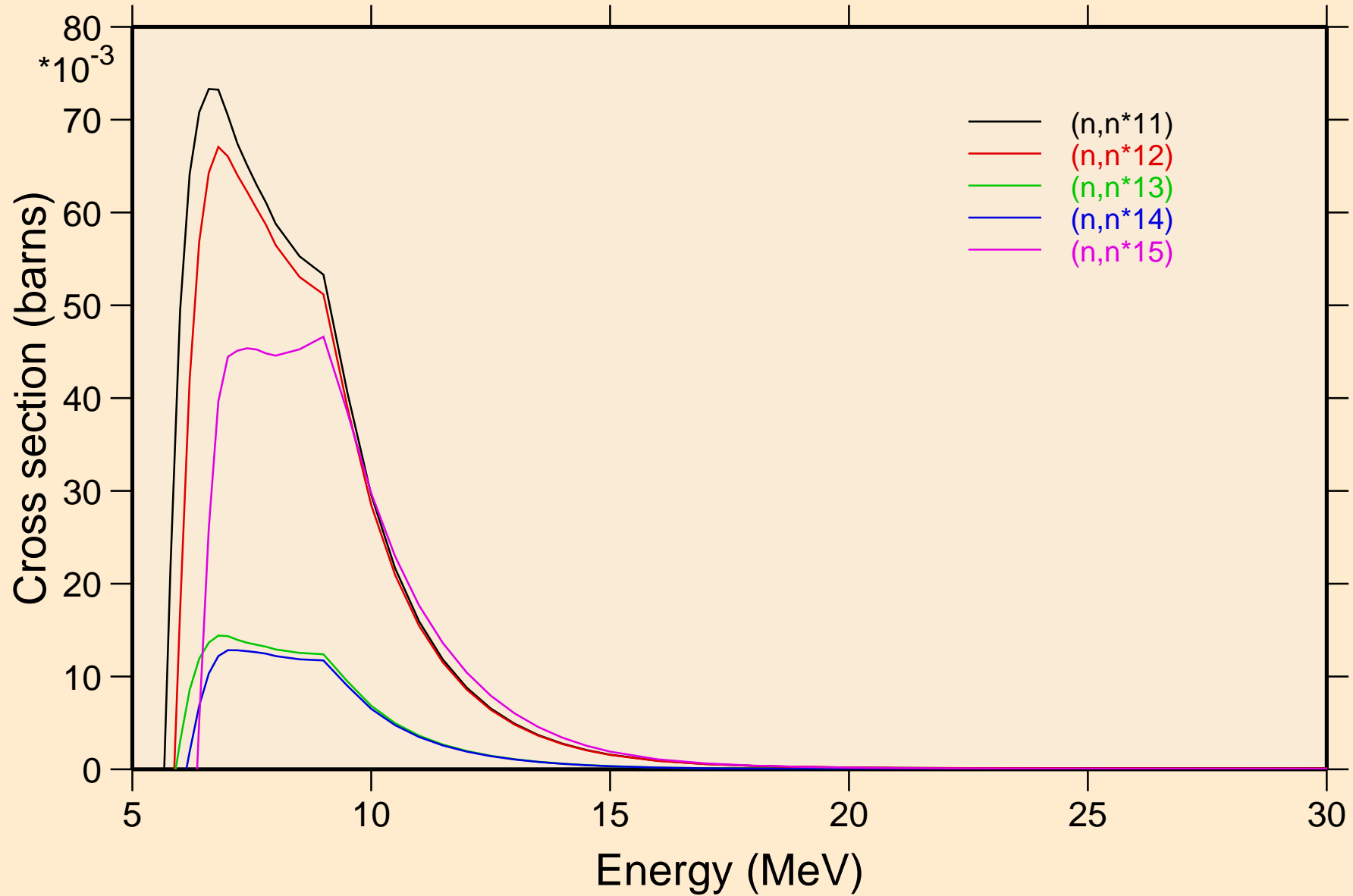

MG028 NEUTRON ACER TENDL-2021 LIBRARY; T=293.6K  
Inelastic levels

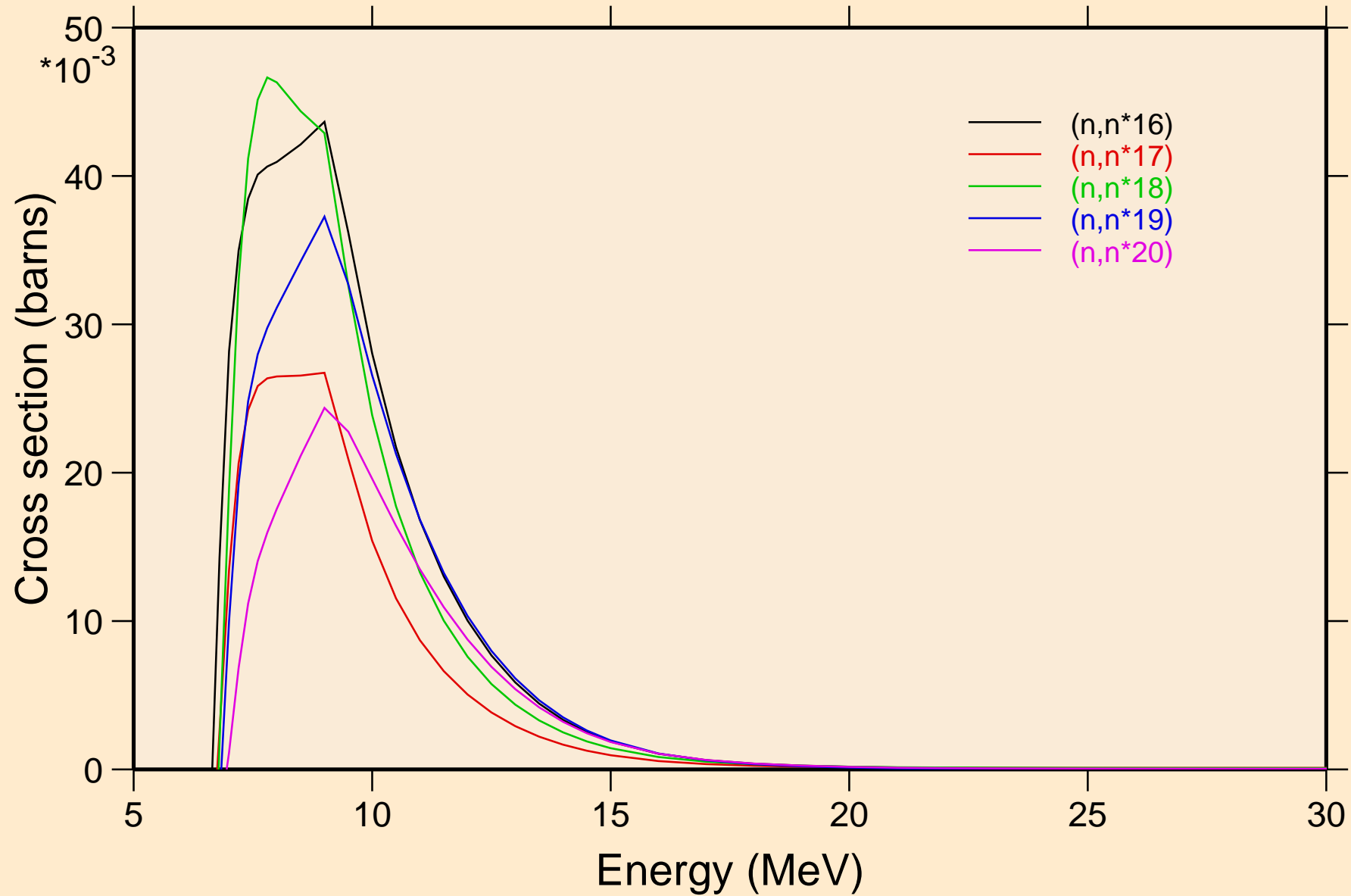

MG028 NEUTRON ACER TENDL-2021 LIBRARY; T=293.6K  
Inelastic levels

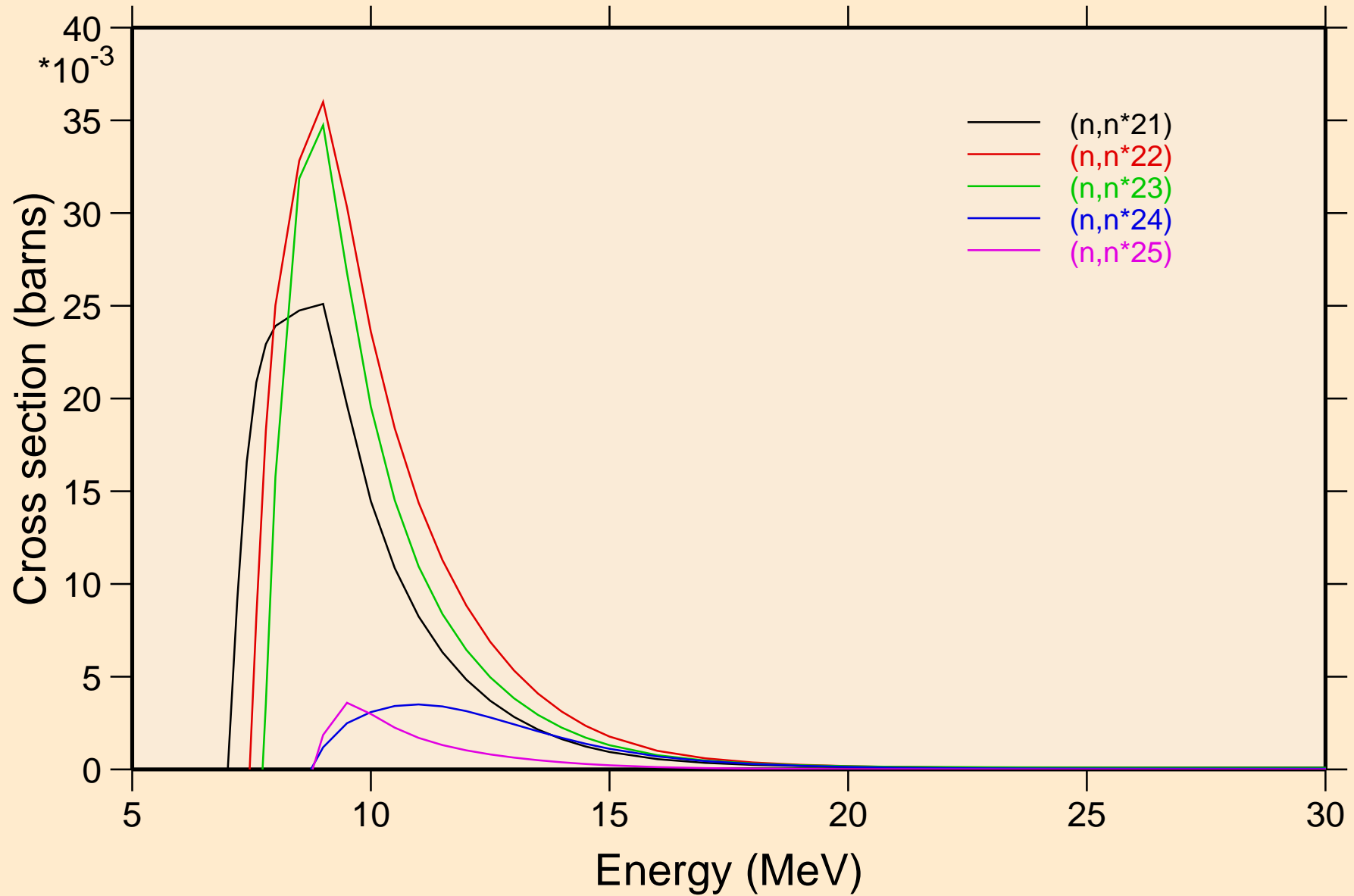

MG028 NEUTRON ACER TENDL-2021 LIBRARY; T=293.6K  
Inelastic levels

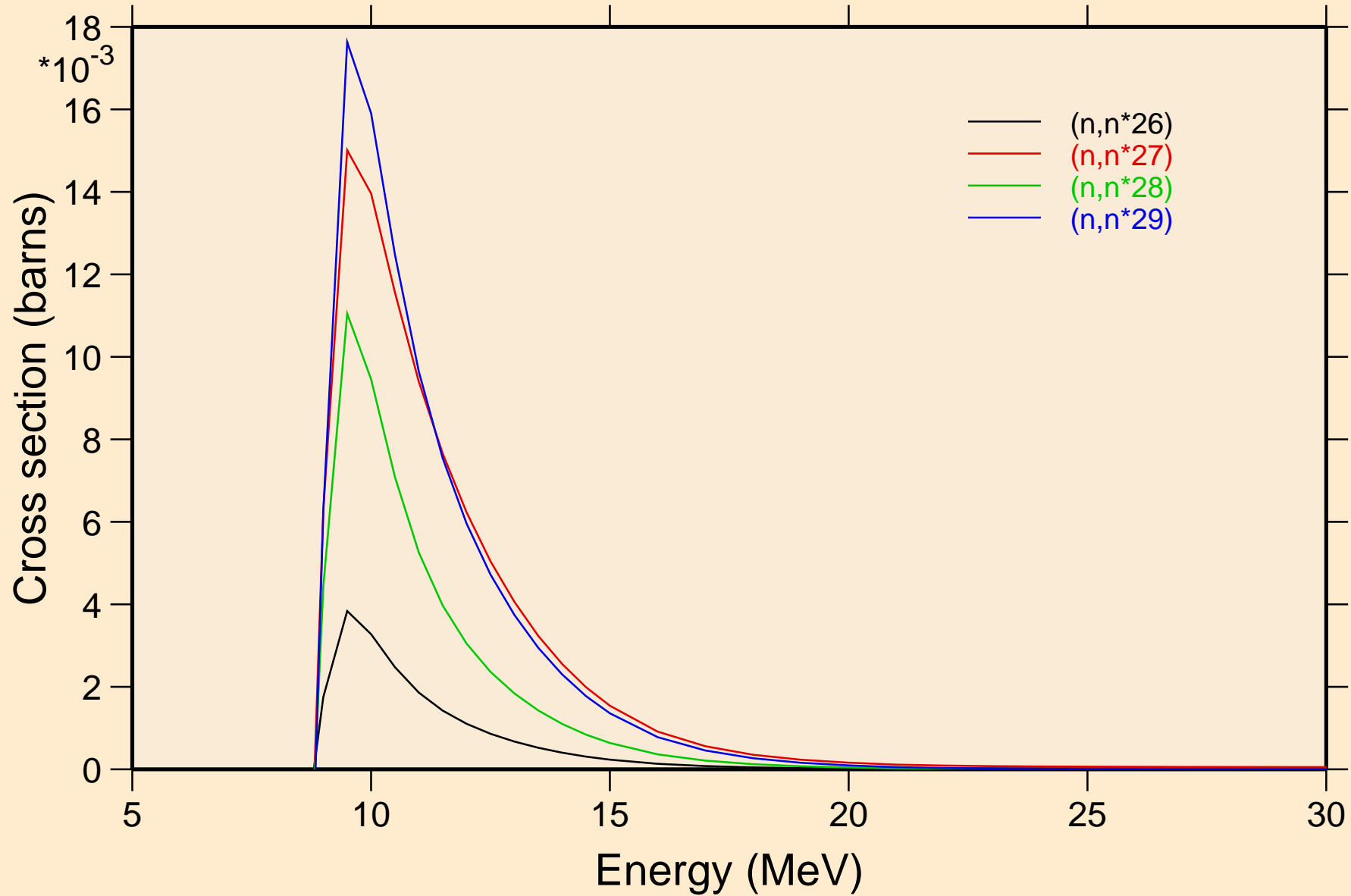

MG028 NEUTRON ACER TENDL-2021 LIBRARY; T=293.6K  
Threshold reactions

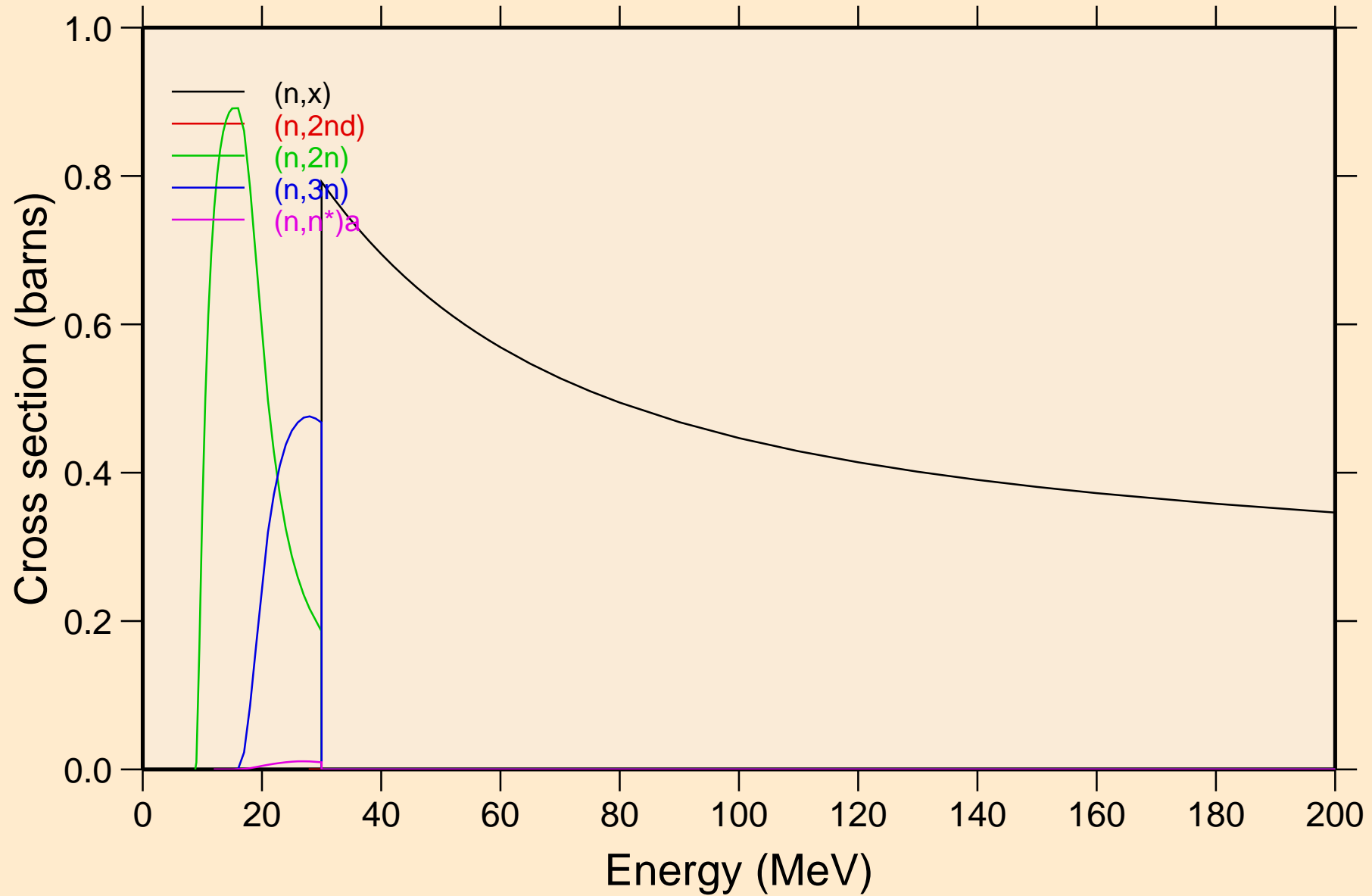

MG028 NEUTRON ACER TENDL-2021 LIBRARY; T=293.6K  
Threshold reactions

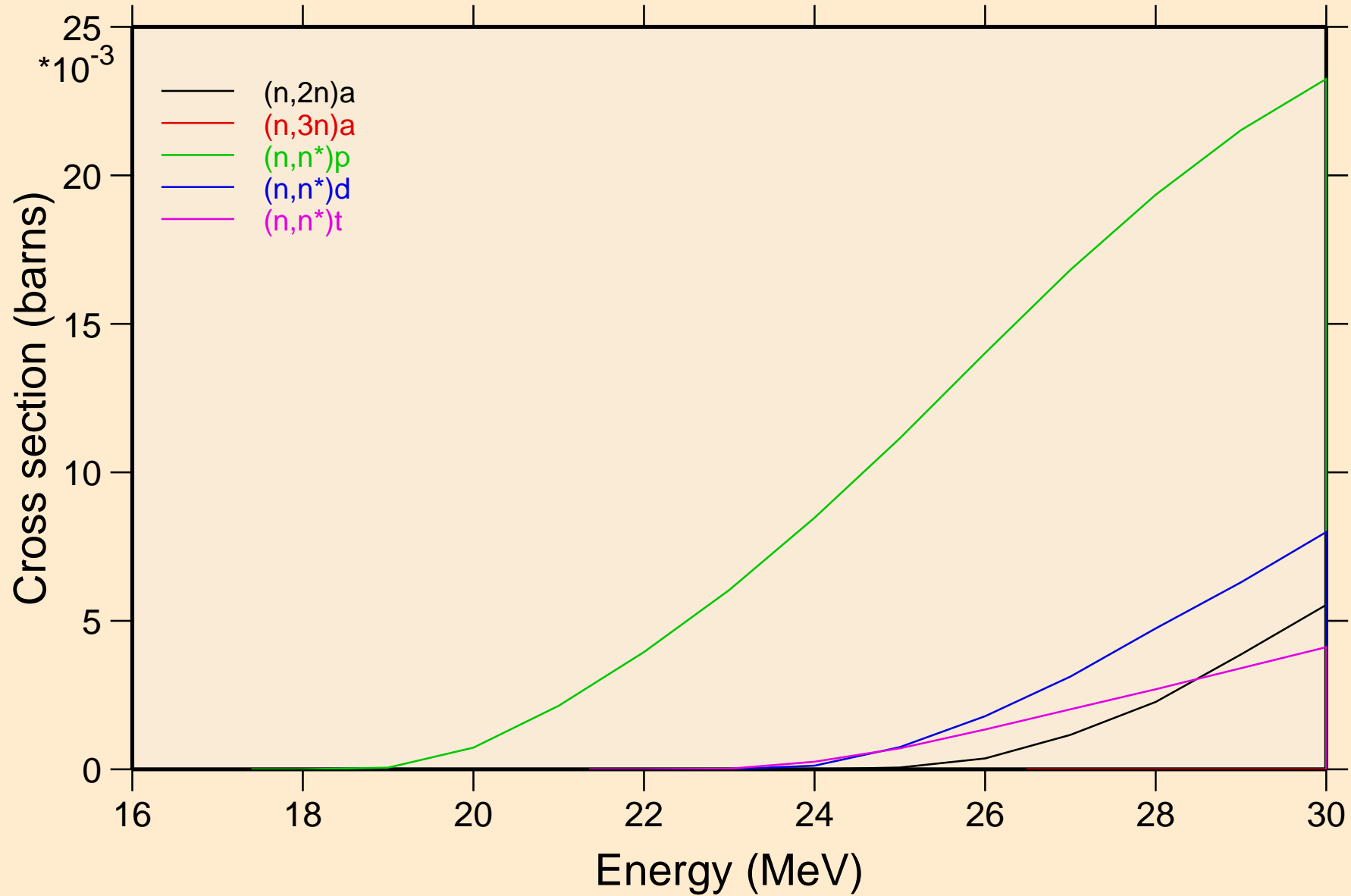

MG028 NEUTRON ACER TENDL-2021 LIBRARY; T=293.6K  
Threshold reactions

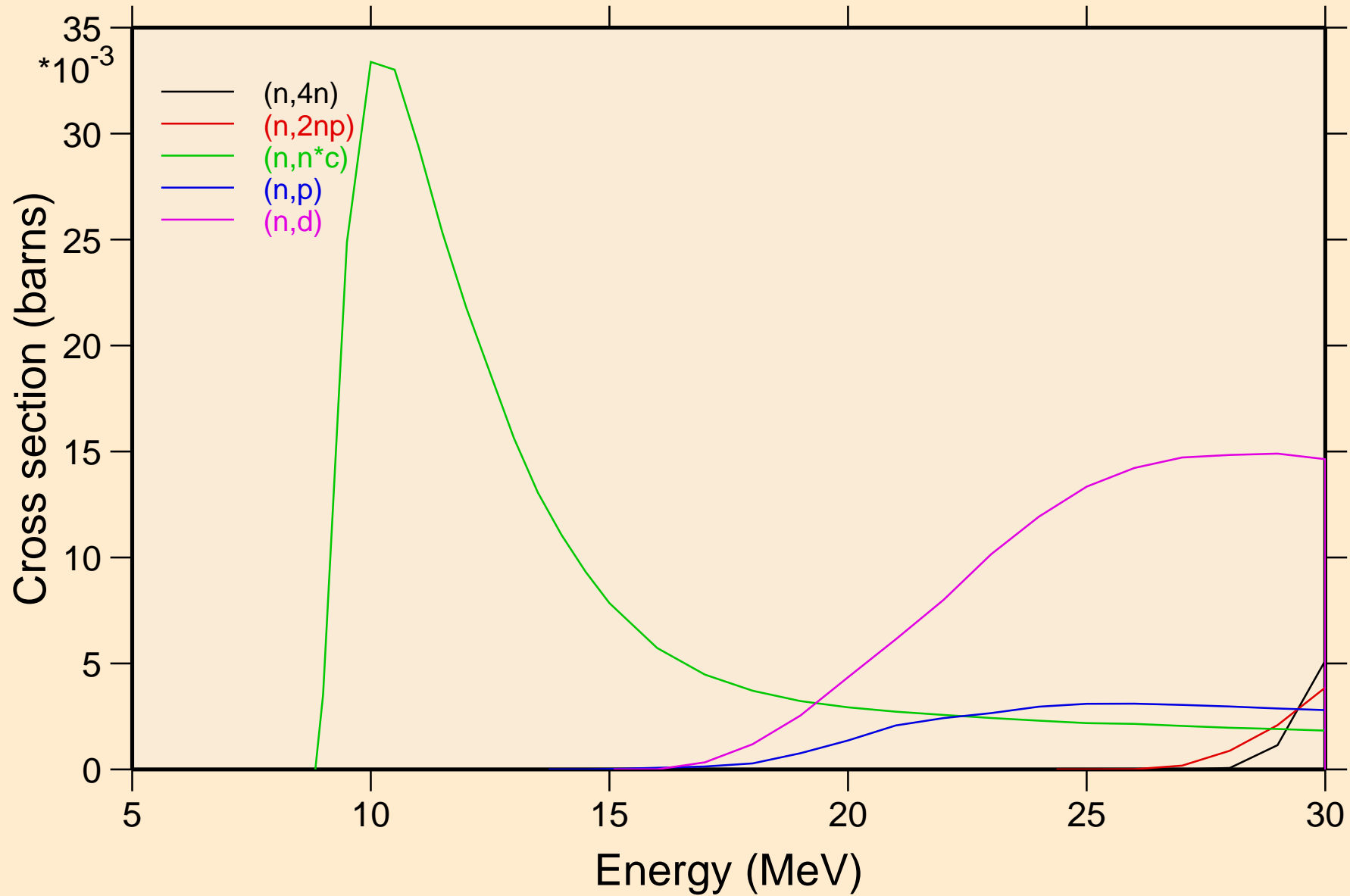

MG028 NEUTRON ACER TENDL-2021 LIBRARY; T=293.6K  
Threshold reactions

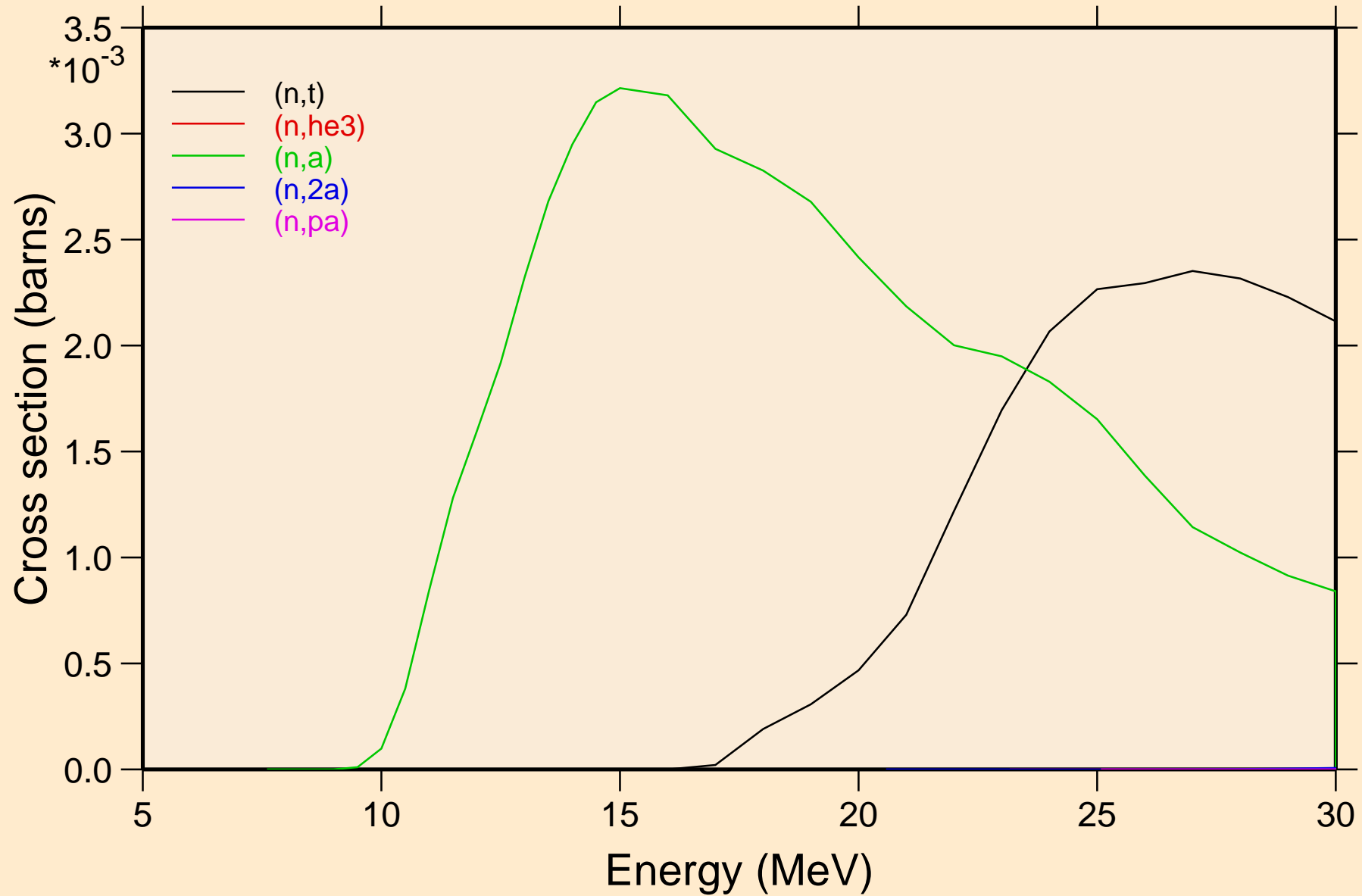



# MG028 NEUTRON ACER TENDL-2021 LIBRARY; T=293.6K

## Threshold reactions

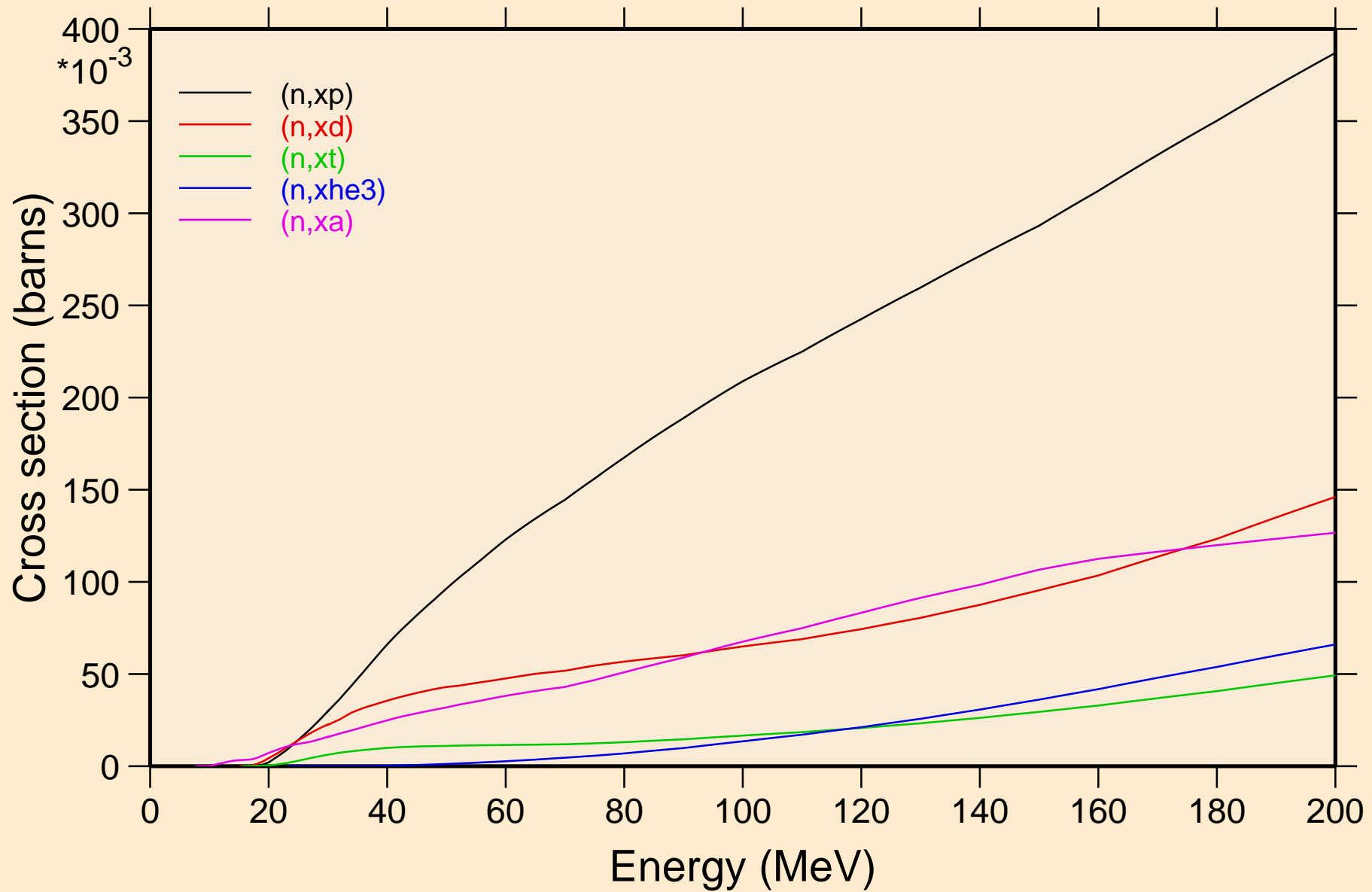

MG028 NEUTRON ACER TENDL-2021 LIBRARY; T=293.6K  
angular distribution for elastic

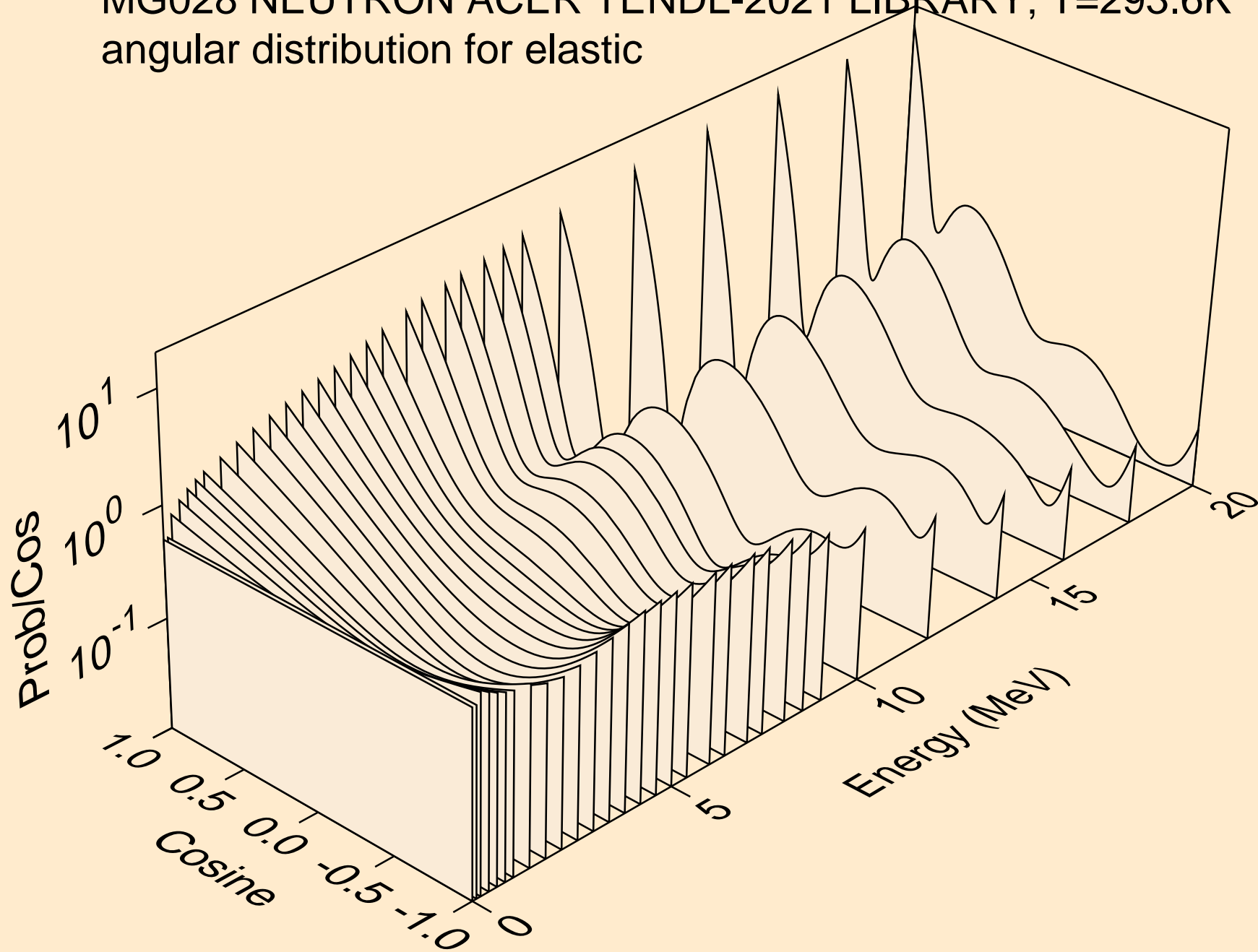

MG028 NEUTRON ACER TENDL-2021 LIBRARY; T=293.6K  
angular distribution for elastic

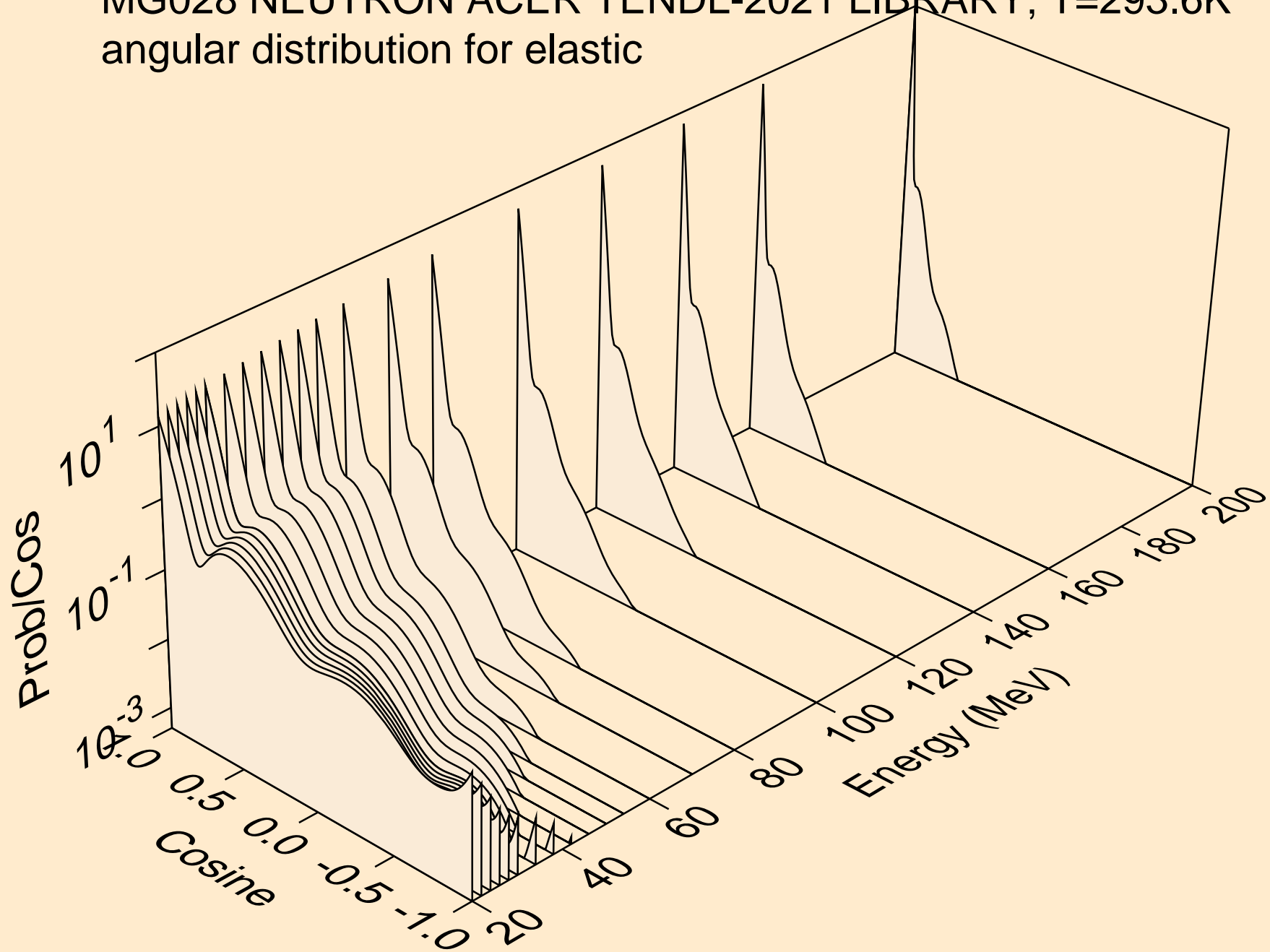

MG028 NEUTRON ACER TENDL-2021 LIBRARY; T=293.6K  
angular distribution for (n,n\*1)

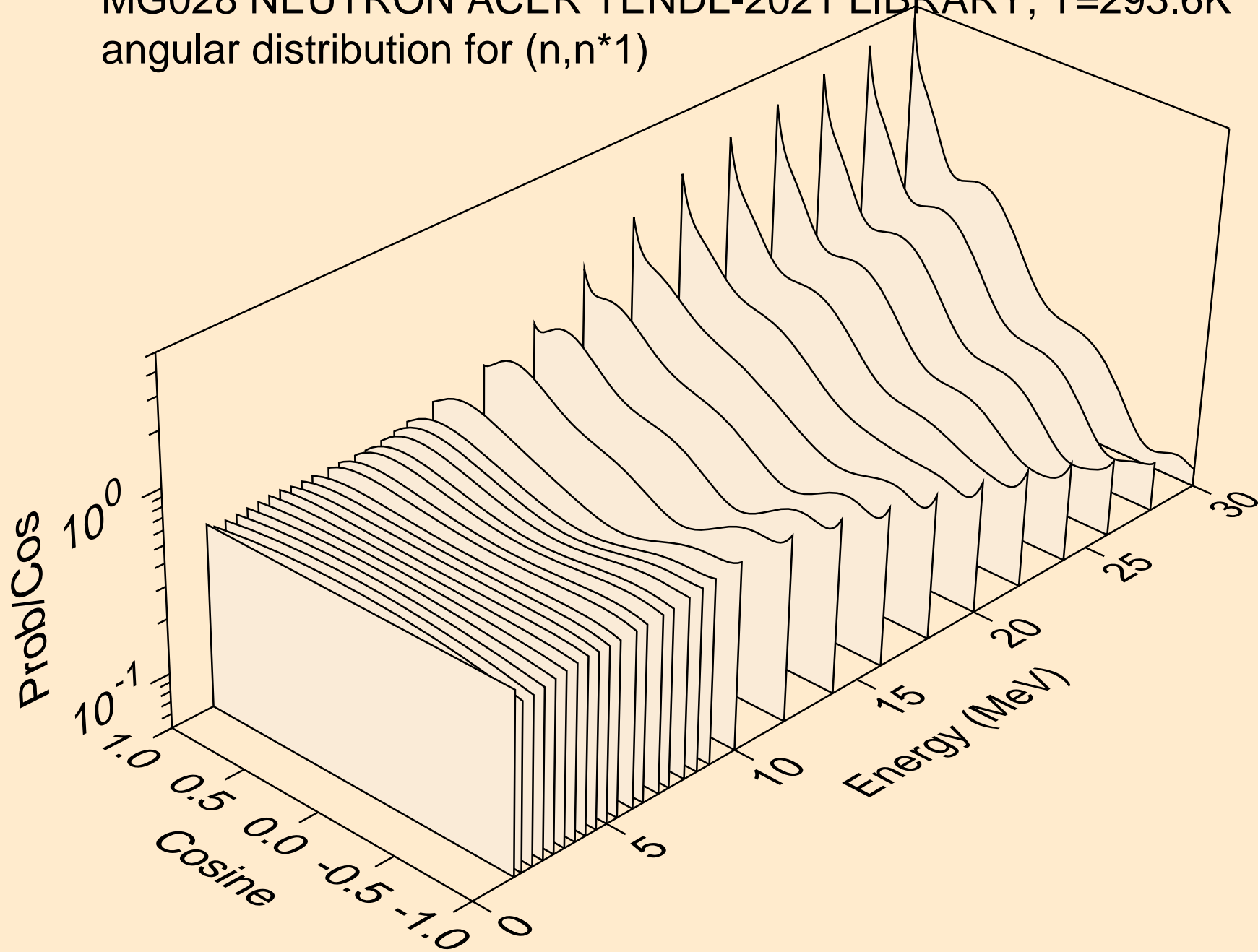

MG028 NEUTRON ACER TENDL-2021 LIBRARY; T=293.6K  
angular distribution for (n,n\*2)

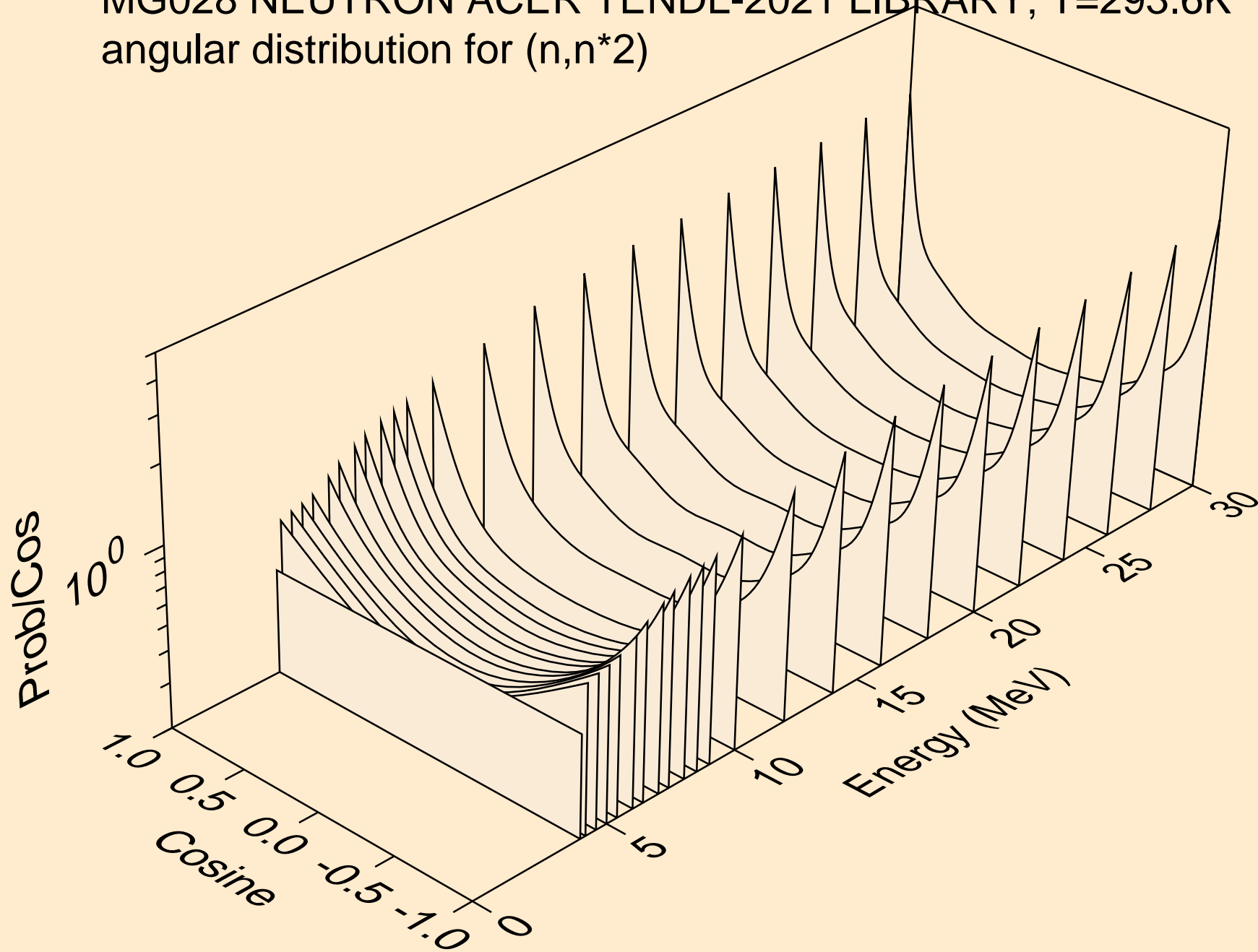

MG028 NEUTRON ACER TENDL-2021 LIBRARY; T=293.6K  
angular distribution for (n,n\*3)

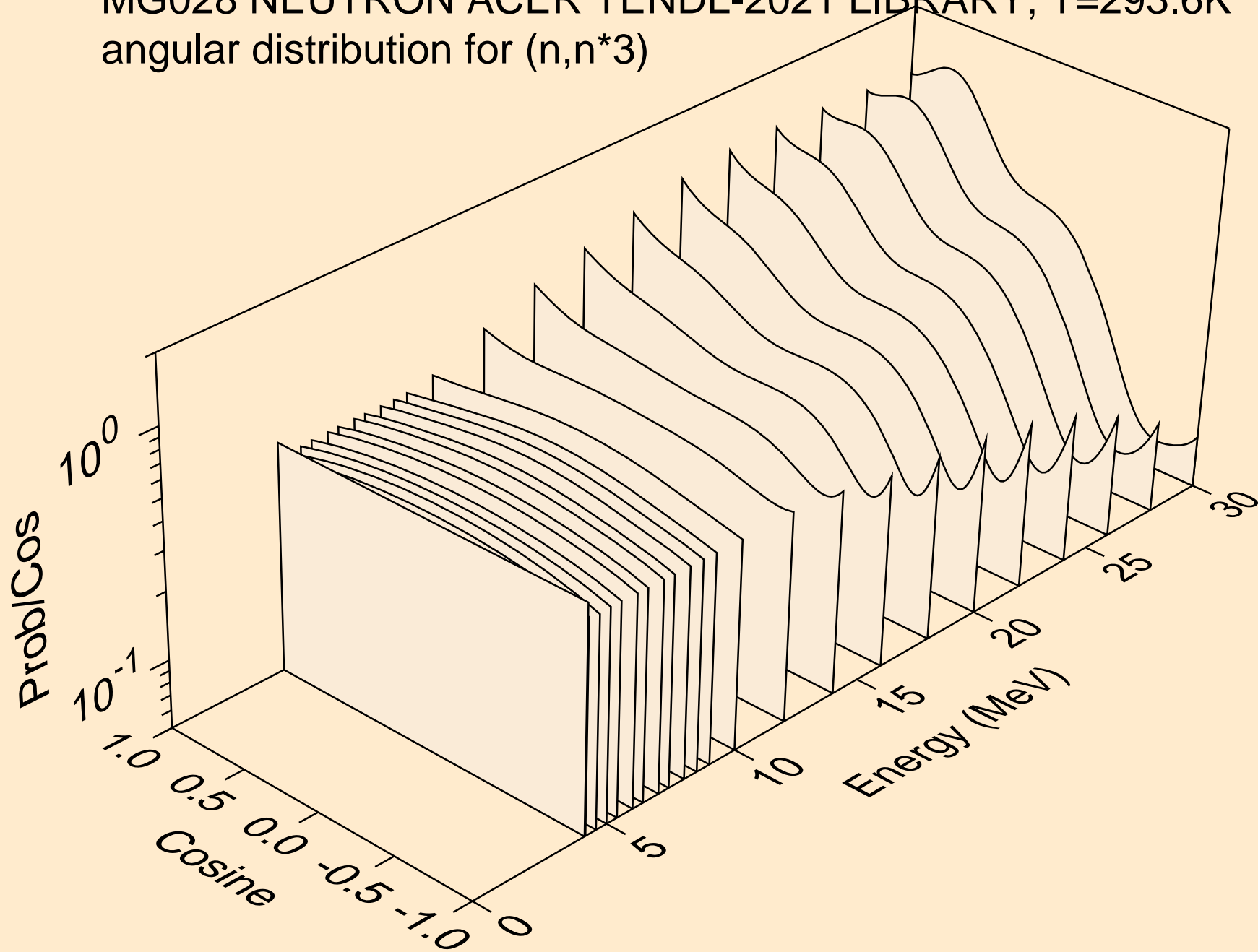

MG028 NEUTRON ACER TENDL-2021 LIBRARY; T=293.6K  
angular distribution for (n,n\*4)

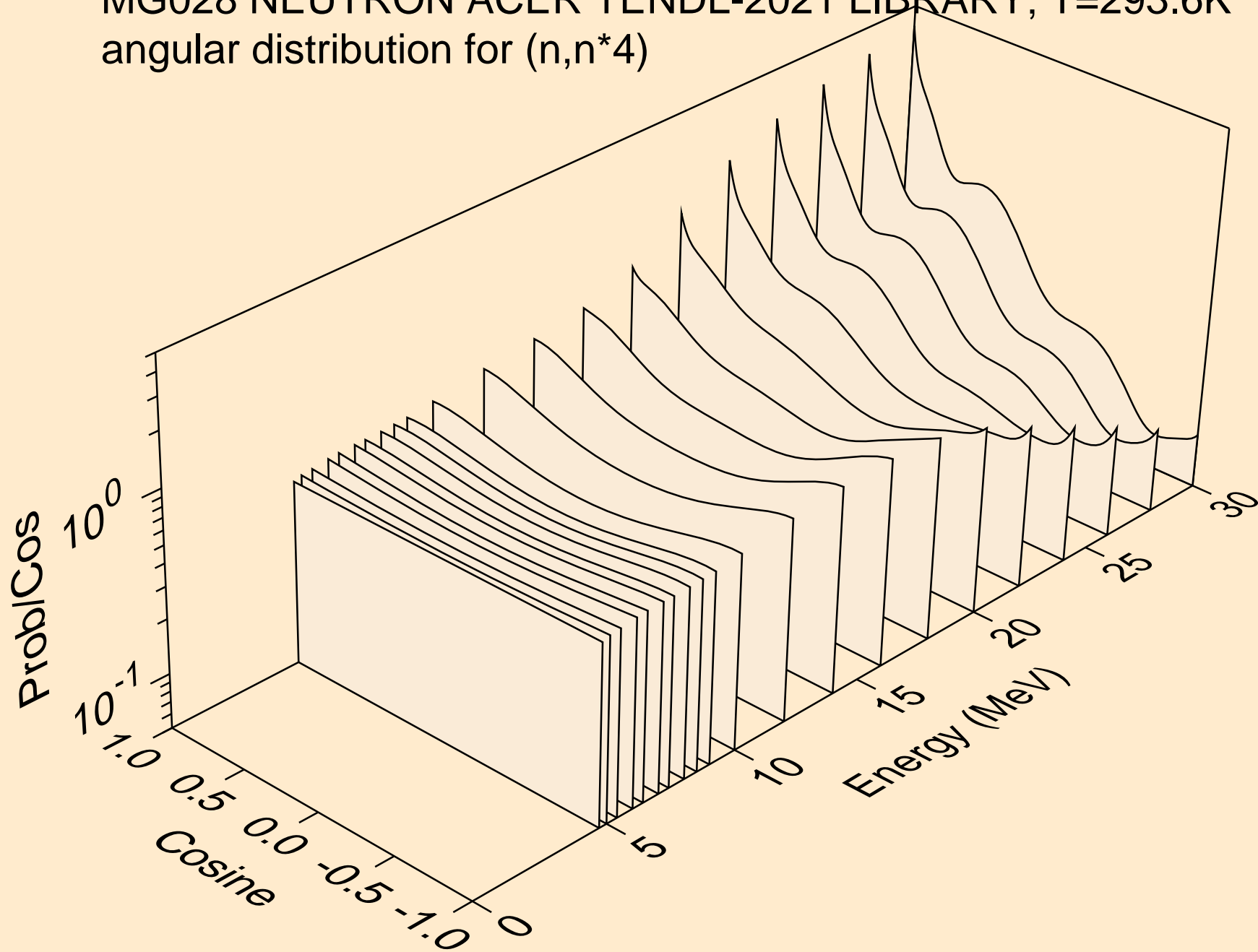

MG028 NEUTRON ACER TENDL-2021 LIBRARY; T=293.6K  
angular distribution for (n,n\*5)

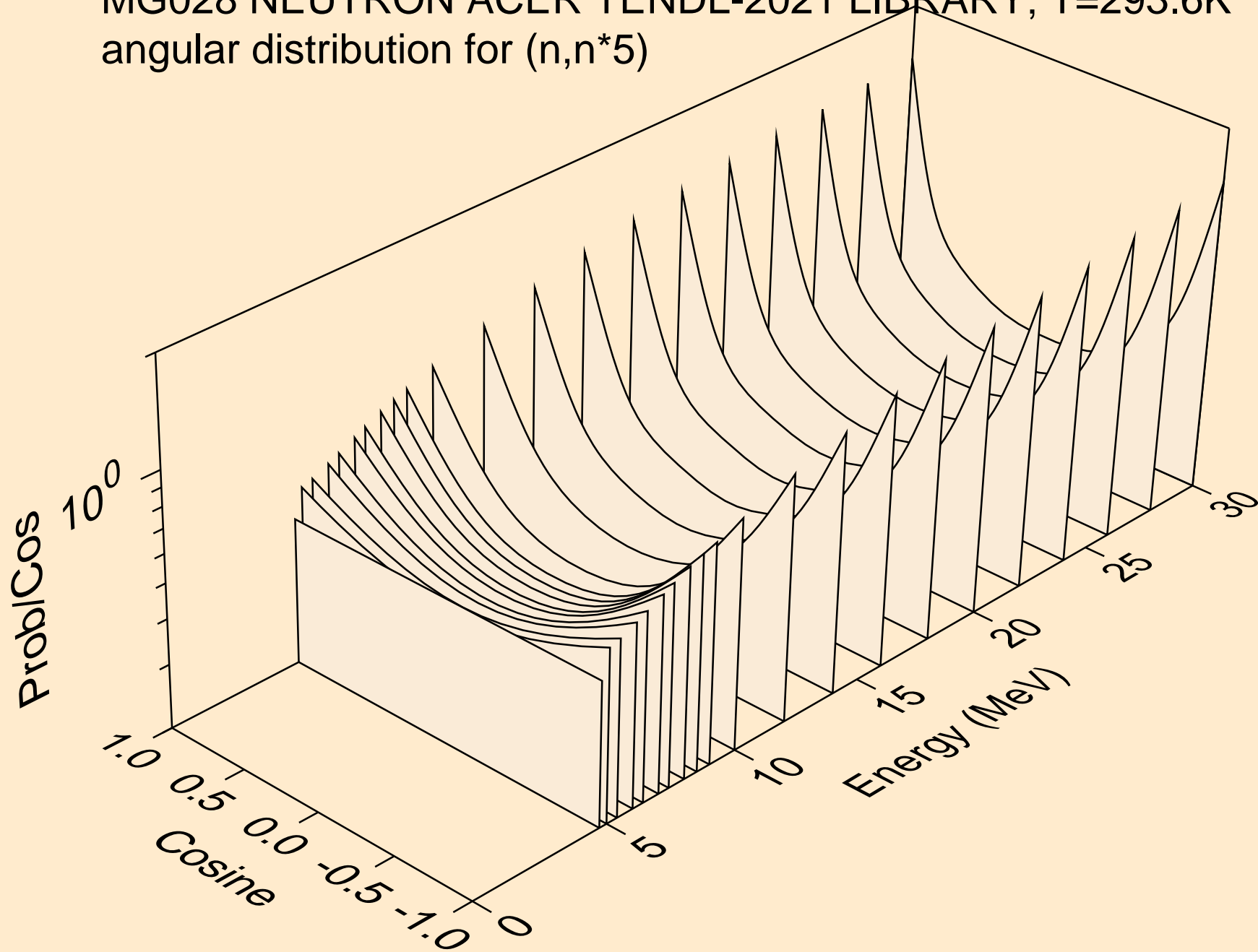



MG028 NEUTRON ACER TENDL-2021 LIBRARY; T=293.6K  
angular distribution for (n,n\*6)

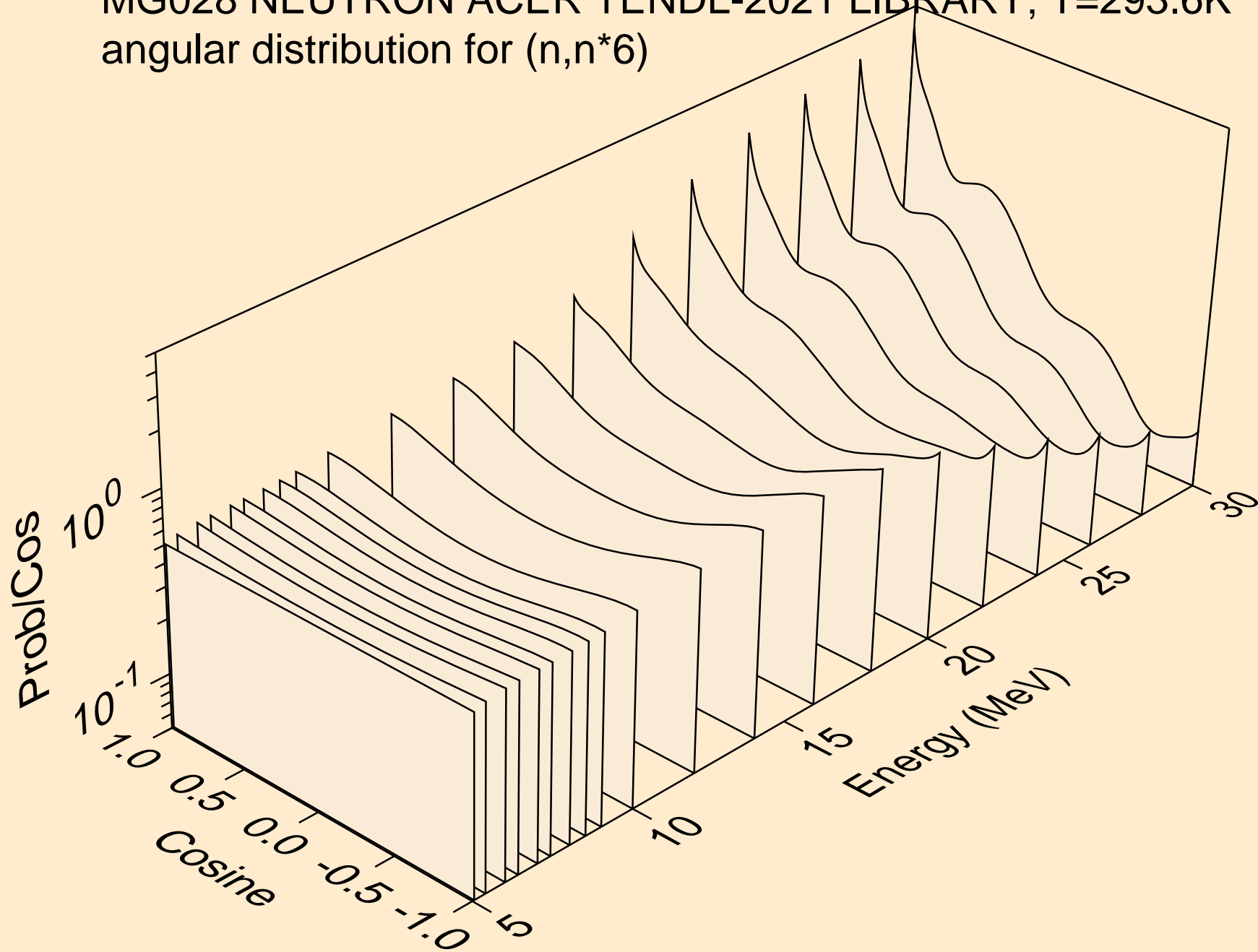

MG028 NEUTRON ACER TENDL-2021 LIBRARY; T=293.6K  
angular distribution for (n,n\*7)

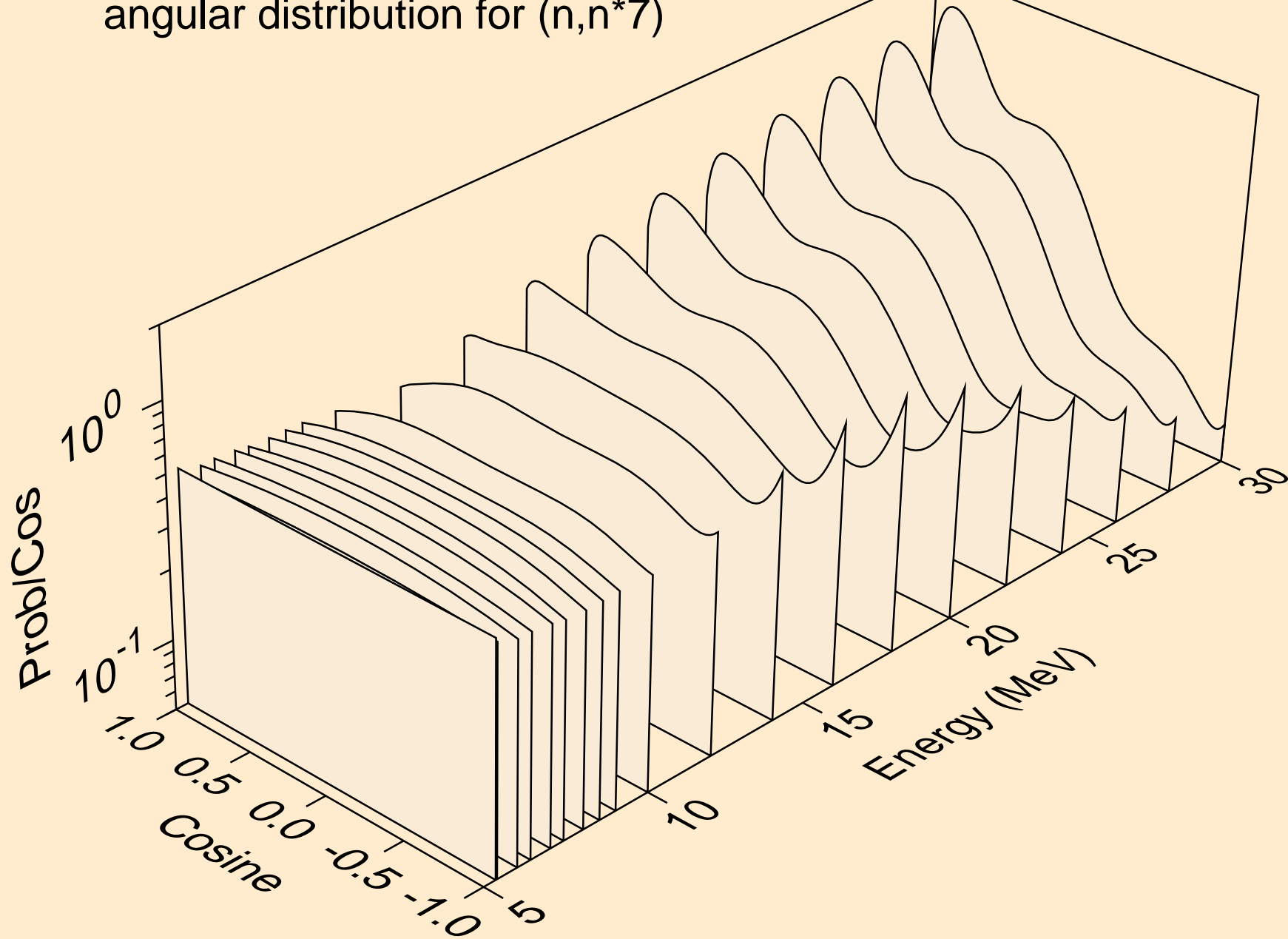

MG028 NEUTRON ACER TENDL-2021 LIBRARY; T=293.6K  
angular distribution for (n,n\*8)

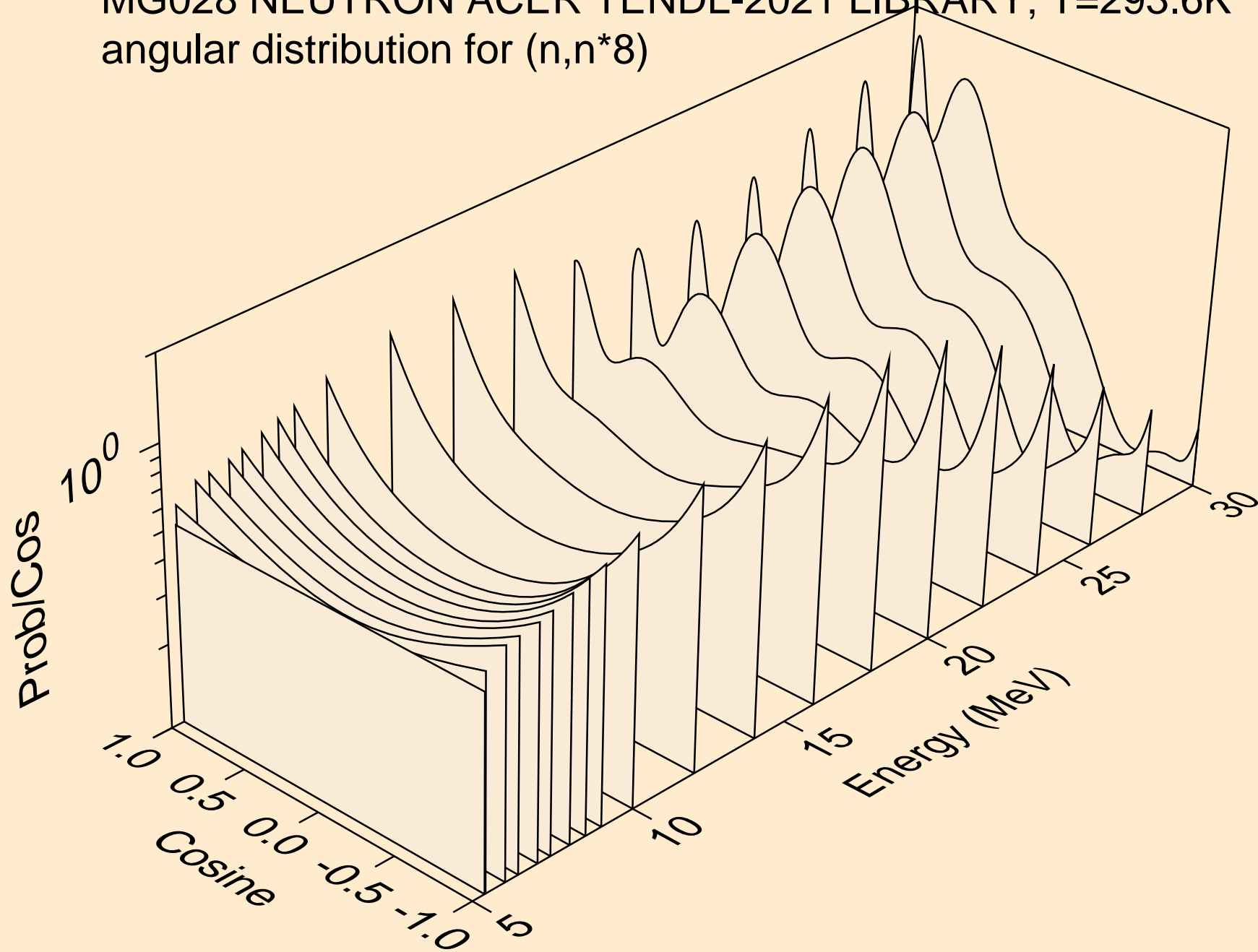

MG028 NEUTRON ACER TENDL-2021 LIBRARY; T=293.6K  
angular distribution for (n,n\*9)

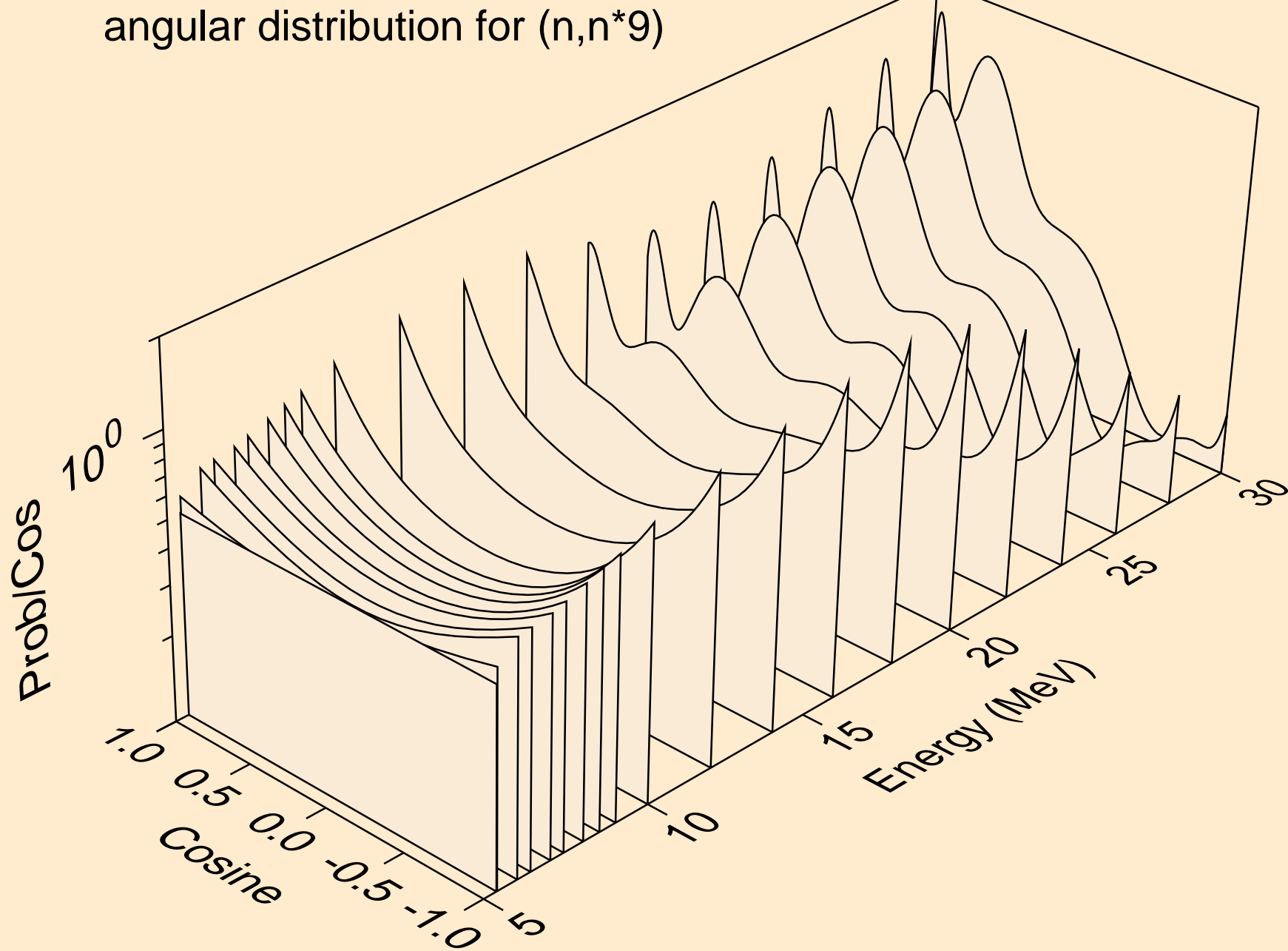

MG028 NEUTRON ACER TENDL-2021 LIBRARY; T=293.6K  
angular distribution for (n,n\*10)

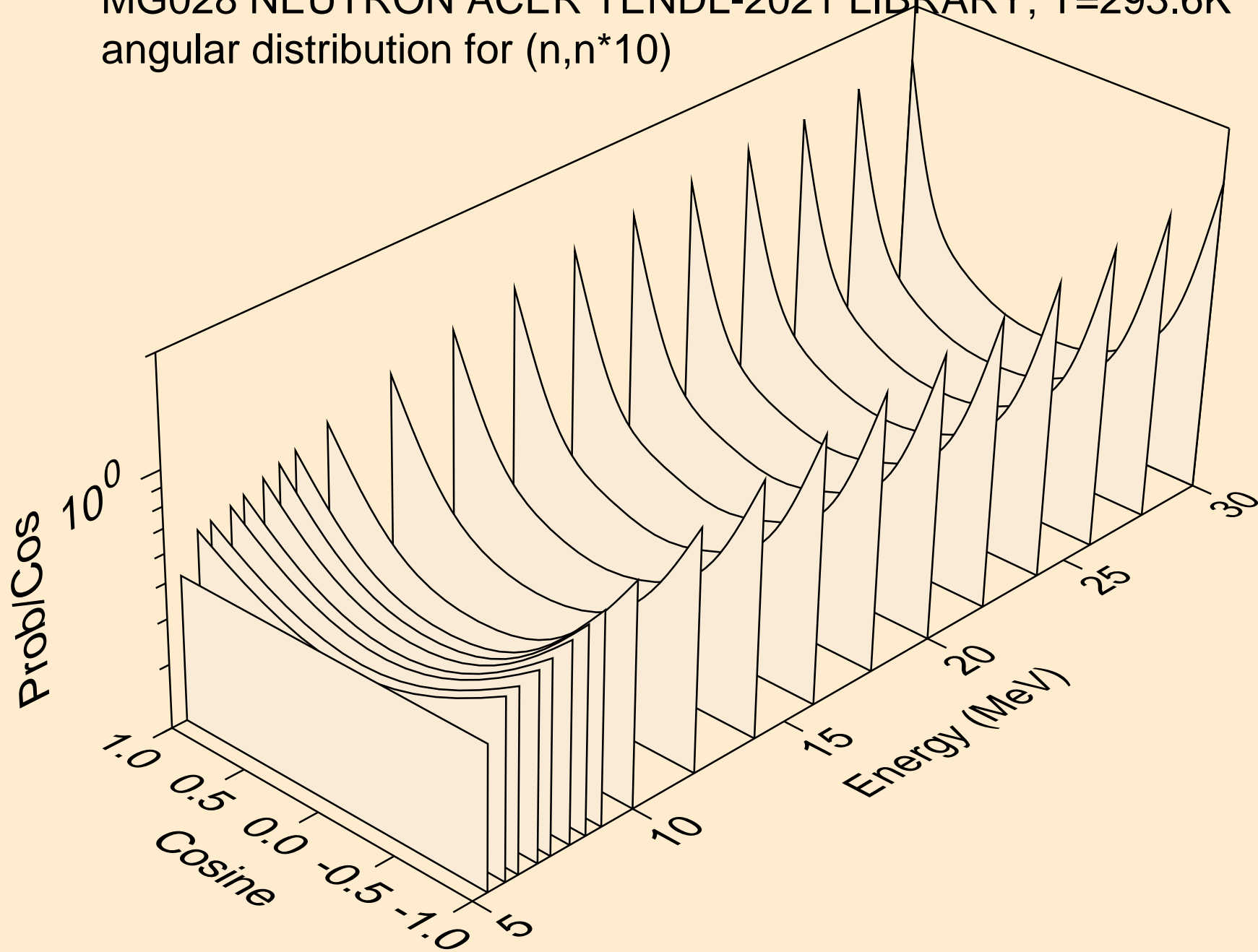

MG028 NEUTRON ACER TENDL-2021 LIBRARY; T=293.6K  
angular distribution for (n,n\*11)

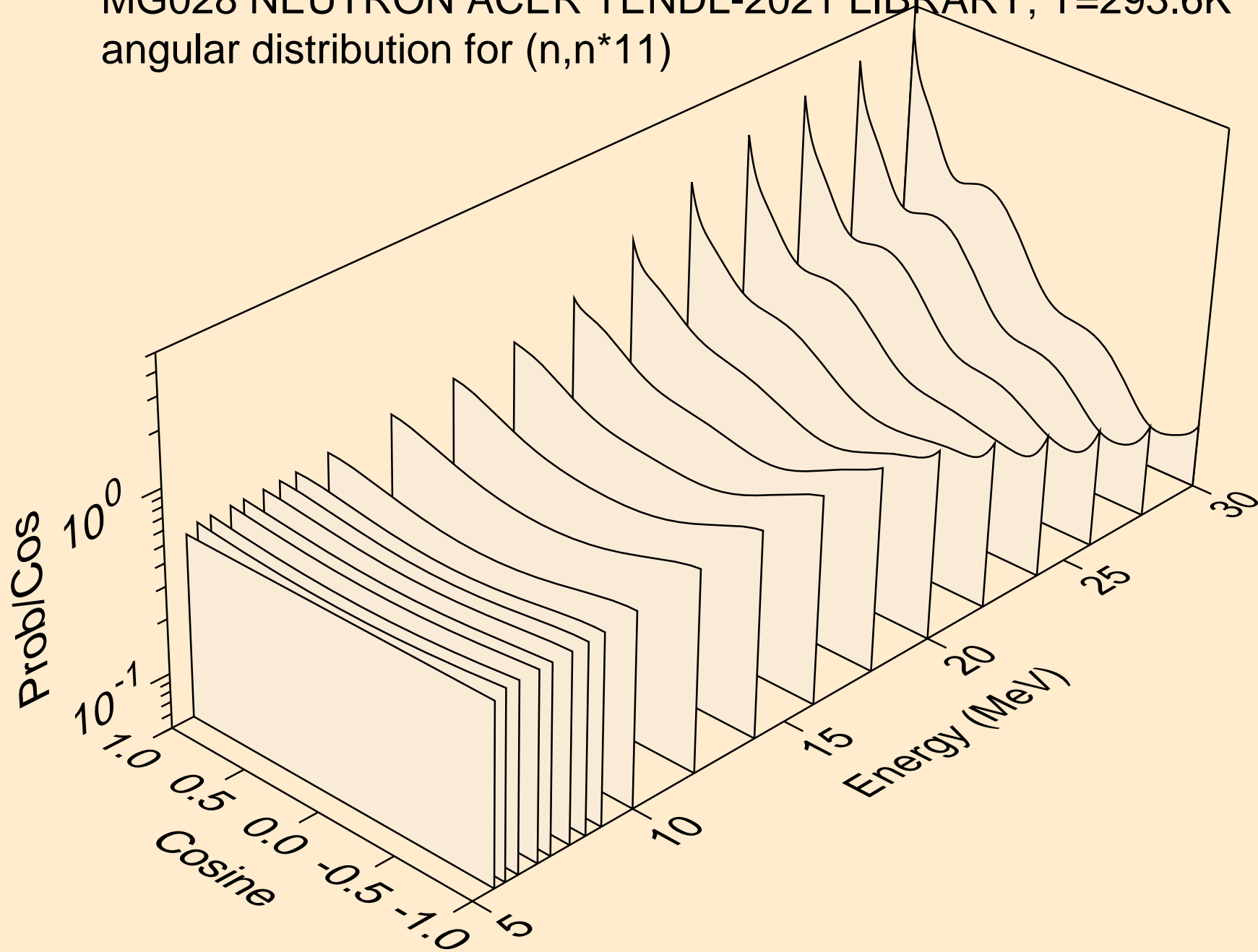

MG028 NEUTRON ACER TENDL-2021 LIBRARY; T=293.6K  
angular distribution for (n,n\*12)

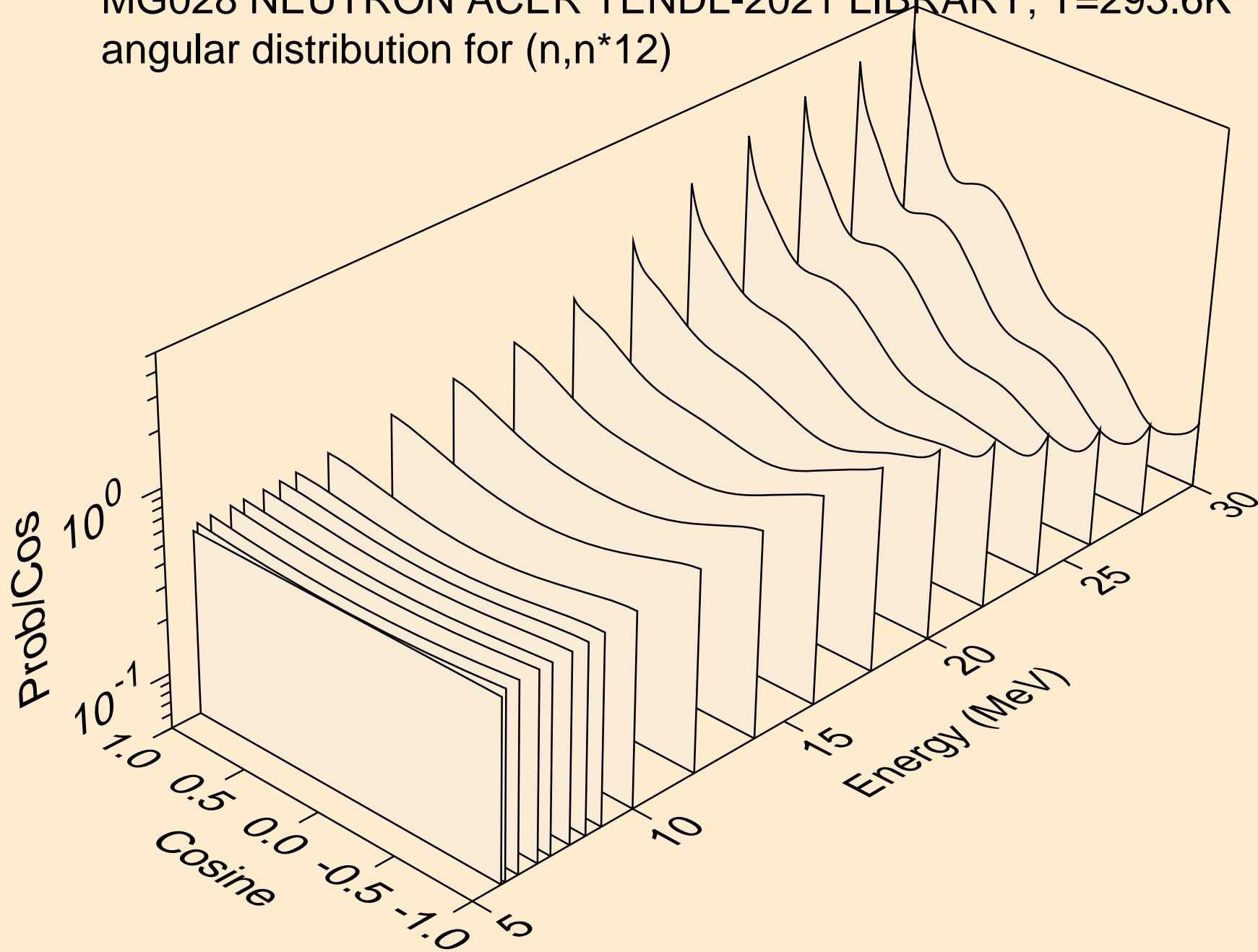

MG028 NEUTRON ACER TENDL-2021 LIBRARY; T=293.6K  
angular distribution for (n,n\*13)

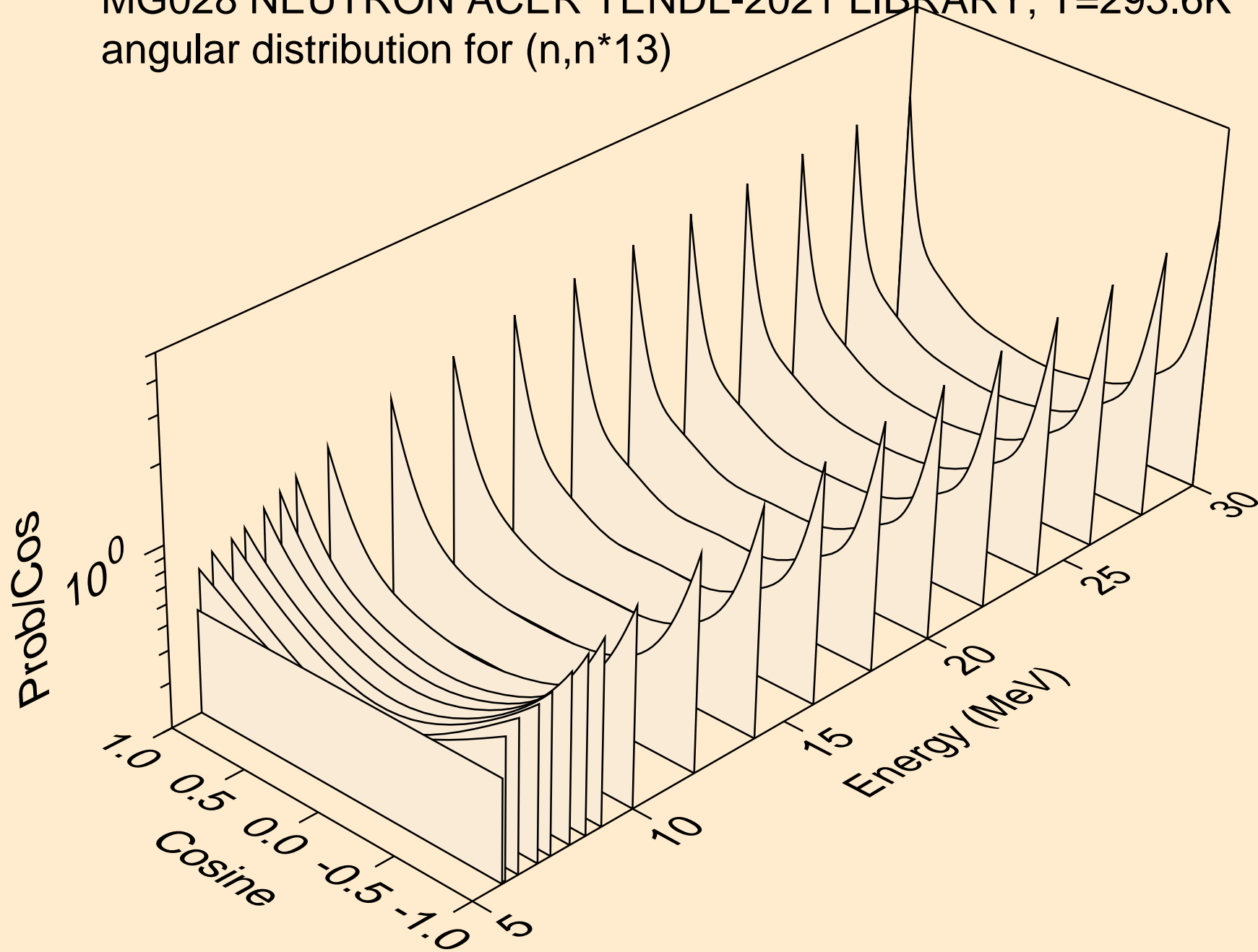



MG028 NEUTRON ACER TENDL-2021 LIBRARY; T=293.6K  
angular distribution for (n,n\*14)

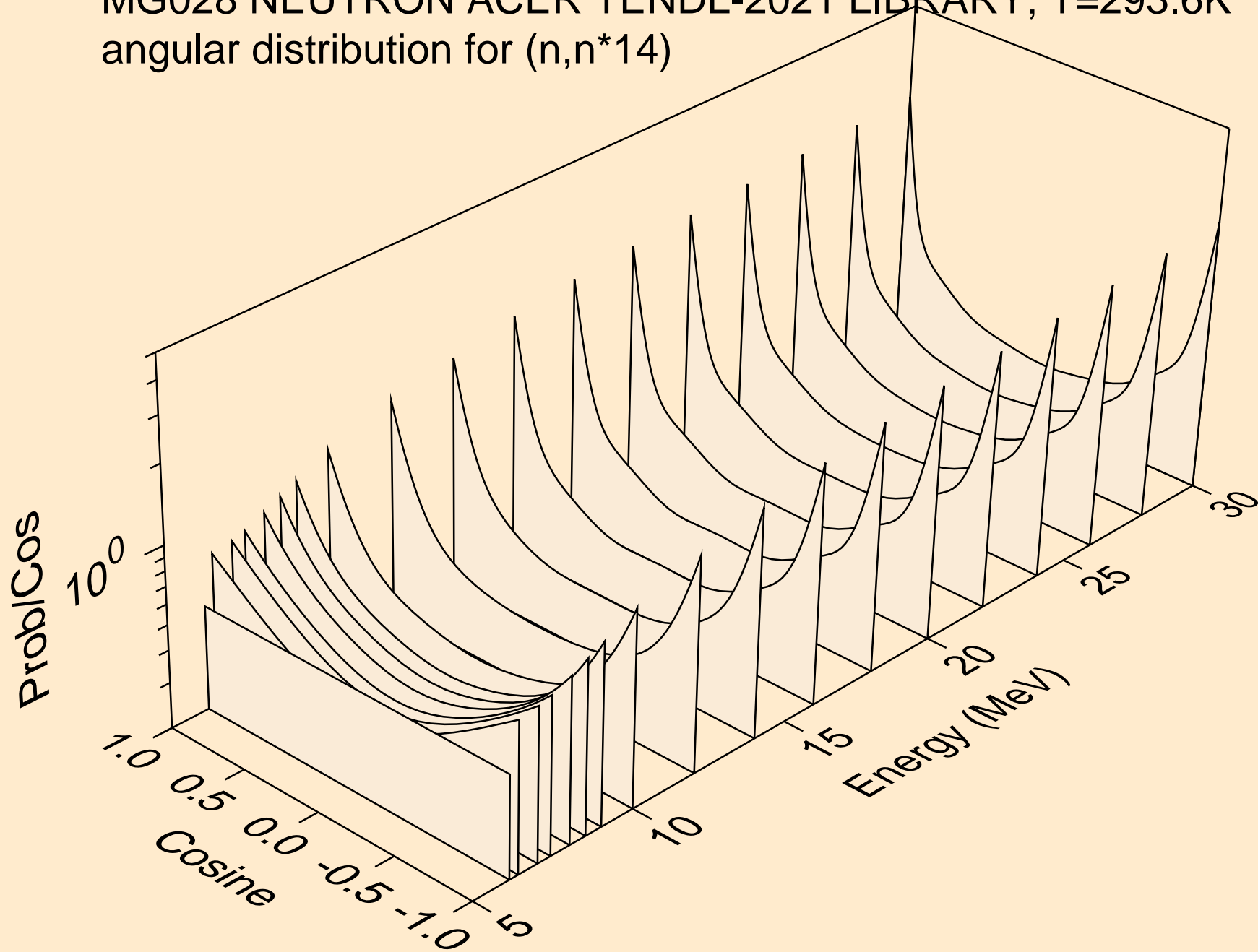

MG028 NEUTRON ACER TENDL-2021 LIBRARY; T=293.6K  
angular distribution for (n,n\*15)

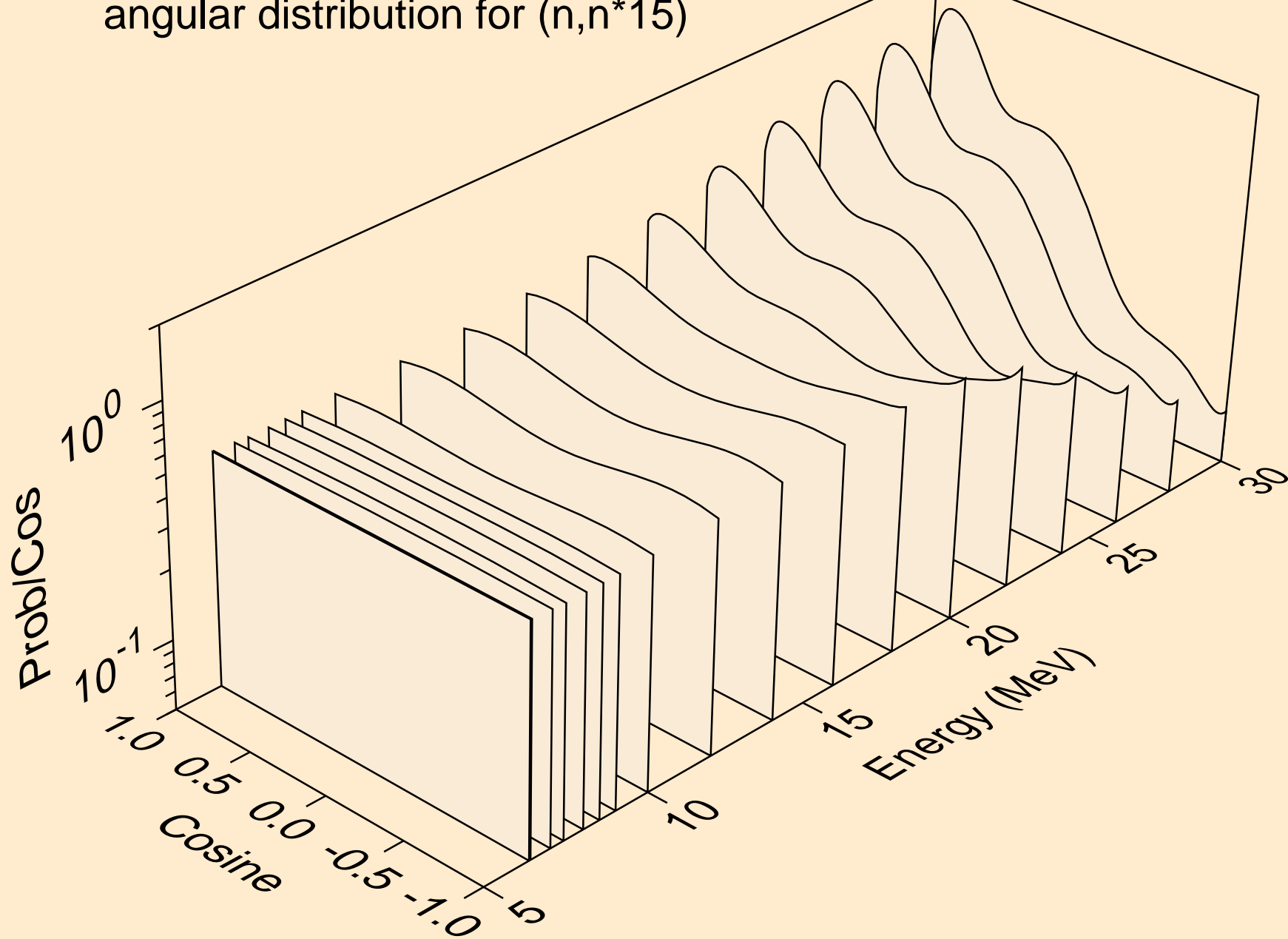

MG028 NEUTRON ACER TENDL-2021 LIBRARY; T=293.6K  
angular distribution for (n,n\*16)

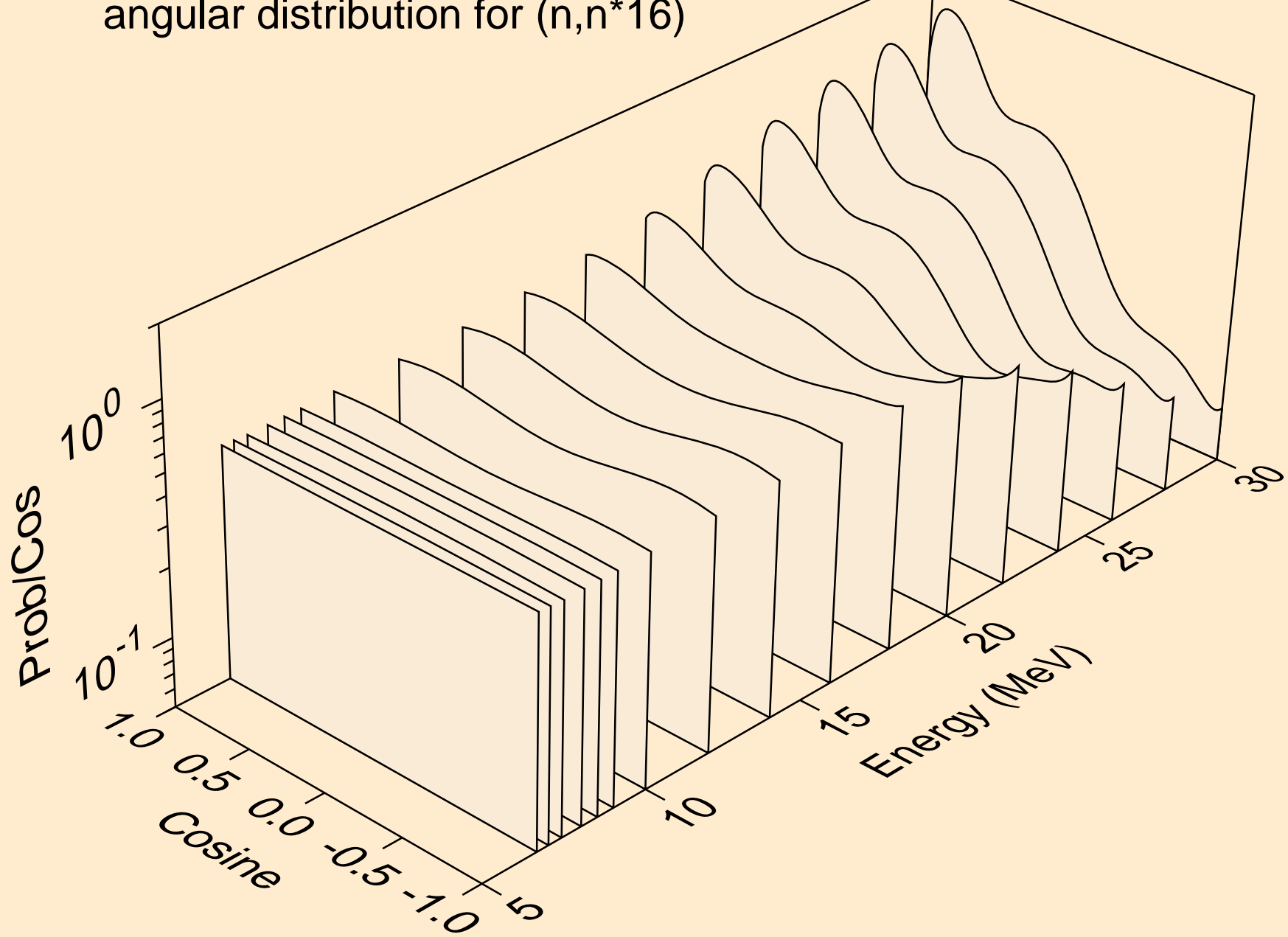

MG028 NEUTRON ACER TENDL-2021 LIBRARY; T=293.6K  
angular distribution for (n,n\*17)

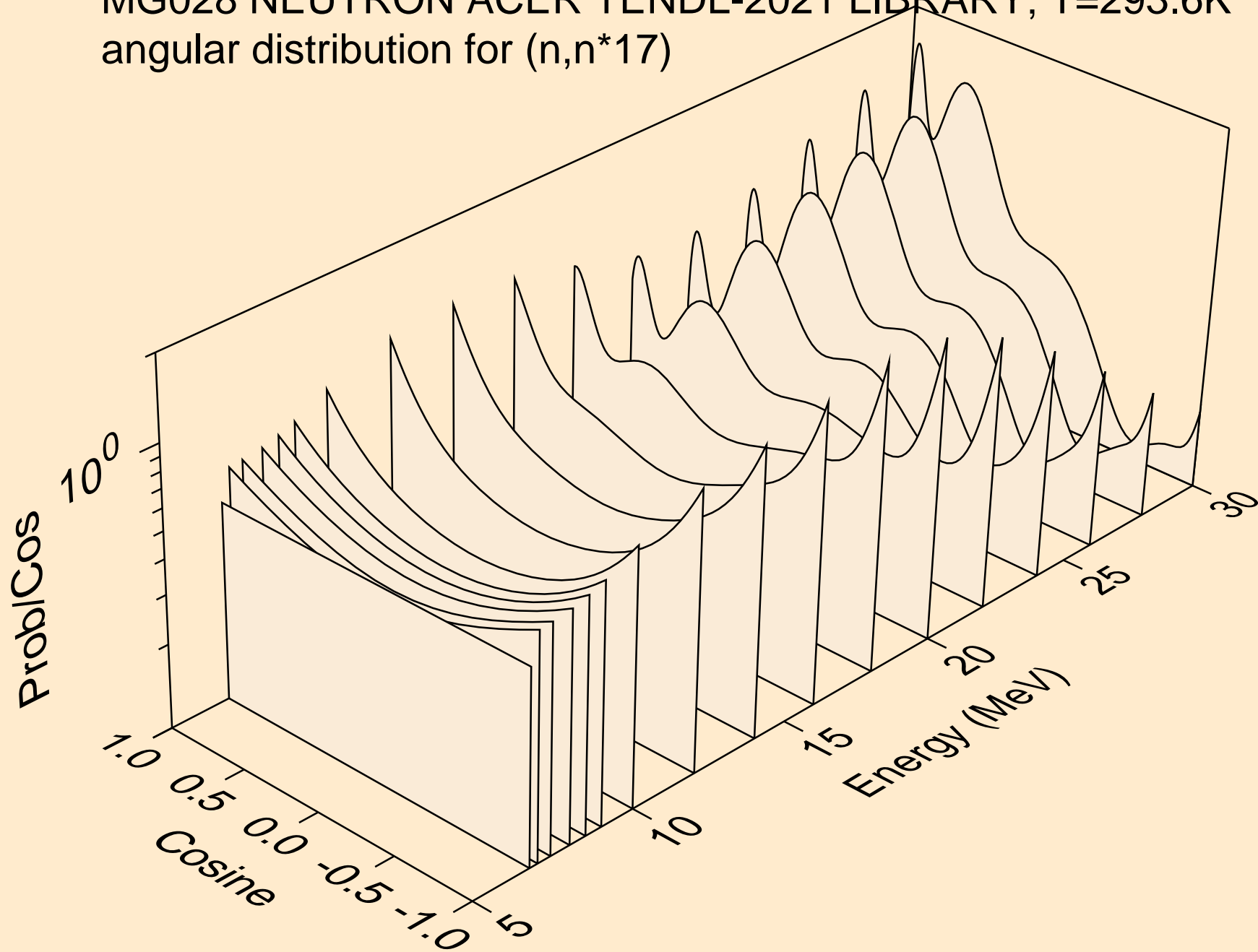

MG028 NEUTRON ACER TENDL-2021 LIBRARY; T=293.6K  
angular distribution for (n,n\*18)

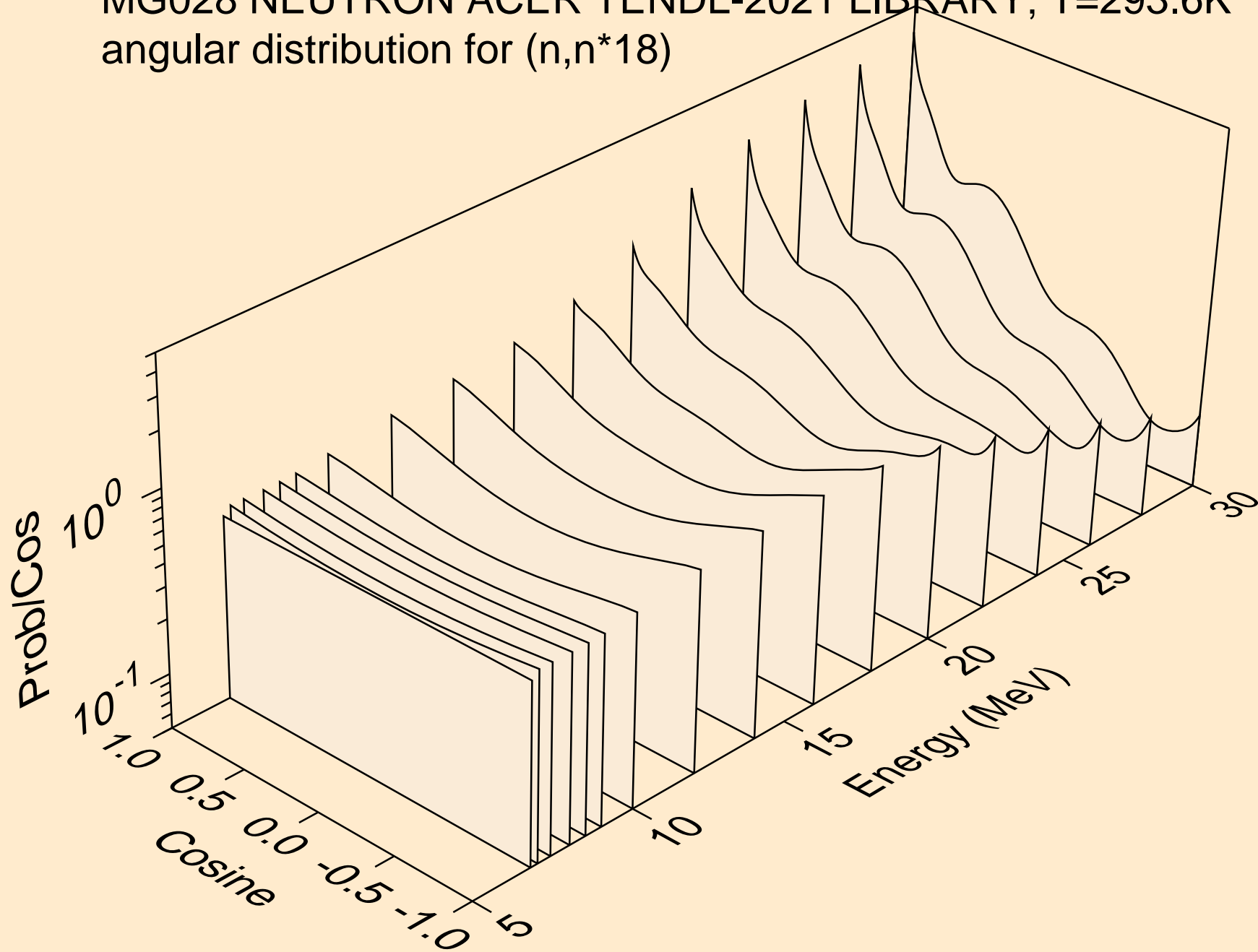

MG028 NEUTRON ACER TENDL-2021 LIBRARY; T=293.6K  
angular distribution for (n,n\*19)

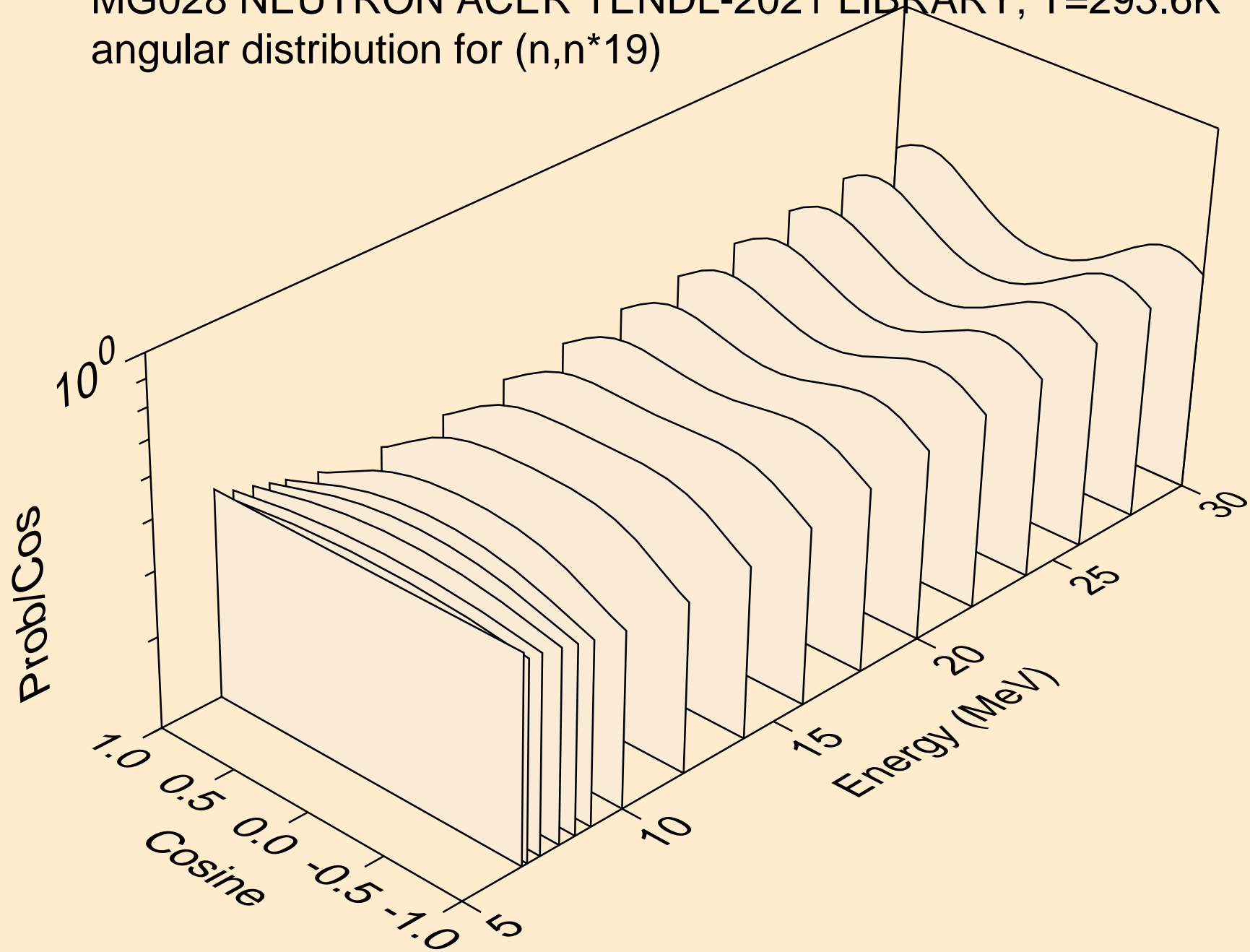

MG028 NEUTRON ACER TENDL-2021 LIBRARY; T=293.6K  
angular distribution for (n,n\*20)

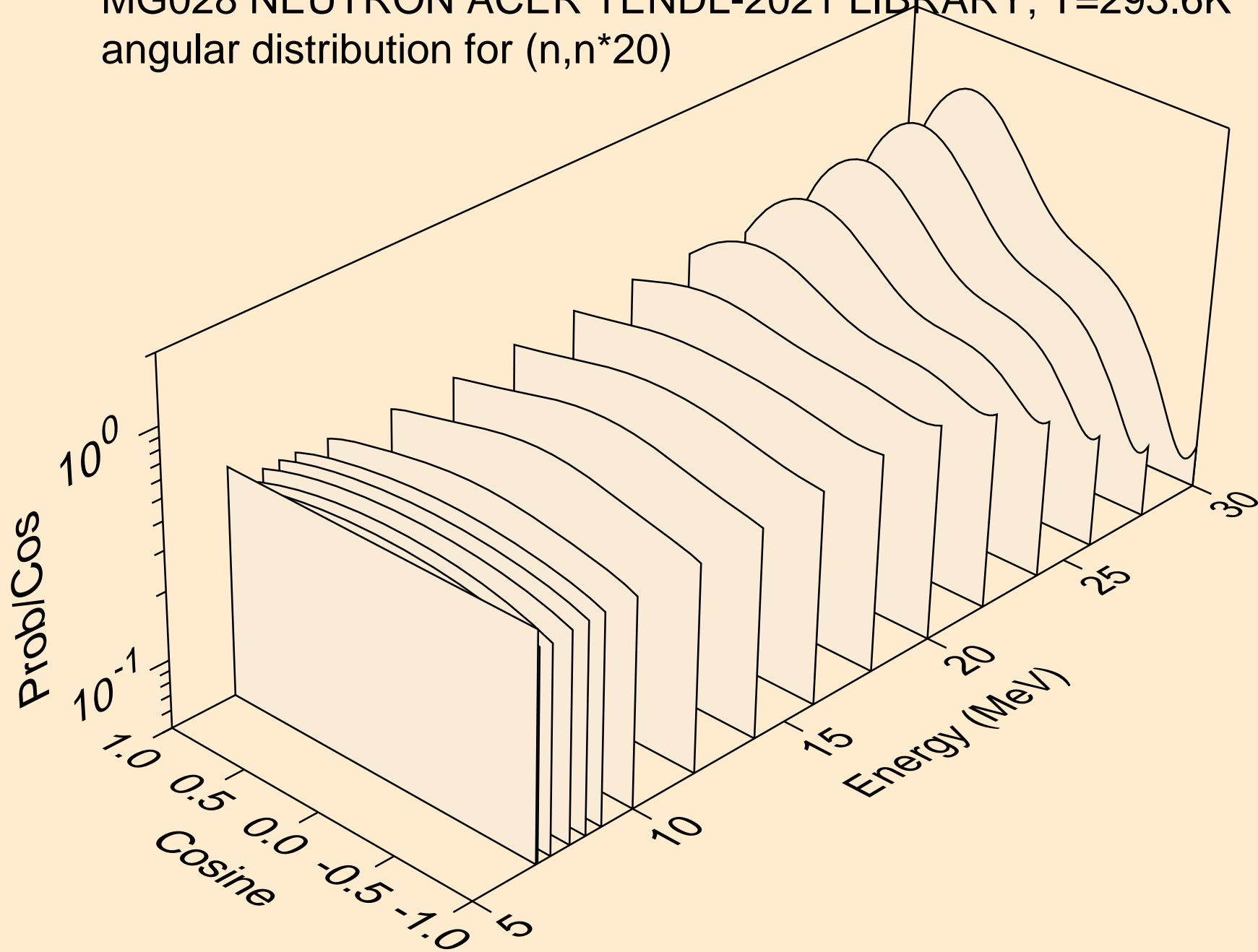

MG028 NEUTRON ACER TENDL-2021 LIBRARY; T=293.6K  
angular distribution for (n,n\*21)

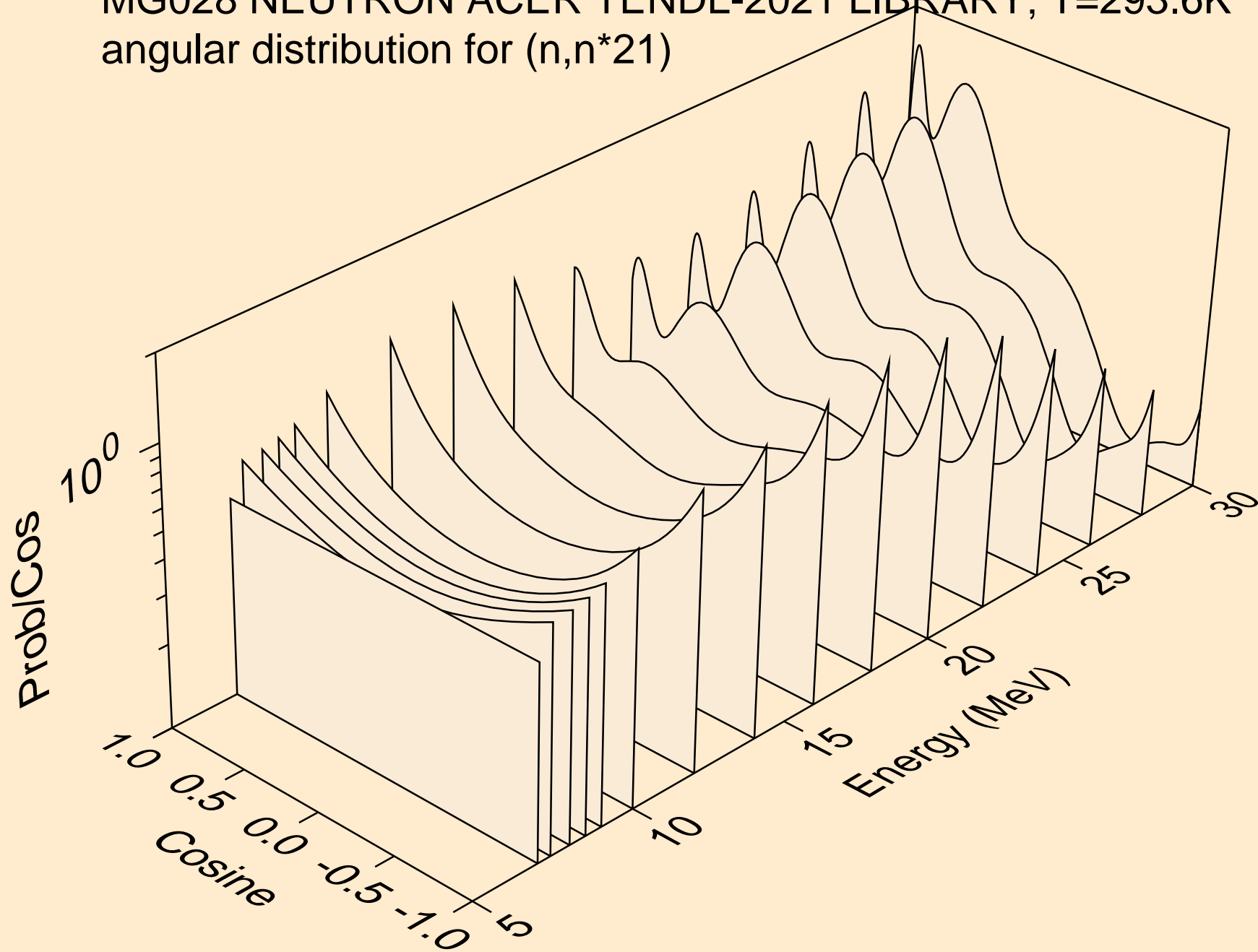



MG028 NEUTRON ACER TENDL-2021 LIBRARY; T=293.6K  
angular distribution for (n,n\*22)

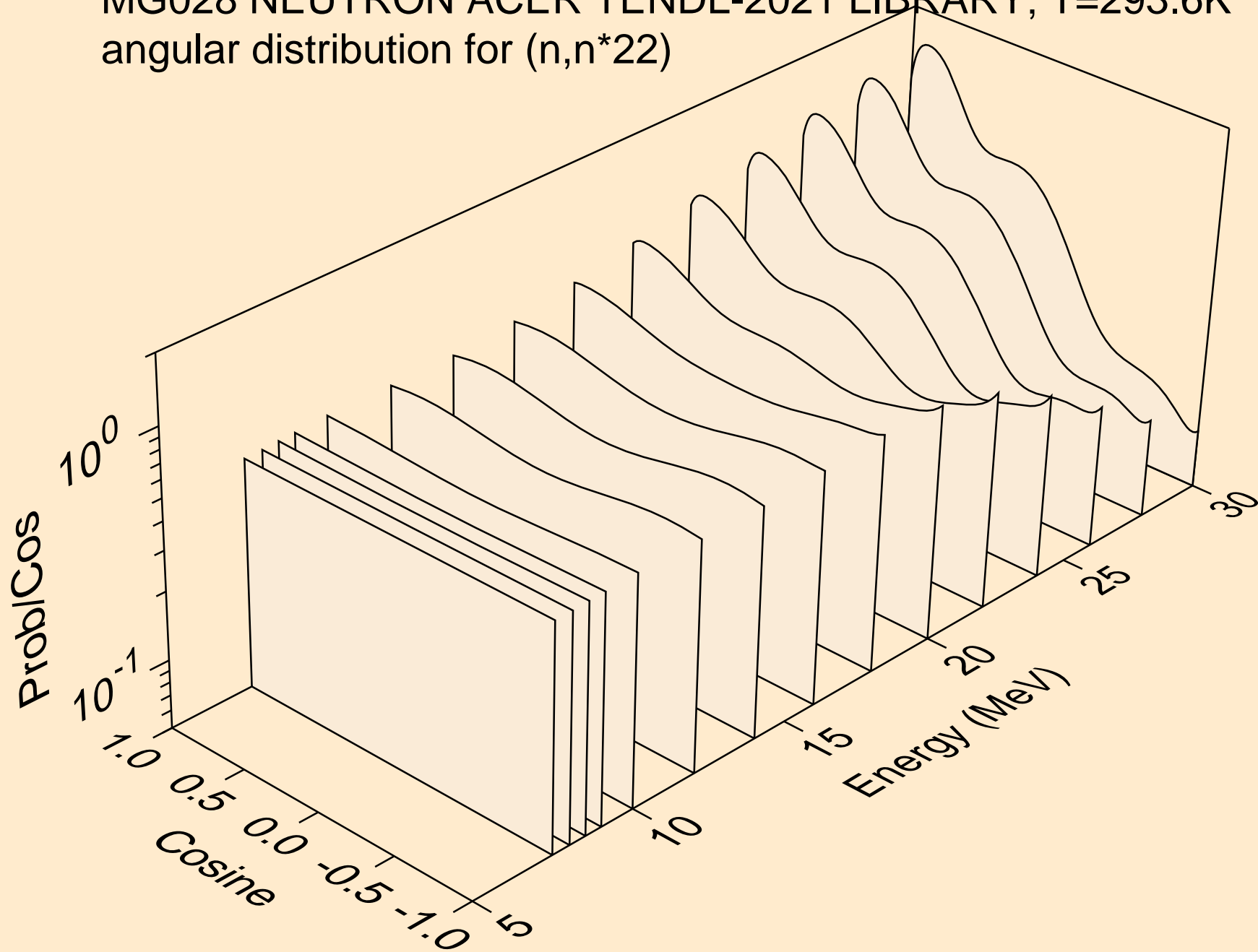

MG028 NEUTRON ACER TENDL-2021 LIBRARY; T=293.6K  
angular distribution for (n,n\*23)

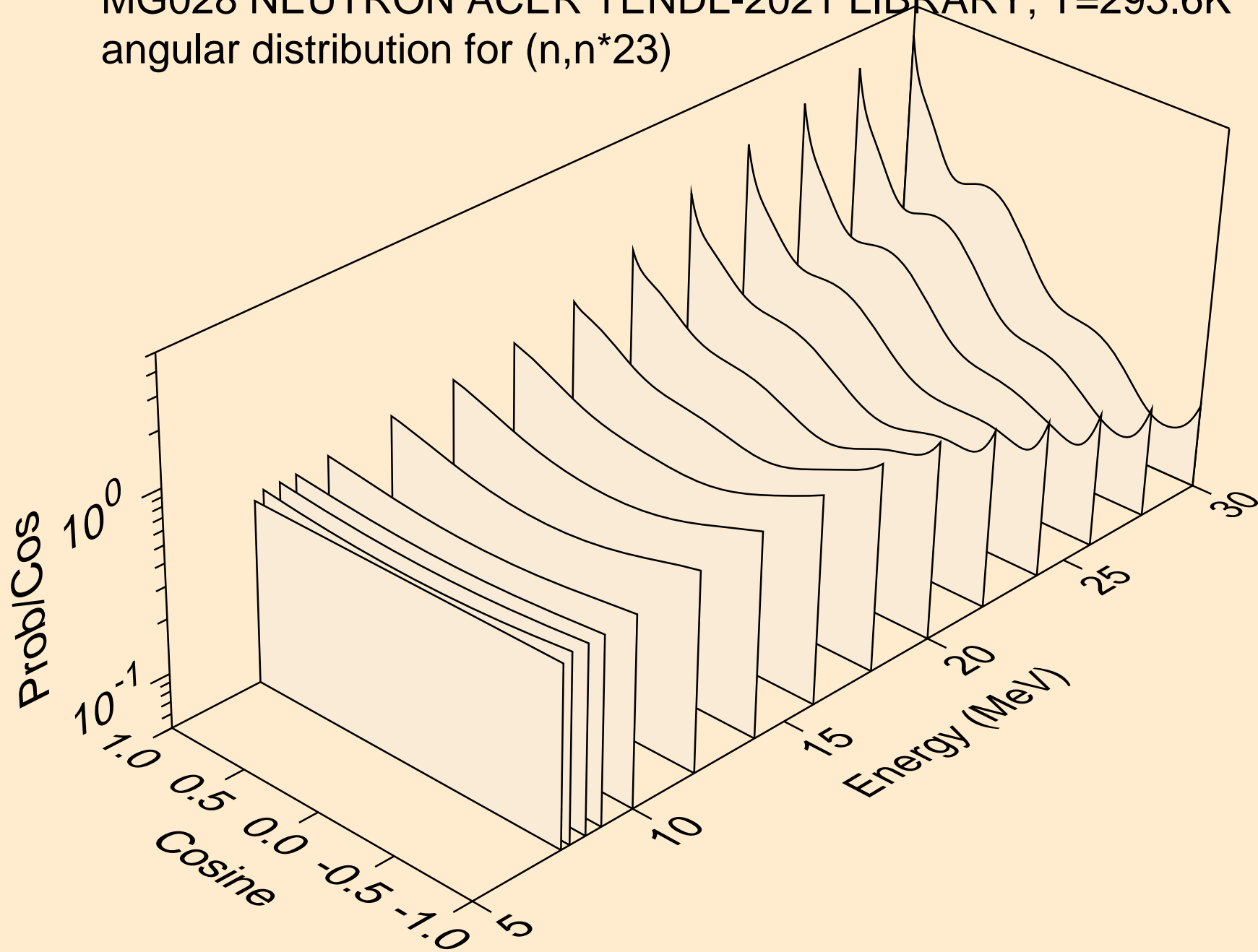

MG028 NEUTRON ACER TENDL-2021 LIBRARY; T=293.6K  
angular distribution for (n,n\*24)

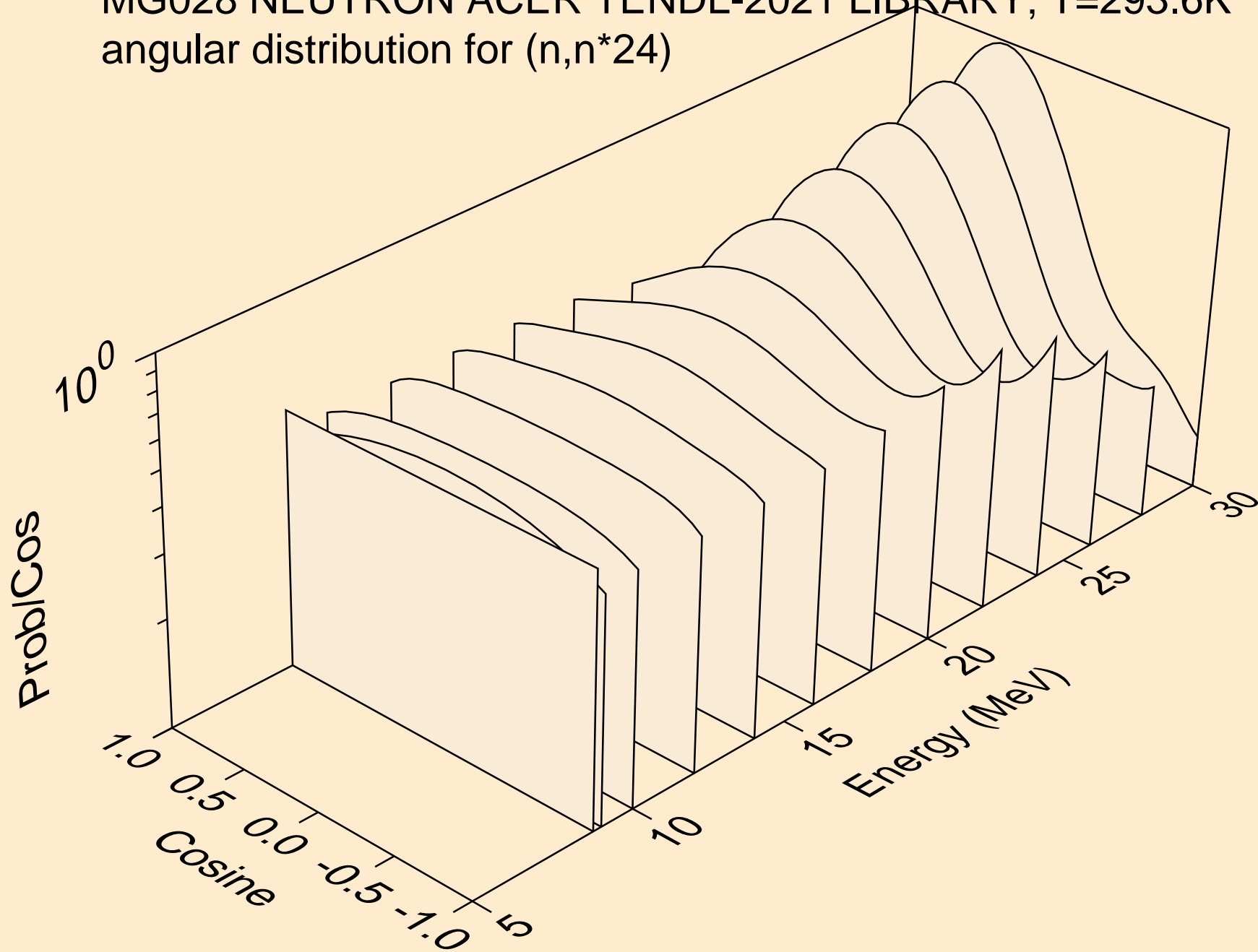

MG028 NEUTRON ACER TENDL-2021 LIBRARY; T=293.6K  
angular distribution for (n,n\*25)

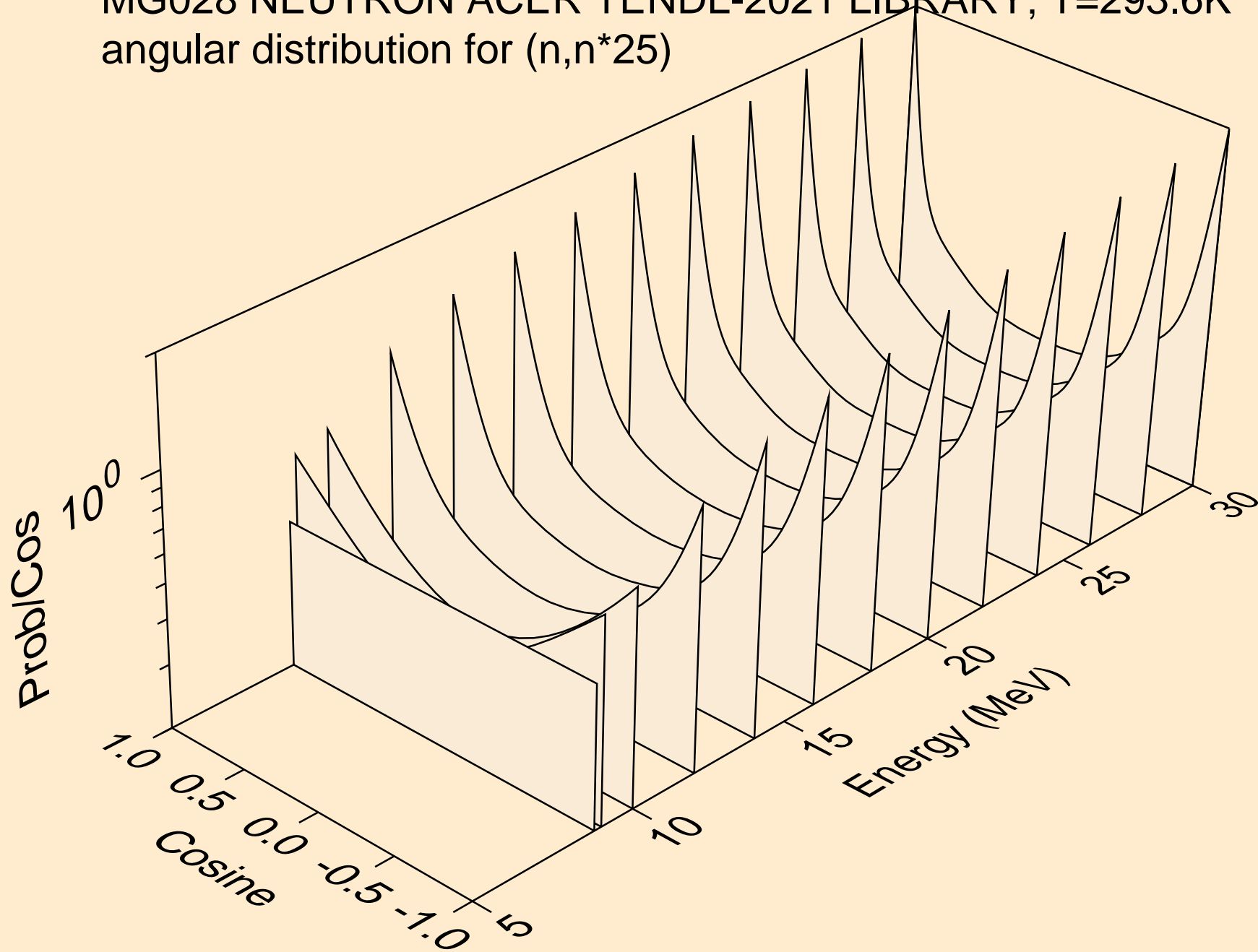

MG028 NEUTRON ACER TENDL-2021 LIBRARY; T=293.6K  
angular distribution for (n,n\*26)

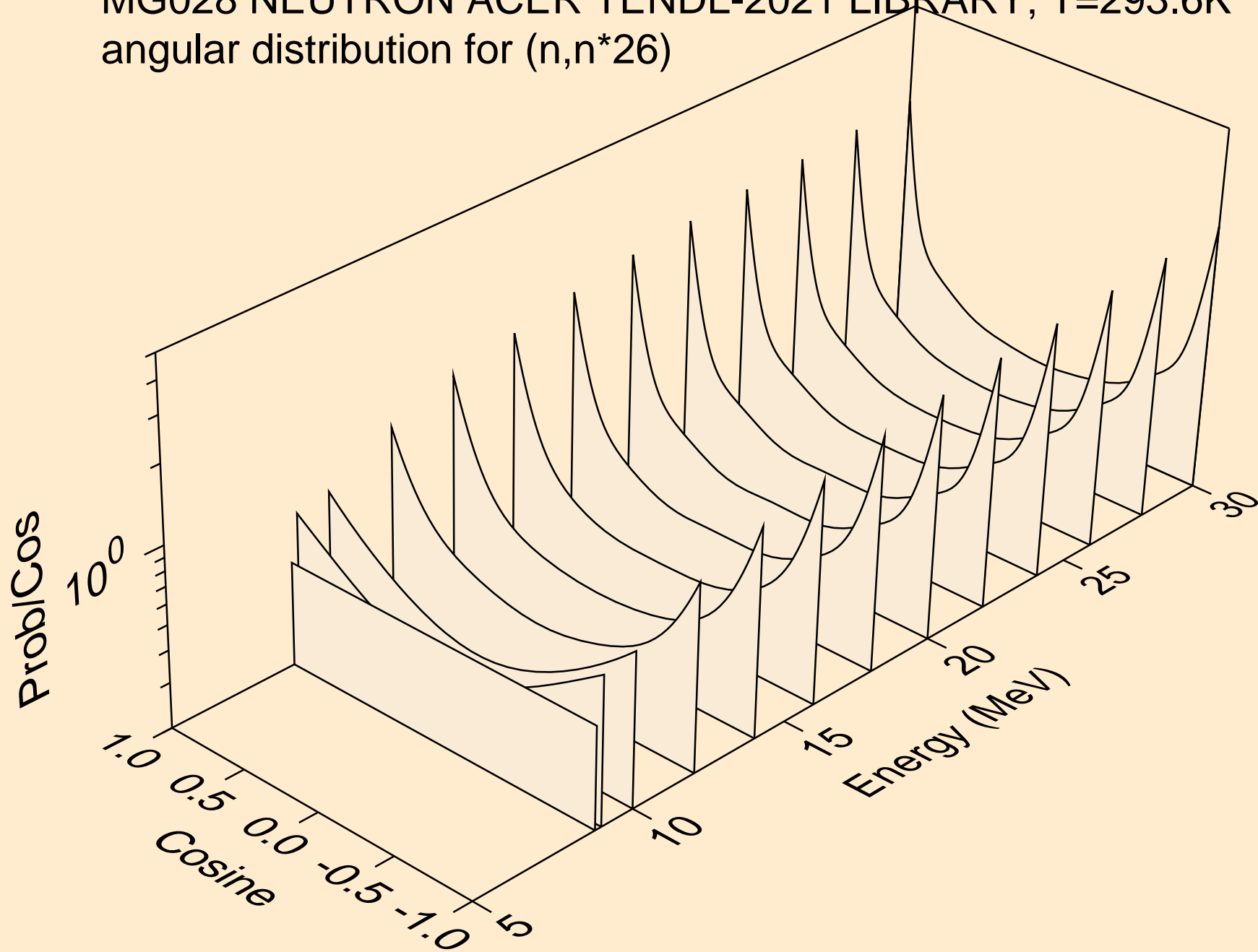

MG028 NEUTRON ACER TENDL-2021 LIBRARY; T=293.6K  
angular distribution for (n,n\*27)

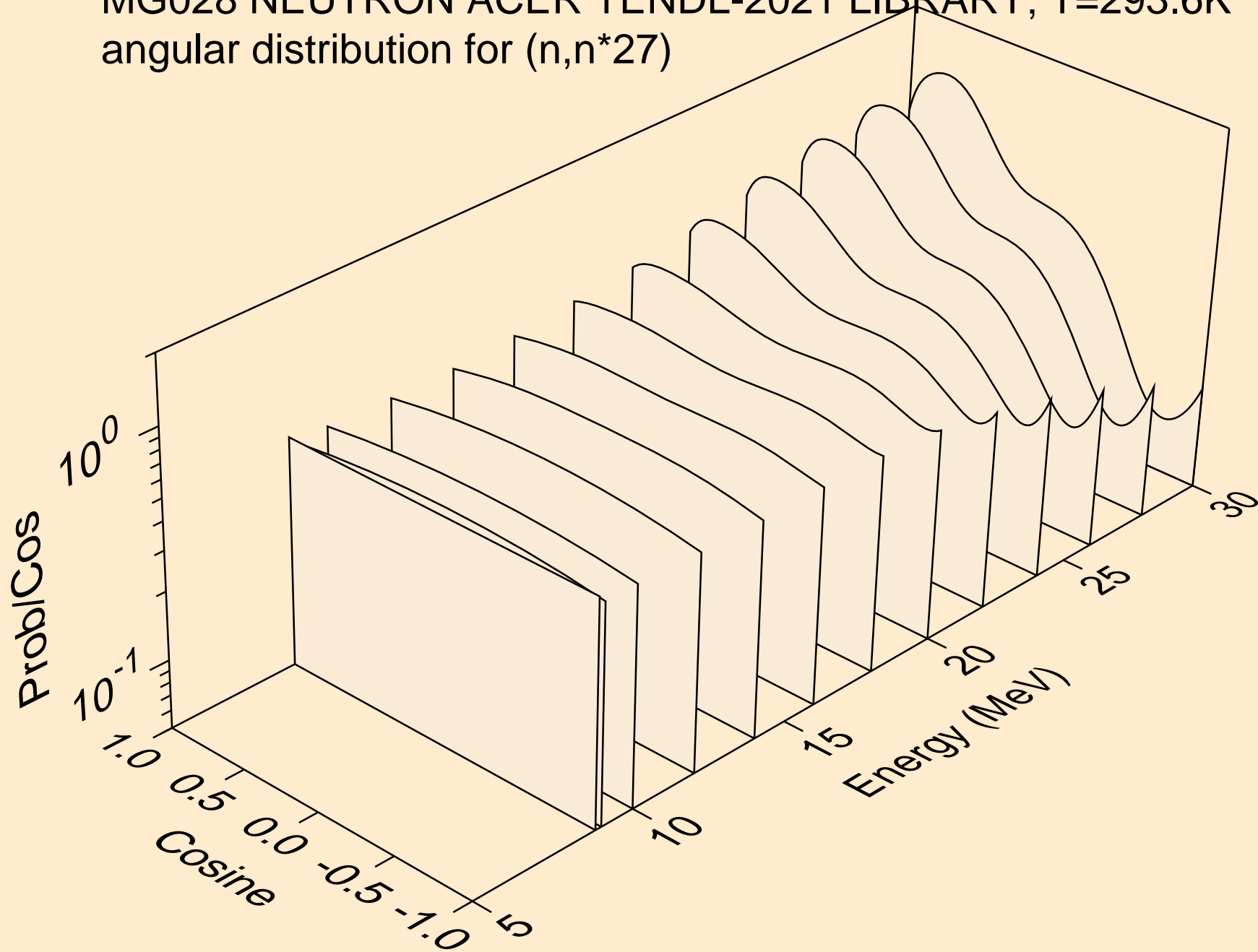

MG028 NEUTRON ACER TENDL-2021 LIBRARY; T=293.6K  
angular distribution for (n,n\*28)

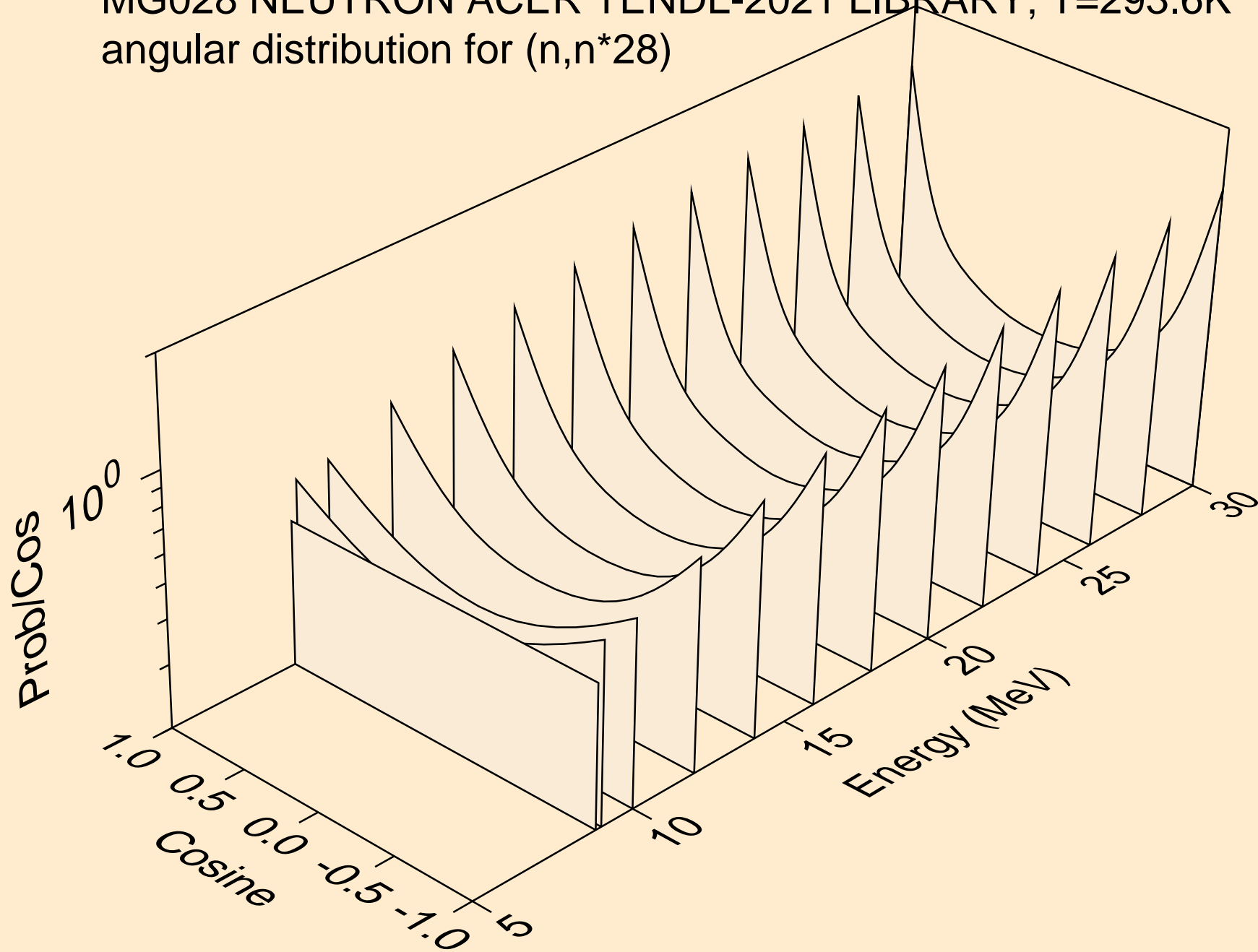

MG028 NEUTRON ACER TENDL-2021 LIBRARY; T=293.6K  
angular distribution for (n,n\*29)

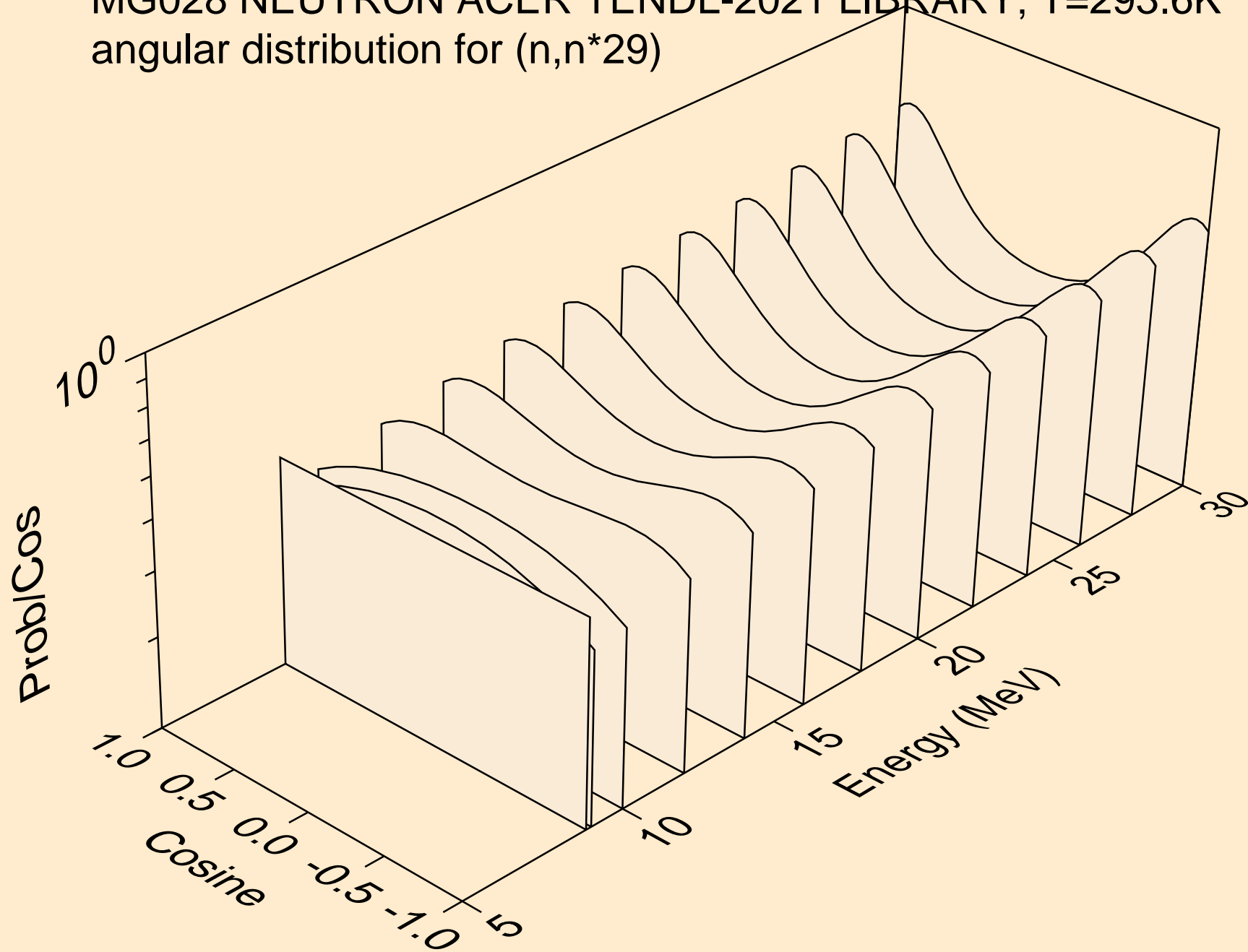



MG028 NEUTRON ACER TENDL-2021 LIBRARY; T=293.6K  
Neutron emission for (n,x)

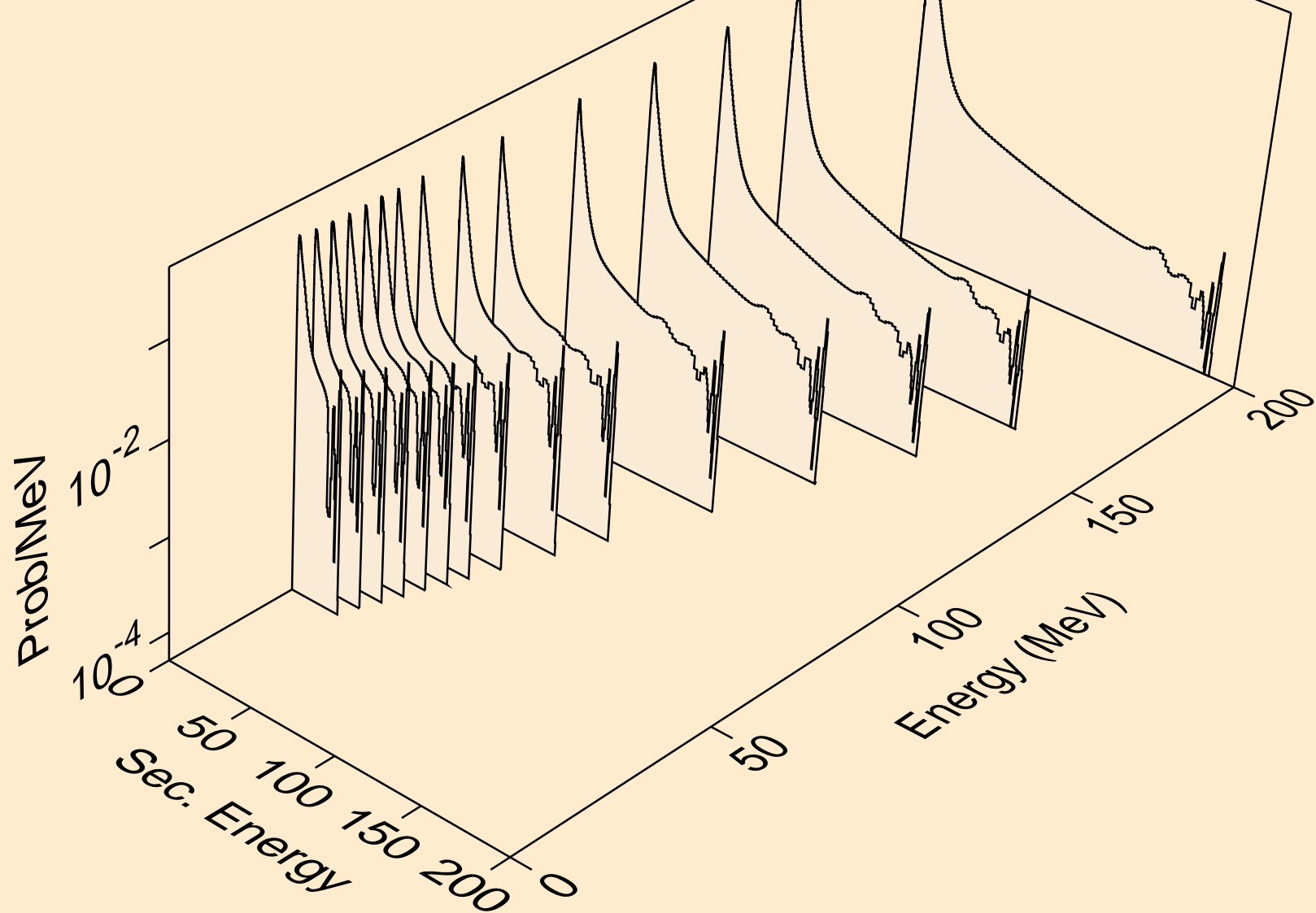

MG028 NEUTRON ACER TENDL-2021 LIBRARY; T=293.6K  
Neutron emission for (n,2nd)

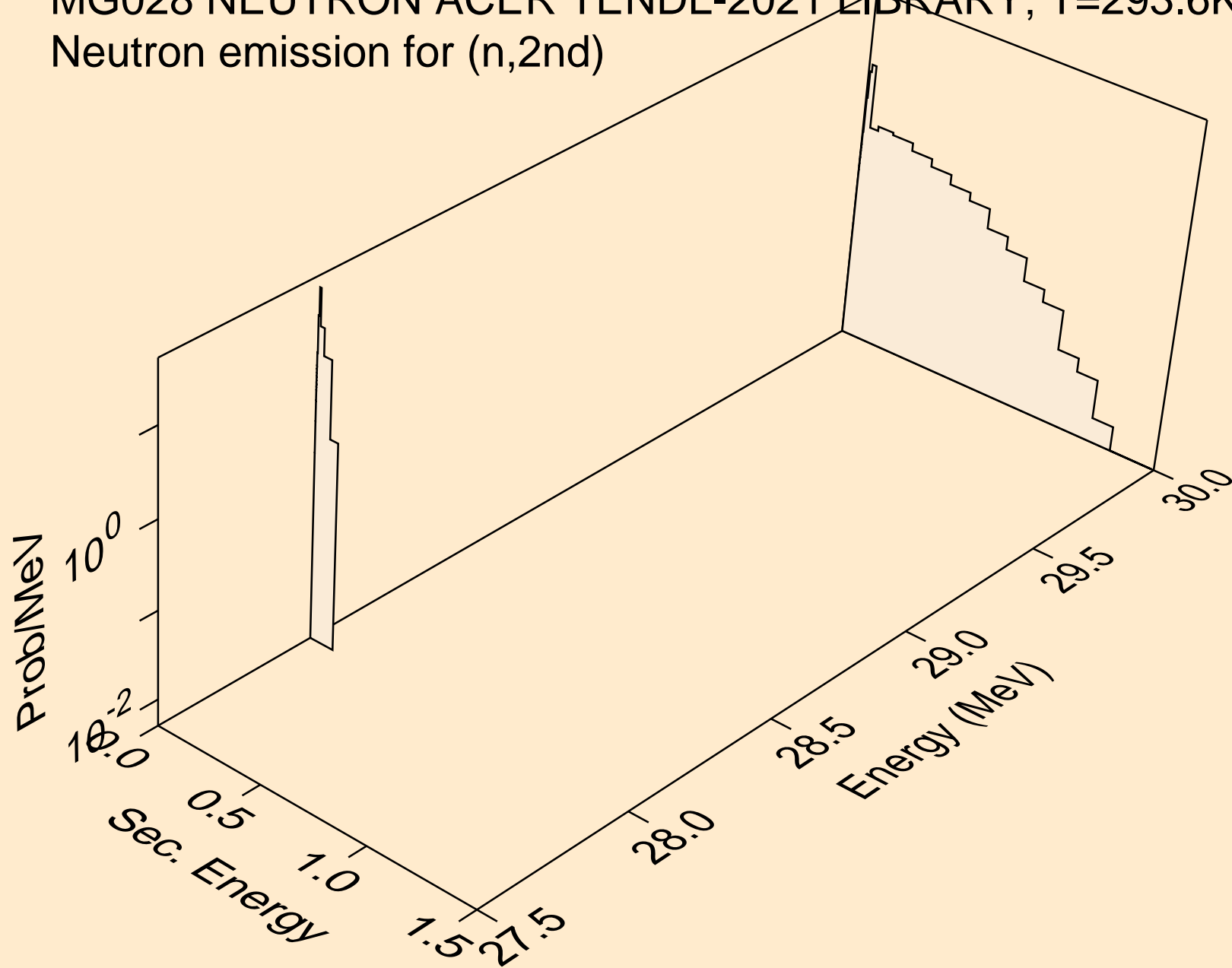

MG028 NEUTRON ACER TENDL-2021 LIBRARY; T=293.6K  
Neutron emission for (n,2n)

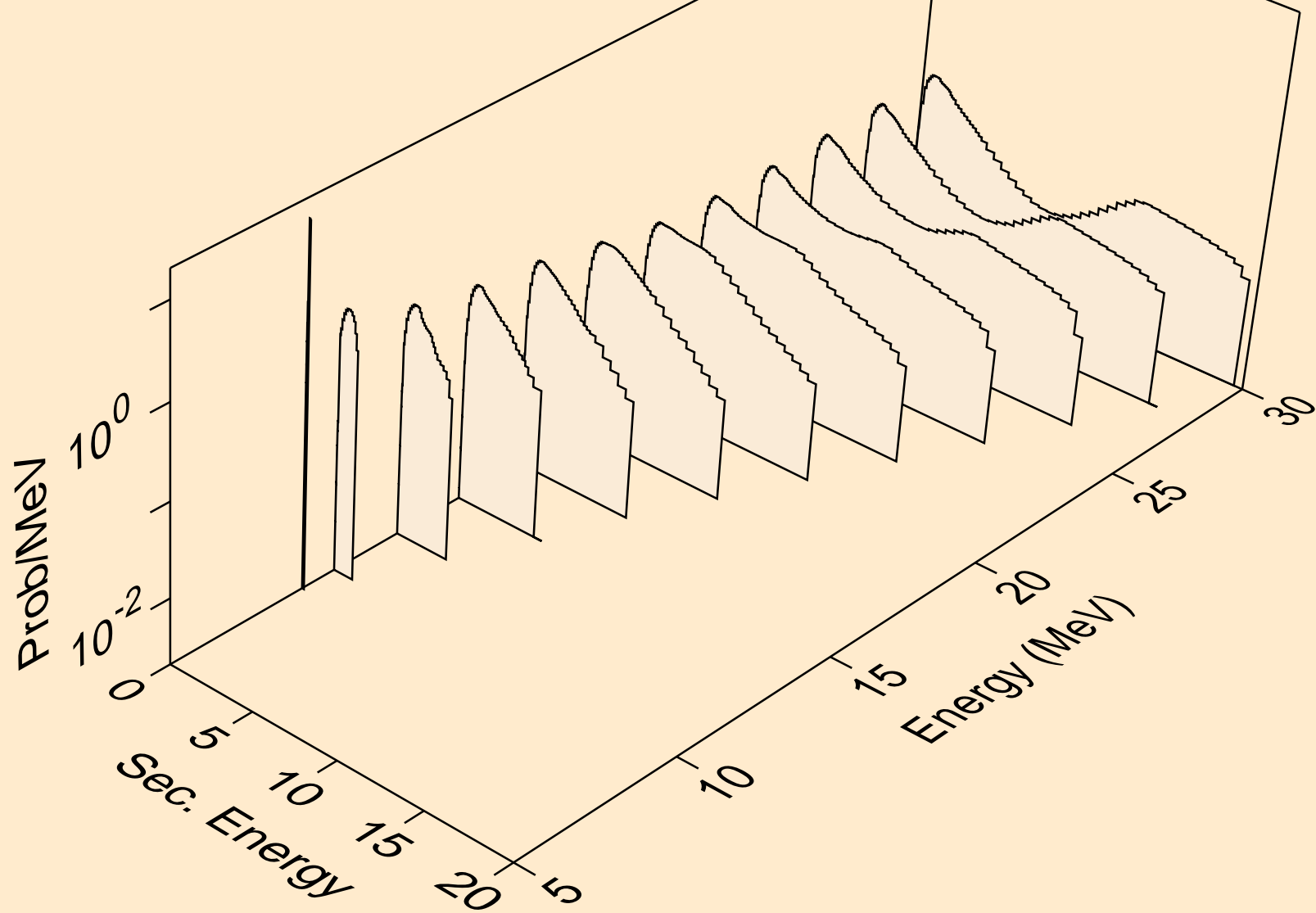

MG028 NEUTRON ACER TENDL-2021 LIBRARY; T=293.6K  
Neutron emission for (n,3n)

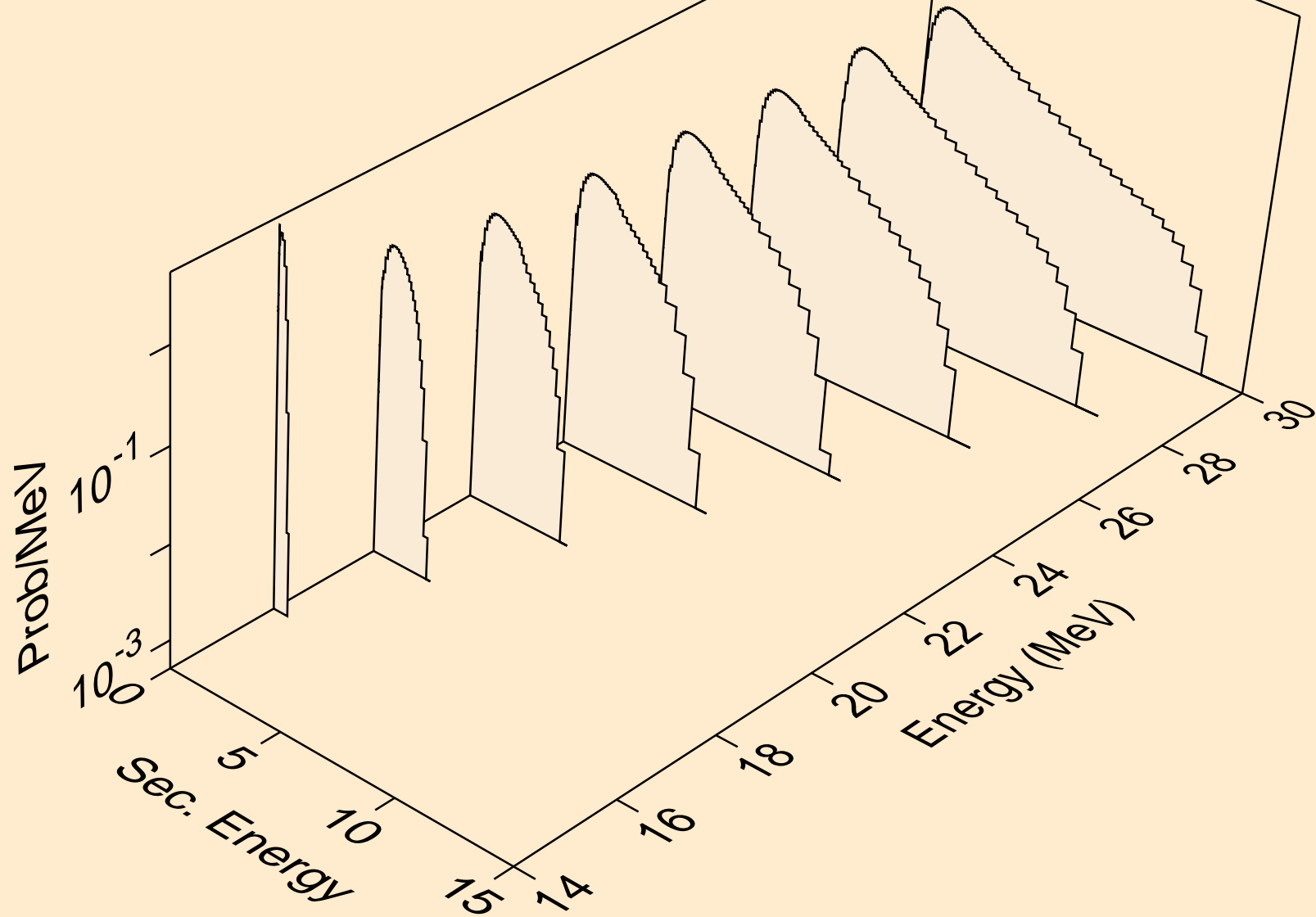

MG028 NEUTRON ACER TENDL-2021 LIBRARY; T=293.6K  
Neutron emission for (n,n\*)a

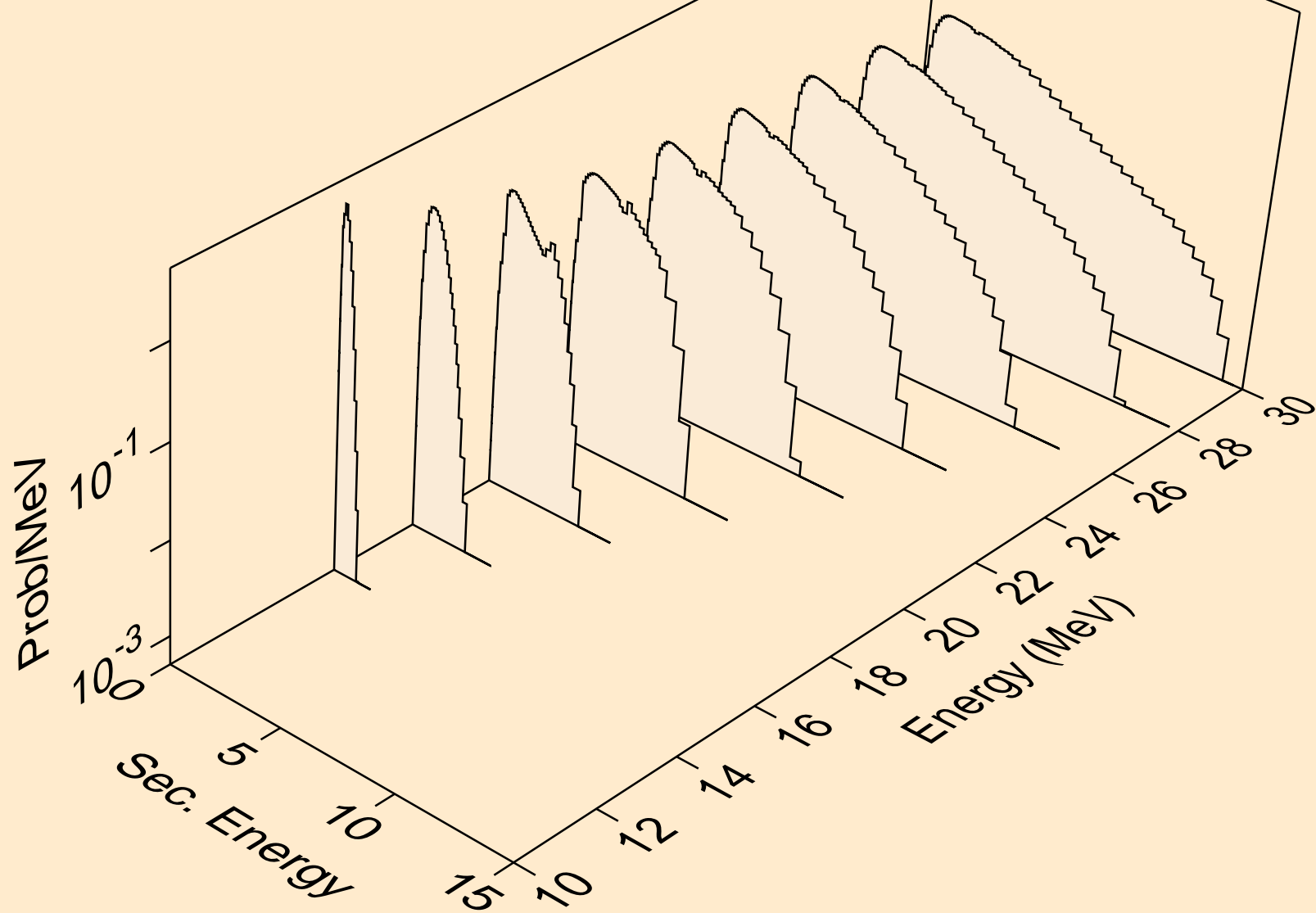

MG028 NEUTRON ACER TENDL-2021 LIBRARY; T=293.6K  
Neutron emission for (n,2n)a

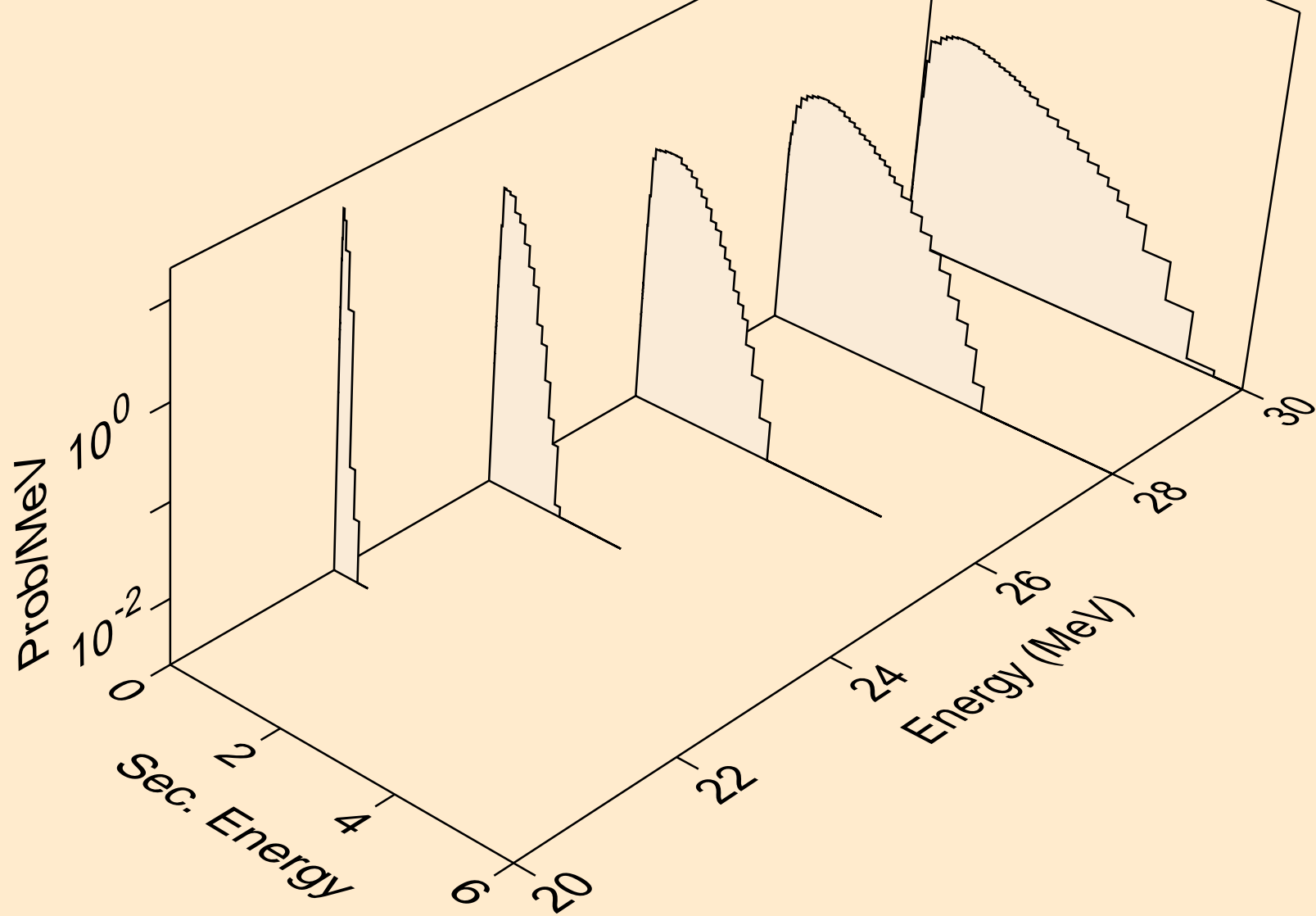

MG028 NEUTRON ACER TENDL-2021 LIBRARY; T=293.6K  
Neutron emission for (n,3n)a

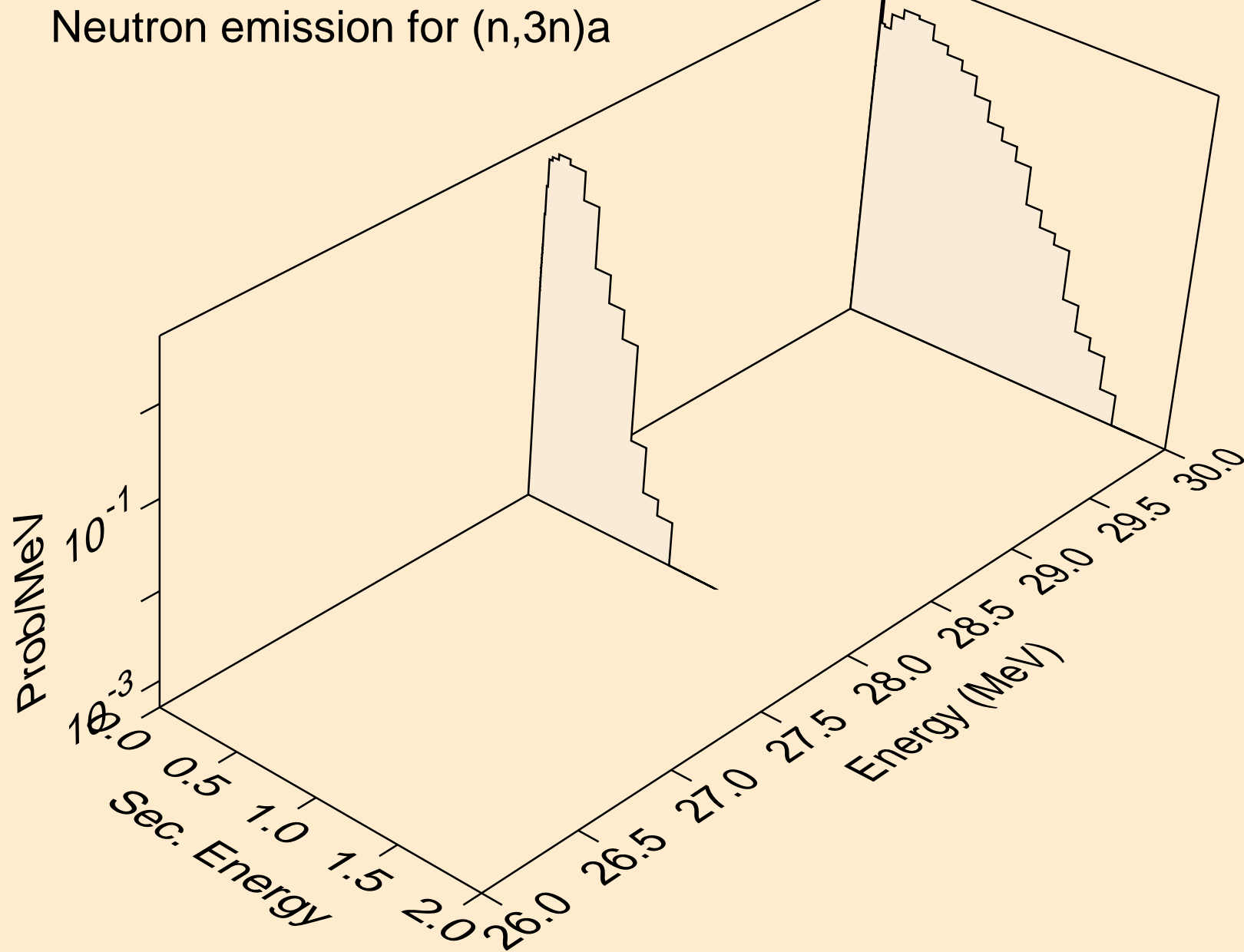

MG028 NEUTRON ACER TENDL-2021 LIBRARY; T=293.6K  
Neutron emission for (n,n\*)p

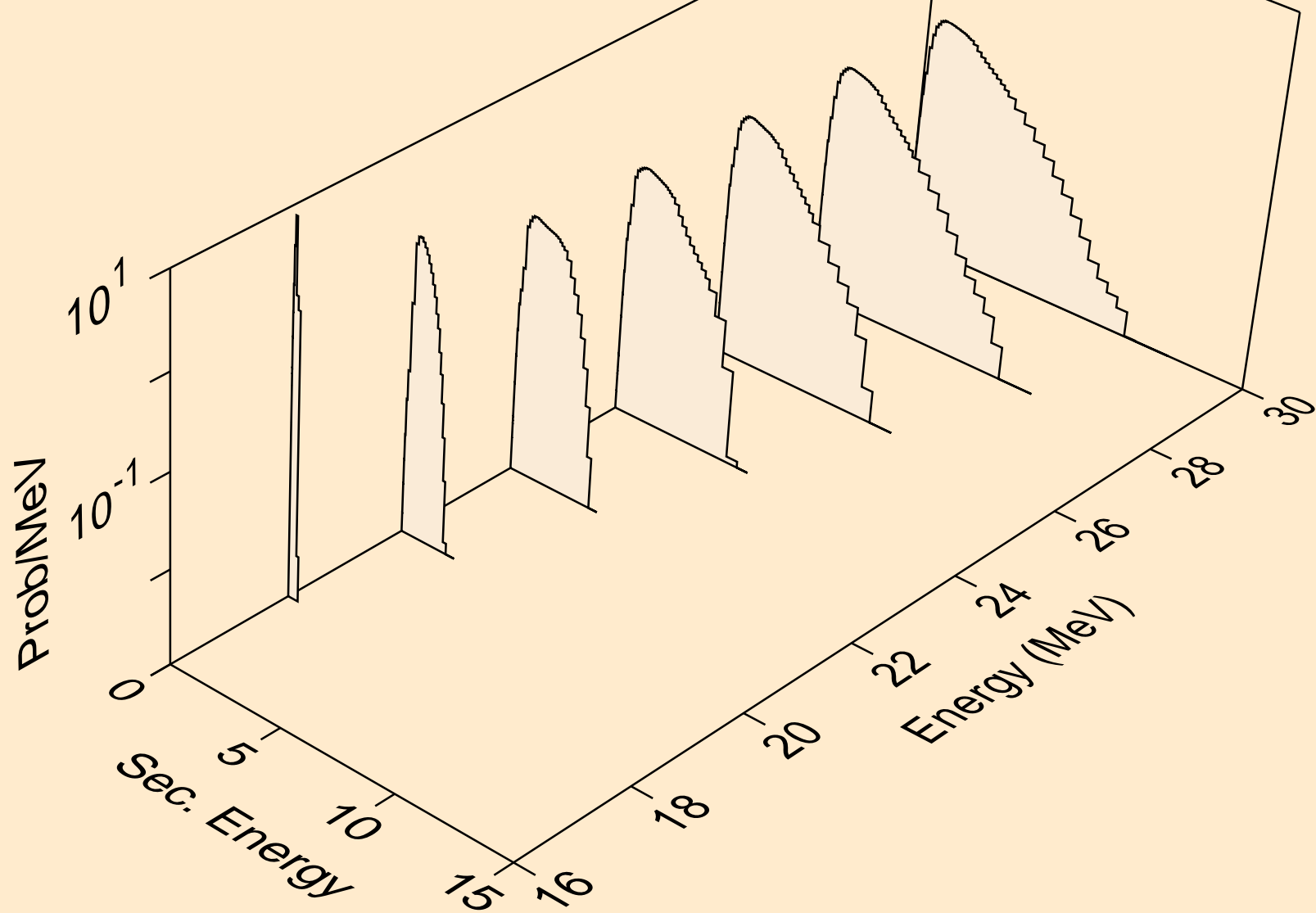



MG028 NEUTRON ACER TENDL-2021 LIBRARY; T=293.6K  
Neutron emission for (n,n\*)d

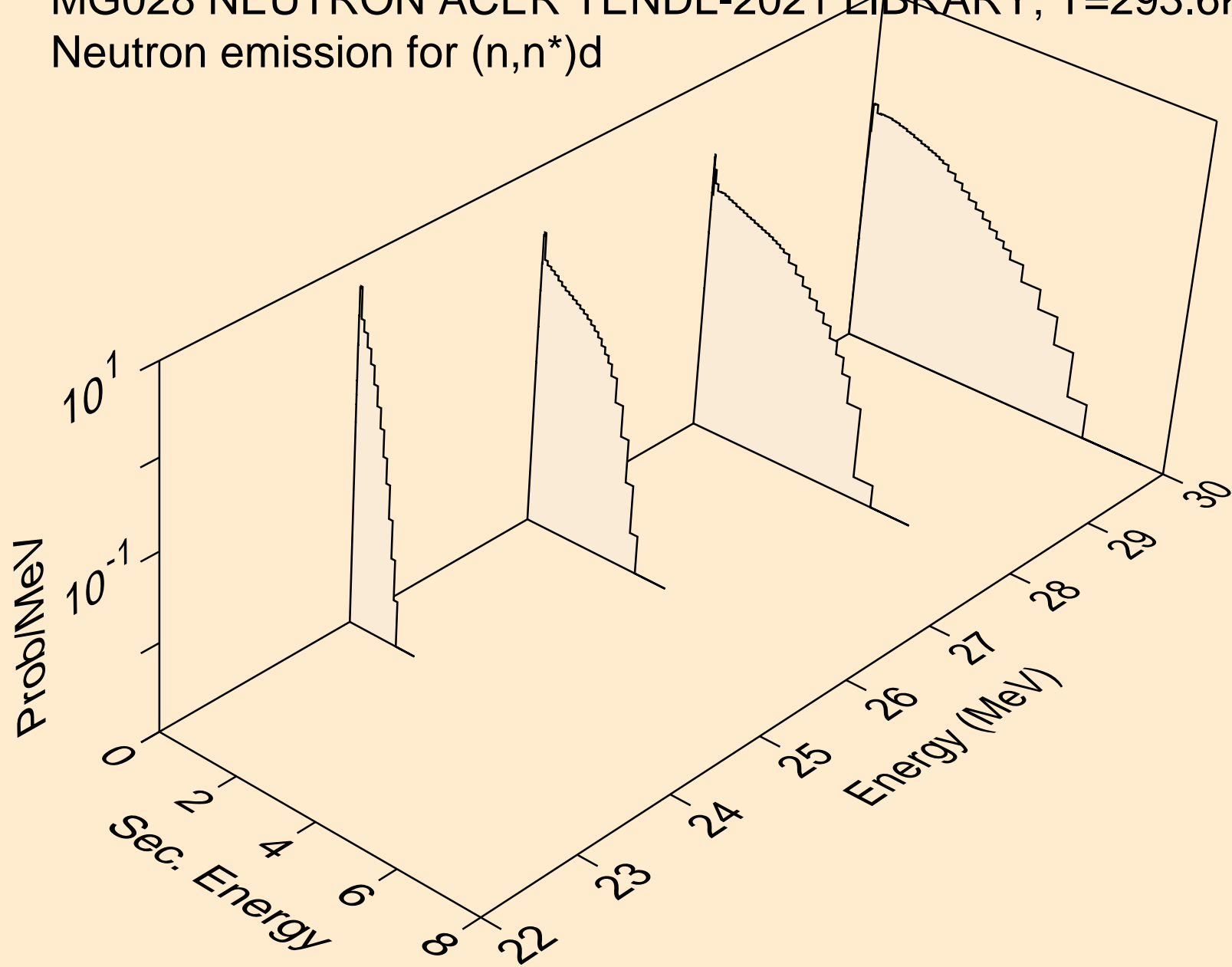

MG028 NEUTRON ACER TENDL-2021 LIBRARY; T=293.6K  
Neutron emission for (n,n\*)t

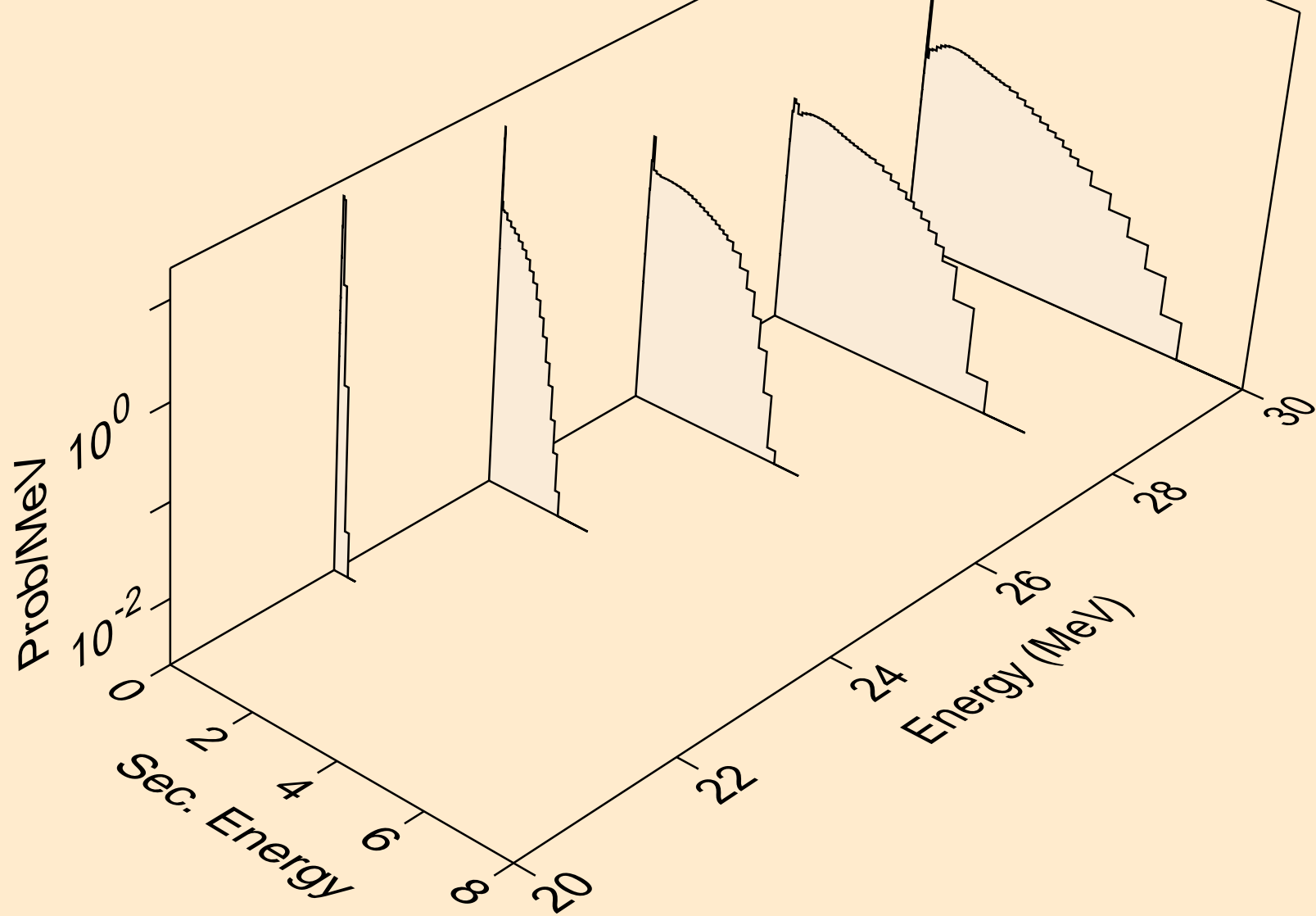

MG028 NEUTRON ACER TENDL-2021 LIBRARY; T=293.6K  
Neutron emission for (n,4n)

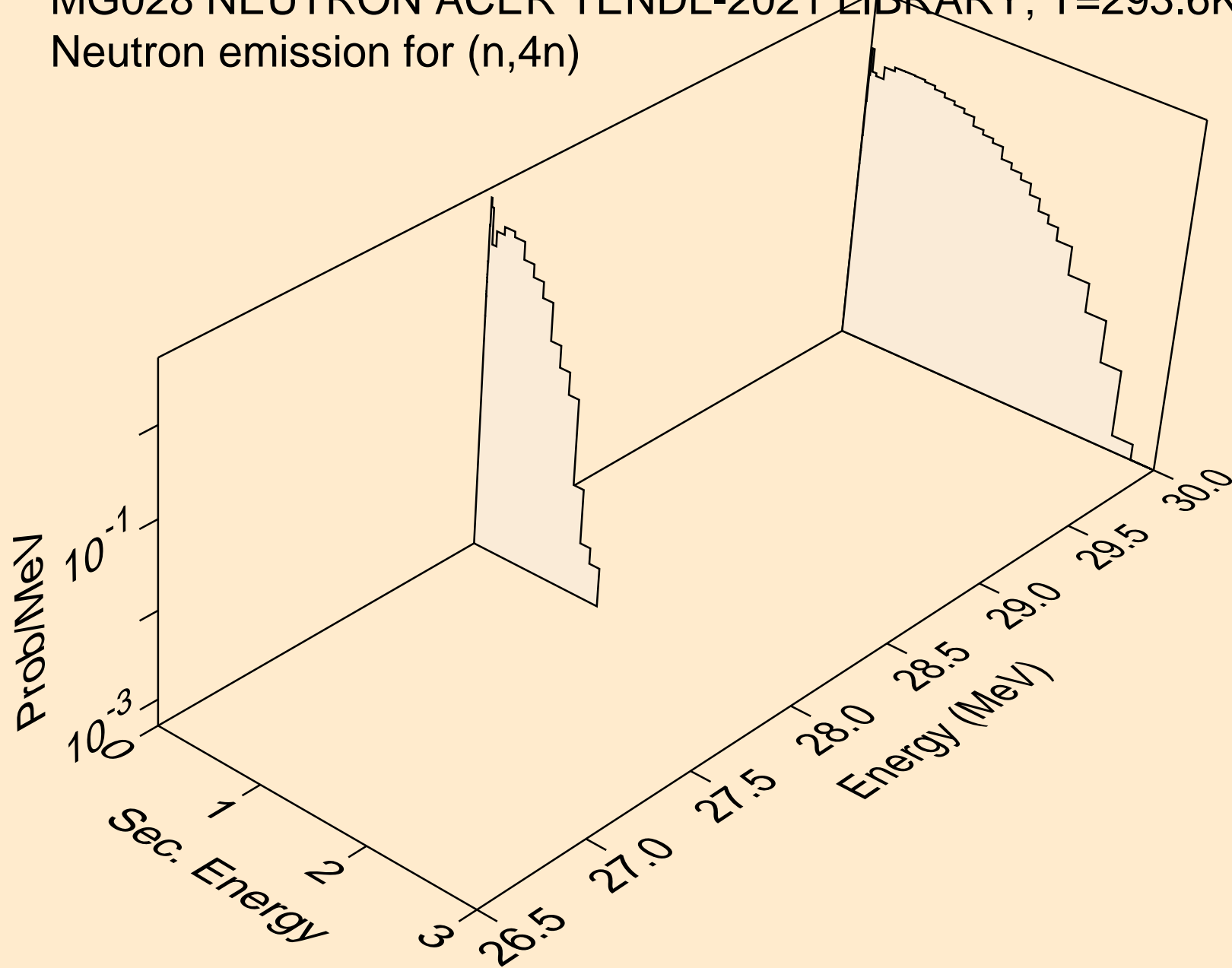

MG028 NEUTRON ACER TENDL-2021 LIBRARY; T=293.6K  
Neutron emission for (n,2np)

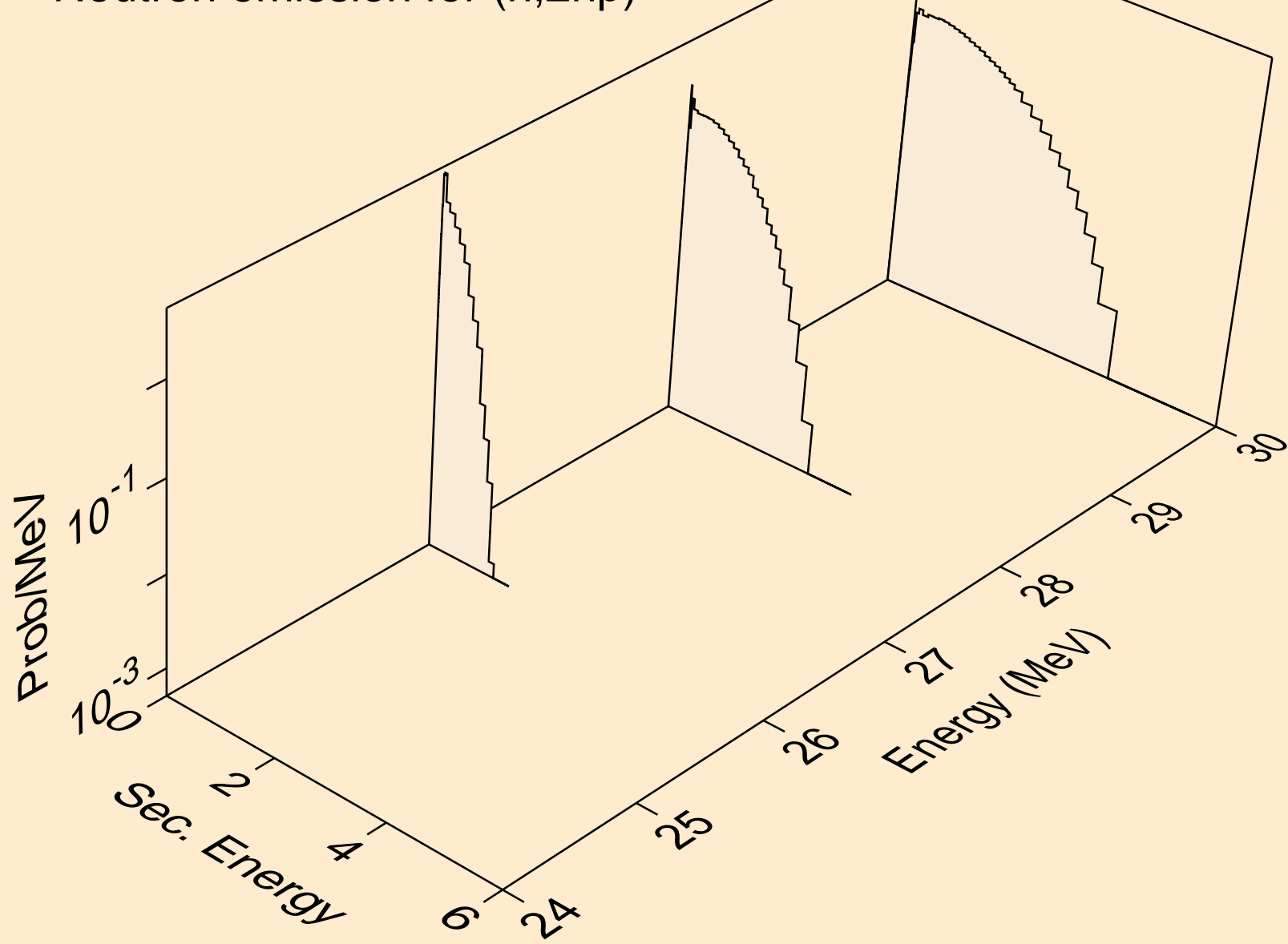

MG028 NEUTRON ACER TENDL-2021 LIBRARY; T=293.6K  
Neutron emission for (n,n\*c)

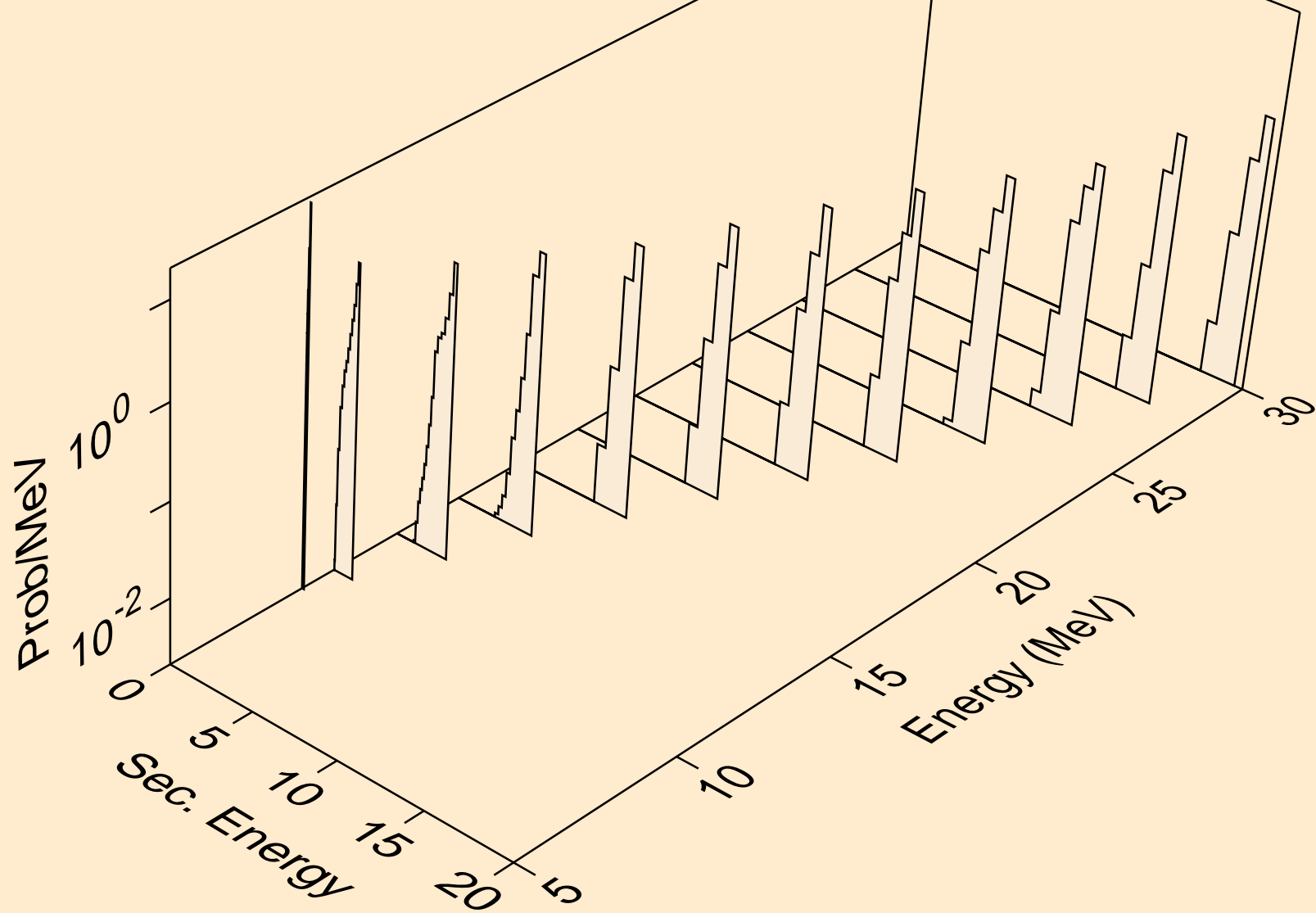

MG028 NEUTRON ACER TENDL-2021 LIBRARY; T=293.6K  
Photon emission for (n,x)

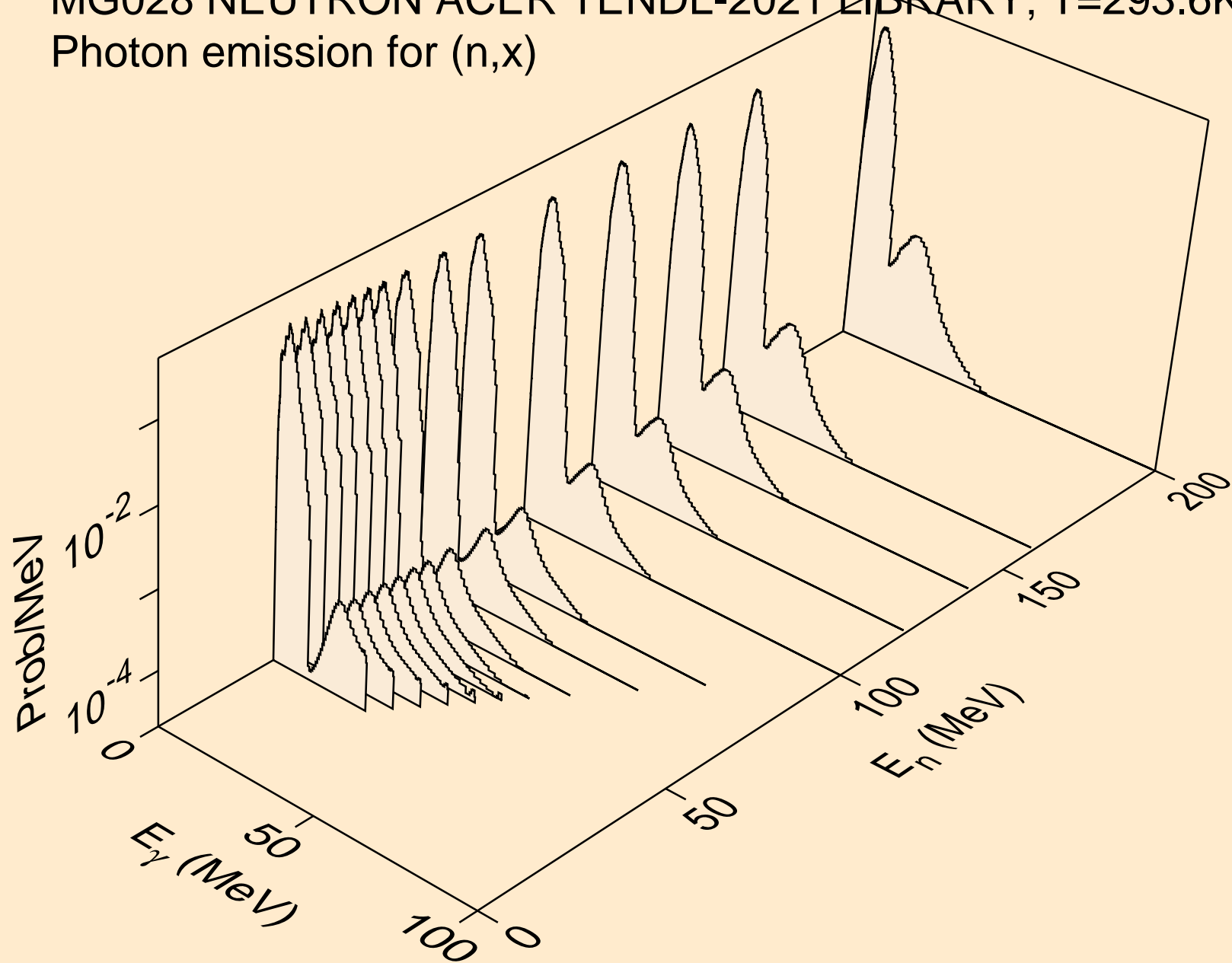

MG028 NEUTRON ACER TENDL-2021 LIBRARY; T=293.6K  
Photon emission for (n,2nd)

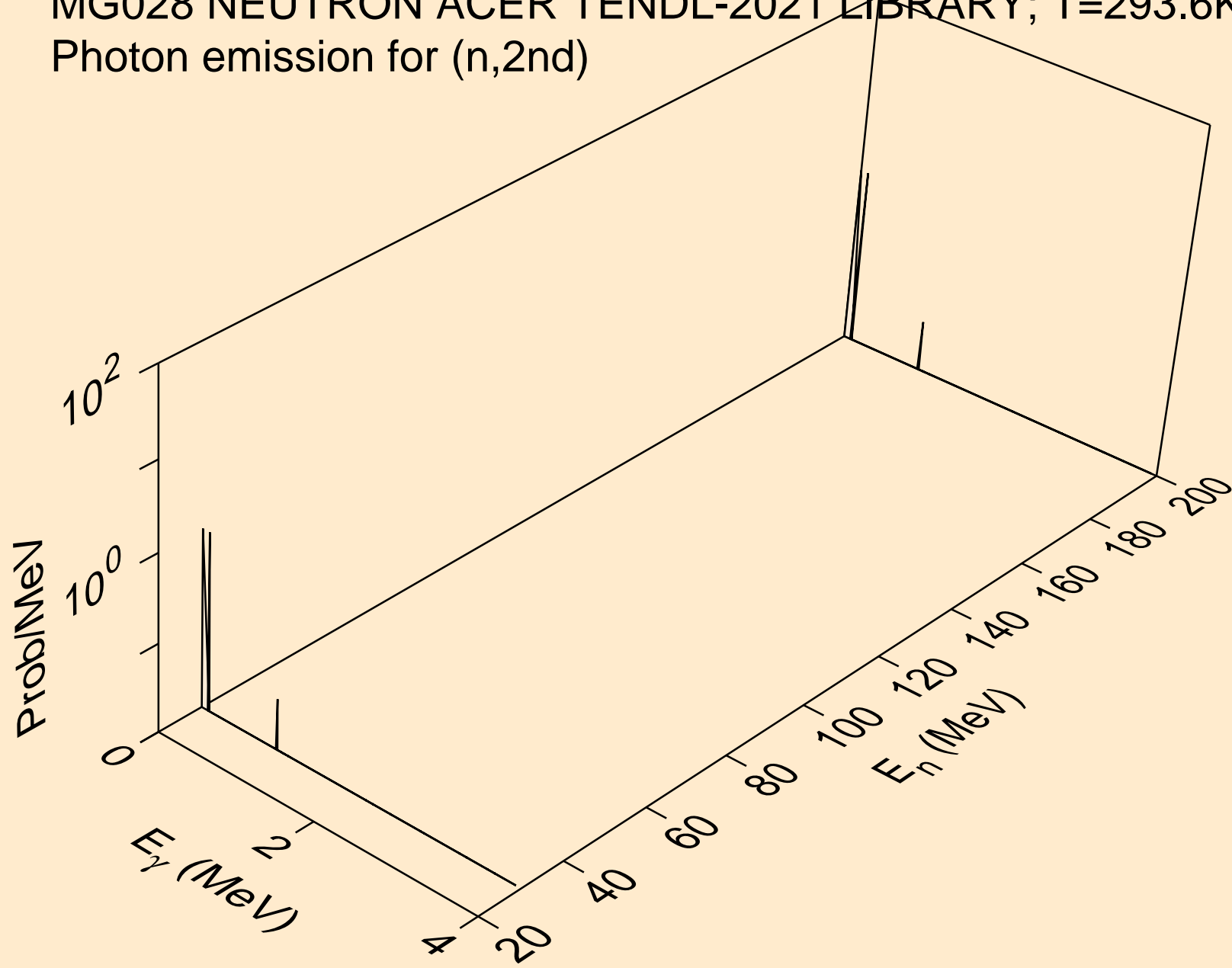

MG028 NEUTRON ACER TENDL-2021 LIBRARY; T=293.6K  
Photon emission for (n,2n)

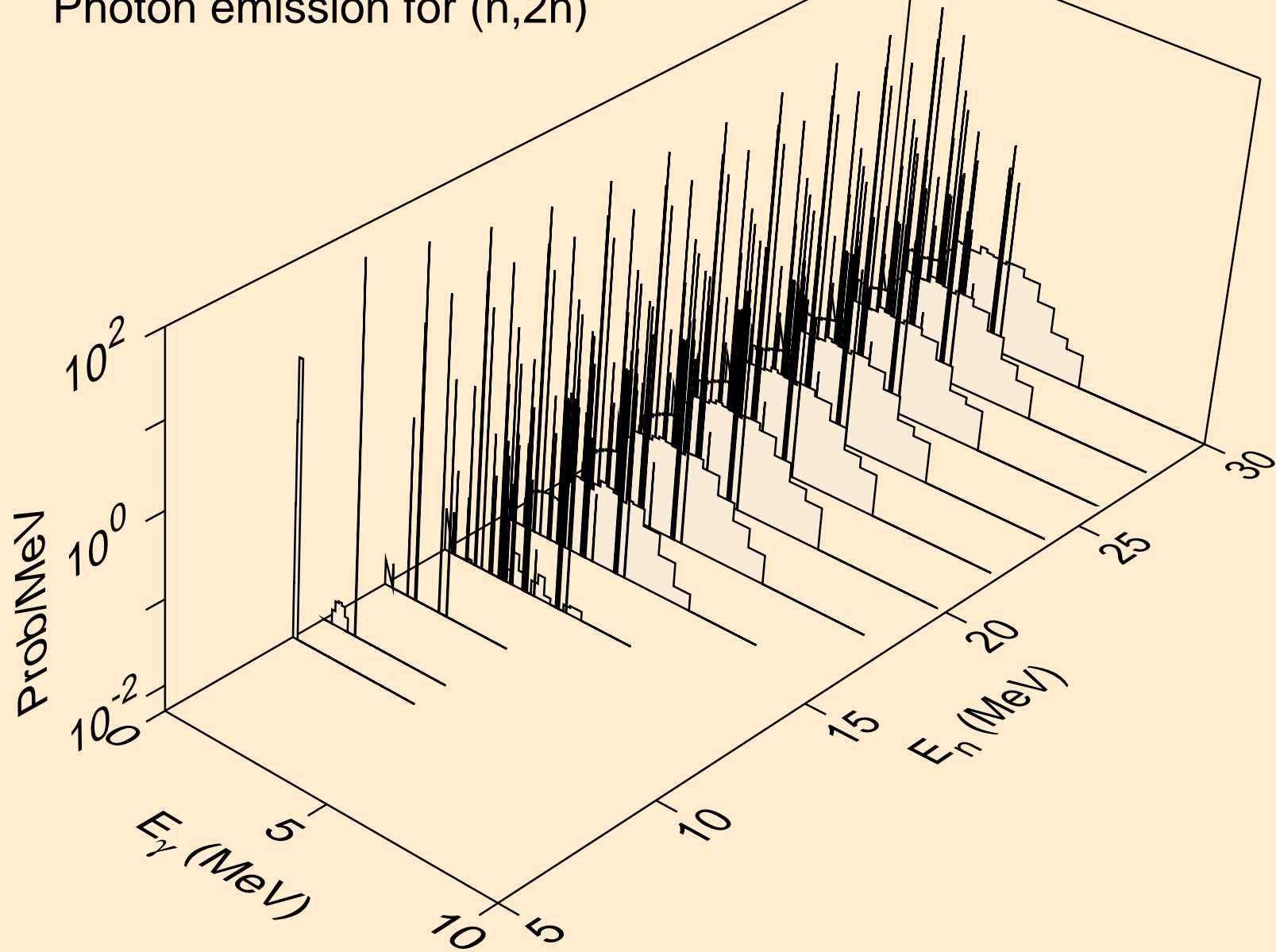



MG028 NEUTRON ACER TENDL-2021 LIBRARY; T=293.6K  
Photon emission for (n,3n)

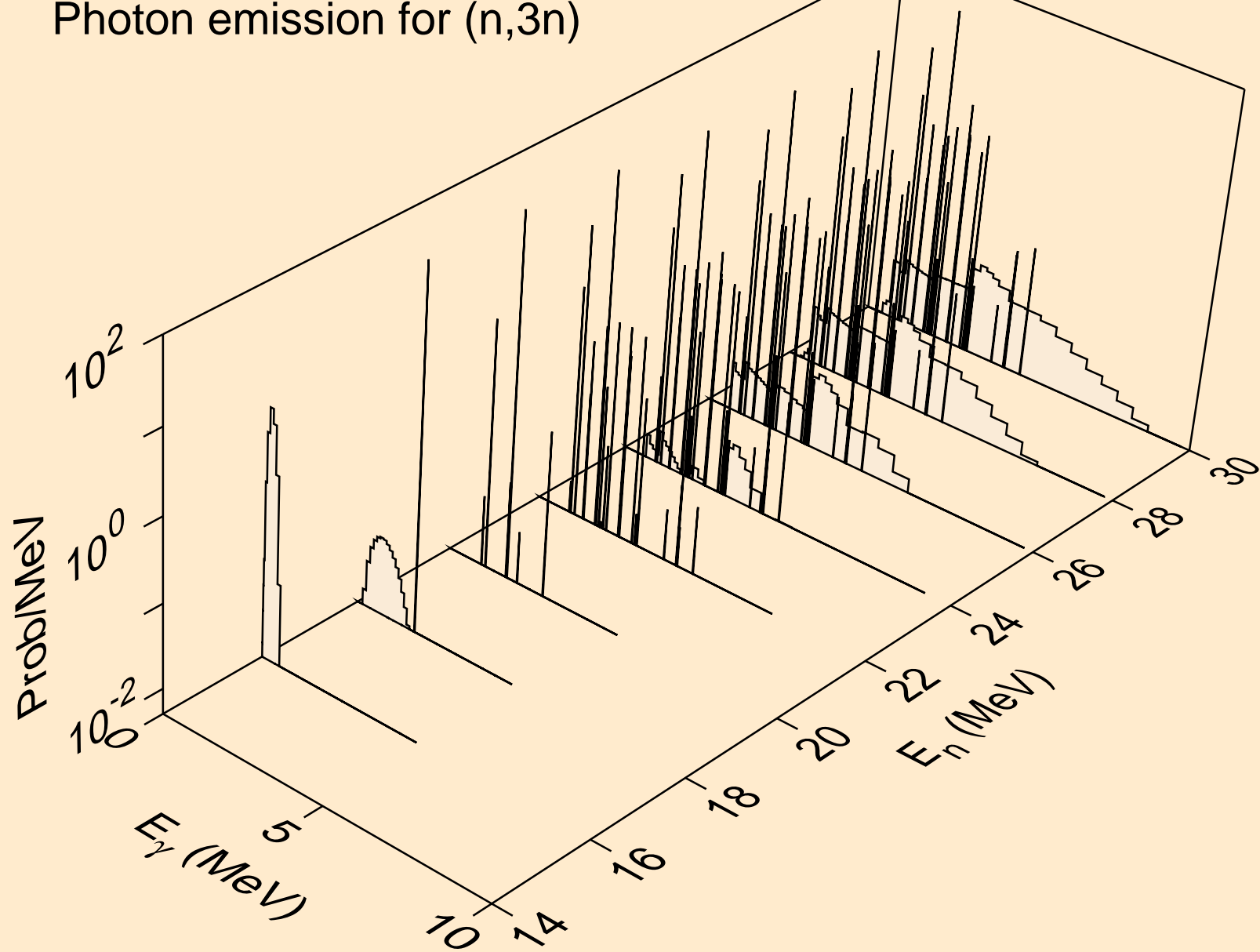

MG028 NEUTRON ACER TENDL-2021 LIBRARY; T=293.6K  
Photon emission for (n,n\*)a

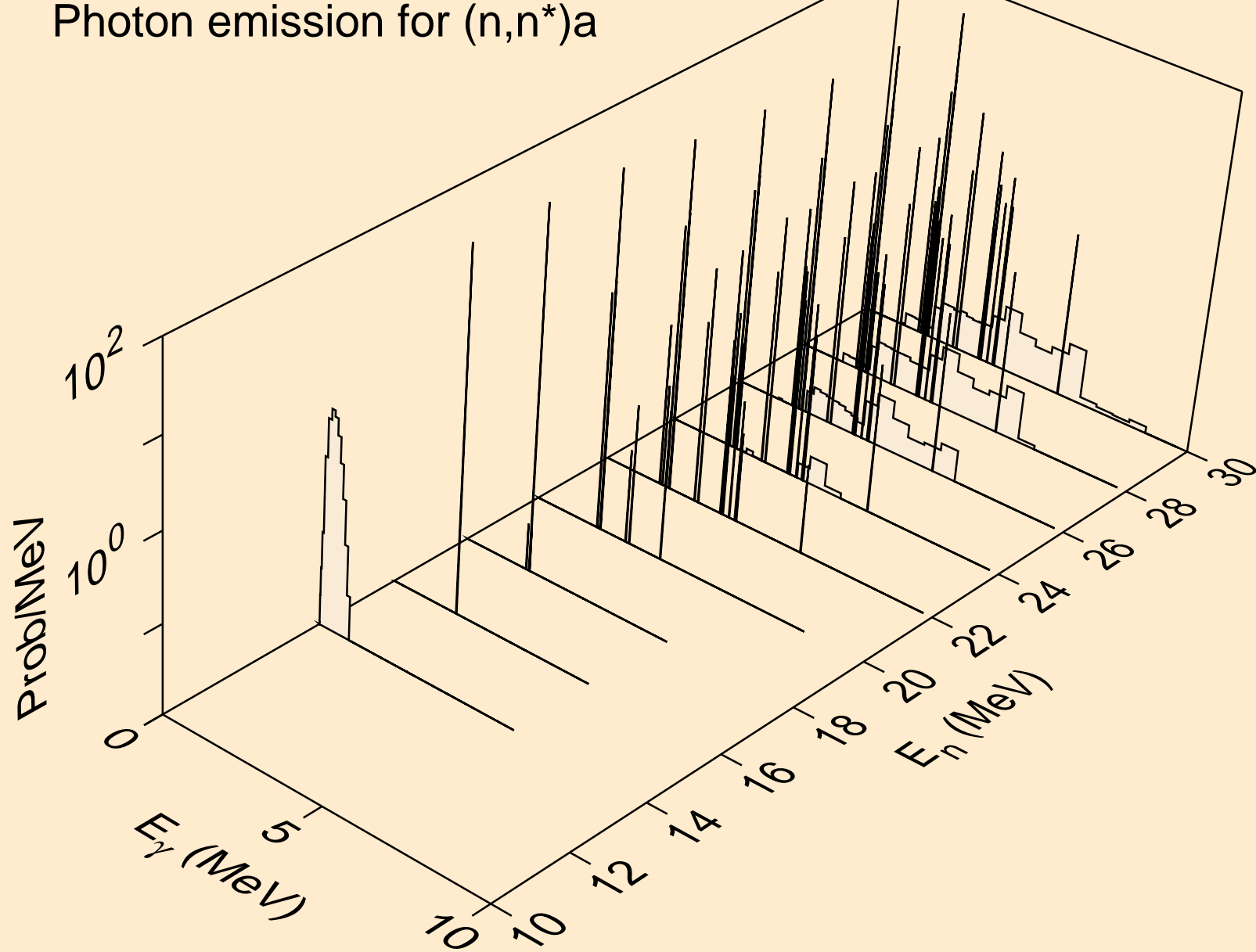

MG028 NEUTRON ACER TENDL-2021 LIBRARY; T=293.6K  
Photon emission for (n,2n)a

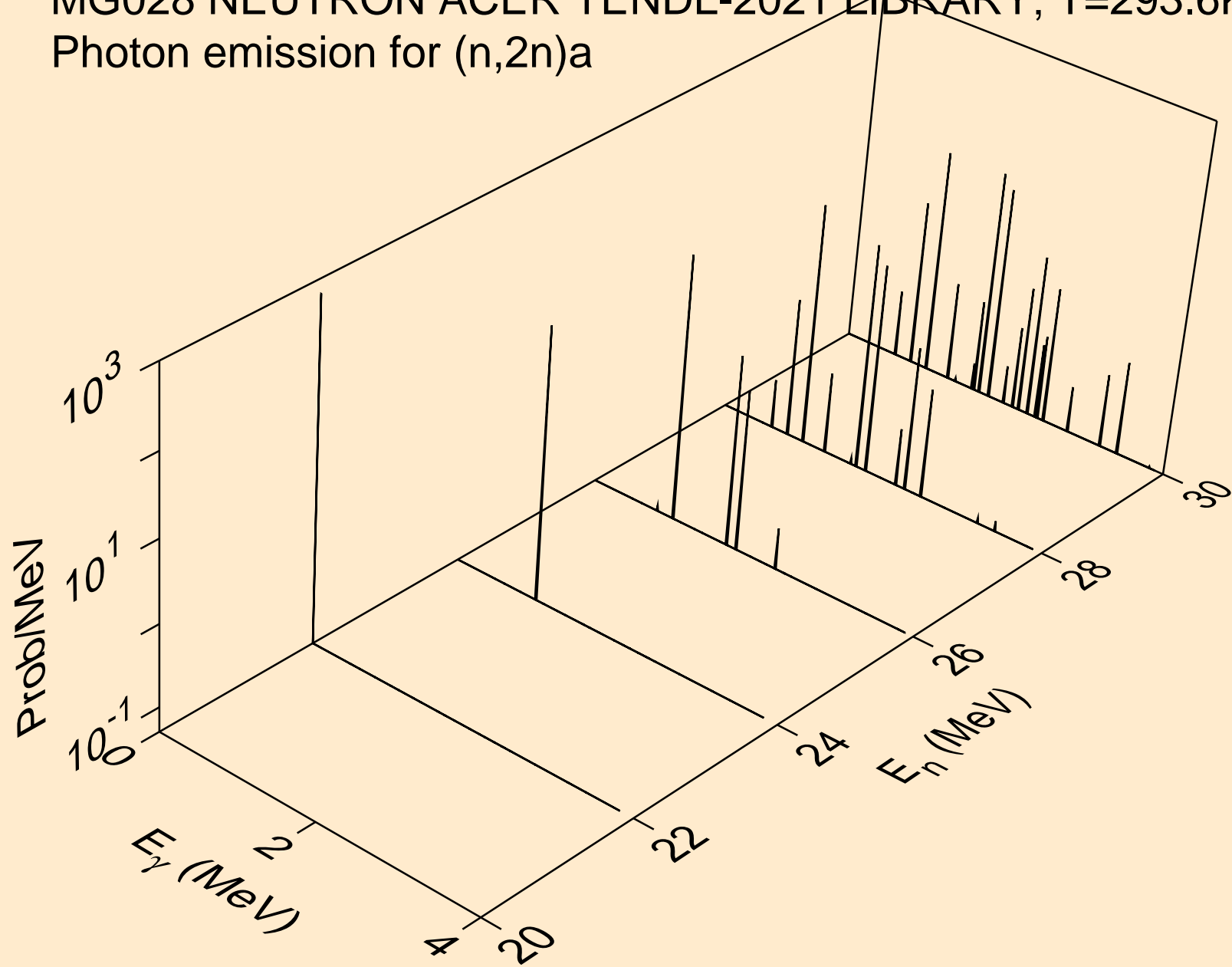

MG028 NEUTRON ACER TENDL-2021 LIBRARY; T=293.6K  
Photon emission for (n,3n)a

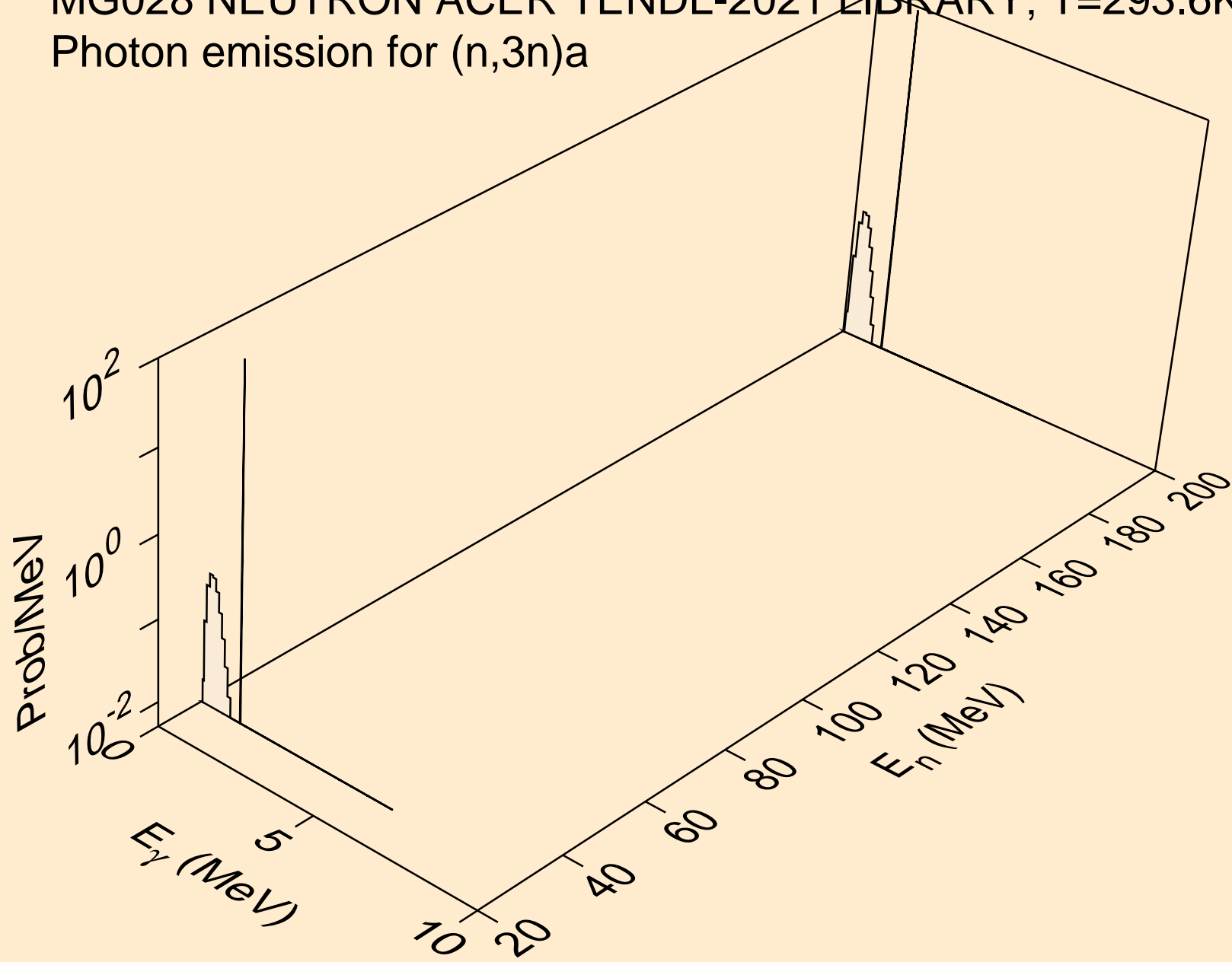

MG028 NEUTRON ACER TENDL-2021 LIBRARY; T=293.6K  
Photon emission for (n,n\*)p

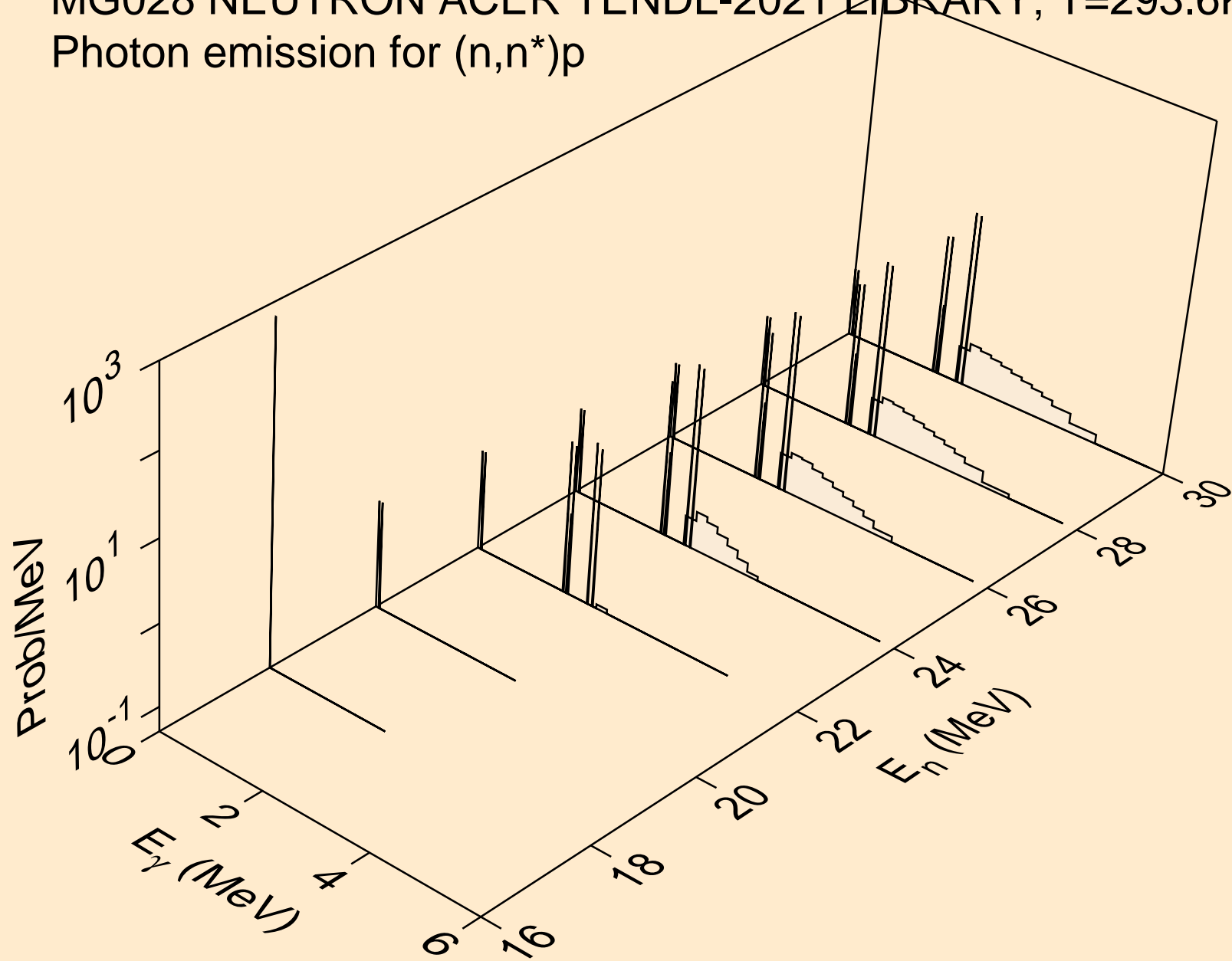

MG028 NEUTRON ACER TENDL-2021 LIBRARY; T=293.6K  
Photon emission for (n,n\*)d

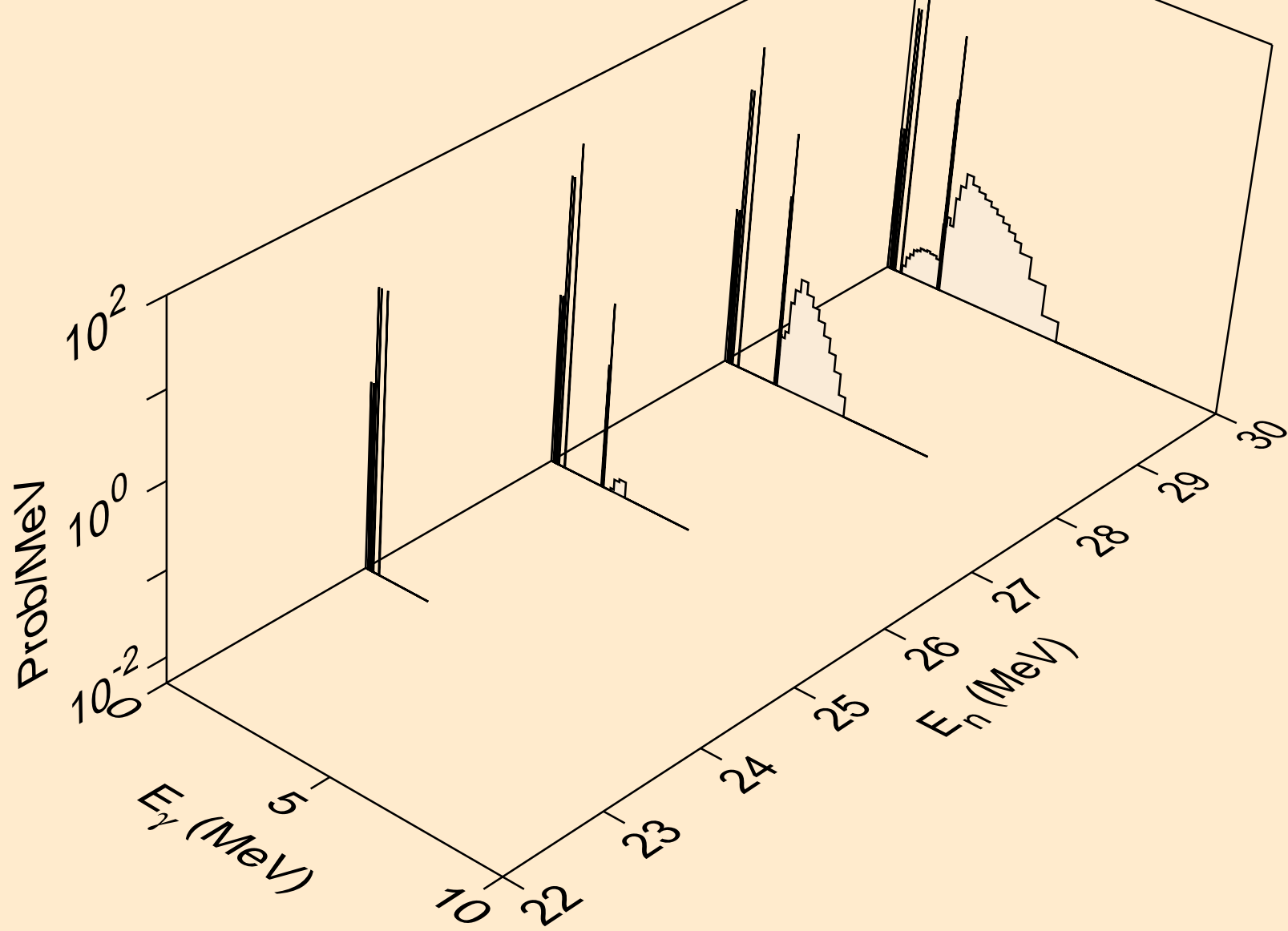

MG028 NEUTRON ACER TENDL-2021 LIBRARY; T=293.6K  
Photon emission for (n,n\*)t

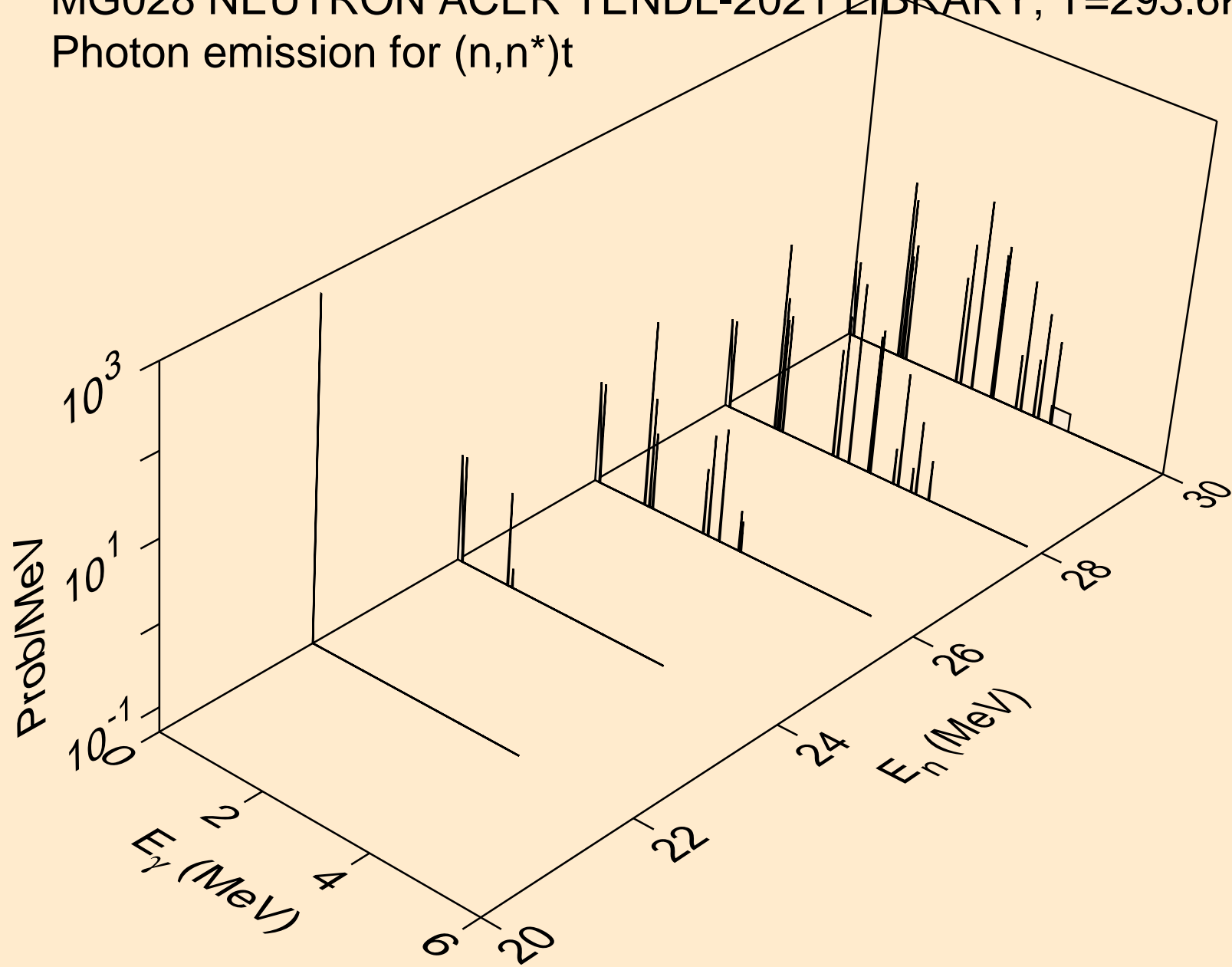

MG028 NEUTRON ACER TENDL-2021 LIBRARY; T=293.6K  
Photon emission for (n,4n)

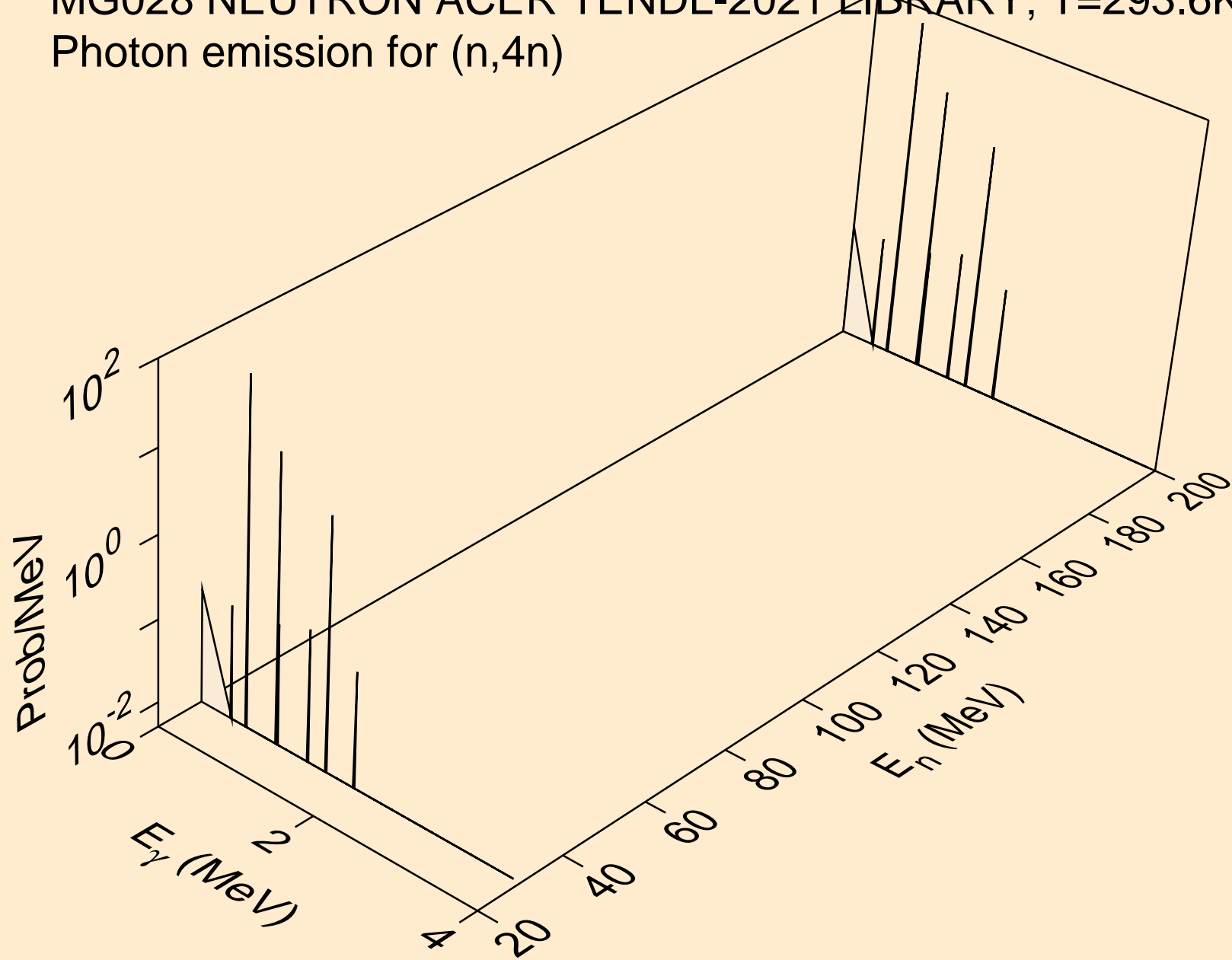



MG028 NEUTRON ACER TENDL-2021 LIBRARY; T=293.6K  
Photon emission for (n,2np)

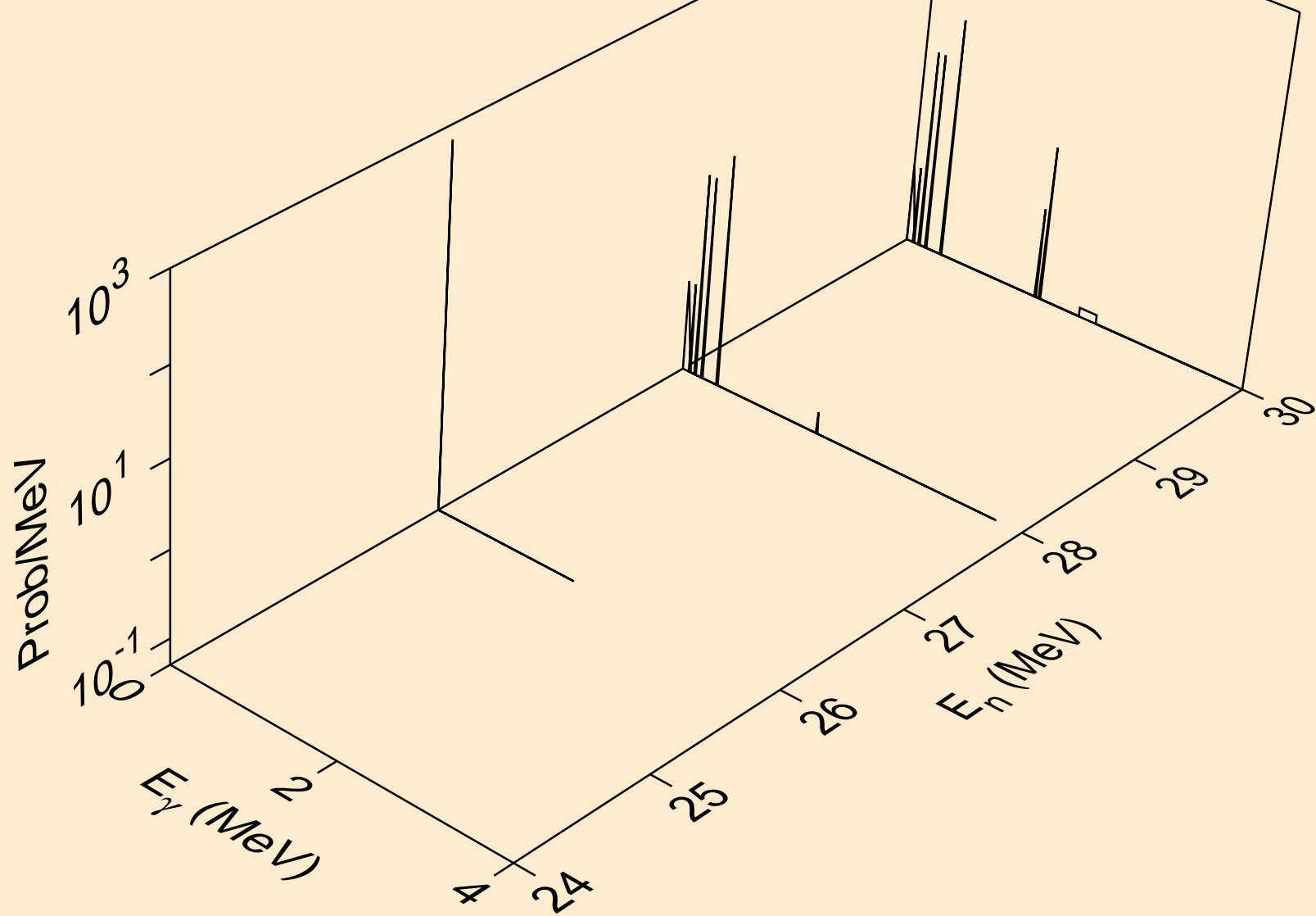

MG028 NEUTRON ACER TENDL-2021 LIBRARY; T=293.6K  
Photon emission for (n,n\*c)

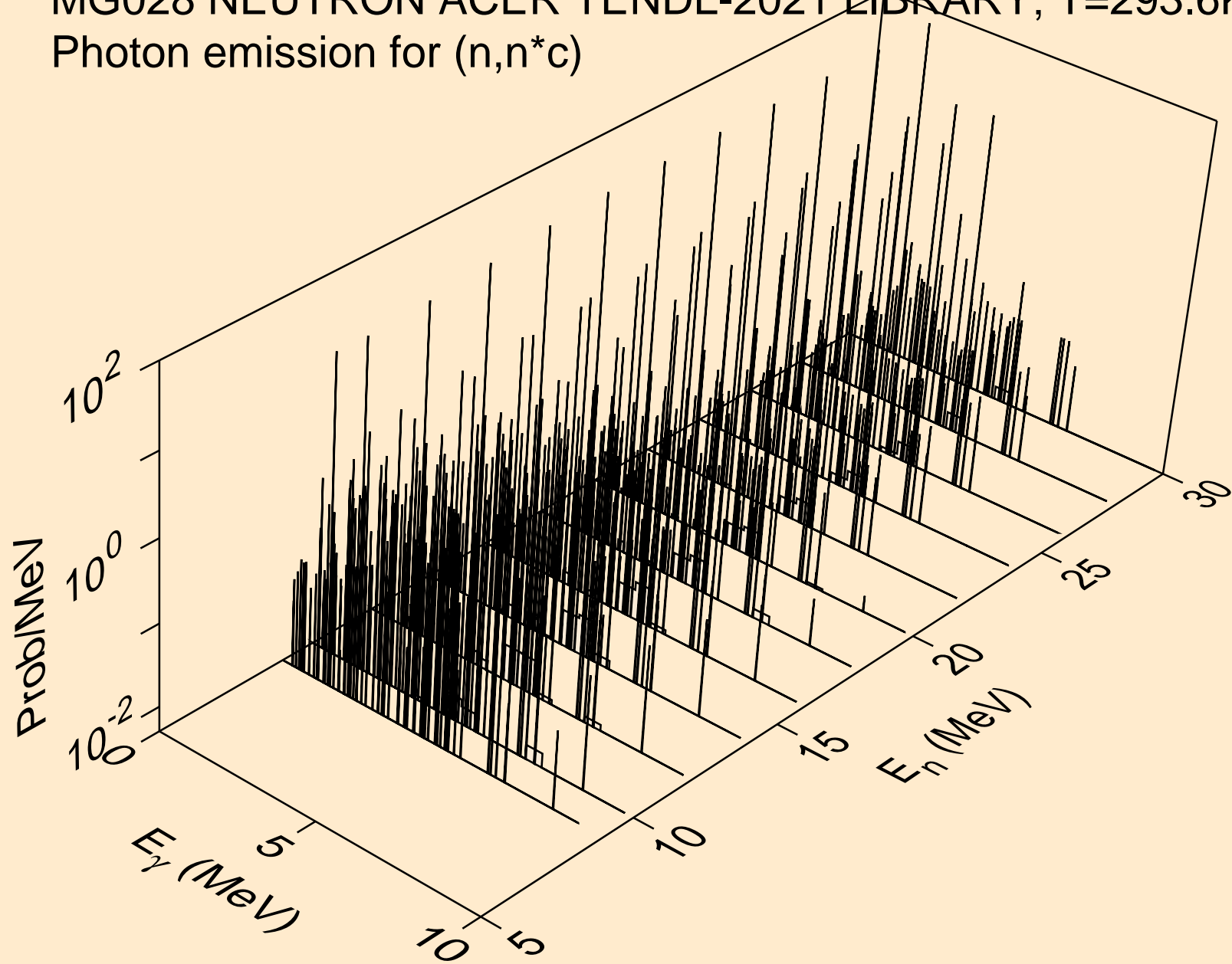

MG028 NEUTRON ACER TENDL-2021 LIBRARY; T=293.6K  
Photon emission for (n,gma)

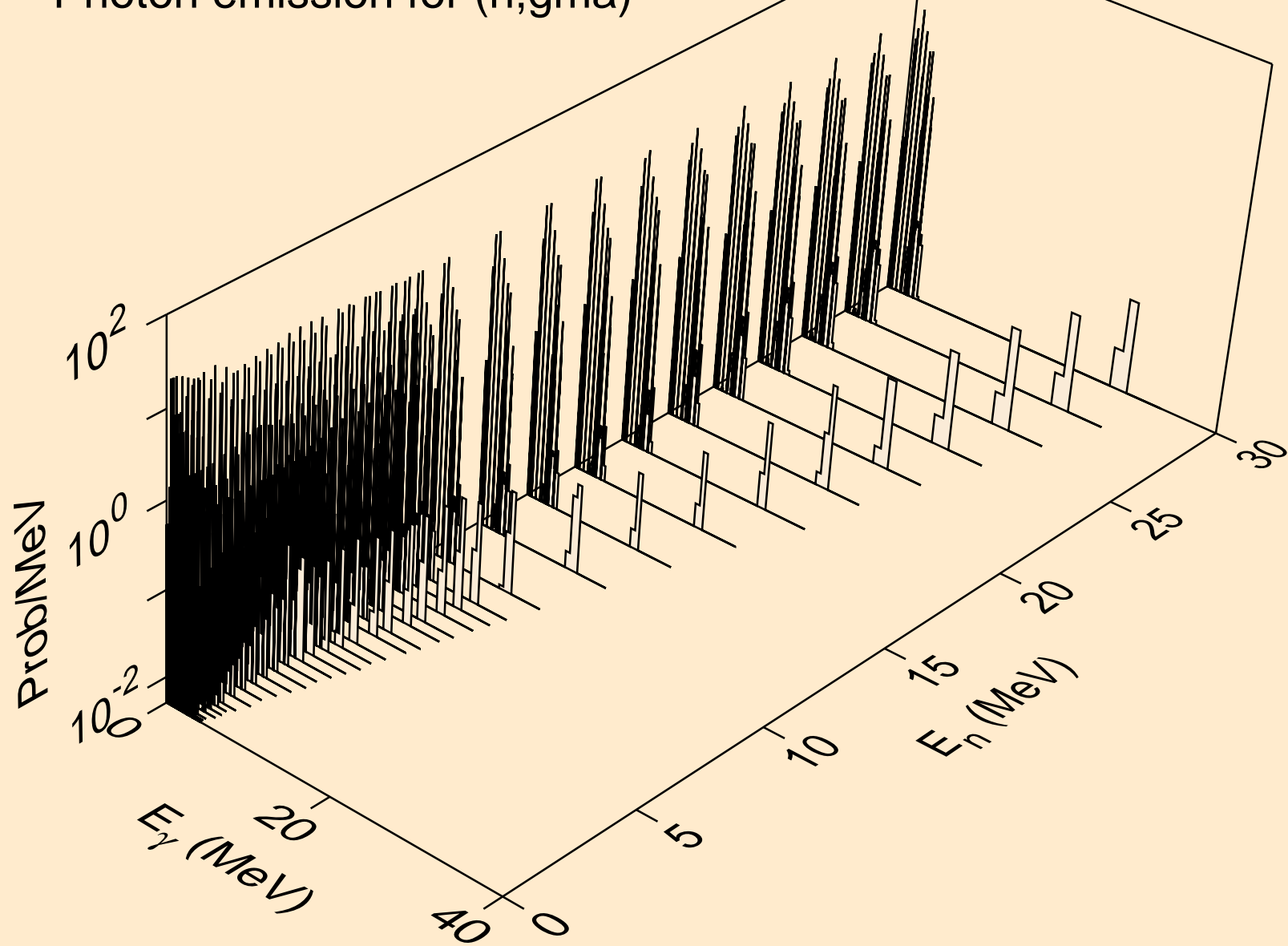

MG028 NEUTRON ACER TENDL-2021 LIBRARY; T=293.6K  
Photon emission for (n,p)

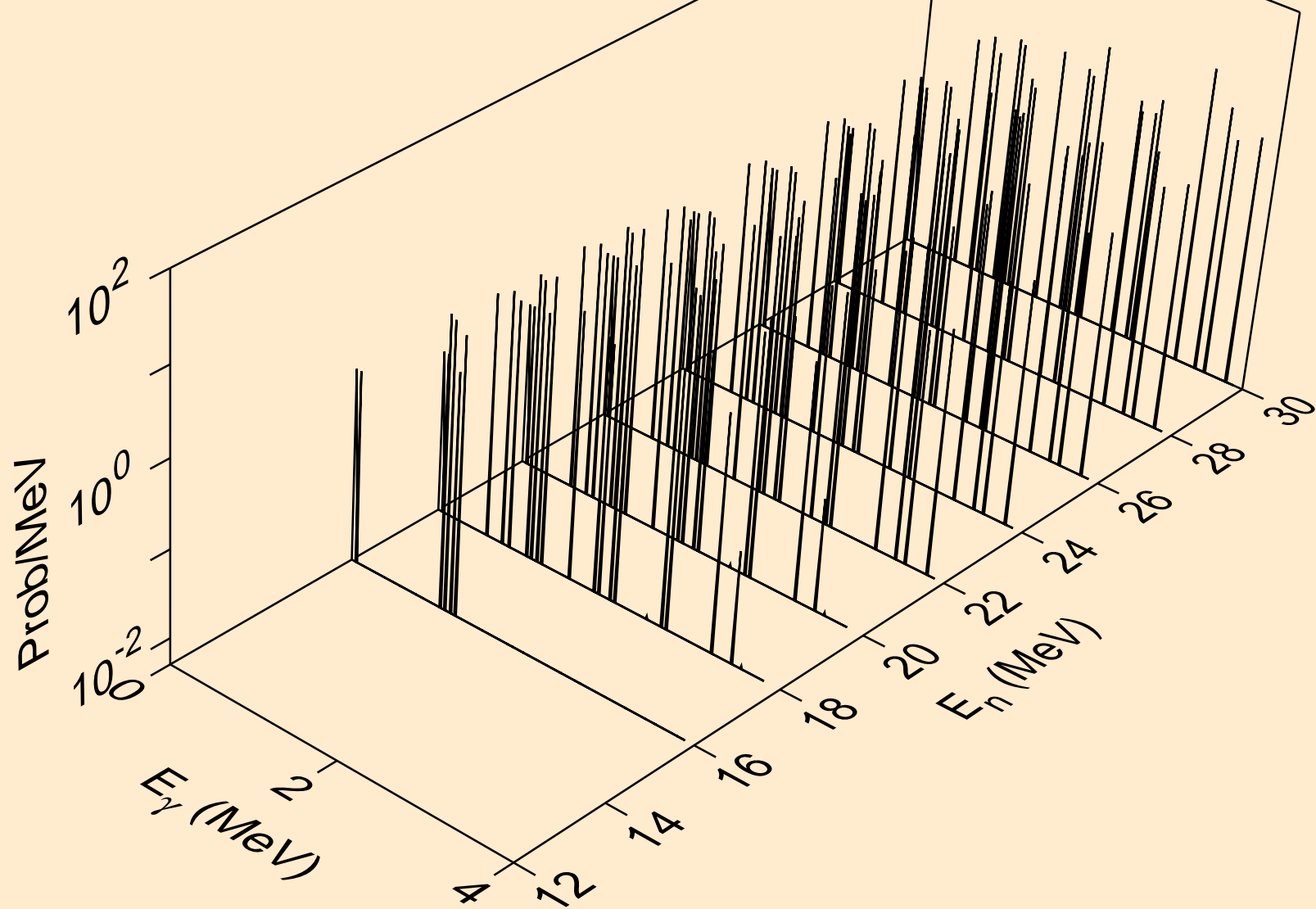

MG028 NEUTRON ACER TENDL-2021 LIBRARY; T=293.6K  
Photon emission for (n,d)

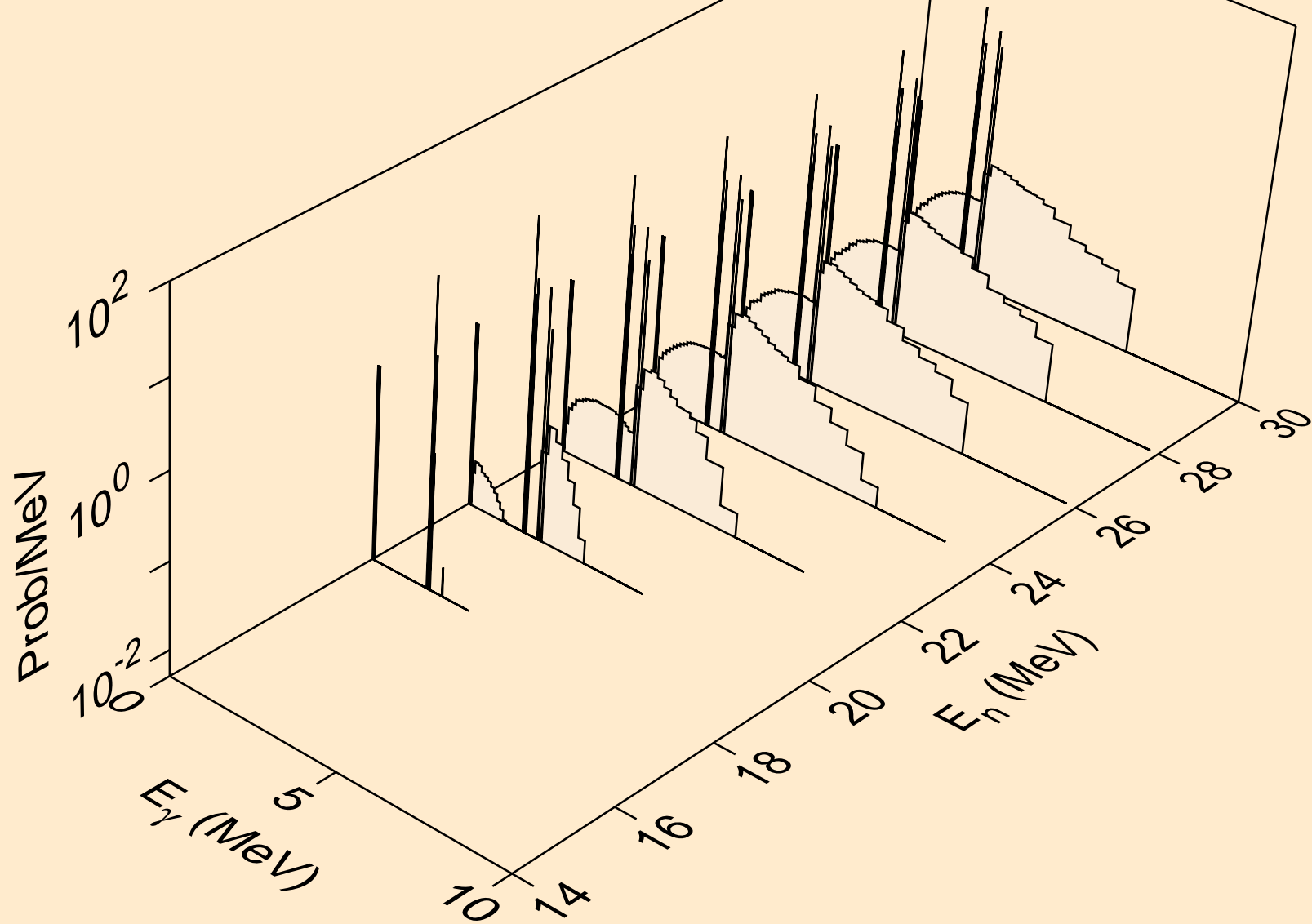

MG028 NEUTRON ACER TENDL-2021 LIBRARY; T=293.6K  
Photon emission for (n,t)

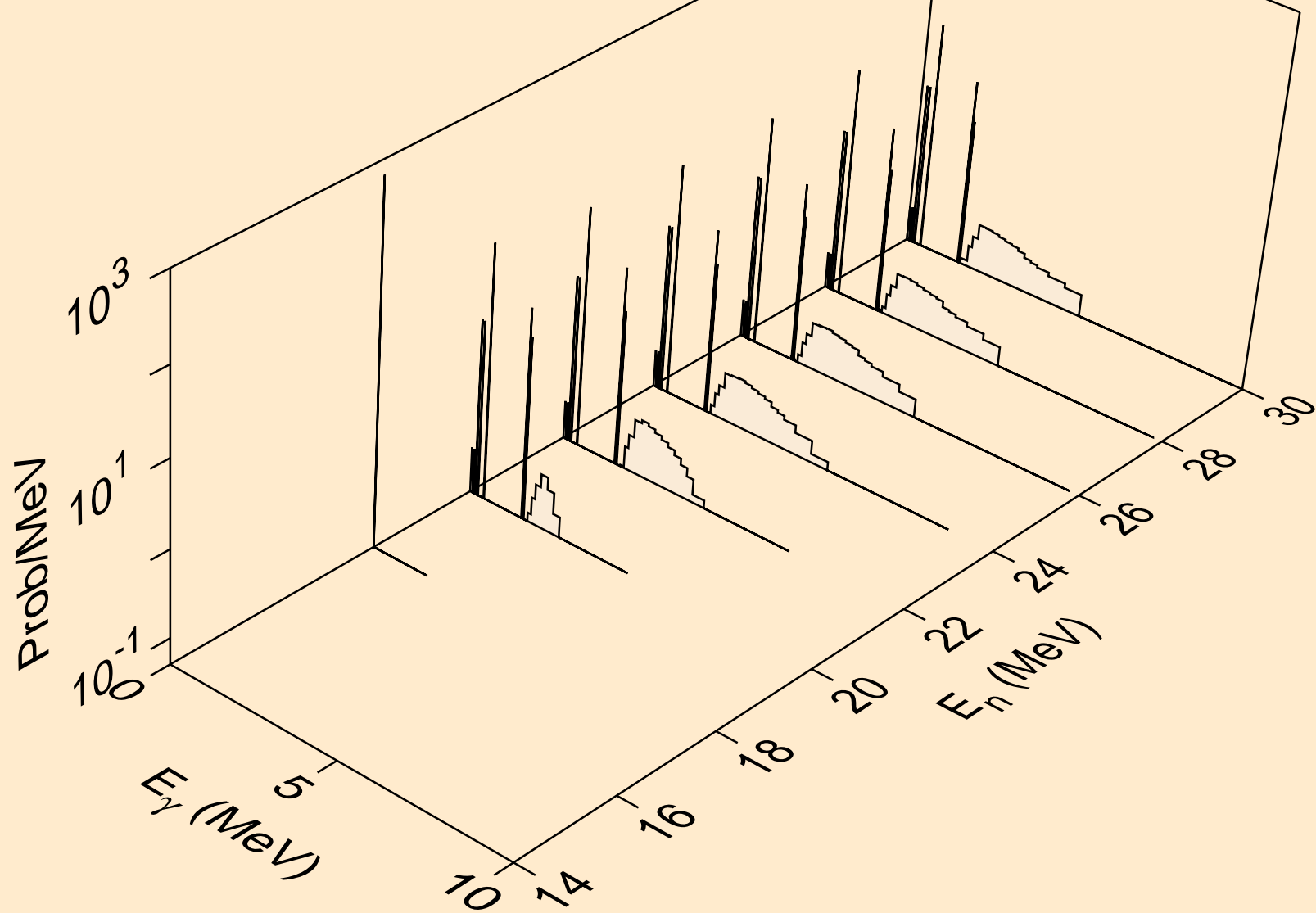

MG028 NEUTRON ACER TENDL-2021 LIBRARY; T=293.6K  
Photon emission for (n,he3)

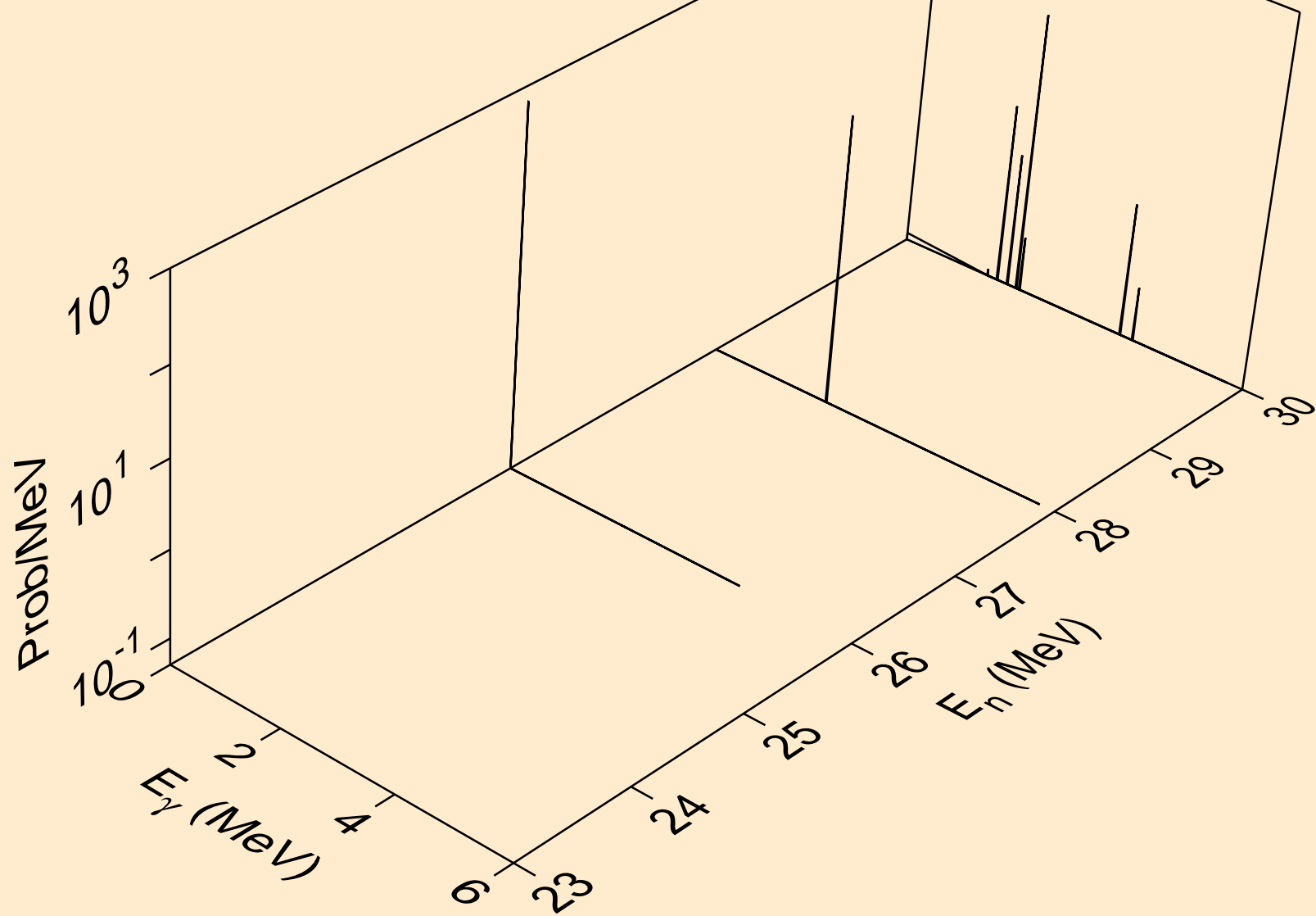

MG028 NEUTRON ACER TENDL-2021 LIBRARY; T=293.6K  
Photon emission for (n,a)

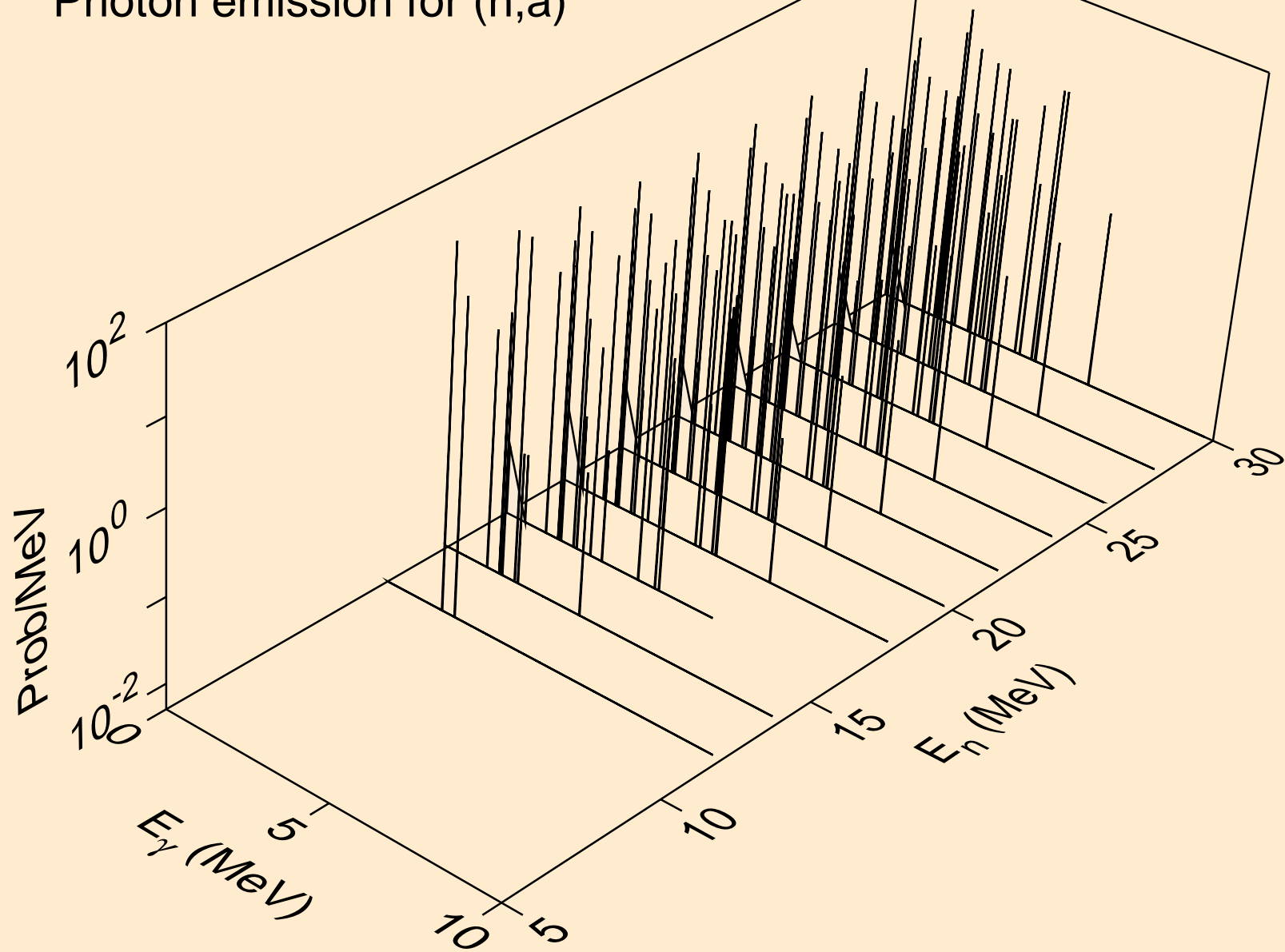



MG028 NEUTRON ACER TENDL-2021 LIBRARY; T=293.6K  
Photon emission for (n,2a)

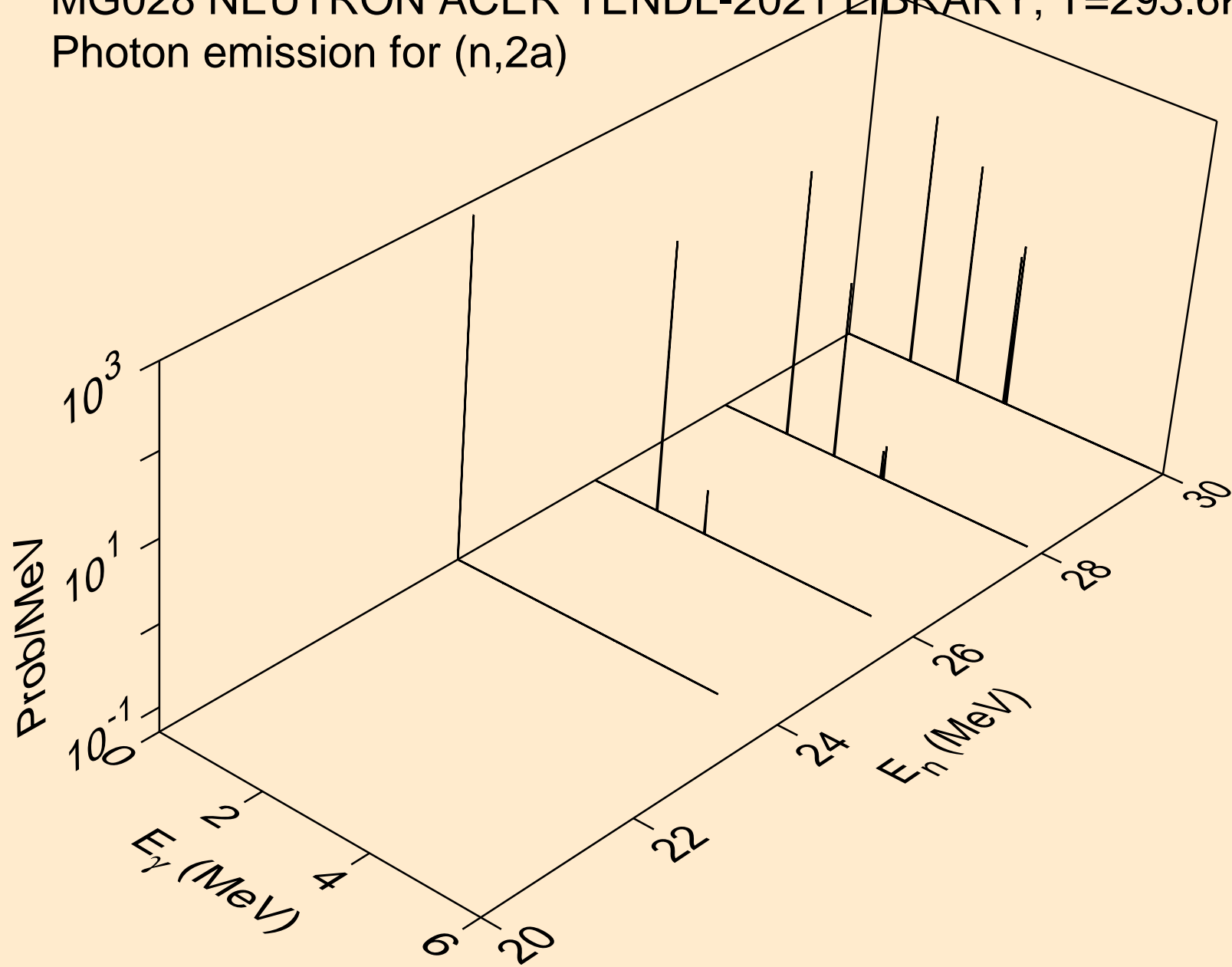

MG028 NEUTRON ACER TENDL-2021 LIBRARY; T=293.6K  
Photon emission for (n,p)

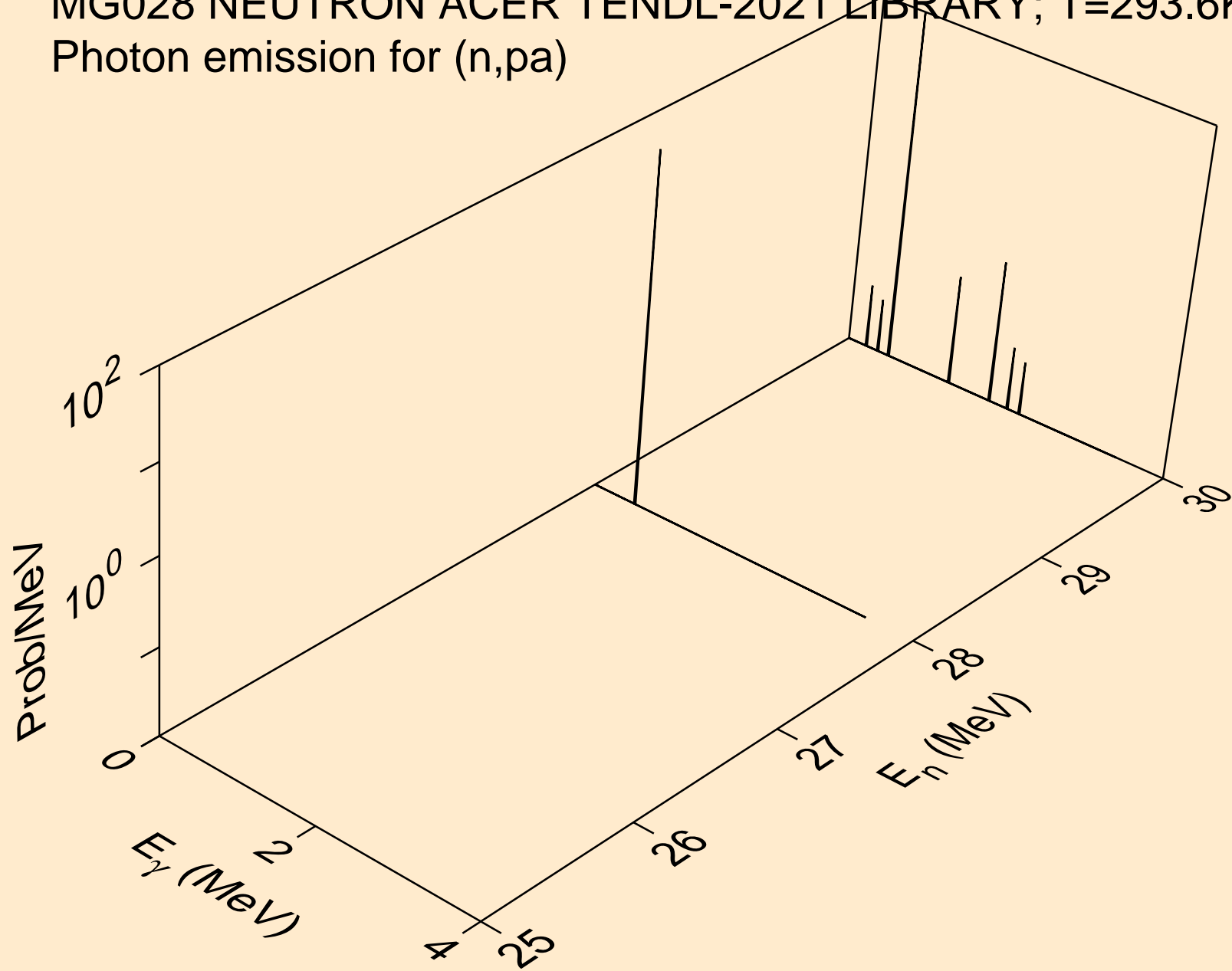

MG028 NEUTRON ACER TENDL-2021 LIBRARY; T=293.6K  
thermal capture photon spectrum

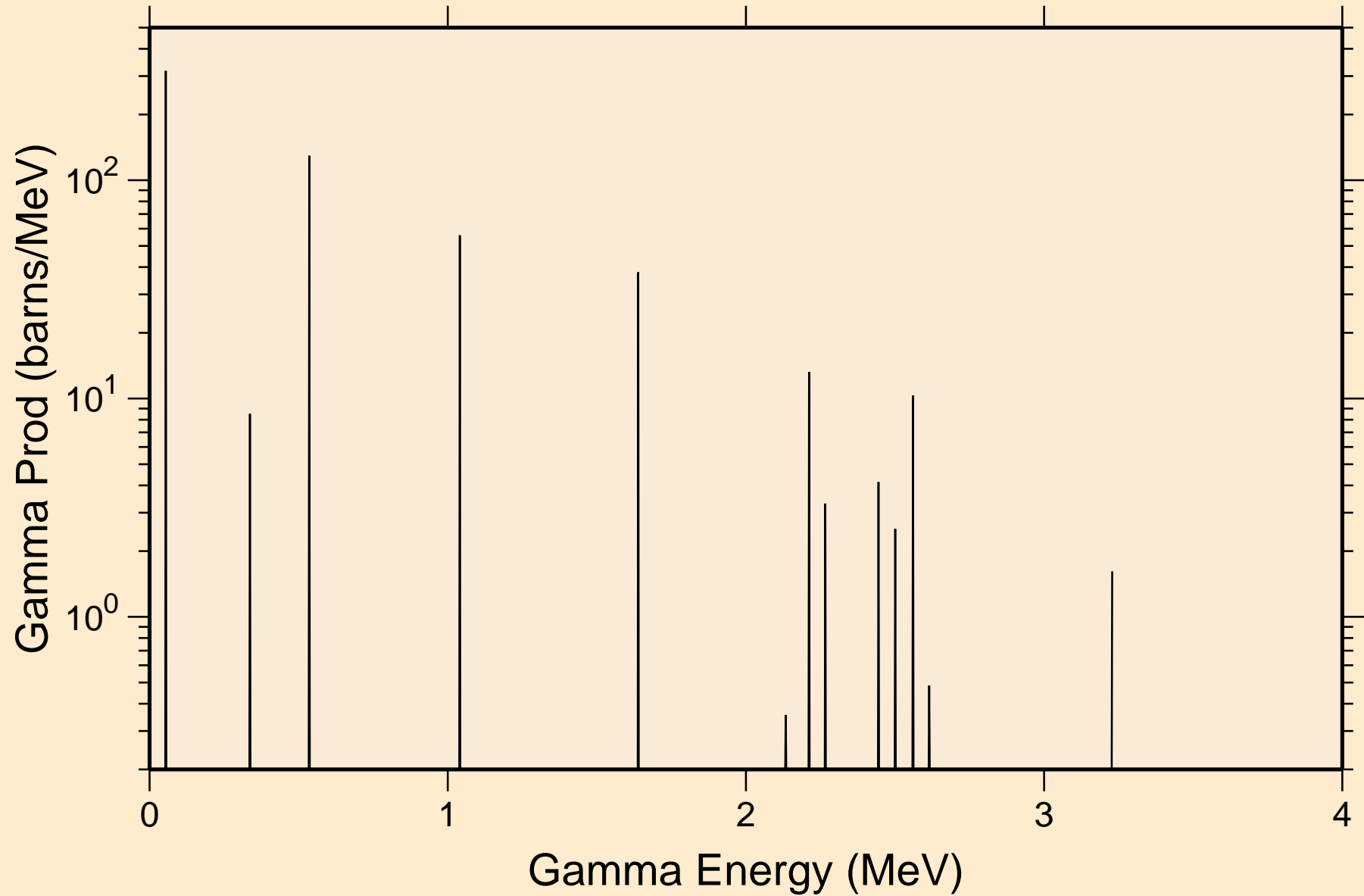

MG028 NEUTRON ACER TENDL-2021 LIBRARY; T=293.6K  
14 MeV photon spectrum

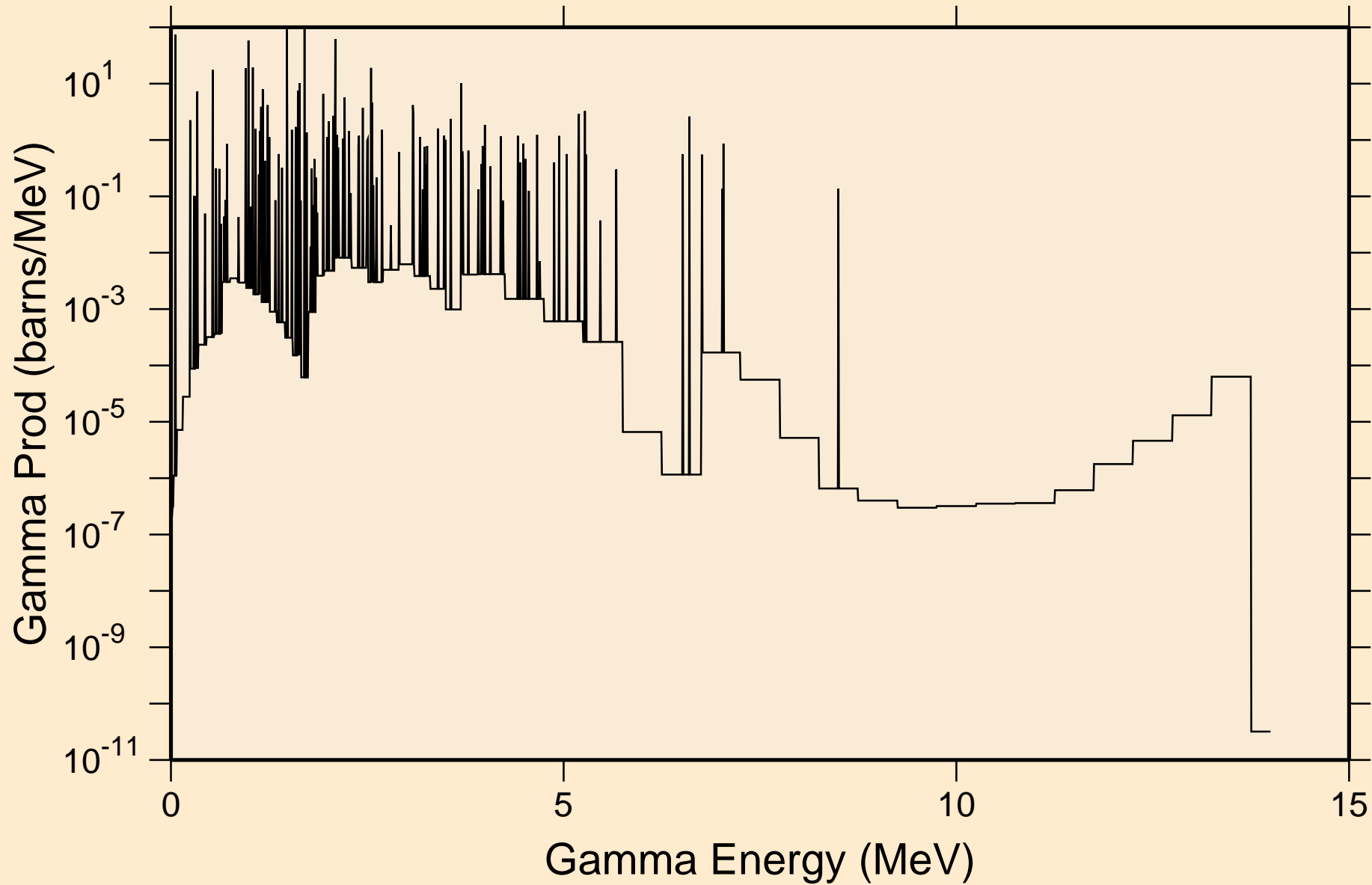

MG028 NEUTRON ACER TENDL-2021 LIBRARY; T=293.6K  
Particle heating contributions

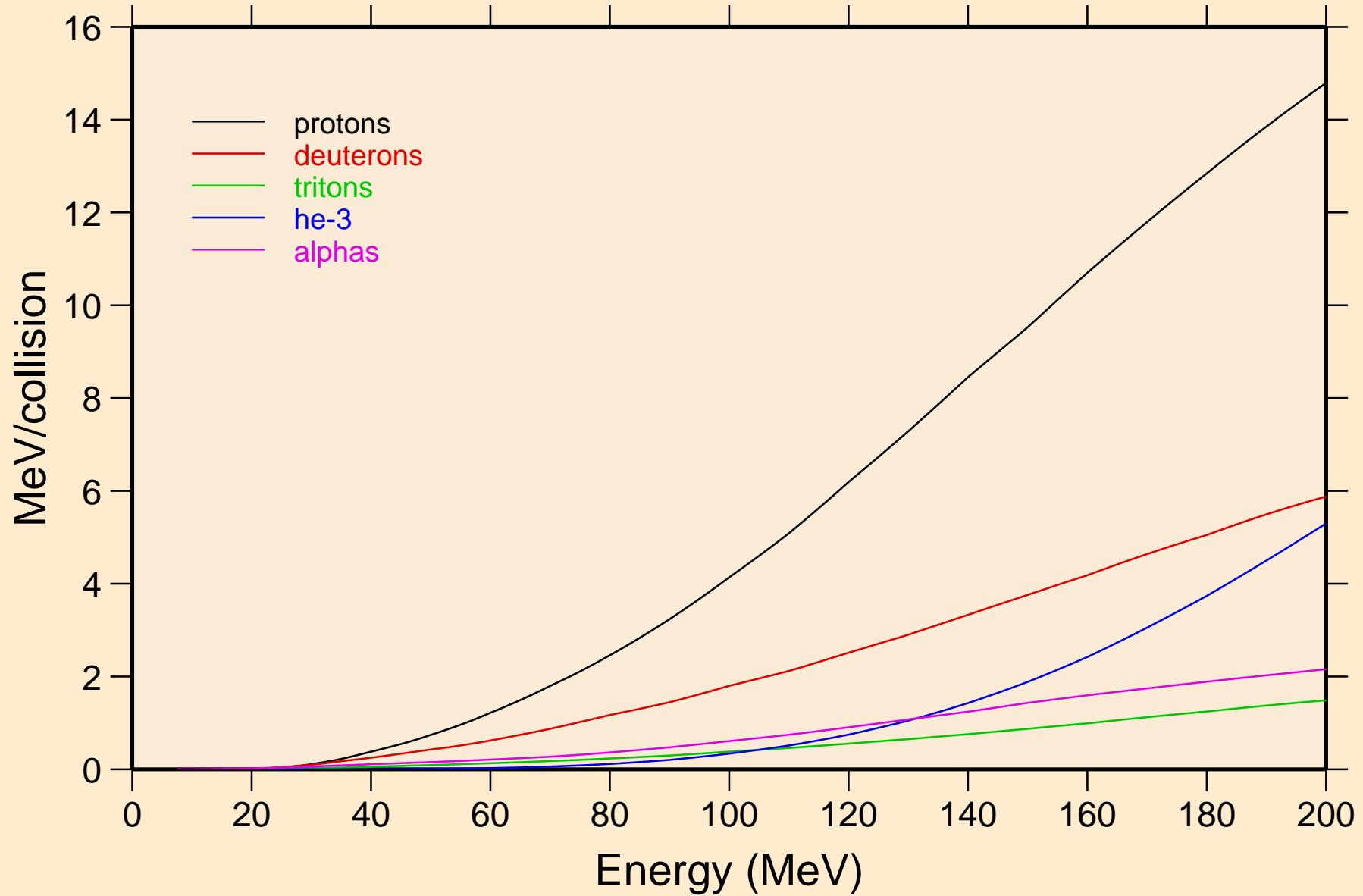

MG028 NEUTRON ACER TENDL-2021 LIBRARY; T=293.6K  
Recoil Heating

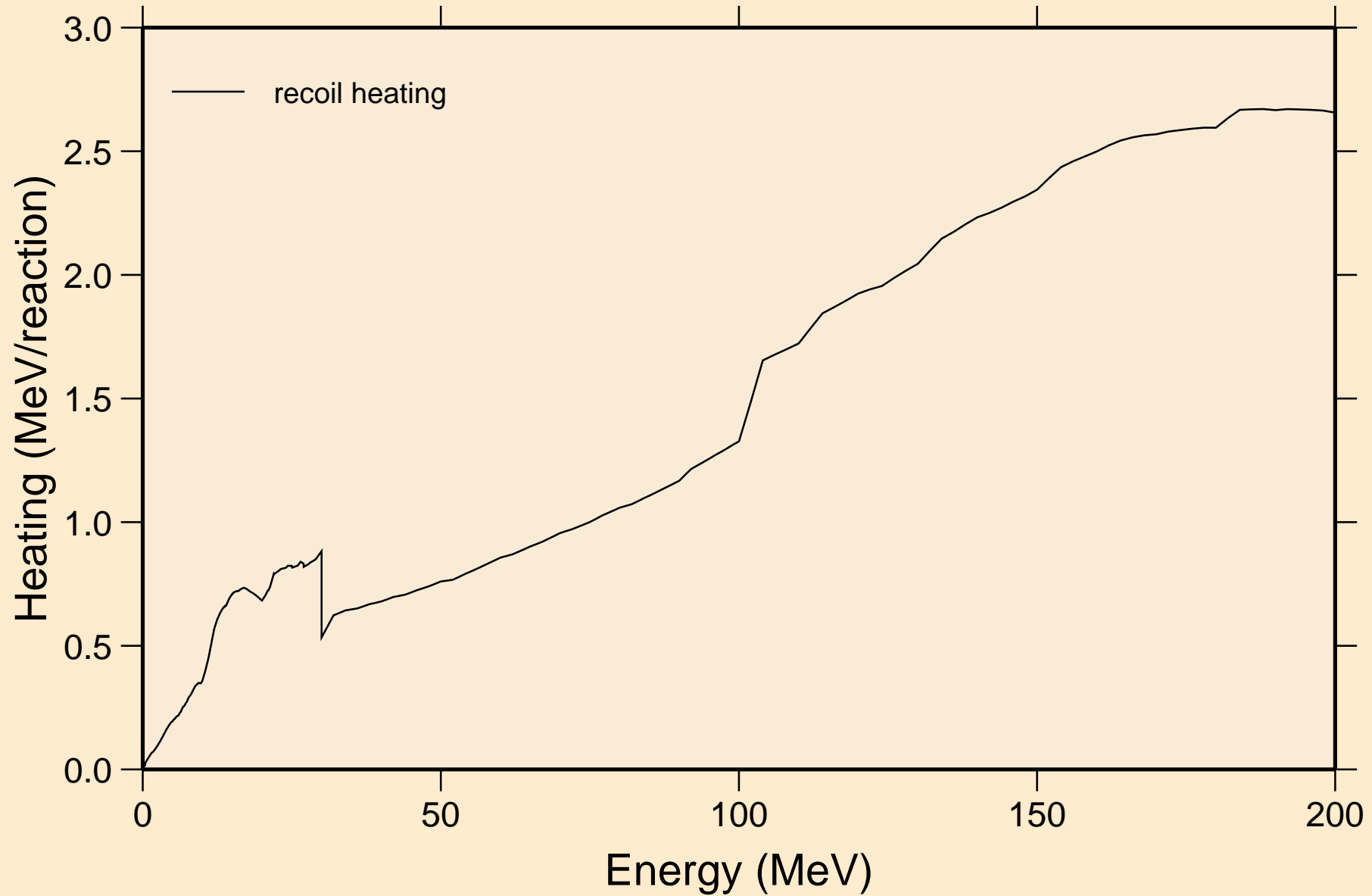

MG028 NEUTRON ACER TENDL-2021 LIBRARY; T=293.6K  
Particle production cross sections

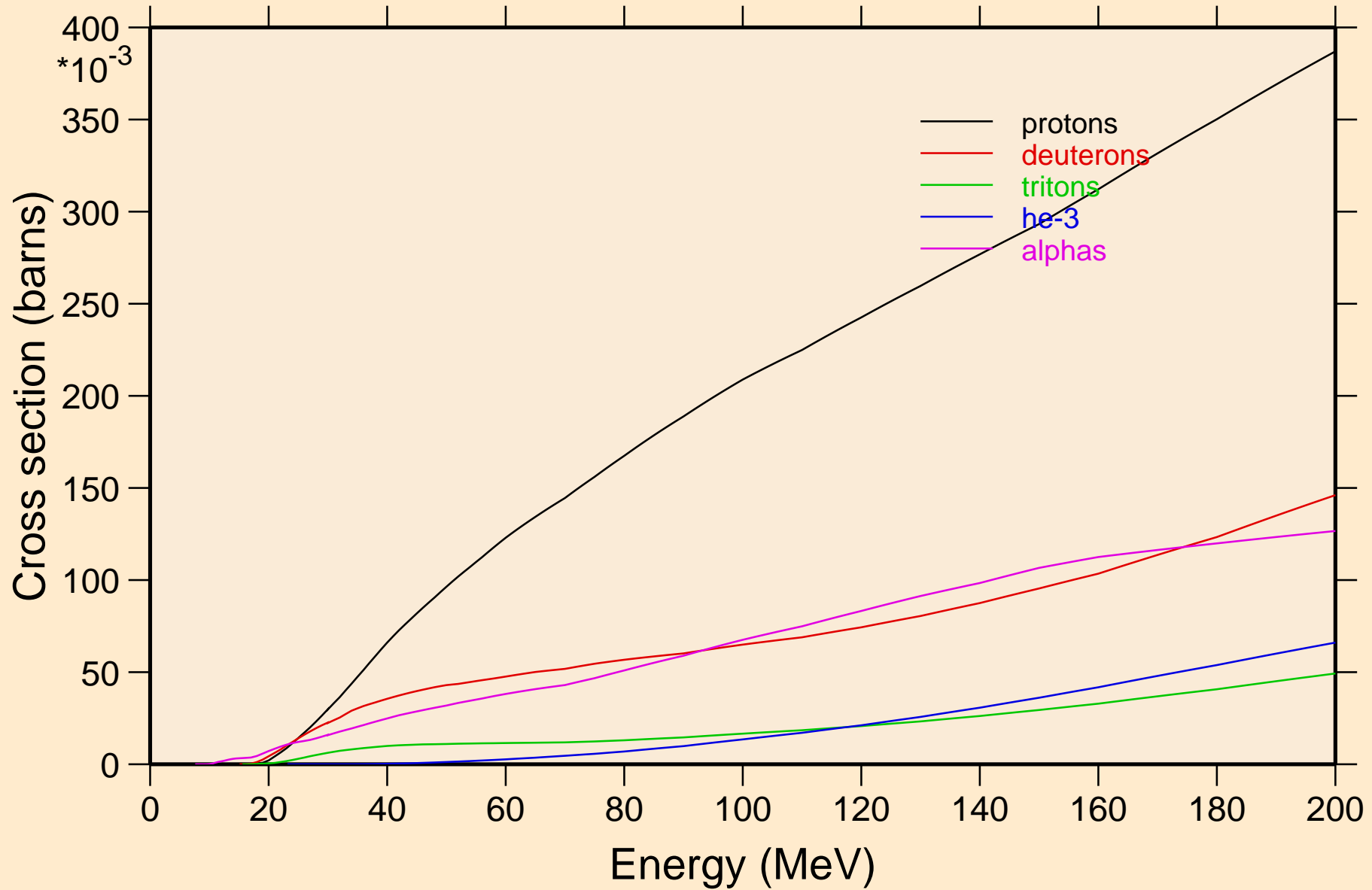

MG028 NEUTRON ACER TENDL-2021 LIBRARY; T=293.6K  
protons from (n,x)

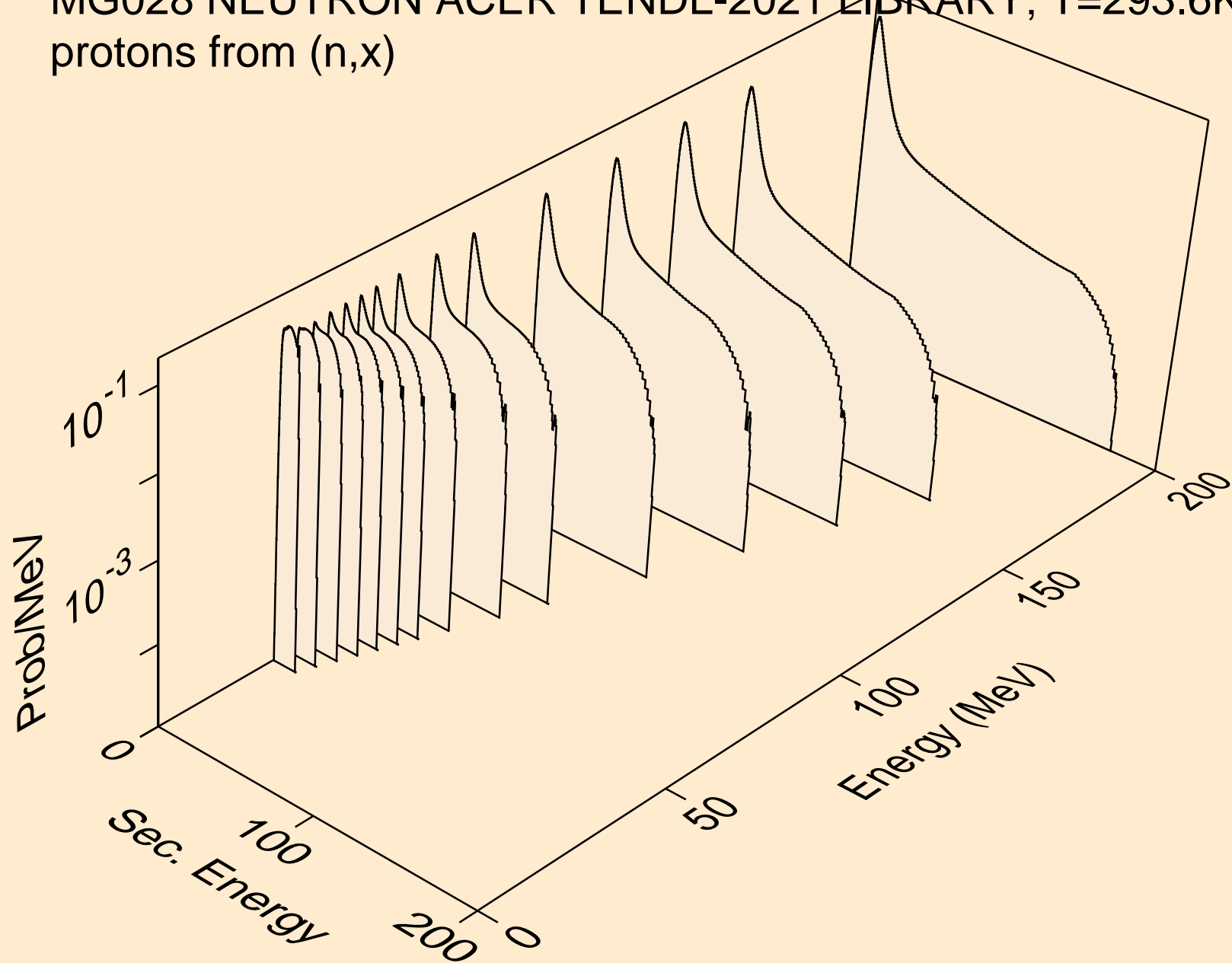



MG028 NEUTRON ACER TENDL-2021 LIBRARY; T=293.6K  
protons from (n,n\*)p

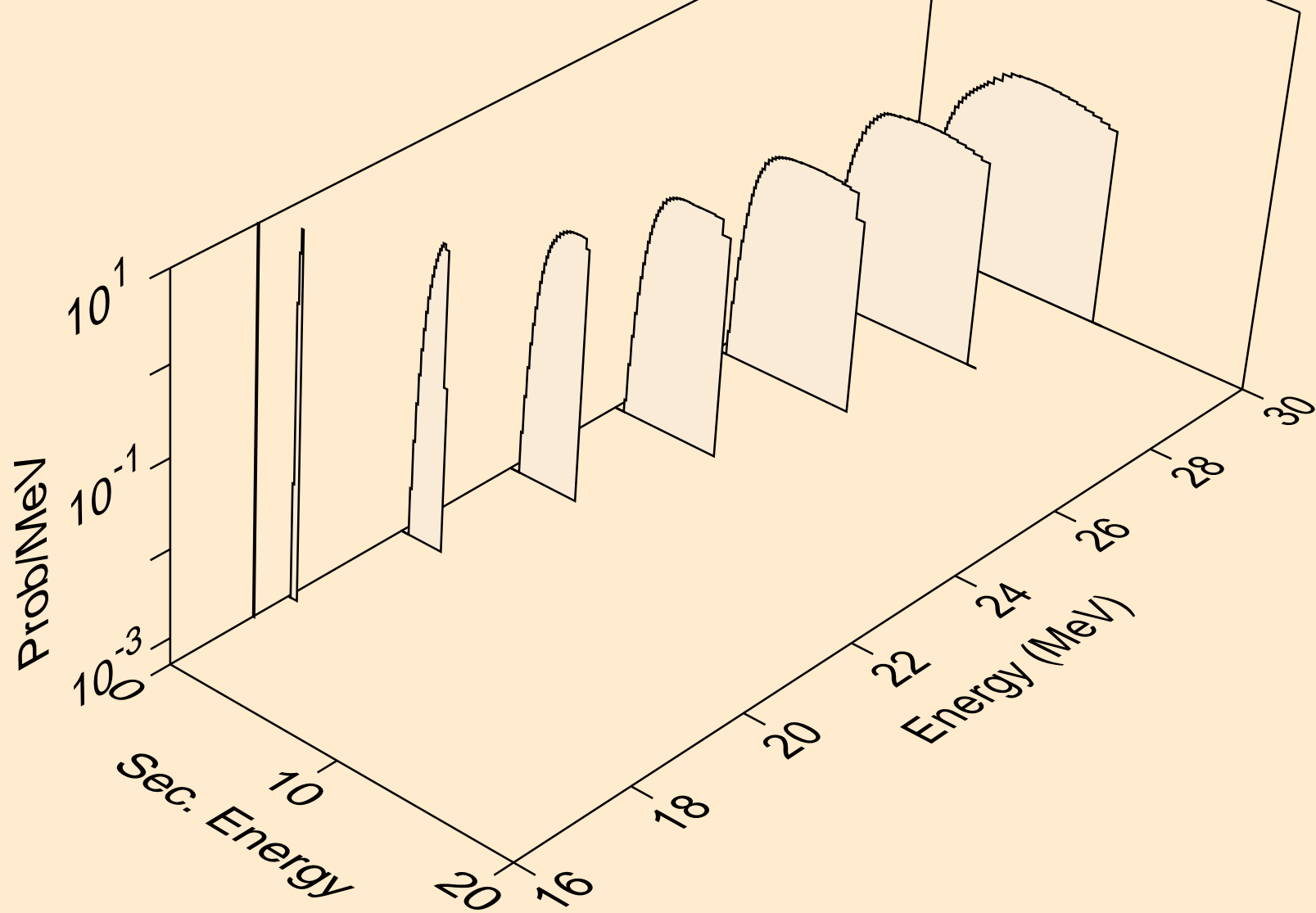

MG028 NEUTRON ACER TENDL-2021 LIBRARY; T=293.6K  
protons from (n,2np)

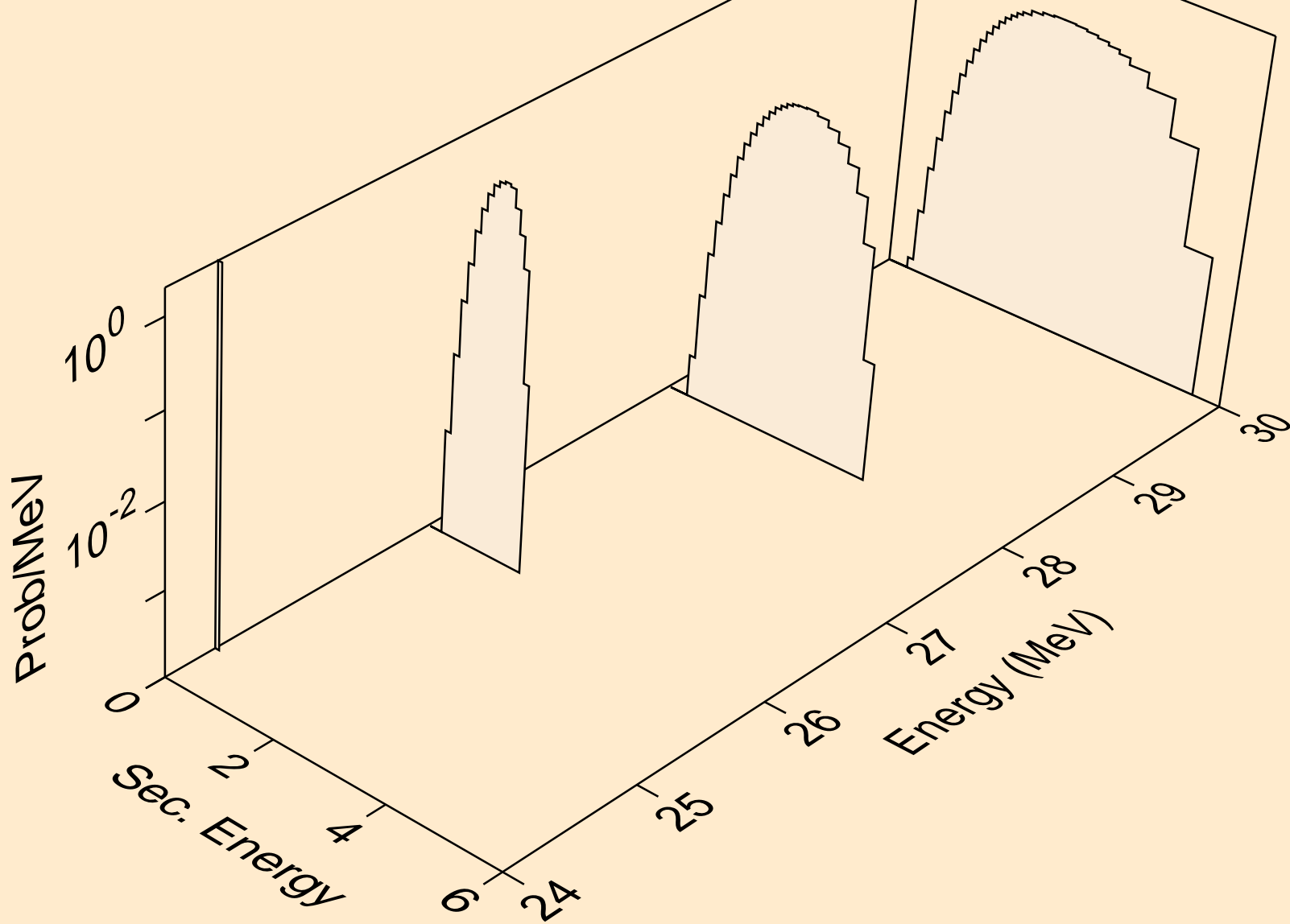

MG028 NEUTRON ACER TENDL-2021 LIBRARY; T=293.6K  
protons from (n,p)

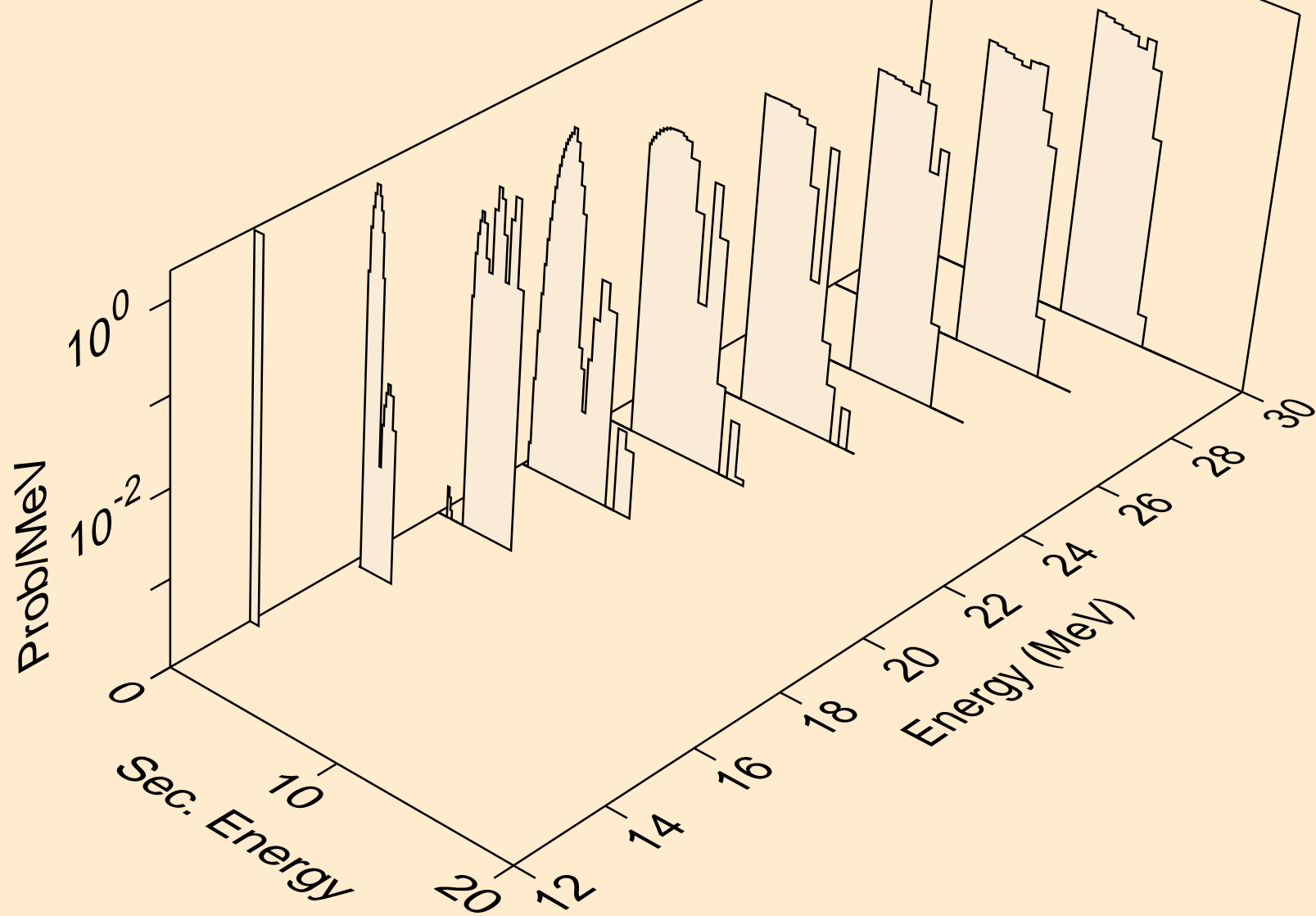

MG028 NEUTRON ACER TENDL-2021 LIBRARY; T=293.6K  
protons from (n,p)

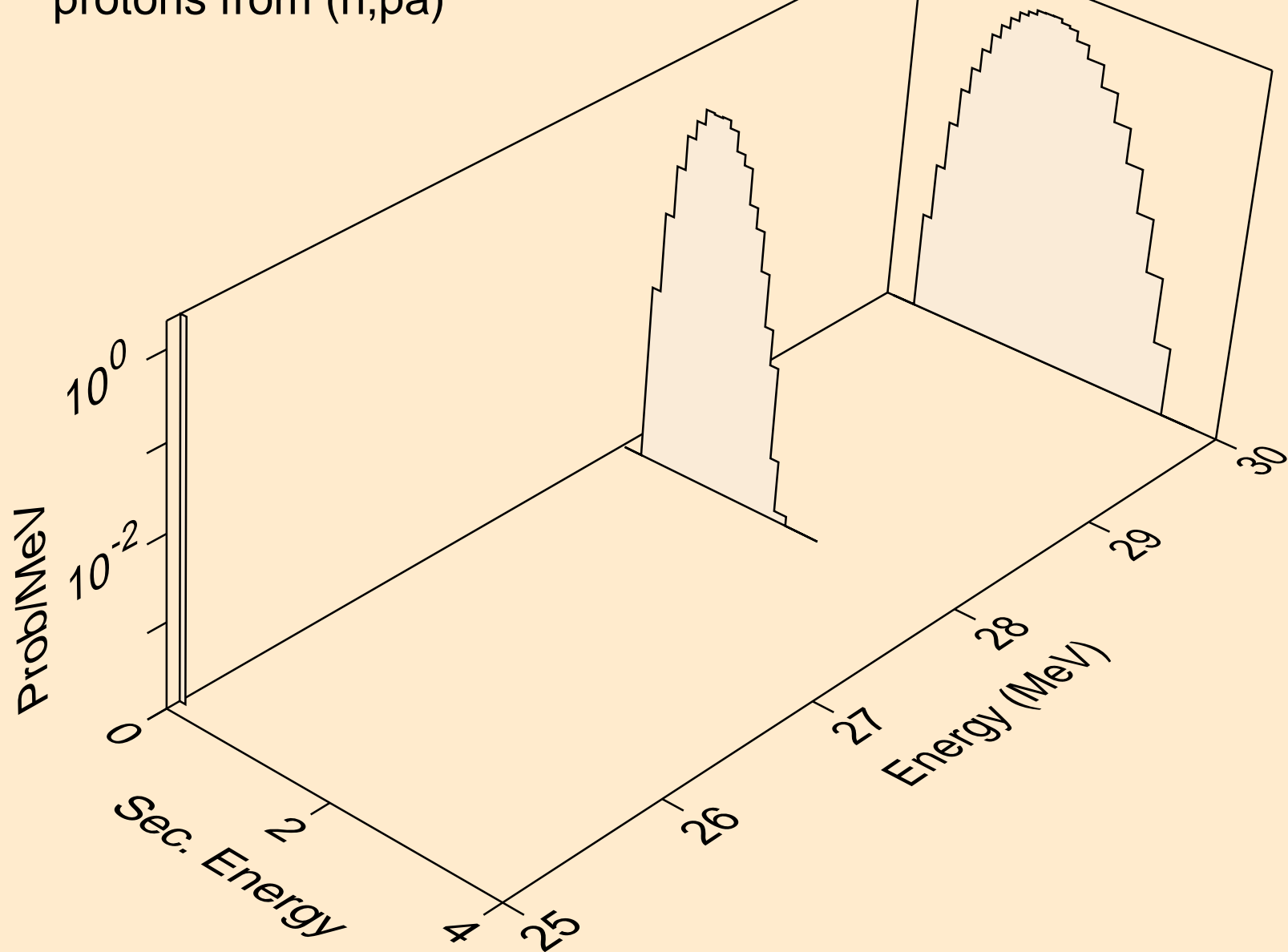

MG028 NEUTRON ACER TENDL-2021 LIBRARY; T=293.6K  
deuterons from (n,x)

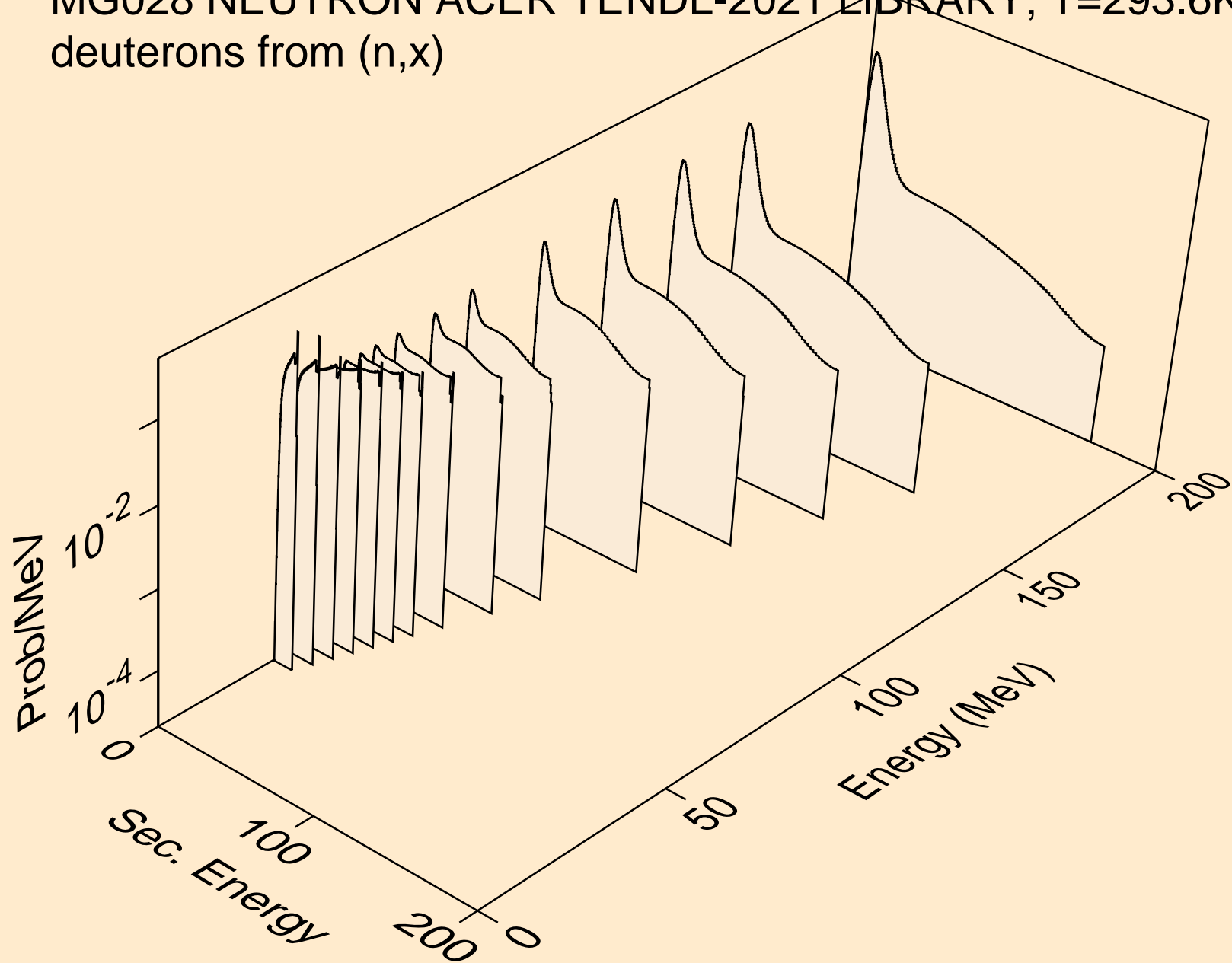

MG028 NEUTRON ACER TENDL-2021 LIBRARY; T=293.6K  
deuterons from (n,2nd)

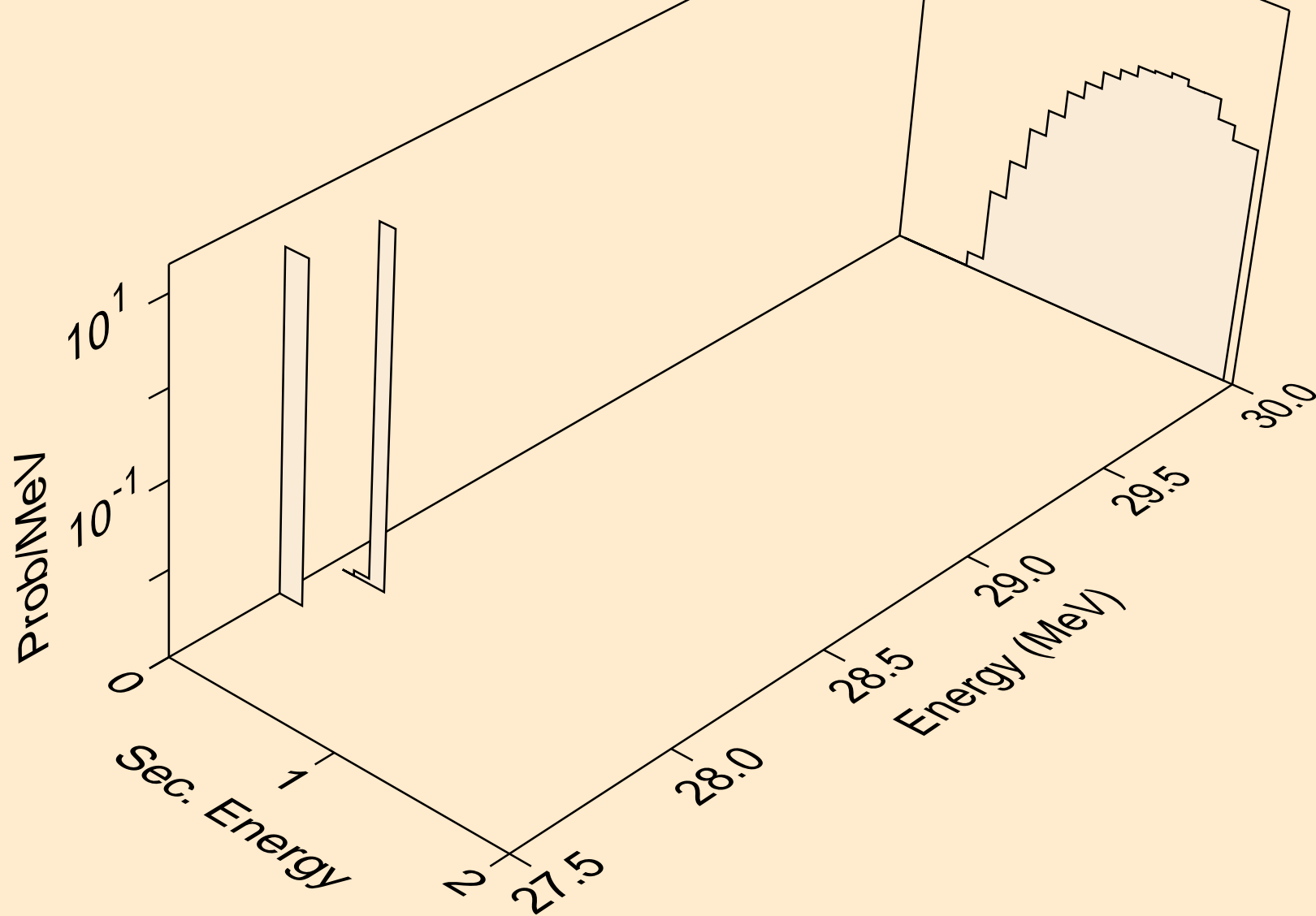

MG028 NEUTRON ACER TENDL-2021 LIBRARY; T=293.6K  
deuterons from (n,n\*)d

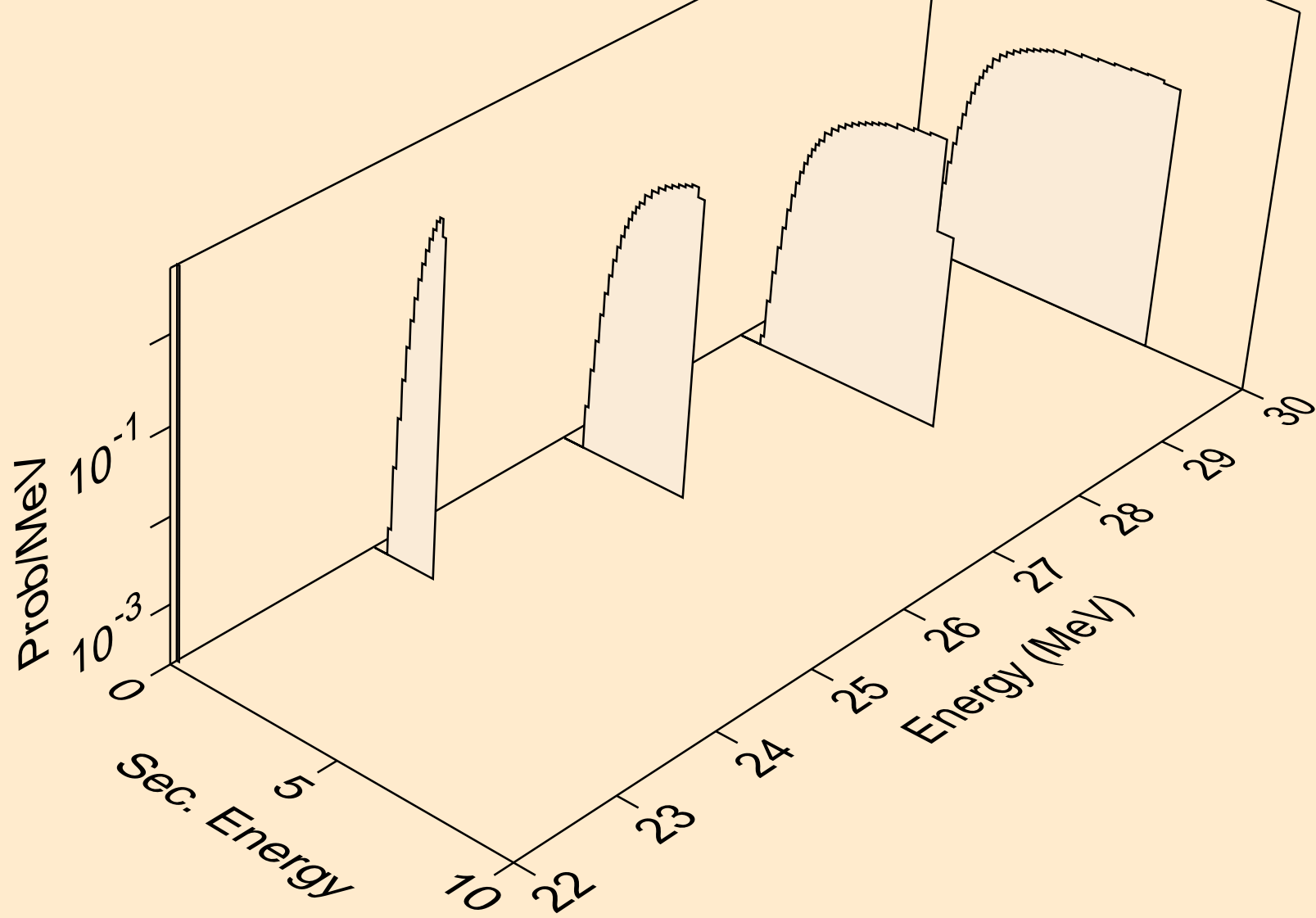

MG028 NEUTRON ACER TENDL-2021 LIBRARY; T=293.6K  
deuterons from (n,d)

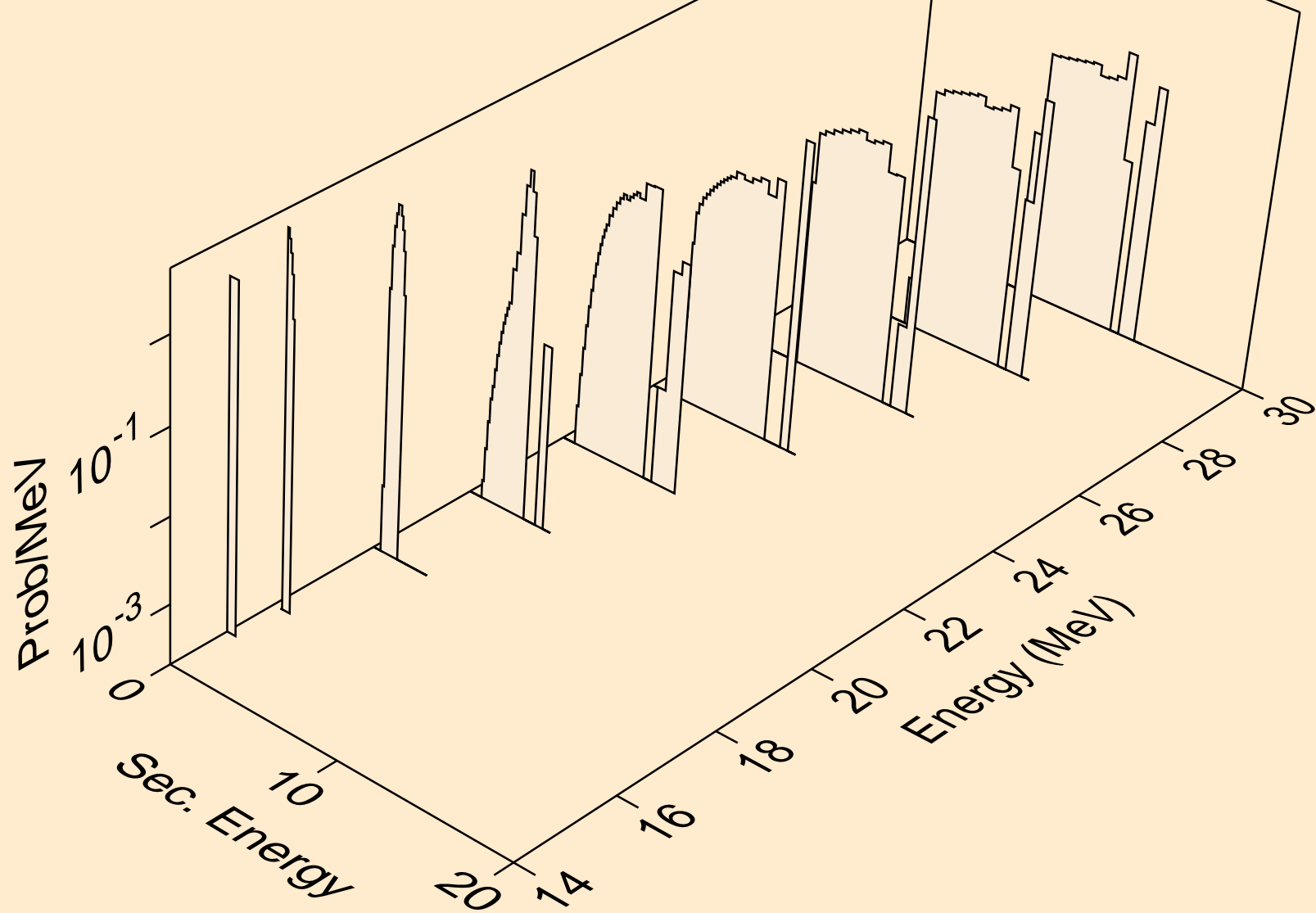



MG028 NEUTRON ACER TENDL-2021 LIBRARY; T=293.6K  
tritons from (n,x)

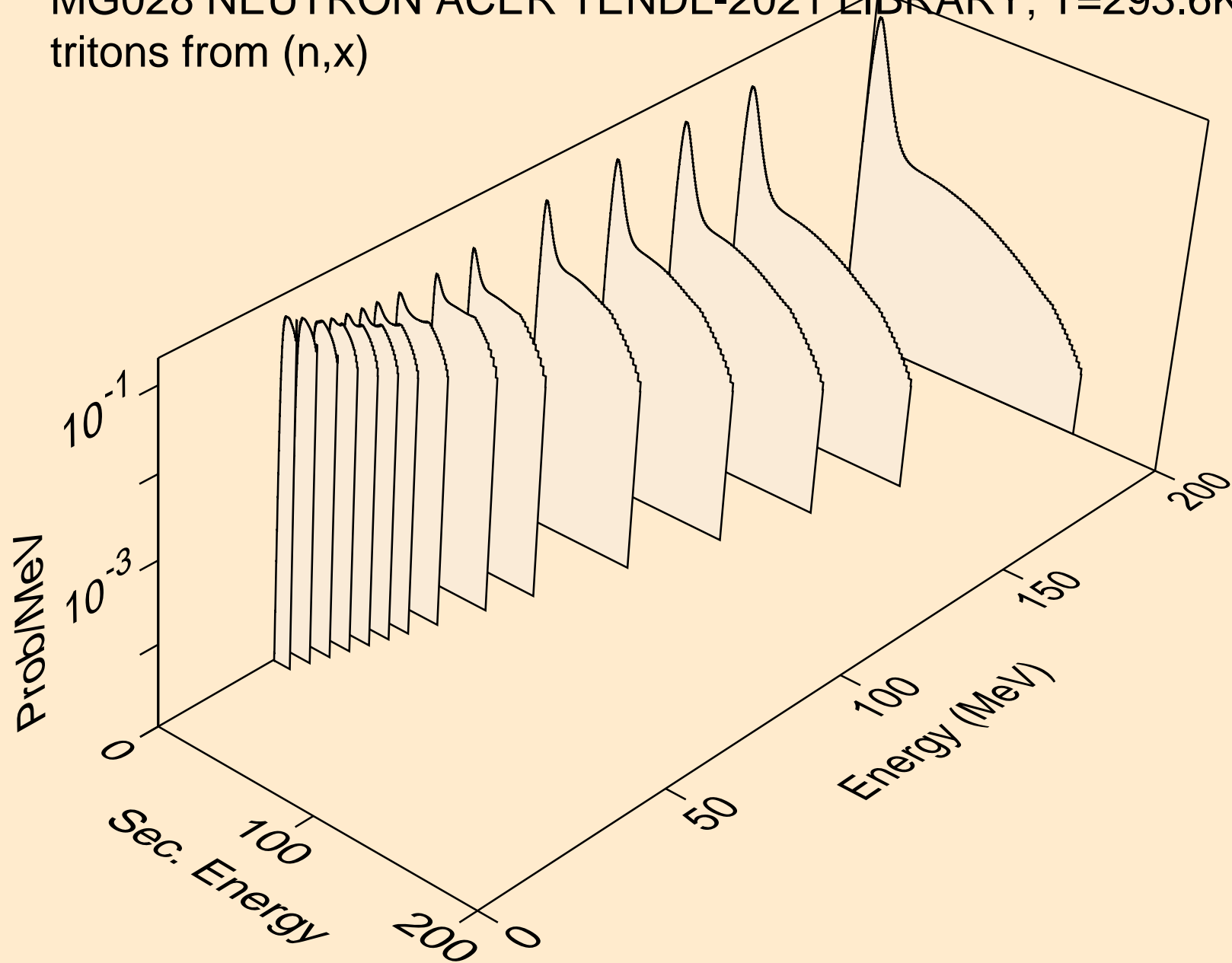

MG028 NEUTRON ACER TENDL-2021 LIBRARY; T=293.6K  
tritons from (n,n\*)t

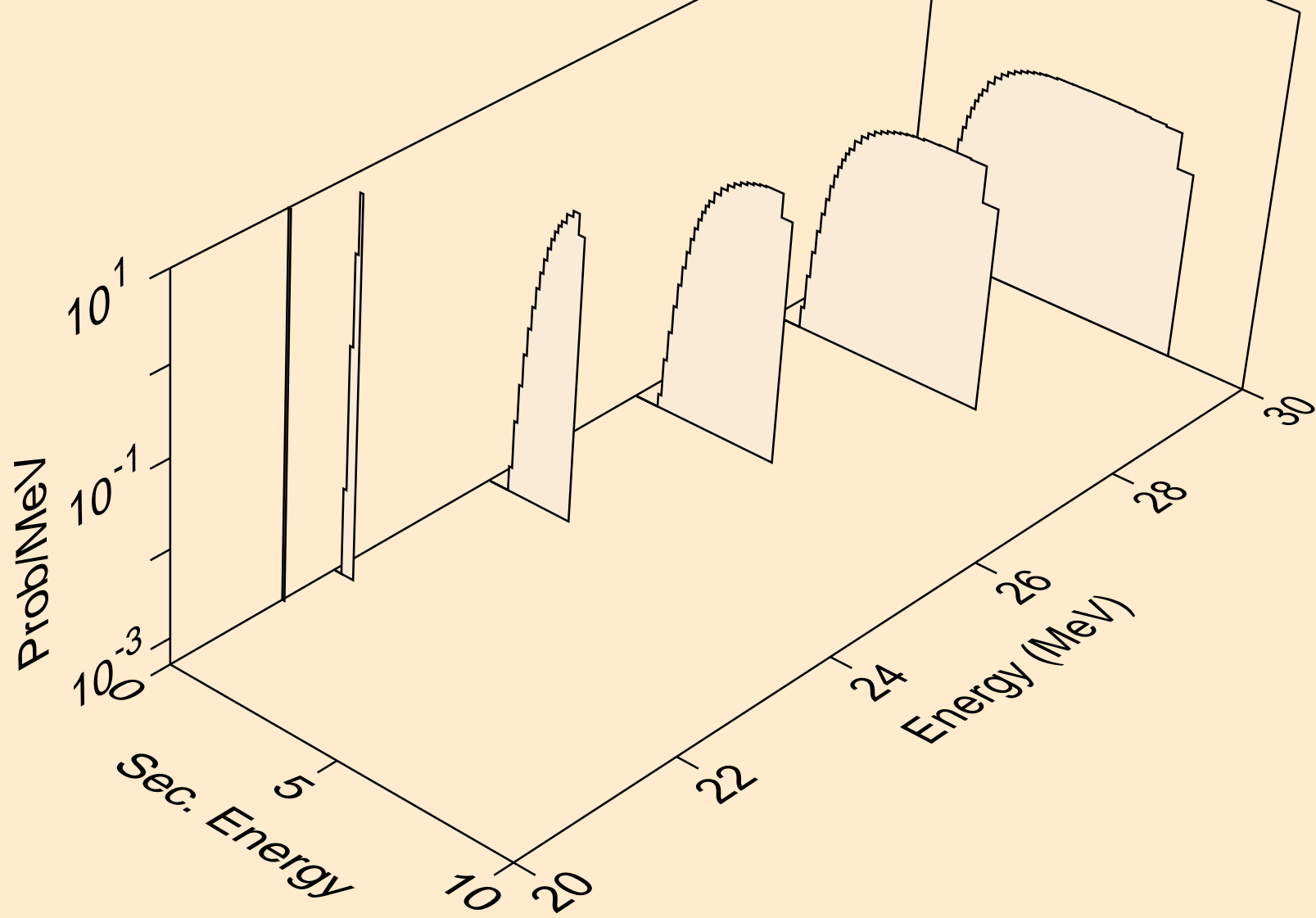

MG028 NEUTRON ACER TENDL-2021 LIBRARY; T=293.6K  
tritons from (n,t)

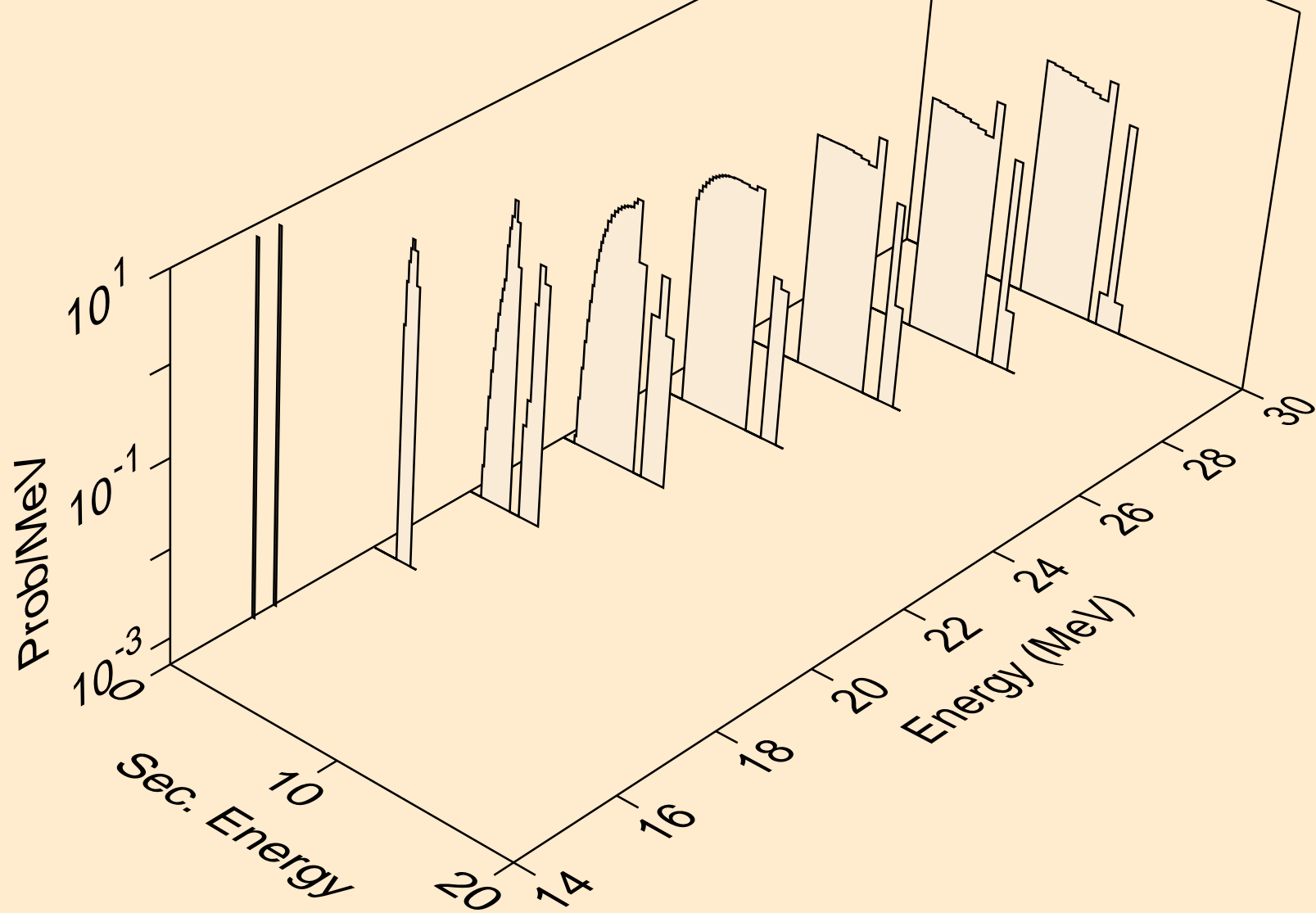

MG028 NEUTRON ACER TENDL-2021 LIBRARY; T=293.6K  
he3s from (n,x)

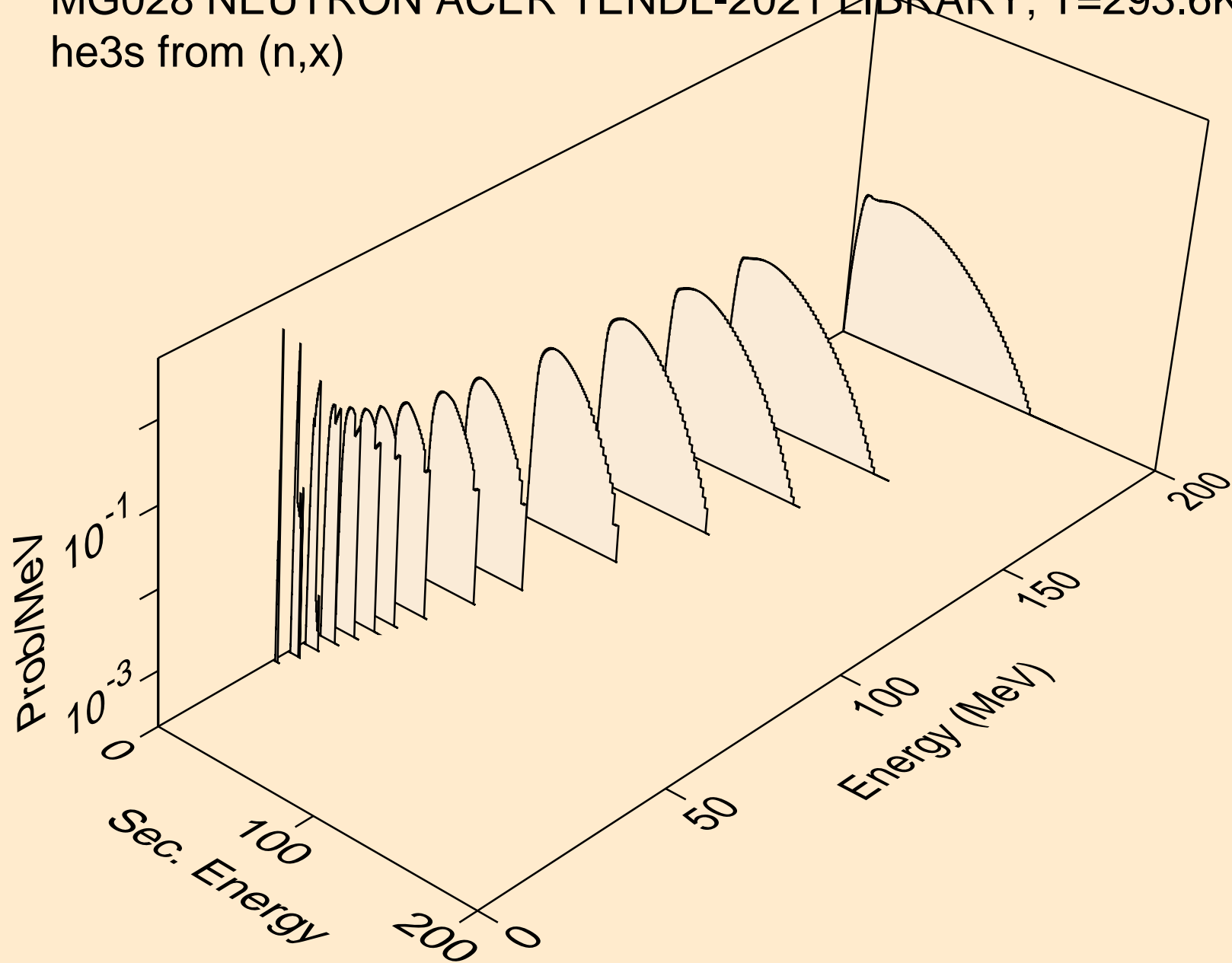

MG028 NEUTRON ACER TENDL-2021 LIBRARY; T=293.6K  
he3s from (n,he3)

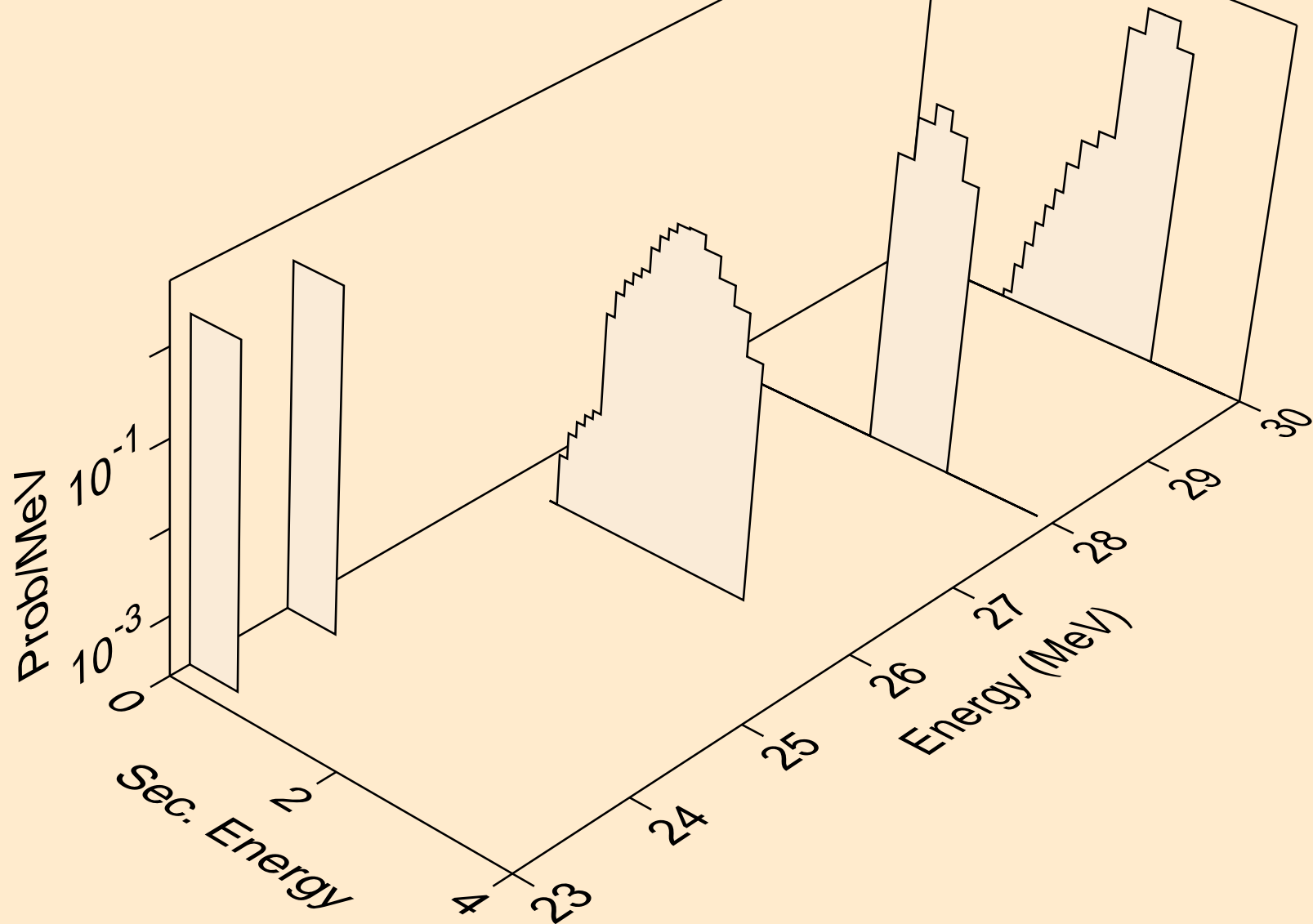

MG028 NEUTRON ACER TENDL-2021 LIBRARY; T=293.6K  
alphas from (n,x)

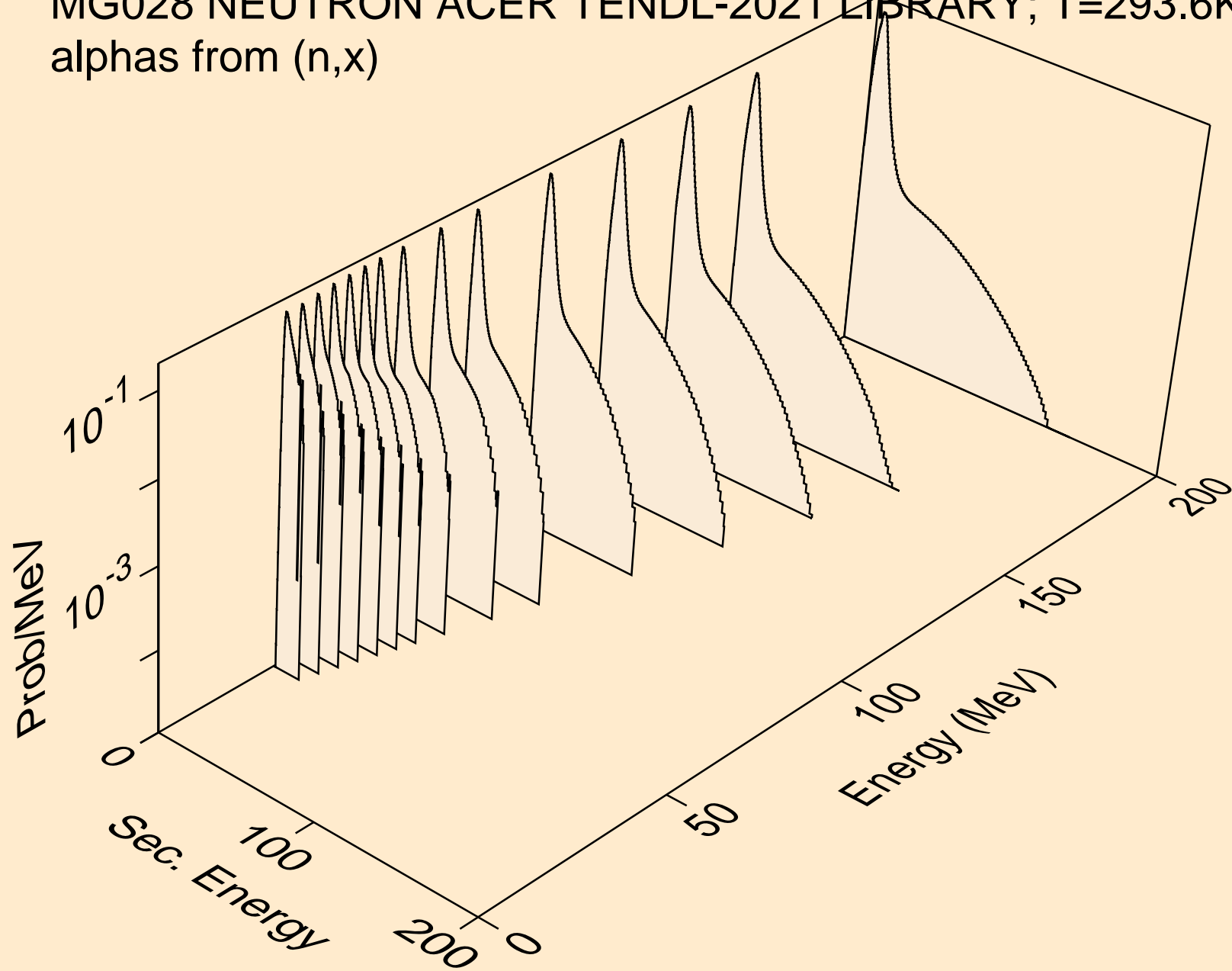

MG028 NEUTRON ACER TENDL-2021 LIBRARY; T=293.6K  
alphas from (n,n\*)a

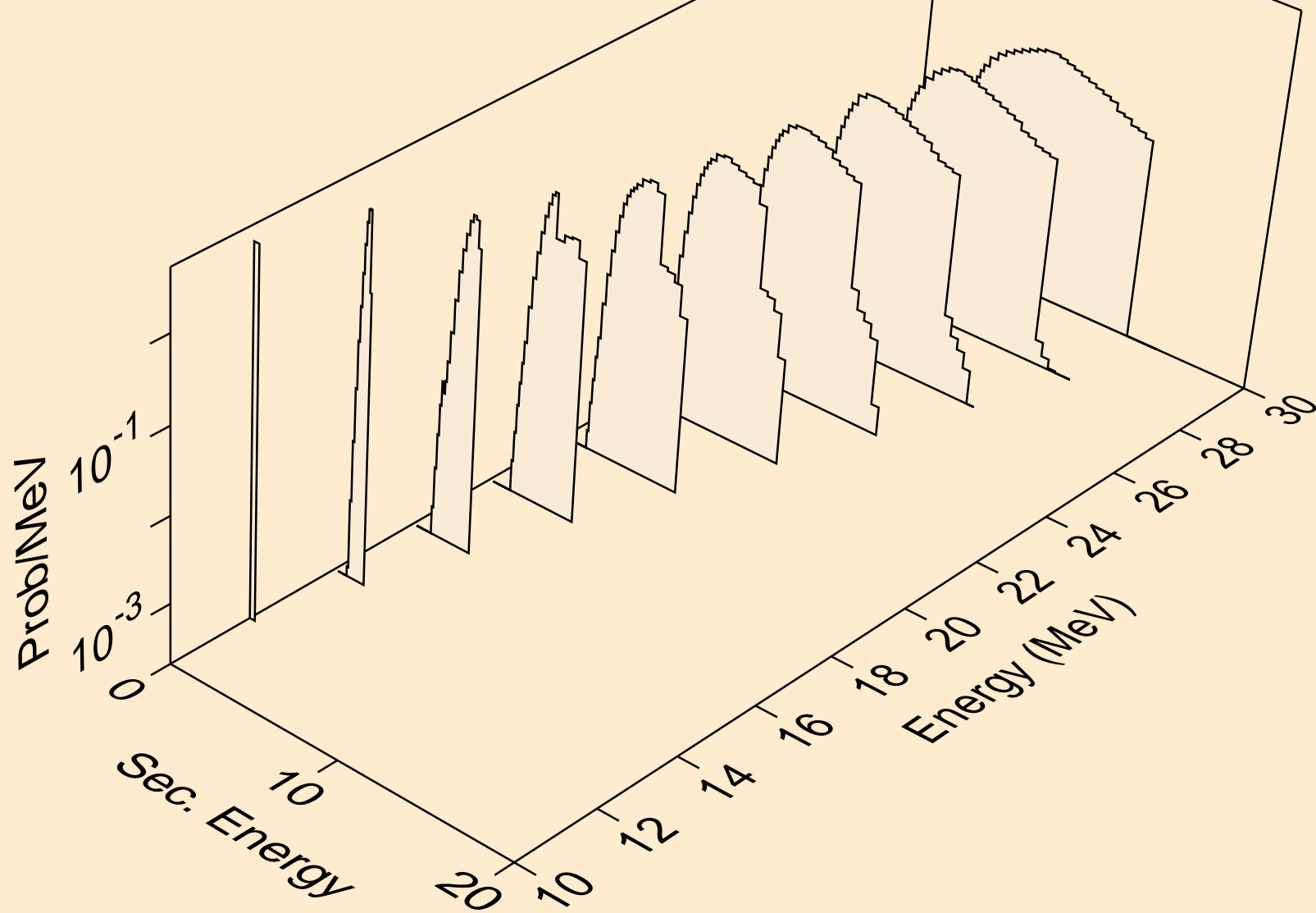

MG028 NEUTRON ACER TENDL-2021 LIBRARY; T=293.6K  
alphas from (n,2n)a

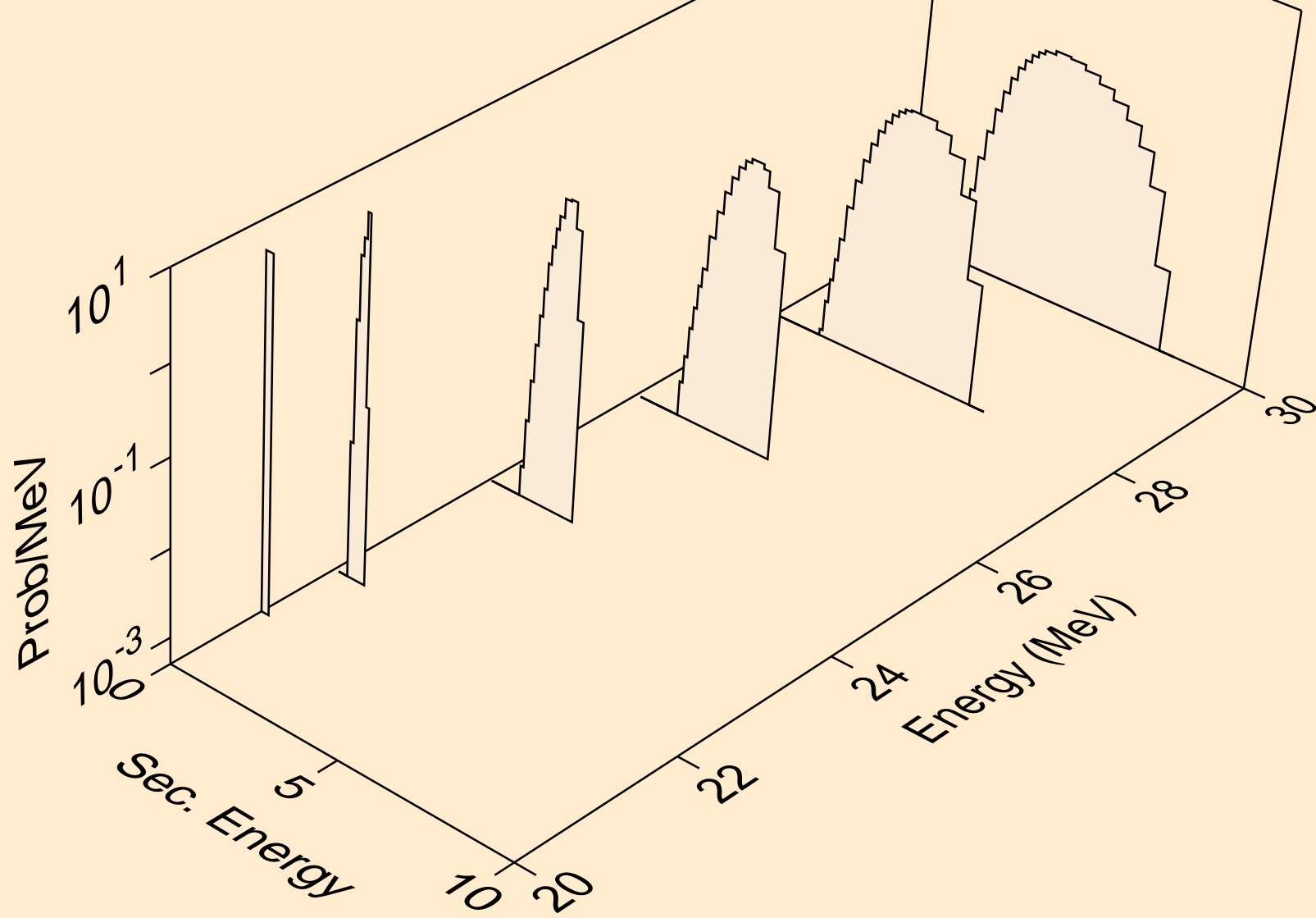



MG028 NEUTRON ACER TENDL-2021 LIBRARY; T=293.6K  
alphas from (n,3n)a

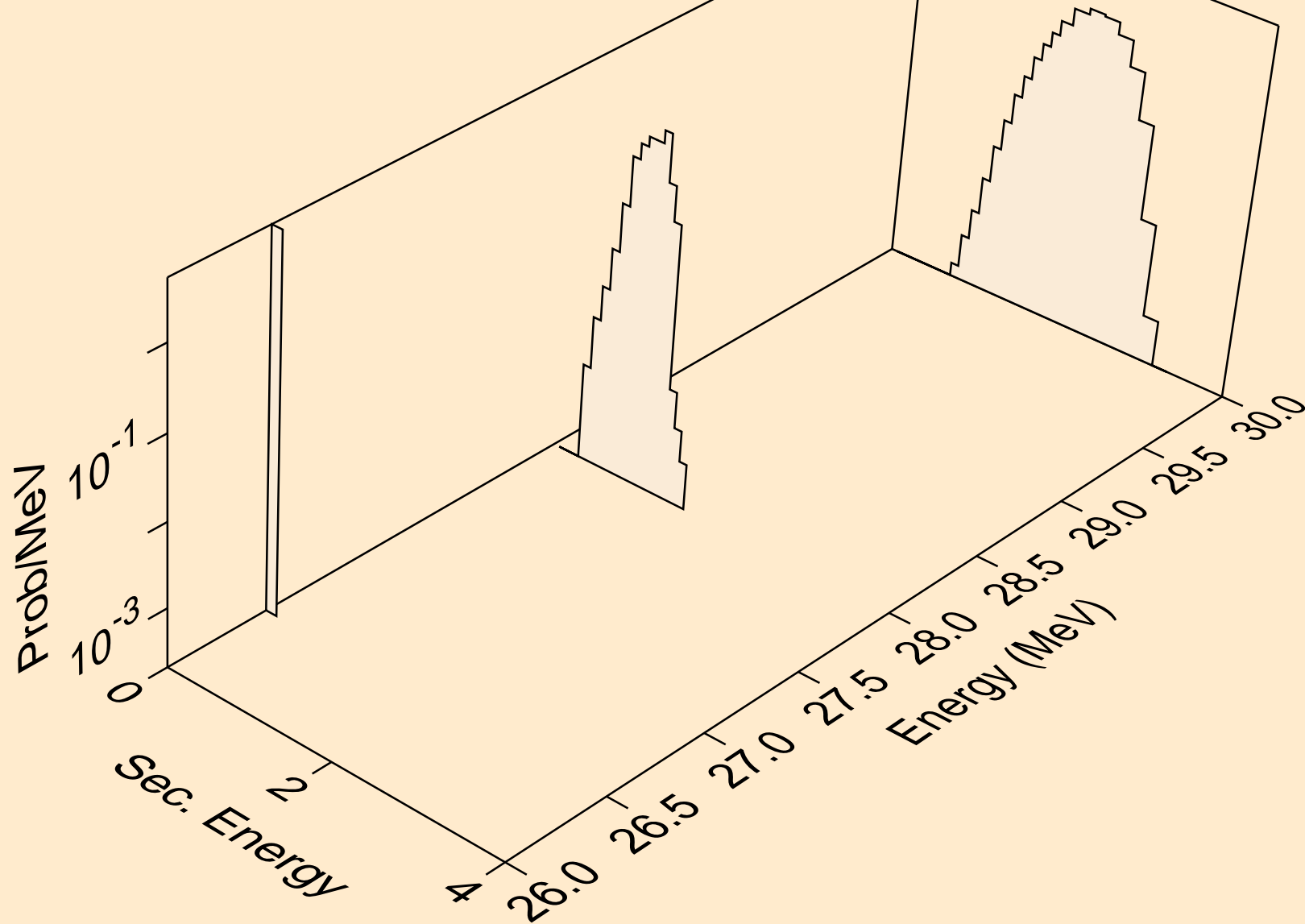

MG028 NEUTRON ACER TENDL-2021 LIBRARY; T=293.6K  
alphas from (n,a)

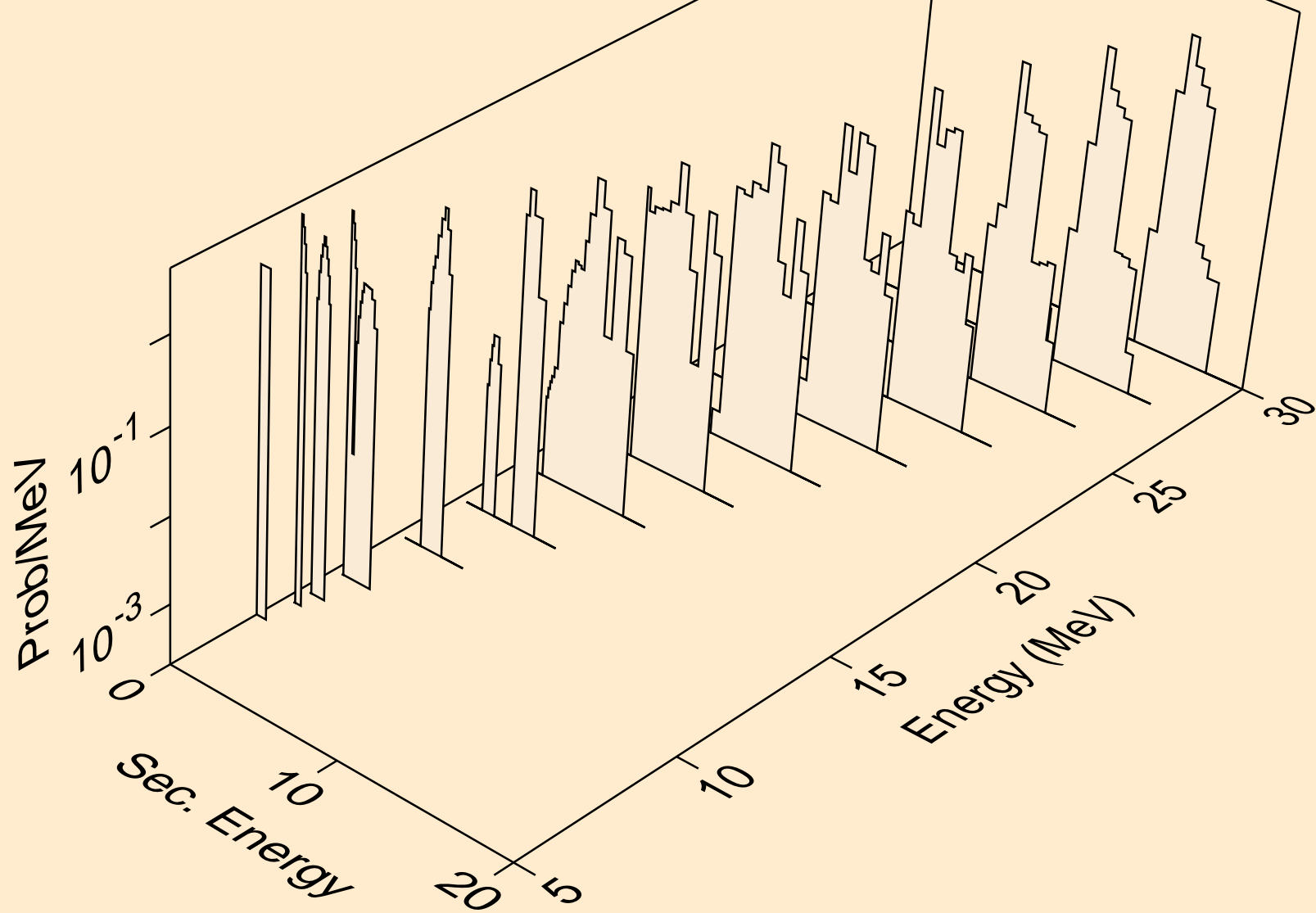

MG028 NEUTRON ACER TENDL-2021 LIBRARY; T=293.6K  
alphas from (n,2a)

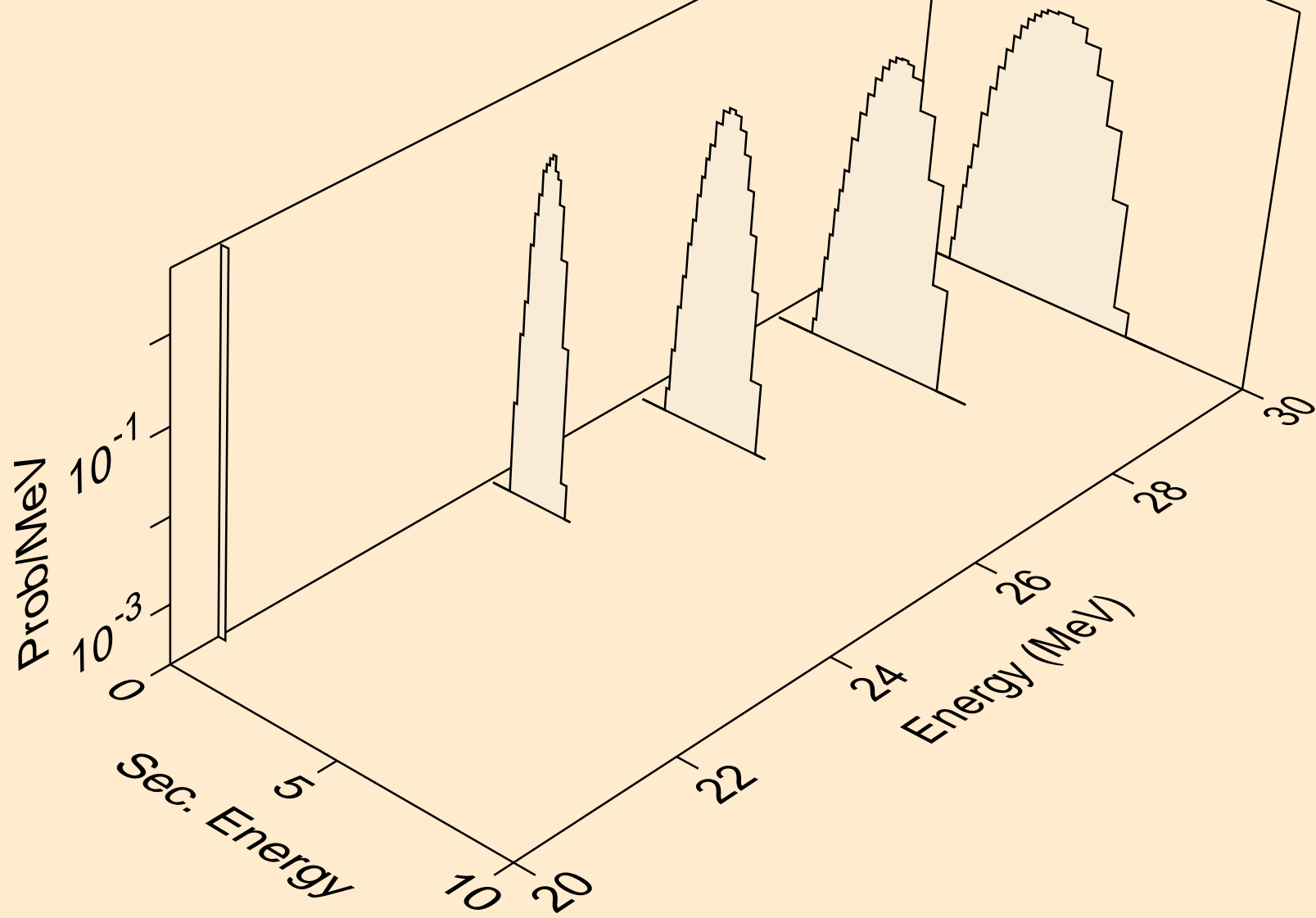

MG028 NEUTRON ACER TENDL-2021 LIBRARY; T=293.6K  
alphas from (n,pa)

