

MN058 NEUTRON ACER TENDL-2021 LIBRARY; T=293.6K
Principal cross sections

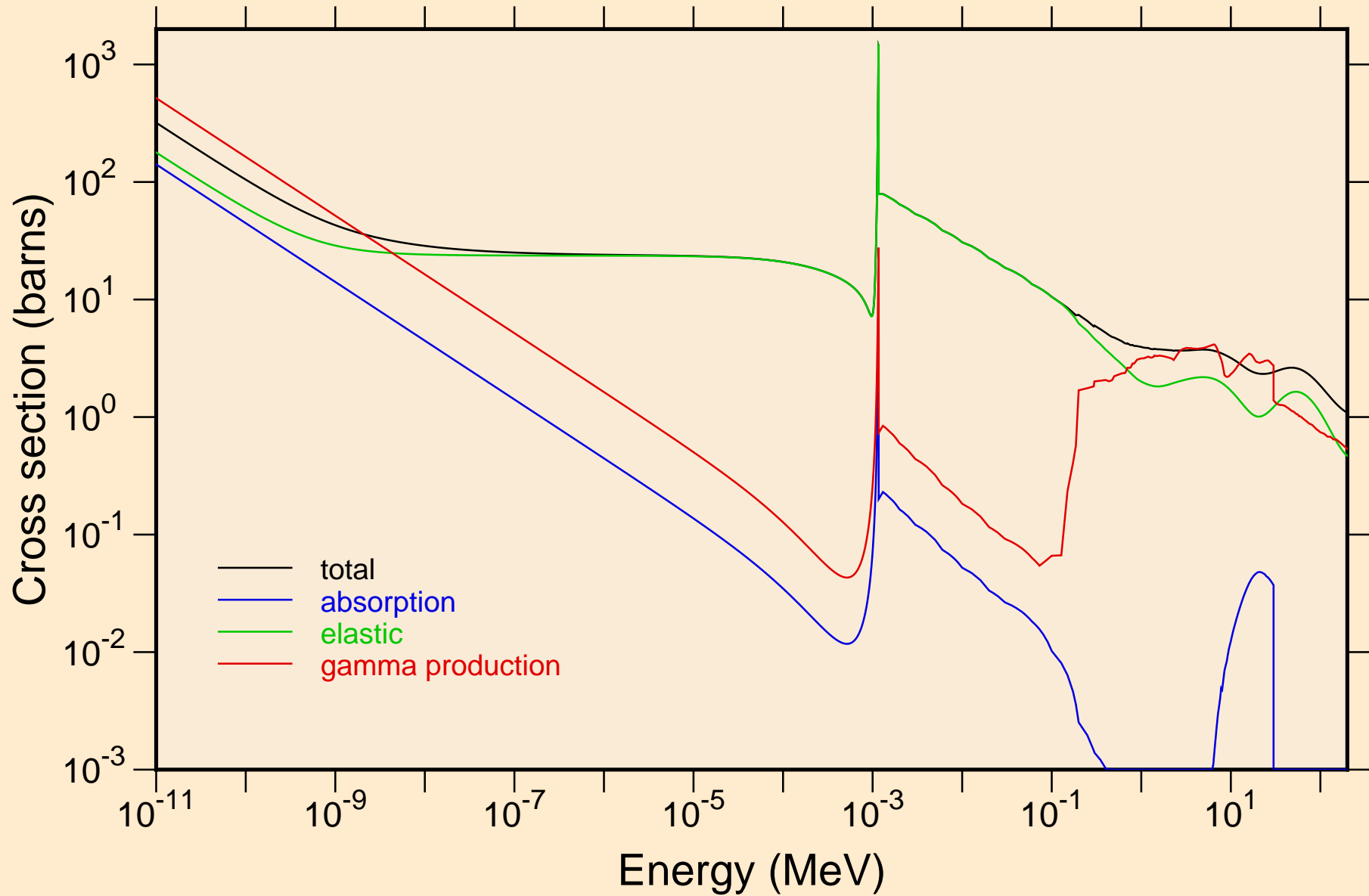

MN058 NEUTRON ACER TENDL-2021 LIBRARY; T=293.6K
Heating

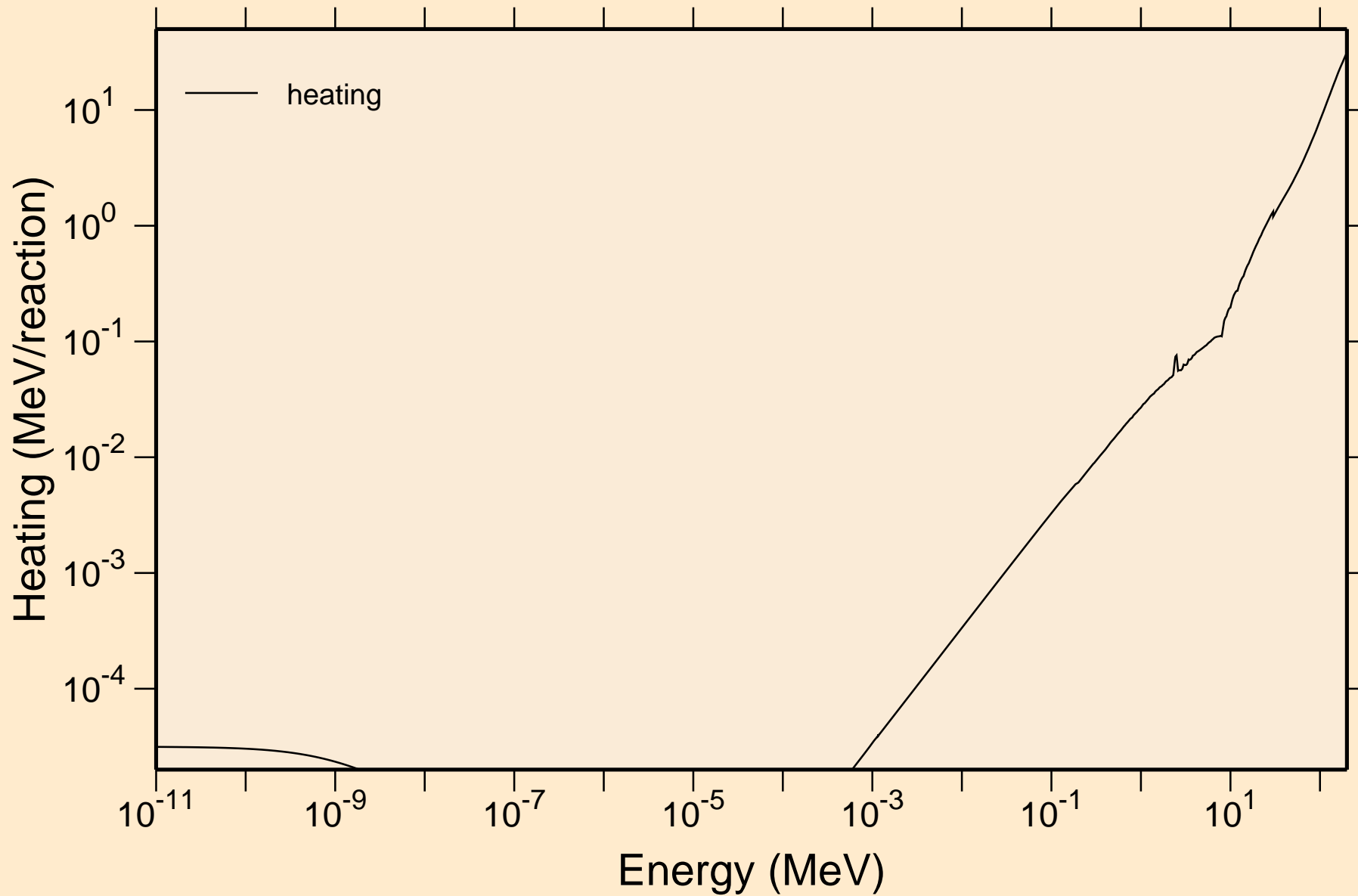

MN058 NEUTRON ACER TENDL-2021 LIBRARY; T=293.6K
Damage

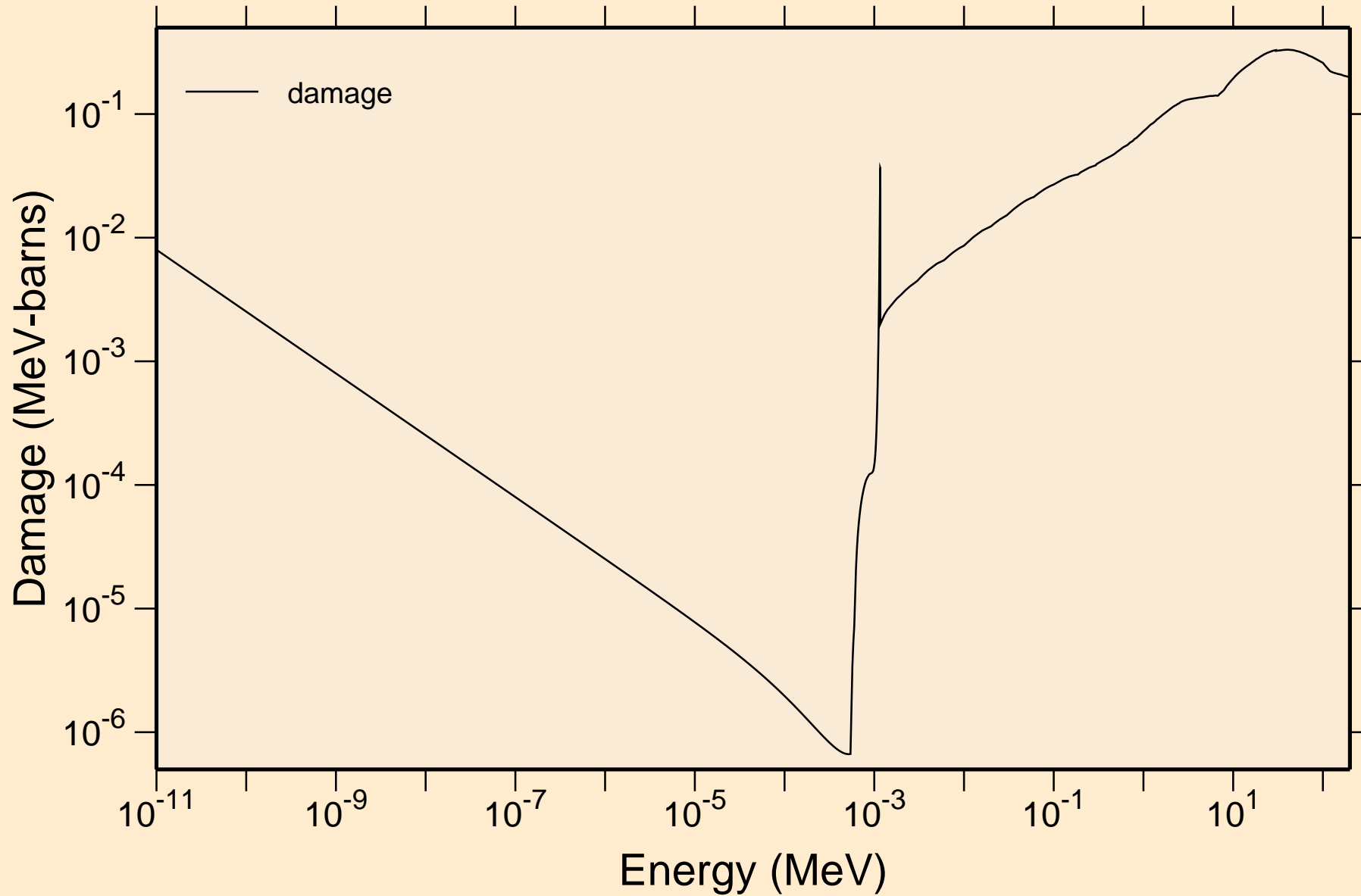

MN058 NEUTRON ACER TENDL-2021 LIBRARY; T=293.6K
Non-threshold reactions

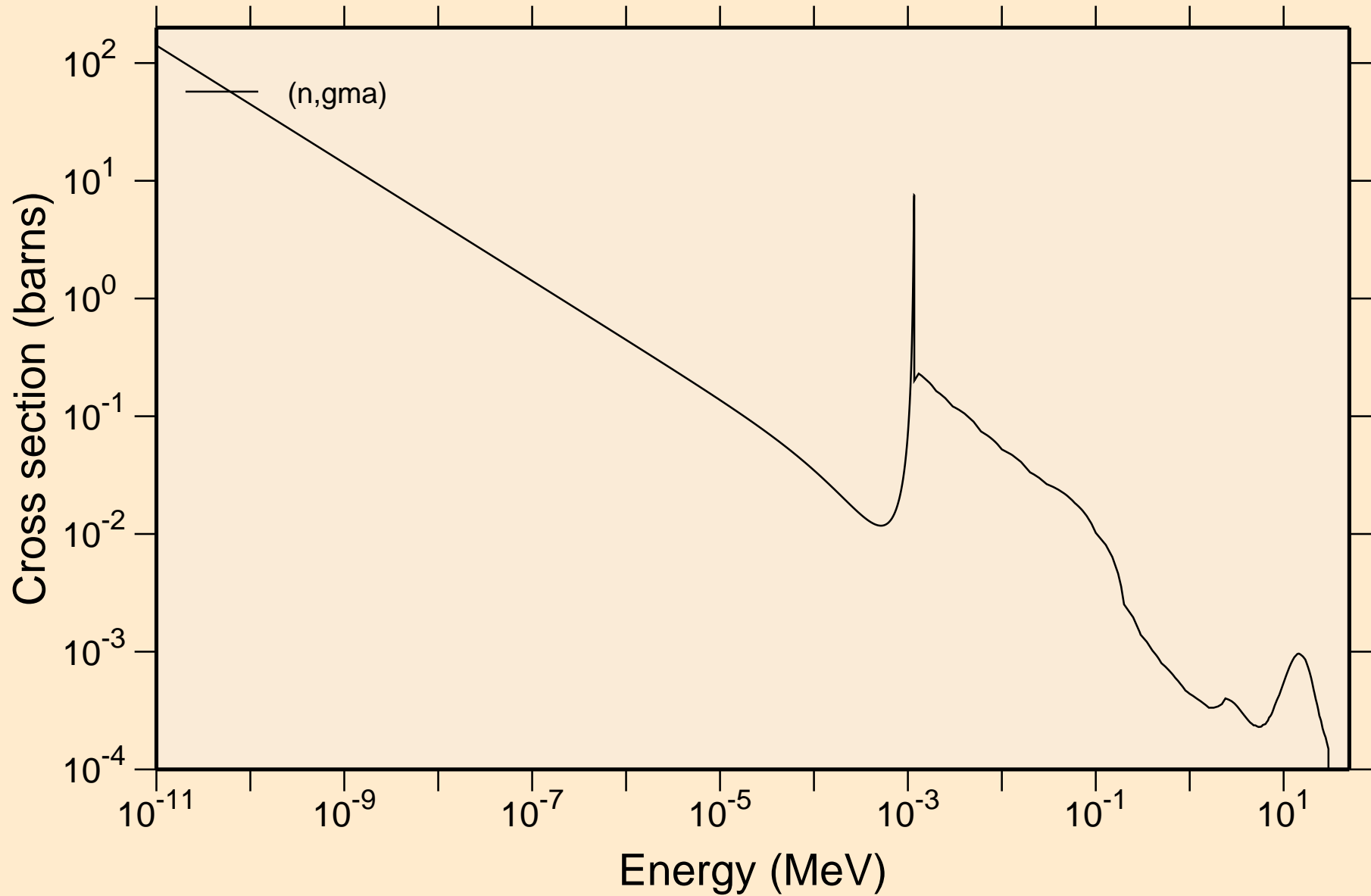

MN058 NEUTRON ACER TENDL-2021 LIBRARY; T=293.6K
Principal cross sections

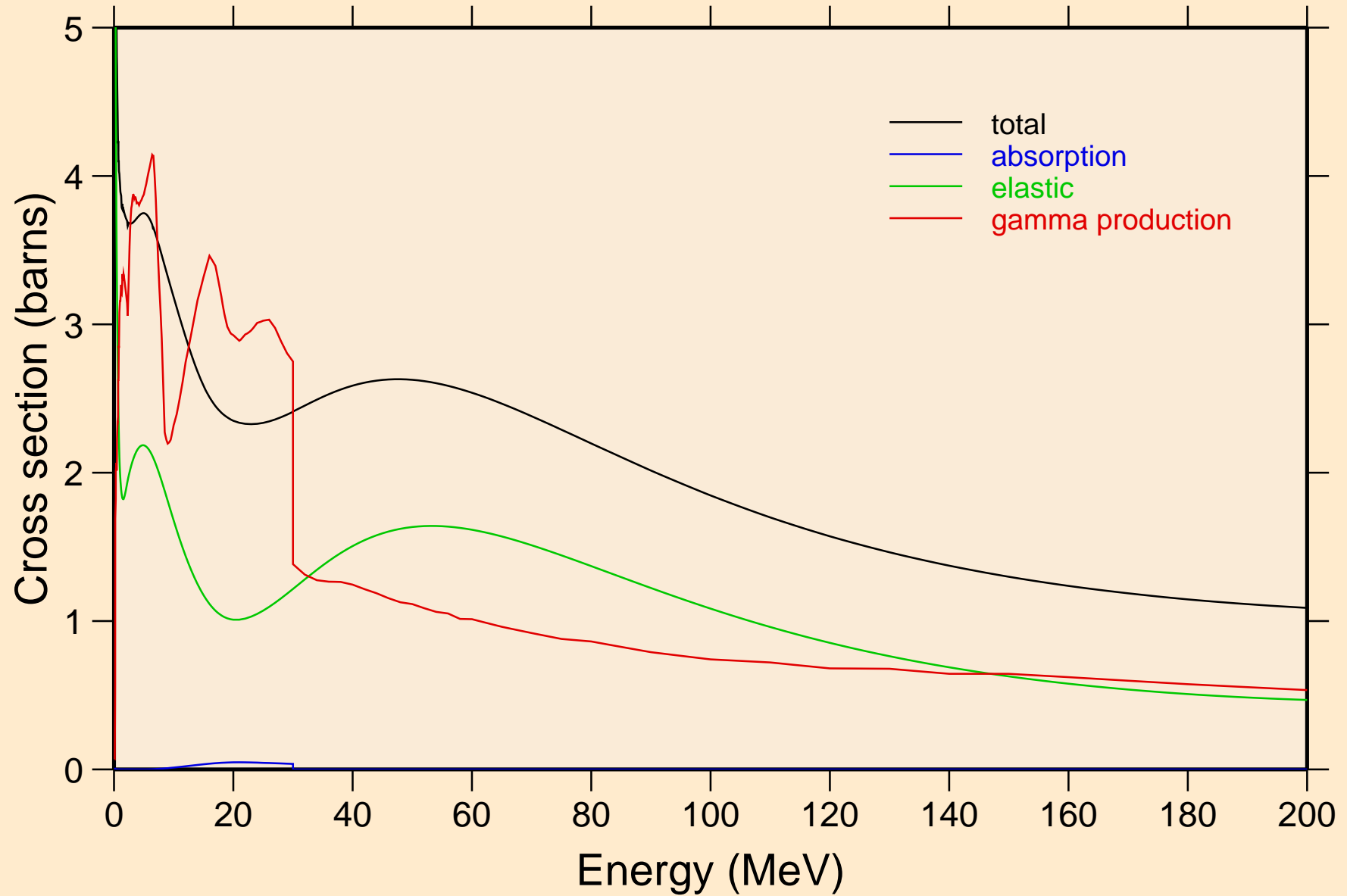

MN058 NEUTRON ACER TENDL-2021 LIBRARY; T=293.6K
Heating

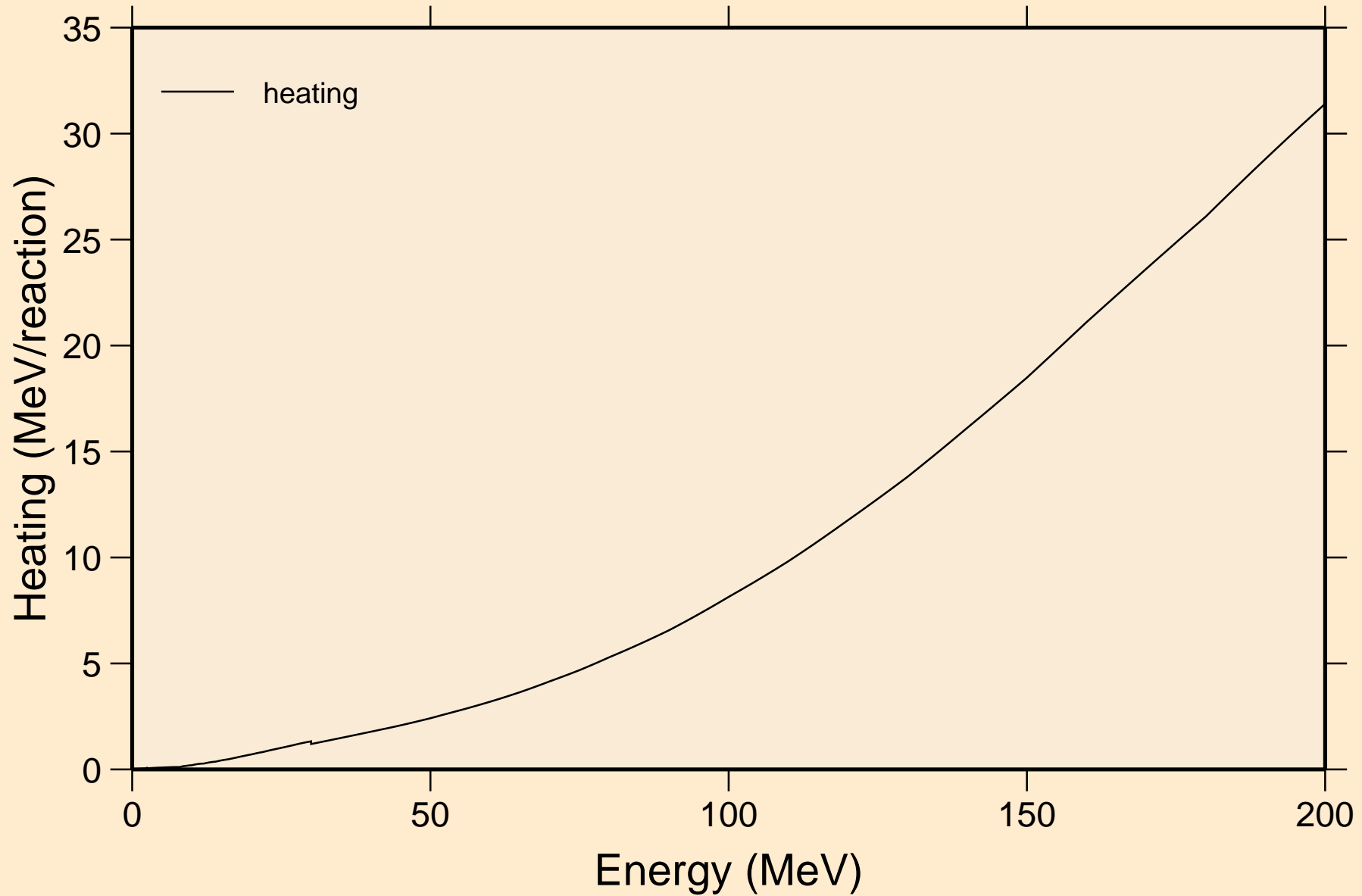

MN058 NEUTRON ACER TENDL-2021 LIBRARY; T=293.6K
Damage

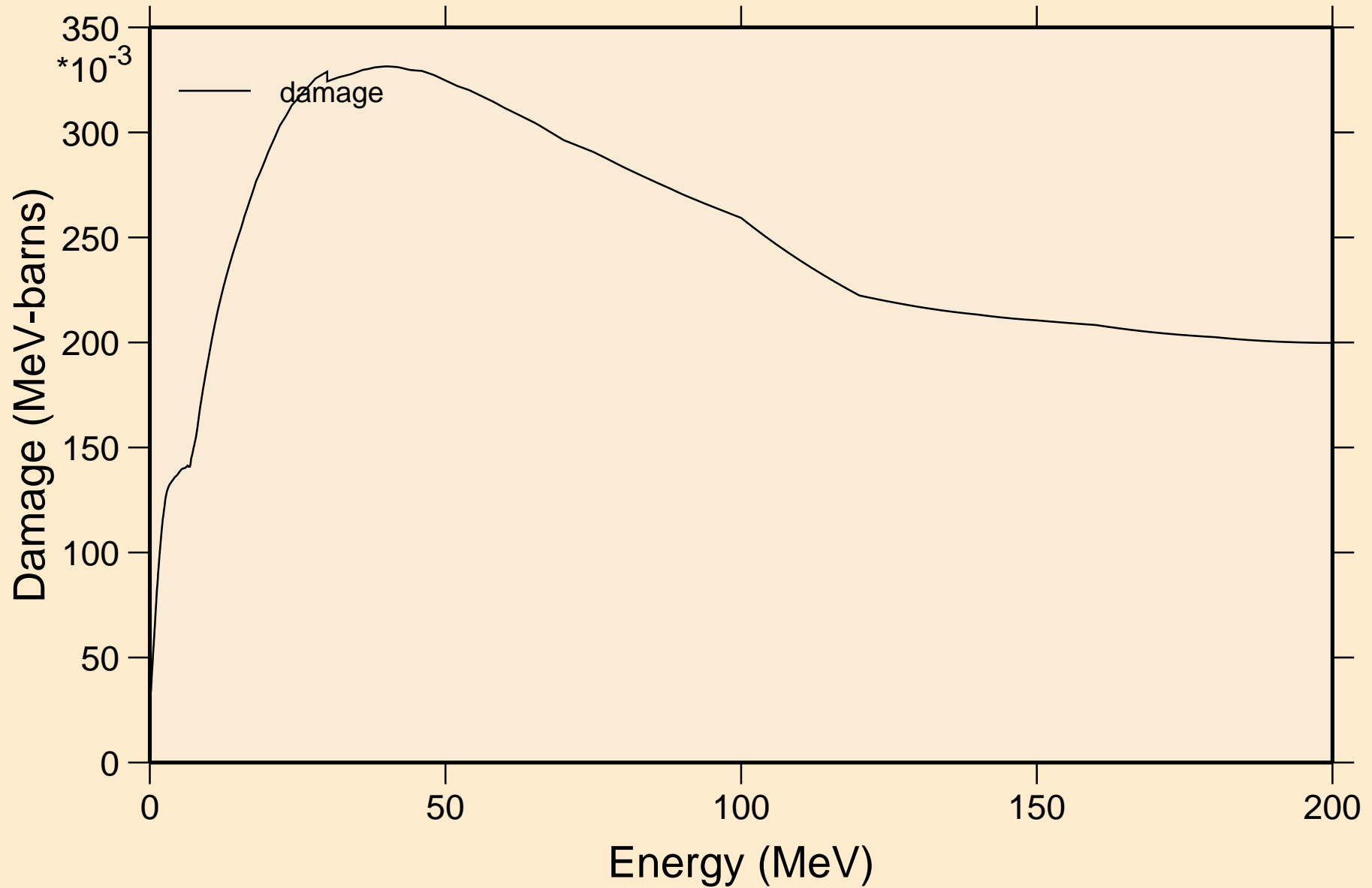

MN058 NEUTRON ACER TENDL-2021 LIBRARY; T=293.6K
Non-threshold reactions

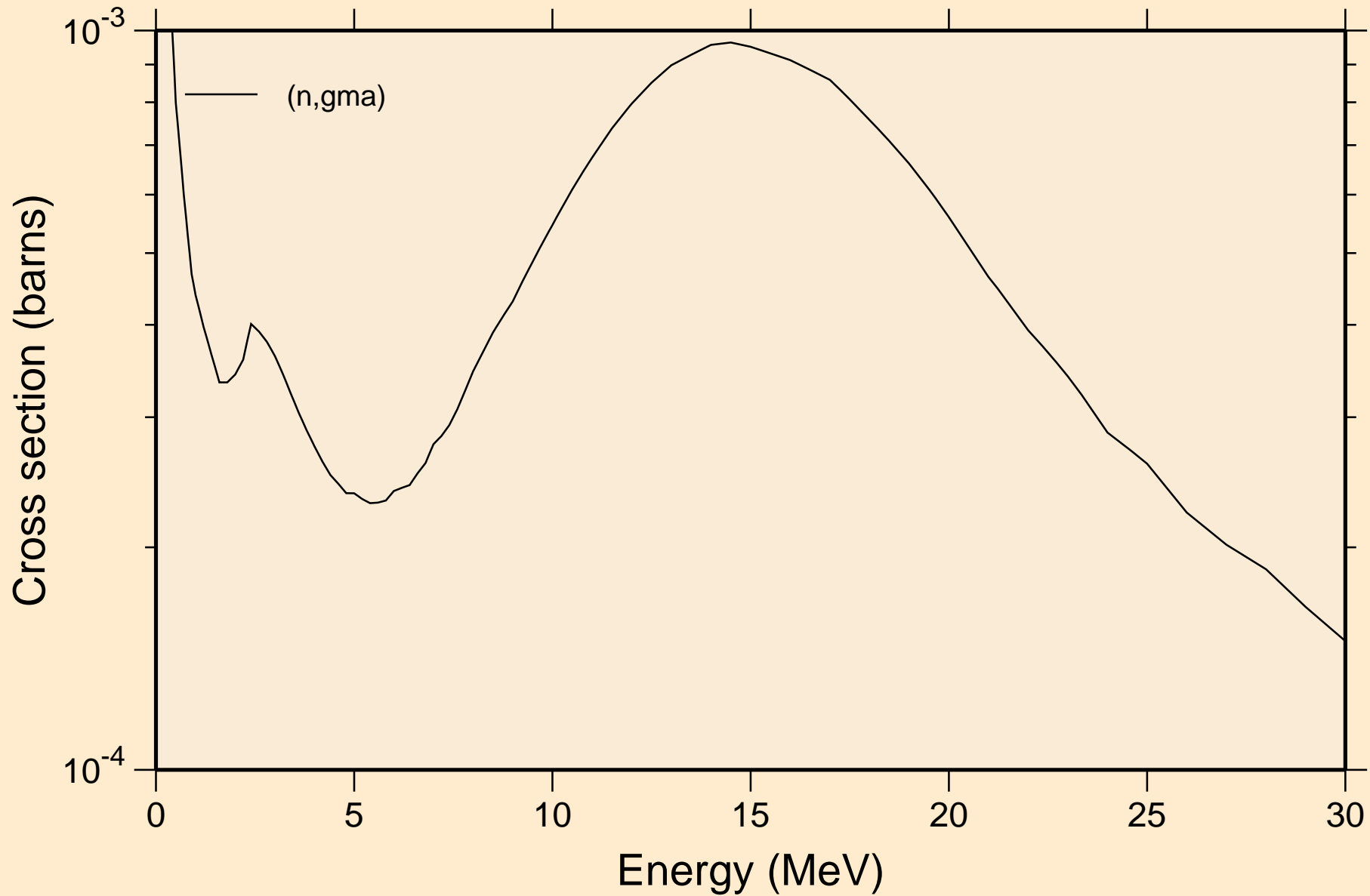

MN058 NEUTRON ACER TENDL-2021 LIBRARY; T=293.6K
Inelastic levels

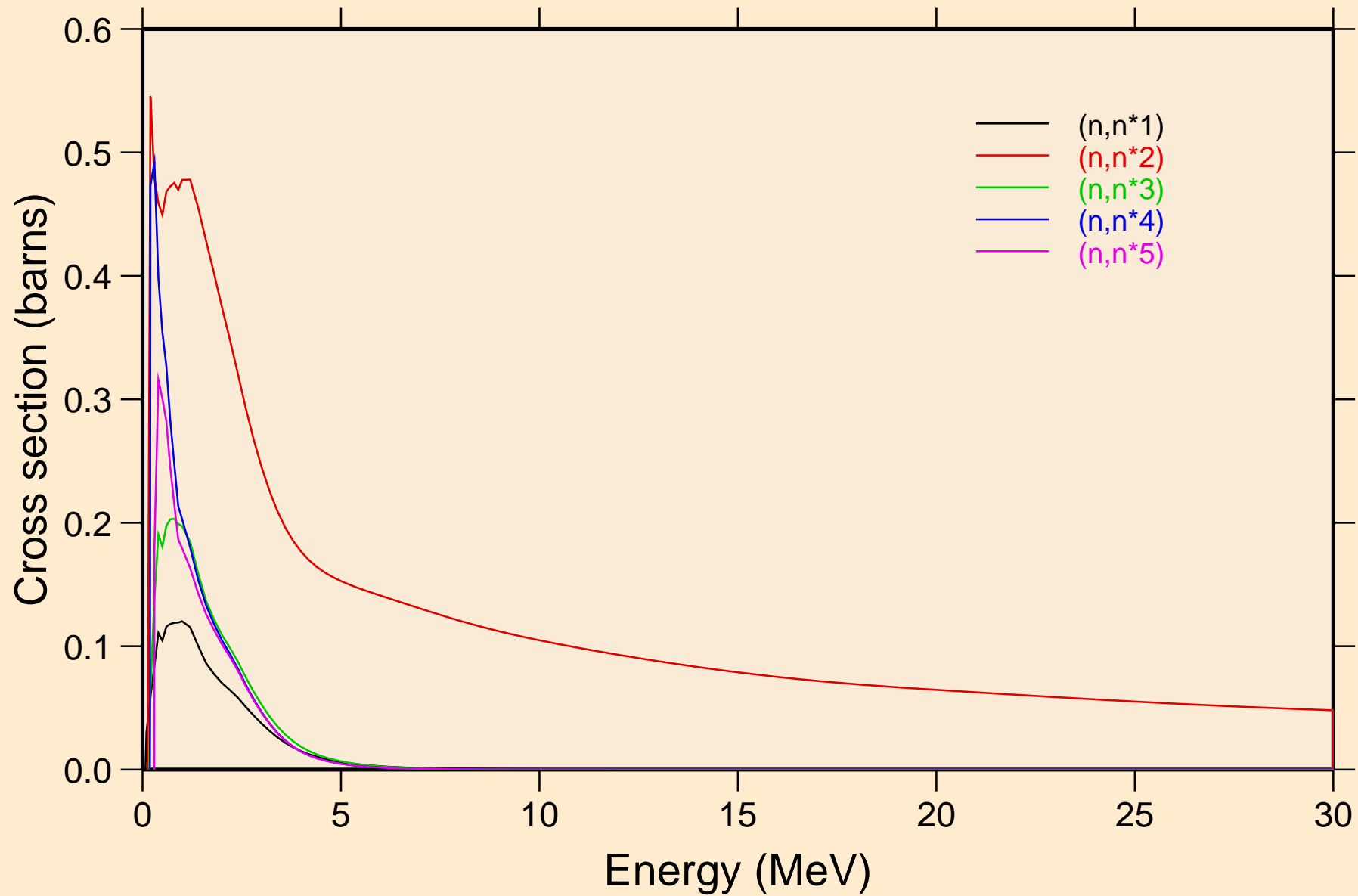

MN058 NEUTRON ACER TENDL-2021 LIBRARY; T=293.6K
Inelastic levels

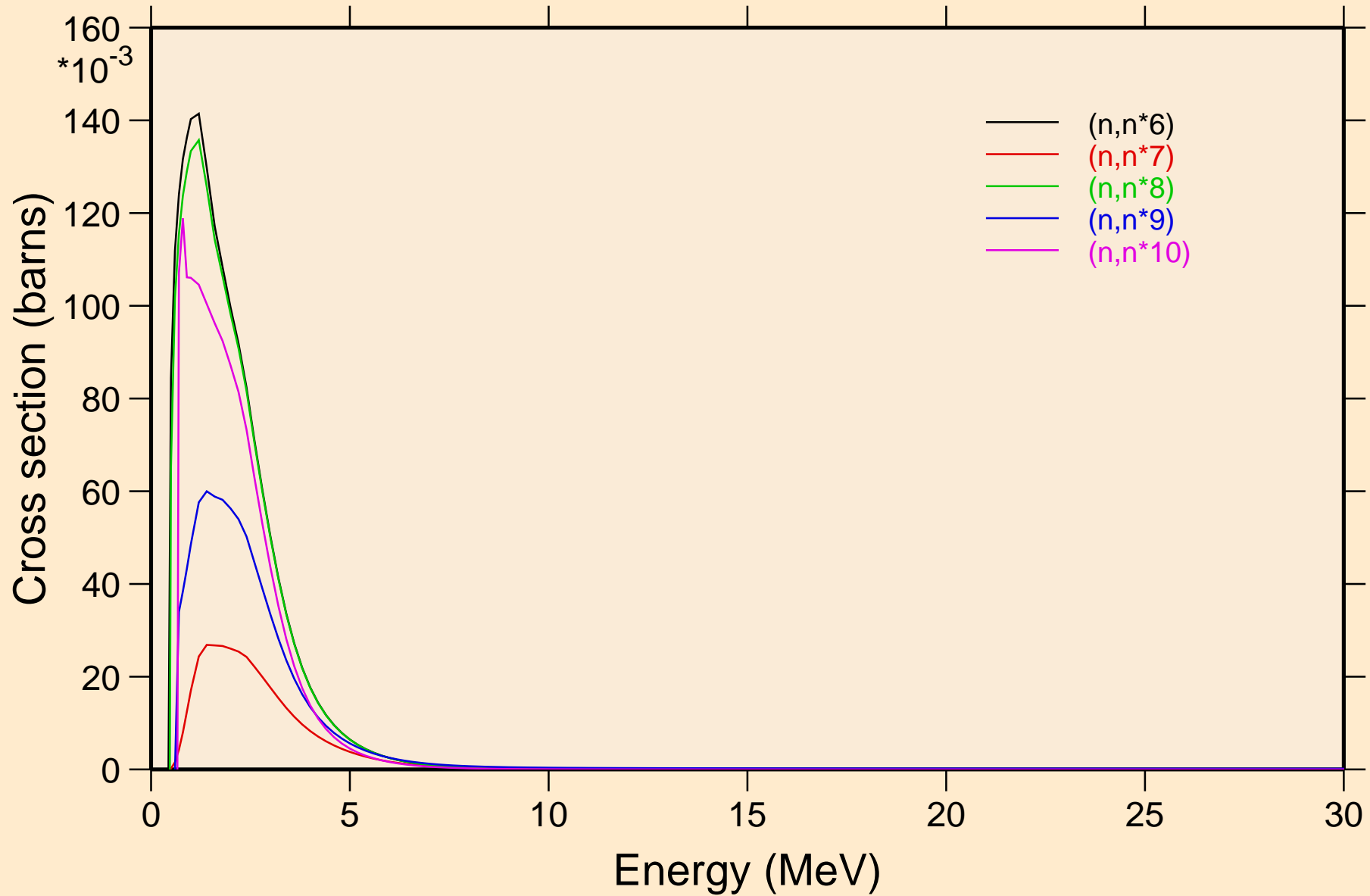

MN058 NEUTRON ACER TENDL-2021 LIBRARY; T=293.6K
Inelastic levels

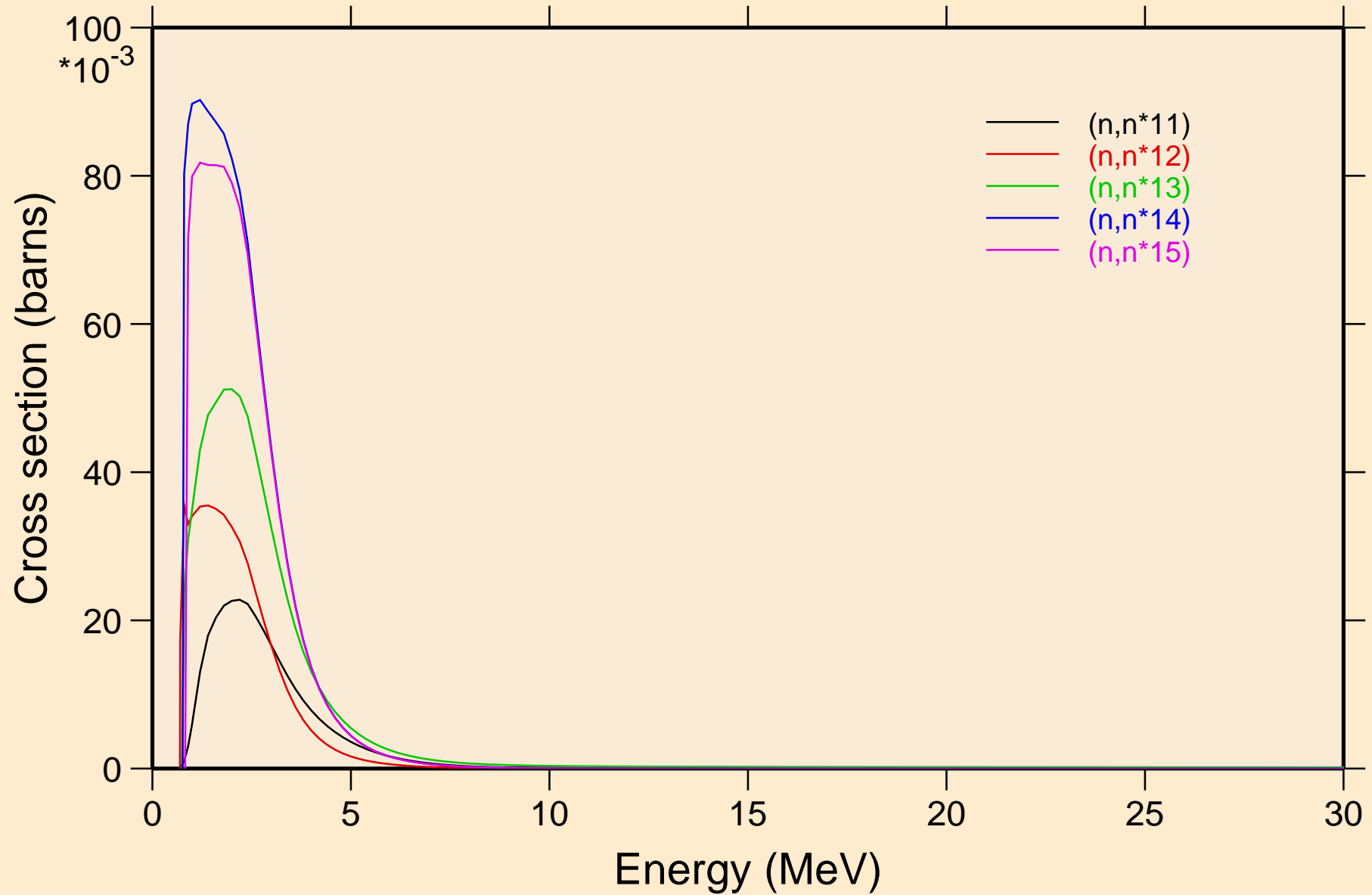

MN058 NEUTRON ACER TENDL-2021 LIBRARY; T=293.6K
Inelastic levels

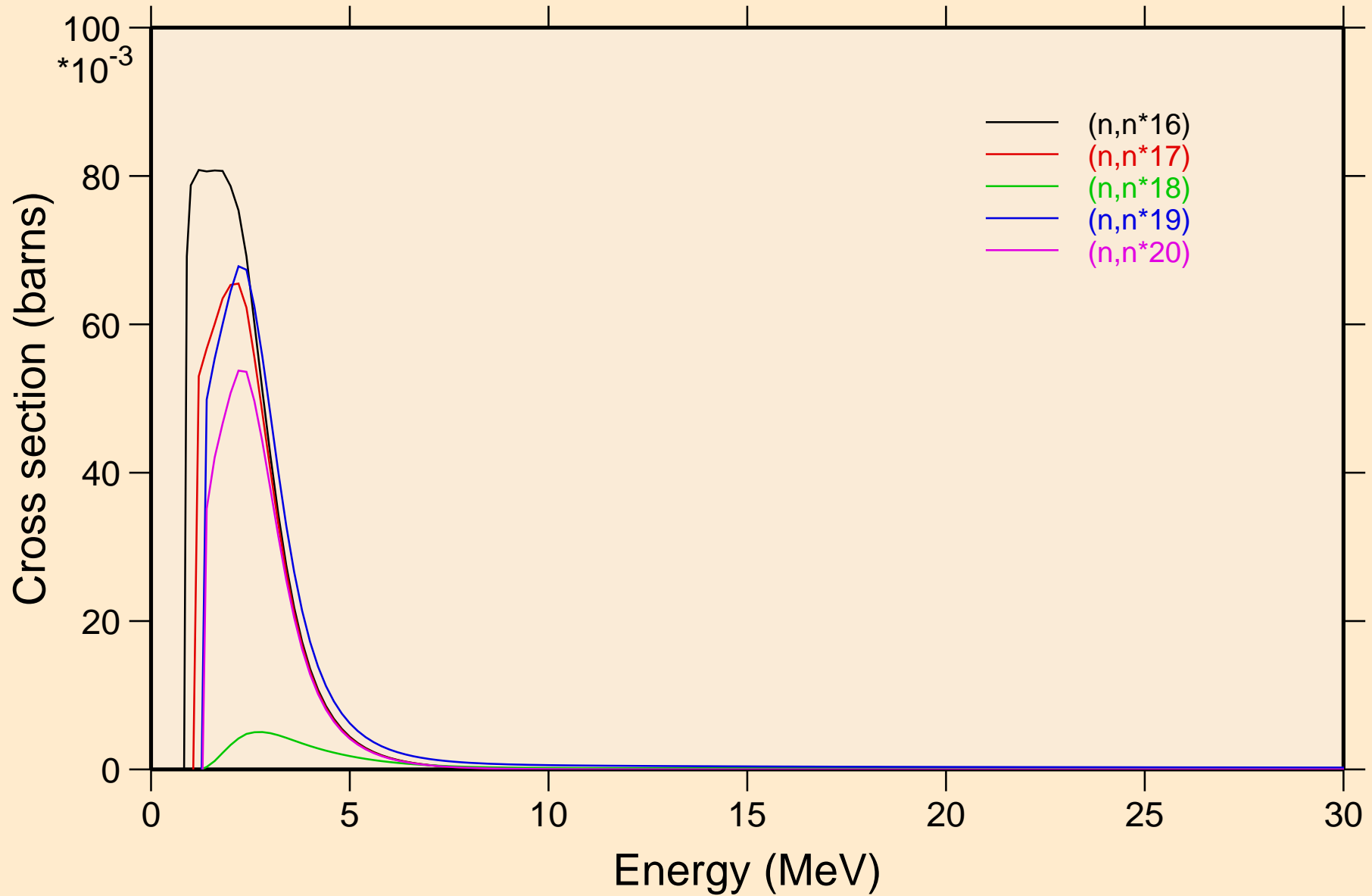

MN058 NEUTRON ACER TENDL-2021 LIBRARY; T=293.6K
Inelastic levels

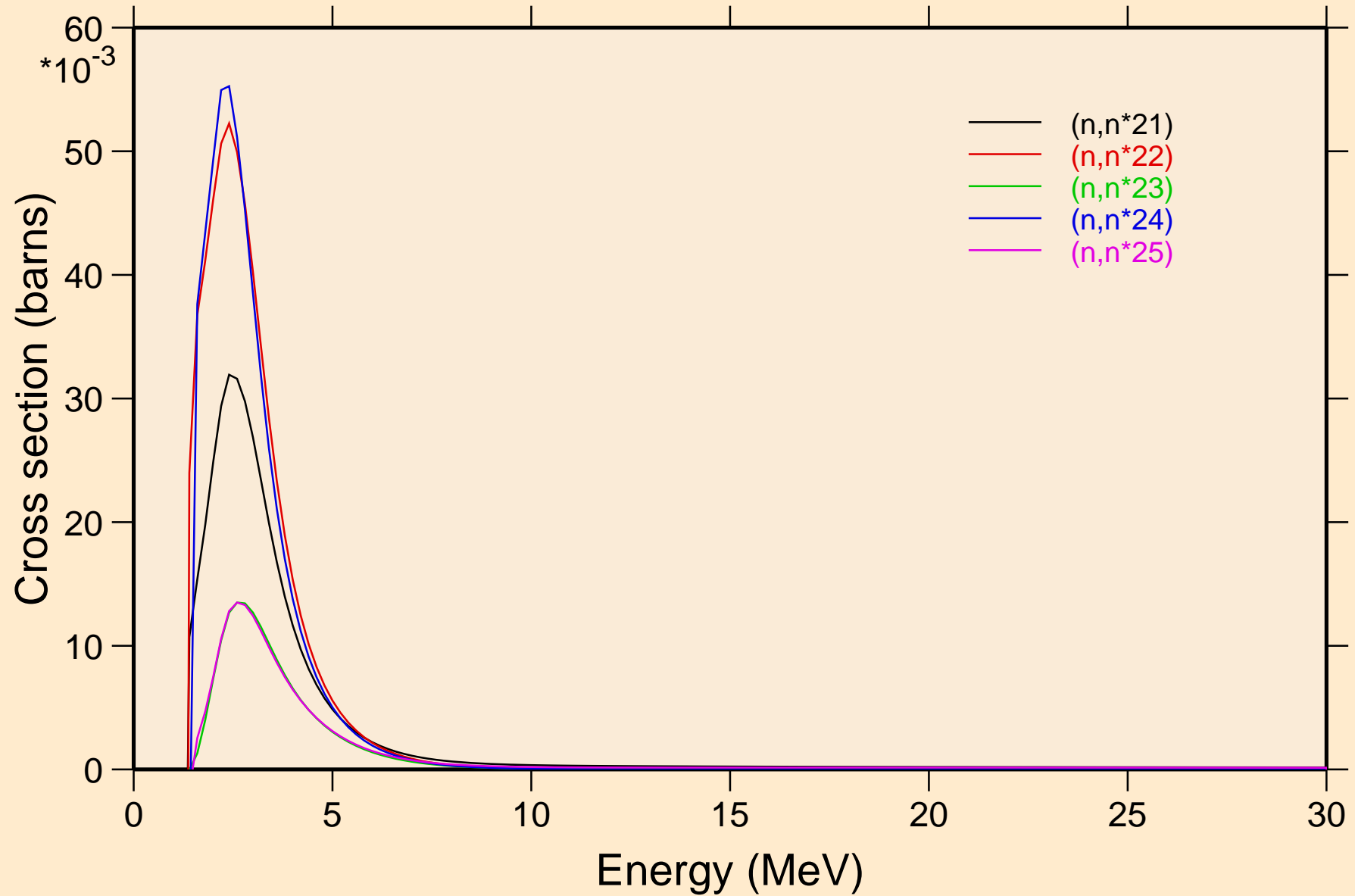

MN058 NEUTRON ACER TENDL-2021 LIBRARY; T=293.6K
Inelastic levels

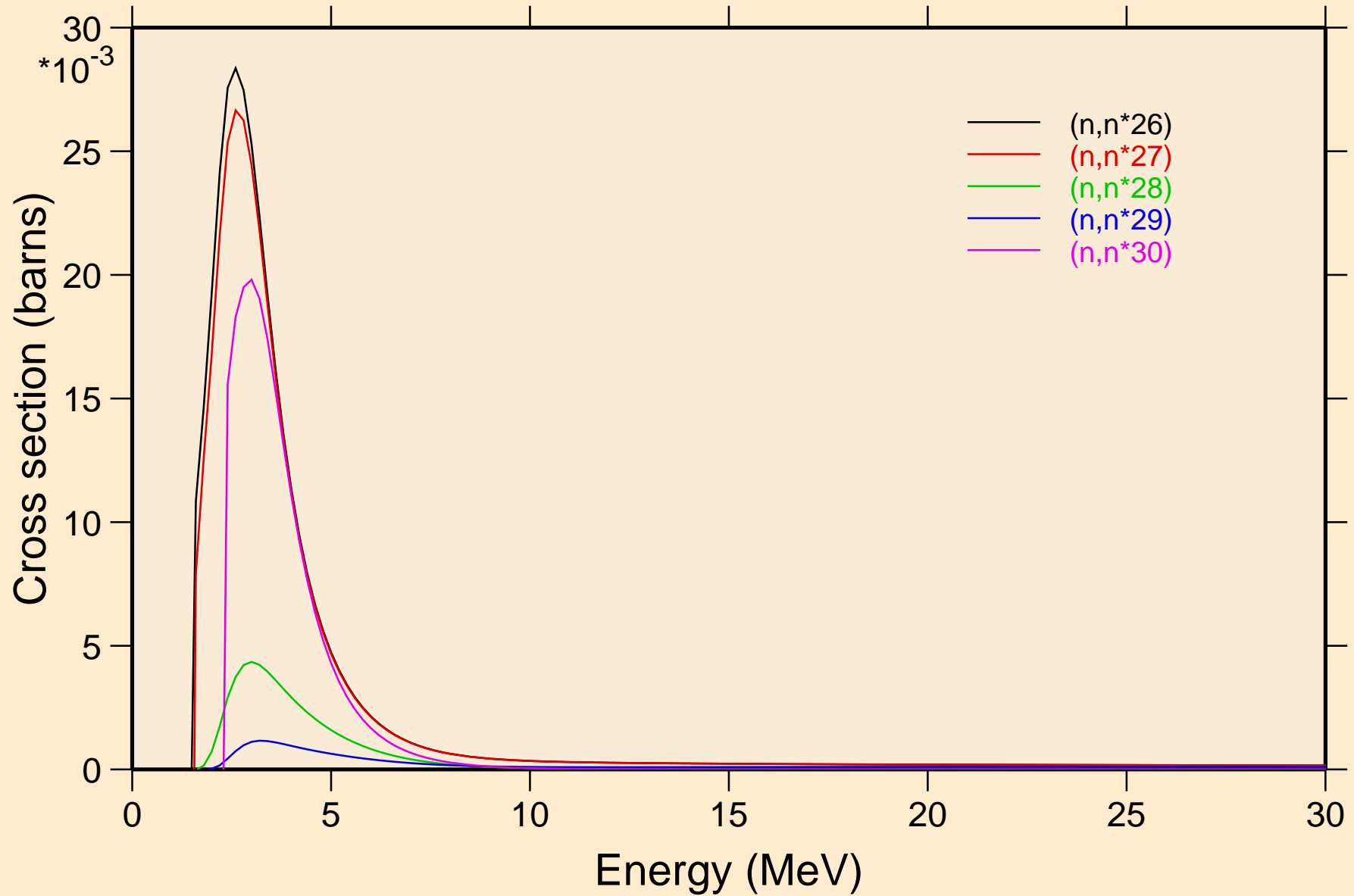

MN058 NEUTRON ACER TENDL-2021 LIBRARY; T=293.6K
Threshold reactions

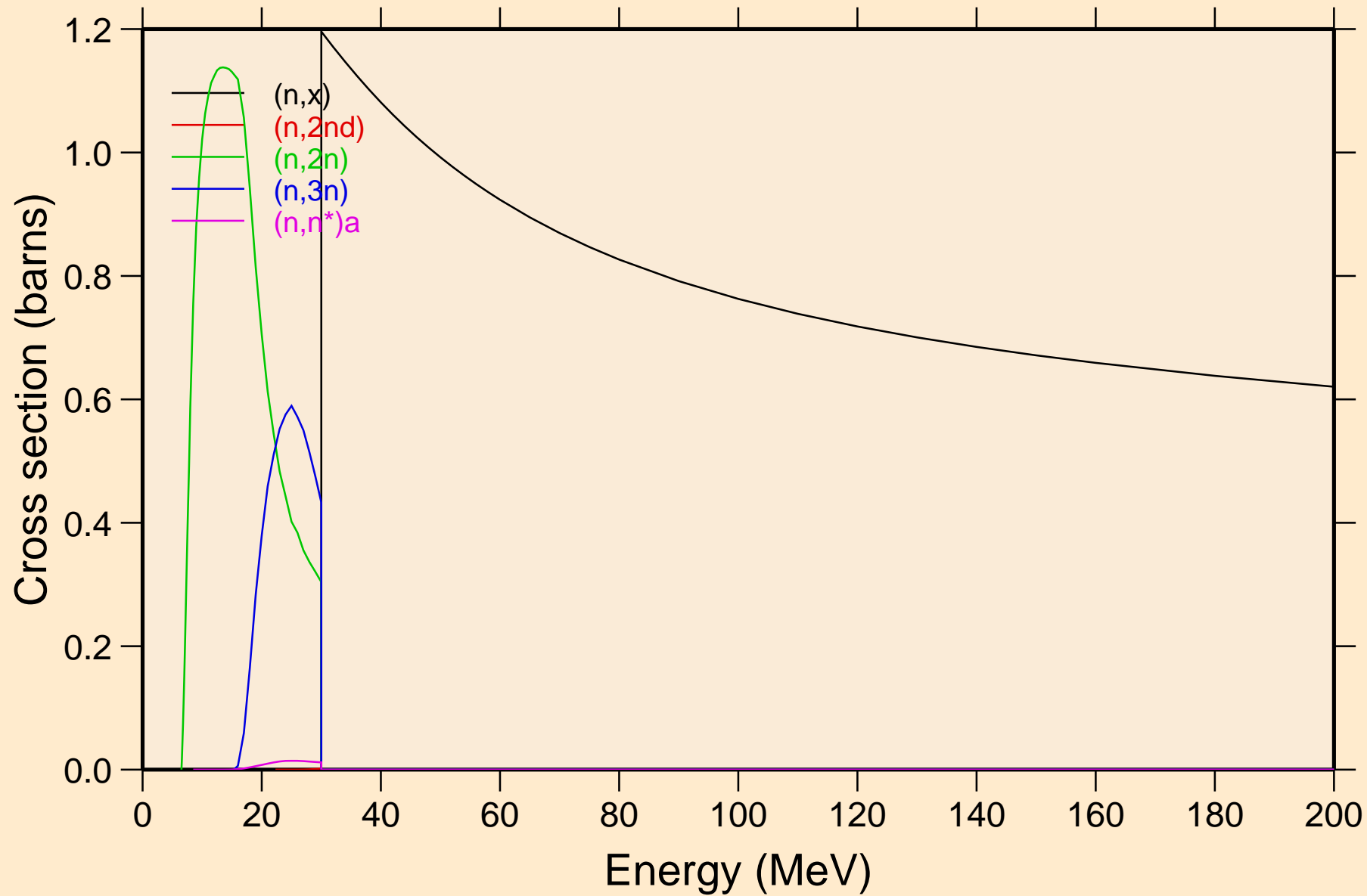

MN058 NEUTRON ACER TENDL-2021 LIBRARY; T=293.6K
Threshold reactions

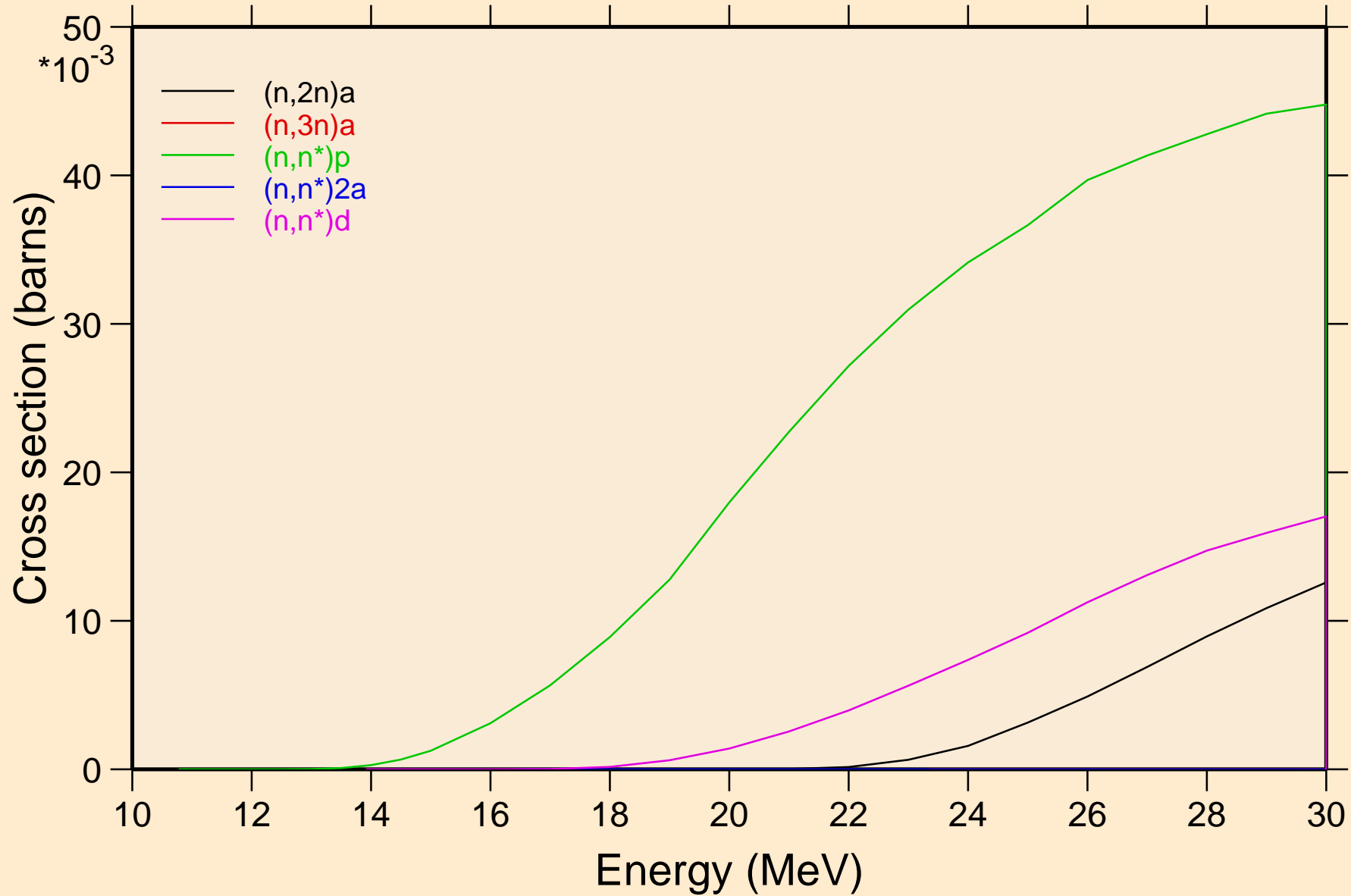

MN058 NEUTRON ACER TENDL-2021 LIBRARY; T=293.6K

Threshold reactions

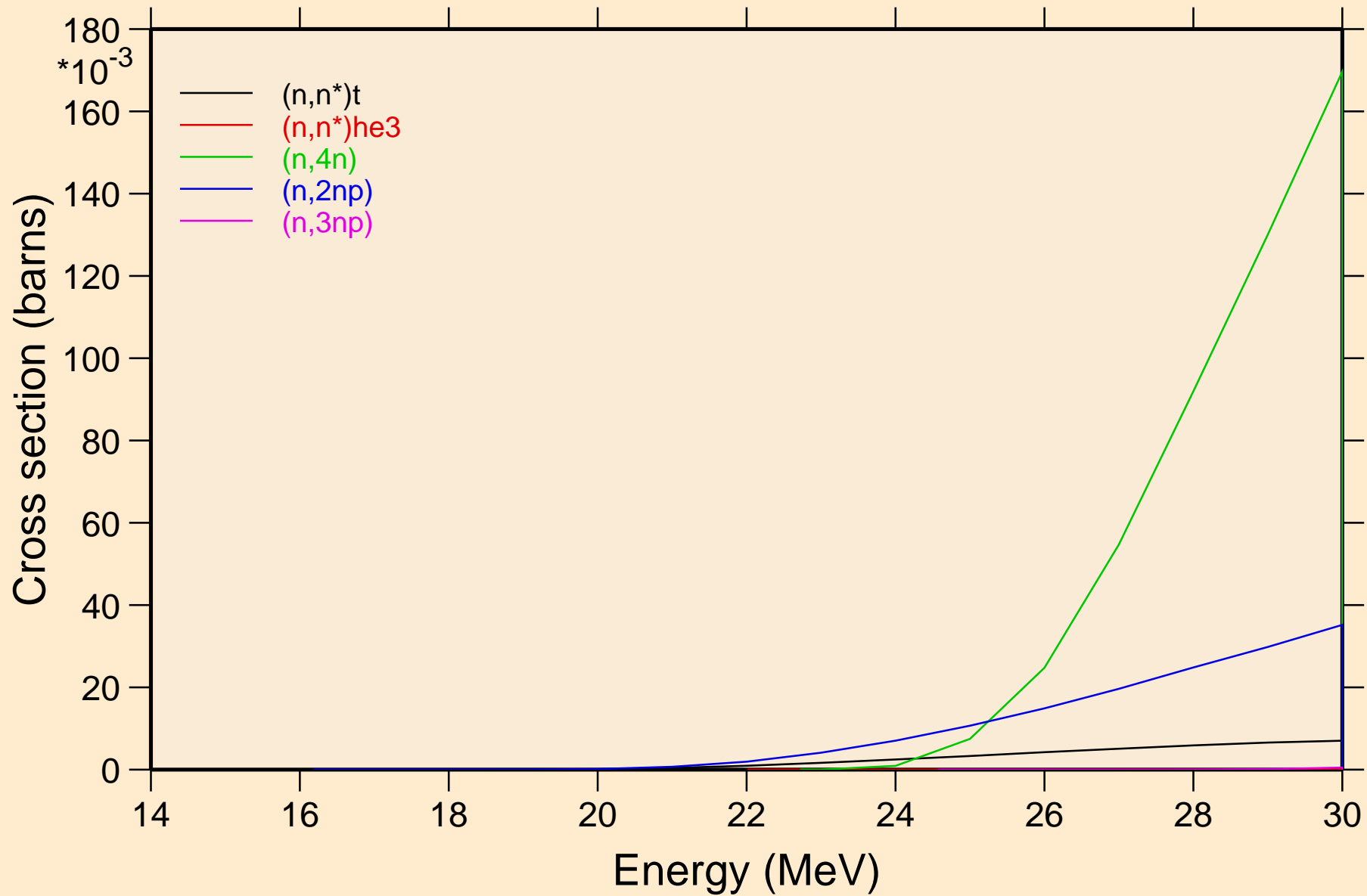

MN058 NEUTRON ACER TENDL-2021 LIBRARY; T=293.6K
Threshold reactions

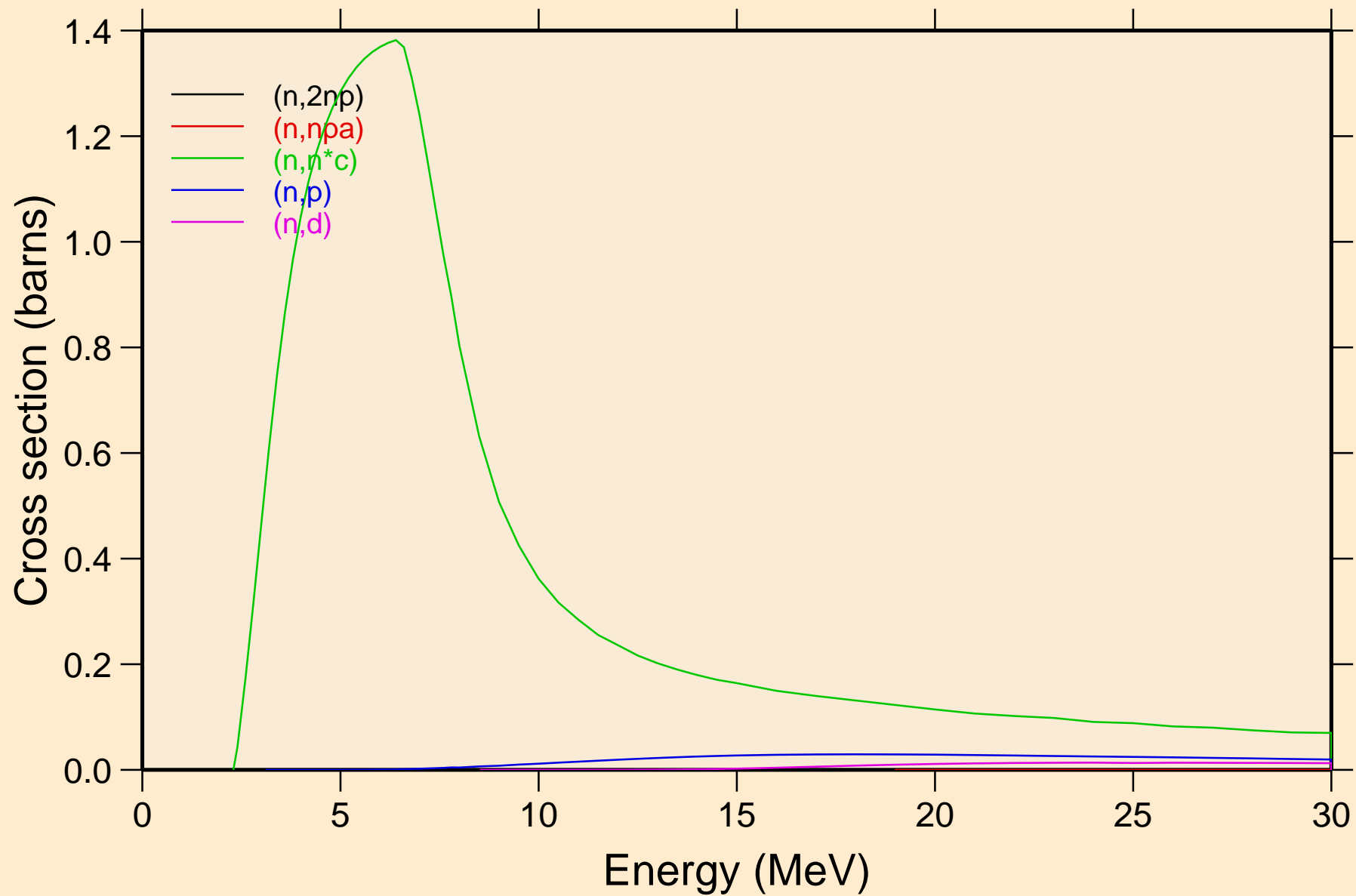

MN058 NEUTRON ACER TENDL-2021 LIBRARY; T=293.6K
Threshold reactions

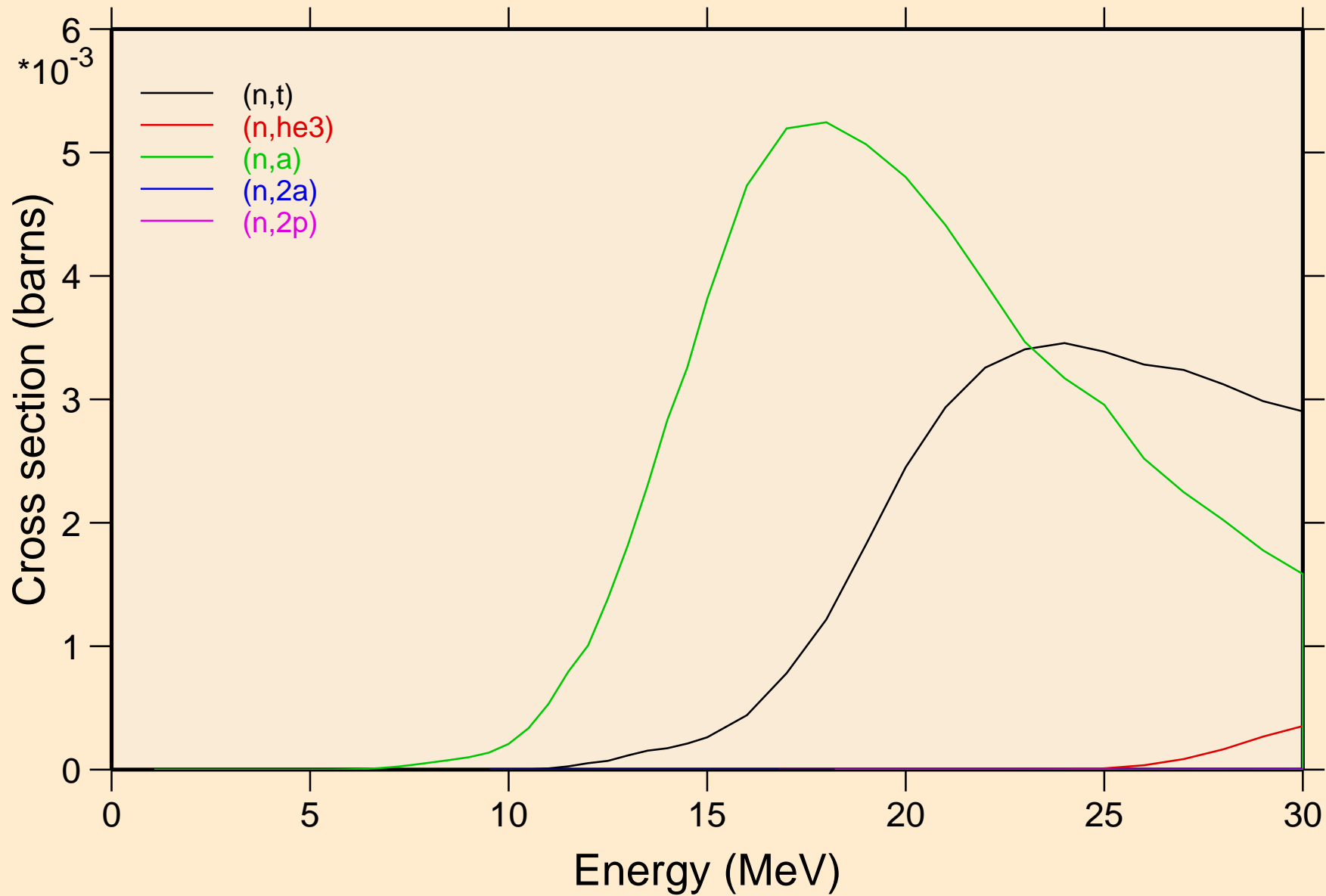

MN058 NEUTRON ACER TENDL-2021 LIBRARY; T=293.6K
Threshold reactions

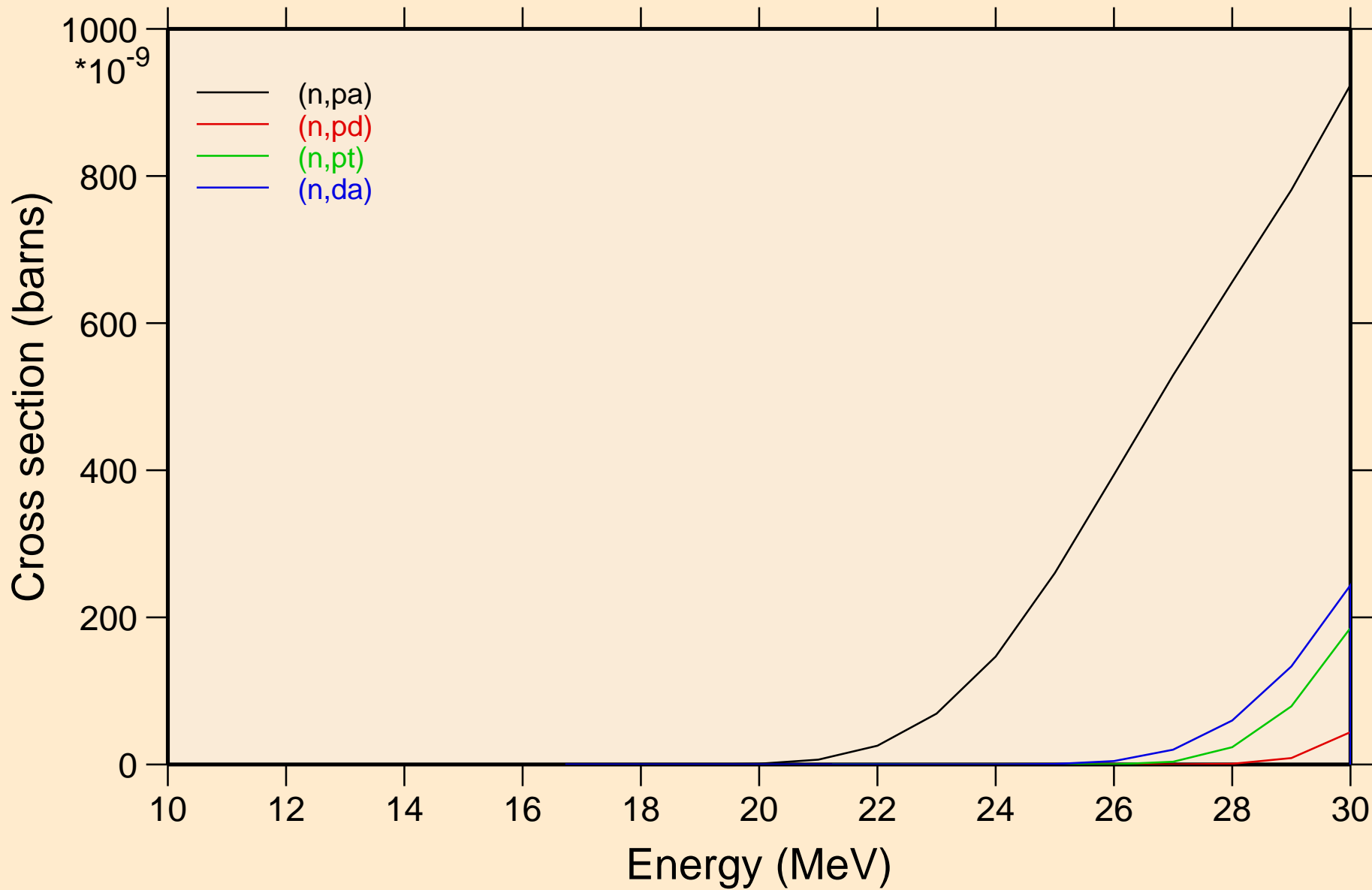

MN058 NEUTRON ACER TENDL-2021 LIBRARY; T=293.6K
Threshold reactions

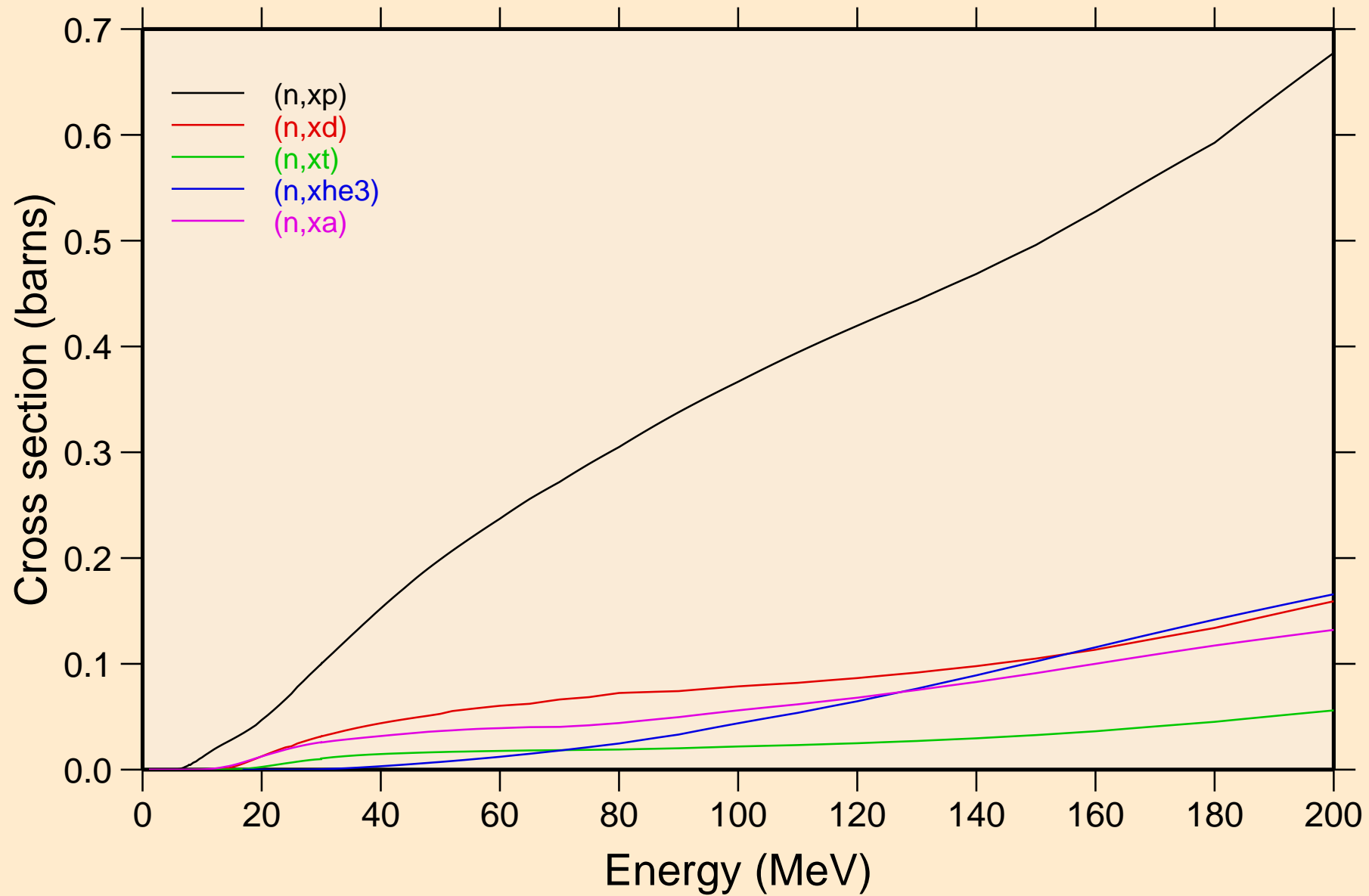

MN058 NEUTRON ACER TENDL-2021 LIBRARY; T=293.6K
angular distribution for elastic

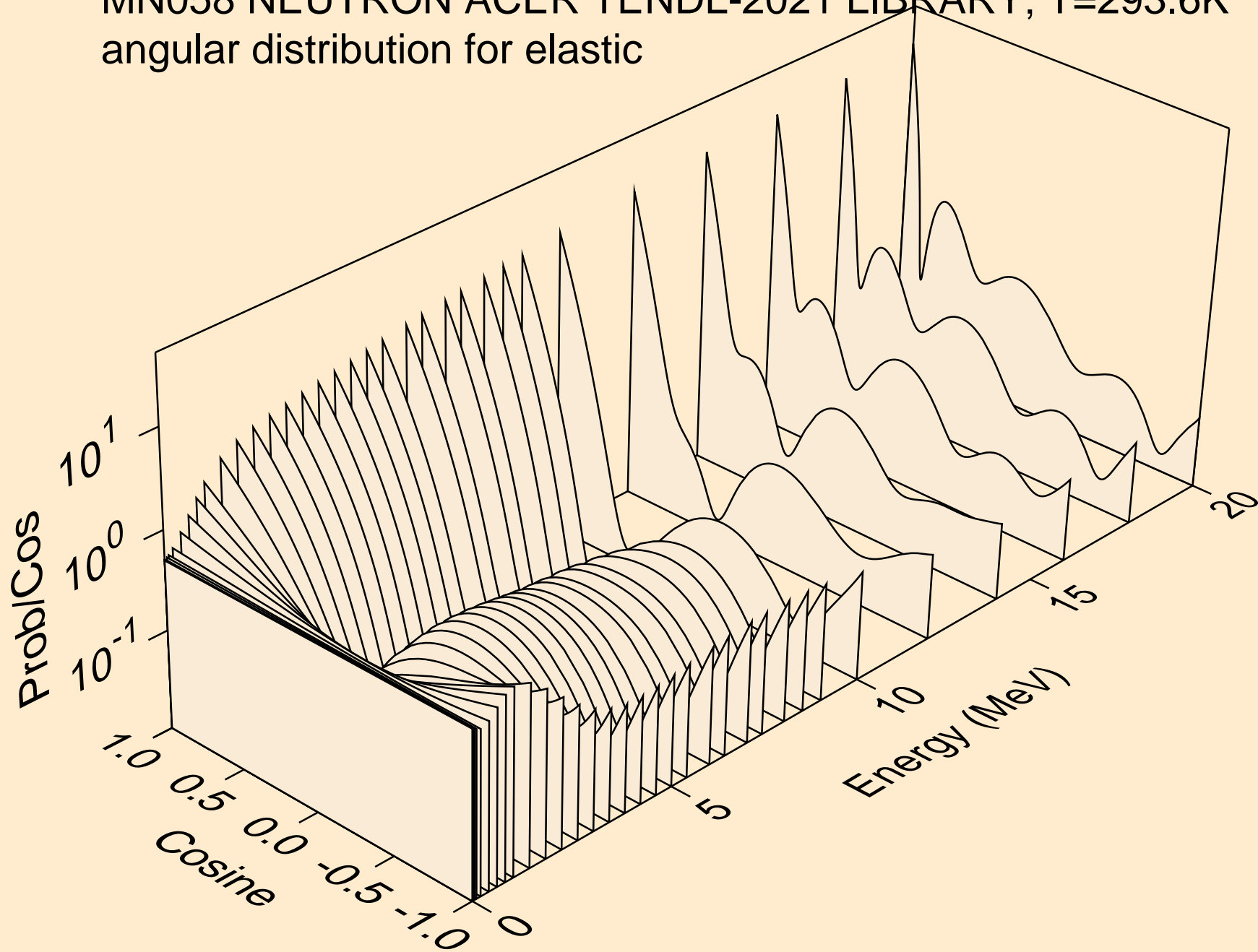

MN058 NEUTRON ACER TENDL-2021 LIBRARY; T=293.6K
angular distribution for elastic

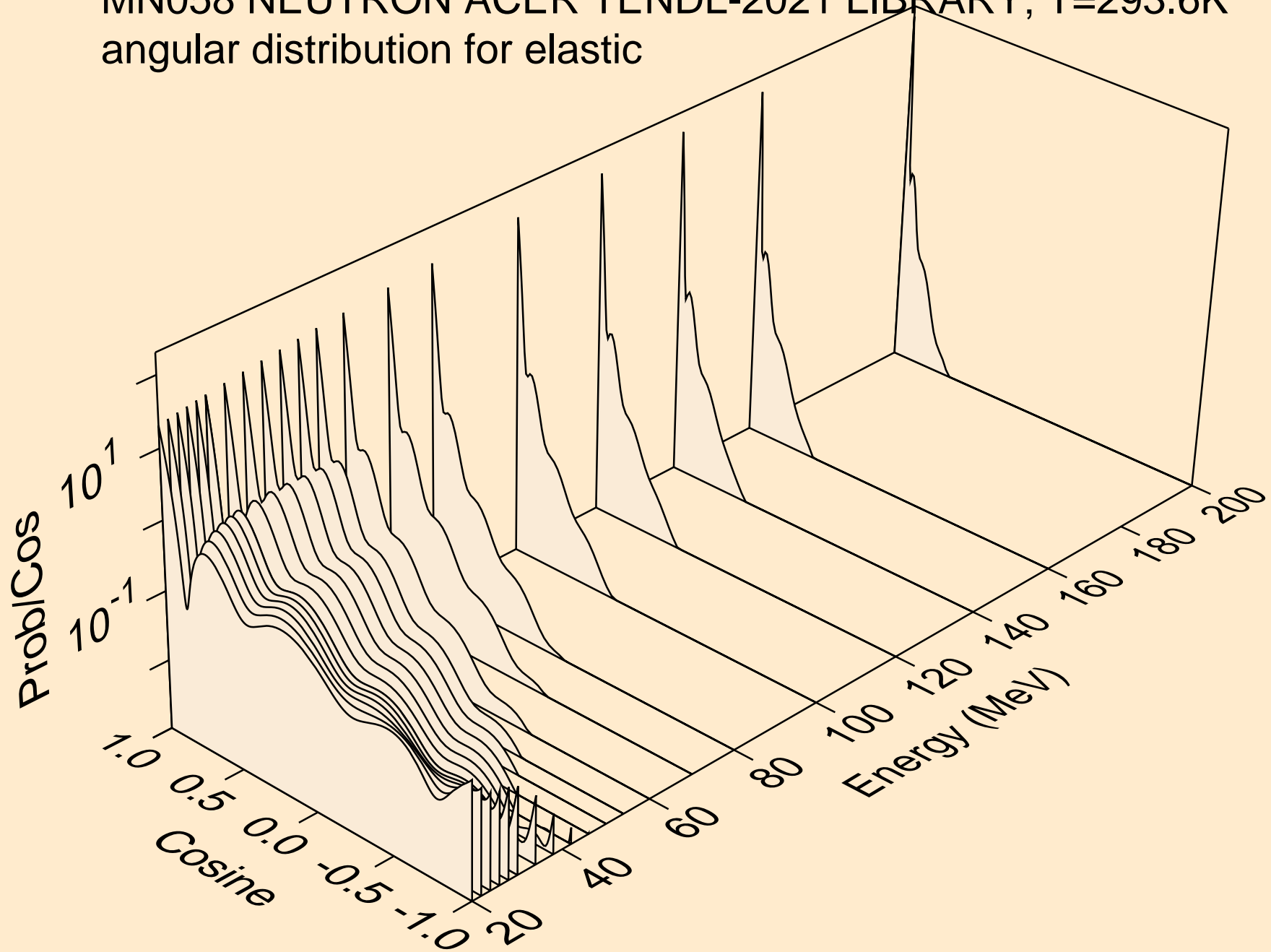

MN058 NEUTRON ACER TENDL-2021 LIBRARY; T=293.6K
angular distribution for (n,n*1)

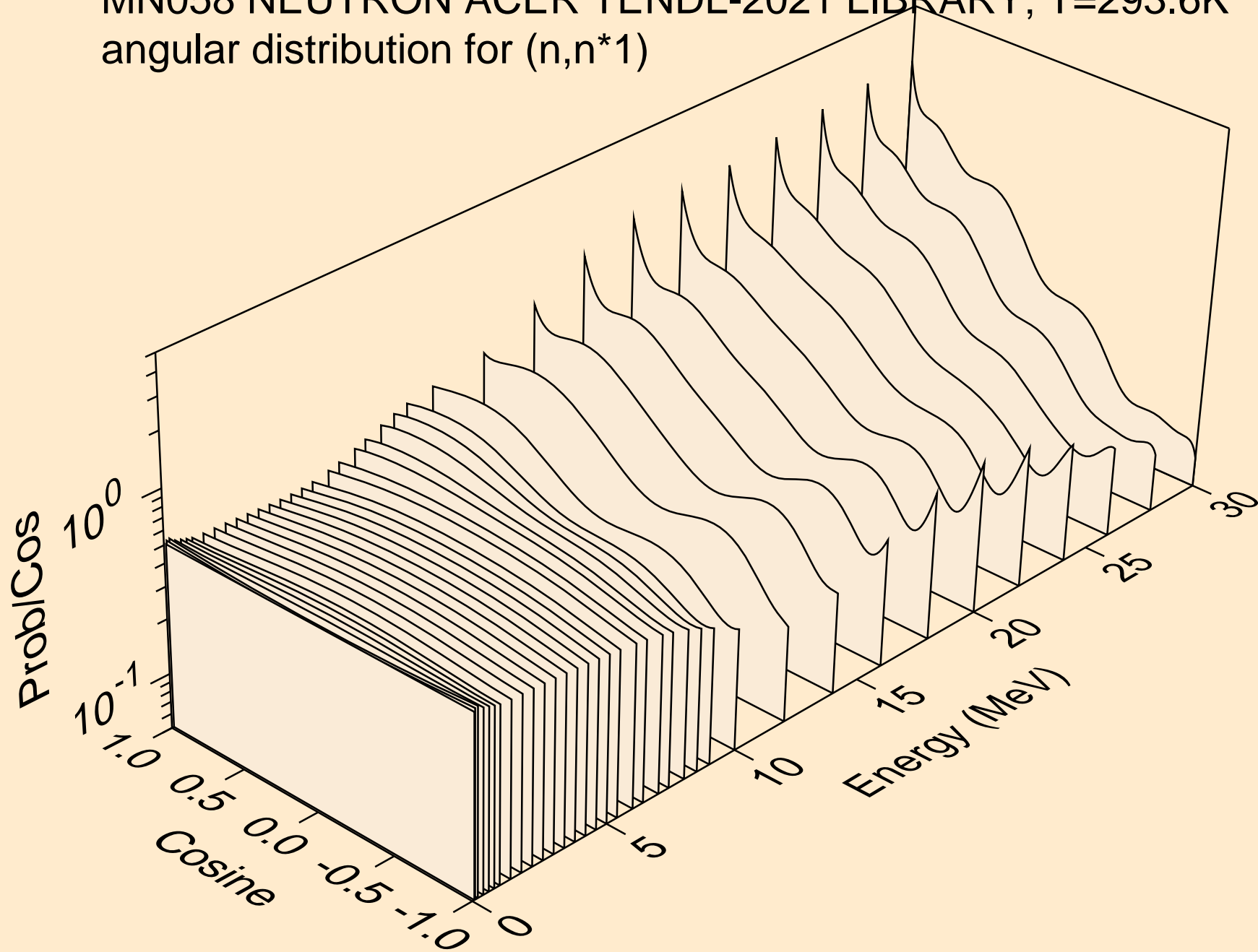

MN058 NEUTRON ACER TENDL-2021 LIBRARY; T=293.6K
angular distribution for (n,n*2)

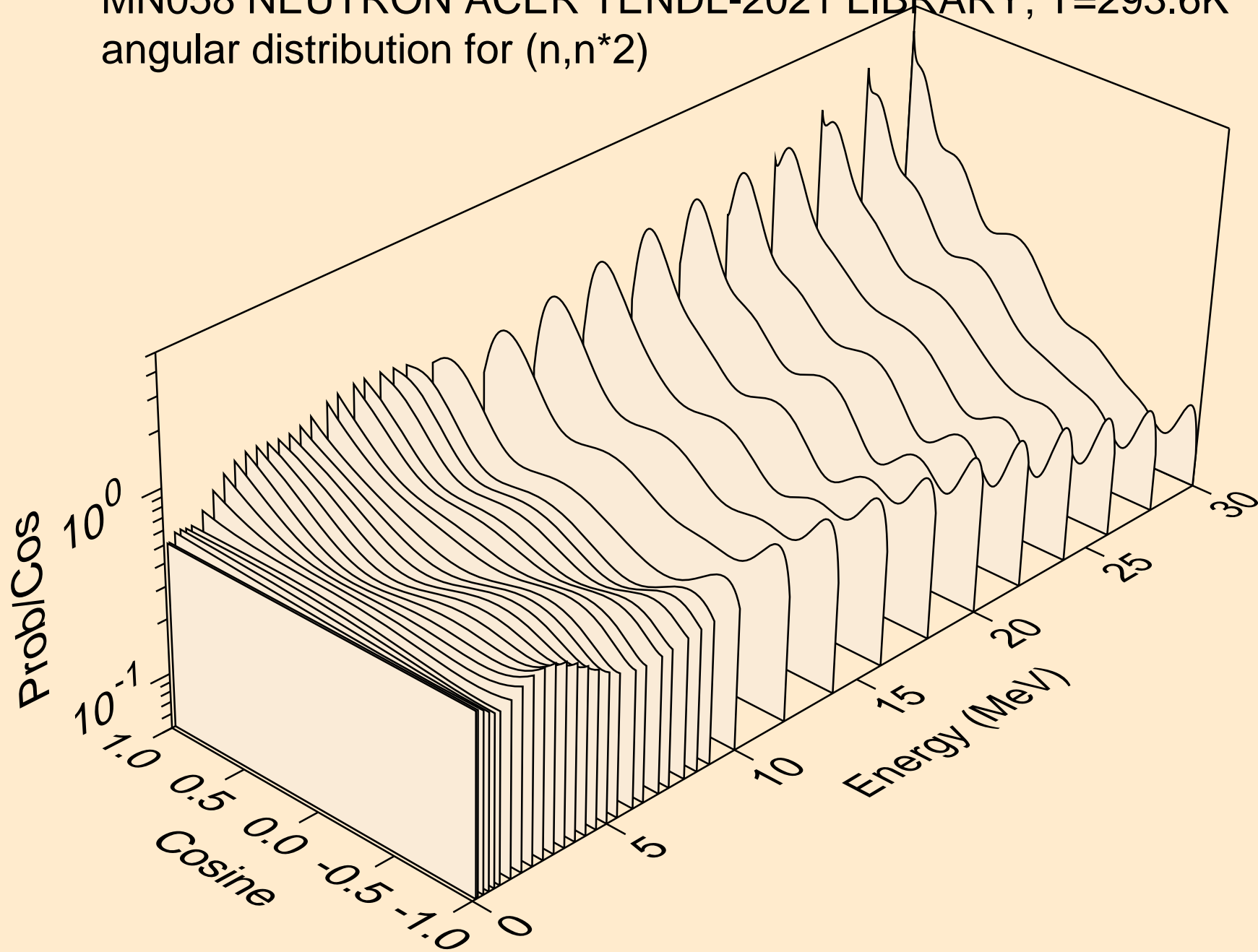

MN058 NEUTRON ACER TENDL-2021 LIBRARY; T=293.6K
angular distribution for (n,n*3)

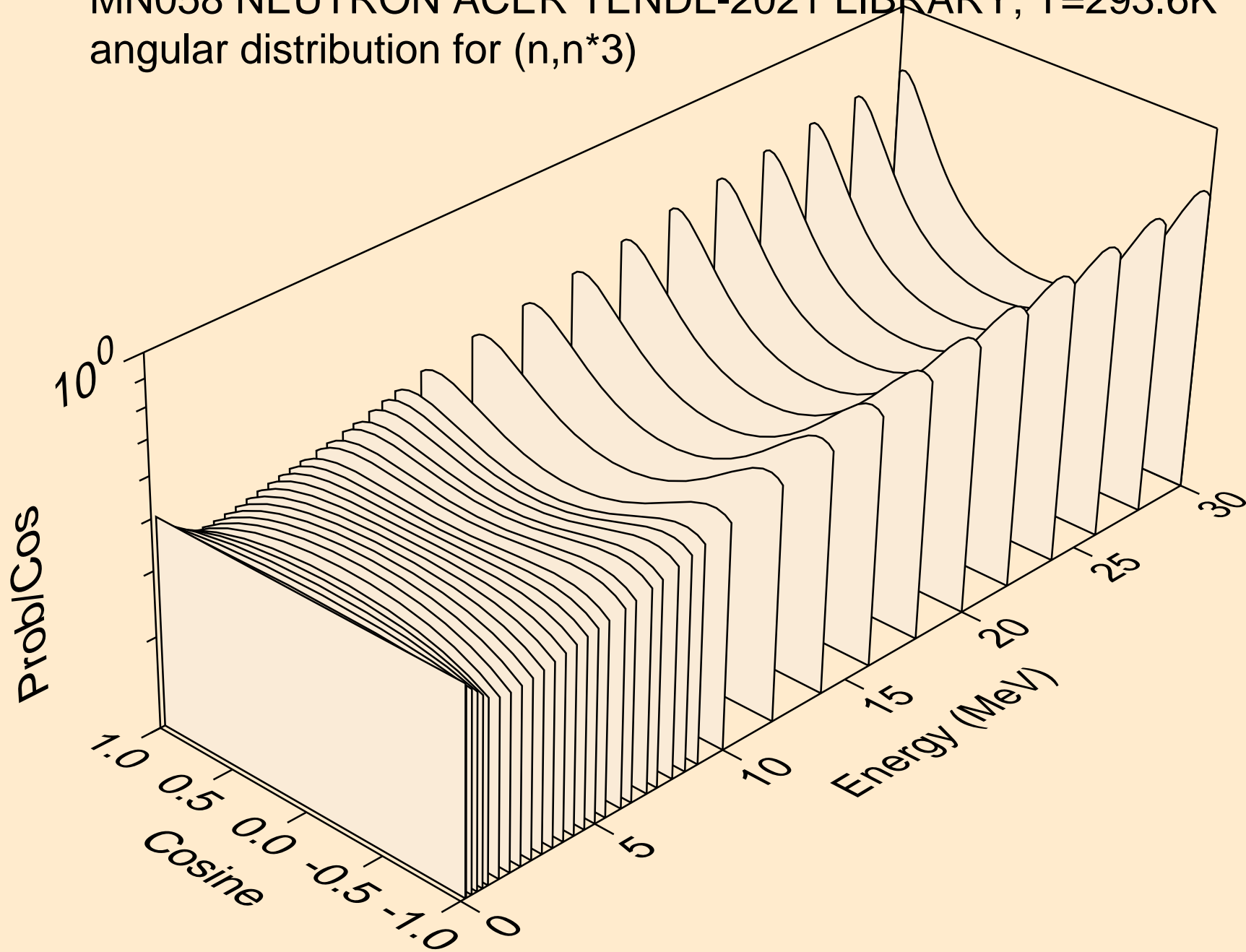

MN058 NEUTRON ACER TENDL-2021 LIBRARY; T=293.6K
angular distribution for (n,n*4)

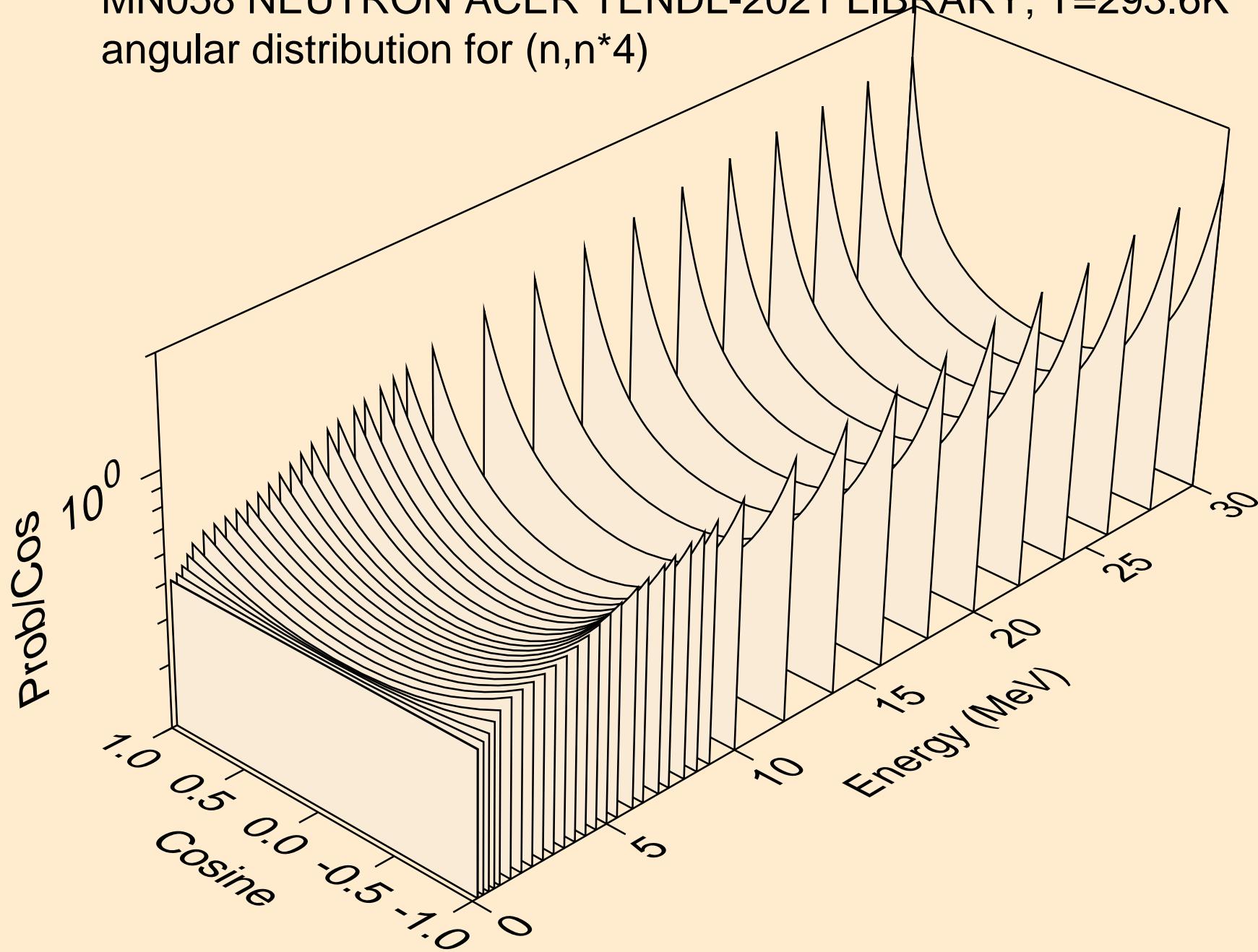

MN058 NEUTRON ACER TENDL-2021 LIBRARY; T=293.6K
angular distribution for (n,n*5)

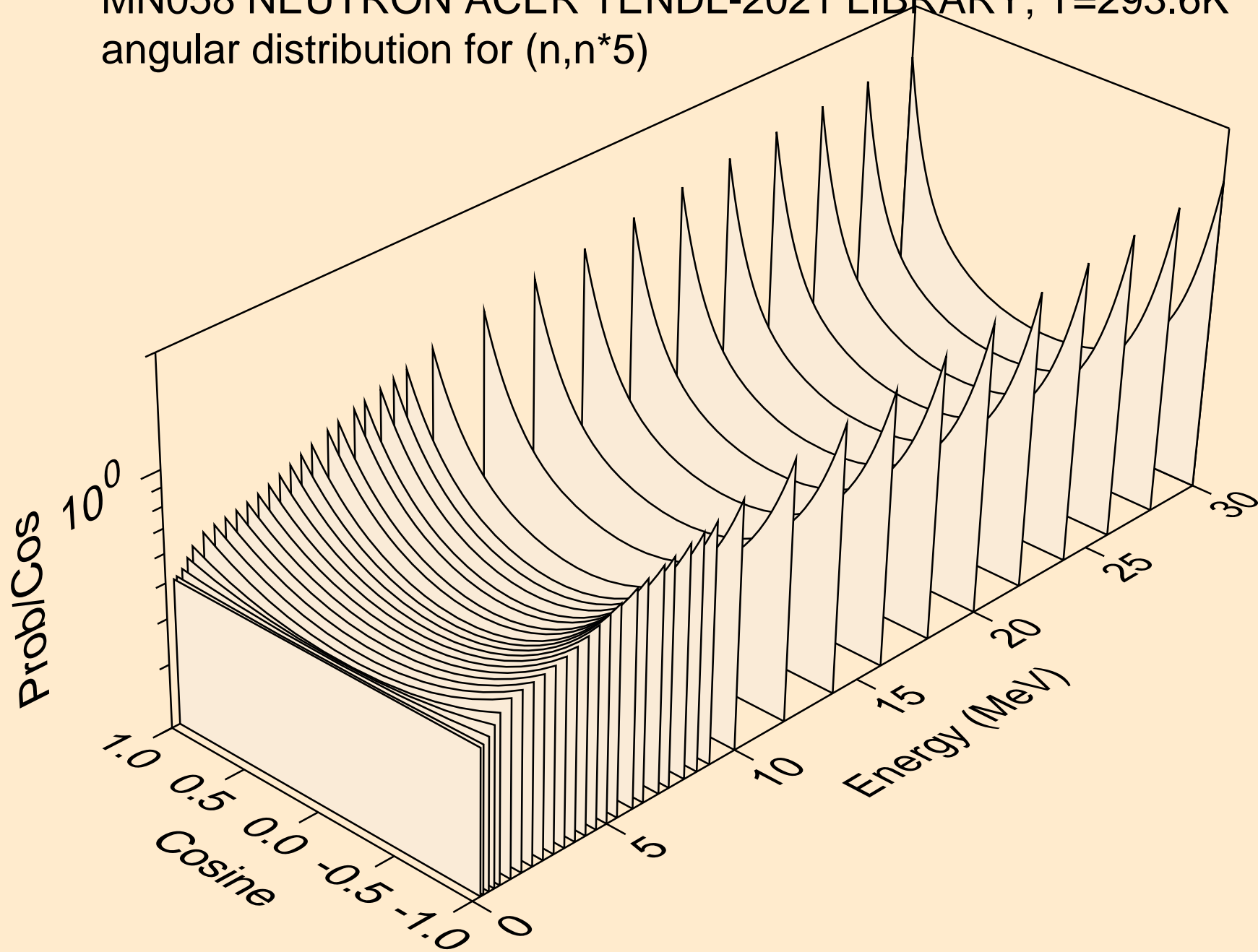

MN058 NEUTRON ACER TENDL-2021 LIBRARY; T=293.6K
angular distribution for (n,n*6)

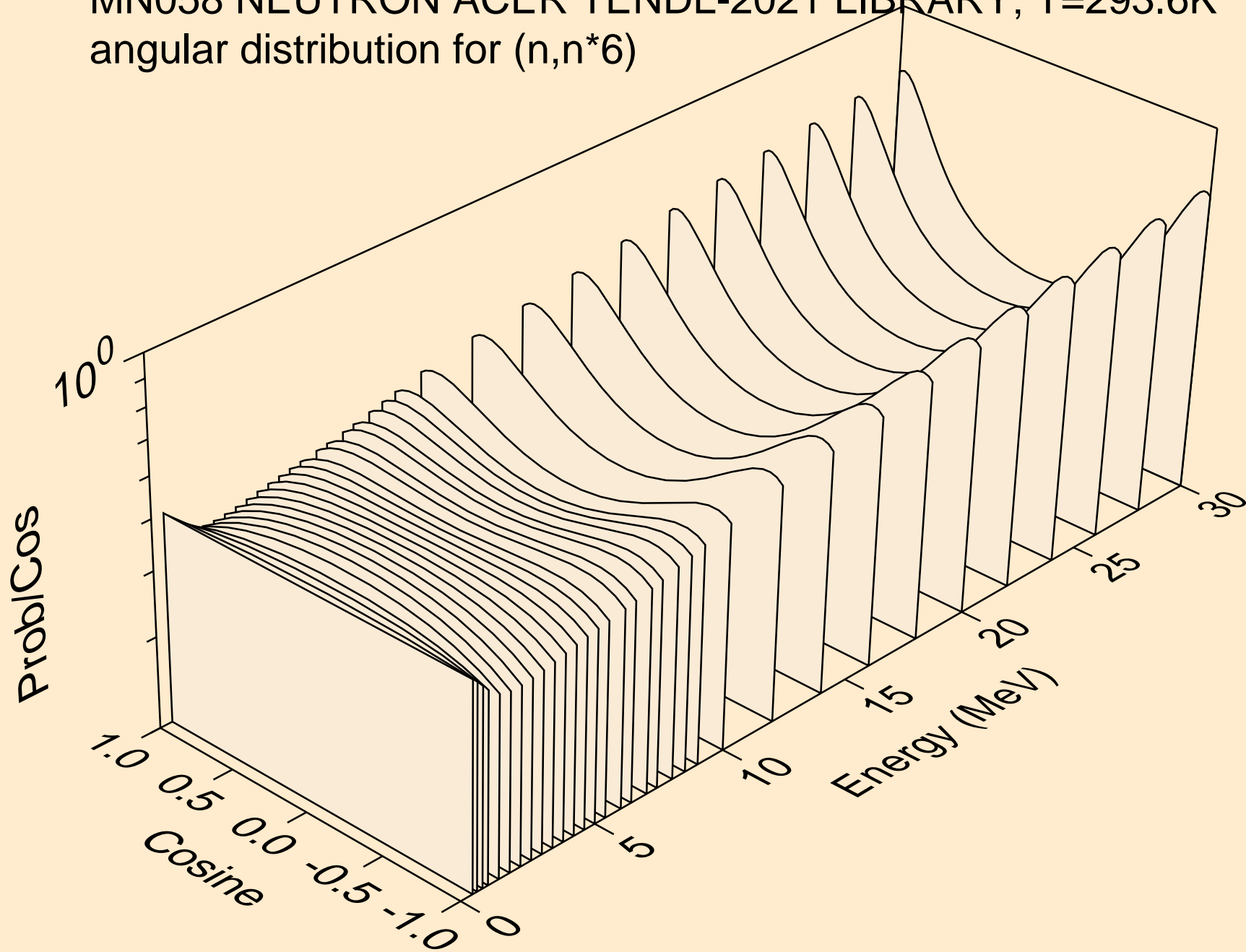

MN058 NEUTRON ACER TENDL-2021 LIBRARY; T=293.6K
angular distribution for (n,n*7)

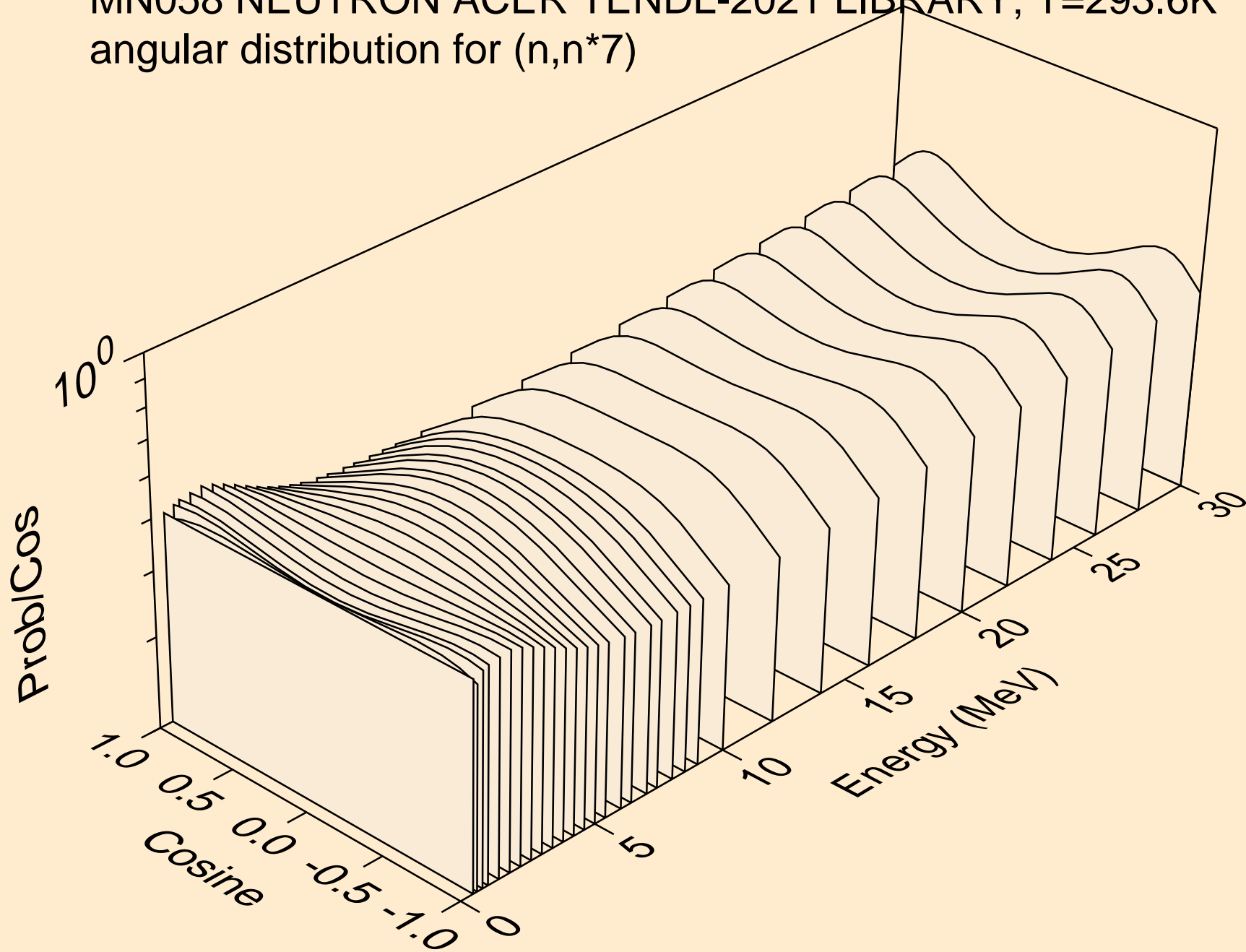

MN058 NEUTRON ACER TENDL-2021 LIBRARY; T=293.6K
angular distribution for (n,n*8)

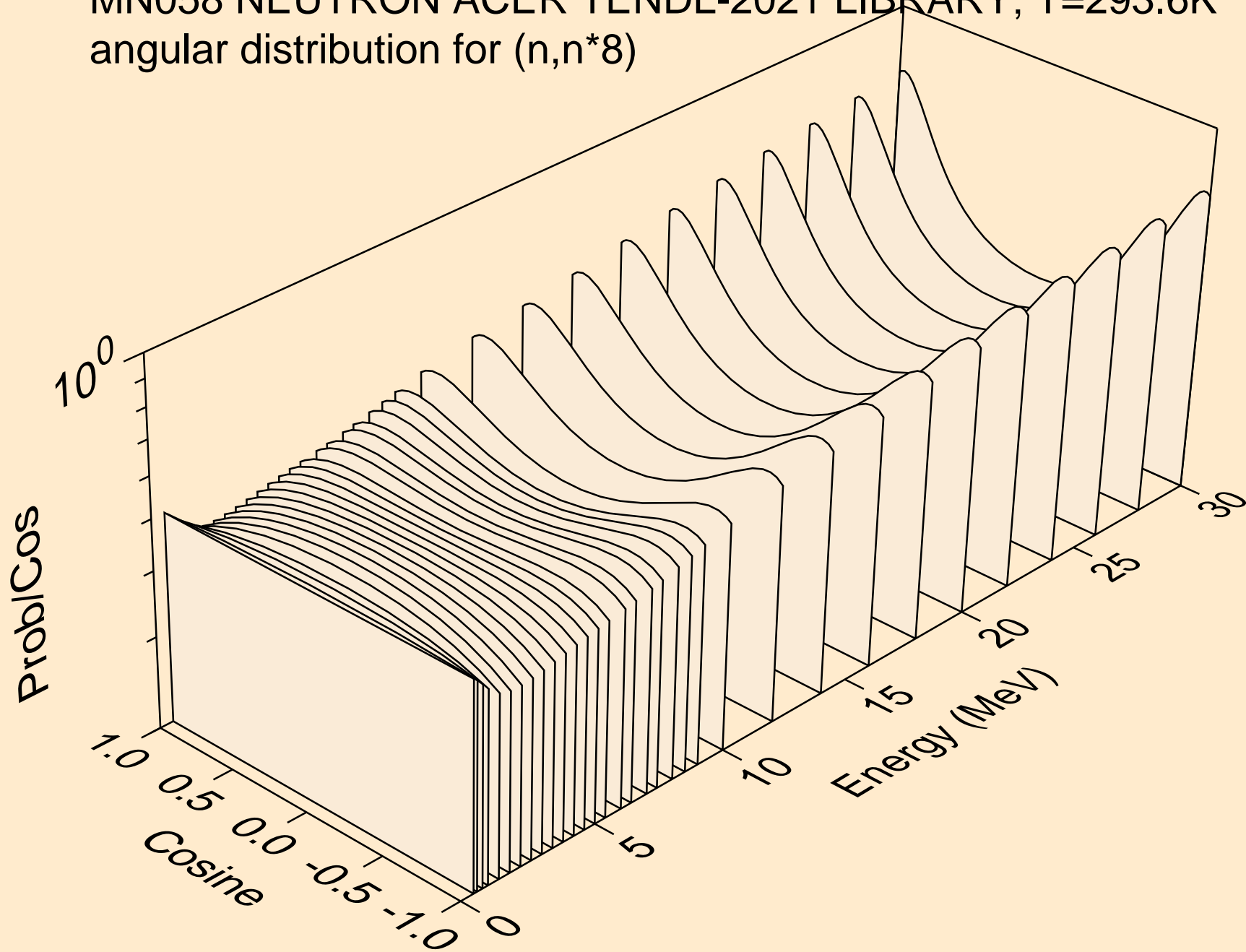

MN058 NEUTRON ACER TENDL-2021 LIBRARY; T=293.6K
angular distribution for (n,n*9)

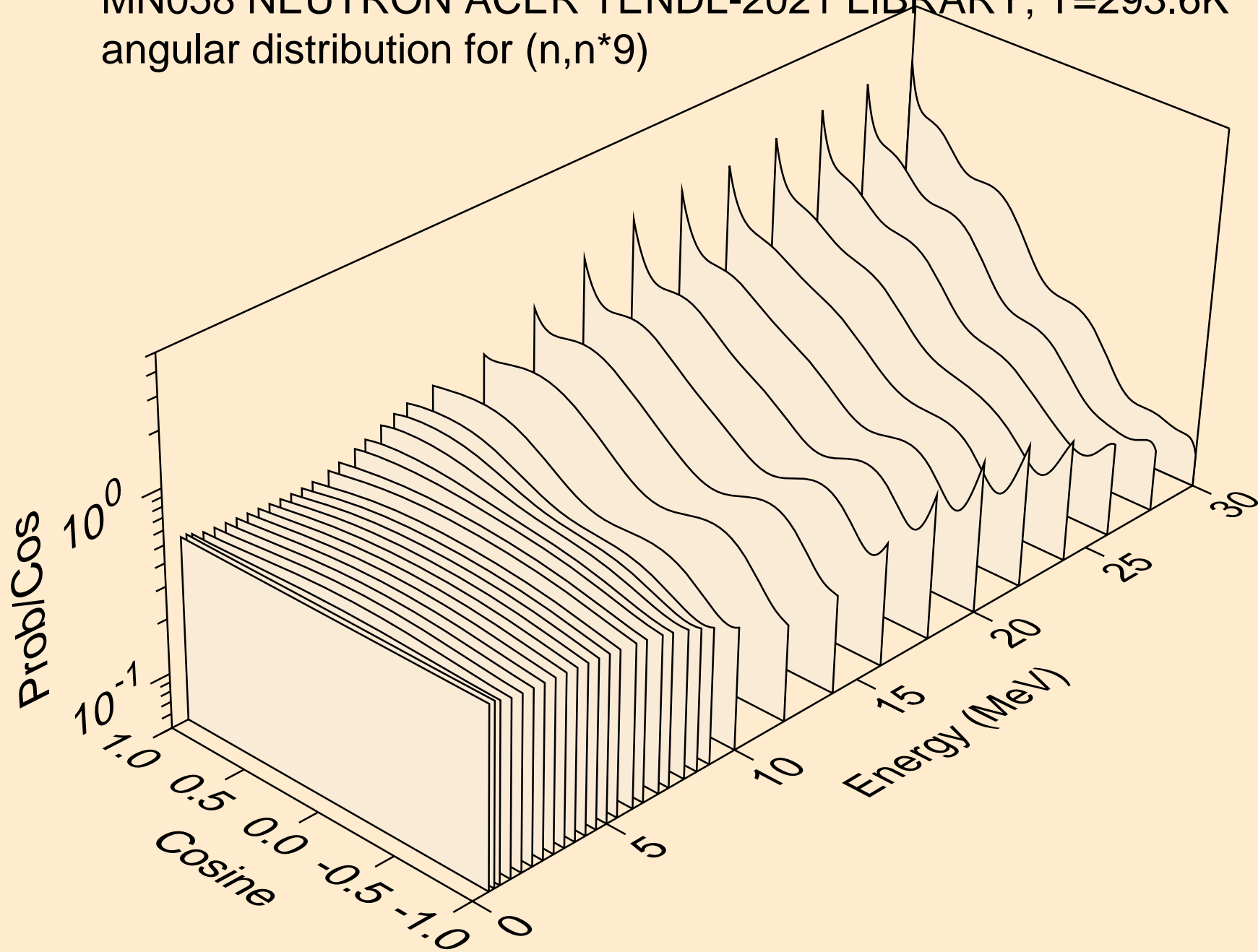

MN058 NEUTRON ACER TENDL-2021 LIBRARY; T=293.6K
angular distribution for (n,n*10)

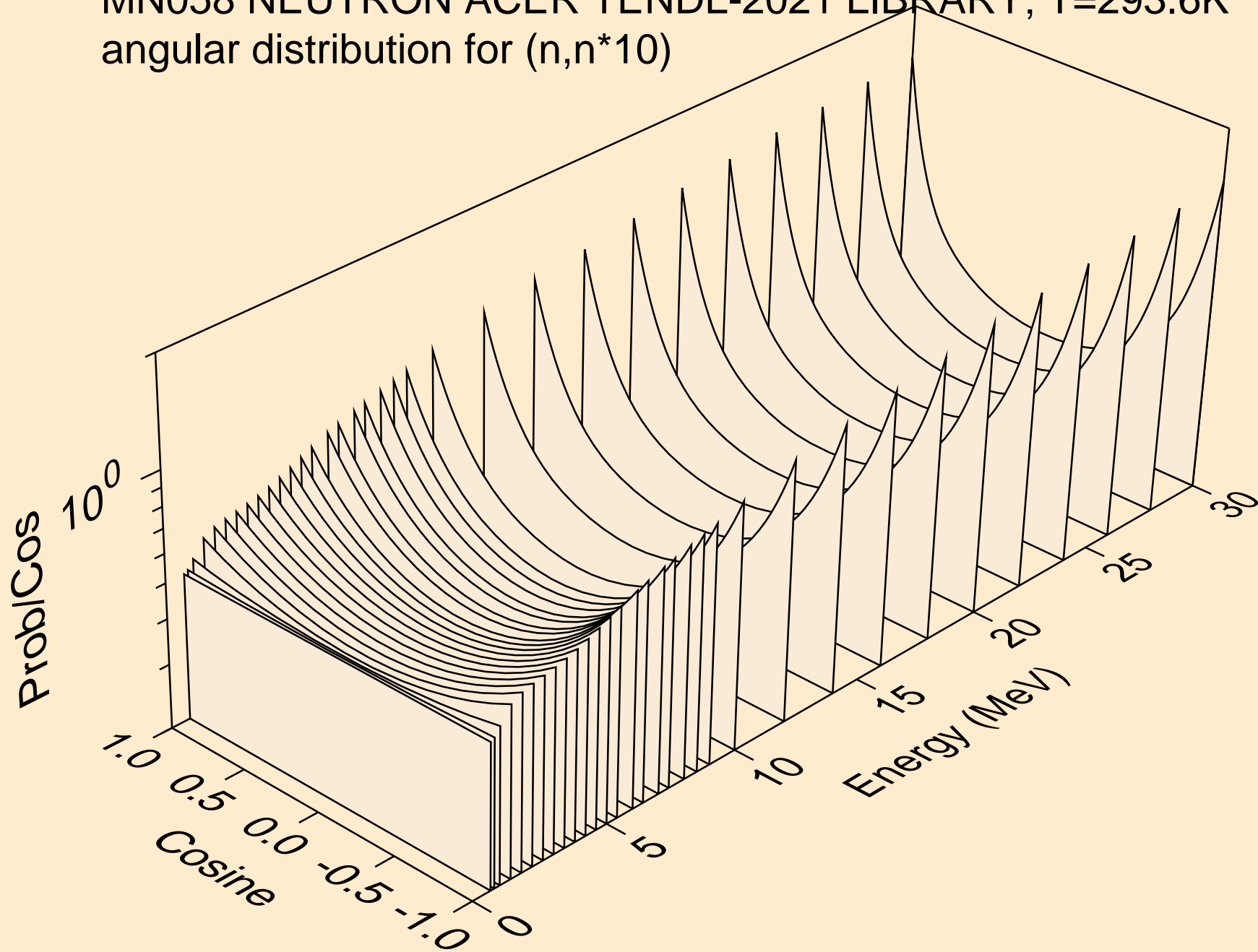

MN058 NEUTRON ACER TENDL-2021 LIBRARY; T=293.6K
angular distribution for (n,n*11)

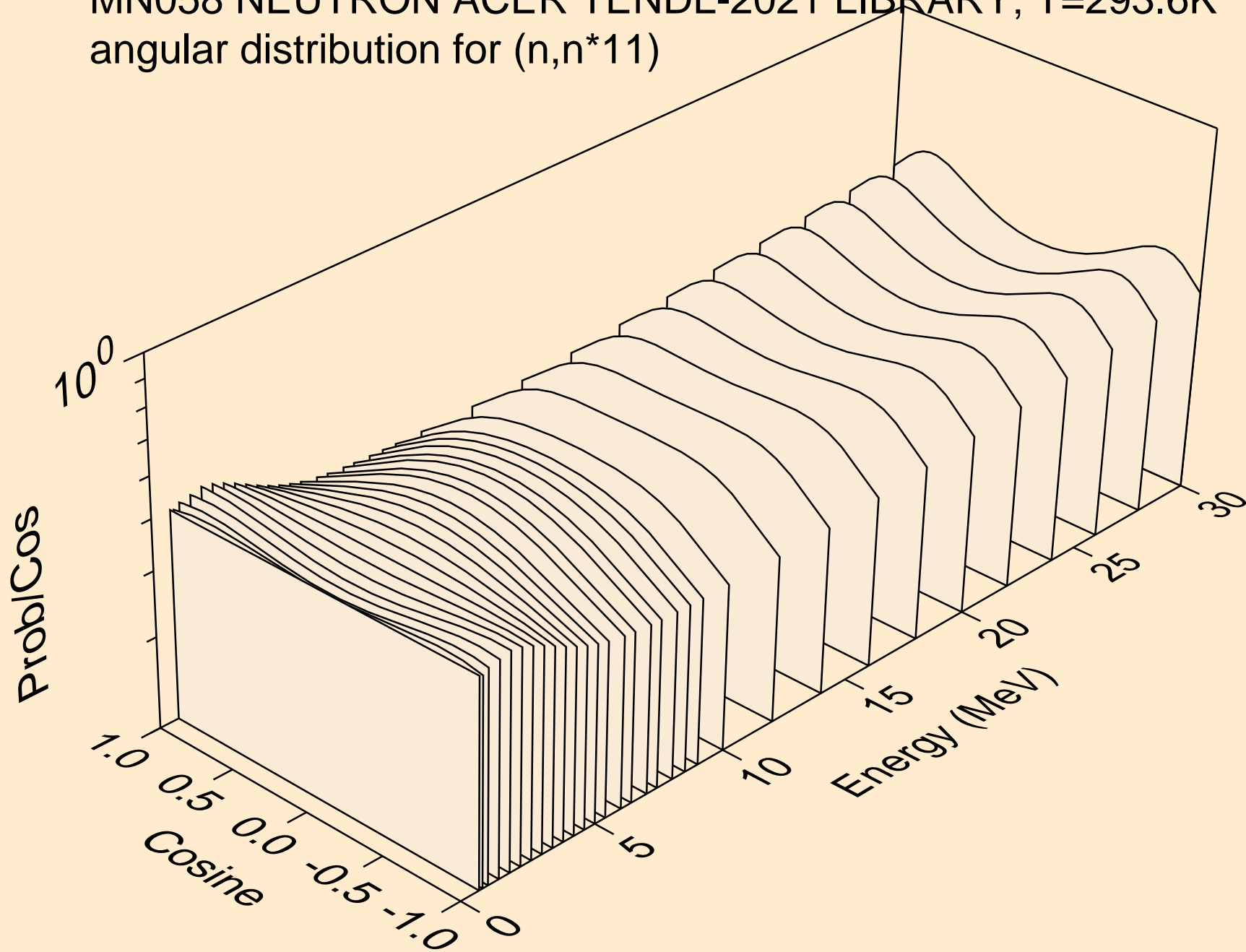

MN058 NEUTRON ACER TENDL-2021 LIBRARY; T=293.6K
angular distribution for (n,n*12)

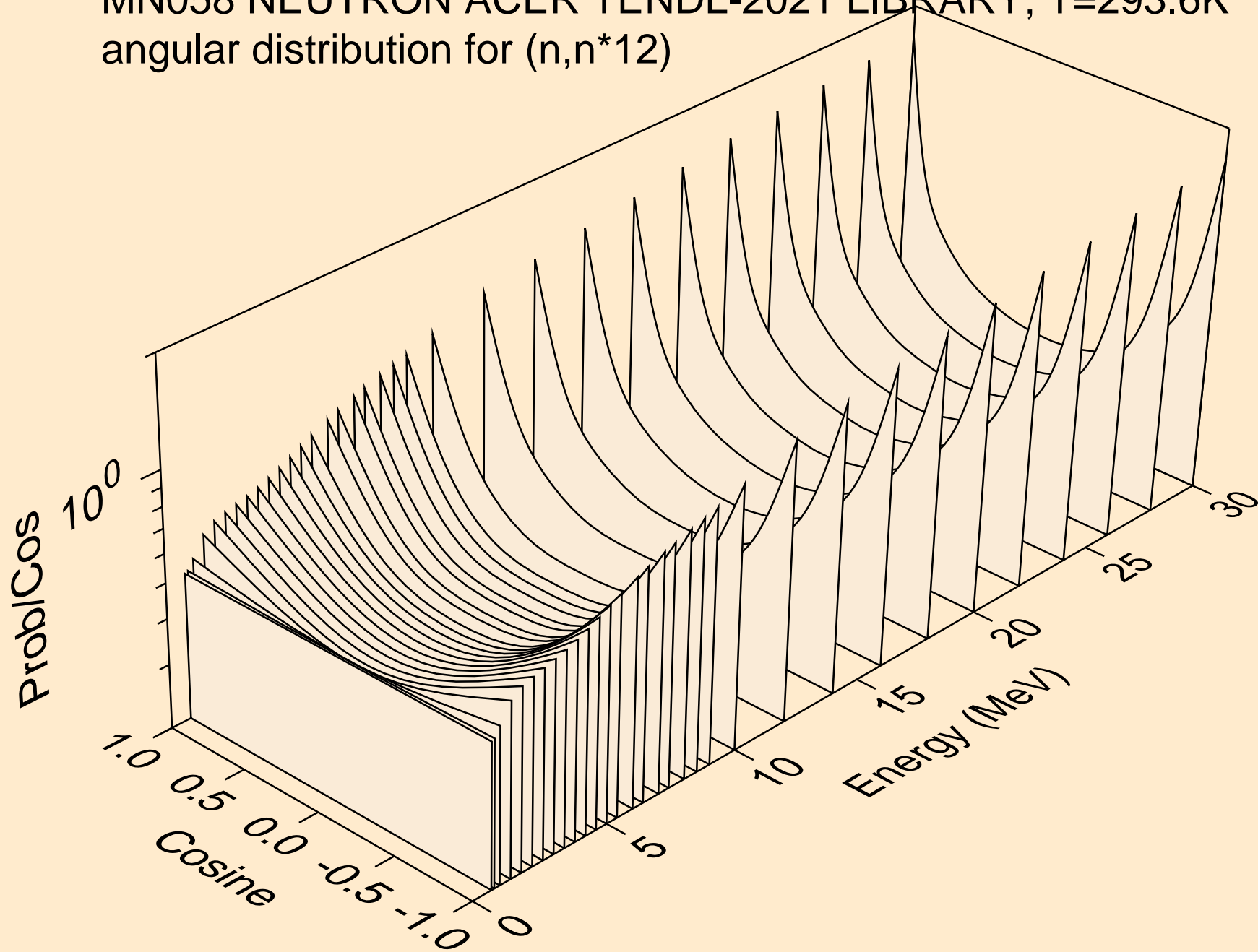

MN058 NEUTRON ACER TENDL-2021 LIBRARY; T=293.6K
angular distribution for (n,n*13)

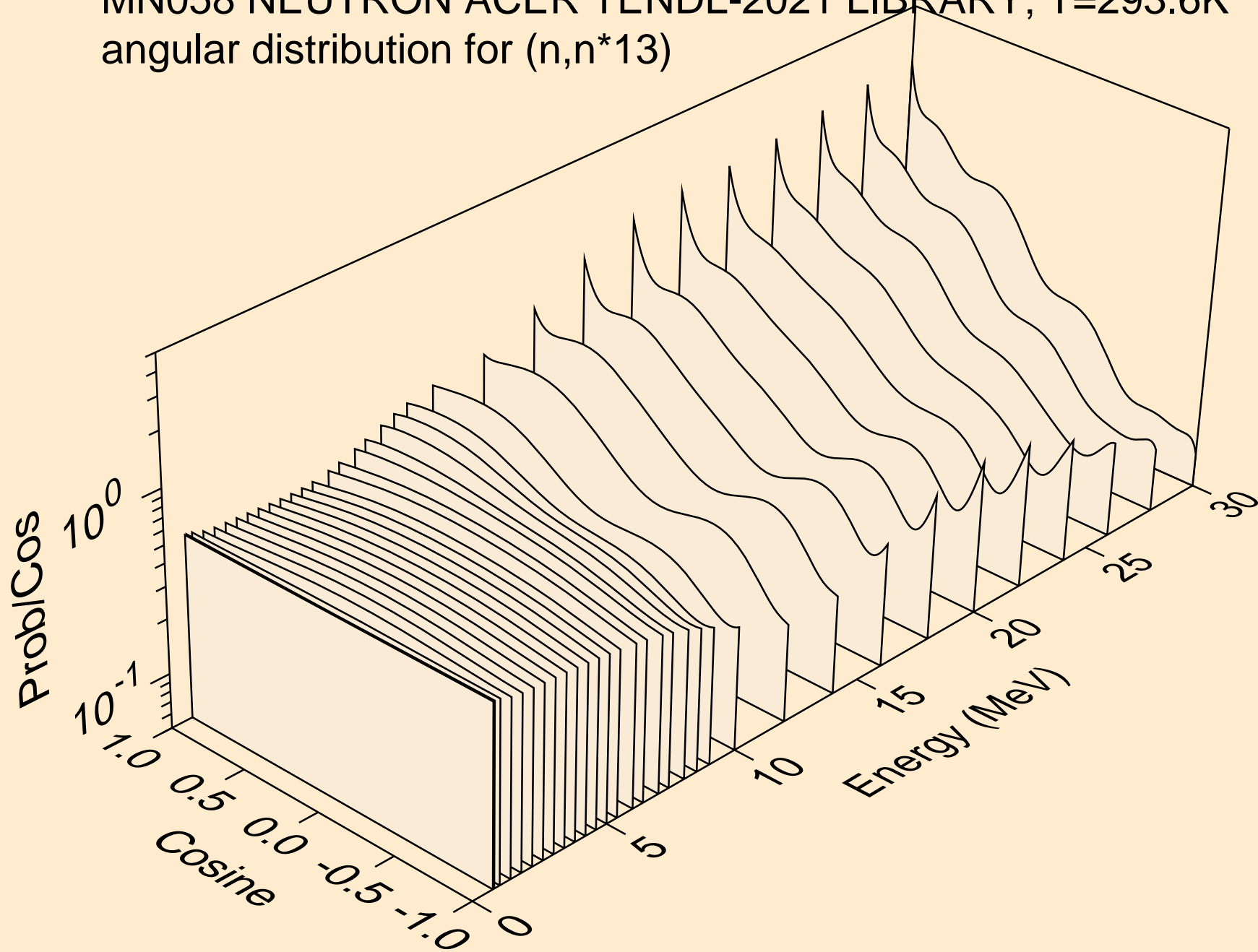

MN058 NEUTRON ACER TENDL-2021 LIBRARY; T=293.6K
angular distribution for (n,n*14)

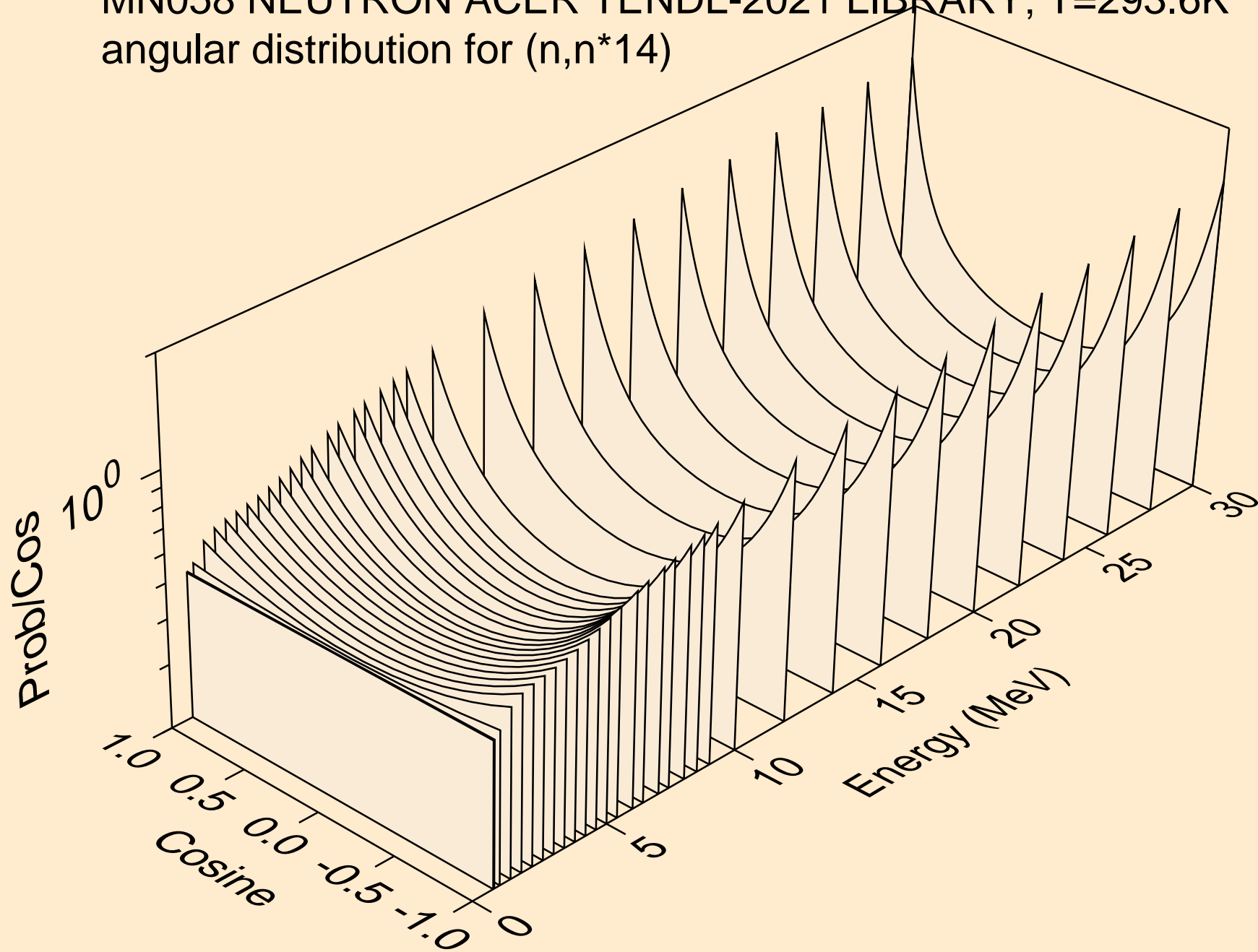

MN058 NEUTRON ACER TENDL-2021 LIBRARY; T=293.6K
angular distribution for (n,n*15)

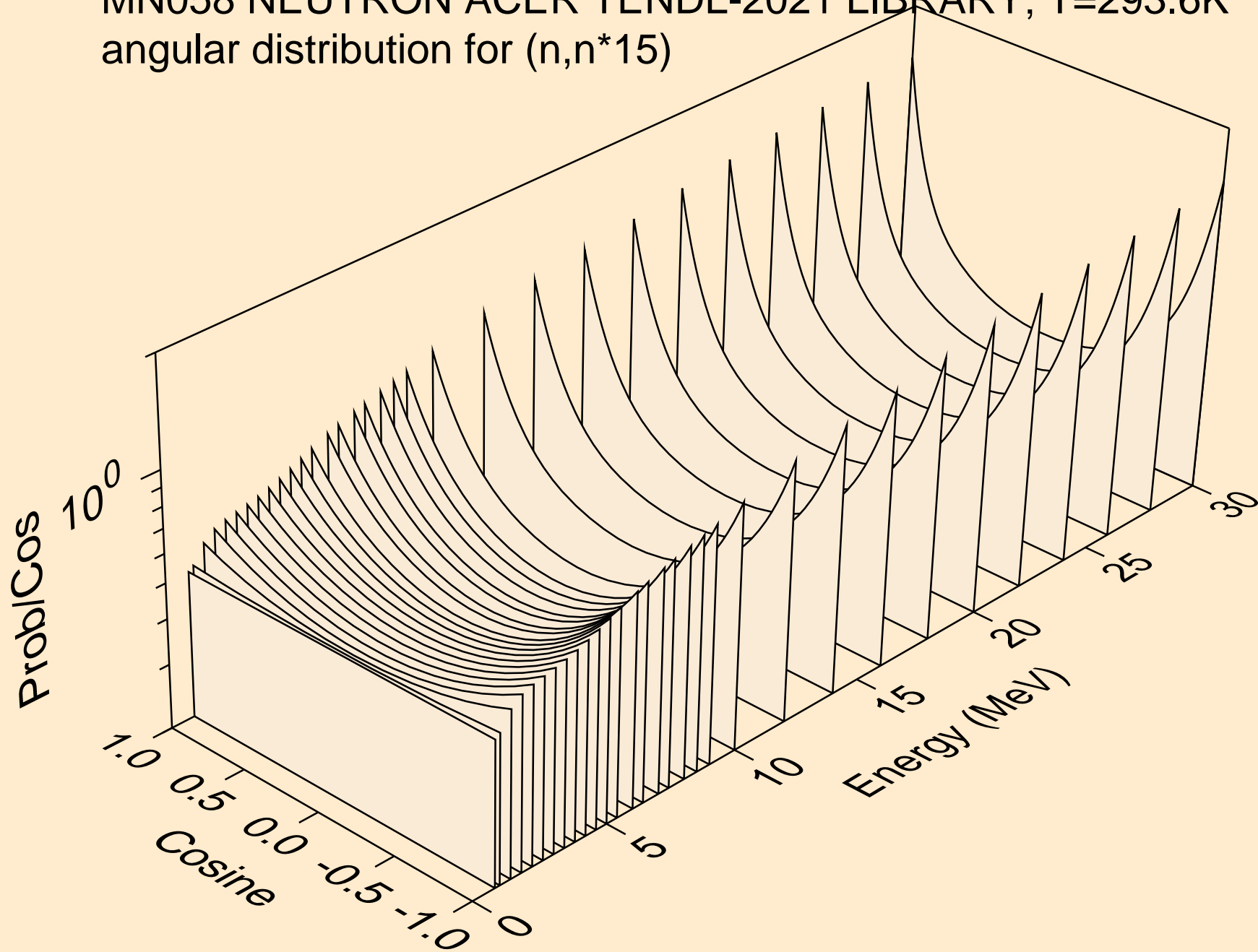

MN058 NEUTRON ACER TENDL-2021 LIBRARY; T=293.6K
angular distribution for (n,n*16)

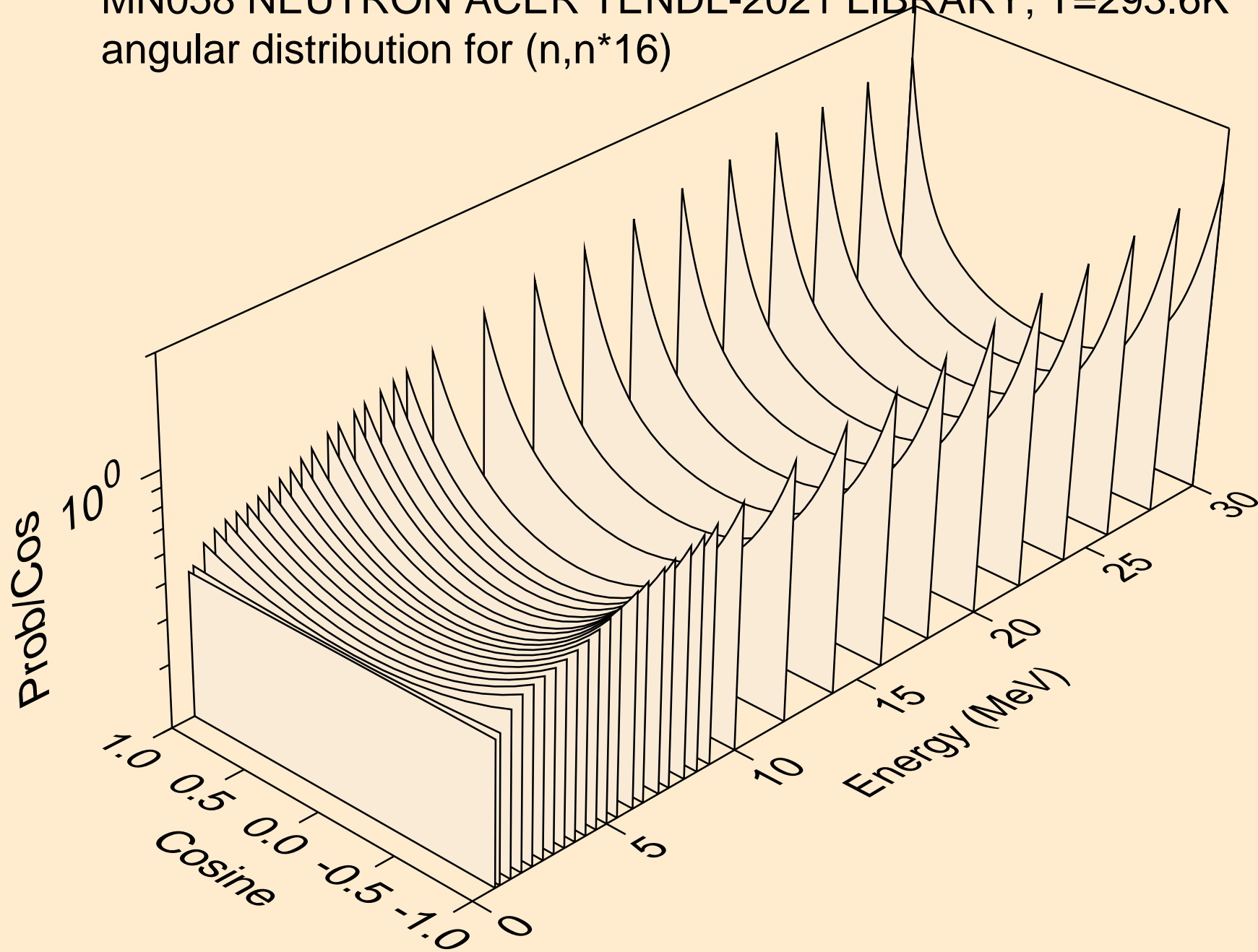

MN058 NEUTRON ACER TENDL-2021 LIBRARY; T=293.6K
angular distribution for (n,n*17)

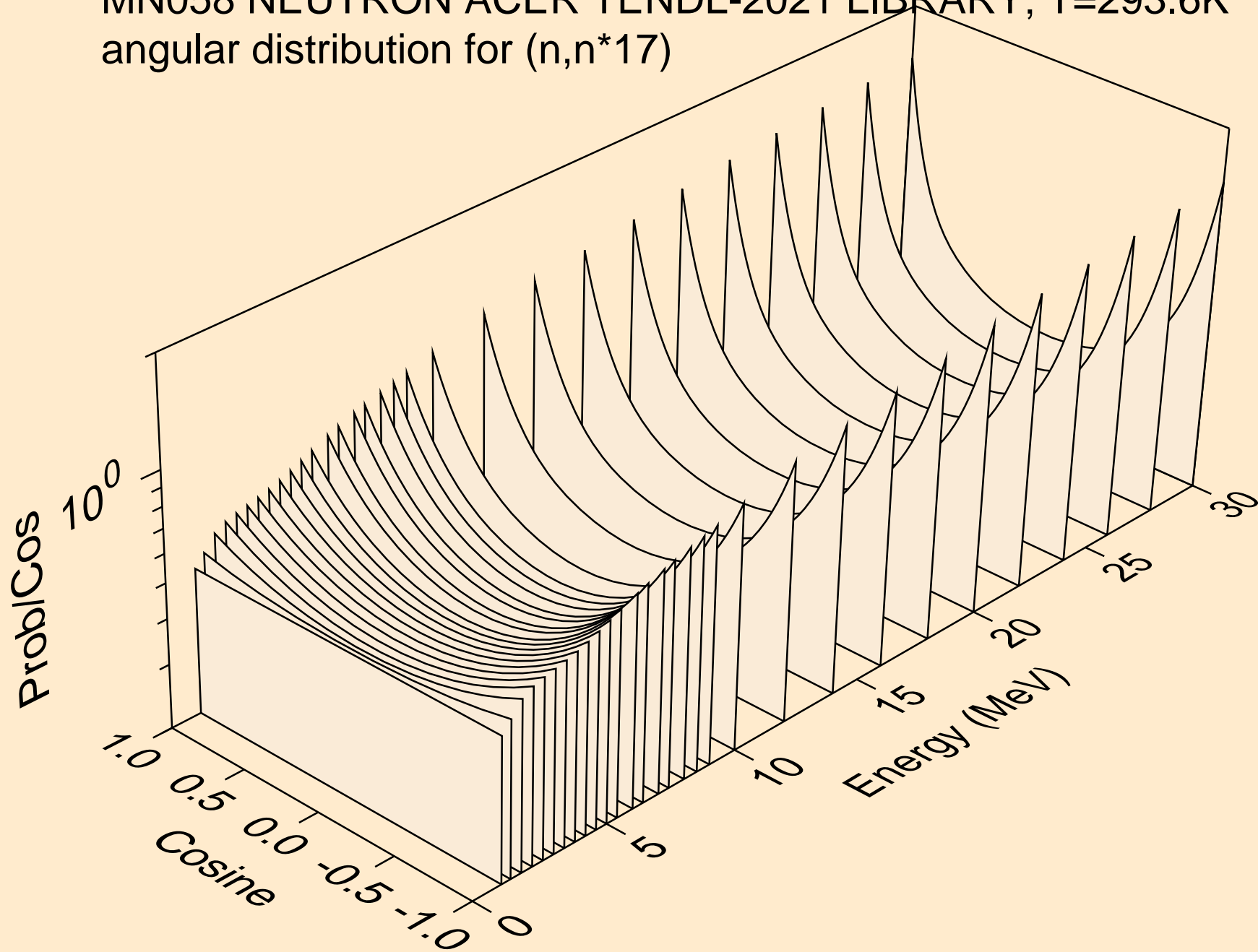

MN058 NEUTRON ACER TENDL-2021 LIBRARY; T=293.6K
angular distribution for (n,n*18)

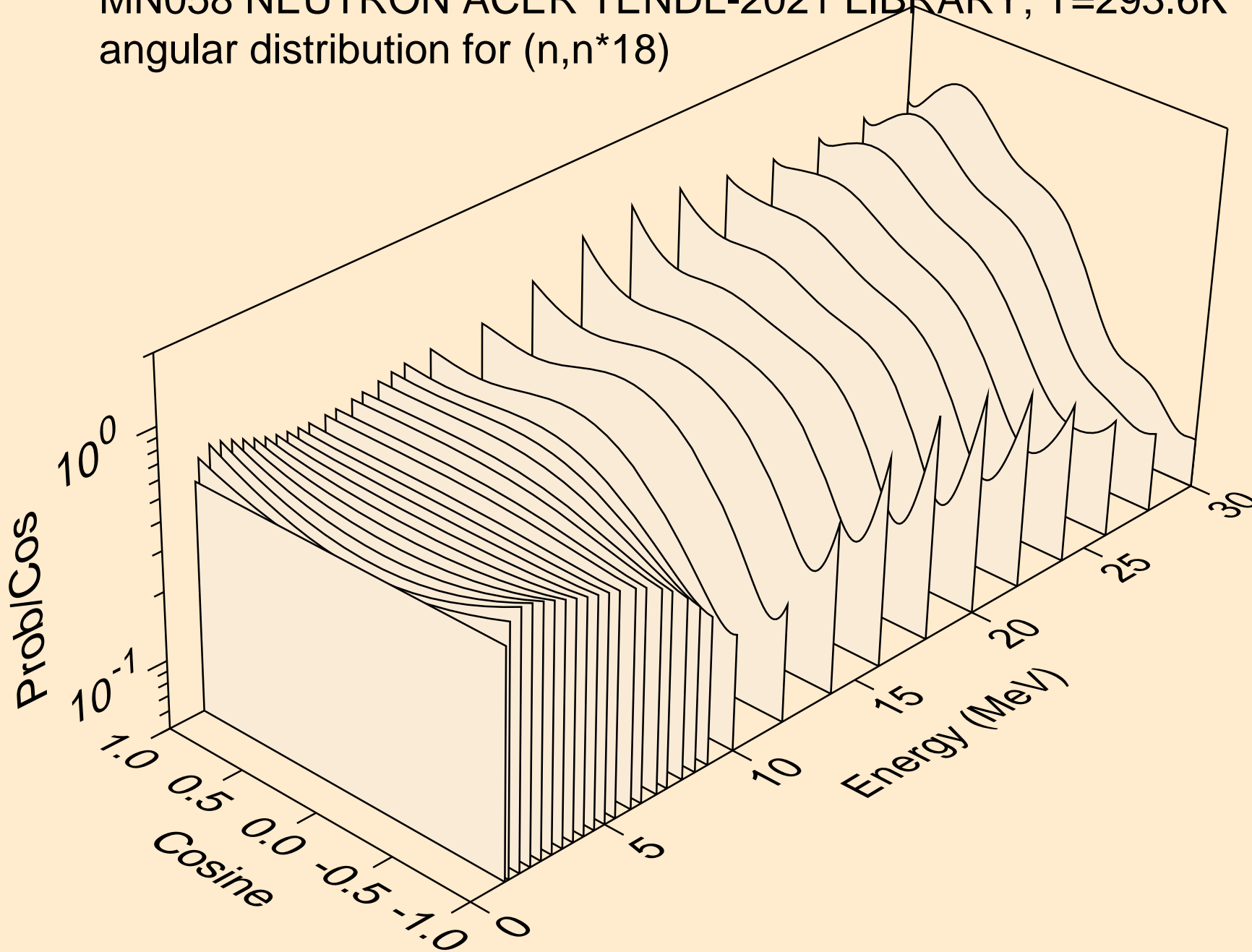

MN058 NEUTRON ACER TENDL-2021 LIBRARY; T=293.6K
angular distribution for (n,n*19)

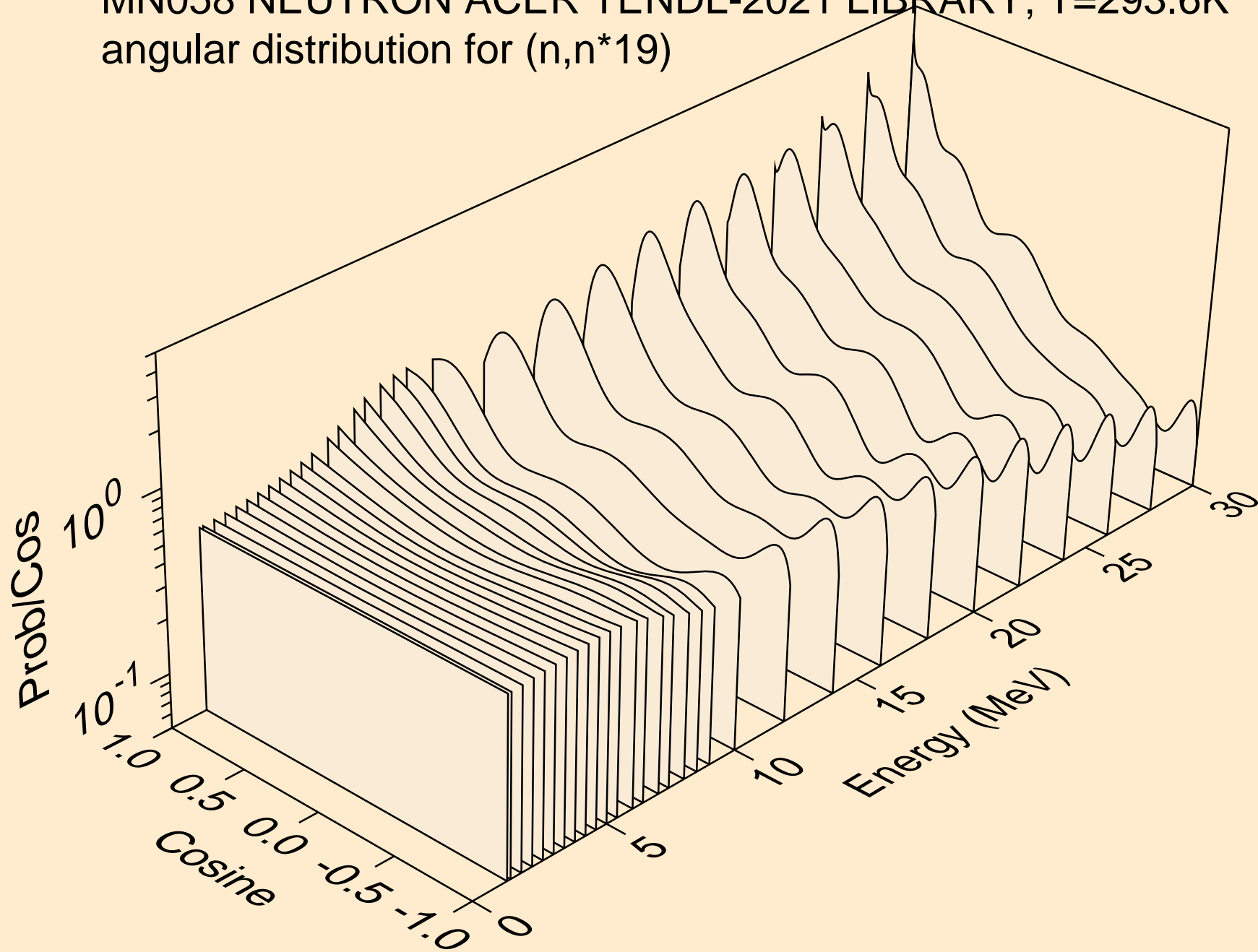

MN058 NEUTRON ACER TENDL-2021 LIBRARY; T=293.6K
angular distribution for (n,n*20)

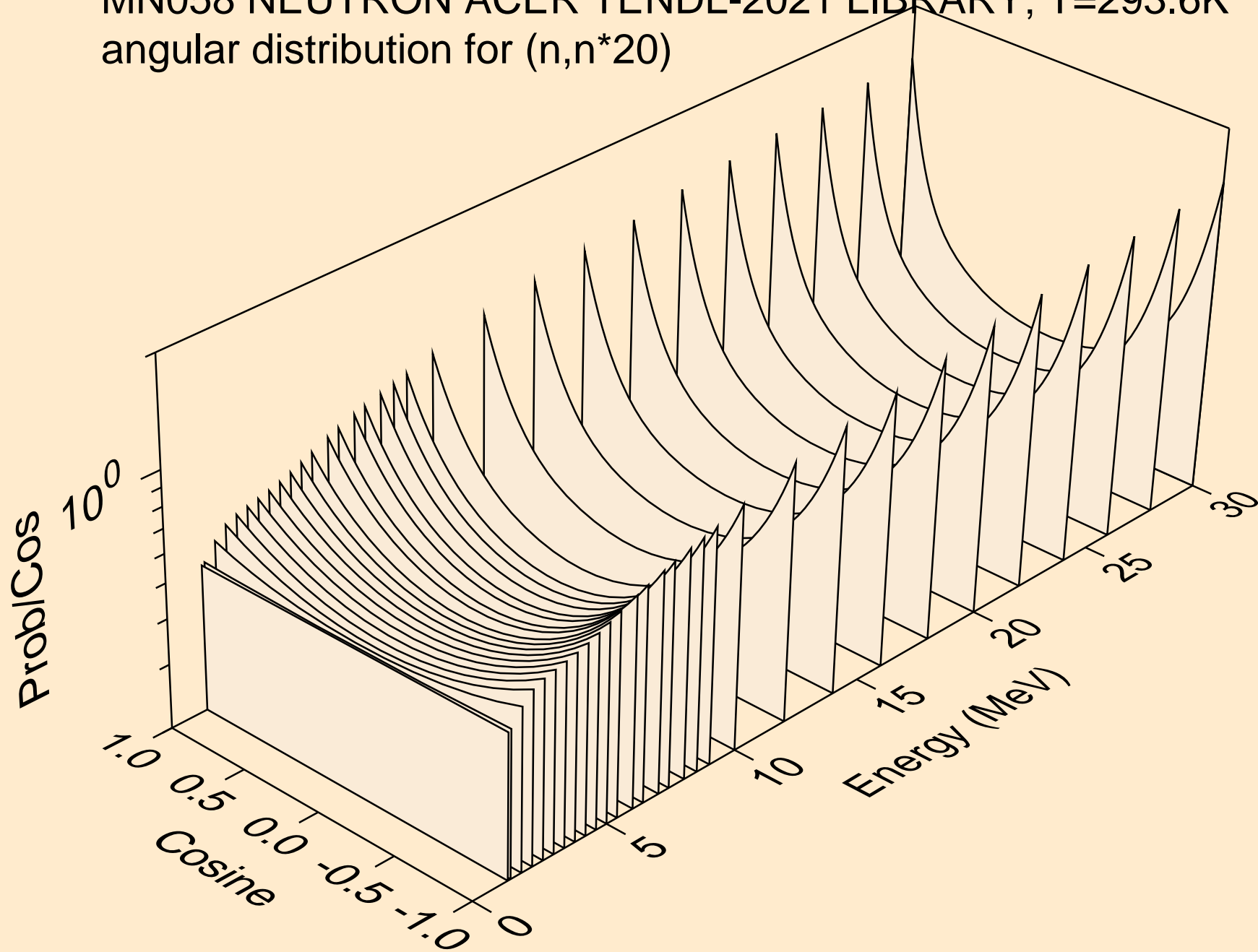

MN058 NEUTRON ACER TENDL-2021 LIBRARY; T=293.6K
angular distribution for (n,n*21)

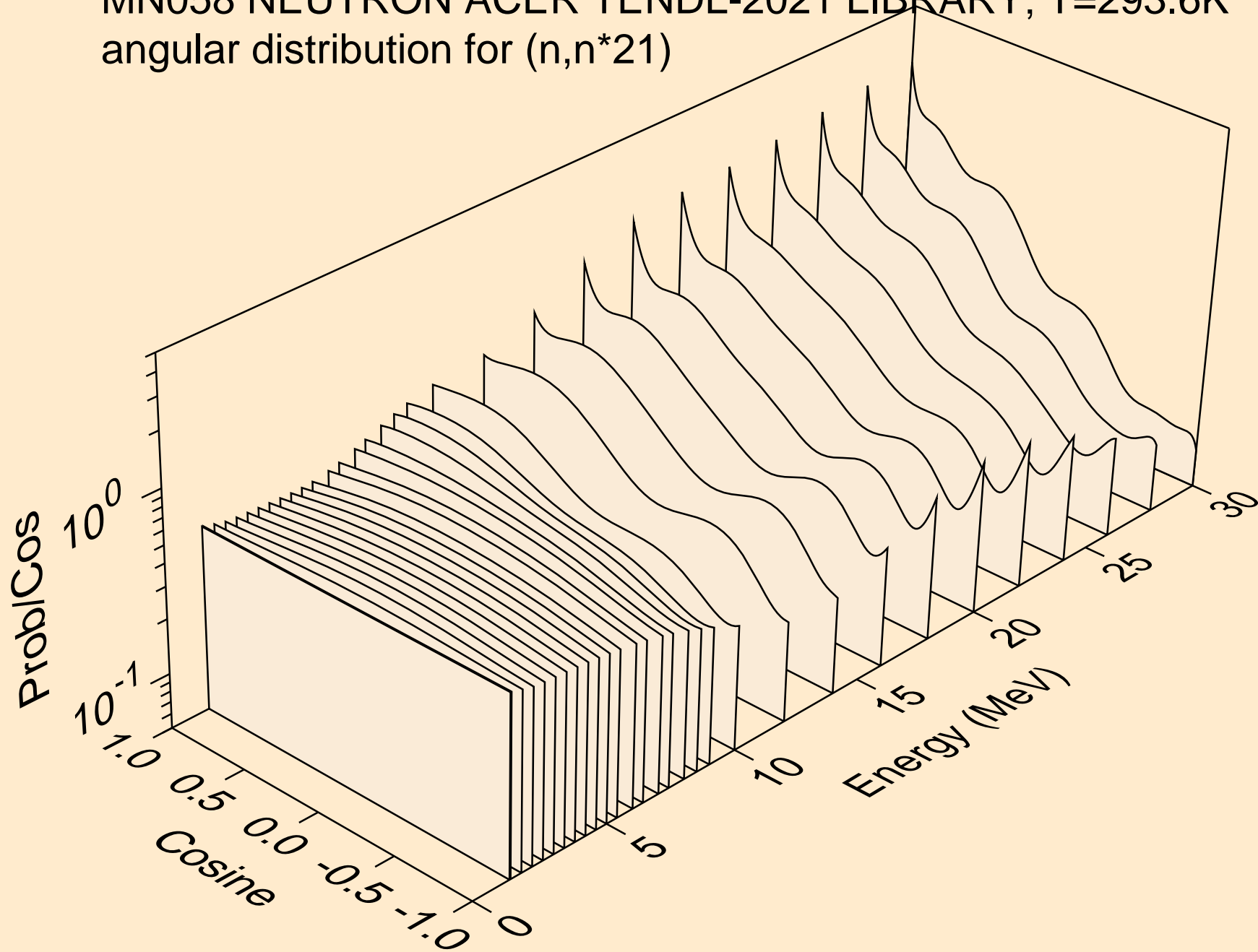

MN058 NEUTRON ACER TENDL-2021 LIBRARY; T=293.6K
angular distribution for (n,n*22)

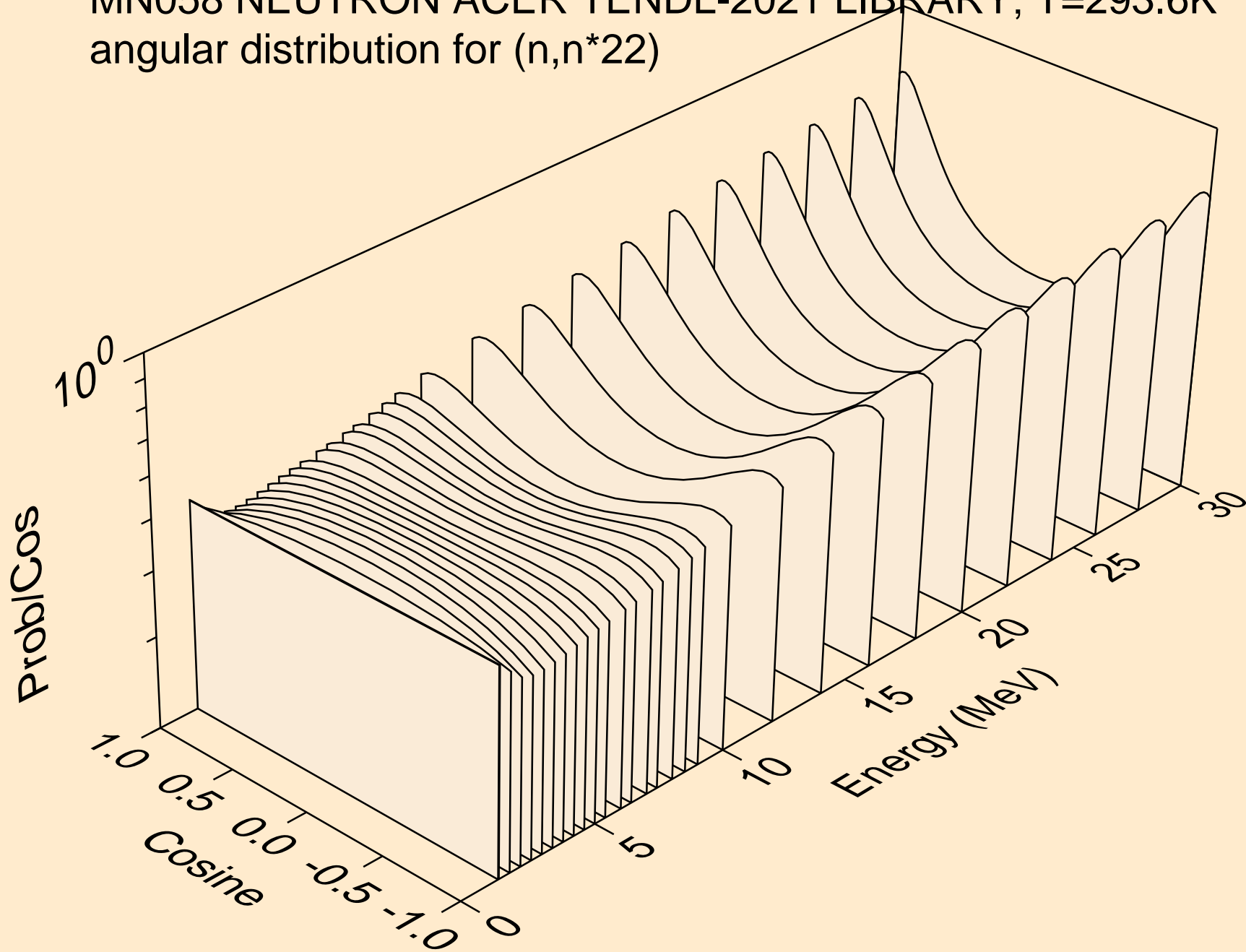

MN058 NEUTRON ACER TENDL-2021 LIBRARY; T=293.6K
angular distribution for (n,n*23)

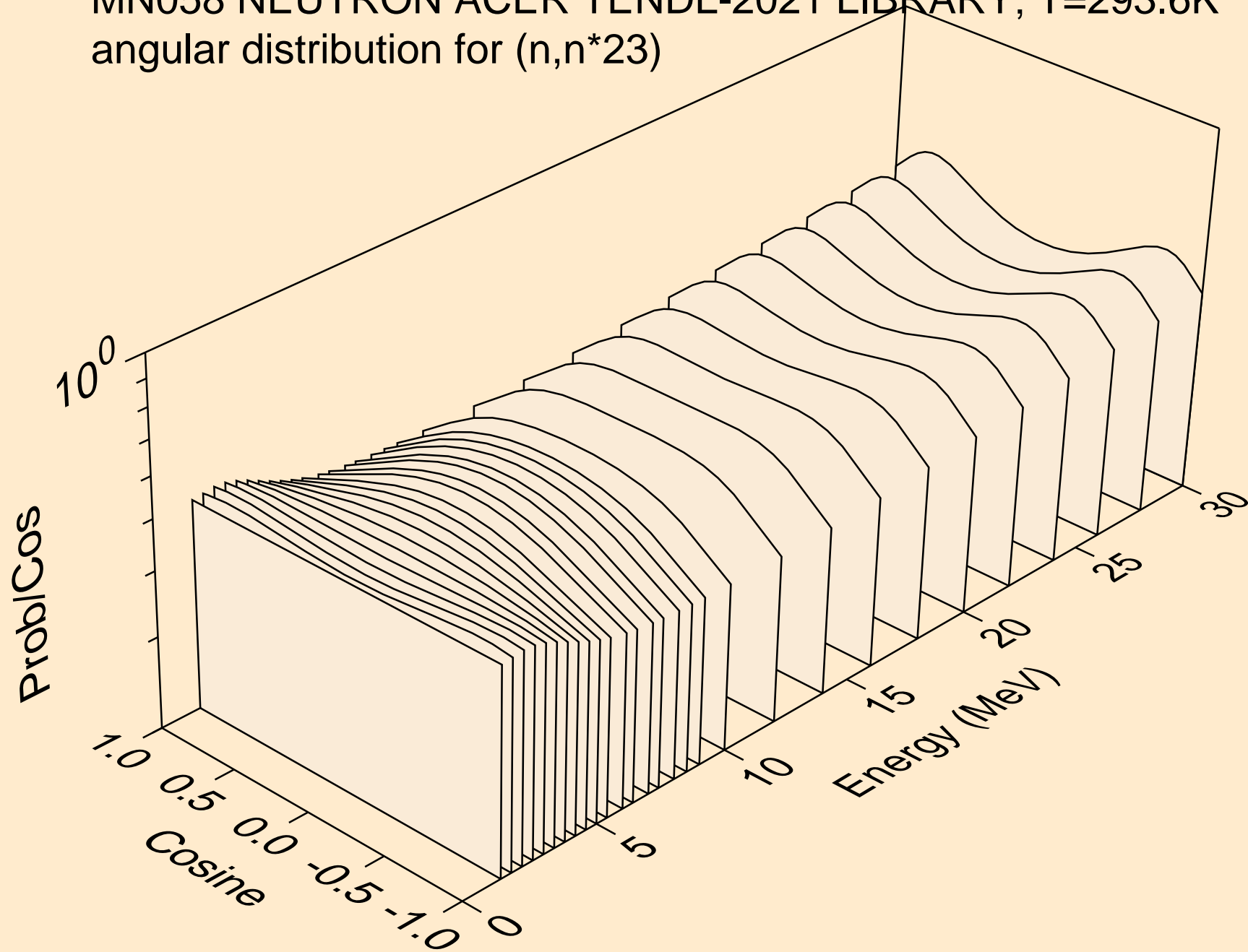

MN058 NEUTRON ACER TENDL-2021 LIBRARY; T=293.6K
angular distribution for (n,n*24)

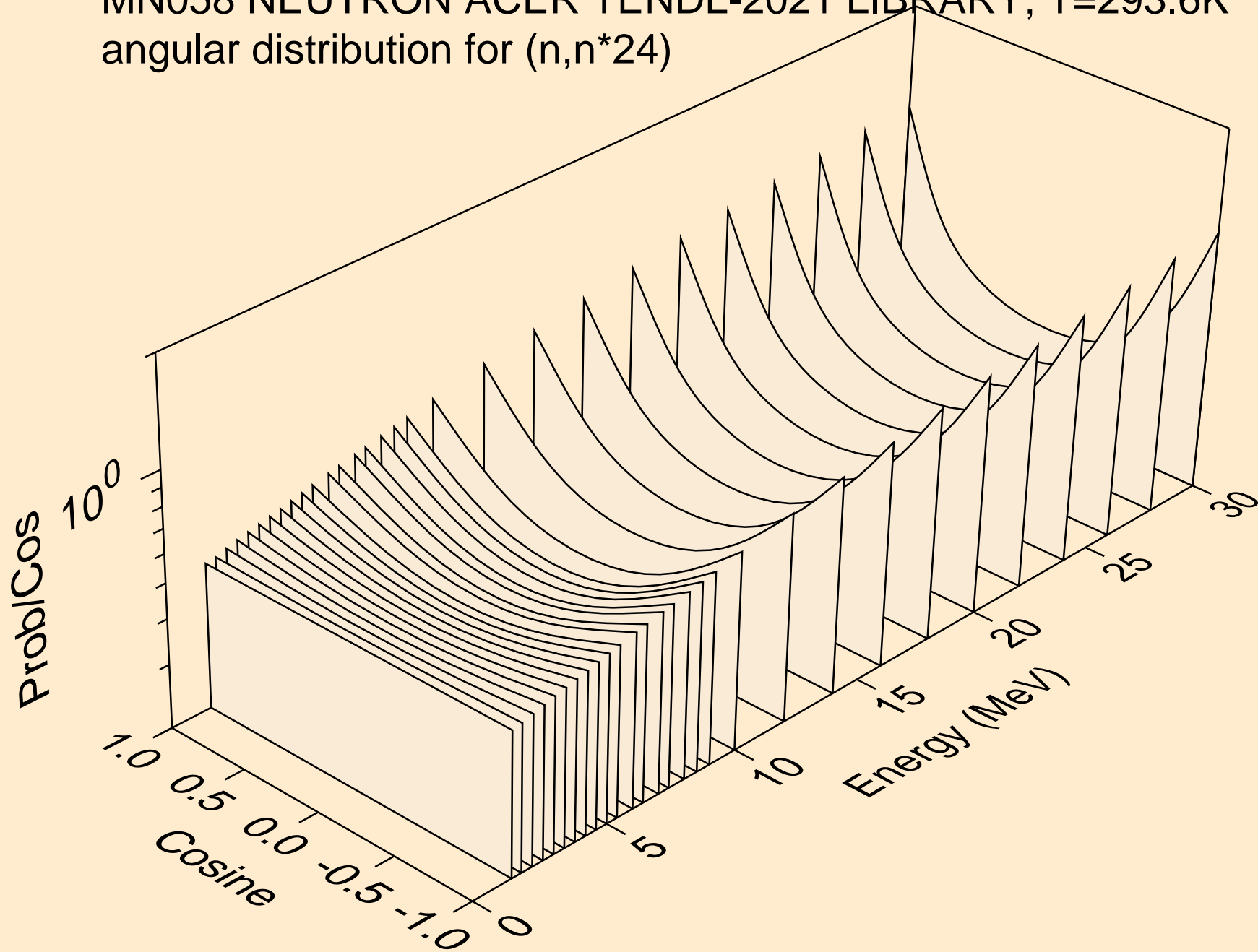

MN058 NEUTRON ACER TENDL-2021 LIBRARY; T=293.6K
angular distribution for (n,n*25)

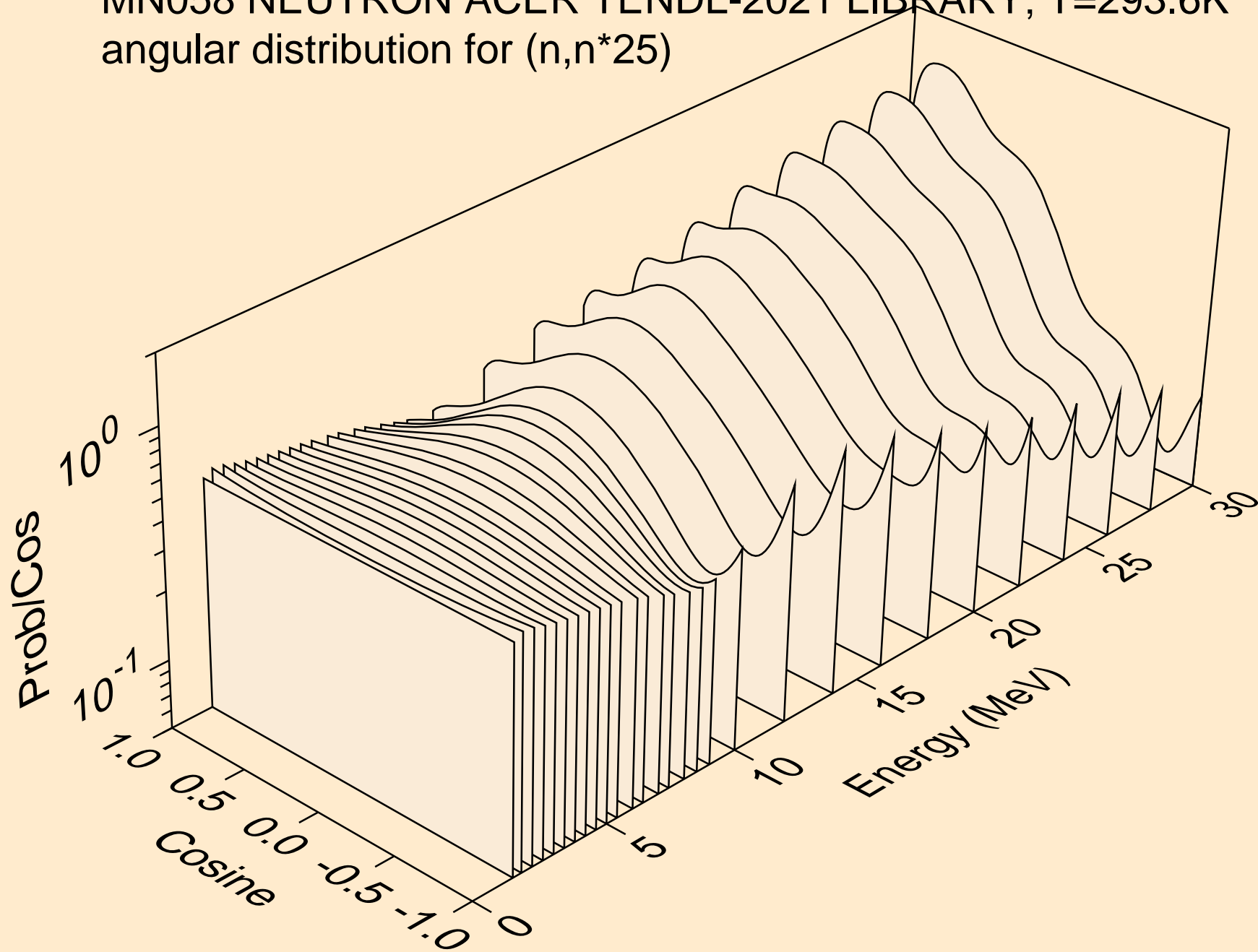

MN058 NEUTRON ACER TENDL-2021 LIBRARY; T=293.6K
angular distribution for (n,n*26)

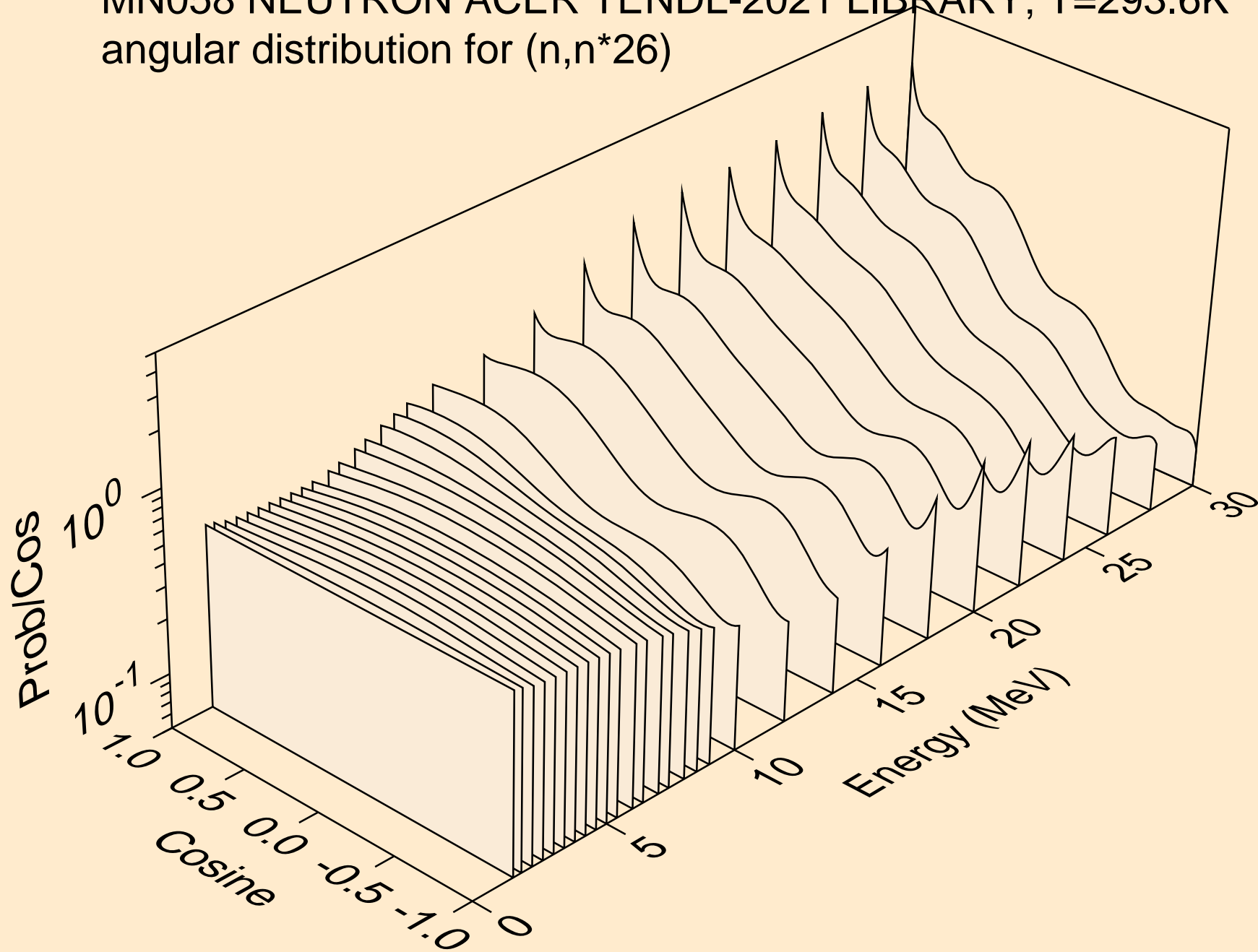

MN058 NEUTRON ACER TENDL-2021 LIBRARY; T=293.6K
angular distribution for (n,n*27)

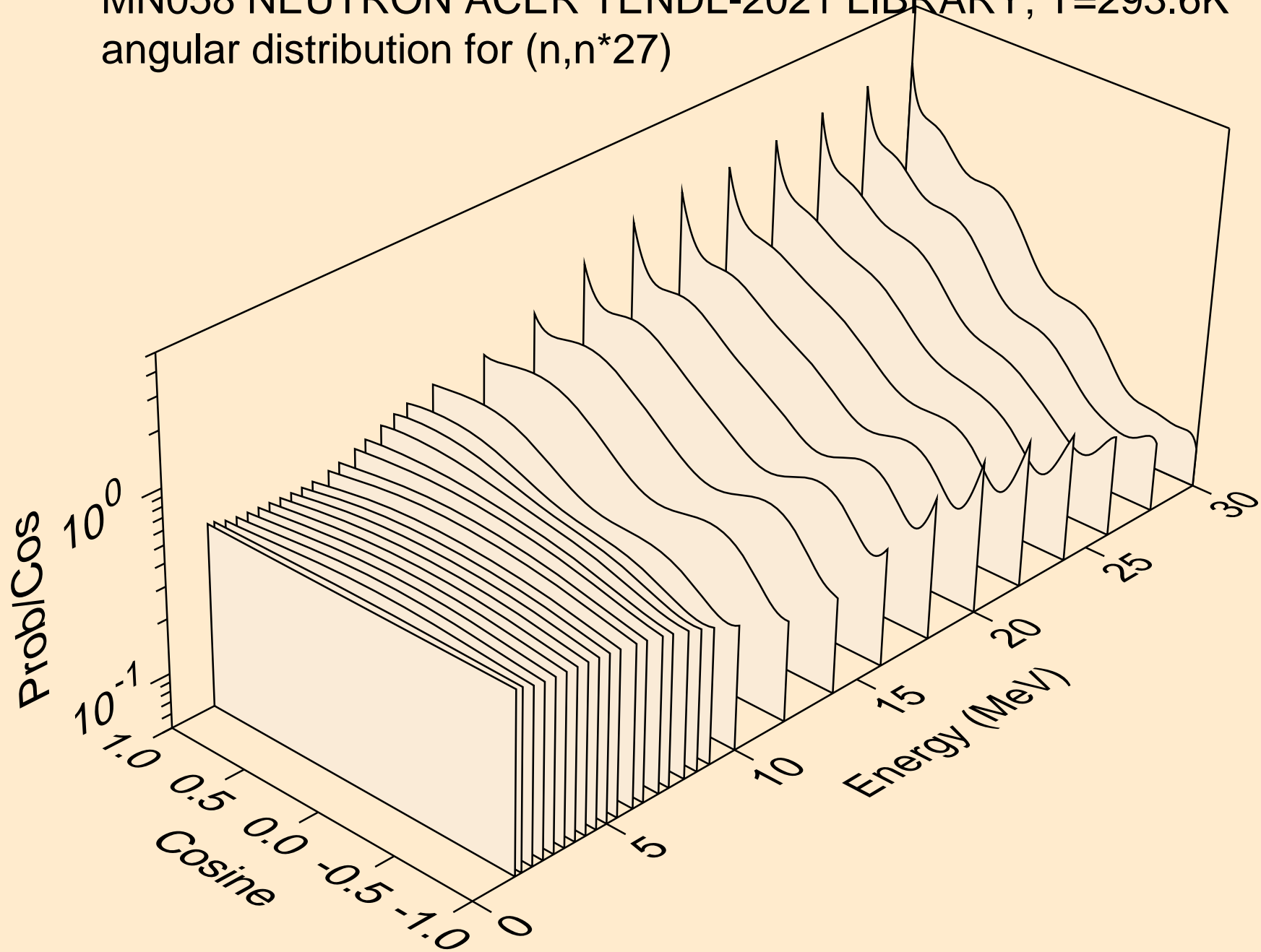

MN058 NEUTRON ACER TENDL-2021 LIBRARY; T=293.6K
angular distribution for (n,n*28)

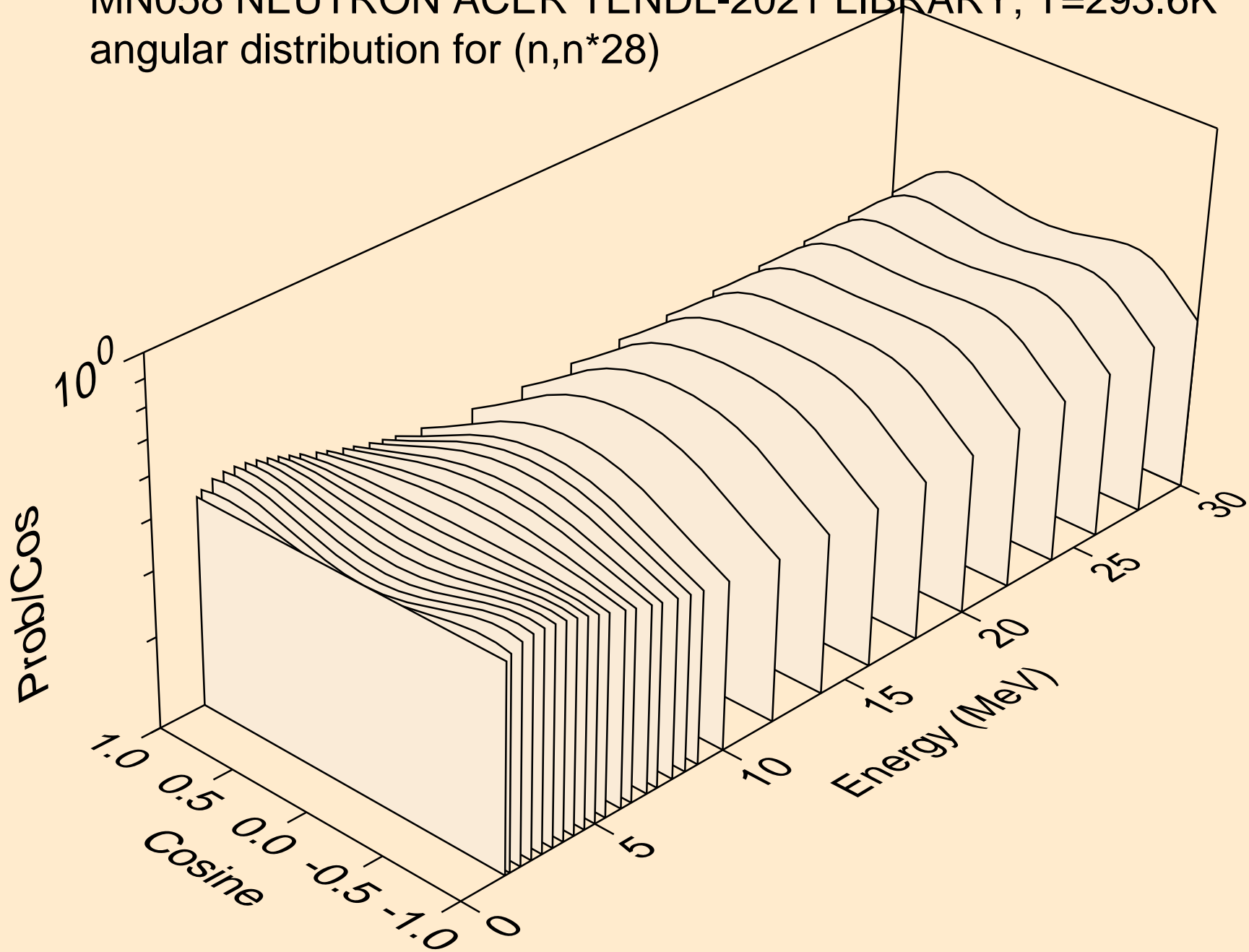

MN058 NEUTRON ACER TENDL-2021 LIBRARY; T=293.6K
angular distribution for (n,n*29)

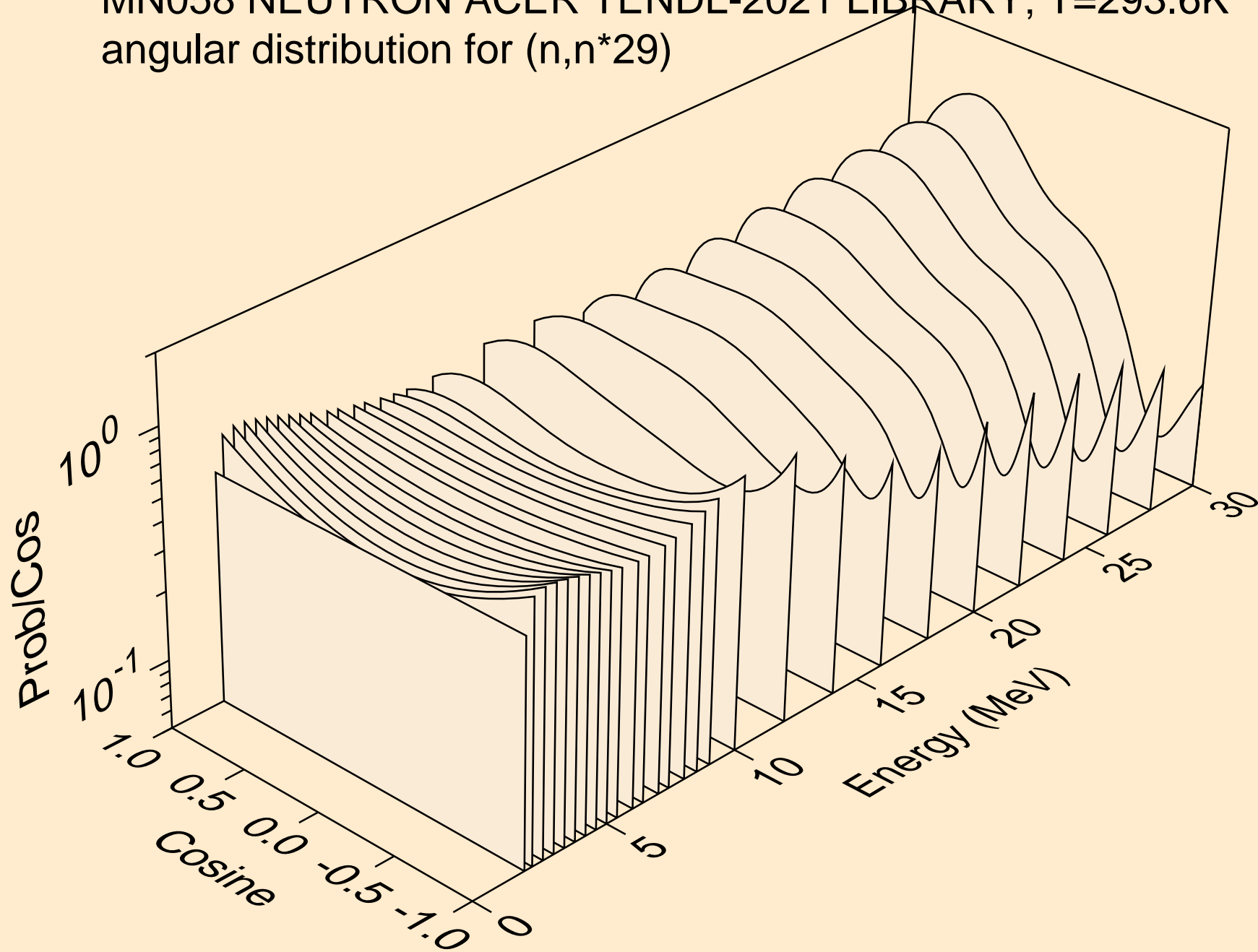

MN058 NEUTRON ACER TENDL-2021 LIBRARY; T=293.6K
angular distribution for (n,n*30)

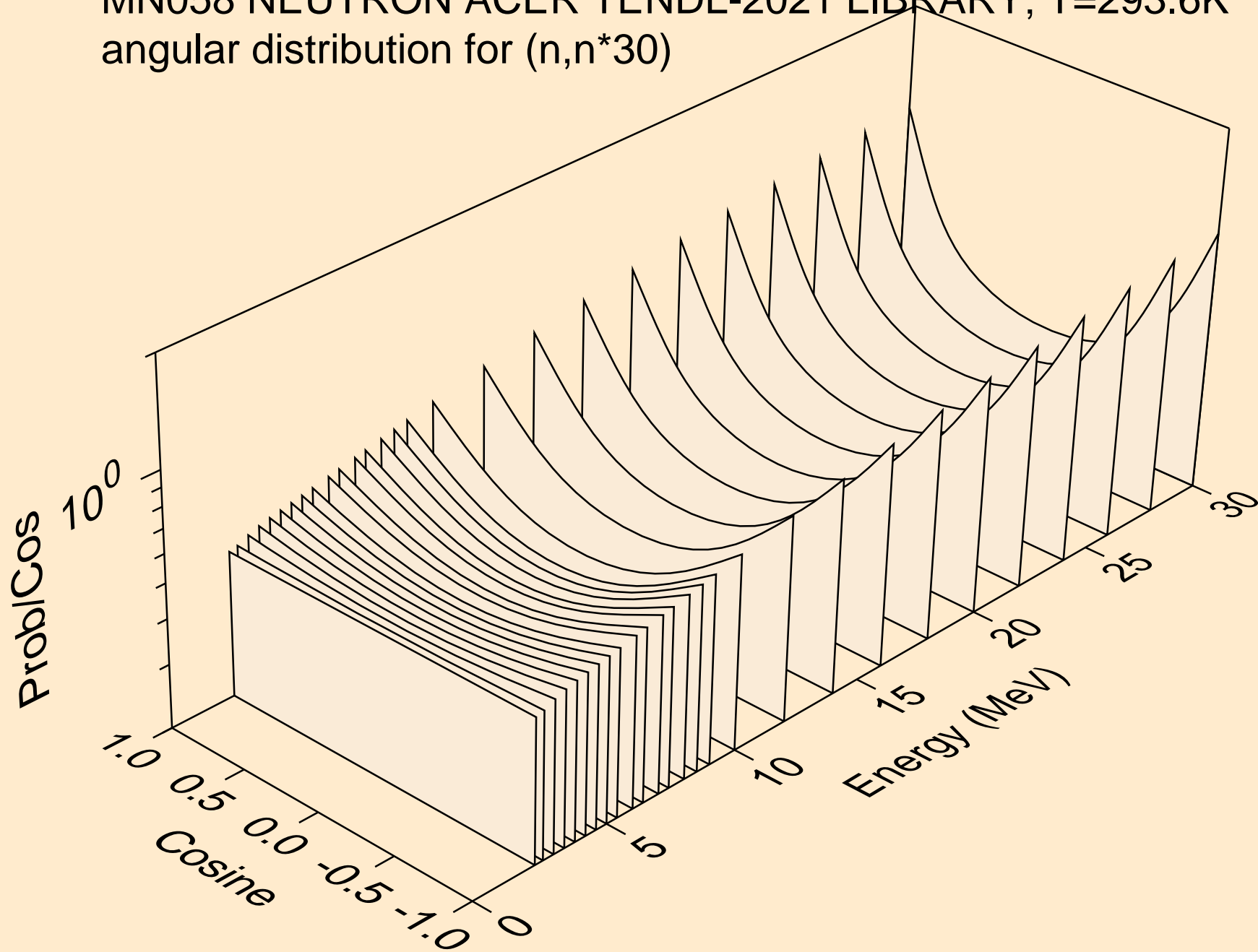

MN058 NEUTRON ACER TENDL-2021 LIBRARY; T=293.6K
Neutron emission for (n,x)

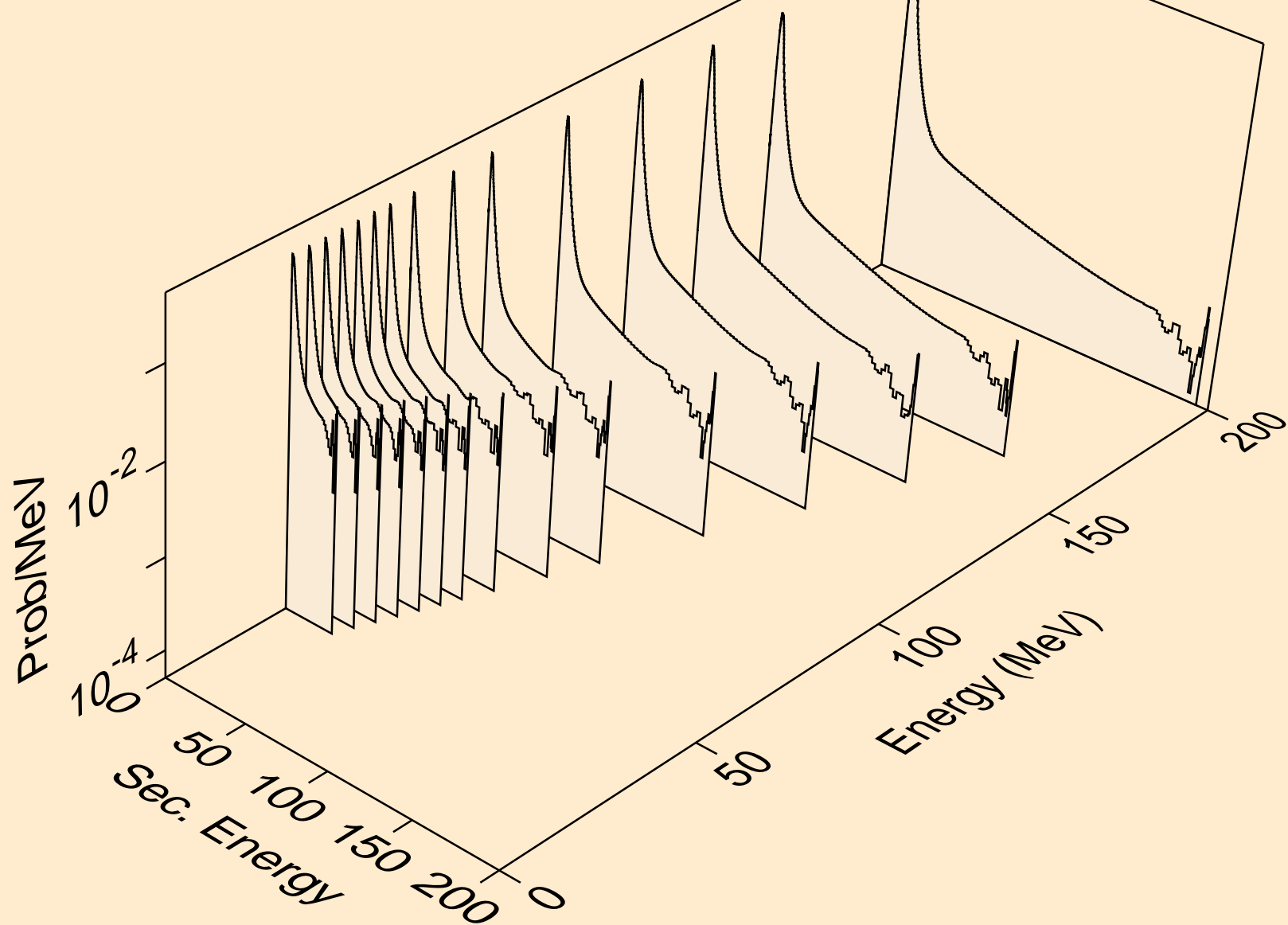

MN058 NEUTRON ACER TENDL-2021 LIBRARY; T=293.6K
Neutron emission for (n,2nd)

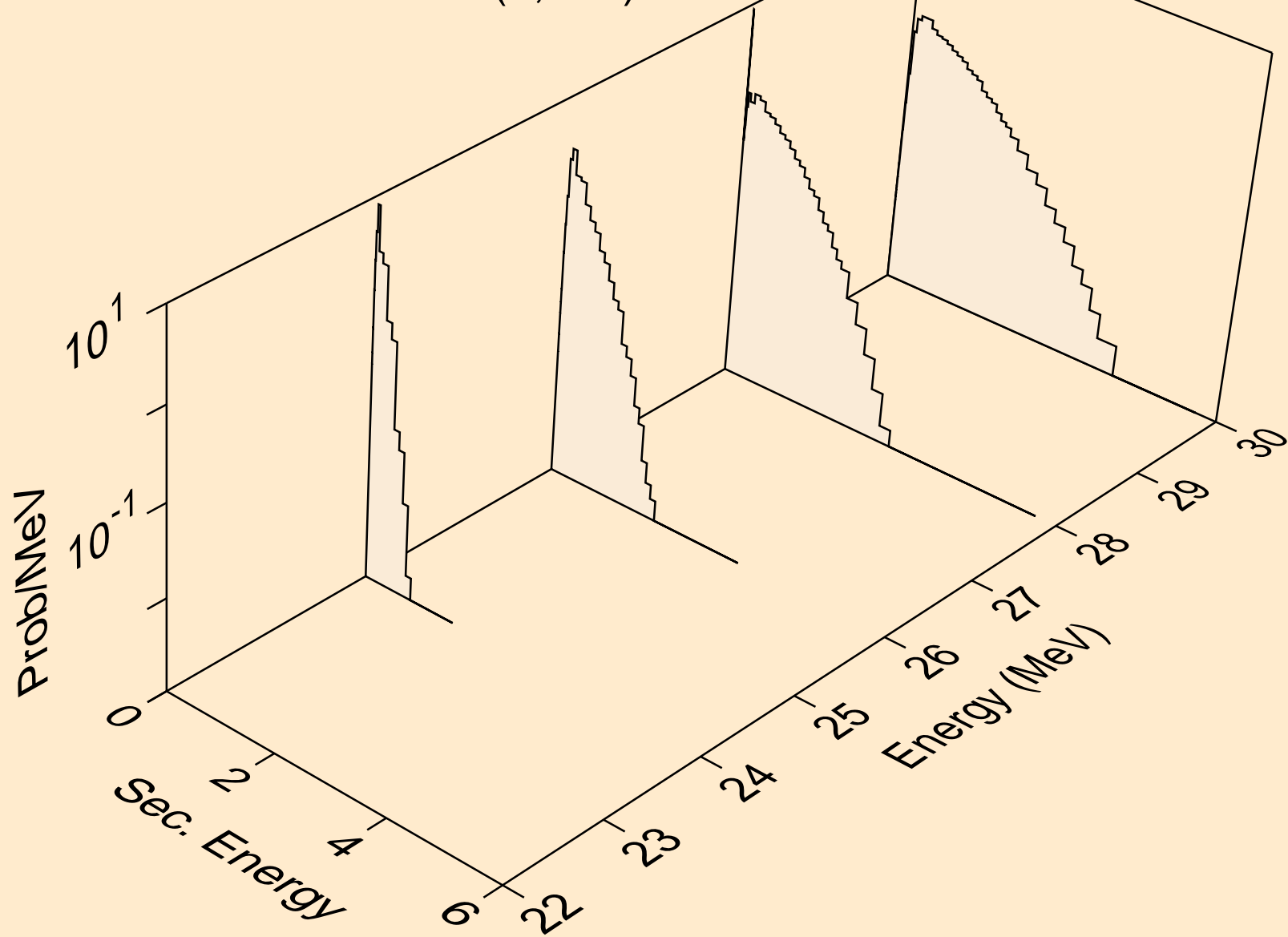

MN058 NEUTRON ACER TENDL-2021 LIBRARY; T=293.6K
Neutron emission for (n,2n)

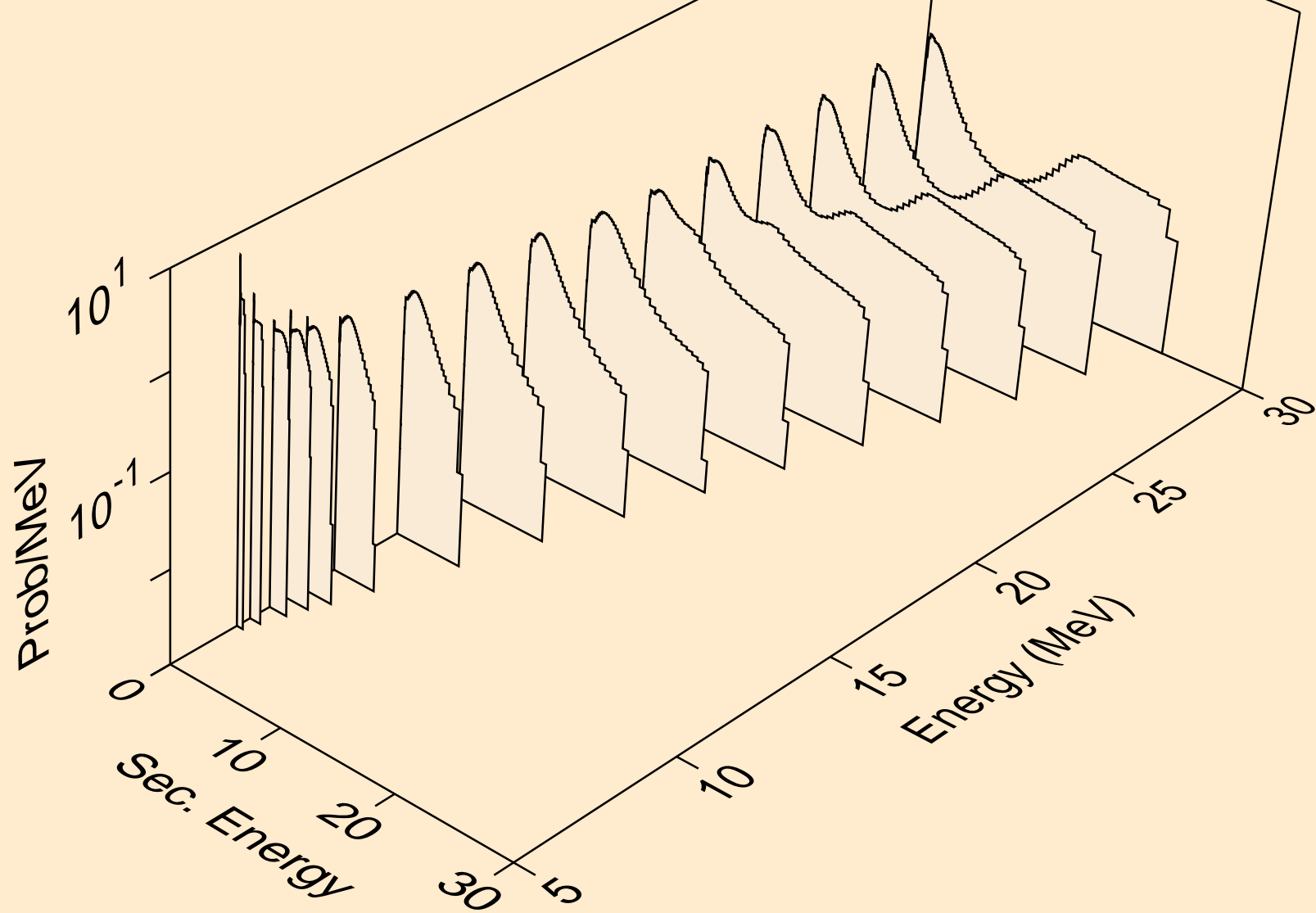

MN058 NEUTRON ACER TENDL-2021 LIBRARY; T=293.6K
Neutron emission for (n,3n)

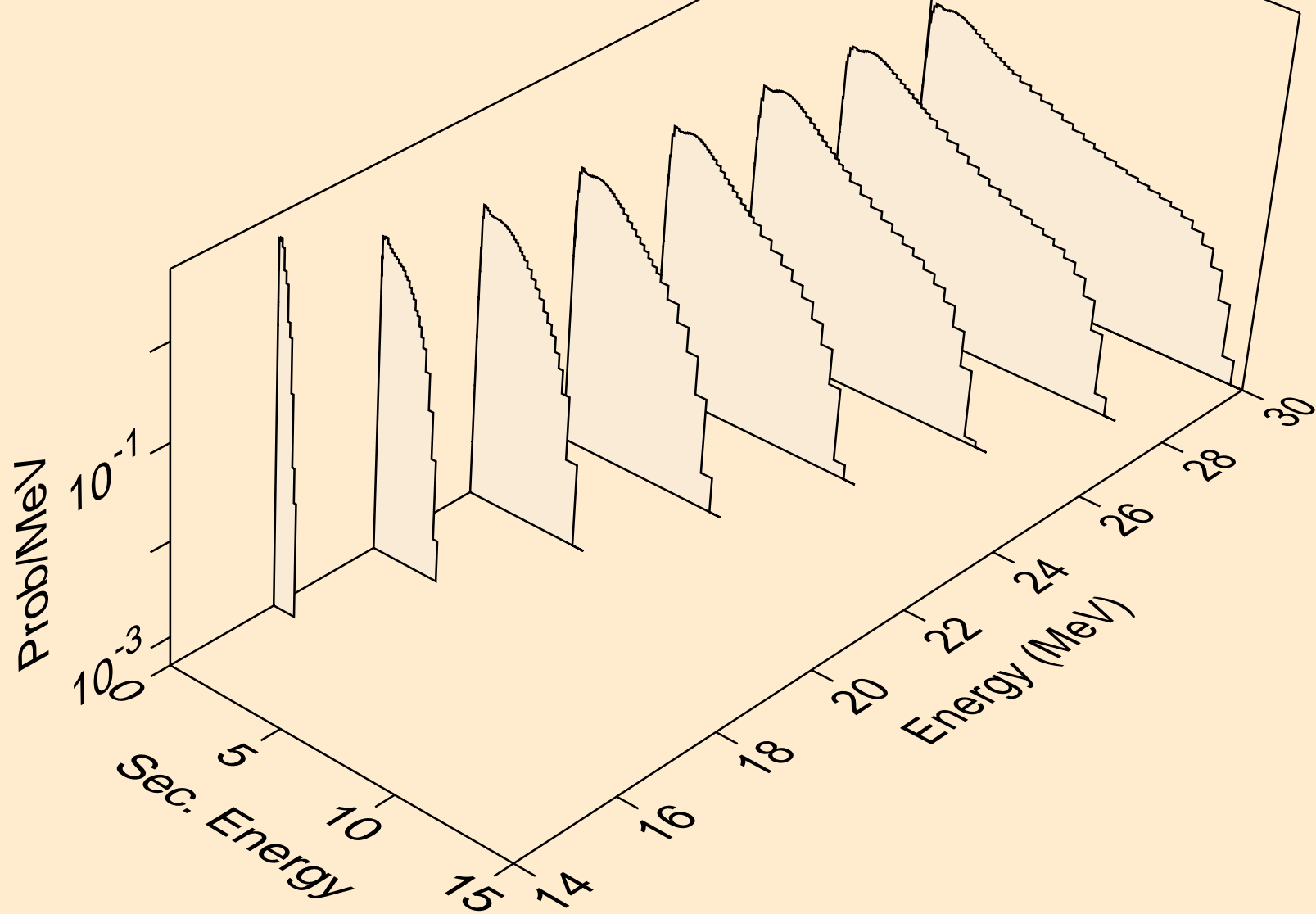

MN058 NEUTRON ACER TENDL-2021 LIBRARY; T=293.6K
Neutron emission for (n,n*)a

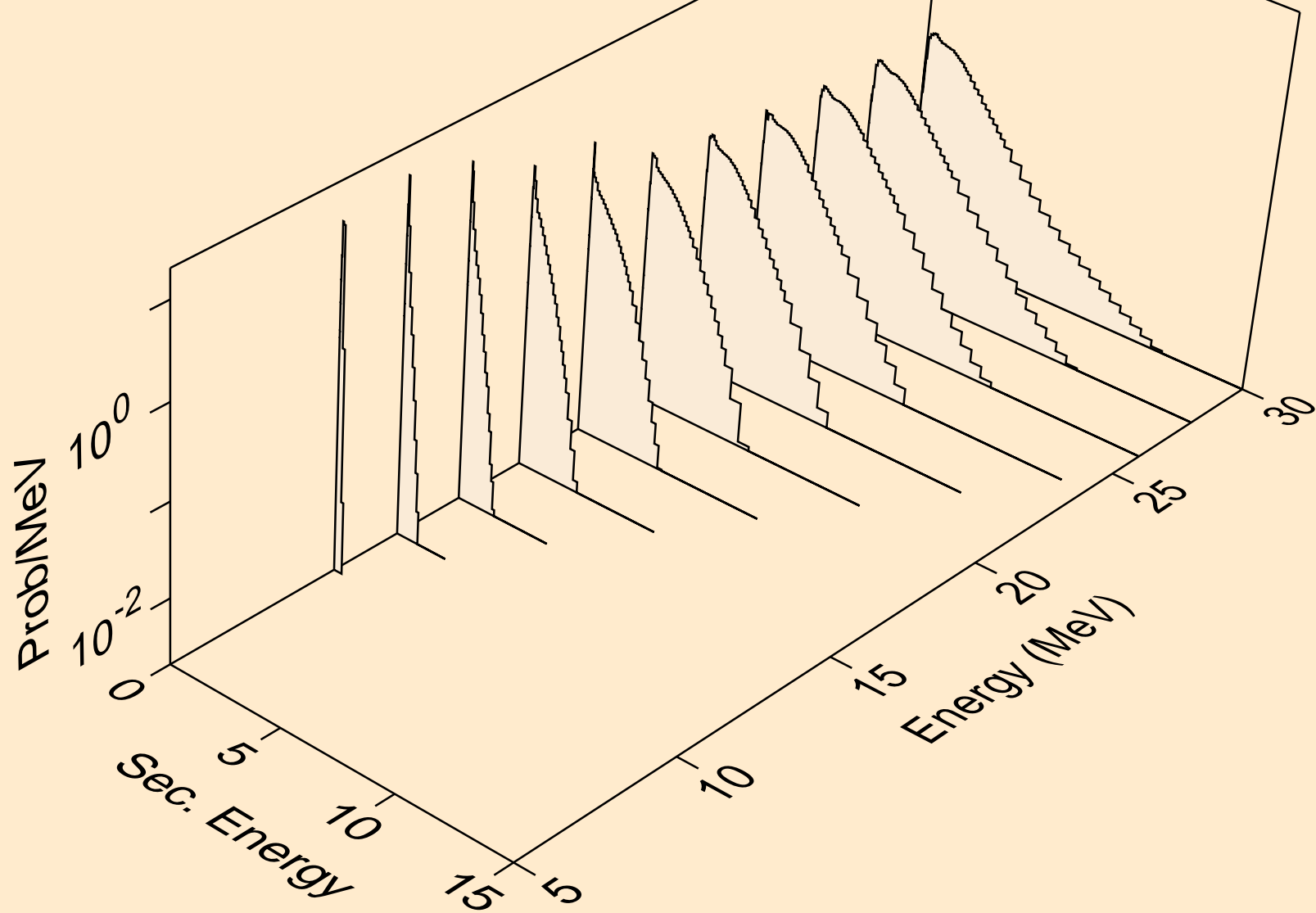

MN058 NEUTRON ACER TENDL-2021 LIBRARY; T=293.6K
Neutron emission for (n,2n)a

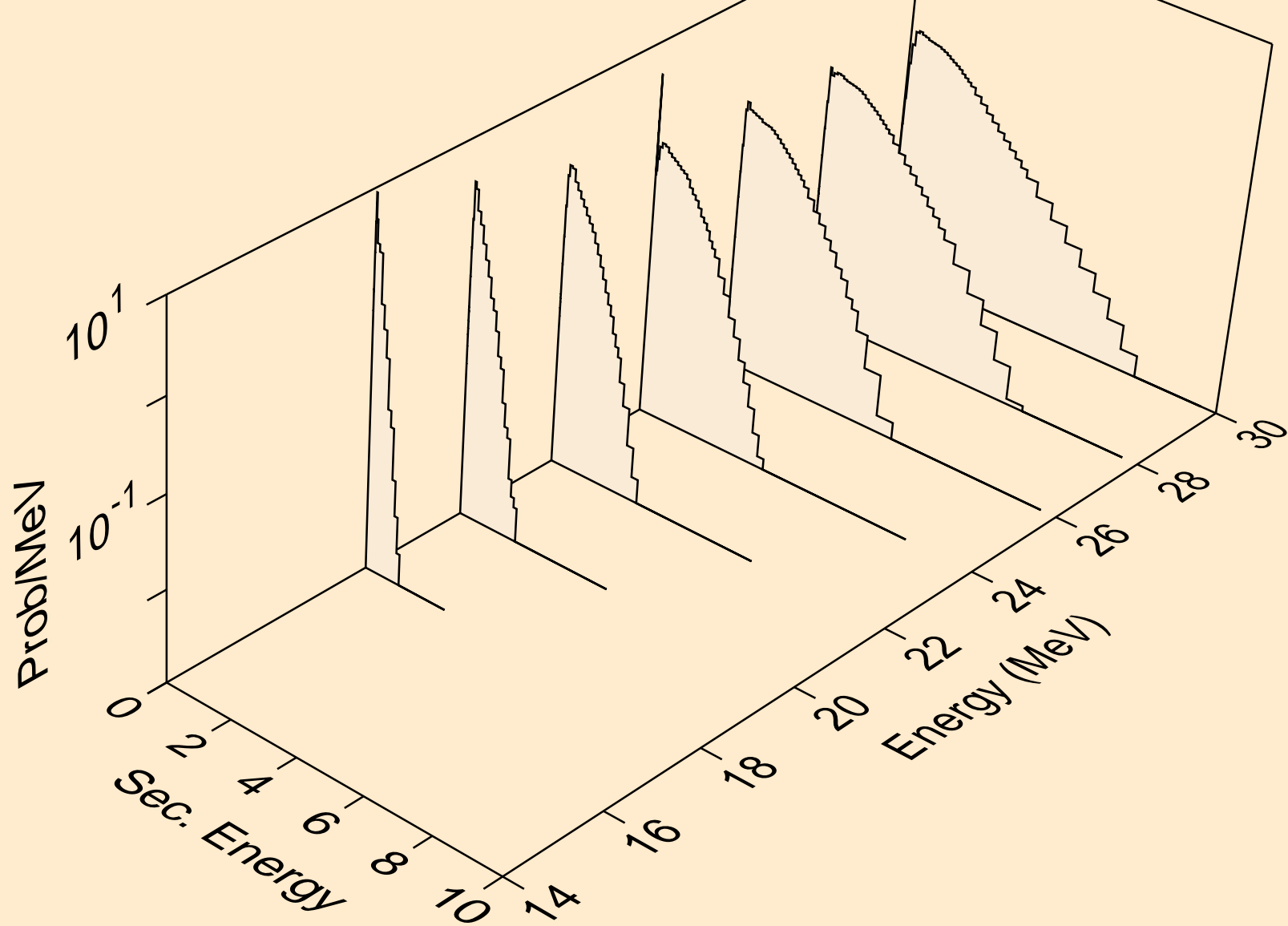

MN058 NEUTRON ACER TENDL-2021 LIBRARY; T=293.6K
Neutron emission for (n,3n)a

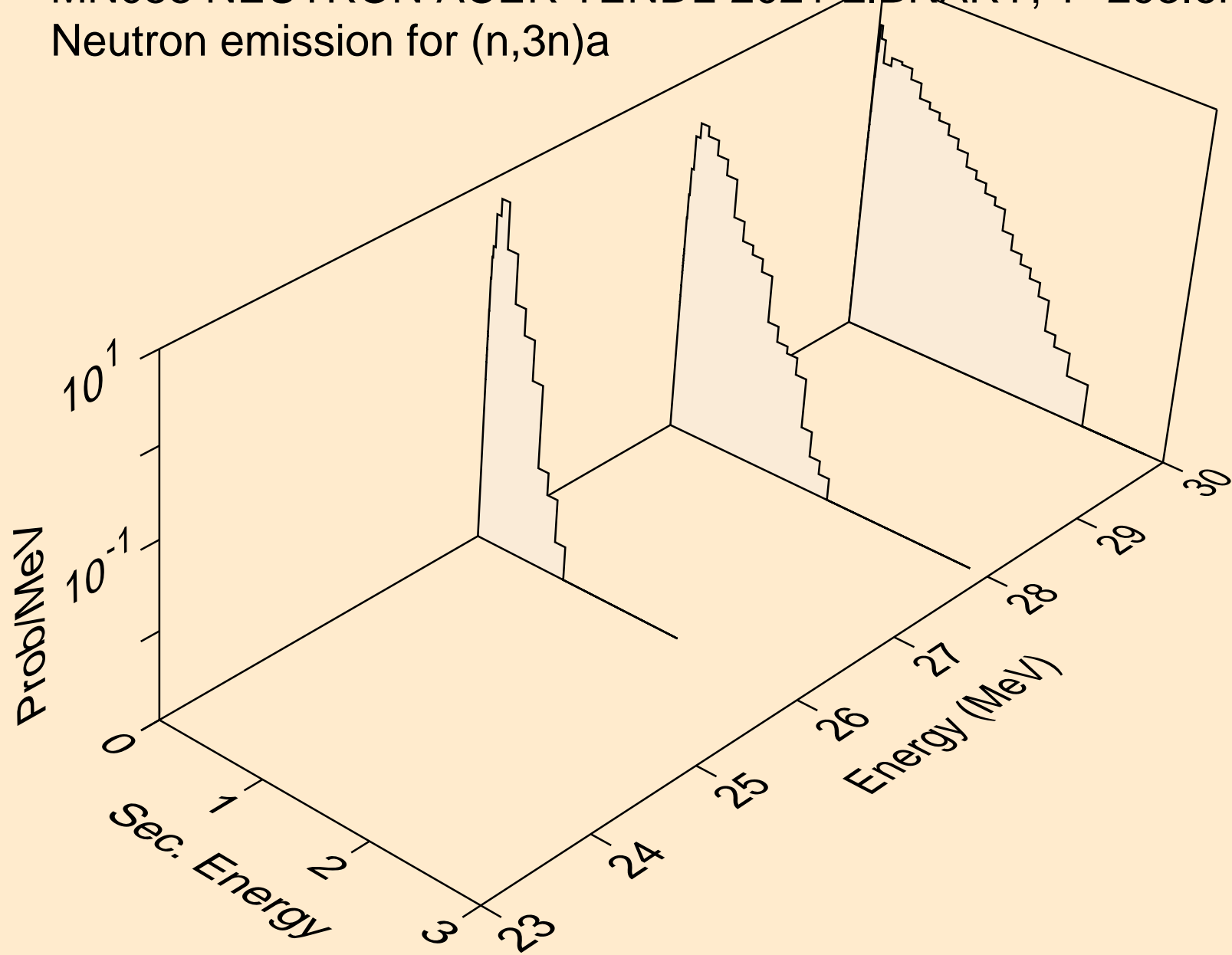

MN058 NEUTRON ACER TENDL-2021 LIBRARY; T=293.6K
Neutron emission for (n,n*)p

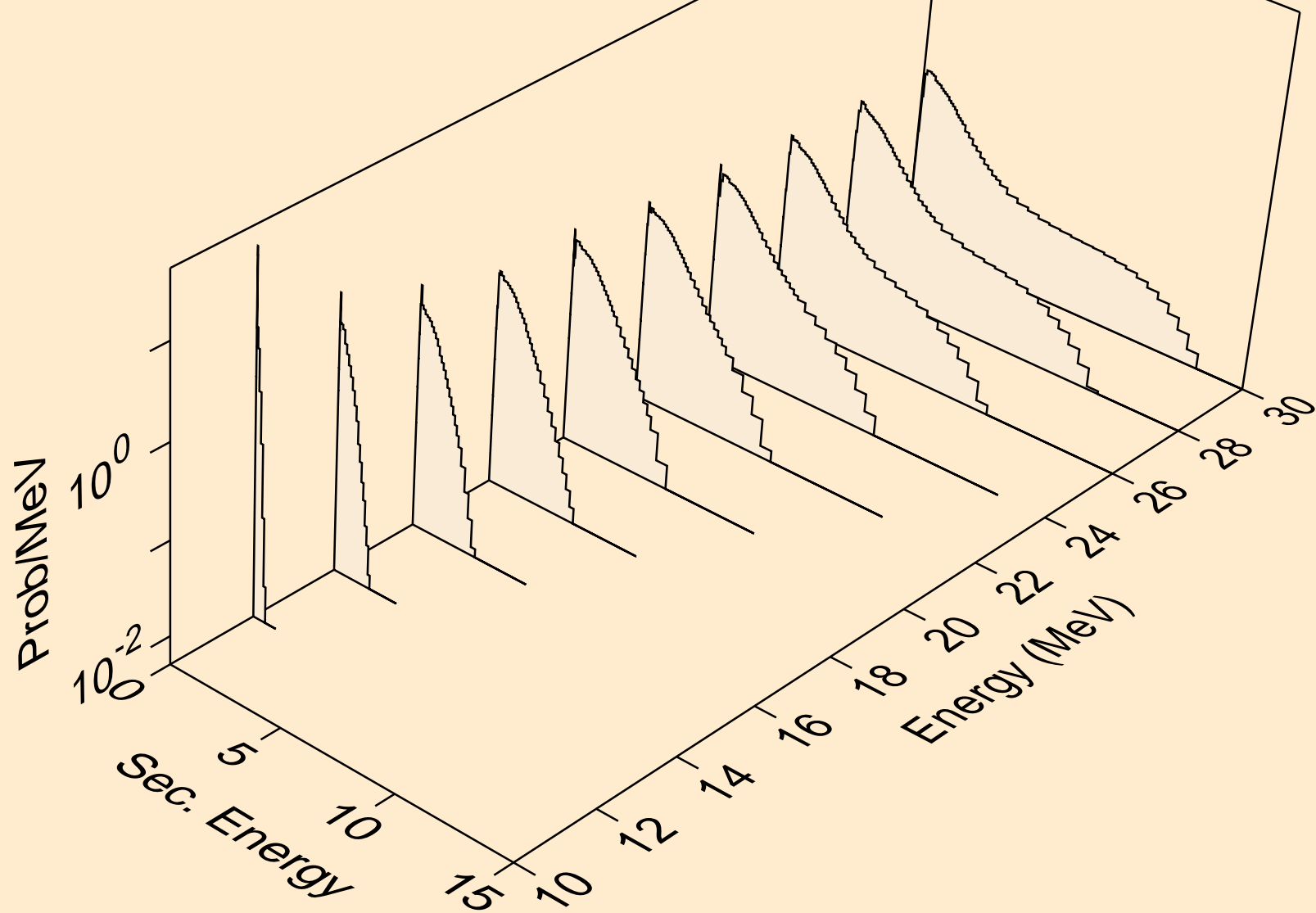

MN058 NEUTRON ACER TENDL-2021 LIBRARY; T=293.6K
Neutron emission for (n,n*)2a

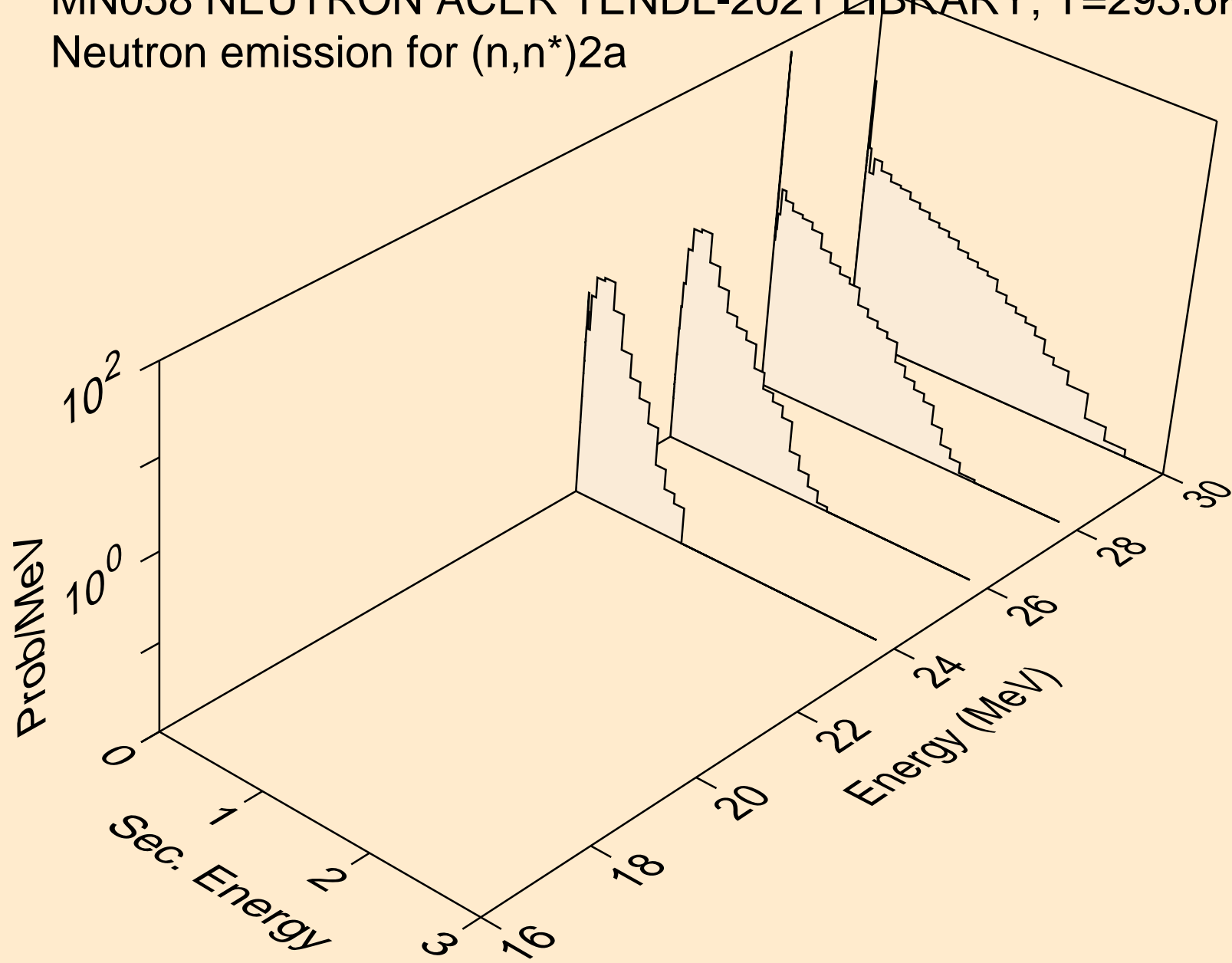

MN058 NEUTRON ACER TENDL-2021 LIBRARY; T=293.6K
Neutron emission for (n,n*)d

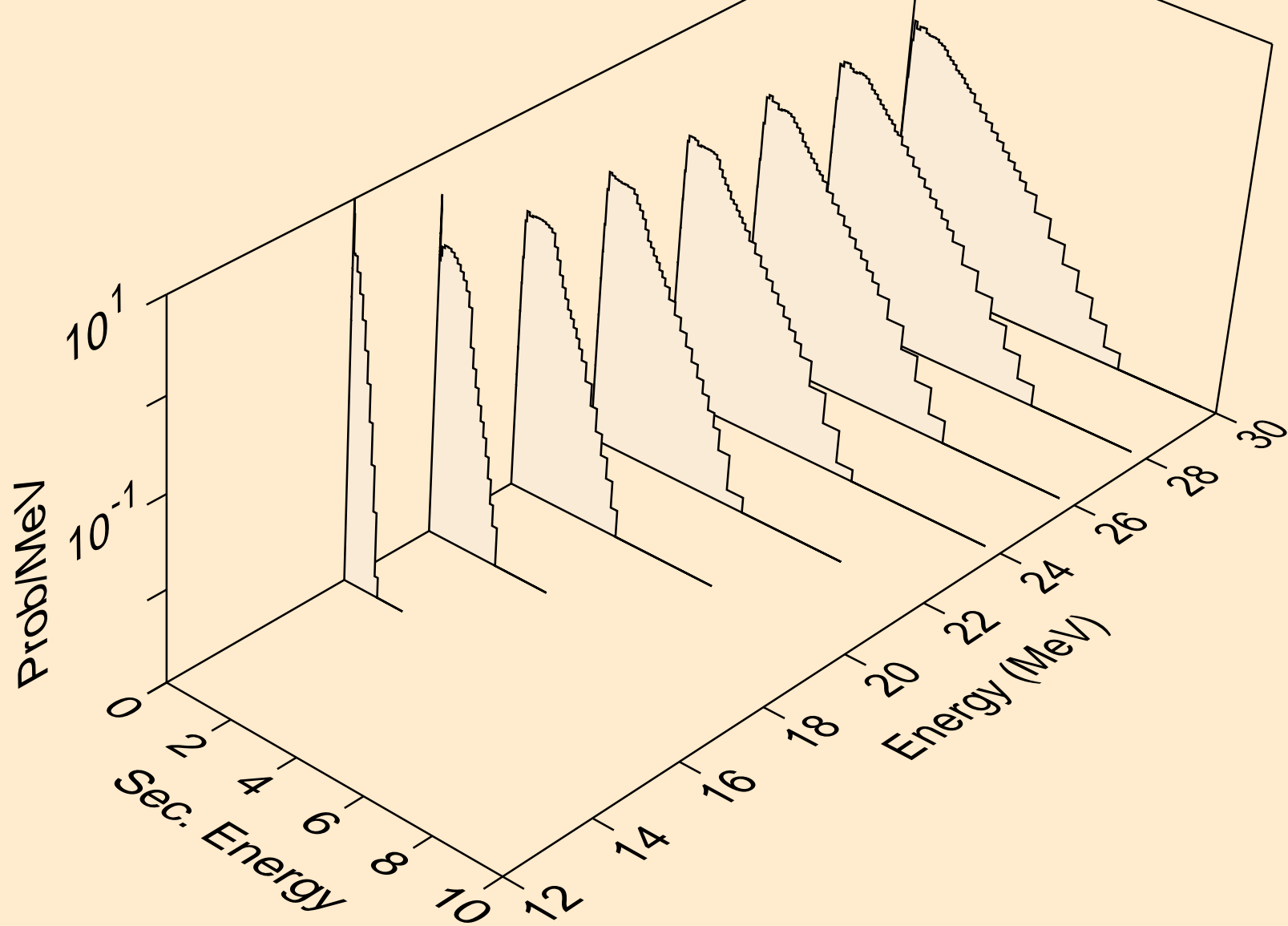

MN058 NEUTRON ACER TENDL-2021 LIBRARY; T=293.6K
Neutron emission for (n,n*)t

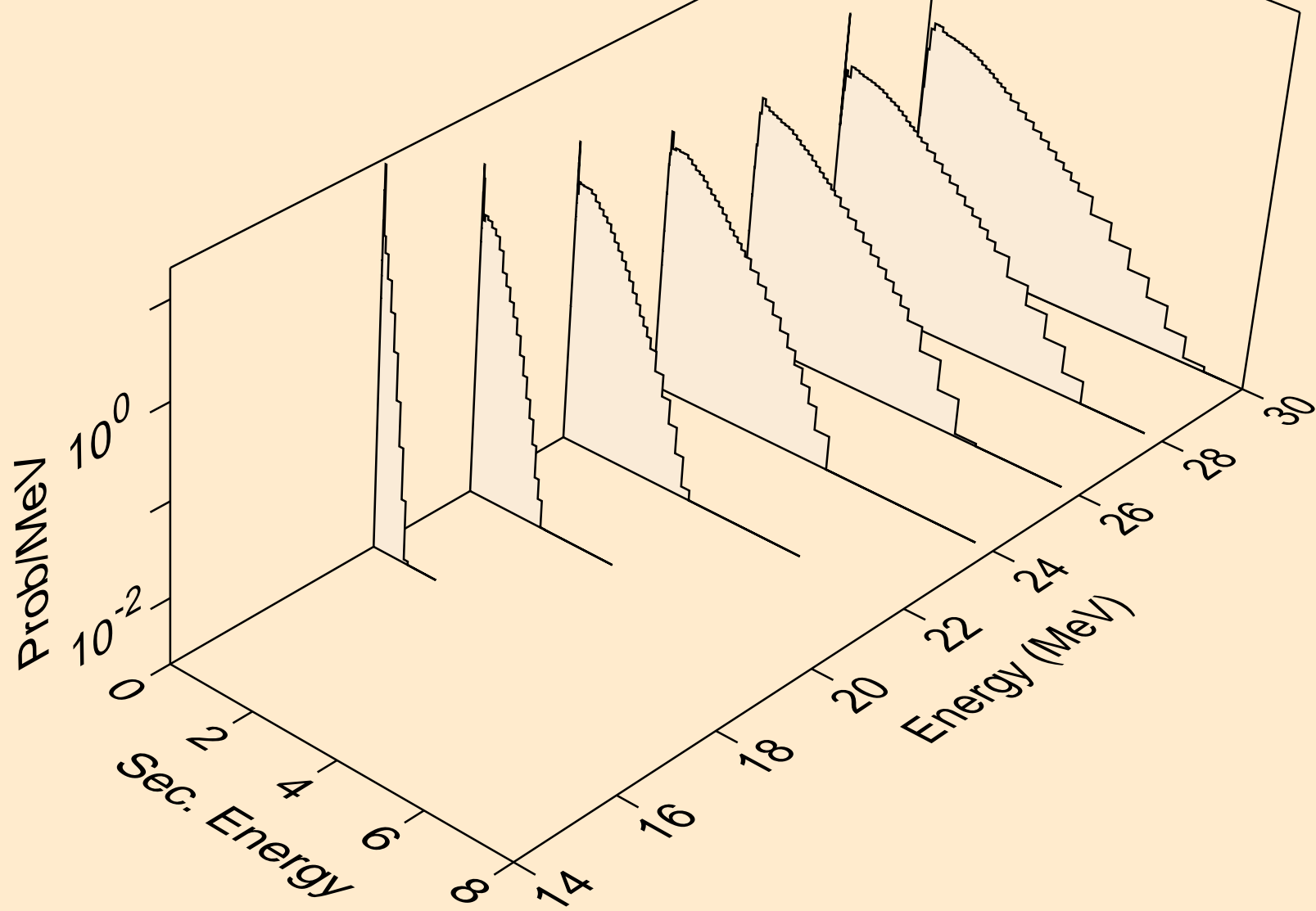

MN058 NEUTRON ACER TENDL-2021 LIBRARY; T=293.6K
Neutron emission for (n,n*)he3

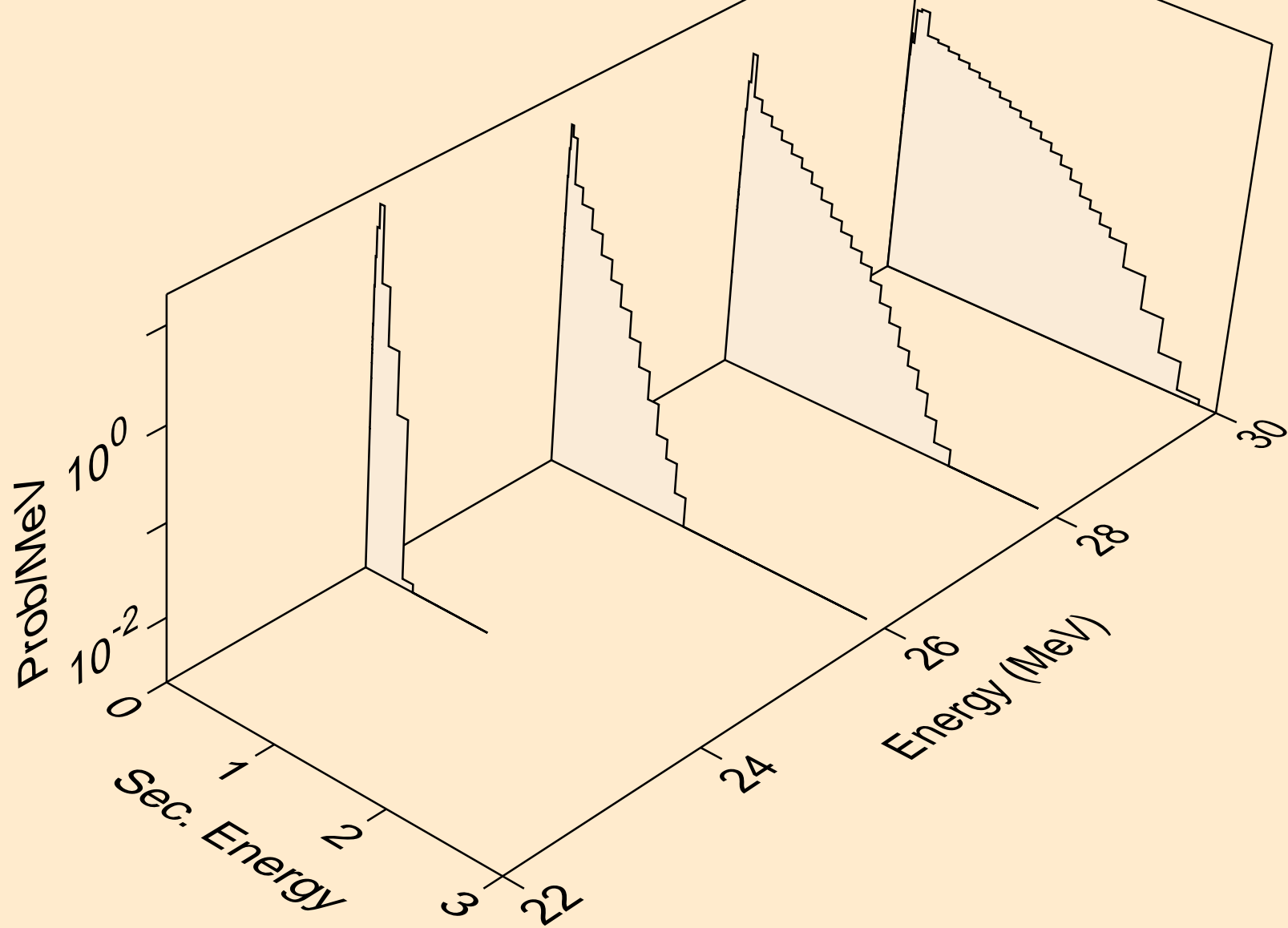

MN058 NEUTRON ACER TENDL-2021 LIBRARY; T=293.6K
Neutron emission for (n,4n)

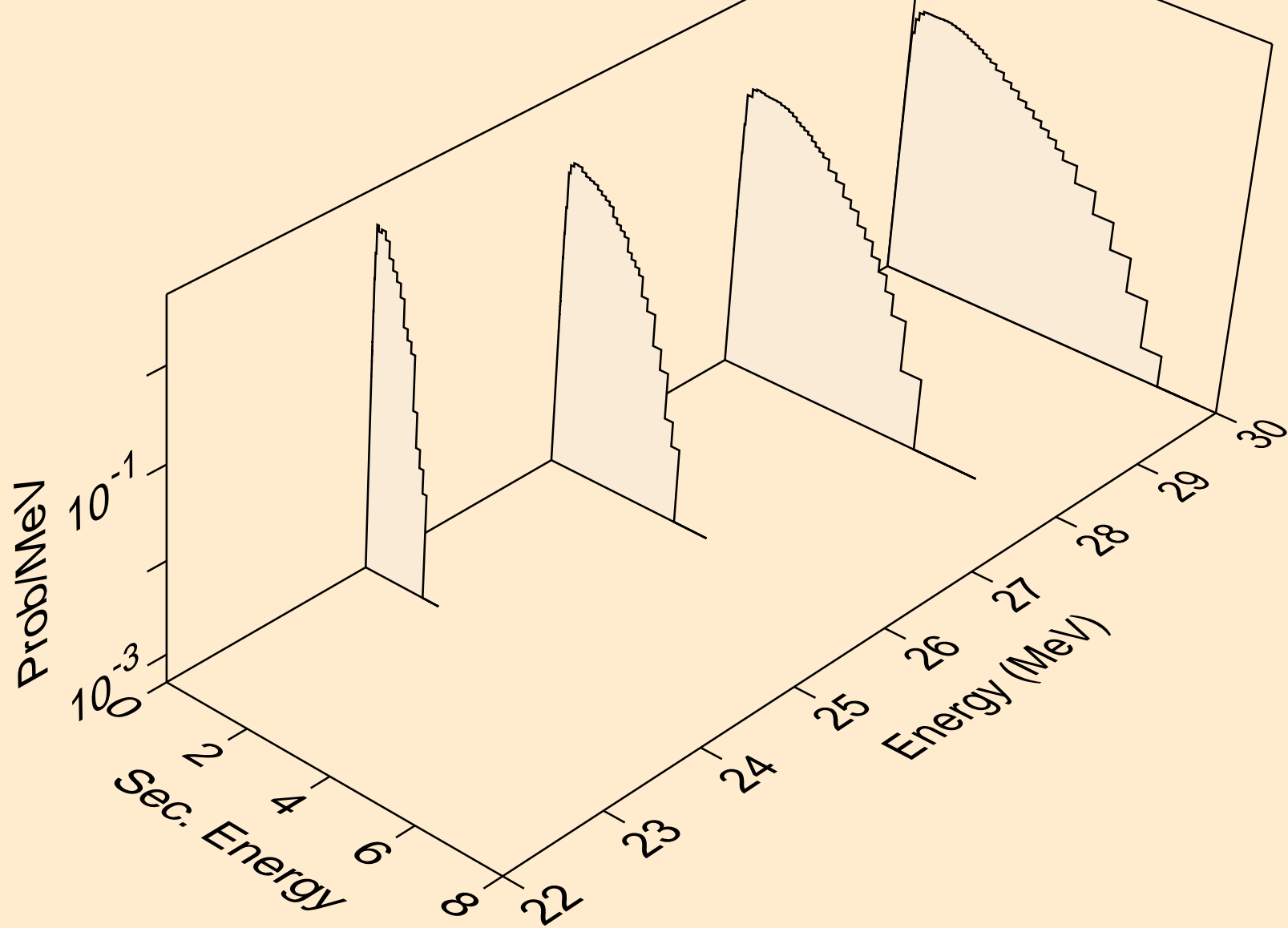

MN058 NEUTRON ACER TENDL-2021 LIBRARY; T=293.6K
Neutron emission for (n,2np)

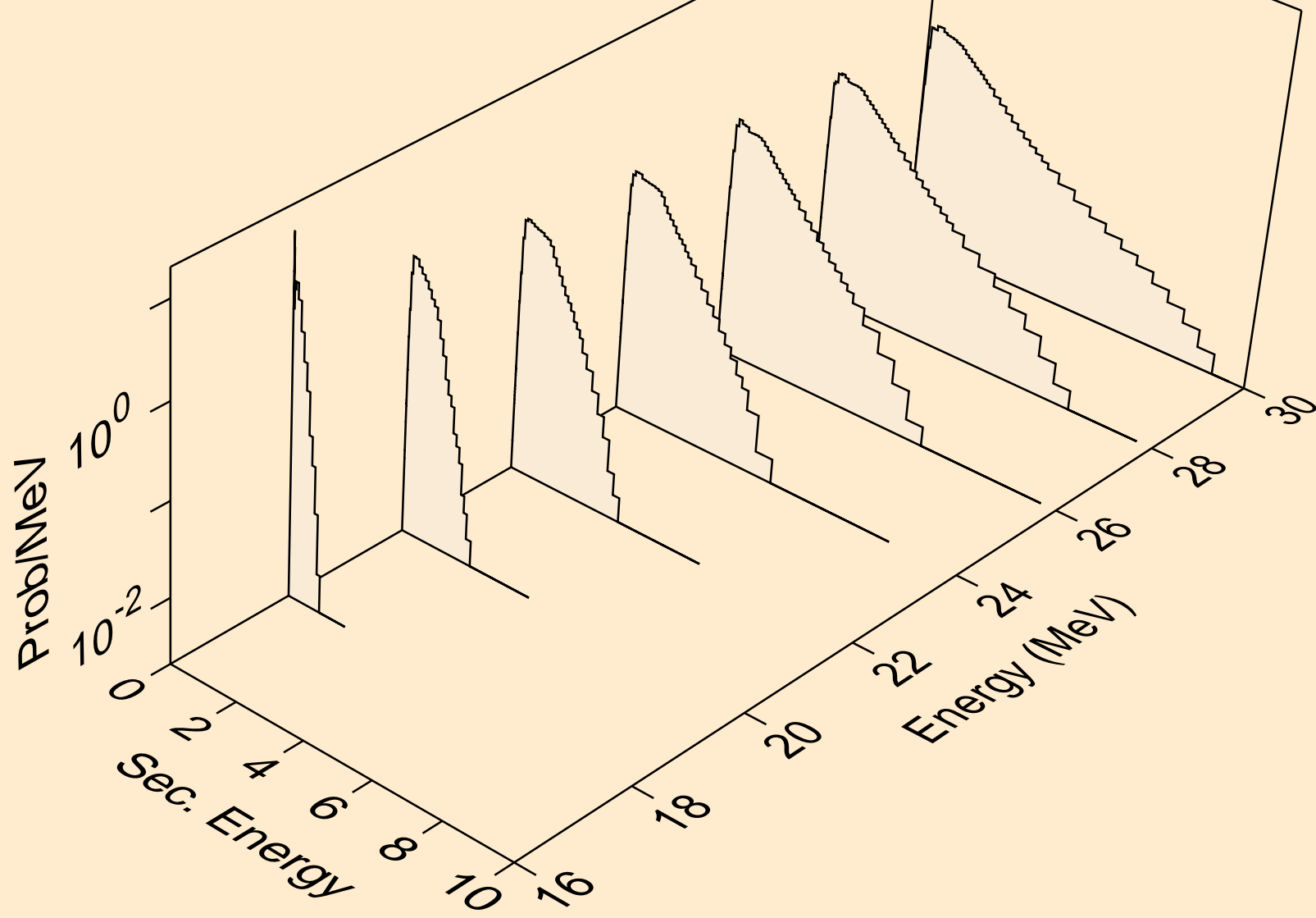

MN058 NEUTRON ACER TENDL-2021 LIBRARY; T=293.6K
Neutron emission for (n,3np)

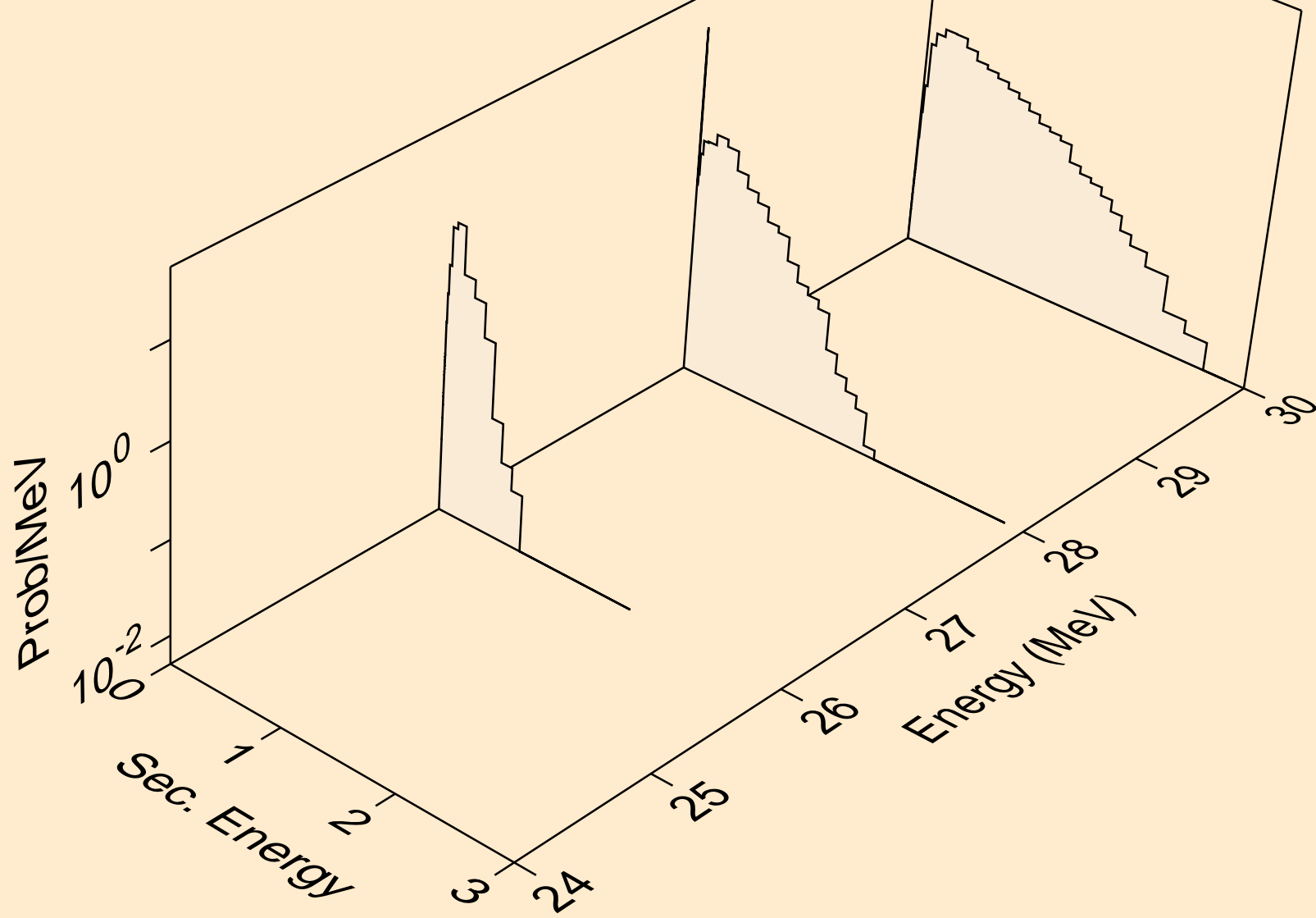

MN058 NEUTRON ACER TENDL-2021 LIBRARY; T=293.6K
Neutron emission for (n,2np)

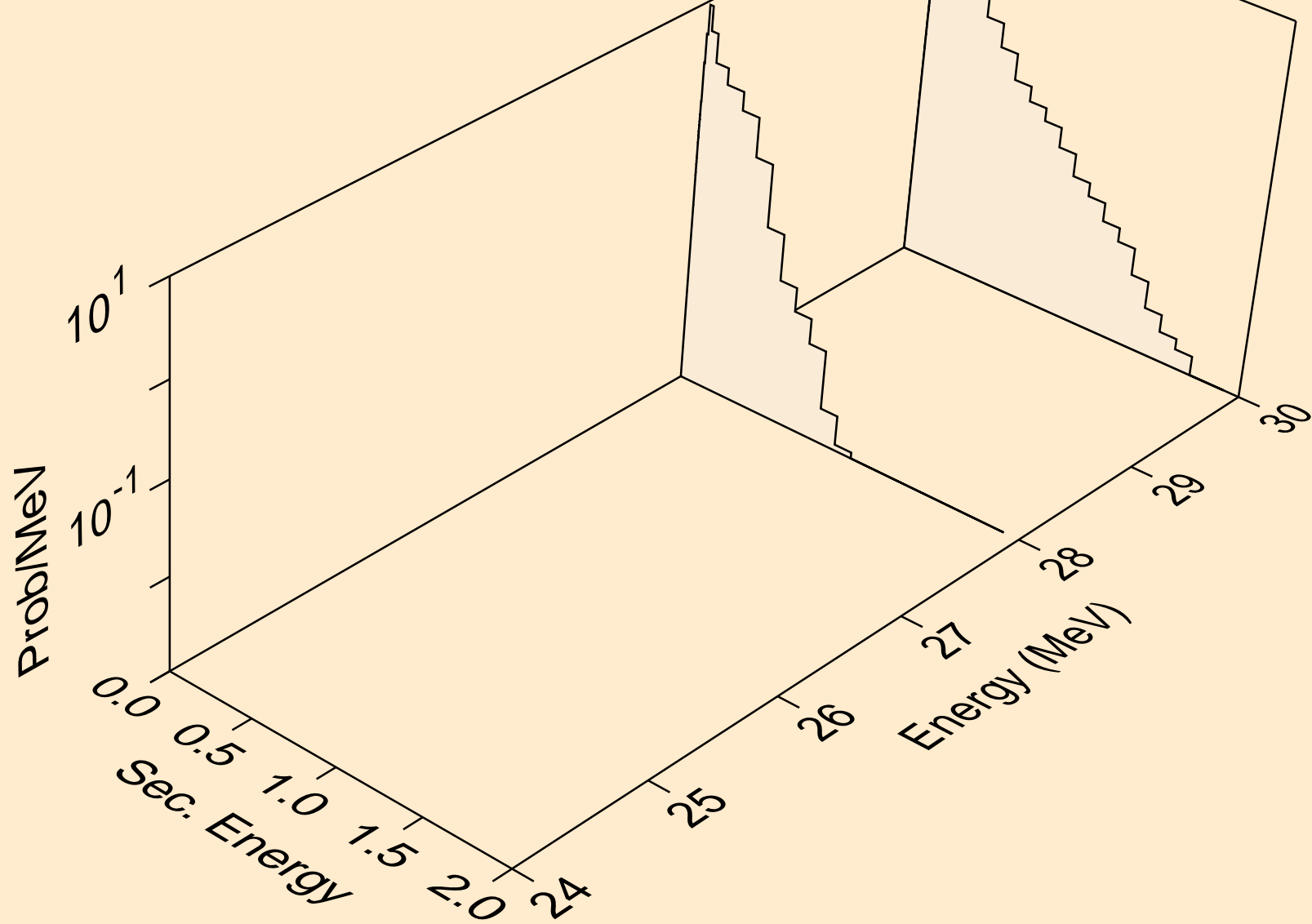

MN058 NEUTRON ACER TENDL-2021 LIBRARY; T=293.6K
Neutron emission for (n,npa)

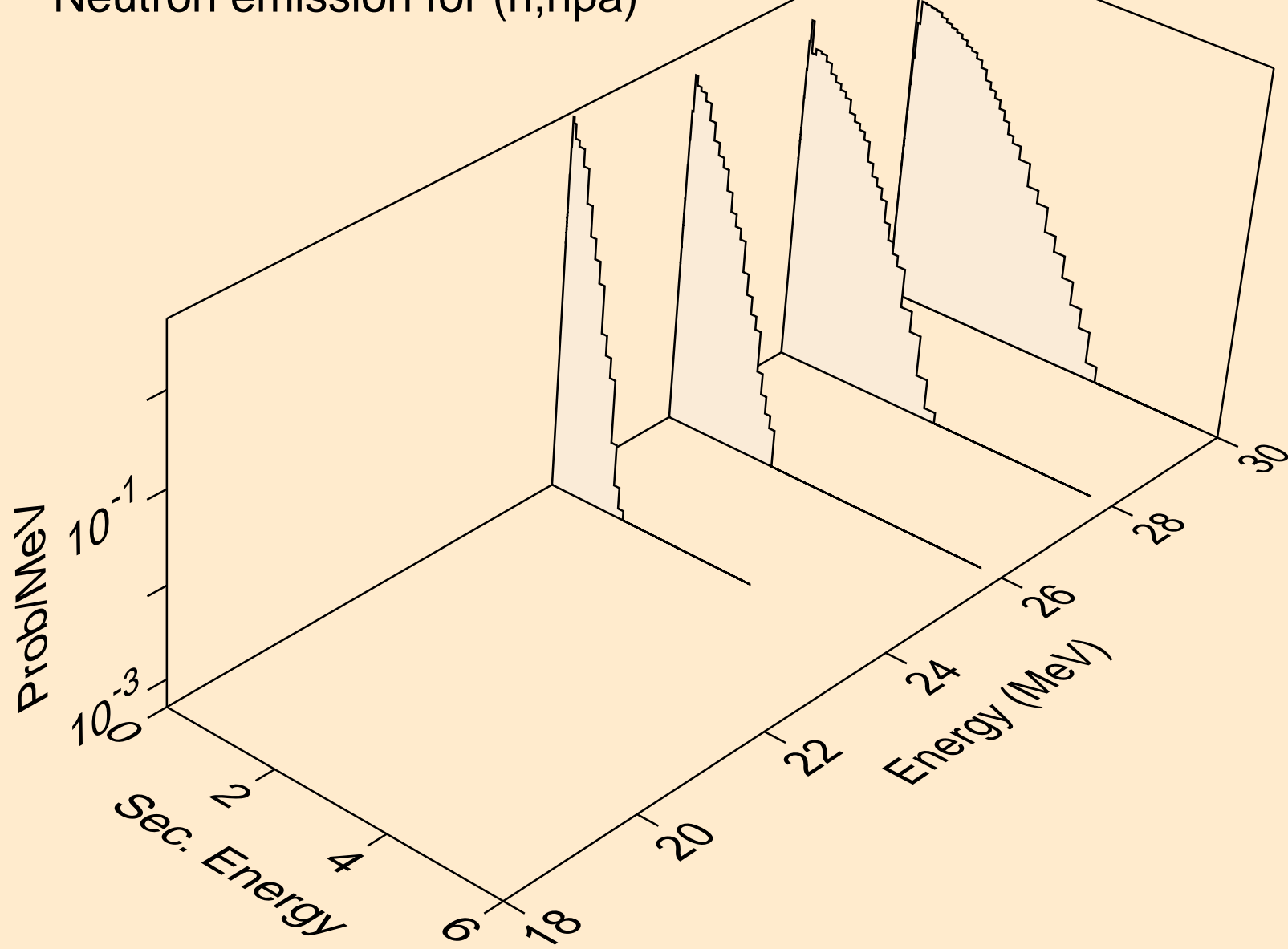

MN058 NEUTRON ACER TENDL-2021 LIBRARY; T=293.6K
Neutron emission for (n,n*c)

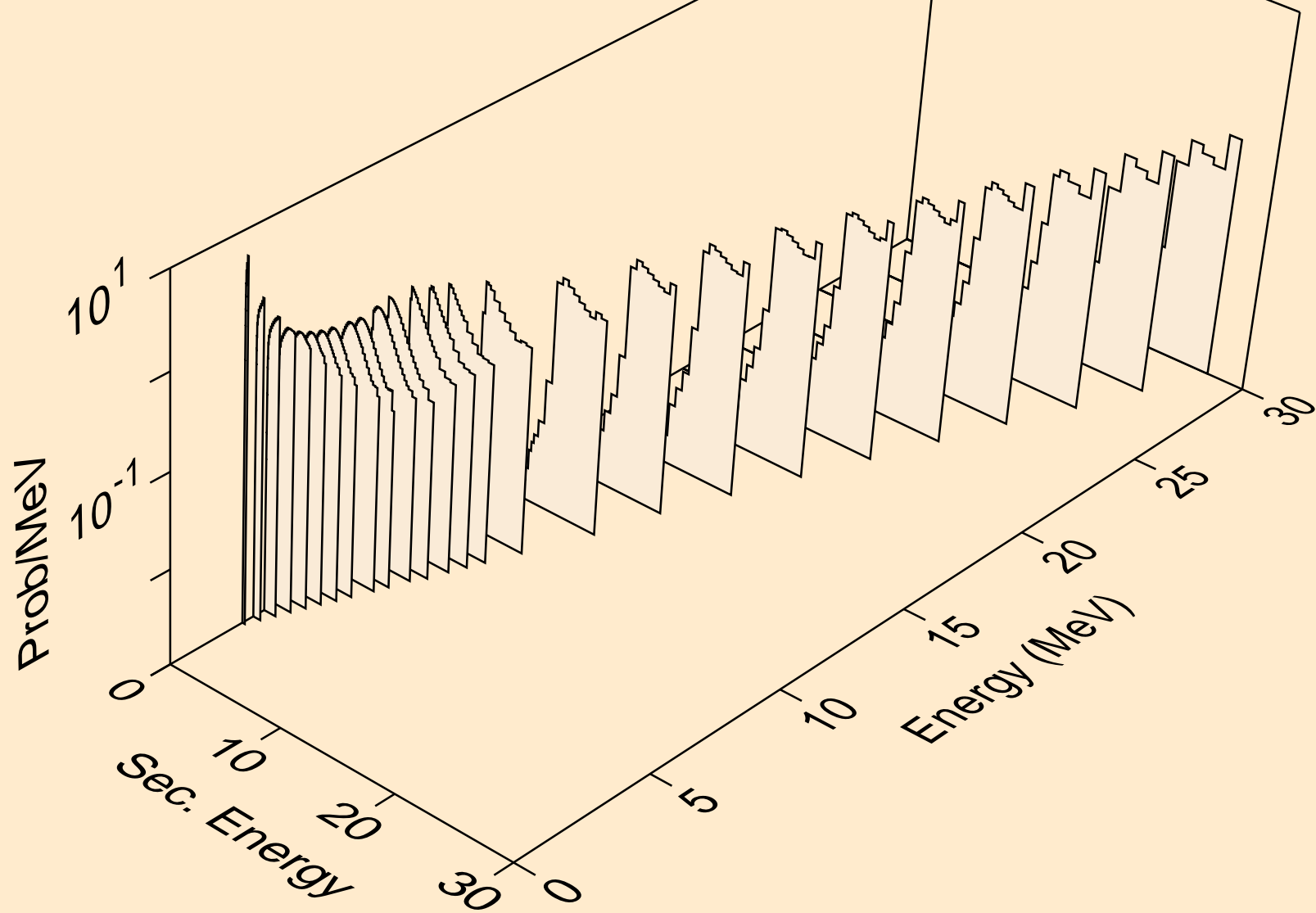

MN058 NEUTRON ACER TENDL-2021 LIBRARY; T=293.6K
Photon emission for (n,x)

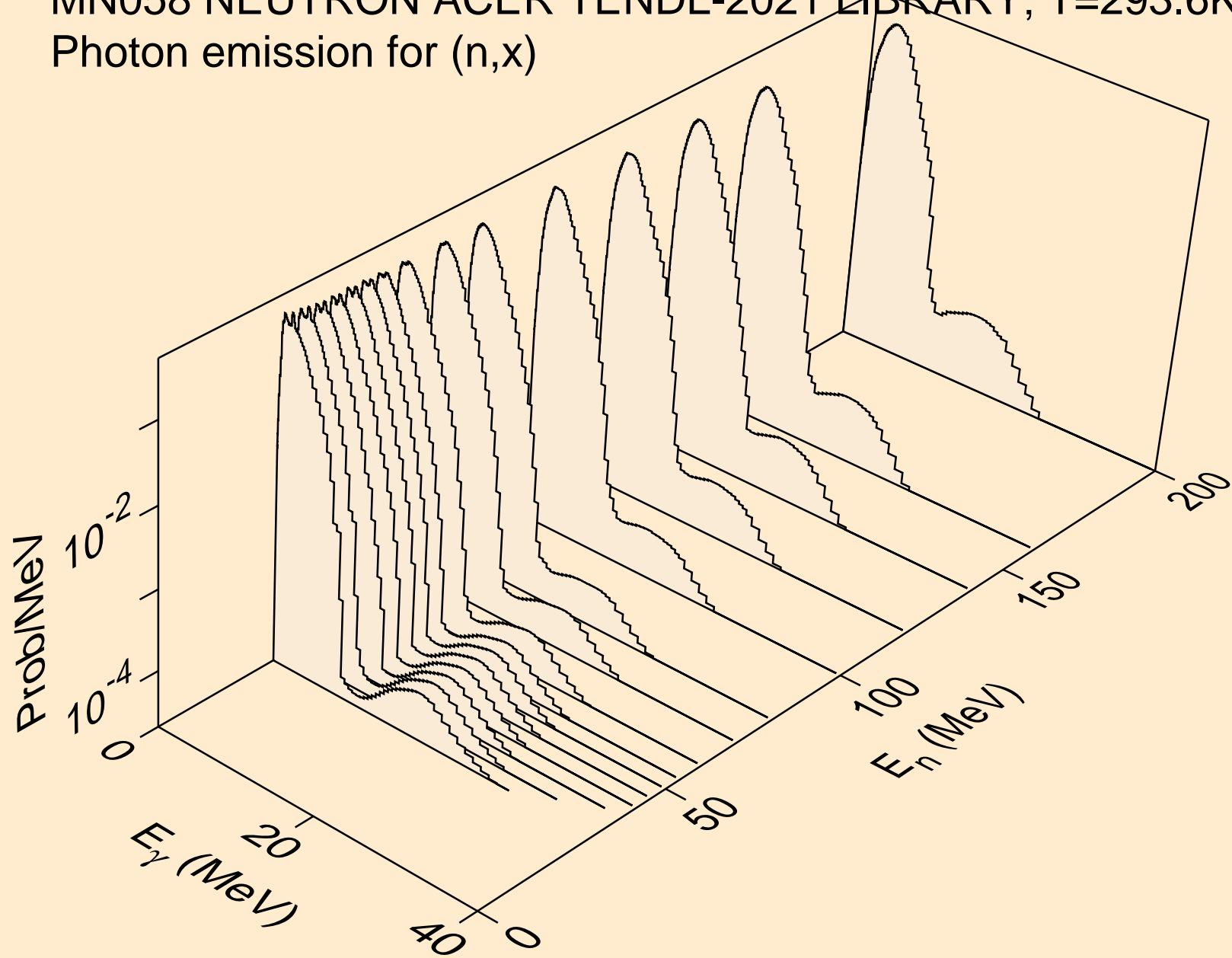

MN058 NEUTRON ACER TENDL-2021 LIBRARY; T=293.6K
Photon emission for (n,2nd)

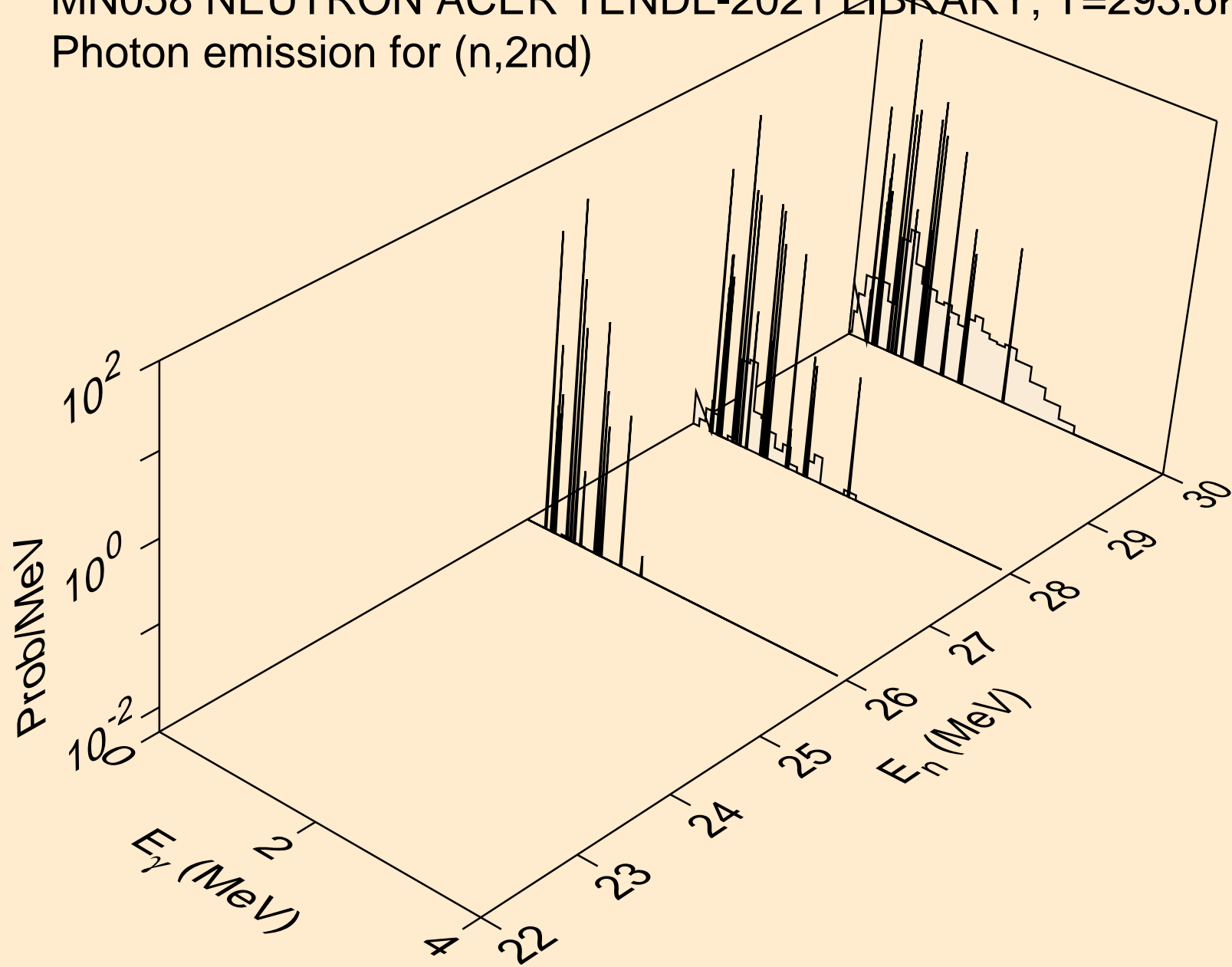

MN058 NEUTRON ACER TENDL-2021 LIBRARY; T=293.6K
Photon emission for (n,2n)

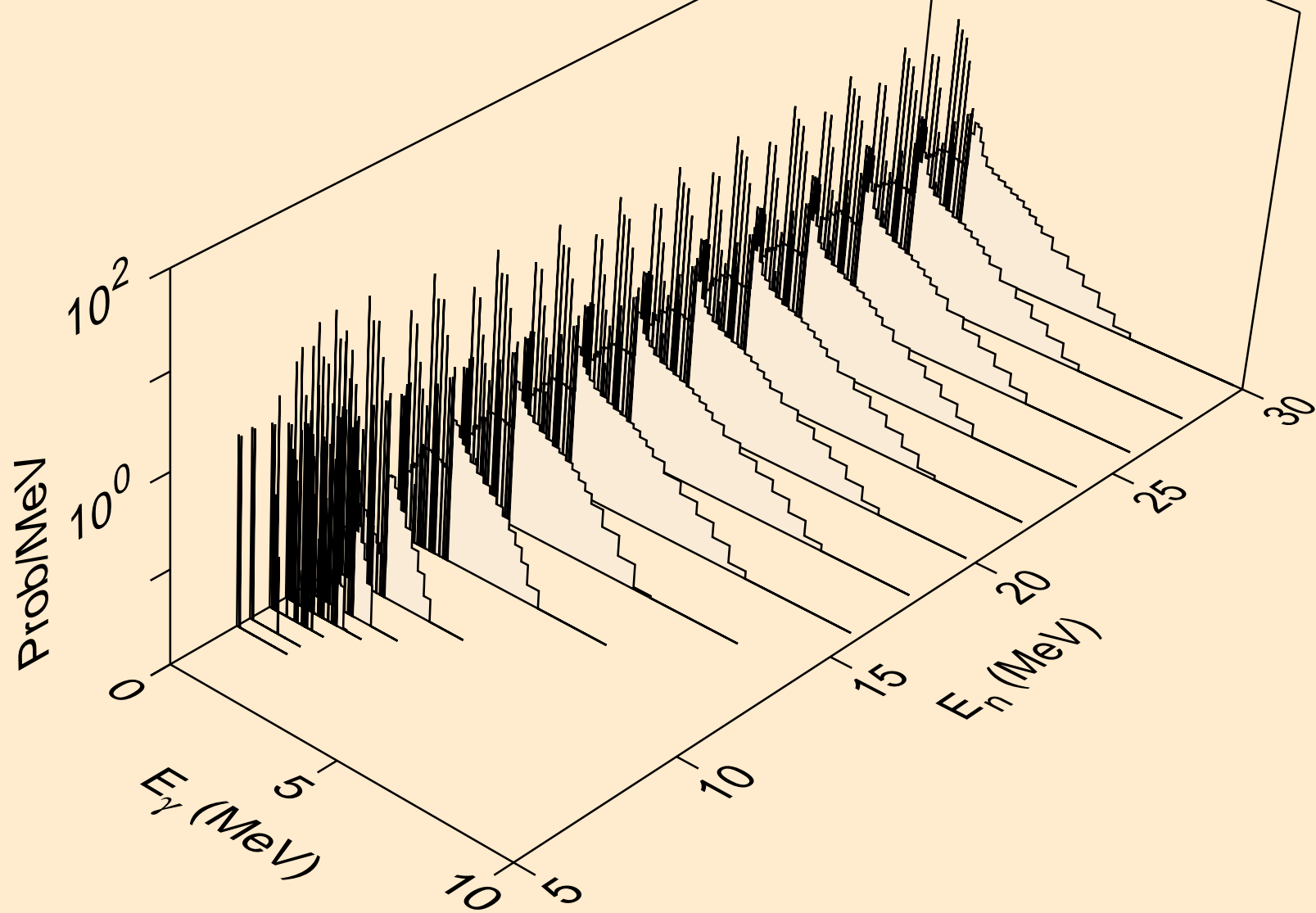

MN058 NEUTRON ACER TENDL-2021 LIBRARY; T=293.6K
Photon emission for (n,3n)

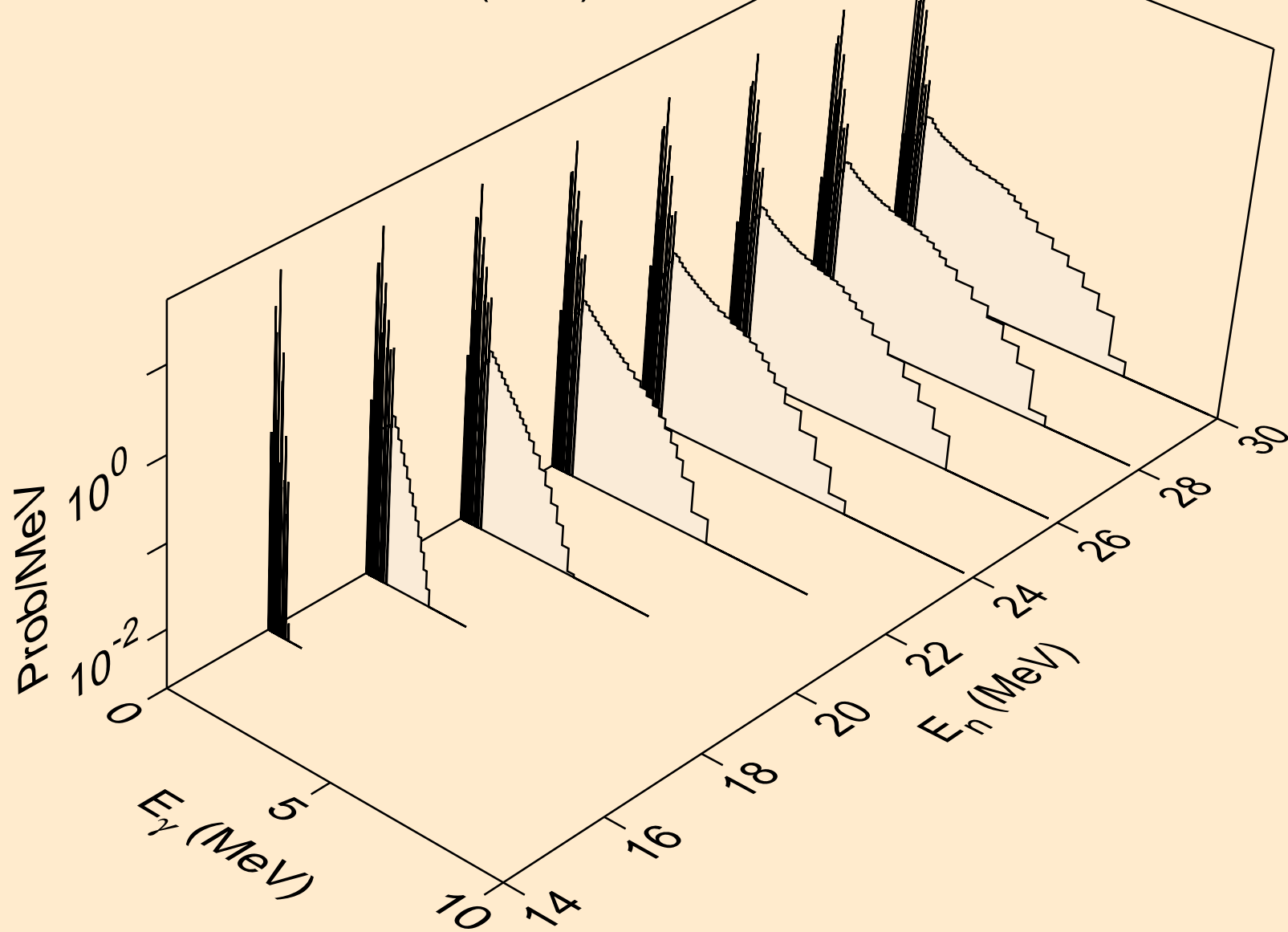

MN058 NEUTRON ACER TENDL-2021 LIBRARY; T=293.6K
Photon emission for (n,n*)a

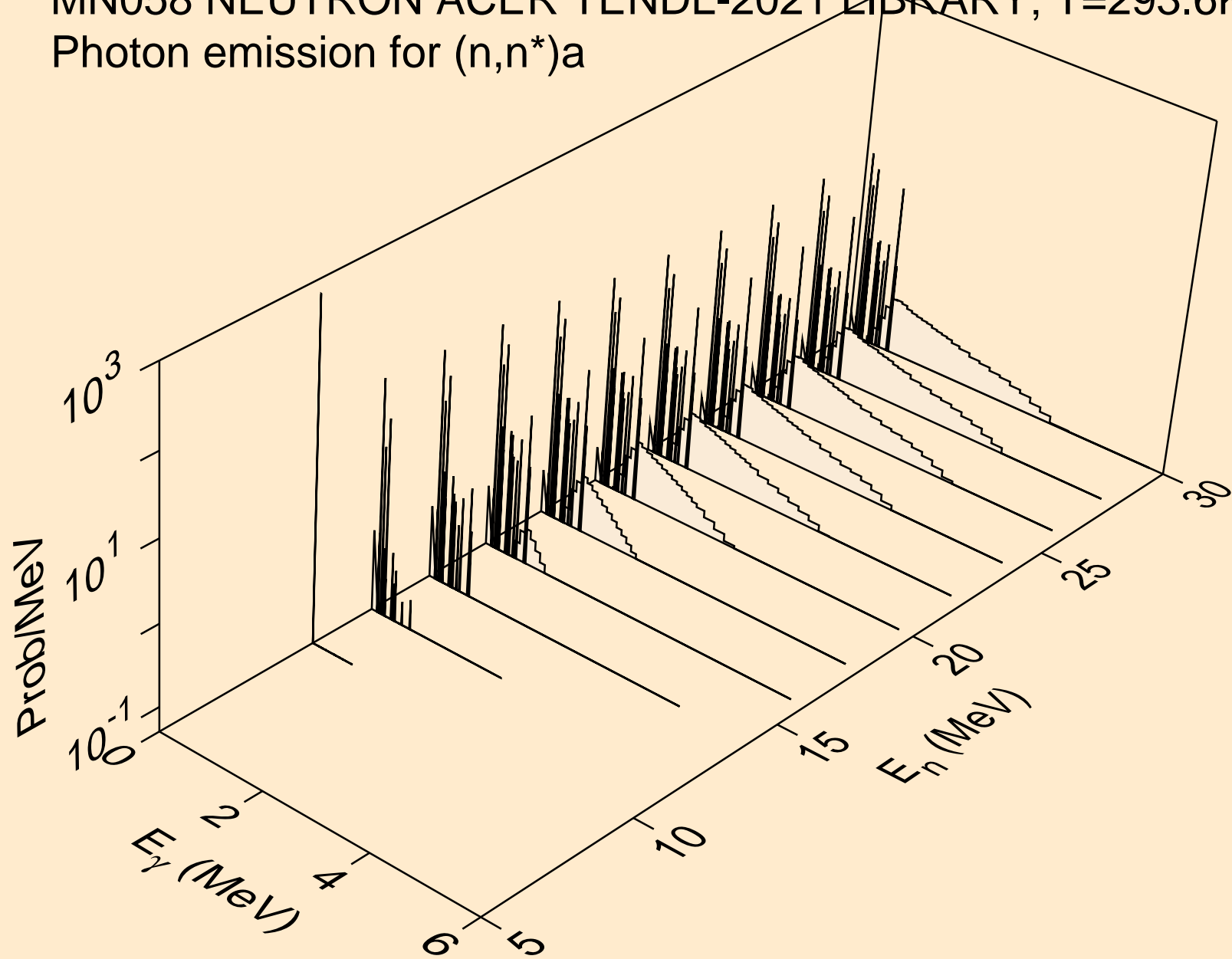

MN058 NEUTRON ACER TENDL-2021 LIBRARY; T=293.6K
Photon emission for (n,2n)a

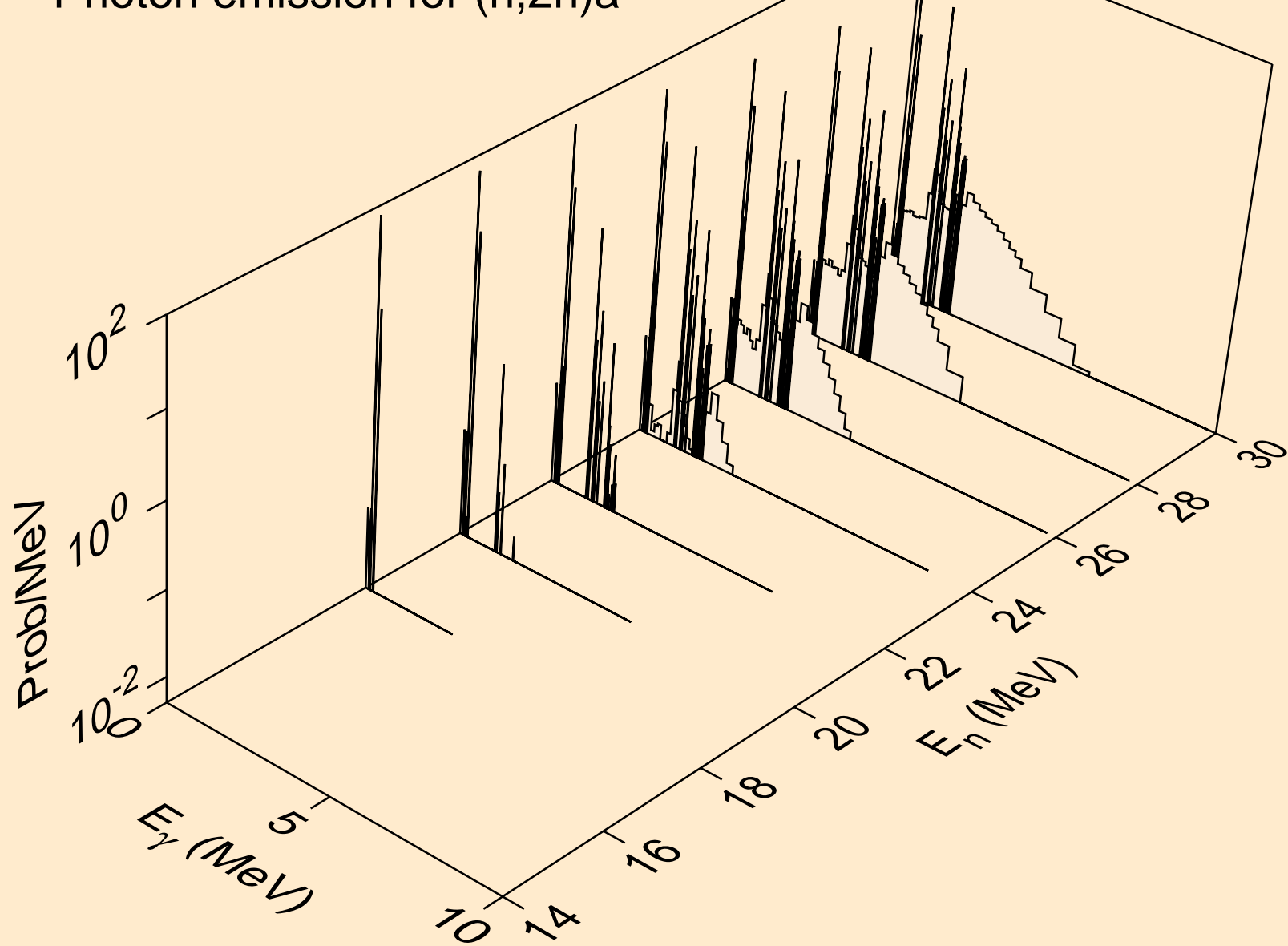

MN058 NEUTRON ACER TENDL-2021 LIBRARY; T=293.6K
Photon emission for (n,3n)a

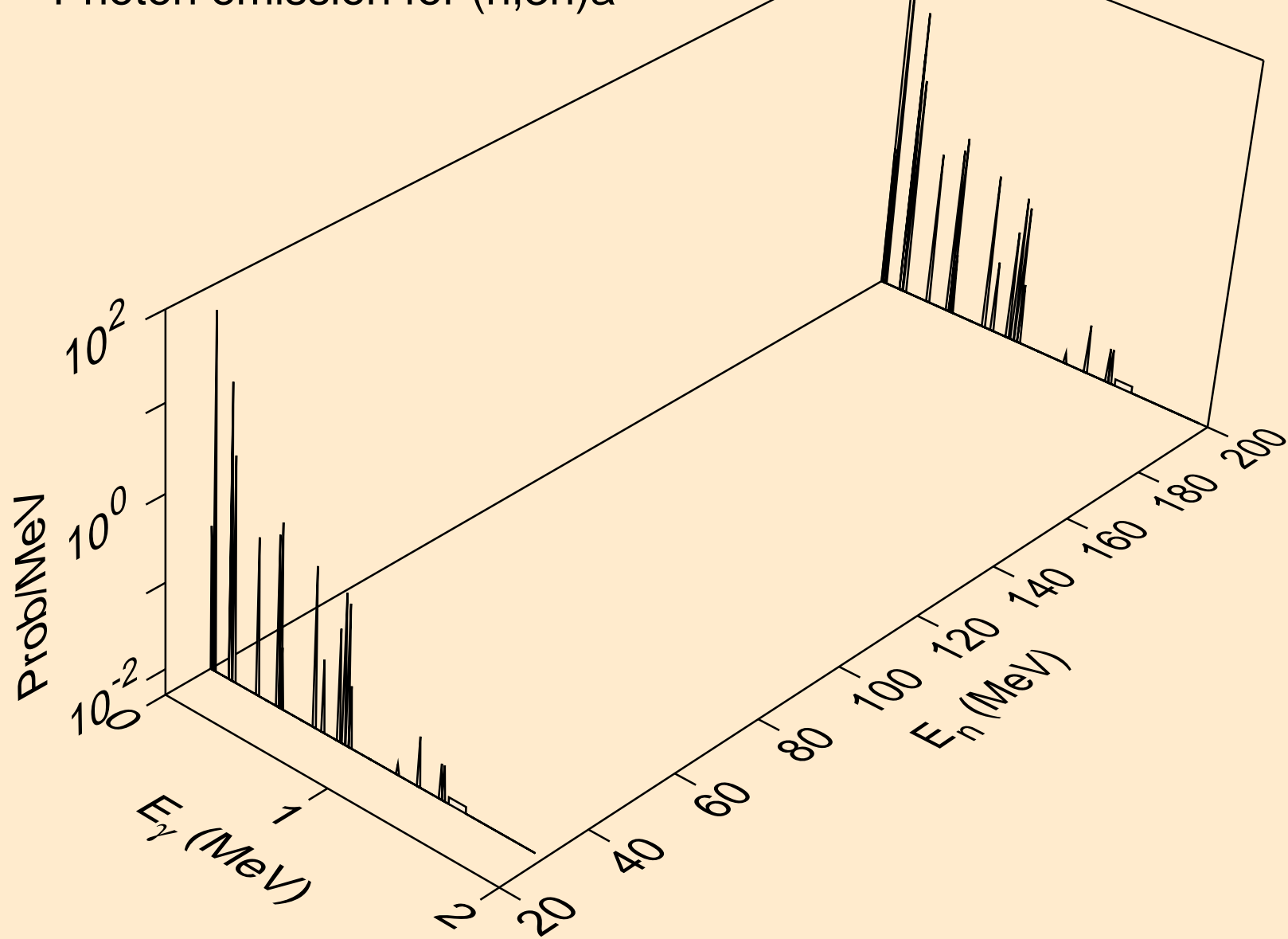

MN058 NEUTRON ACER TENDL-2021 LIBRARY; T=293.6K
Photon emission for (n,n*)p

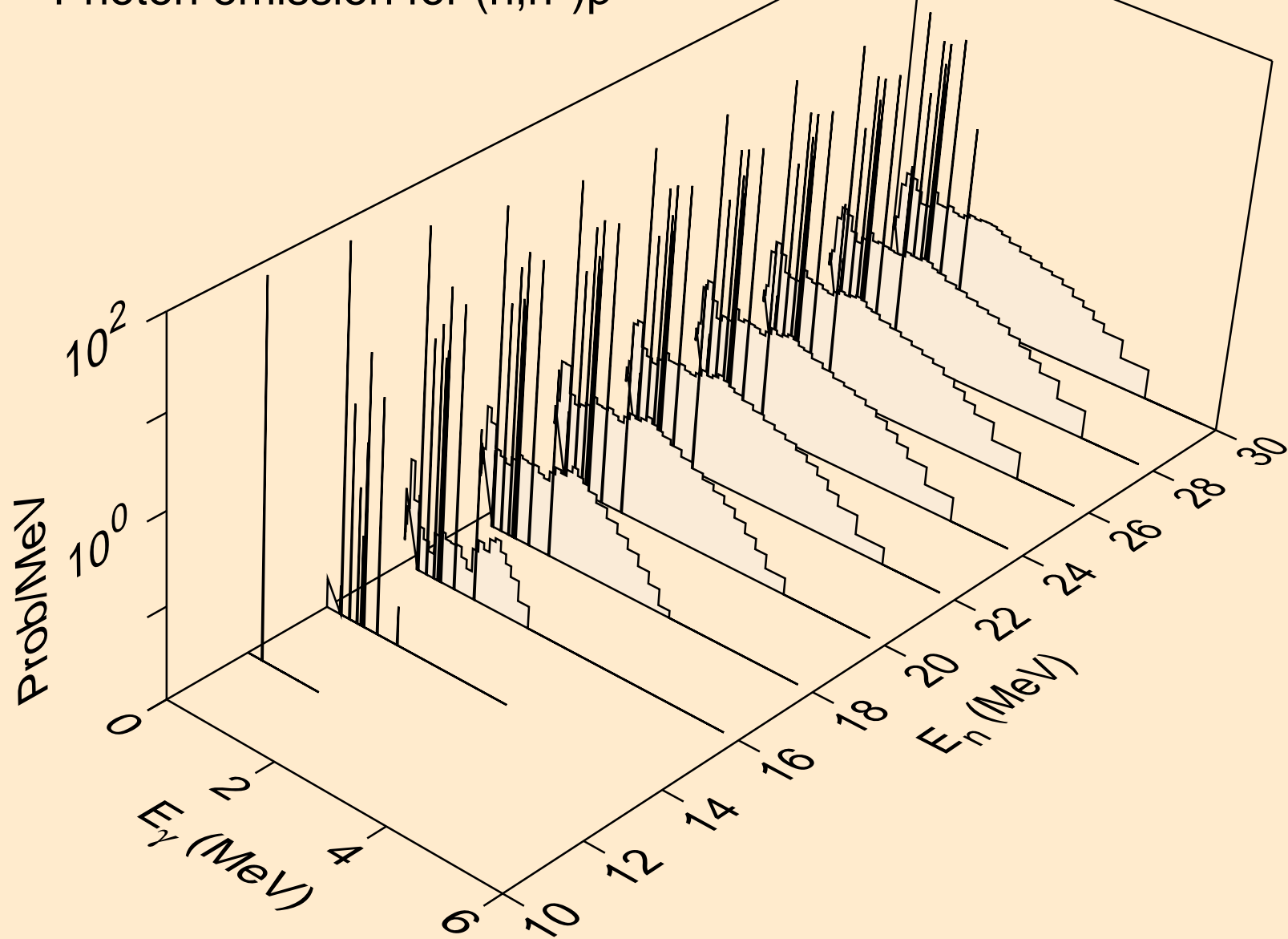

MN058 NEUTRON ACER TENDL-2021 LIBRARY; T=293.6K
Photon emission for (n,n*)2a

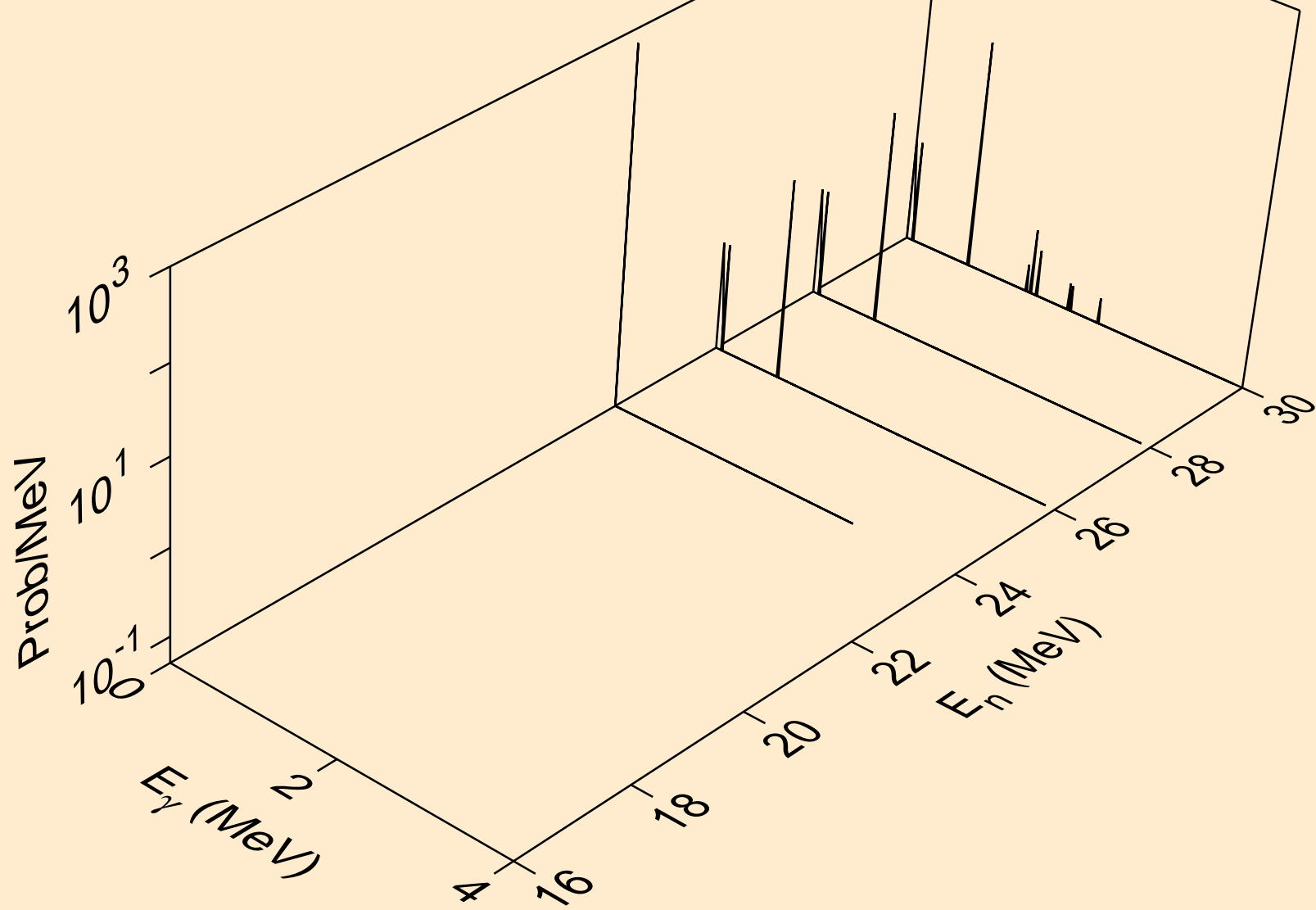

MN058 NEUTRON ACER TENDL-2021 LIBRARY; T=293.6K
Photon emission for (n,n*)d

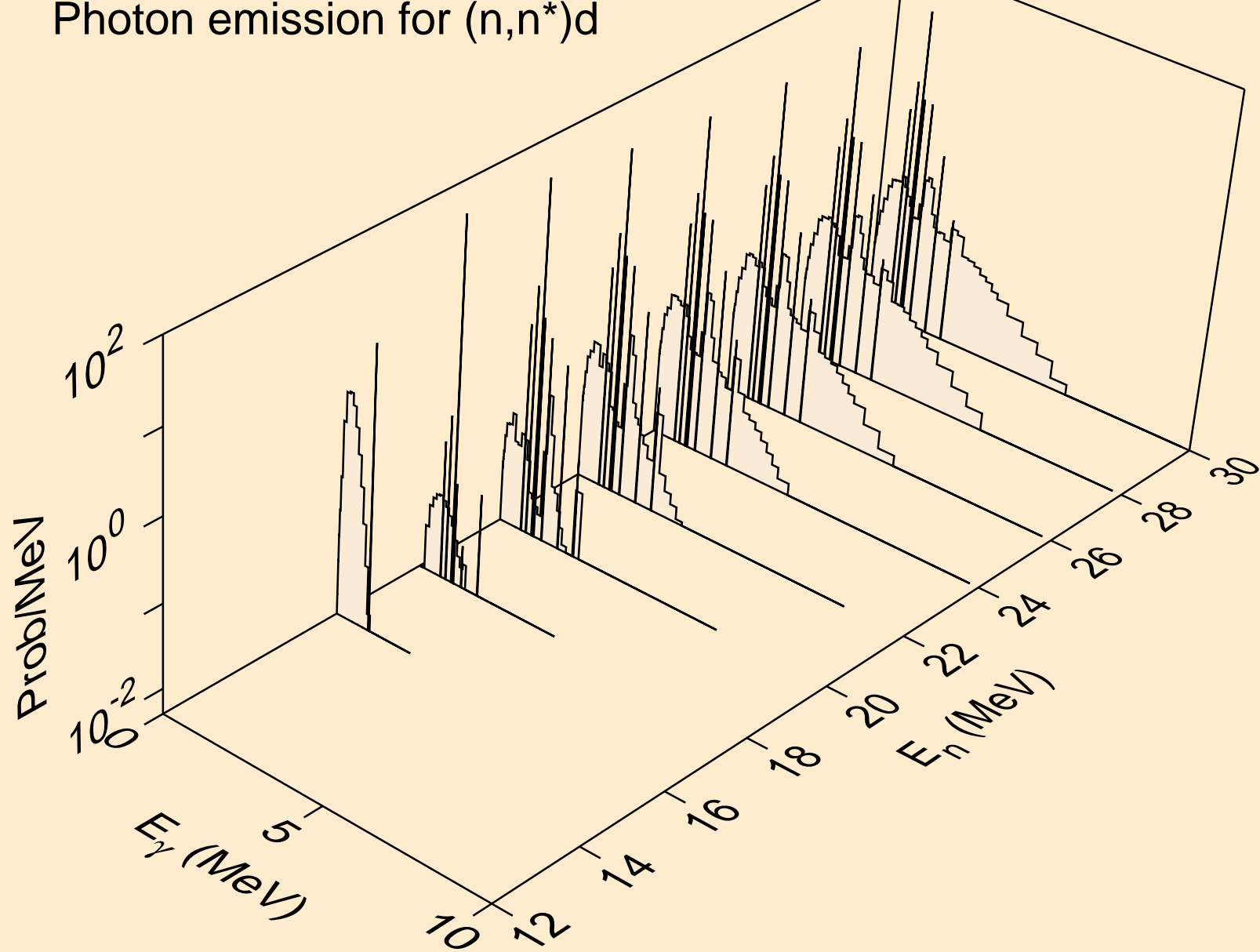

MN058 NEUTRON ACER TENDL-2021 LIBRARY; T=293.6K
Photon emission for (n,n*)t

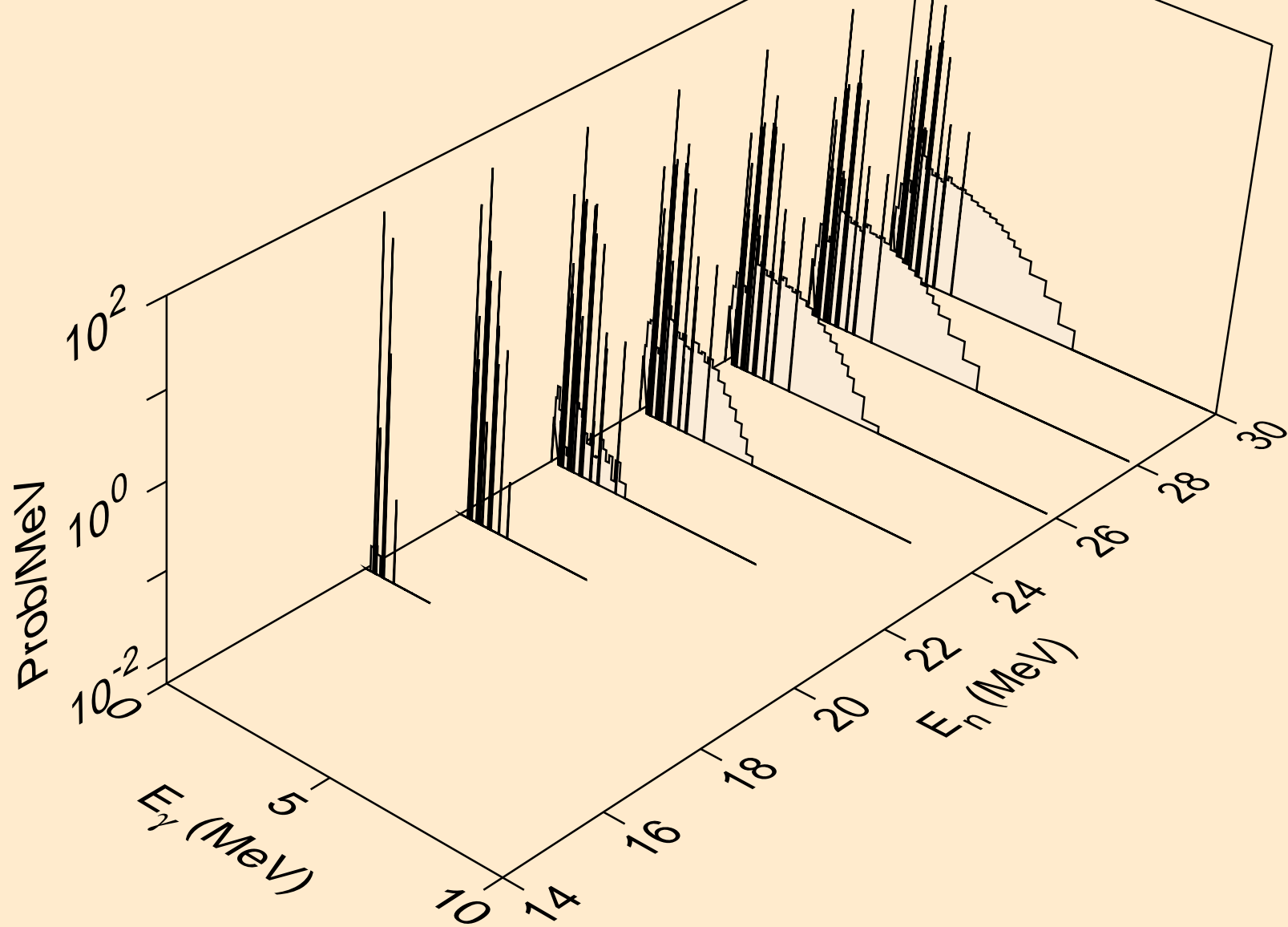

MN058 NEUTRON ACER TENDL-2021 LIBRARY; T=293.6K
Photon emission for (n,n*)he3

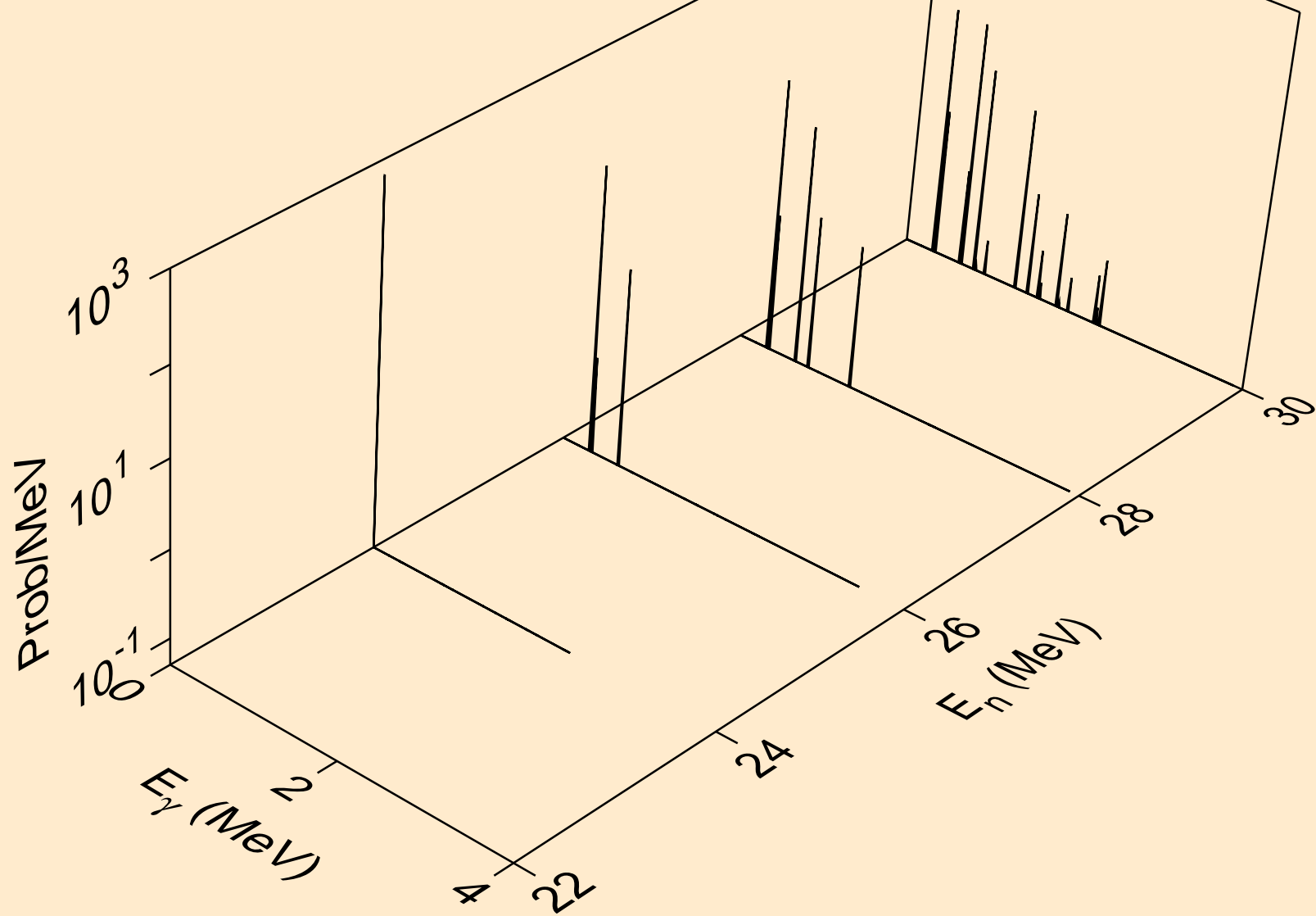

MN058 NEUTRON ACER TENDL-2021 LIBRARY; T=293.6K
Photon emission for (n,4n)

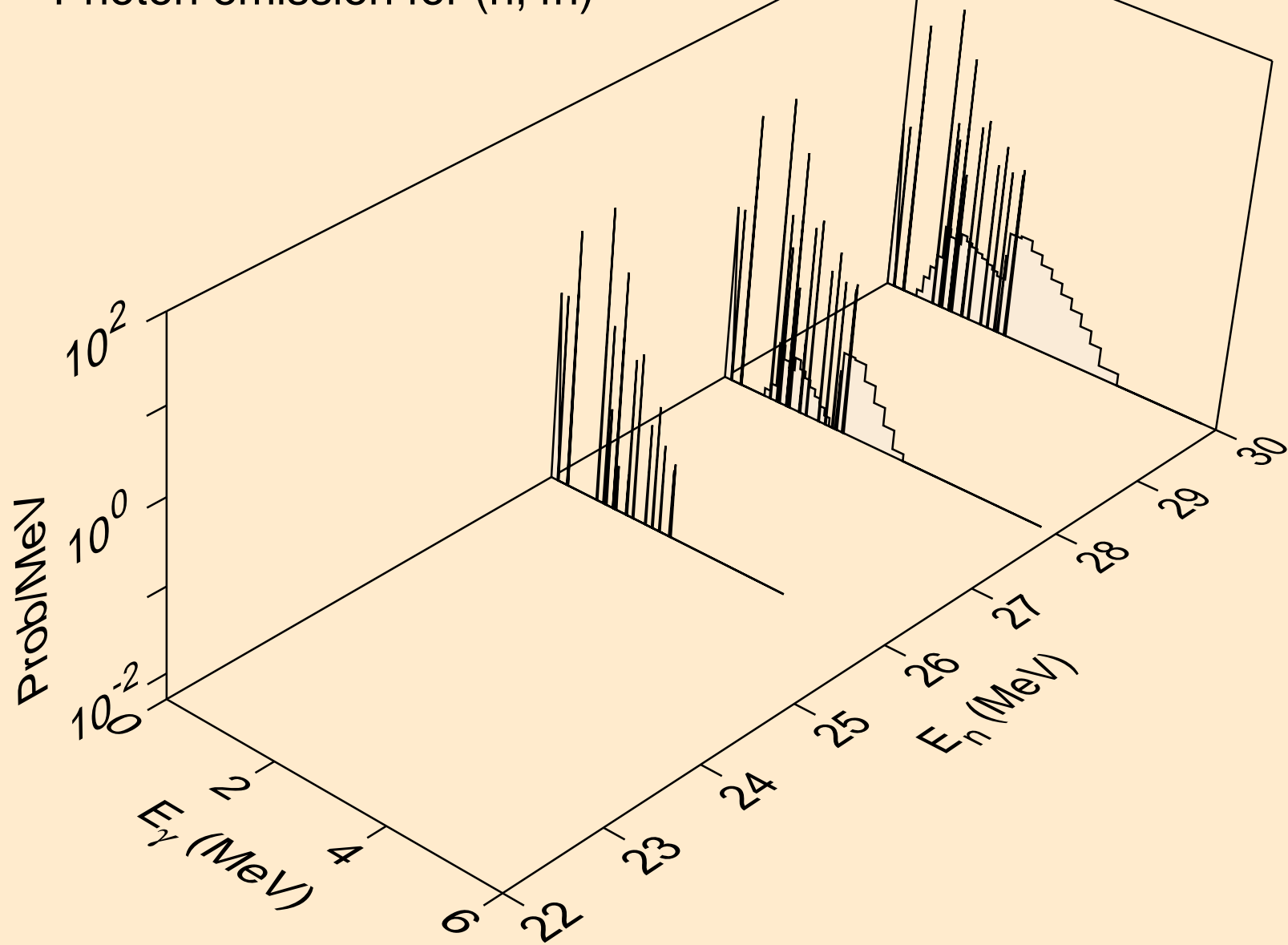

MN058 NEUTRON ACER TENDL-2021 LIBRARY; T=293.6K
Photon emission for (n,2np)

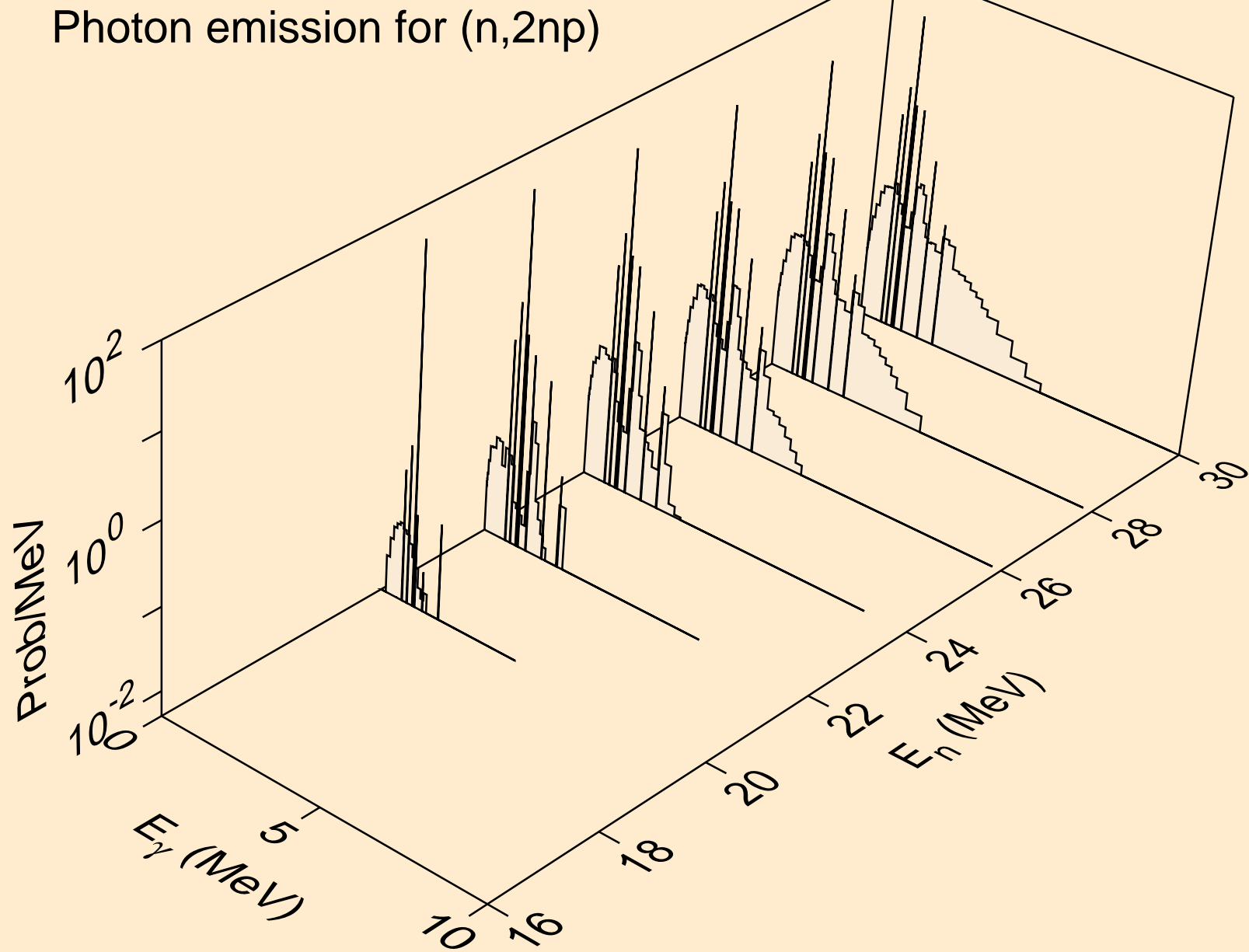

MN058 NEUTRON ACER TENDL-2021 LIBRARY; T=293.6K
Photon emission for (n,3np)

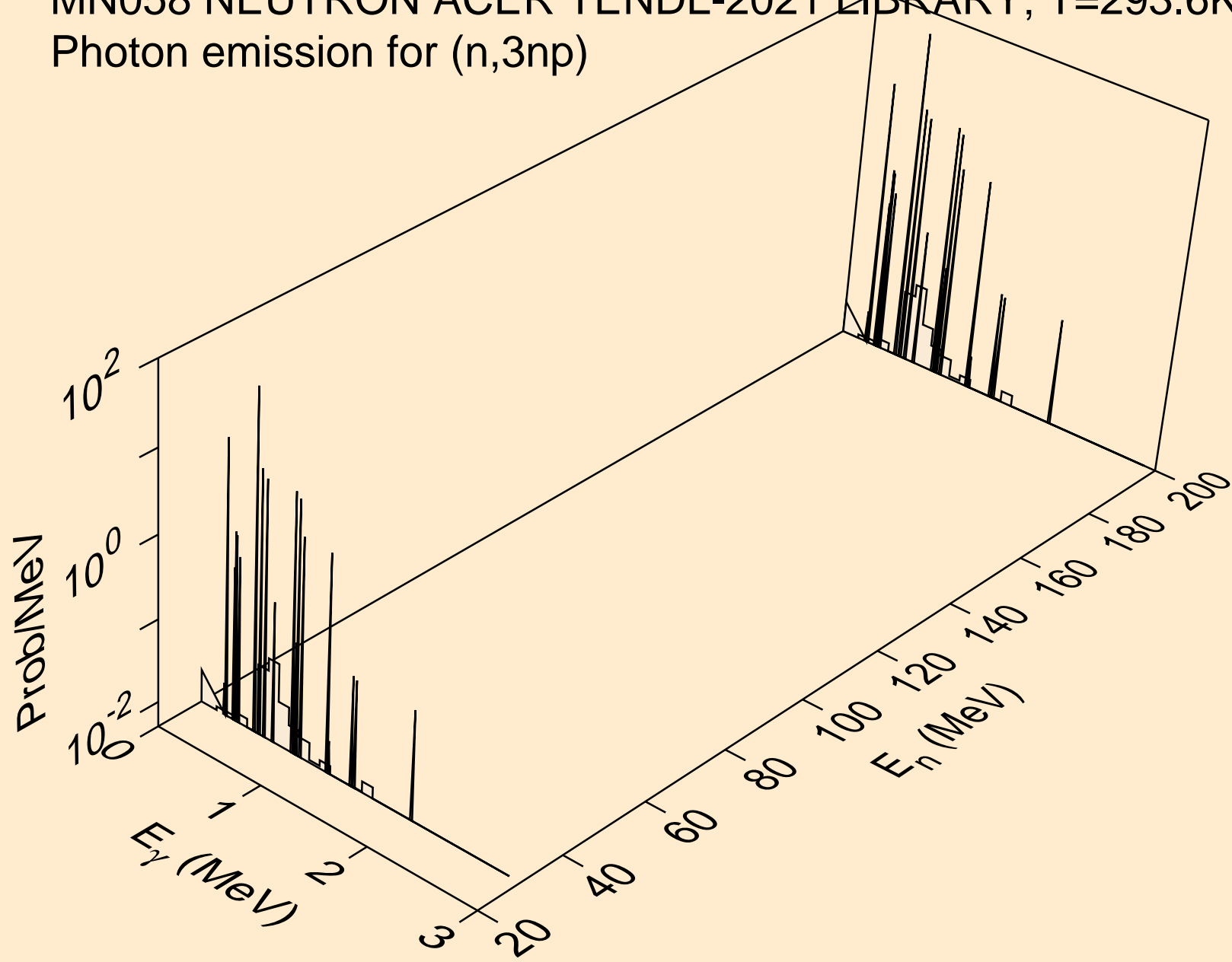

MN058 NEUTRON ACER TENDL-2021 LIBRARY; T=293.6K
Photon emission for (n,2np)

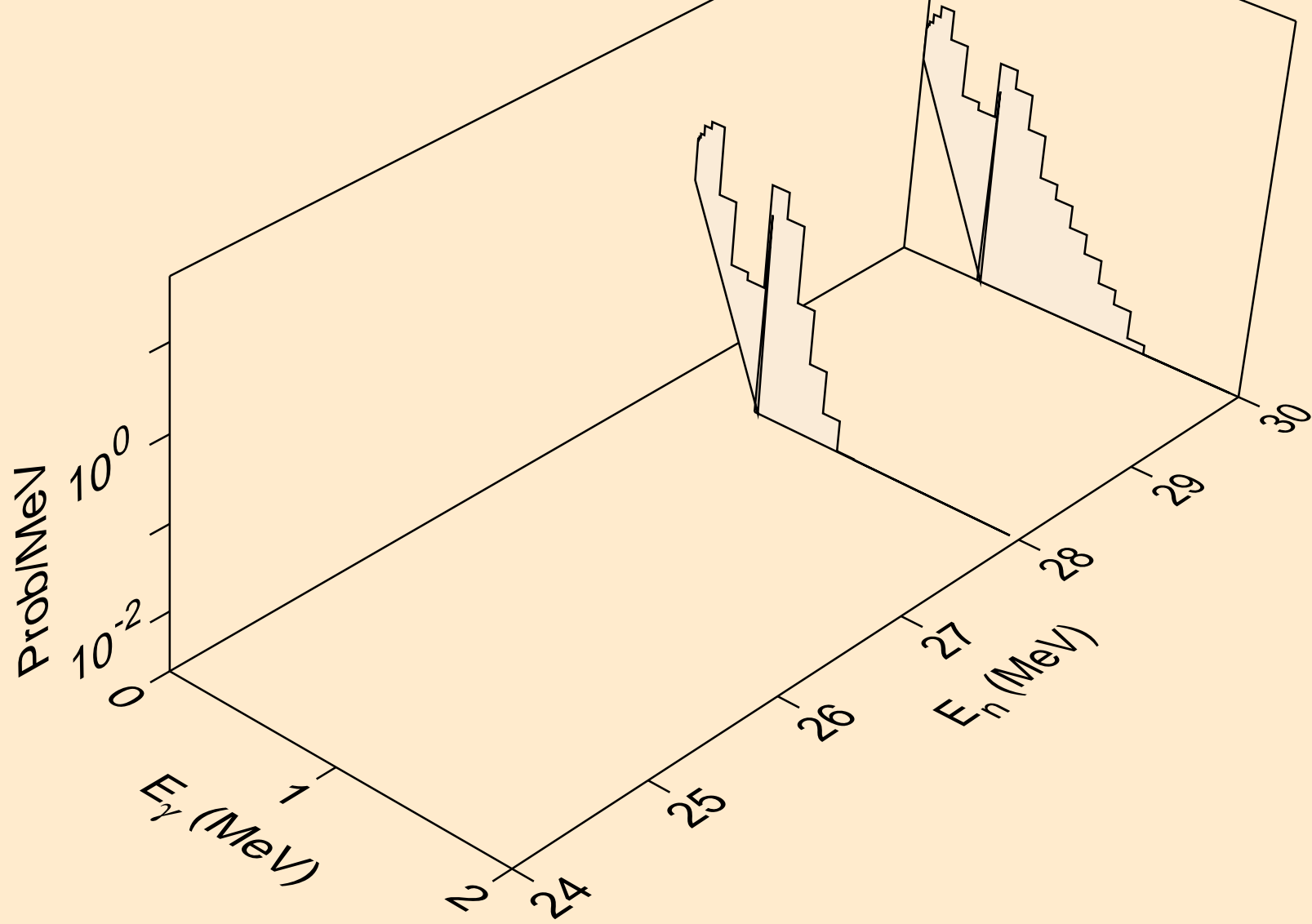

MN058 NEUTRON ACER TENDL-2021 LIBRARY; T=293.6K
Photon emission for (n,npa)

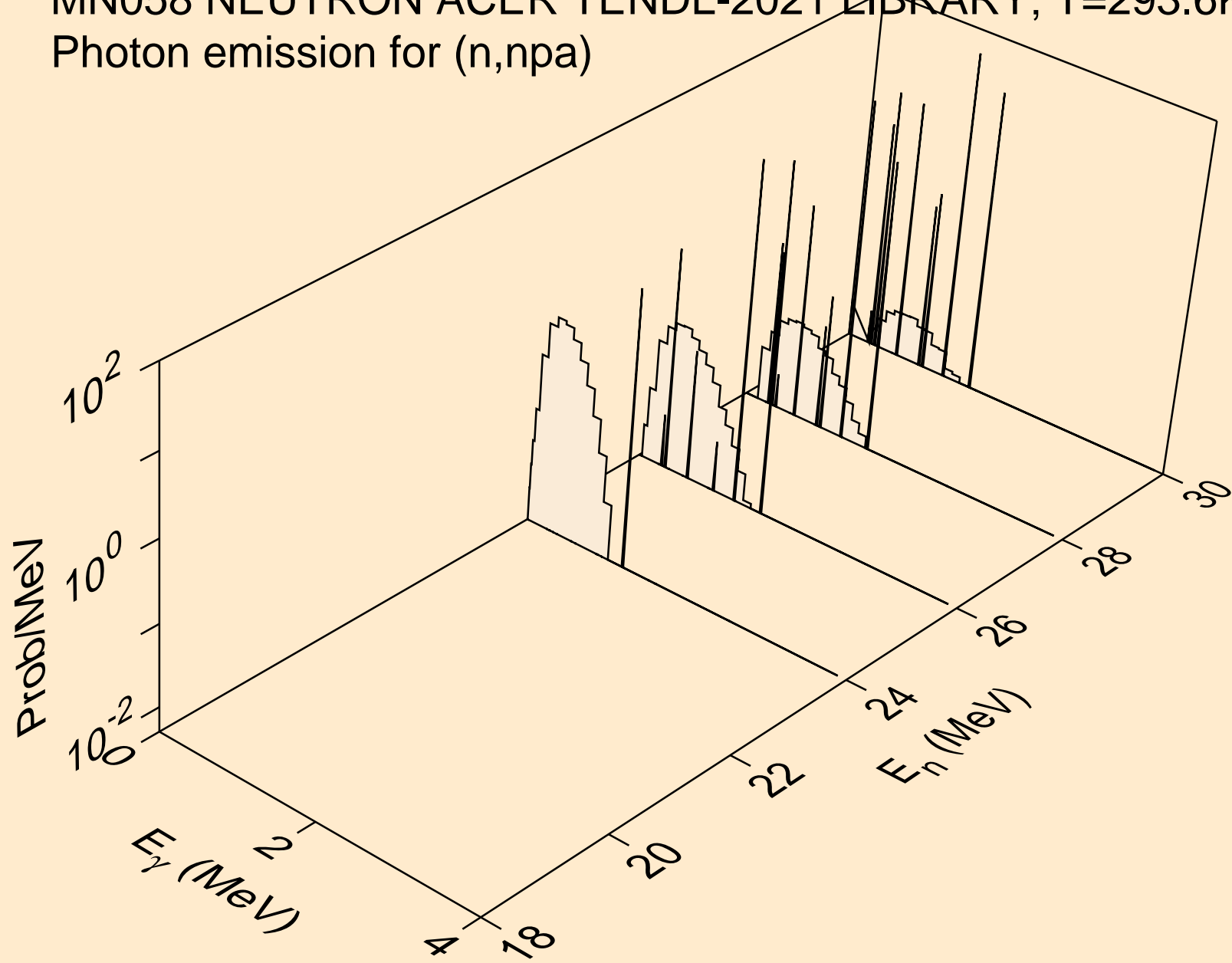

MN058 NEUTRON ACER TENDL-2021 LIBRARY; T=293.6K
Photon emission for (n,n*c)

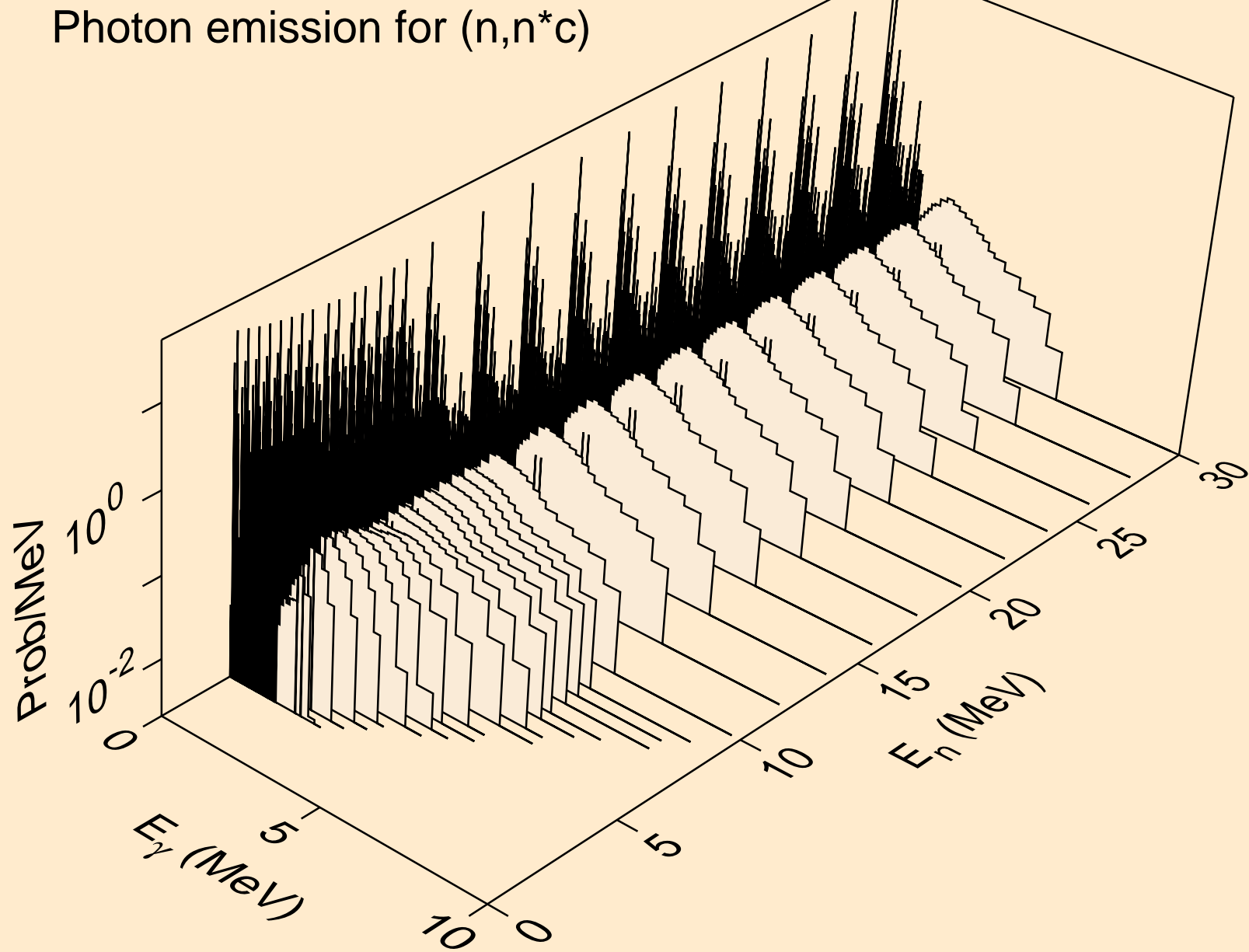

MN058 NEUTRON ACER TENDL-2021 LIBRARY; T=293.6K
Photon emission for (n,gma)

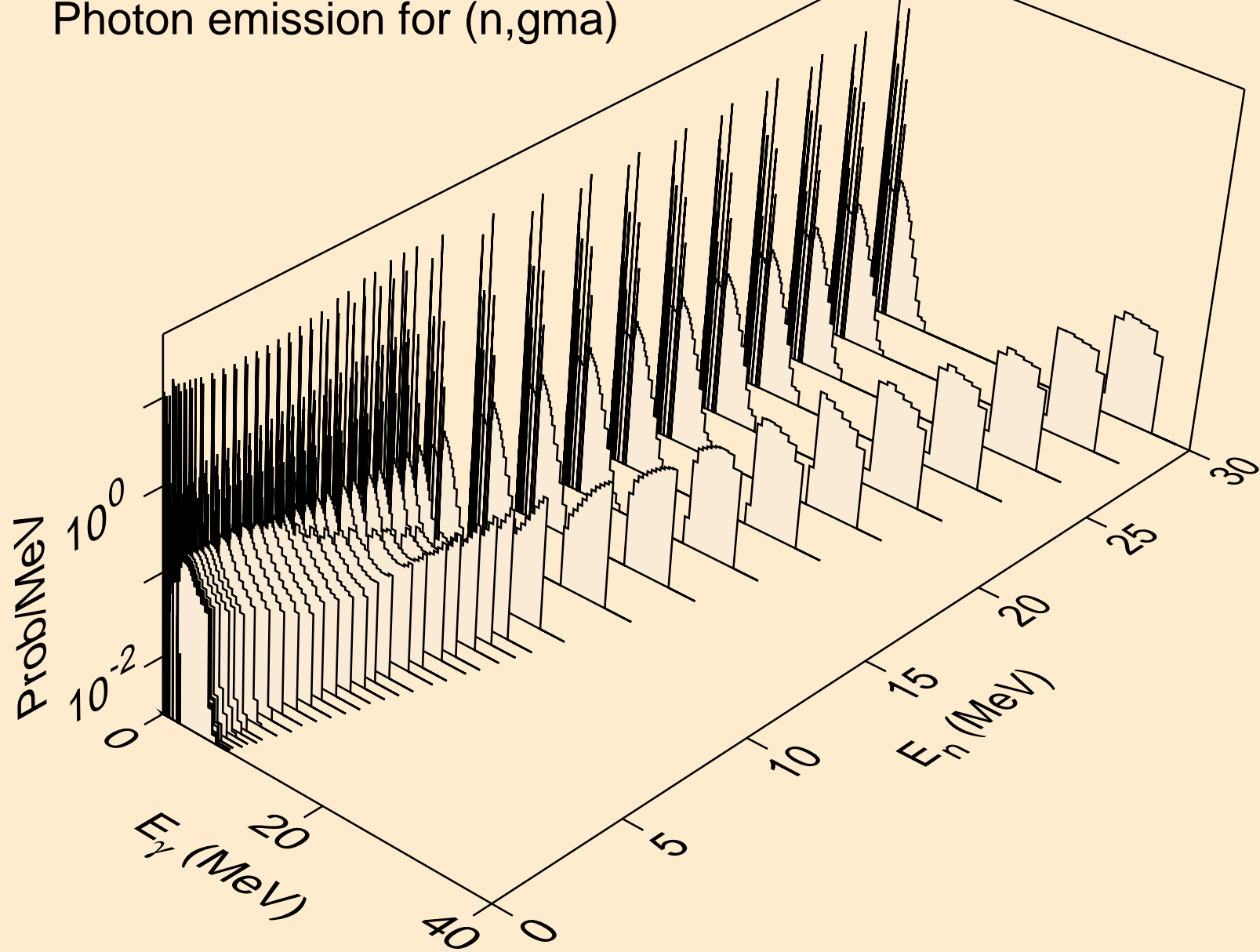

MN058 NEUTRON ACER TENDL-2021 LIBRARY; T=293.6K
Photon emission for (n,p)

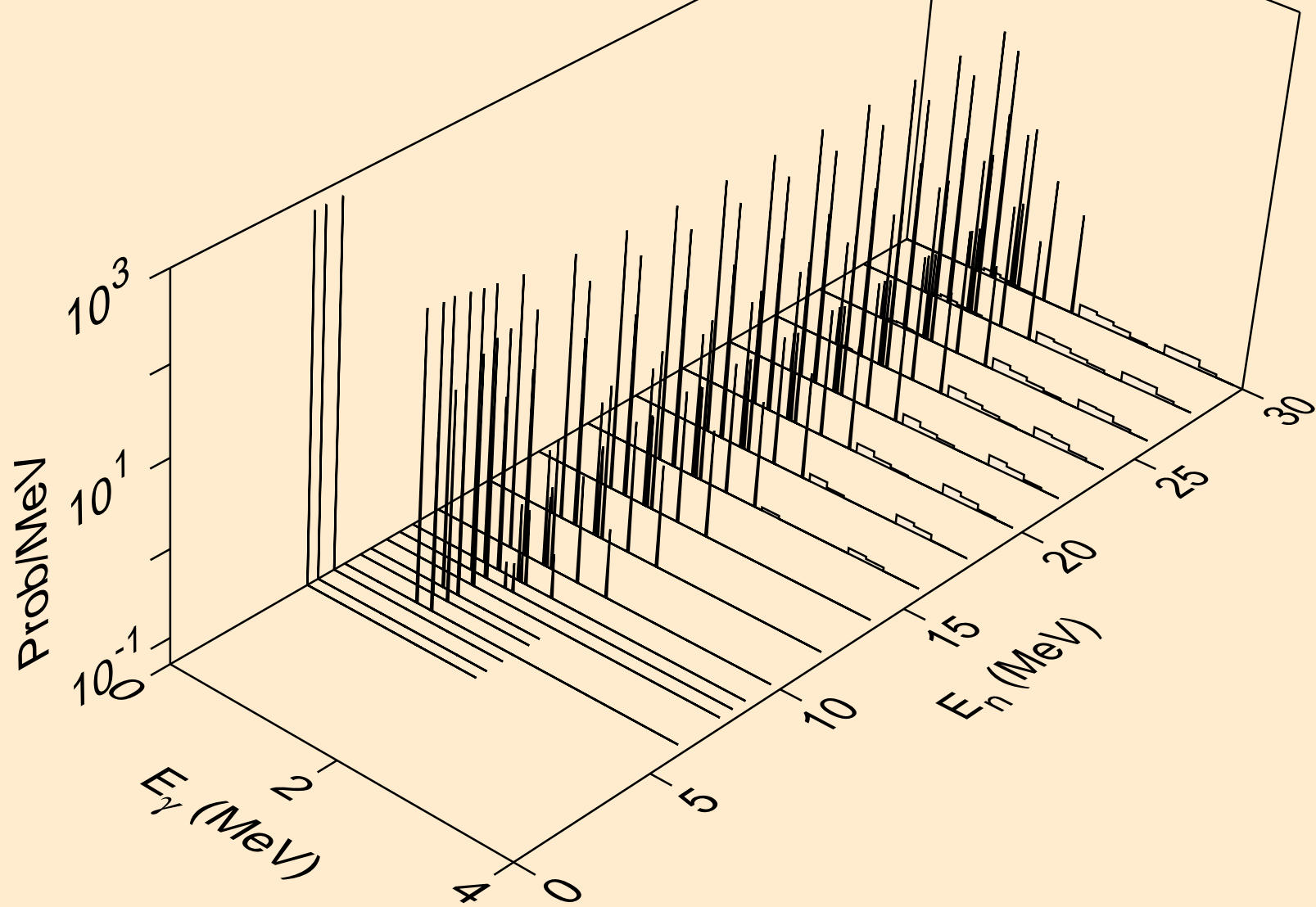

MN058 NEUTRON ACER TENDL-2021 LIBRARY; T=293.6K
Photon emission for (n,d)

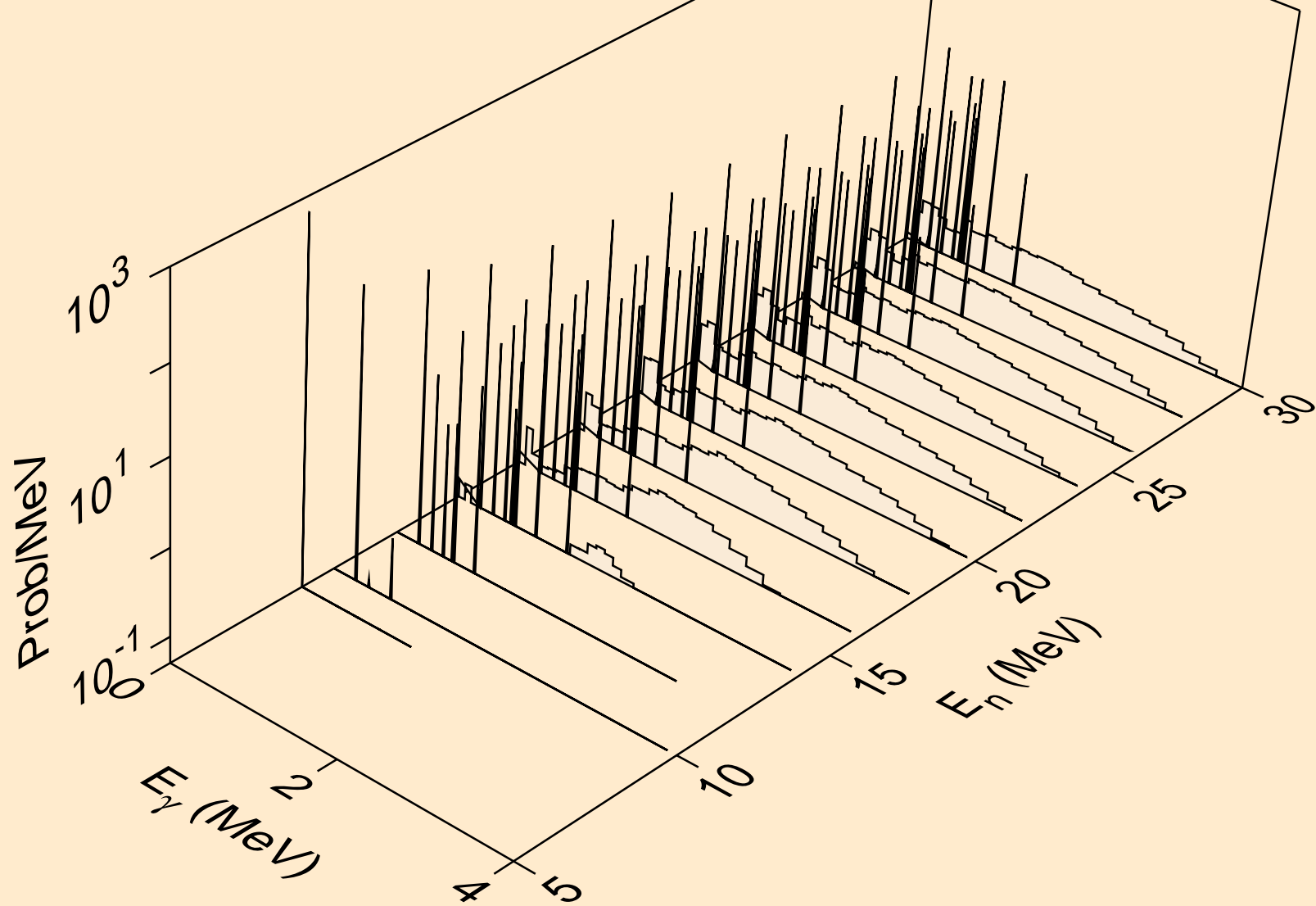

MN058 NEUTRON ACER TENDL-2021 LIBRARY; T=293.6K
Photon emission for (n,t)

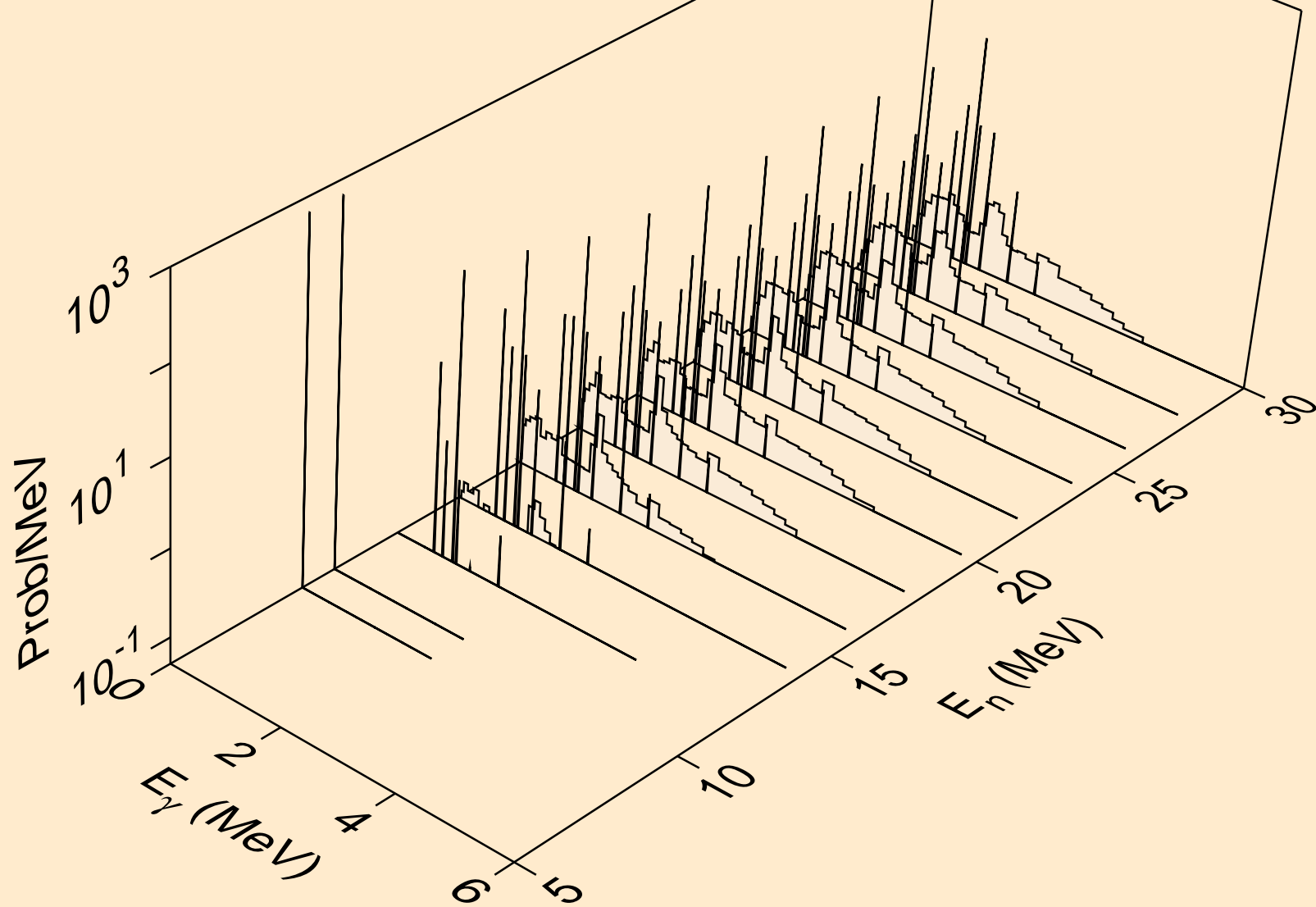

MN058 NEUTRON ACER TENDL-2021 LIBRARY; T=293.6K
Photon emission for (n,he3)

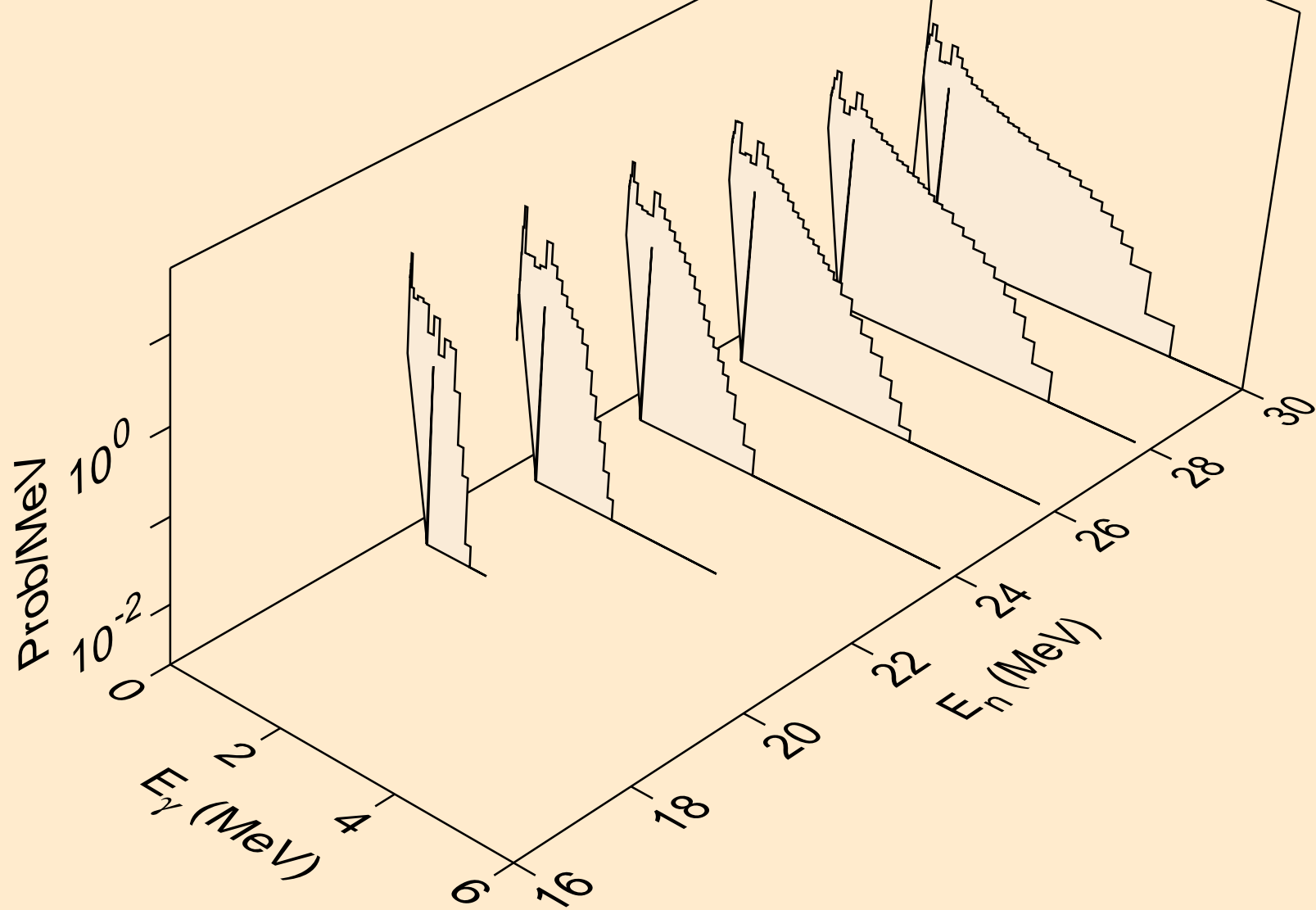

MN058 NEUTRON ACER TENDL-2021 LIBRARY; T=293.6K
Photon emission for (n,a)

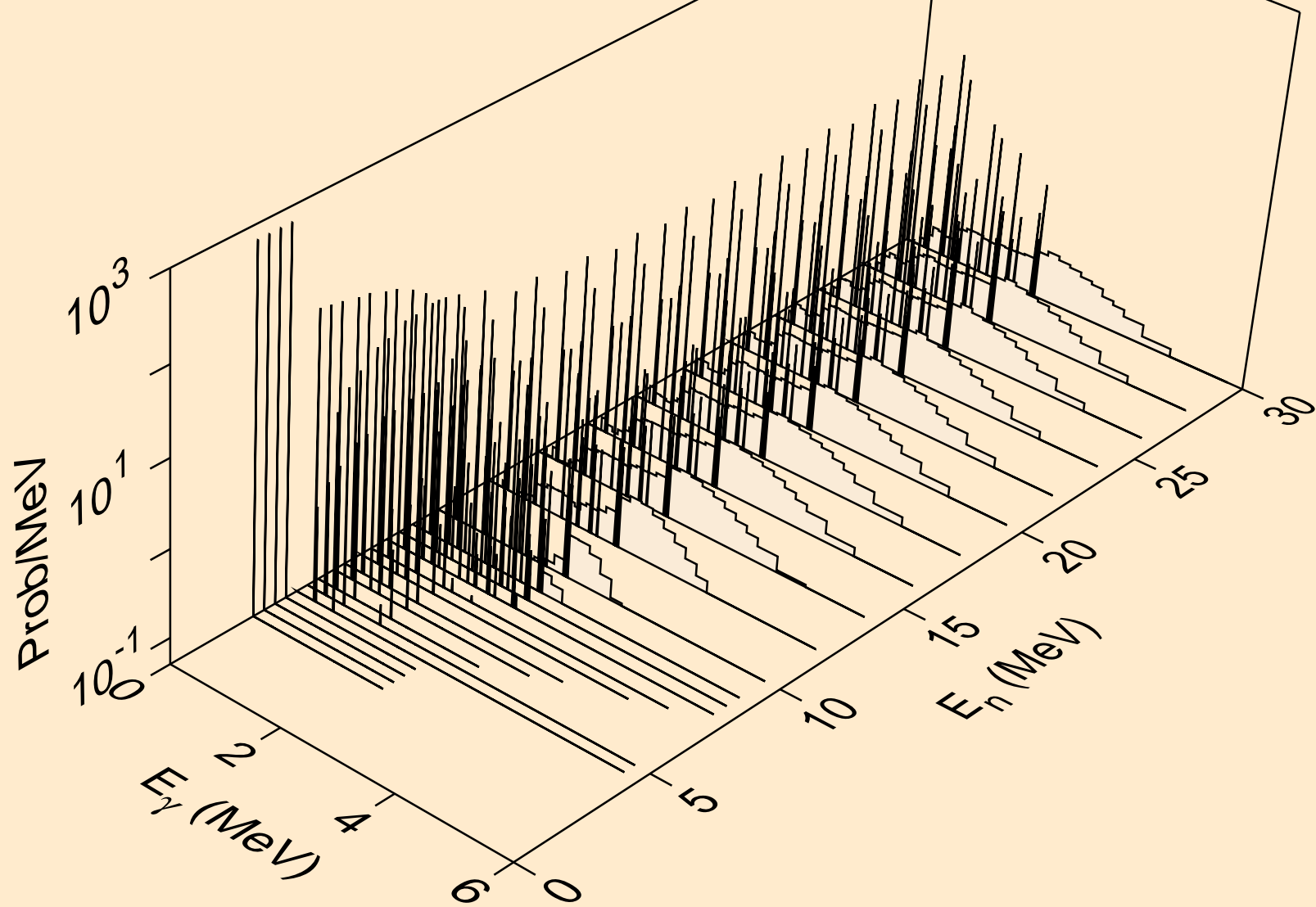

MN058 NEUTRON ACER TENDL-2021 LIBRARY; T=293.6K
Photon emission for (n,2a)

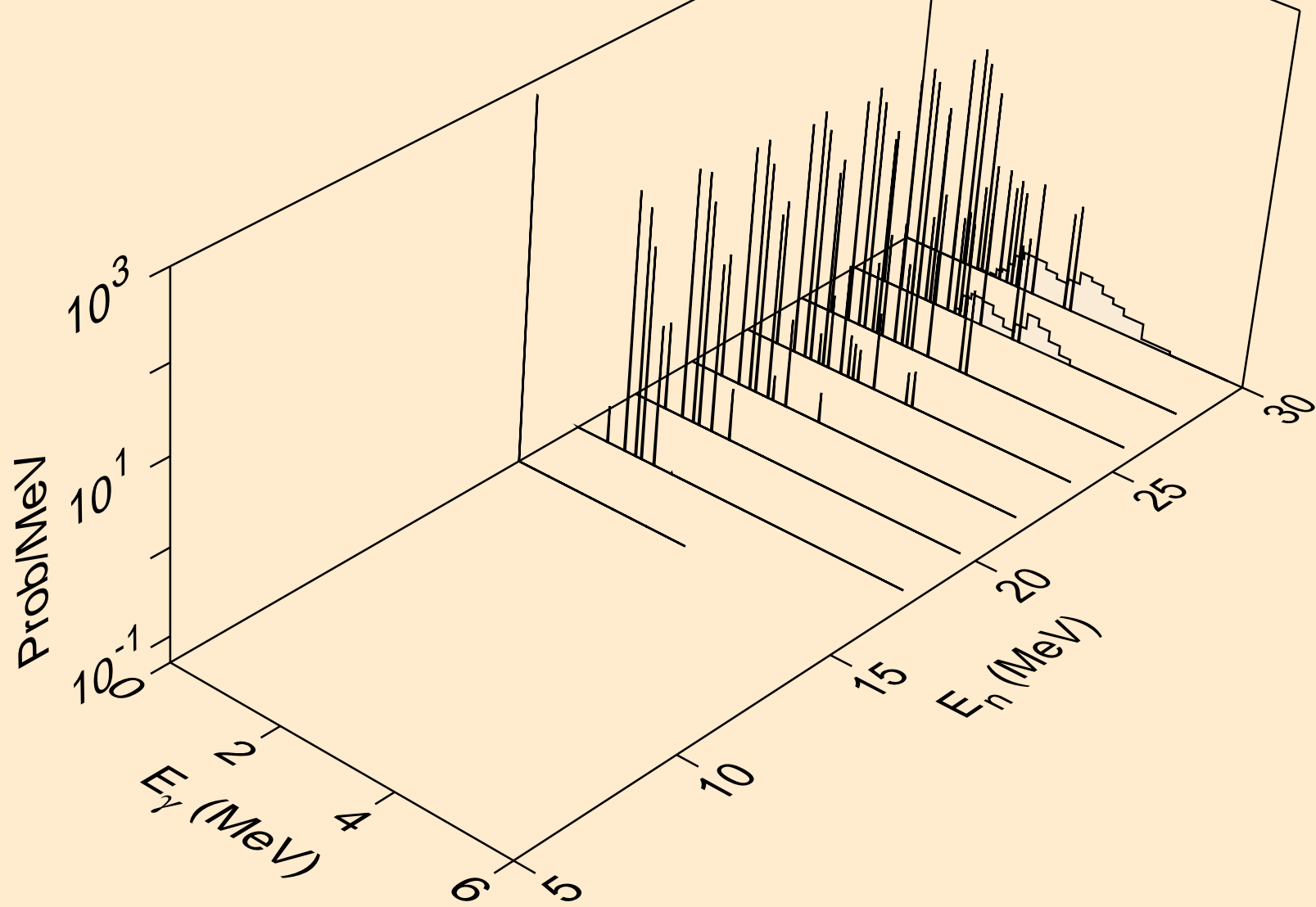

MN058 NEUTRON ACER TENDL-2021 LIBRARY; T=293.6K
Photon emission for (n,2p)

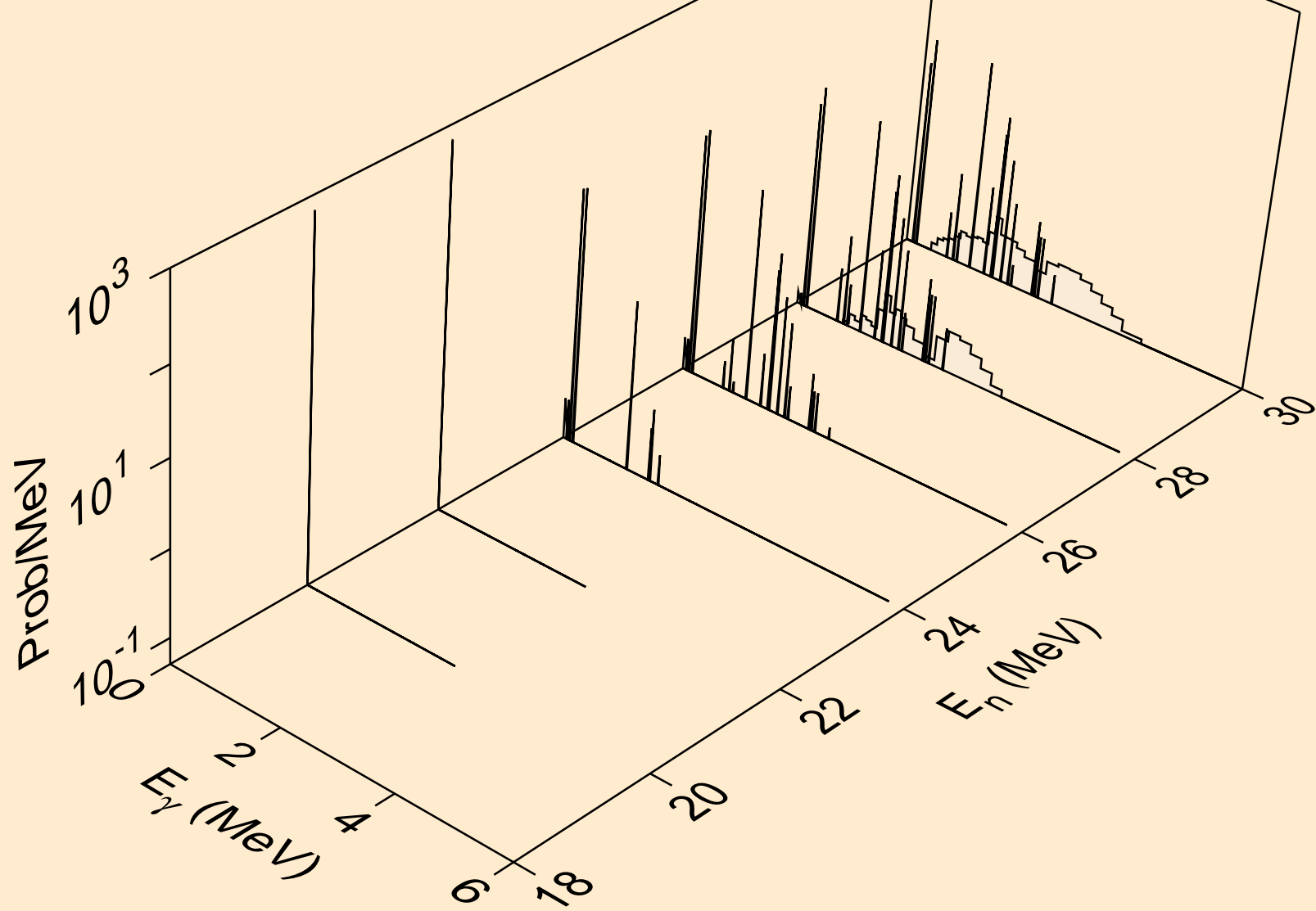

MN058 NEUTRON ACER TENDL-2021 LIBRARY; T=293.6K
Photon emission for (n,p α)

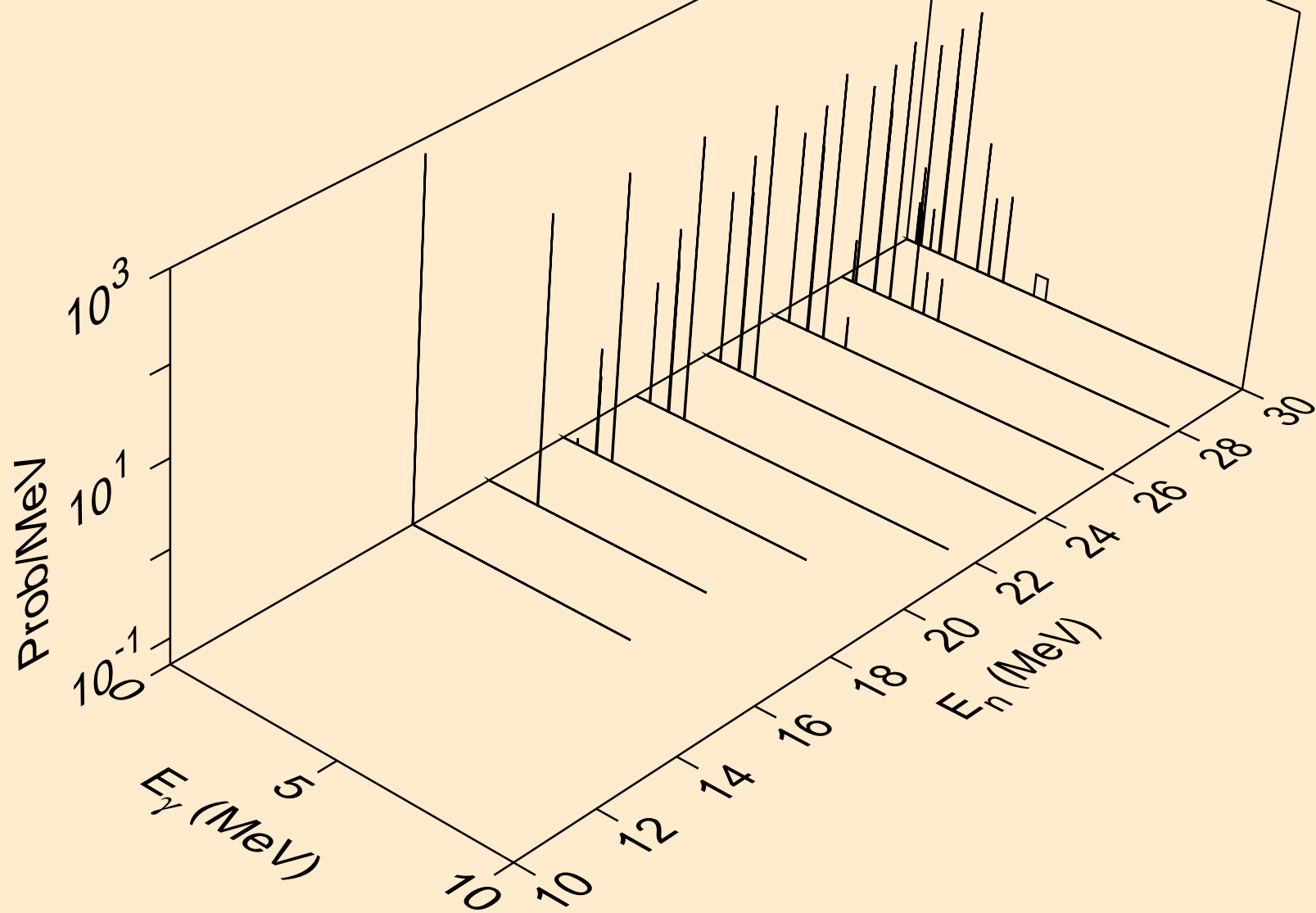

MN058 NEUTRON ACER TENDL-2021 LIBRARY; T=293.6K
Photon emission for (n,pd)

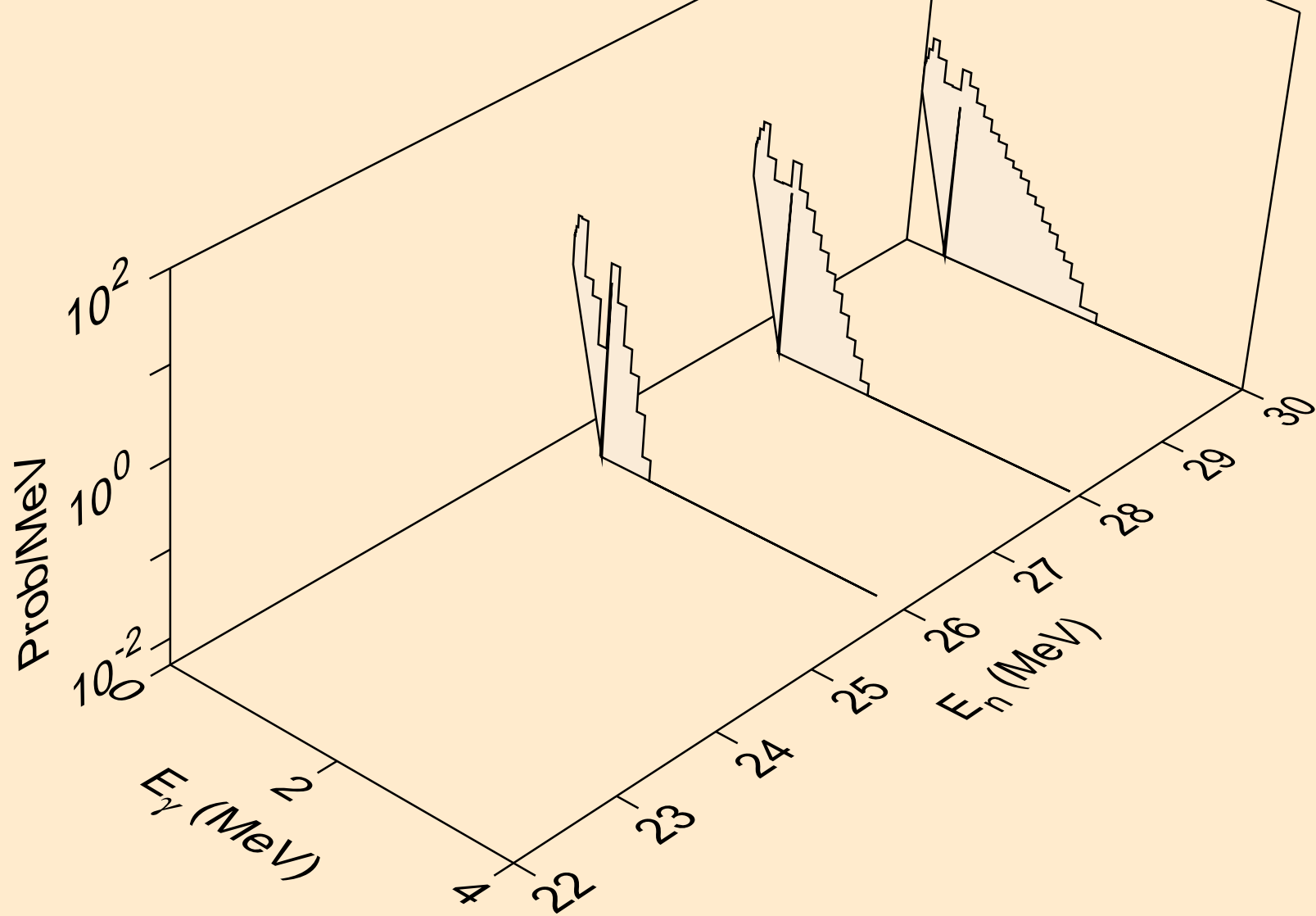

MN058 NEUTRON ACER TENDL-2021 LIBRARY; T=293.6K
Photon emission for (n,pt)

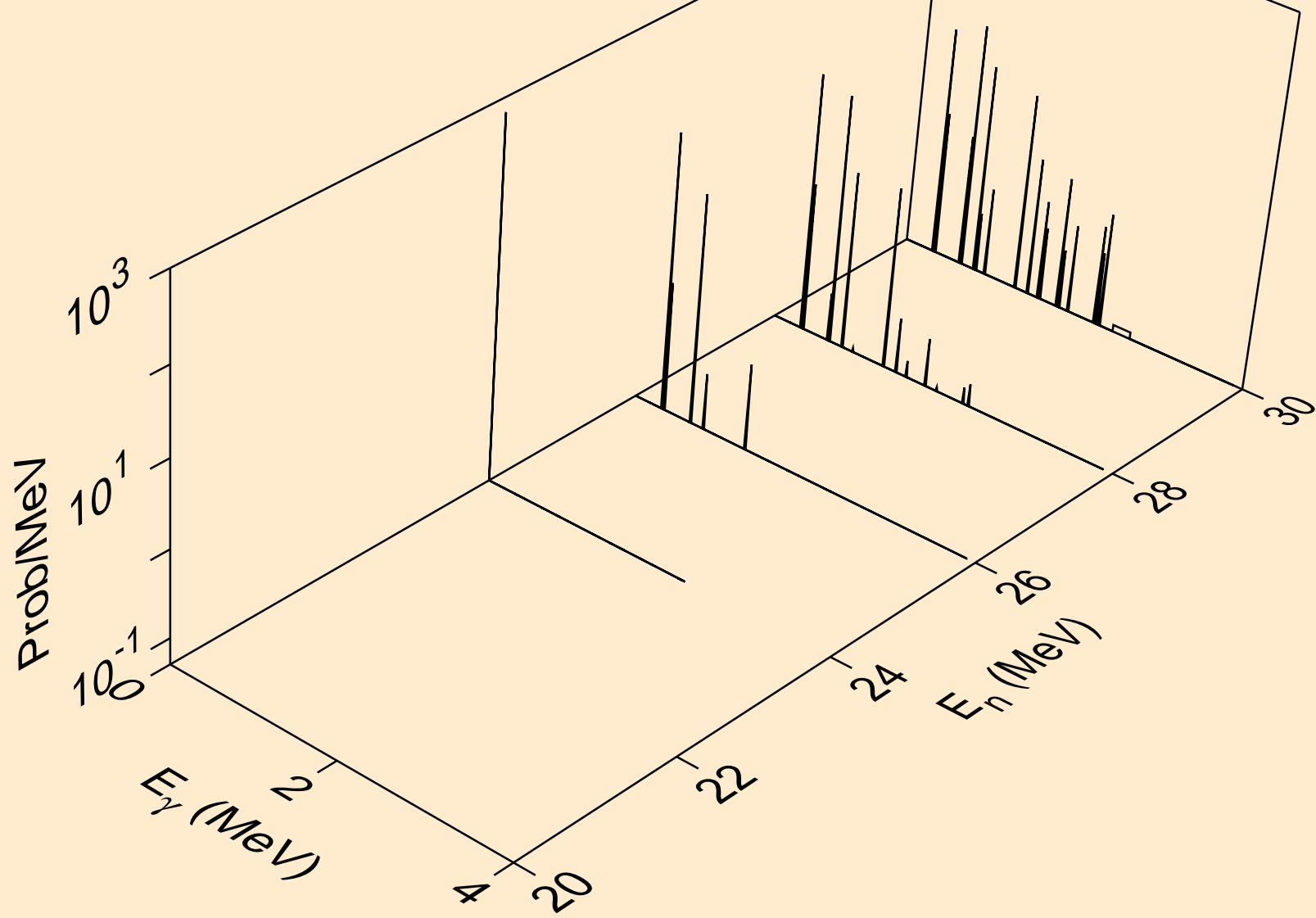

MN058 NEUTRON ACER TENDL-2021 LIBRARY; T=293.6K
Photon emission for (n,da)

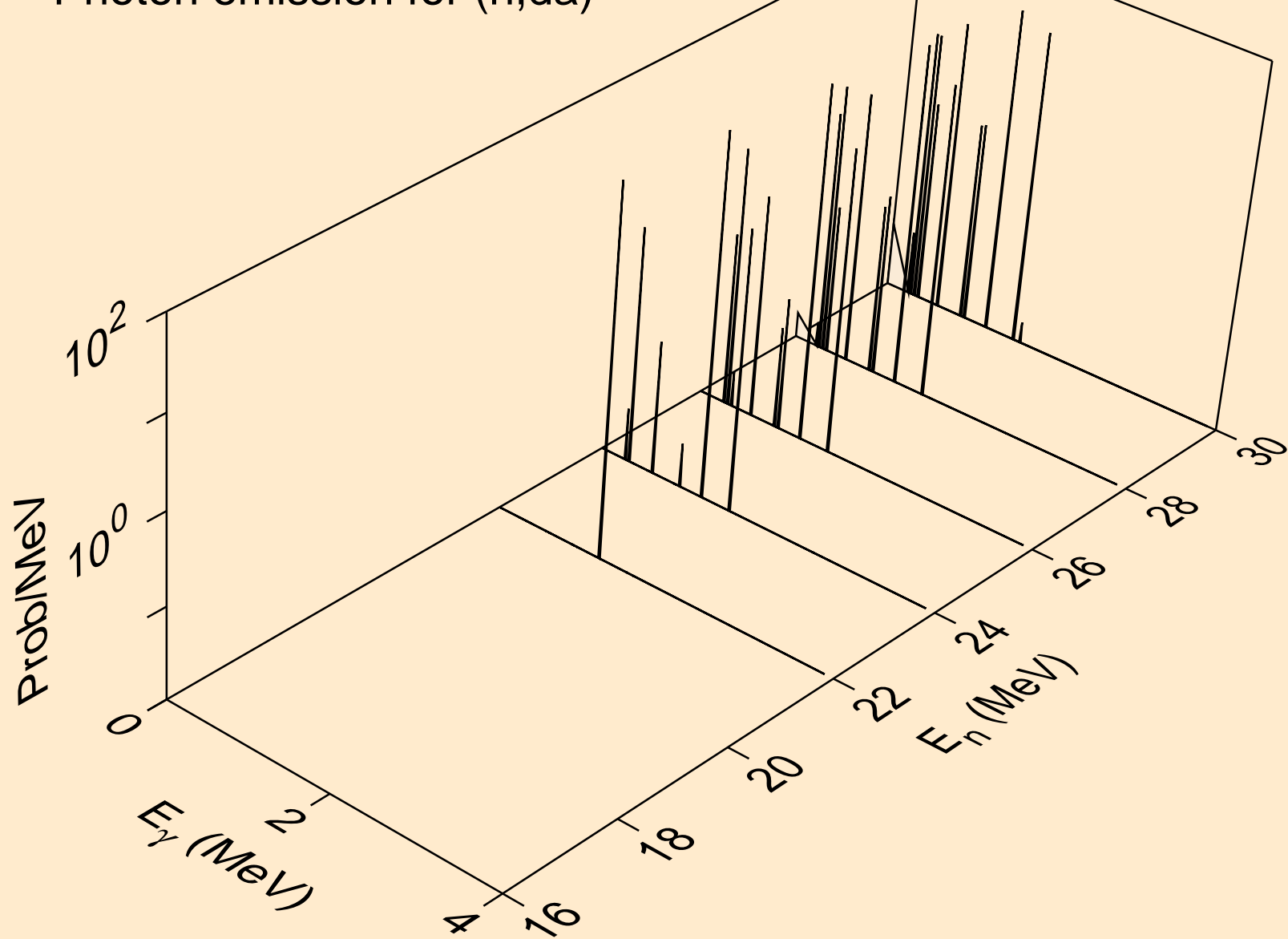

MN058 NEUTRON ACER TENDL-2021 LIBRARY; T=293.6K
thermal capture photon spectrum

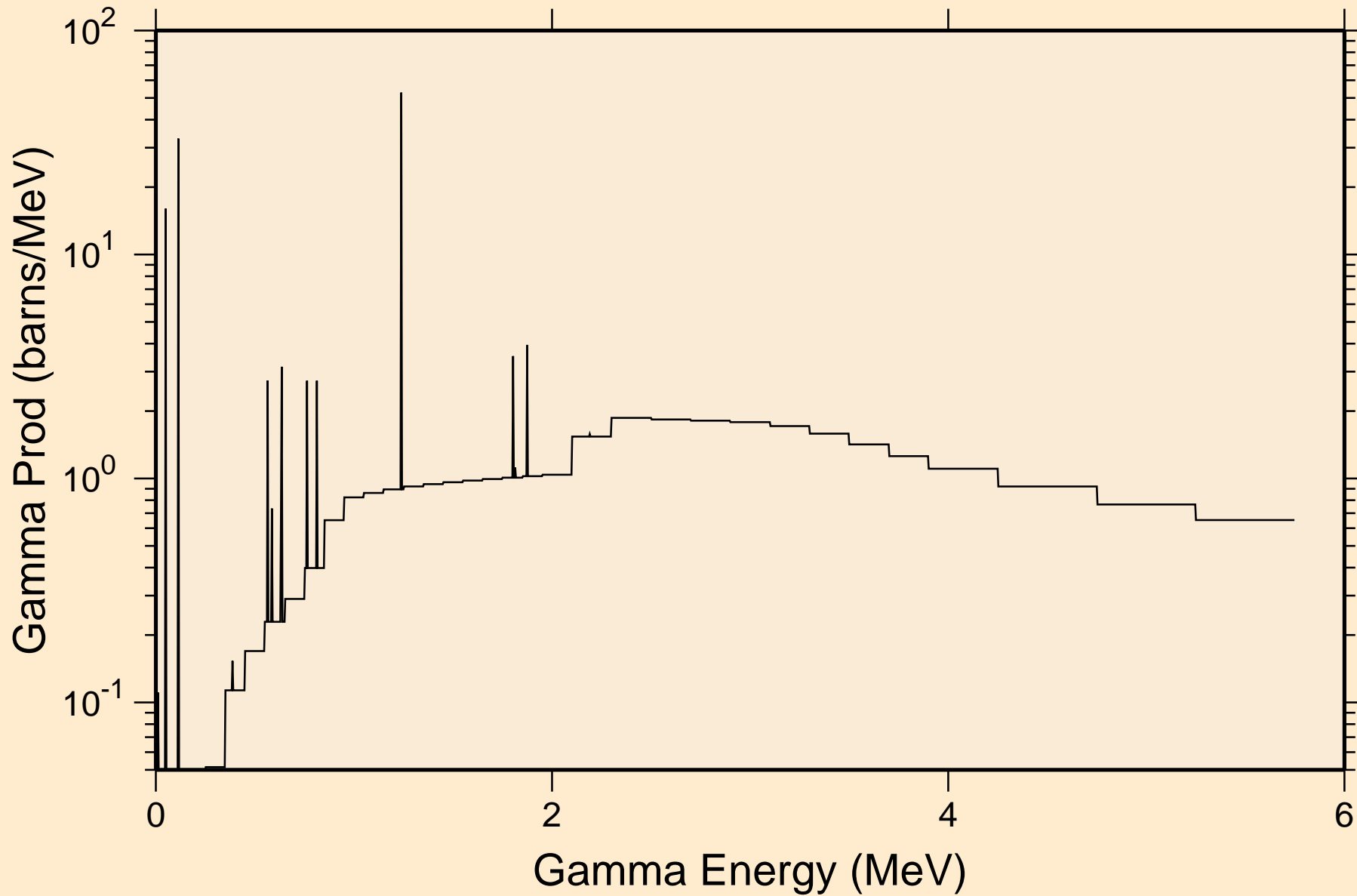

MN058 NEUTRON ACER TENDL-2021 LIBRARY; T=293.6K
14 MeV photon spectrum

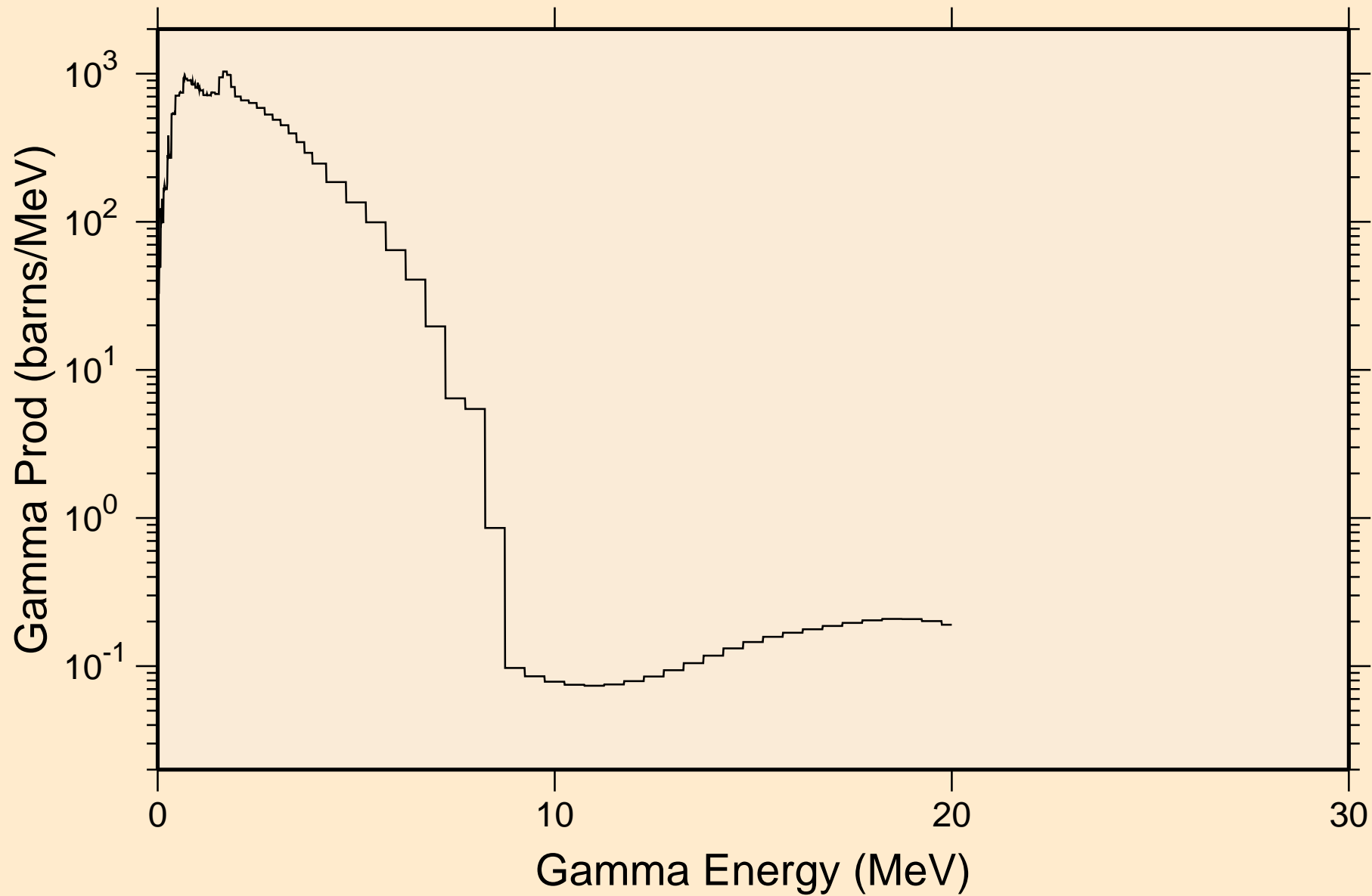

MN058 NEUTRON ACER TENDL-2021 LIBRARY; T=293.6K

Particle heating contributions

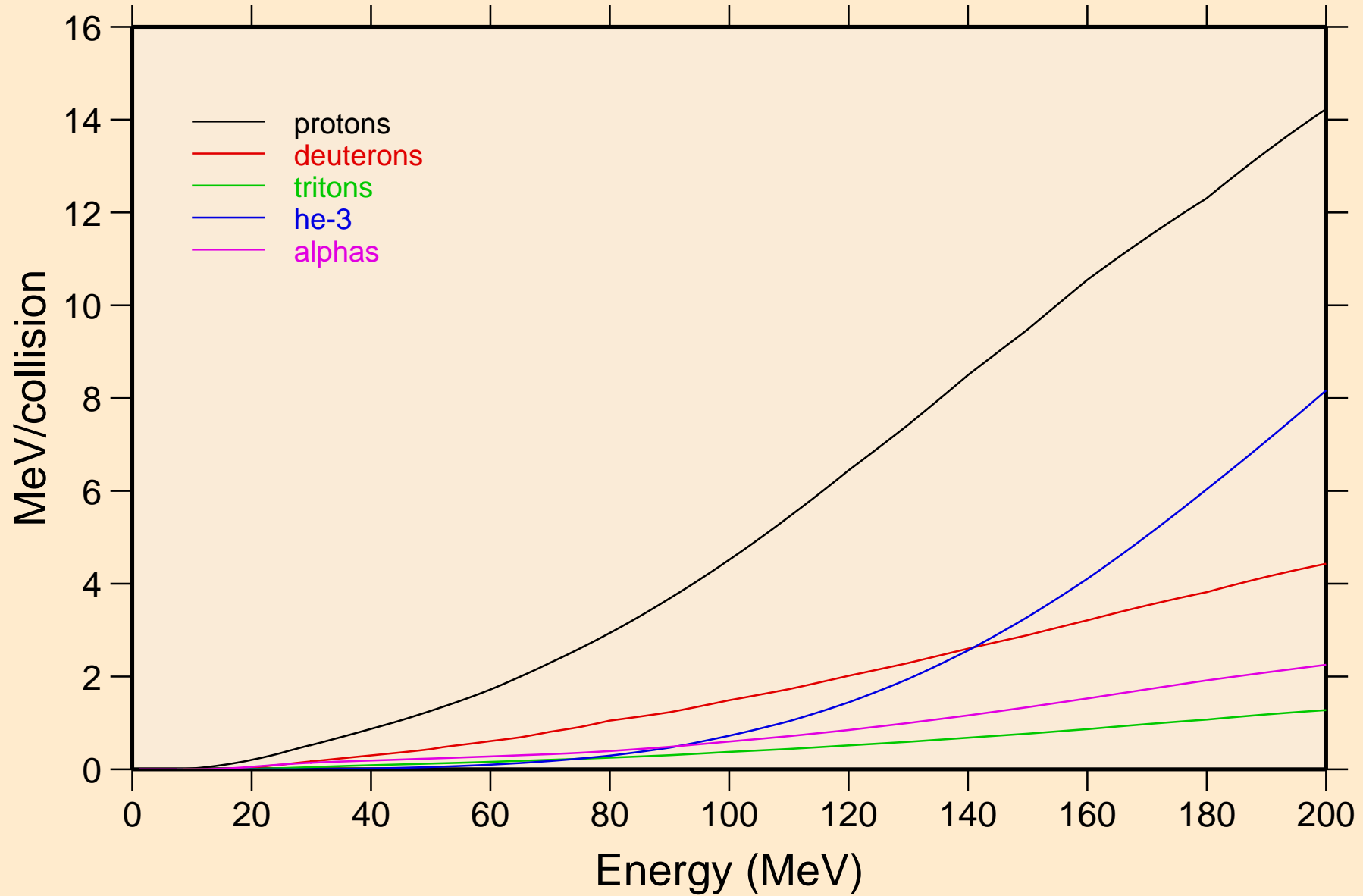

MN058 NEUTRON ACER TENDL-2021 LIBRARY; T=293.6K
Recoil Heating

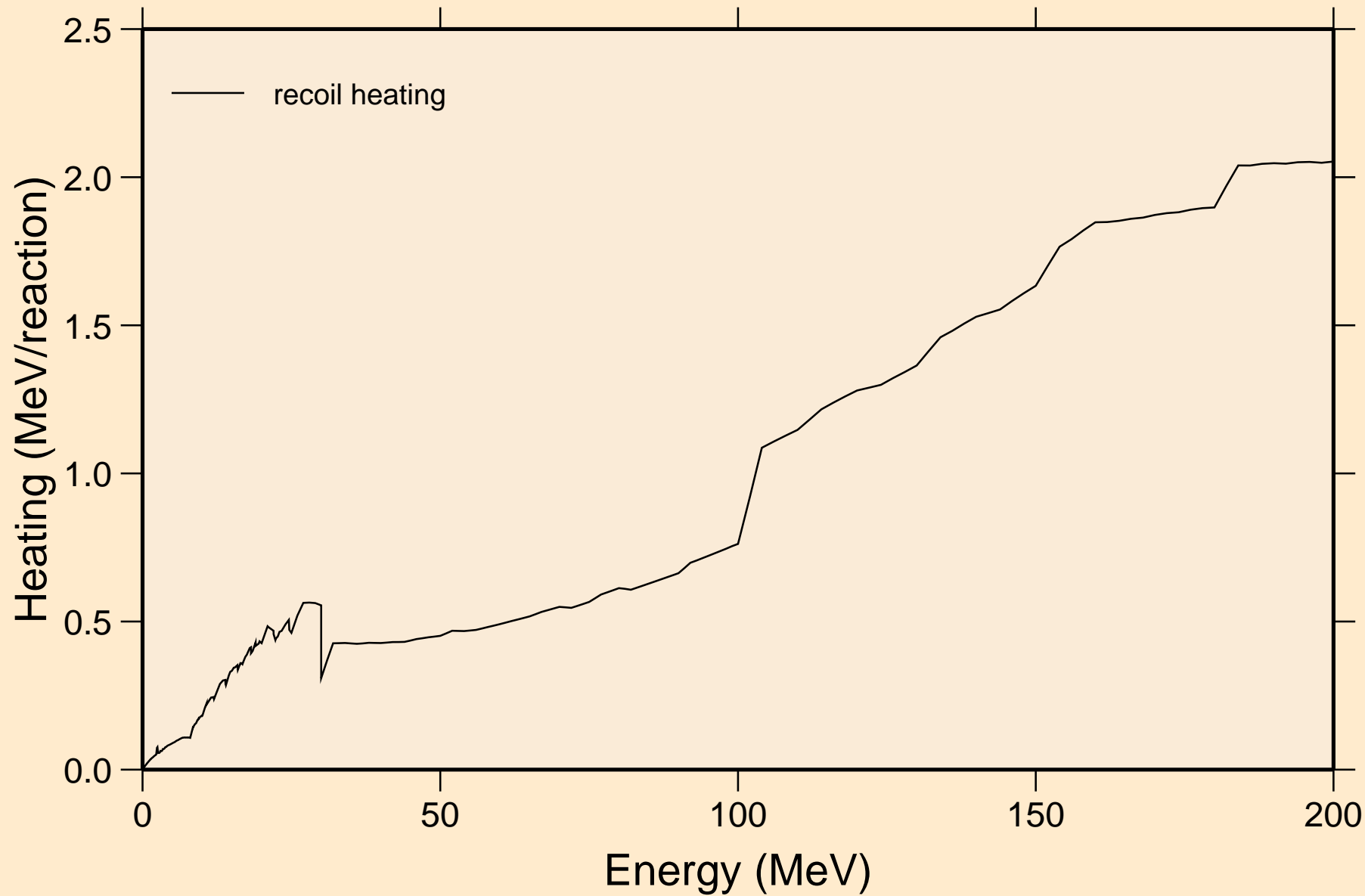

MN058 NEUTRON ACER TENDL-2021 LIBRARY; T=293.6K
Particle production cross sections

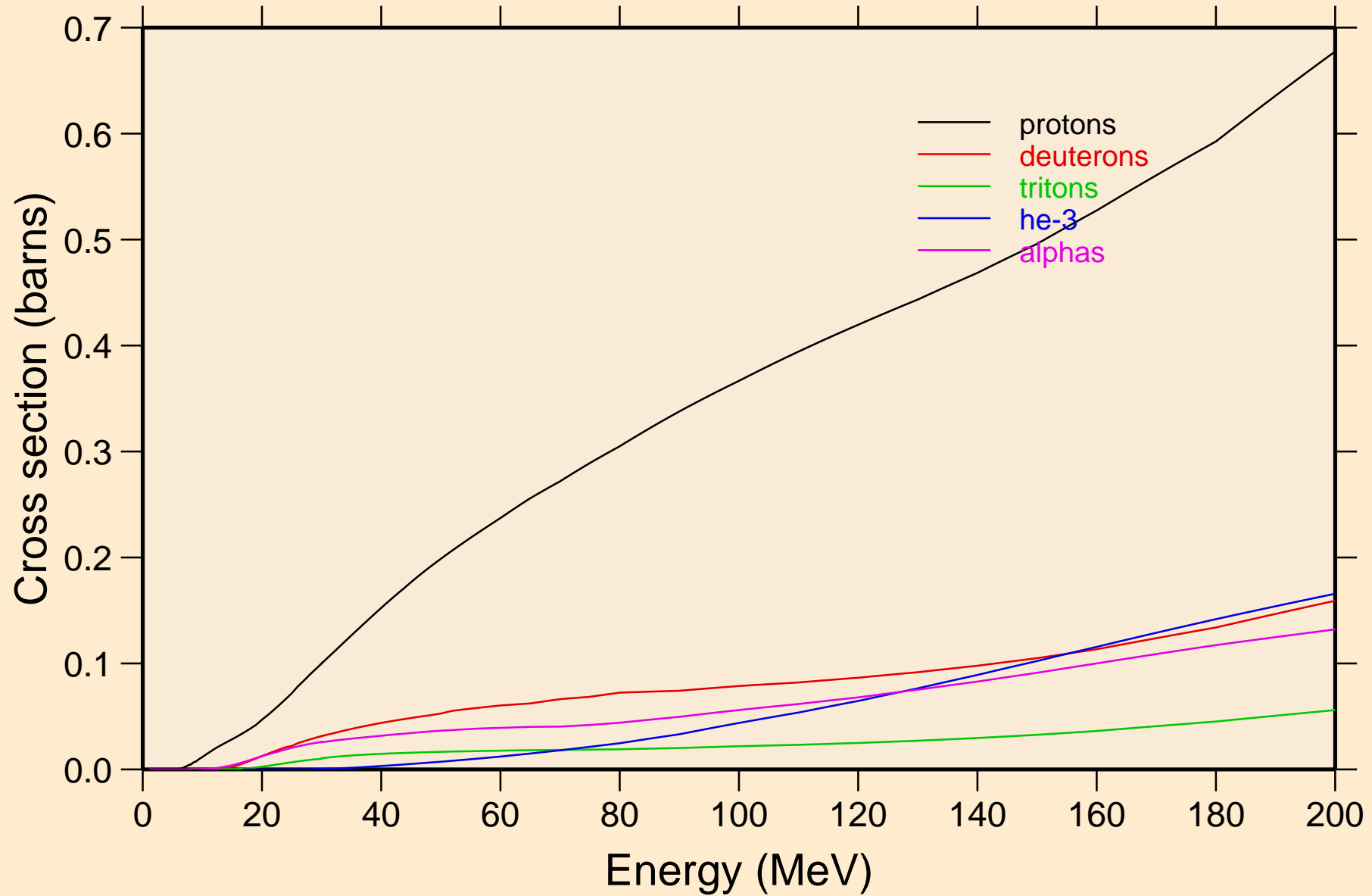

MN058 NEUTRON ACER TENDL-2021 LIBRARY; T=293.6K
protons from (n,x)

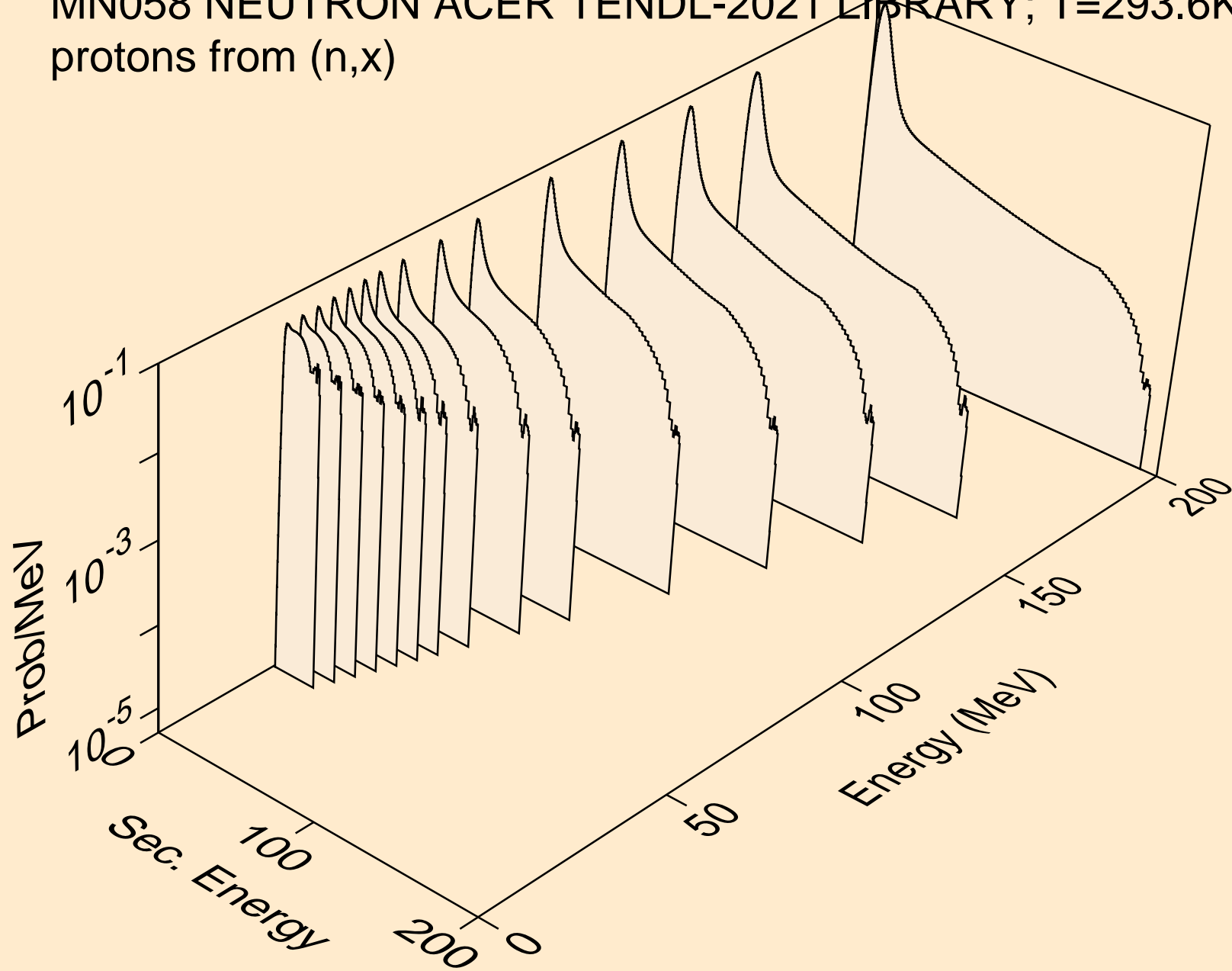

MN058 NEUTRON ACER TENDL-2021 LIBRARY; T=293.6K
protons from (n,n*)p

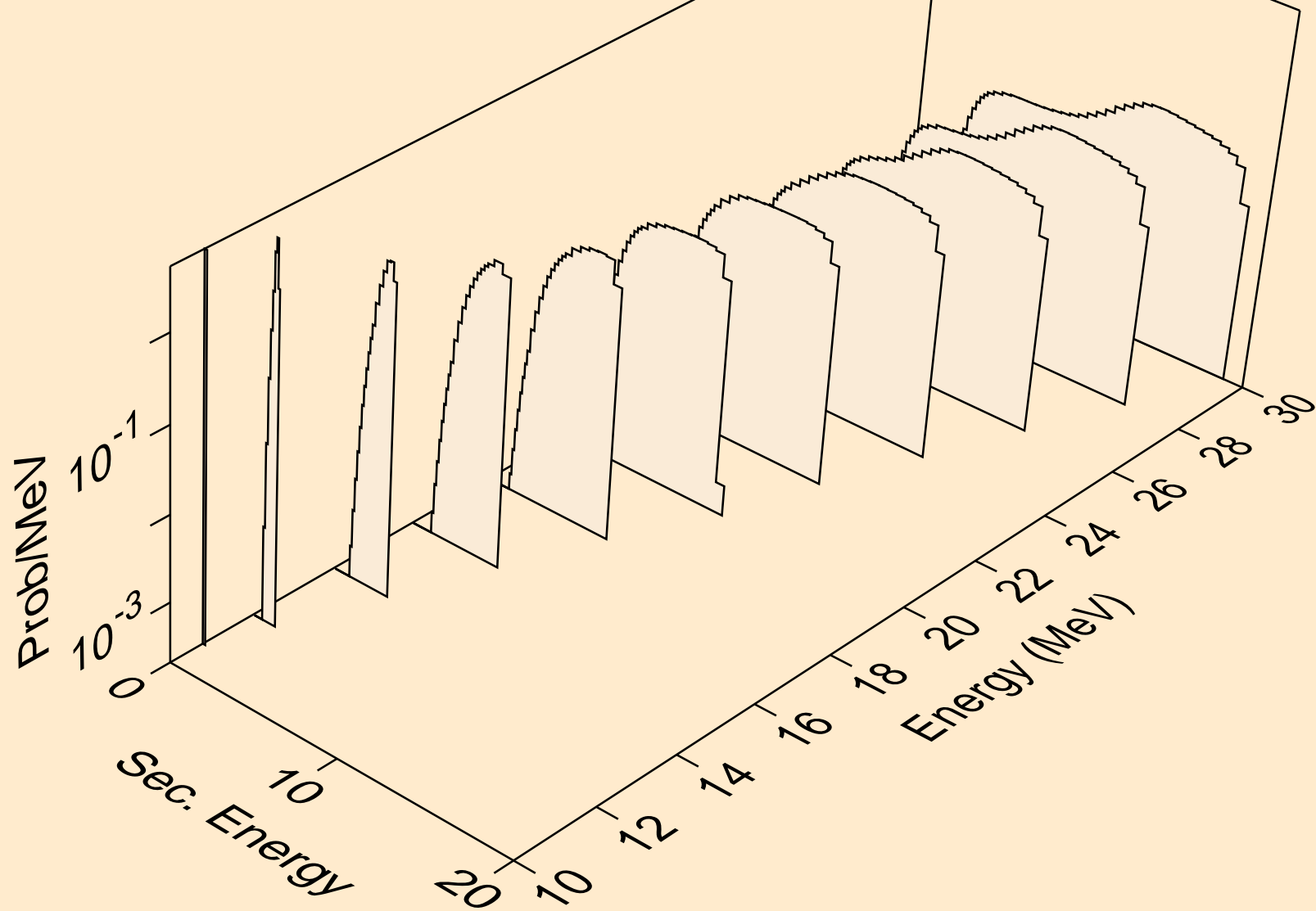

MN058 NEUTRON ACER TENDL-2021 LIBRARY; T=293.6K
protons from (n,2np)

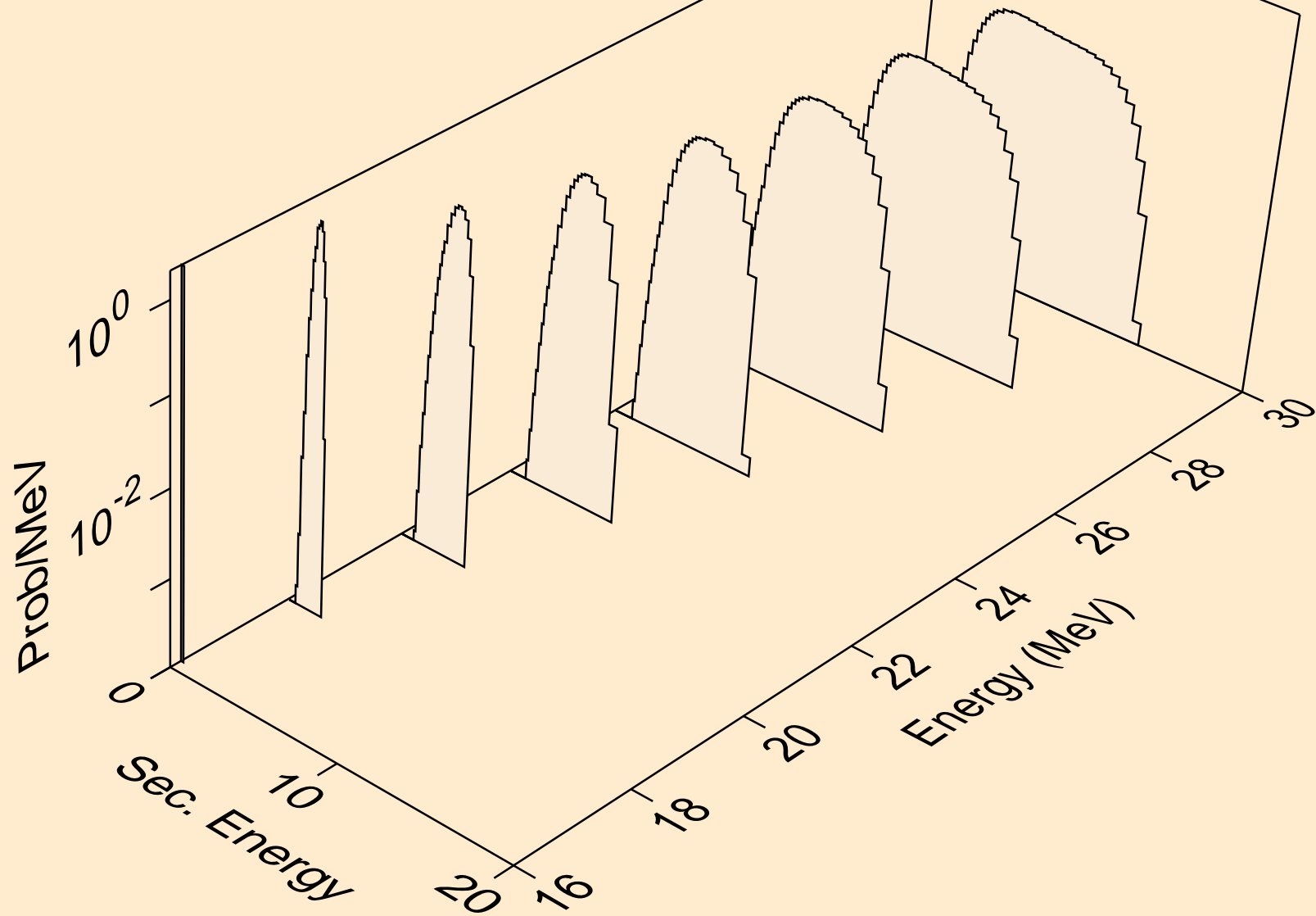

MN058 NEUTRON ACER TENDL-2021 LIBRARY; T=293.6K
protons from (n,3np)

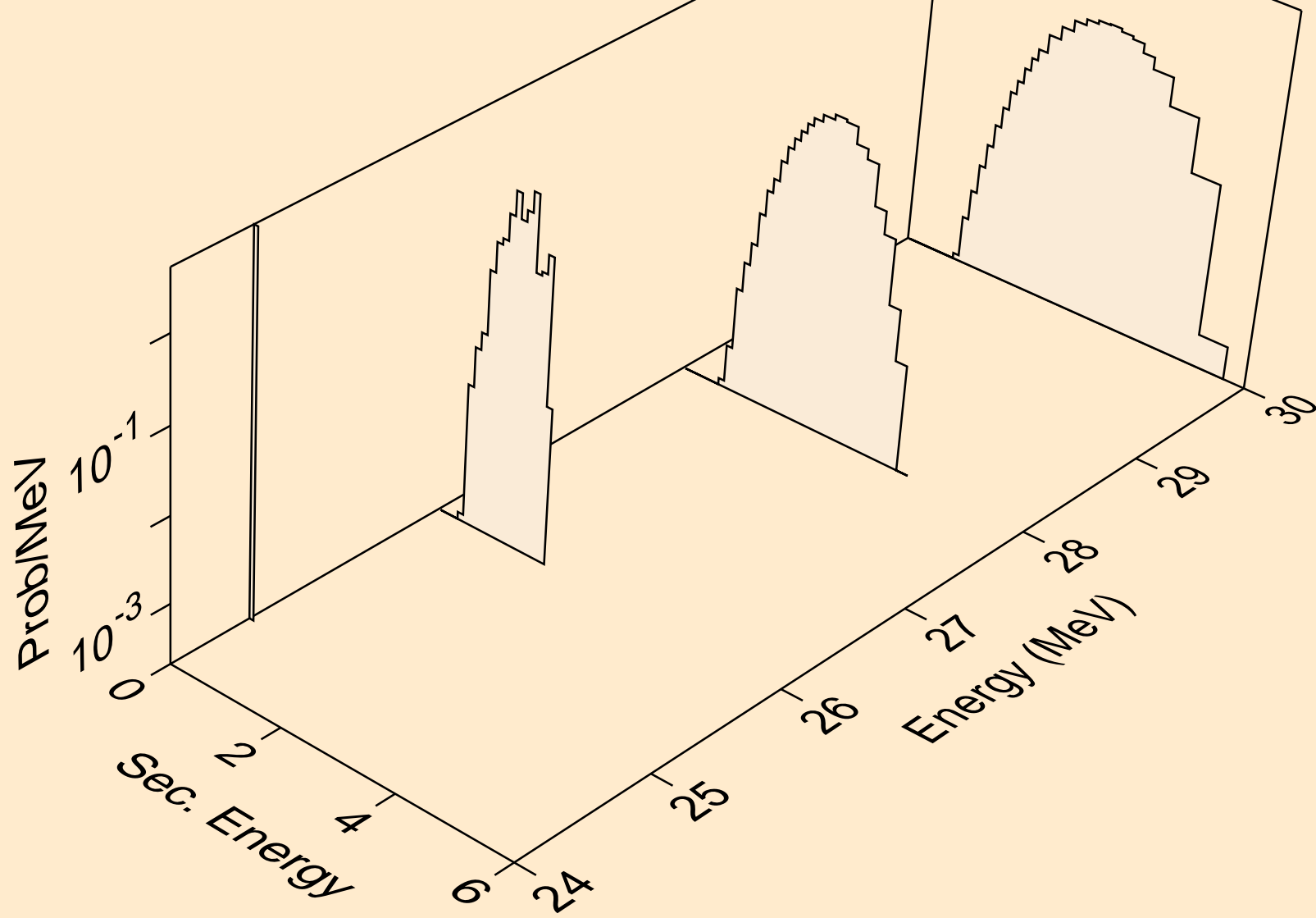

MN058 NEUTRON ACER TENDL-2021 LIBRARY; T=293.6K
protons from (n,2np)

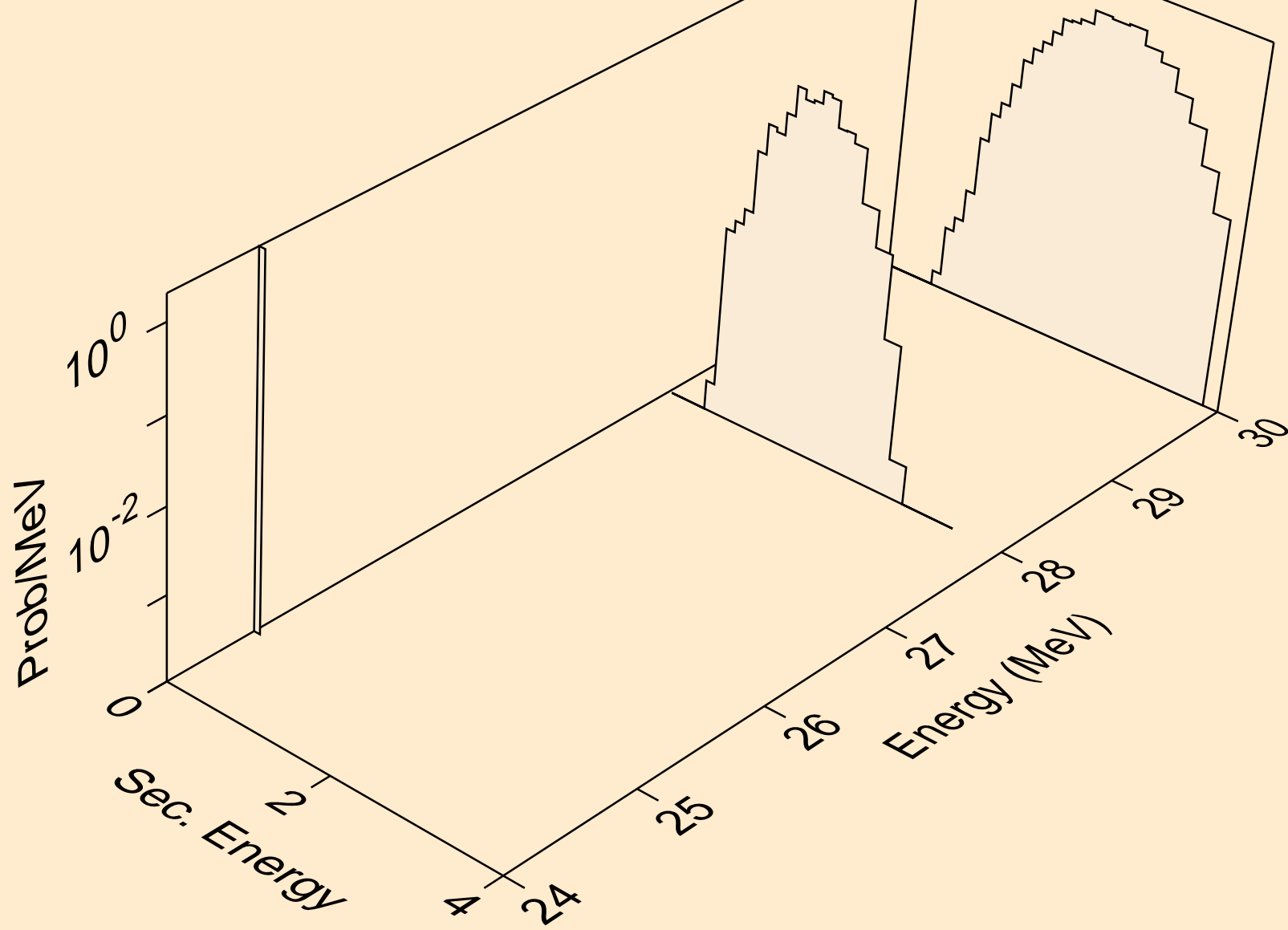

MN058 NEUTRON ACER TENDL-2021 LIBRARY; T=293.6K
protons from (n,npa)

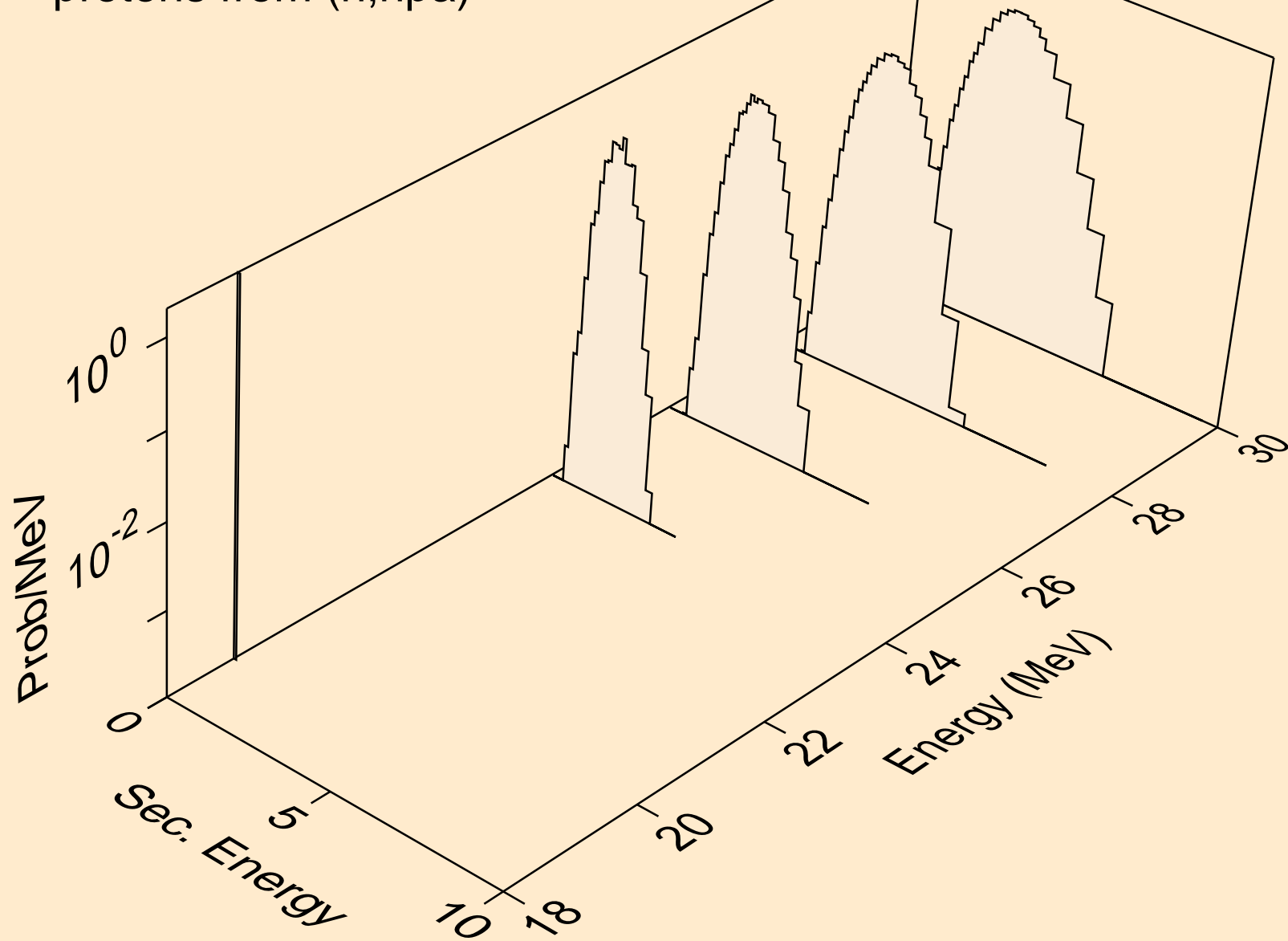

MN058 NEUTRON ACER TENDL-2021 LIBRARY; T=293.6K
protons from (n,p)

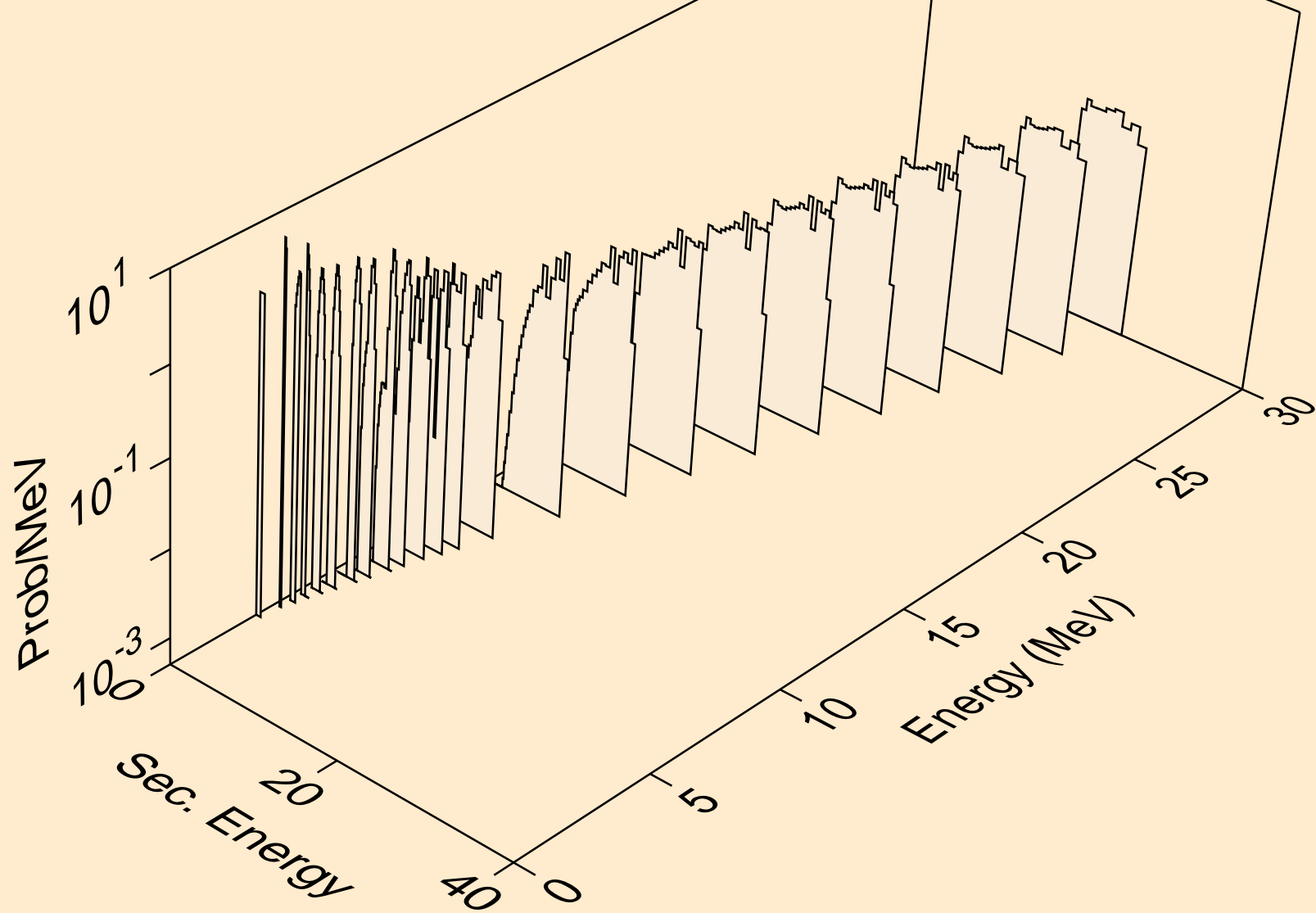

MN058 NEUTRON ACER TENDL-2021 LIBRARY; T=293.6K
protons from (n,2p)

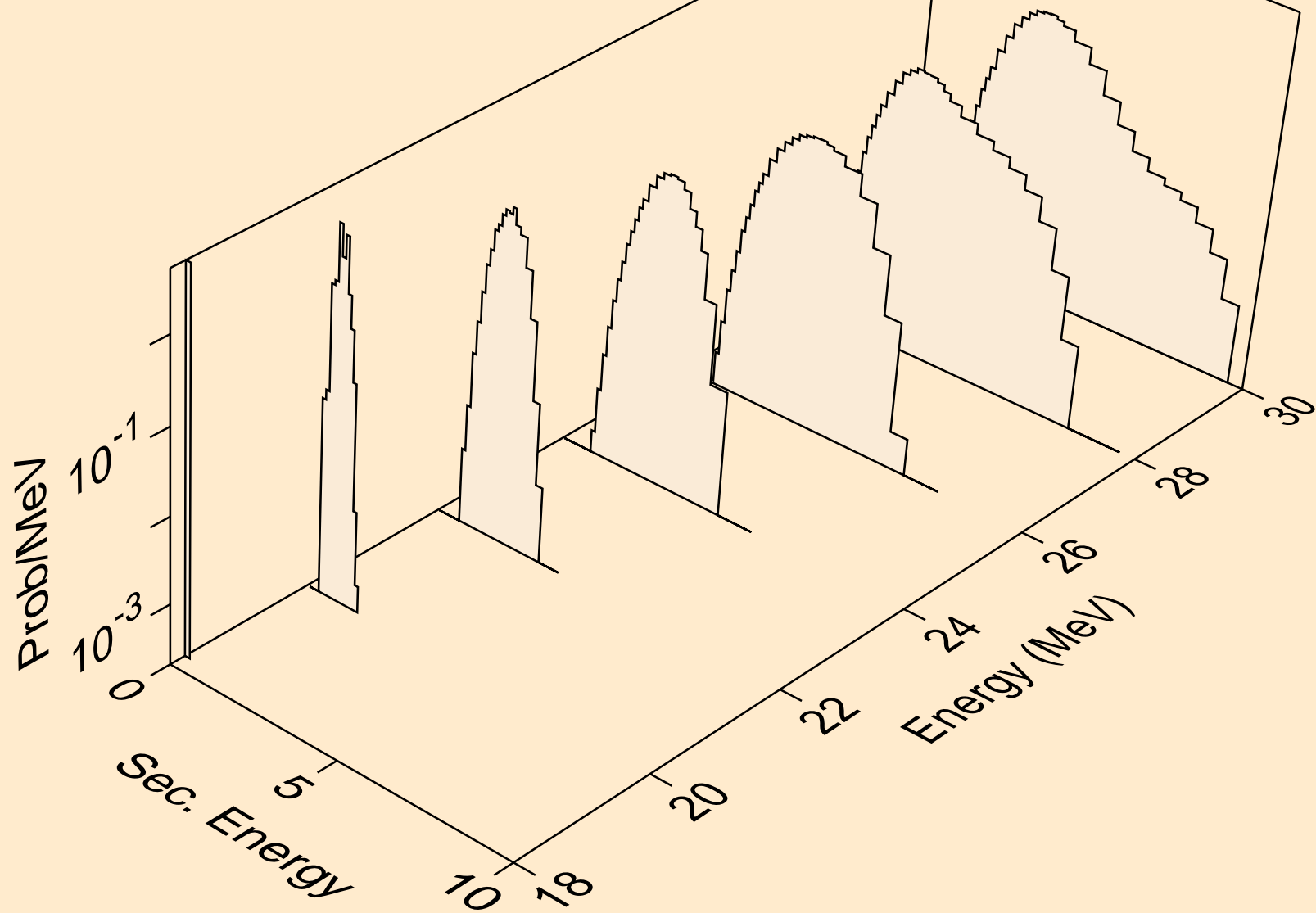

MN058 NEUTRON ACER TENDL-2021 LIBRARY; T=293.6K
protons from (n,p)

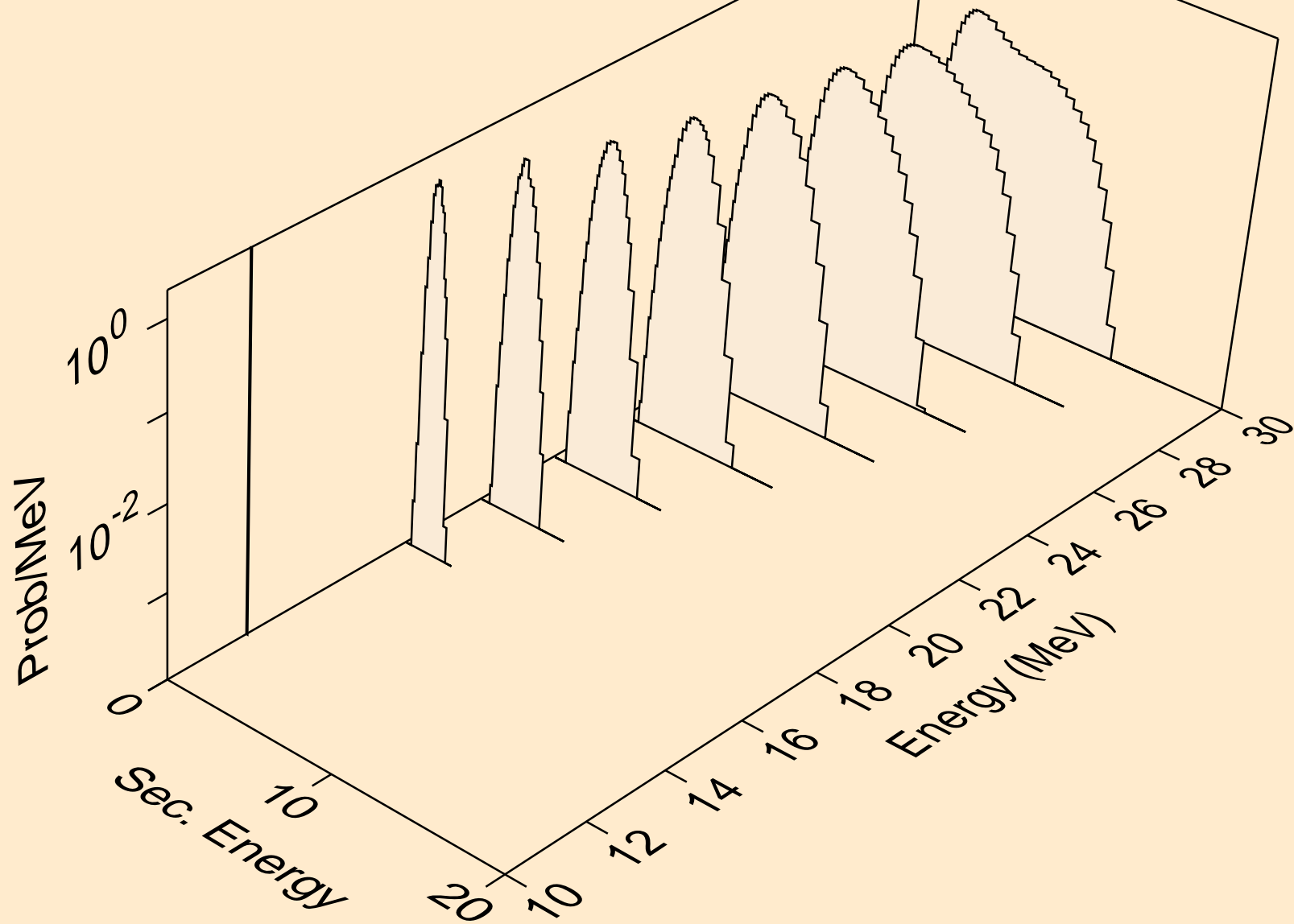

MN058 NEUTRON ACER TENDL-2021 LIBRARY; T=293.6K
protons from (n,pd)

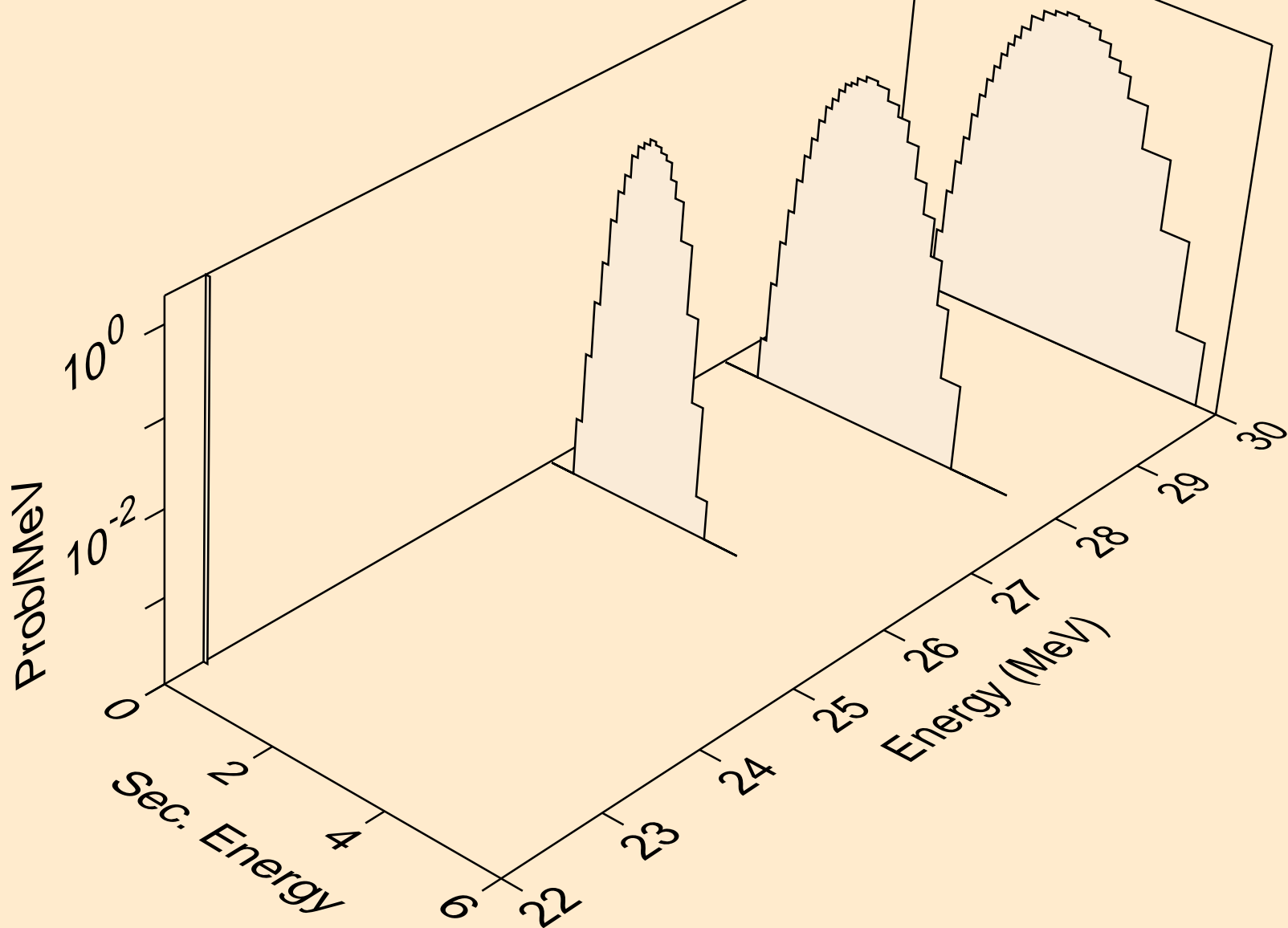

MN058 NEUTRON ACER TENDL-2021 LIBRARY; T=293.6K
protons from (n,pt)

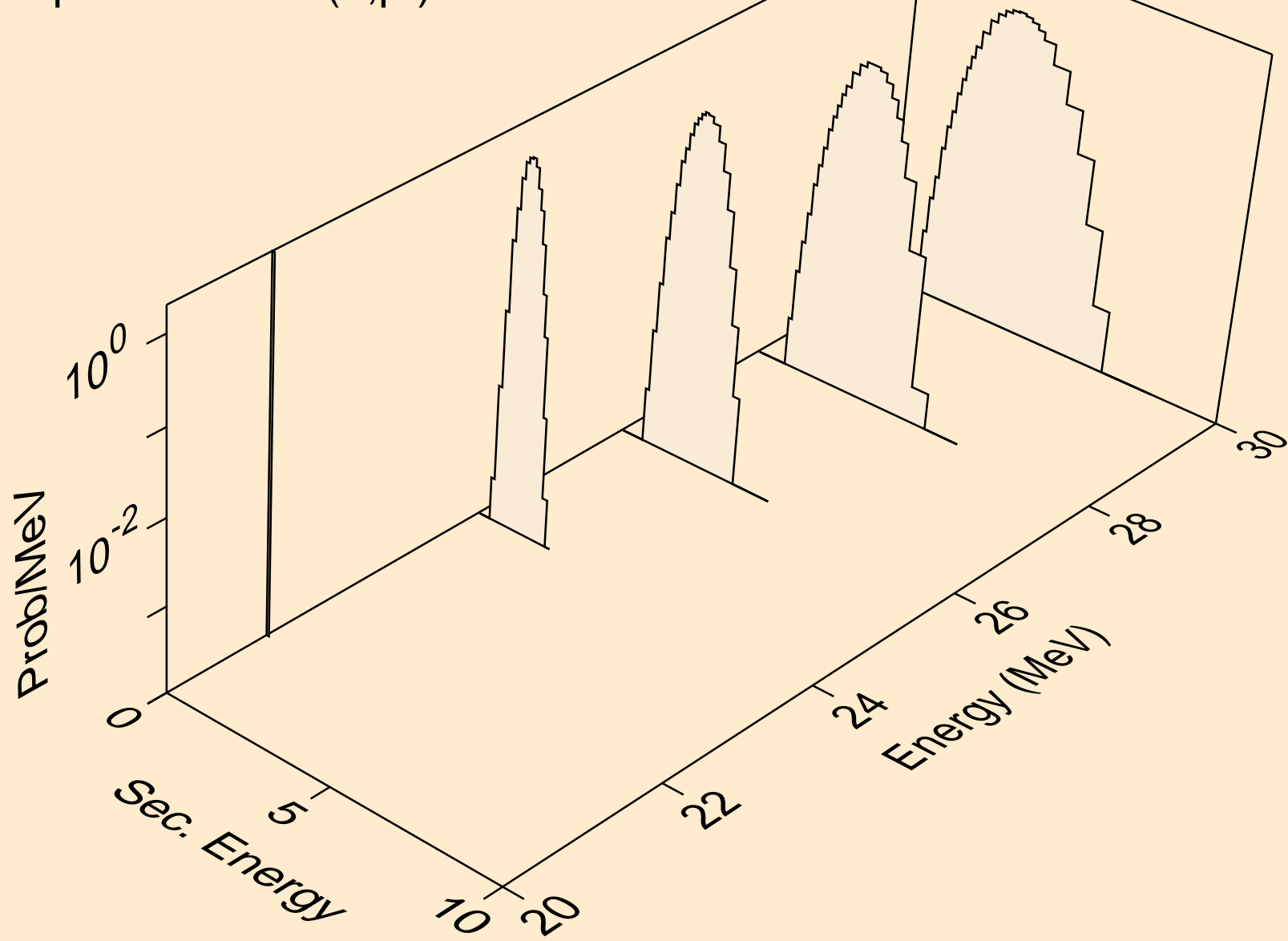

MN058 NEUTRON ACER TENDL-2021 LIBRARY; T=293.6K
deuterons from (n,x)

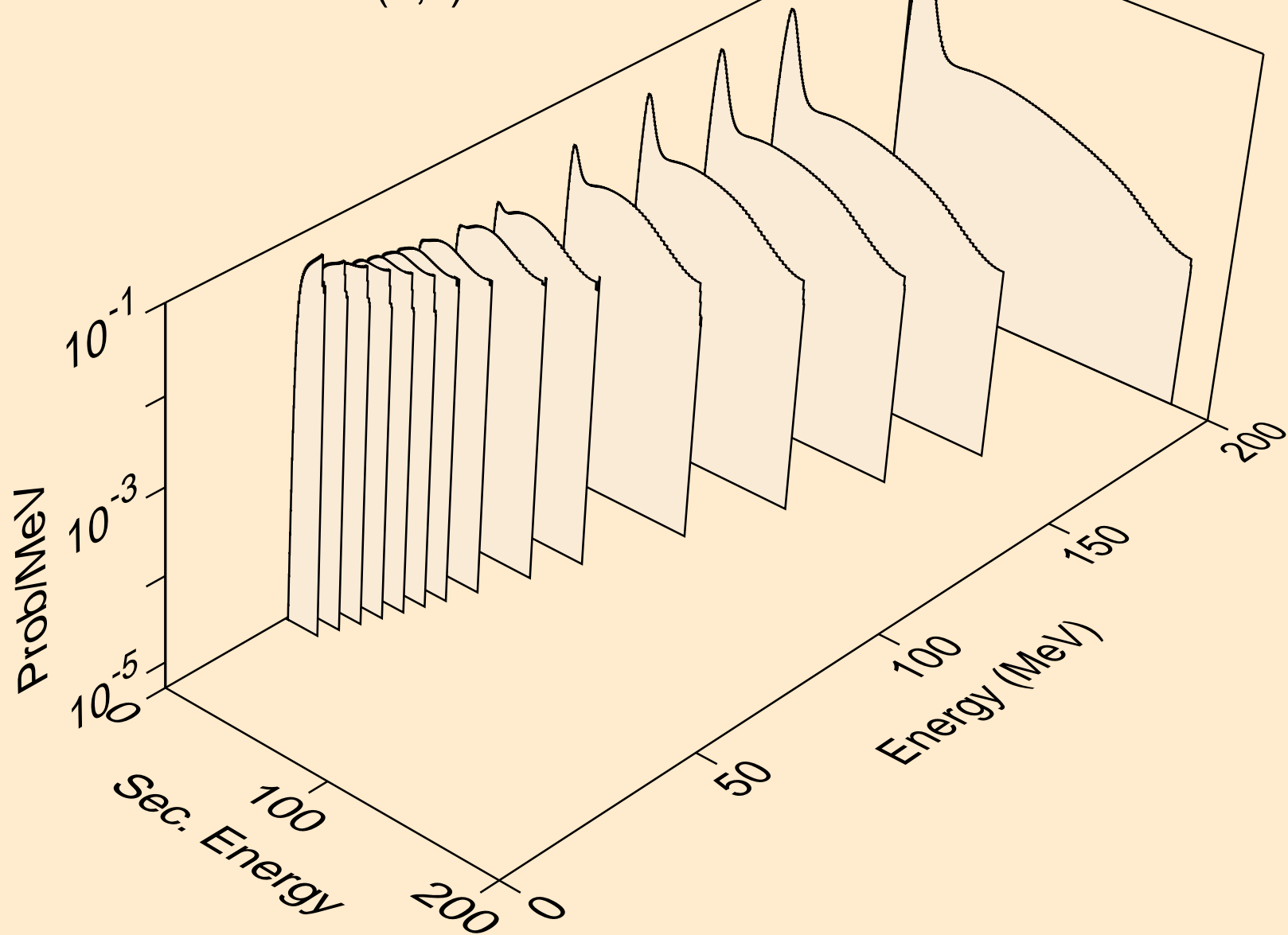

MN058 NEUTRON ACER TENDL-2021 LIBRARY; T=293.6K
deuterons from (n,2nd)

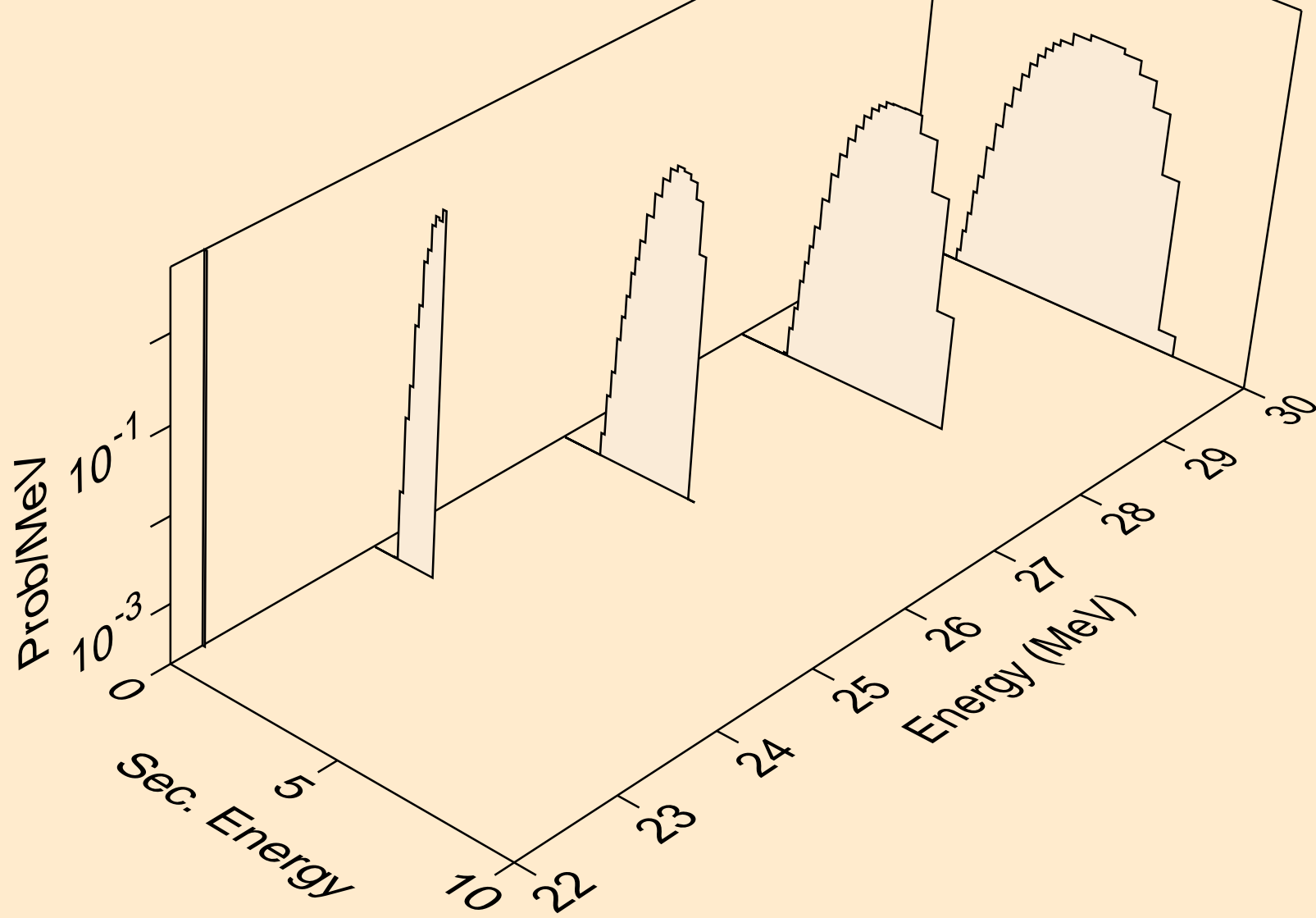

MN058 NEUTRON ACER TENDL-2021 LIBRARY; T=293.6K
deuterons from (n,n*)d

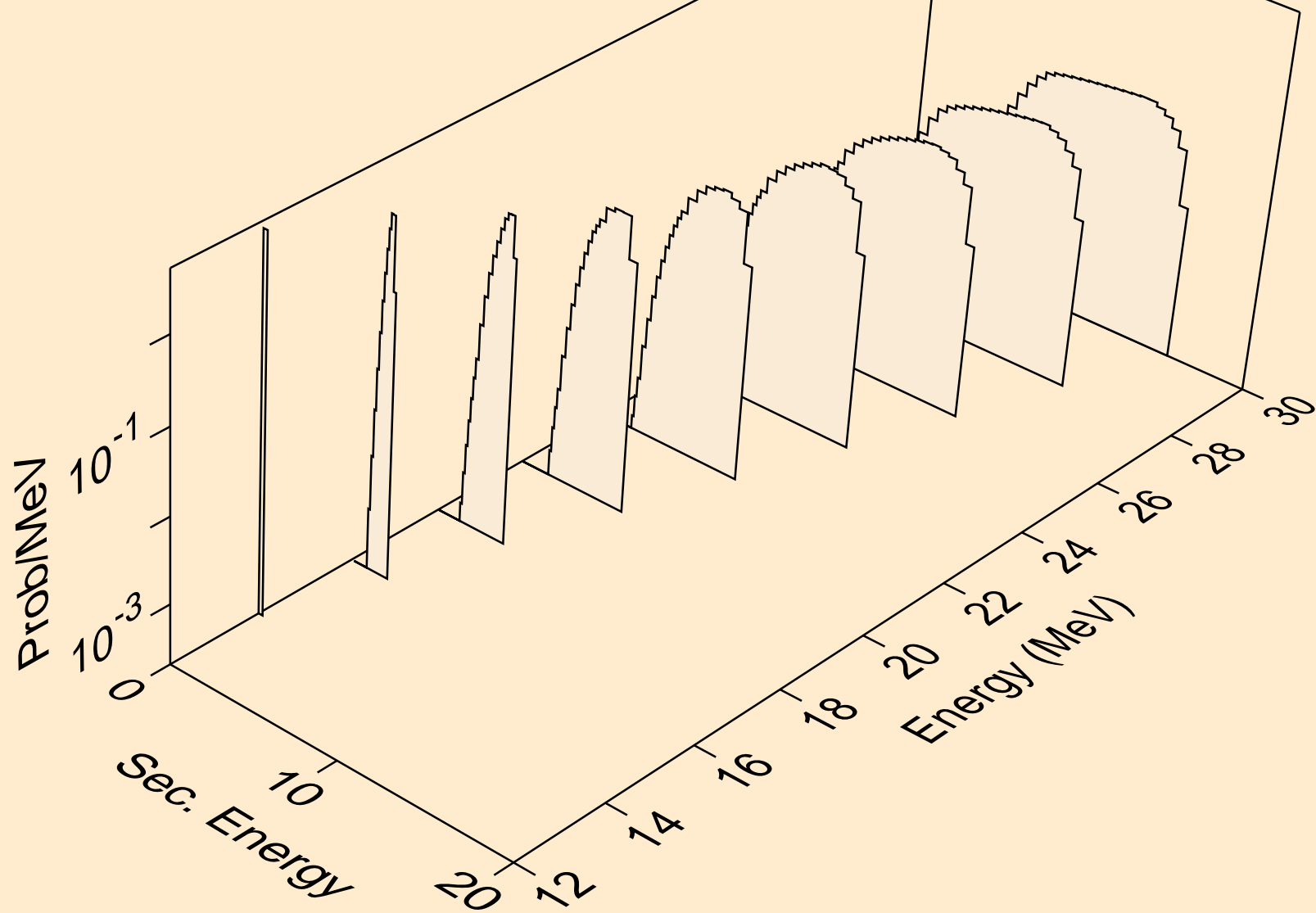

MN058 NEUTRON ACER TENDL-2021 LIBRARY; T=293.6K
deuterons from (n,d)

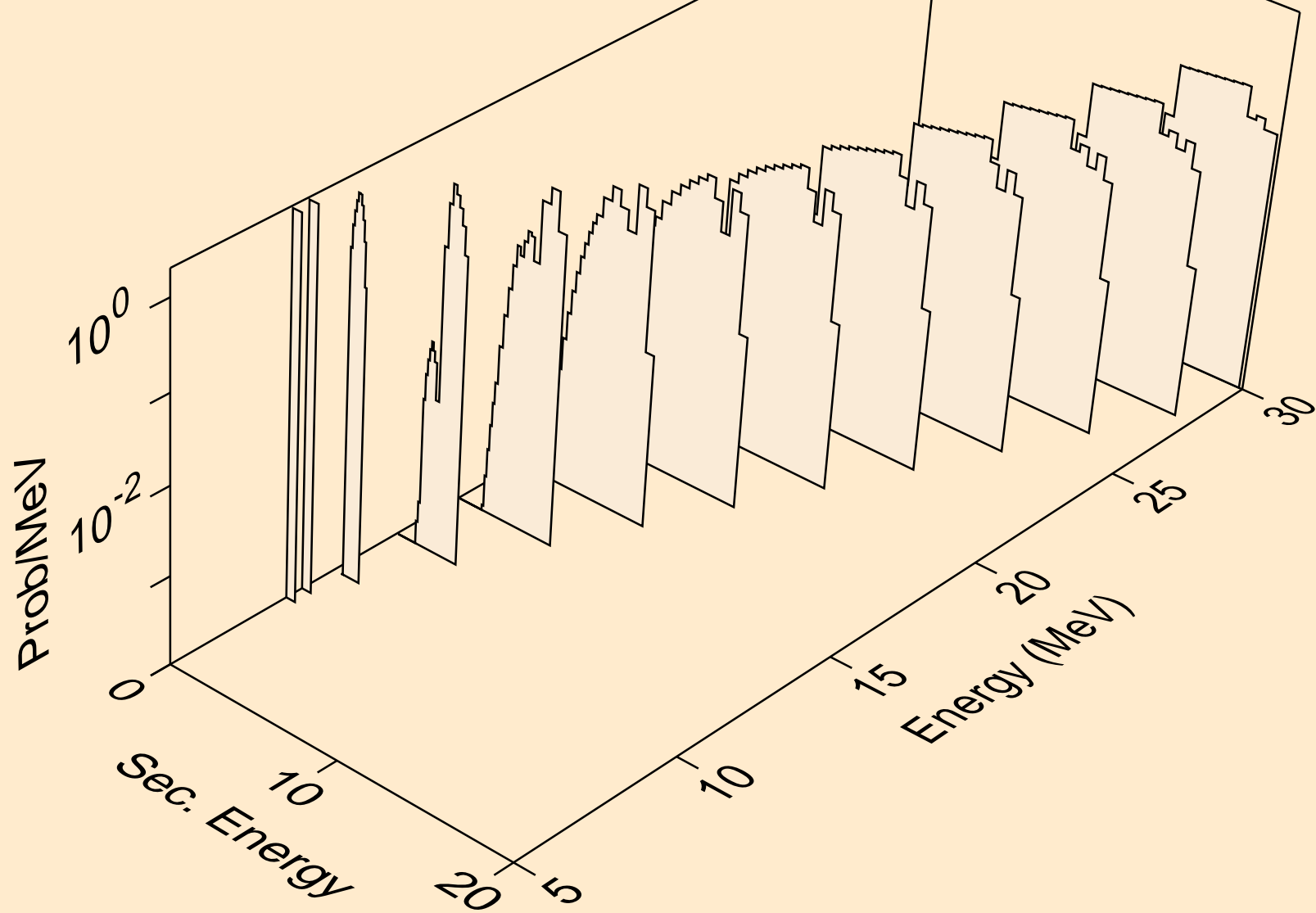

MN058 NEUTRON ACER TENDL-2021 LIBRARY; T=293.6K
deuterons from (n,pd)

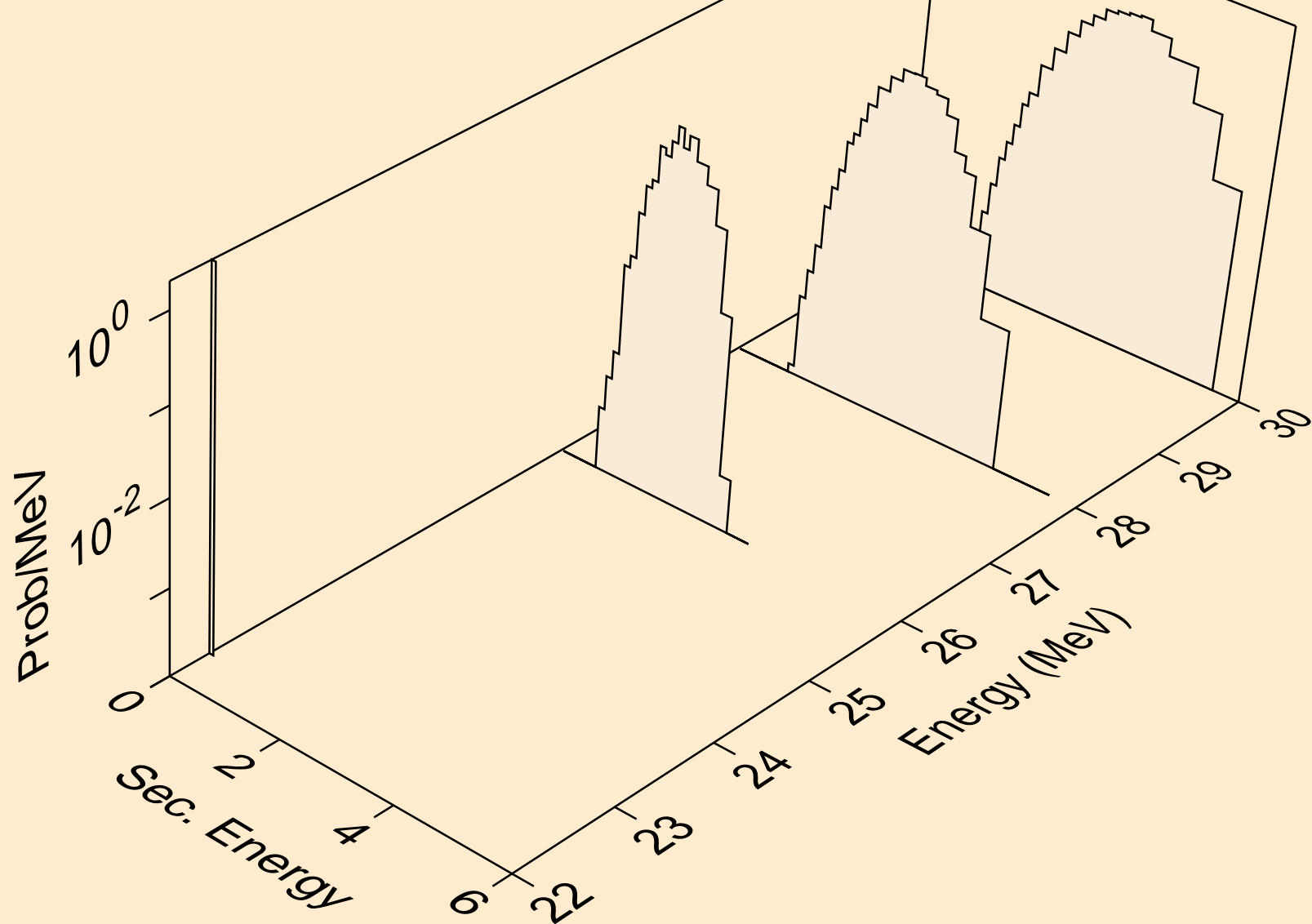

MN058 NEUTRON ACER TENDL-2021 LIBRARY; T=293.6K
deuterons from (n,da)

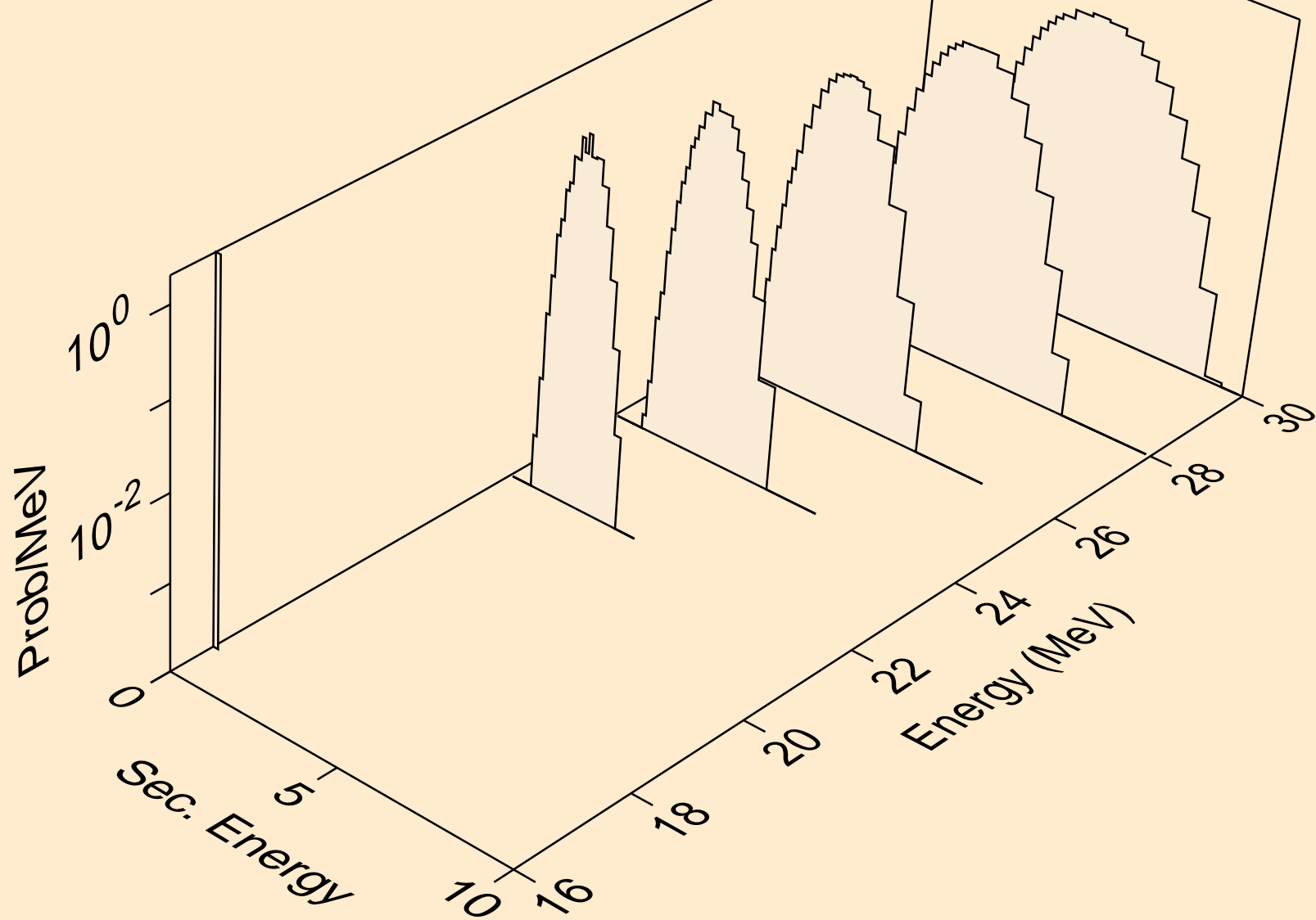

MN058 NEUTRON ACER TENDL-2021 LIBRARY; T=293.6K
tritons from (n,x)

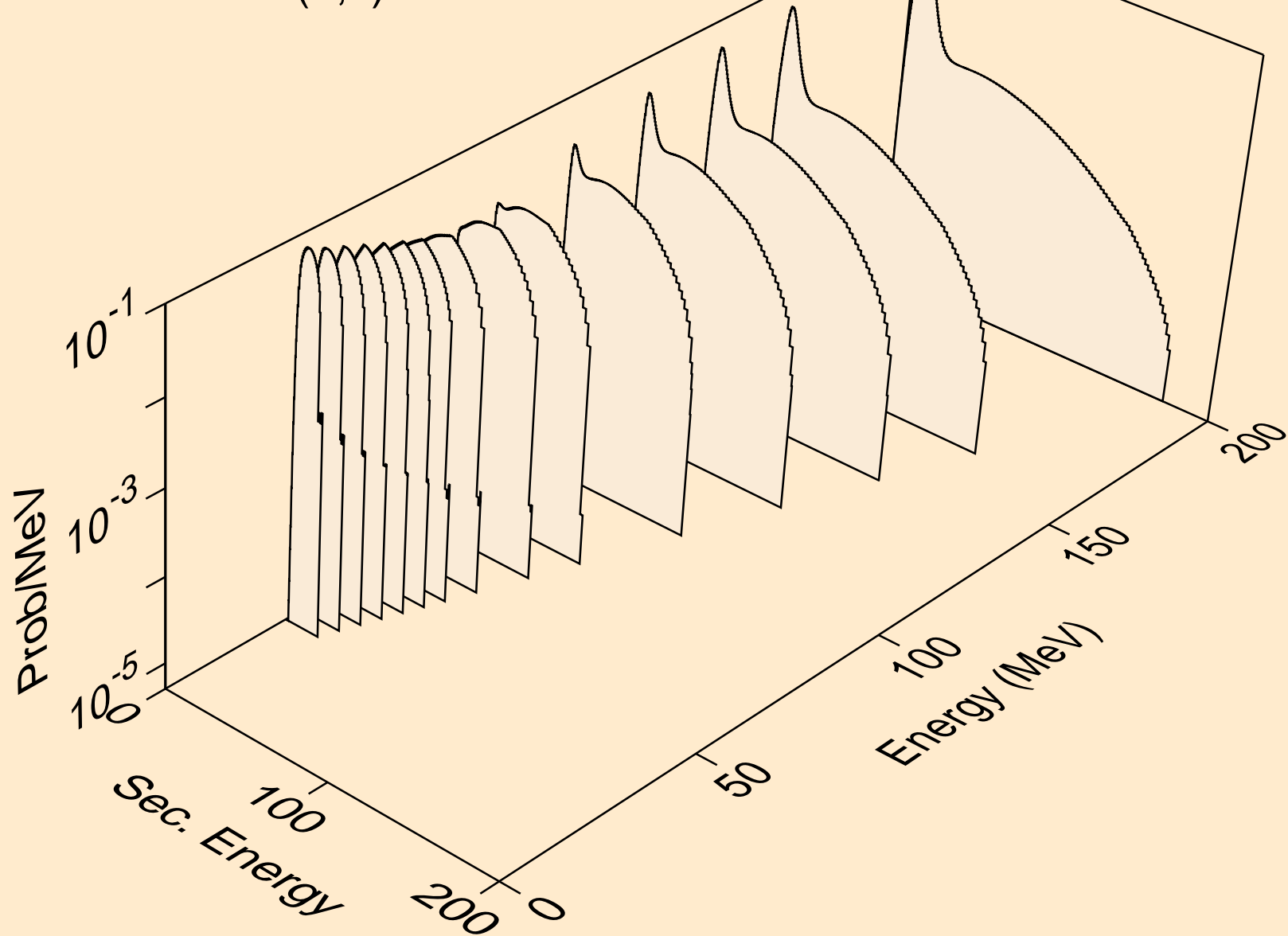

MN058 NEUTRON ACER TENDL-2021 LIBRARY; T=293.6K
tritons from (n,n*)t

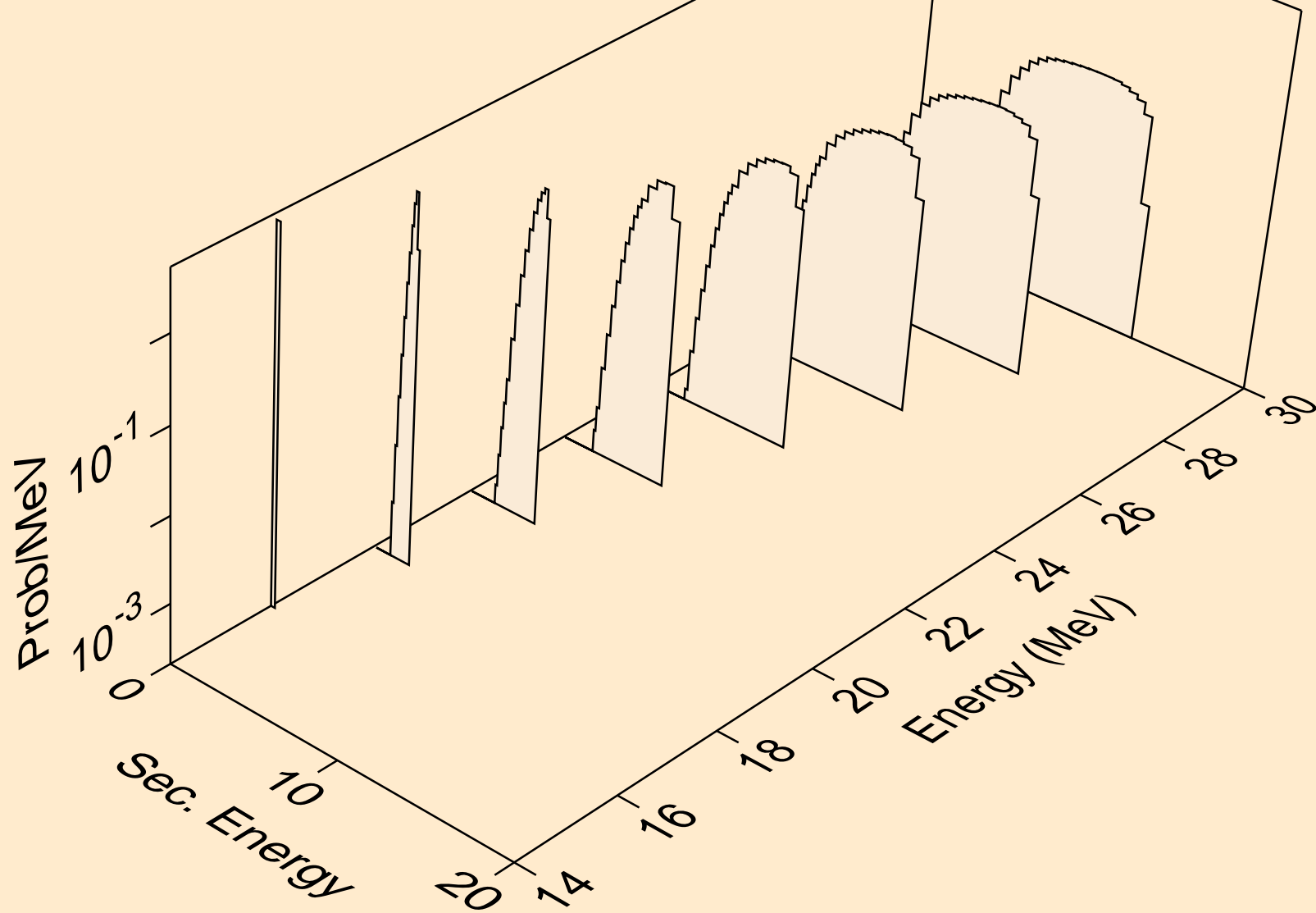

MN058 NEUTRON ACER TENDL-2021 LIBRARY; T=293.6K
tritons from (n,t)

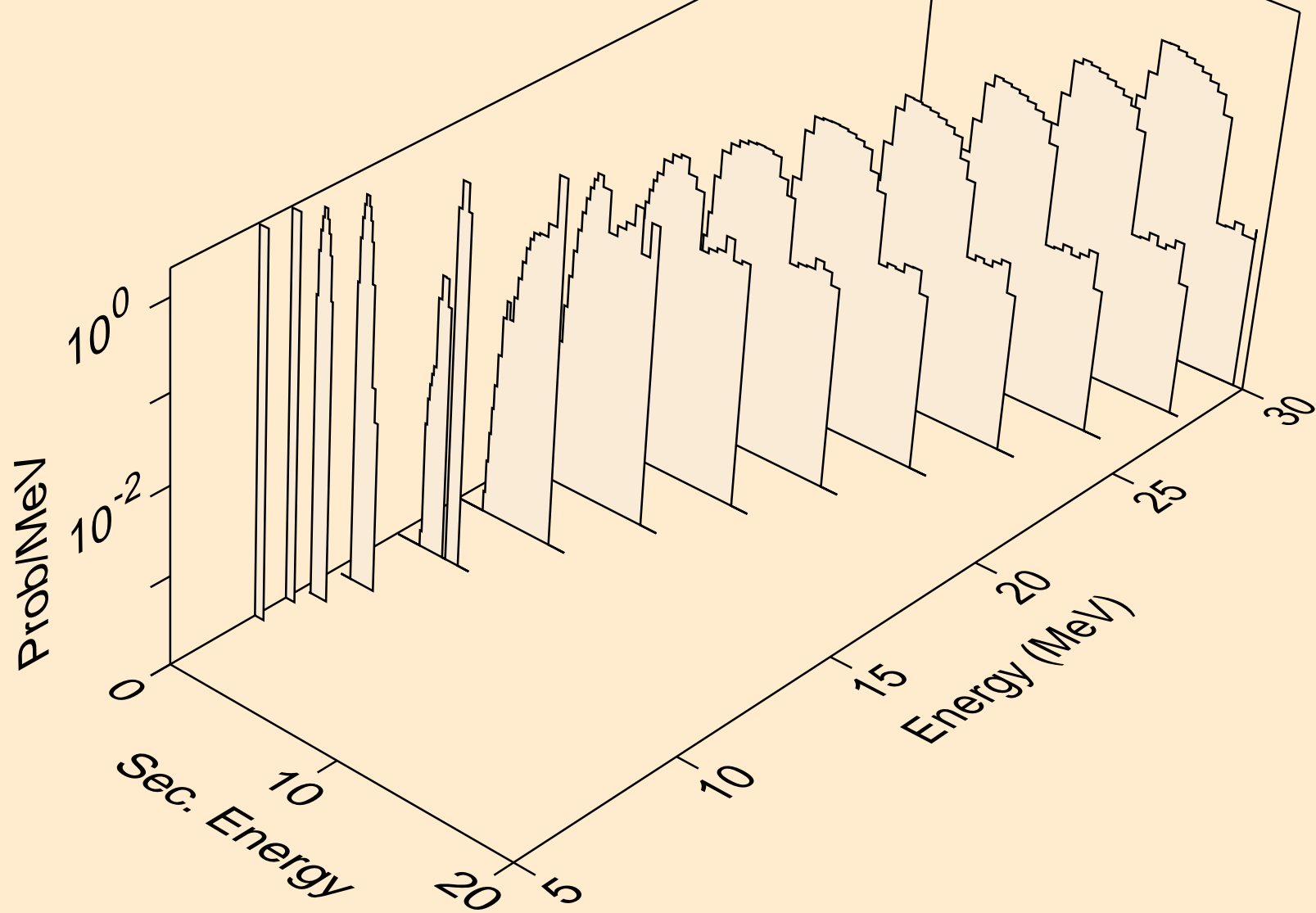

MN058 NEUTRON ACER TENDL-2021 LIBRARY; T=293.6K
tritons from (n,pt)

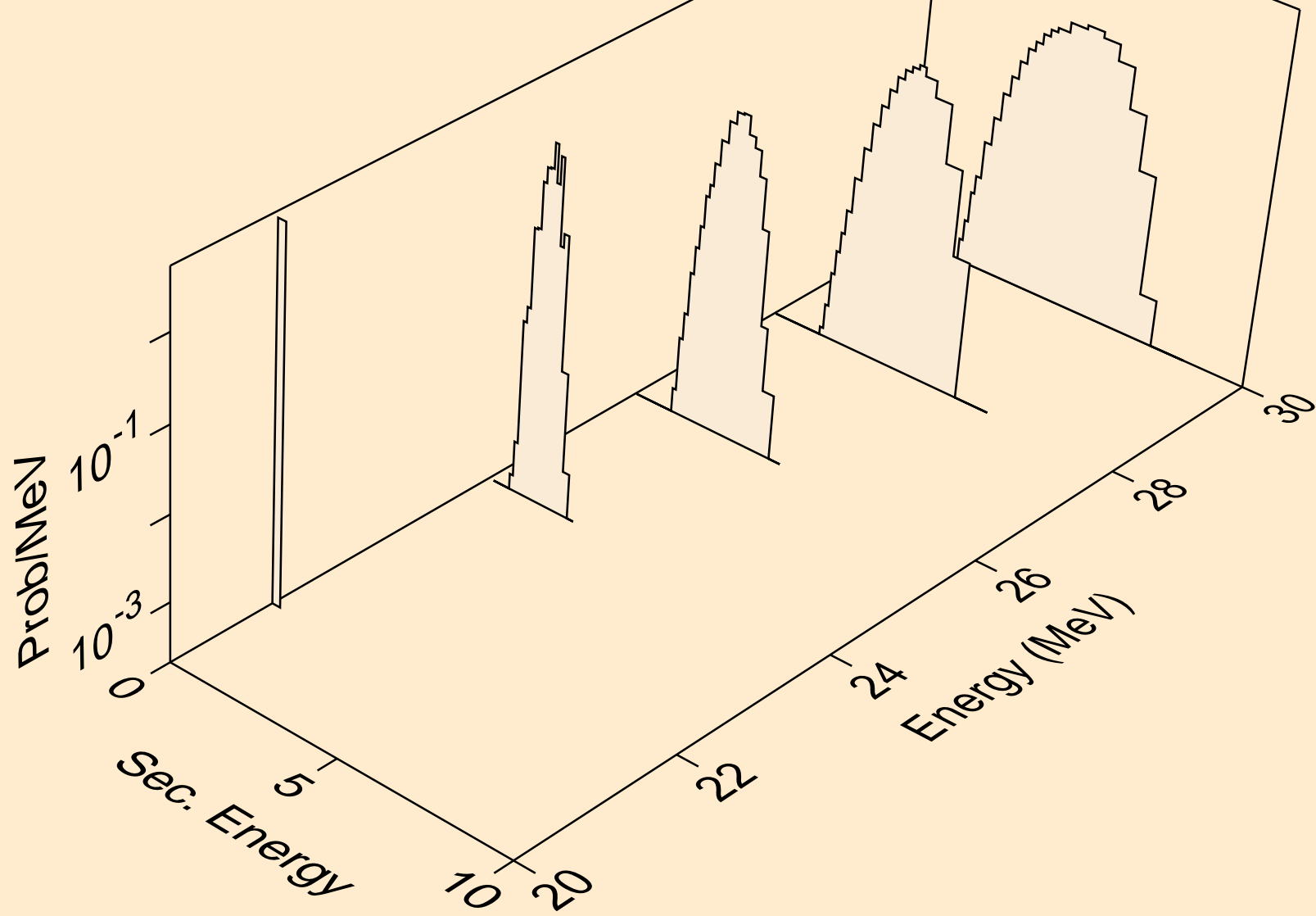

MN058 NEUTRON ACER TENDL-2021 LIBRARY; T=293.6K
he3s from (n,x)

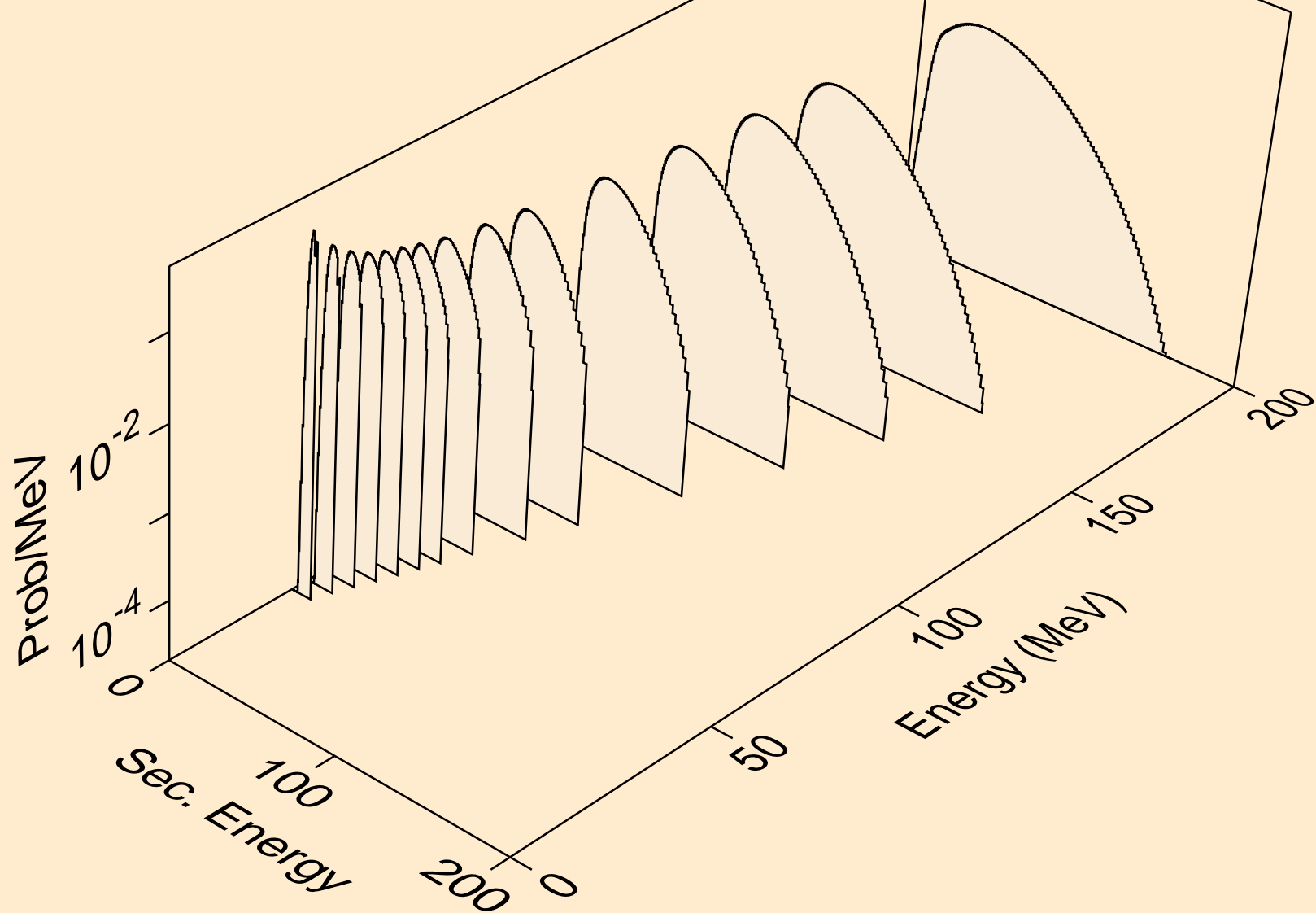

MN058 NEUTRON ACER TENDL-2021 LIBRARY; T=293.6K
he3s from (n,n*)he3

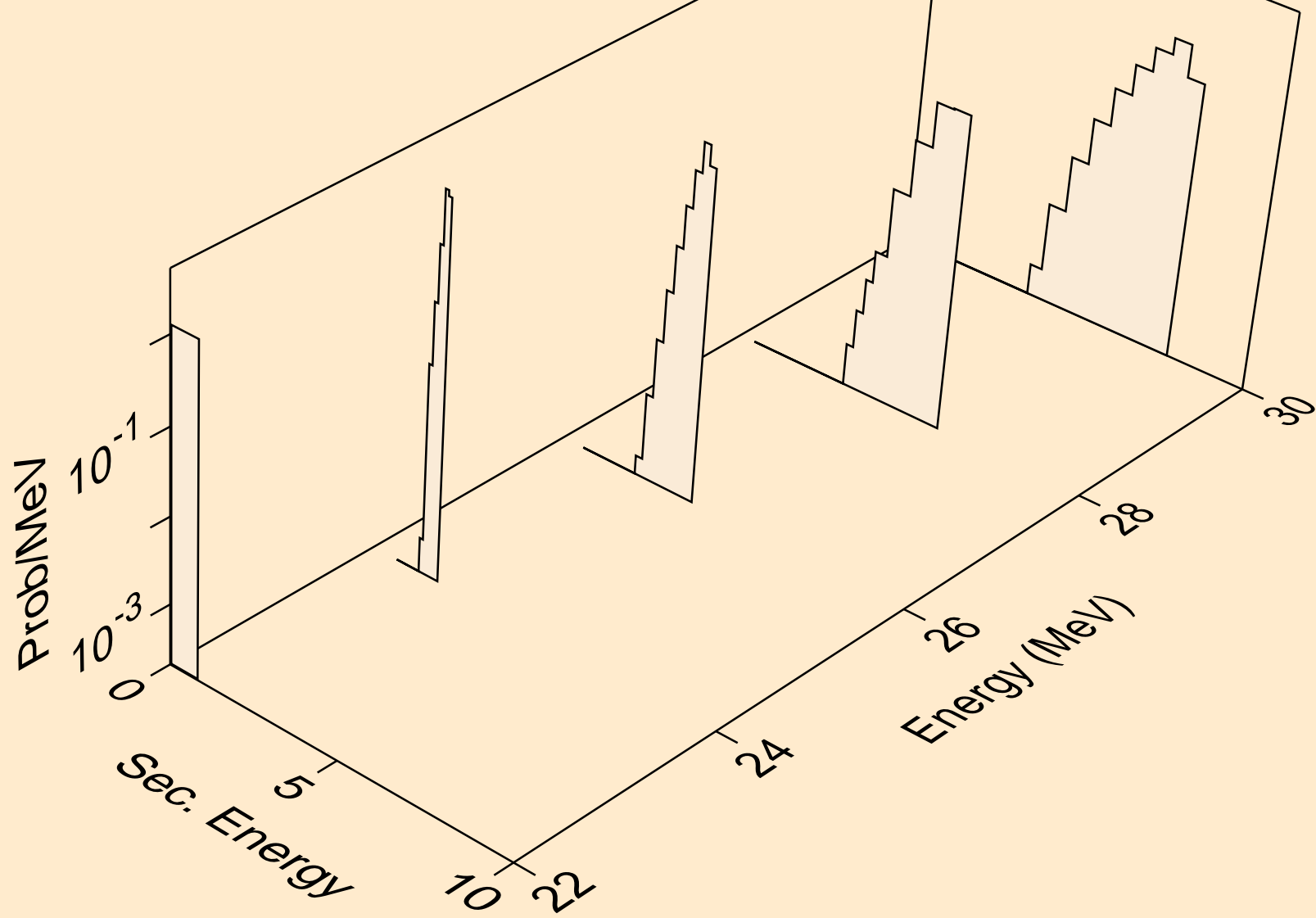

MN058 NEUTRON ACER TENDL-2021 LIBRARY; T=293.6K
he3s from (n,he3)

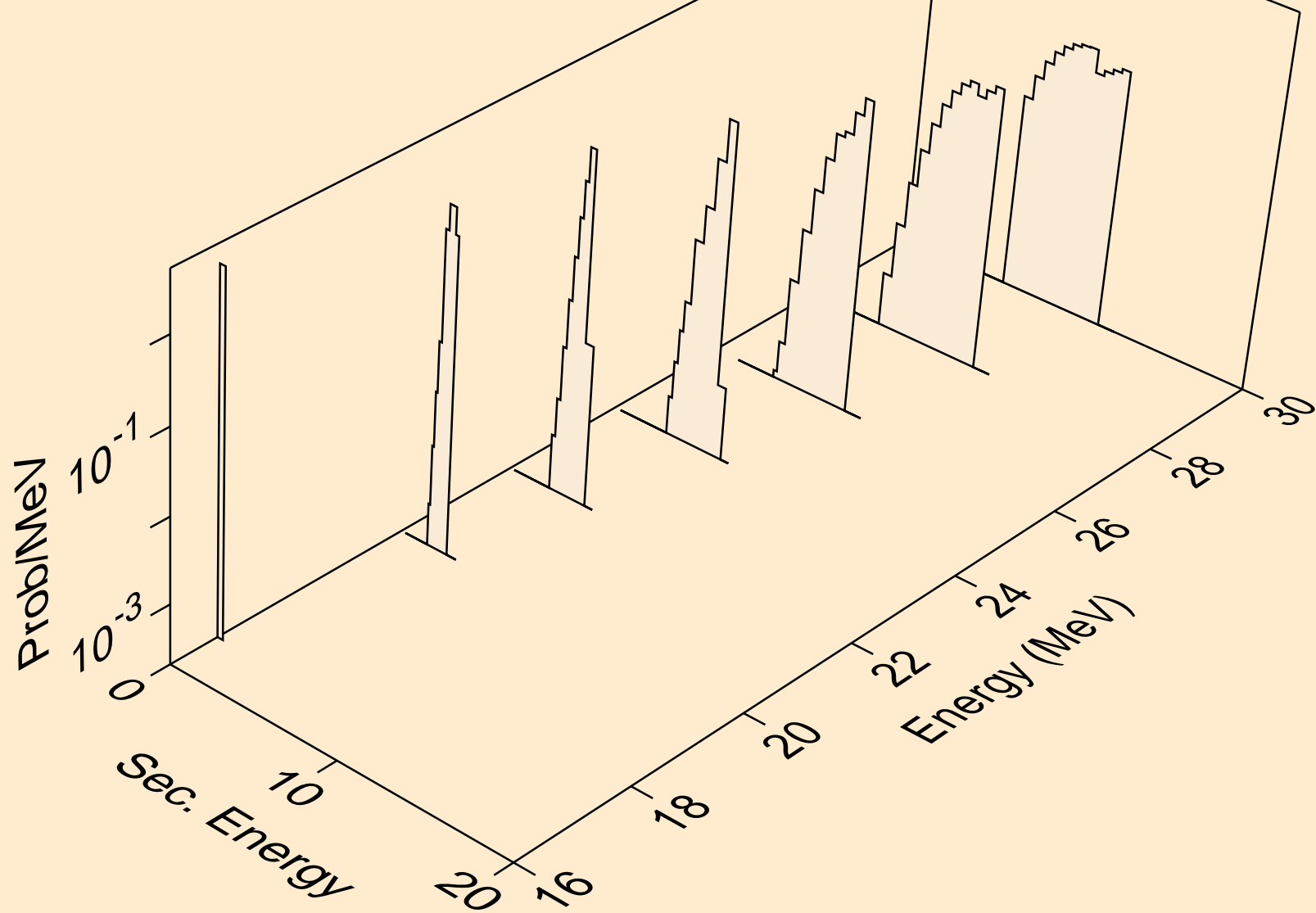

MN058 NEUTRON ACER TENDL-2021 LIBRARY; T=293.6K
alphas from (n,x)

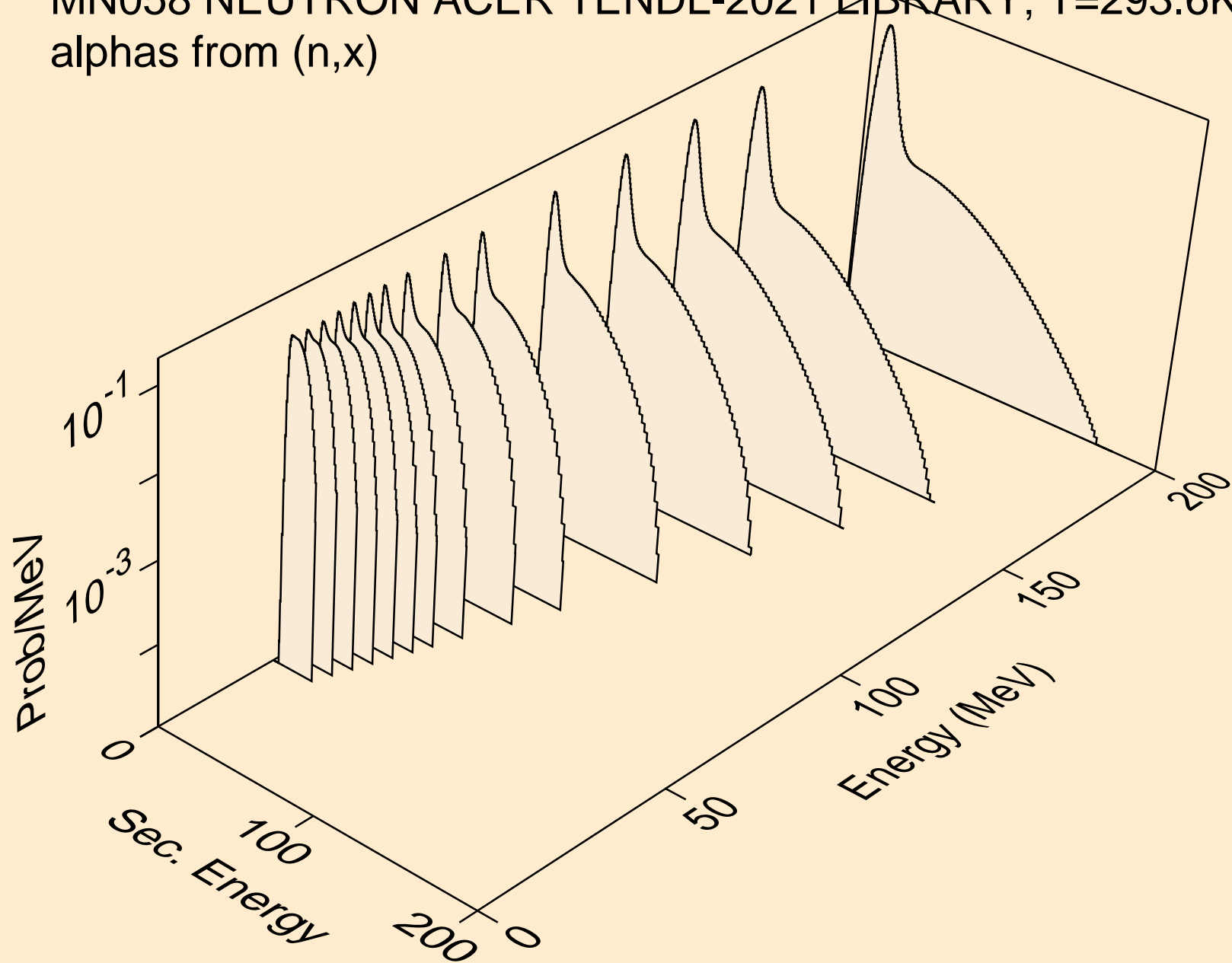

MN058 NEUTRON ACER TENDL-2021 LIBRARY; T=293.6K
alphas from (n,n*)a

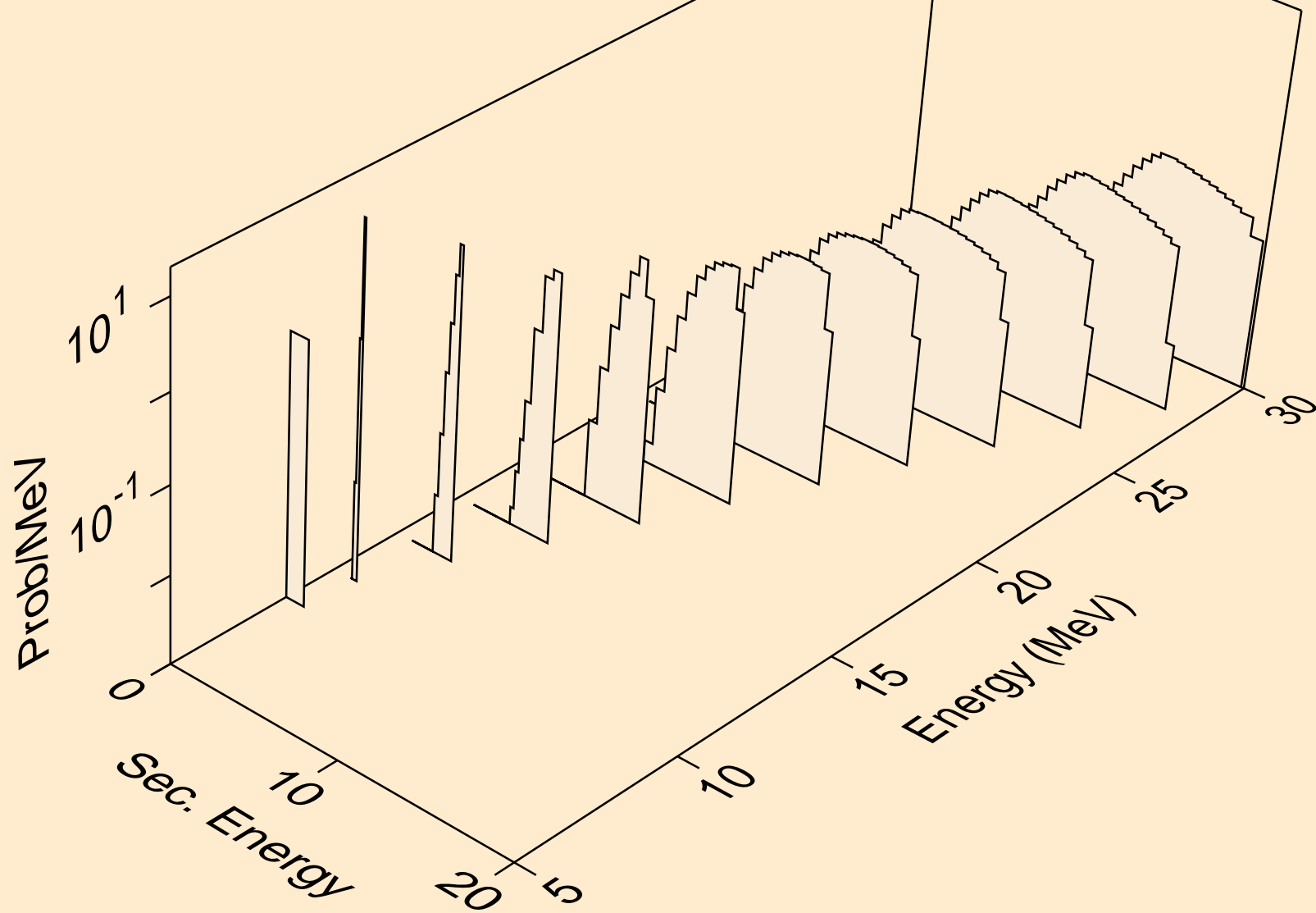

MN058 NEUTRON ACER TENDL-2021 LIBRARY; T=293.6K
alphas from (n,2n)a

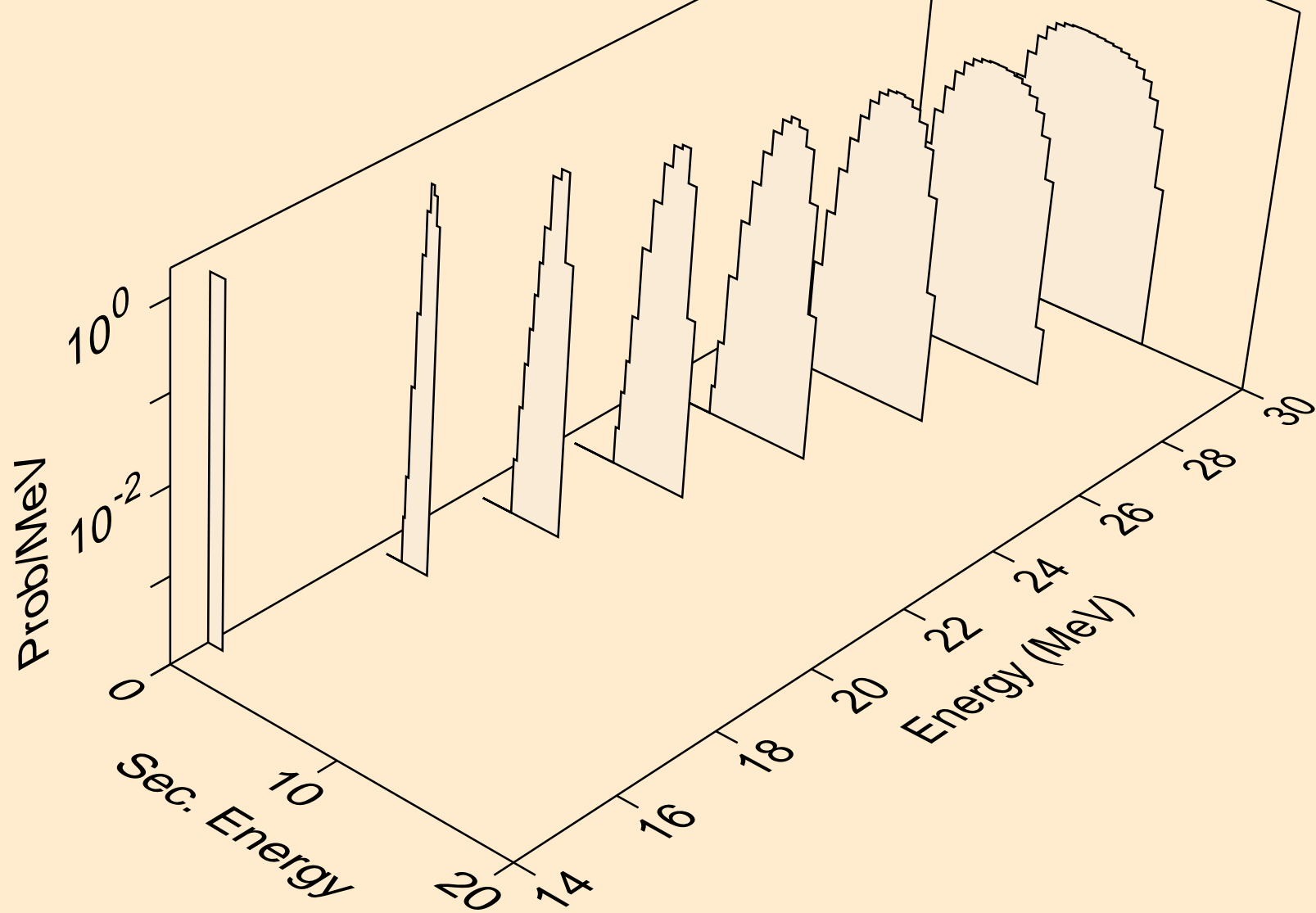

MN058 NEUTRON ACER TENDL-2021 LIBRARY; T=293.6K
alphas from (n,3n)a

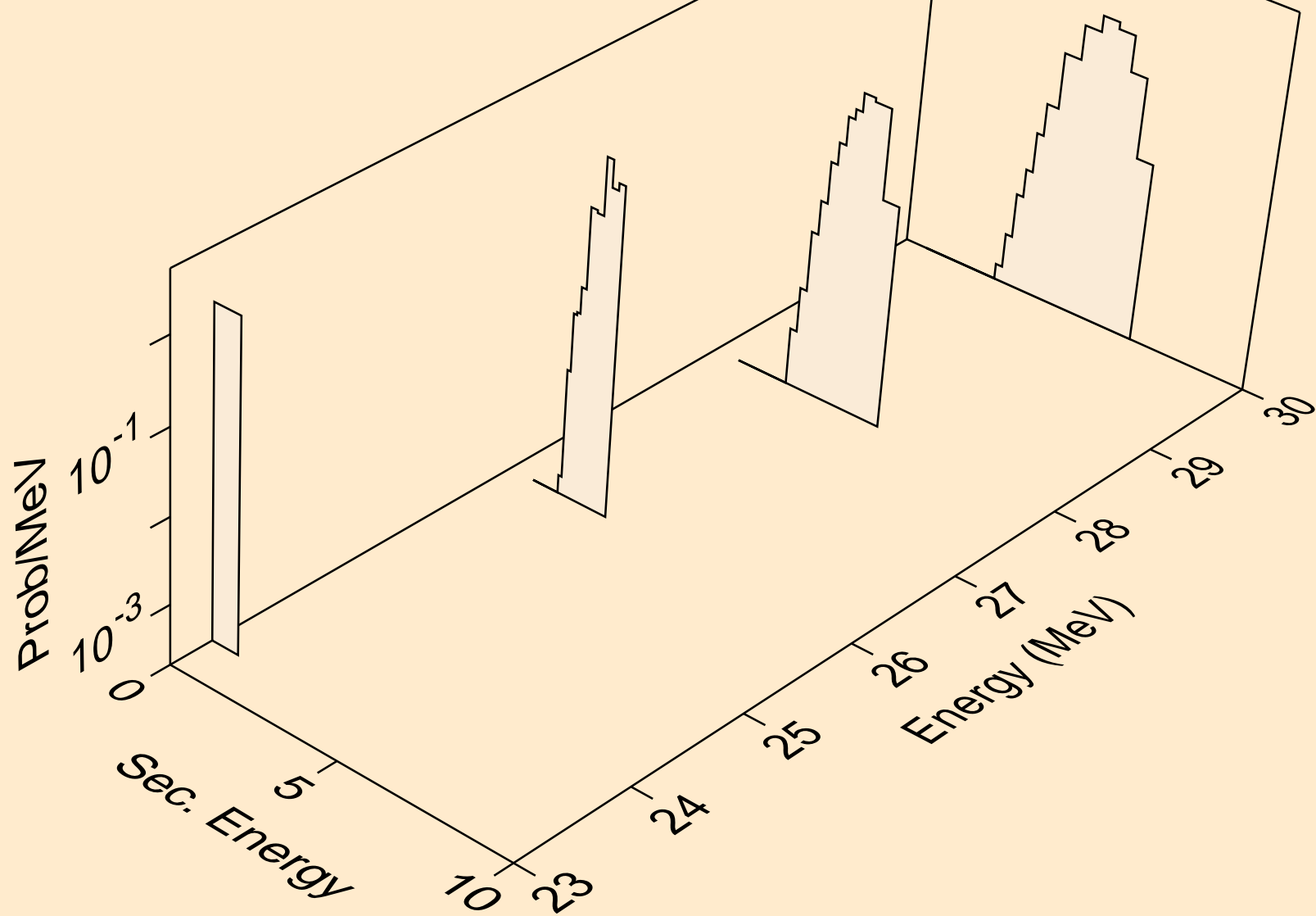

MN058 NEUTRON ACER TENDL-2021 LIBRARY; T=293.6K
alphas from (n,n*)2a

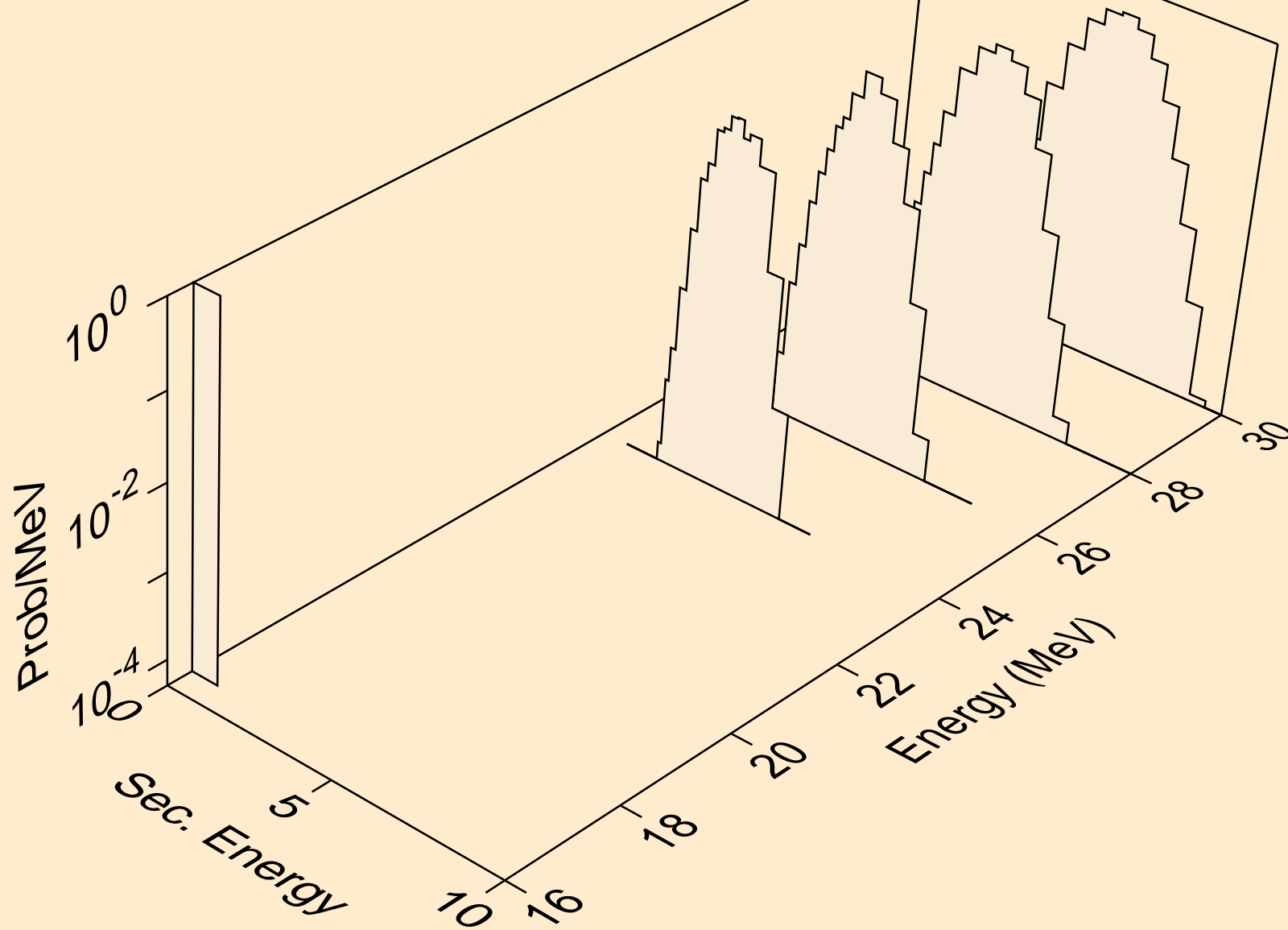

MN058 NEUTRON ACER TENDL-2021 LIBRARY; T=293.6K
alphas from (n,npa)

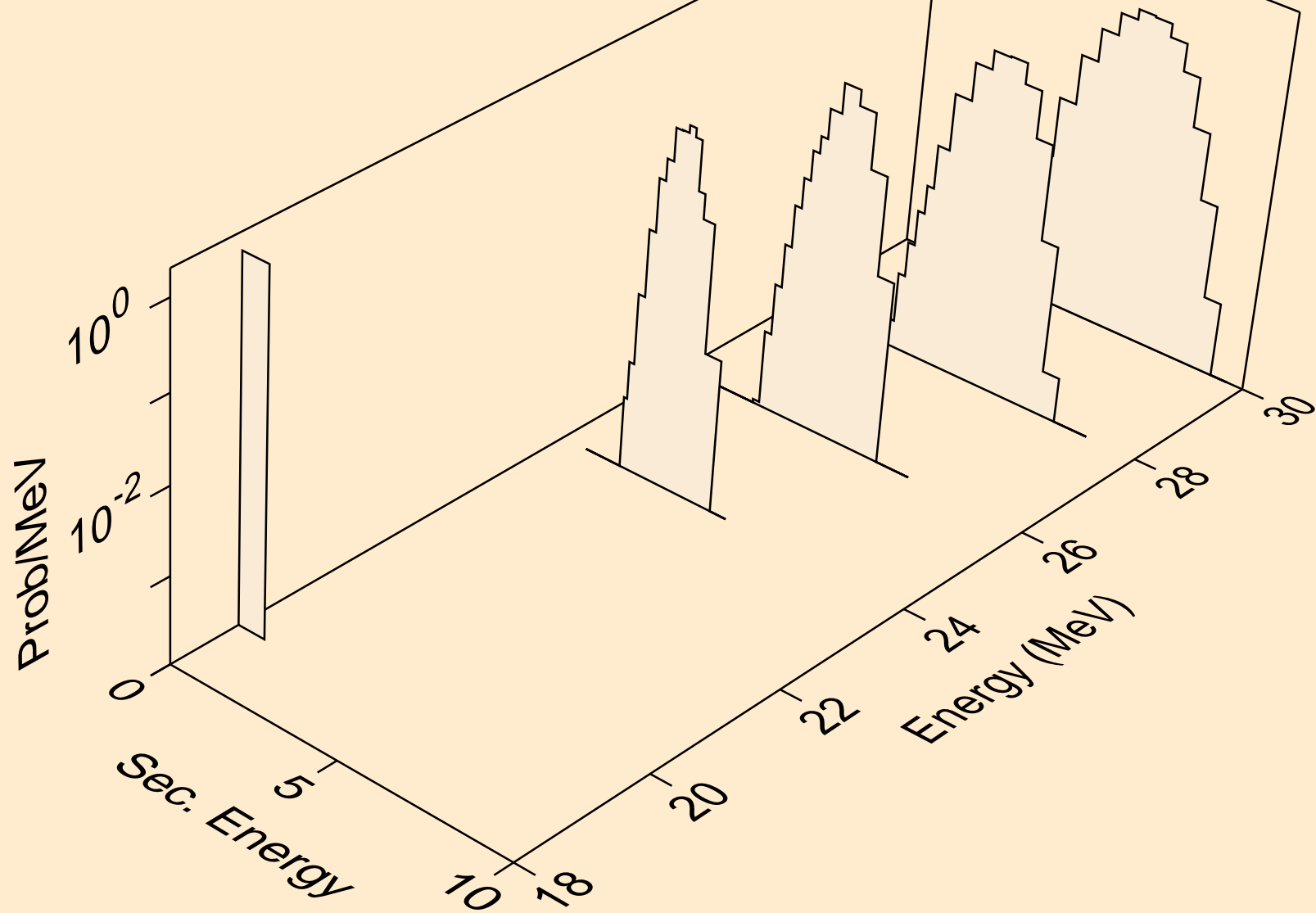

MN058 NEUTRON ACER TENDL-2021 LIBRARY; T=293.6K
alphas from (n,a)

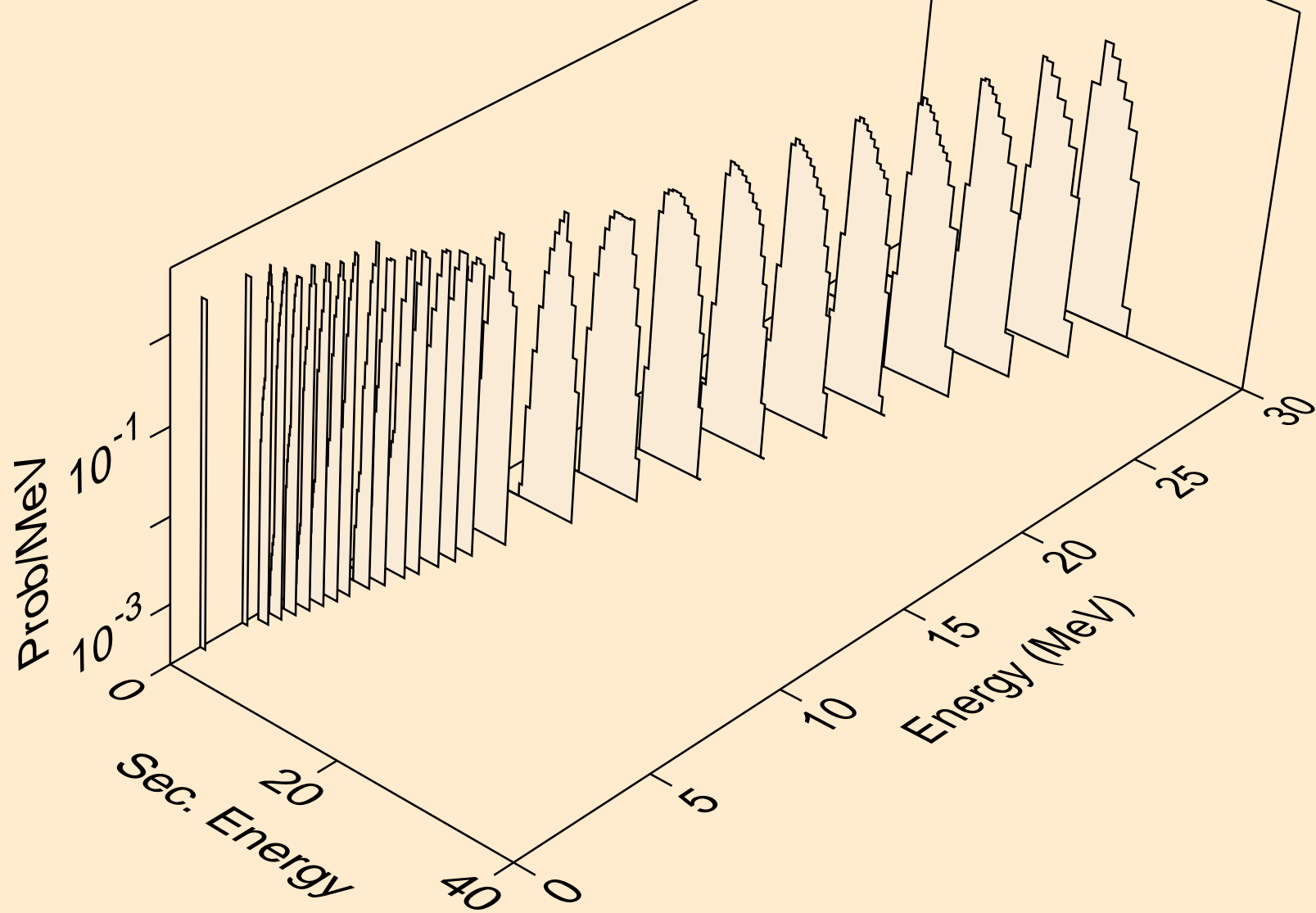

MN058 NEUTRON ACER TENDL-2021 LIBRARY; T=293.6K
alphas from (n,2a)

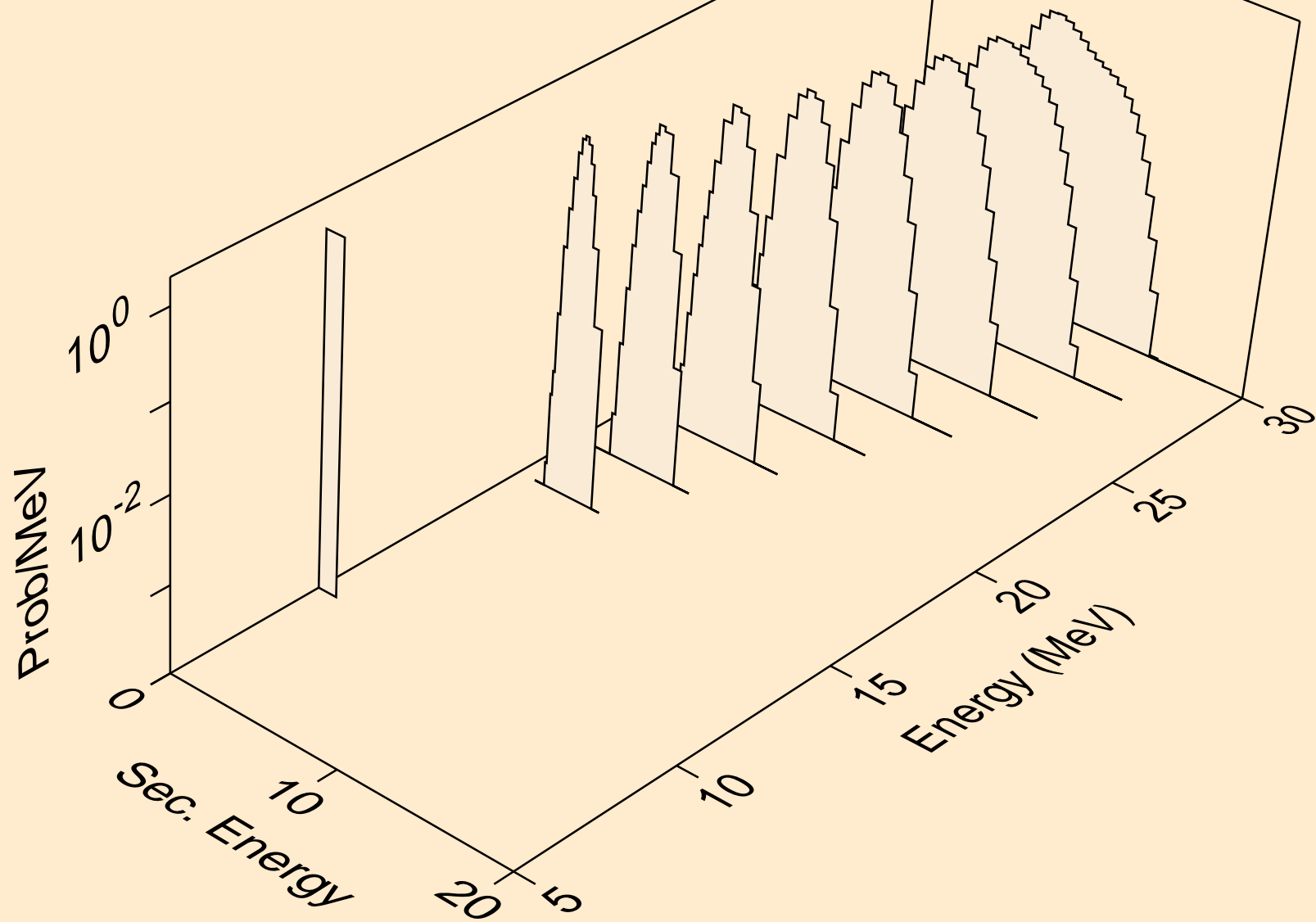

MN058 NEUTRON ACER TENDL-2021 LIBRARY; T=293.6K
alphas from (n,pa)

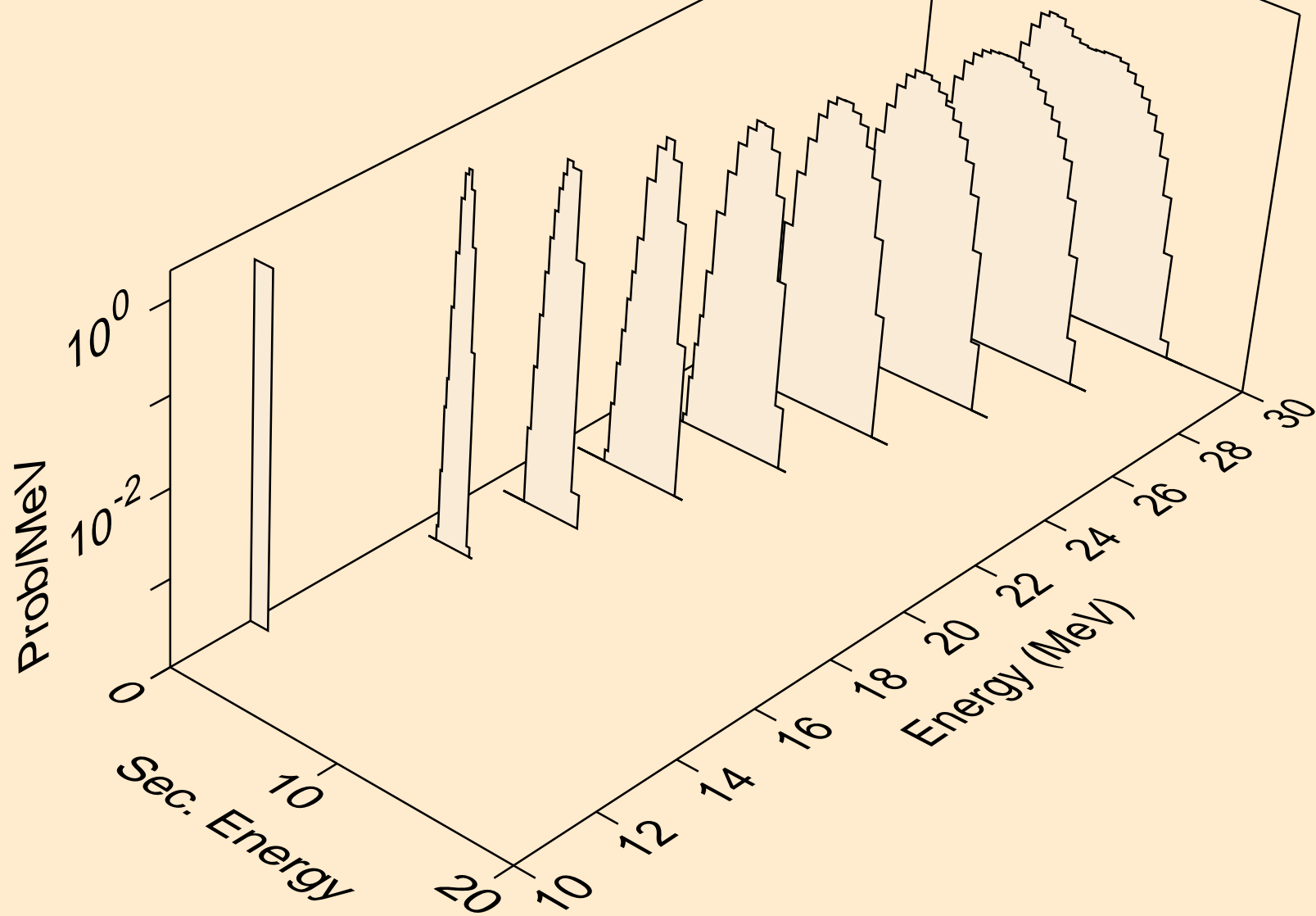

MN058 NEUTRON ACER TENDL-2021 LIBRARY; T=293.6K
alphas from (n,da)

