

MO085 NEUTRON ACER TENDL-2021 LIBRARY; T=293.6K

Principal cross sections

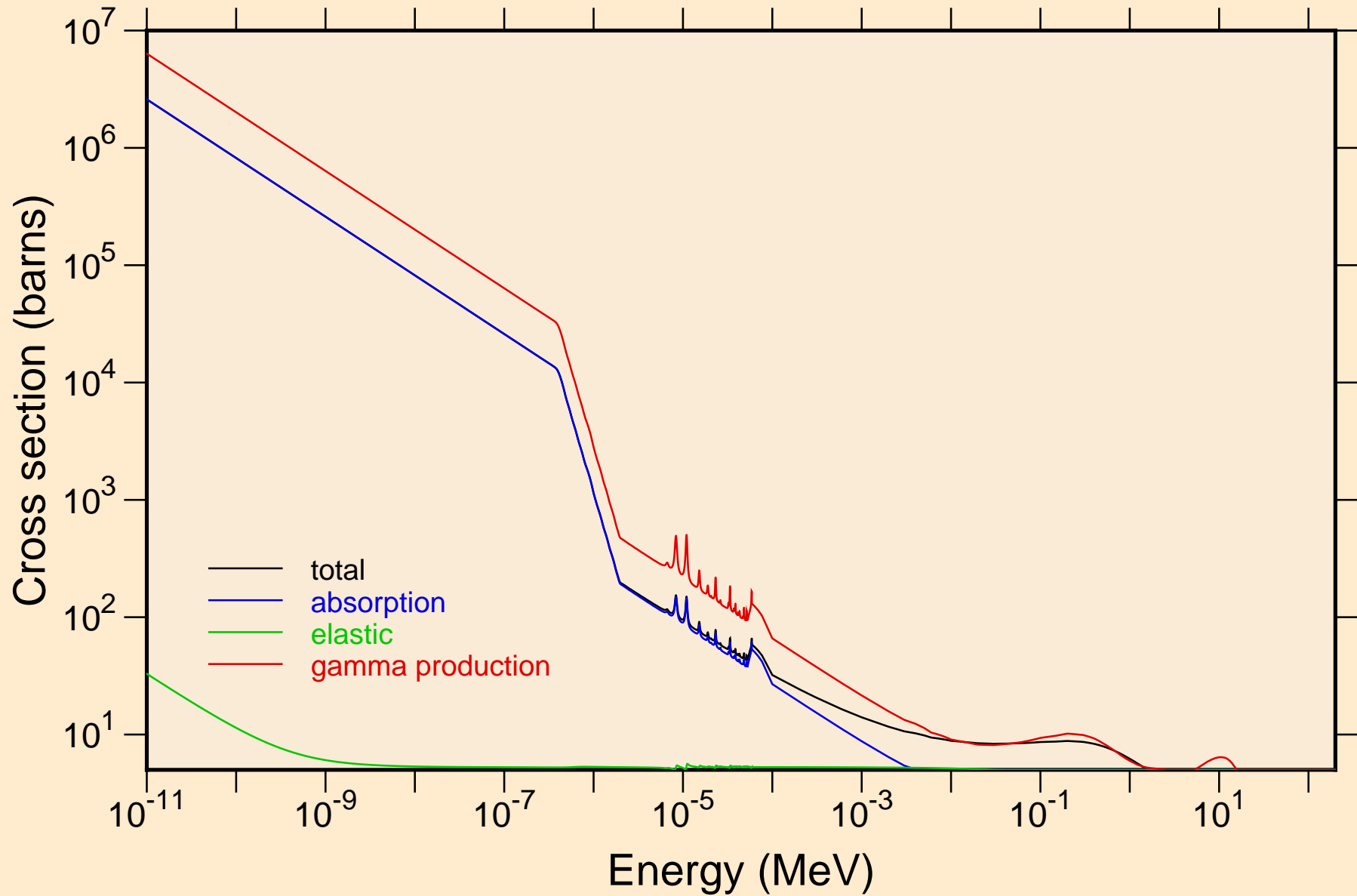

MO085 NEUTRON ACER TENDL-2021 LIBRARY; T=293.6K
resonance total cross section

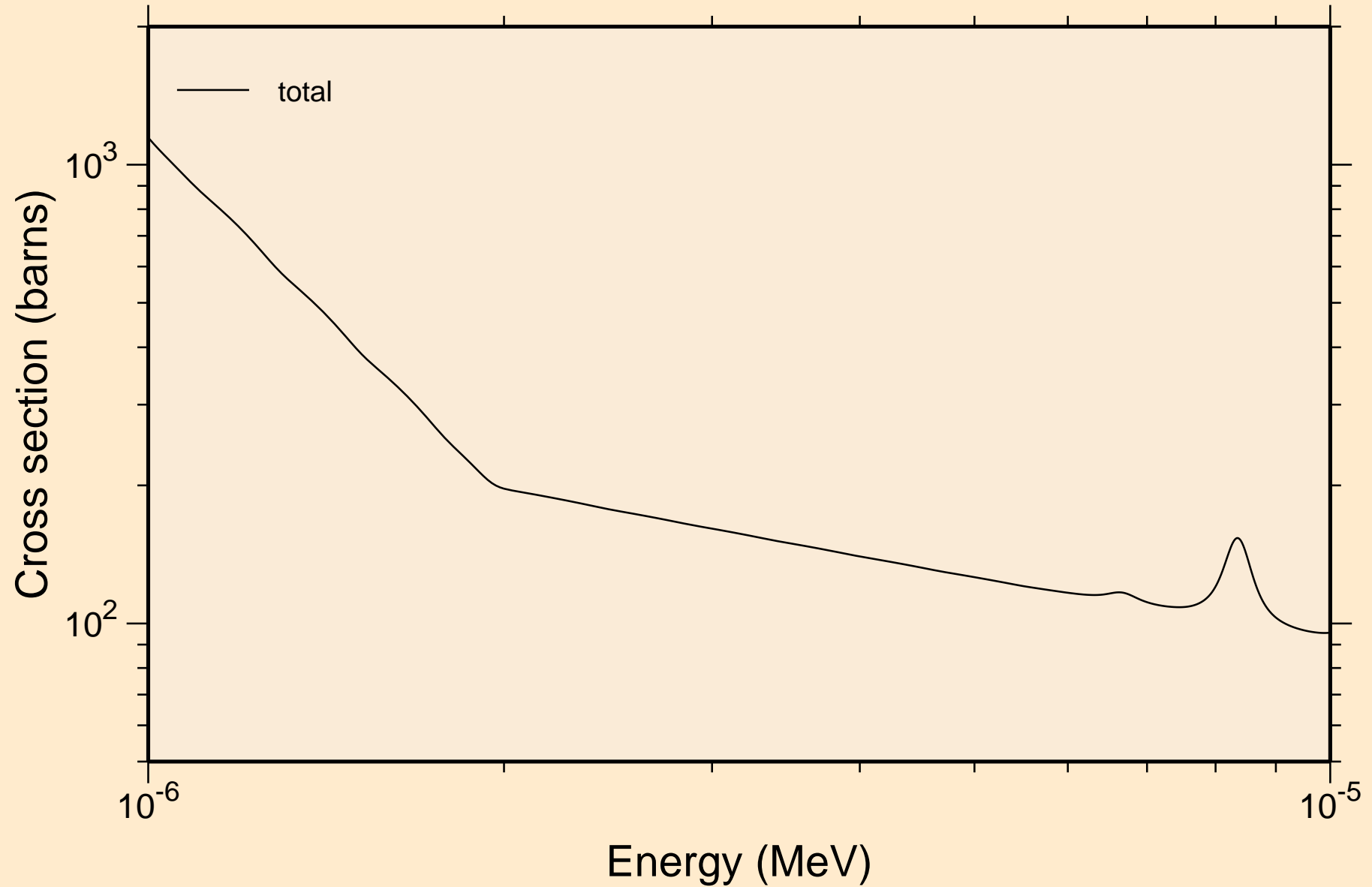

MO085 NEUTRON ACER TENDL-2021 LIBRARY; T=293.6K
resonance total cross section

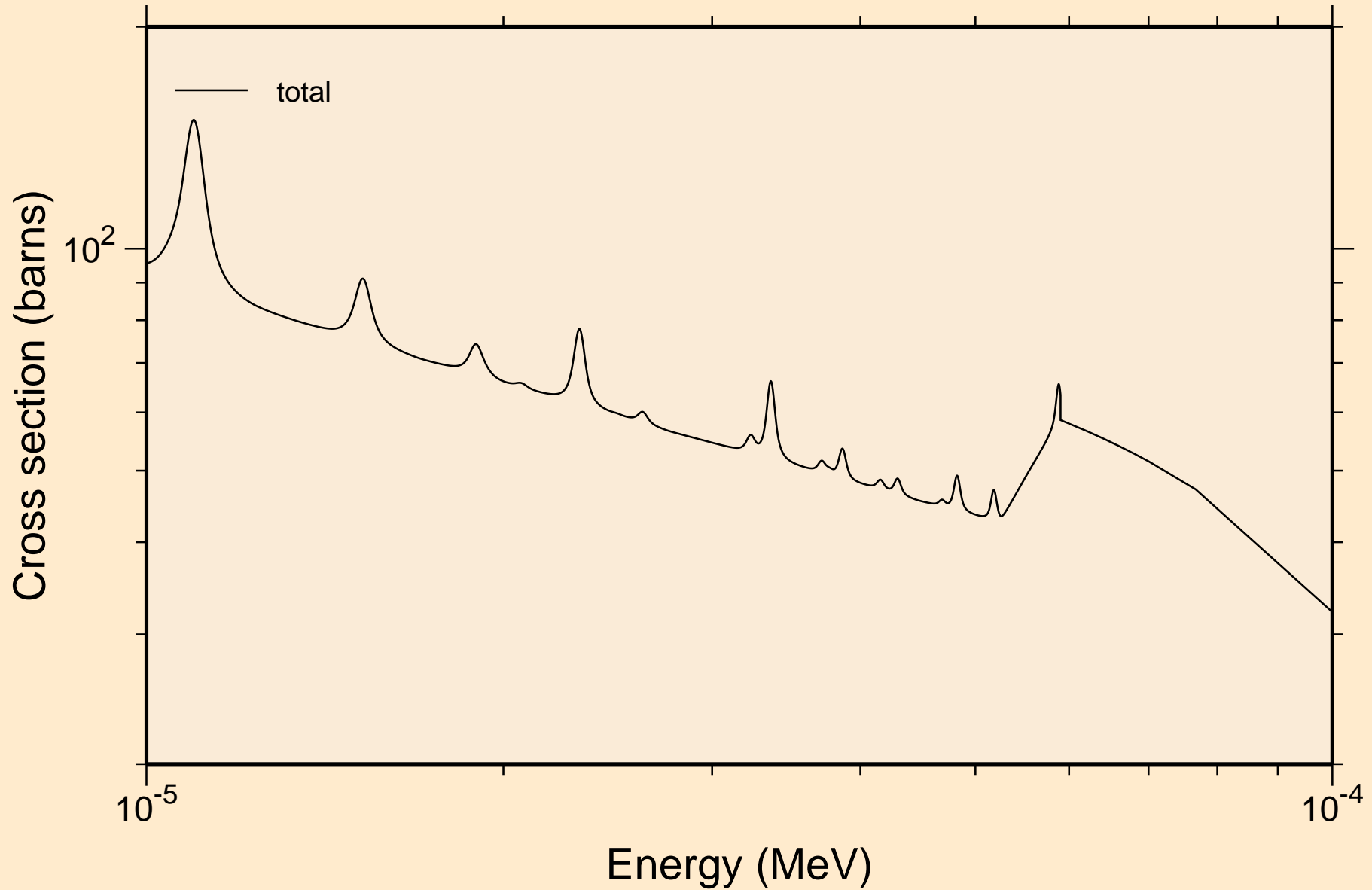

M0085 NEUTRON ACER TENDL-2021 LIBRARY; T=293.6K
resonance total cross section

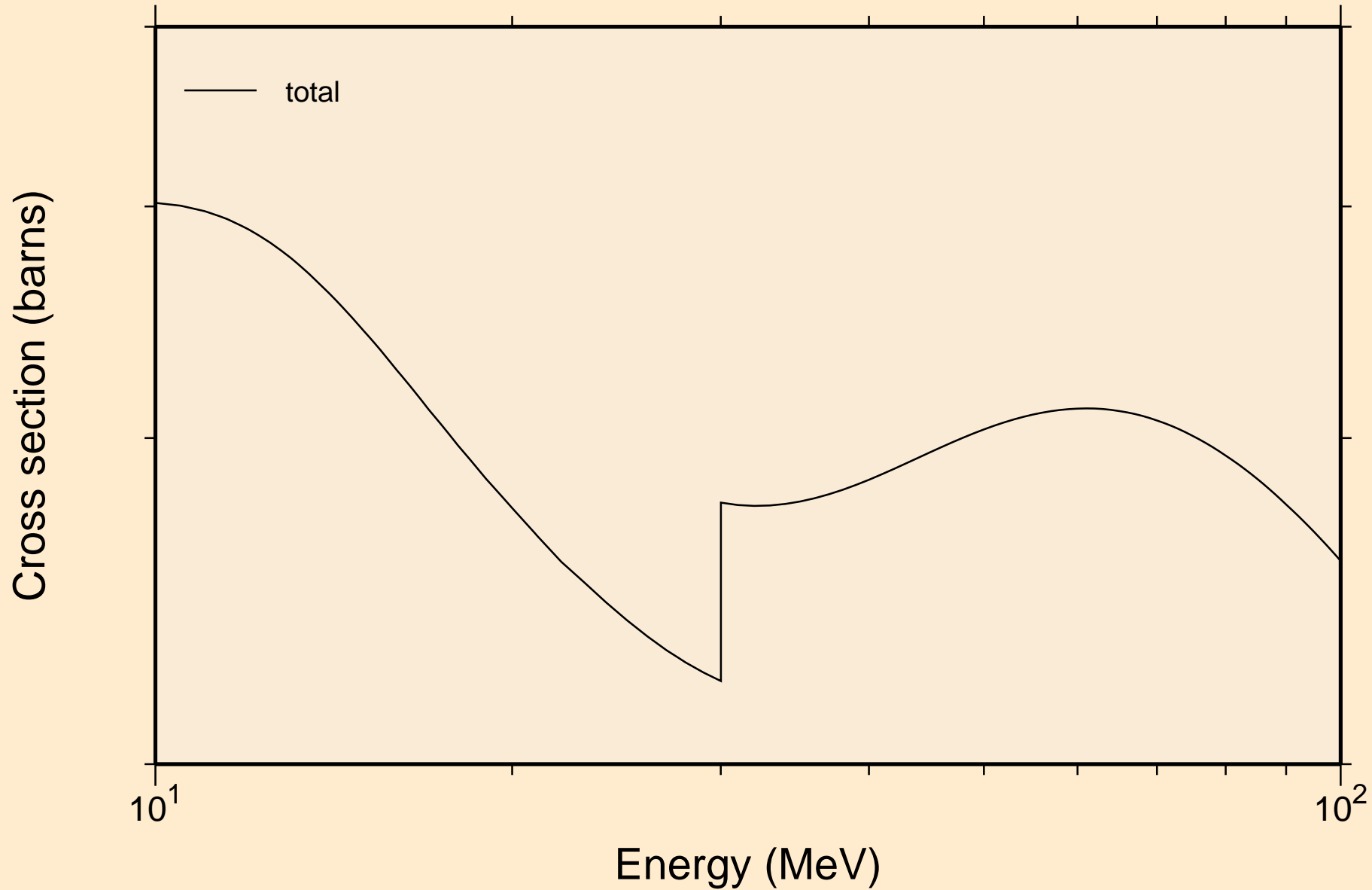

MO085 NEUTRON ACER TENDL-2021 LIBRARY; T=293.6K
resonance absorption cross sections

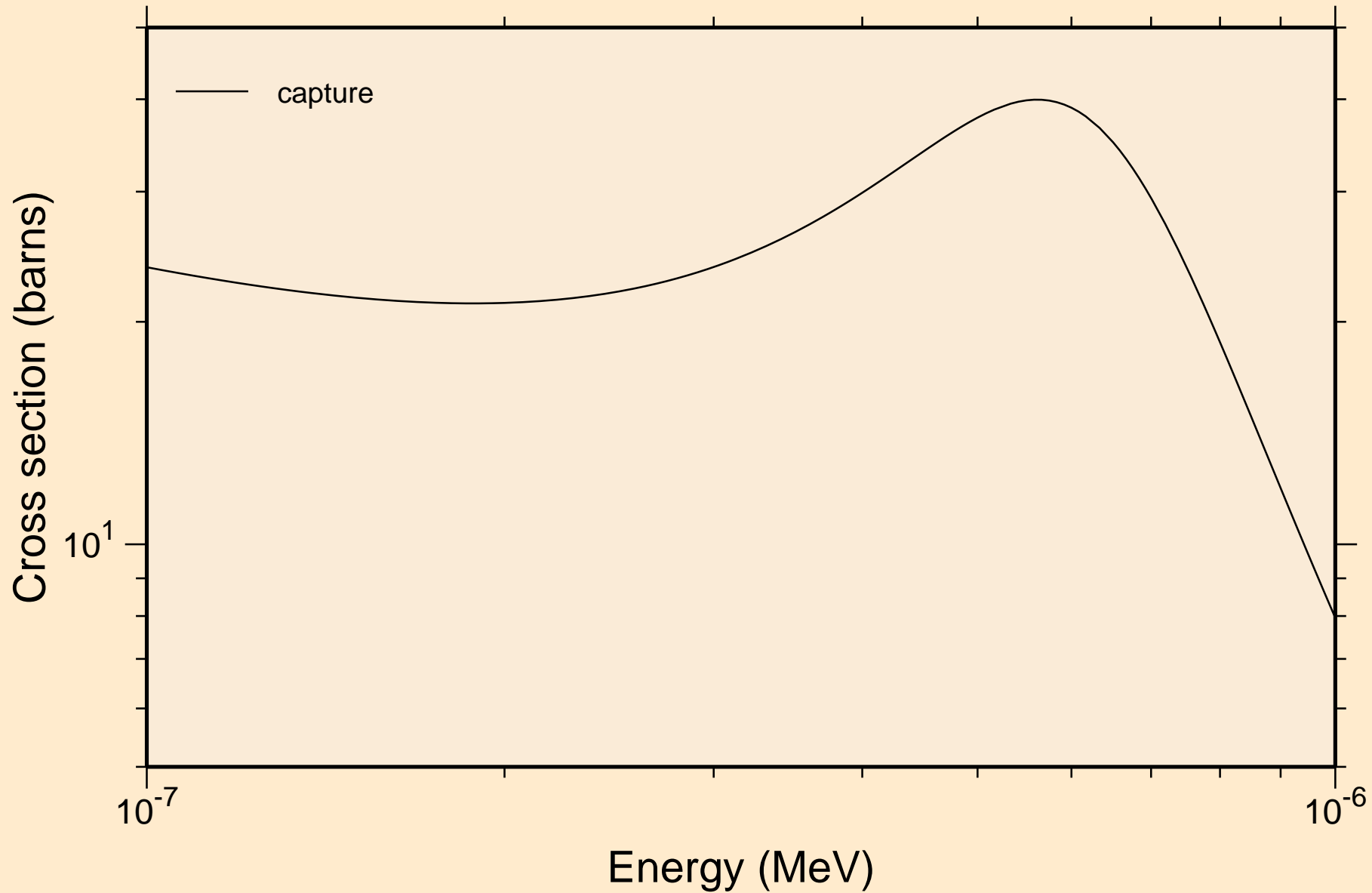

MO085 NEUTRON ACER TENDL-2021 LIBRARY; T=293.6K
resonance absorption cross sections

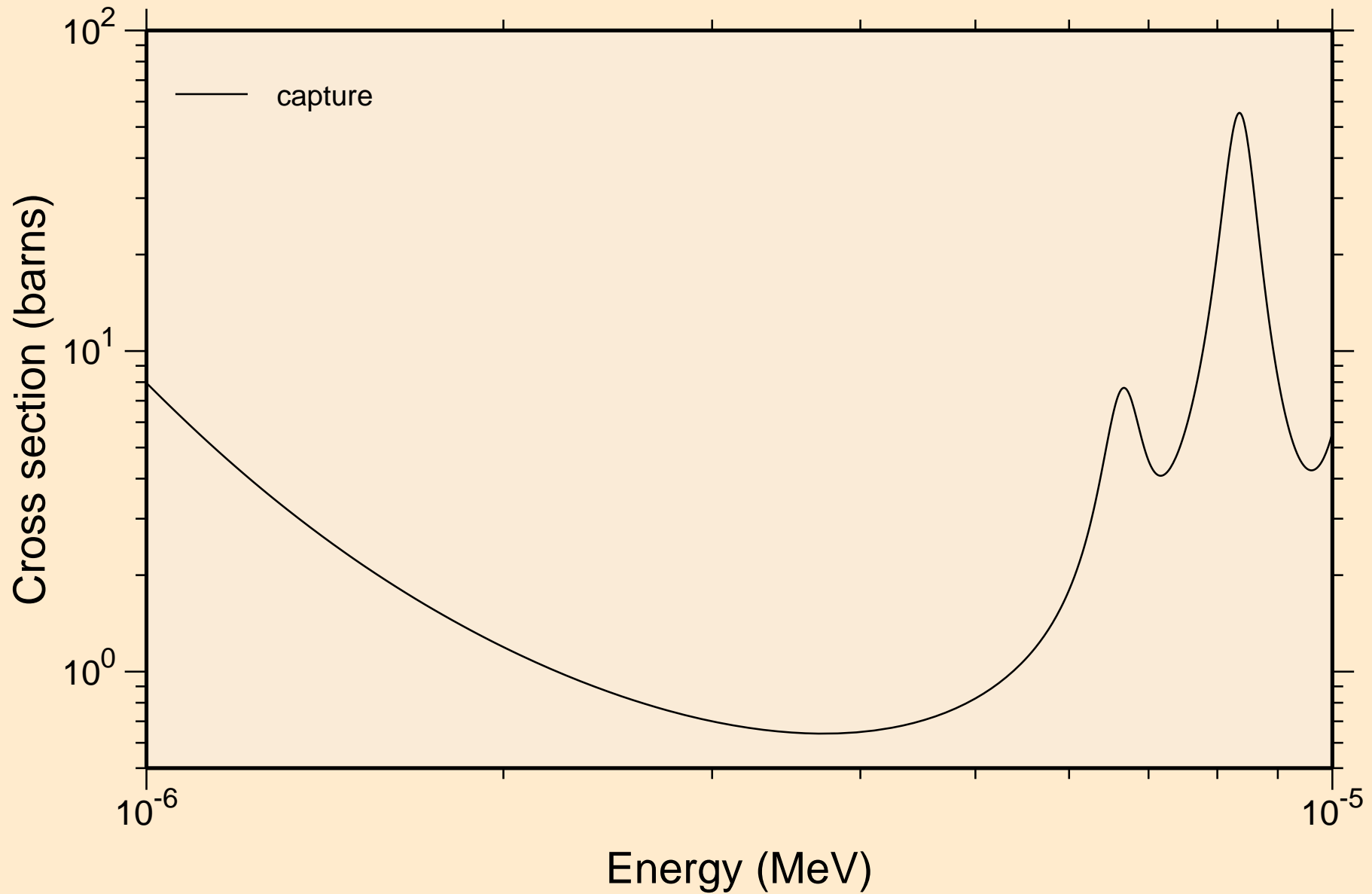

MO085 NEUTRON ACER TENDL-2021 LIBRARY; T=293.6K
resonance absorption cross sections

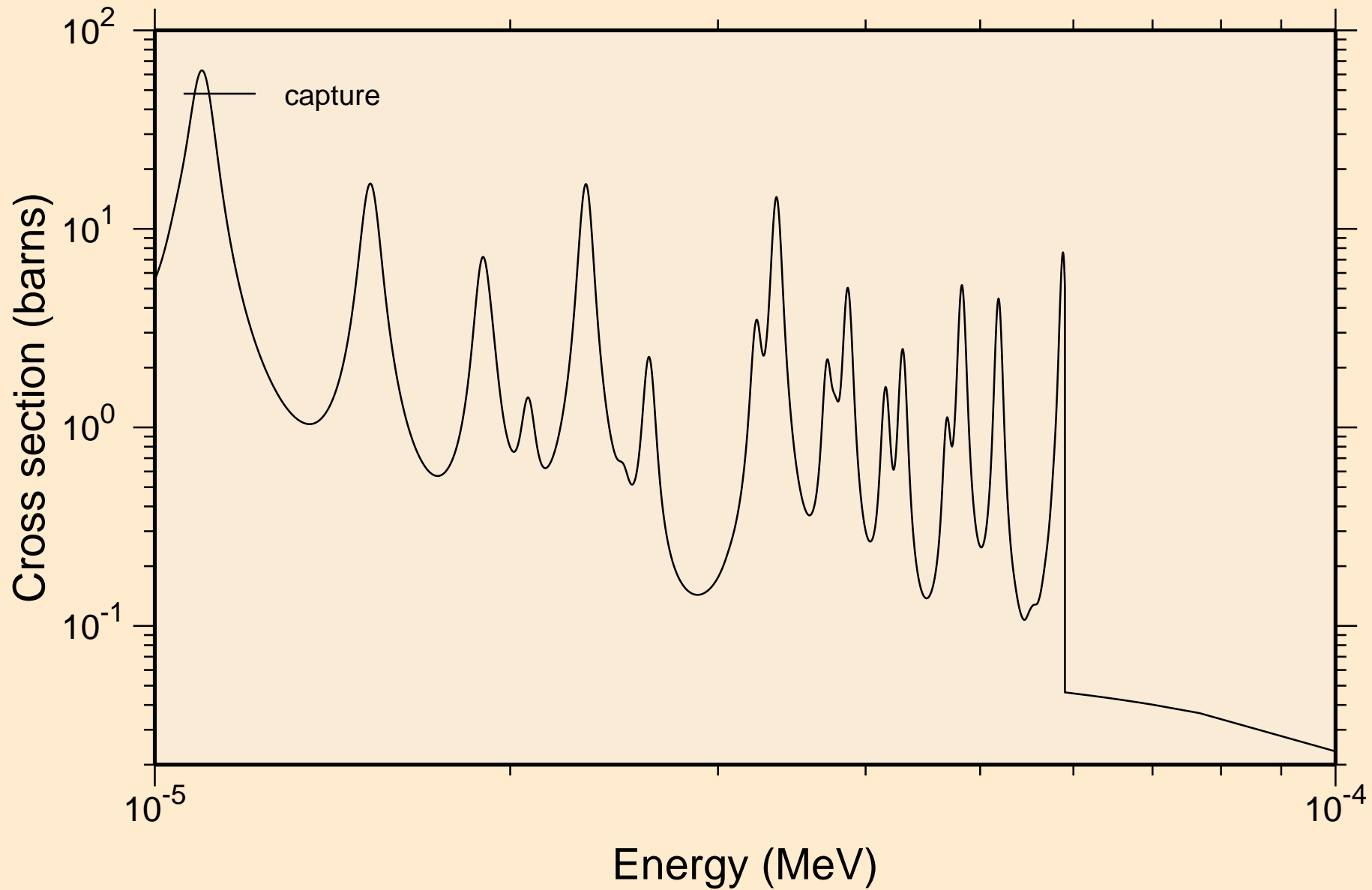

MO085 NEUTRON ACER TENDL-2021 LIBRARY; T=293.6K
resonance absorption cross sections

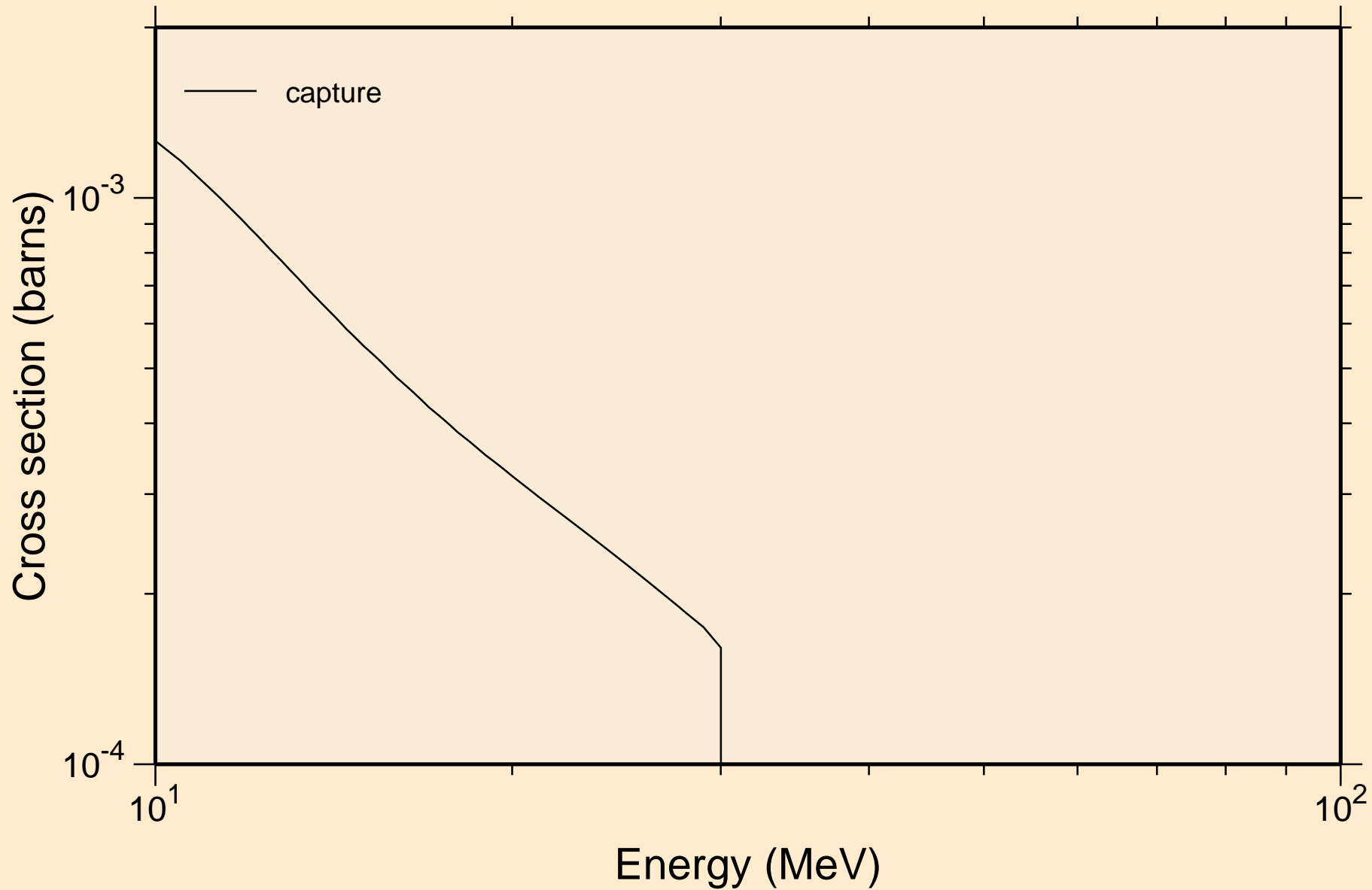

MO085 NEUTRON ACER TENDL-2021 LIBRARY; T=293.6K
Heating

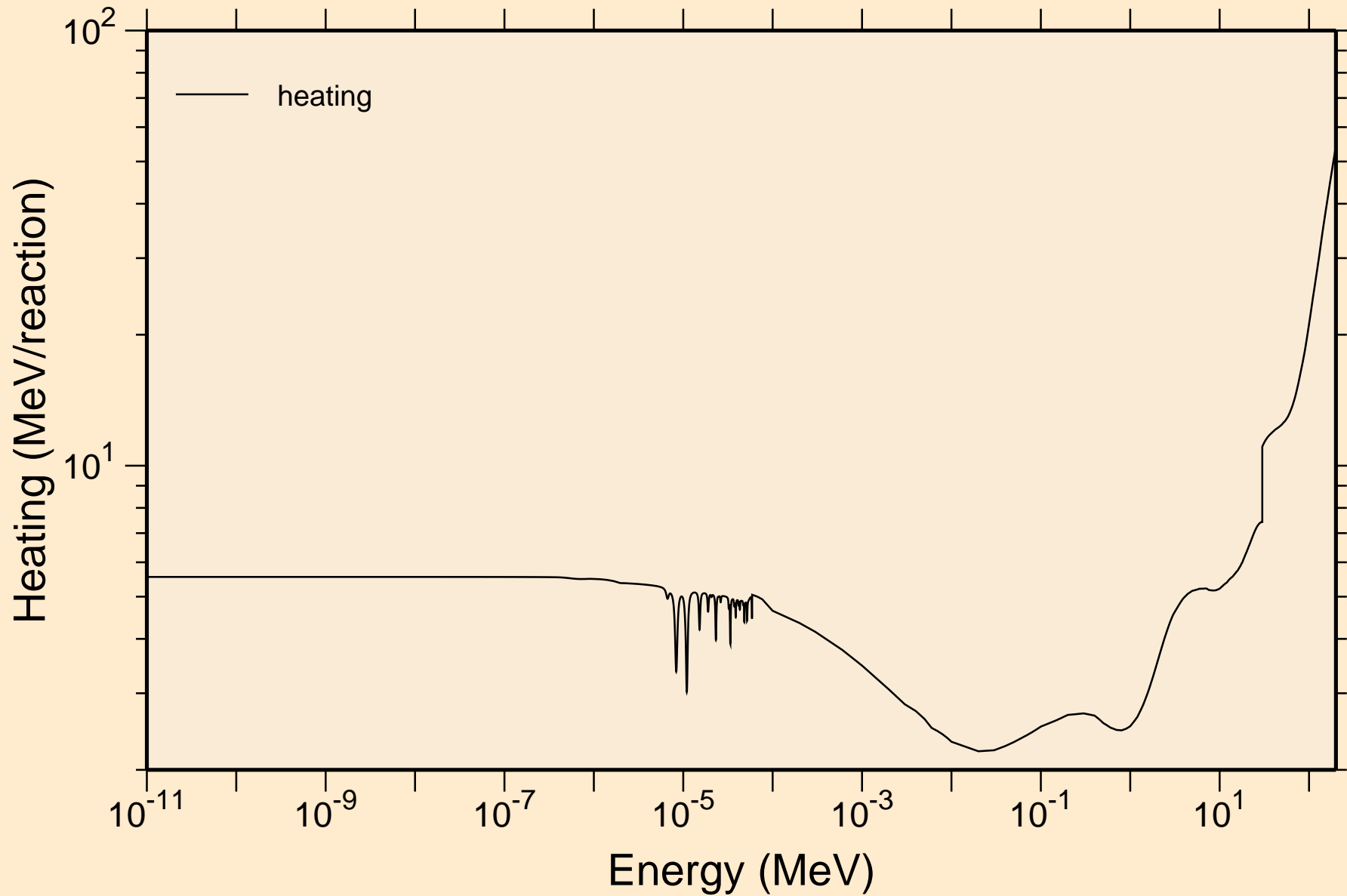

MO085 NEUTRON ACER TENDL-2021 LIBRARY; T=293.6K Damage

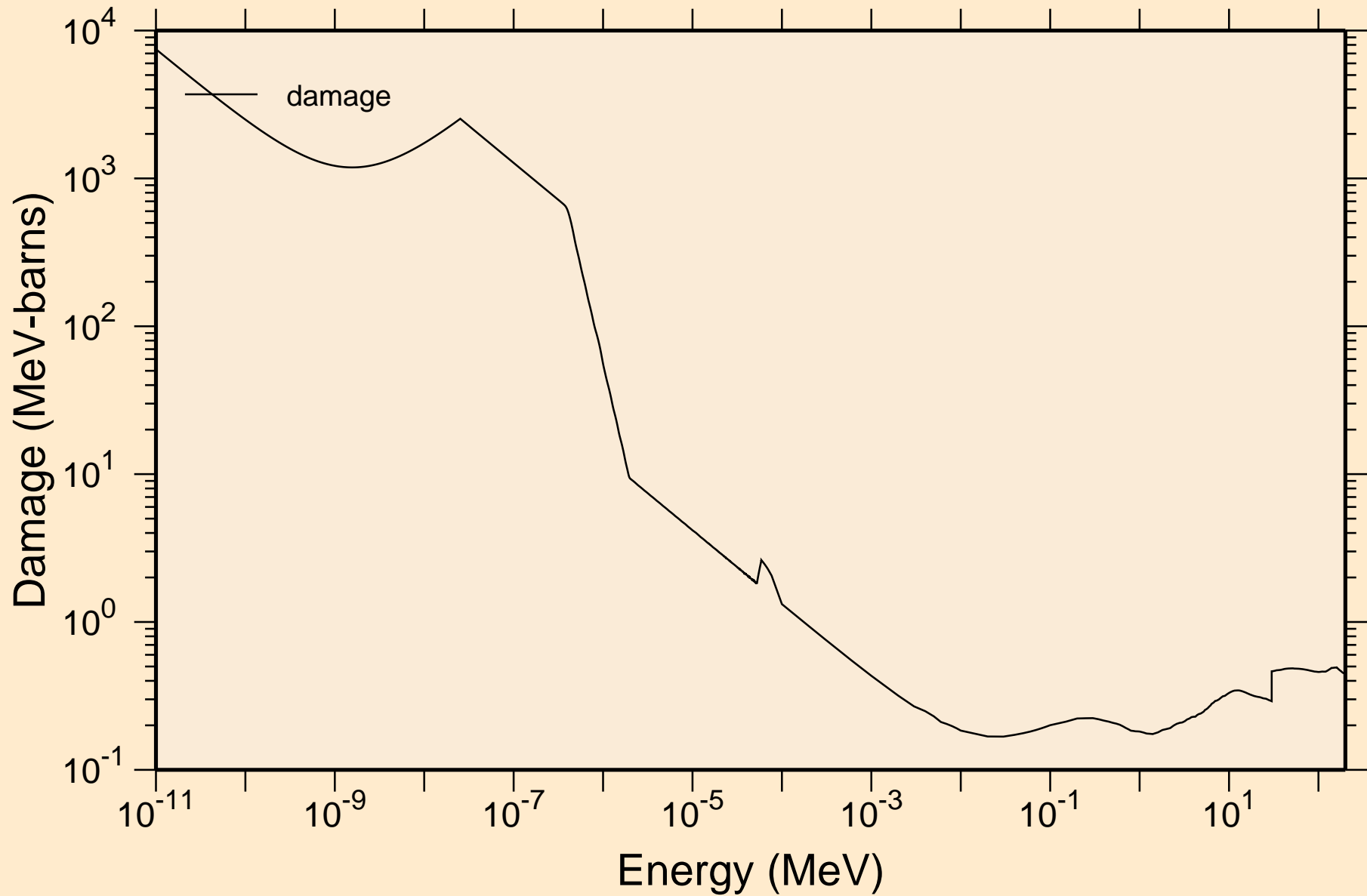

MO085 NEUTRON ACER TENDL-2021 LIBRARY; T=293.6K
Non-threshold reactions

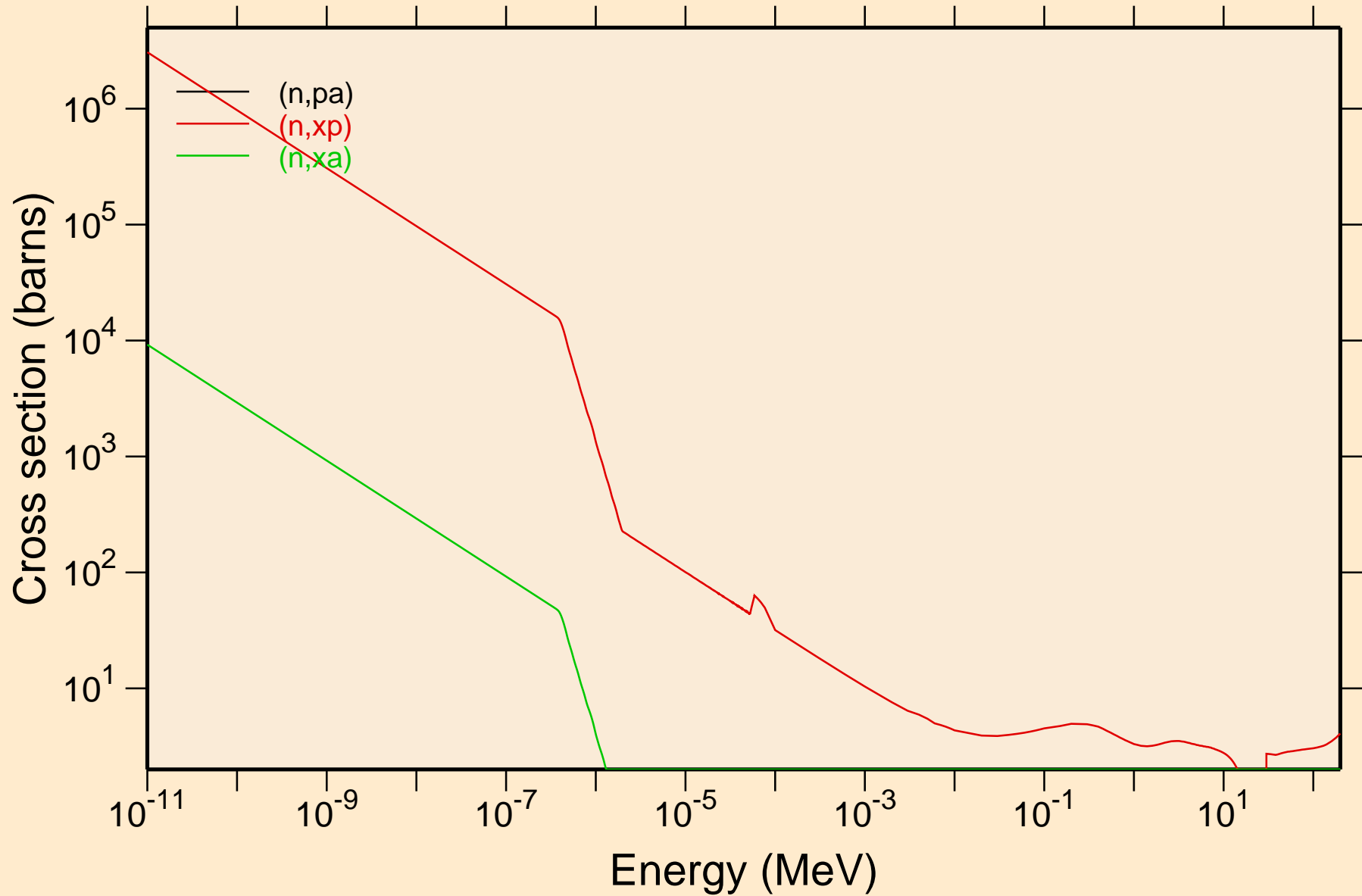

MO085 NEUTRON ACER TENDL-2021 LIBRARY; T=293.6K
Principal cross sections

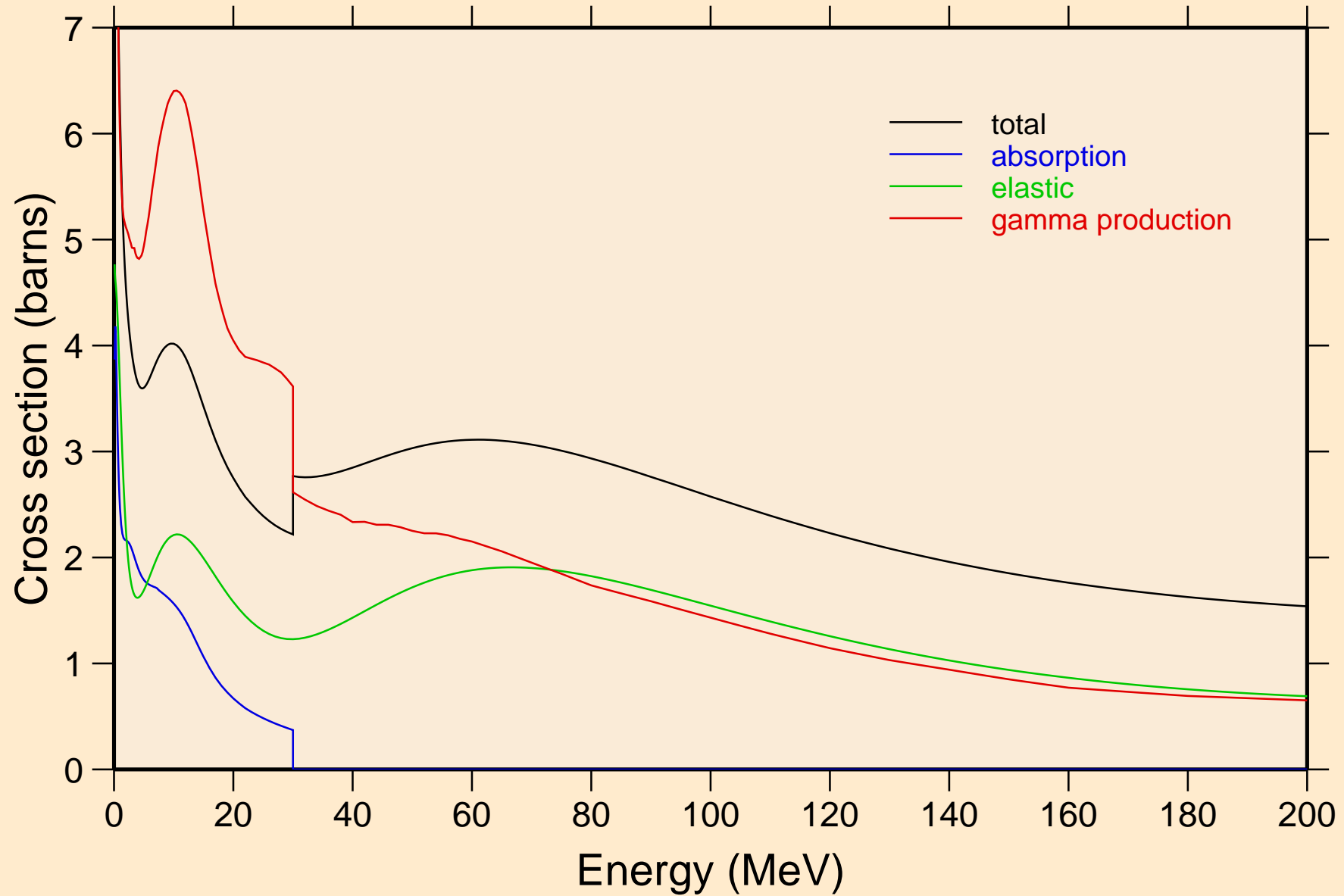

MO085 NEUTRON ACER TENDL-2021 LIBRARY; T=293.6K
Heating

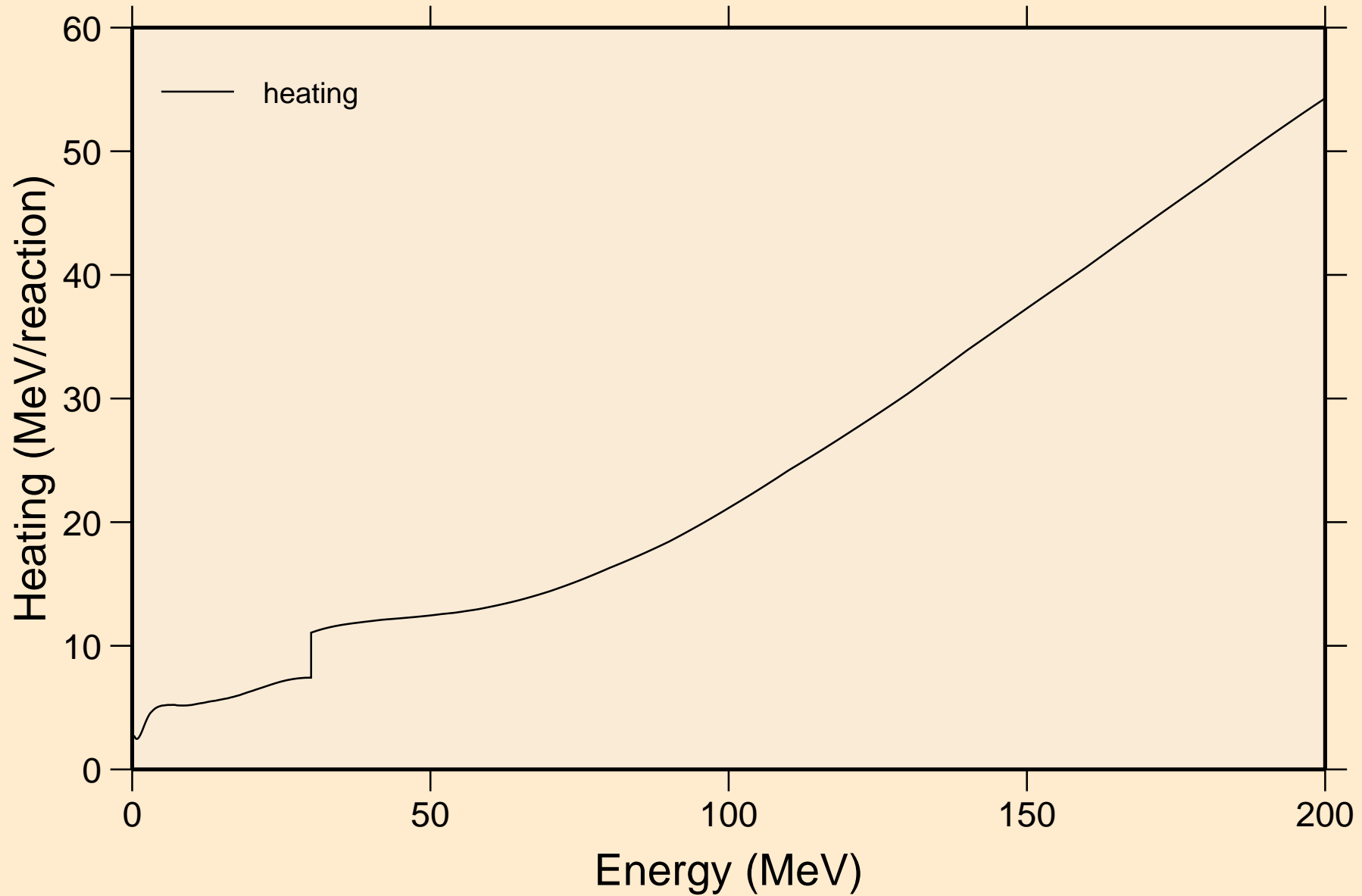

MO085 NEUTRON ACER TENDL-2021 LIBRARY; T=293.6K
Damage

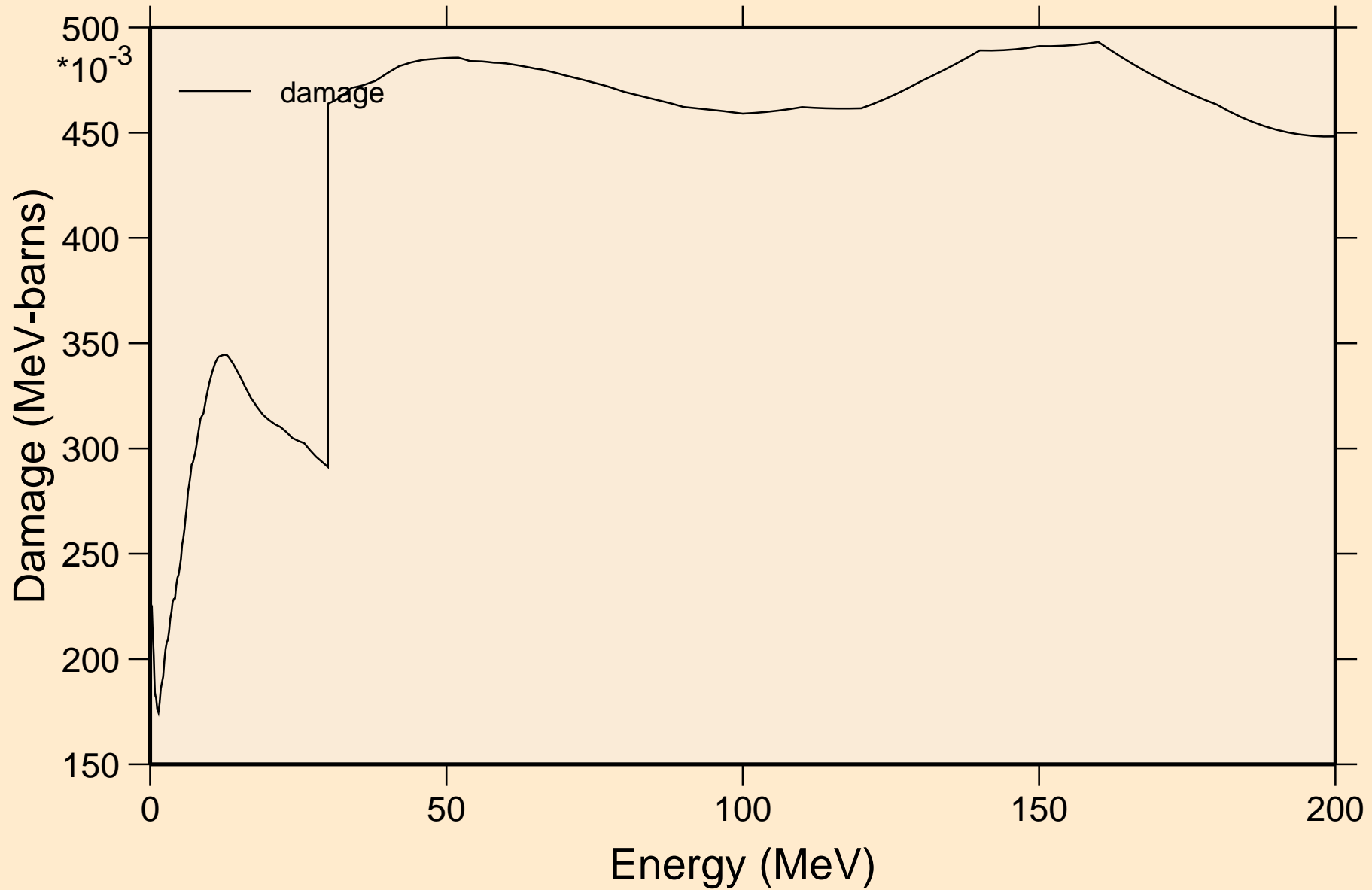

MO085 NEUTRON ACER TENDL-2021 LIBRARY; T=293.6K
Non-threshold reactions

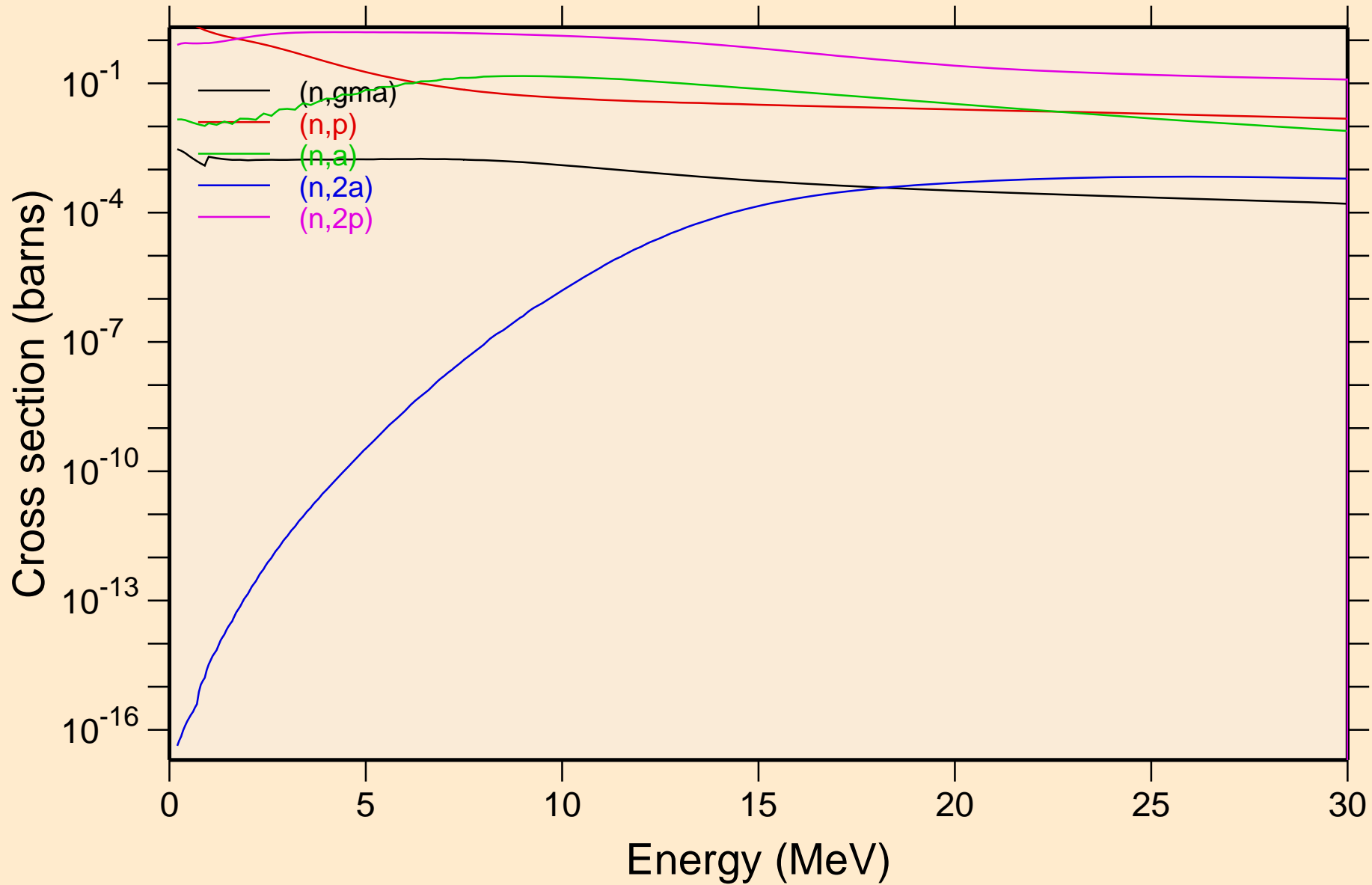

MO085 NEUTRON ACER TENDL-2021 LIBRARY; T=293.6K
Non-threshold reactions

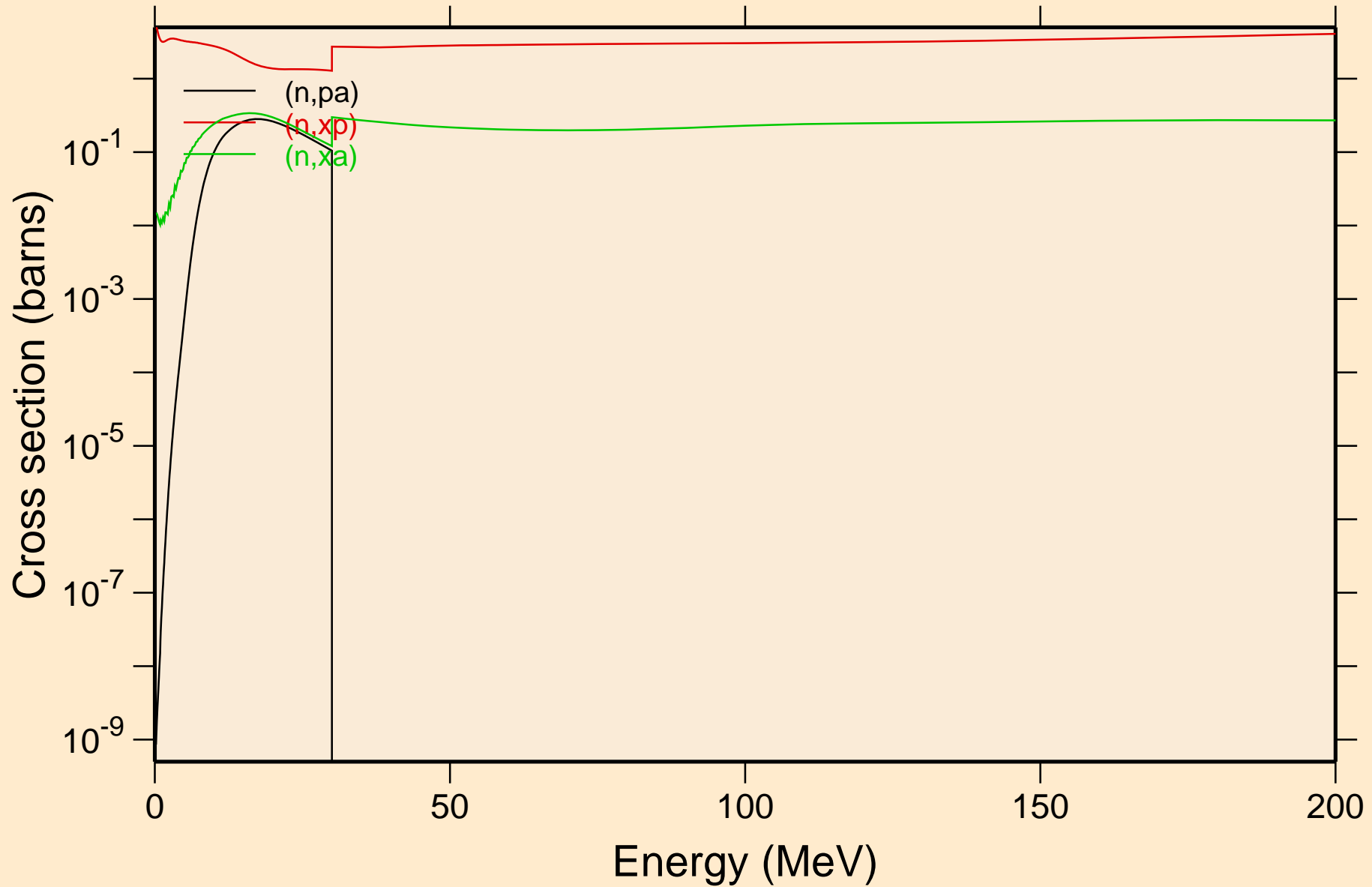

MO085 NEUTRON ACER TENDL-2021 LIBRARY; T=293.6K
Inelastic levels

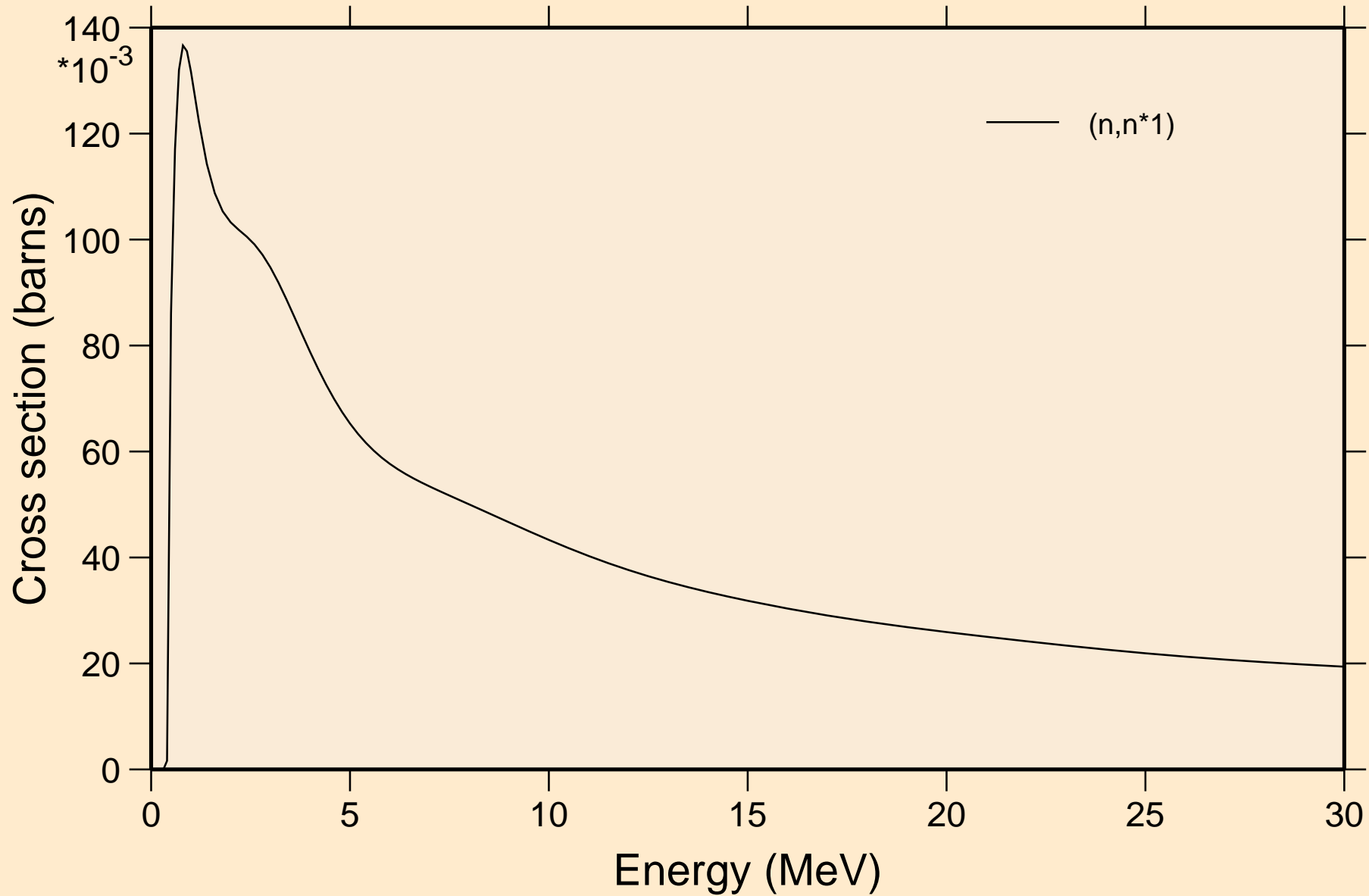

MO085 NEUTRON ACER TENDL-2021 LIBRARY; T=293.6K
Threshold reactions

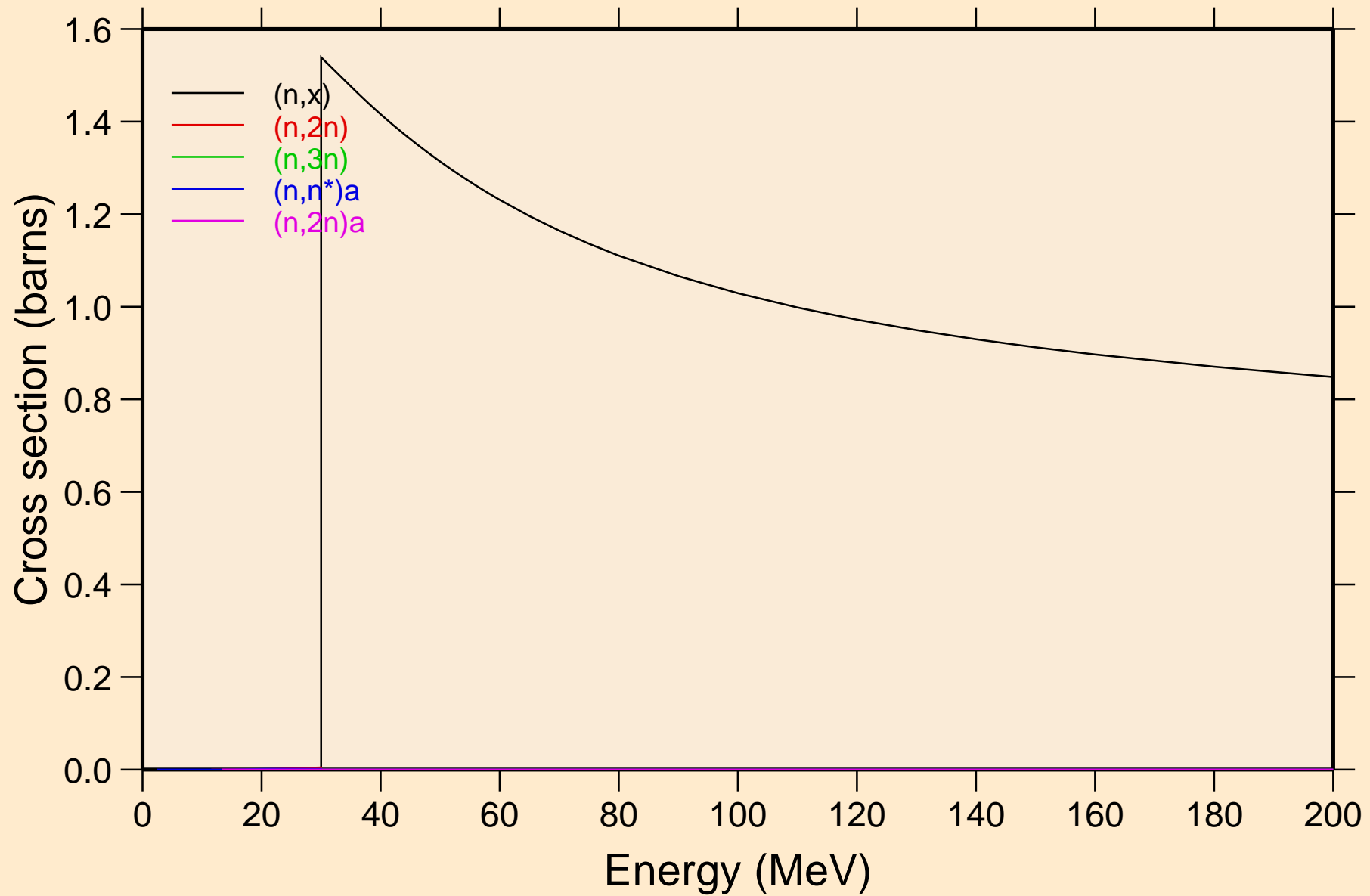

MO085 NEUTRON ACER TENDL-2021 LIBRARY; T=293.6K
Threshold reactions

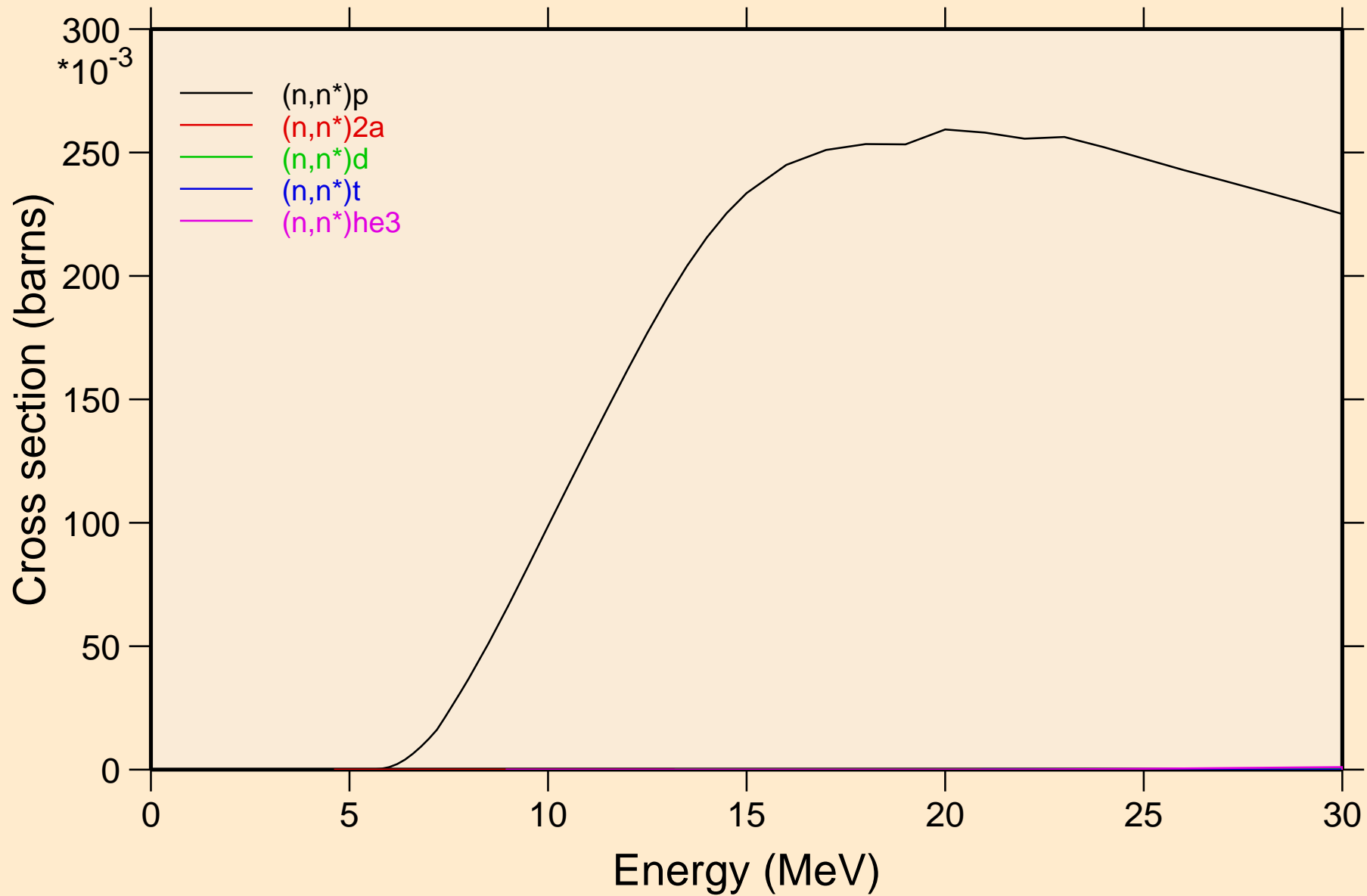

MO085 NEUTRON ACER TENDL-2021 LIBRARY; T=293.6K
Threshold reactions

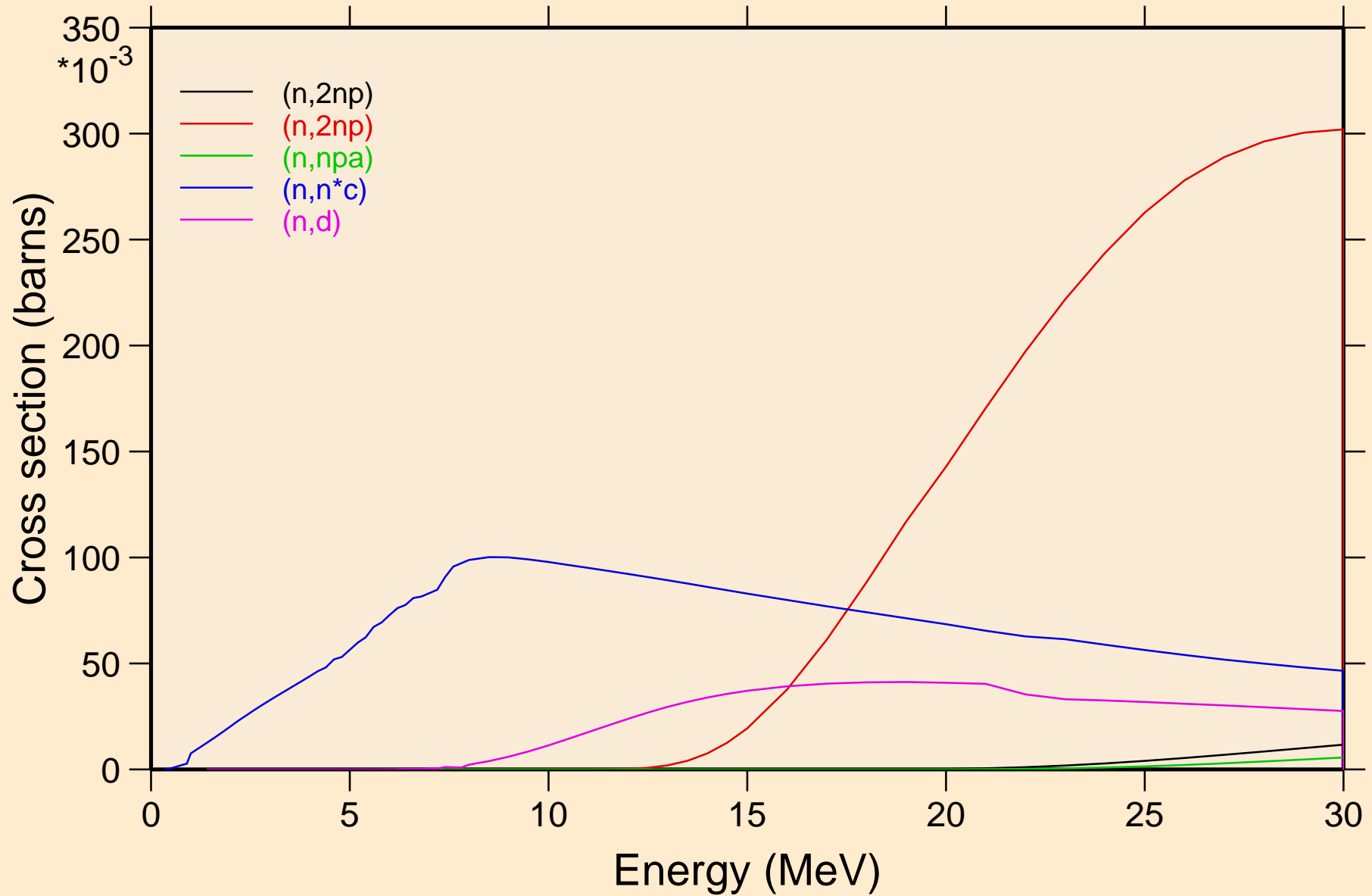

MO085 NEUTRON ACER TENDL-2021 LIBRARY; T=293.6K
Threshold reactions

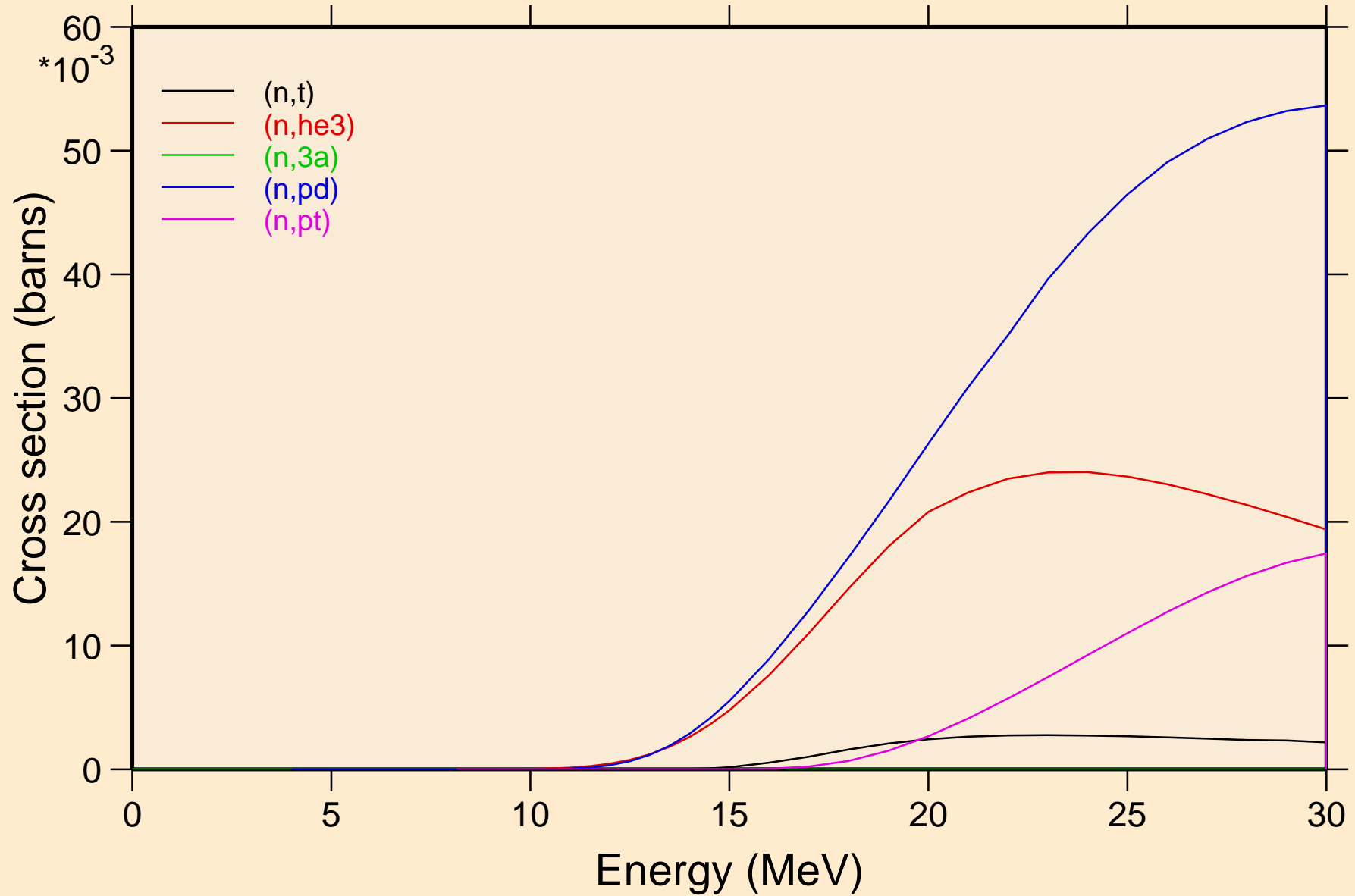

MO085 NEUTRON ACER TENDL-2021 LIBRARY; T=293.6K
Threshold reactions

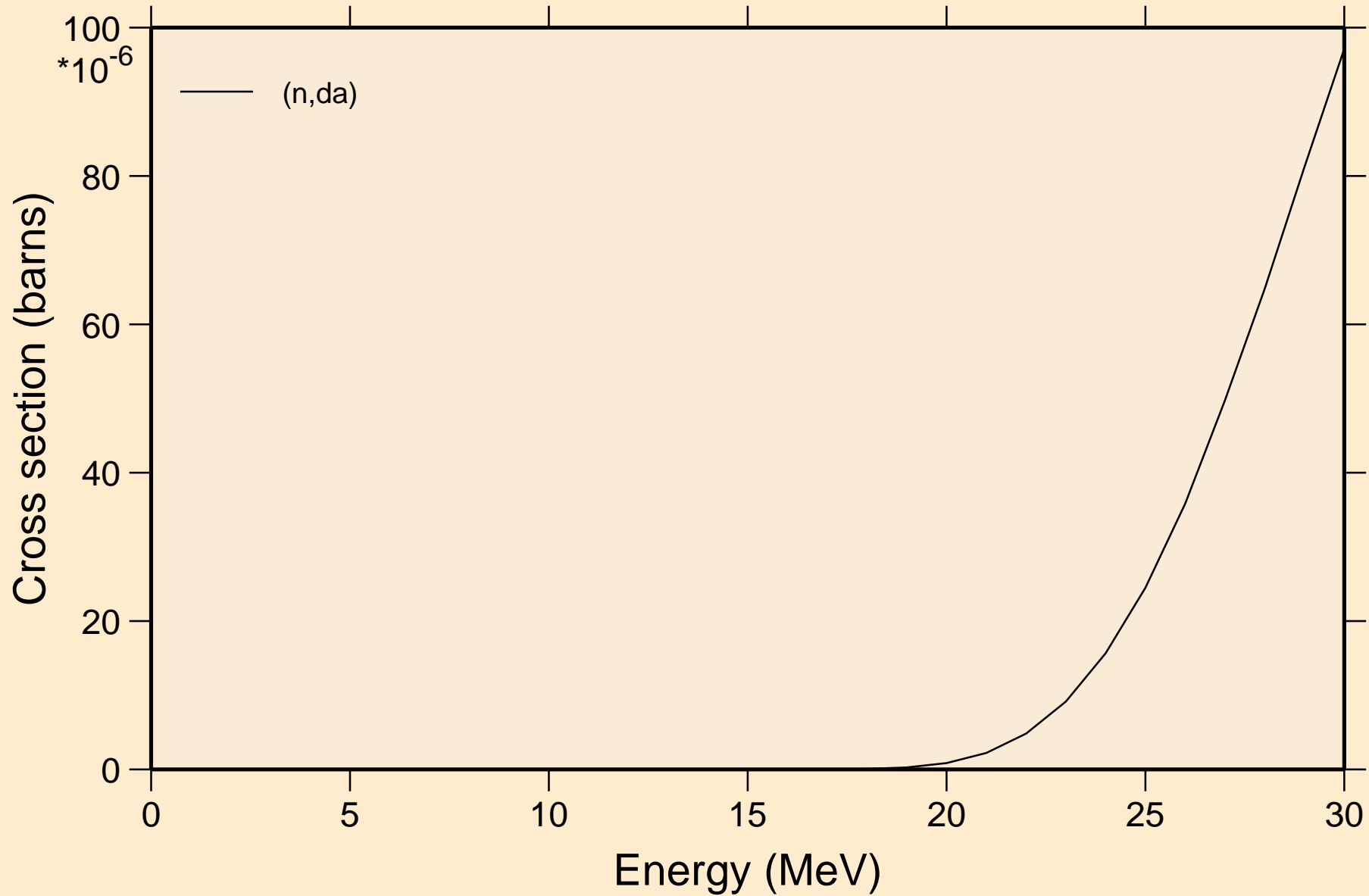

MO085 NEUTRON ACER TENDL-2021 LIBRARY; T=293.6K
Threshold reactions

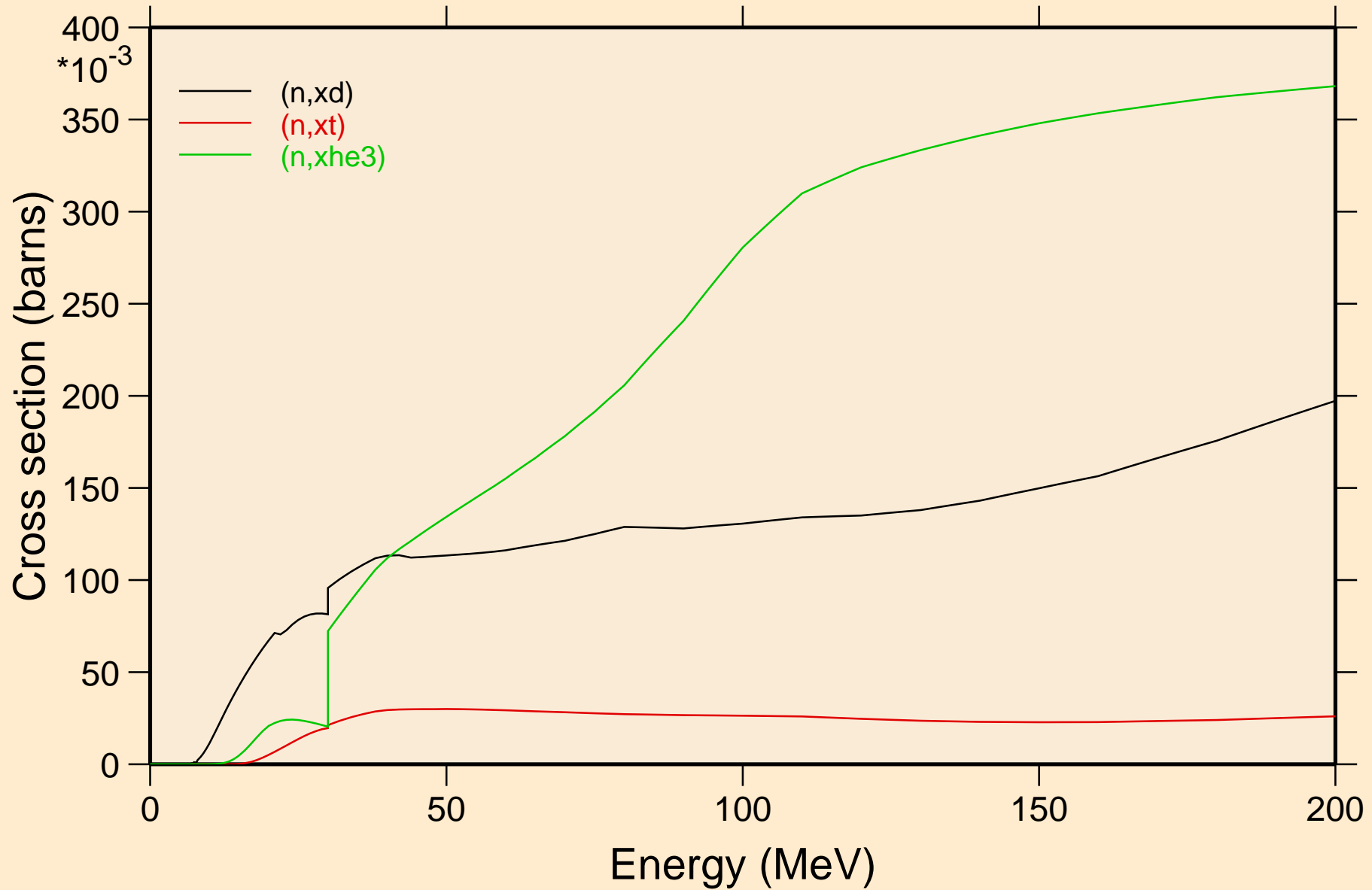

MO085 NEUTRON ACER TENDL-2021 LIBRARY; T=293.6K
angular distribution for elastic

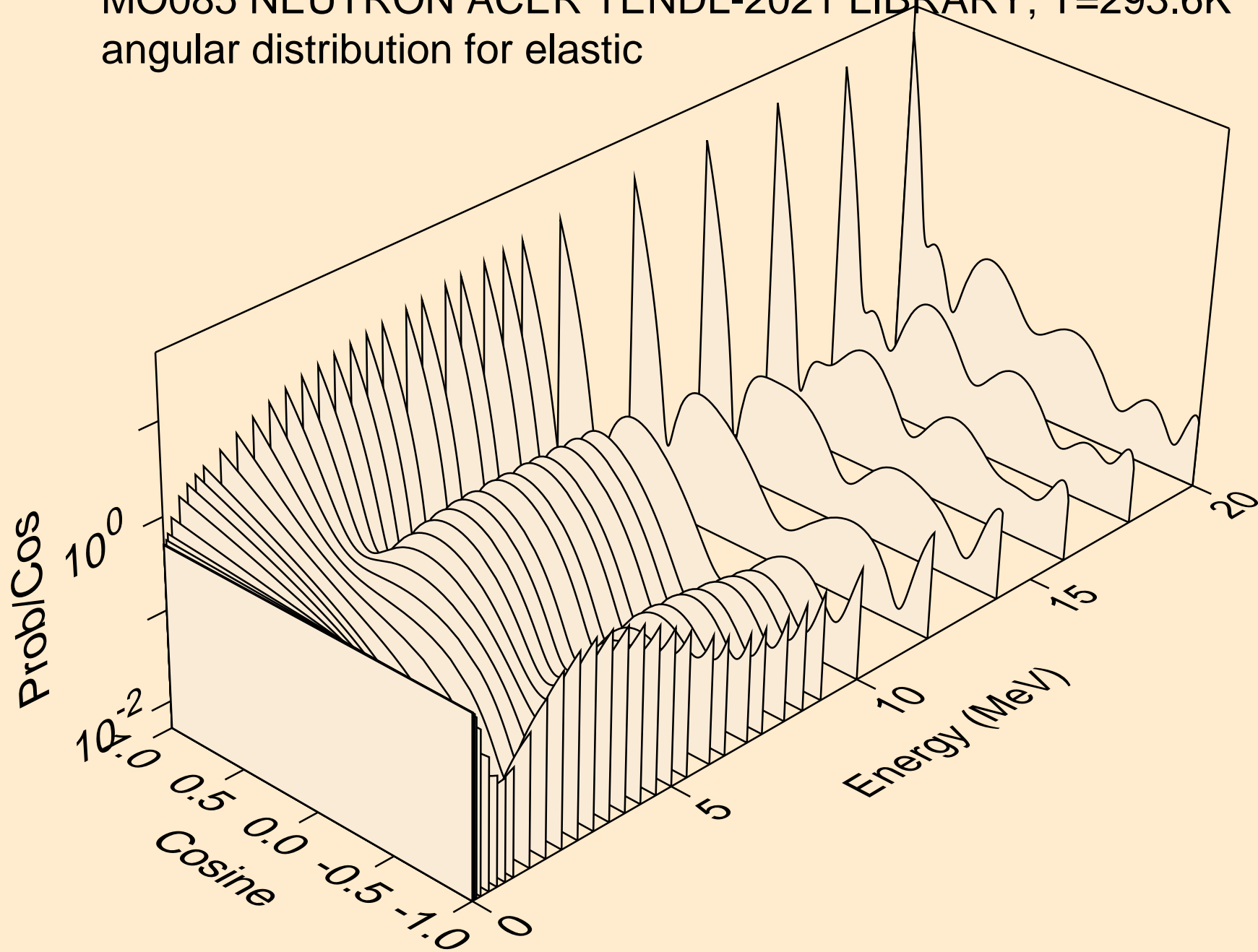

MO085 NEUTRON ACER TENDL-2021 LIBRARY; T=293.6K
angular distribution for elastic

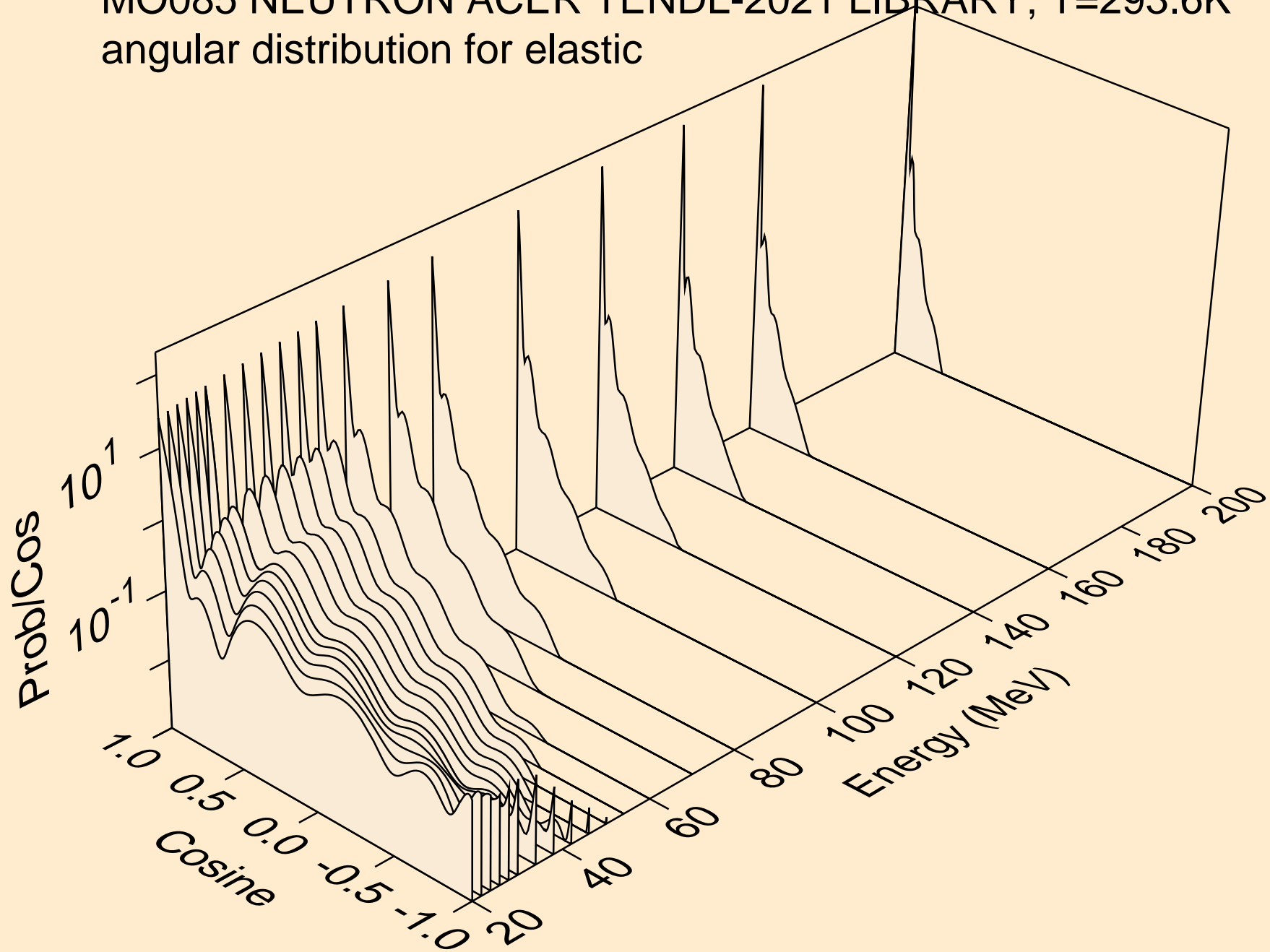

MO085 NEUTRON ACER TENDL-2021 LIBRARY; T=293.6K
angular distribution for (n,n*1)

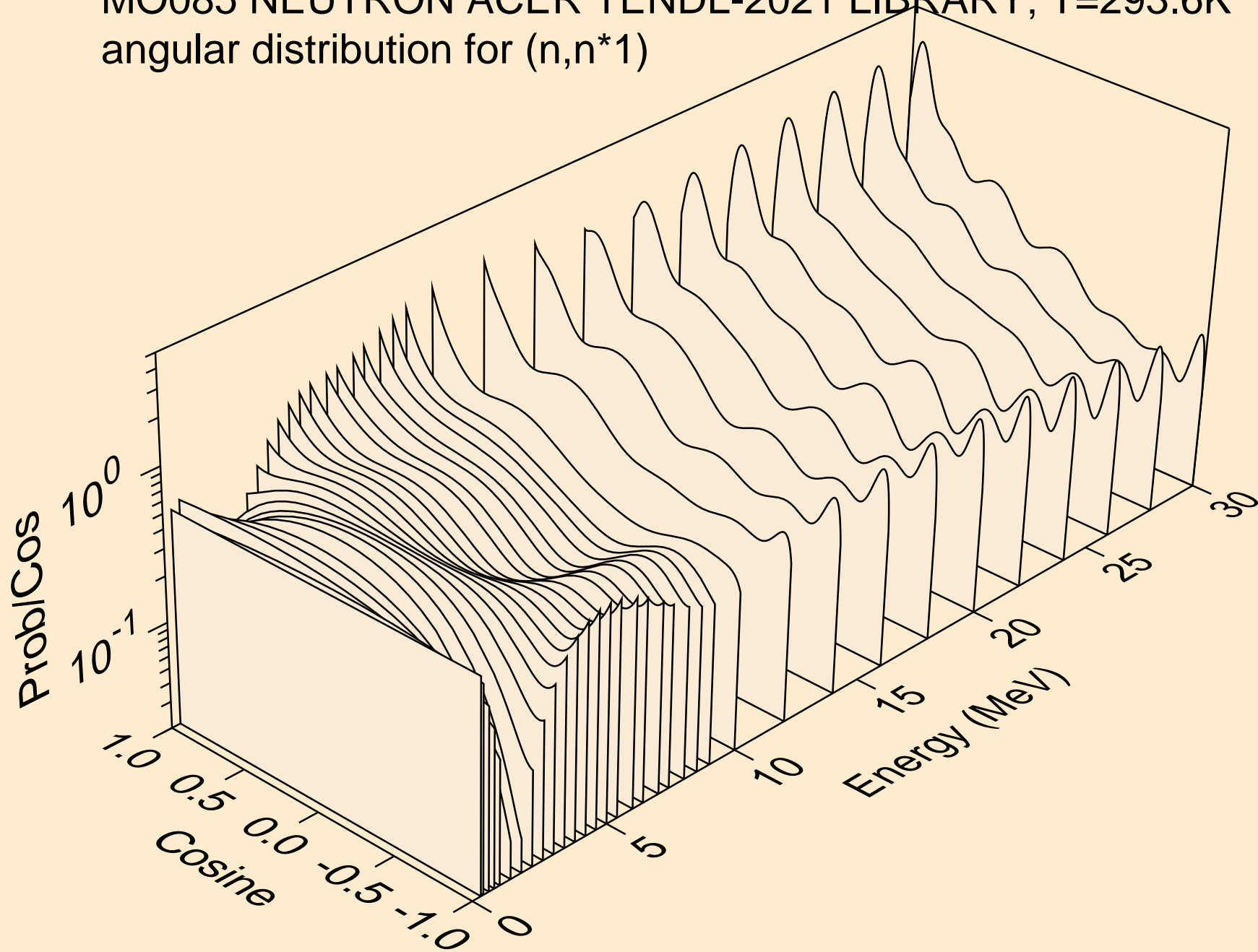

MO085 NEUTRON ACER TENDL-2021 LIBRARY; T=293.6K
Neutron emission for (n,x)

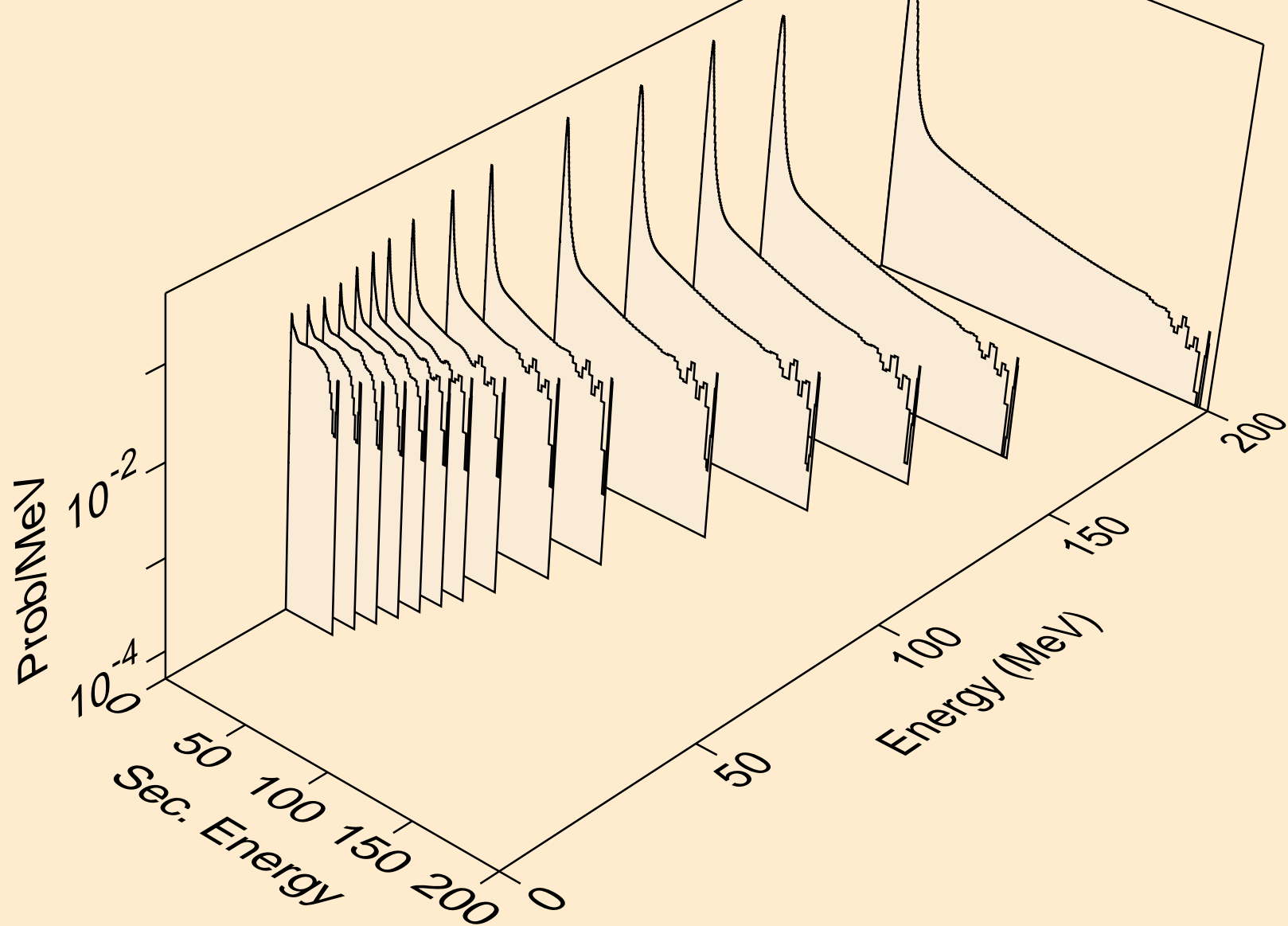

MO085 NEUTRON ACER TENDL-2021 LIBRARY; T=293.6K
Neutron emission for (n,2n)

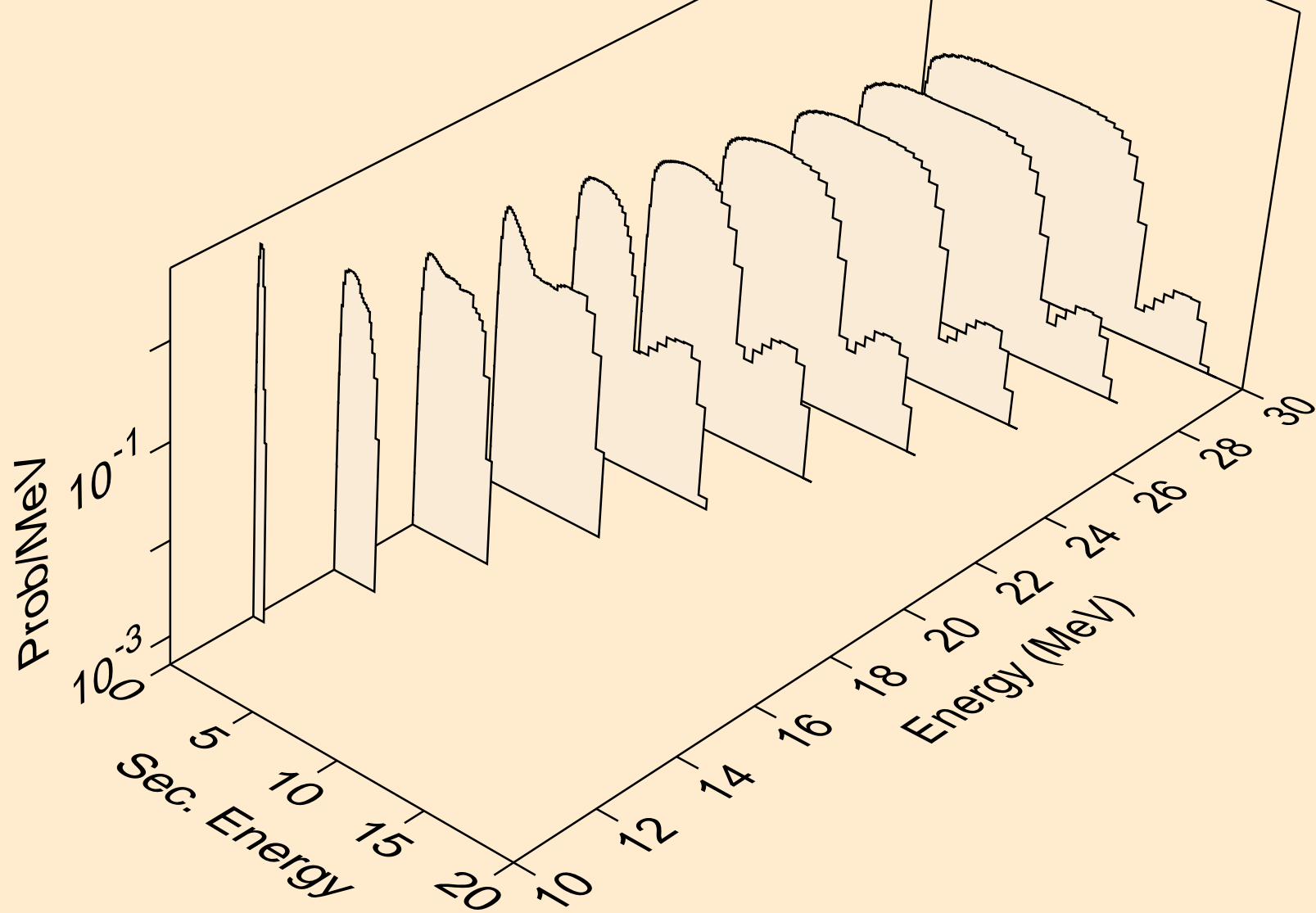

MO085 NEUTRON ACER TENDL-2021 LIBRARY; T=293.6K
Neutron emission for (n,3n)

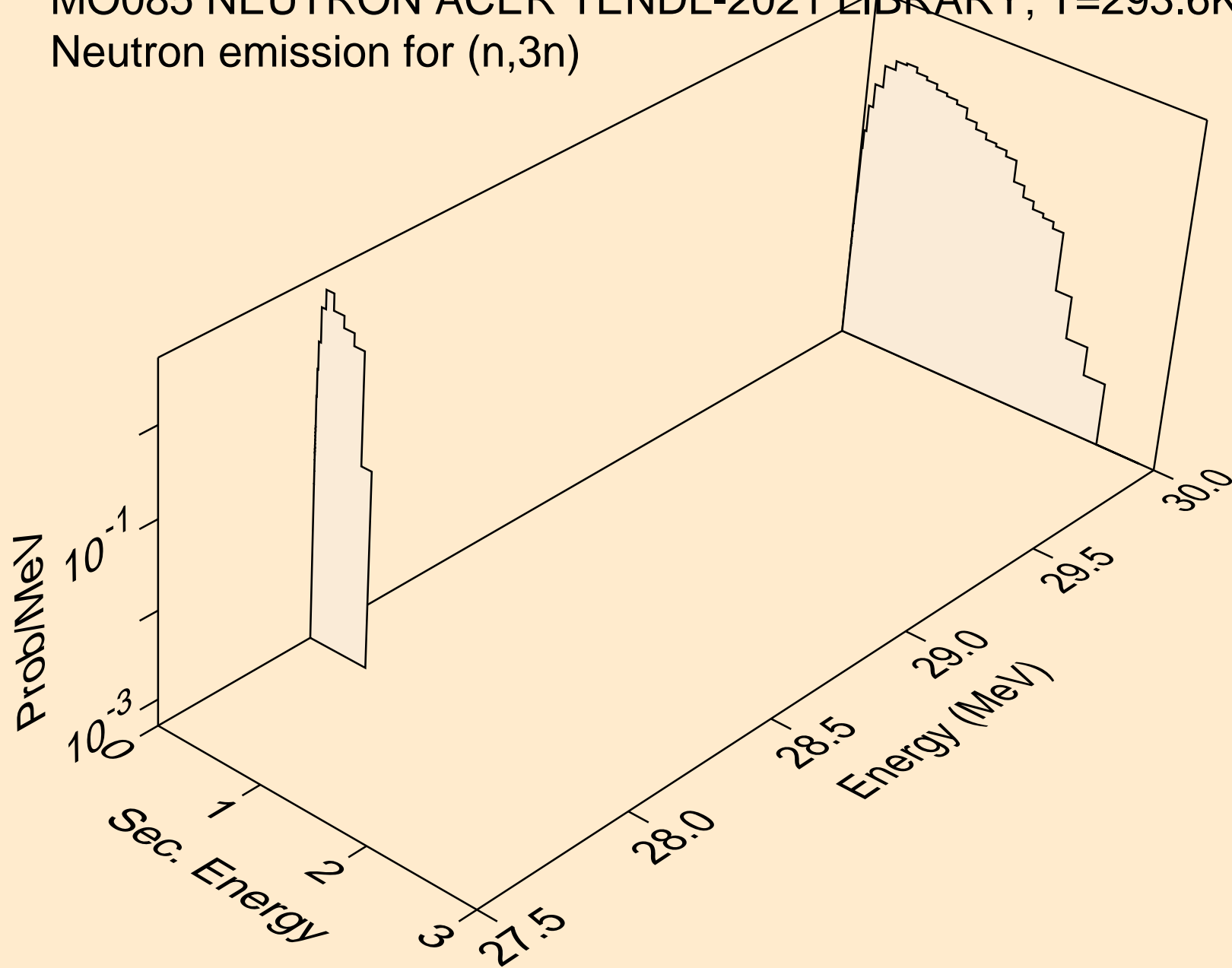

MO085 NEUTRON ACER TENDL-2021 LIBRARY; T=293.6K
Neutron emission for (n,n*)a

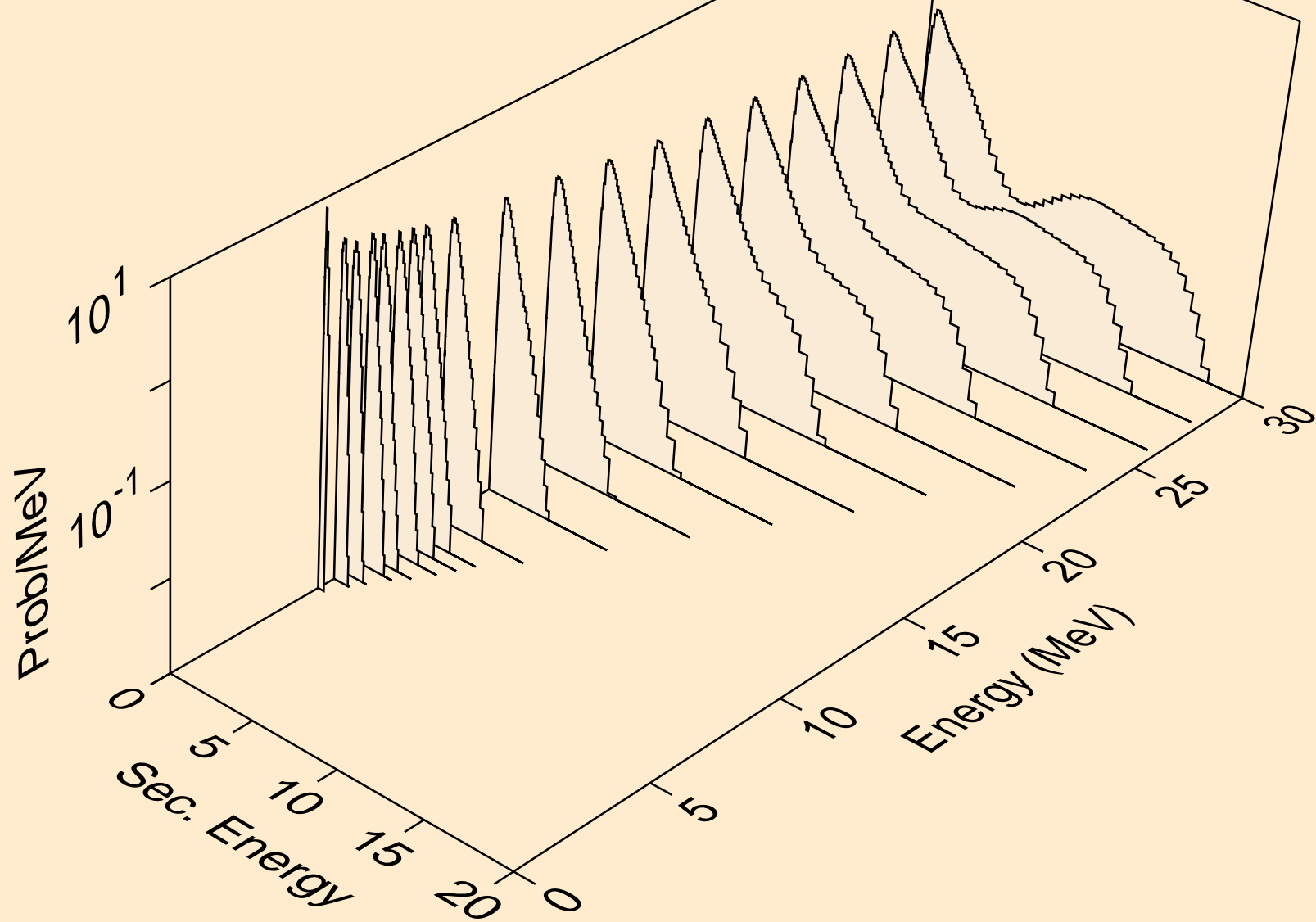

MO085 NEUTRON ACER TENDL-2021 LIBRARY; T=293.6K
Neutron emission for (n,2n)a

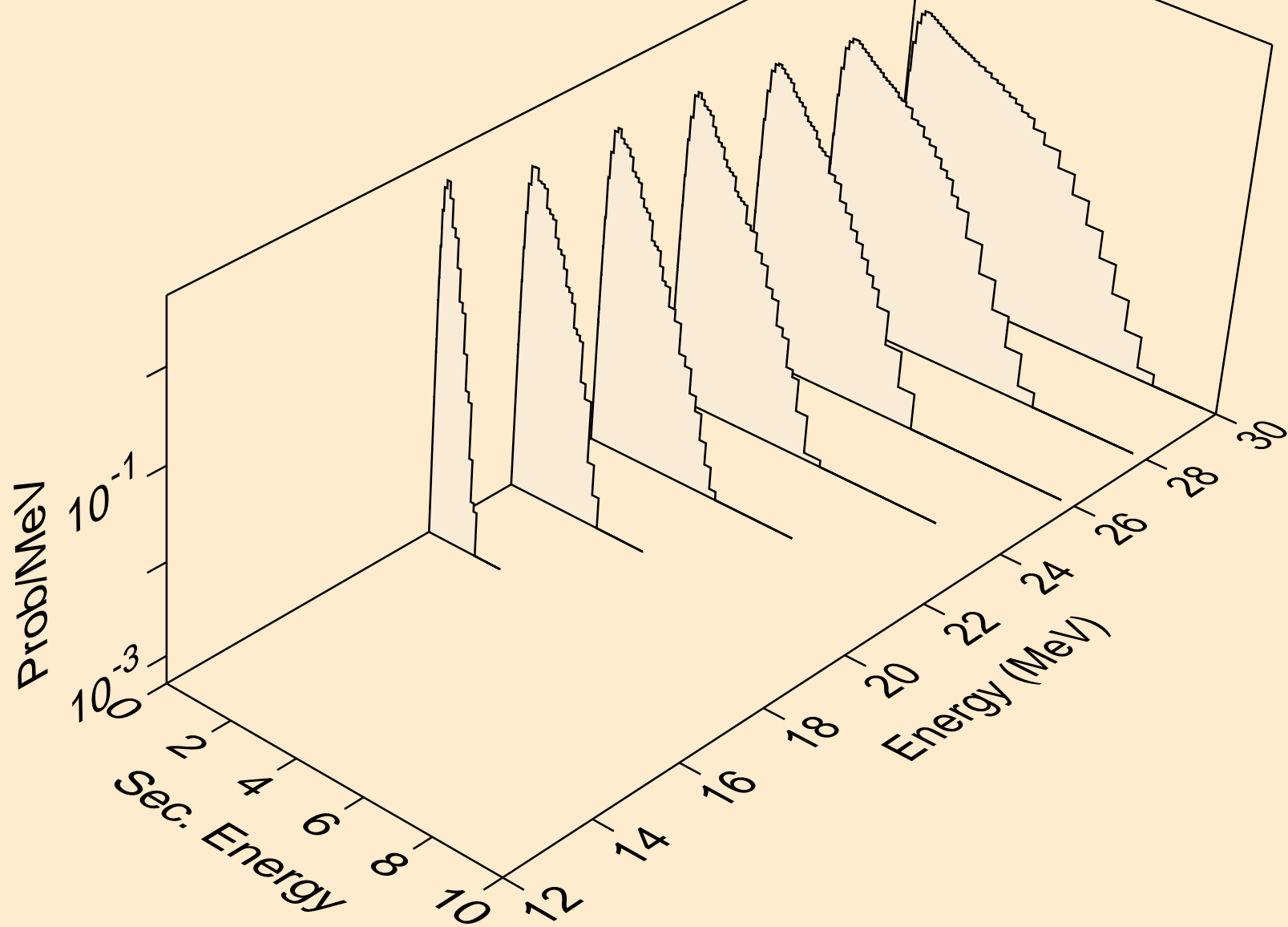

MO085 NEUTRON ACER TENDL-2021 LIBRARY; T=293.6K
Neutron emission for (n,n*)p

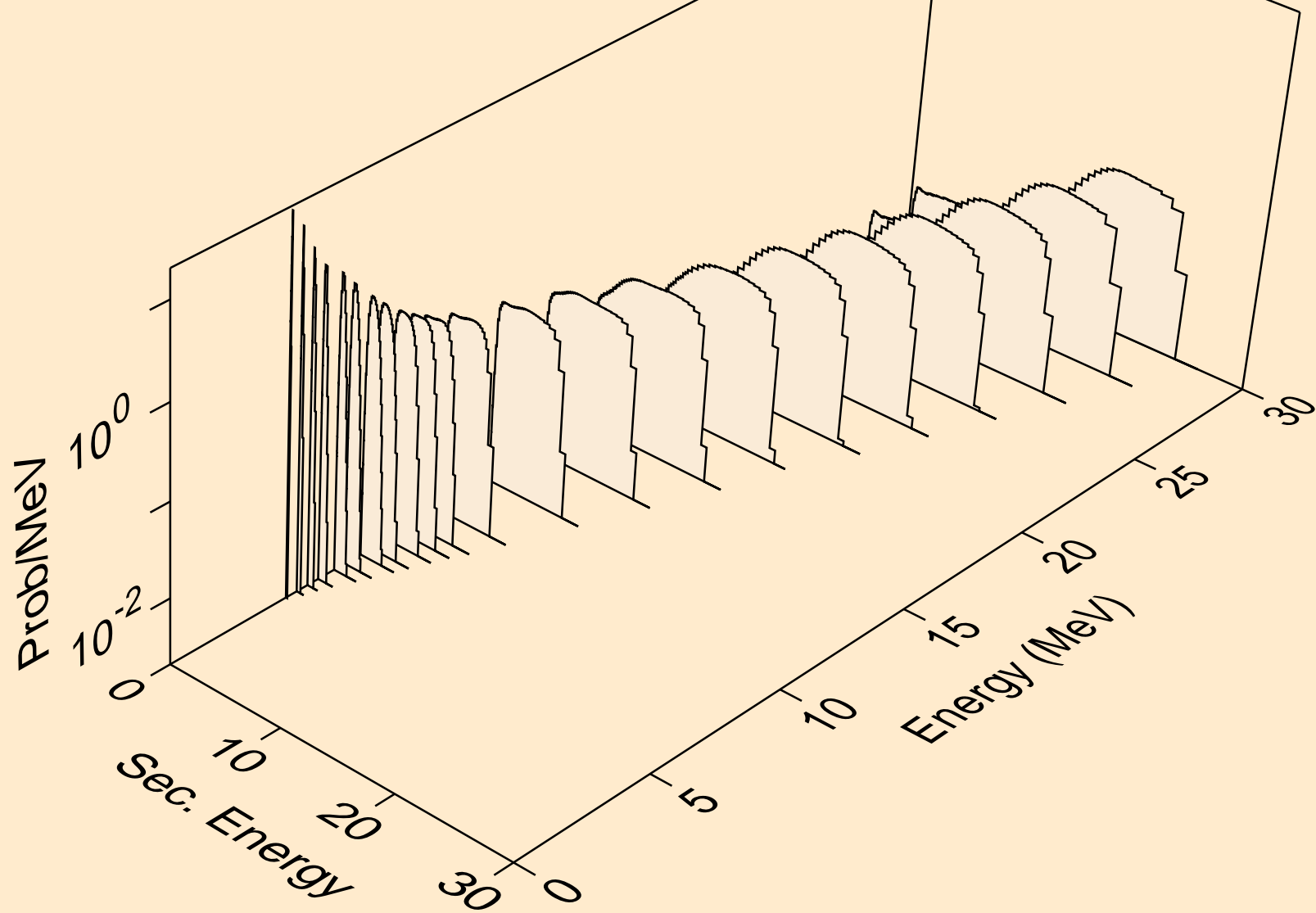

MO085 NEUTRON ACER TENDL-2021 LIBRARY; T=293.6K
Neutron emission for (n,n*)2a

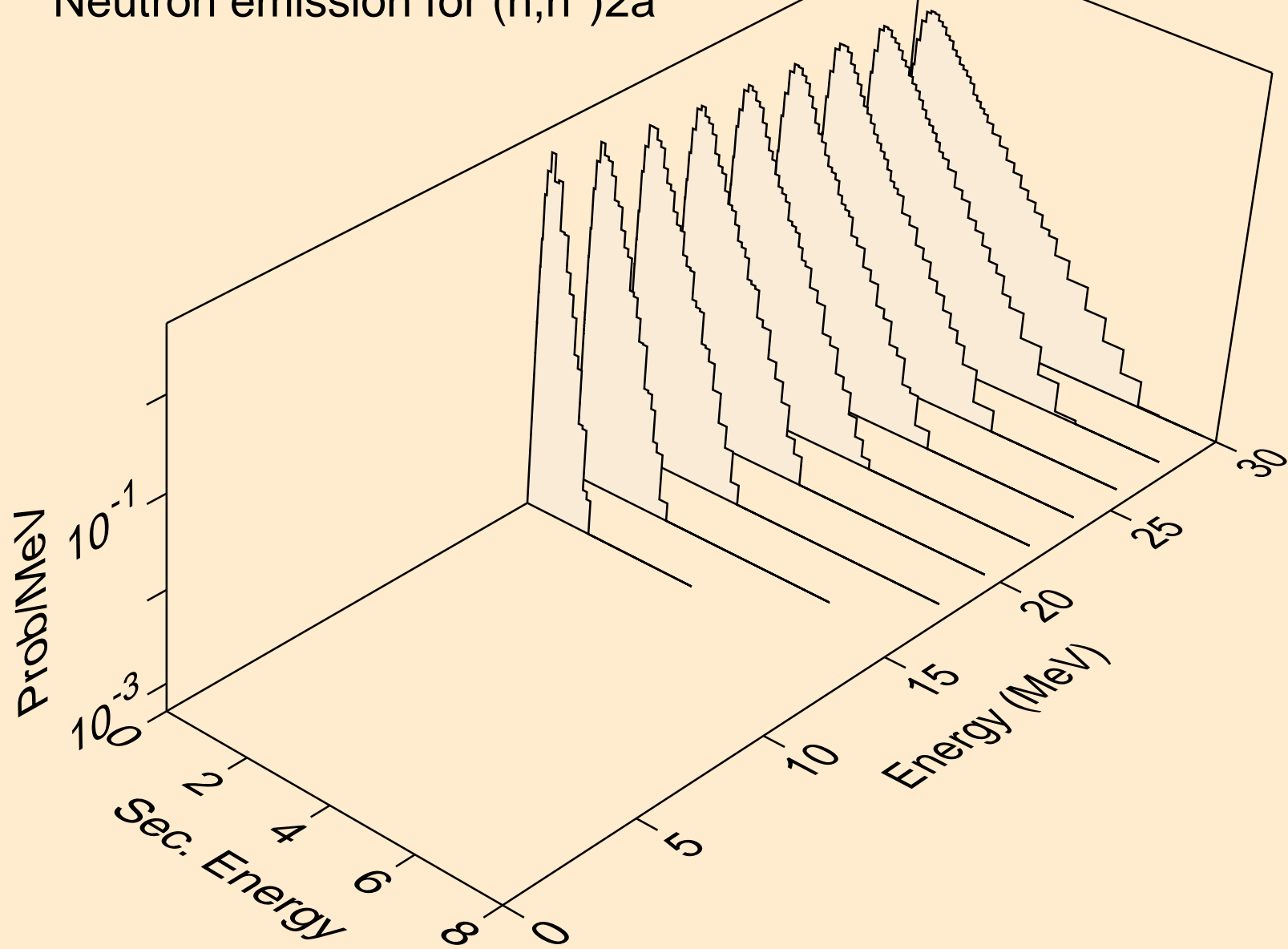

MO085 NEUTRON ACER TENDL-2021 LIBRARY; T=293.6K
Neutron emission for (n,n*)d

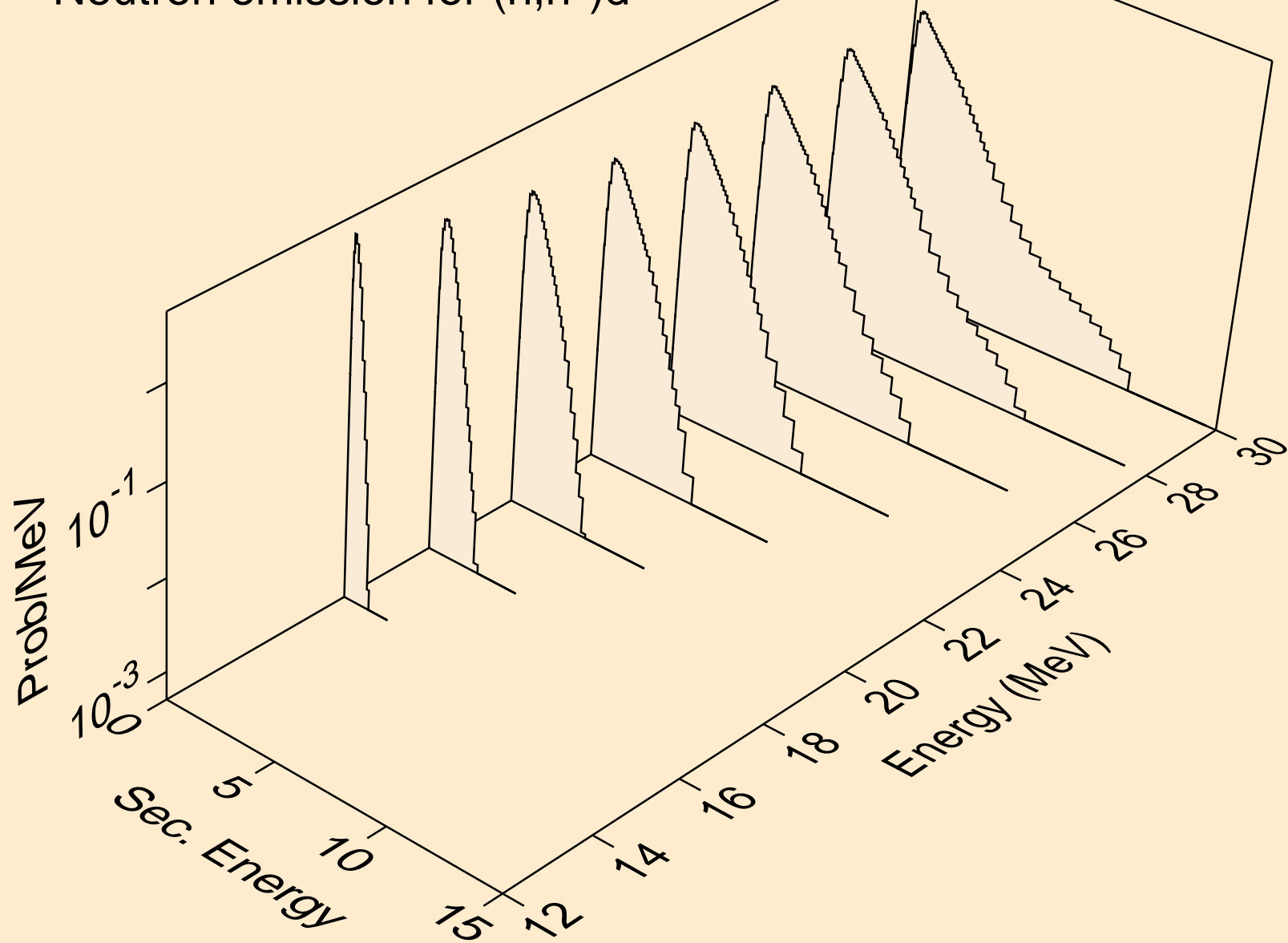

MO085 NEUTRON ACER TENDL-2021 LIBRARY; T=293.6K
Neutron emission for (n,n*)t

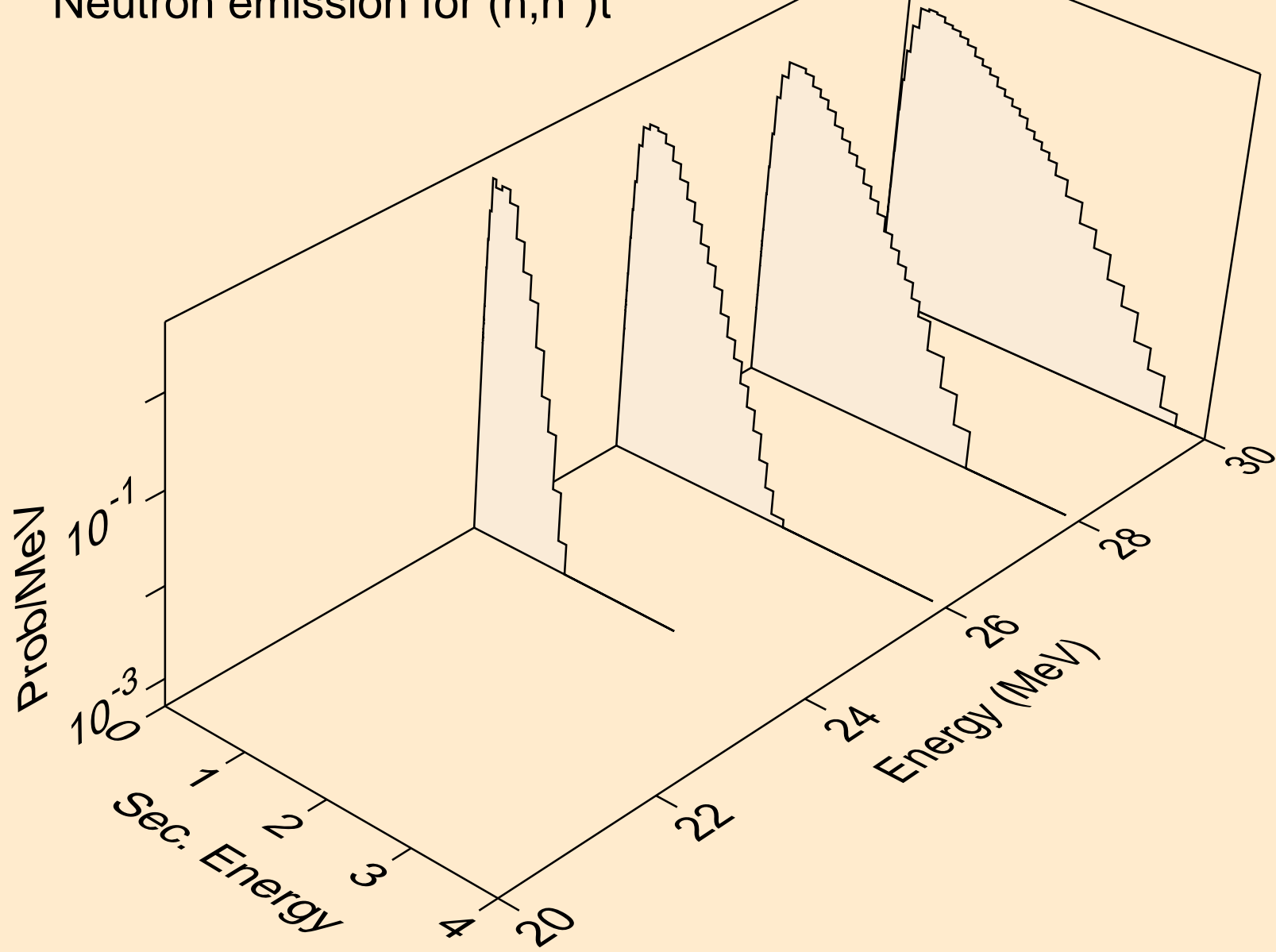

MO085 NEUTRON ACER TENDL-2021 LIBRARY; T=293.6K
Neutron emission for (n,n*)he3

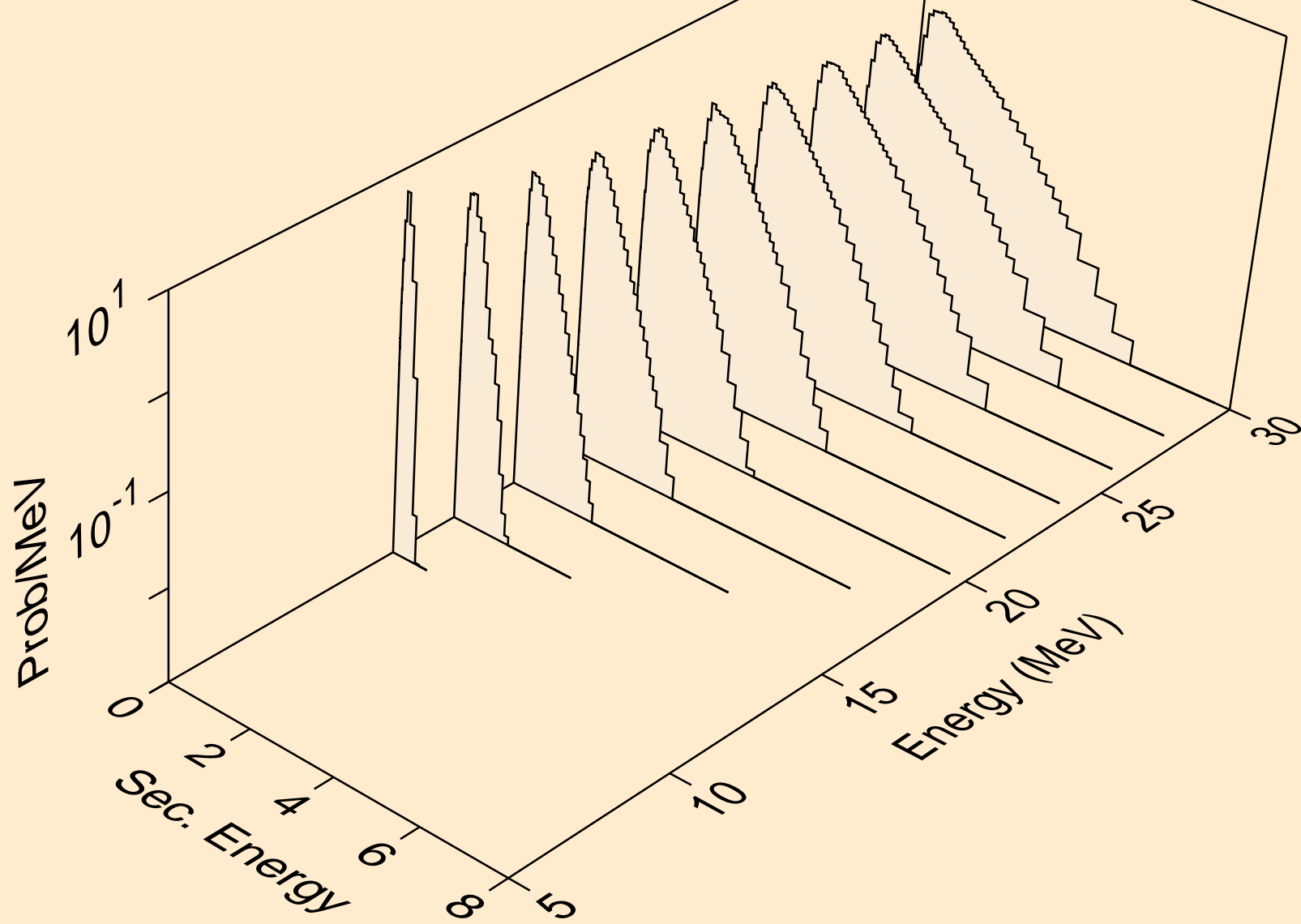

MO085 NEUTRON ACER TENDL-2021 LIBRARY; T=293.6K
Neutron emission for (n,2np)

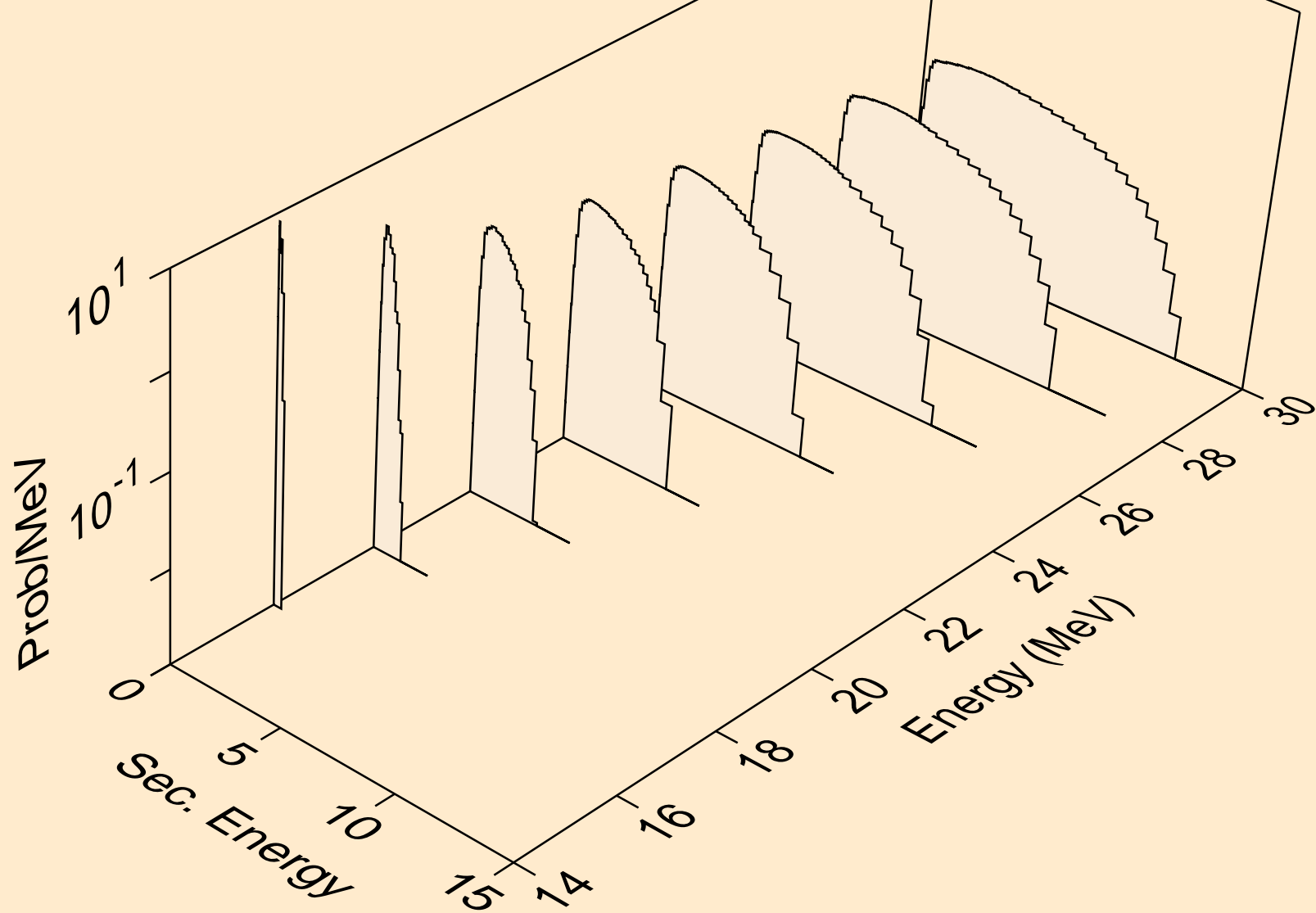

MO085 NEUTRON ACER TENDL-2021 LIBRARY; T=293.6K
Neutron emission for (n,2np)

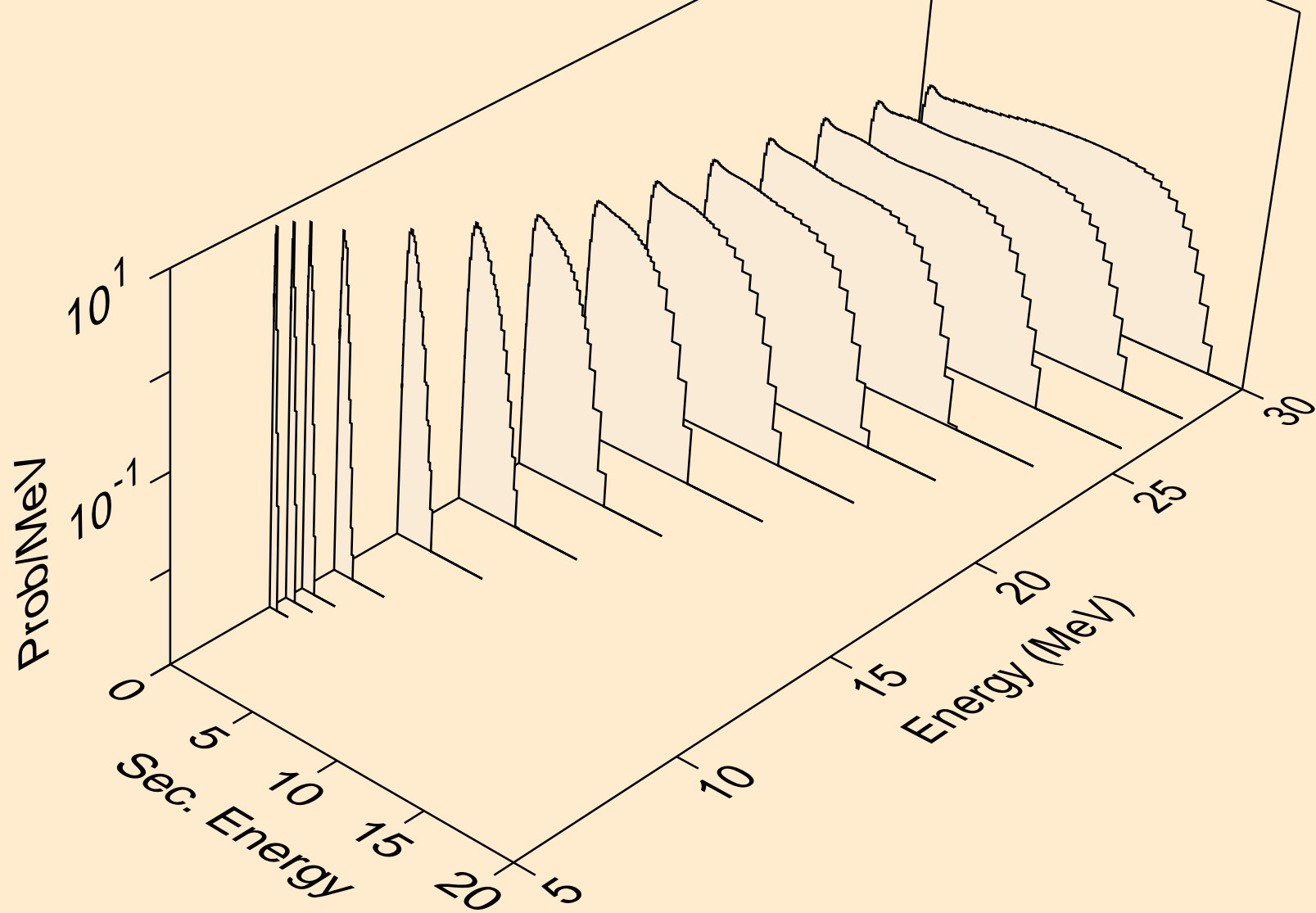

MO085 NEUTRON ACER TENDL-2021 LIBRARY; T=293.6K
Neutron emission for (n,npa)

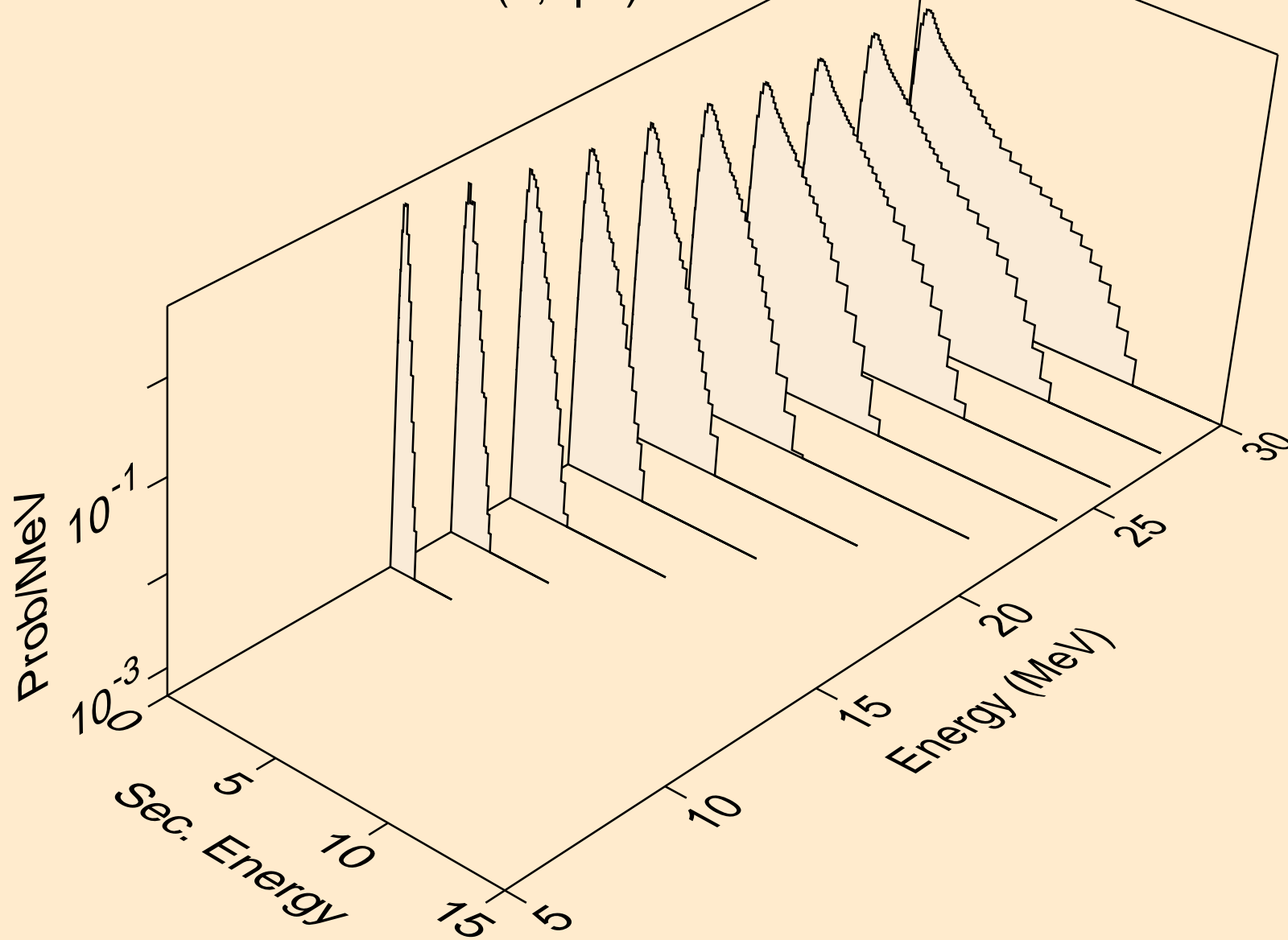

MO085 NEUTRON ACER TENDL-2021 LIBRARY; T=293.6K
Neutron emission for (n,n*c)

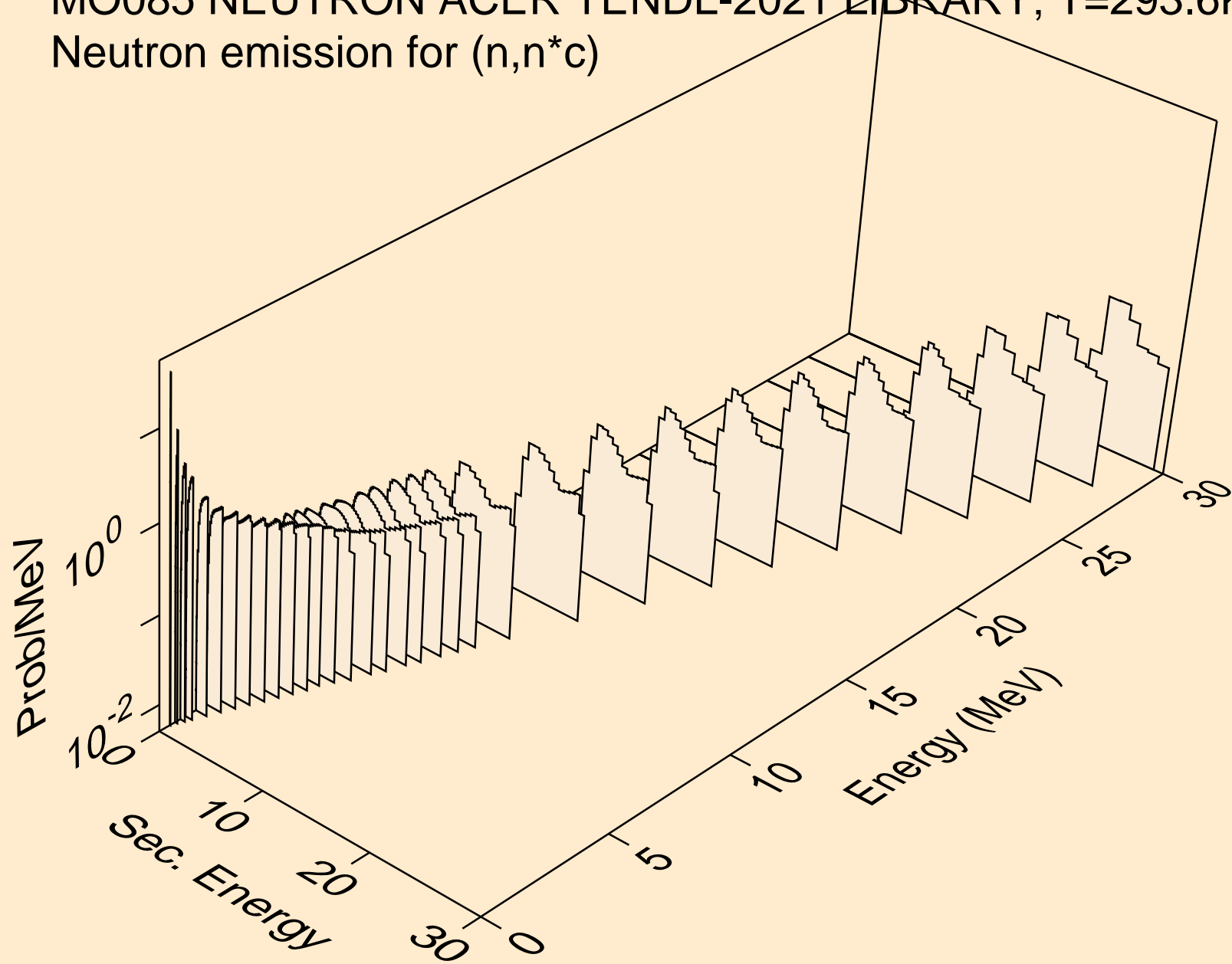

MO085 NEUTRON ACER TENDL-2021 LIBRARY; T=293.6K
Photon emission for (n,x)

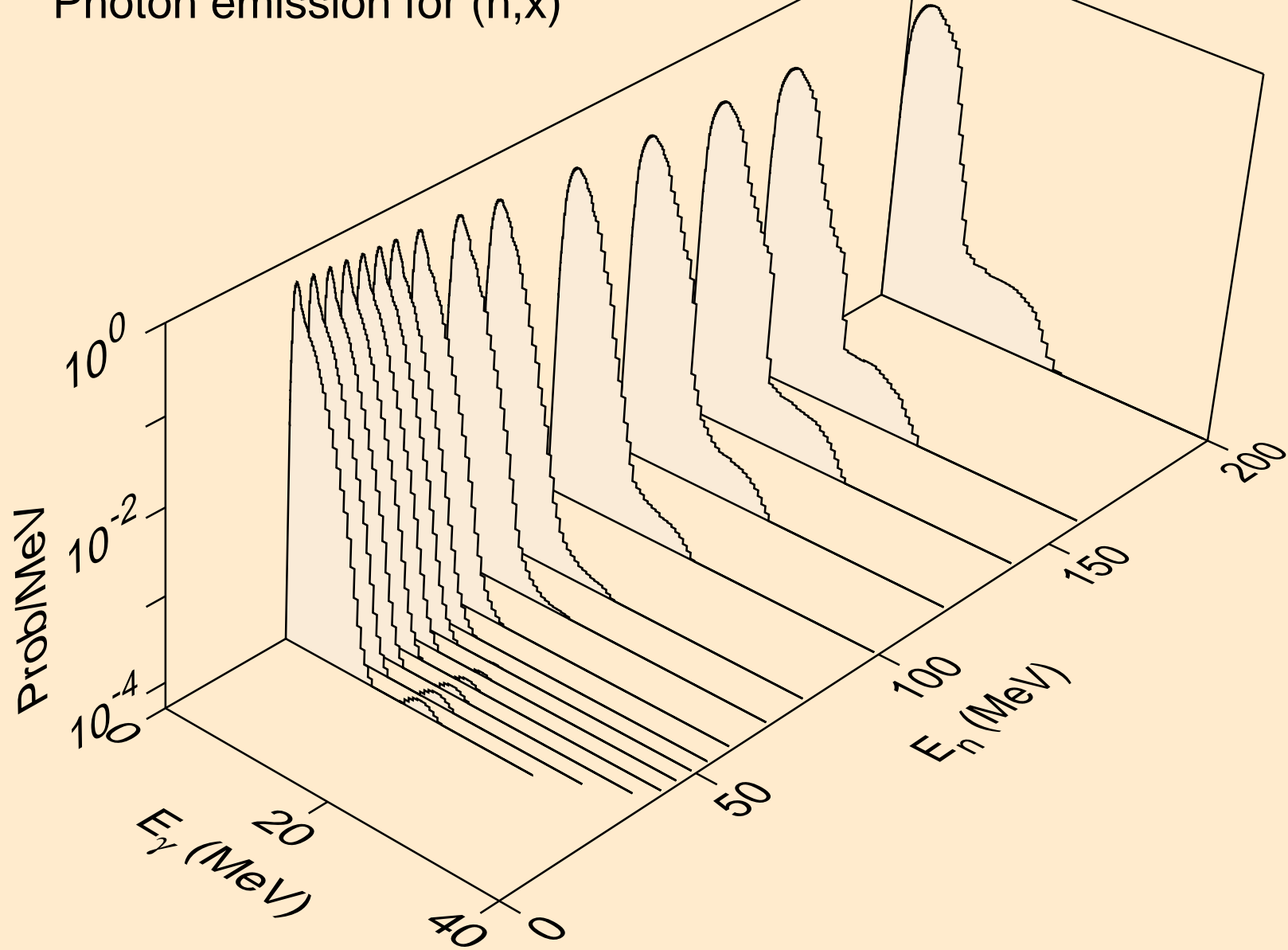

MO085 NEUTRON ACER TENDL-2021 LIBRARY; T=293.6K
Photon emission for (n,2n)

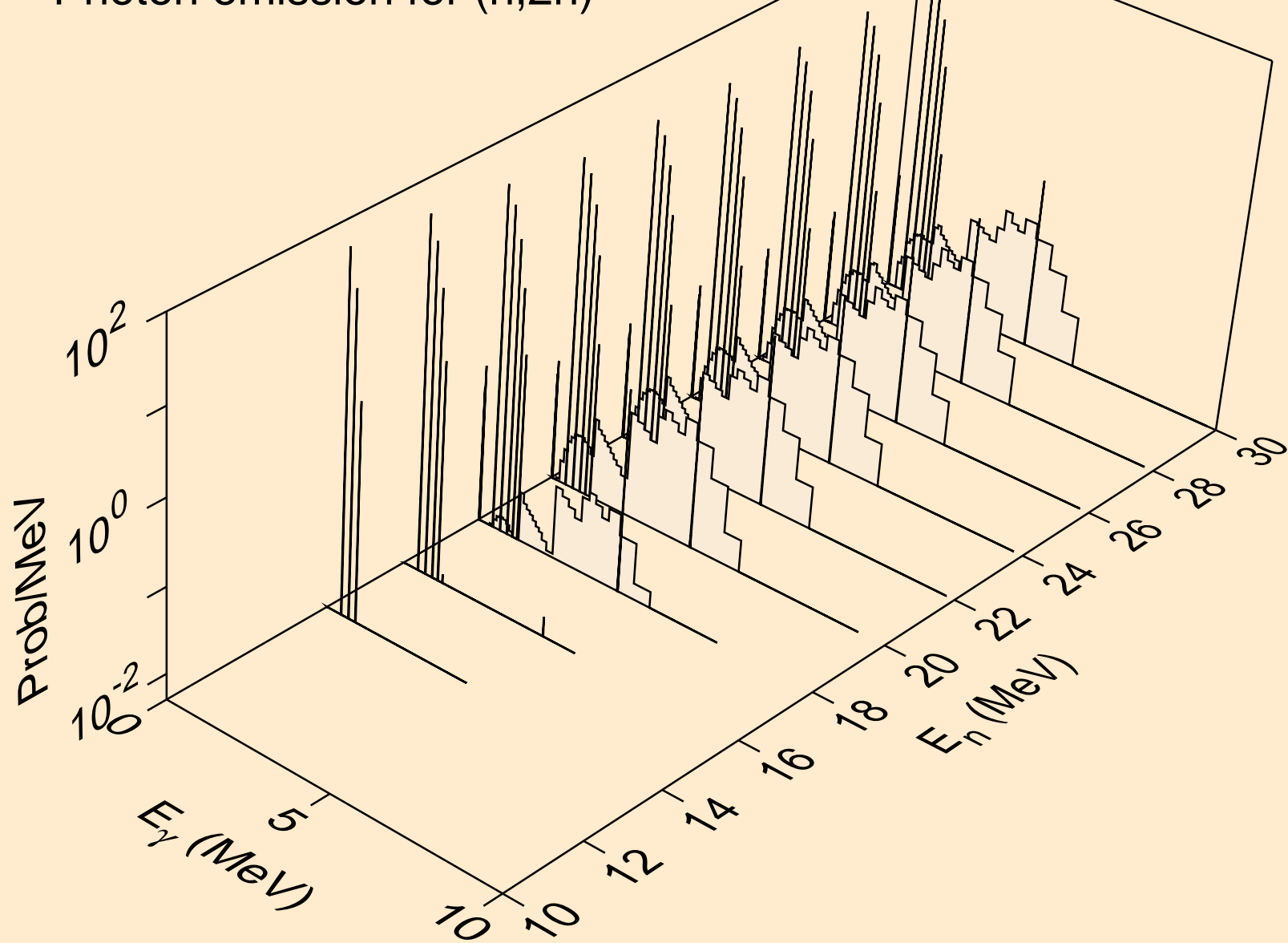

MO085 NEUTRON ACER TENDL-2021 LIBRARY; T=293.6K
Photon emission for (n,3n)

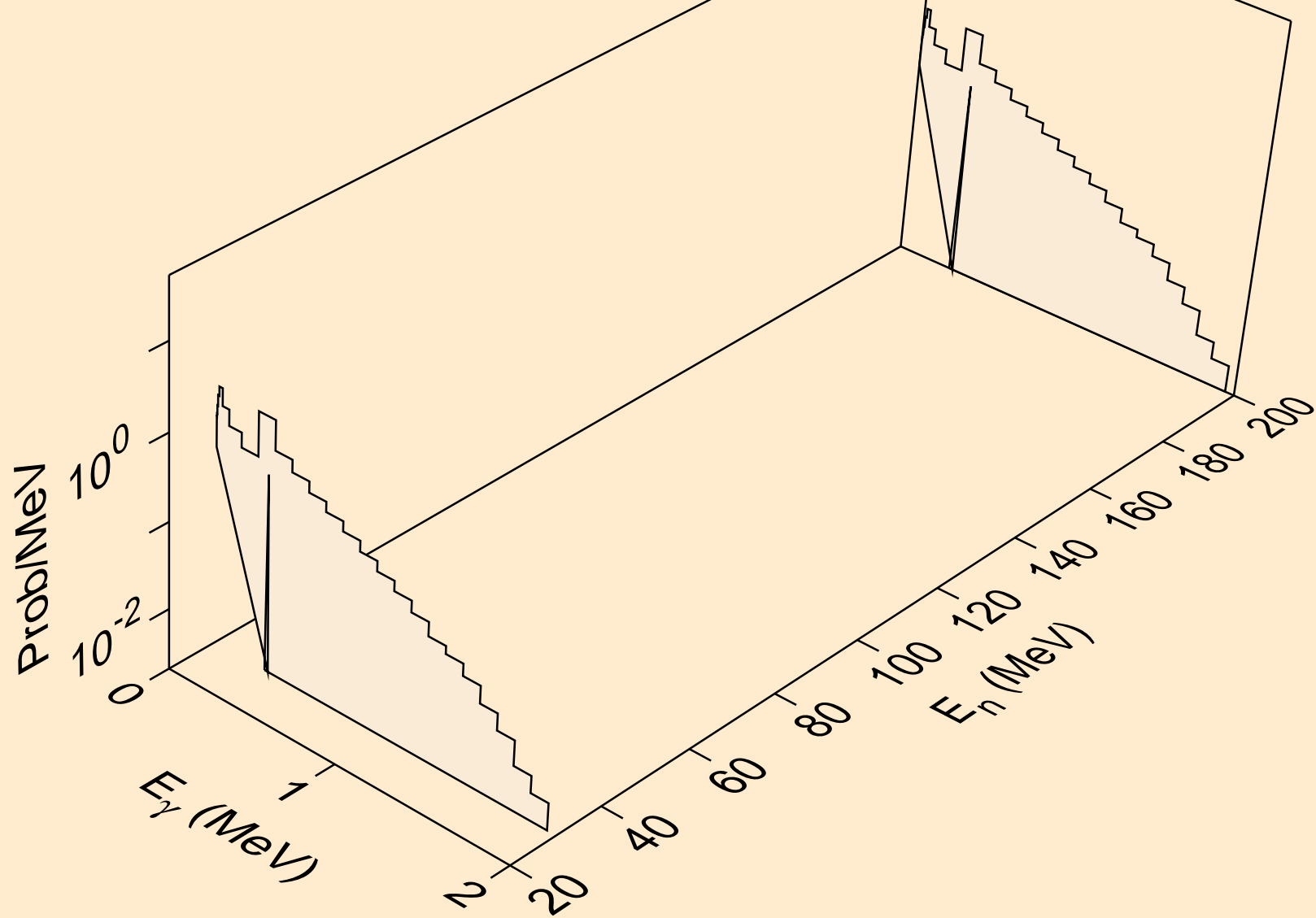

MO085 NEUTRON ACER TENDL-2021 LIBRARY; T=293.6K
Photon emission for (n,n*)a

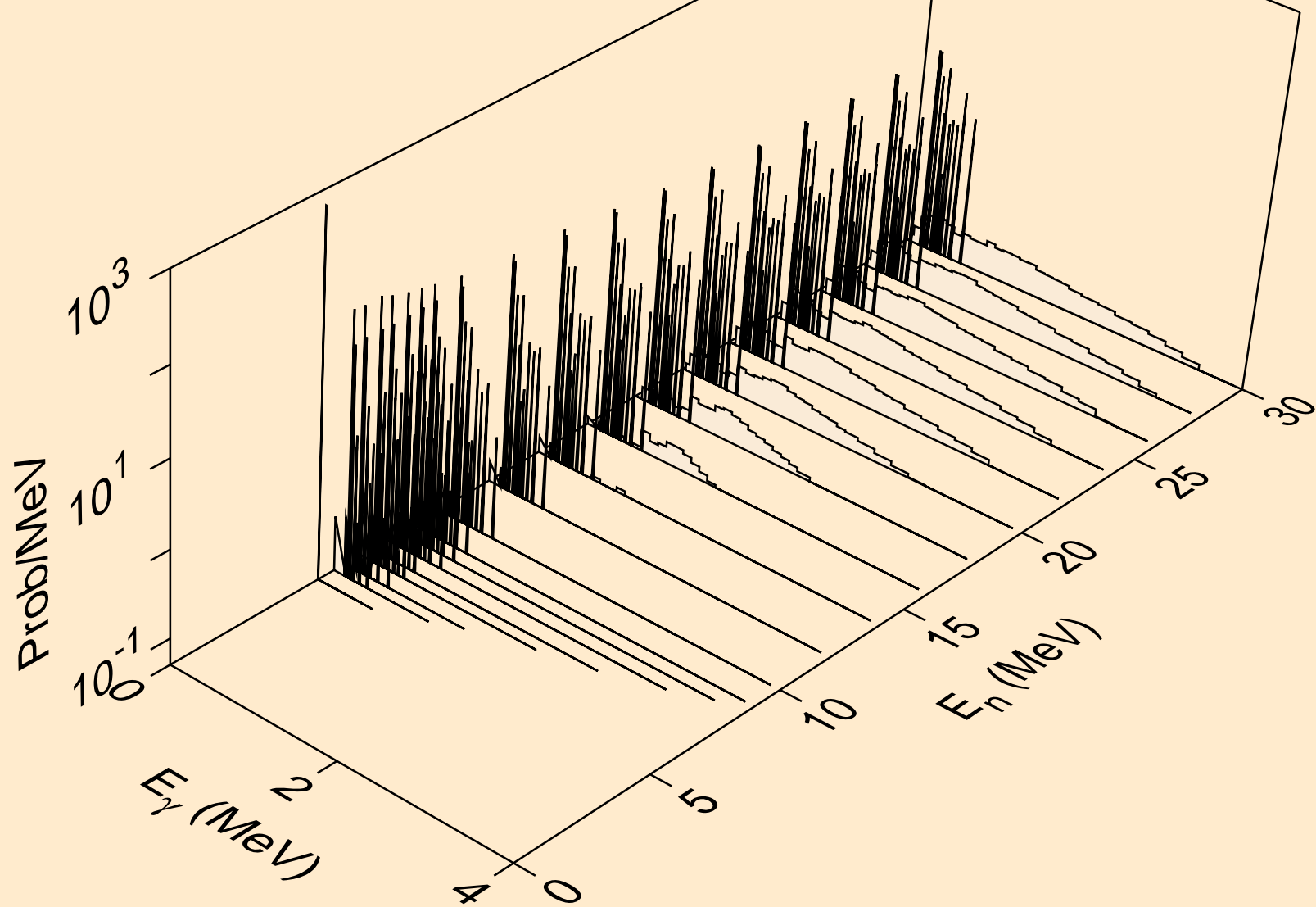

MO085 NEUTRON ACER TENDL-2021 LIBRARY; T=293.6K
Photon emission for (n,2n)a

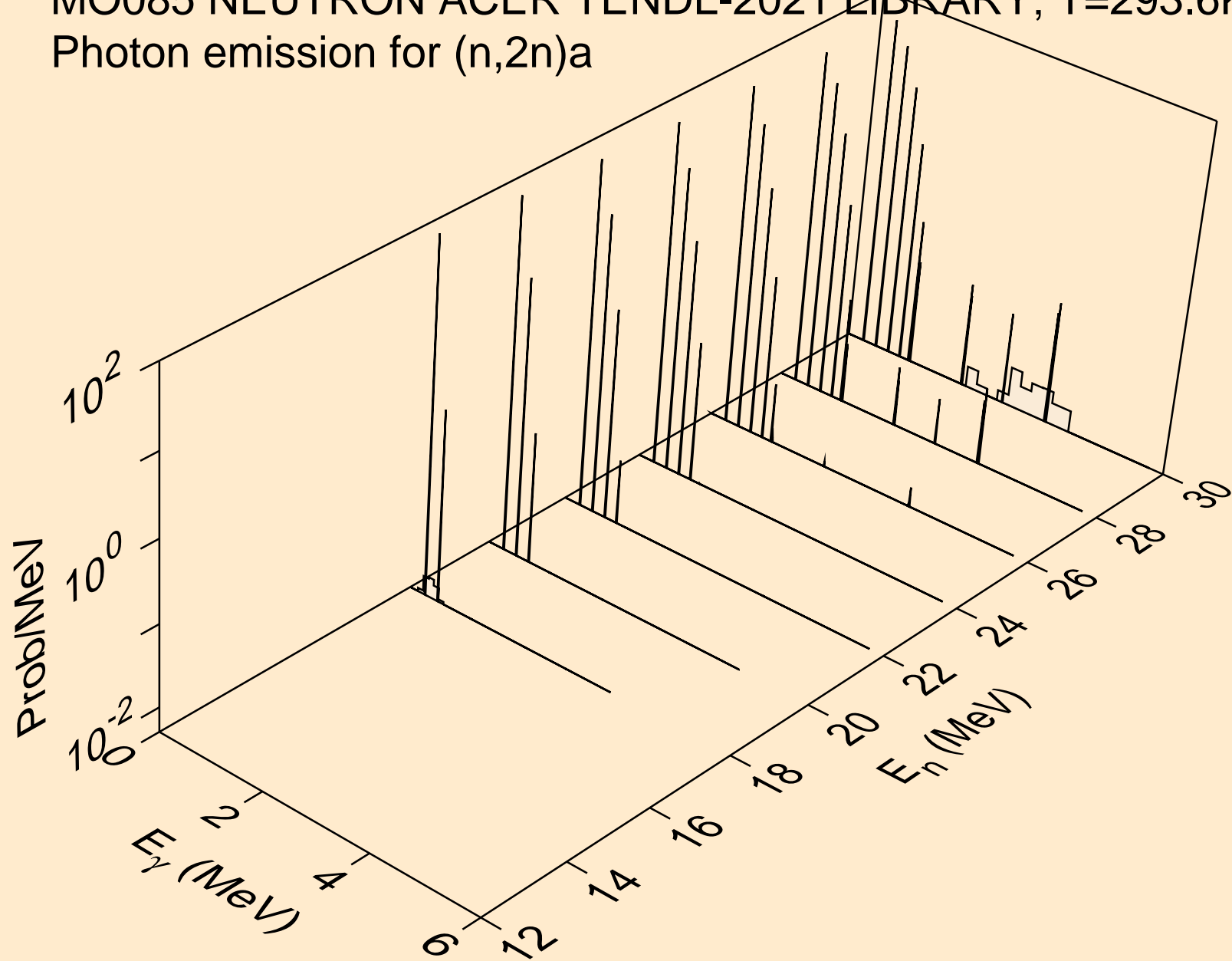

MO085 NEUTRON ACER TENDL-2021 LIBRARY; T=293.6K
Photon emission for (n,n*)p

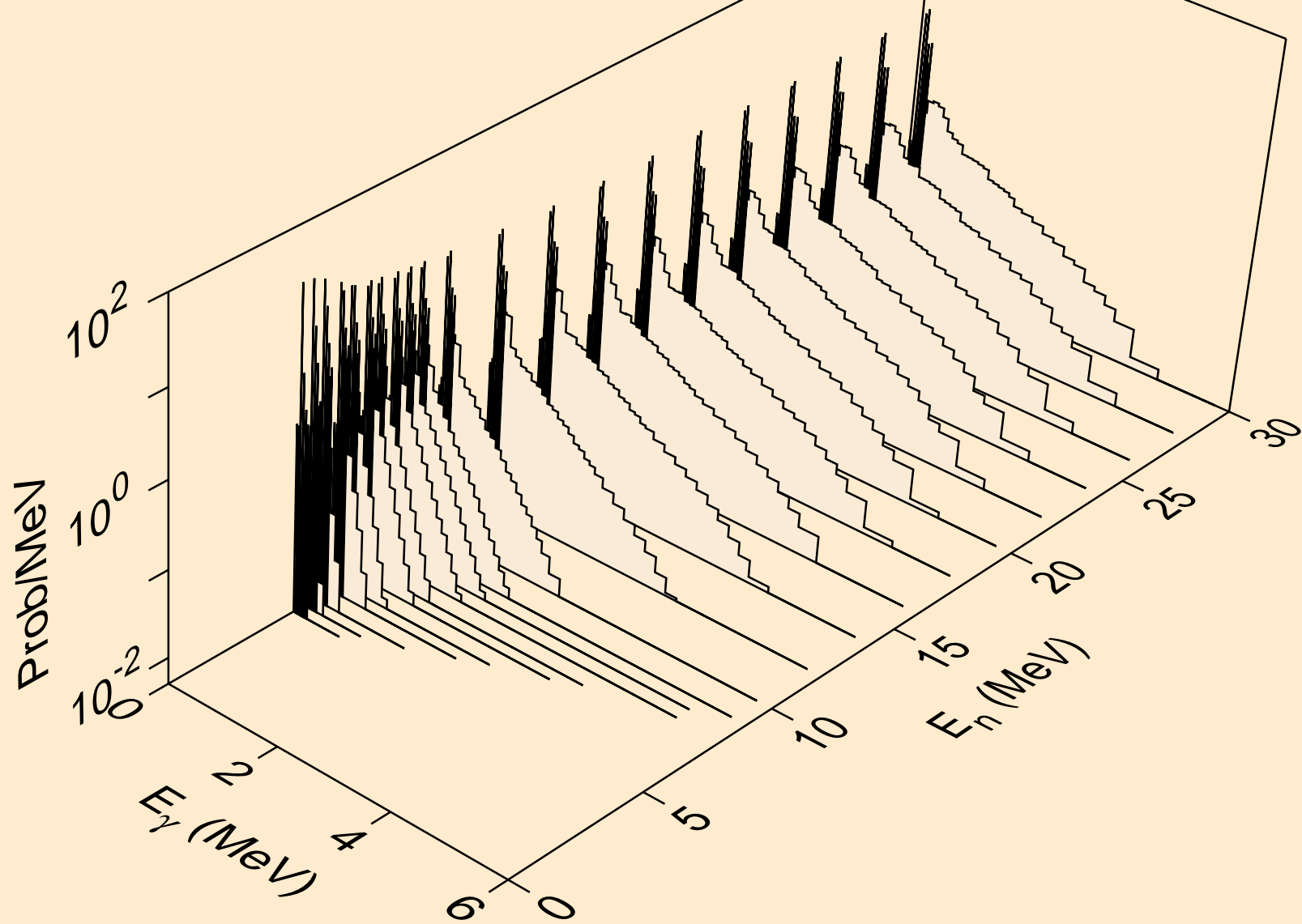

MO085 NEUTRON ACER TENDL-2021 LIBRARY; T=293.6K
Photon emission for (n,n*)2a

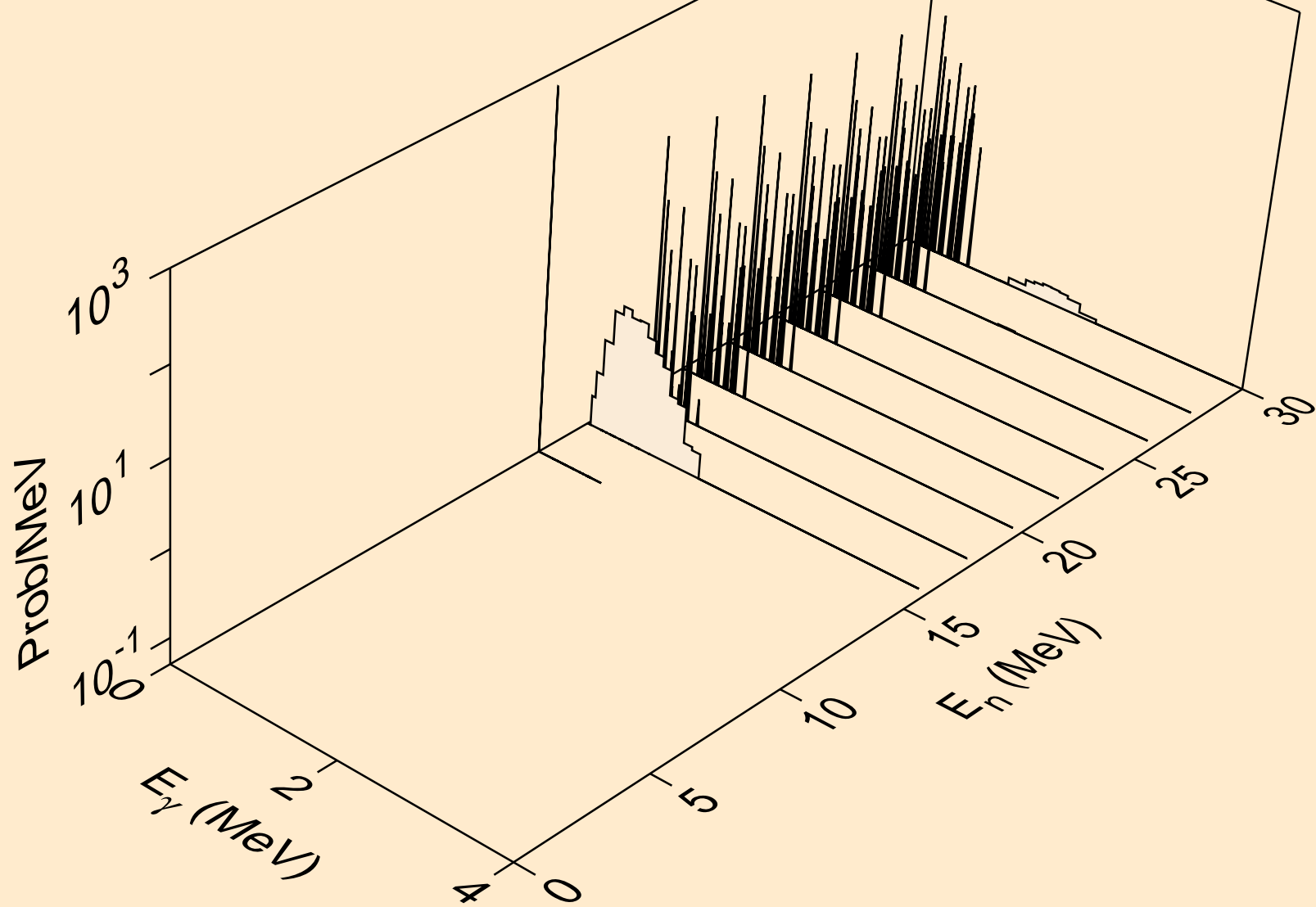

MO085 NEUTRON ACER TENDL-2021 LIBRARY; T=293.6K
Photon emission for (n,n*)d

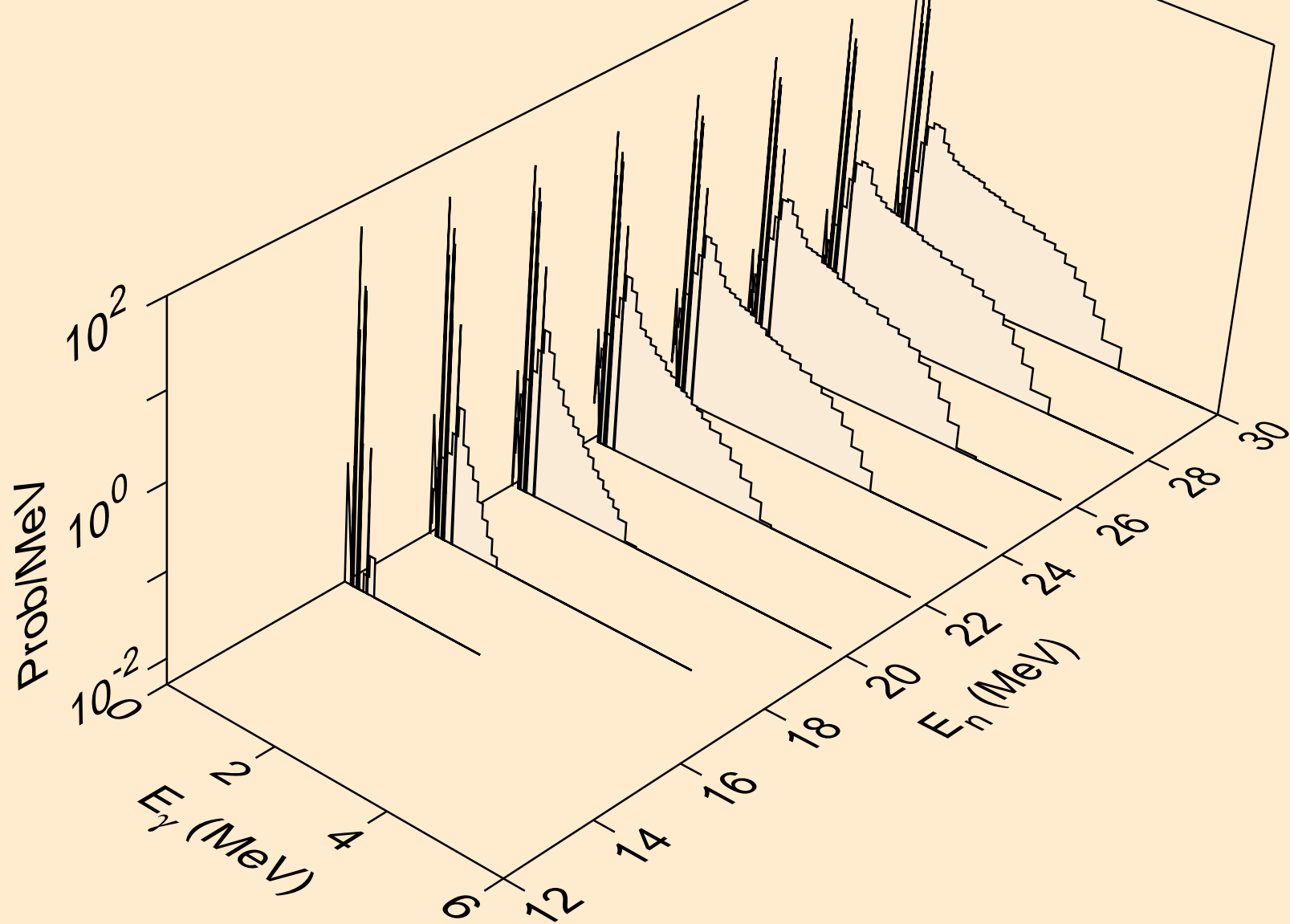

MO085 NEUTRON ACER TENDL-2021 LIBRARY; T=293.6K
Photon emission for (n,n*)t

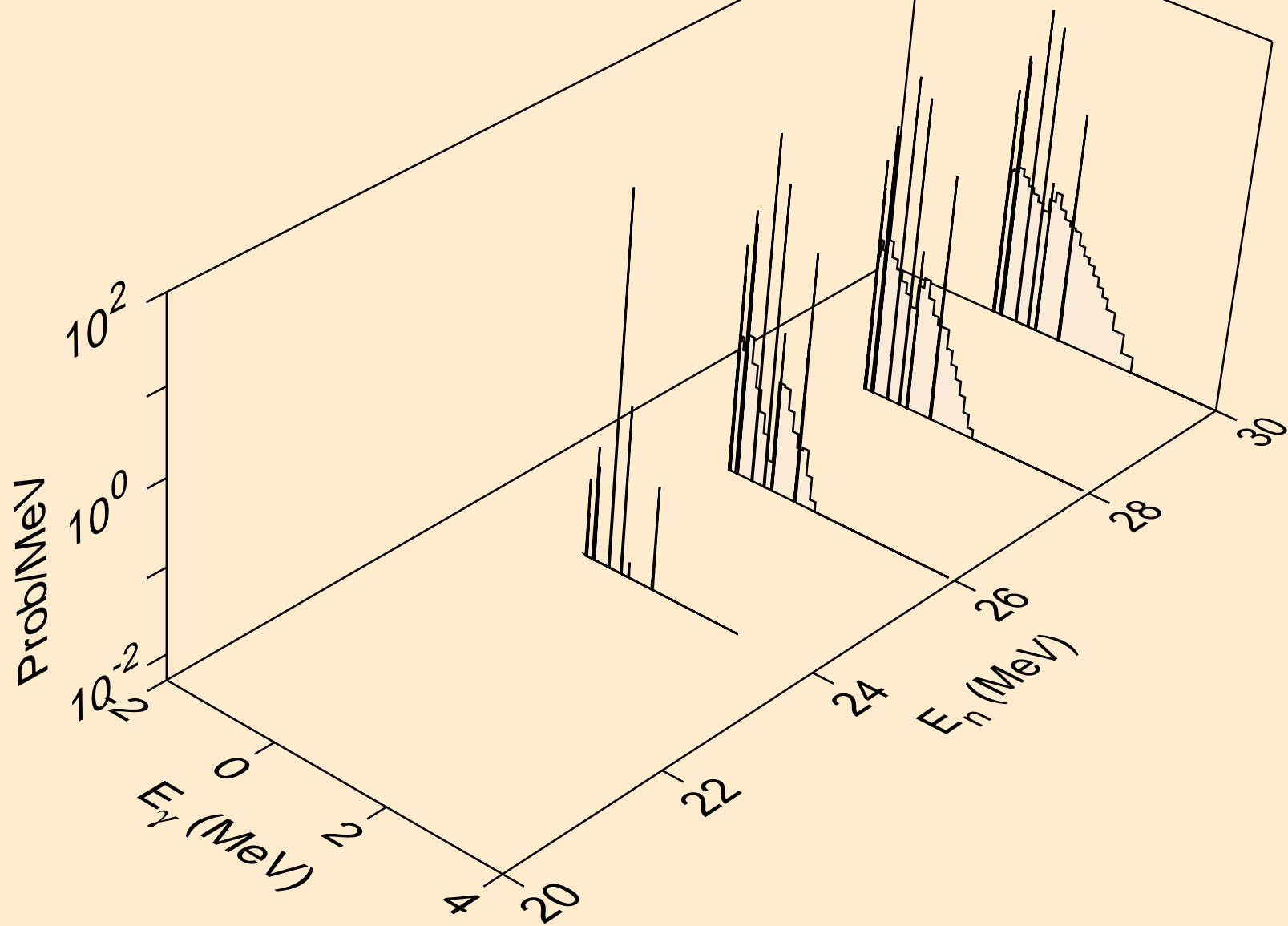

MO085 NEUTRON ACER TENDL-2021 LIBRARY; T=293.6K
Photon emission for (n,n*)he3

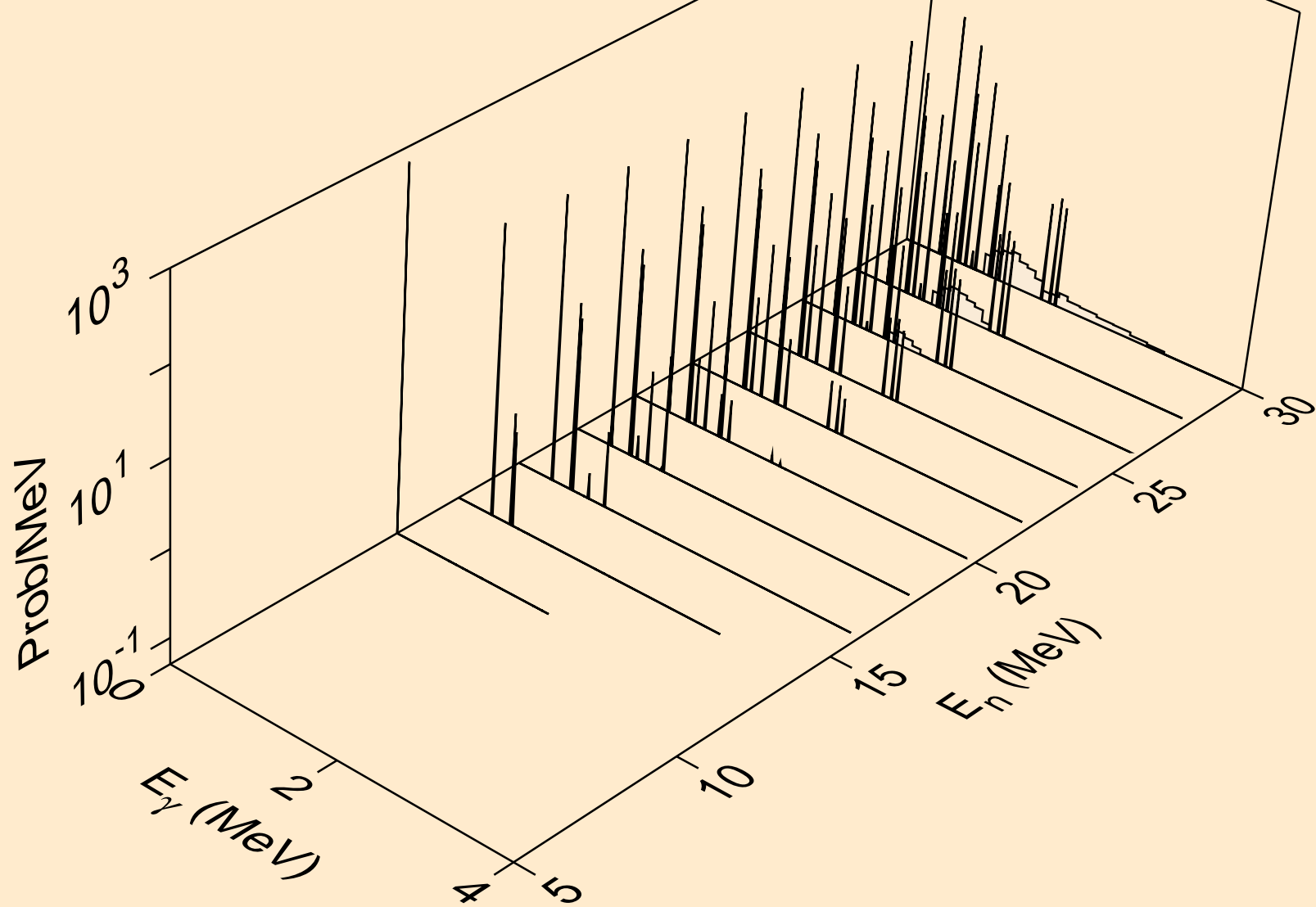

MO085 NEUTRON ACER TENDL-2021 LIBRARY; T=293.6K
Photon emission for (n,2np)

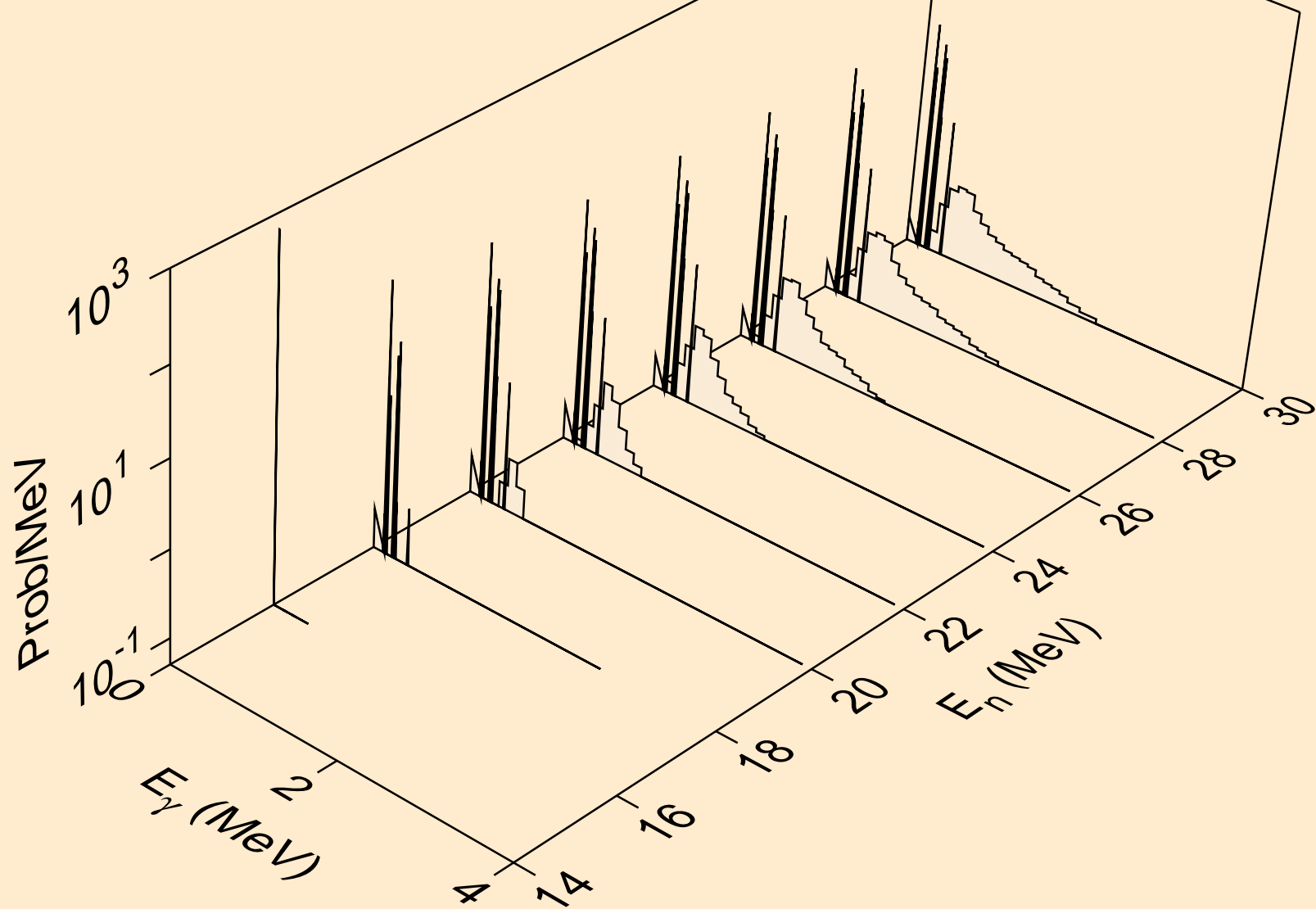

MO085 NEUTRON ACER TENDL-2021 LIBRARY; T=293.6K
Photon emission for (n,2np)

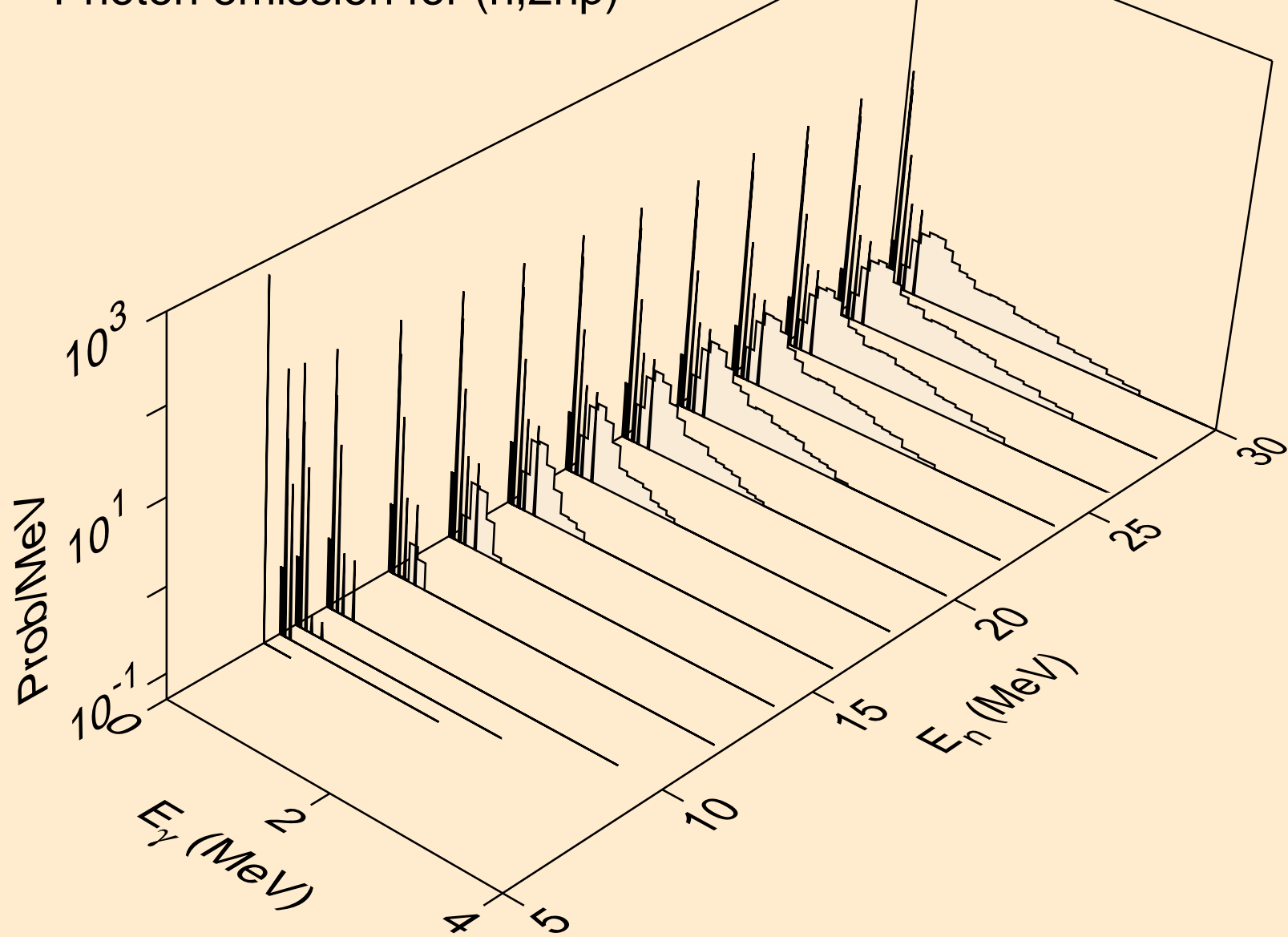

MO085 NEUTRON ACER TENDL-2021 LIBRARY; T=293.6K
Photon emission for (n,npa)

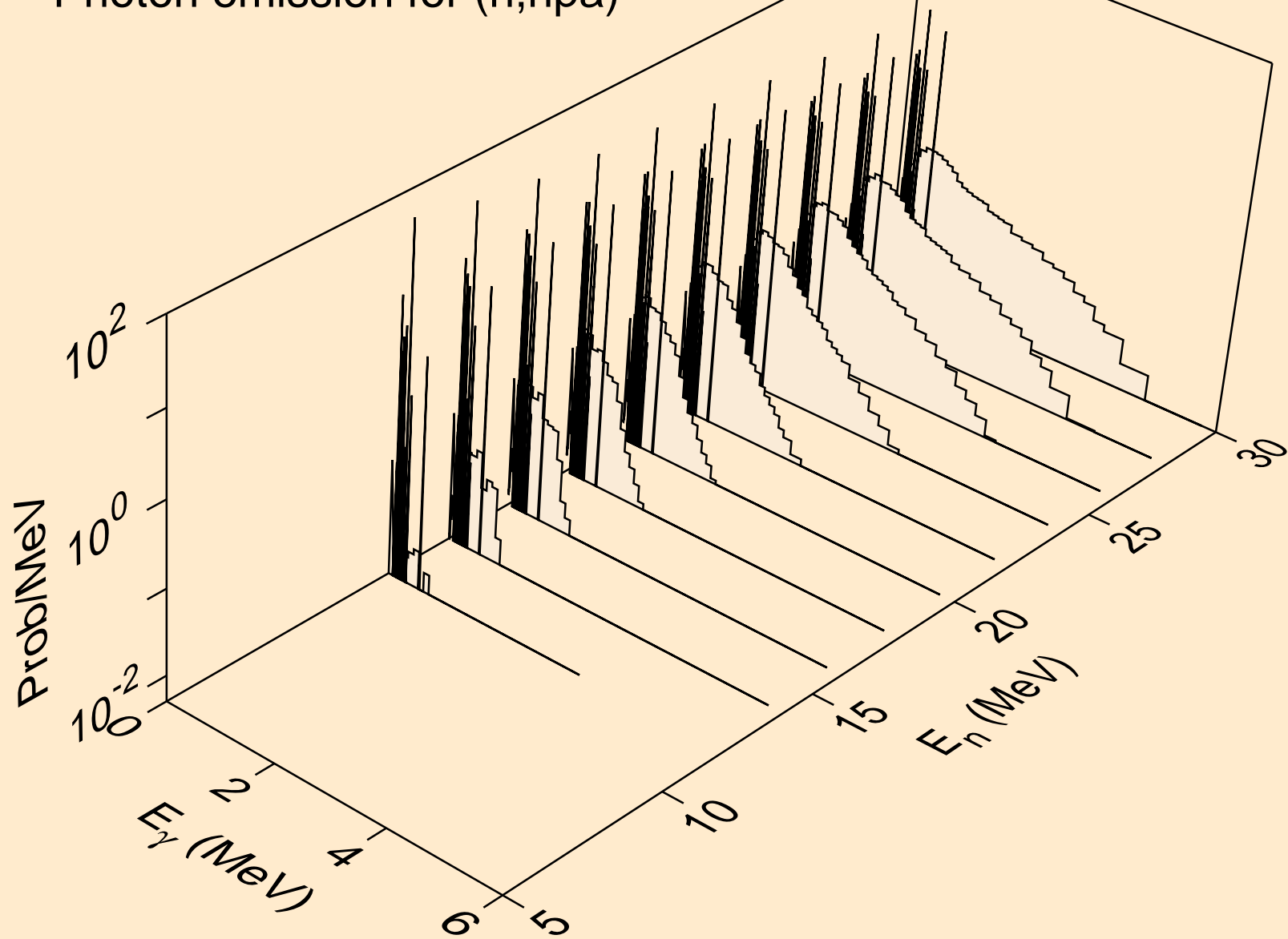

MO085 NEUTRON ACER TENDL-2021 LIBRARY; T=293.6K
Photon emission for (n,n*c)

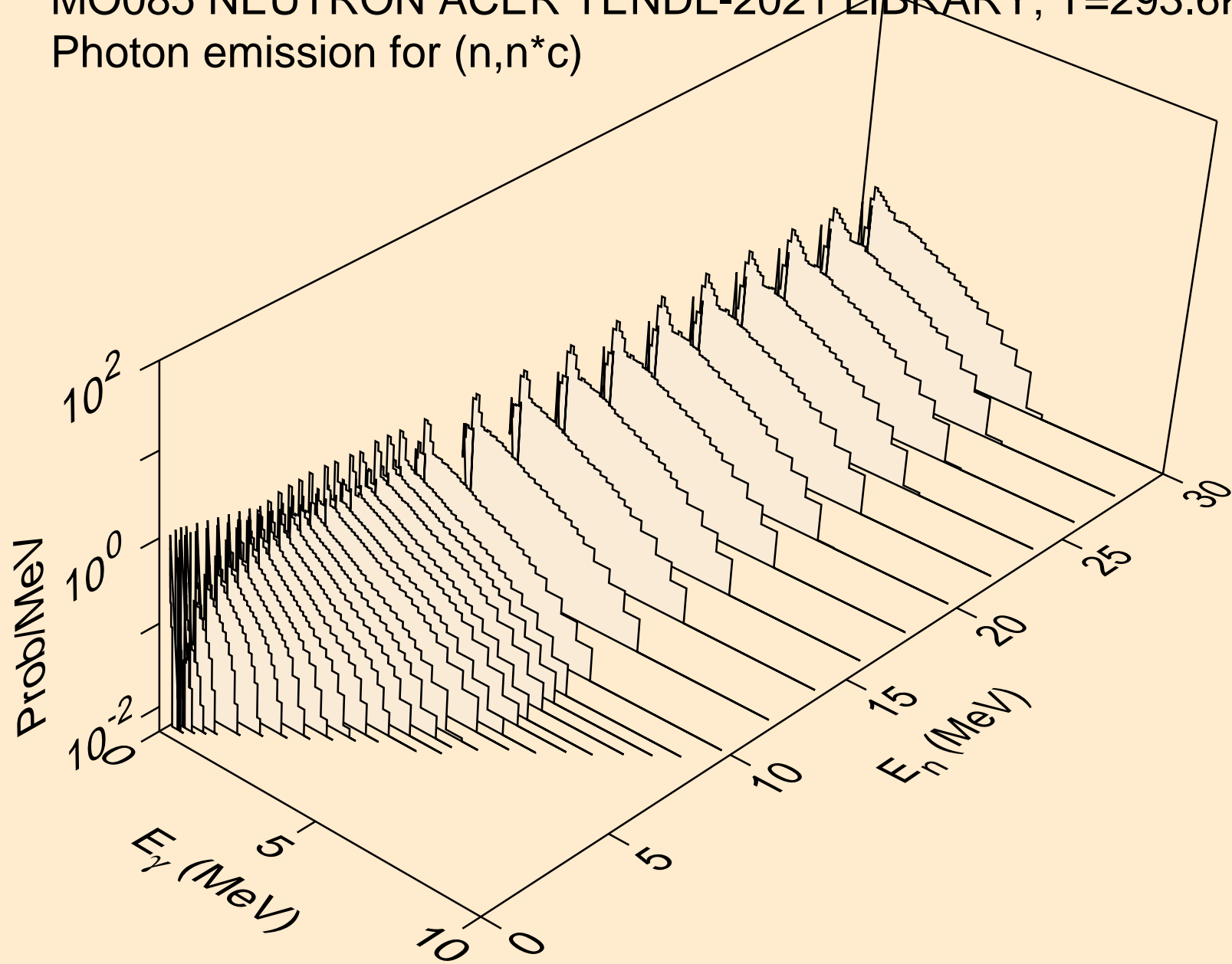

MO085 NEUTRON ACER TENDL-2021 LIBRARY; T=293.6K
Photon emission for (n,gma)

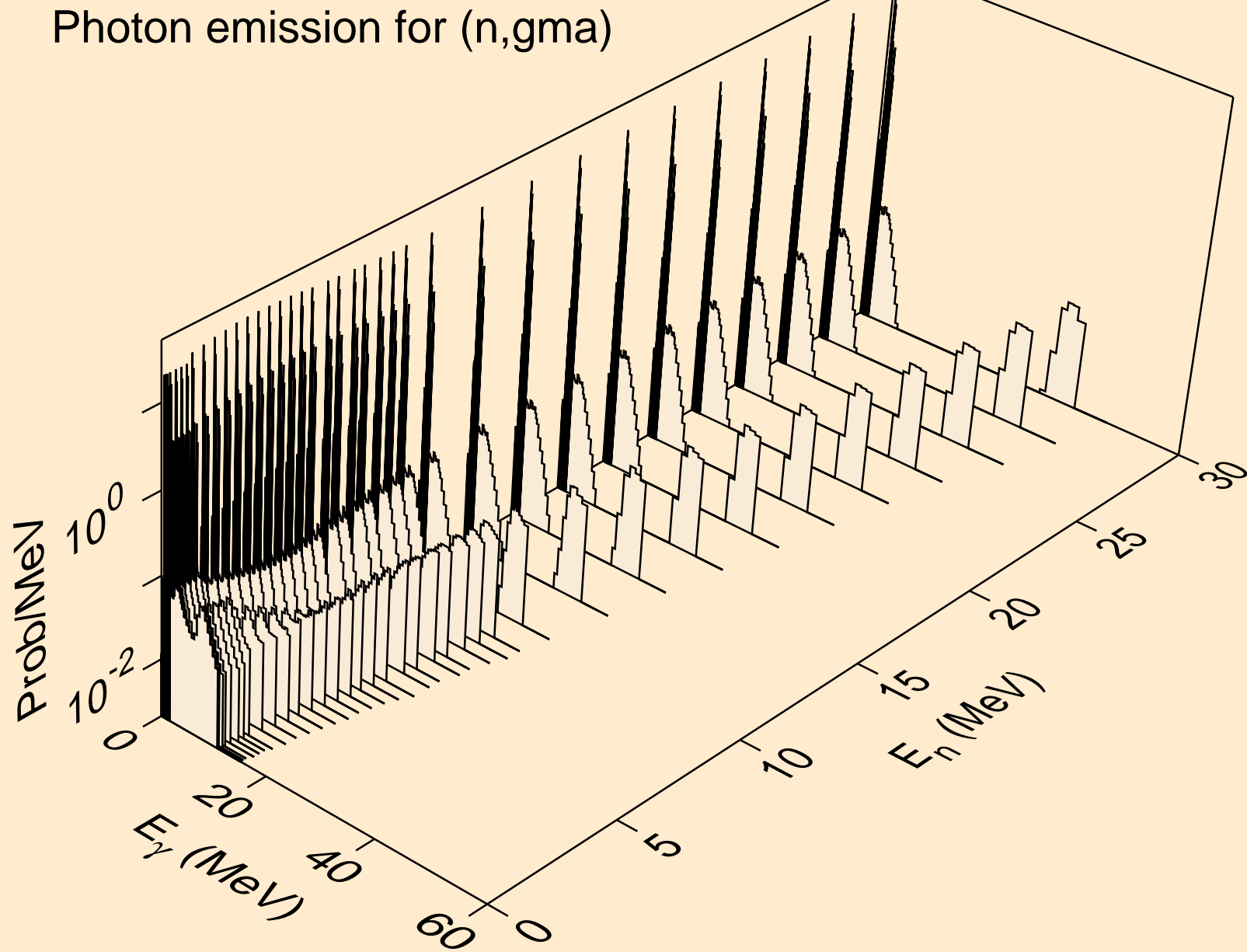

MO085 NEUTRON ACER TENDL-2021 LIBRARY; T=293.6K
Photon emission for (n,p)

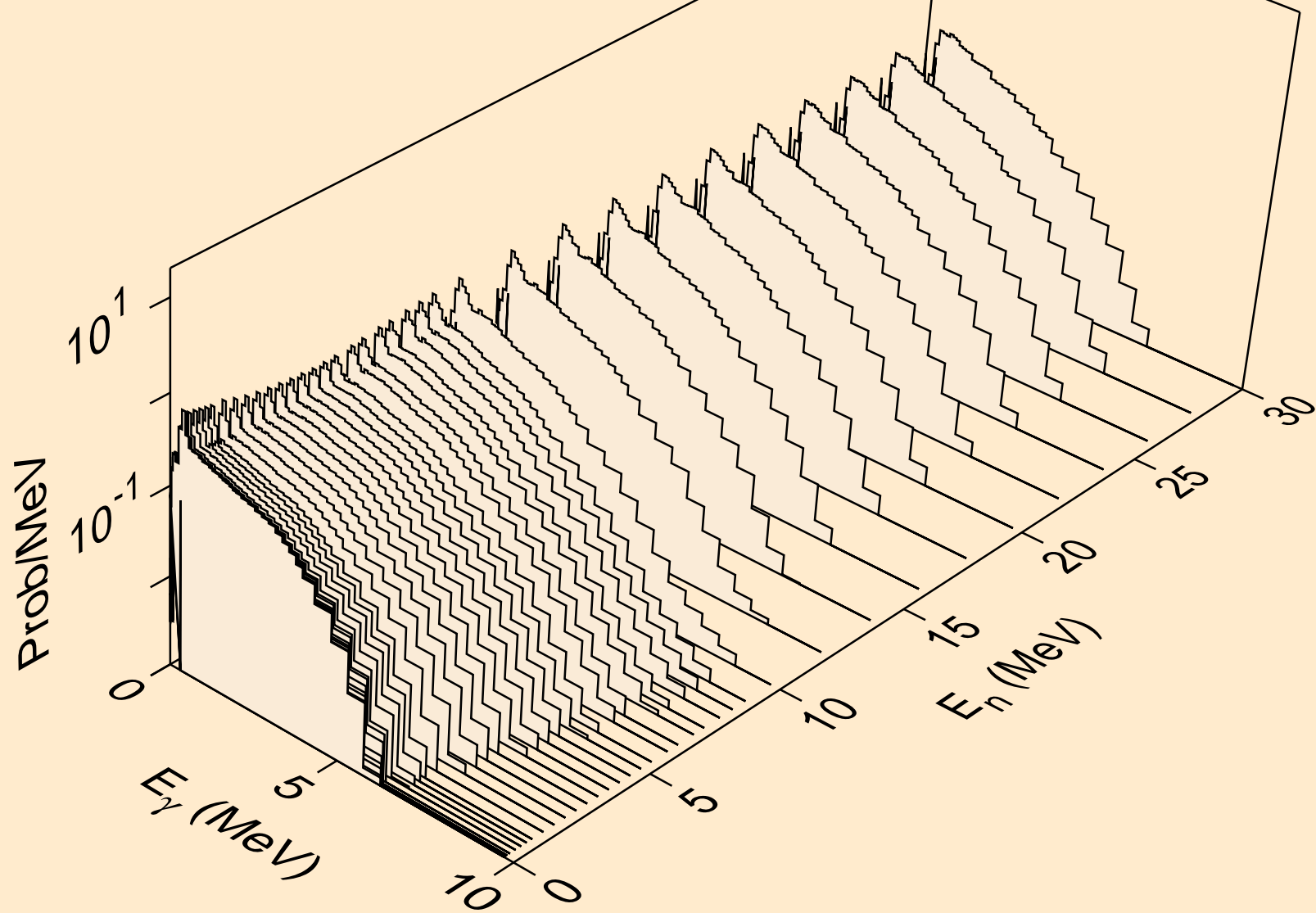

MO085 NEUTRON ACER TENDL-2021 LIBRARY; T=293.6K
Photon emission for (n,d)

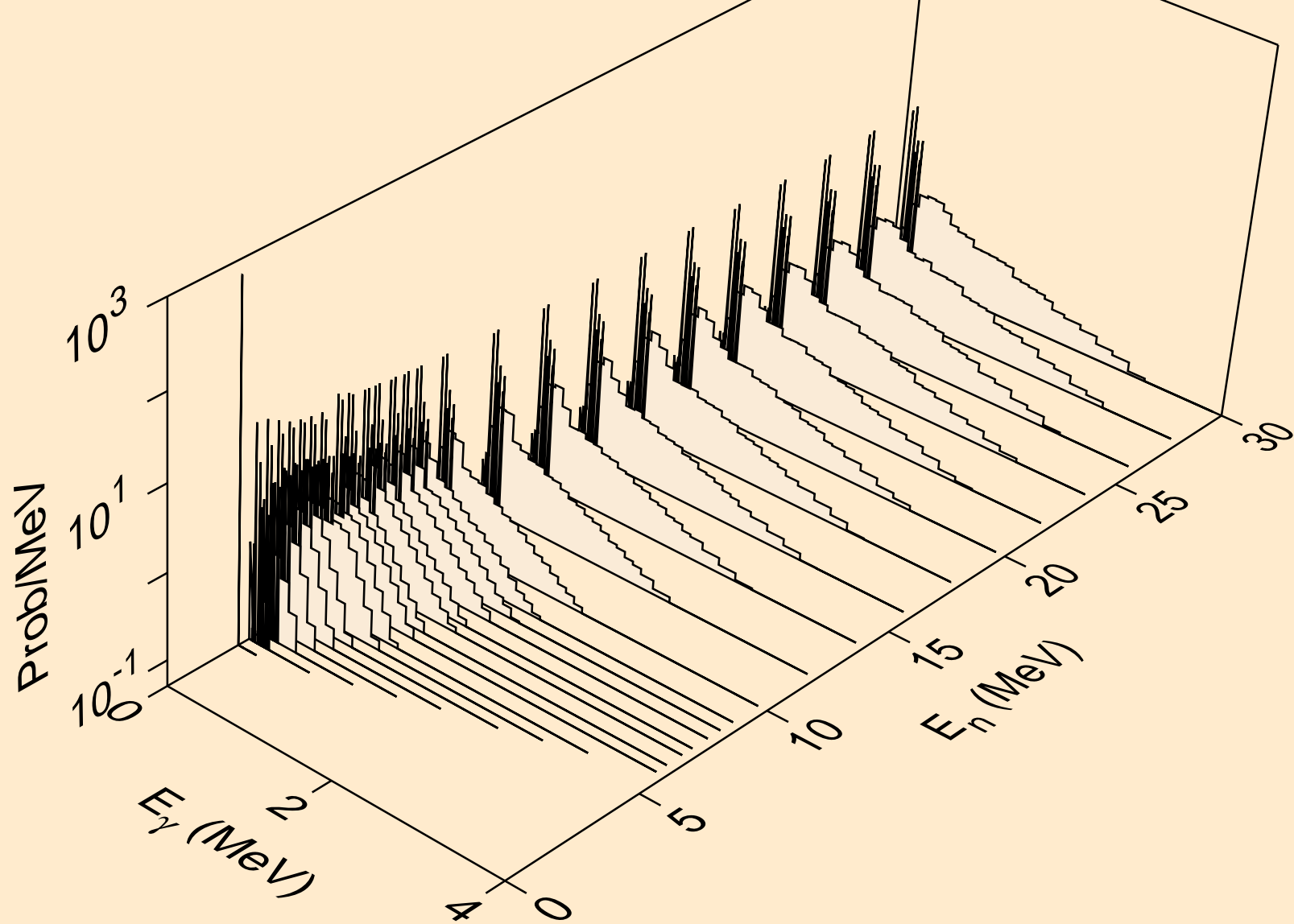

MO085 NEUTRON ACER TENDL-2021 LIBRARY; T=293.6K
Photon emission for (n,t)

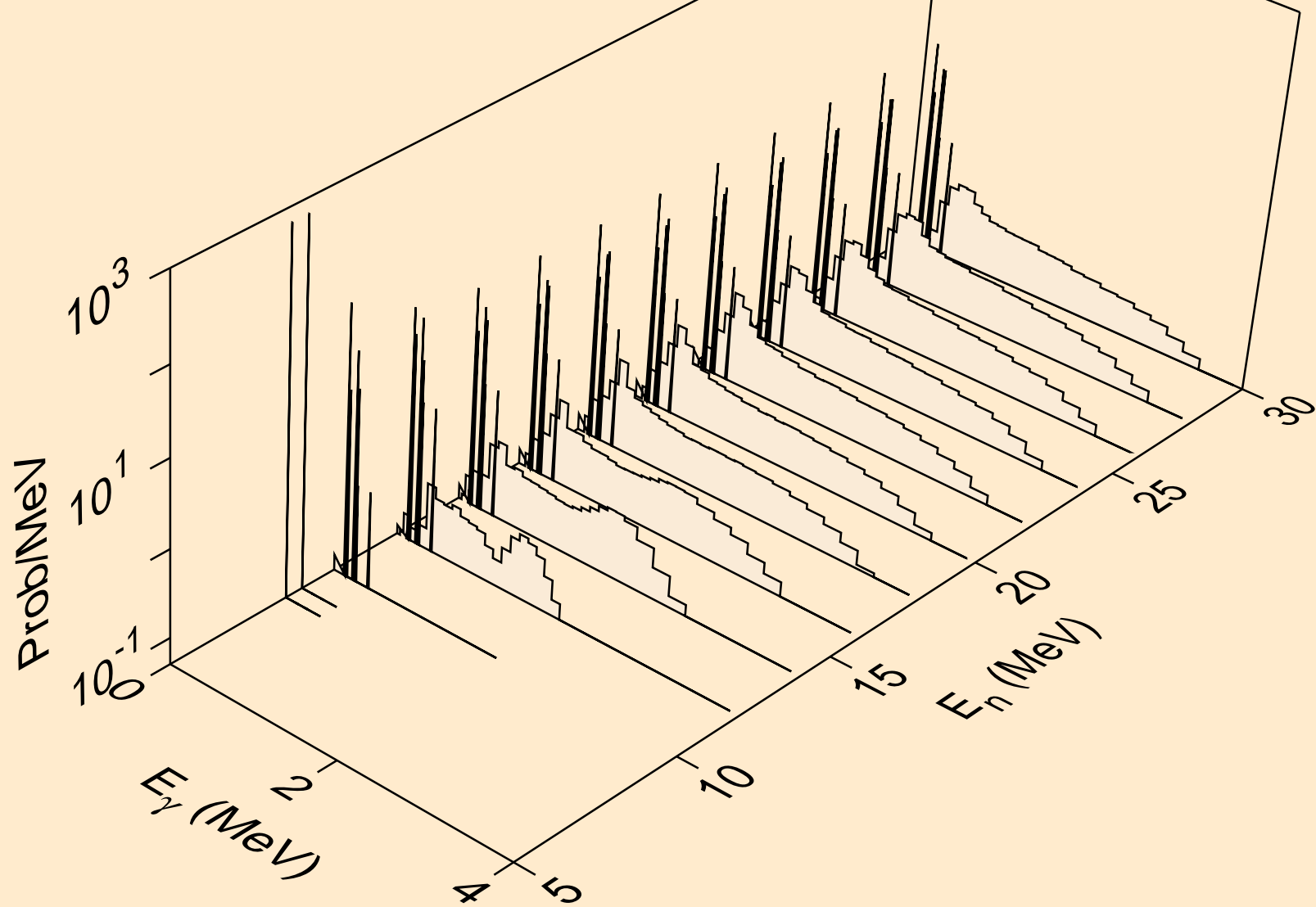

MO085 NEUTRON ACER TENDL-2021 LIBRARY; T=293.6K
Photon emission for (n,he3)

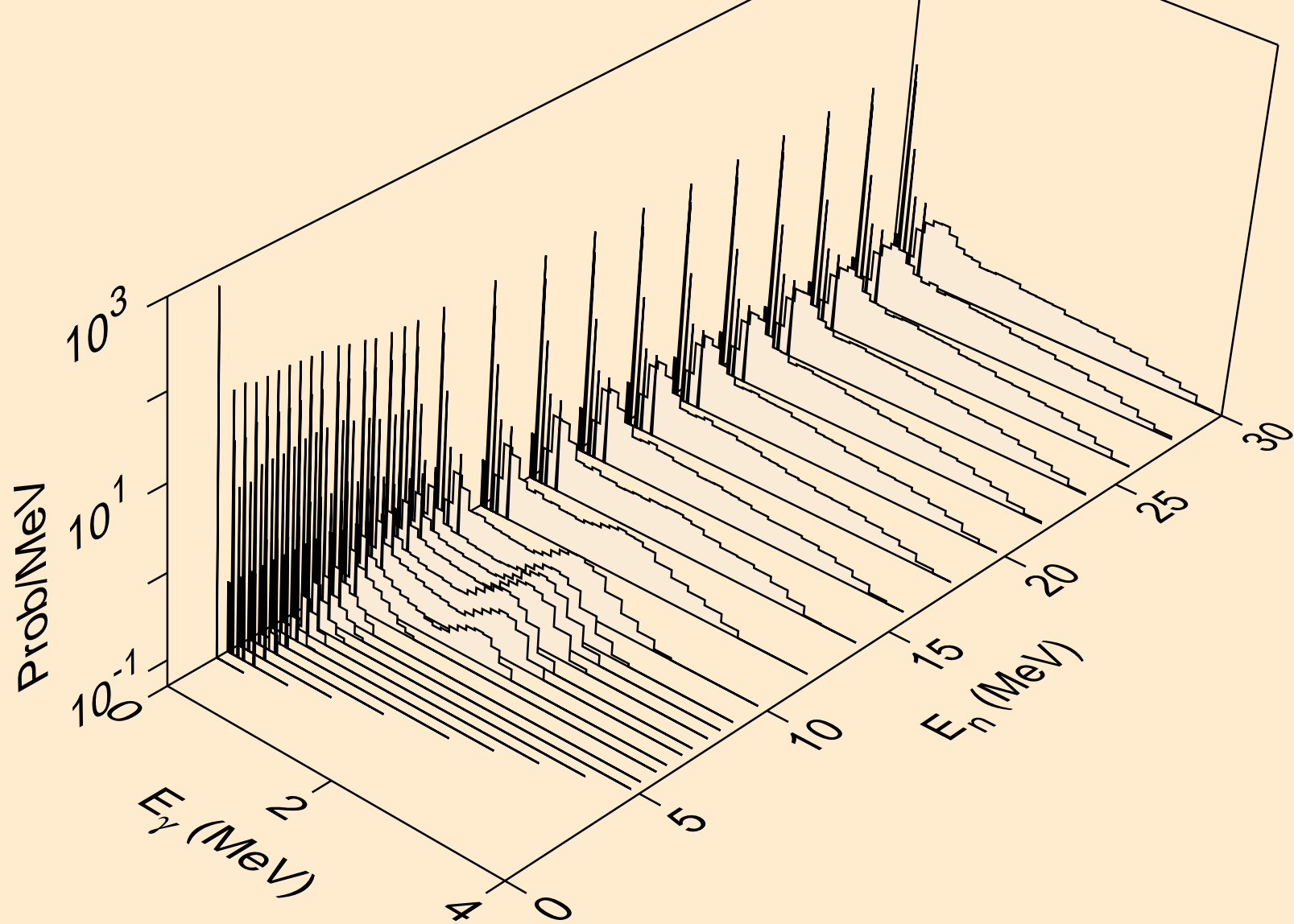

MO085 NEUTRON ACER TENDL-2021 LIBRARY; T=293.6K
Photon emission for (n,a)

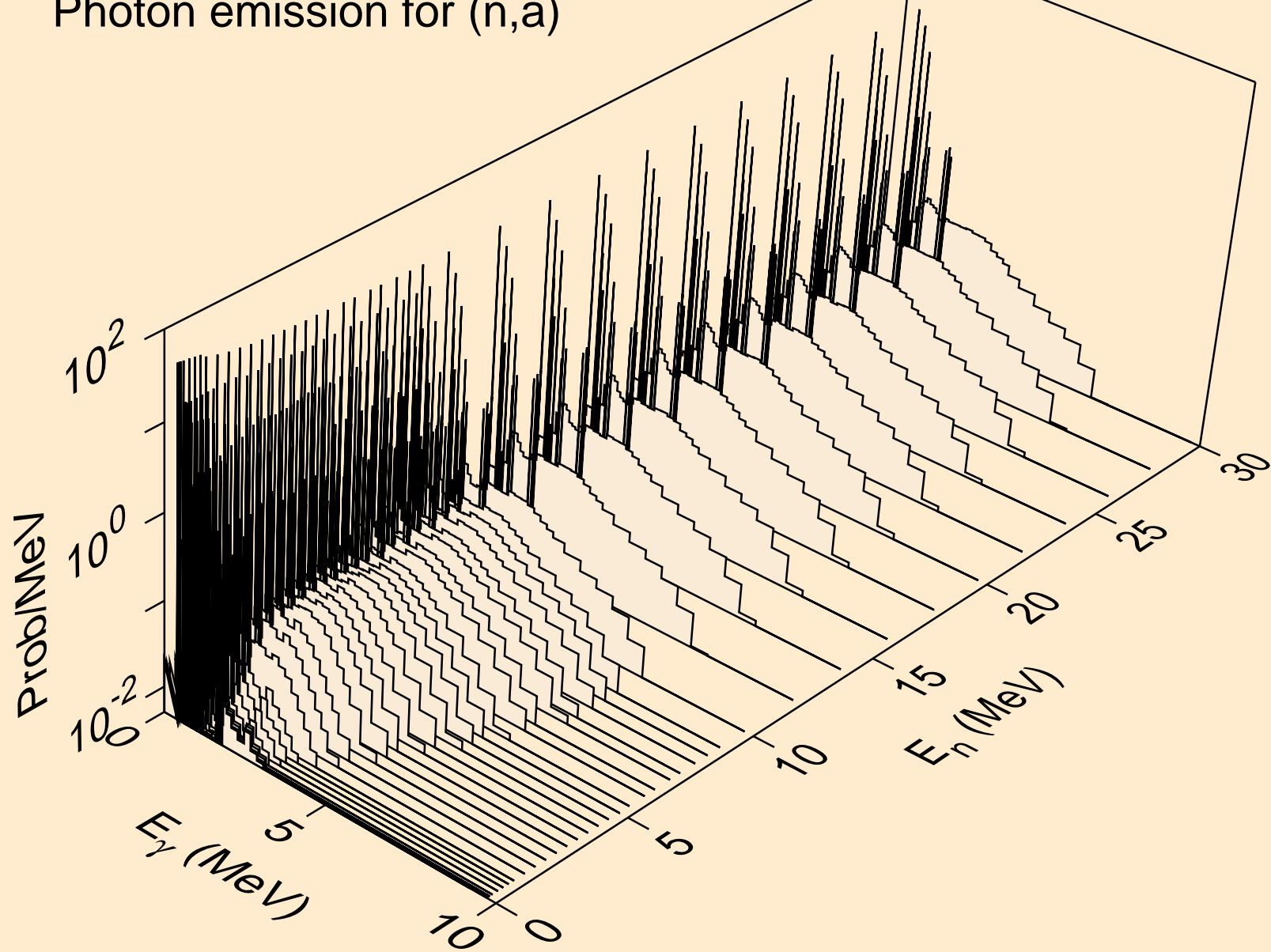

MO085 NEUTRON ACER TENDL-2021 LIBRARY; T=293.6K
Photon emission for (n,2a)

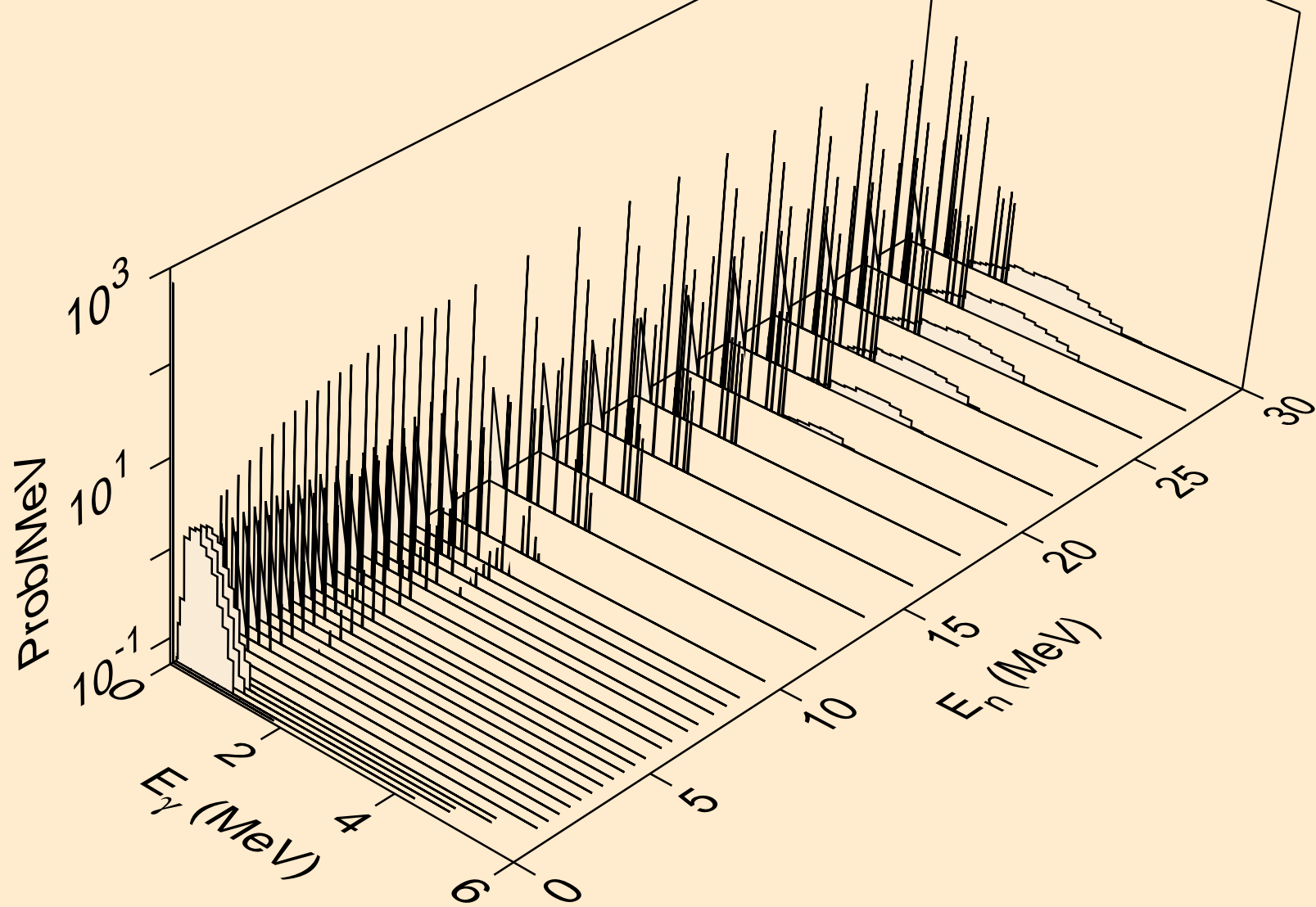

MO085 NEUTRON ACER TENDL-2021 LIBRARY; T=293.6K
Photon emission for (n,3a)

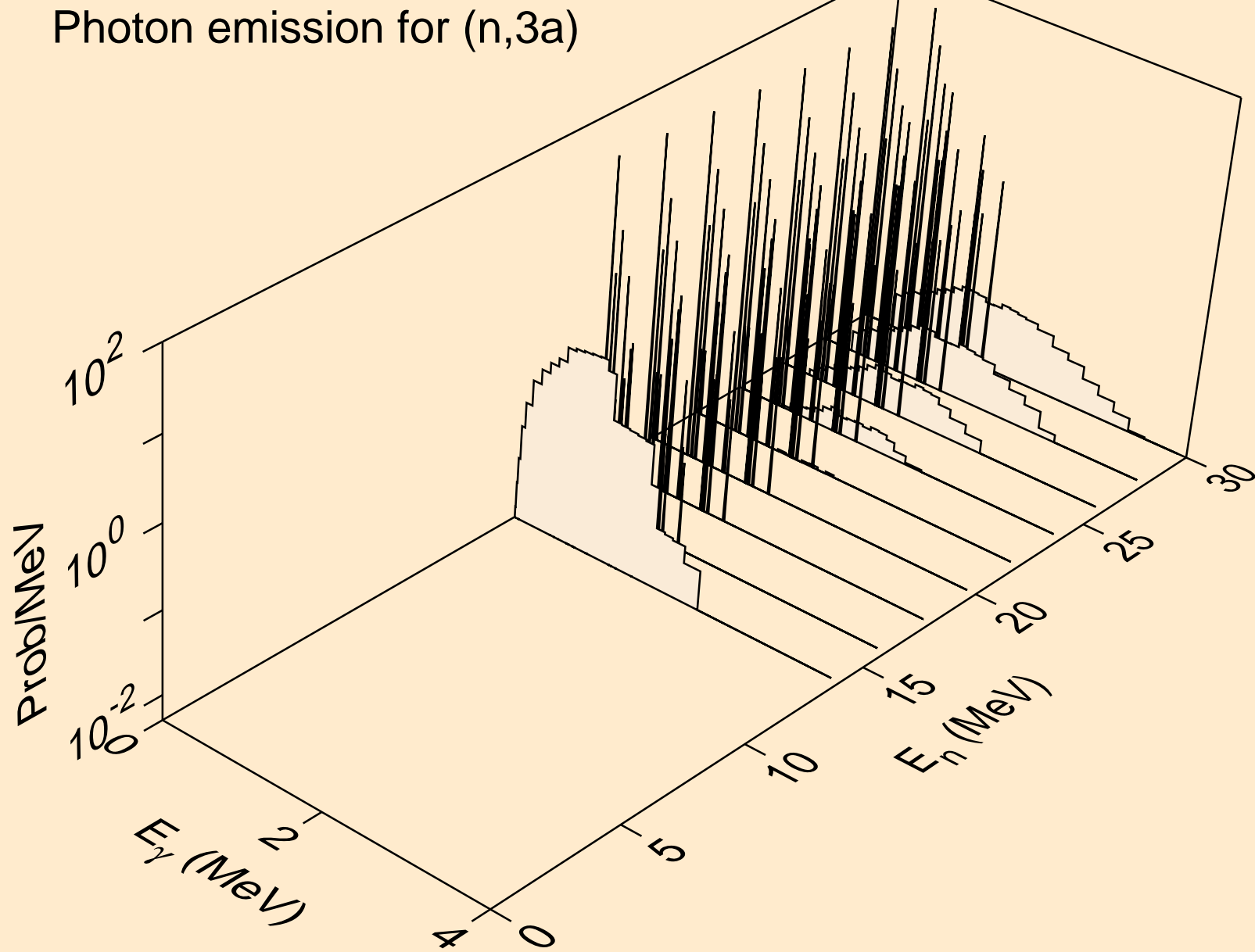

MO085 NEUTRON ACER TENDL-2021 LIBRARY; T=293.6K
Photon emission for (n,2p)

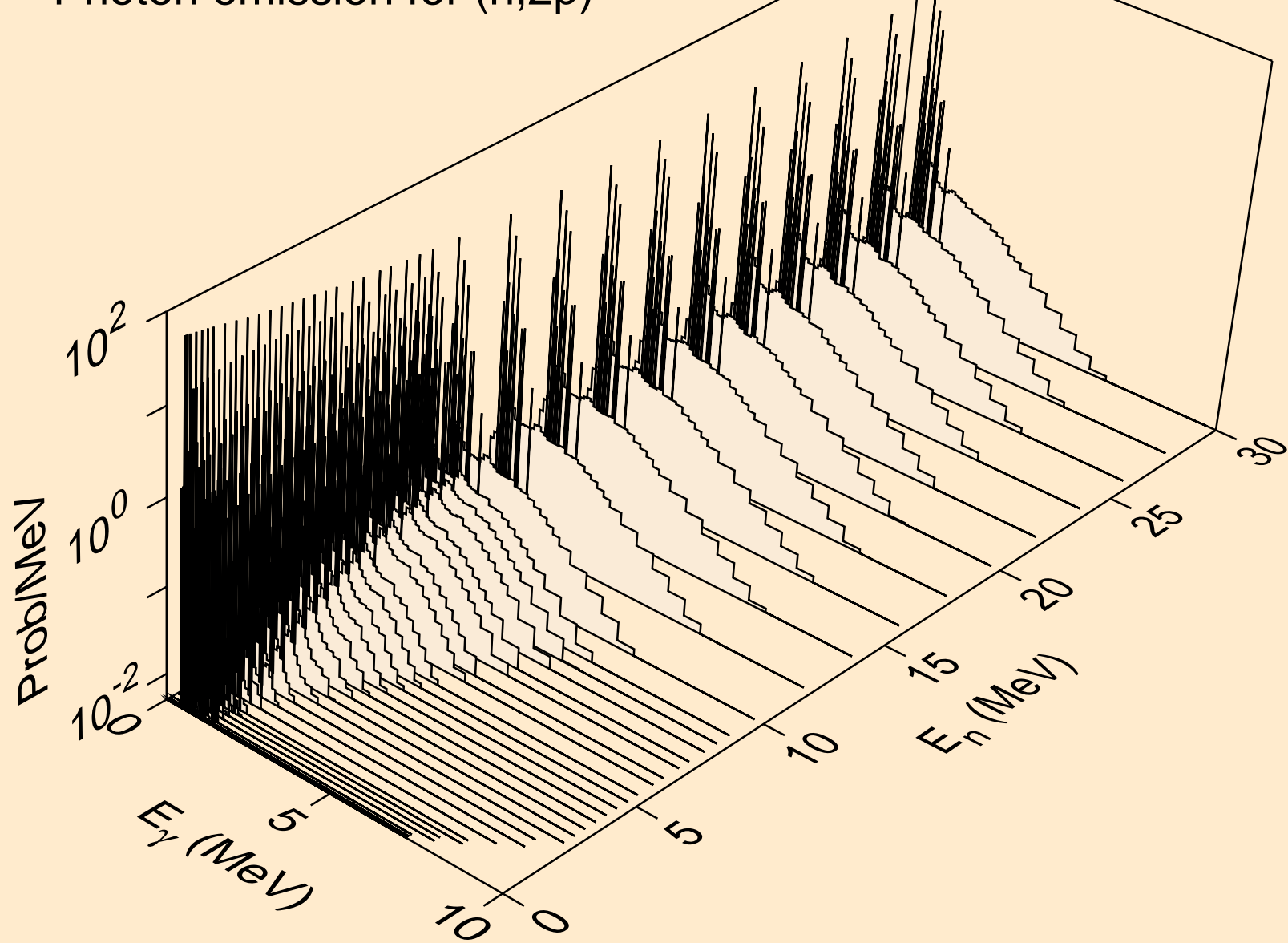

MO085 NEUTRON ACER TENDL-2021 LIBRARY; T=293.6K
Photon emission for (n,p)

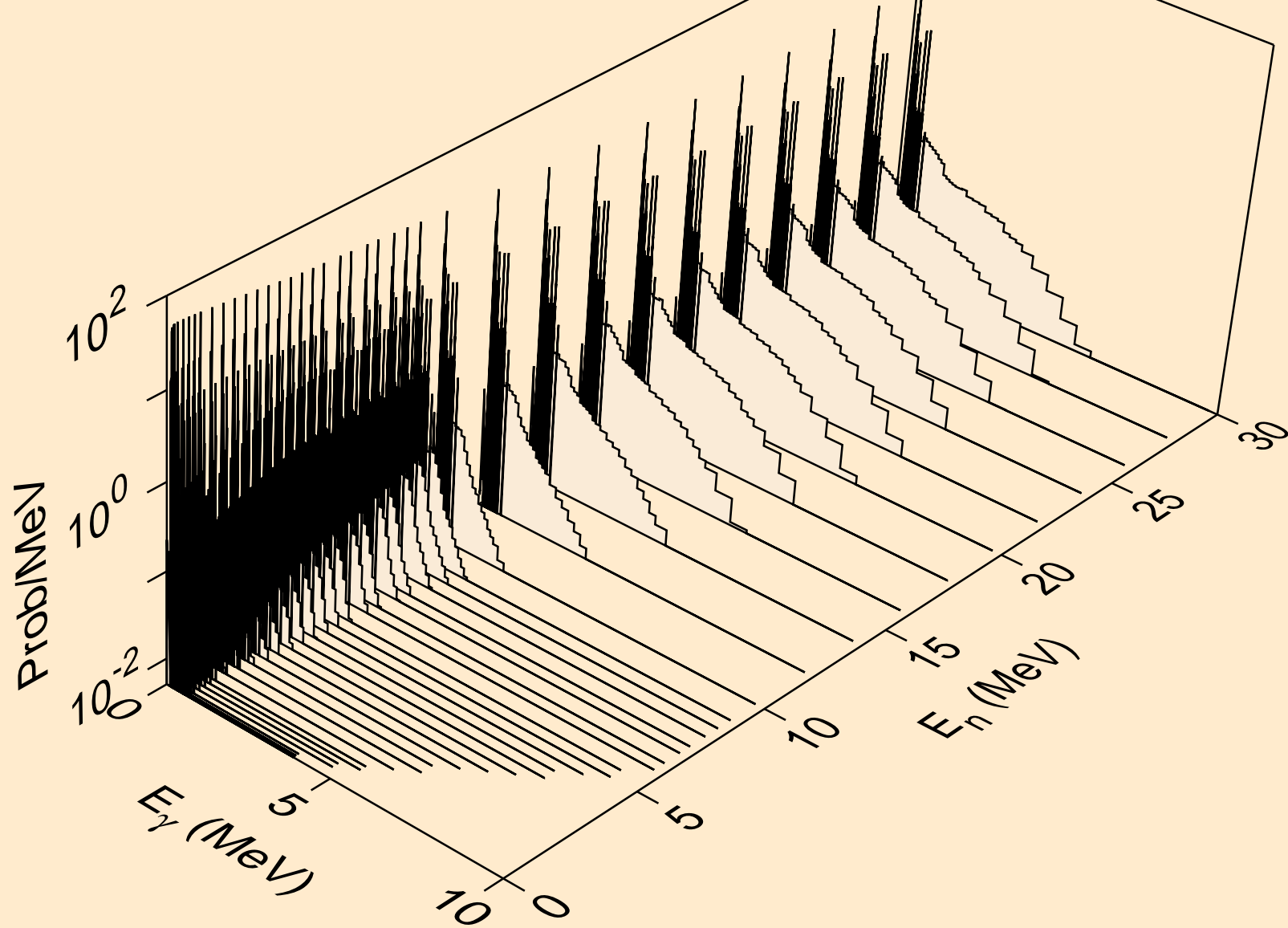

MO085 NEUTRON ACER TENDL-2021 LIBRARY; T=293.6K
Photon emission for (n,pd)

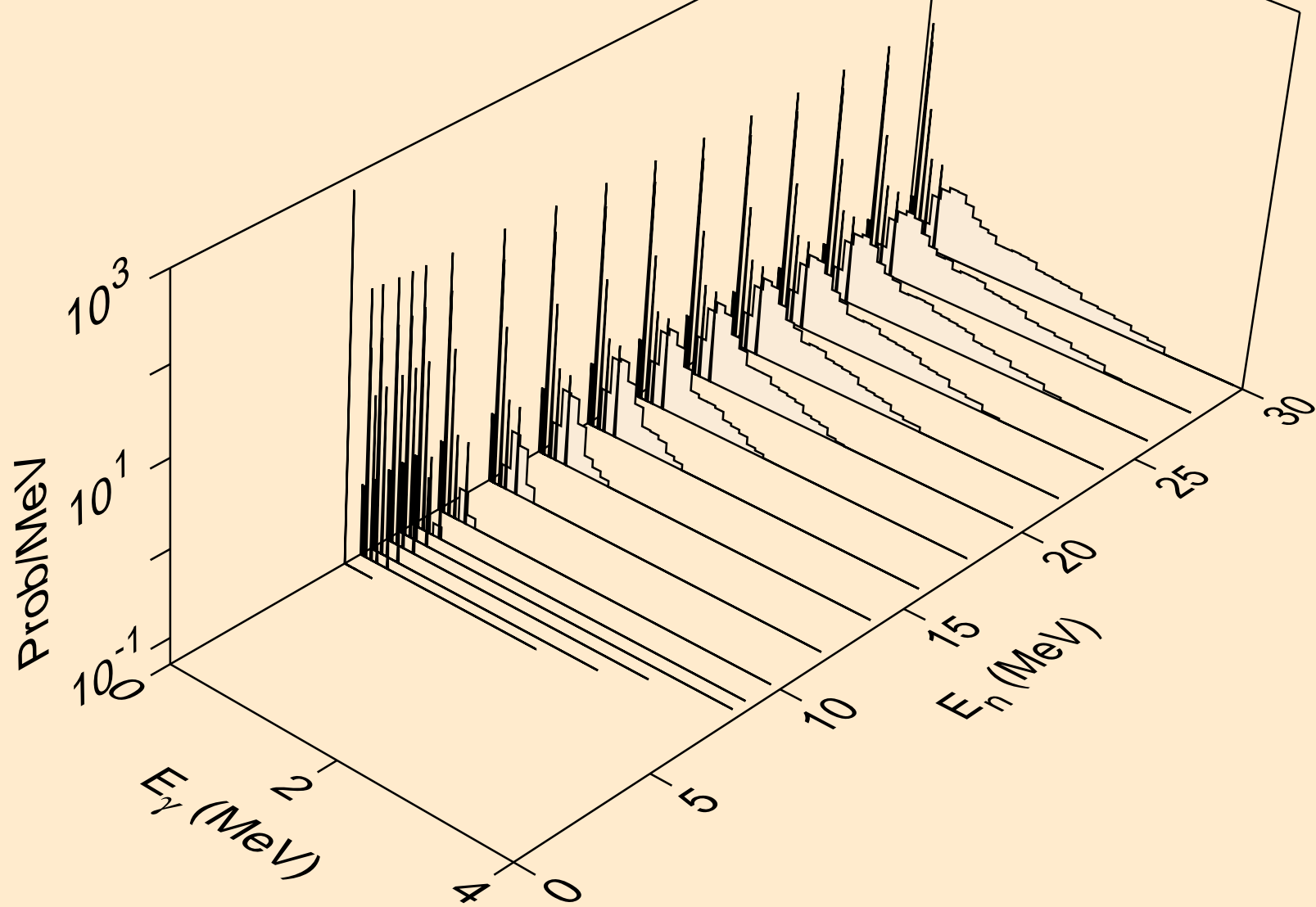

MO085 NEUTRON ACER TENDL-2021 LIBRARY; T=293.6K
Photon emission for (n,pt)

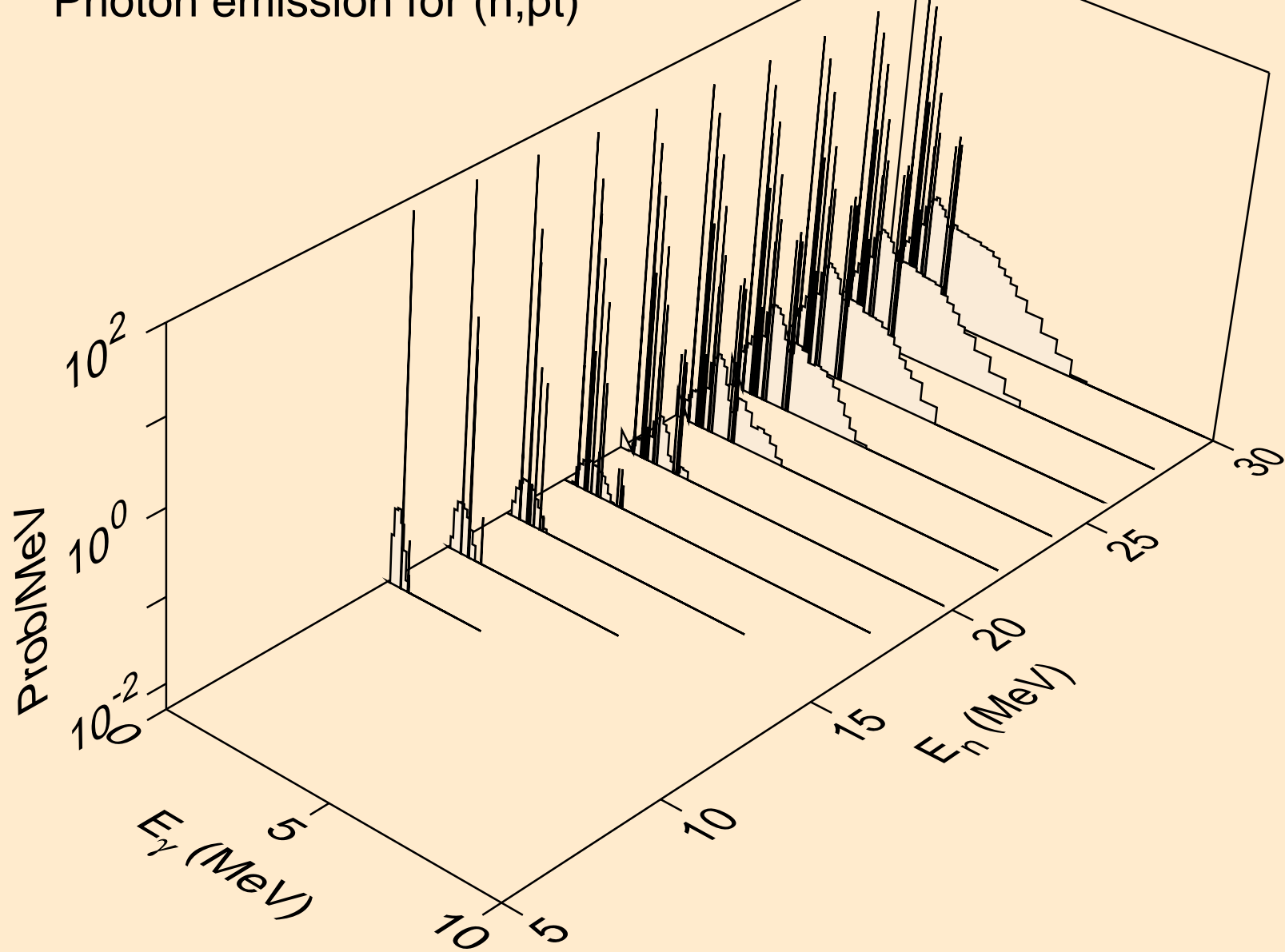

MO085 NEUTRON ACER TENDL-2021 LIBRARY; T=293.6K
Photon emission for (n,da)

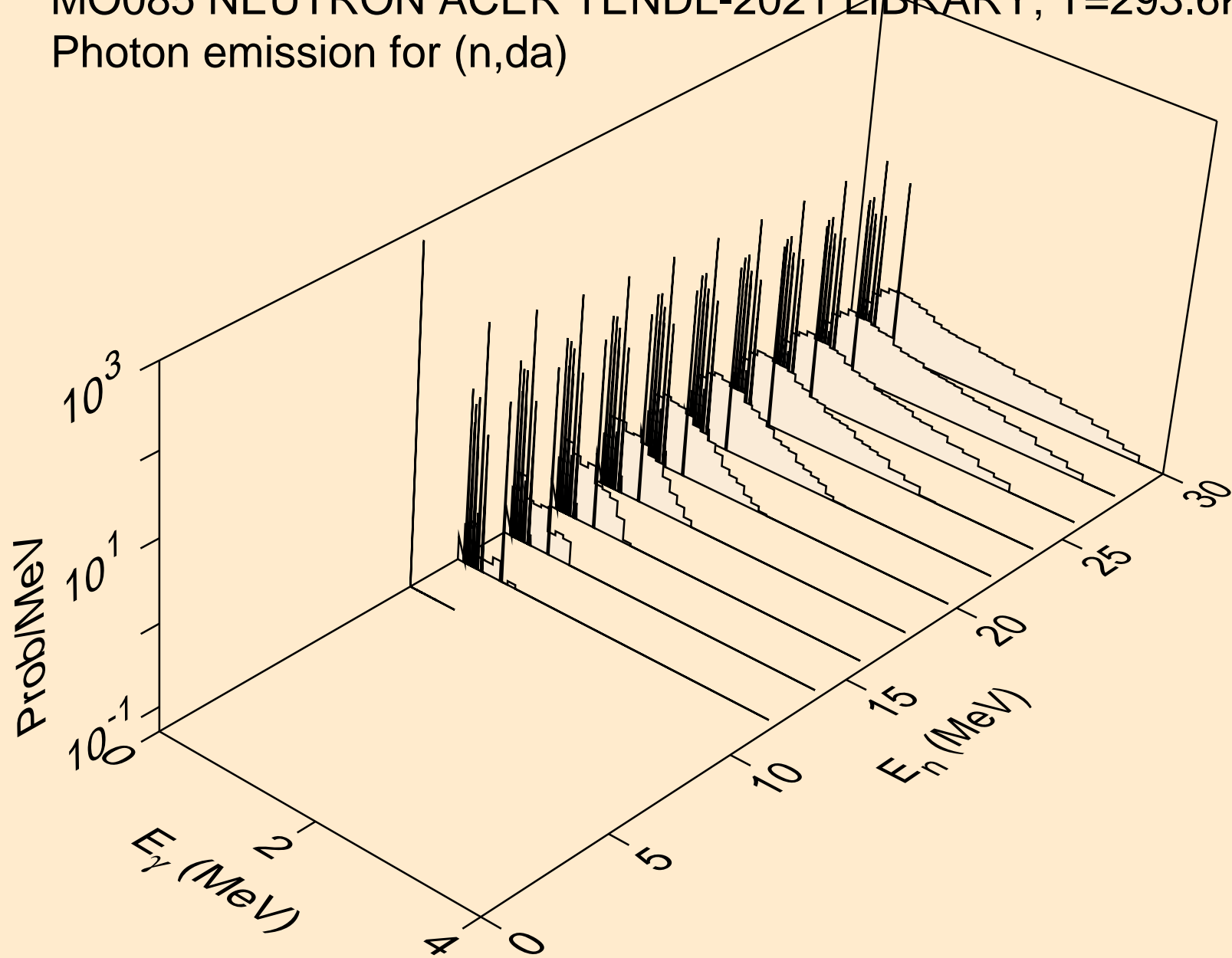

MO085 NEUTRON ACER TENDL-2021 LIBRARY; T=293.6K
thermal capture photon spectrum

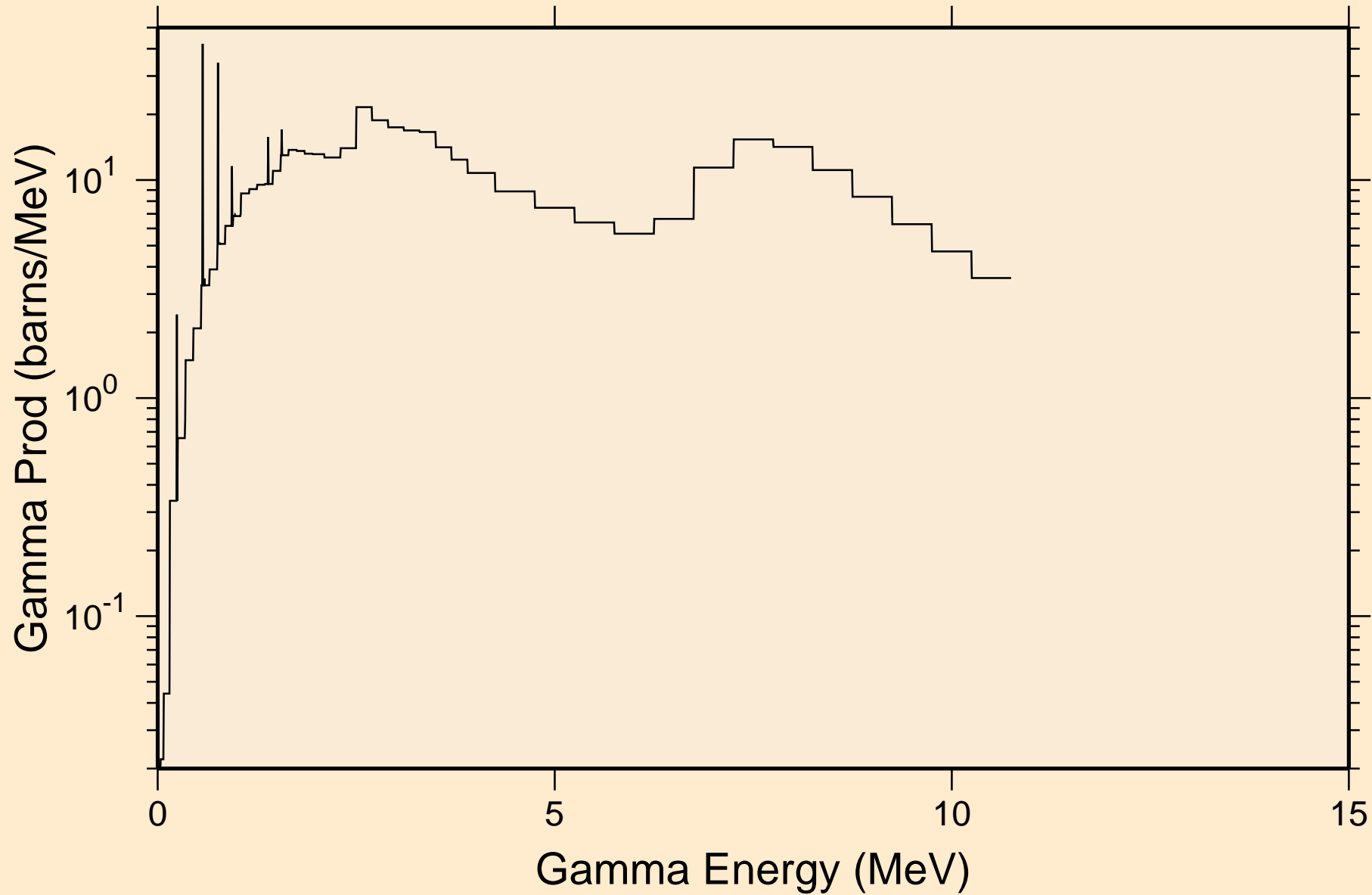

MO085 NEUTRON ACER TENDL-2021 LIBRARY; T=293.6K
14 MeV photon spectrum

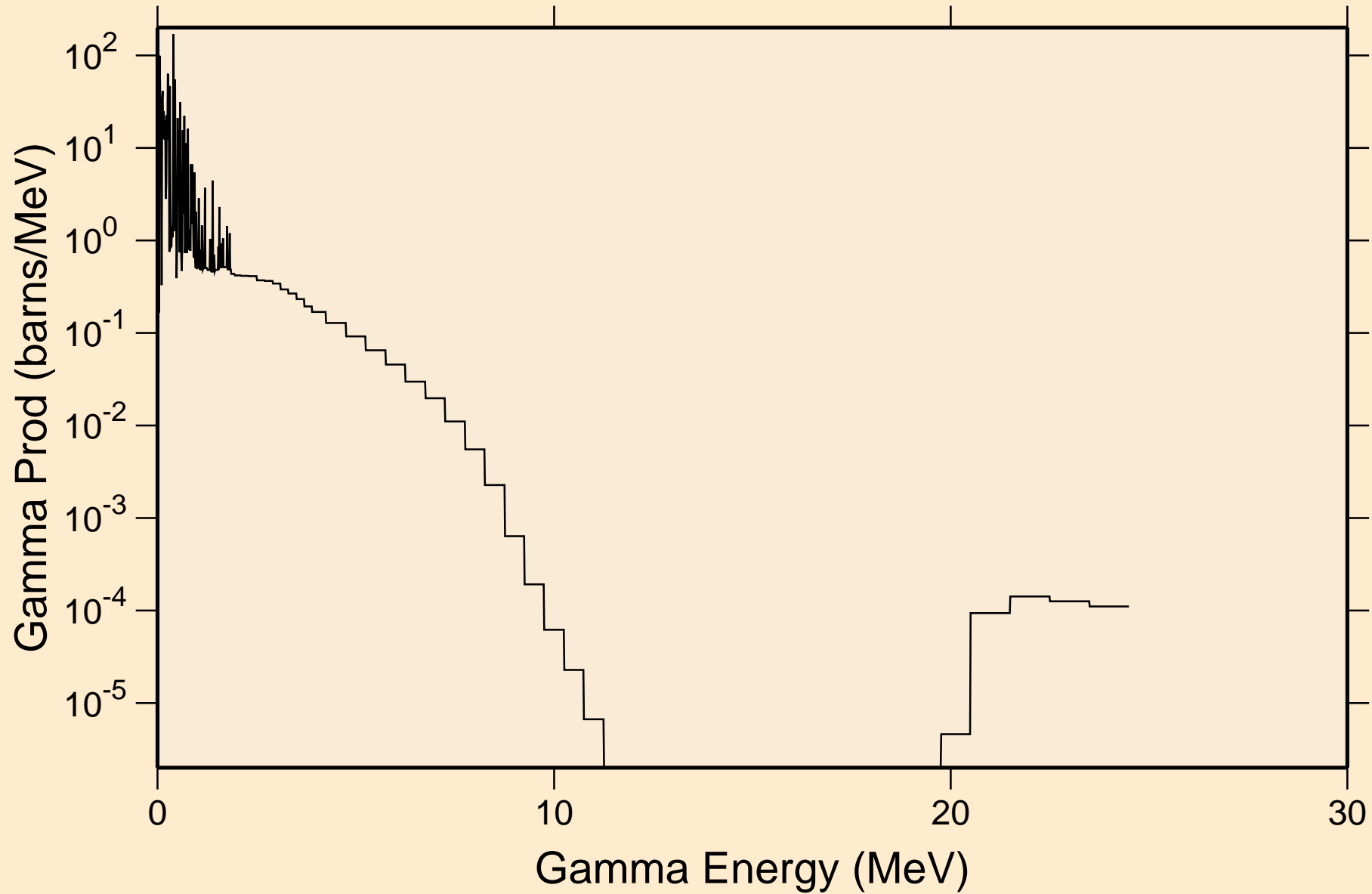

MO085 NEUTRON ACER TENDL-2021 LIBRARY; T=293.6K
Particle heating contributions

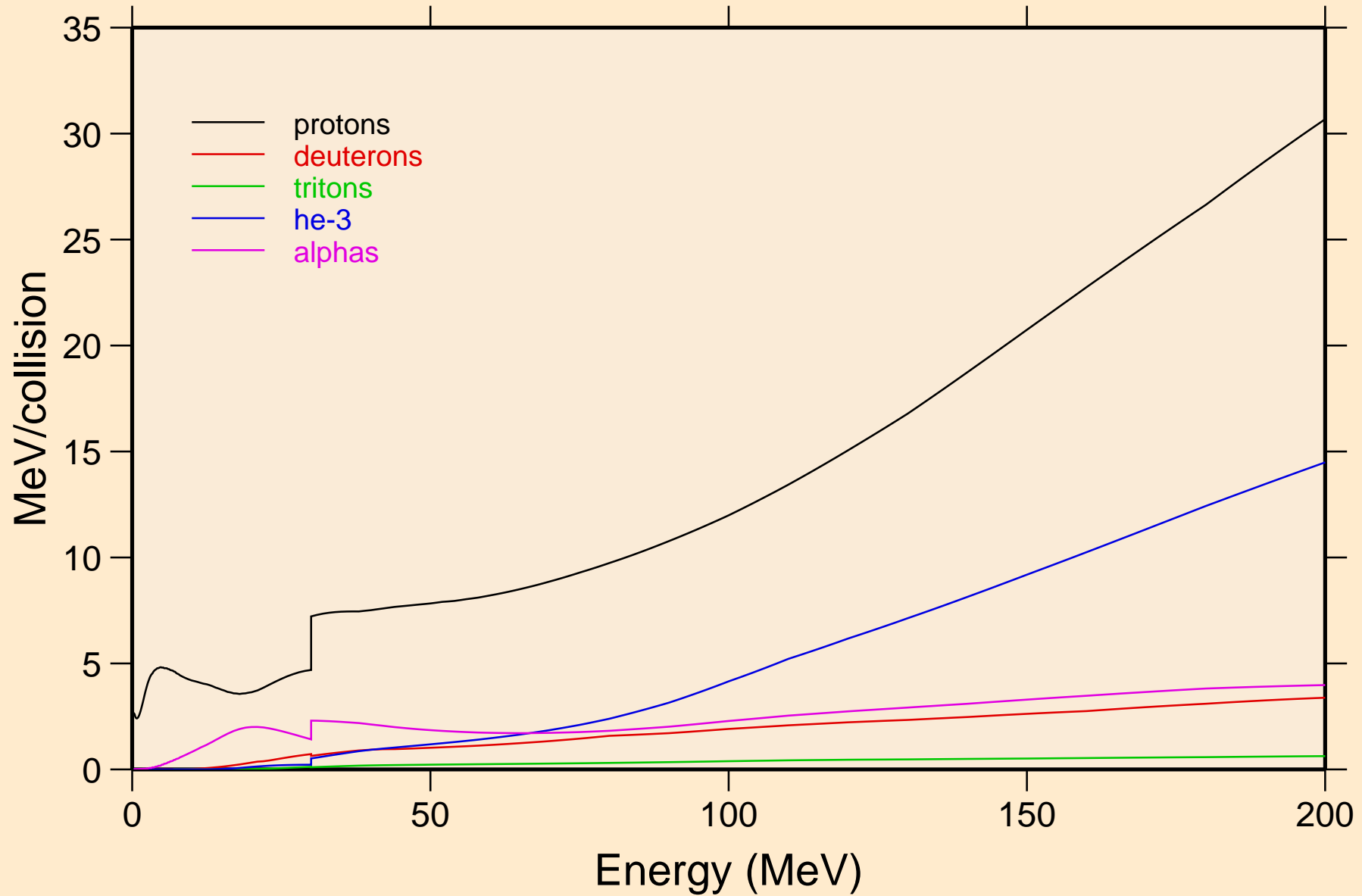

MO085 NEUTRON ACER TENDL-2021 LIBRARY; T=293.6K
Recoil Heating

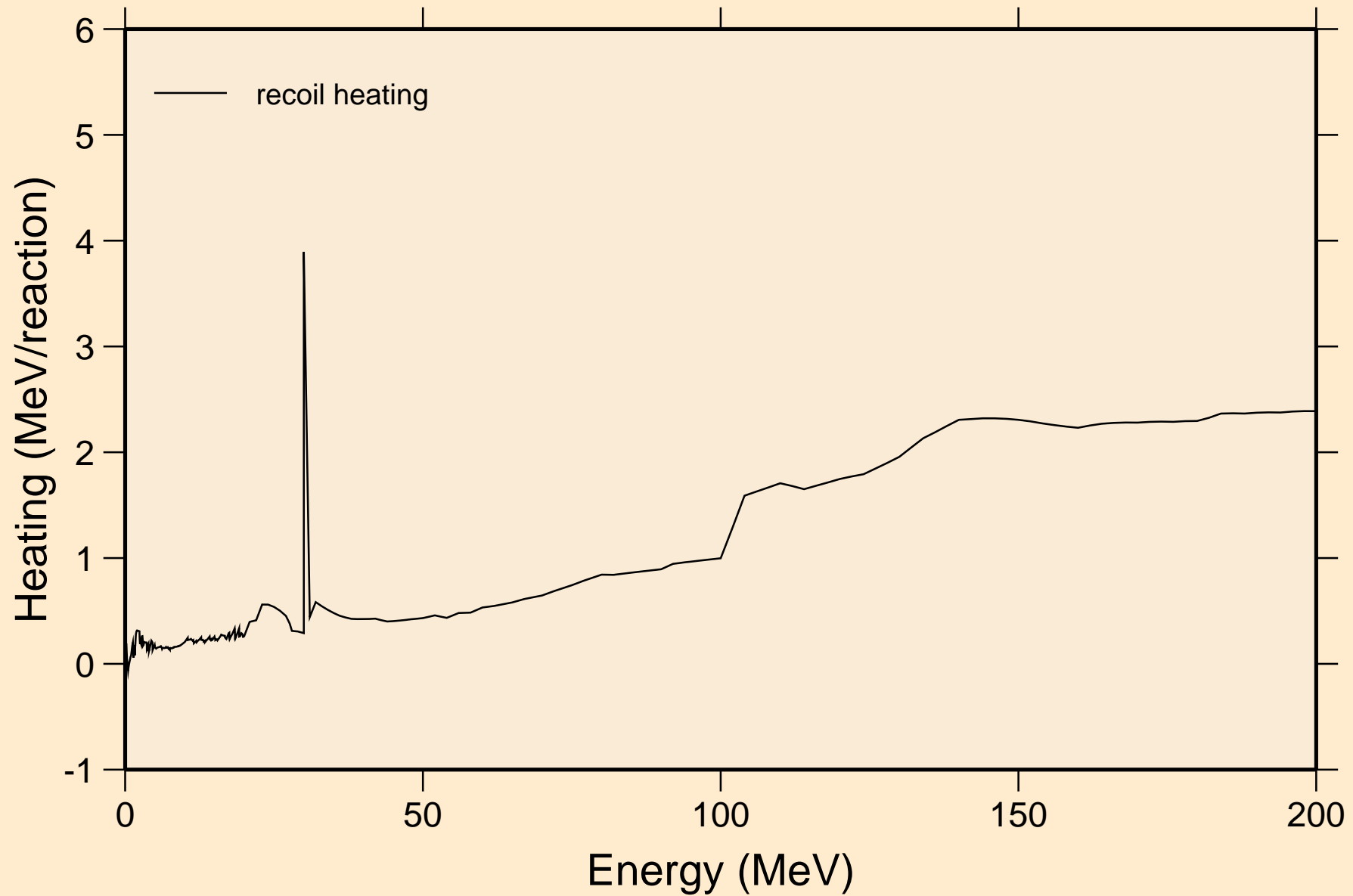

MO085 NEUTRON ACER TENDL-2021 LIBRARY; T=293.6K
Particle production cross sections

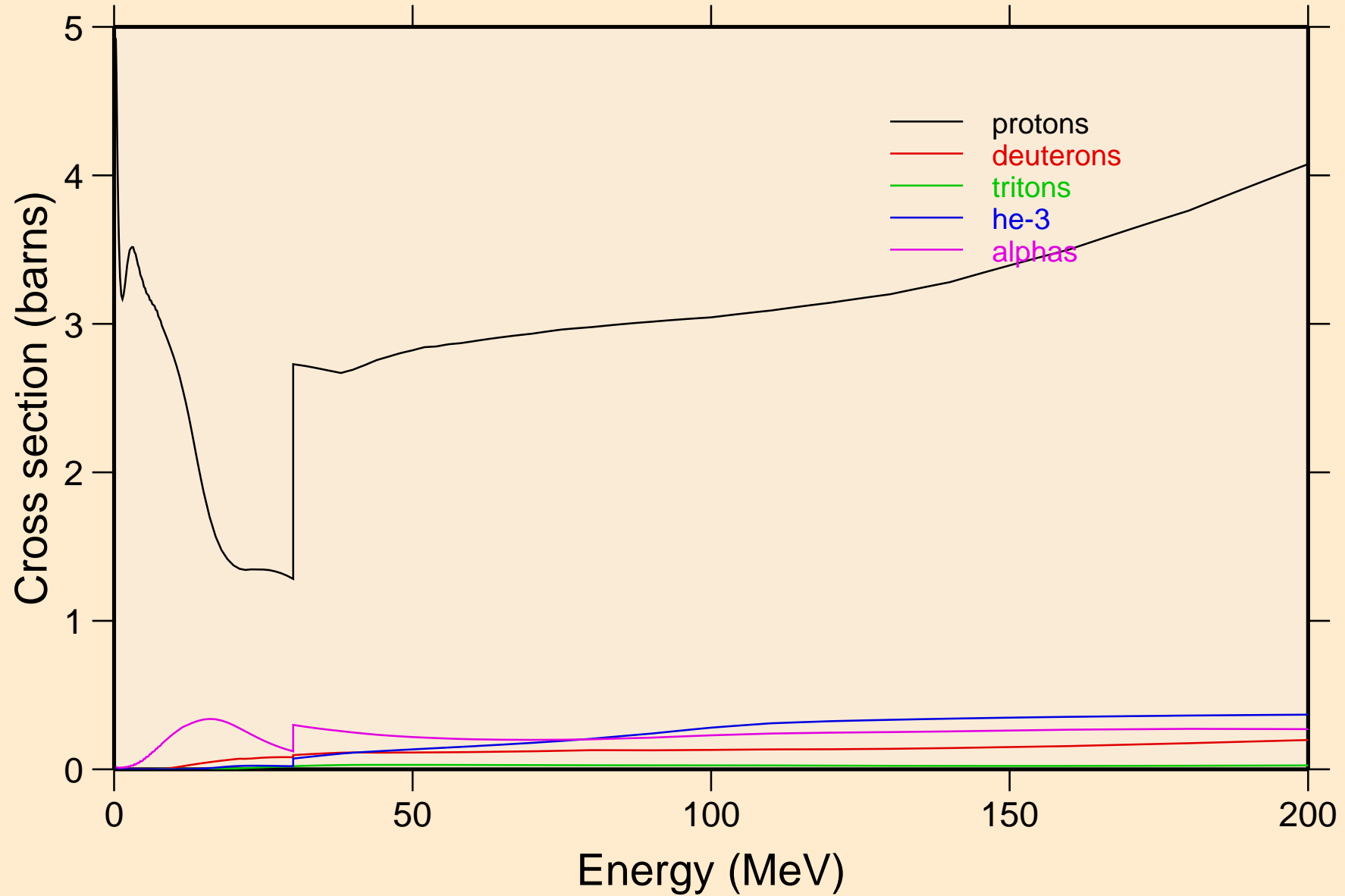

MO085 NEUTRON ACER TENDL-2021 LIBRARY; T=293.6K
protons from (n,x)

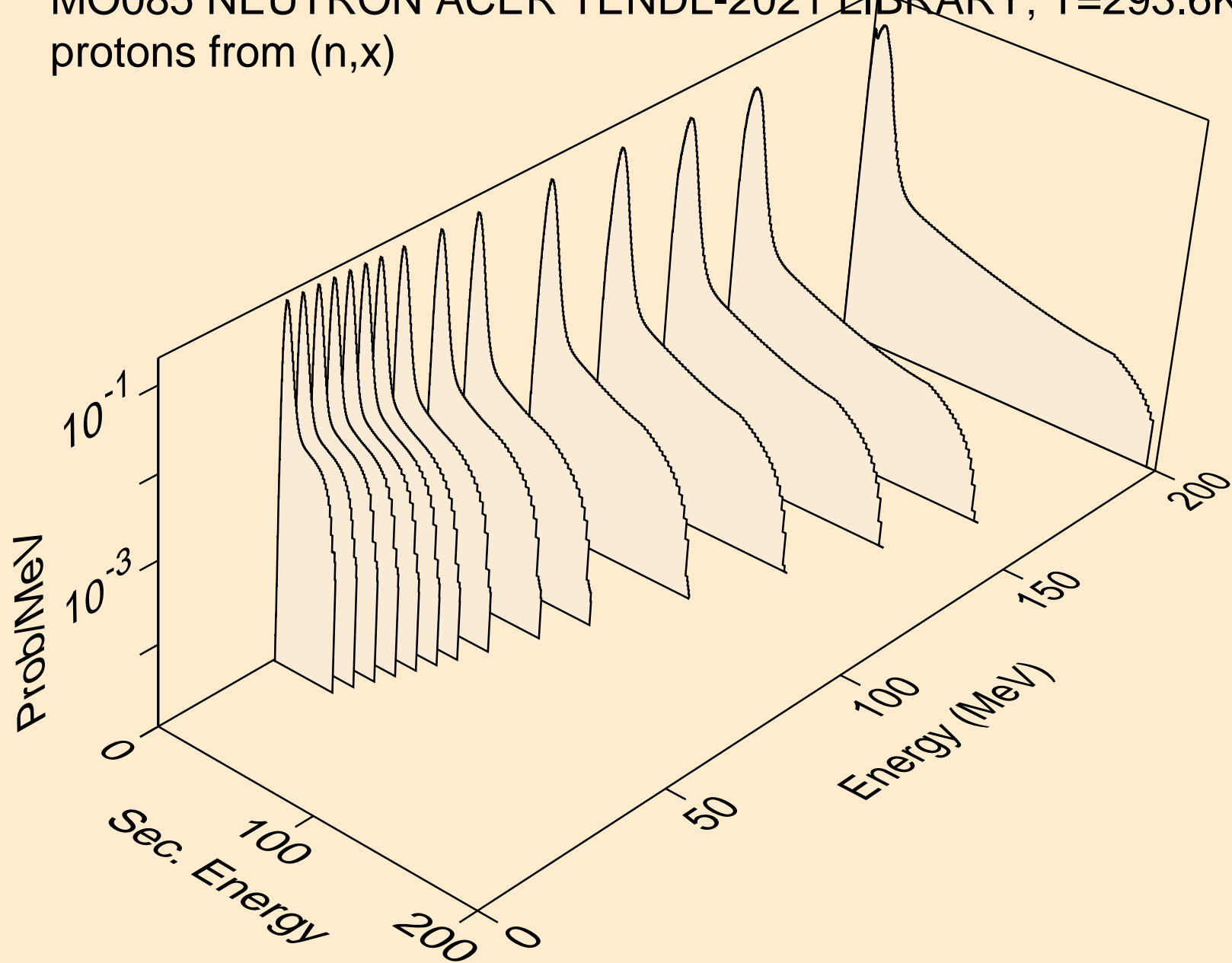

MO085 NEUTRON ACER TENDL-2021 LIBRARY; T=293.6K
protons from (n,n*)p

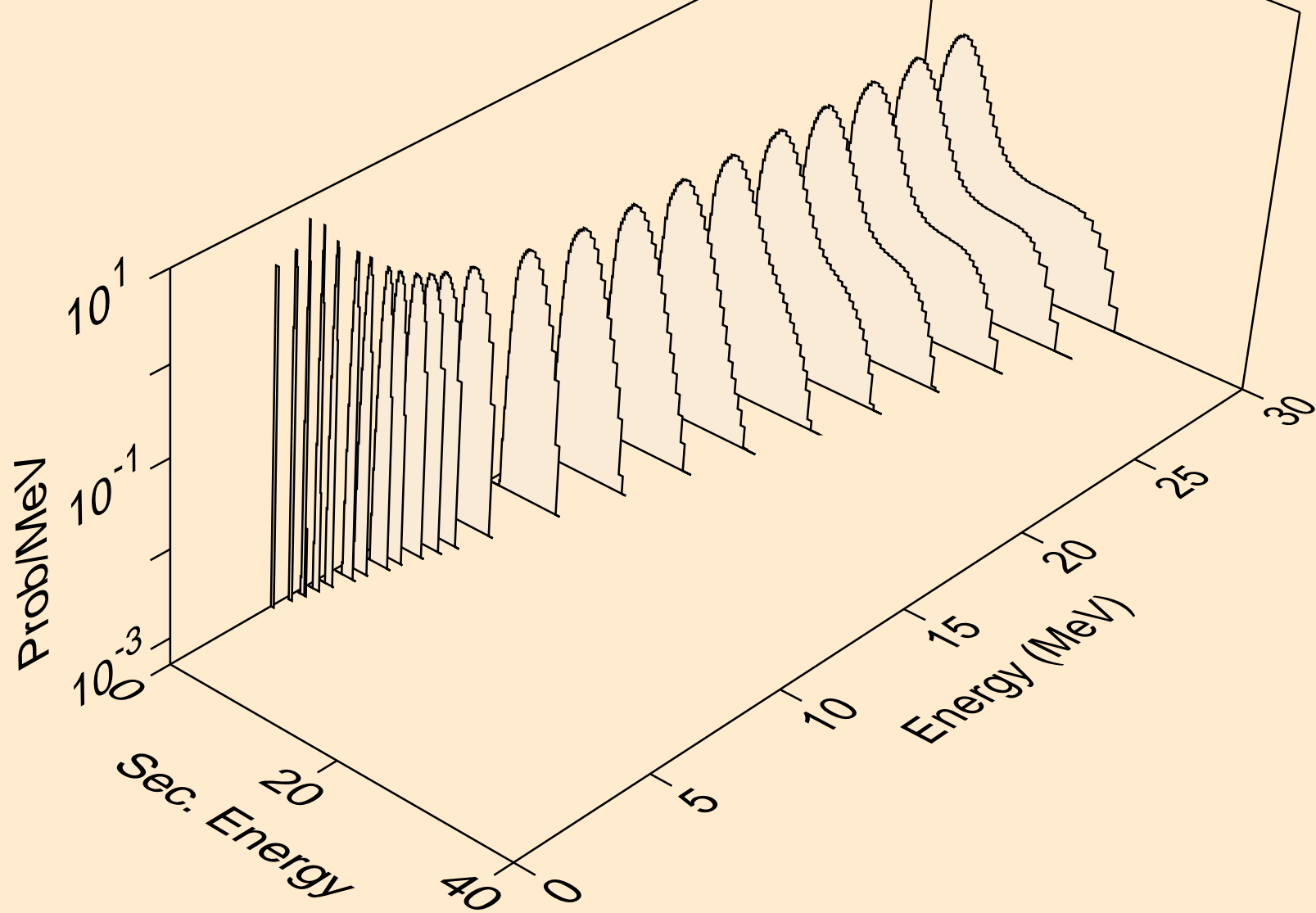

MO085 NEUTRON ACER TENDL-2021 LIBRARY; T=293.6K
protons from (n,2np)

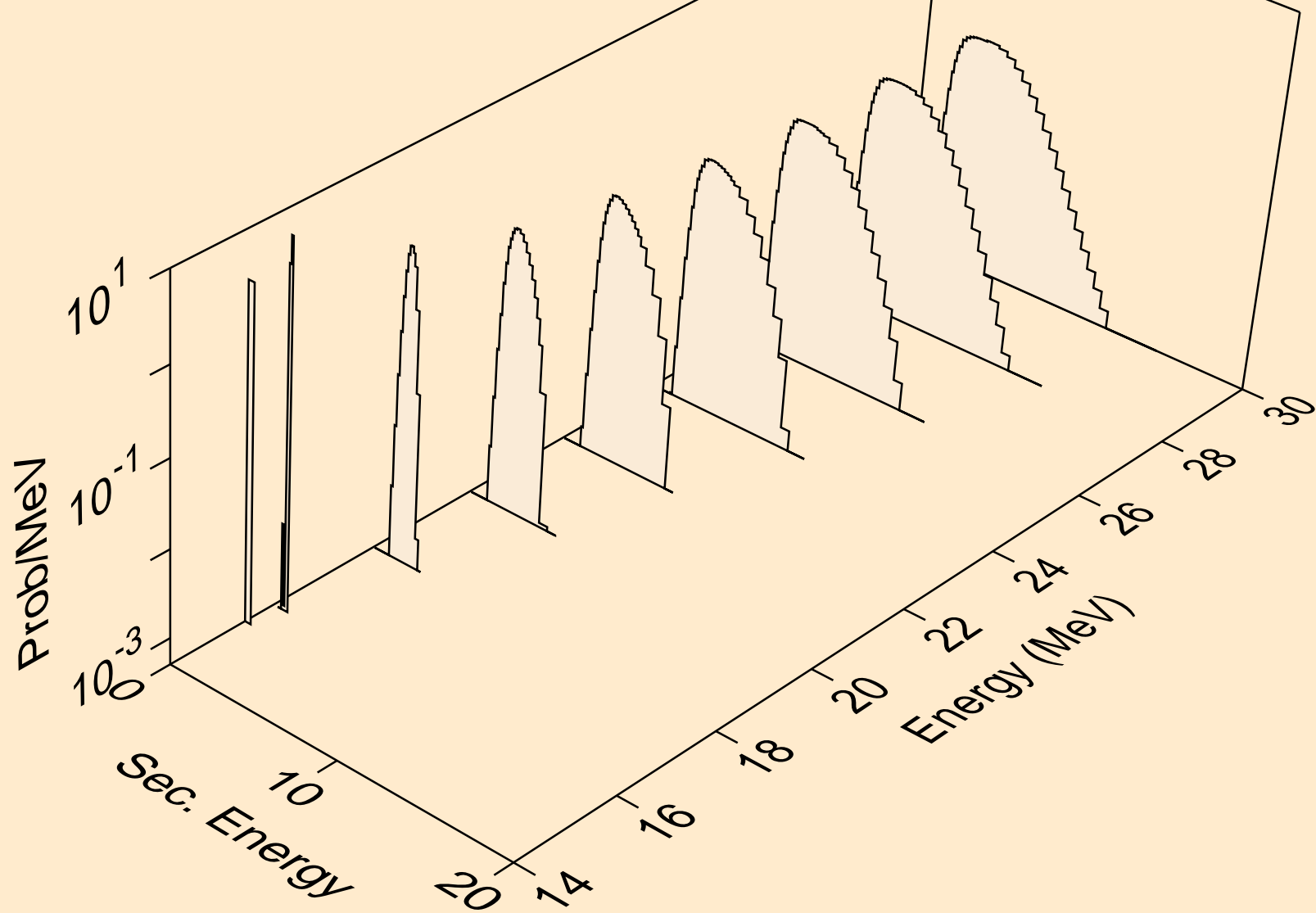

MO085 NEUTRON ACER TENDL-2021 LIBRARY; T=293.6K
protons from (n,2np)

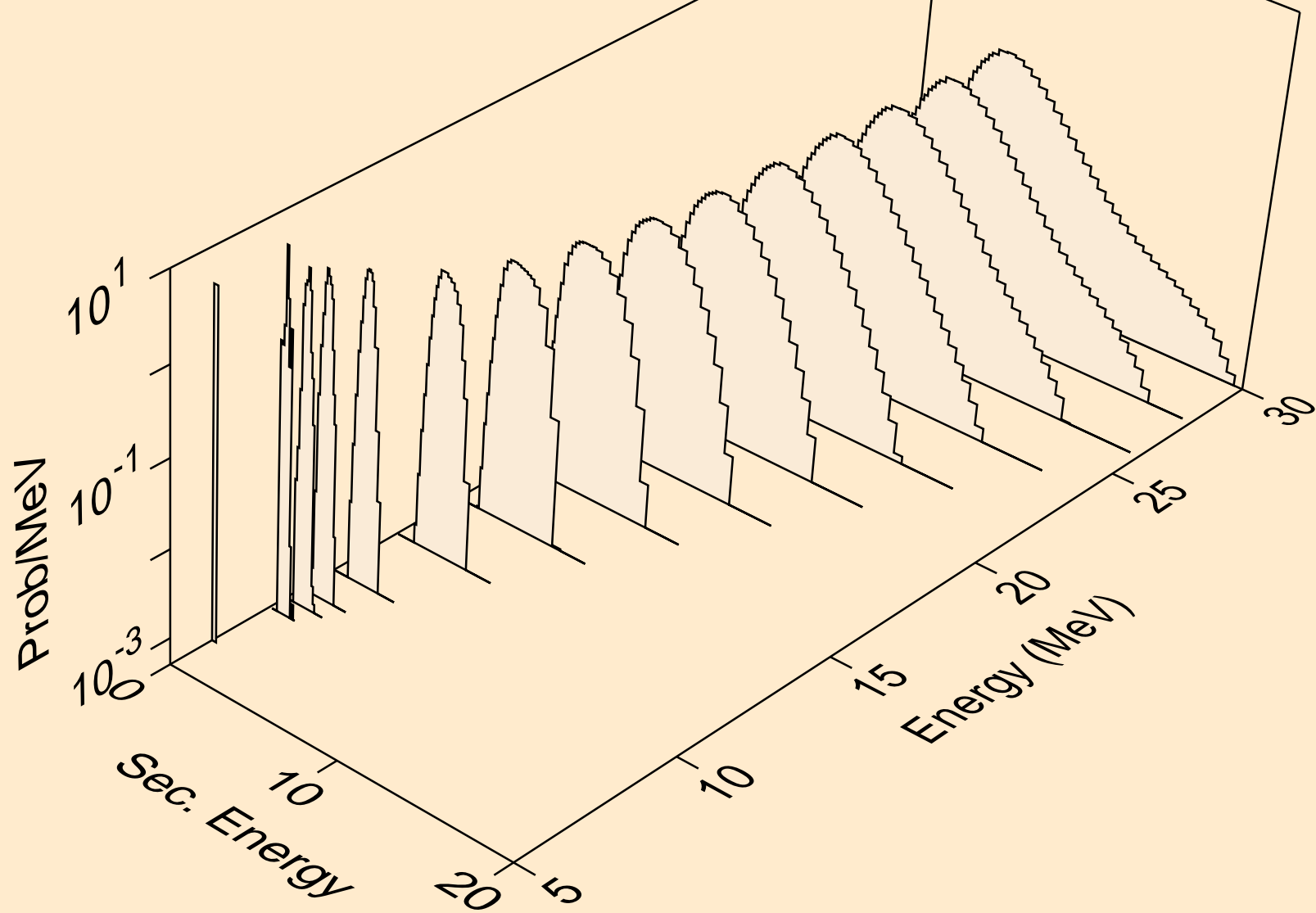

MO085 NEUTRON ACER TENDL-2021 LIBRARY; T=293.6K
protons from (n,npa)

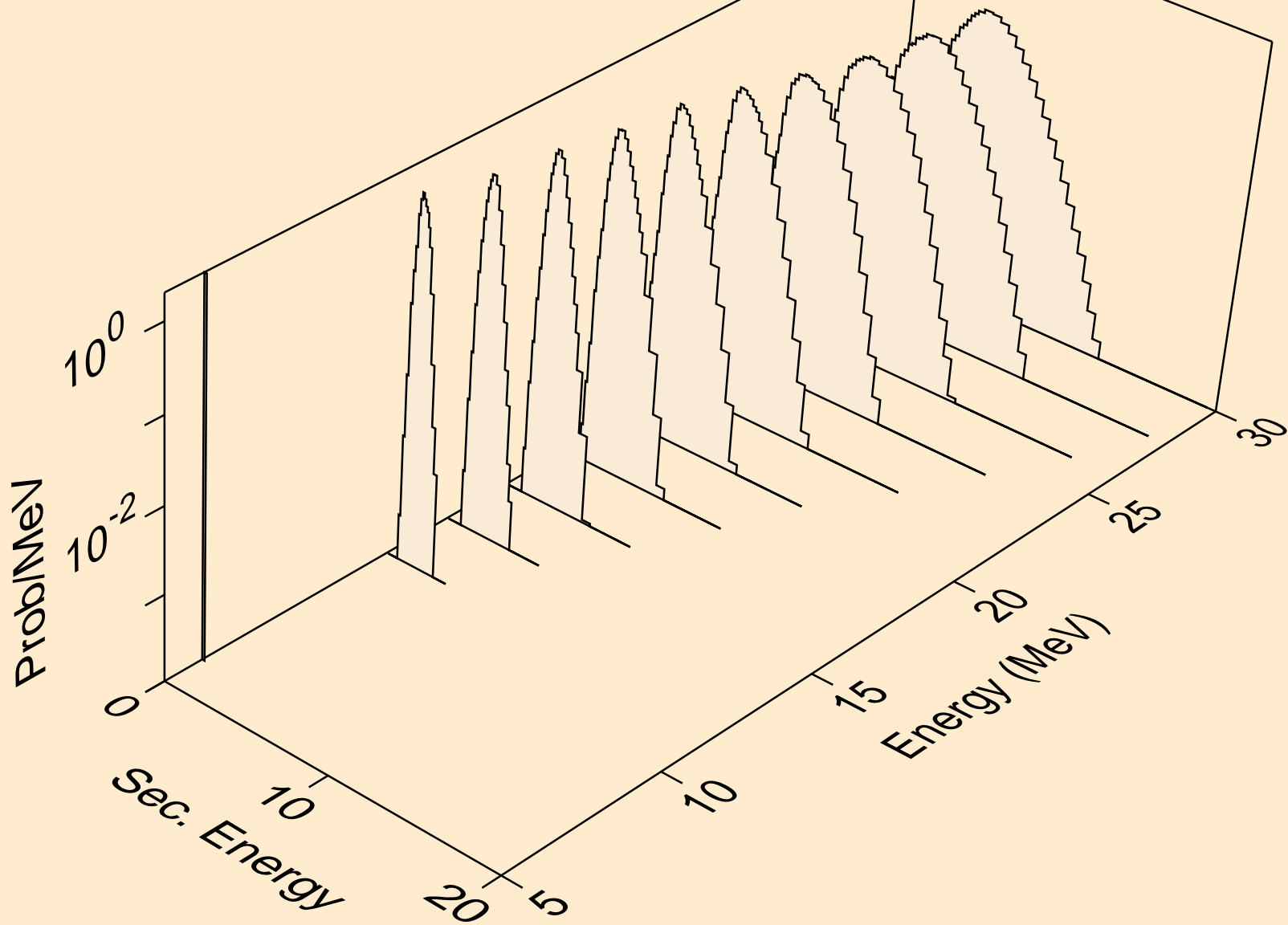

MO085 NEUTRON ACER TENDL-2021 LIBRARY; T=293.6K
protons from (n,p)

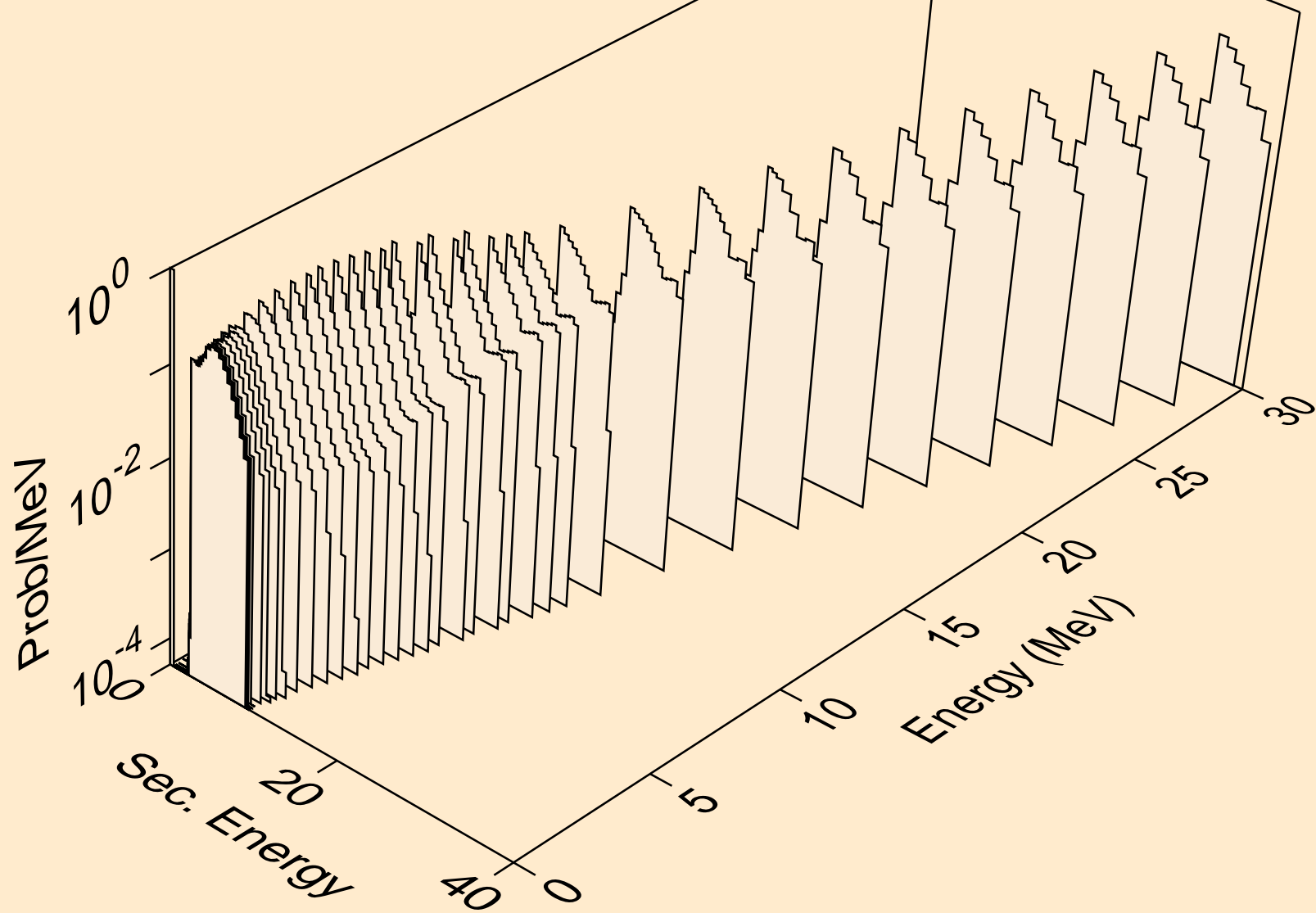

MO085 NEUTRON ACER TENDL-2021 LIBRARY; T=293.6K
protons from (n,2p)

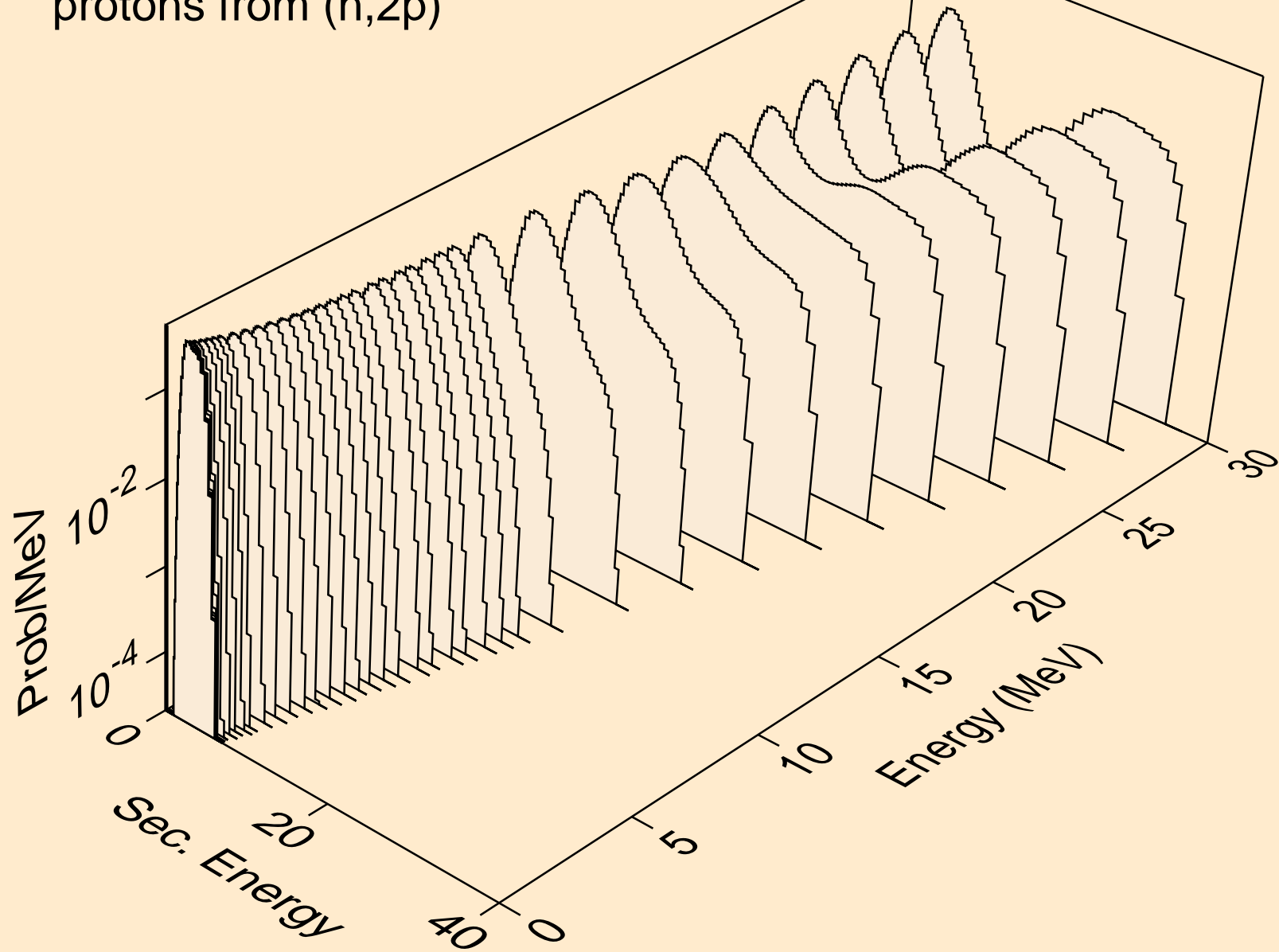

MO085 NEUTRON ACER TENDL-2021 LIBRARY; T=293.6K
protons from (n,p)

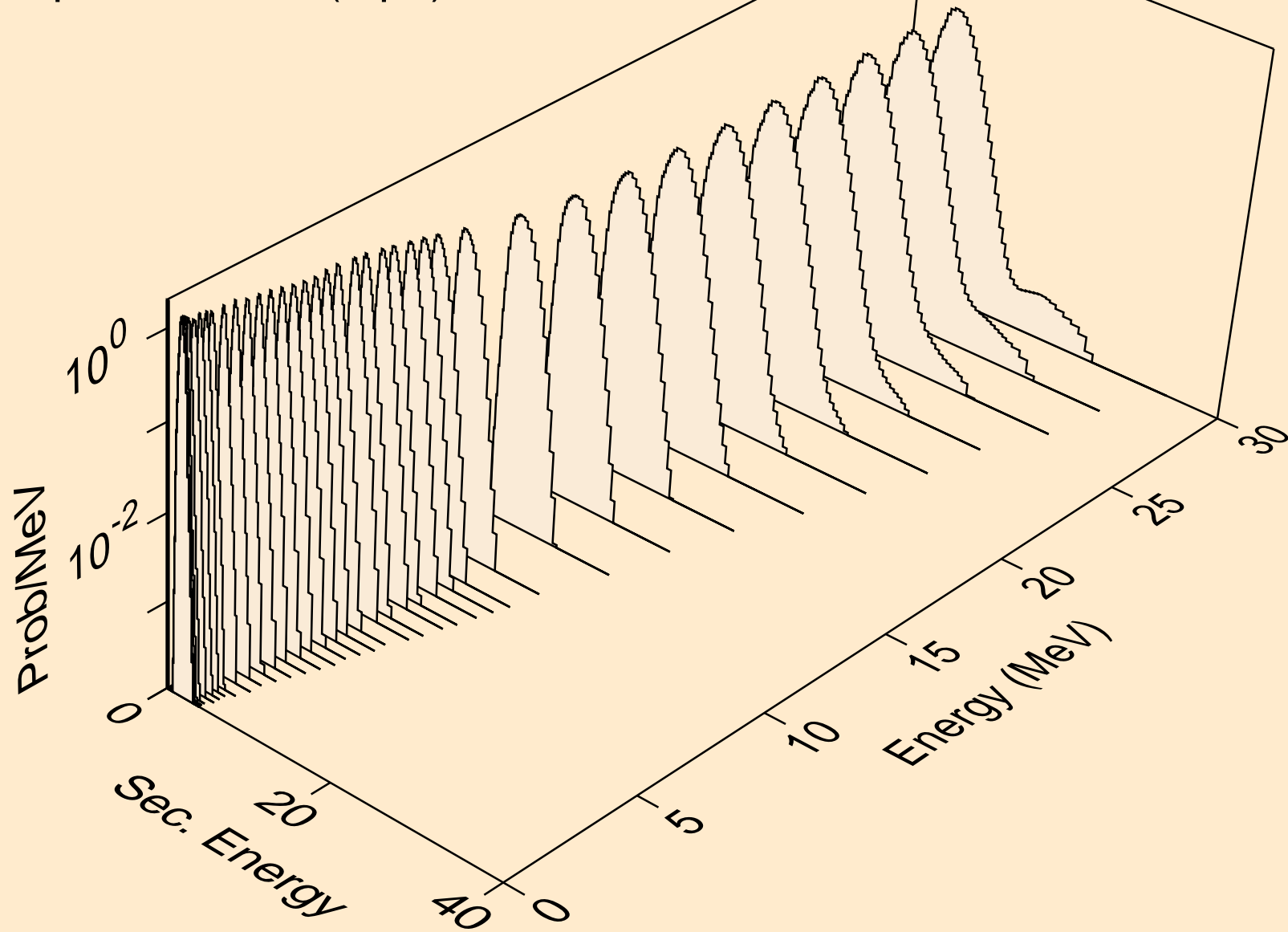

MO085 NEUTRON ACER TENDL-2021 LIBRARY; T=293.6K
protons from (n,pd)

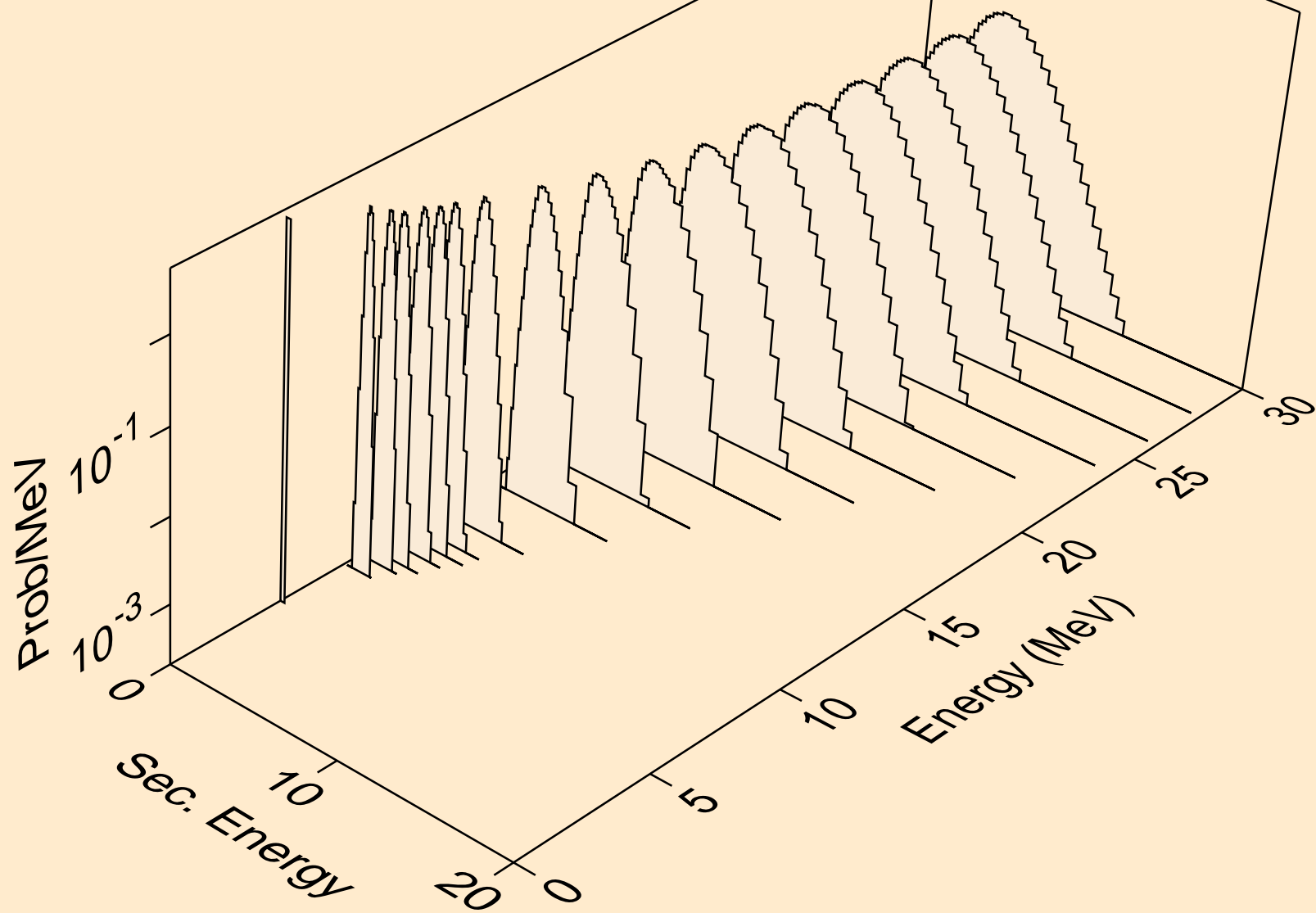

MO085 NEUTRON ACER TENDL-2021 LIBRARY; T=293.6K
protons from (n,pt)

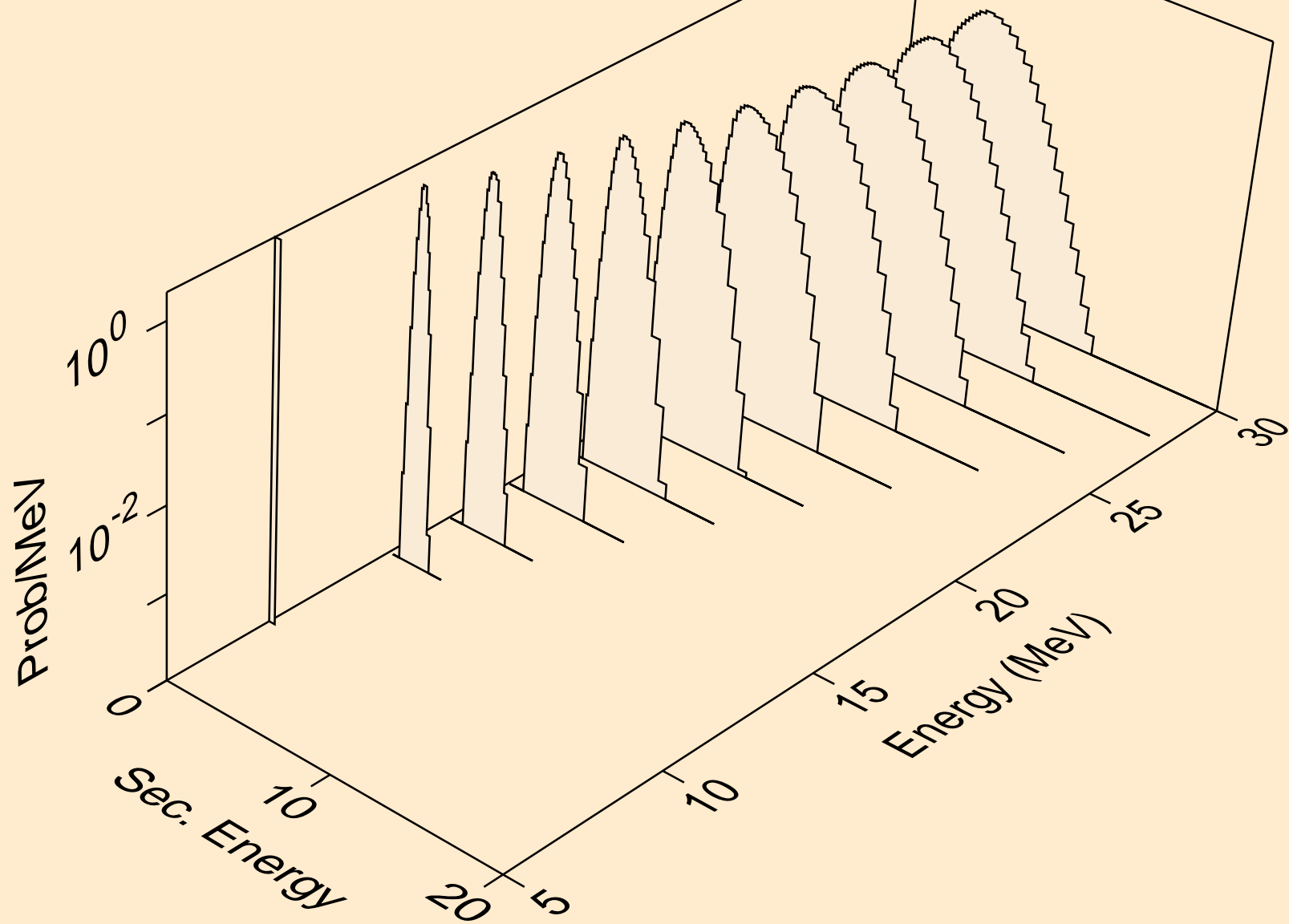

MO085 NEUTRON ACER TENDL-2021 LIBRARY; T=293.6K
deuterons from (n,x)

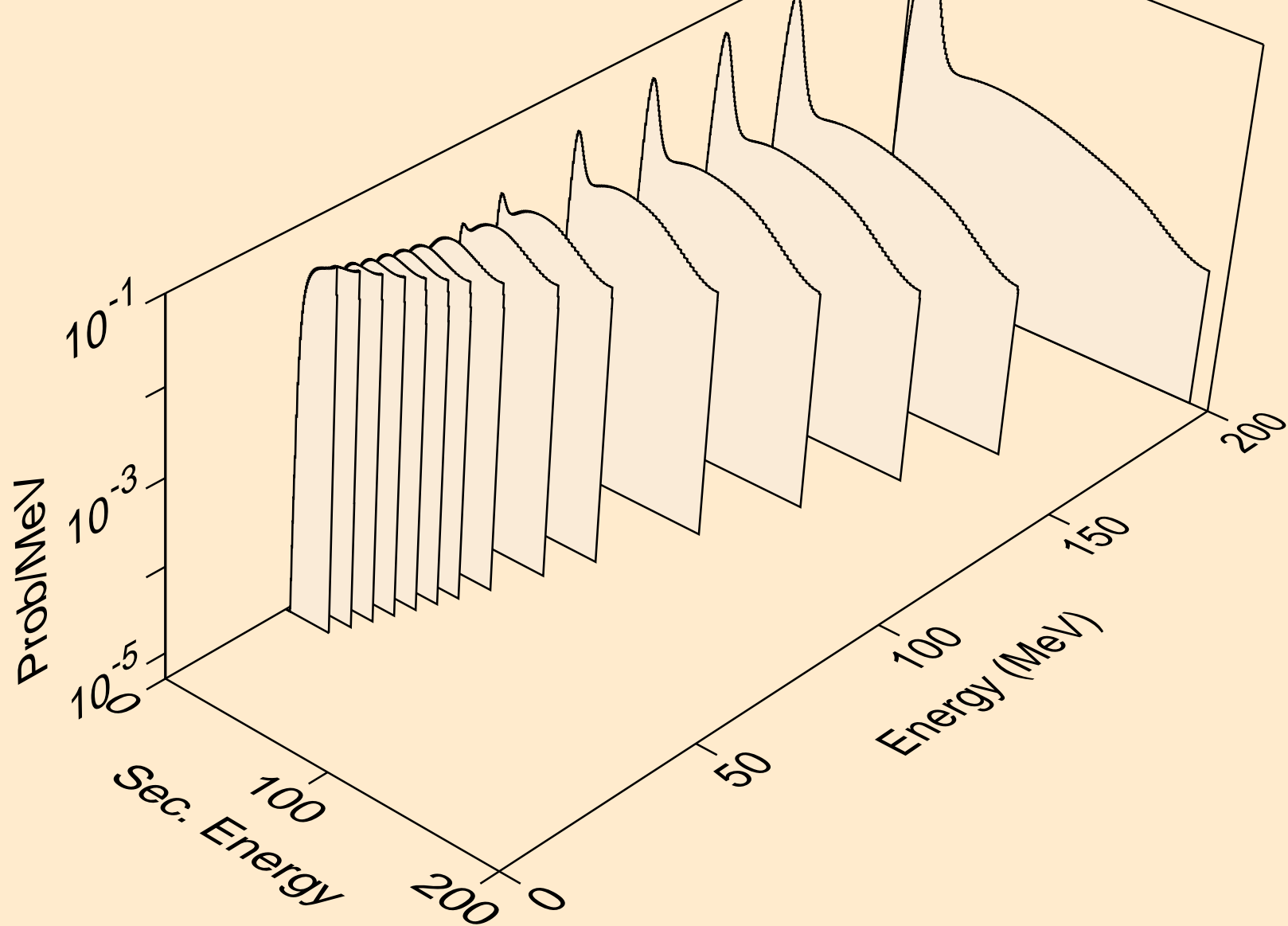

MO085 NEUTRON ACER TENDL-2021 LIBRARY; T=293.6K
deuterons from (n,n*)d

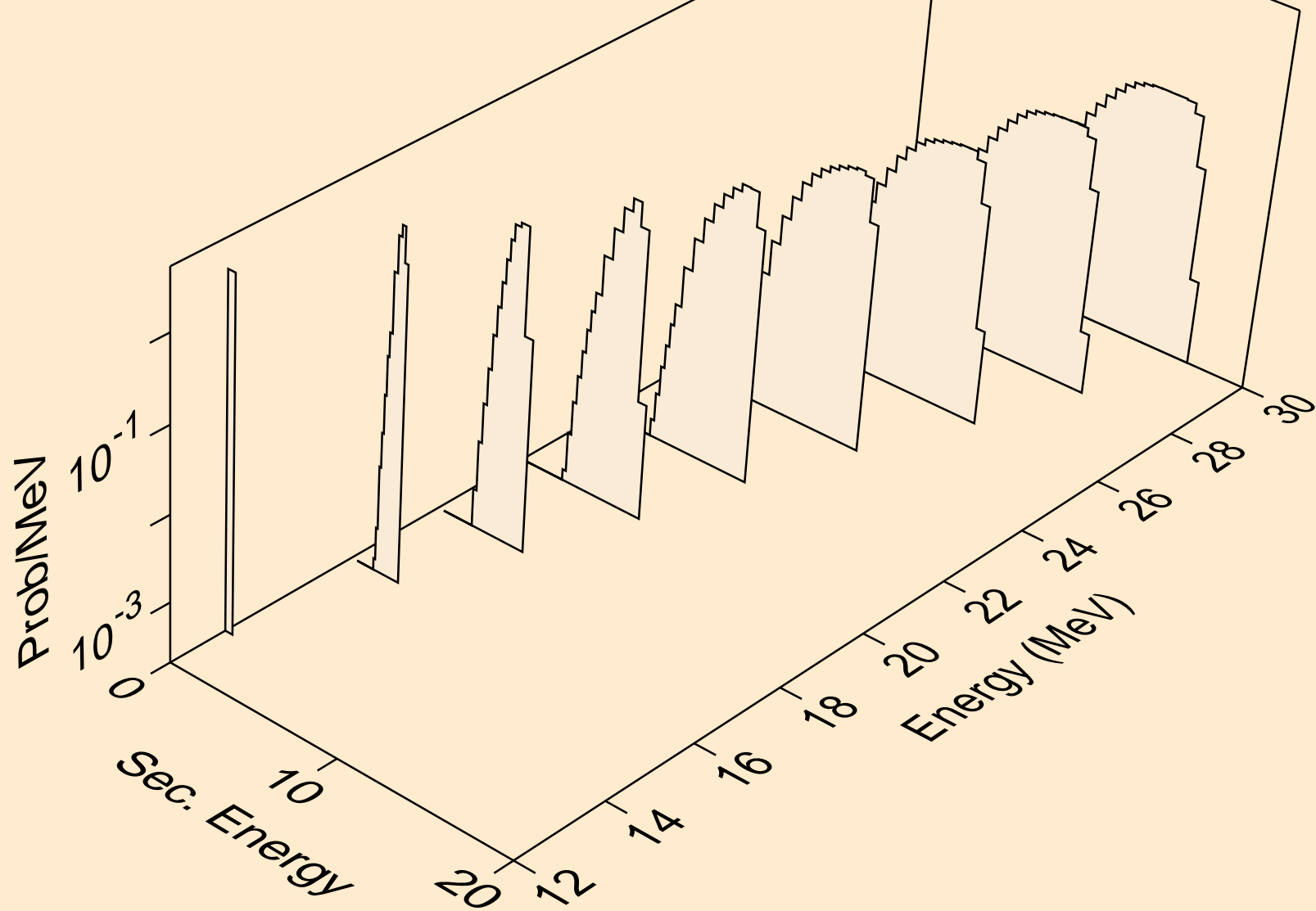

MO085 NEUTRON ACER TENDL-2021 LIBRARY; T=293.6K
deuterons from (n,d)

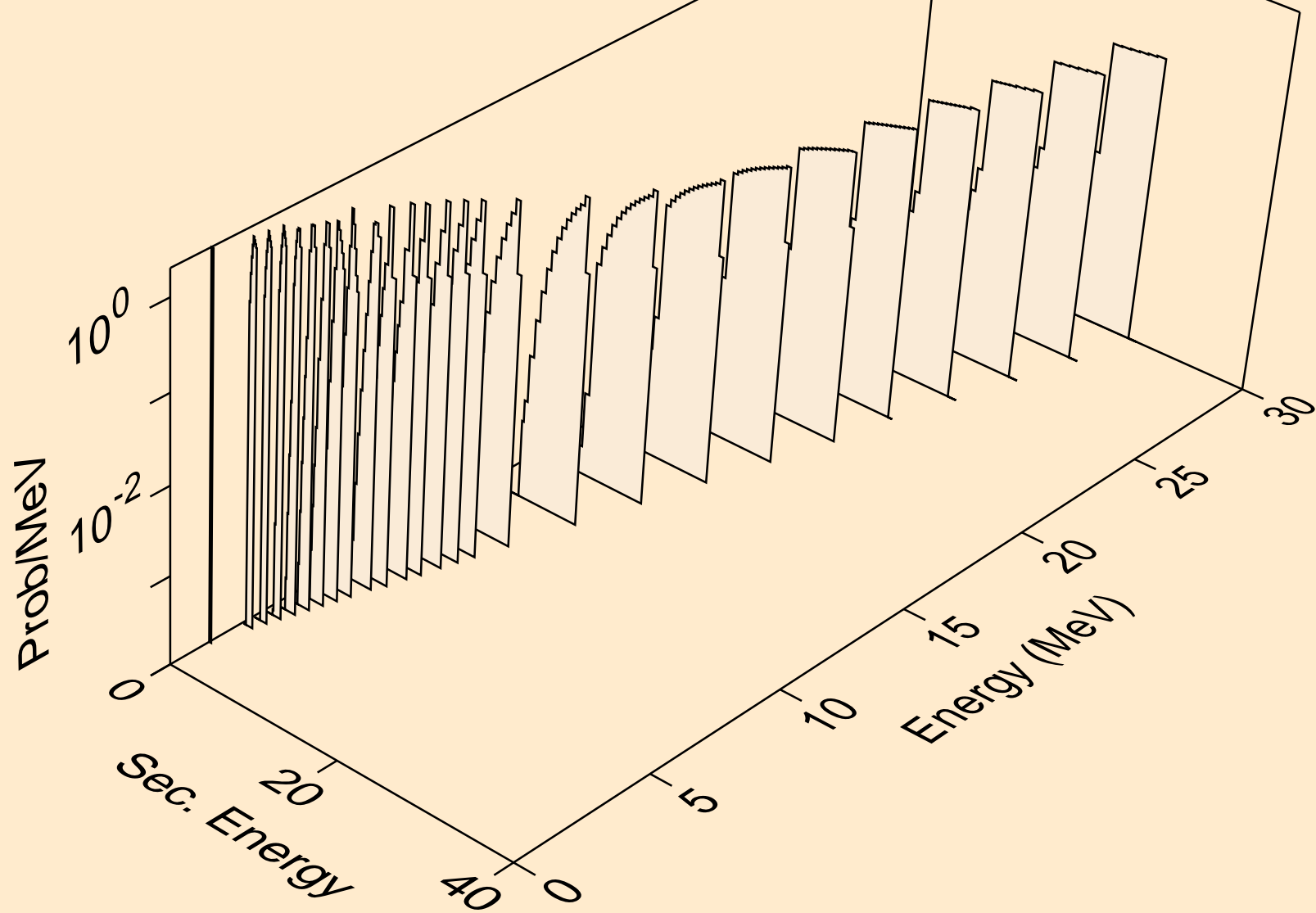

MO085 NEUTRON ACER TENDL-2021 LIBRARY; T=293.6K
deuterons from (n,pd)

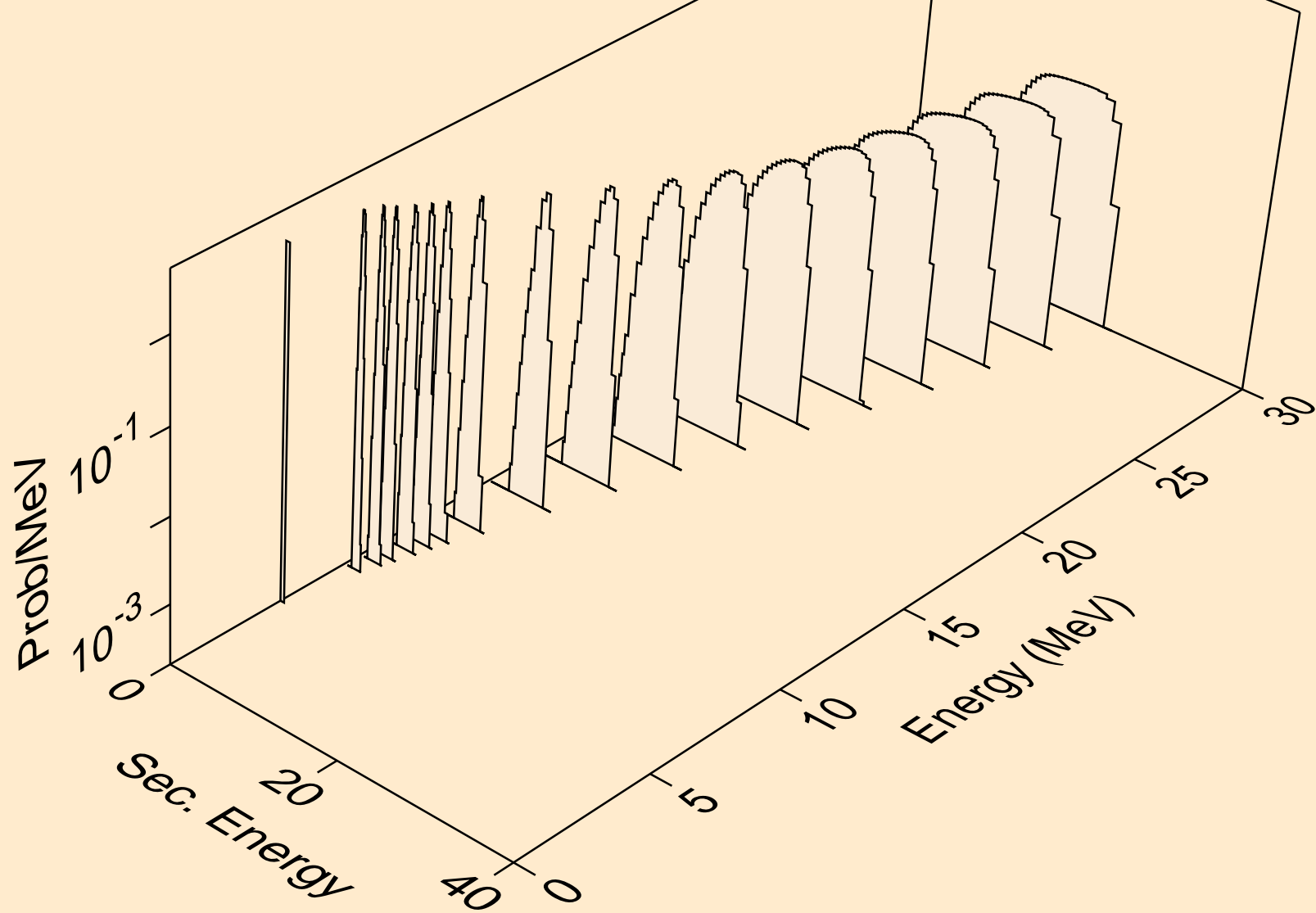

MO085 NEUTRON ACER TENDL-2021 LIBRARY; T=293.6K
deuterons from (n,da)

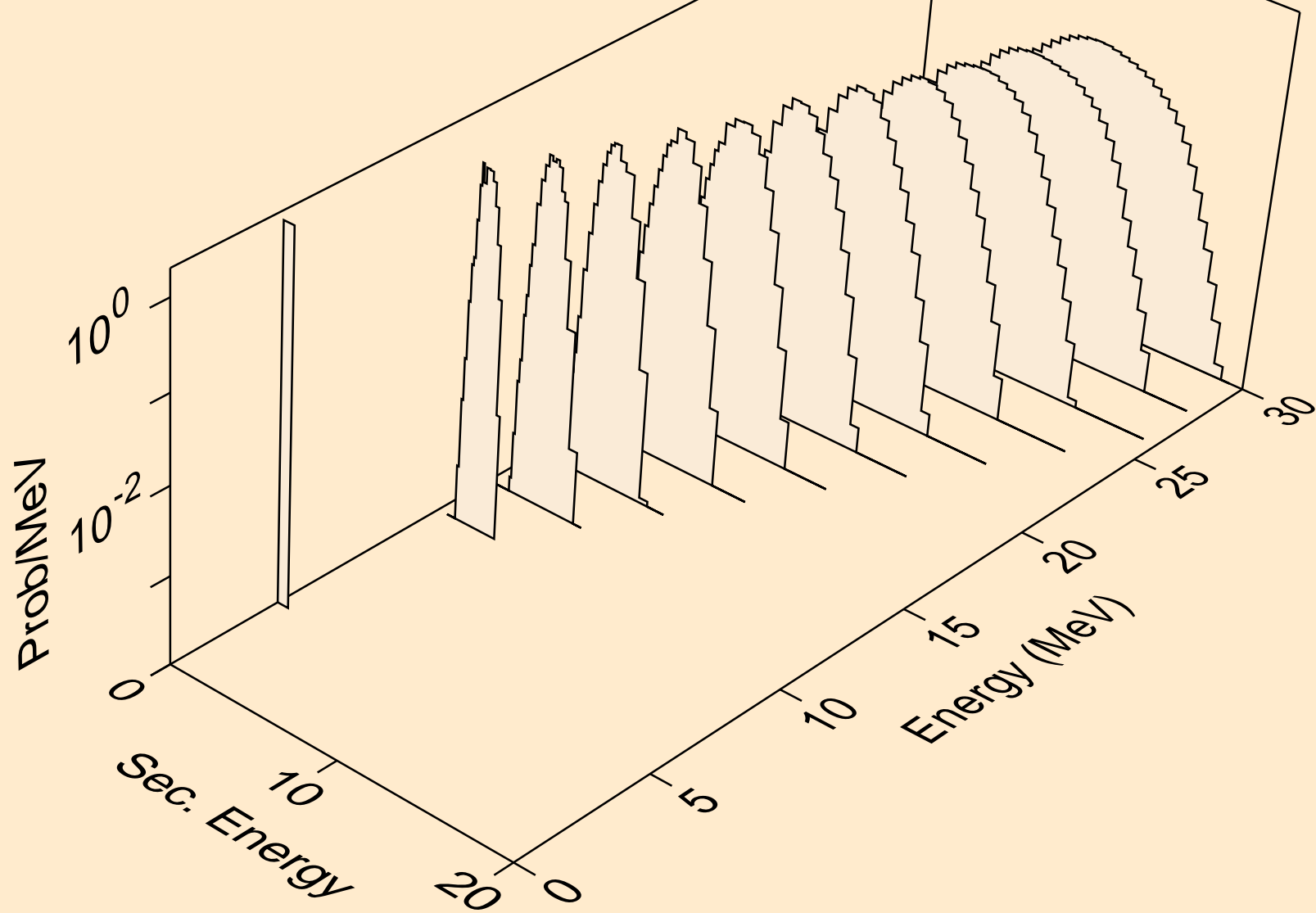

MO085 NEUTRON ACER TENDL-2021 LIBRARY; T=293.6K
tritons from (n,x)

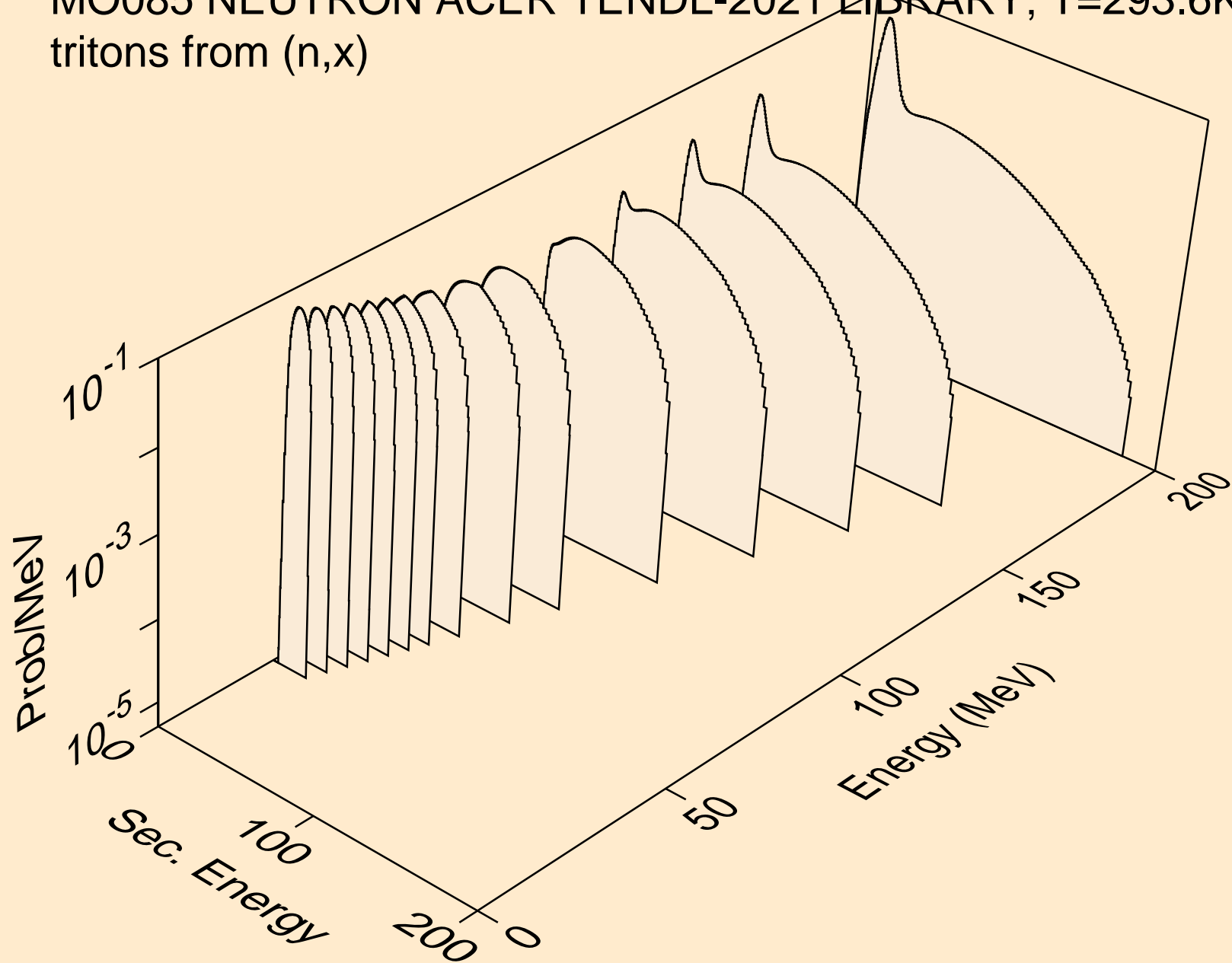

MO085 NEUTRON ACER TENDL-2021 LIBRARY; T=293.6K
tritons from (n,n*)t

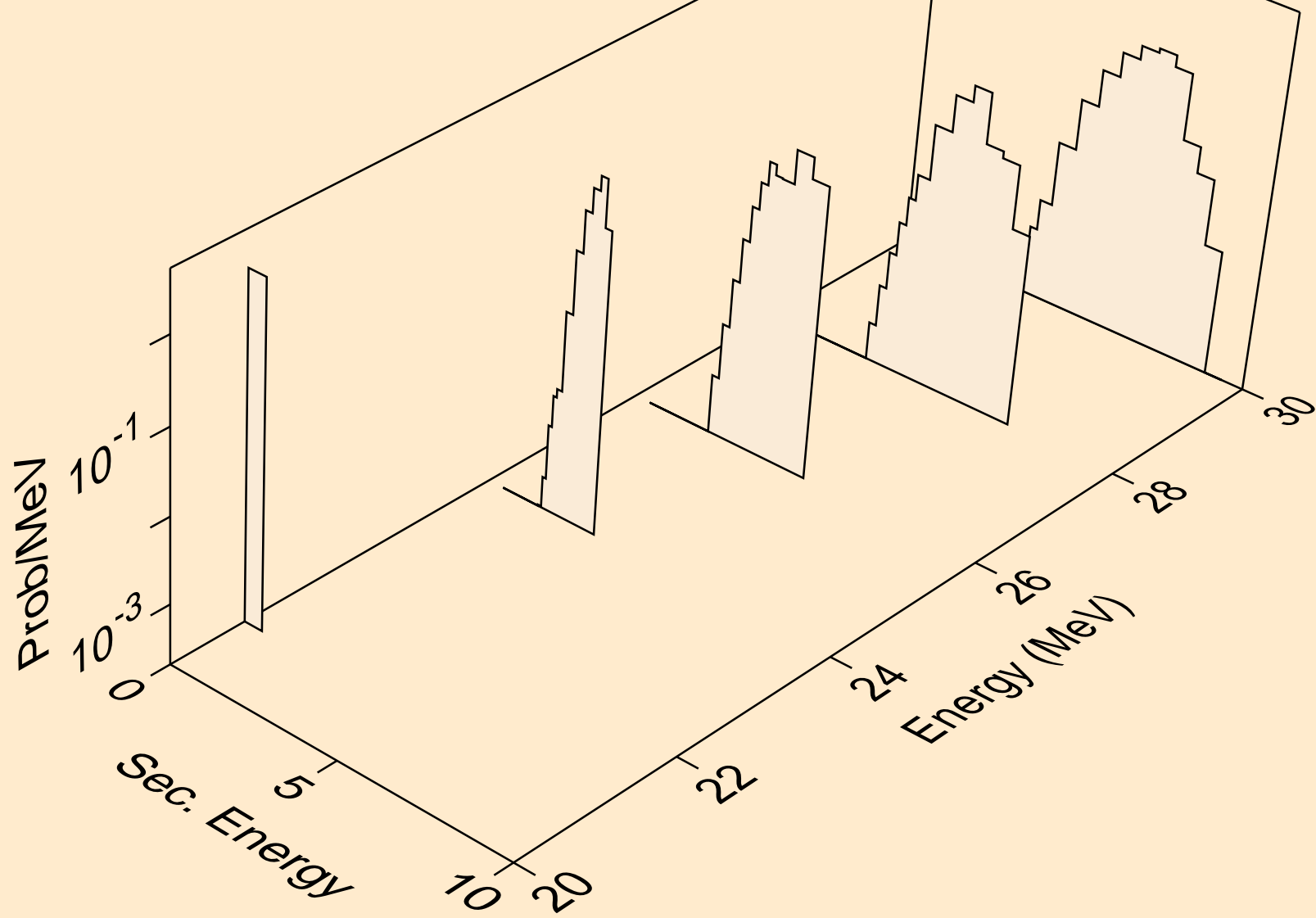

MO085 NEUTRON ACER TENDL-2021 LIBRARY; T=293.6K
tritons from (n,t)

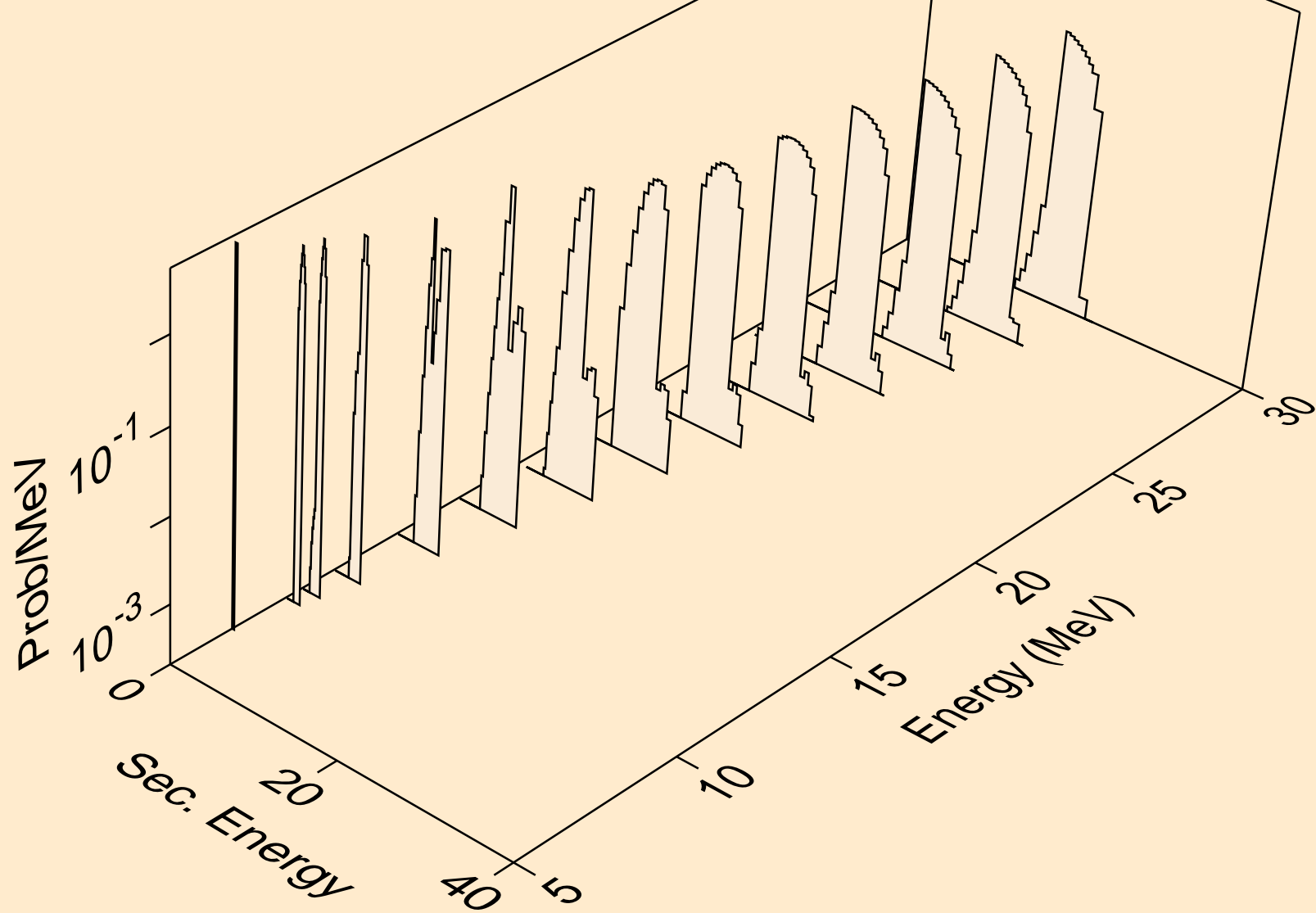

MO085 NEUTRON ACER TENDL-2021 LIBRARY; T=293.6K
tritons from (n,pt)

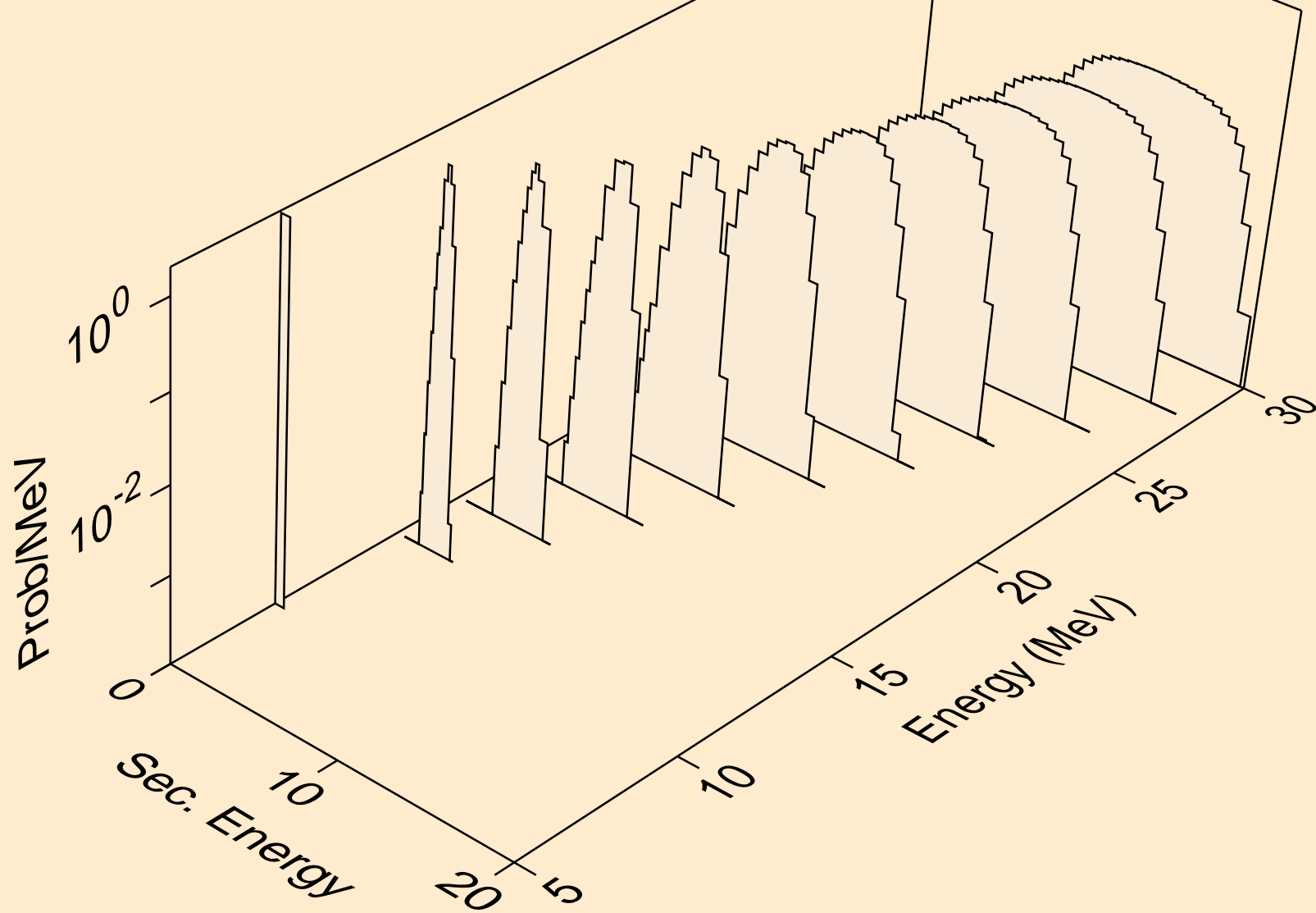

MO085 NEUTRON ACER TENDL-2021 LIBRARY; T=293.6K
he3s from (n,x)

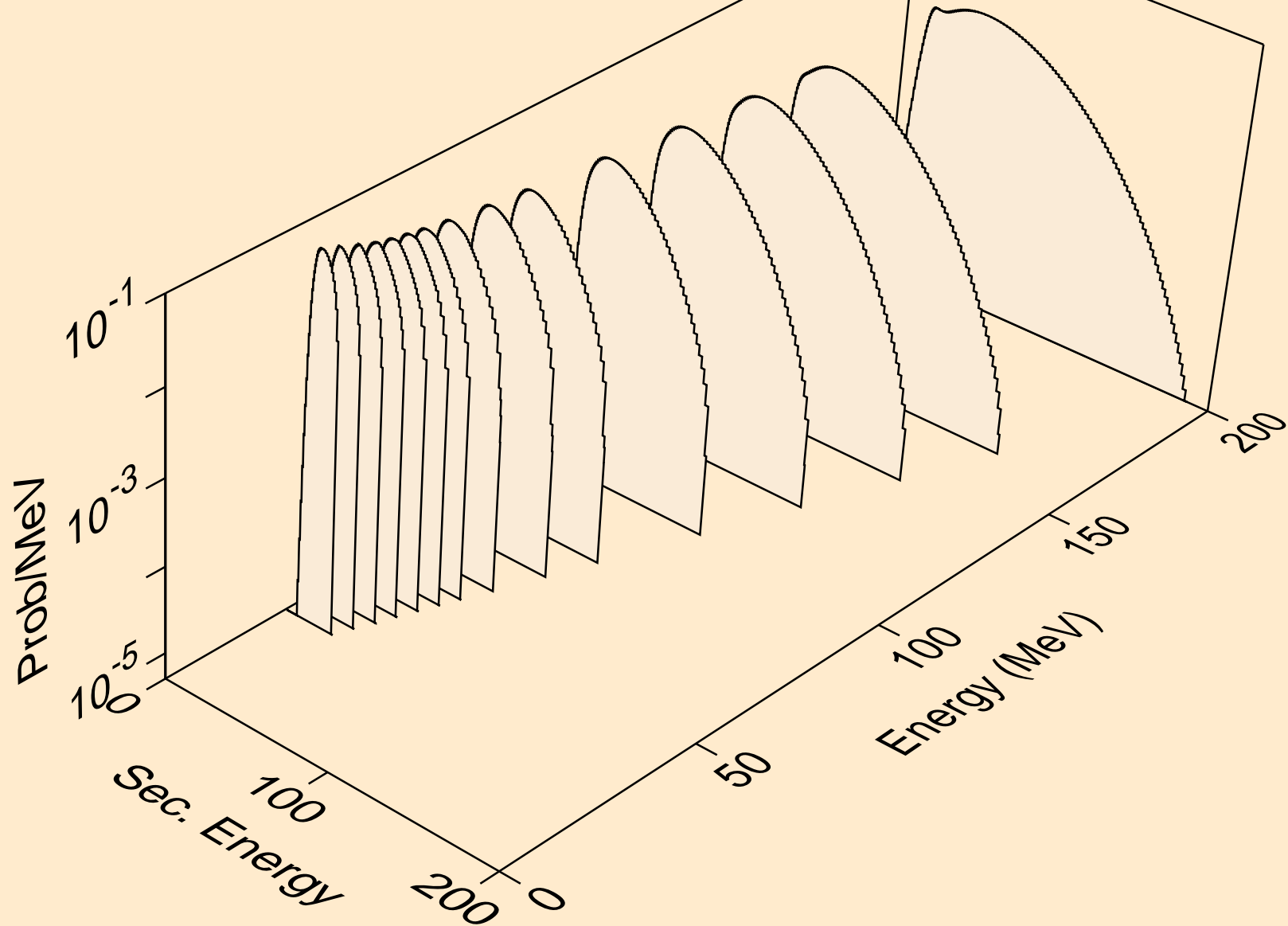

MO085 NEUTRON ACER TENDL-2021 LIBRARY; T=293.6K
he3s from (n,n*)he3

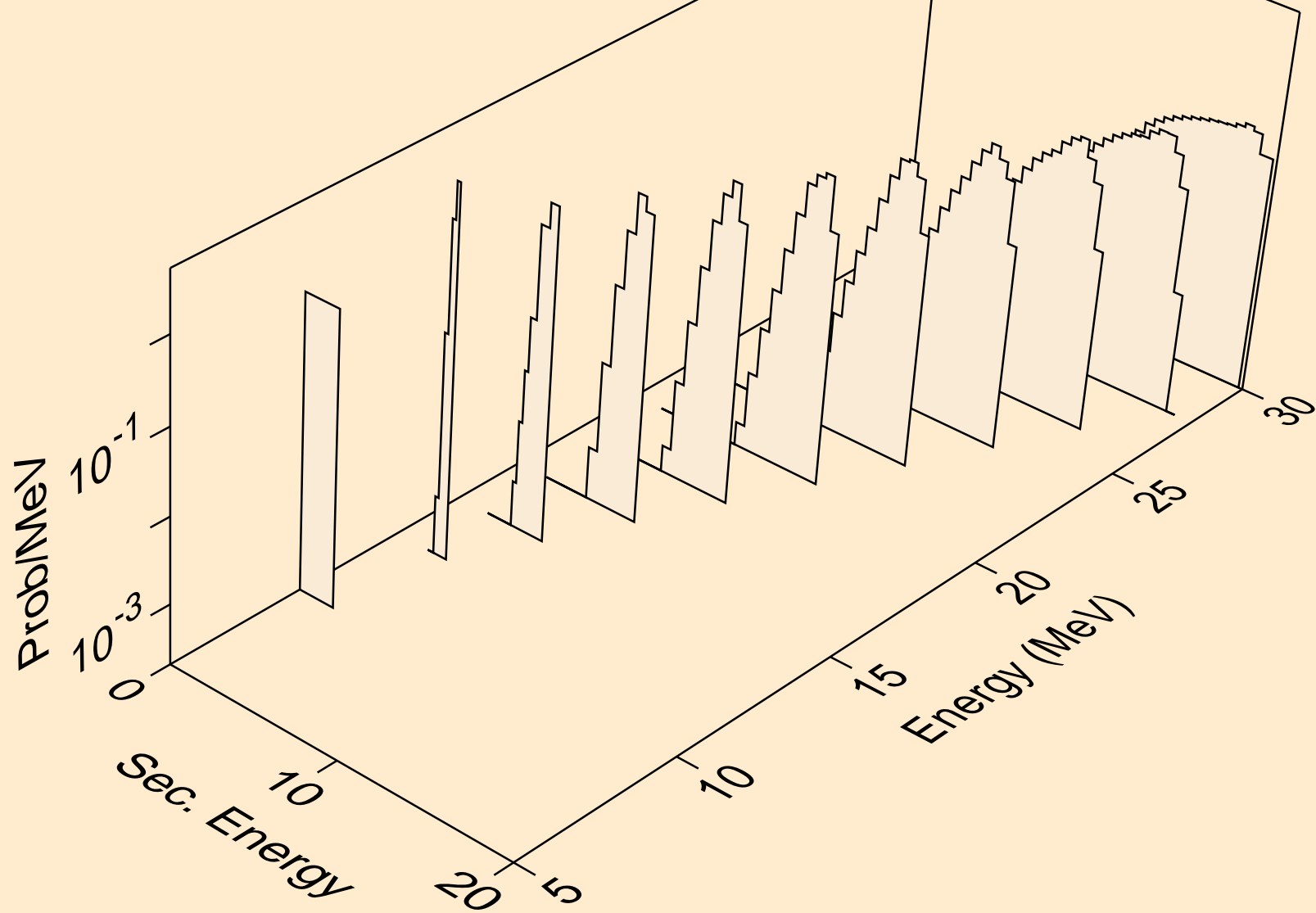

MO085 NEUTRON ACER TENDL-2021 LIBRARY; T=293.6K
he3s from (n,he3)

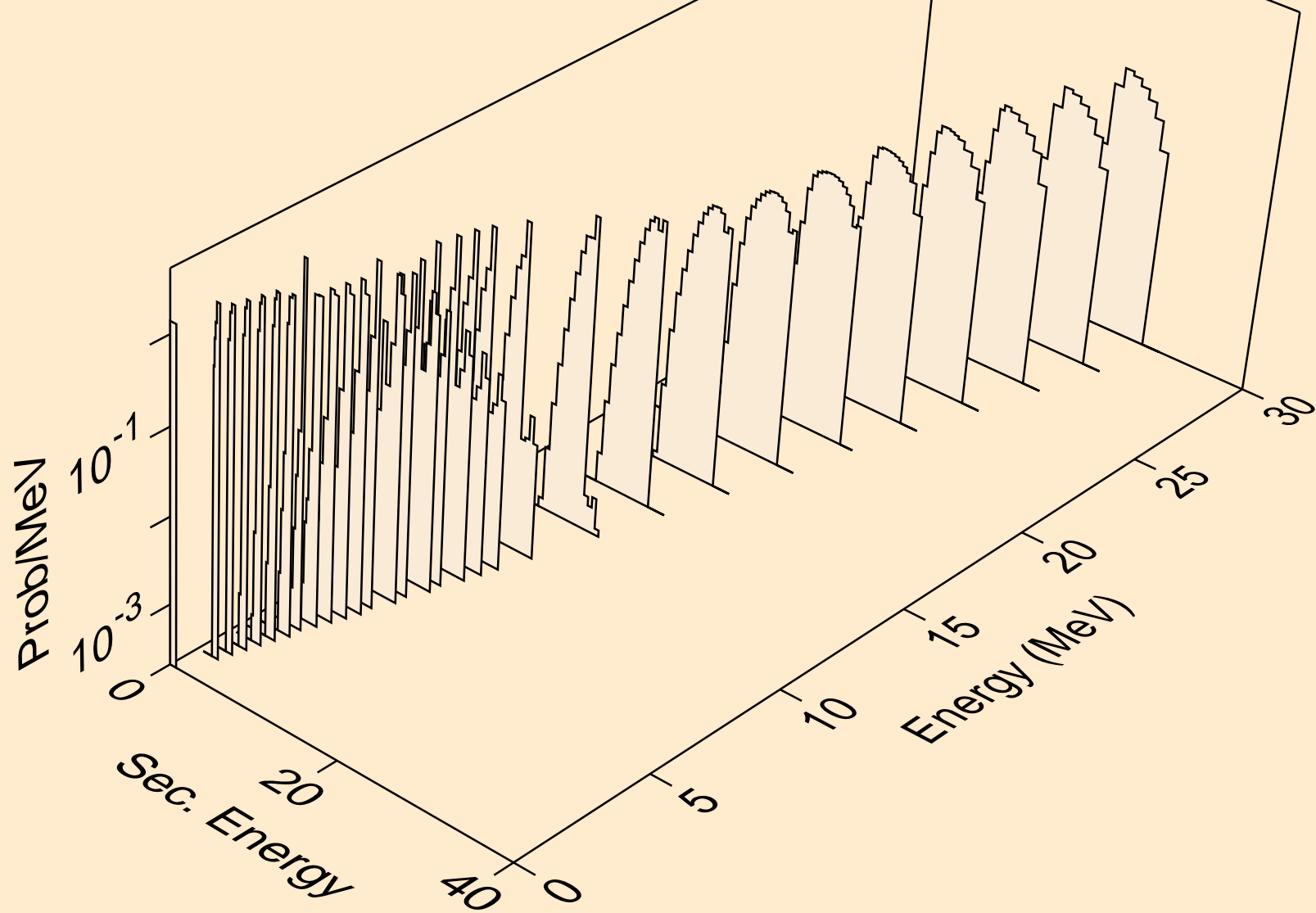

MO085 NEUTRON ACER TENDL-2021 LIBRARY; T=293.6K
alphas from (n,x)

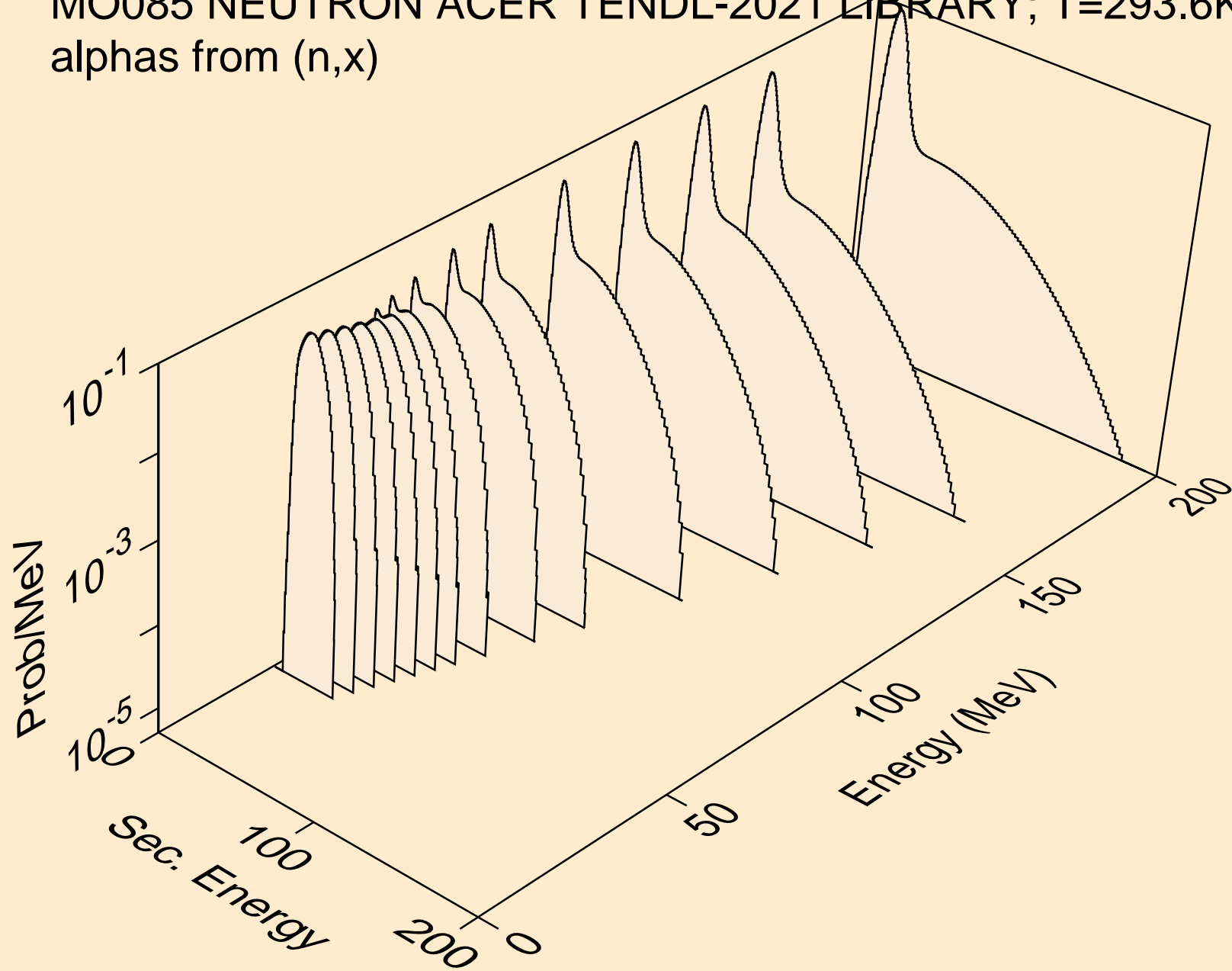

MO085 NEUTRON ACER TENDL-2021 LIBRARY; T=293.6K
alphas from (n,n*)a

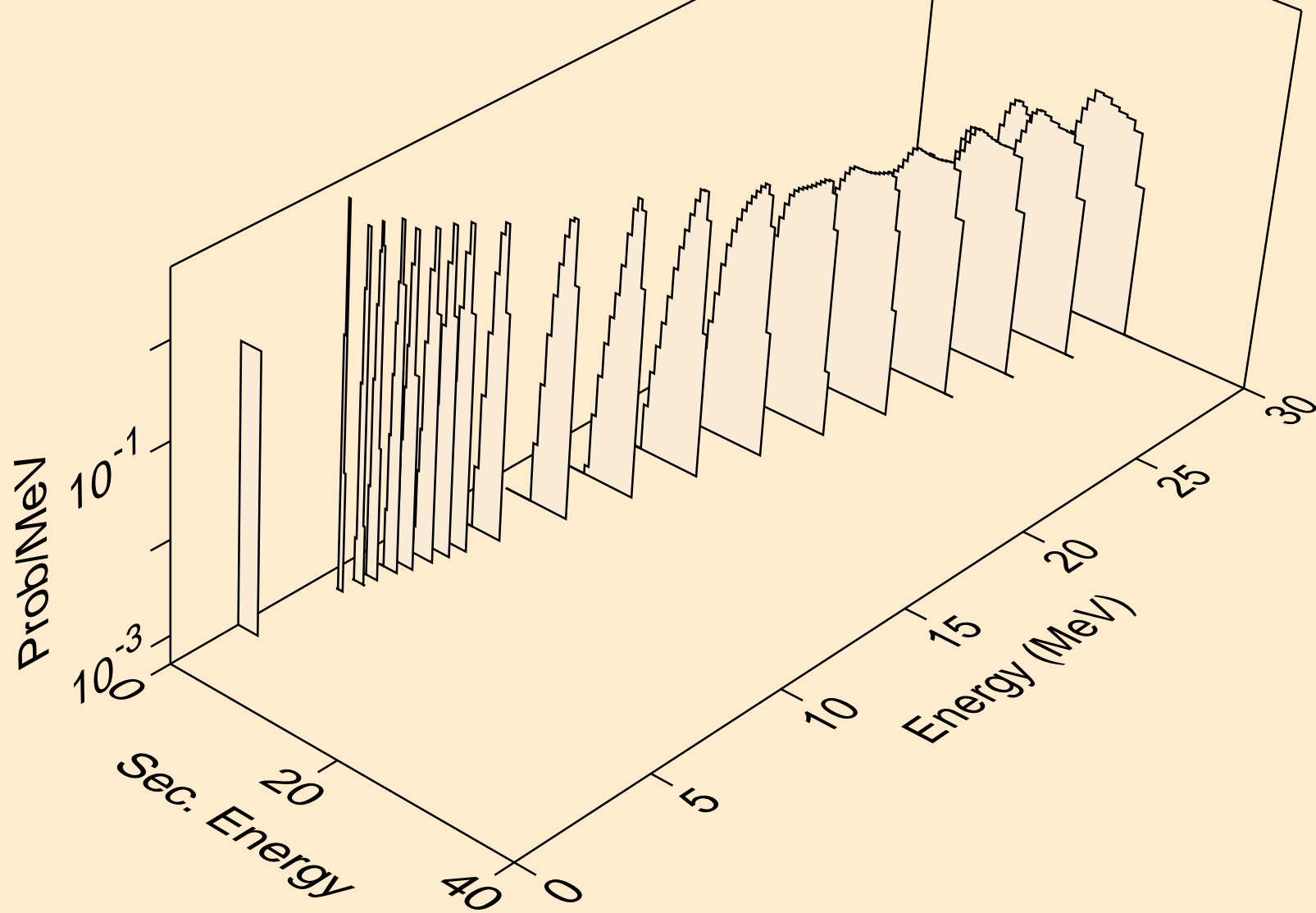

MO085 NEUTRON ACER TENDL-2021 LIBRARY; T=293.6K
alphas from (n,2n)a

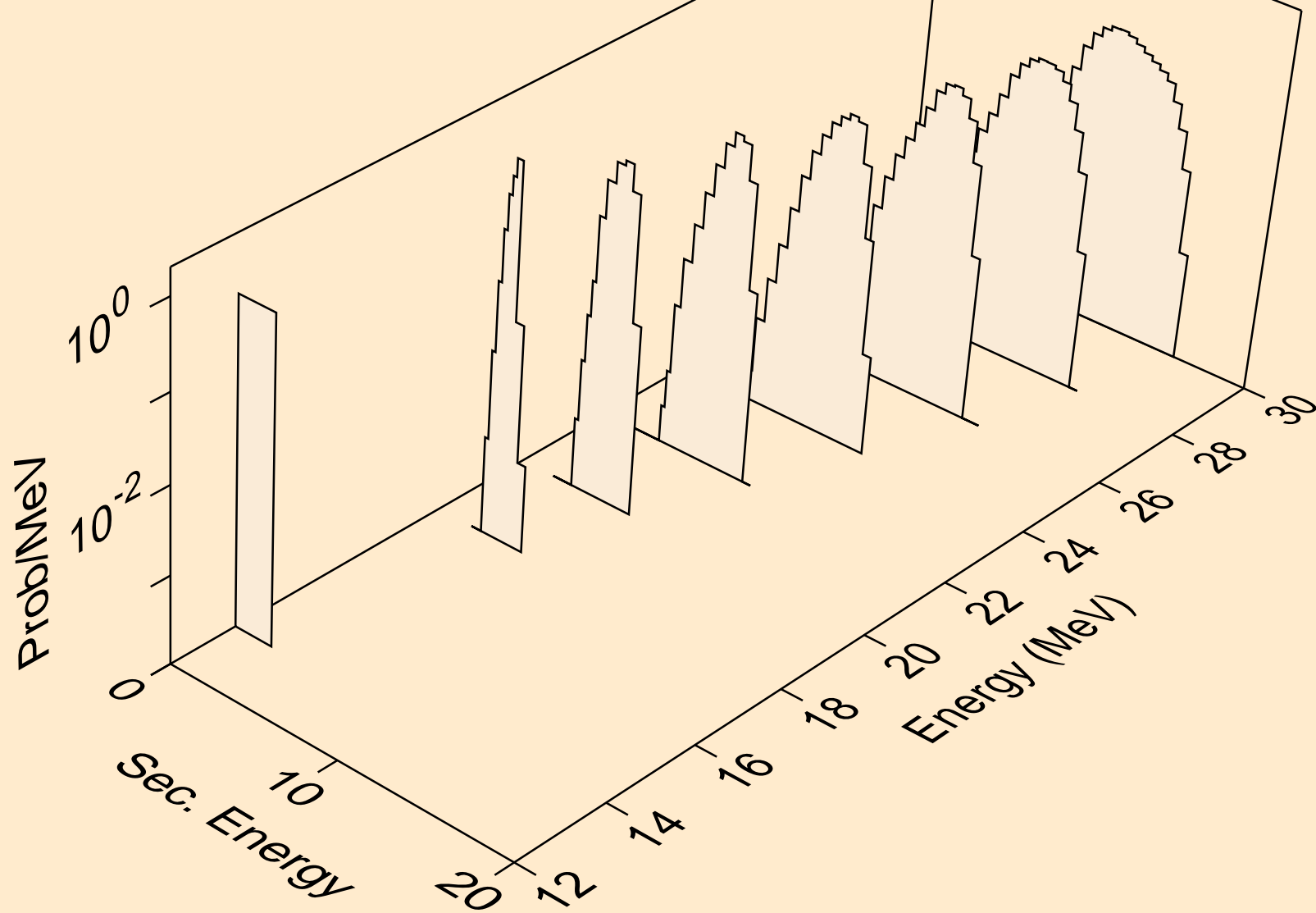

MO085 NEUTRON ACER TENDL-2021 LIBRARY; T=293.6K
alphas from (n,n*)2a

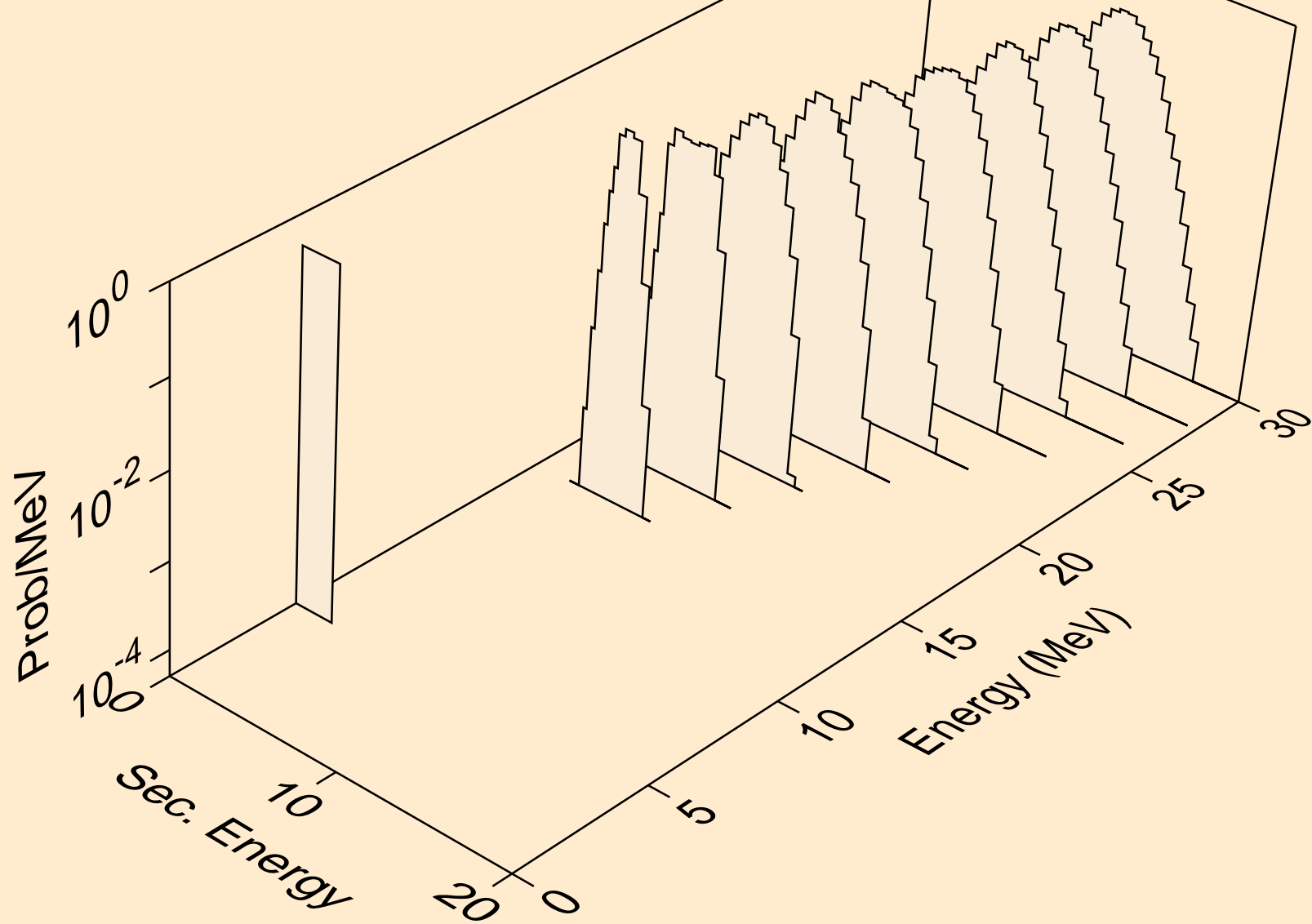

MO085 NEUTRON ACER TENDL-2021 LIBRARY; T=293.6K
alphas from (n,npa)

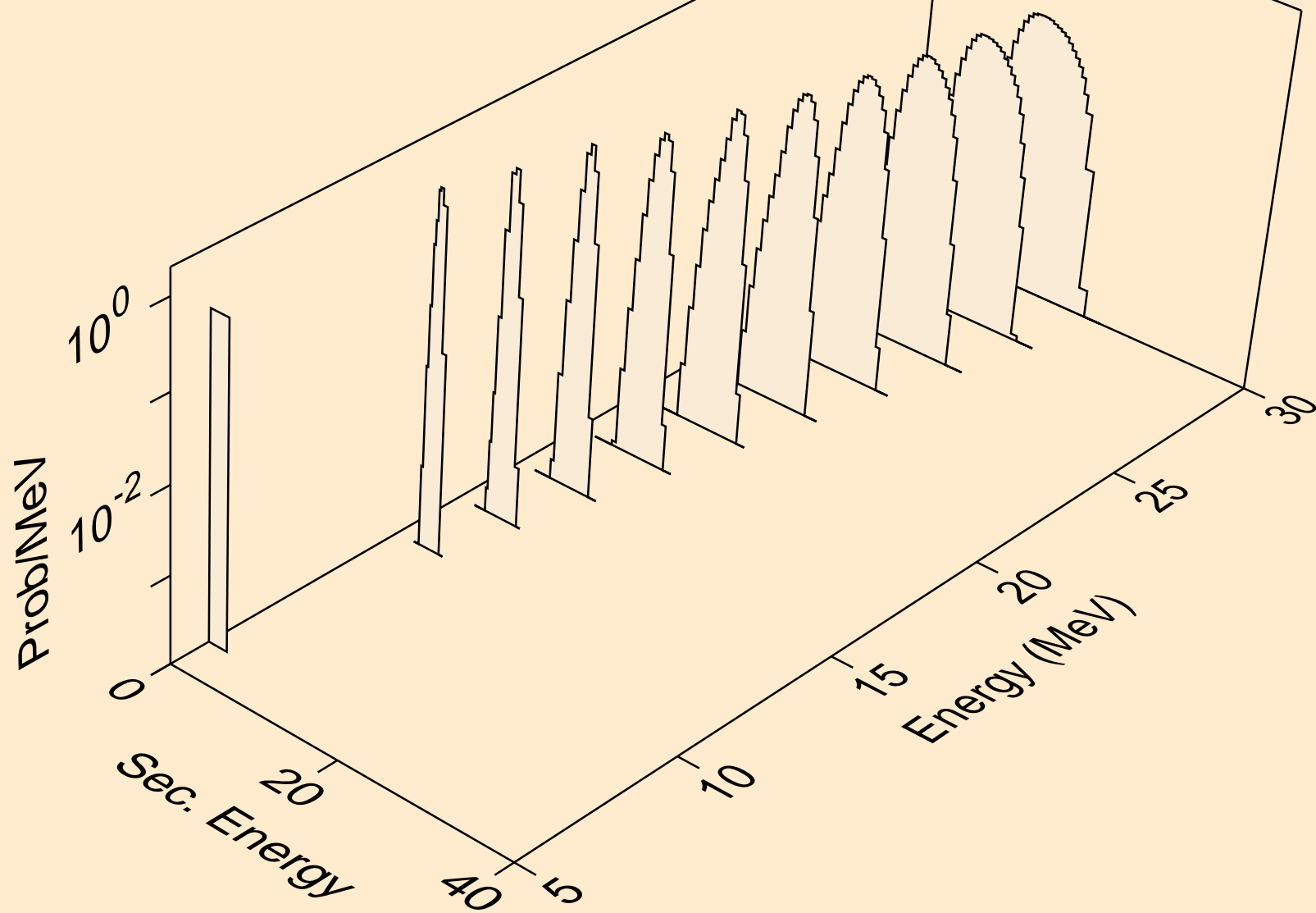

MO085 NEUTRON ACER TENDL-2021 LIBRARY; T=293.6K
alphas from (n,a)

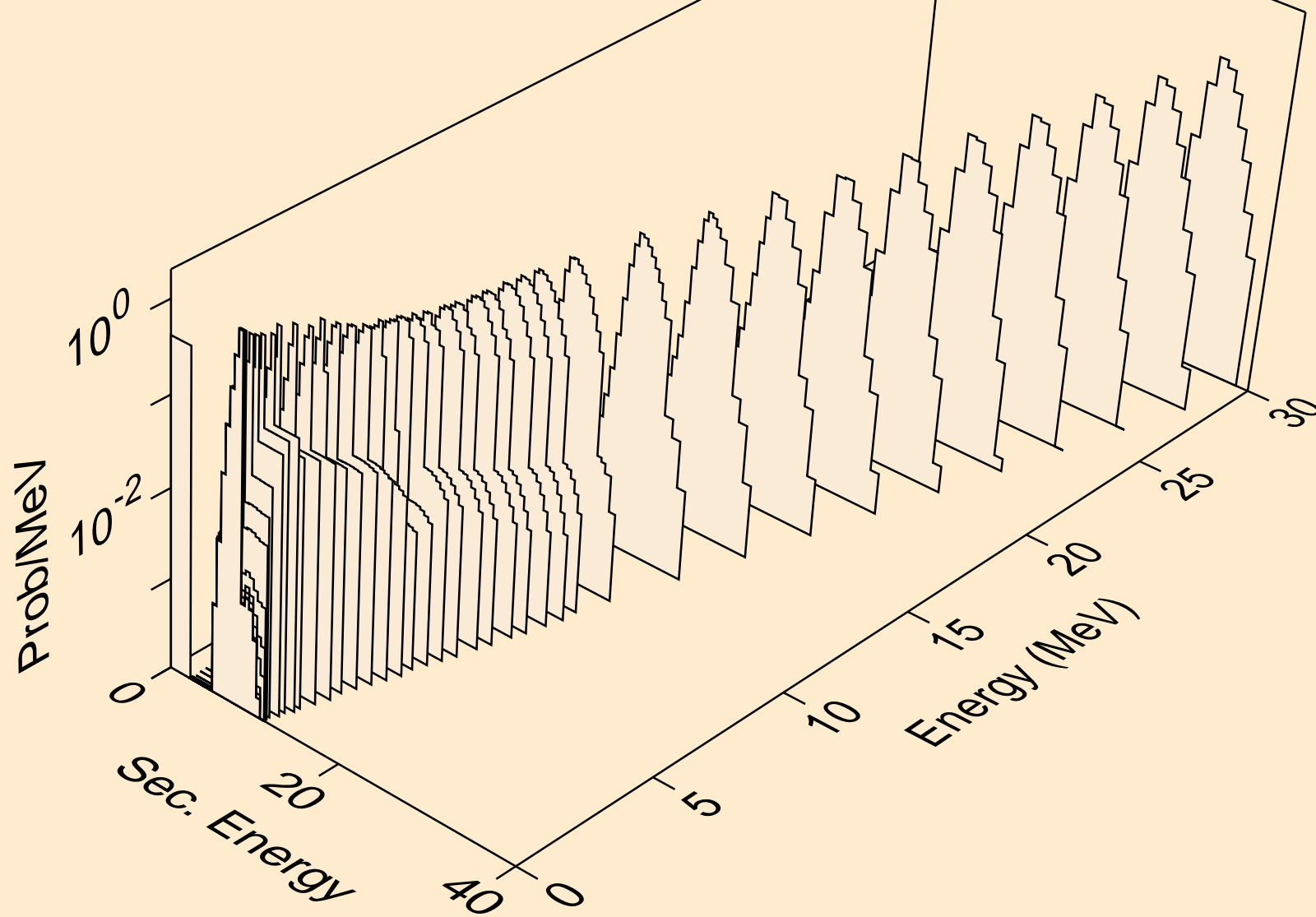

MO085 NEUTRON ACER TENDL-2021 LIBRARY; T=293.6K
alphas from (n,2a)

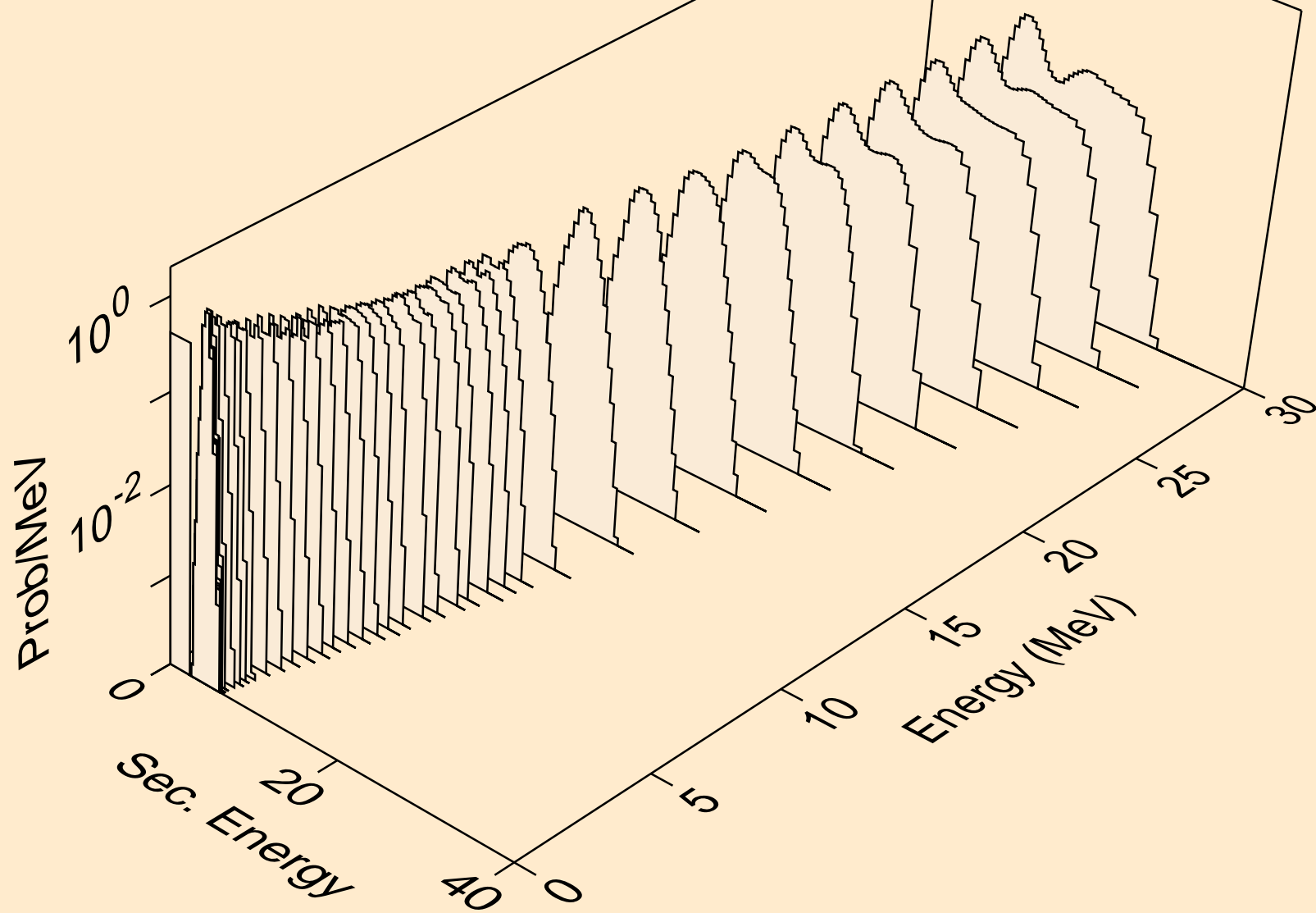

MO085 NEUTRON ACER TENDL-2021 LIBRARY; T=293.6K
alphas from (n,3a)

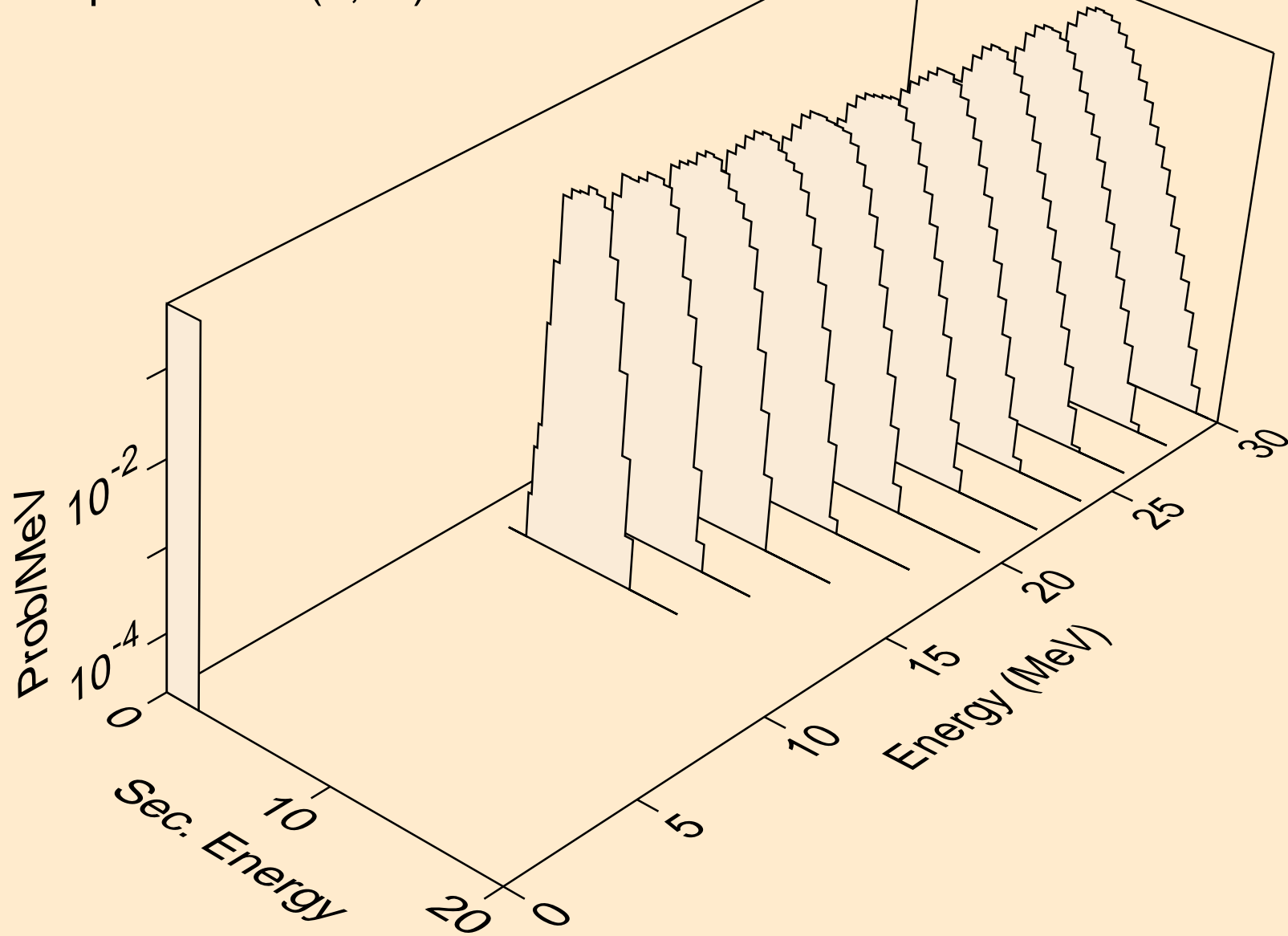

MO085 NEUTRON ACER TENDL-2021 LIBRARY; T=293.6K
alphas from (n,pa)

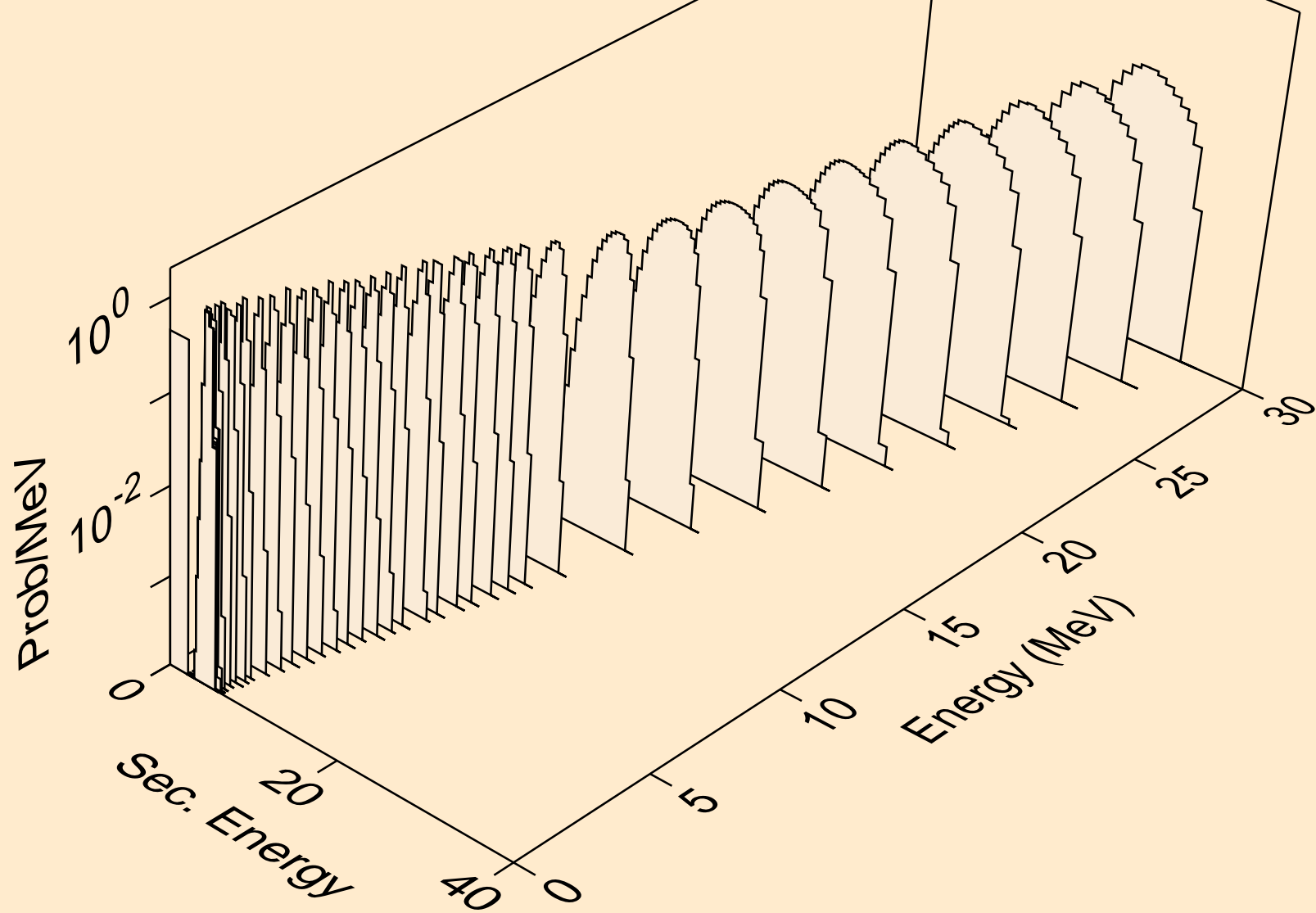

MO085 NEUTRON ACER TENDL-2021 LIBRARY; T=293.6K
alphas from (n,da)

