

MO091M NEUTRON ACER TENDL-2021 LIBRARY; T=293.6K
Principal cross sections

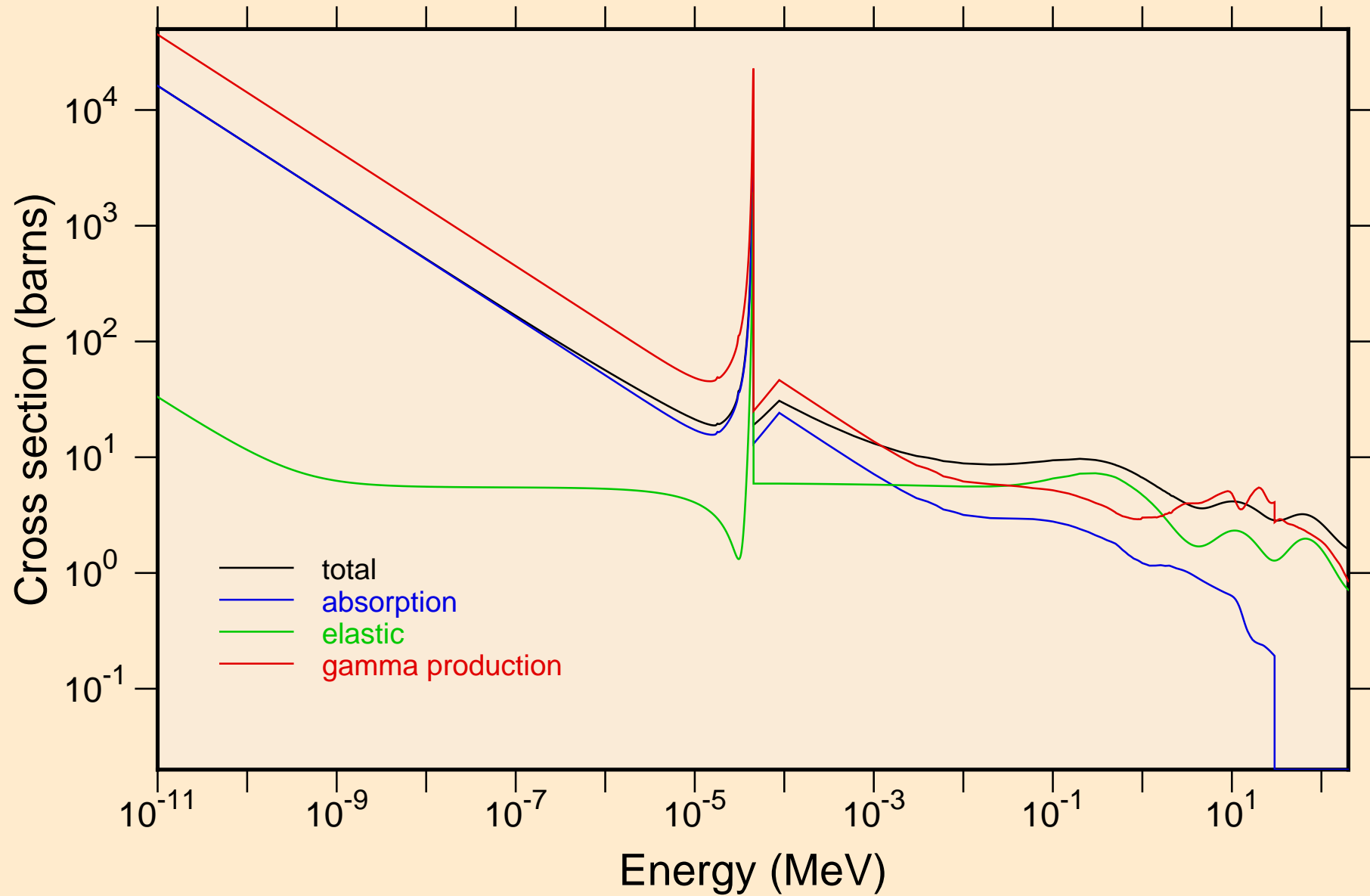

MO091M NEUTRON ACER TENDL-2021 LIBRARY; T=293.6K
Heating

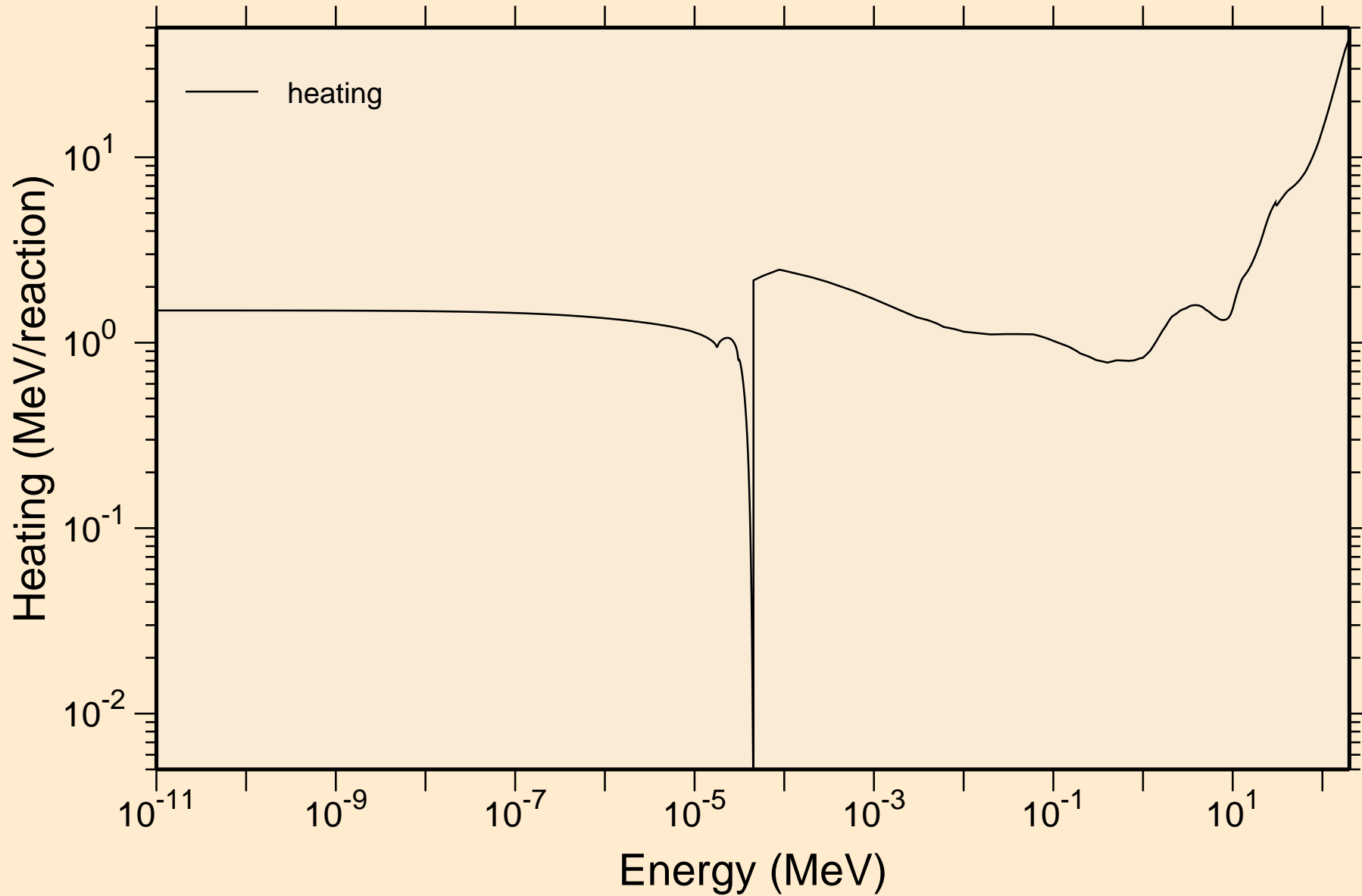

MO091M NEUTRON ACER TENDL-2021 LIBRARY; T=293.6K
Damage

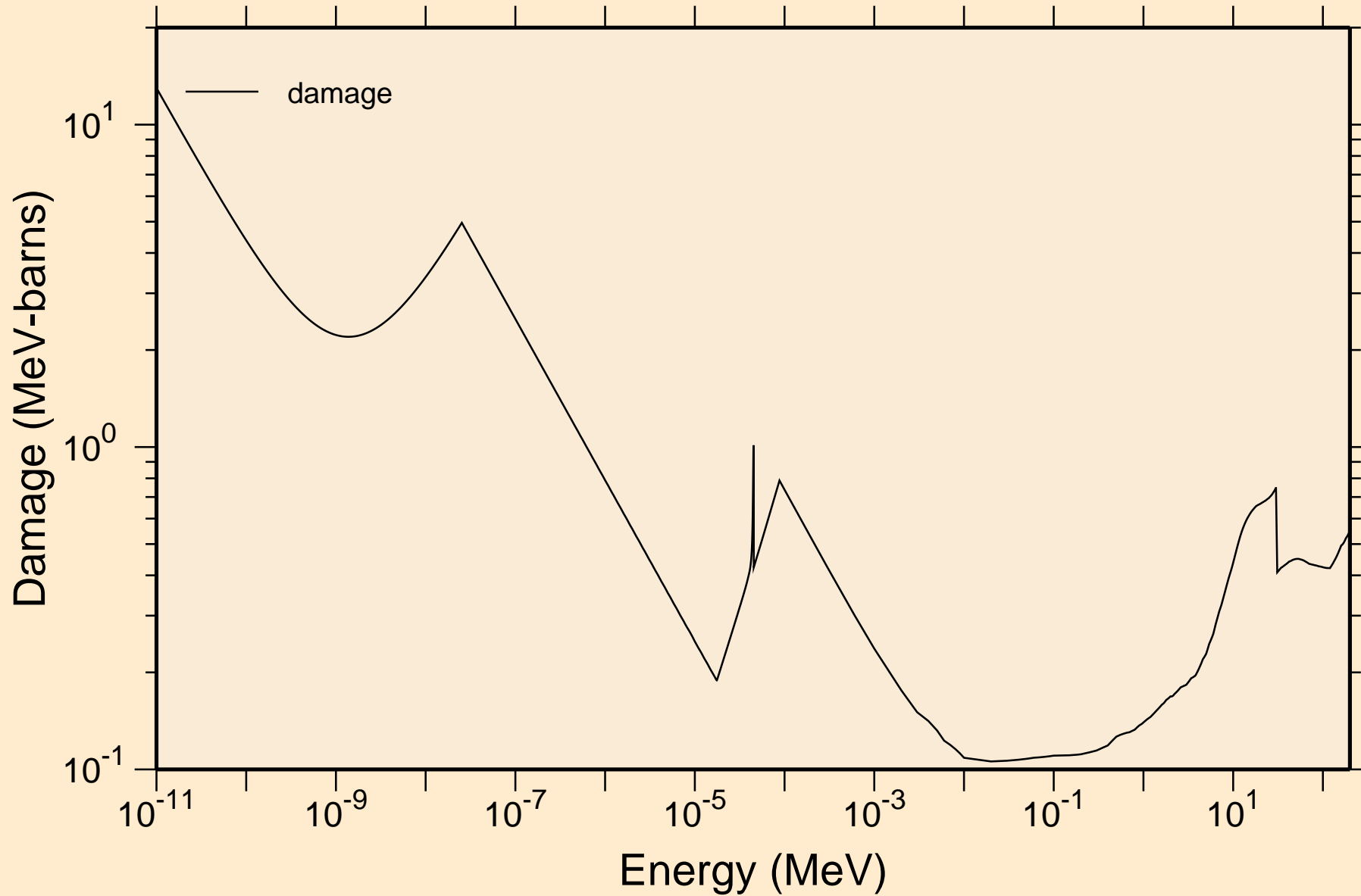

MO091M NEUTRON ACER TENDL-2021 LIBRARY; T=293.6K
Non-threshold reactions

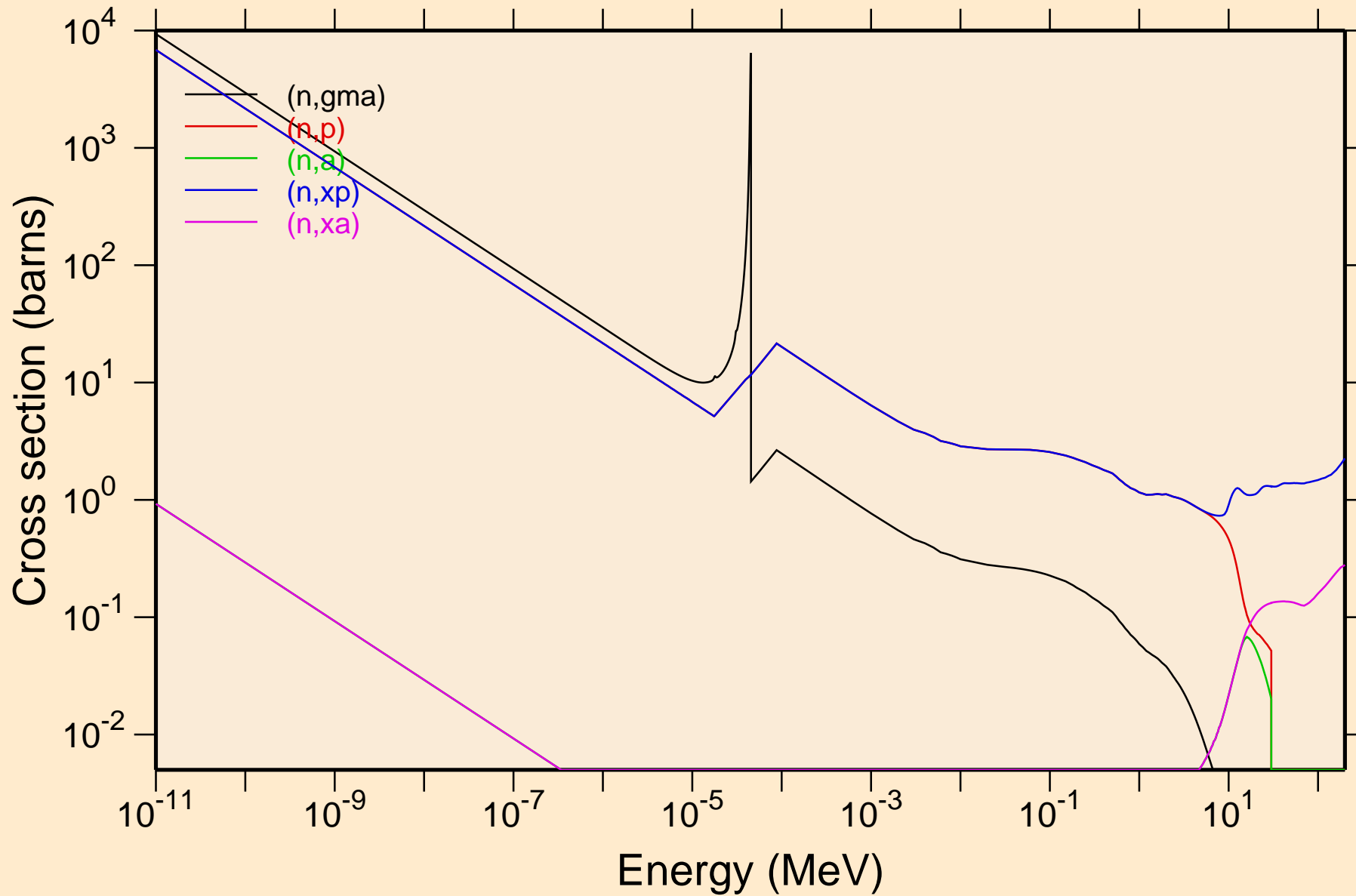

MO091M NEUTRON ACER TENDL-2021 LIBRARY; T=293.6K
Principal cross sections

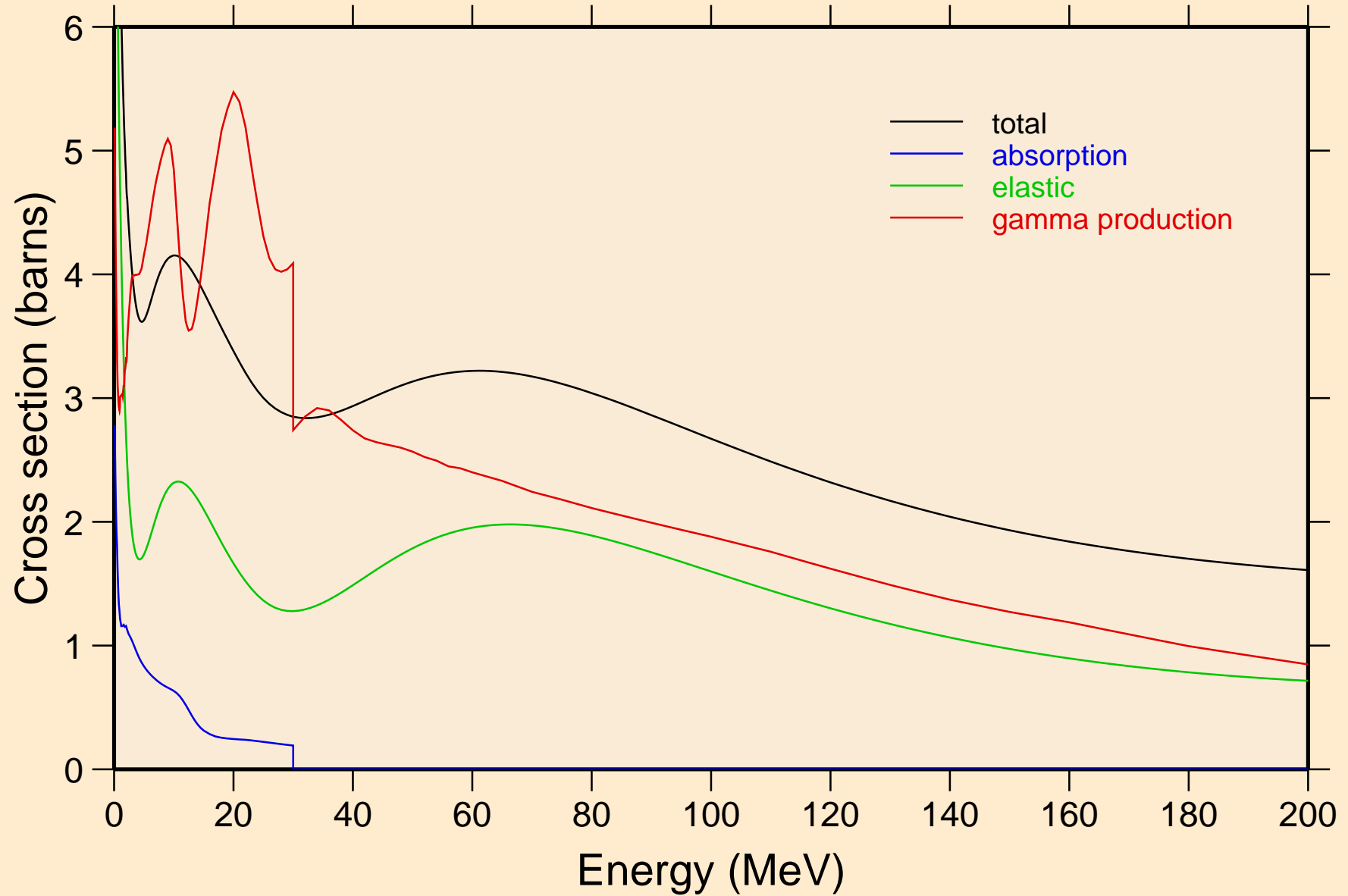

MO091M NEUTRON ACER TENDL-2021 LIBRARY; T=293.6K
Heating

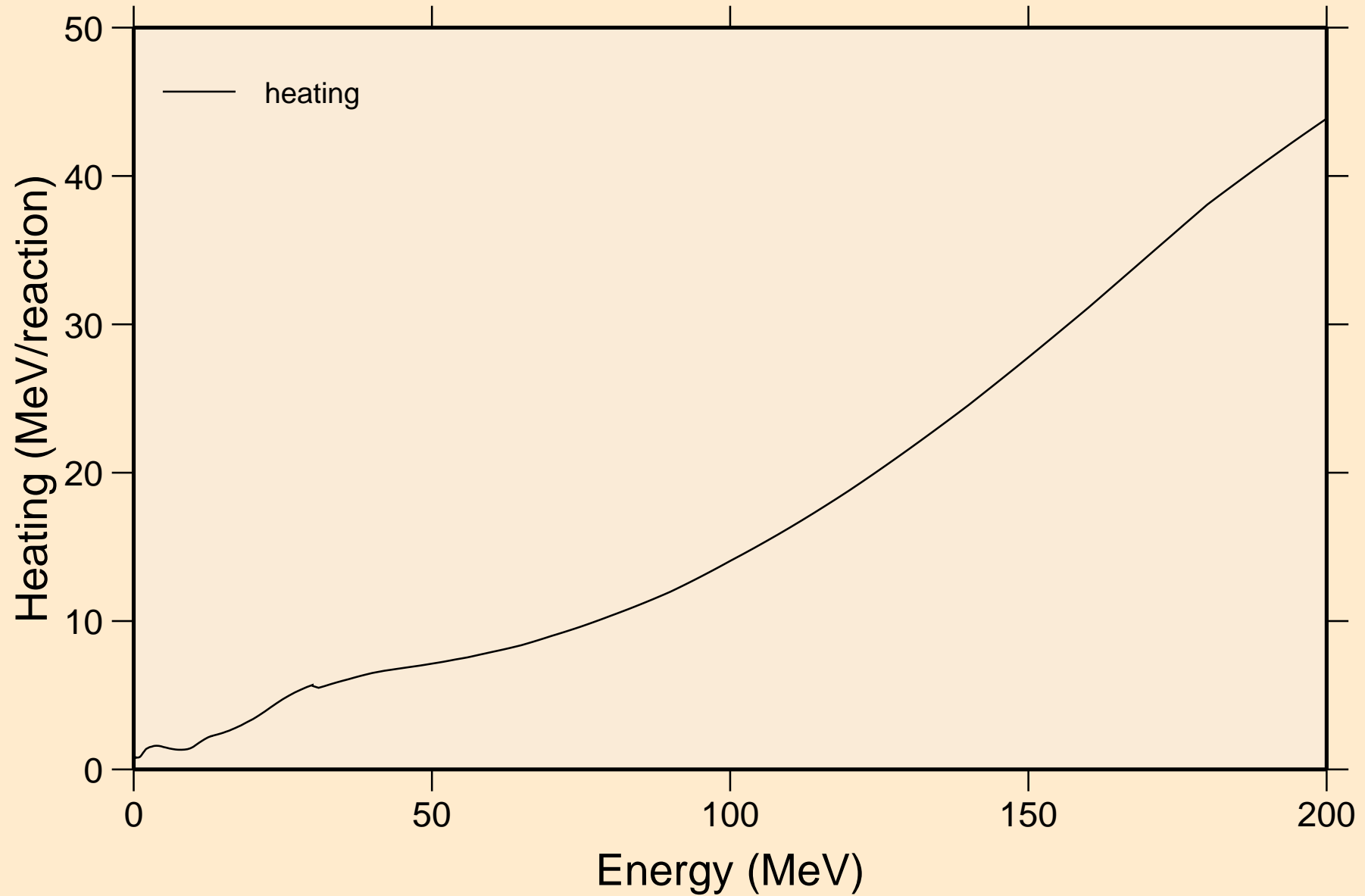

MO091M NEUTRON ACER TENDL-2021 LIBRARY; T=293.6K
Damage

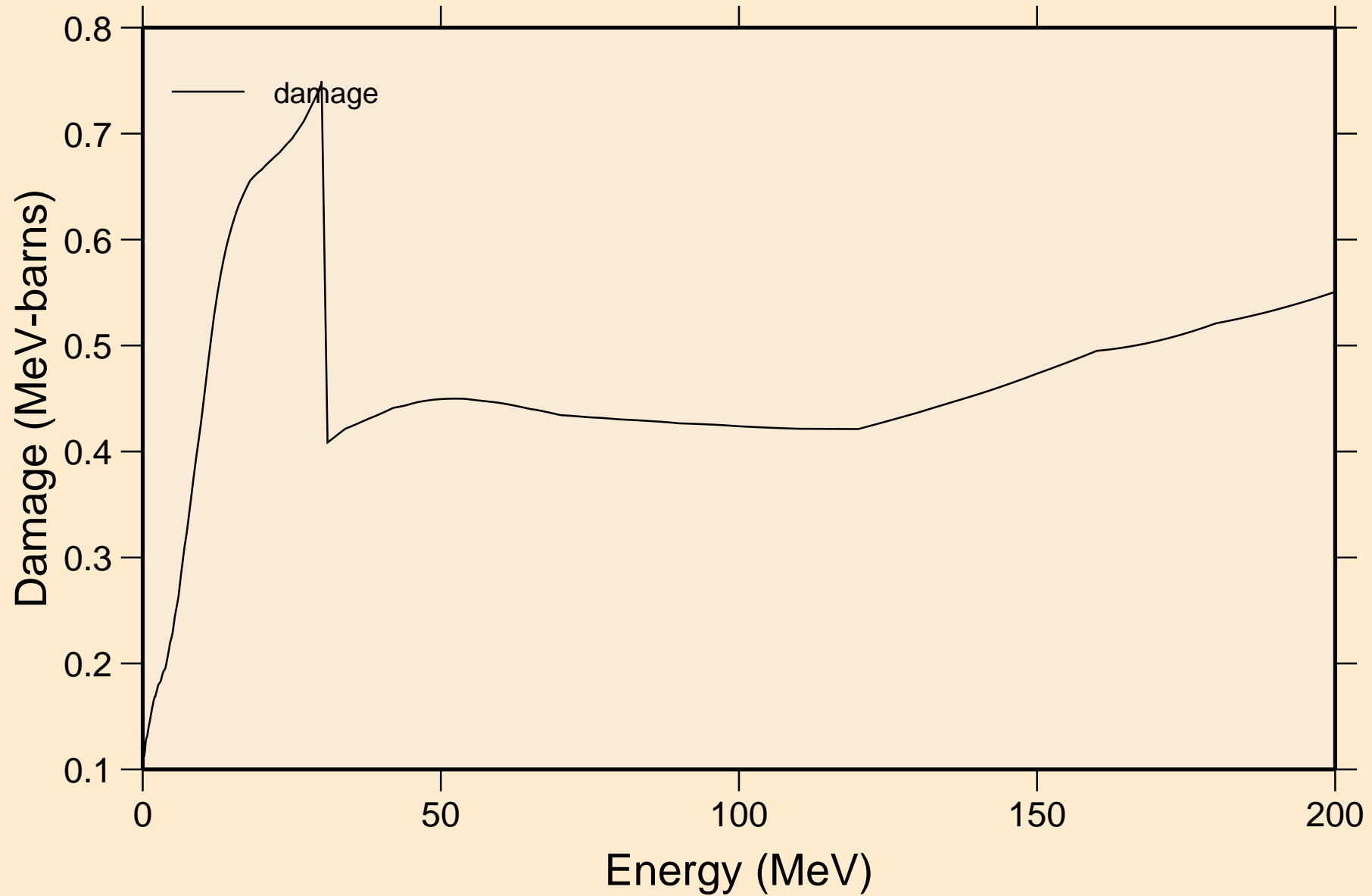

MO091M NEUTRON ACER TENDL-2021 LIBRARY; T=293.6K
Non-threshold reactions

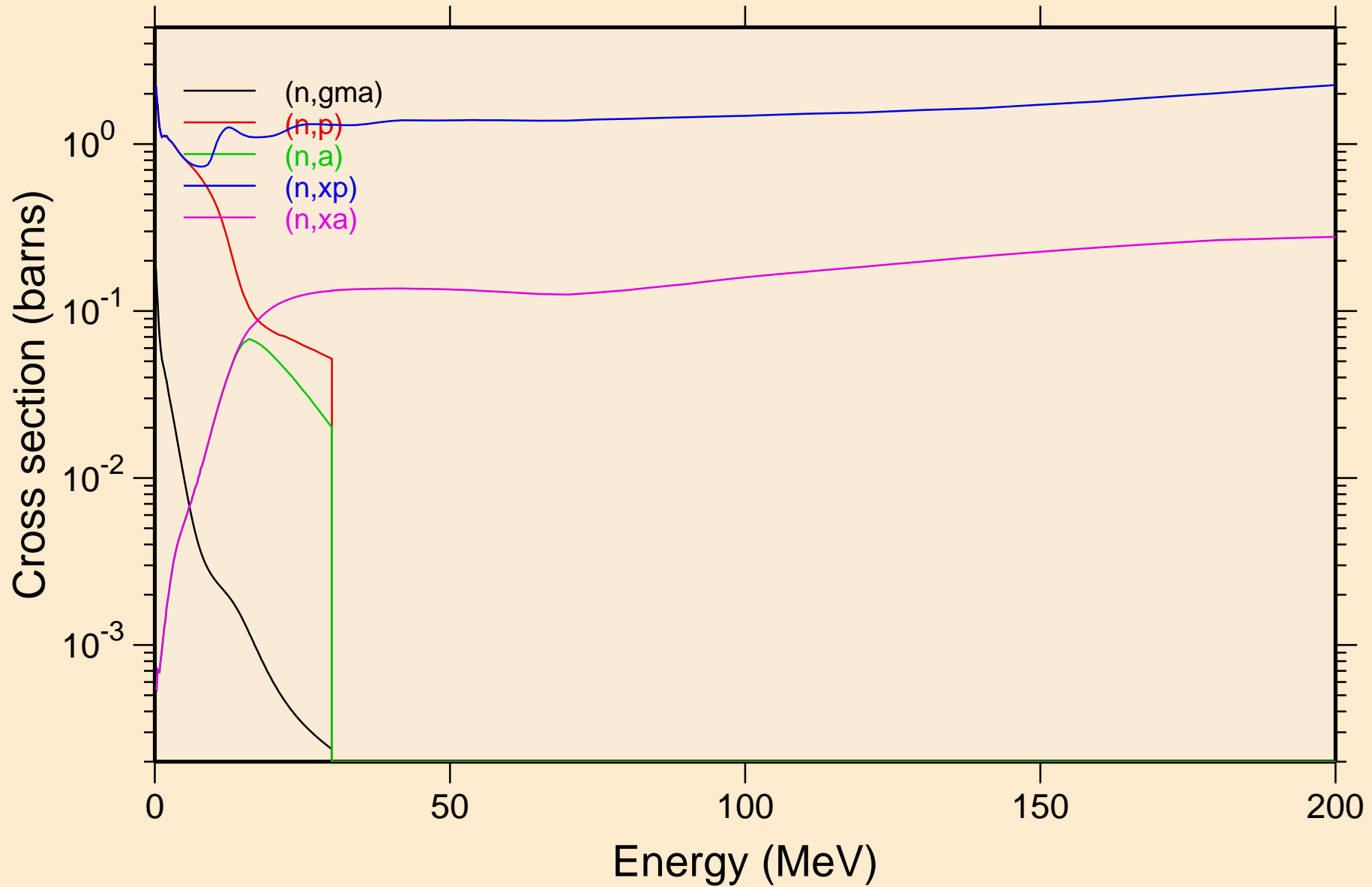

MO091M NEUTRON ACER TENDL-2021 LIBRARY; T=293.6K
Inelastic levels

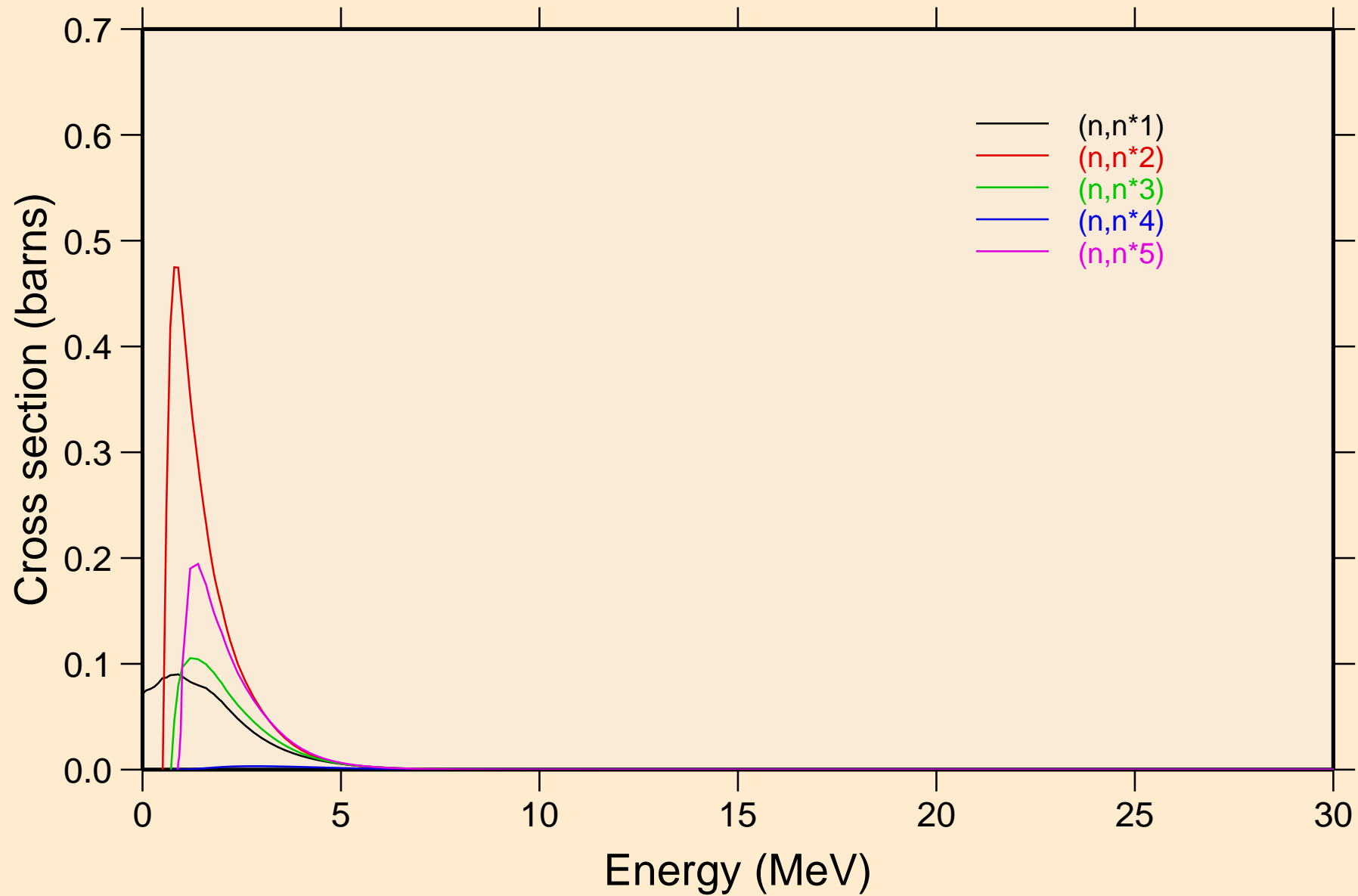

MO091M NEUTRON ACER TENDL-2021 LIBRARY; T=293.6K
Inelastic levels

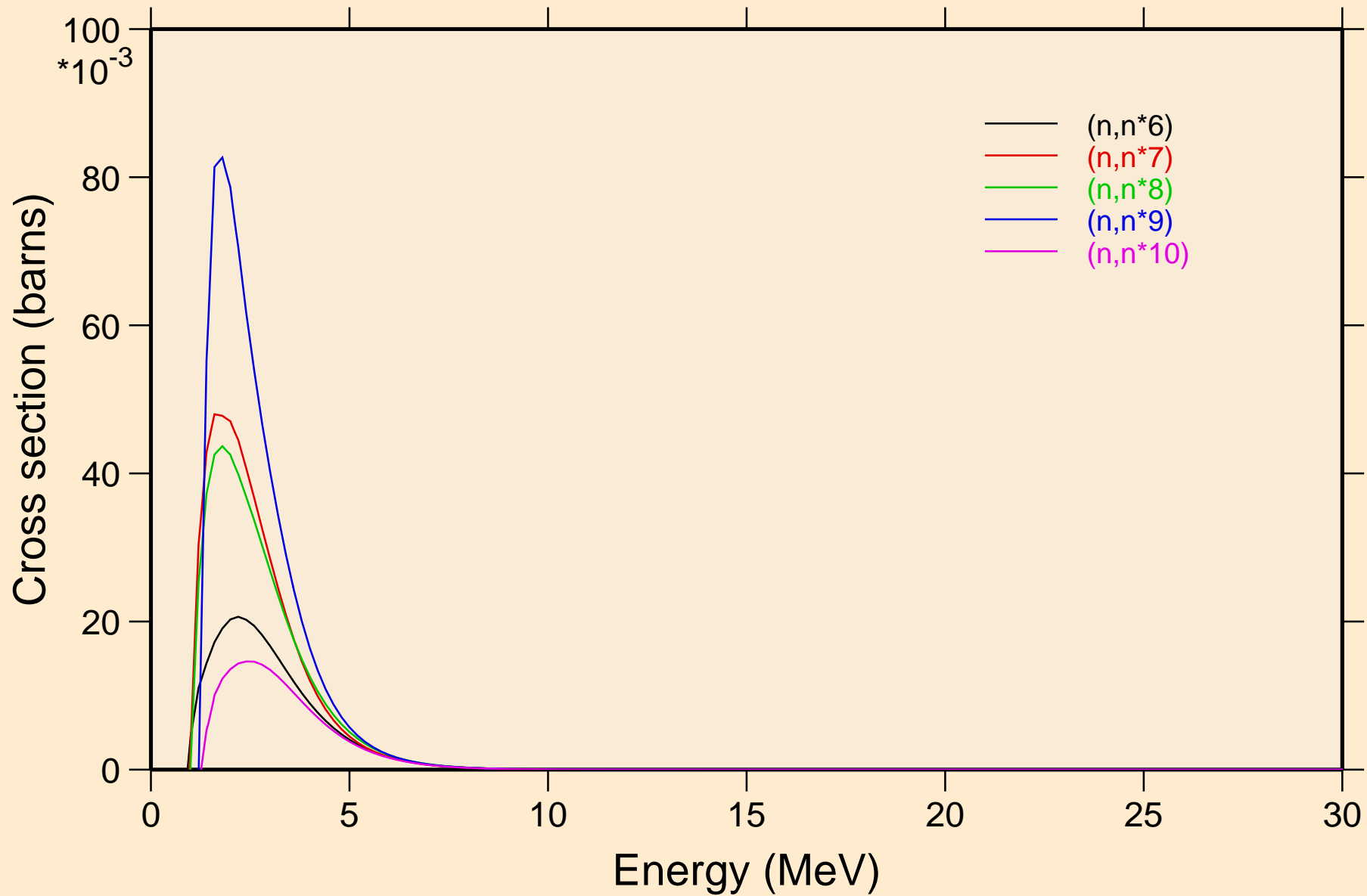

MO091M NEUTRON ACER TENDL-2021 LIBRARY; T=293.6K
Inelastic levels

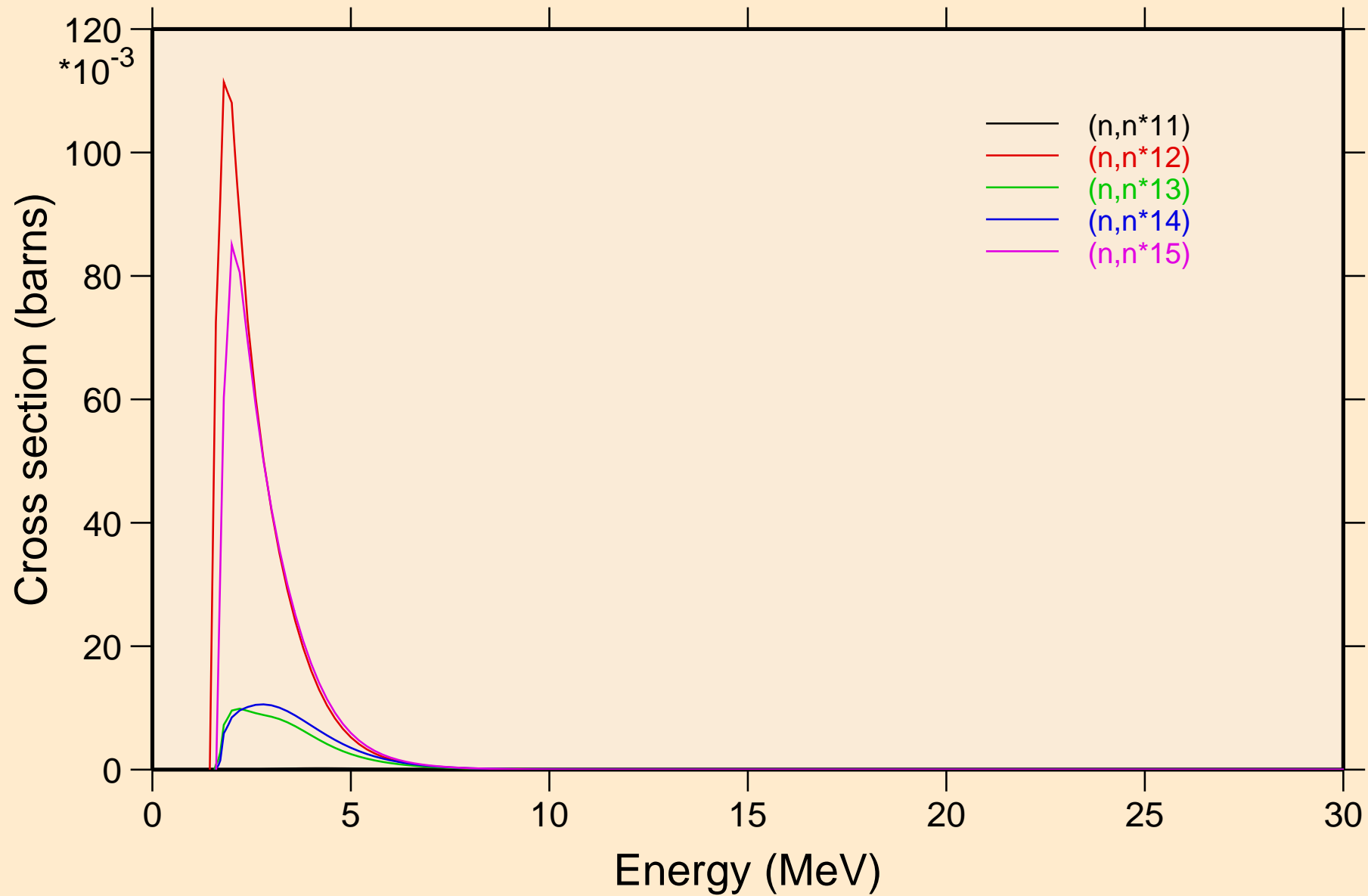

MO091M NEUTRON ACER TENDL-2021 LIBRARY; T=293.6K
Inelastic levels

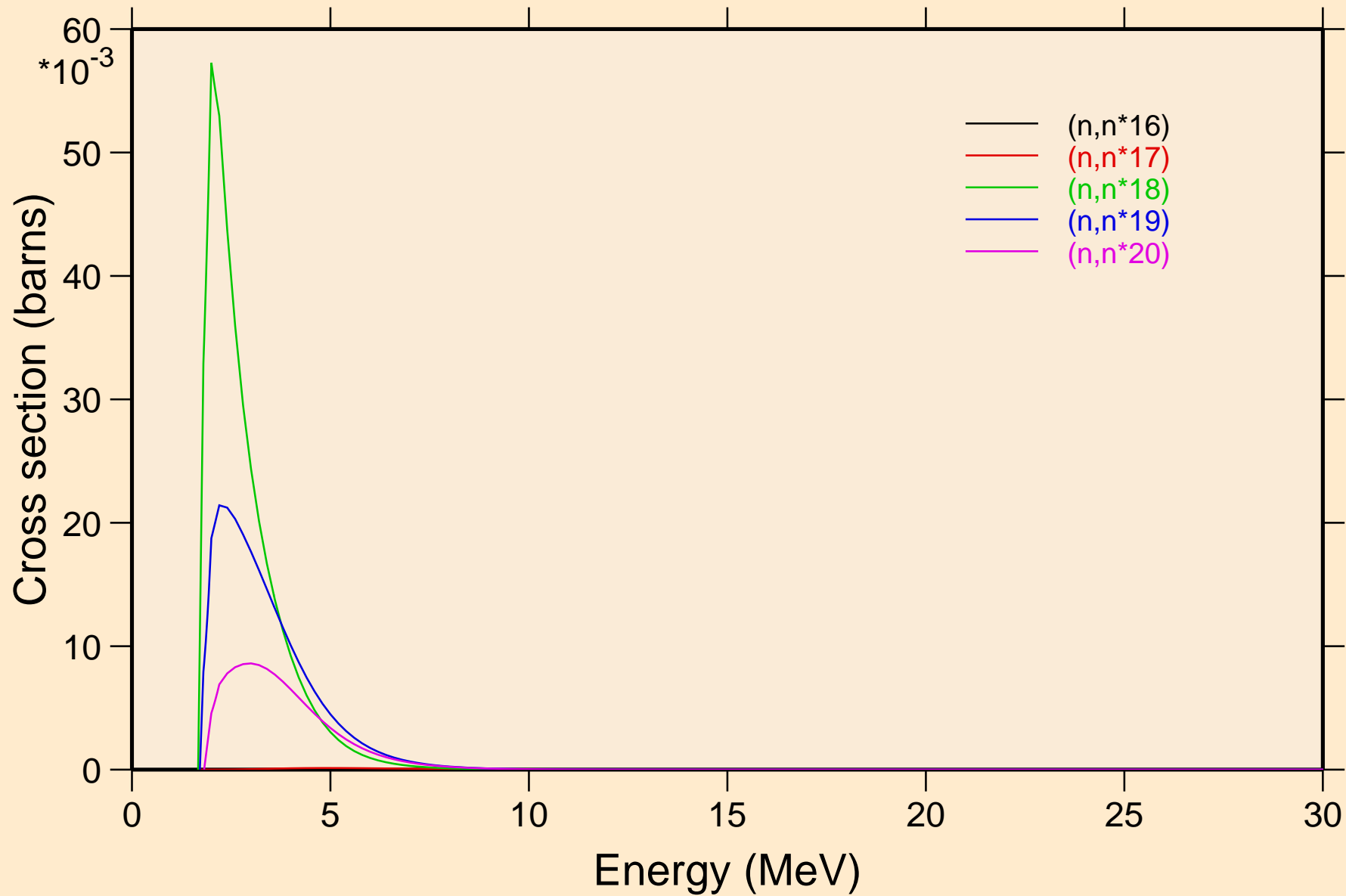

MO091M NEUTRON ACER TENDL-2021 LIBRARY; T=293.6K
Inelastic levels

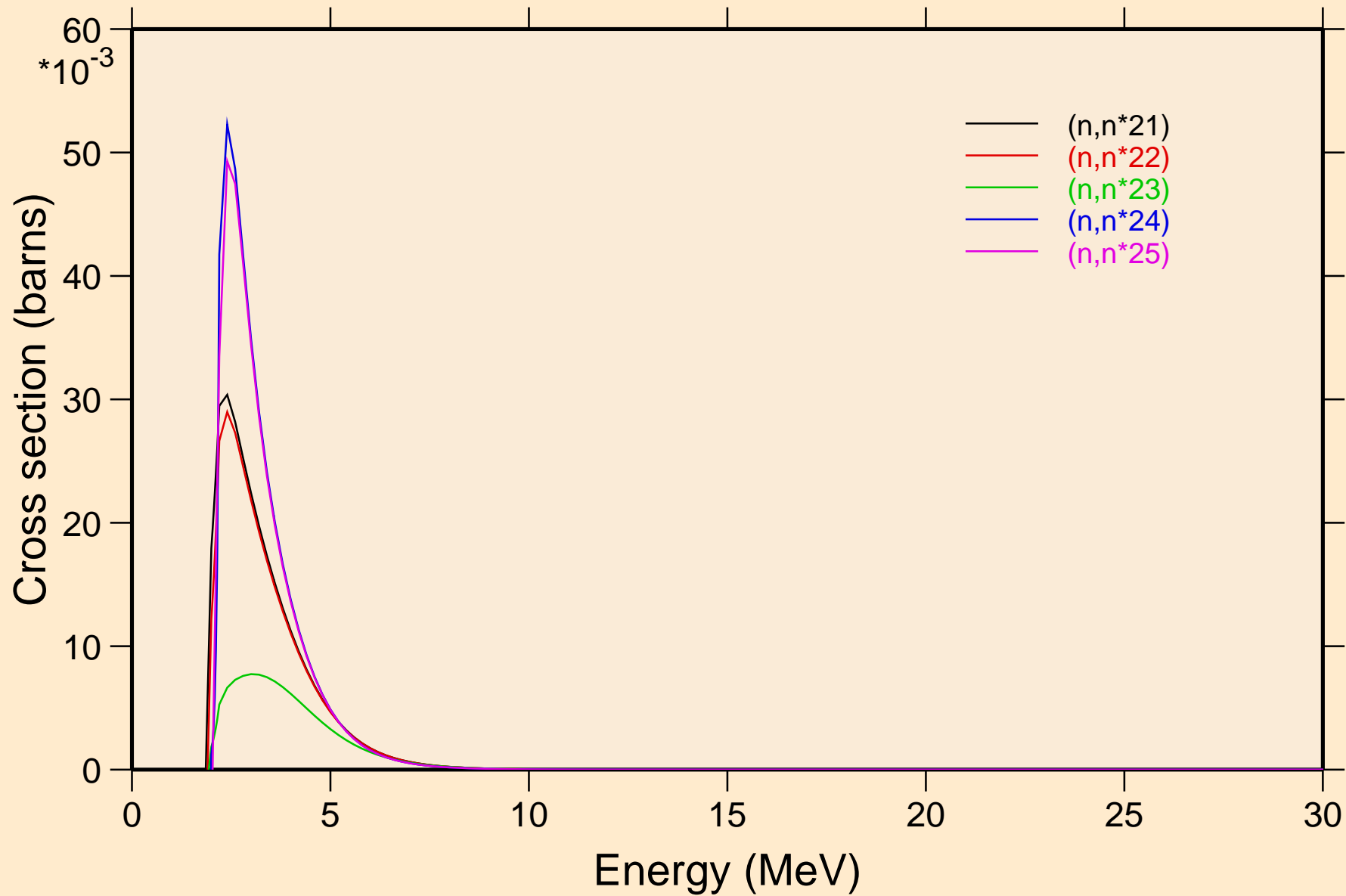

MO091M NEUTRON ACER TENDL-2021 LIBRARY; T=293.6K
Inelastic levels

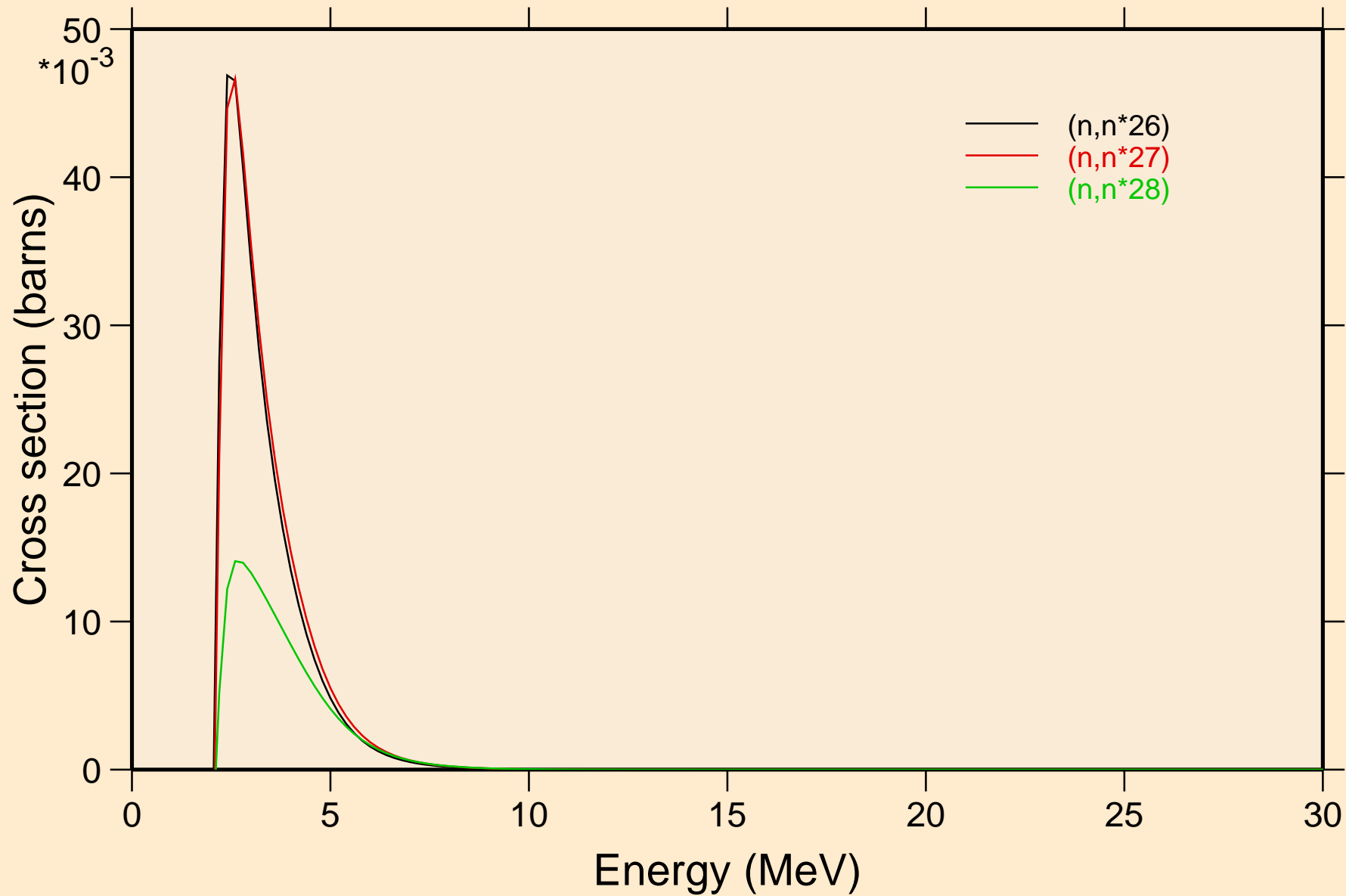

MO091M NEUTRON ACER TENDL-2021 LIBRARY; T=293.6K
Threshold reactions

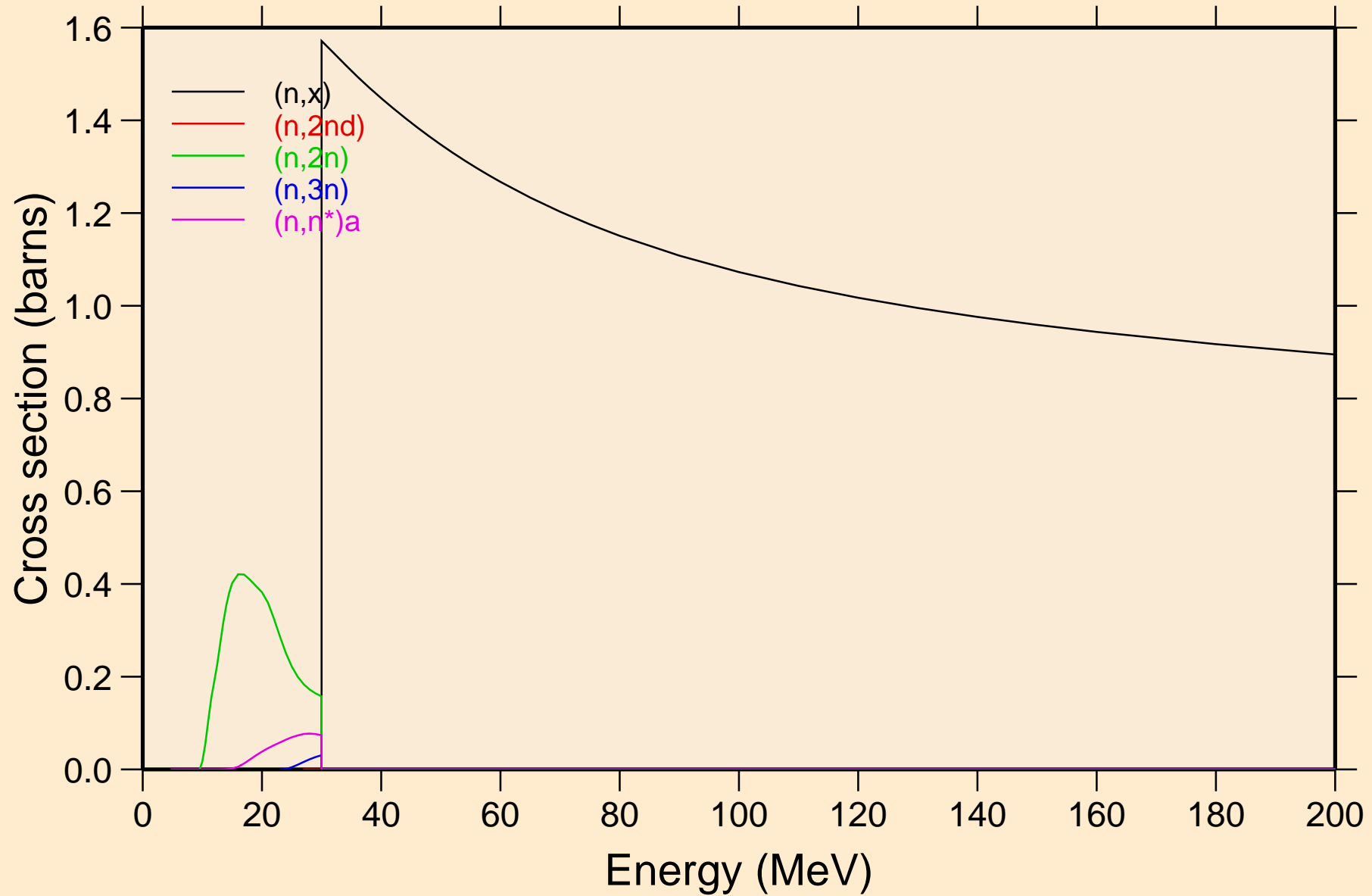

MO091M NEUTRON ACER TENDL-2021 LIBRARY; T=293.6K
Threshold reactions

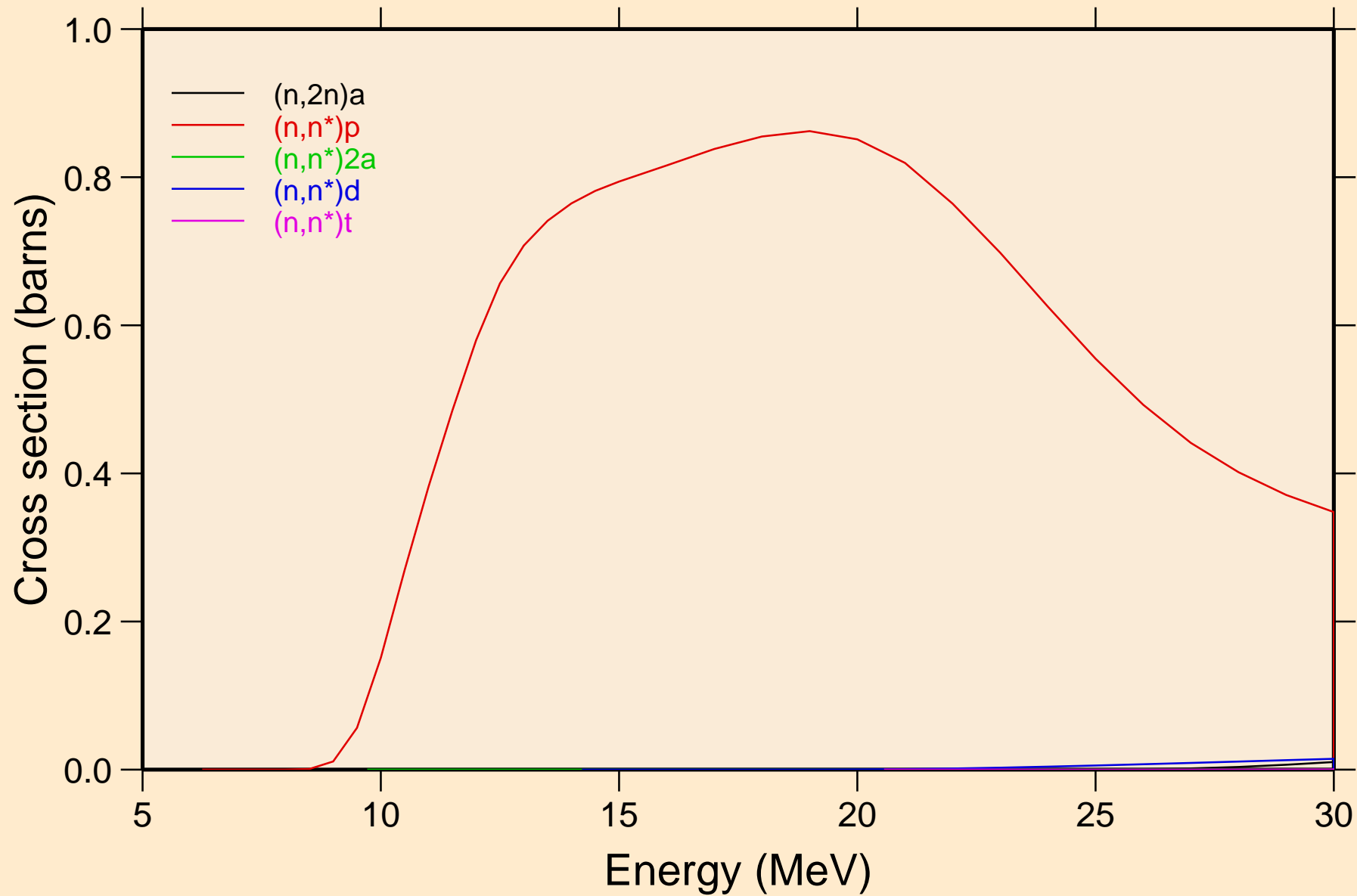

MO091M NEUTRON ACER TENDL-2021 LIBRARY; T=293.6K
Threshold reactions

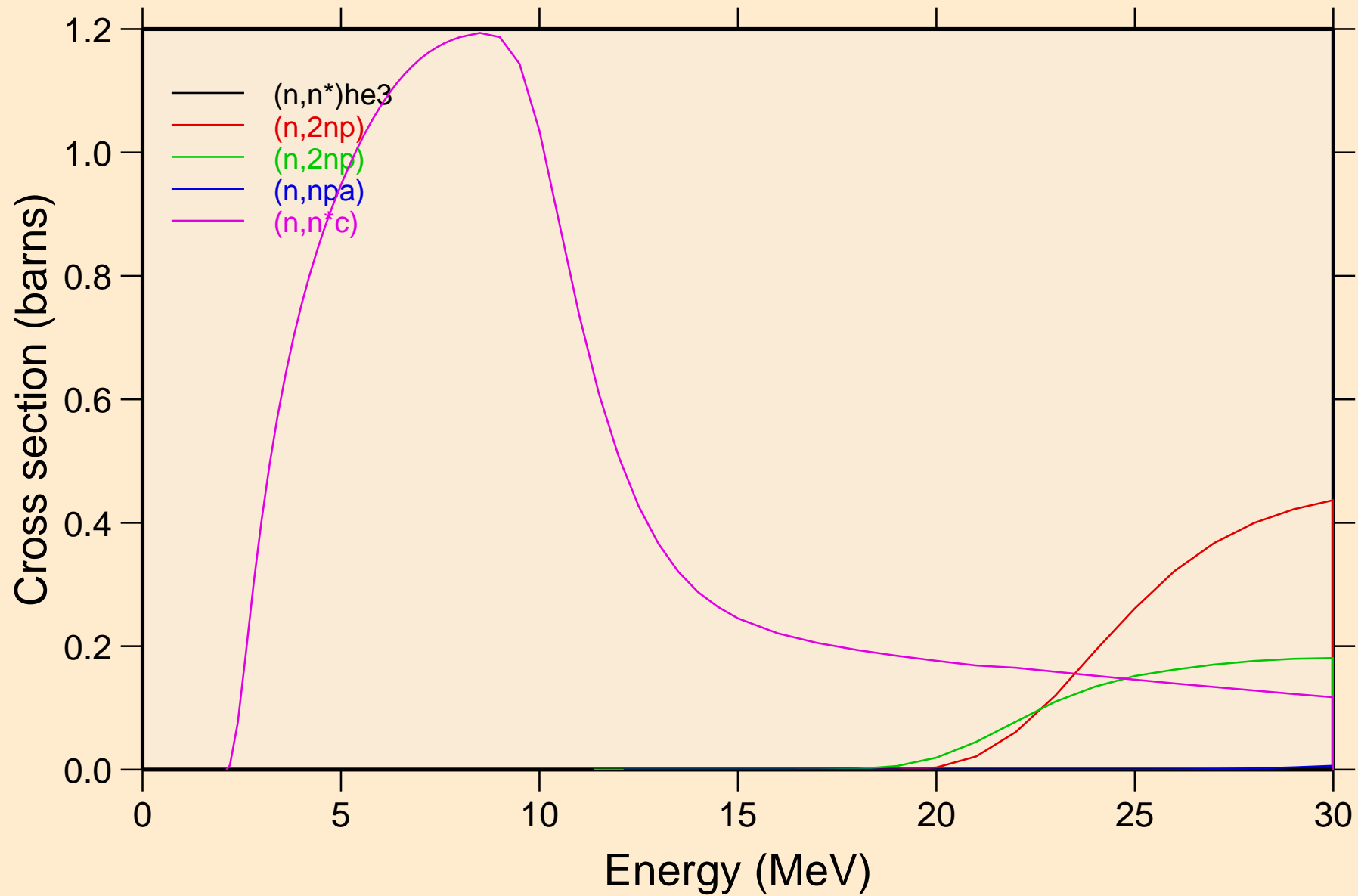

MO091M NEUTRON ACER TENDL-2021 LIBRARY; T=293.6K
Threshold reactions

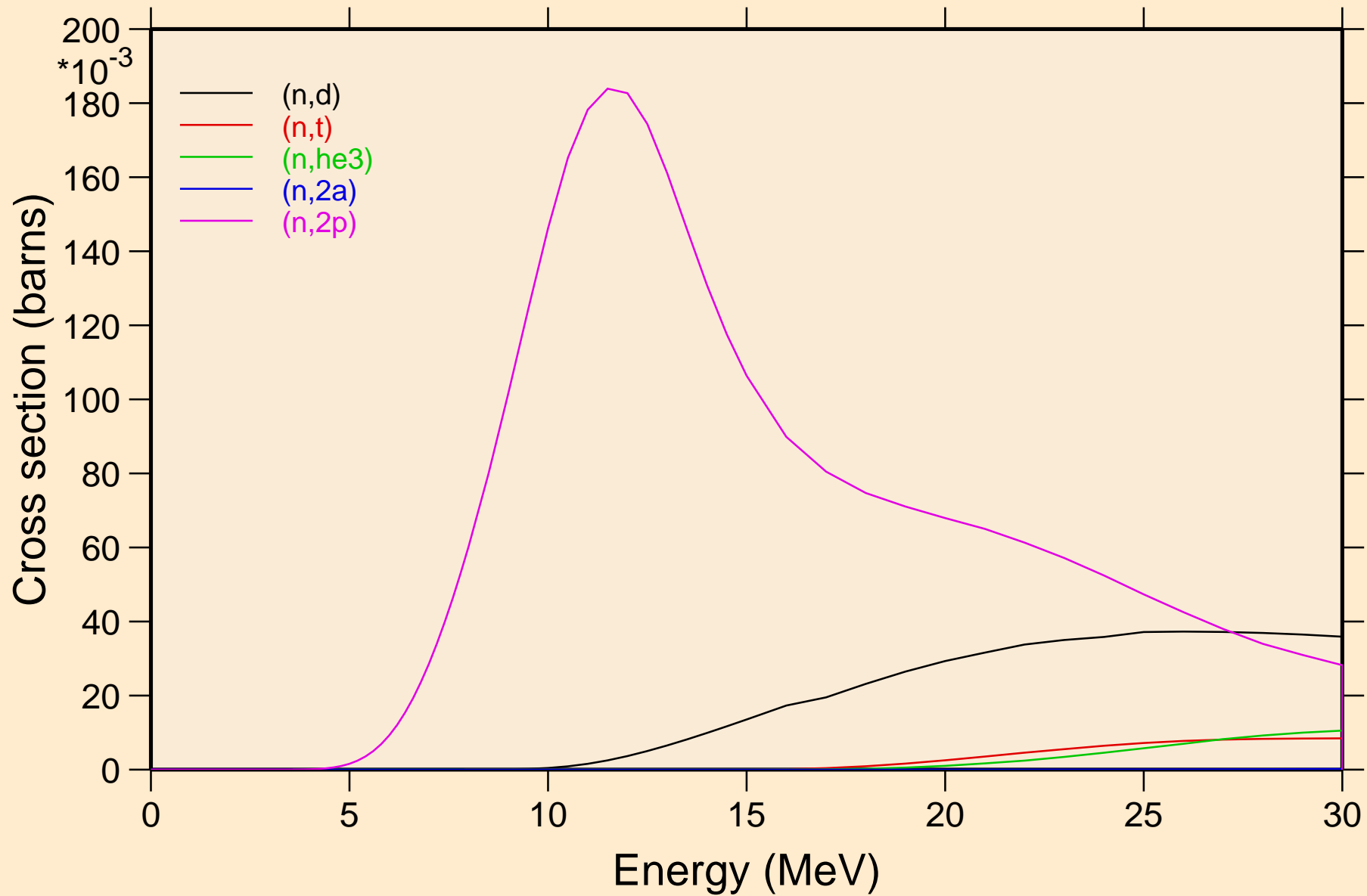

MO091M NEUTRON ACER TENDL-2021 LIBRARY; T=293.6K
Threshold reactions

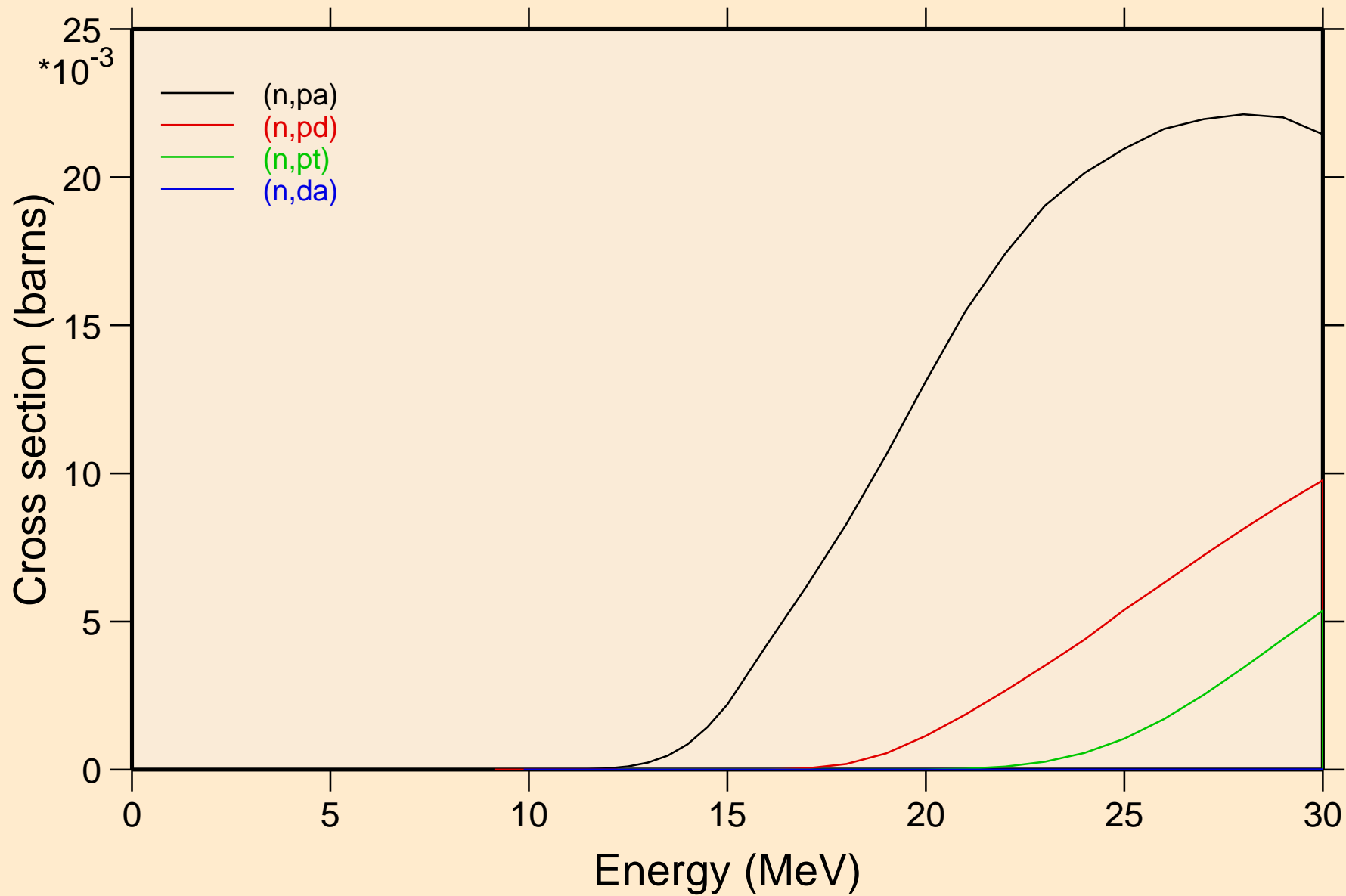

MO091M NEUTRON ACER TENDL-2021 LIBRARY; T=293.6K
Threshold reactions

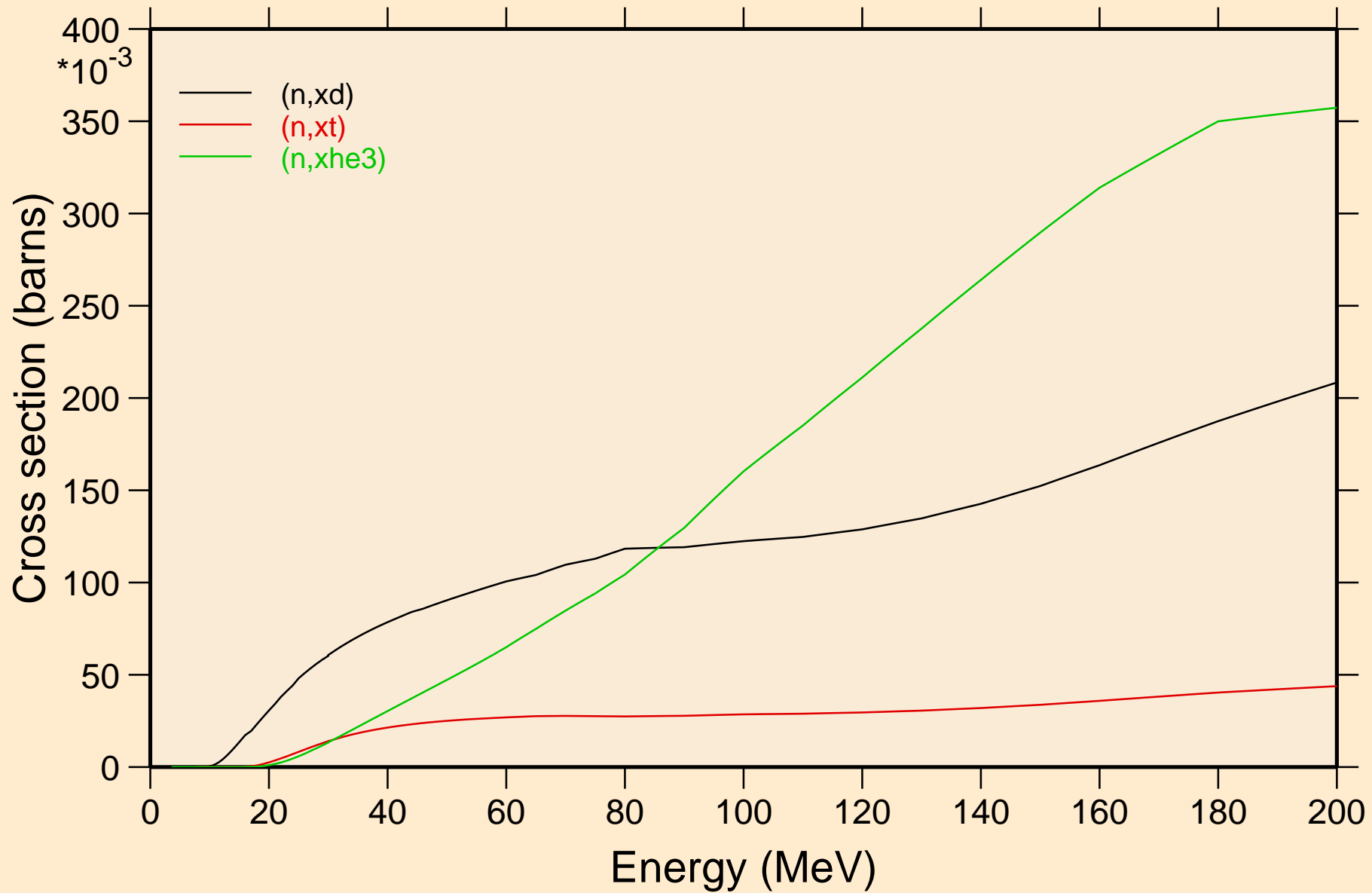

MO091M NEUTRON ACER TENDL-2021 LIBRARY; T=293.6K
angular distribution for elastic

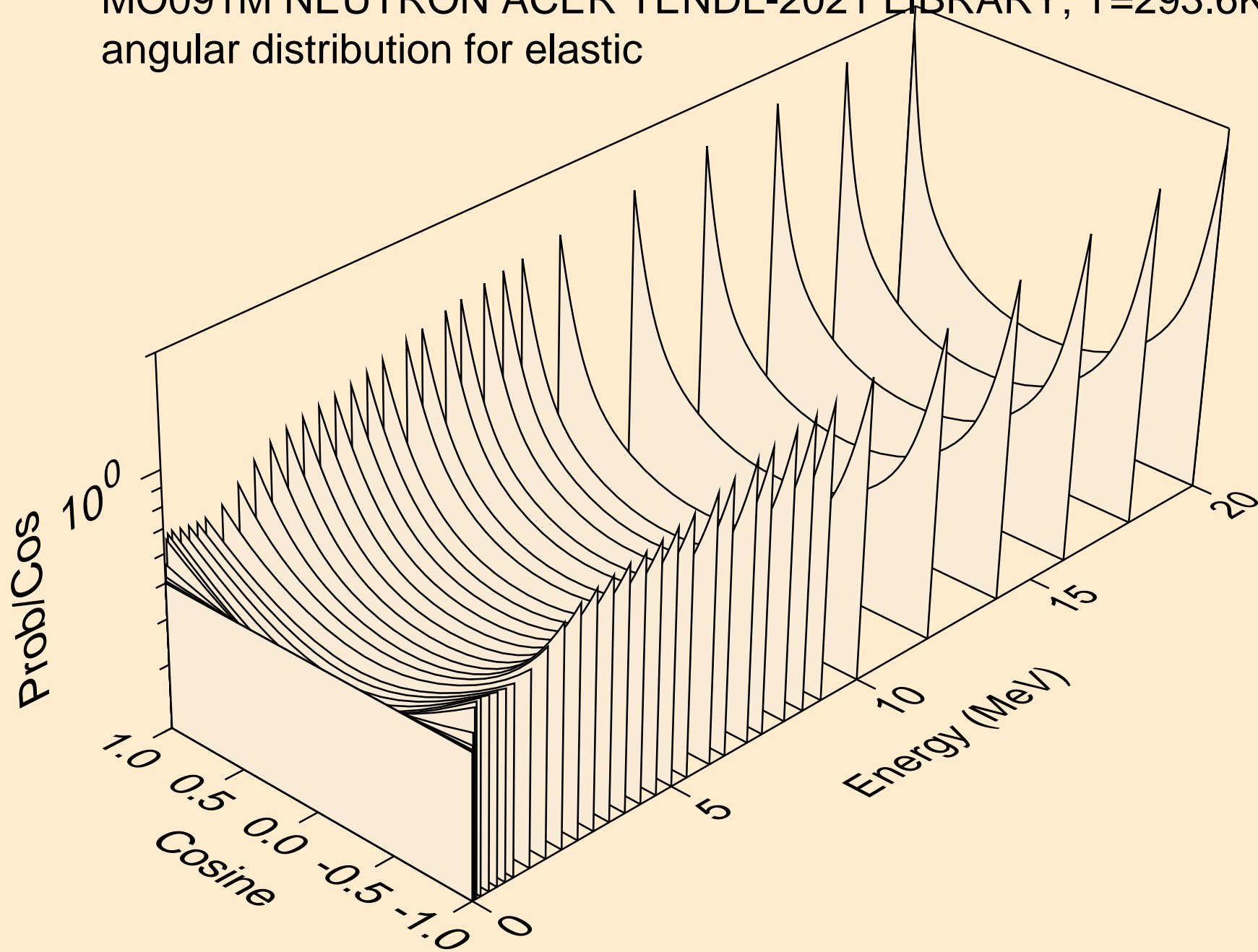

MO091M NEUTRON ACER TENDL-2021 LIBRARY; T=293.6K
angular distribution for elastic

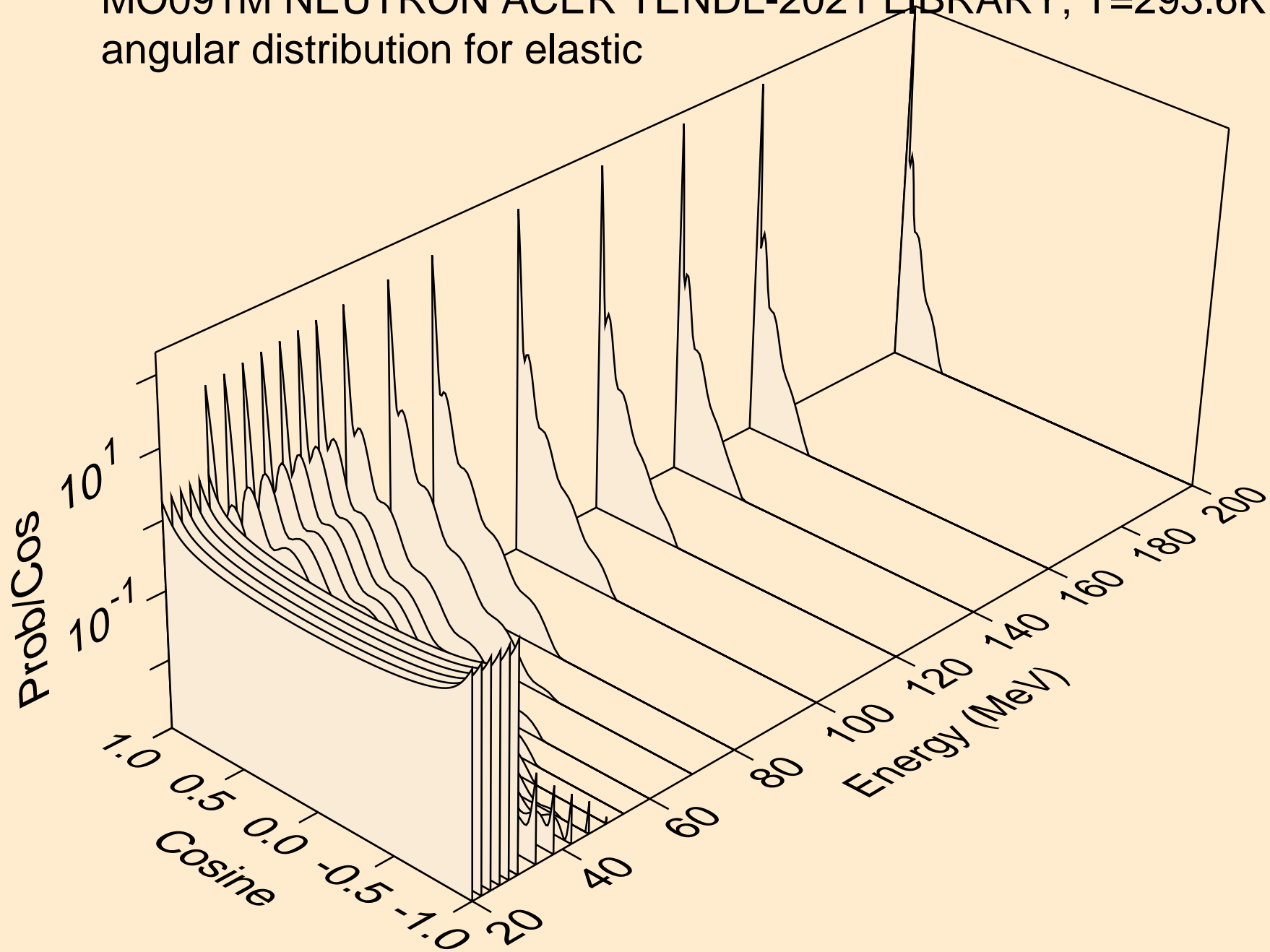

MO091M NEUTRON ACER TENDL-2021 LIBRARY; T=293.6K
angular distribution for (n,n*1)

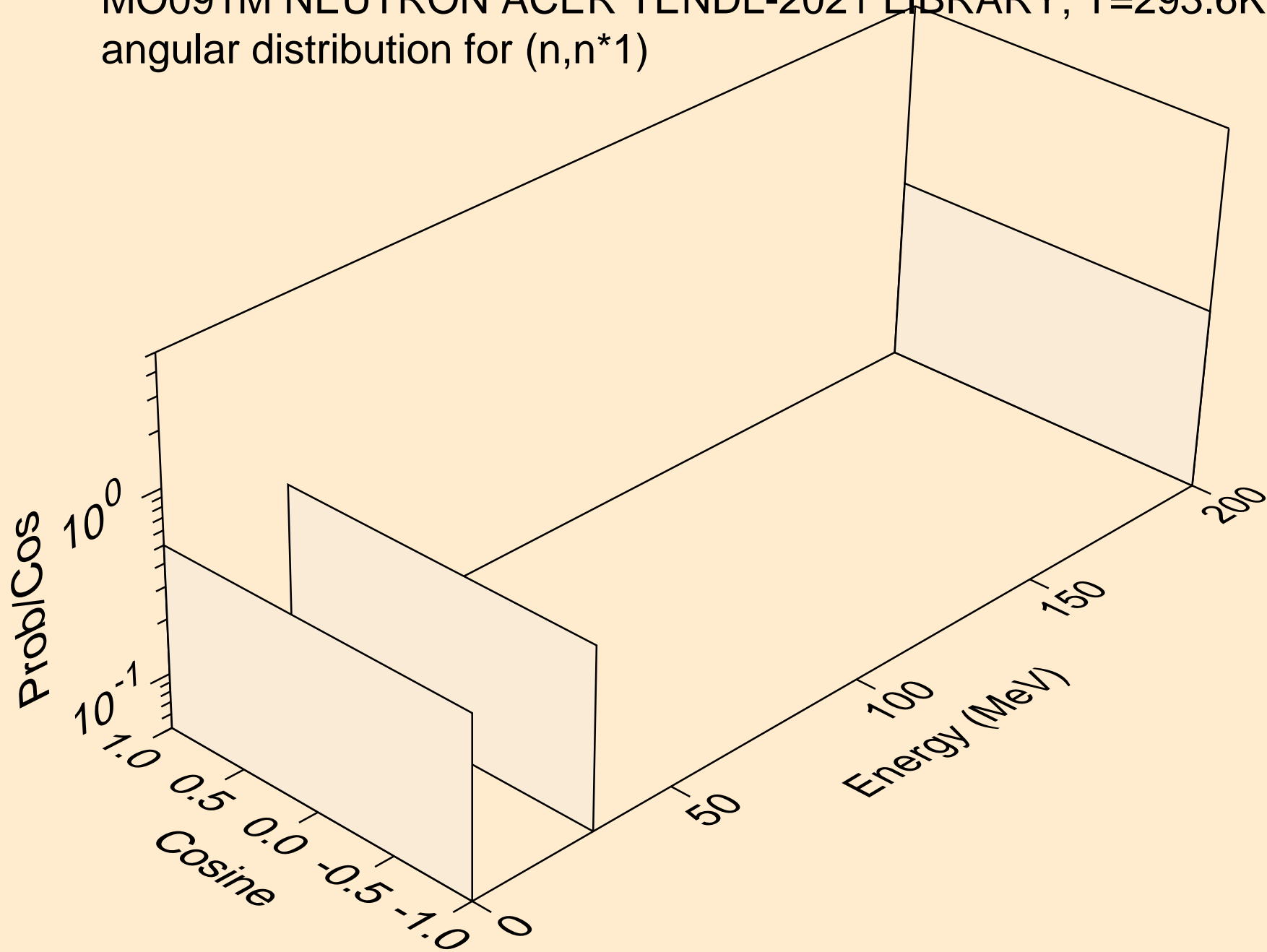

MO091M NEUTRON ACER TENDL-2021 LIBRARY; T=293.6K
angular distribution for (n,n*2)

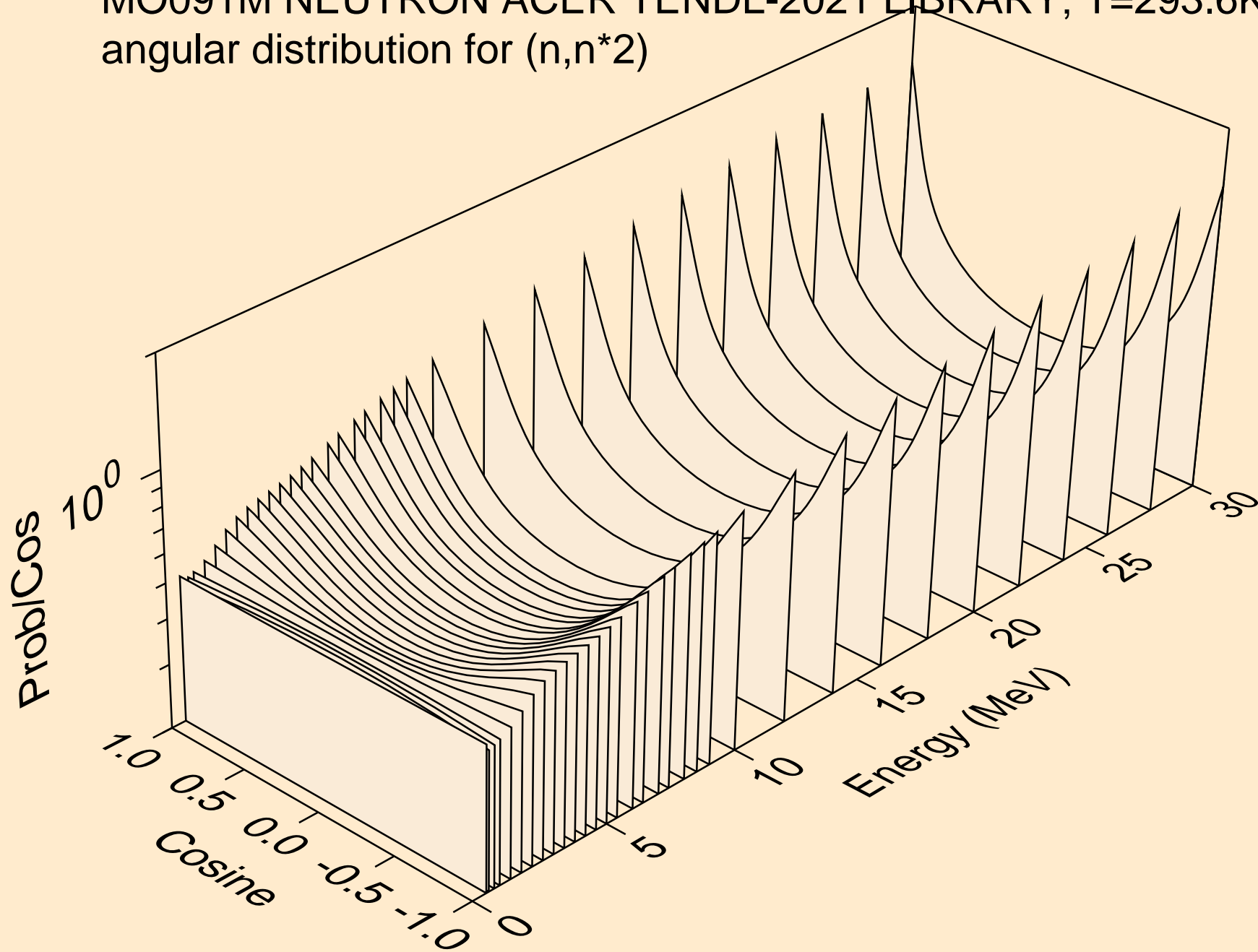

MO091M NEUTRON ACER TENDL-2021 LIBRARY; T=293.6K
angular distribution for (n,n*3)

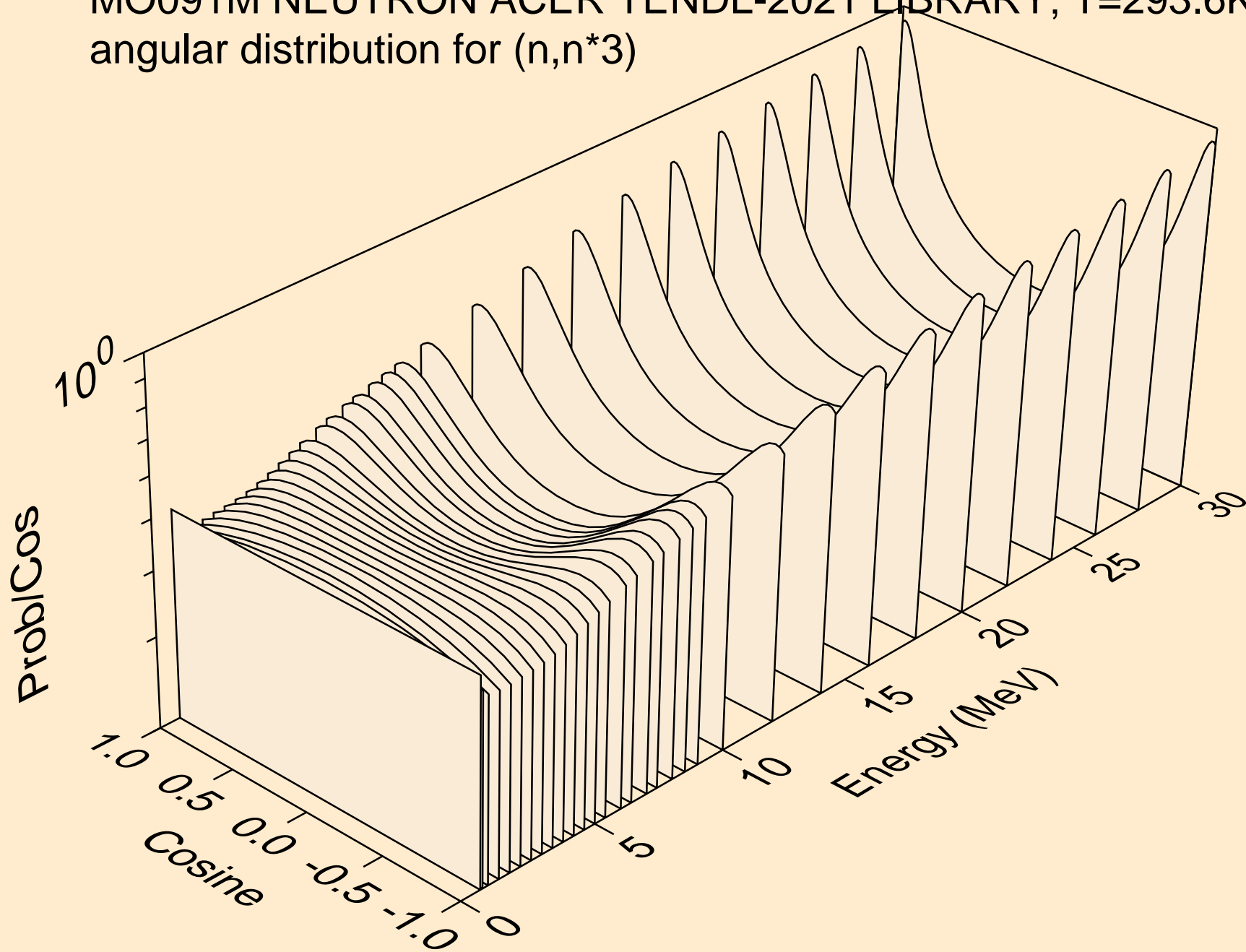

MO091M NEUTRON ACER TENDL-2021 LIBRARY; T=293.6K
angular distribution for (n,n*4)

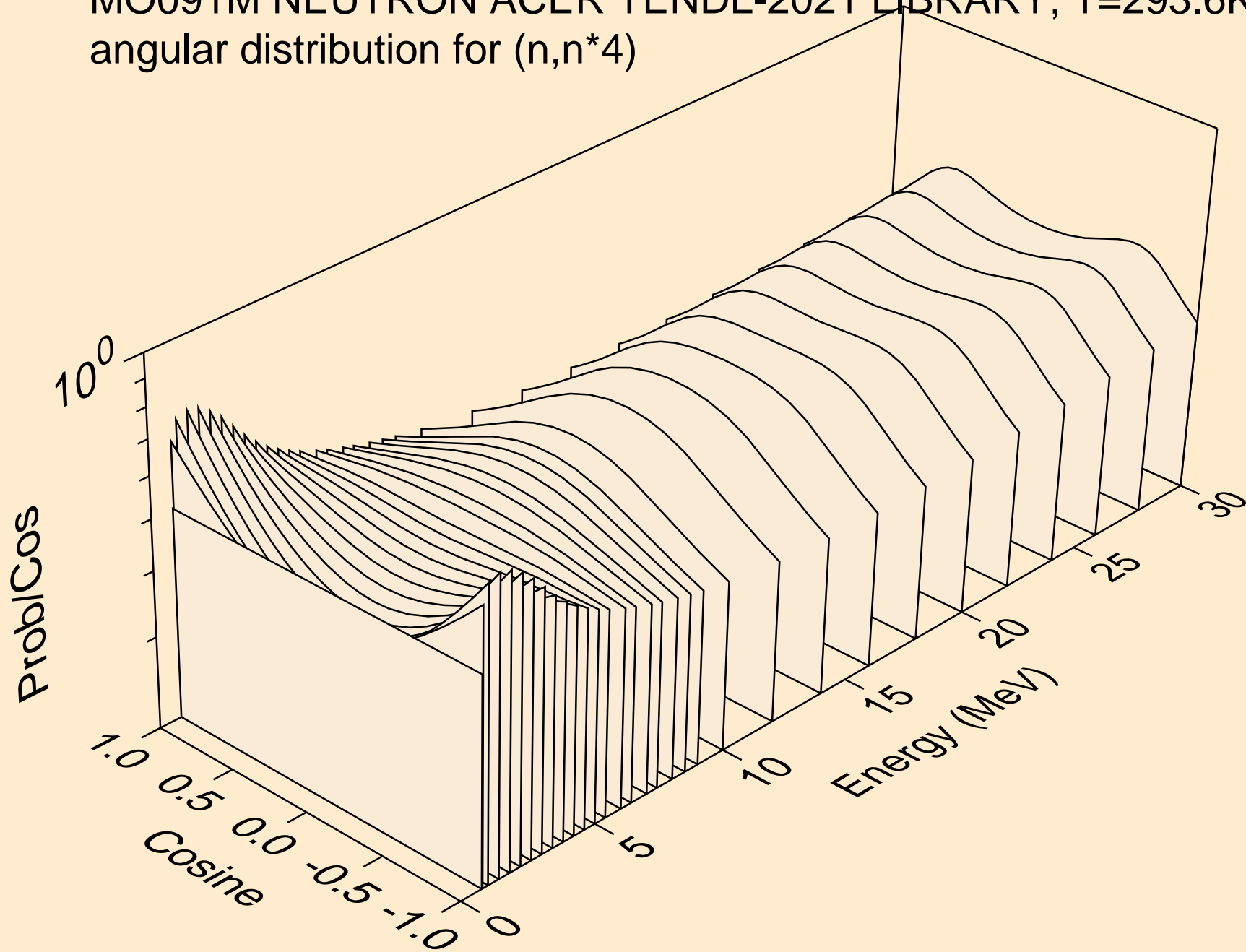

MO091M NEUTRON ACER TENDL-2021 LIBRARY; T=293.6K
angular distribution for (n,n*5)

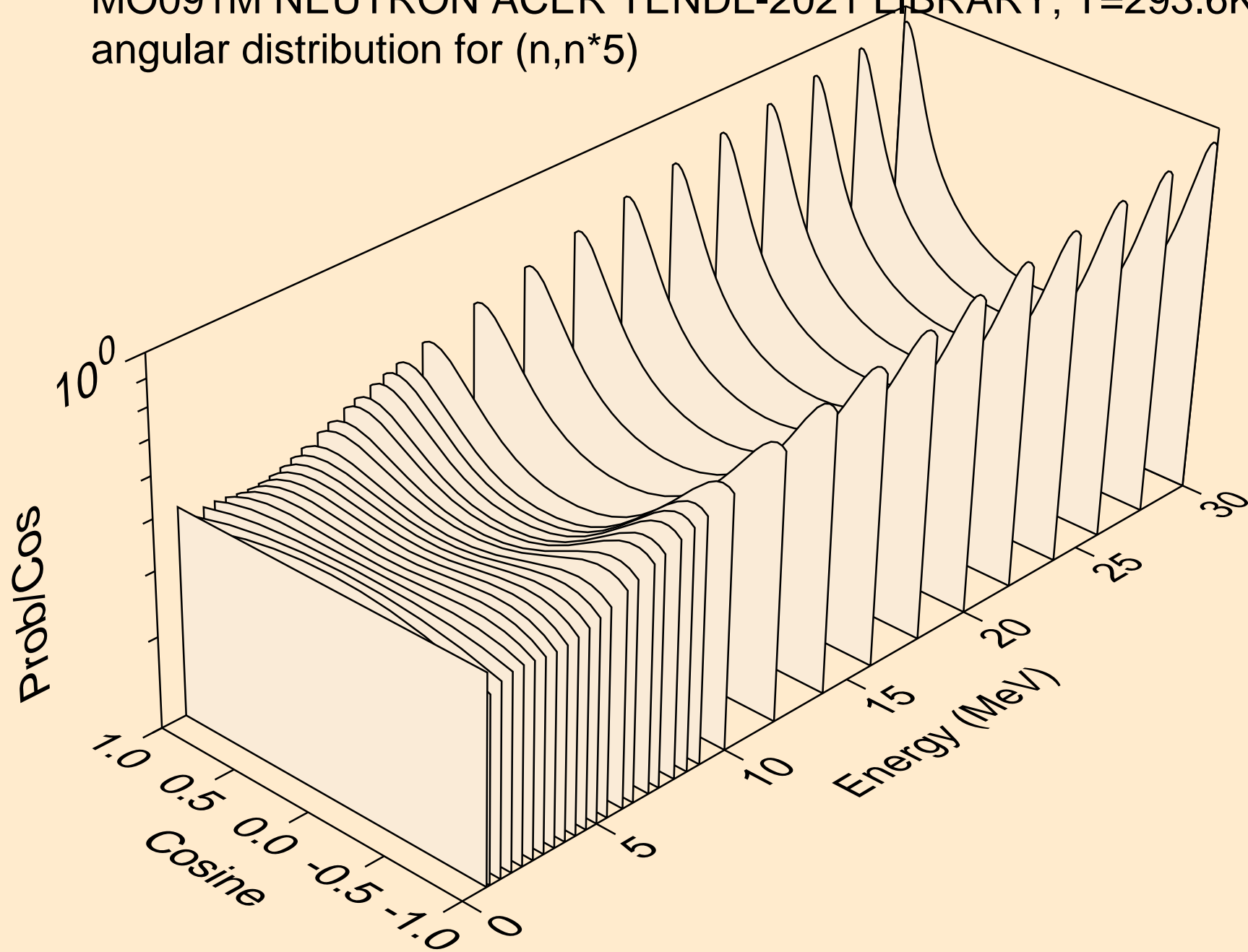

MO091M NEUTRON ACER TENDL-2021 LIBRARY; T=293.6K
angular distribution for (n,n*6)

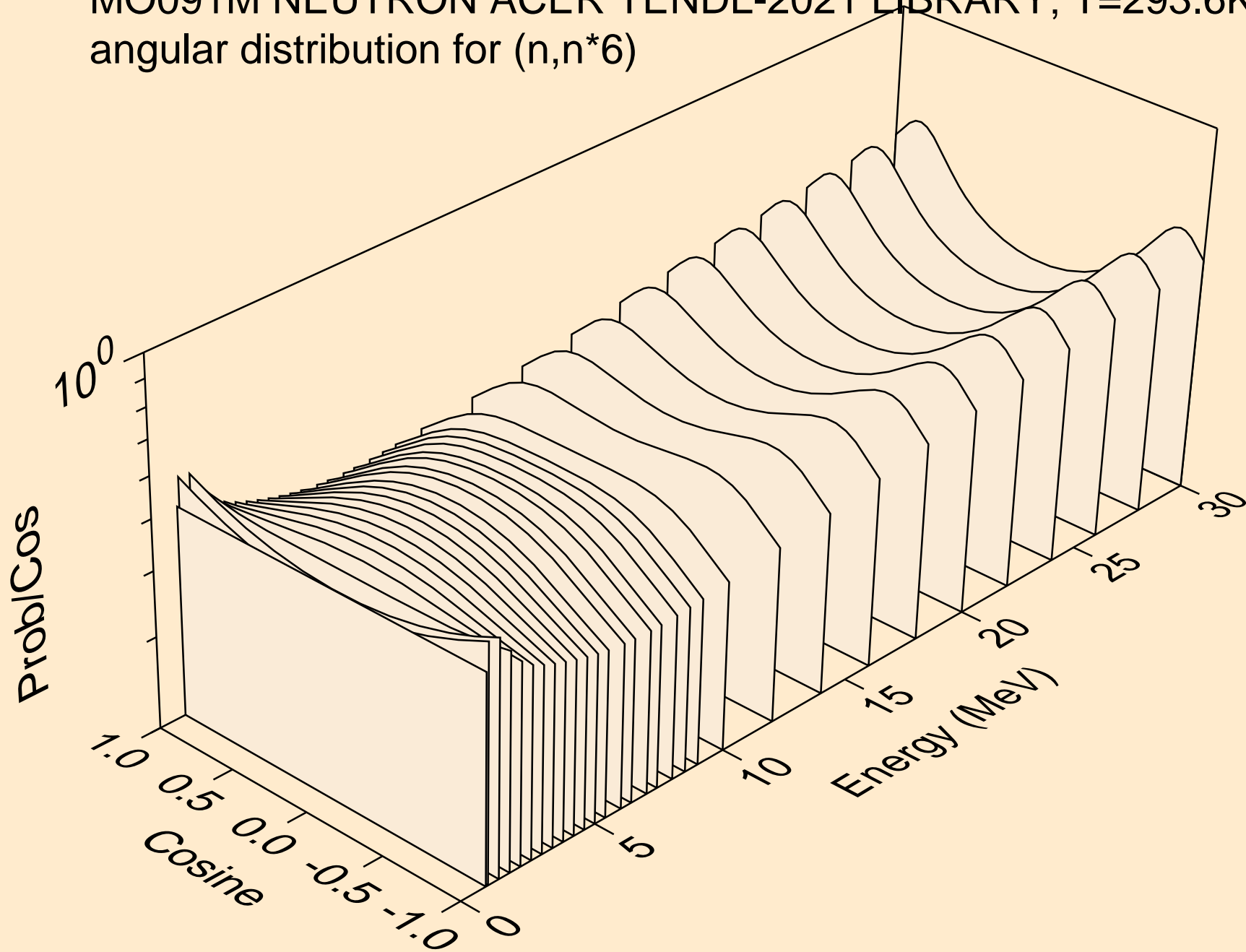

MO091M NEUTRON ACER TENDL-2021 LIBRARY; T=293.6K
angular distribution for (n,n*7)

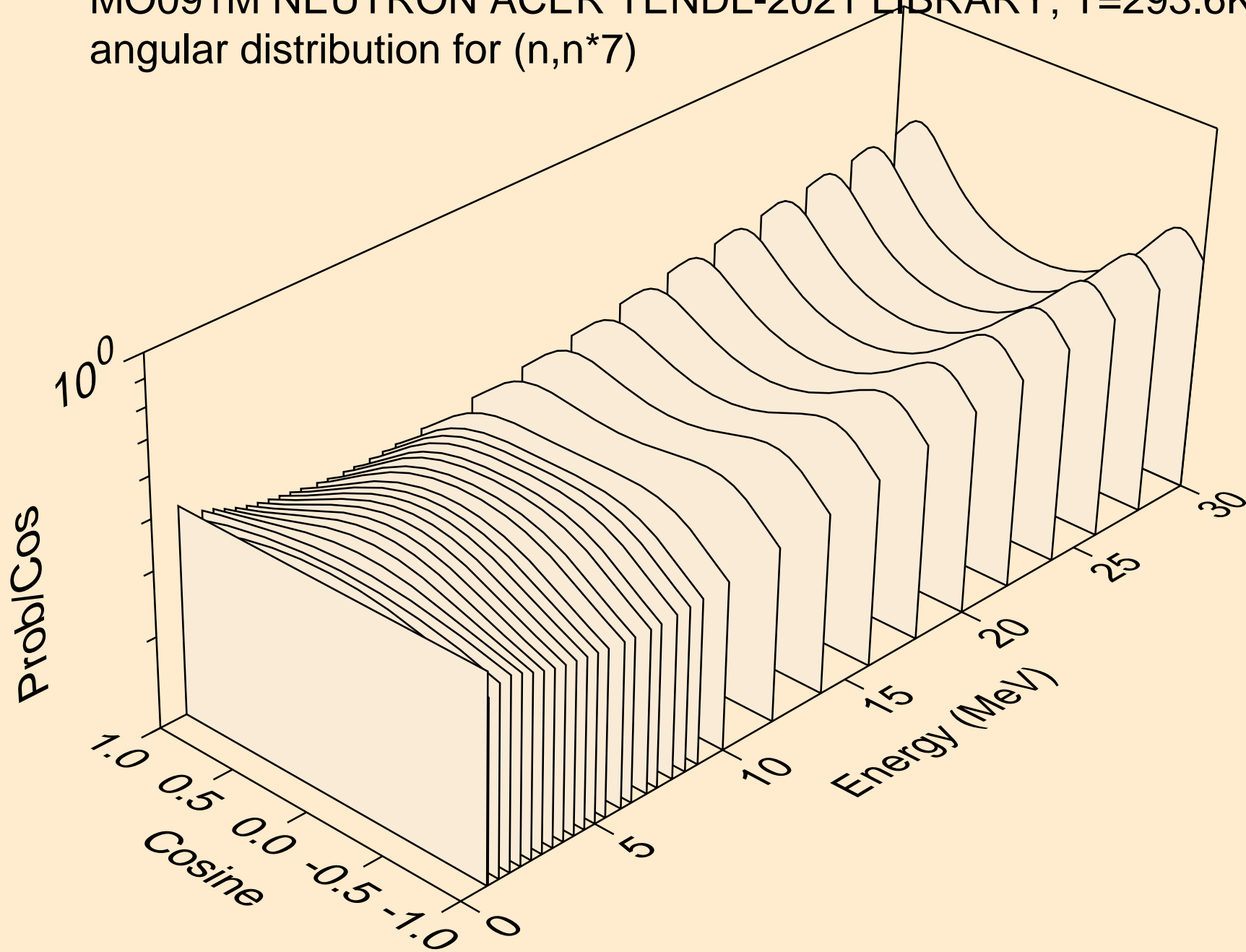

MO091M NEUTRON ACER TENDL-2021 LIBRARY; T=293.6K
angular distribution for (n,n*8)

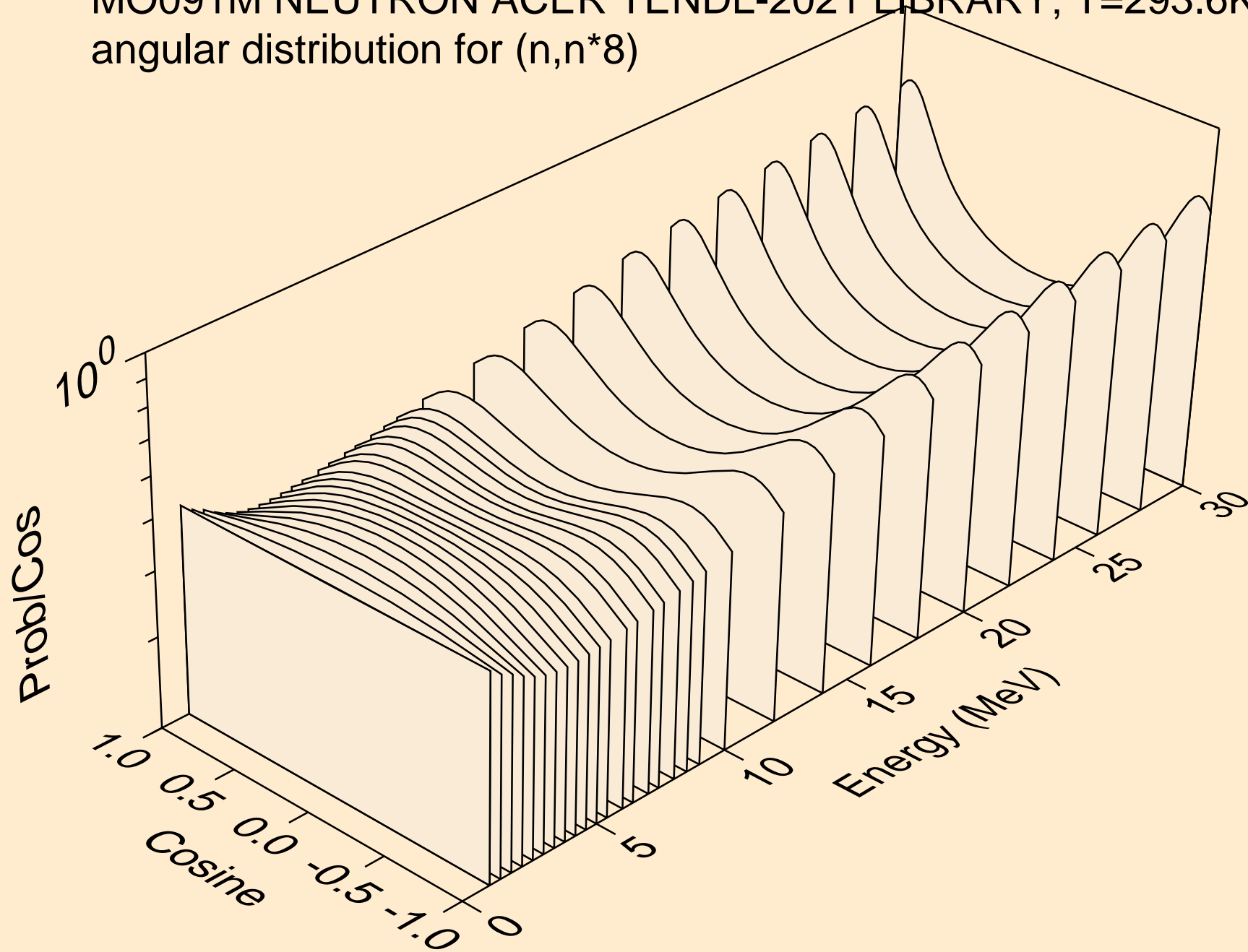

MO091M NEUTRON ACER TENDL-2021 LIBRARY; T=293.6K
angular distribution for (n,n*9)

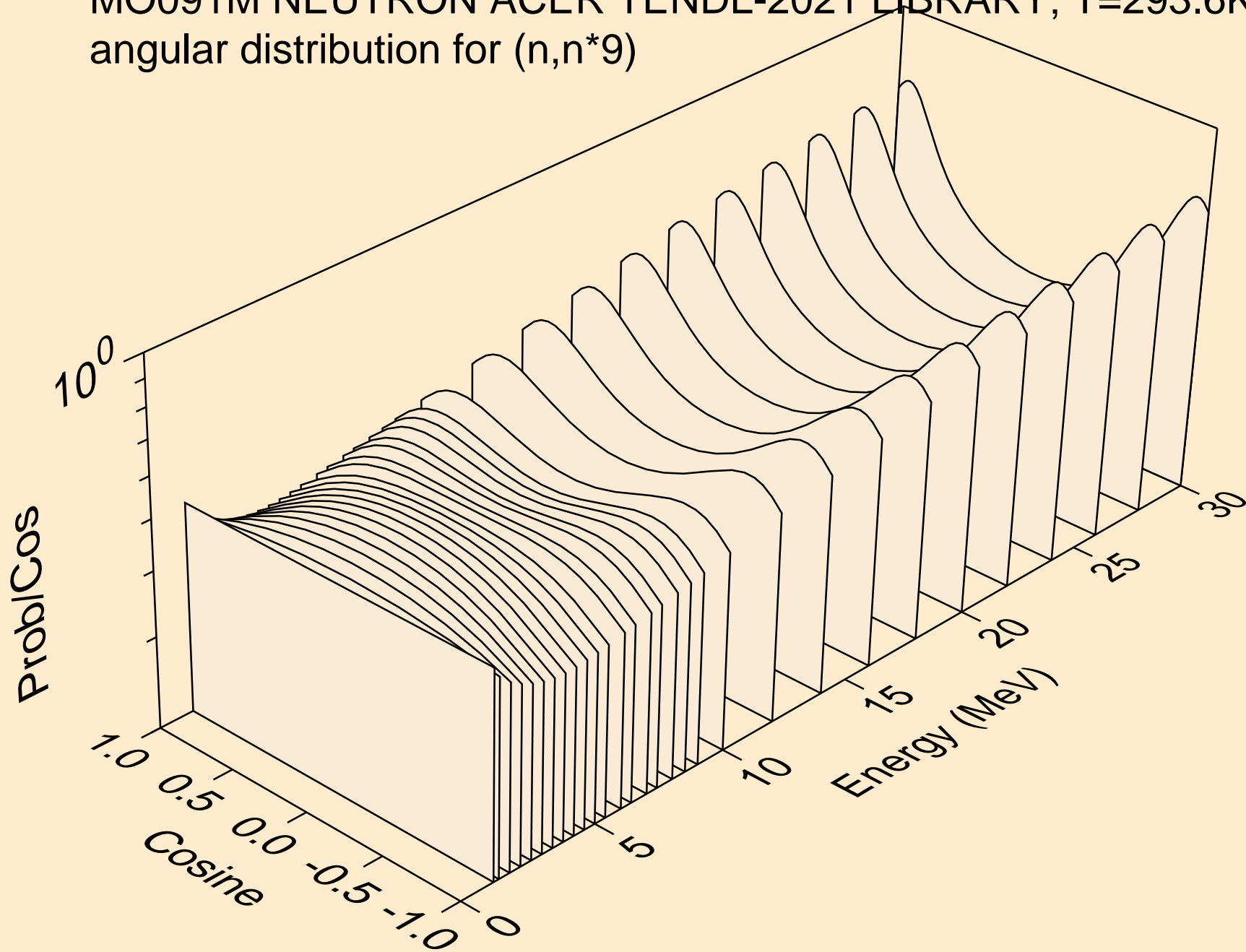

MO091M NEUTRON ACER TENDL-2021 LIBRARY; T=293.6K
angular distribution for (n,n*10)

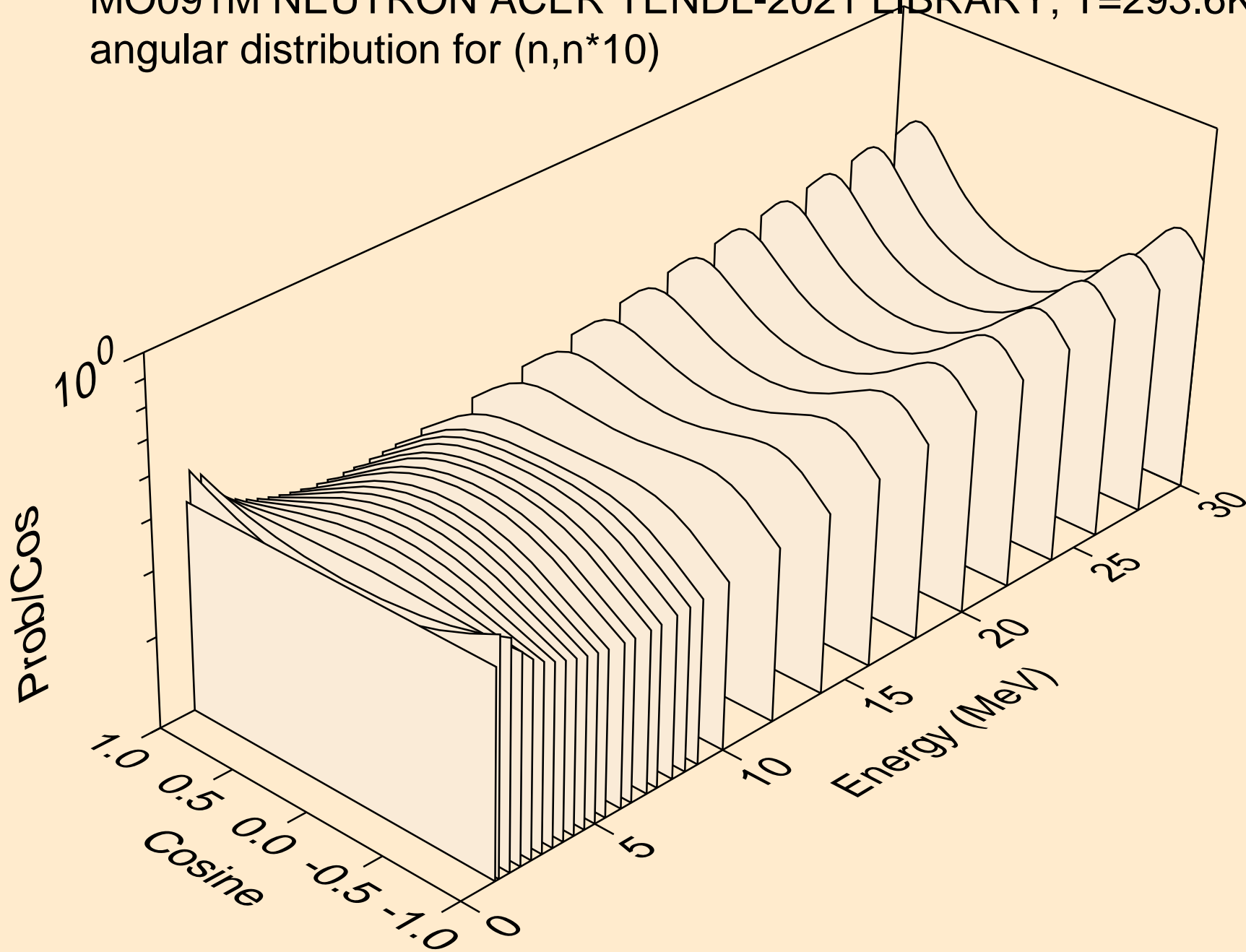

MO091M NEUTRON ACER TENDL-2021 LIBRARY; T=293.6K
angular distribution for (n,n*11)

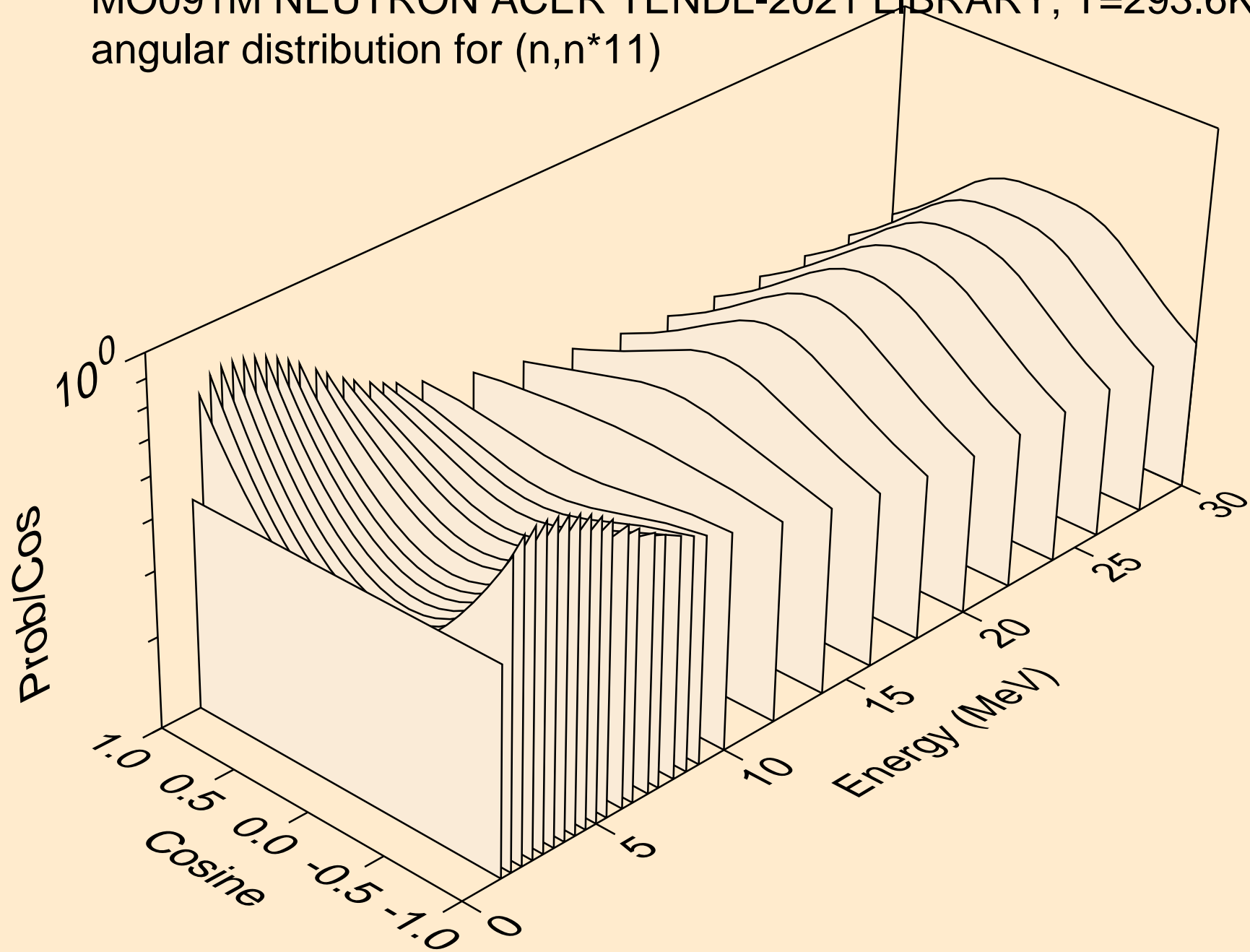

MO091M NEUTRON ACER TENDL-2021 LIBRARY; T=293.6K
angular distribution for (n,n*12)

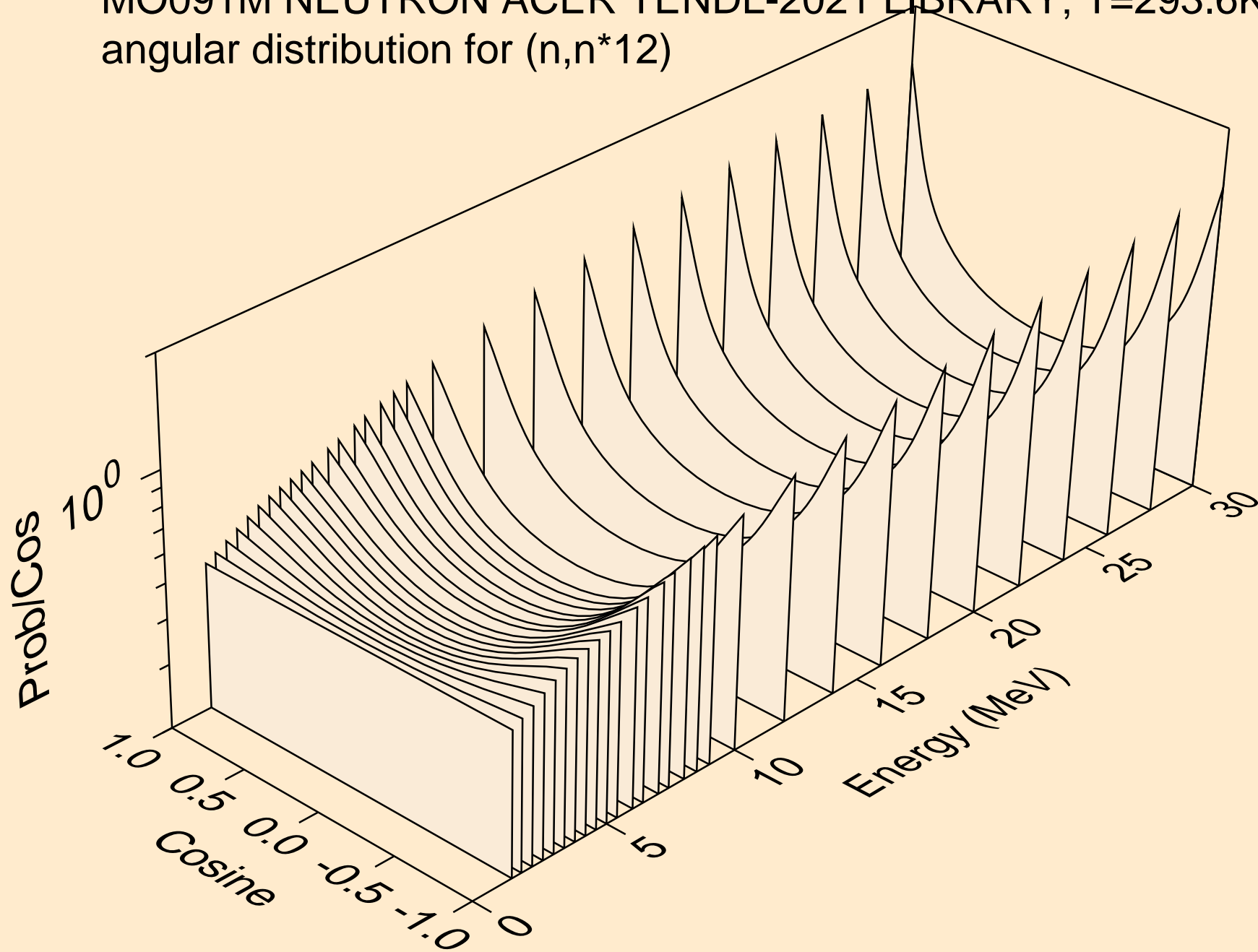

MO091M NEUTRON ACER TENDL-2021 LIBRARY; T=293.6K
angular distribution for (n,n*13)

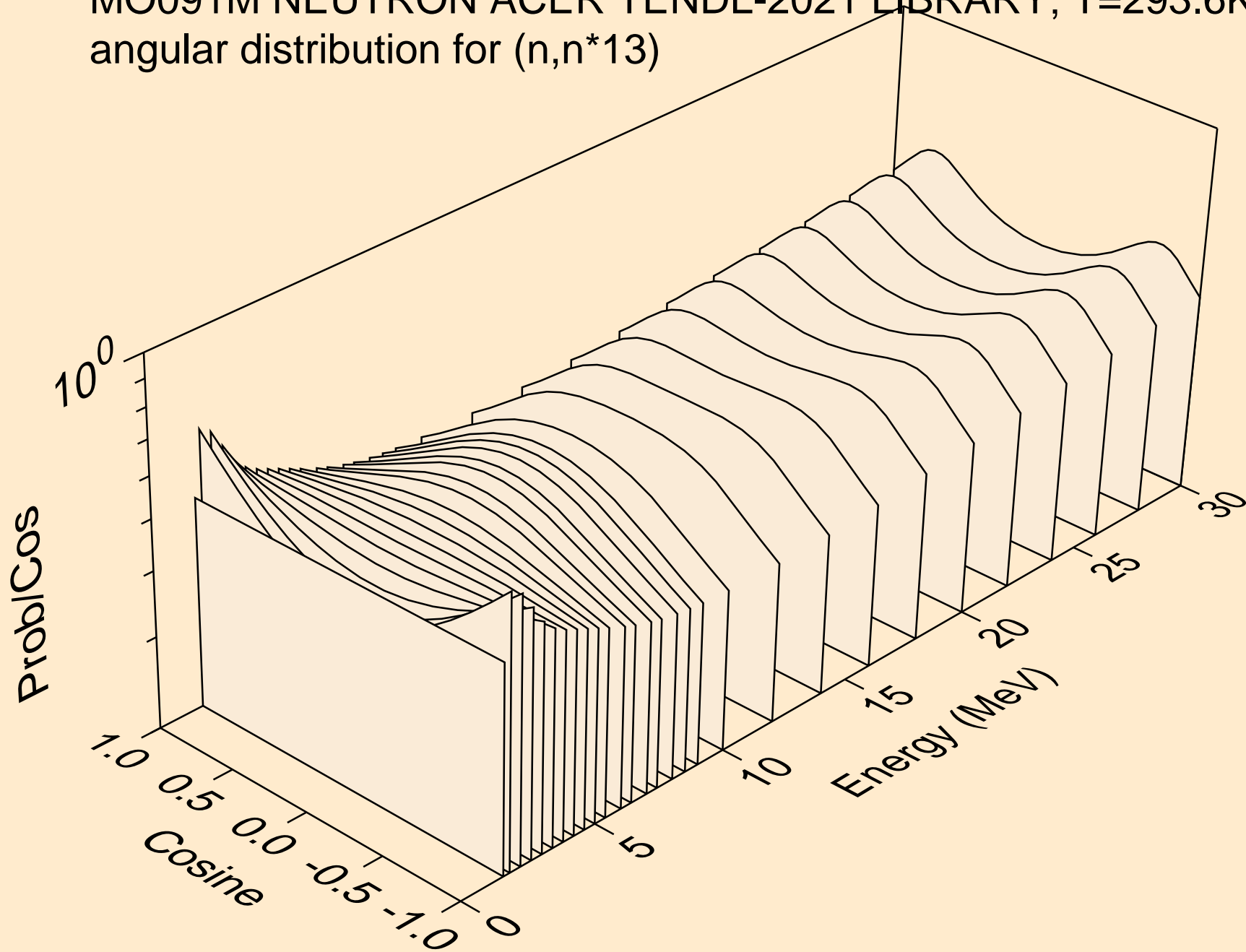

MO091M NEUTRON ACER TENDL-2021 LIBRARY; T=293.6K
angular distribution for (n,n*14)

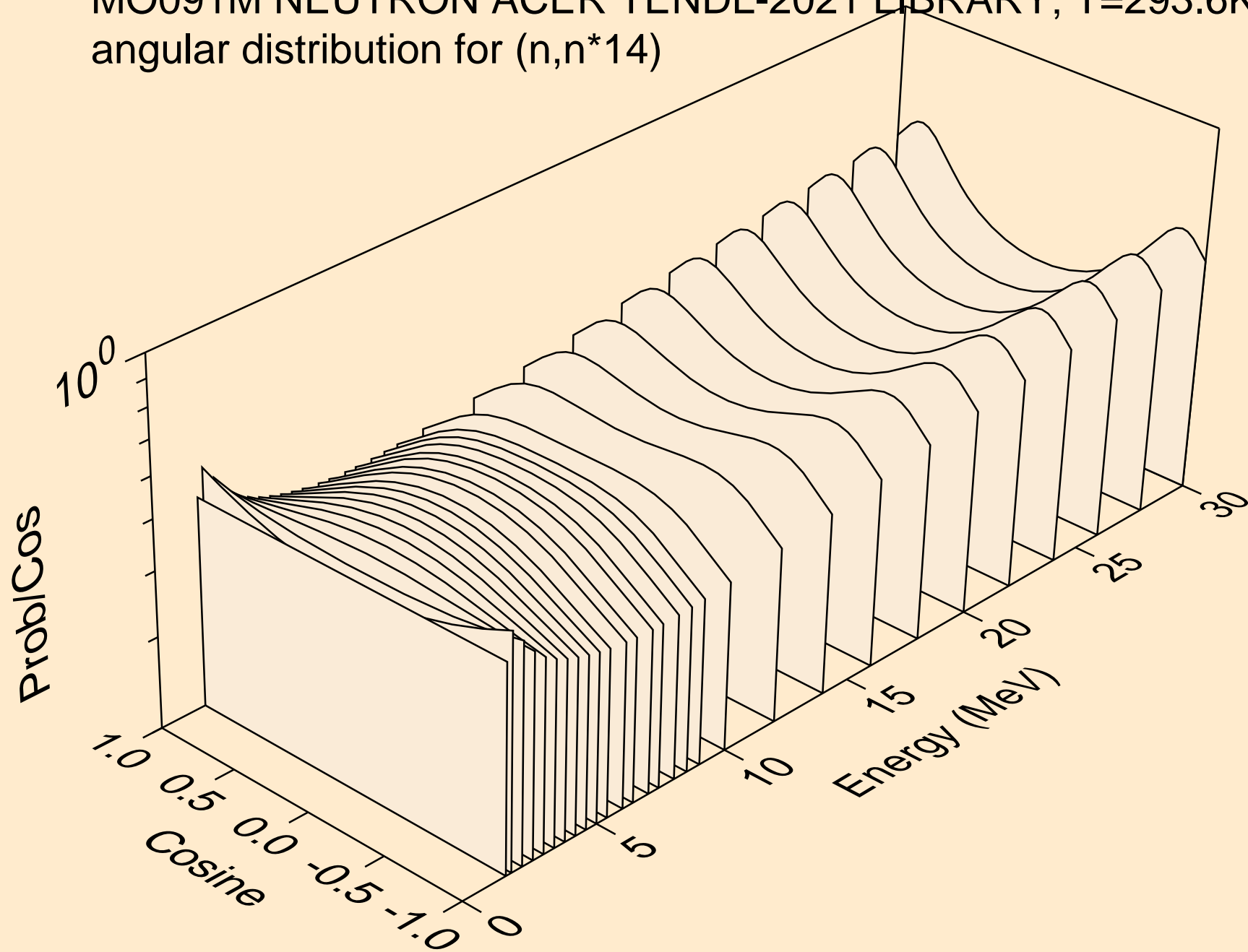

MO091M NEUTRON ACER TENDL-2021 LIBRARY; T=293.6K
angular distribution for (n,n*15)

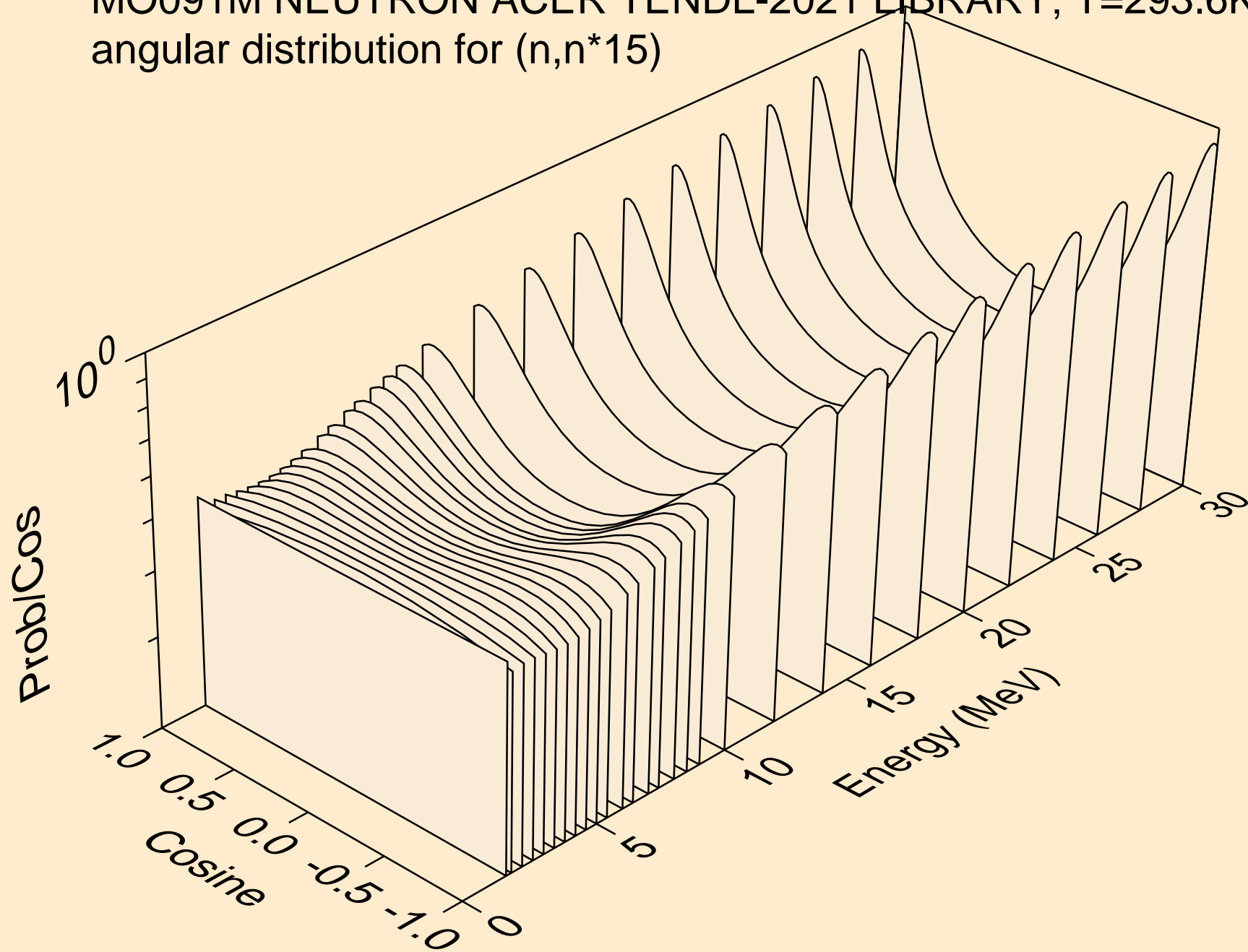

MO091M NEUTRON ACER TENDL-2021 LIBRARY; T=293.6K
angular distribution for (n,n*16)

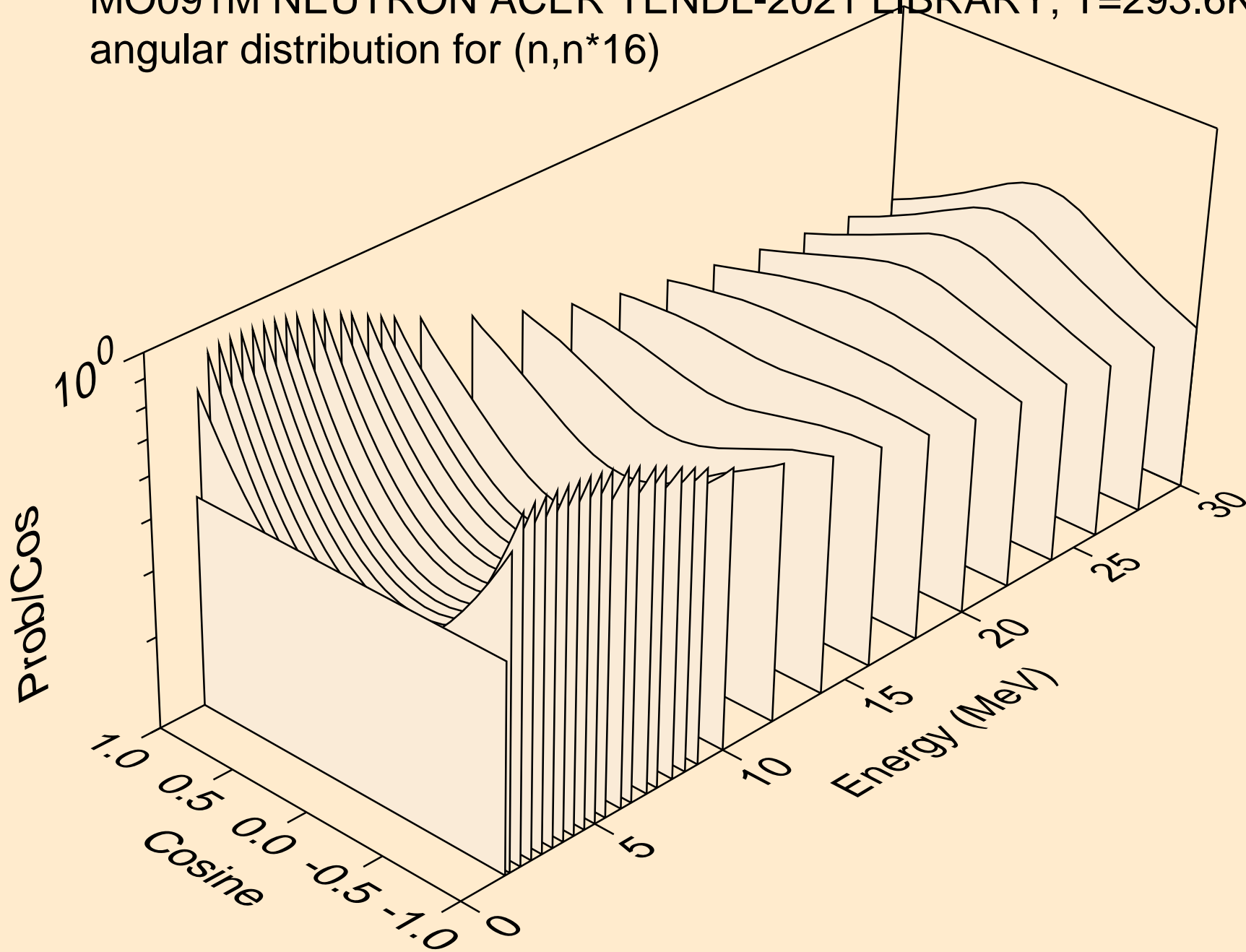

MO091M NEUTRON ACER TENDL-2021 LIBRARY; T=293.6K
angular distribution for (n,n*17)

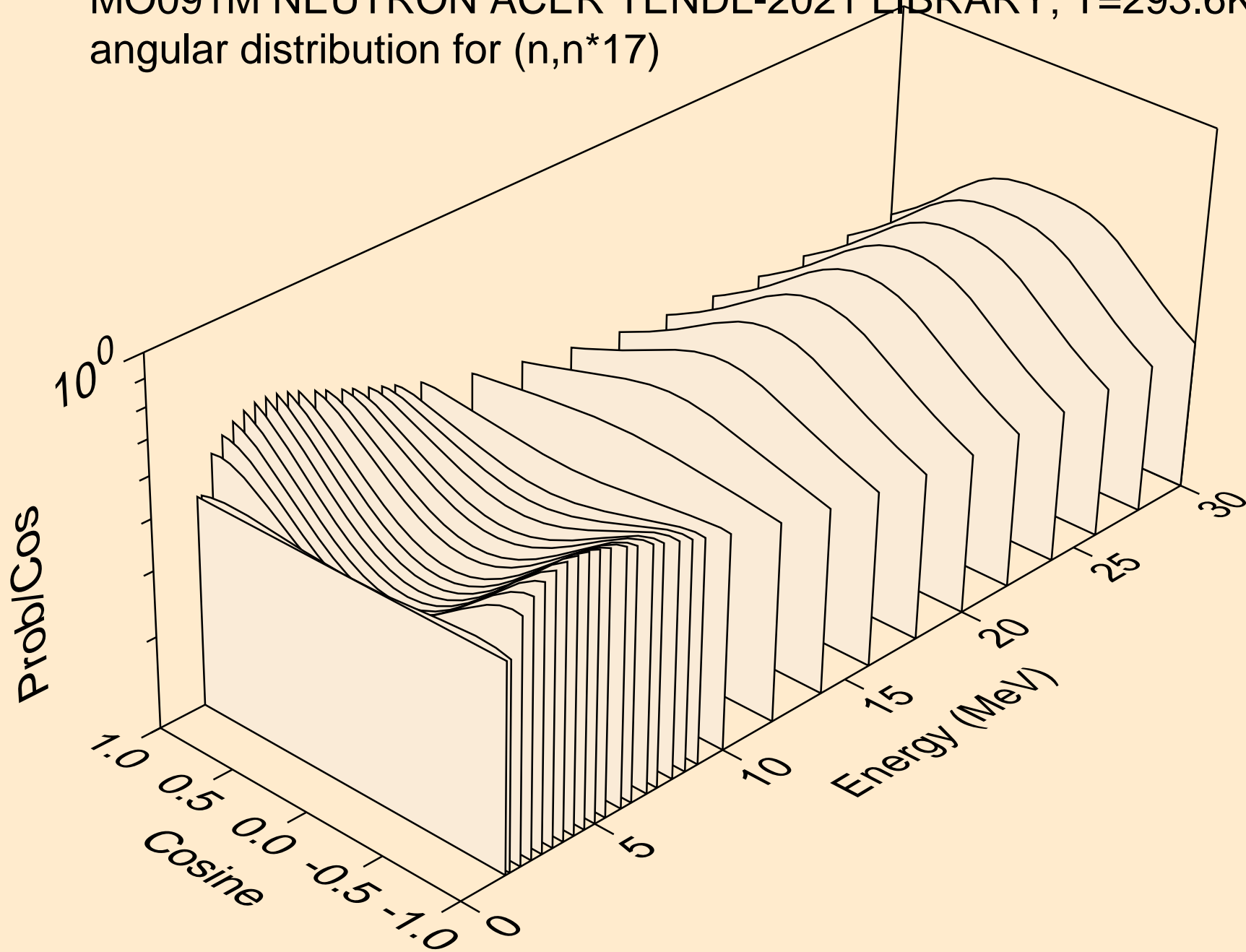

MO091M NEUTRON ACER TENDL-2021 LIBRARY; T=293.6K
angular distribution for (n,n*18)

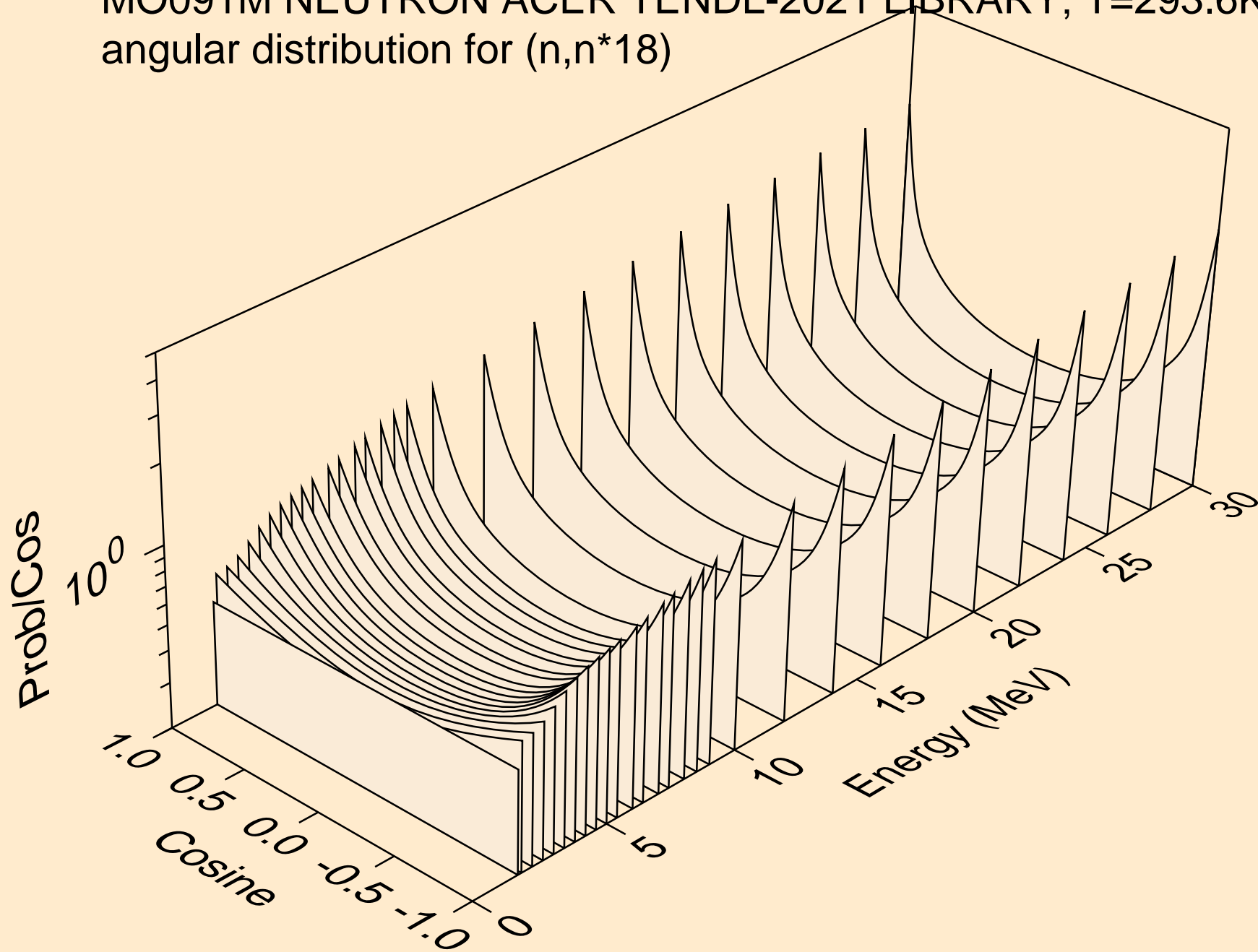

MO091M NEUTRON ACER TENDL-2021 LIBRARY; T=293.6K
angular distribution for (n,n*19)

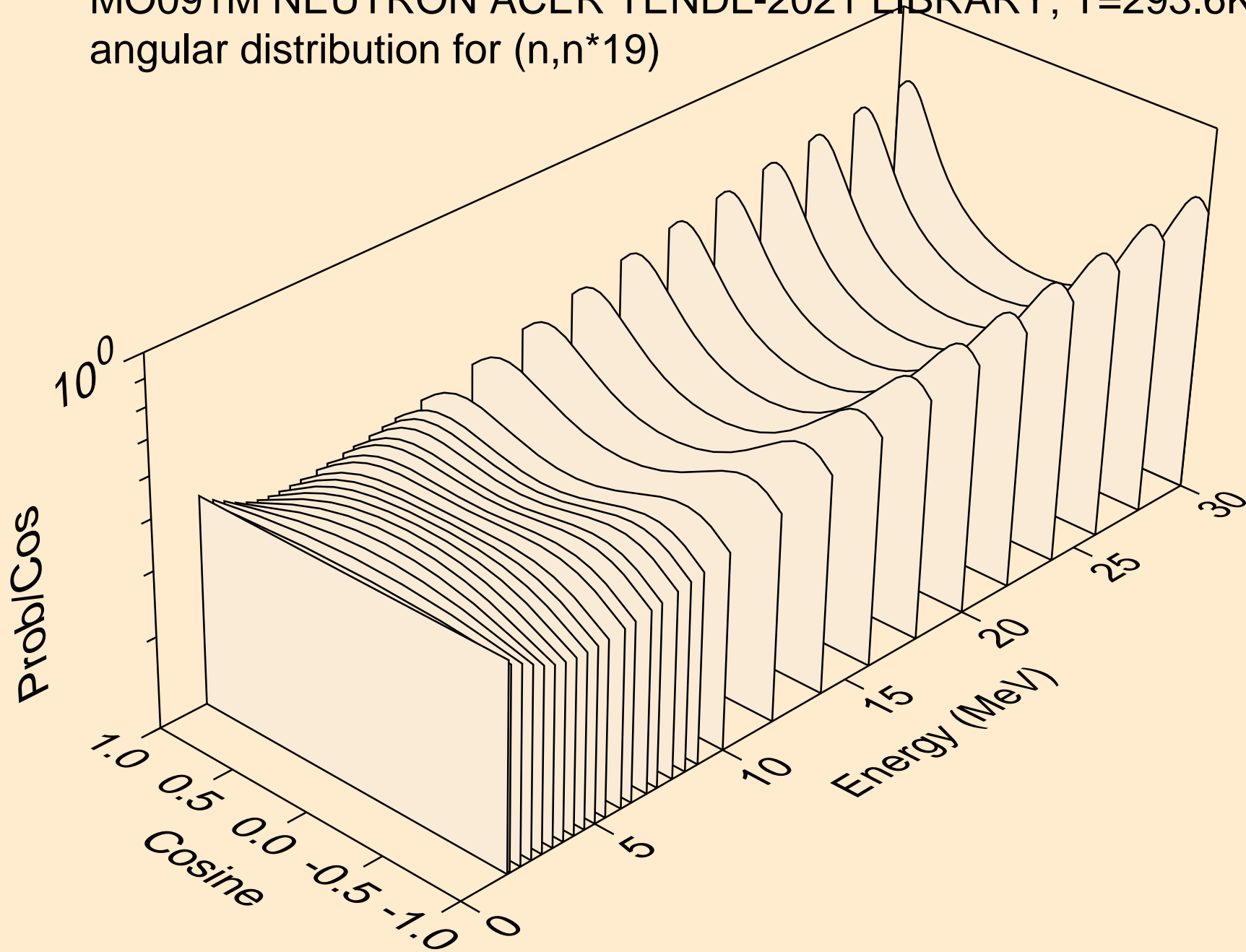

MO091M NEUTRON ACER TENDL-2021 LIBRARY; T=293.6K
angular distribution for (n,n*20)

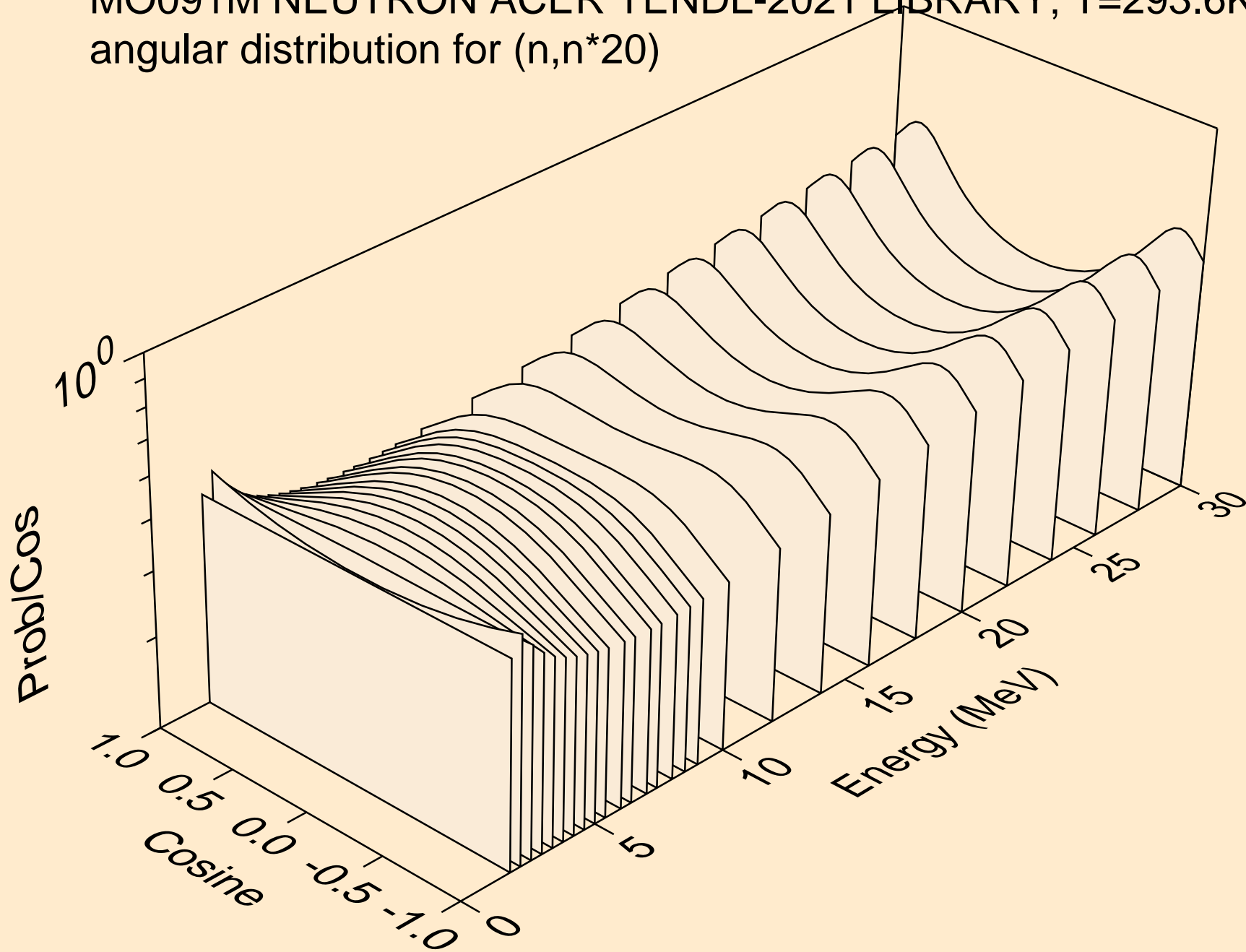

MO091M NEUTRON ACER TENDL-2021 LIBRARY; T=293.6K
angular distribution for (n,n*21)

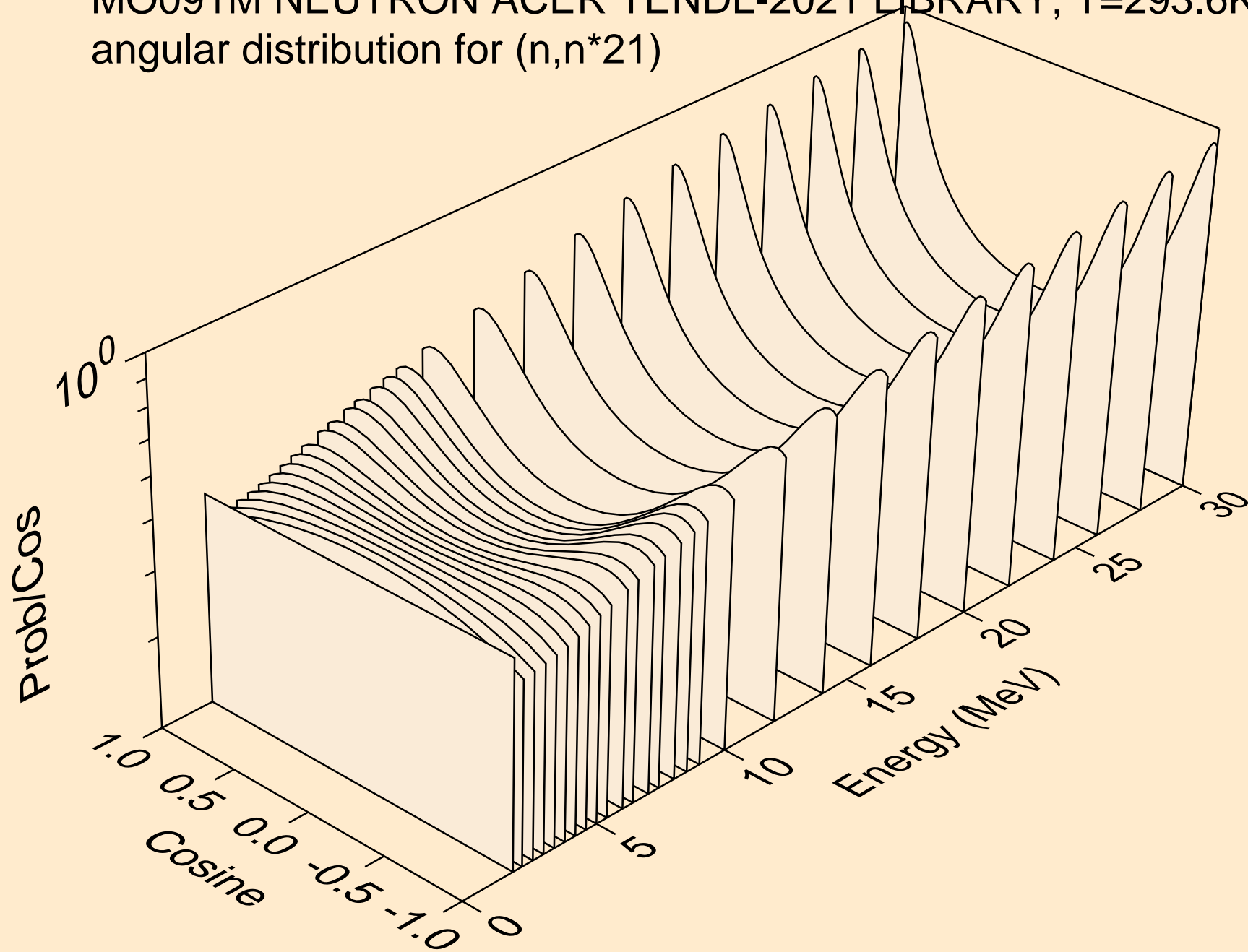

MO091M NEUTRON ACER TENDL-2021 LIBRARY; T=293.6K
angular distribution for (n,n*22)

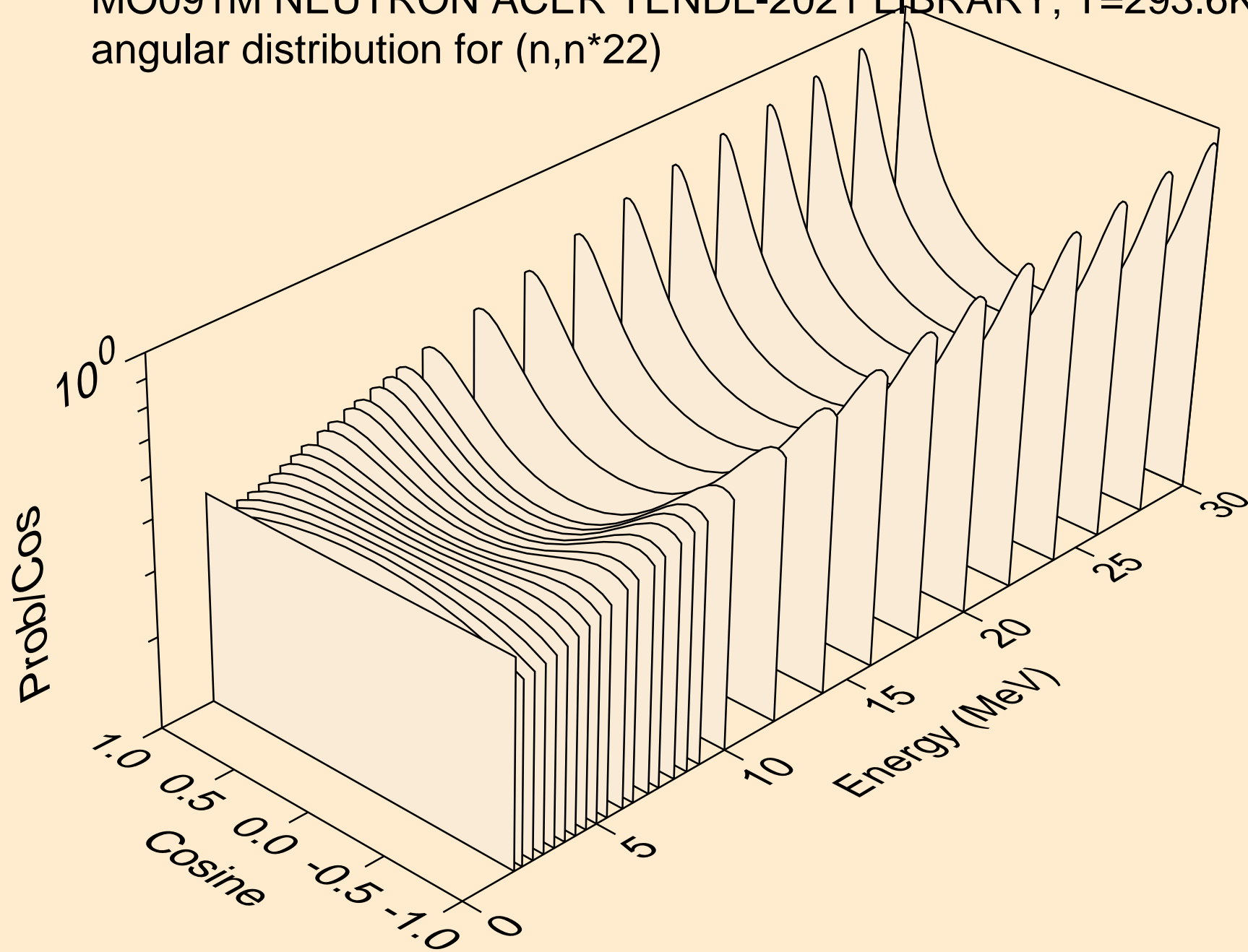

MO091M NEUTRON ACER TENDL-2021 LIBRARY; T=293.6K
angular distribution for (n,n*23)

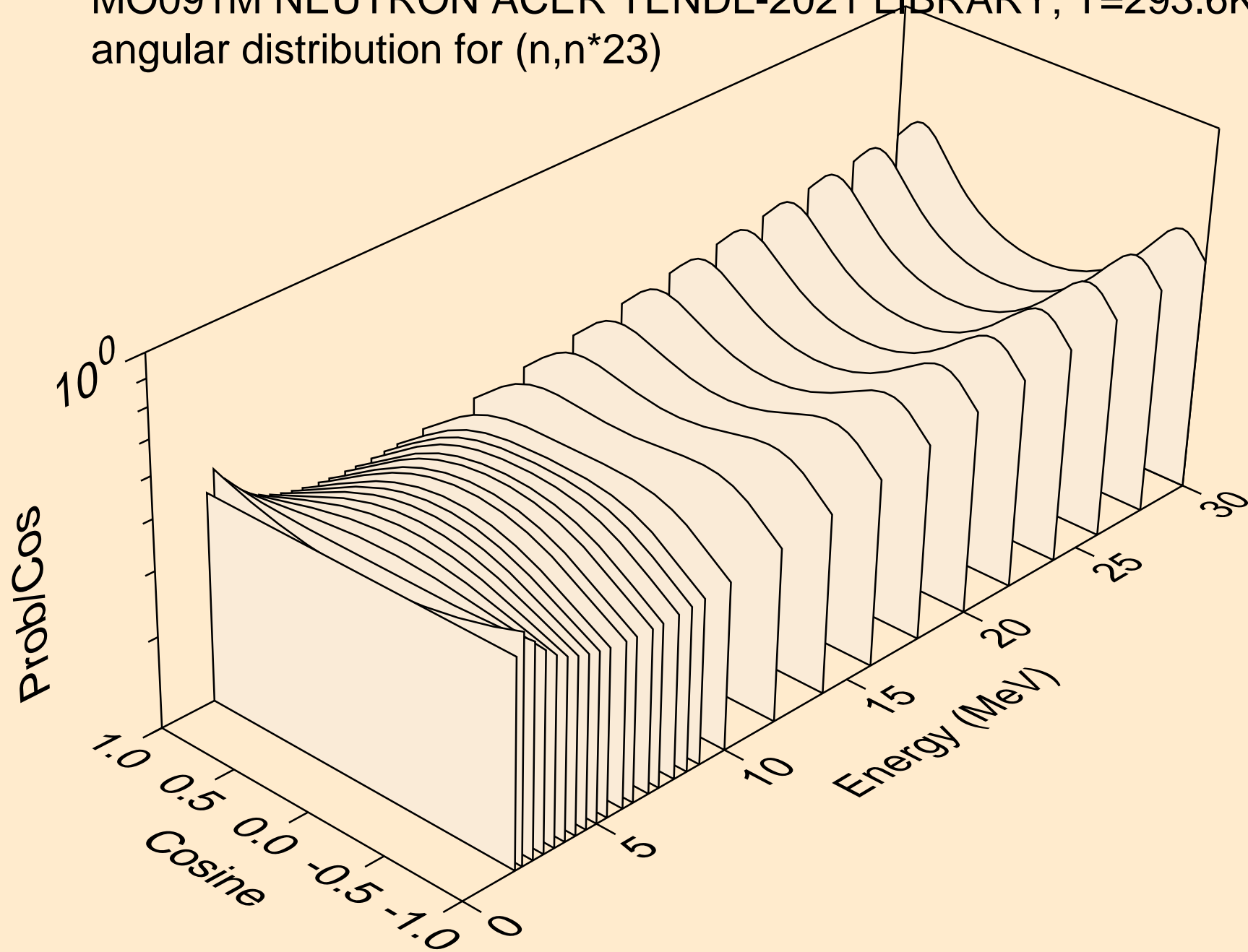

MO091M NEUTRON ACER TENDL-2021 LIBRARY; T=293.6K
angular distribution for (n,n*24)

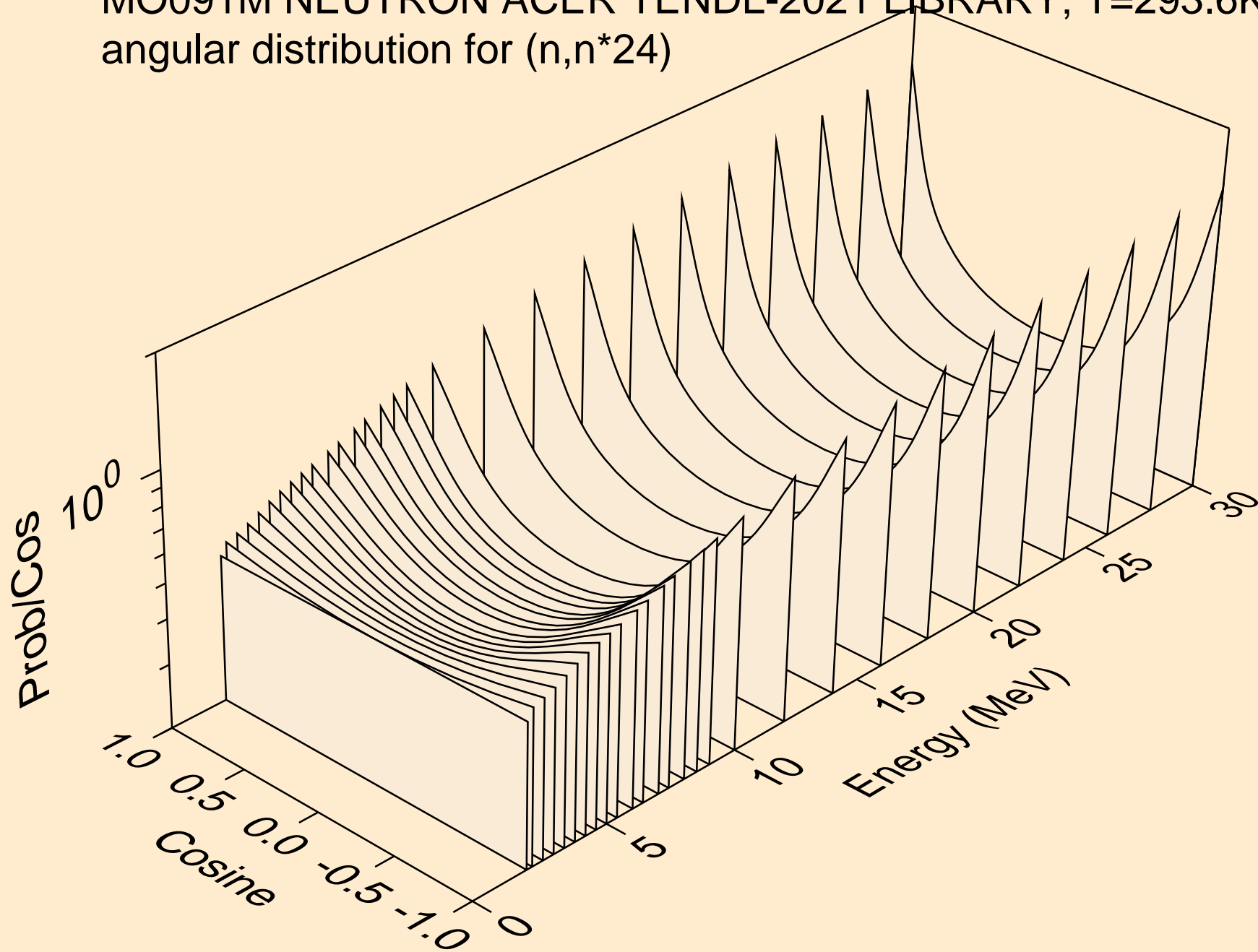

MO091M NEUTRON ACER TENDL-2021 LIBRARY; T=293.6K
angular distribution for (n,n*25)

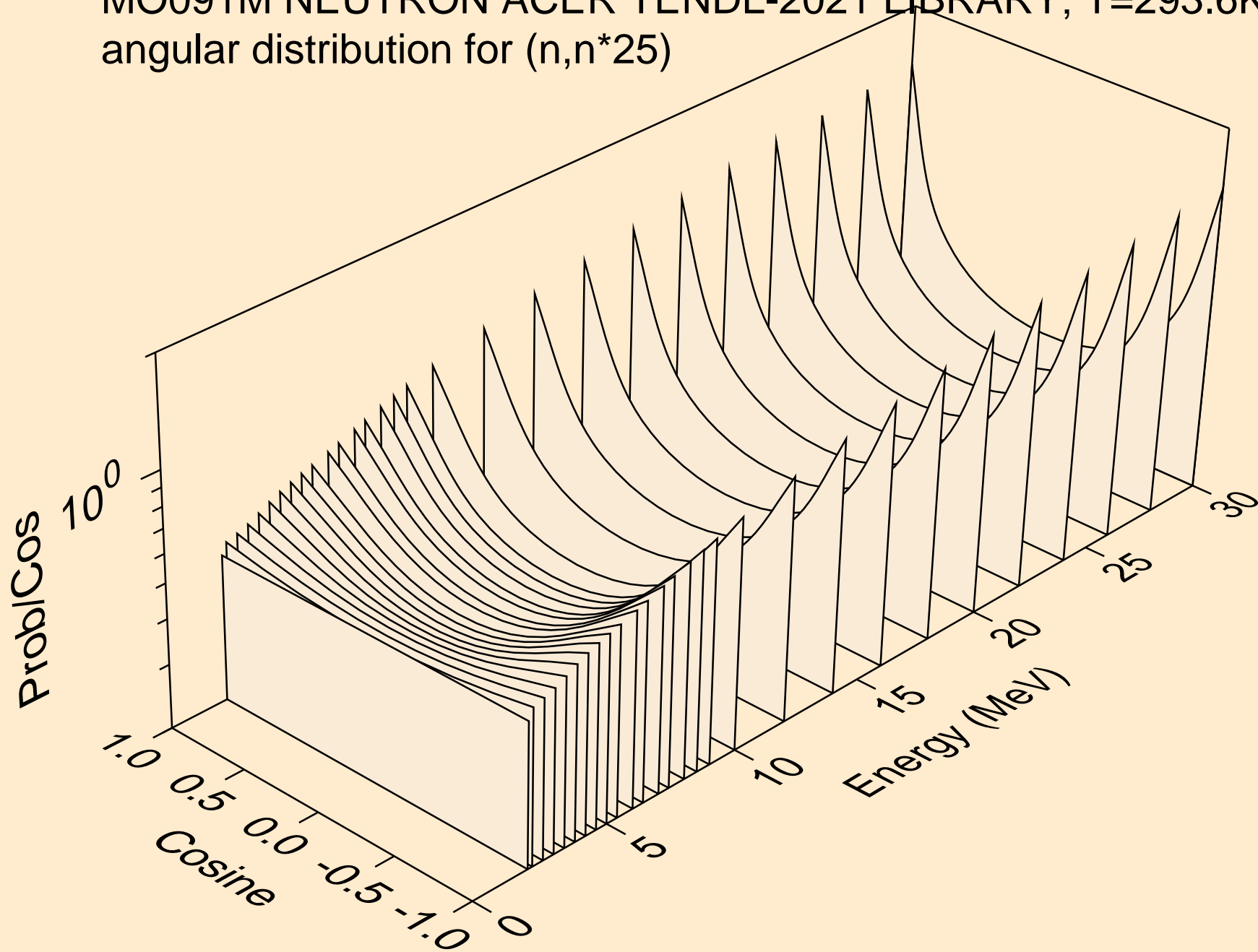

MO091M NEUTRON ACER TENDL-2021 LIBRARY; T=293.6K
angular distribution for (n,n*26)

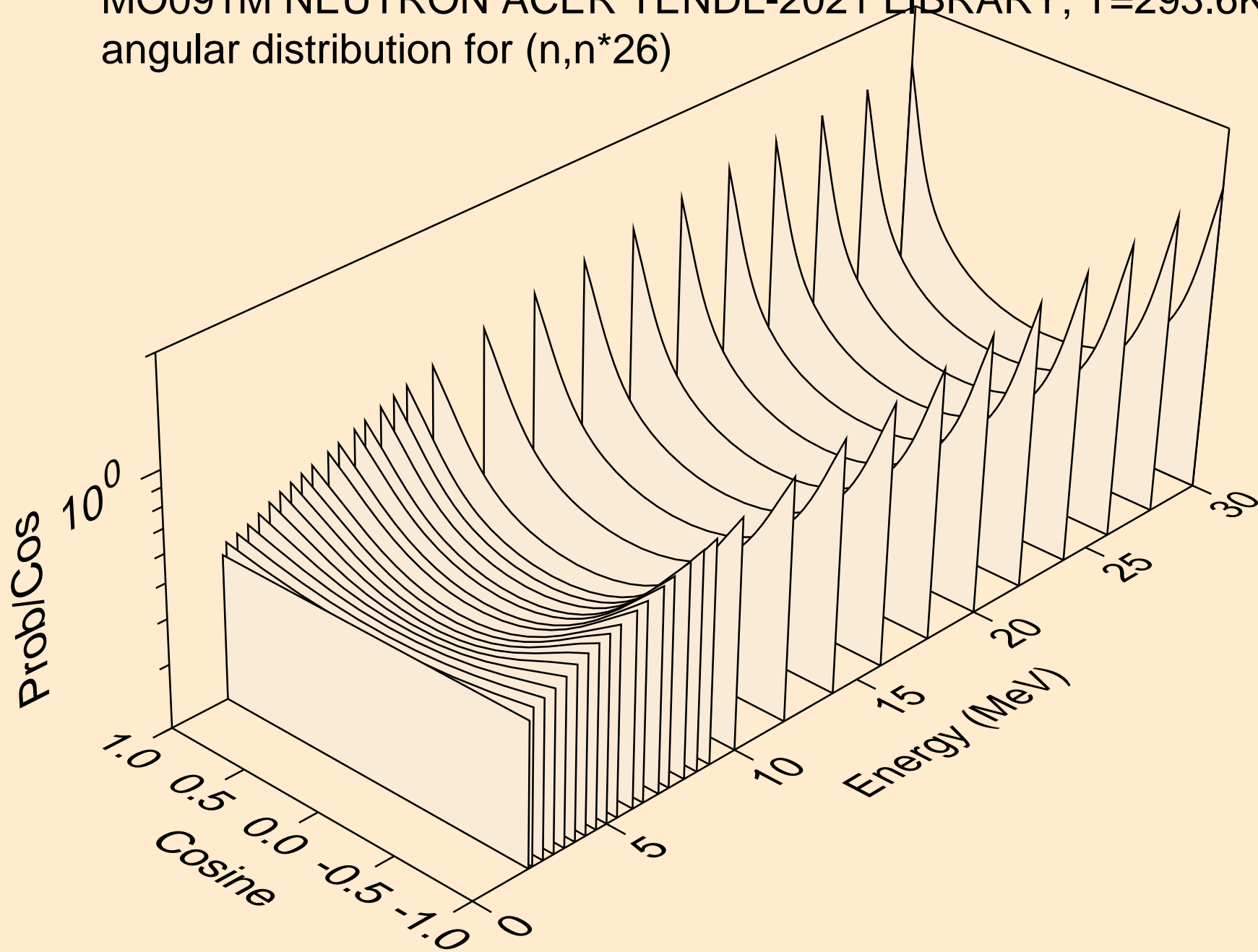

MO091M NEUTRON ACER TENDL-2021 LIBRARY; T=293.6K
angular distribution for (n,n*27)

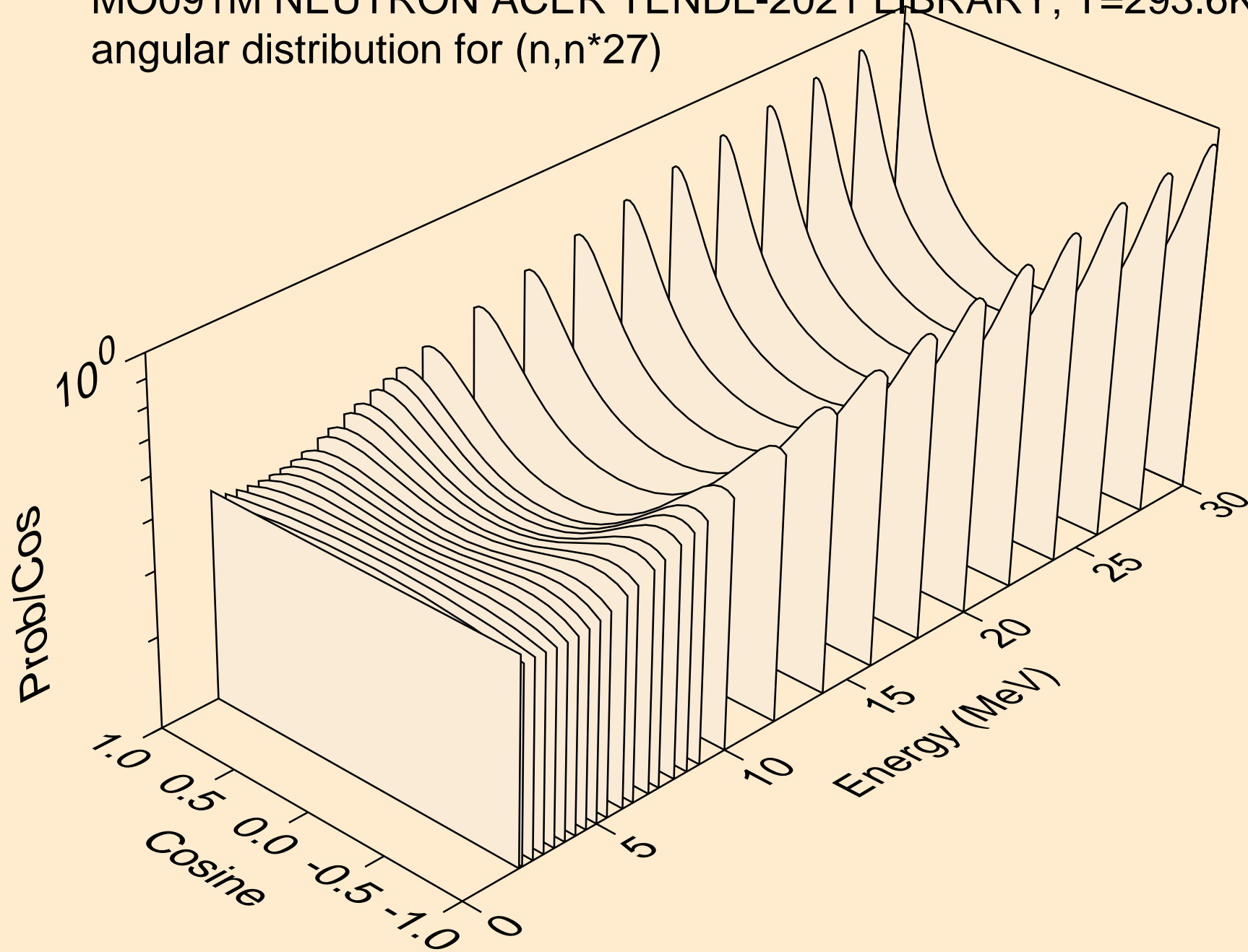

MO091M NEUTRON ACER TENDL-2021 LIBRARY; T=293.6K
angular distribution for (n,n*28)

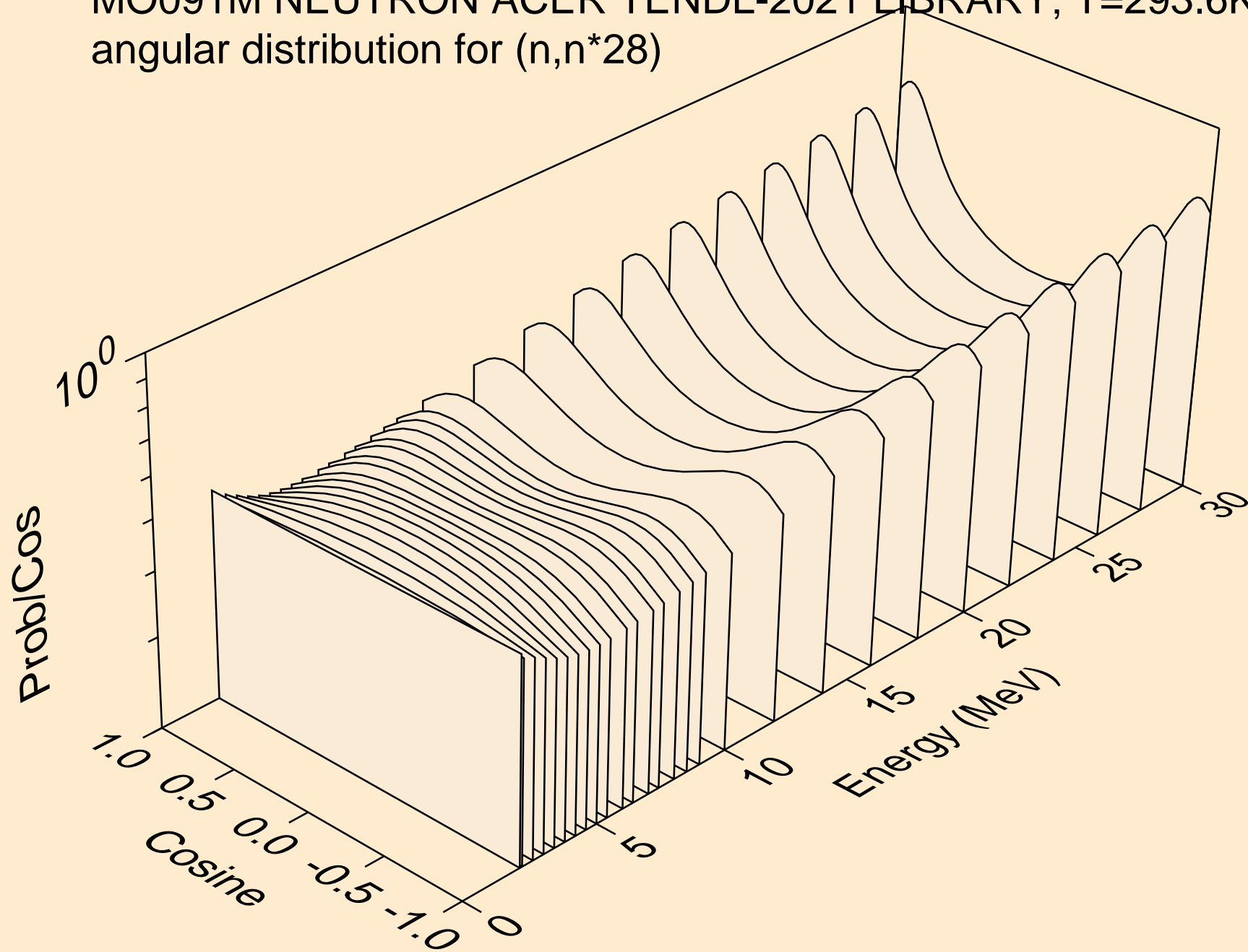

MO091M NEUTRON ACER TENDL-2021 LIBRARY; T=293.6K
Neutron emission for (n,x)

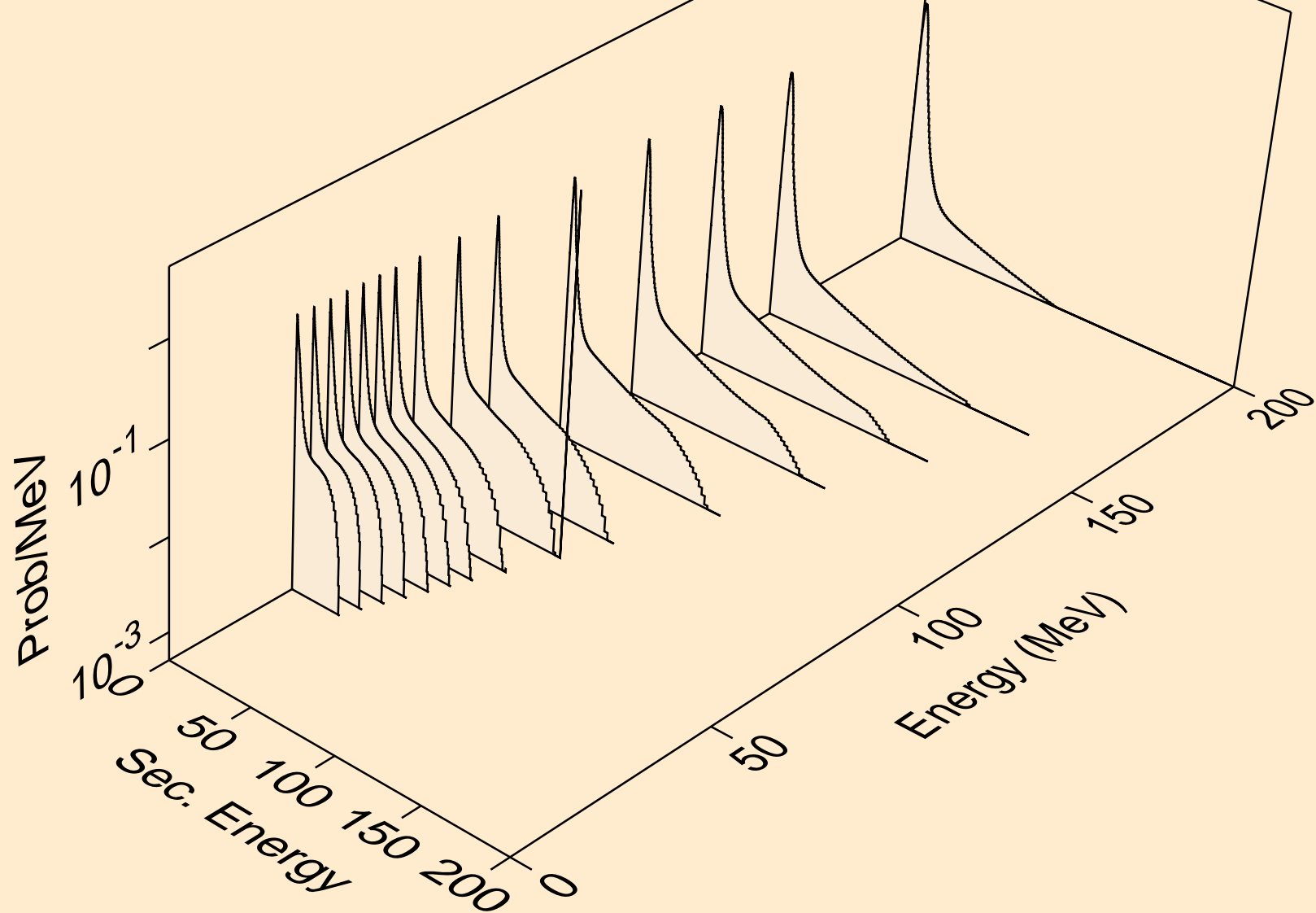

MO091M NEUTRON ACER TENDL-2021 LIBRARY; T=293.6K
Neutron emission for (n,2nd)

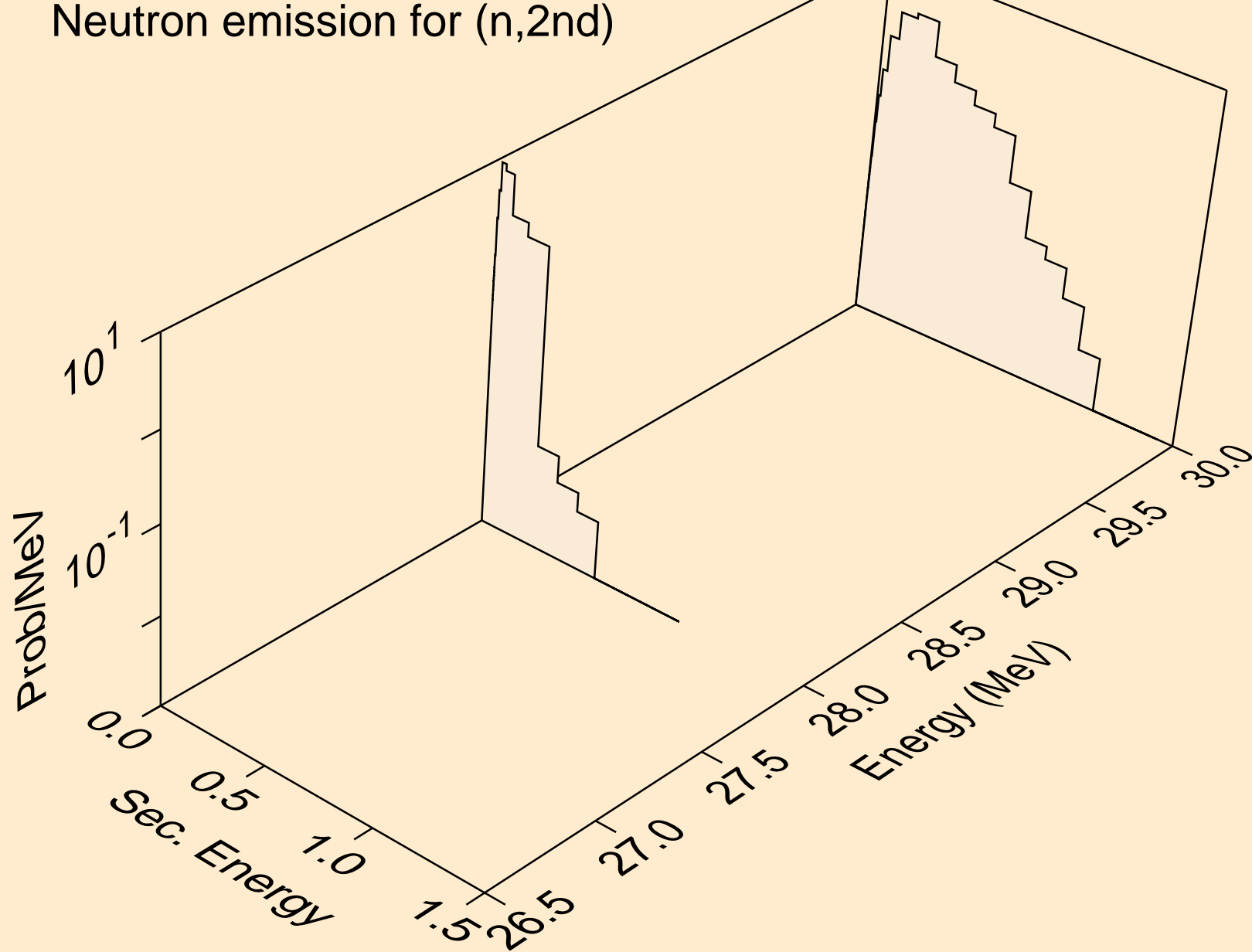

MO091M NEUTRON ACER TENDL-2021 LIBRARY; T=293.6K
Neutron emission for (n,2n)

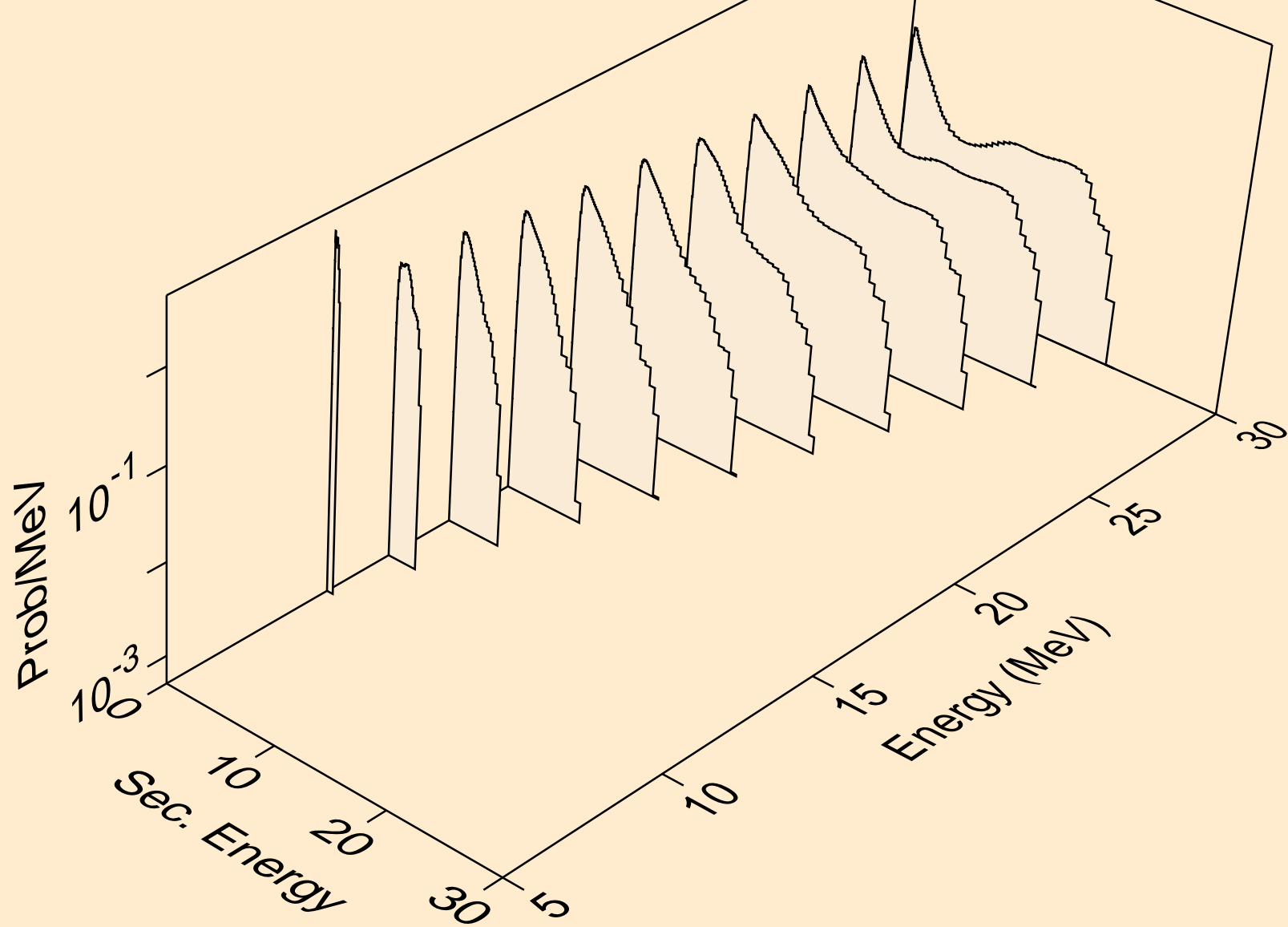

MO091M NEUTRON ACER TENDL-2021 LIBRARY; T=293.6K
Neutron emission for (n,3n)

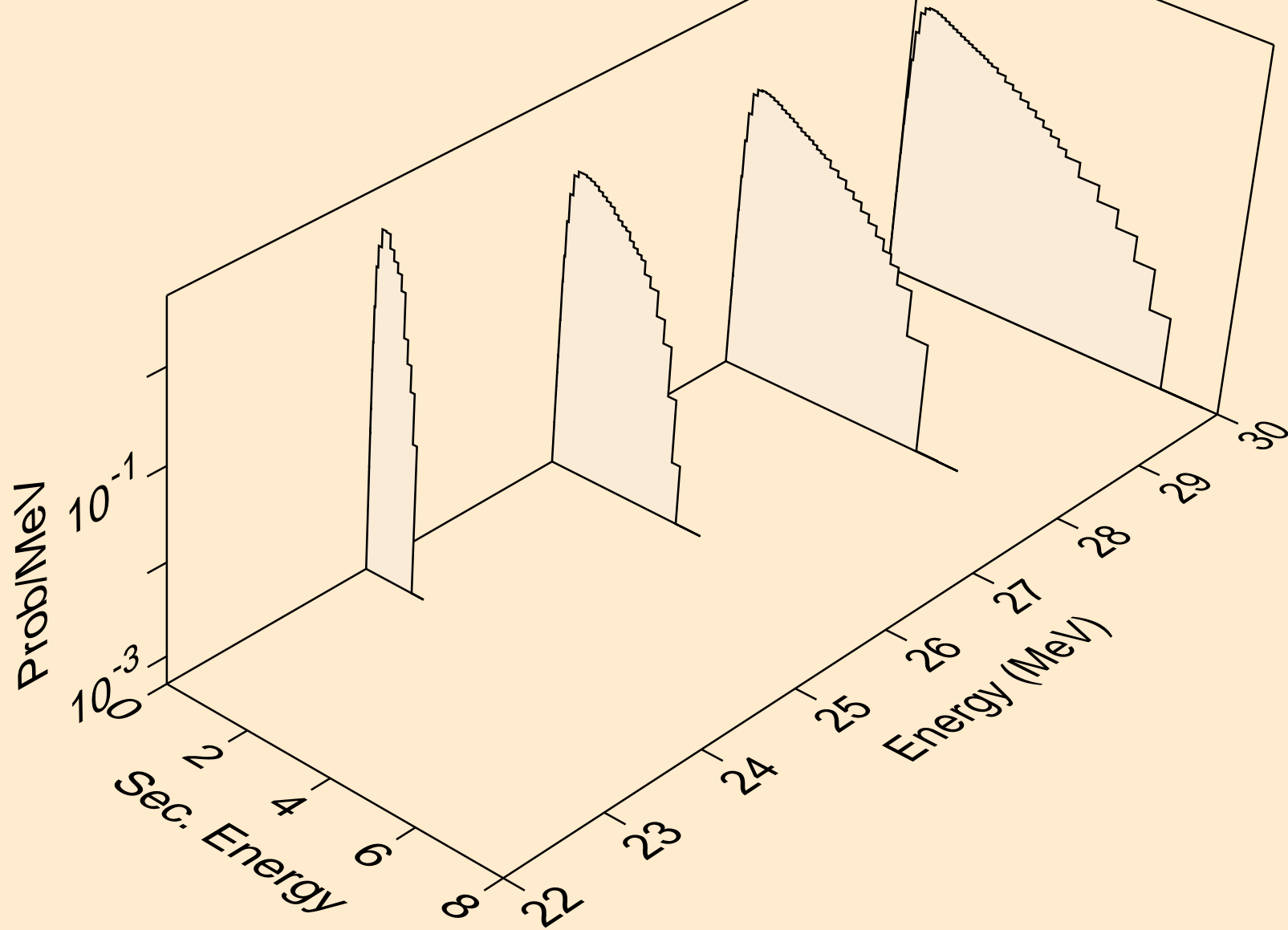

MO091M NEUTRON ACER TENDL-2021 LIBRARY; T=293.6K
Neutron emission for (n,n*)a

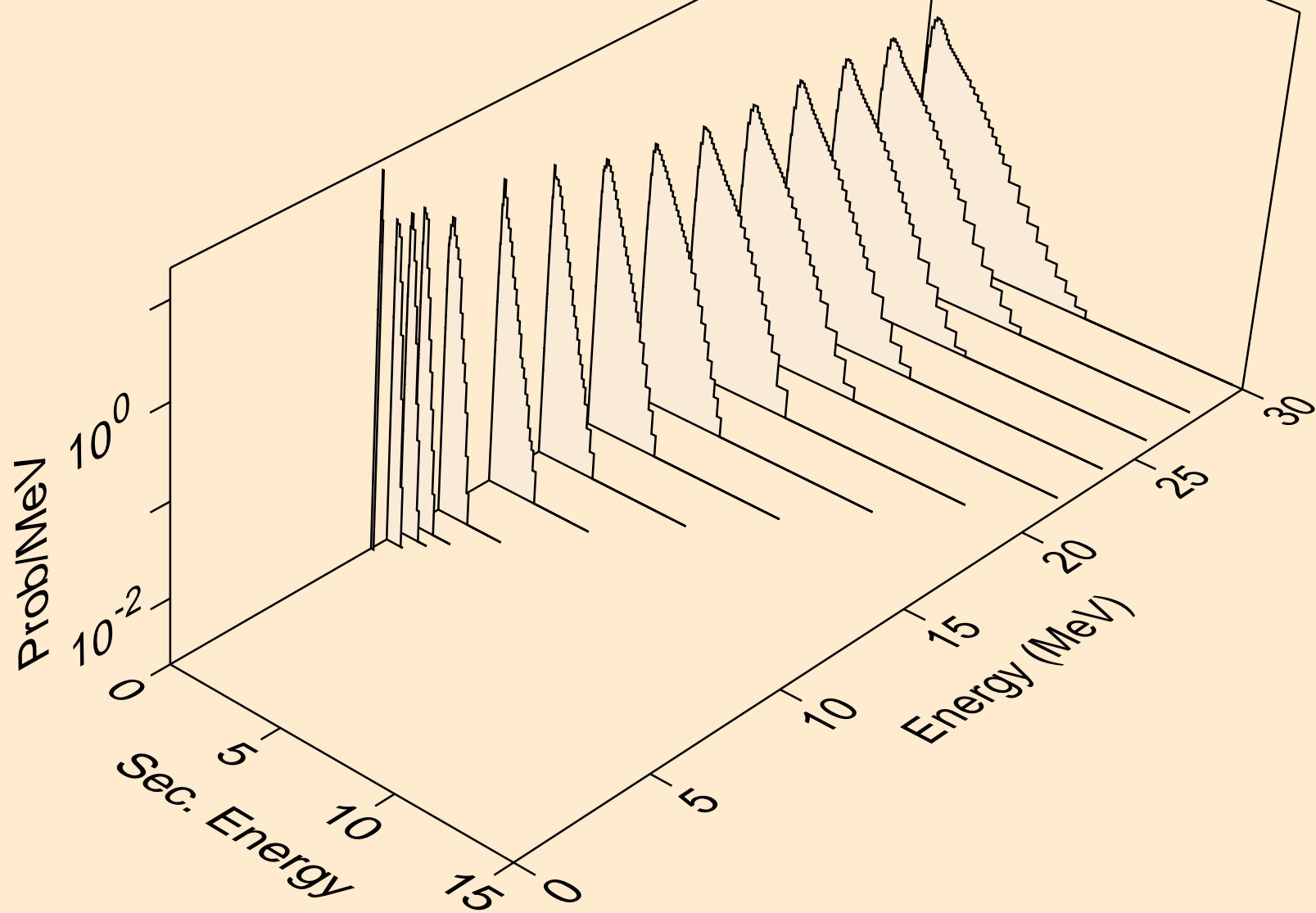

MO091M NEUTRON ACER TENDL-2021 LIBRARY; T=293.6K
Neutron emission for (n,2n)a

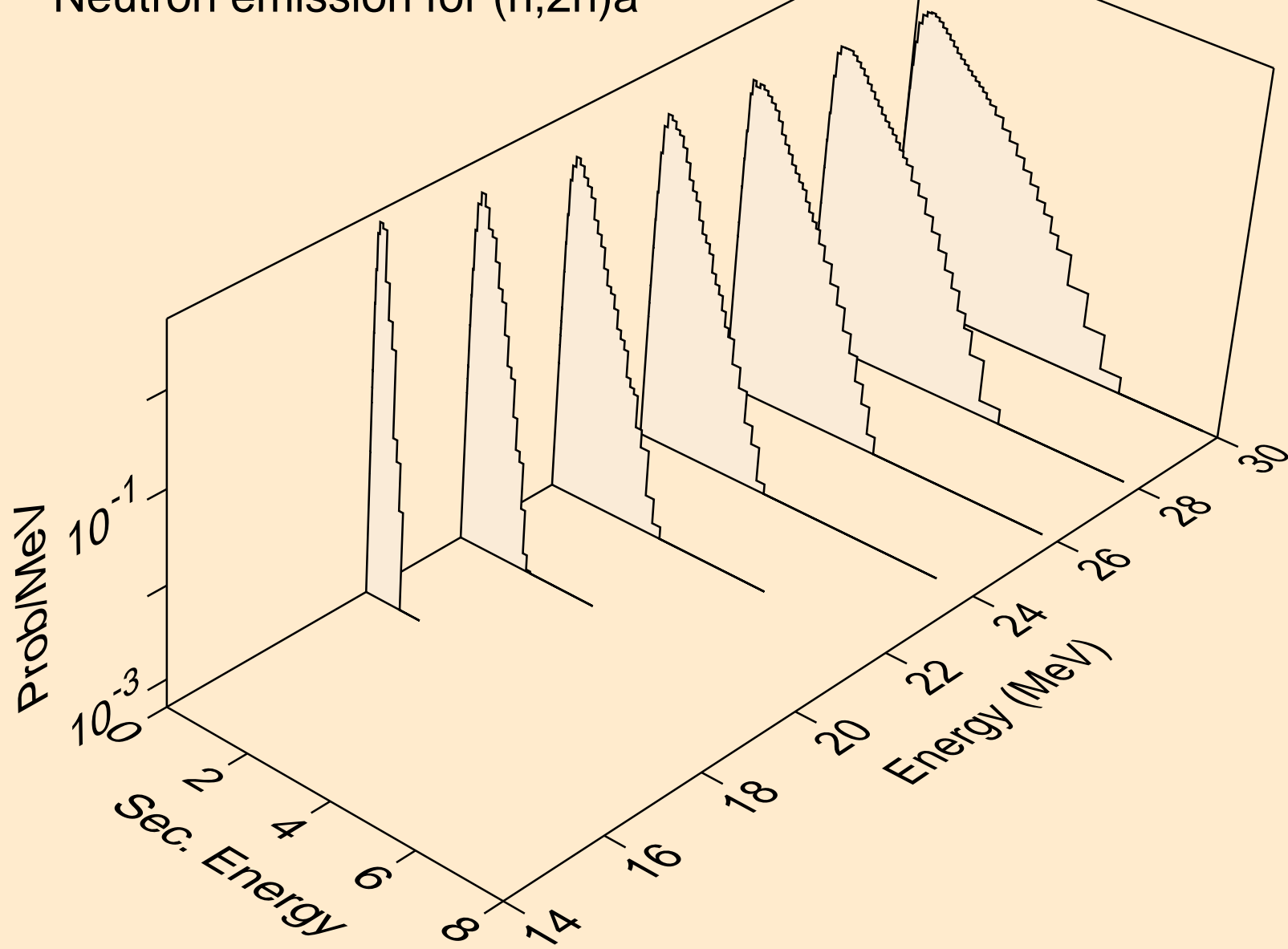

MO091M NEUTRON ACER TENDL-2021 LIBRARY; T=293.6K
Neutron emission for (n,n*)p

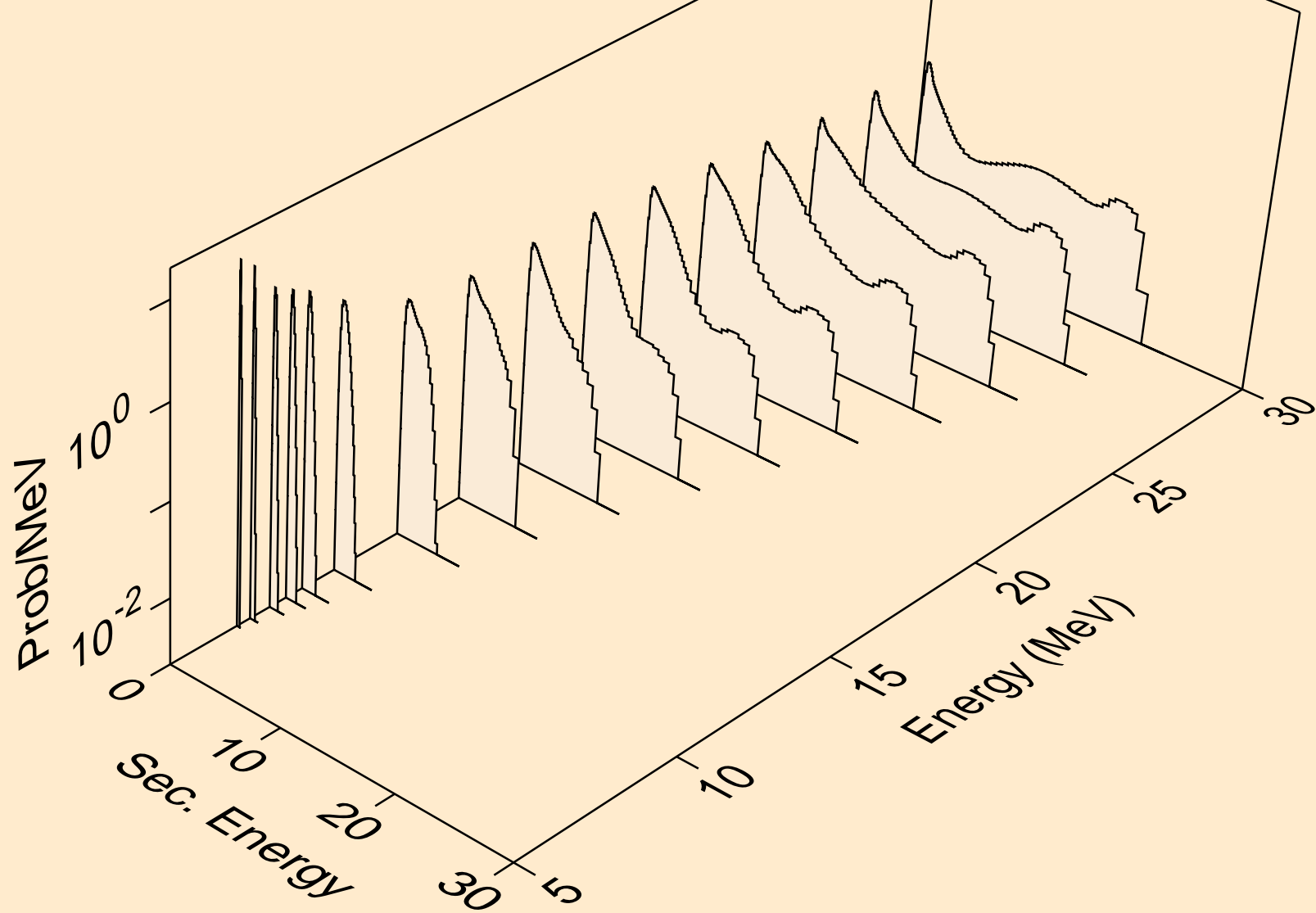

MO091M NEUTRON ACER TENDL-2021 LIBRARY; T=293.6K
Neutron emission for (n,n*)2a

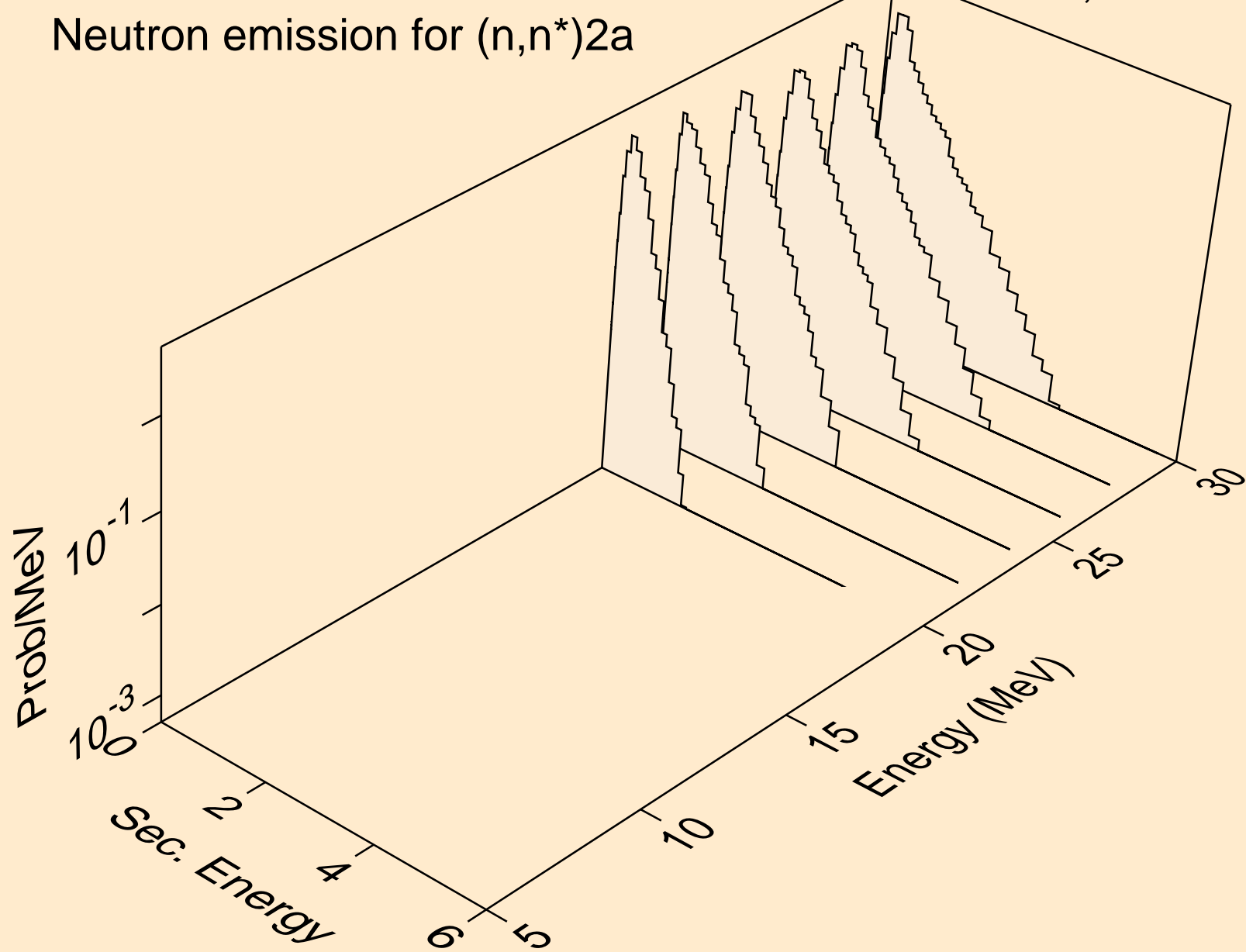

MO091M NEUTRON ACER TENDL-2021 LIBRARY; T=293.6K
Neutron emission for (n,n*)d

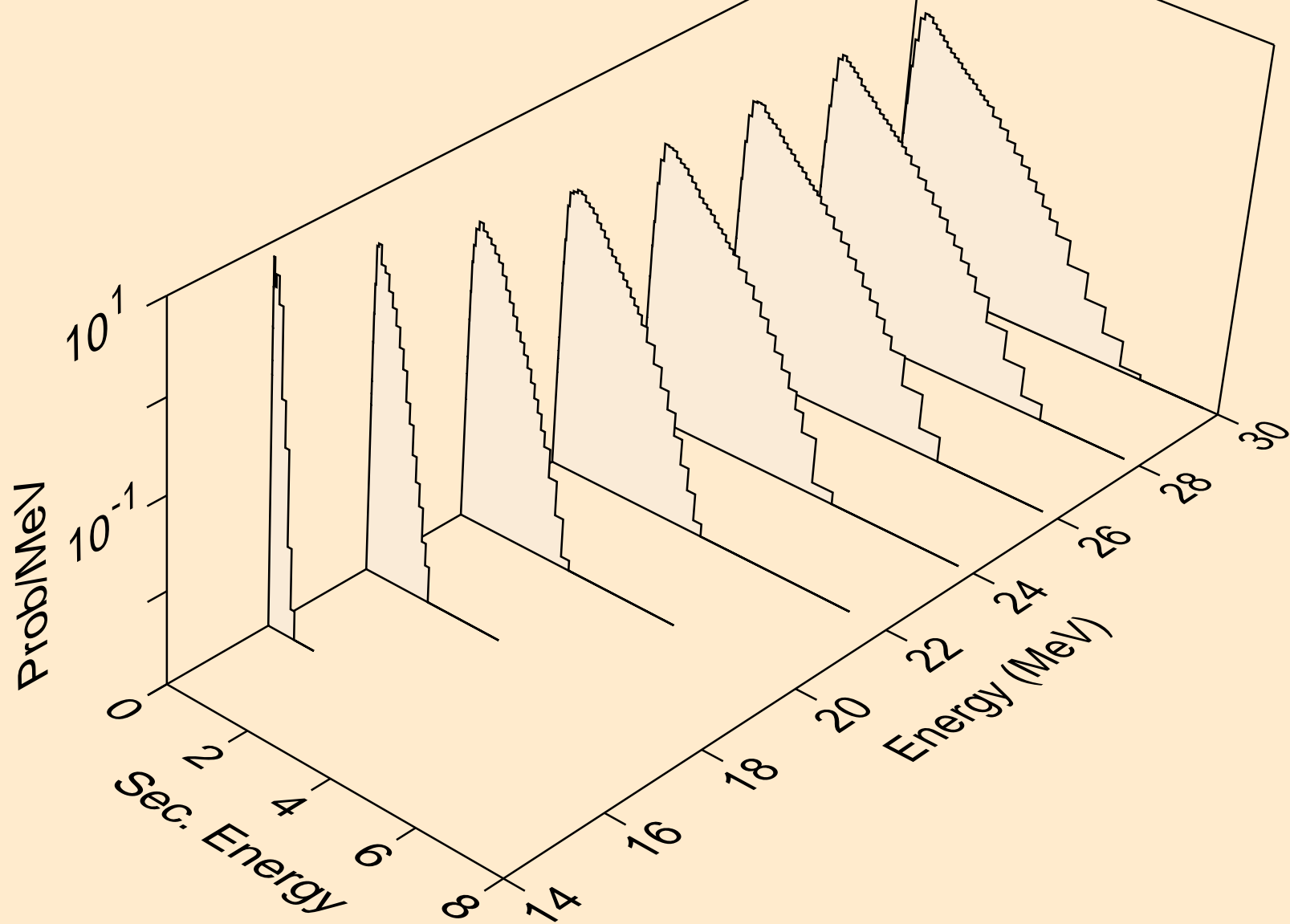

MO091M NEUTRON ACER TENDL-2021 LIBRARY; T=293.6K
Neutron emission for (n,n*)t

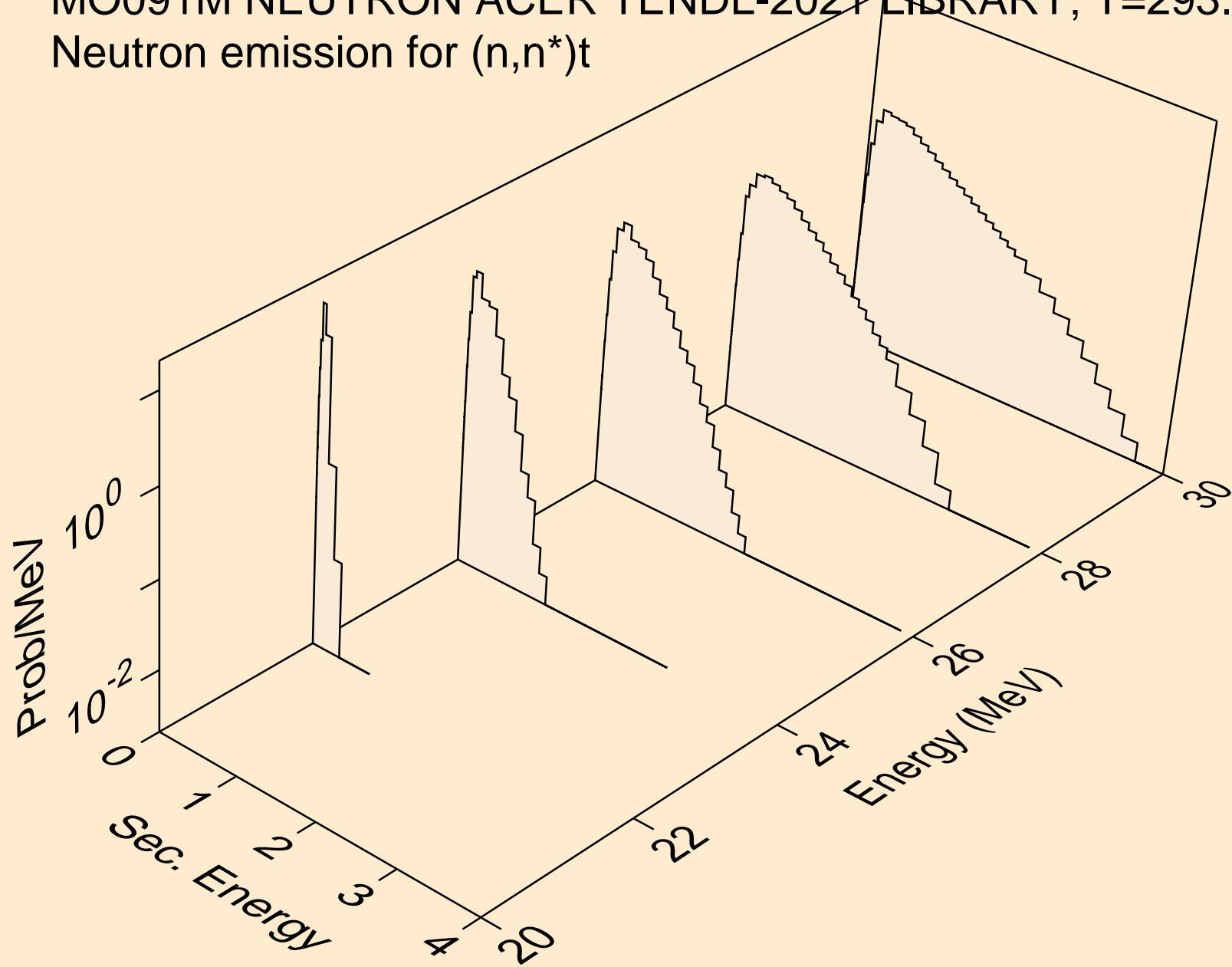

MO091M NEUTRON ACER TENDL-2021 LIBRARY; T=293.6K
Neutron emission for (n,n*)he3

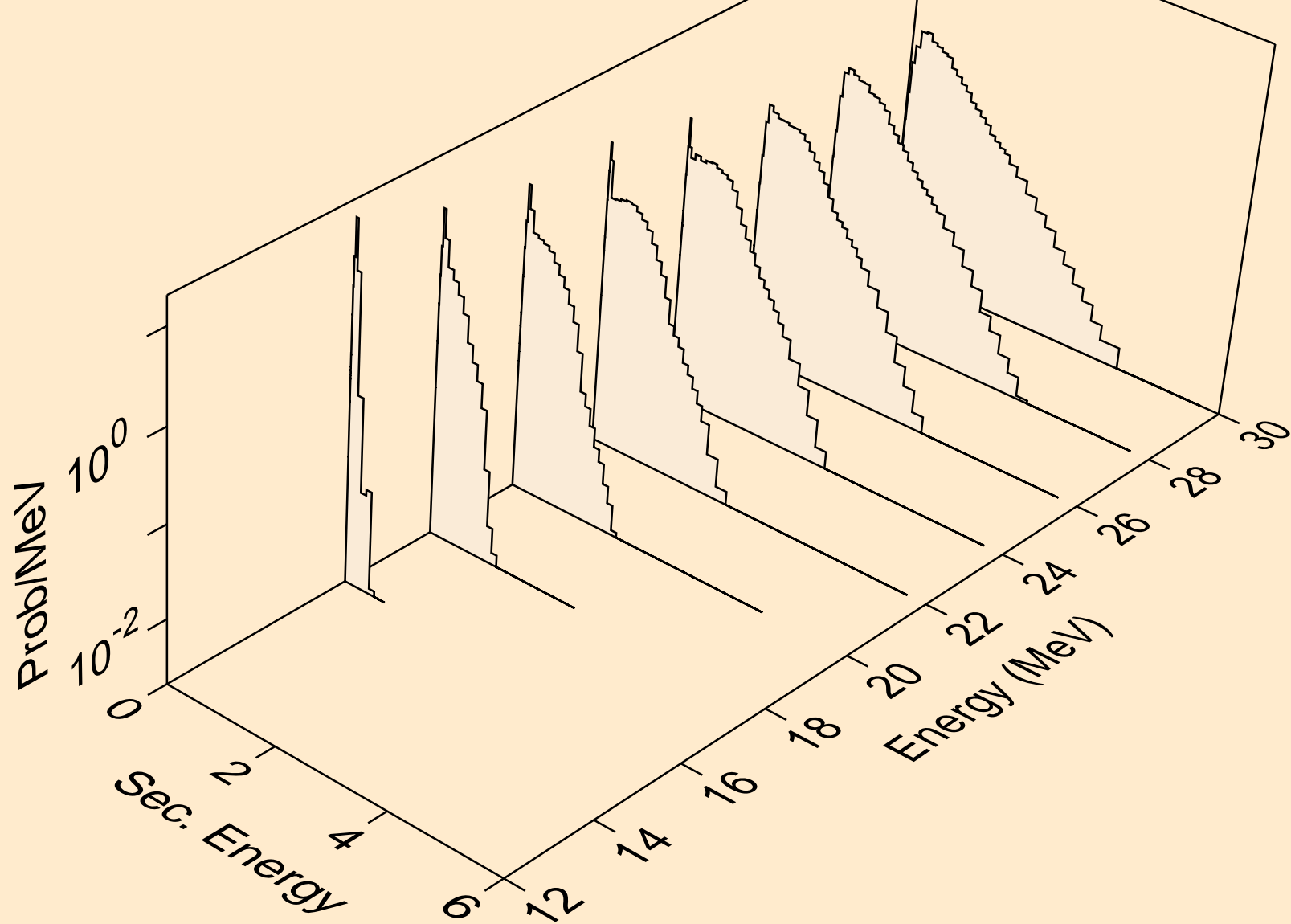

MO091M NEUTRON ACER TENDL-2021 LIBRARY; T=293.6K
Neutron emission for (n,2np)

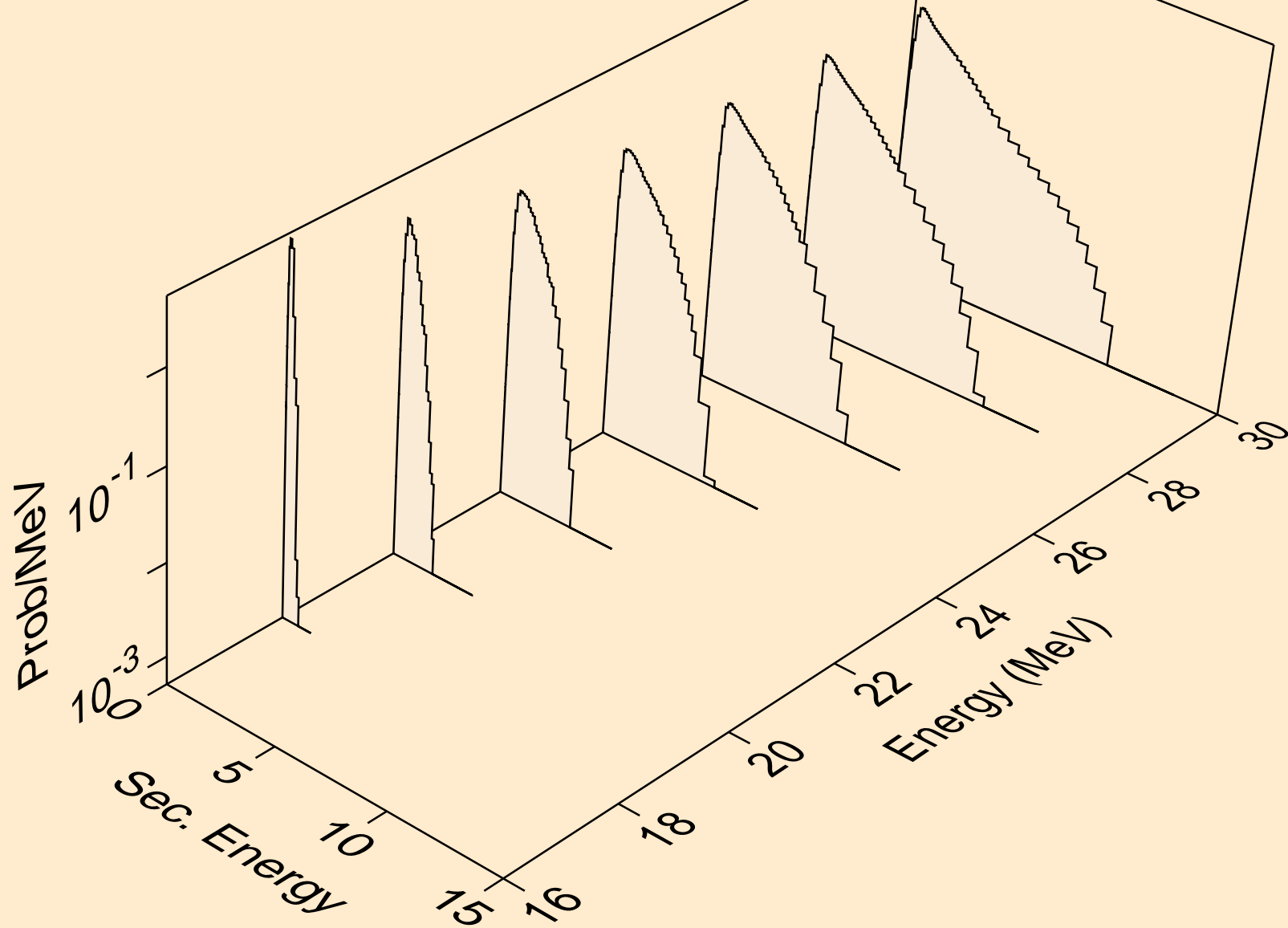

MO091M NEUTRON ACER TENDL-2021 LIBRARY; T=293.6K
Neutron emission for (n,2np)

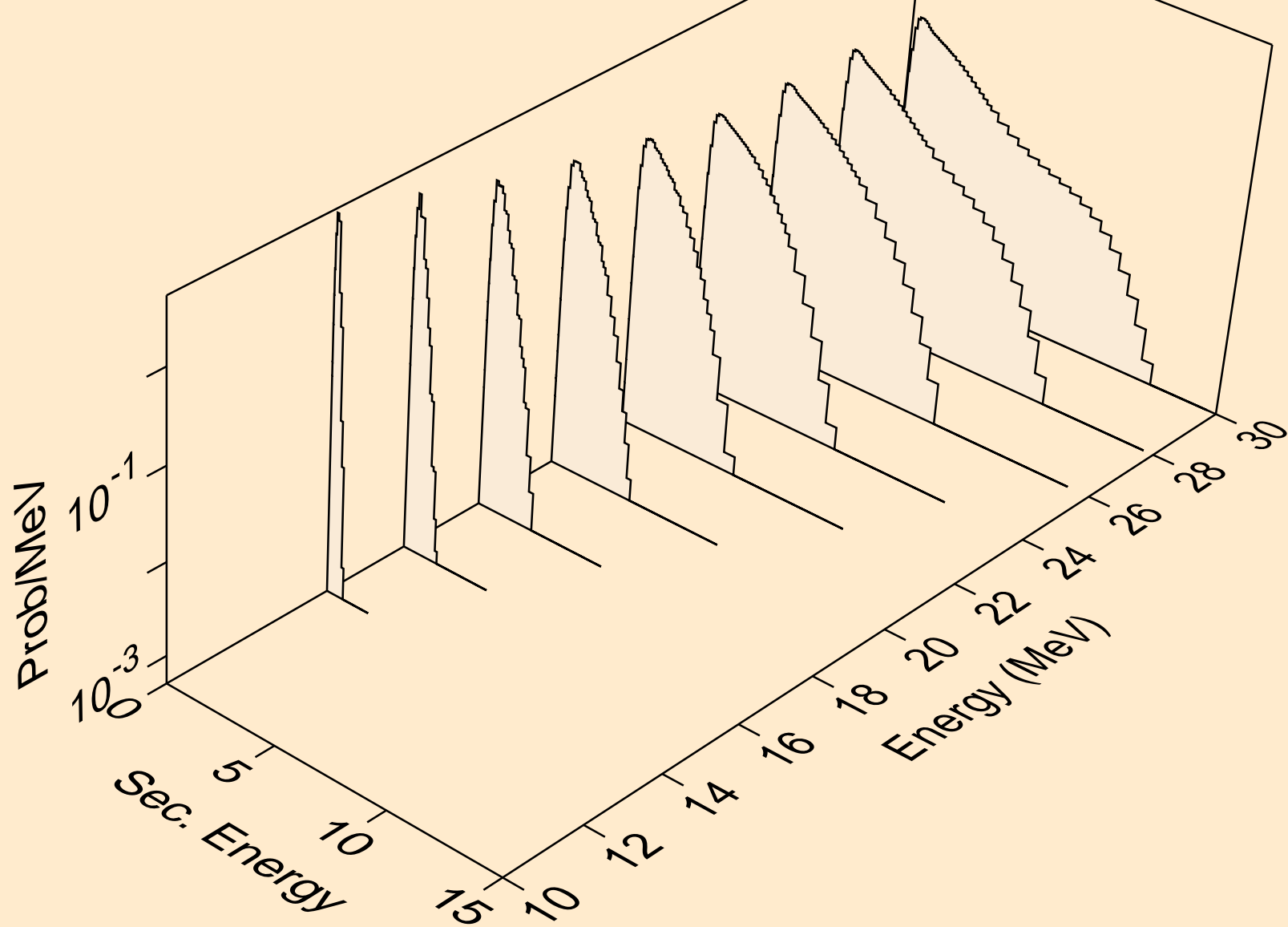

MO091M NEUTRON ACER TENDL-2021 LIBRARY; T=293.6K
Neutron emission for (n,npa)

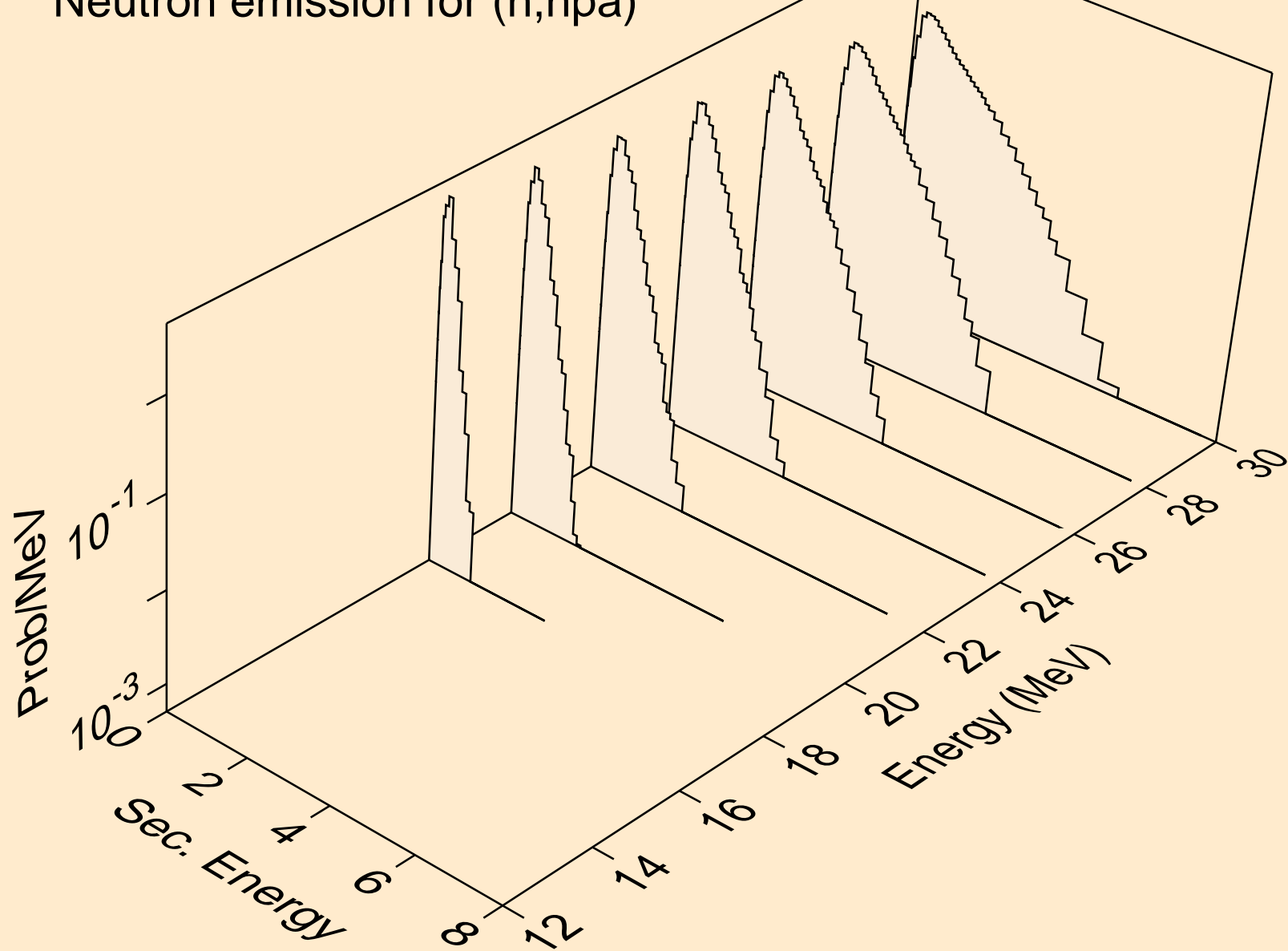

MO091M NEUTRON ACER TENDL-2021 LIBRARY; T=293.6K
Neutron emission for (n,n*c)

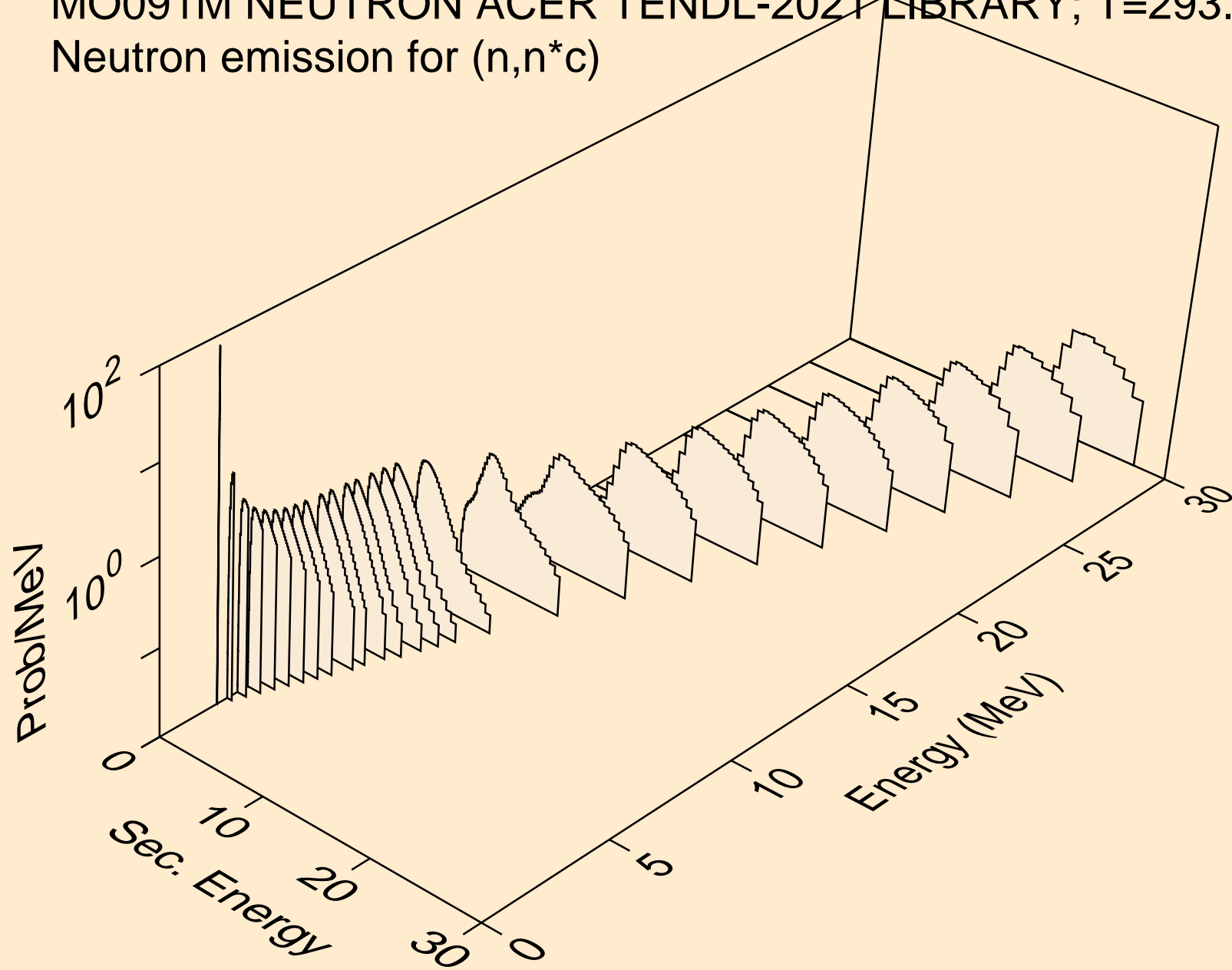

MO091M NEUTRON ACER TENDL-2021 LIBRARY; T=293.6K
Photon emission for (n,x)

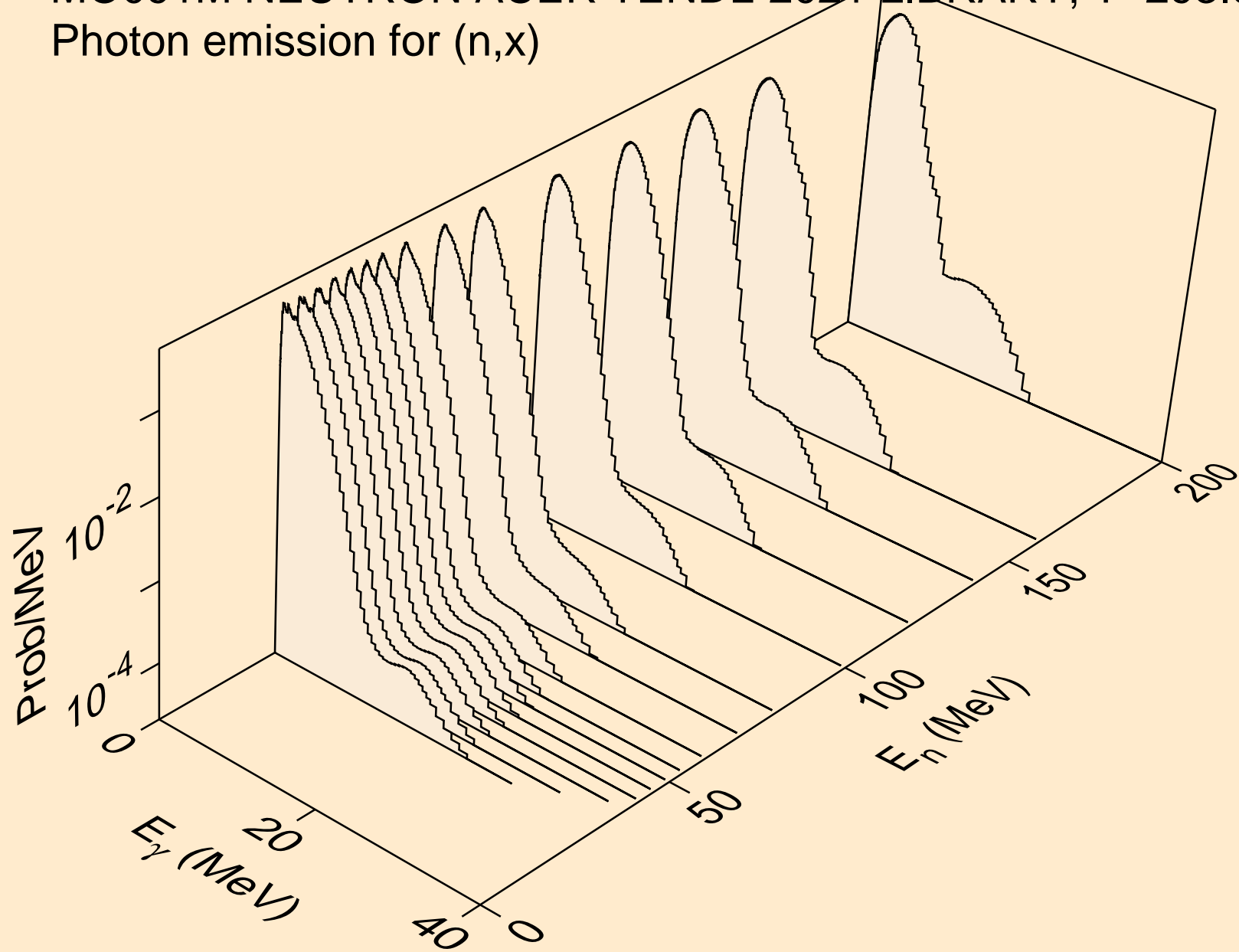

MO091M NEUTRON ACER TENDL-2021 LIBRARY; T=293.6K
Photon emission for (n,2nd)

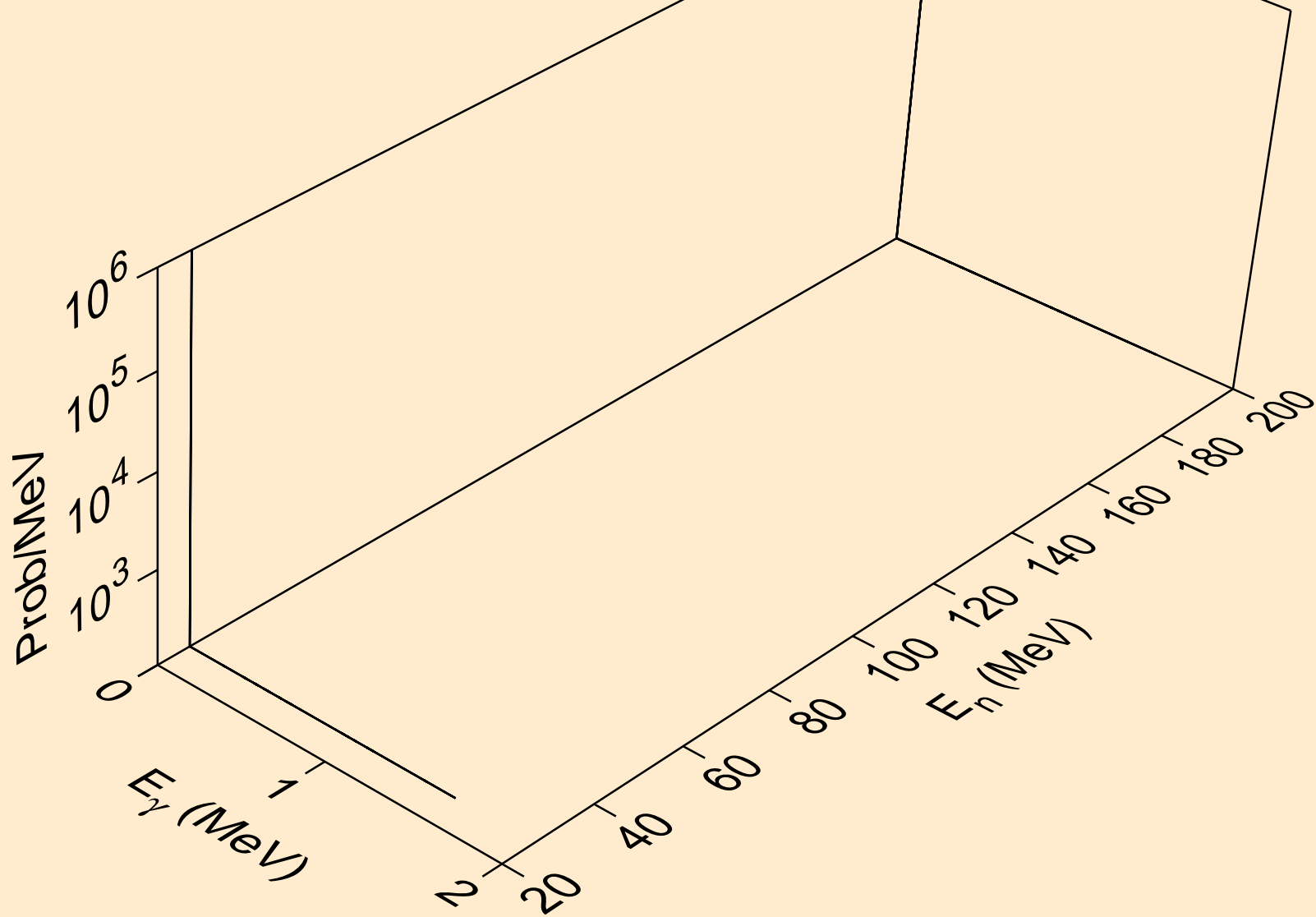

MO091M NEUTRON ACER TENDL-2021 LIBRARY; T=293.6K
Photon emission for (n,2n)

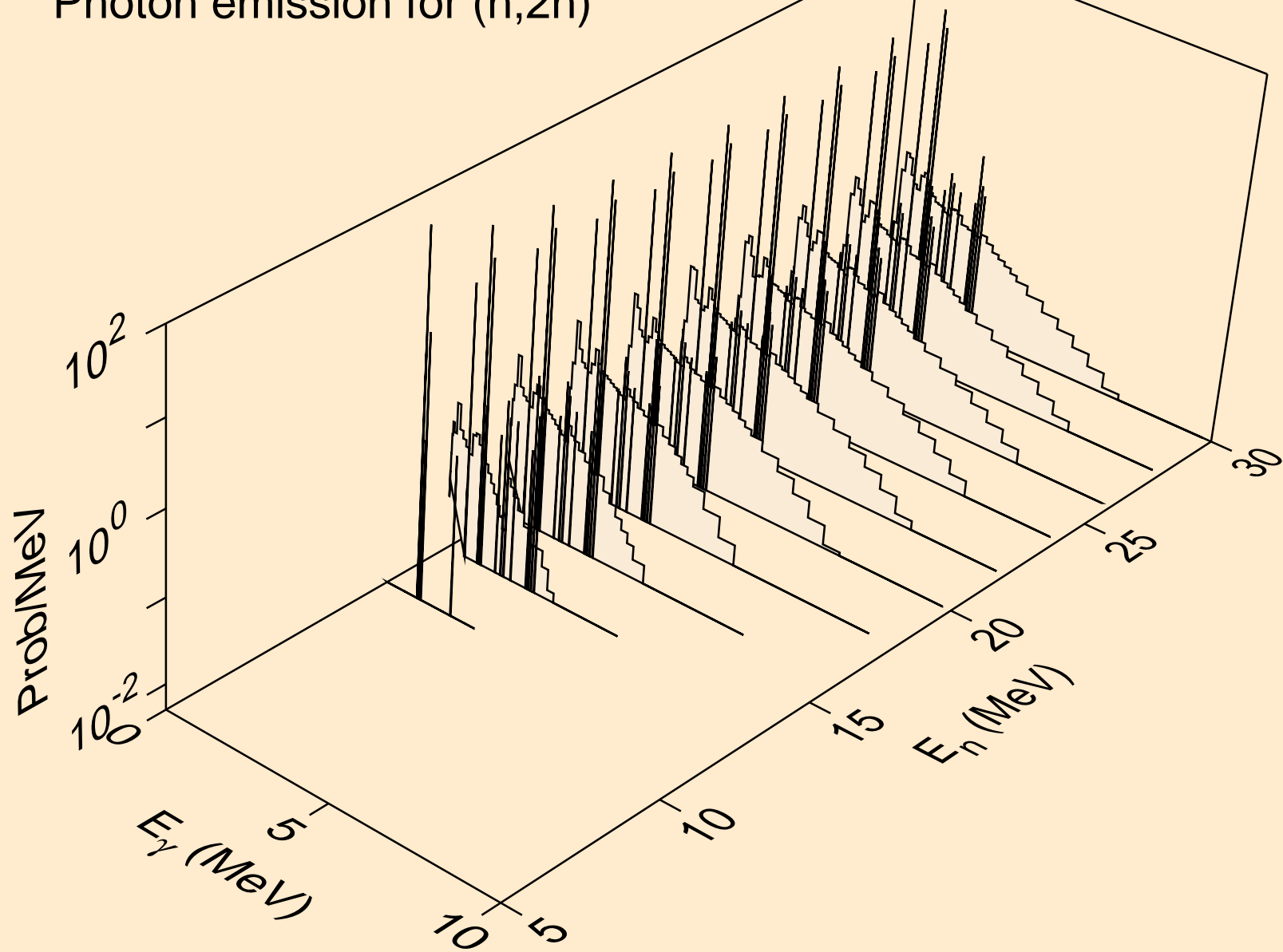

MO091M NEUTRON ACER TENDL-2021 LIBRARY; T=293.6K
Photon emission for (n,3n)

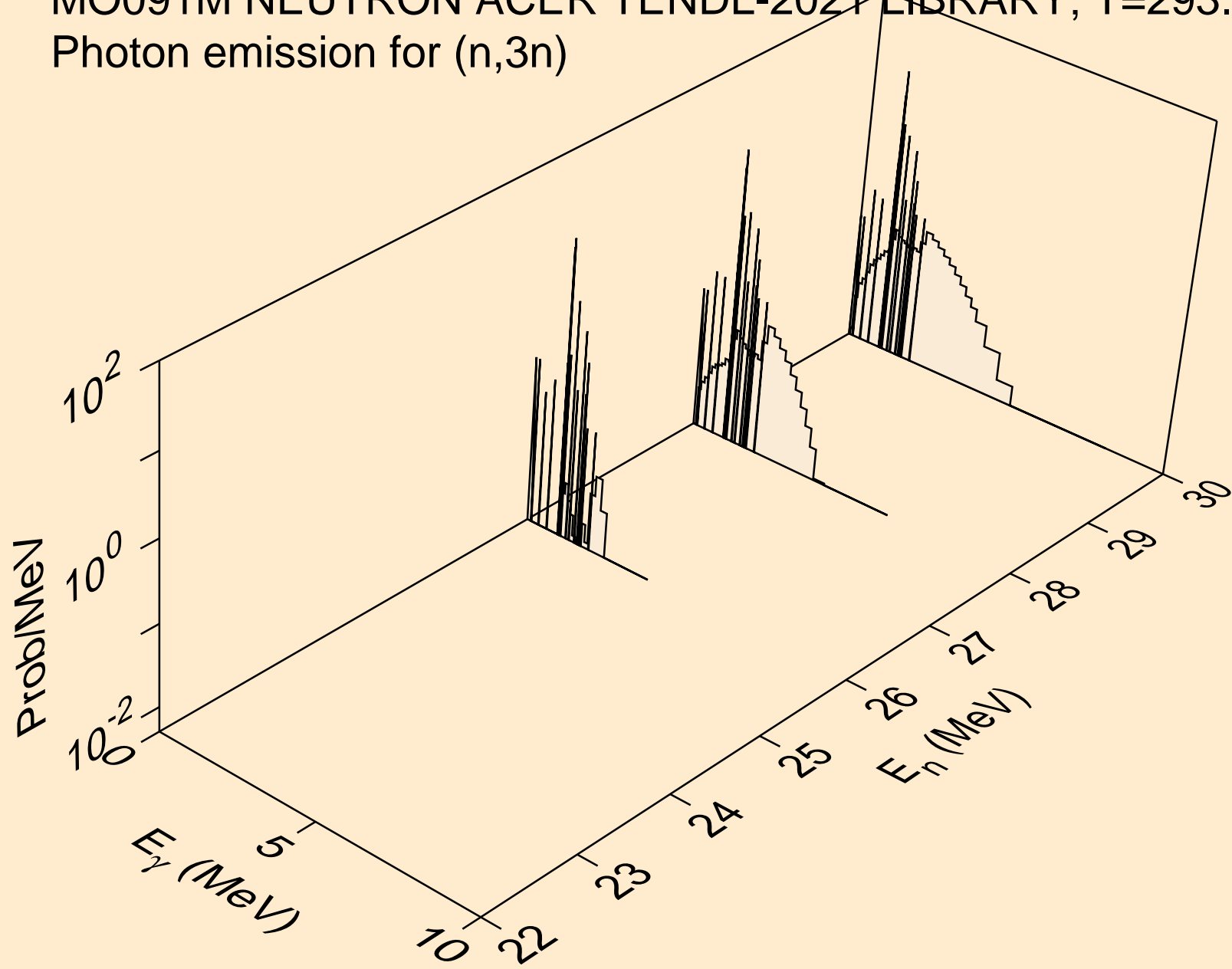

MO091M NEUTRON ACER TENDL-2021 LIBRARY; T=293.6K
Photon emission for (n,n*)a

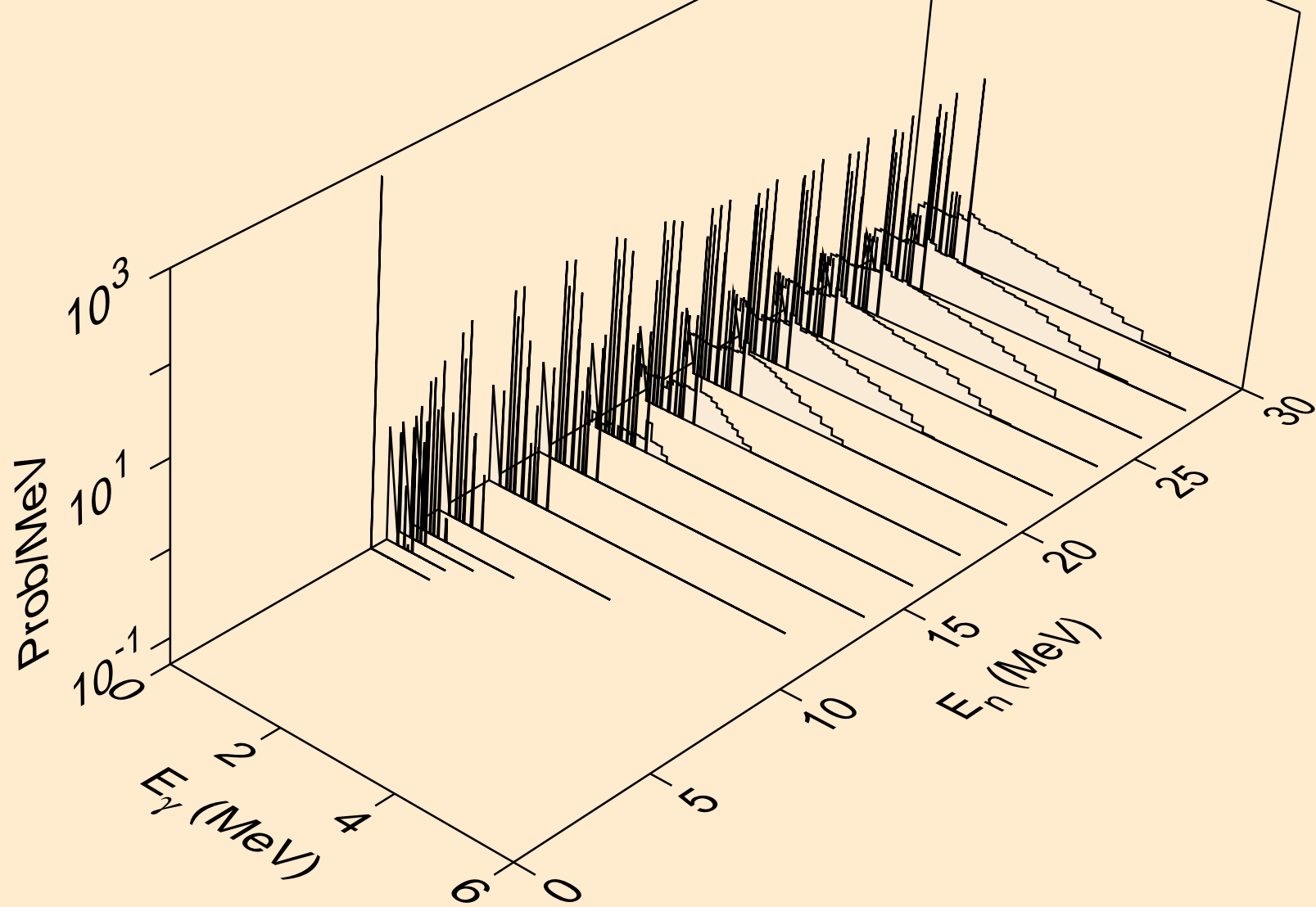

MO091M NEUTRON ACER TENDL-2021 LIBRARY; T=293.6K
Photon emission for (n,2n)a

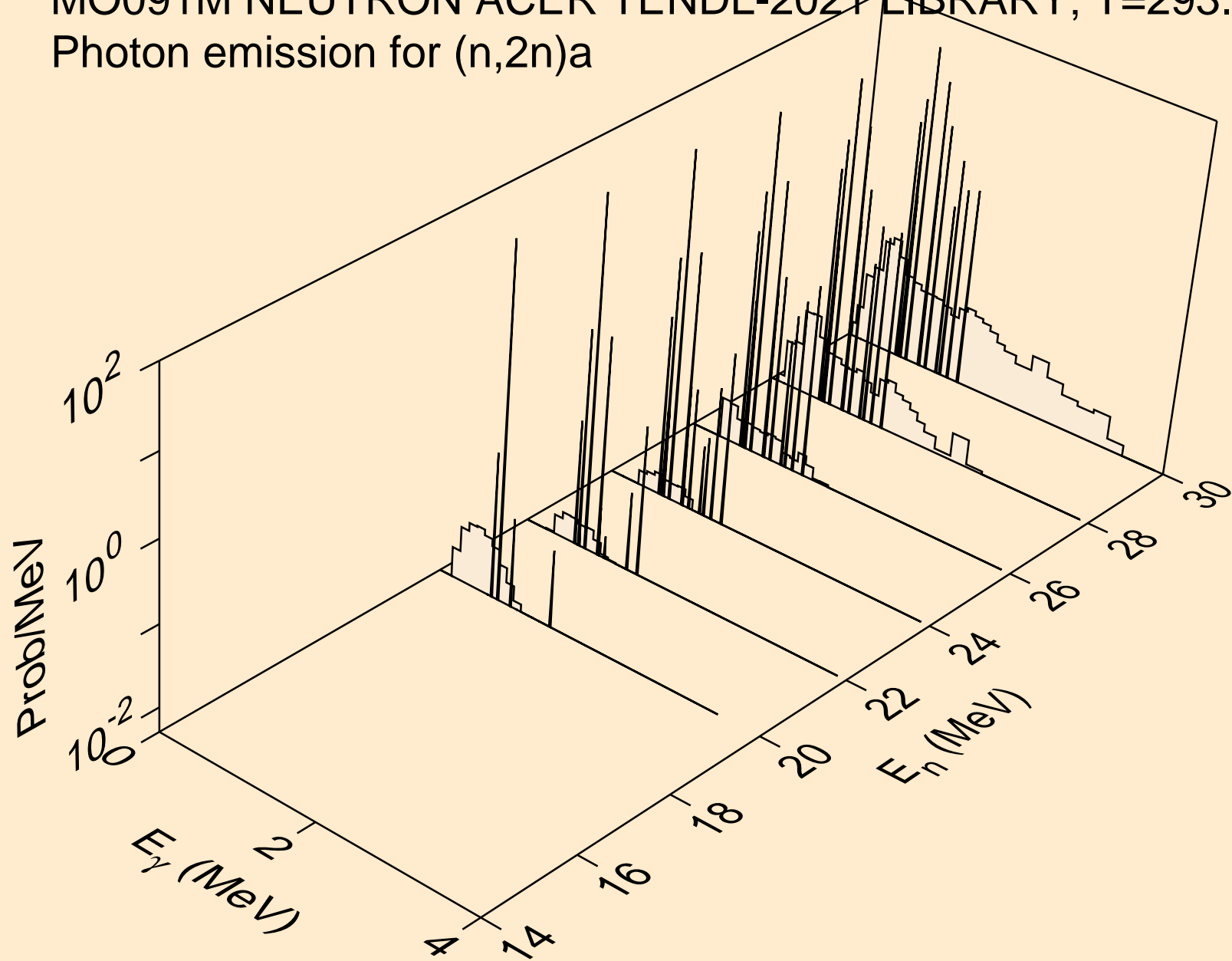

MO091M NEUTRON ACER TENDL-2021 LIBRARY; T=293.6K
Photon emission for (n,n*)p

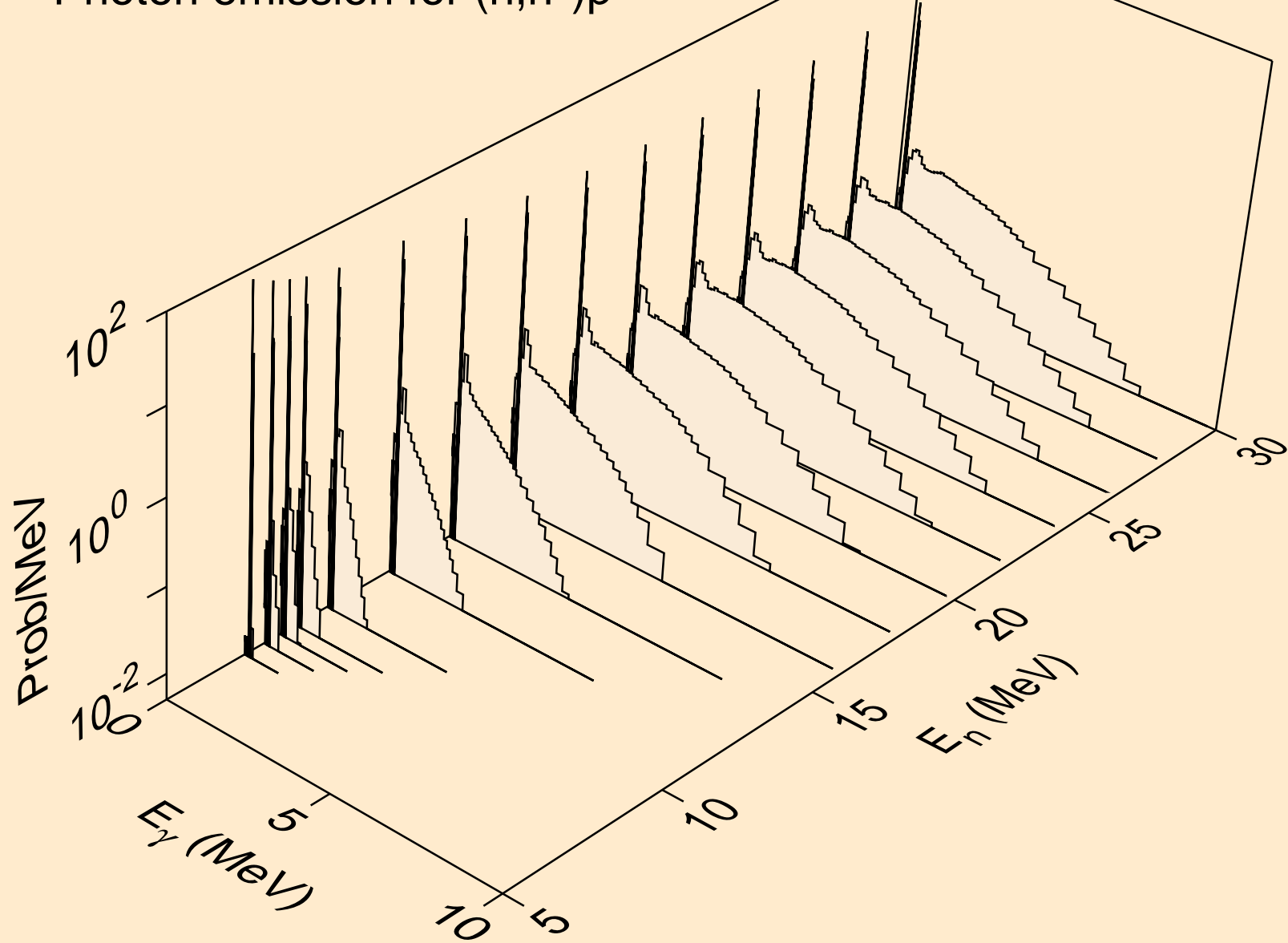

MO091M NEUTRON ACER TENDL-2021 LIBRARY; T=293.6K
Photon emission for (n,n*)2a

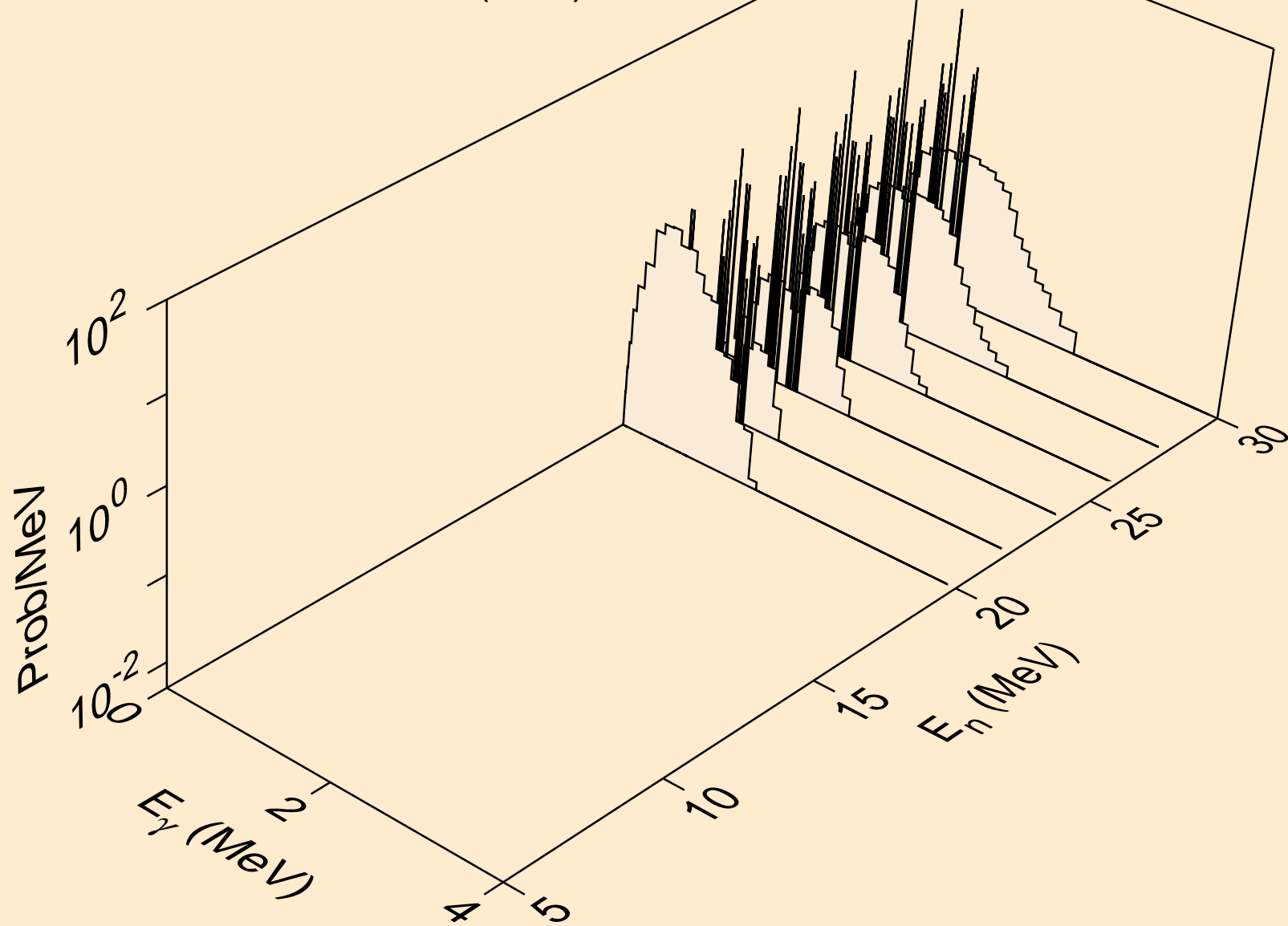

MO091M NEUTRON ACER TENDL-2021 LIBRARY; T=293.6K
Photon emission for (n,n*)d

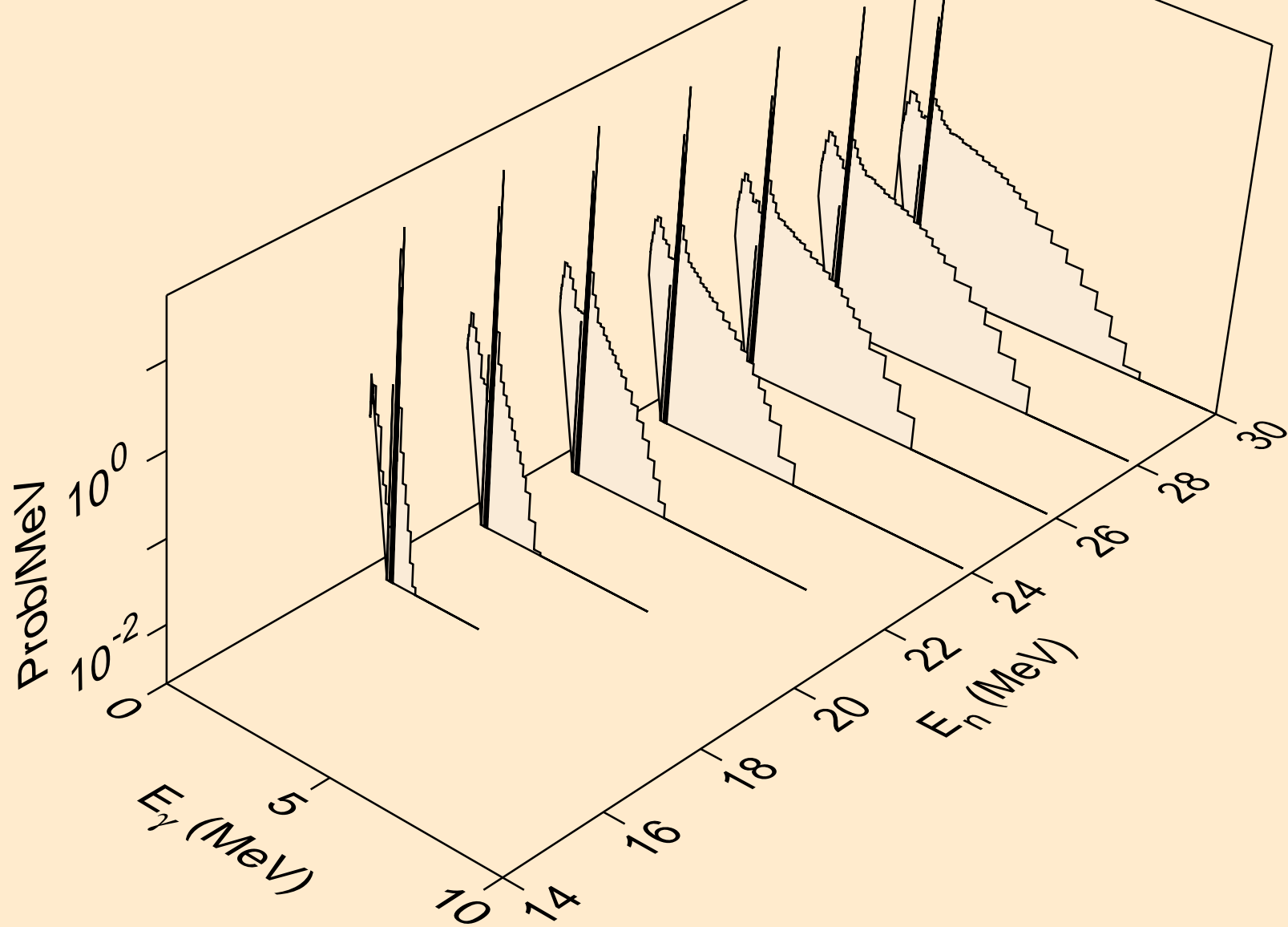

MO091M NEUTRON ACER TENDL-2021 LIBRARY; T=293.6K
Photon emission for (n,n*)t

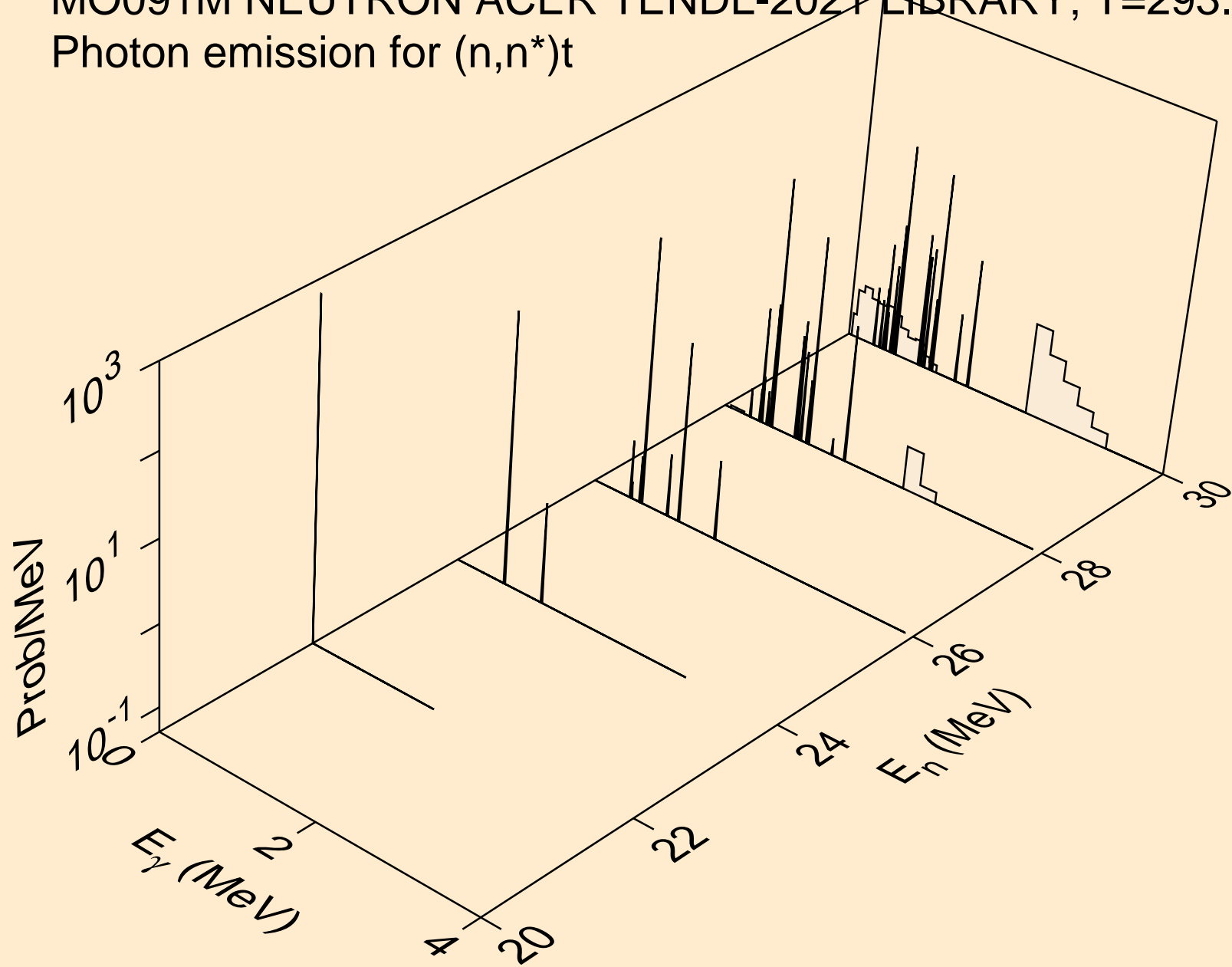

MO091M NEUTRON ACER TENDL-2021 LIBRARY; T=293.6K
Photon emission for (n,n*)he3

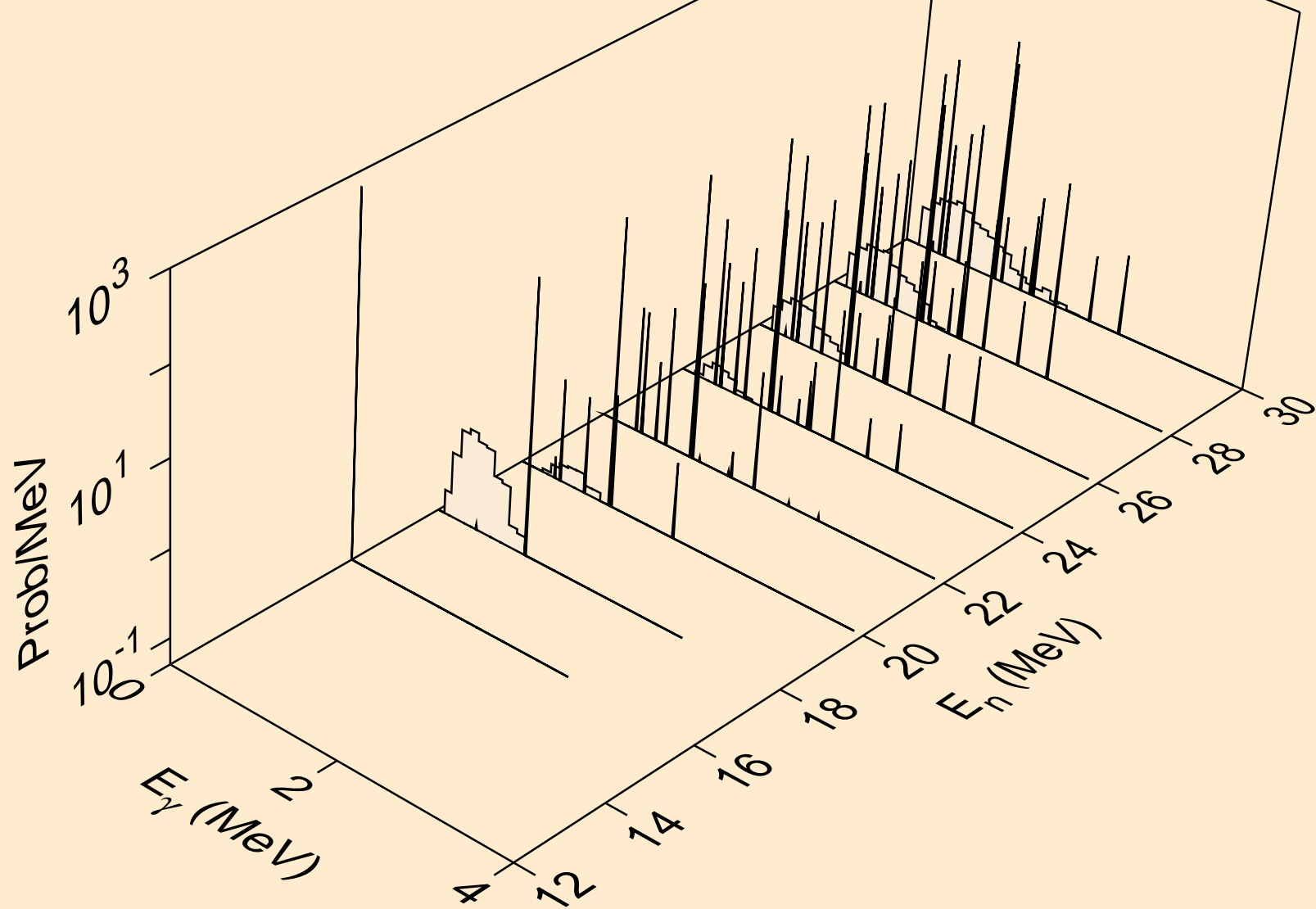

MO091M NEUTRON ACER TENDL-2021 LIBRARY; T=293.6K
Photon emission for (n,2np)

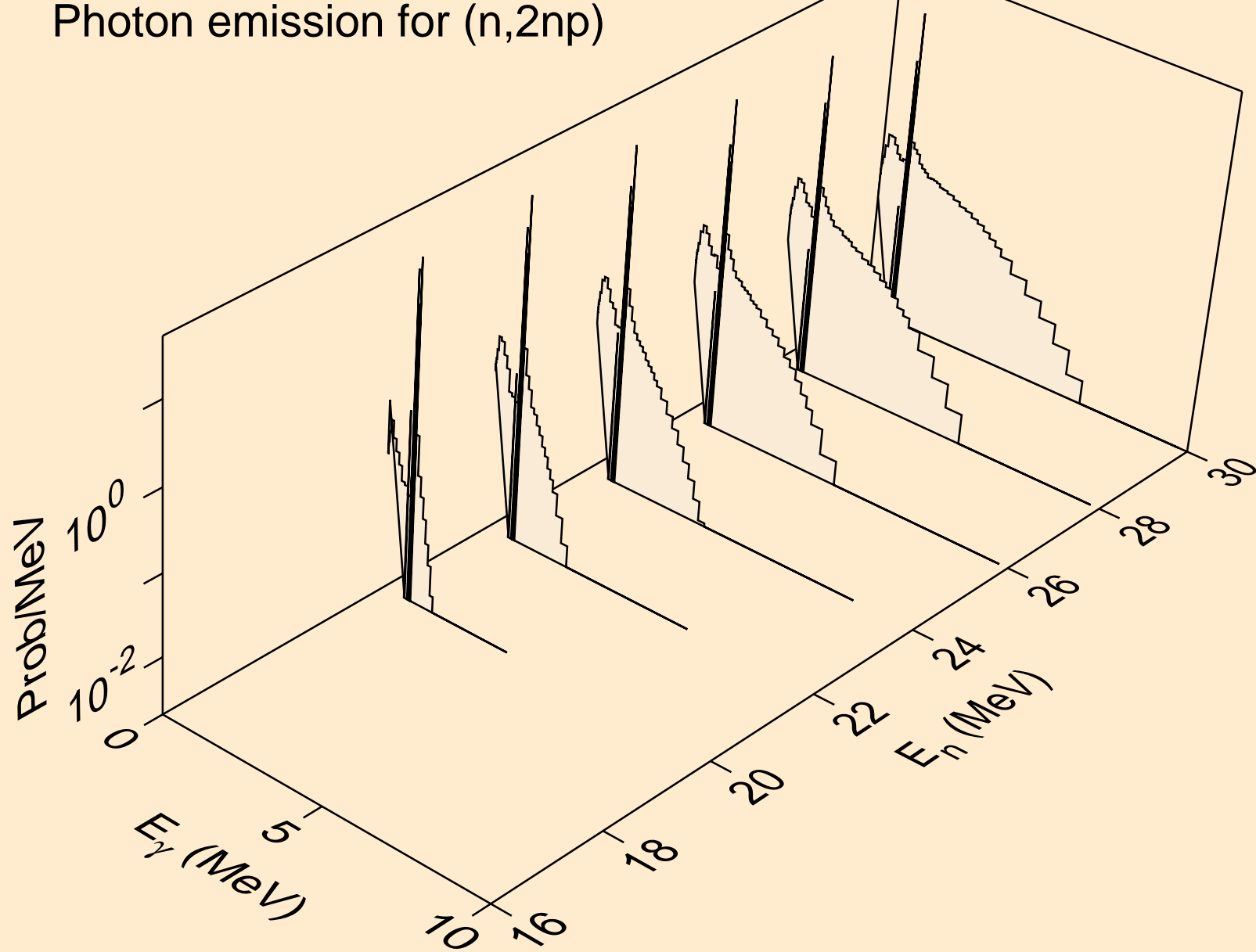

MO091M NEUTRON ACER TENDL-2021 LIBRARY; T=293.6K
Photon emission for (n,2np)

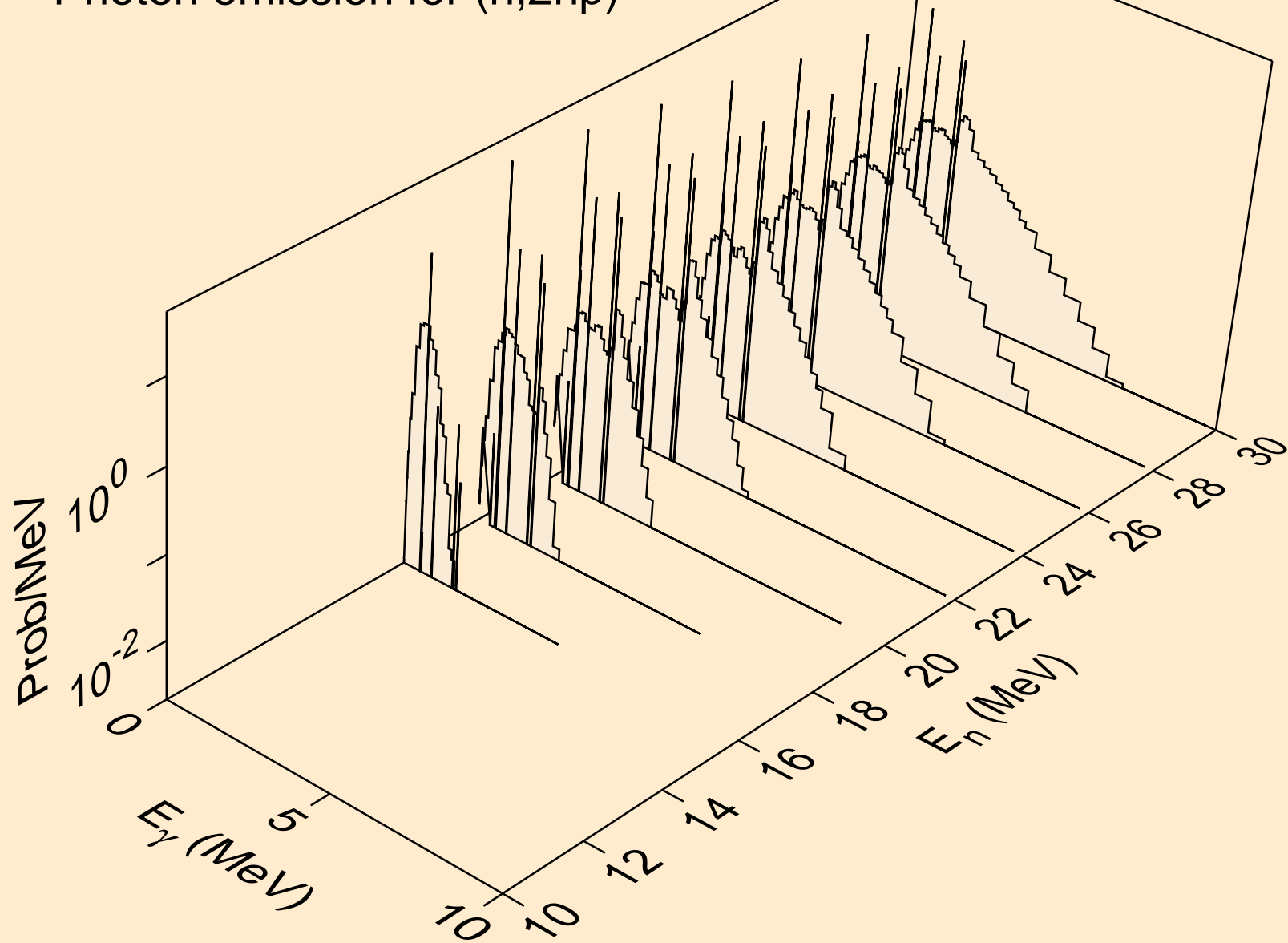

MO091M NEUTRON ACER TENDL-2021 LIBRARY; T=293.6K
Photon emission for (n,npa)

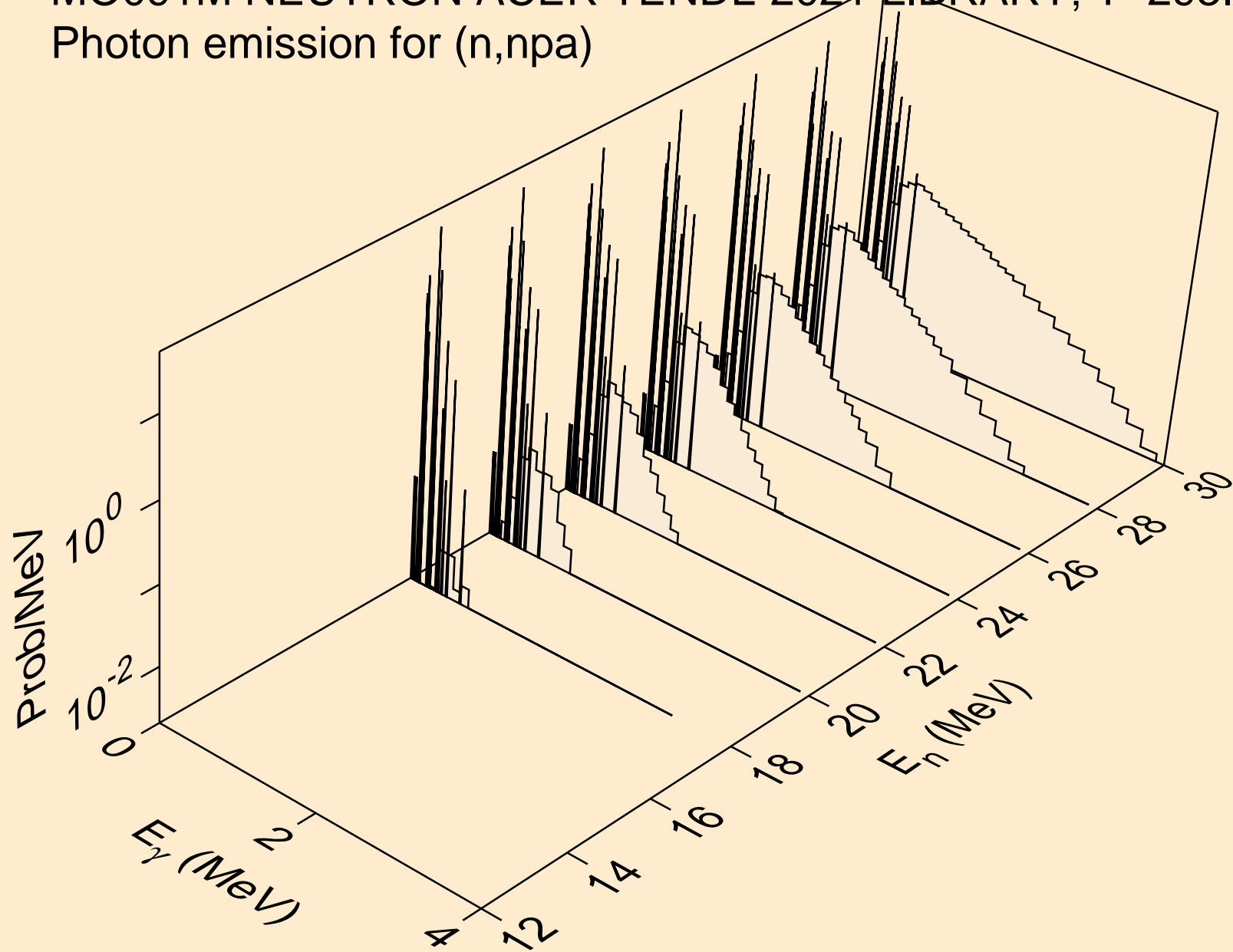

MO091M NEUTRON ACER TENDL-2021 LIBRARY; T=293.6K
Photon emission for (n,n*2)

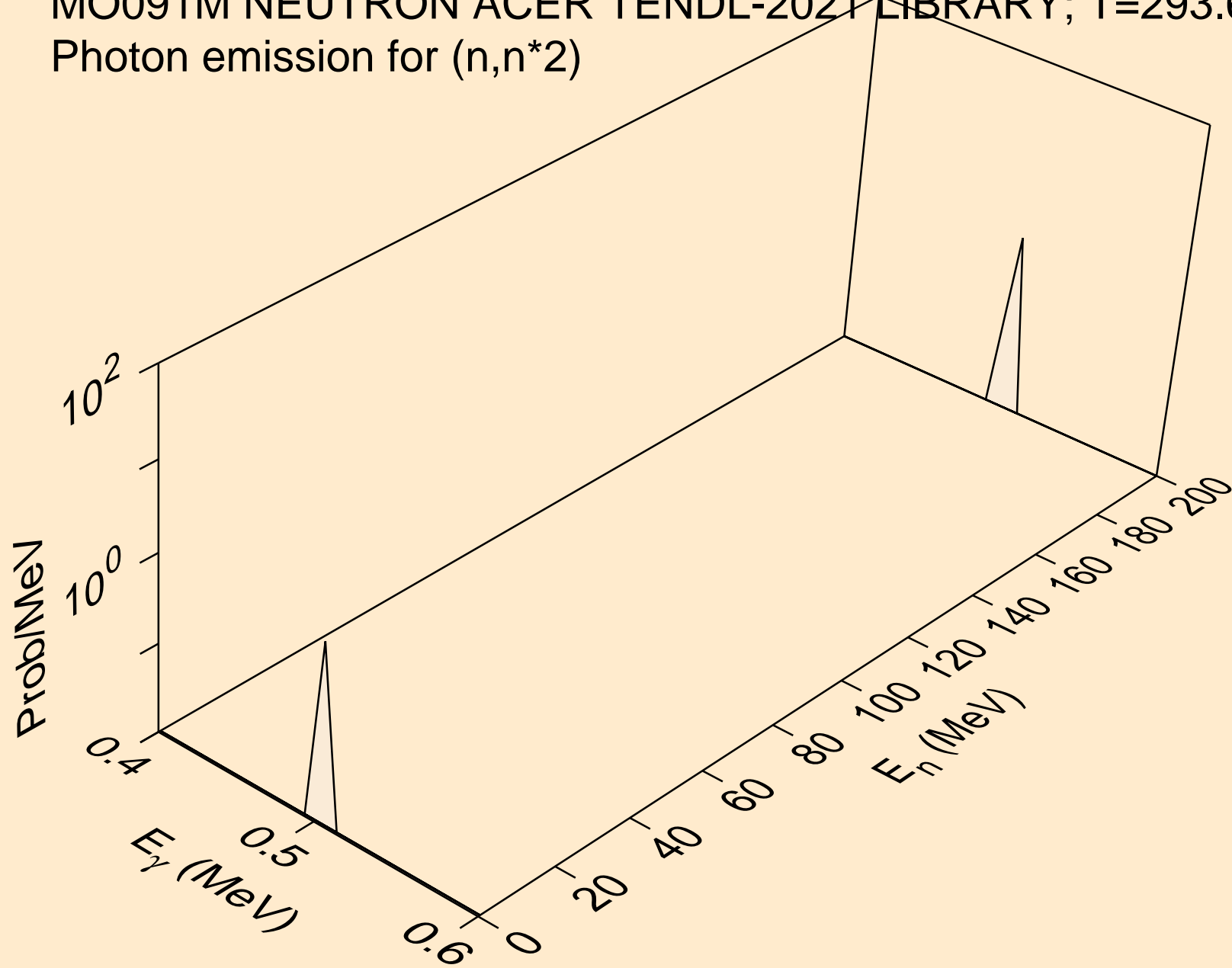

MO091M NEUTRON ACER TENDL-2021 LIBRARY; T=293.6K
Photon emission for (n,n*3)

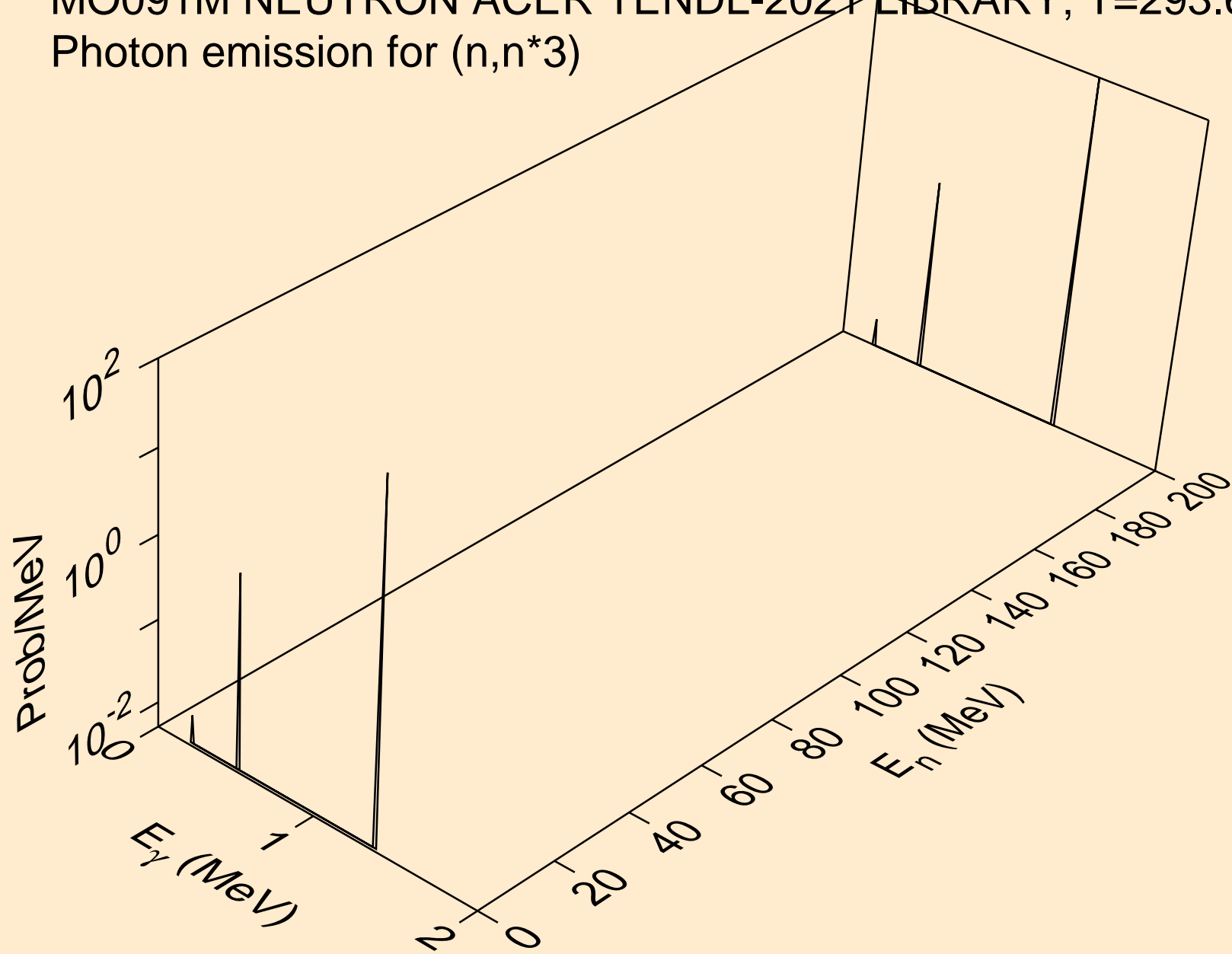

MO091M NEUTRON ACER TENDL-2021 LIBRARY; T=293.6K
Photon emission for (n,n*4)

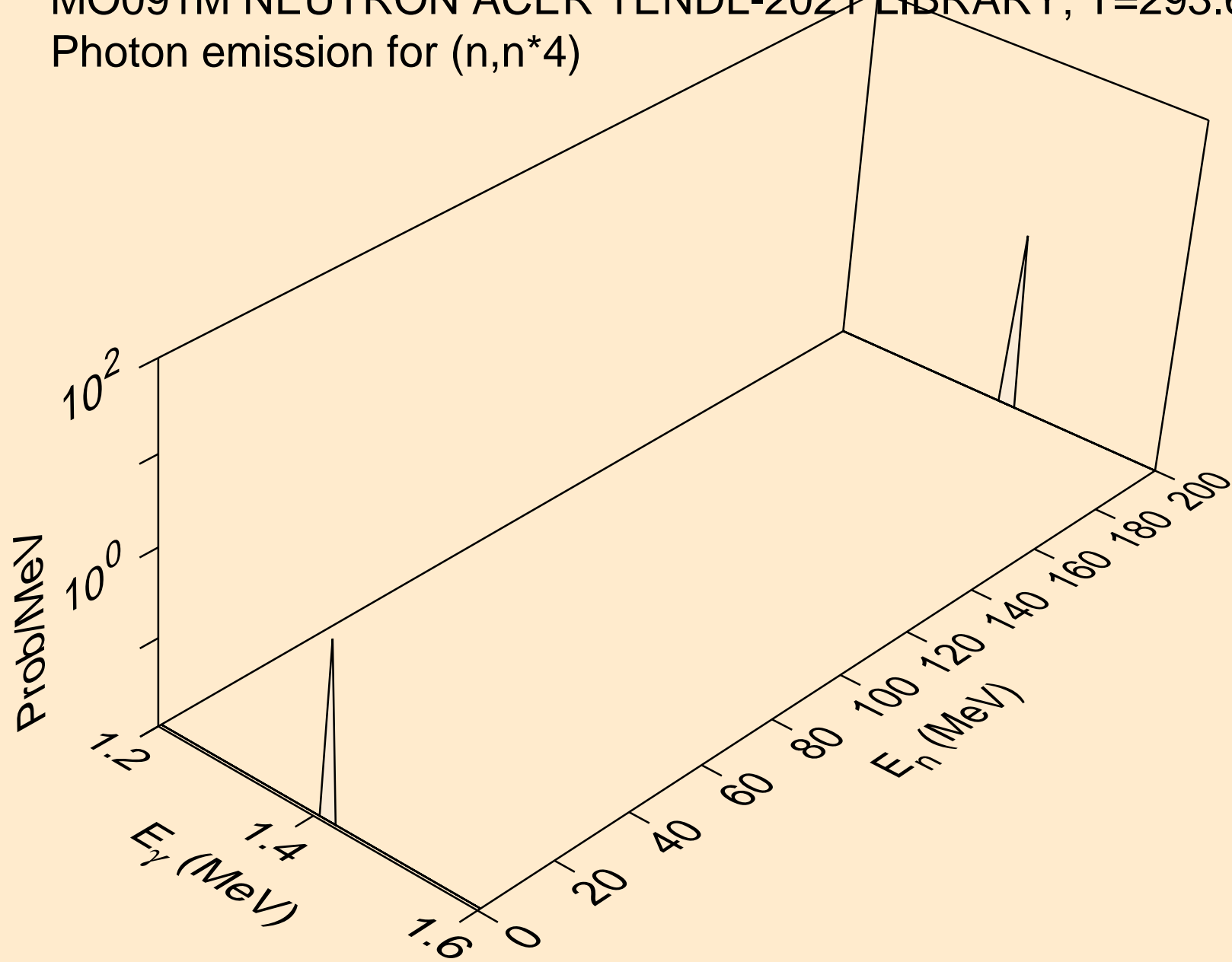

MO091M NEUTRON ACER TENDL-2021 LIBRARY; T=293.6K
Photon emission for (n,n*5)

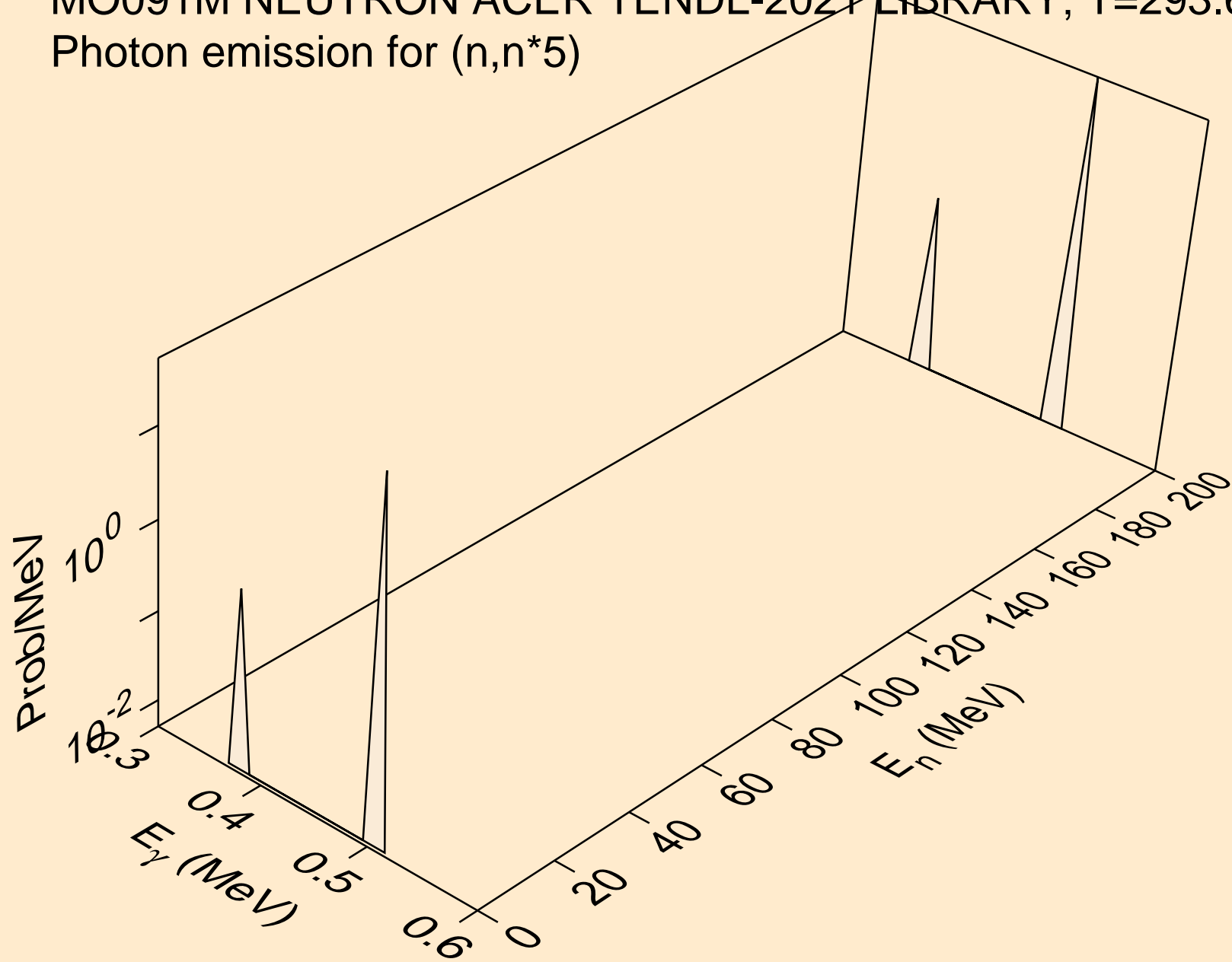

MO091M NEUTRON ACER TENDL-2021 LIBRARY; T=293.6K
Photon emission for (n,n*6)

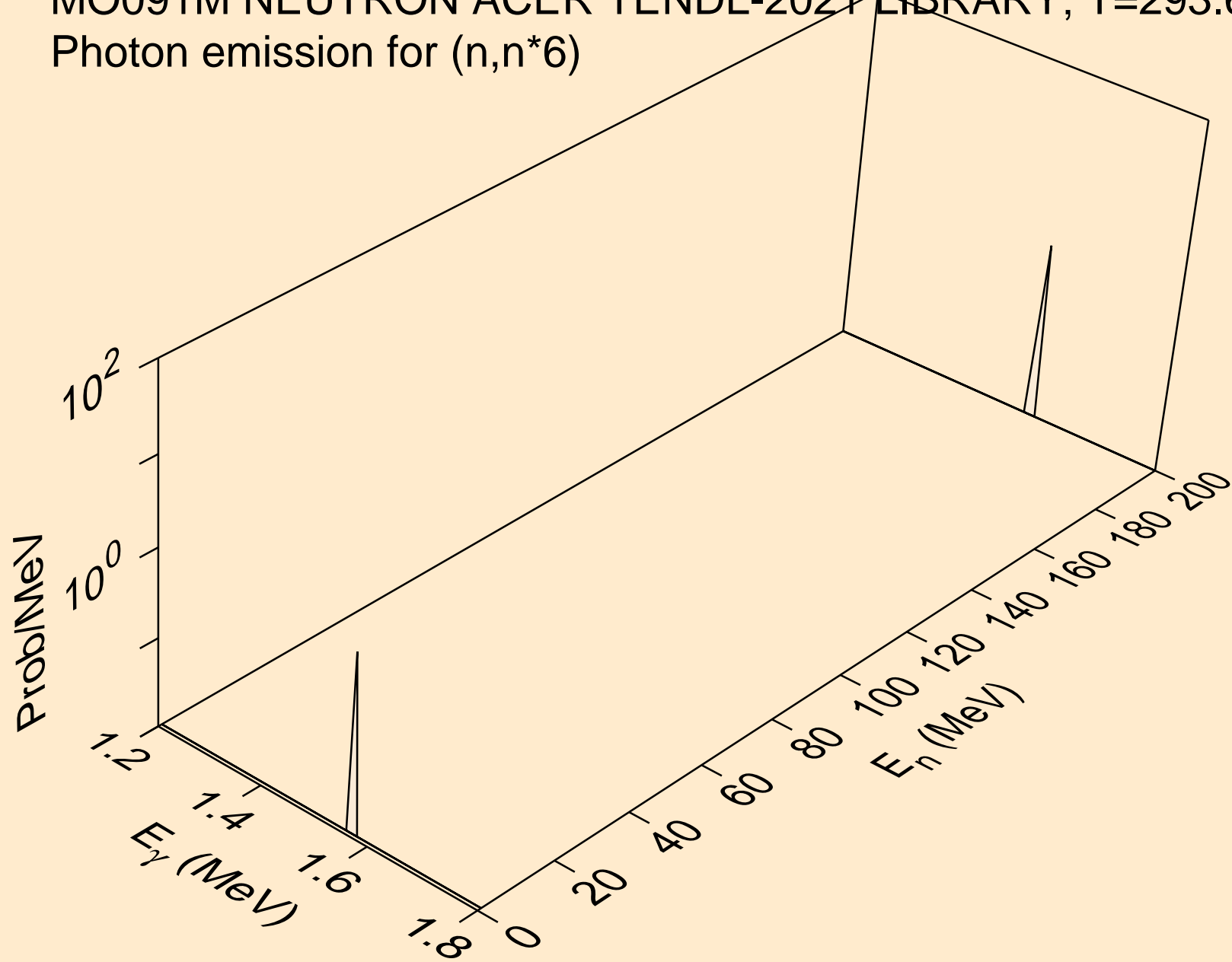

MO091M NEUTRON ACER TENDL-2021 LIBRARY; T=293.6K
Photon emission for (n,n*7)

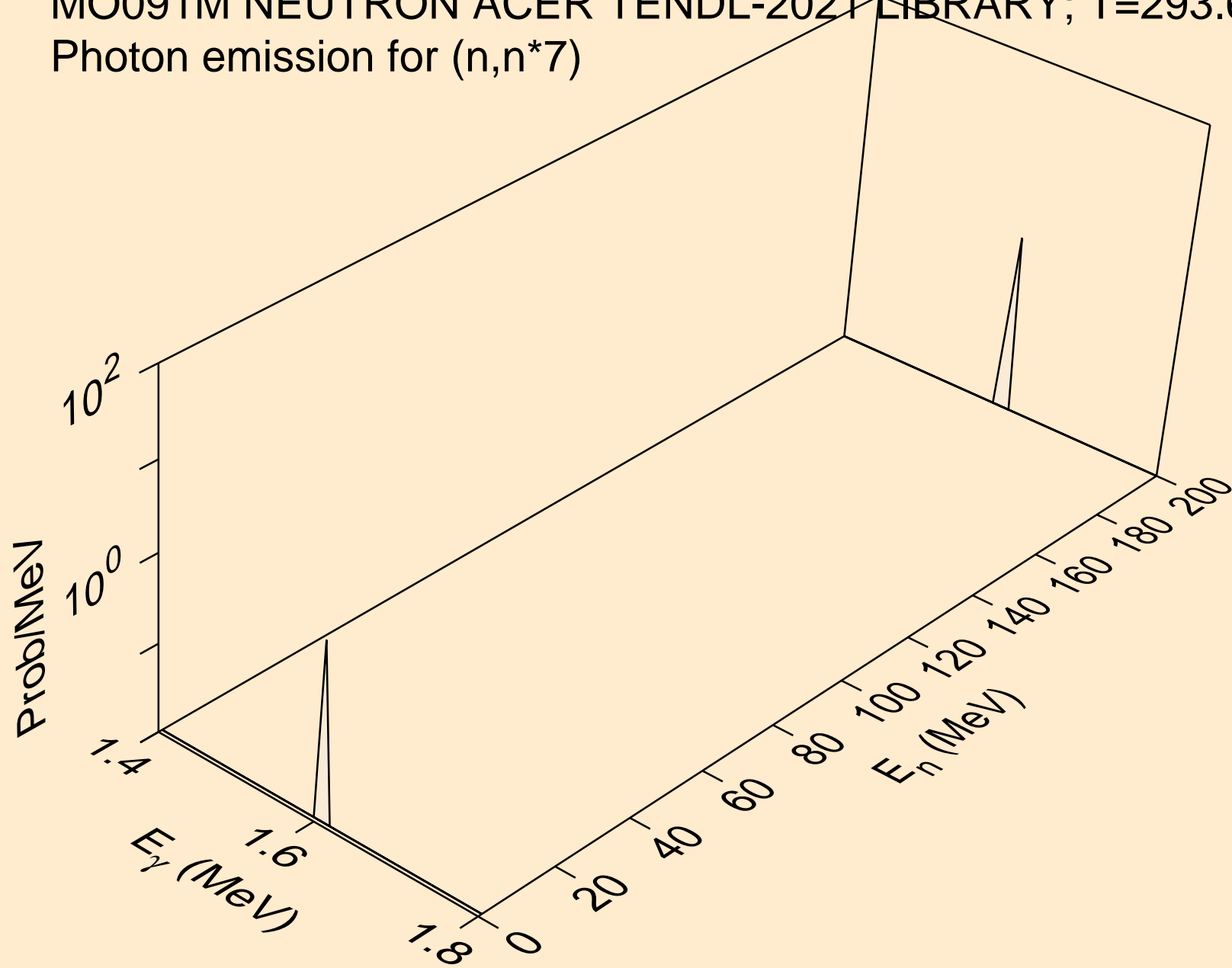

MO091M NEUTRON ACER TENDL-2021 LIBRARY; T=293.6K
Photon emission for (n,n*8)

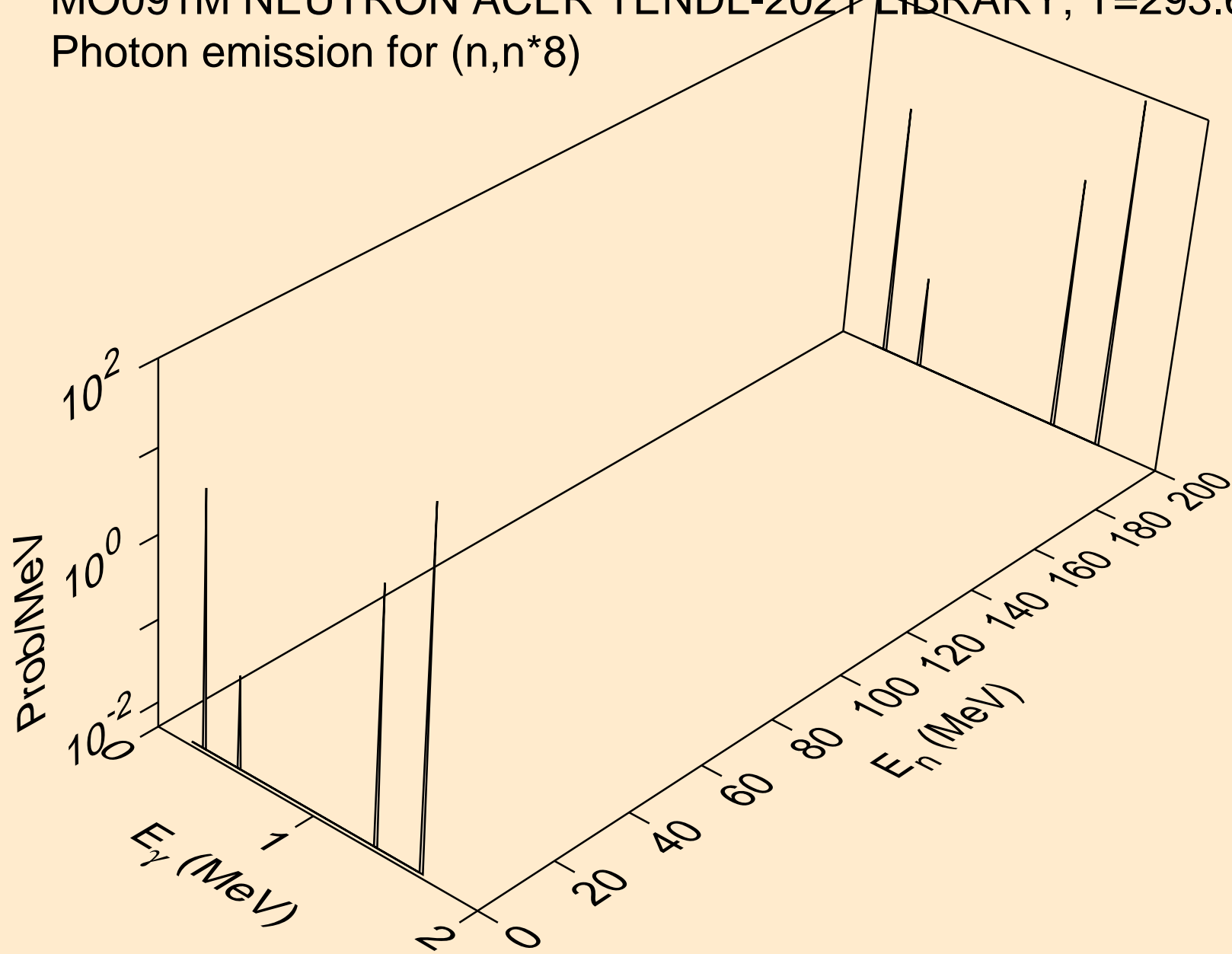

MO091M NEUTRON ACER TENDL-2021 LIBRARY; T=293.6K
Photon emission for (n,n*9)

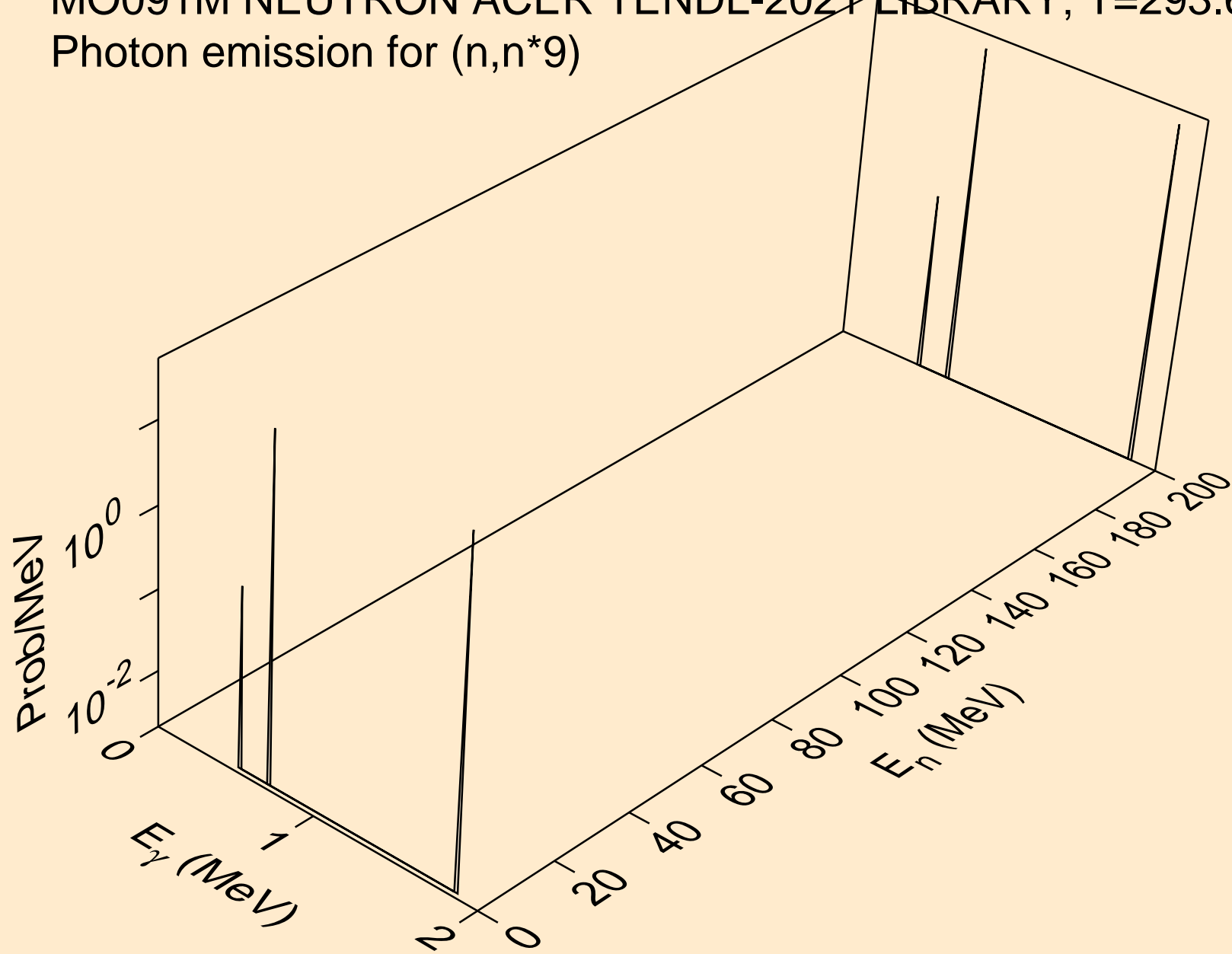

MO091M NEUTRON ACER TENDL-2021 LIBRARY; T=293.6K
Photon emission for (n,n*10)

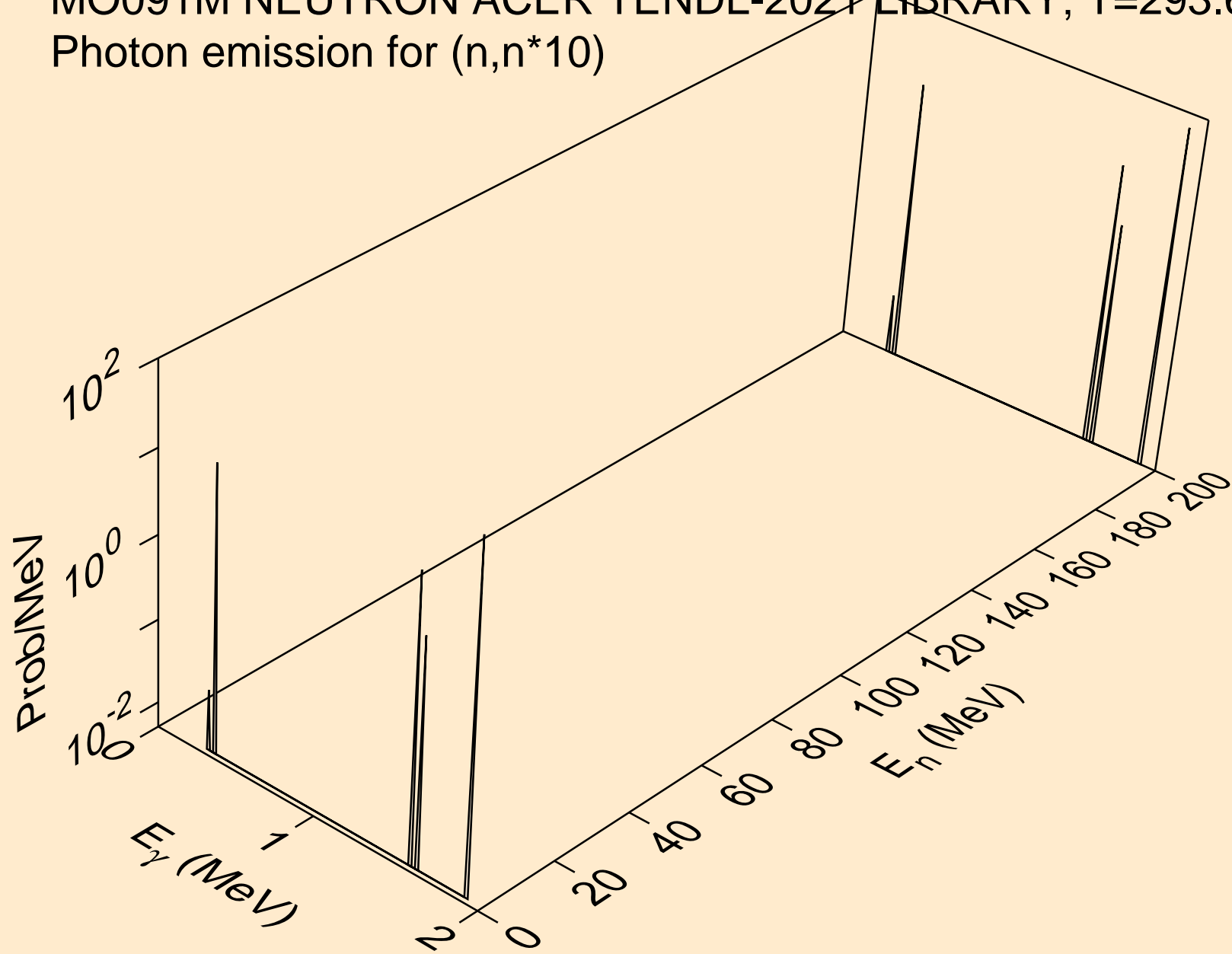

MO091M NEUTRON ACER TENDL-2021 LIBRARY; T=293.6K
Photon emission for (n,n*11)

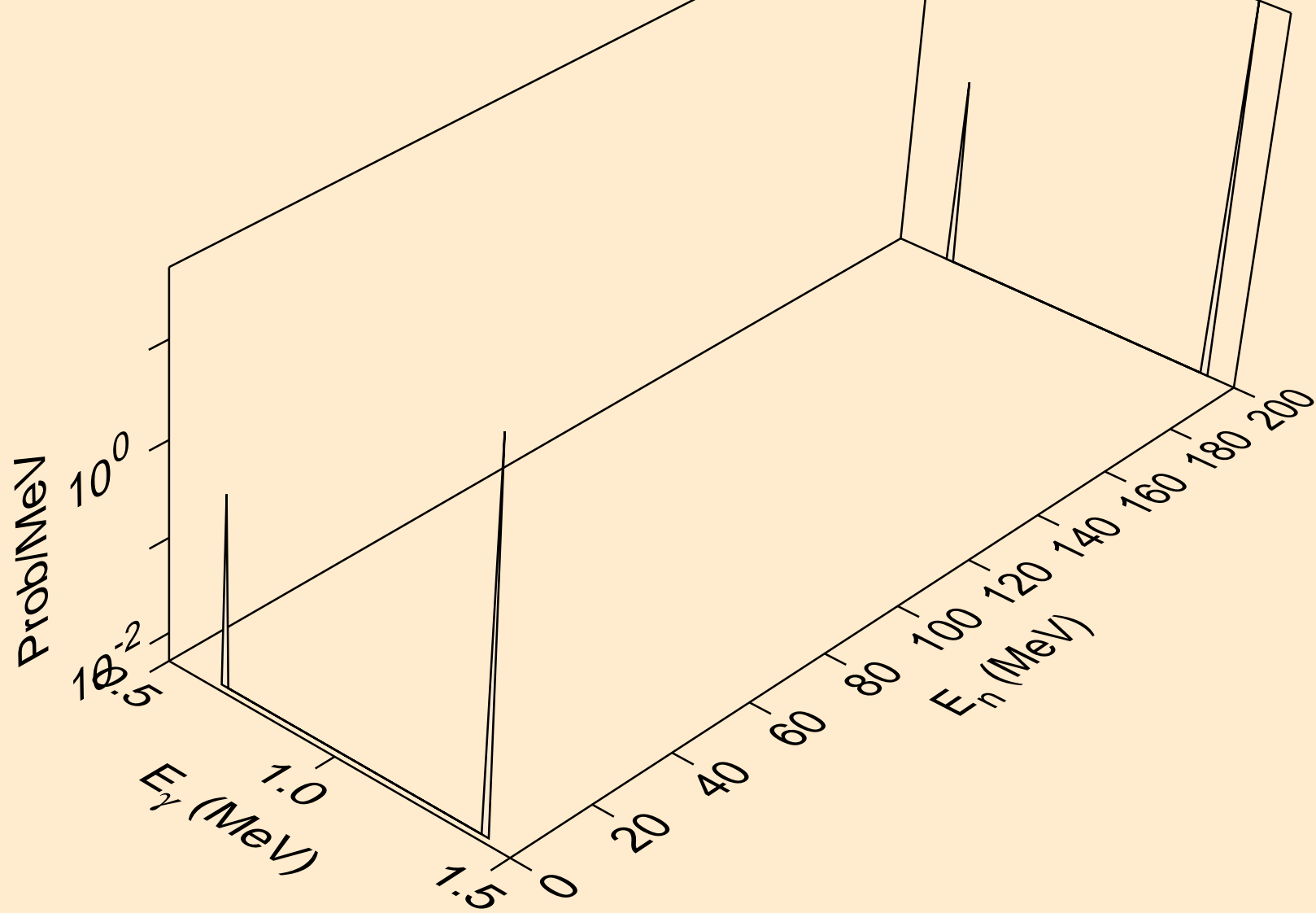

MO091M NEUTRON ACER TENDL-2021 LIBRARY; T=293.6K
Photon emission for (n,n*12)

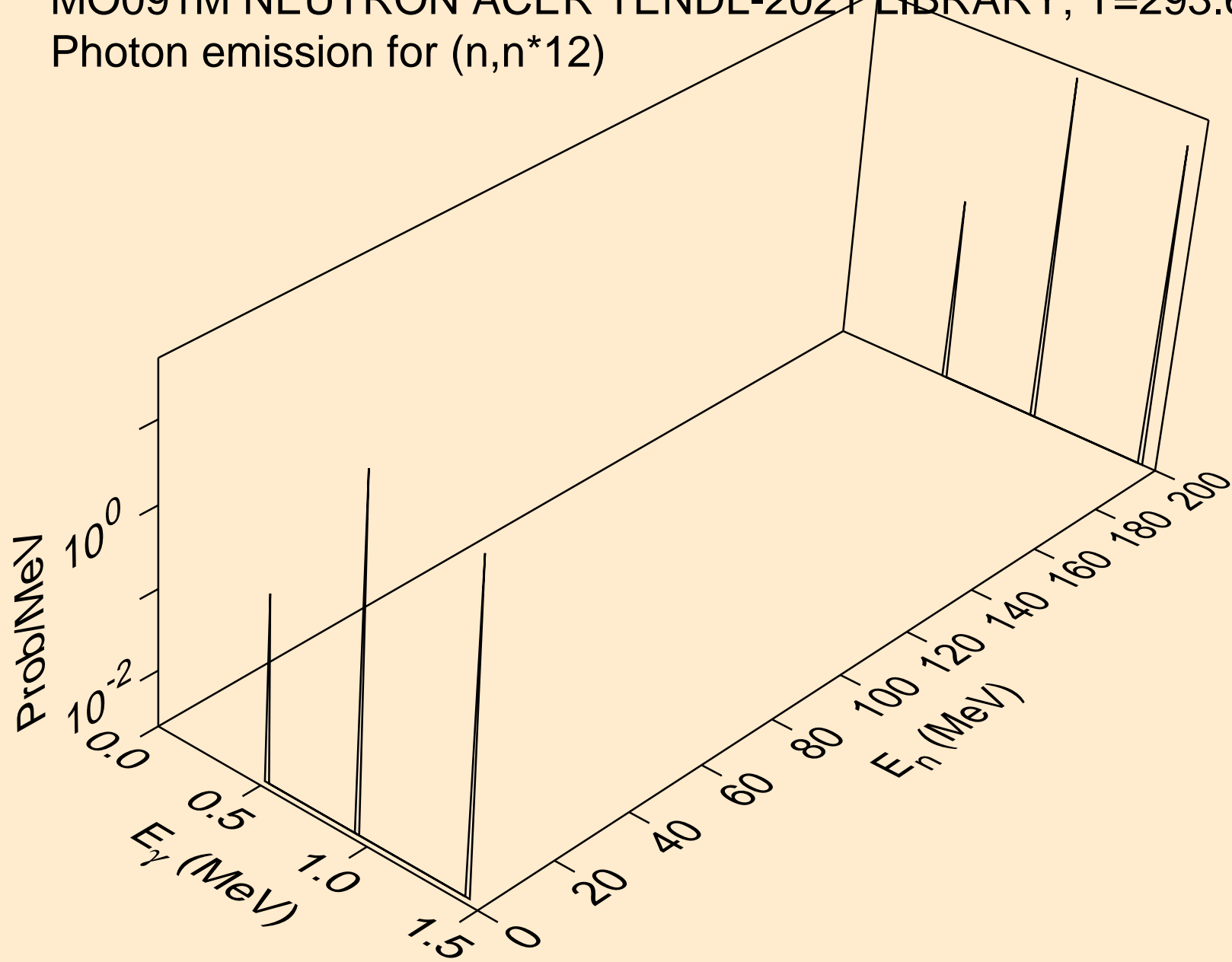

MO091M NEUTRON ACER TENDL-2021 LIBRARY; T=293.6K
Photon emission for (n,n*13)

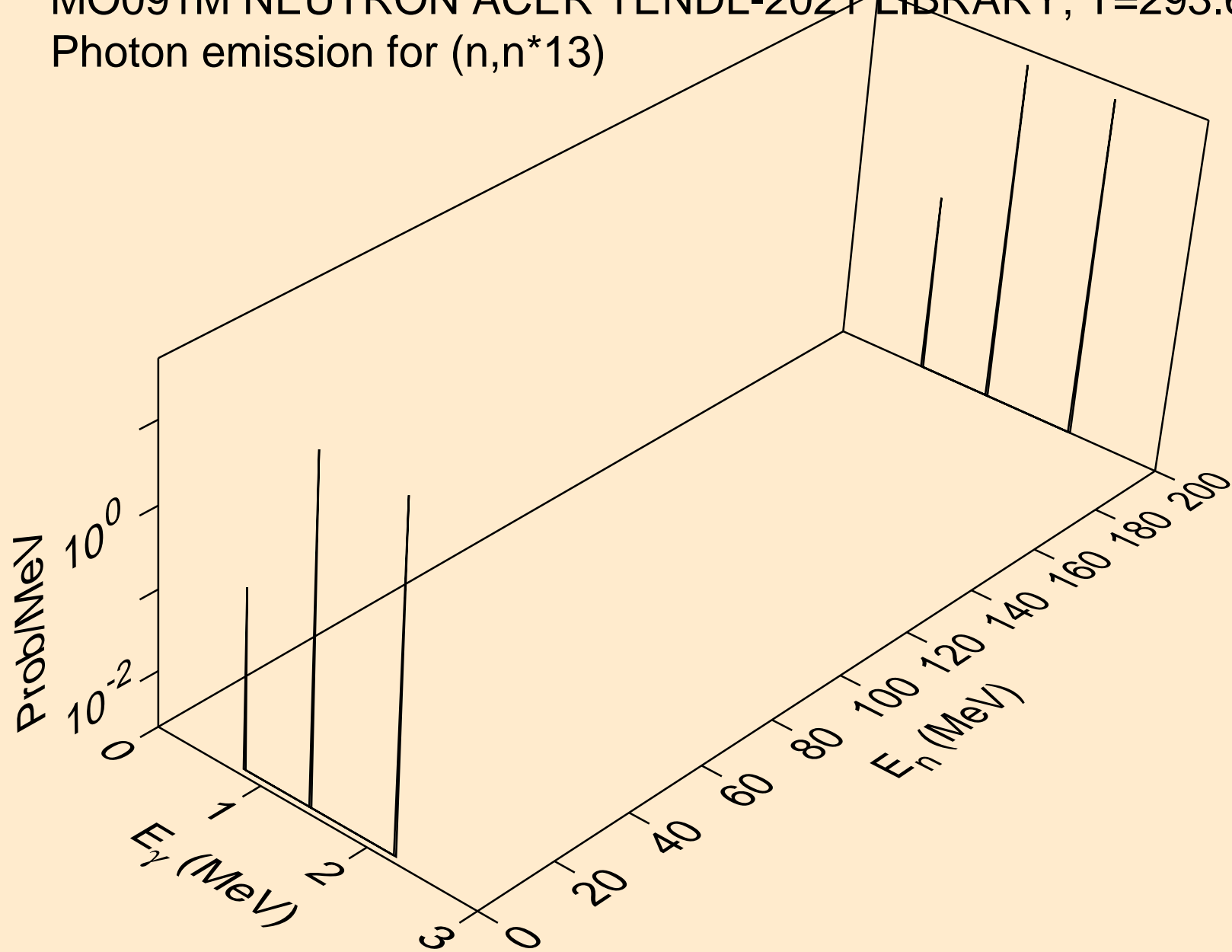

MO091M NEUTRON ACER TENDL-2021 LIBRARY; T=293.6K
Photon emission for (n,n*14)

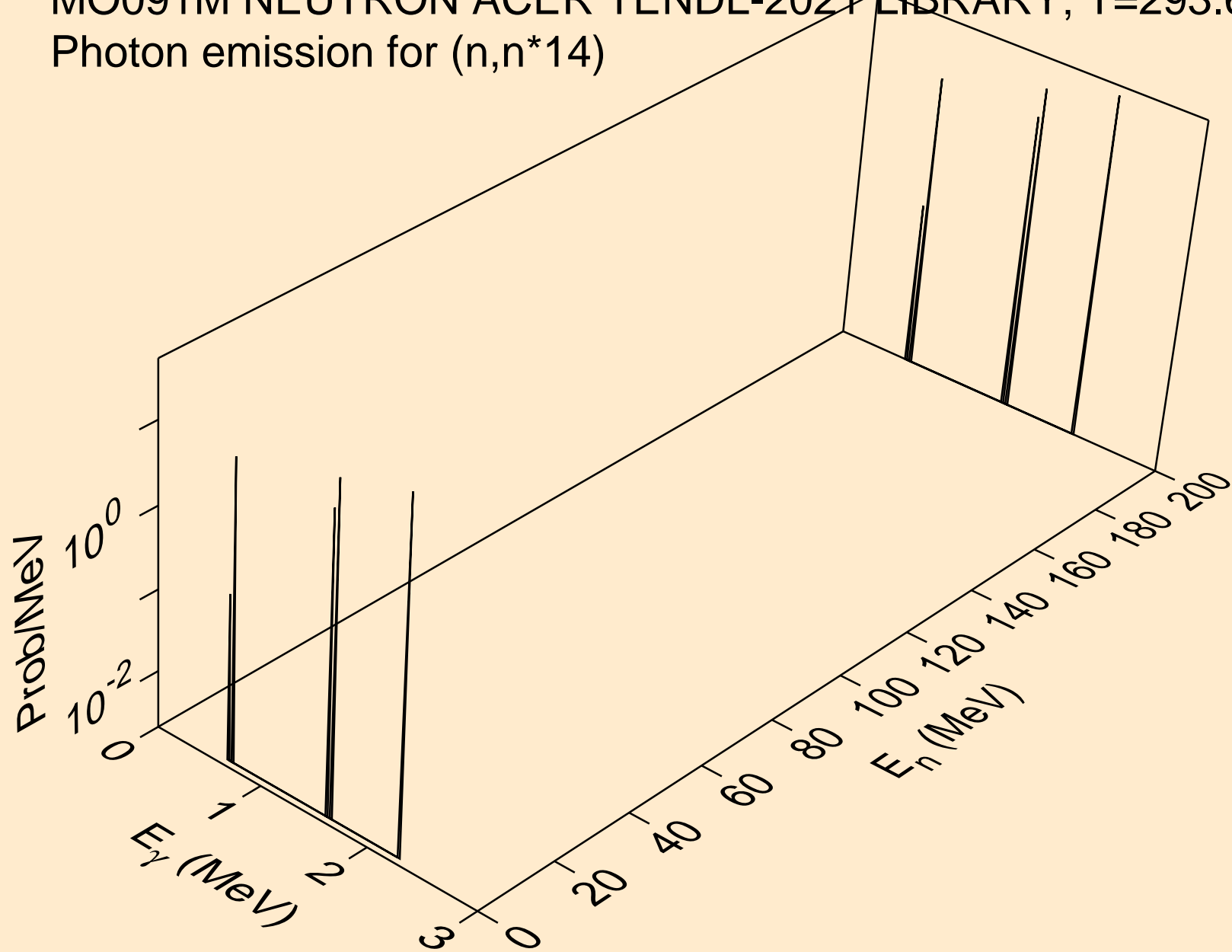

MO091M NEUTRON ACER TENDL-2021 LIBRARY; T=293.6K
Photon emission for (n,n*15)

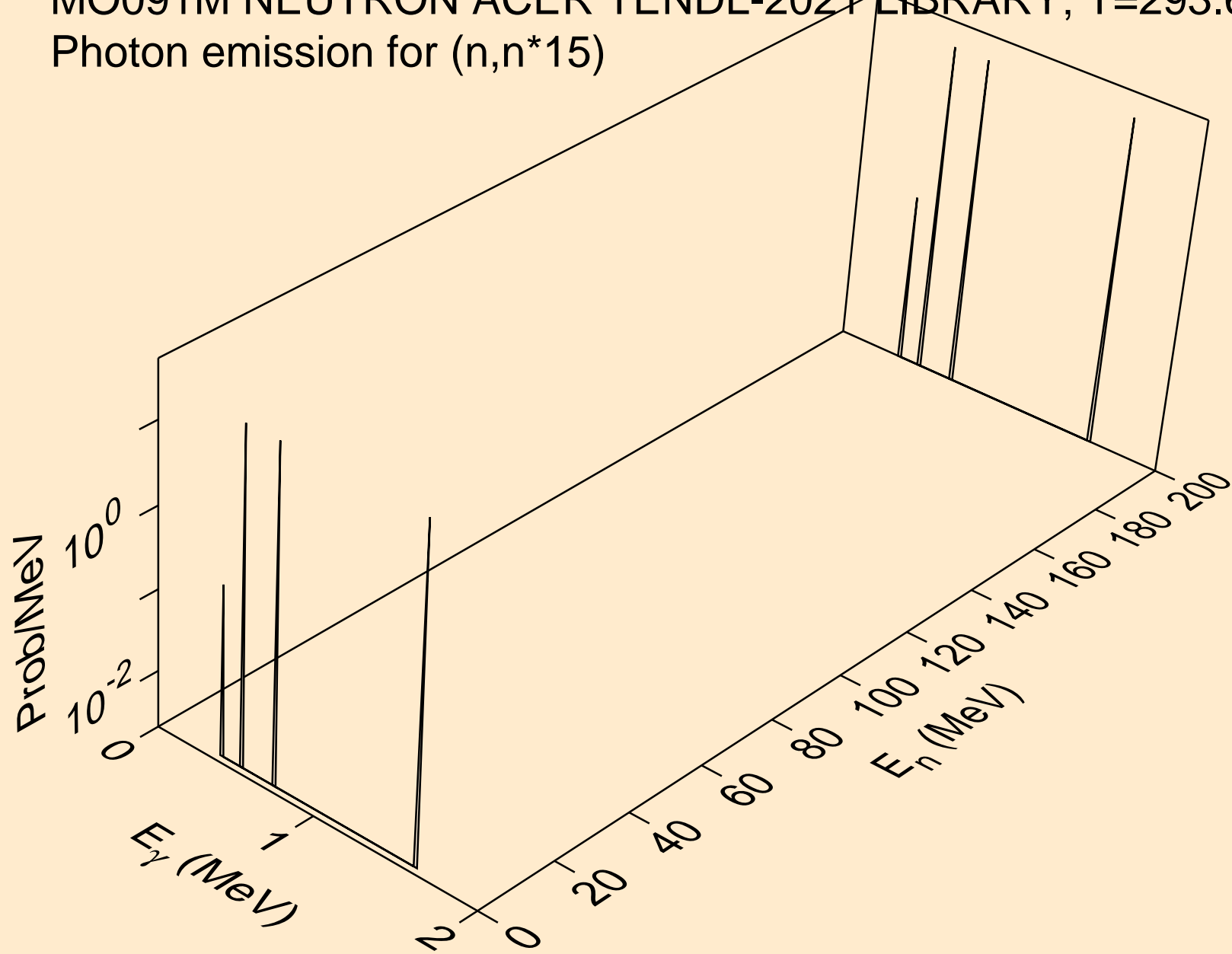

MO091M NEUTRON ACER TENDL-2021 LIBRARY; T=293.6K
Photon emission for (n,n*16)

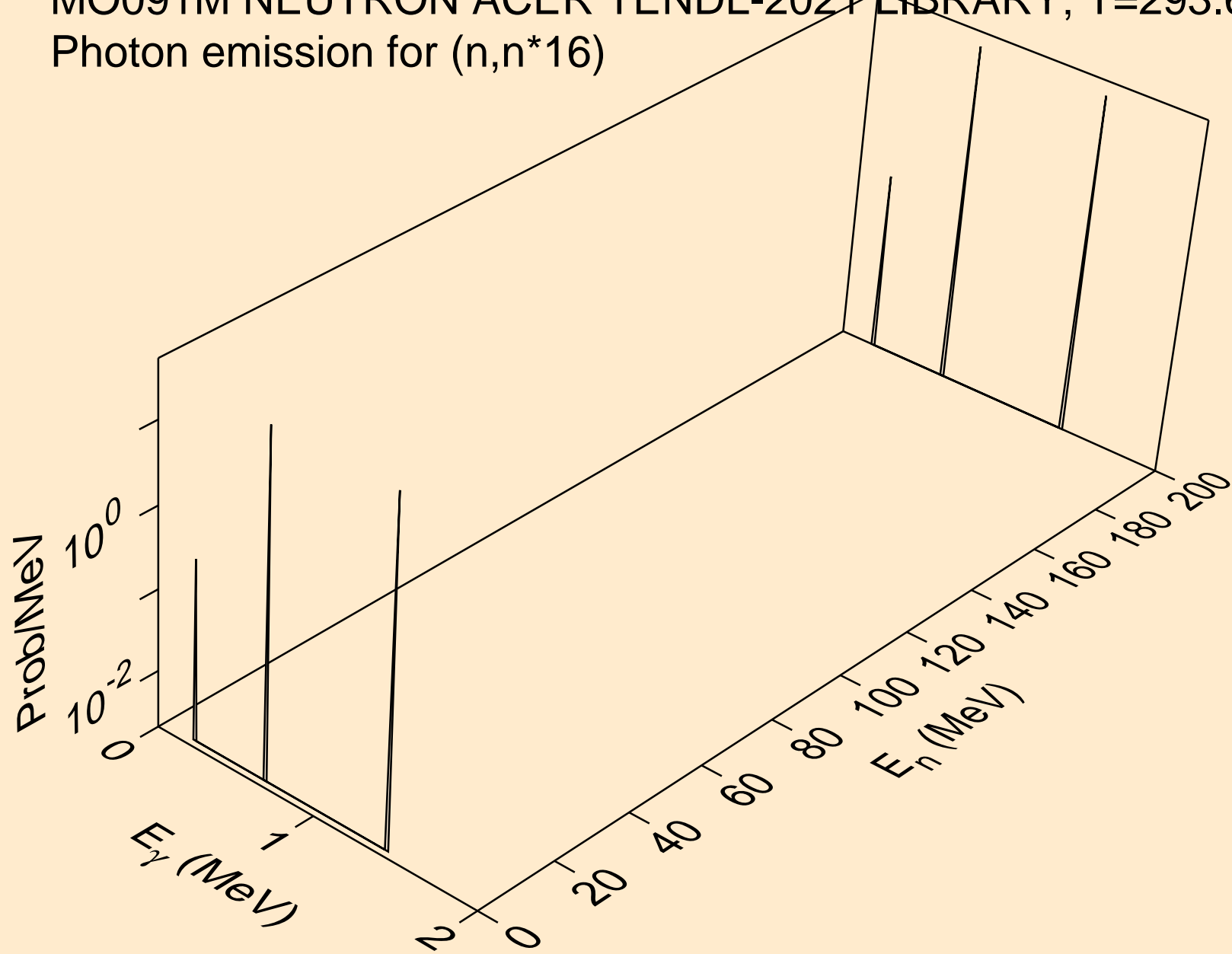

MO091M NEUTRON ACER TENDL-2021 LIBRARY; T=293.6K
Photon emission for (n,n*17)

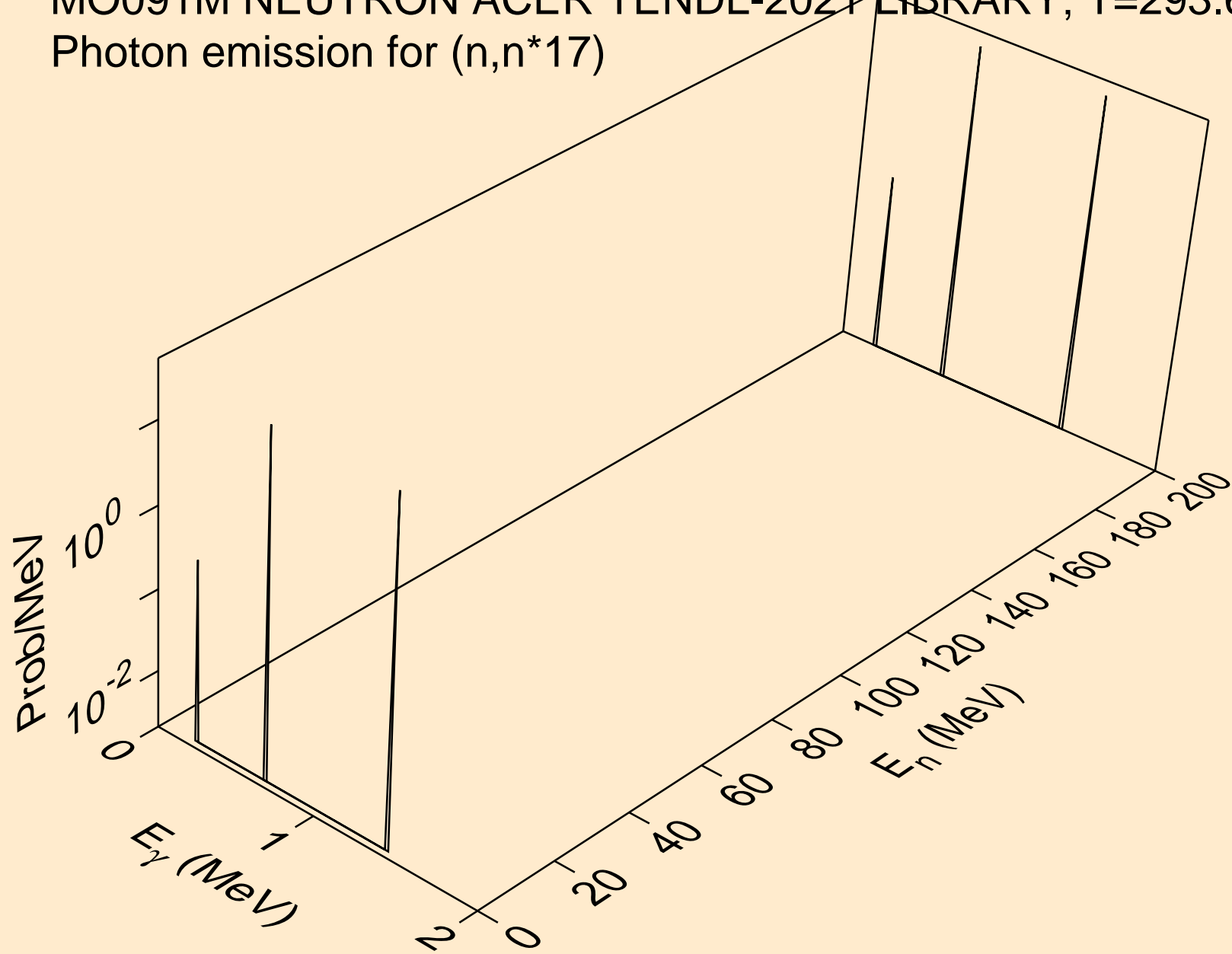

MO091M NEUTRON ACER TENDL-2021 LIBRARY; T=293.6K
Photon emission for (n,n*18)

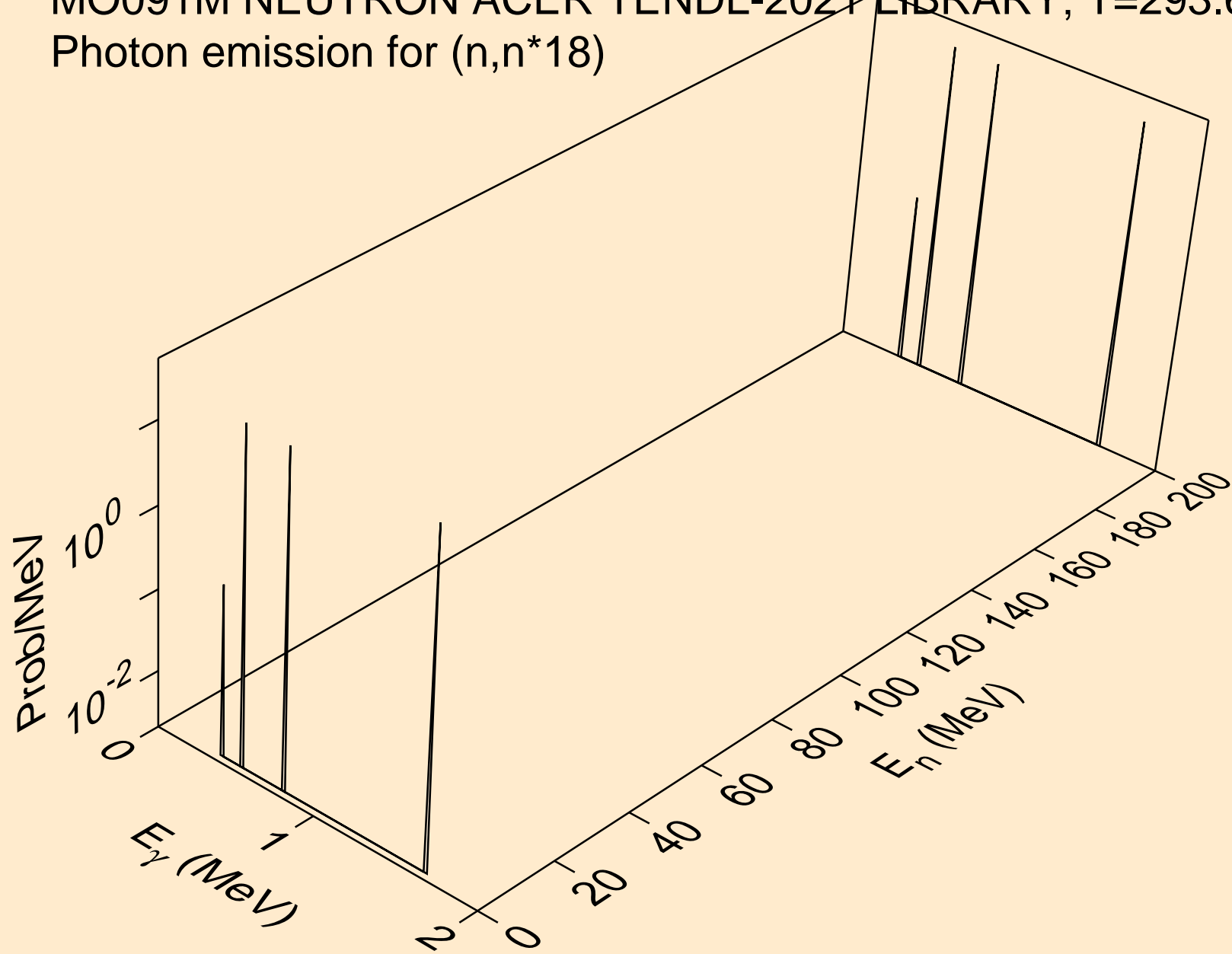

MO091M NEUTRON ACER TENDL-2021 LIBRARY; T=293.6K
Photon emission for (n,n*19)

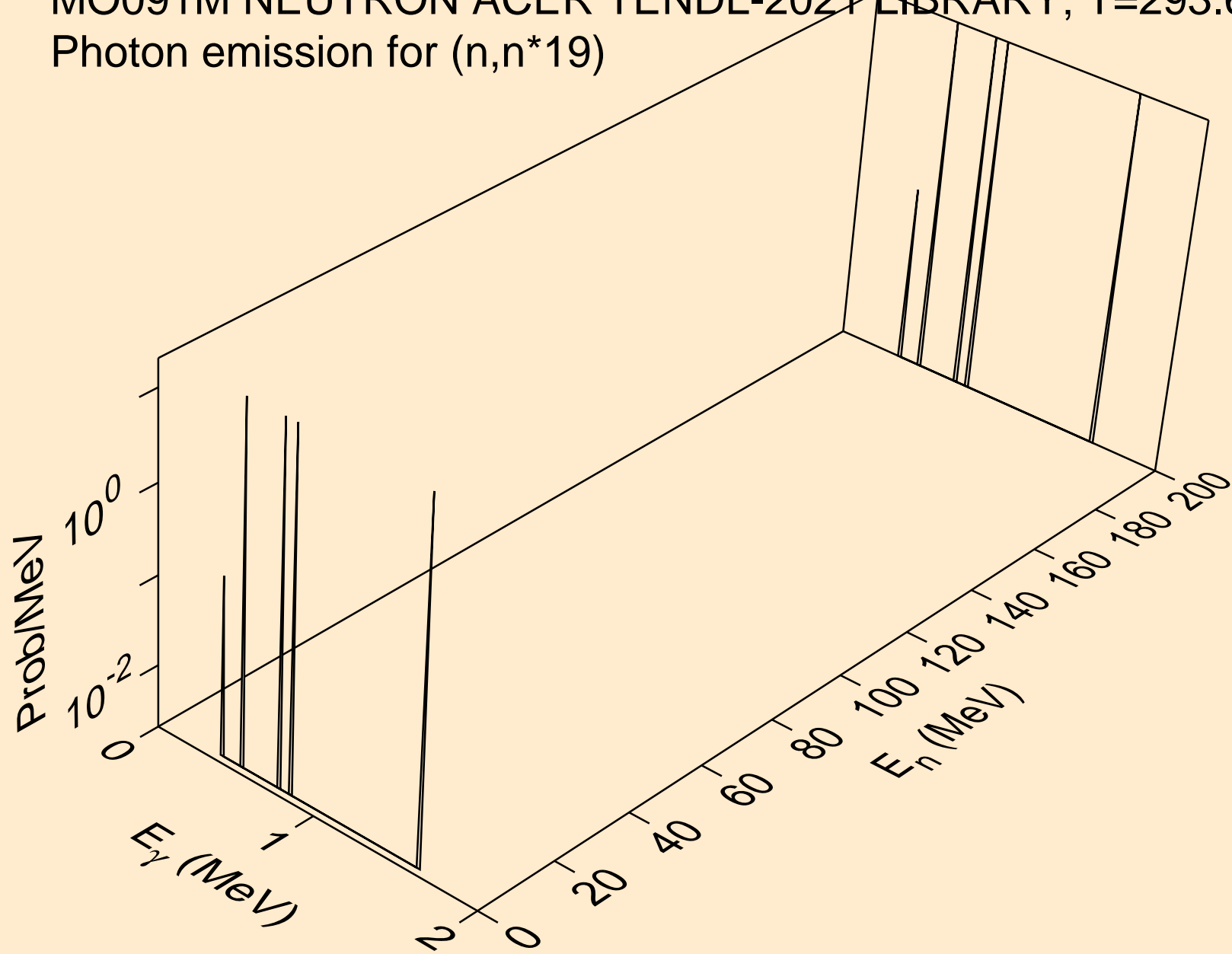

MO091M NEUTRON ACER TENDL-2021 LIBRARY; T=293.6K
Photon emission for (n,n*20)

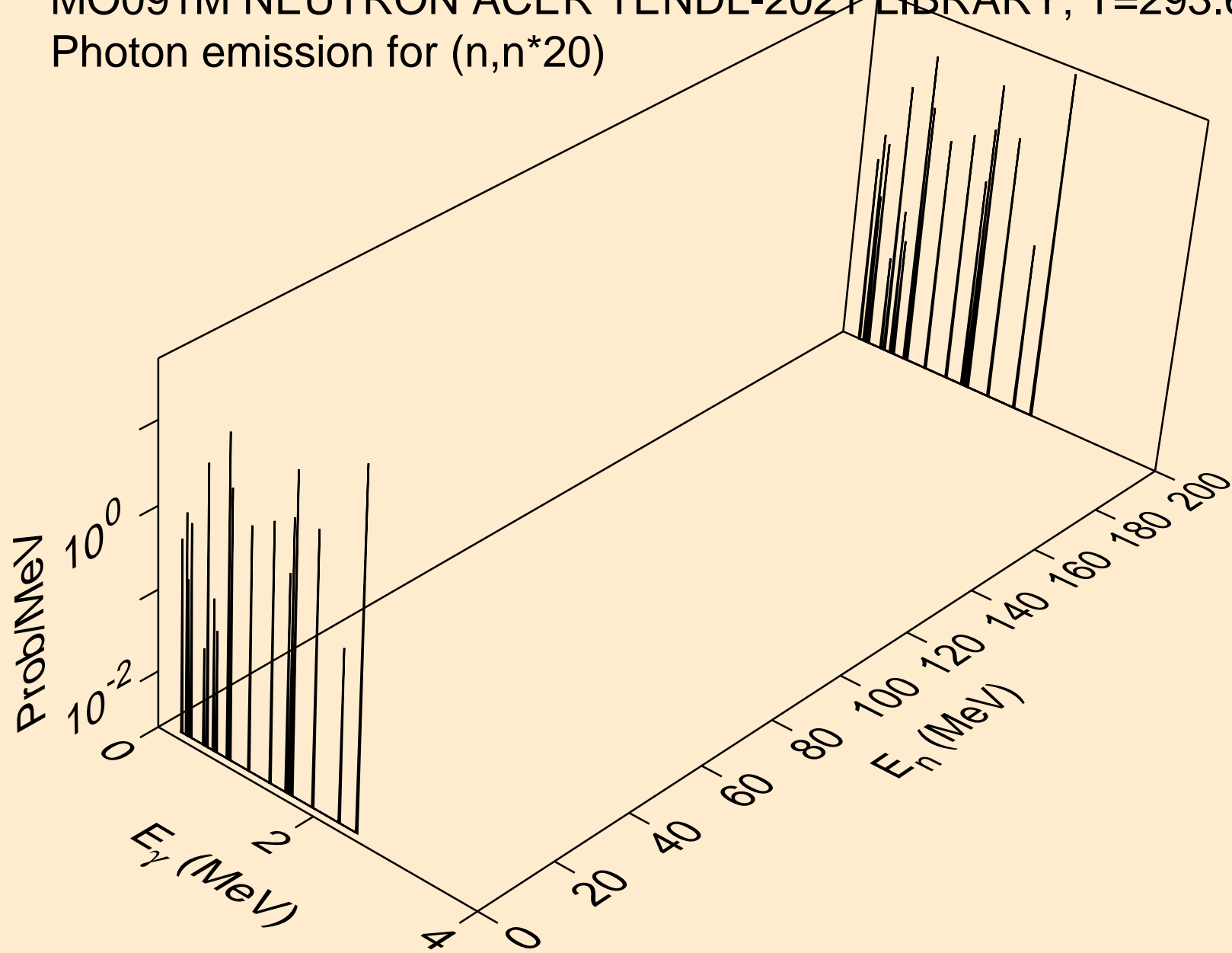

MO091M NEUTRON ACER TENDL-2021 LIBRARY; T=293.6K
Photon emission for (n,n*21)

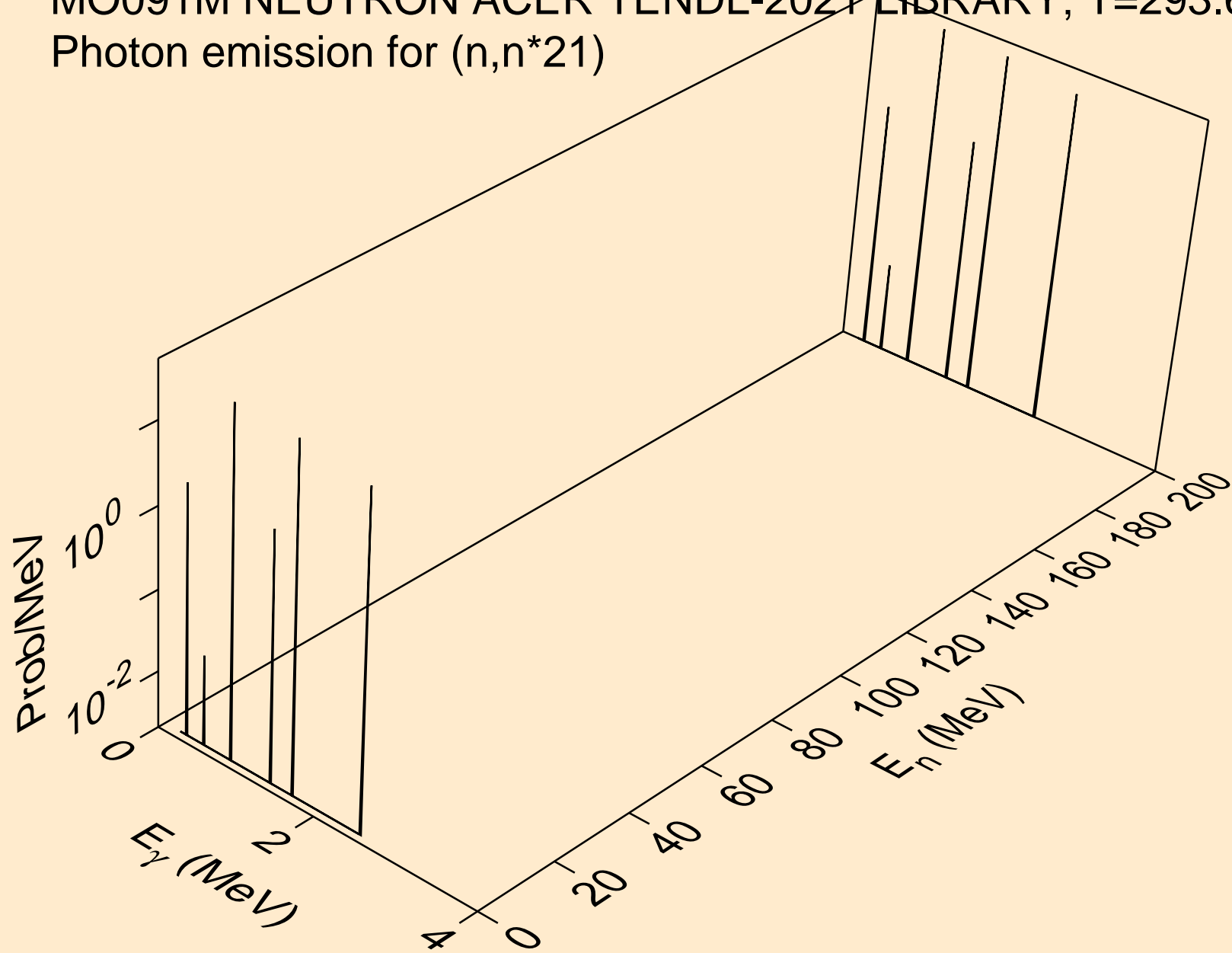

MO091M NEUTRON ACER TENDL-2021 LIBRARY; T=293.6K
Photon emission for (n,n*22)

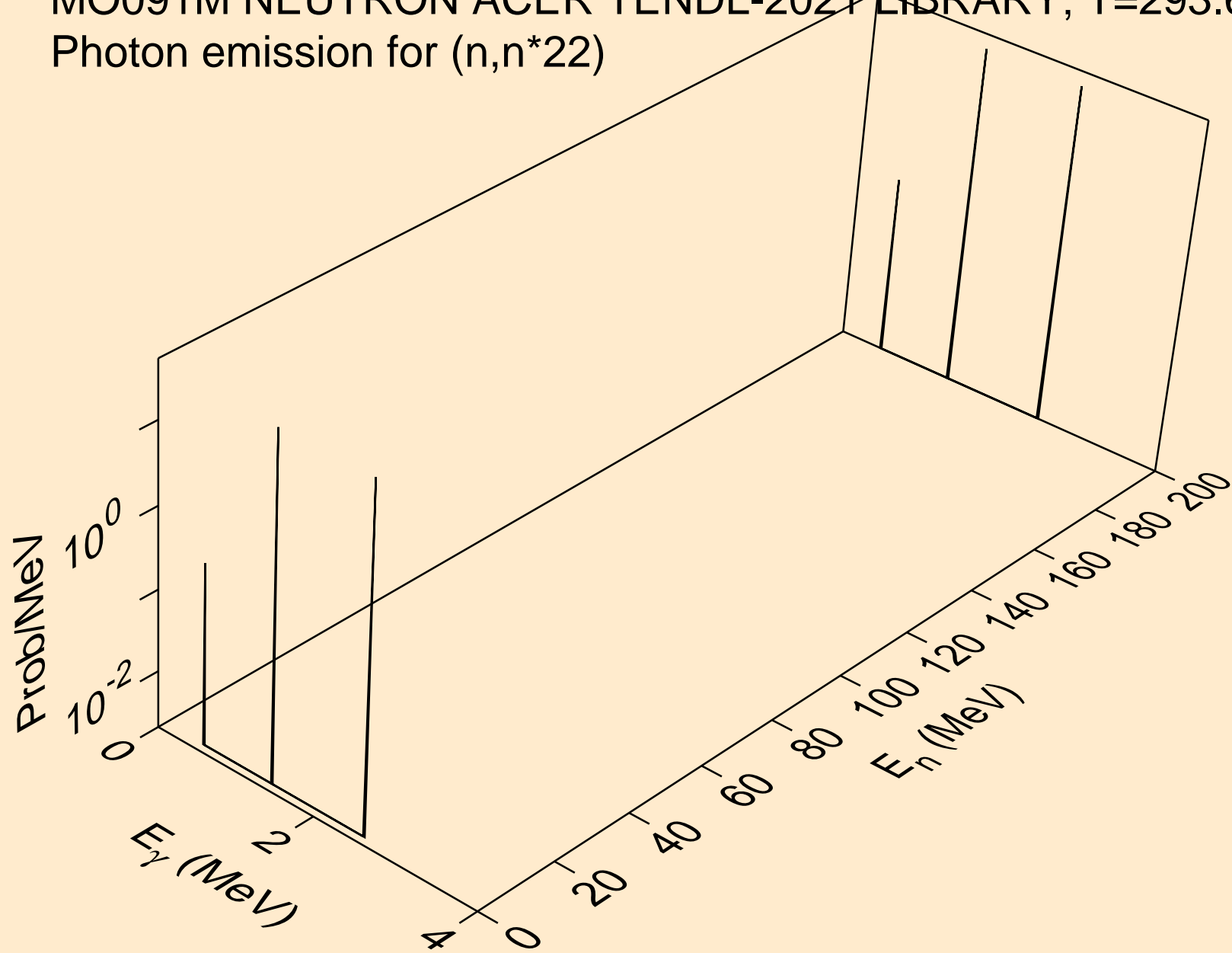

MO091M NEUTRON ACER TENDL-2021 LIBRARY; T=293.6K
Photon emission for (n,n*23)

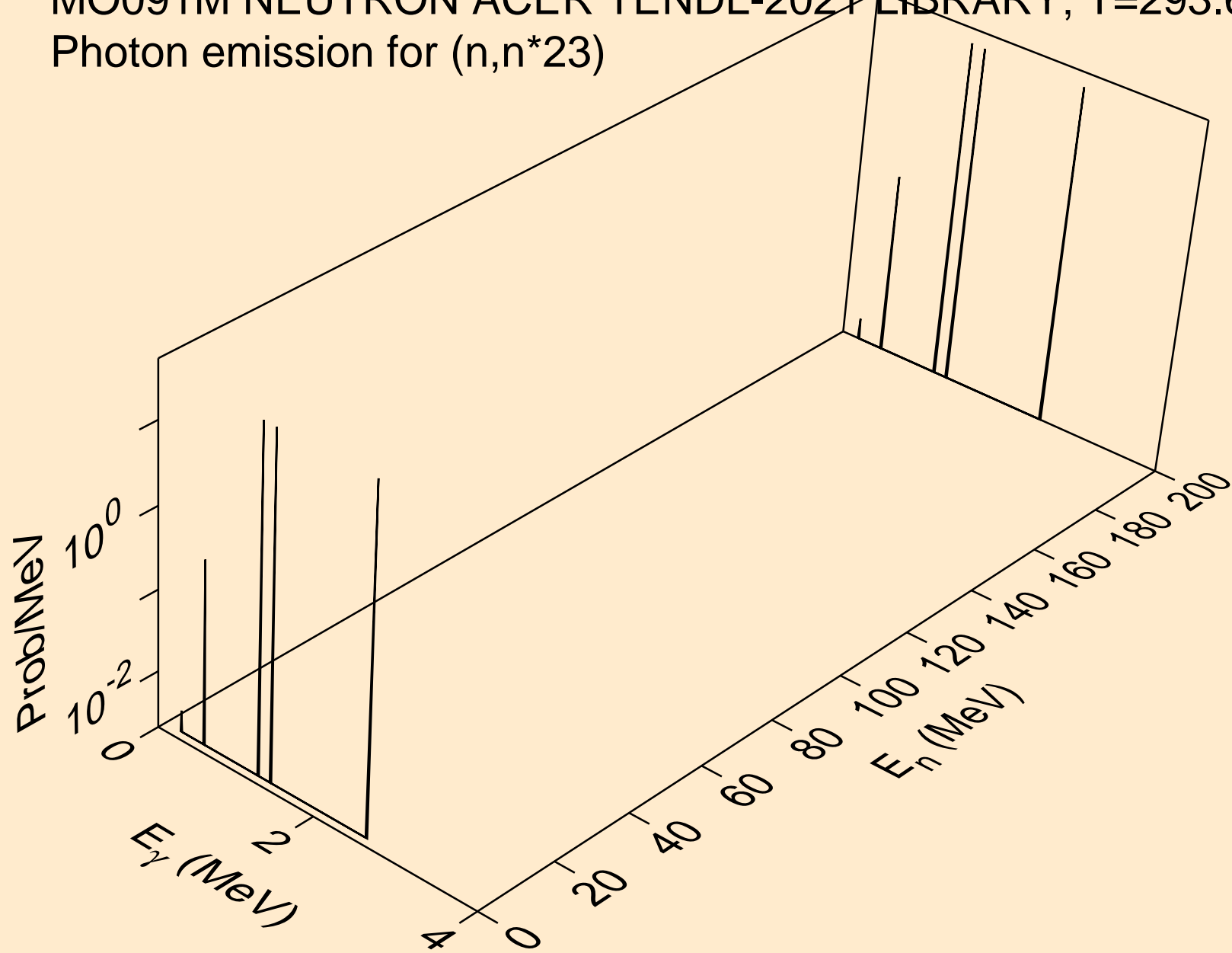

MO091M NEUTRON ACER TENDL-2021 LIBRARY; T=293.6K
Photon emission for (n,n*24)

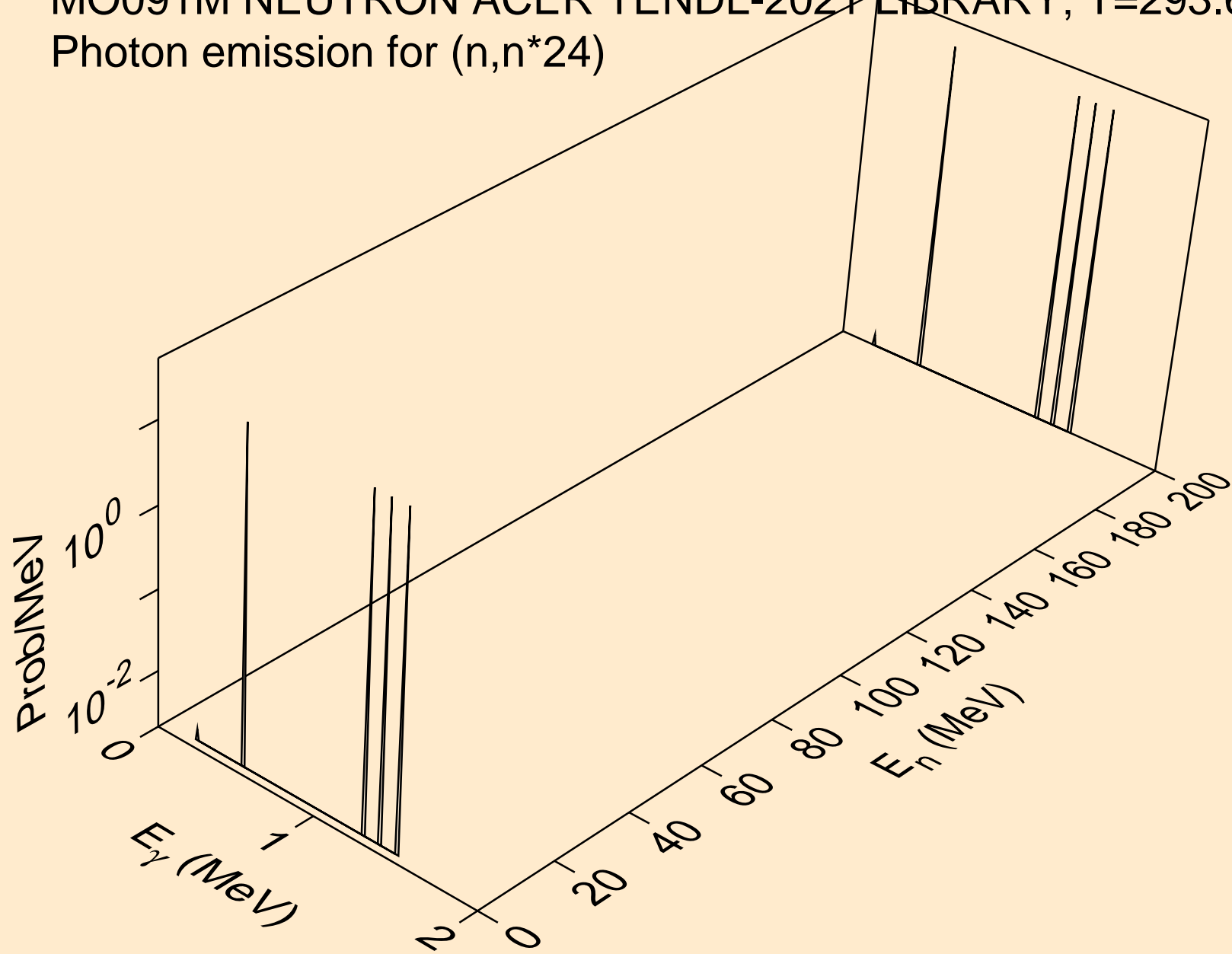

MO091M NEUTRON ACER TENDL-2021 LIBRARY; T=293.6K
Photon emission for (n,n*25)

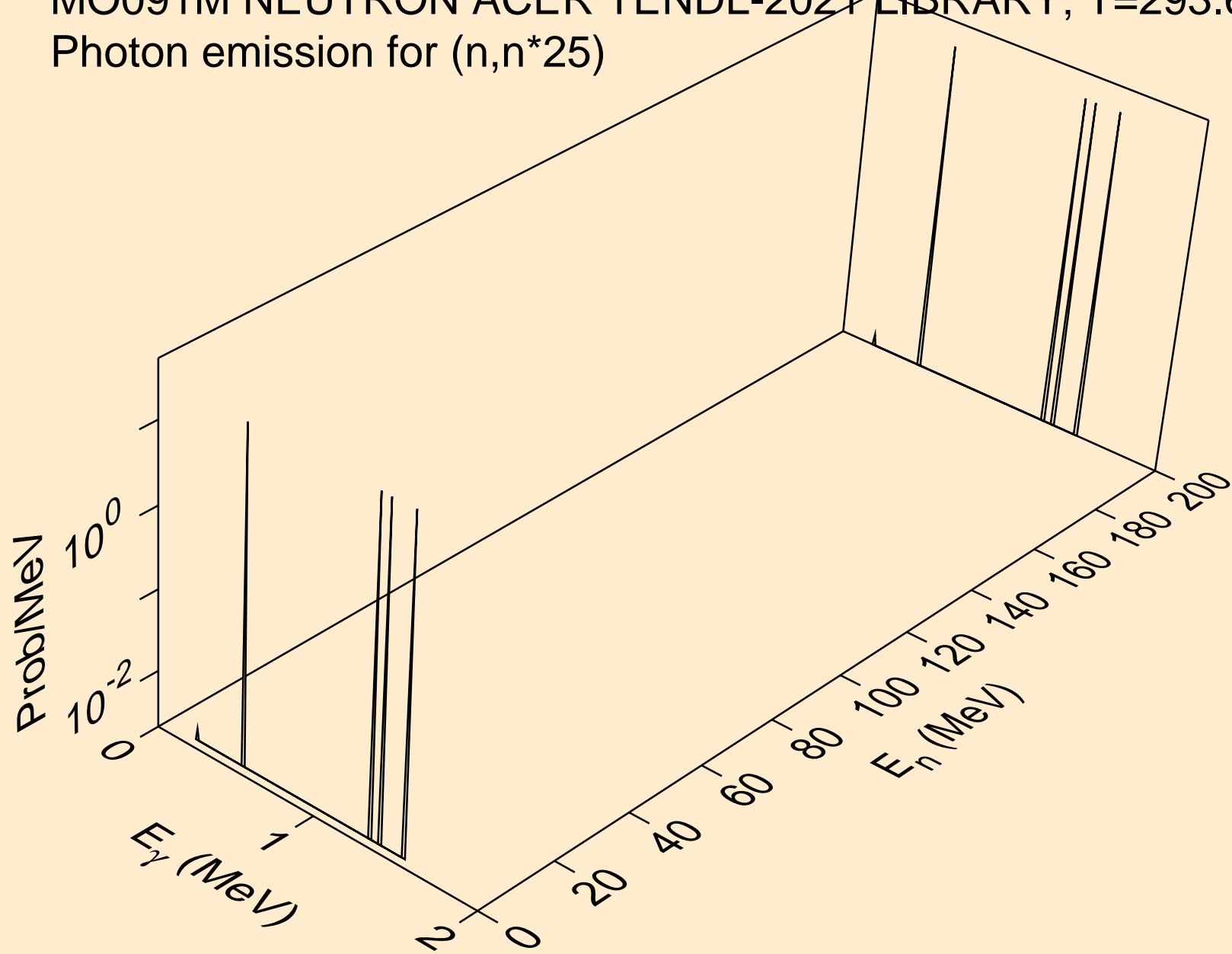

MO091M NEUTRON ACER TENDL-2021 LIBRARY; T=293.6K
Photon emission for (n,n*26)

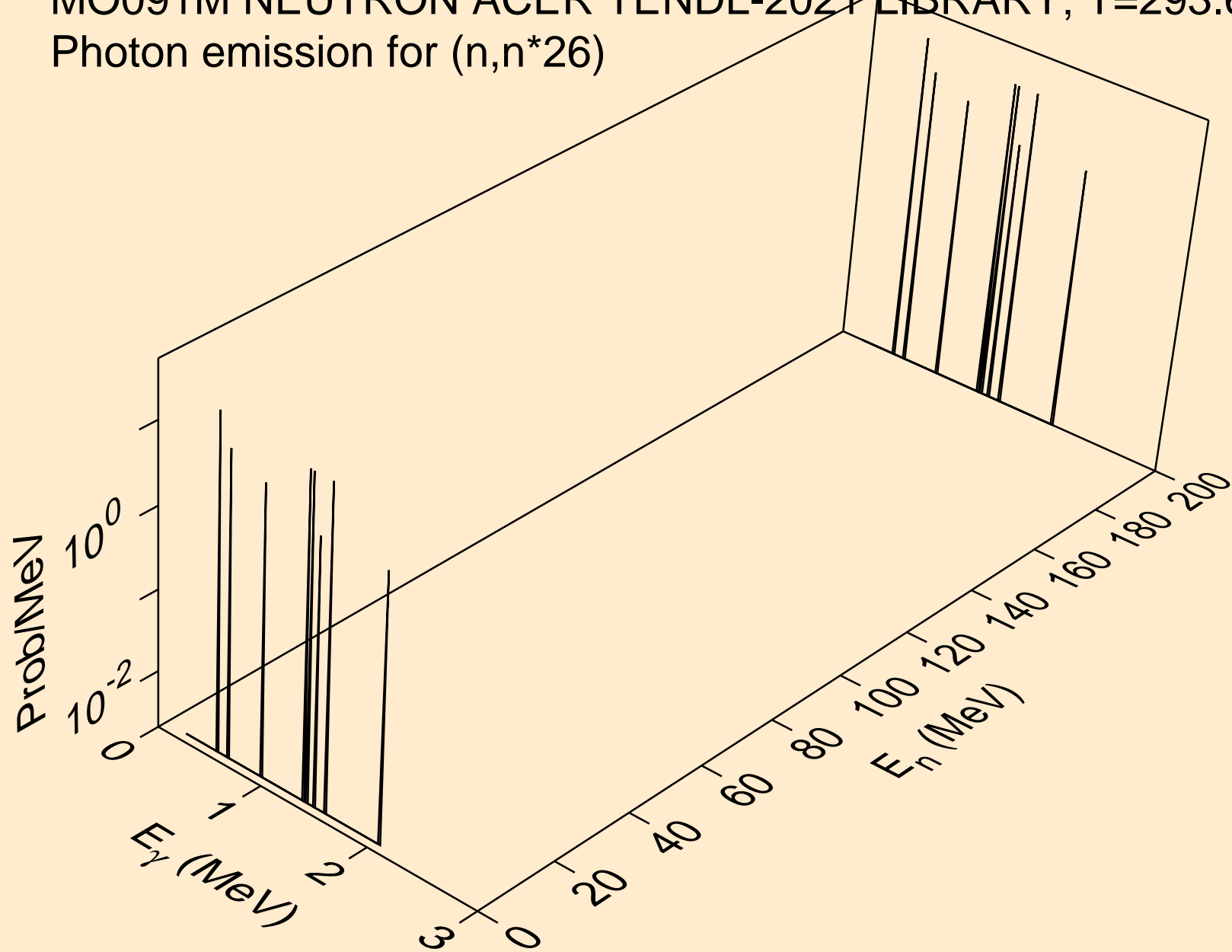

MO091M NEUTRON ACER TENDL-2021 LIBRARY; T=293.6K
Photon emission for (n,n*27)

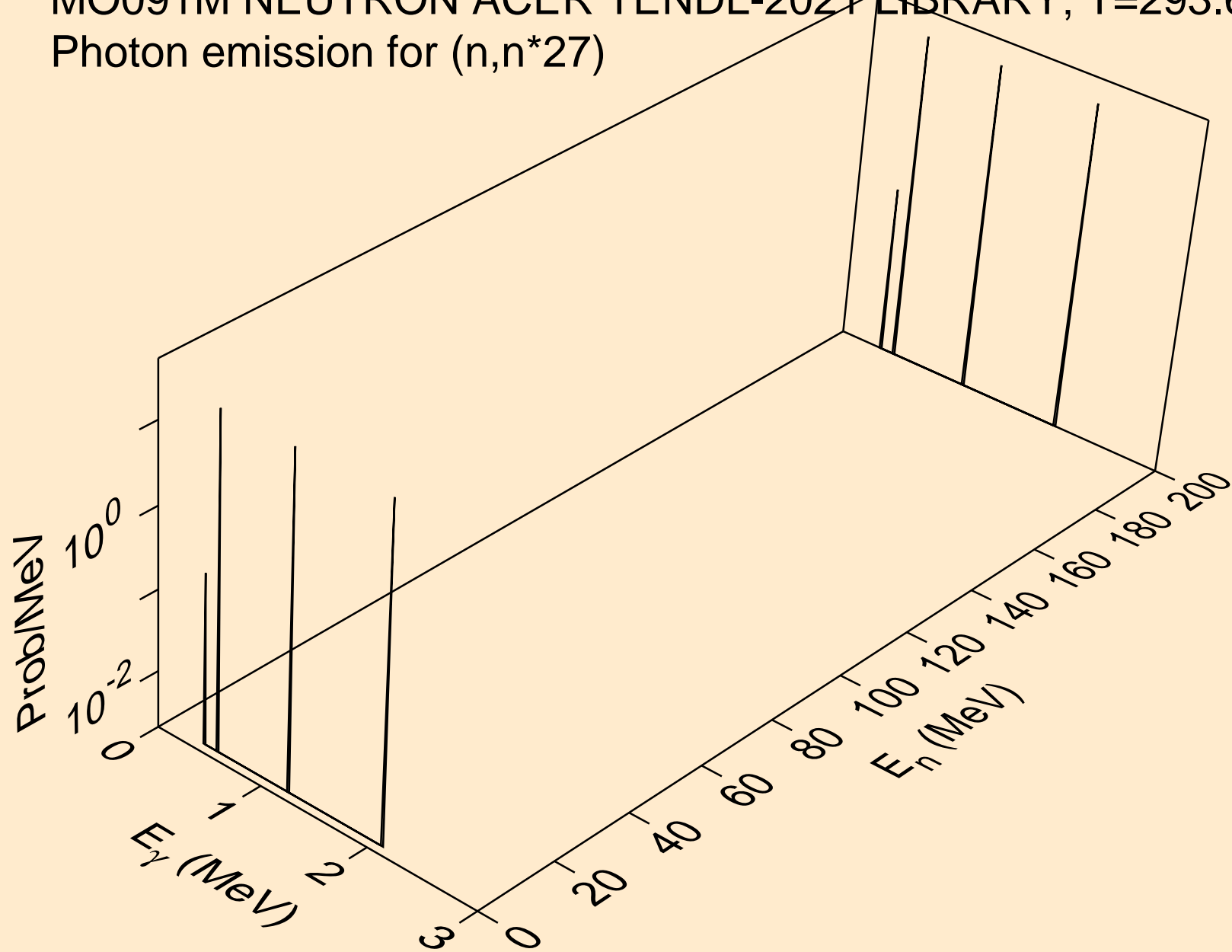

MO091M NEUTRON ACER TENDL-2021 LIBRARY; T=293.6K
Photon emission for (n,n*28)

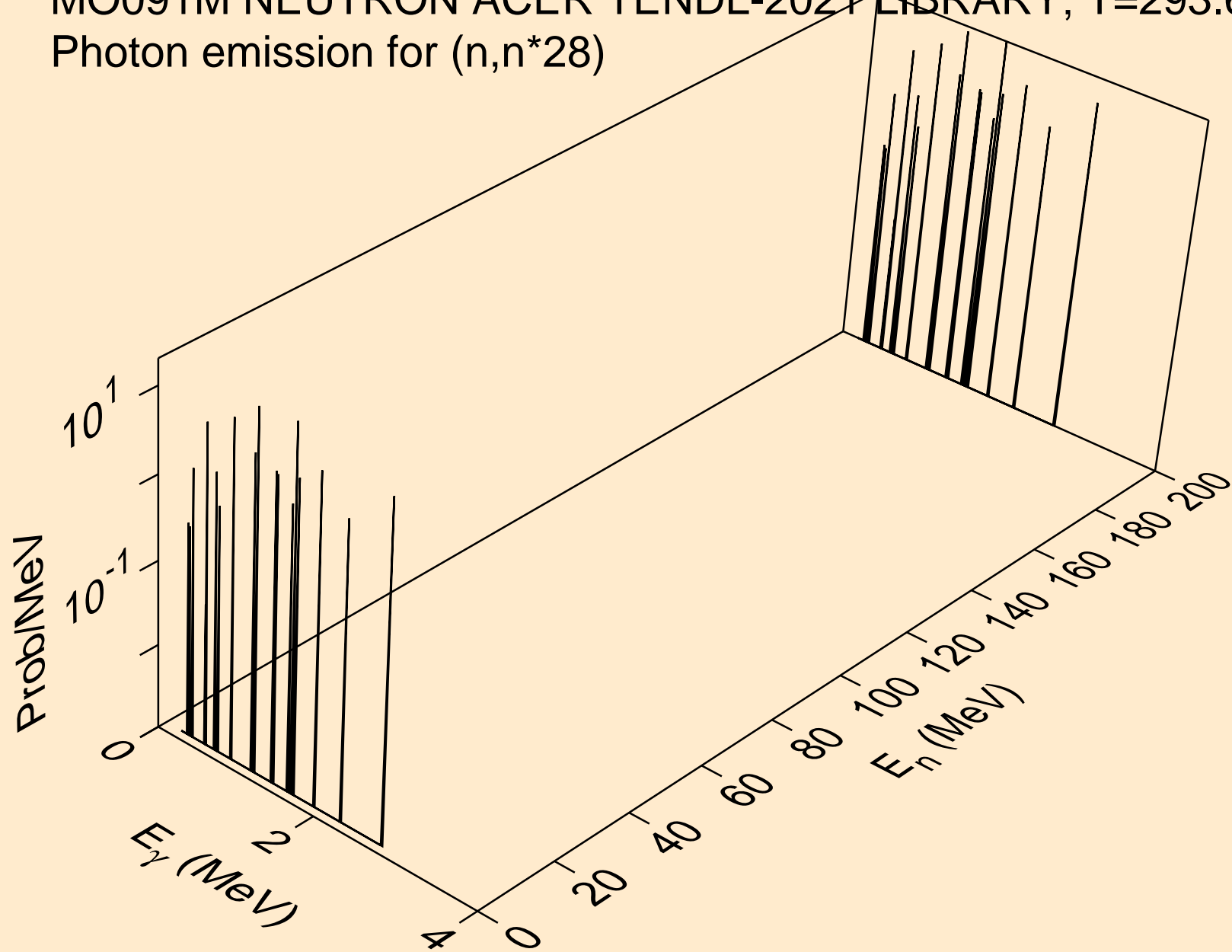

MO091M NEUTRON ACER TENDL-2021 LIBRARY; T=293.6K
Photon emission for (n,n*c)

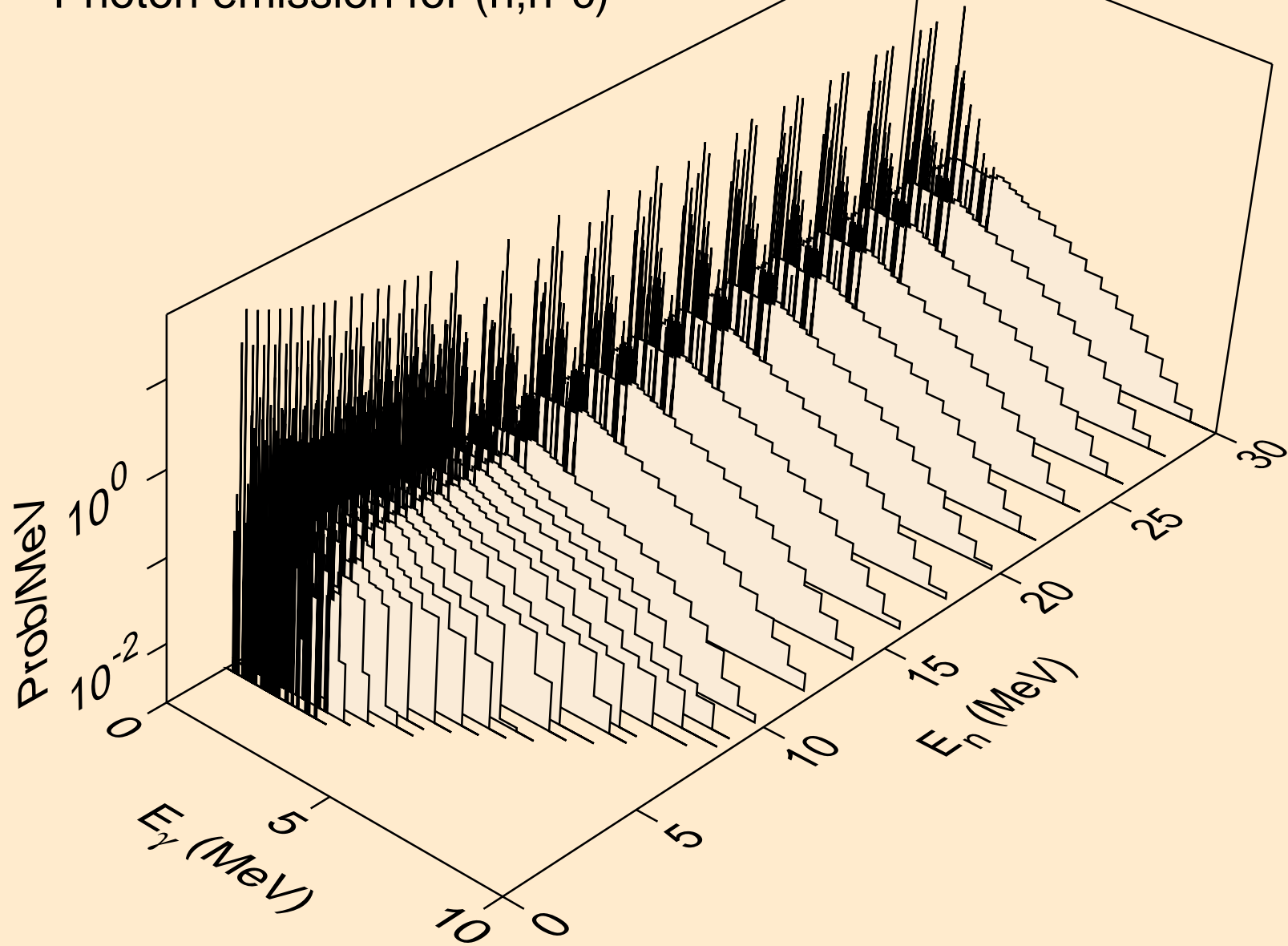

MO091M NEUTRON ACER TENDL-2021 LIBRARY; T=293.6K
Photon emission for (n,gma)

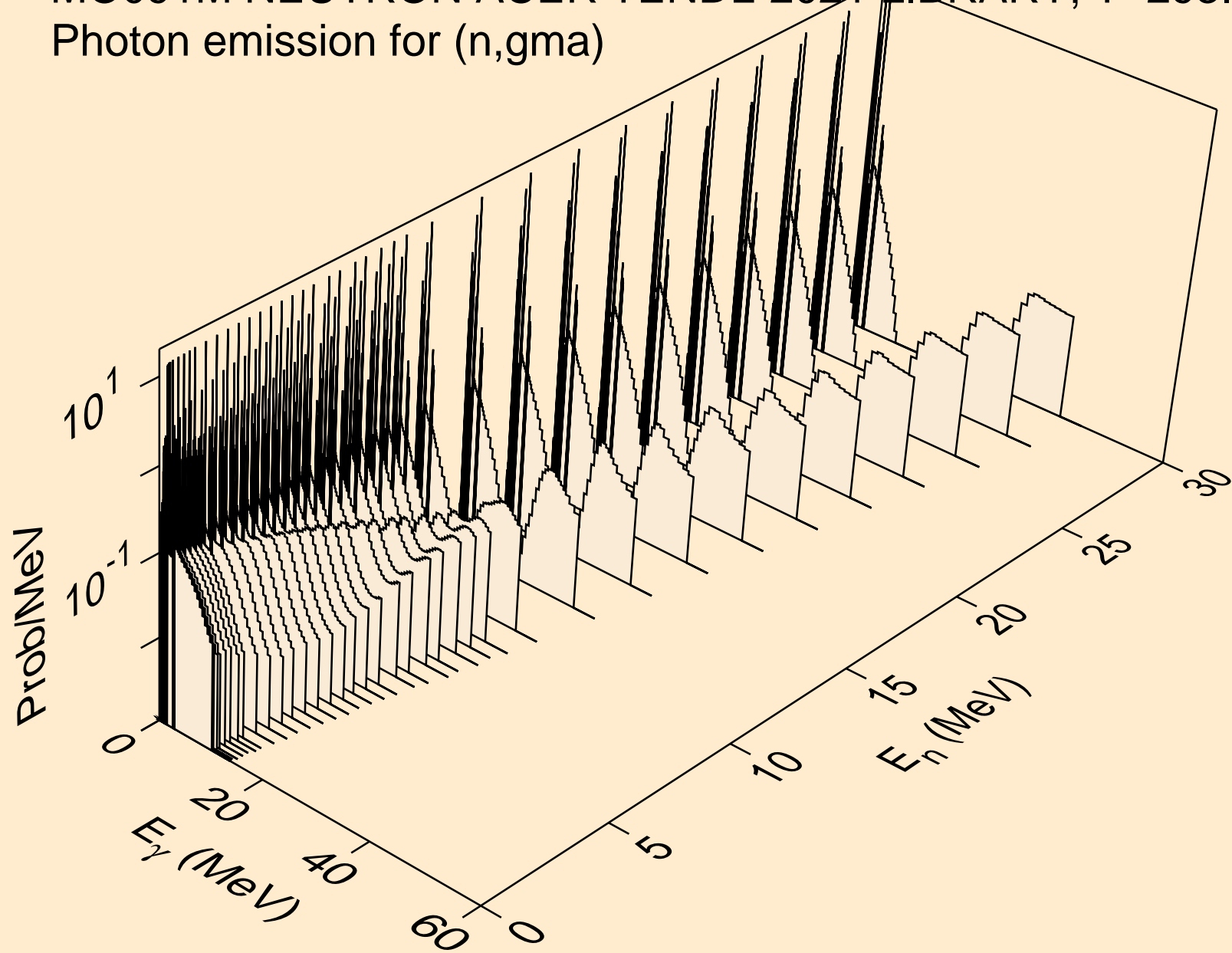

MO091M NEUTRON ACER TENDL-2021 LIBRARY; T=293.6K
Photon emission for (n,p)

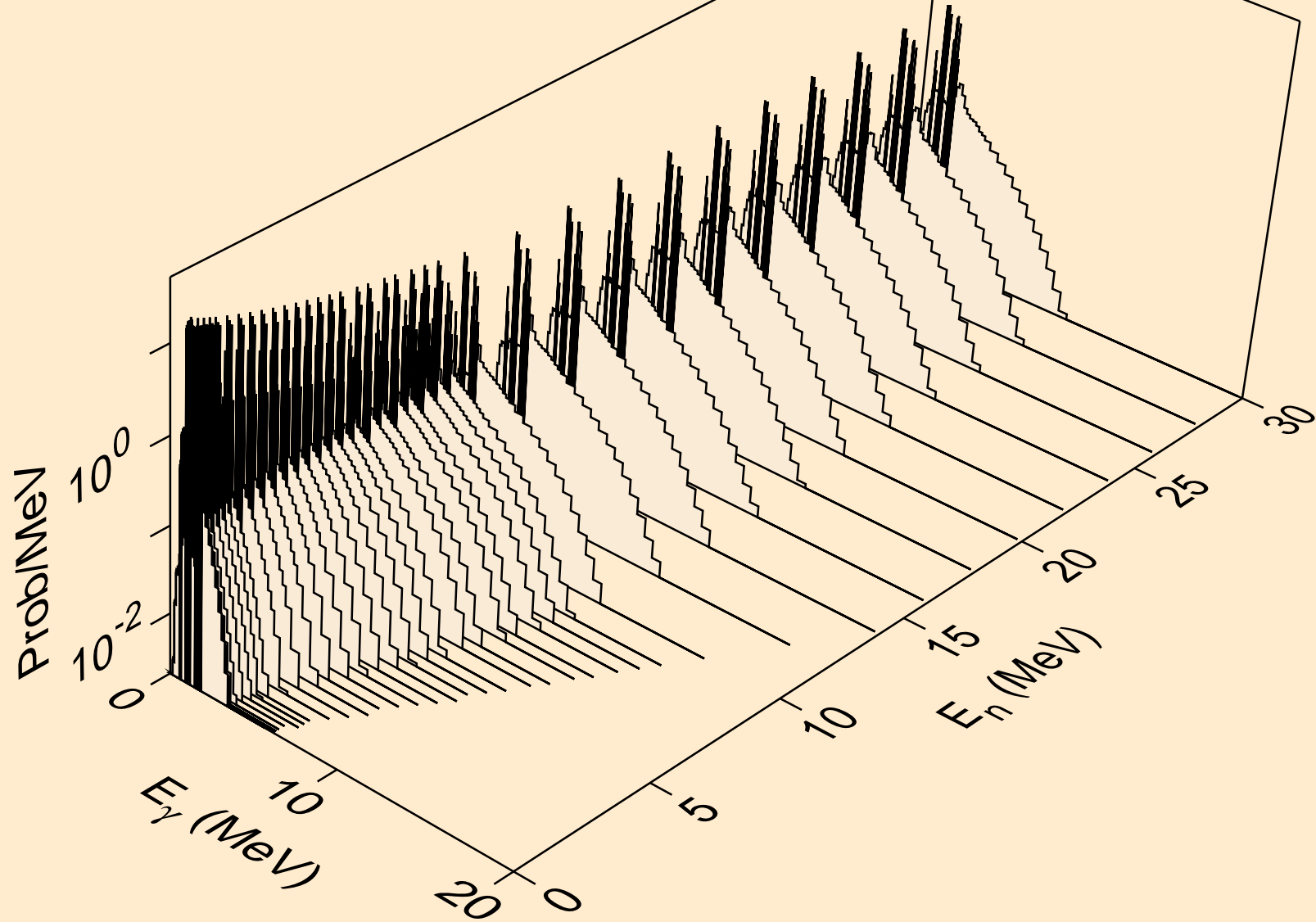

MO091M NEUTRON ACER TENDL-2021 LIBRARY; T=293.6K
Photon emission for (n,d)

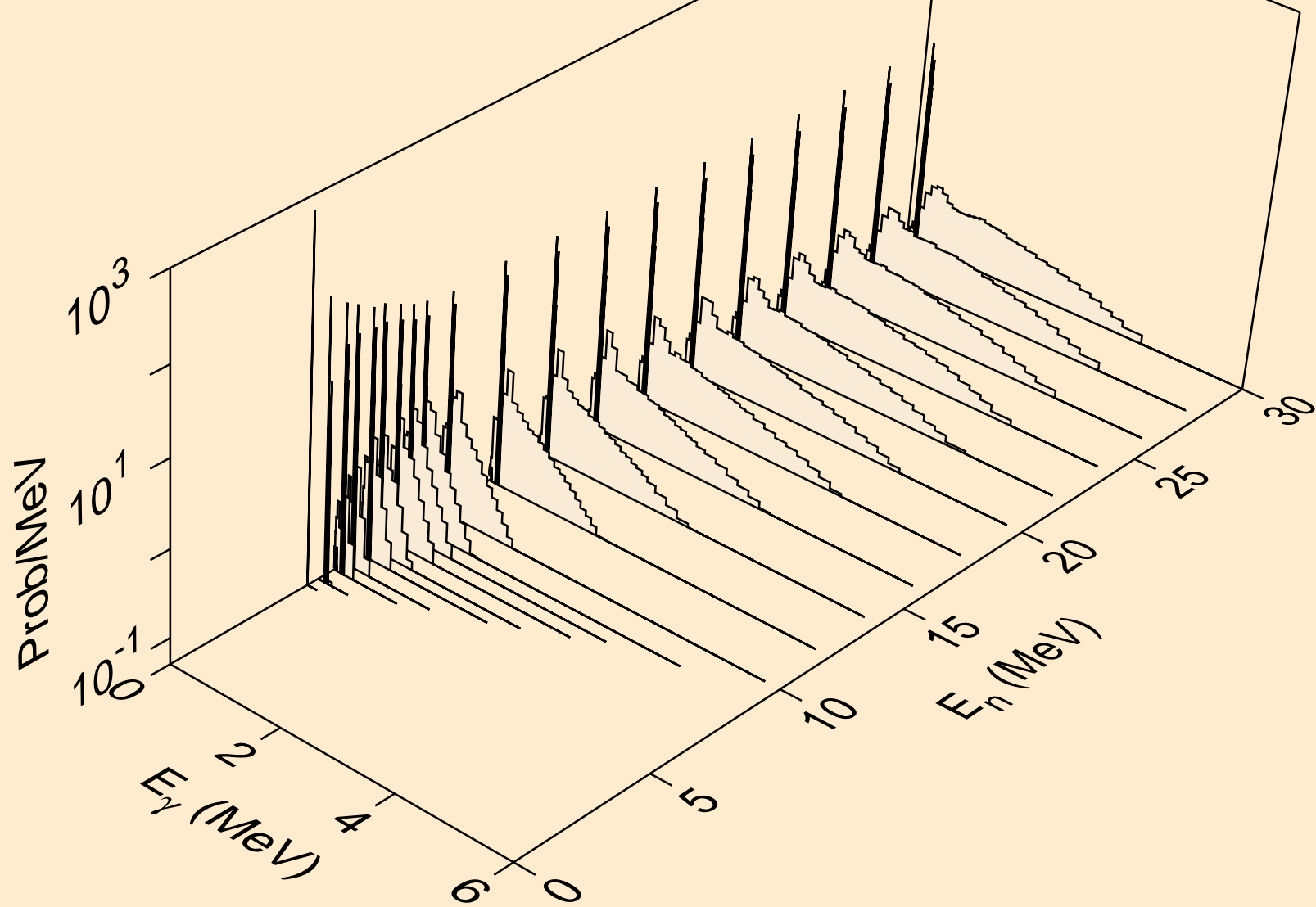

MO091M NEUTRON ACER TENDL-2021 LIBRARY; T=293.6K
Photon emission for (n,t)

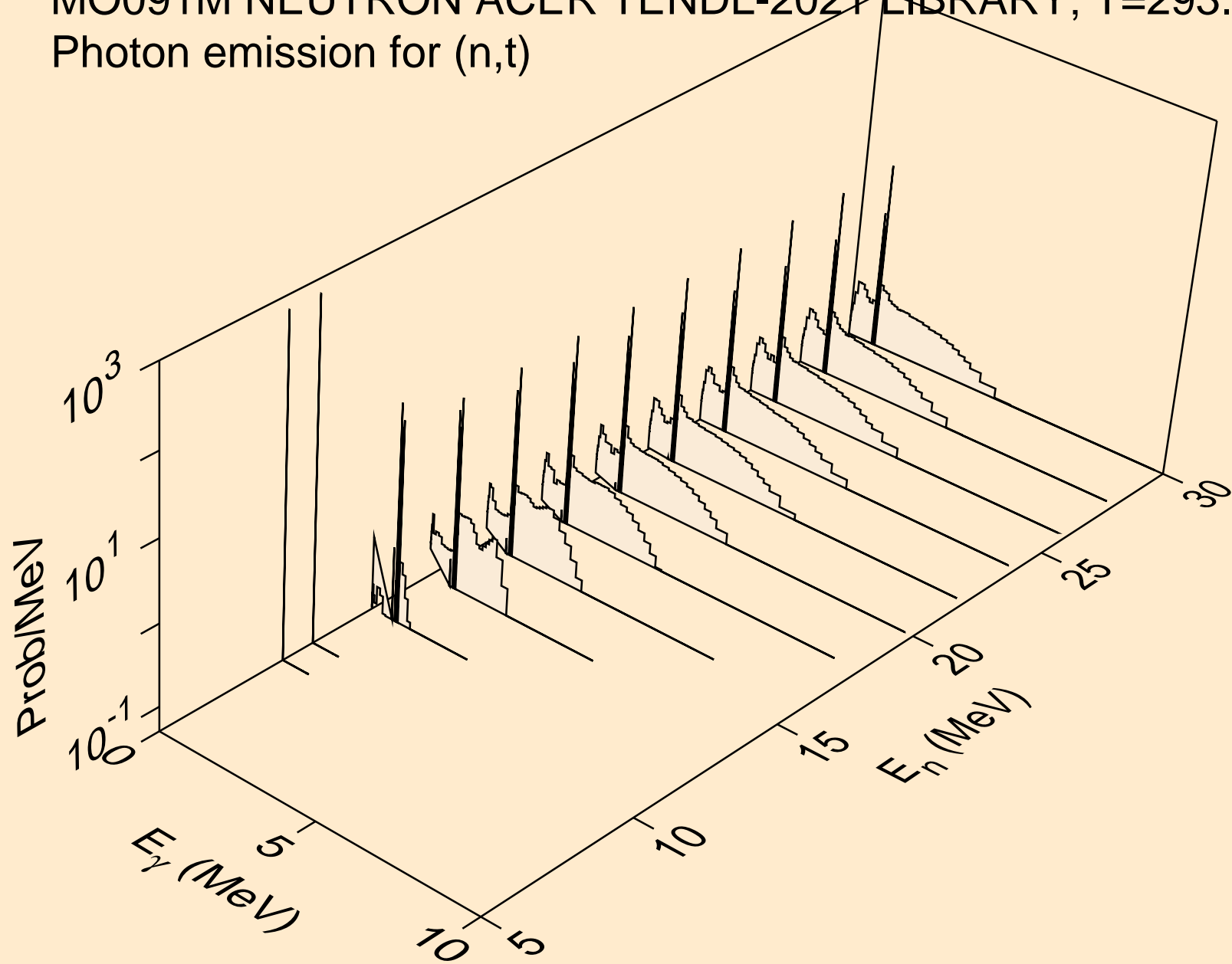

MO091M NEUTRON ACER TENDL-2021 LIBRARY; T=293.6K
Photon emission for (n,he3)

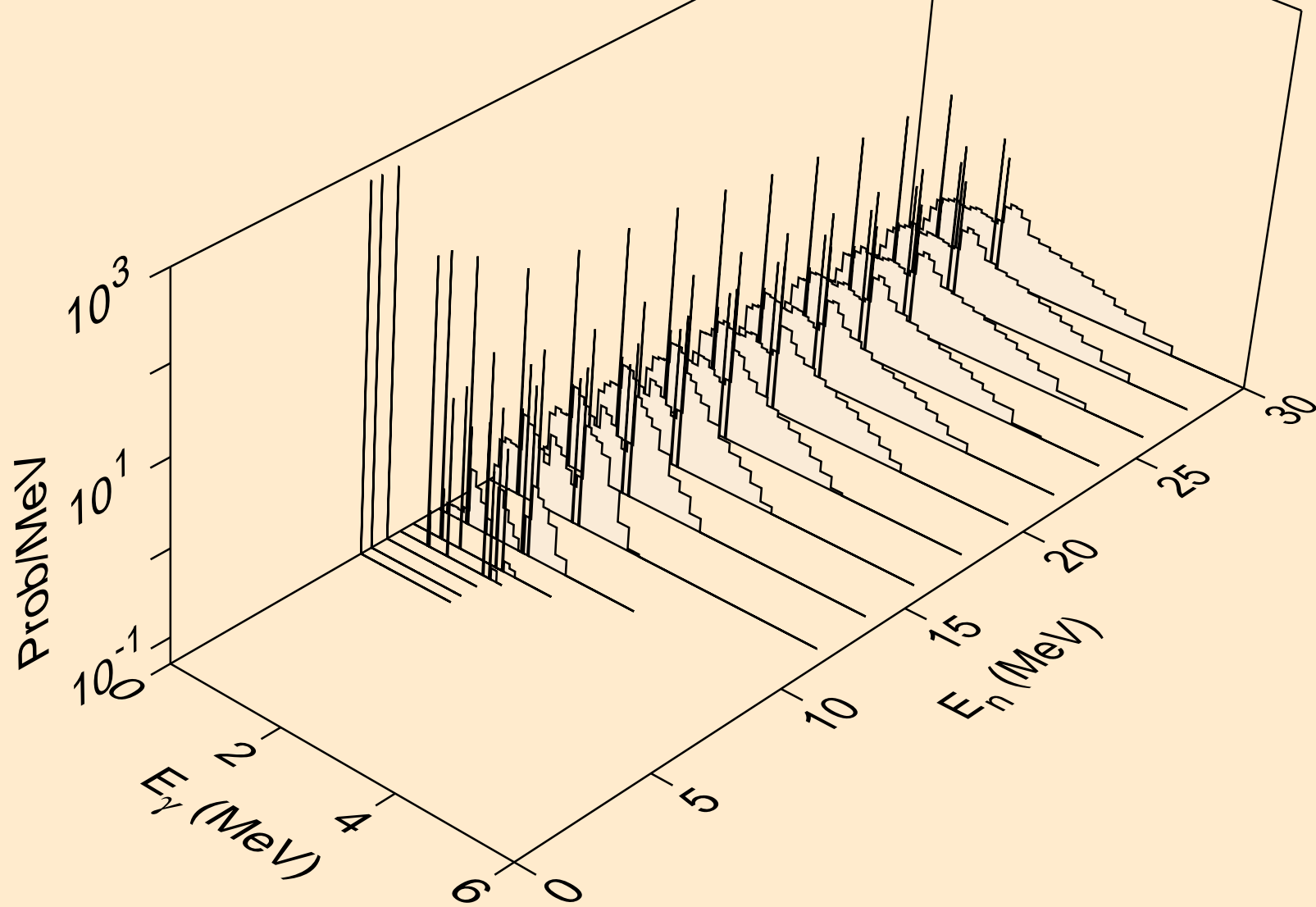

MO091M NEUTRON ACER TENDL-2021 LIBRARY; T=293.6K
Photon emission for (n,a)

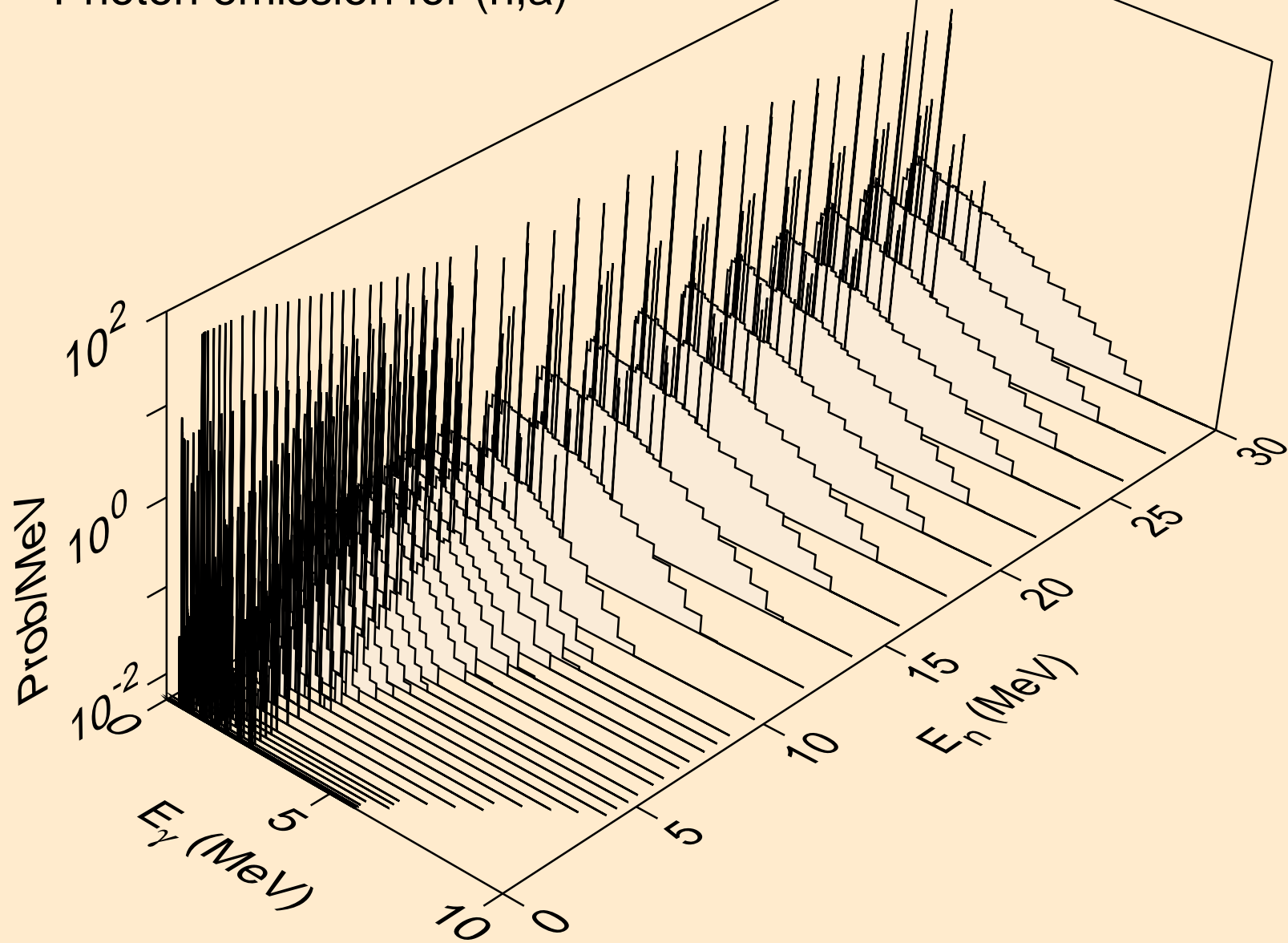

MO091M NEUTRON ACER TENDL-2021 LIBRARY; T=293.6K
Photon emission for (n,2a)

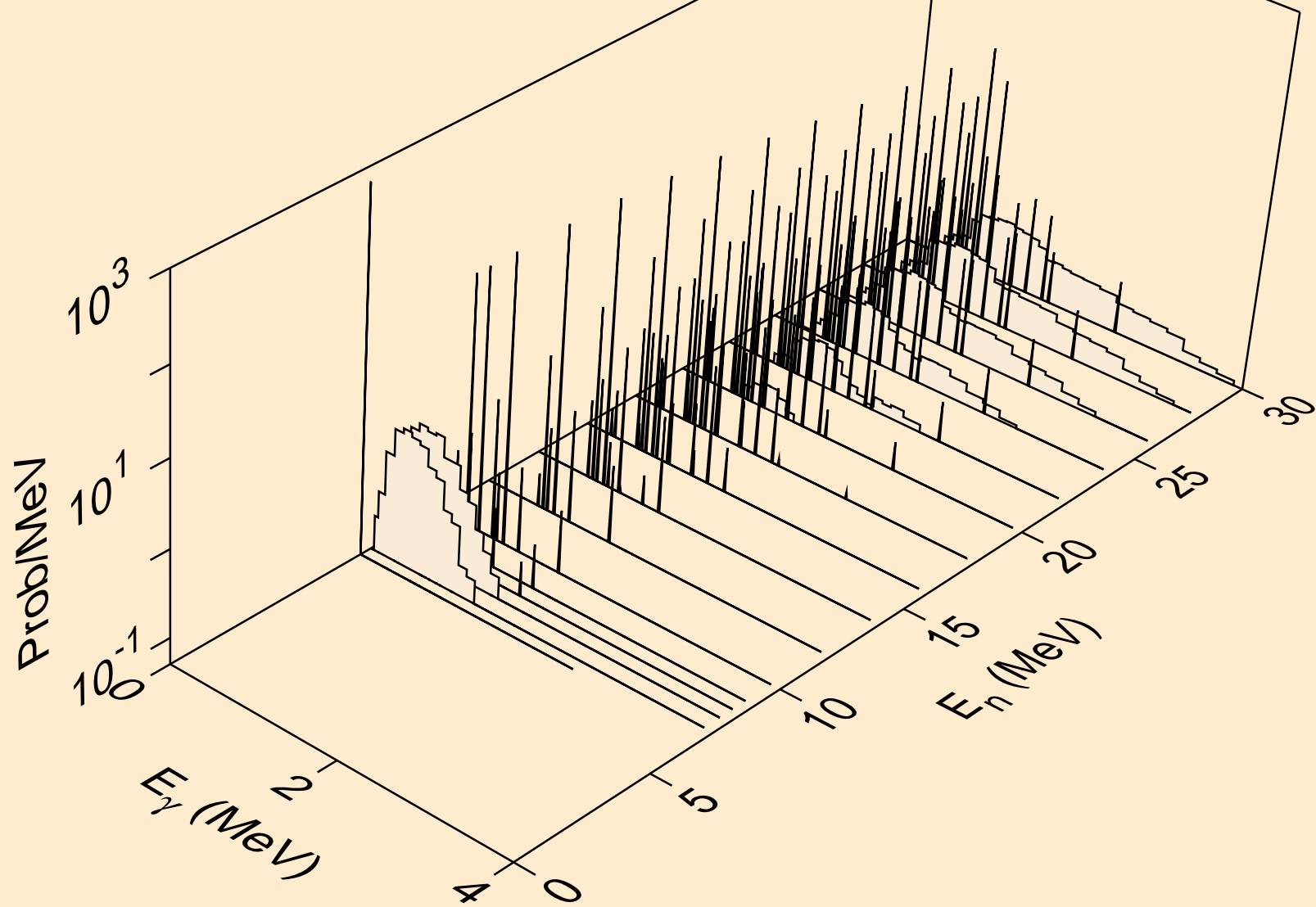

MO091M NEUTRON ACER TENDL-2021 LIBRARY; T=293.6K
Photon emission for (n,2p)

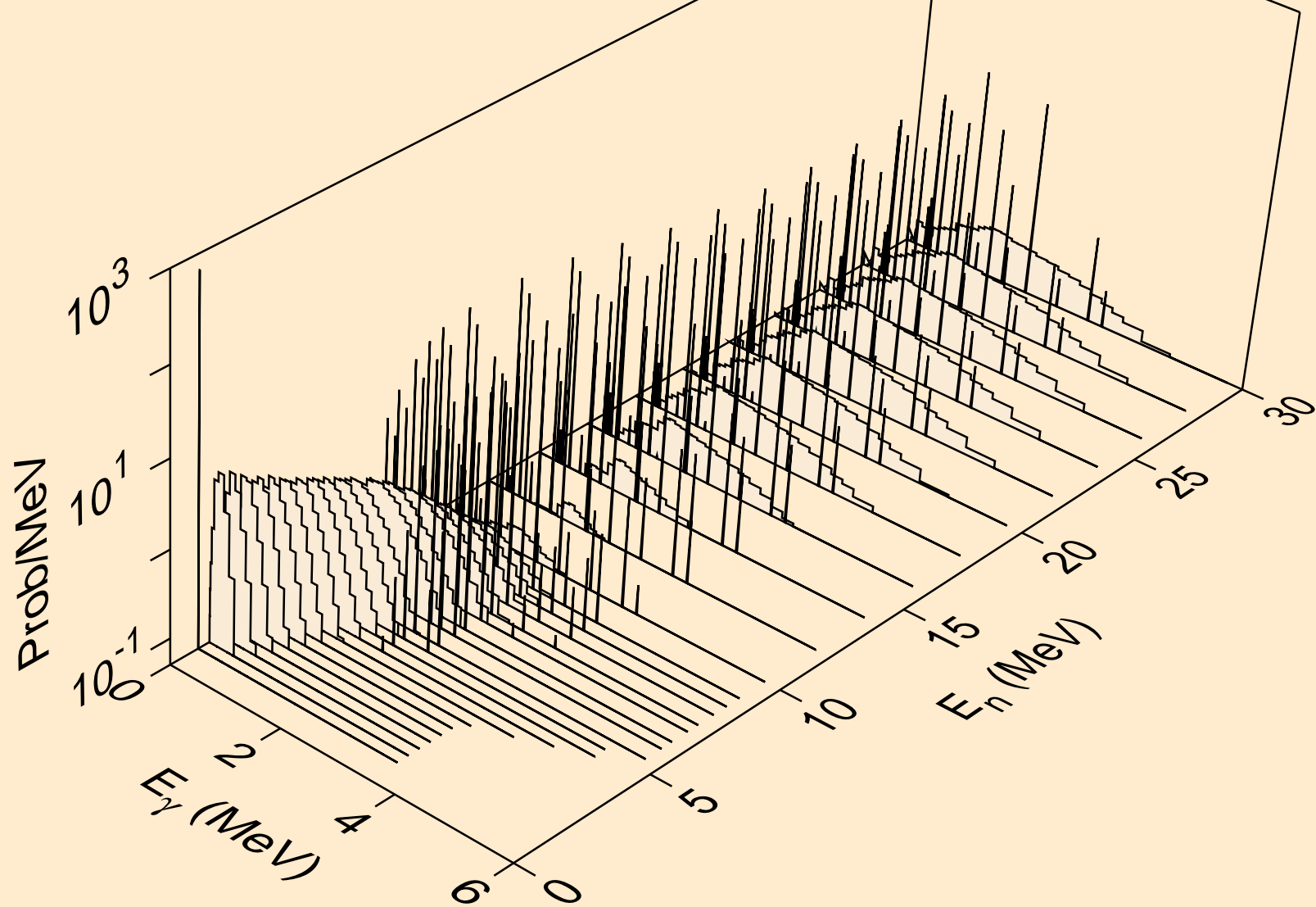

MO091M NEUTRON ACER TENDL-2021 LIBRARY; T=293.6K
Photon emission for (n,p α)

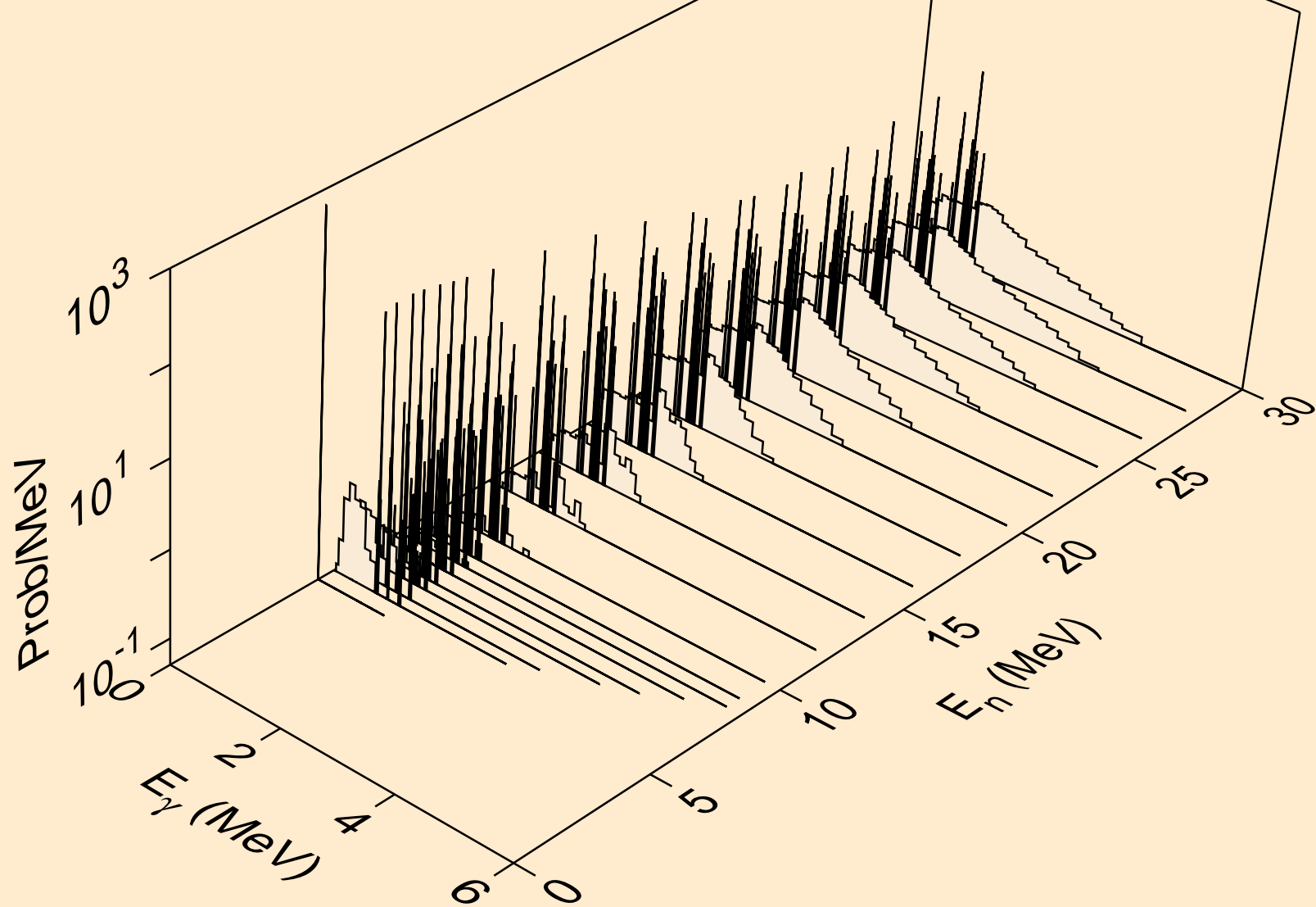

MO091M NEUTRON ACER TENDL-2021 LIBRARY; T=293.6K
Photon emission for (n,pd)

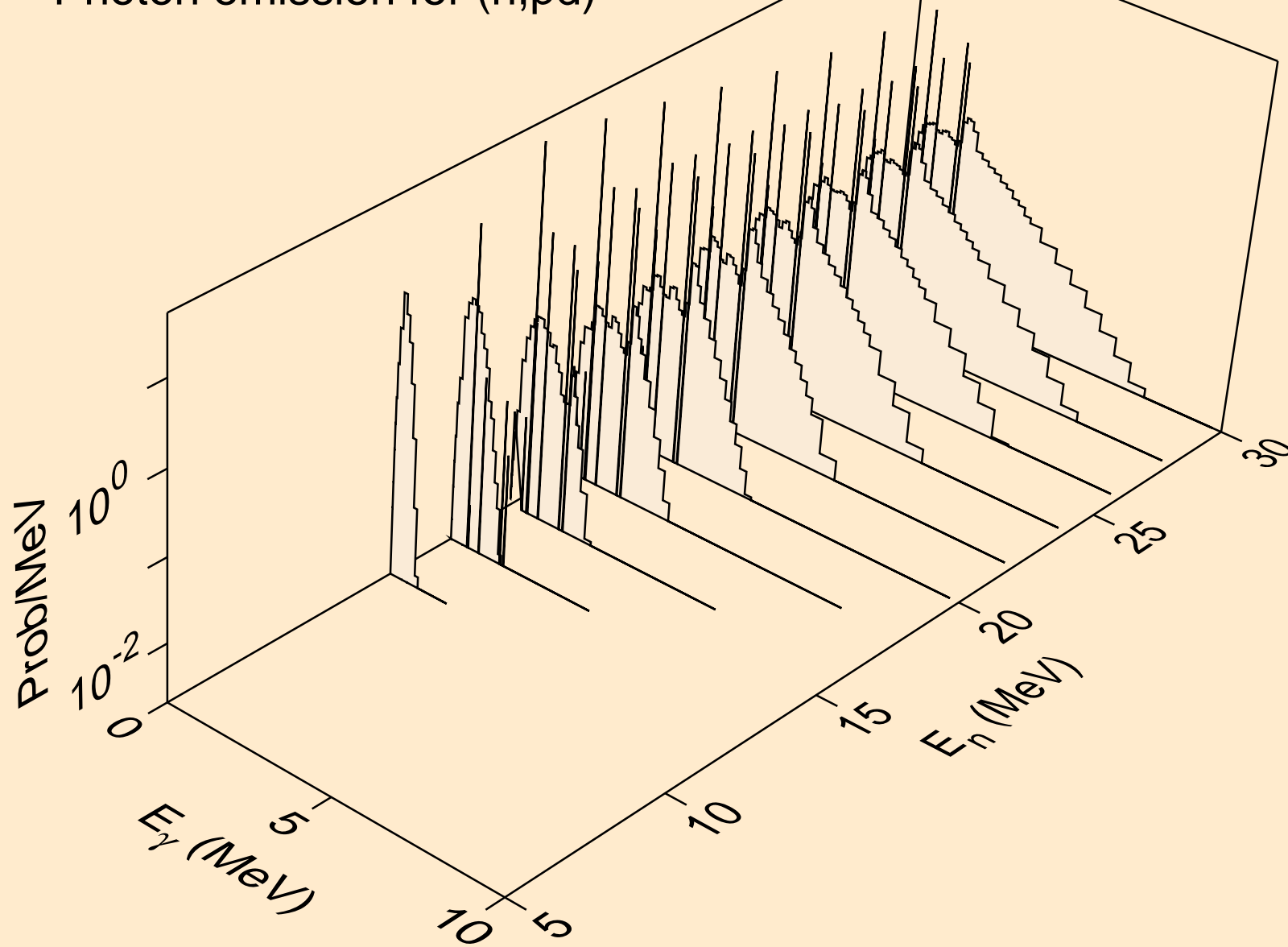

MO091M NEUTRON ACER TENDL-2021 LIBRARY; T=293.6K
Photon emission for (n,pt)

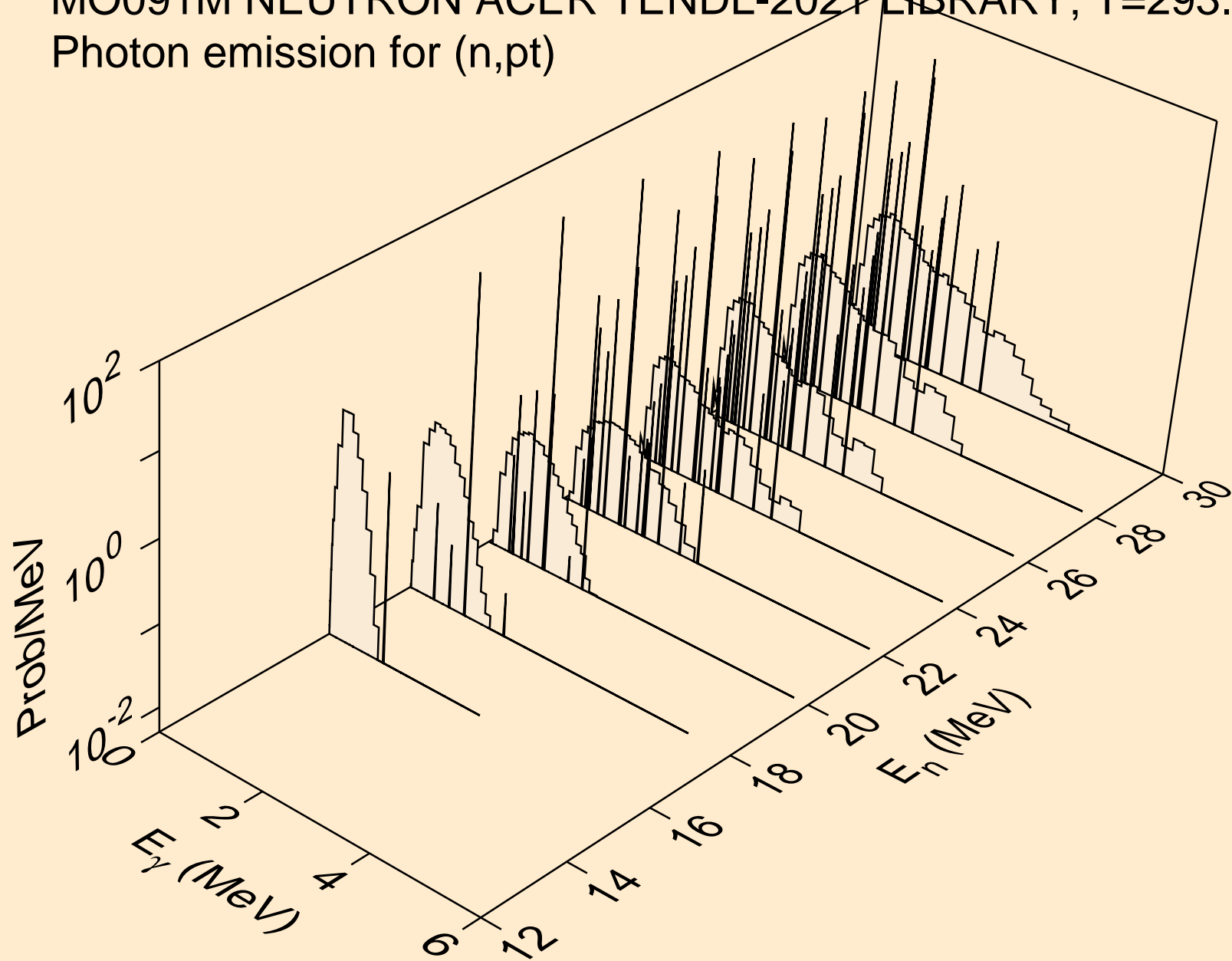

MO091M NEUTRON ACER TENDL-2021 LIBRARY; T=293.6K
Photon emission for (n,da)

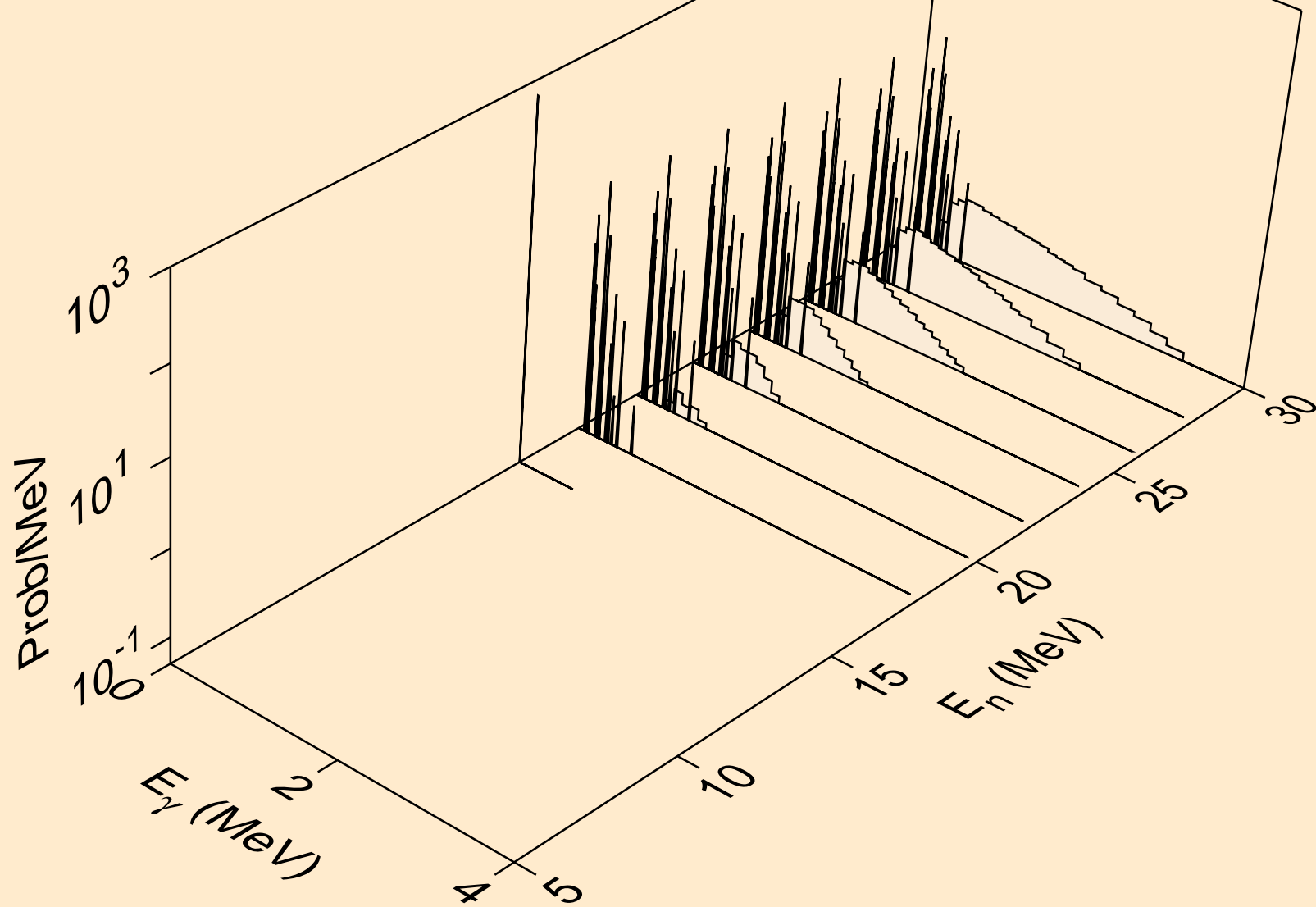

MO091M NEUTRON ACER TENDL-2021 LIBRARY; T=293.6K
thermal capture photon spectrum

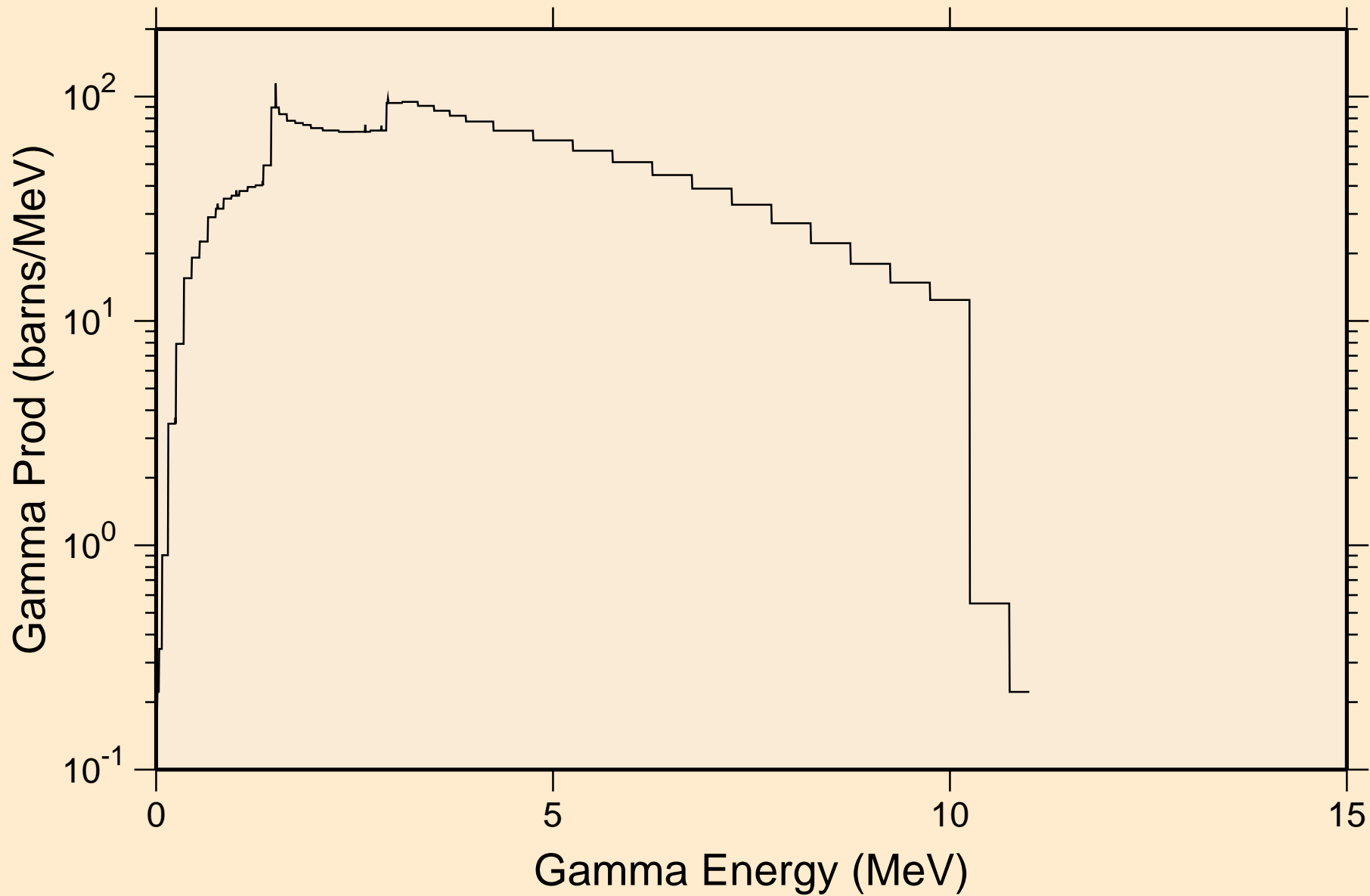

MO091M NEUTRON ACER TENDL-2021 LIBRARY; T=293.6K
14 MeV photon spectrum

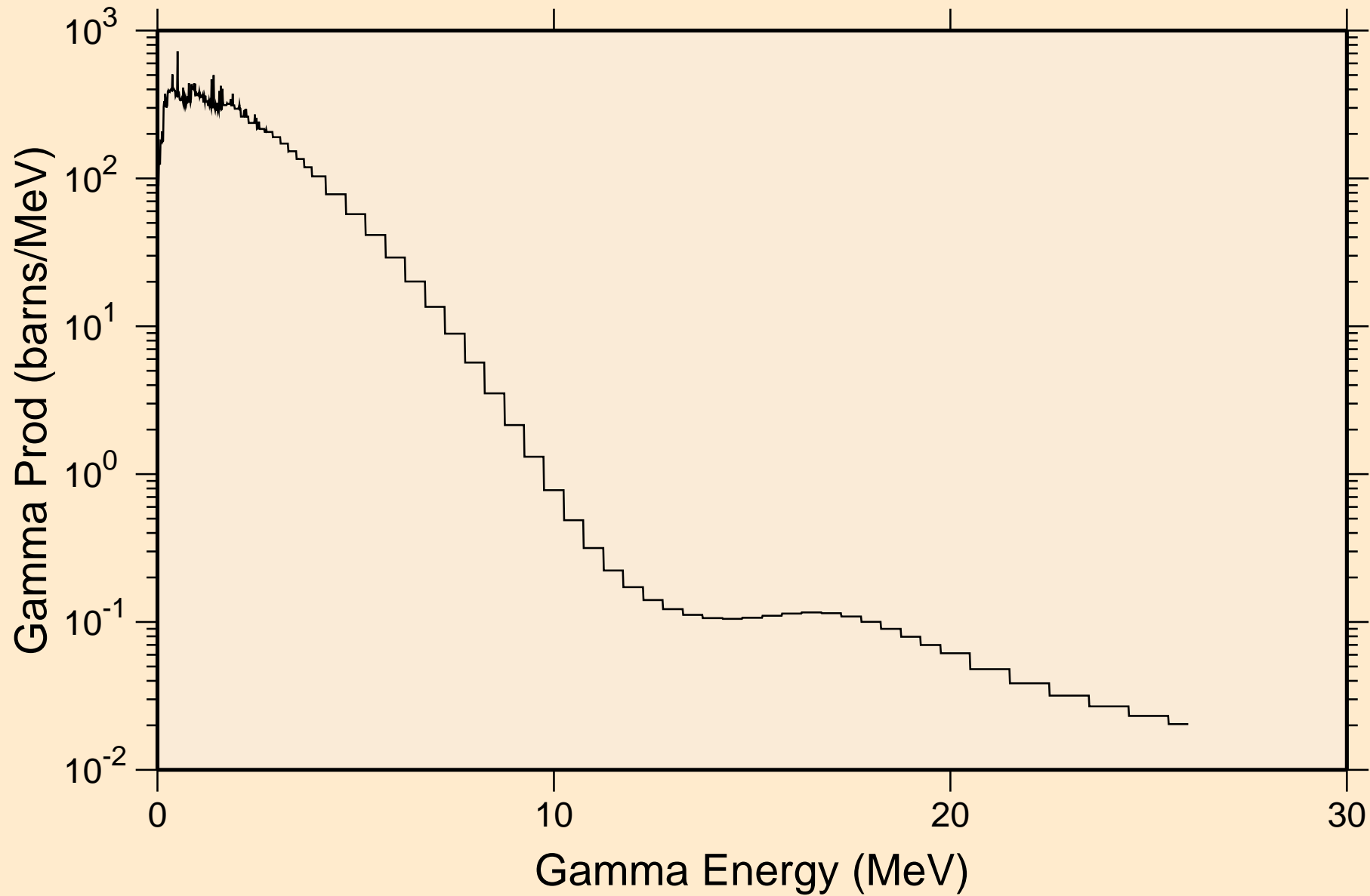

MO091M NEUTRON ACER TENDL-2021 LIBRARY; T=293.6K
Particle heating contributions

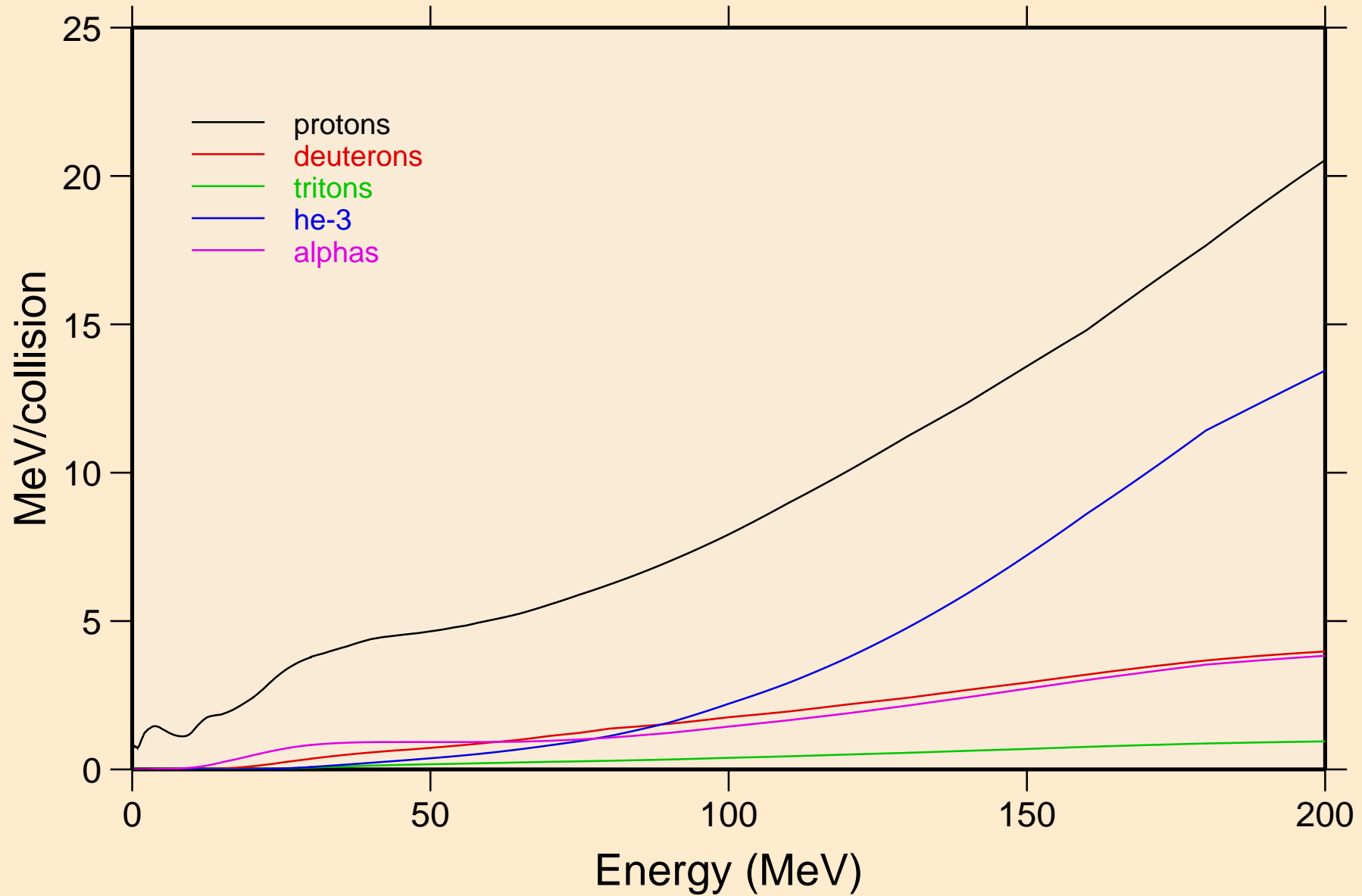

MO091M NEUTRON ACER TENDL-2021 LIBRARY; T=293.6K
Recoil Heating

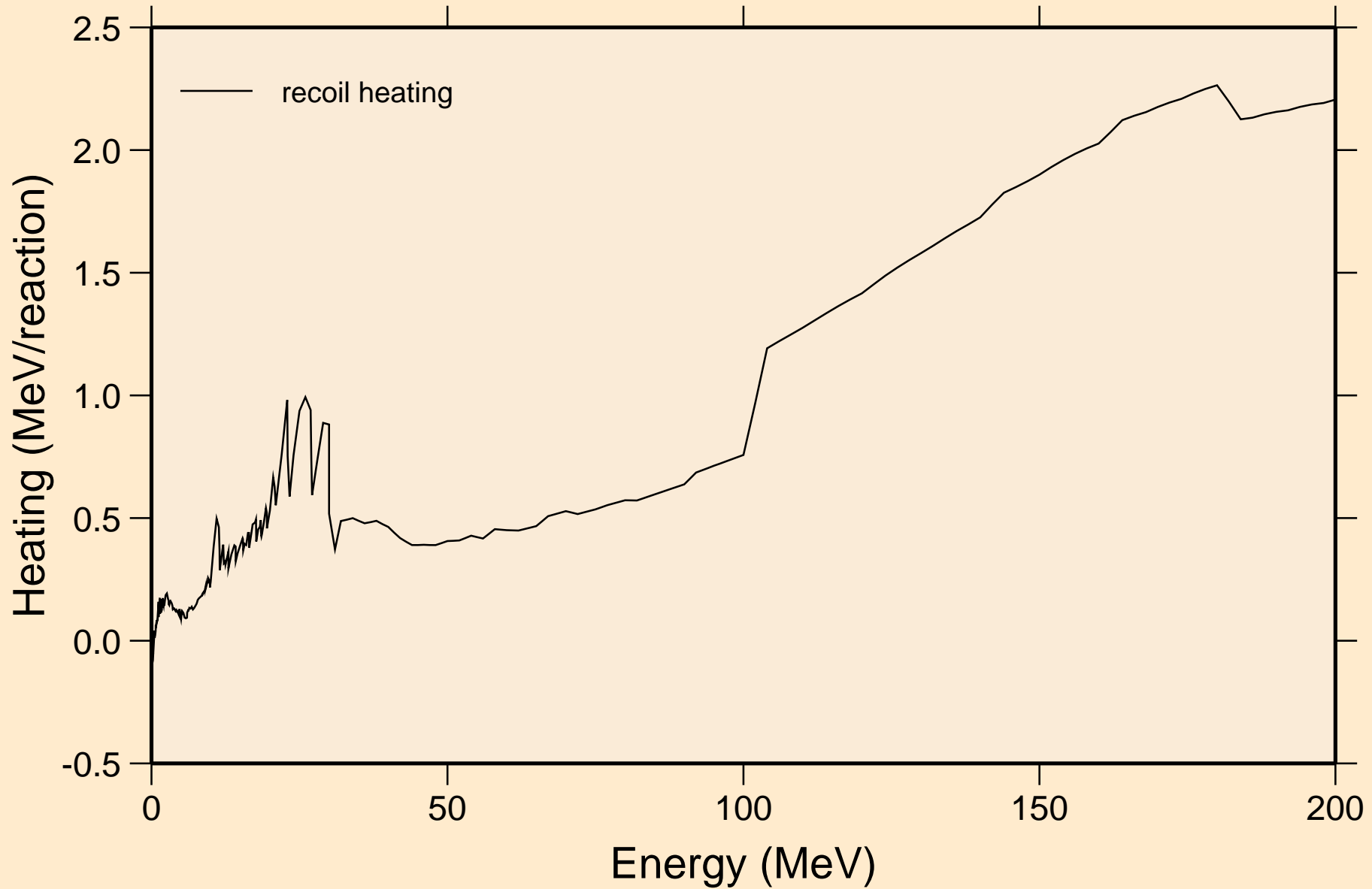

MO091M NEUTRON ACER TENDL-2021 LIBRARY; T=293.6K
Particle production cross sections

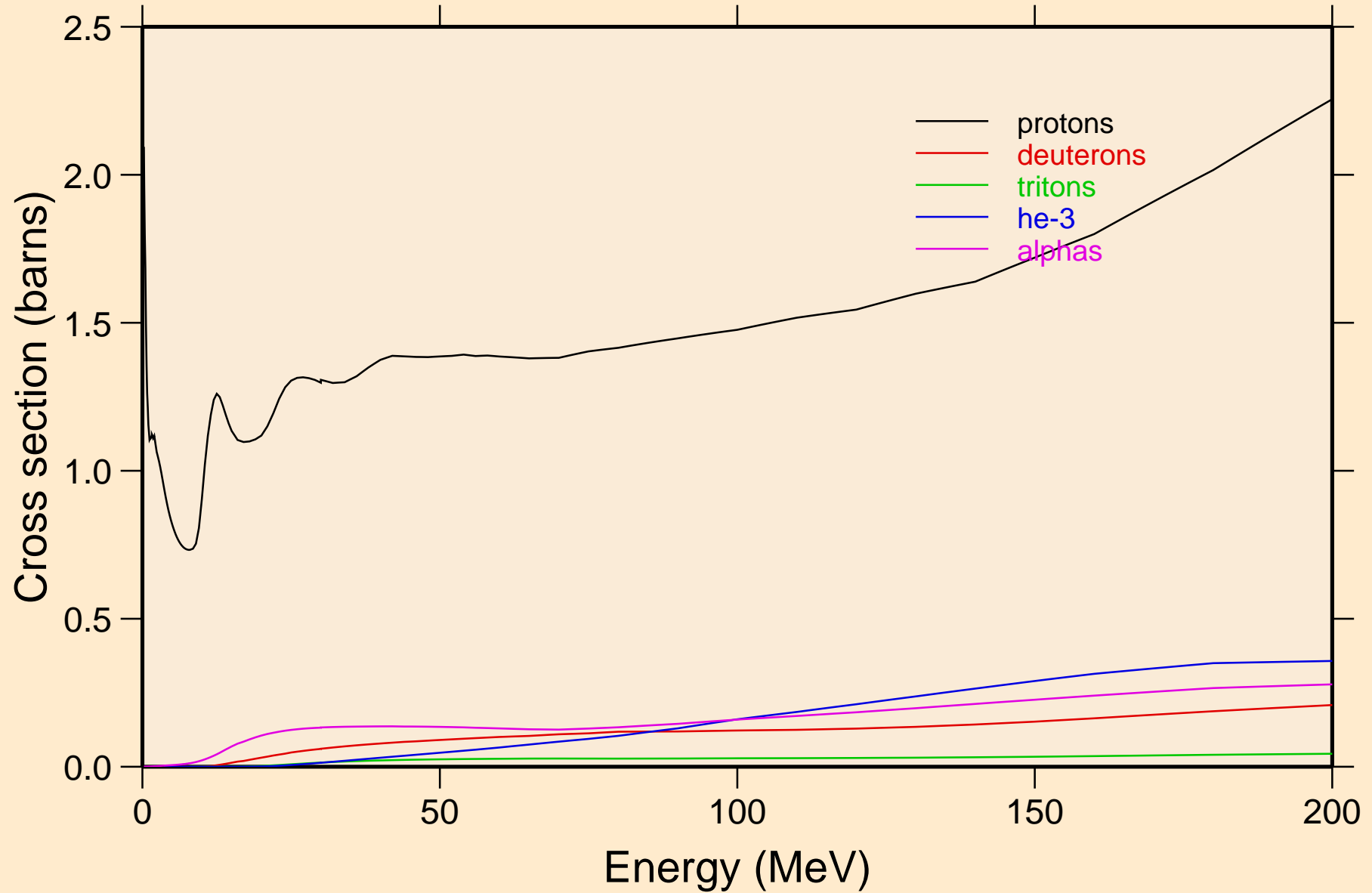

MO091M NEUTRON ACER TENDL-2021 LIBRARY; T=293.6K
protons from (n,x)

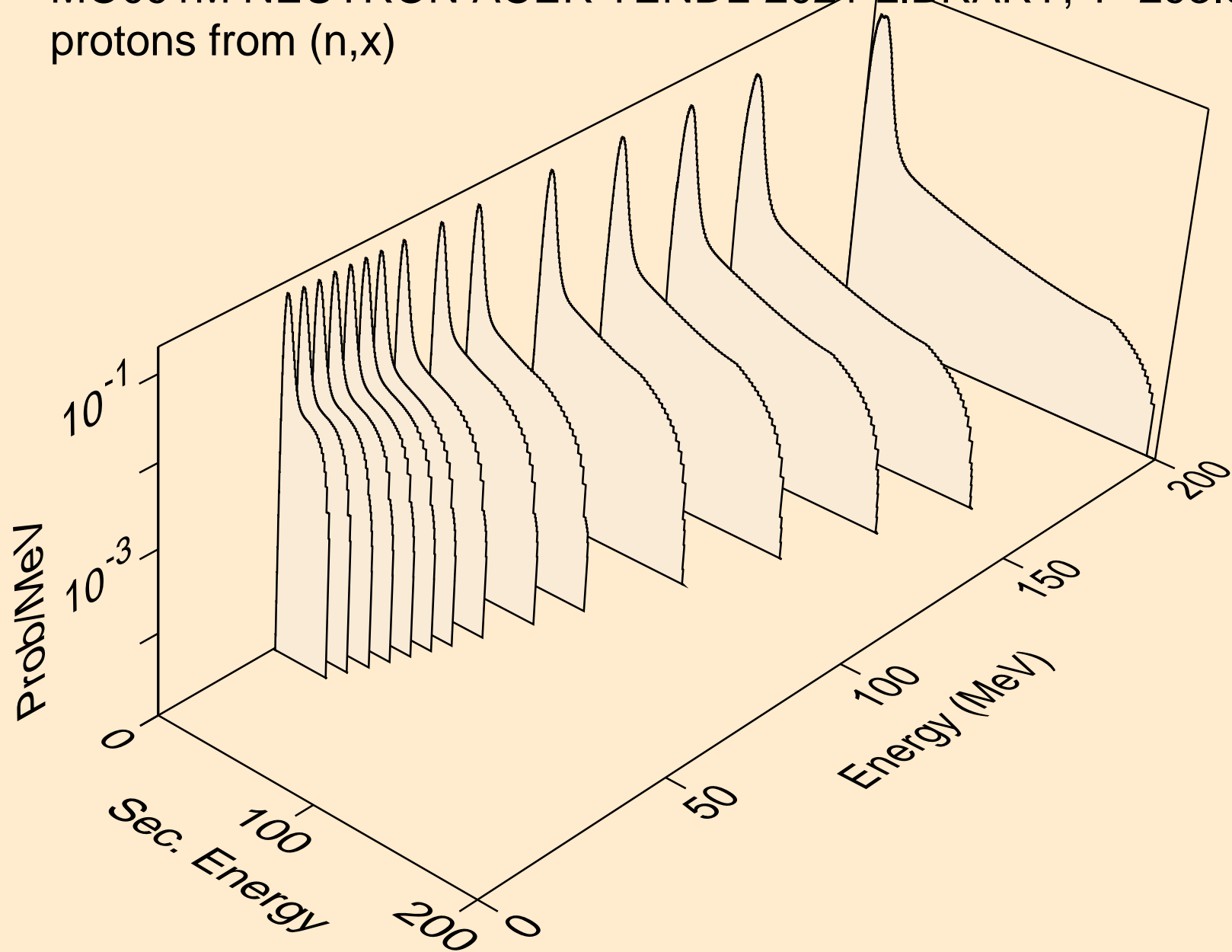

MO091M NEUTRON ACER TENDL-2021 LIBRARY; T=293.6K
protons from (n,n*)p

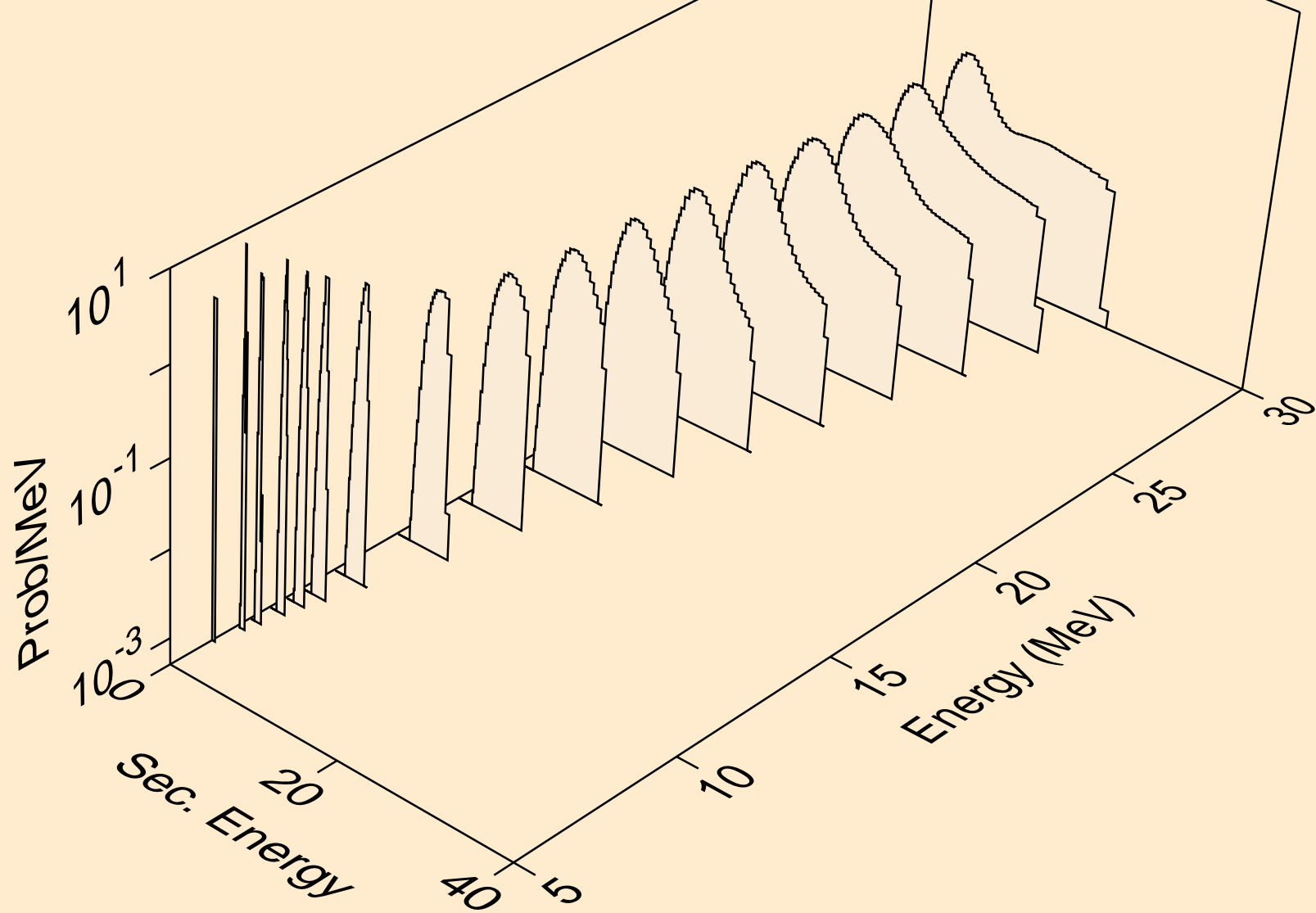

MO091M NEUTRON ACER TENDL-2021 LIBRARY; T=293.6K
protons from (n,2np)

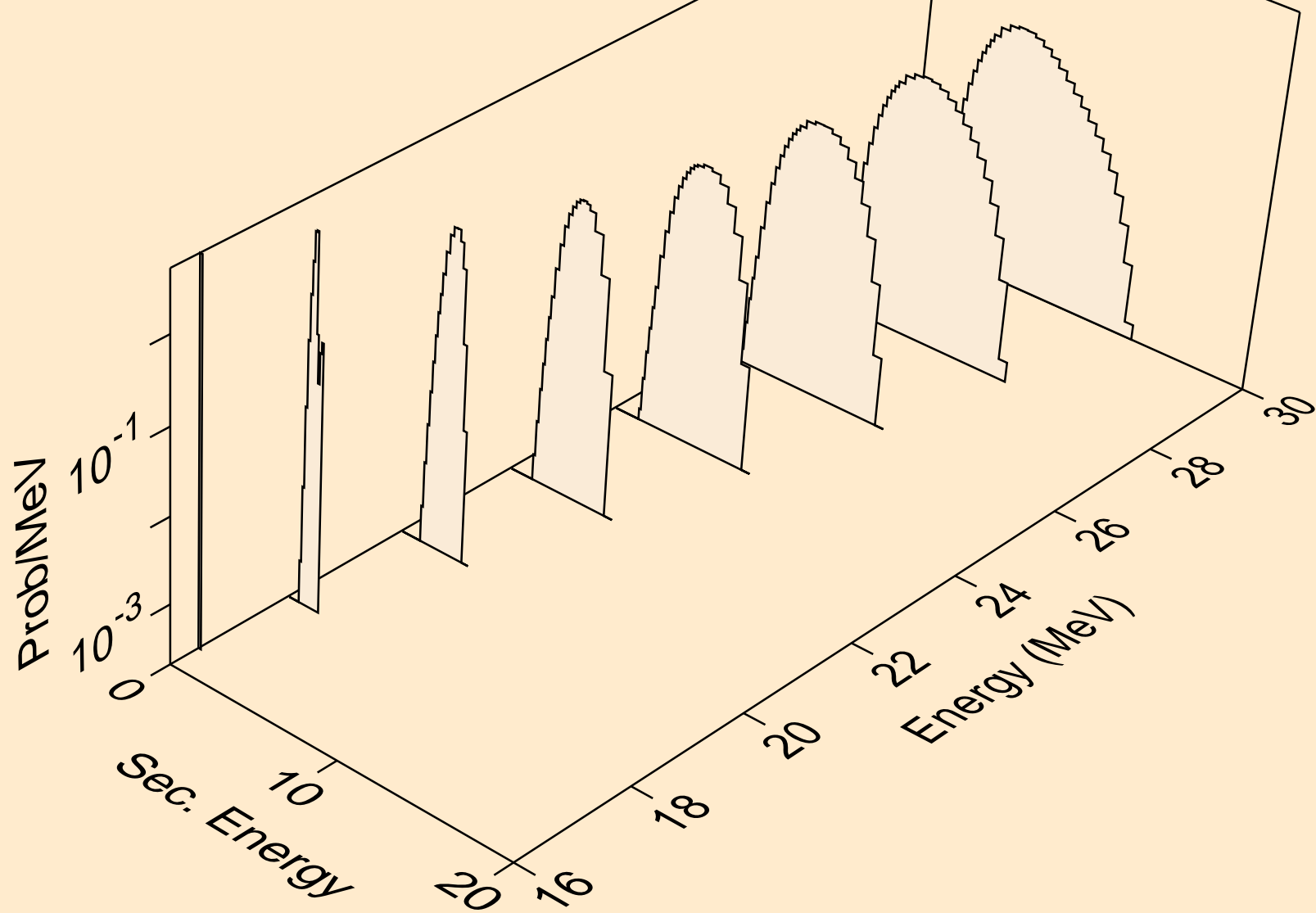

MO091M NEUTRON ACER TENDL-2021 LIBRARY; T=293.6K
protons from (n,2np)

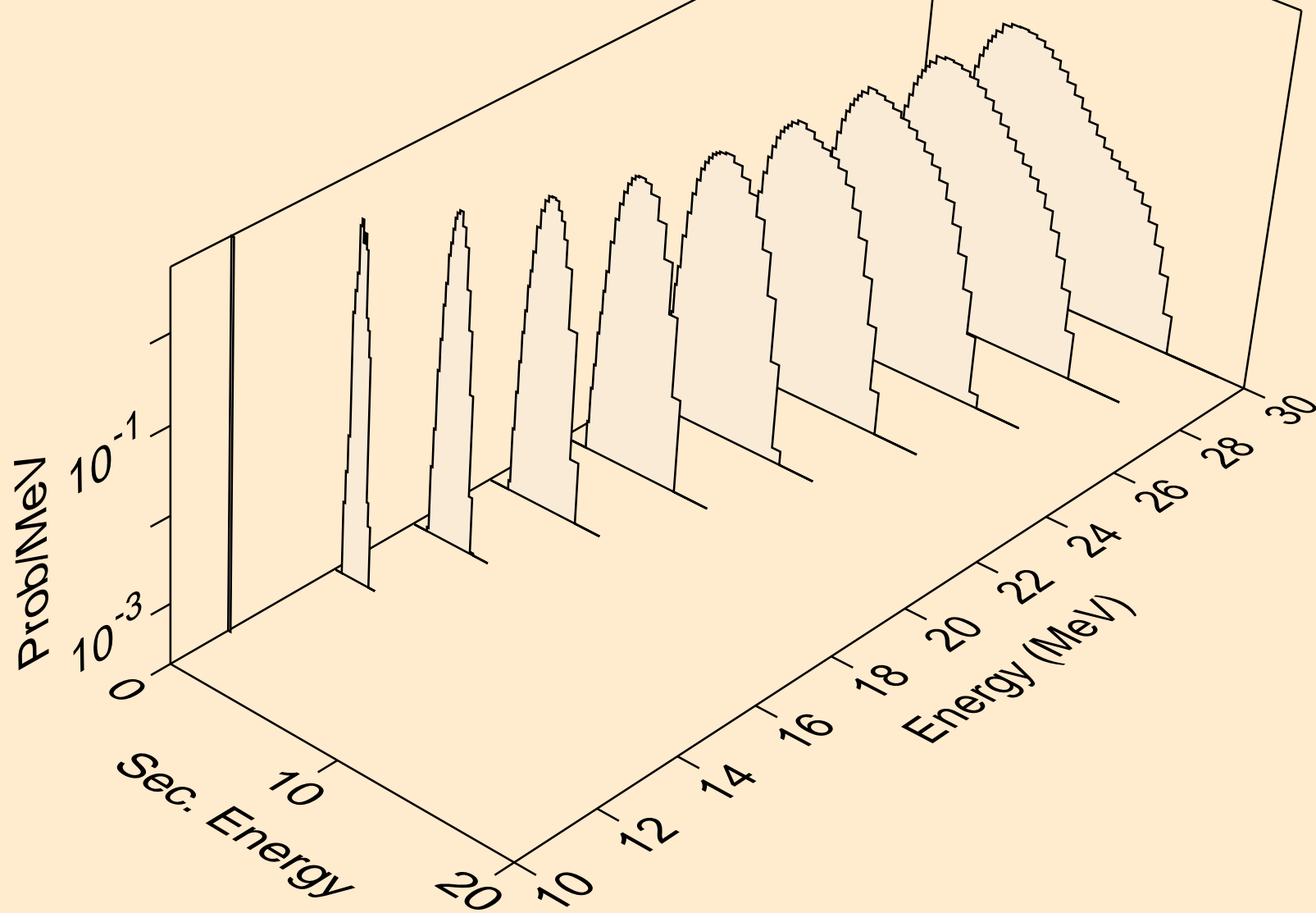

MO091M NEUTRON ACER TENDL-2021 LIBRARY; T=293.6K
protons from (n,npa)

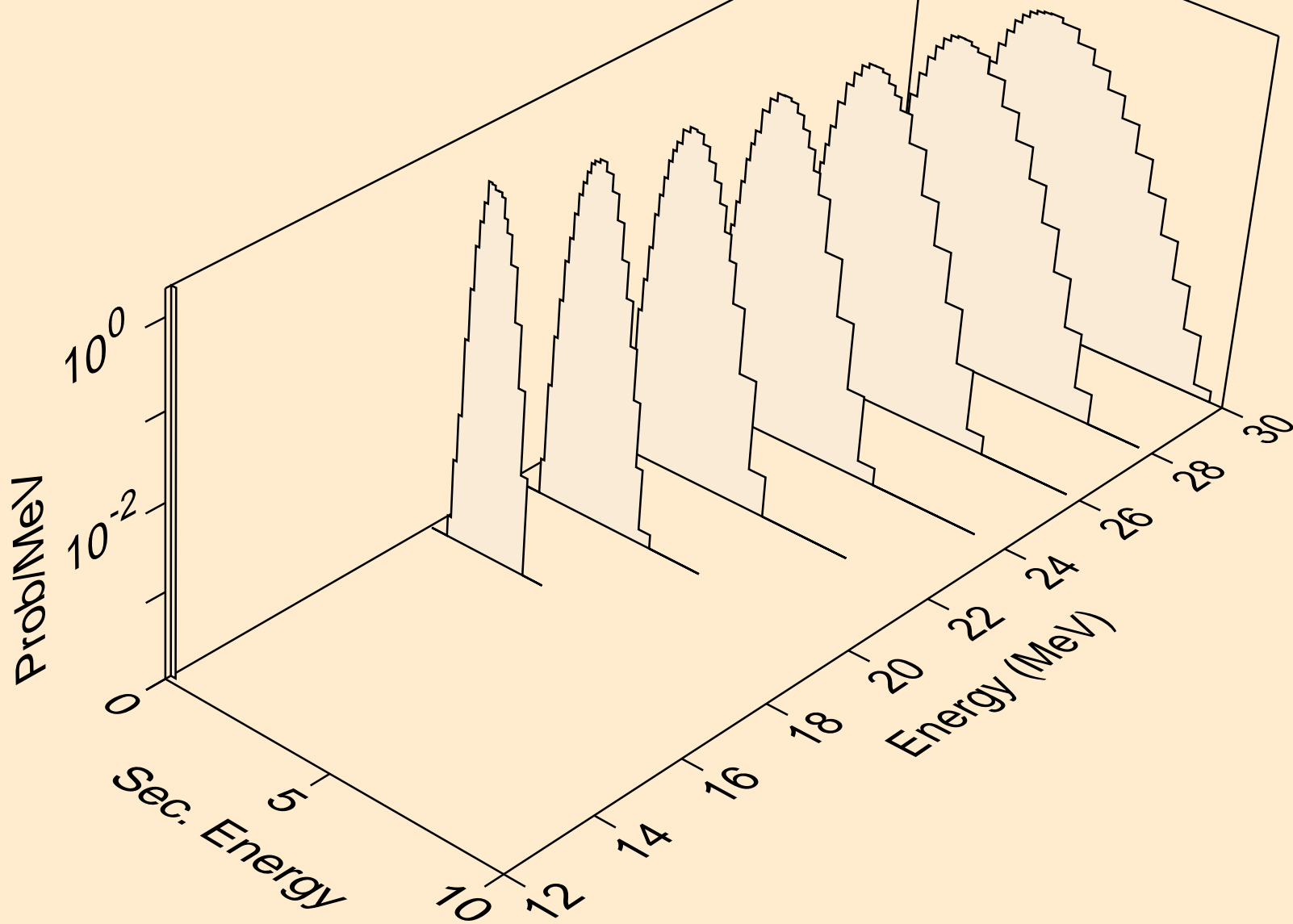

MO091M NEUTRON ACER TENDL-2021 LIBRARY; T=293.6K
protons from (n,p)

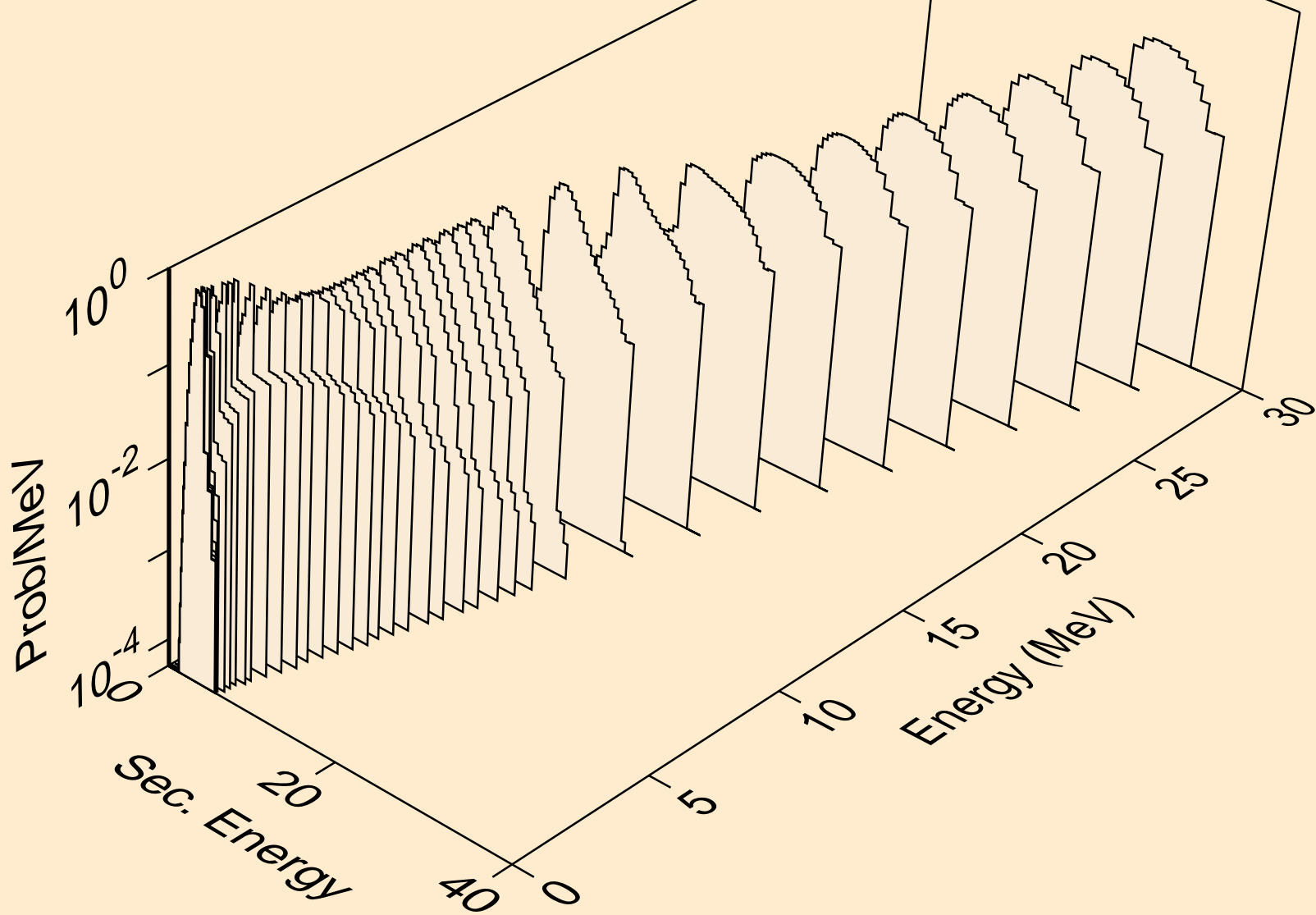

MO091M NEUTRON ACER TENDL-2021 LIBRARY; T=293.6K
protons from (n,2p)

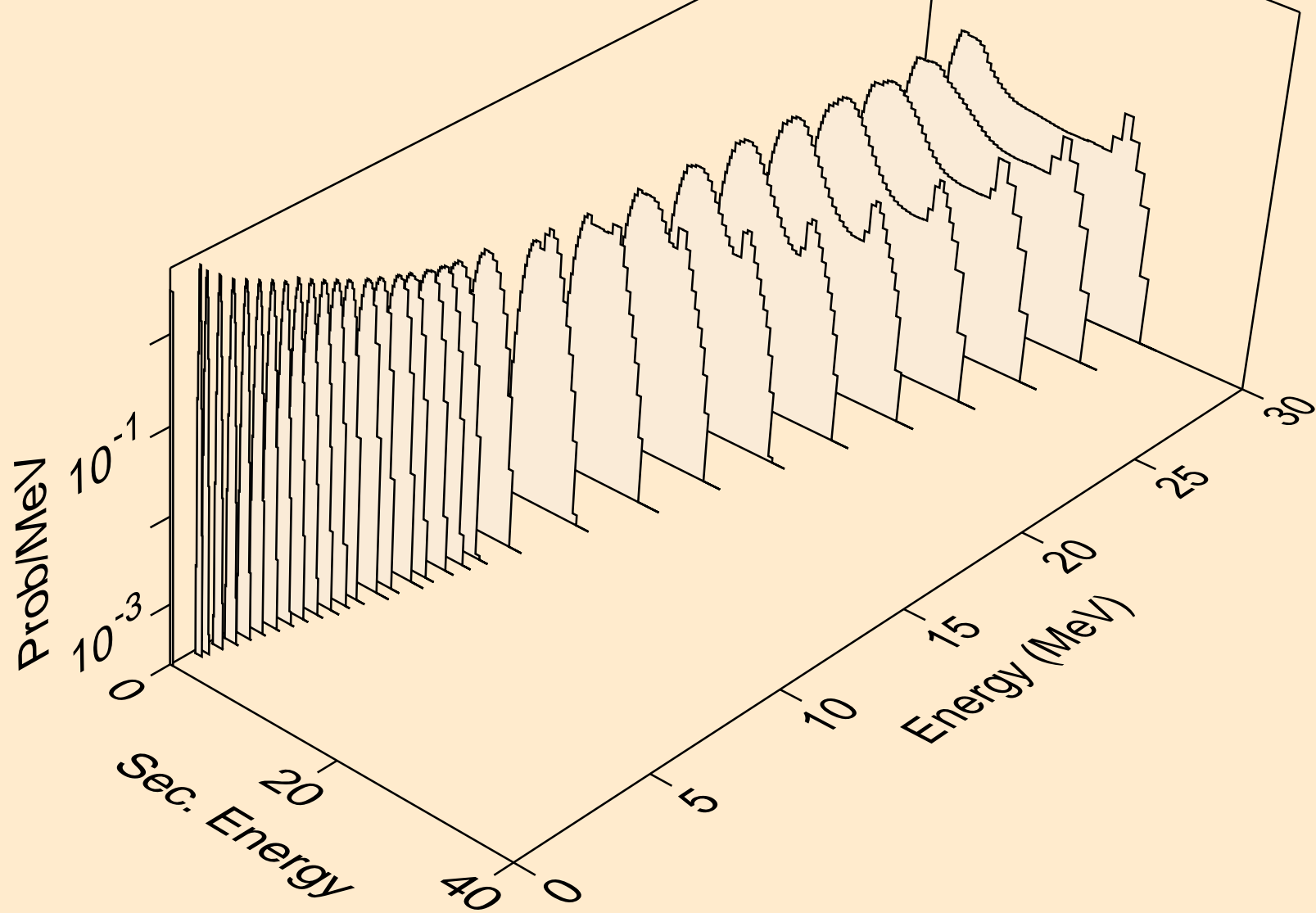

MO091M NEUTRON ACER TENDL-2021 LIBRARY; T=293.6K
protons from (n,p)

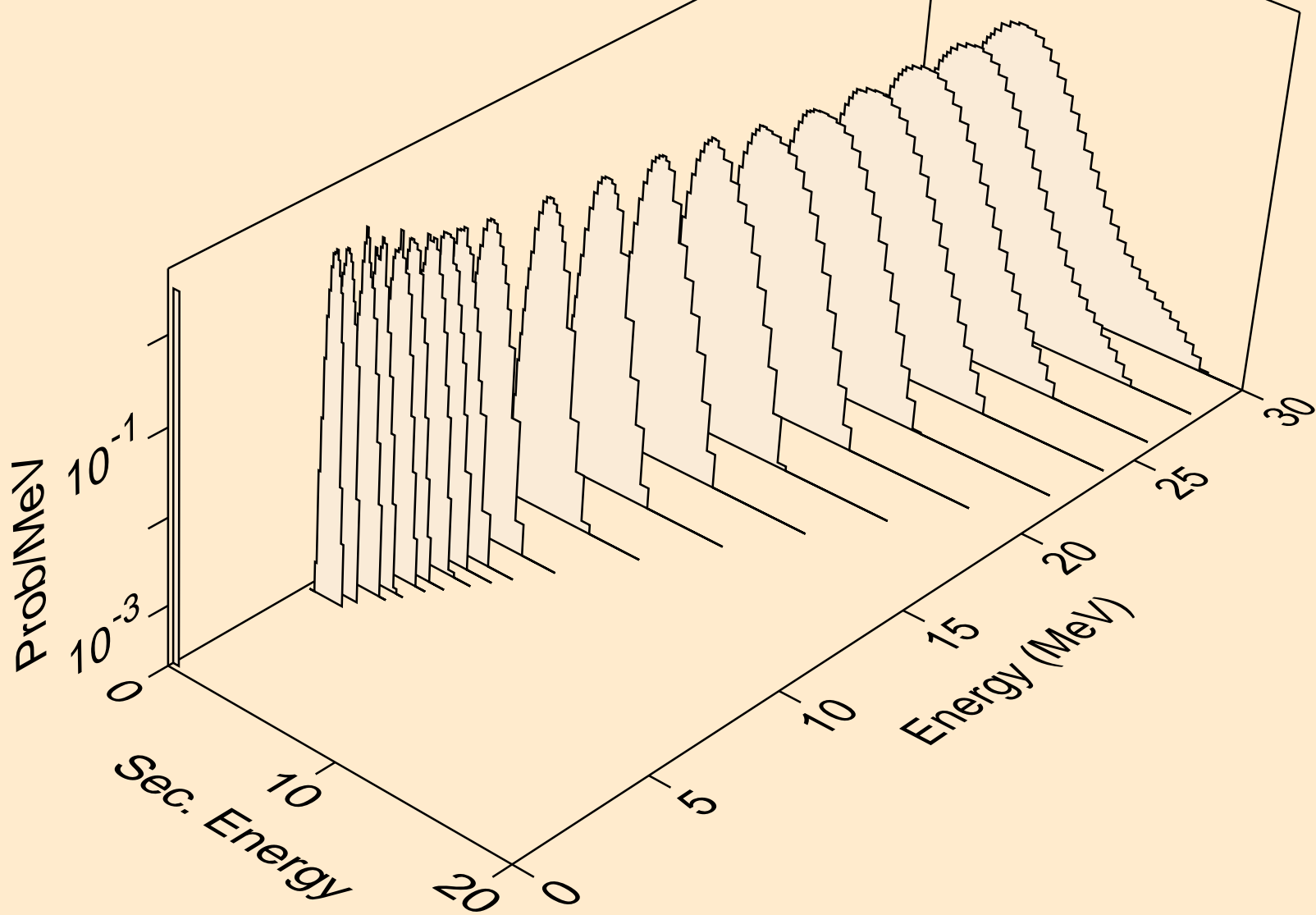

MO091M NEUTRON ACER TENDL-2021 LIBRARY; T=293.6K
protons from (n,pd)

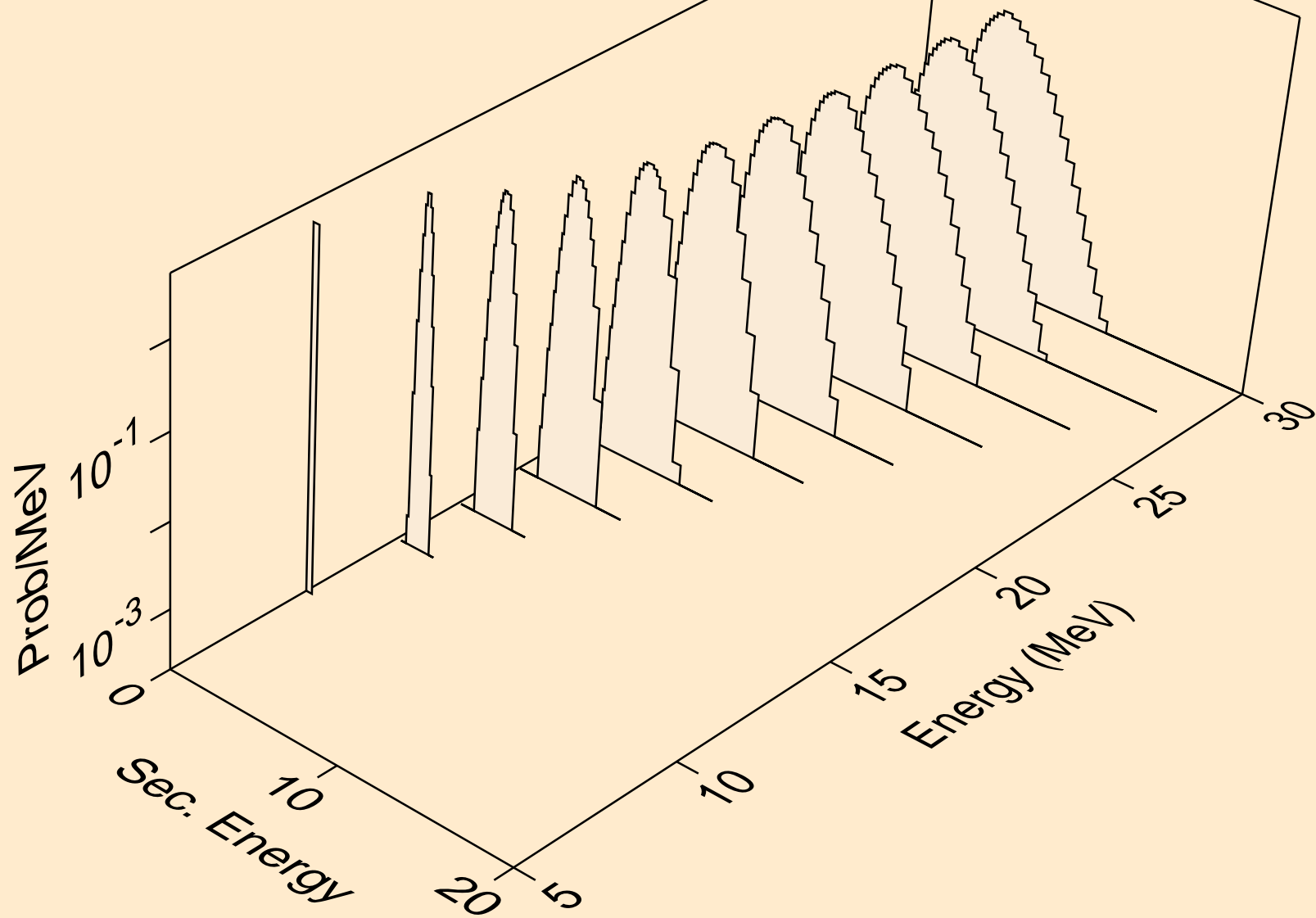

MO091M NEUTRON ACER TENDL-2021 LIBRARY; T=293.6K
protons from (n,pt)

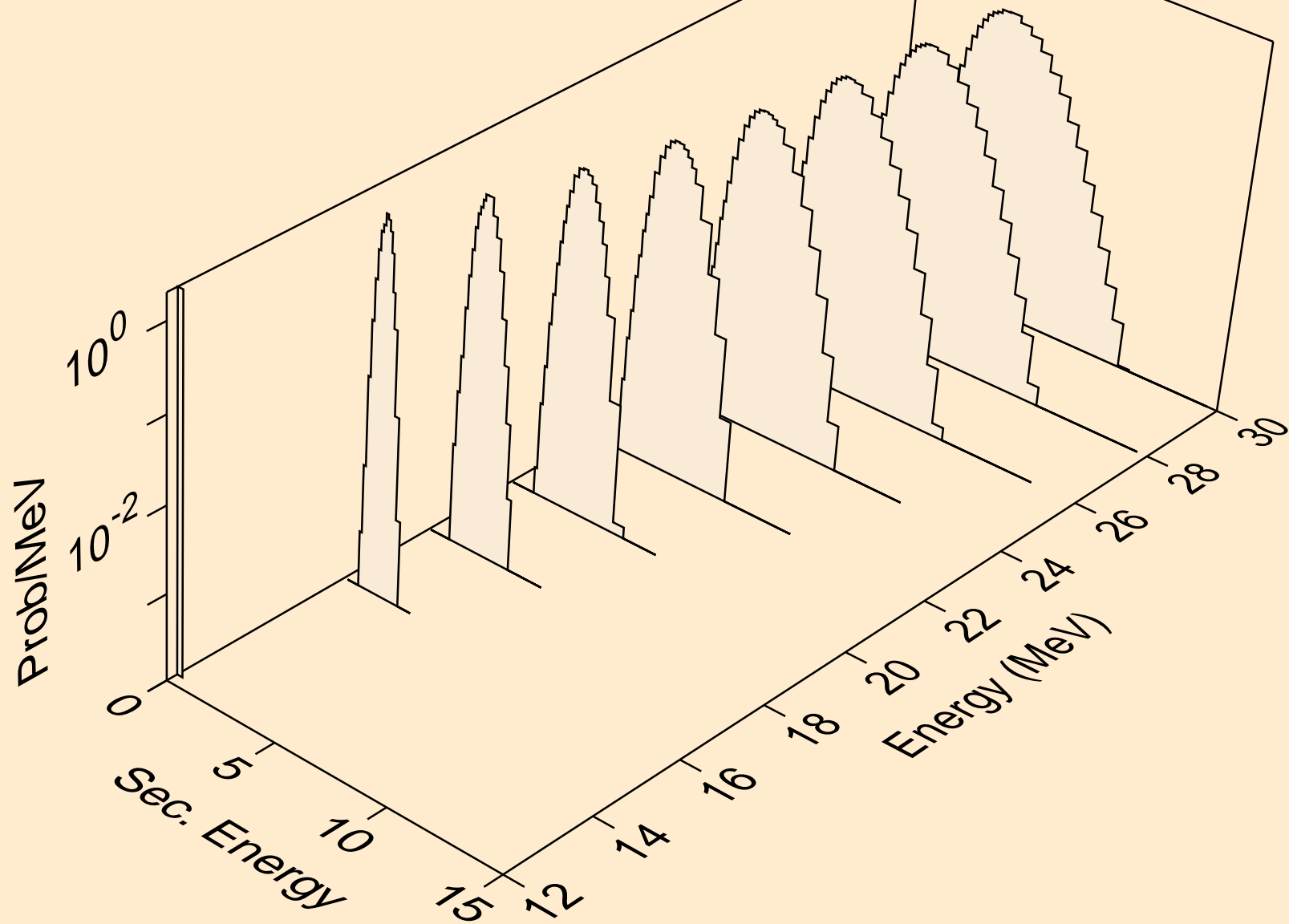

MO091M NEUTRON ACER TENDL-2021 LIBRARY; T=293.6K
deuterons from (n,x)

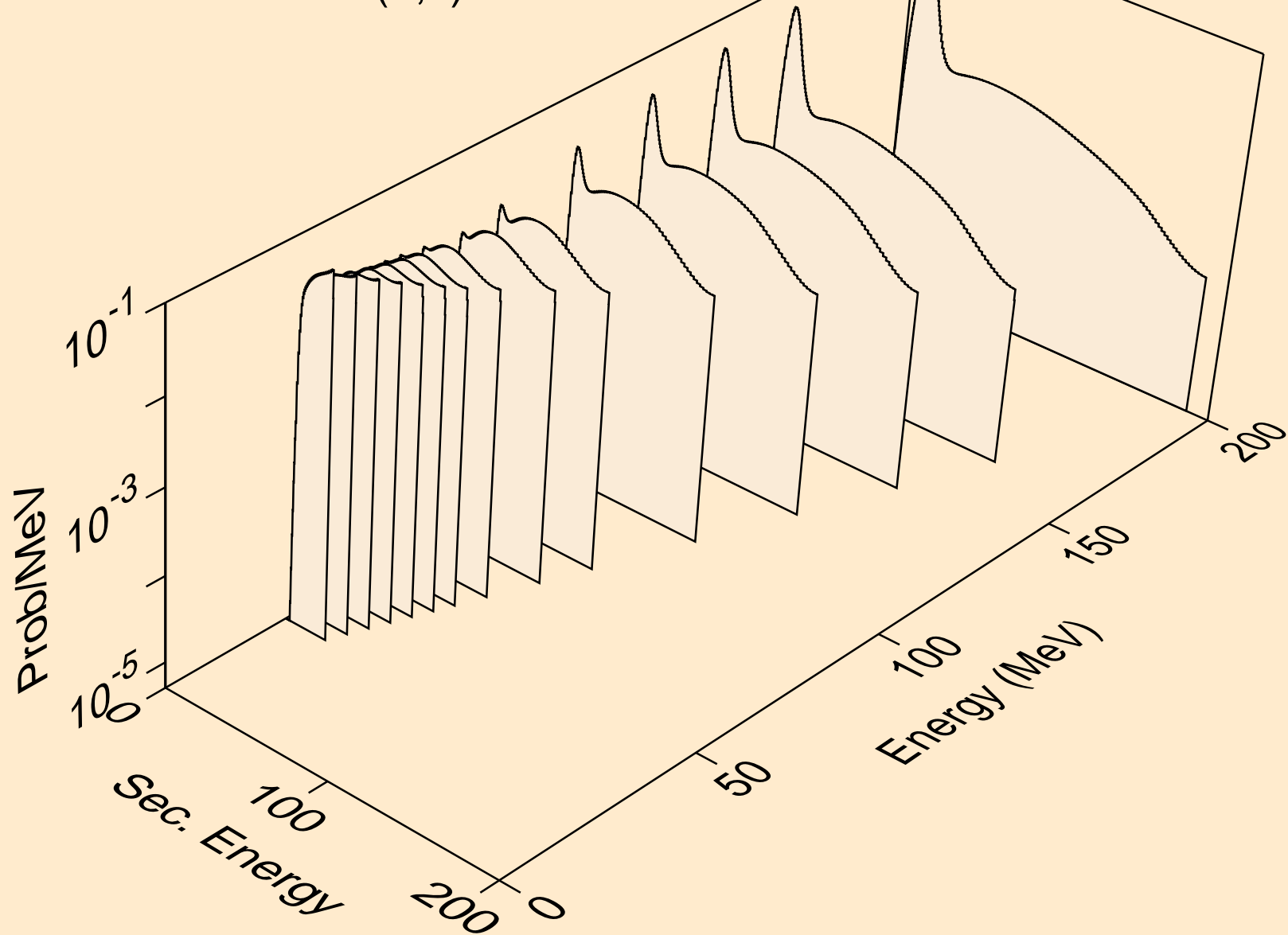

MO091M NEUTRON ACER TENDL-2021 LIBRARY; T=293.6K
deuterons from (n,2nd)

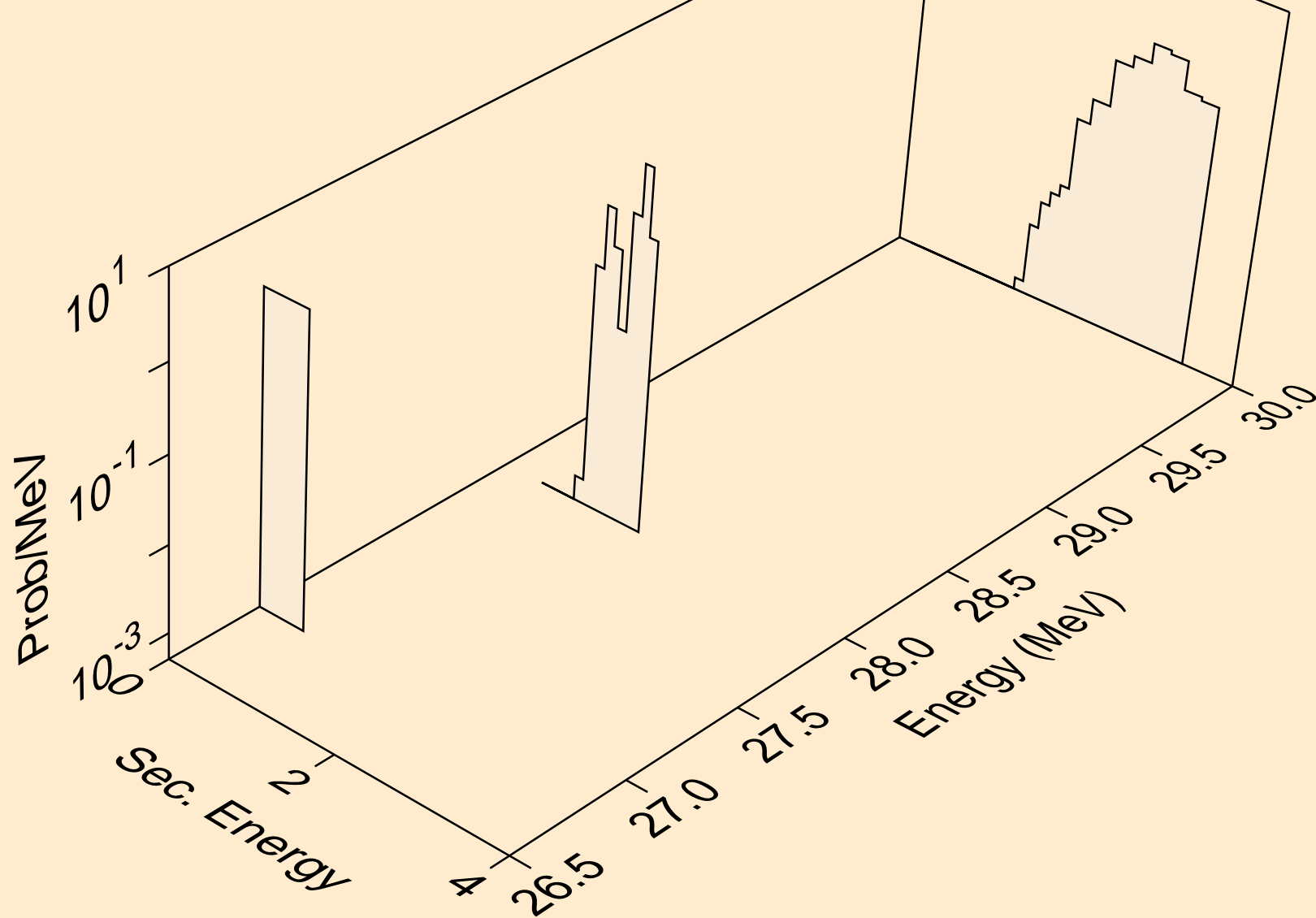

MO091M NEUTRON ACER TENDL-2021 LIBRARY; T=293.6K
deuterons from (n,n*)d

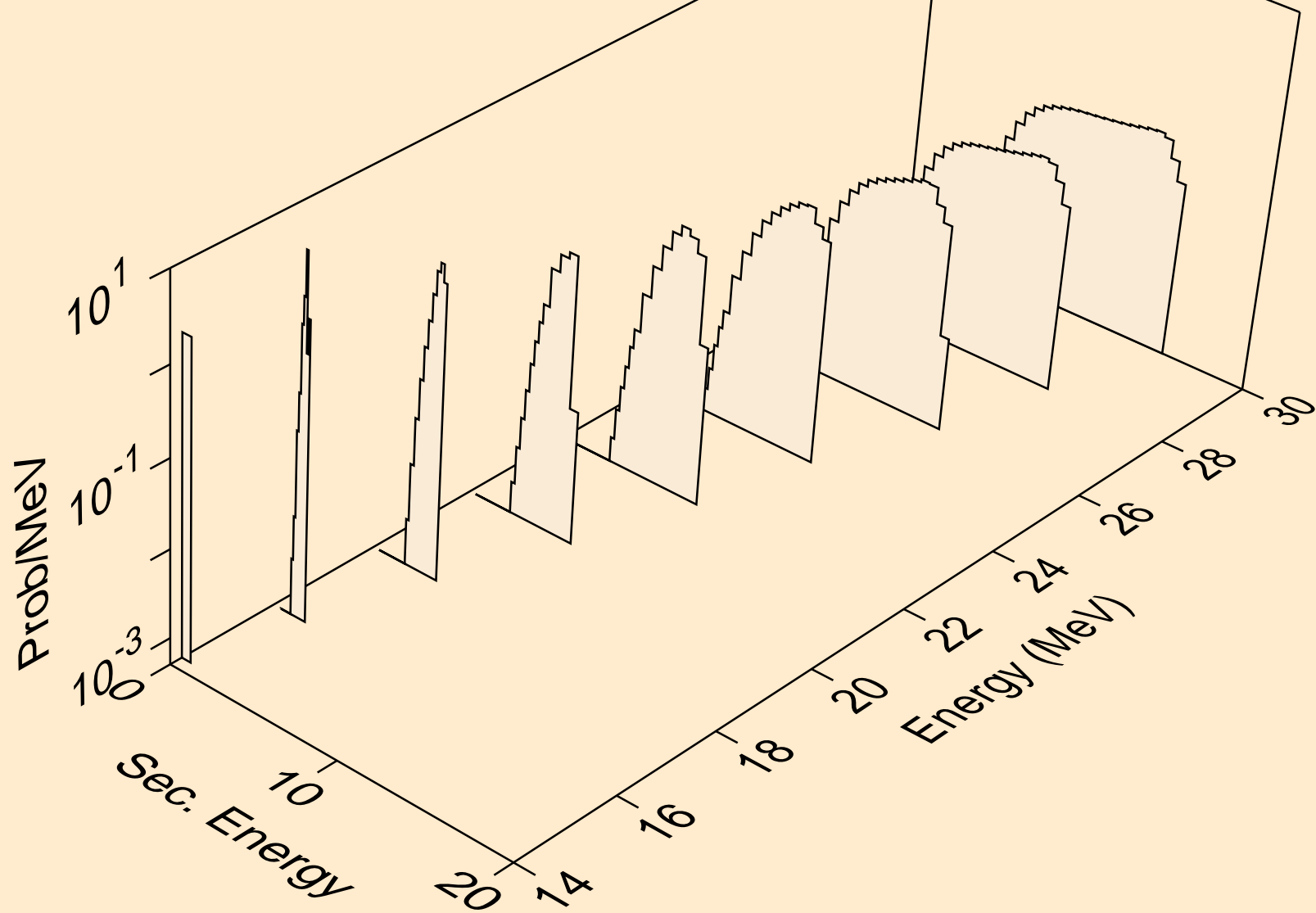

MO091M NEUTRON ACER TENDL-2021 LIBRARY; T=293.6K
deuterons from (n,d)

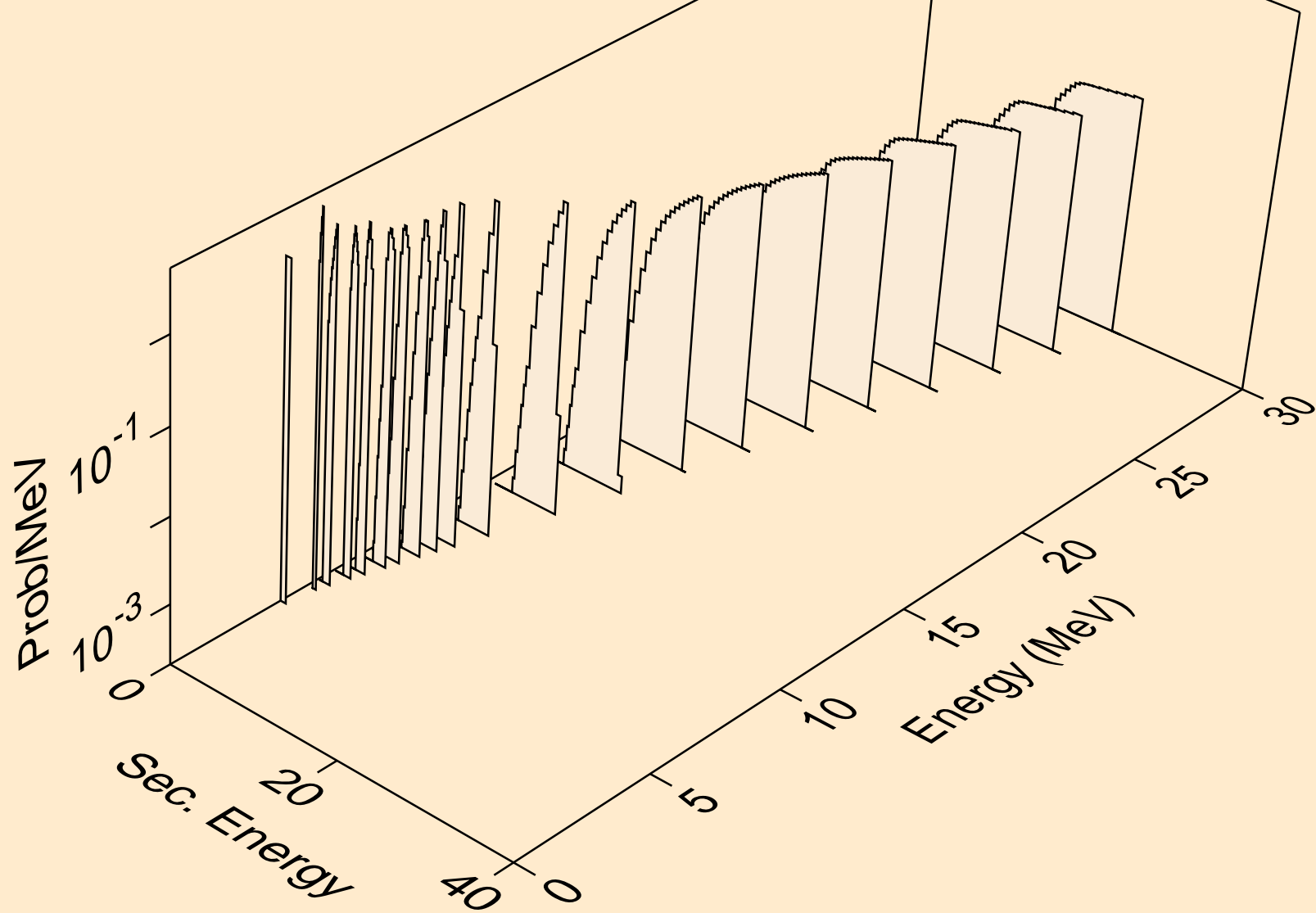

MO091M NEUTRON ACER TENDL-2021 LIBRARY; T=293.6K
deuterons from (n,pd)

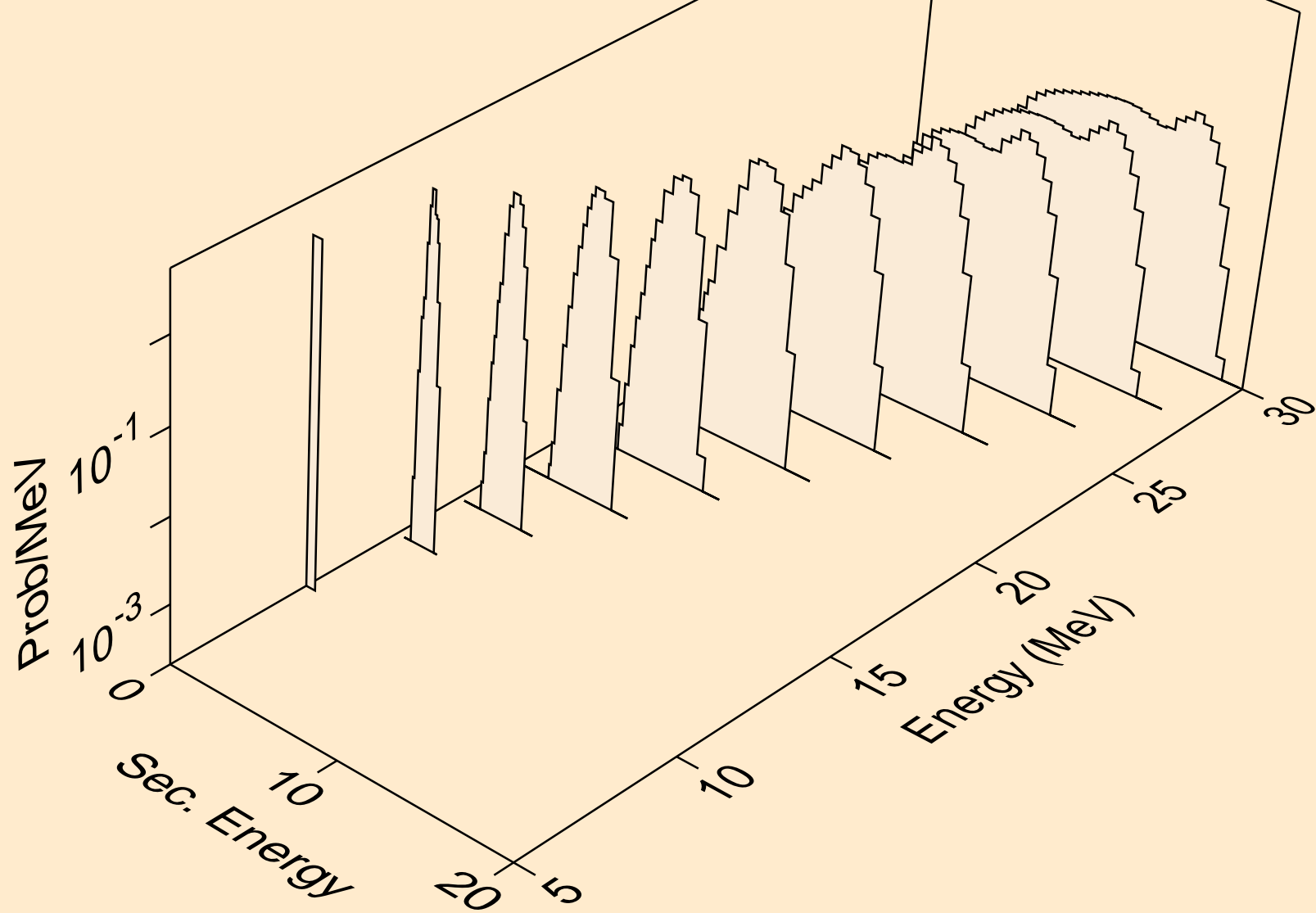

MO091M NEUTRON ACER TENDL-2021 LIBRARY; T=293.6K
deuterons from (n,da)

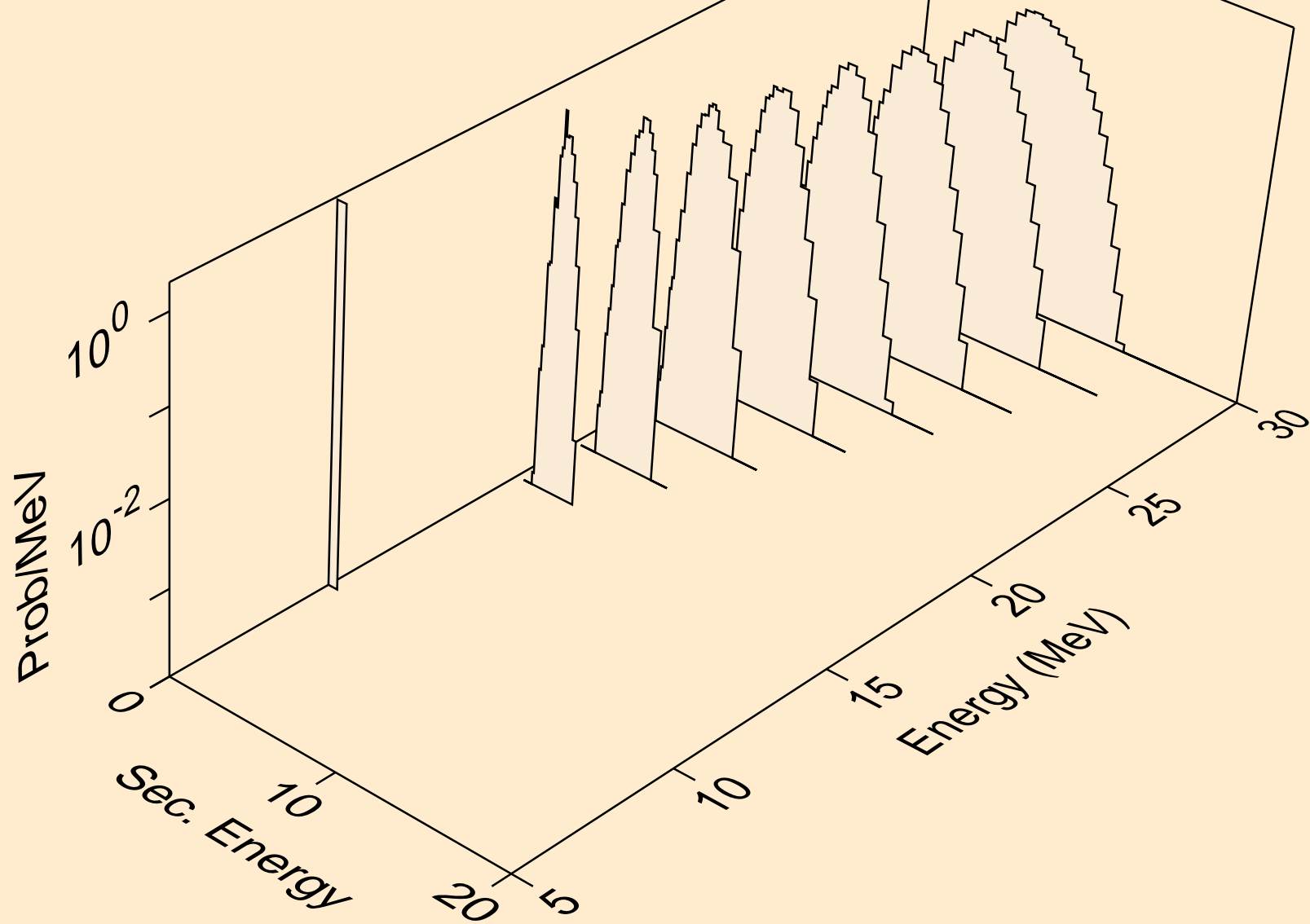

MO091M NEUTRON ACER TENDL-2021 LIBRARY; T=293.6K
tritons from (n,x)

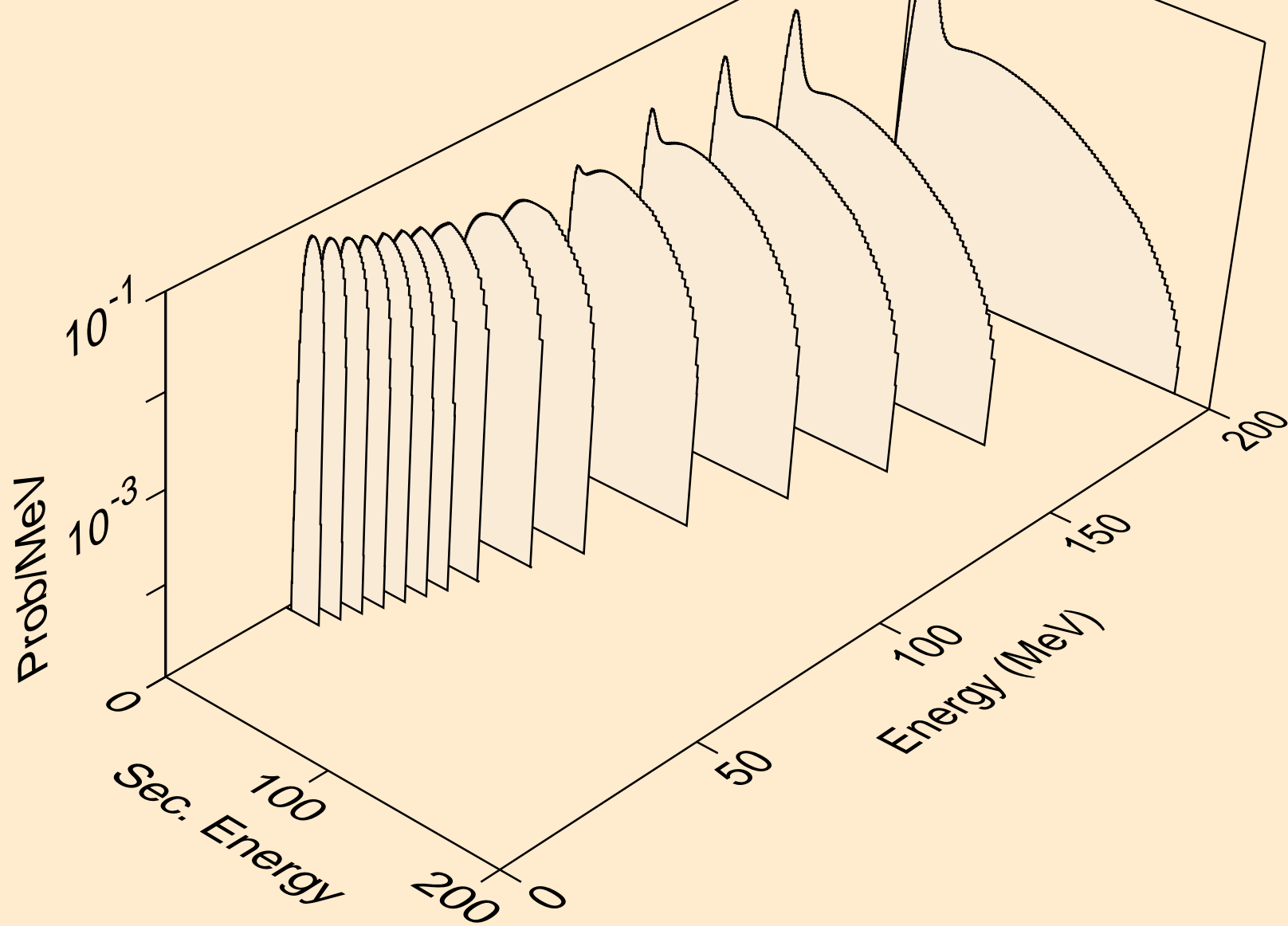

MO091M NEUTRON ACER TENDL-2021 LIBRARY; T=293.6K
tritons from (n,n*)t

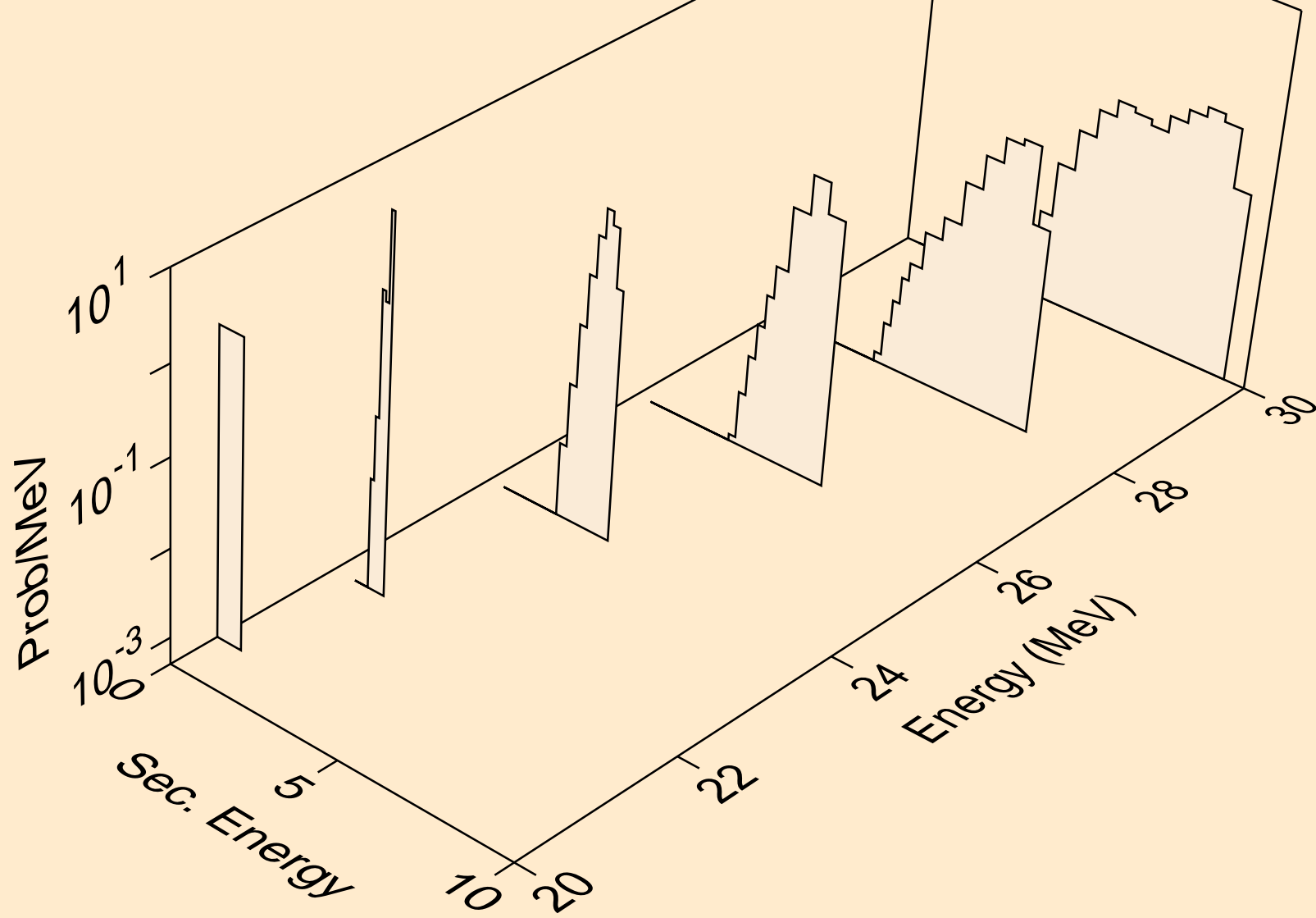

MO091M NEUTRON ACER TENDL-2021 LIBRARY; T=293.6K
tritons from (n,t)

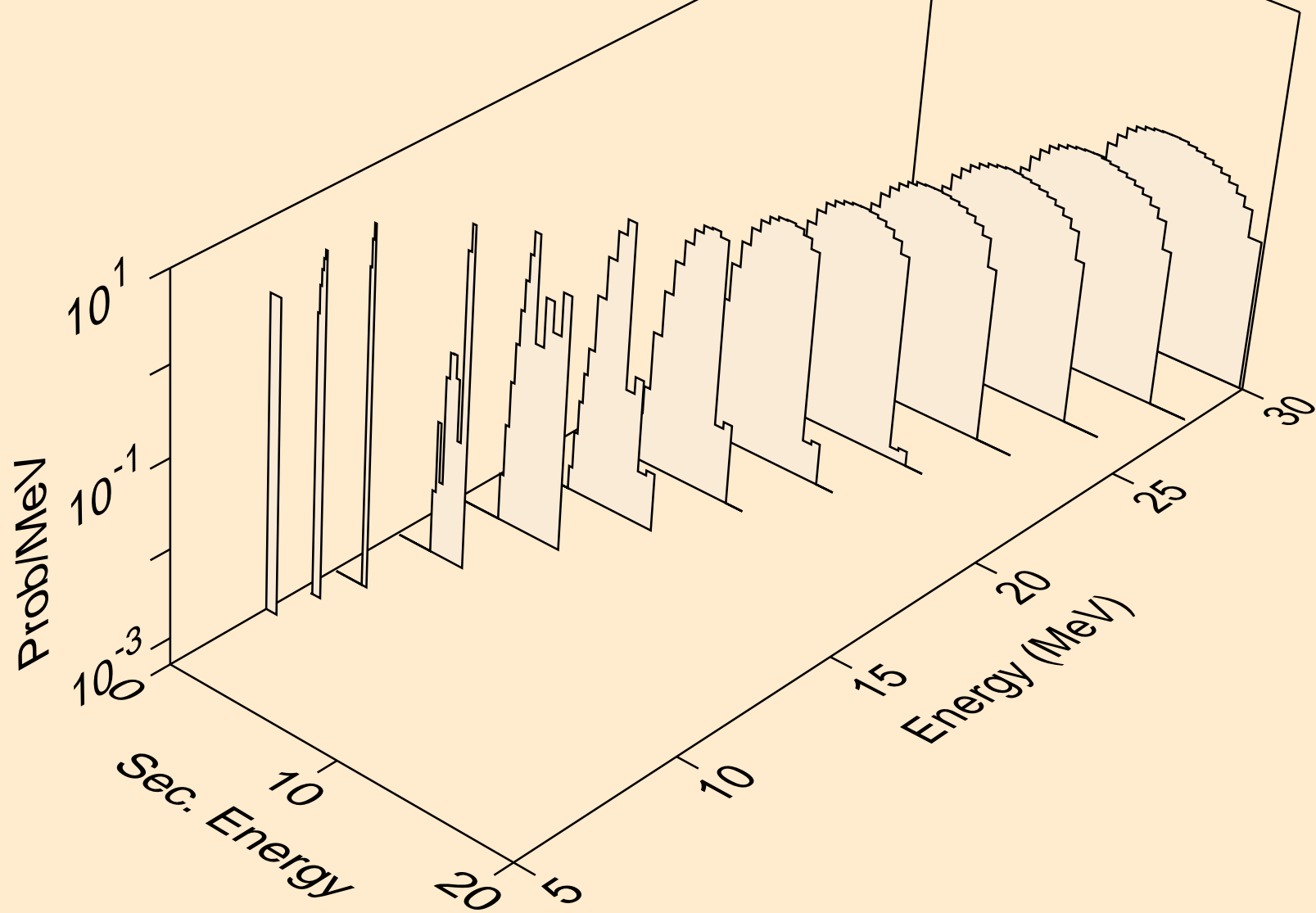

MO091M NEUTRON ACER TENDL-2021 LIBRARY; T=293.6K
tritons from (n,pt)

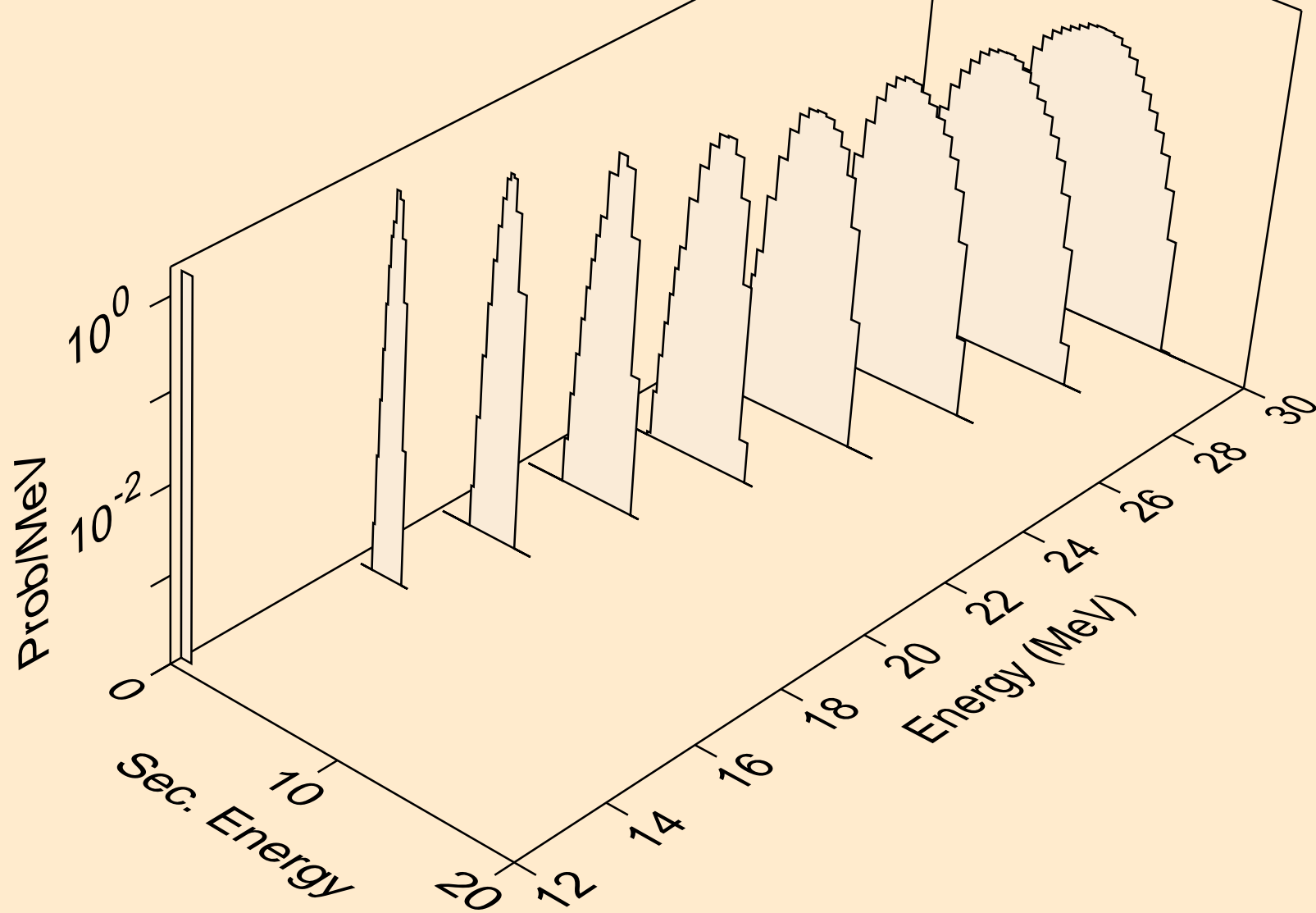

MO091M NEUTRON ACER TENDL-2021 LIBRARY; T=293.6K
he3s from (n,x)

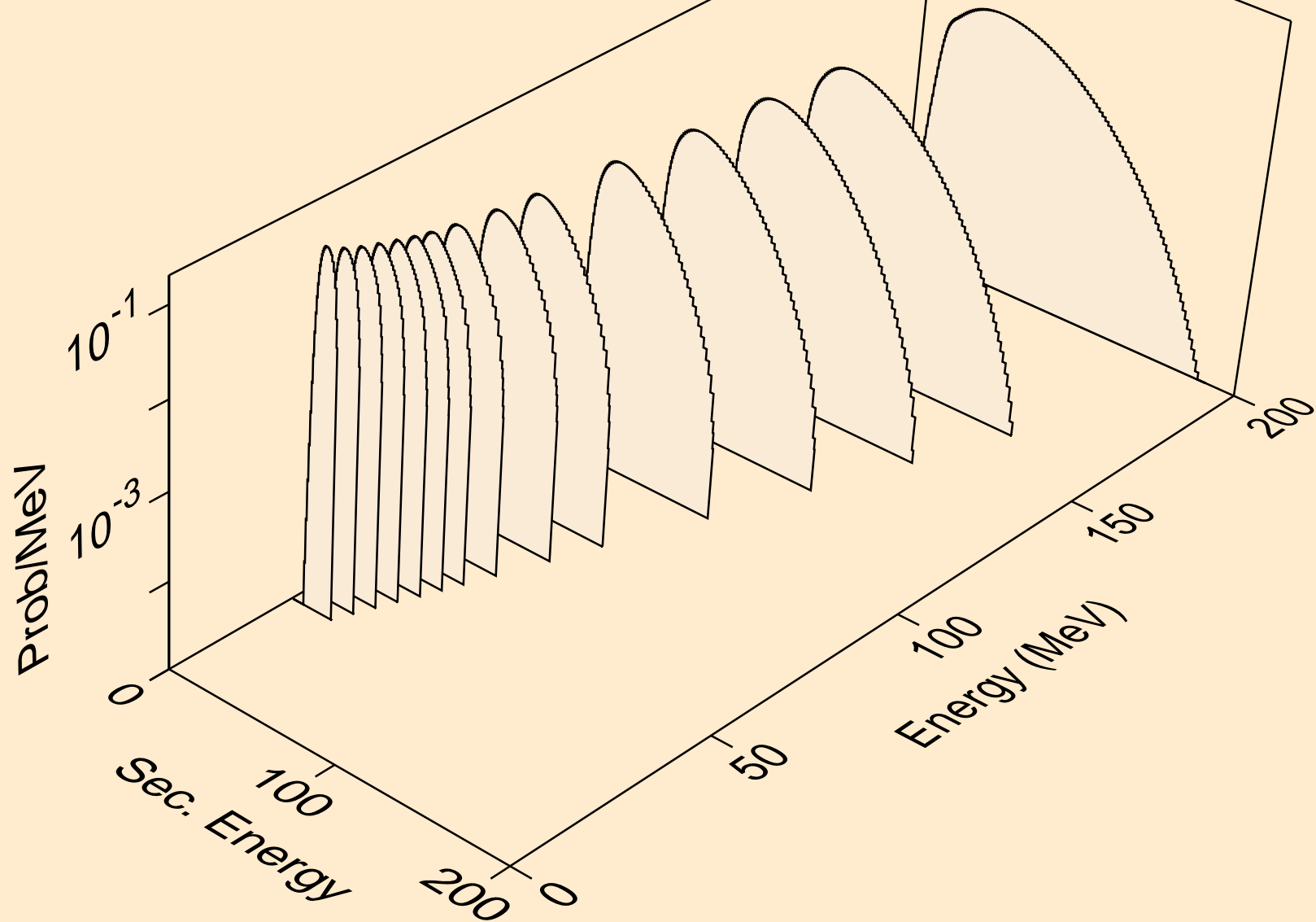

MO091M NEUTRON ACER TENDL-2021 LIBRARY; T=293.6K
he3s from (n,n*)he3

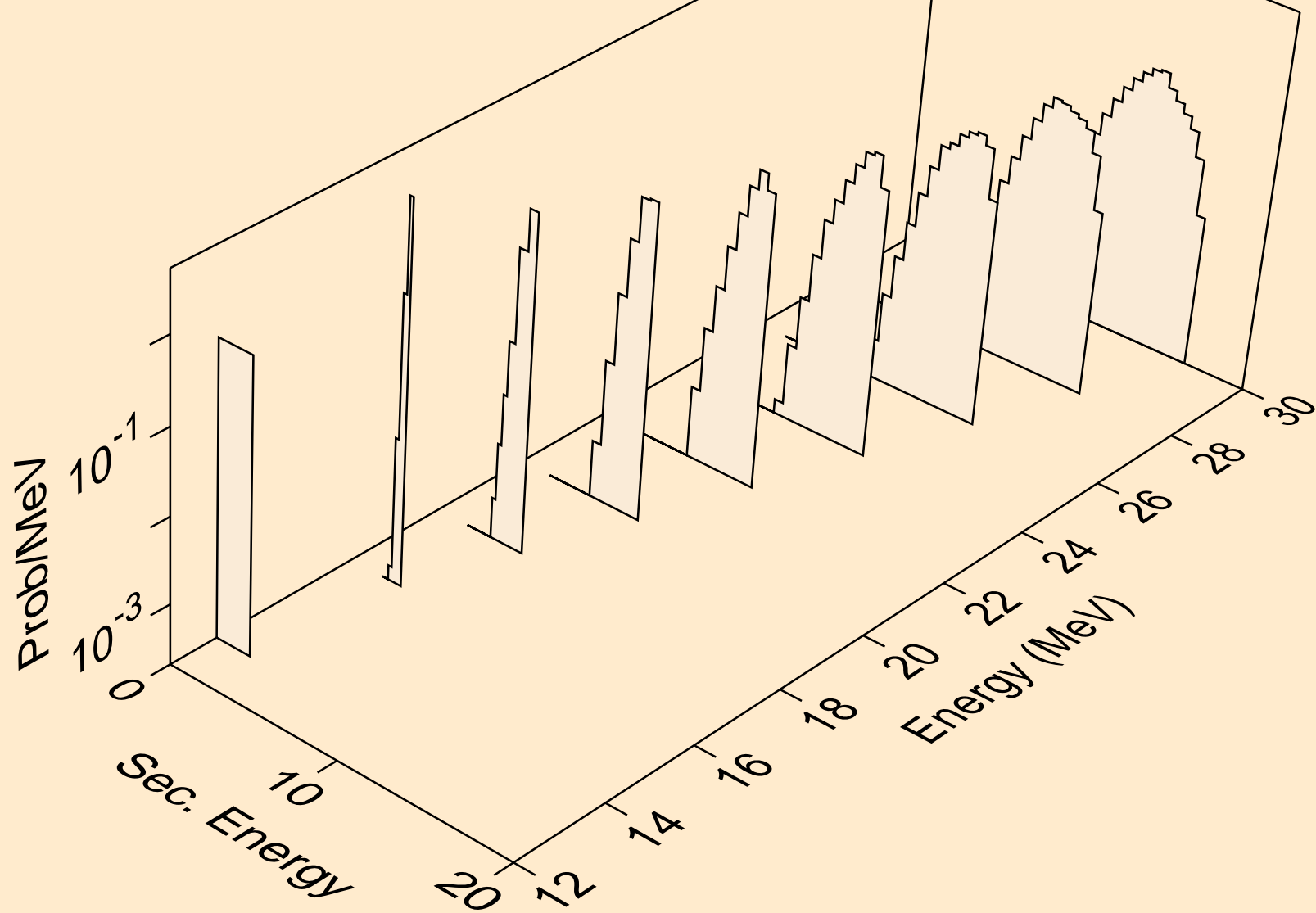

MO091M NEUTRON ACER TENDL-2021 LIBRARY; T=293.6K
he3s from (n,he3)

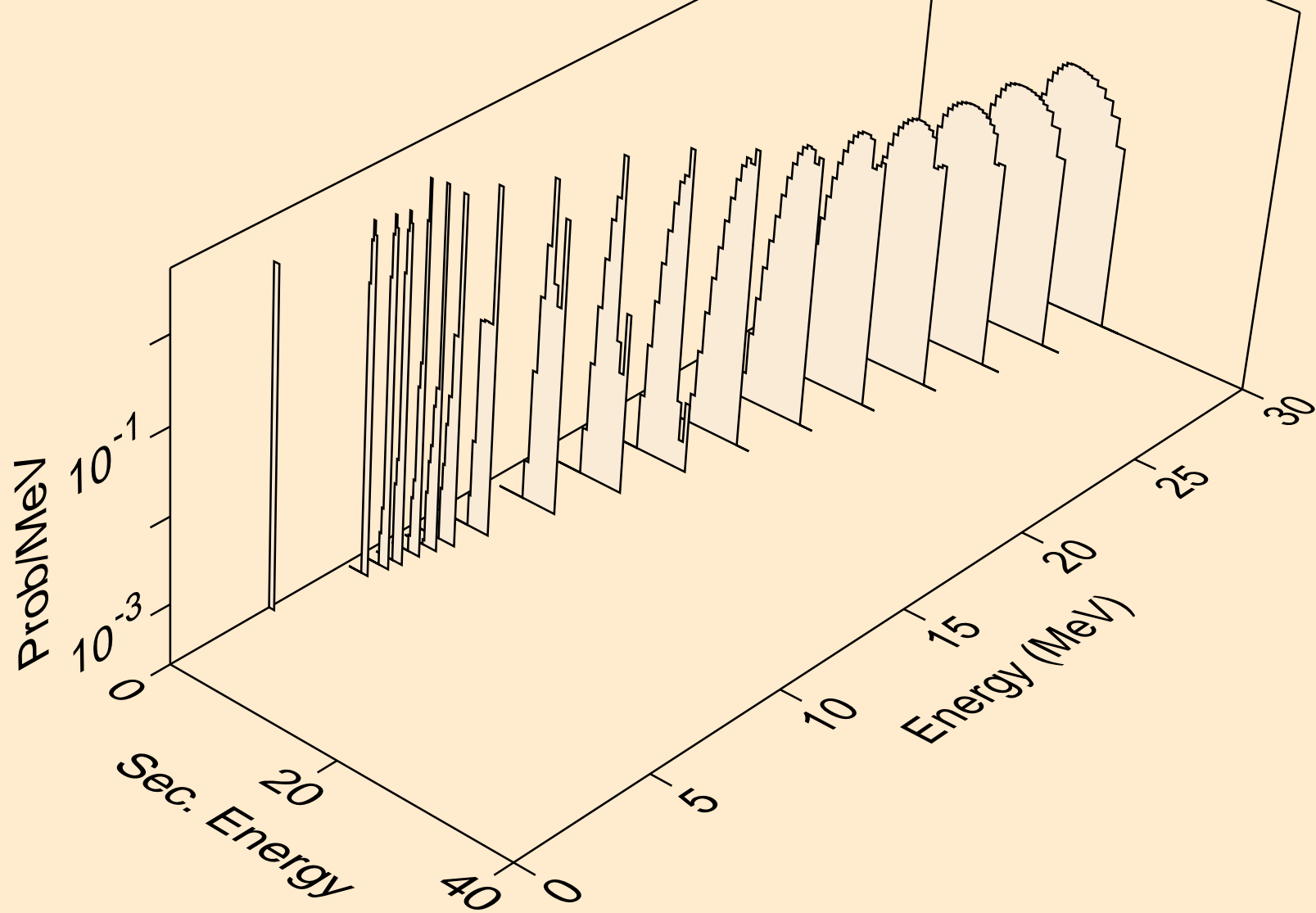

MO091M NEUTRON ACER TENDL-2021 LIBRARY; T=293.6K
alphas from (n,x)

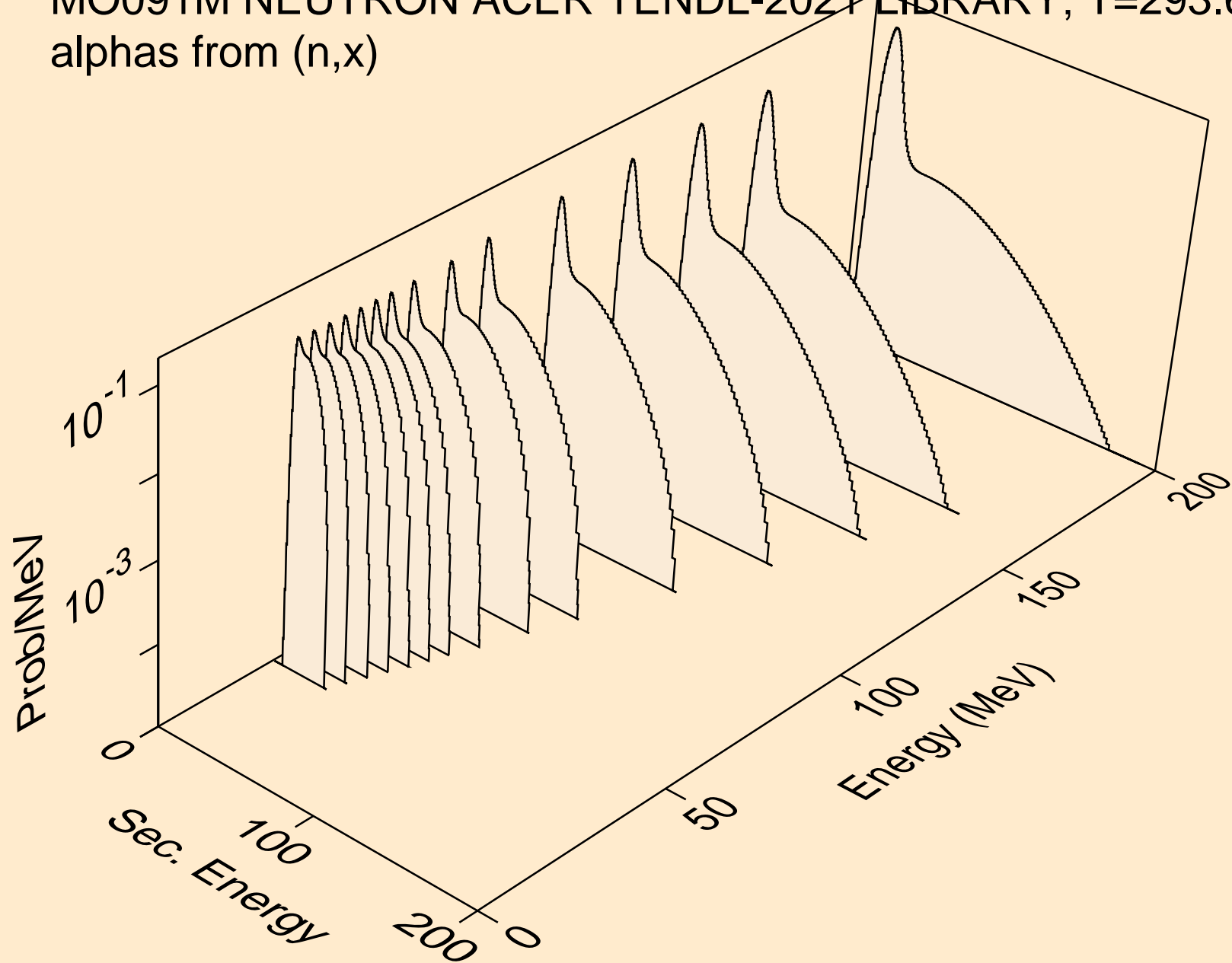

MO091M NEUTRON ACER TENDL-2021 LIBRARY; T=293.6K
alphas from (n,n*)a

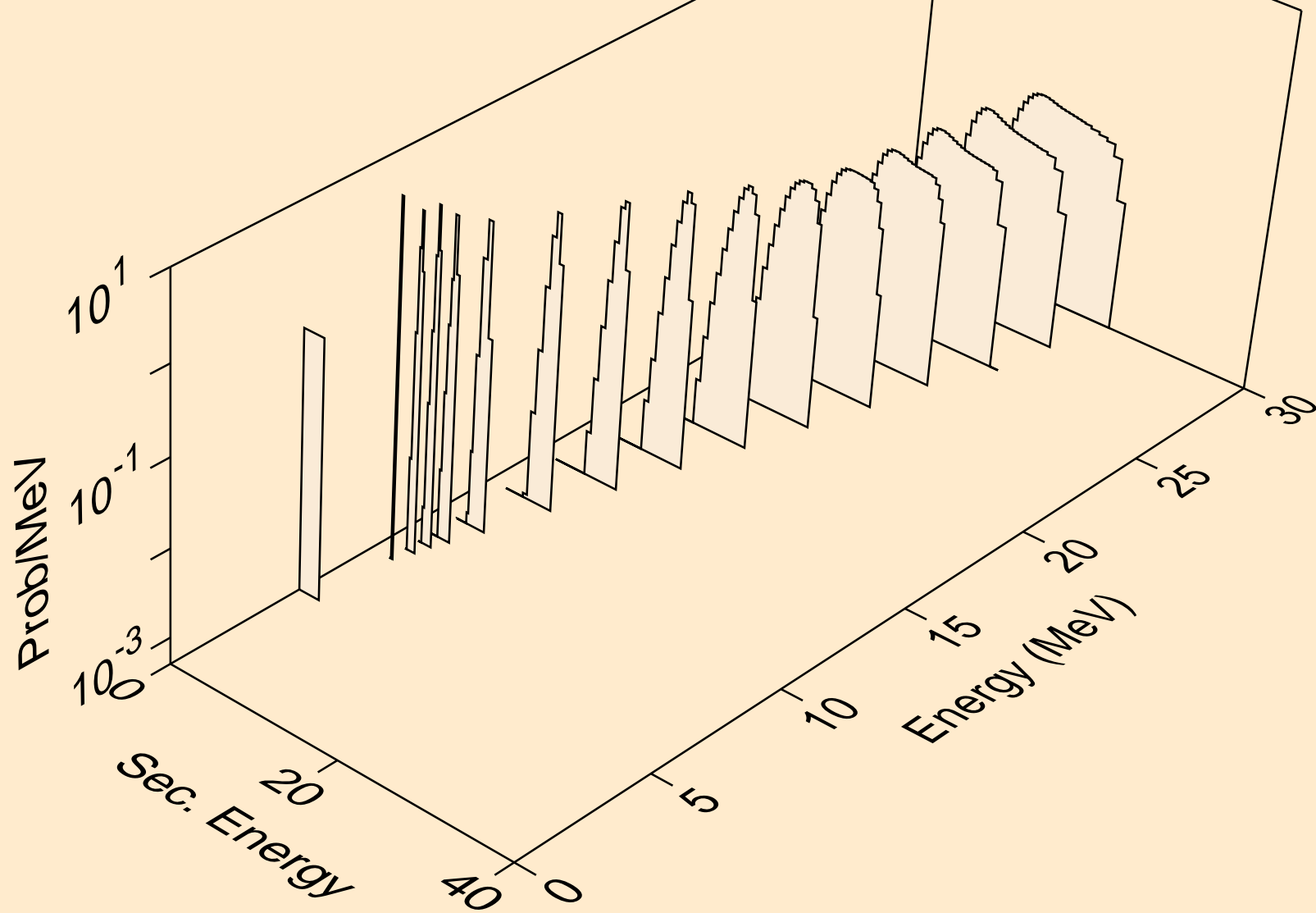

MO091M NEUTRON ACER TENDL-2021 LIBRARY; T=293.6K
alphas from (n,2n)a

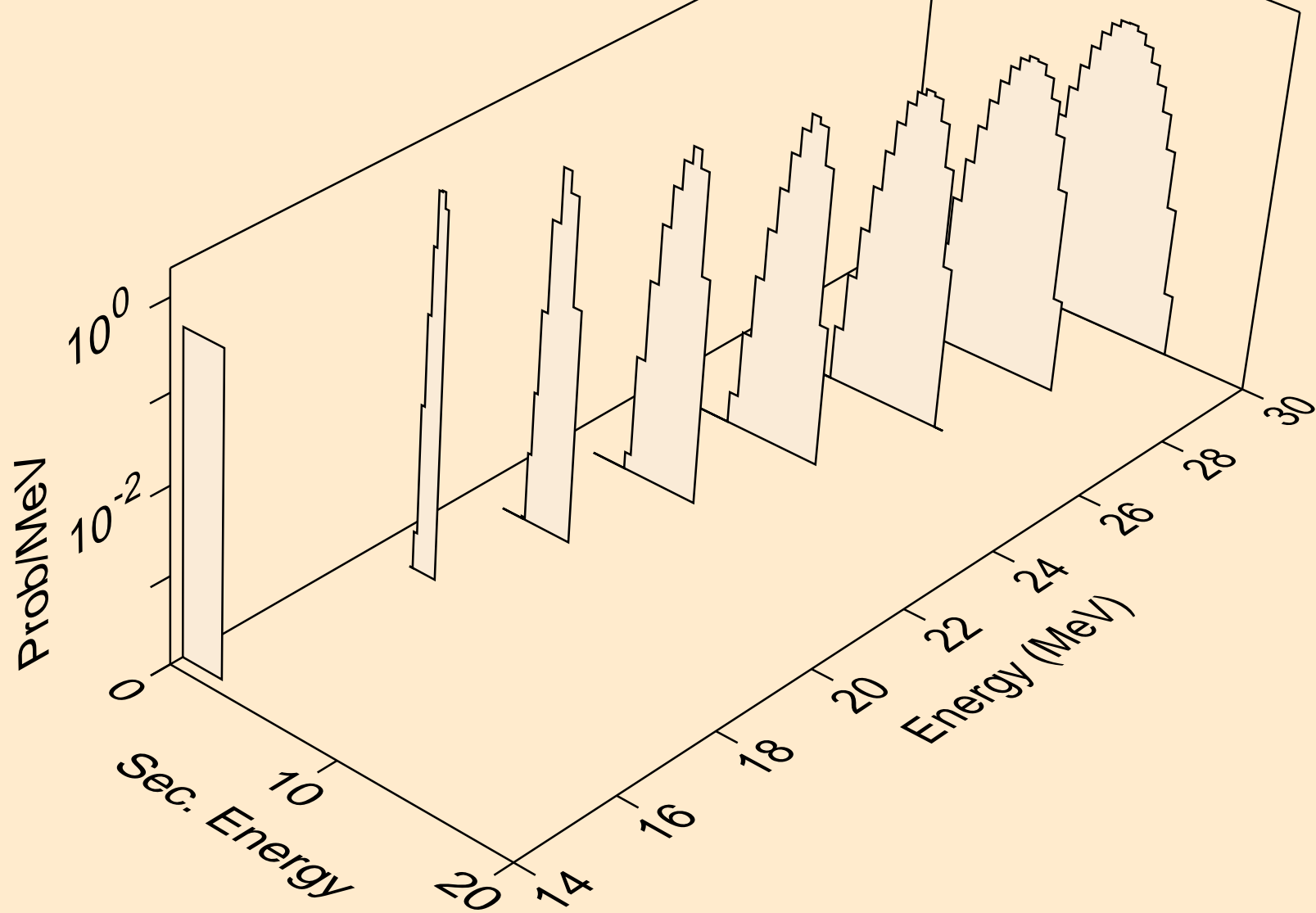

MO091M NEUTRON ACER TENDL-2021 LIBRARY; T=293.6K
alphas from (n,n*)2a

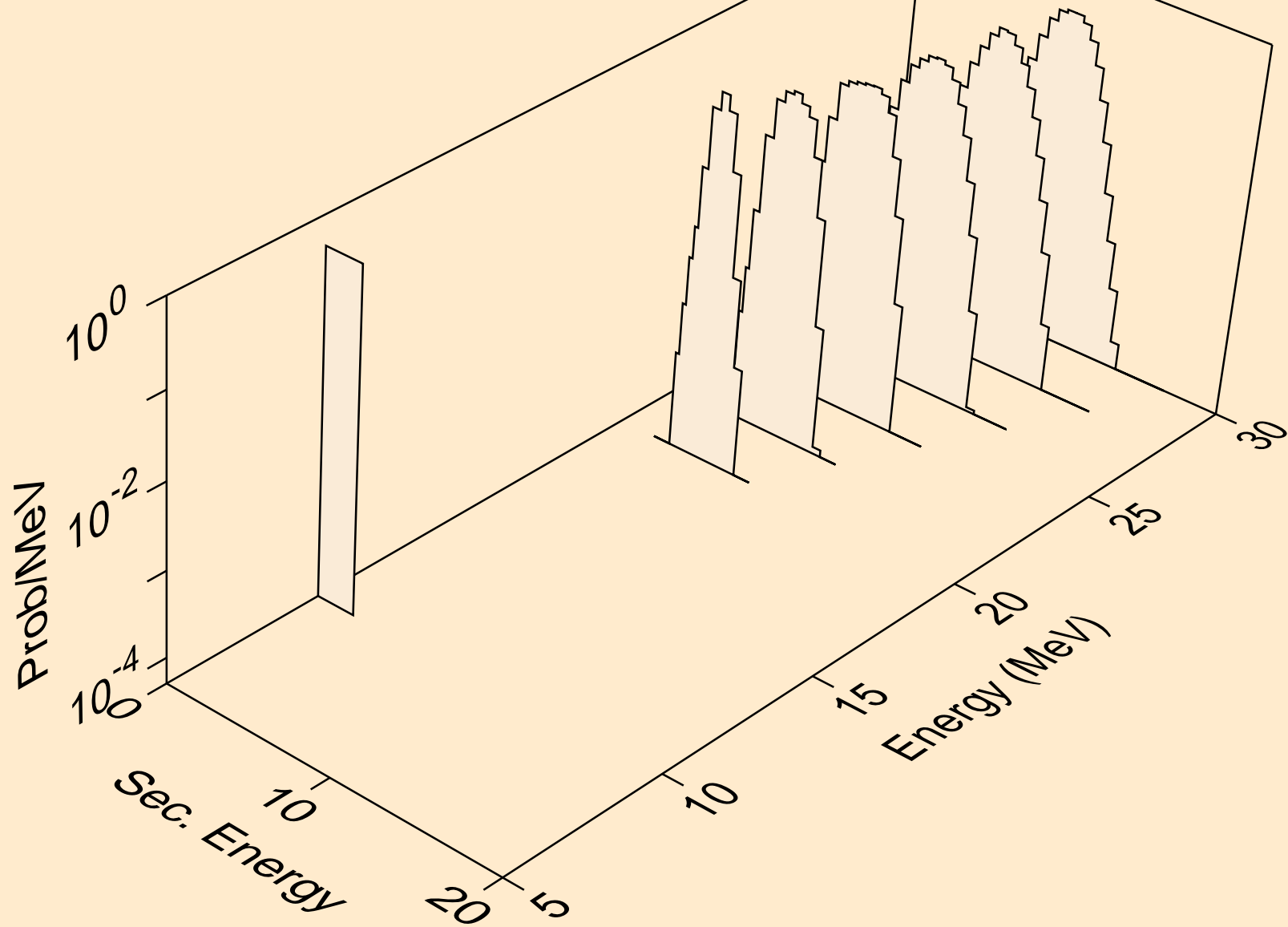

MO091M NEUTRON ACER TENDL-2021 LIBRARY; T=293.6K
alphas from (n,npa)

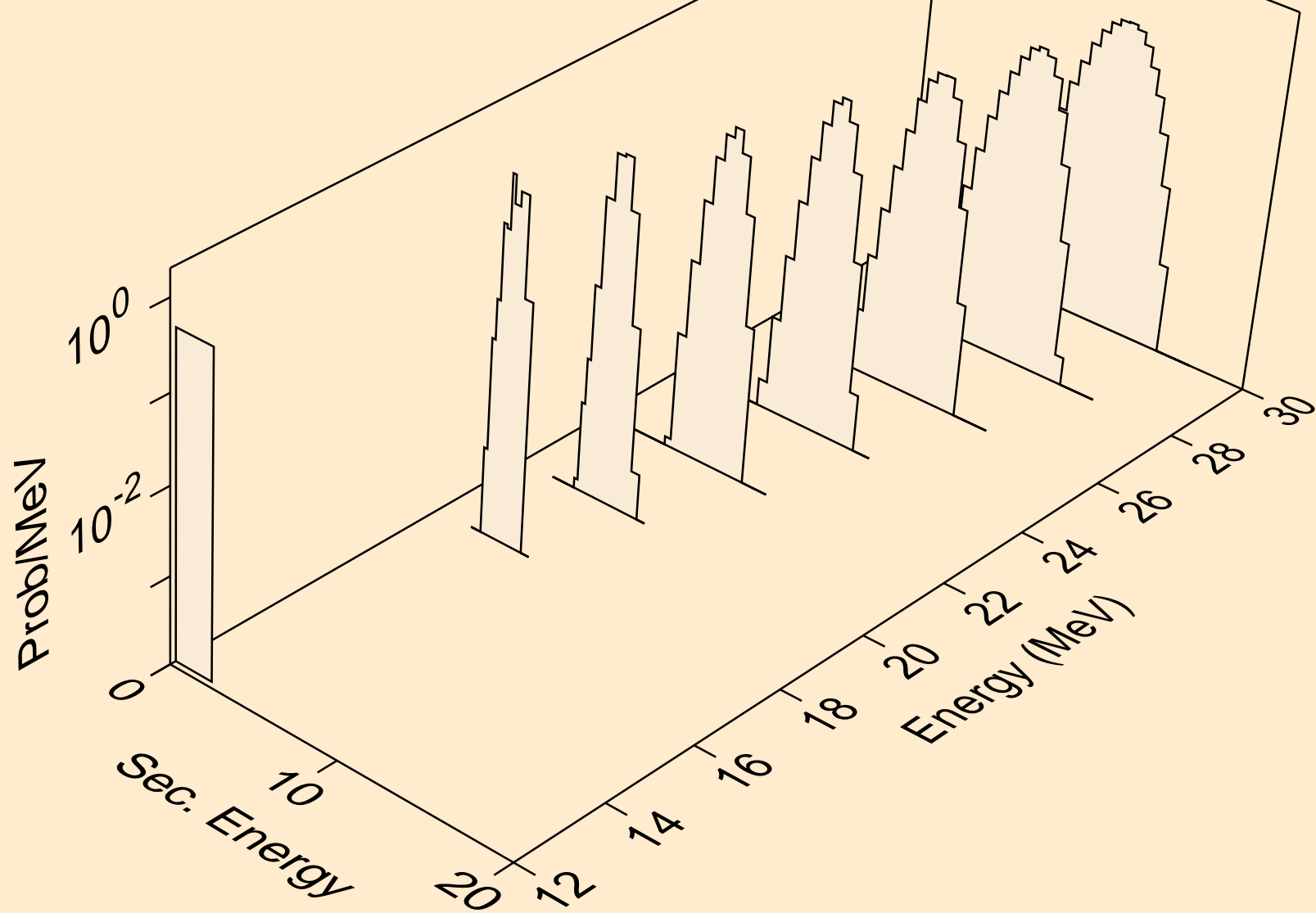

MO091M NEUTRON ACER TENDL-2021 LIBRARY; T=293.6K
alphas from (n,a)

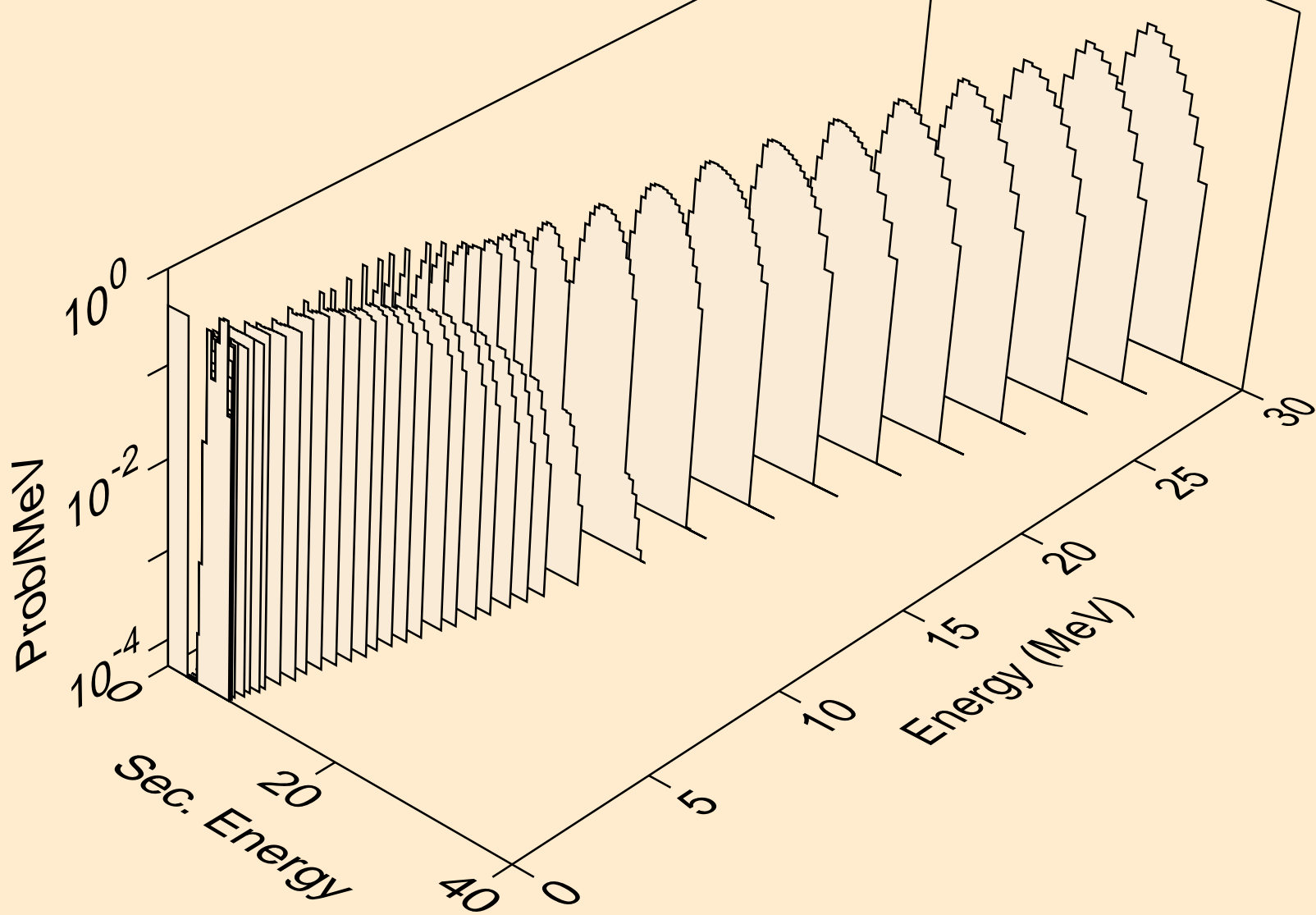

MO091M NEUTRON ACER TENDL-2021 LIBRARY; T=293.6K
alphas from (n,2a)

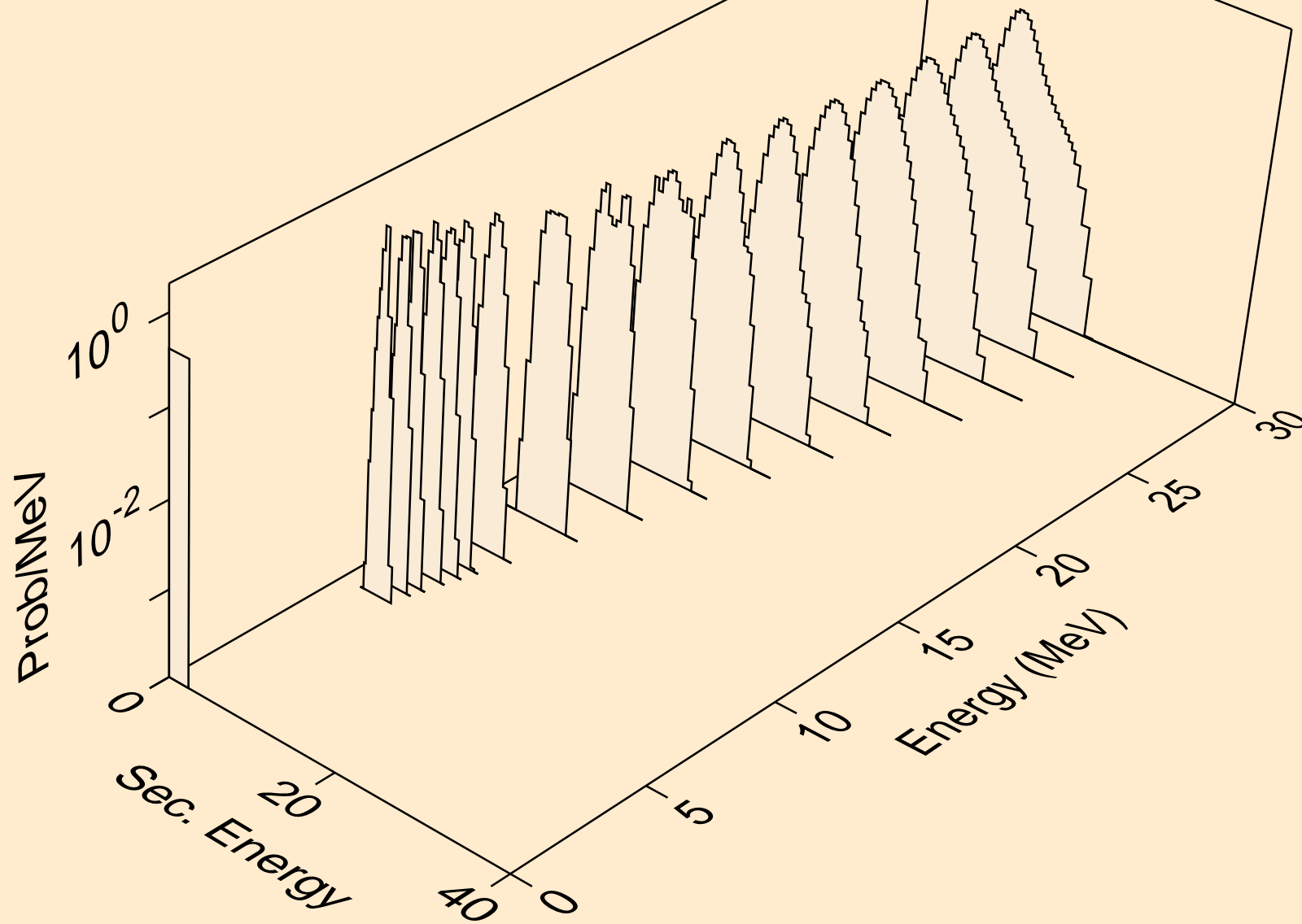

MO091M NEUTRON ACER TENDL-2021 LIBRARY; T=293.6K
alphas from (n,pa)

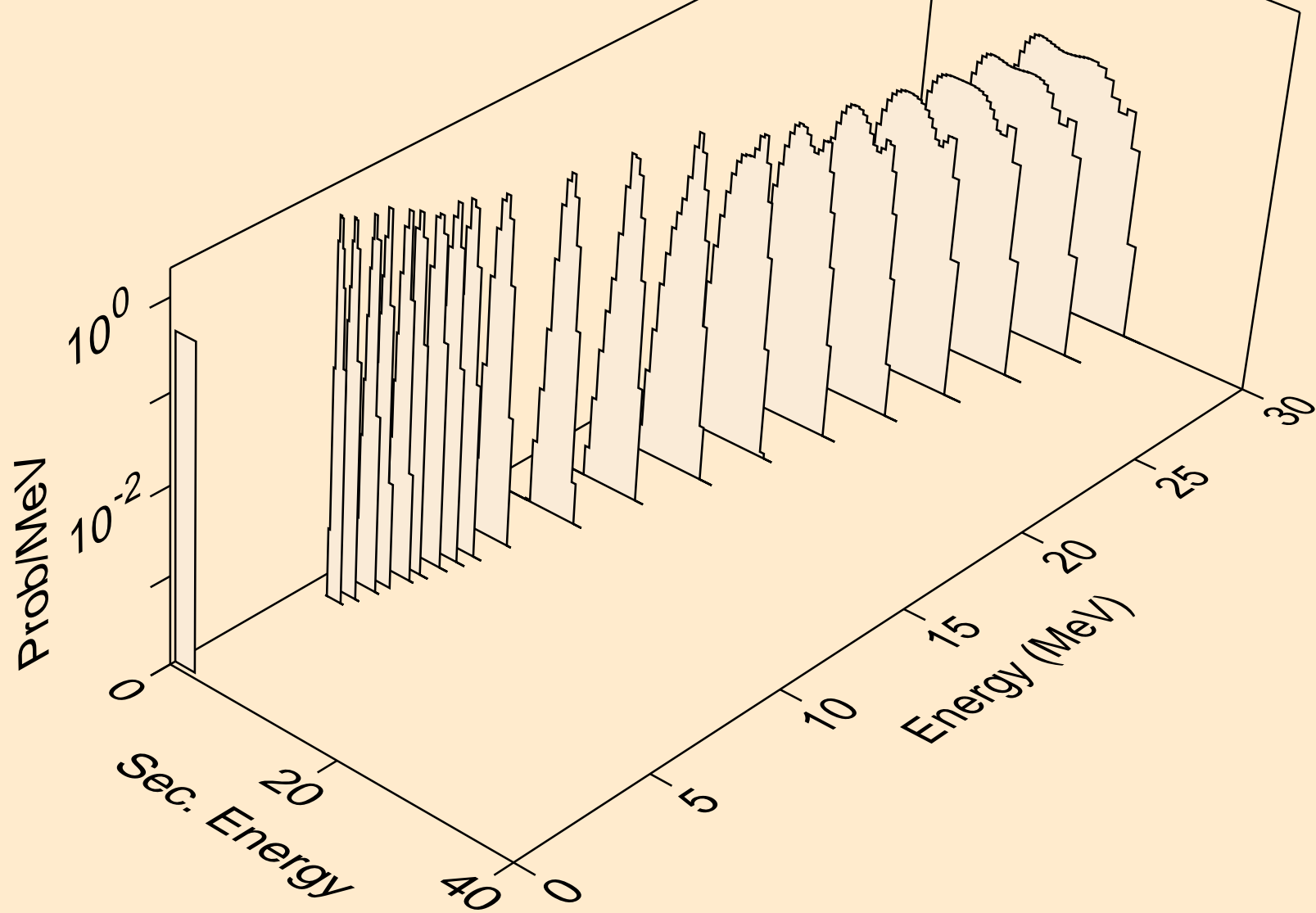

MO091M NEUTRON ACER TENDL-2021 LIBRARY; T=293.6K
alphas from (n,da)

