

N013 NEUTRON ACER TENDL-2021 LIBRARY; T=293.6K

Principal cross sections

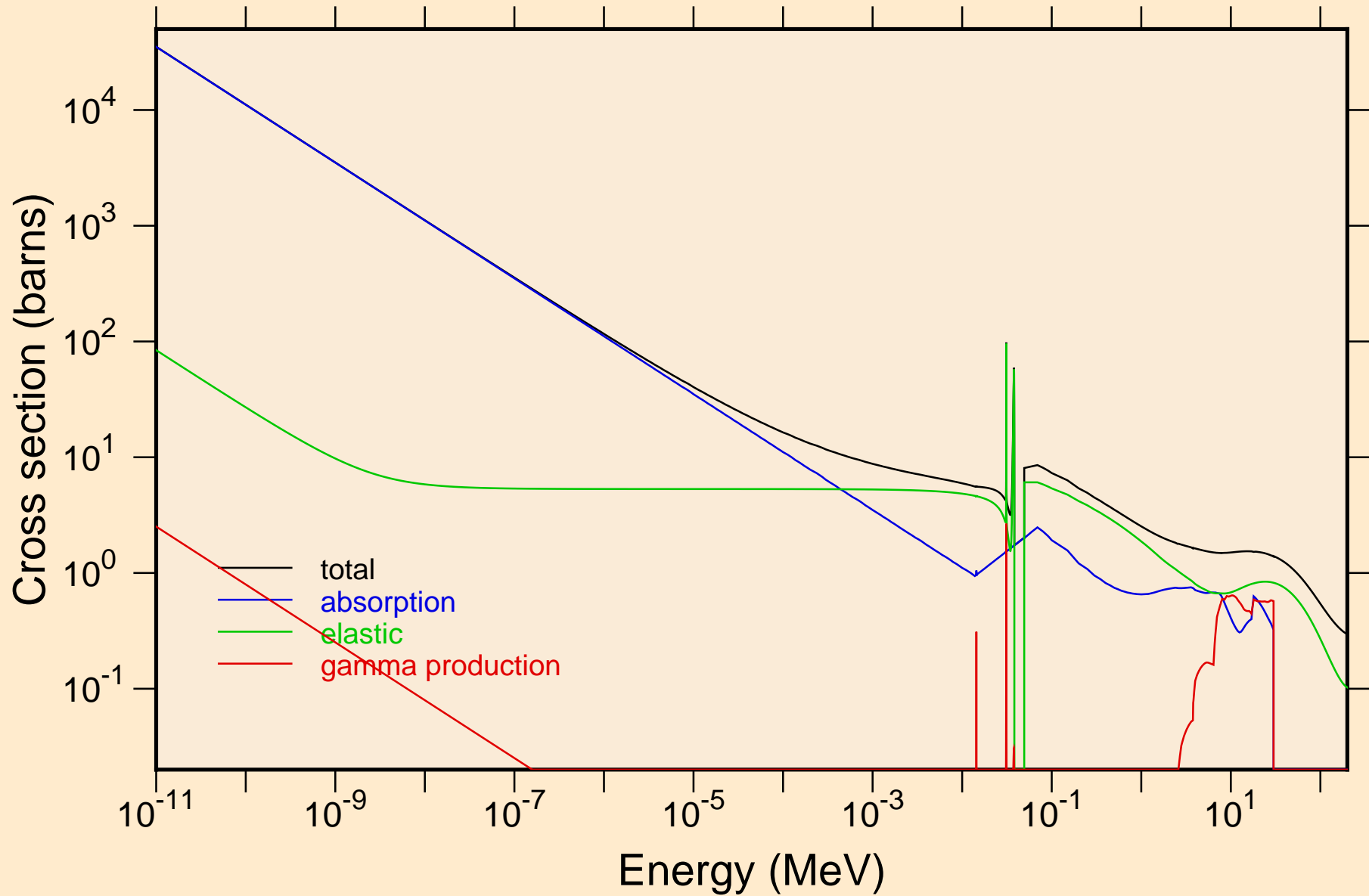

N013 NEUTRON ACER TENDL-2021 LIBRARY; T=293.6K

Heating

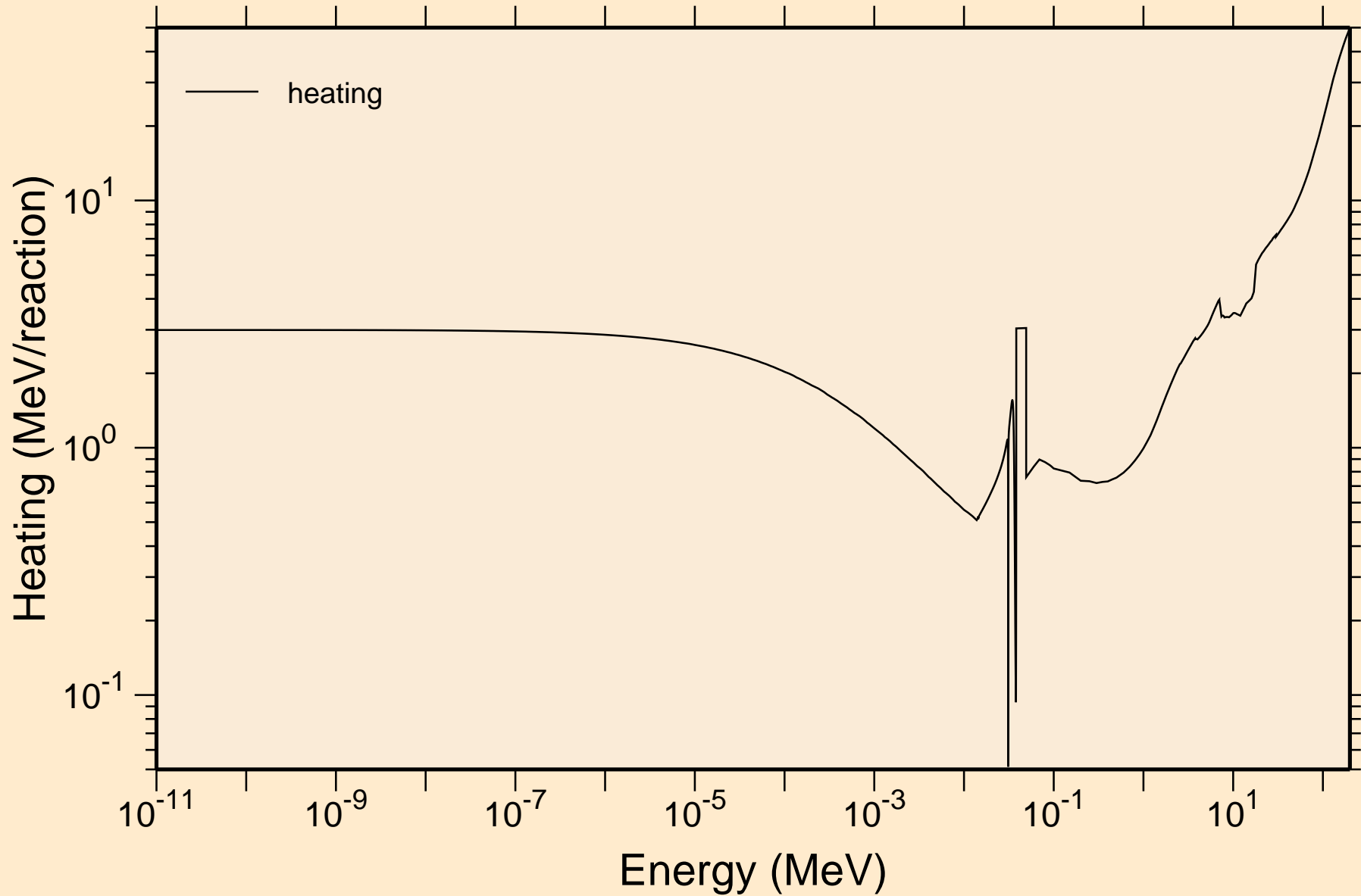

N013 NEUTRON ACER TENDL-2021 LIBRARY; T=293.6K
Damage

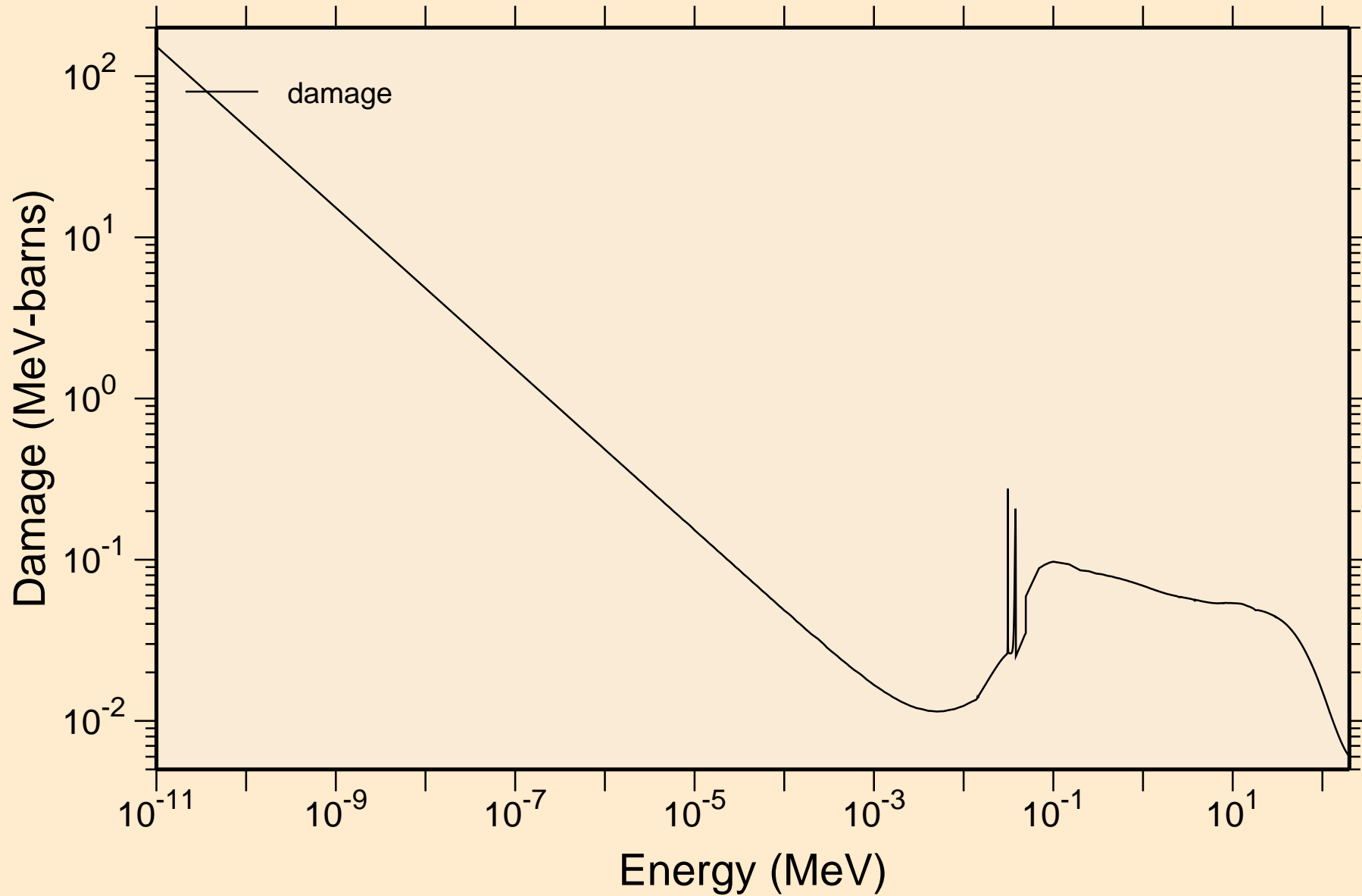

N013 NEUTRON ACER TENDL-2021 LIBRARY; T=293.6K

Non-threshold reactions

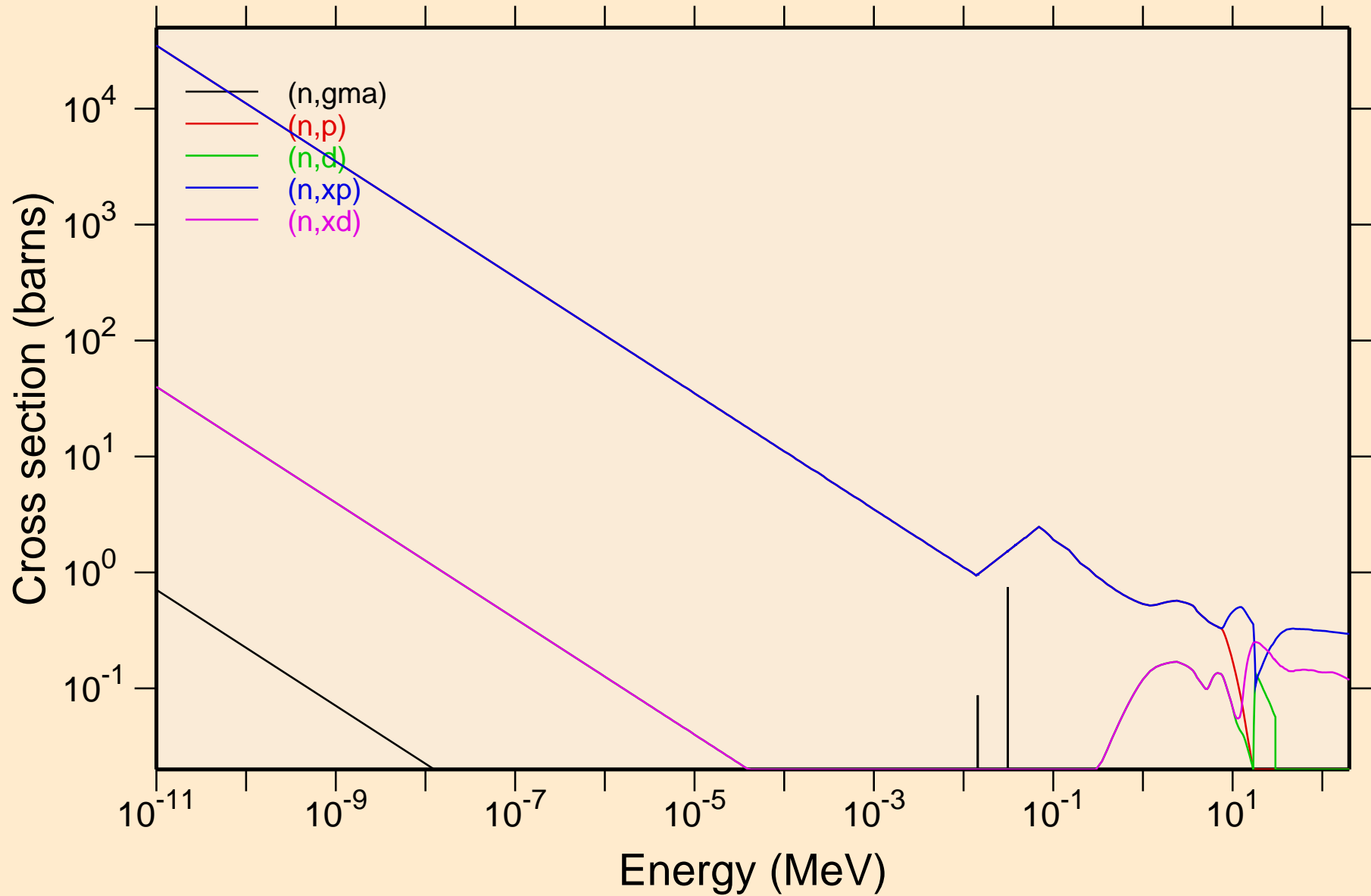

N013 NEUTRON ACER TENDL-2021 LIBRARY; T=293.6K

Principal cross sections

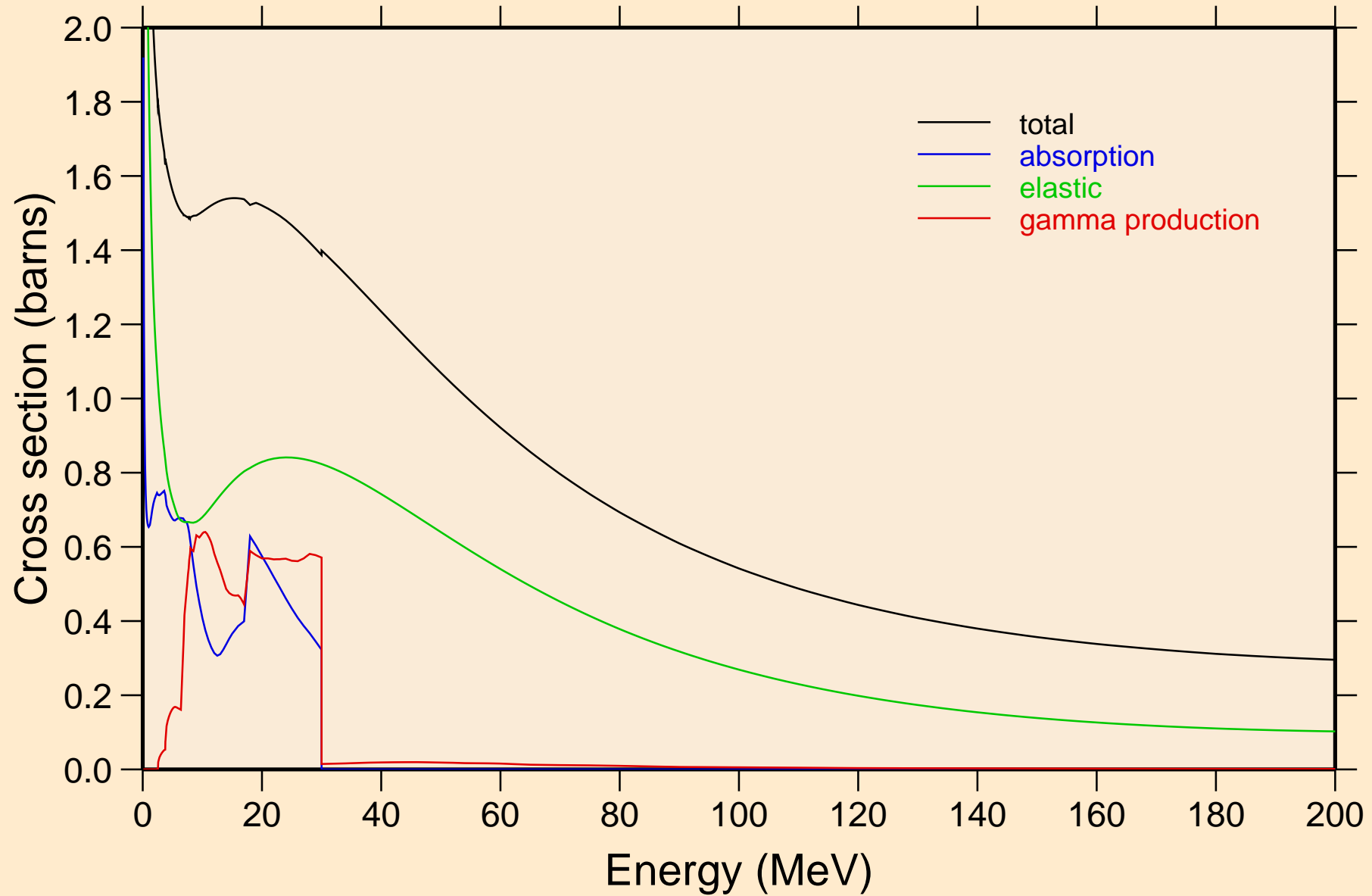

N013 NEUTRON ACER TENDL-2021 LIBRARY; T=293.6K

Heating

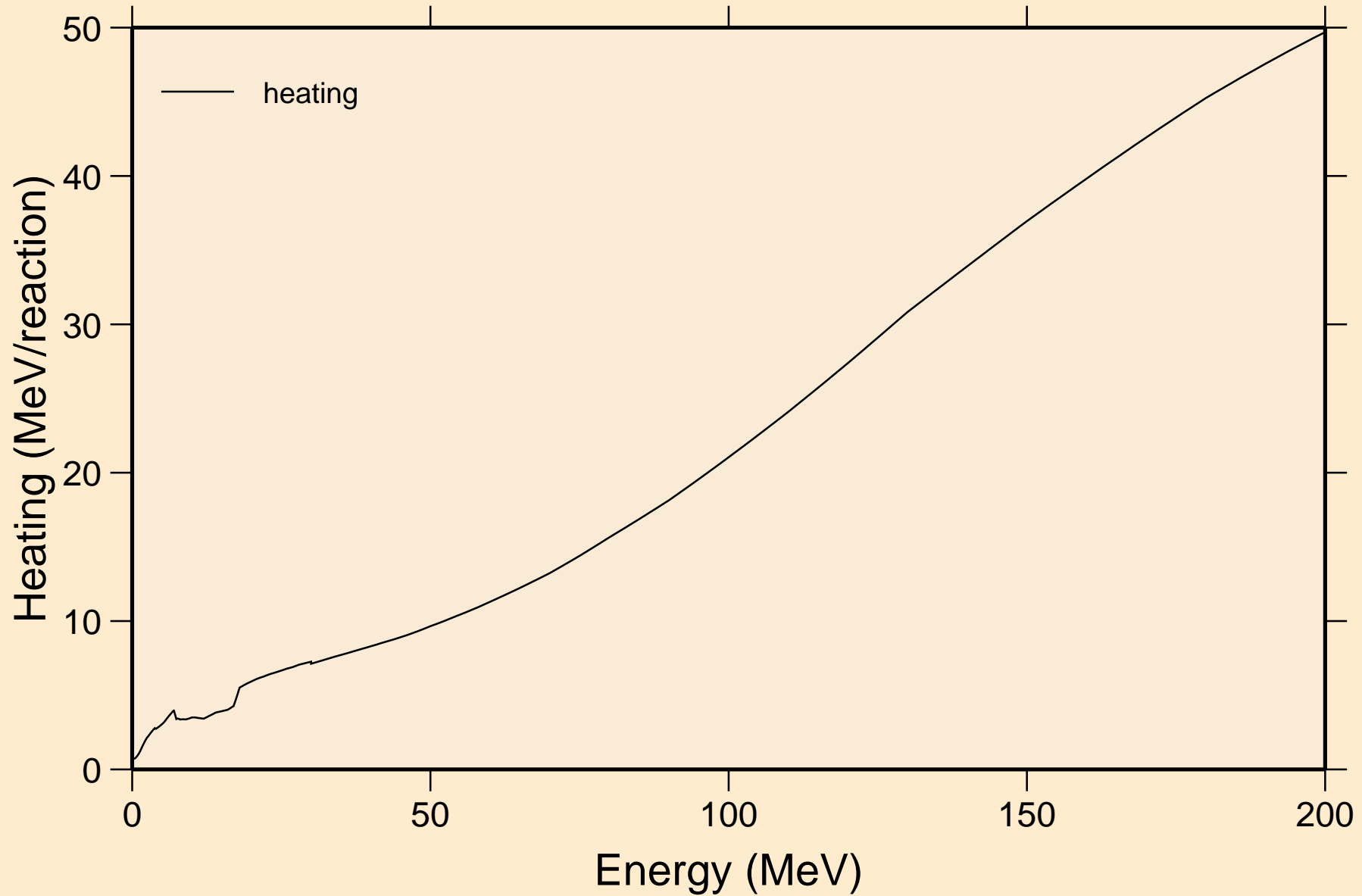

N013 NEUTRON ACER TENDL-2021 LIBRARY; T=293.6K
Damage

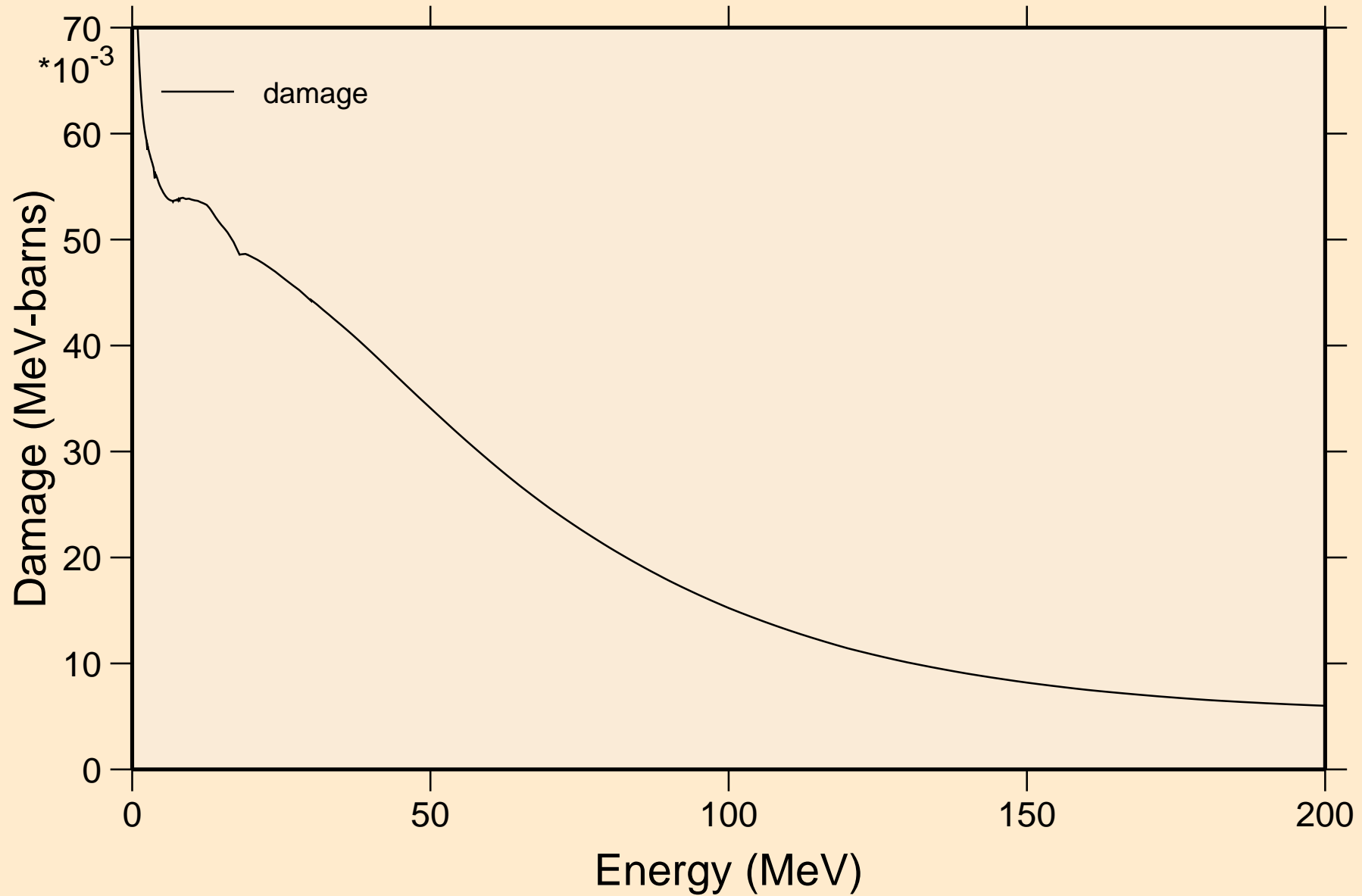

N013 NEUTRON ACER TENDL-2021 LIBRARY; T=293.6K
Non-threshold reactions

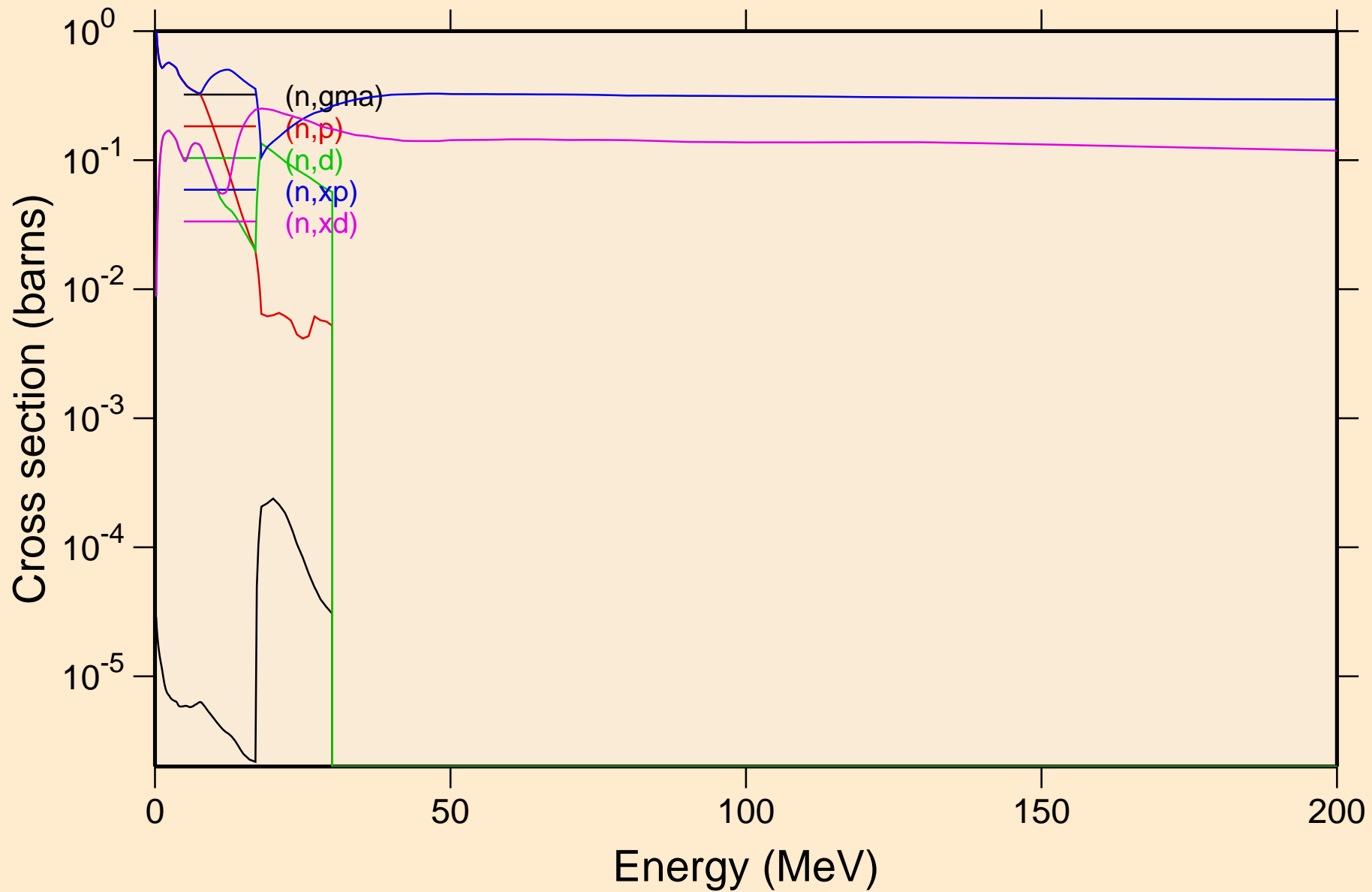

N013 NEUTRON ACER TENDL-2021 LIBRARY; T=293.6K
Inelastic levels

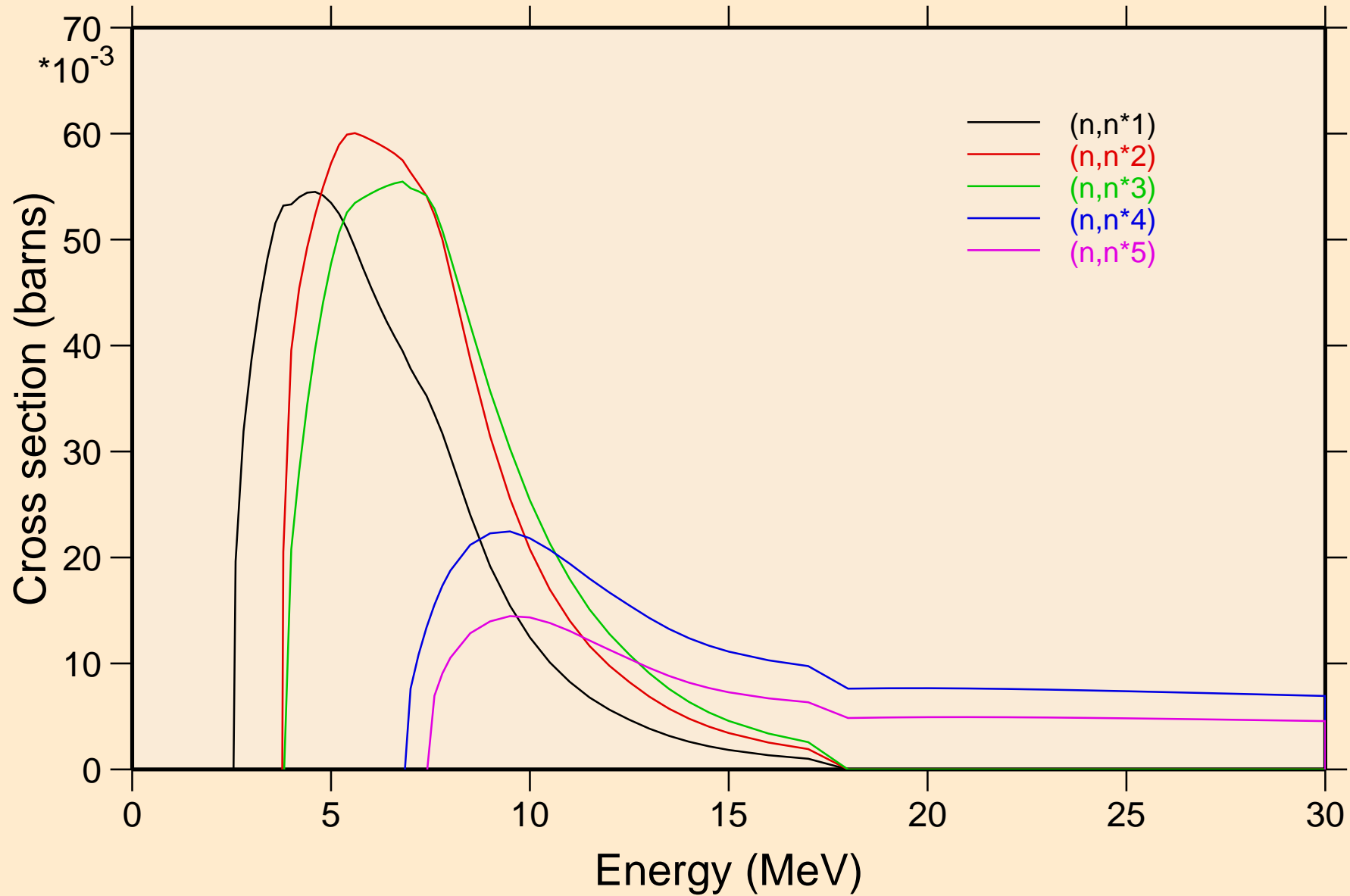

N013 NEUTRON ACER TENDL-2021 LIBRARY; T=293.6K
Inelastic levels

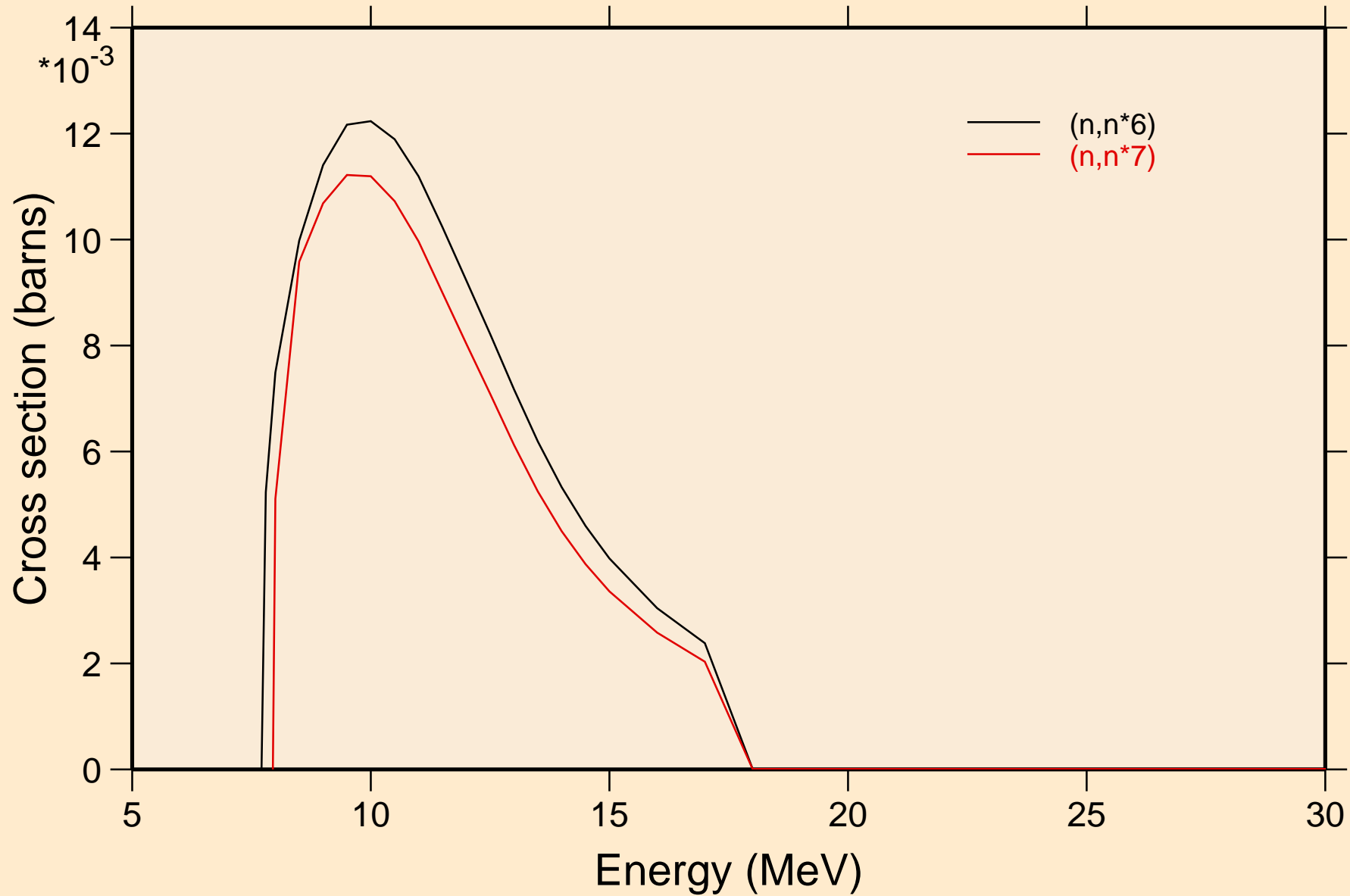

N013 NEUTRON ACER TENDL-2021 LIBRARY; T=293.6K

Threshold reactions

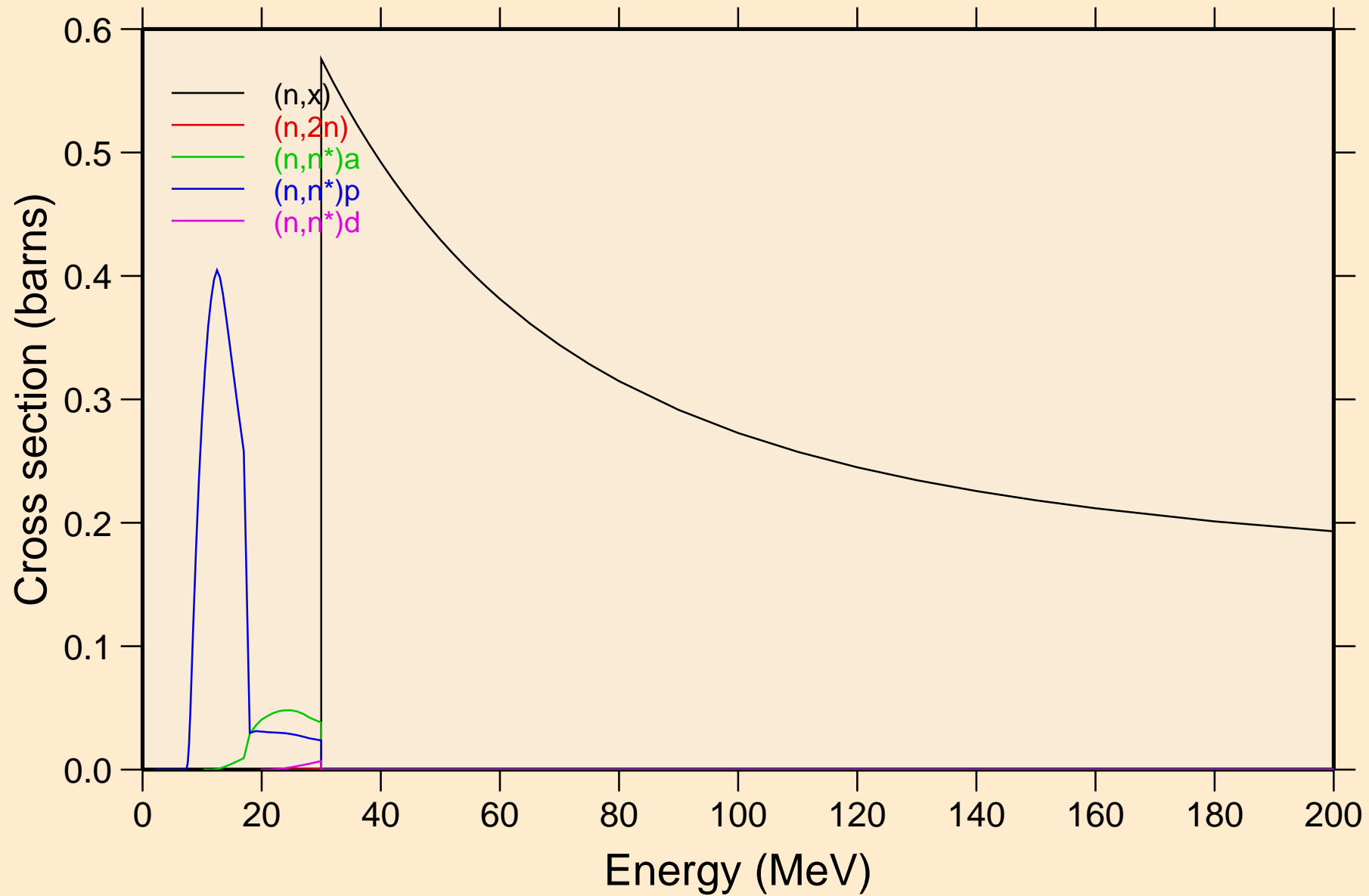

N013 NEUTRON ACER TENDL-2021 LIBRARY; T=293.6K
Threshold reactions

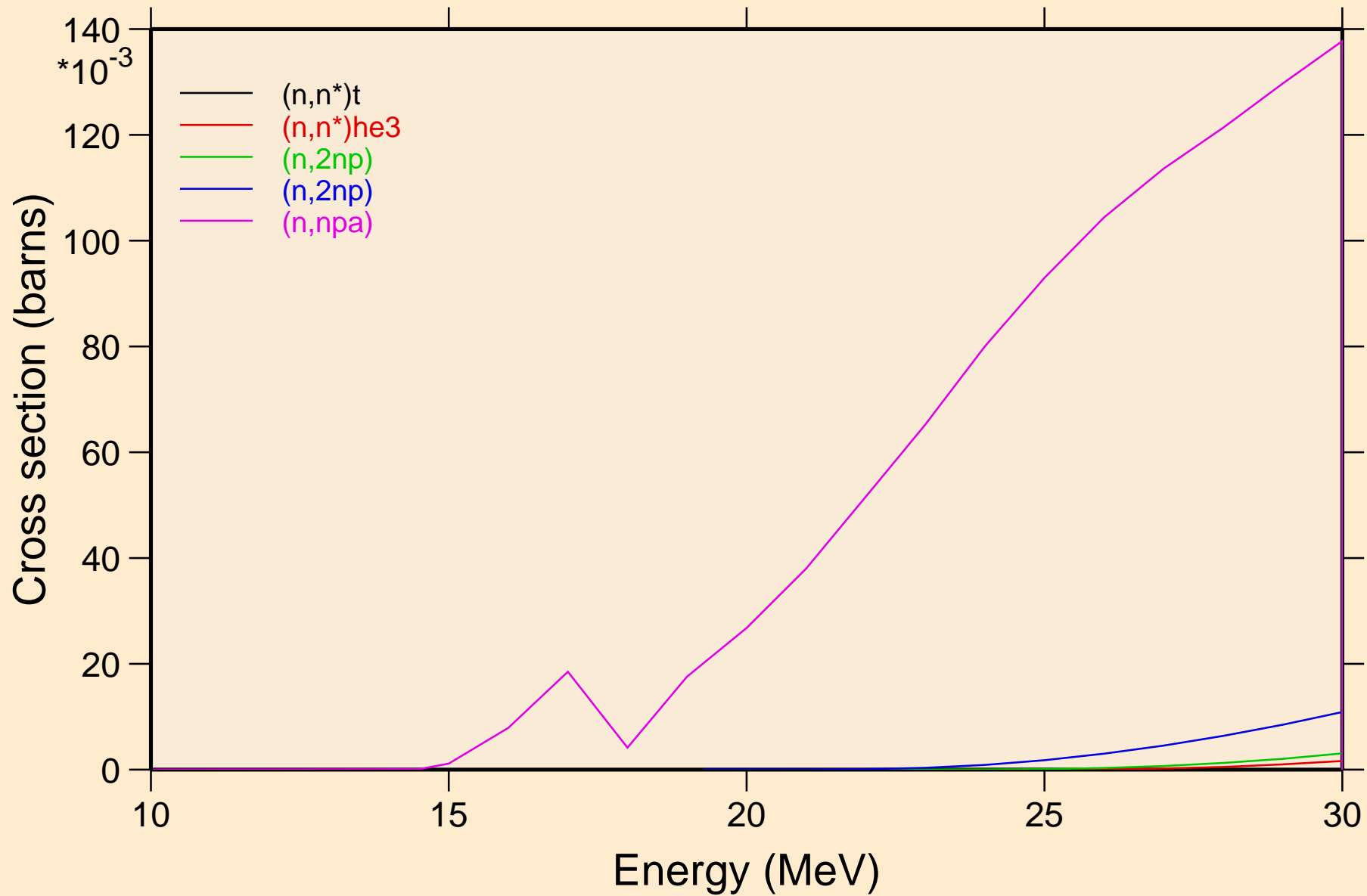

N013 NEUTRON ACER TENDL-2021 LIBRARY; T=293.6K

Threshold reactions

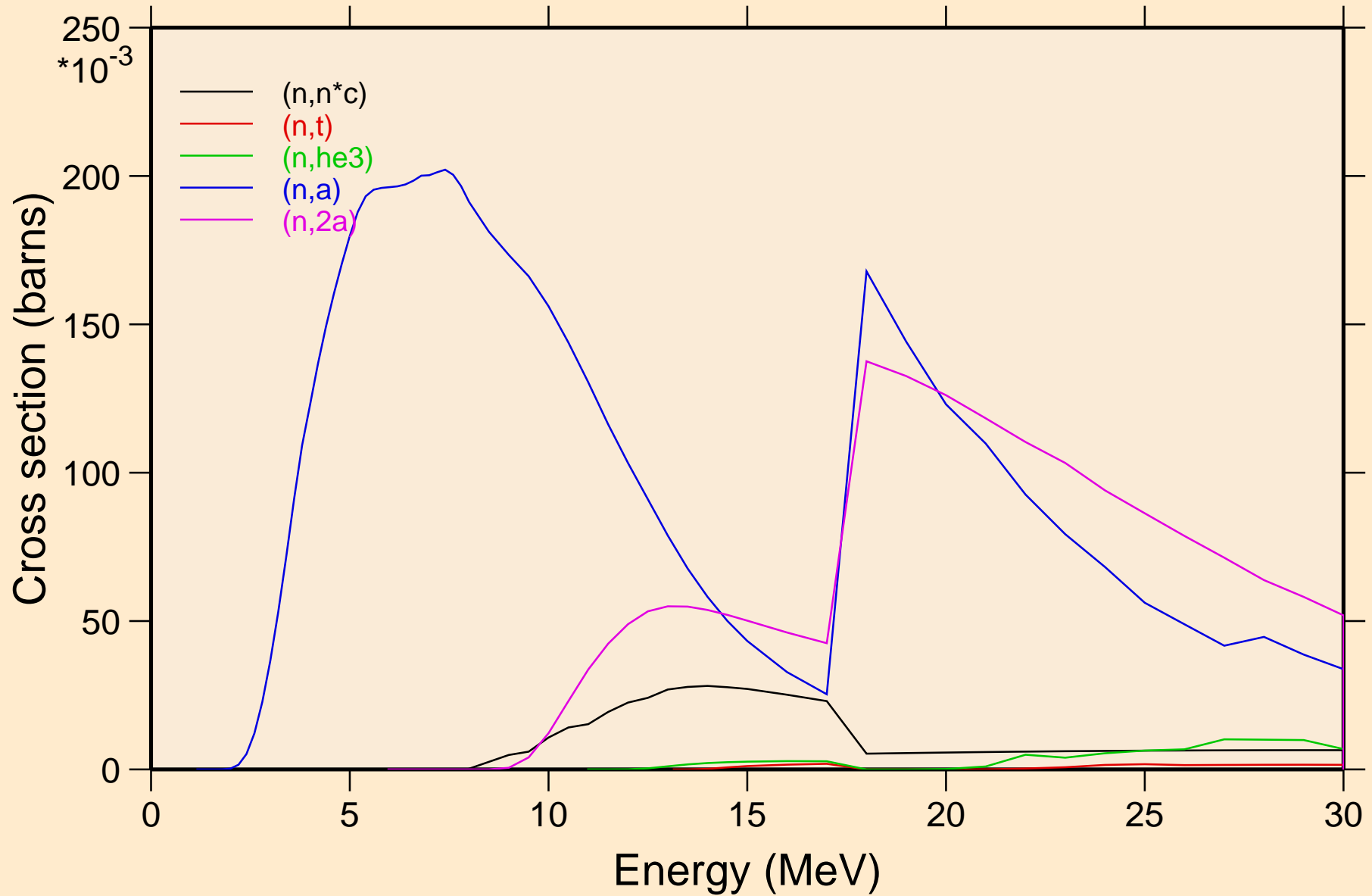

N013 NEUTRON ACER TENDL-2021 LIBRARY; T=293.6K

Threshold reactions

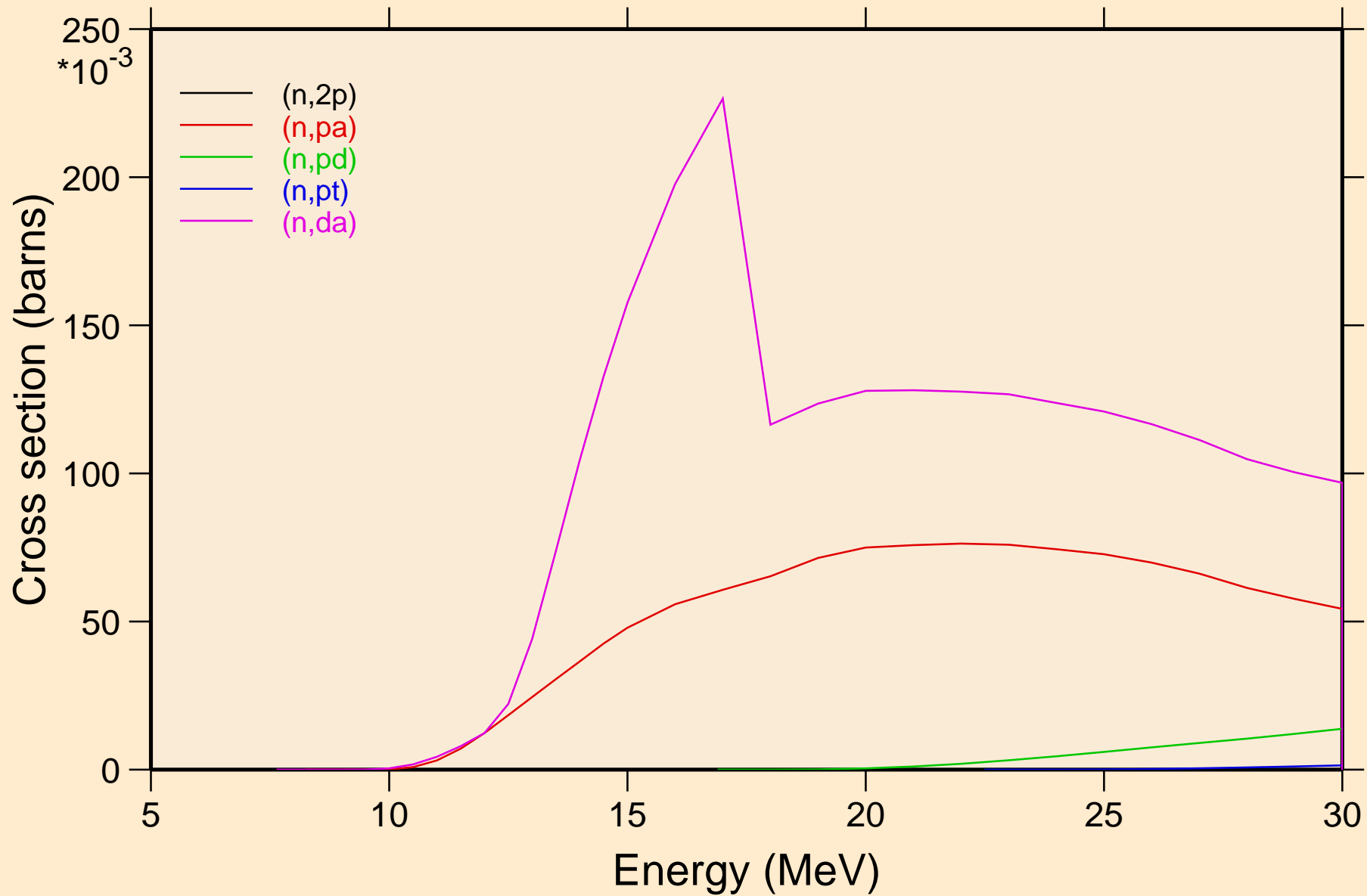

N013 NEUTRON ACER TENDL-2021 LIBRARY; T=293.6K
Threshold reactions

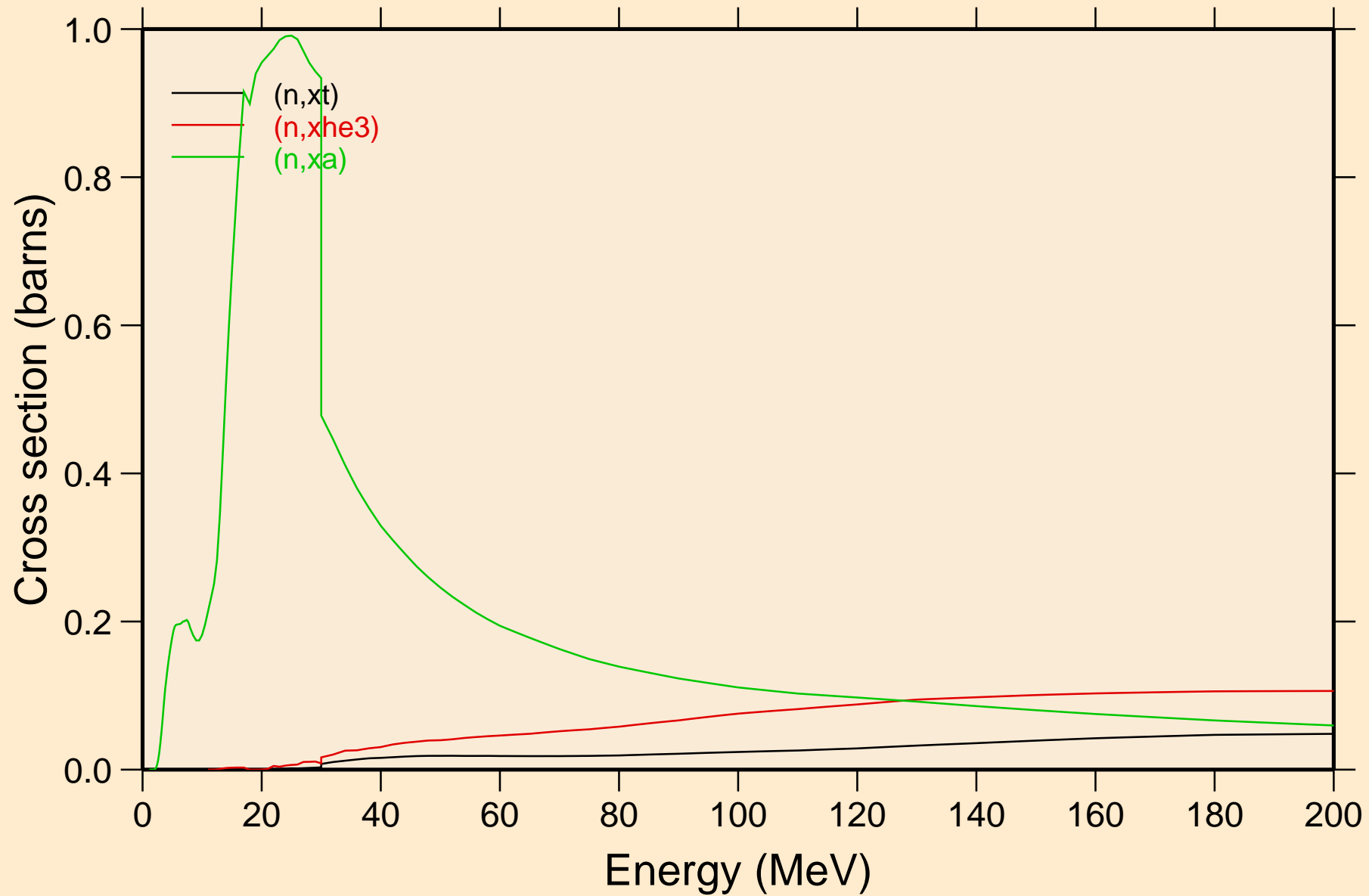

N013 NEUTRON ACER TENDL-2021 LIBRARY; T=293.6K
angular distribution for elastic

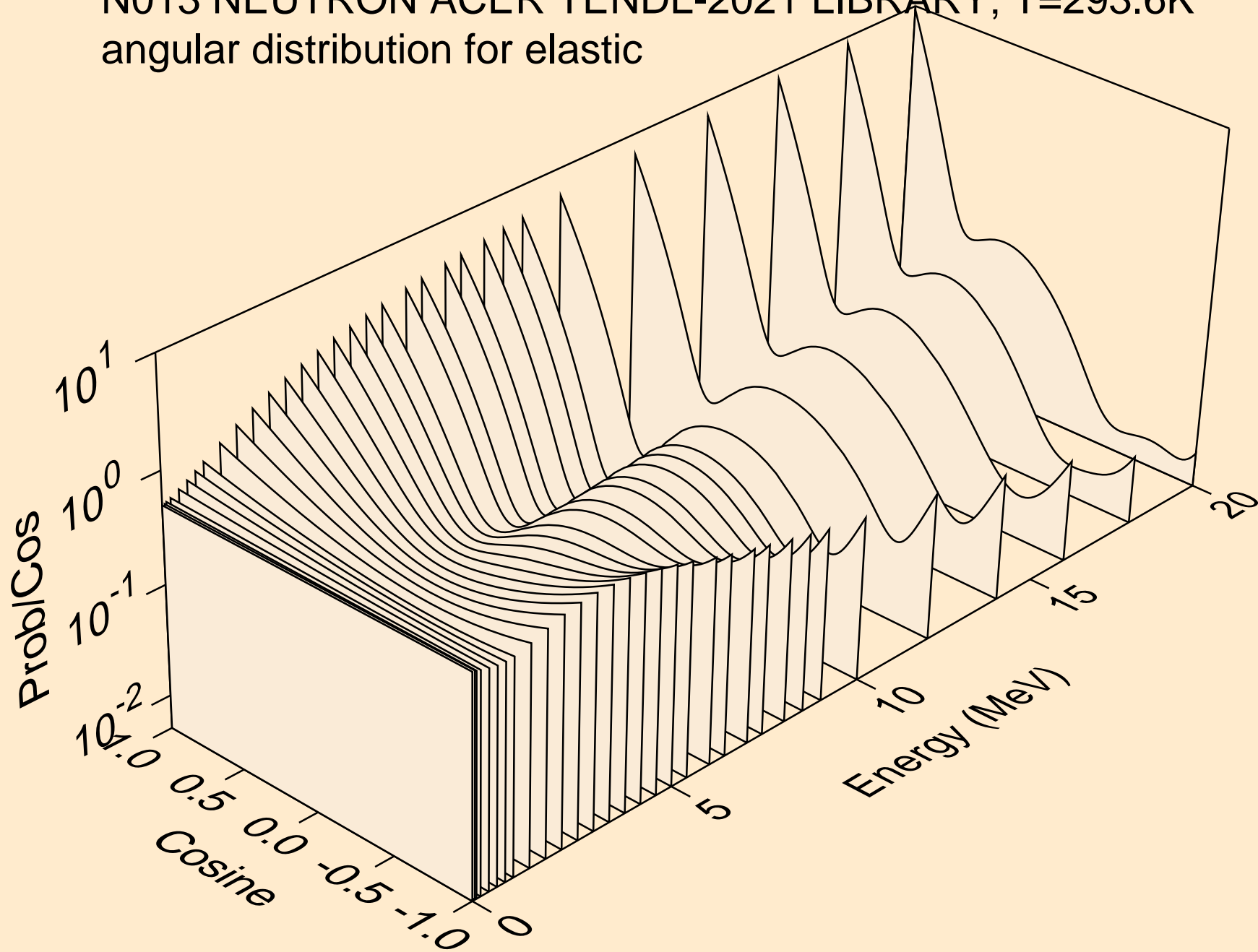

N013 NEUTRON ACER TENDL-2021 LIBRARY; T=293.6K
angular distribution for elastic

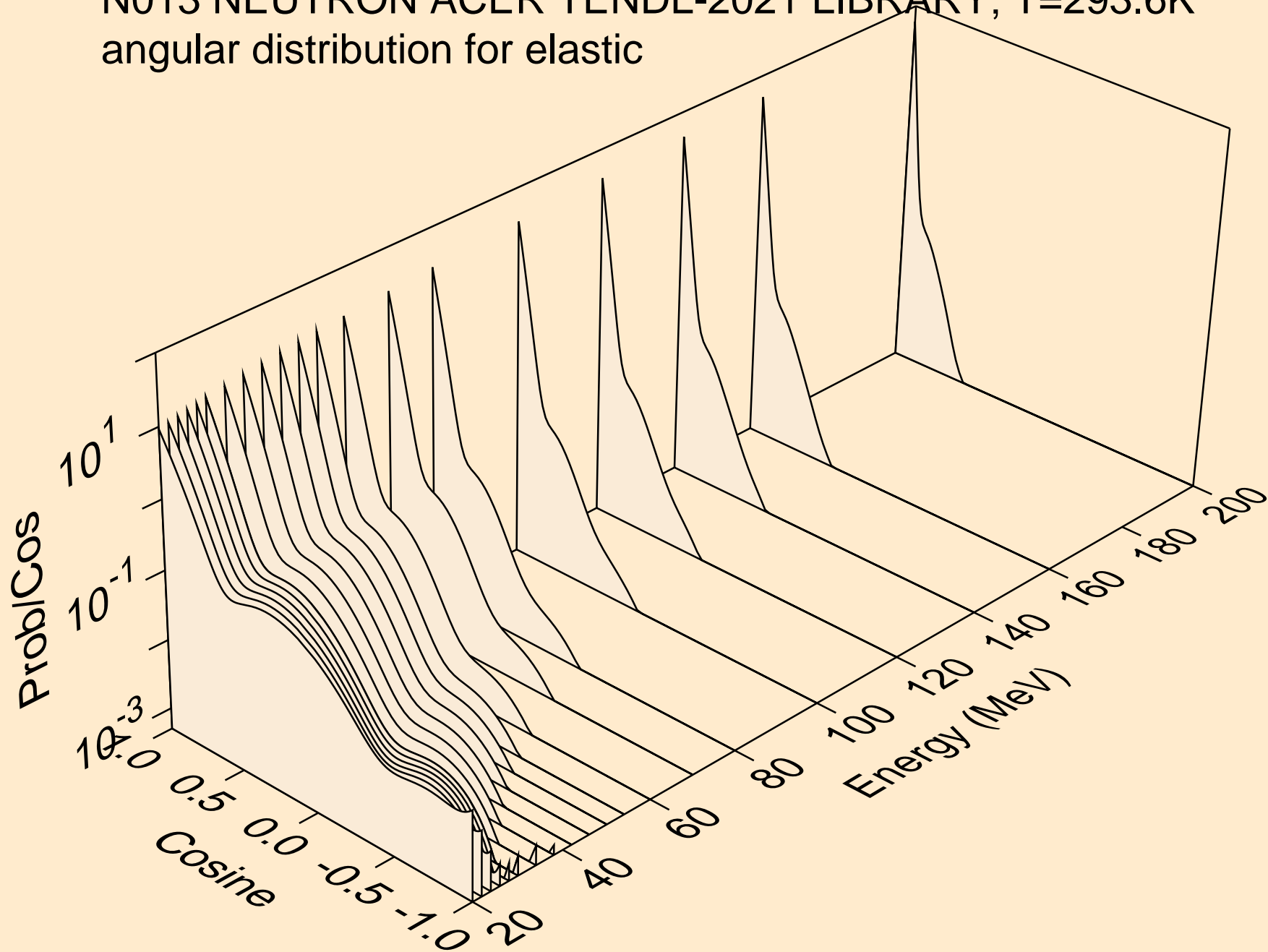

N013 NEUTRON ACER TENDL-2021 LIBRARY; T=293.6K
angular distribution for (n,n*1)

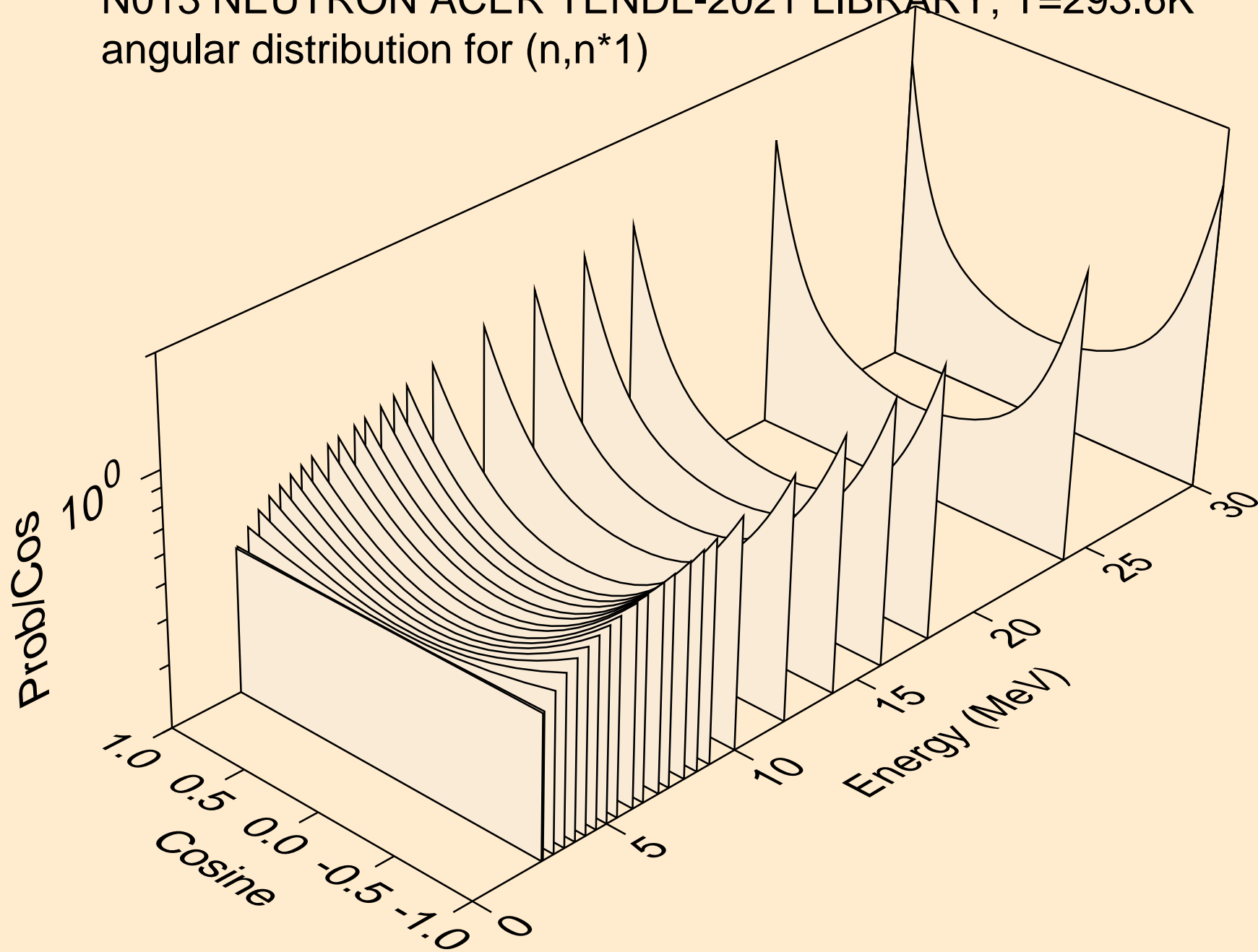

N013 NEUTRON ACER TENDL-2021 LIBRARY; T=293.6K
angular distribution for (n,n*2)

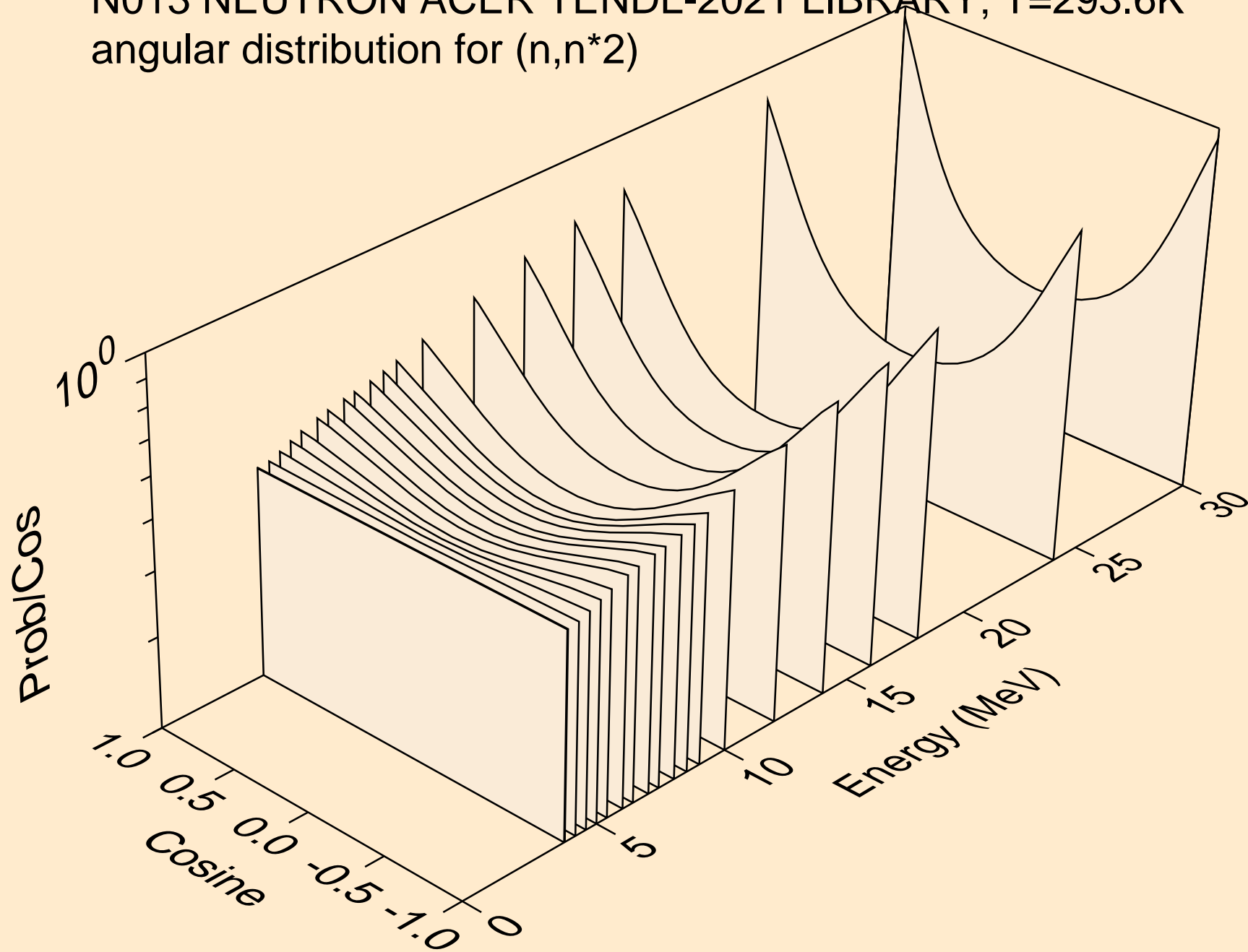

N013 NEUTRON ACER TENDL-2021 LIBRARY; T=293.6K
angular distribution for (n,n*3)

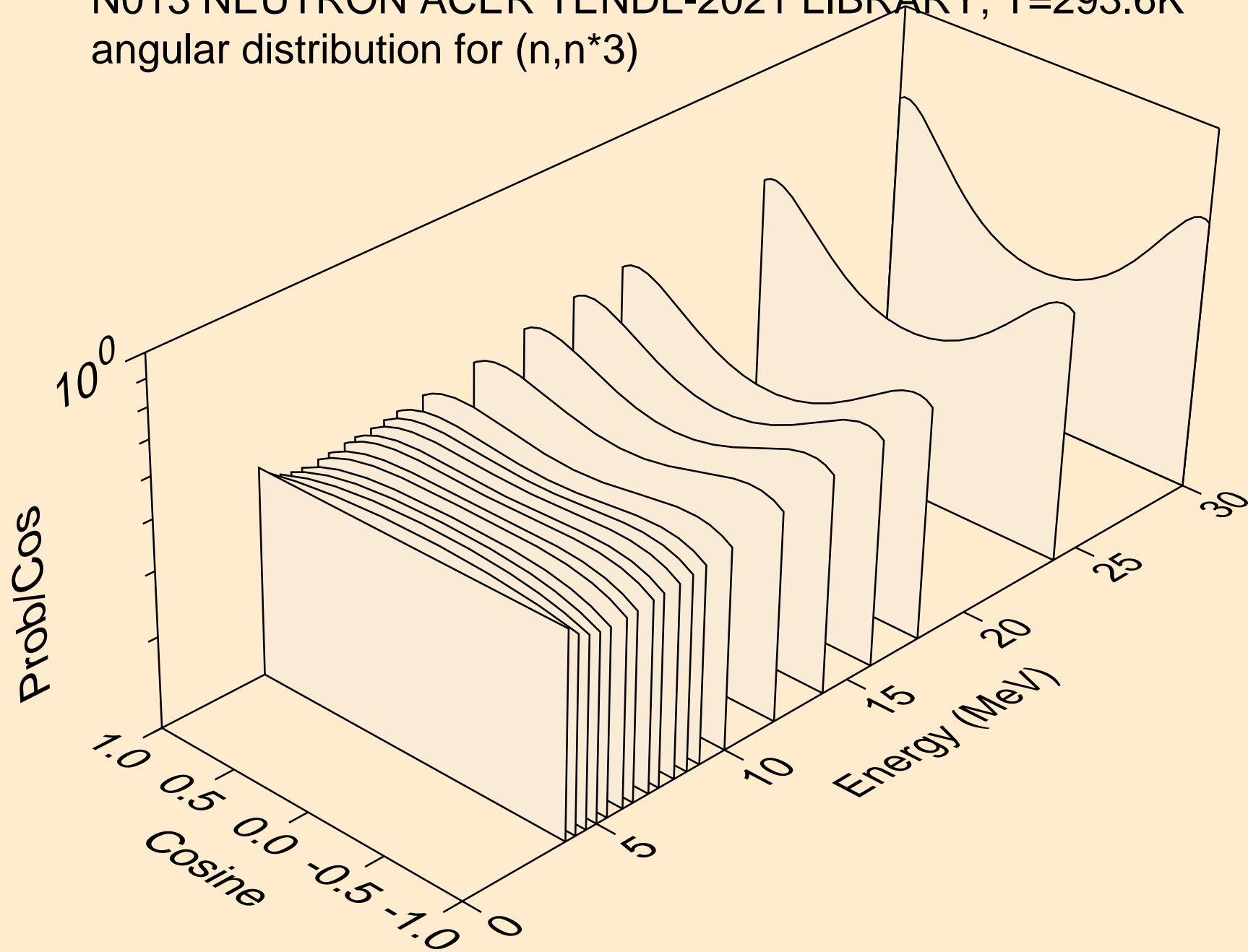

N013 NEUTRON ACER TENDL-2021 LIBRARY; T=293.6K
angular distribution for (n,n*4)

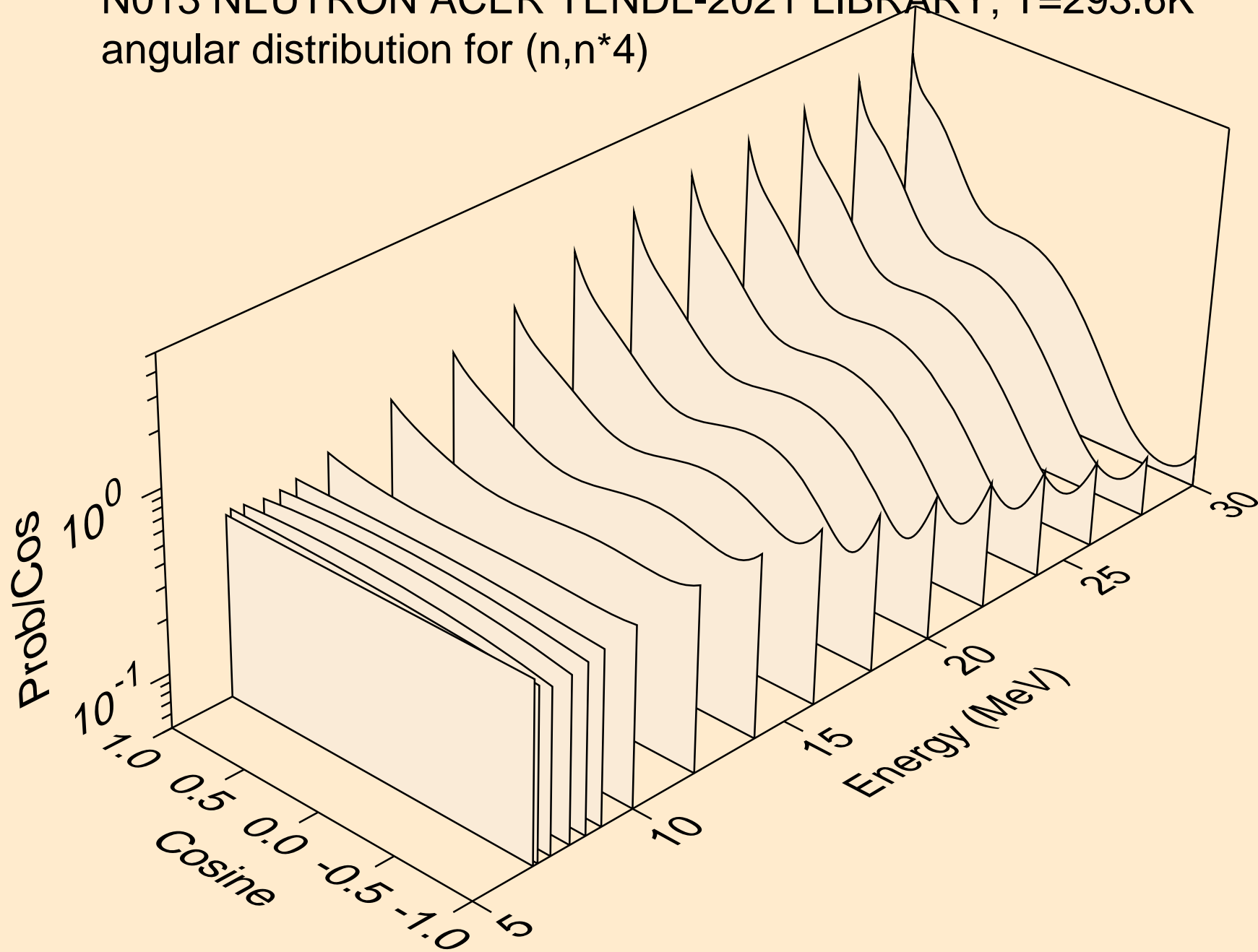

N013 NEUTRON ACER TENDL-2021 LIBRARY; T=293.6K
angular distribution for (n,n*5)

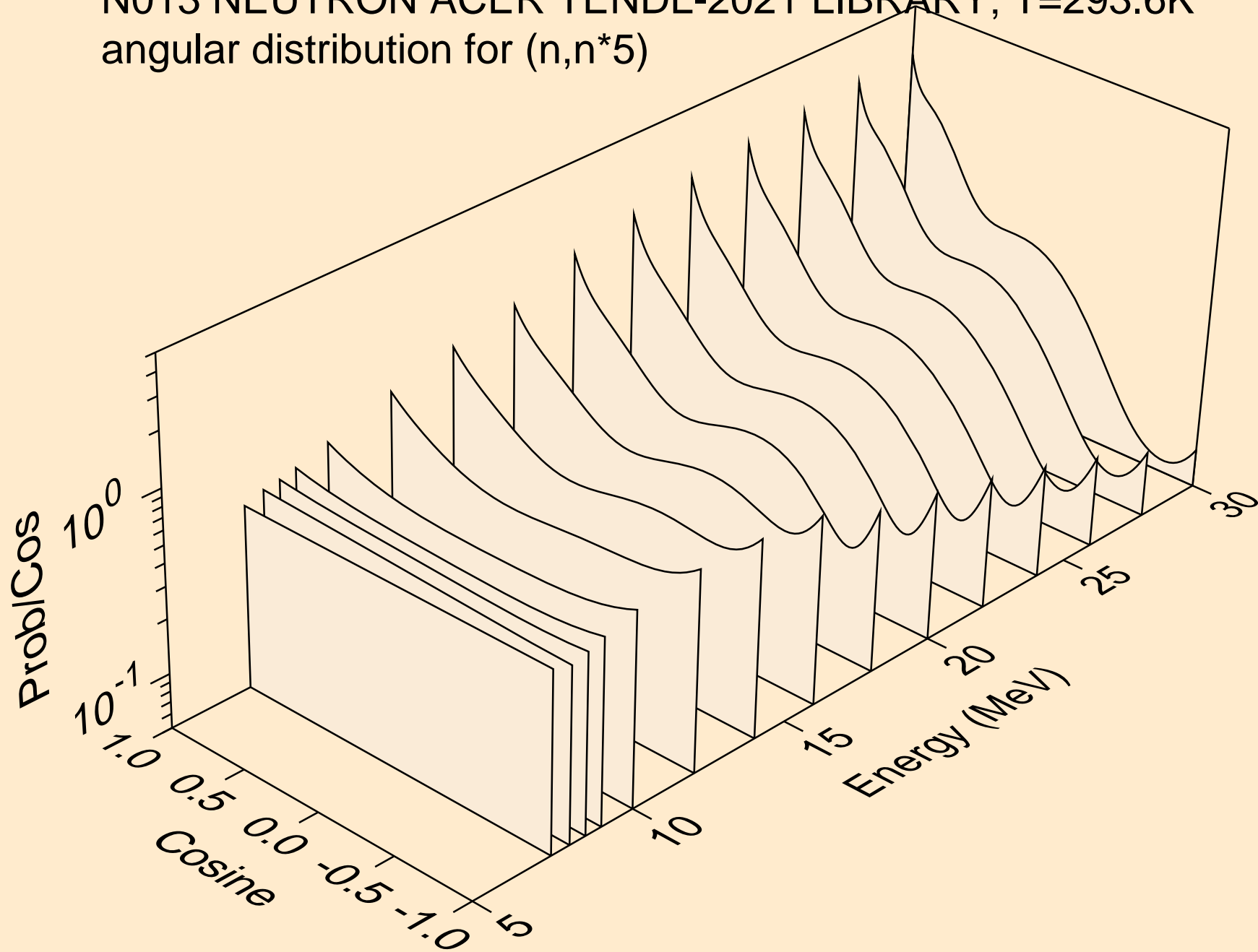

N013 NEUTRON ACER TENDL-2021 LIBRARY; T=293.6K
angular distribution for (n,n*6)

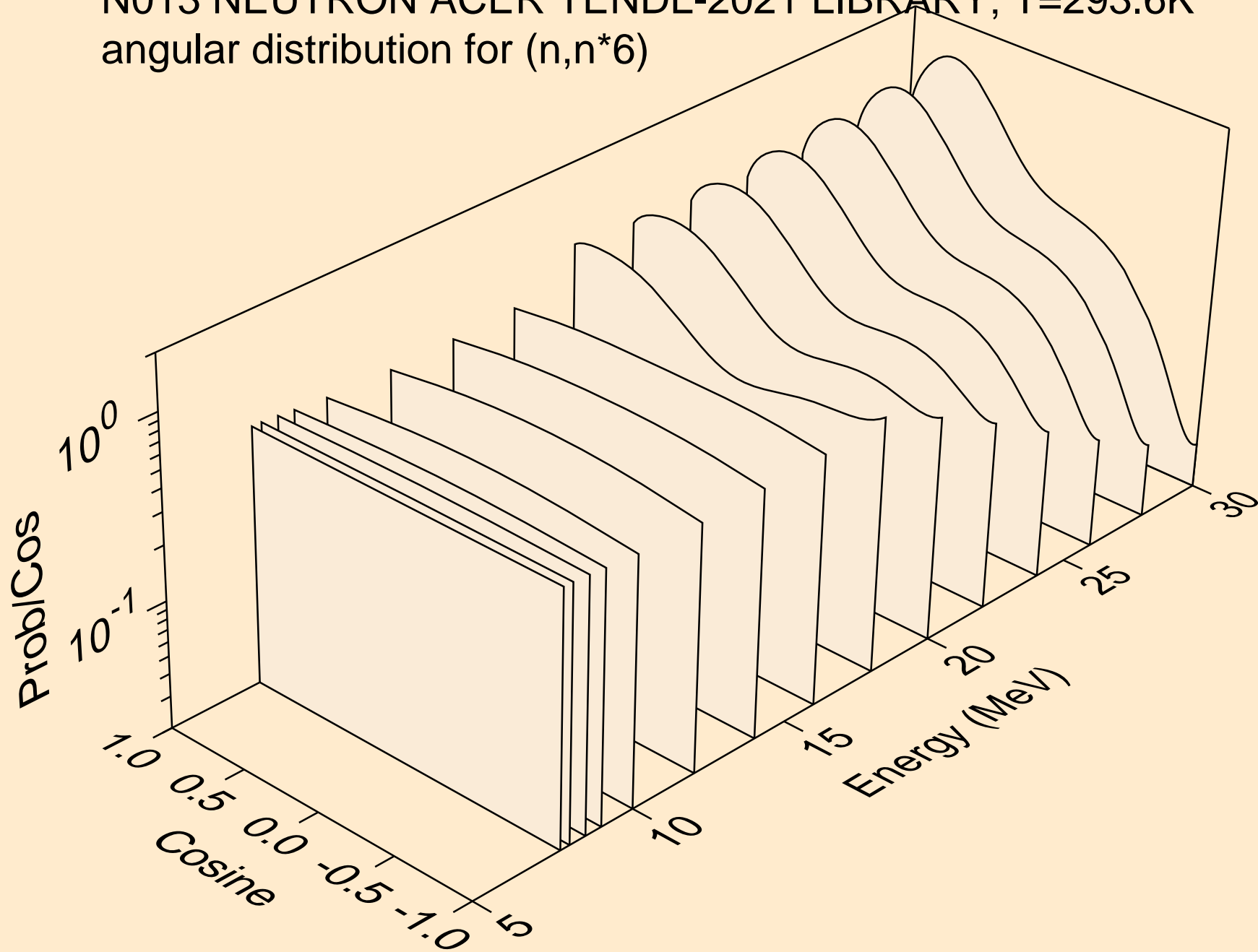

N013 NEUTRON ACER TENDL-2021 LIBRARY; T=293.6K
angular distribution for (n,n*7)

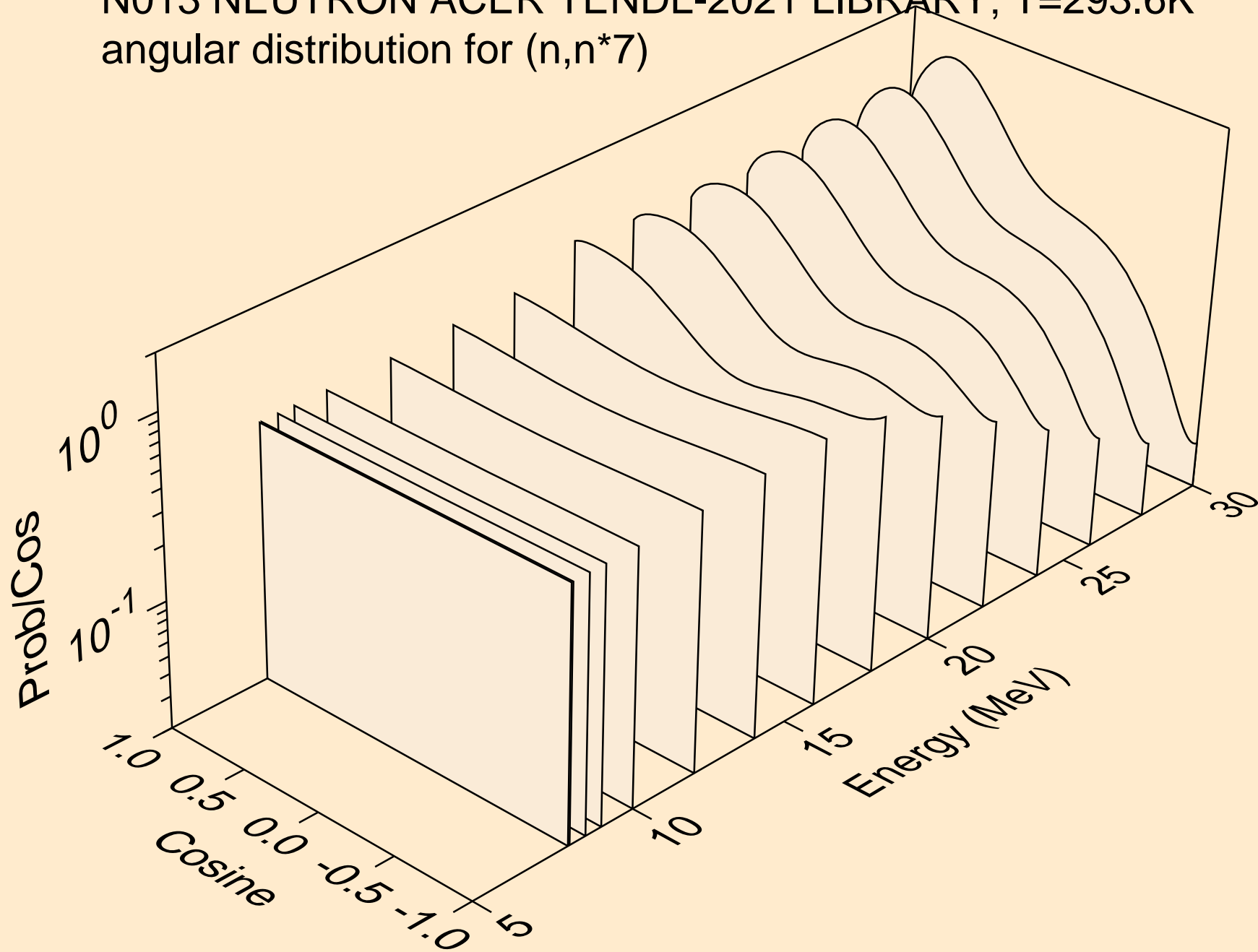

N013 NEUTRON ACER TENDL-2021 LIBRARY; T=293.6K
Neutron emission for (n,x)

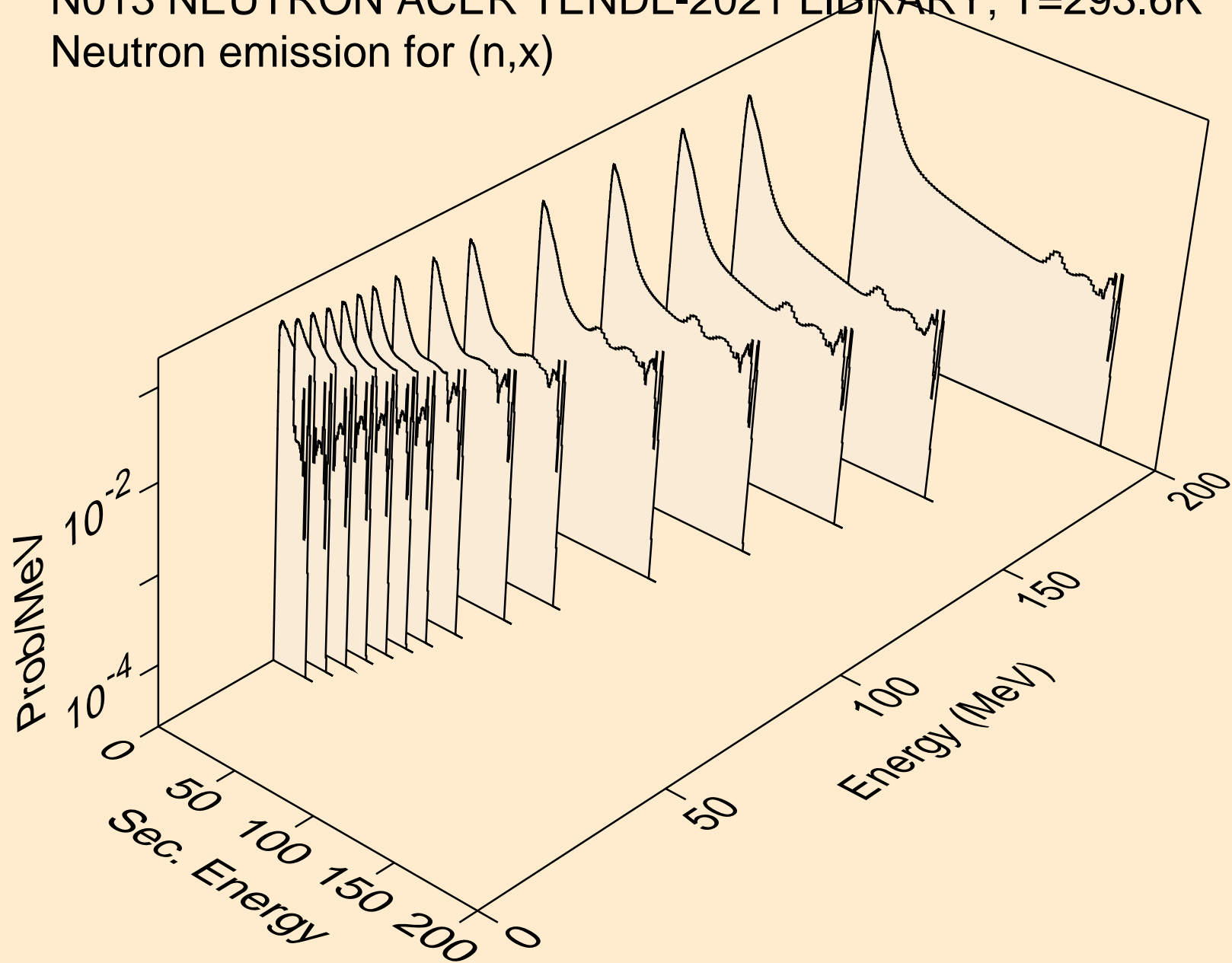

N013 NEUTRON ACER TENDL-2021 LIBRARY; T=293.6K
Neutron emission for (n,2n)

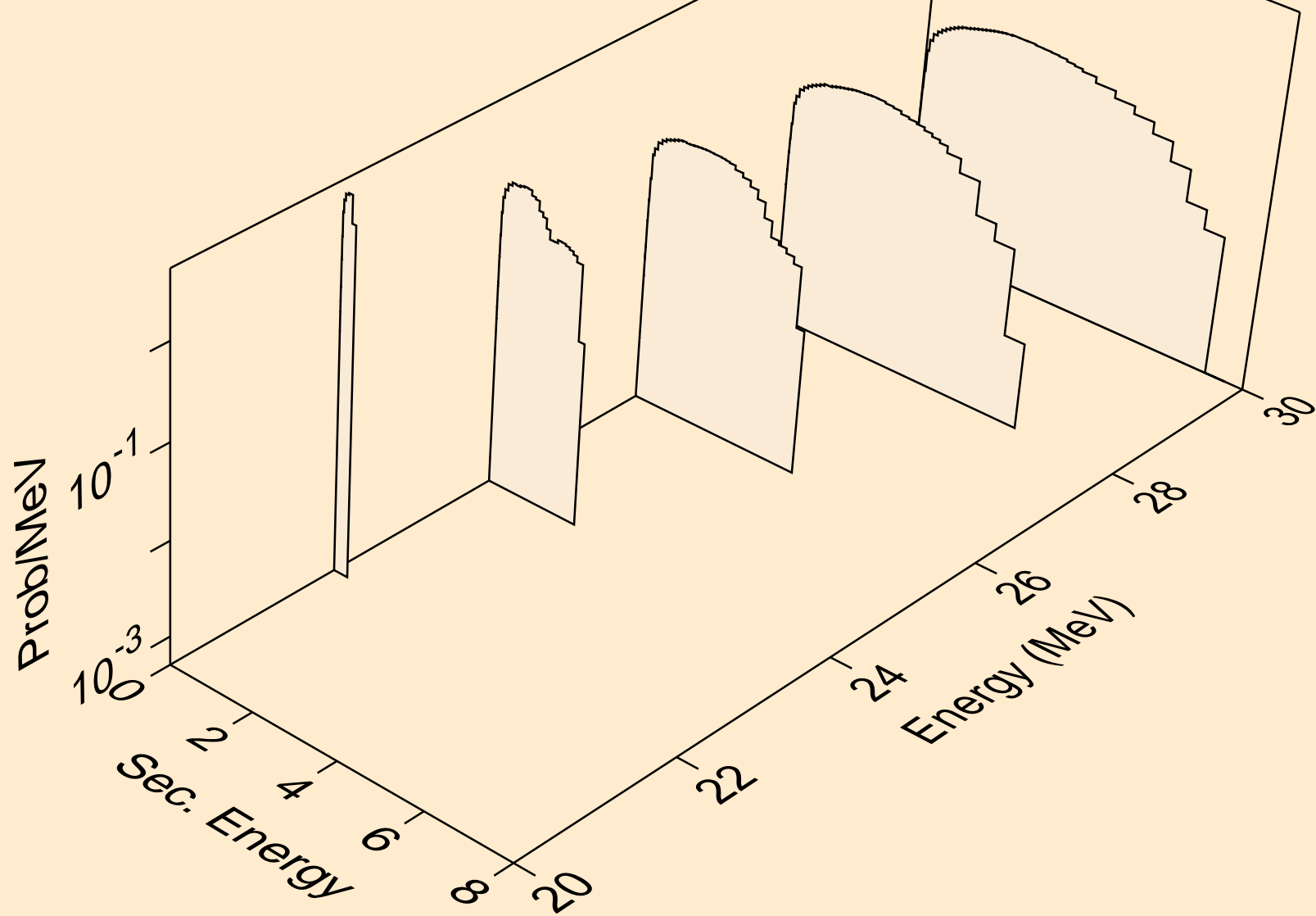

N013 NEUTRON ACER TENDL-2021 LIBRARY; T=293.6K
Neutron emission for (n,n*)a

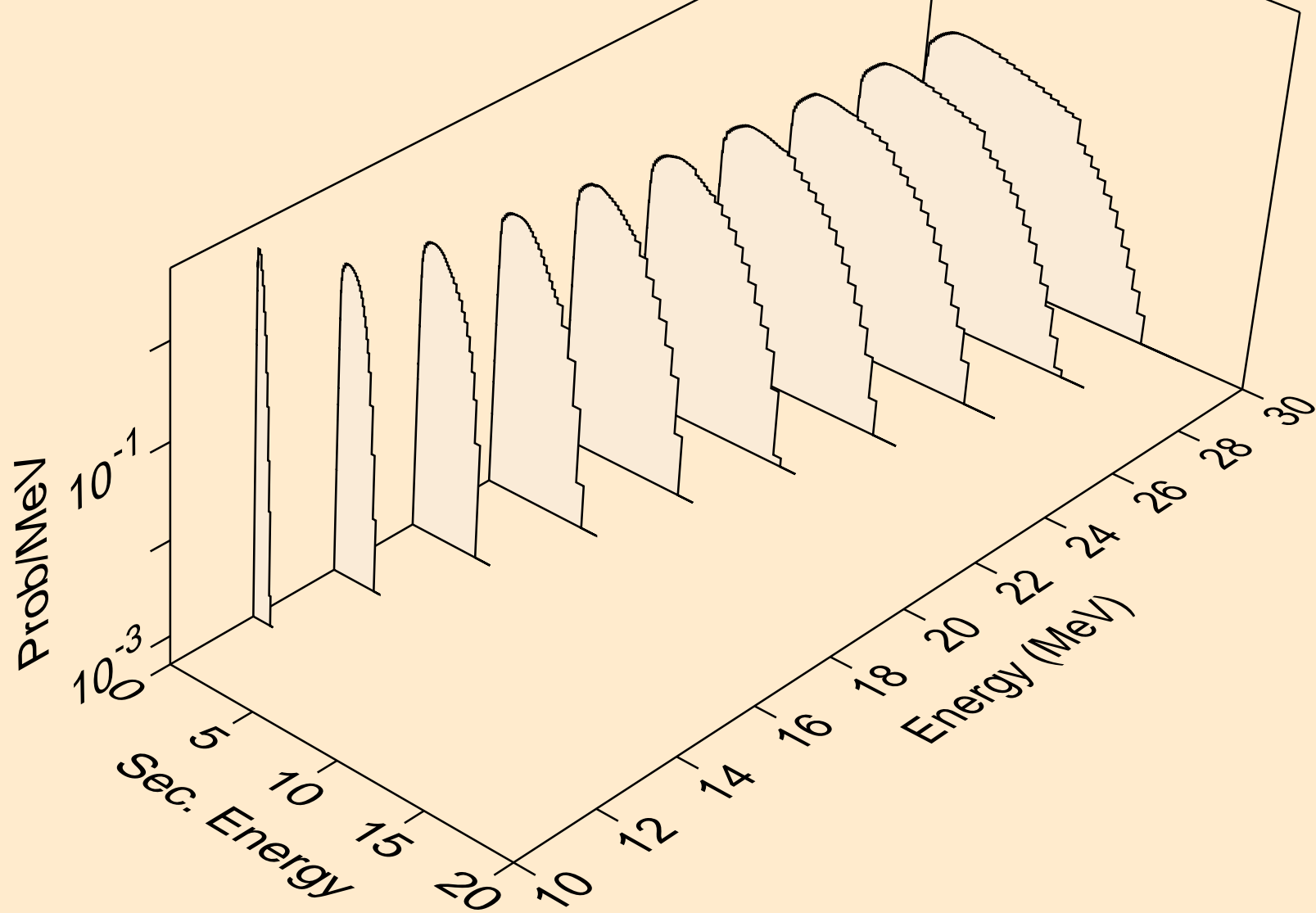

N013 NEUTRON ACER TENDL-2021 LIBRARY; T=293.6K
Neutron emission for (n,n*)p

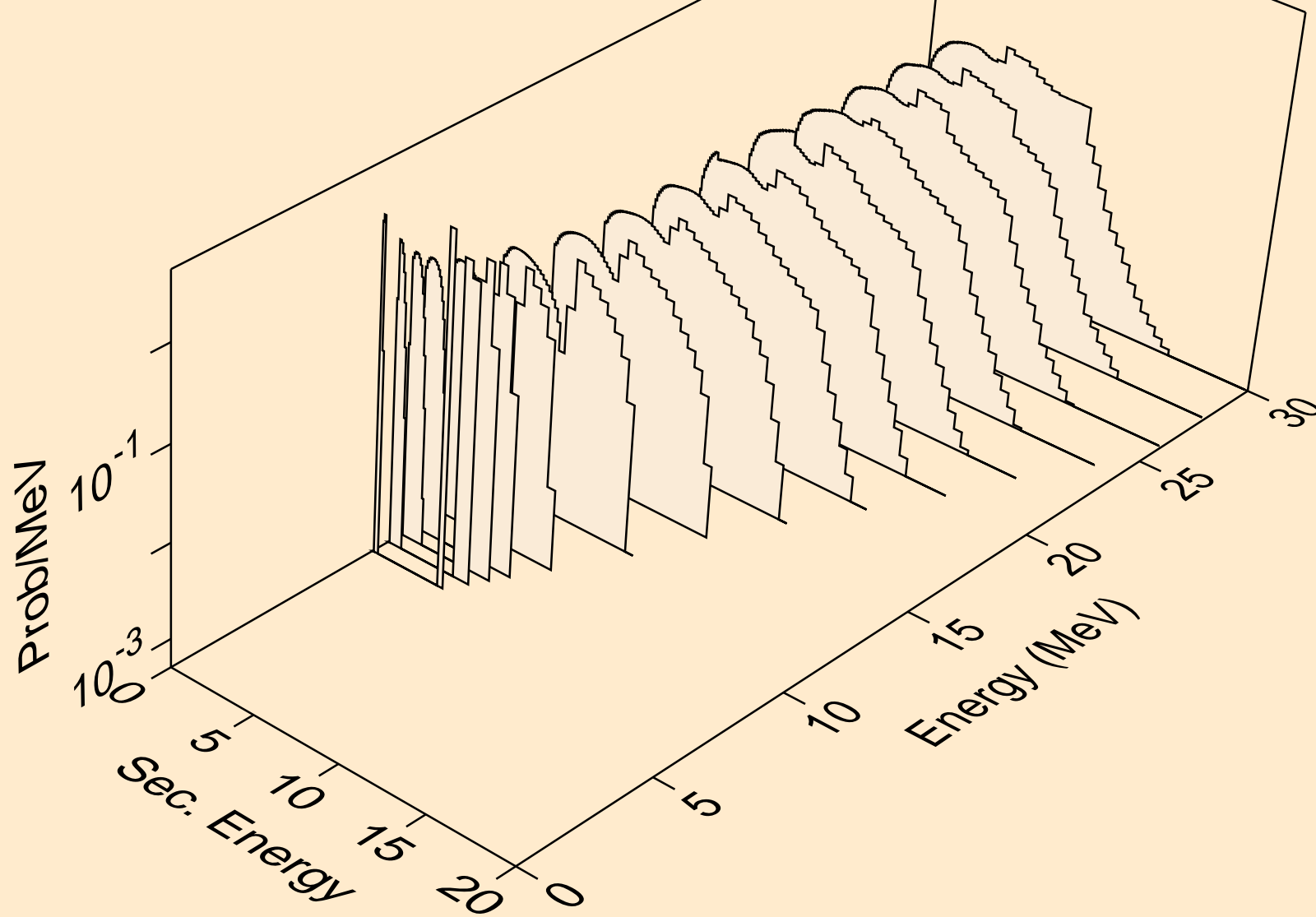

N013 NEUTRON ACER TENDL-2021 LIBRARY; T=293.6K
Neutron emission for (n,n*)d

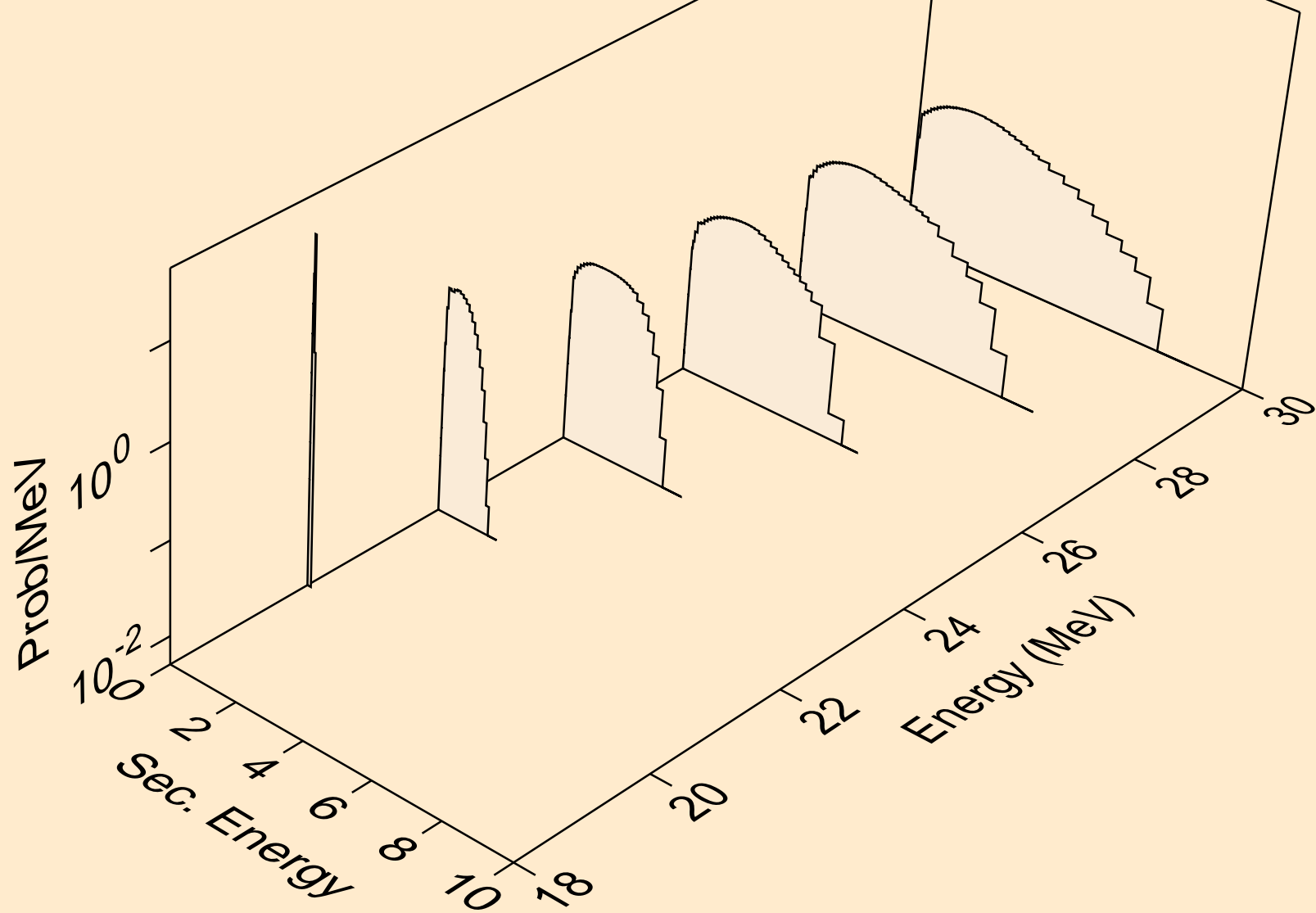

N013 NEUTRON ACER TENDL-2021 LIBRARY; T=293.6K
Neutron emission for (n,n*)t

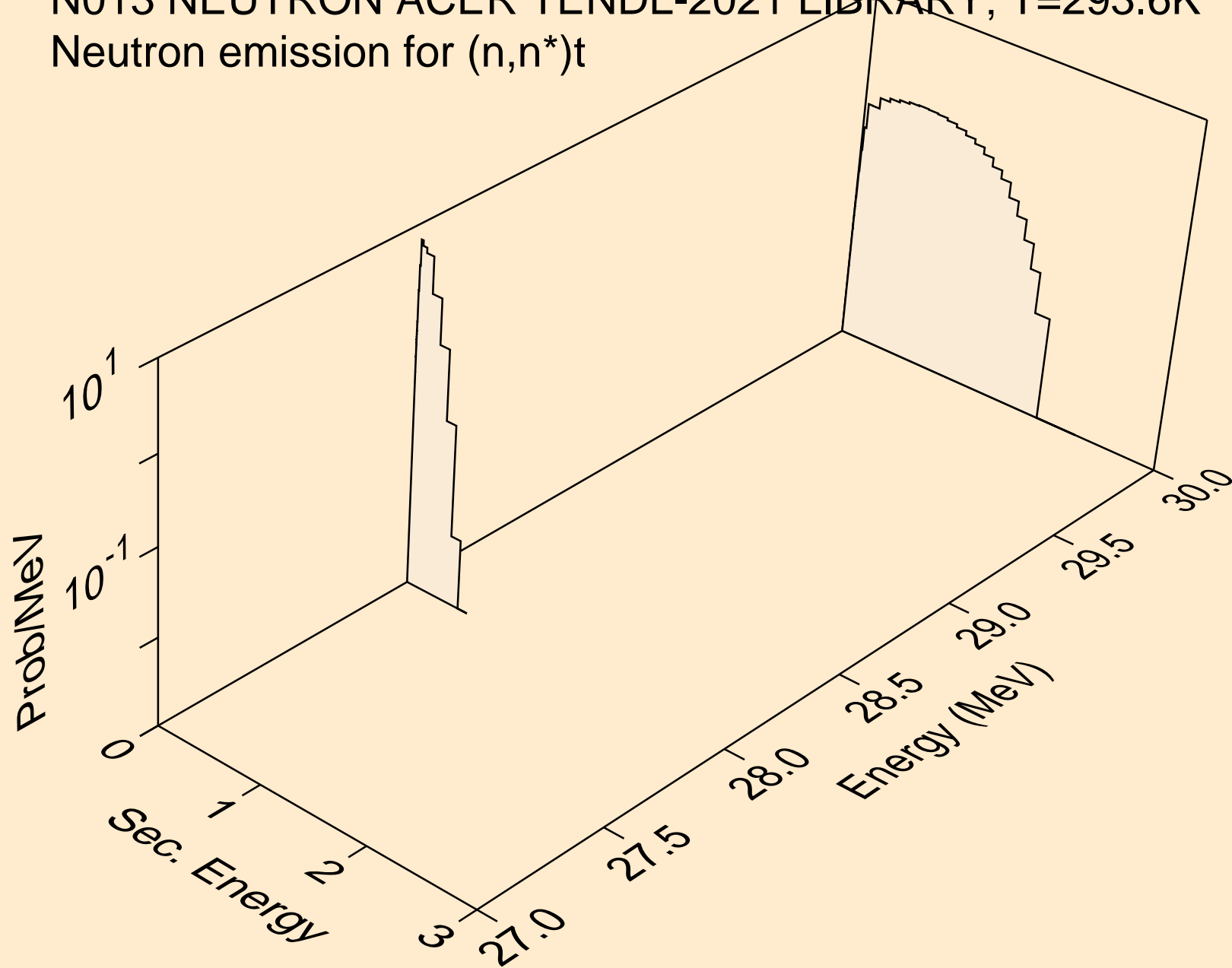

N013 NEUTRON ACER TENDL-2021 LIBRARY; T=293.6K
Neutron emission for (n,n*)he3

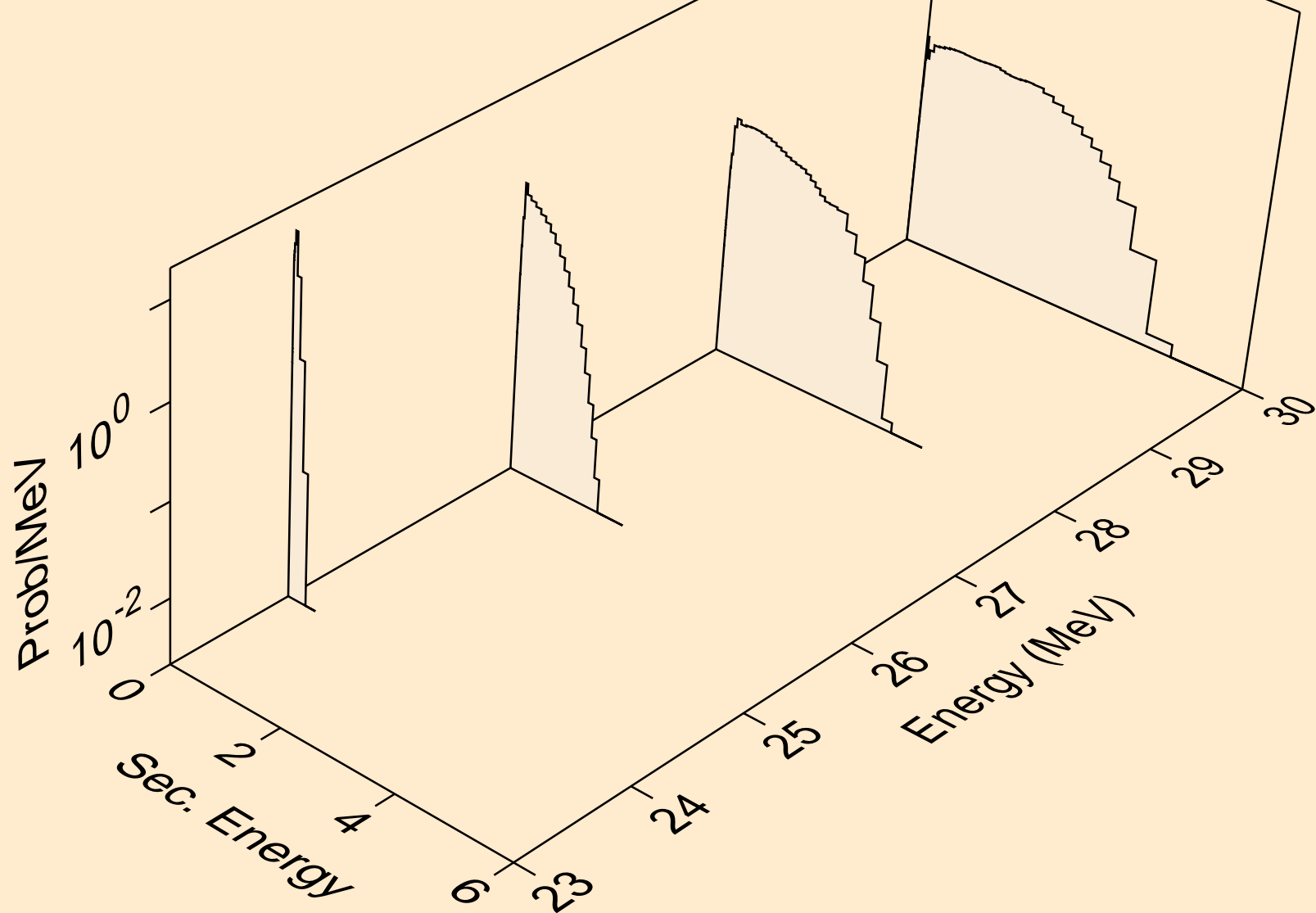

N013 NEUTRON ACER TENDL-2021 LIBRARY; T=293.6K
Neutron emission for (n,2np)

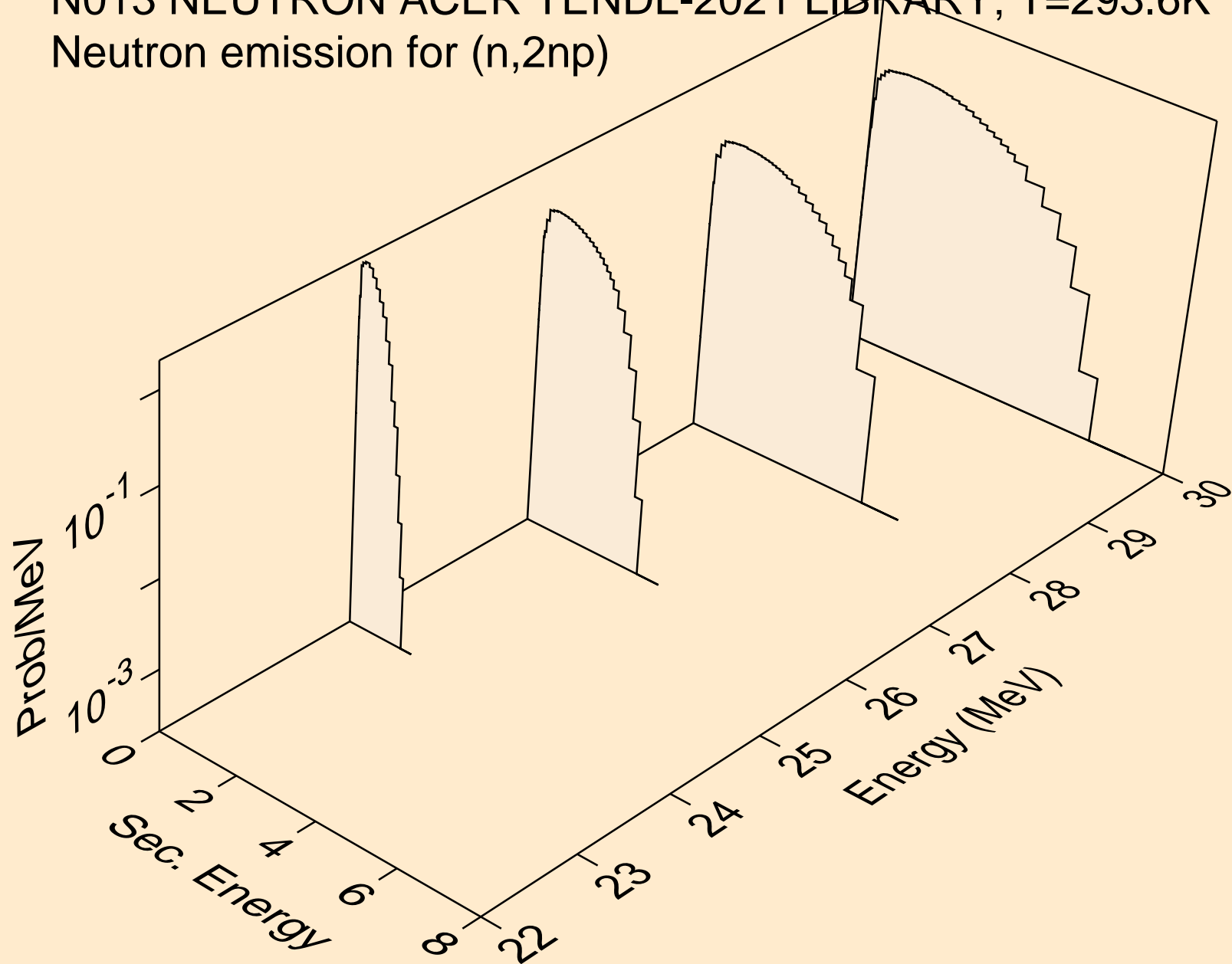

N013 NEUTRON ACER TENDL-2021 LIBRARY; T=293.6K
Neutron emission for (n,2np)

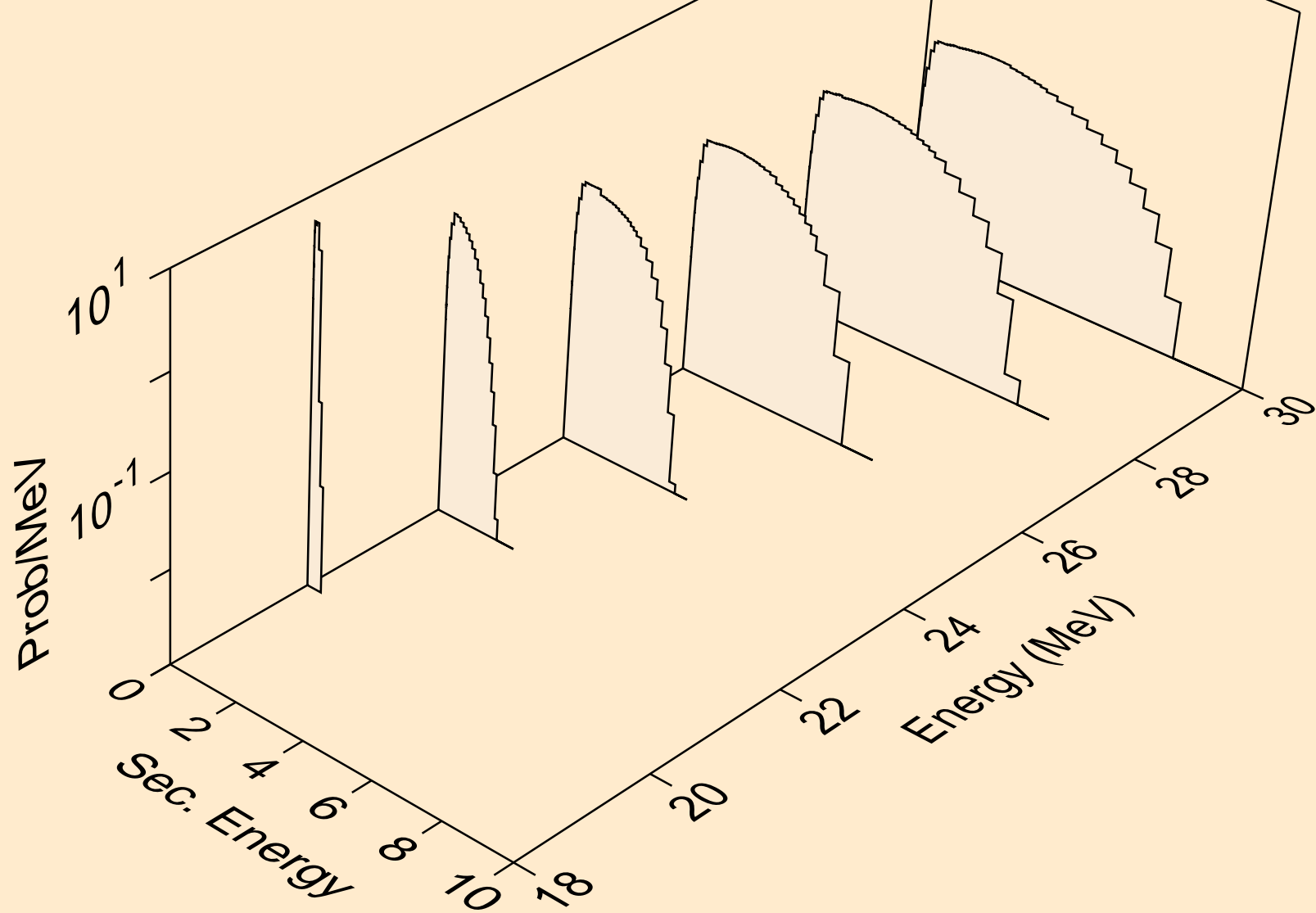

N013 NEUTRON ACER TENDL-2021 LIBRARY; T=293.6K
Neutron emission for (n,npa)

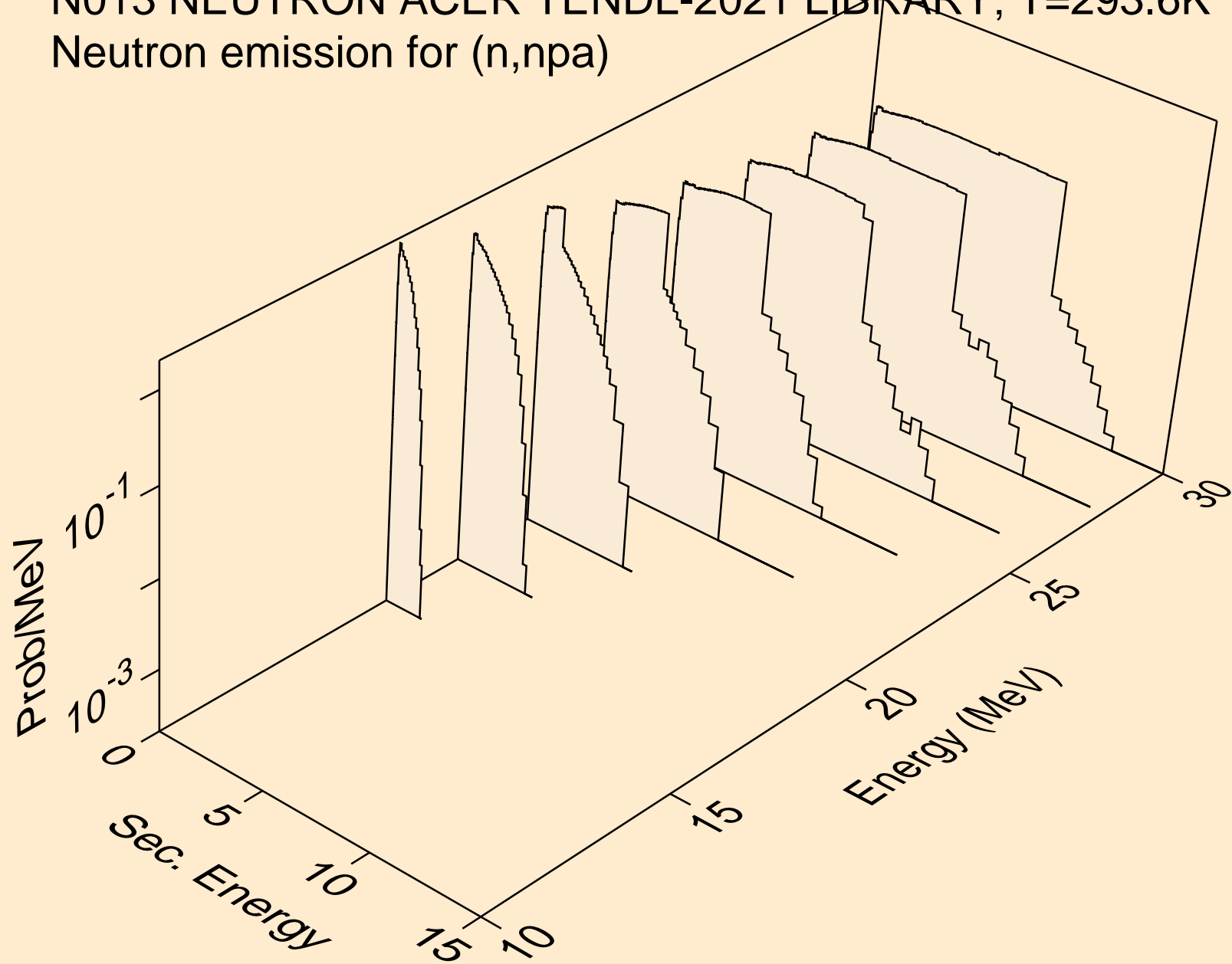

N013 NEUTRON ACER TENDL-2021 LIBRARY; T=293.6K
Neutron emission for (n,n*c)

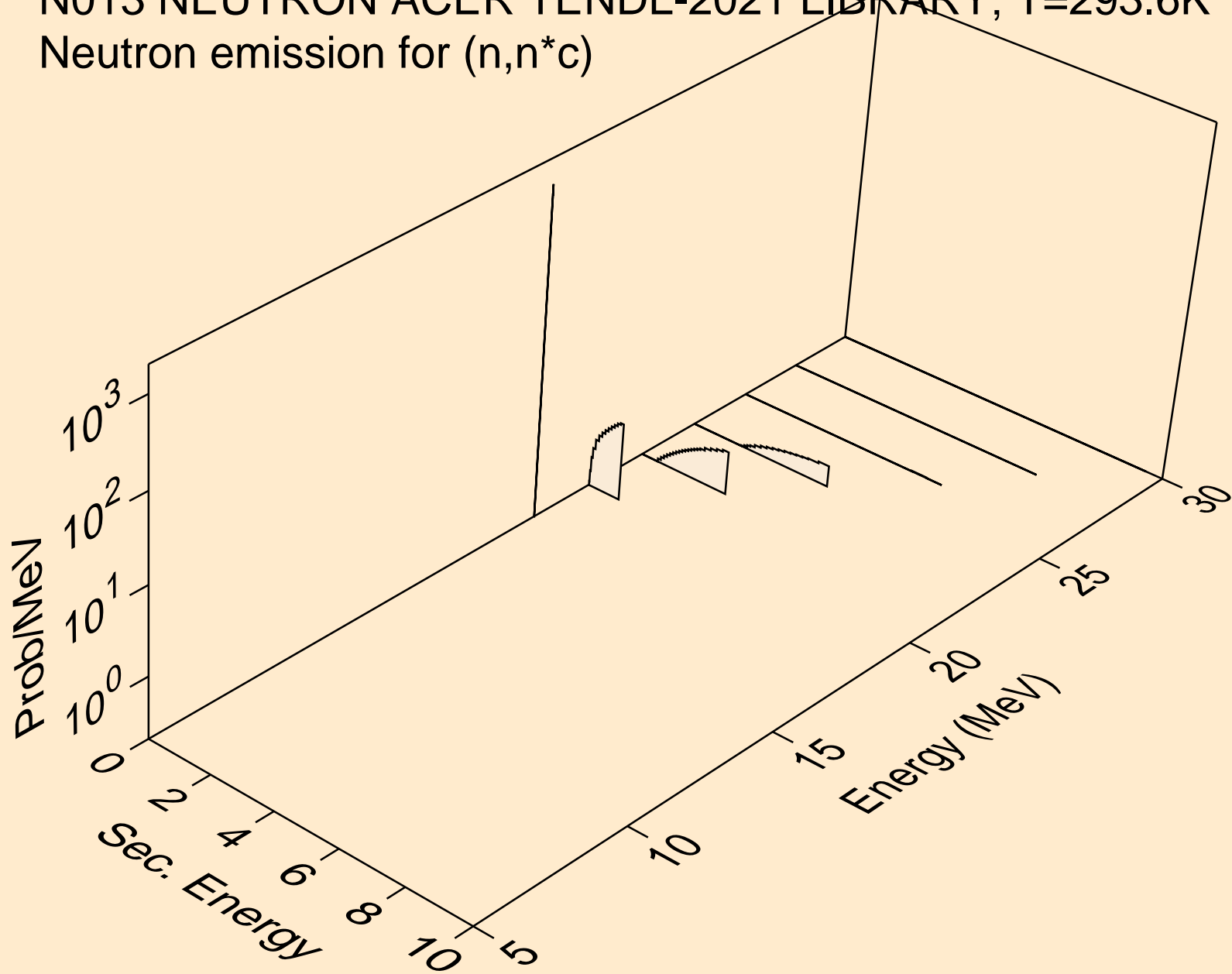

N013 NEUTRON ACER TENDL-2021 LIBRARY; T=293.6K
Photon emission for (n,x)

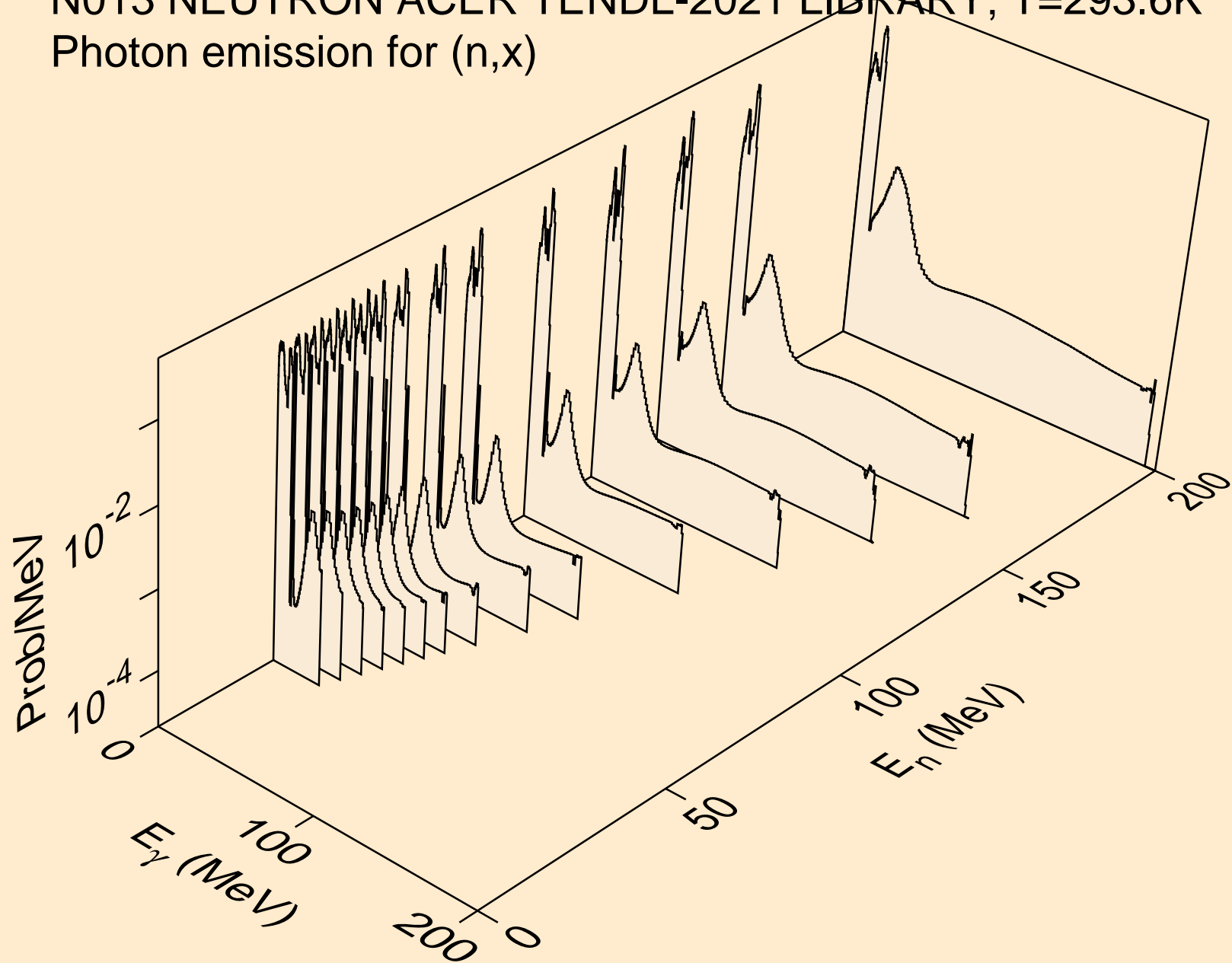

N013 NEUTRON ACER TENDL-2021 LIBRARY; T=293.6K
Photon emission for (n,2n)

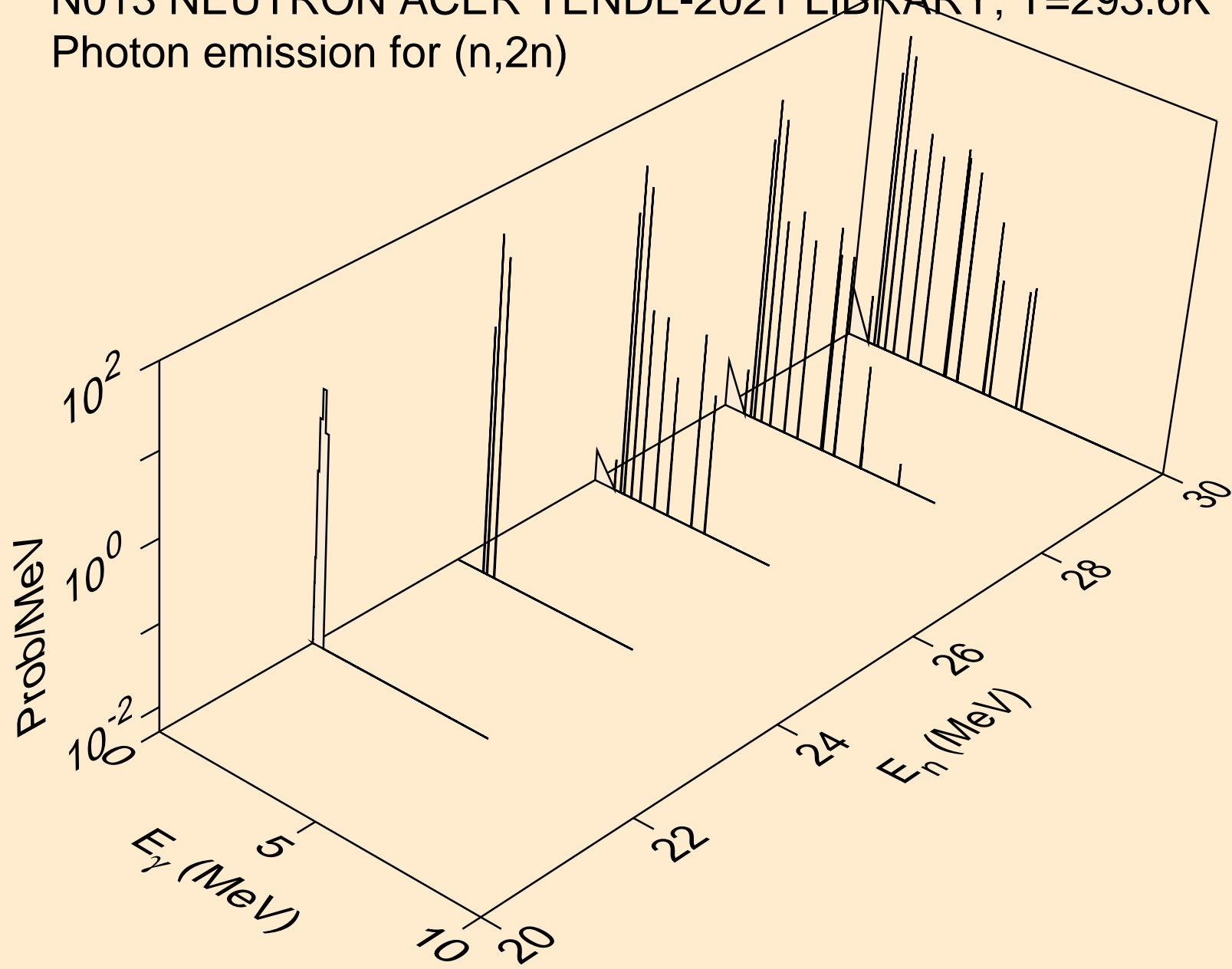

N013 NEUTRON ACER TENDL-2021 LIBRARY; T=293.6K
Photon emission for (n,n*)a

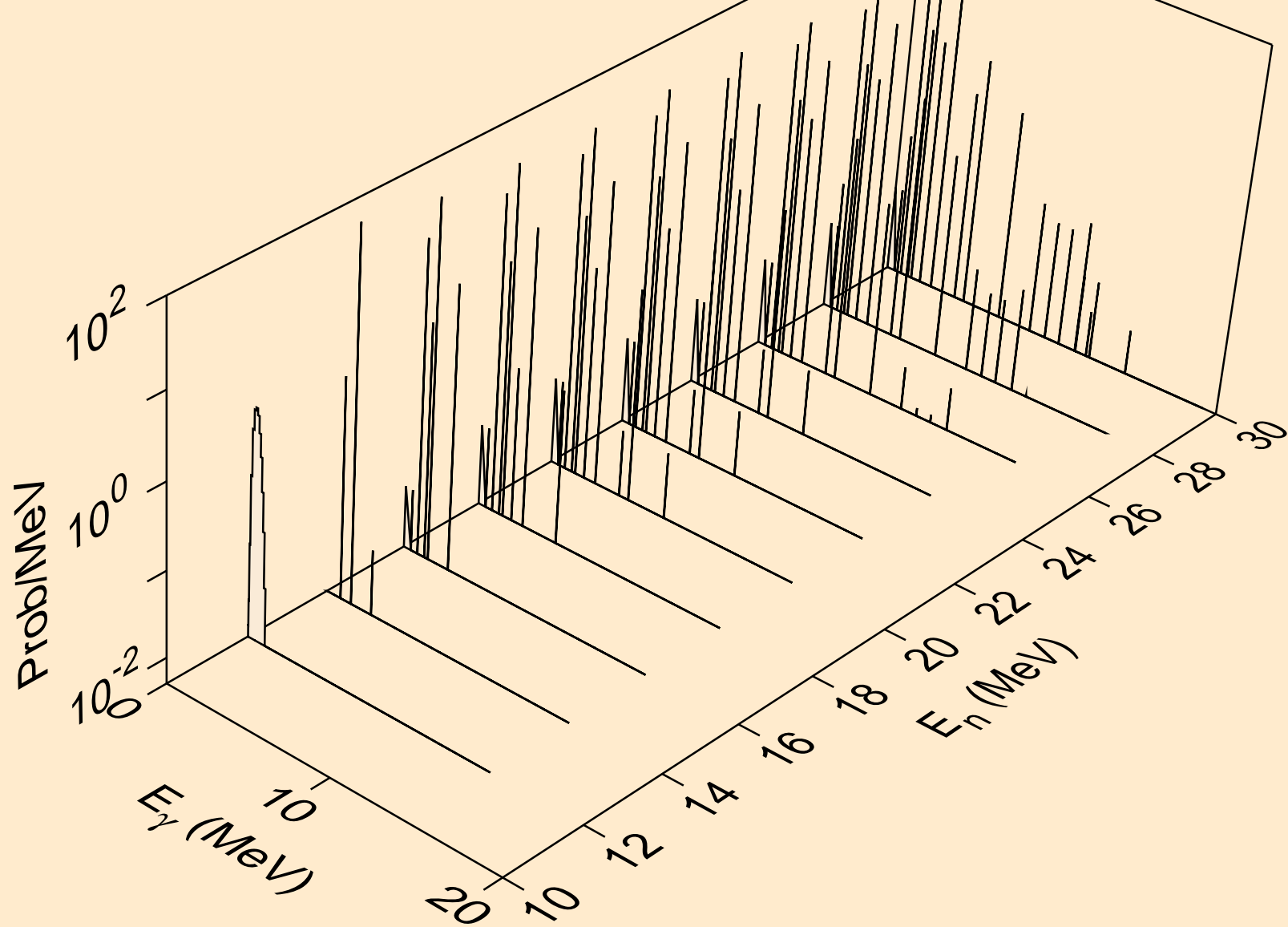

N013 NEUTRON ACER TENDL-2021 LIBRARY; T=293.6K
Photon emission for (n,n*)p

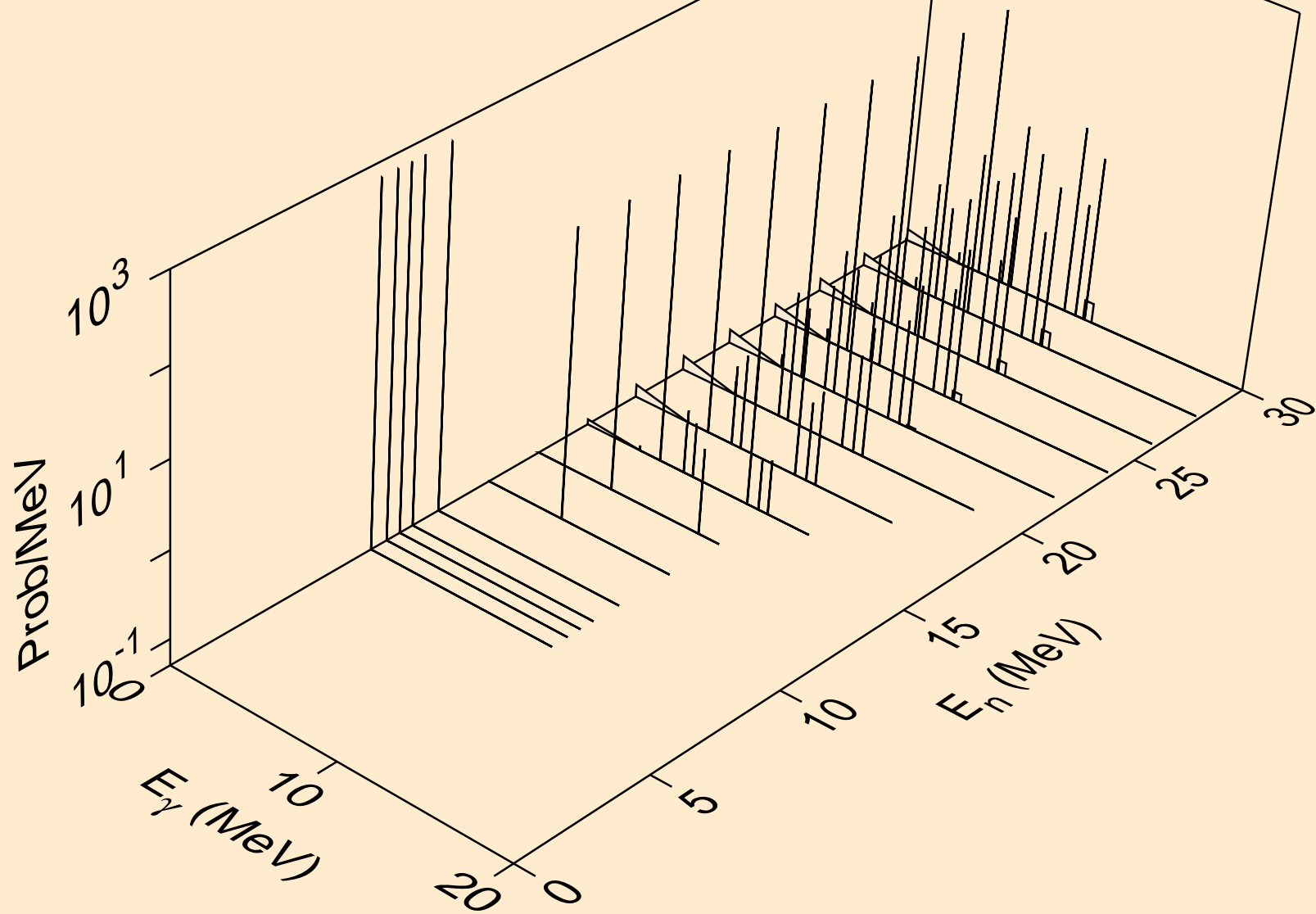

N013 NEUTRON ACER TENDL-2021 LIBRARY; T=293.6K
Photon emission for (n,n*)d

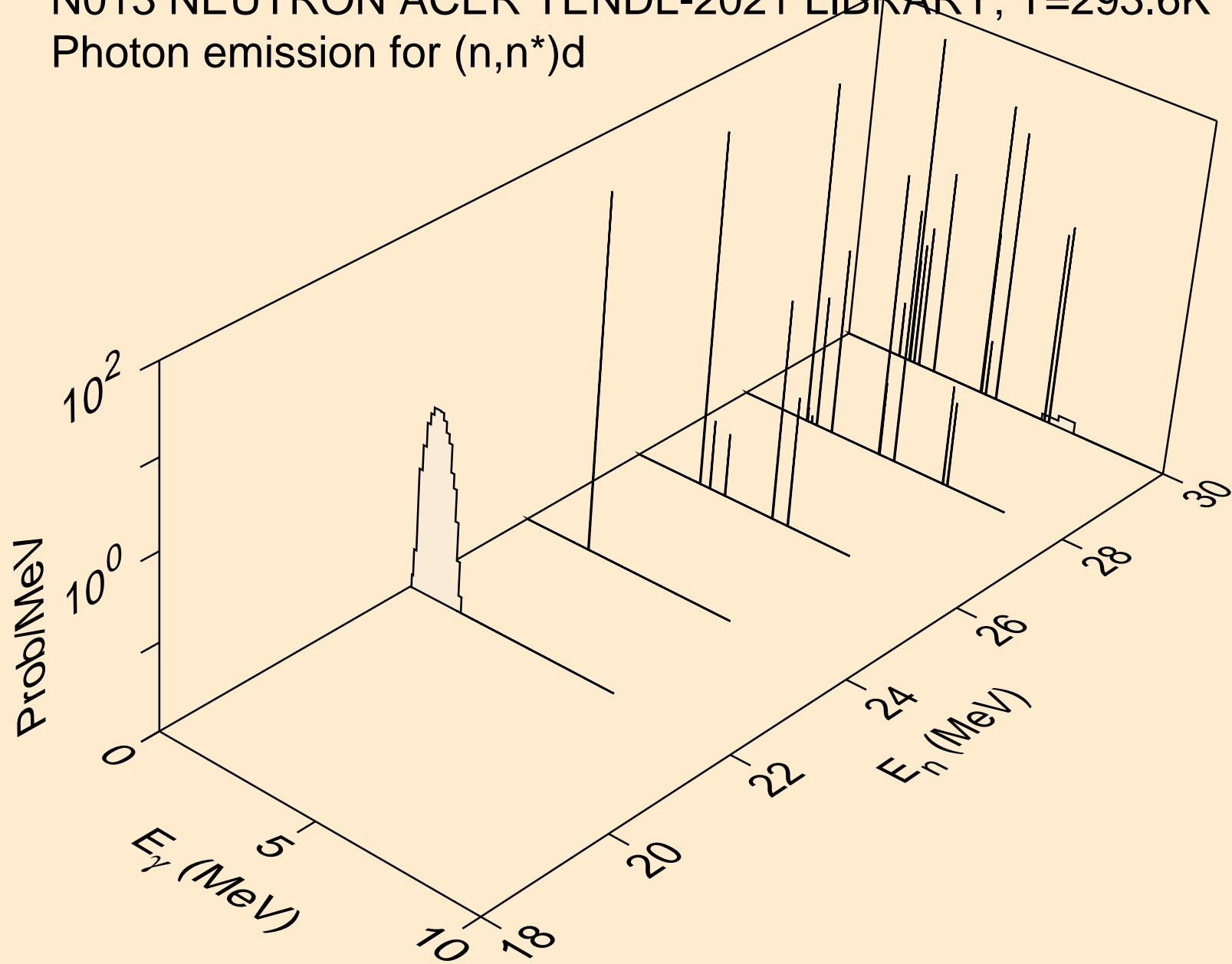

N013 NEUTRON ACER TENDL-2021 LIBRARY; T=293.6K
Photon emission for (n,n*)t

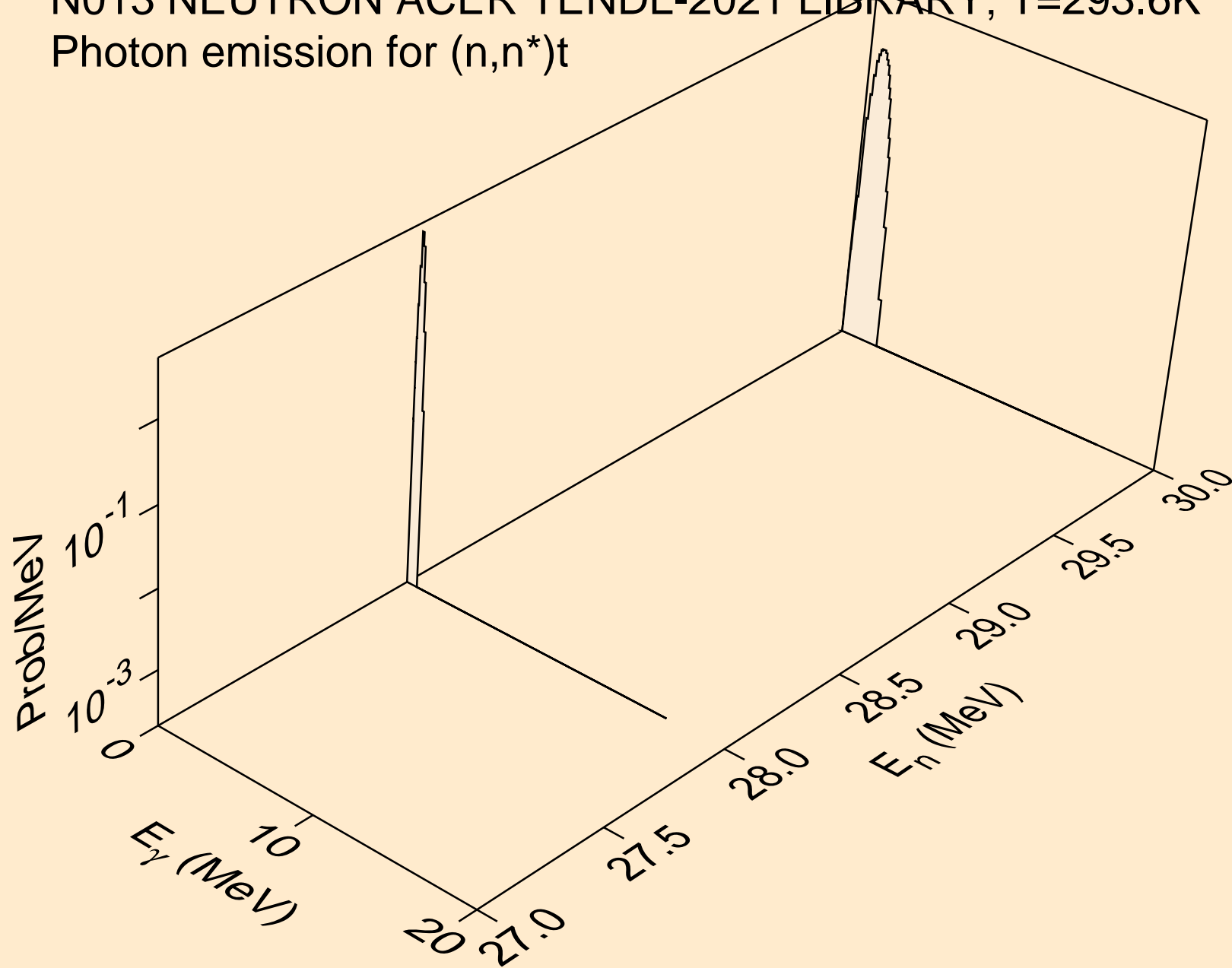

N013 NEUTRON ACER TENDL-2021 LIBRARY; T=293.6K
Photon emission for (n,n*)he3

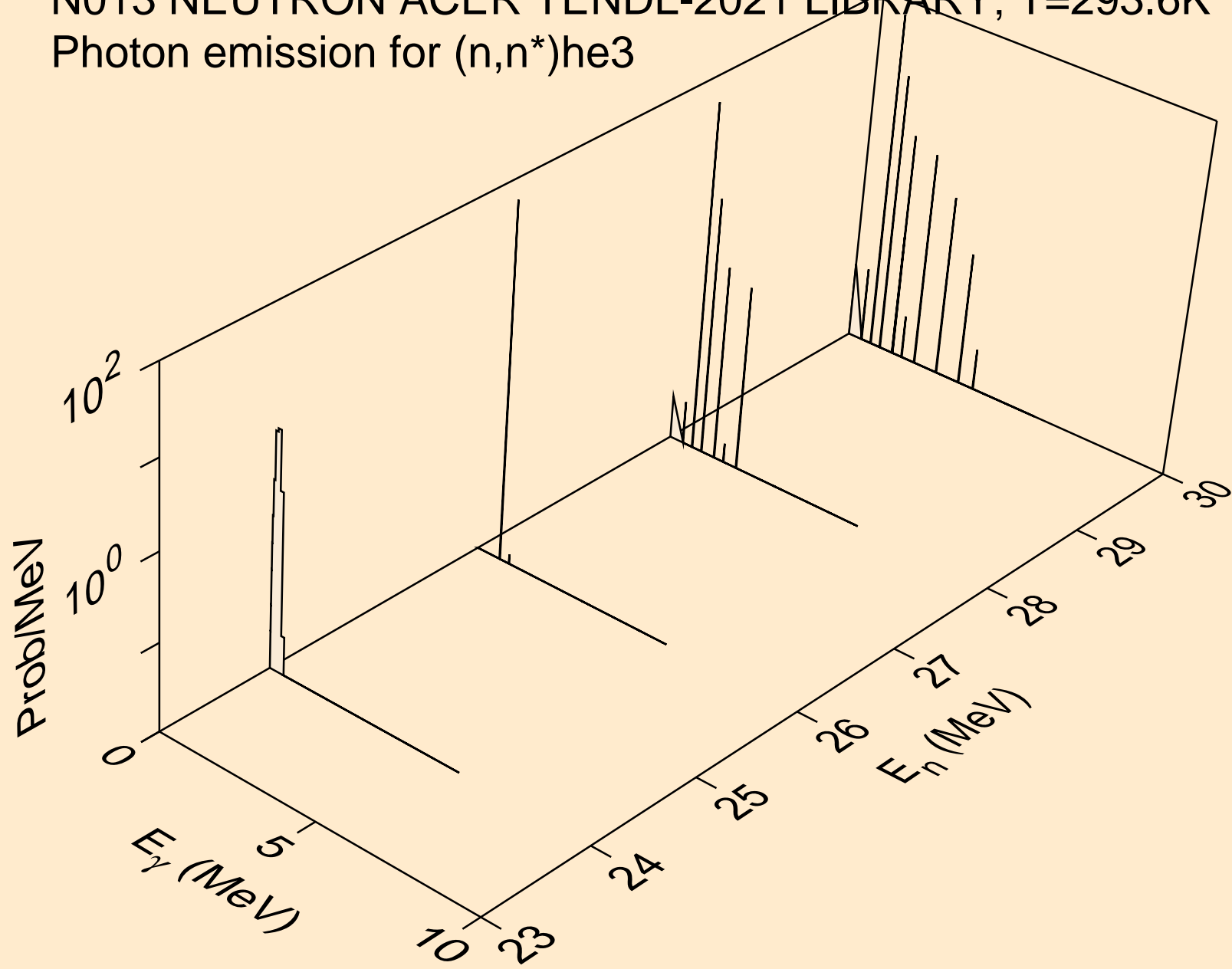

N013 NEUTRON ACER TENDL-2021 LIBRARY; T=293.6K
Photon emission for (n,2np)

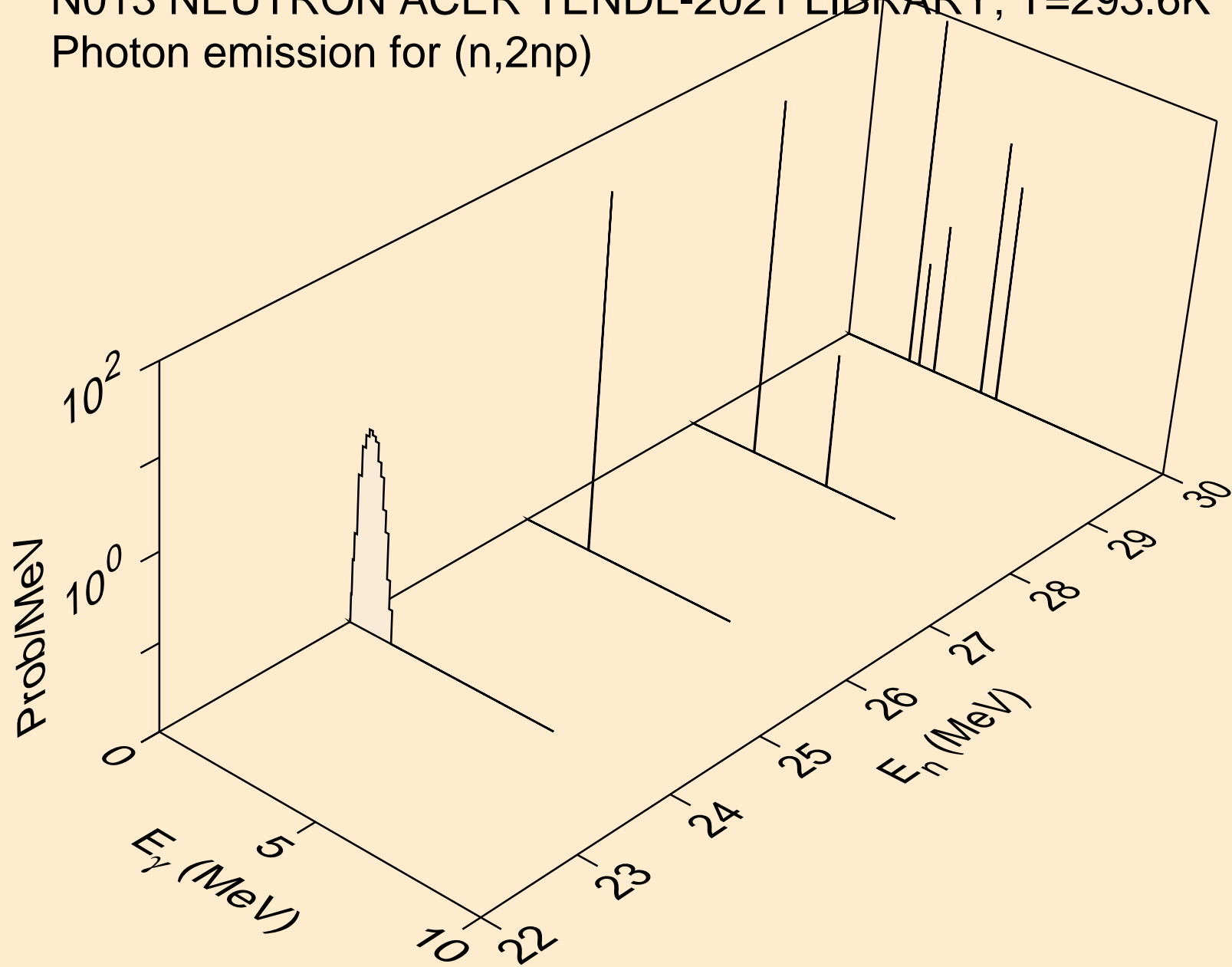

N013 NEUTRON ACER TENDL-2021 LIBRARY; T=293.6K
Photon emission for (n,2np)

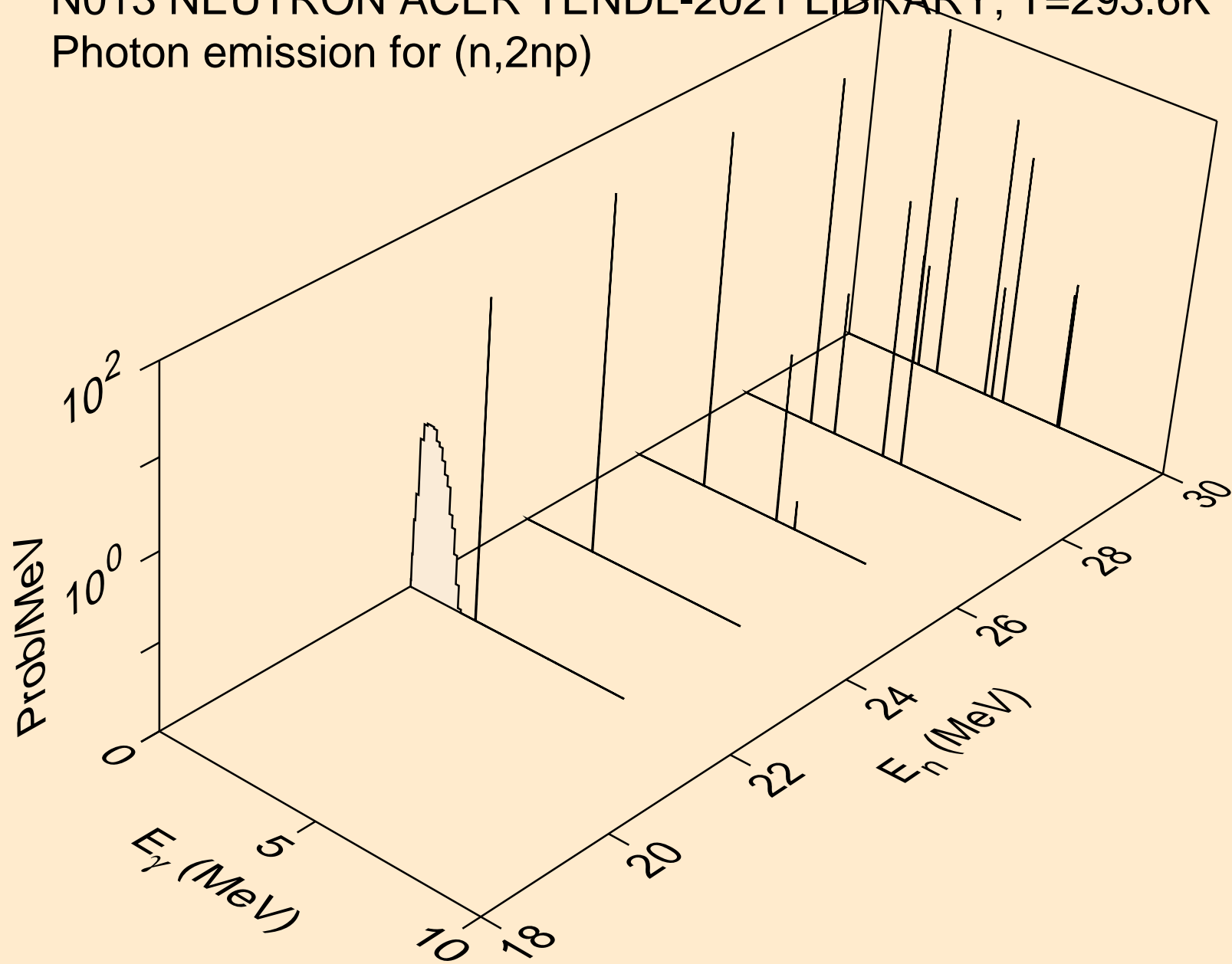

N013 NEUTRON ACER TENDL-2021 LIBRARY; T=293.6K
Photon emission for (n,npa)

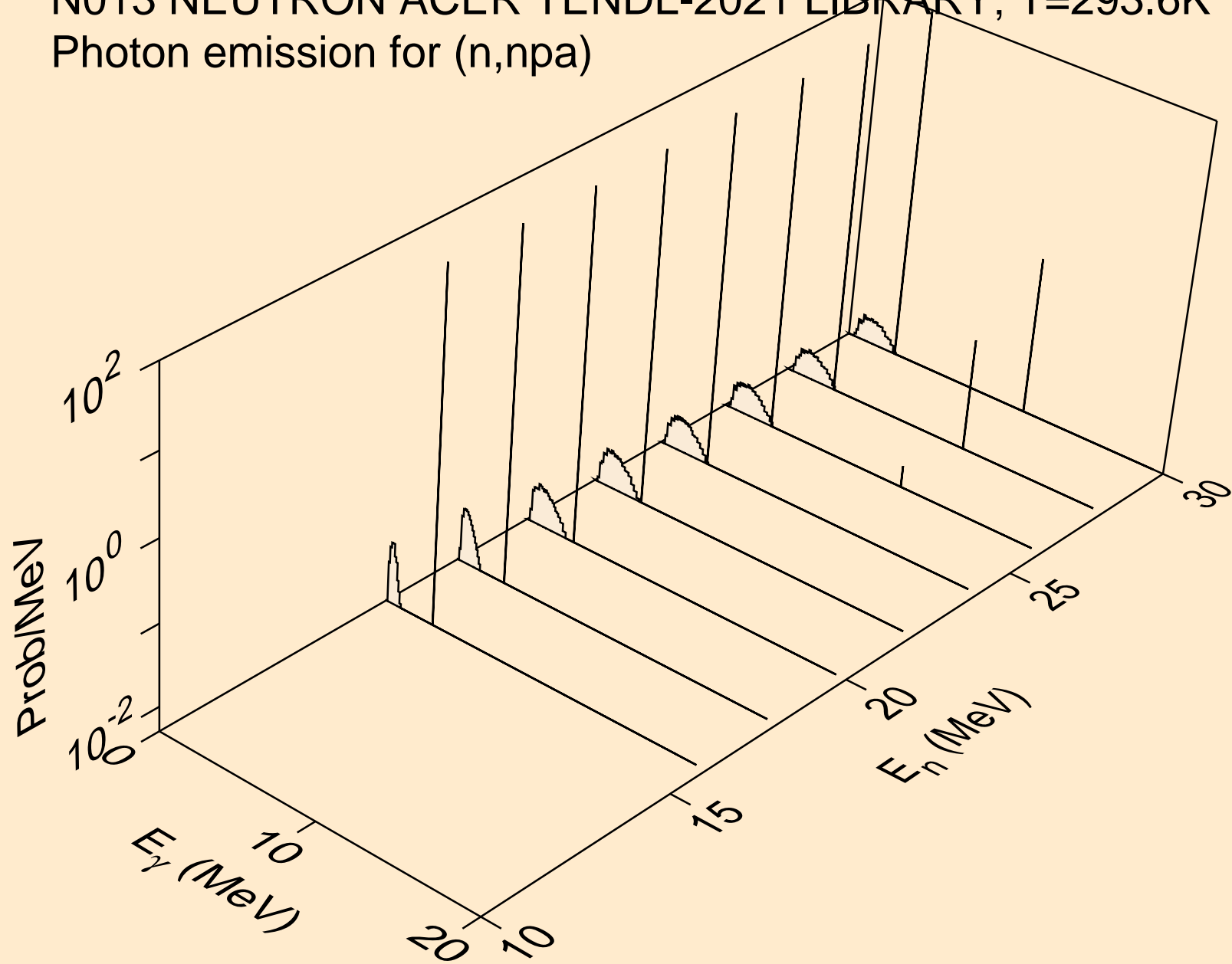

N013 NEUTRON ACER TENDL-2021 LIBRARY; T=293.6K
Photon emission for (n,n*c)

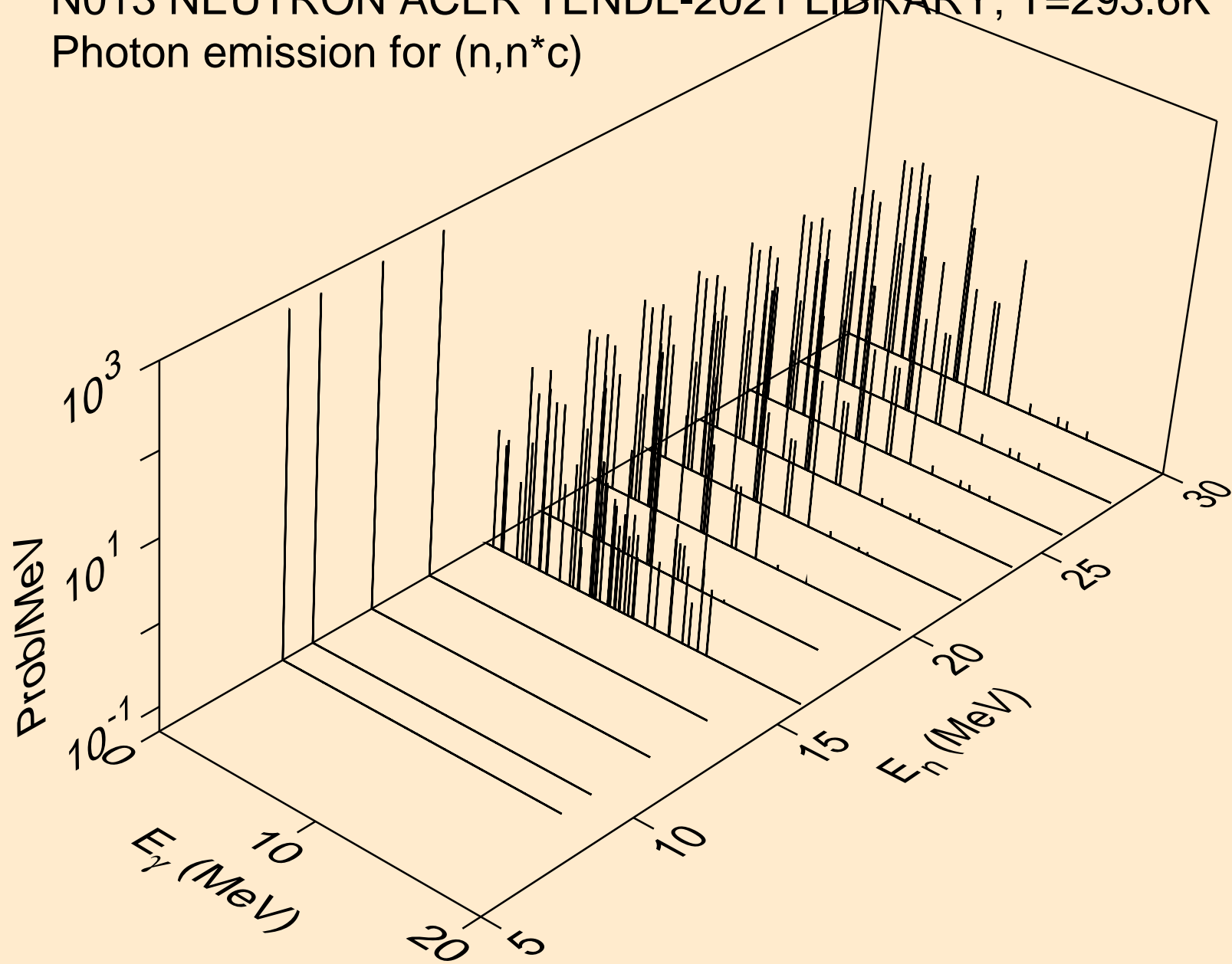

N013 NEUTRON ACER TENDL-2021 LIBRARY; T=293.6K
Photon emission for (n,gma)

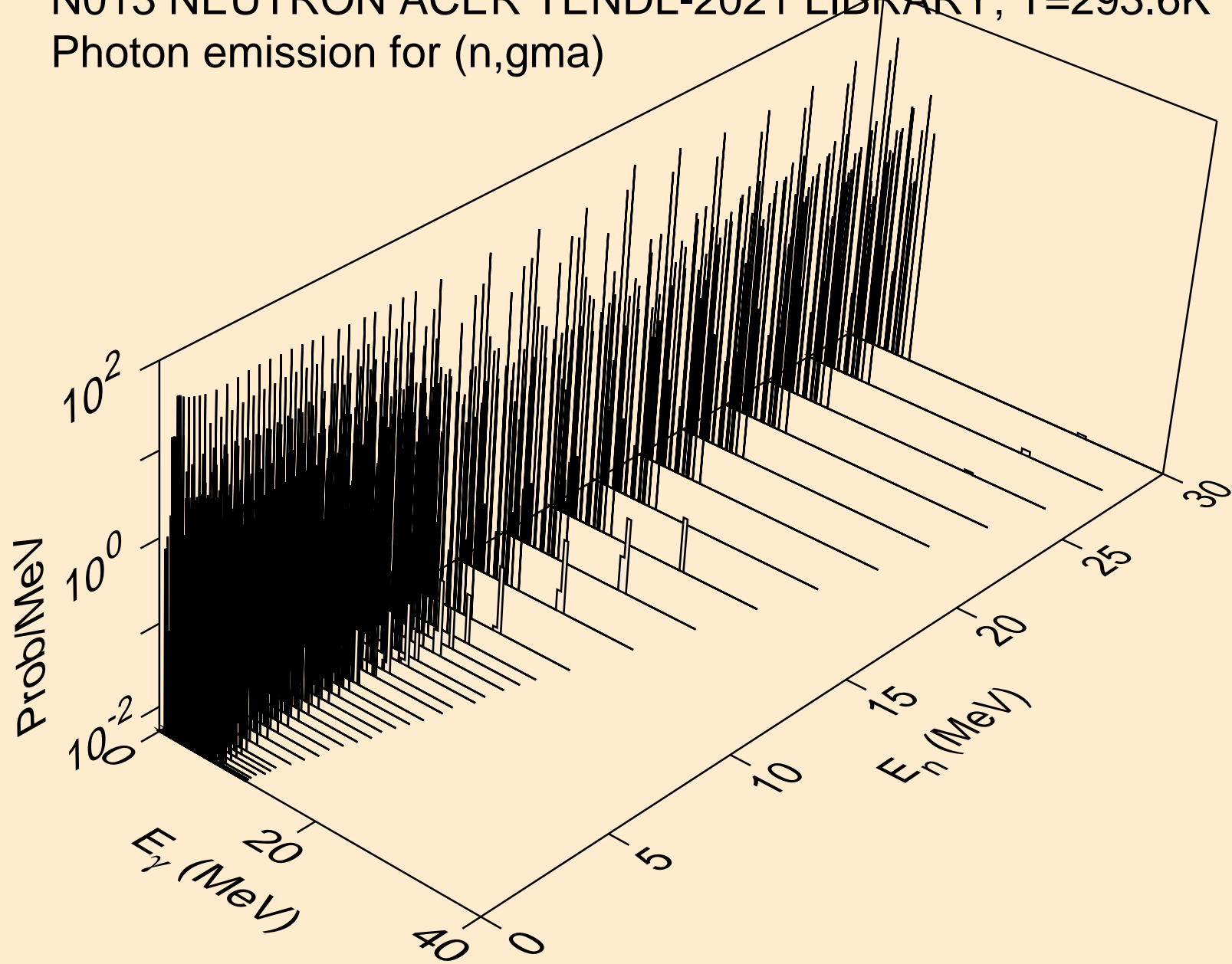

N013 NEUTRON ACER TENDL-2021 LIBRARY; T=293.6K
Photon emission for (n,p)

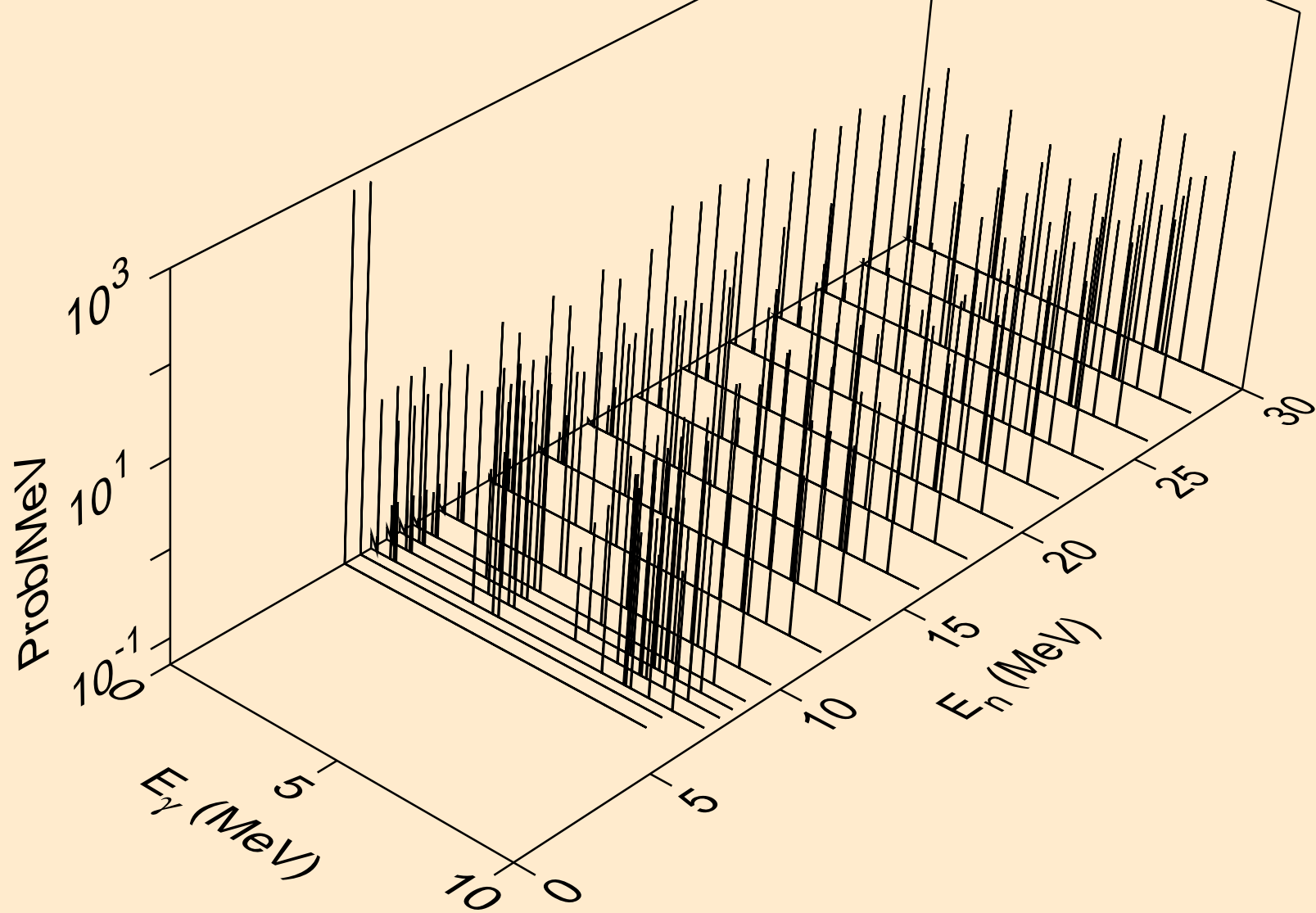

N013 NEUTRON ACER TENDL-2021 LIBRARY; T=293.6K
Photon emission for (n,d)

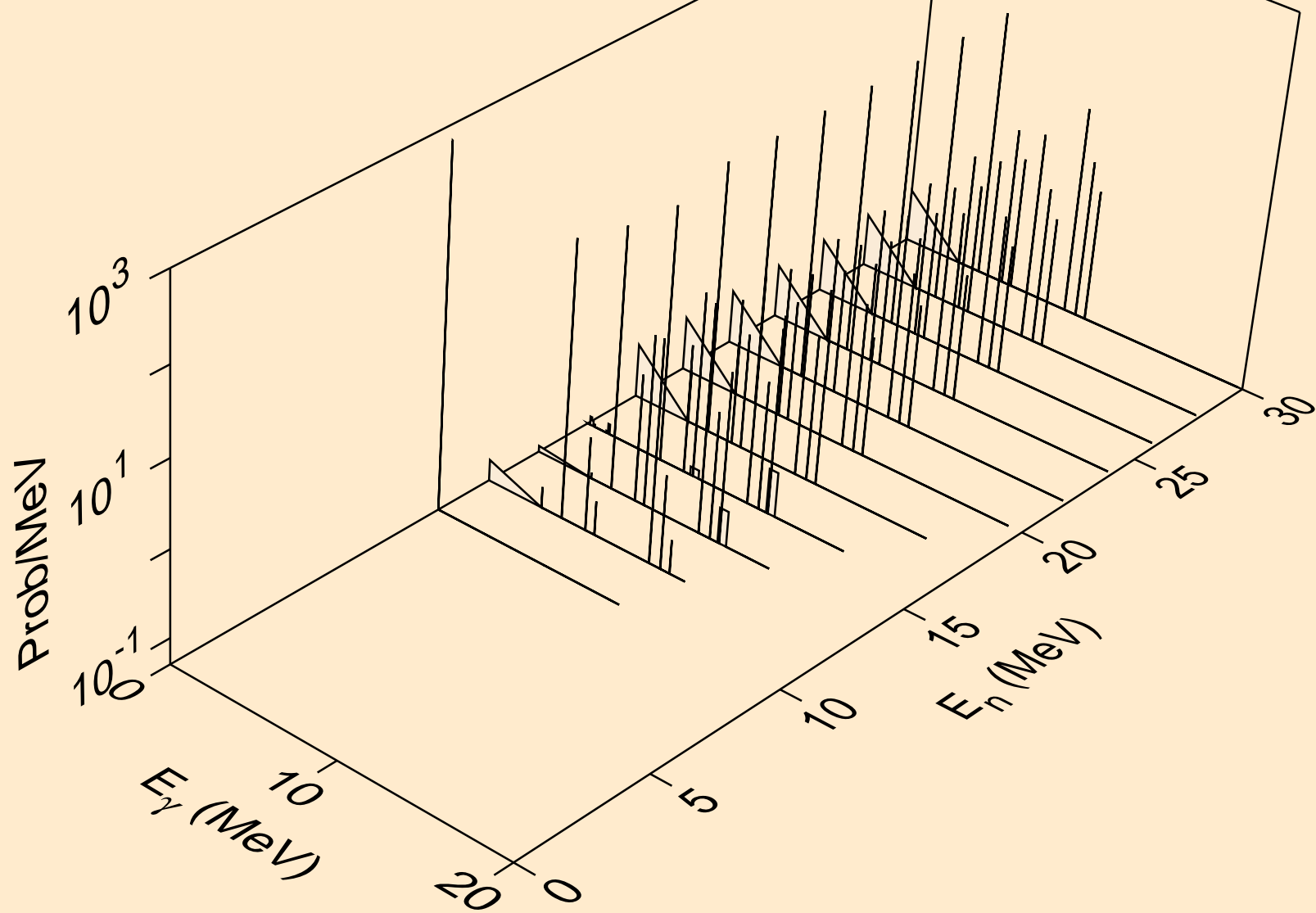

N013 NEUTRON ACER TENDL-2021 LIBRARY; T=293.6K
Photon emission for (n,t)

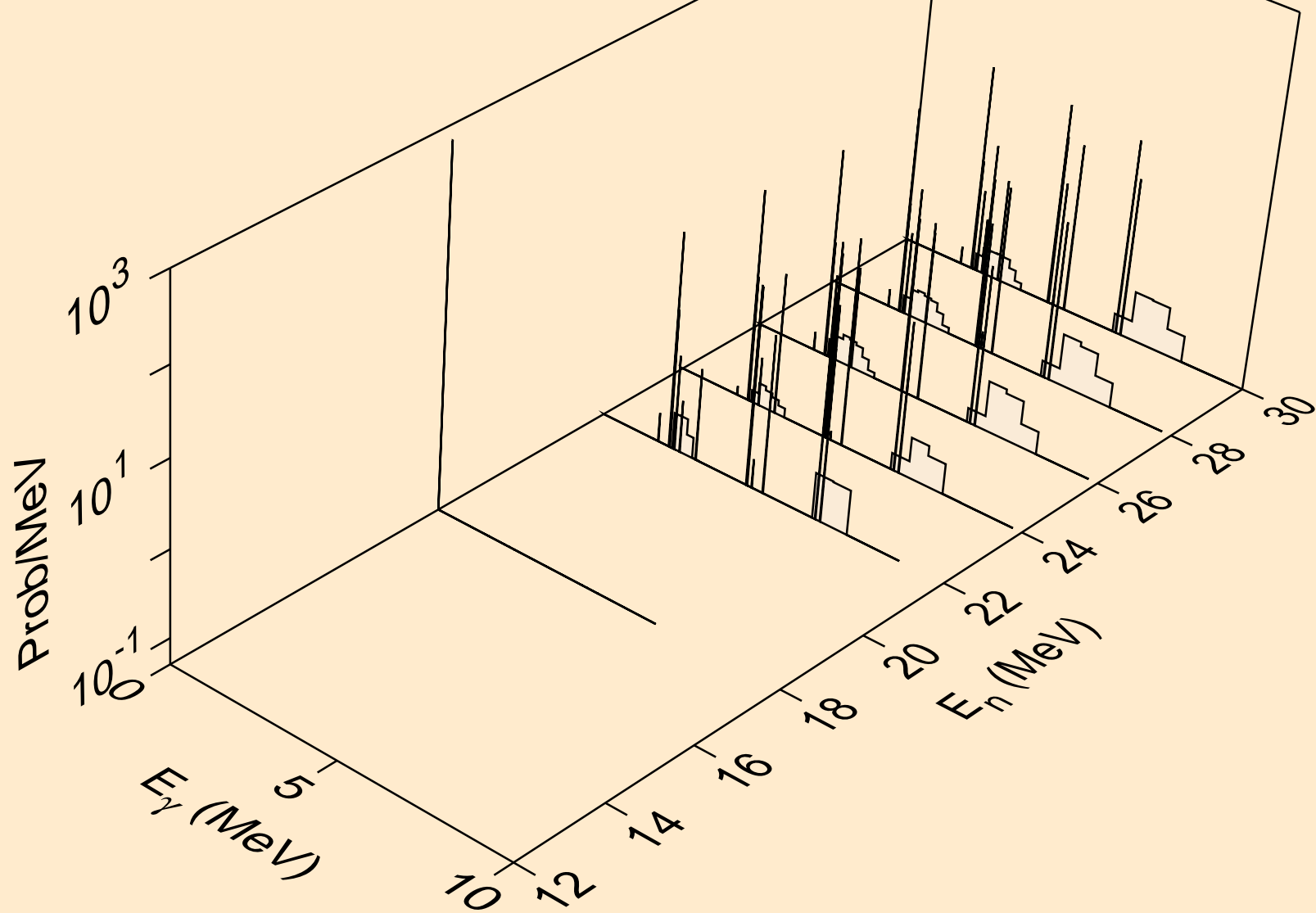

N013 NEUTRON ACER TENDL-2021 LIBRARY; T=293.6K
Photon emission for (n,he3)

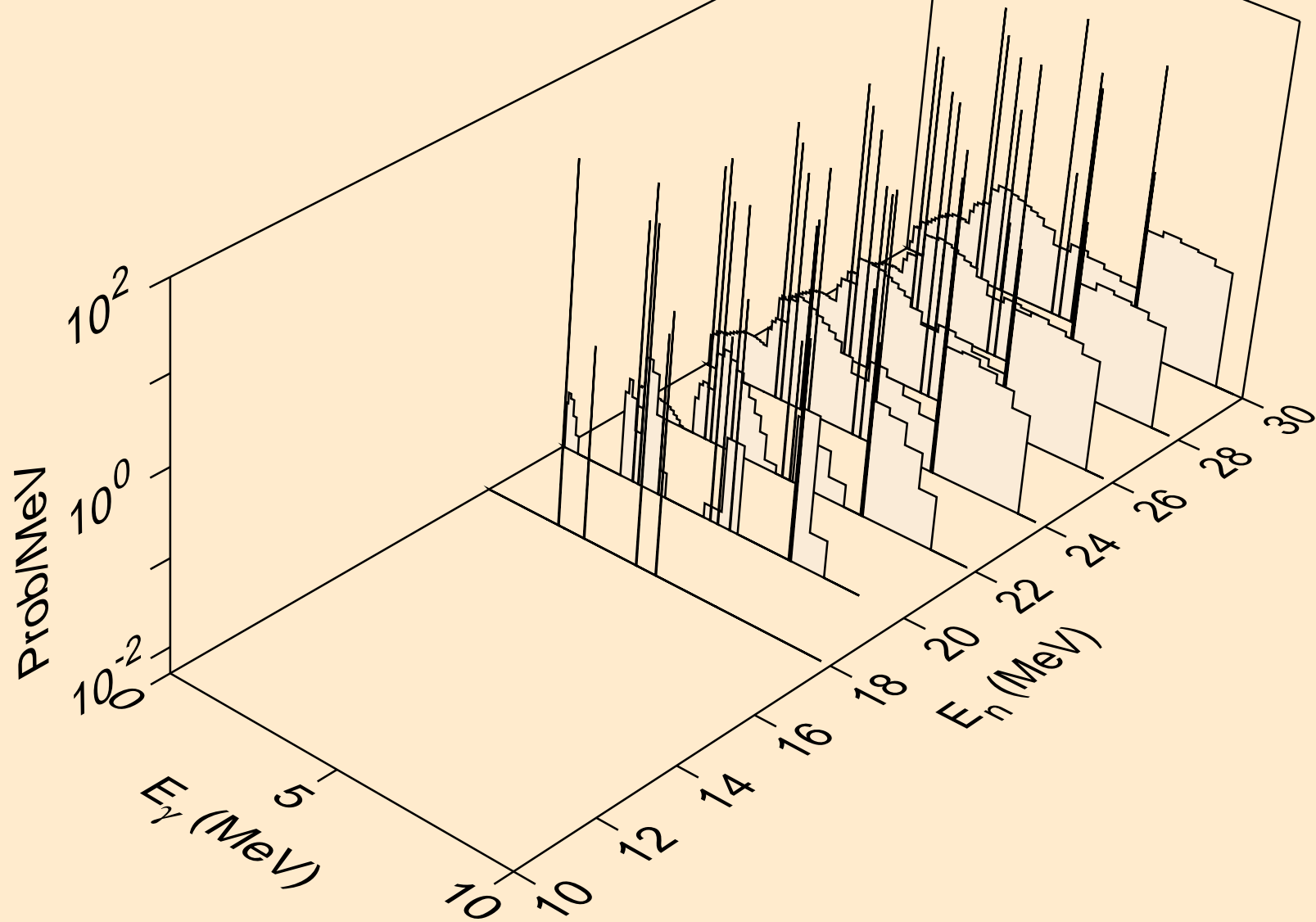

N013 NEUTRON ACER TENDL-2021 LIBRARY; T=293.6K
Photon emission for (n,a)

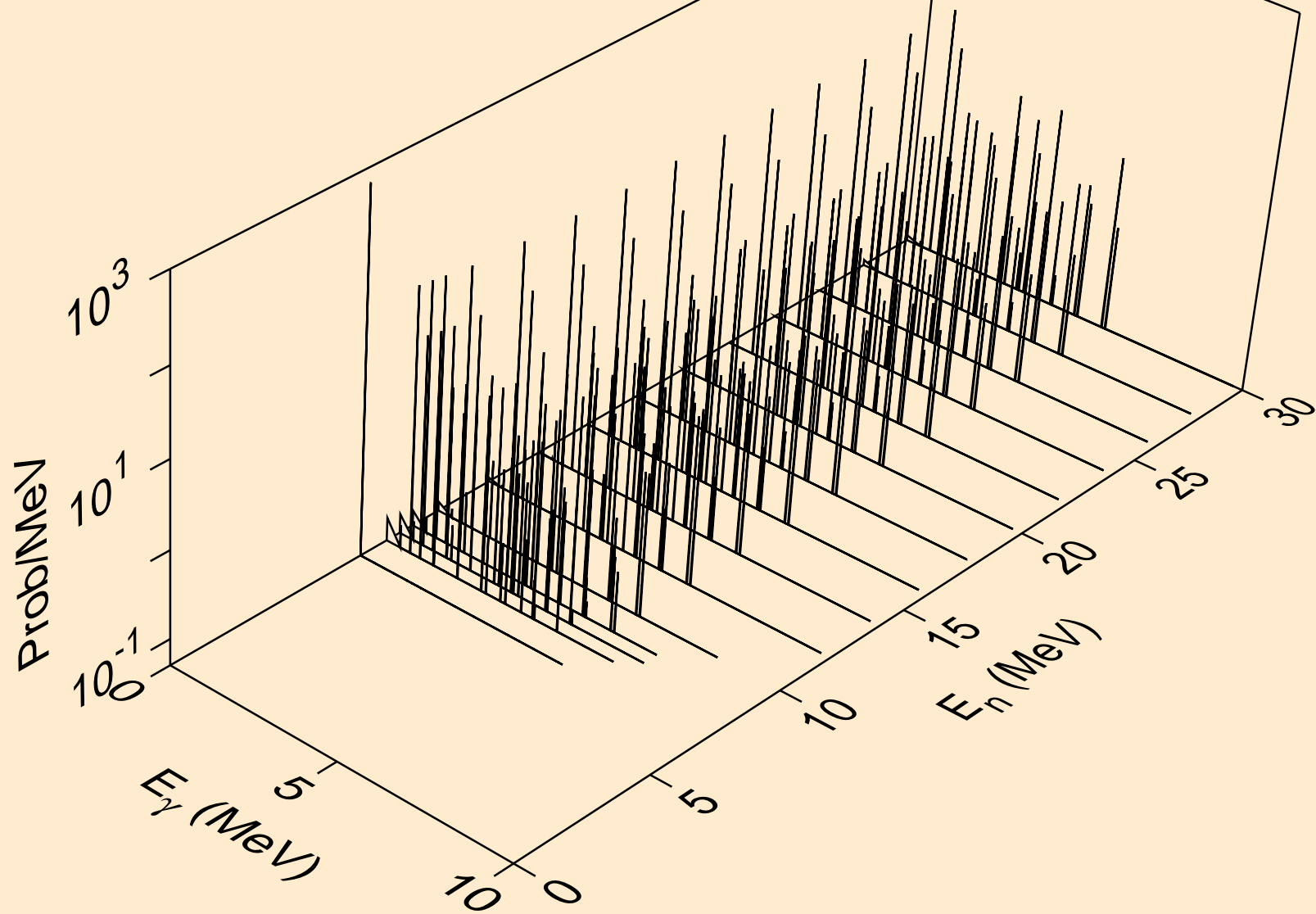

N013 NEUTRON ACER TENDL-2021 LIBRARY; T=293.6K
Photon emission for (n,2a)

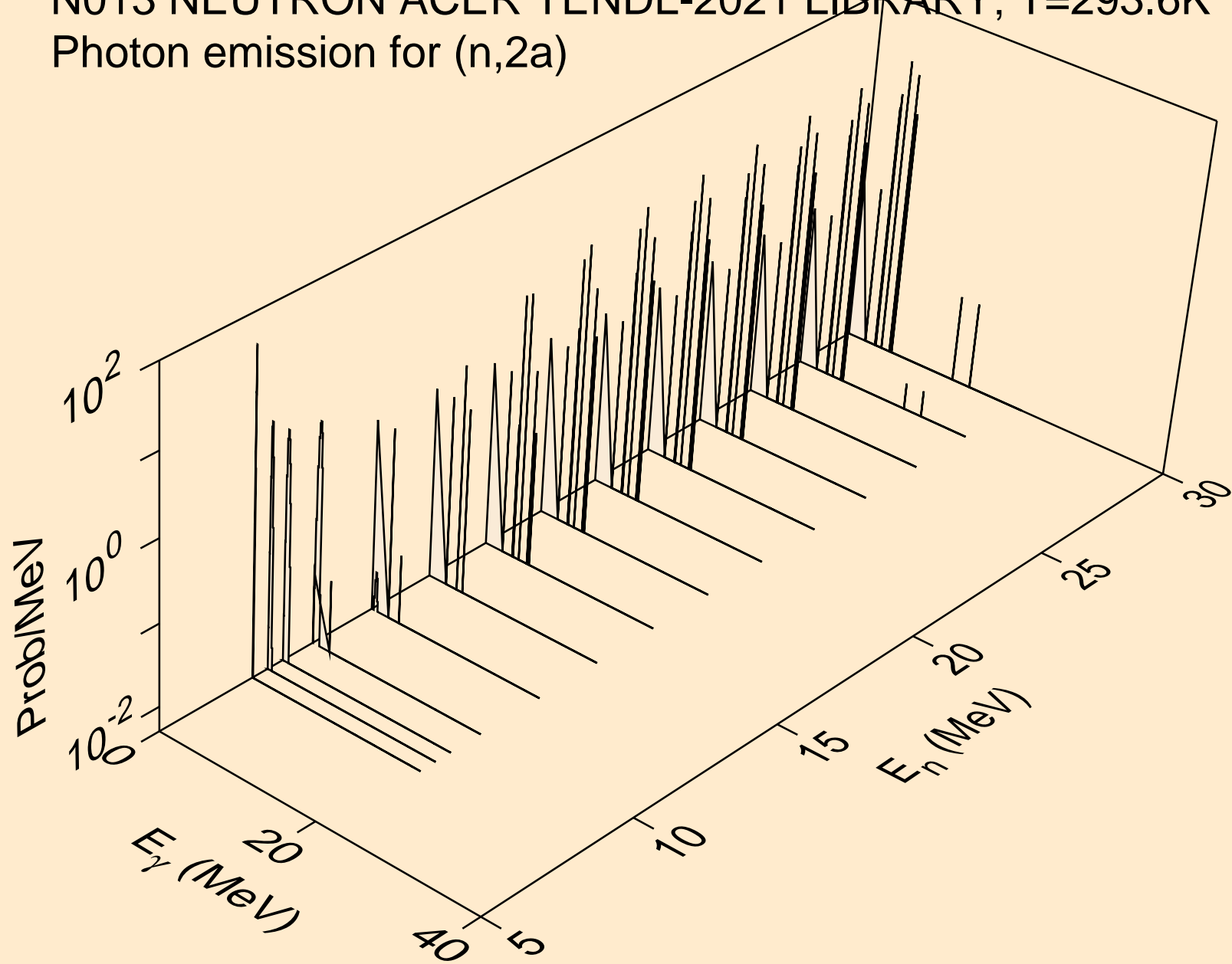

N013 NEUTRON ACER TENDL-2021 LIBRARY; T=293.6K
Photon emission for (n,2p)

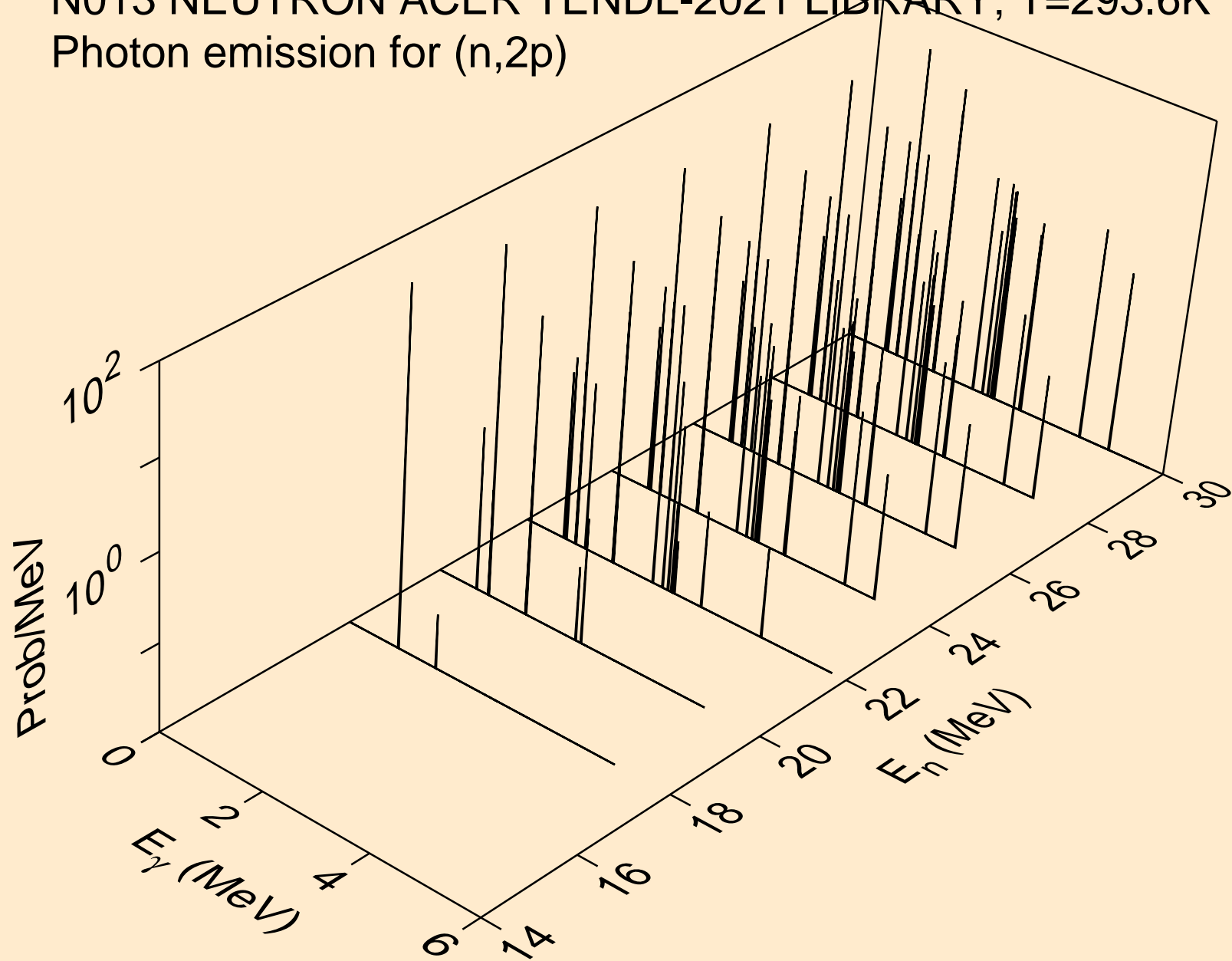

N013 NEUTRON ACER TENDL-2021 LIBRARY; T=293.6K
Photon emission for (n,p)

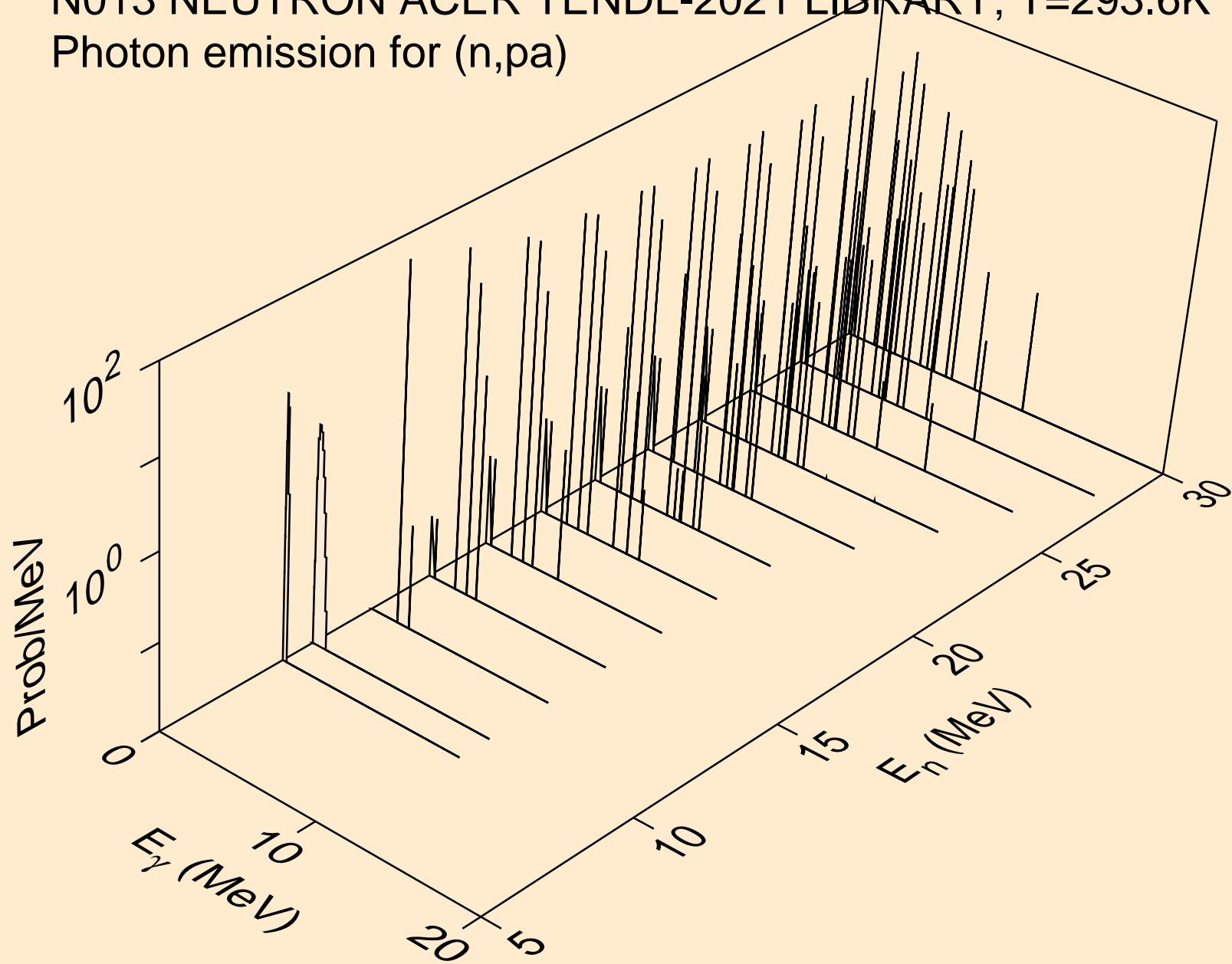

N013 NEUTRON ACER TENDL-2021 LIBRARY; T=293.6K
Photon emission for (n,pd)

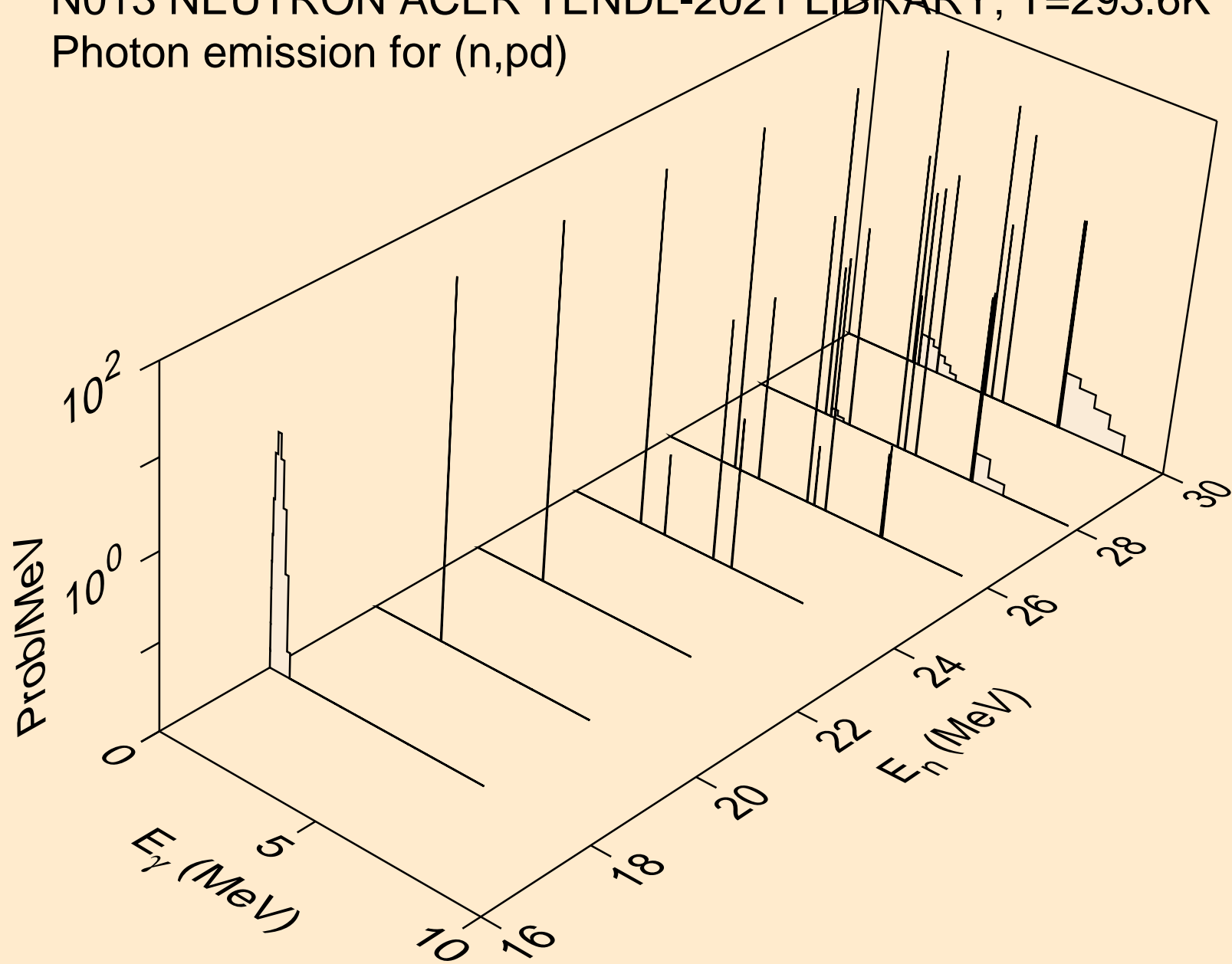

N013 NEUTRON ACER TENDL-2021 LIBRARY; T=293.6K
Photon emission for (n,pt)

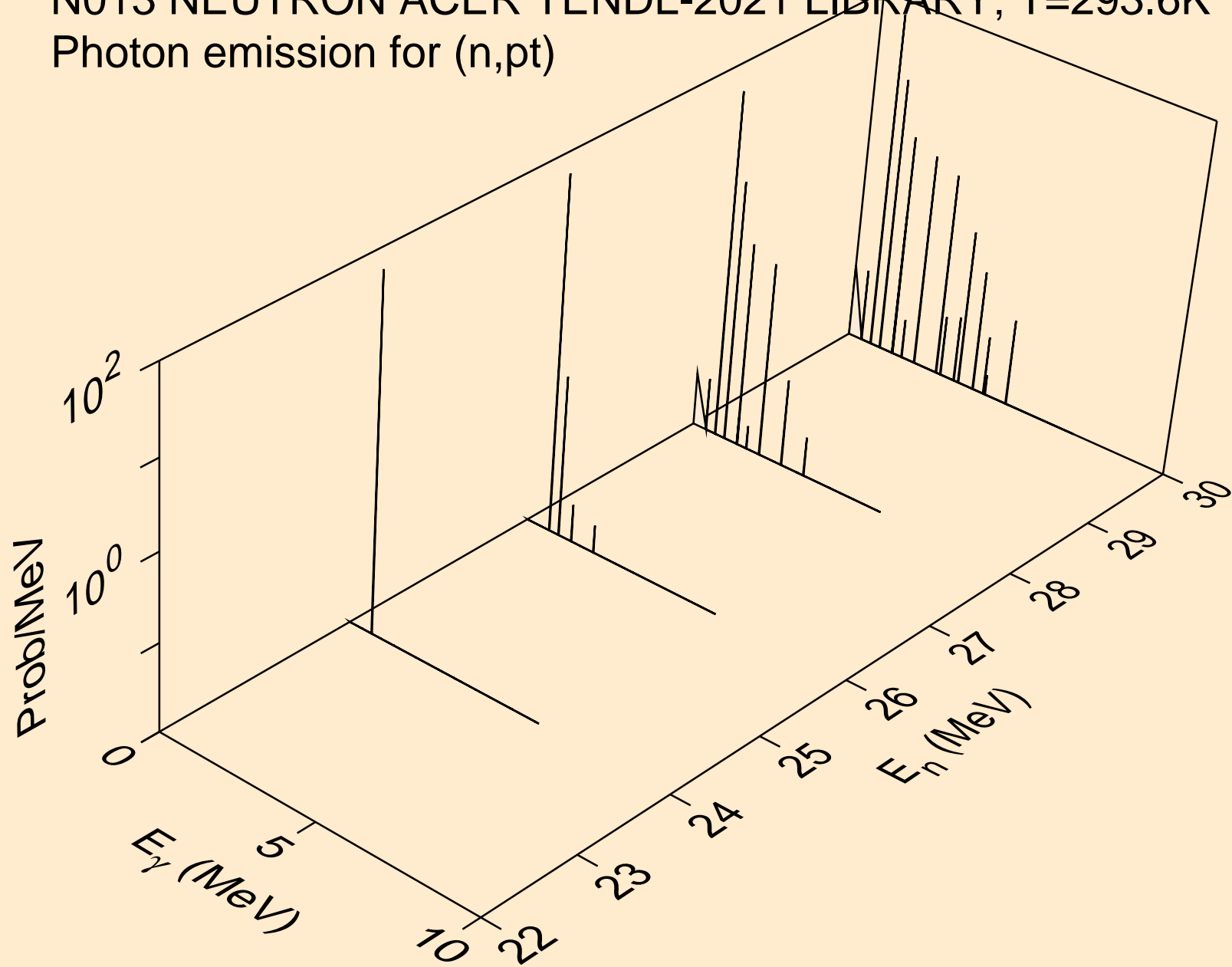

N013 NEUTRON ACER TENDL-2021 LIBRARY; T=293.6K
Photon emission for (n,da)

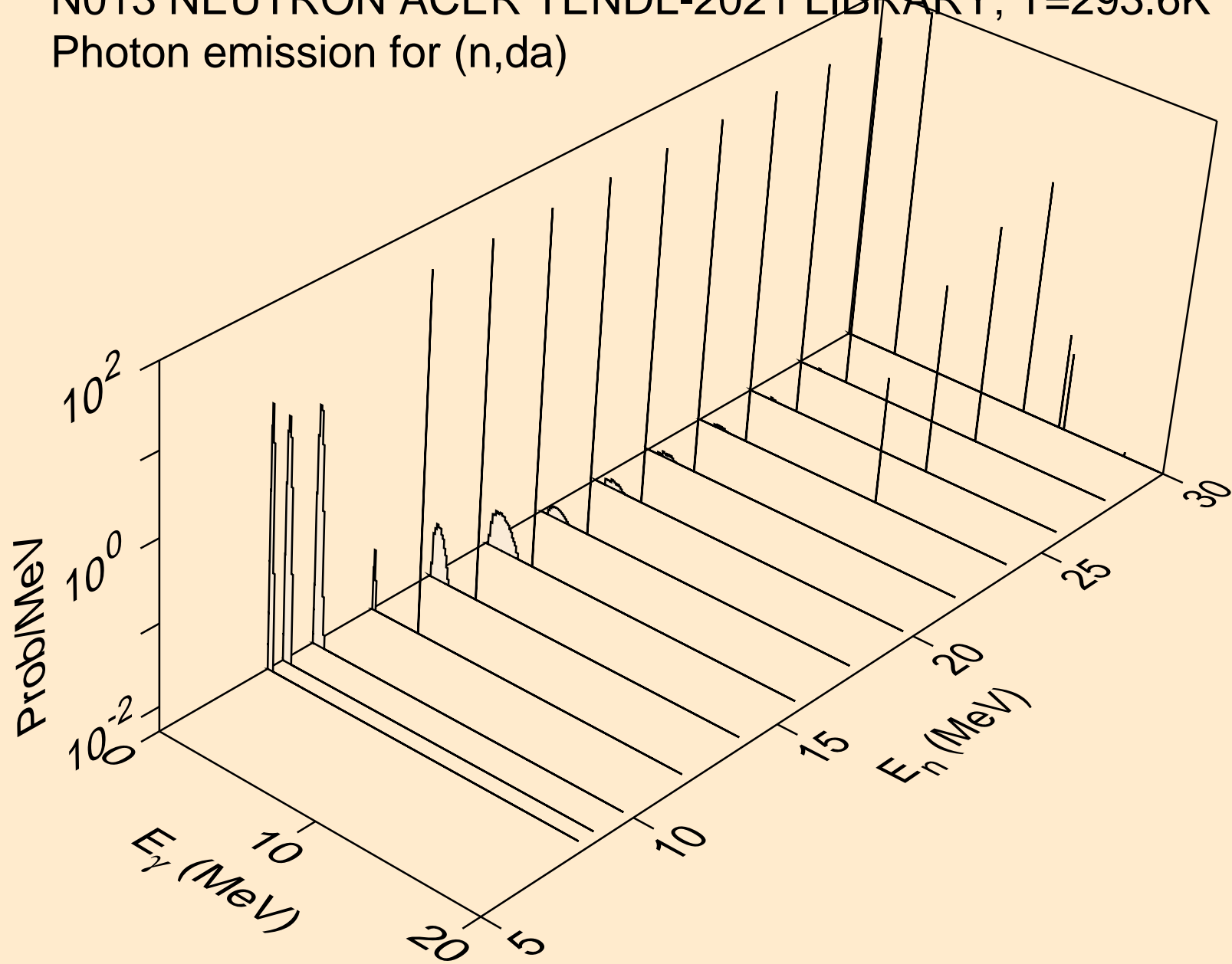

N013 NEUTRON ACER TENDL-2021 LIBRARY; T=293.6K
thermal capture photon spectrum

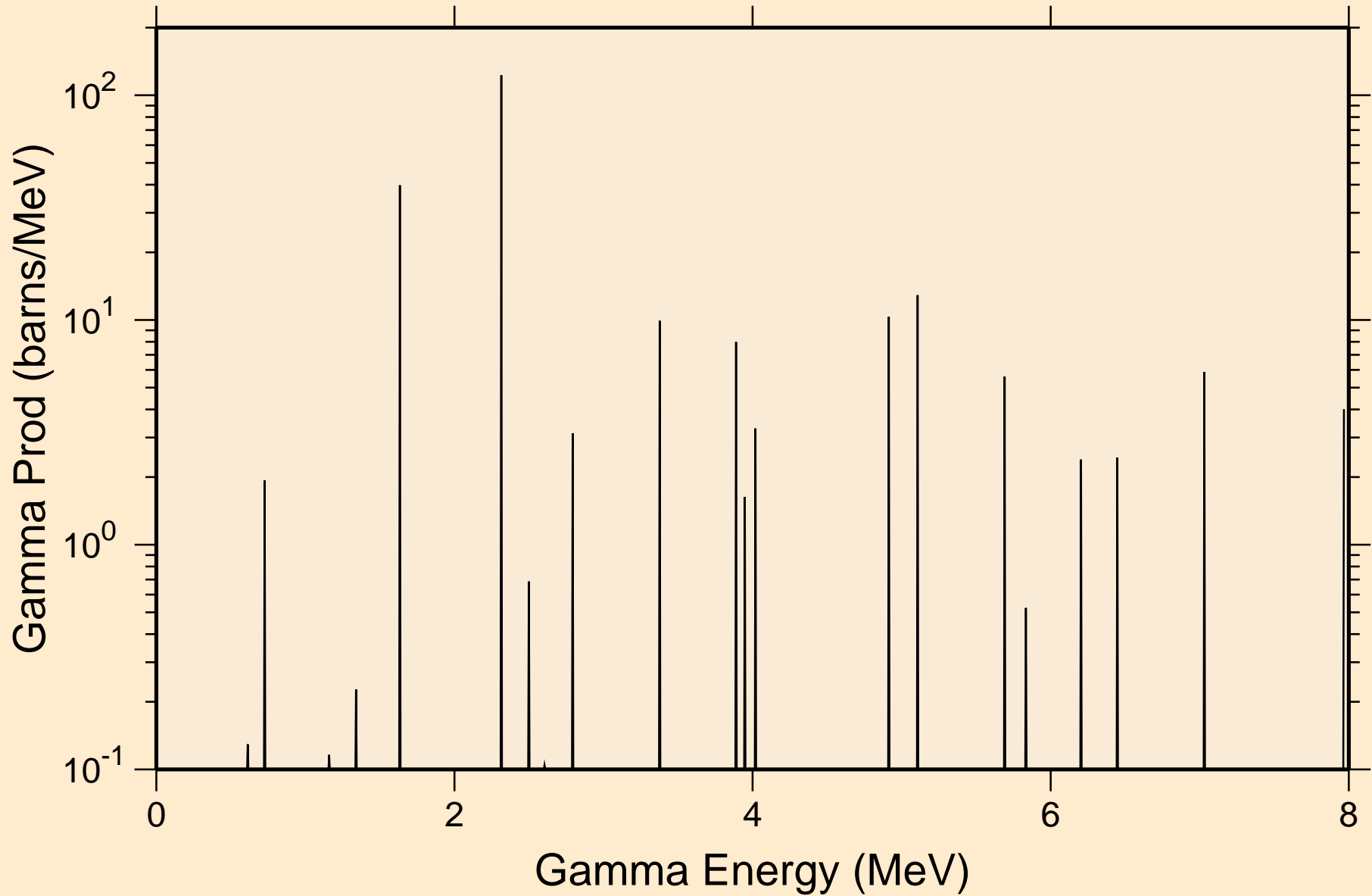

N013 NEUTRON ACER TENDL-2021 LIBRARY; T=293.6K
14 MeV photon spectrum

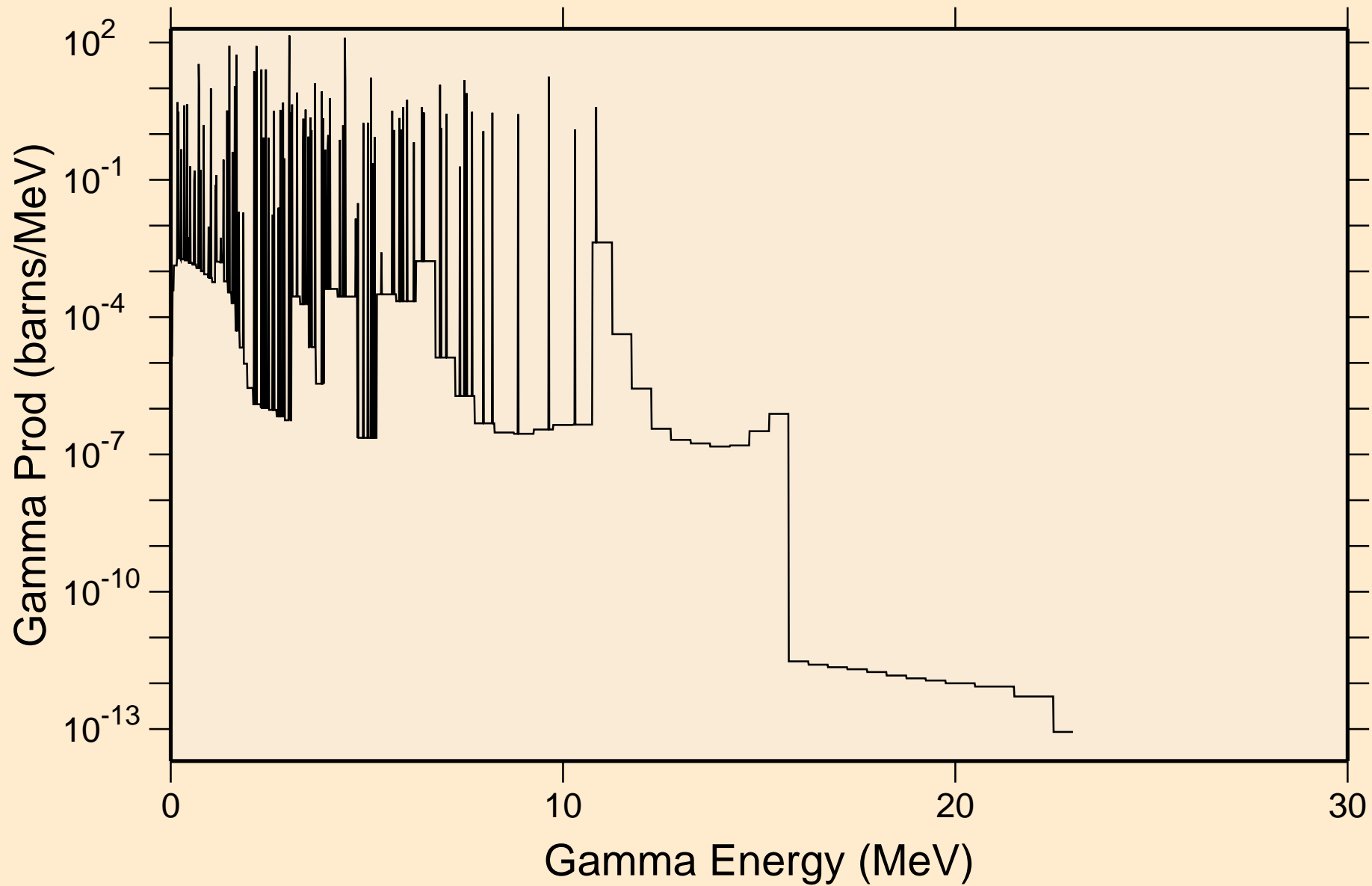

N013 NEUTRON ACER TENDL-2021 LIBRARY; T=293.6K

Particle heating contributions

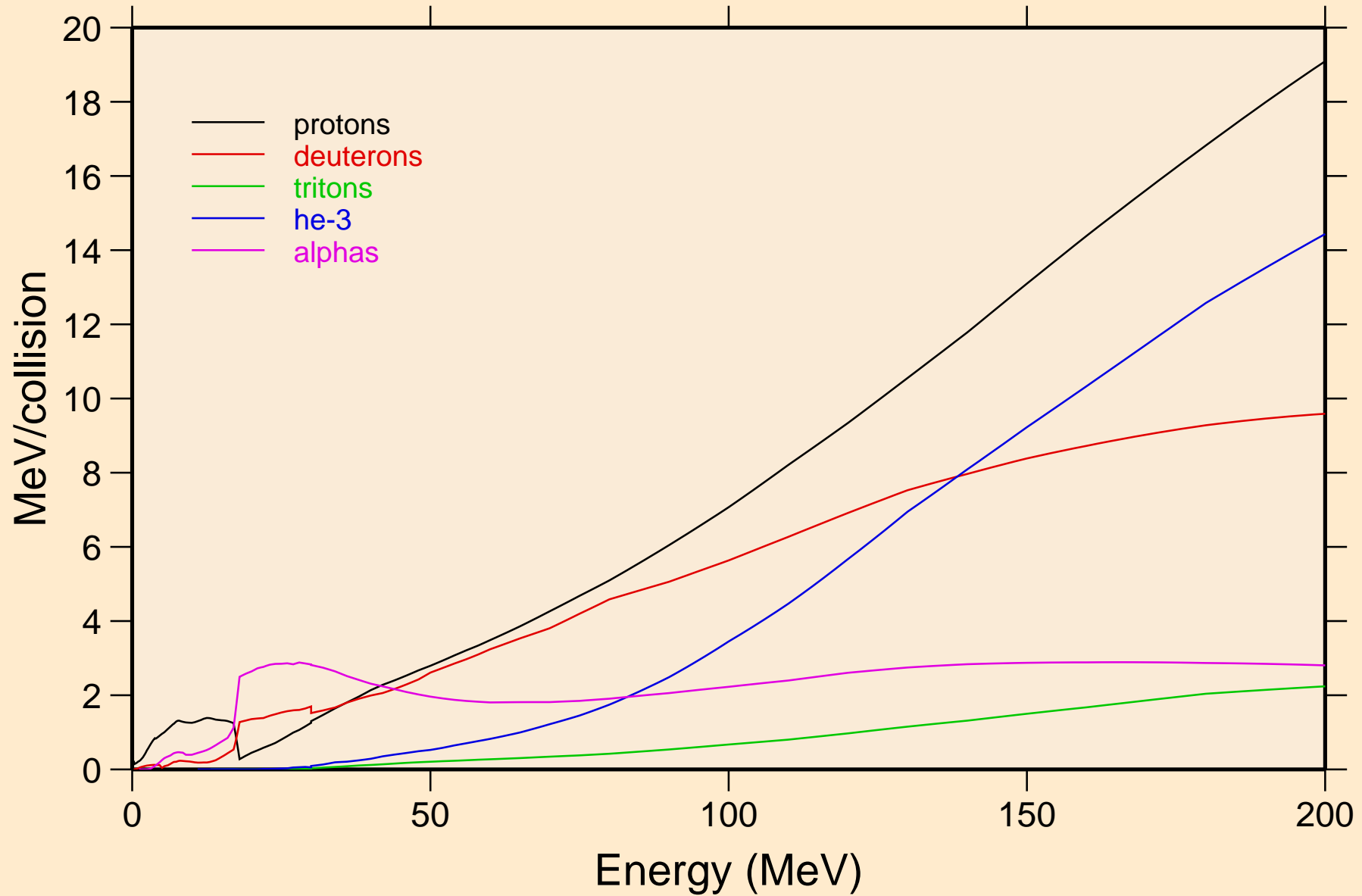

N013 NEUTRON ACER TENDL-2021 LIBRARY; T=293.6K
Recoil Heating

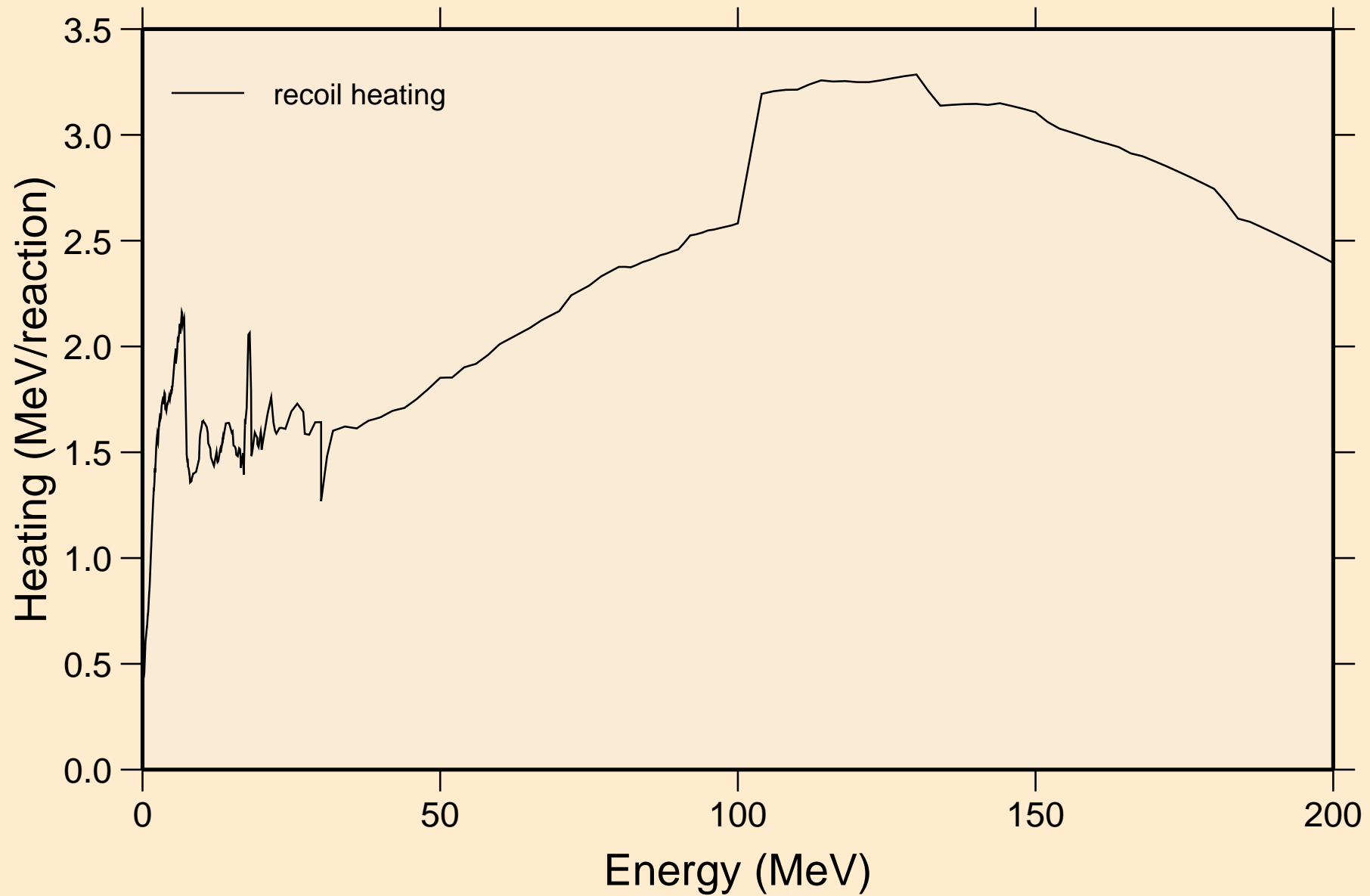

N013 NEUTRON ACER TENDL-2021 LIBRARY; T=293.6K

Particle production cross sections

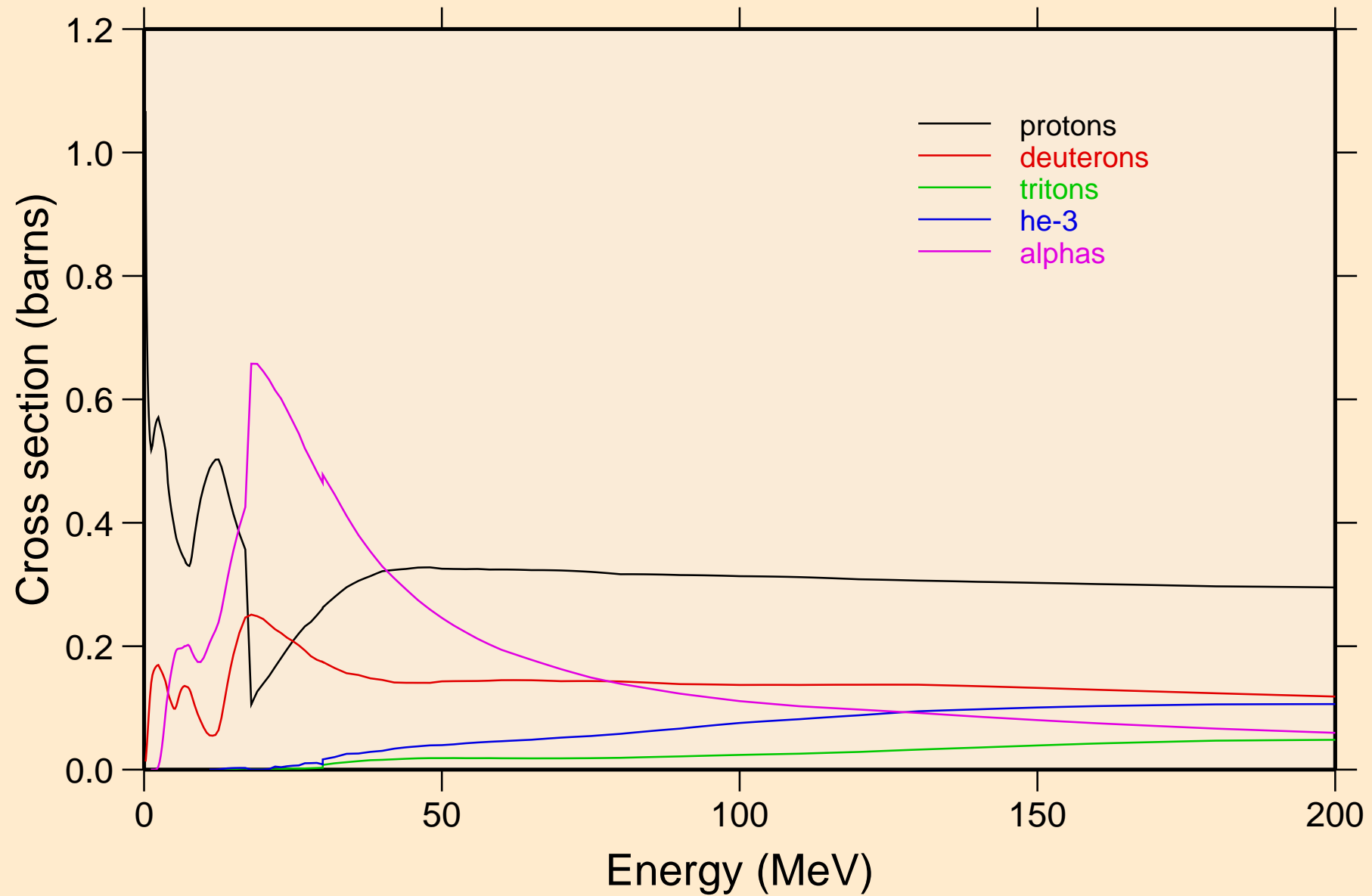

N013 NEUTRON ACER TENDL-2021 LIBRARY; T=293.6K
protons from (n,x)

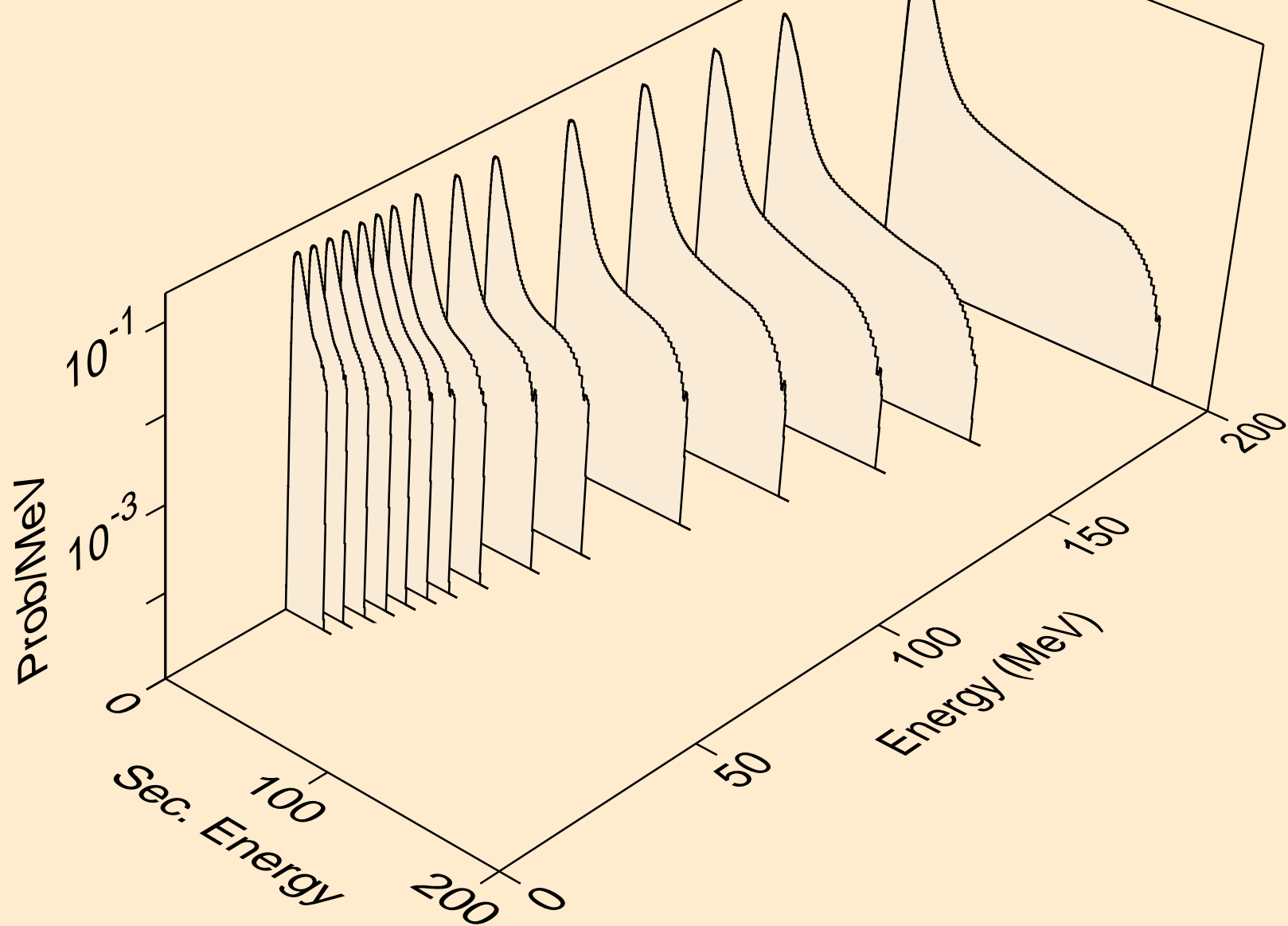

N013 NEUTRON ACER TENDL-2021 LIBRARY; T=293.6K
protons from (n,n*)p

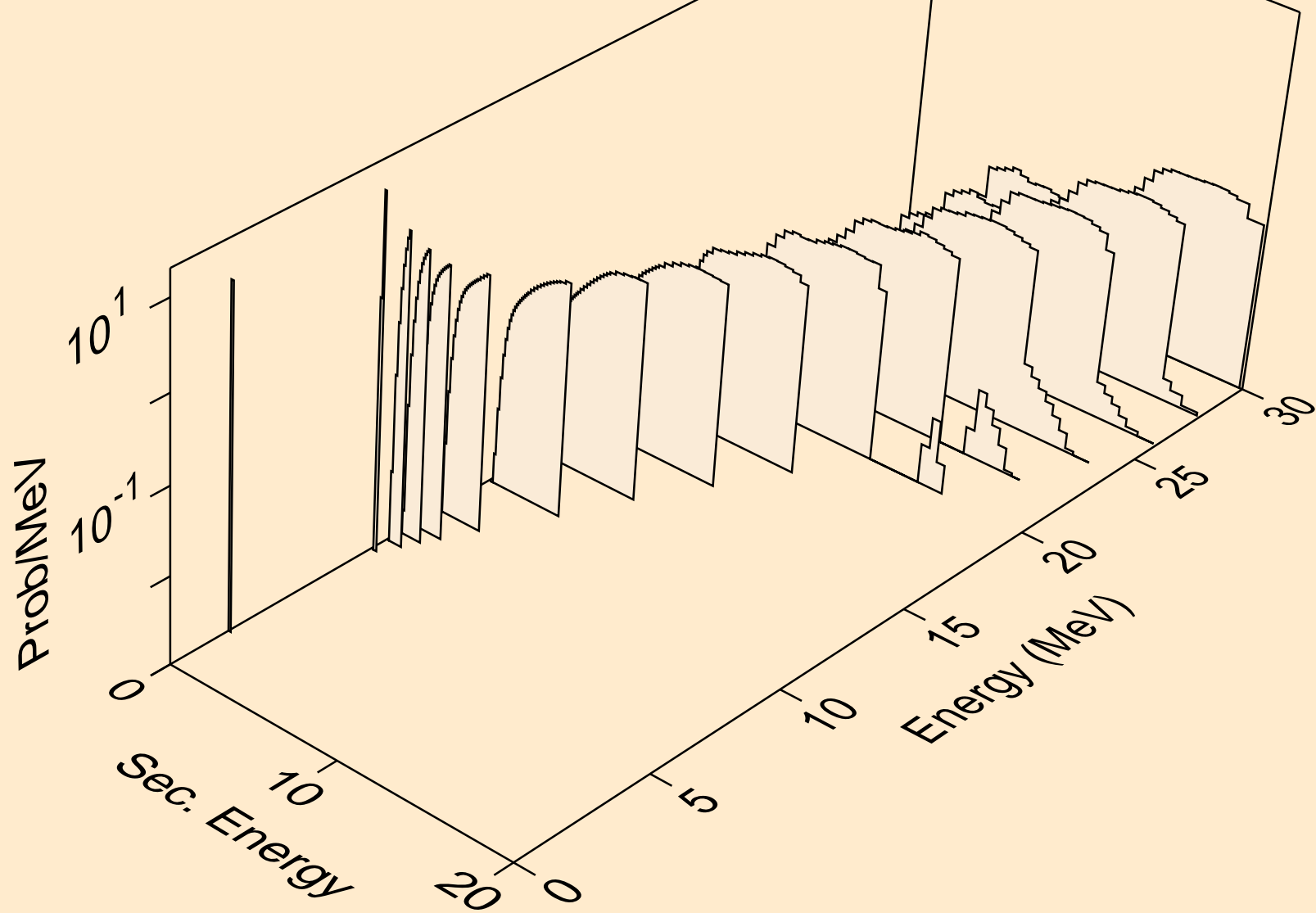

N013 NEUTRON ACER TENDL-2021 LIBRARY; T=293.6K
protons from (n,2np)

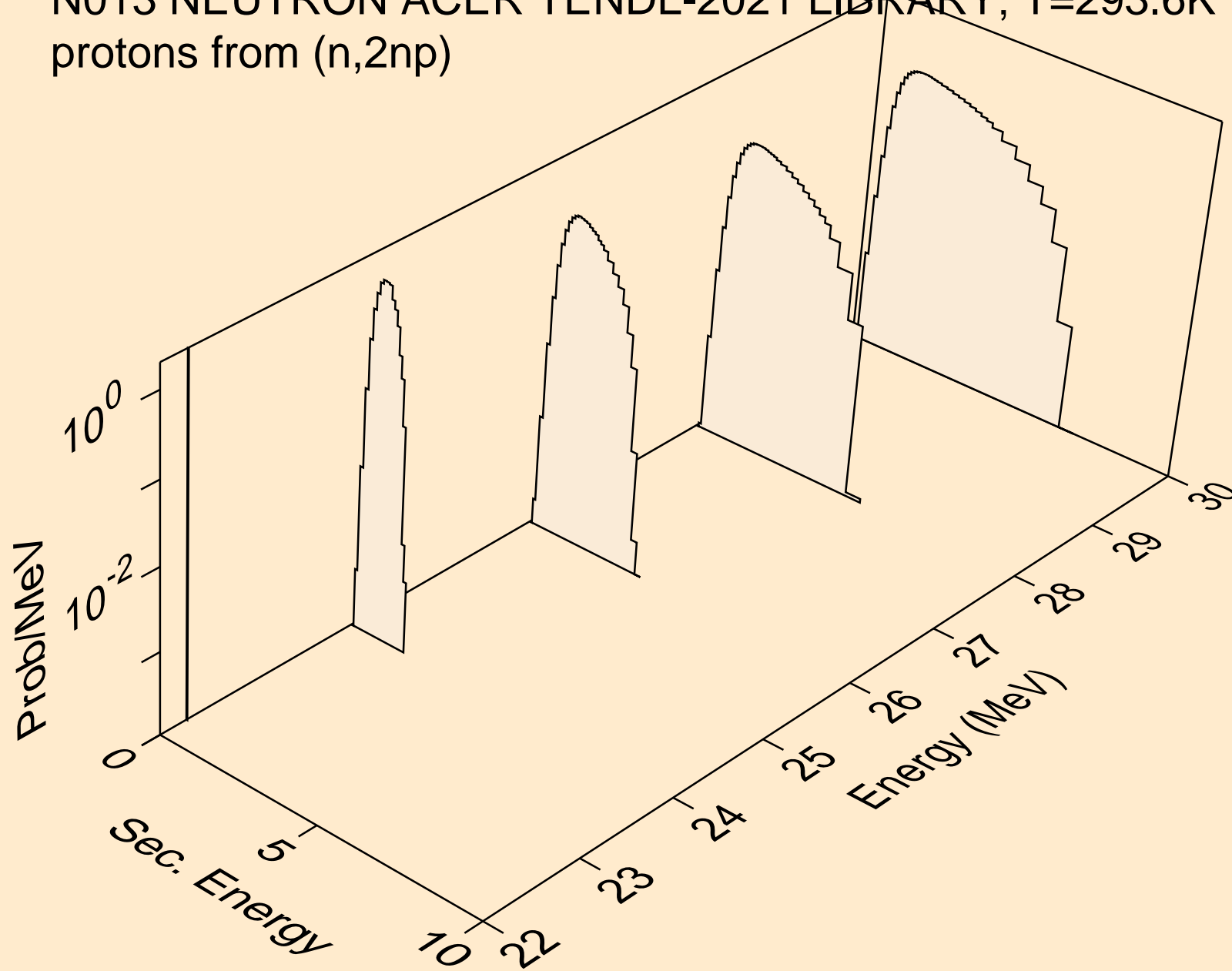

N013 NEUTRON ACER TENDL-2021 LIBRARY; T=293.6K
protons from (n,2np)

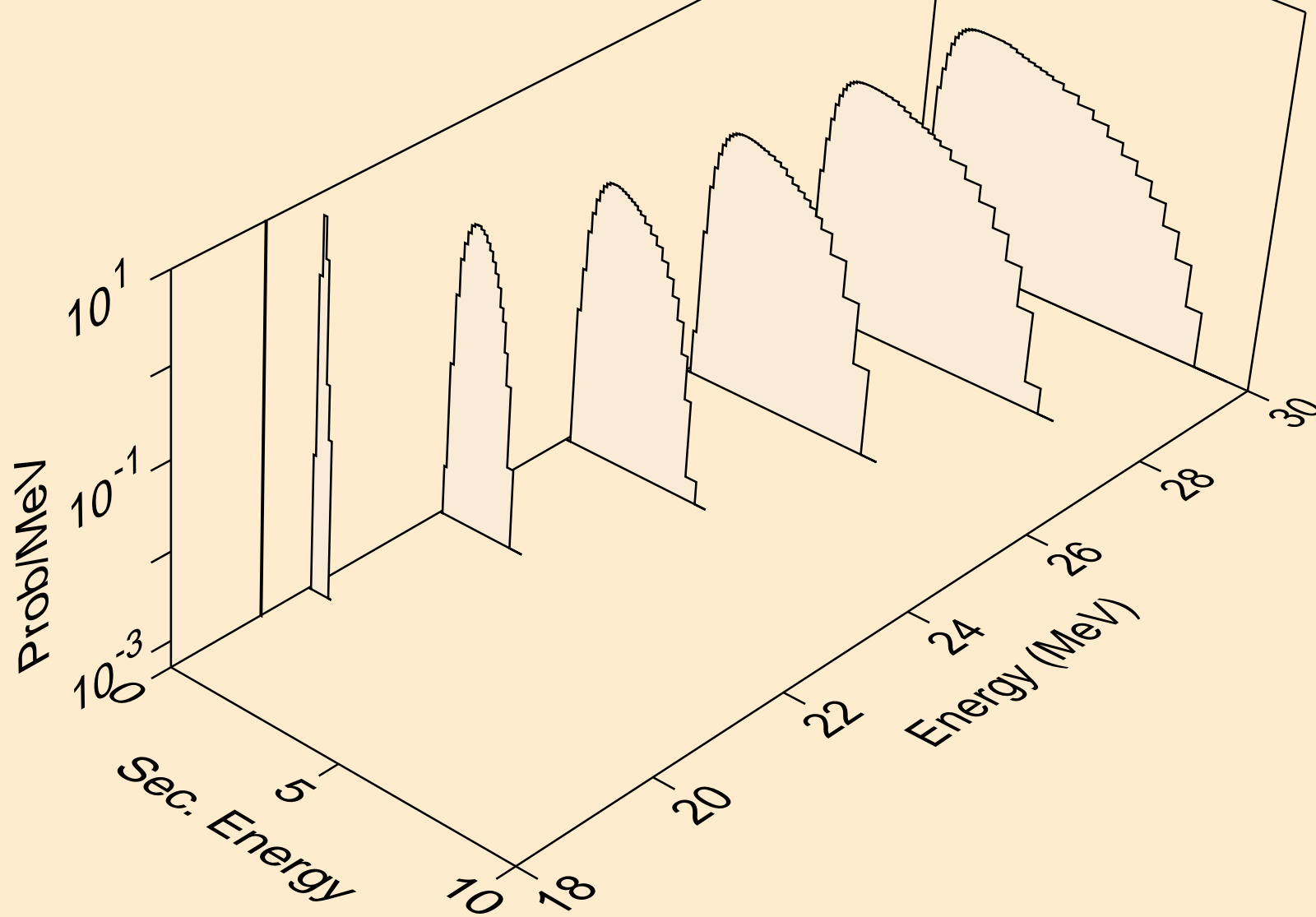

N013 NEUTRON ACER TENDL-2021 LIBRARY; T=293.6K
protons from (n,npa)

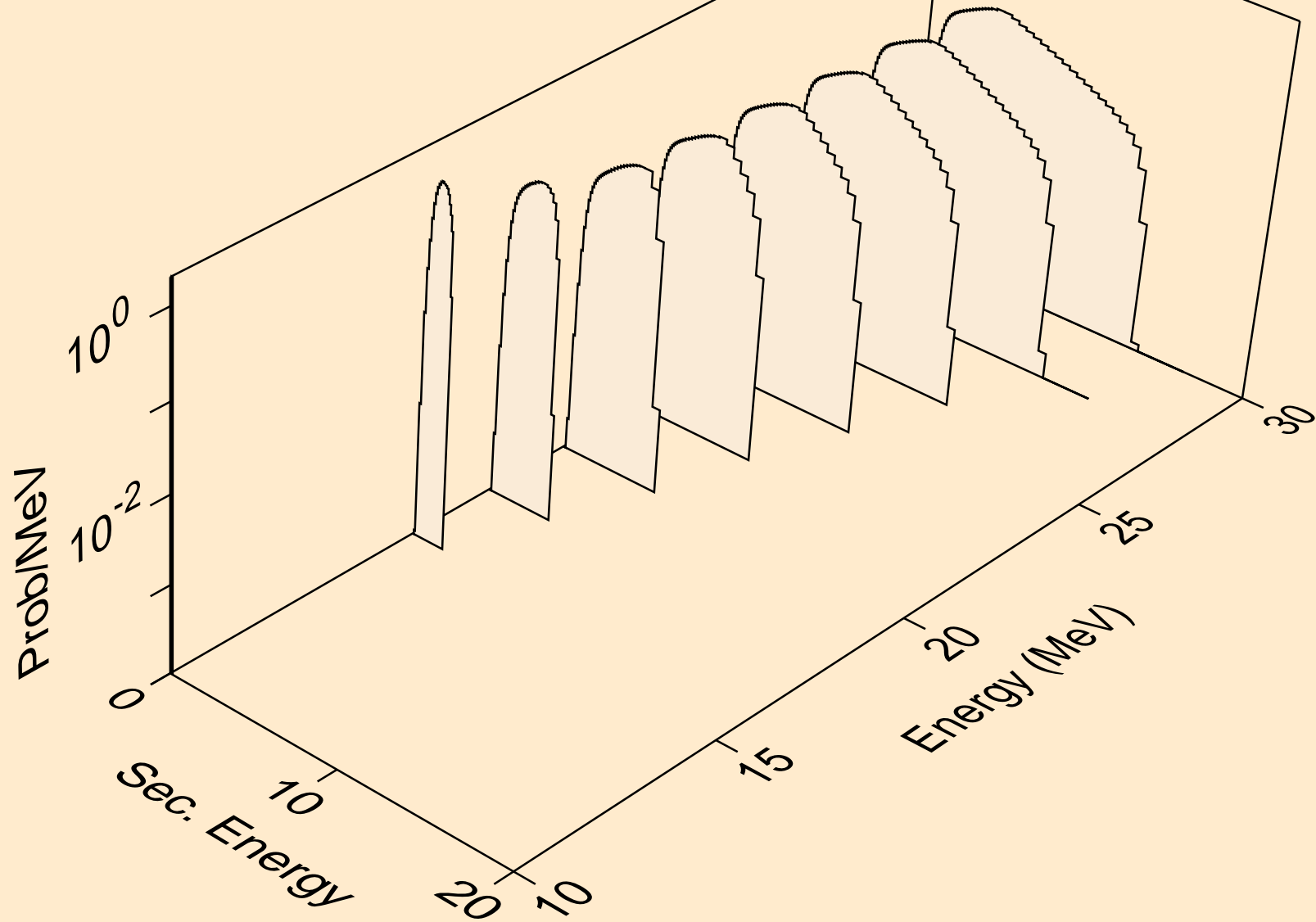

N013 NEUTRON ACER TENDL-2021 LIBRARY; T=293.6K
protons from (n,p)

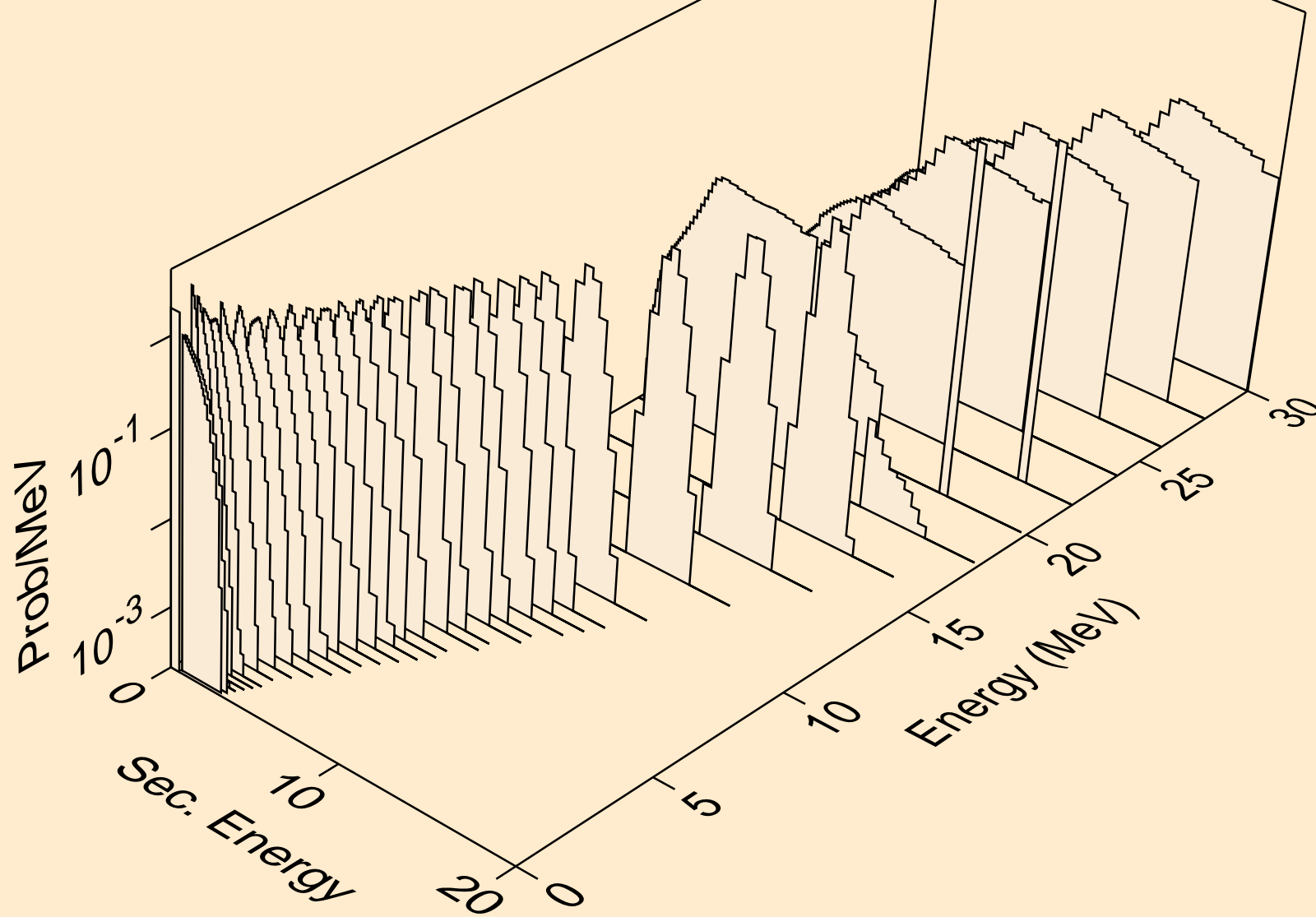

N013 NEUTRON ACER TENDL-2021 LIBRARY; T=293.6K
protons from (n,2p)

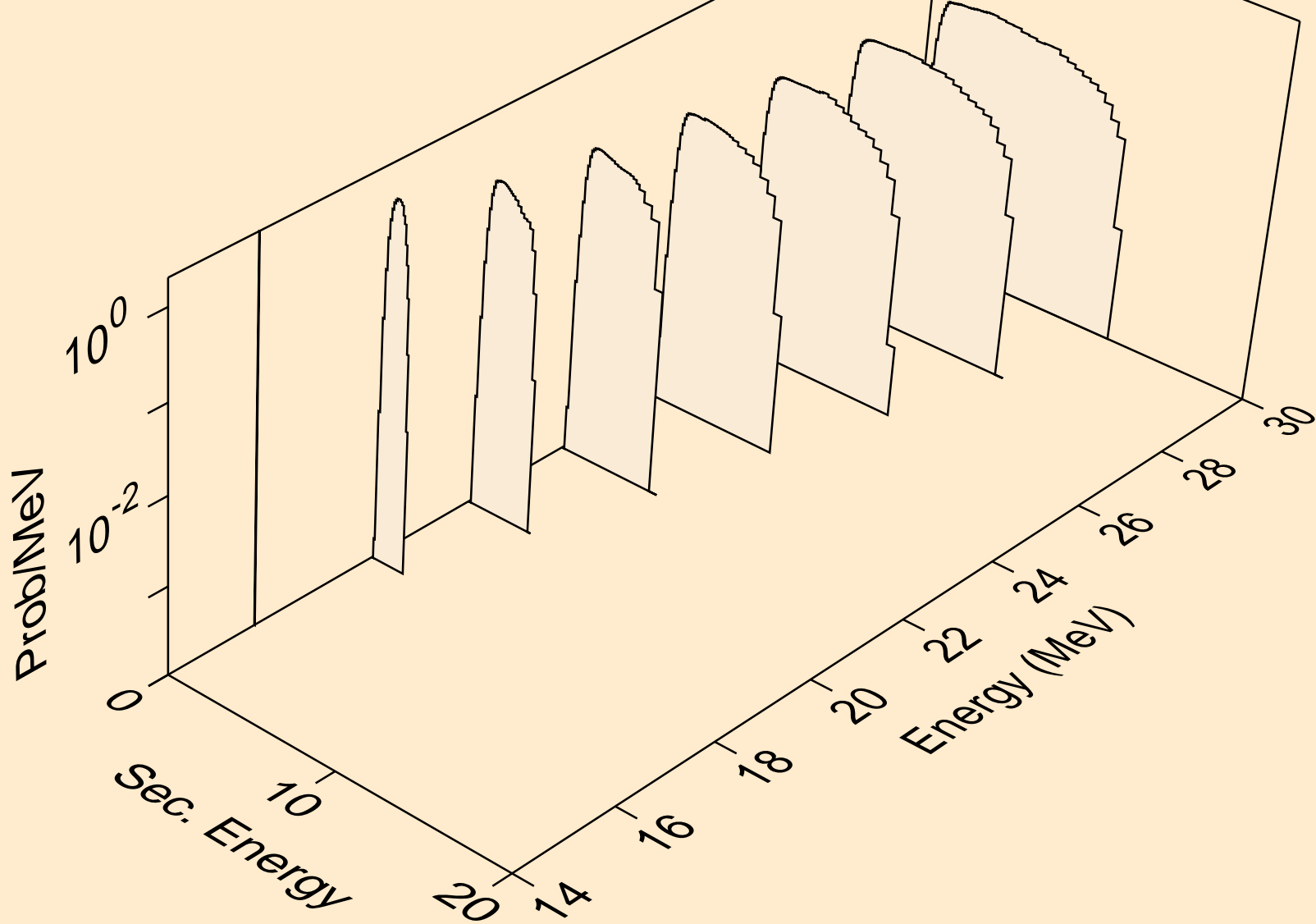

N013 NEUTRON ACER TENDL-2021 LIBRARY; T=293.6K
protons from (n,p)

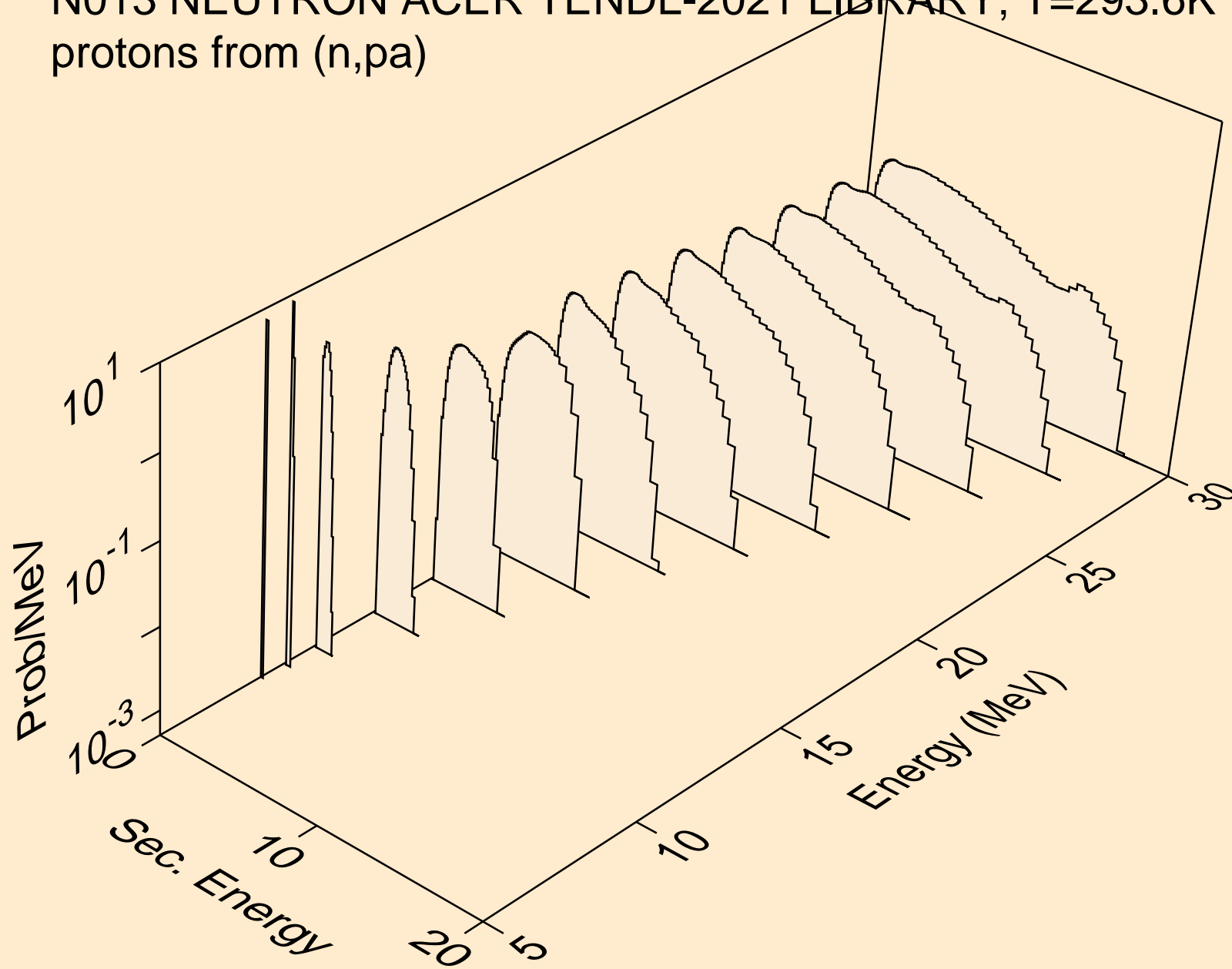

N013 NEUTRON ACER TENDL-2021 LIBRARY; T=293.6K
protons from (n,pd)

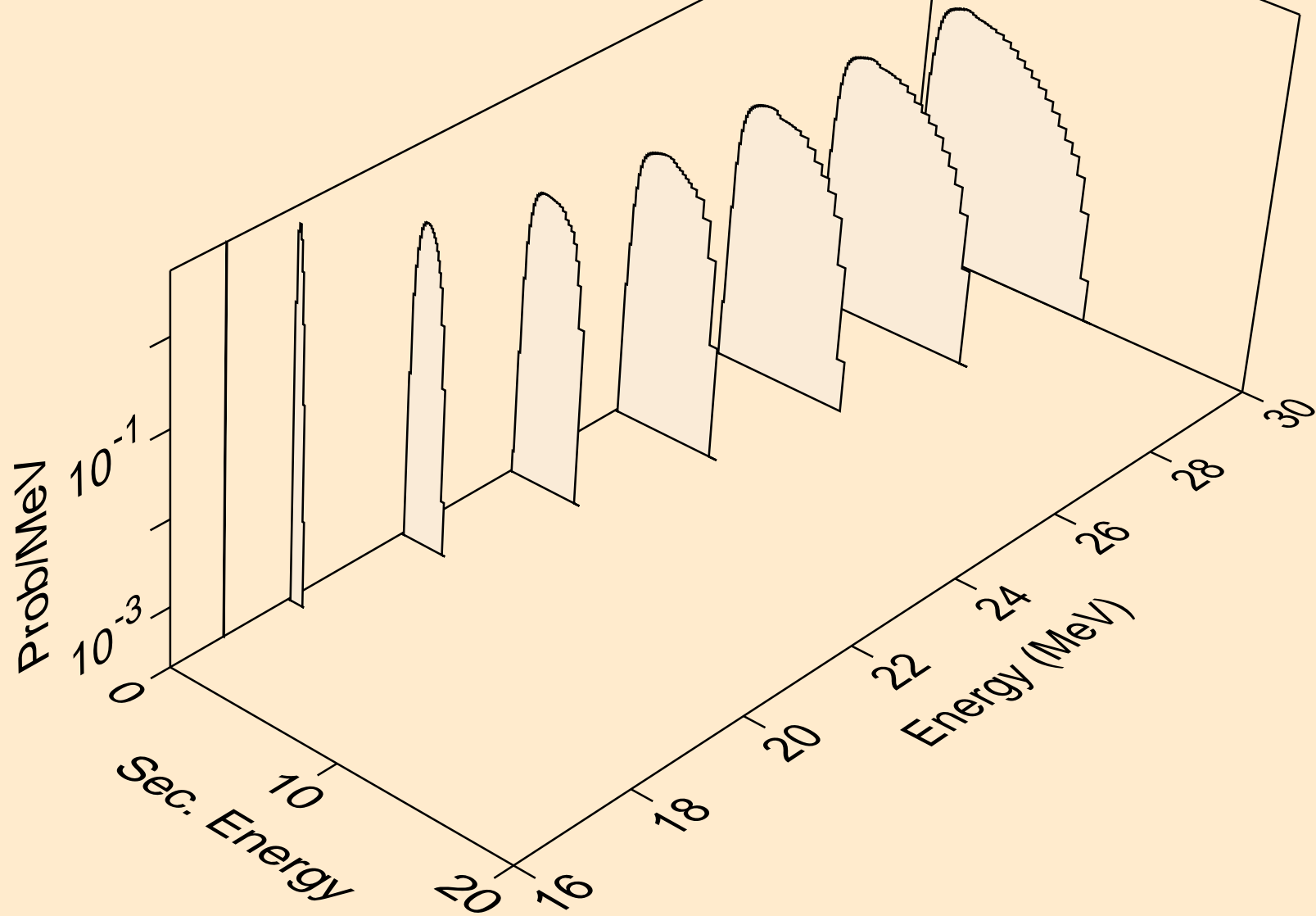

N013 NEUTRON ACER TENDL-2021 LIBRARY; T=293.6K
protons from (n,pt)

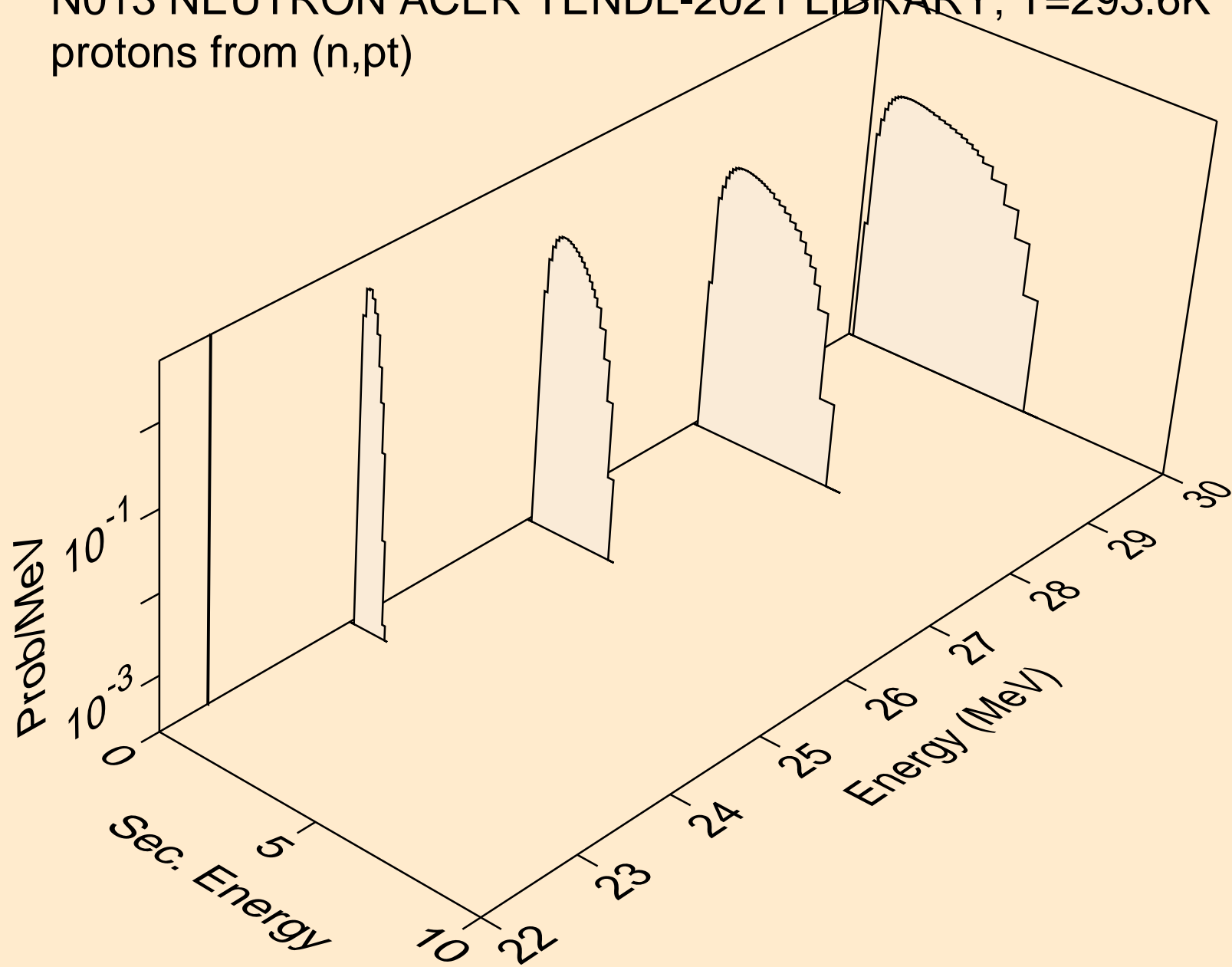

N013 NEUTRON ACER TENDL-2021 LIBRARY; T=293.6K
deuterons from (n,x)

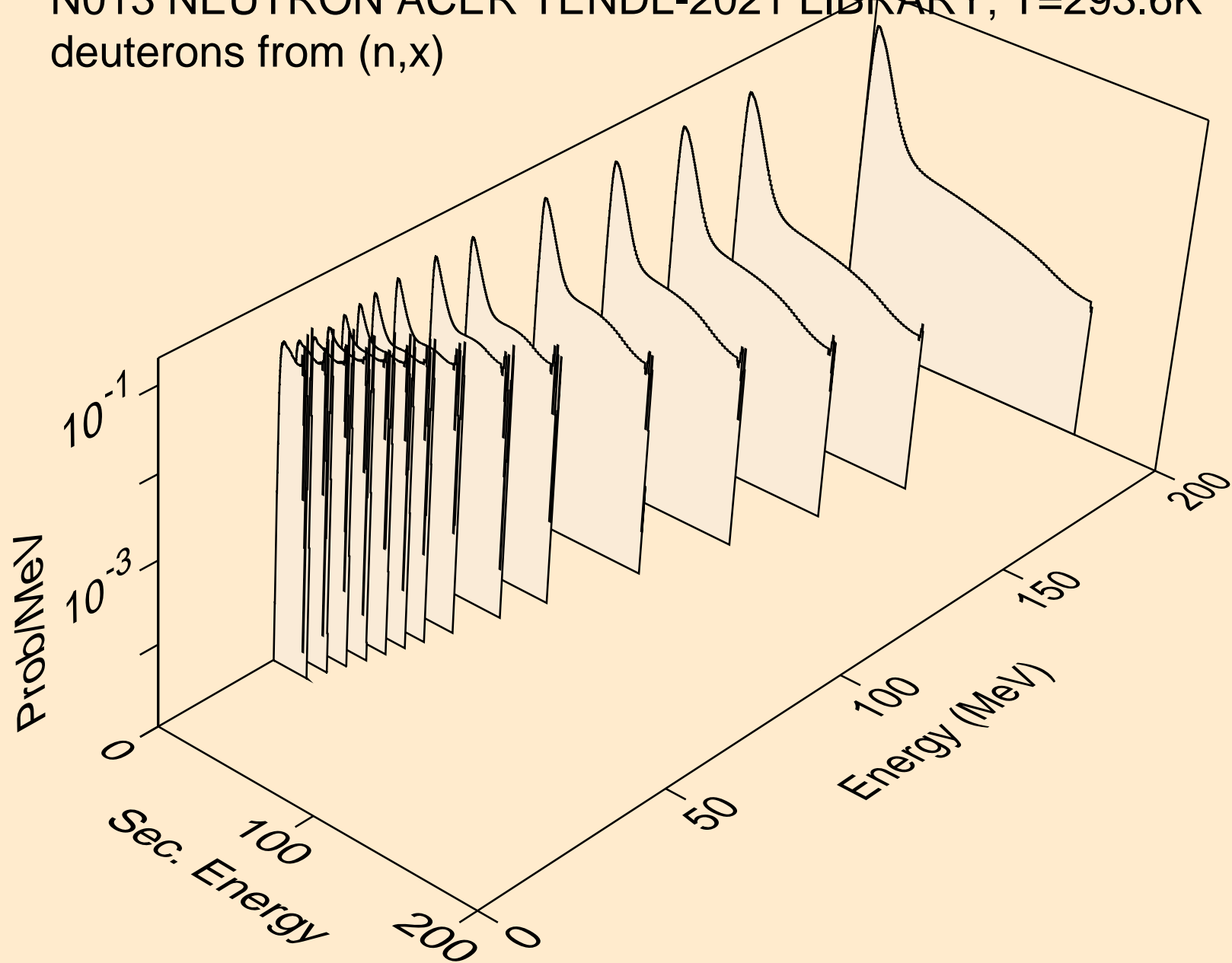

N013 NEUTRON ACER TENDL-2021 LIBRARY; T=293.6K
deuterons from (n,n*)d

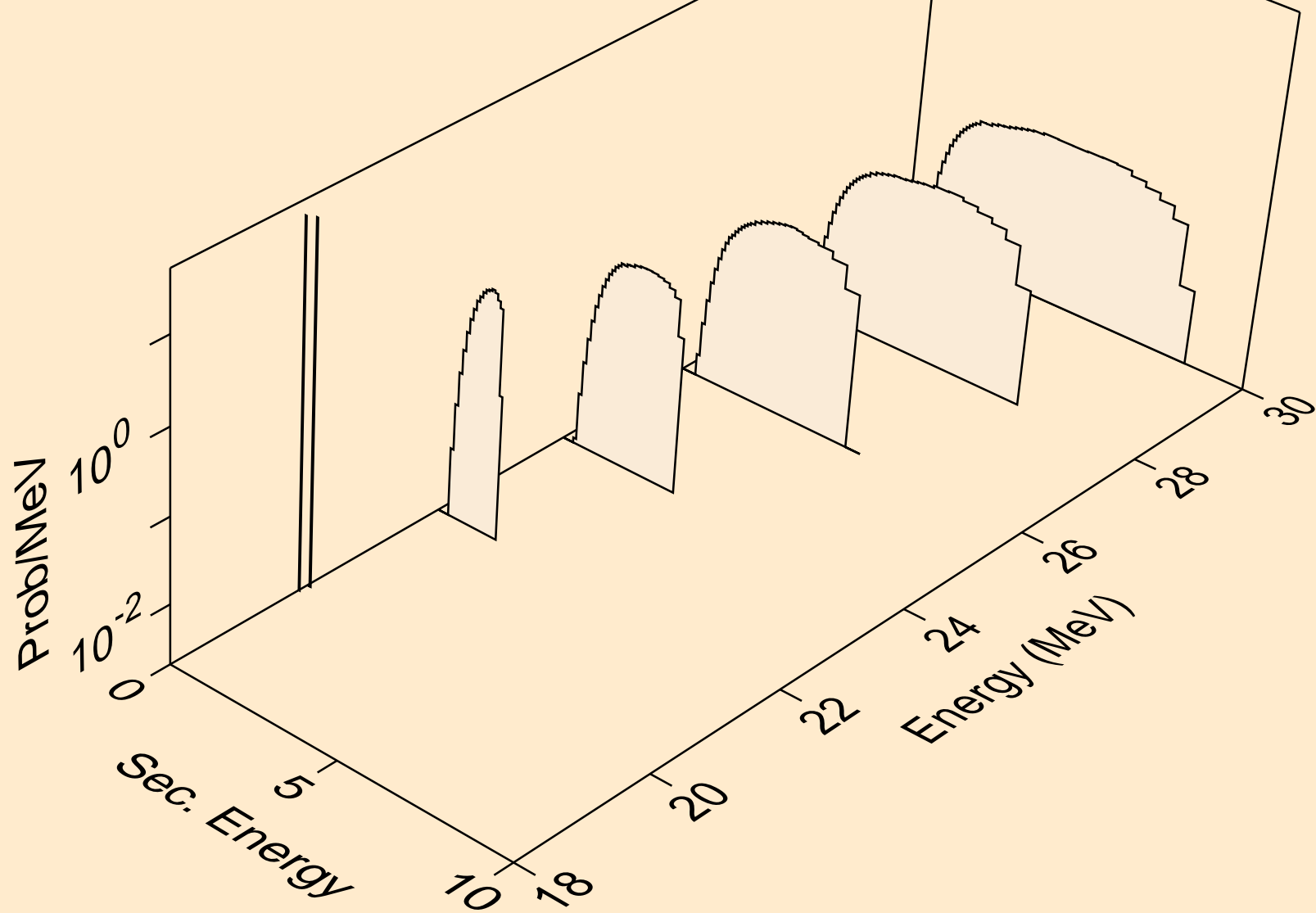

N013 NEUTRON ACER TENDL-2021 LIBRARY; T=293.6K
deuterons from (n,d)

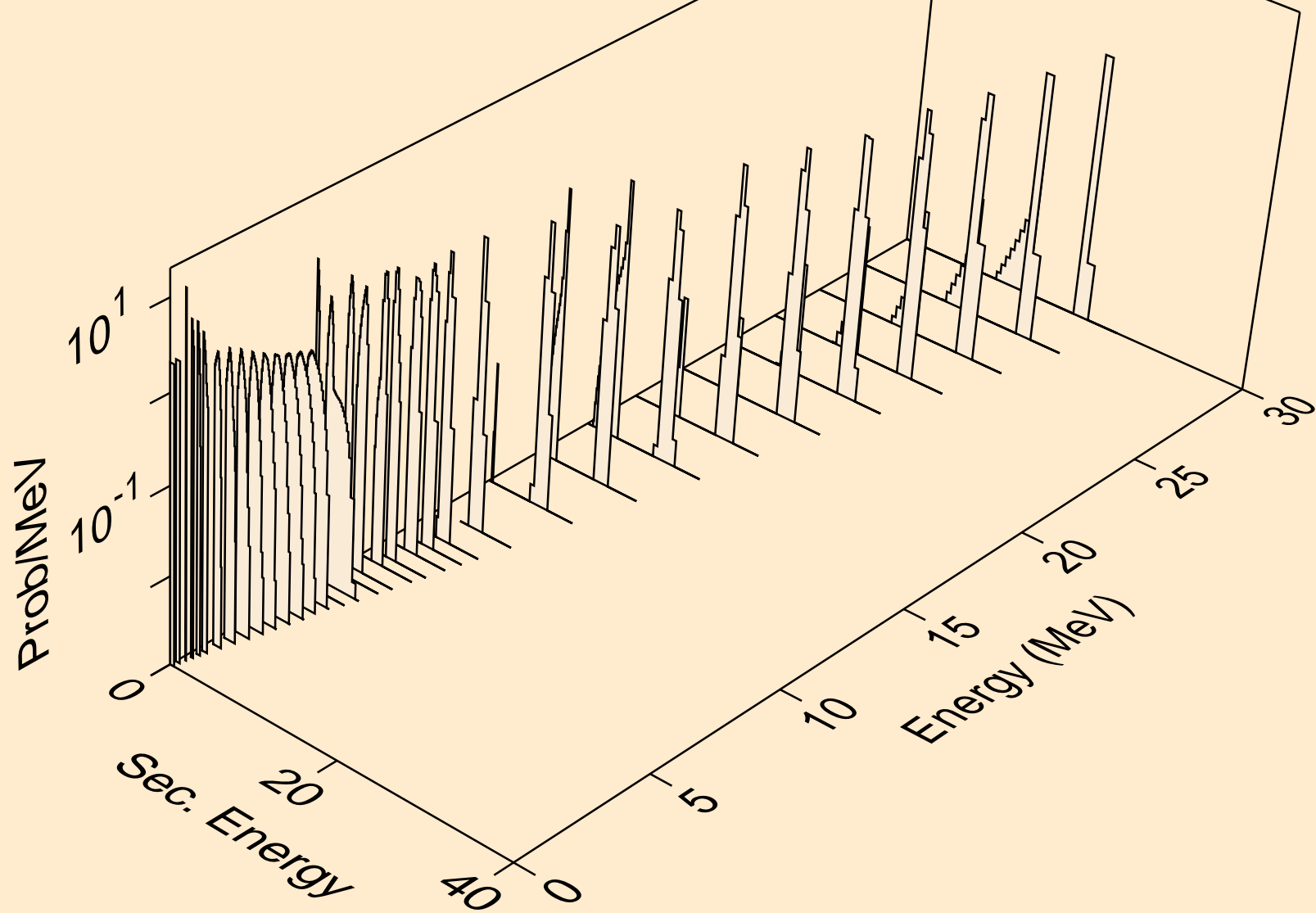

N013 NEUTRON ACER TENDL-2021 LIBRARY; T=293.6K
deuterons from (n,pd)

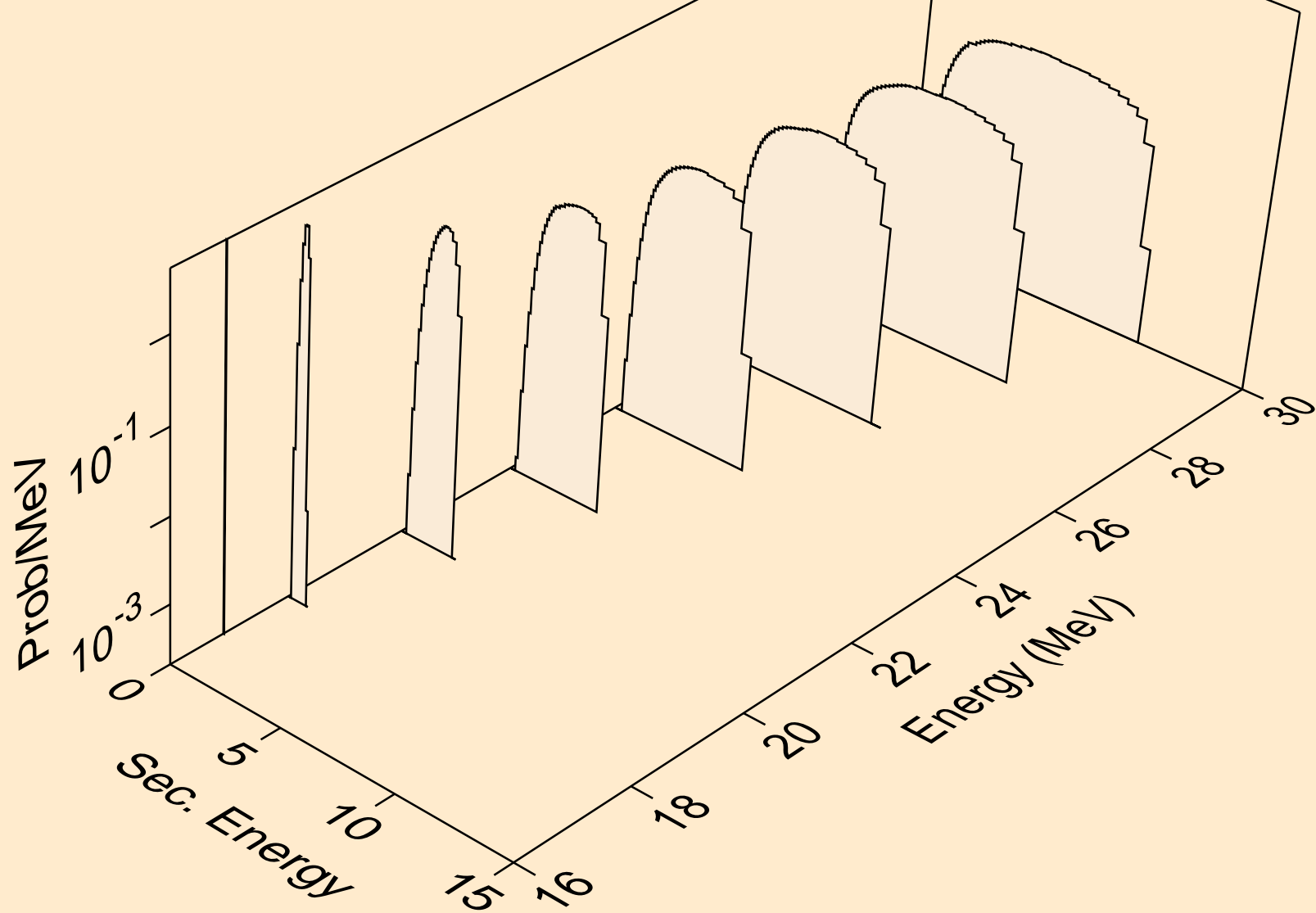

N013 NEUTRON ACER TENDL-2021 LIBRARY; T=293.6K
deuterons from (n,da)

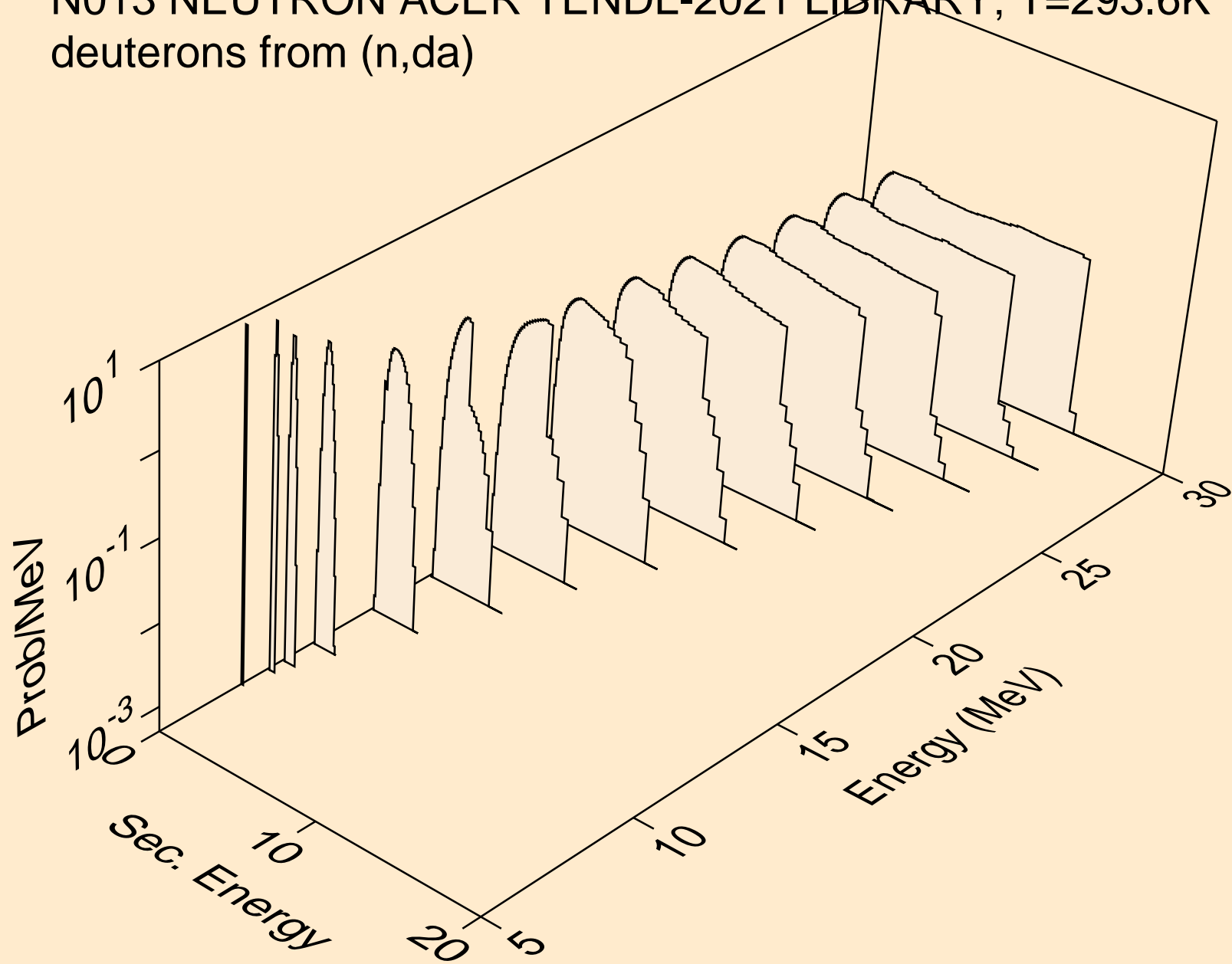

N013 NEUTRON ACER TENDL-2021 LIBRARY; T=293.6K
tritons from (n,x)

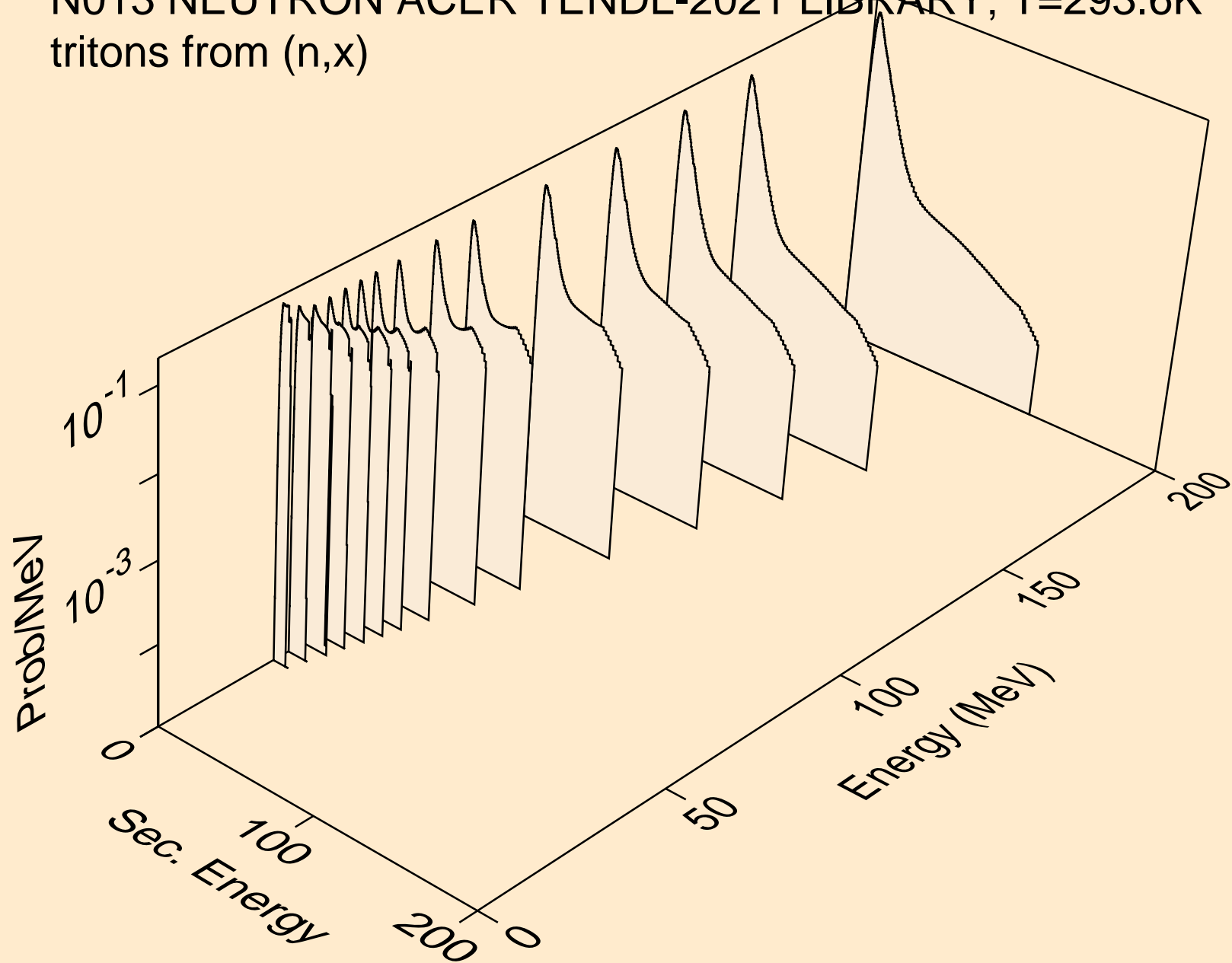

N013 NEUTRON ACER TENDL-2021 LIBRARY; T=293.6K
tritons from (n,n*)t

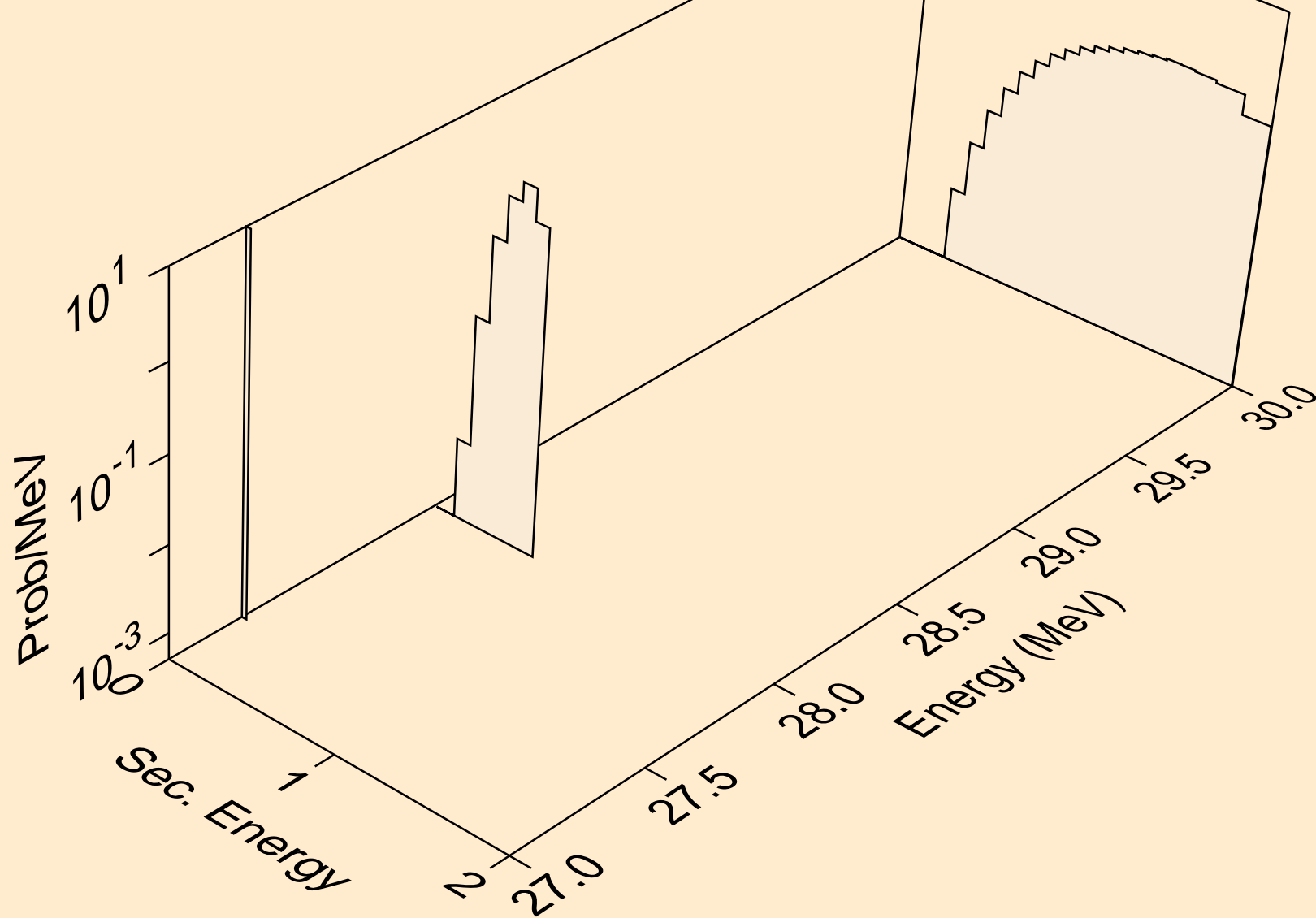

N013 NEUTRON ACER TENDL-2021 LIBRARY; T=293.6K
tritons from (n,t)

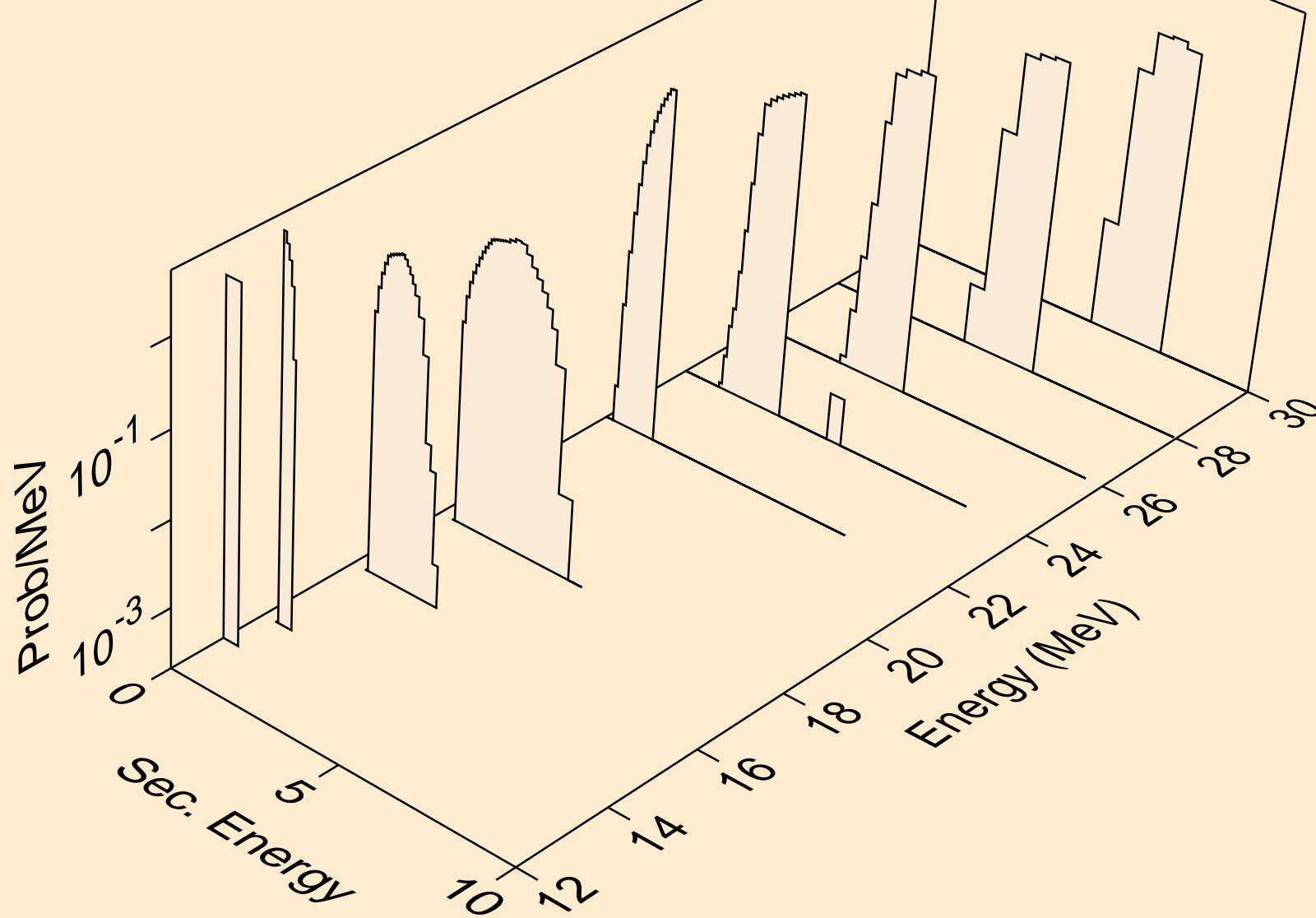

N013 NEUTRON ACER TENDL-2021 LIBRARY; T=293.6K
tritons from (n,pt)

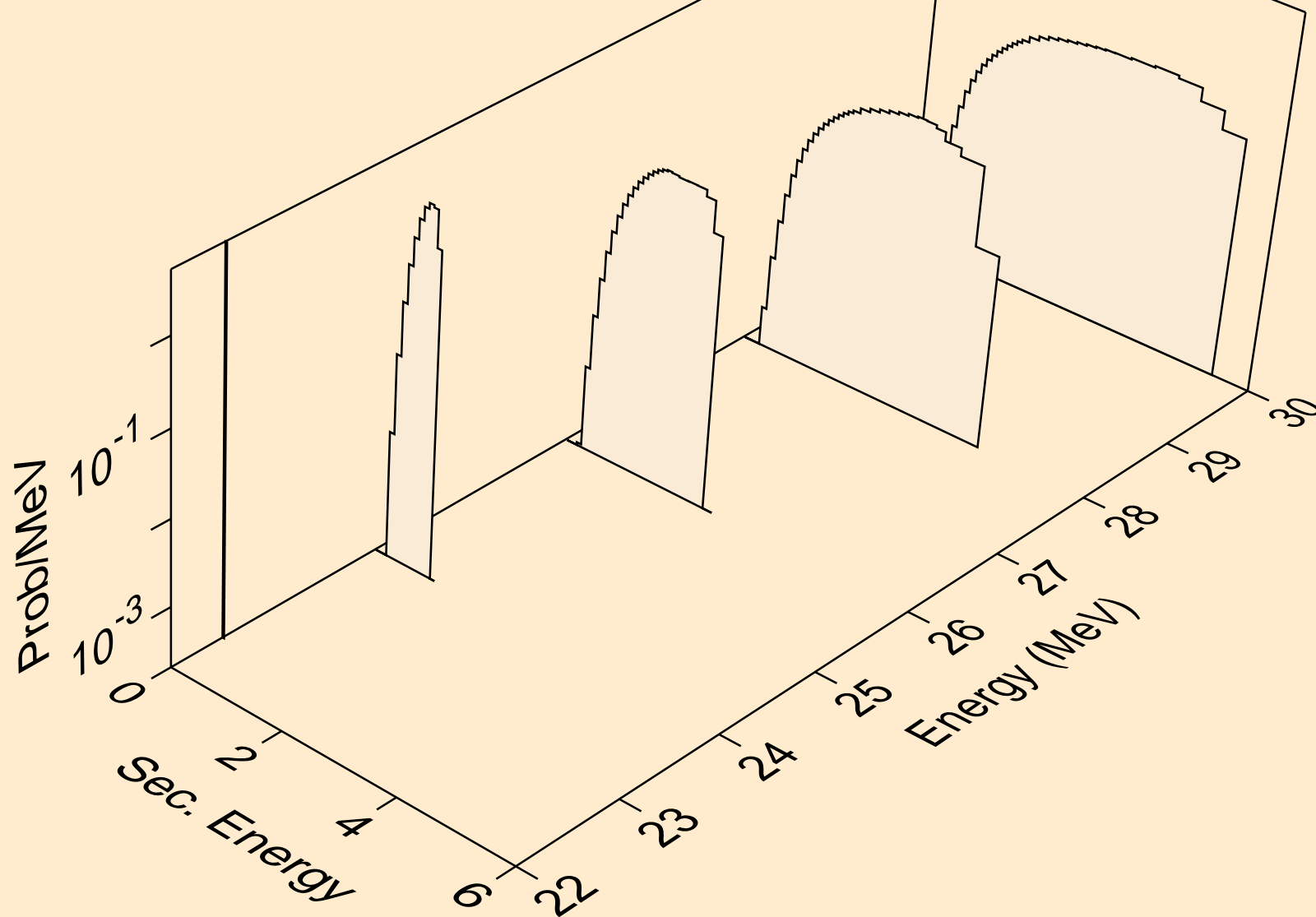

N013 NEUTRON ACER TENDL-2021 LIBRARY; T=293.6K
he3s from (n,x)

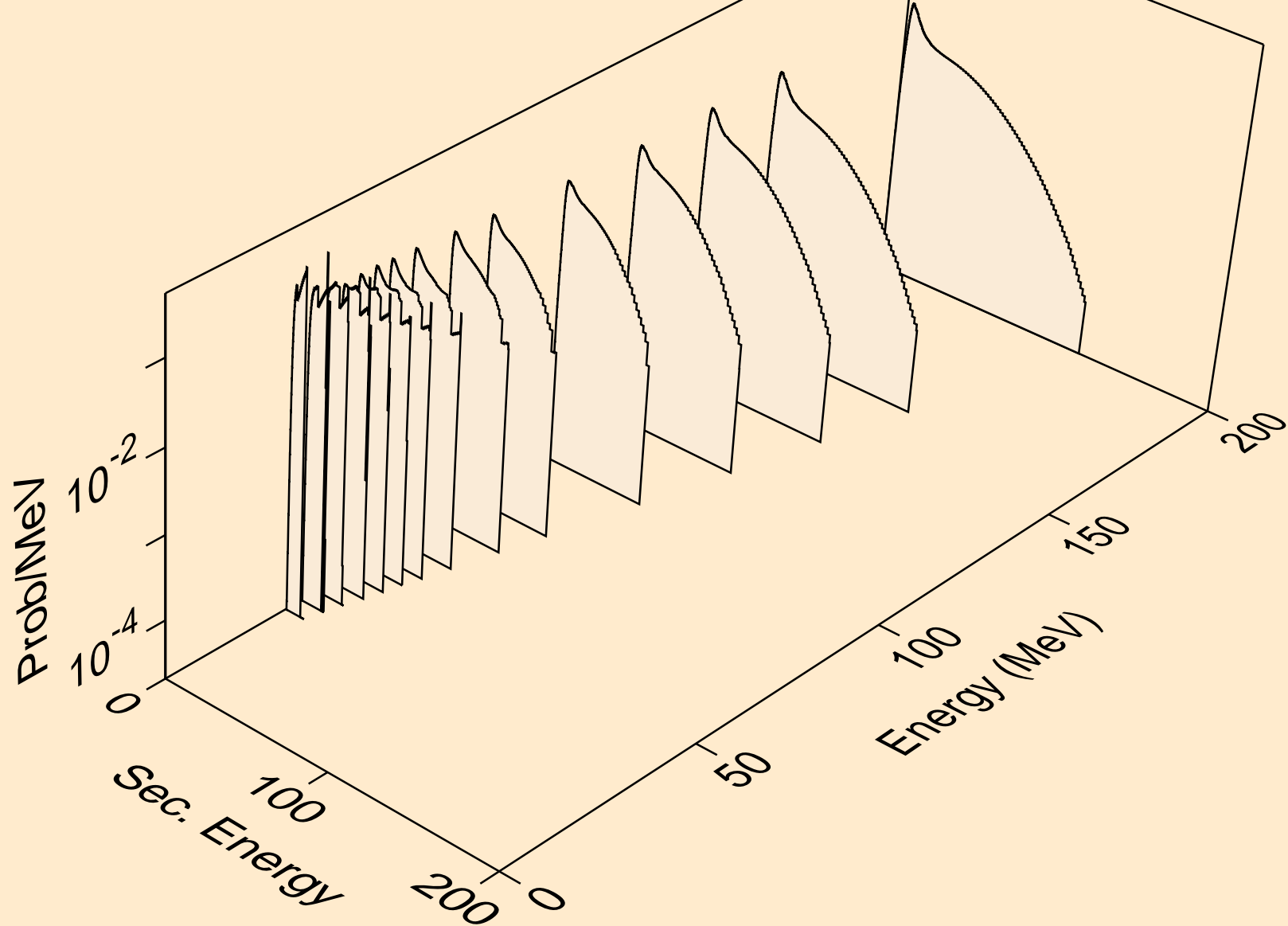

N013 NEUTRON ACER TENDL-2021 LIBRARY; T=293.6K
he3s from (n,n*)he3

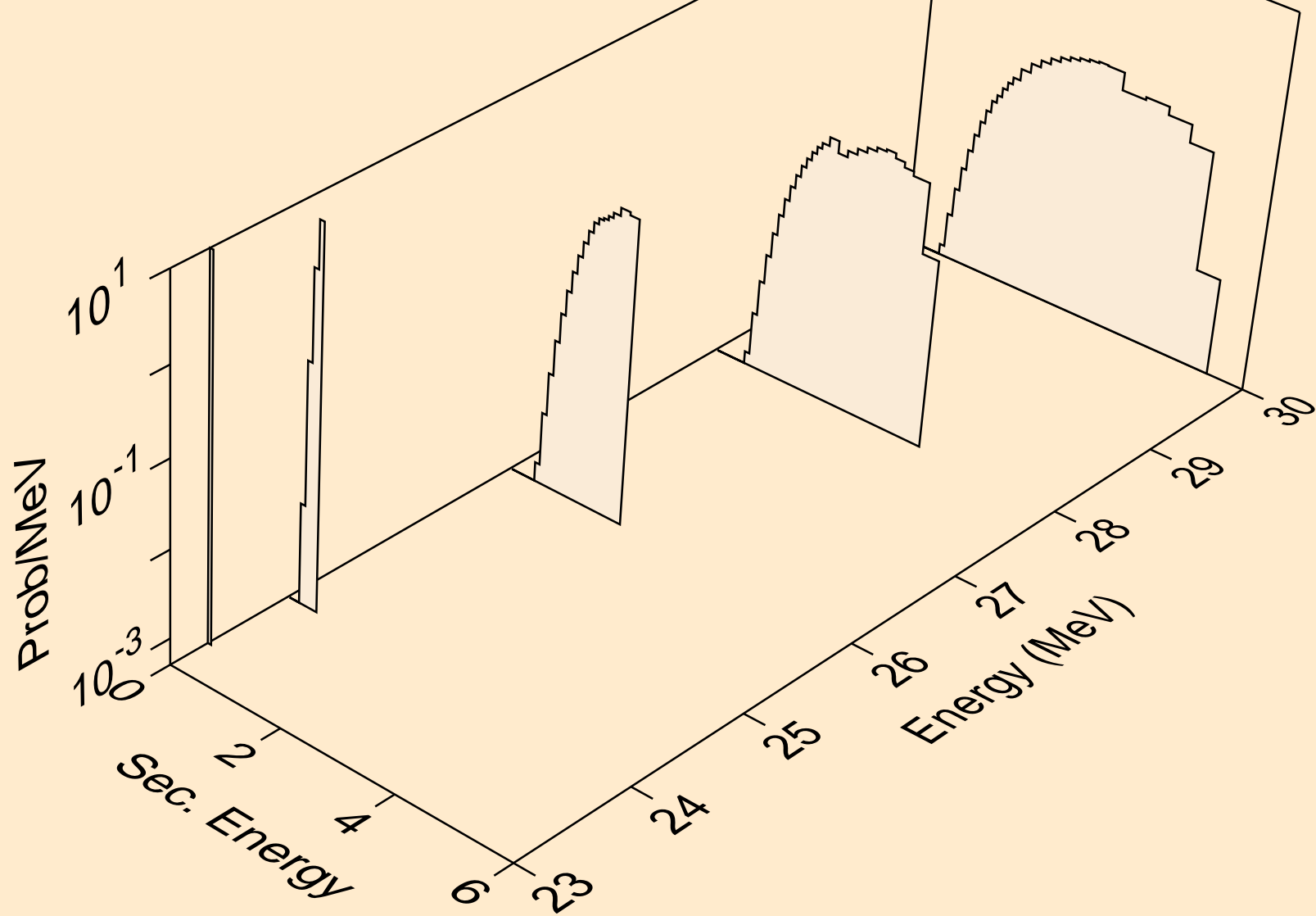

N013 NEUTRON ACER TENDL-2021 LIBRARY; T=293.6K
he3s from (n,he3)

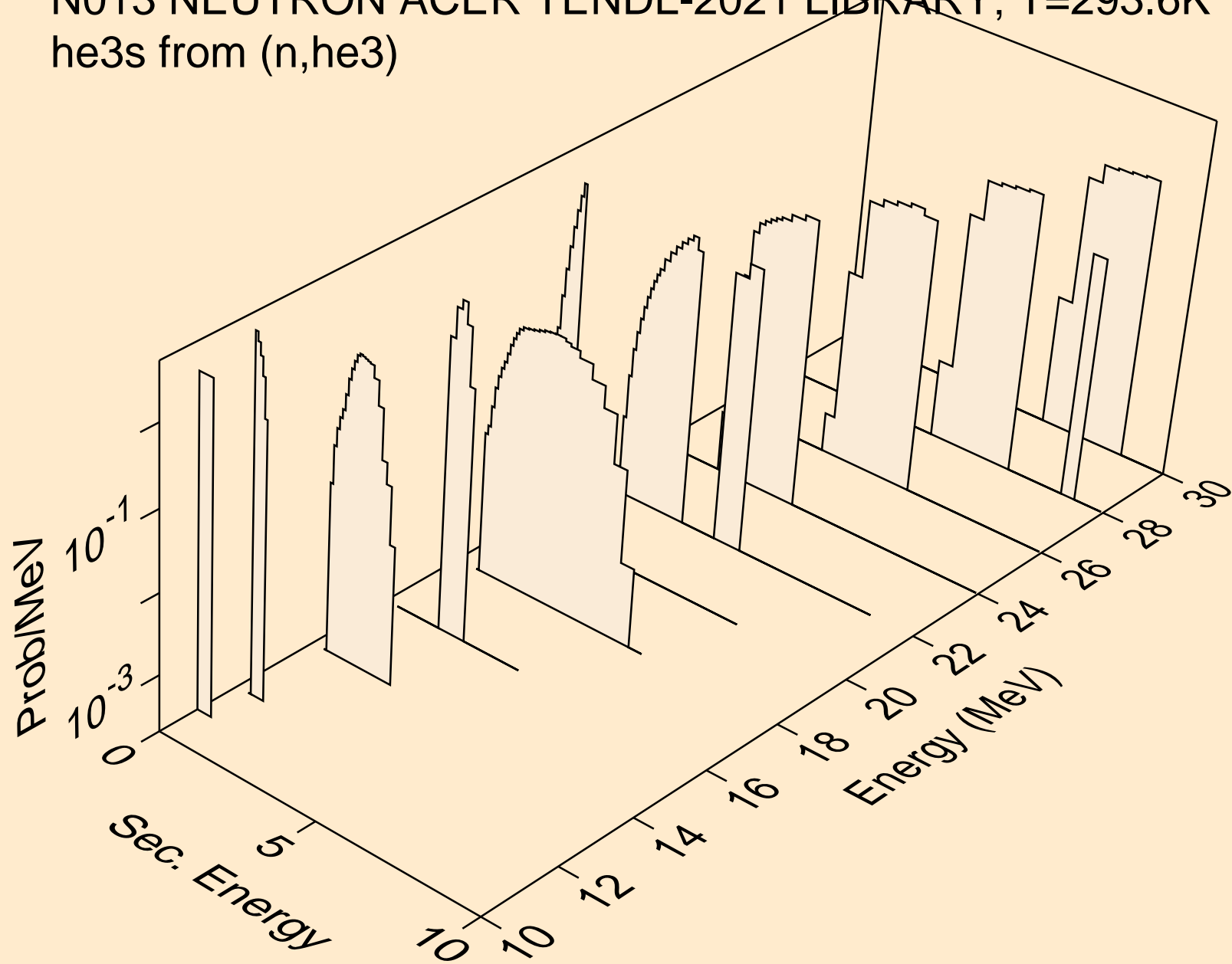

N013 NEUTRON ACER TENDL-2021 LIBRARY; T=293.6K
alphas from (n,x)

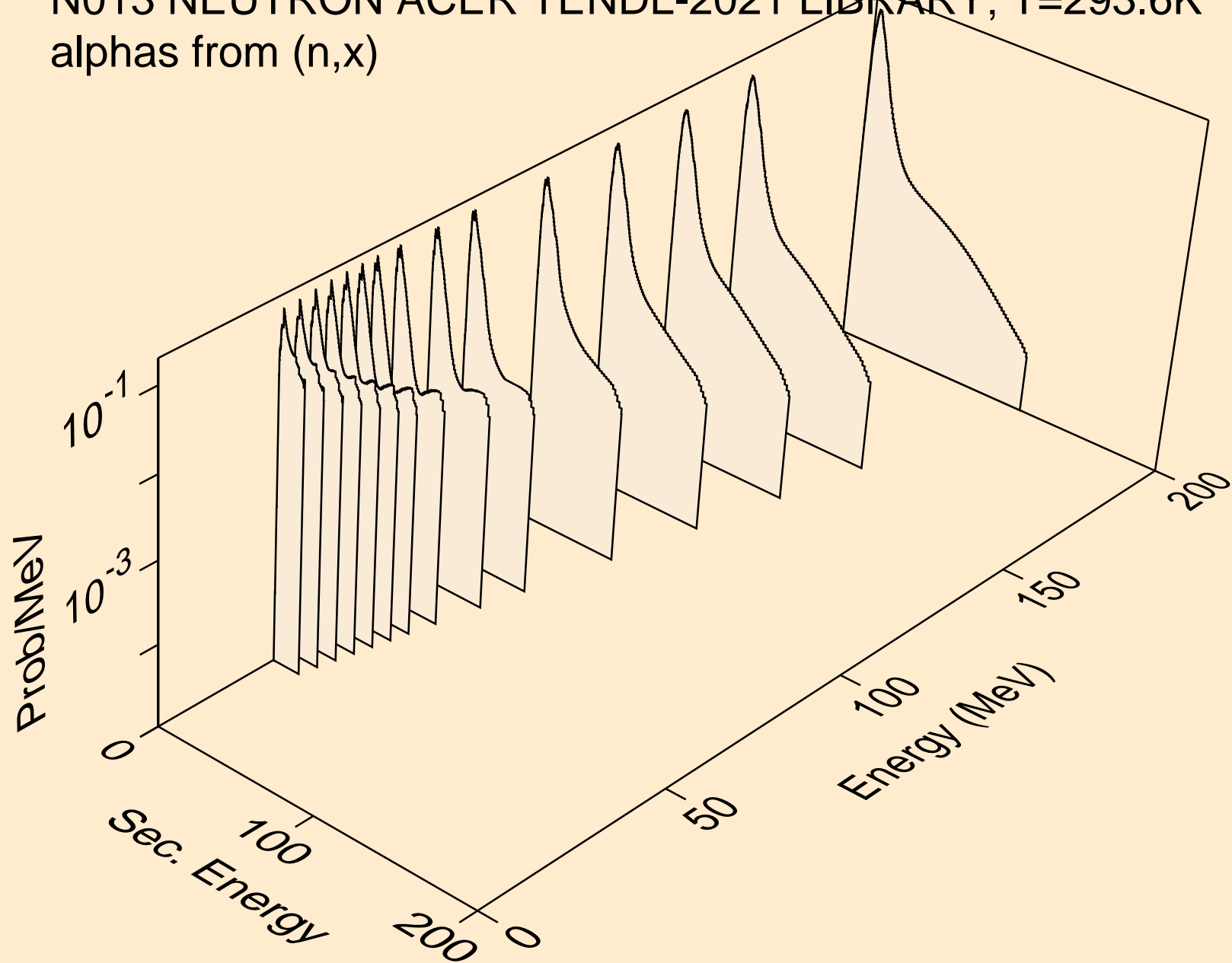

N013 NEUTRON ACER TENDL-2021 LIBRARY; T=293.6K
alphas from (n,n*)a

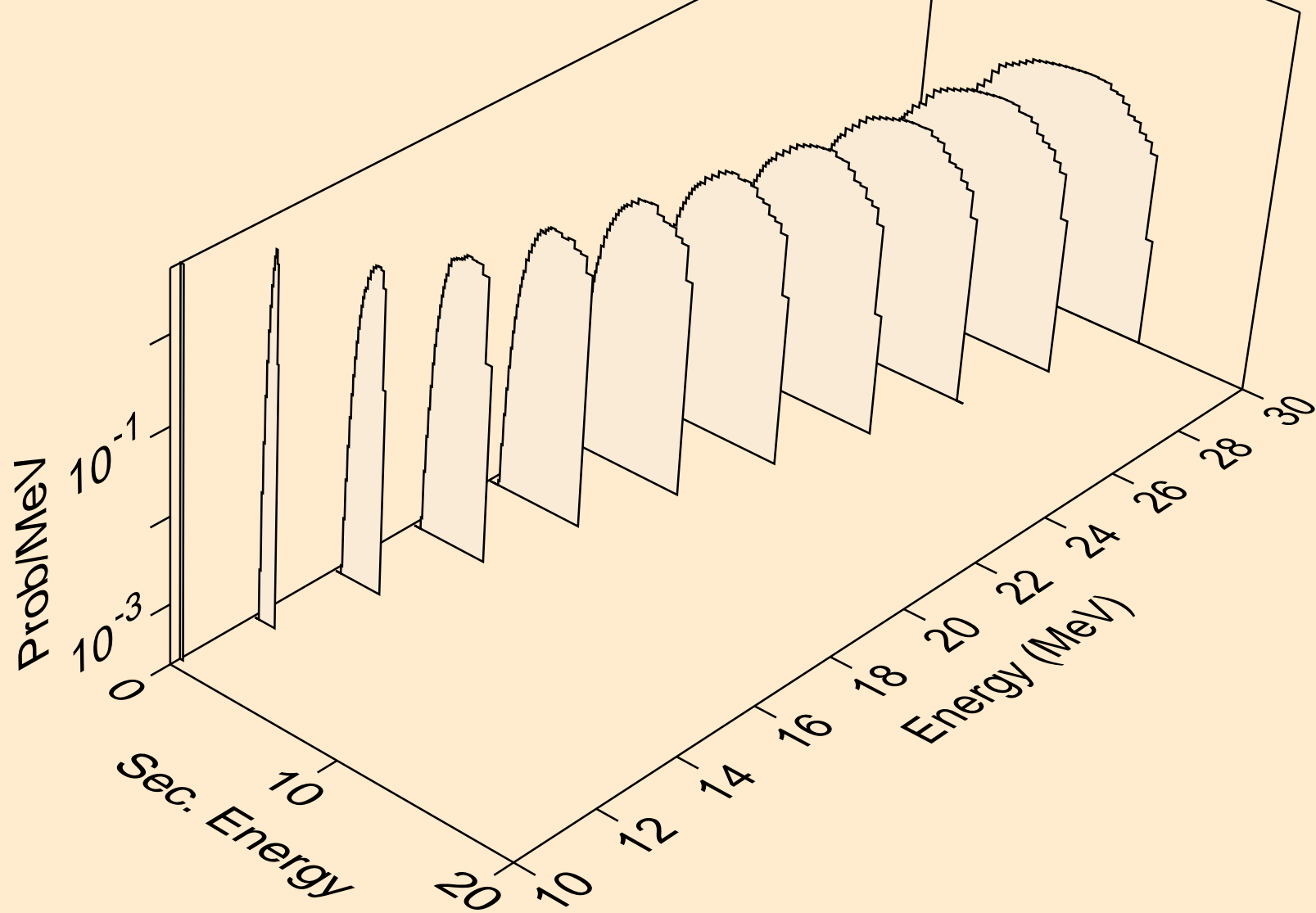

N013 NEUTRON ACER TENDL-2021 LIBRARY; T=293.6K
alphas from (n,npa)

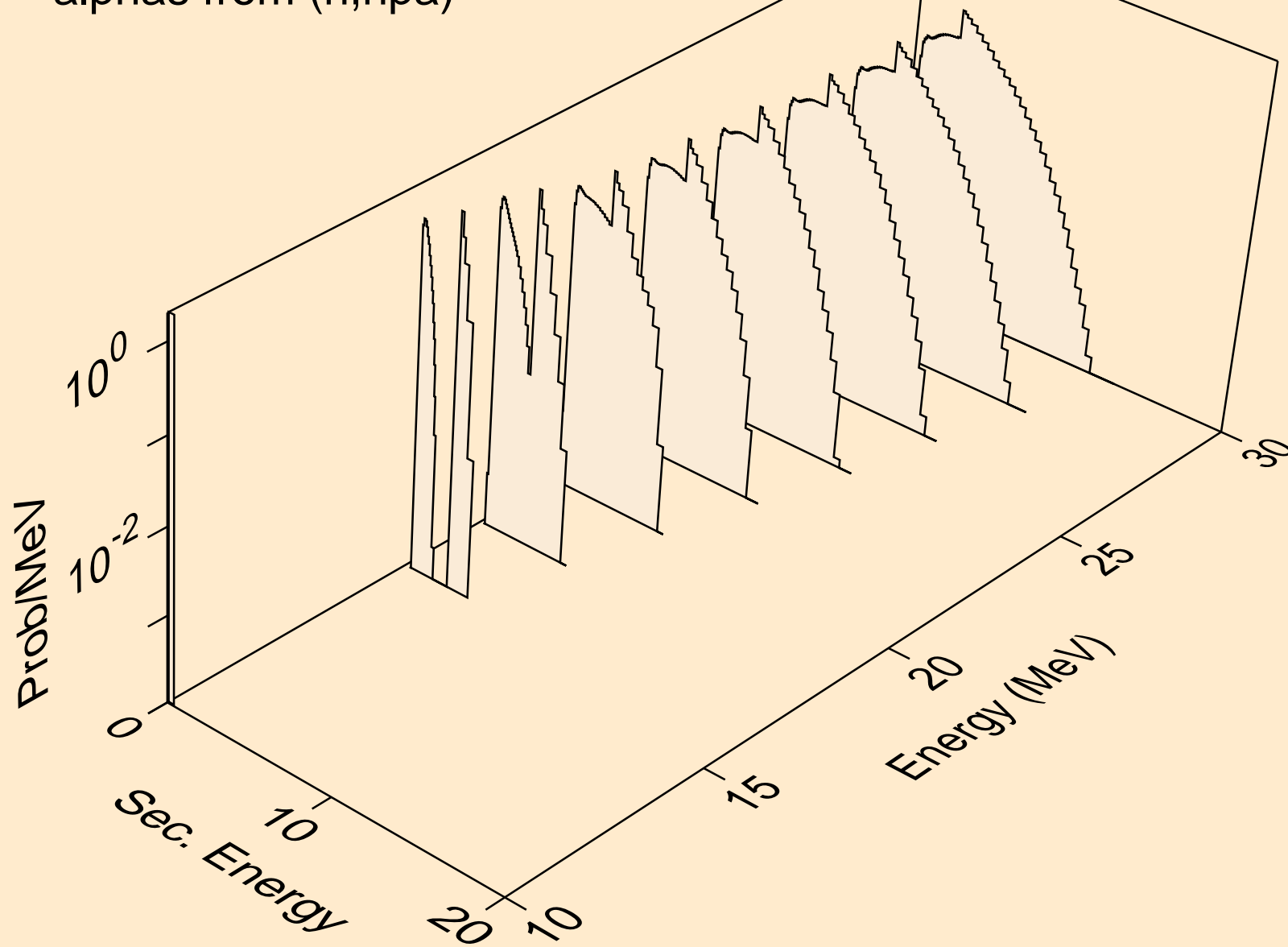

N013 NEUTRON ACER TENDL-2021 LIBRARY; T=293.6K
alphas from (n,a)

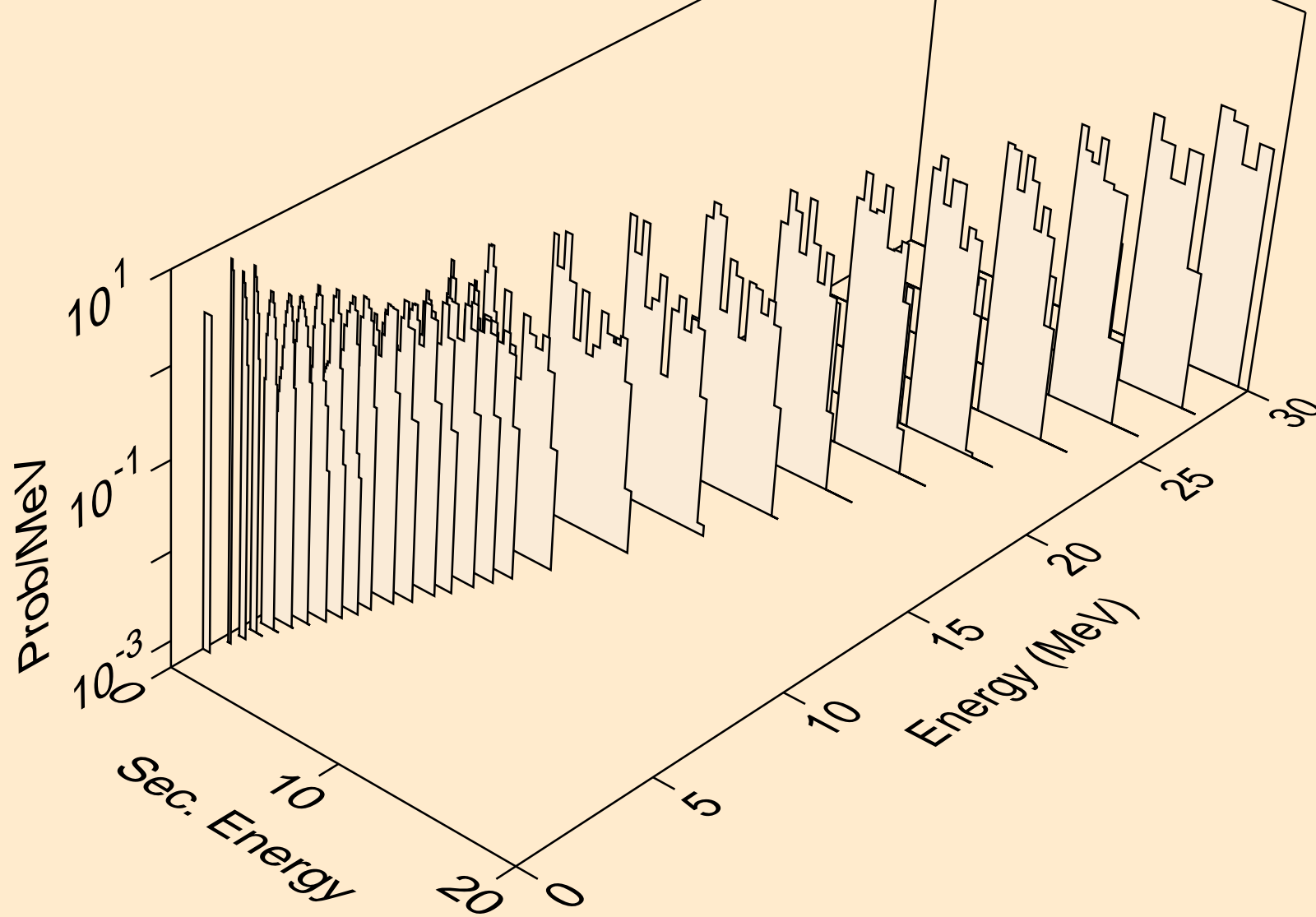

N013 NEUTRON ACER TENDL-2021 LIBRARY; T=293.6K
alphas from (n,2a)

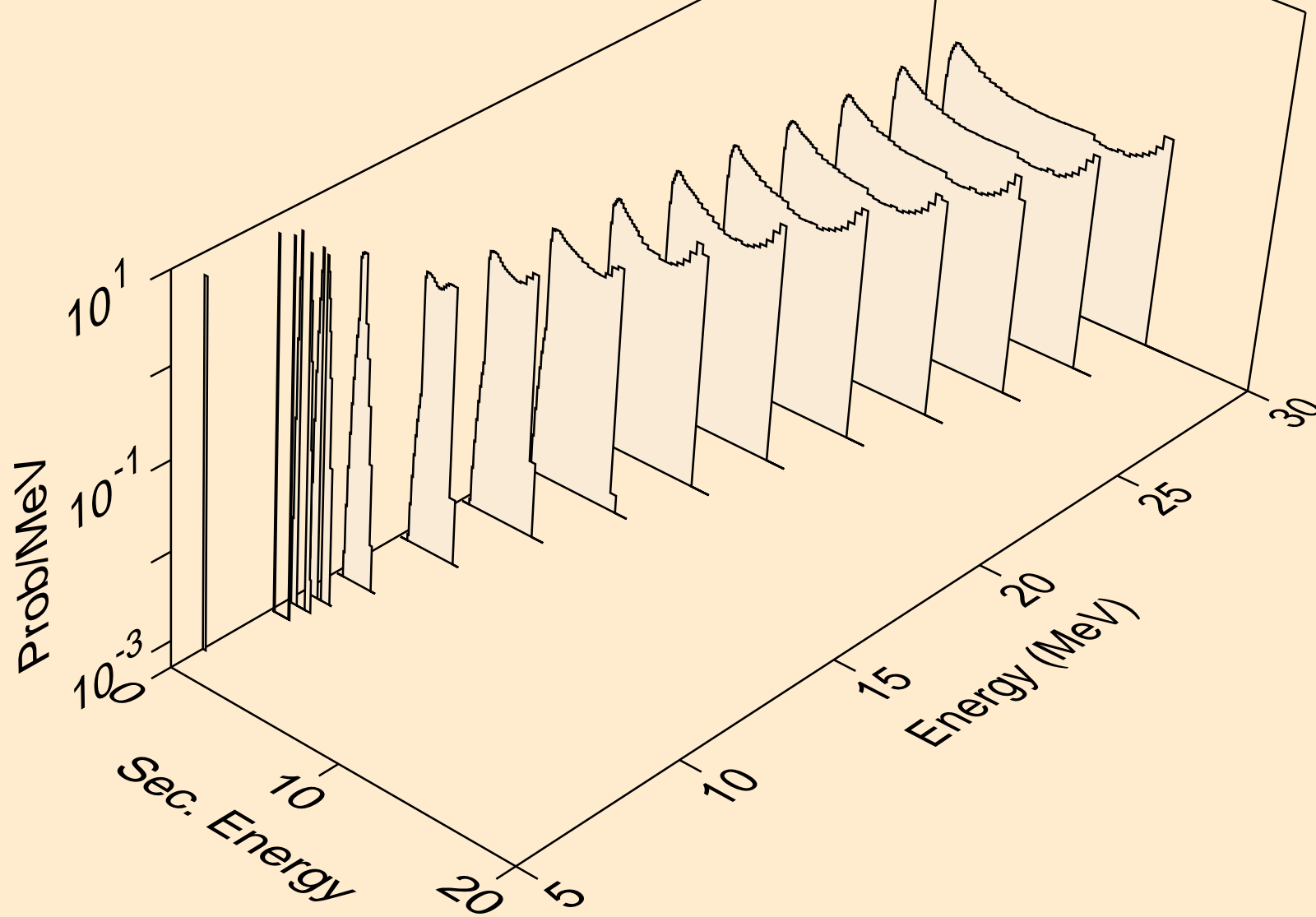

N013 NEUTRON ACER TENDL-2021 LIBRARY; T=293.6K
alphas from (n,pa)

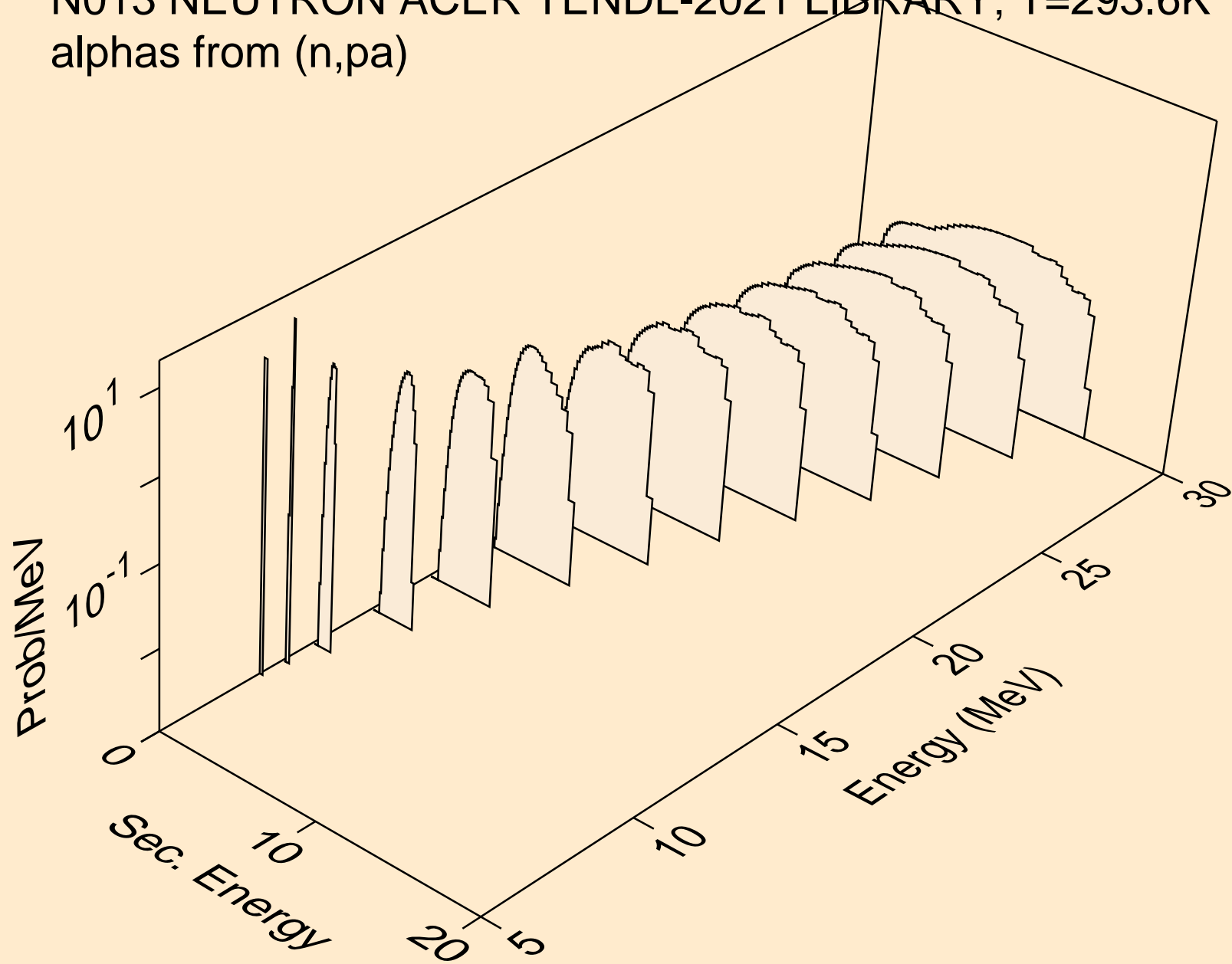

N013 NEUTRON ACER TENDL-2021 LIBRARY; T=293.6K
alphas from (n,da)

