

NB083 NEUTRON ACER TENDL-2021 LIBRARY; T=293.6K

Principal cross sections

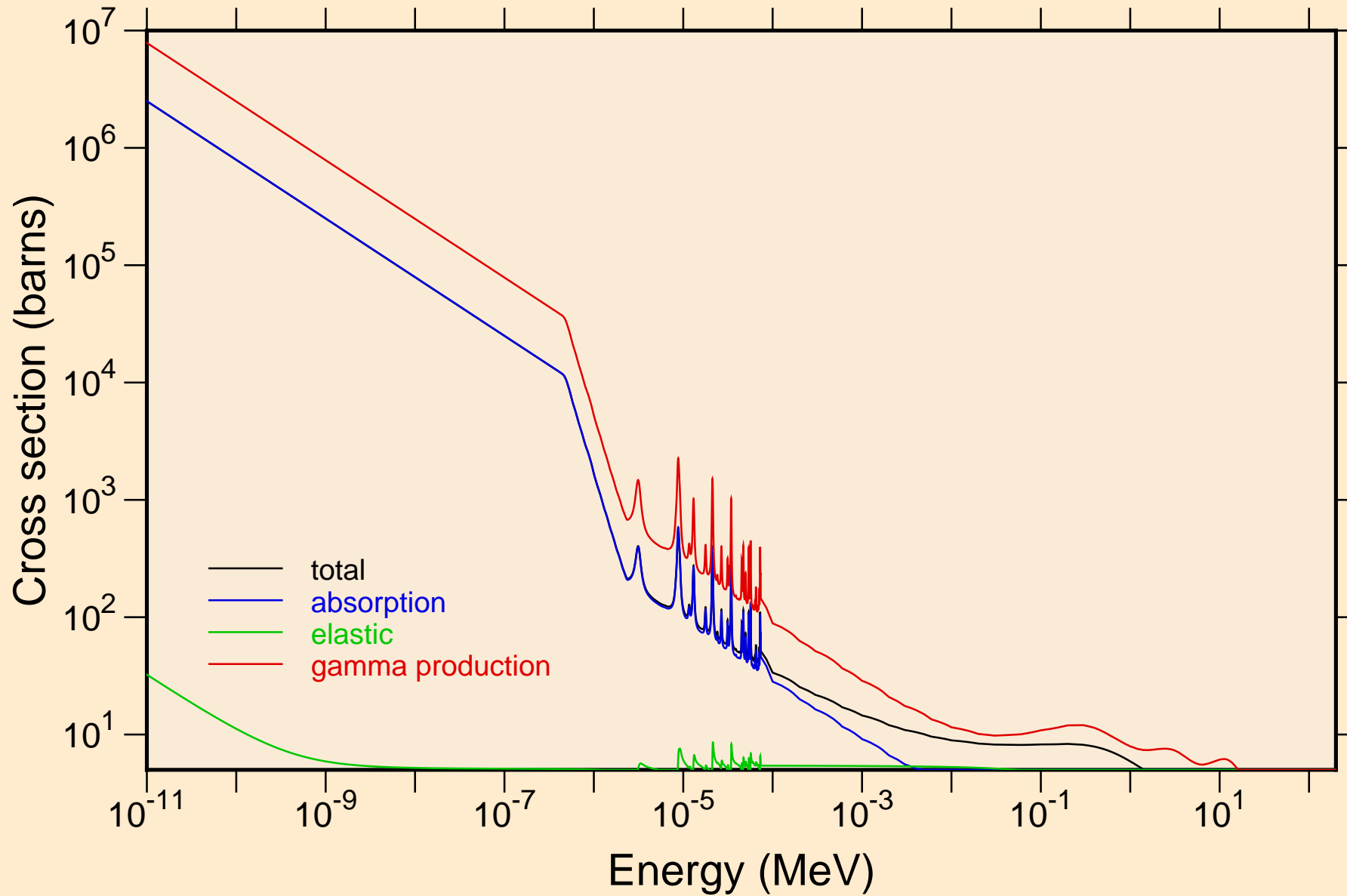

NB083 NEUTRON ACER TENDL-2021 LIBRARY; T=293.6K
resonance total cross section

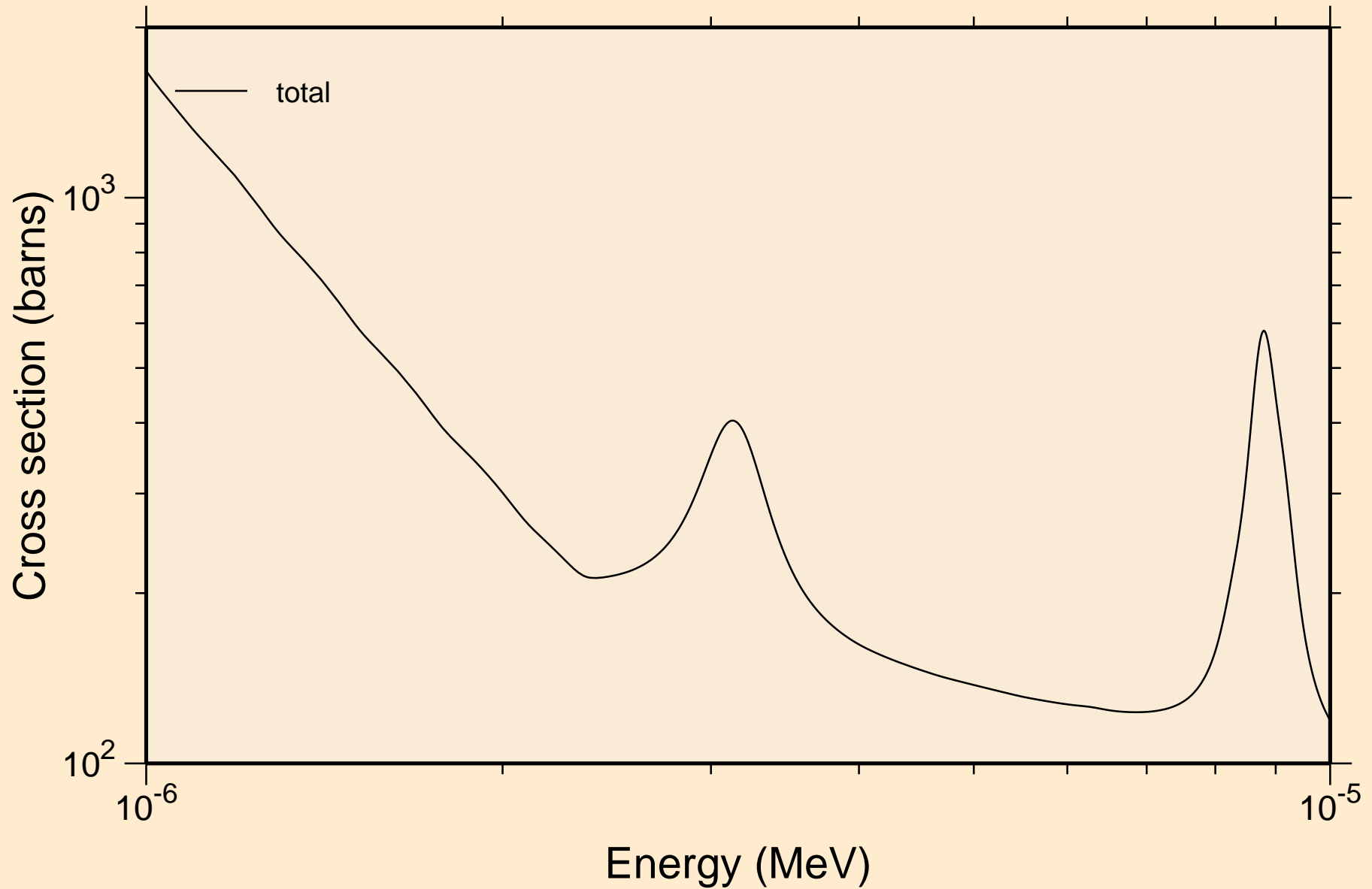

NB083 NEUTRON ACER TENDL-2021 LIBRARY; T=293.6K
resonance total cross section

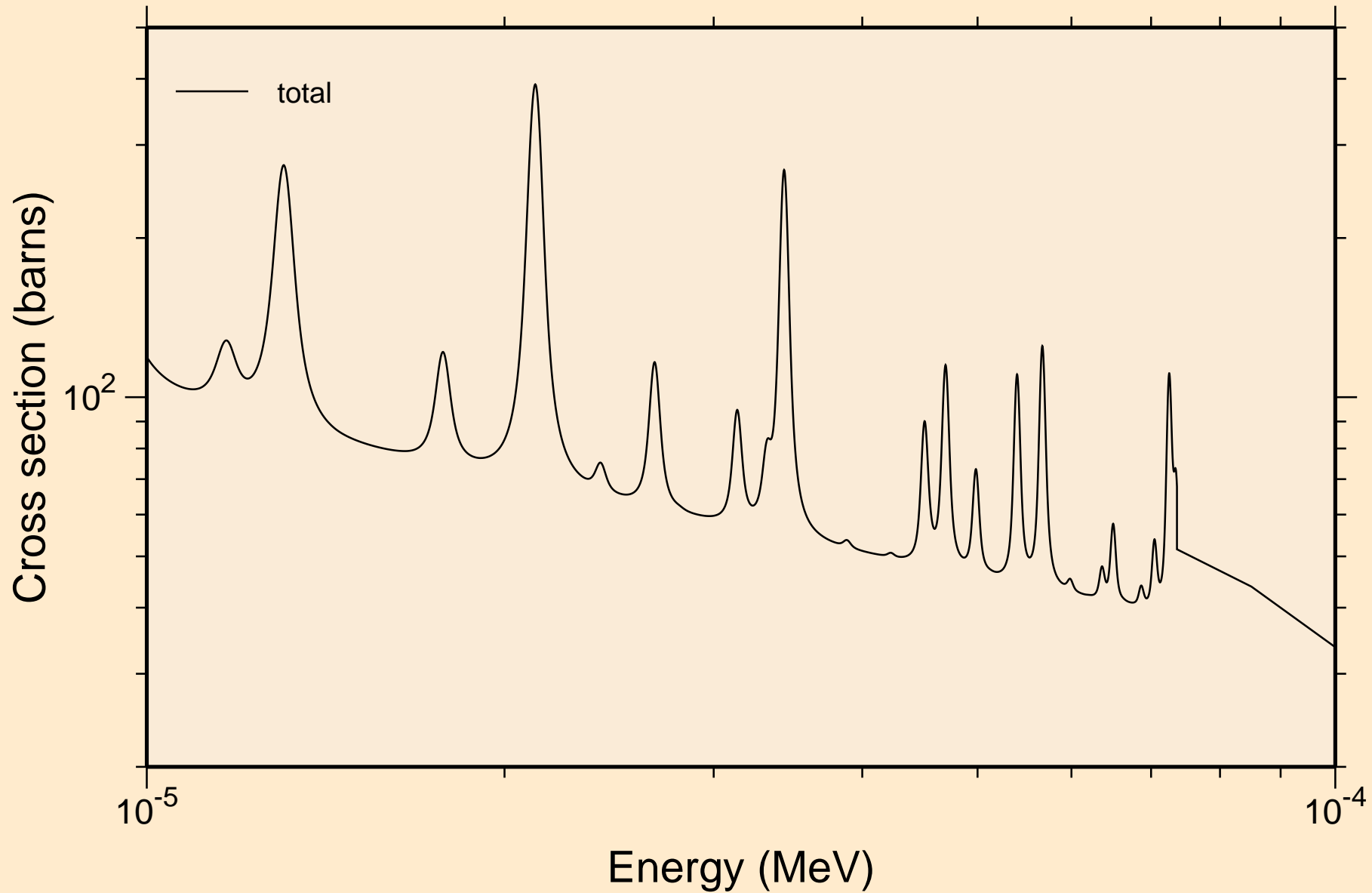

NB083 NEUTRON ACER TENDL-2021 LIBRARY; T=293.6K
resonance total cross section

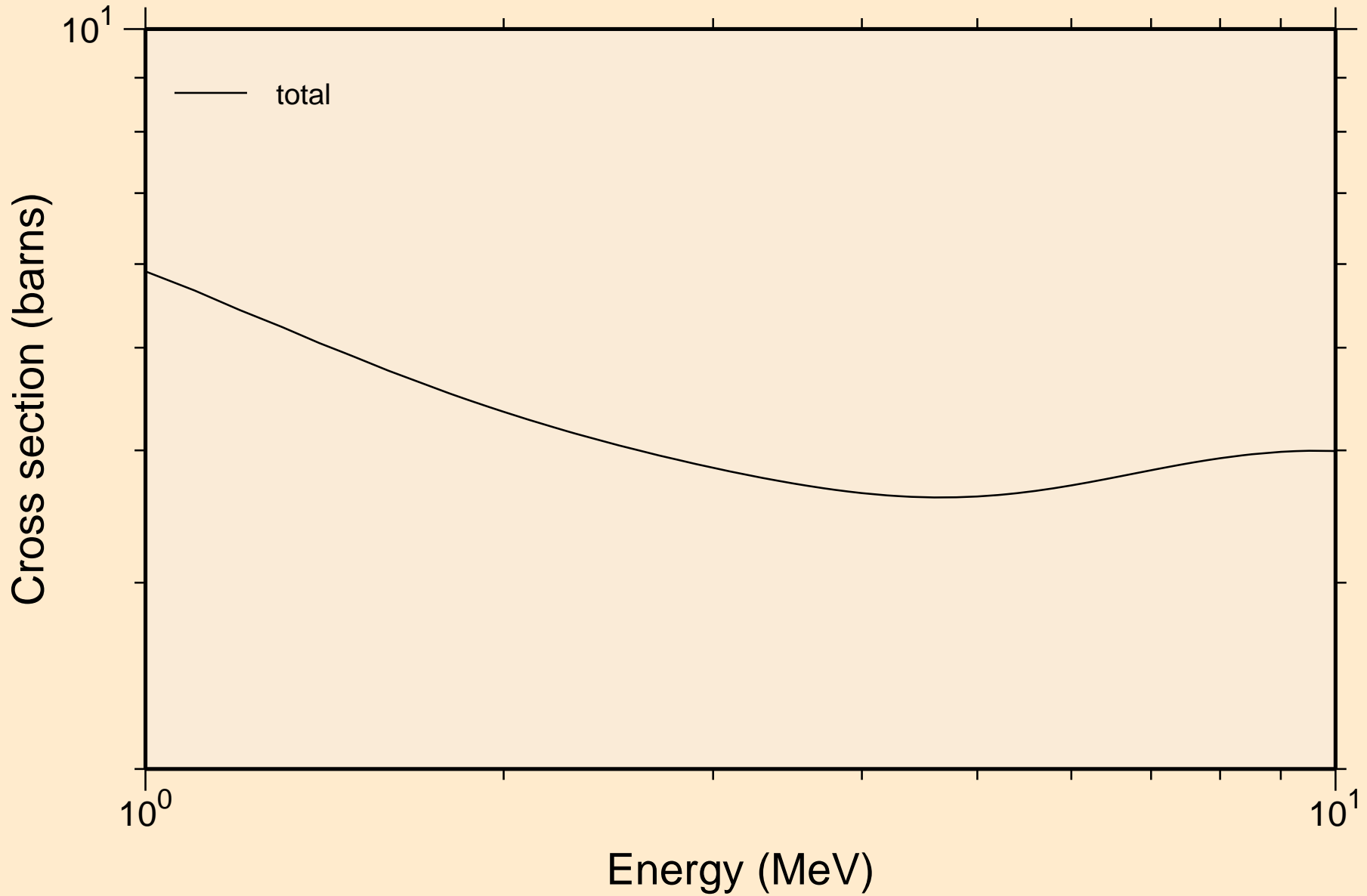

NB083 NEUTRON ACER TENDL-2021 LIBRARY; T=293.6K
resonance absorption cross sections

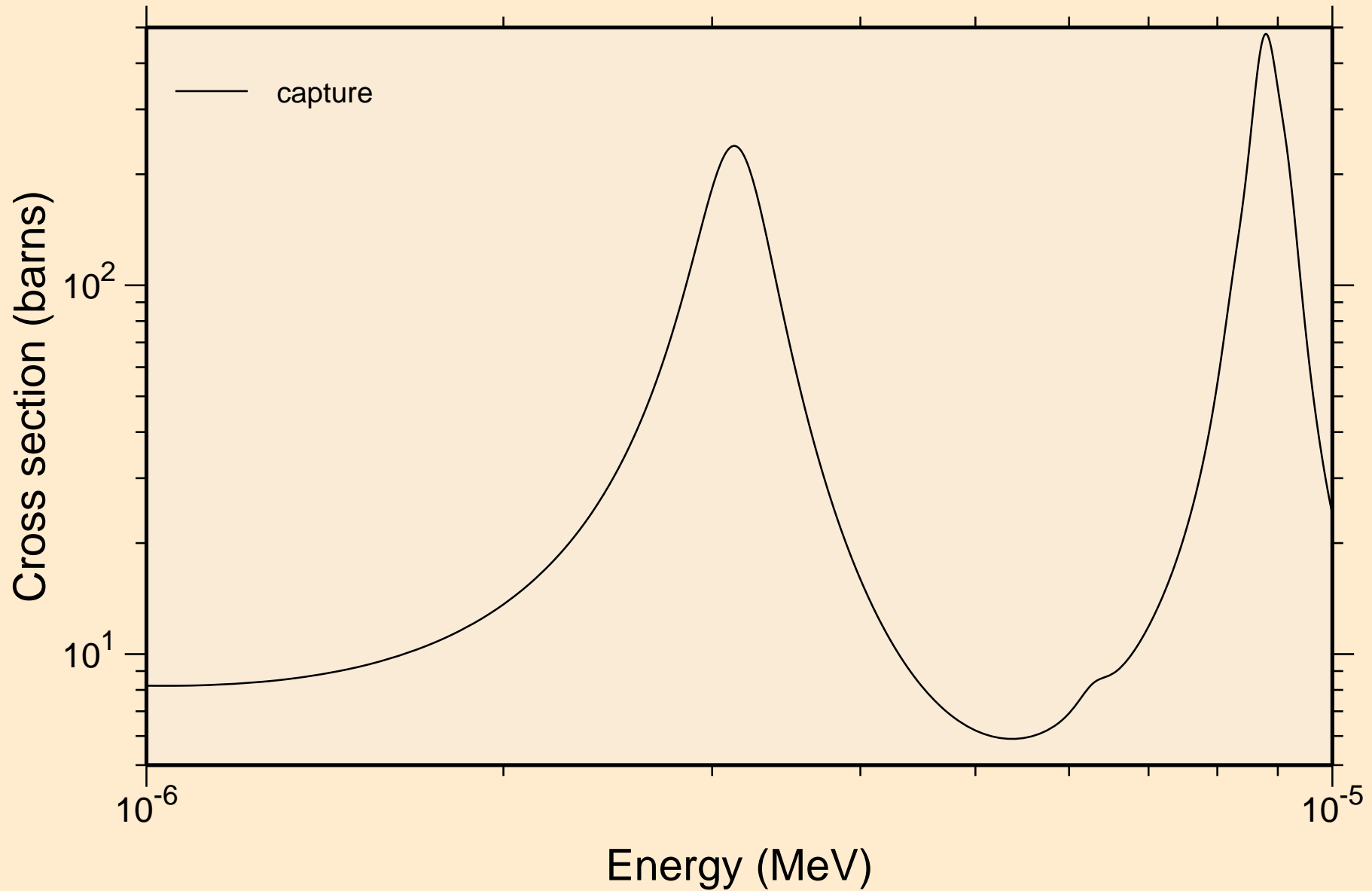

NB083 NEUTRON ACER TENDL-2021 LIBRARY; T=293.6K
resonance absorption cross sections

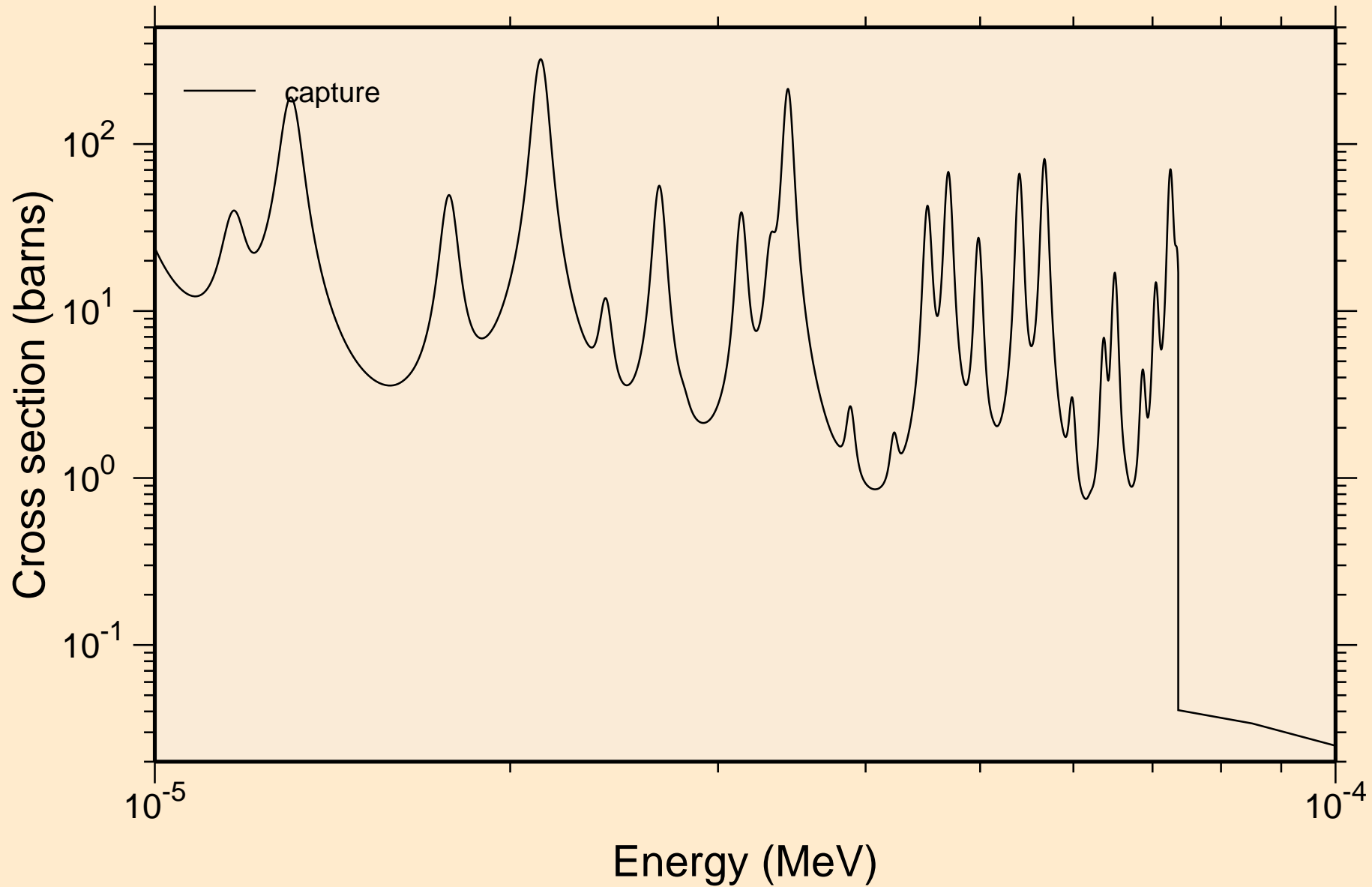

NB083 NEUTRON ACER TENDL-2021 LIBRARY; T=293.6K
resonance absorption cross sections

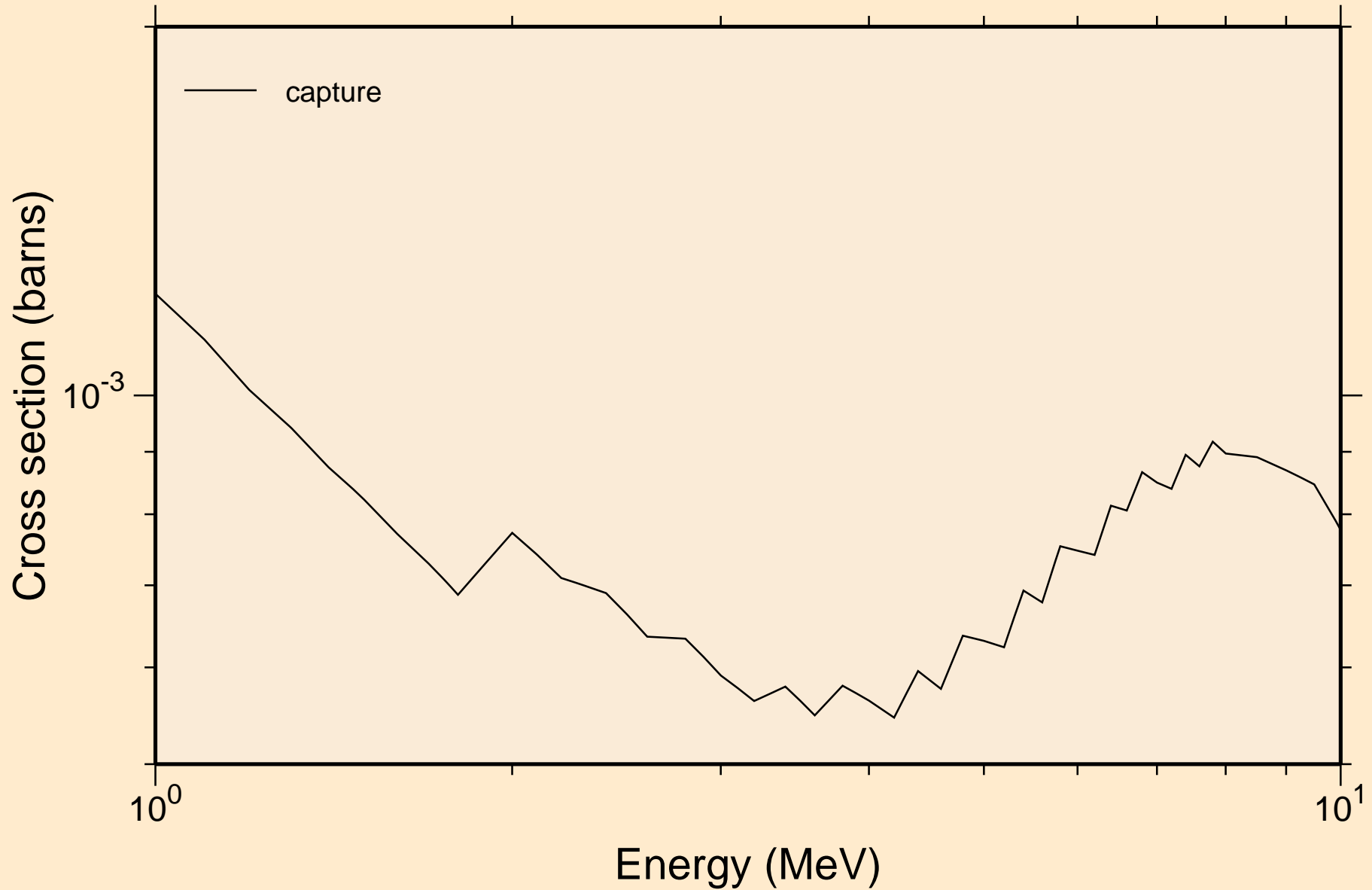

NB083 NEUTRON ACER TENDL-2021 LIBRARY; T=293.6K
Heating

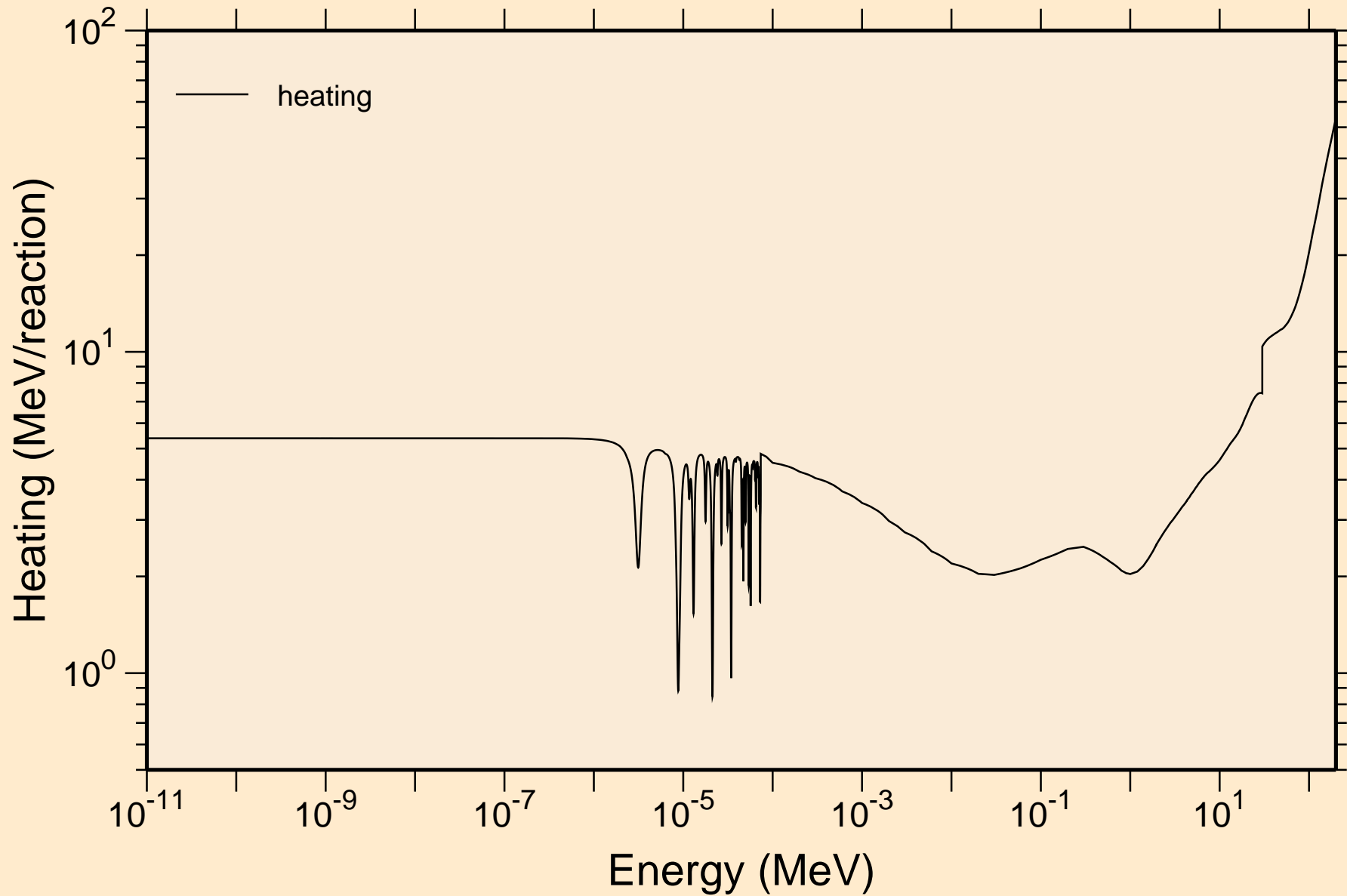

NB083 NEUTRON ACER TENDL-2021 LIBRARY; T=293.6K
Damage

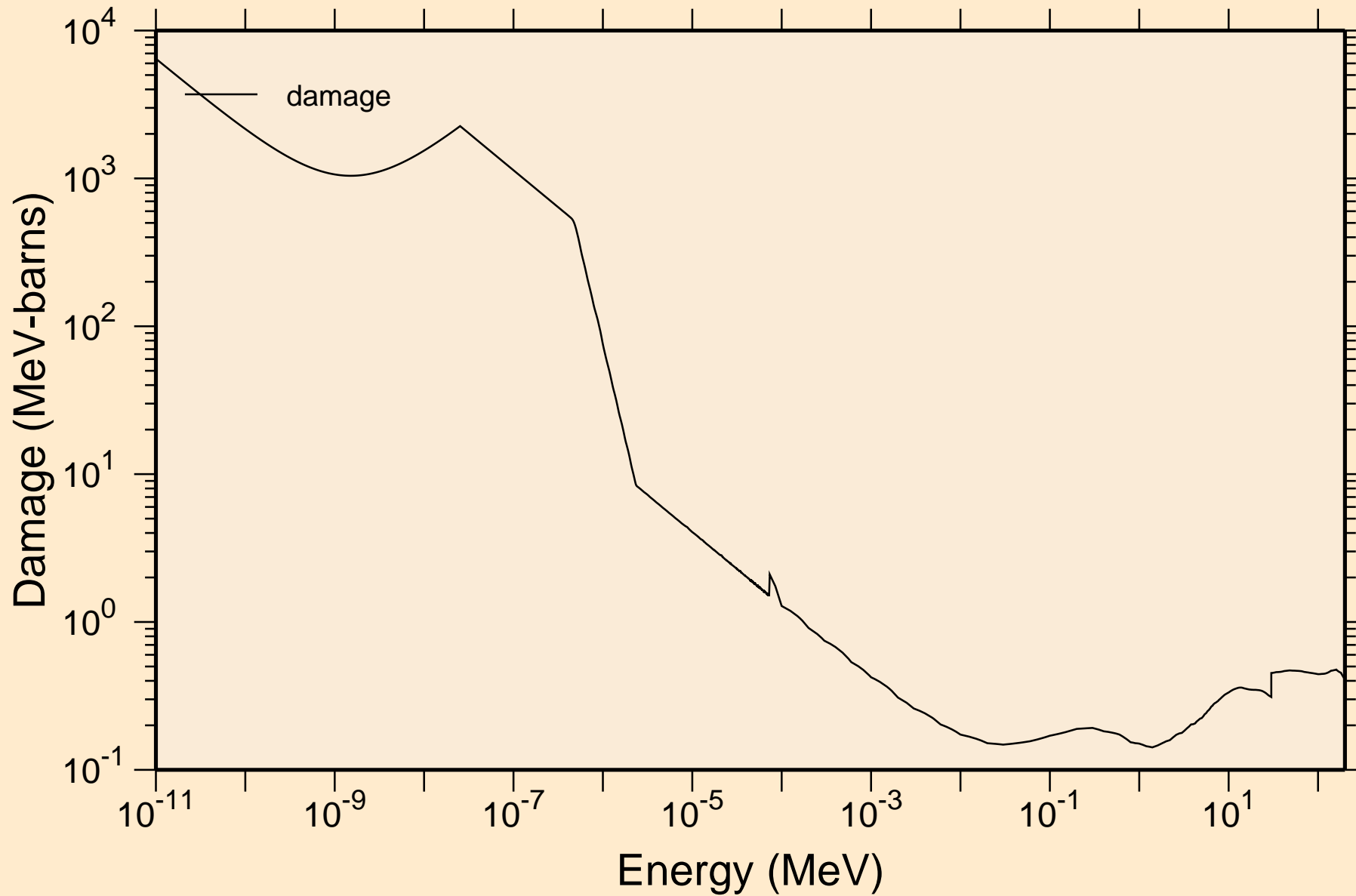

NB083 NEUTRON ACER TENDL-2021 LIBRARY; T=293.6K
Non-threshold reactions

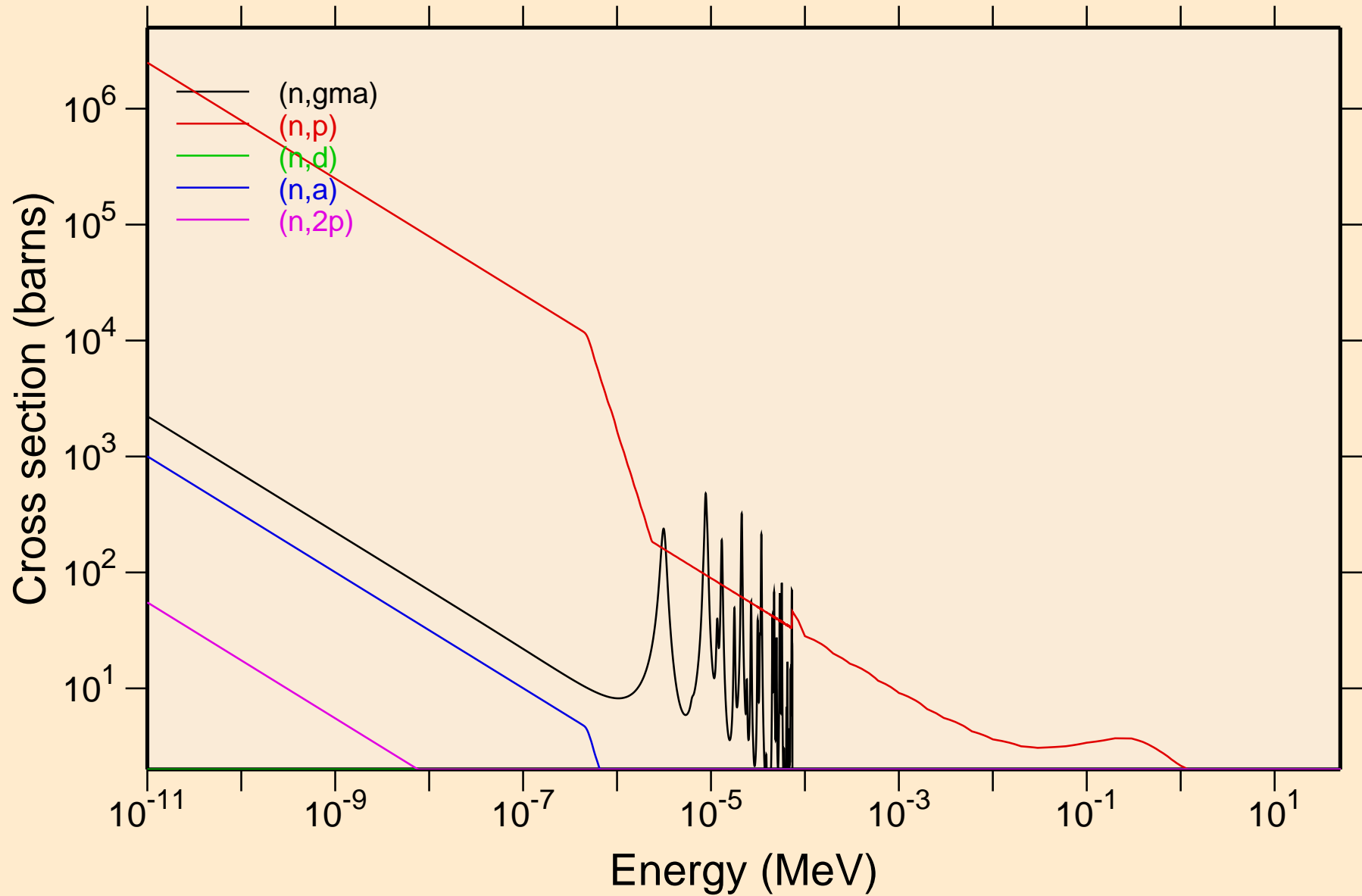

NB083 NEUTRON ACER TENDL-2021 LIBRARY; T=293.6K
Non-threshold reactions

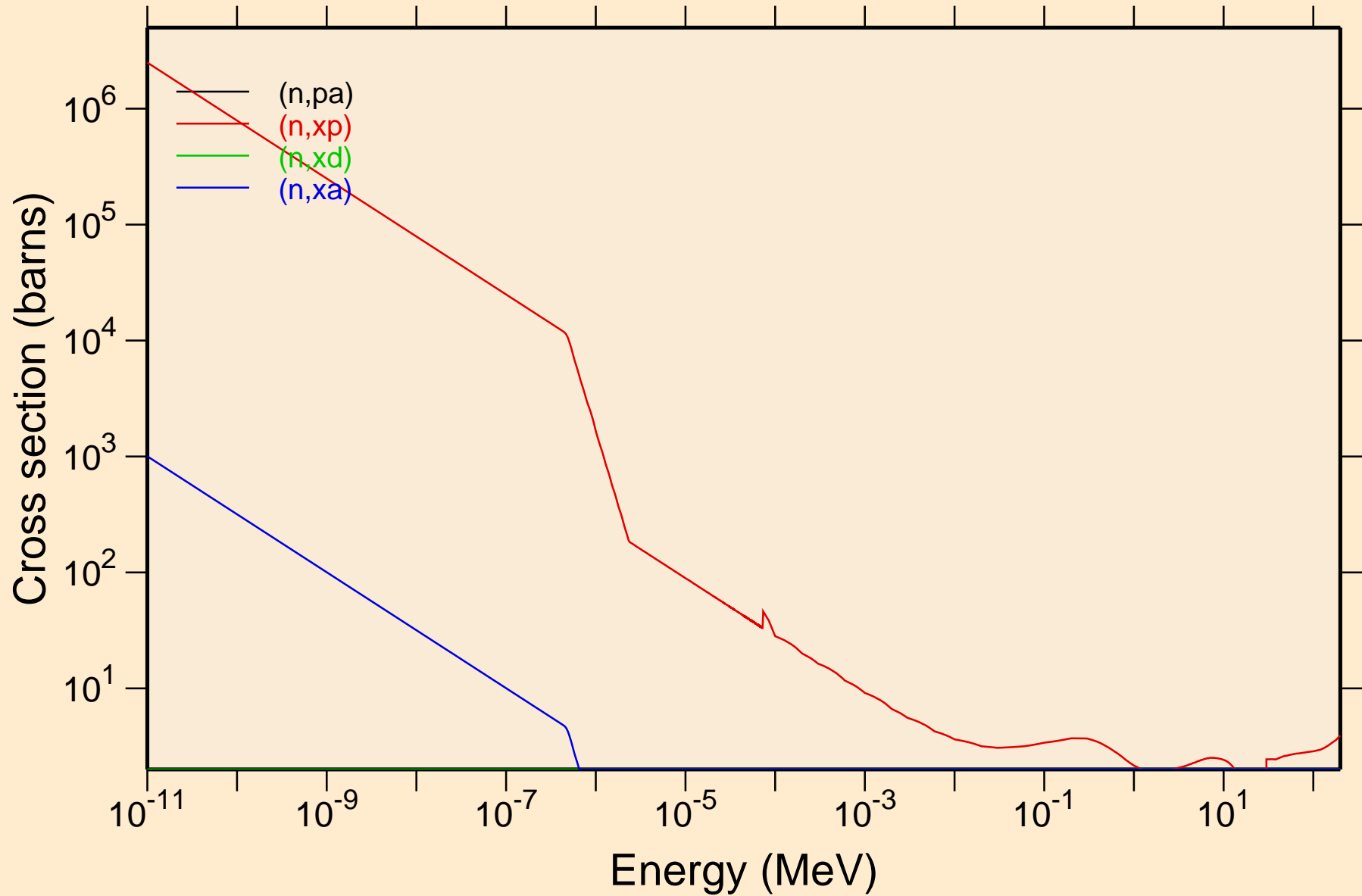

NB083 NEUTRON ACER TENDL-2021 LIBRARY; T=293.6K

Principal cross sections

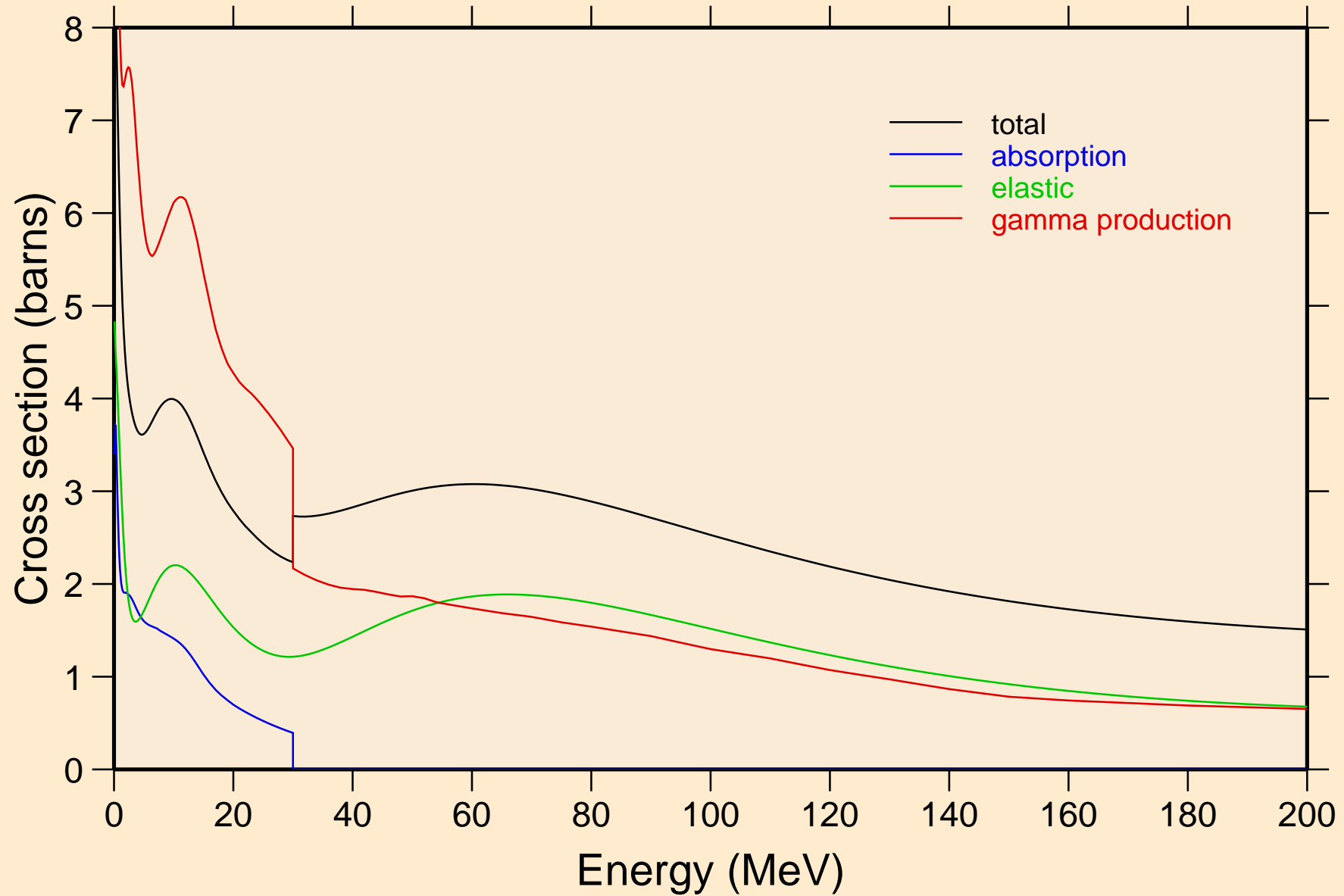

NB083 NEUTRON ACER TENDL-2021 LIBRARY; T=293.6K
Heating

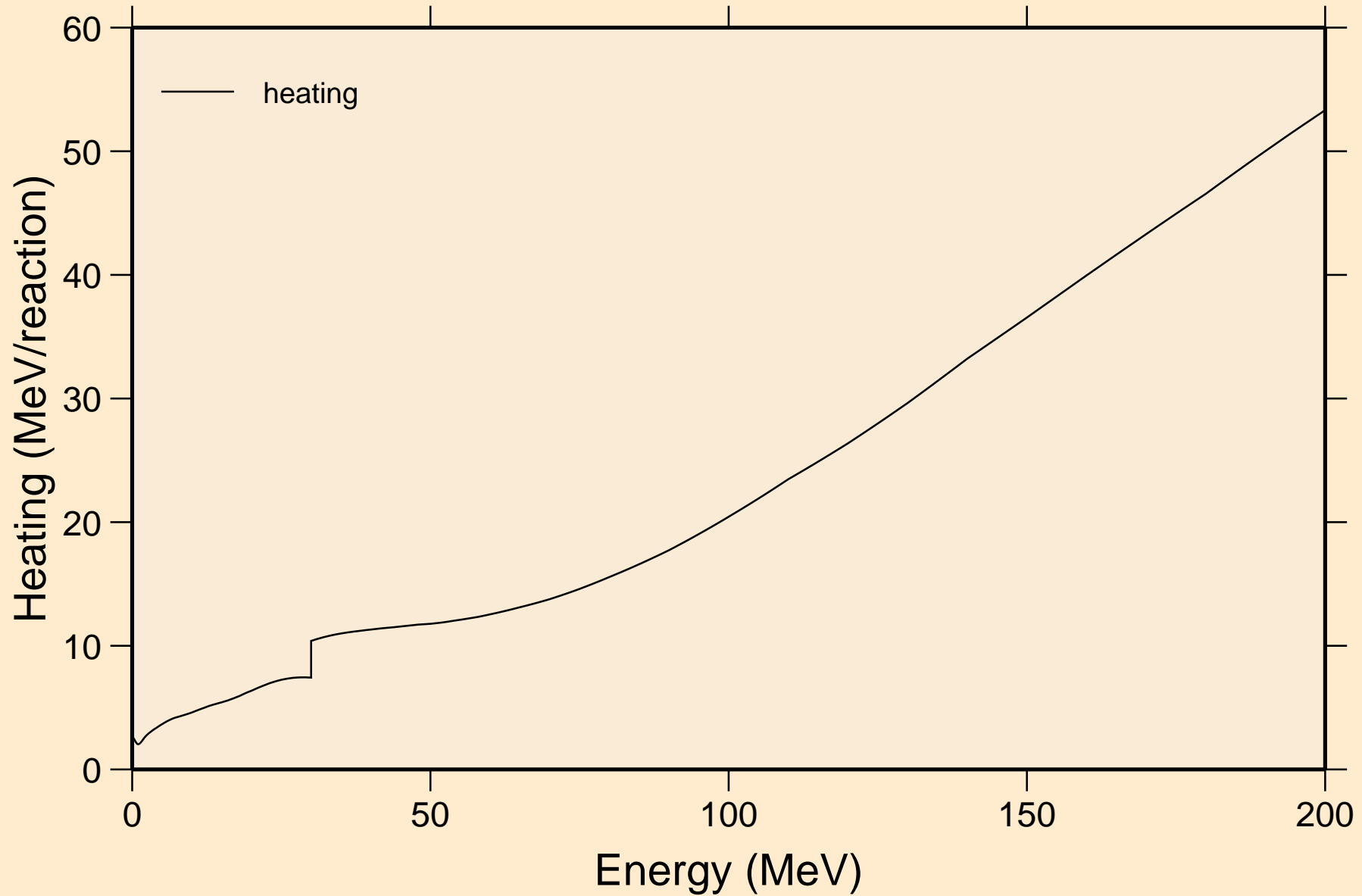

NB083 NEUTRON ACER TENDL-2021 LIBRARY; T=293.6K
Damage

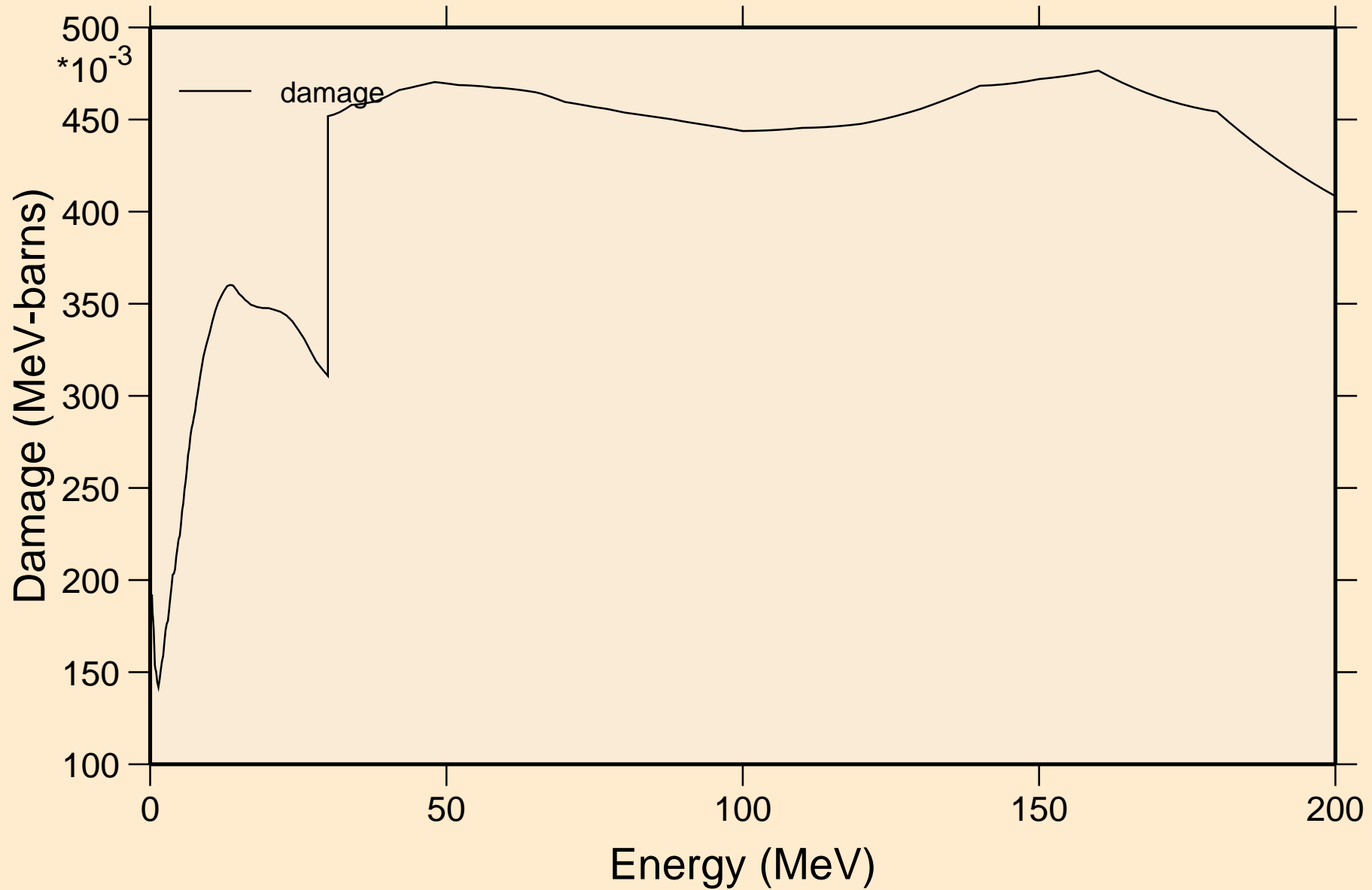

NB083 NEUTRON ACER TENDL-2021 LIBRARY; T=293.6K
Non-threshold reactions

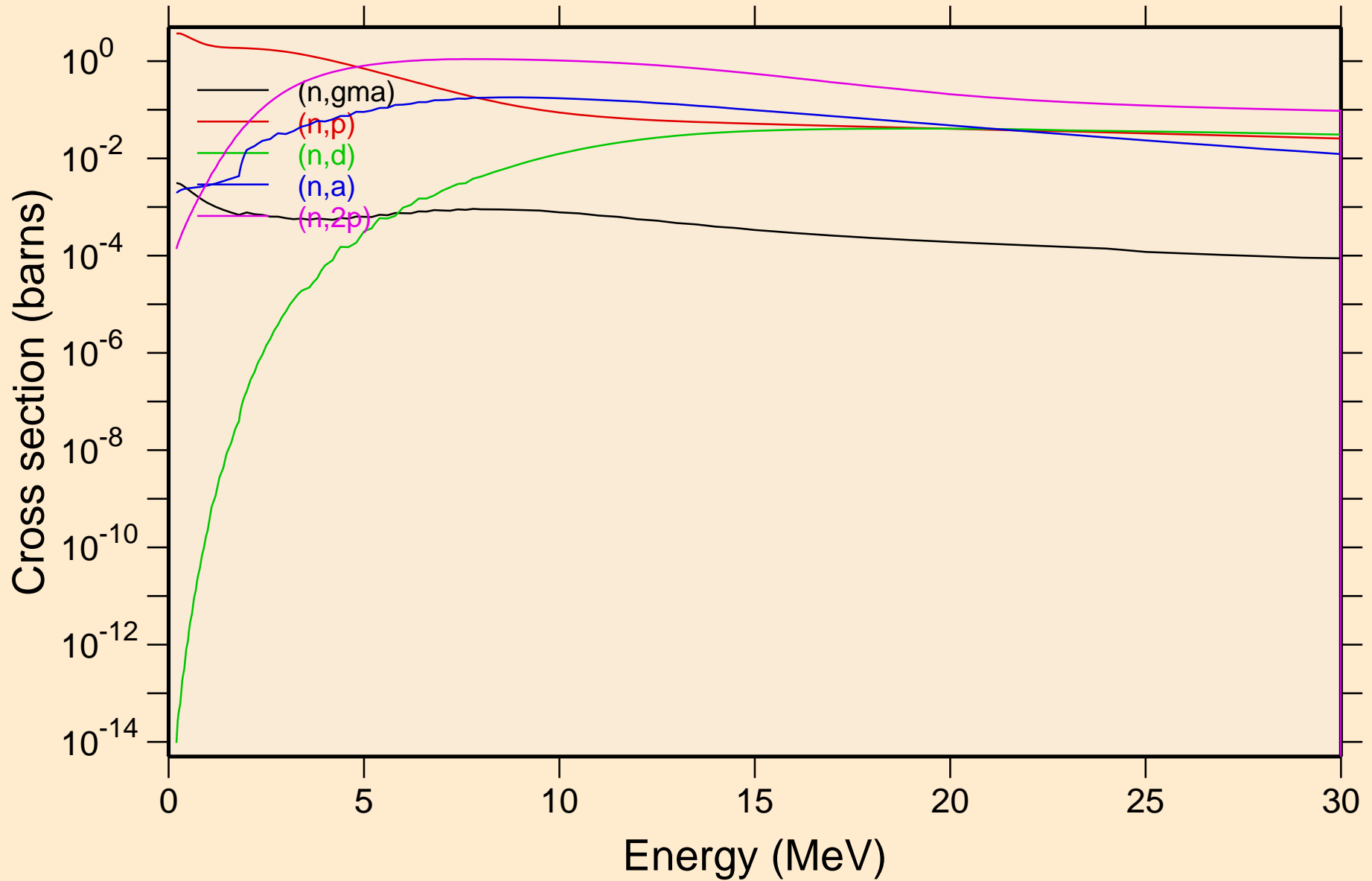

NB083 NEUTRON ACER TENDL-2021 LIBRARY; T=293.6K
Non-threshold reactions

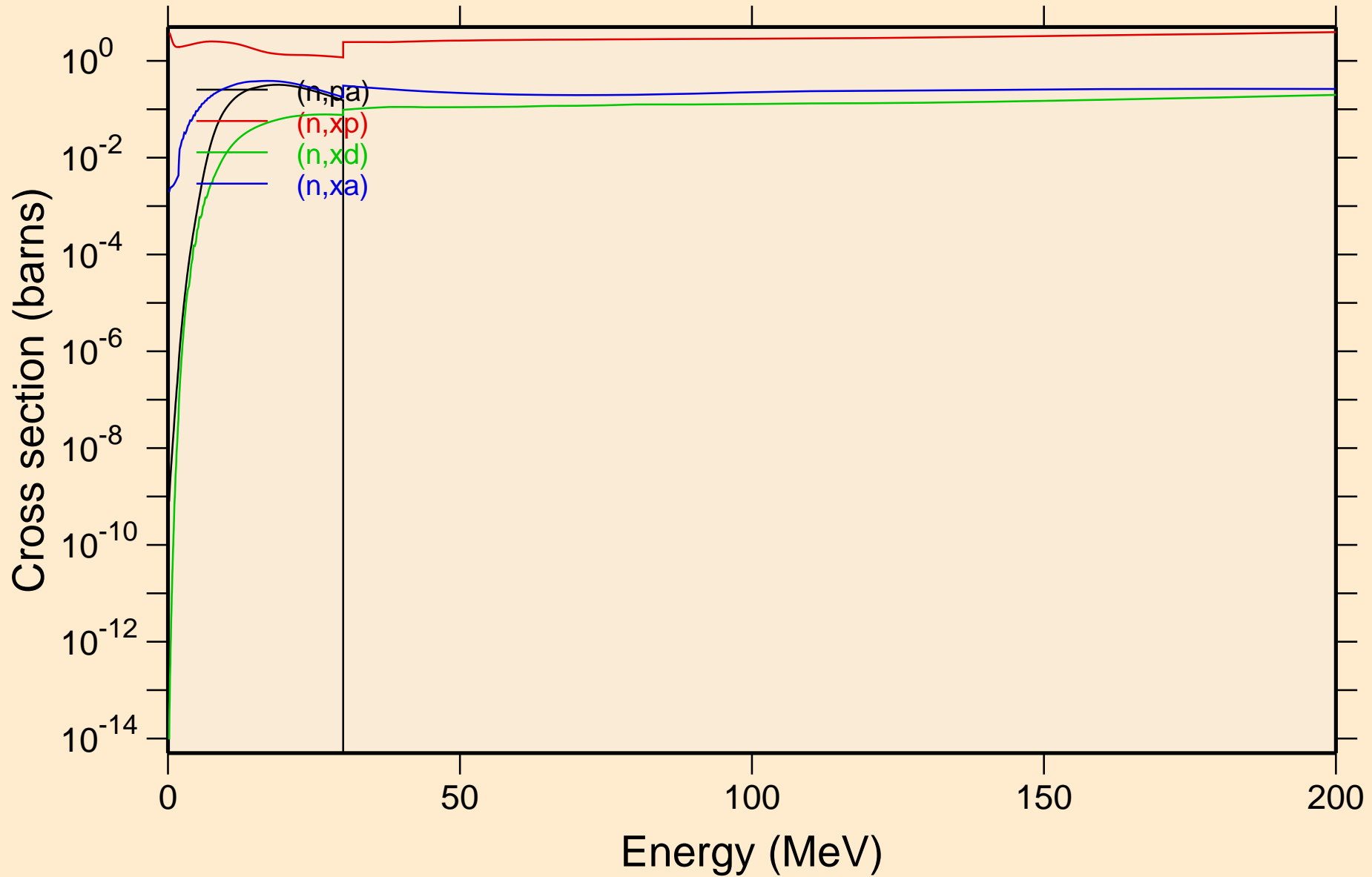

NB083 NEUTRON ACER TENDL-2021 LIBRARY; T=293.6K
Inelastic levels

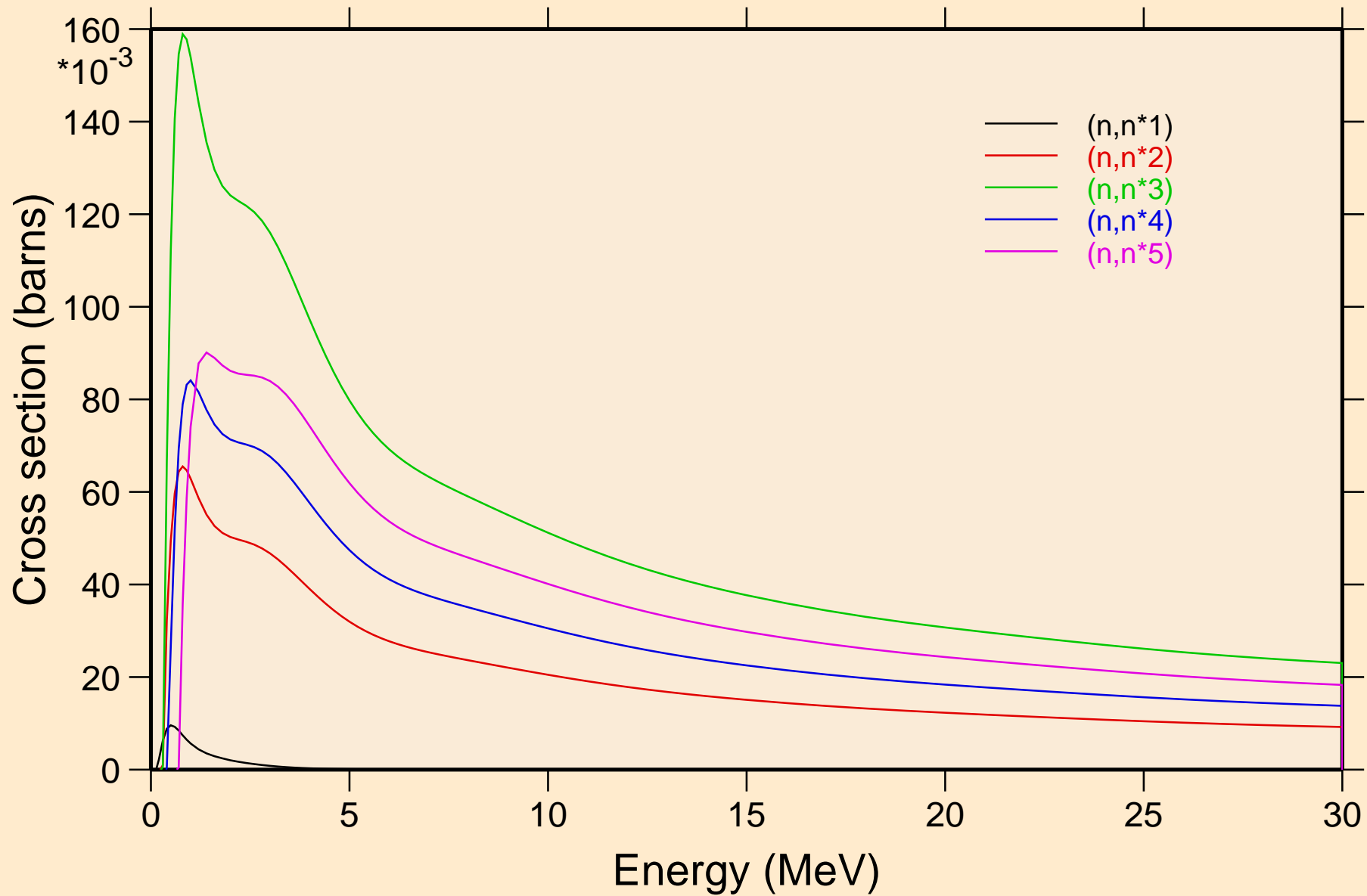

NB083 NEUTRON ACER TENDL-2021 LIBRARY; T=293.6K
Inelastic levels

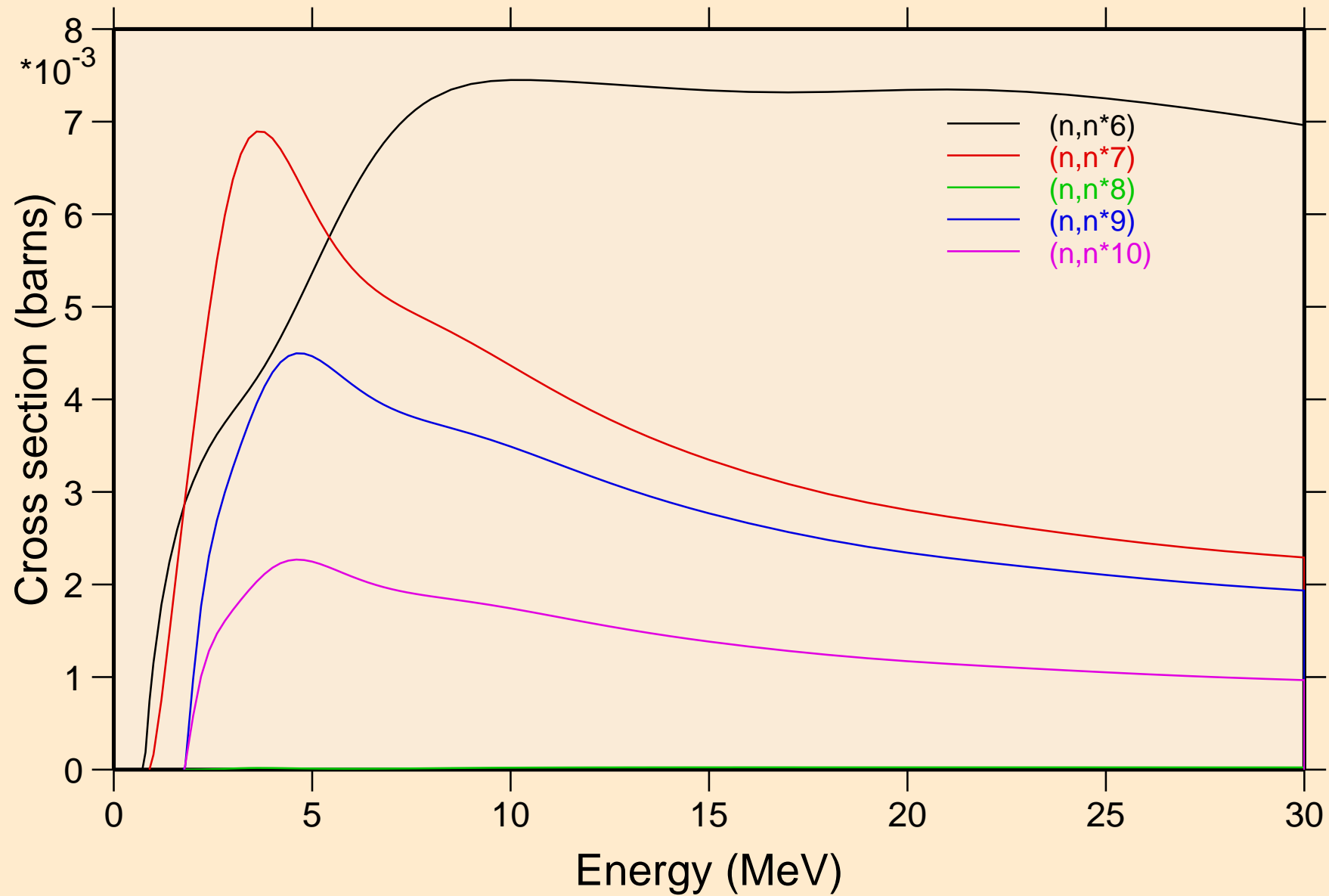

NB083 NEUTRON ACER TENDL-2021 LIBRARY; T=293.6K
Inelastic levels

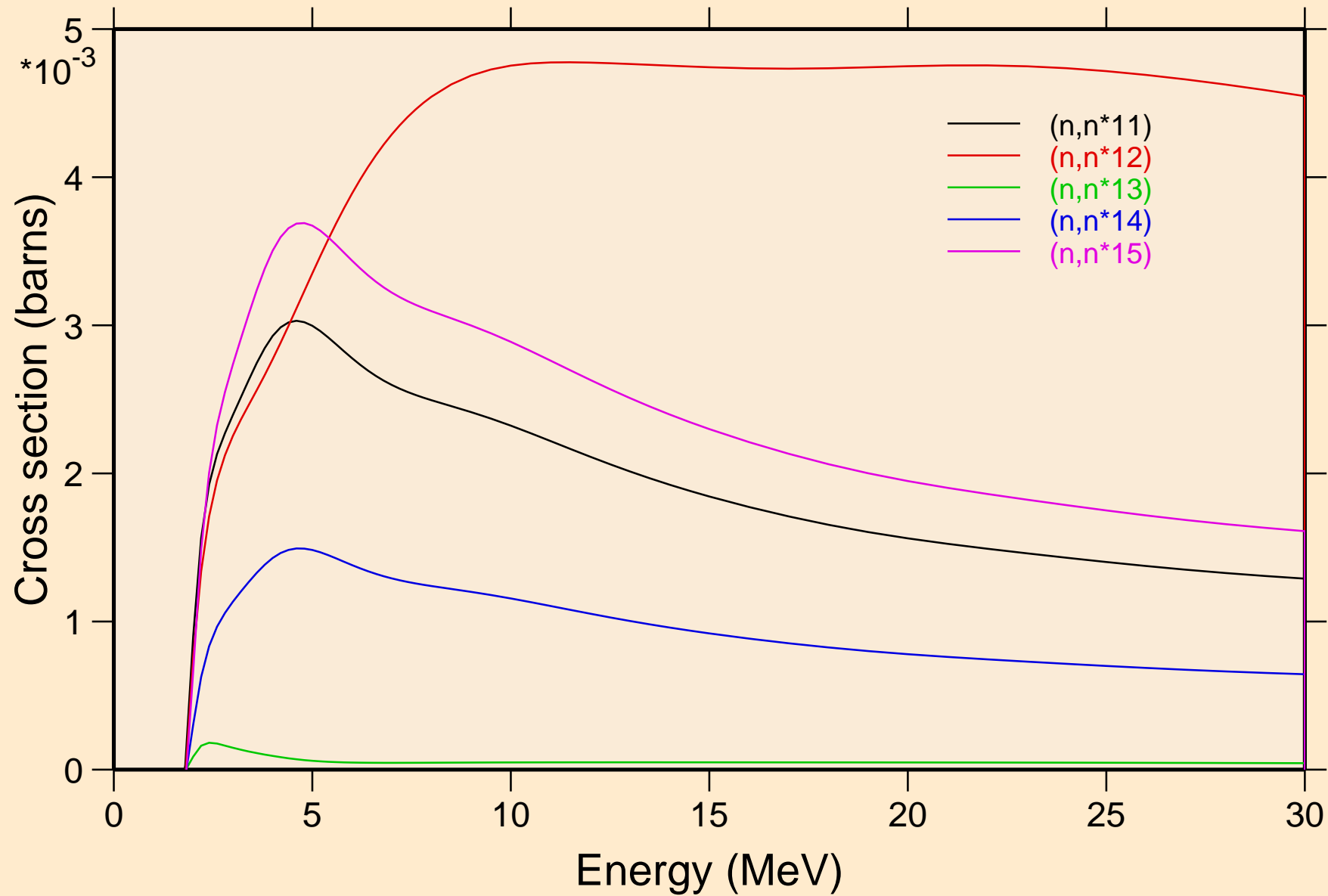

NB083 NEUTRON ACER TENDL-2021 LIBRARY; T=293.6K
Inelastic levels

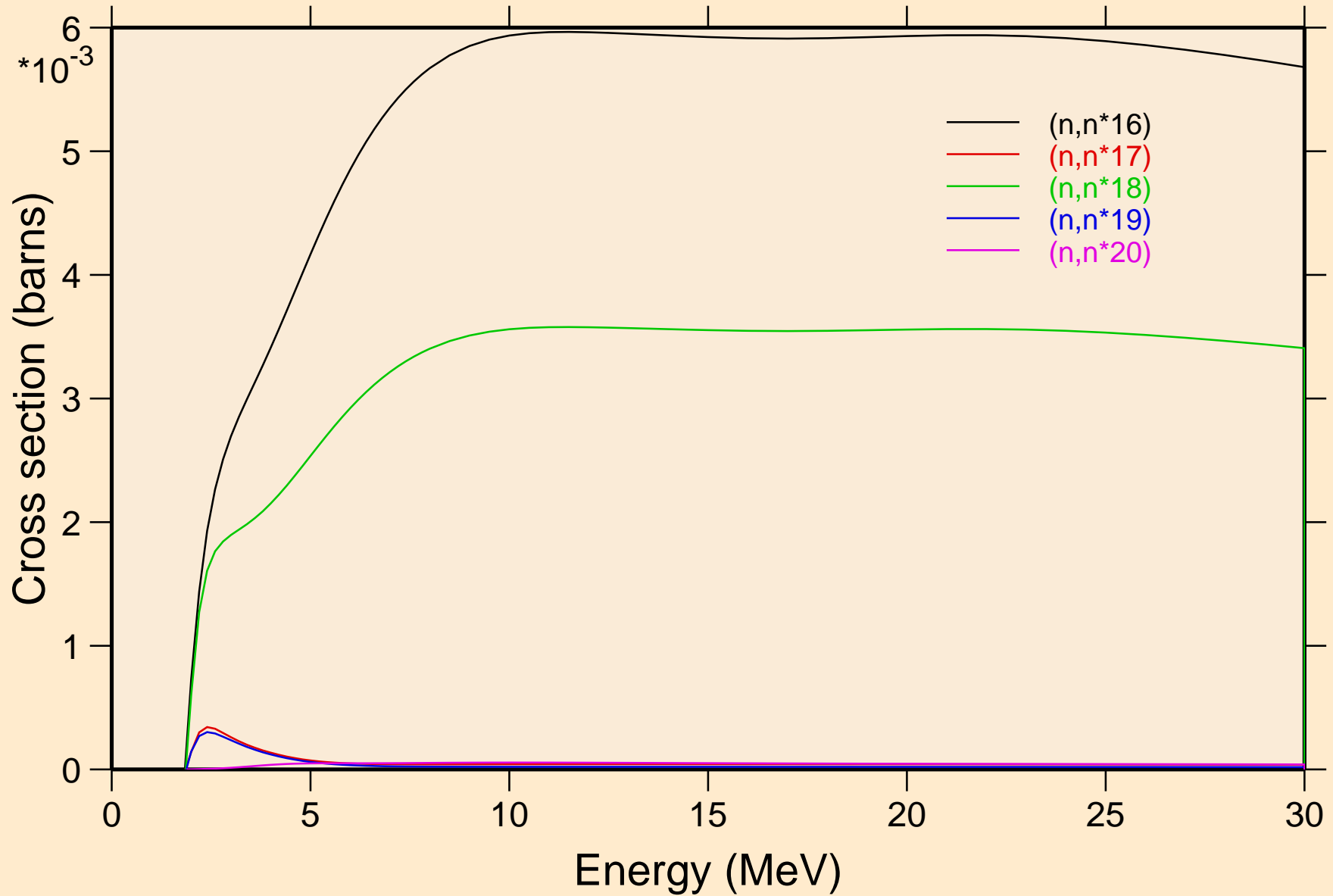

NB083 NEUTRON ACER TENDL-2021 LIBRARY; T=293.6K
Inelastic levels

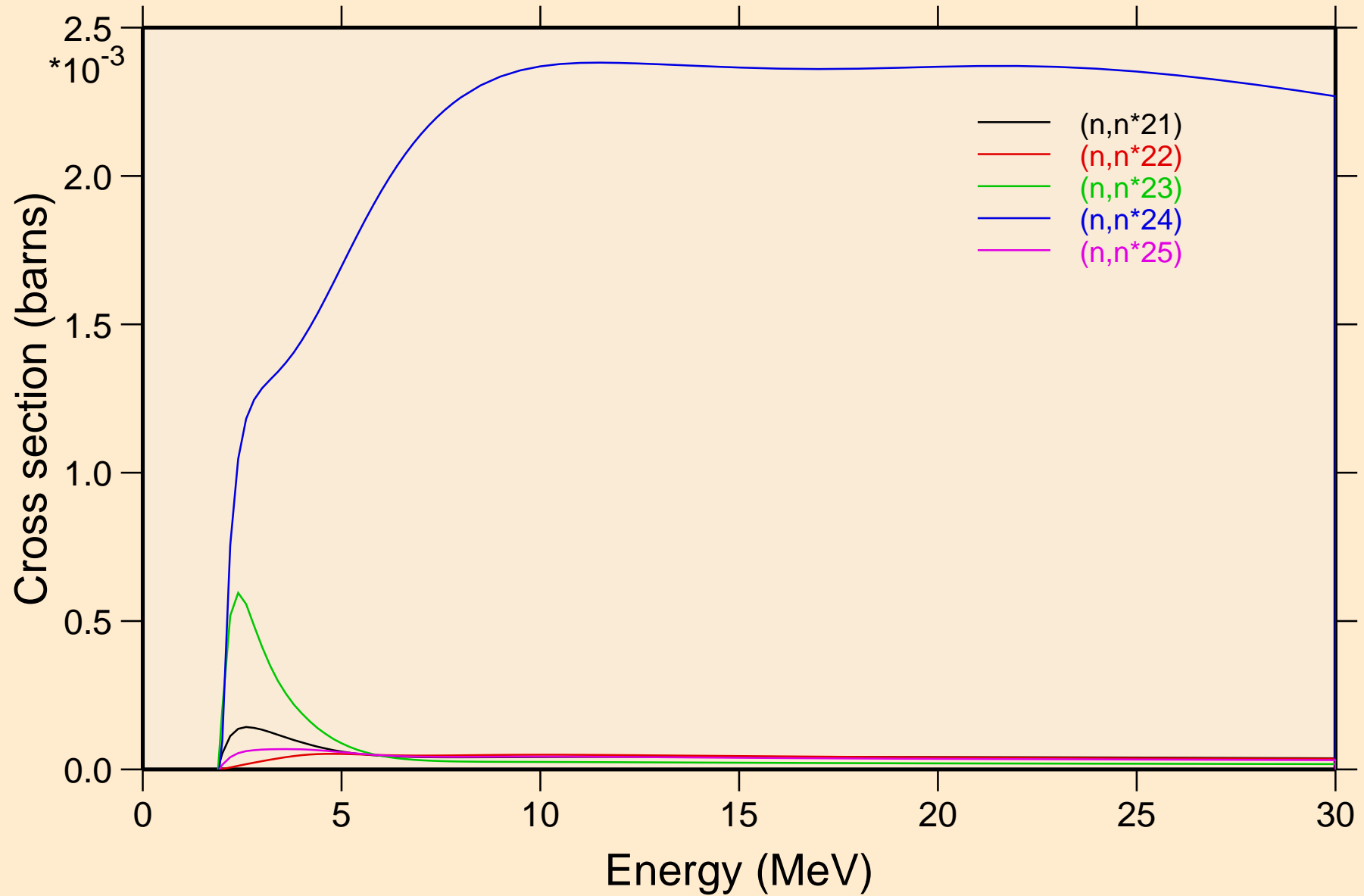

NB083 NEUTRON ACER TENDL-2021 LIBRARY; T=293.6K
Inelastic levels

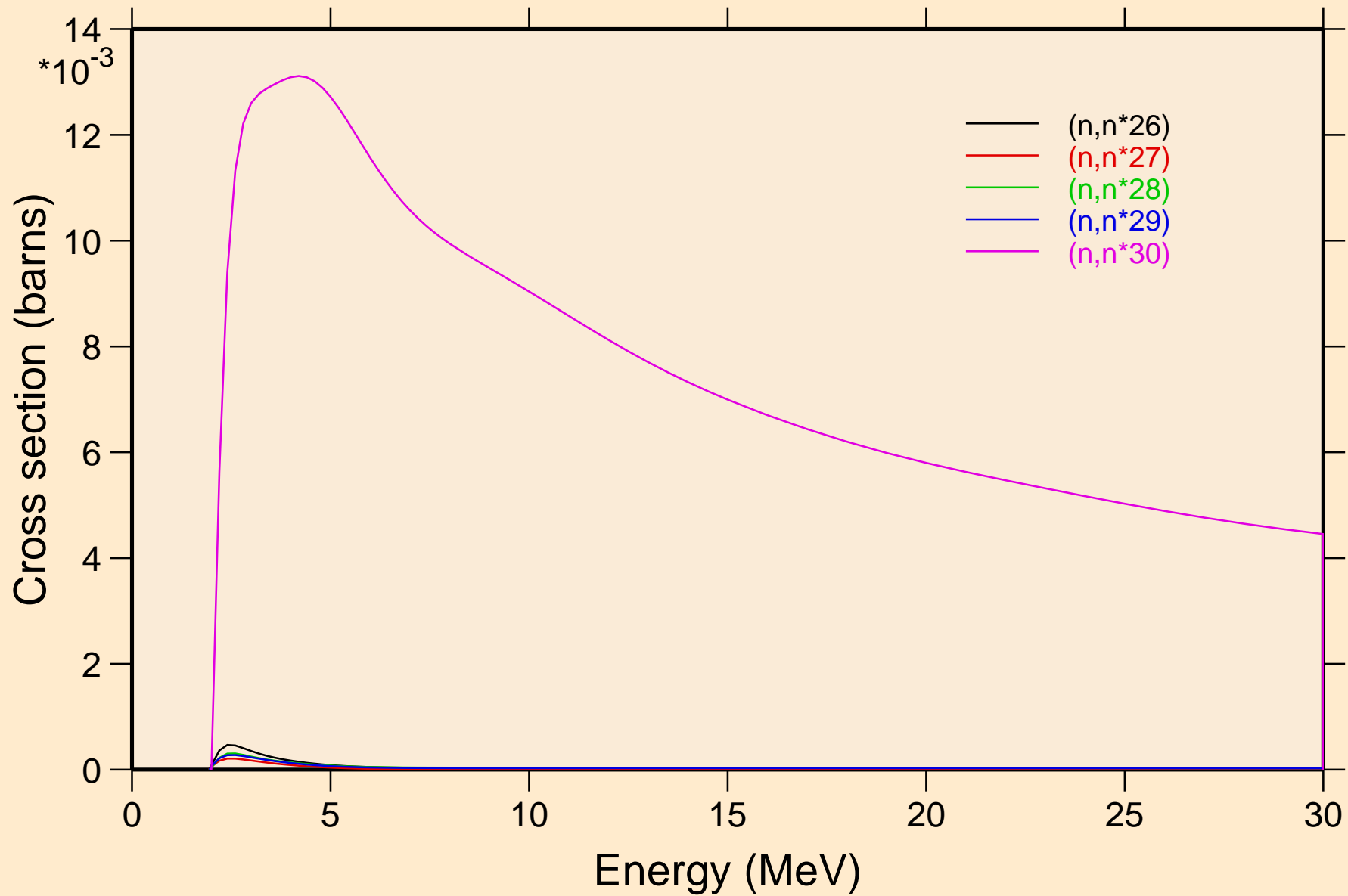

NB083 NEUTRON ACER TENDL-2021 LIBRARY; T=293.6K
Threshold reactions

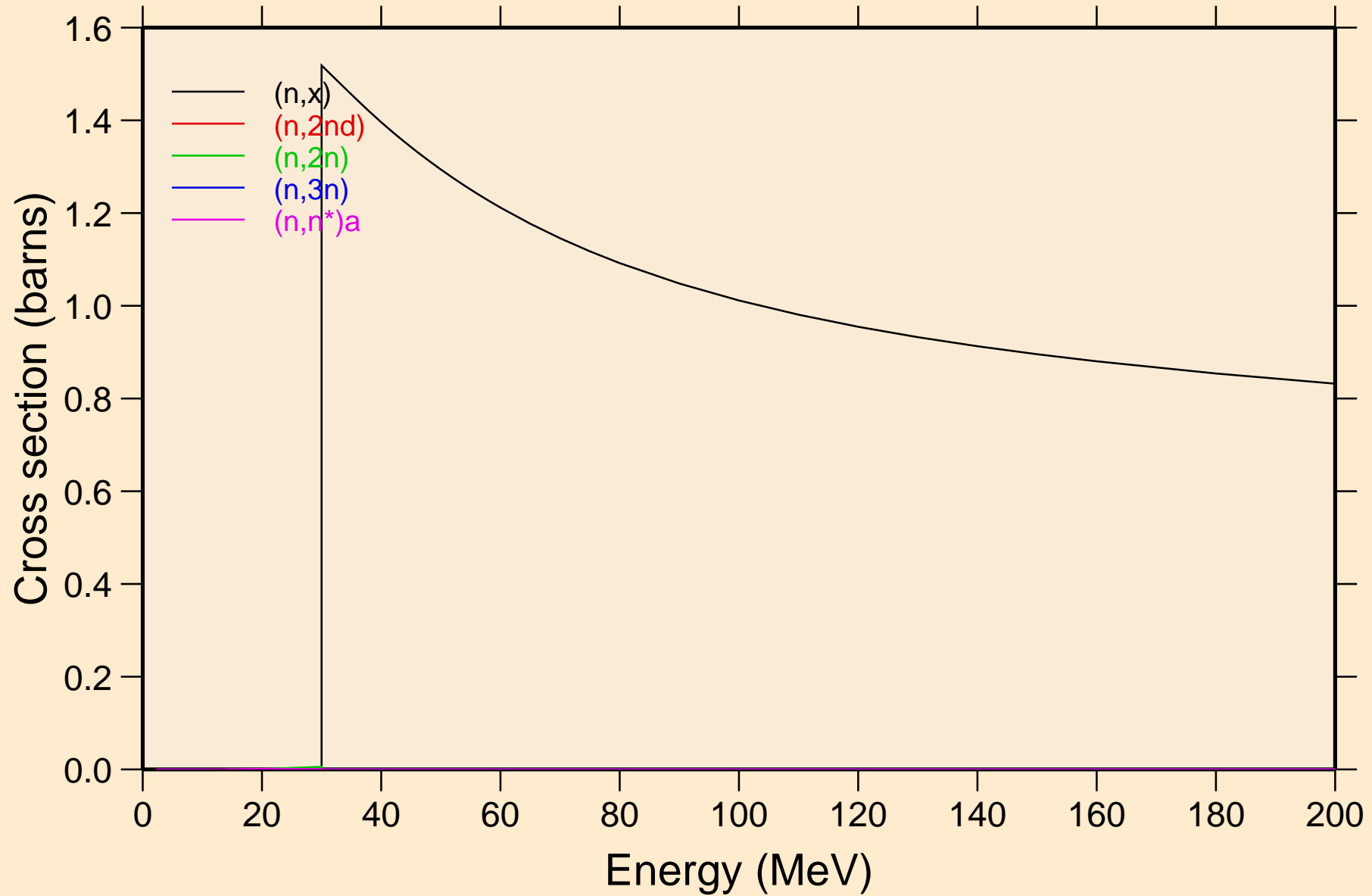

NB083 NEUTRON ACER TENDL-2021 LIBRARY; T=293.6K
Threshold reactions

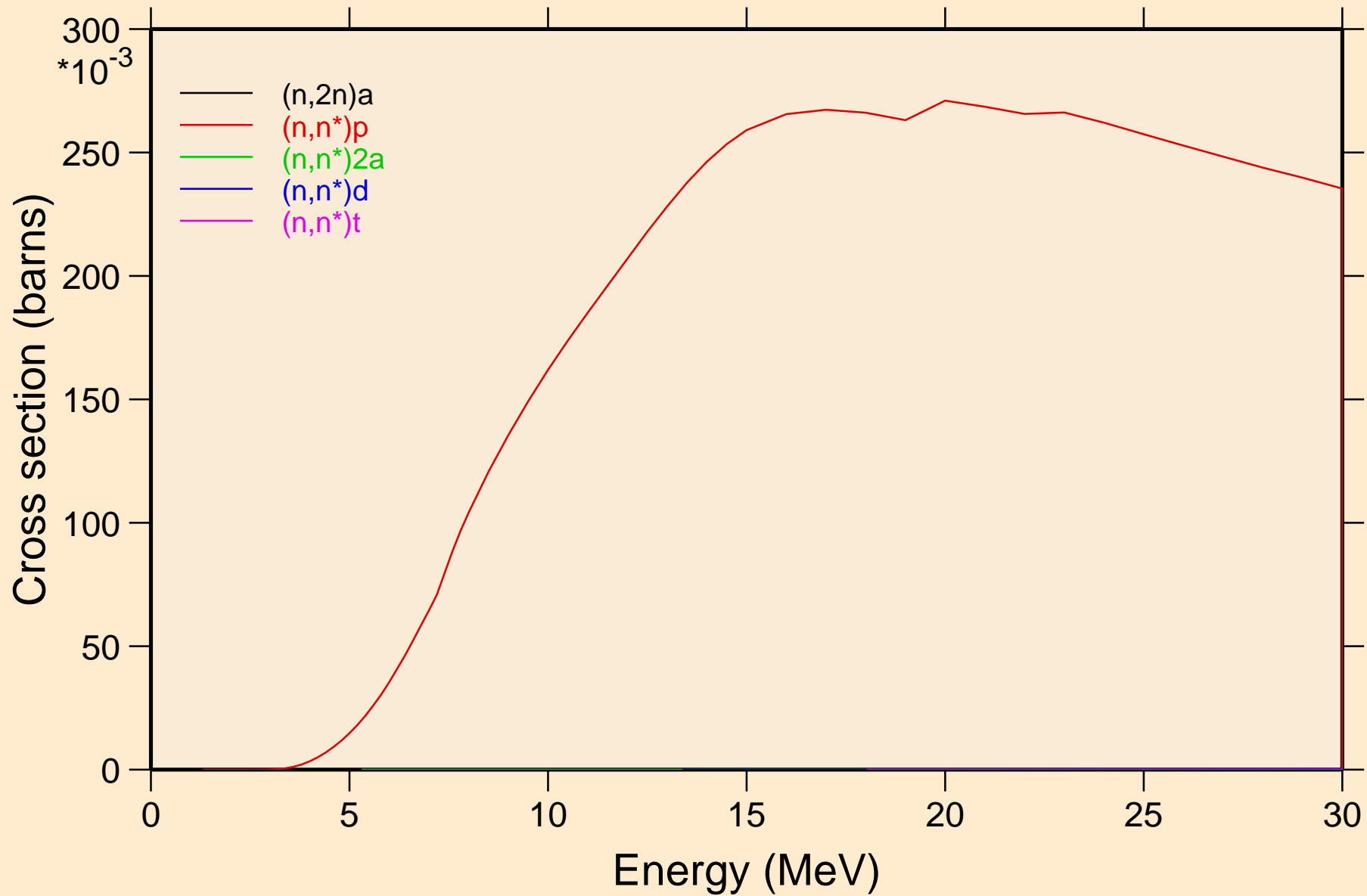

NB083 NEUTRON ACER TENDL-2021 LIBRARY; T=293.6K
Threshold reactions

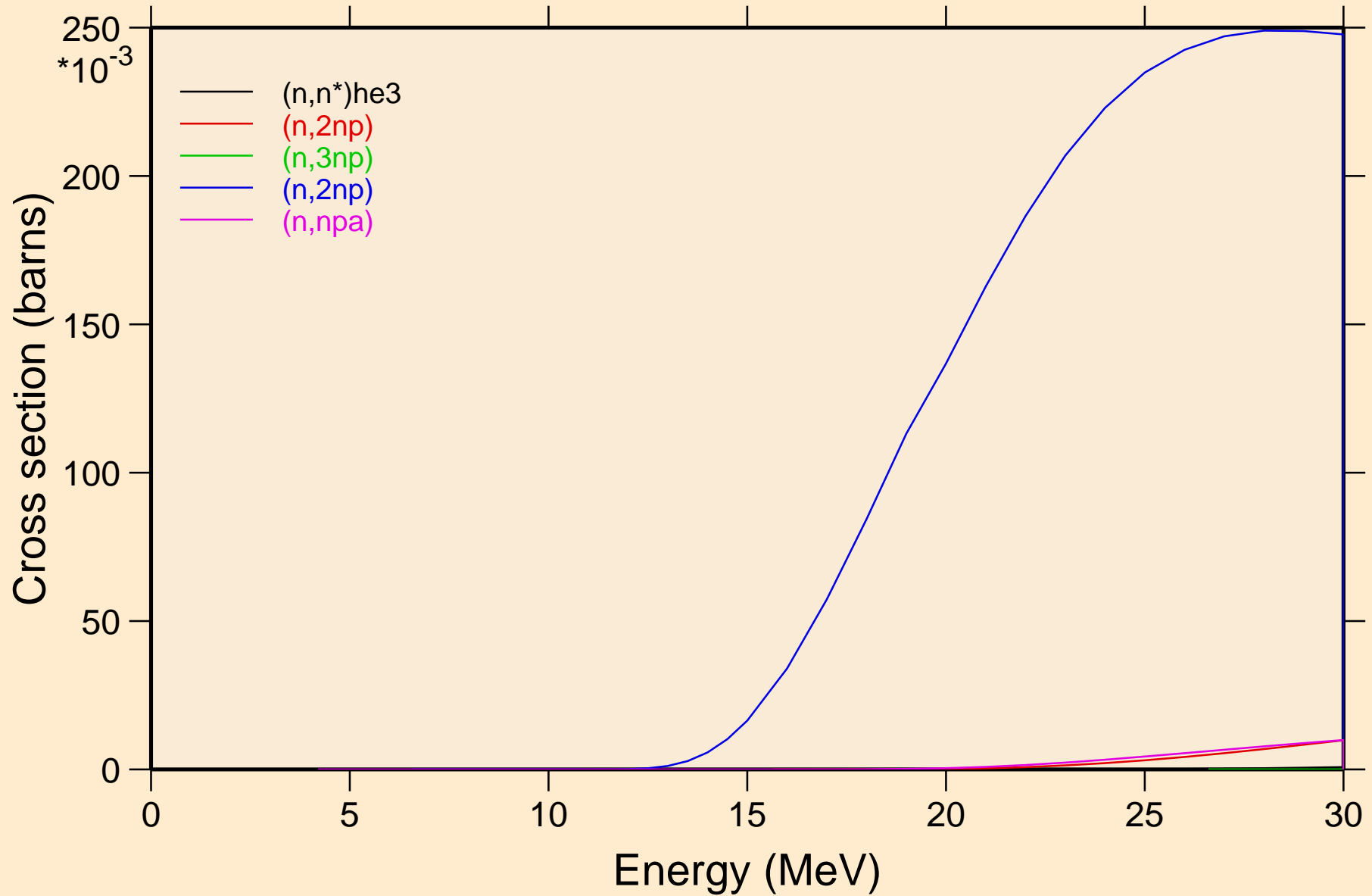

NB083 NEUTRON ACER TENDL-2021 LIBRARY; T=293.6K

Threshold reactions

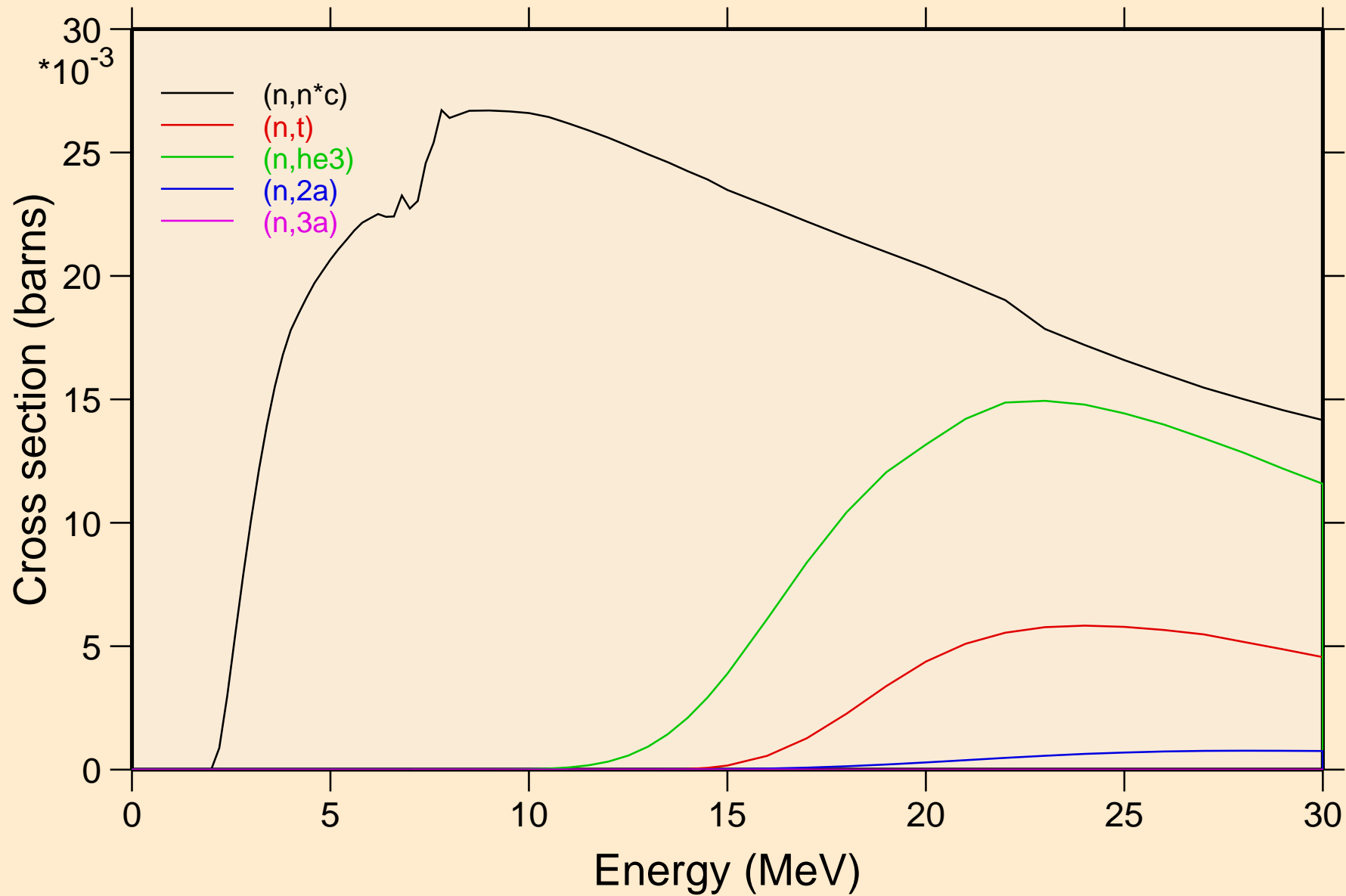

NB083 NEUTRON ACER TENDL-2021 LIBRARY; T=293.6K
Threshold reactions

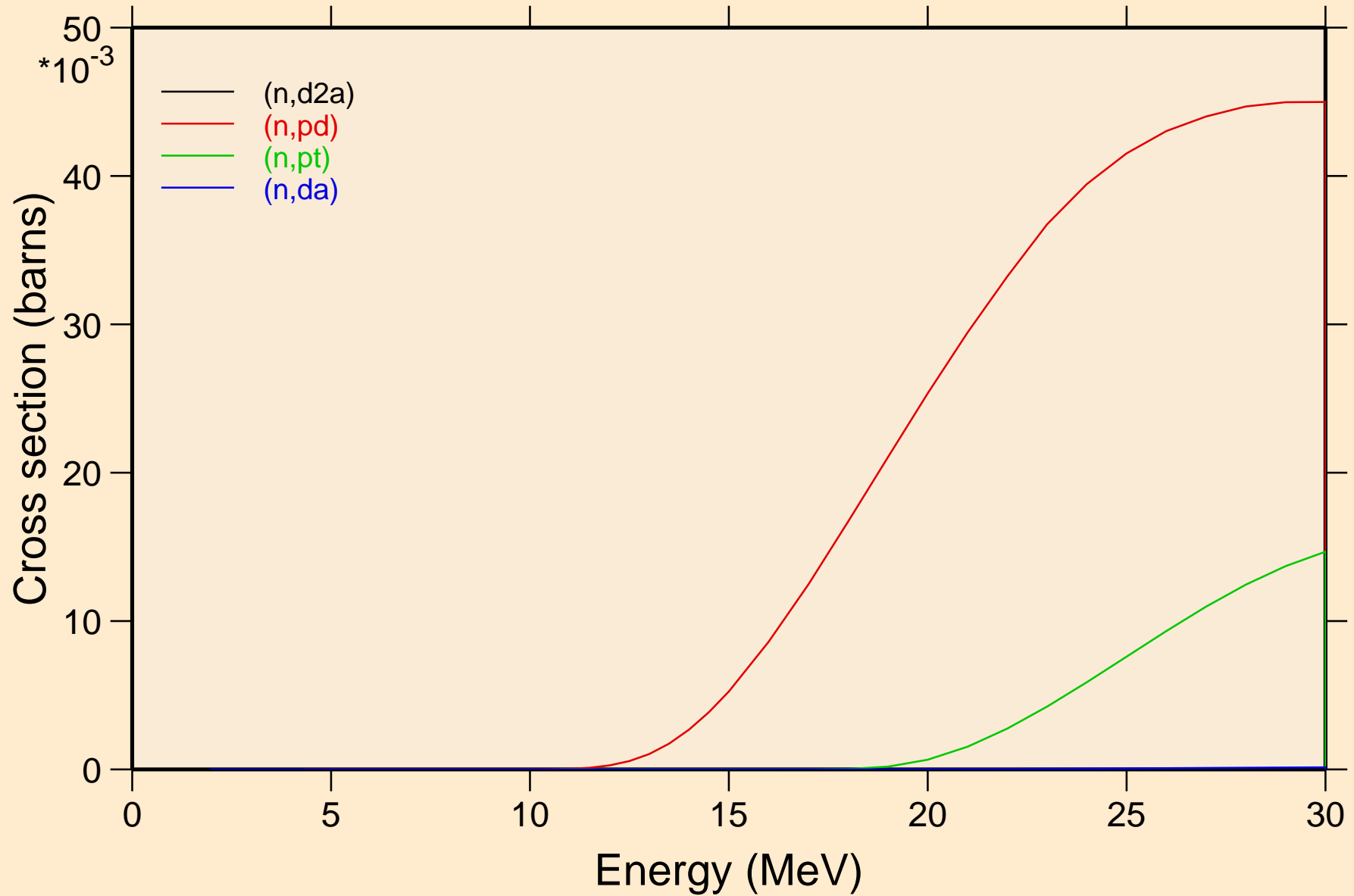

NB083 NEUTRON ACER TENDL-2021 LIBRARY; T=293.6K
Threshold reactions

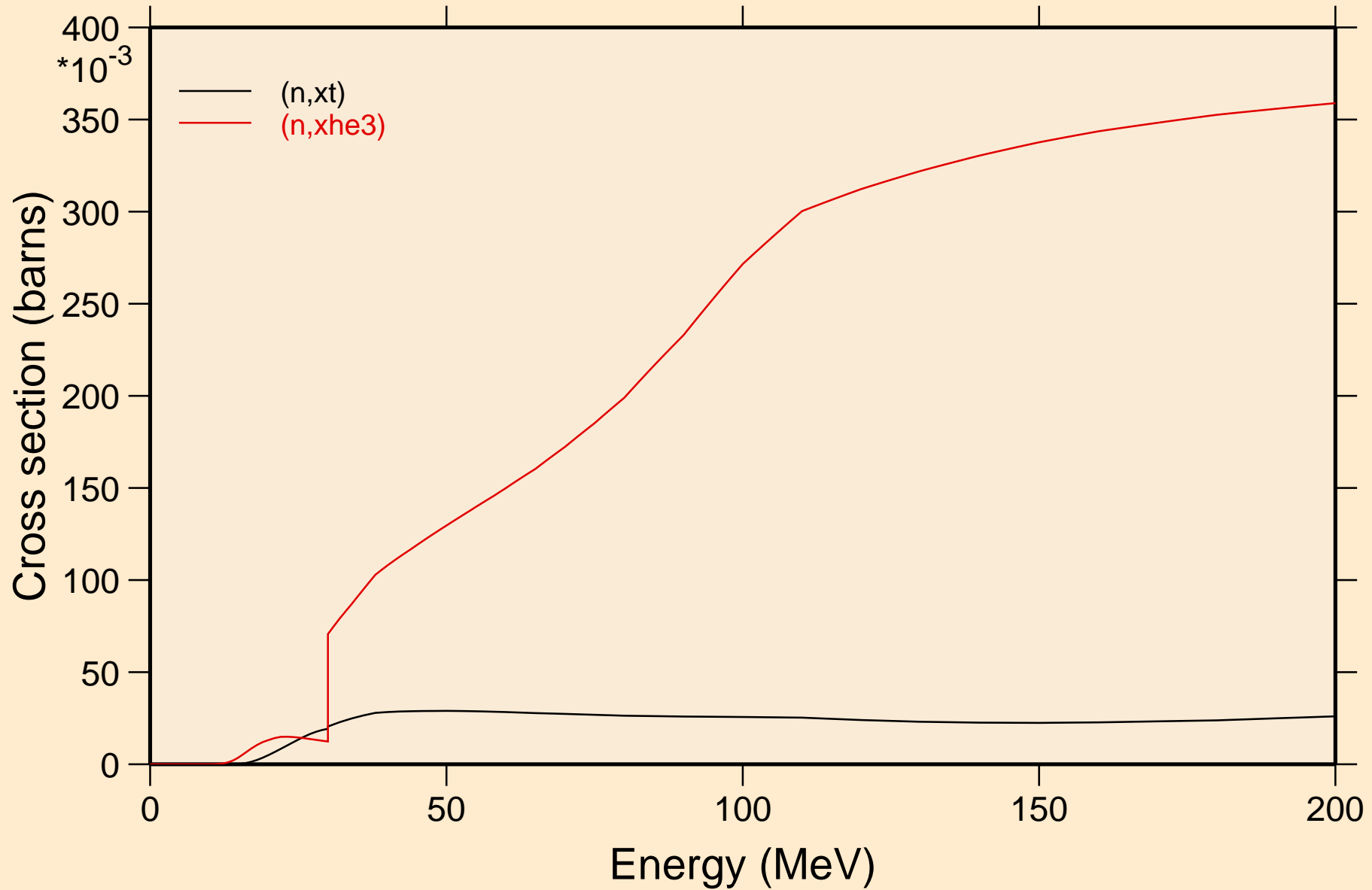

NB083 NEUTRON ACER TENDL-2021 LIBRARY; T=293.6K
angular distribution for elastic

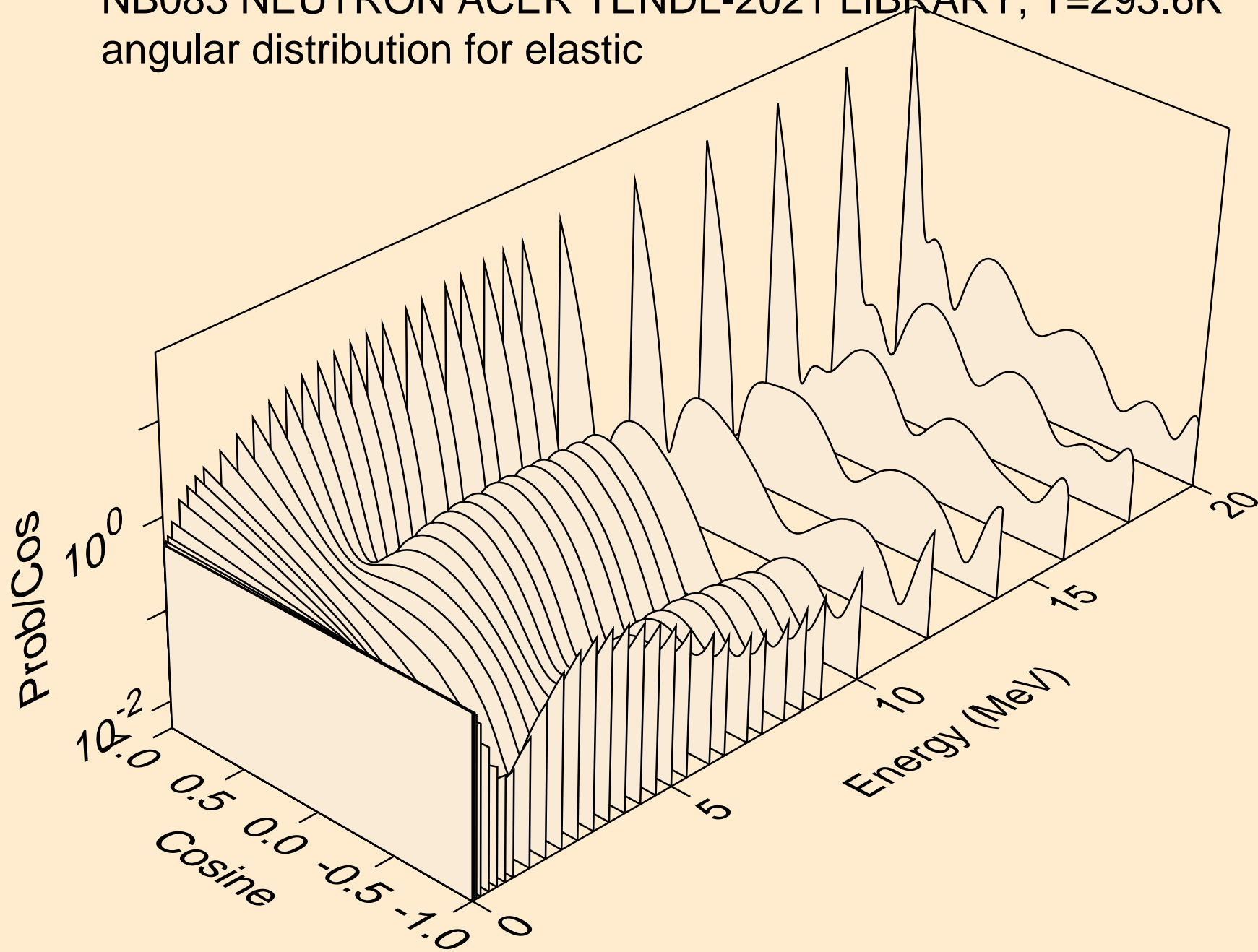

NB083 NEUTRON ACER TENDL-2021 LIBRARY; T=293.6K
angular distribution for elastic

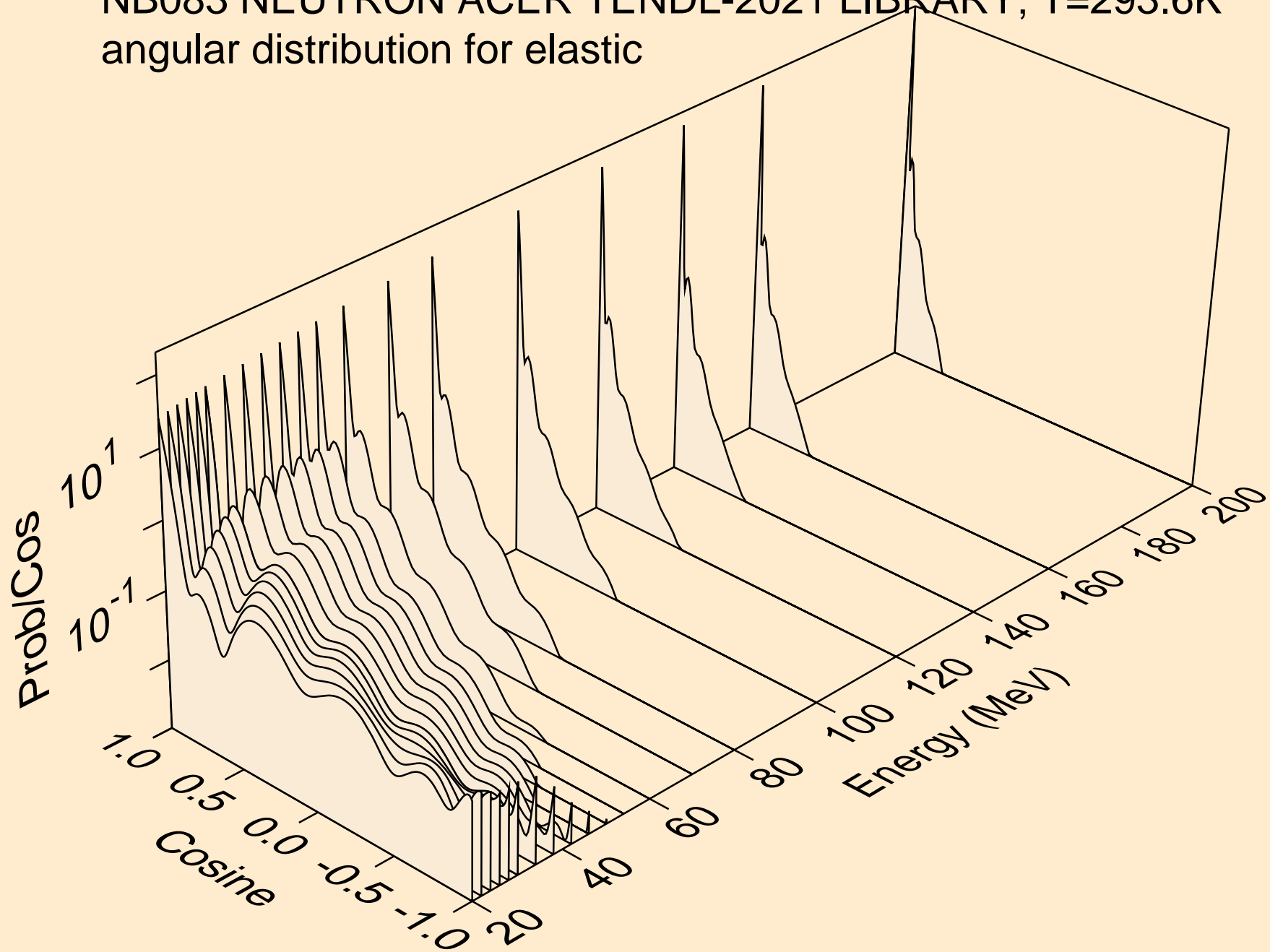

NB083 NEUTRON ACER TENDL-2021 LIBRARY; T=293.6K
angular distribution for (n,n*1)

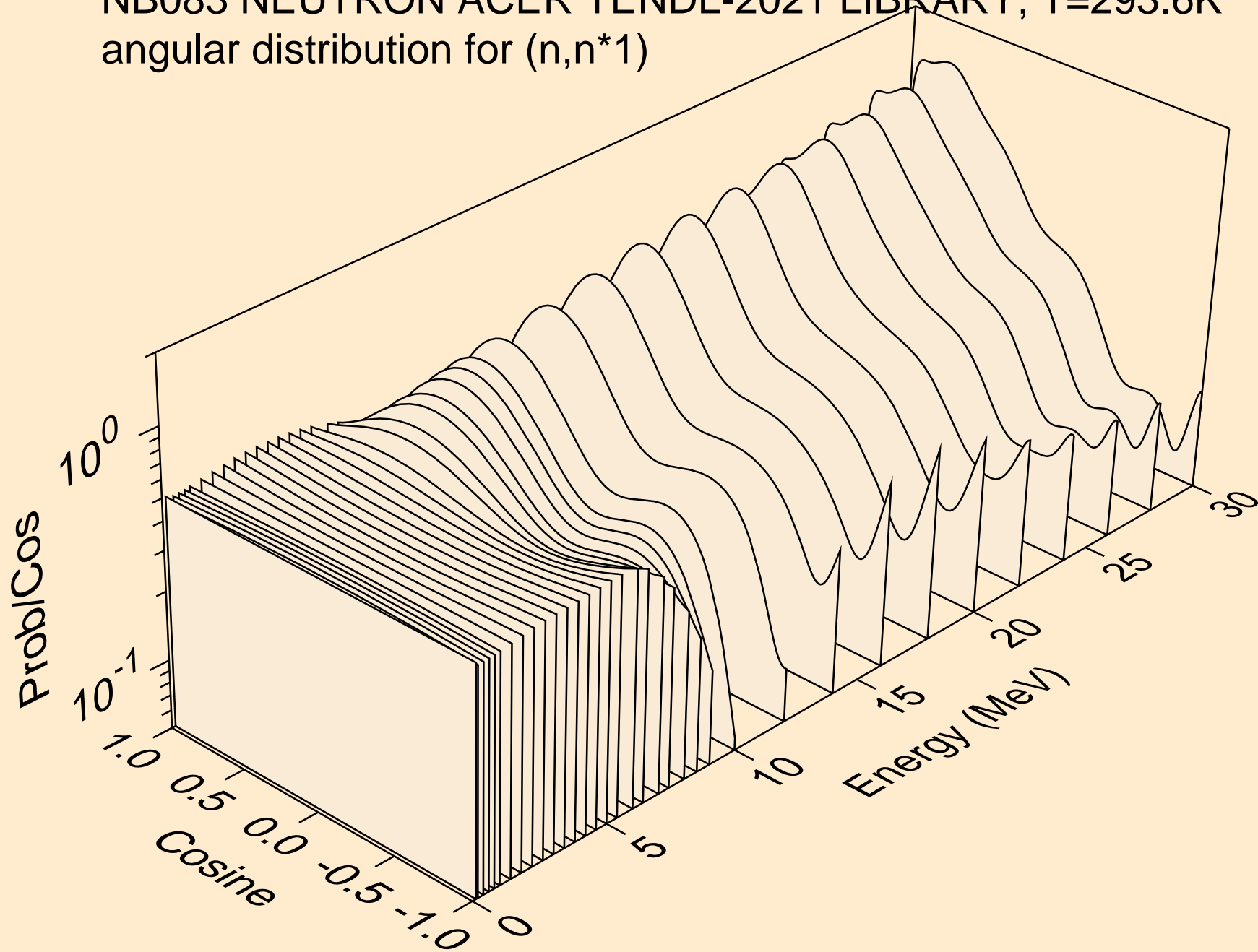

NB083 NEUTRON ACER TENDL-2021 LIBRARY; T=293.6K
angular distribution for (n,n*2)

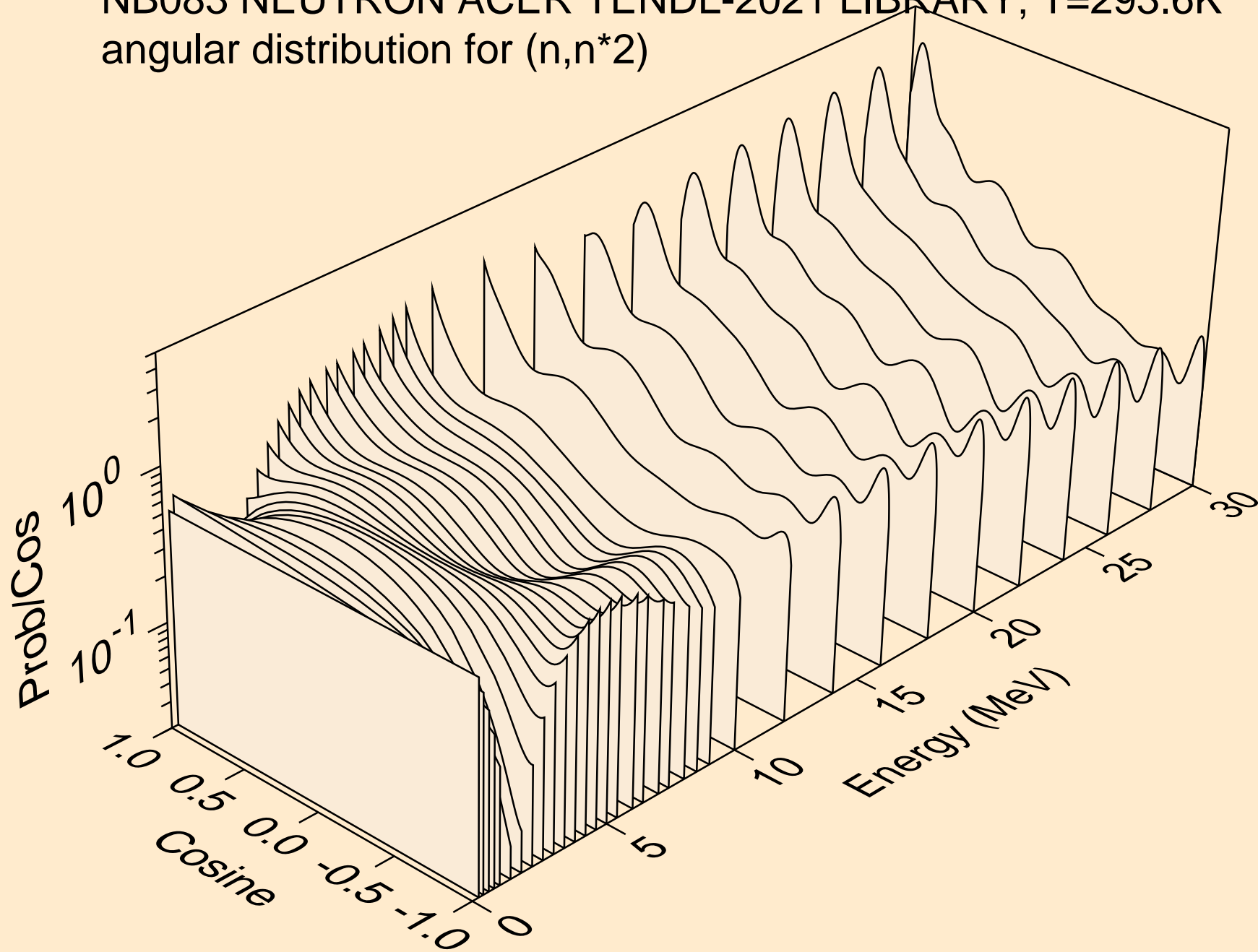

NB083 NEUTRON ACER TENDL-2021 LIBRARY; T=293.6K
angular distribution for (n,n*3)

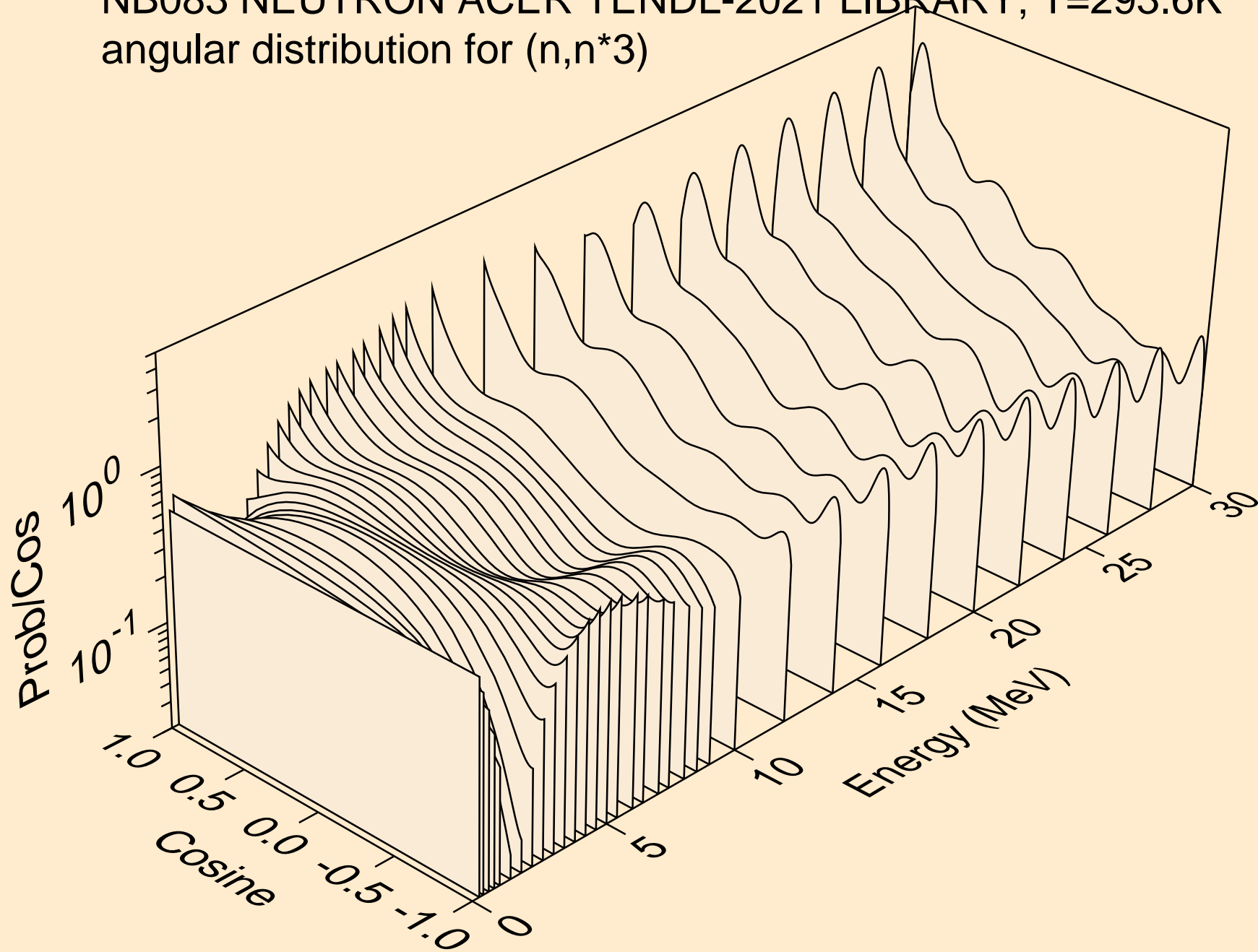

NB083 NEUTRON ACER TENDL-2021 LIBRARY; T=293.6K
angular distribution for (n,n*4)

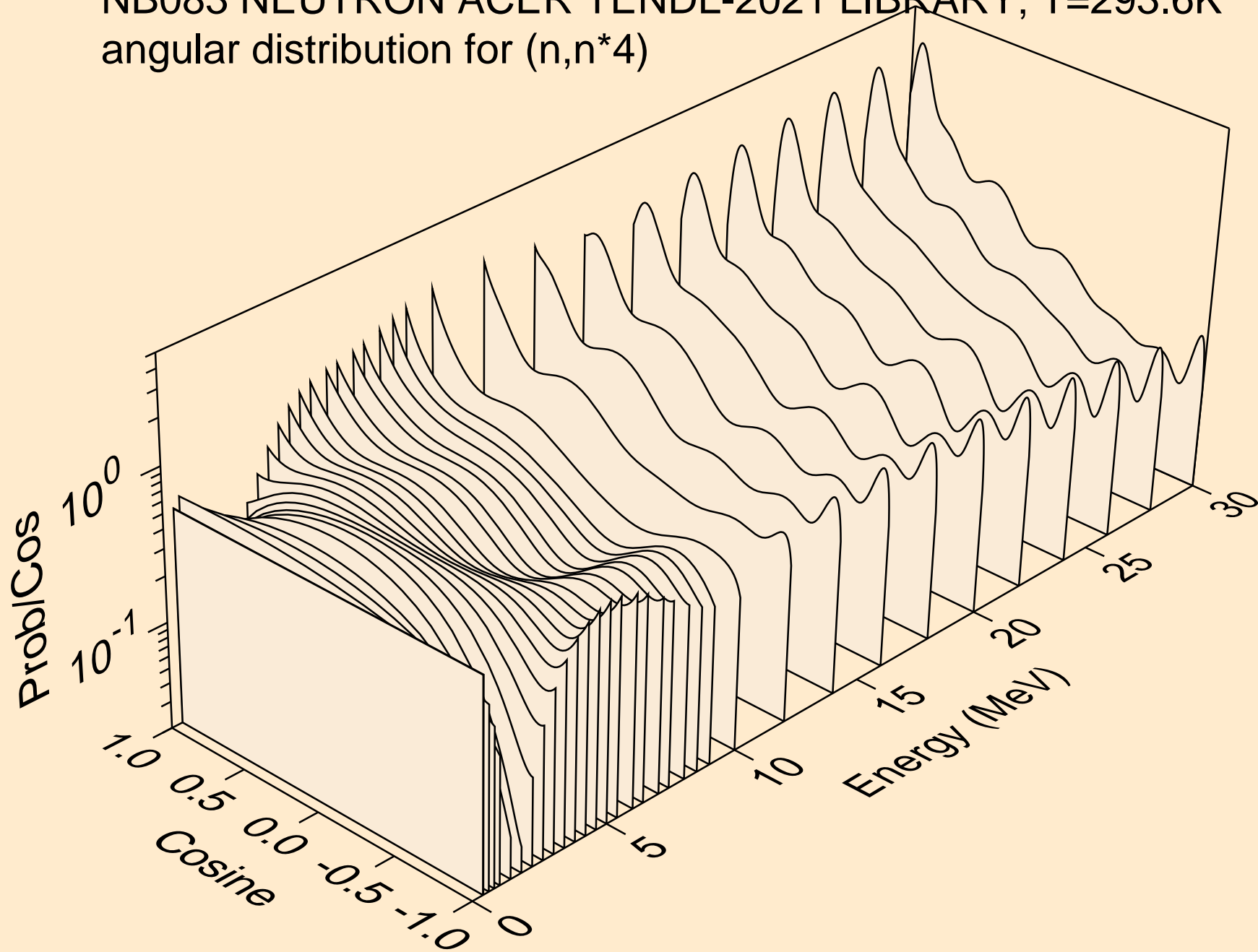

NB083 NEUTRON ACER TENDL-2021 LIBRARY; T=293.6K
angular distribution for (n,n*5)

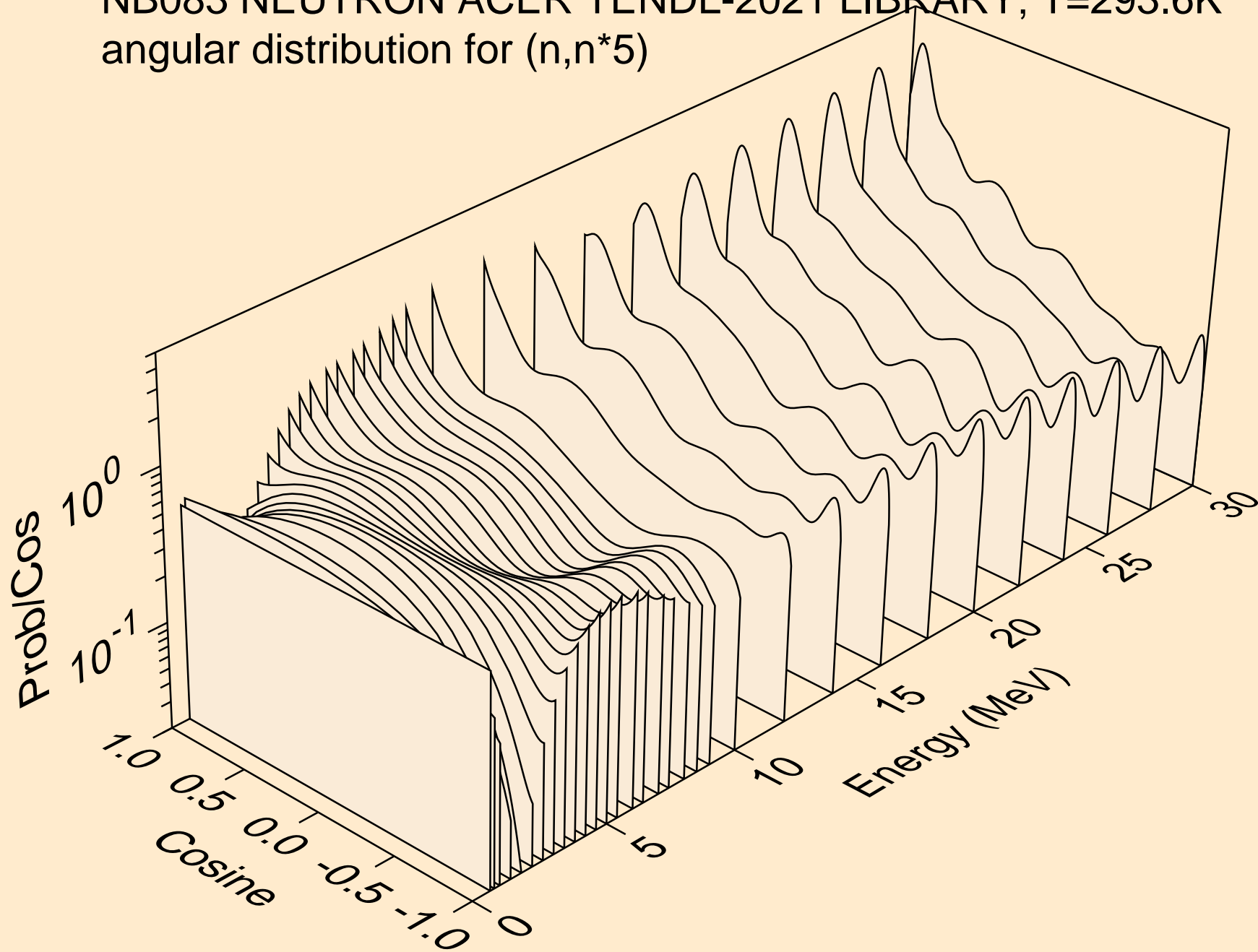

NB083 NEUTRON ACER TENDL-2021 LIBRARY; T=293.6K
angular distribution for (n,n*6)

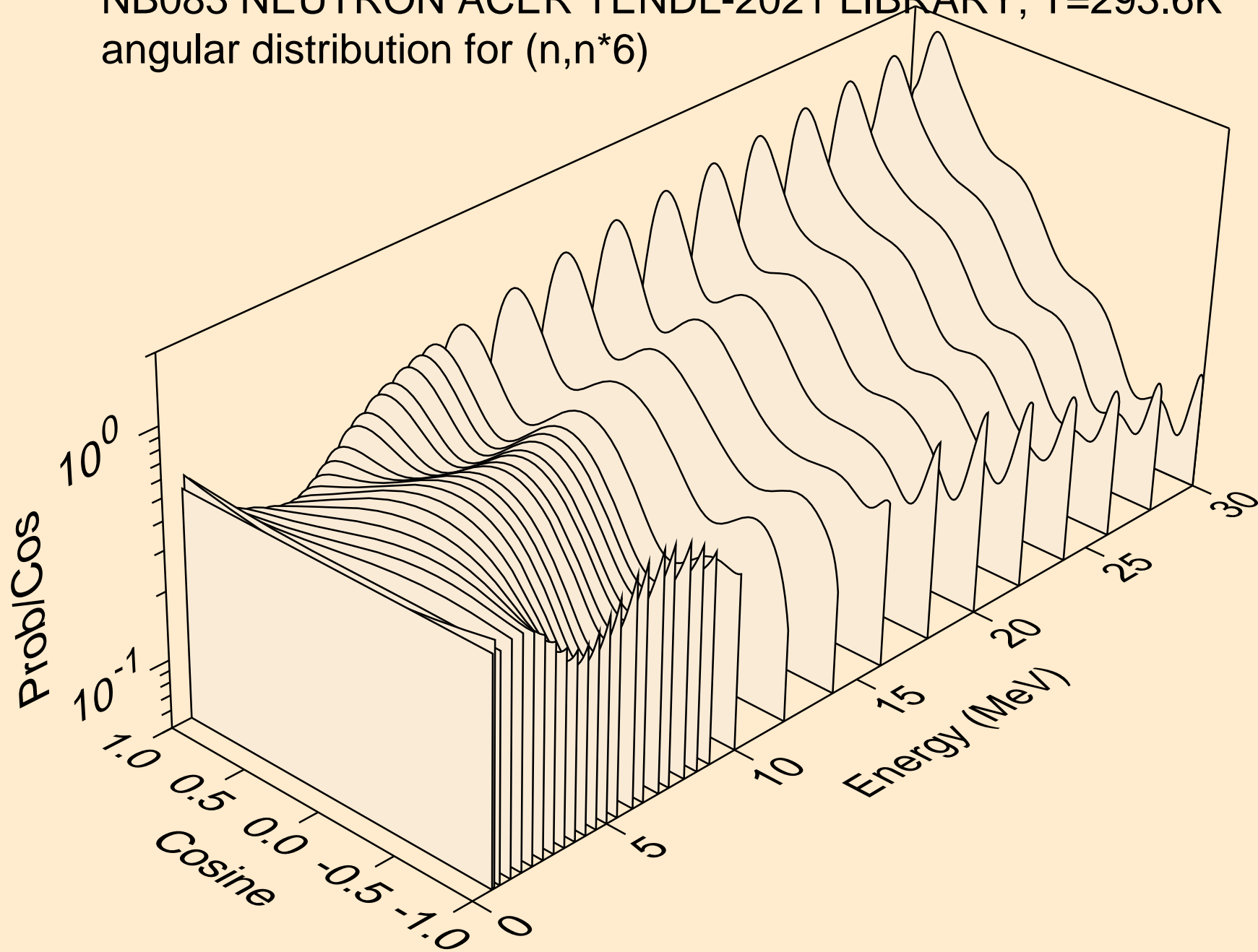

NB083 NEUTRON ACER TENDL-2021 LIBRARY; T=293.6K
angular distribution for (n,n*7)

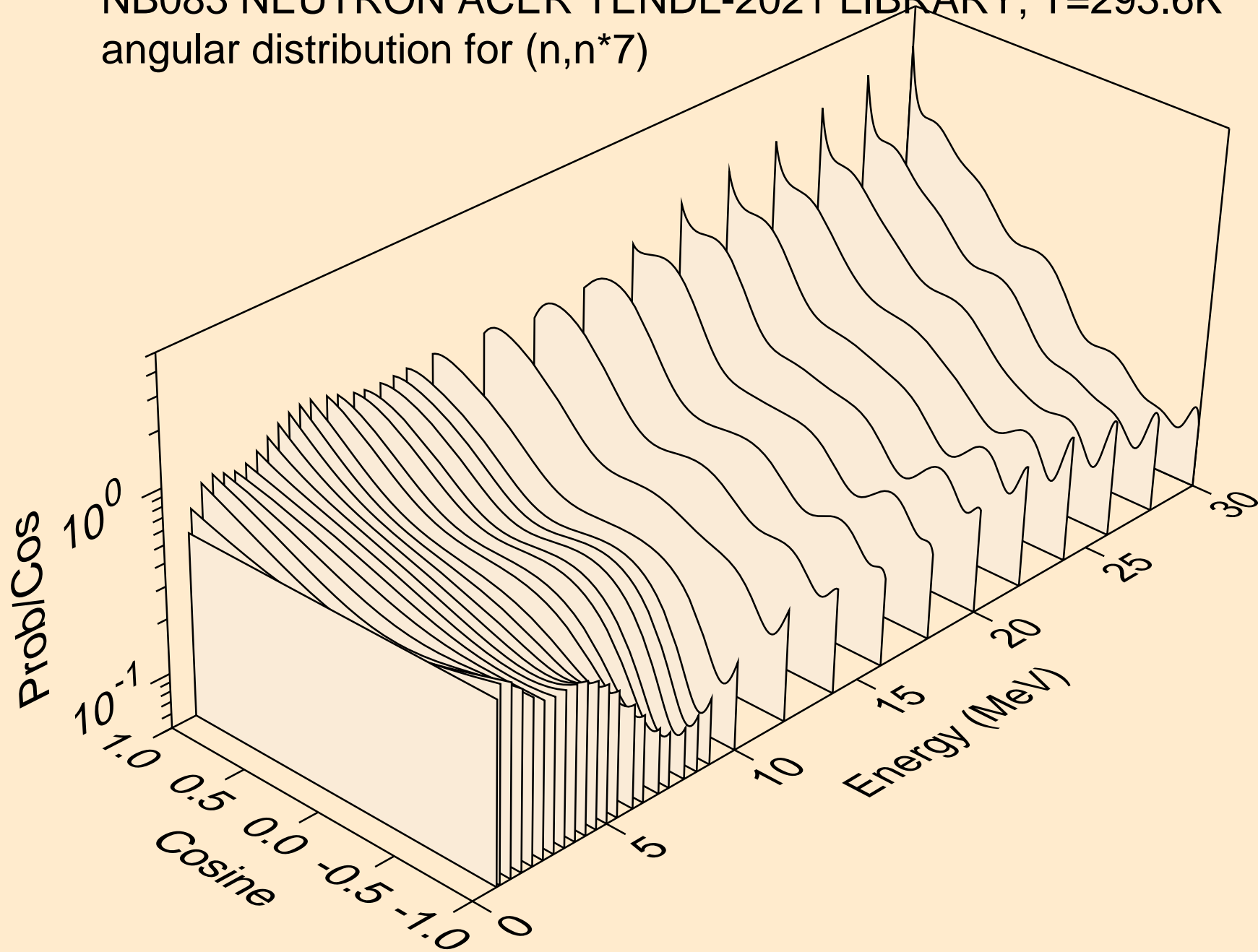

NB083 NEUTRON ACER TENDL-2021 LIBRARY; T=293.6K
angular distribution for (n,n*8)

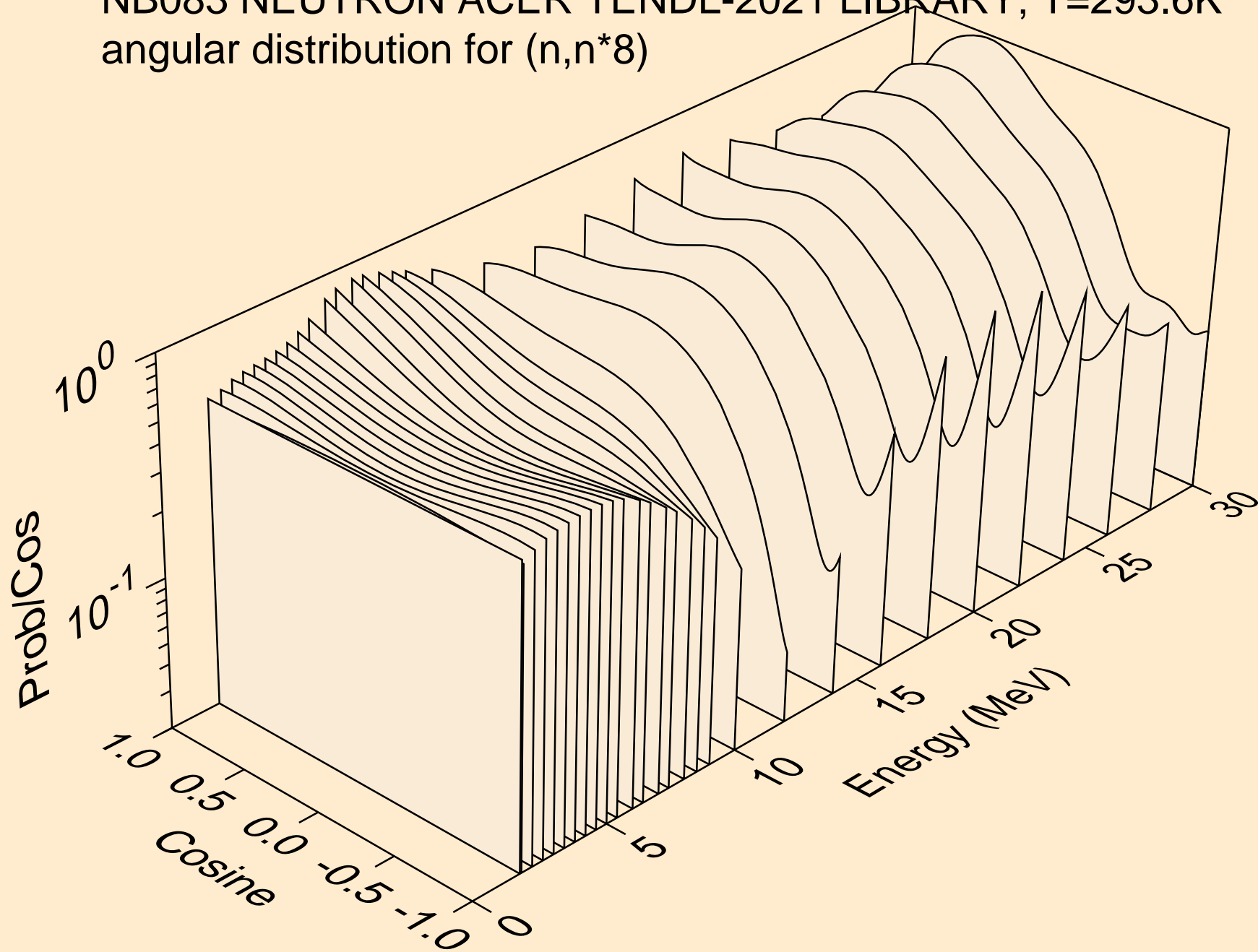

NB083 NEUTRON ACER TENDL-2021 LIBRARY; T=293.6K
angular distribution for (n,n*9)

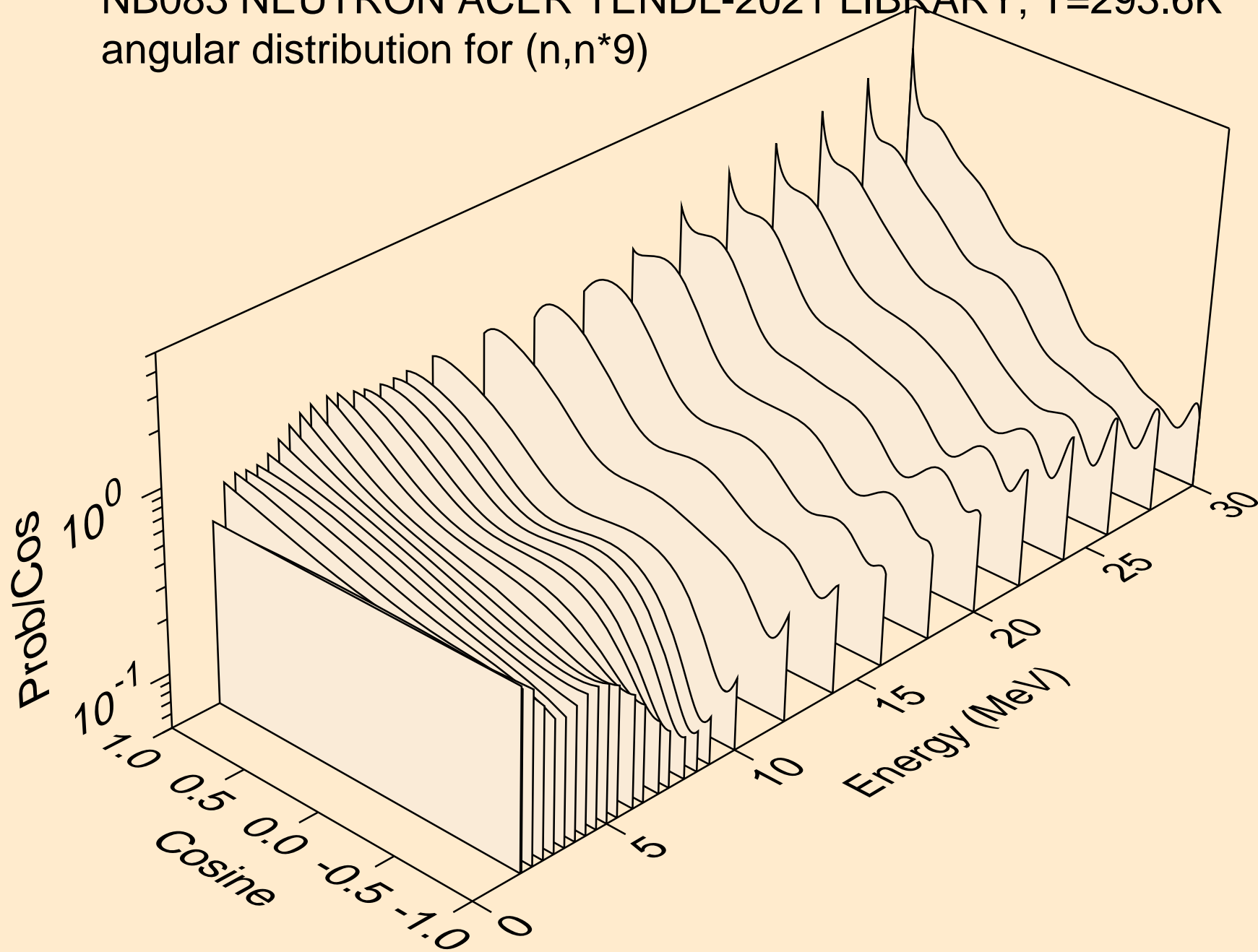

NB083 NEUTRON ACER TENDL-2021 LIBRARY; T=293.6K
angular distribution for (n,n*10)

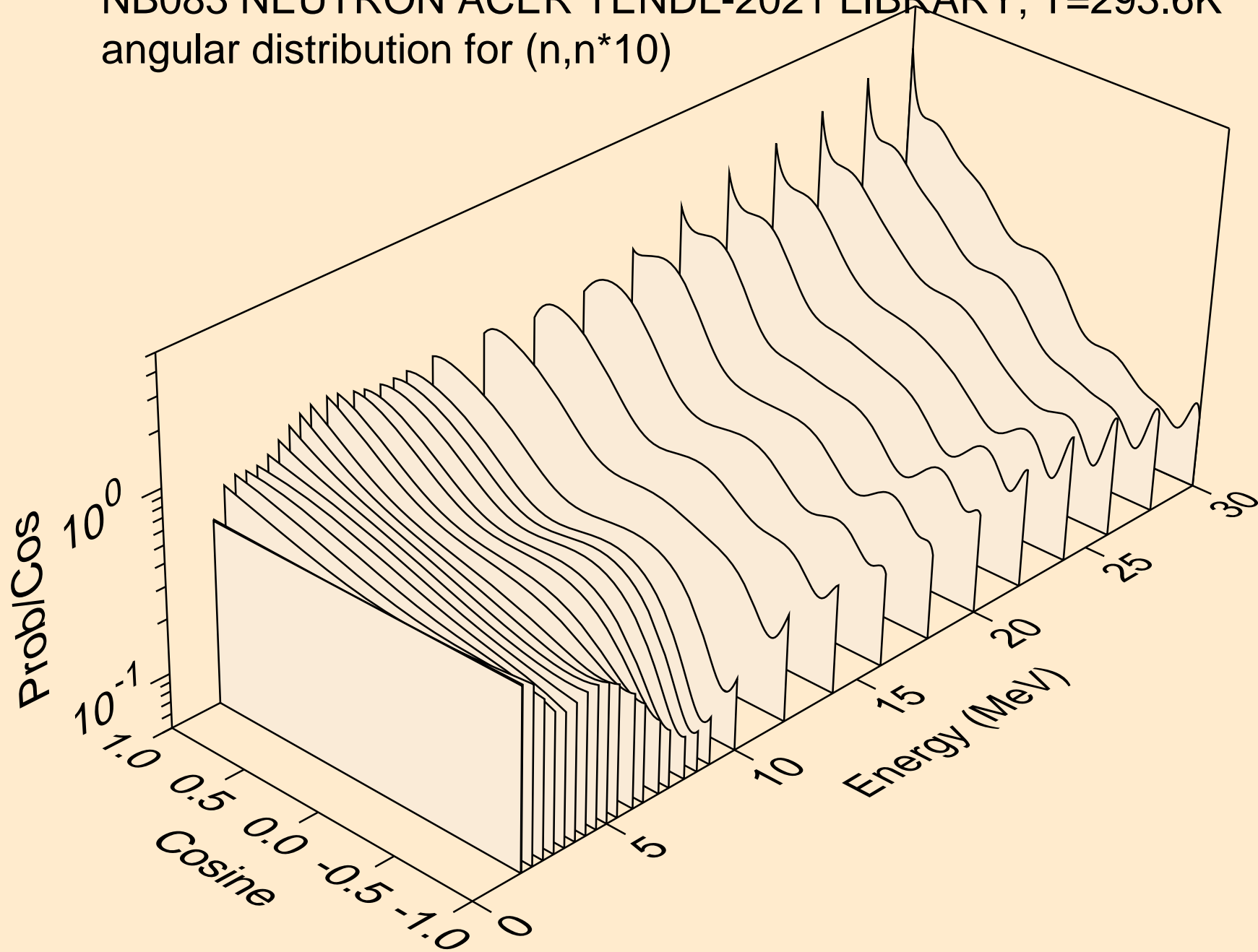

NB083 NEUTRON ACER TENDL-2021 LIBRARY; T=293.6K
angular distribution for (n,n*11)

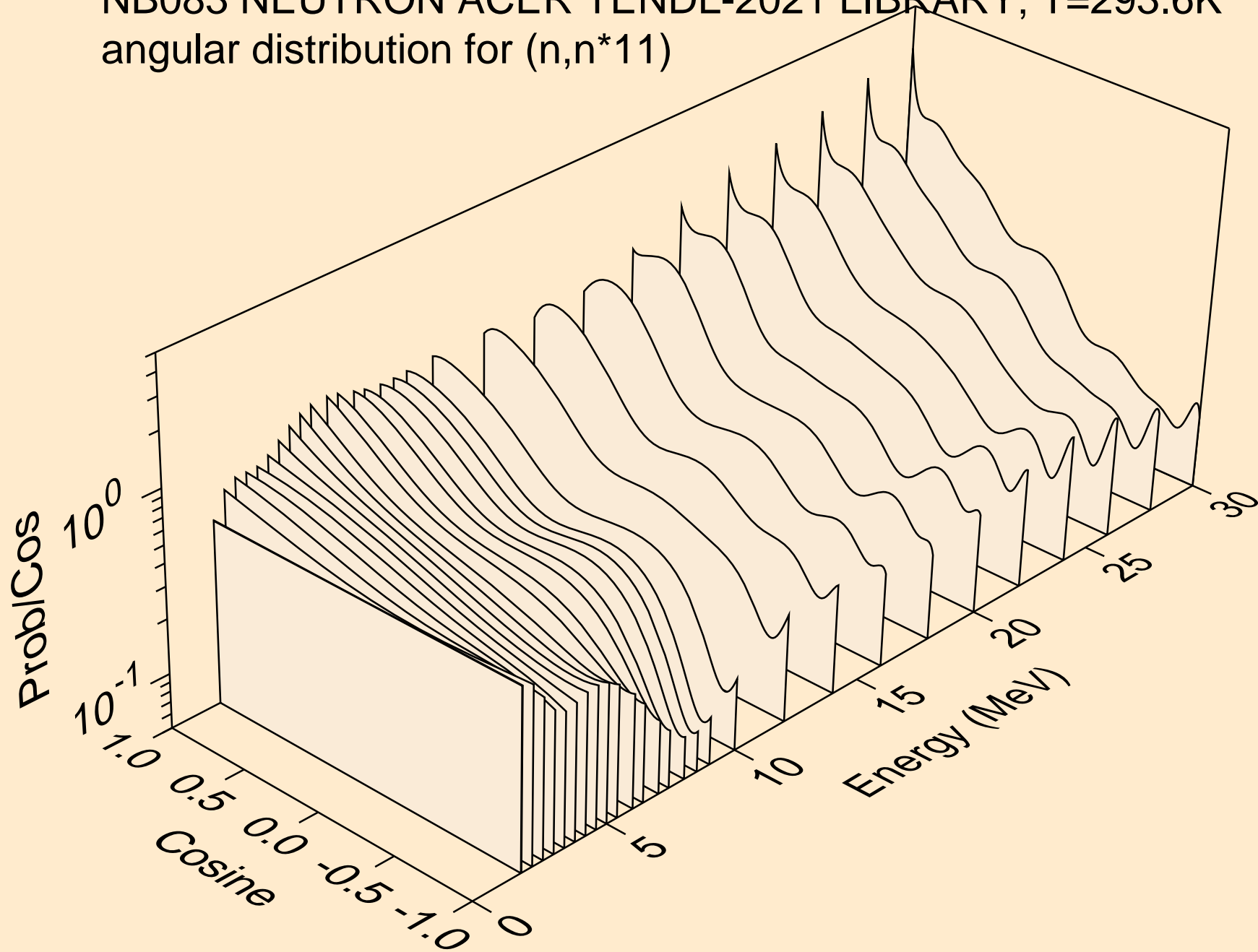

NB083 NEUTRON ACER TENDL-2021 LIBRARY; T=293.6K
angular distribution for (n,n*12)

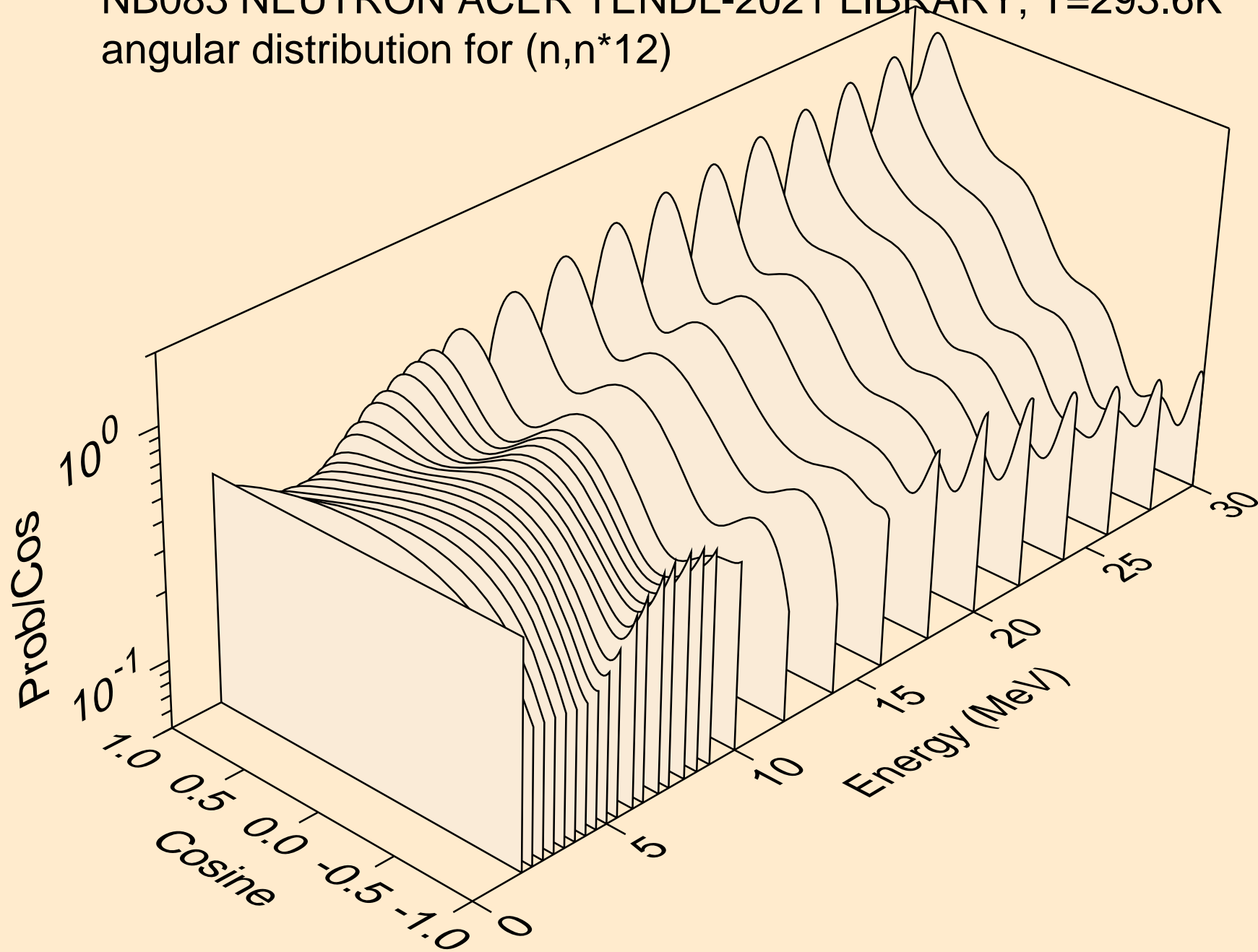

NB083 NEUTRON ACER TENDL-2021 LIBRARY; T=293.6K
angular distribution for (n,n*13)

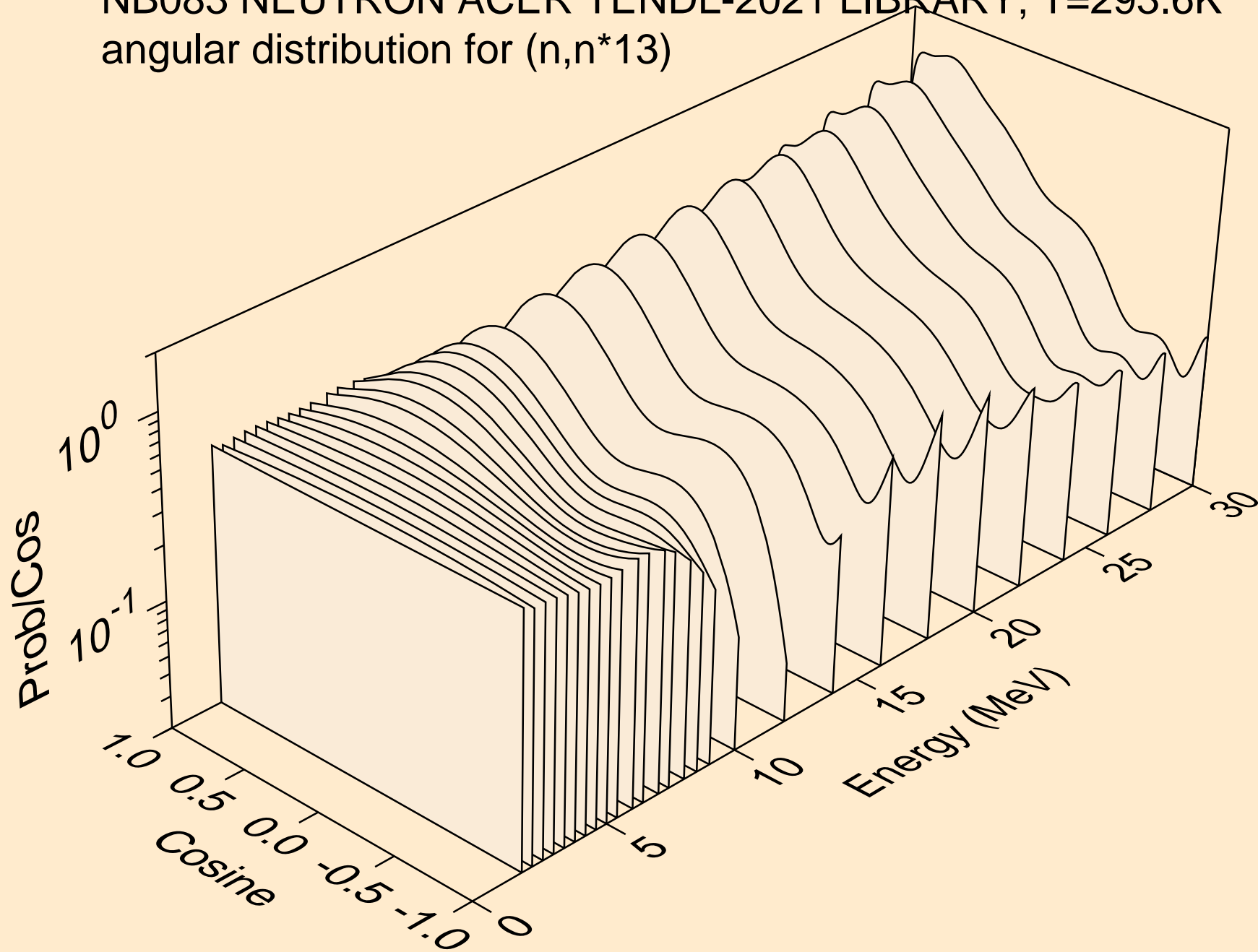

NB083 NEUTRON ACER TENDL-2021 LIBRARY; T=293.6K
angular distribution for (n,n*14)

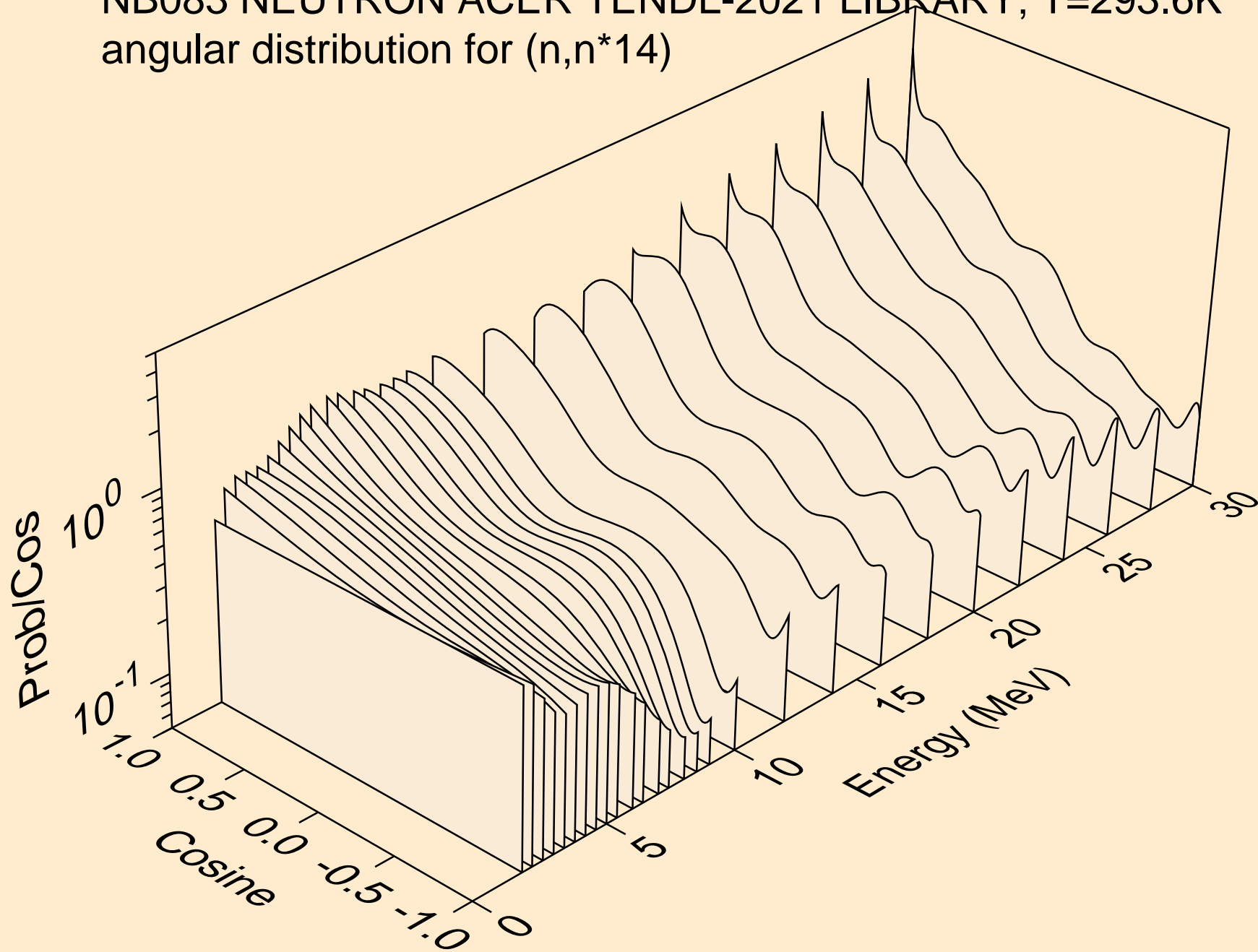

NB083 NEUTRON ACER TENDL-2021 LIBRARY; T=293.6K
angular distribution for (n,n*15)

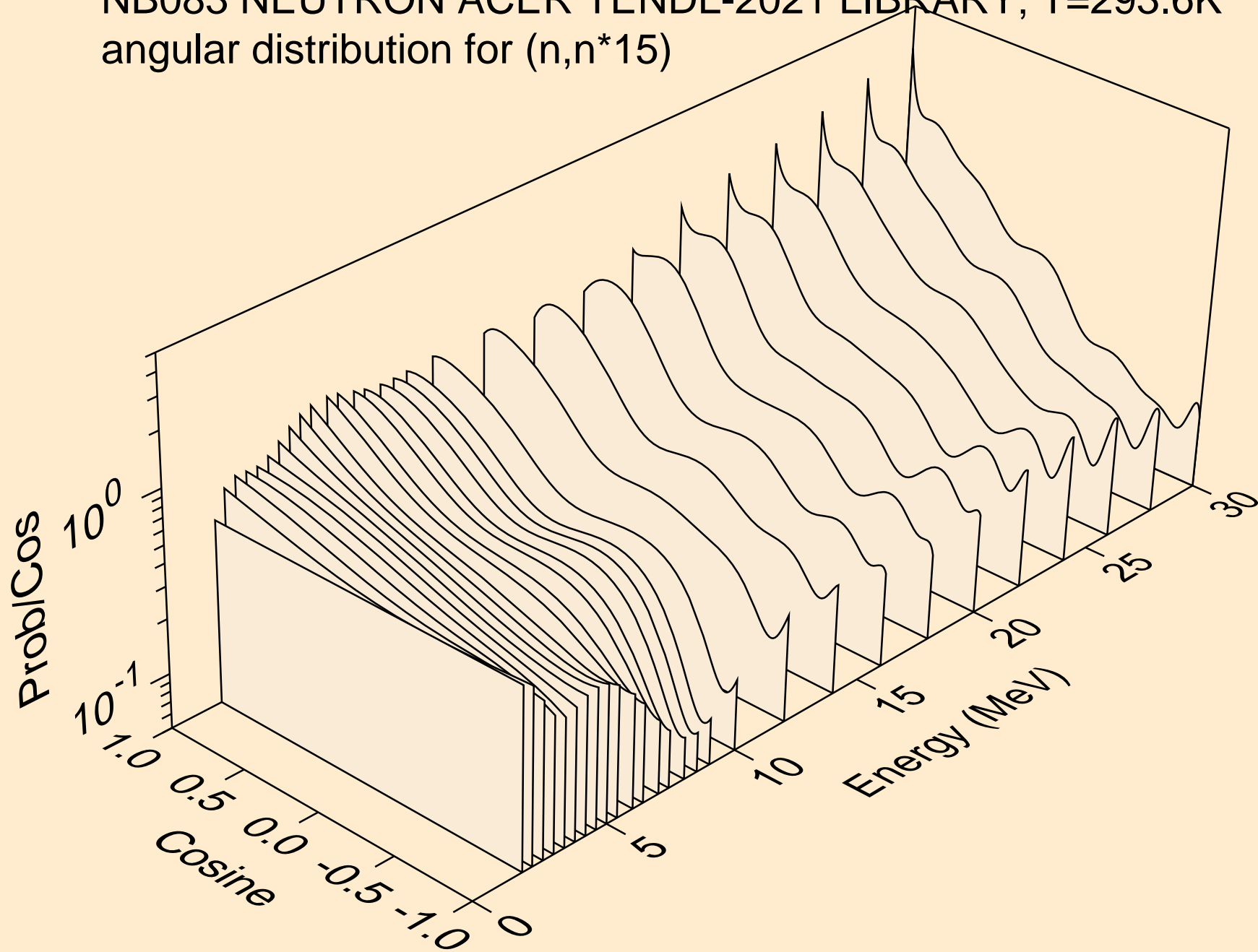

NB083 NEUTRON ACER TENDL-2021 LIBRARY; T=293.6K
angular distribution for (n,n*16)

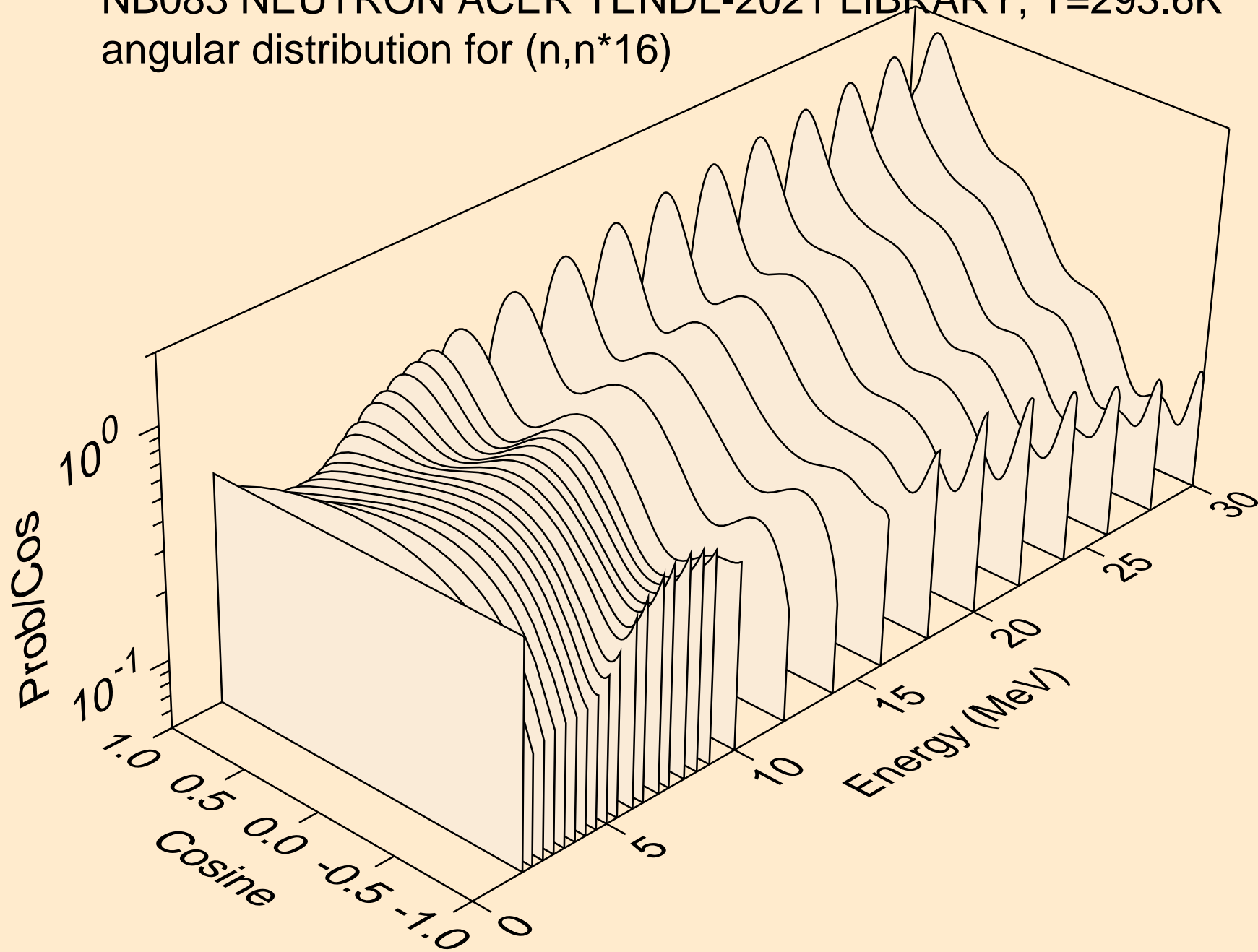

NB083 NEUTRON ACER TENDL-2021 LIBRARY; T=293.6K
angular distribution for (n,n*17)

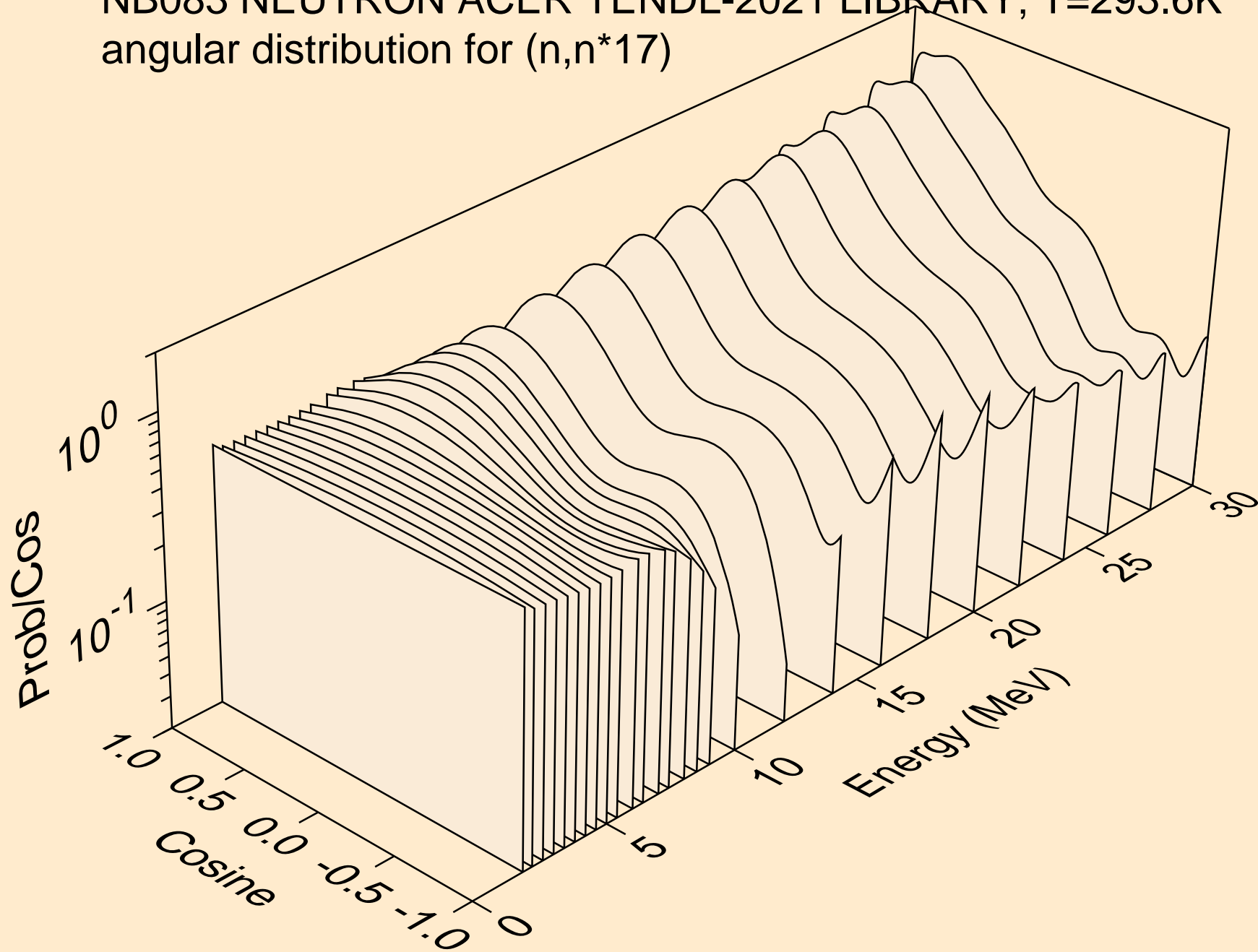

NB083 NEUTRON ACER TENDL-2021 LIBRARY; T=293.6K
angular distribution for (n,n*18)

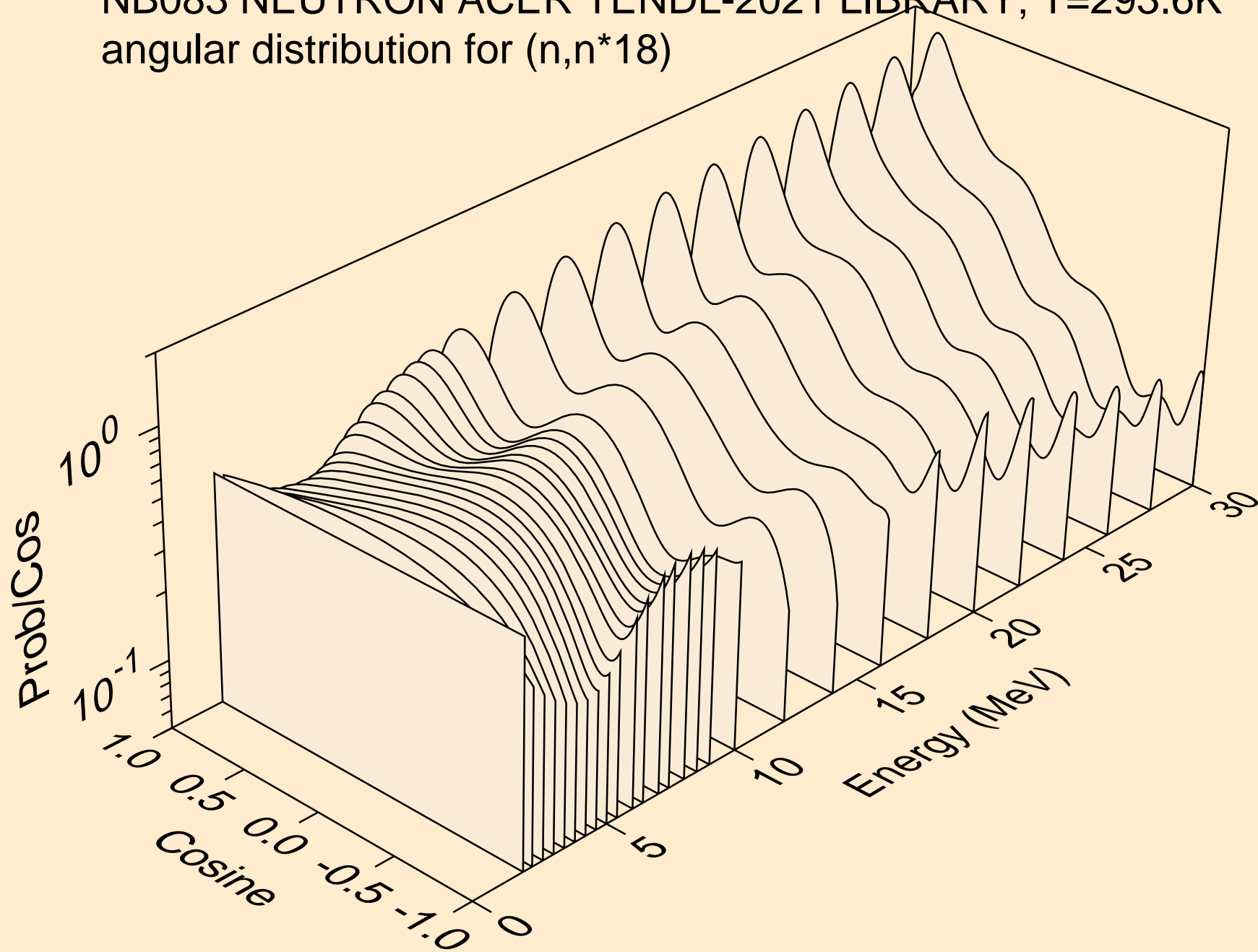

NB083 NEUTRON ACER TENDL-2021 LIBRARY; T=293.6K
angular distribution for (n,n*19)

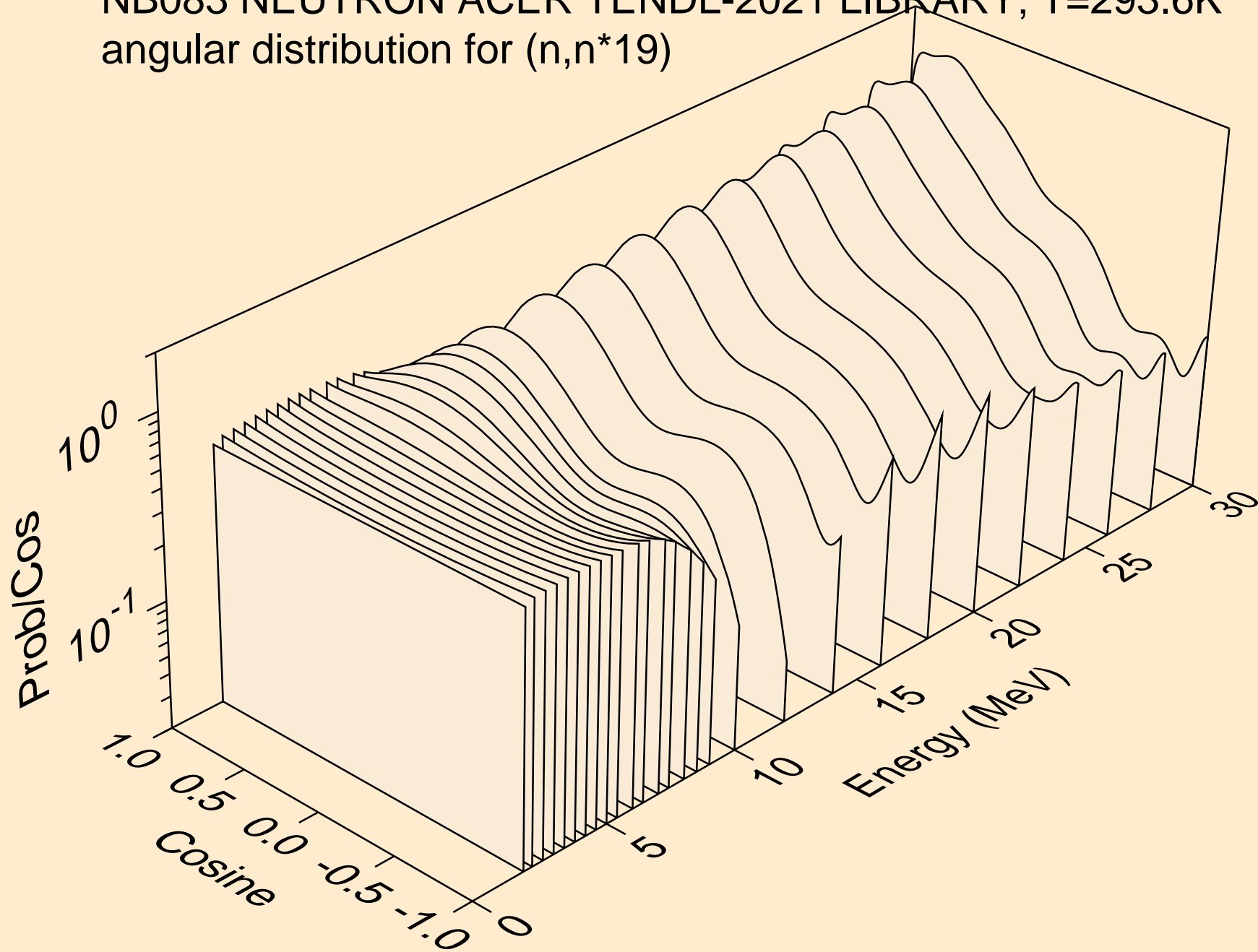

NB083 NEUTRON ACER TENDL-2021 LIBRARY; T=293.6K
angular distribution for (n,n*20)

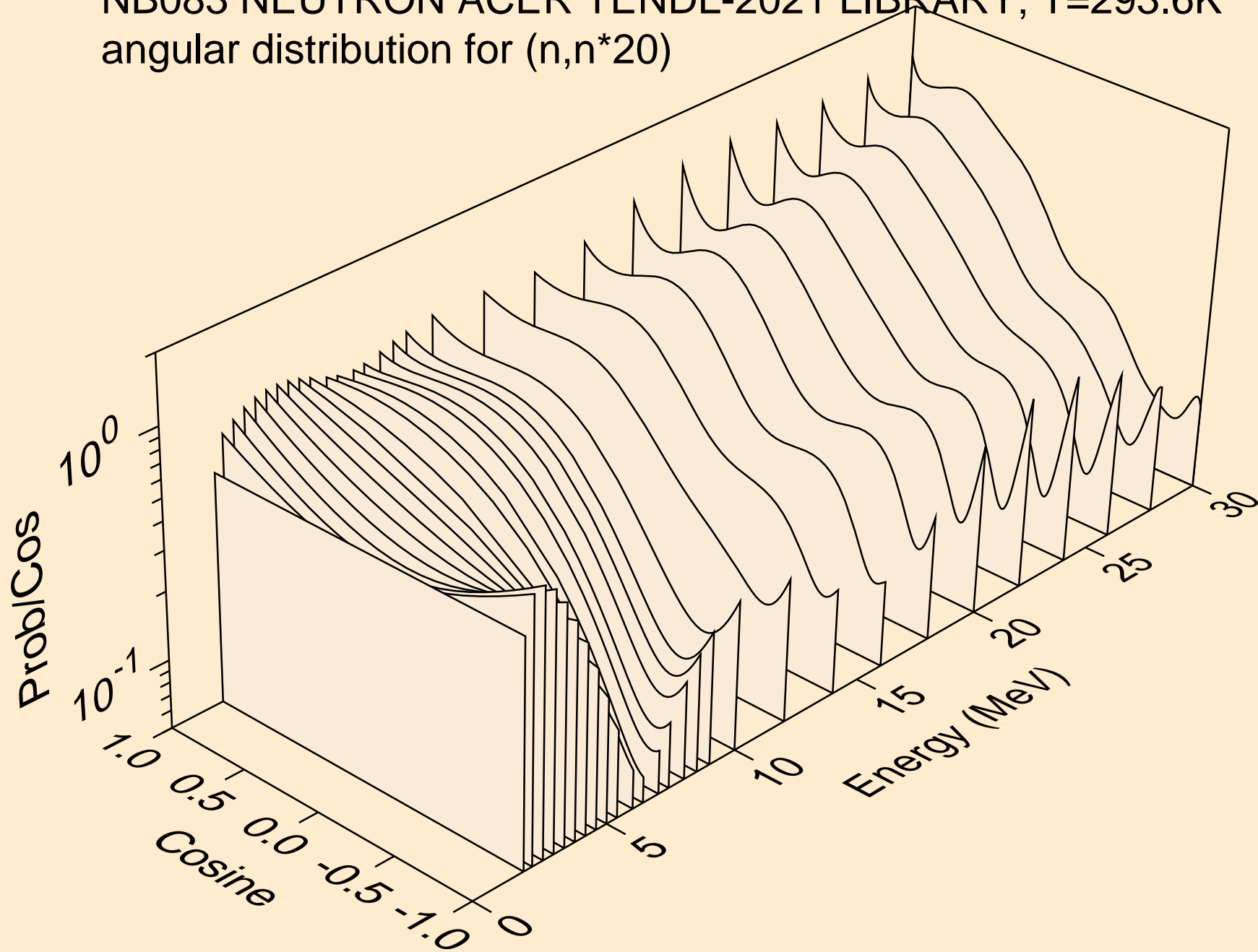

NB083 NEUTRON ACER TENDL-2021 LIBRARY; T=293.6K
angular distribution for (n,n*21)

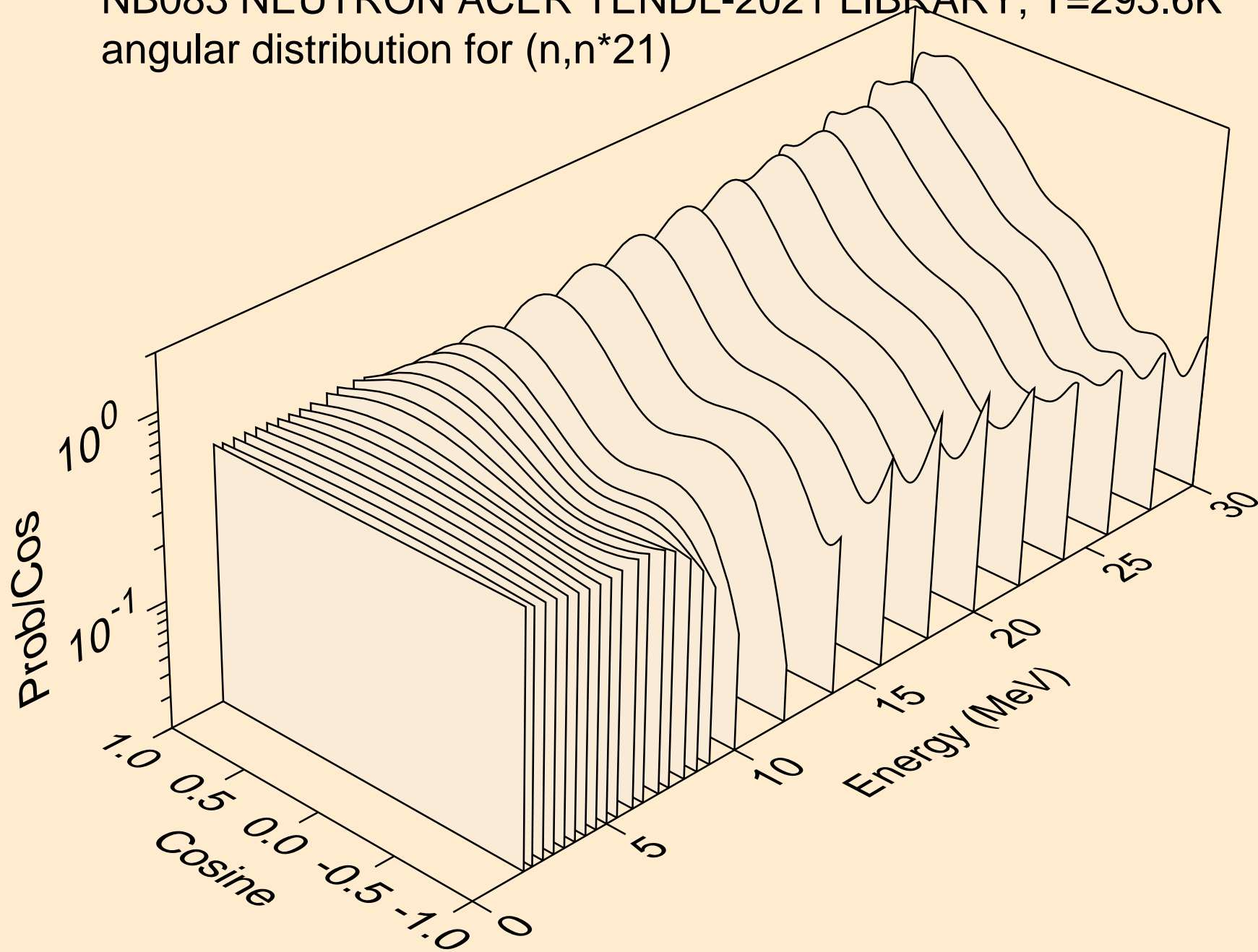

NB083 NEUTRON ACER TENDL-2021 LIBRARY; T=293.6K
angular distribution for (n,n*22)

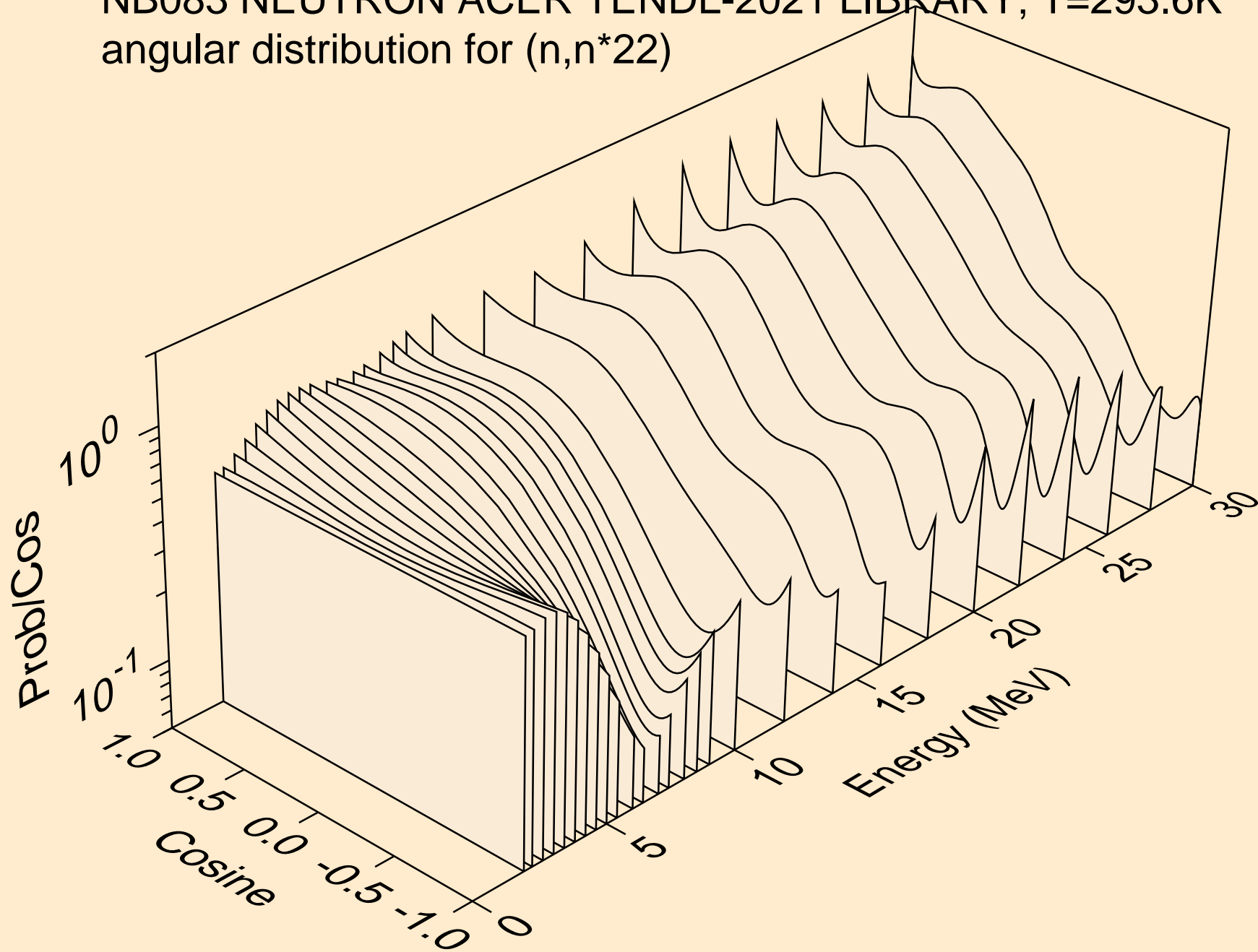

NB083 NEUTRON ACER TENDL-2021 LIBRARY; T=293.6K
angular distribution for (n,n*23)

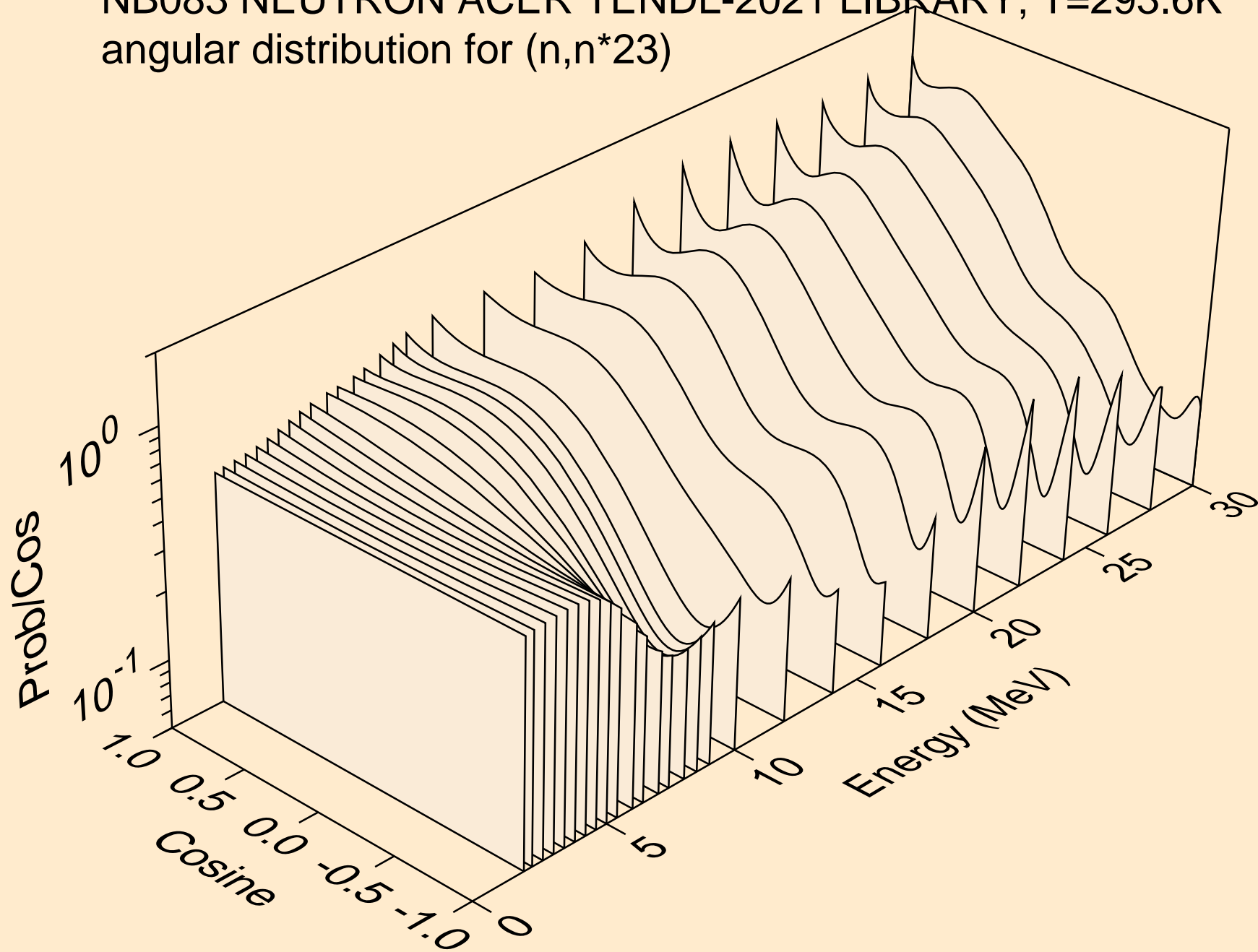

NB083 NEUTRON ACER TENDL-2021 LIBRARY; T=293.6K
angular distribution for (n,n*24)

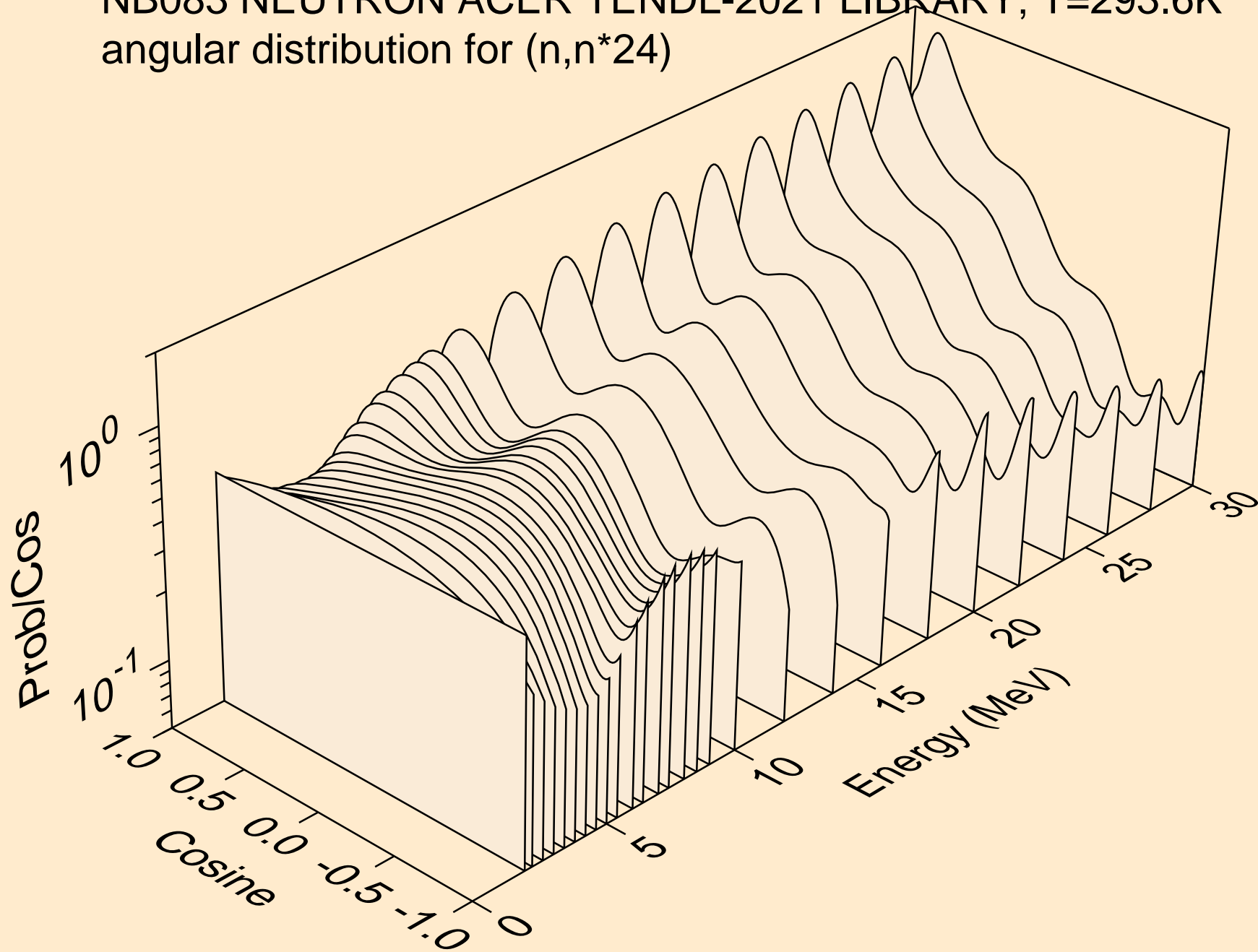

NB083 NEUTRON ACER TENDL-2021 LIBRARY; T=293.6K
angular distribution for (n,n*25)

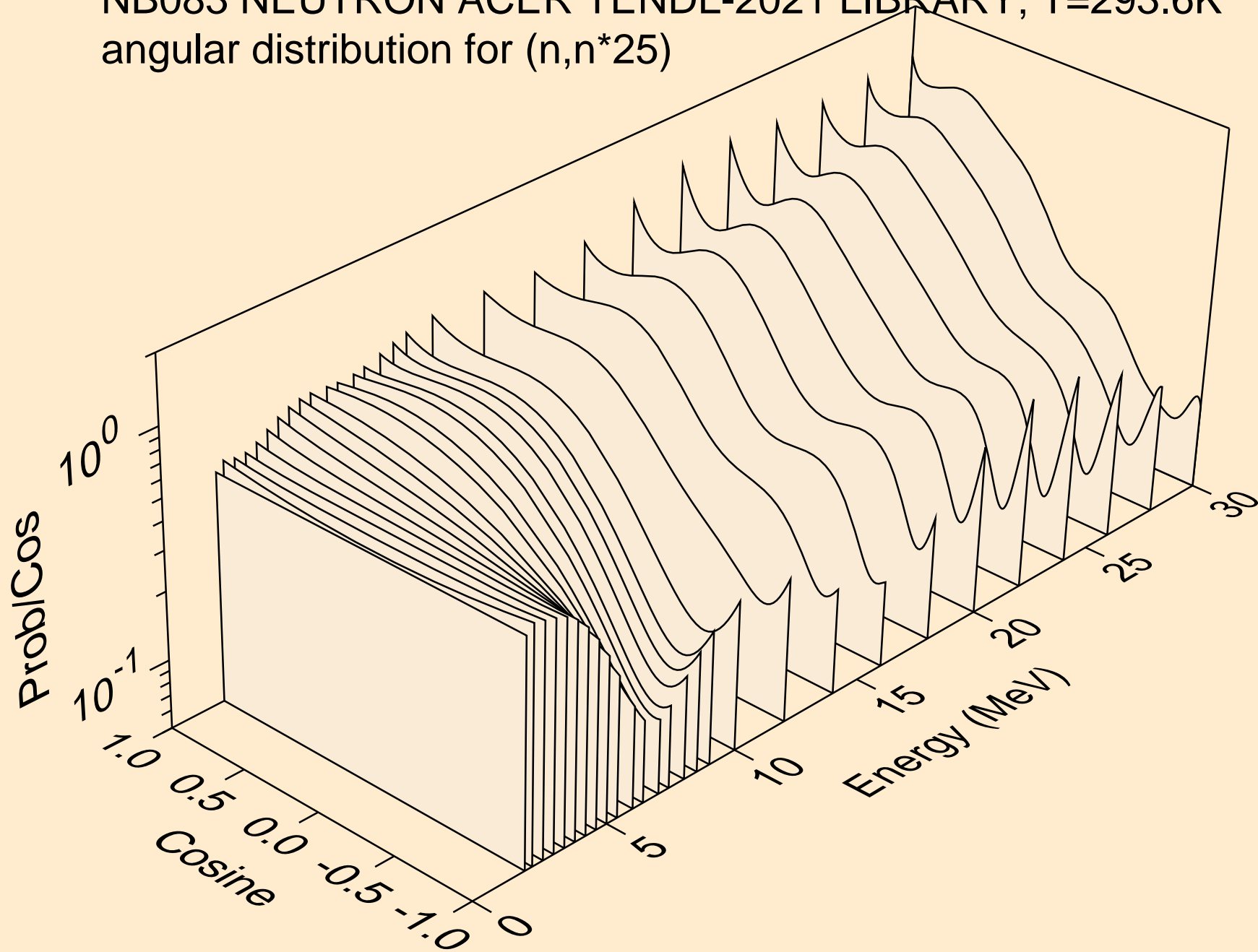

NB083 NEUTRON ACER TENDL-2021 LIBRARY; T=293.6K
angular distribution for (n,n*26)

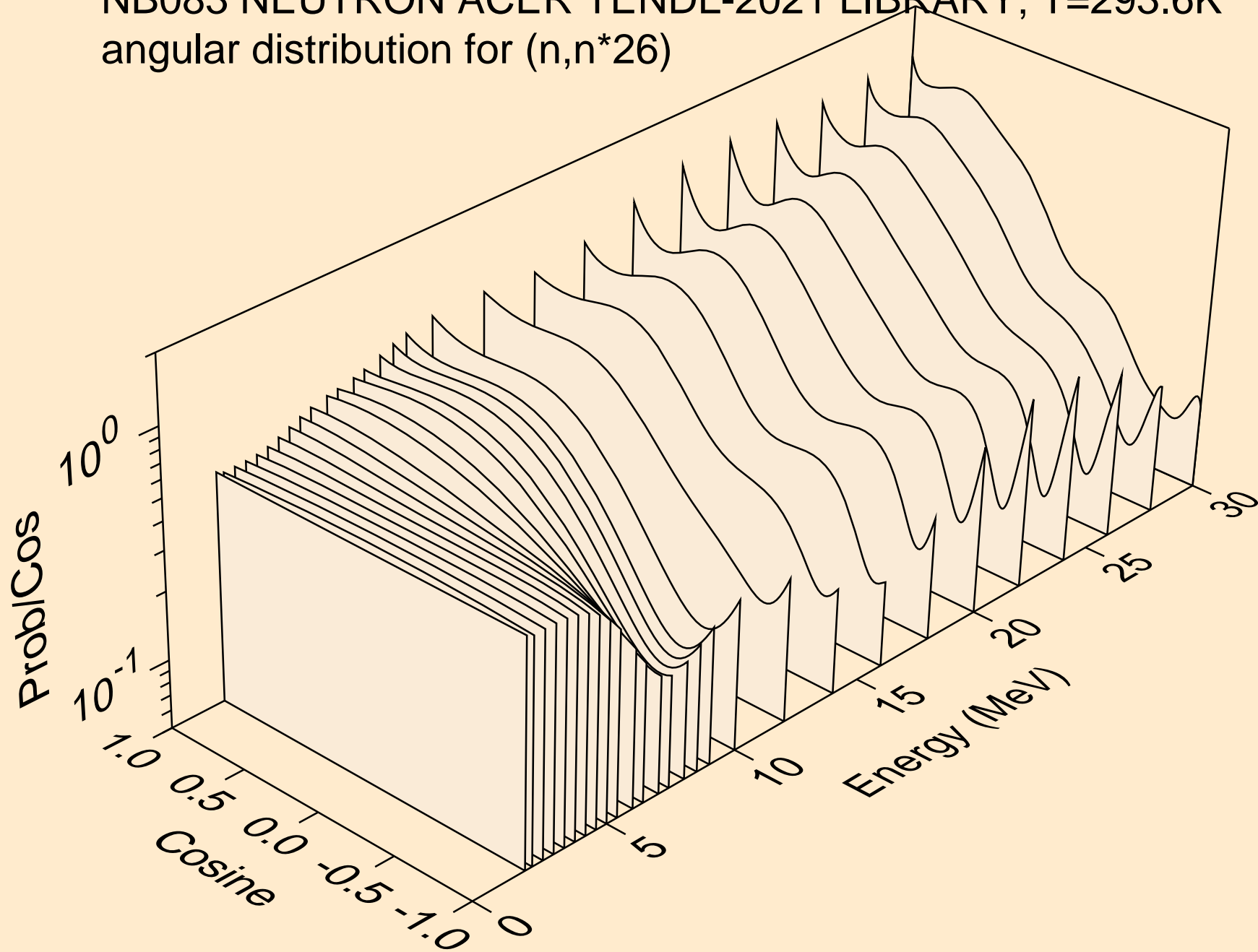

NB083 NEUTRON ACER TENDL-2021 LIBRARY; T=293.6K
angular distribution for (n,n*27)

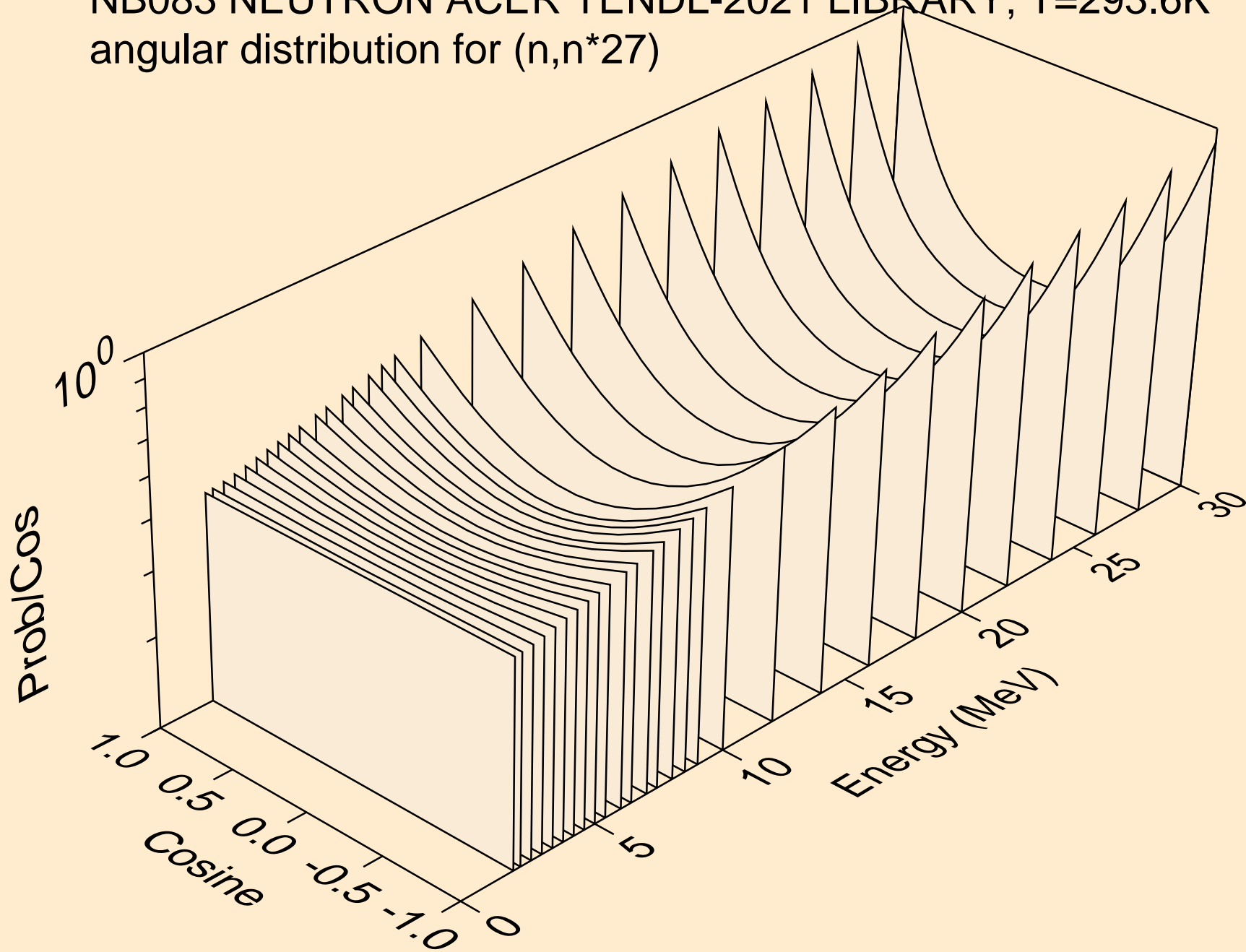

NB083 NEUTRON ACER TENDL-2021 LIBRARY; T=293.6K
angular distribution for (n,n*28)

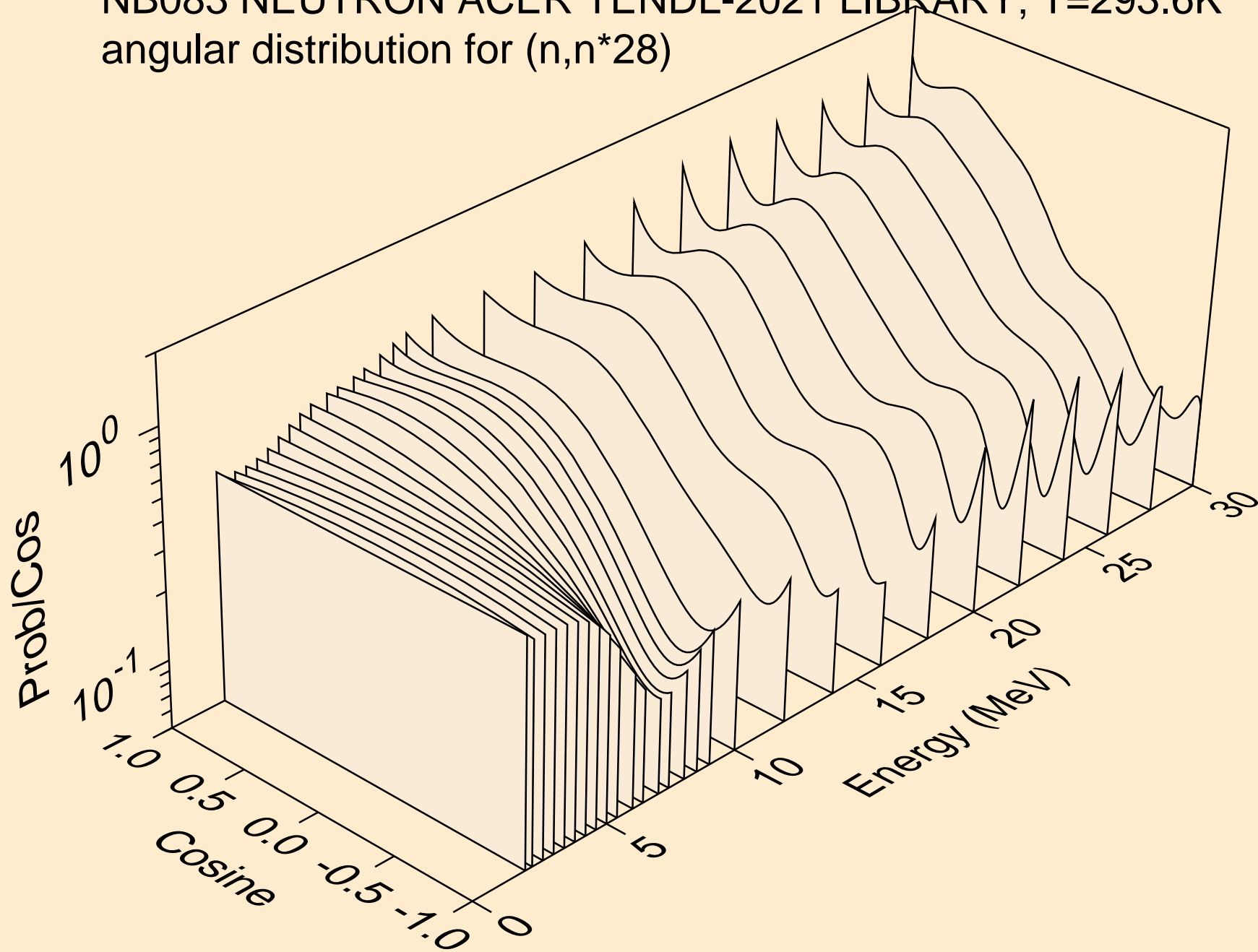

NB083 NEUTRON ACER TENDL-2021 LIBRARY; T=293.6K
angular distribution for (n,n*29)

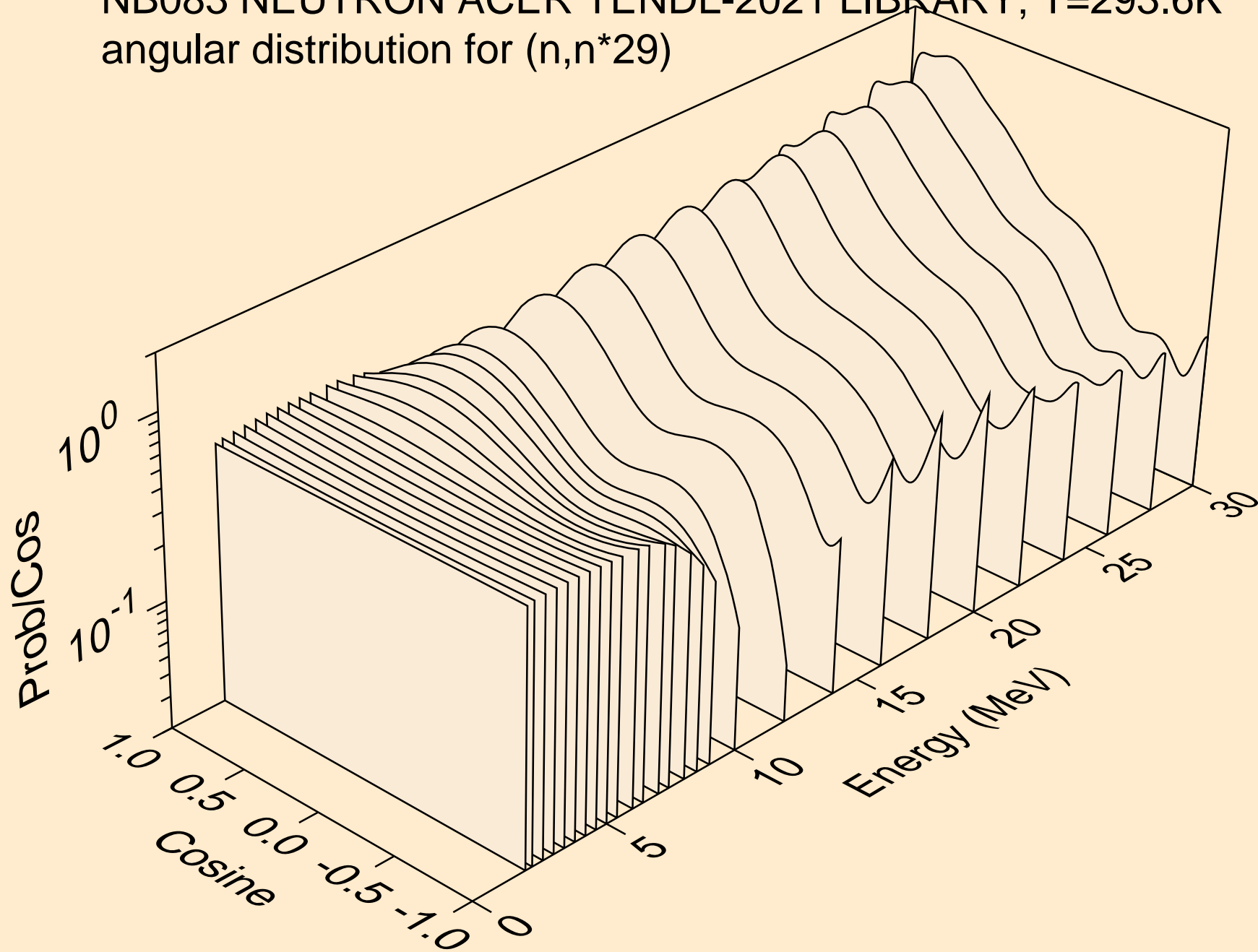

NB083 NEUTRON ACER TENDL-2021 LIBRARY; T=293.6K
angular distribution for (n,n*30)

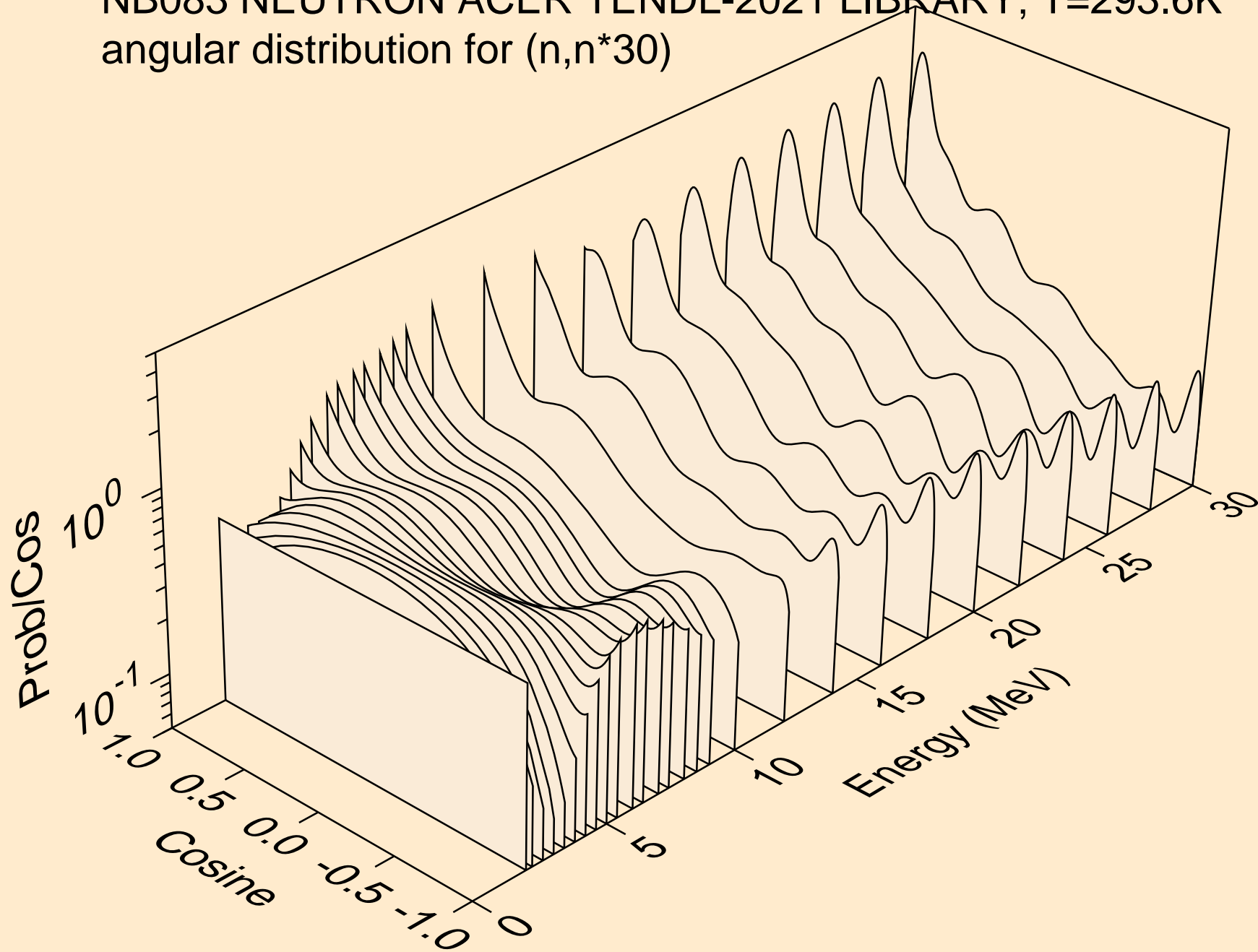

NB083 NEUTRON ACER TENDL-2021 LIBRARY; T=293.6K
Neutron emission for (n,x)

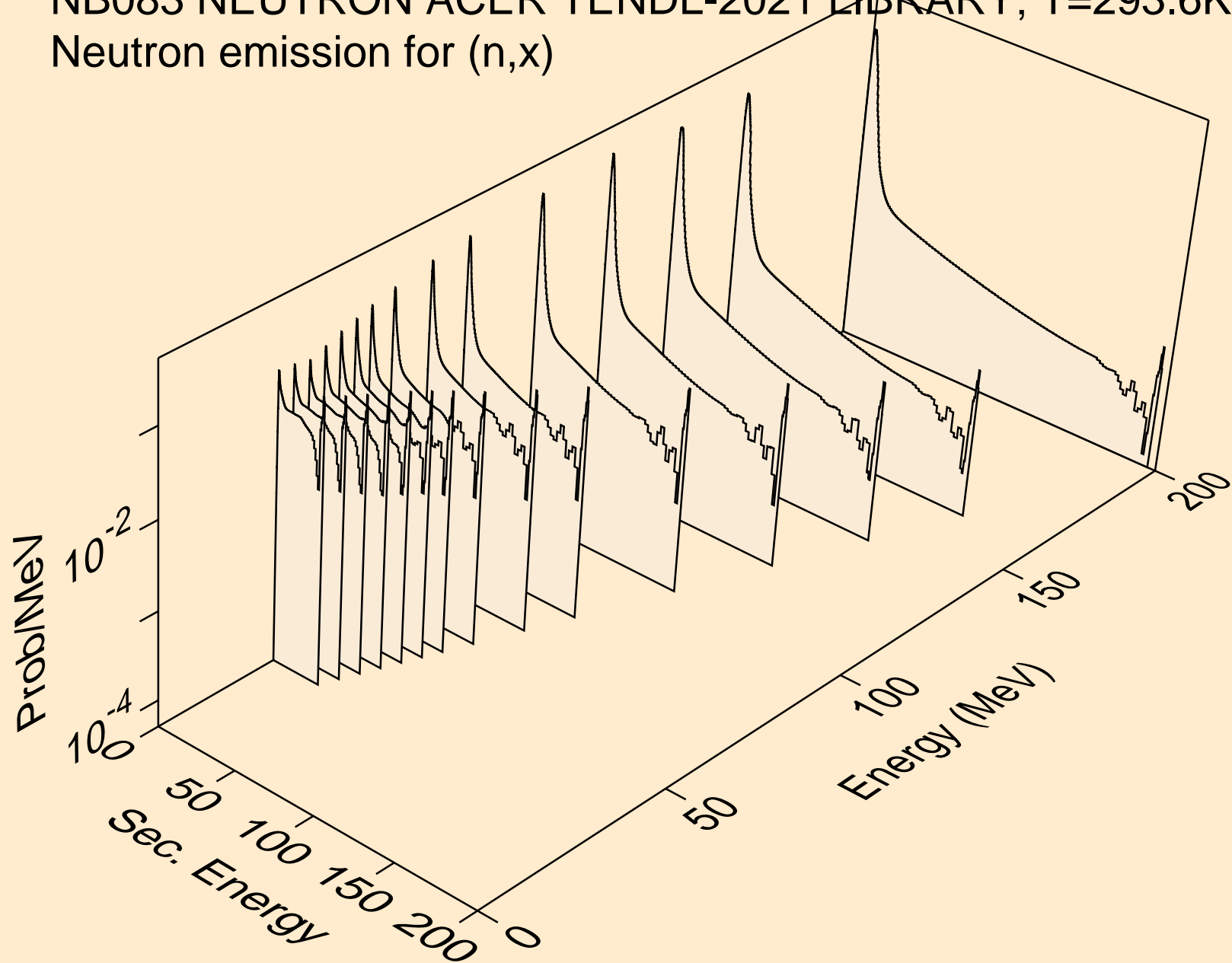

NB083 NEUTRON ACER TENDL-2021 LIBRARY; T=293.6K
Neutron emission for (n,2nd)

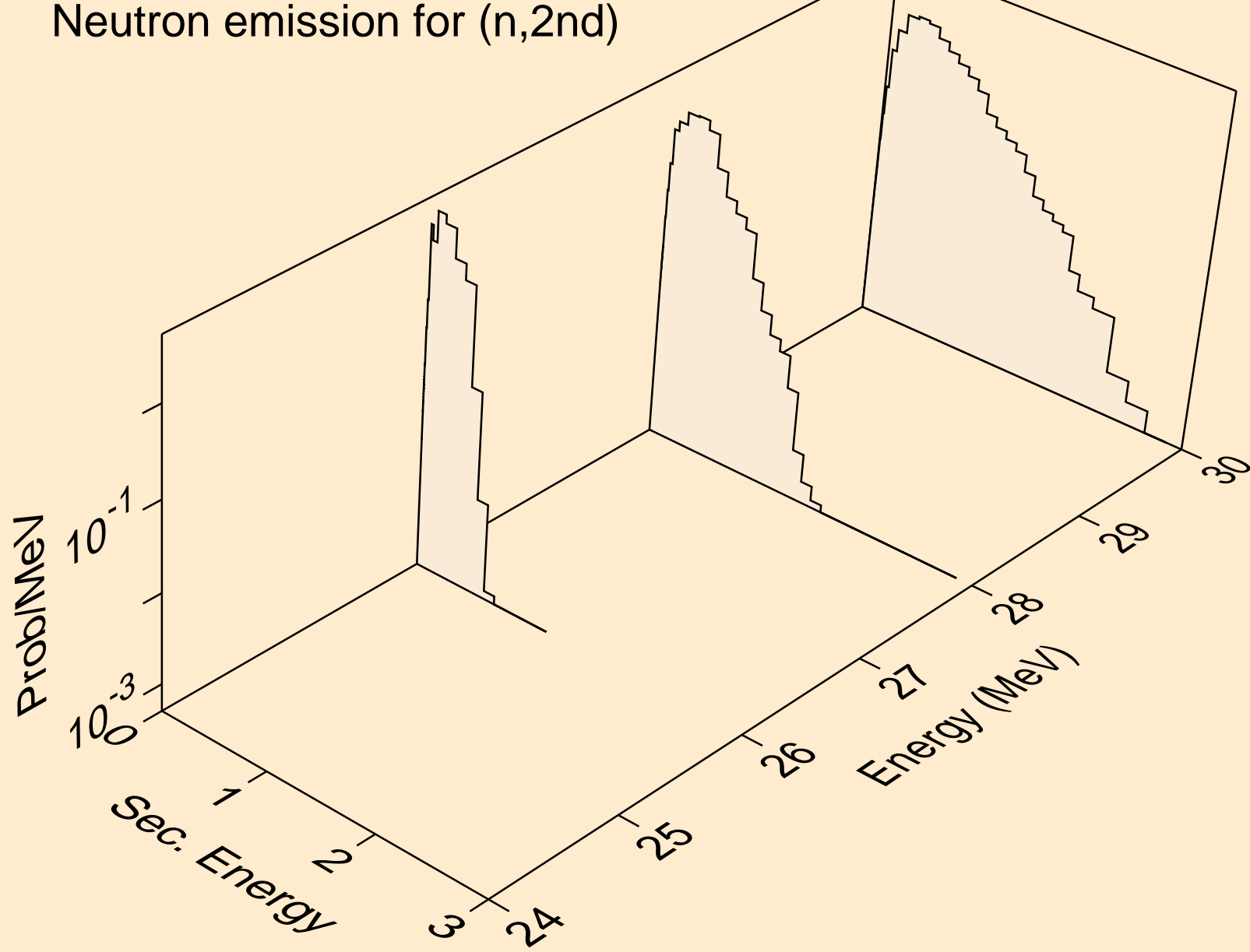

NB083 NEUTRON ACER TENDL-2021 LIBRARY; T=293.6K
Neutron emission for (n,2n)

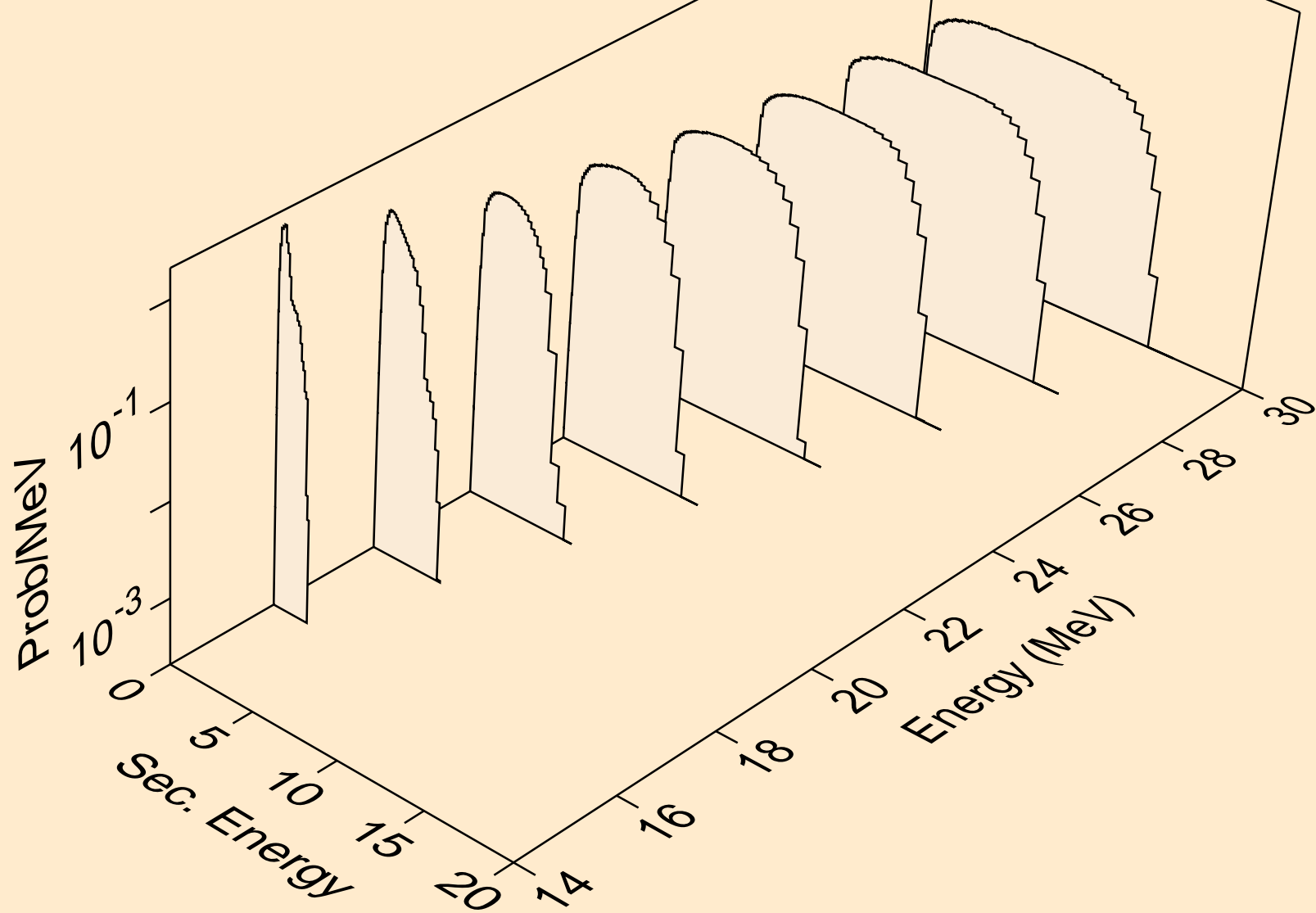

NB083 NEUTRON ACER TENDL-2021 LIBRARY; T=293.6K
Neutron emission for (n,3n)

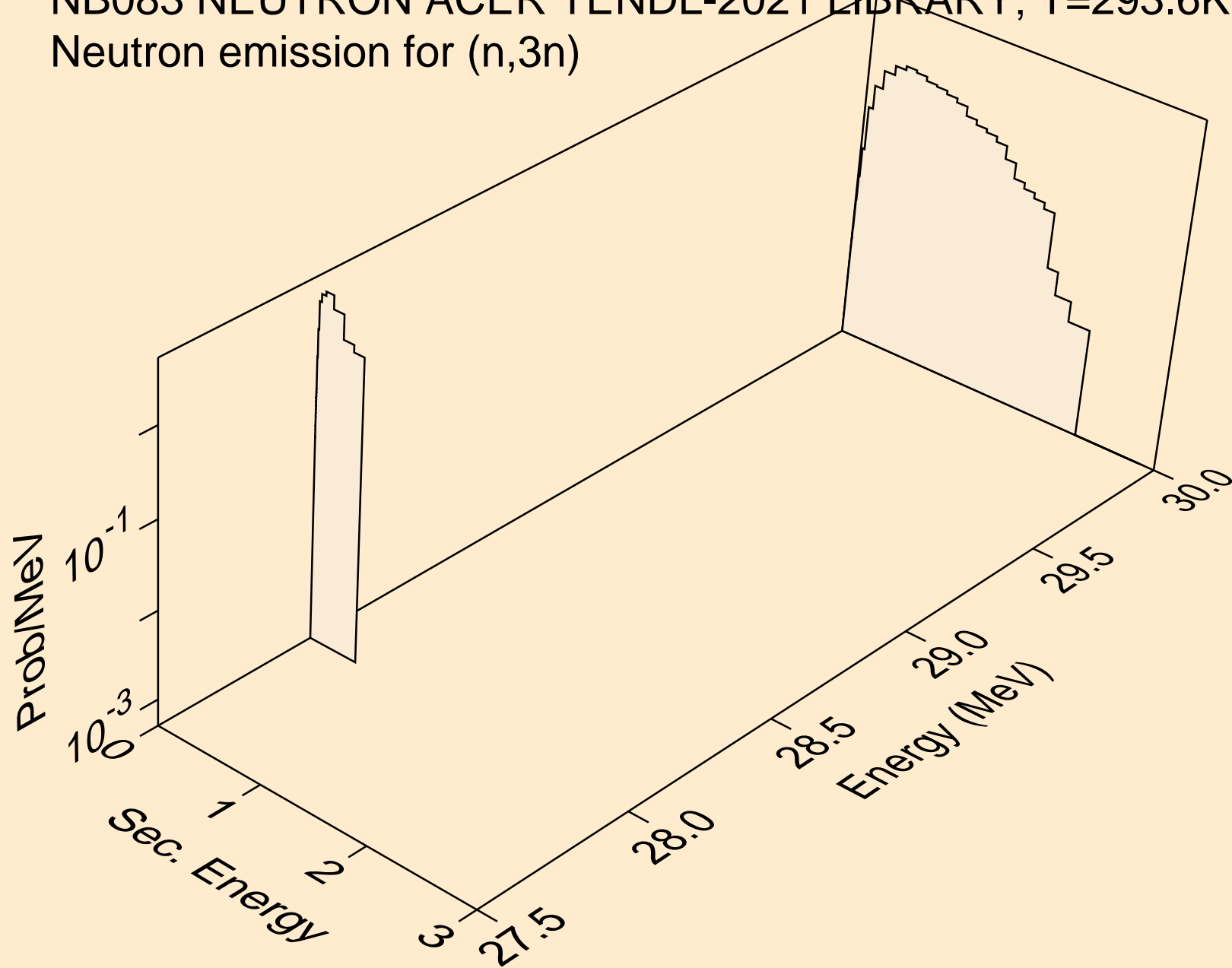

NB083 NEUTRON ACER TENDL-2021 LIBRARY; T=293.6K
Neutron emission for (n,n*)a

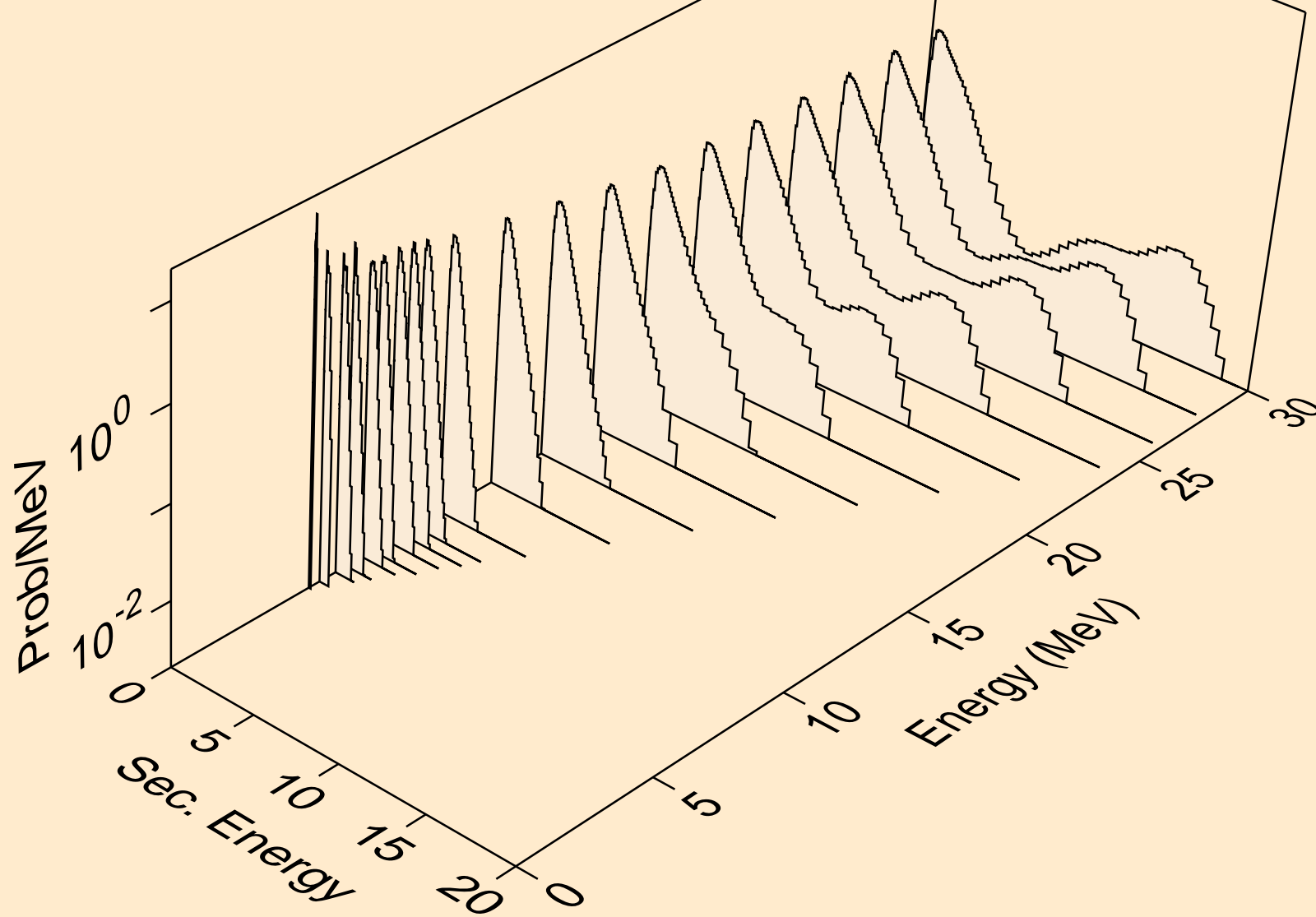

NB083 NEUTRON ACER TENDL-2021 LIBRARY; T=293.6K
Neutron emission for (n,2n)a

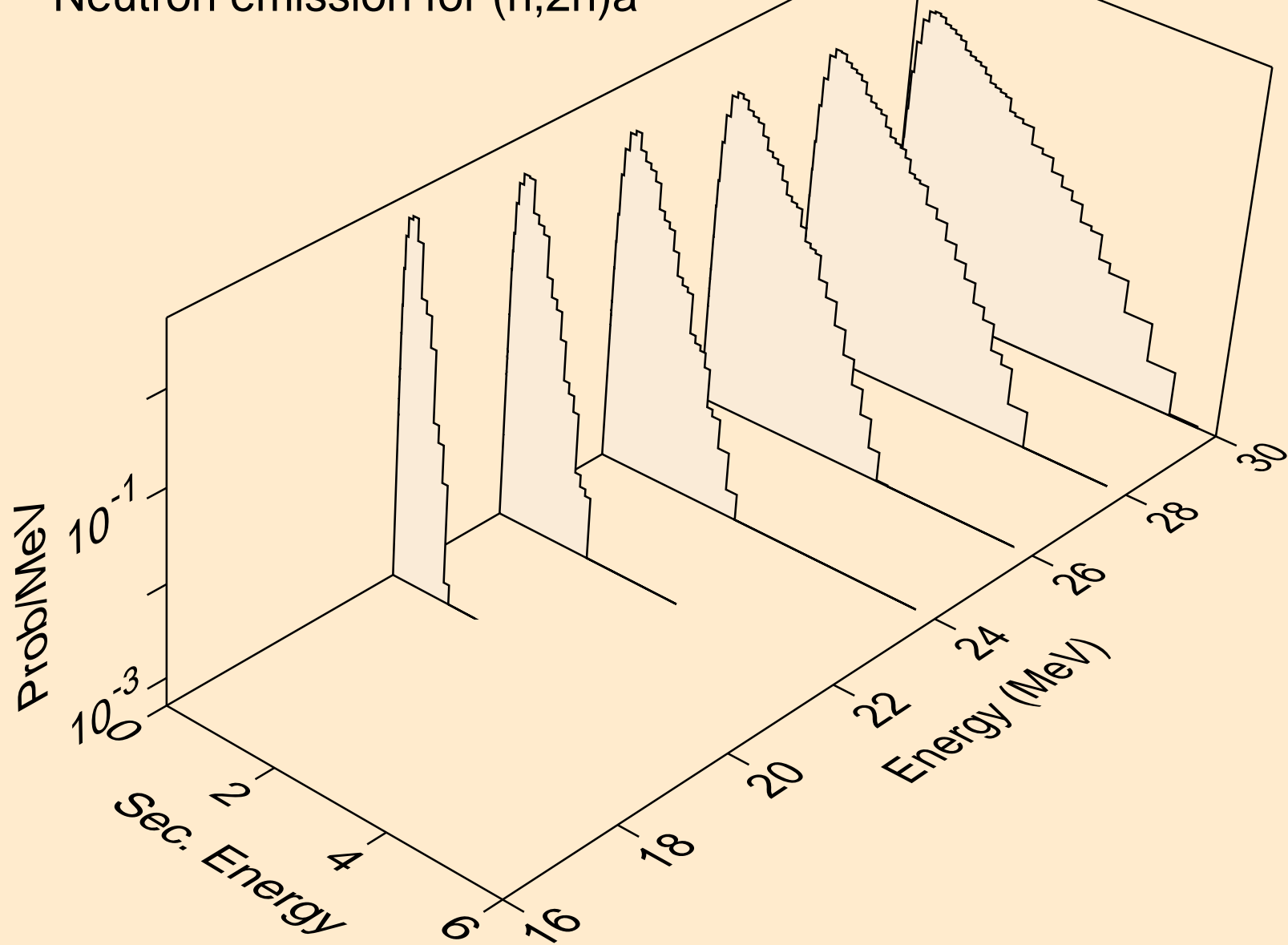

NB083 NEUTRON ACER TENDL-2021 LIBRARY; T=293.6K
Neutron emission for (n,n*)p

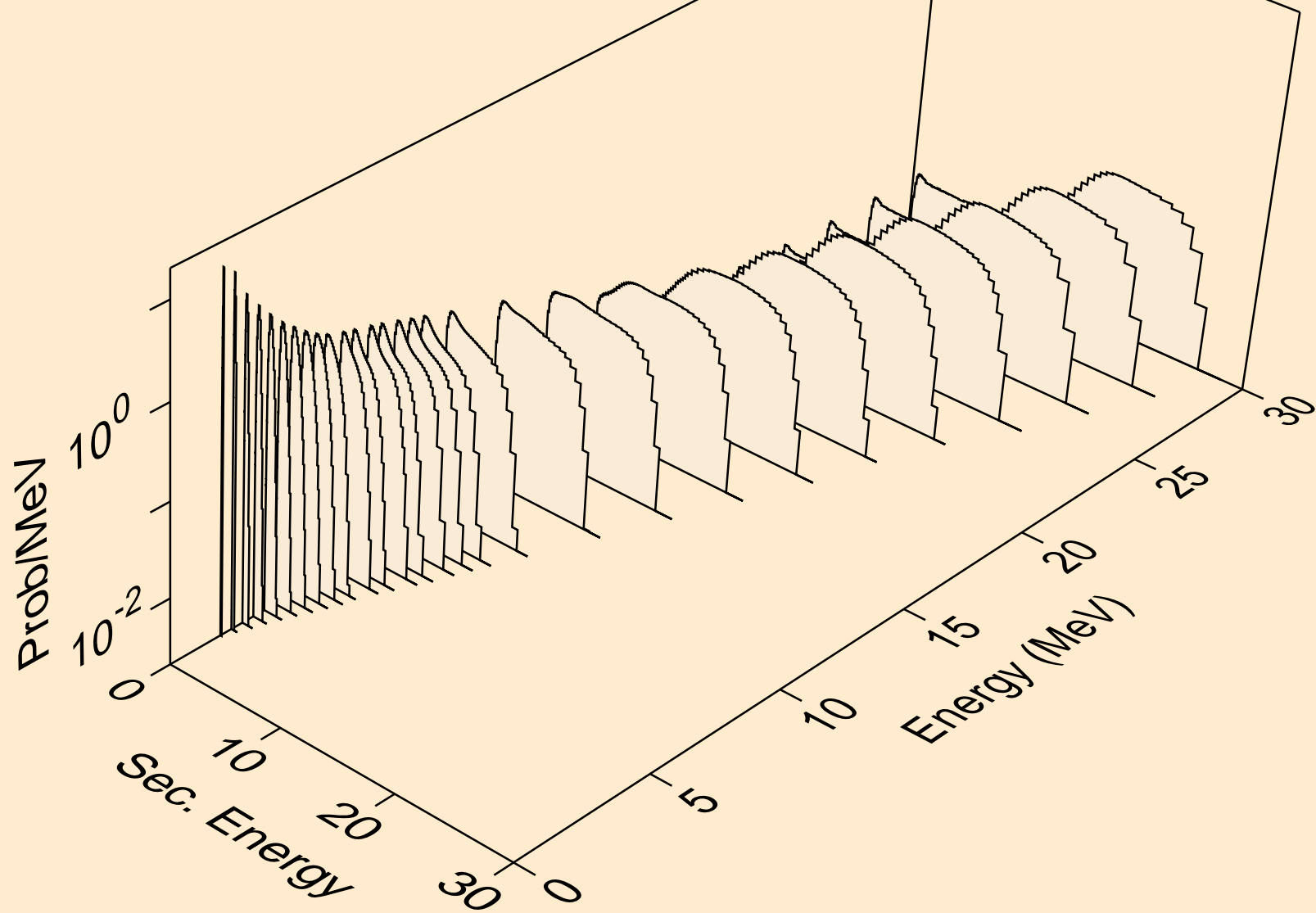

NB083 NEUTRON ACER TENDL-2021 LIBRARY; T=293.6K
Neutron emission for (n,n*)2a

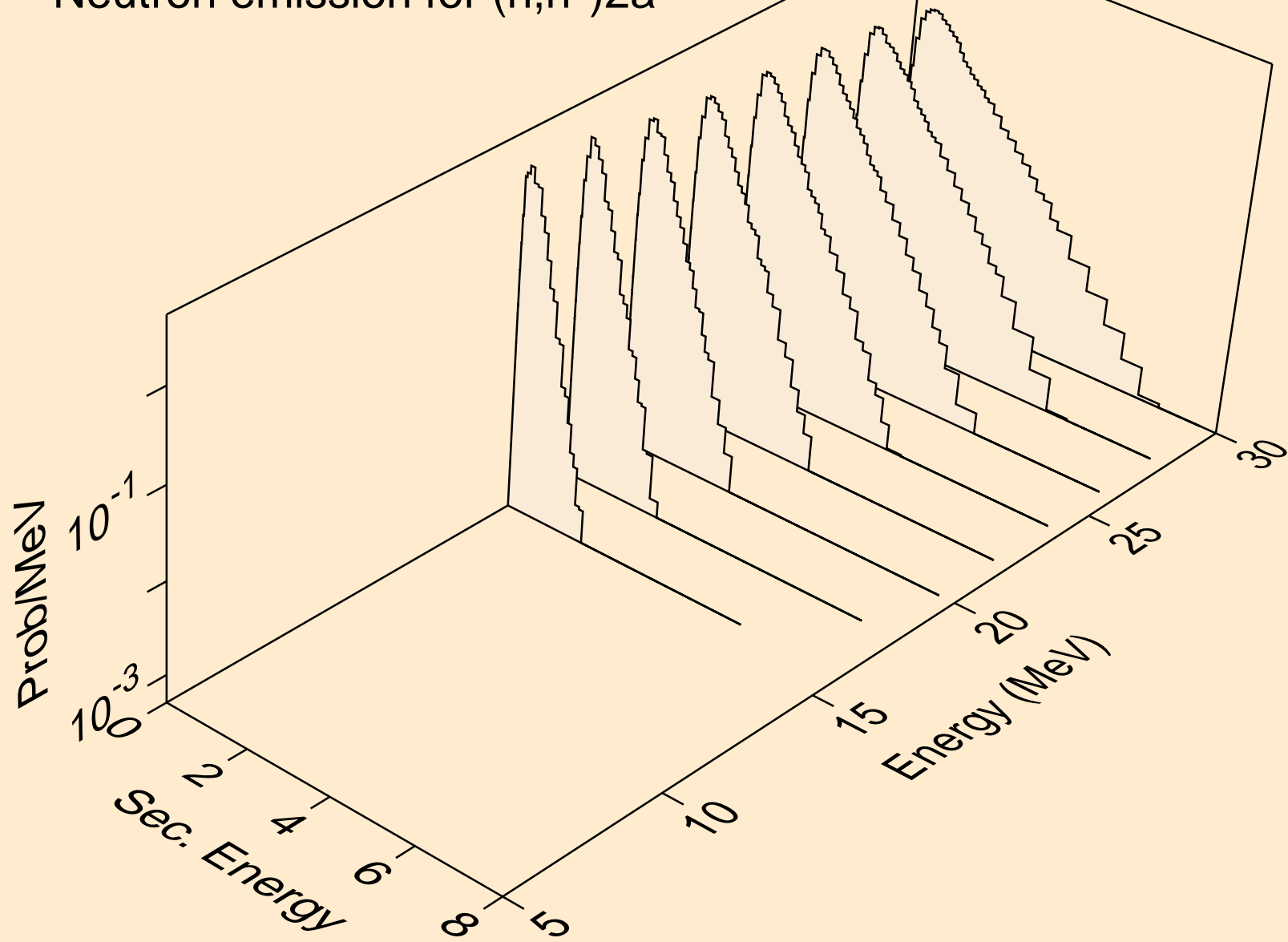

NB083 NEUTRON ACER TENDL-2021 LIBRARY; T=293.6K
Neutron emission for (n,n*)d

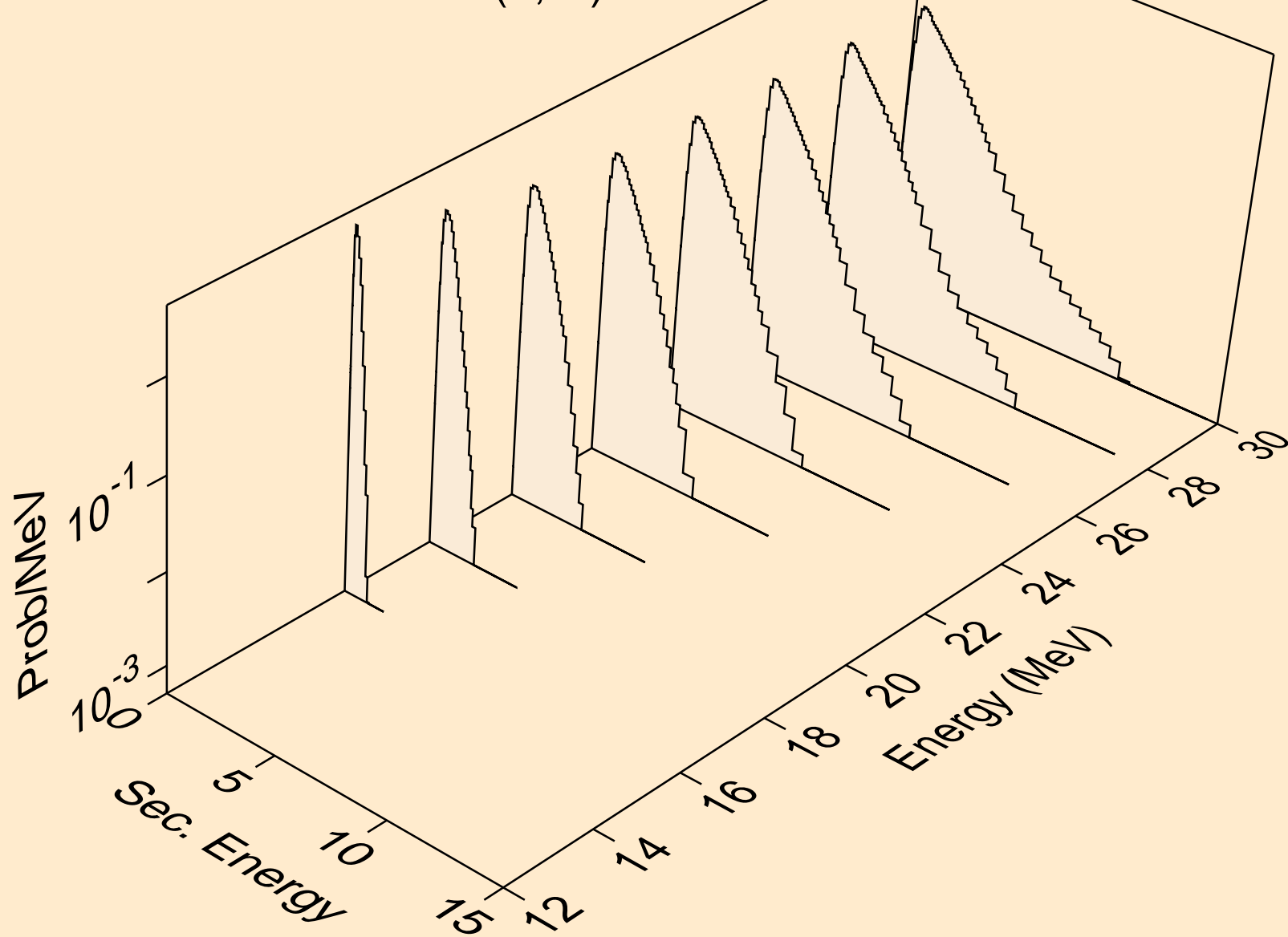

NB083 NEUTRON ACER TENDL-2021 LIBRARY; T=293.6K
Neutron emission for (n,n*)t

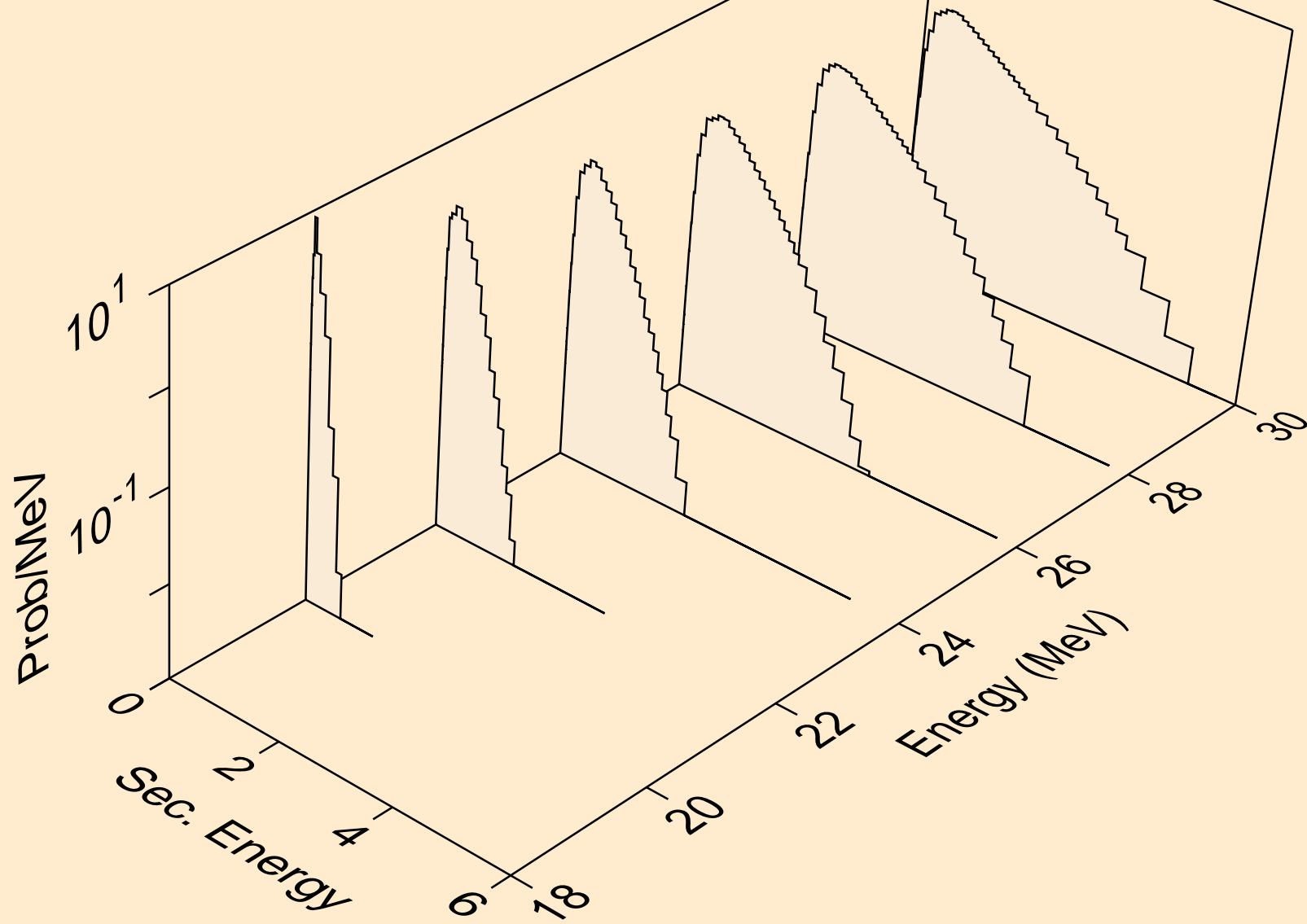

NB083 NEUTRON ACER TENDL-2021 LIBRARY; T=293.6K
Neutron emission for (n,n*)he3

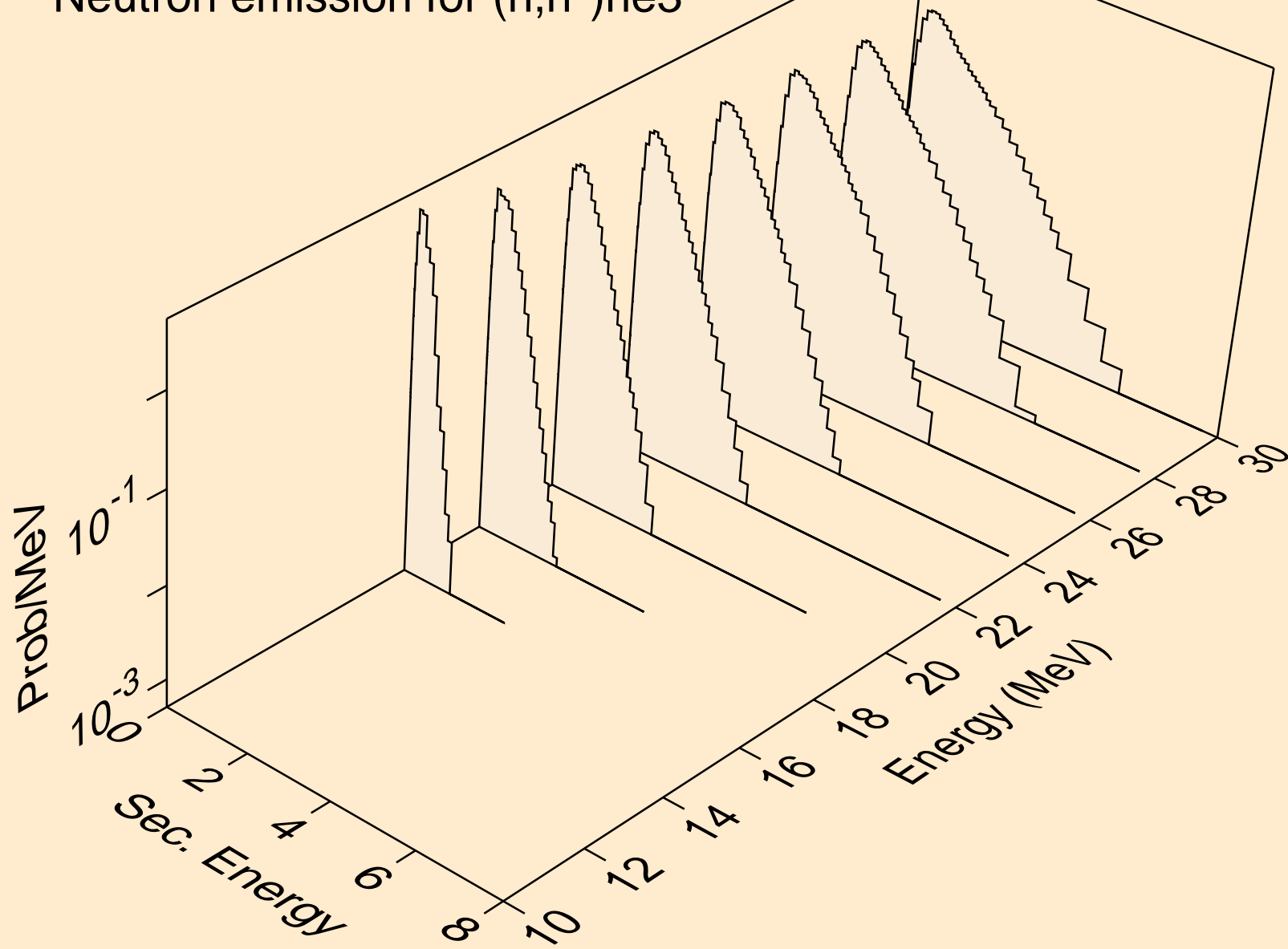

NB083 NEUTRON ACER TENDL-2021 LIBRARY; T=293.6K
Neutron emission for (n,2np)

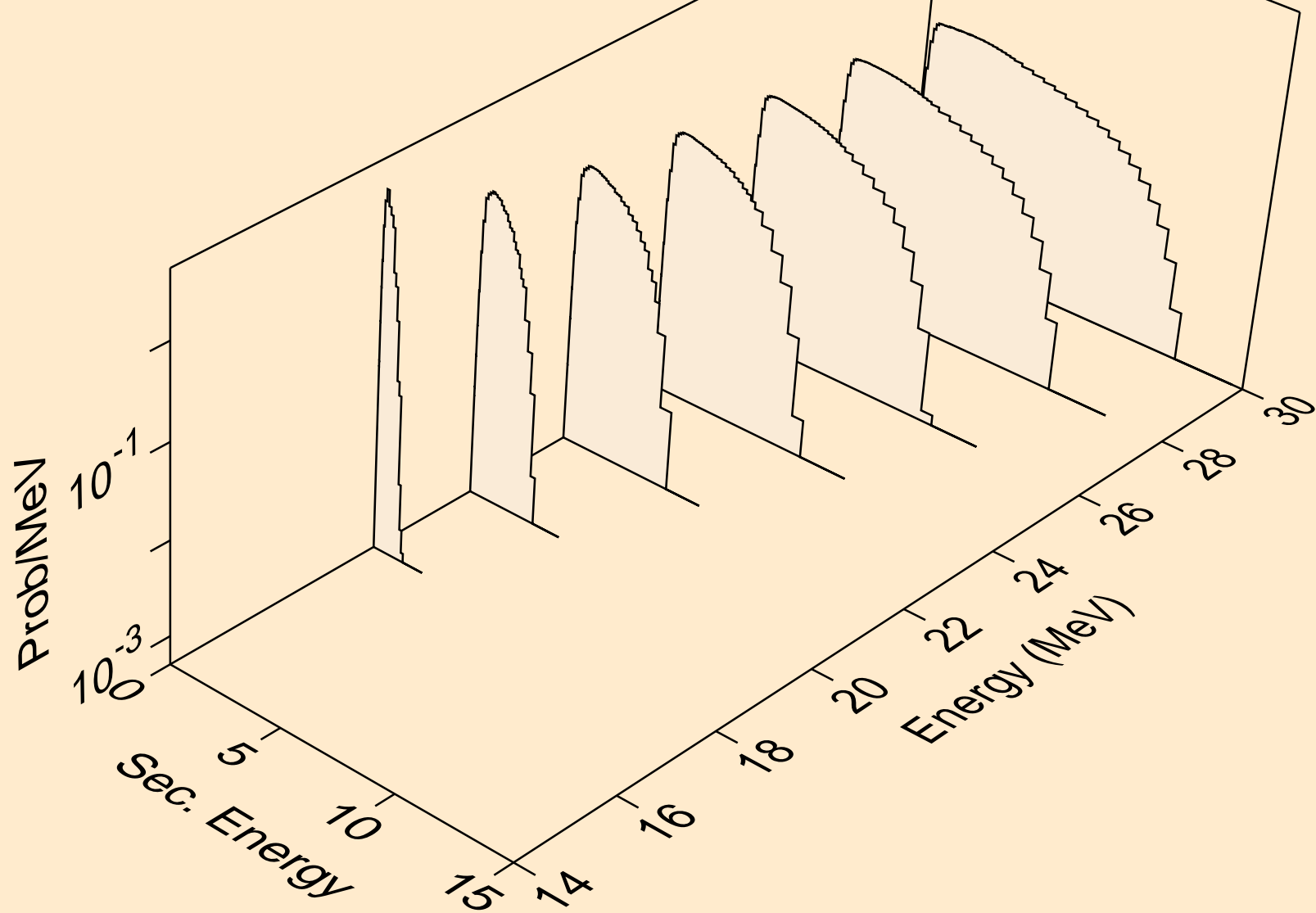

NB083 NEUTRON ACER TENDL-2021 LIBRARY; T=293.6K
Neutron emission for (n,3np)

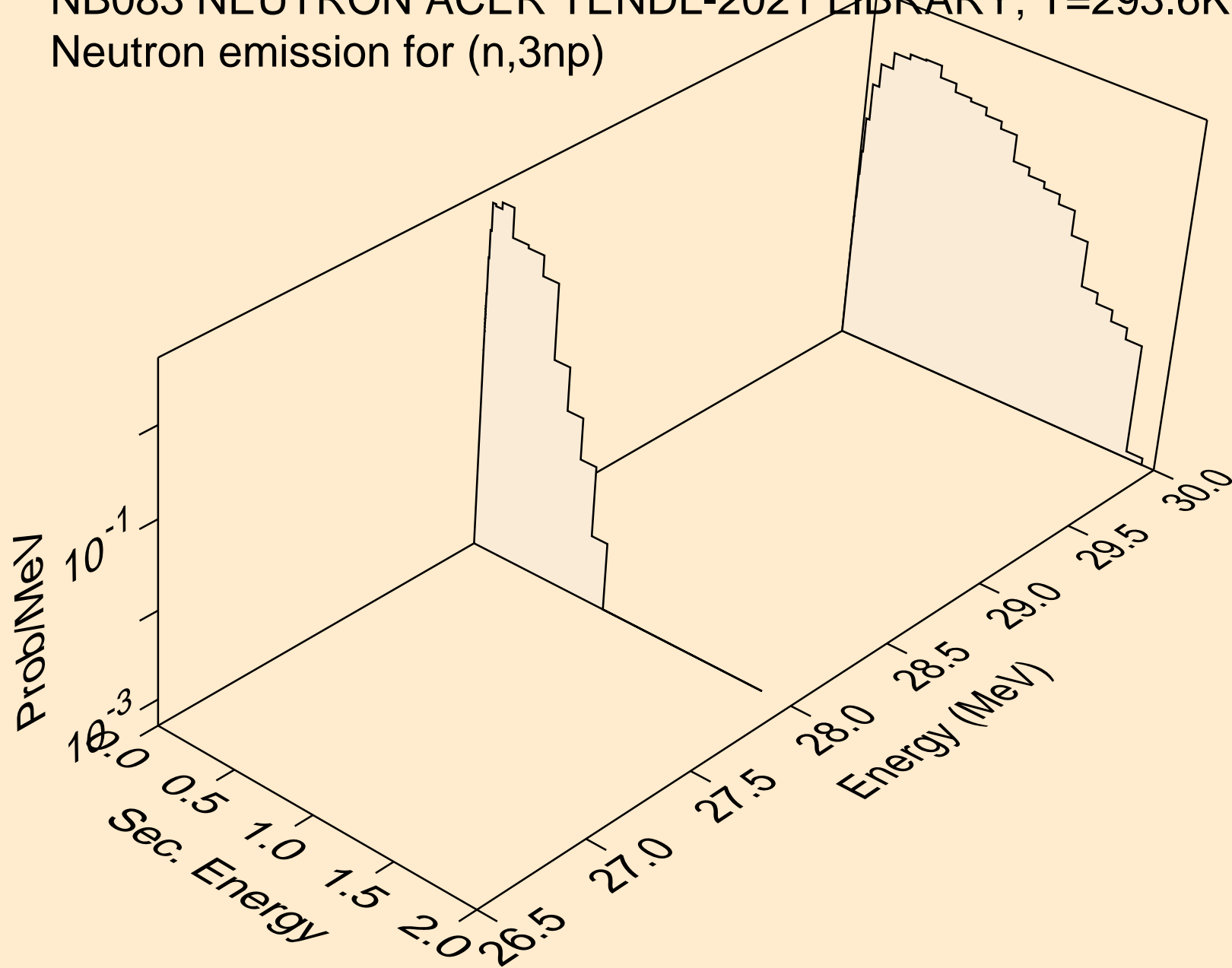

NB083 NEUTRON ACER TENDL-2021 LIBRARY; T=293.6K
Neutron emission for (n,2np)

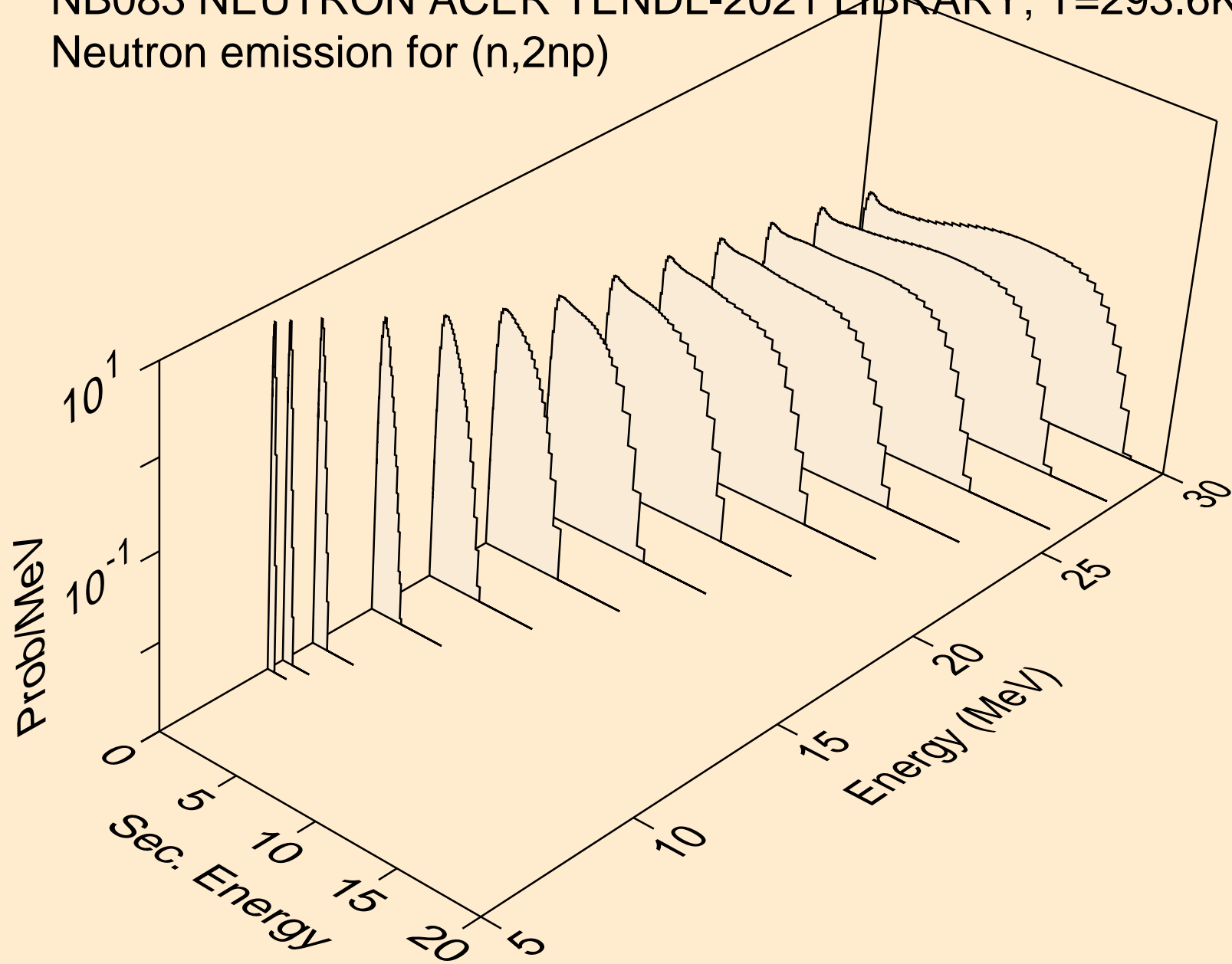

NB083 NEUTRON ACER TENDL-2021 LIBRARY; T=293.6K
Neutron emission for (n,npa)

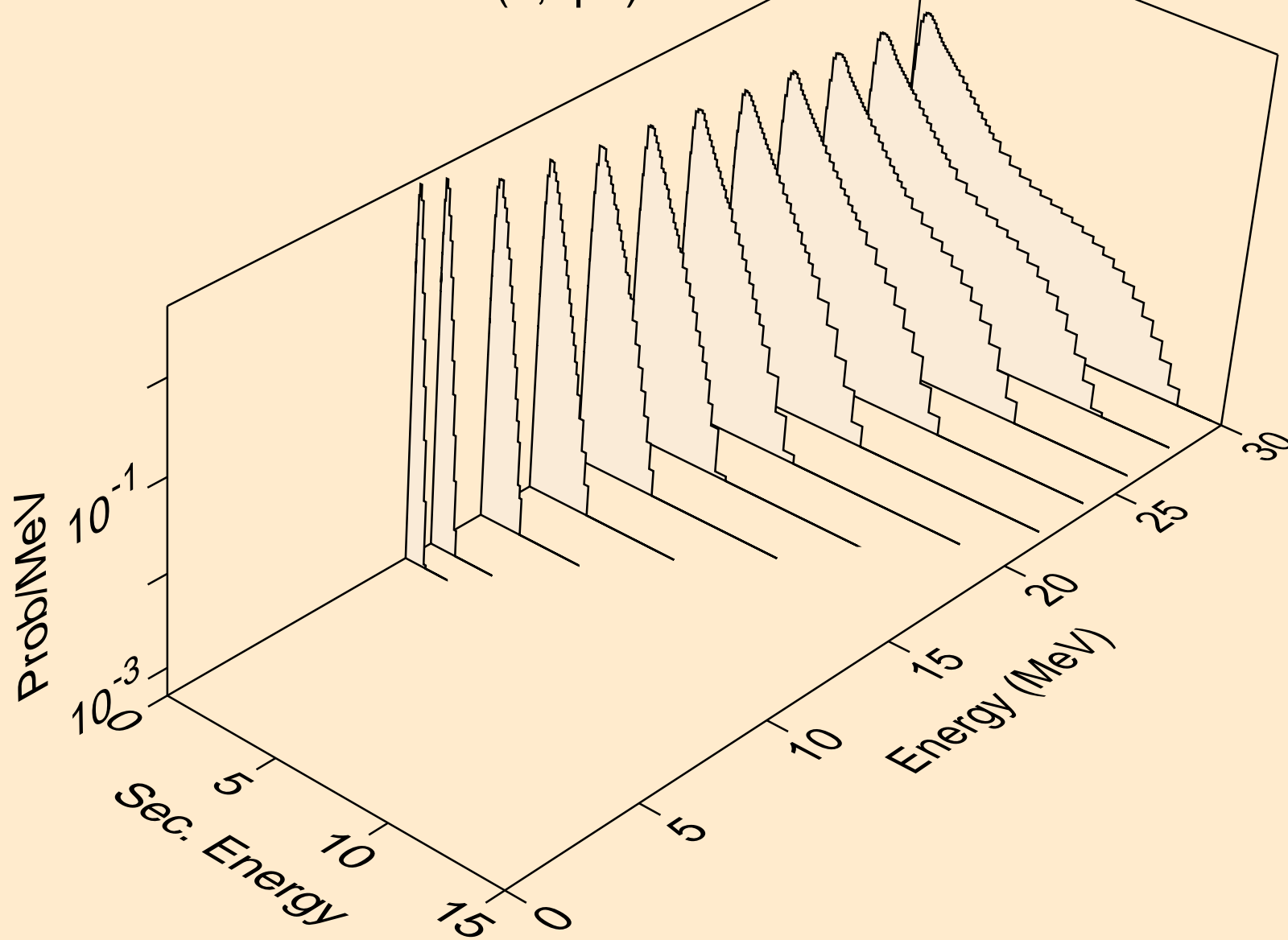

NB083 NEUTRON ACER TENDL-2021 LIBRARY; T=293.6K
Neutron emission for (n,n*c)

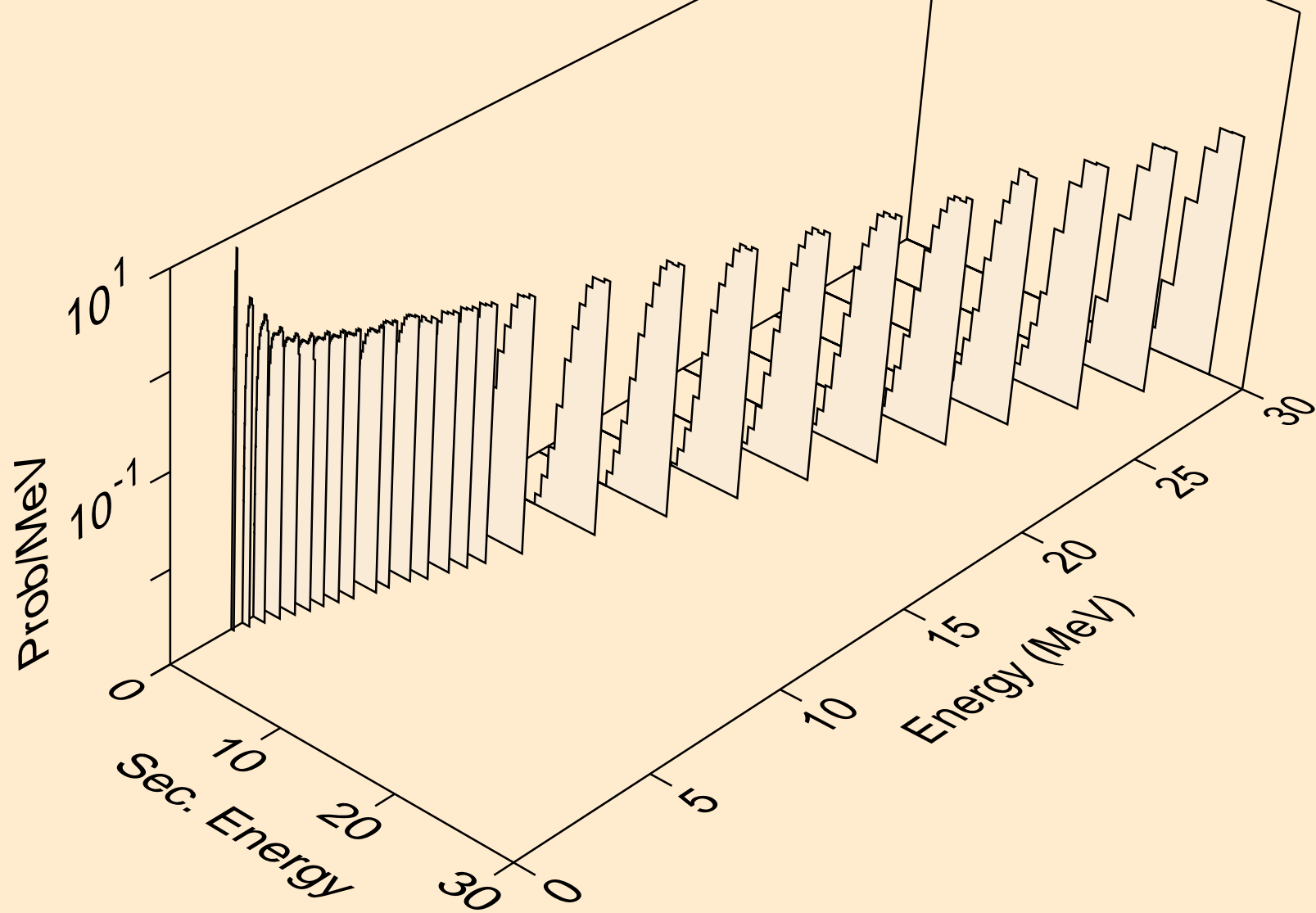

NB083 NEUTRON ACER TENDL-2021 LIBRARY; T=293.6K
Photon emission for (n,x)

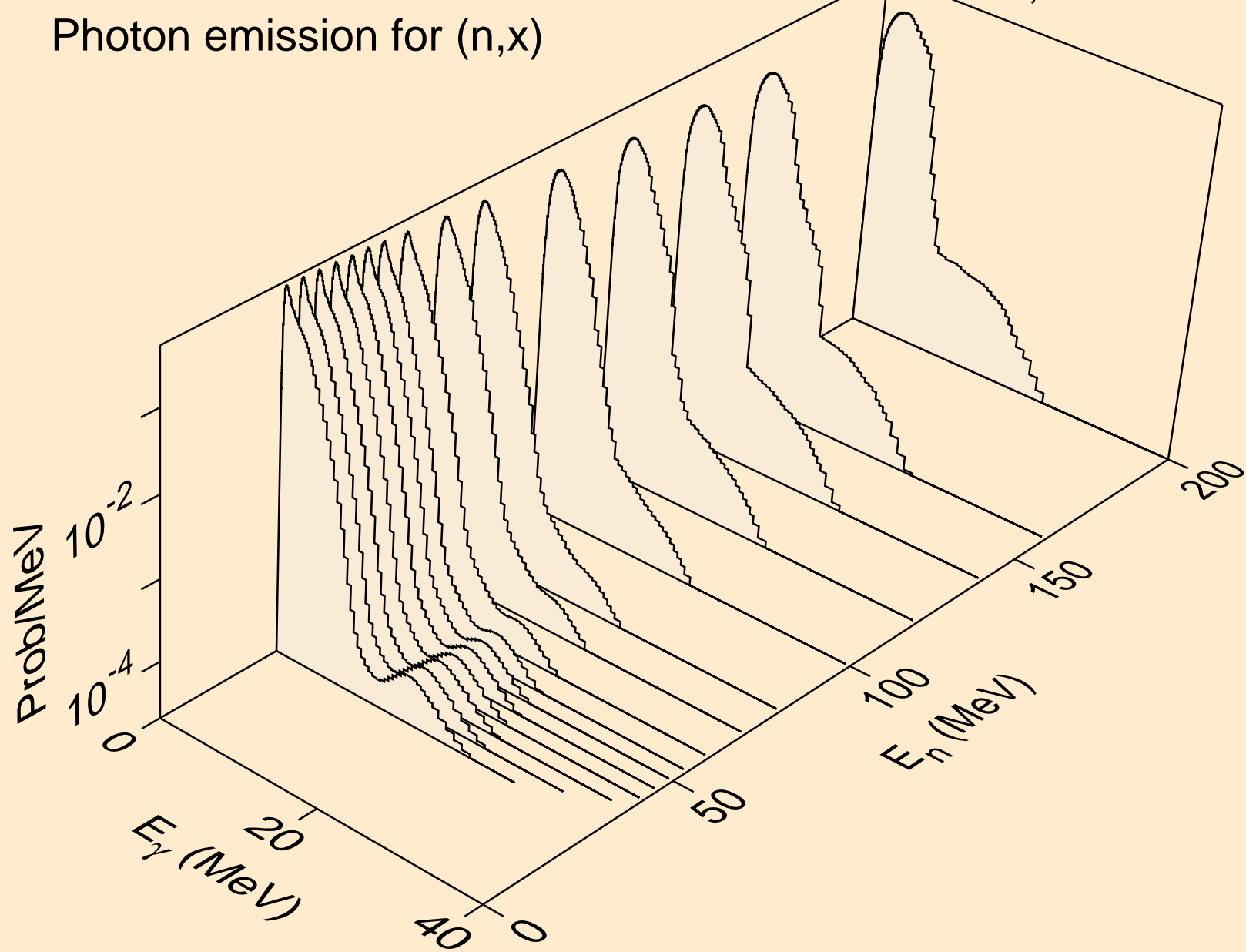

NB083 NEUTRON ACER TENDL-2021 LIBRARY; T=293.6K
Photon emission for (n,2nd)

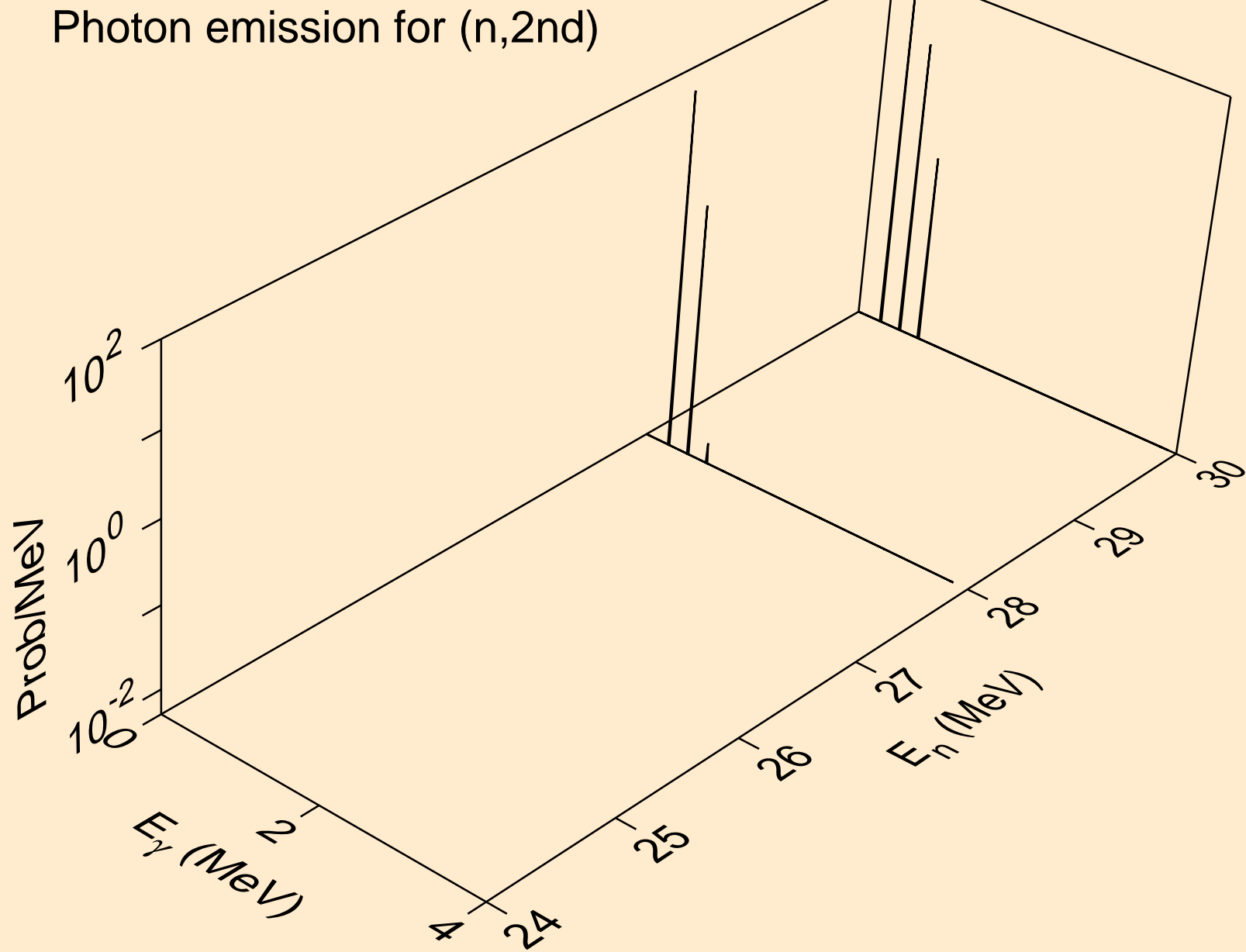

NB083 NEUTRON ACER TENDL-2021 LIBRARY; T=293.6K
Photon emission for (n,2n)

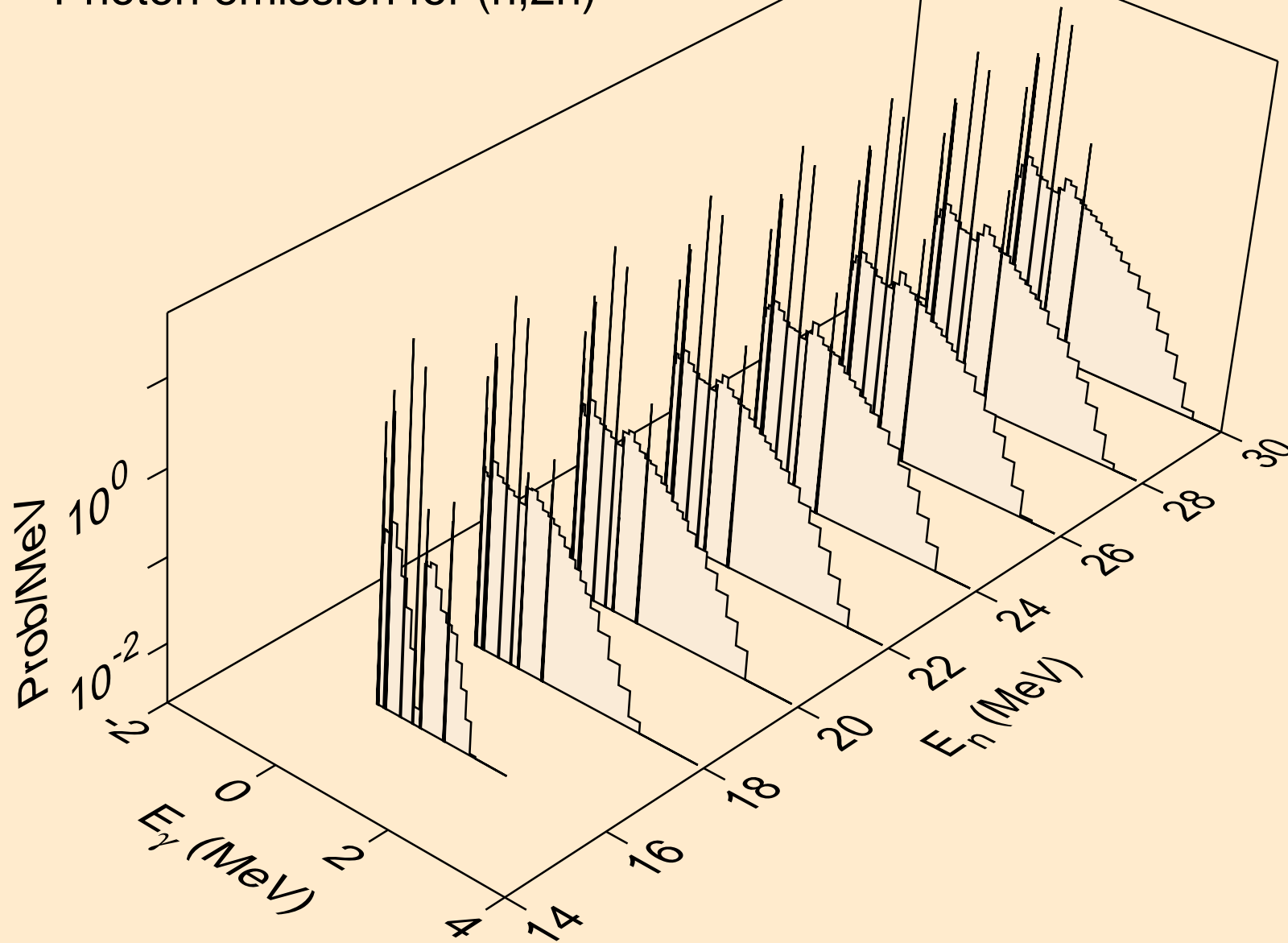

NB083 NEUTRON ACER TENDL-2021 LIBRARY; T=293.6K
Photon emission for (n,3n)

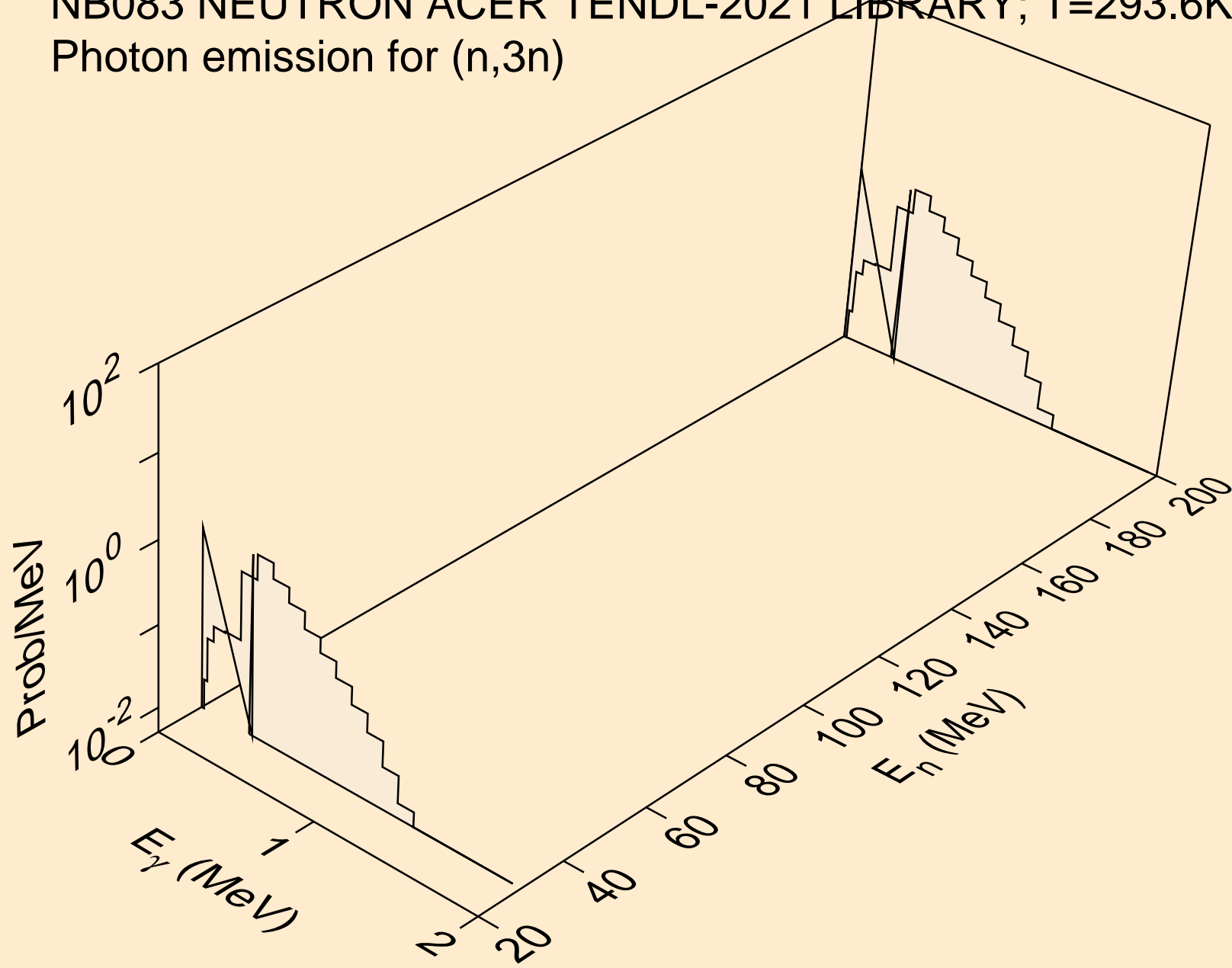

NB083 NEUTRON ACER TENDL-2021 LIBRARY; T=293.6K
Photon emission for (n,n*)a

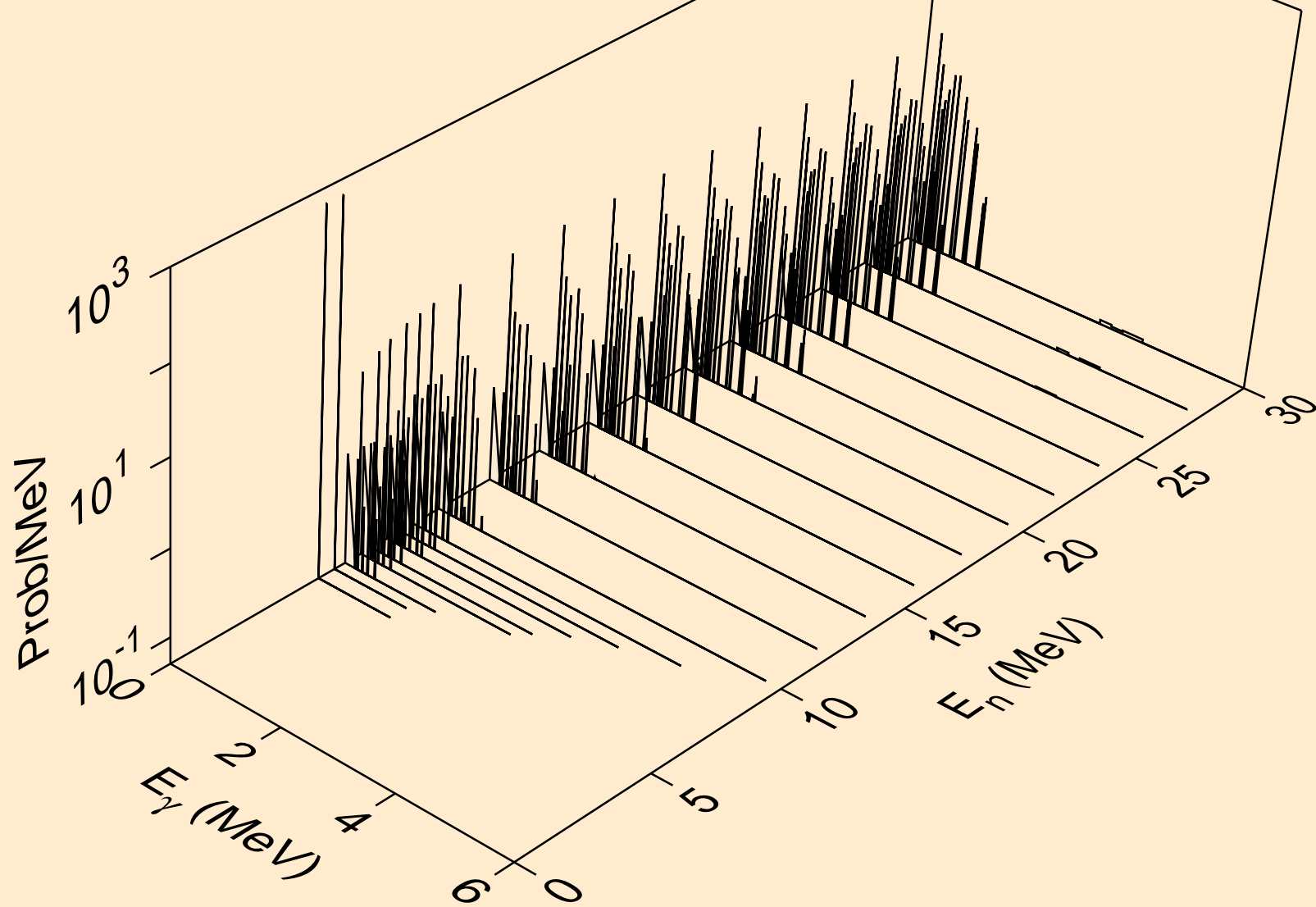

NB083 NEUTRON ACER TENDL-2021 LIBRARY; T=293.6K
Photon emission for (n,2n)a

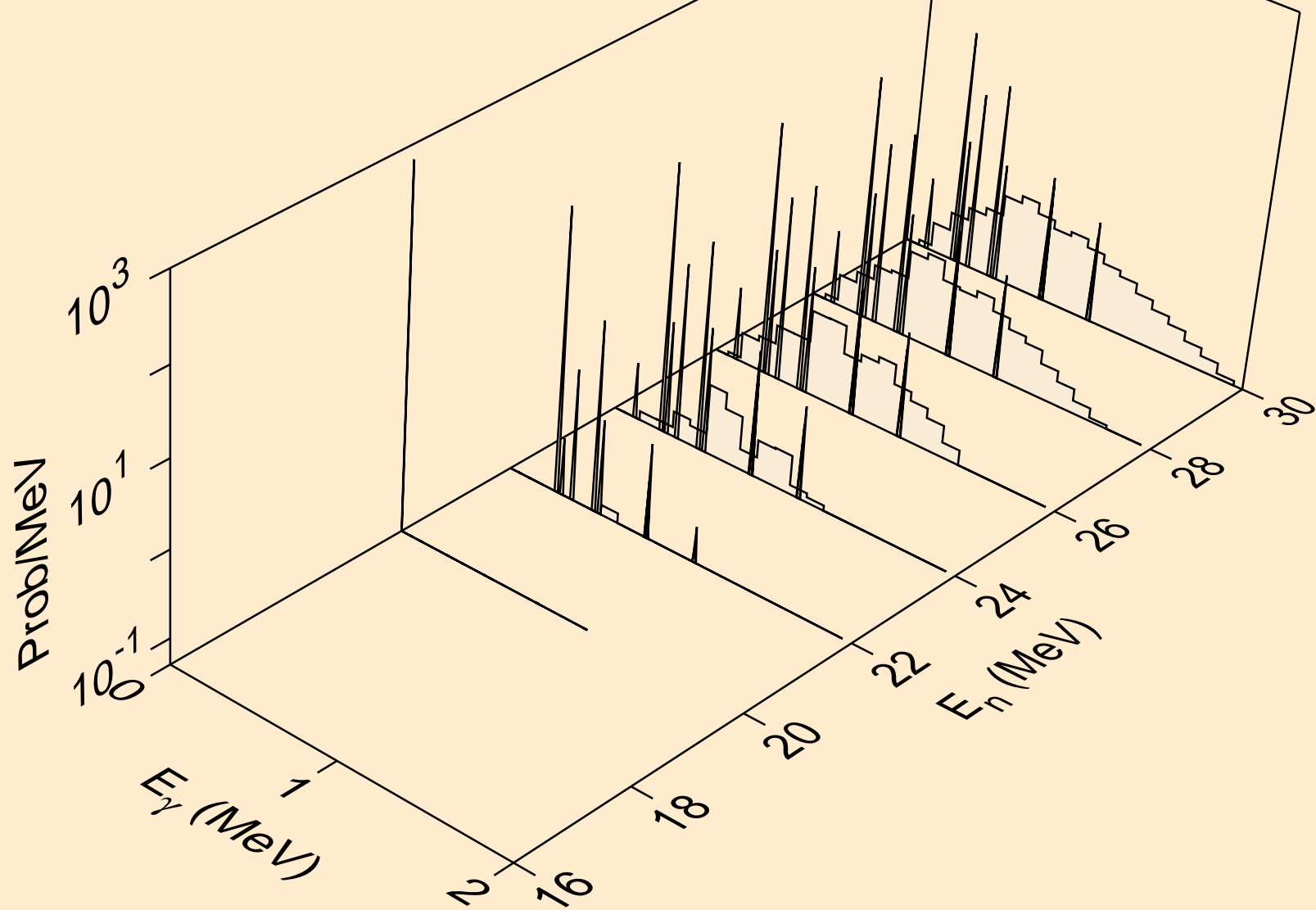

NB083 NEUTRON ACER TENDL-2021 LIBRARY; T=293.6K
Photon emission for (n,n*)p

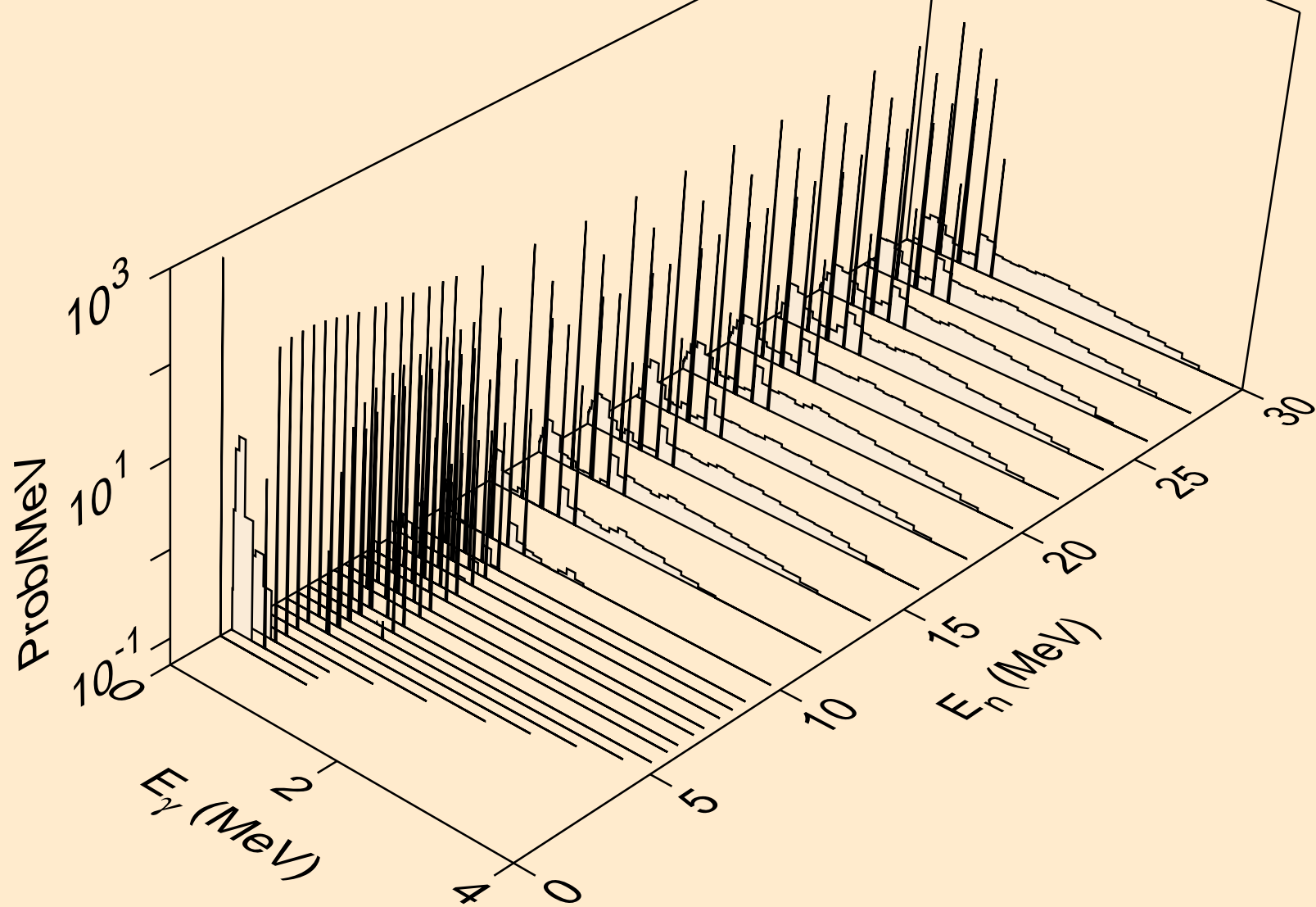

NB083 NEUTRON ACER TENDL-2021 LIBRARY; T=293.6K
Photon emission for (n,n*)2a

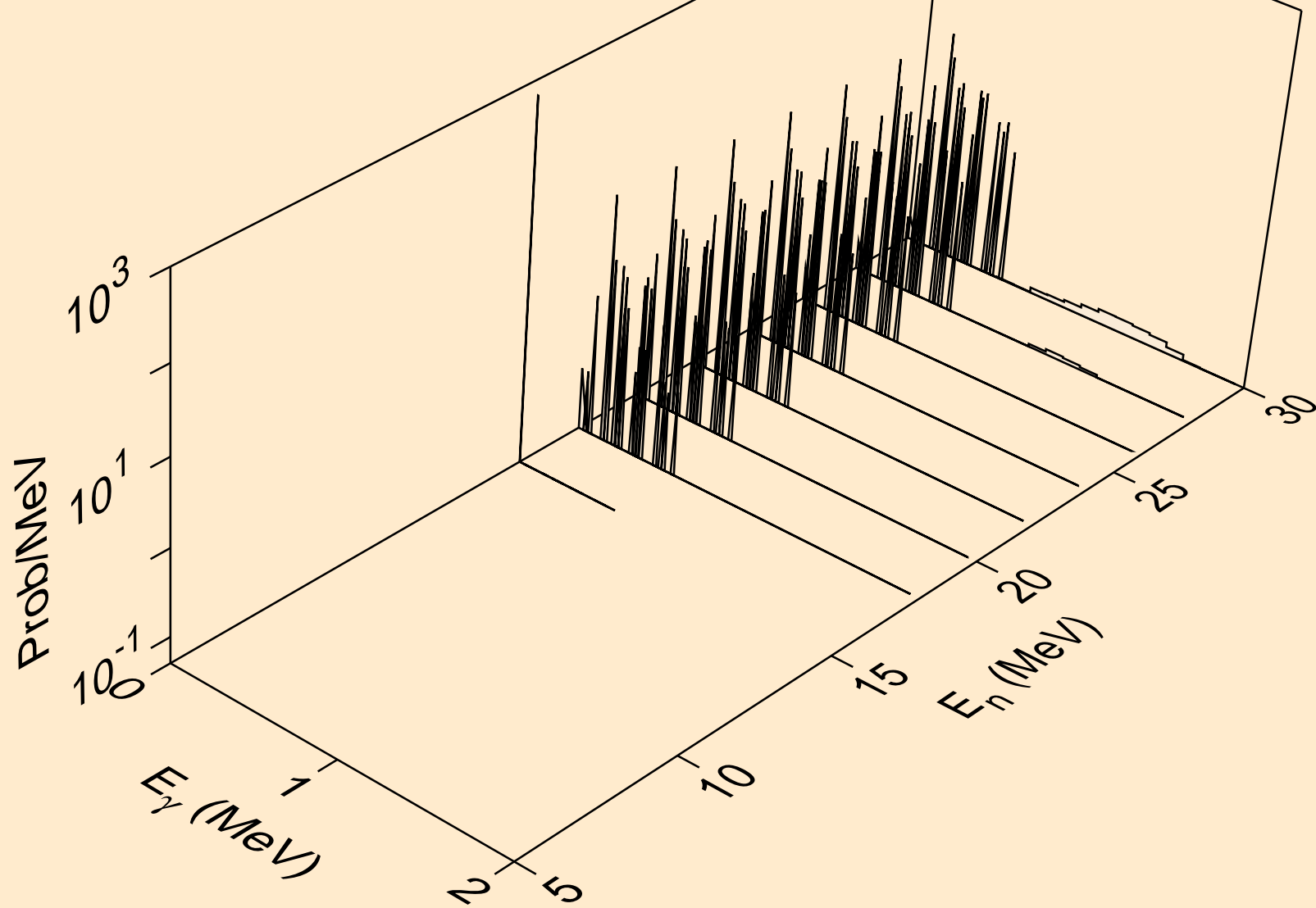

NB083 NEUTRON ACER TENDL-2021 LIBRARY; T=293.6K
Photon emission for (n,n*)d

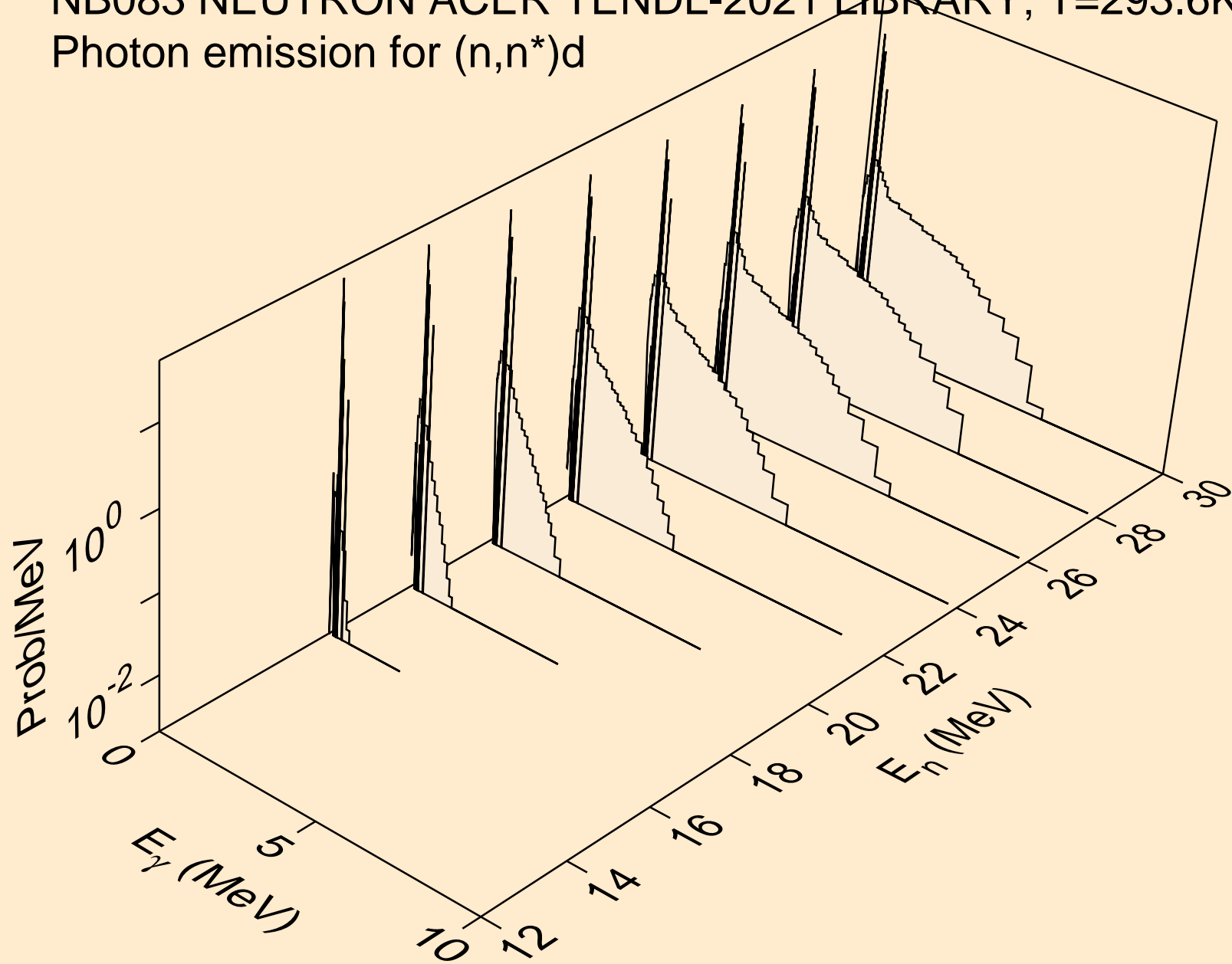

NB083 NEUTRON ACER TENDL-2021 LIBRARY; T=293.6K
Photon emission for (n,n*)t

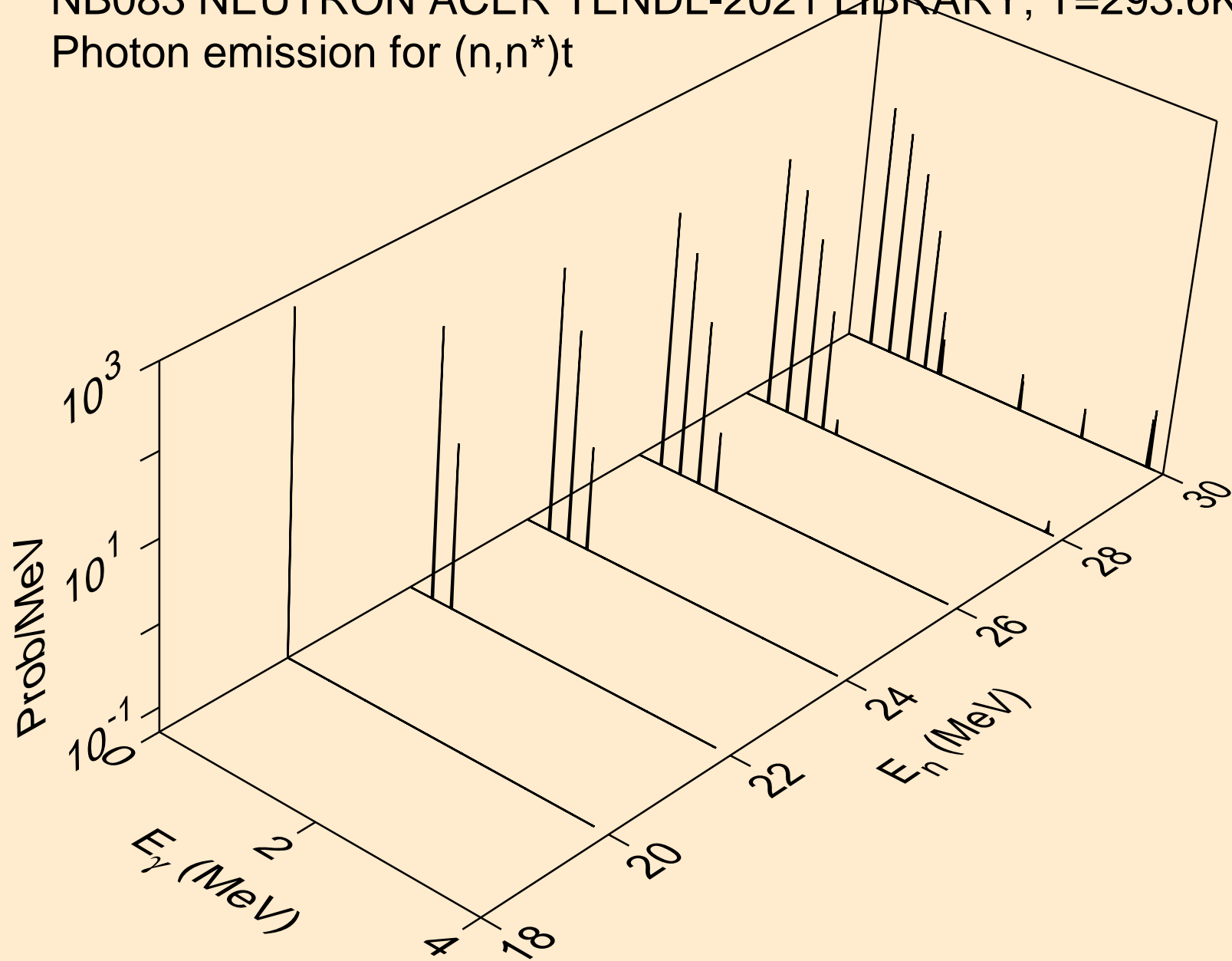

NB083 NEUTRON ACER TENDL-2021 LIBRARY; T=293.6K
Photon emission for (n,n*)he3

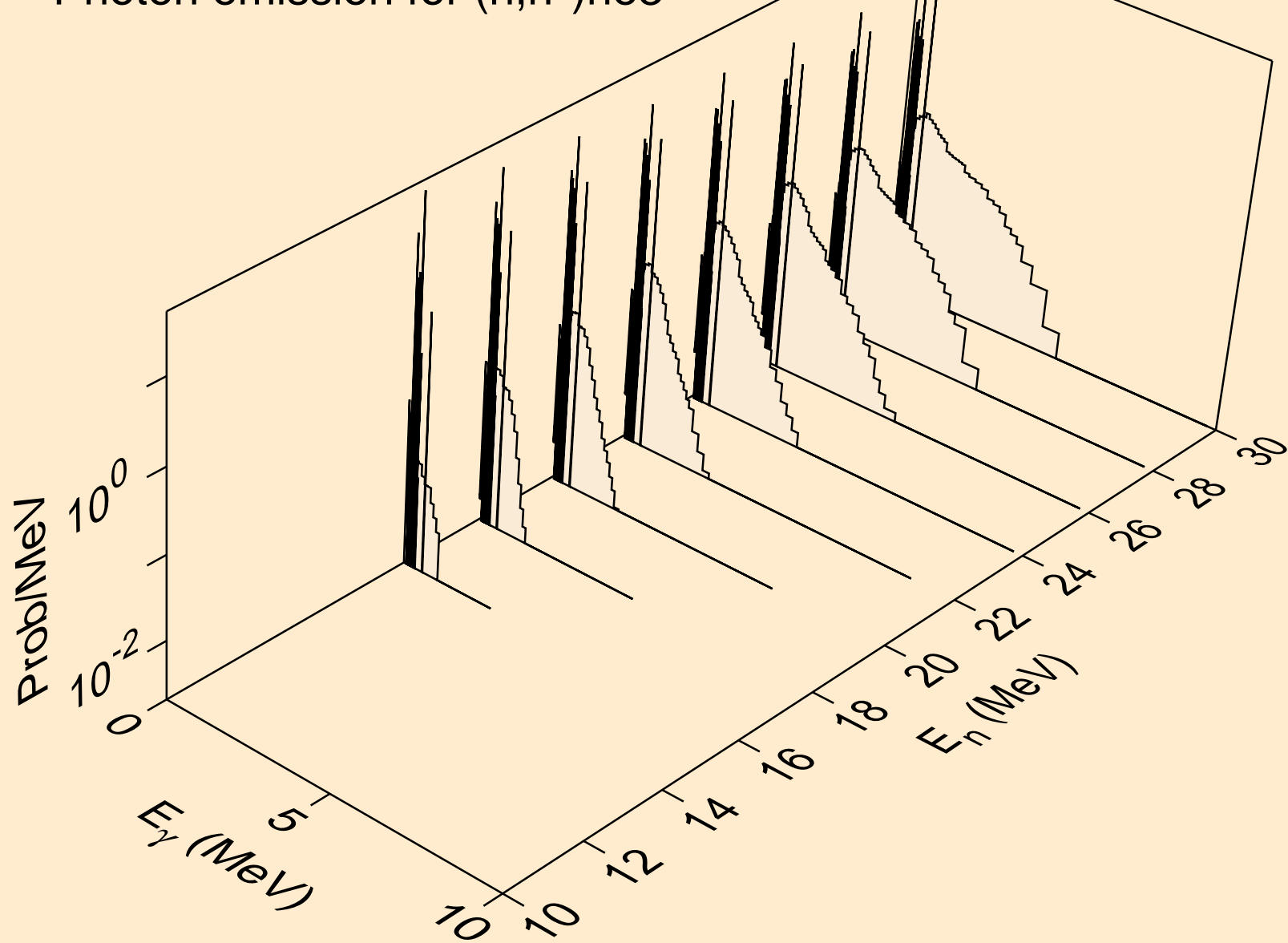

NB083 NEUTRON ACER TENDL-2021 LIBRARY; T=293.6K
Photon emission for (n,2np)

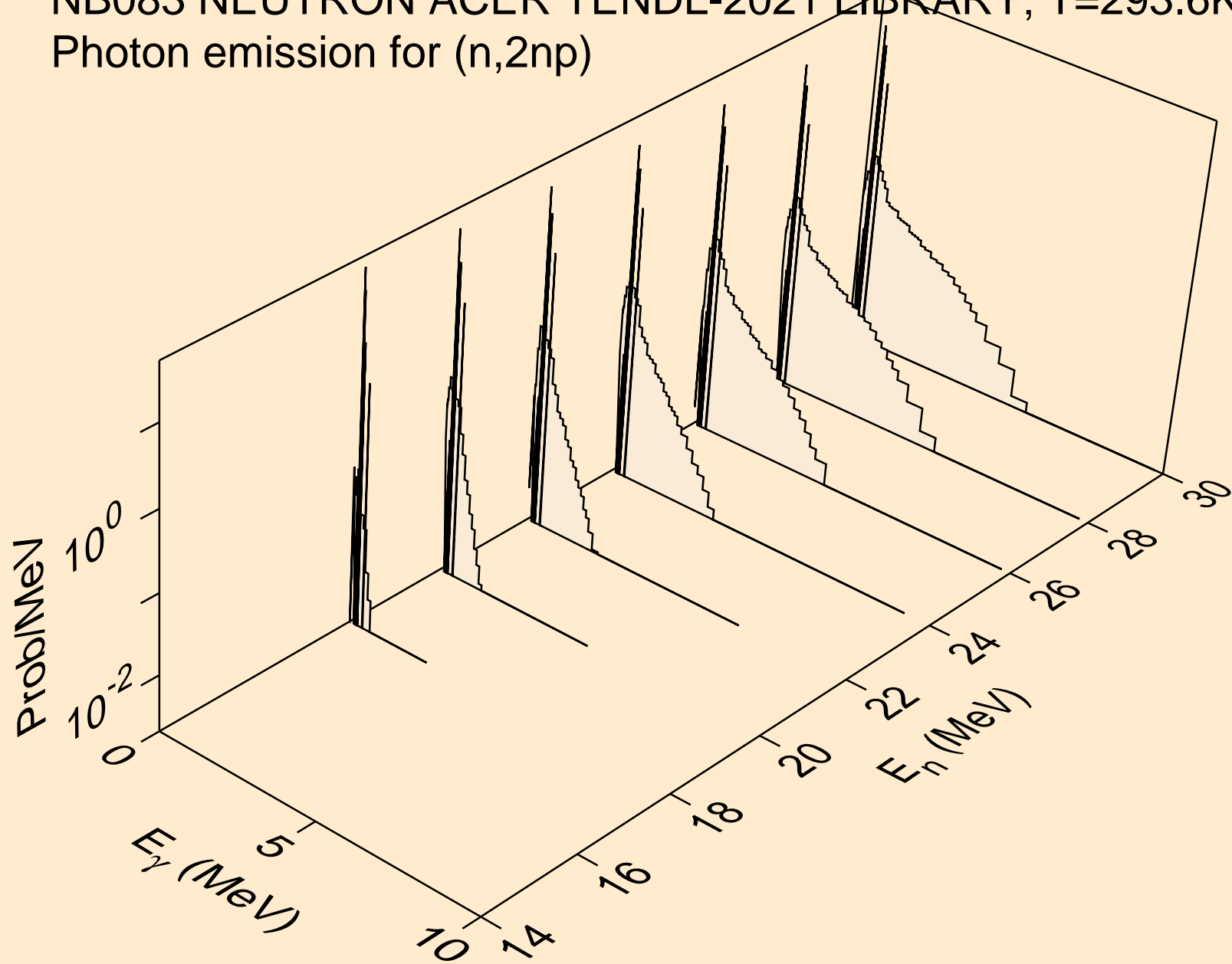

NB083 NEUTRON ACER TENDL-2021 LIBRARY; T=293.6K
Photon emission for (n,3np)

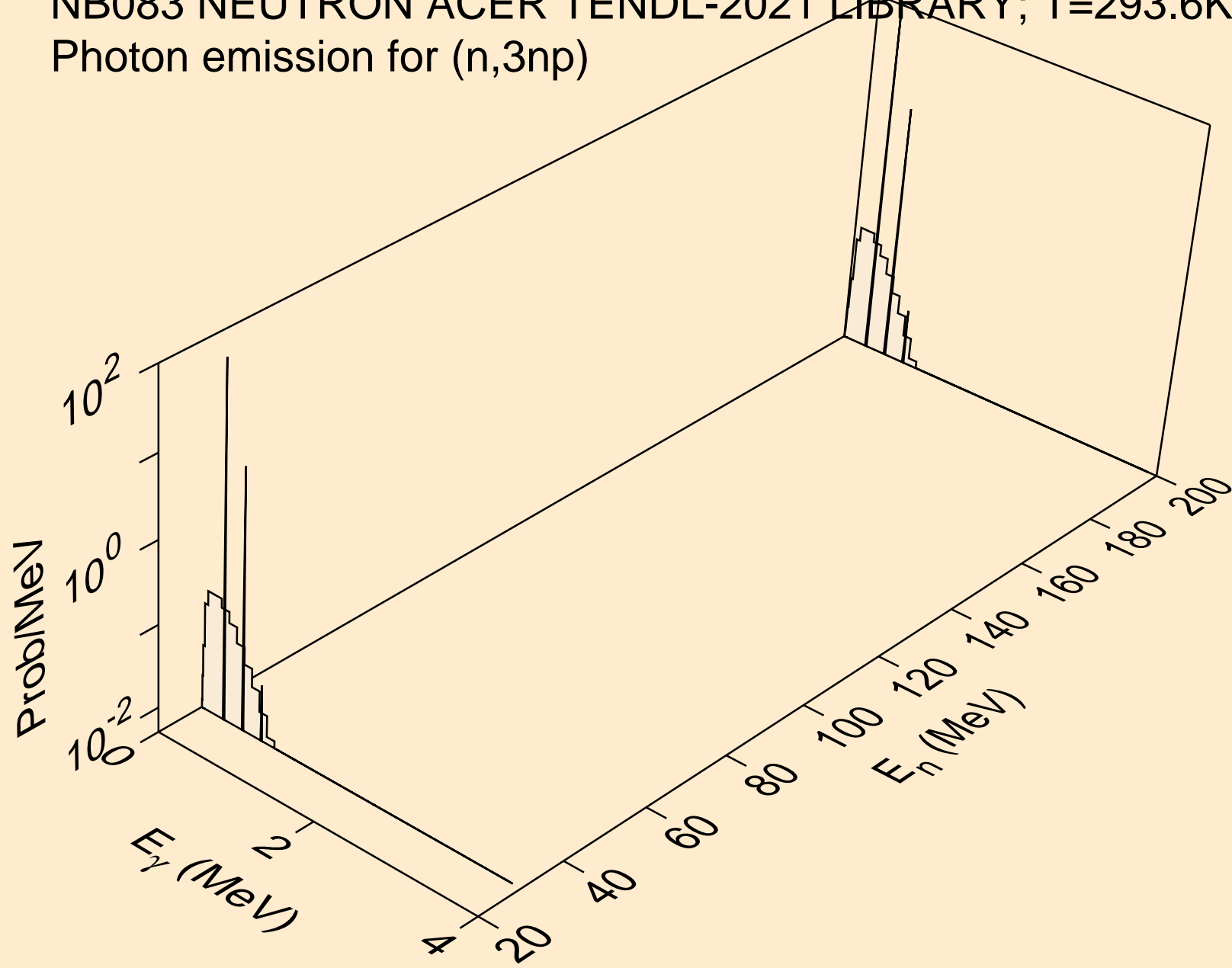

NB083 NEUTRON ACER TENDL-2021 LIBRARY; T=293.6K
Photon emission for (n,2np)

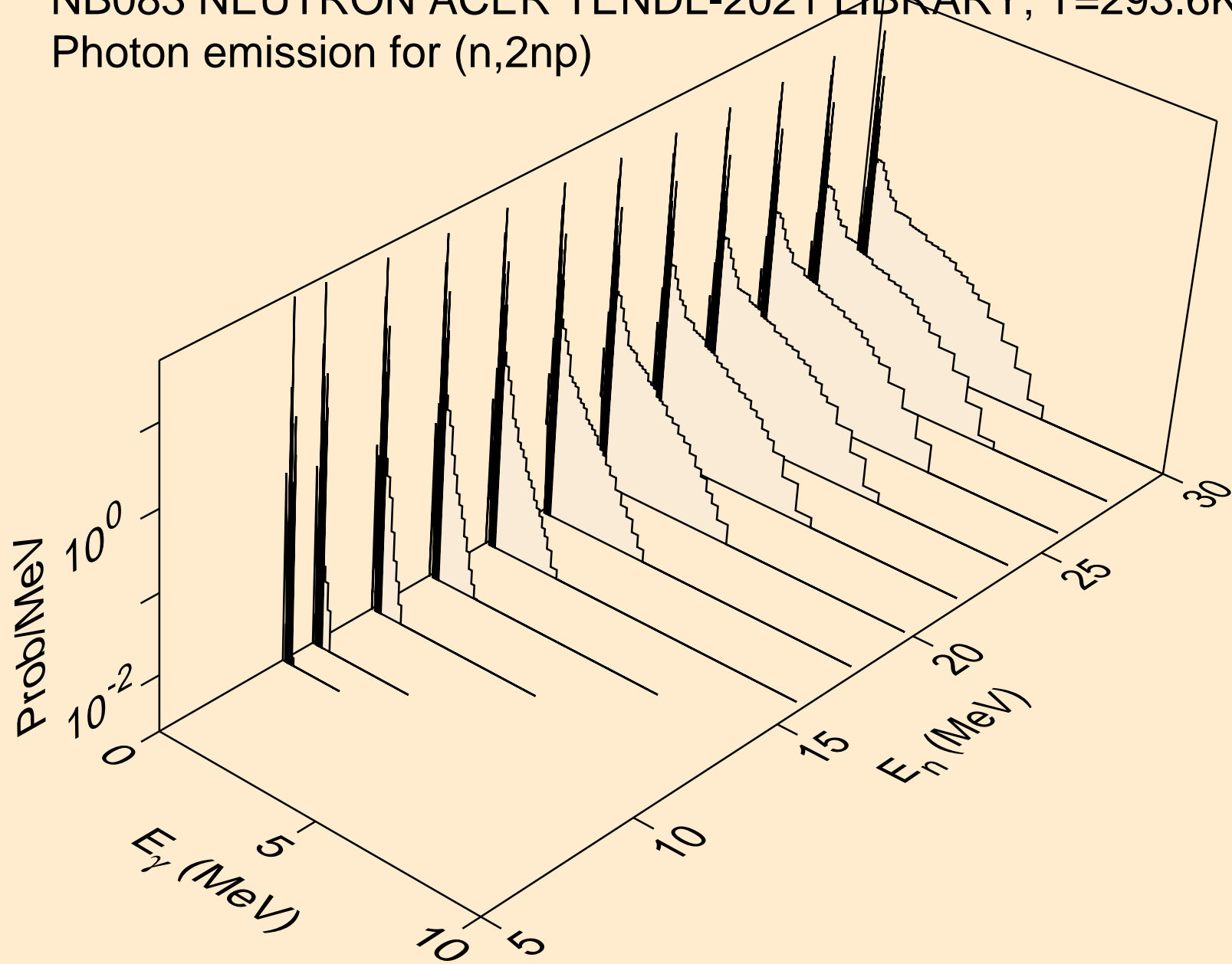

NB083 NEUTRON ACER TENDL-2021 LIBRARY; T=293.6K
Photon emission for (n,npa)

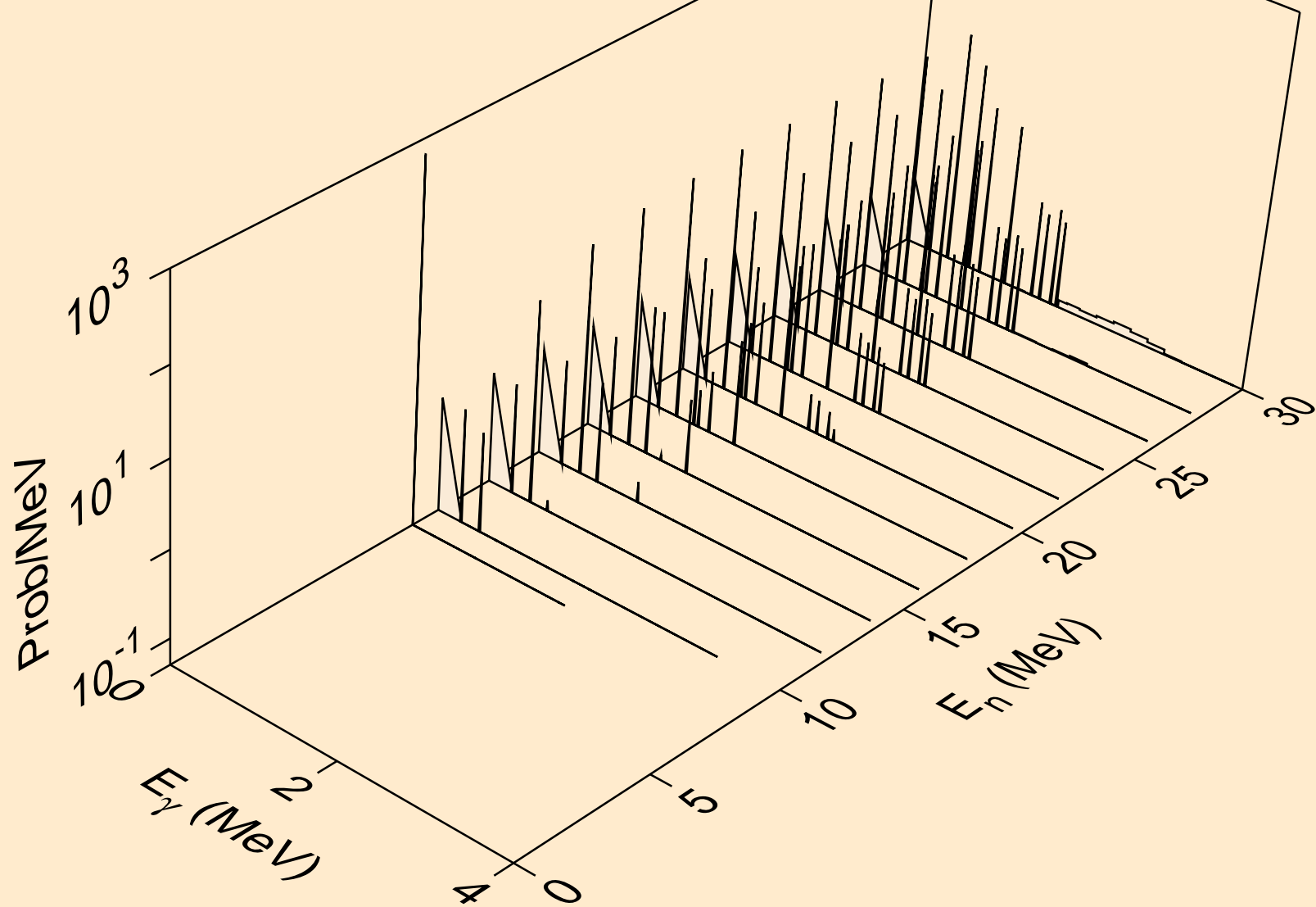

NB083 NEUTRON ACER TENDL-2021 LIBRARY; T=293.6K
Photon emission for (n,n*c)

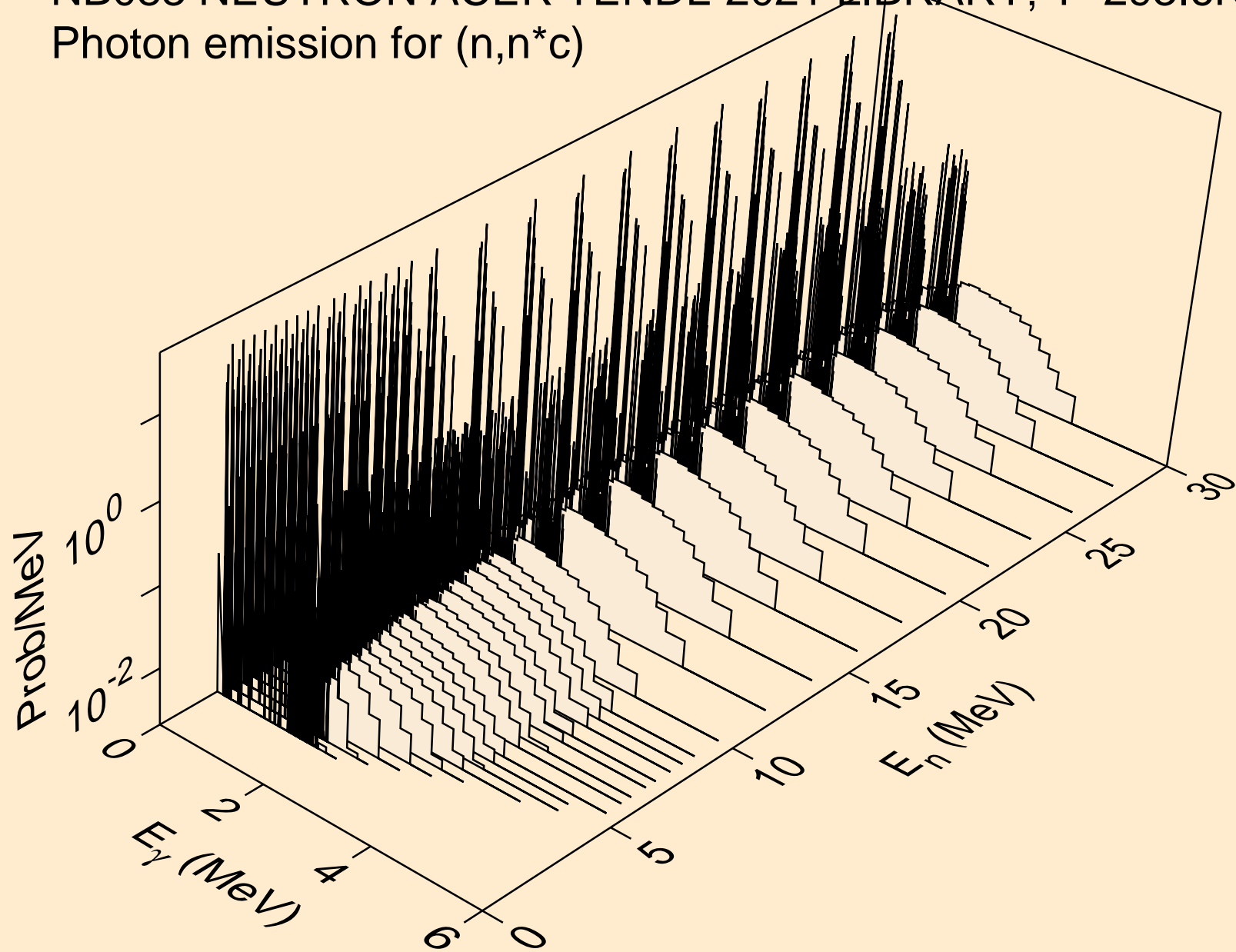

NB083 NEUTRON ACER TENDL-2021 LIBRARY; T=293.6K
Photon emission for (n,gma)

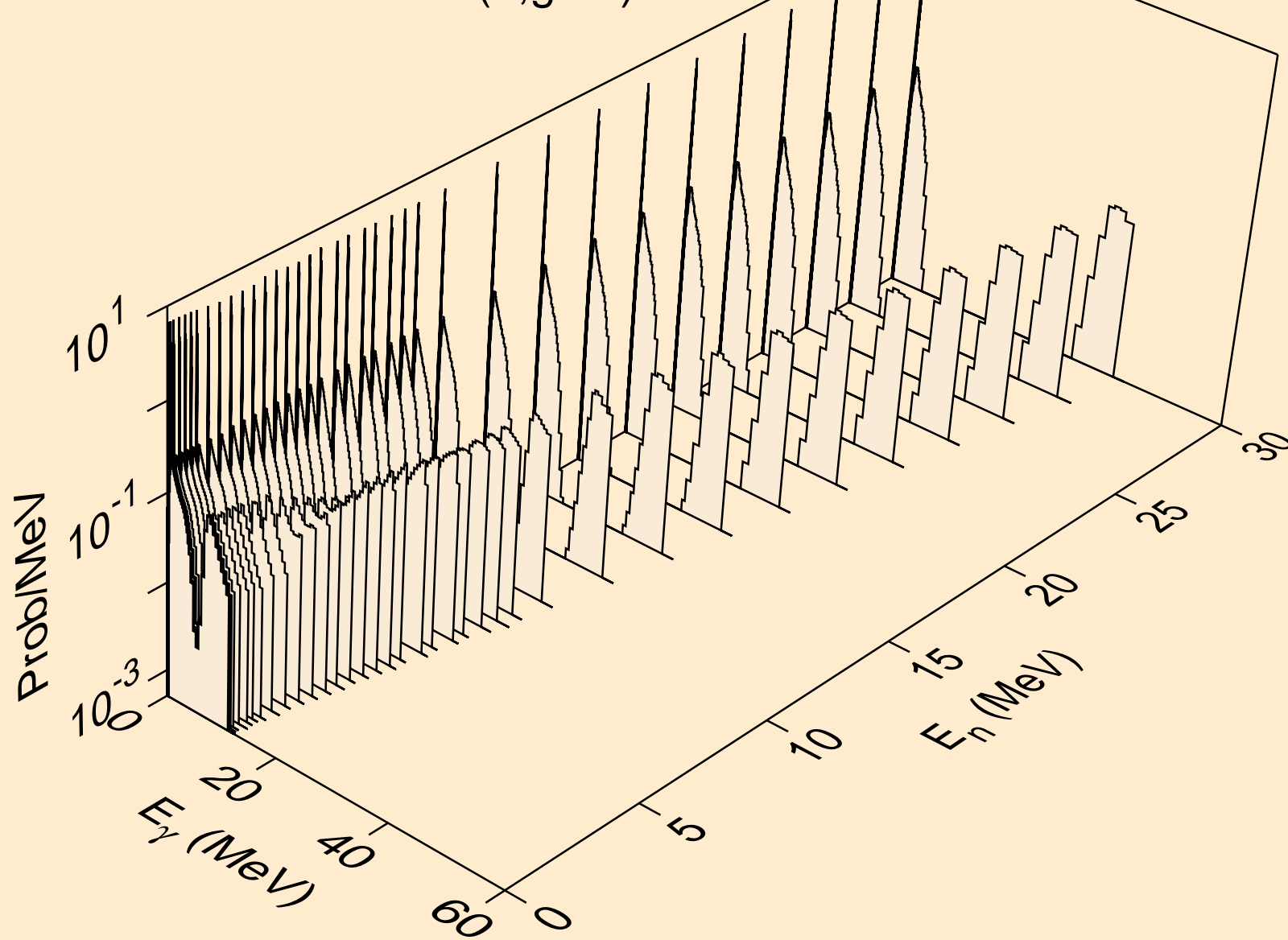

NB083 NEUTRON ACER TENDL-2021 LIBRARY; T=293.6K
Photon emission for (n,p)

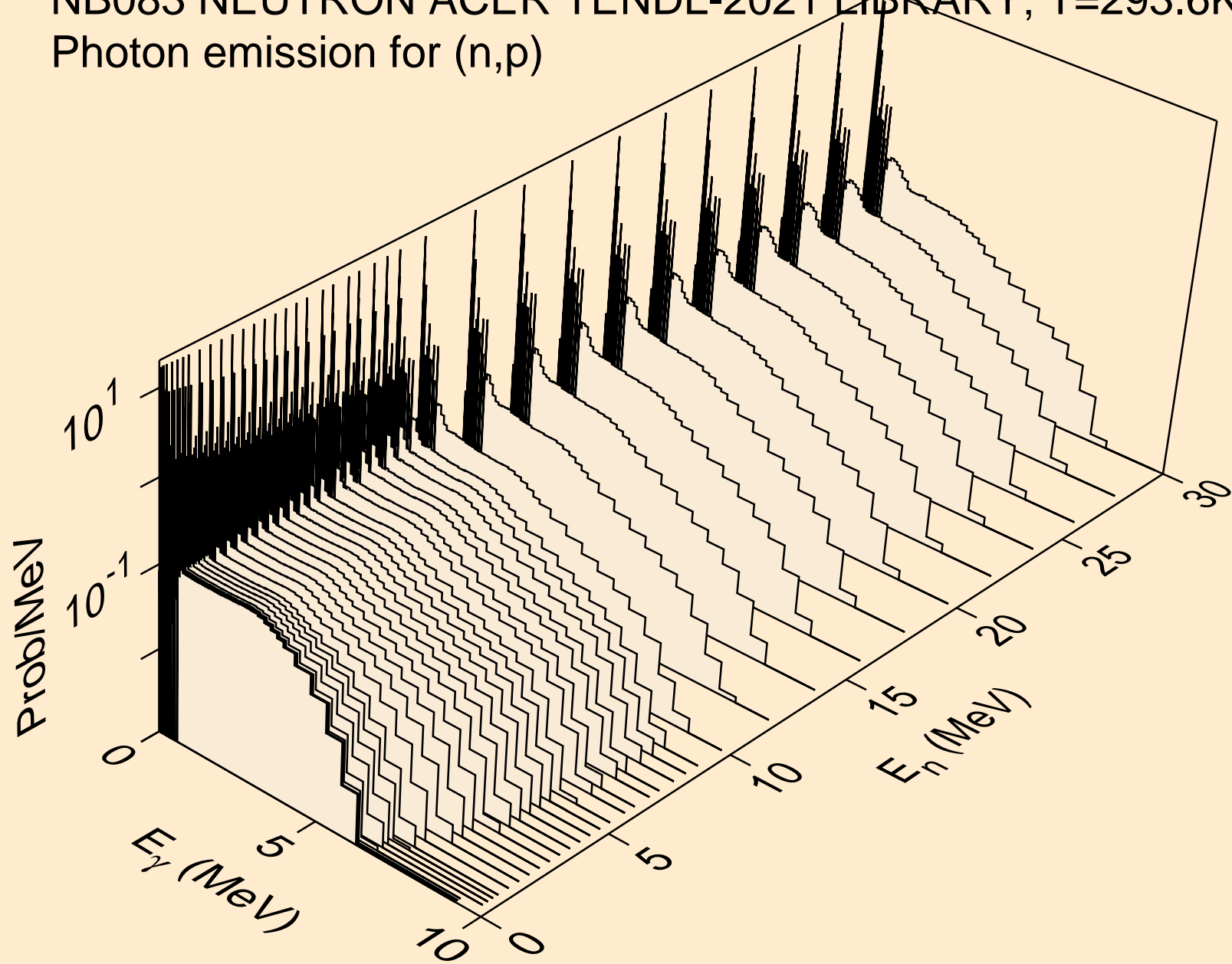

NB083 NEUTRON ACER TENDL-2021 LIBRARY; T=293.6K
Photon emission for (n,d)

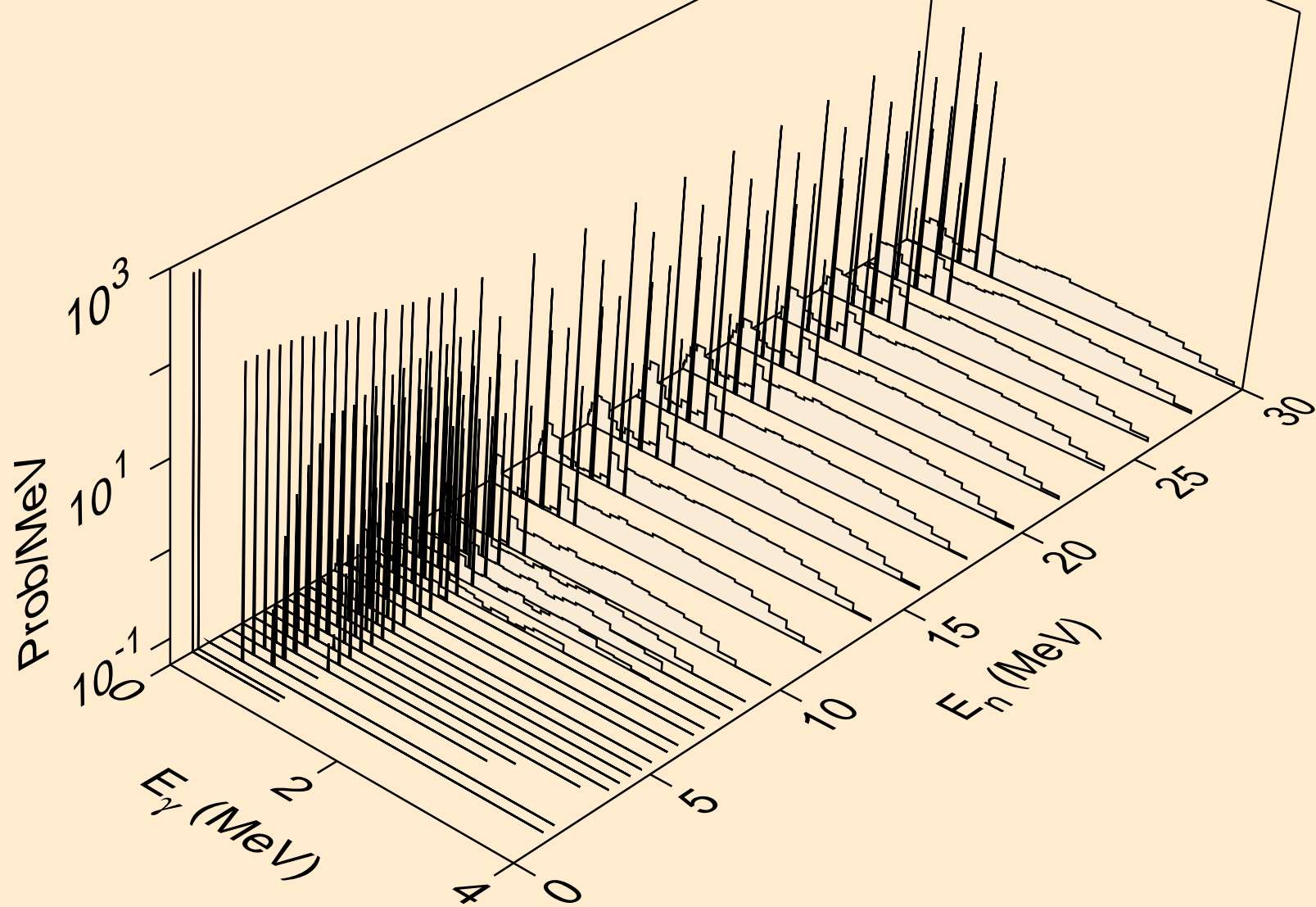

NB083 NEUTRON ACER TENDL-2021 LIBRARY; T=293.6K
Photon emission for (n,t)

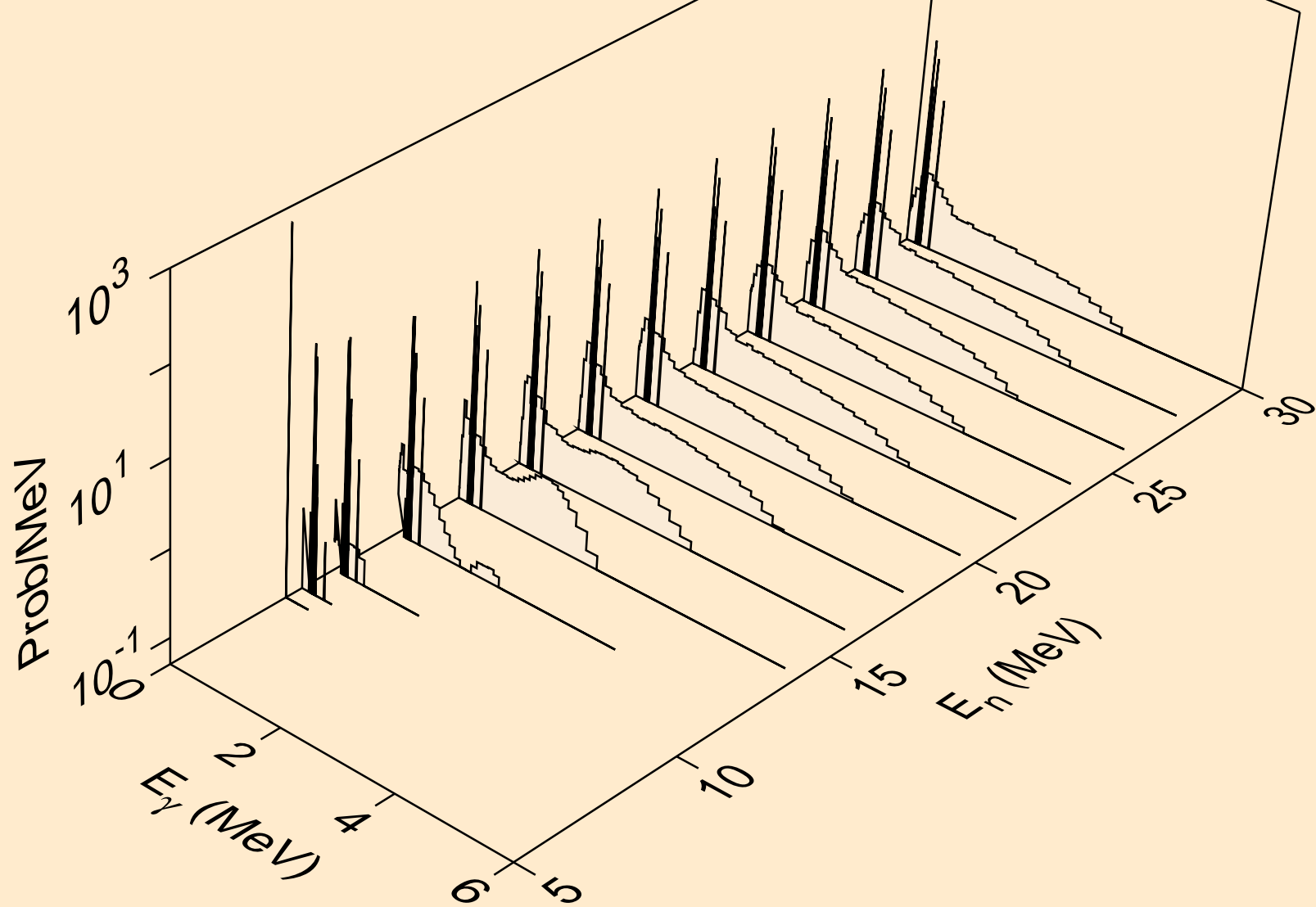

NB083 NEUTRON ACER TENDL-2021 LIBRARY; T=293.6K
Photon emission for (n,he3)

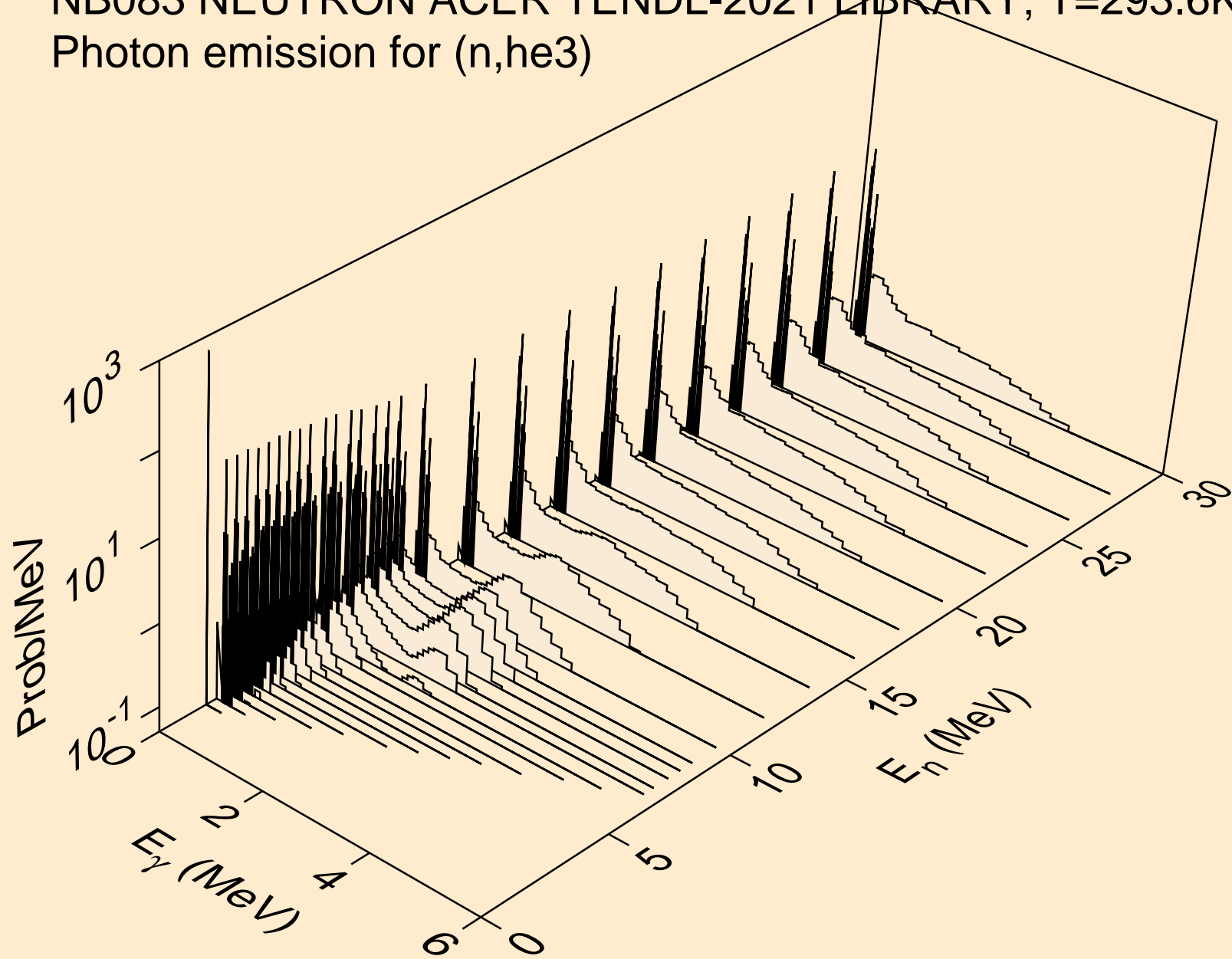

NB083 NEUTRON ACER TENDL-2021 LIBRARY; T=293.6K
Photon emission for (n,a)

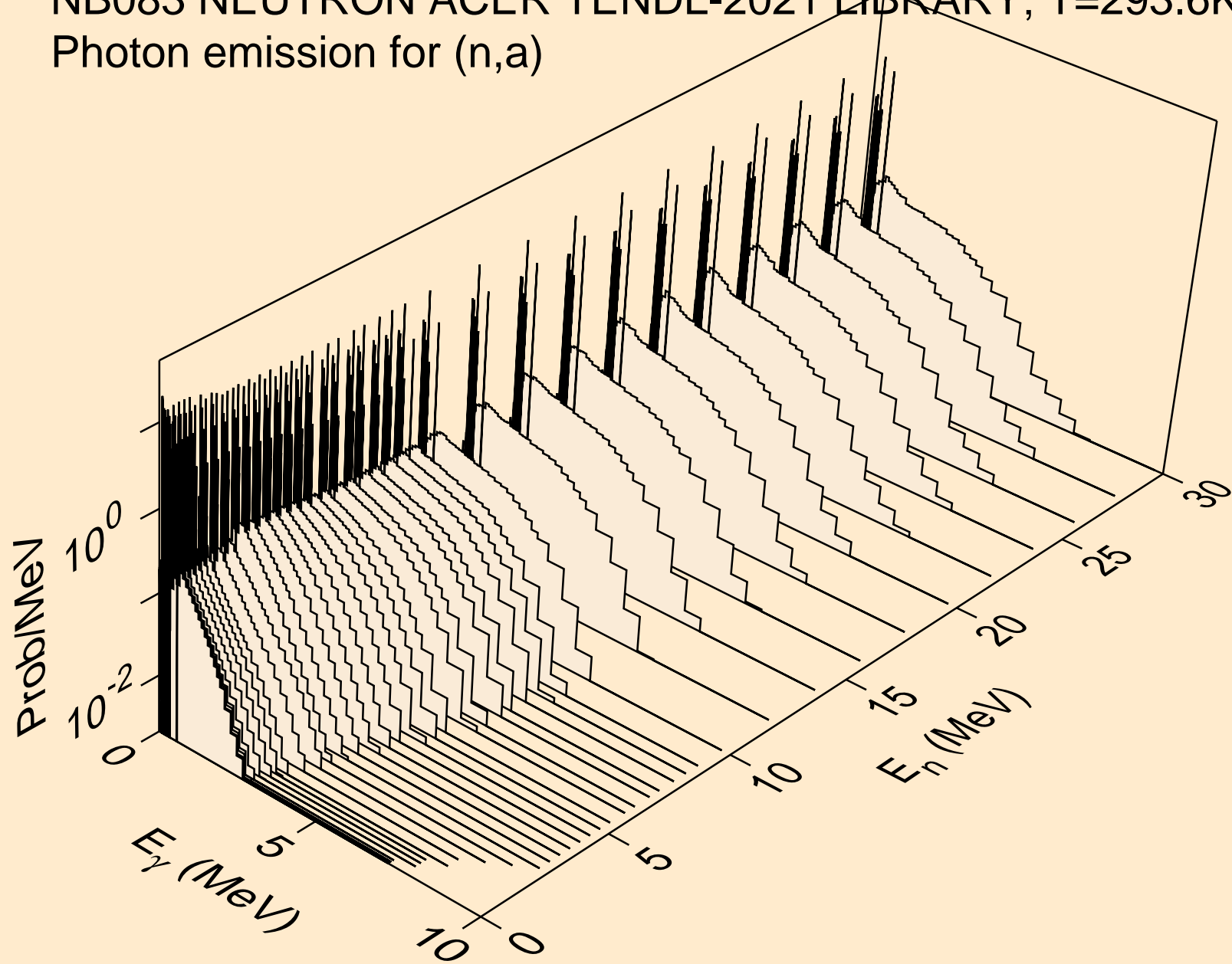

NB083 NEUTRON ACER TENDL-2021 LIBRARY; T=293.6K
Photon emission for (n,2a)

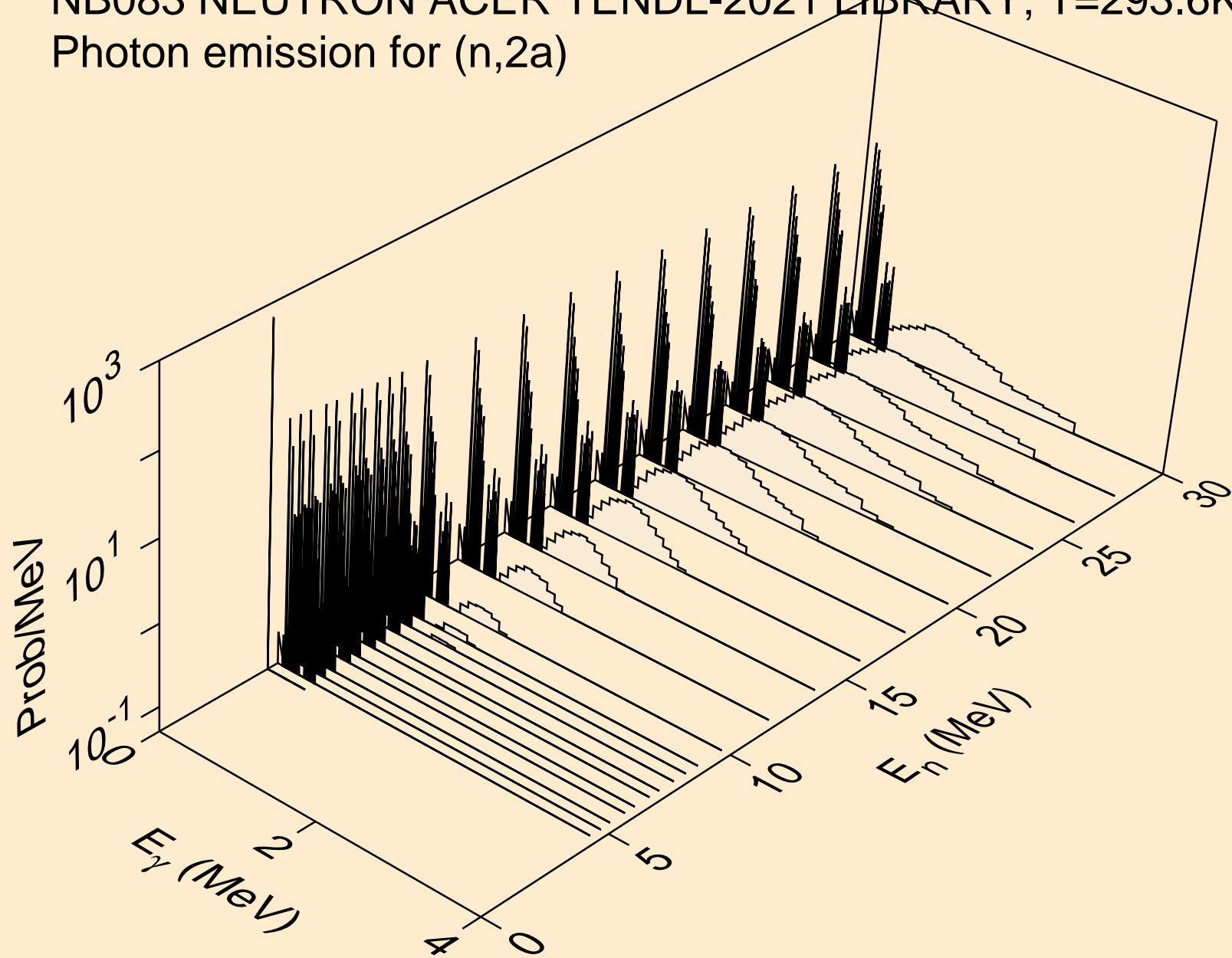

NB083 NEUTRON ACER TENDL-2021 LIBRARY; T=293.6K
Photon emission for (n,3a)

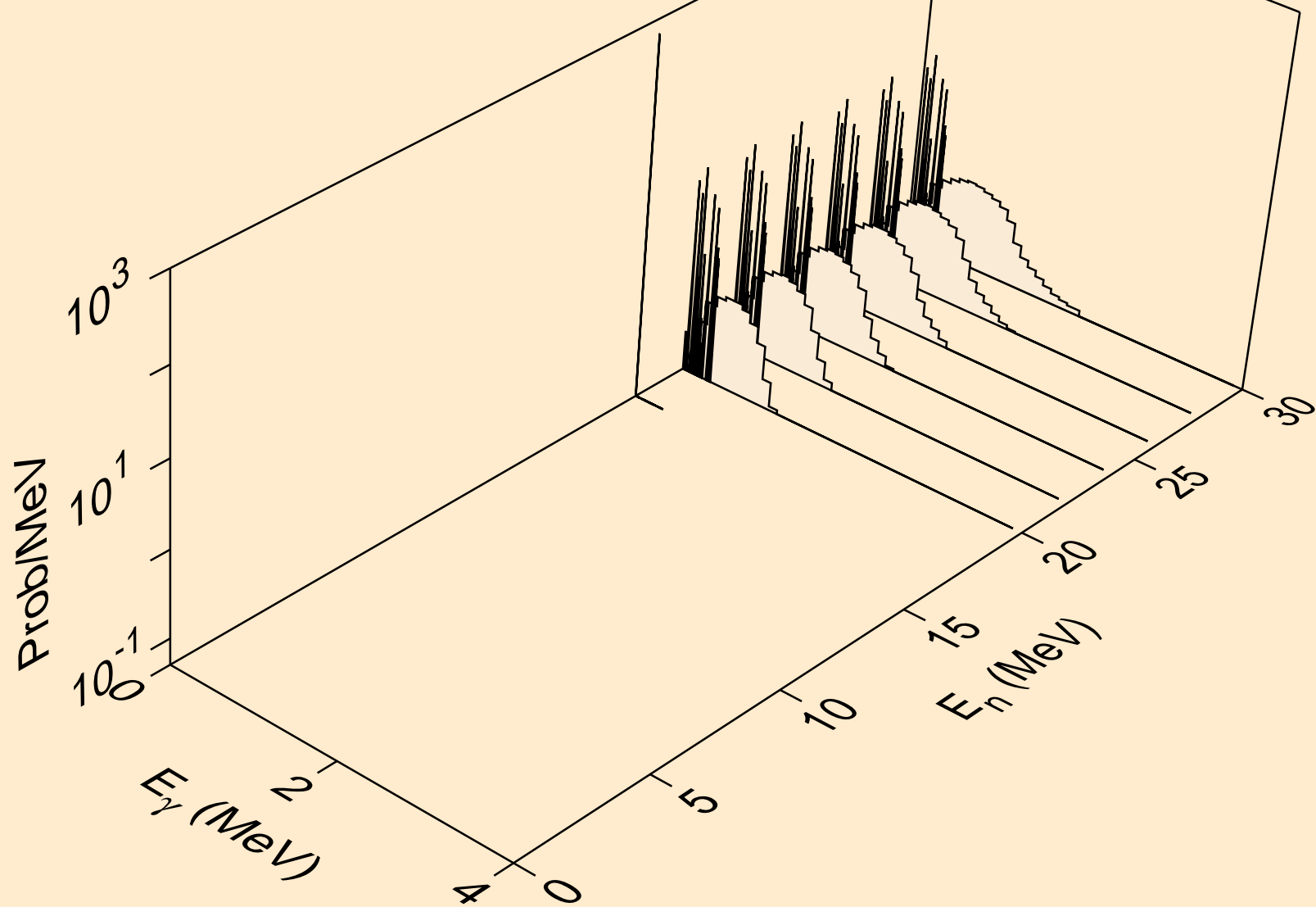

NB083 NEUTRON ACER TENDL-2021 LIBRARY; T=293.6K
Photon emission for (n,2p)

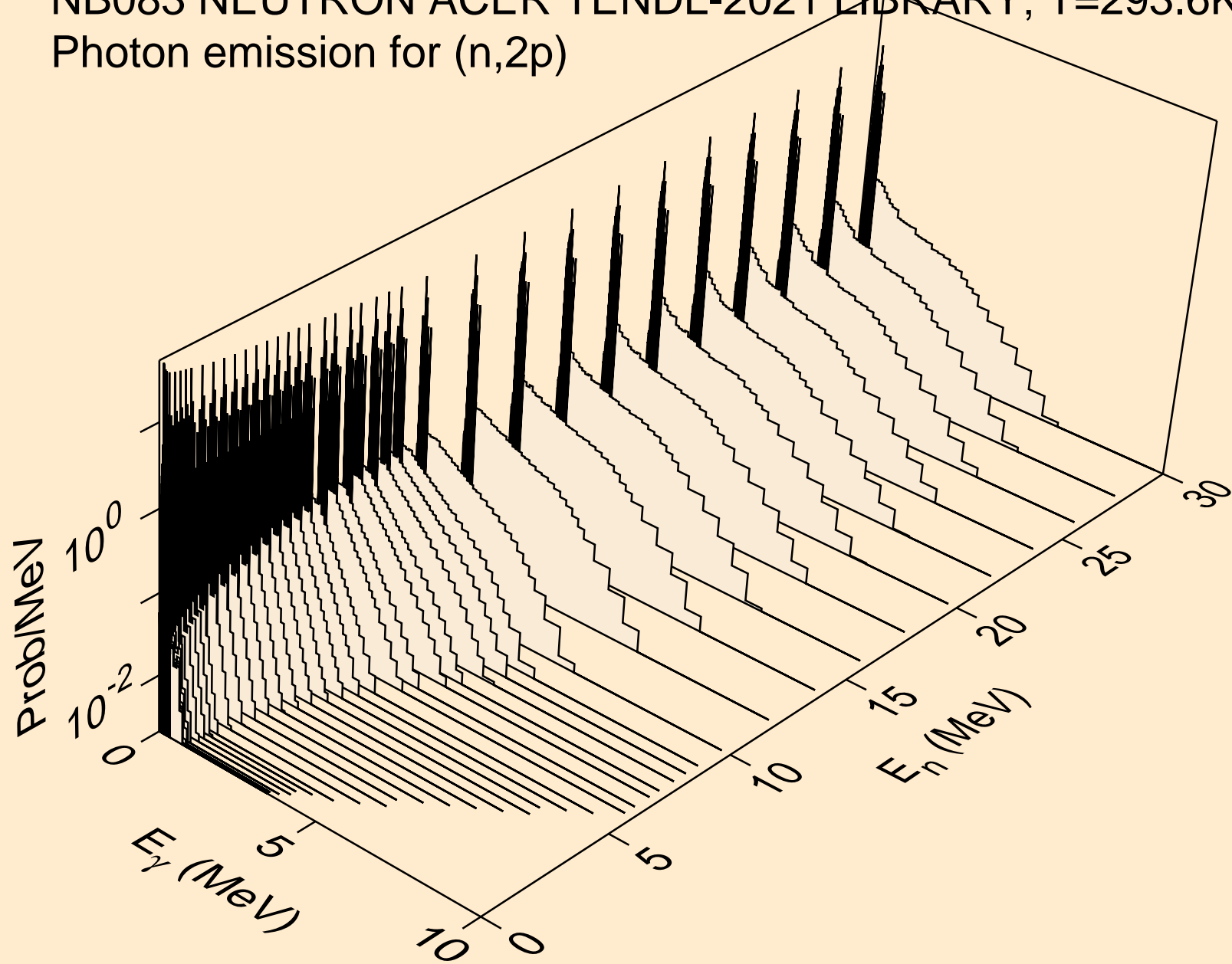

NB083 NEUTRON ACER TENDL-2021 LIBRARY; T=293.6K
Photon emission for (n,p α)

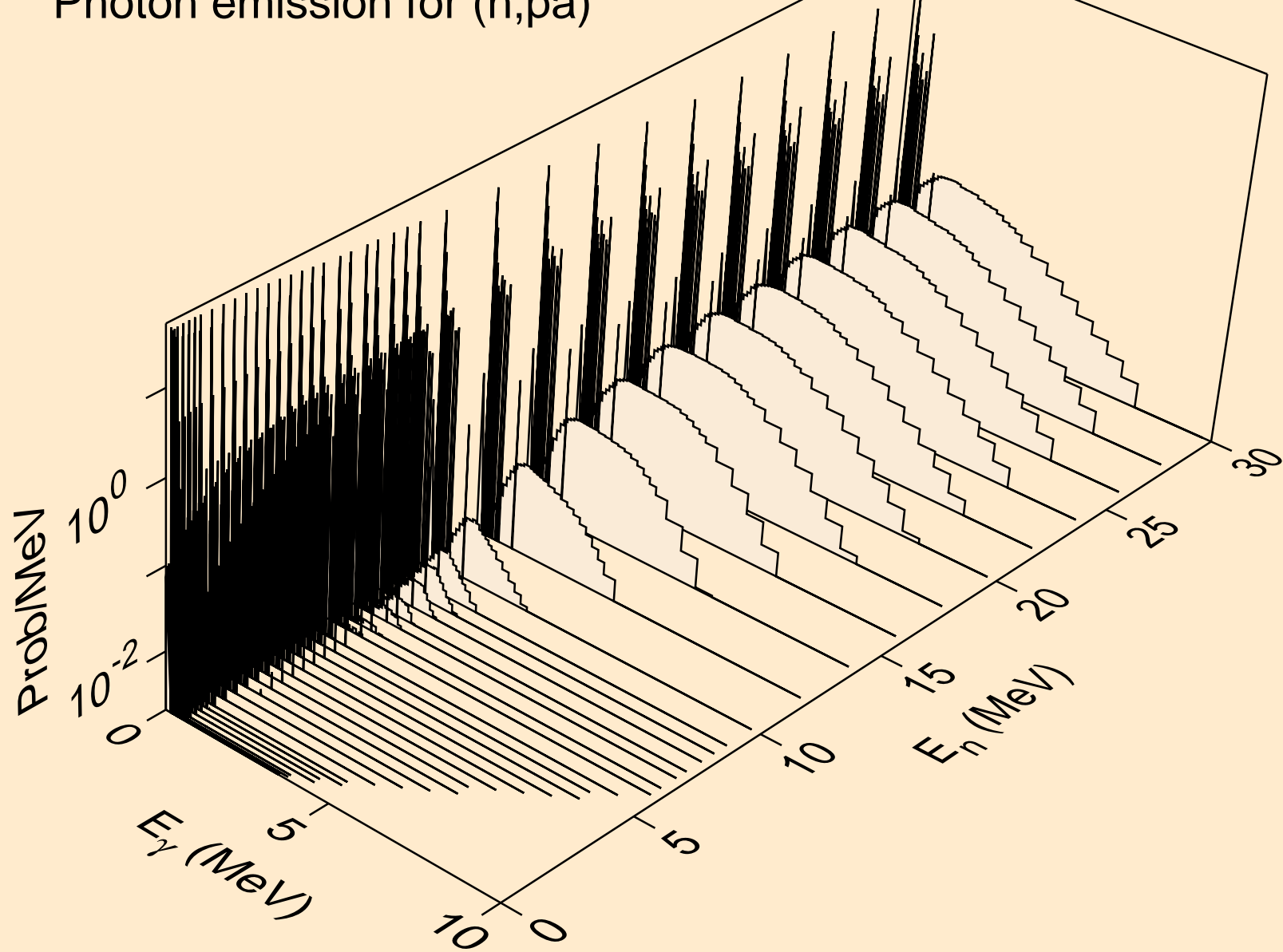

NB083 NEUTRON ACER TENDL-2021 LIBRARY; T=293.6K
Photon emission for (n,d2a)

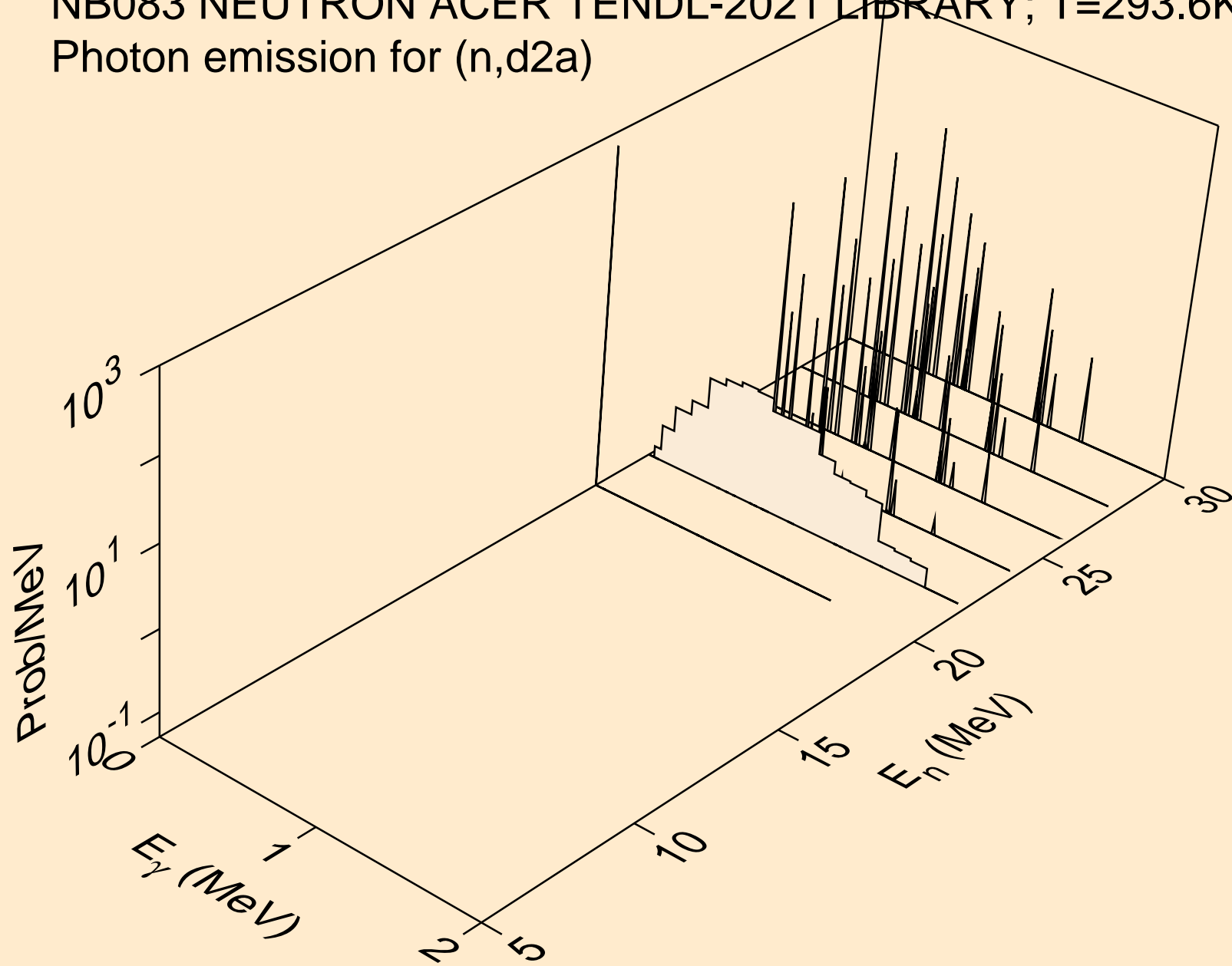

NB083 NEUTRON ACER TENDL-2021 LIBRARY; T=293.6K
Photon emission for (n,pd)

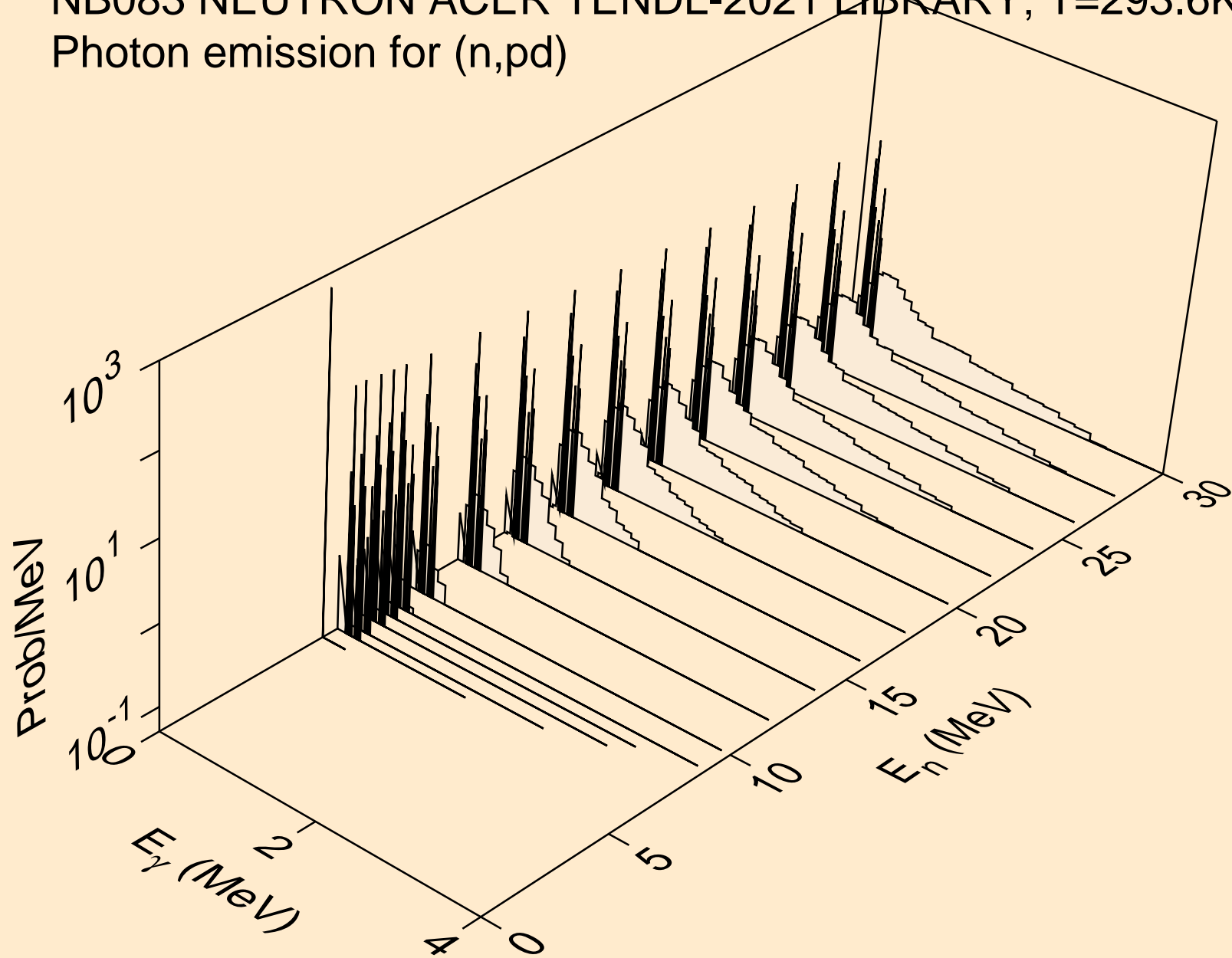

NB083 NEUTRON ACER TENDL-2021 LIBRARY; T=293.6K
Photon emission for (n,pt)

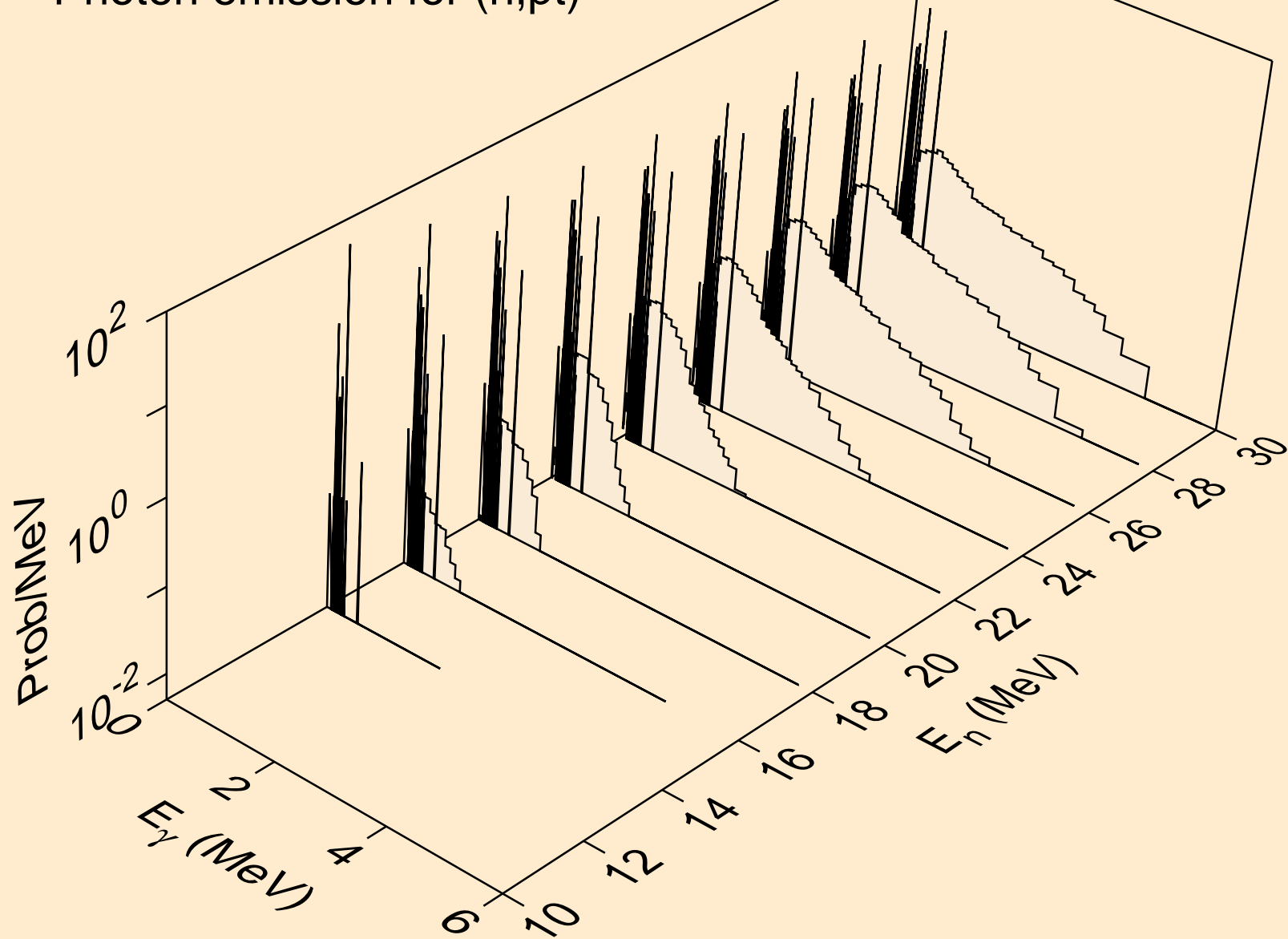

NB083 NEUTRON ACER TENDL-2021 LIBRARY; T=293.6K
Photon emission for (n,da)

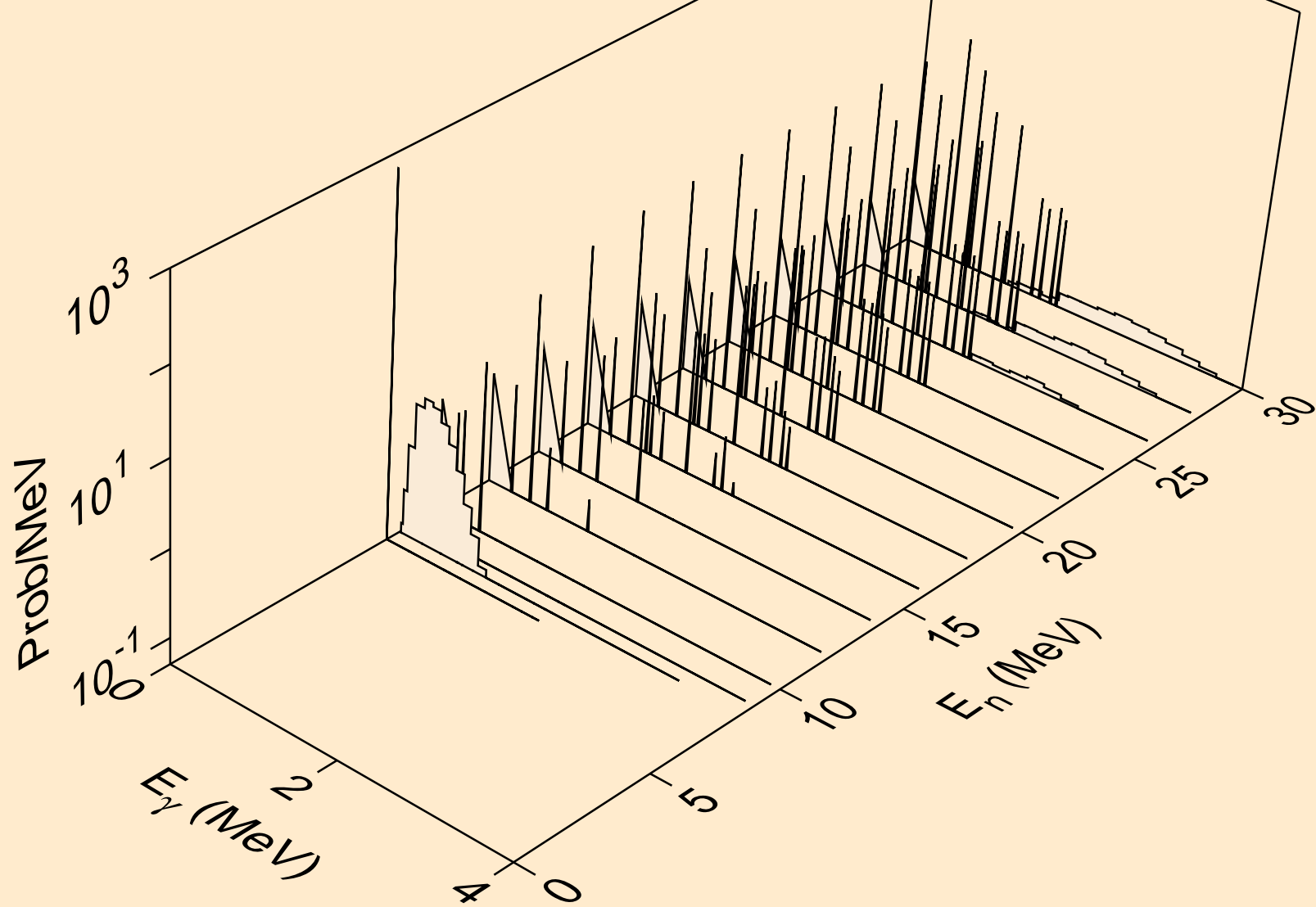

NB083 NEUTRON ACER TENDL-2021 LIBRARY; T=293.6K
thermal capture photon spectrum

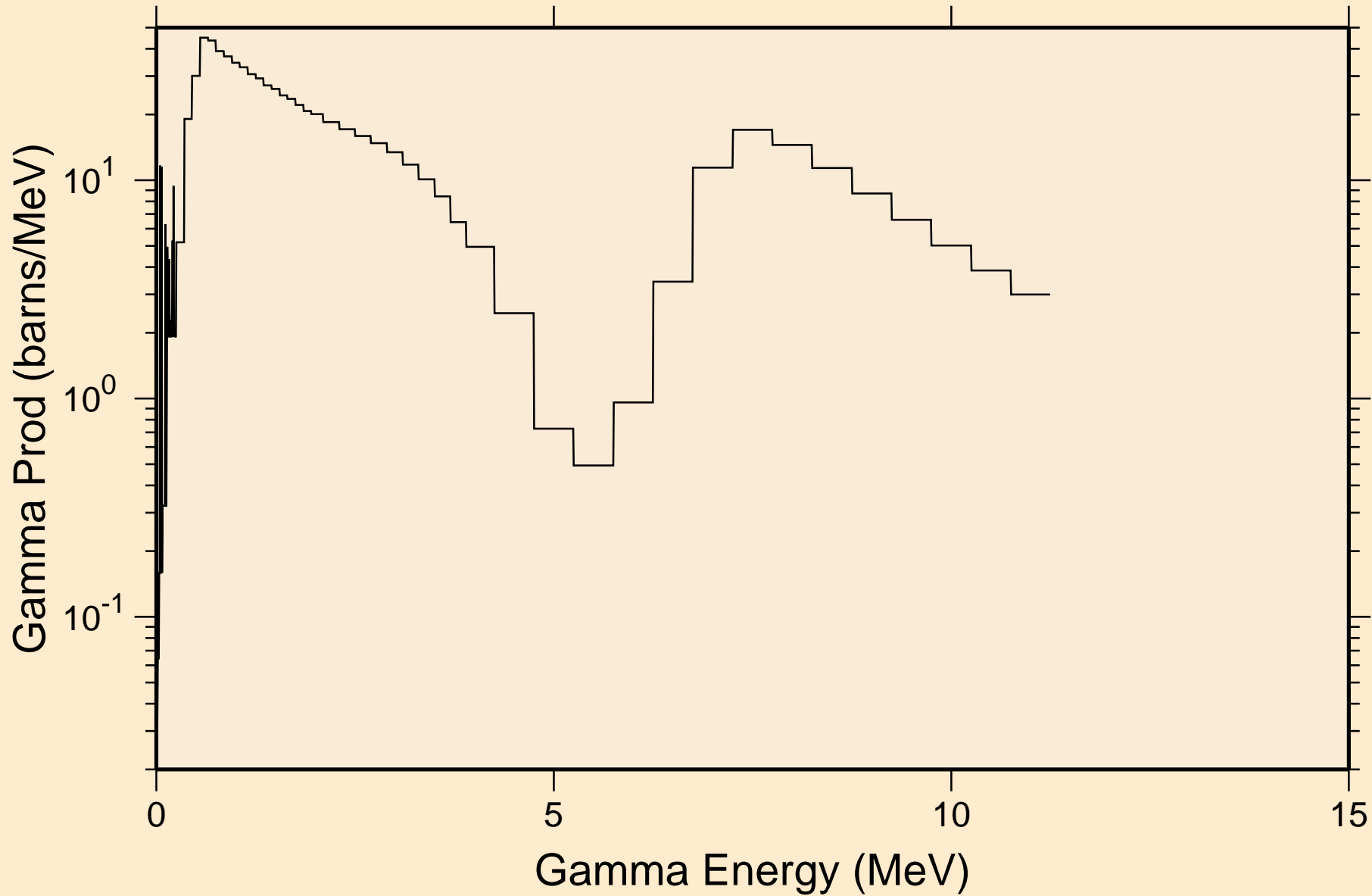

NB083 NEUTRON ACER TENDL-2021 LIBRARY; T=293.6K
14 MeV photon spectrum

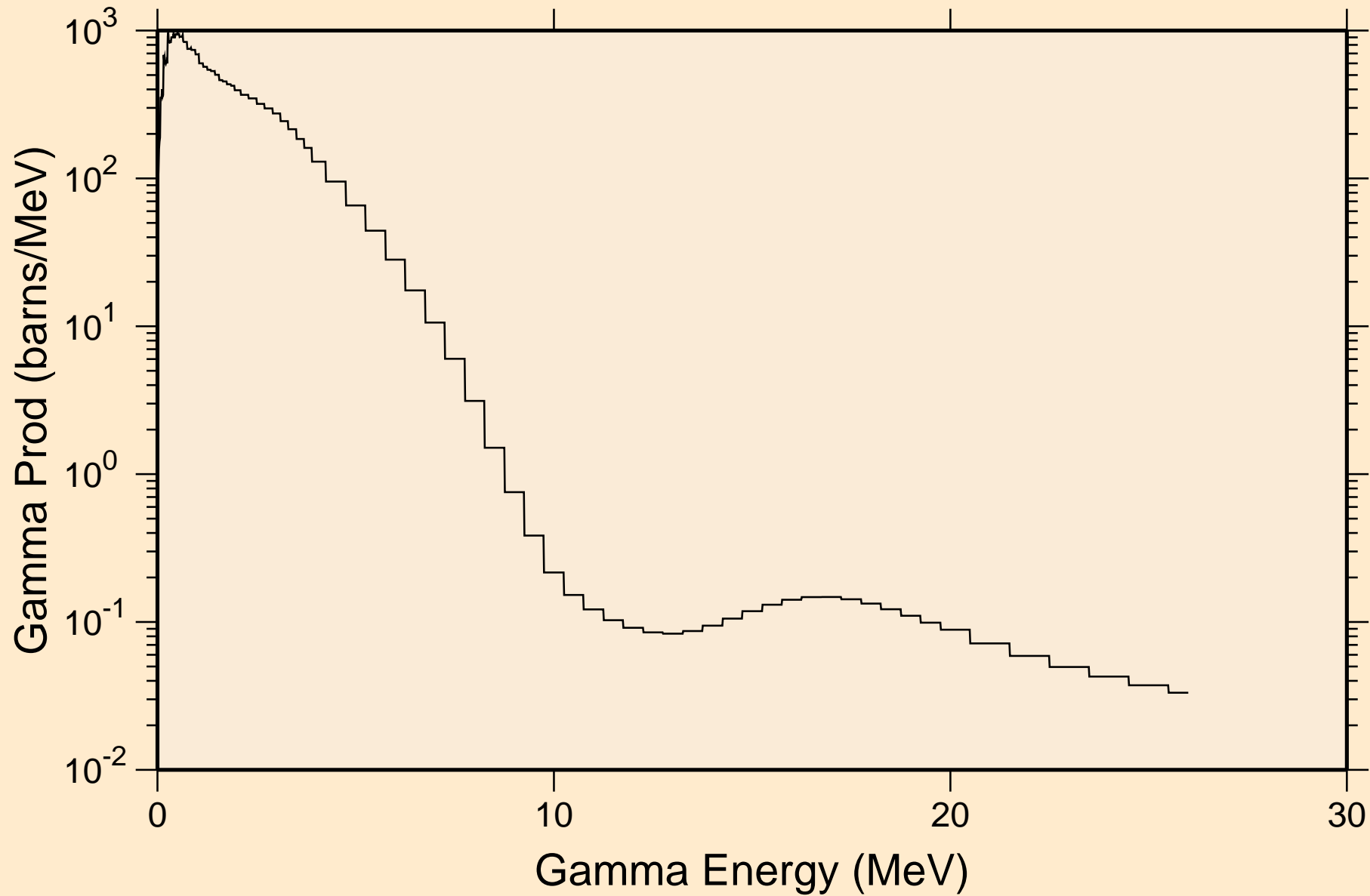

NB083 NEUTRON ACER TENDL-2021 LIBRARY; T=293.6K
Particle heating contributions

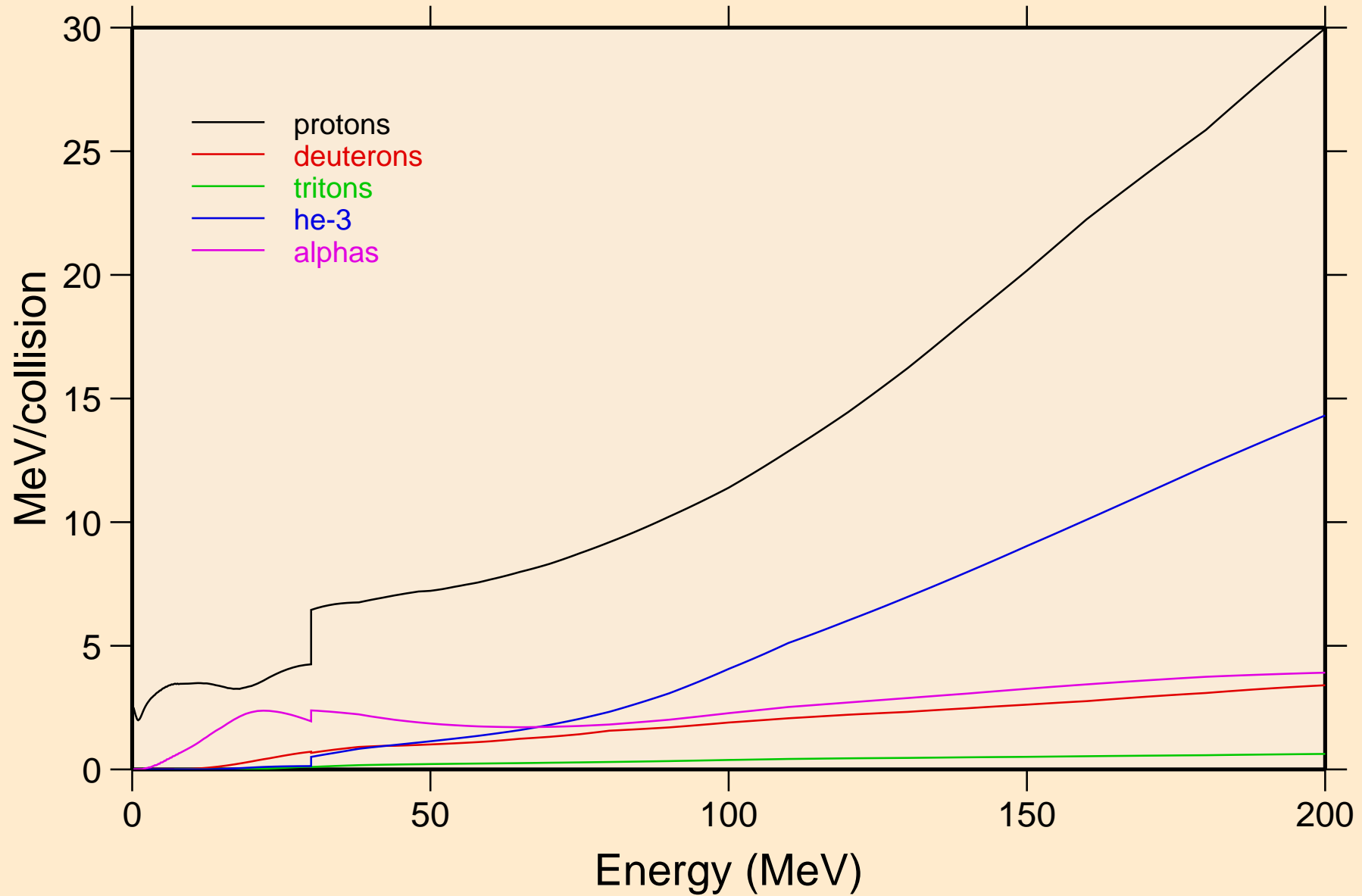

NB083 NEUTRON ACER TENDL-2021 LIBRARY; T=293.6K
Recoil Heating

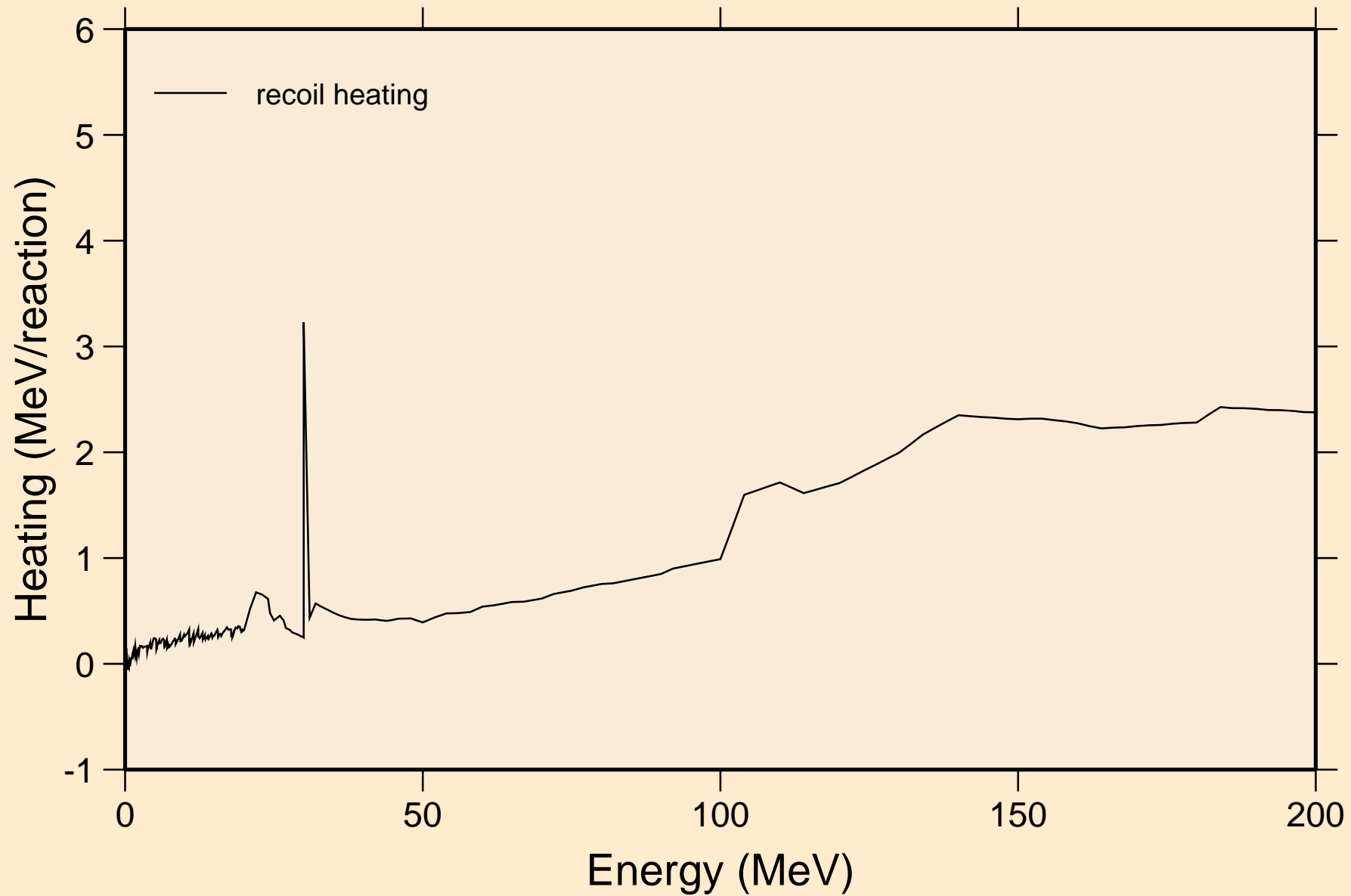

NB083 NEUTRON ACER TENDL-2021 LIBRARY; T=293.6K

Particle production cross sections

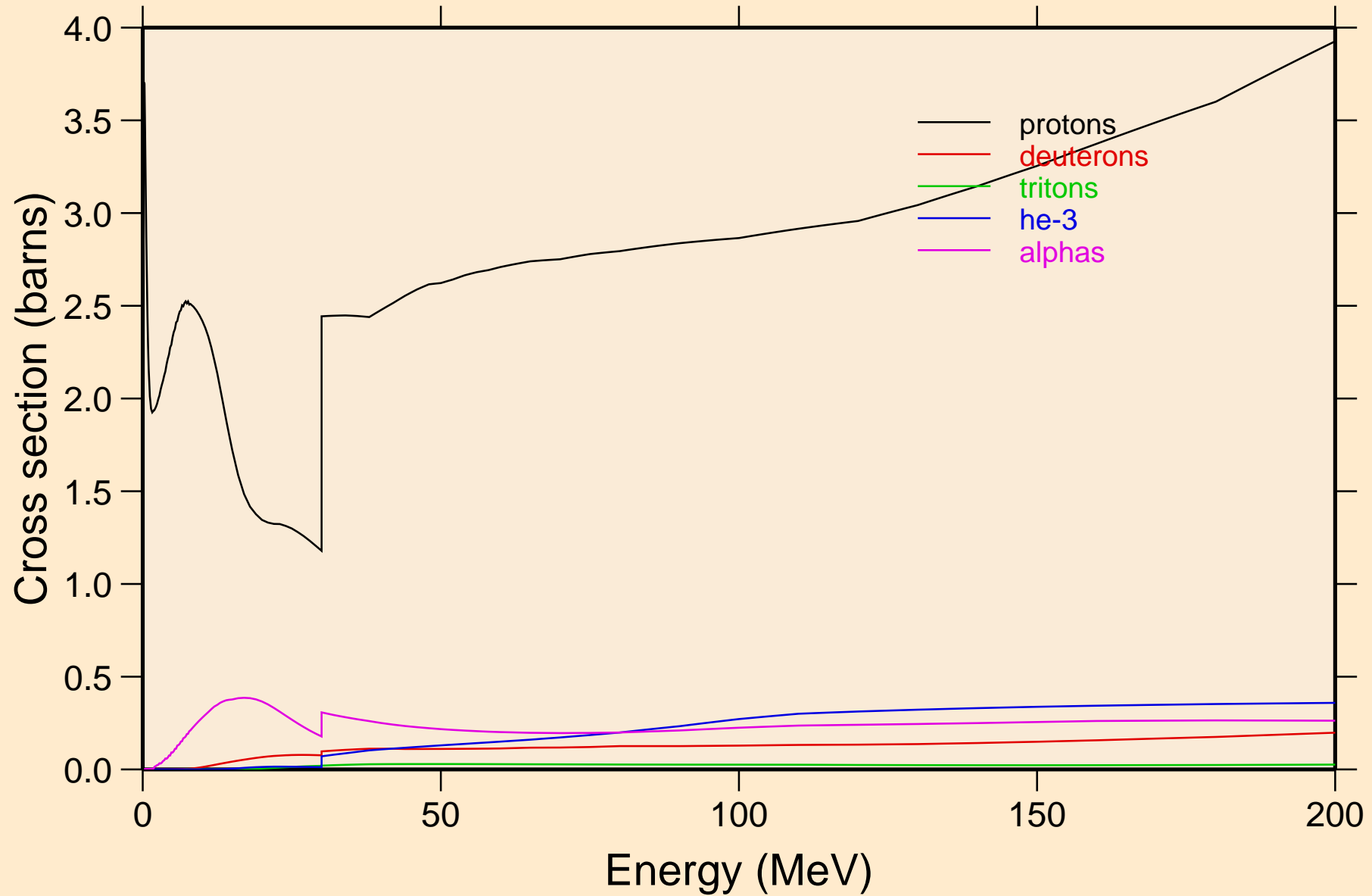

NB083 NEUTRON ACER TENDL-2021 LIBRARY; T=293.6K
protons from (n,x)

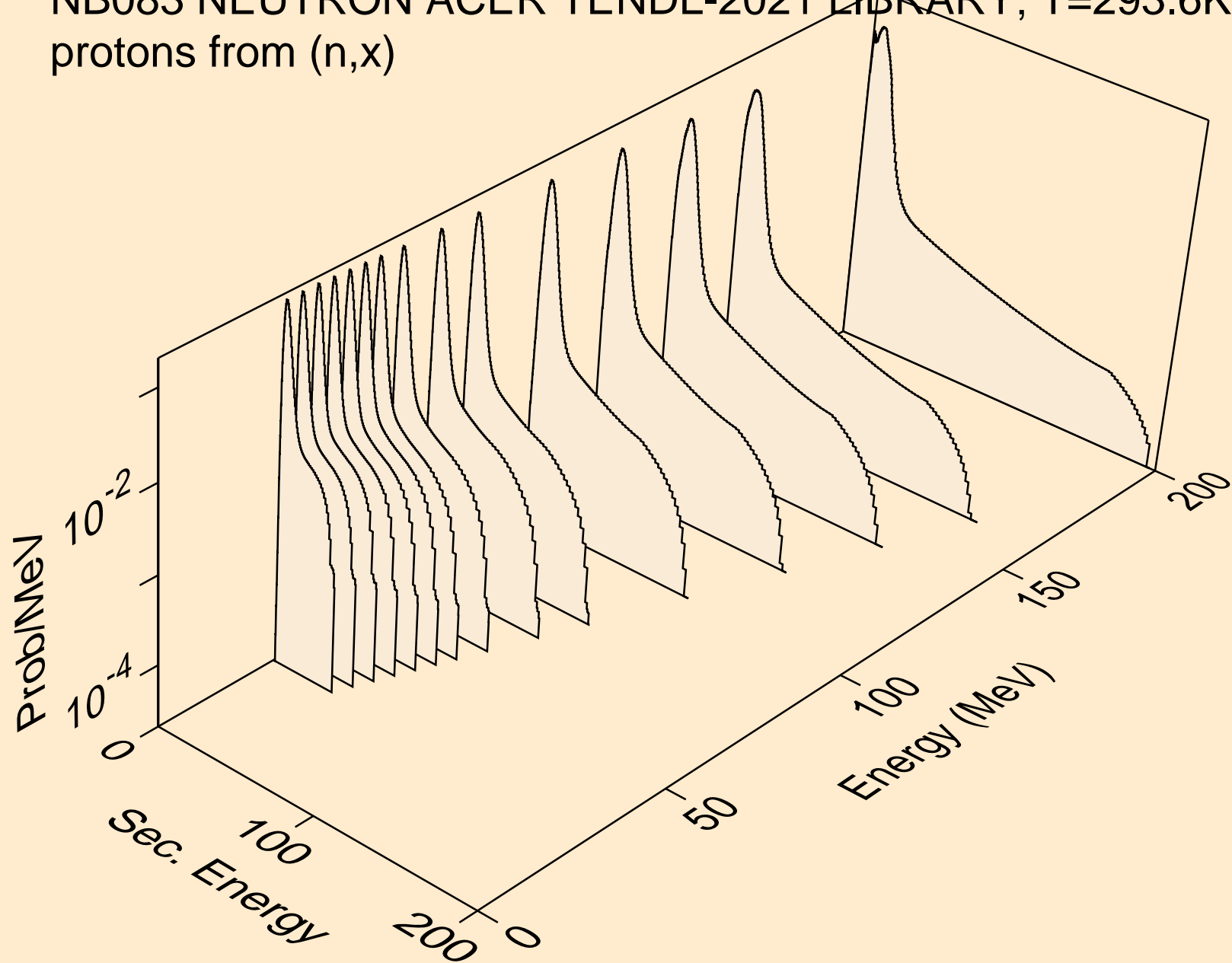

NB083 NEUTRON ACER TENDL-2021 LIBRARY; T=293.6K
protons from (n,n*)p

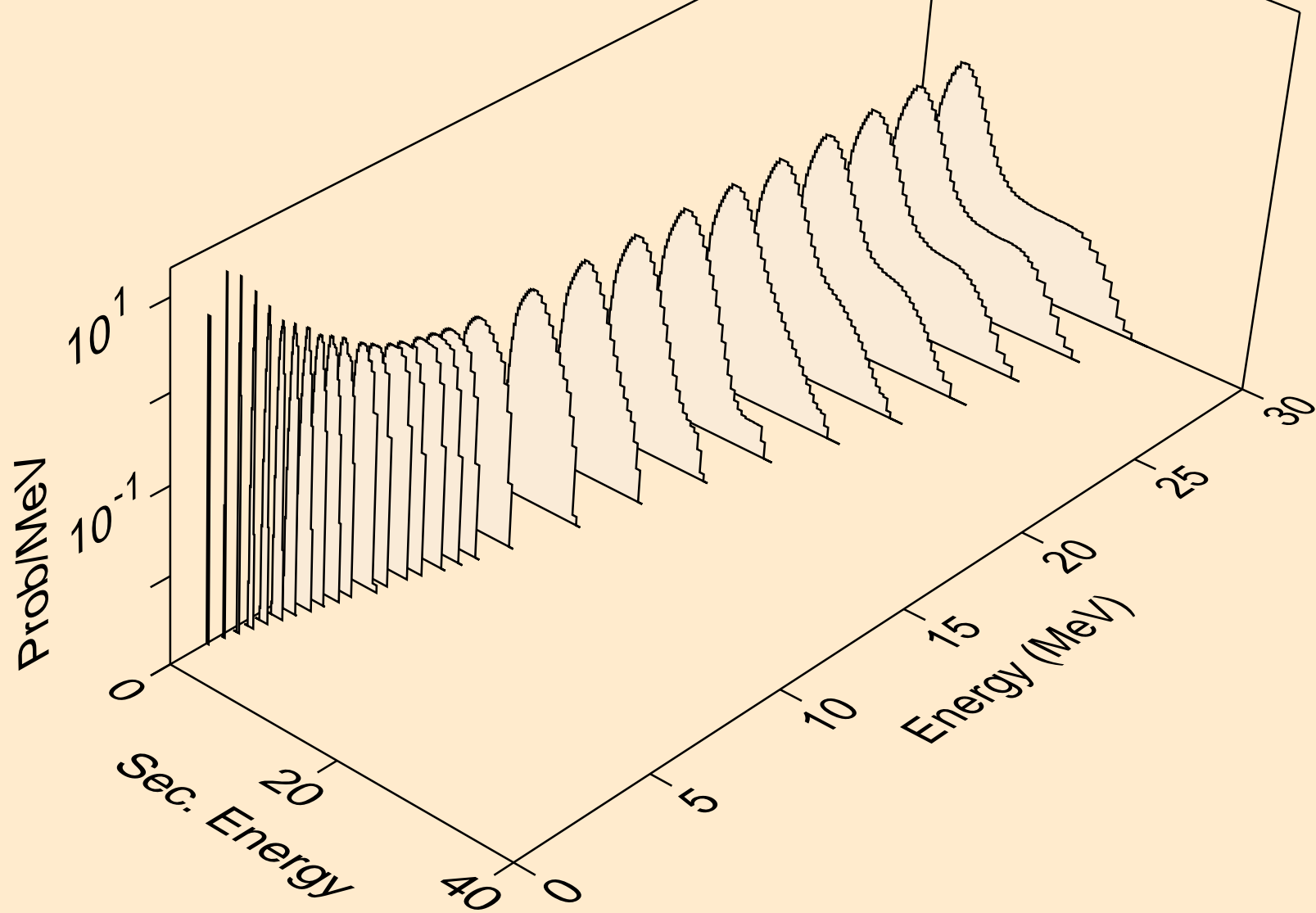

NB083 NEUTRON ACER TENDL-2021 LIBRARY; T=293.6K
protons from (n,2np)

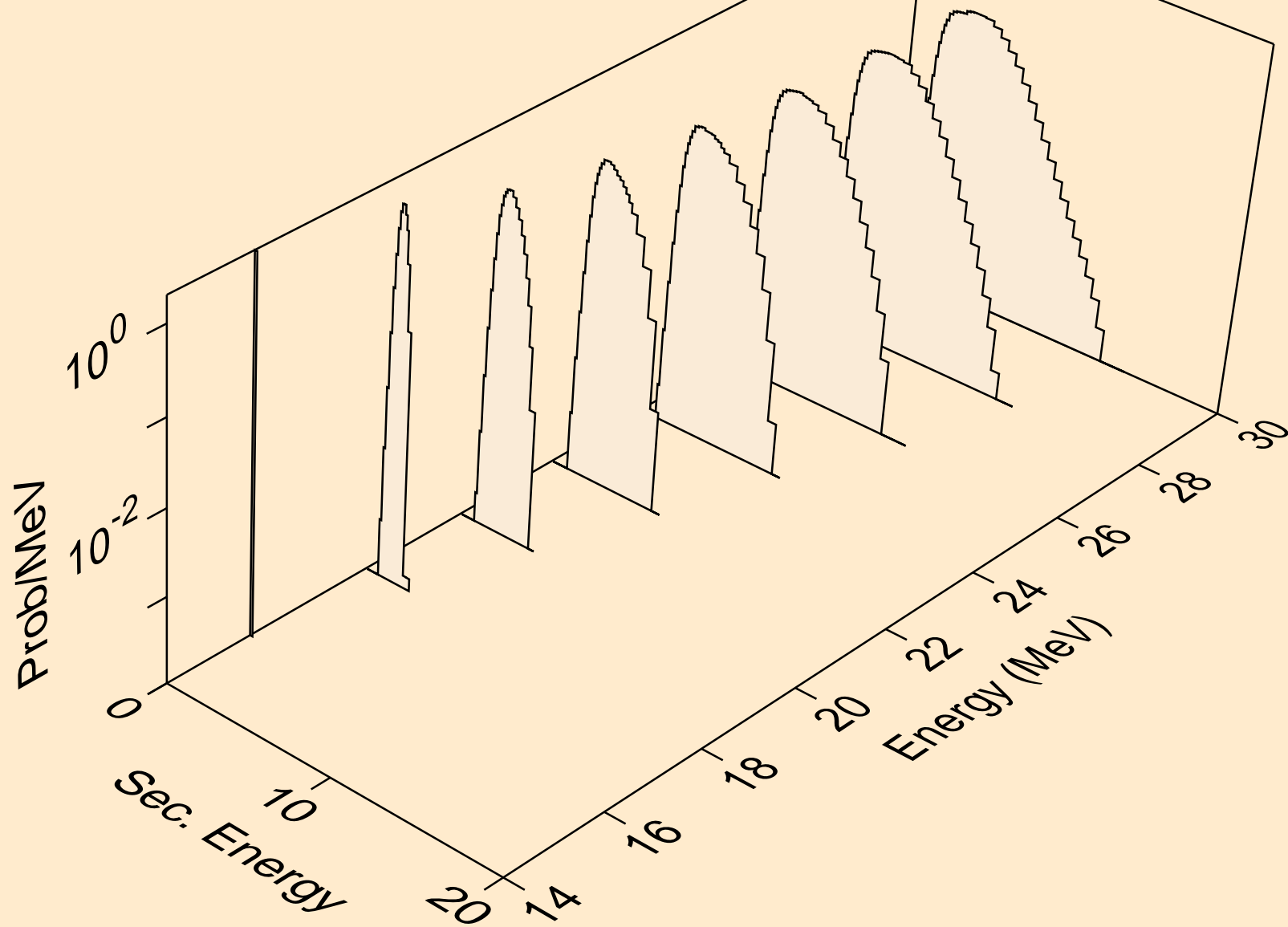

NB083 NEUTRON ACER TENDL-2021 LIBRARY; T=293.6K
protons from (n,3np)

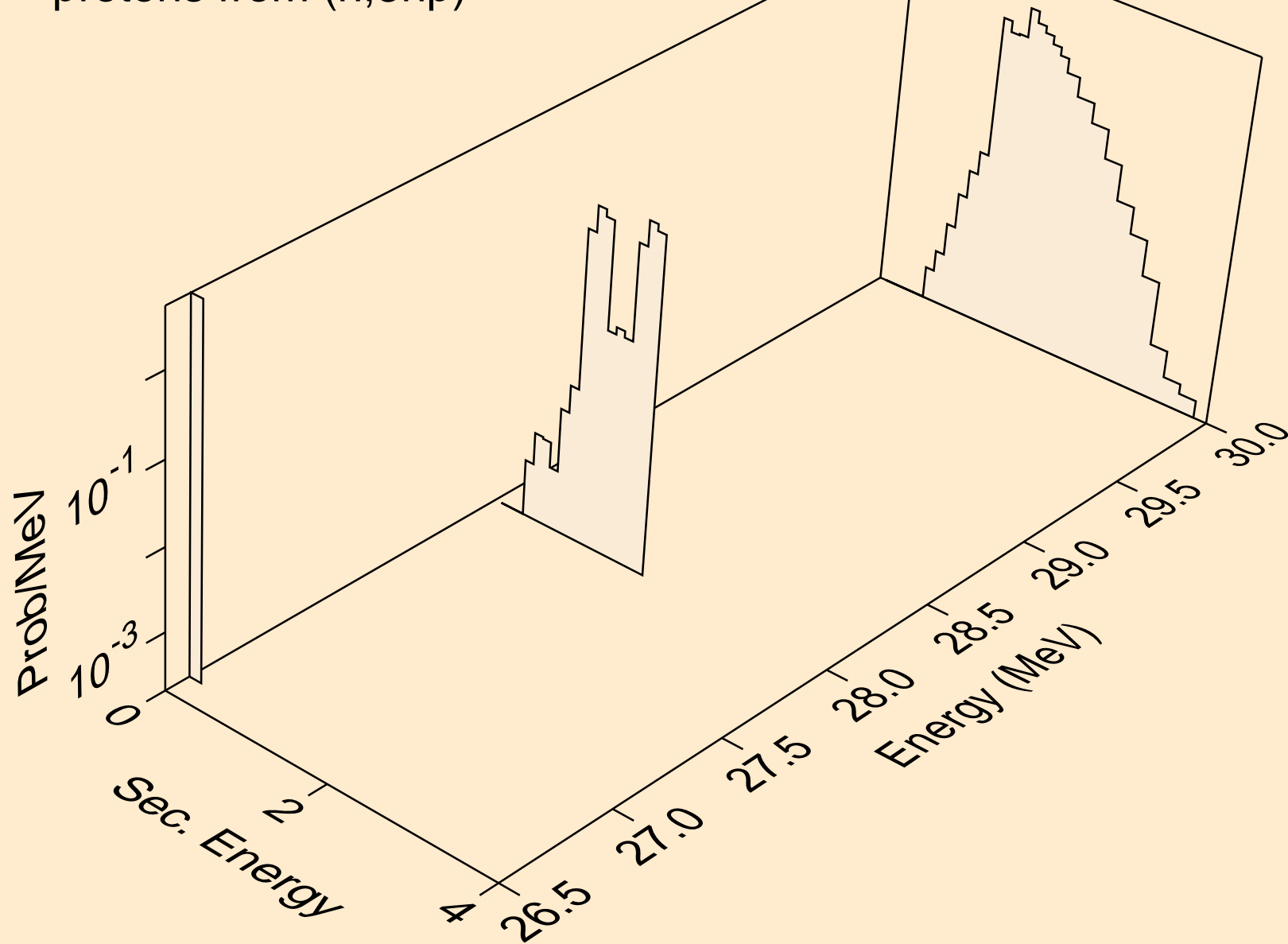

NB083 NEUTRON ACER TENDL-2021 LIBRARY; T=293.6K
protons from (n,2np)

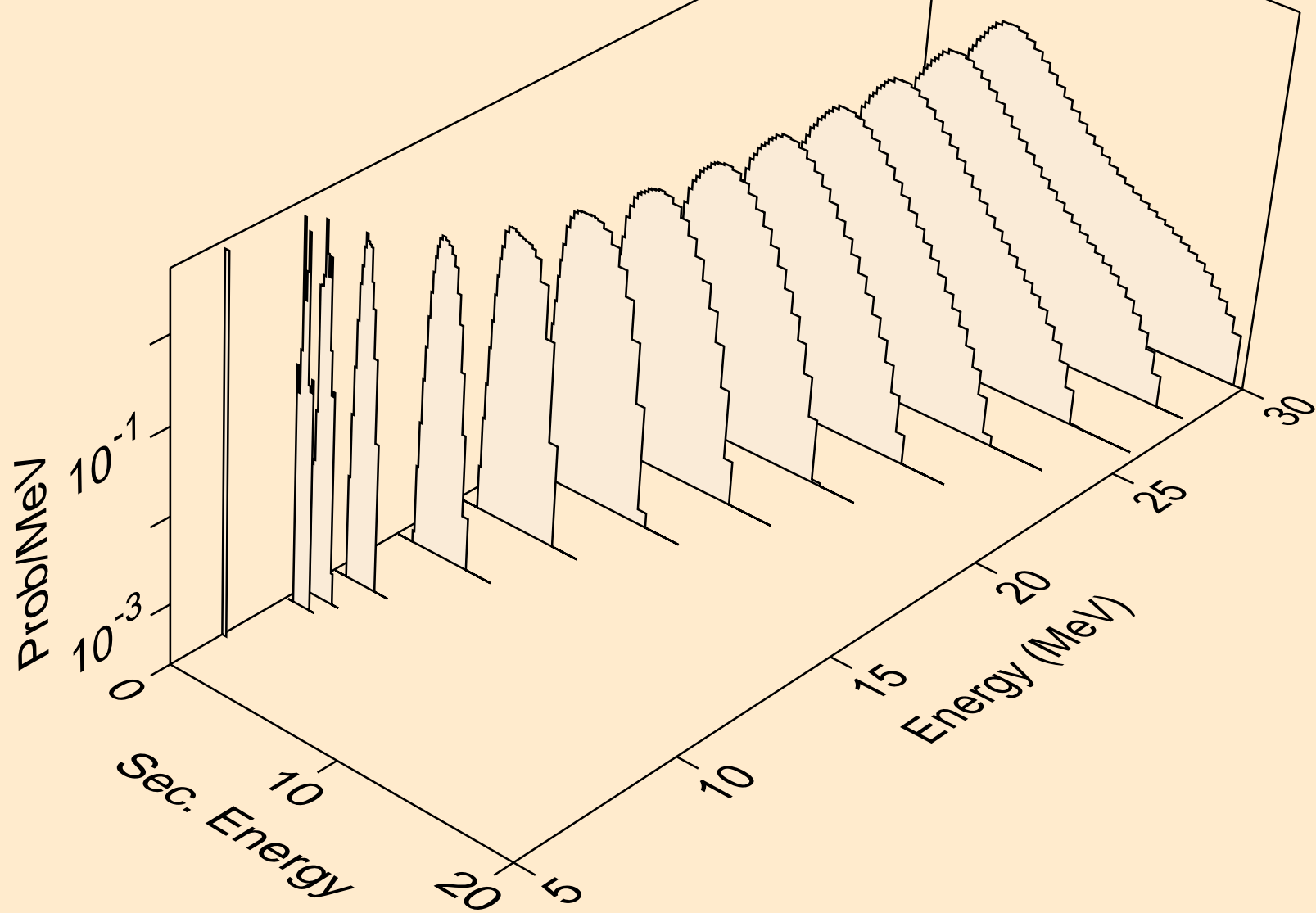

NB083 NEUTRON ACER TENDL-2021 LIBRARY; T=293.6K
protons from (n,npa)

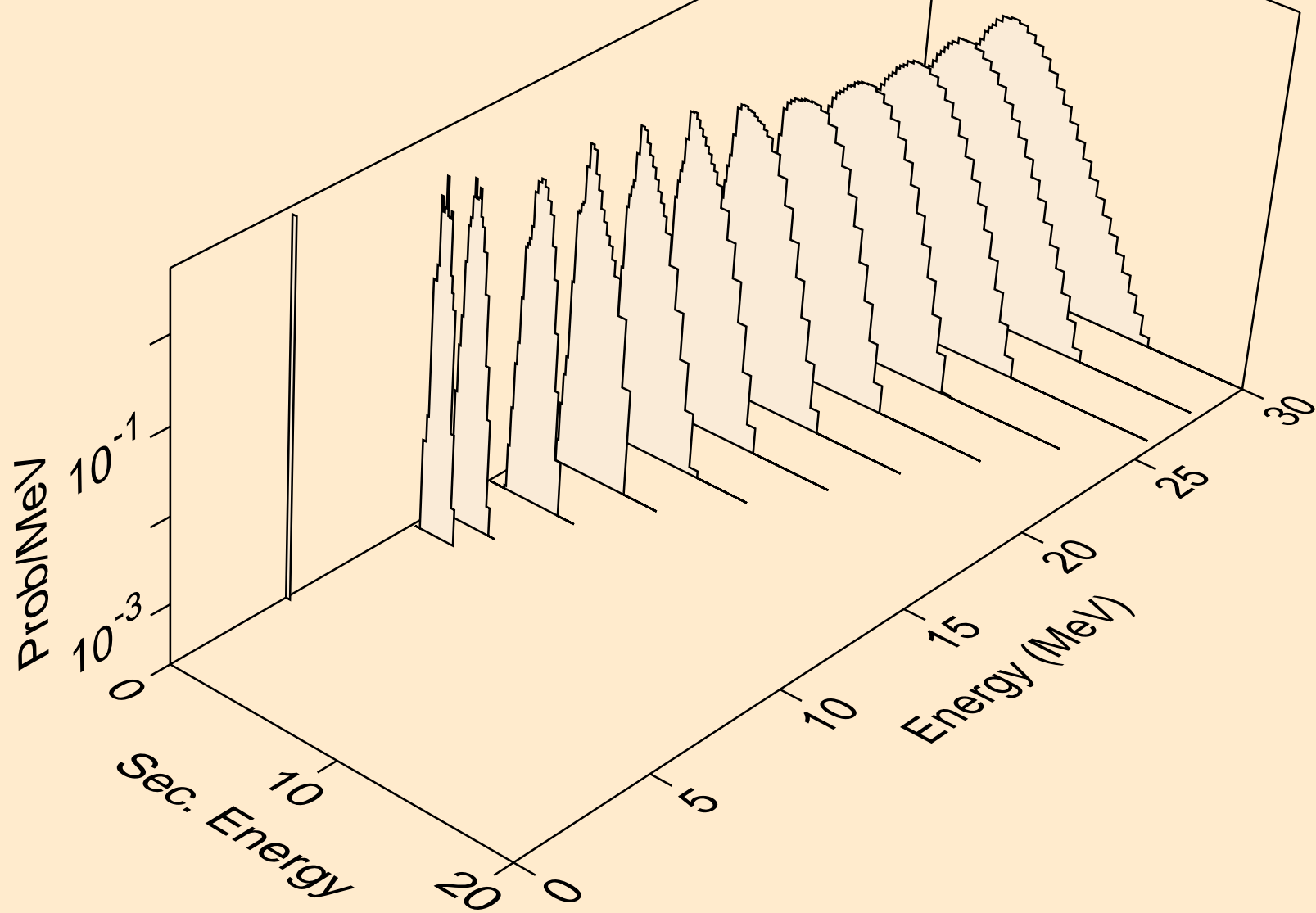

NB083 NEUTRON ACER TENDL-2021 LIBRARY; T=293.6K
protons from (n,p)

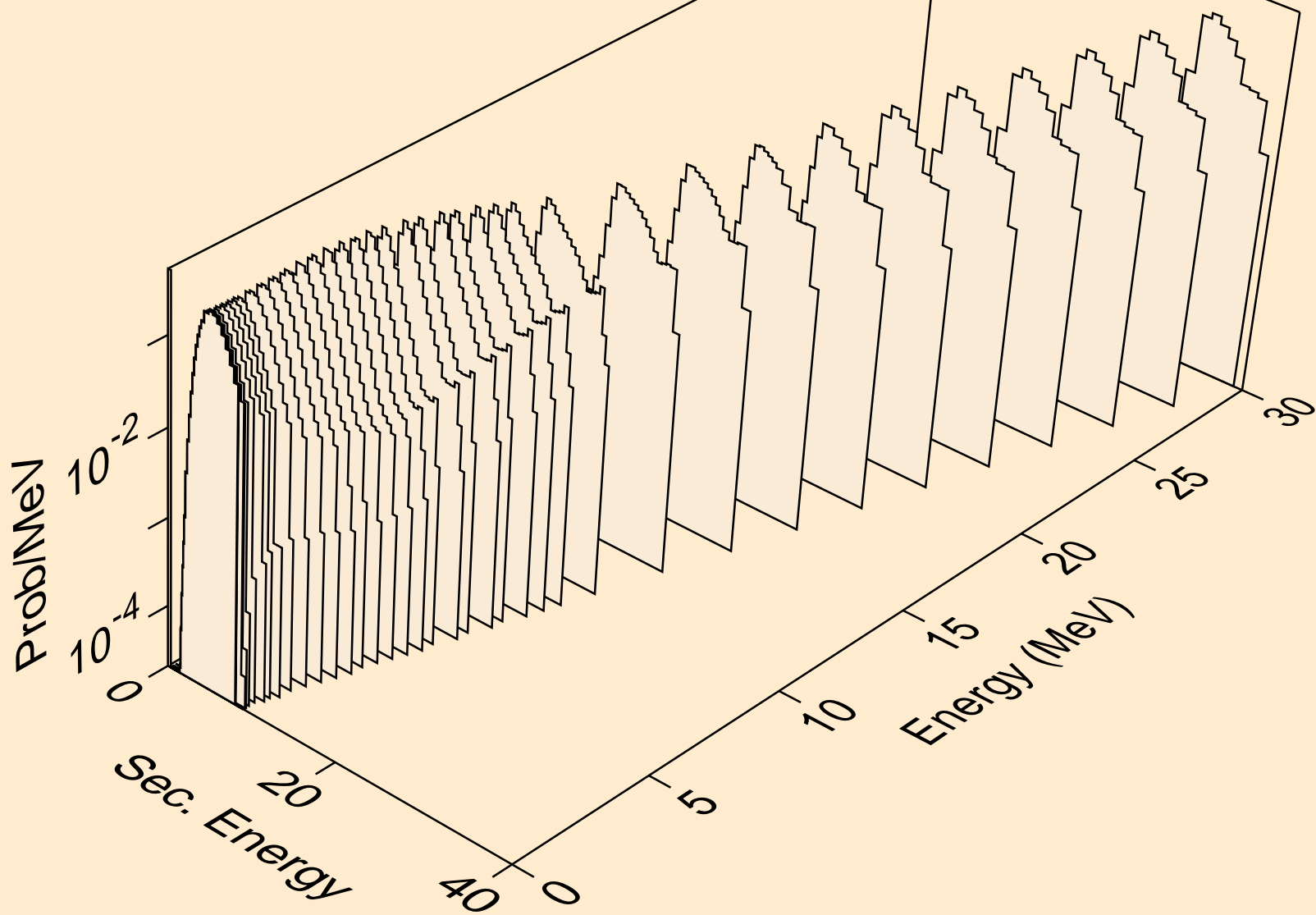

NB083 NEUTRON ACER TENDL-2021 LIBRARY; T=293.6K
protons from (n,2p)

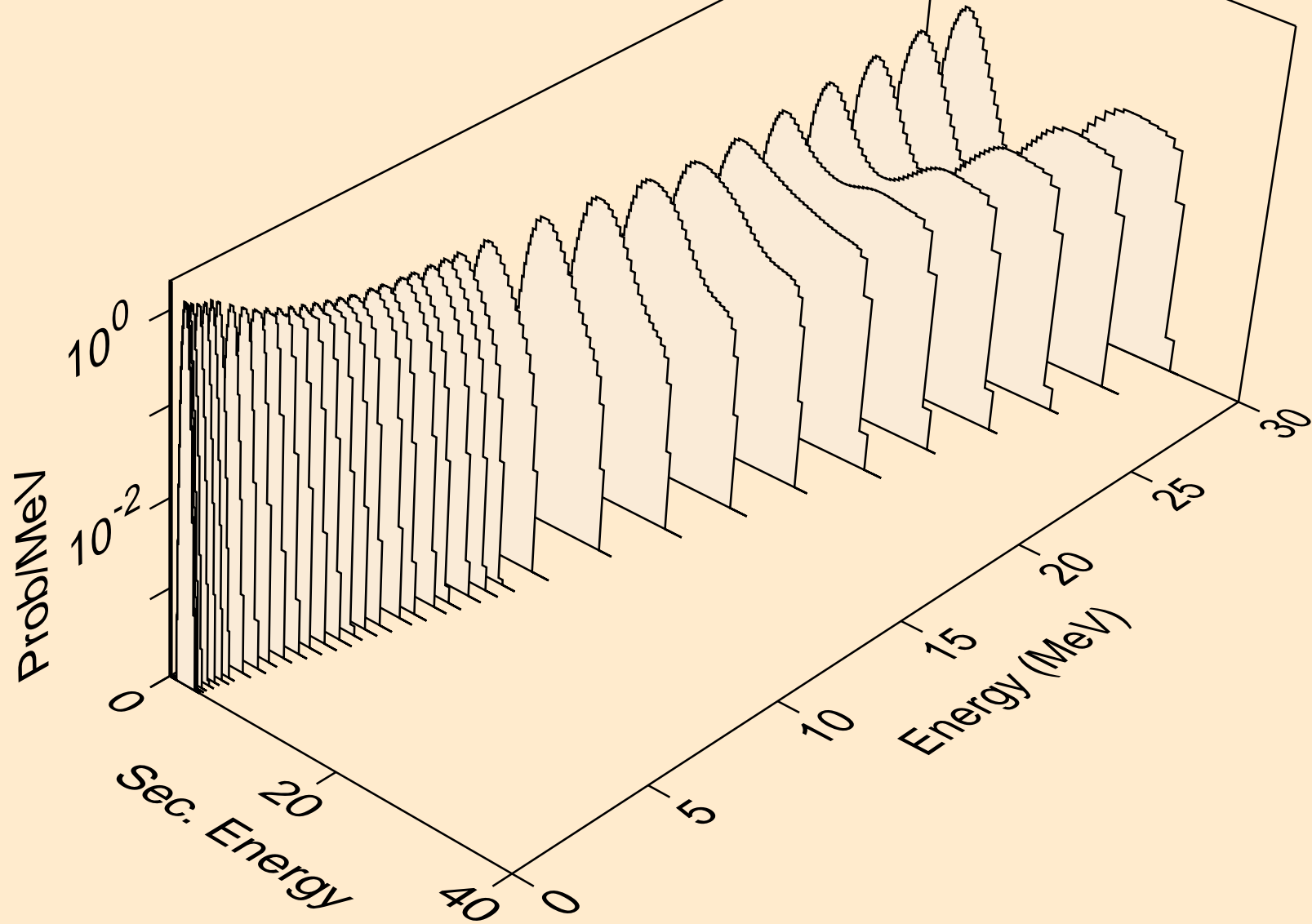

NB083 NEUTRON ACER TENDL-2021 LIBRARY; T=293.6K
protons from (n,p)

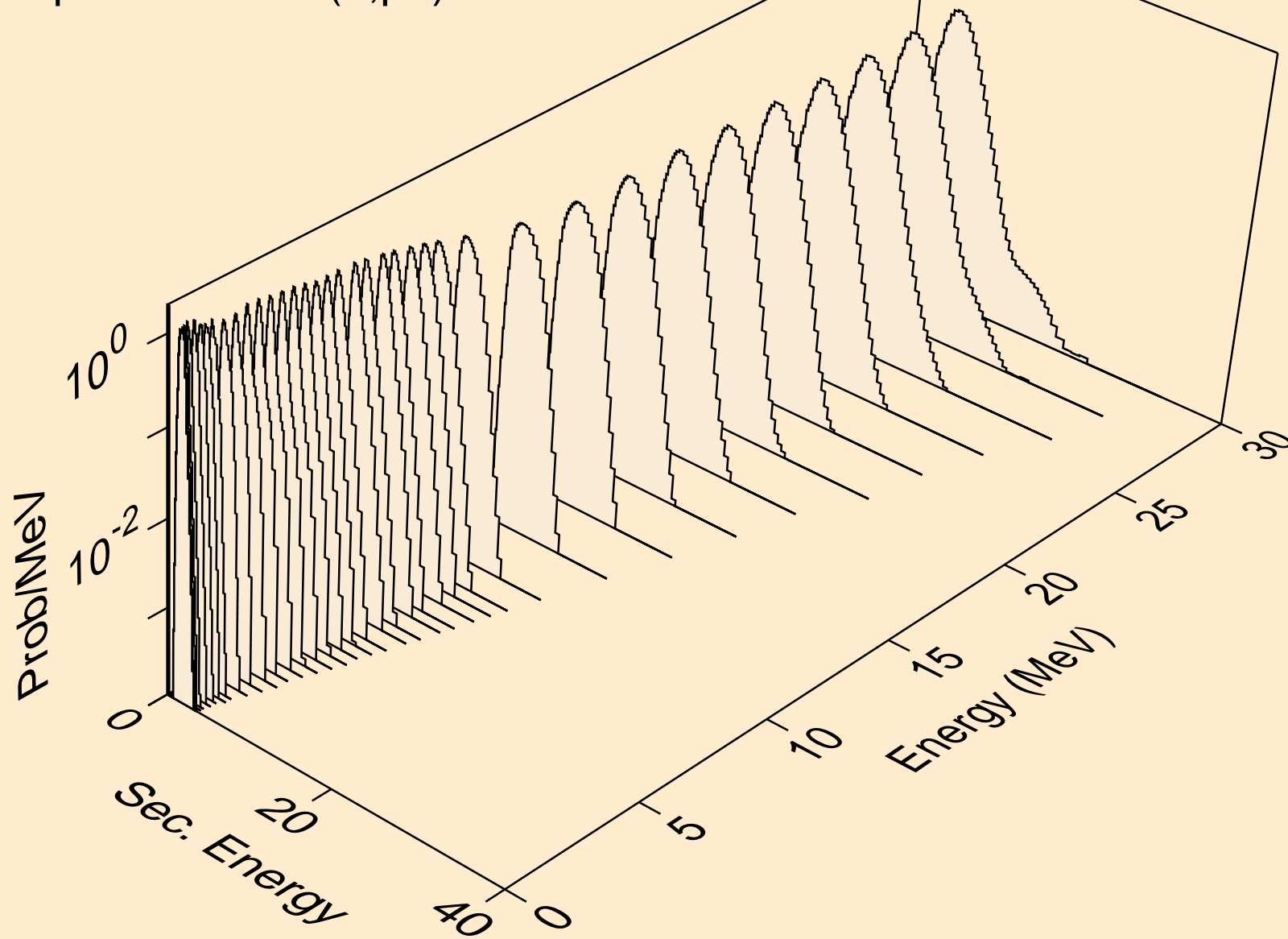

NB083 NEUTRON ACER TENDL-2021 LIBRARY; T=293.6K
protons from (n,pd)

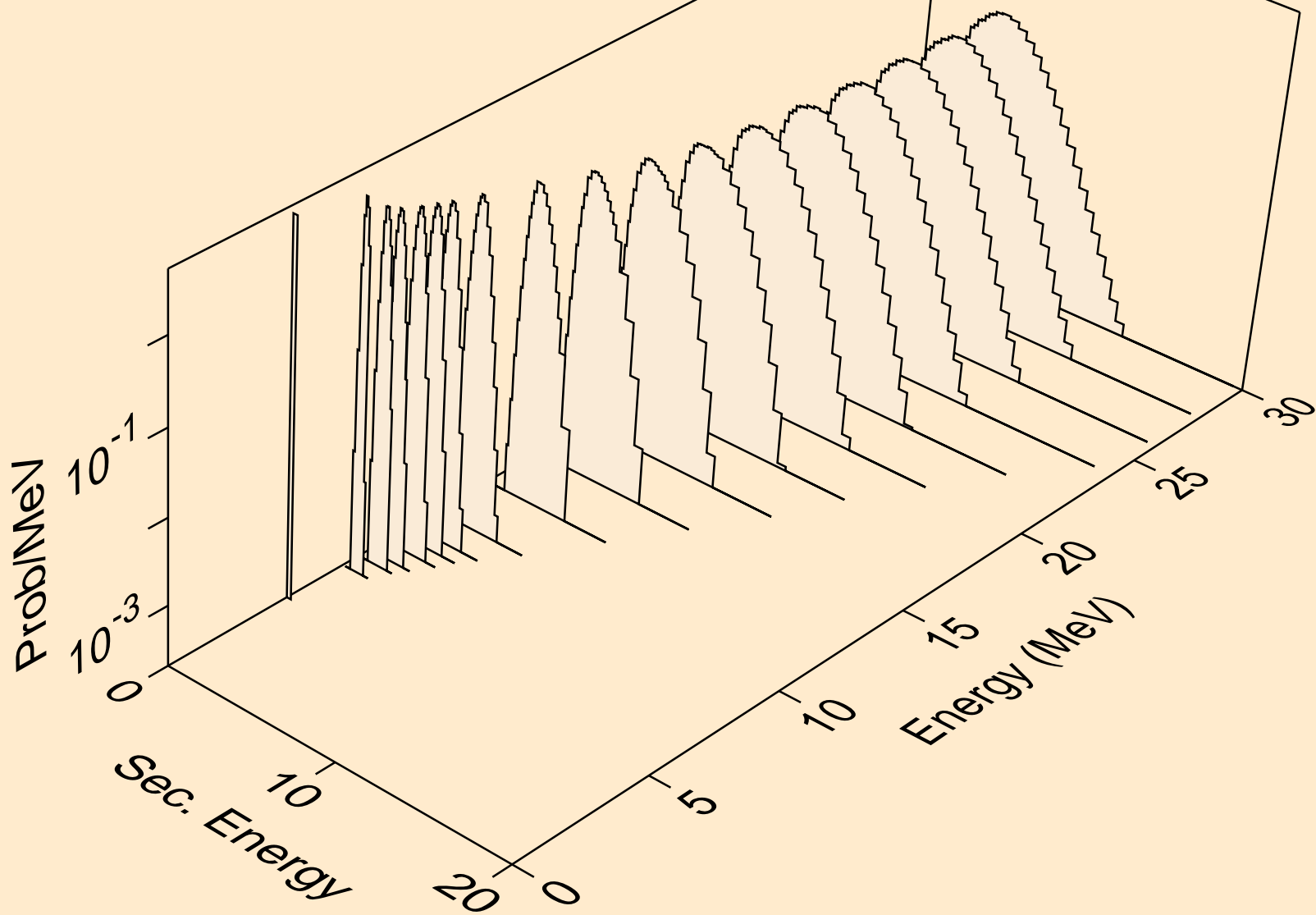

NB083 NEUTRON ACER TENDL-2021 LIBRARY; T=293.6K
protons from (n,pt)

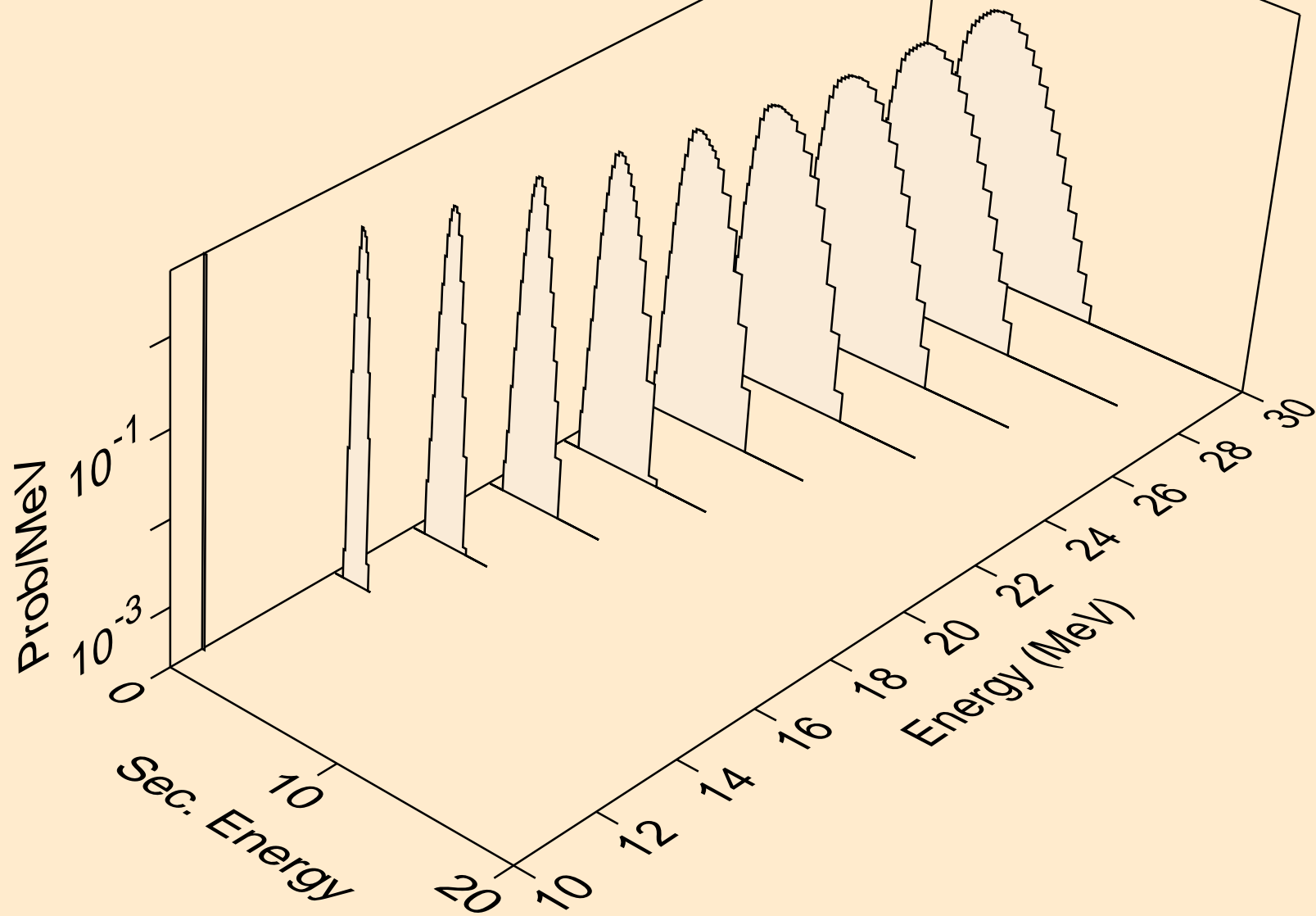

NB083 NEUTRON ACER TENDL-2021 LIBRARY; T=293.6K
deuterons from (n,x)

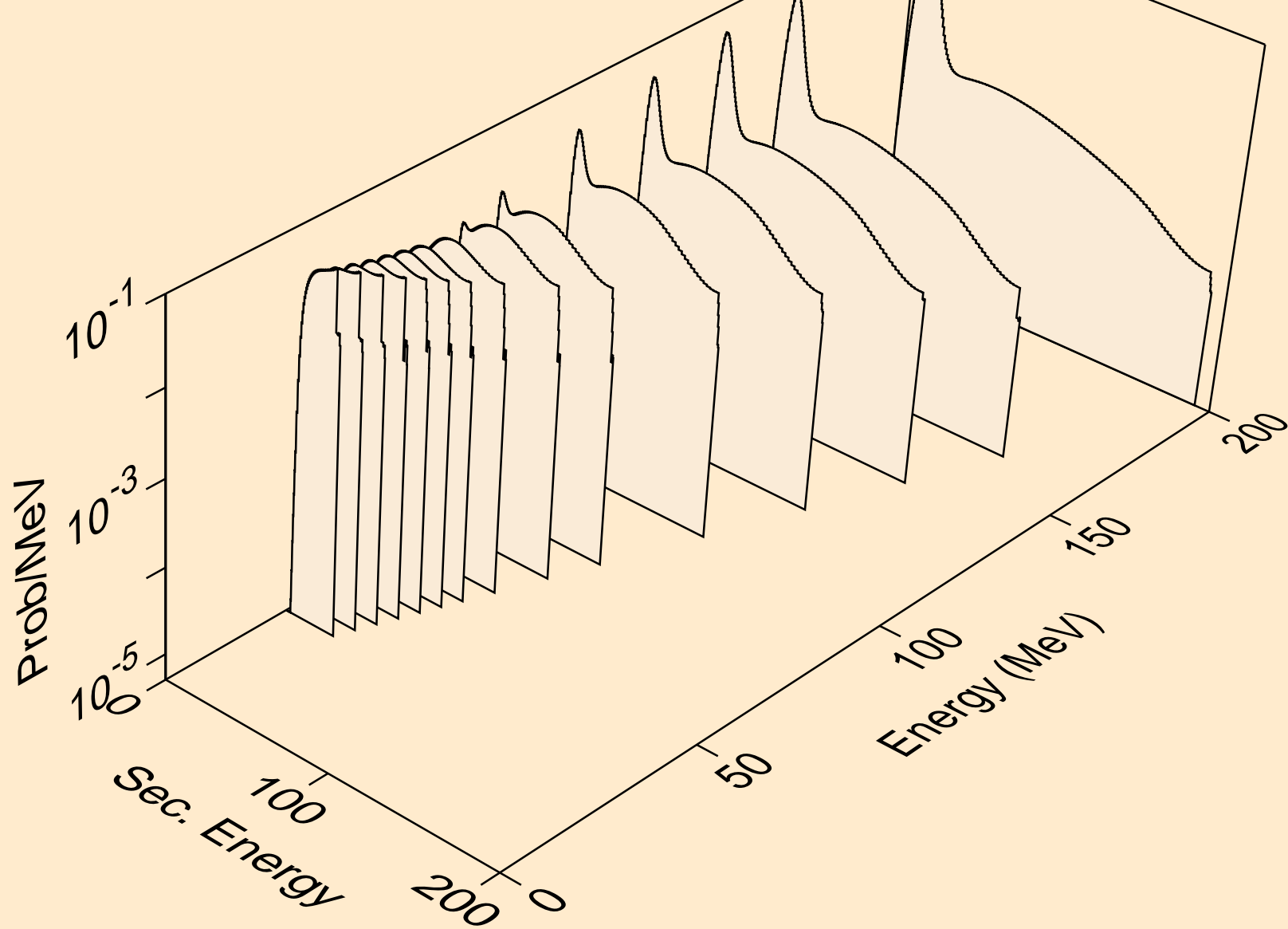

NB083 NEUTRON ACER TENDL-2021 LIBRARY; T=293.6K
deuterons from (n,2nd)

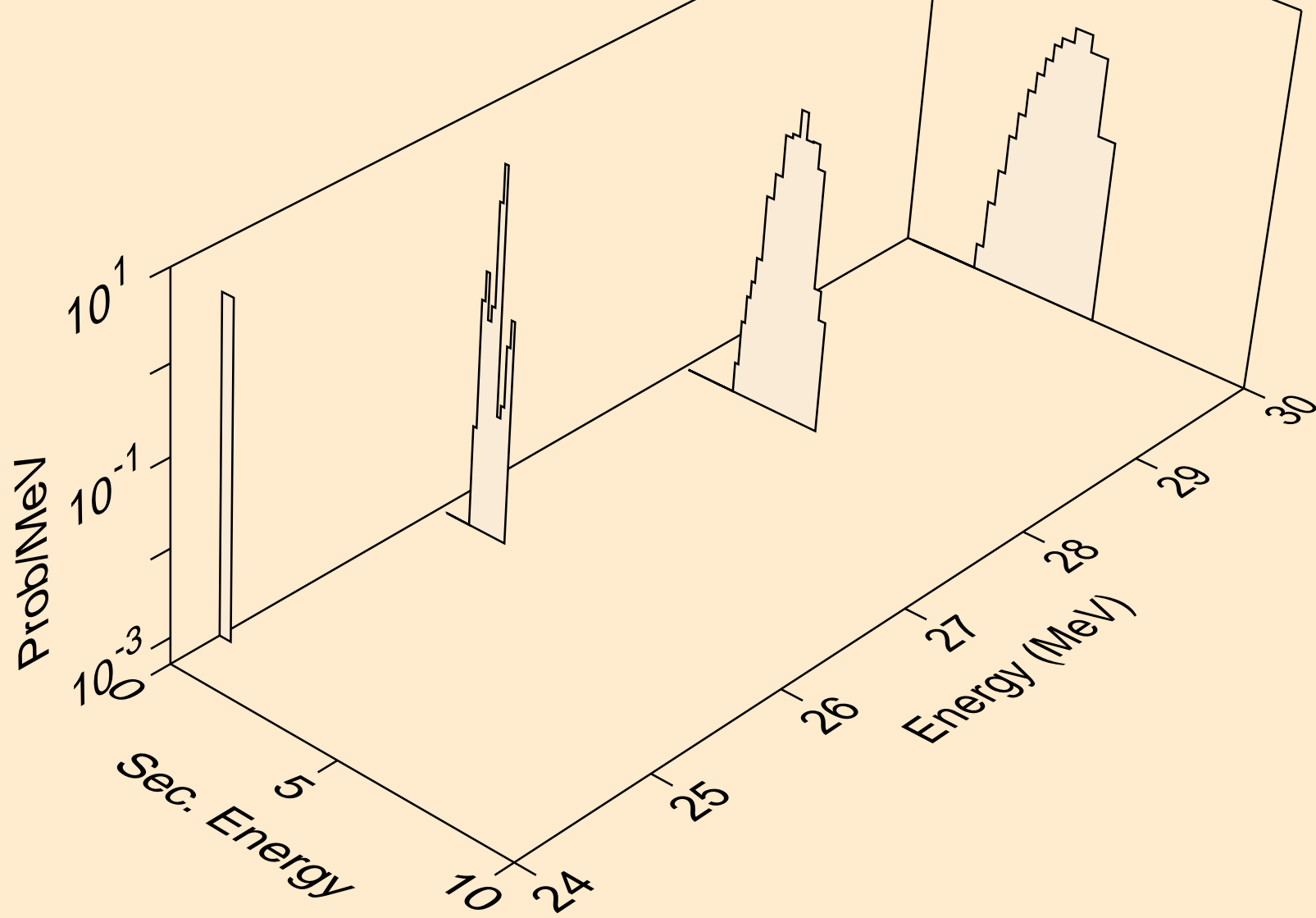

NB083 NEUTRON ACER TENDL-2021 LIBRARY; T=293.6K
deuterons from (n,n*)d

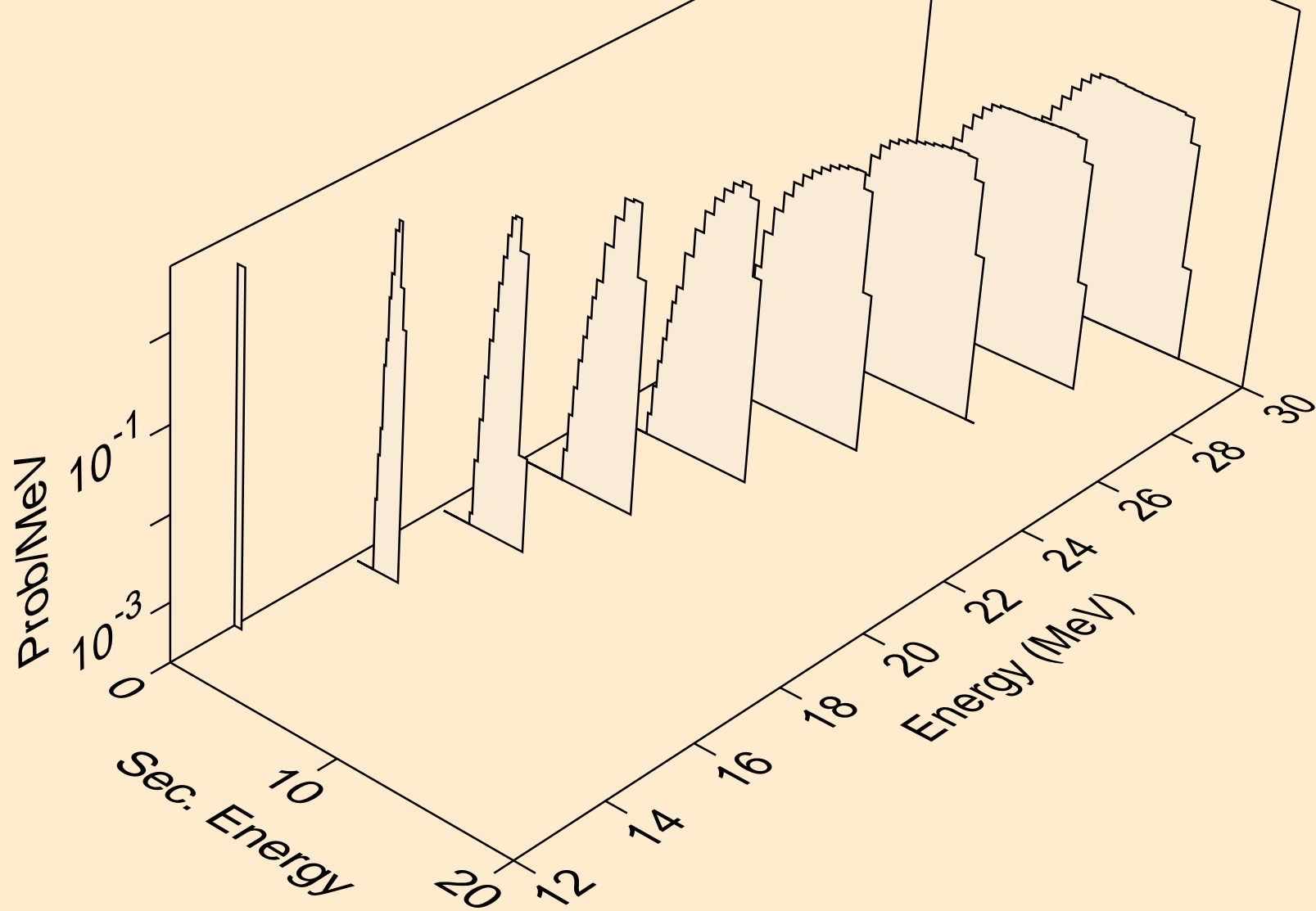

NB083 NEUTRON ACER TENDL-2021 LIBRARY; T=293.6K
deuterons from (n,d)

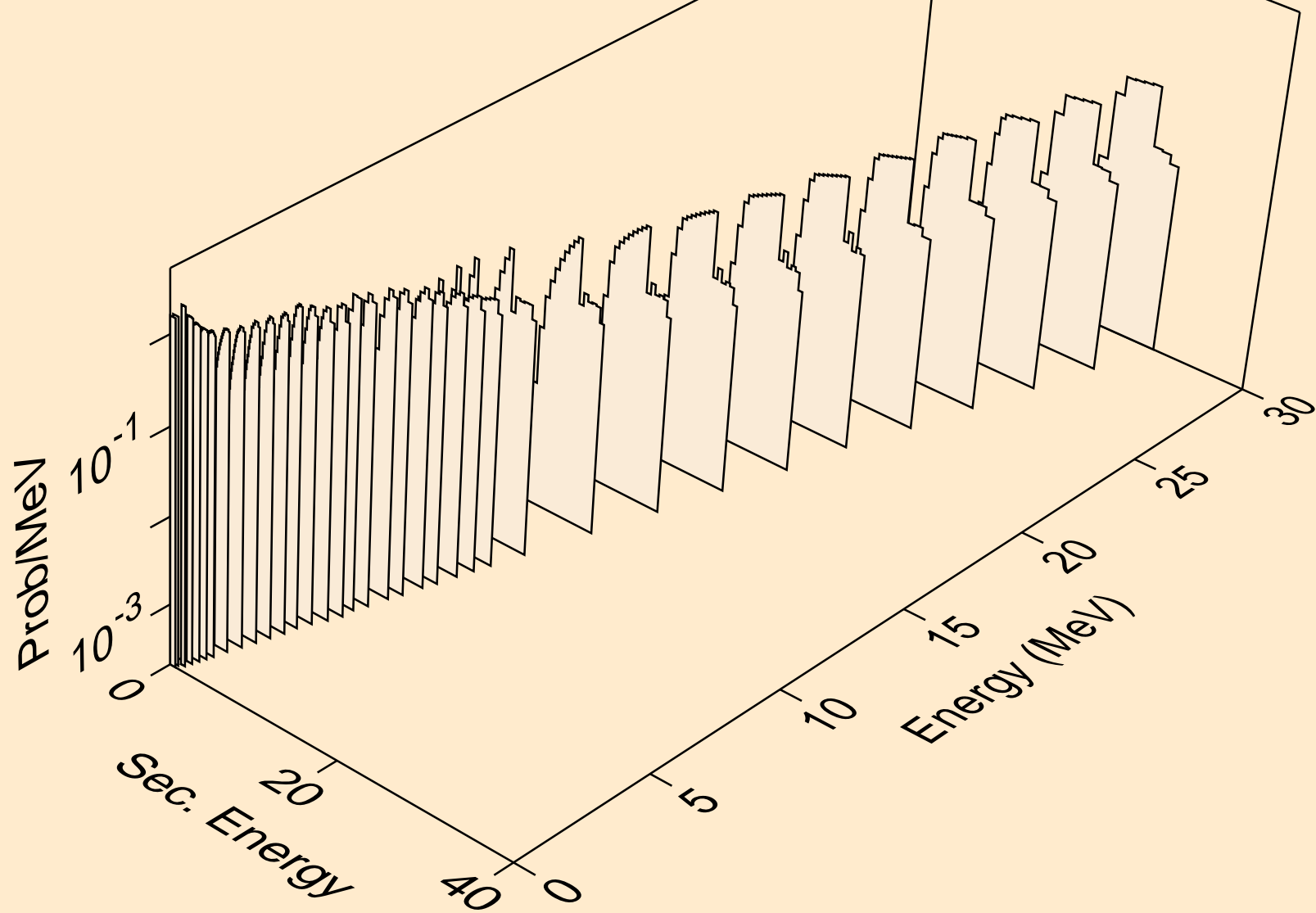

NB083 NEUTRON ACER TENDL-2021 LIBRARY; T=293.6K
deuterons from (n,d2a)

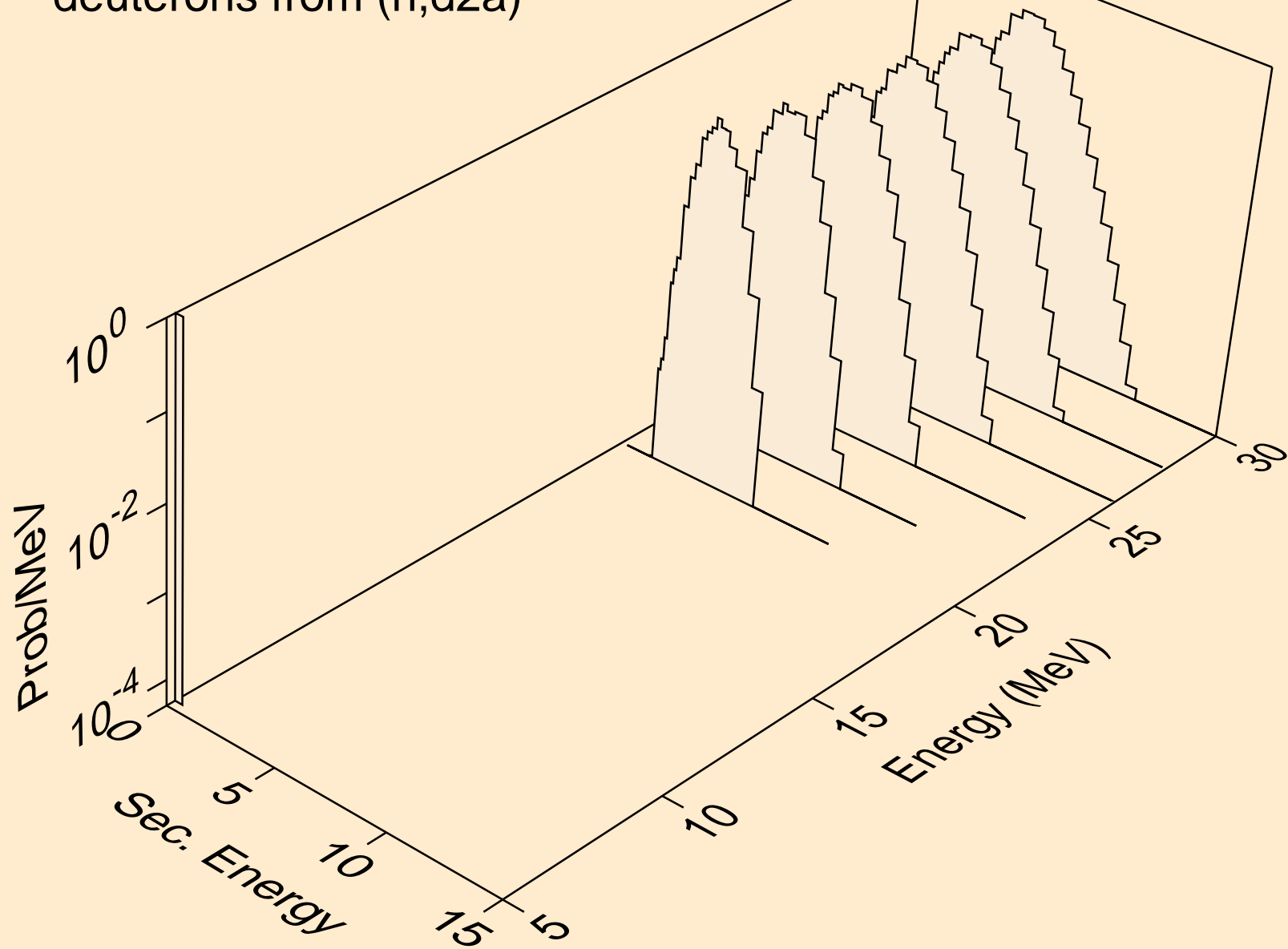

NB083 NEUTRON ACER TENDL-2021 LIBRARY; T=293.6K
deuterons from (n,pd)

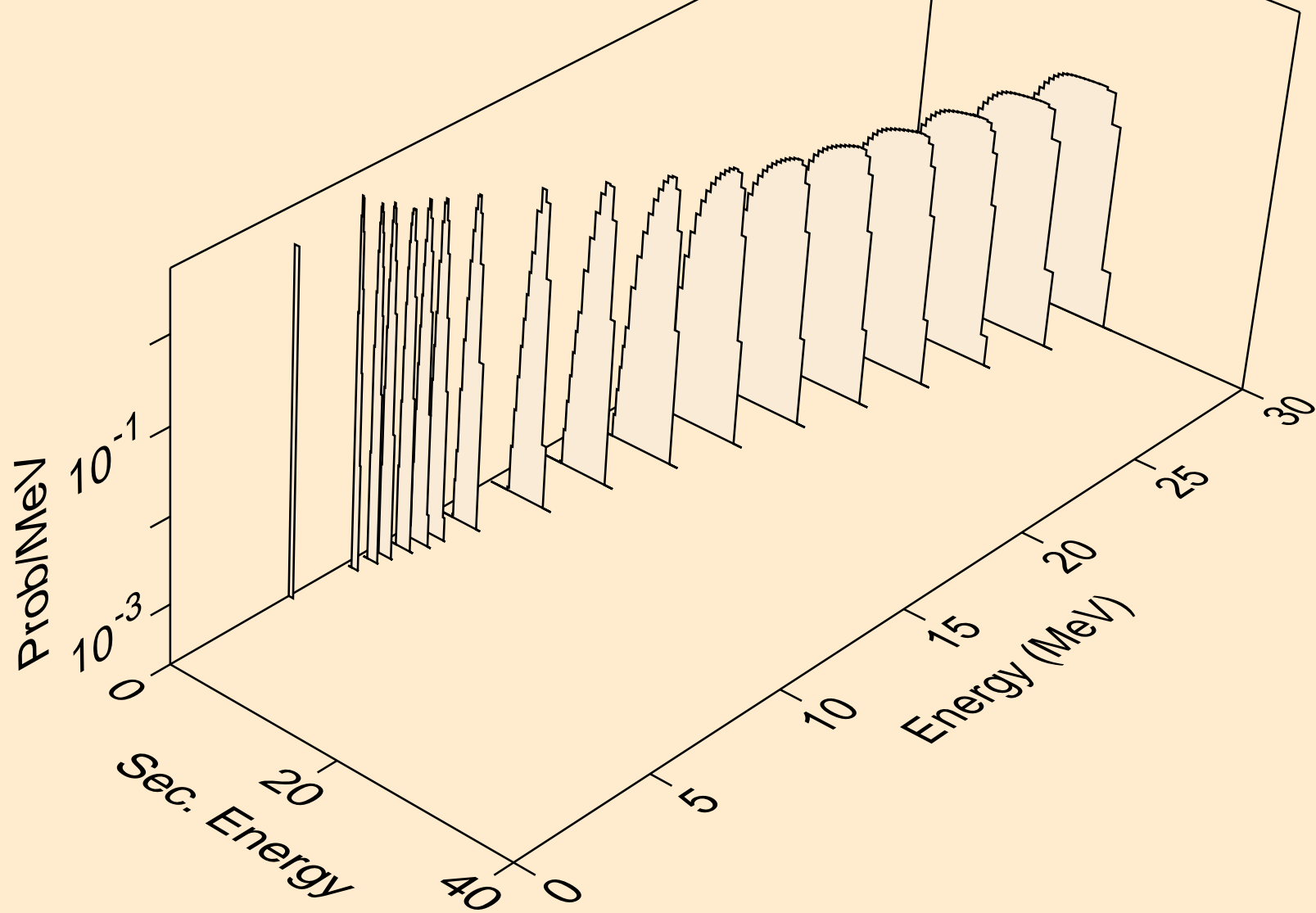

NB083 NEUTRON ACER TENDL-2021 LIBRARY; T=293.6K
deuterons from (n,da)

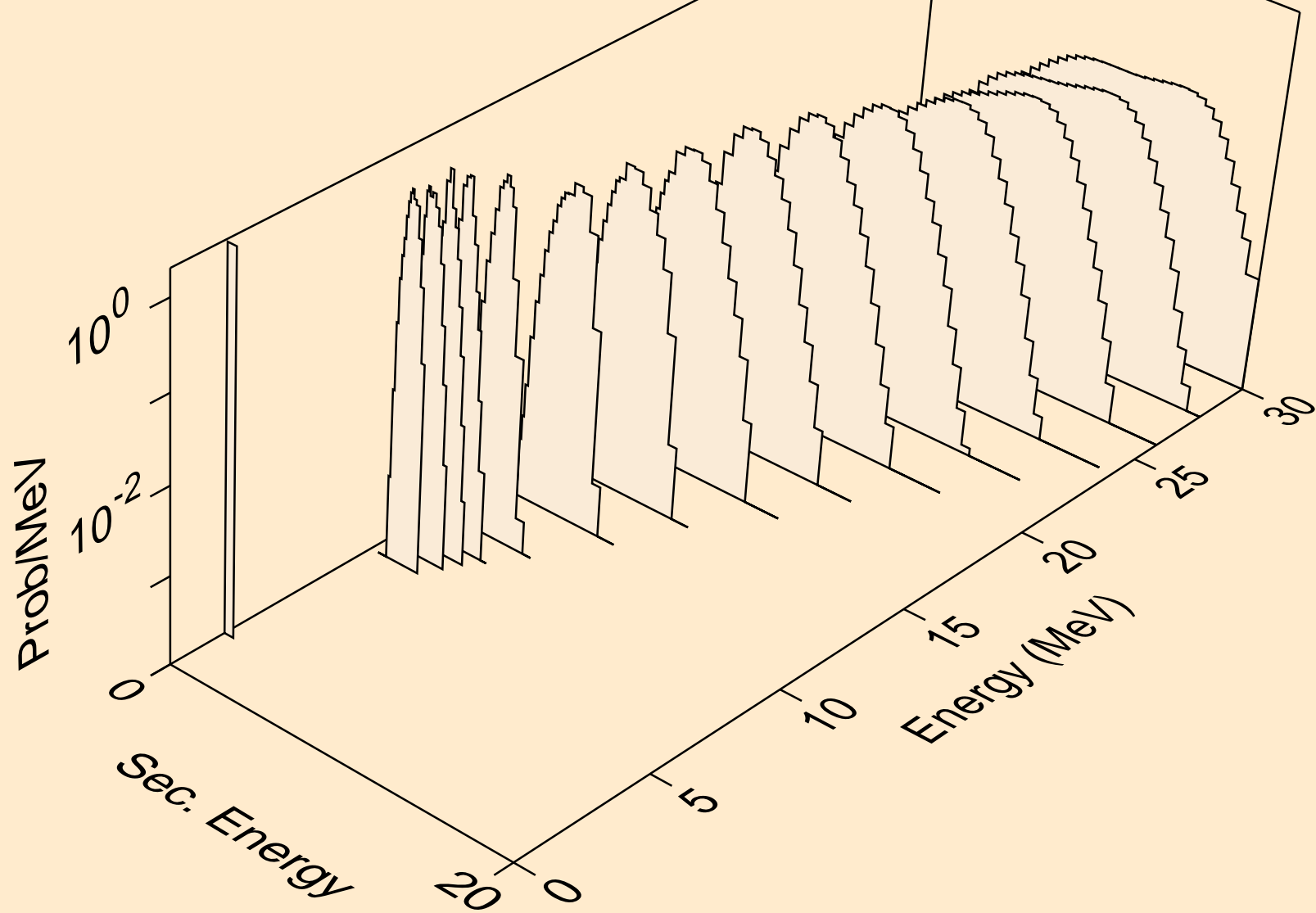

NB083 NEUTRON ACER TENDL-2021 LIBRARY; T=293.6K
tritons from (n,x)

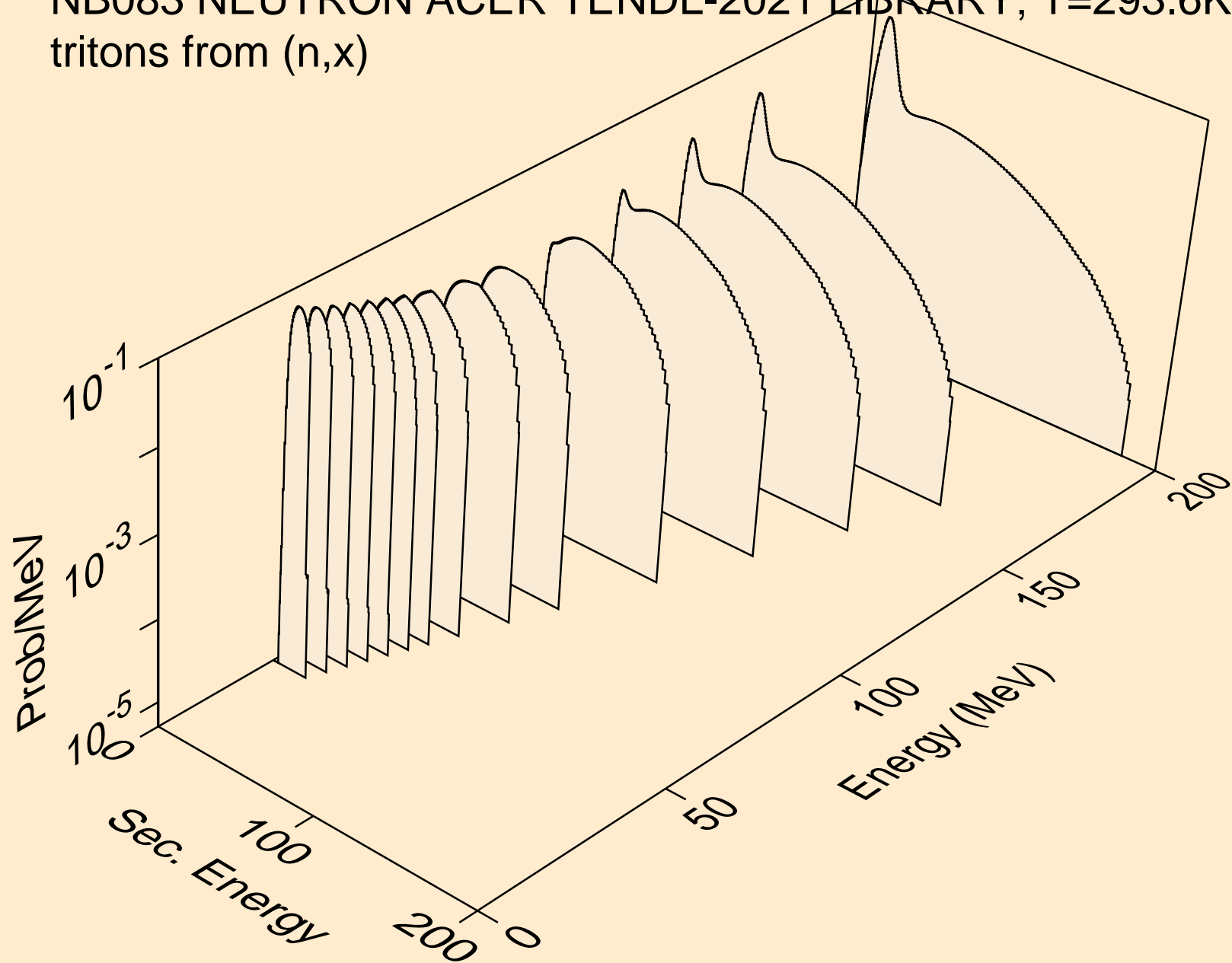

NB083 NEUTRON ACER TENDL-2021 LIBRARY; T=293.6K
tritons from (n,n*)t

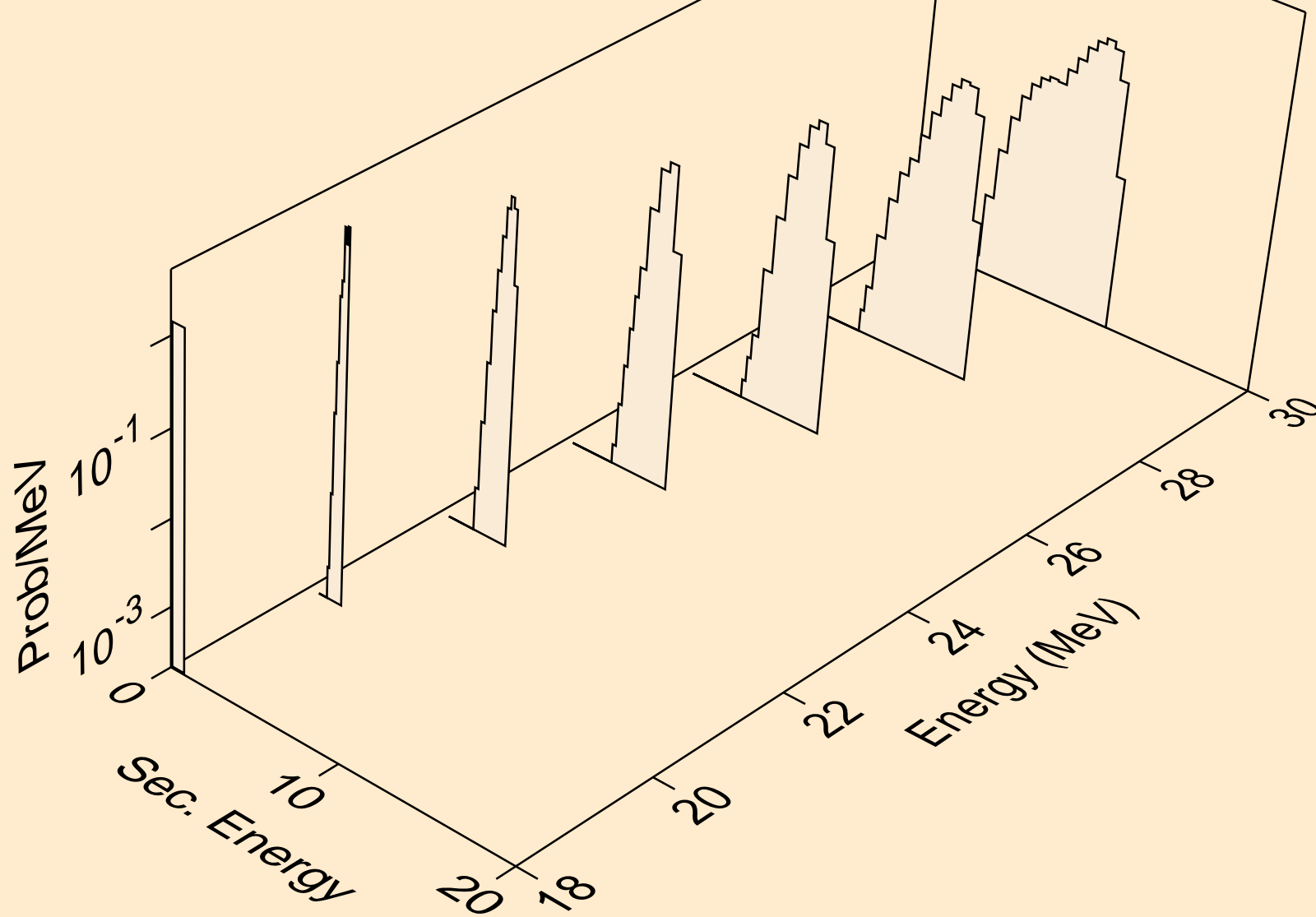

NB083 NEUTRON ACER TENDL-2021 LIBRARY; T=293.6K
tritons from (n,t)

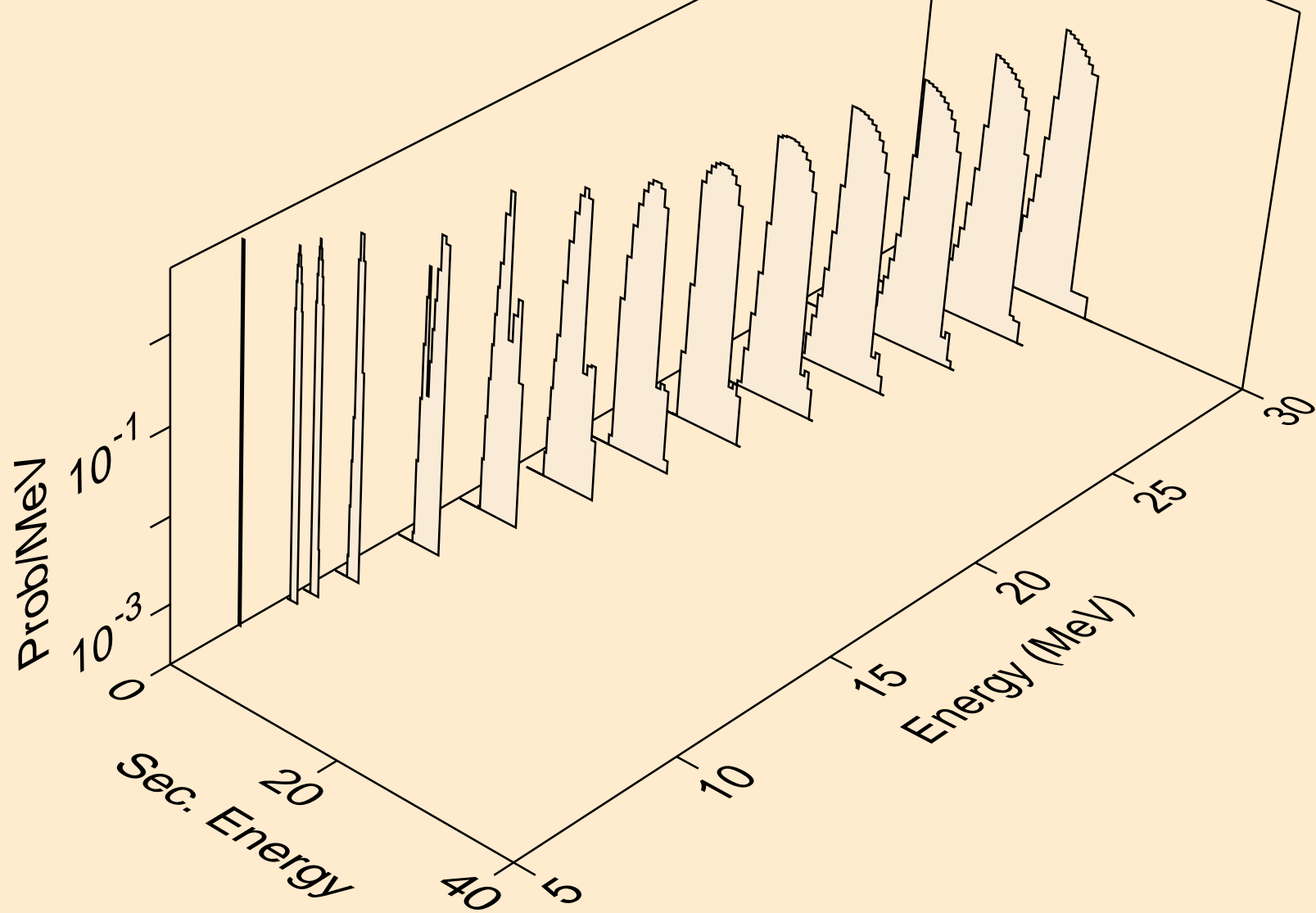

NB083 NEUTRON ACER TENDL-2021 LIBRARY; T=293.6K
tritons from (n,pt)

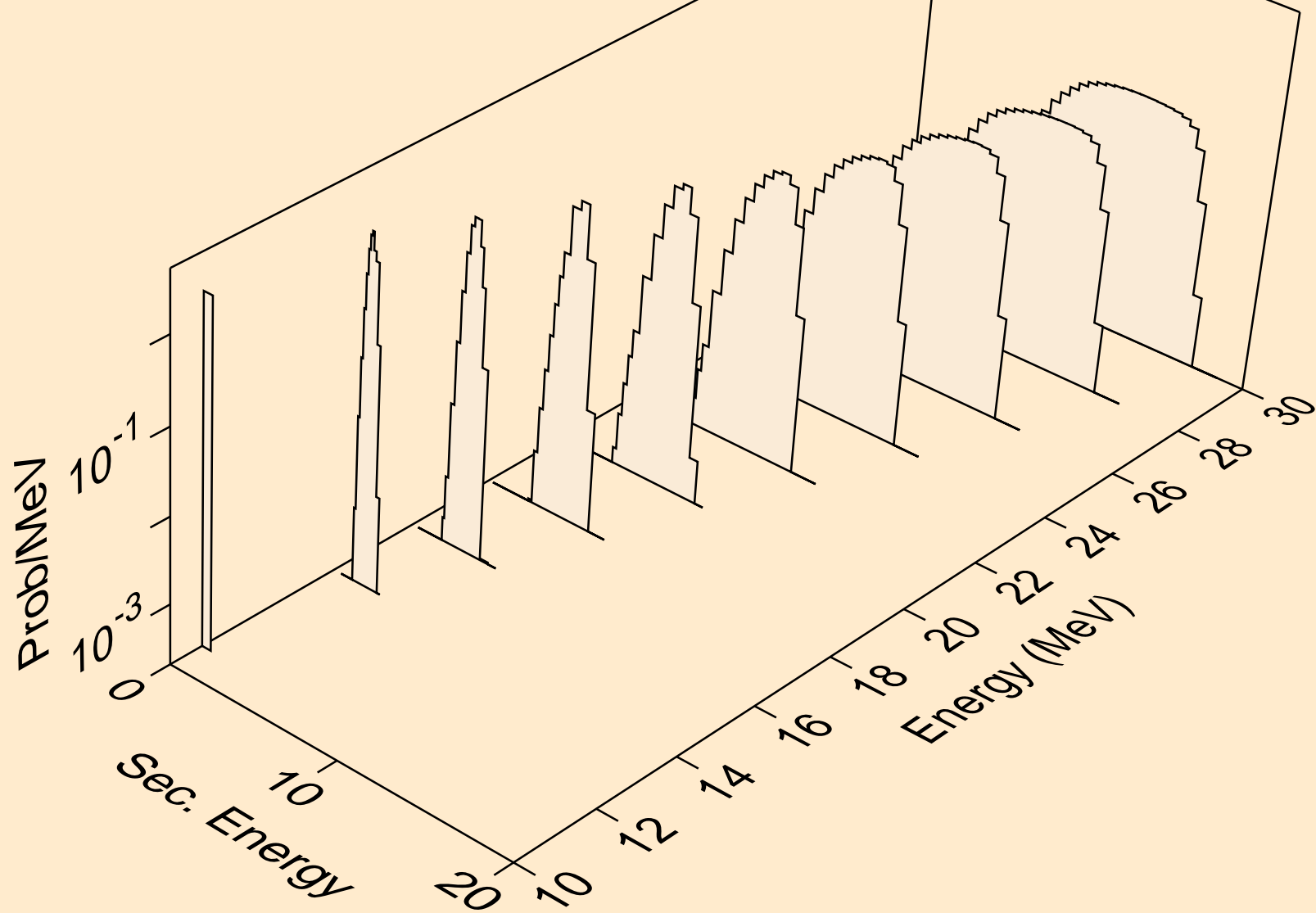

NB083 NEUTRON ACER TENDL-2021 LIBRARY; T=293.6K
he3s from (n,x)

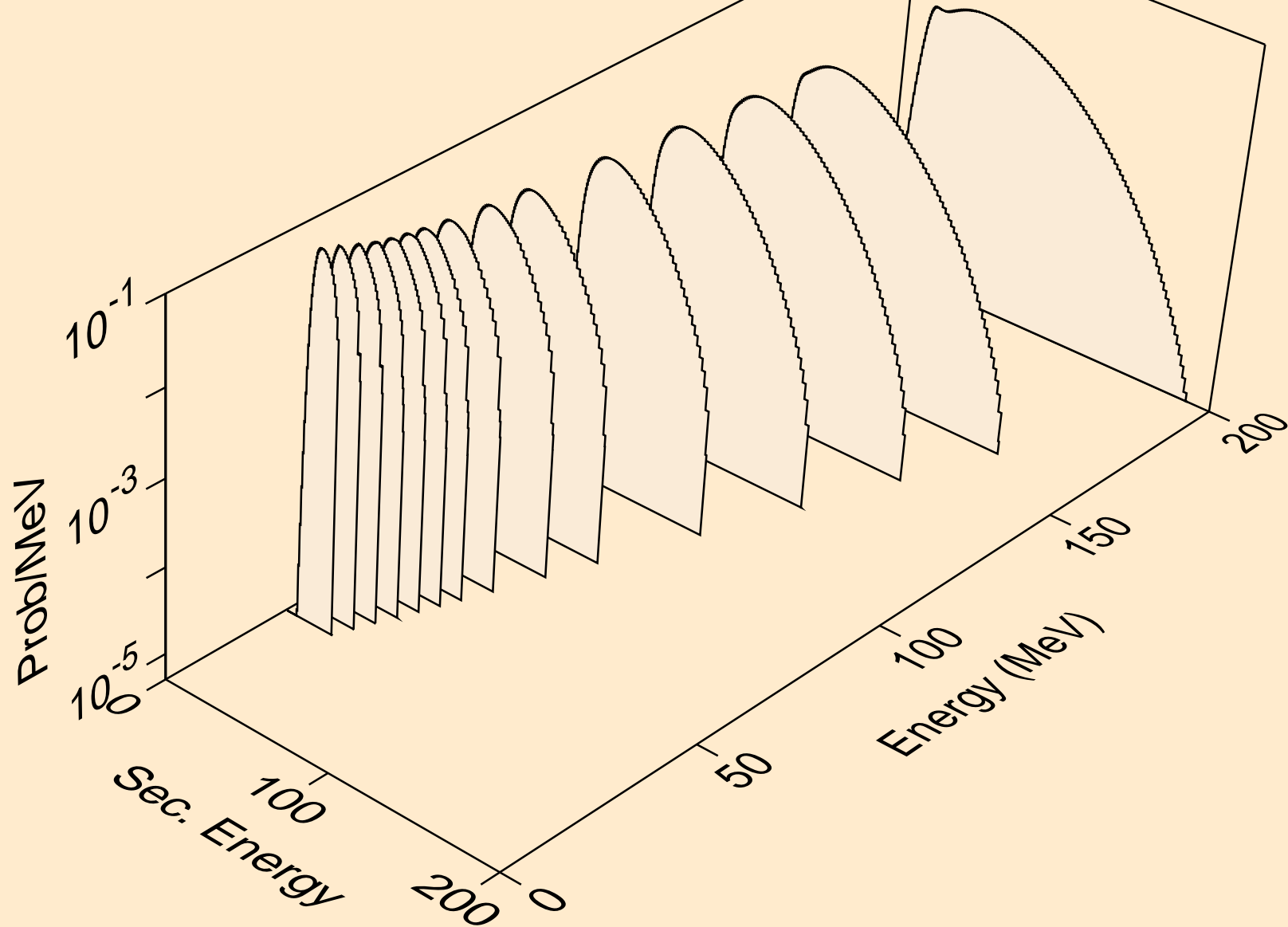

NB083 NEUTRON ACER TENDL-2021 LIBRARY; T=293.6K
he3s from (n,n*)he3

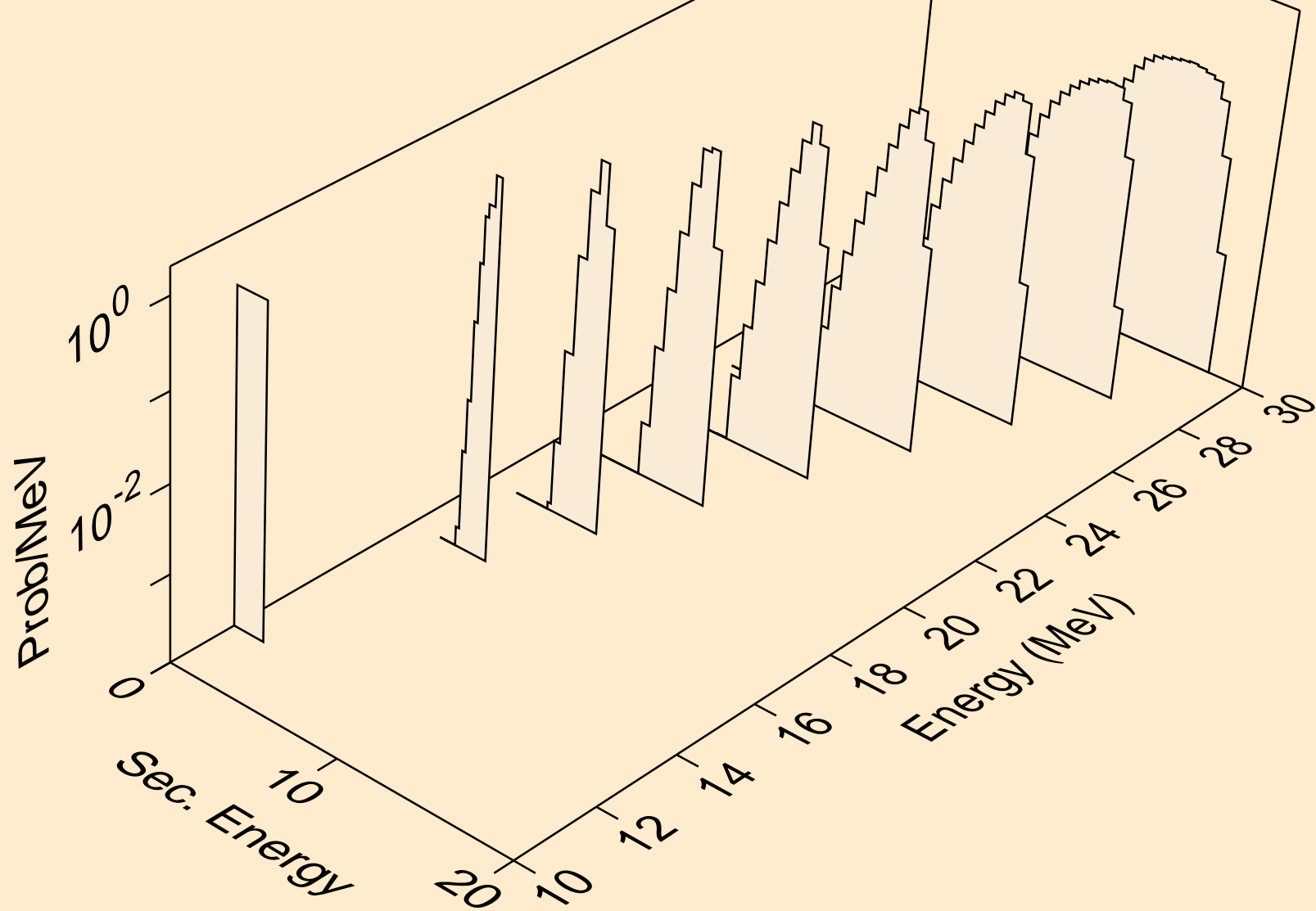

NB083 NEUTRON ACER TENDL-2021 LIBRARY; T=293.6K
he3s from (n,he3)

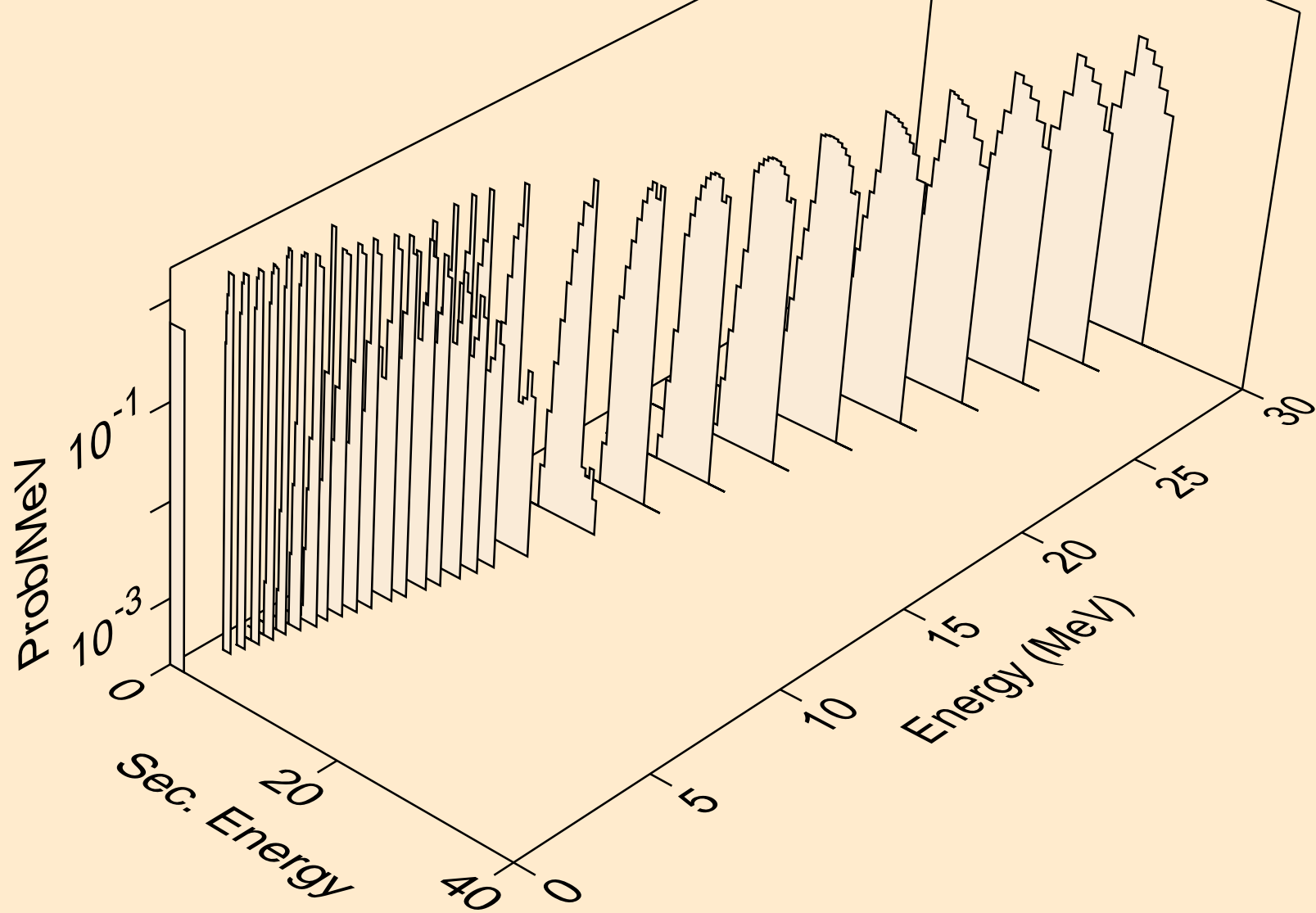

NB083 NEUTRON ACER TENDL-2021 LIBRARY; T=293.6K
alphas from (n,x)

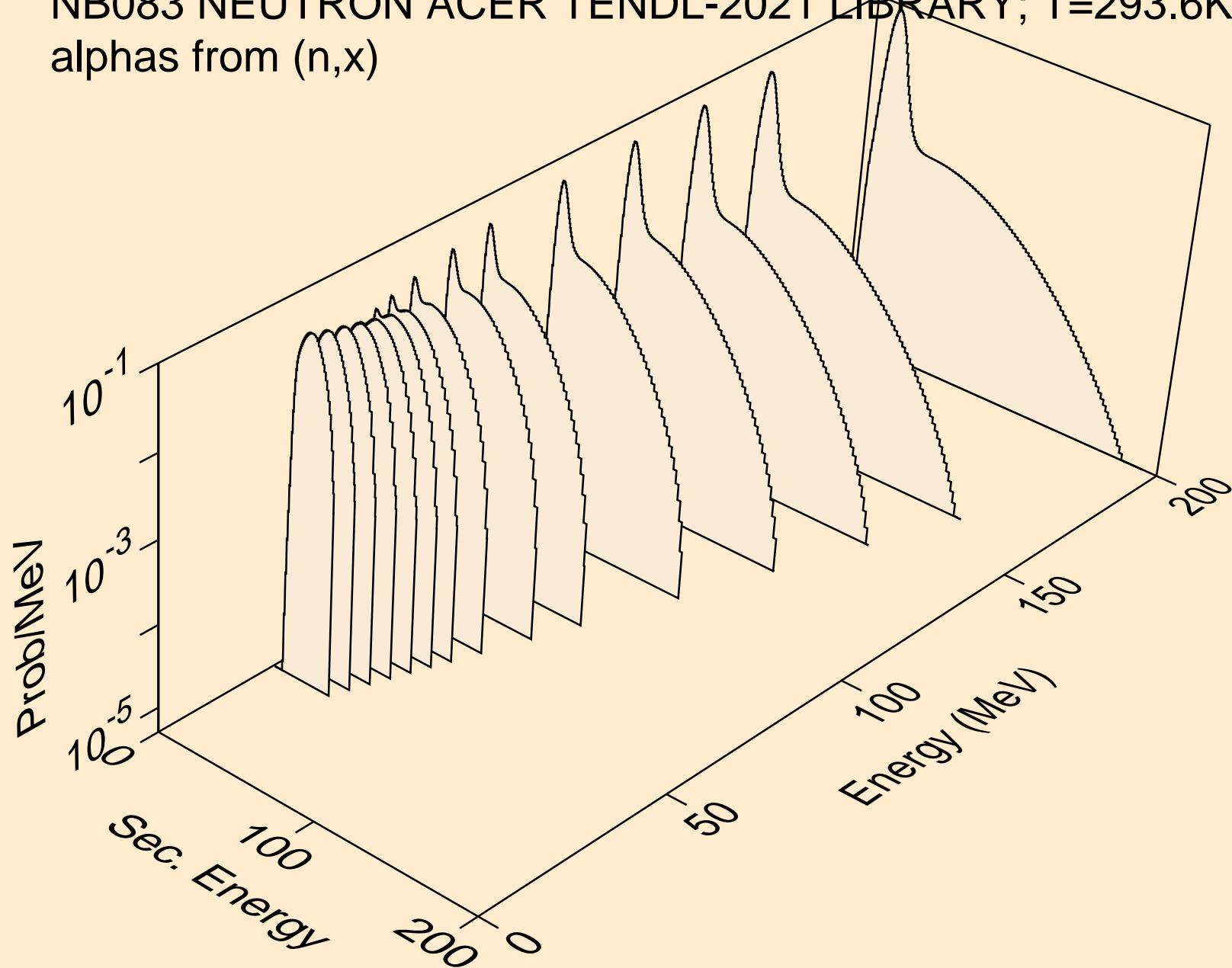

NB083 NEUTRON ACER TENDL-2021 LIBRARY; T=293.6K
alphas from (n,n*)a

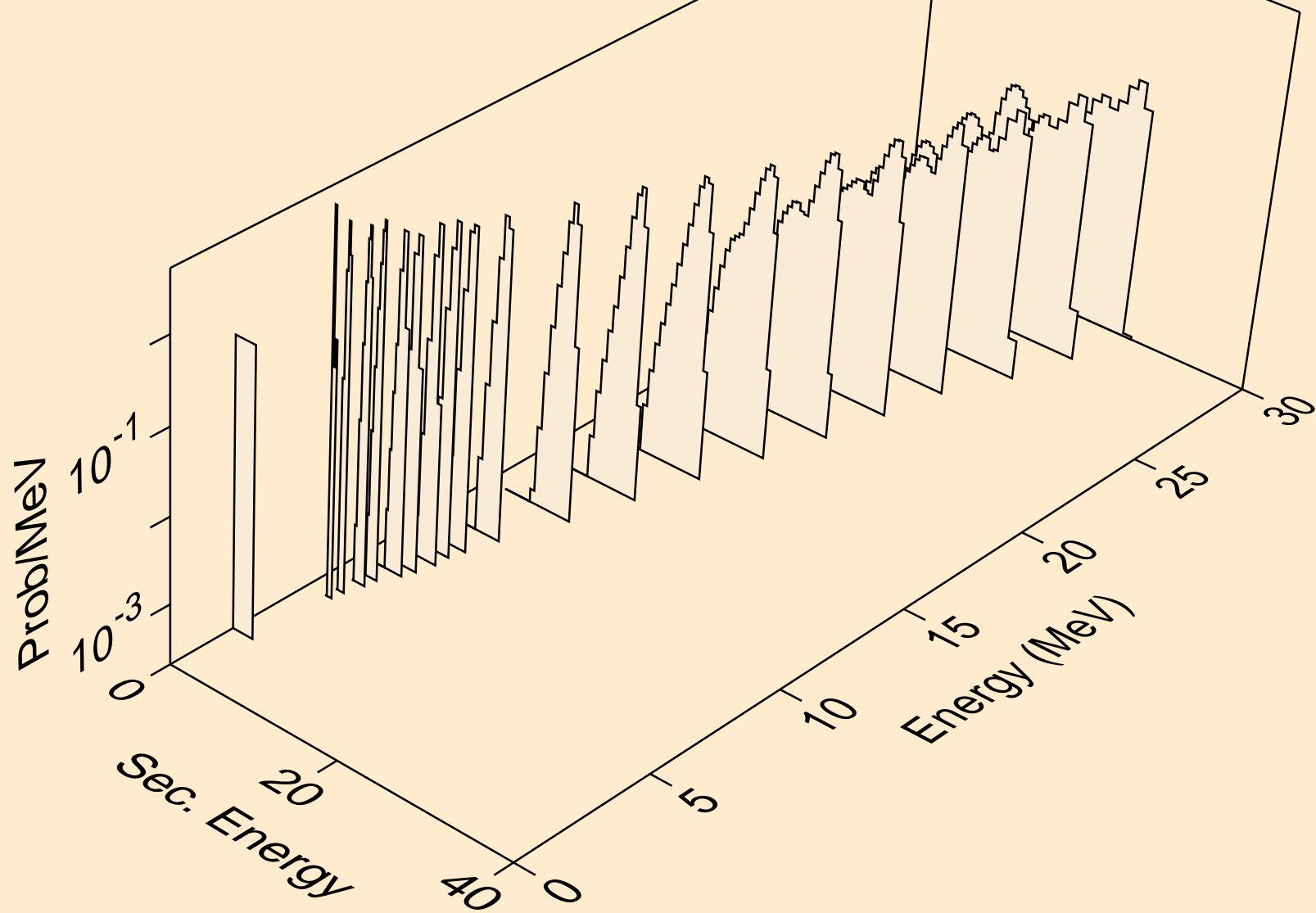

NB083 NEUTRON ACER TENDL-2021 LIBRARY; T=293.6K
alphas from (n,2n)a

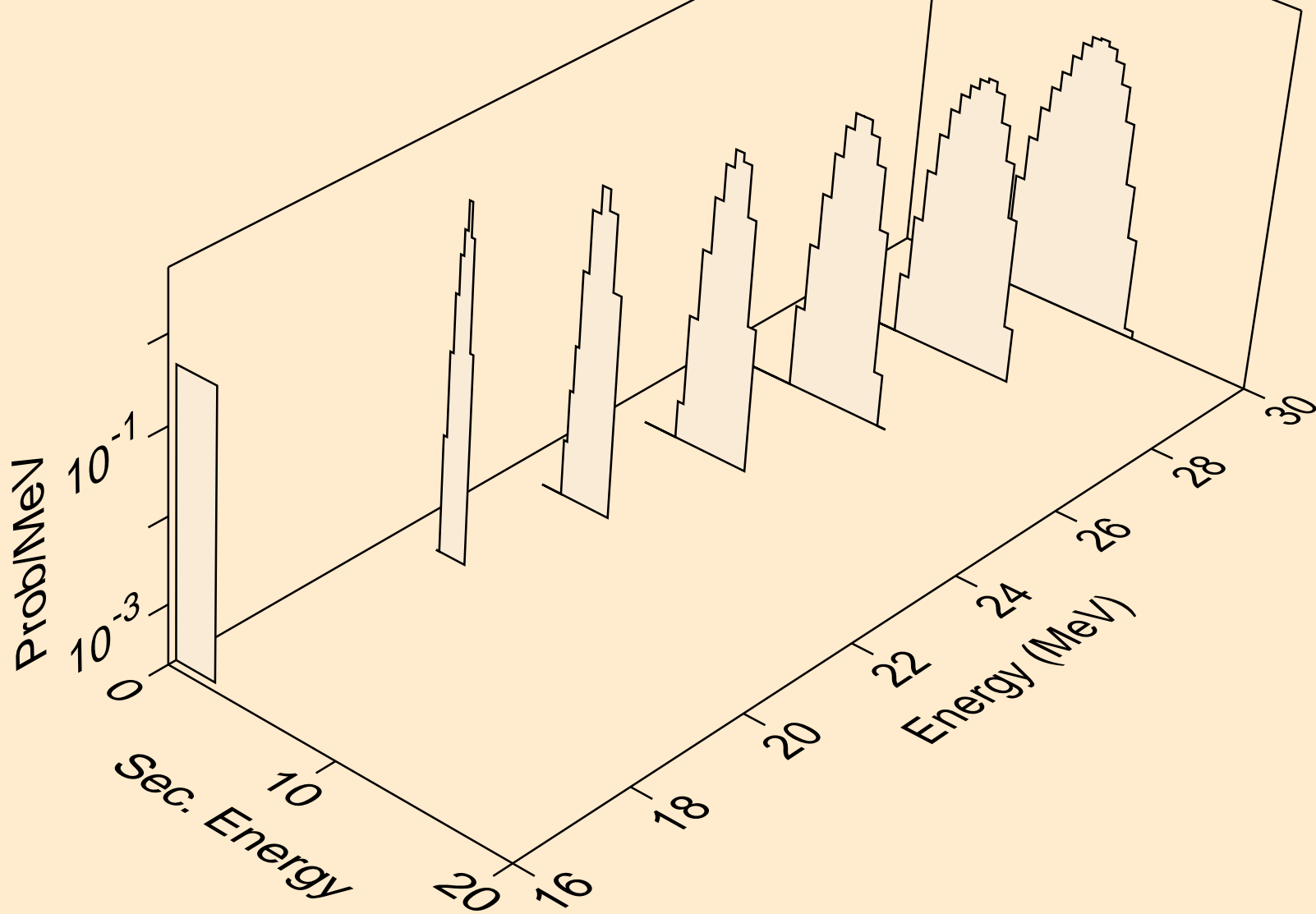

NB083 NEUTRON ACER TENDL-2021 LIBRARY; T=293.6K
alphas from (n,n*)2a

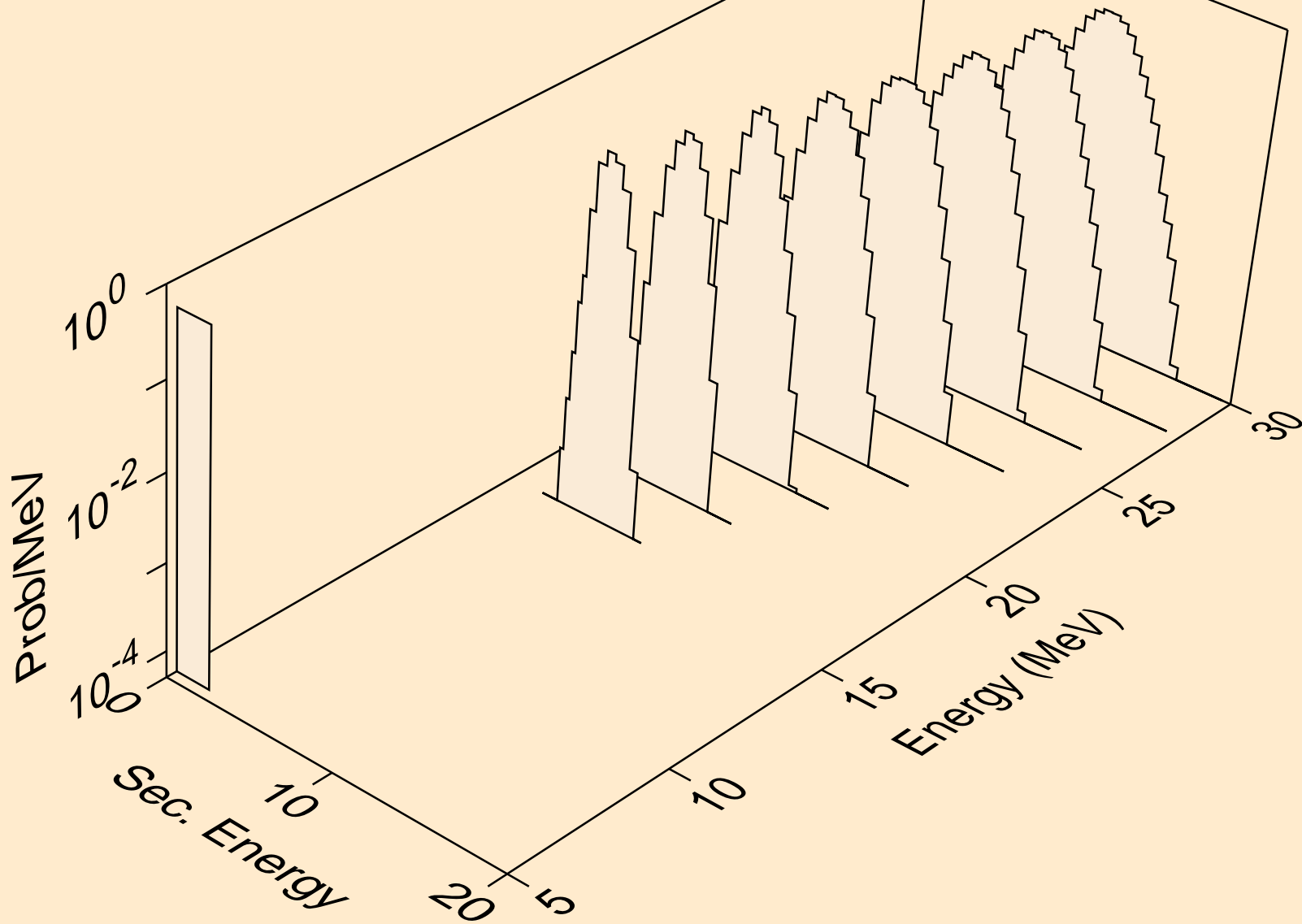

NB083 NEUTRON ACER TENDL-2021 LIBRARY; T=293.6K
alphas from (n,npa)

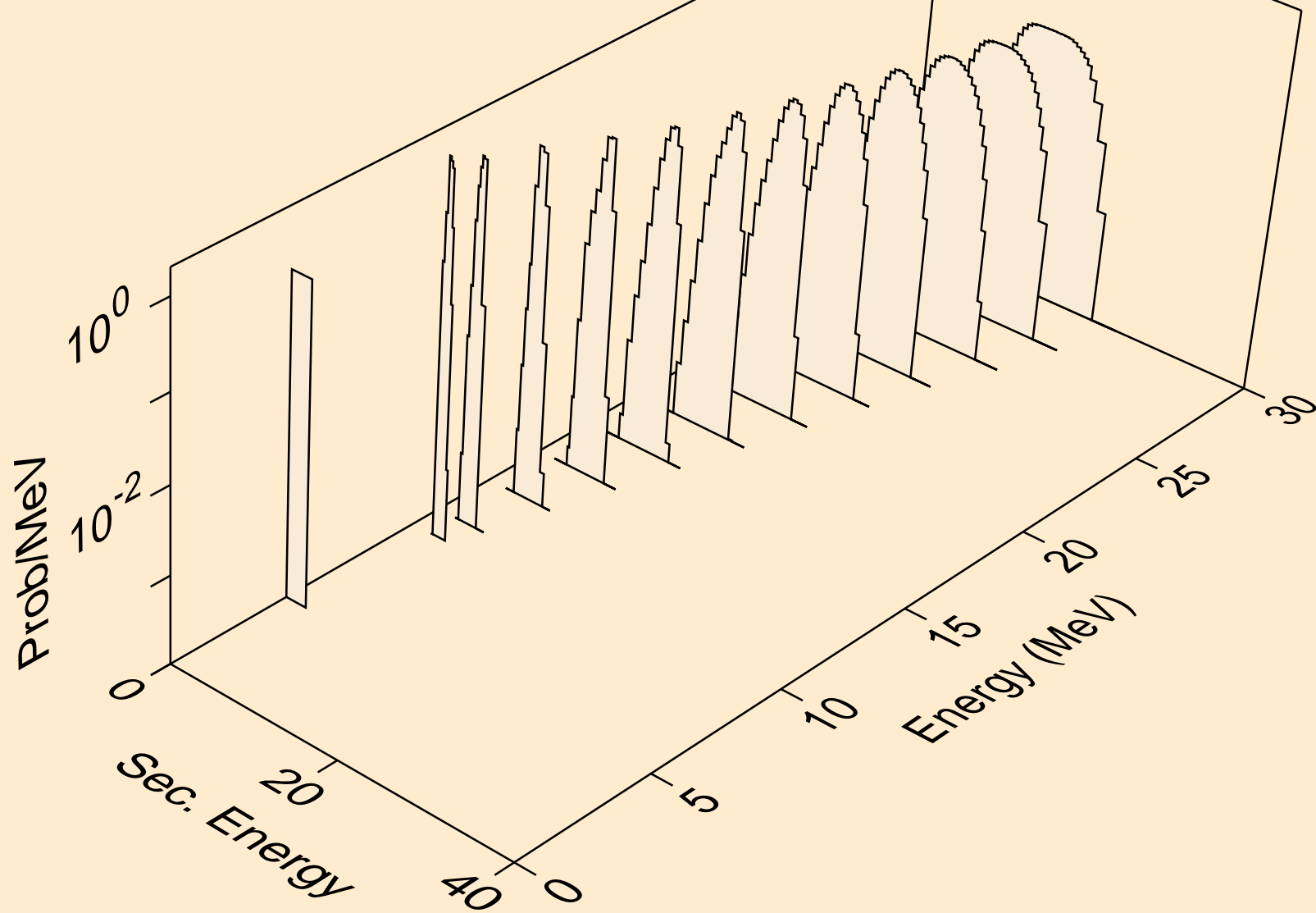

NB083 NEUTRON ACER TENDL-2021 LIBRARY; T=293.6K
alphas from (n,a)

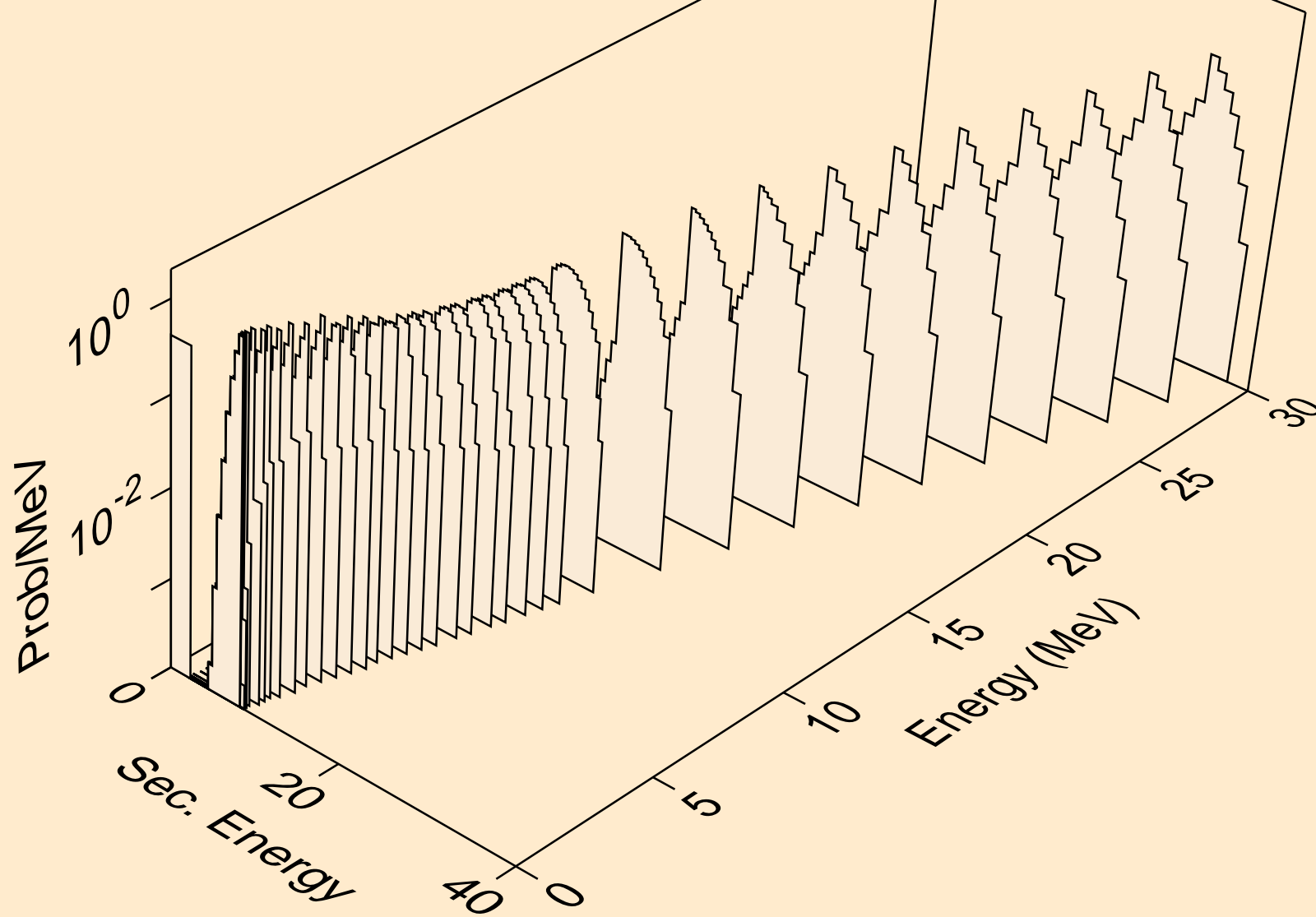

NB083 NEUTRON ACER TENDL-2021 LIBRARY; T=293.6K
alphas from (n,2a)

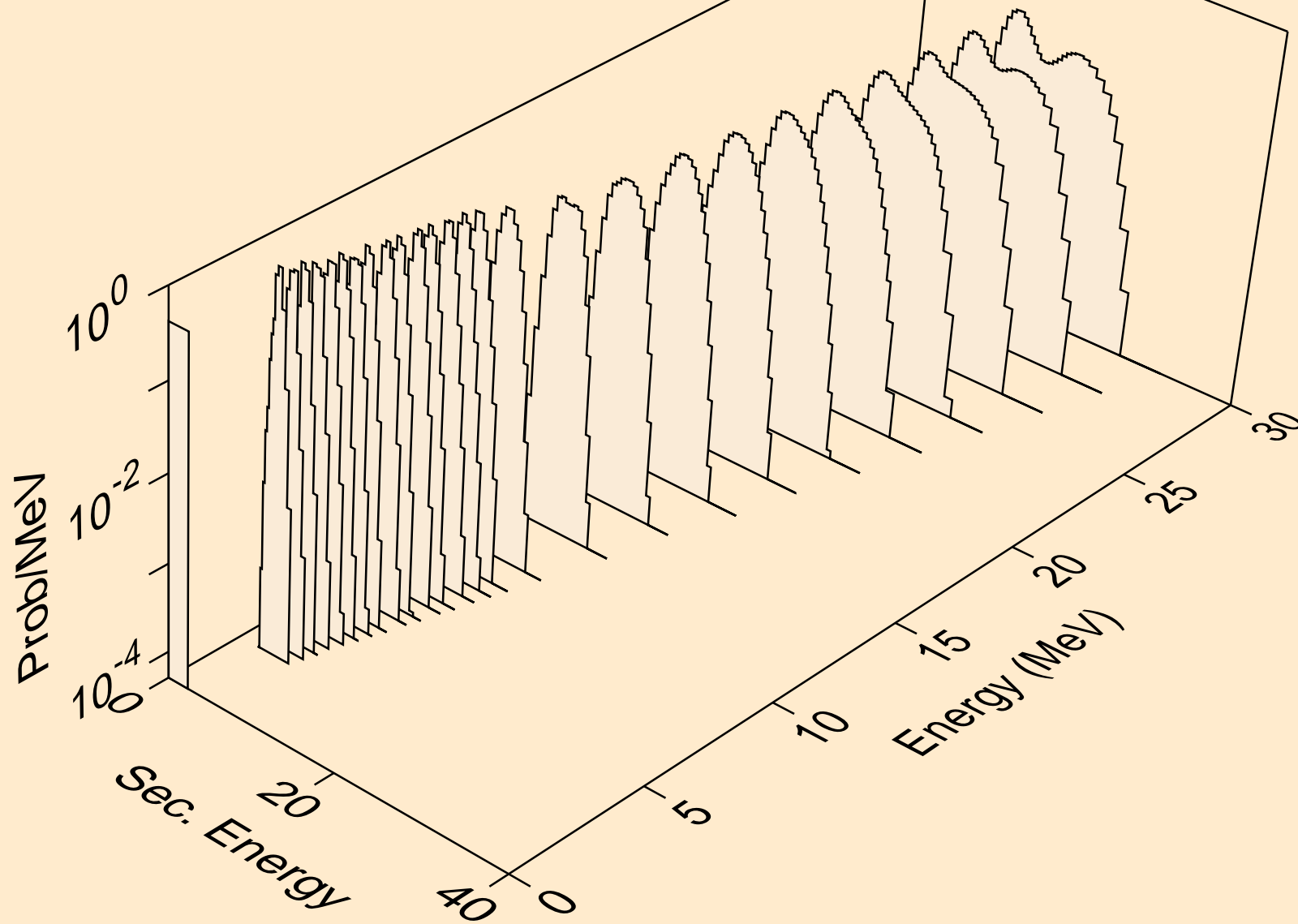

NB083 NEUTRON ACER TENDL-2021 LIBRARY; T=293.6K
alphas from (n,3a)

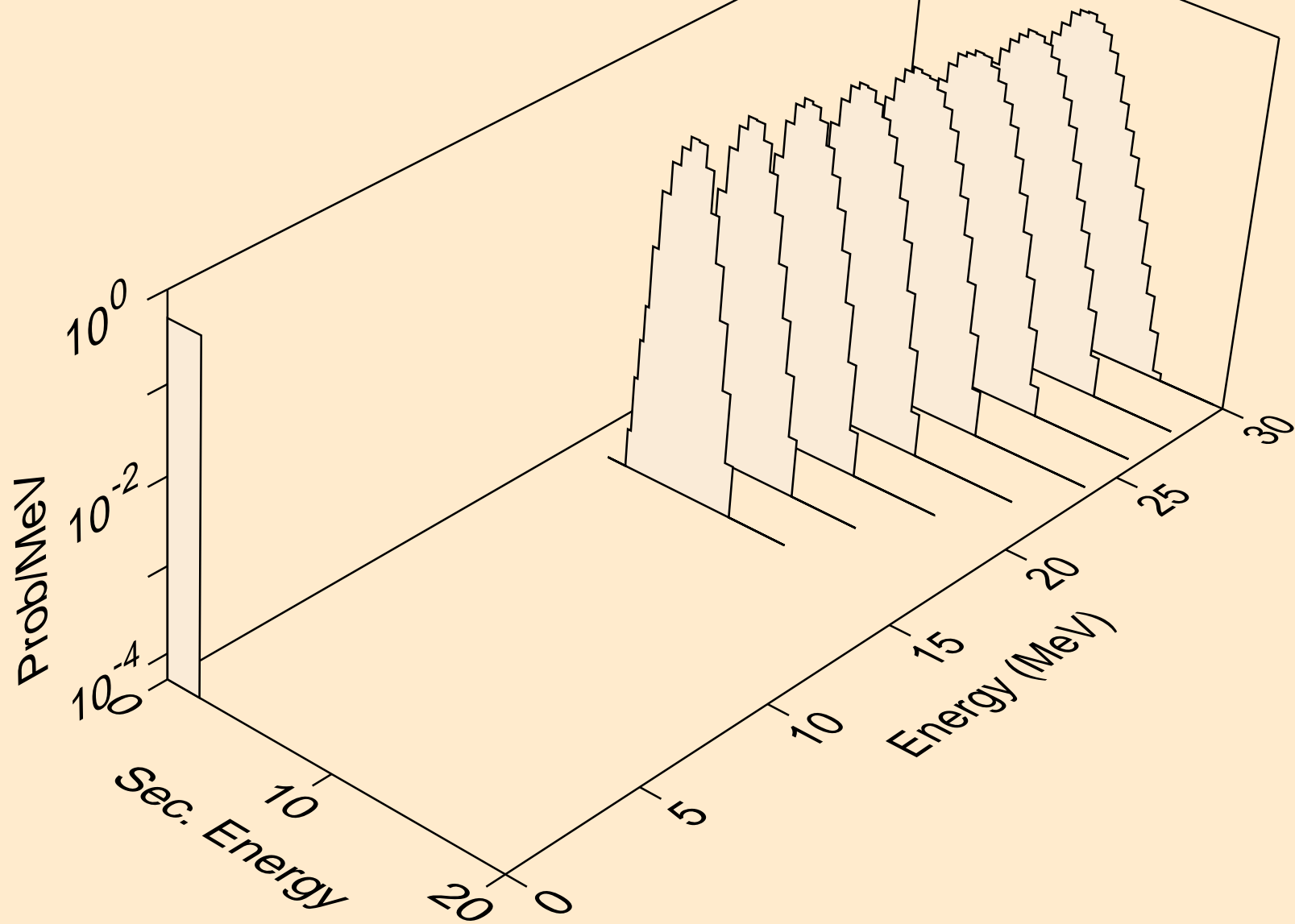

NB083 NEUTRON ACER TENDL-2021 LIBRARY; T=293.6K
alphas from (n,pa)

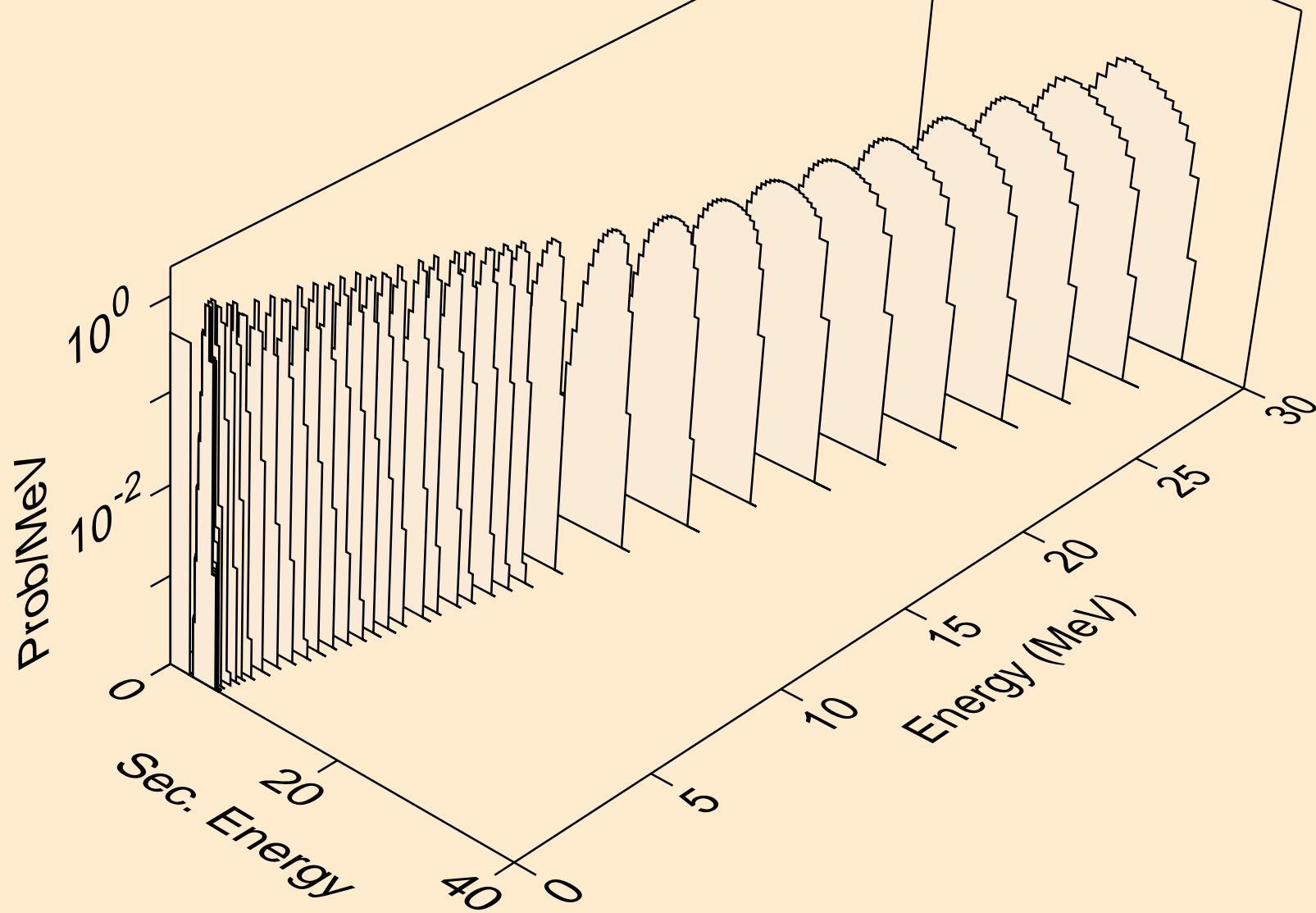

NB083 NEUTRON ACER TENDL-2021 LIBRARY; T=293.6K
alphas from (n,d2a)

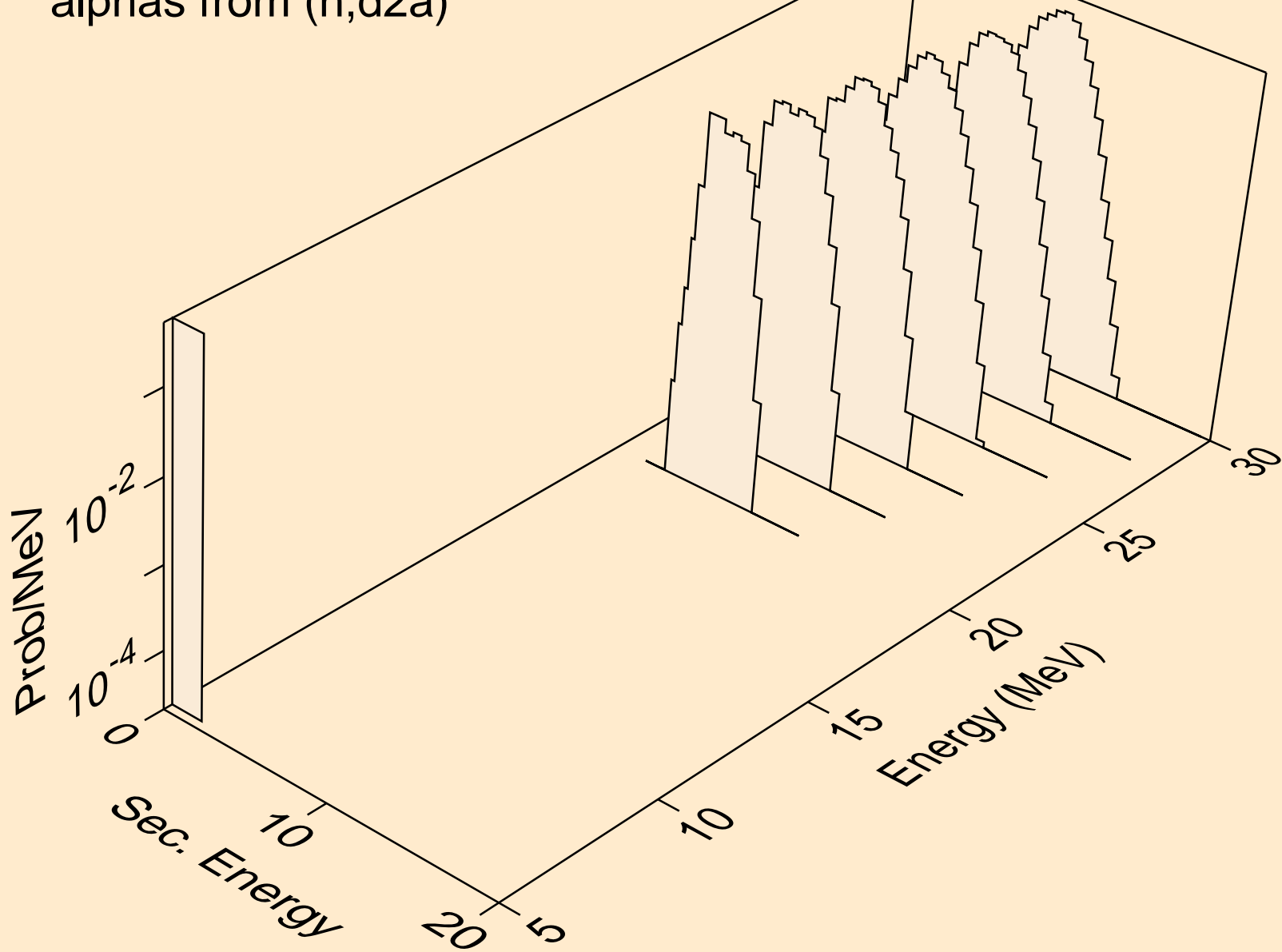

NB083 NEUTRON ACER TENDL-2021 LIBRARY; T=293.6K
alphas from (n,da)

