

ND129 NEUTRON ACER TENDL-2021 LIBRARY; T=293.6K

Principal cross sections

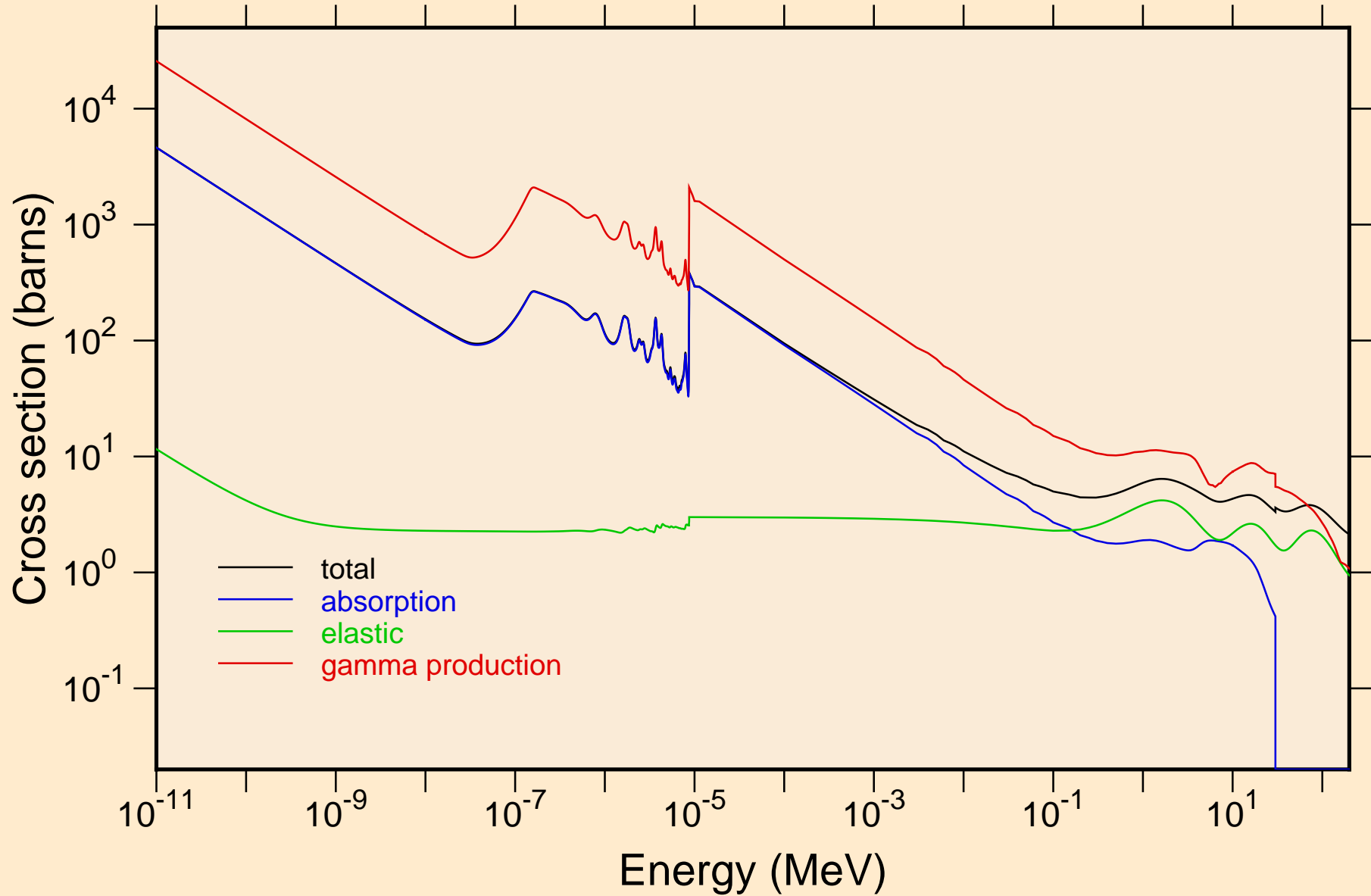

ND129 NEUTRON ACER TENDL-2021 LIBRARY; T=293.6K
Heating

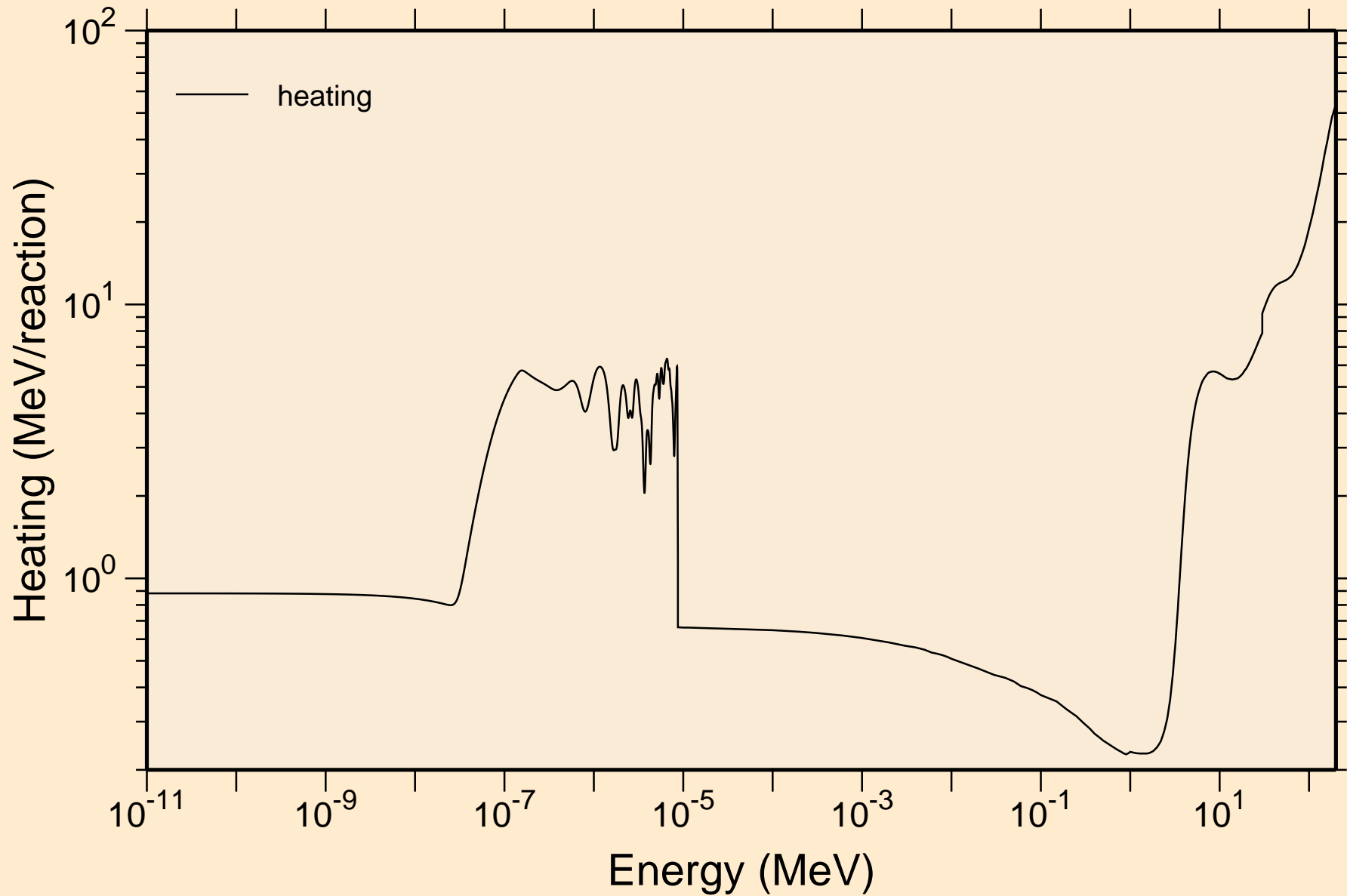

ND129 NEUTRON ACER TENDL-2021 LIBRARY; T=293.6K
Damage

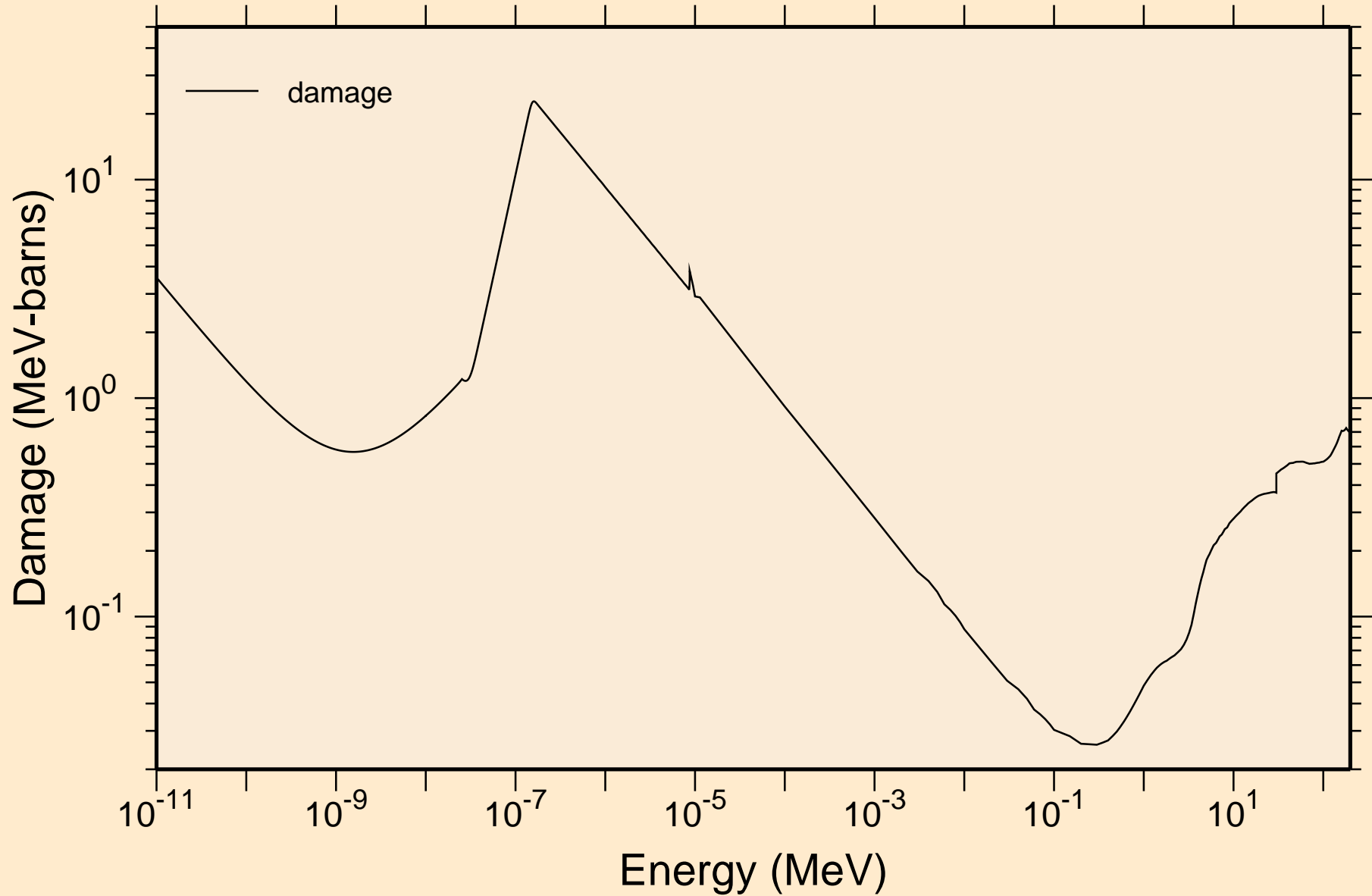

ND129 NEUTRON ACER TENDL-2021 LIBRARY; T=293.6K
Non-threshold reactions

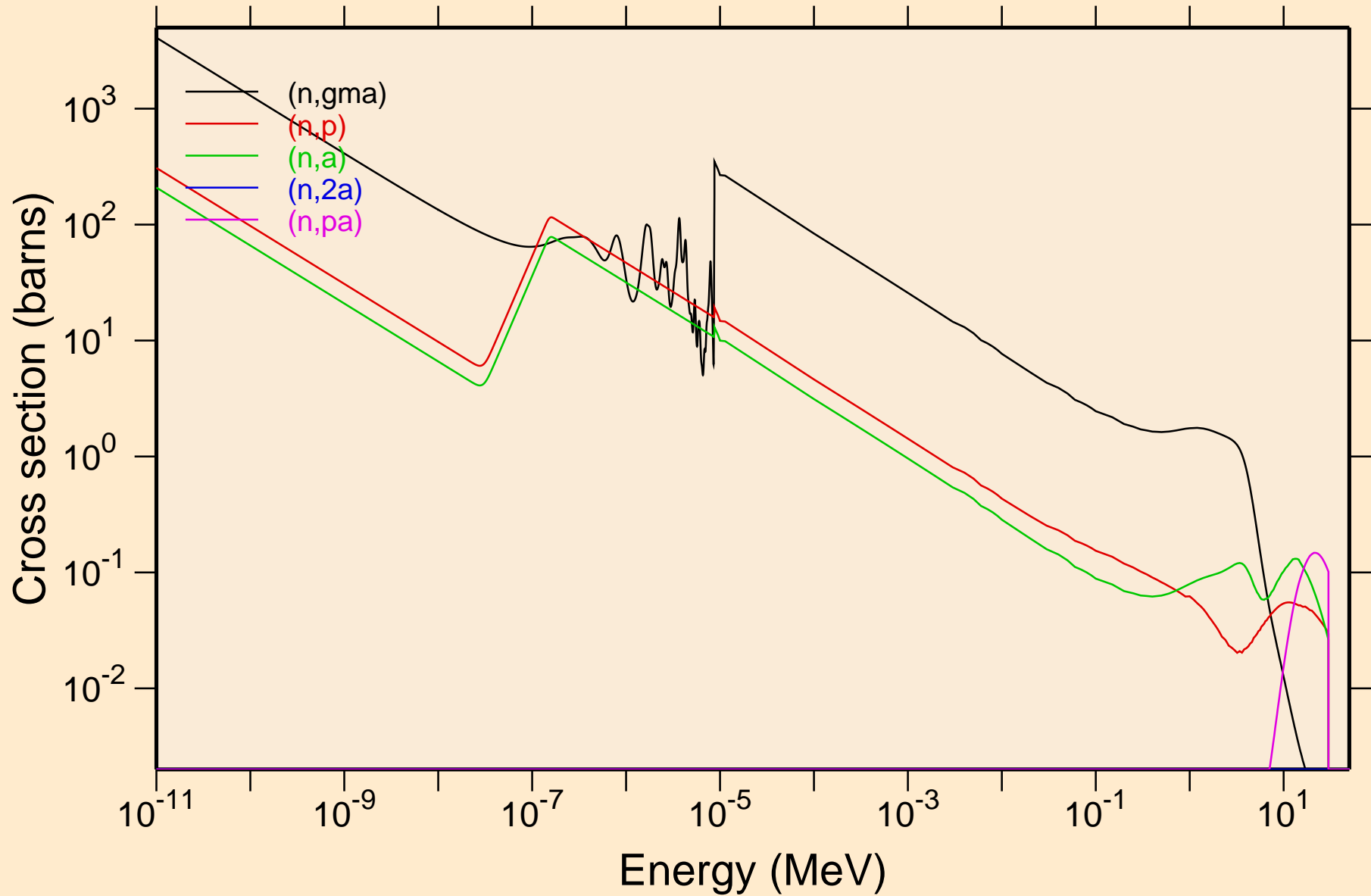

ND129 NEUTRON ACER TENDL-2021 LIBRARY; T=293.6K
Non-threshold reactions

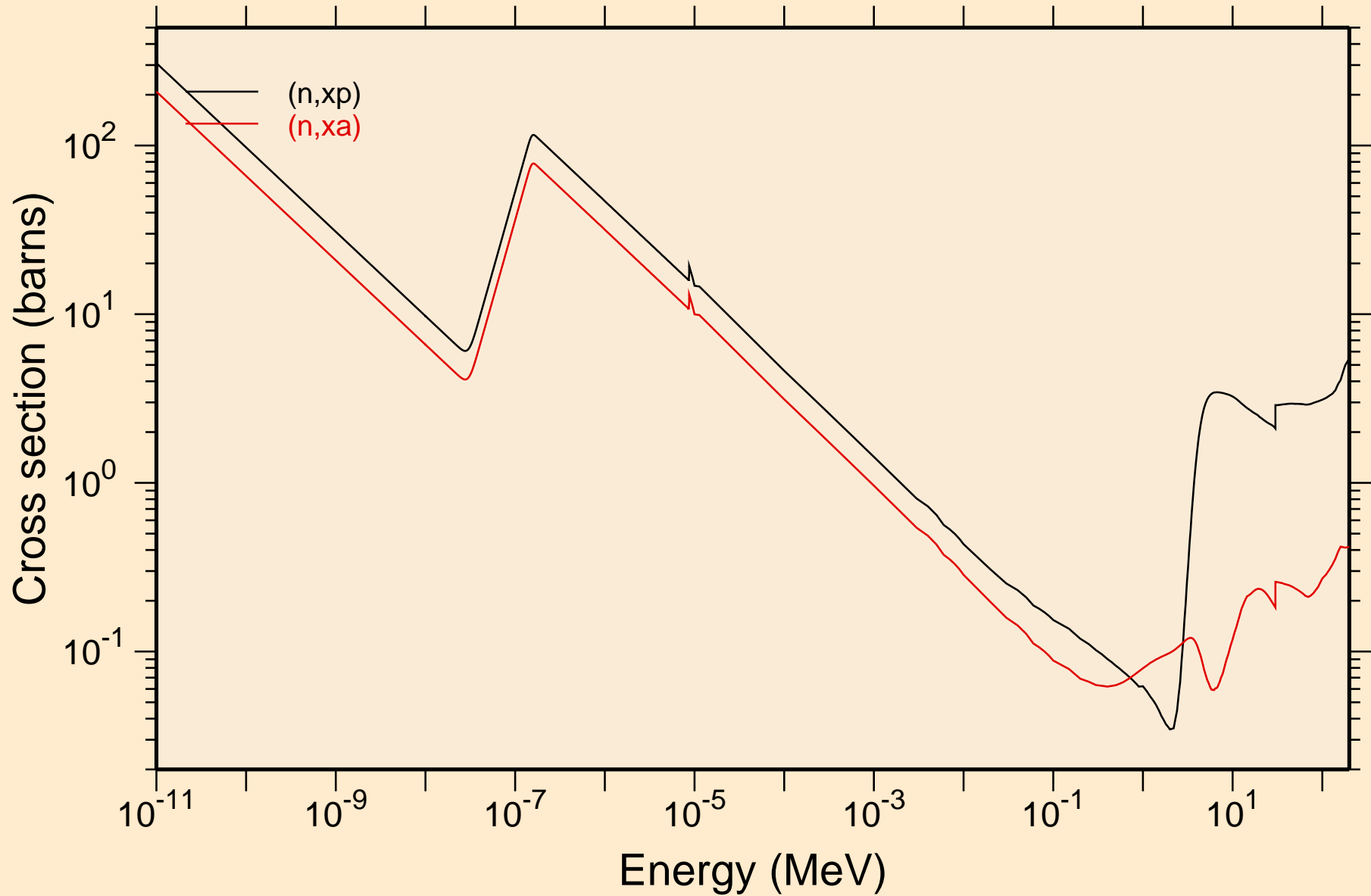

ND129 NEUTRON ACER TENDL-2021 LIBRARY; T=293.6K

Principal cross sections

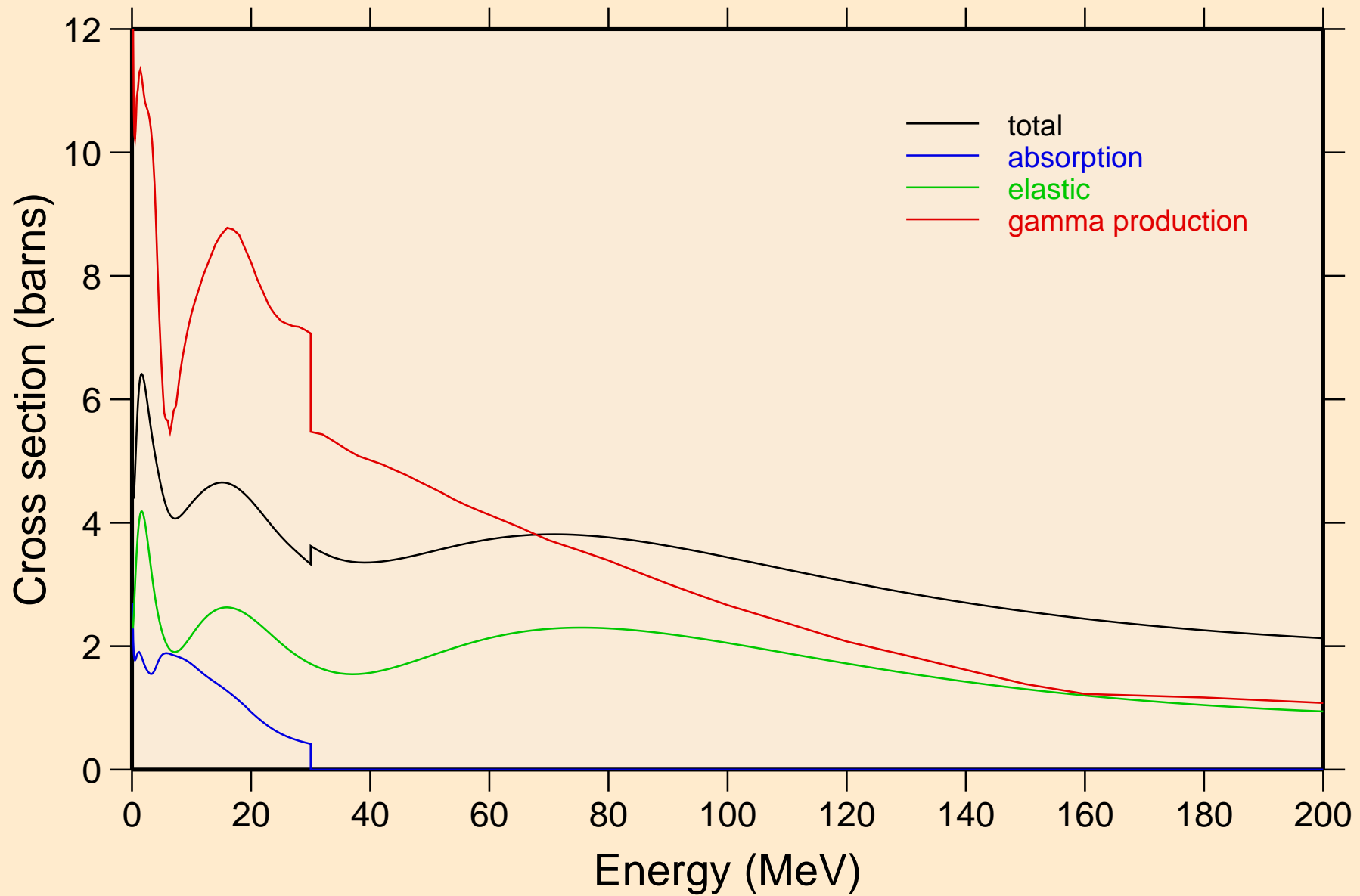

ND129 NEUTRON ACER TENDL-2021 LIBRARY; T=293.6K
Heating

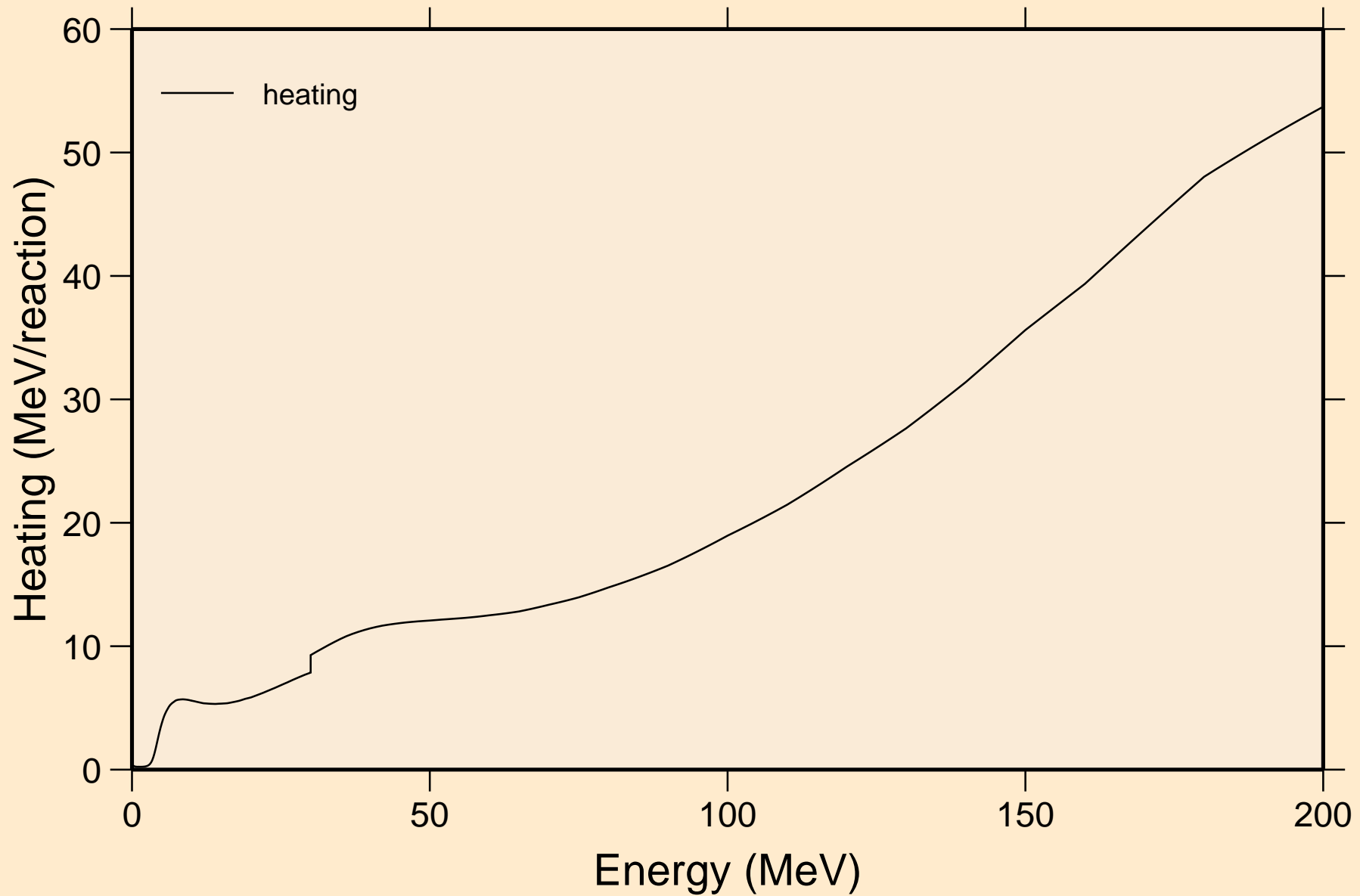

ND129 NEUTRON ACER TENDL-2021 LIBRARY; T=293.6K

Damage

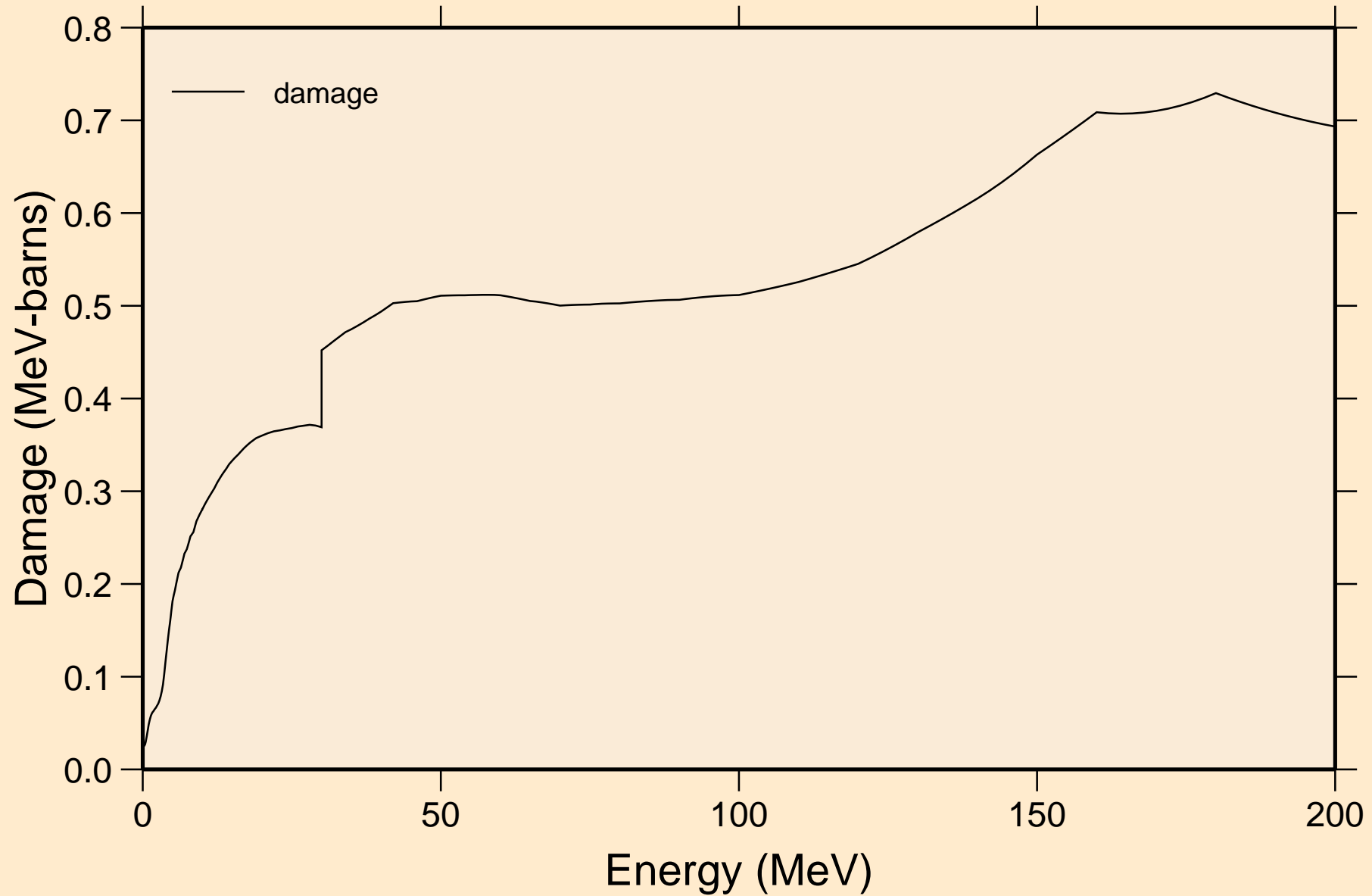

ND129 NEUTRON ACER TENDL-2021 LIBRARY; T=293.6K
Non-threshold reactions

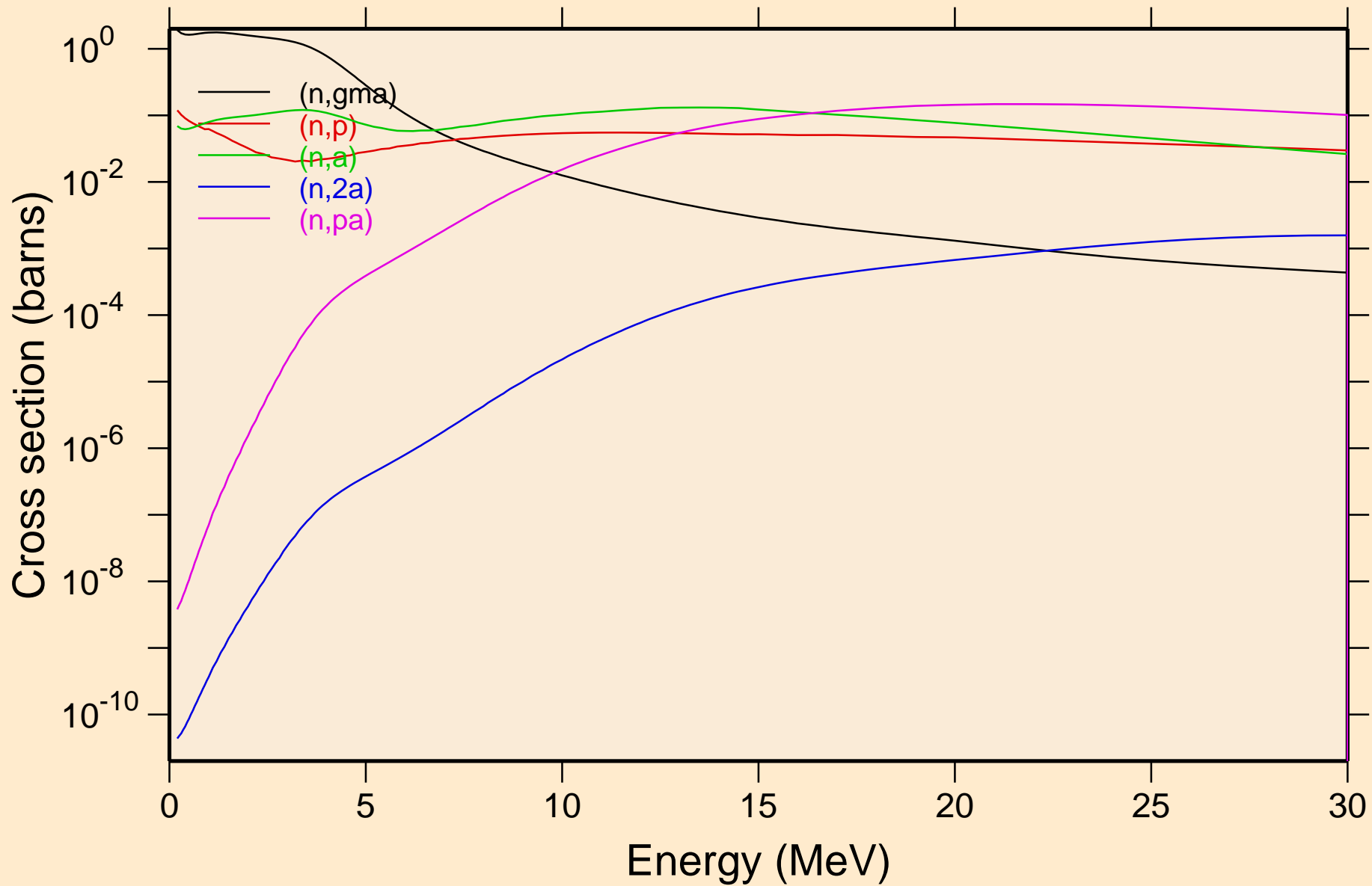

ND129 NEUTRON ACER TENDL-2021 LIBRARY; T=293.6K
Non-threshold reactions

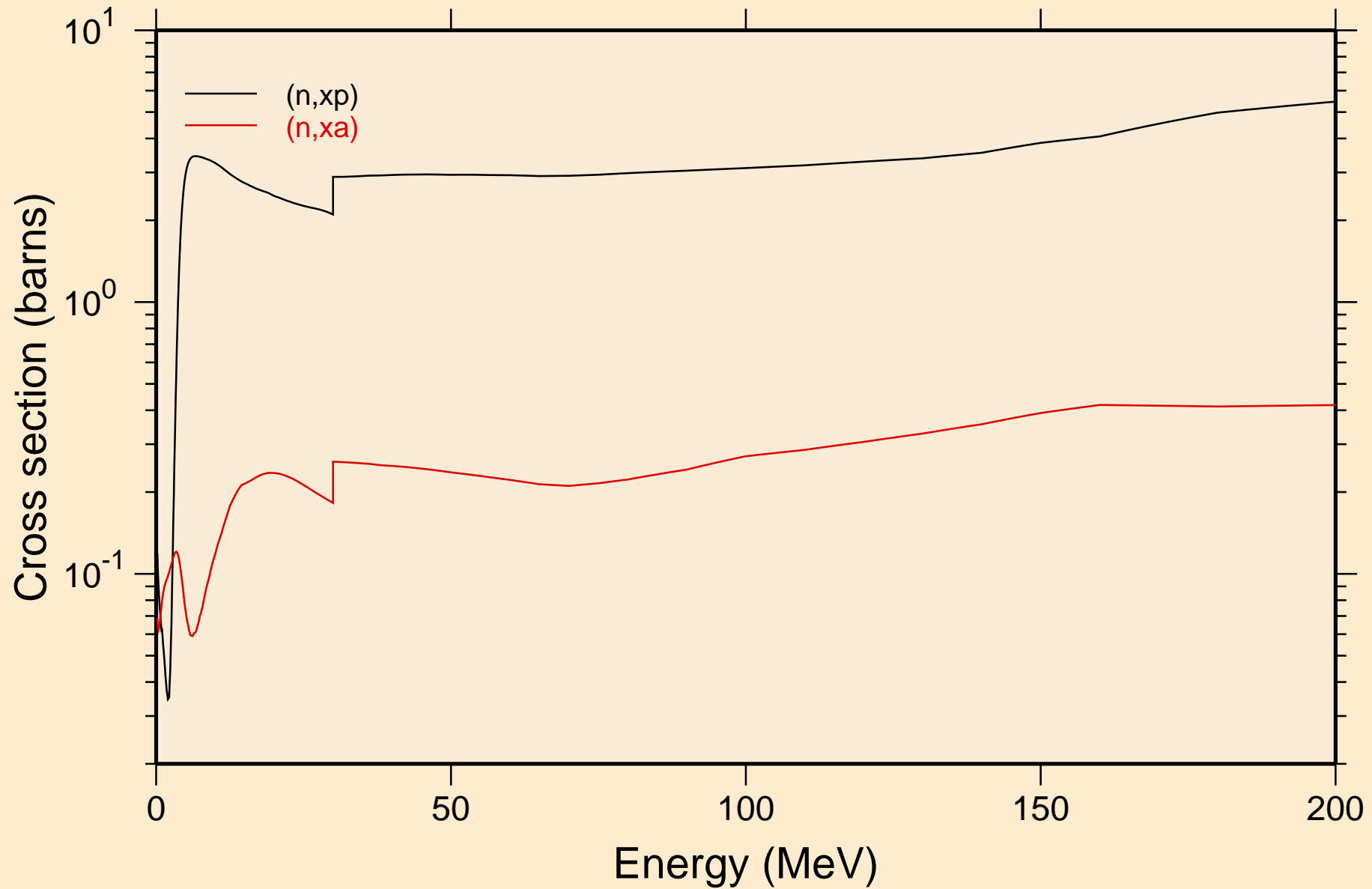

ND129 NEUTRON ACER TENDL-2021 LIBRARY; T=293.6K
Inelastic levels

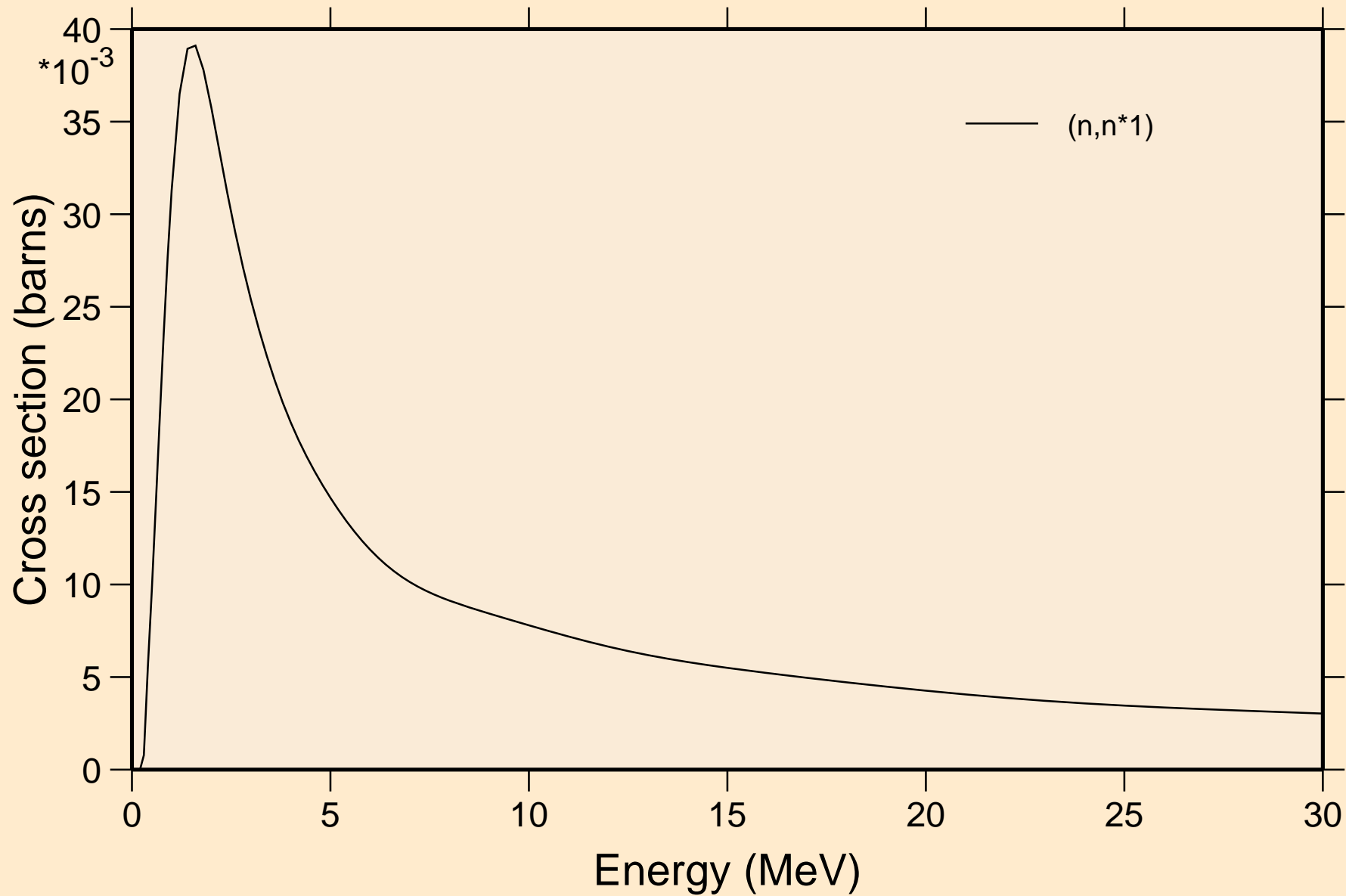

ND129 NEUTRON ACER TENDL-2021 LIBRARY; T=293.6K
Threshold reactions

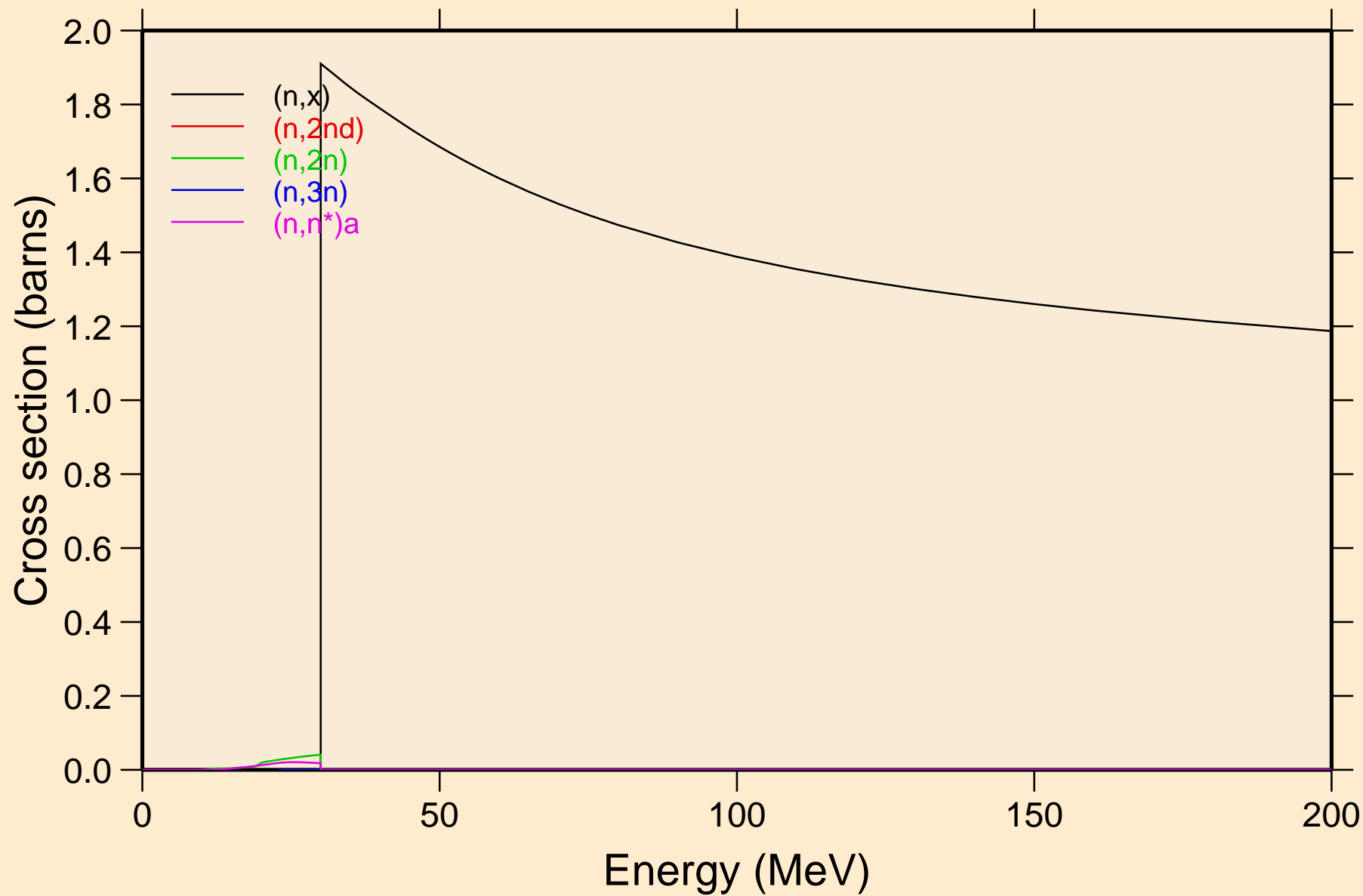

ND129 NEUTRON ACER TENDL-2021 LIBRARY; T=293.6K
Threshold reactions

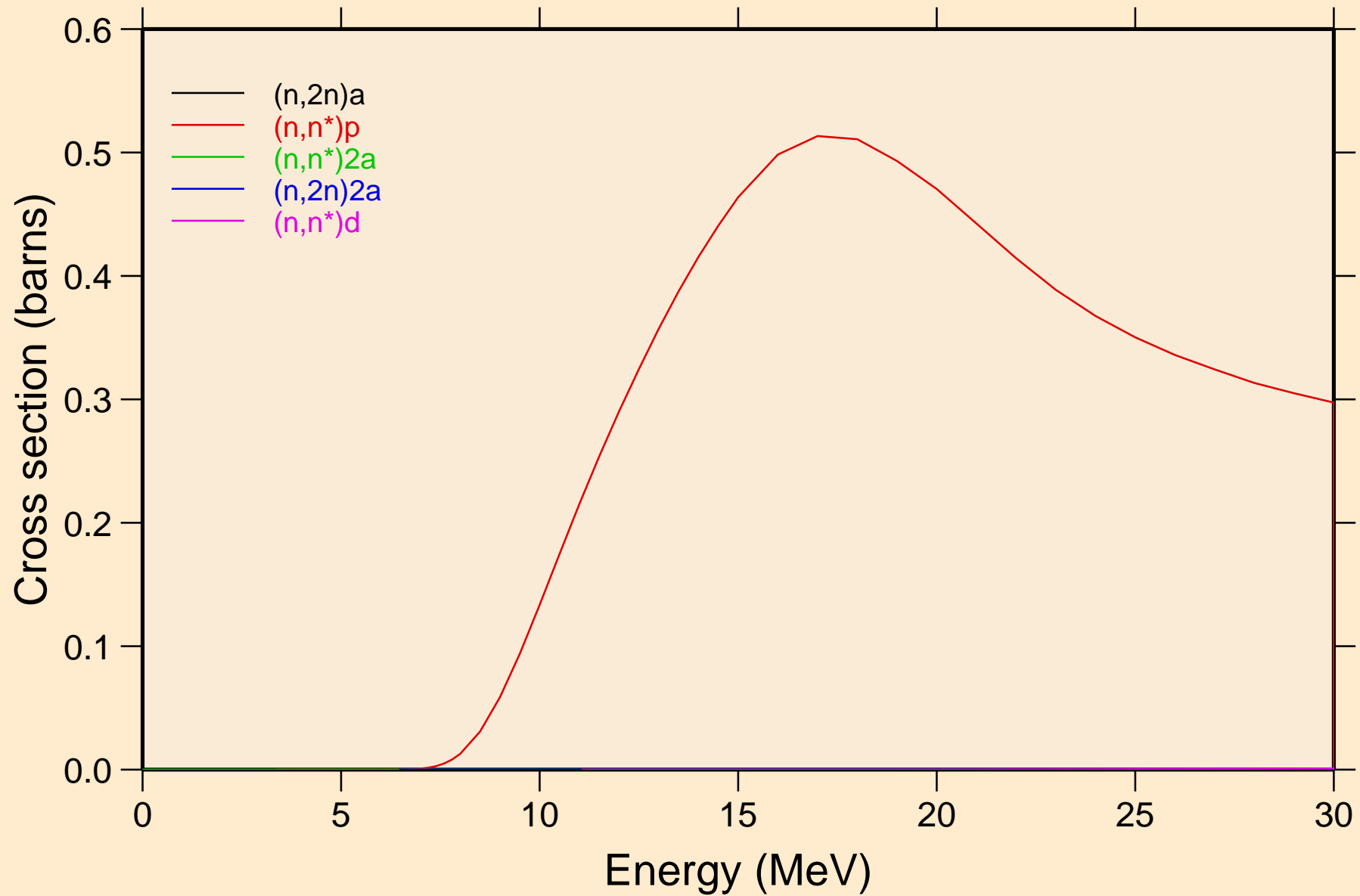

ND129 NEUTRON ACER TENDL-2021 LIBRARY; T=293.6K

Threshold reactions

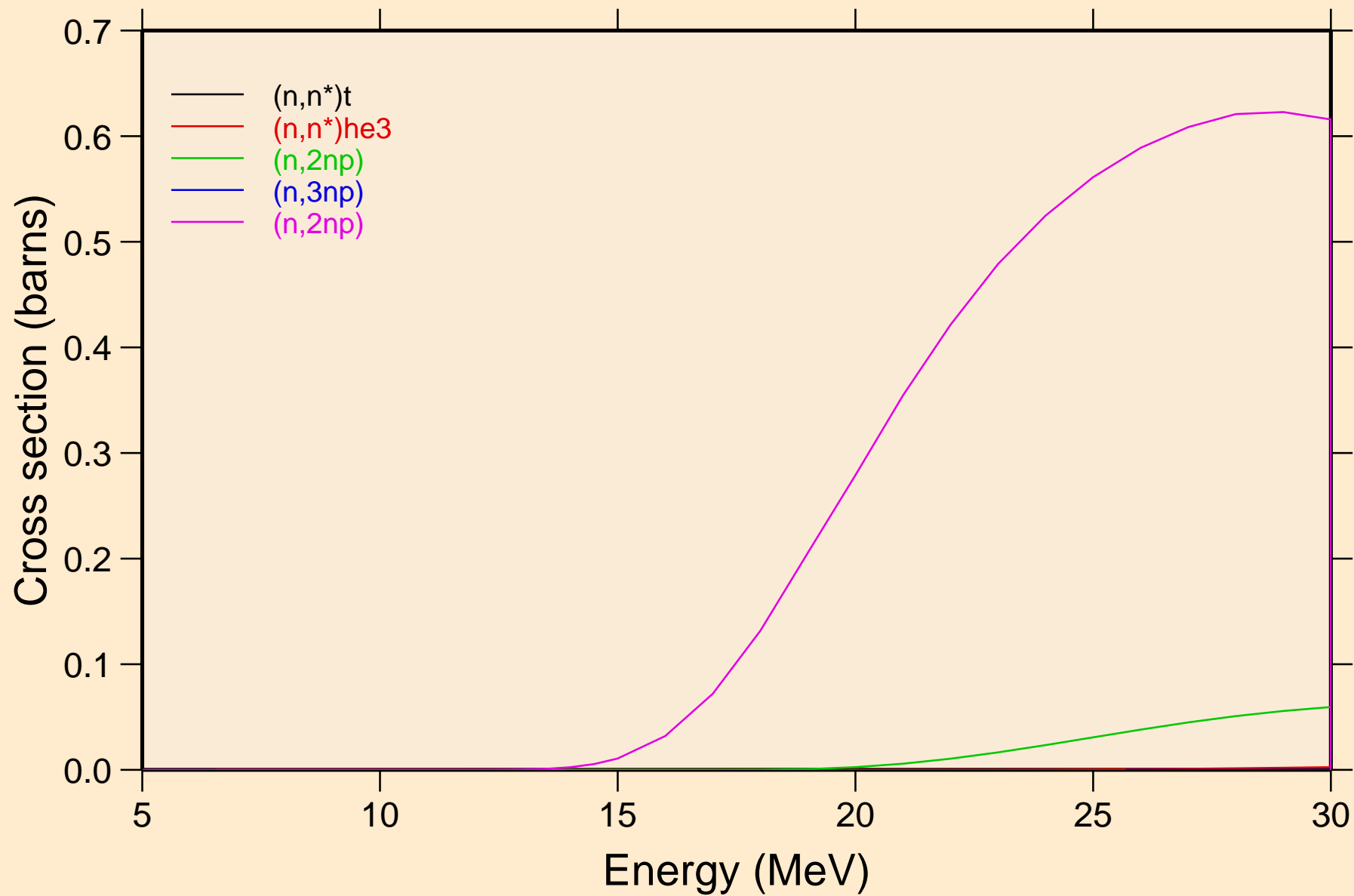

ND129 NEUTRON ACER TENDL-2021 LIBRARY; T=293.6K
Threshold reactions

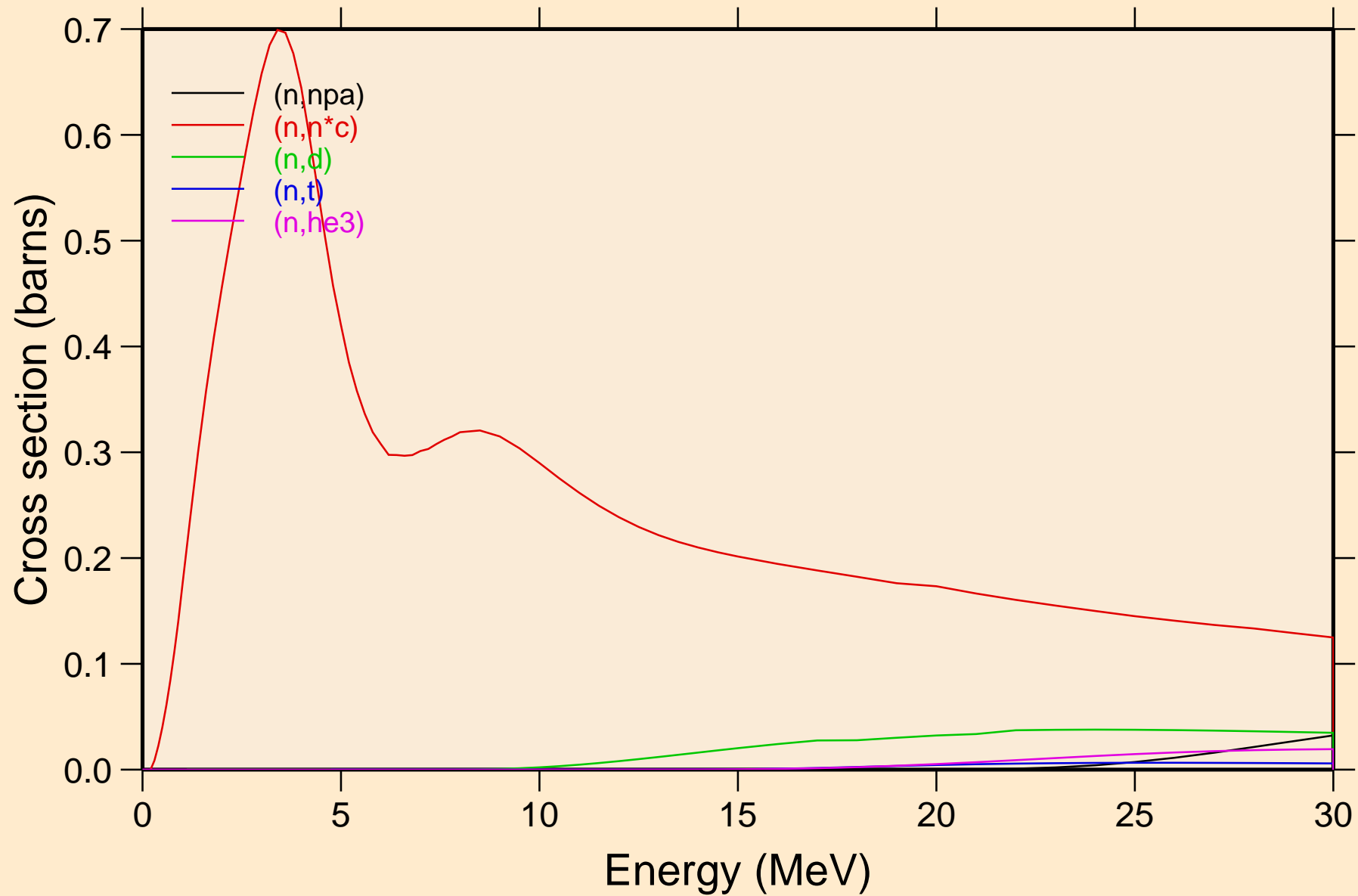

ND129 NEUTRON ACER TENDL-2021 LIBRARY; T=293.6K
Threshold reactions

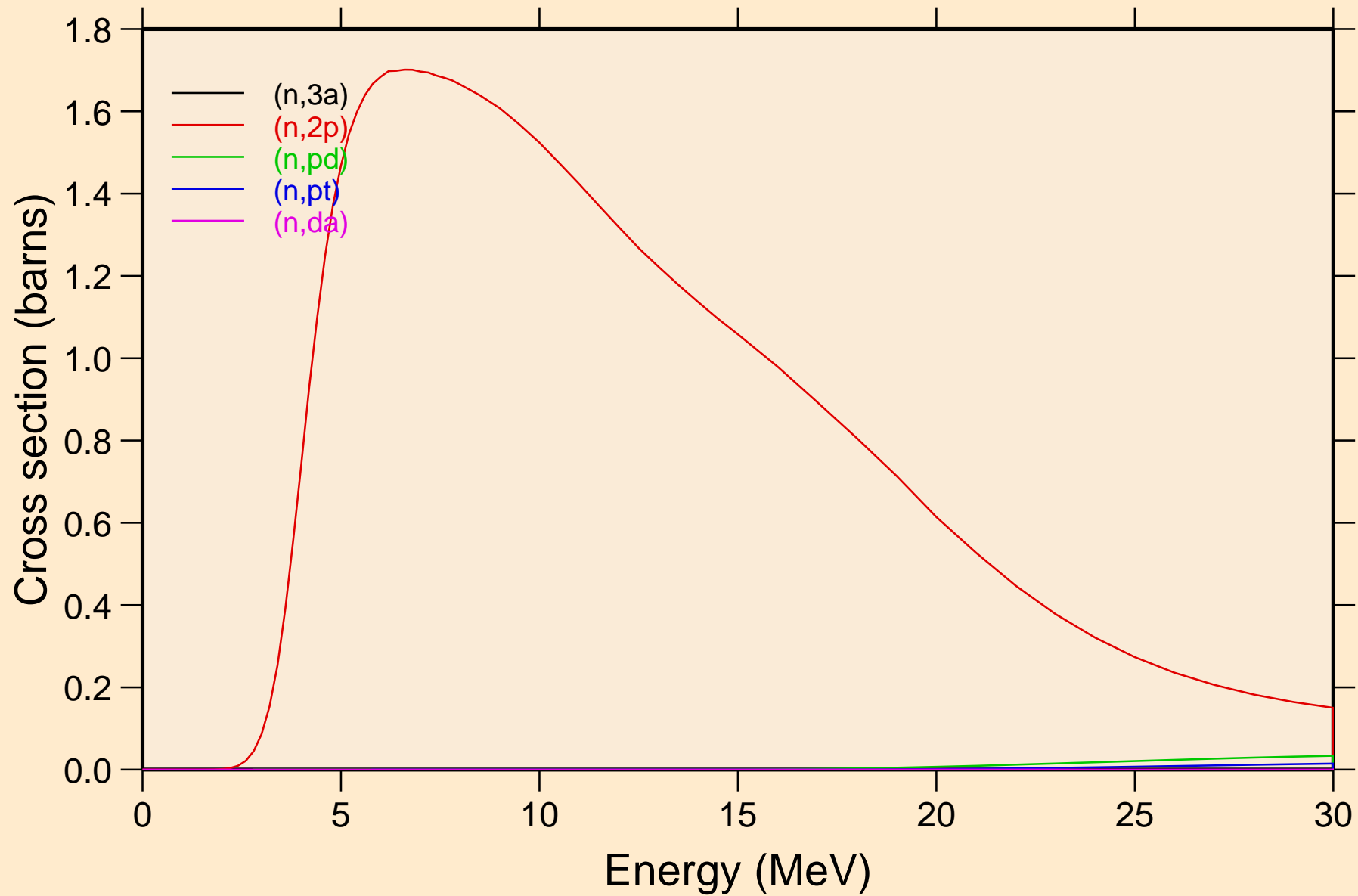

ND129 NEUTRON ACER TENDL-2021 LIBRARY; T=293.6K
Threshold reactions

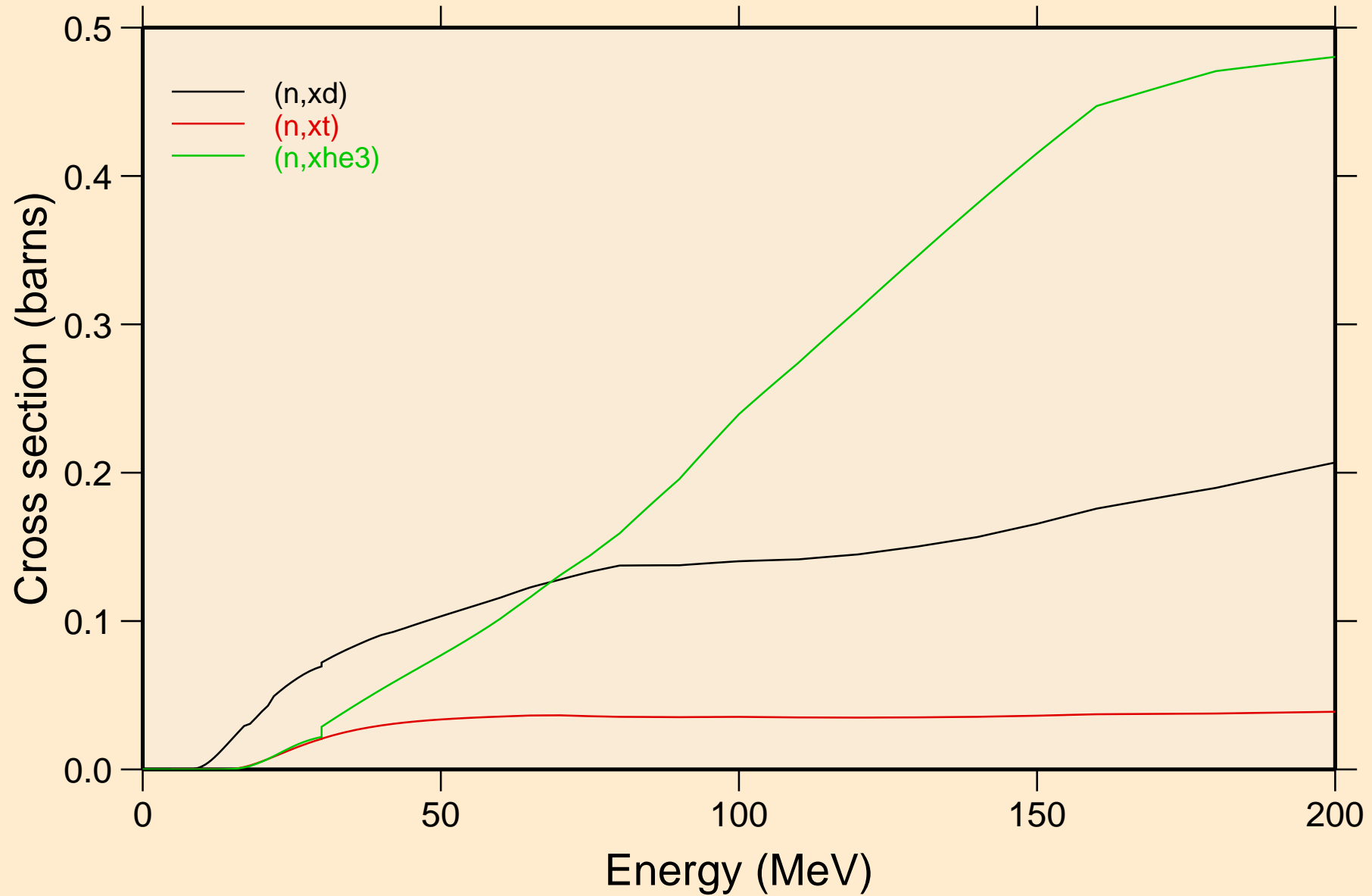

ND129 NEUTRON ACER TENDL-2021 LIBRARY; T=293.6K
angular distribution for elastic

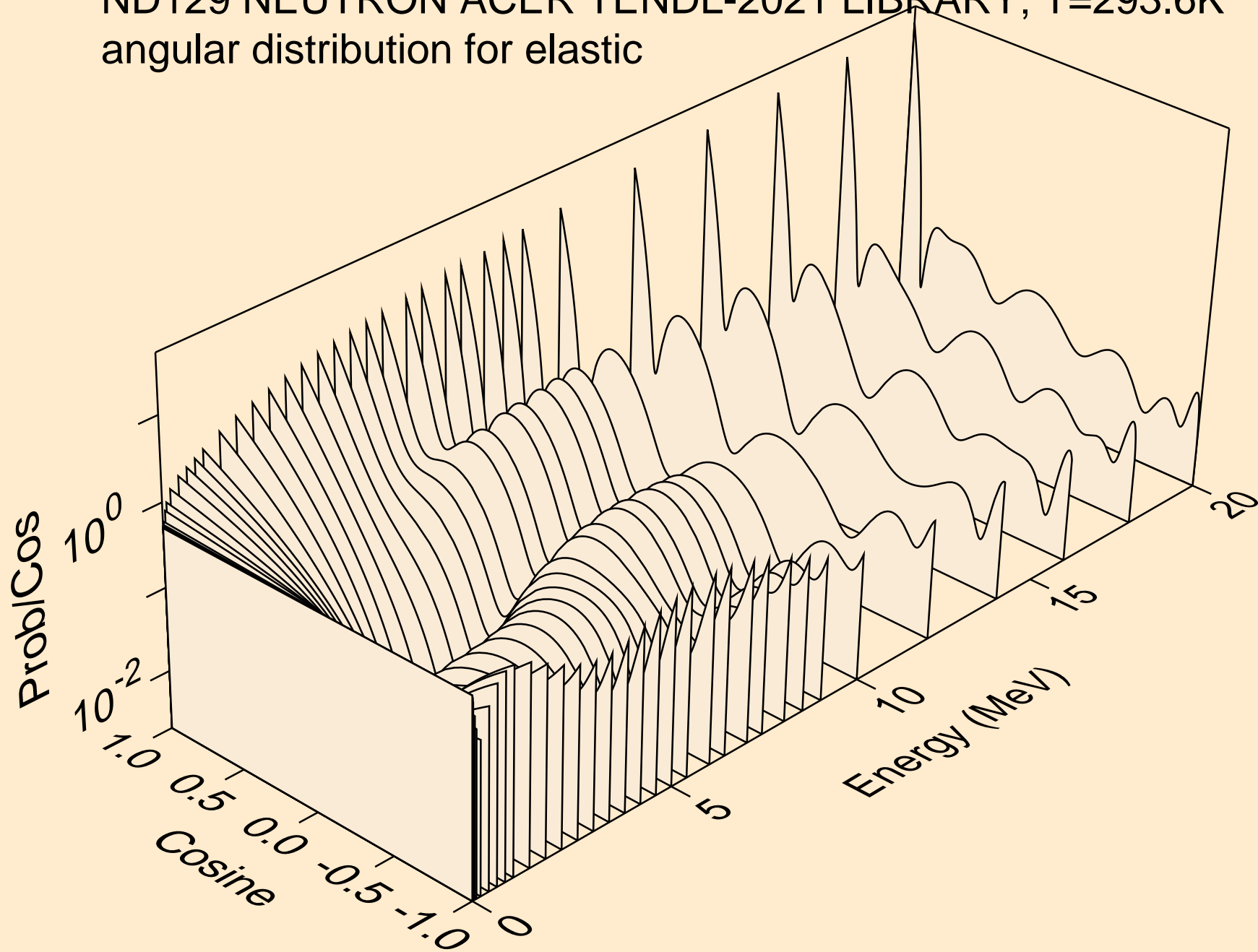

ND129 NEUTRON ACER TENDL-2021 LIBRARY; T=293.6K
angular distribution for elastic

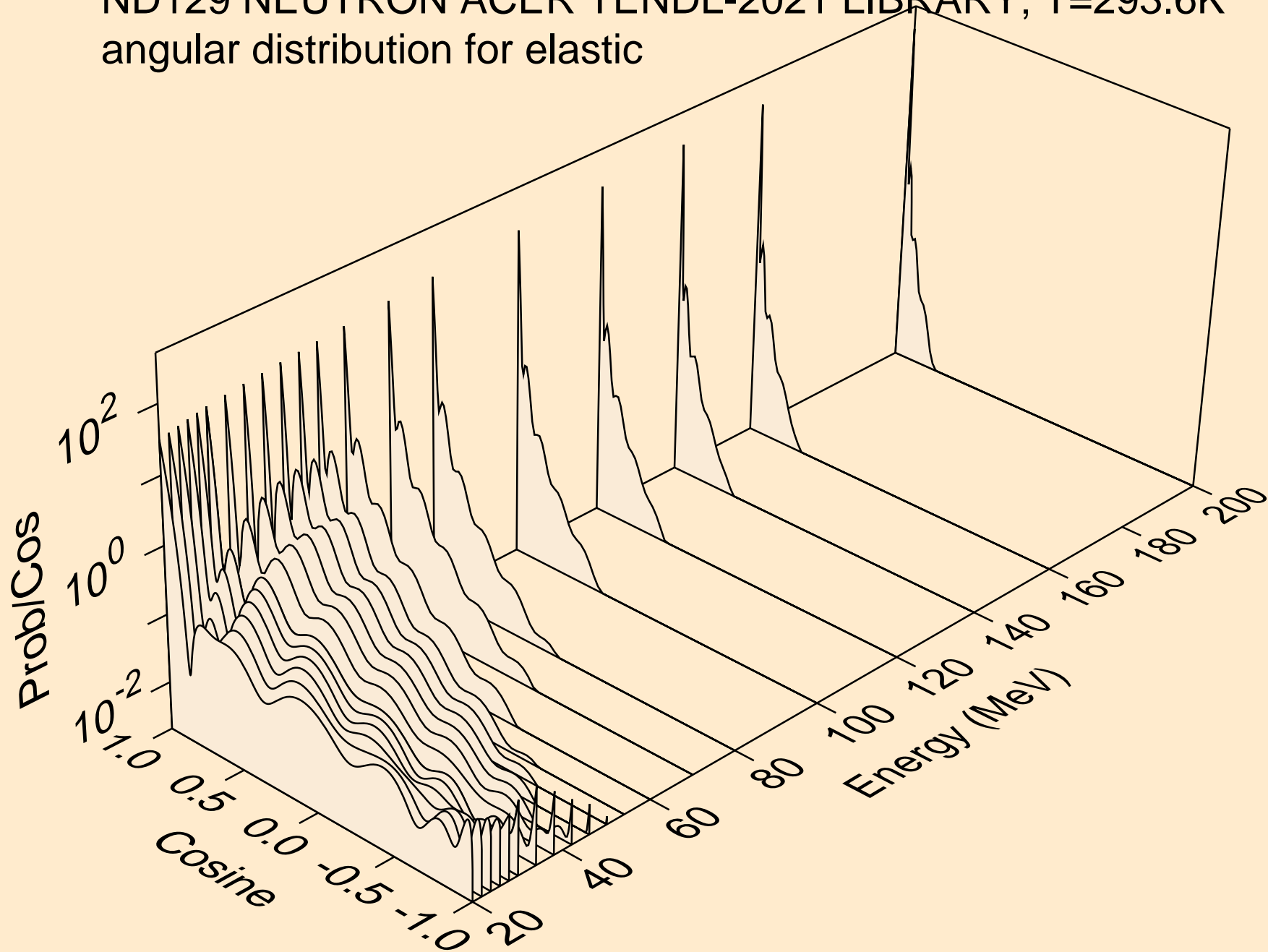

ND129 NEUTRON ACER TENDL-2021 LIBRARY; T=293.6K
angular distribution for (n,n*1)

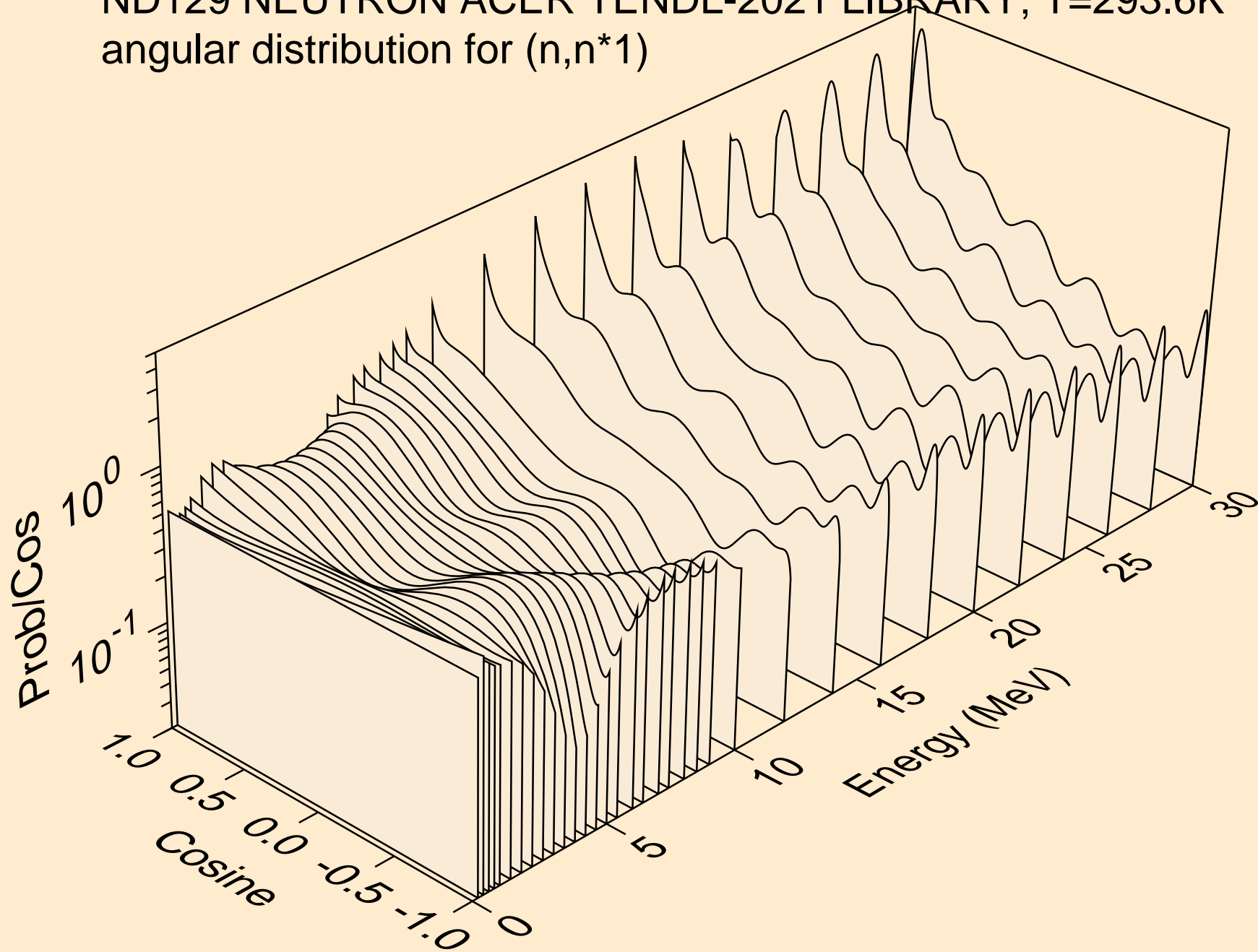

ND129 NEUTRON ACER TENDL-2021 LIBRARY; T=293.6K
Neutron emission for (n,x)

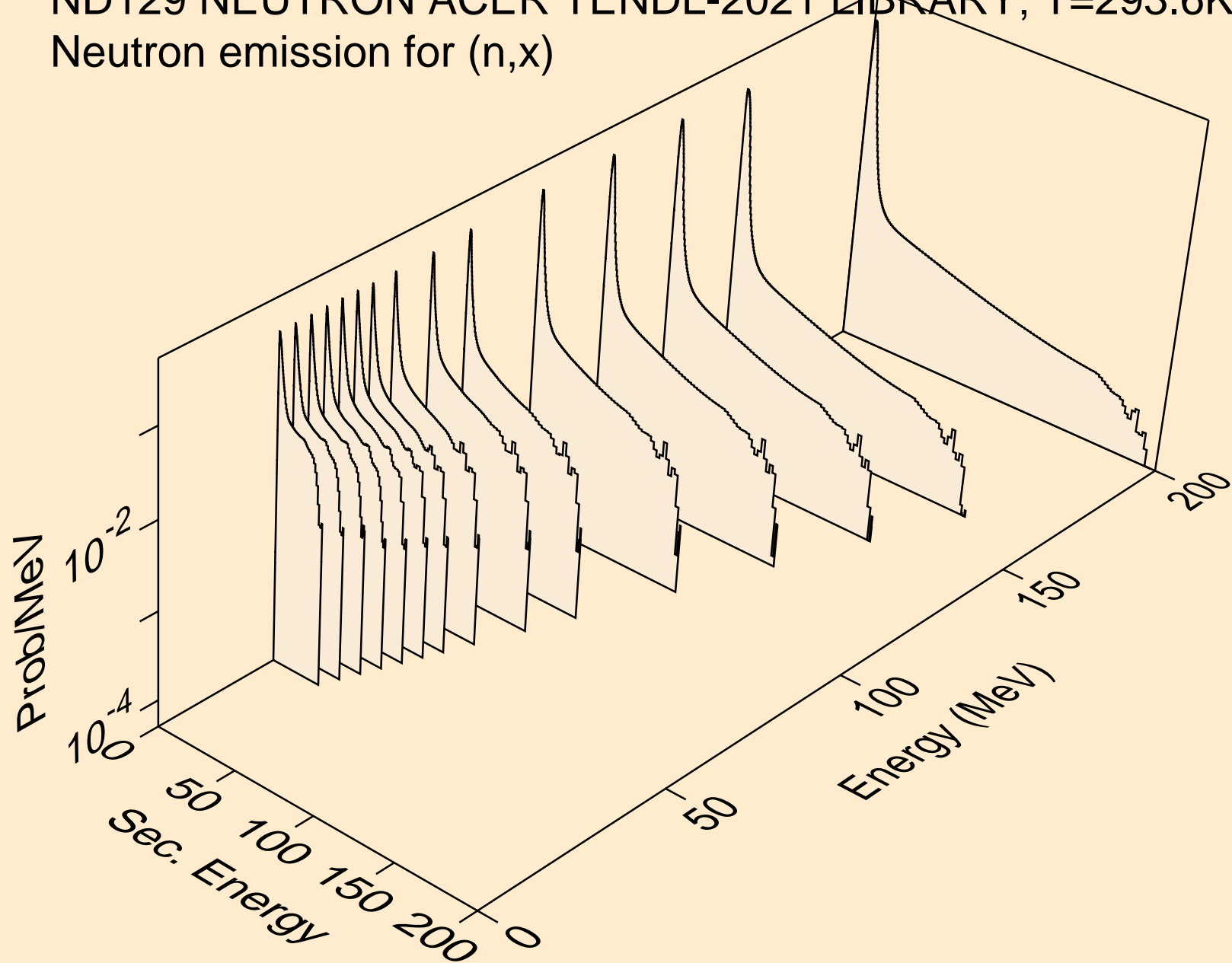

ND129 NEUTRON ACER TENDL-2021 LIBRARY; T=293.6K
Neutron emission for (n,2nd)

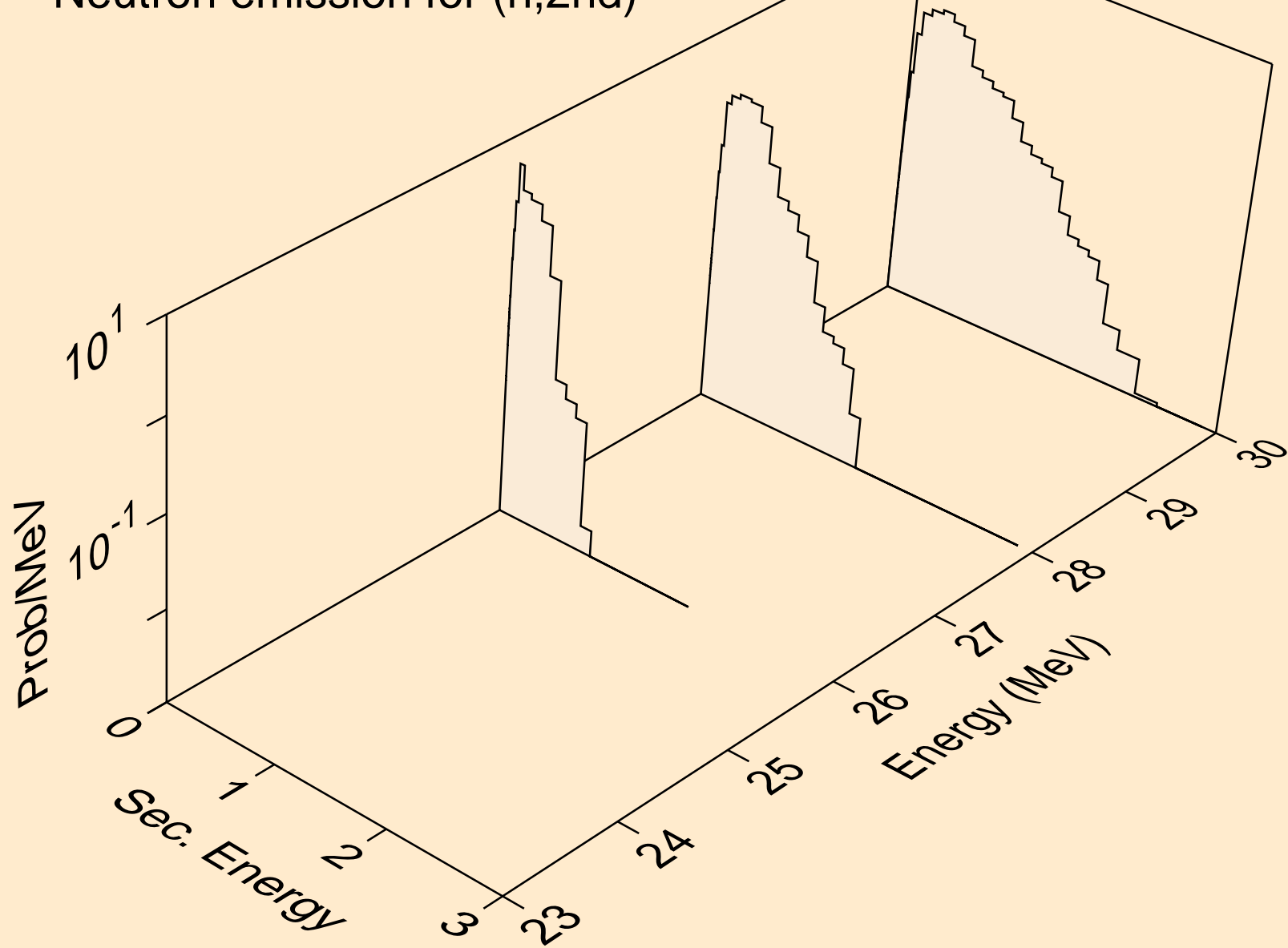

ND129 NEUTRON ACER TENDL-2021 LIBRARY; T=293.6K
Neutron emission for (n,2n)

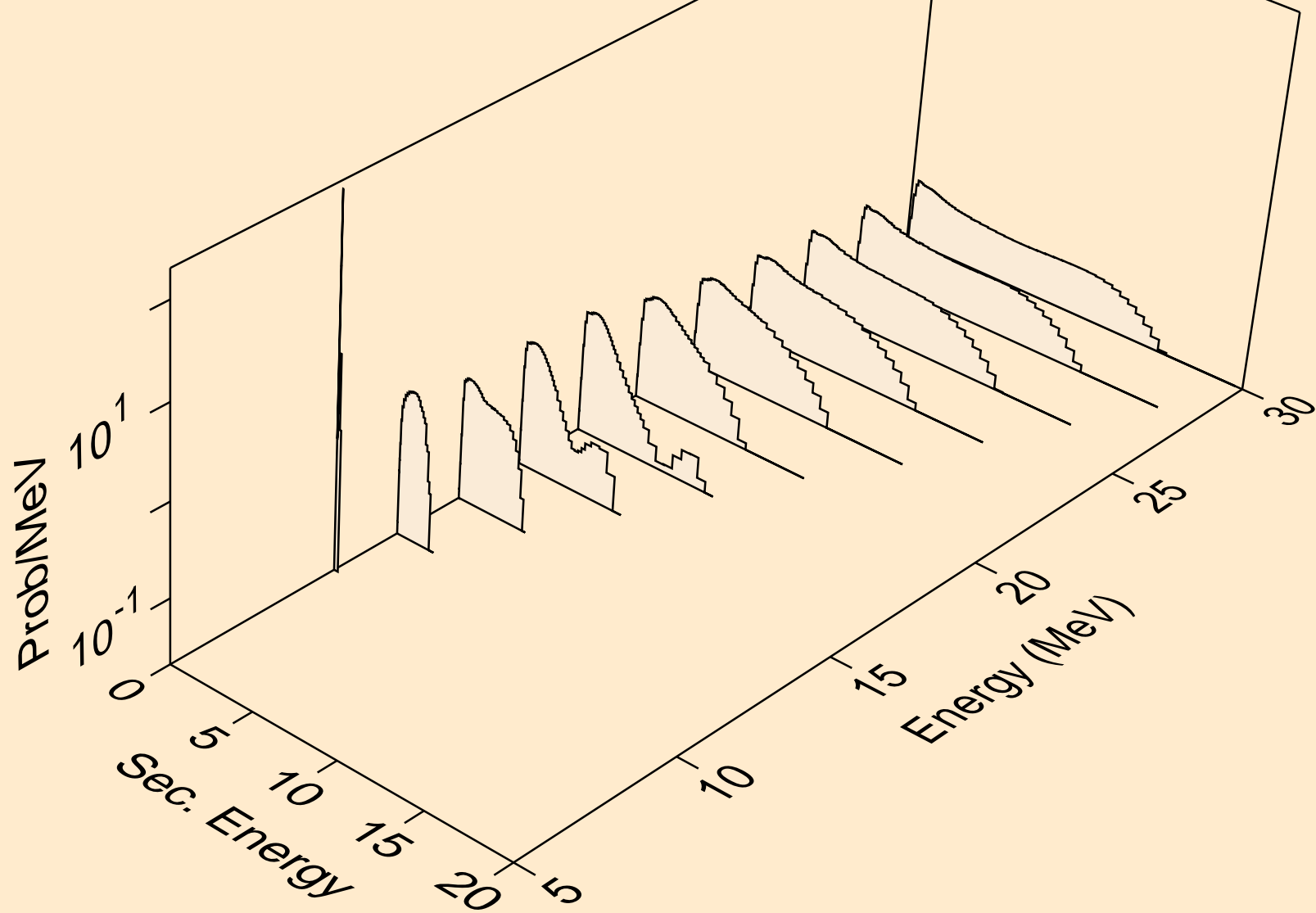

ND129 NEUTRON ACER TENDL-2021 LIBRARY; T=293.6K
Neutron emission for (n,3n)

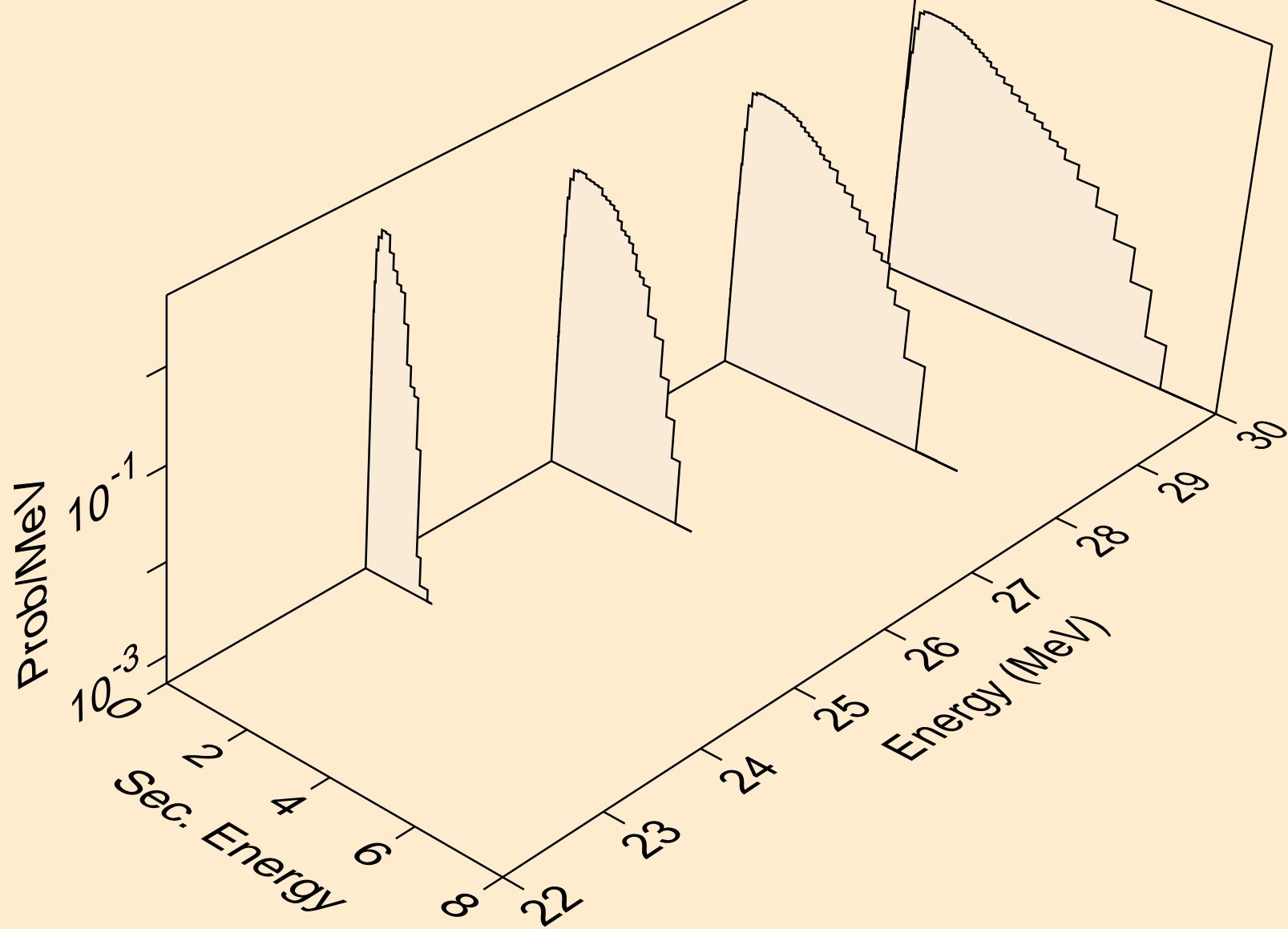

ND129 NEUTRON ACER TENDL-2021 LIBRARY; T=293.6K
Neutron emission for (n,n*)a

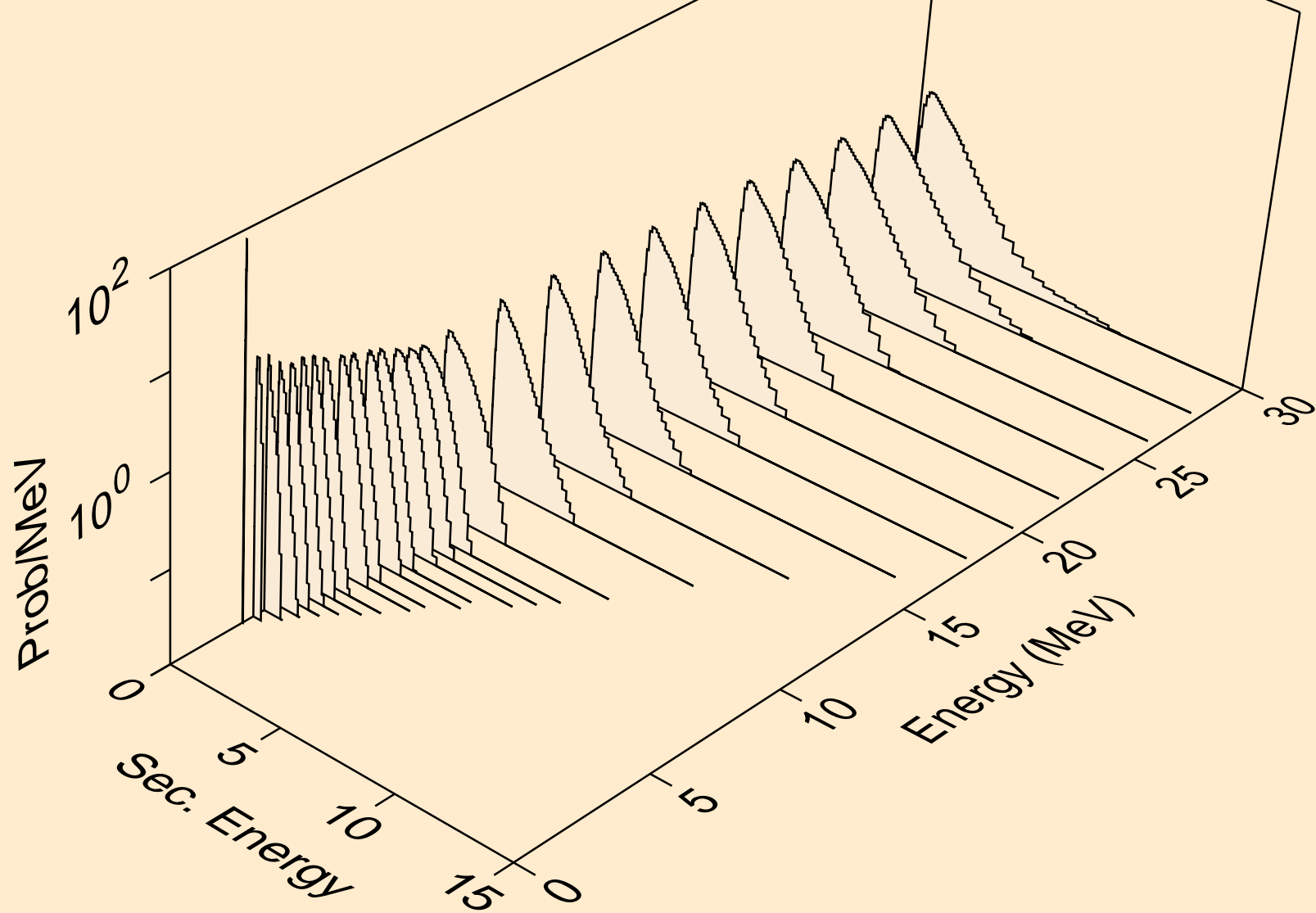

ND129 NEUTRON ACER TENDL-2021 LIBRARY; T=293.6K
Neutron emission for (n,2n)_a

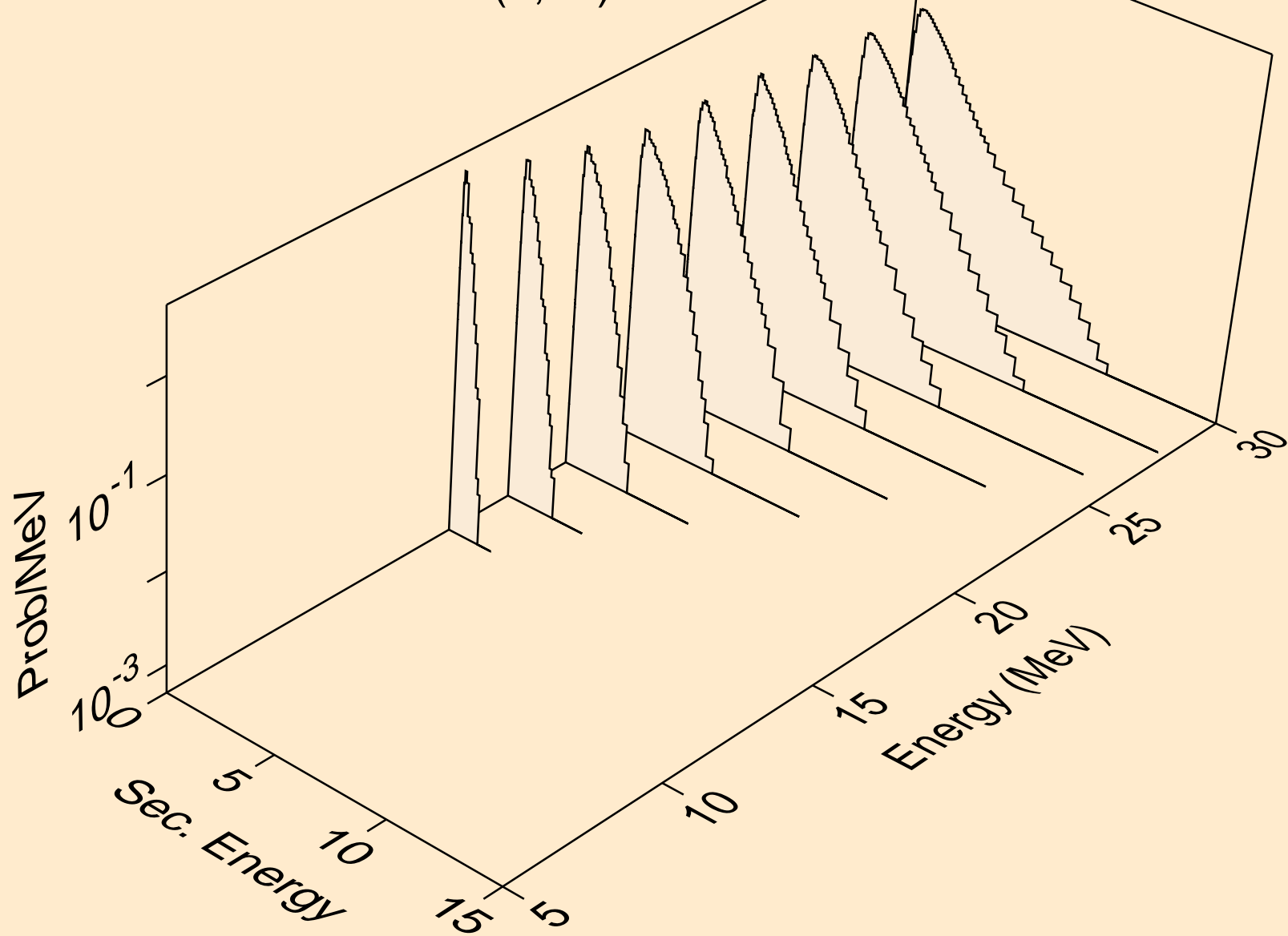

ND129 NEUTRON ACER TENDL-2021 LIBRARY; T=293.6K
Neutron emission for (n,n*)p

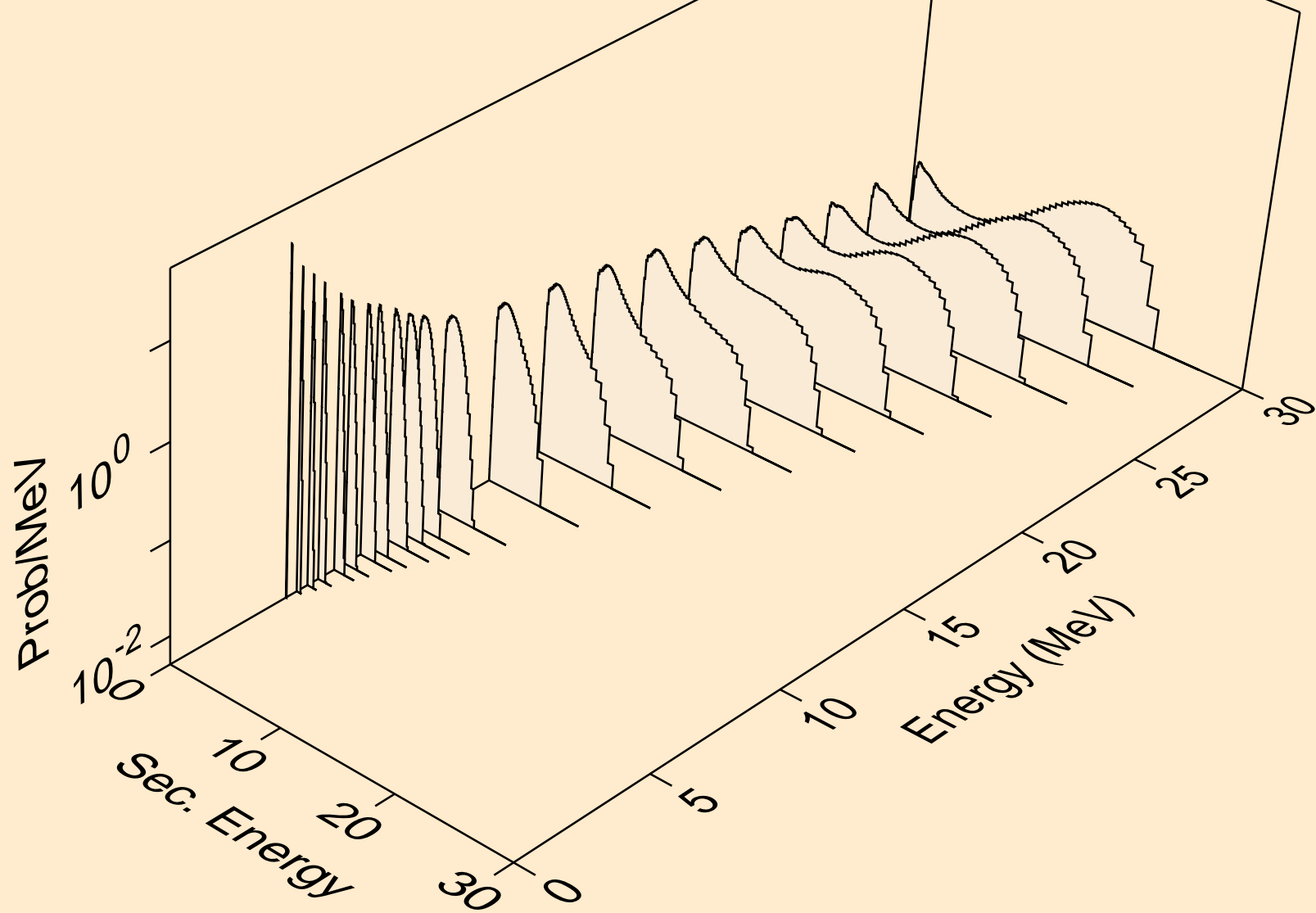

ND129 NEUTRON ACER TENDL-2021 LIBRARY; T=293.6K
Neutron emission for (n,n*)2a

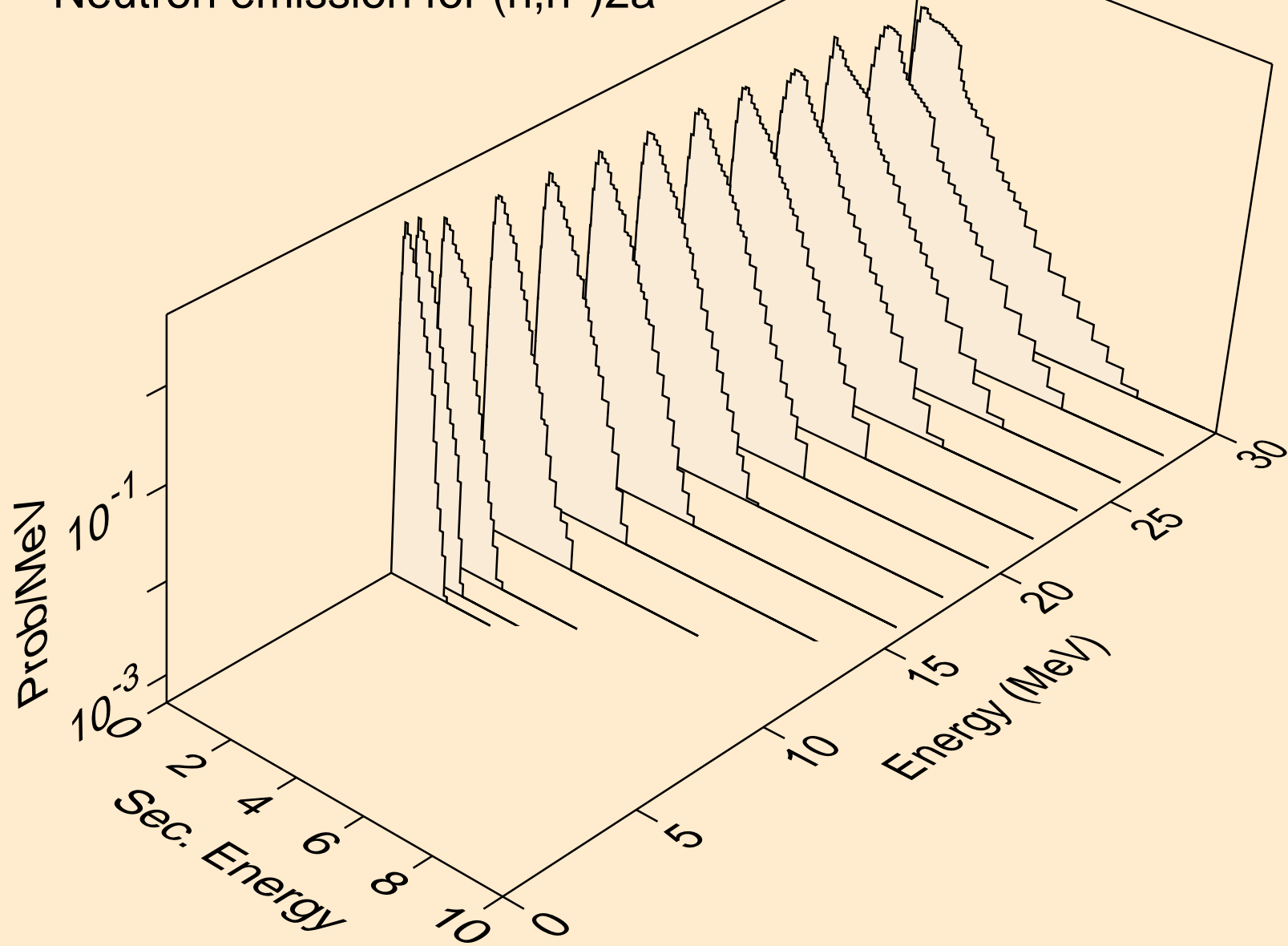

ND129 NEUTRON ACER TENDL-2021 LIBRARY; T=293.6K
Neutron emission for (n,2n)2a

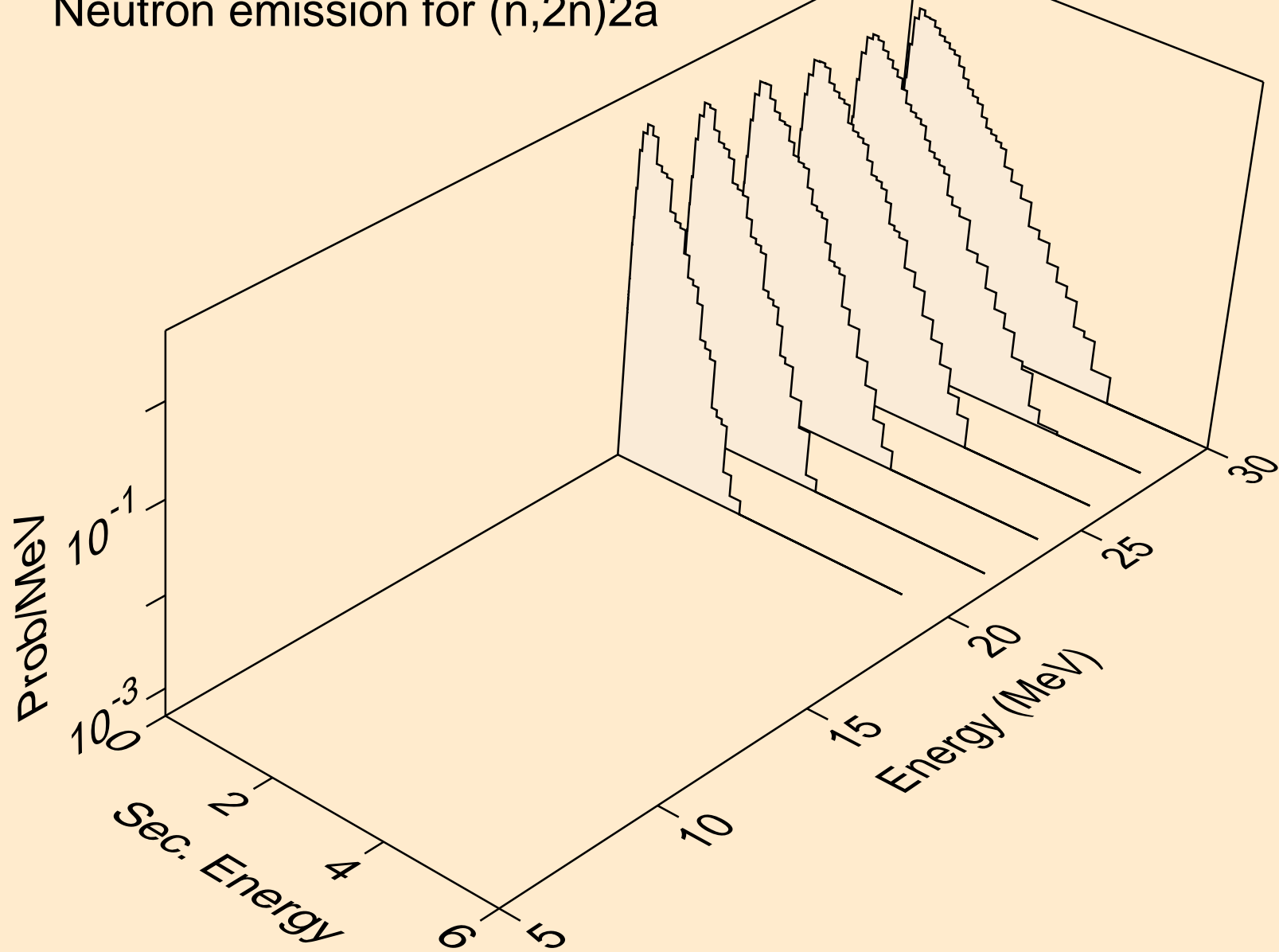

ND129 NEUTRON ACER TENDL-2021 LIBRARY; T=293.6K
Neutron emission for (n,n*)d

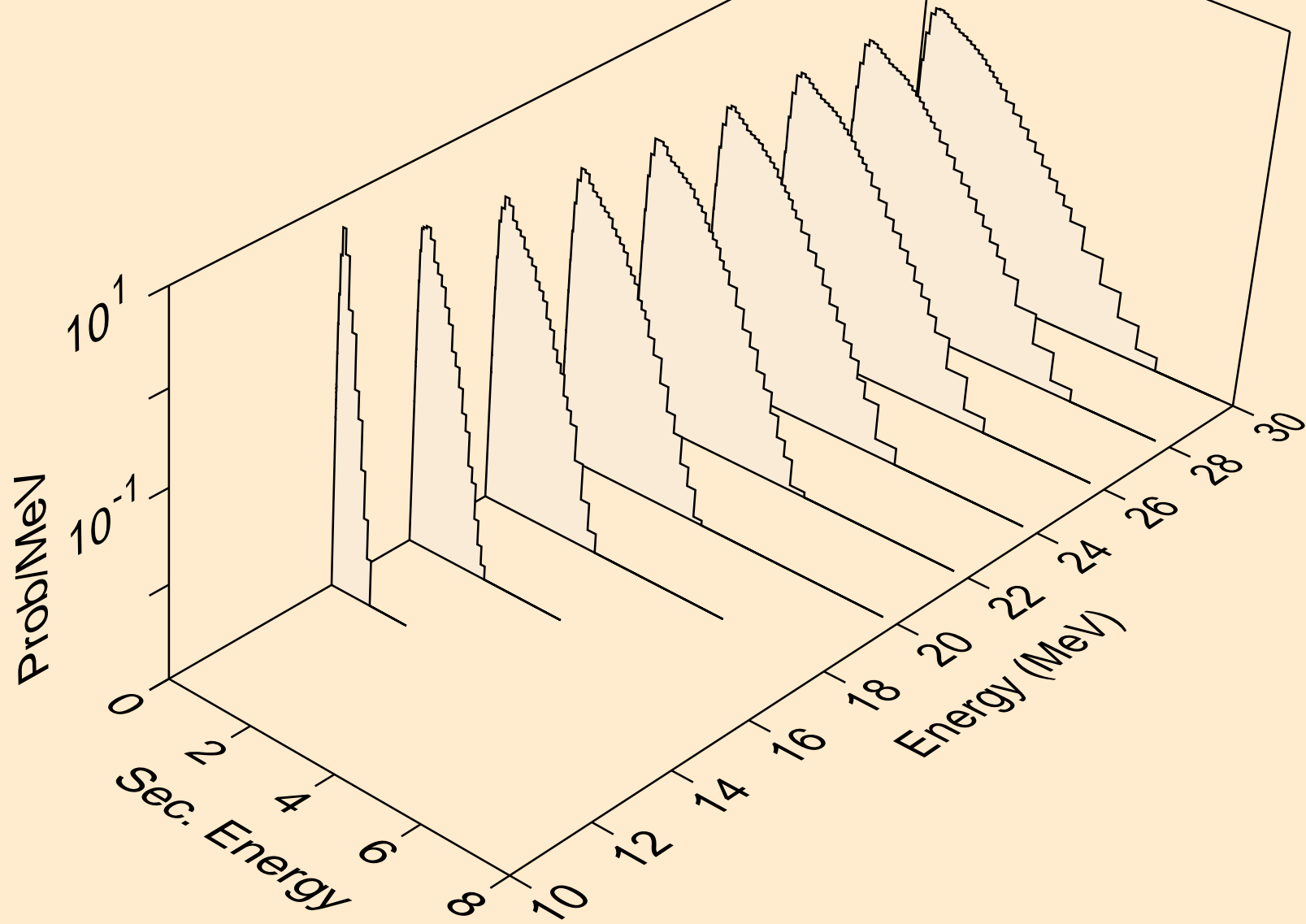

ND129 NEUTRON ACER TENDL-2021 LIBRARY; T=293.6K
Neutron emission for (n,n*)t

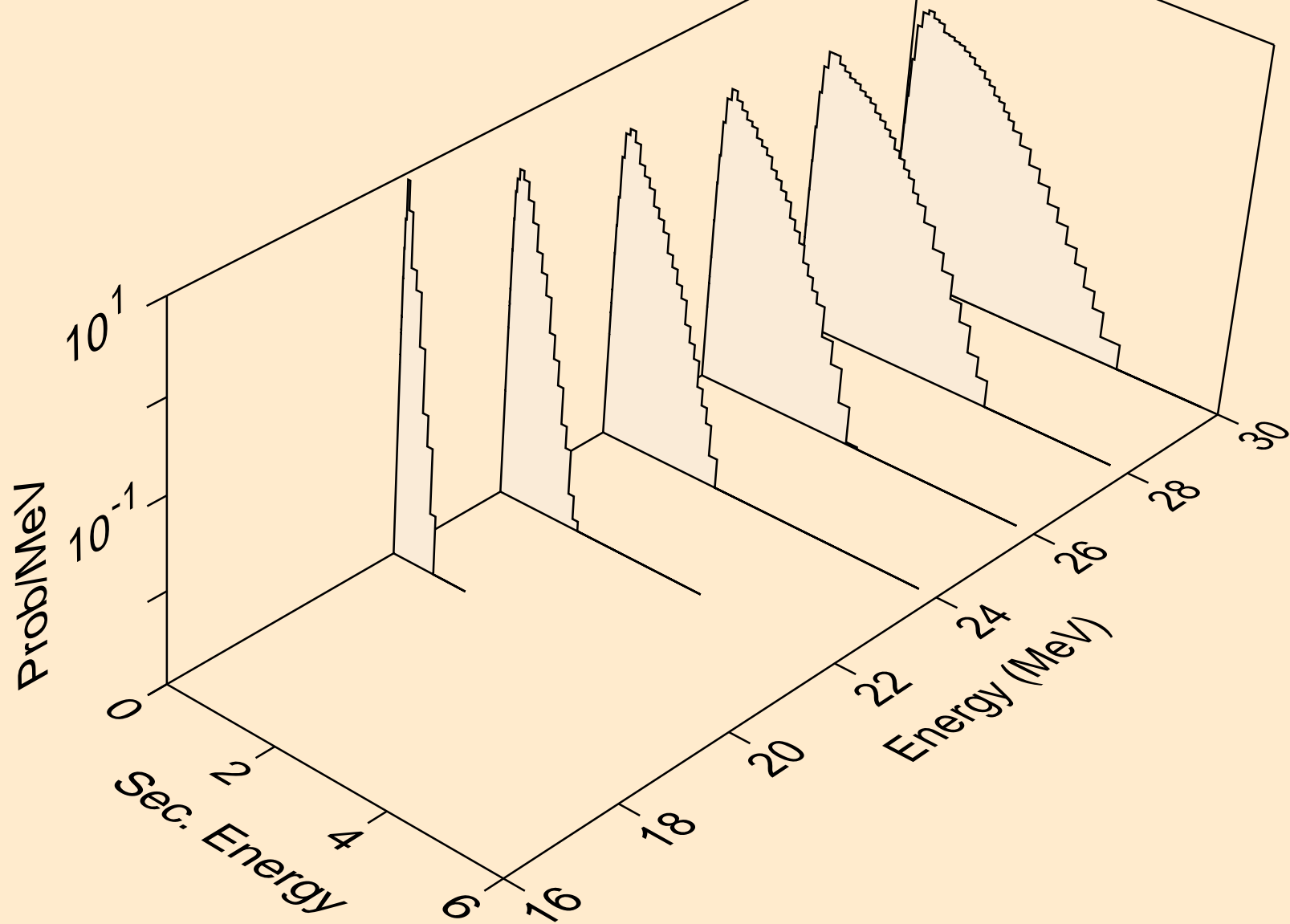

ND129 NEUTRON ACER TENDL-2021 LIBRARY; T=293.6K
Neutron emission for (n,n*)he3

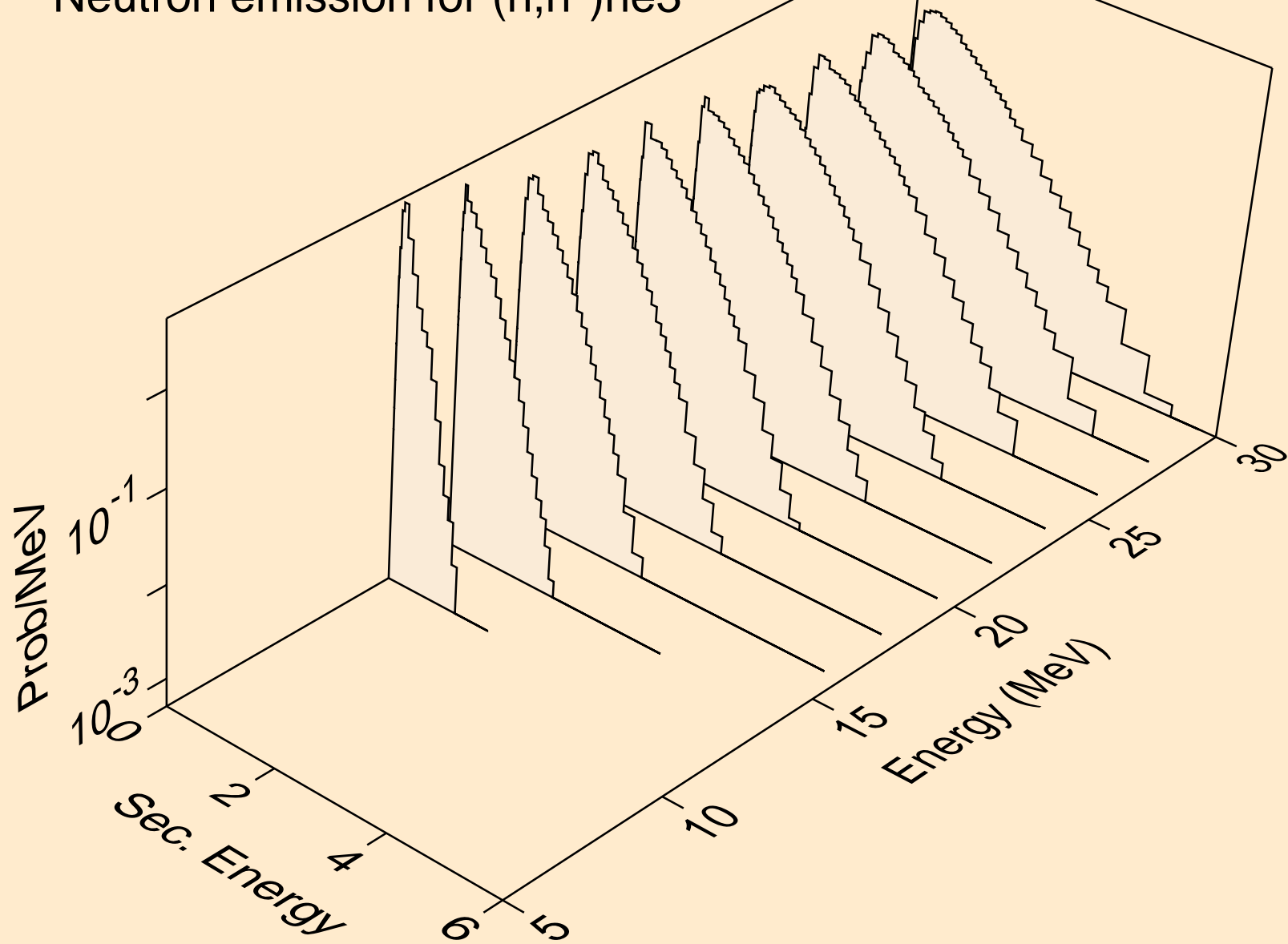

ND129 NEUTRON ACER TENDL-2021 LIBRARY; T=293.6K
Neutron emission for (n,2np)

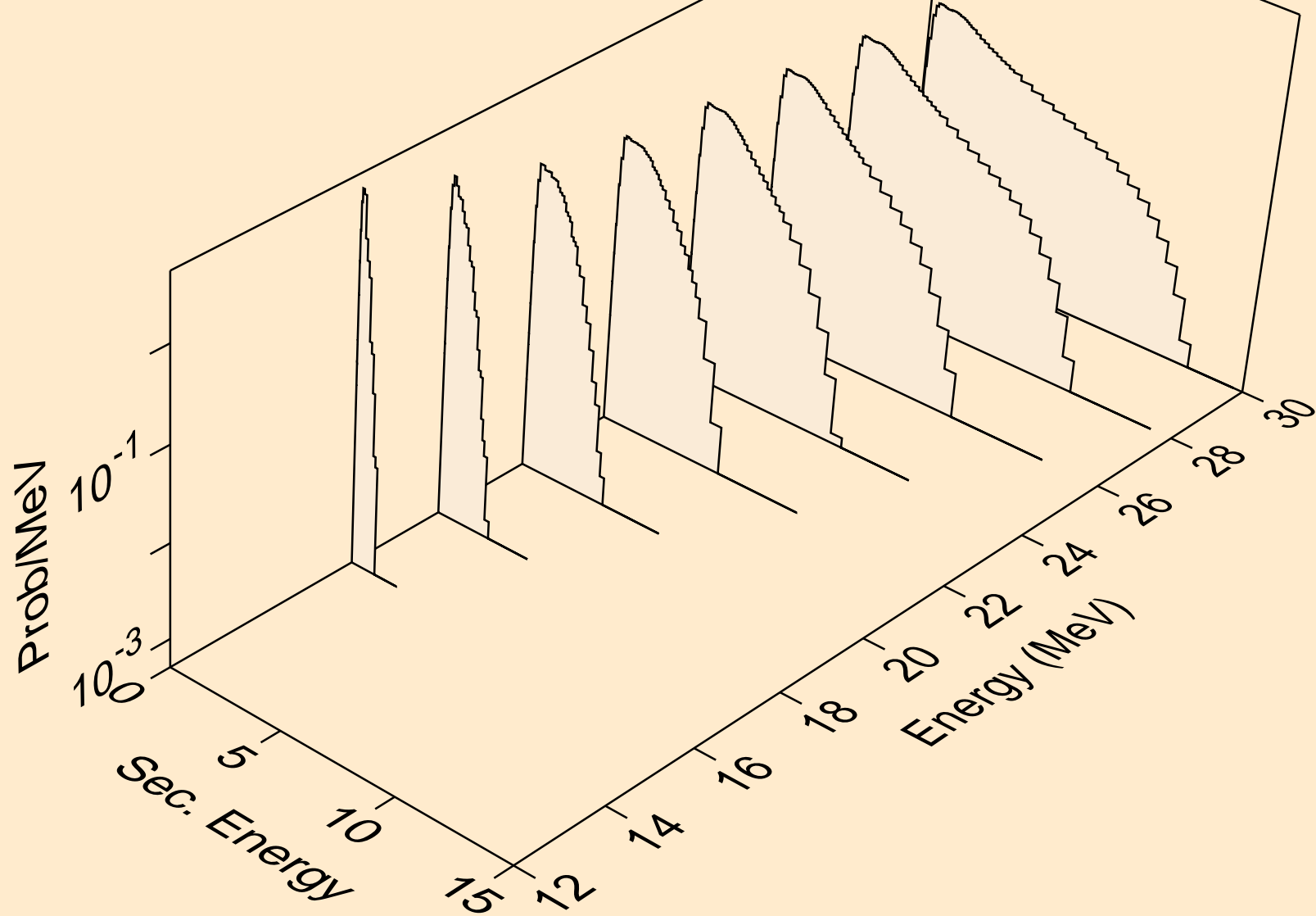

ND129 NEUTRON ACER TENDL-2021 LIBRARY; T=293.6K
Neutron emission for (n,3np)

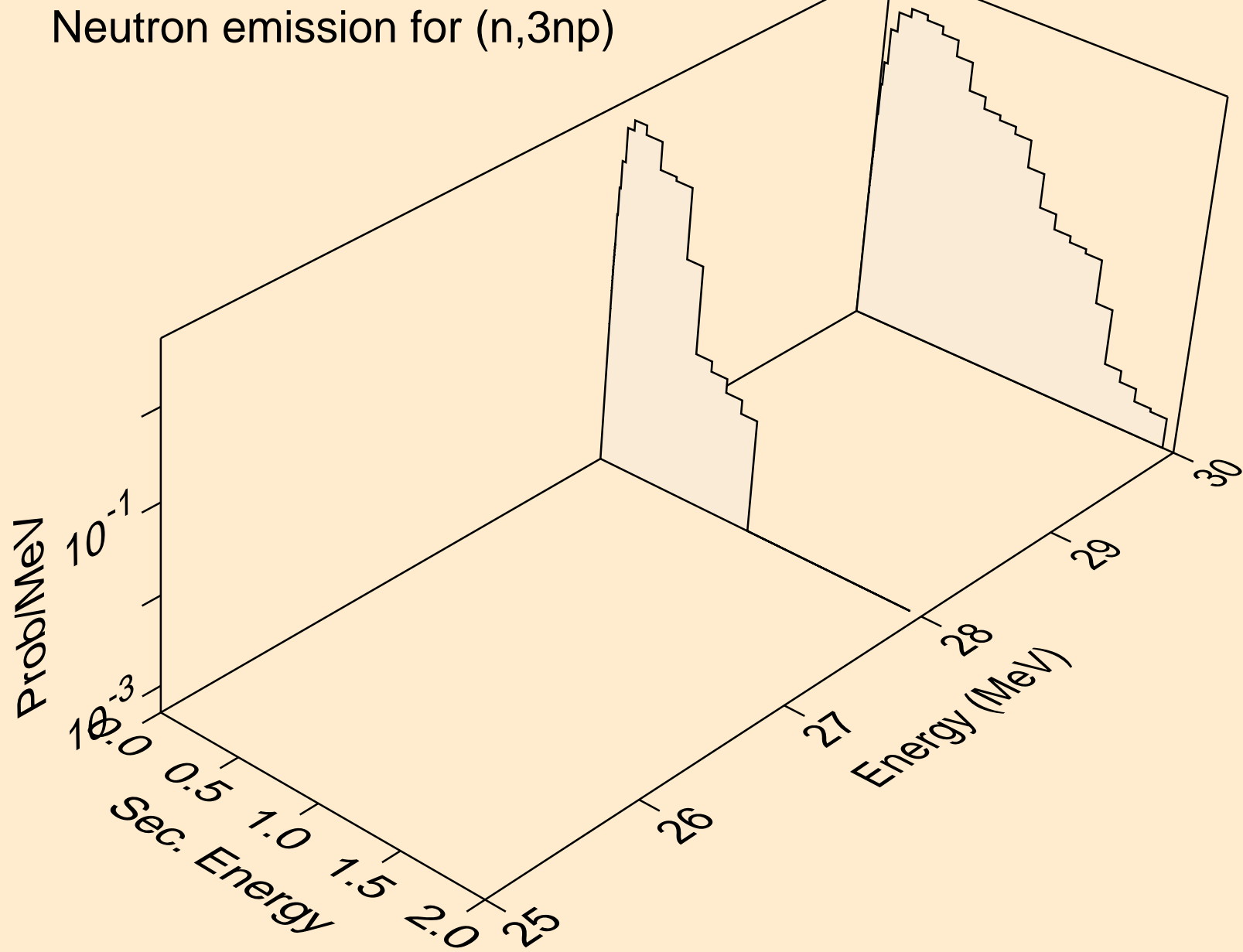

ND129 NEUTRON ACER TENDL-2021 LIBRARY; T=293.6K
Neutron emission for (n,2np)

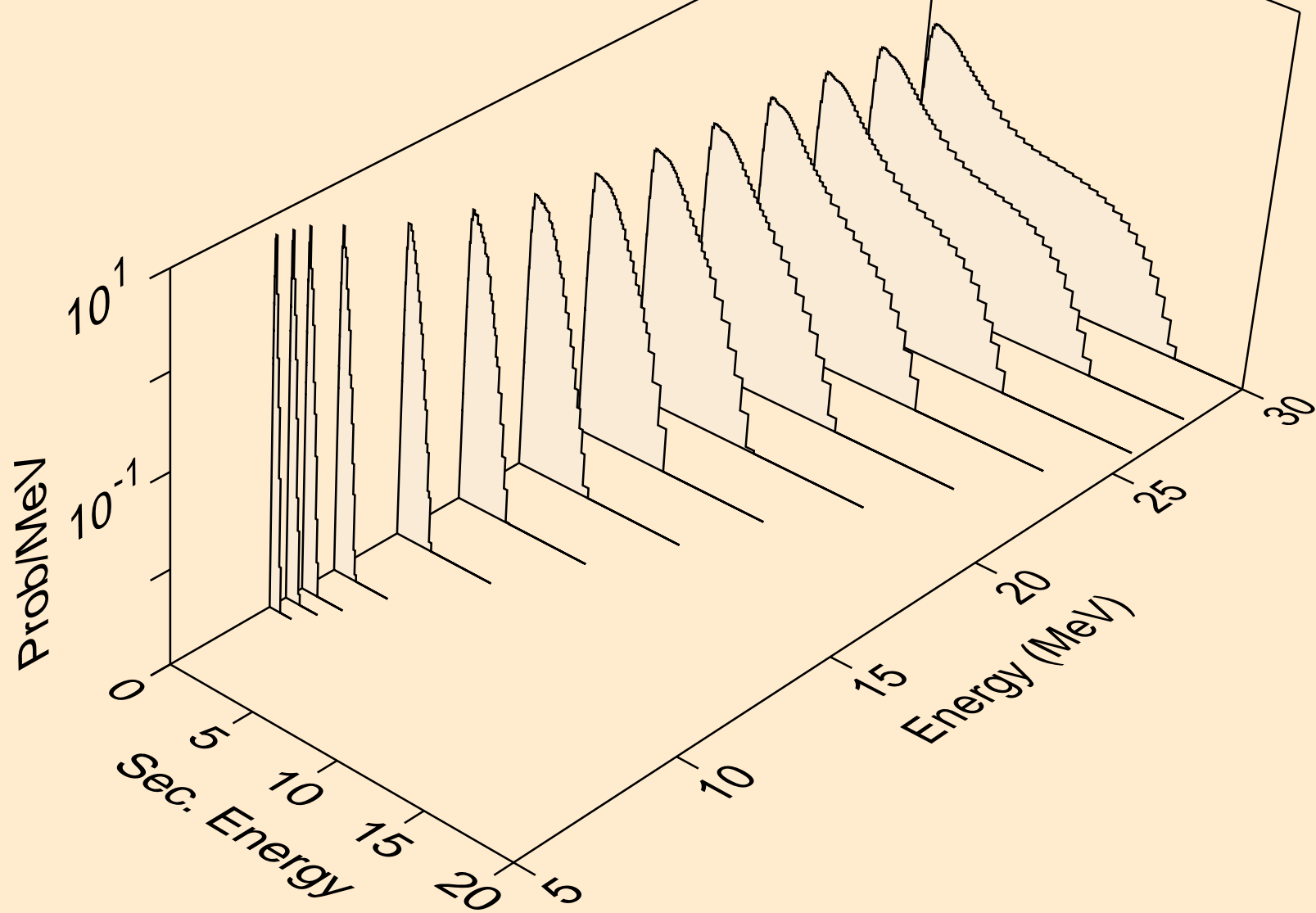

ND129 NEUTRON ACER TENDL-2021 LIBRARY; T=293.6K
Neutron emission for (n,npa)

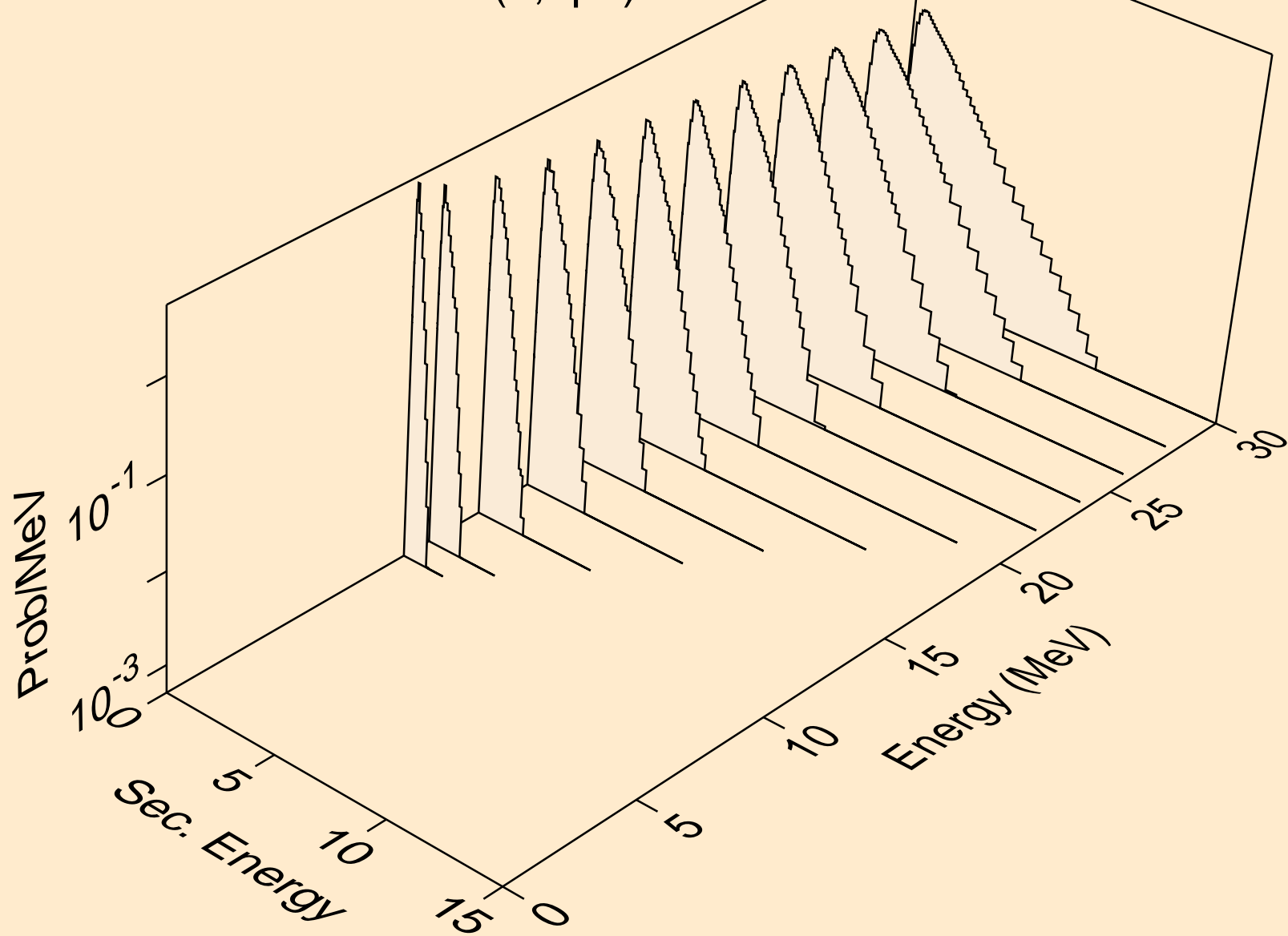

ND129 NEUTRON ACER TENDL-2021 LIBRARY; T=293.6K
Neutron emission for (n,n*c)

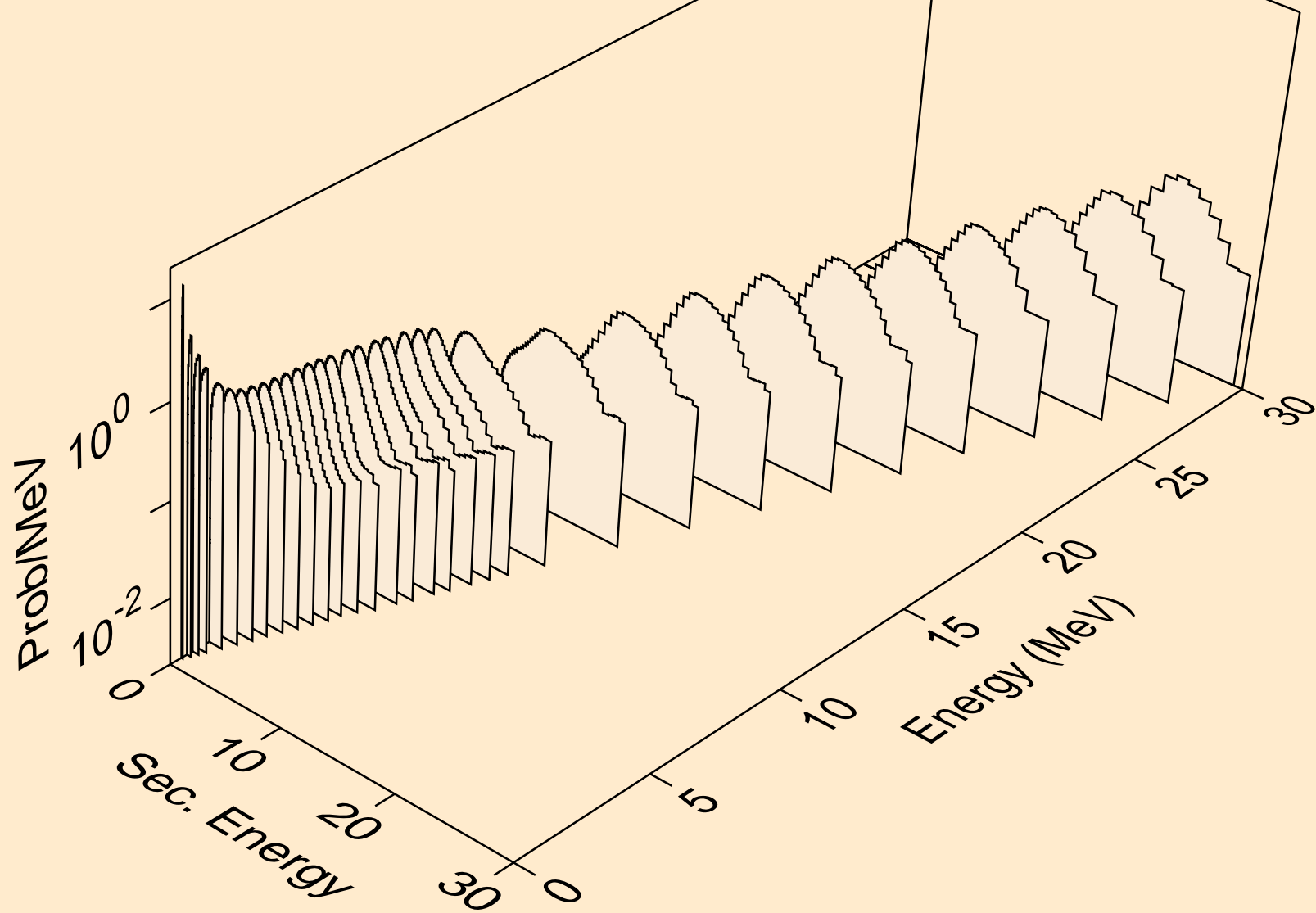

ND129 NEUTRON ACER TENDL-2021 LIBRARY; T=293.6K
Photon emission for (n,x)

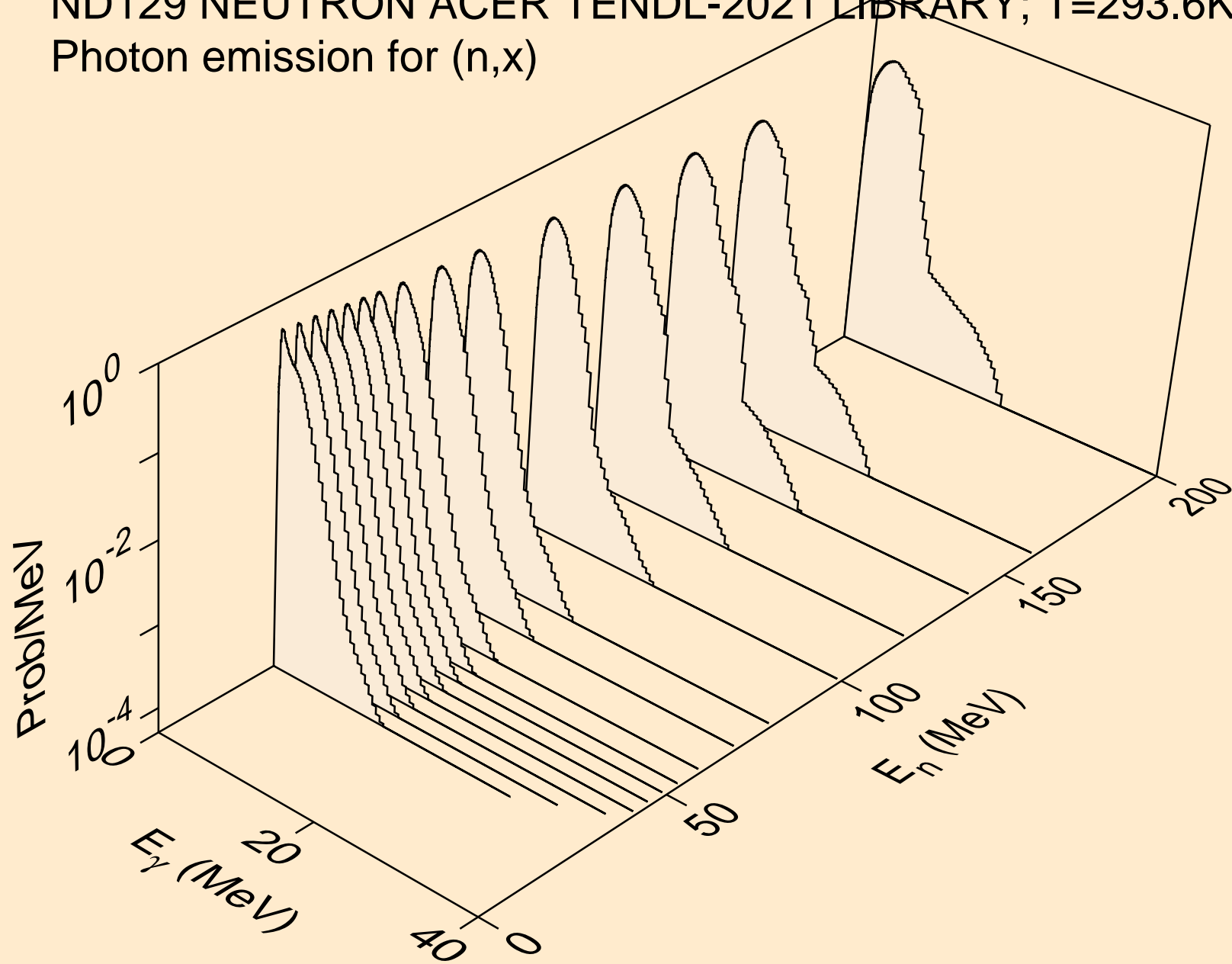

ND129 NEUTRON ACER TENDL-2021 LIBRARY; T=293.6K
Photon emission for (n,2nd)

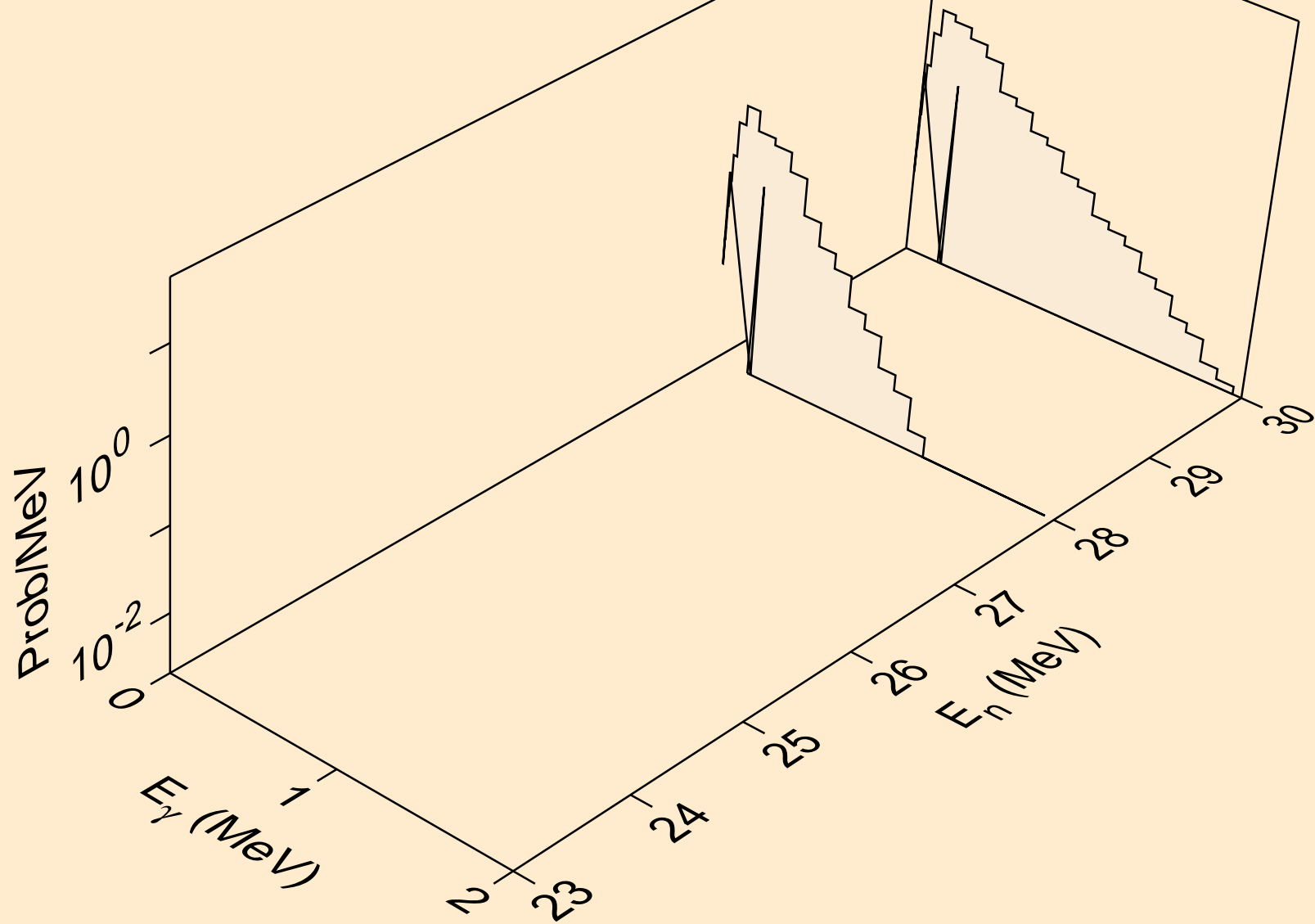

ND129 NEUTRON ACER TENDL-2021 LIBRARY; T=293.6K
Photon emission for (n,2n)

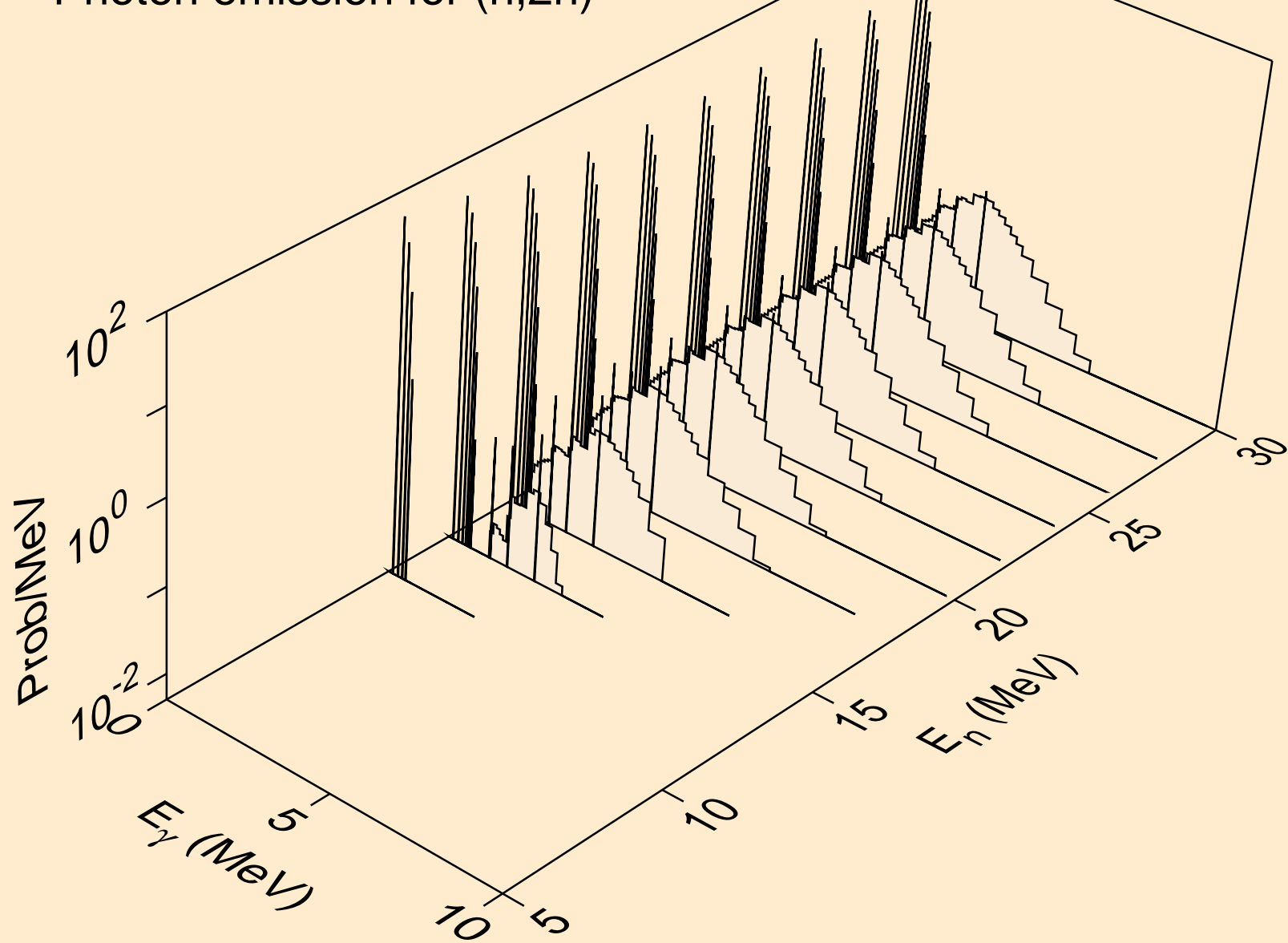

ND129 NEUTRON ACER TENDL-2021 LIBRARY; T=293.6K
Photon emission for (n,3n)

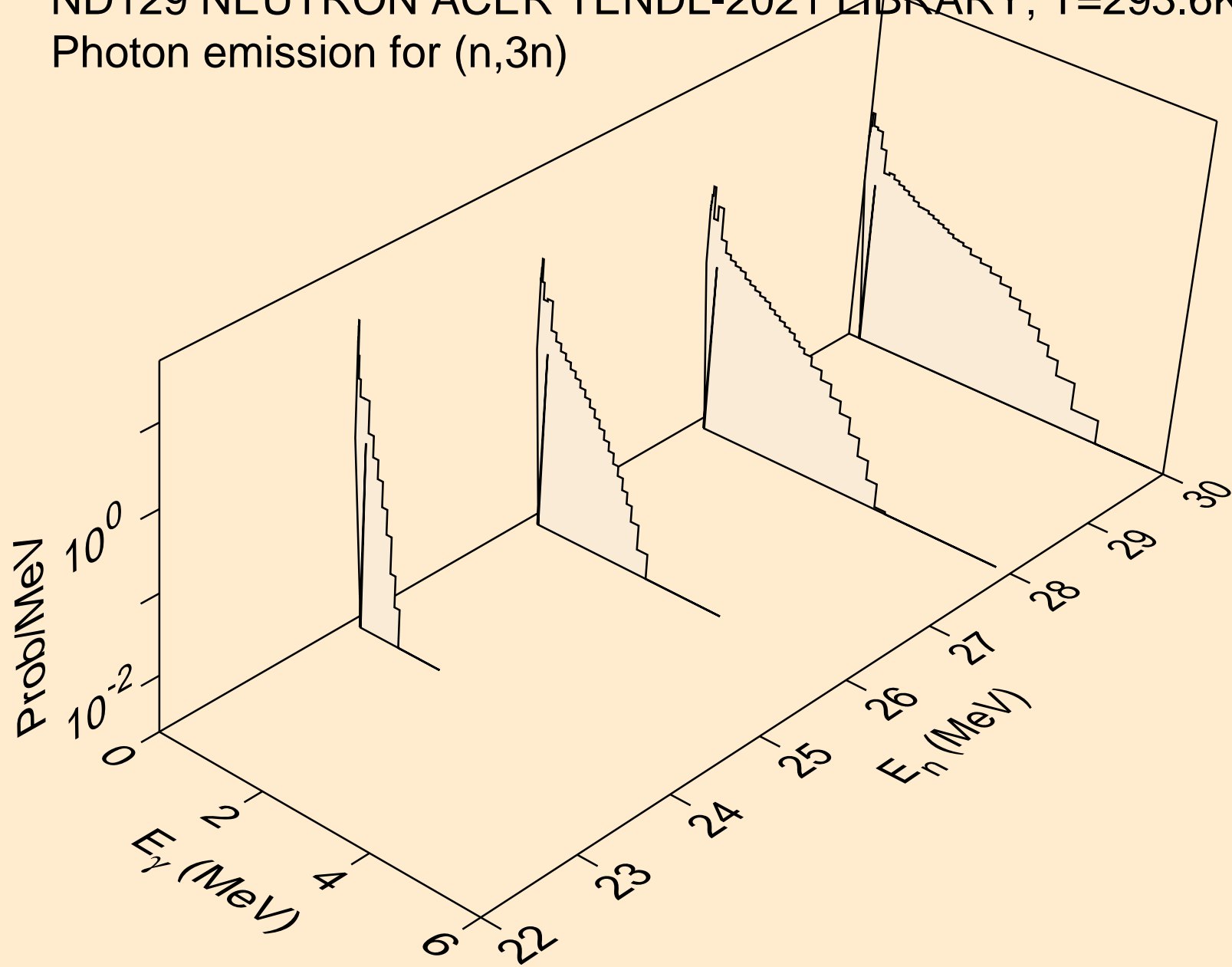

ND129 NEUTRON ACER TENDL-2021 LIBRARY; T=293.6K
Photon emission for (n,n*)a

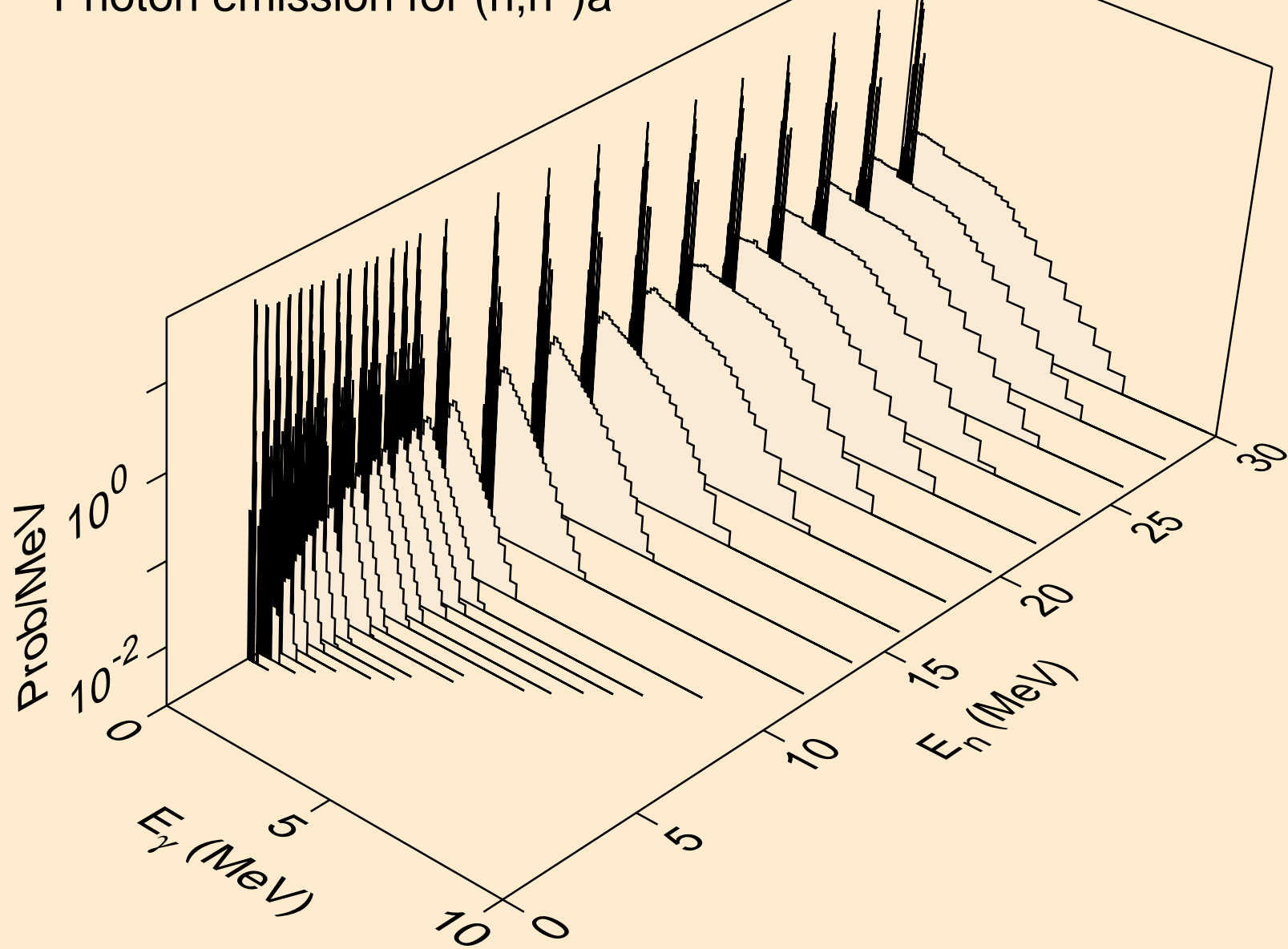

ND129 NEUTRON ACER TENDL-2021 LIBRARY; T=293.6K
Photon emission for (n,2n)a

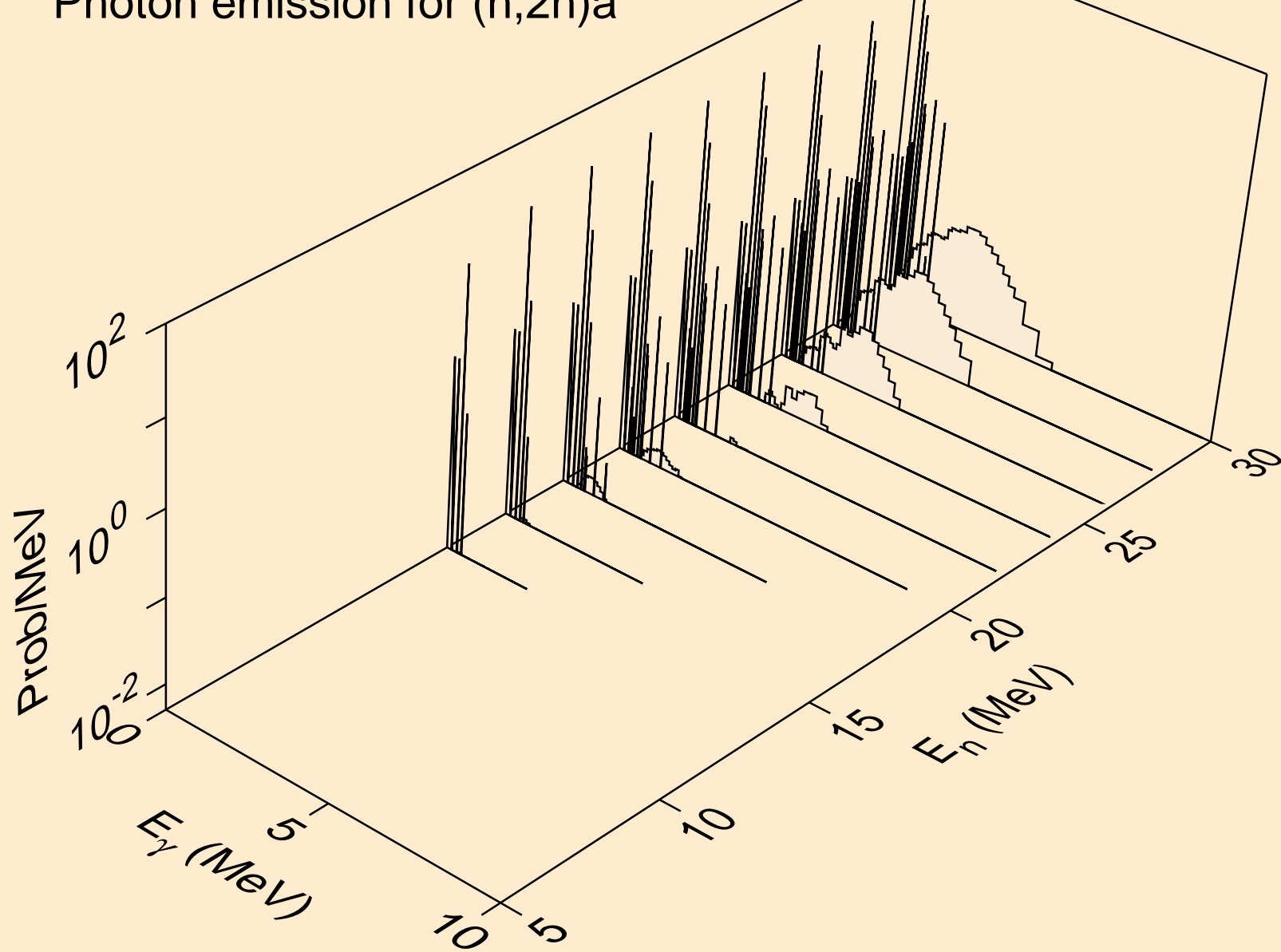

ND129 NEUTRON ACER TENDL-2021 LIBRARY; T=293.6K
Photon emission for (n,n*)p

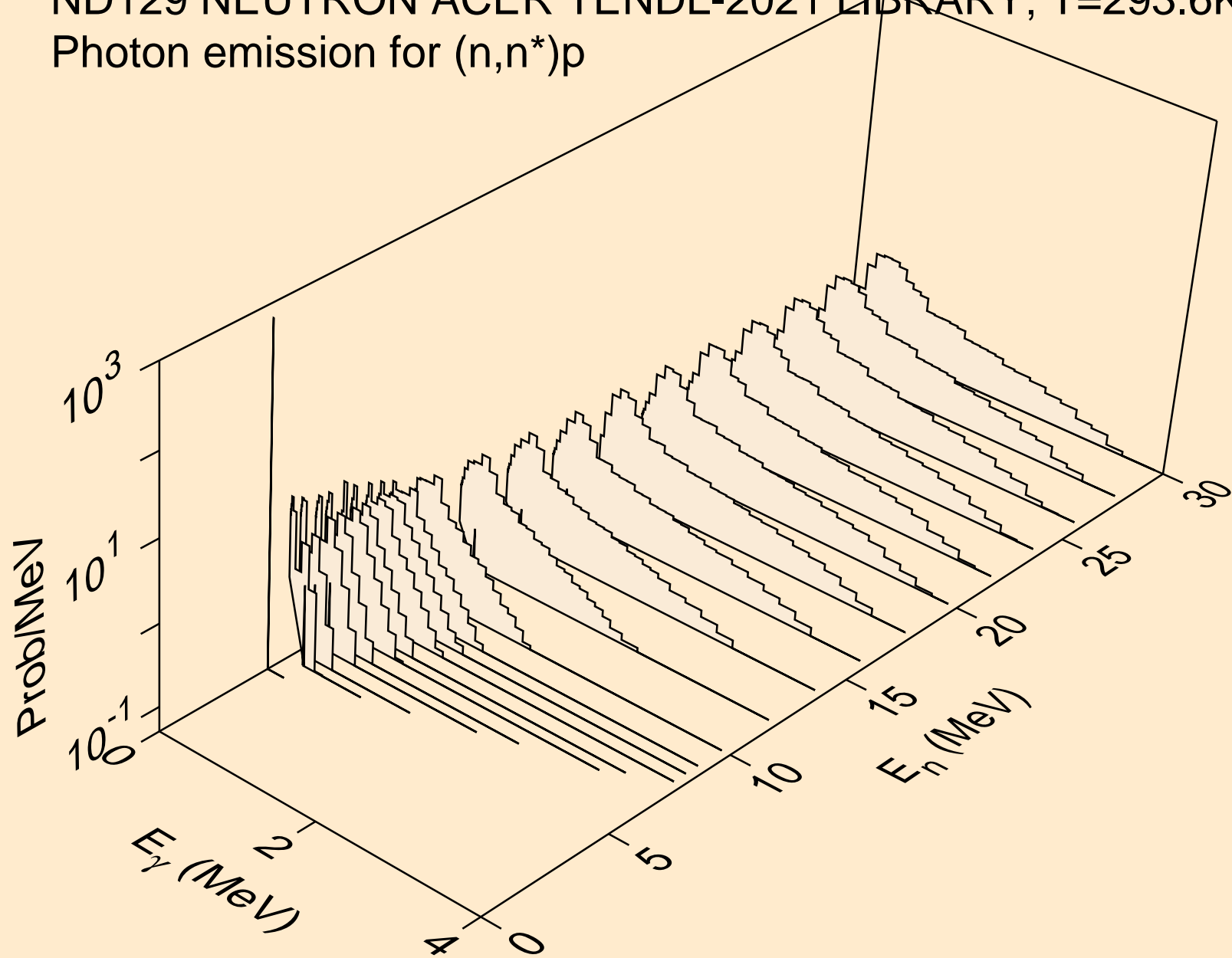

ND129 NEUTRON ACER TENDL-2021 LIBRARY; T=293.6K
Photon emission for (n,n*)2a

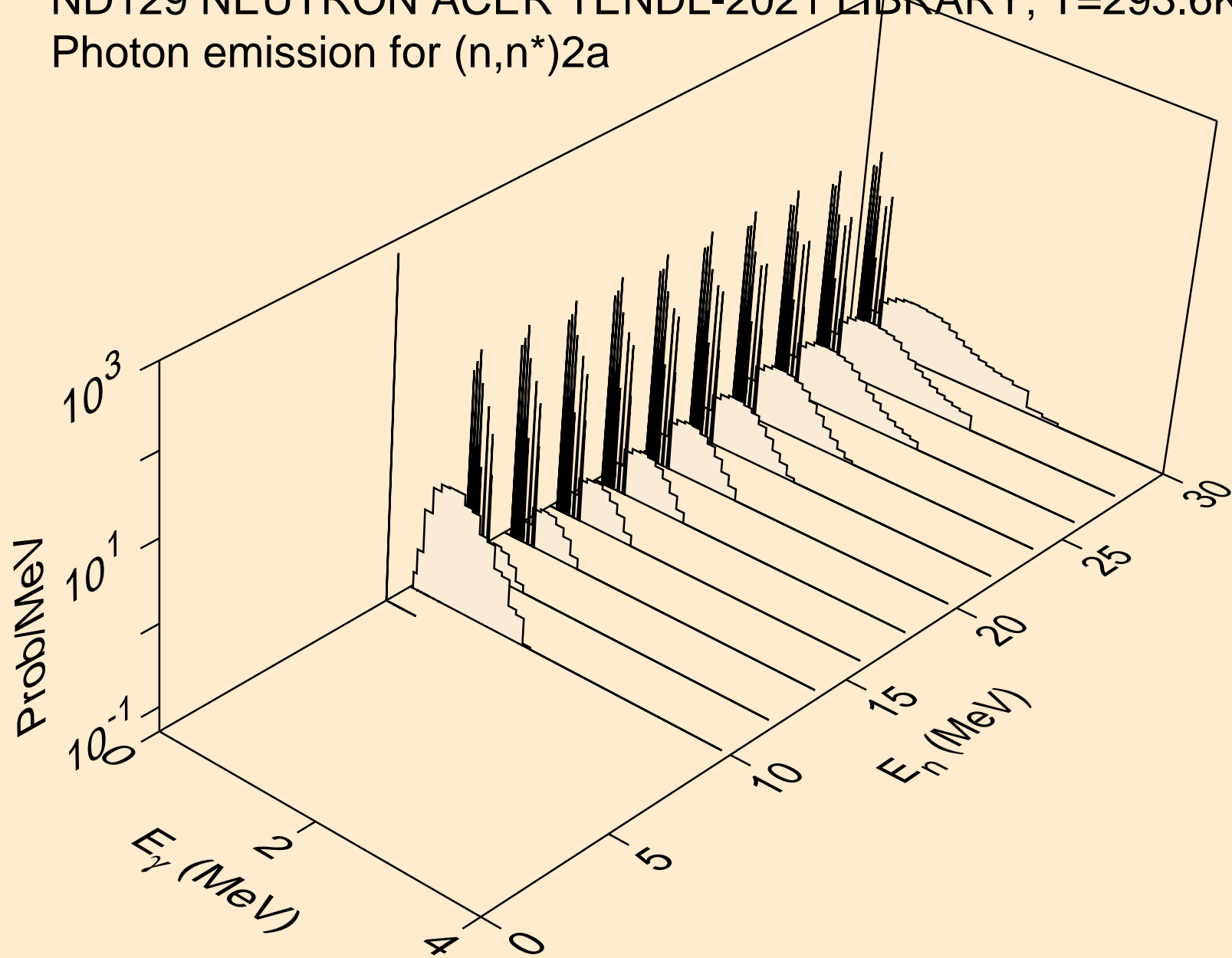

ND129 NEUTRON ACER TENDL-2021 LIBRARY; T=293.6K
Photon emission for (n,2n)2a

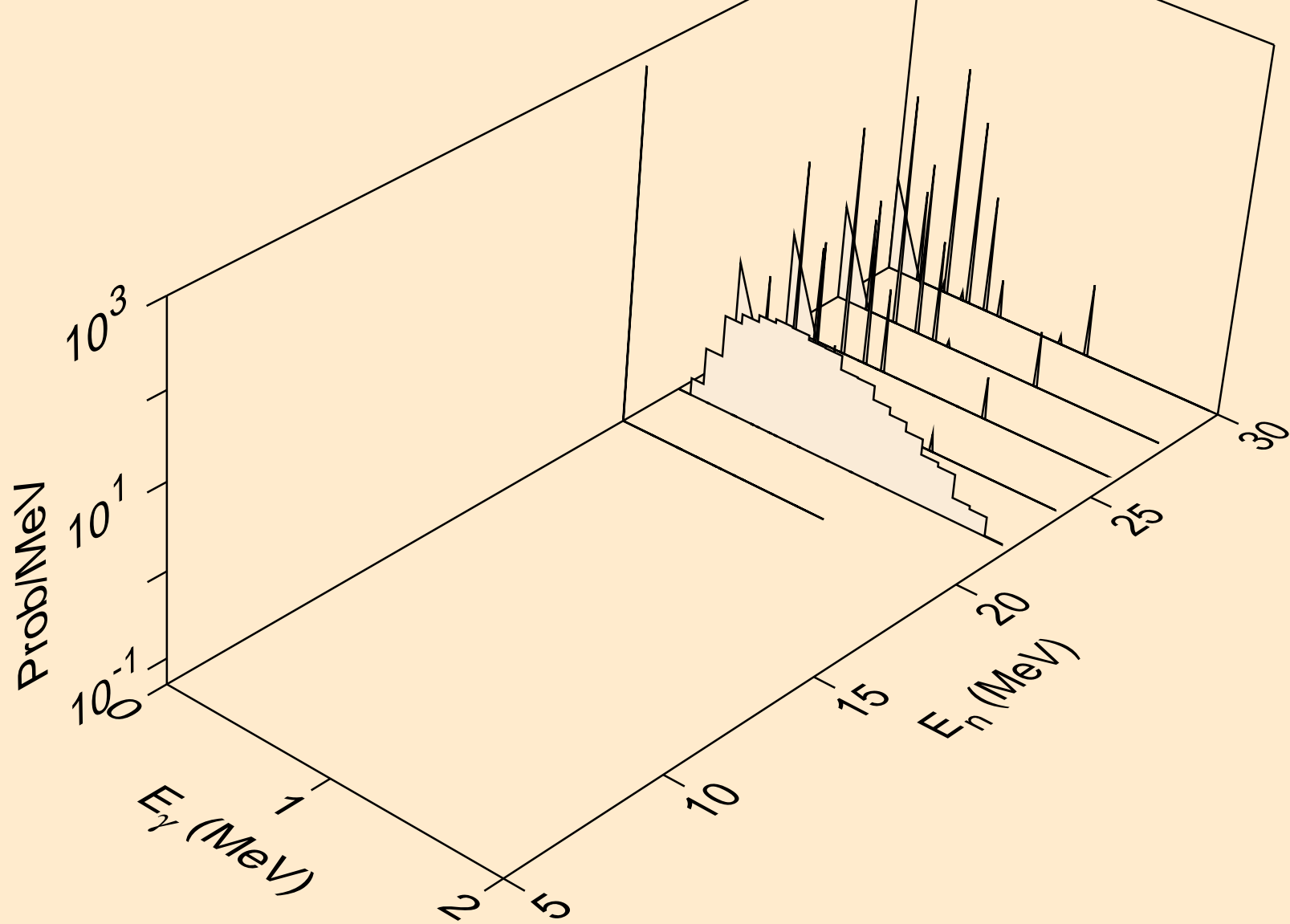

ND129 NEUTRON ACER TENDL-2021 LIBRARY; T=293.6K
Photon emission for (n,n*)d

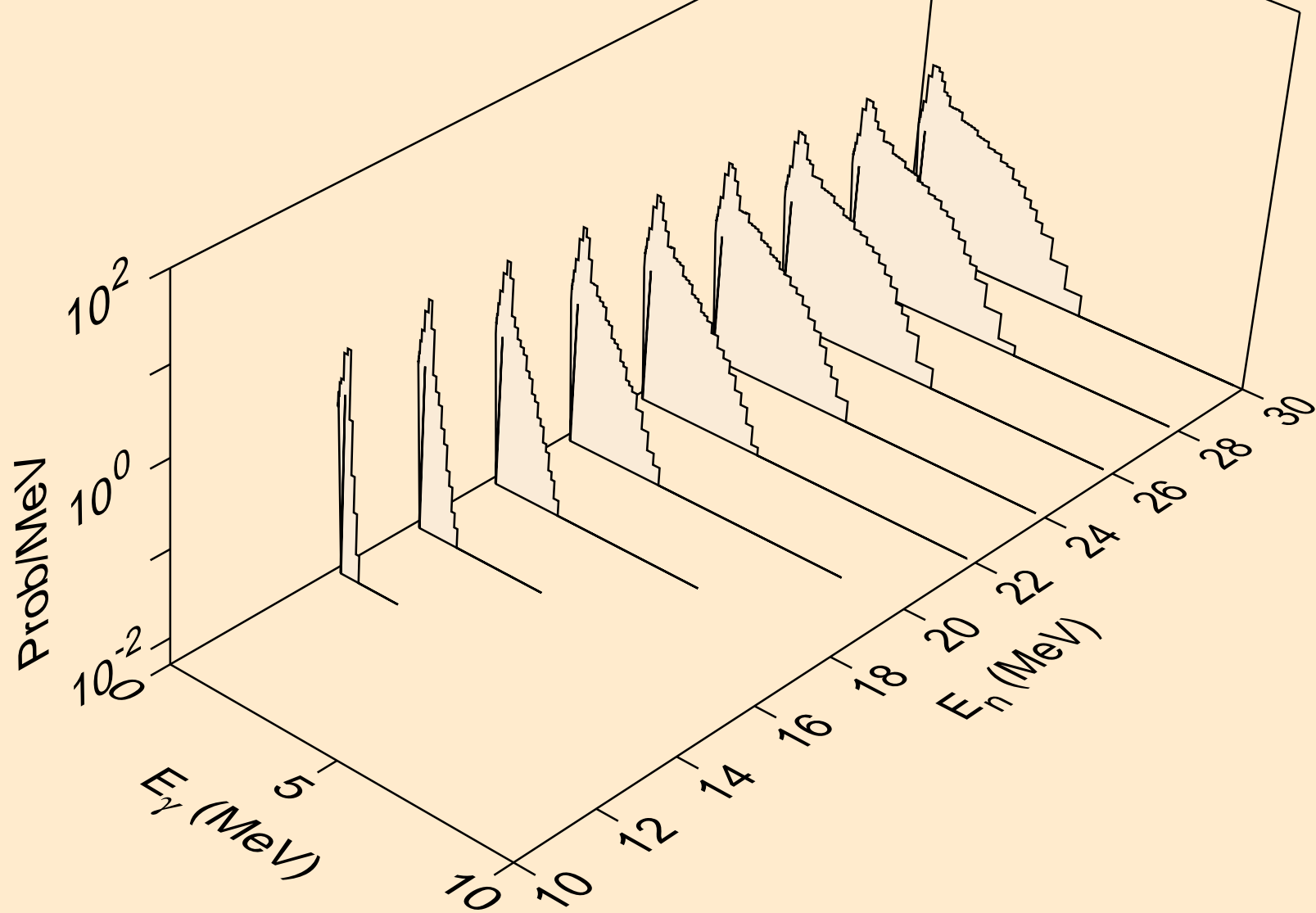

ND129 NEUTRON ACER TENDL-2021 LIBRARY; T=293.6K
Photon emission for (n,n*)t

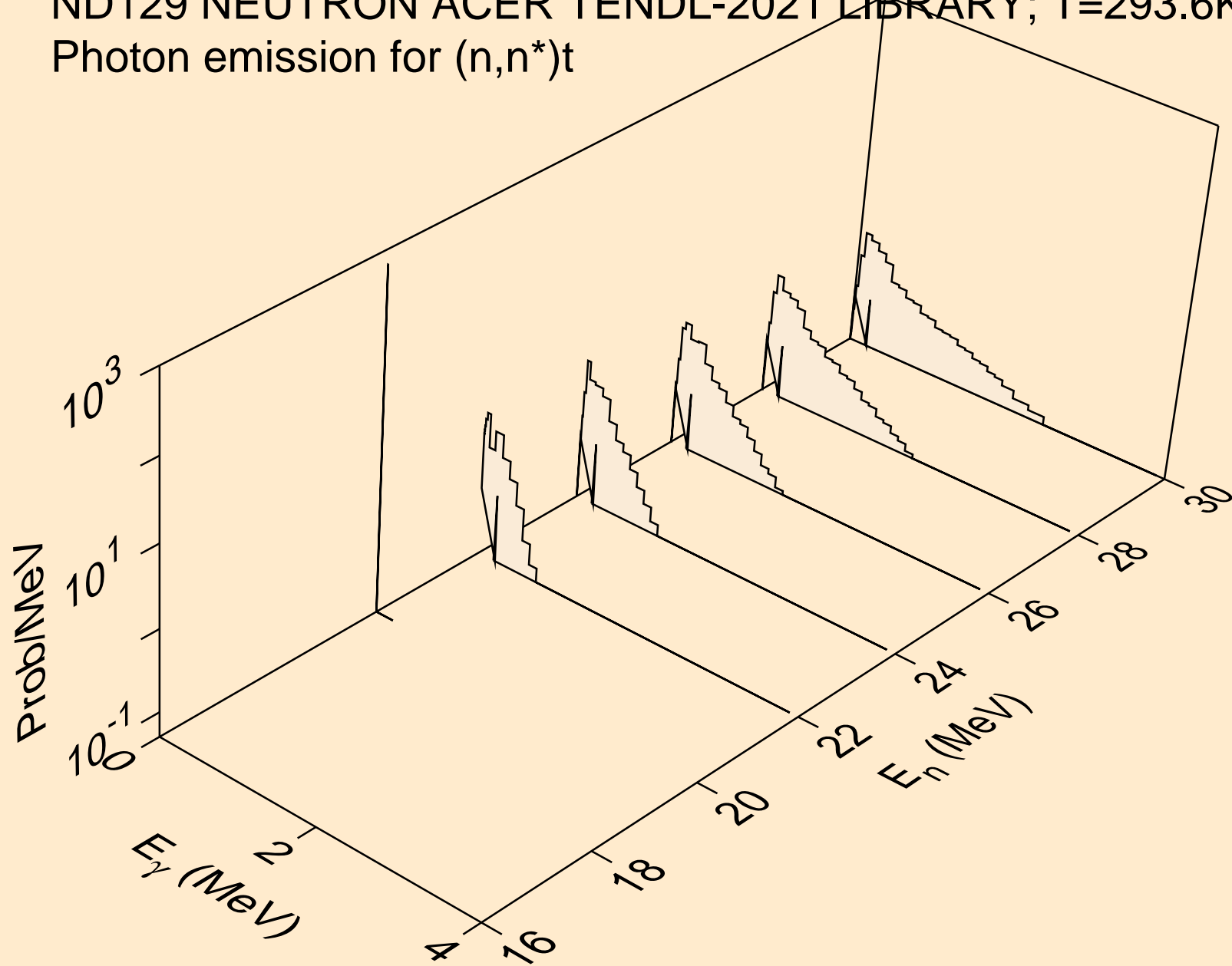

ND129 NEUTRON ACER TENDL-2021 LIBRARY; T=293.6K
Photon emission for (n,n*)he3

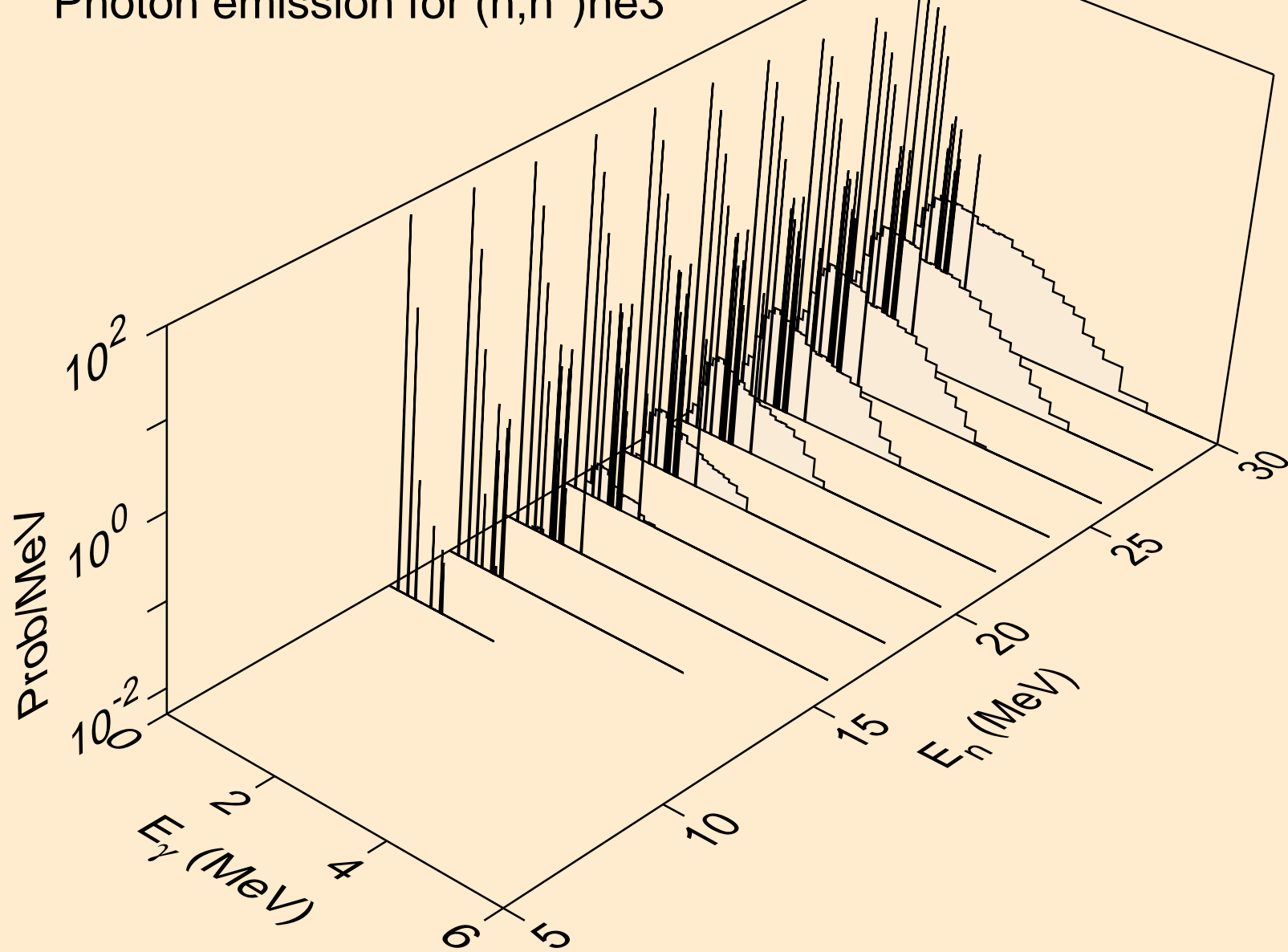

ND129 NEUTRON ACER TENDL-2021 LIBRARY; T=293.6K
Photon emission for (n,2np)

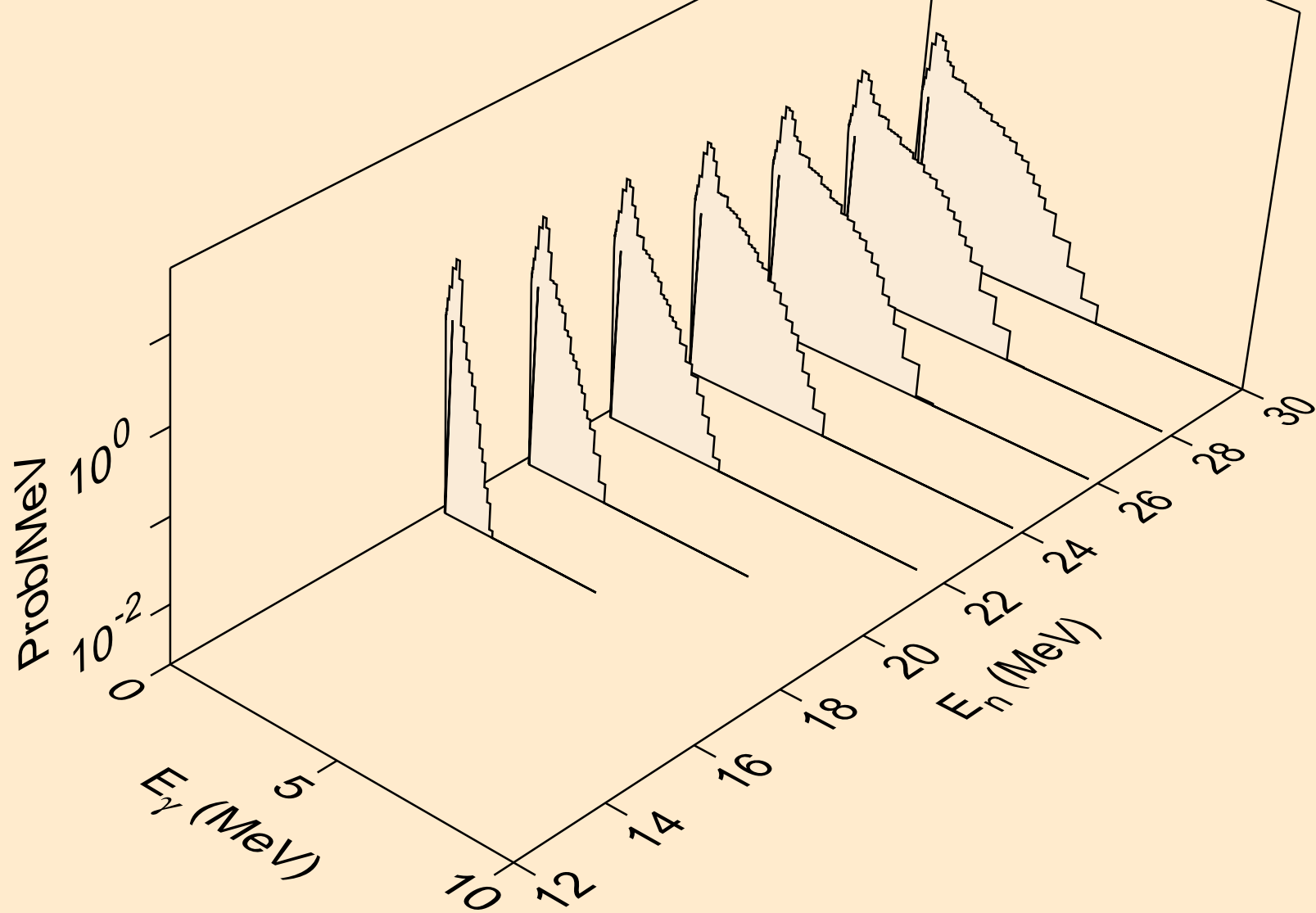

ND129 NEUTRON ACER TENDL-2021 LIBRARY; T=293.6K
Photon emission for (n,3np)

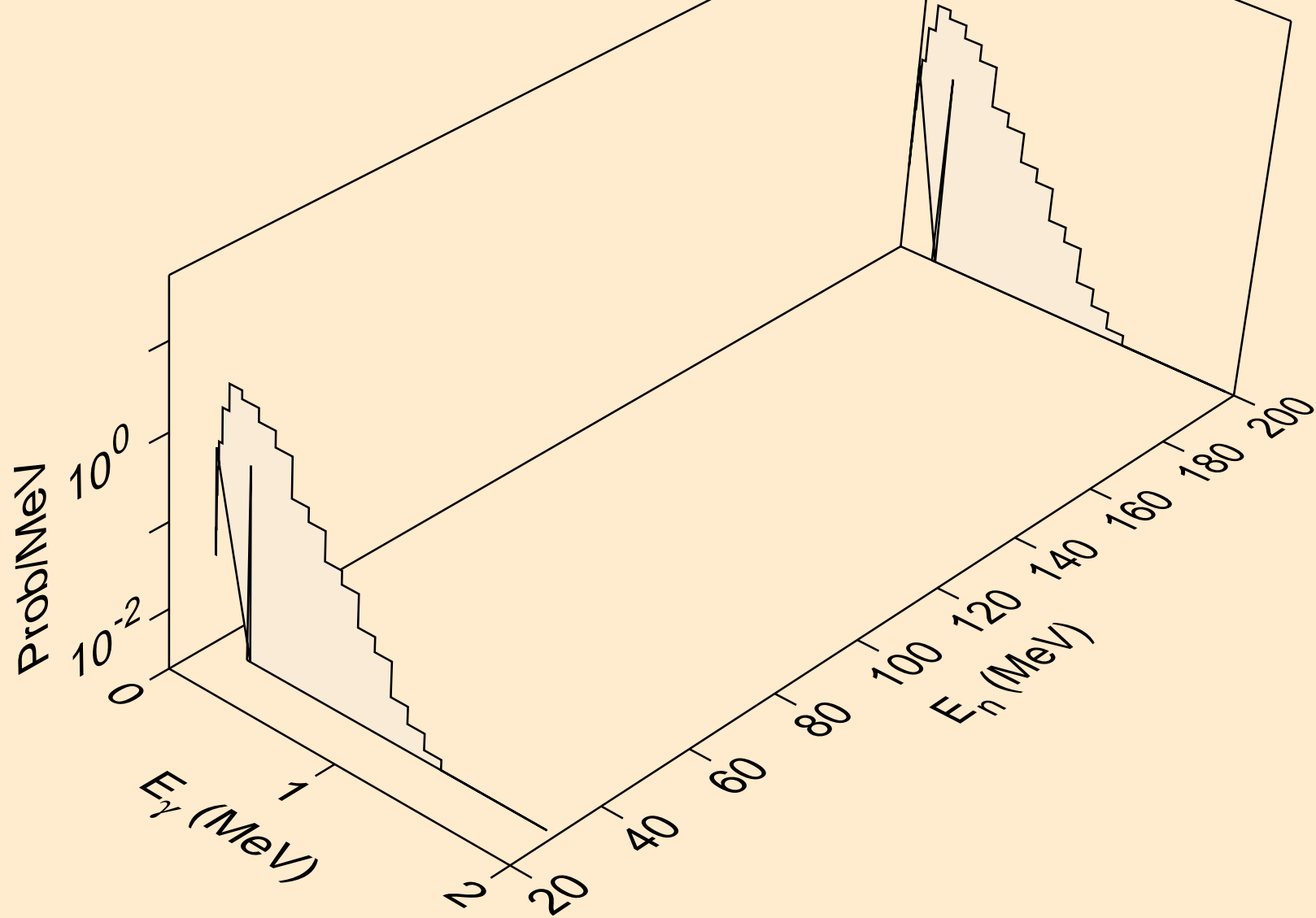

ND129 NEUTRON ACER TENDL-2021 LIBRARY; T=293.6K
Photon emission for (n,2np)

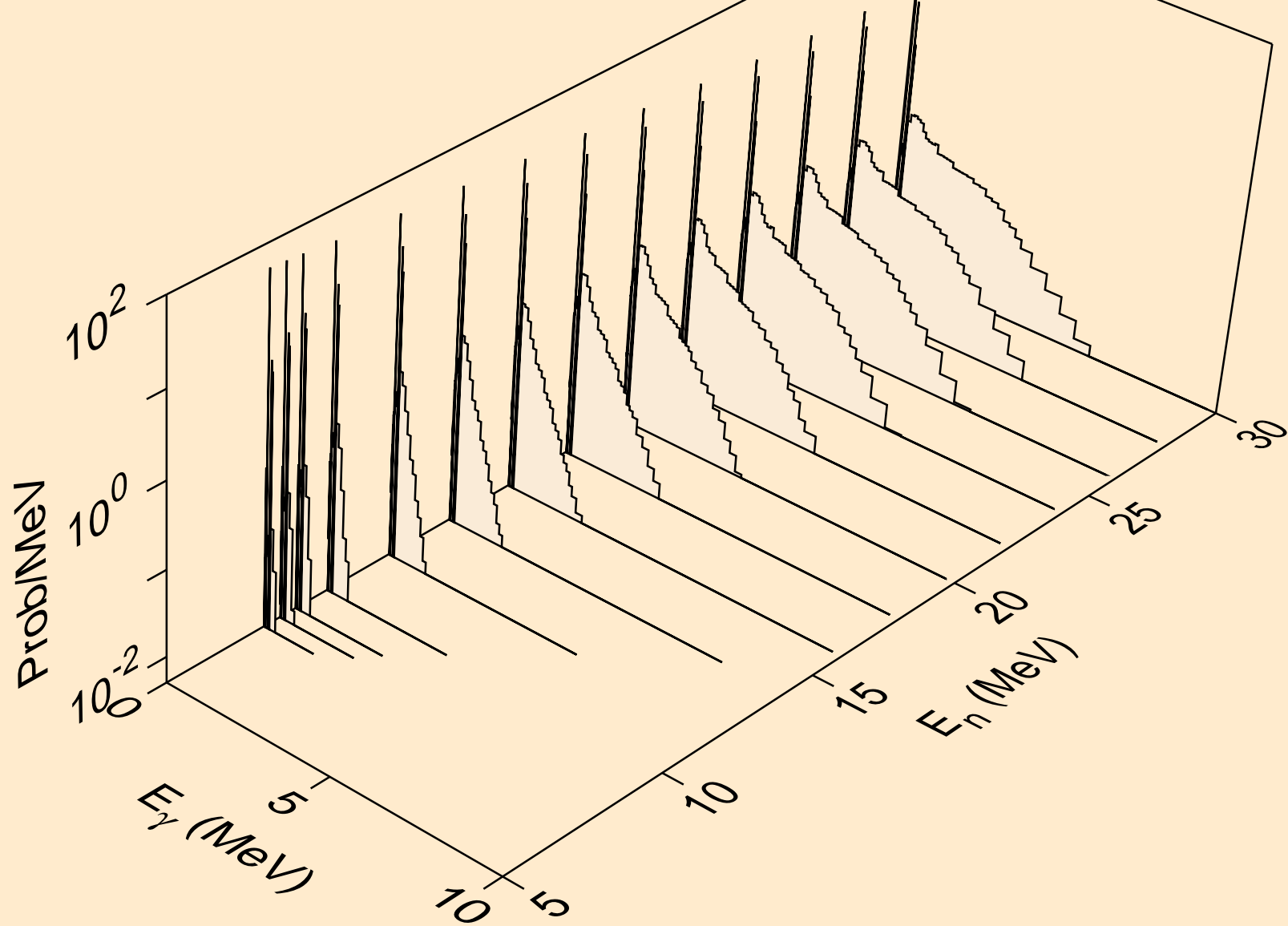

ND129 NEUTRON ACER TENDL-2021 LIBRARY; T=293.6K
Photon emission for (n,npa)

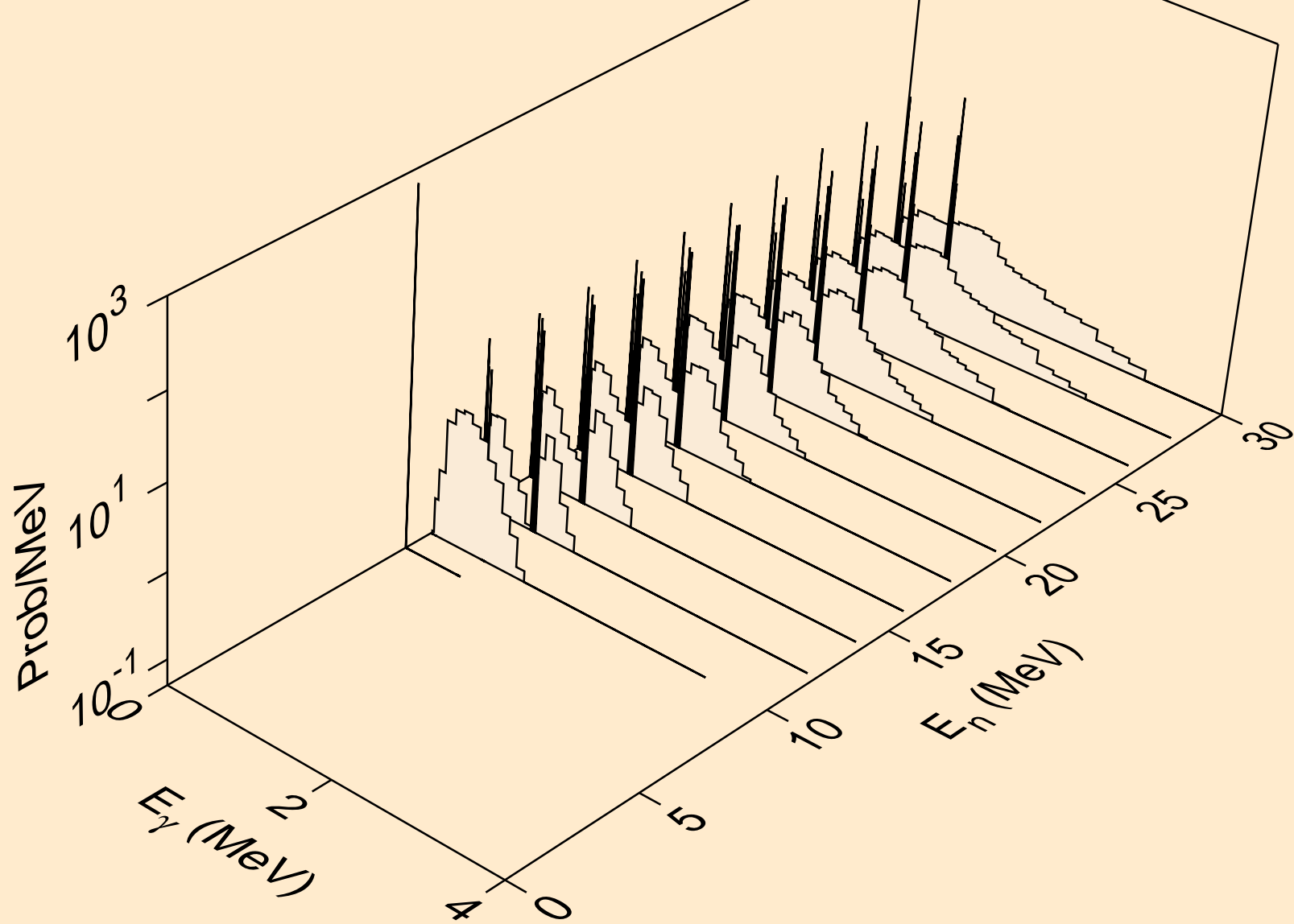

ND129 NEUTRON ACER TENDL-2021 LIBRARY; T=293.6K
Photon emission for (n,n*c)

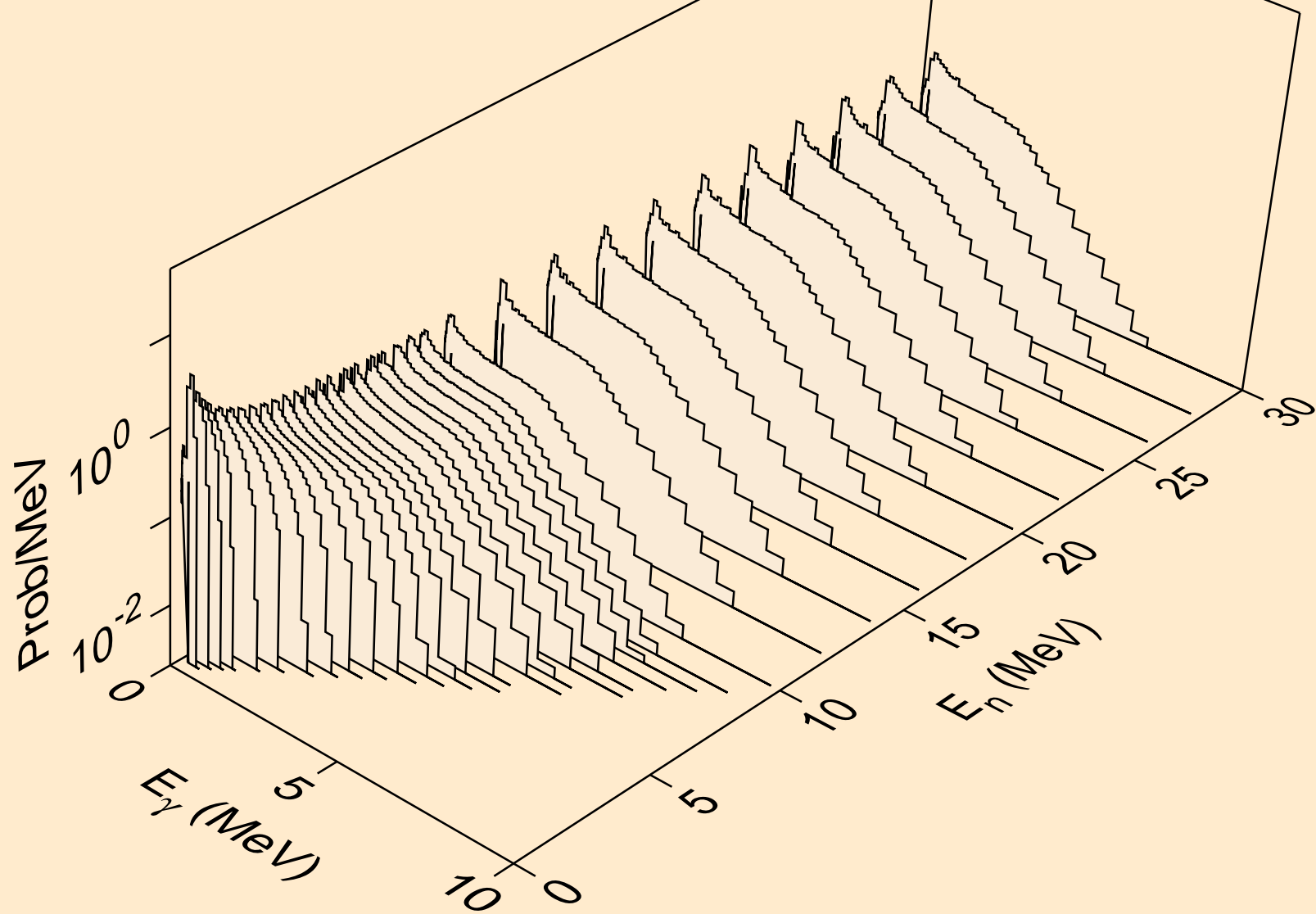

ND129 NEUTRON ACER TENDL-2021 LIBRARY; T=293.6K
Photon emission for (n,gma)

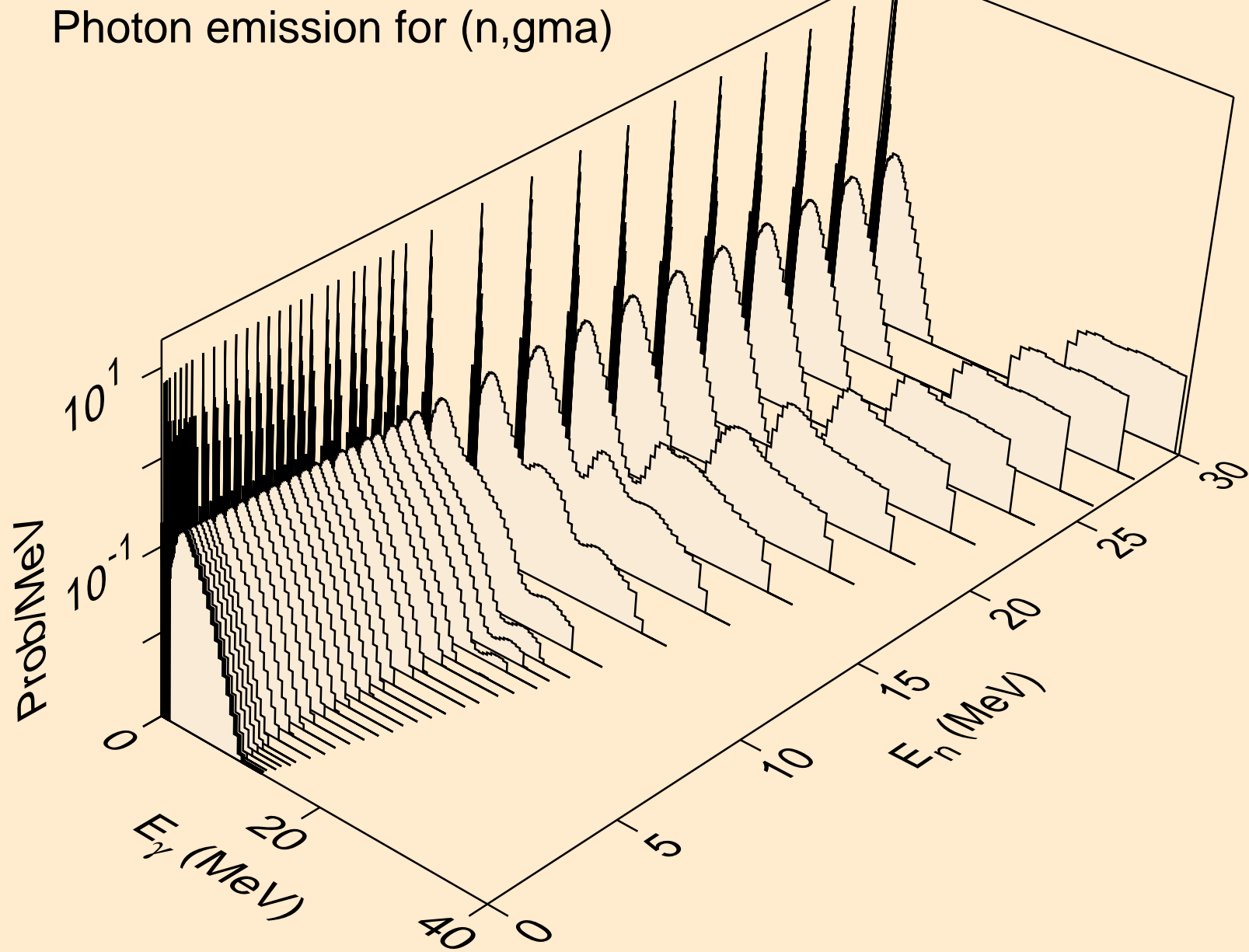

ND129 NEUTRON ACER TENDL-2021 LIBRARY; T=293.6K
Photon emission for (n,p)

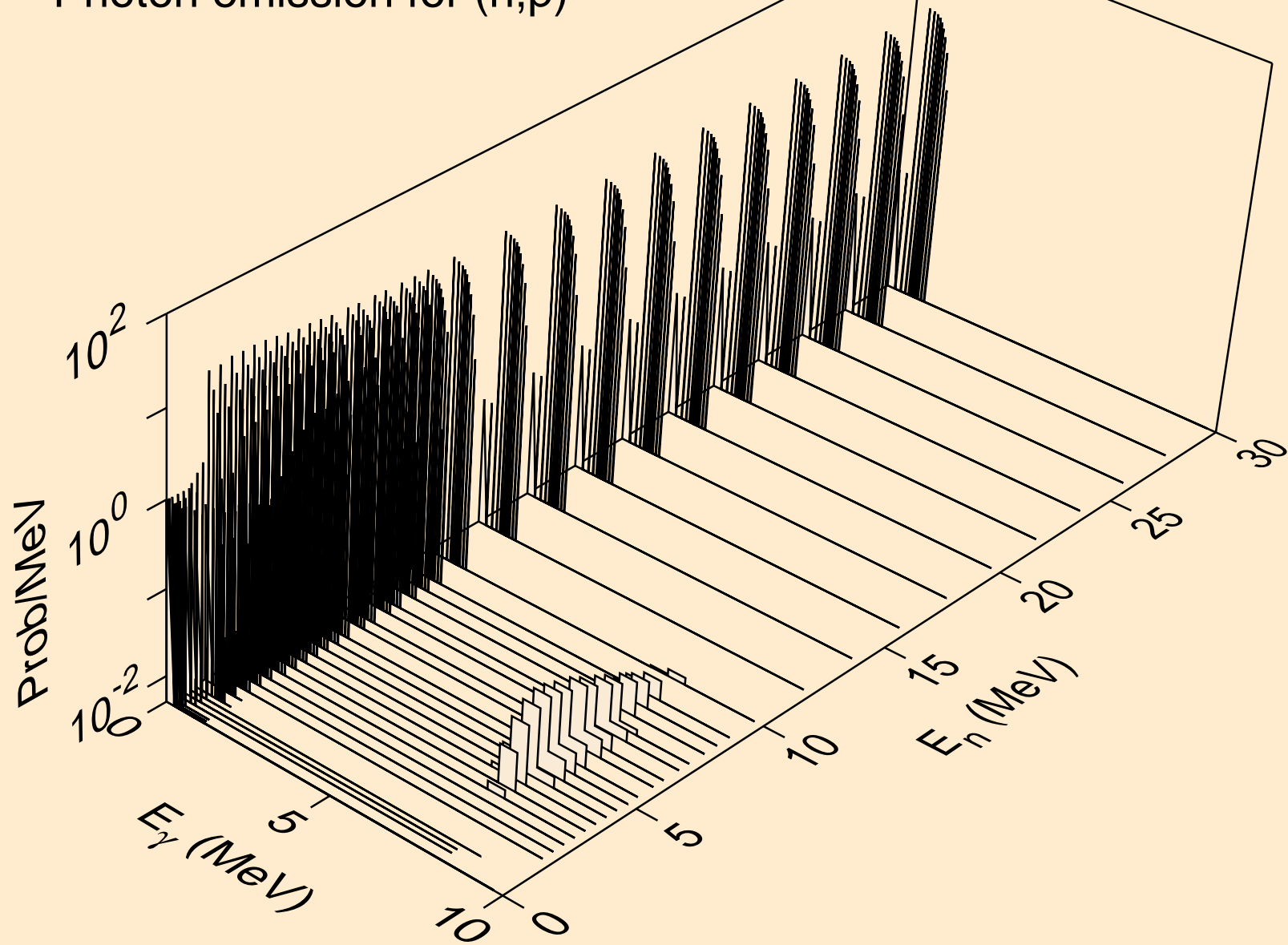

ND129 NEUTRON ACER TENDL-2021 LIBRARY; T=293.6K
Photon emission for (n,d)

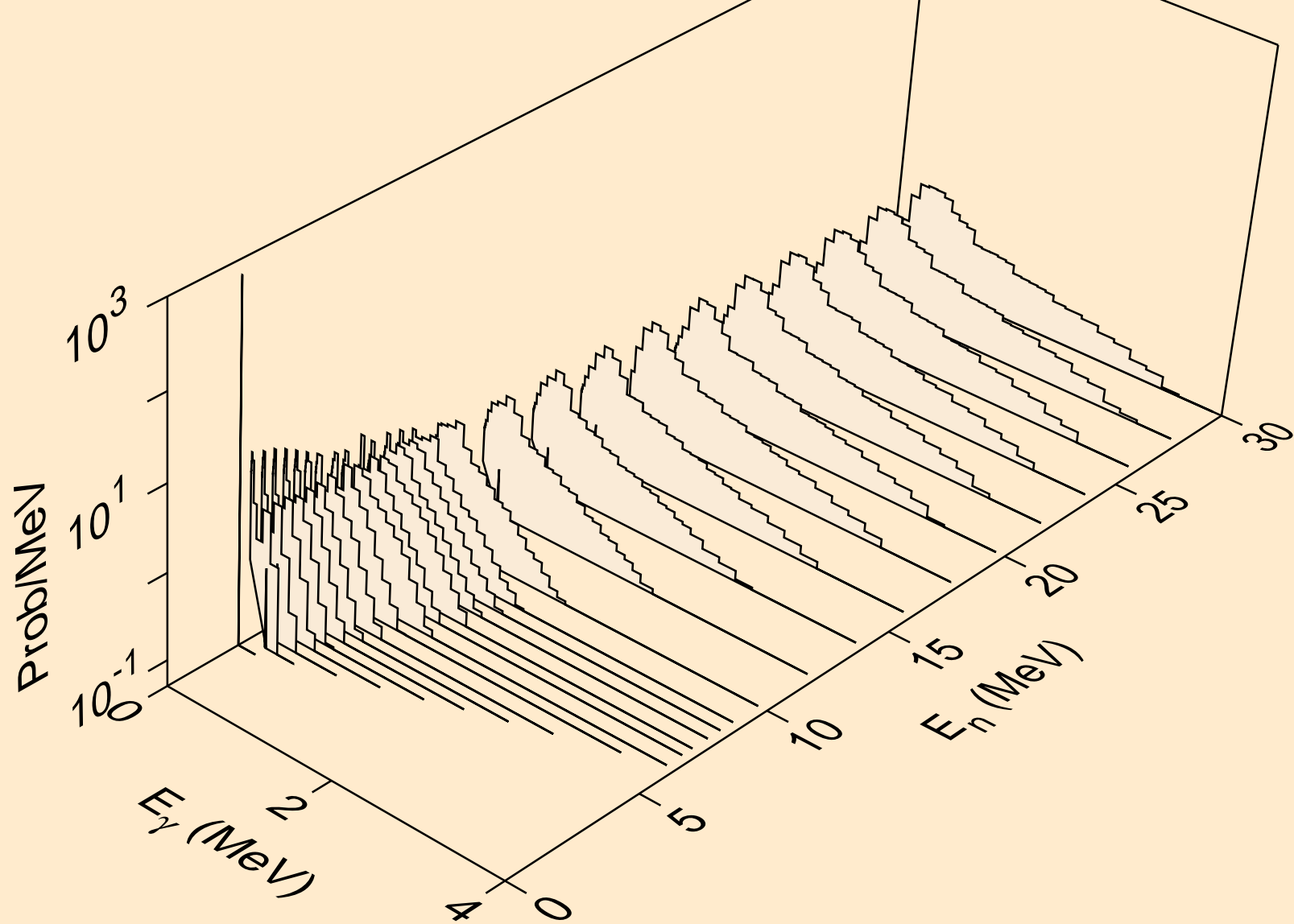

ND129 NEUTRON ACER TENDL-2021 LIBRARY; T=293.6K
Photon emission for (n,t)

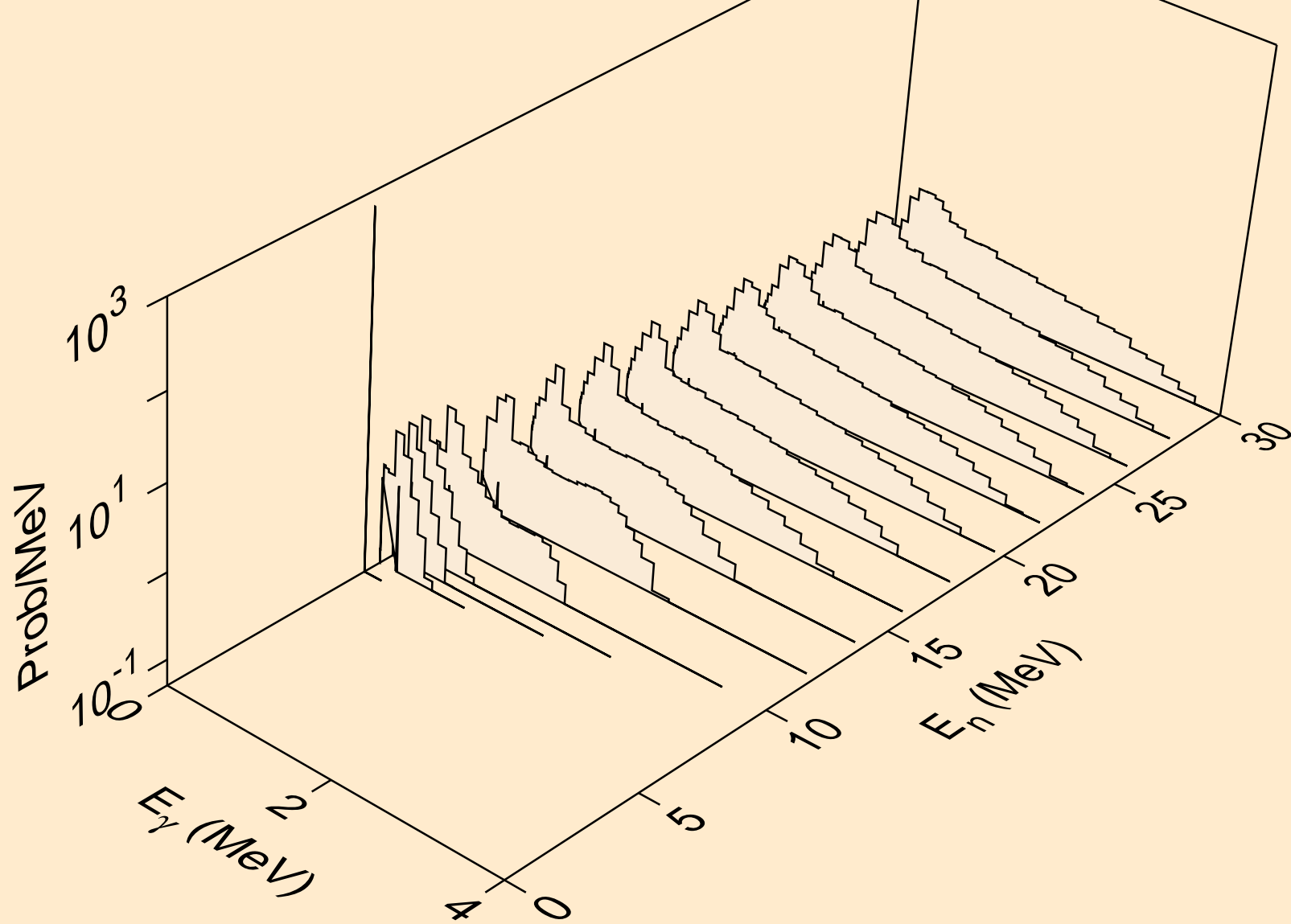

ND129 NEUTRON ACER TENDL-2021 LIBRARY; T=293.6K
Photon emission for (n,he3)

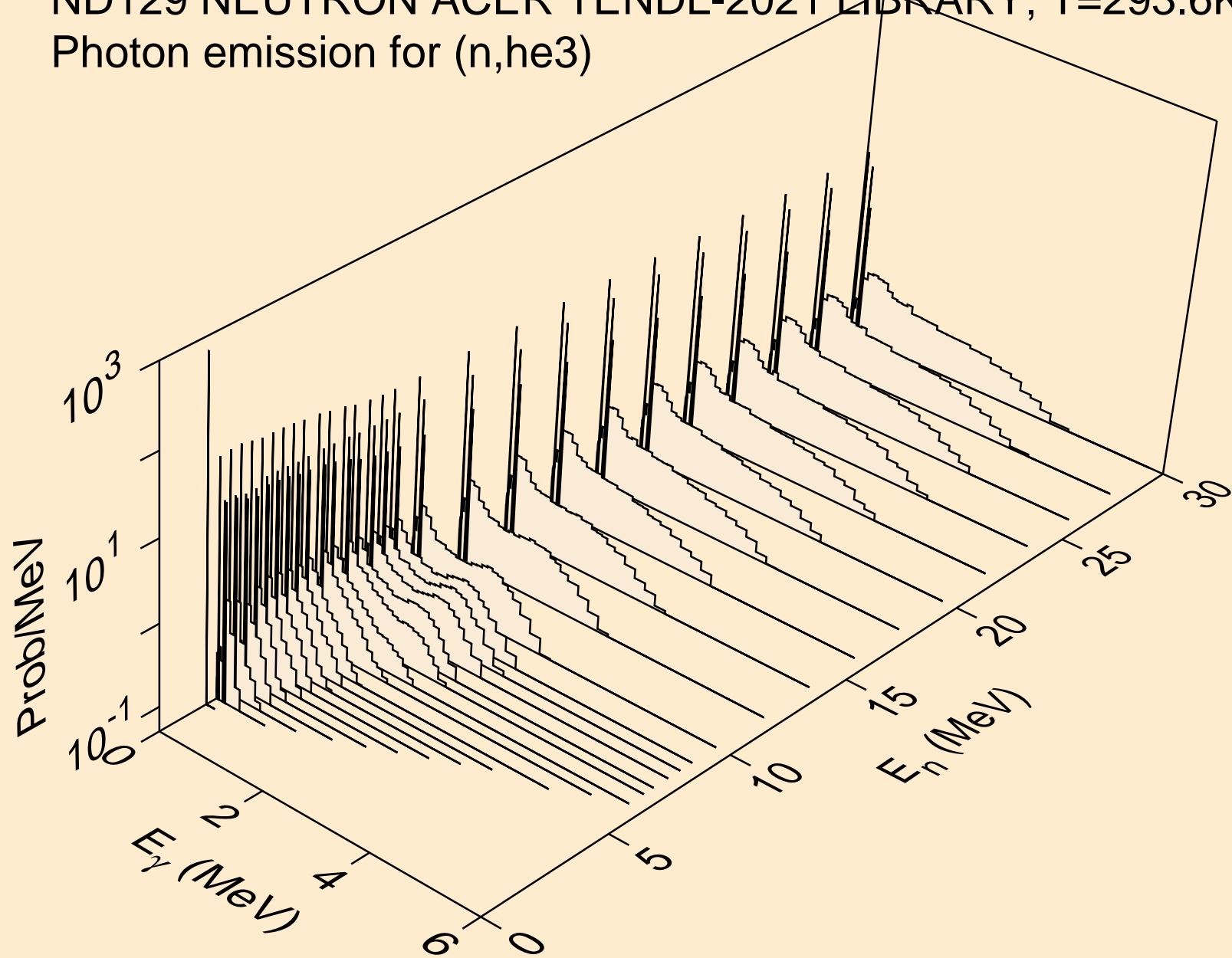

ND129 NEUTRON ACER TENDL-2021 LIBRARY; T=293.6K
Photon emission for (n,a)

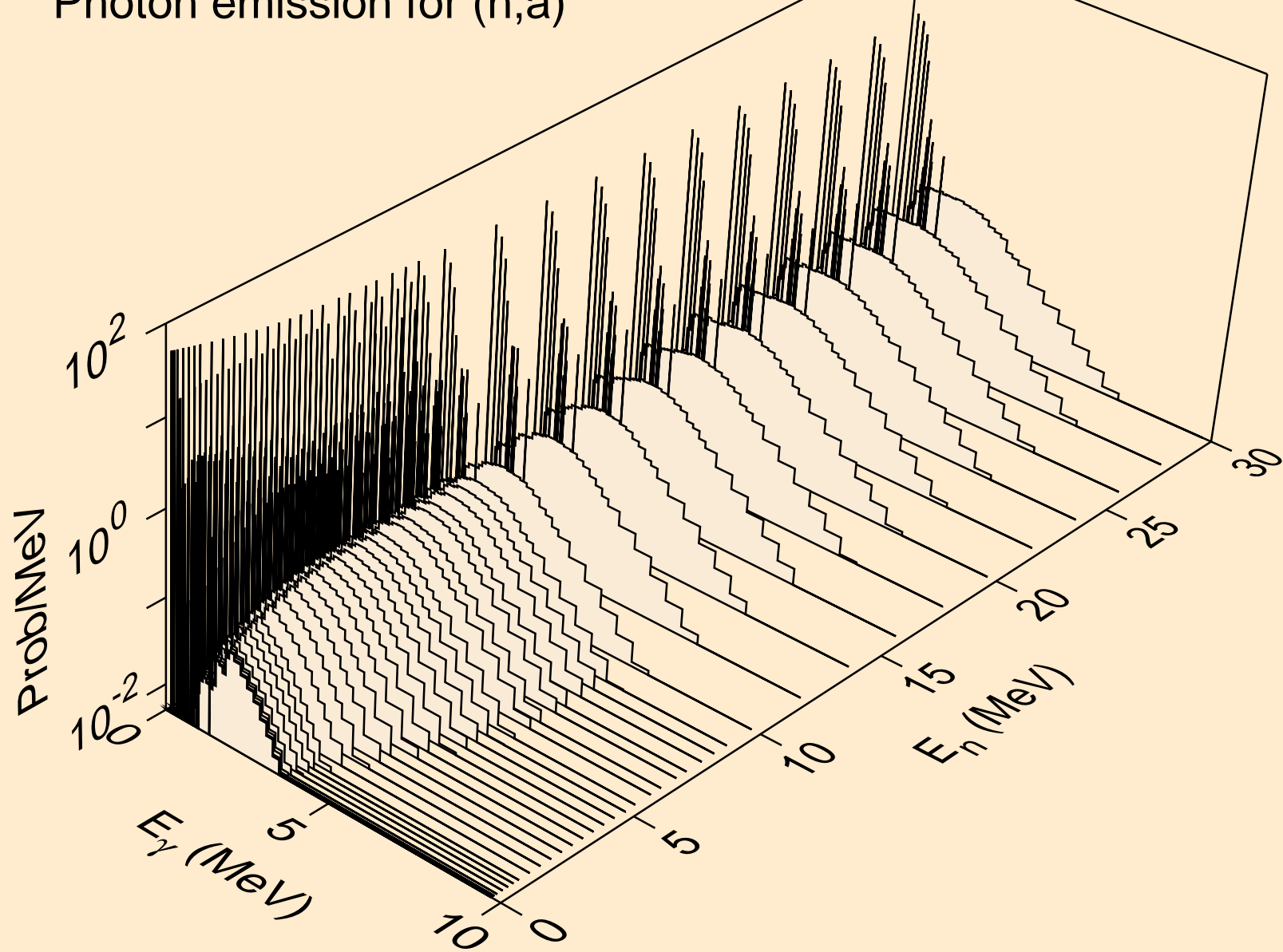

ND129 NEUTRON ACER TENDL-2021 LIBRARY; T=293.6K
Photon emission for (n,2a)

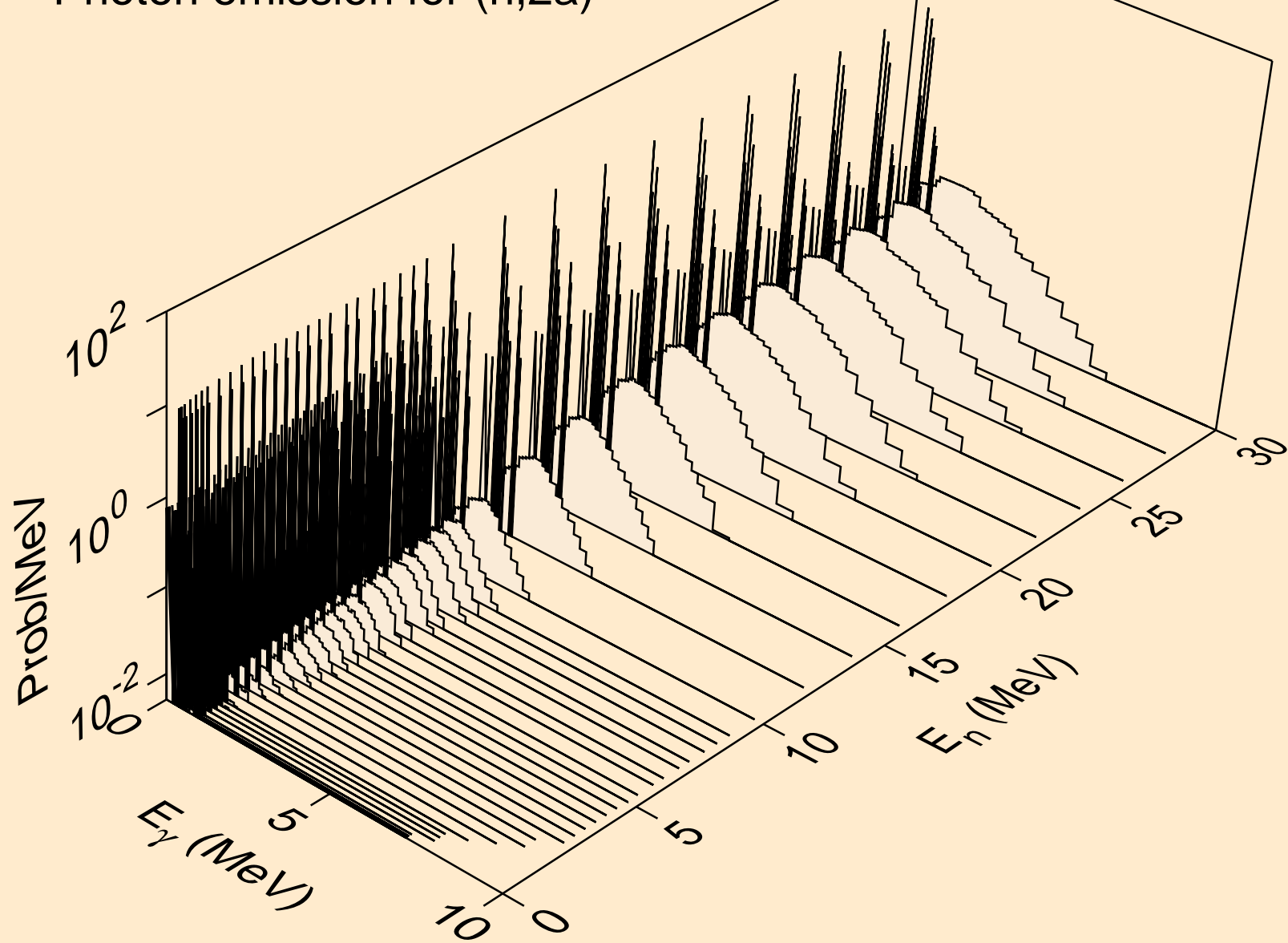

ND129 NEUTRON ACER TENDL-2021 LIBRARY; T=293.6K
Photon emission for (n,3a)

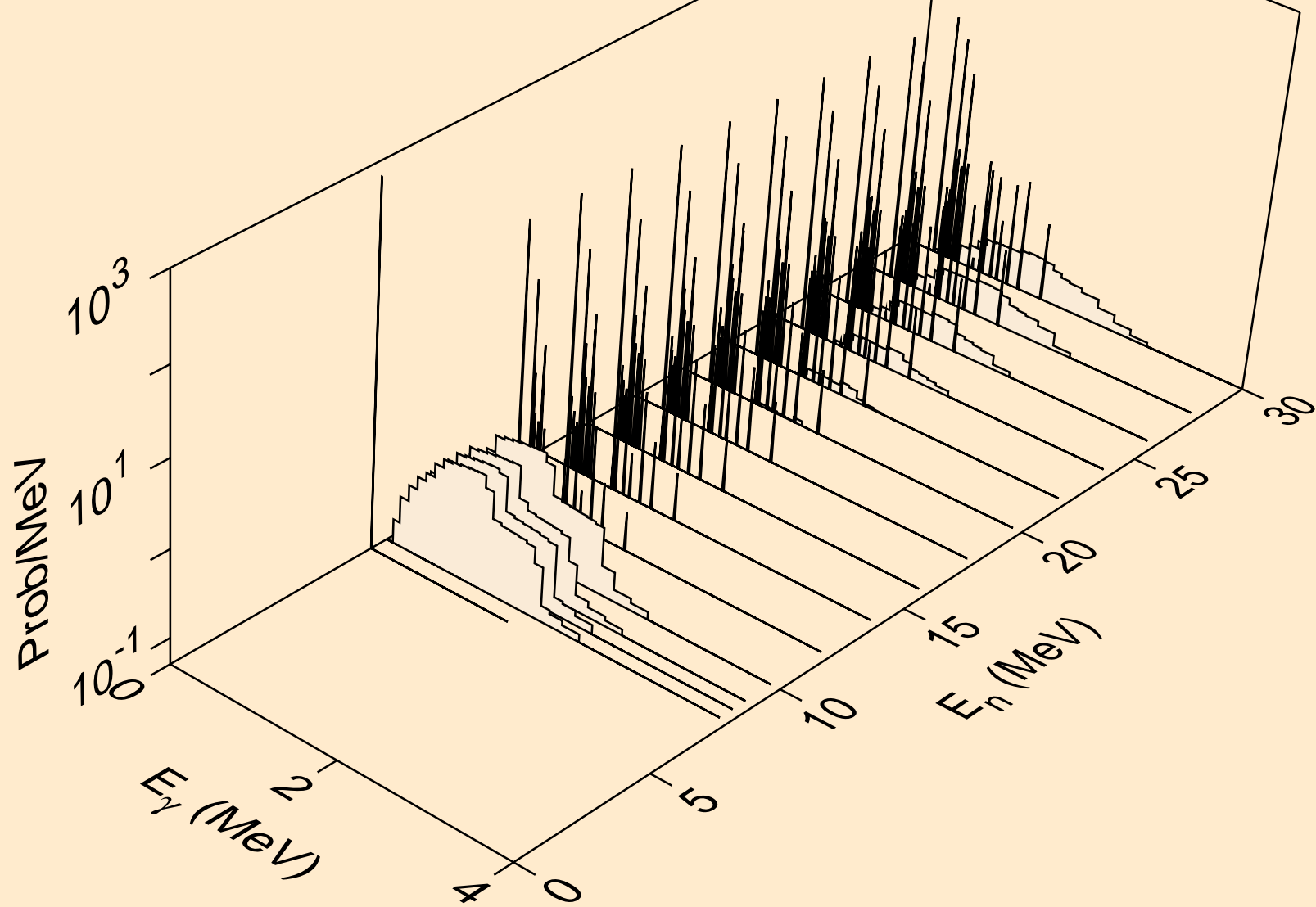

ND129 NEUTRON ACER TENDL-2021 LIBRARY; T=293.6K
Photon emission for (n,2p)

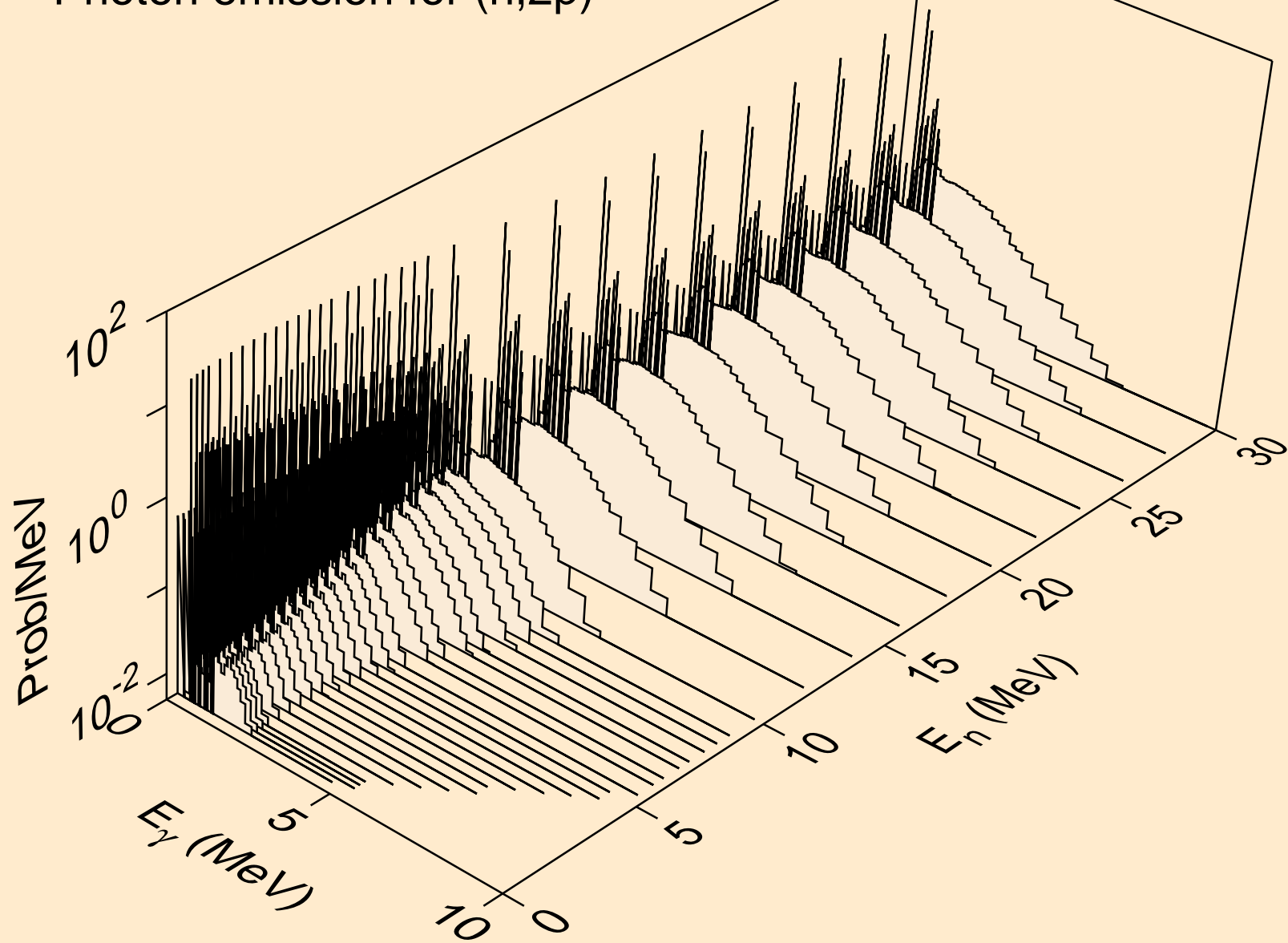

ND129 NEUTRON ACER TENDL-2021 LIBRARY; T=293.6K
Photon emission for (n,p α)

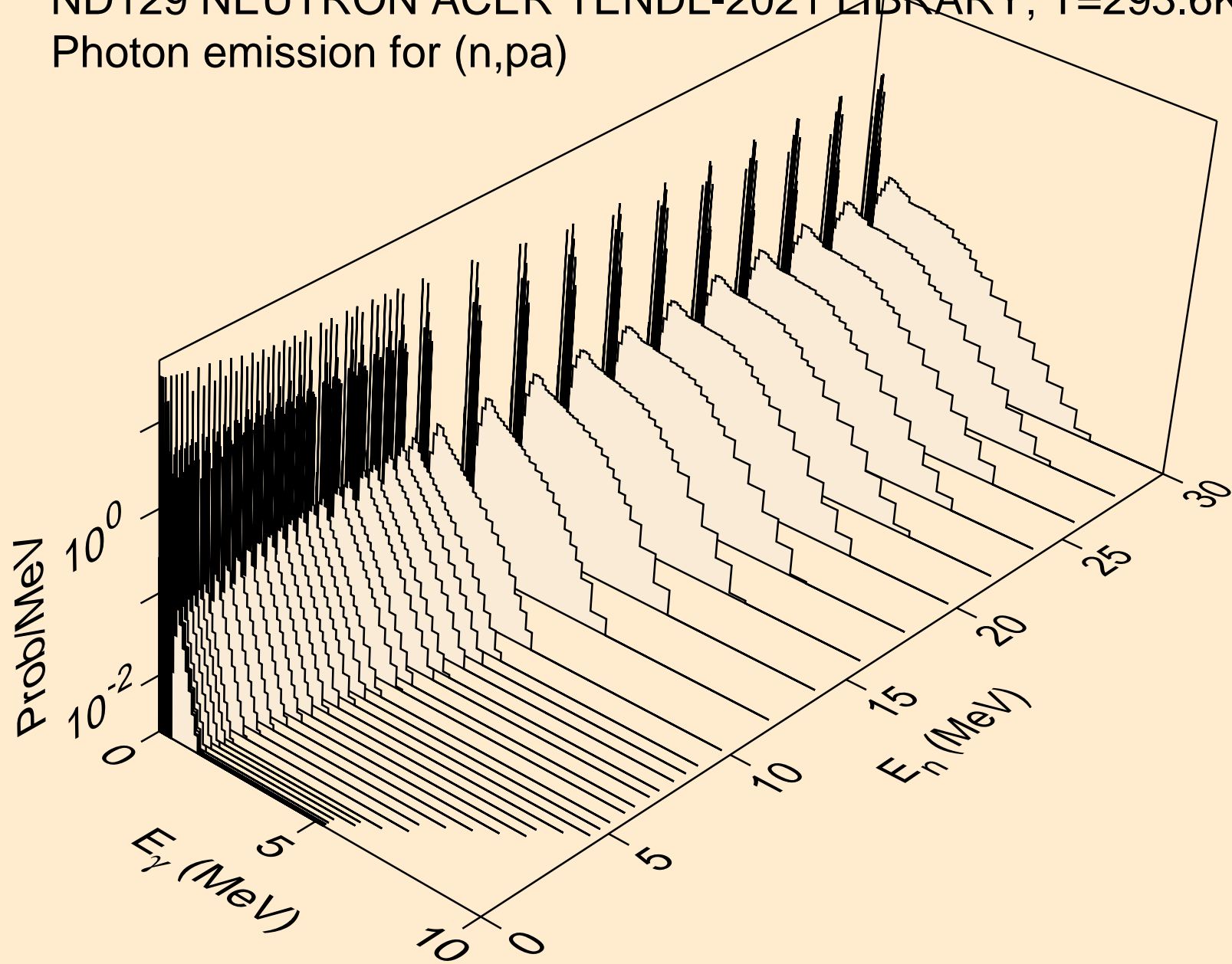

ND129 NEUTRON ACER TENDL-2021 LIBRARY; T=293.6K
Photon emission for (n,pd)

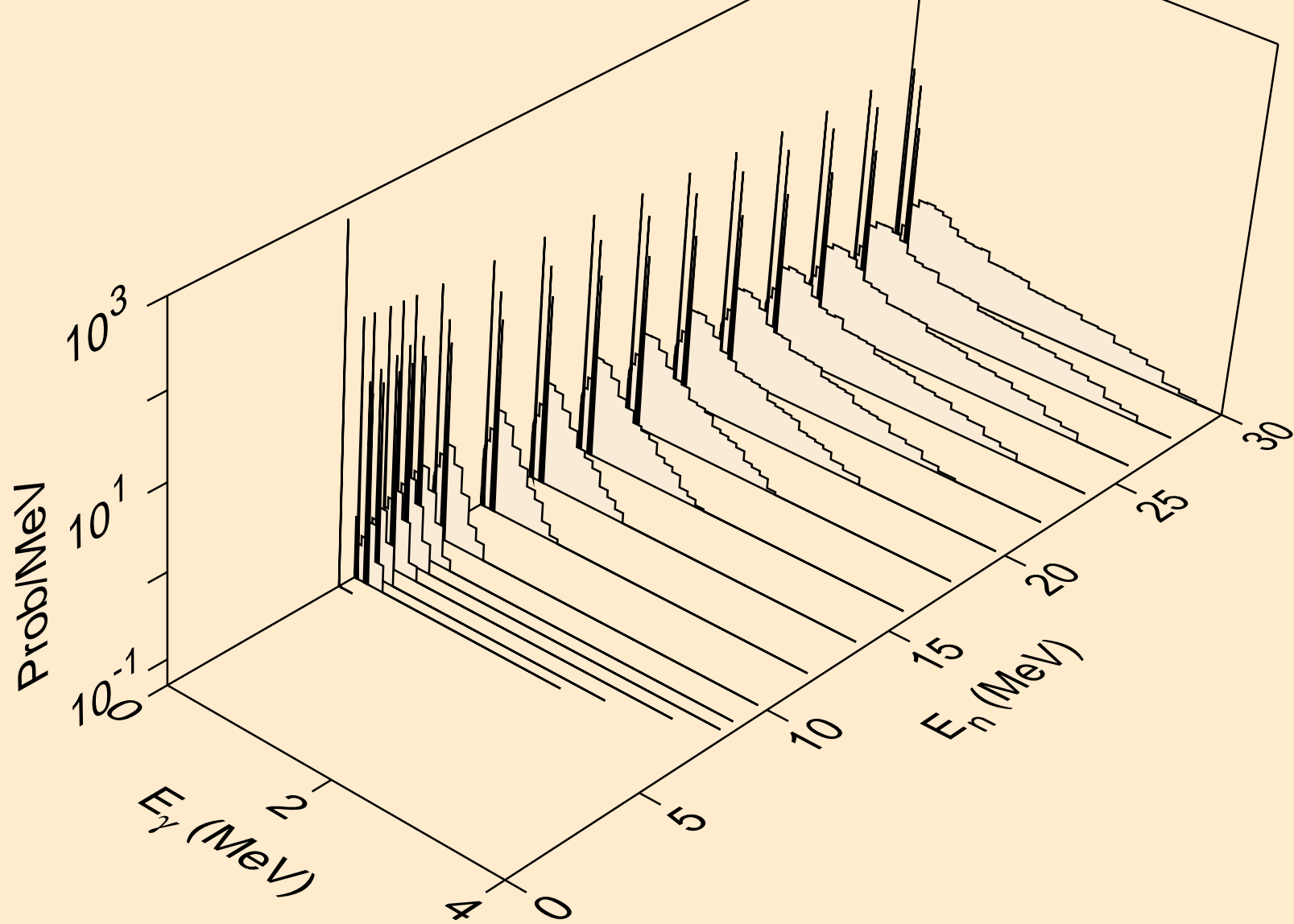

ND129 NEUTRON ACER TENDL-2021 LIBRARY; T=293.6K
Photon emission for (n,pt)

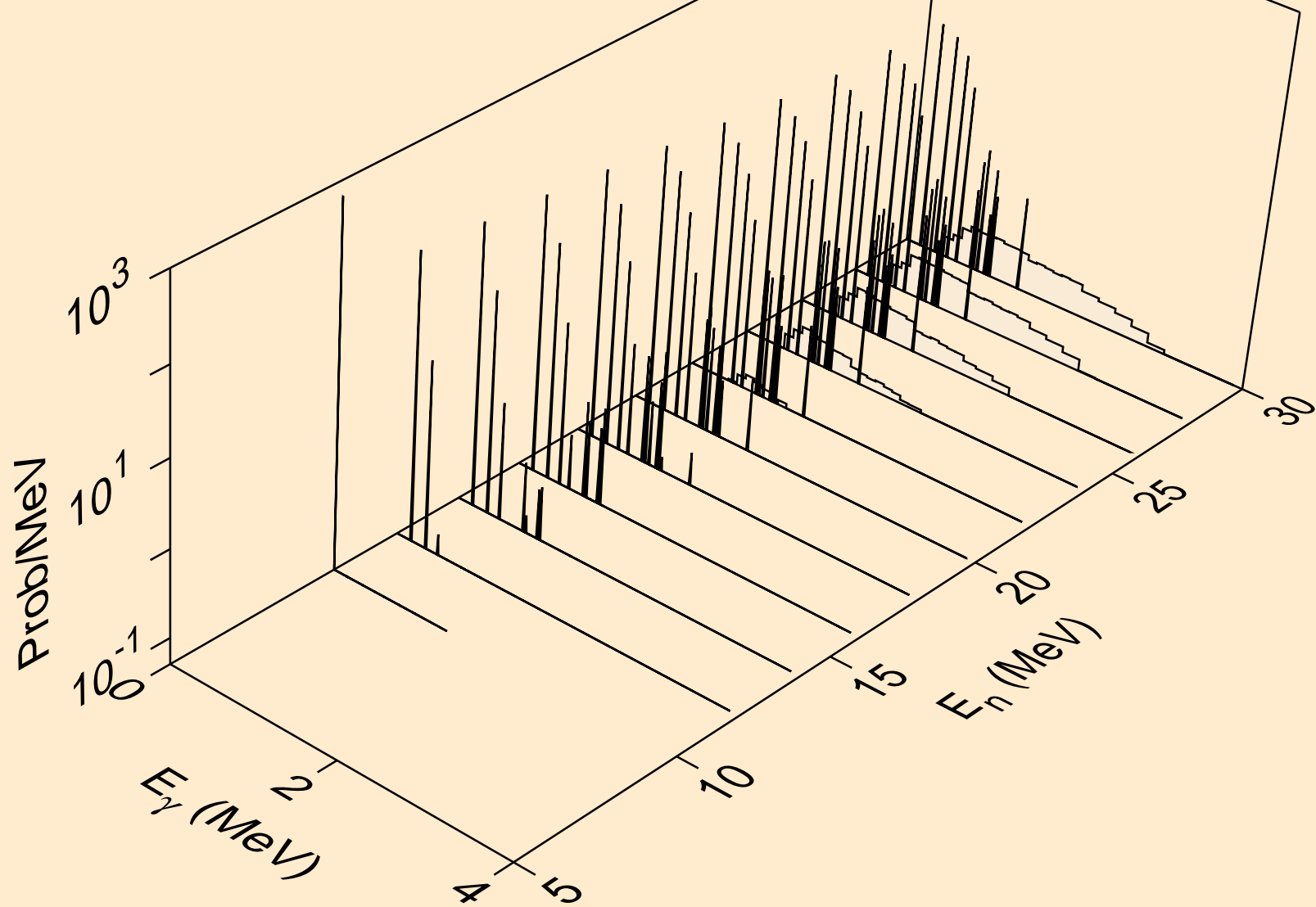

ND129 NEUTRON ACER TENDL-2021 LIBRARY; T=293.6K
Photon emission for (n,da)

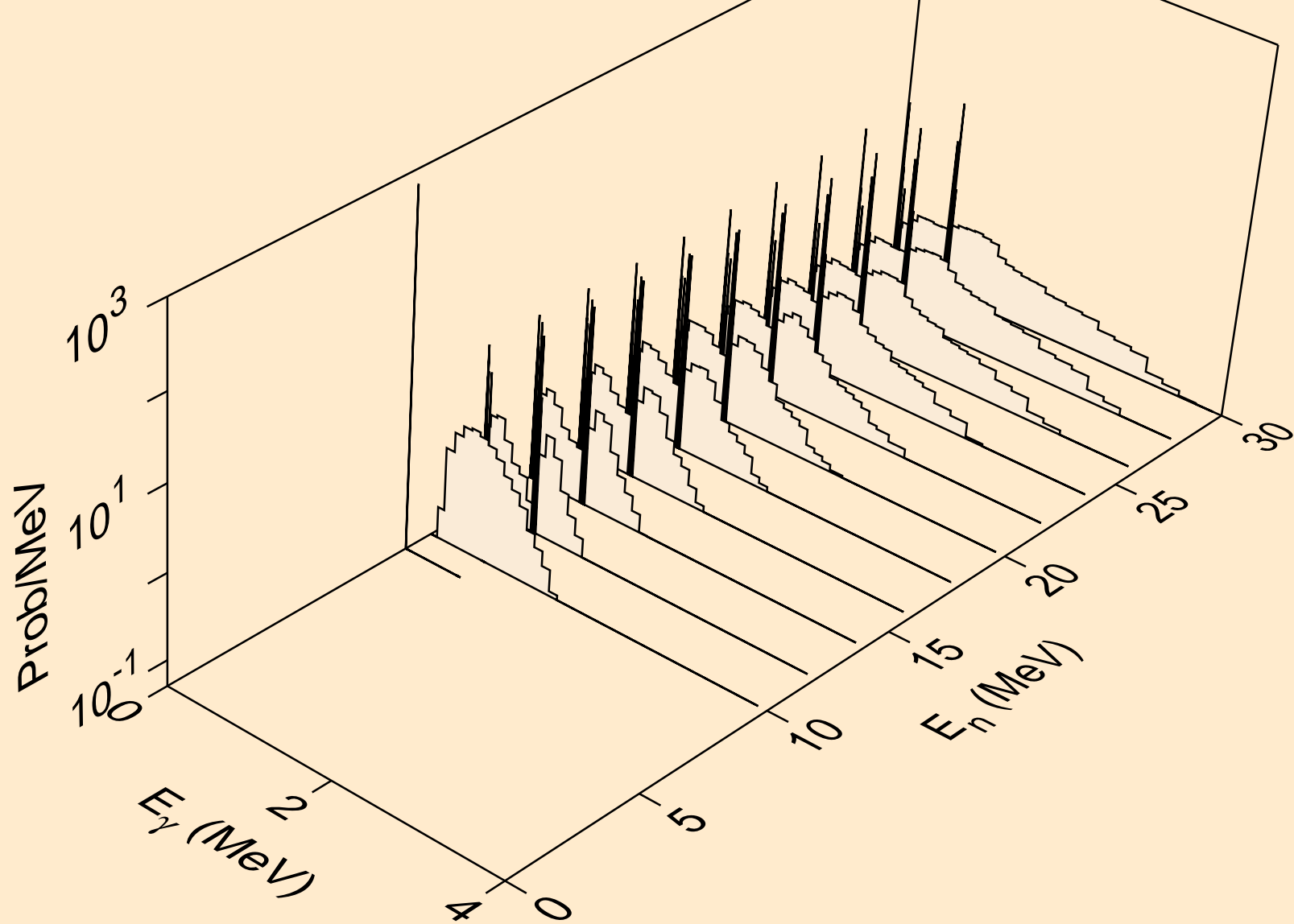

ND129 NEUTRON ACER TENDL-2021 LIBRARY; T=293.6K
thermal capture photon spectrum

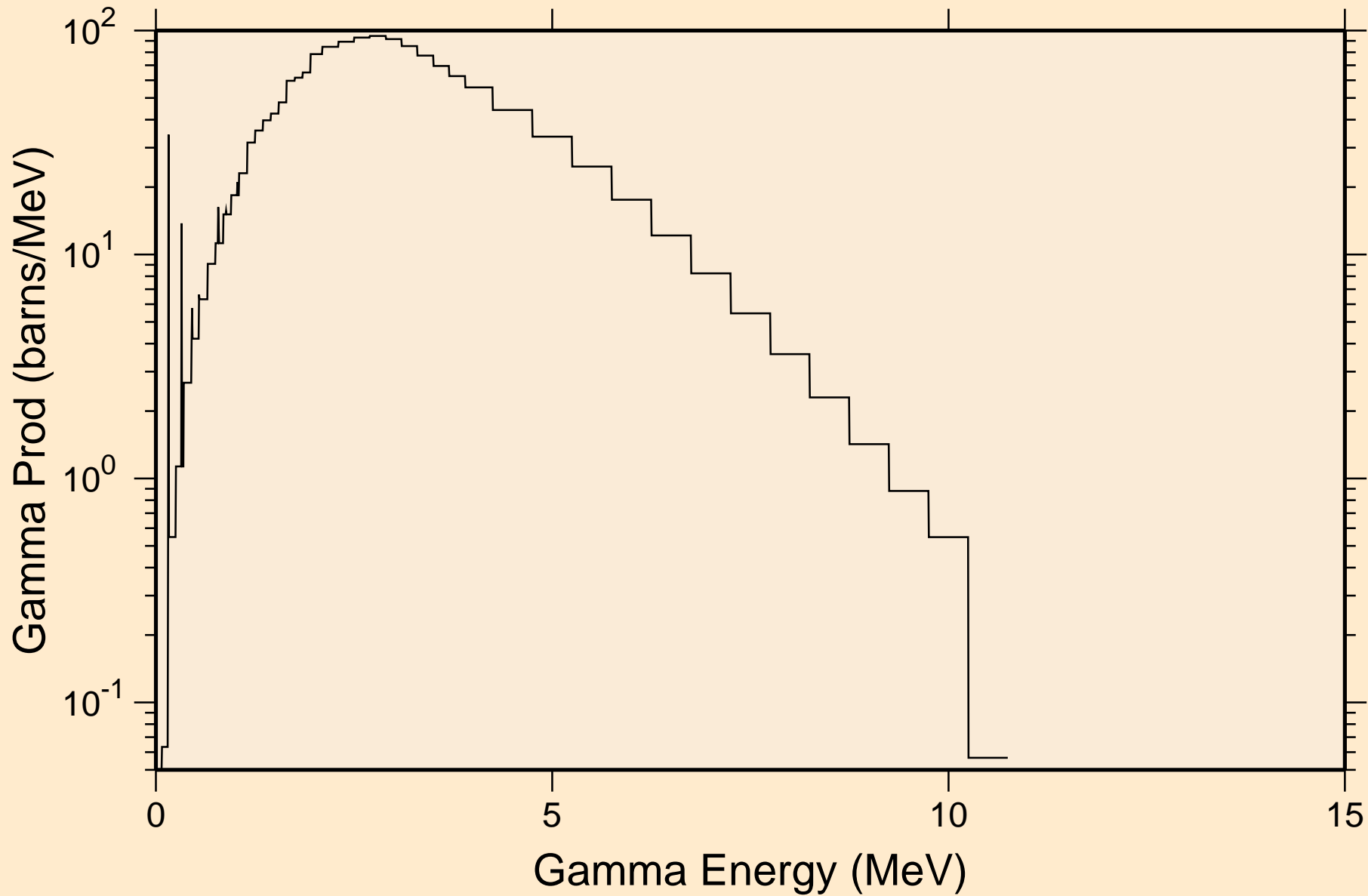

ND129 NEUTRON ACER TENDL-2021 LIBRARY; T=293.6K
14 MeV photon spectrum

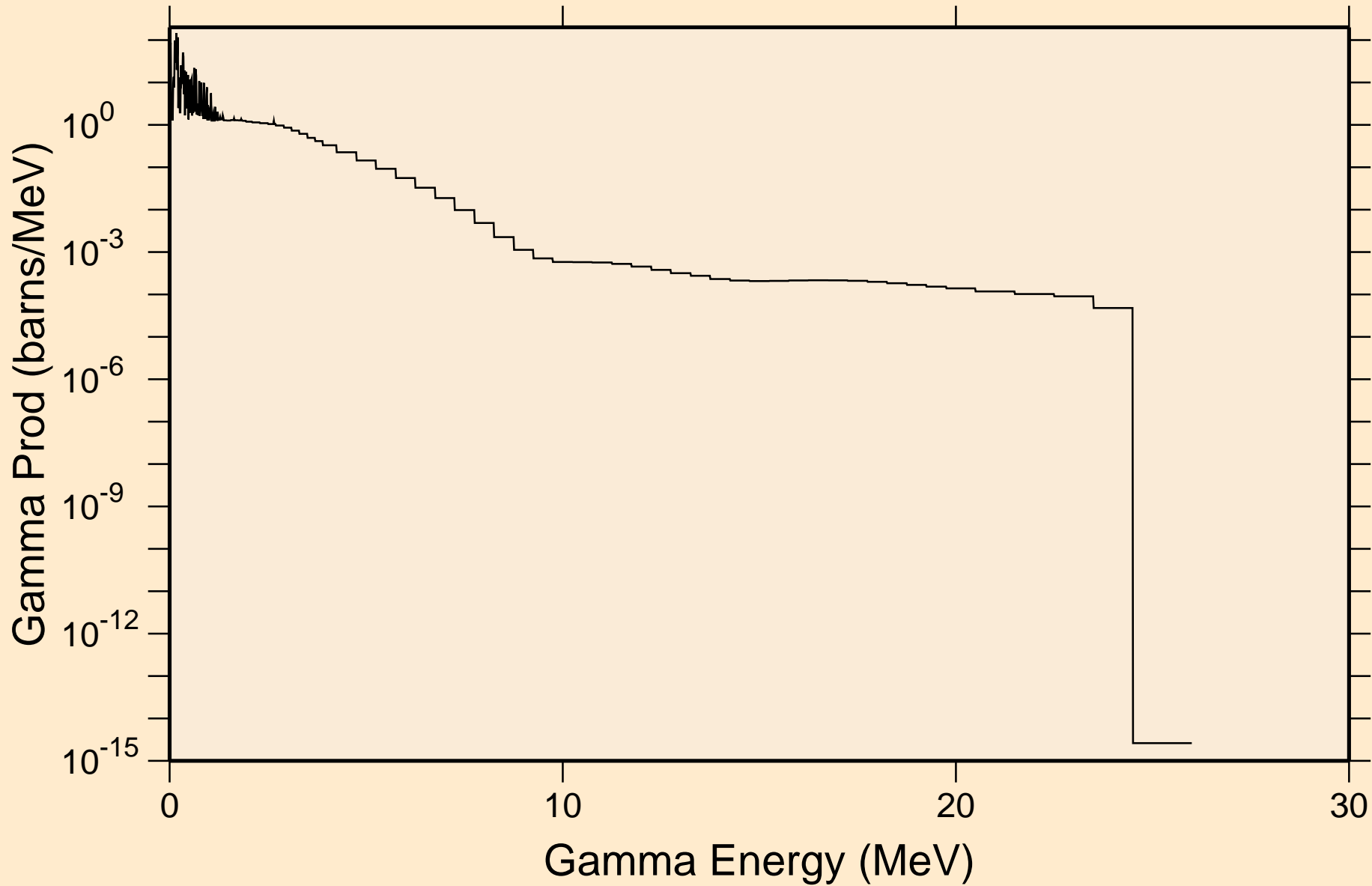

ND129 NEUTRON ACER TENDL-2021 LIBRARY; T=293.6K

Particle heating contributions

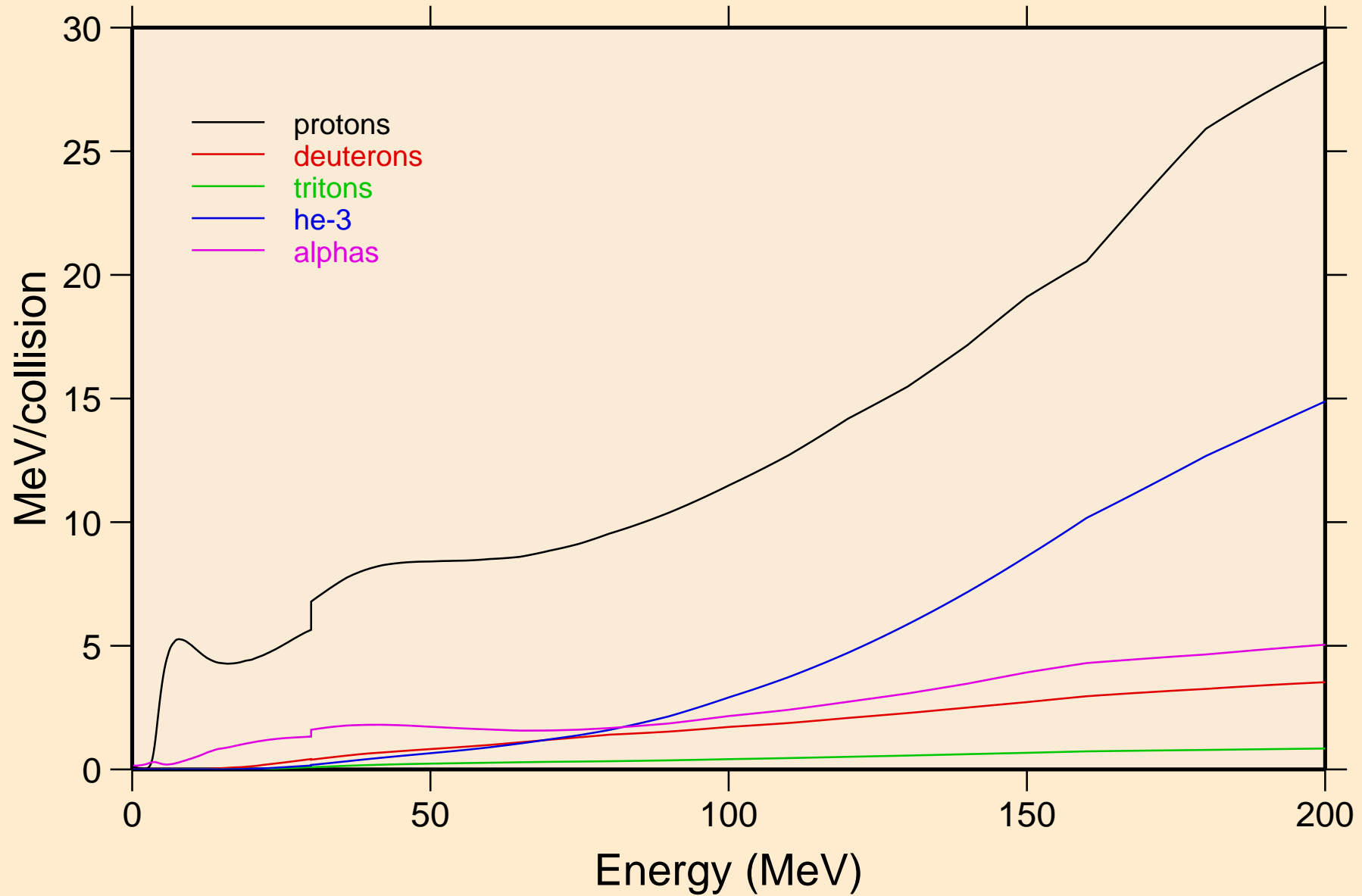

ND129 NEUTRON ACER TENDL-2021 LIBRARY; T=293.6K
Recoil Heating

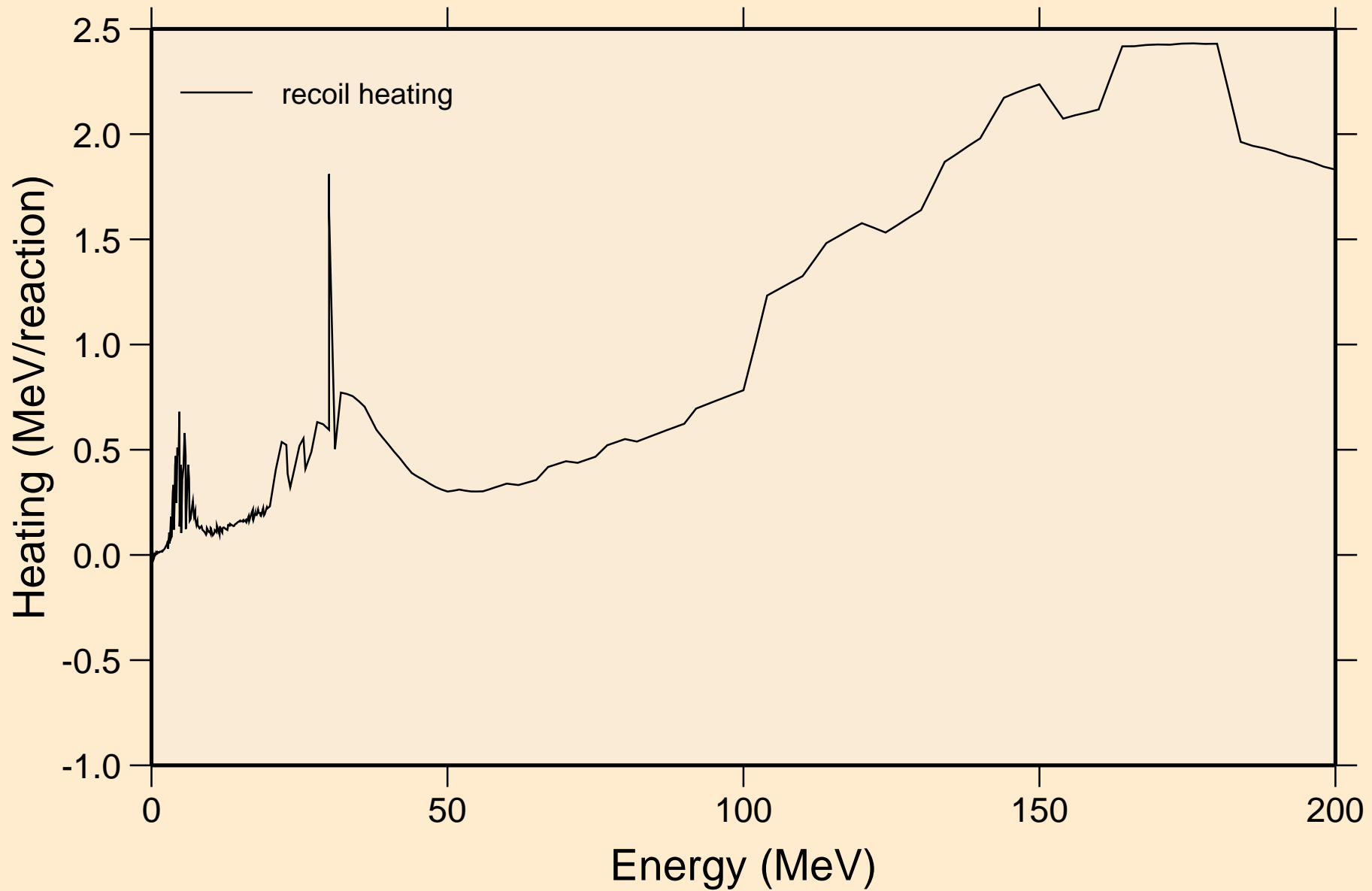

ND129 NEUTRON ACER TENDL-2021 LIBRARY; T=293.6K

Particle production cross sections

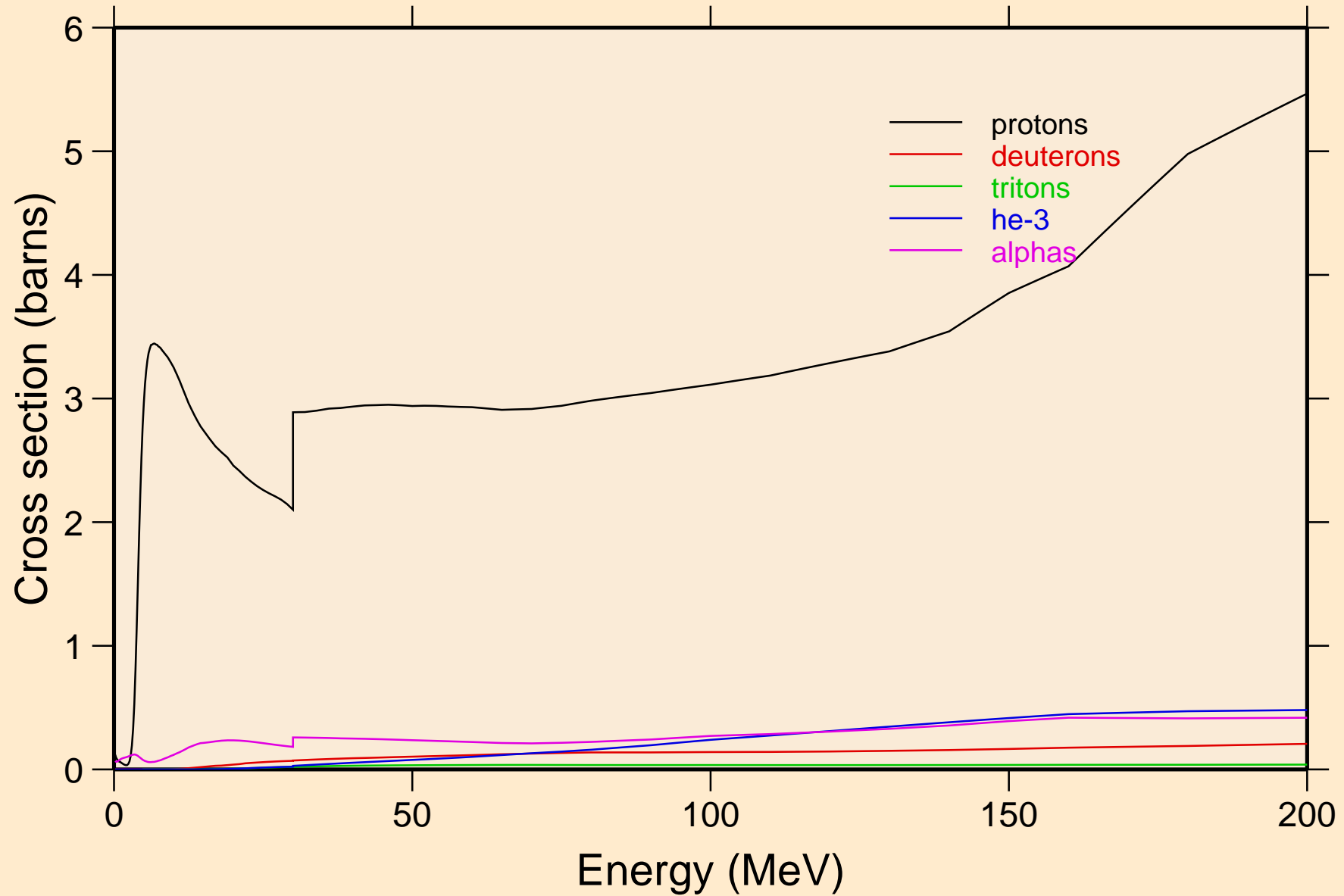

ND129 NEUTRON ACER TENDL-2021 LIBRARY; T=293.6K
protons from (n,x)

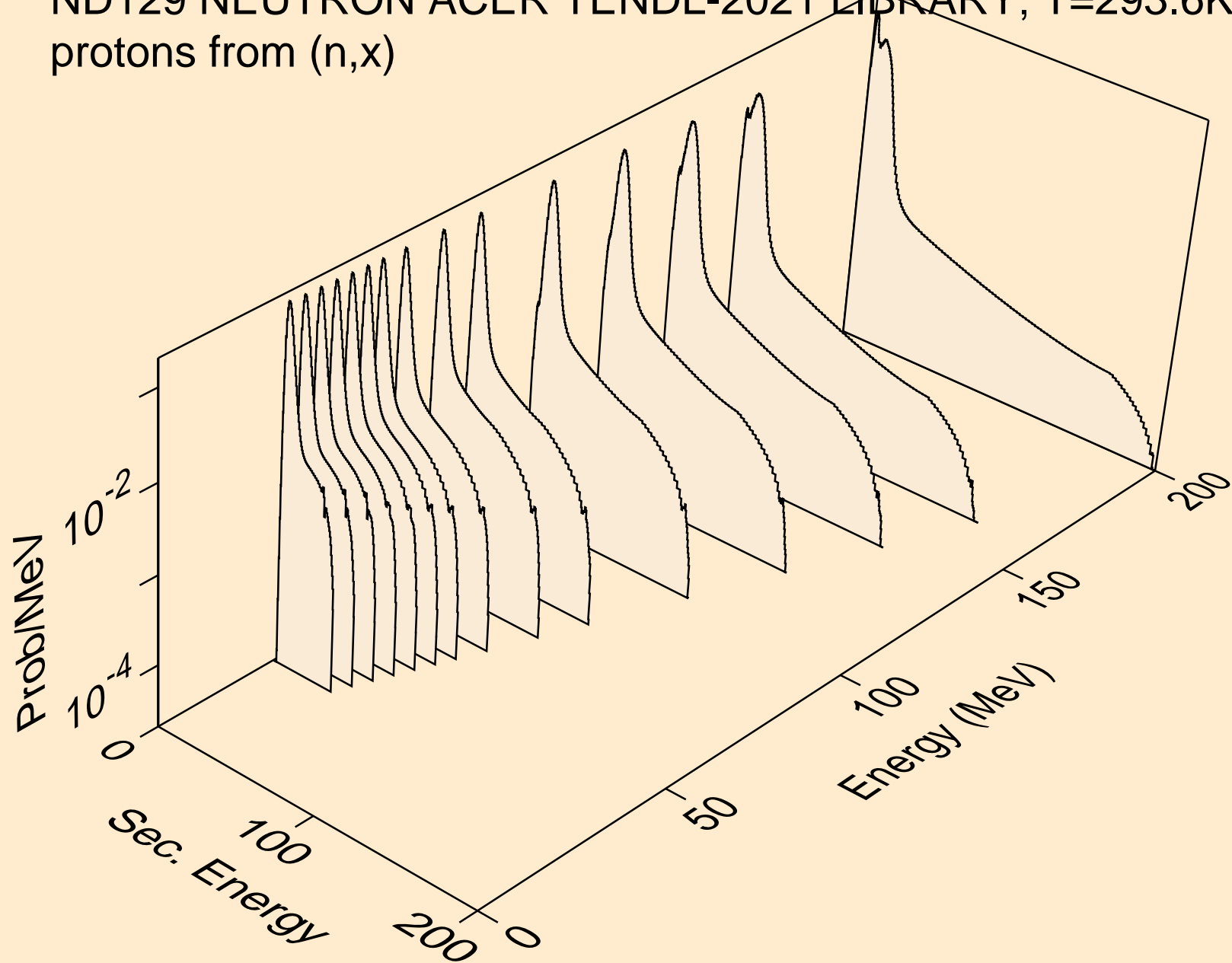

ND129 NEUTRON ACER TENDL-2021 LIBRARY; T=293.6K
protons from (n,n*)p

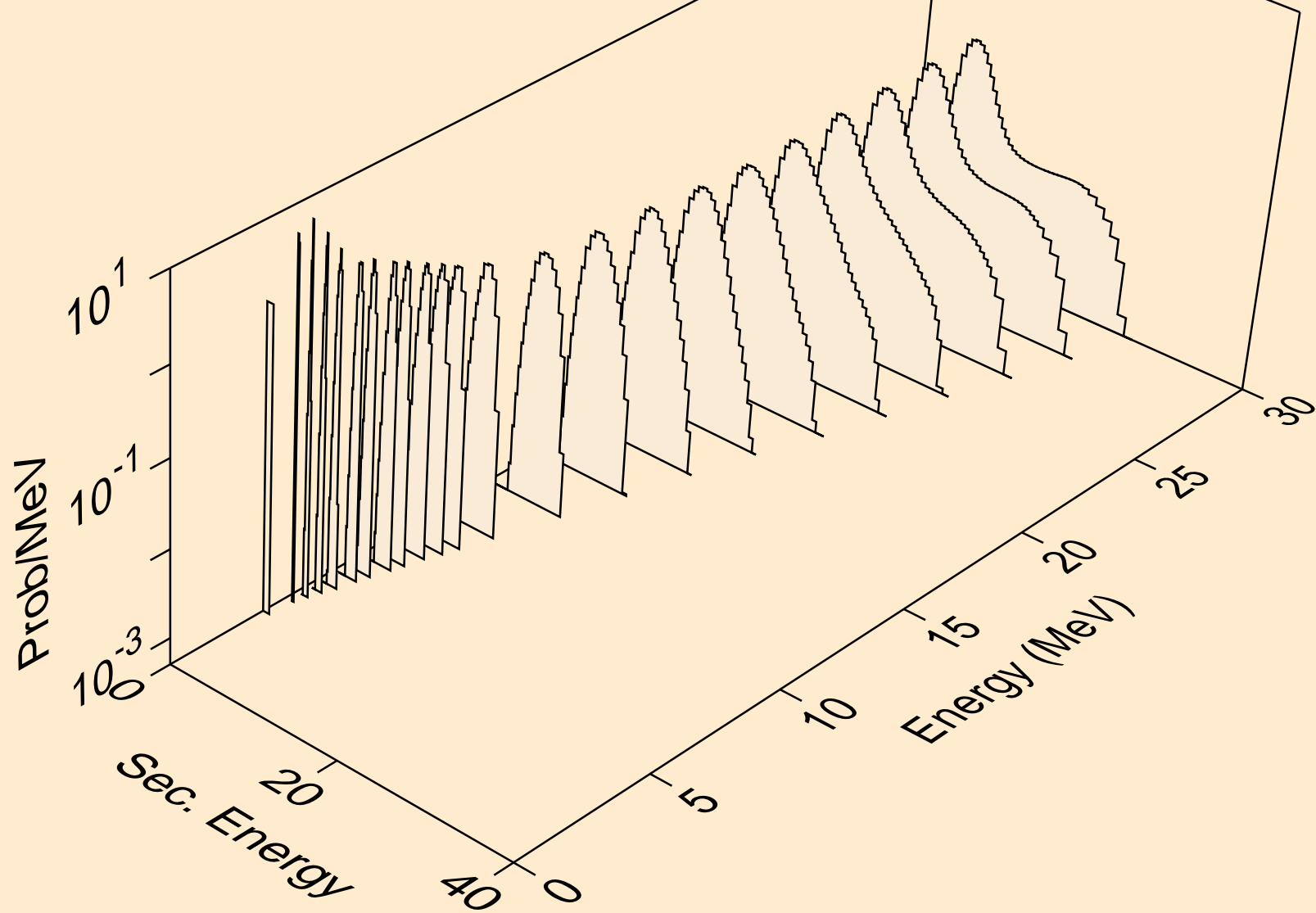

ND129 NEUTRON ACER TENDL-2021 LIBRARY; T=293.6K
protons from (n,2np)

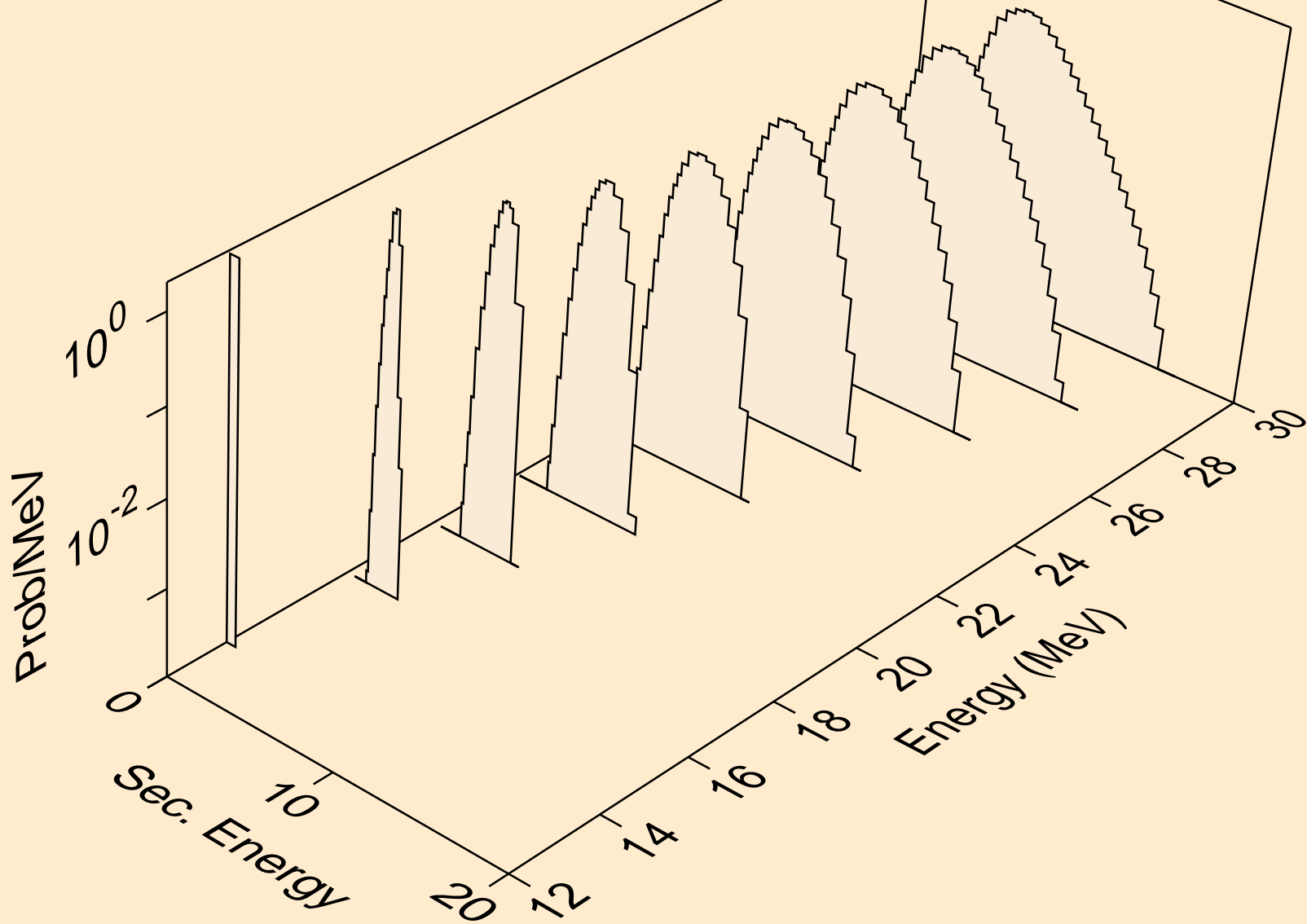

ND129 NEUTRON ACER TENDL-2021 LIBRARY; T=293.6K
protons from (n,3np)

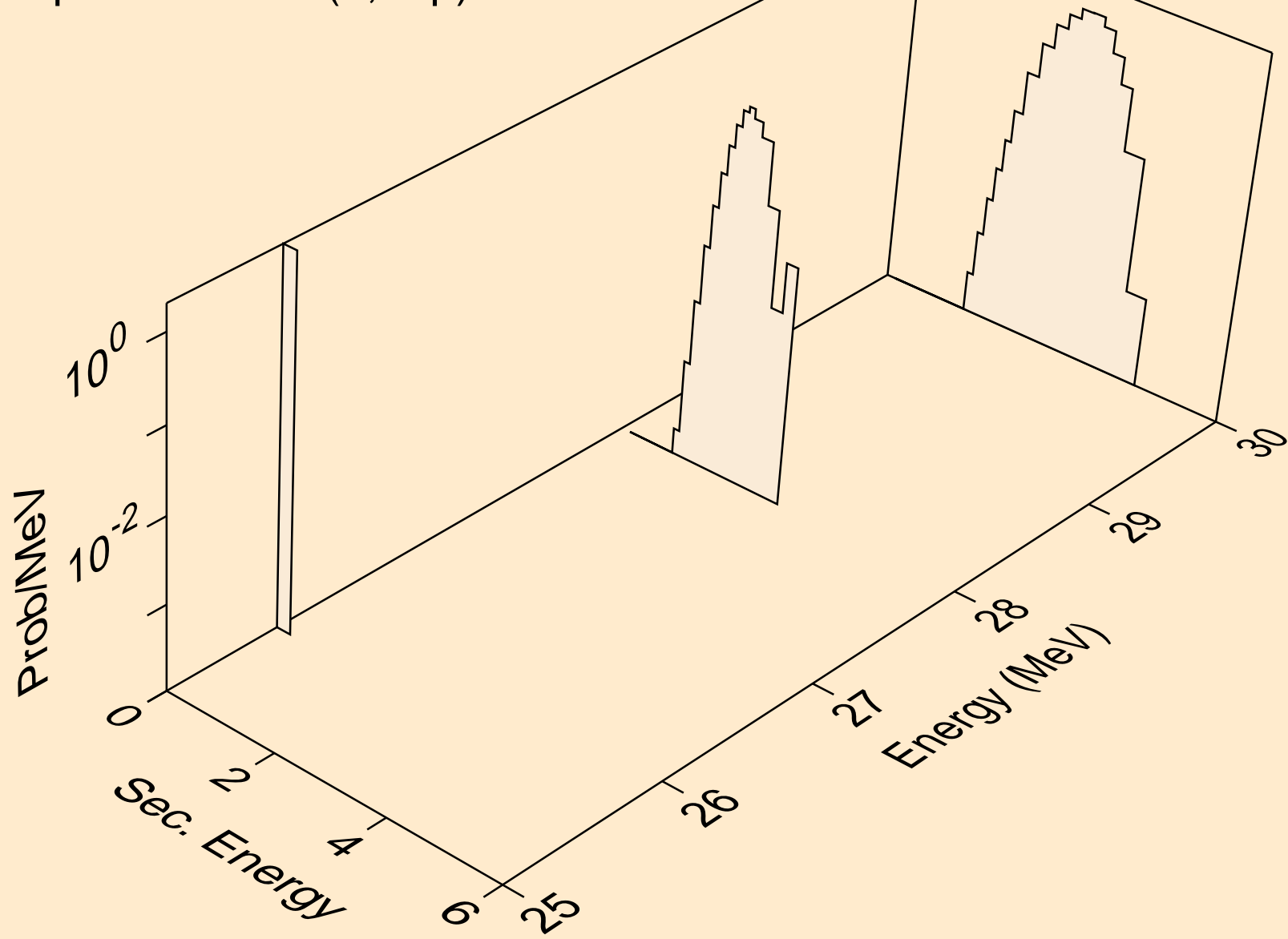

ND129 NEUTRON ACER TENDL-2021 LIBRARY; T=293.6K
protons from (n,2np)

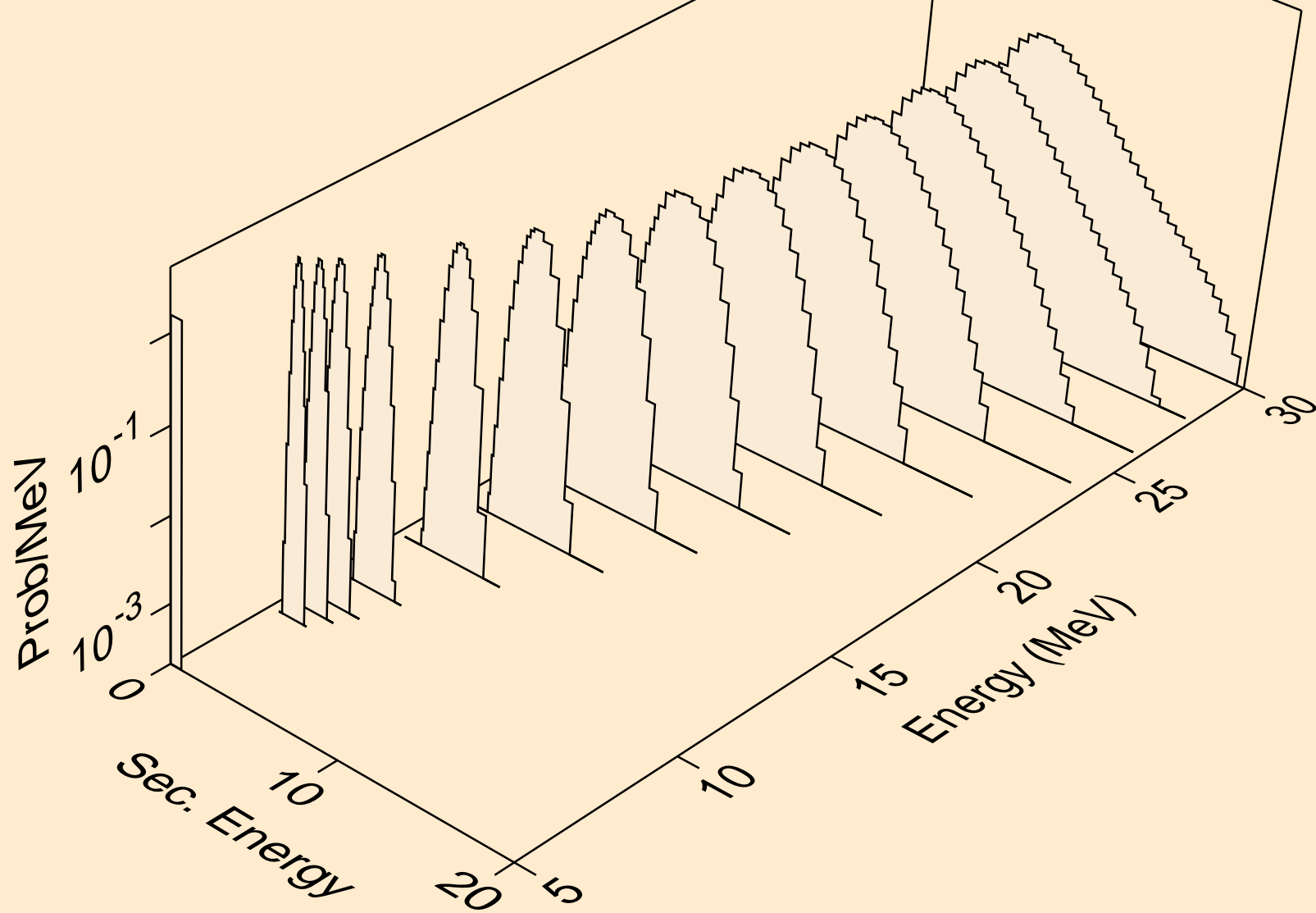

ND129 NEUTRON ACER TENDL-2021 LIBRARY; T=293.6K
protons from (n,npa)

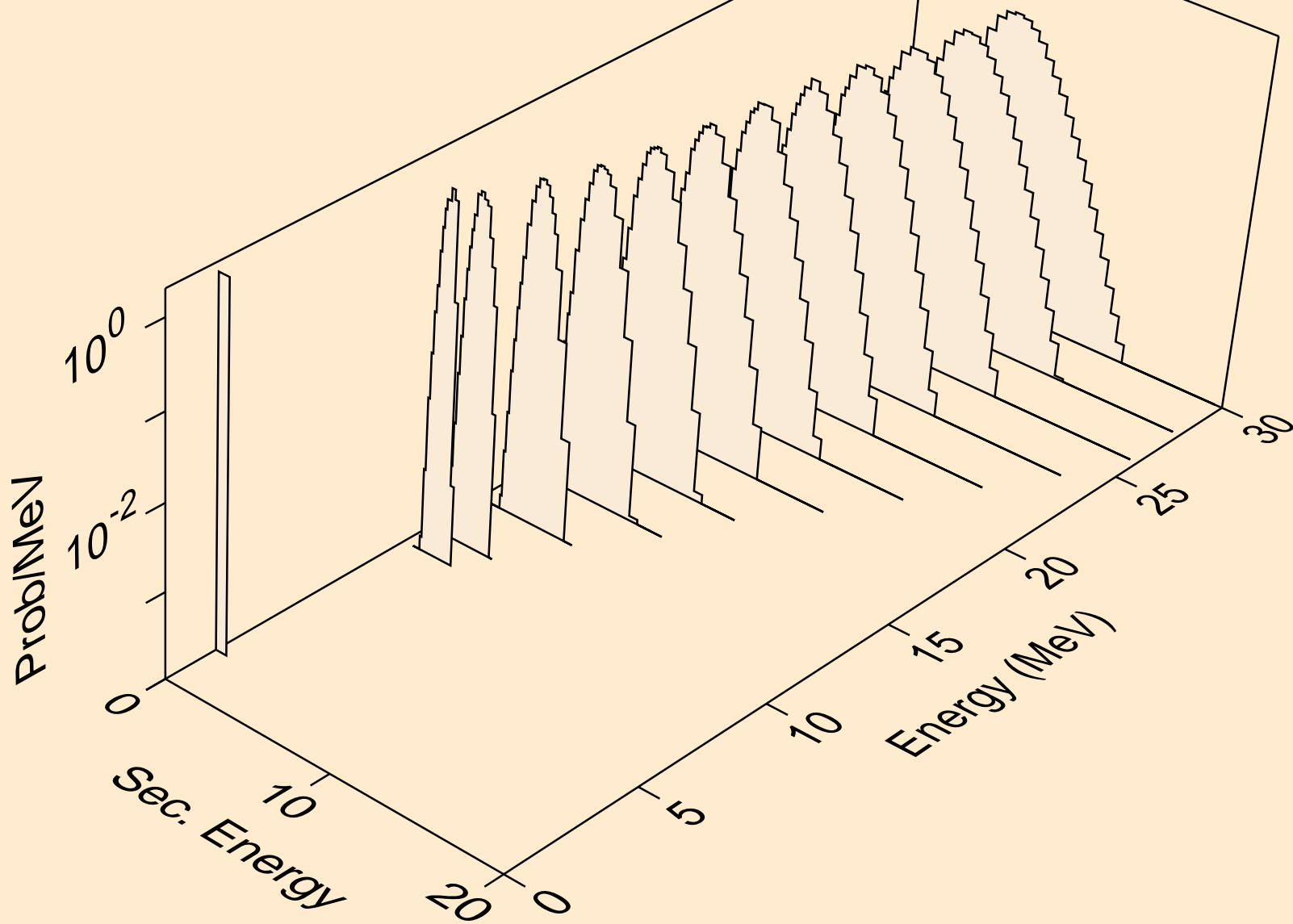

ND129 NEUTRON ACER TENDL-2021 LIBRARY; T=293.6K
protons from (n,p)

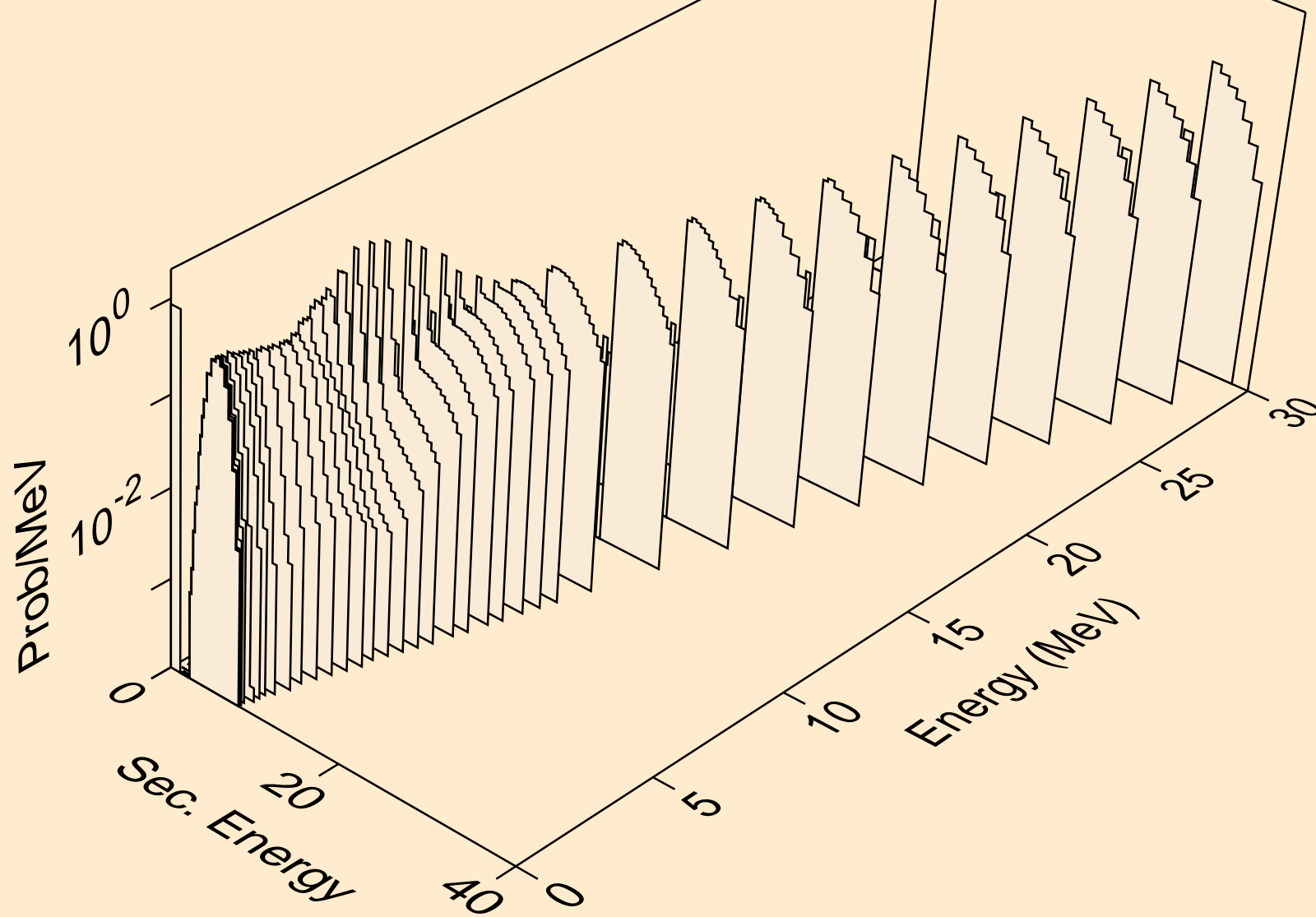

ND129 NEUTRON ACER TENDL-2021 LIBRARY; T=293.6K
protons from (n,2p)

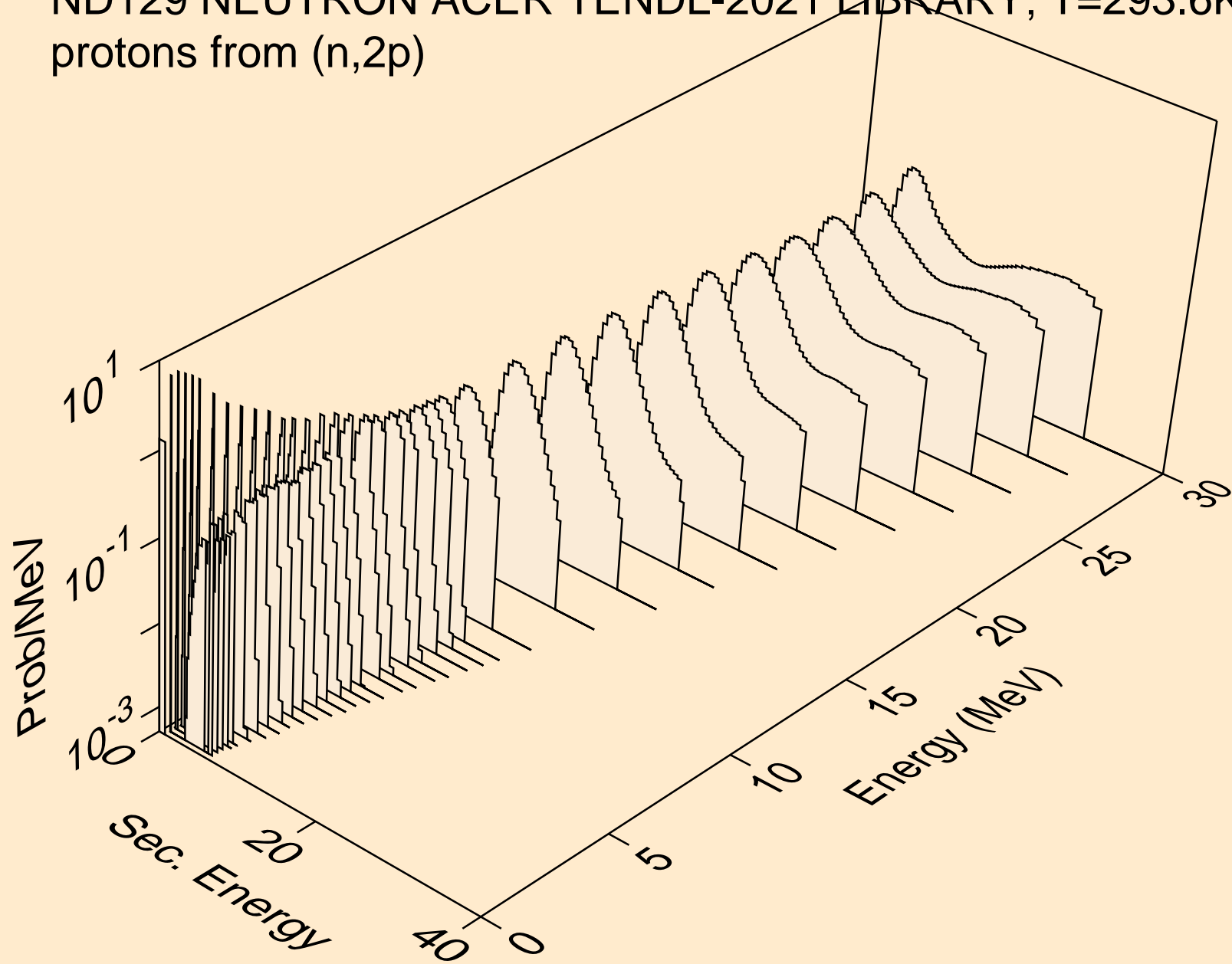

ND129 NEUTRON ACER TENDL-2021 LIBRARY; T=293.6K
protons from (n,p)

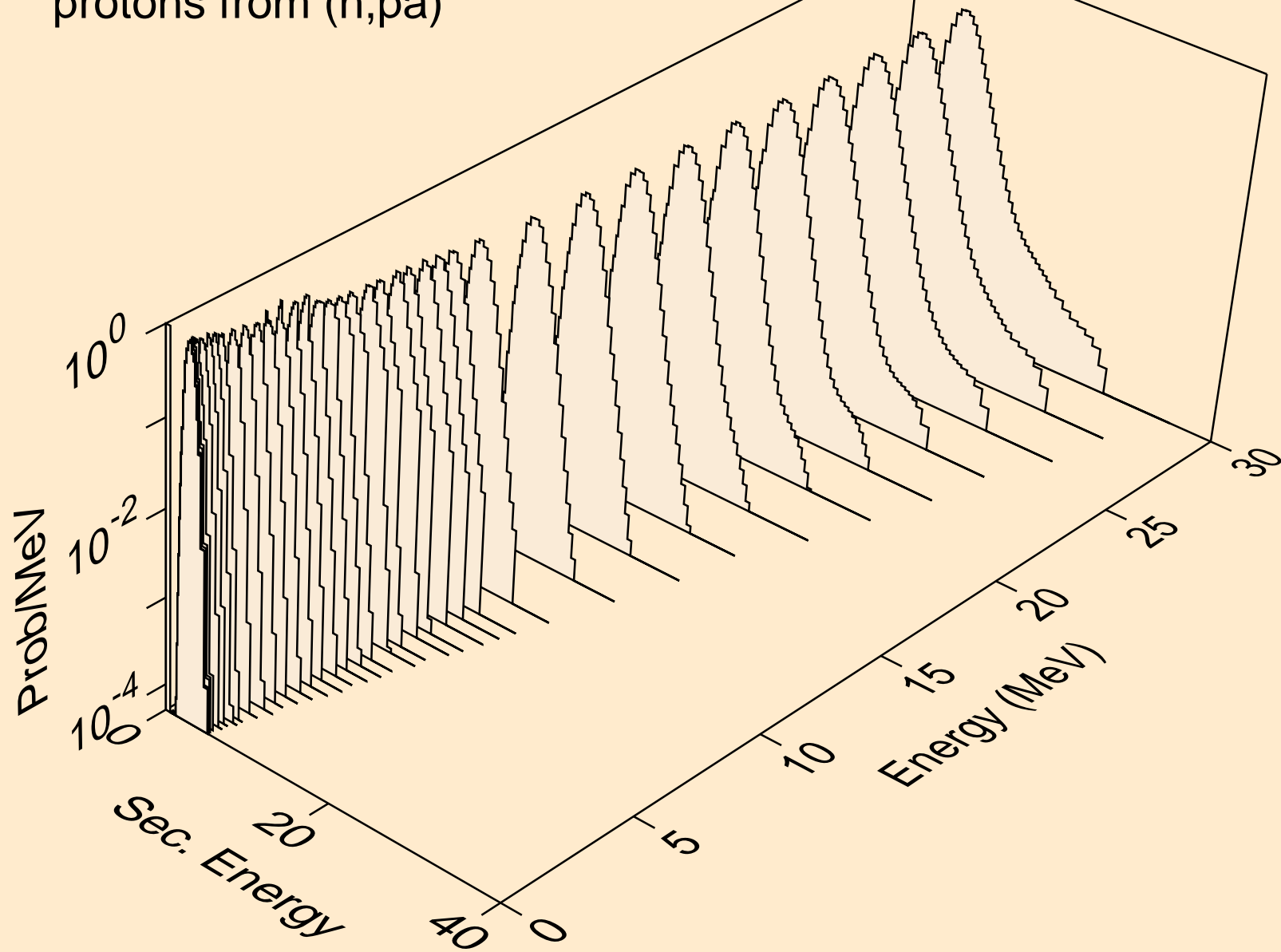

ND129 NEUTRON ACER TENDL-2021 LIBRARY; T=293.6K
protons from (n,pd)

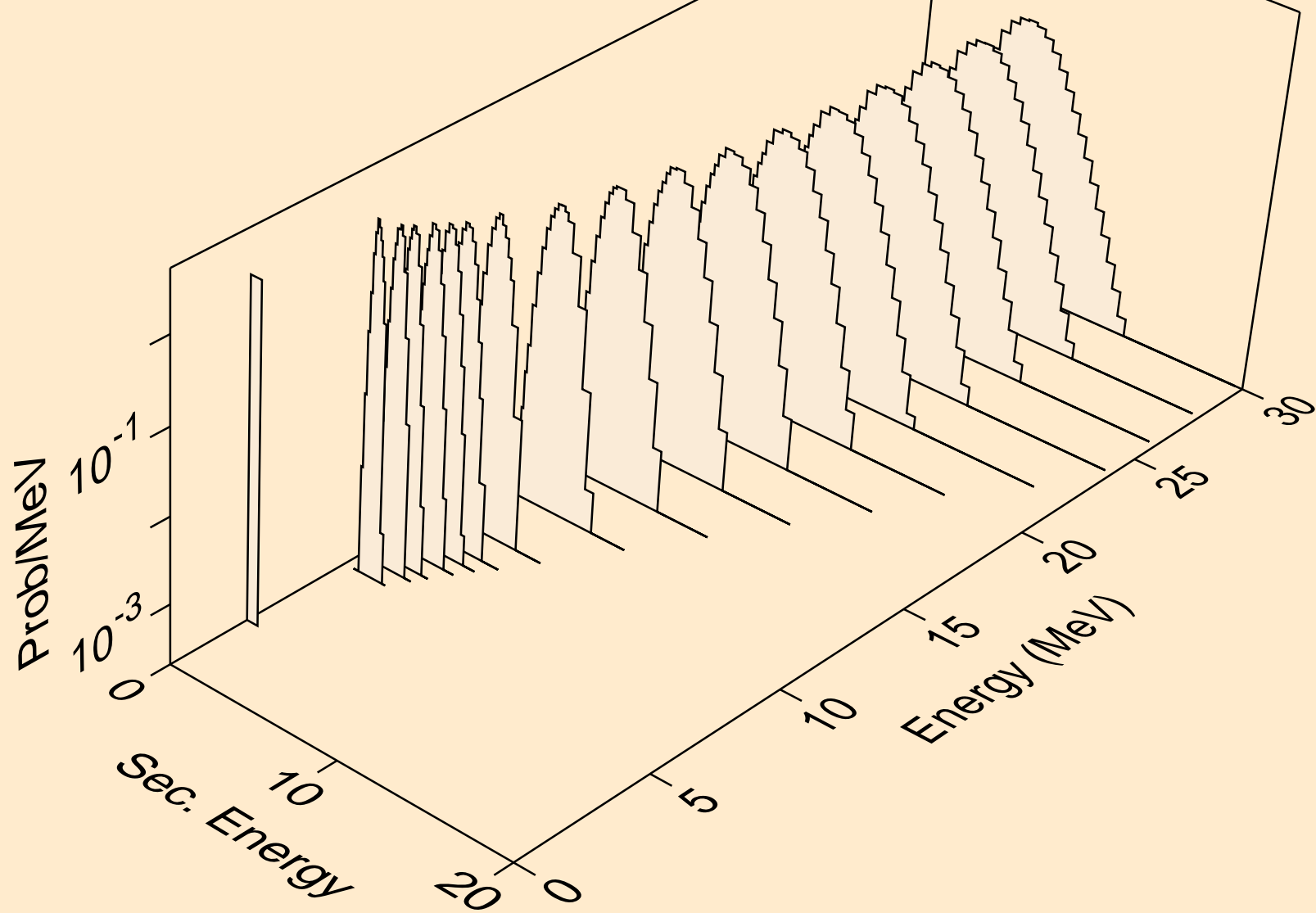

ND129 NEUTRON ACER TENDL-2021 LIBRARY; T=293.6K
protons from (n,pt)

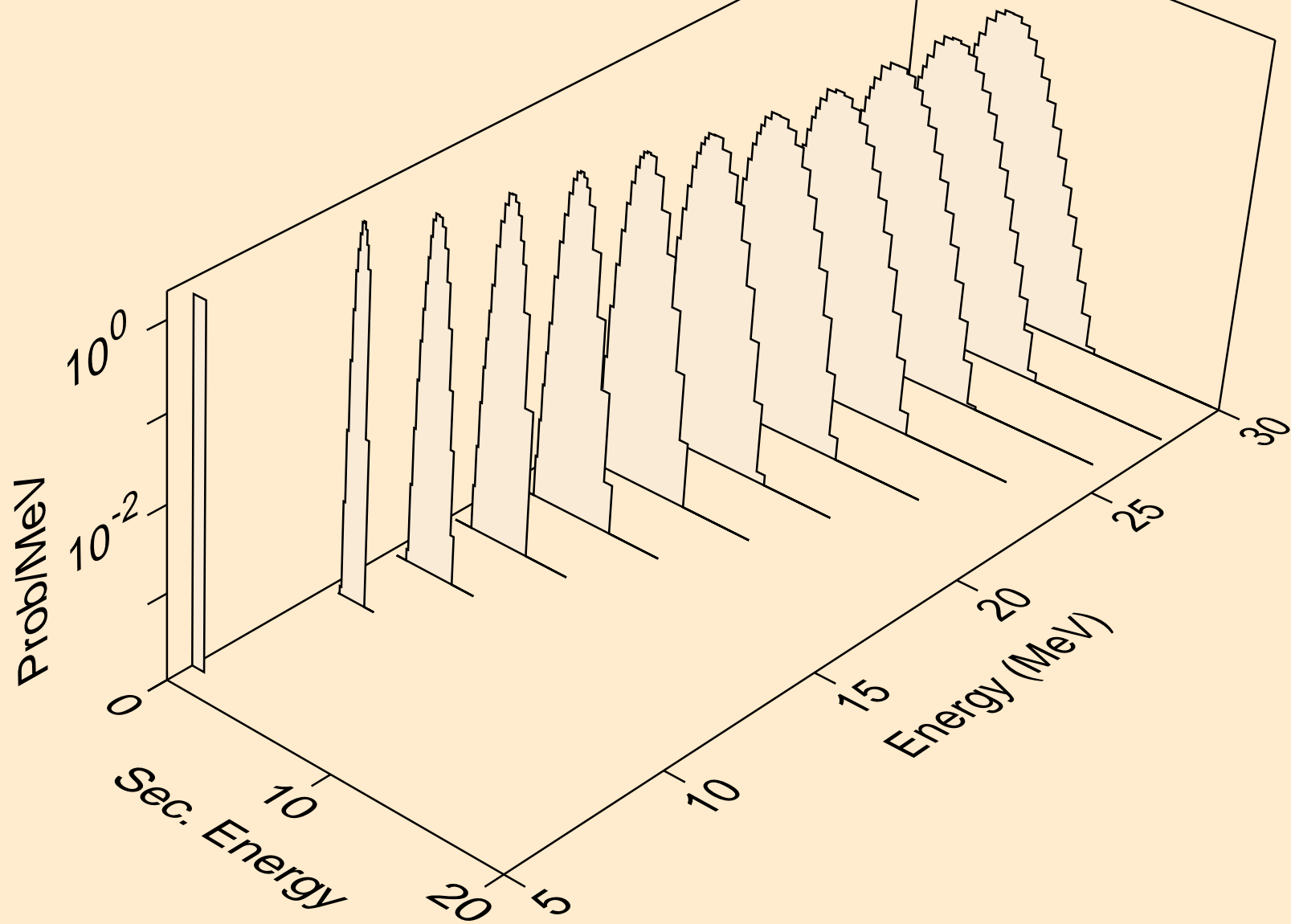

ND129 NEUTRON ACER TENDL-2021 LIBRARY; T=293.6K
deuterons from (n,x)

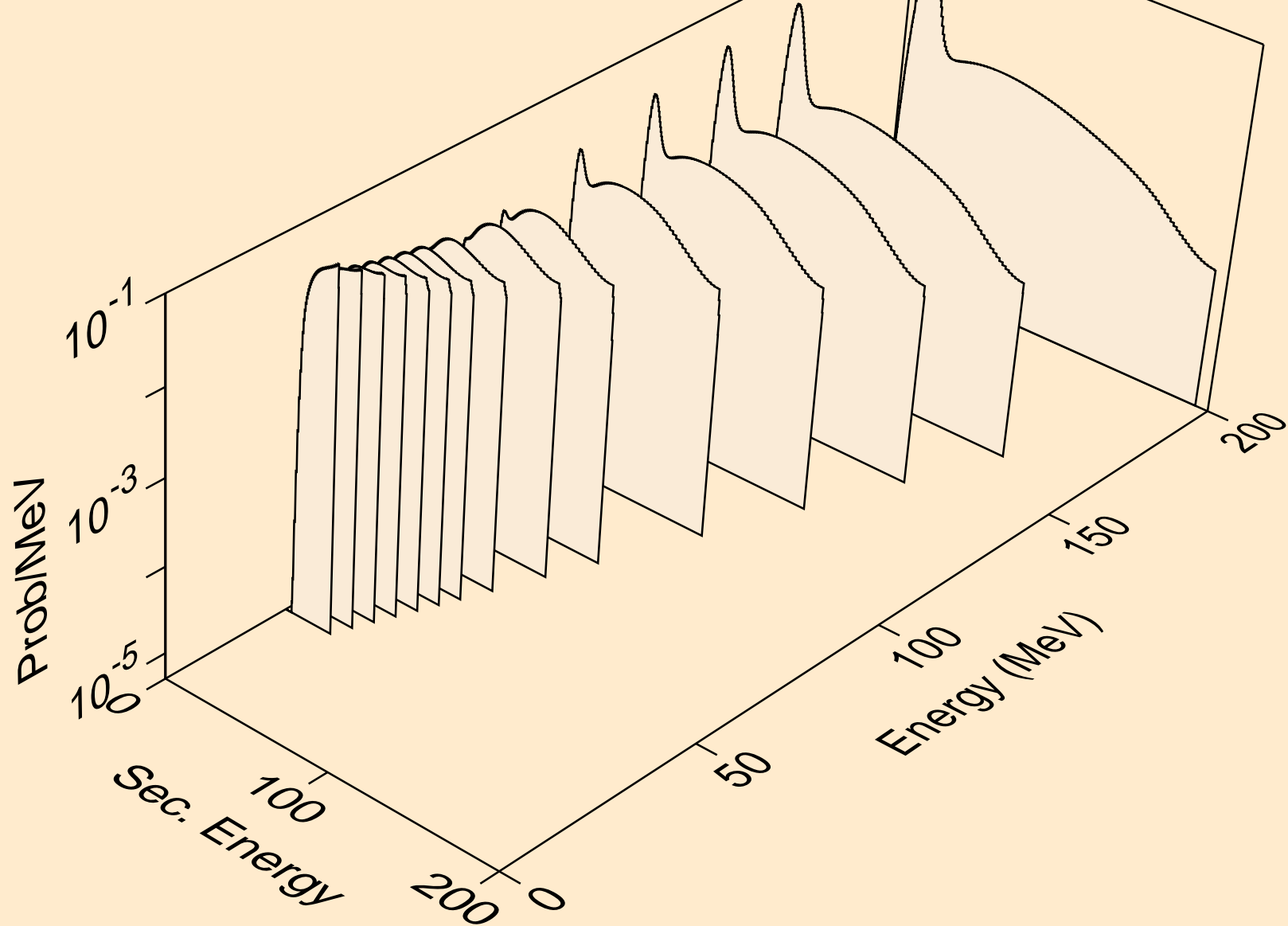

ND129 NEUTRON ACER TENDL-2021 LIBRARY; T=293.6K
deuterons from (n,2nd)

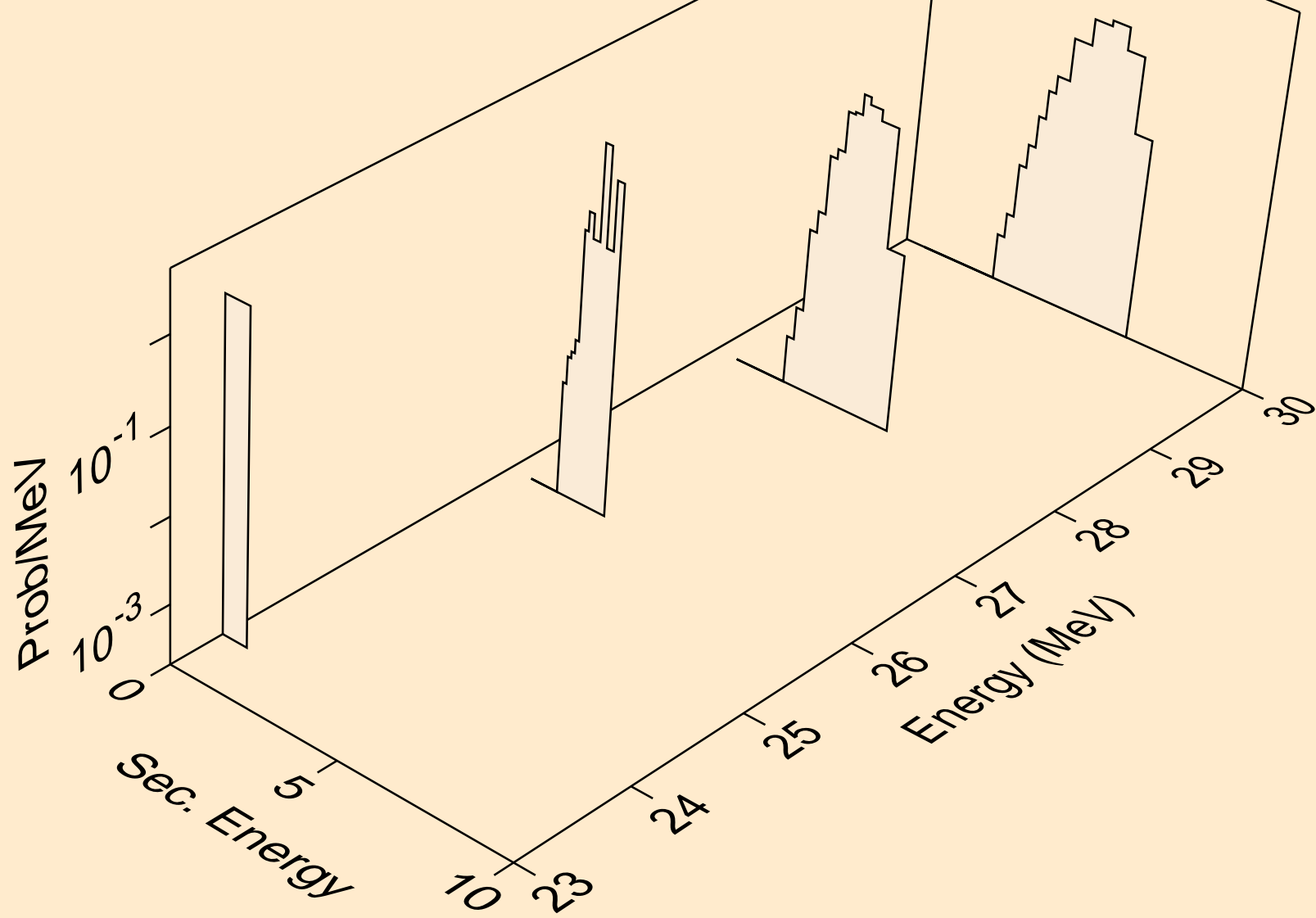

ND129 NEUTRON ACER TENDL-2021 LIBRARY; T=293.6K
deuterons from (n,n*)d

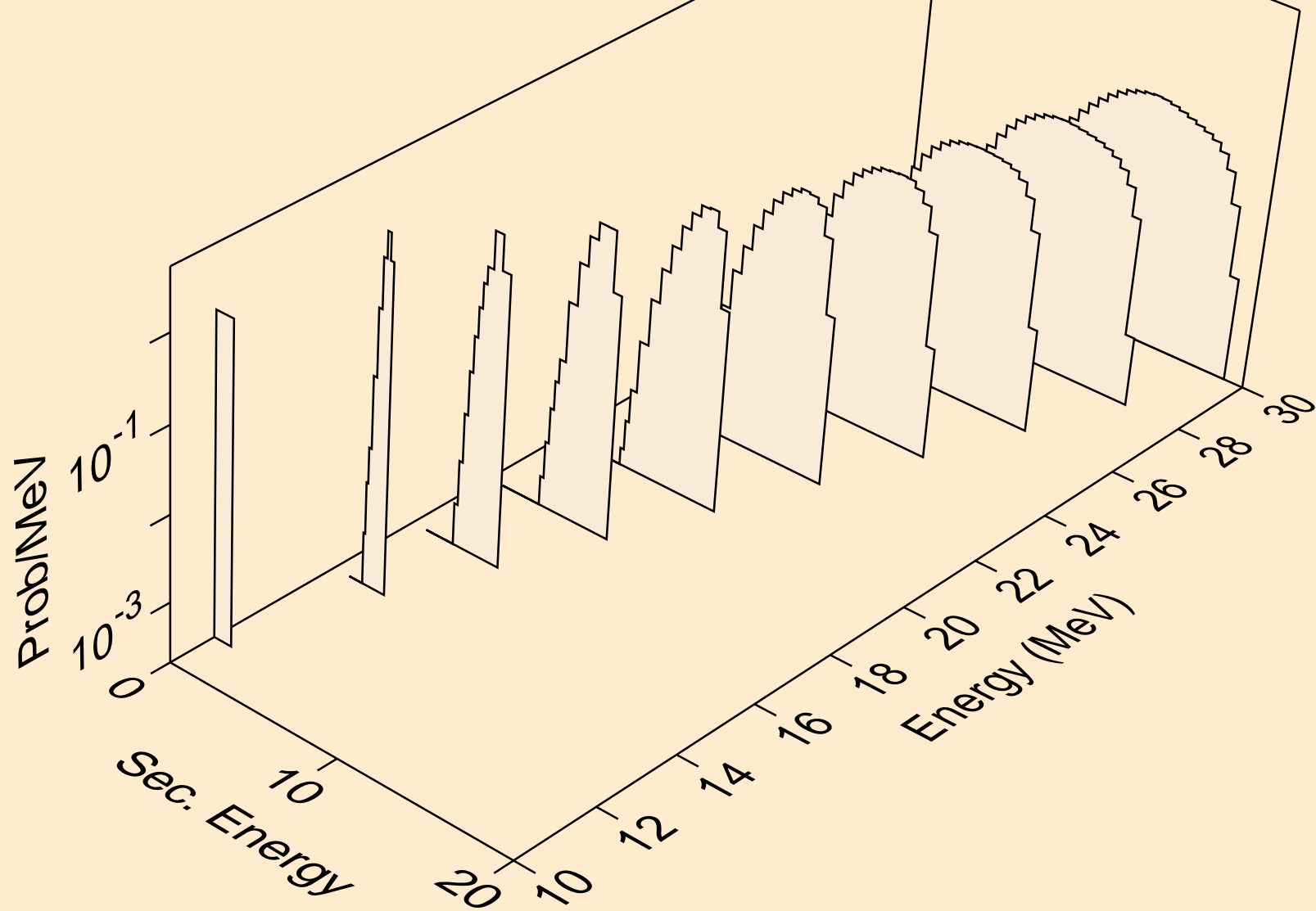

ND129 NEUTRON ACER TENDL-2021 LIBRARY; T=293.6K
deuterons from (n,d)

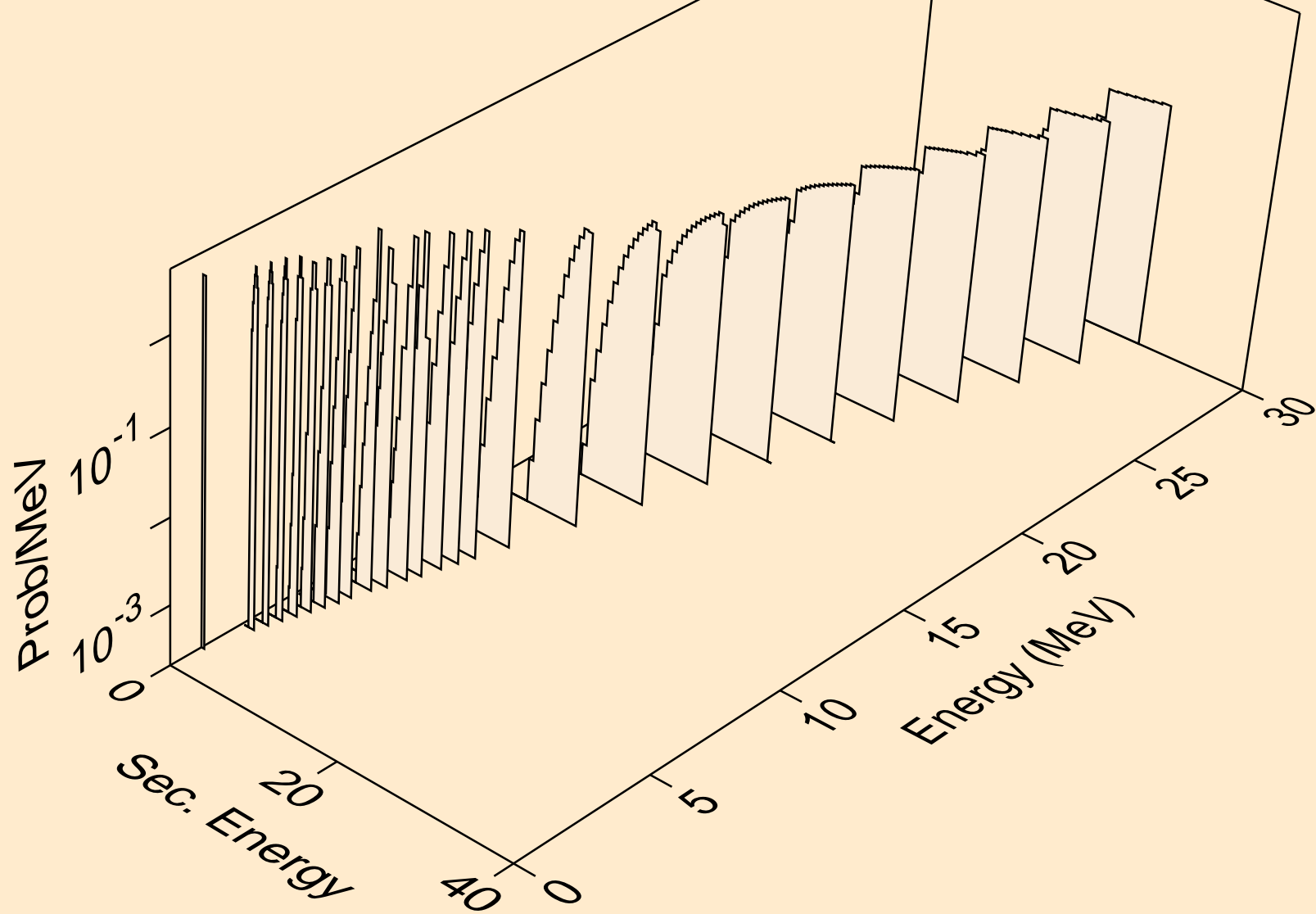

ND129 NEUTRON ACER TENDL-2021 LIBRARY; T=293.6K
deuterons from (n,pd)

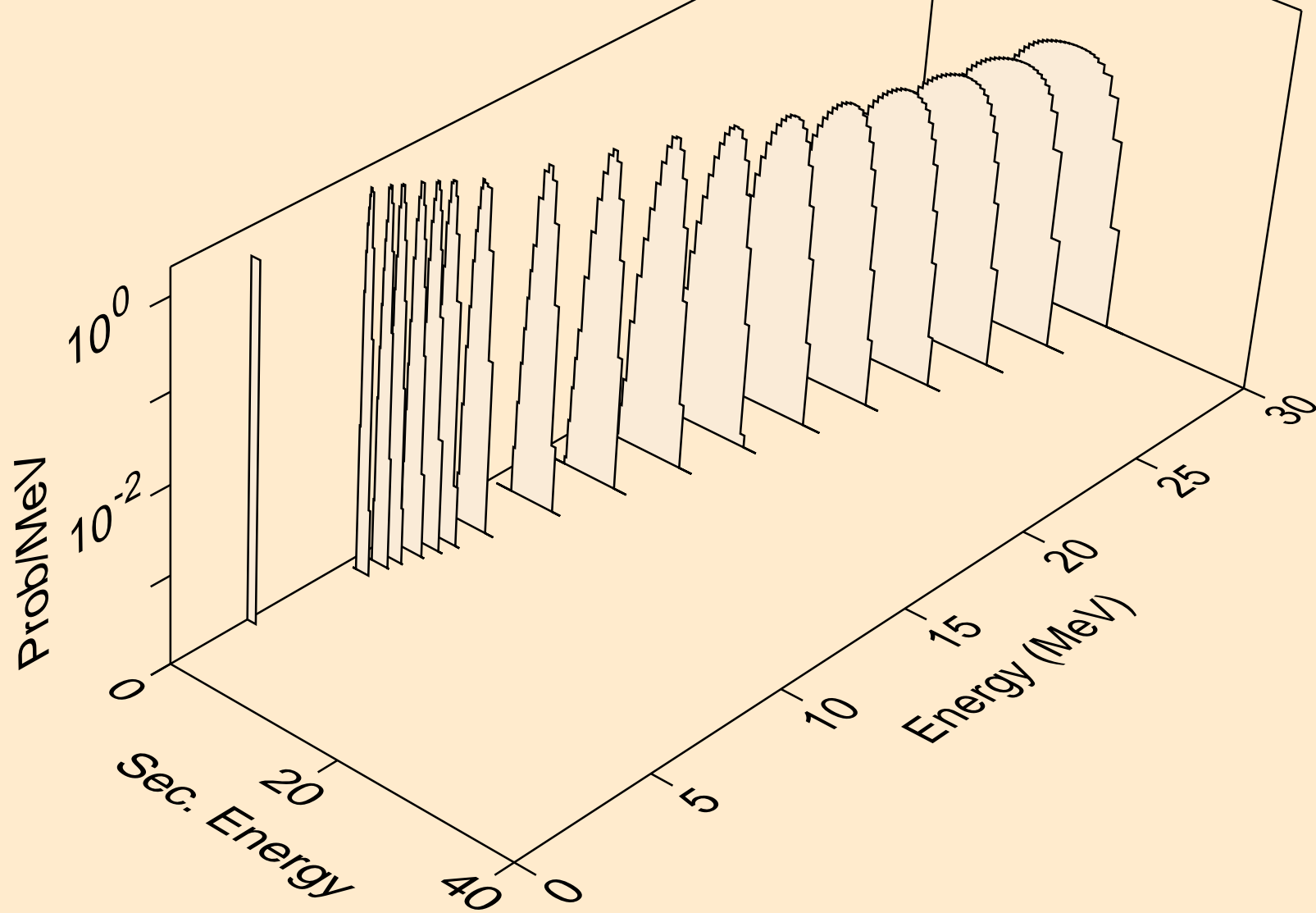

ND129 NEUTRON ACER TENDL-2021 LIBRARY; T=293.6K
deuterons from (n,da)

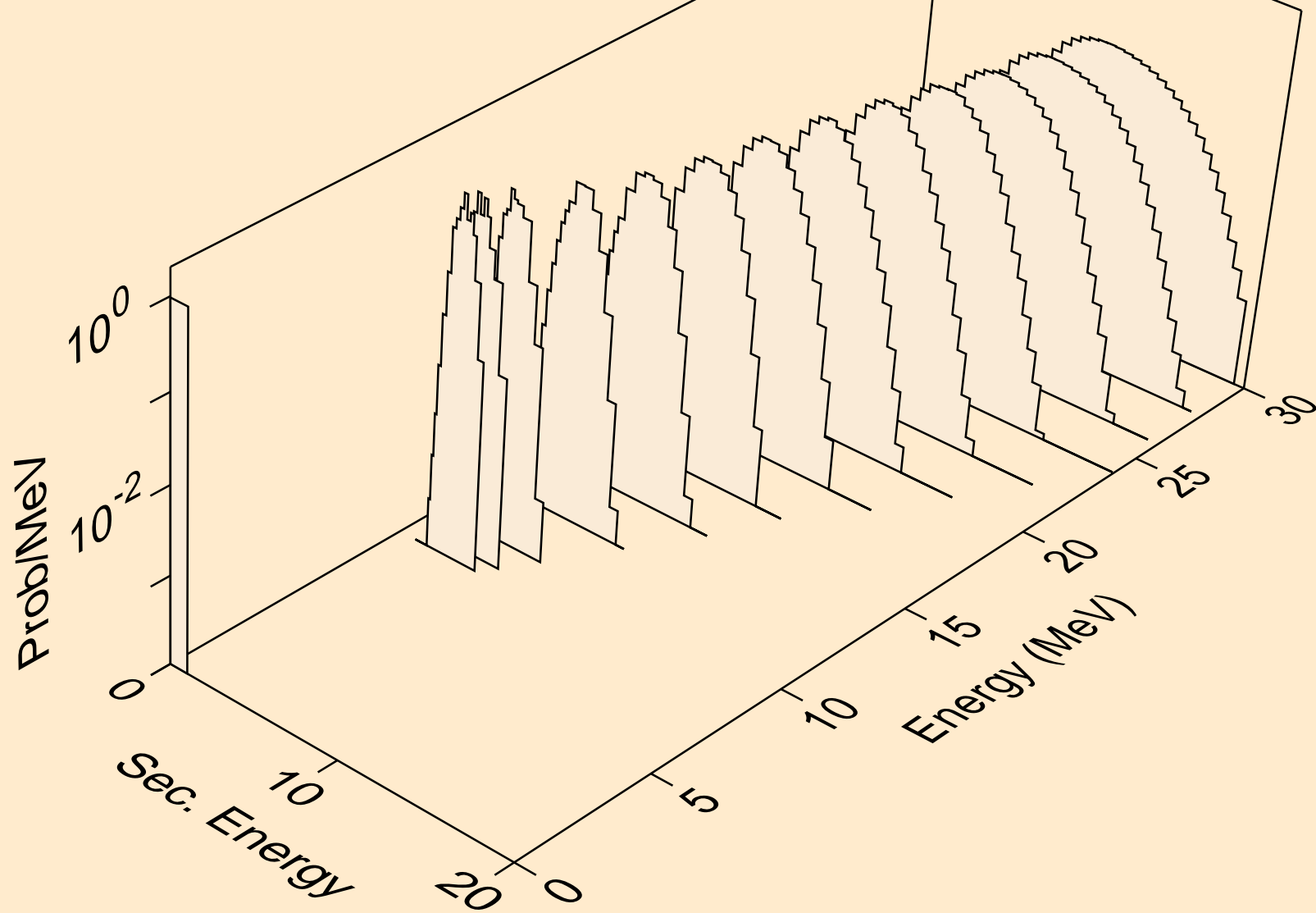

ND129 NEUTRON ACER TENDL-2021 LIBRARY; T=293.6K
tritons from (n,x)

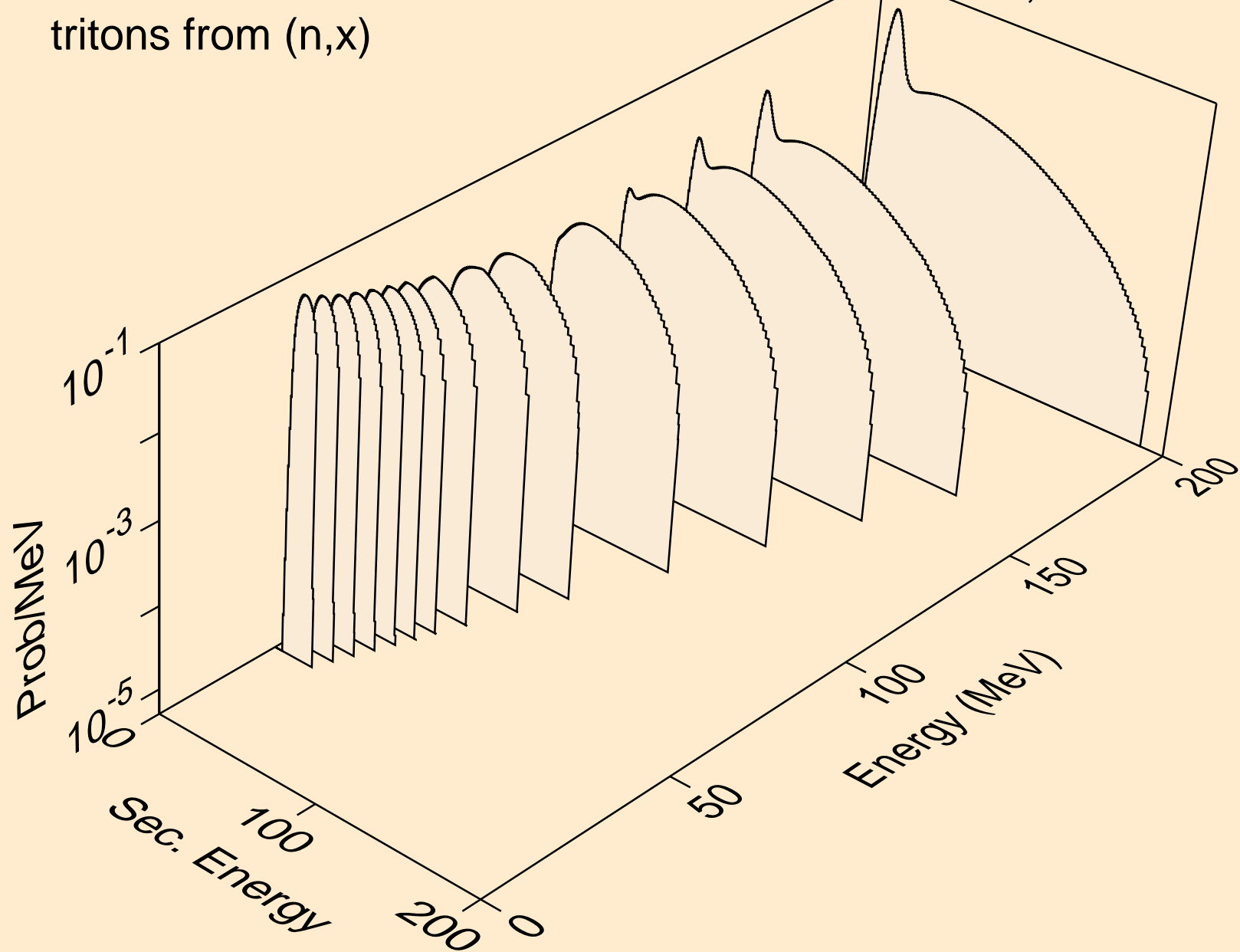

ND129 NEUTRON ACER TENDL-2021 LIBRARY; T=293.6K
tritons from (n,n*)t

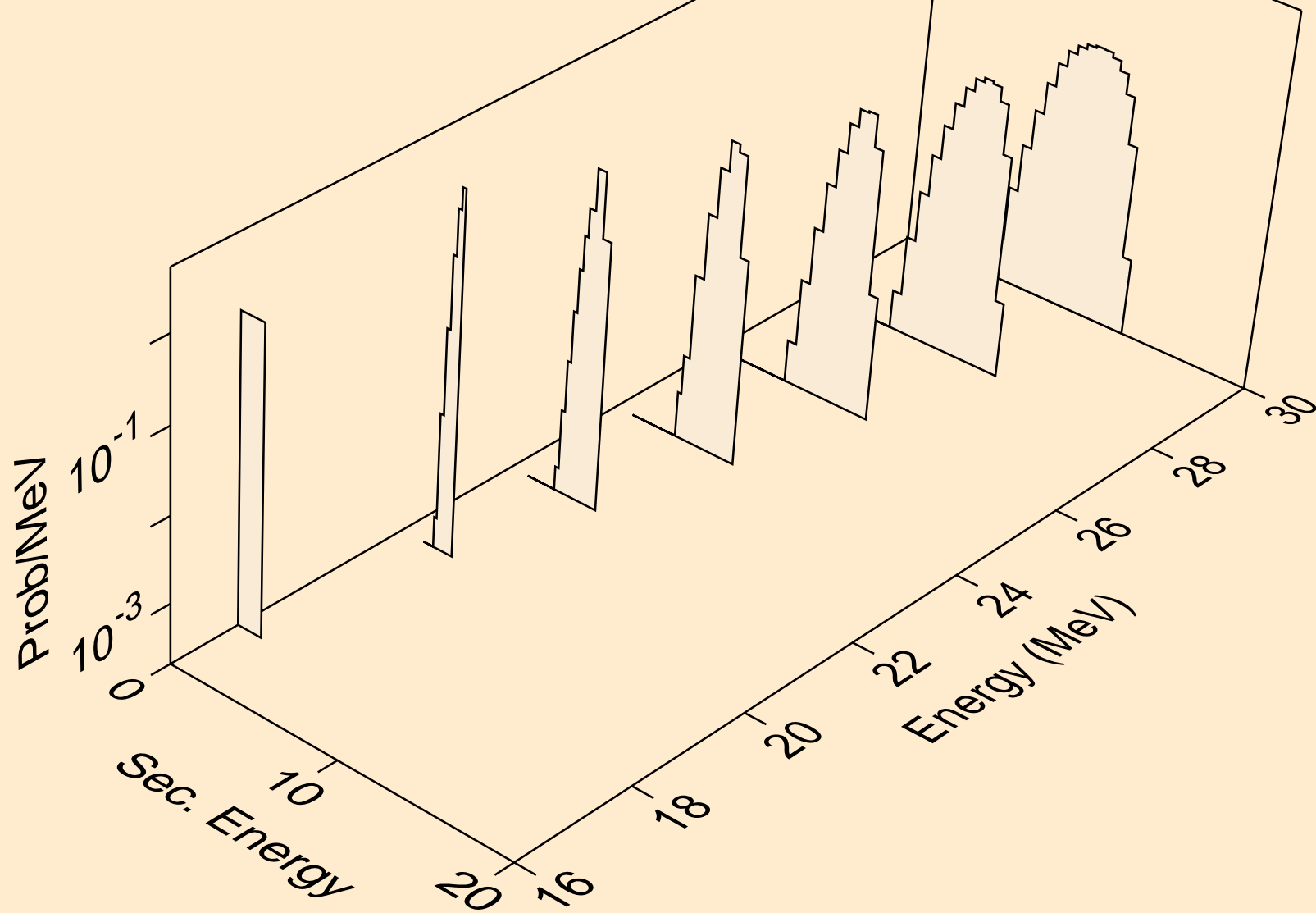

ND129 NEUTRON ACER TENDL-2021 LIBRARY; T=293.6K
tritons from (n,t)

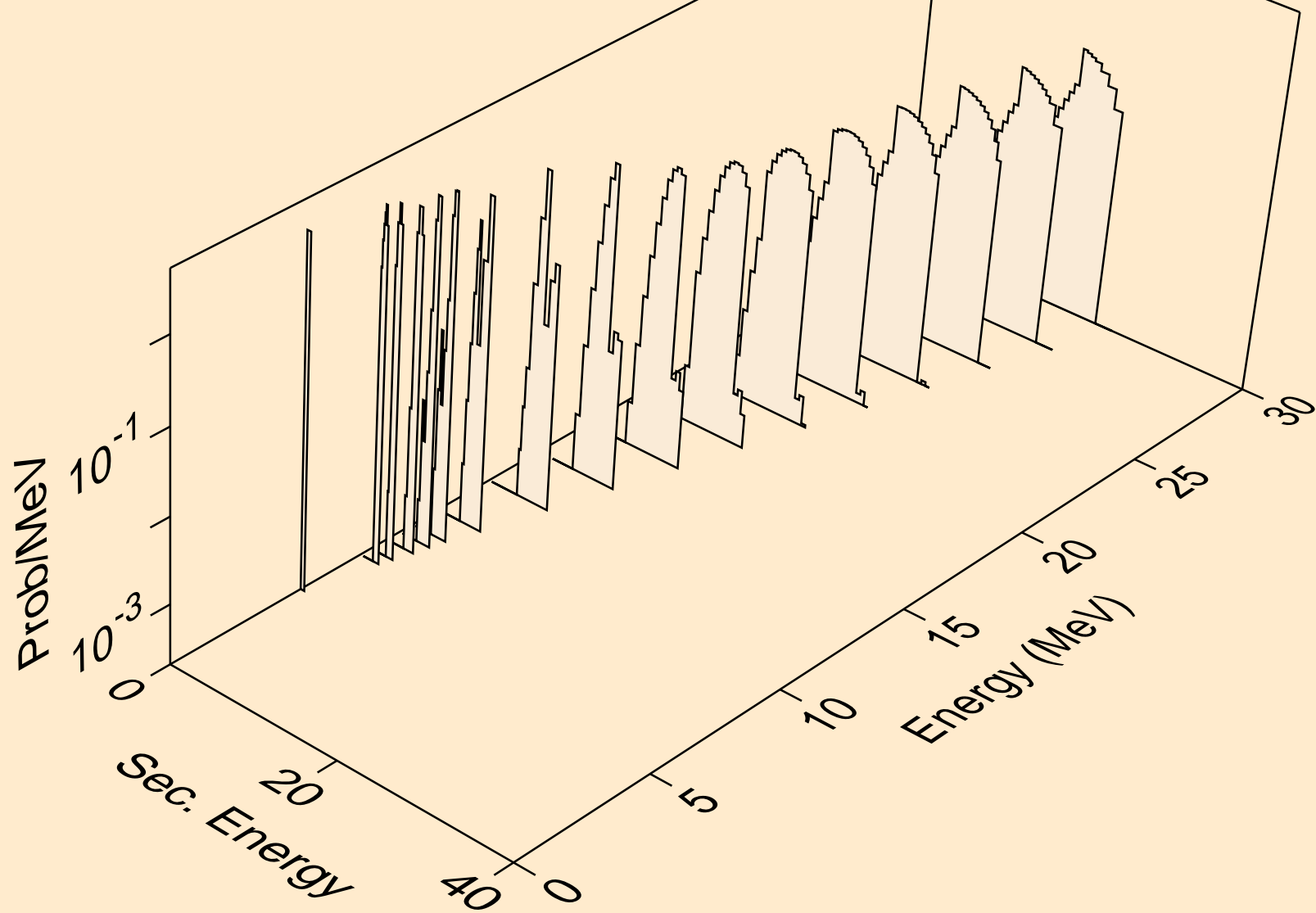

ND129 NEUTRON ACER TENDL-2021 LIBRARY; T=293.6K
tritons from (n,pt)

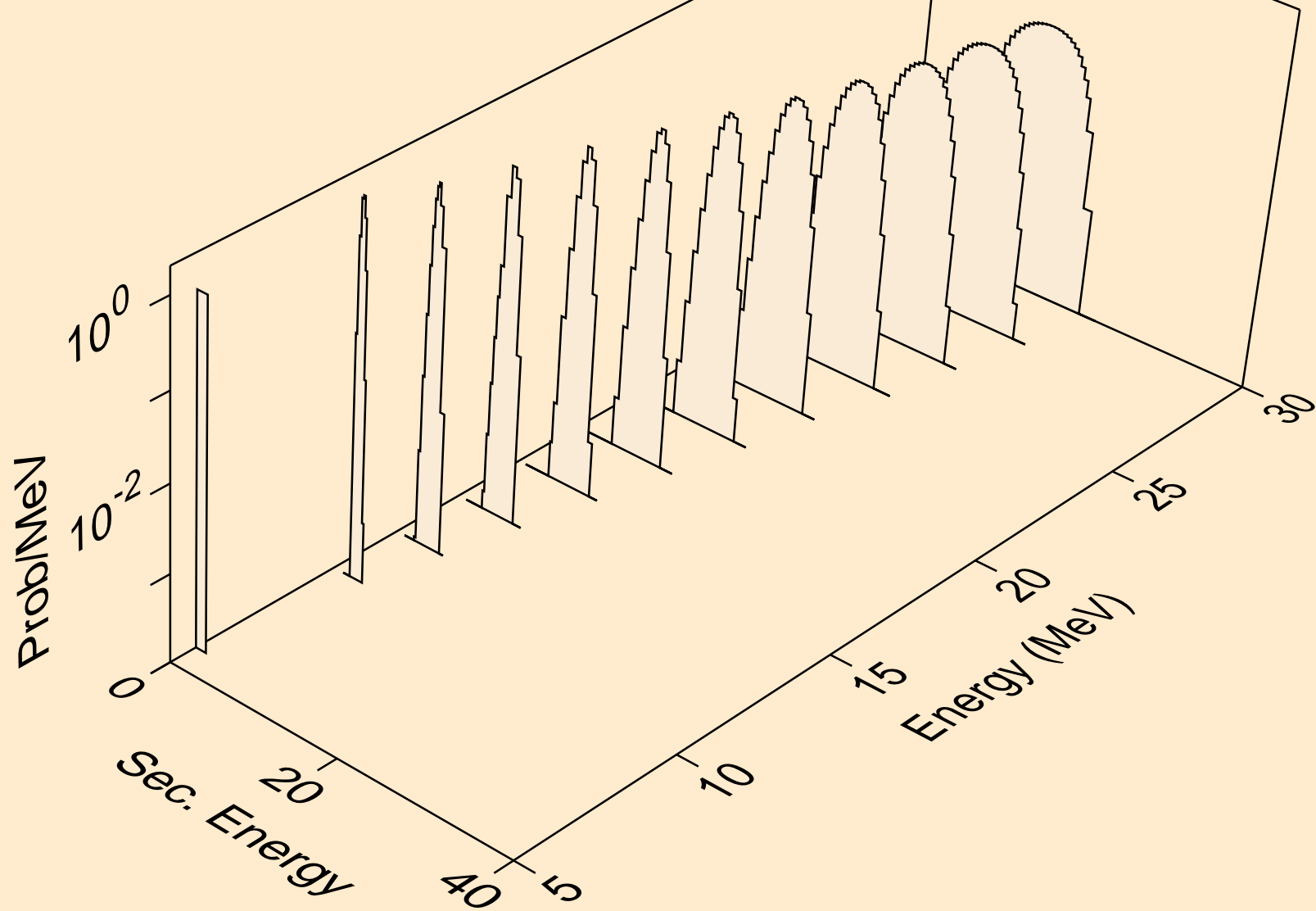

ND129 NEUTRON ACER TENDL-2021 LIBRARY; T=293.6K
he3s from (n,x)

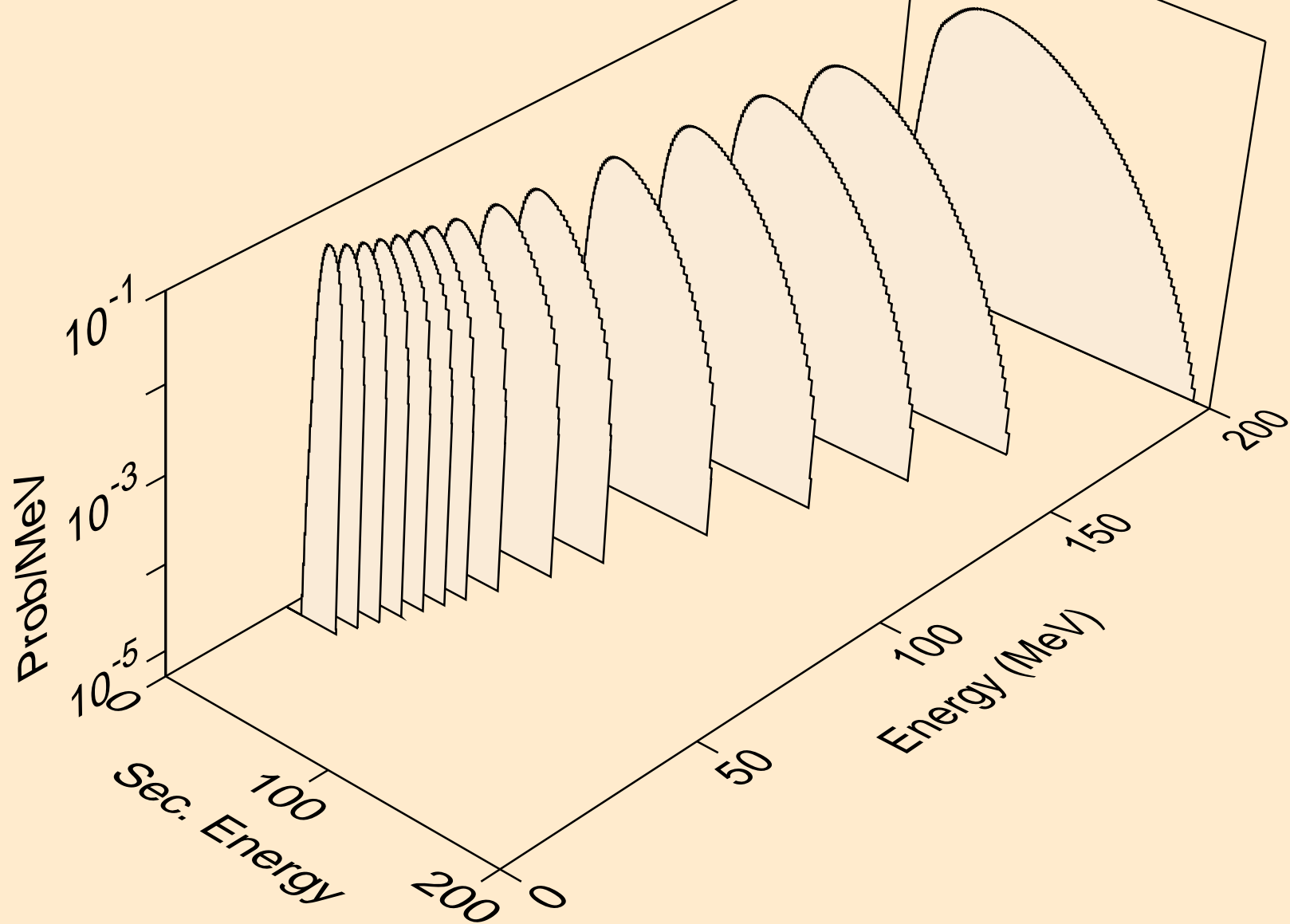

ND129 NEUTRON ACER TENDL-2021 LIBRARY; T=293.6K
he3s from (n,n*)he3

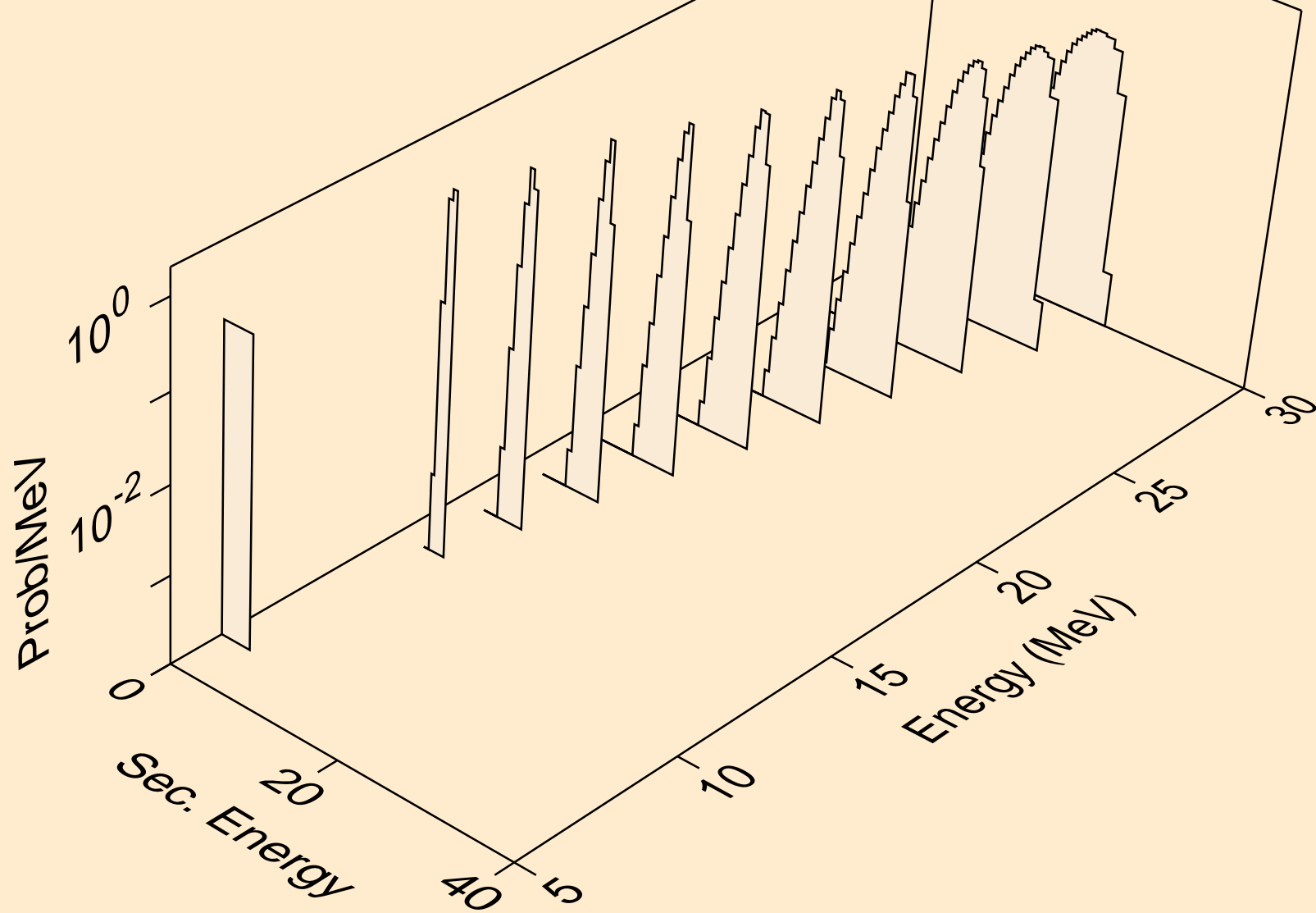

ND129 NEUTRON ACER TENDL-2021 LIBRARY; T=293.6K
he3s from (n,he3)

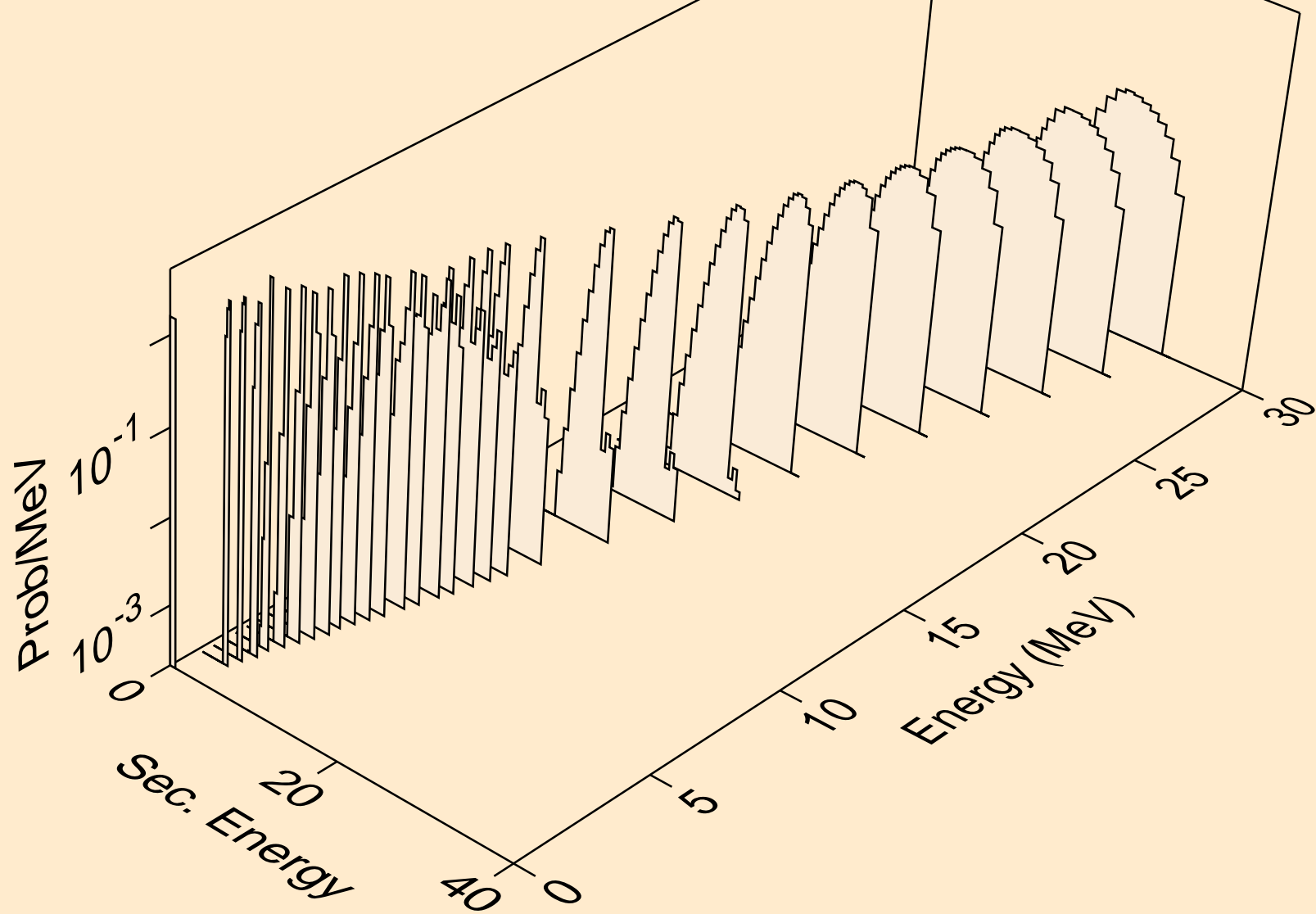

ND129 NEUTRON ACER TENDL-2021 LIBRARY; T=293.6K
alphas from (n,x)

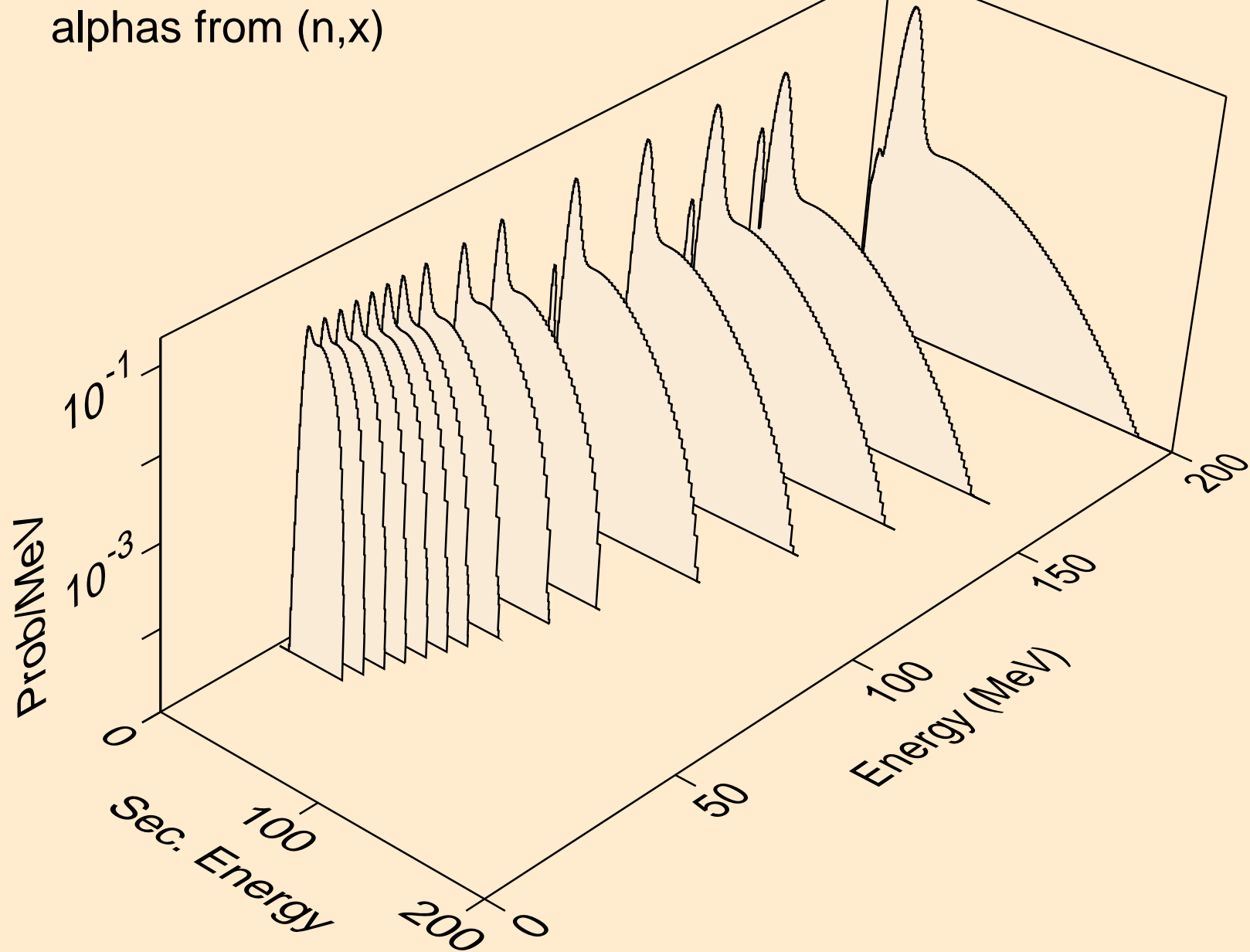

ND129 NEUTRON ACER TENDL-2021 LIBRARY; T=293.6K
alphas from (n,n*)a

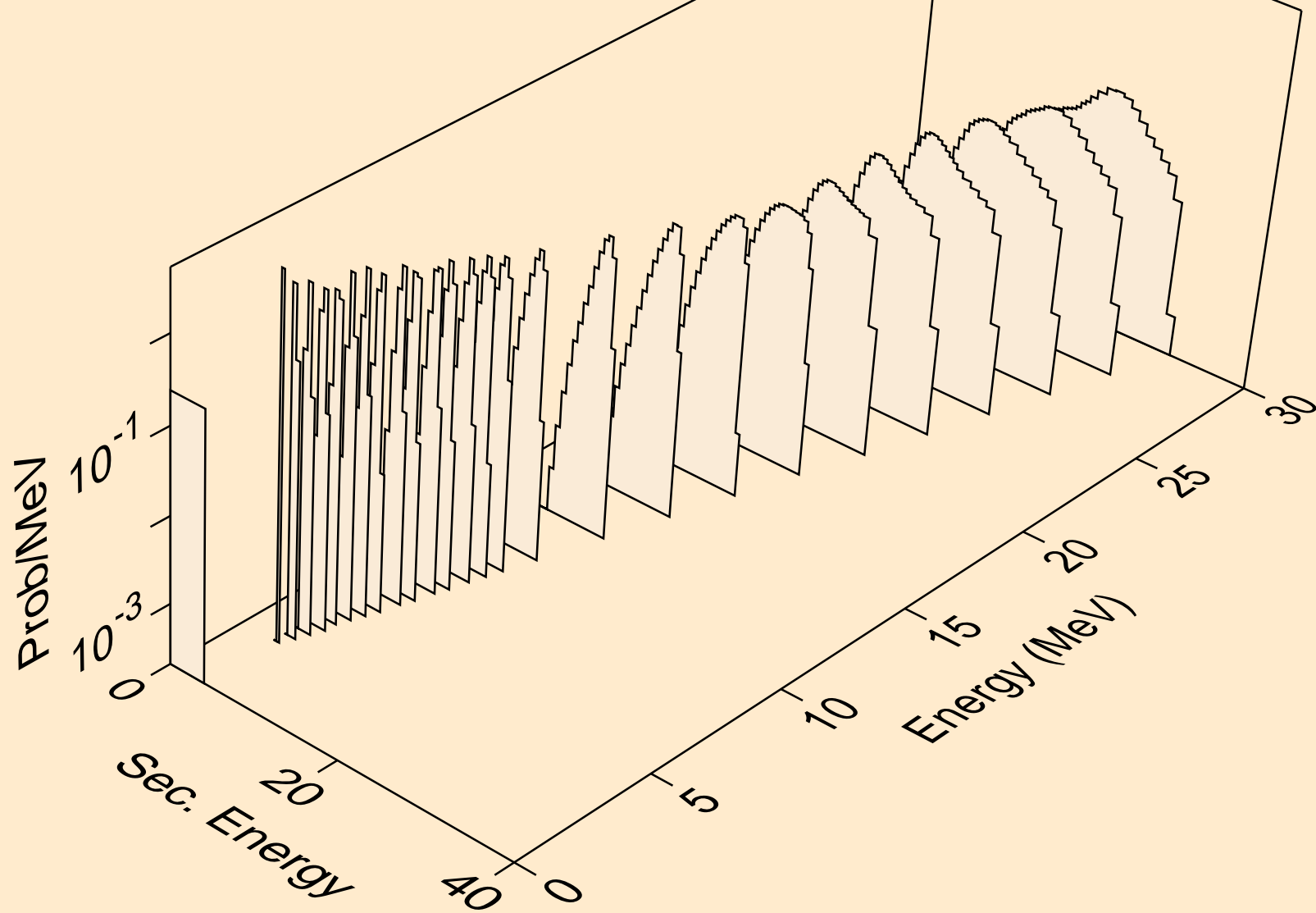

ND129 NEUTRON ACER TENDL-2021 LIBRARY; T=293.6K
alphas from (n,2n)a

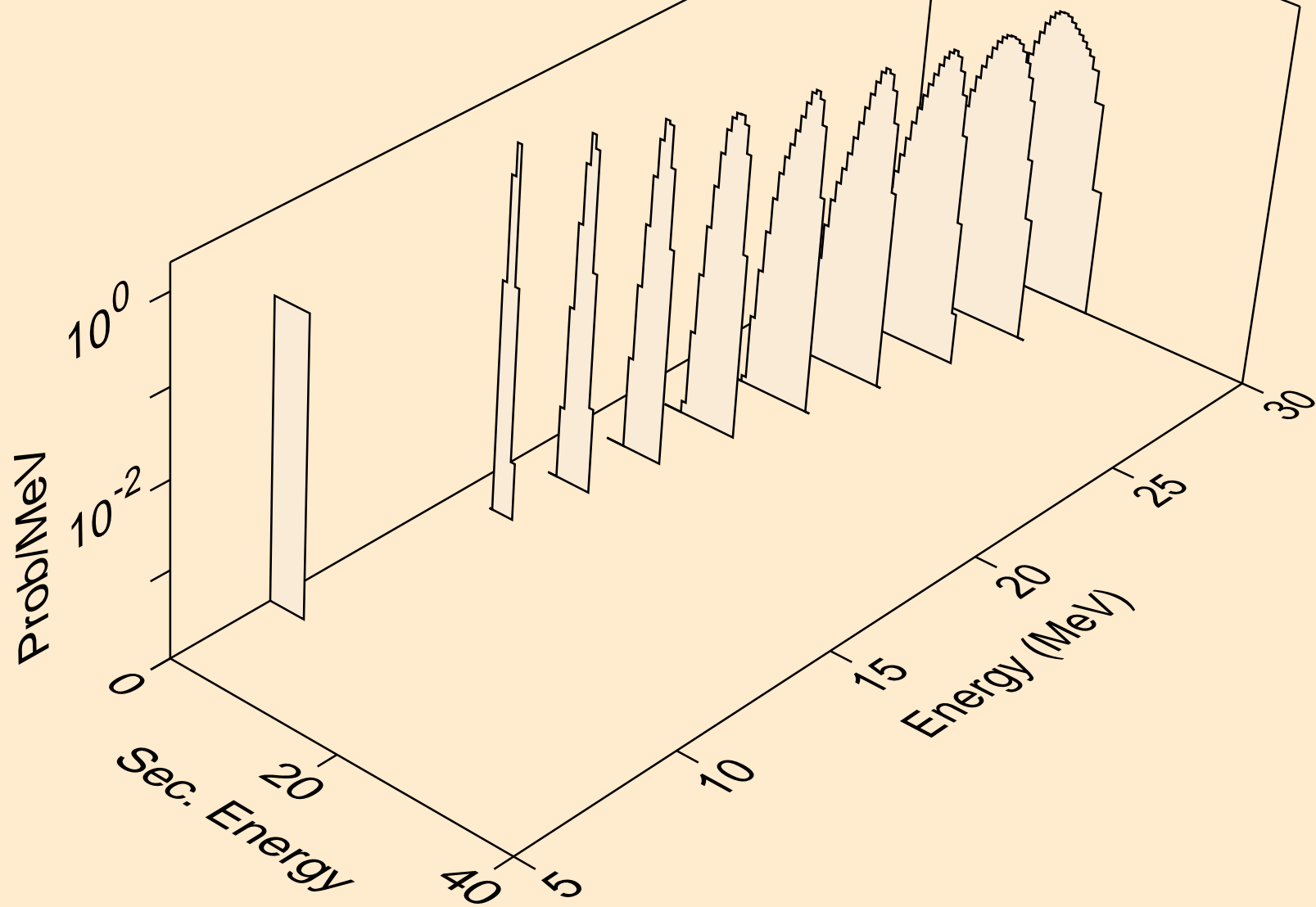

ND129 NEUTRON ACER TENDL-2021 LIBRARY; T=293.6K
alphas from (n,n*)2a

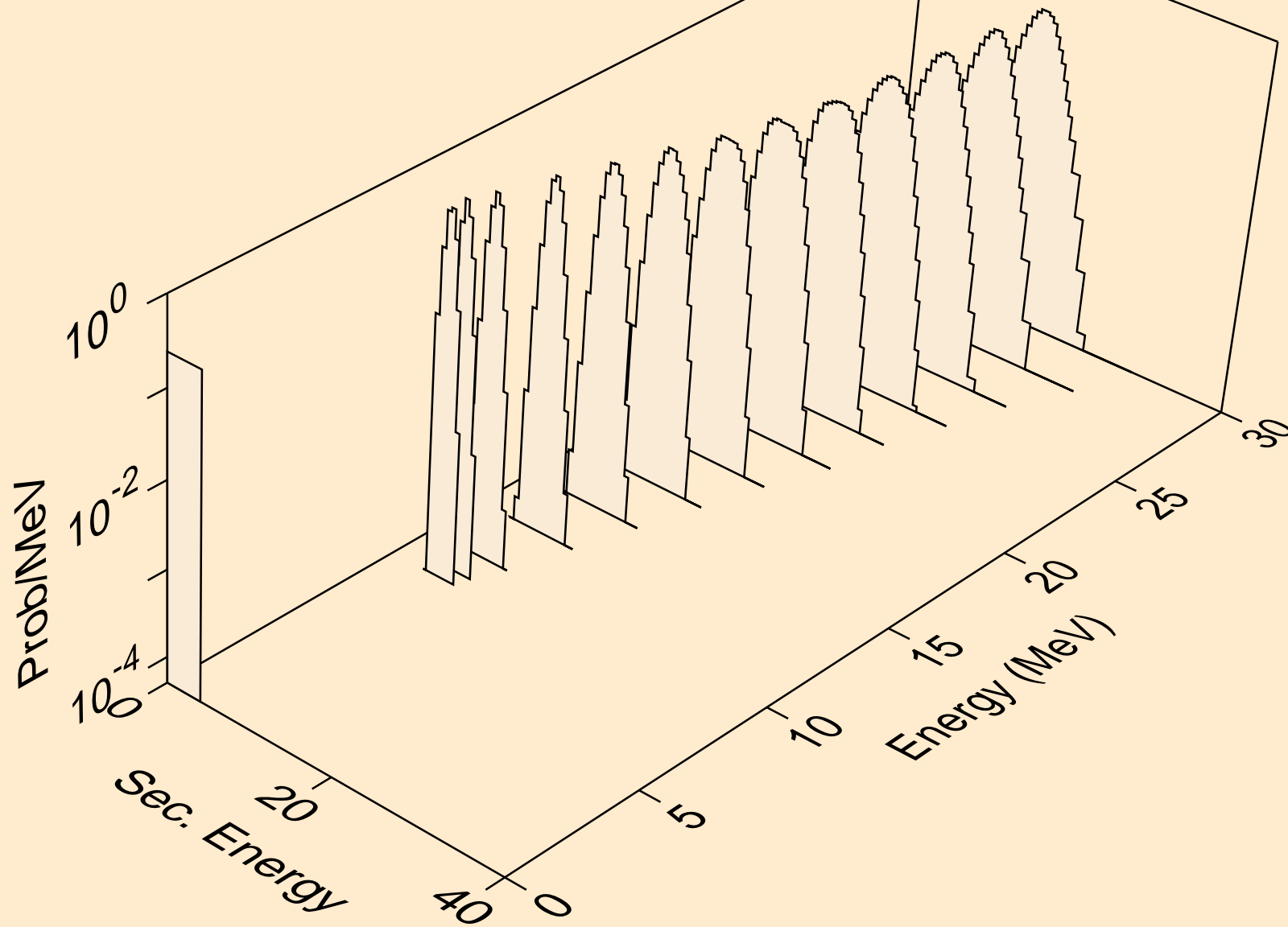

ND129 NEUTRON ACER TENDL-2021 LIBRARY; T=293.6K
alphas from (n,2n)2a

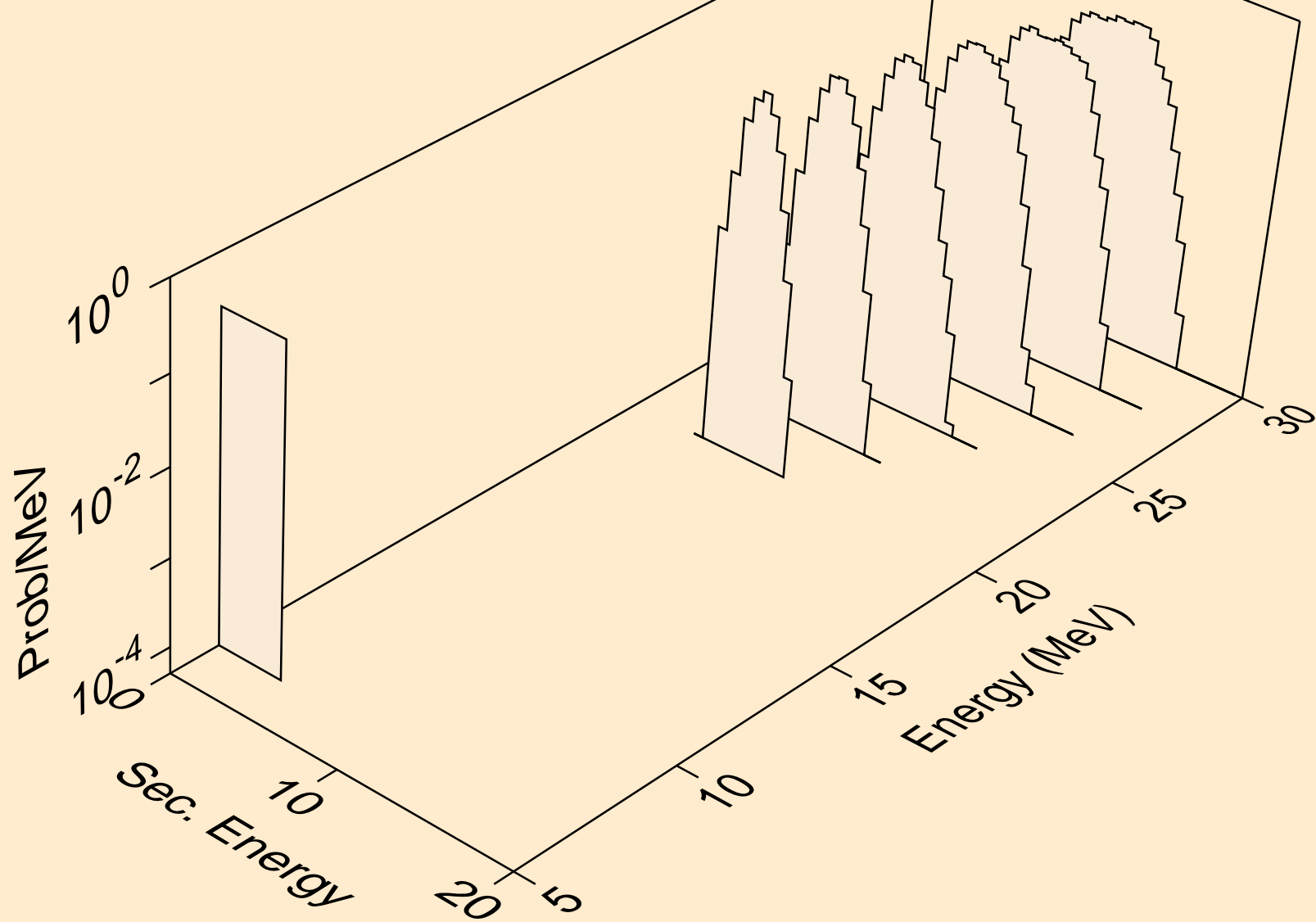

ND129 NEUTRON ACER TENDL-2021 LIBRARY; T=293.6K
alphas from (n,npa)

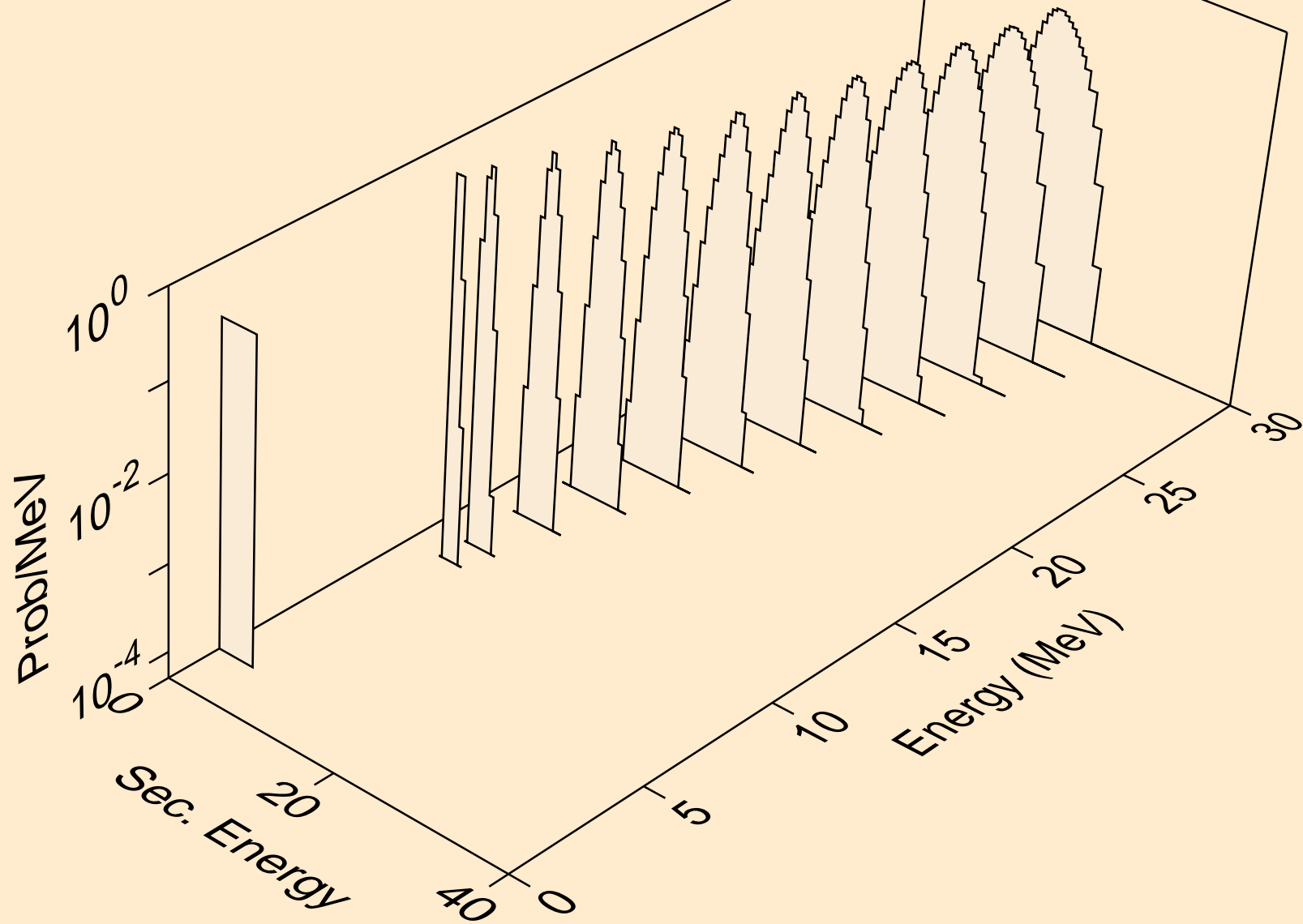

ND129 NEUTRON ACER TENDL-2021 LIBRARY; T=293.6K
alphas from (n,a)

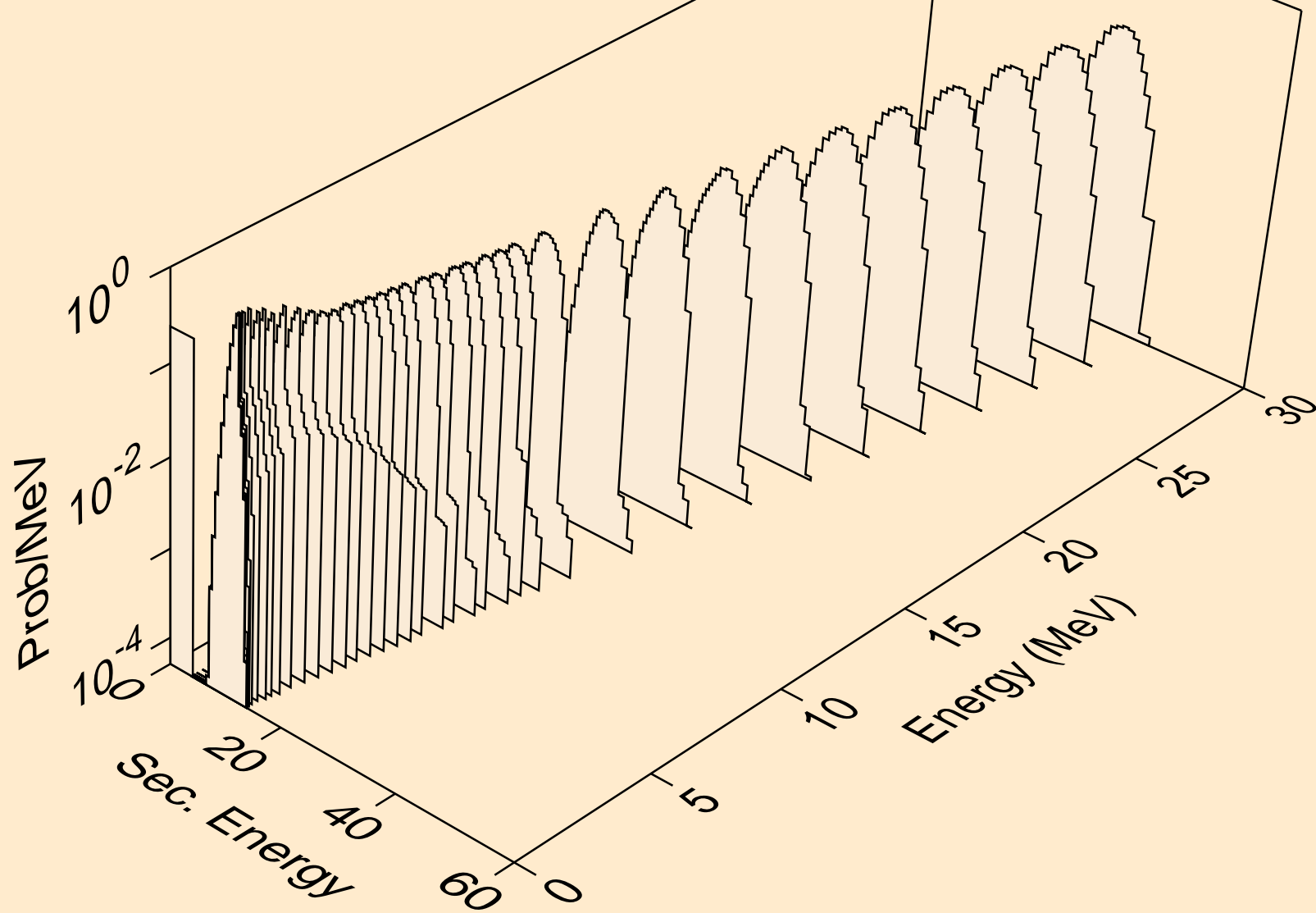

ND129 NEUTRON ACER TENDL-2021 LIBRARY; T=293.6K
alphas from (n,2a)

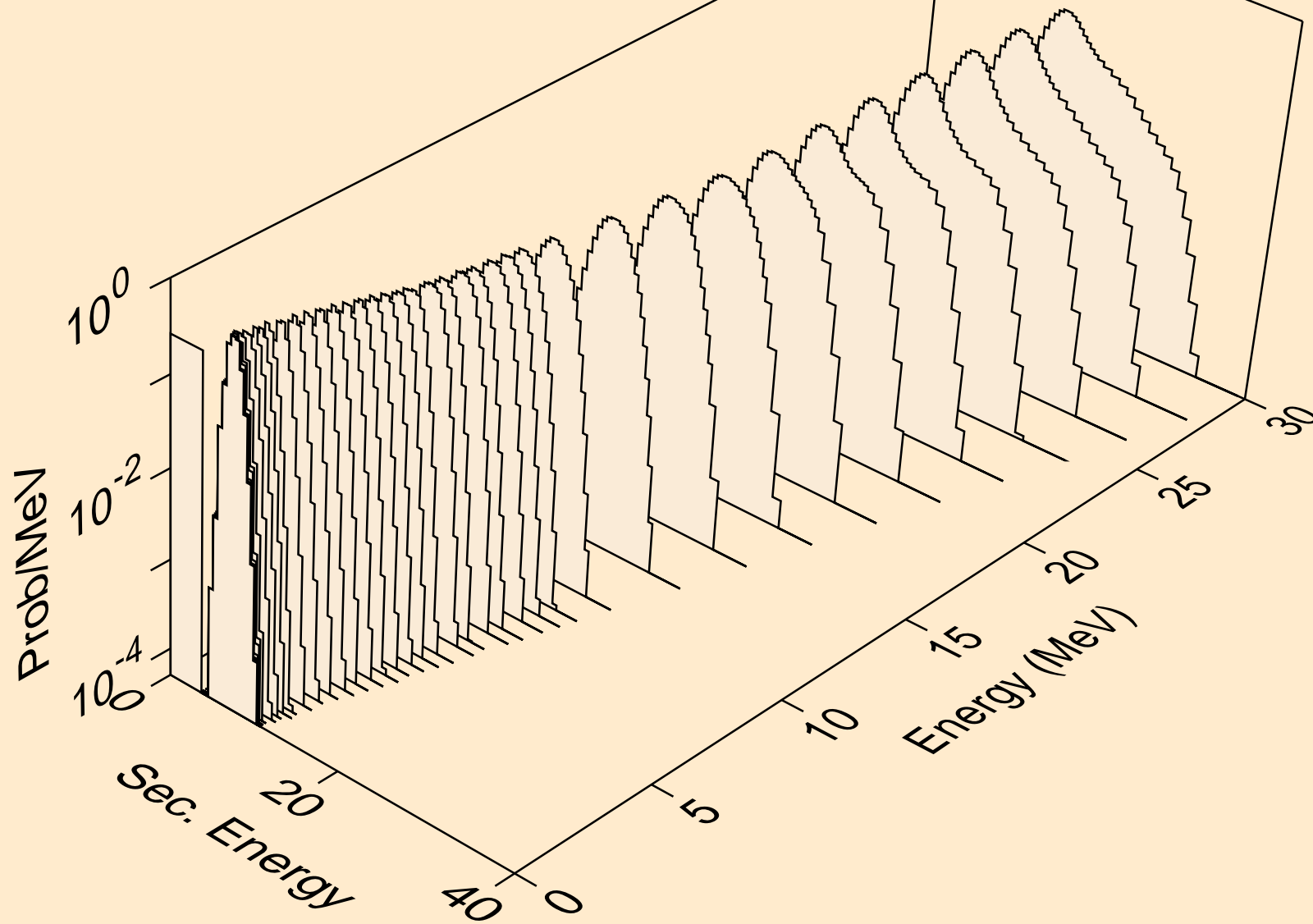

ND129 NEUTRON ACER TENDL-2021 LIBRARY; T=293.6K
alphas from (n,3a)

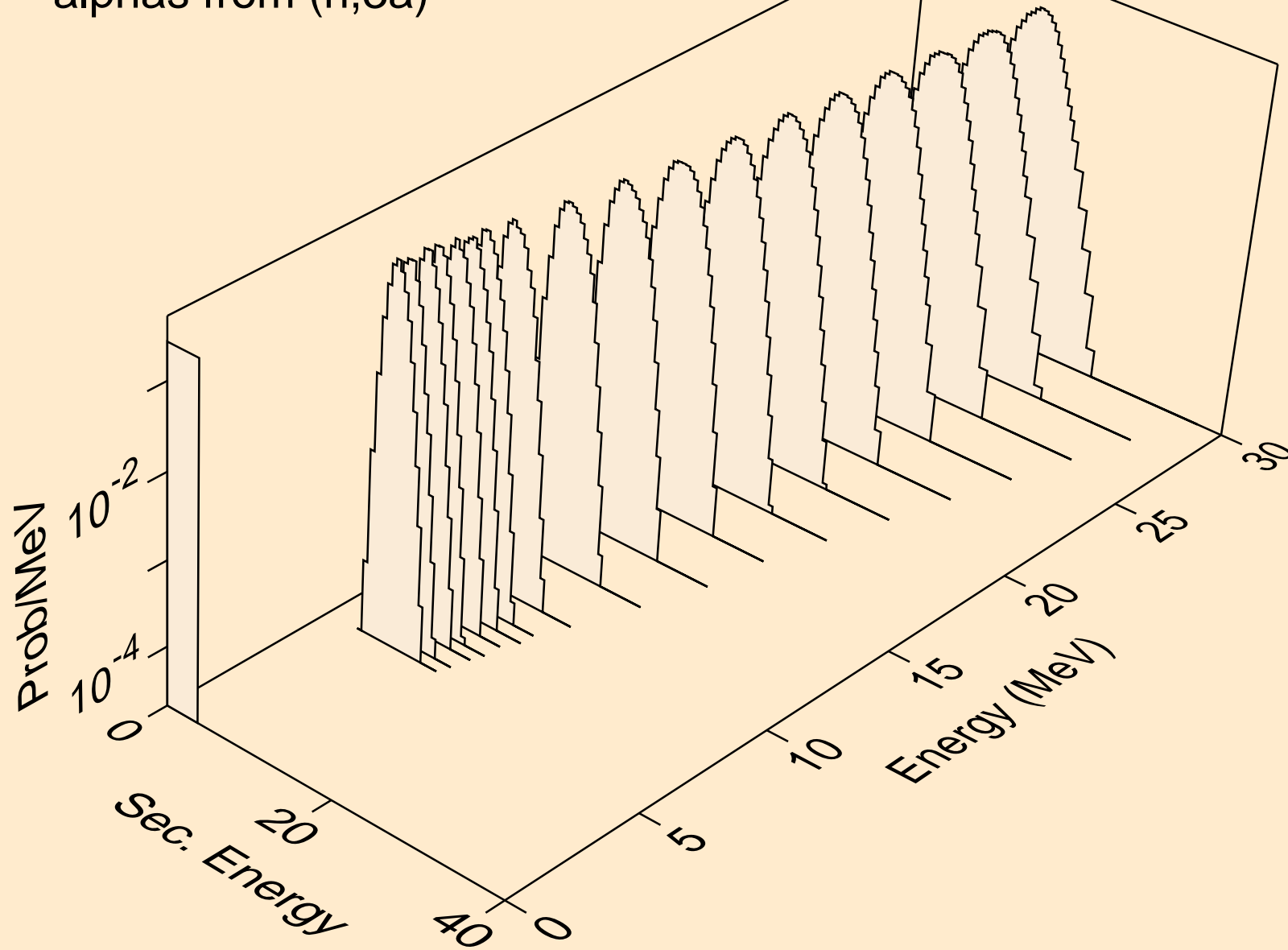

ND129 NEUTRON ACER TENDL-2021 LIBRARY; T=293.6K
alphas from (n,pa)

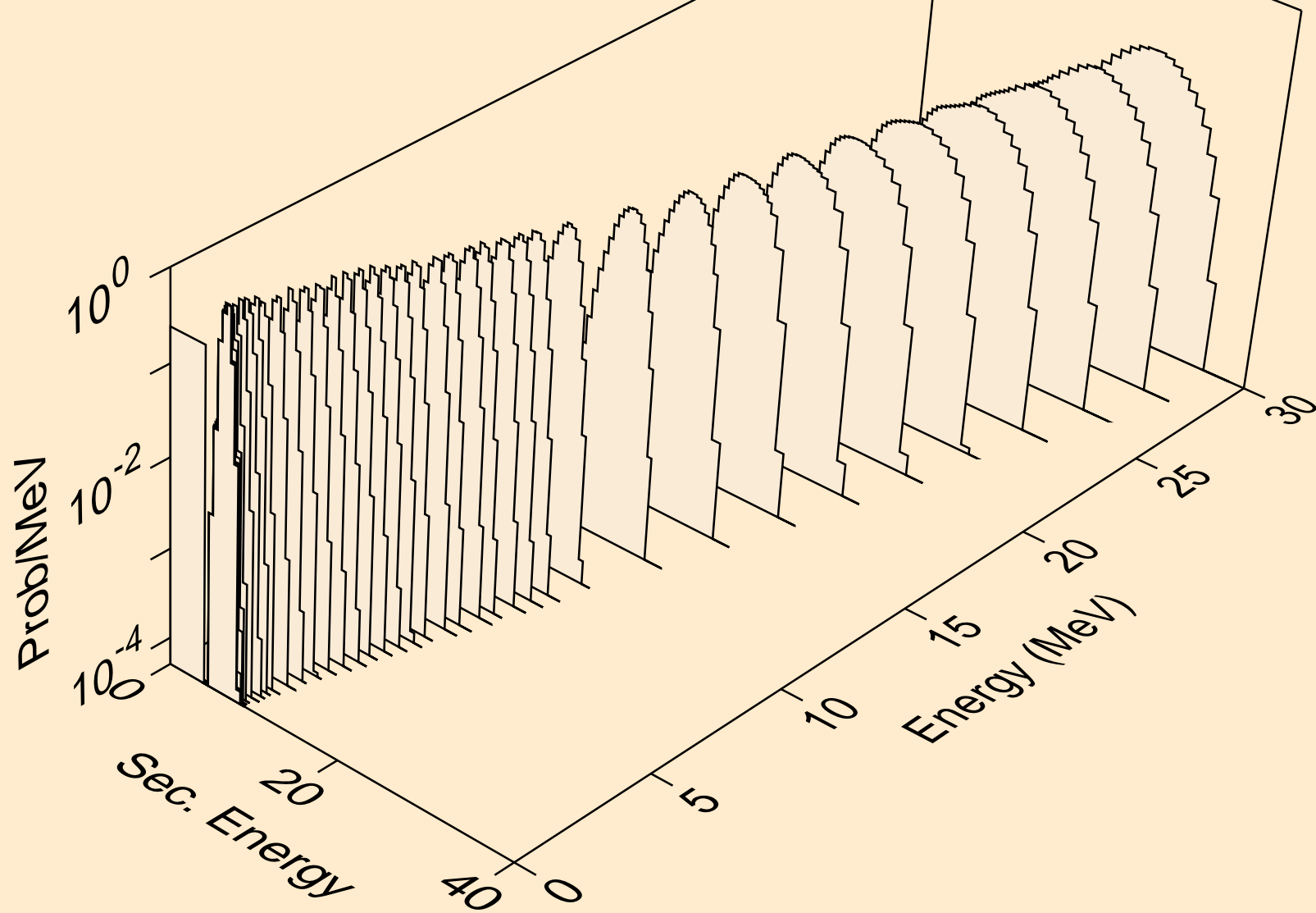

ND129 NEUTRON ACER TENDL-2021 LIBRARY; T=293.6K
alphas from (n,da)

