

ND132 NEUTRON ACER TENDL-2021 LIBRARY; T=293.6K

Principal cross sections

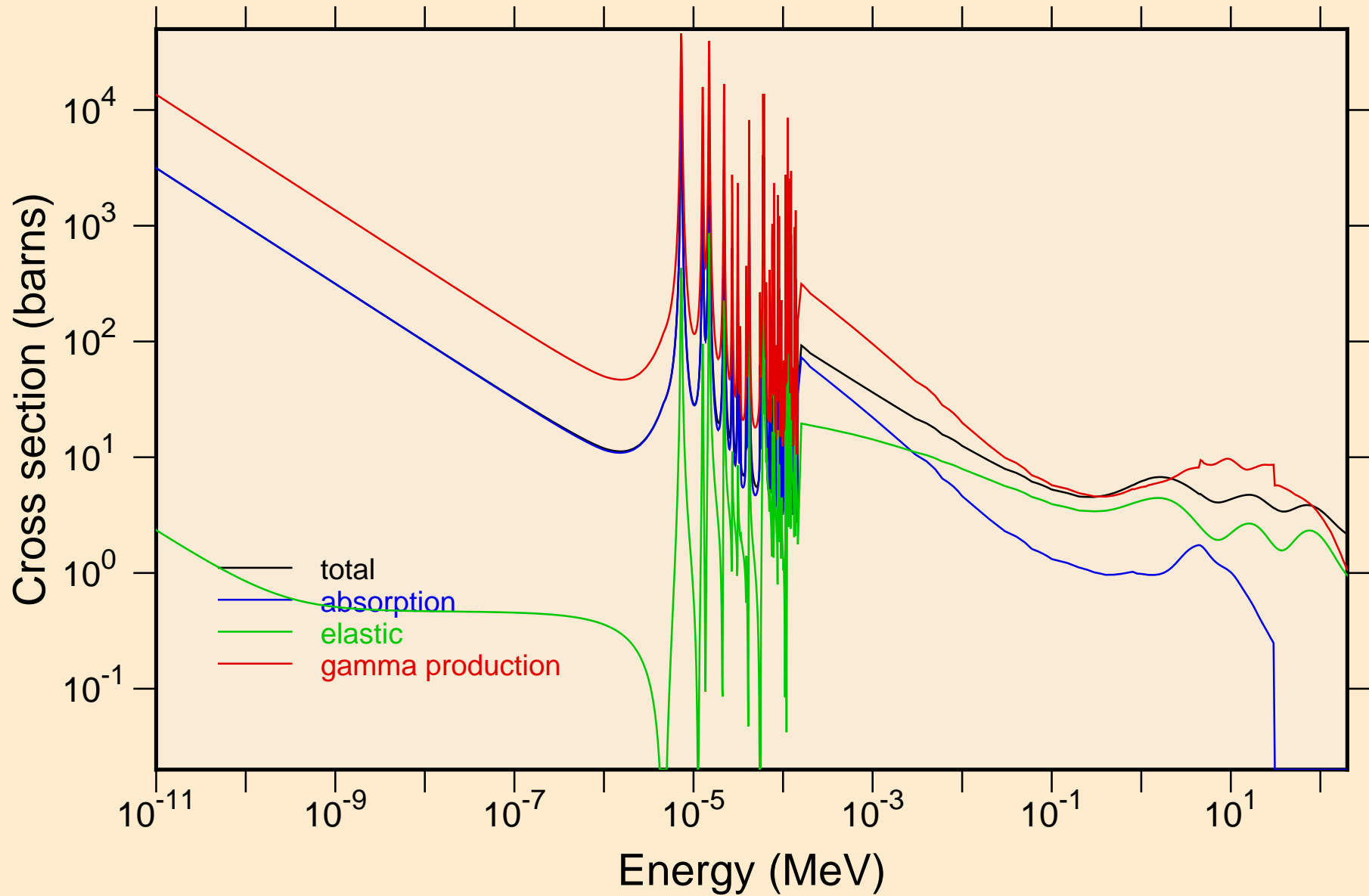

ND132 NEUTRON ACER TENDL-2021 LIBRARY; T=293.6K
resonance total cross section

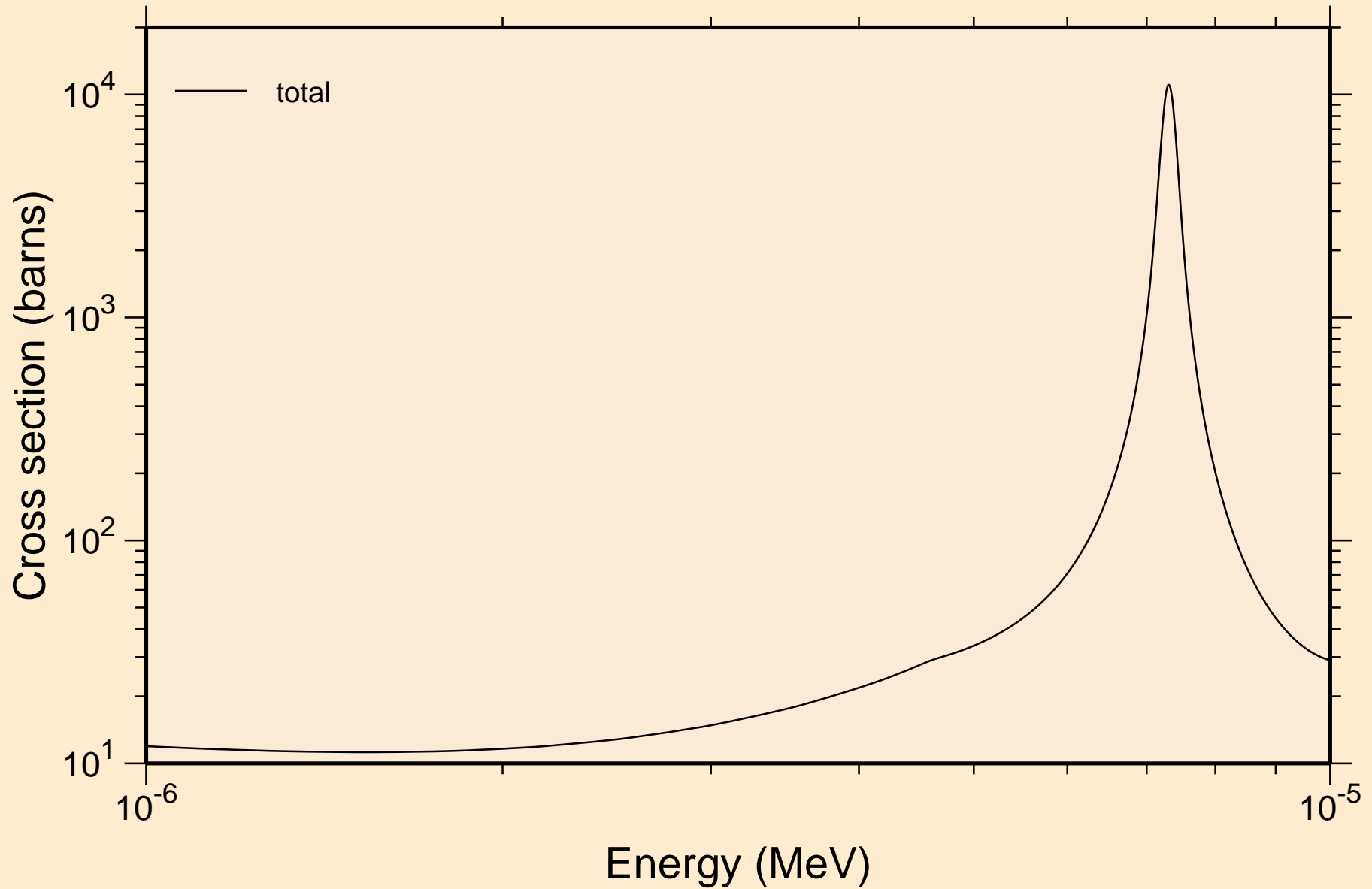

ND132 NEUTRON ACER TENDL-2021 LIBRARY; T=293.6K
resonance total cross section

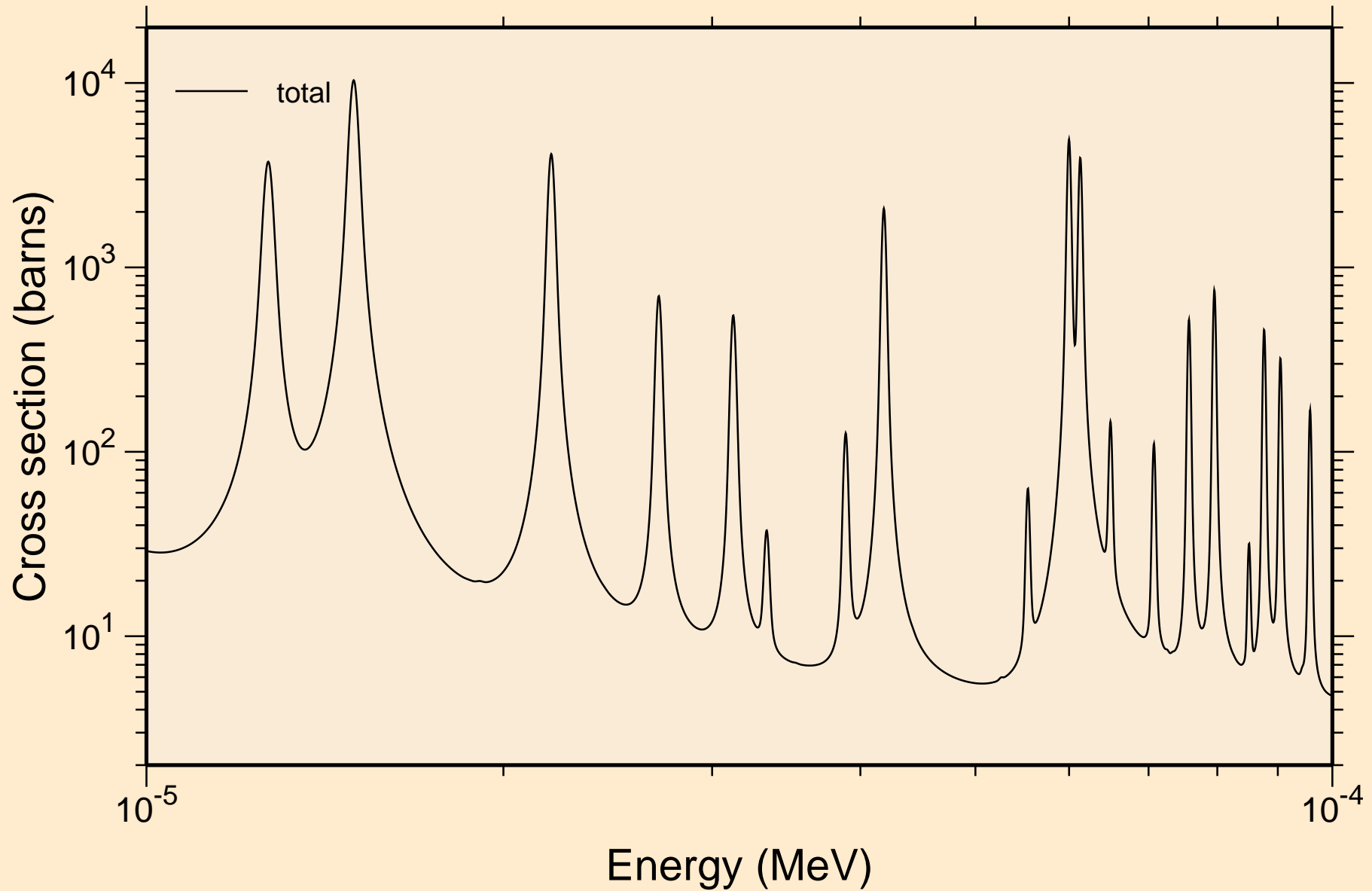

ND132 NEUTRON ACER TENDL-2021 LIBRARY; T=293.6K
resonance total cross section

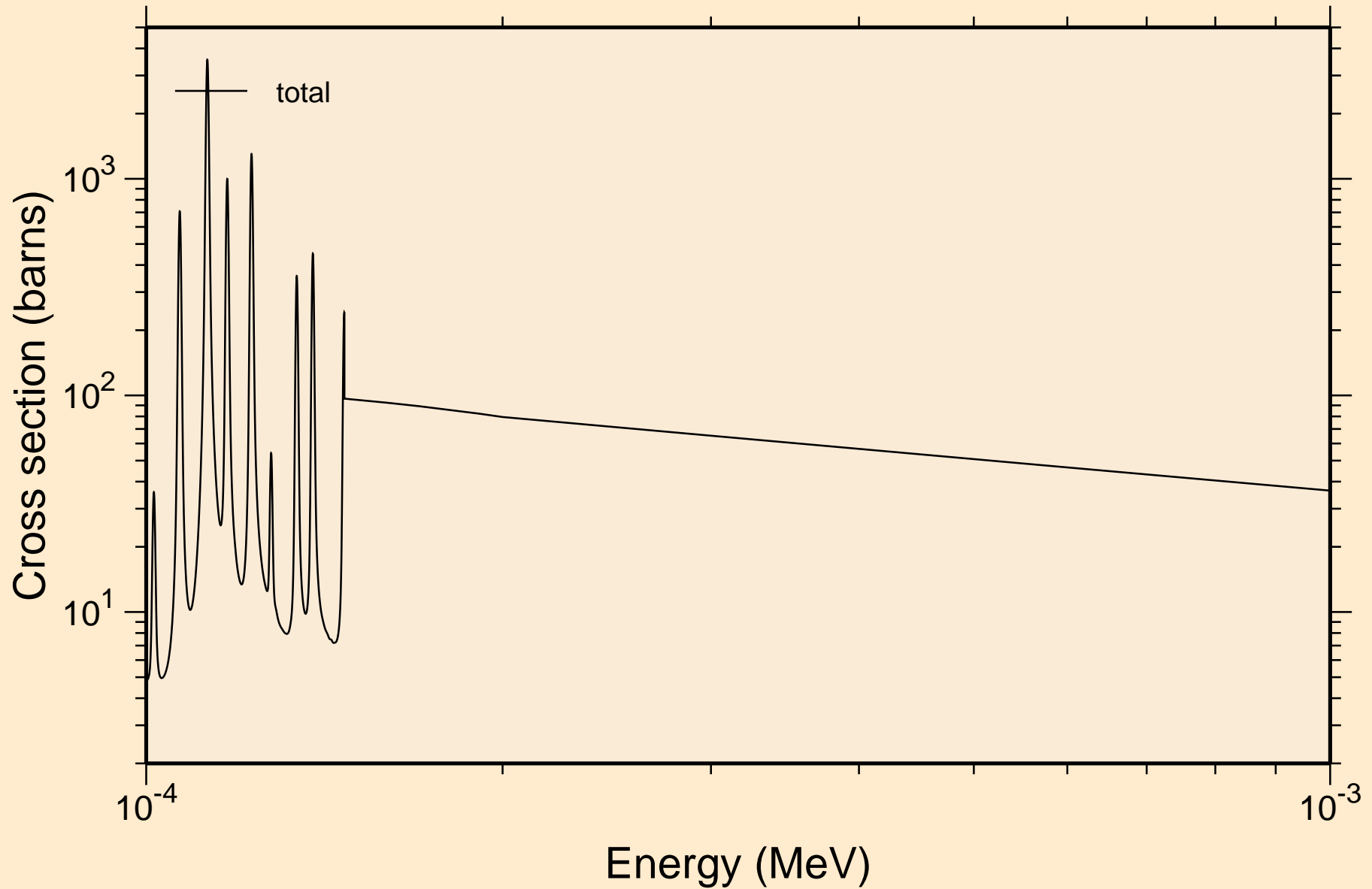

ND132 NEUTRON ACER TENDL-2021 LIBRARY; T=293.6K
resonance total cross section

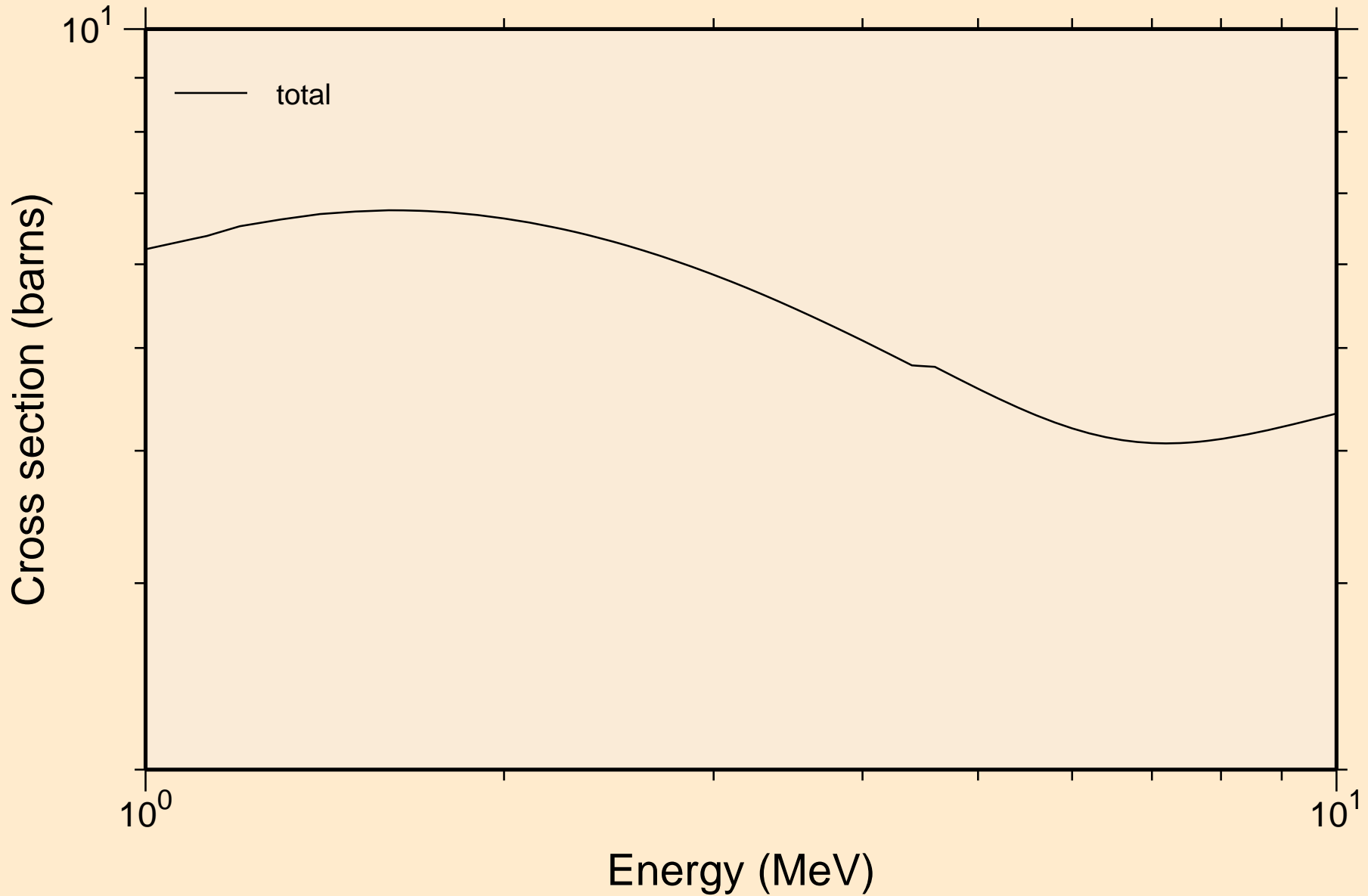

ND132 NEUTRON ACER TENDL-2021 LIBRARY; T=293.6K
resonance absorption cross sections

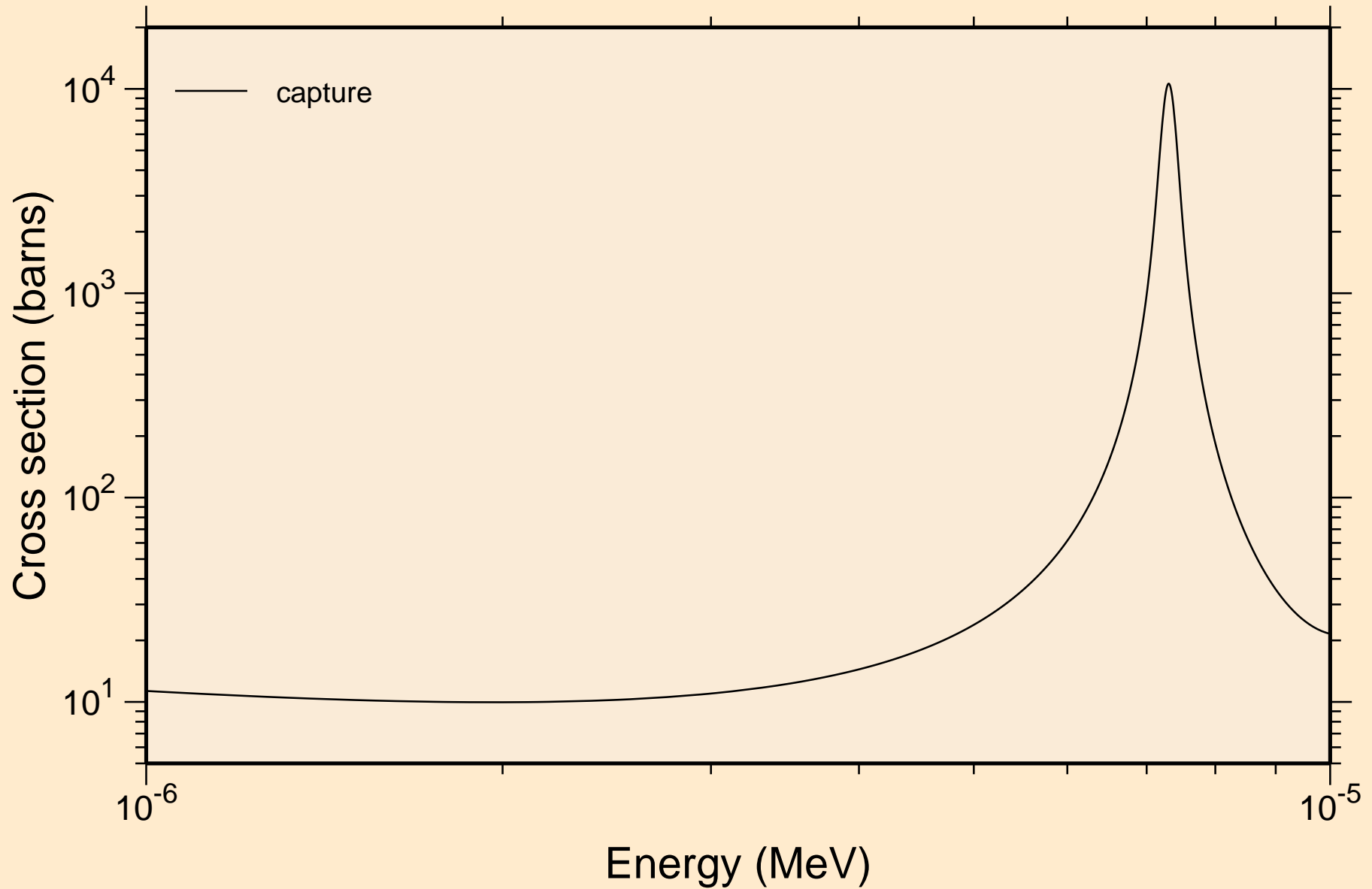

ND132 NEUTRON ACER TENDL-2021 LIBRARY; T=293.6K
resonance absorption cross sections

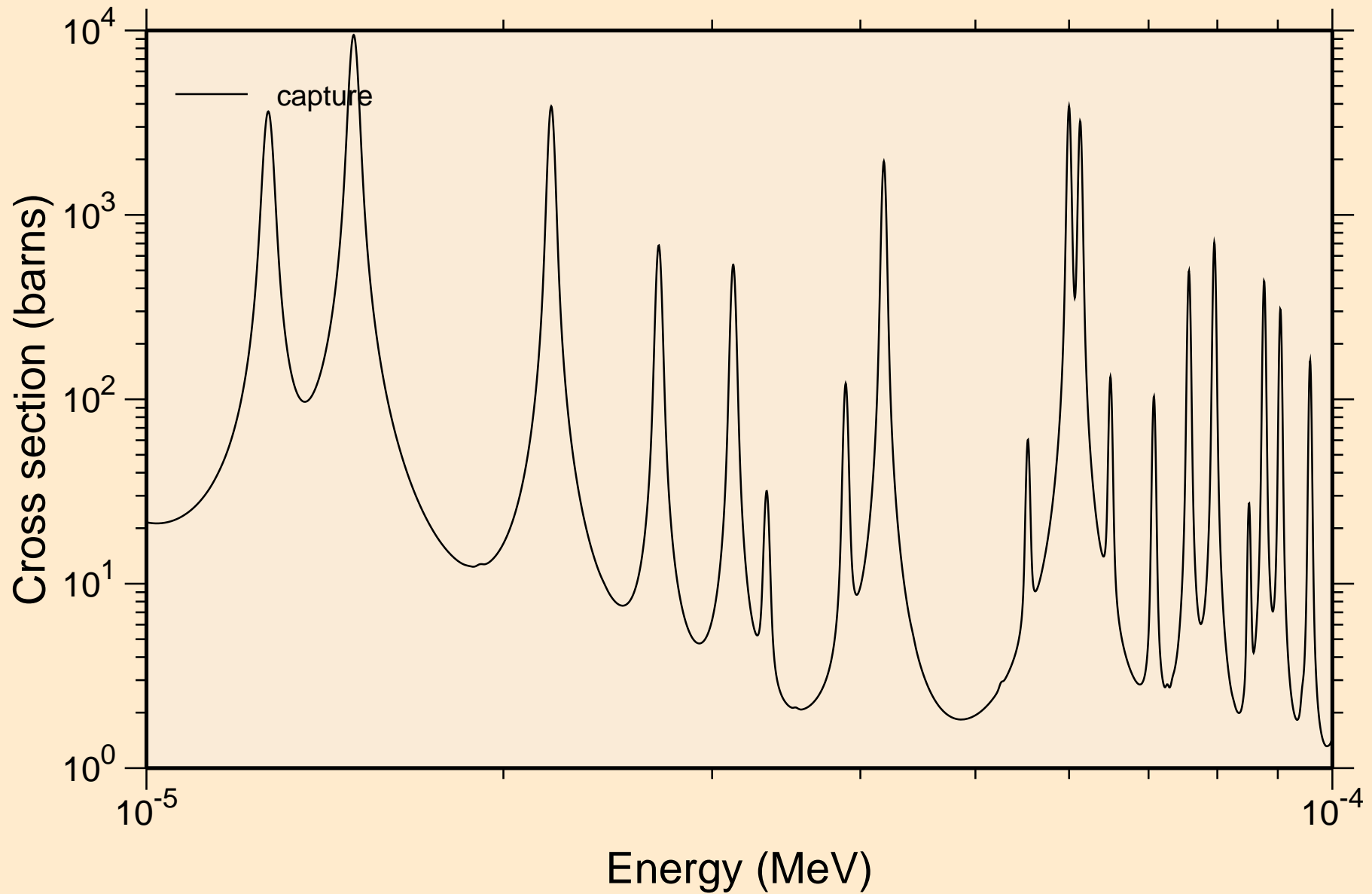

ND132 NEUTRON ACER TENDL-2021 LIBRARY; T=293.6K
resonance absorption cross sections

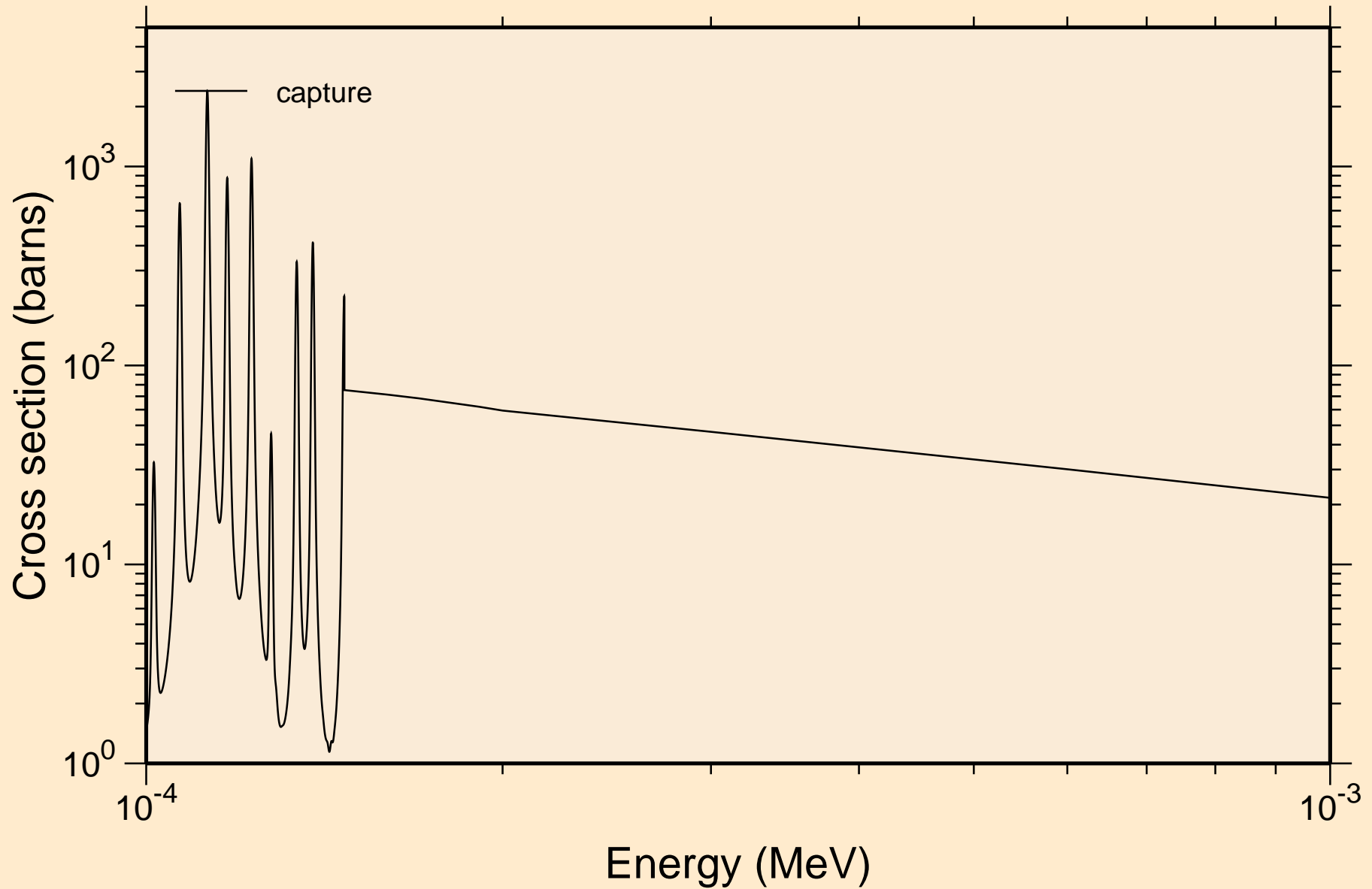

ND132 NEUTRON ACER TENDL-2021 LIBRARY; T=293.6K
resonance absorption cross sections

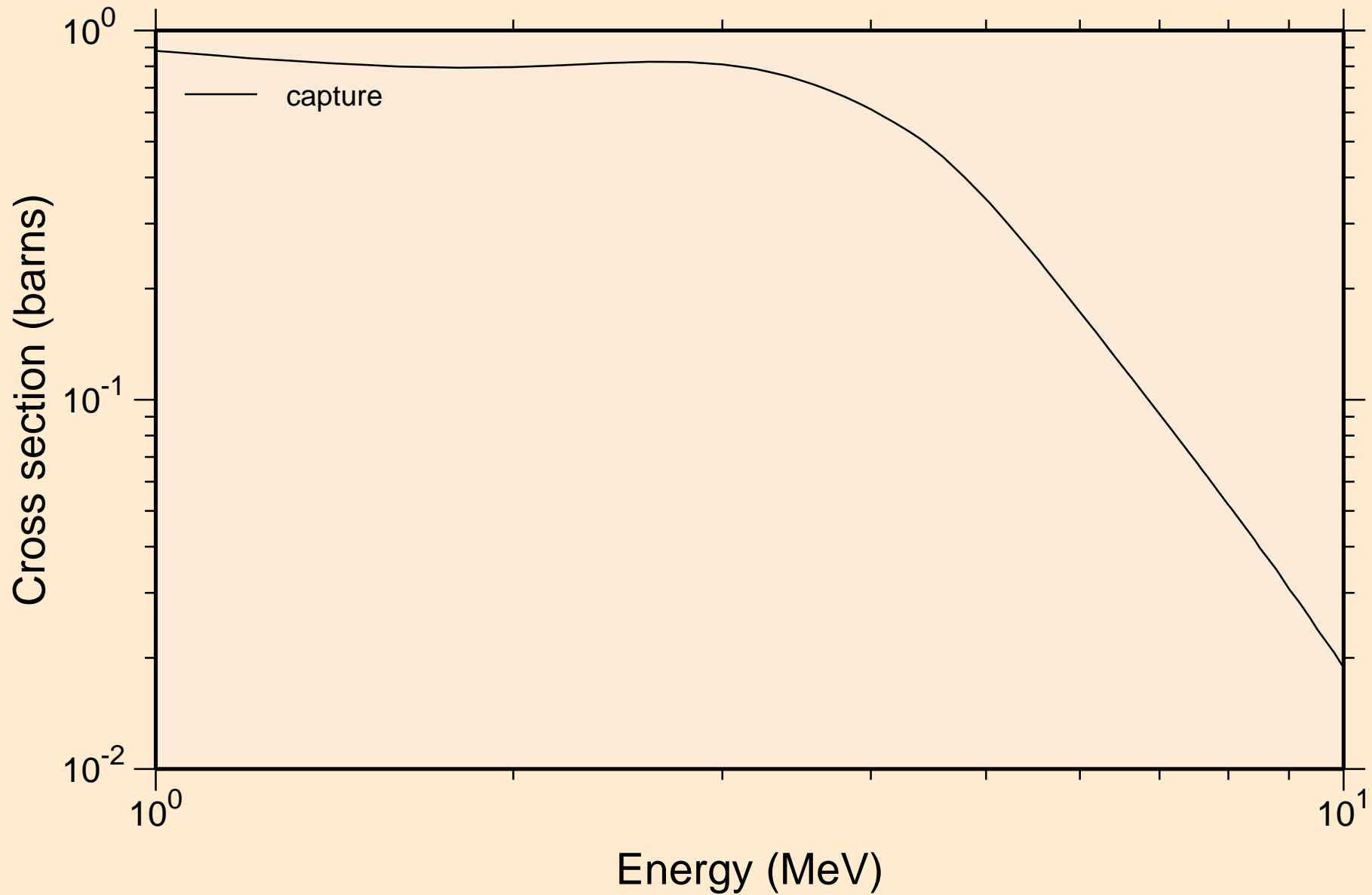

ND132 NEUTRON ACER TENDL-2021 LIBRARY; T=293.6K
Heating

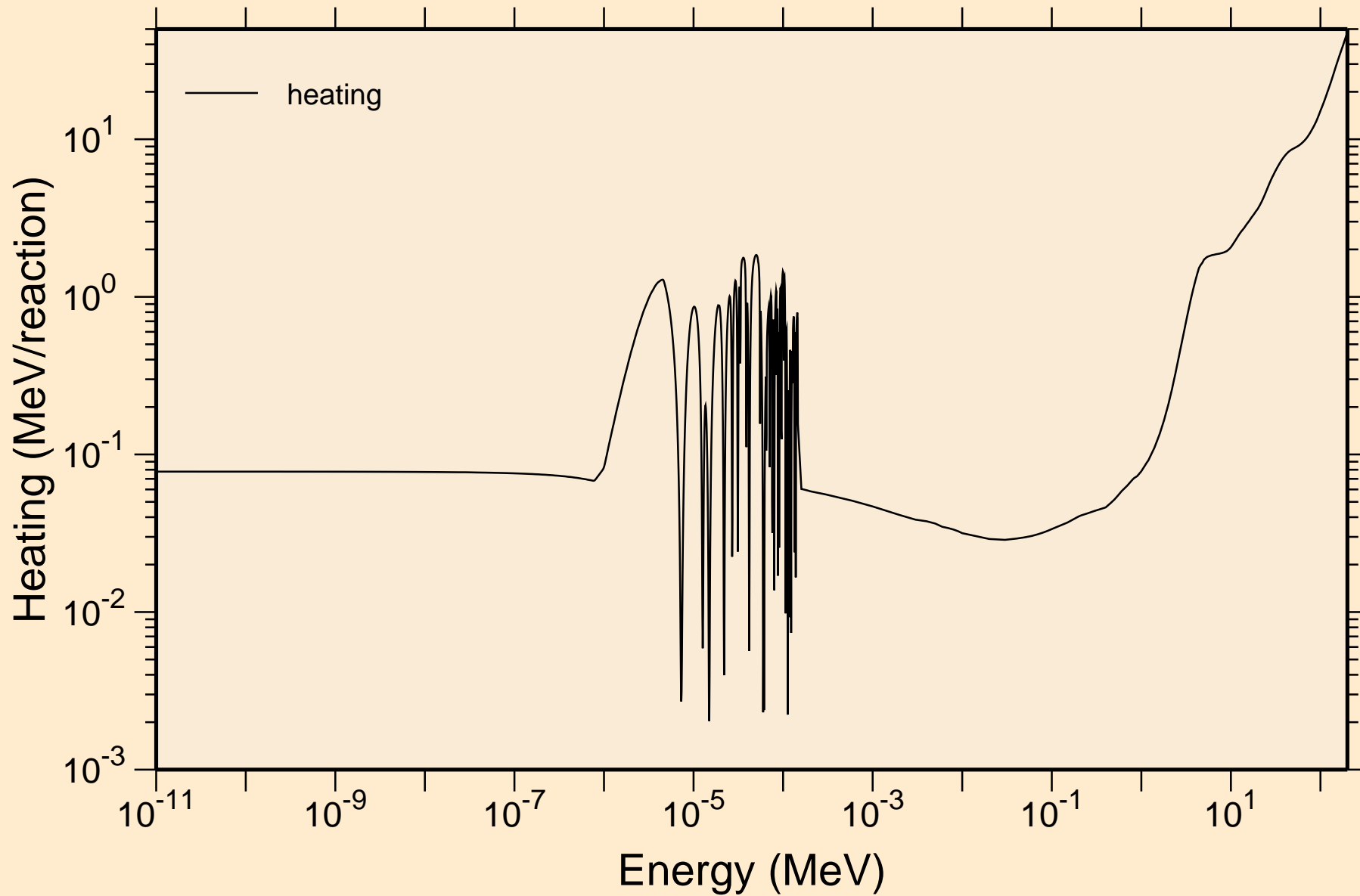

ND132 NEUTRON ACER TENDL-2021 LIBRARY; T=293.6K
Damage

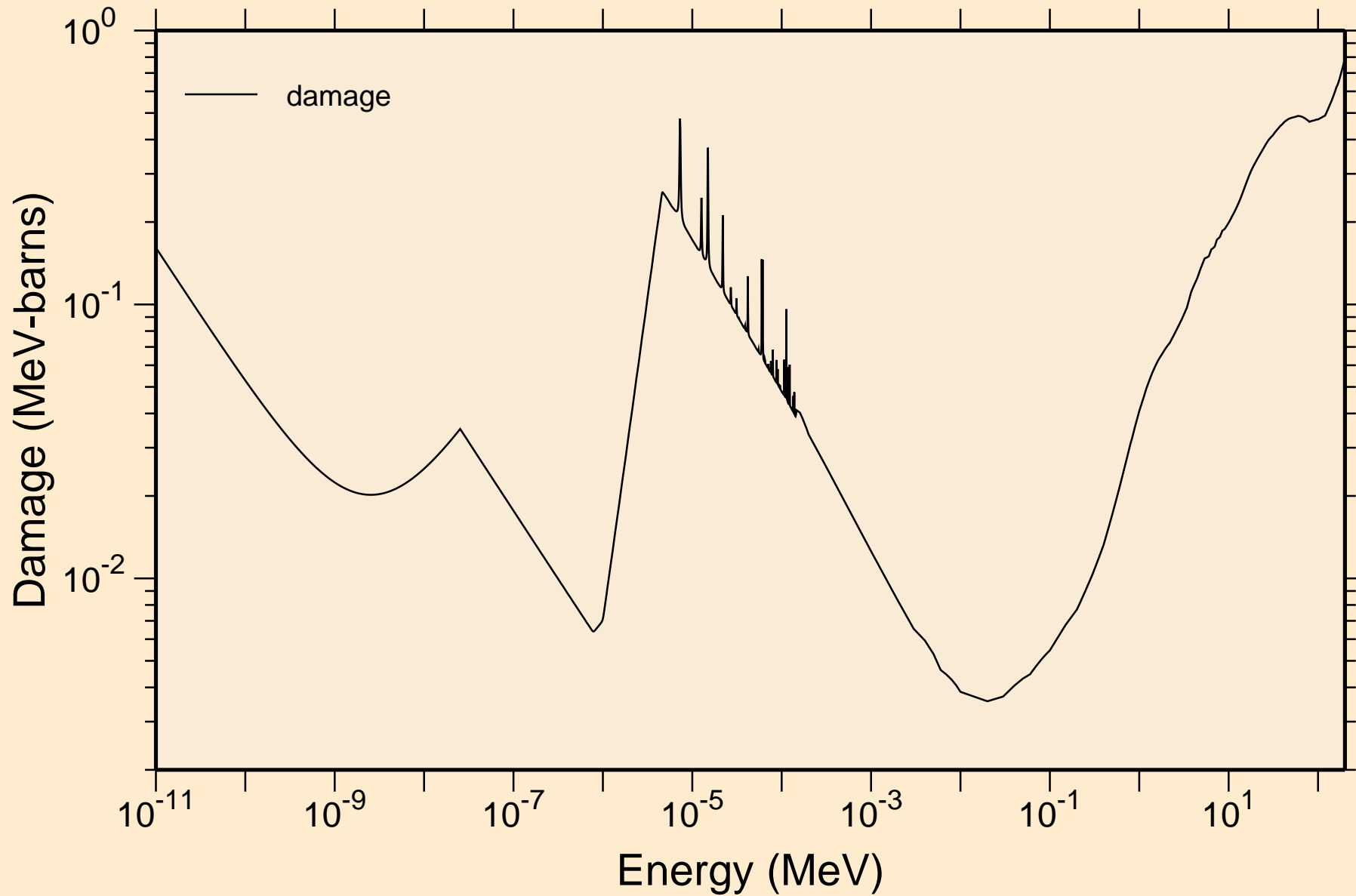

ND132 NEUTRON ACER TENDL-2021 LIBRARY; T=293.6K

Non-threshold reactions

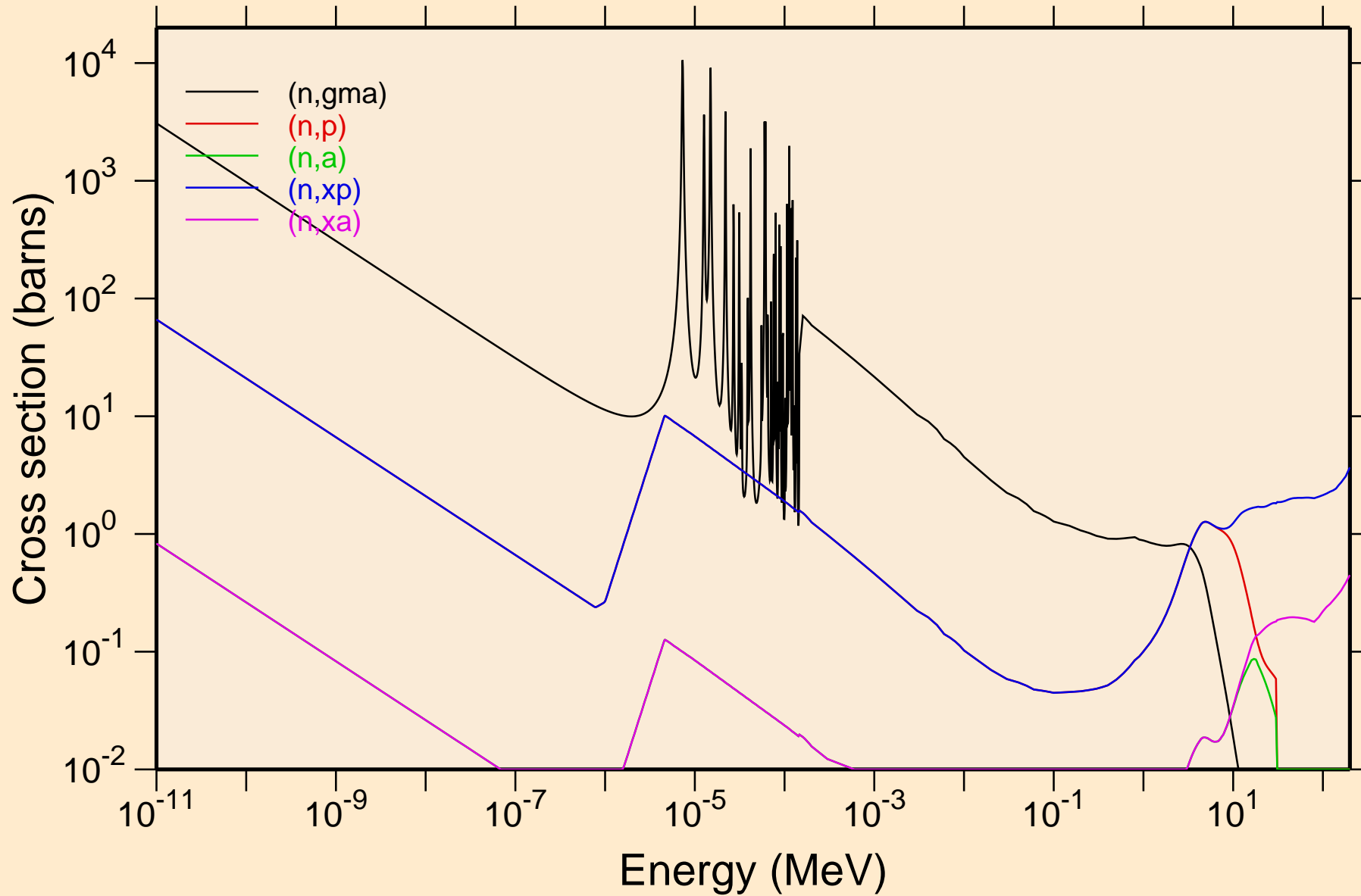

ND132 NEUTRON ACER TENDL-2021 LIBRARY; T=293.6K

Principal cross sections

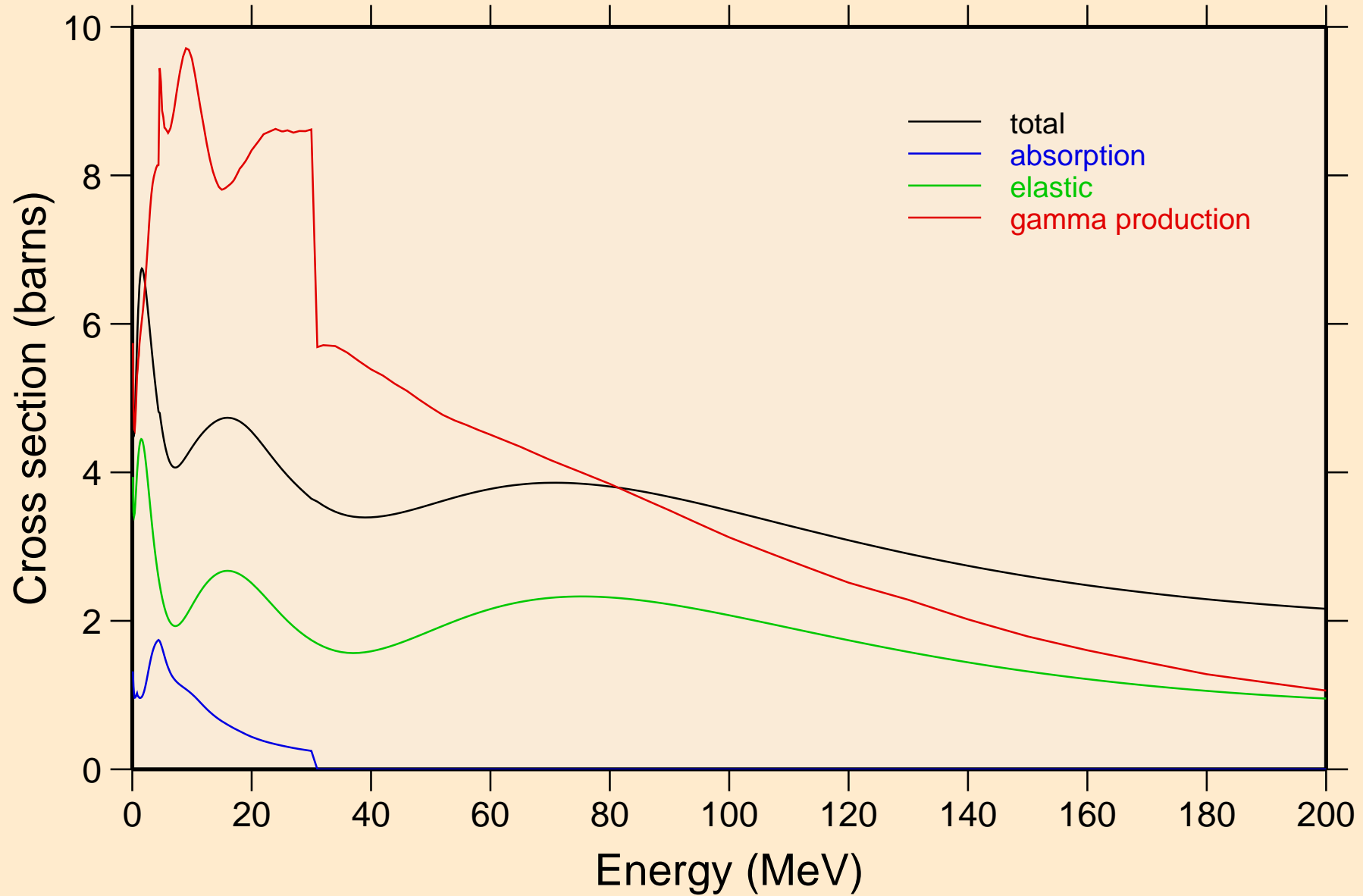

ND132 NEUTRON ACER TENDL-2021 LIBRARY; T=293.6K
Heating

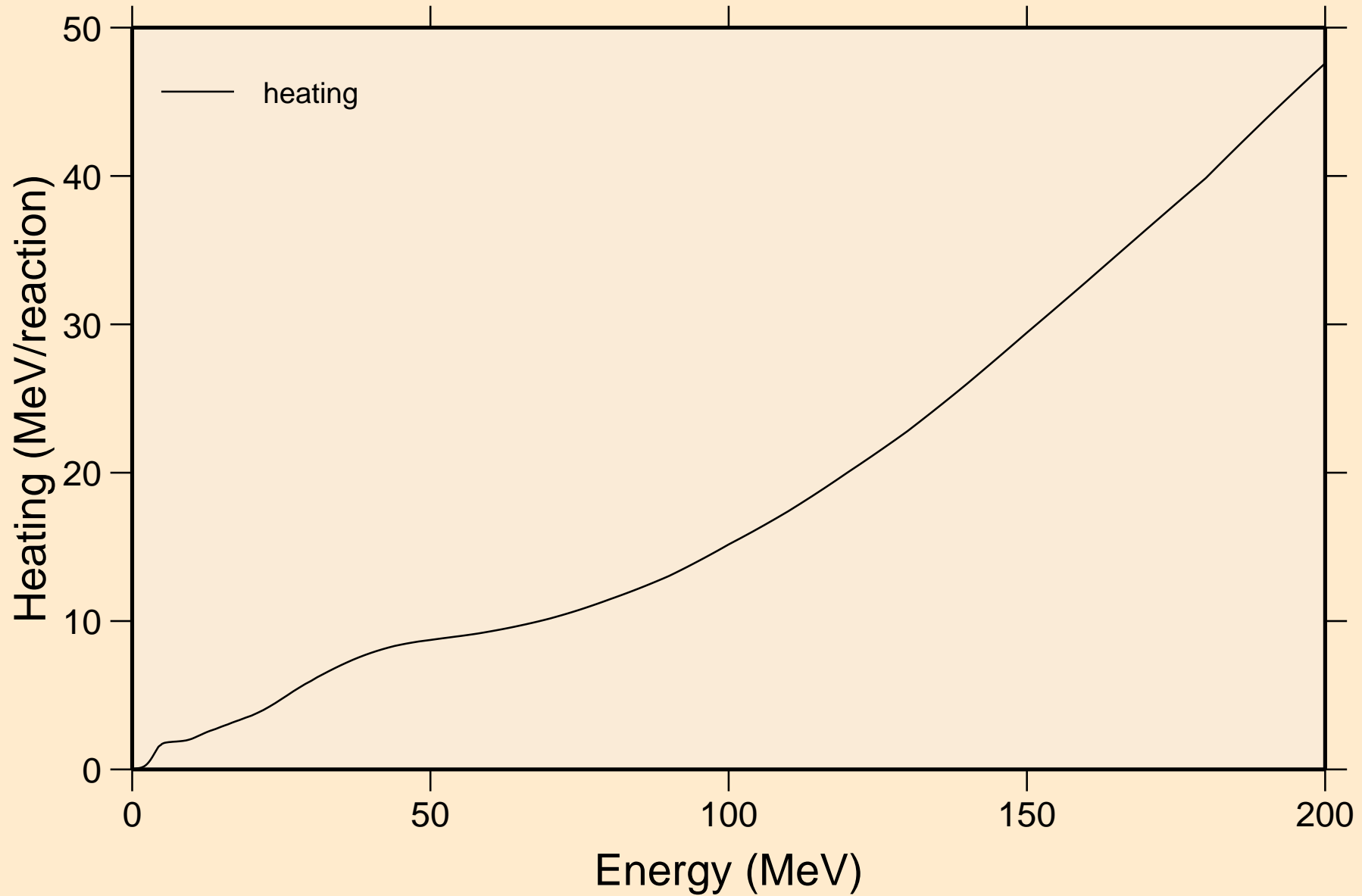

ND132 NEUTRON ACER TENDL-2021 LIBRARY; T=293.6K

Damage

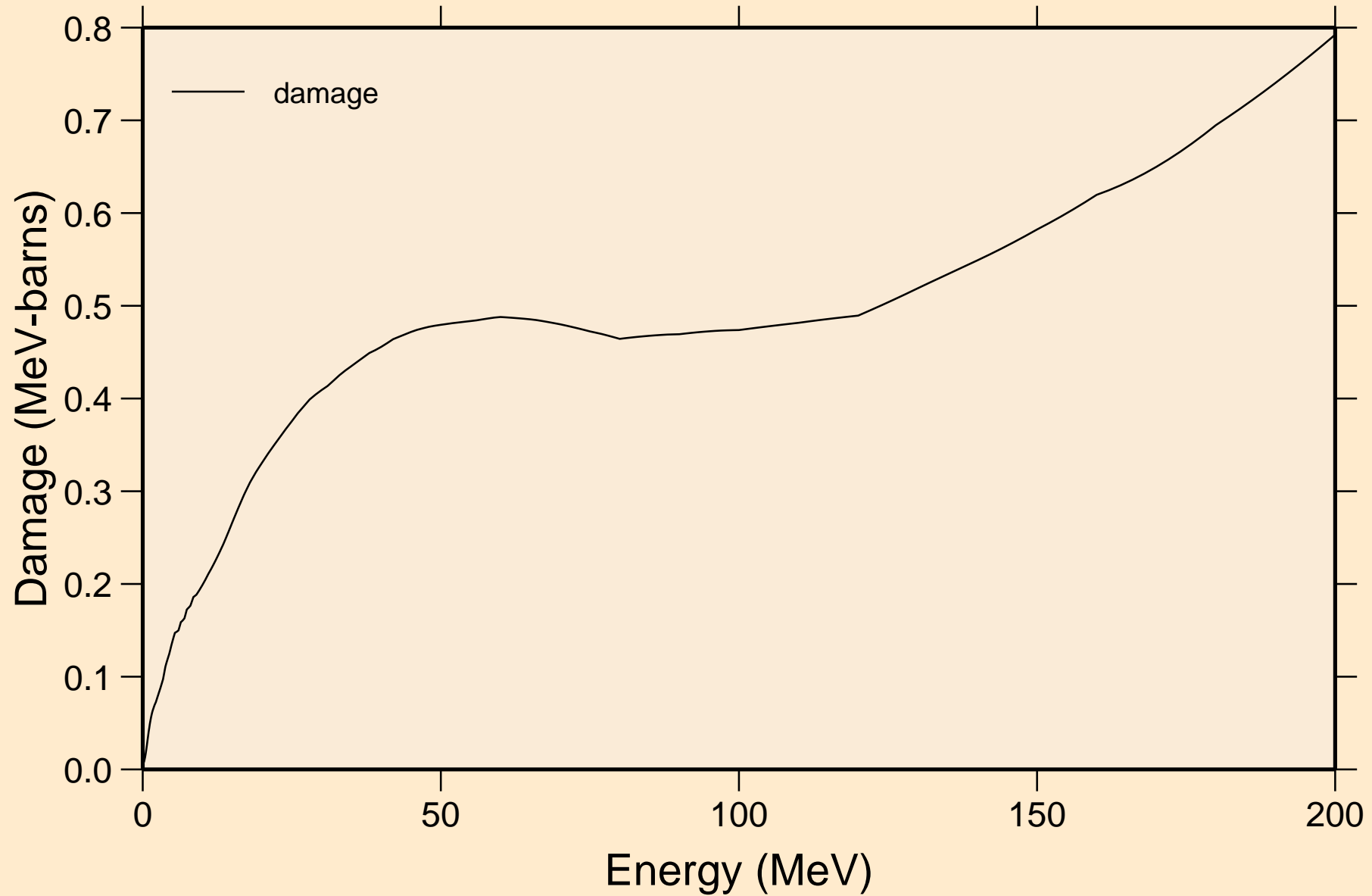

ND132 NEUTRON ACER TENDL-2021 LIBRARY; T=293.6K
Non-threshold reactions

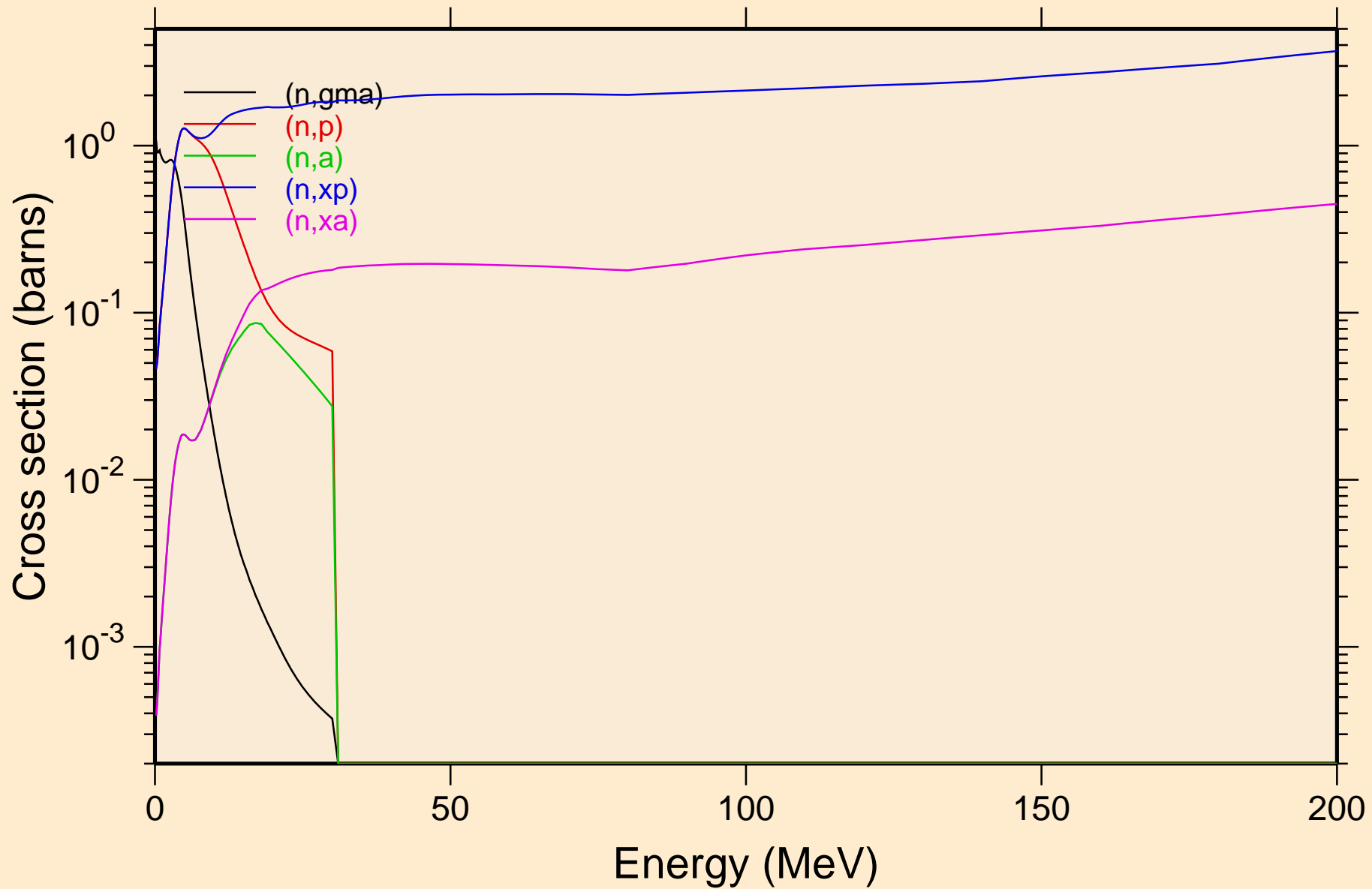

ND132 NEUTRON ACER TENDL-2021 LIBRARY; T=293.6K
Inelastic levels

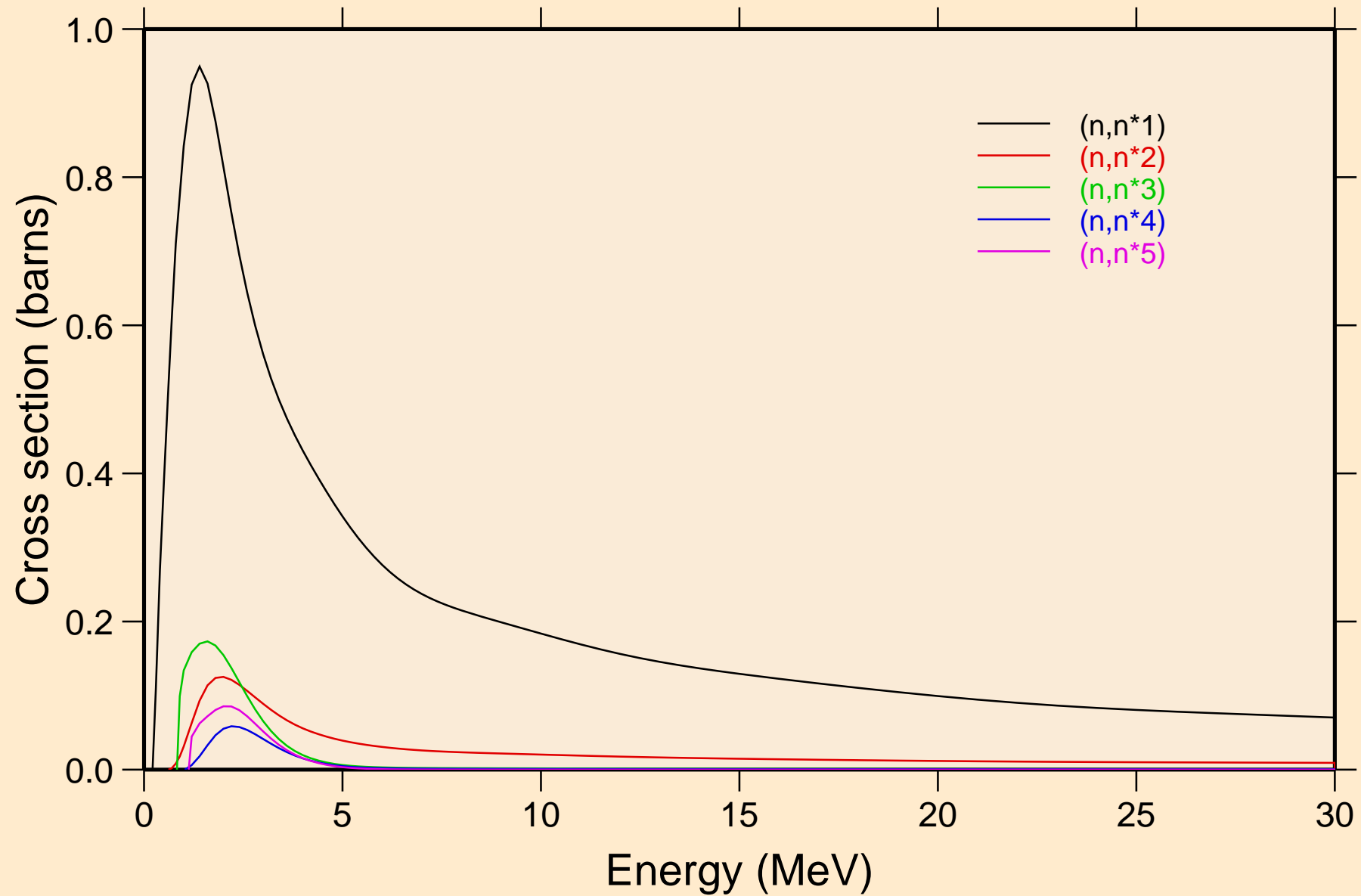

ND132 NEUTRON ACER TENDL-2021 LIBRARY; T=293.6K
Inelastic levels

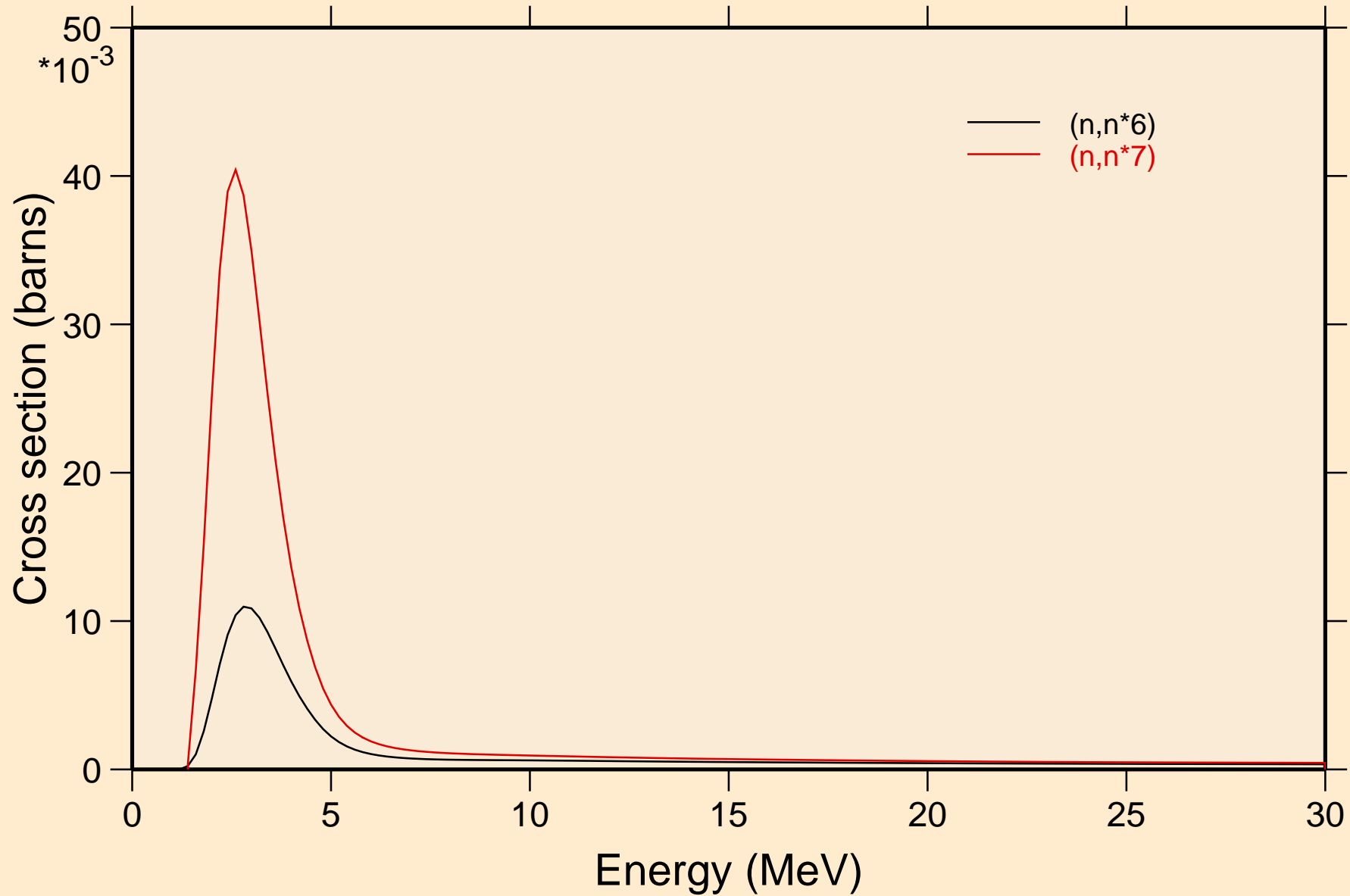

ND132 NEUTRON ACER TENDL-2021 LIBRARY; T=293.6K

Threshold reactions

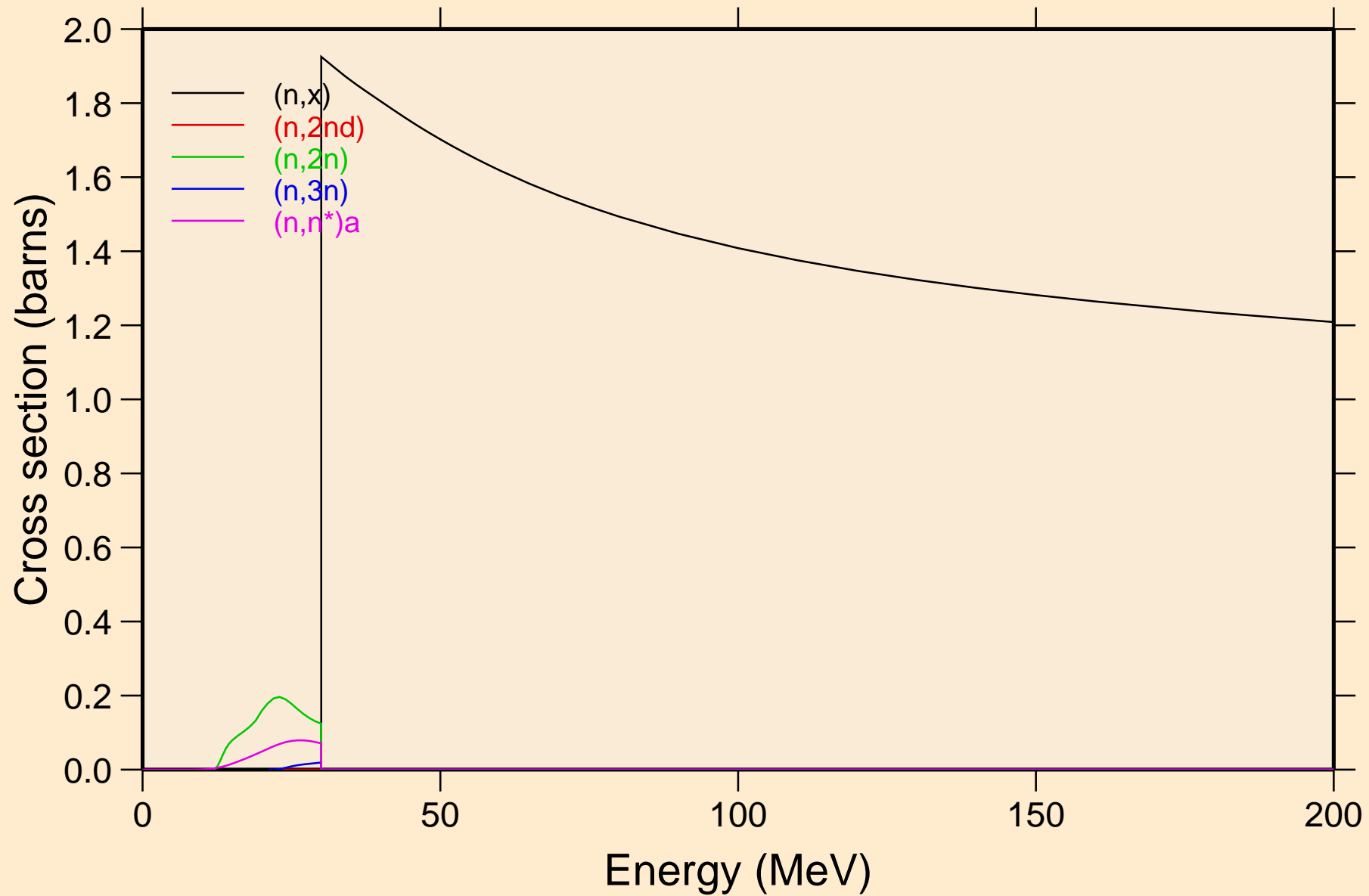

ND132 NEUTRON ACER TENDL-2021 LIBRARY; T=293.6K
Threshold reactions

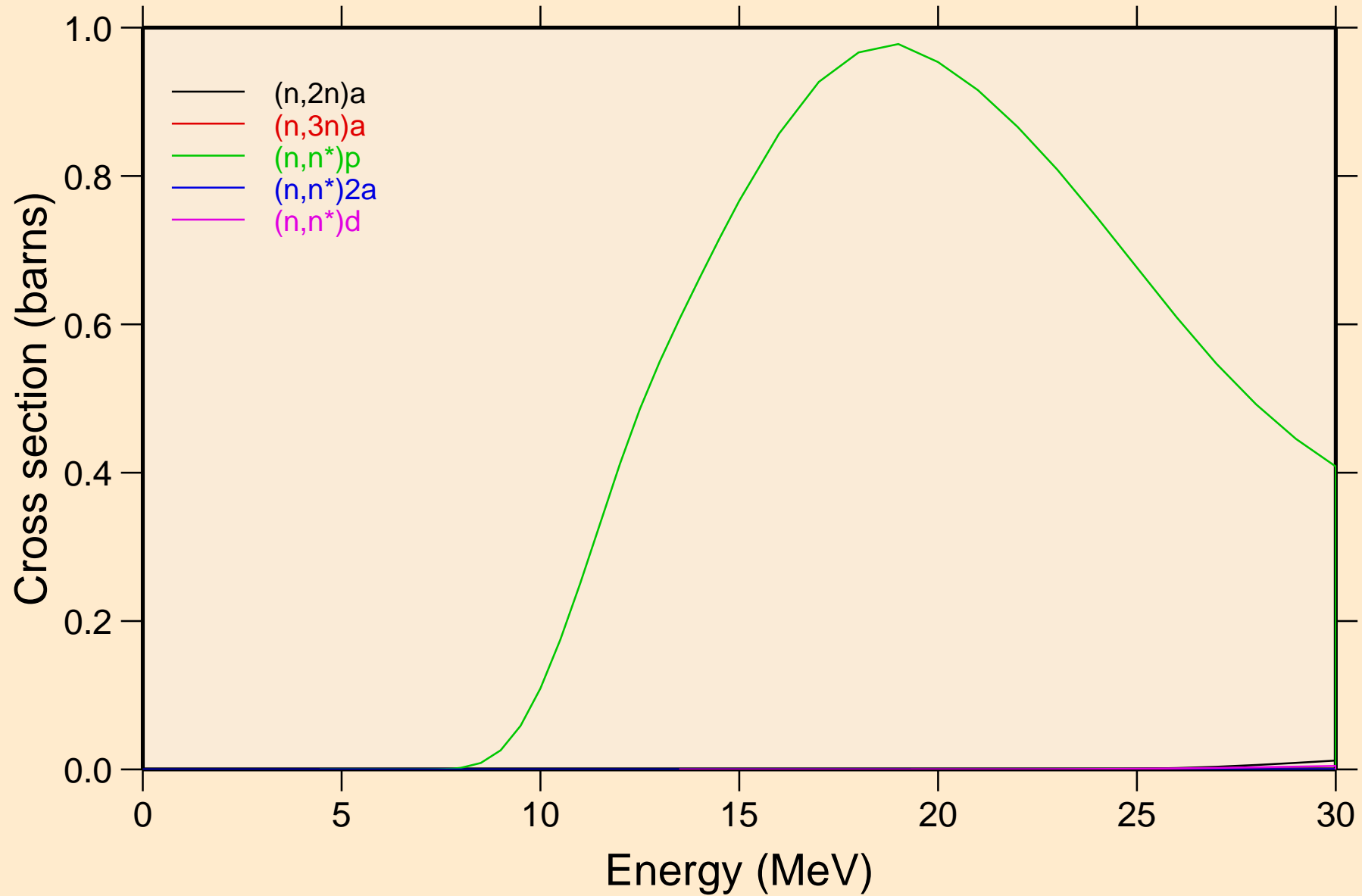

ND132 NEUTRON ACER TENDL-2021 LIBRARY; T=293.6K

Threshold reactions

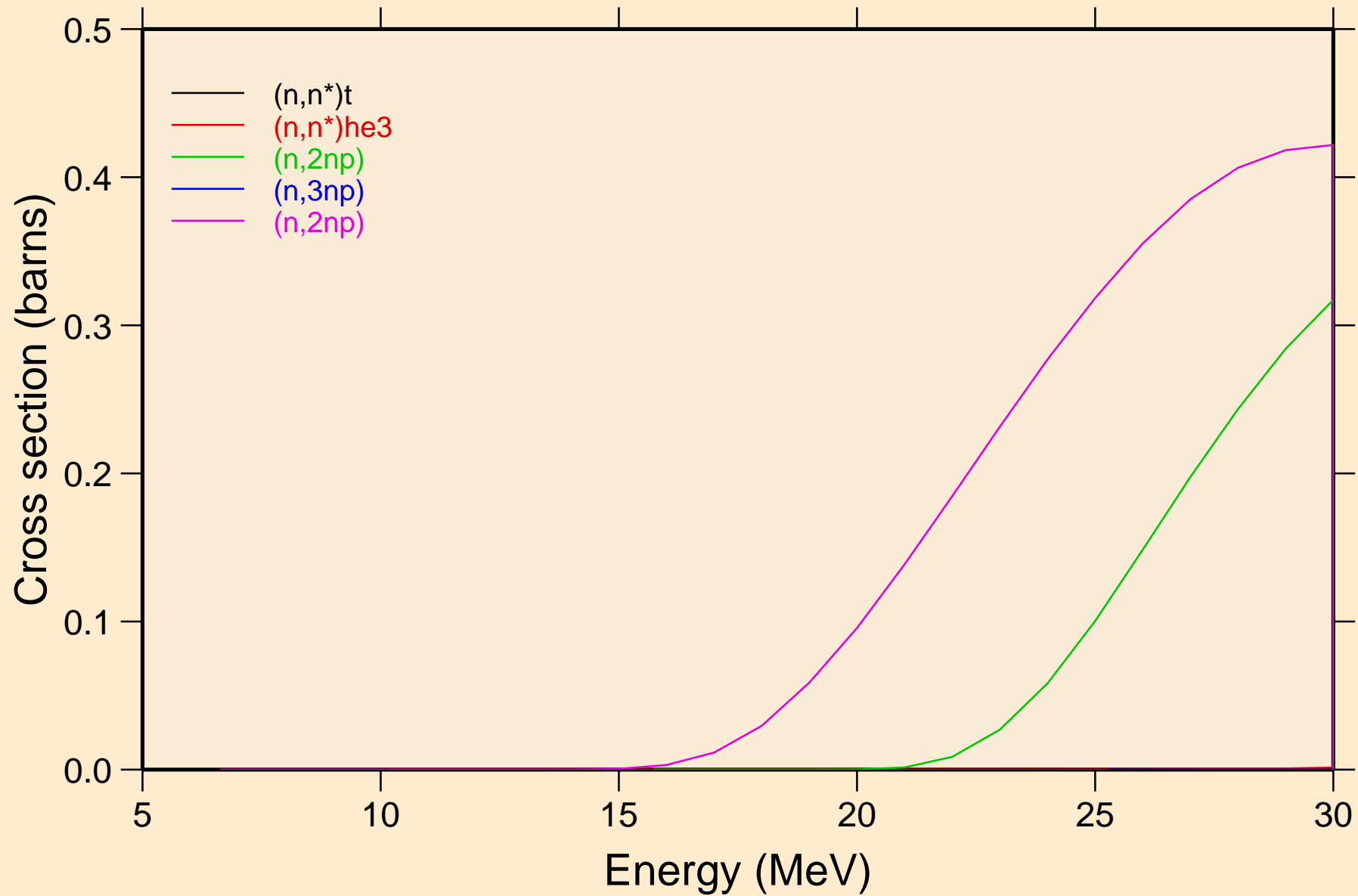

ND132 NEUTRON ACER TENDL-2021 LIBRARY; T=293.6K

Threshold reactions

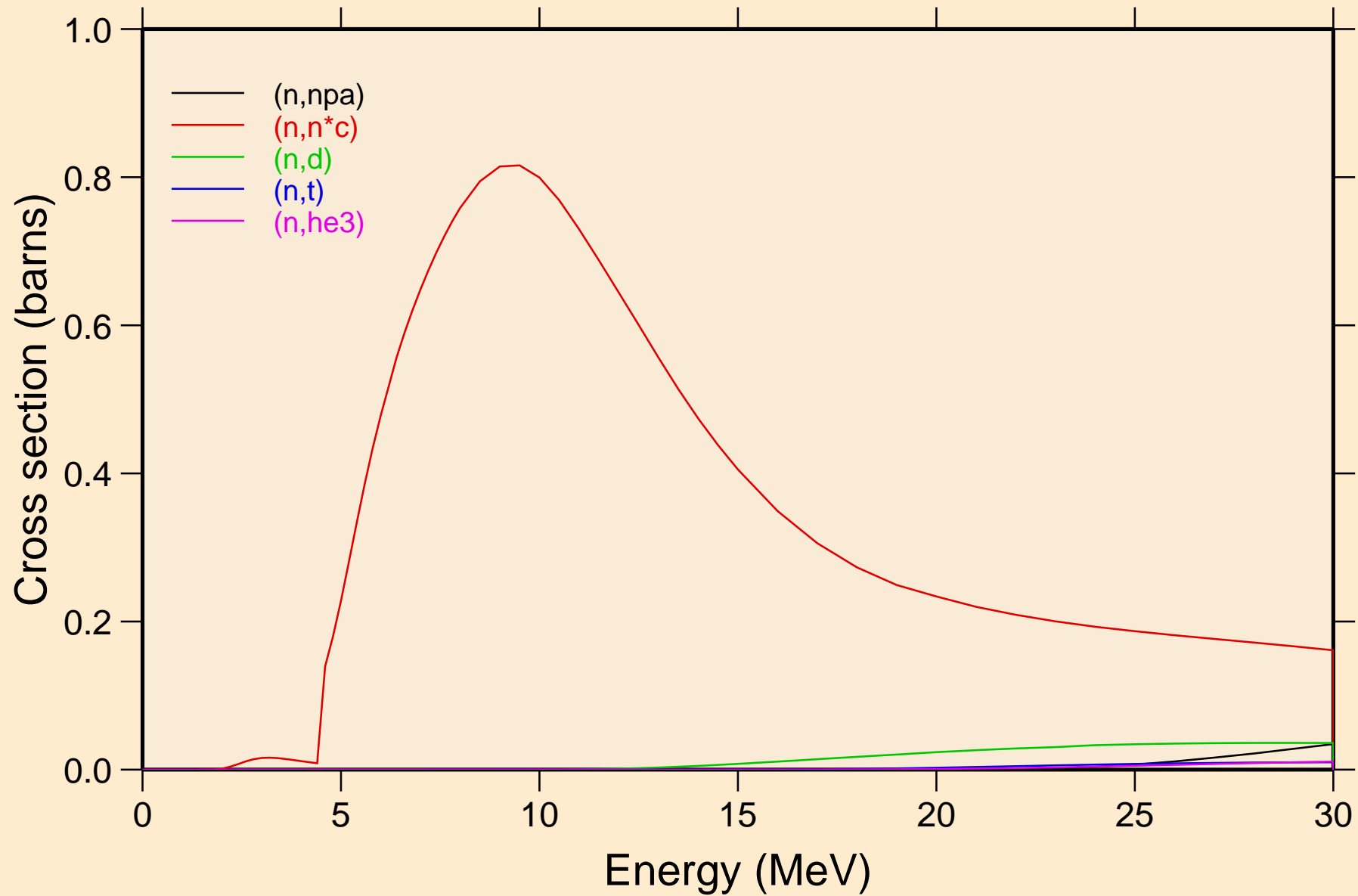

ND132 NEUTRON ACER TENDL-2021 LIBRARY; T=293.6K

Threshold reactions

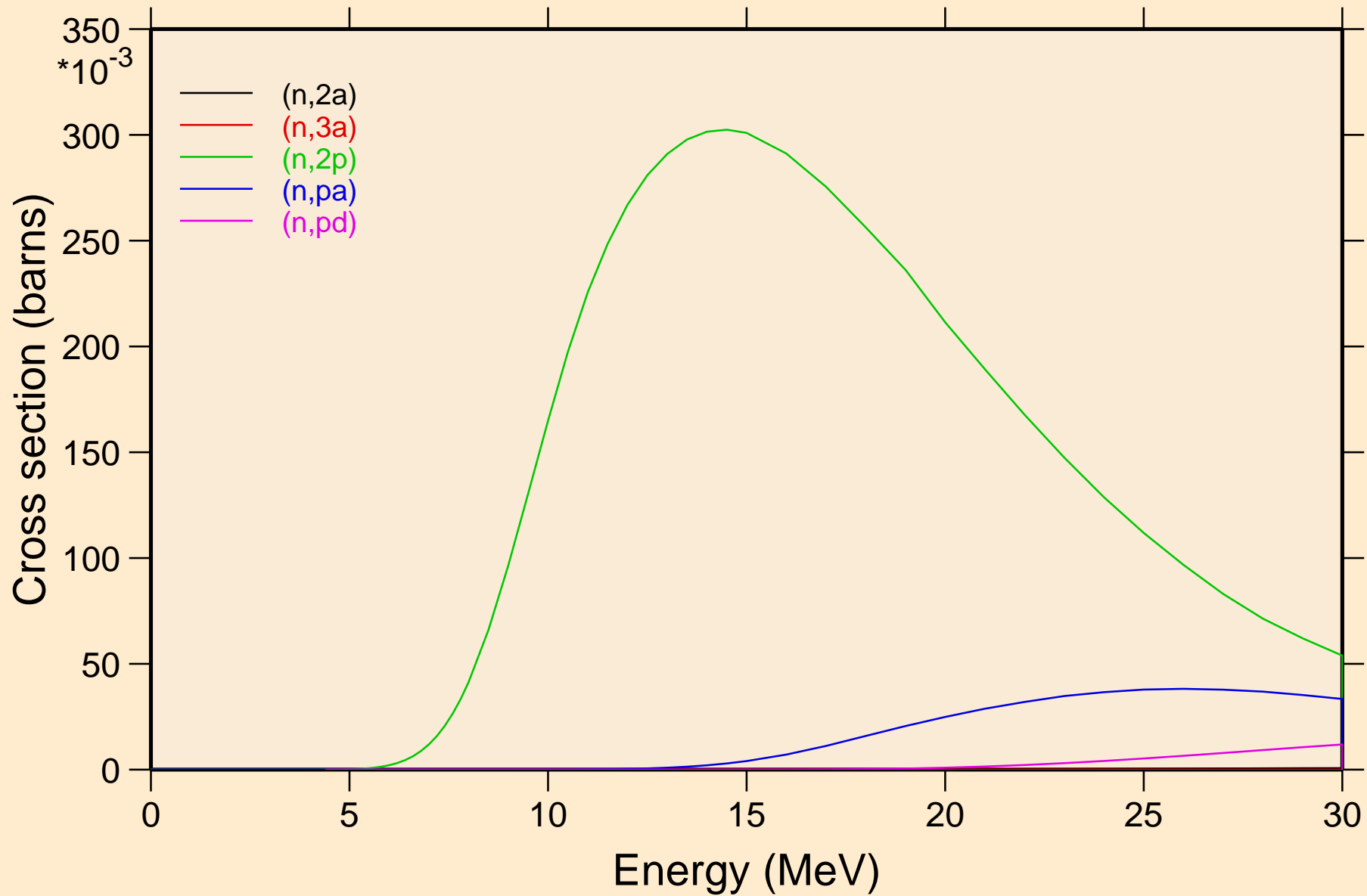

ND132 NEUTRON ACER TENDL-2021 LIBRARY; T=293.6K
Threshold reactions

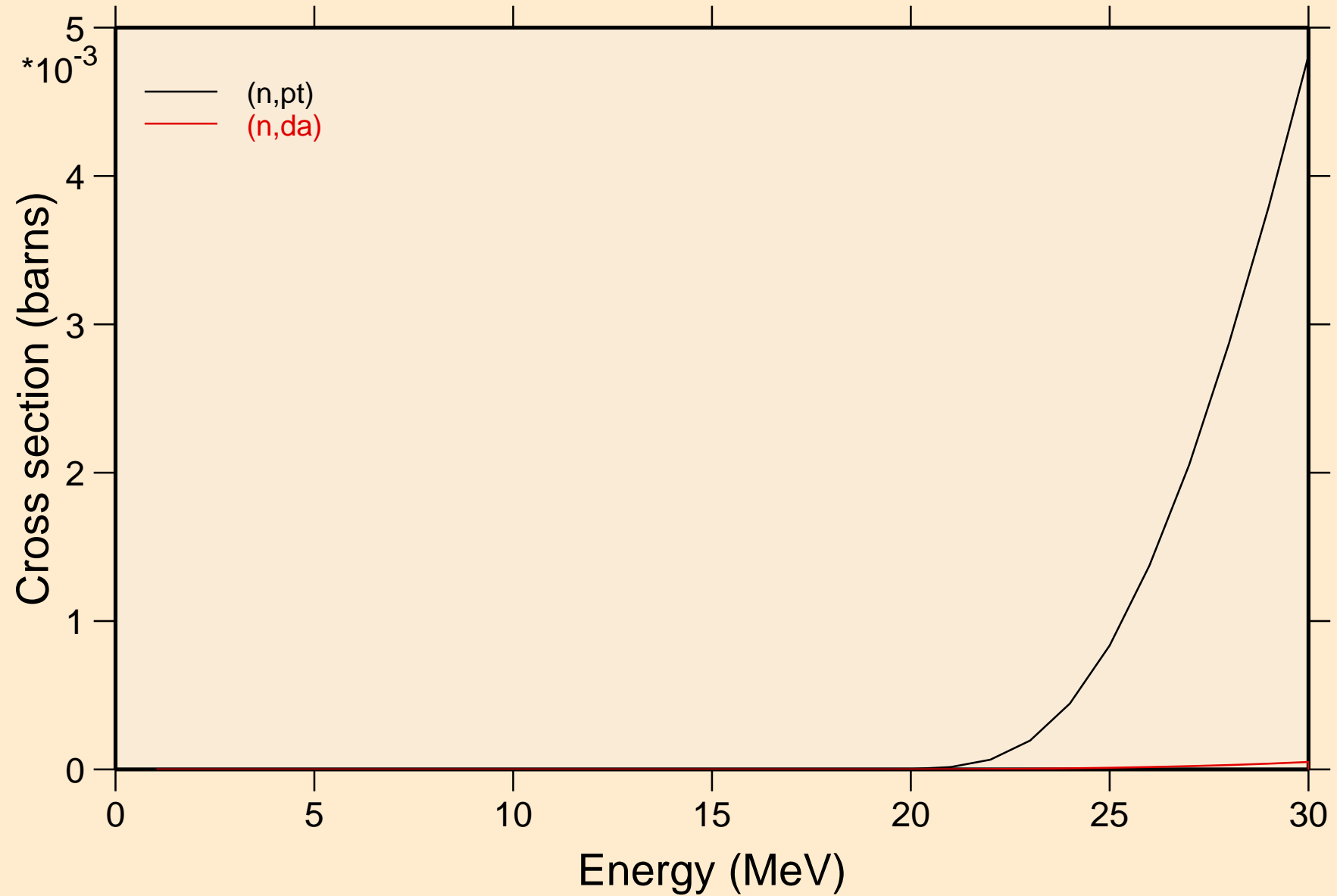

ND132 NEUTRON ACER TENDL-2021 LIBRARY; T=293.6K
Threshold reactions

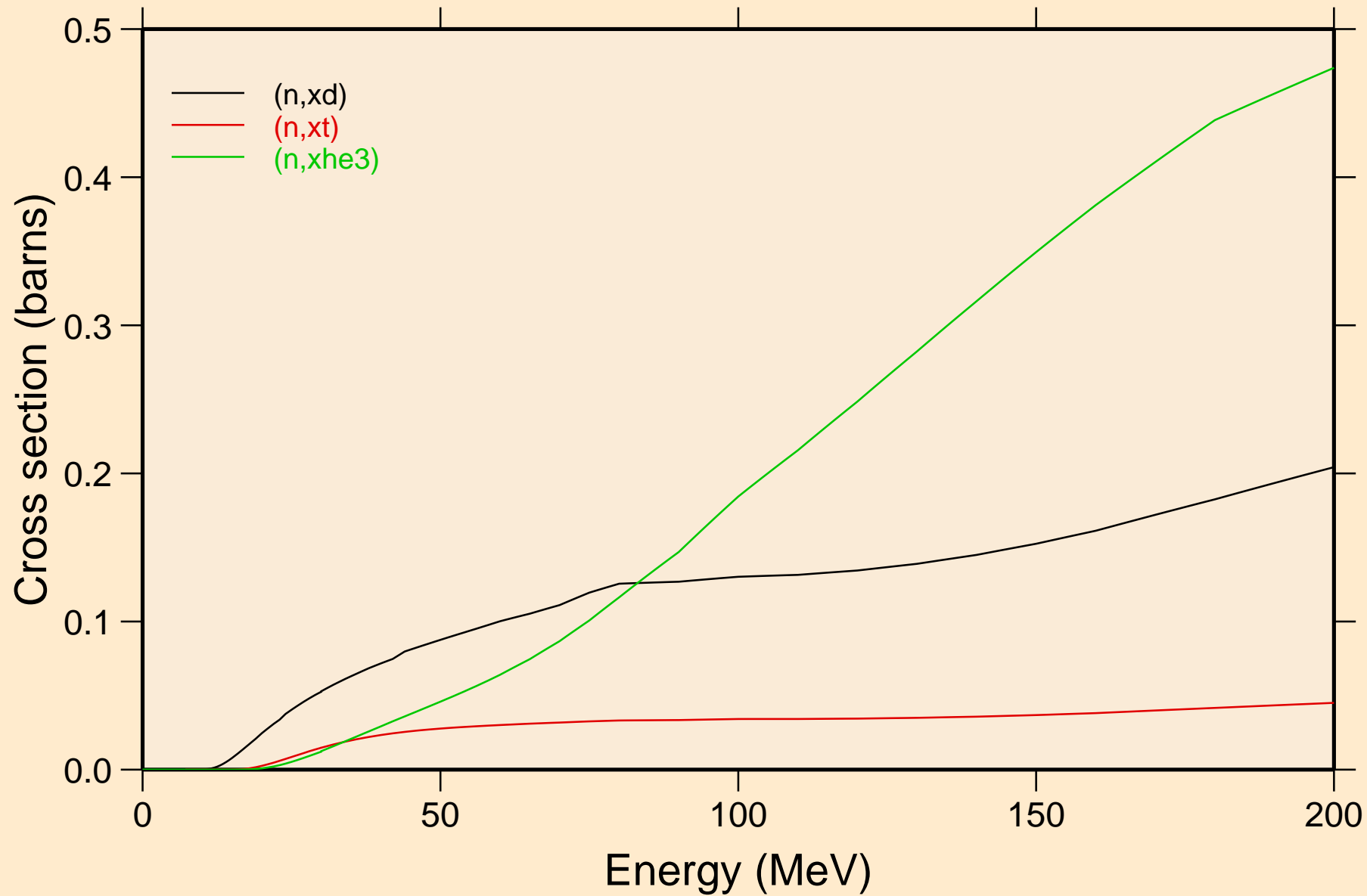

ND132 NEUTRON ACER TENDL-2021 LIBRARY; T=293.6K
angular distribution for elastic

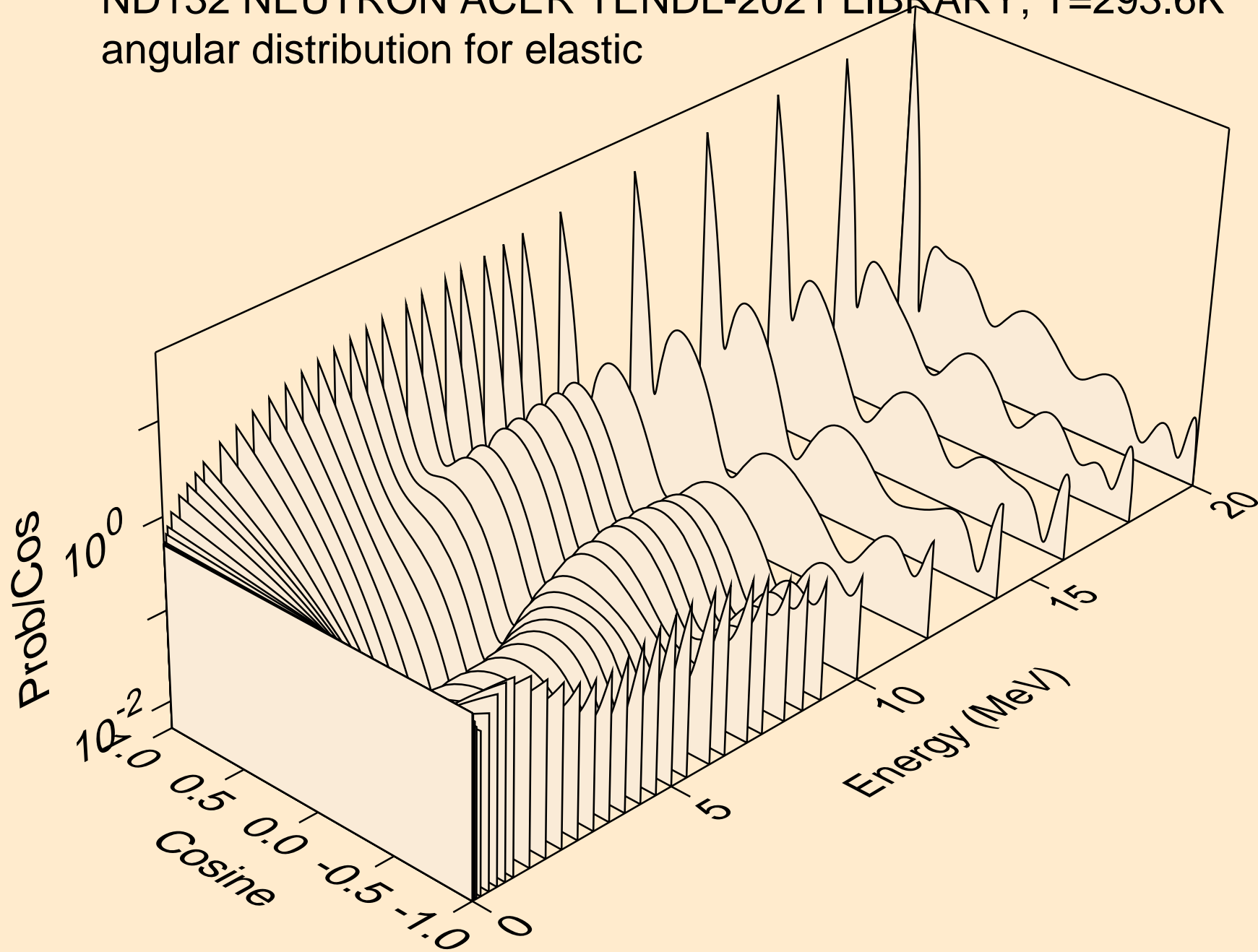

ND132 NEUTRON ACER TENDL-2021 LIBRARY; T=293.6K
angular distribution for elastic

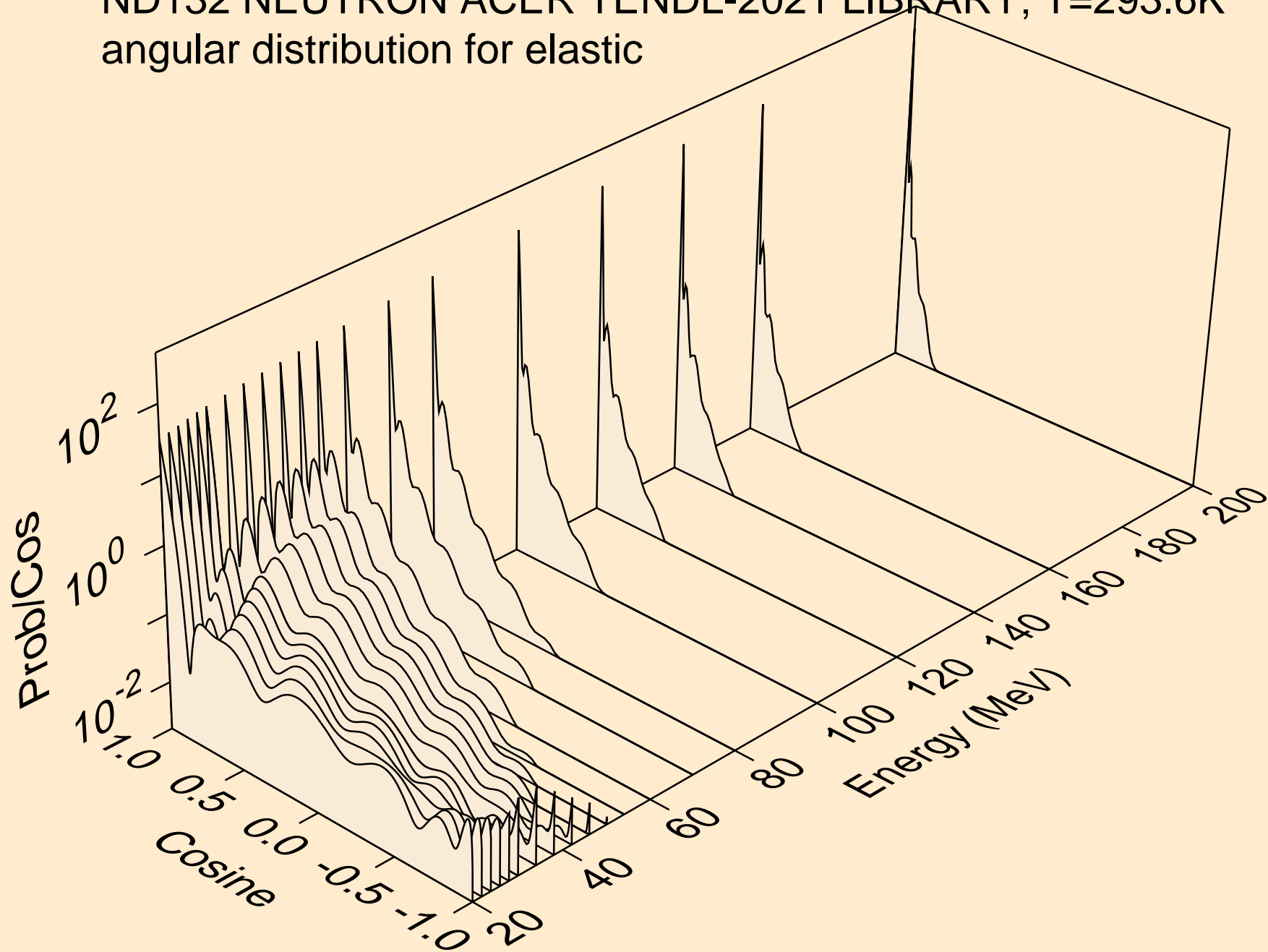

ND132 NEUTRON ACER TENDL-2021 LIBRARY; T=293.6K
angular distribution for (n,n*1)

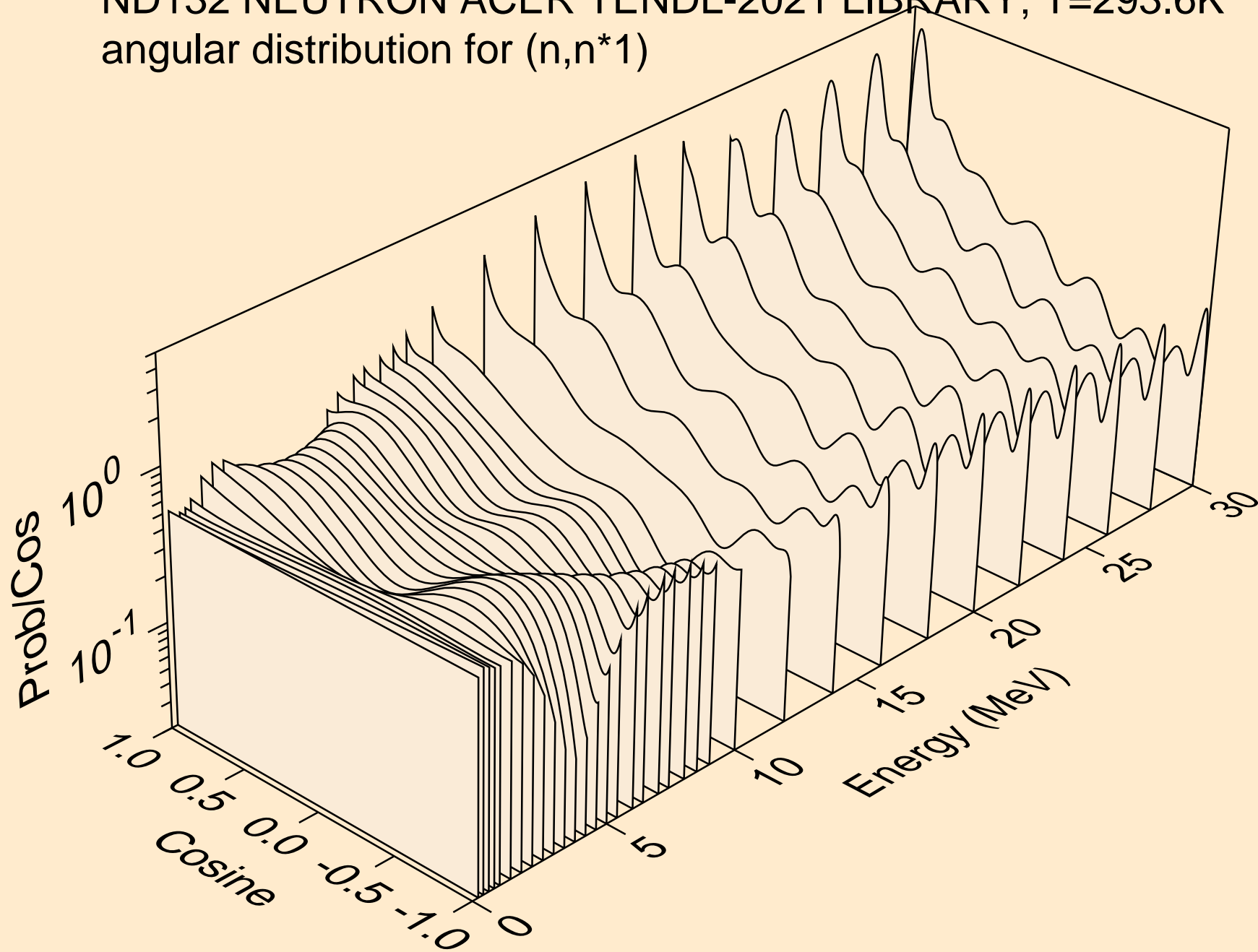

ND132 NEUTRON ACER TENDL-2021 LIBRARY; T=293.6K
angular distribution for (n,n*2)

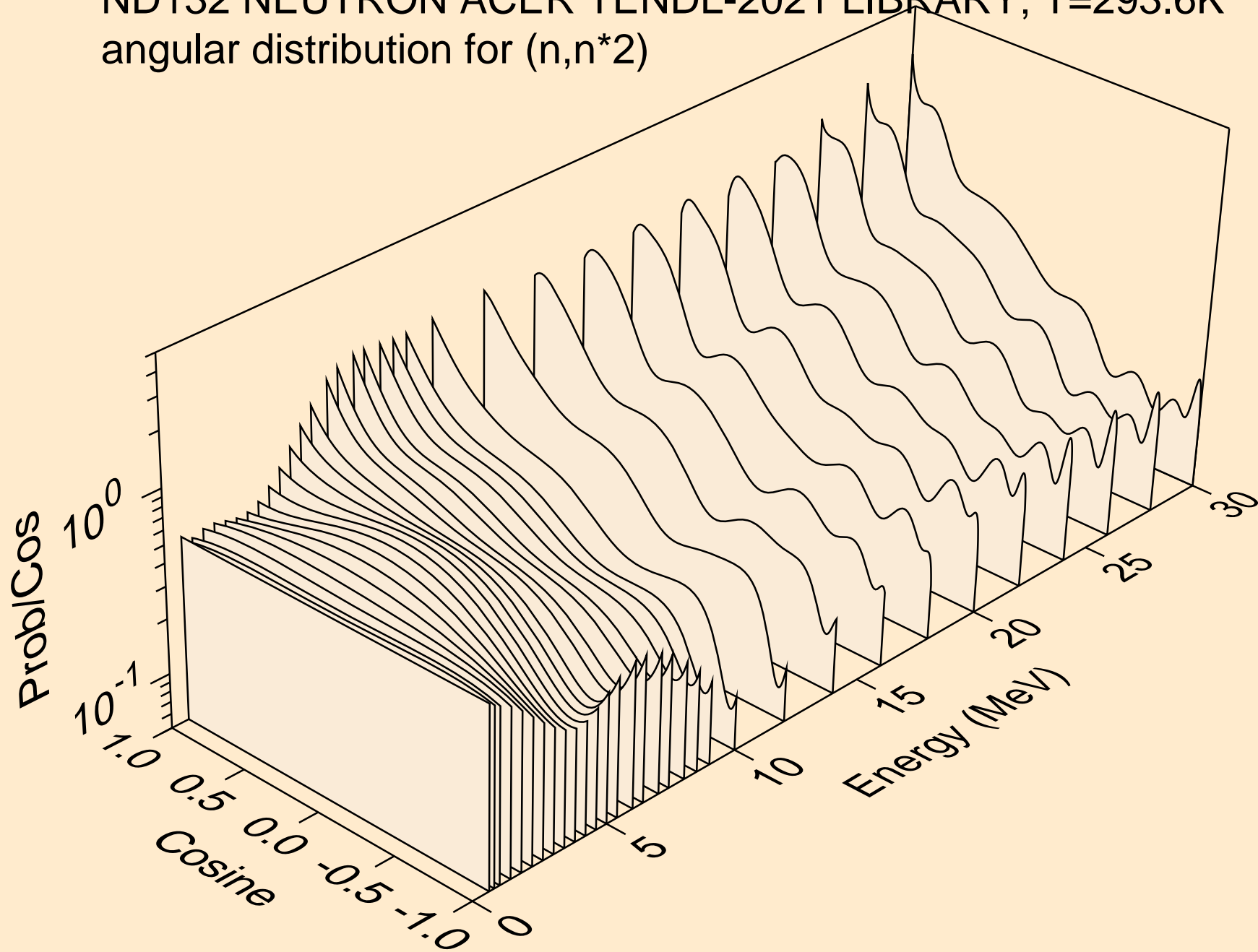

ND132 NEUTRON ACER TENDL-2021 LIBRARY; T=293.6K
angular distribution for (n,n*3)

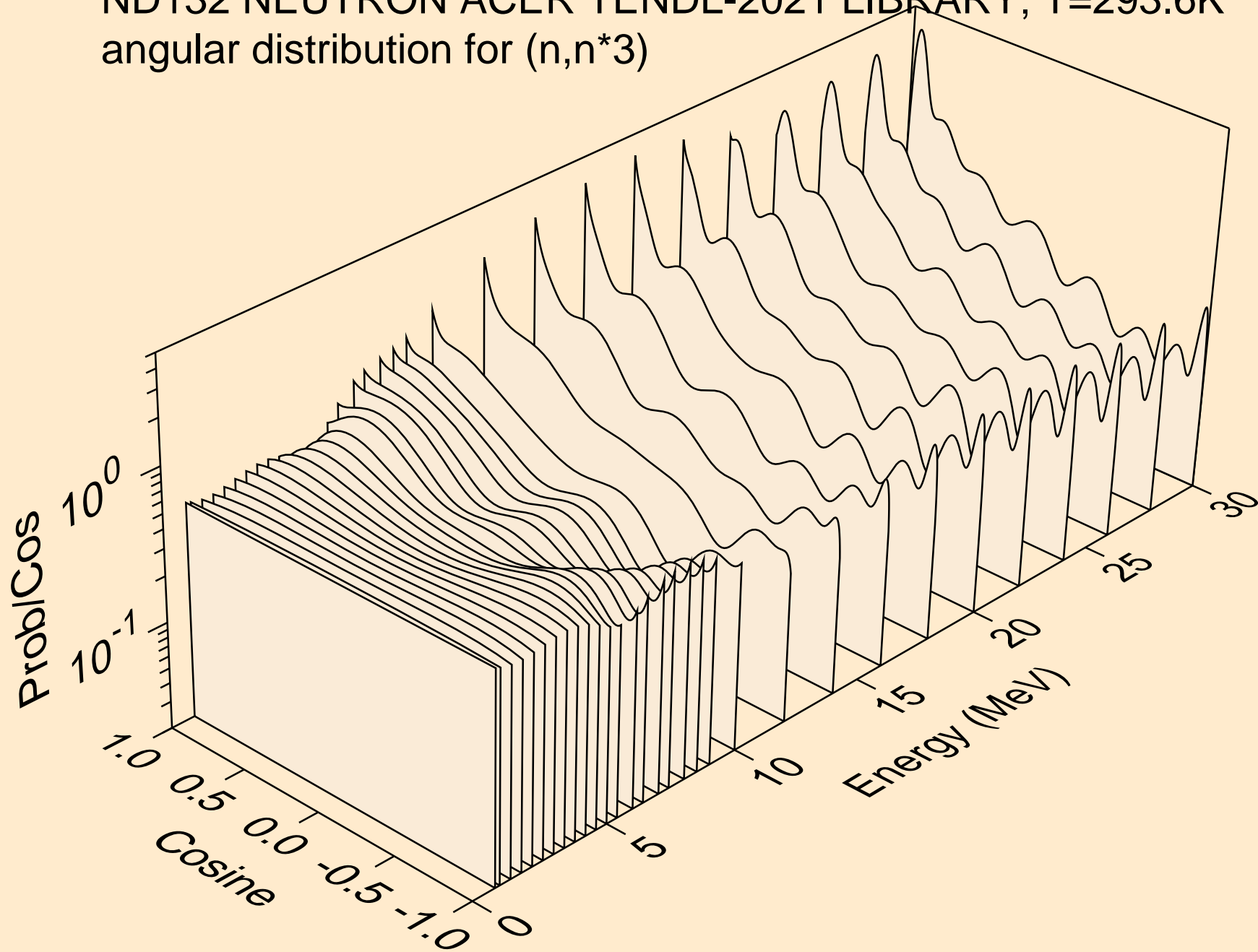

ND132 NEUTRON ACER TENDL-2021 LIBRARY; T=293.6K
angular distribution for (n,n*4)

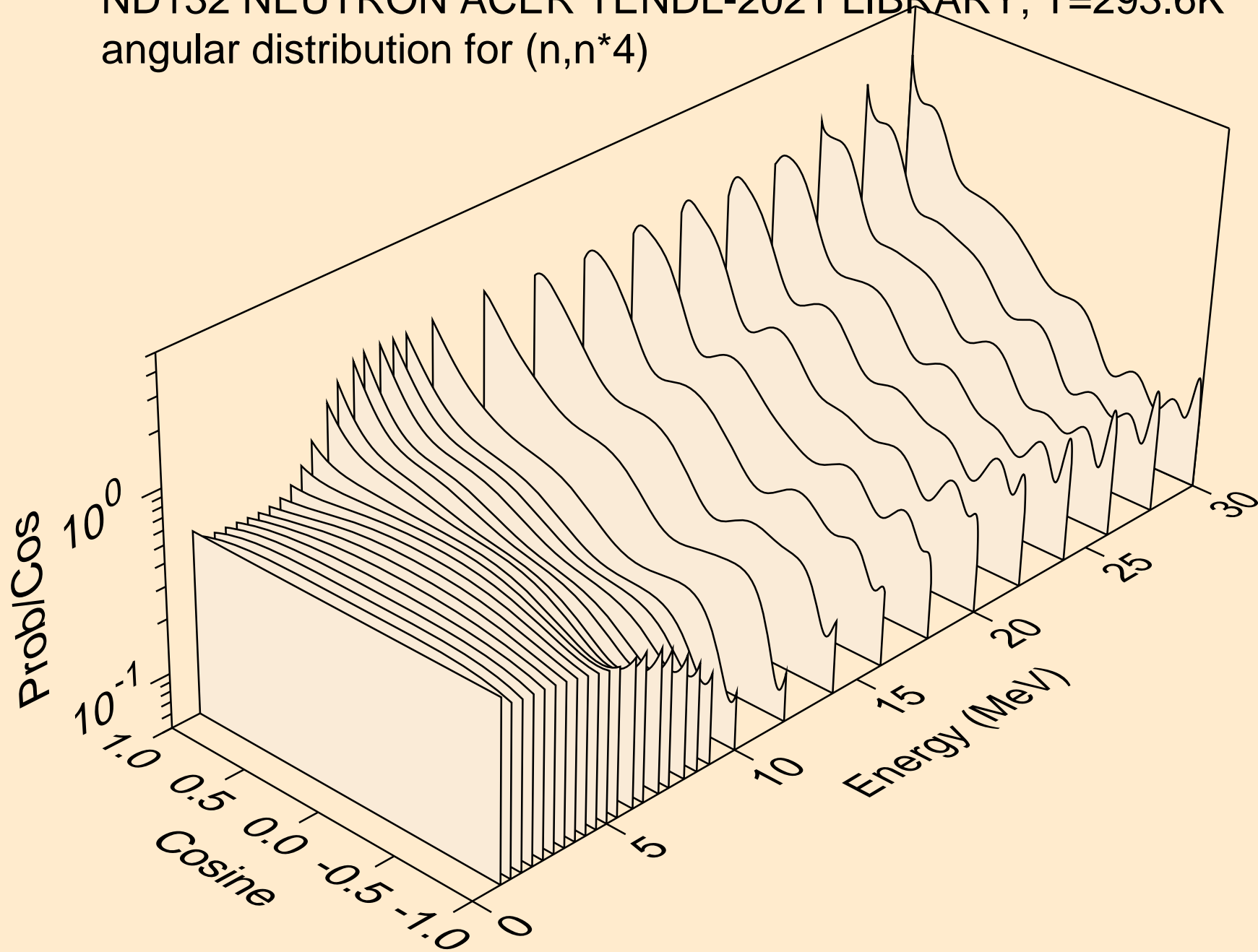

ND132 NEUTRON ACER TENDL-2021 LIBRARY; T=293.6K
angular distribution for (n,n*5)

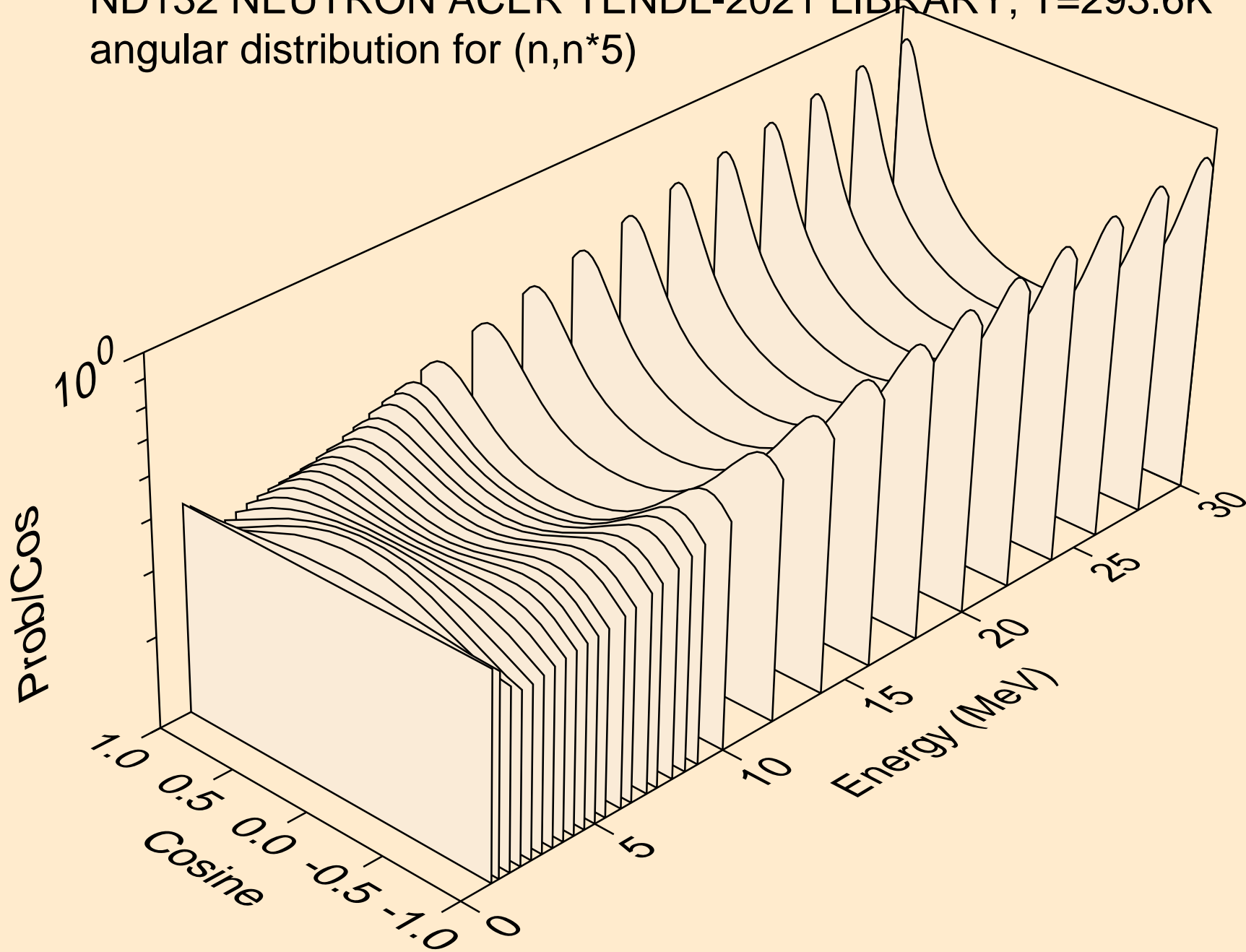

ND132 NEUTRON ACER TENDL-2021 LIBRARY; T=293.6K
angular distribution for (n,n*6)

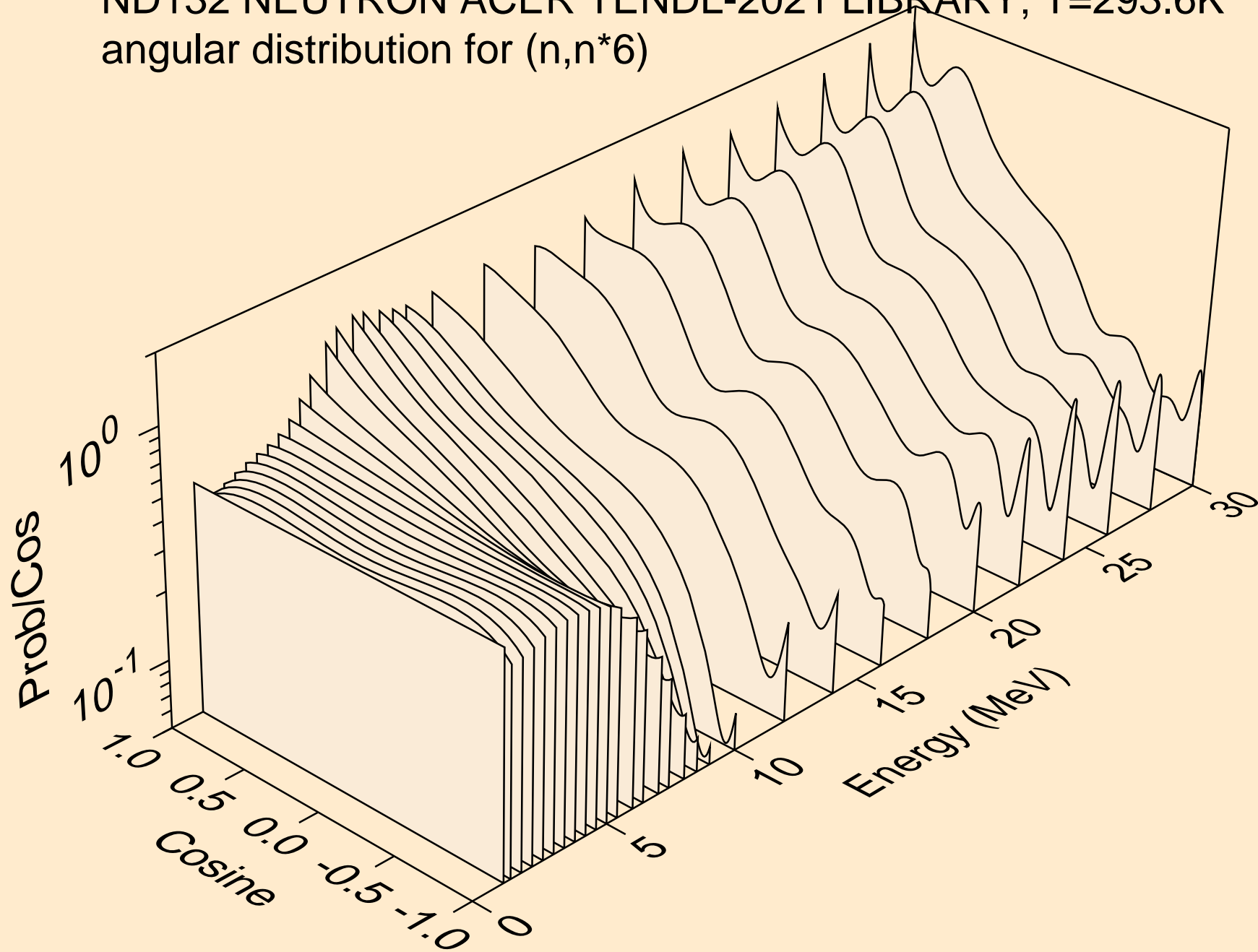

ND132 NEUTRON ACER TENDL-2021 LIBRARY; T=293.6K
angular distribution for (n,n*7)

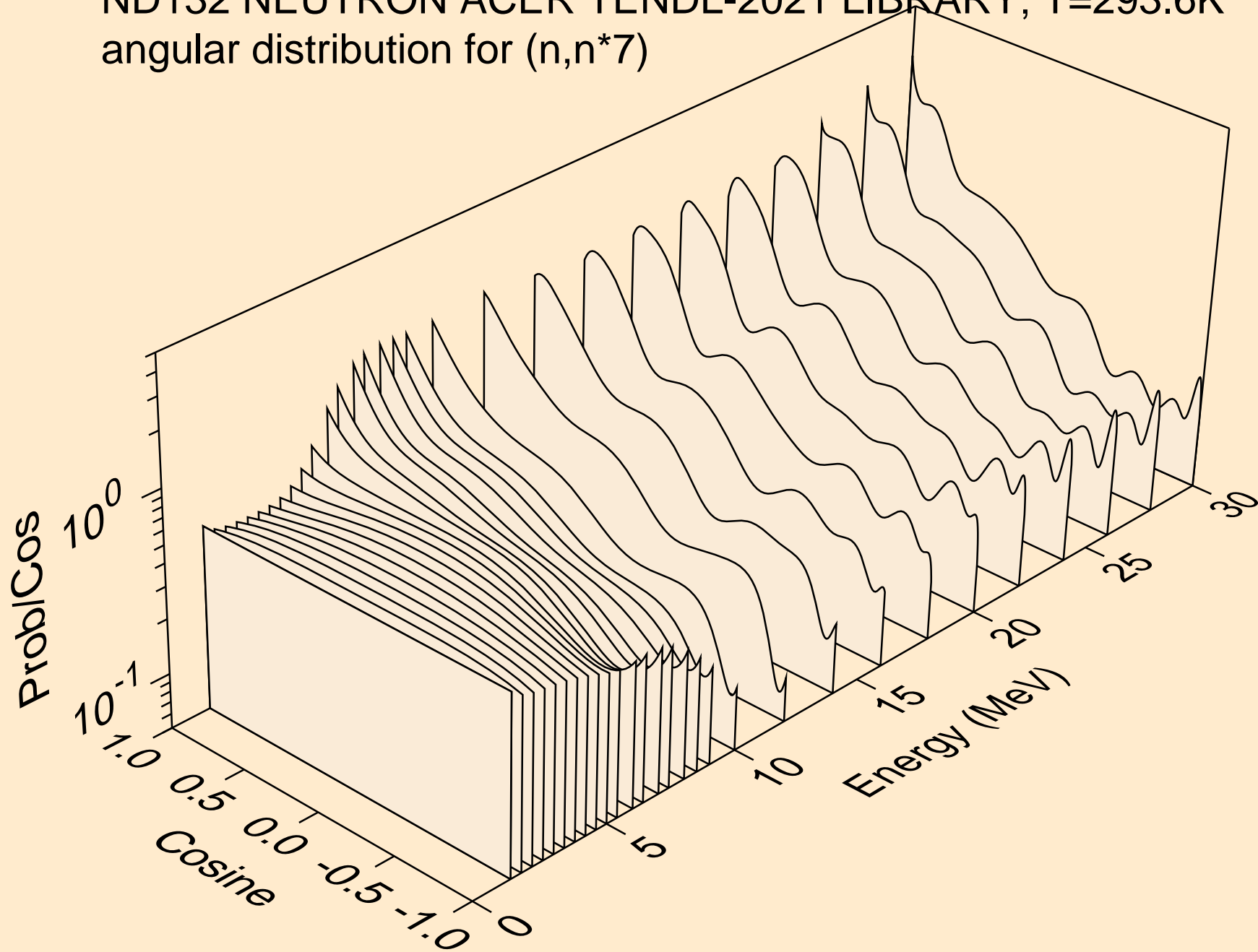

ND132 NEUTRON ACER TENDL-2021 LIBRARY; T=293.6K
Neutron emission for (n,x)

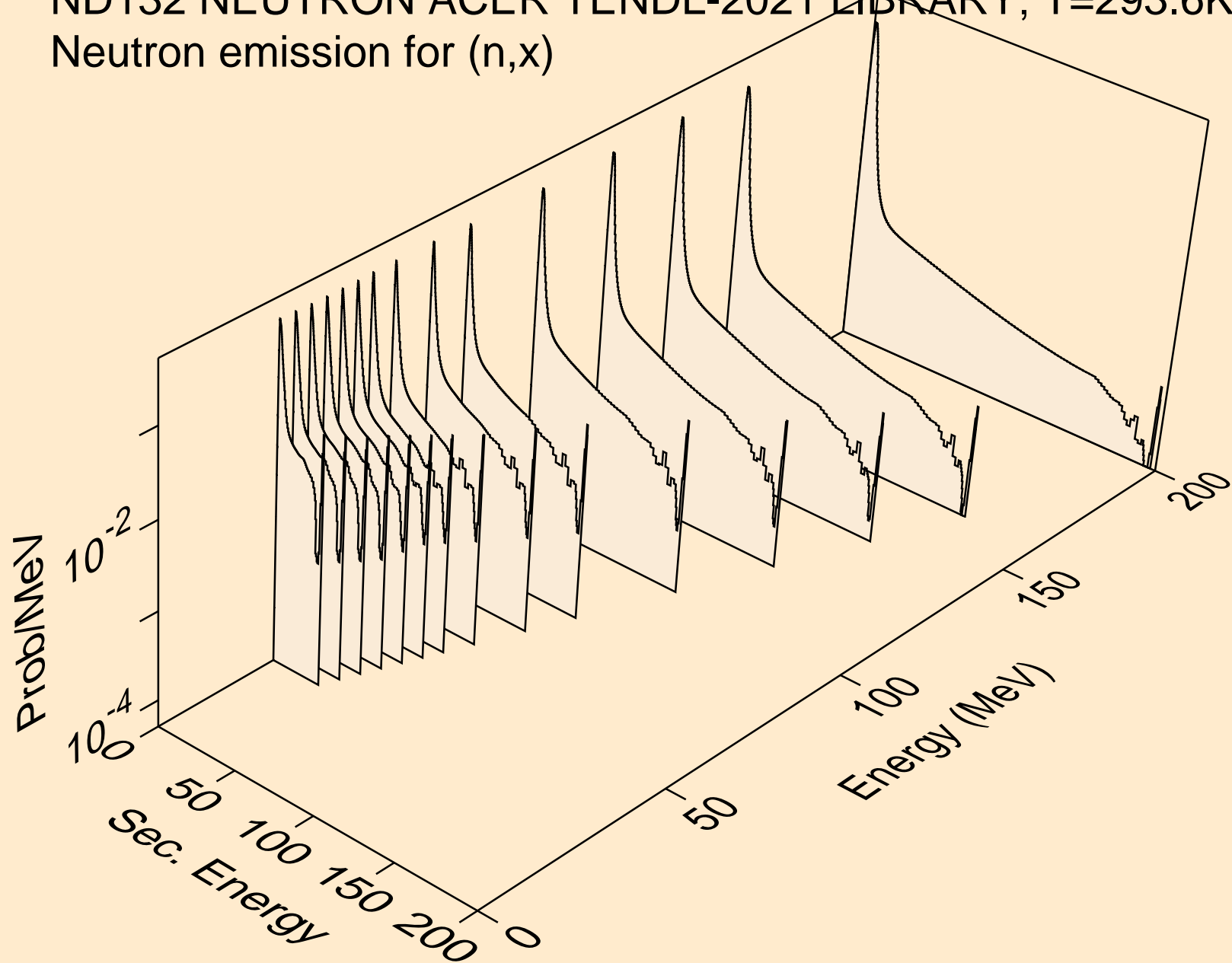

ND132 NEUTRON ACER TENDL-2021 LIBRARY; T=293.6K
Neutron emission for (n,2nd)

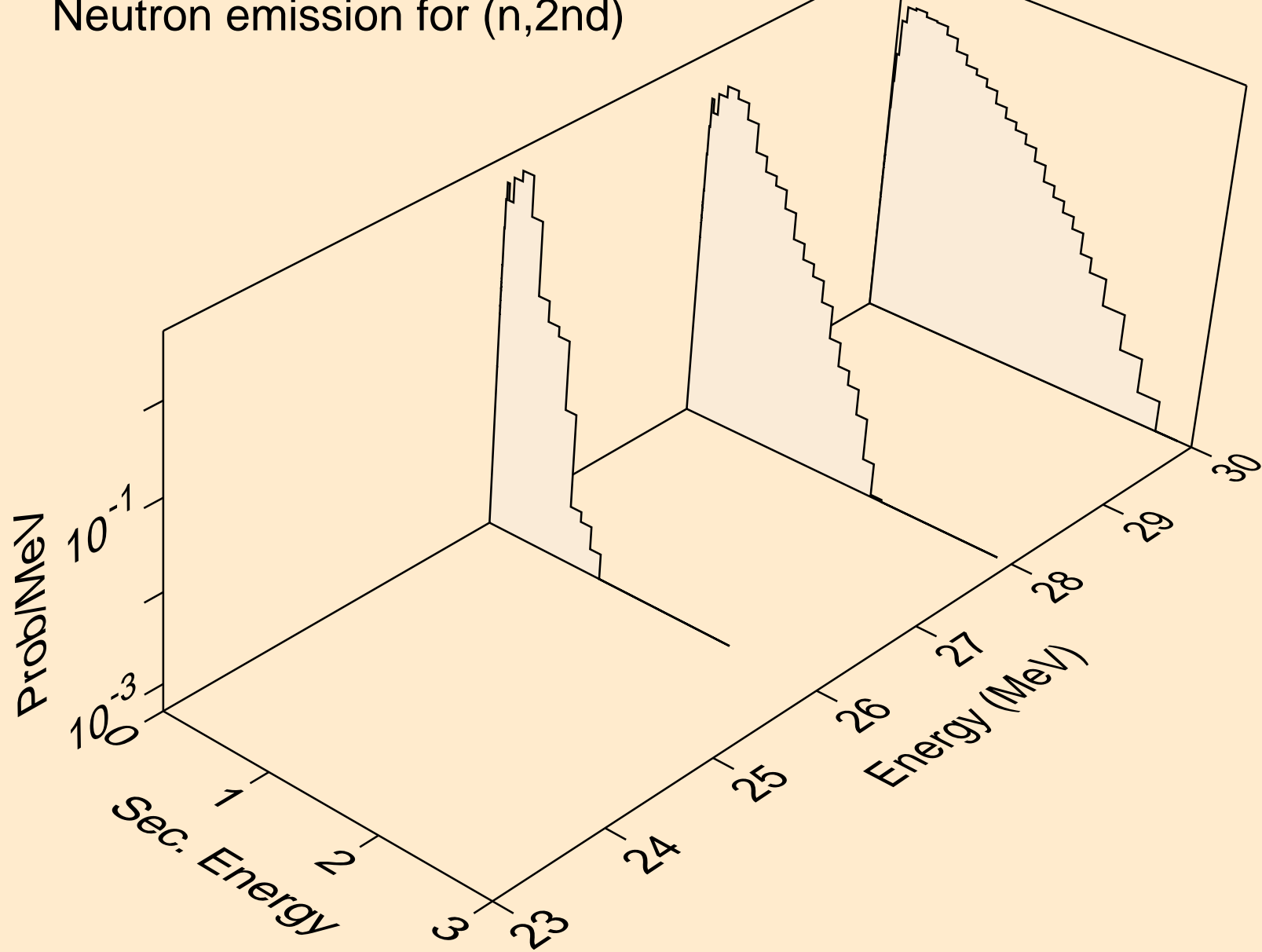

ND132 NEUTRON ACER TENDL-2021 LIBRARY; T=293.6K
Neutron emission for (n,2n)

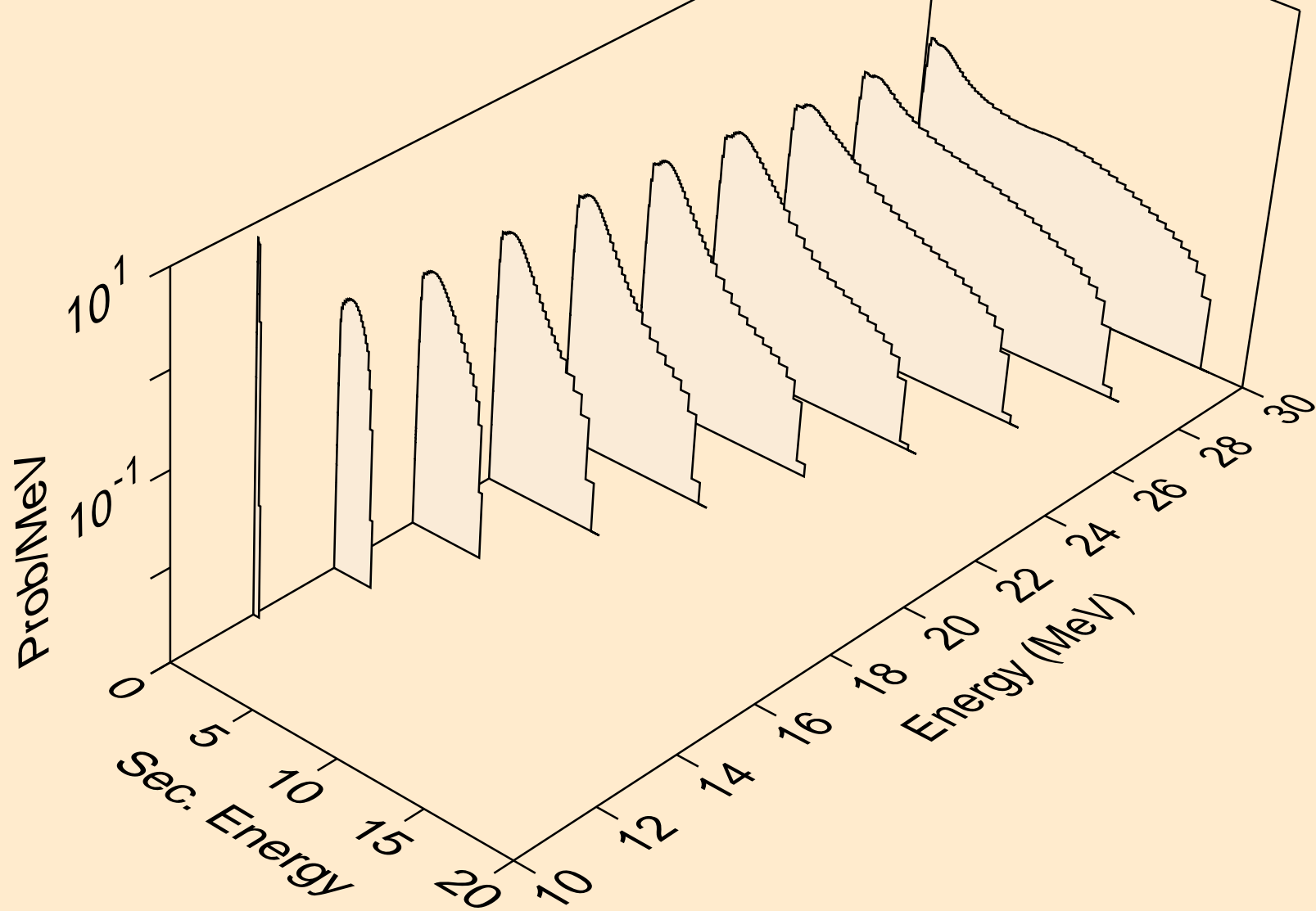

ND132 NEUTRON ACER TENDL-2021 LIBRARY; T=293.6K
Neutron emission for (n,3n)

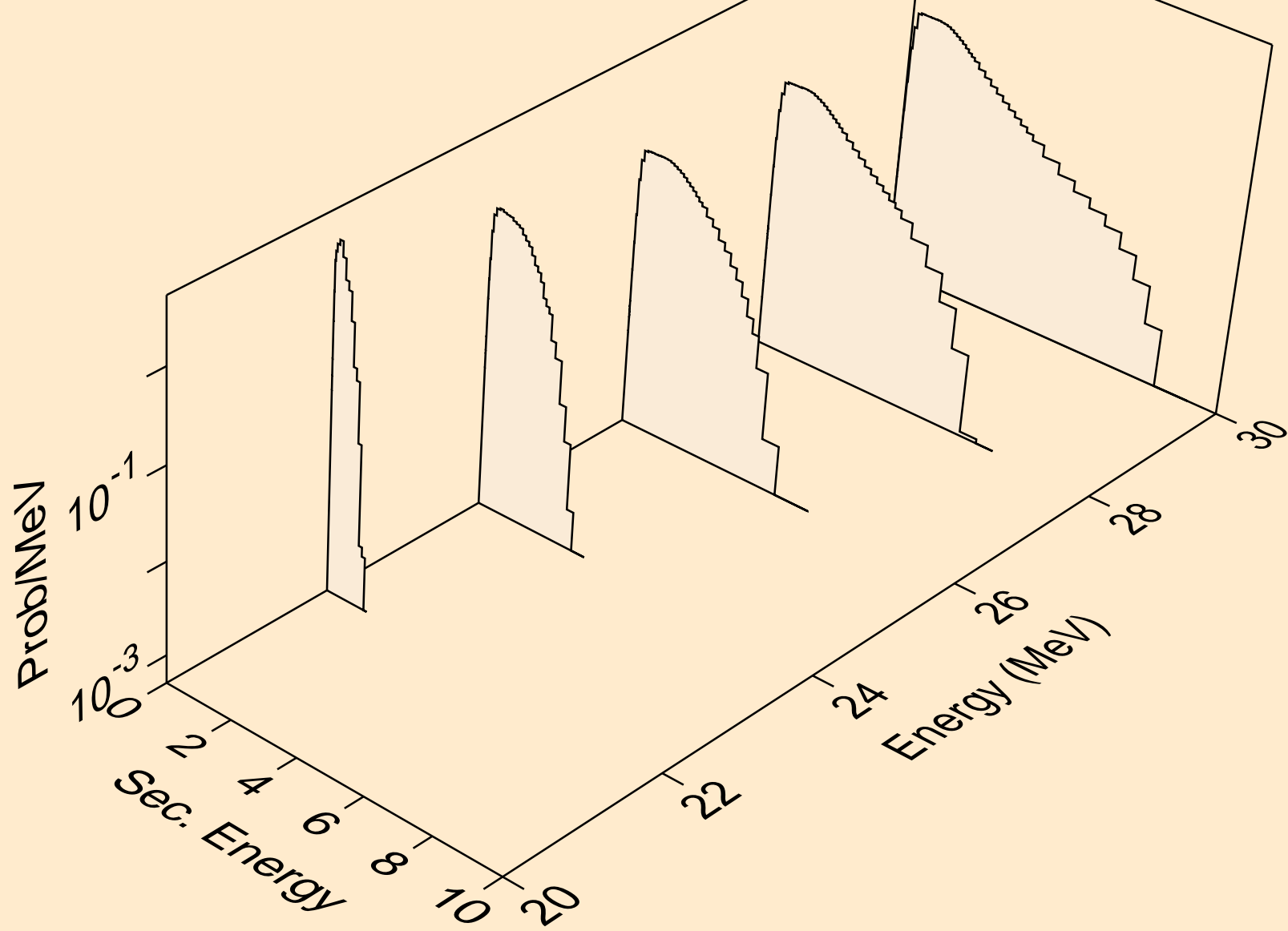

ND132 NEUTRON ACER TENDL-2021 LIBRARY; T=293.6K
Neutron emission for (n,n*)a

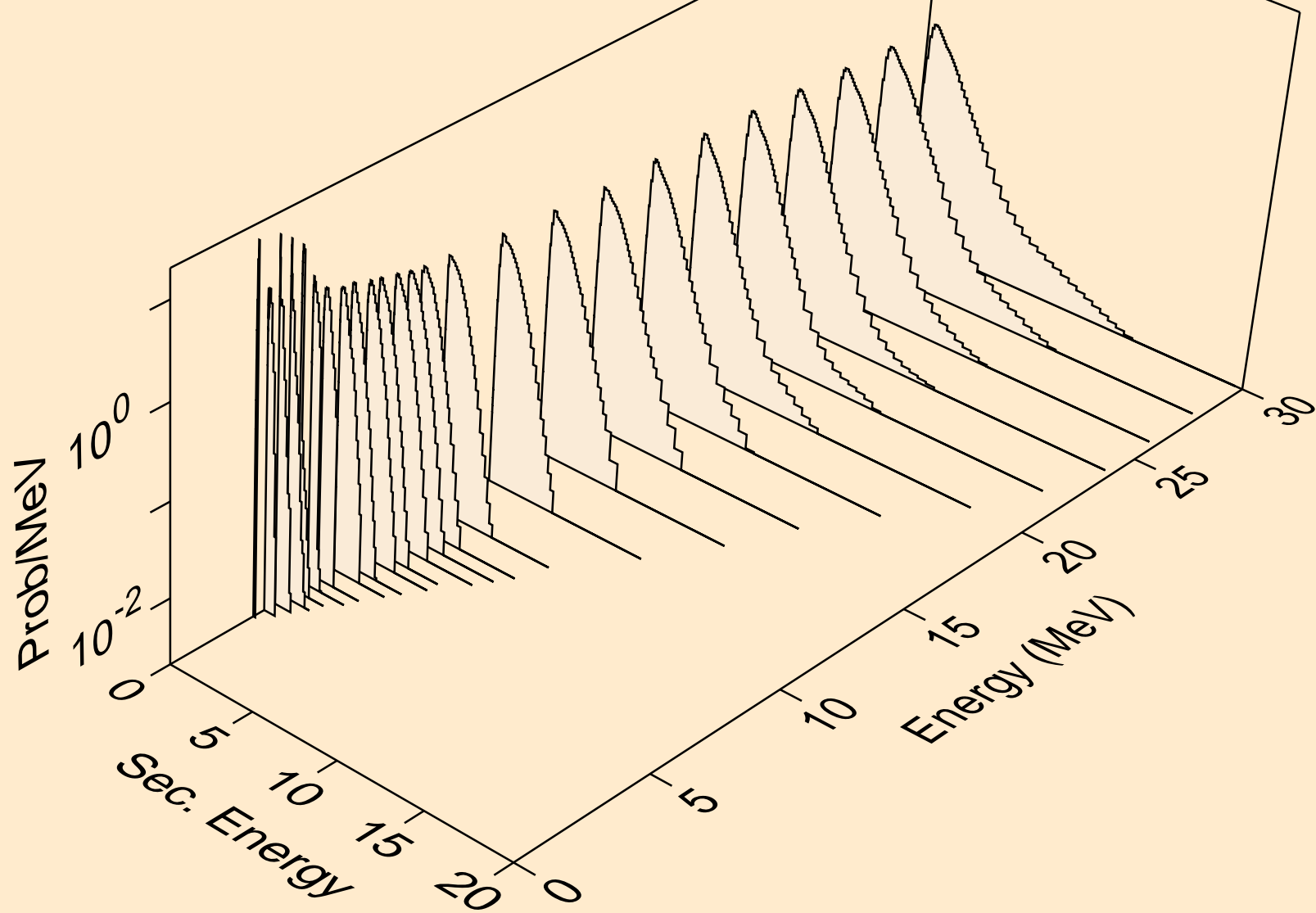

ND132 NEUTRON ACER TENDL-2021 LIBRARY; T=293.6K
Neutron emission for (n,2n)a

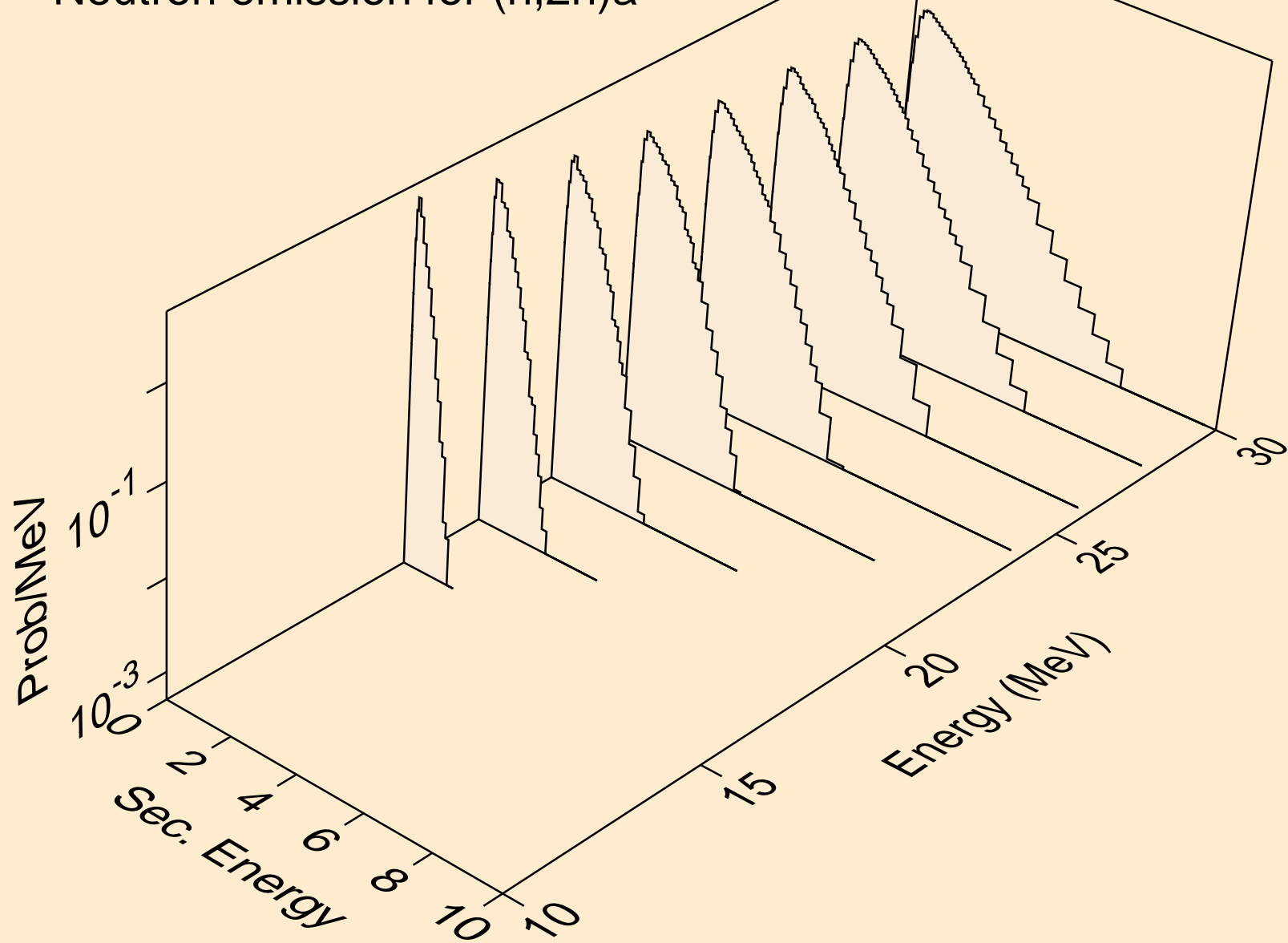

ND132 NEUTRON ACER TENDL-2021 LIBRARY; T=293.6K
Neutron emission for (n,3n)a

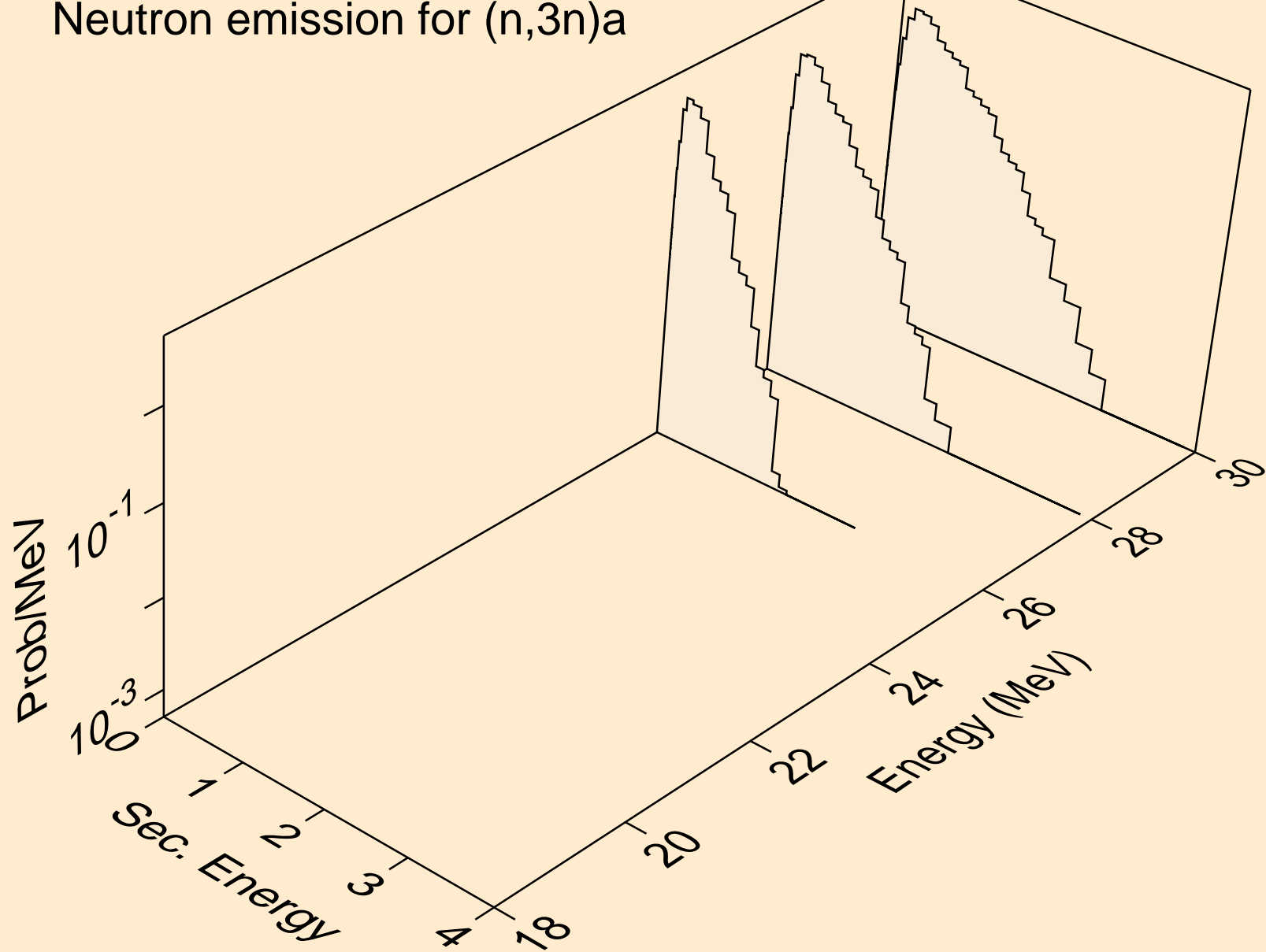

ND132 NEUTRON ACER TENDL-2021 LIBRARY; T=293.6K
Neutron emission for (n,n*)p

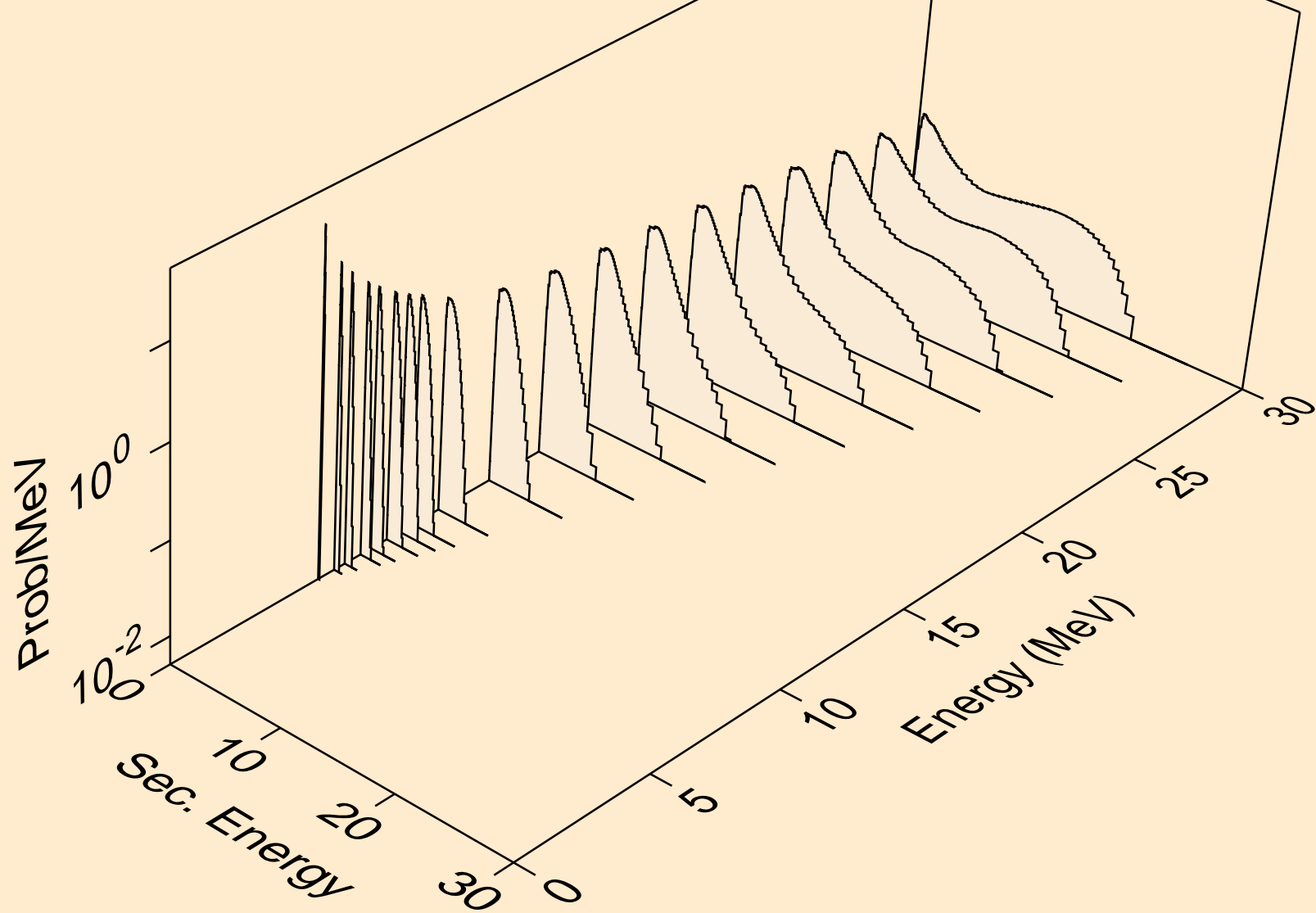

ND132 NEUTRON ACER TENDL-2021 LIBRARY; T=293.6K
Neutron emission for (n,n*)2a

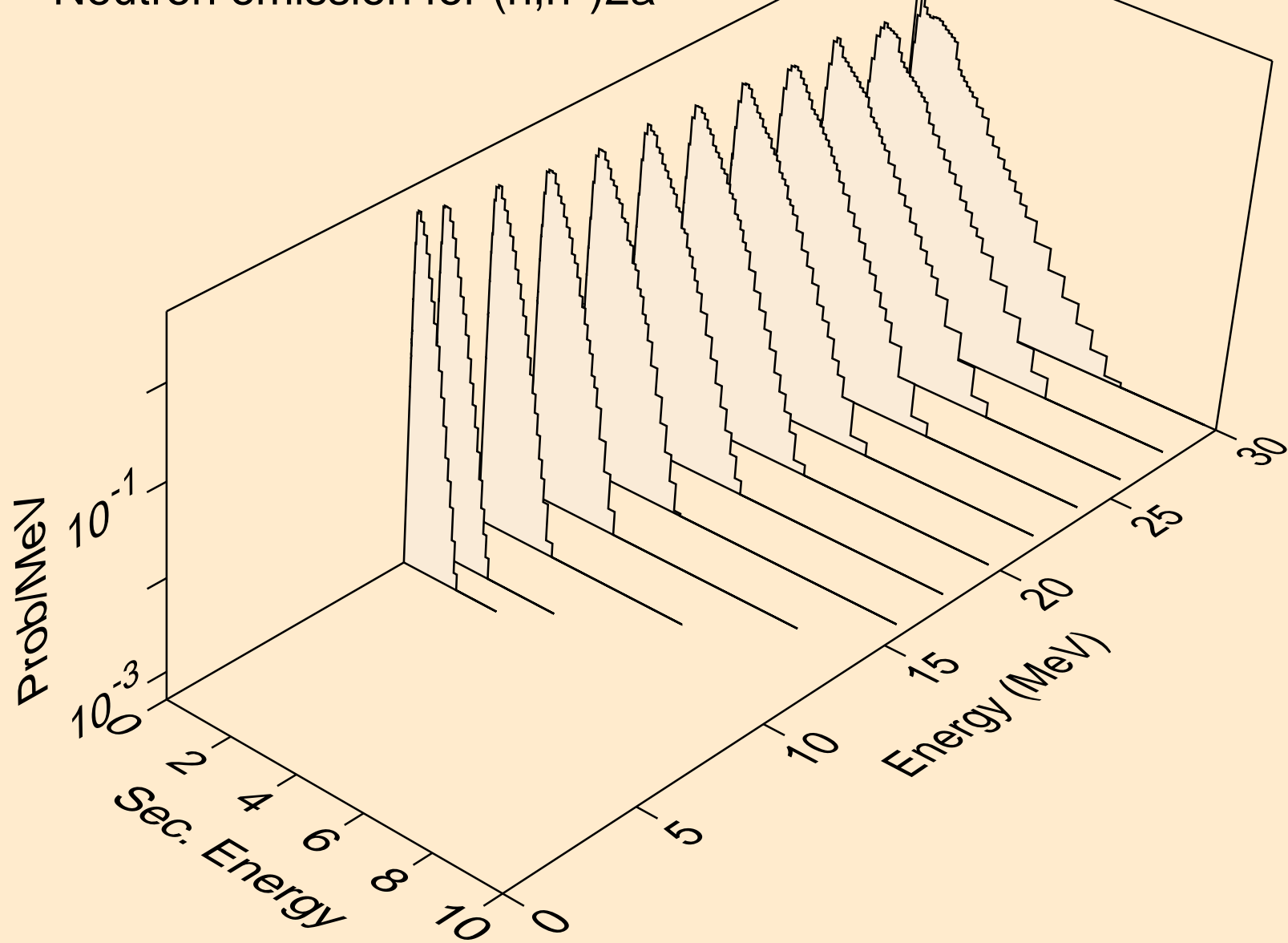

ND132 NEUTRON ACER TENDL-2021 LIBRARY; T=293.6K
Neutron emission for (n,n*)d

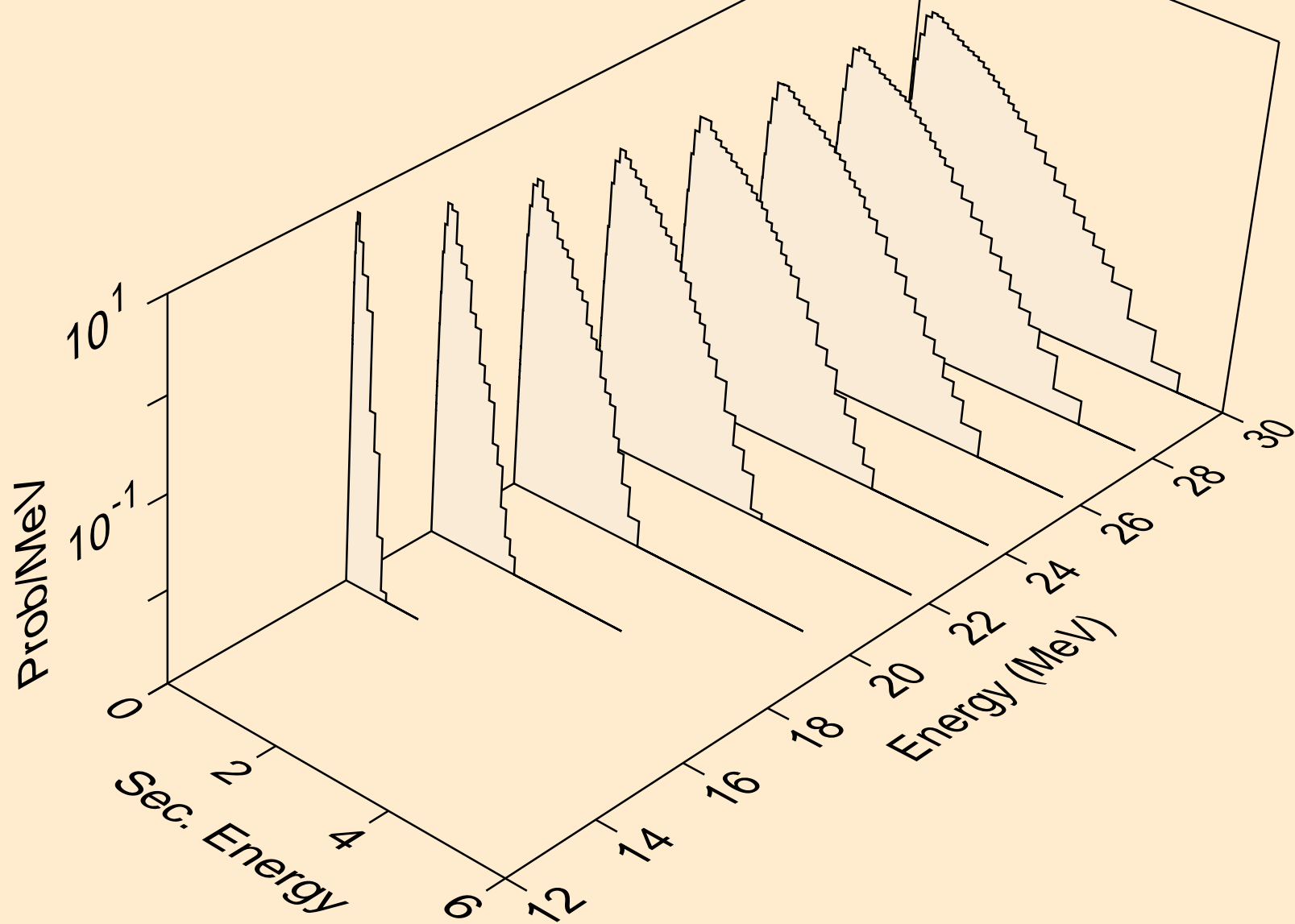

ND132 NEUTRON ACER TENDL-2021 LIBRARY; T=293.6K
Neutron emission for (n,n*)t

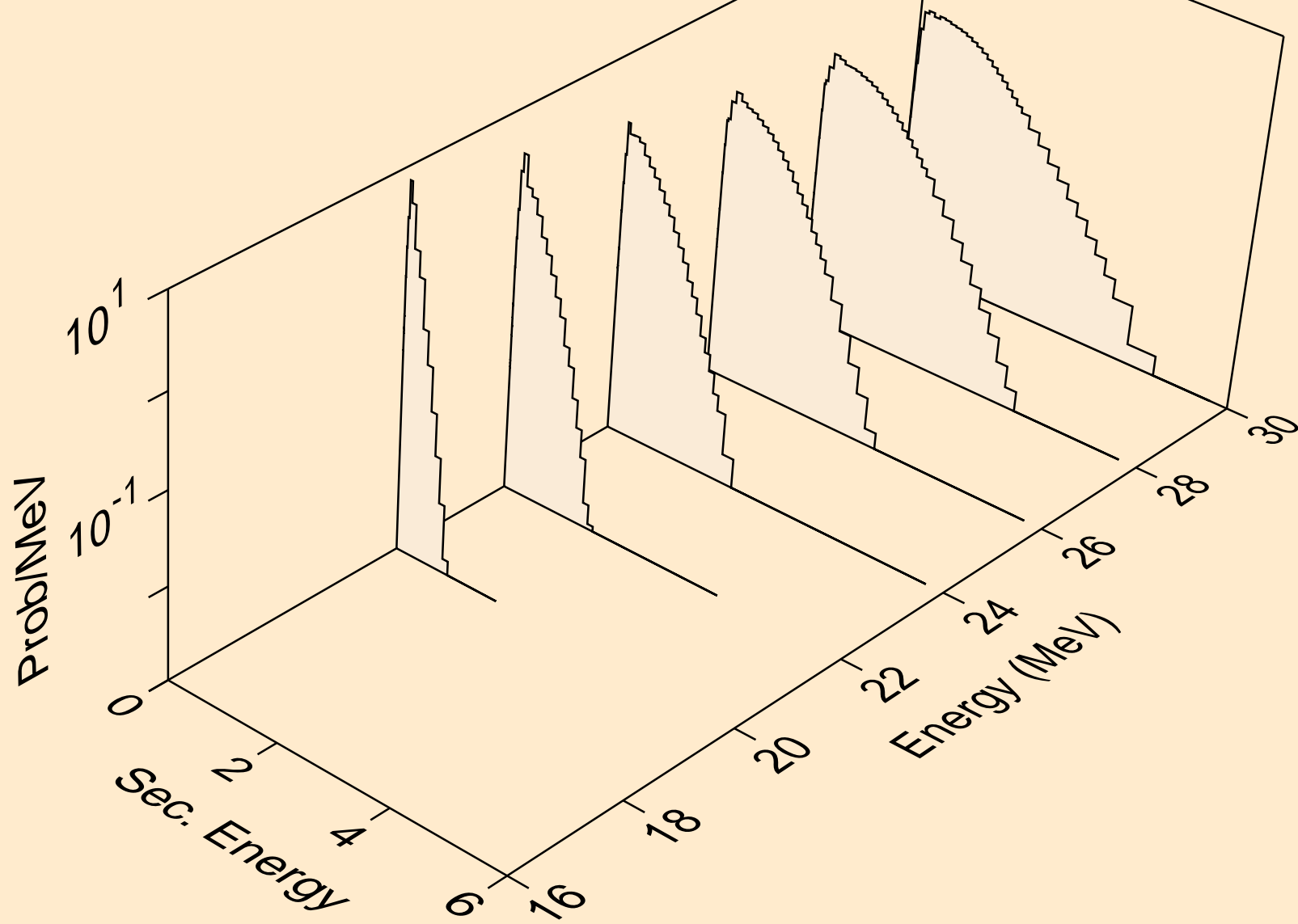

ND132 NEUTRON ACER TENDL-2021 LIBRARY; T=293.6K
Neutron emission for (n,n*)he3

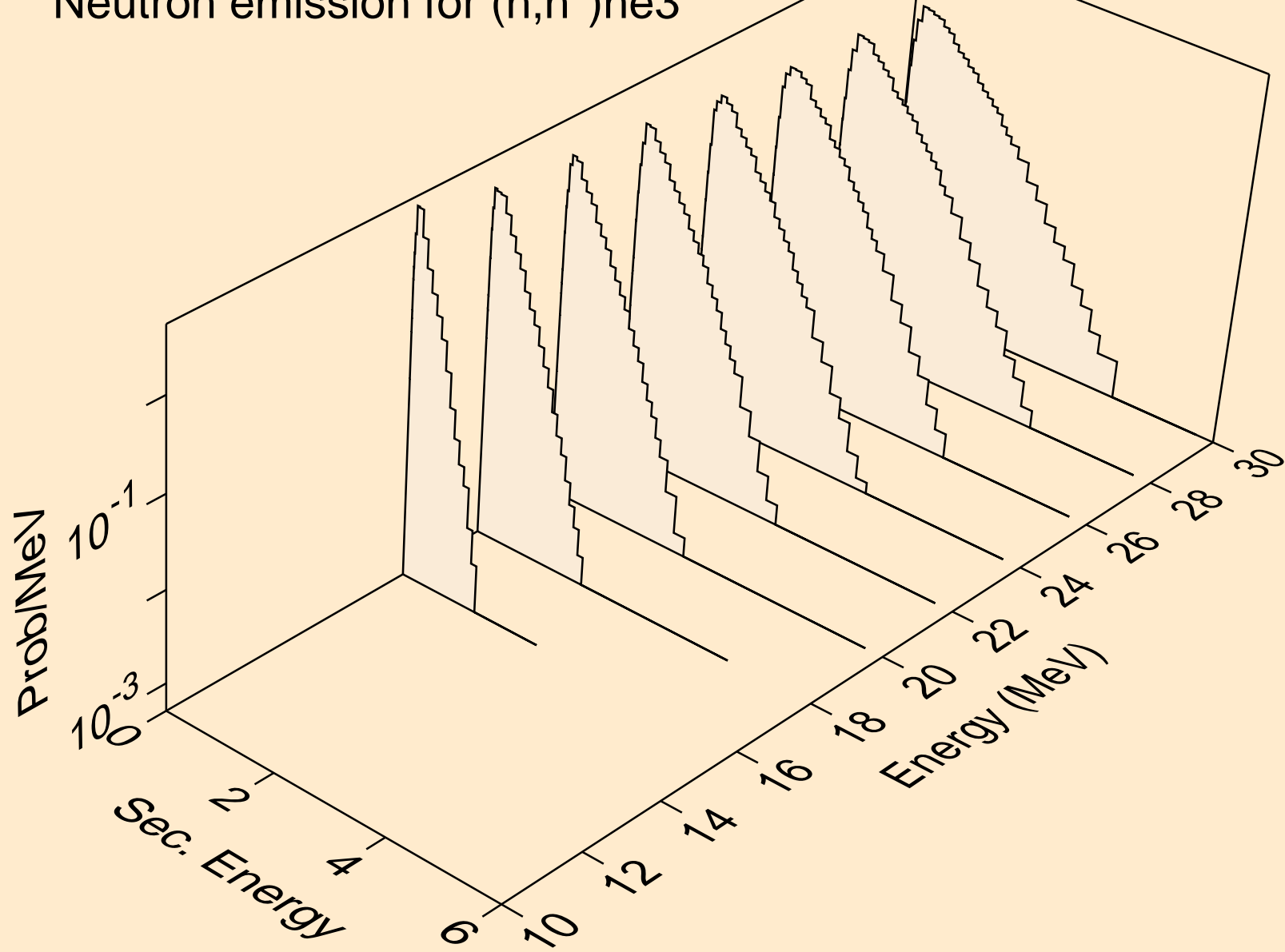

ND132 NEUTRON ACER TENDL-2021 LIBRARY; T=293.6K
Neutron emission for (n,2np)

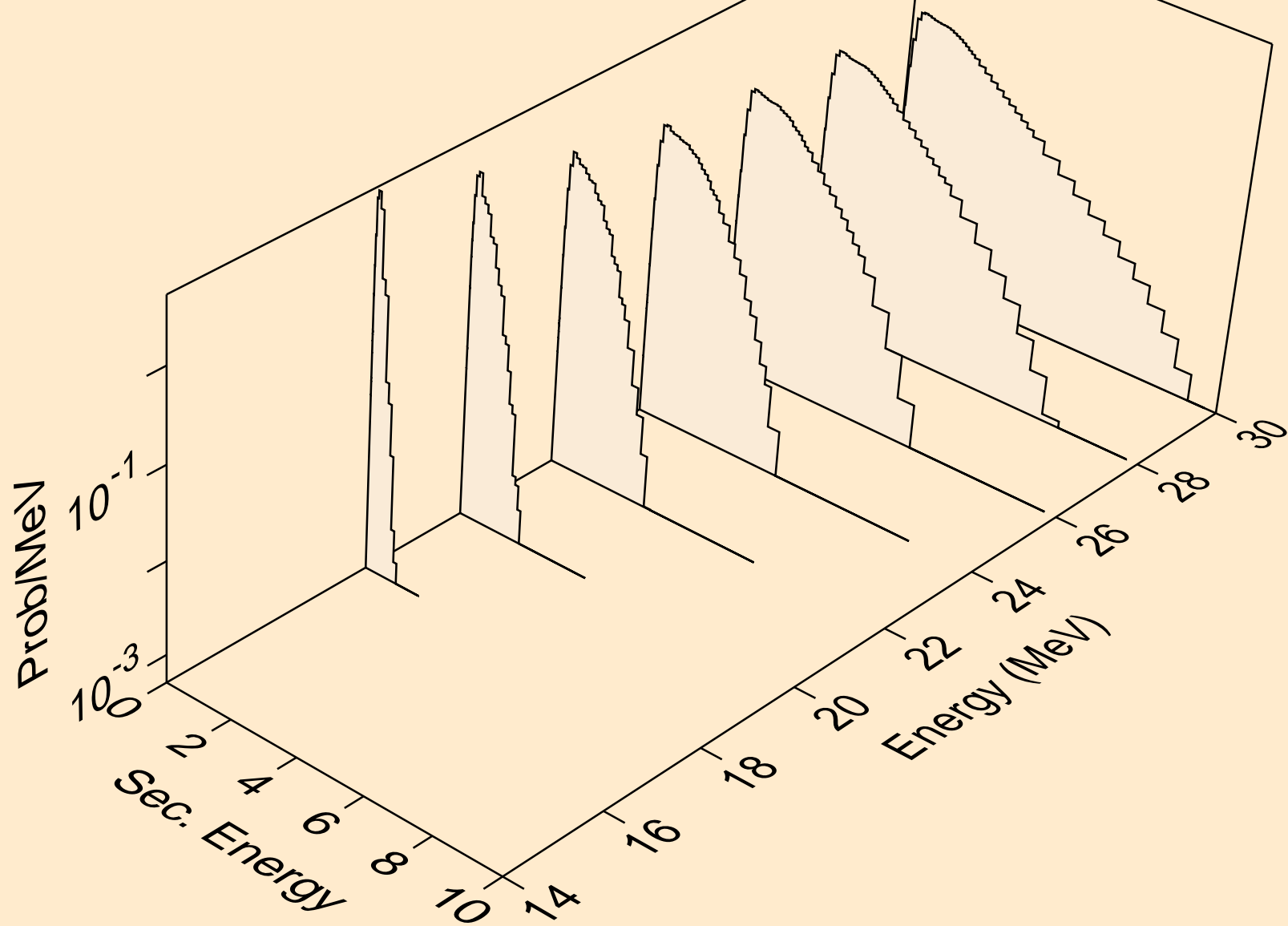

ND132 NEUTRON ACER TENDL-2021 LIBRARY; T=293.6K
Neutron emission for (n,3np)

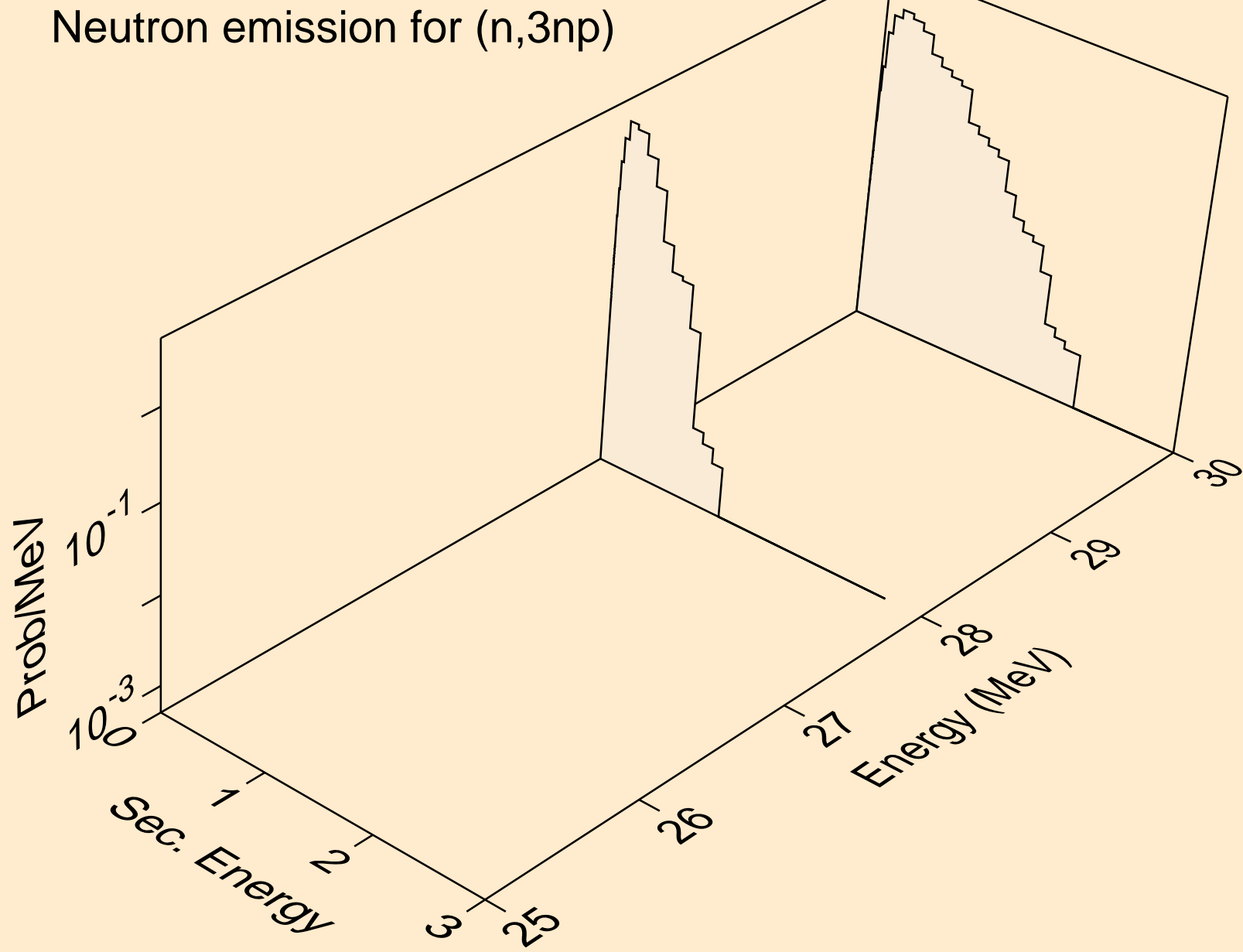

ND132 NEUTRON ACER TENDL-2021 LIBRARY; T=293.6K
Neutron emission for (n,2np)

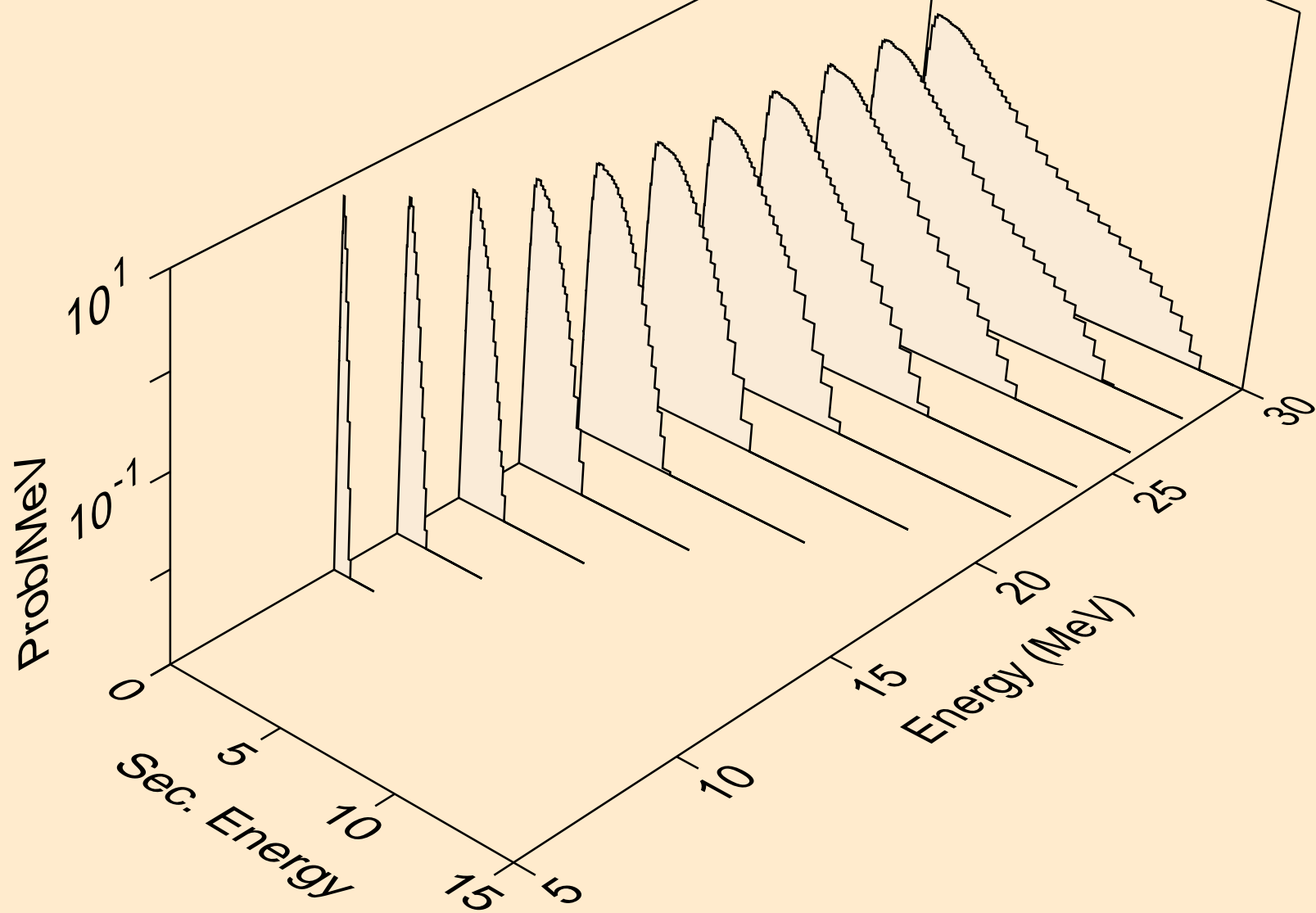

ND132 NEUTRON ACER TENDL-2021 LIBRARY; T=293.6K
Neutron emission for (n,npa)

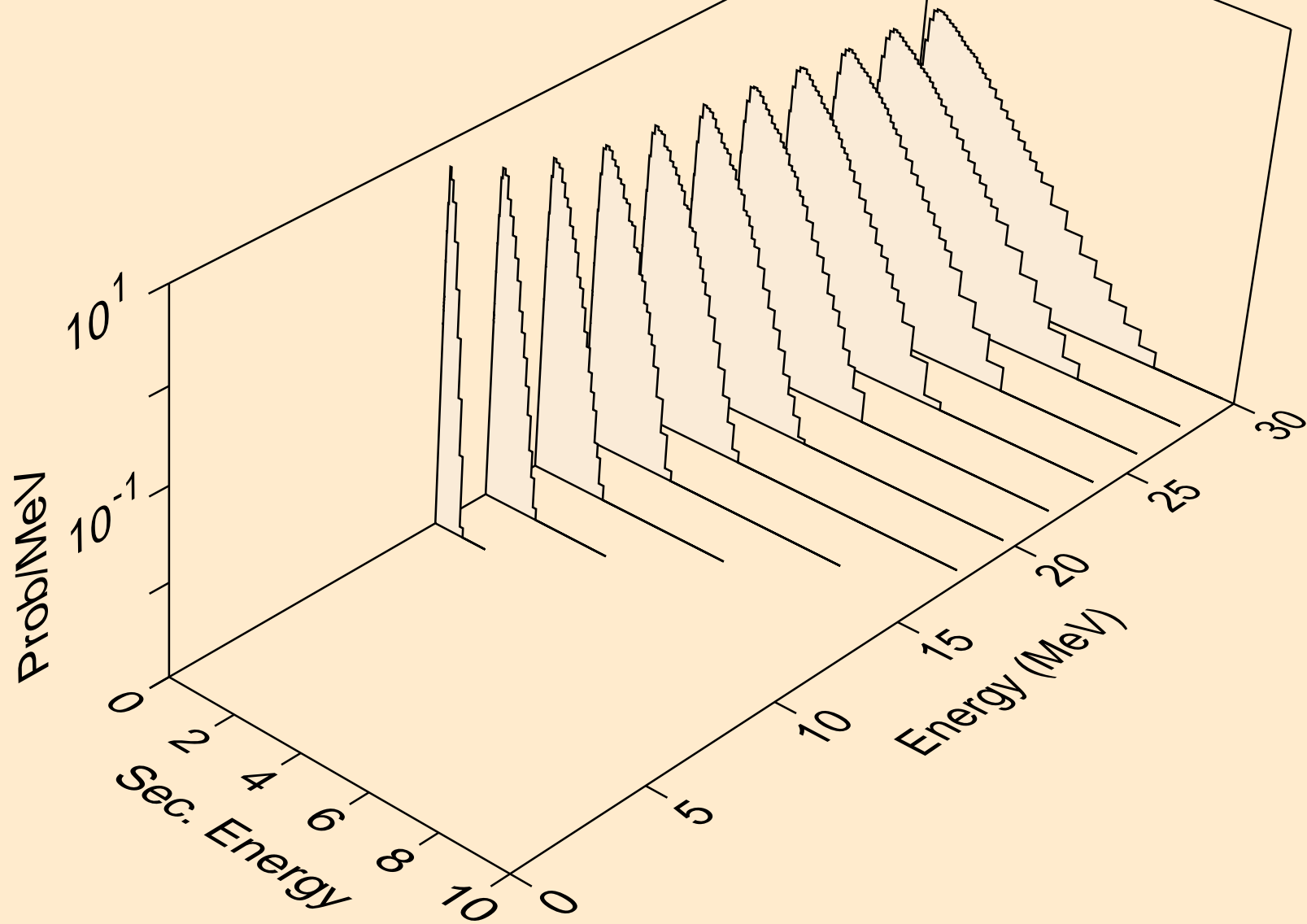

ND132 NEUTRON ACER TENDL-2021 LIBRARY; T=293.6K
Neutron emission for (n,n*c)

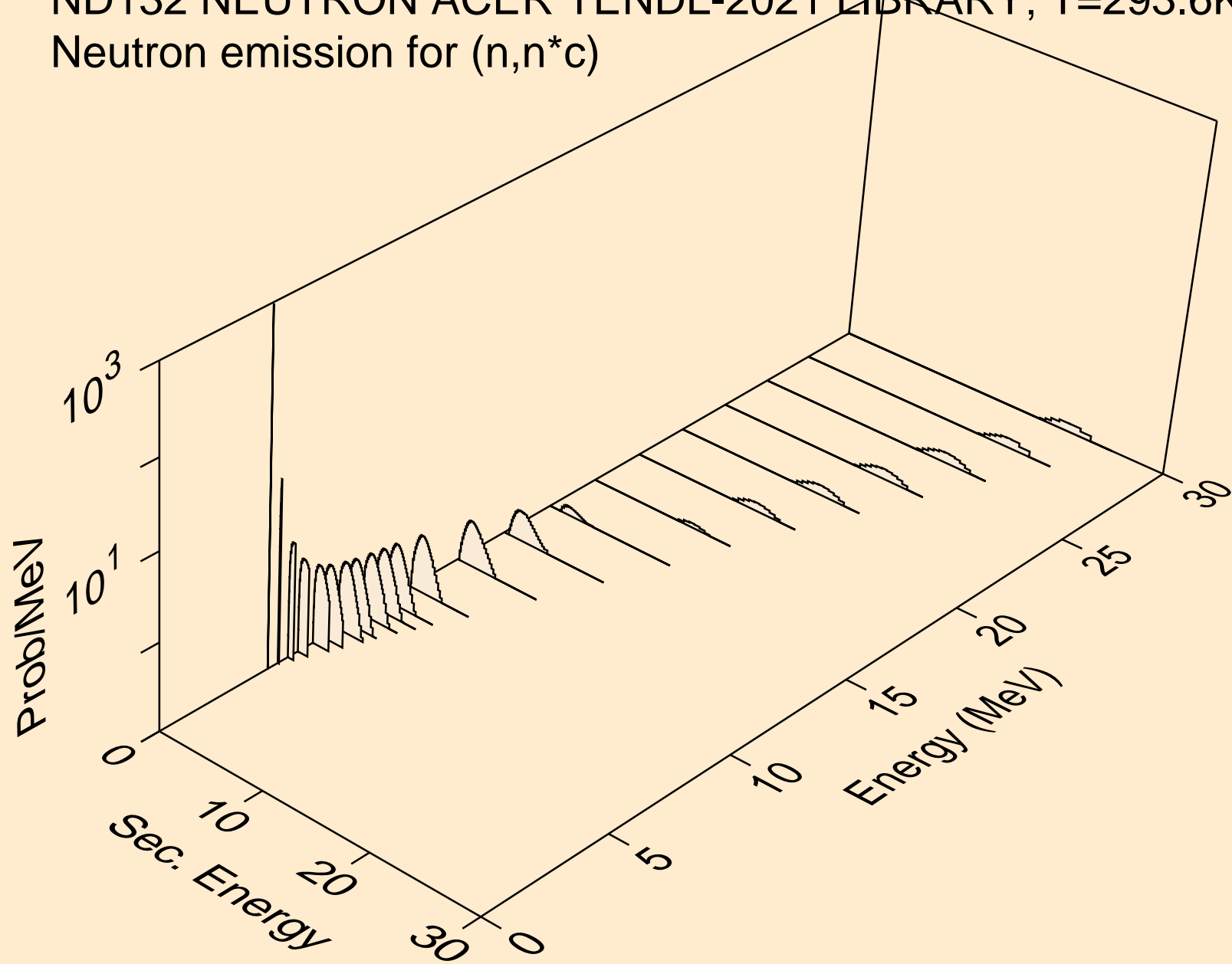

ND132 NEUTRON ACER TENDL-2021 LIBRARY; T=293.6K
Photon emission for (n,x)

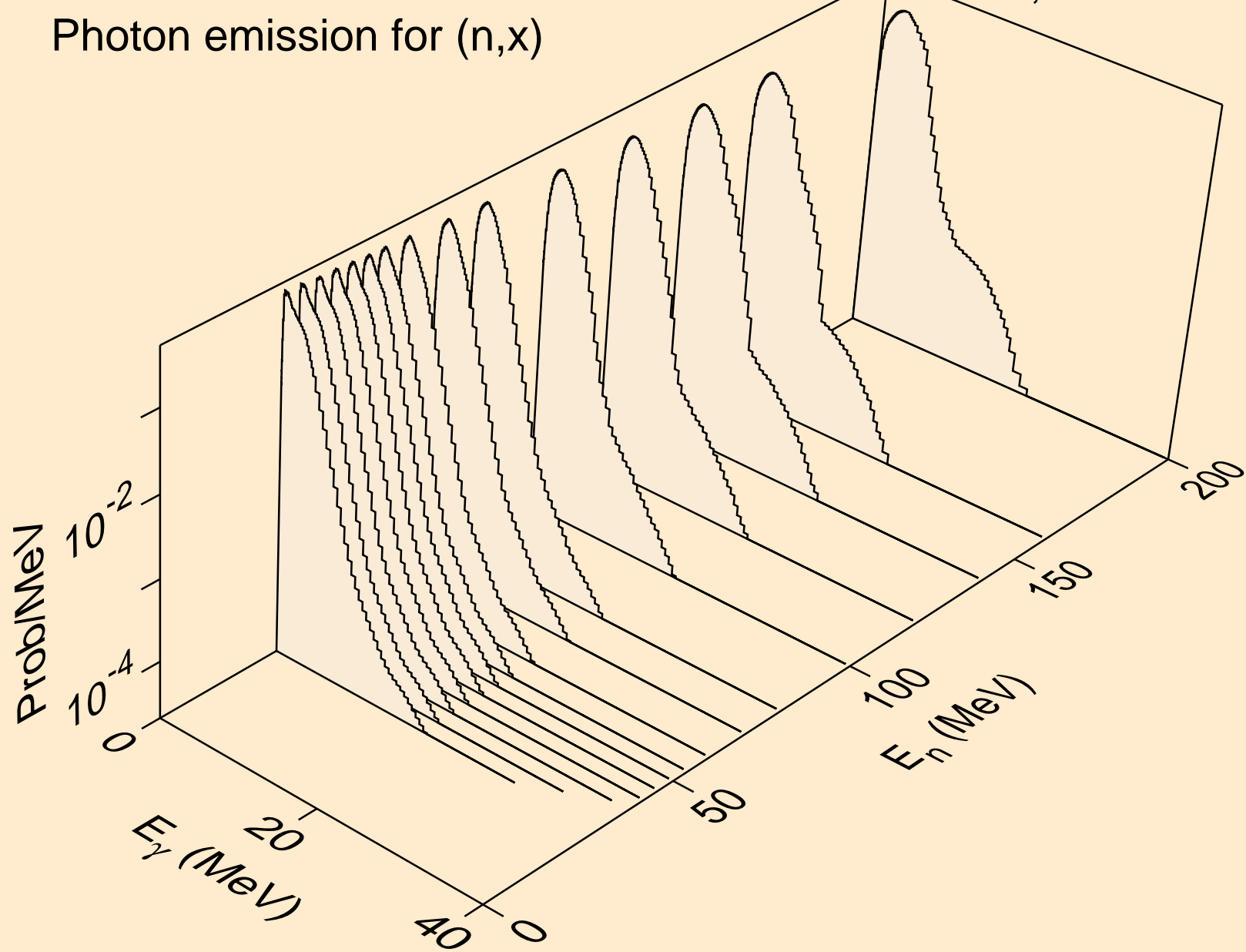

ND132 NEUTRON ACER TENDL-2021 LIBRARY; T=293.6K
Photon emission for (n,2nd)

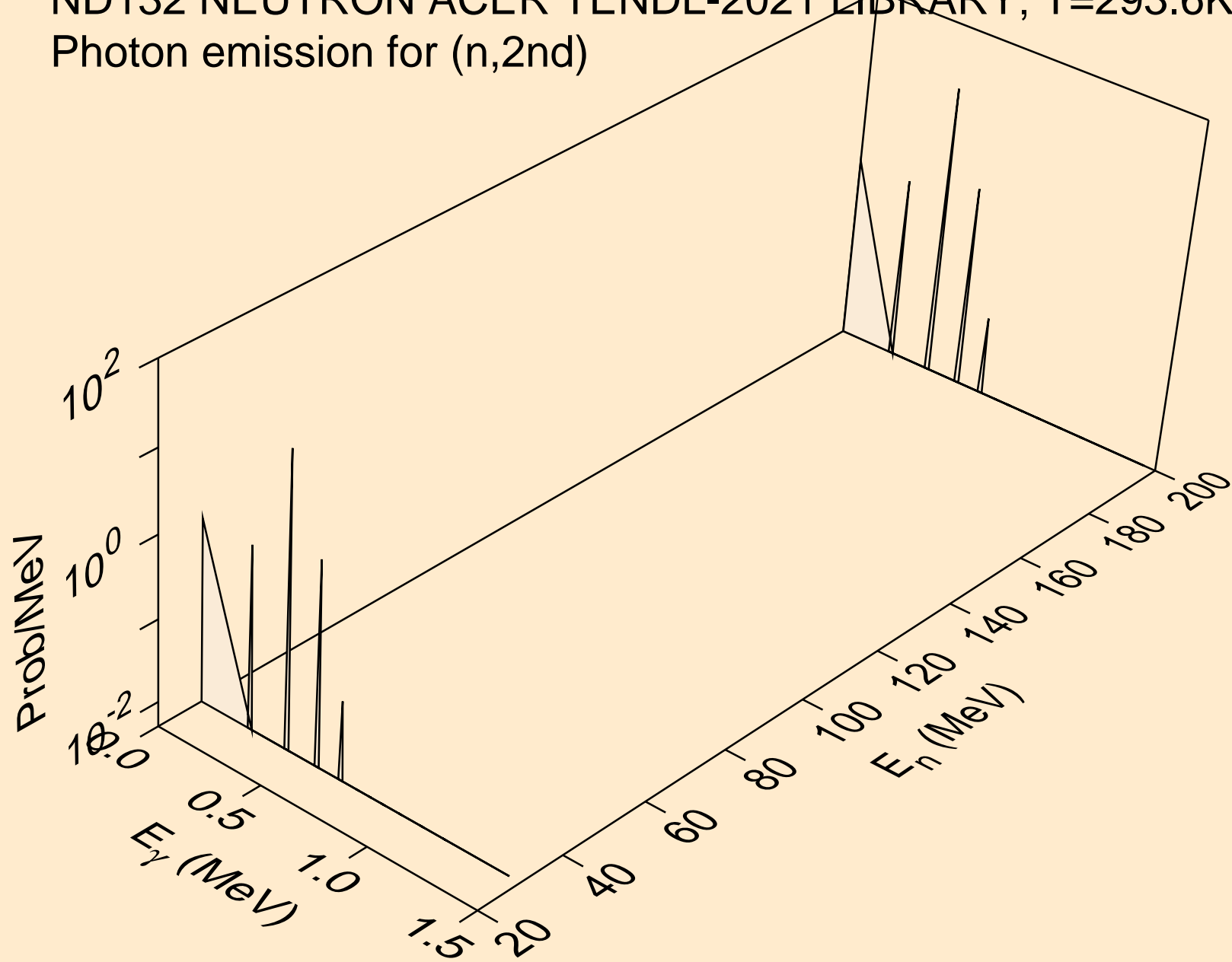

ND132 NEUTRON ACER TENDL-2021 LIBRARY; T=293.6K
Photon emission for (n,2n)

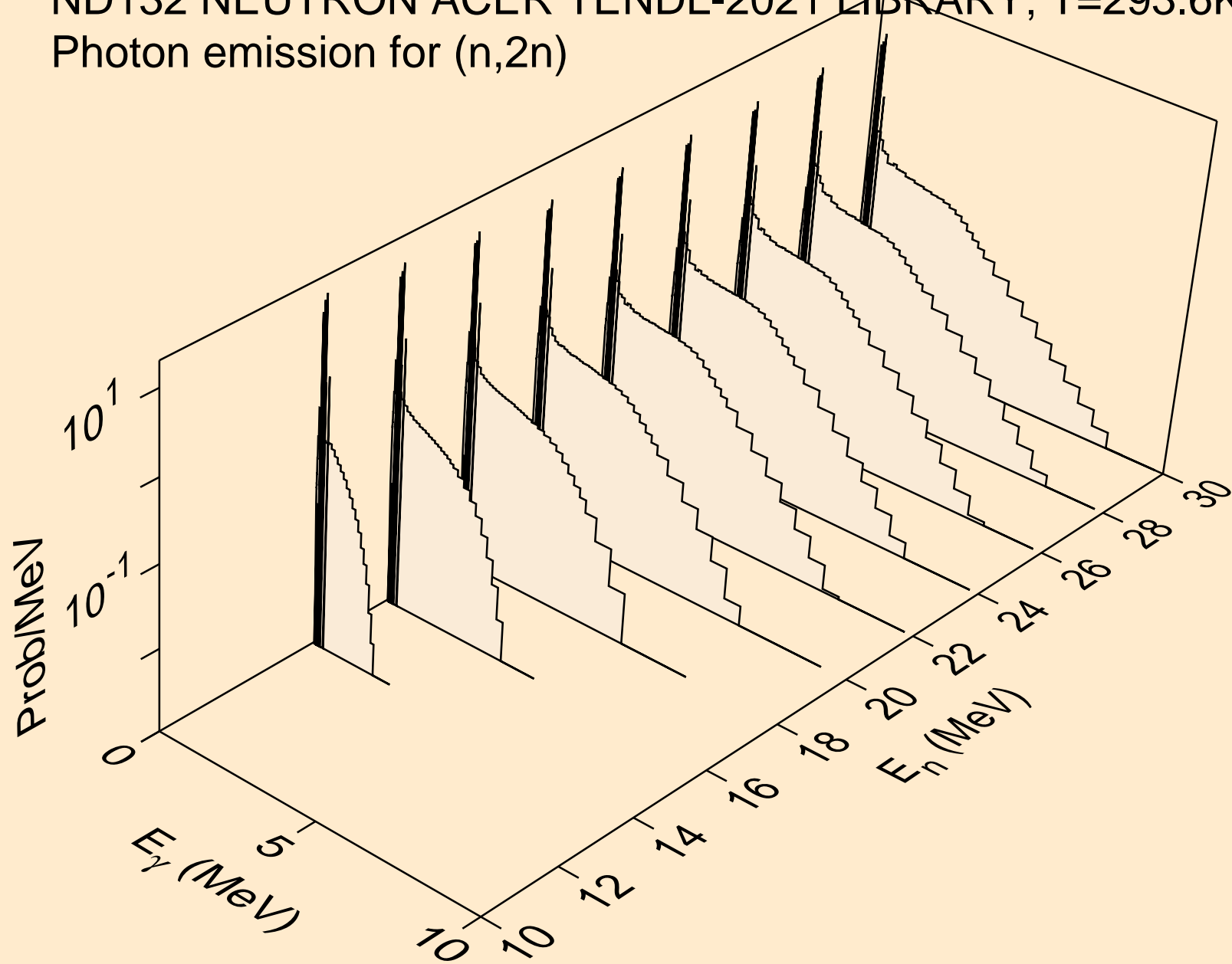

ND132 NEUTRON ACER TENDL-2021 LIBRARY; T=293.6K
Photon emission for (n,3n)

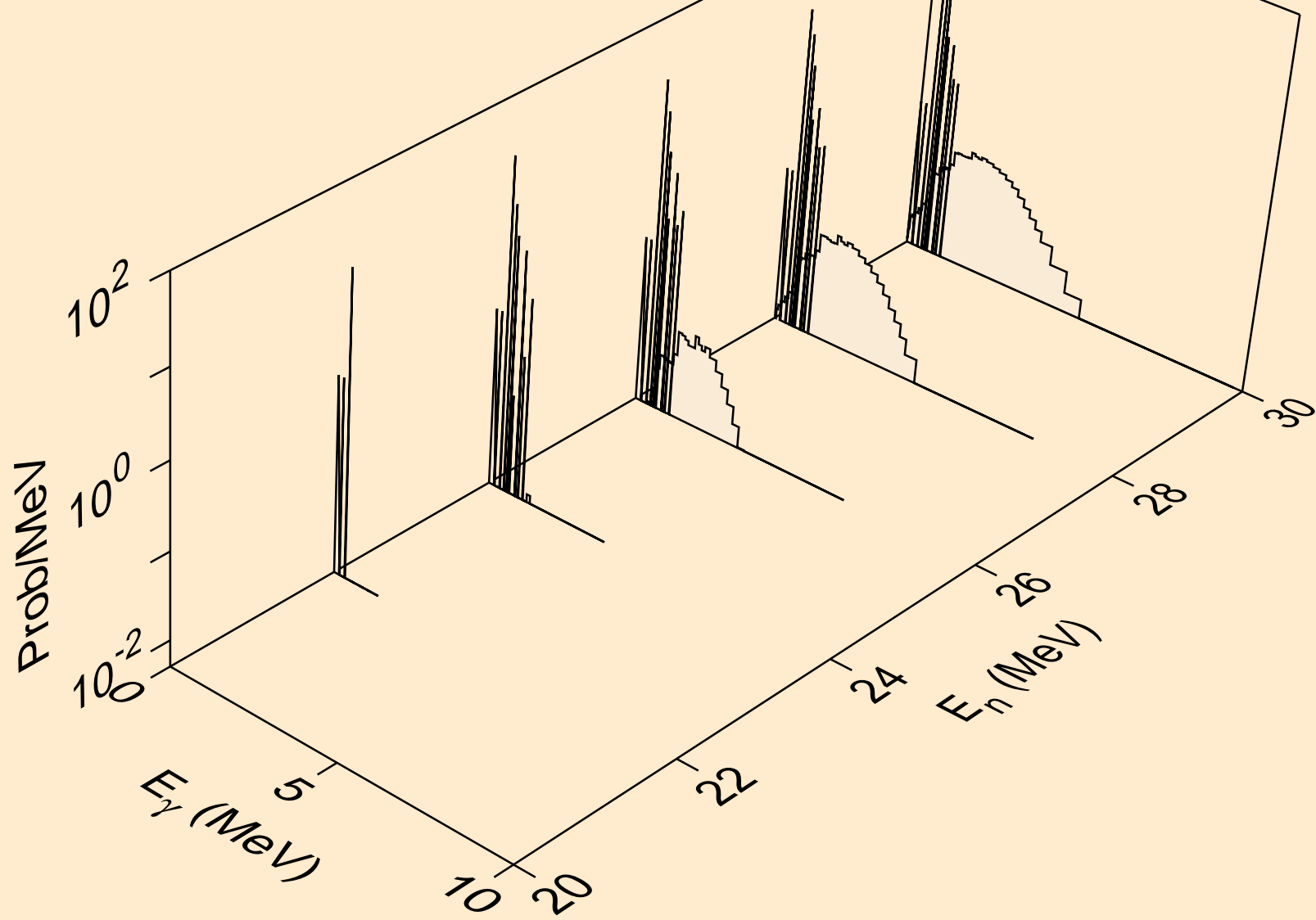

ND132 NEUTRON ACER TENDL-2021 LIBRARY; T=293.6K
Photon emission for (n,n*)a

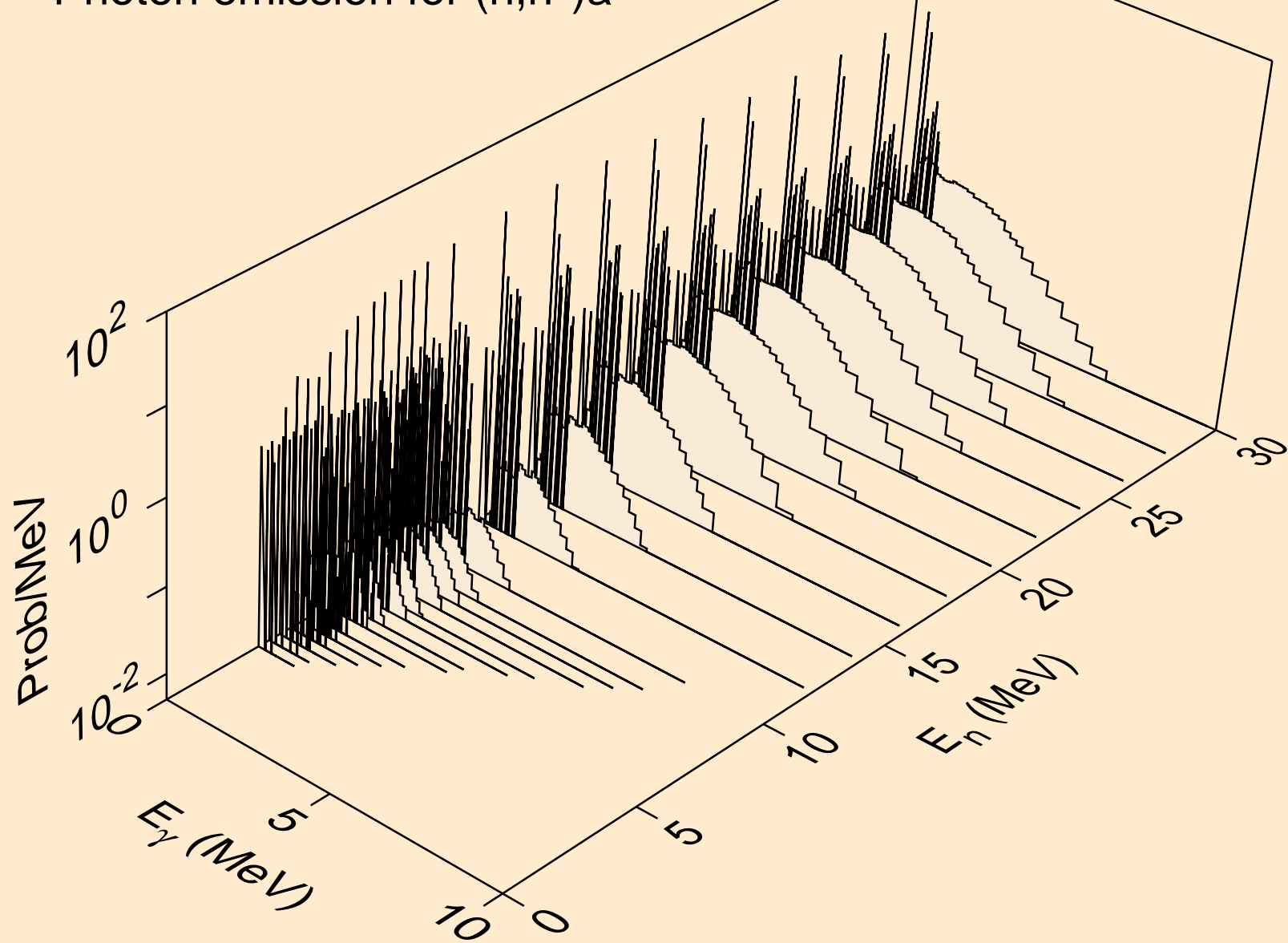

ND132 NEUTRON ACER TENDL-2021 LIBRARY; T=293.6K
Photon emission for (n,2n)a

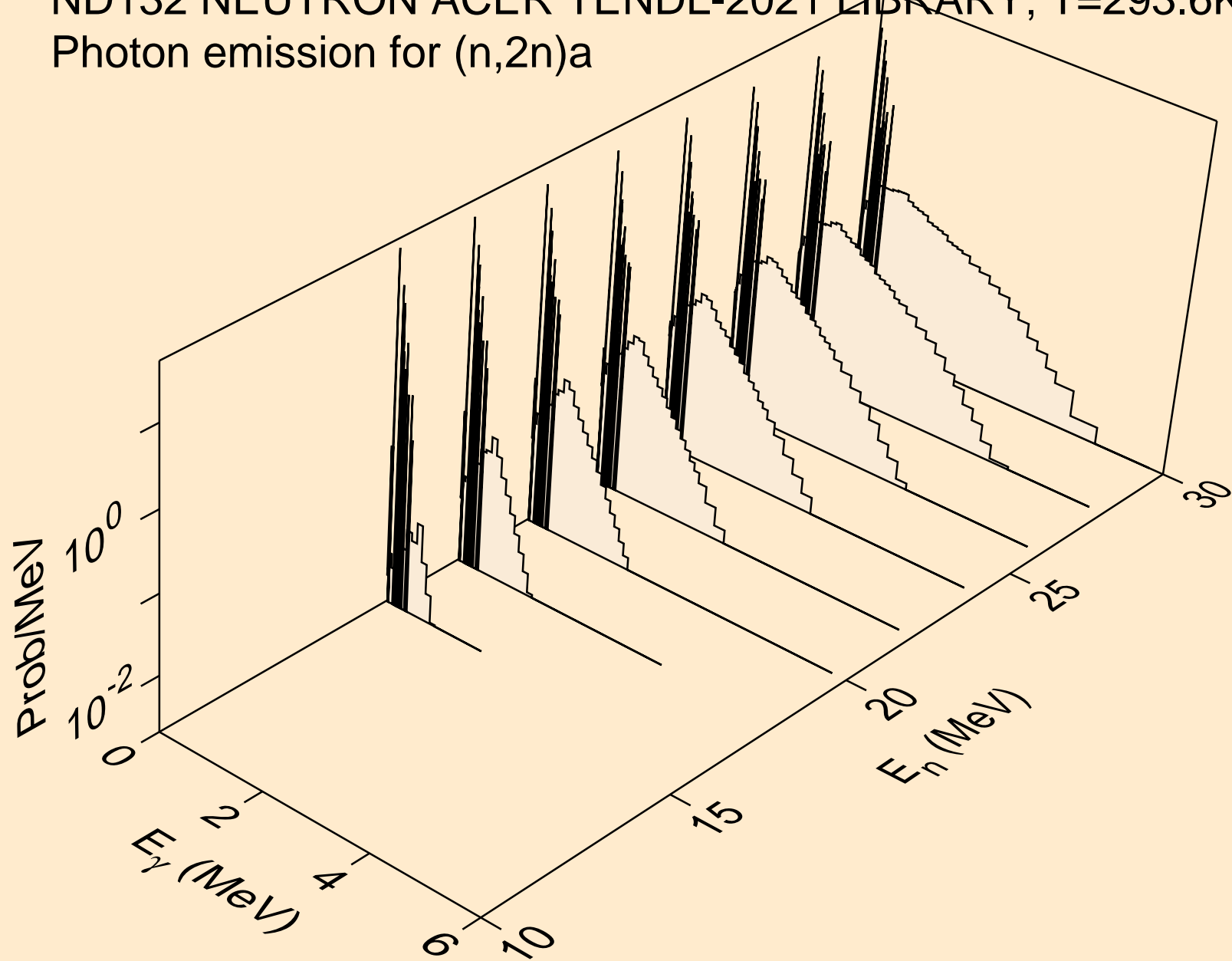

ND132 NEUTRON ACER TENDL-2021 LIBRARY; T=293.6K
Photon emission for (n,3n)a

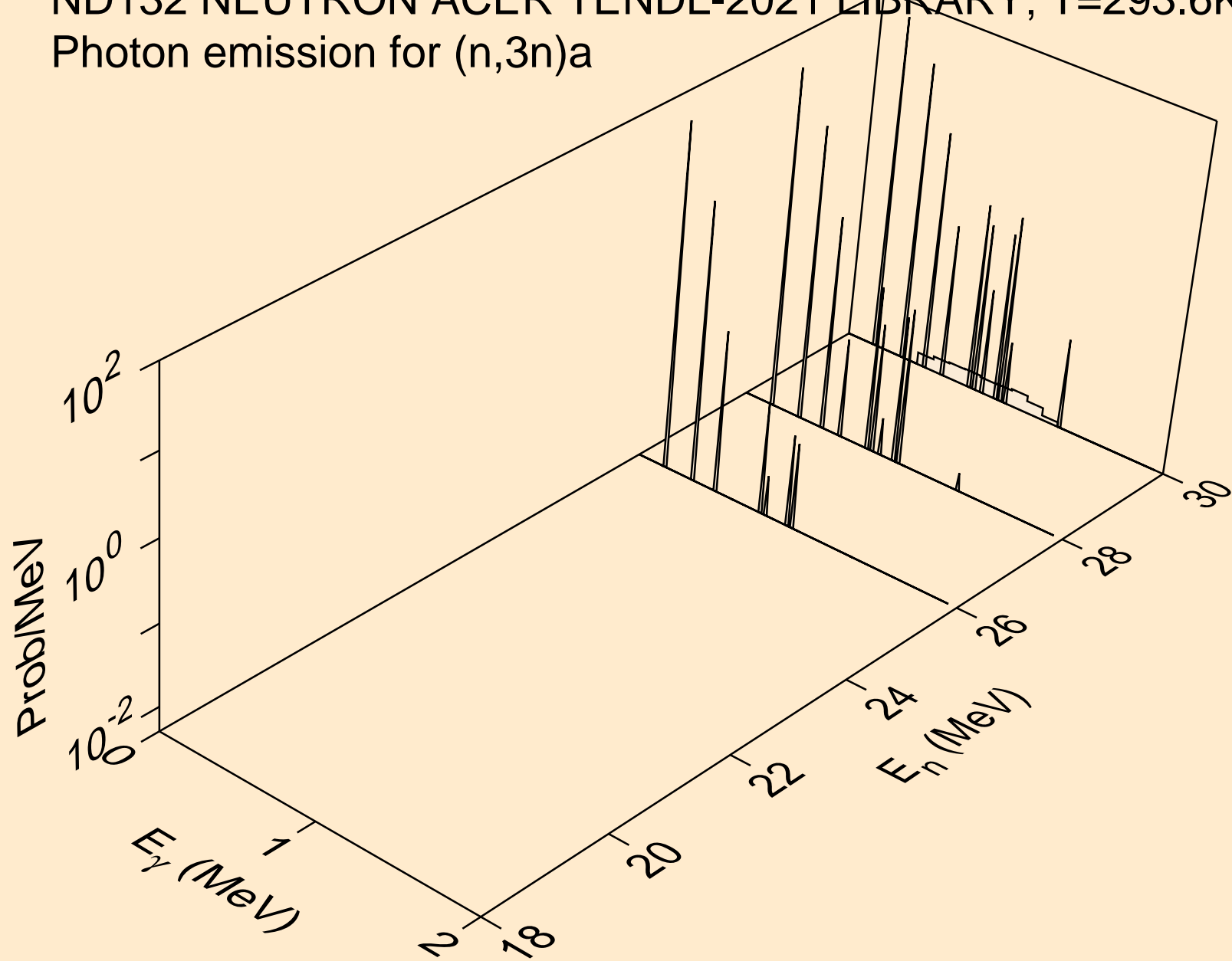

ND132 NEUTRON ACER TENDL-2021 LIBRARY; T=293.6K
Photon emission for (n,n*)p

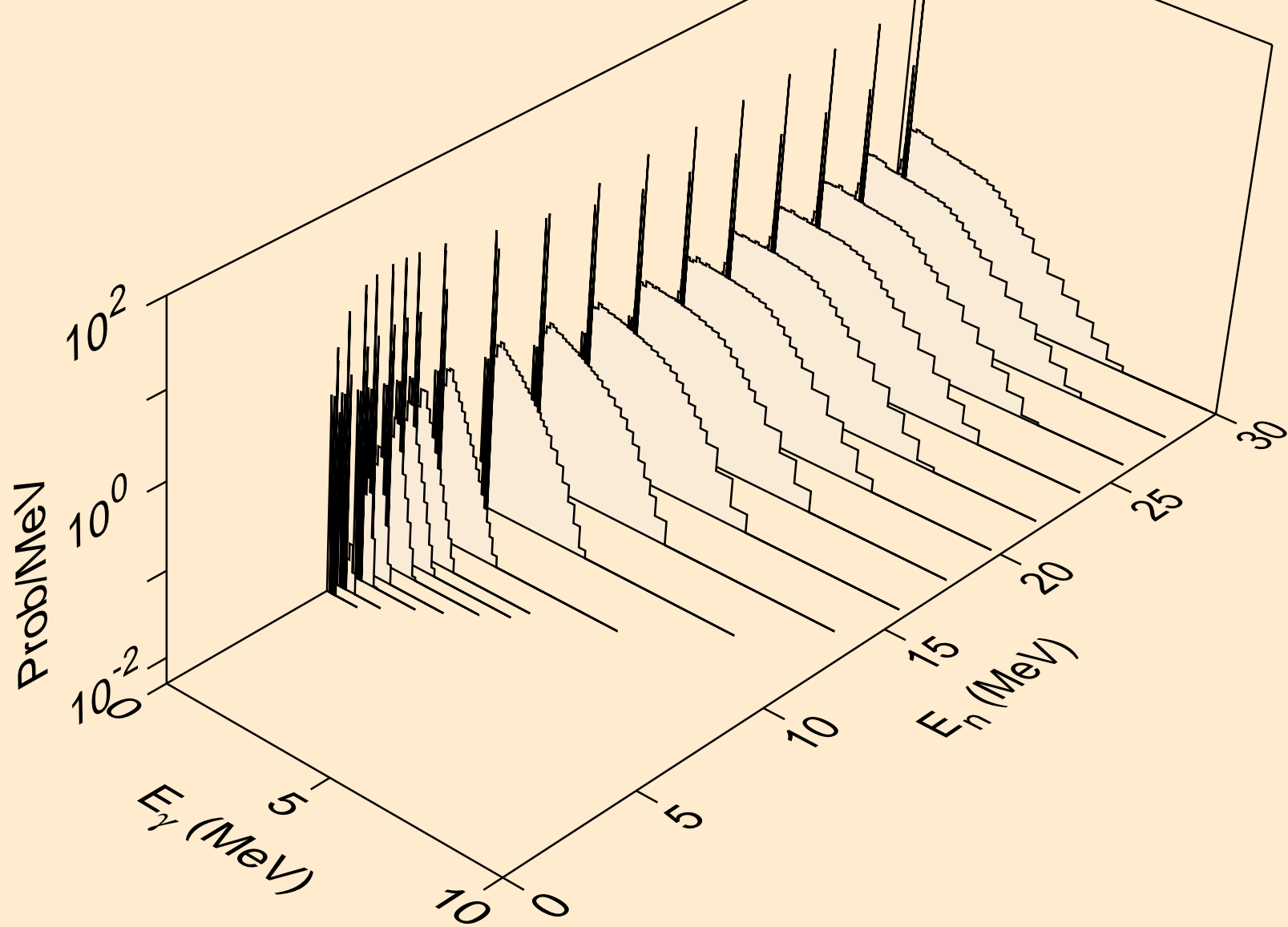

ND132 NEUTRON ACER TENDL-2021 LIBRARY; T=293.6K
Photon emission for (n,n*)2a

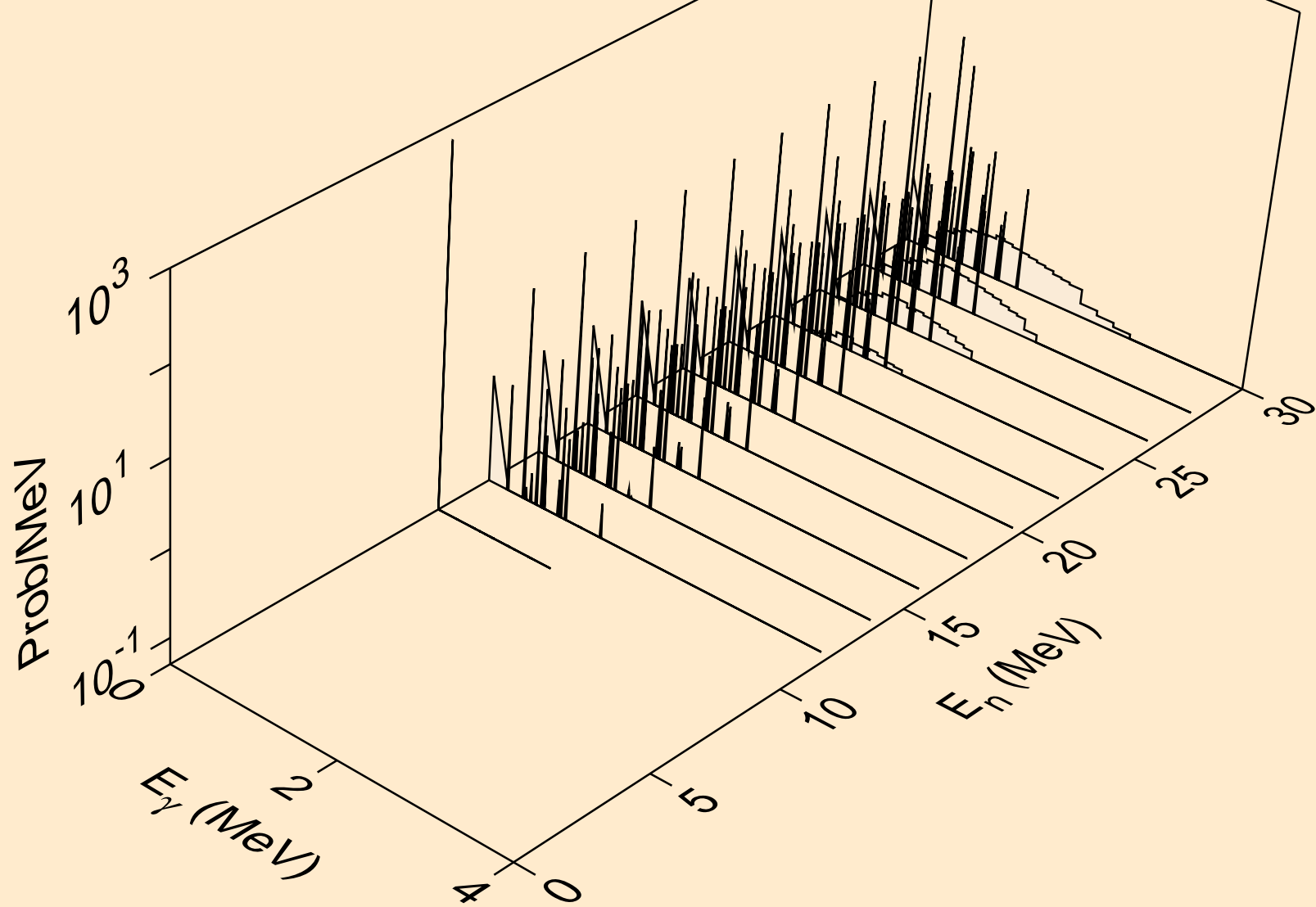

ND132 NEUTRON ACER TENDL-2021 LIBRARY; T=293.6K
Photon emission for (n,n*)d

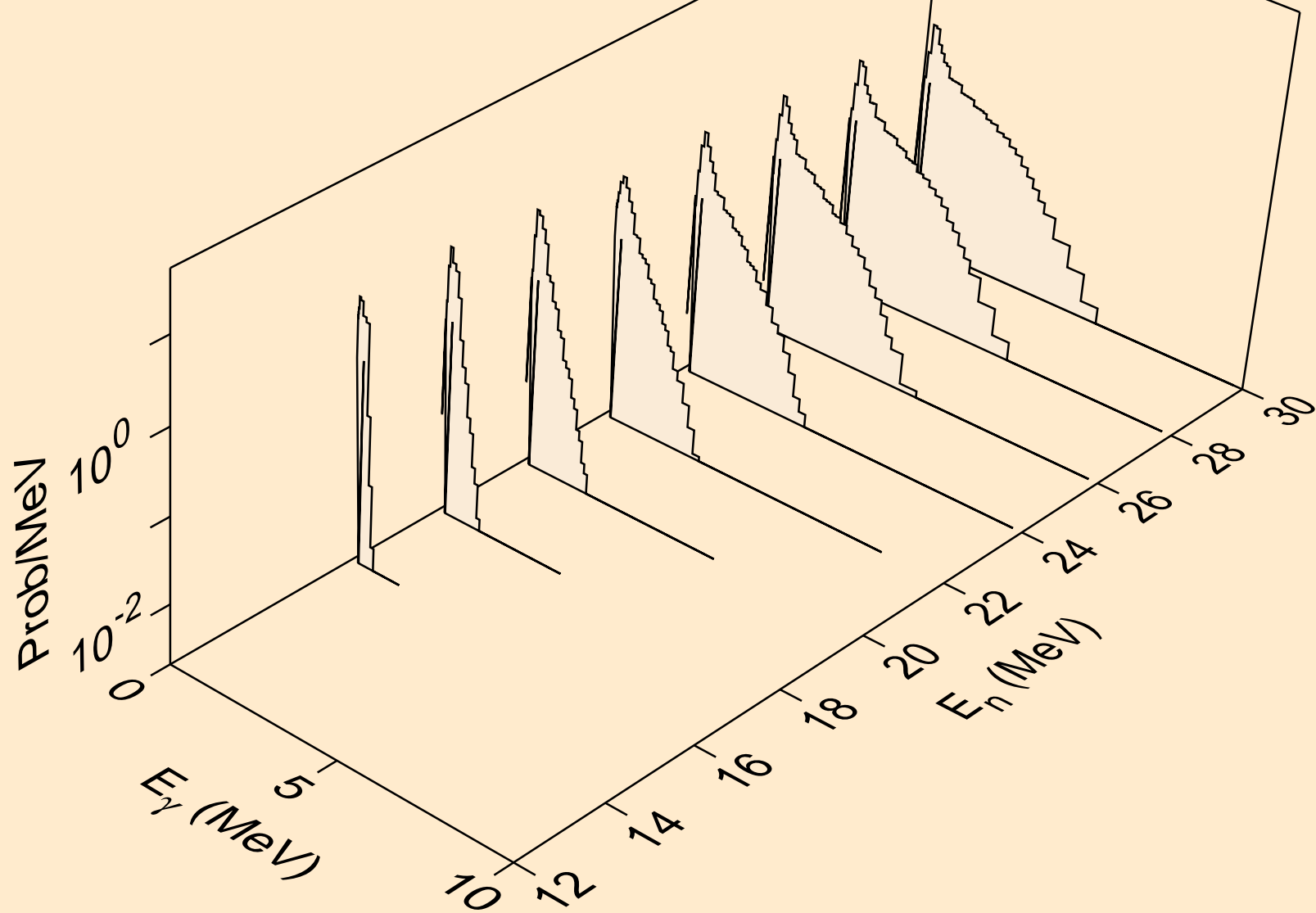

ND132 NEUTRON ACER TENDL-2021 LIBRARY; T=293.6K
Photon emission for (n,n*)t

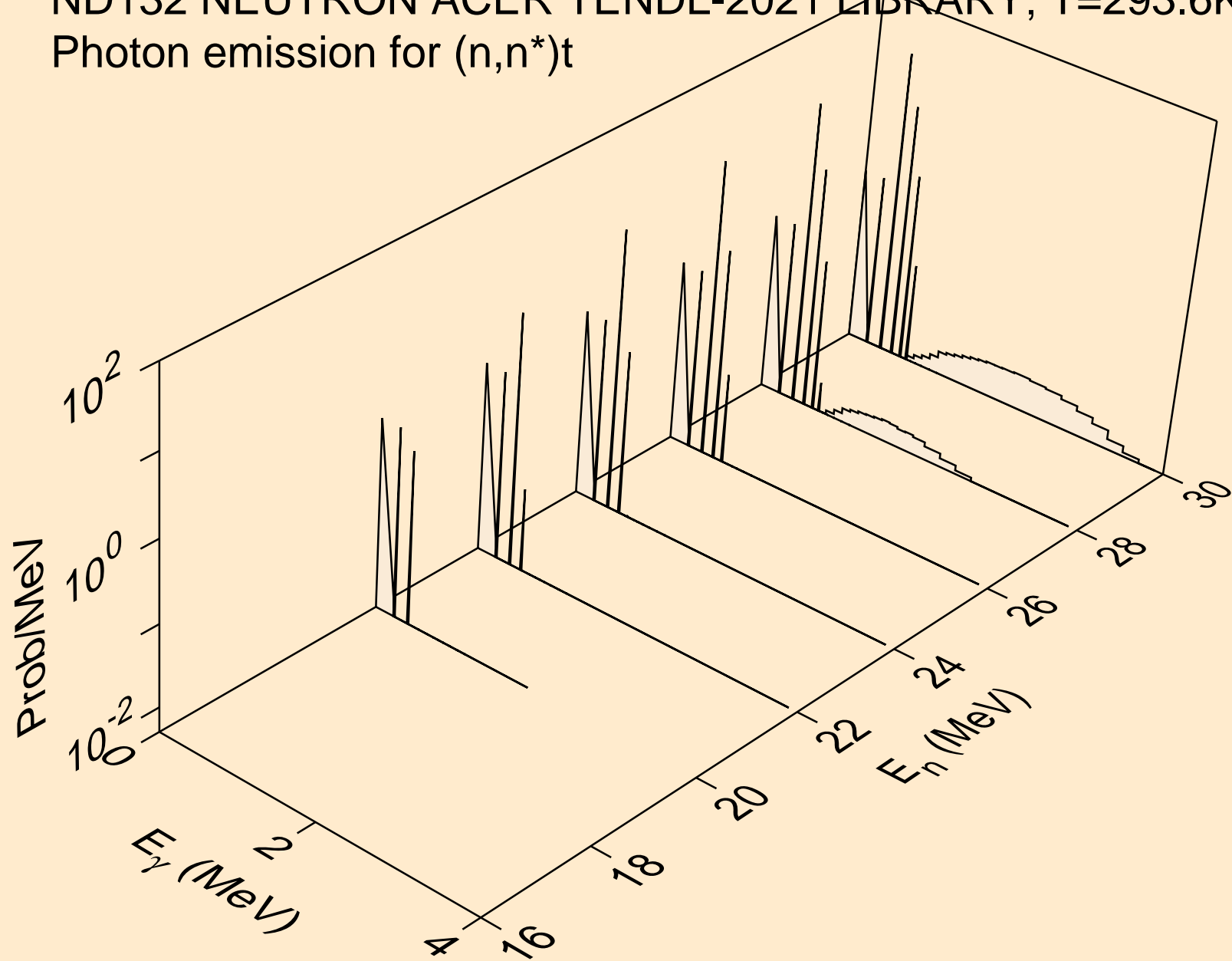

ND132 NEUTRON ACER TENDL-2021 LIBRARY; T=293.6K
Photon emission for (n,n*)he3

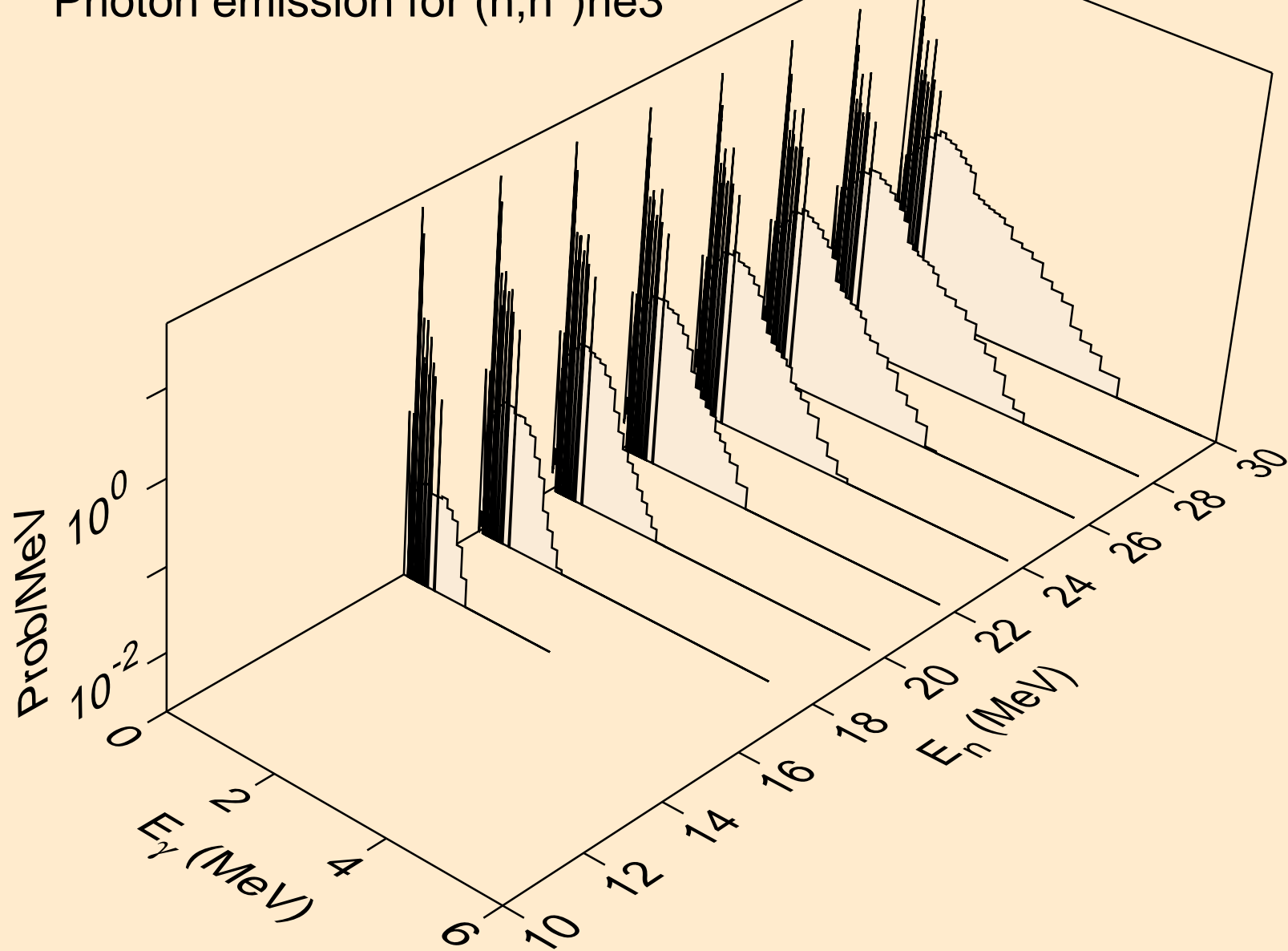

ND132 NEUTRON ACER TENDL-2021 LIBRARY; T=293.6K
Photon emission for (n,2np)

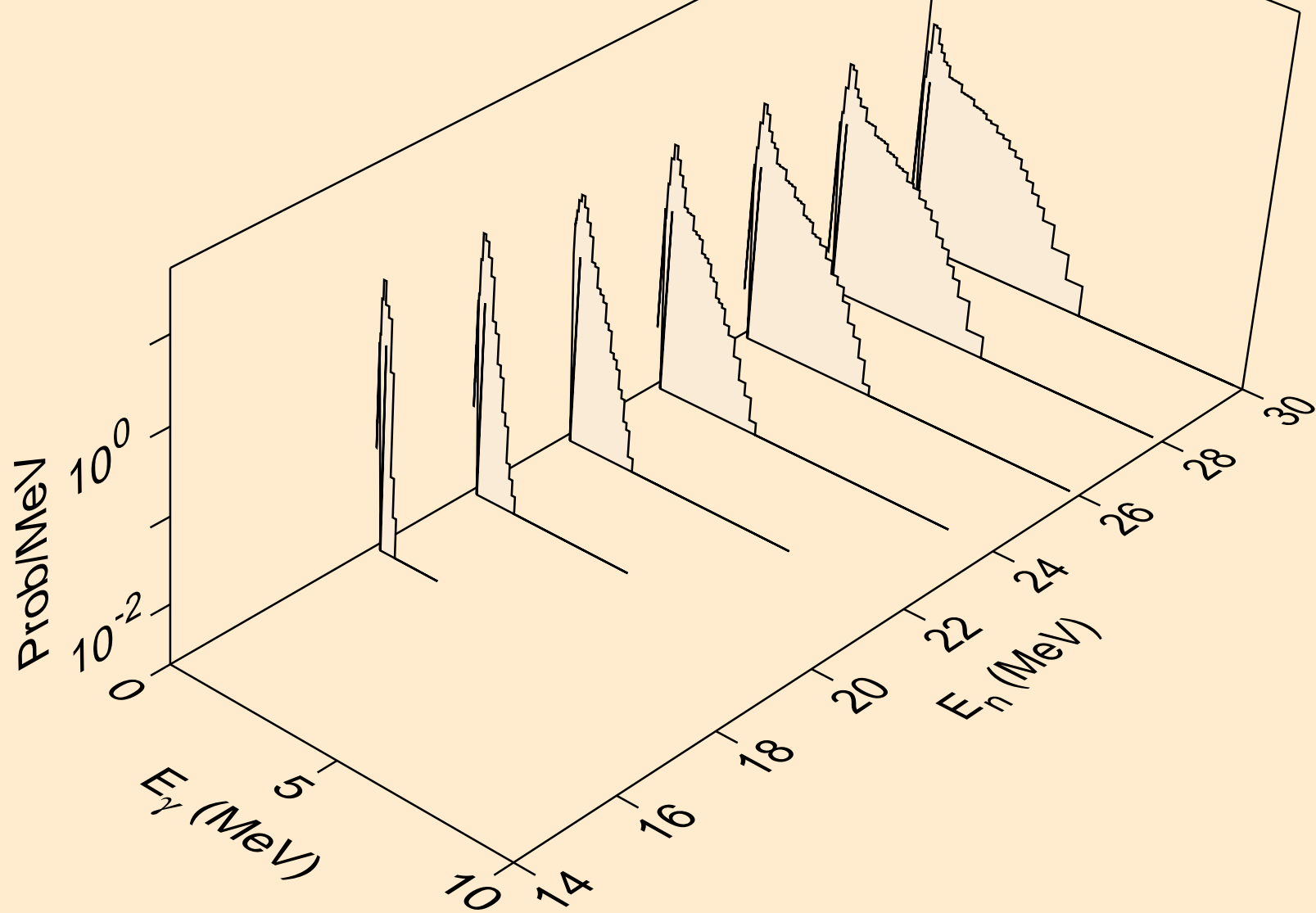

ND132 NEUTRON ACER TENDL-2021 LIBRARY; T=293.6K
Photon emission for (n,3np)

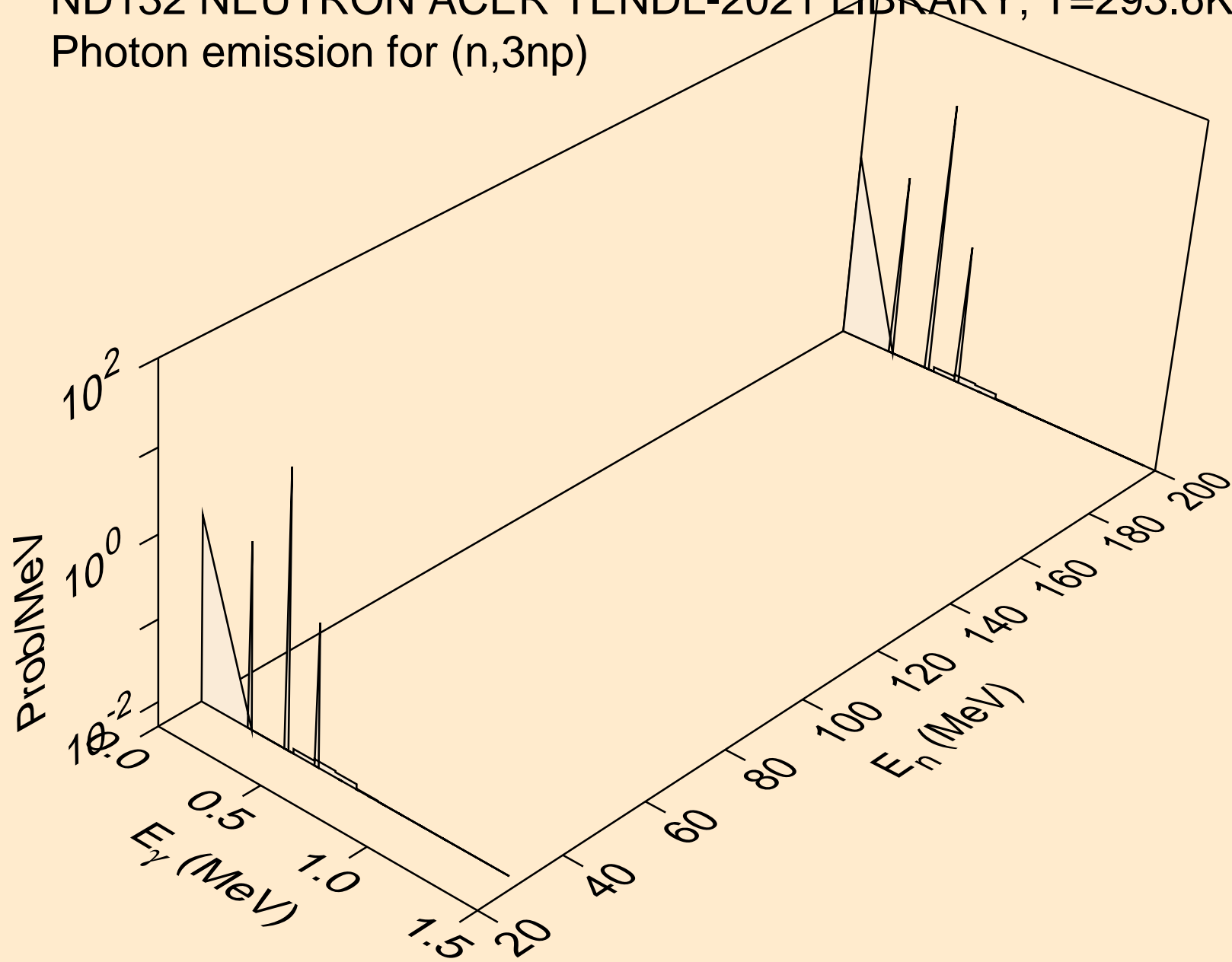

ND132 NEUTRON ACER TENDL-2021 LIBRARY; T=293.6K
Photon emission for (n,2np)

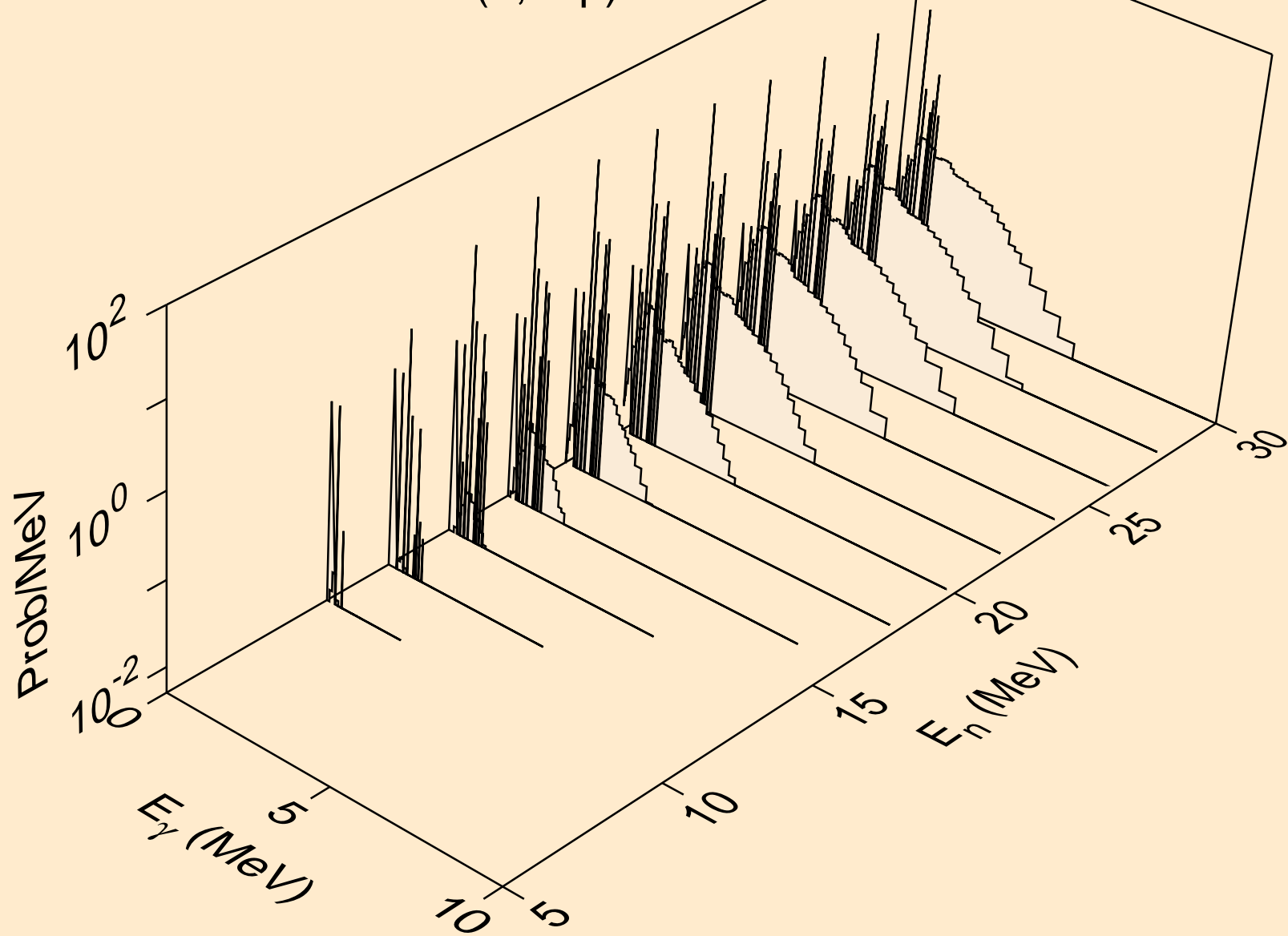

ND132 NEUTRON ACER TENDL-2021 LIBRARY; T=293.6K
Photon emission for (n,npa)

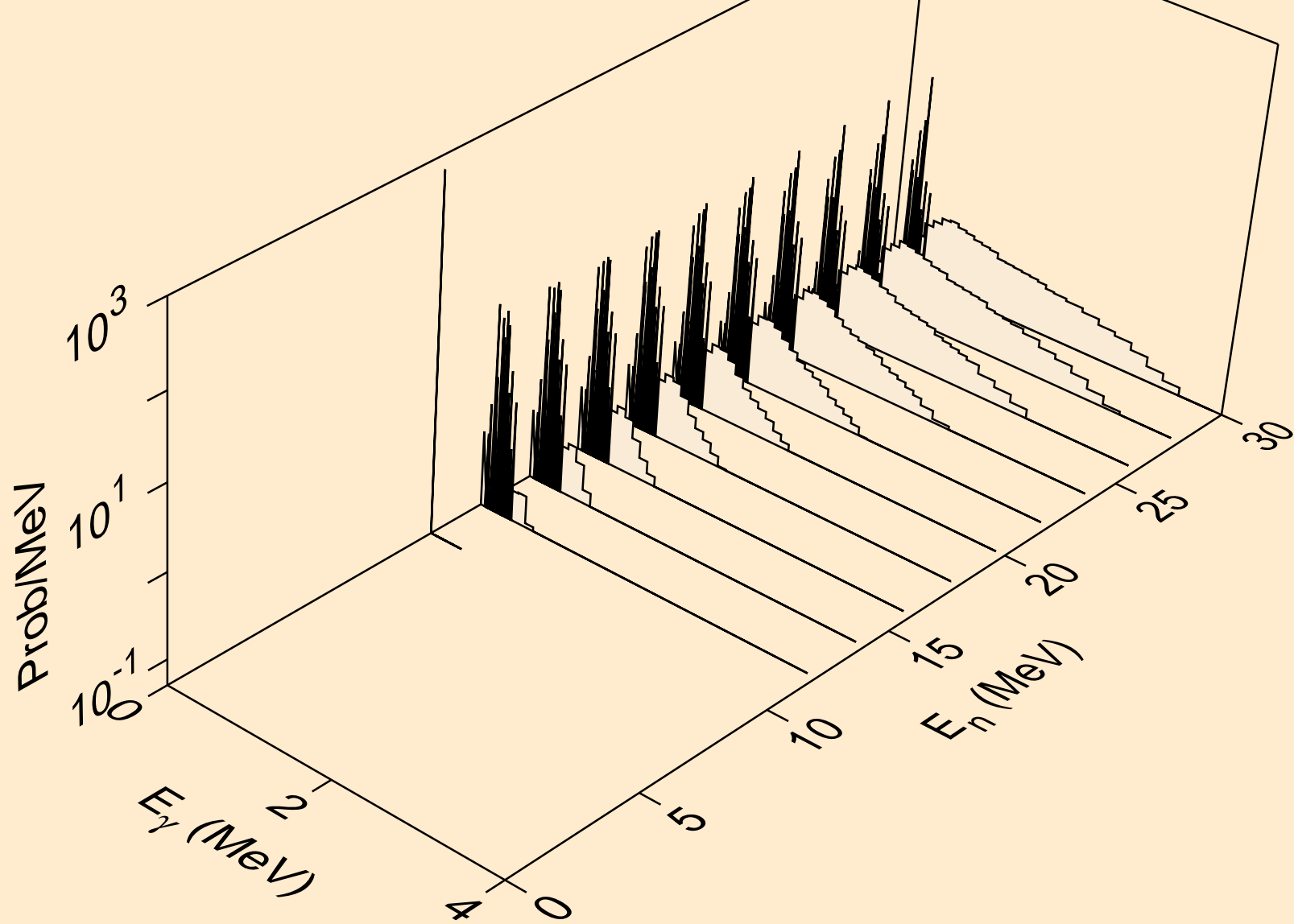

ND132 NEUTRON ACER TENDL-2021 LIBRARY; T=293.6K
Photon emission for (n,n*c)

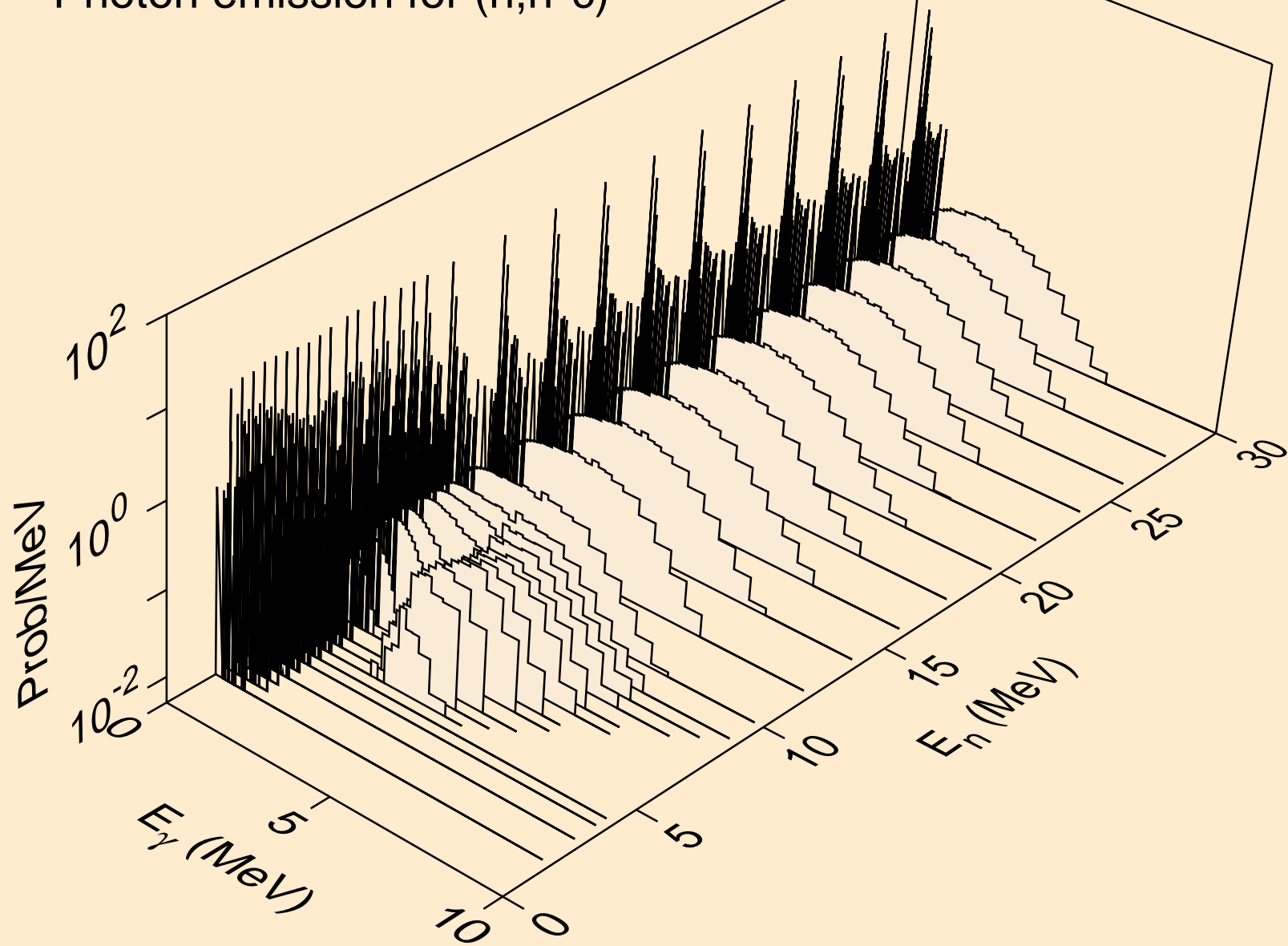

ND132 NEUTRON ACER TENDL-2021 LIBRARY; T=293.6K
Photon emission for (n,gma)

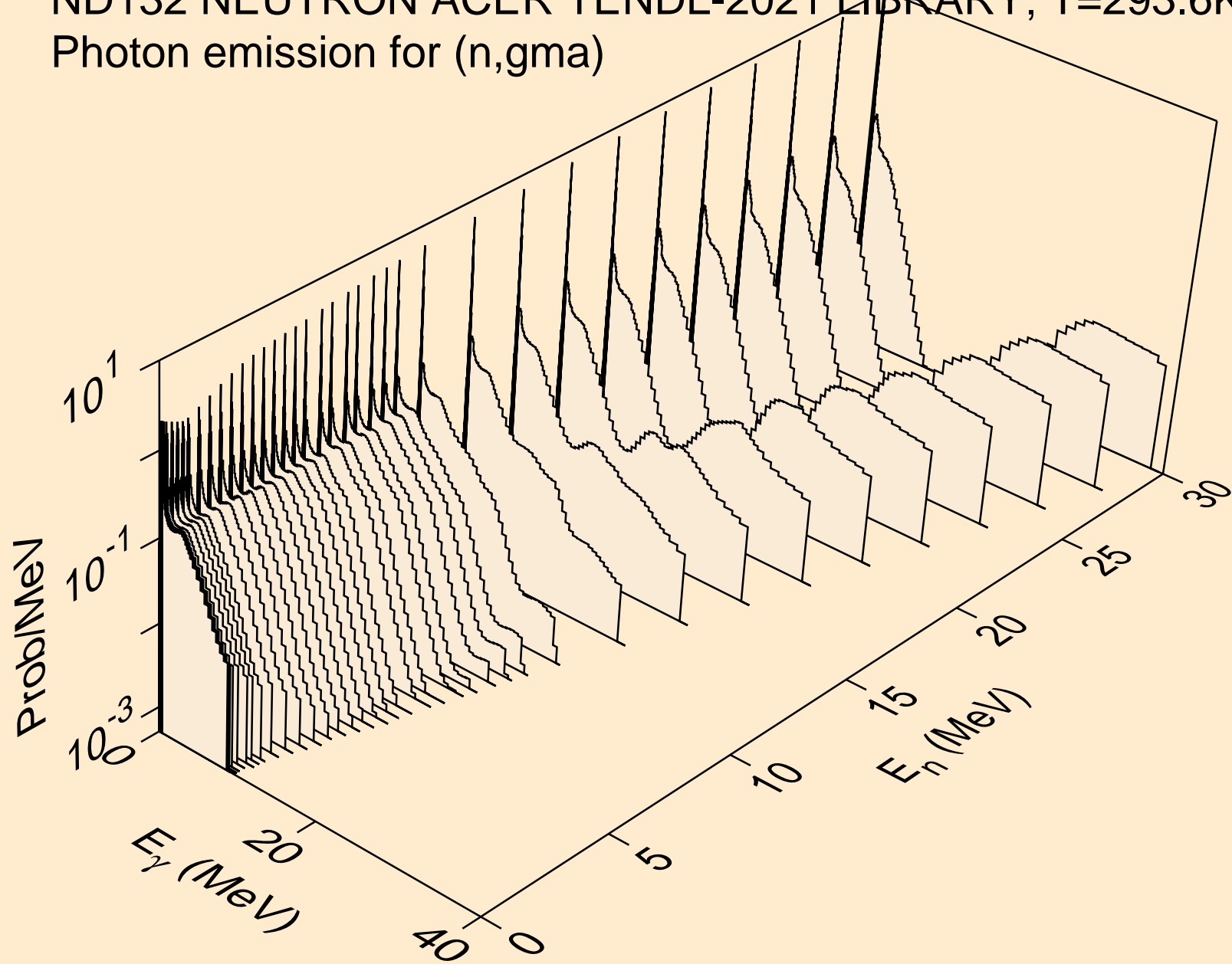

ND132 NEUTRON ACER TENDL-2021 LIBRARY; T=293.6K
Photon emission for (n,p)

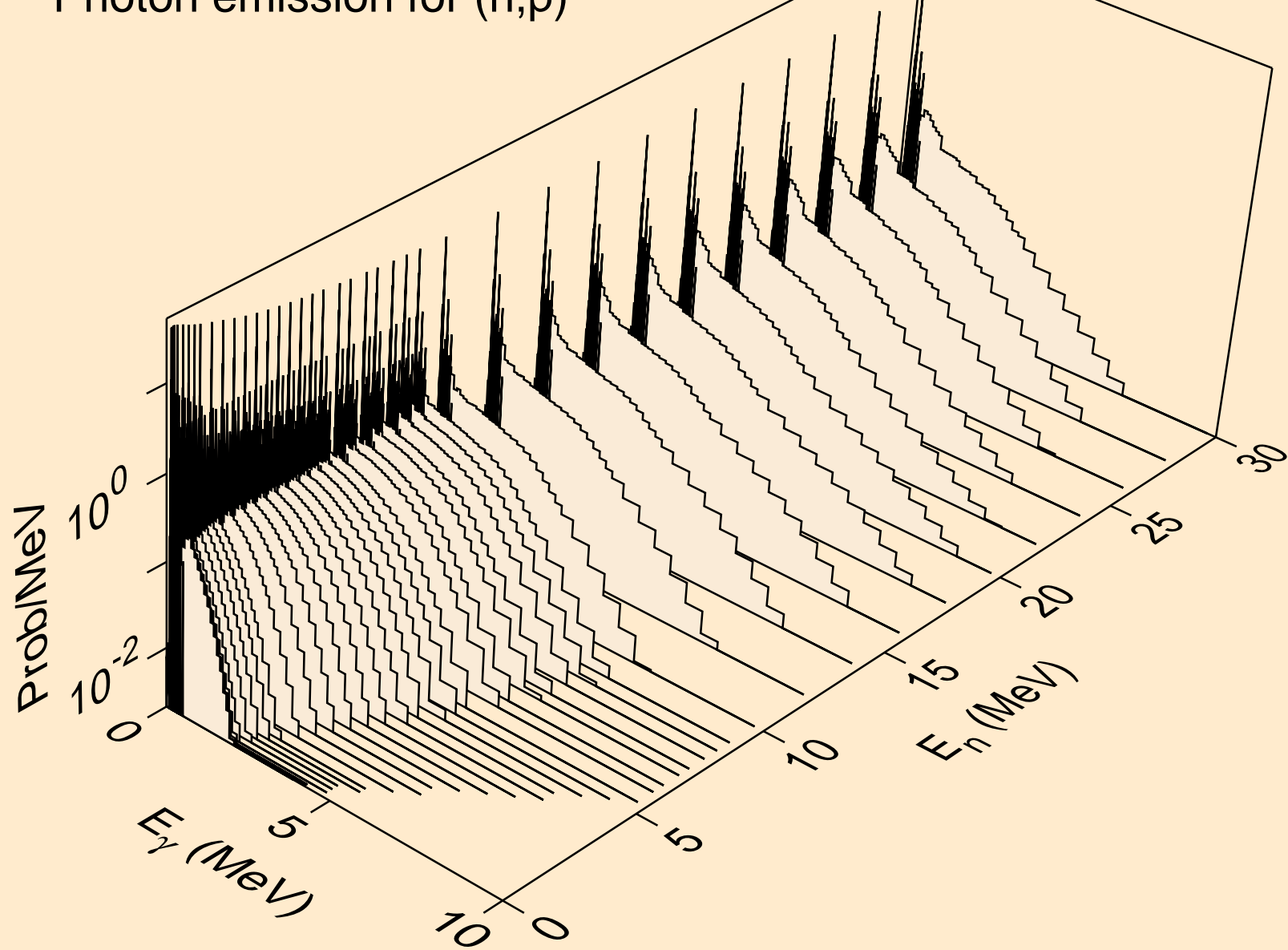

ND132 NEUTRON ACER TENDL-2021 LIBRARY; T=293.6K
Photon emission for (n,d)

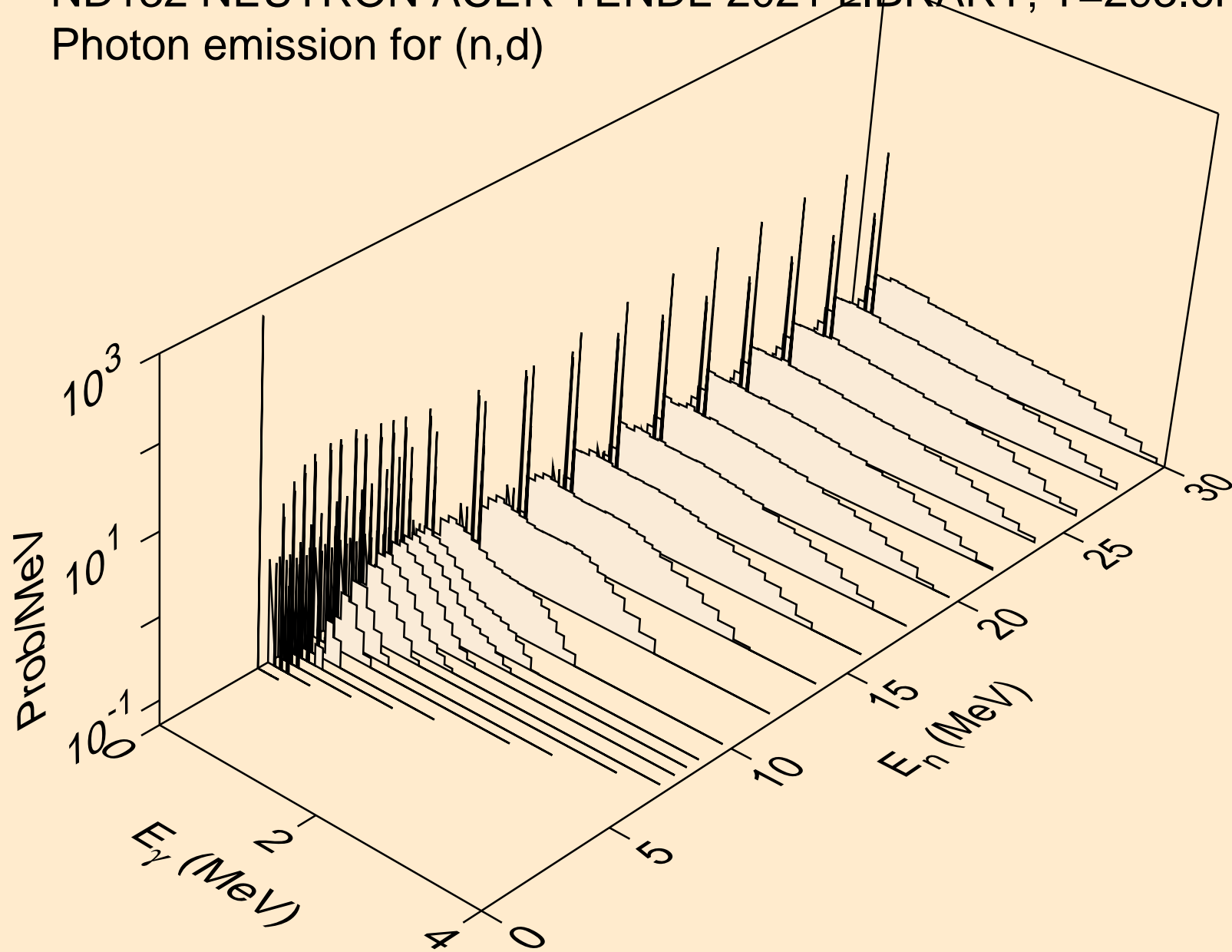

ND132 NEUTRON ACER TENDL-2021 LIBRARY; T=293.6K
Photon emission for (n,t)

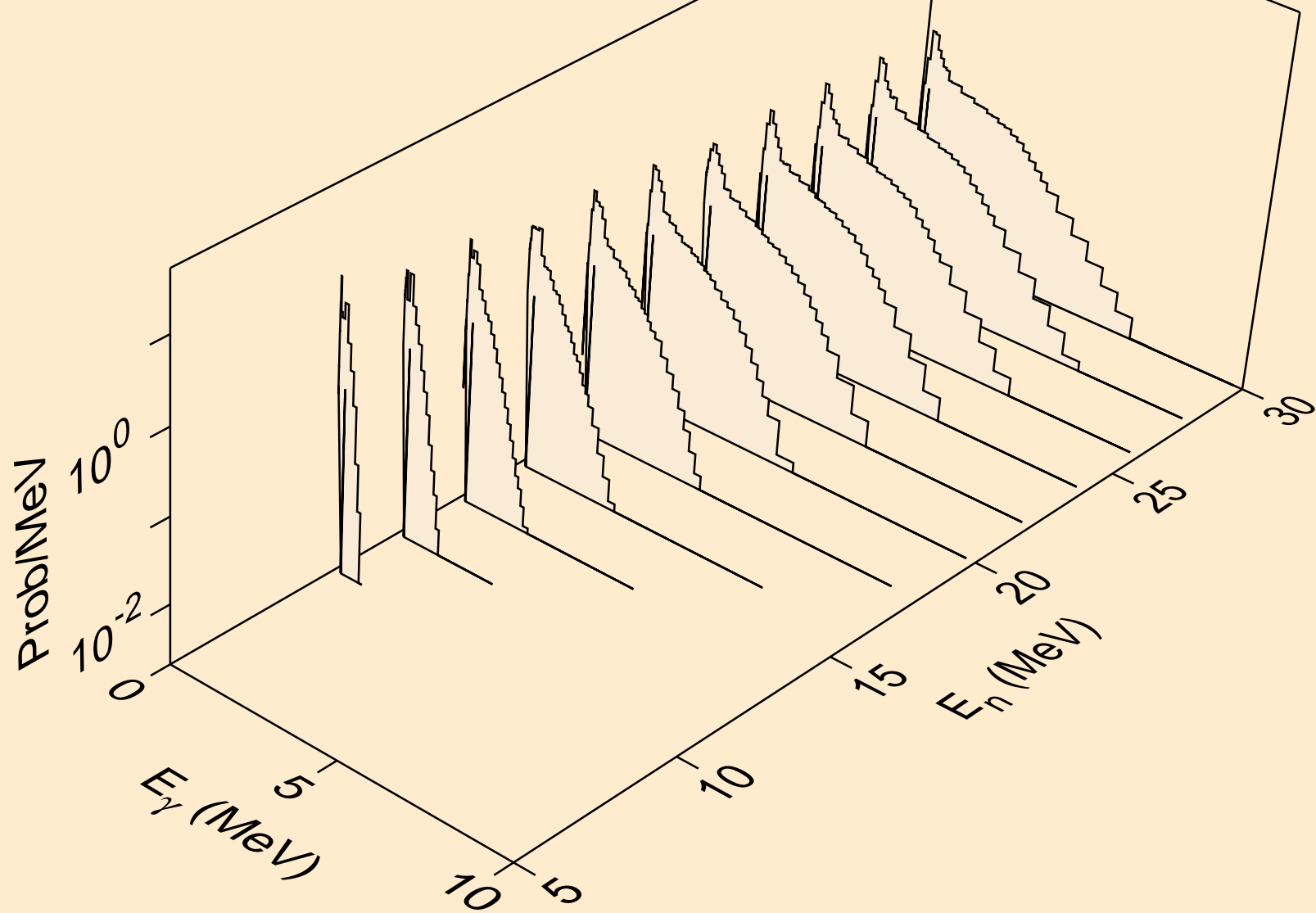

ND132 NEUTRON ACER TENDL-2021 LIBRARY; T=293.6K
Photon emission for (n,he3)

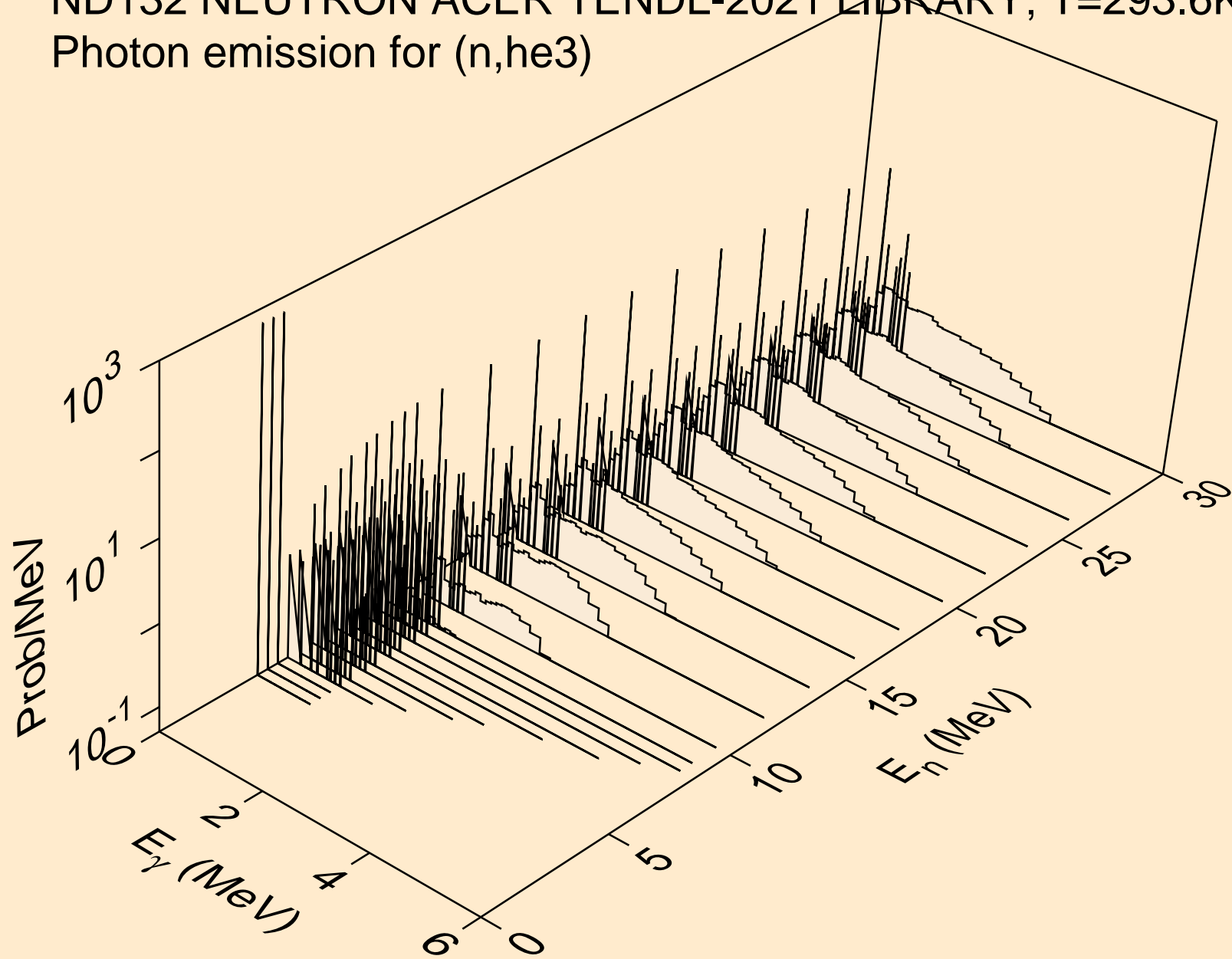

ND132 NEUTRON ACER TENDL-2021 LIBRARY; T=293.6K
Photon emission for (n,a)

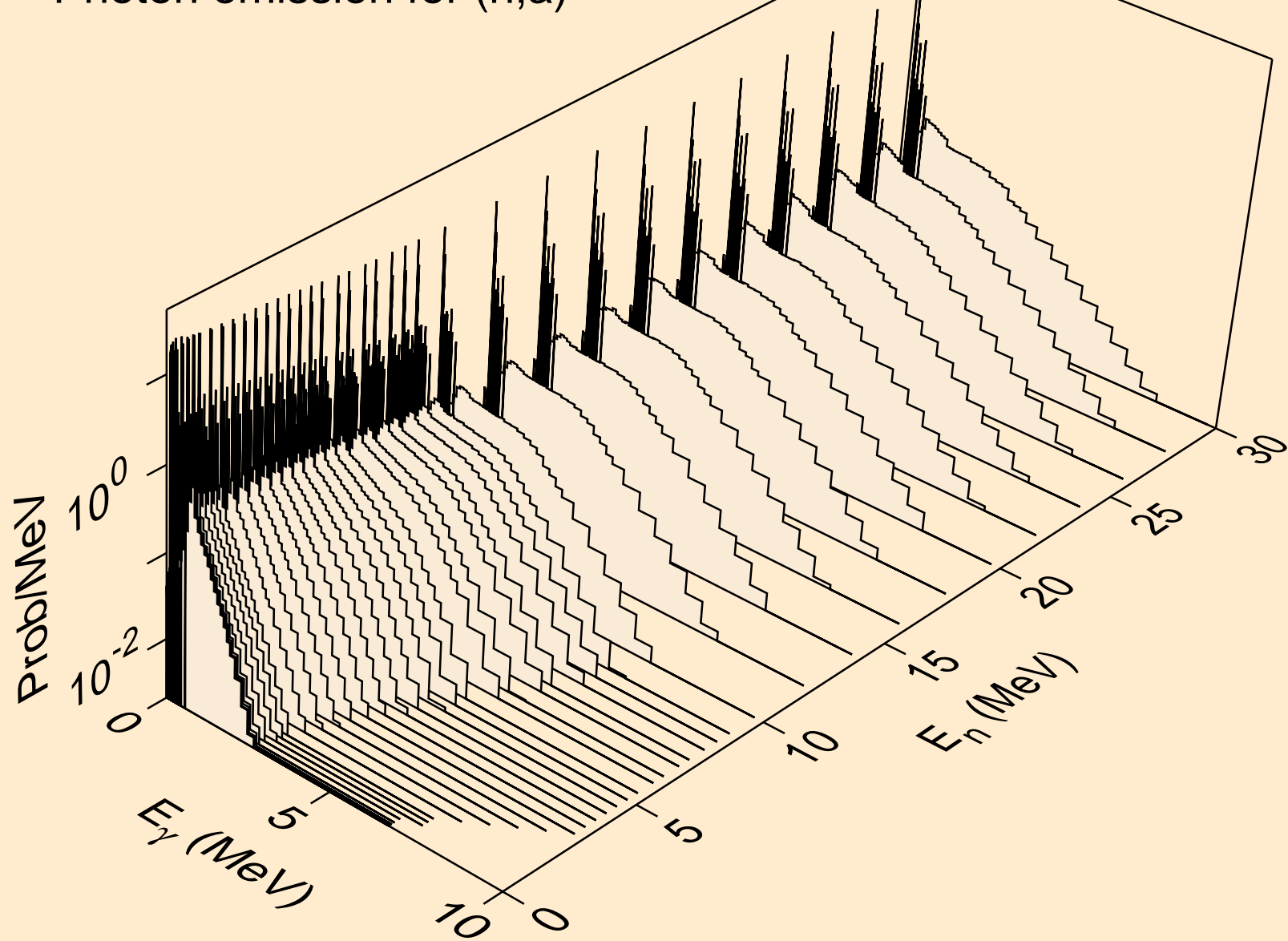

ND132 NEUTRON ACER TENDL-2021 LIBRARY; T=293.6K
Photon emission for (n,2a)

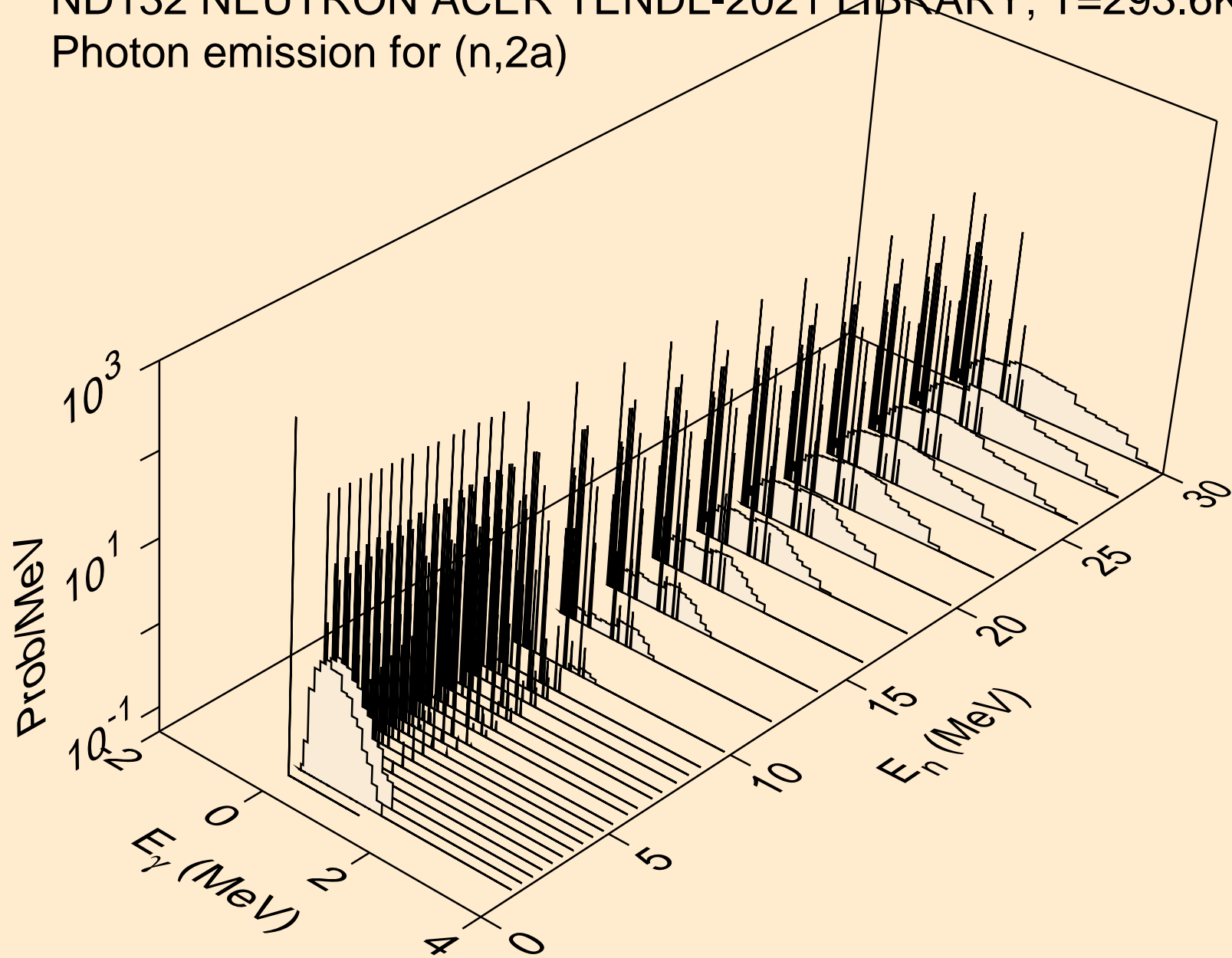

ND132 NEUTRON ACER TENDL-2021 LIBRARY; T=293.6K
Photon emission for (n,3a)

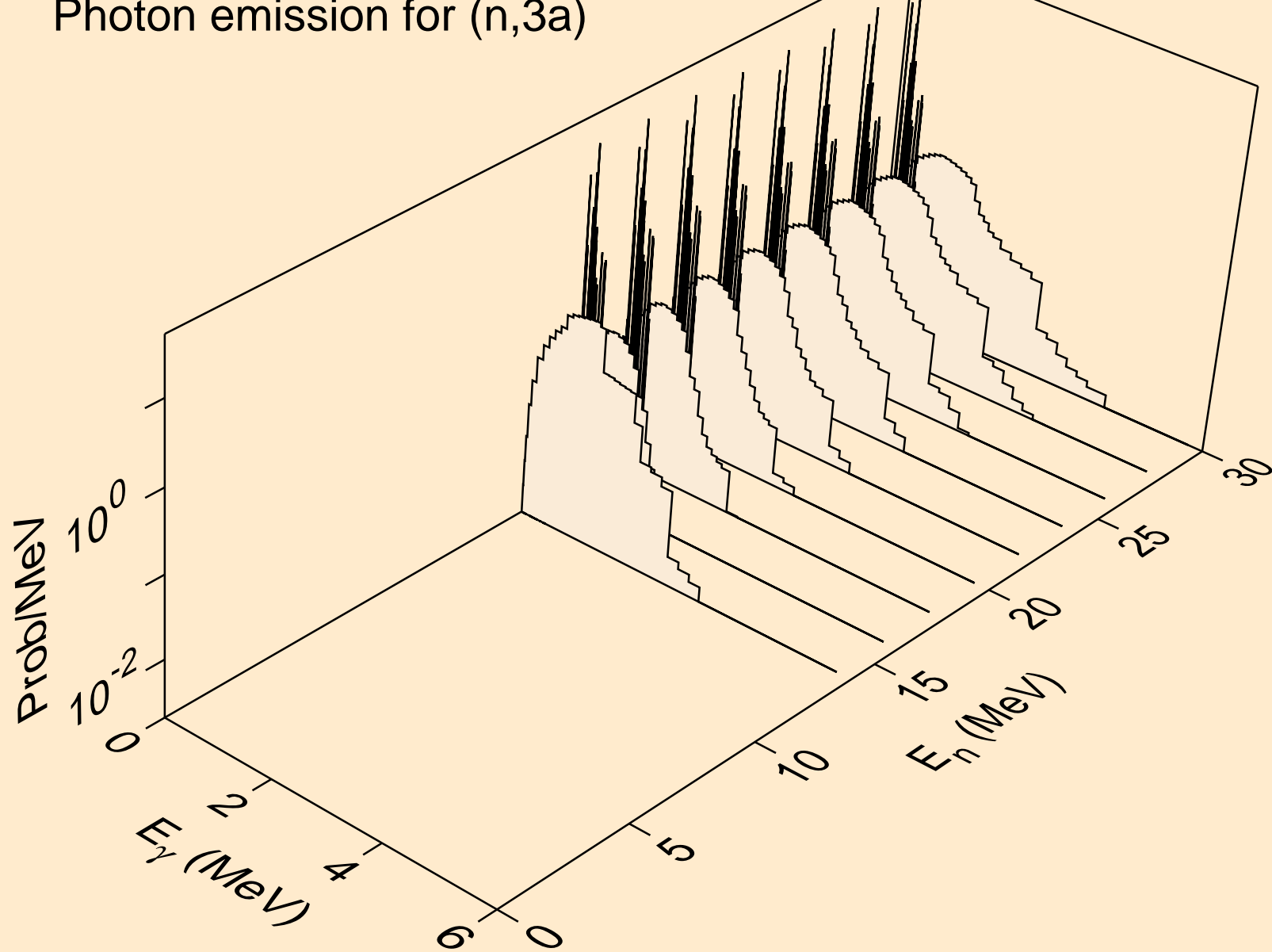

ND132 NEUTRON ACER TENDL-2021 LIBRARY; T=293.6K
Photon emission for (n,2p)

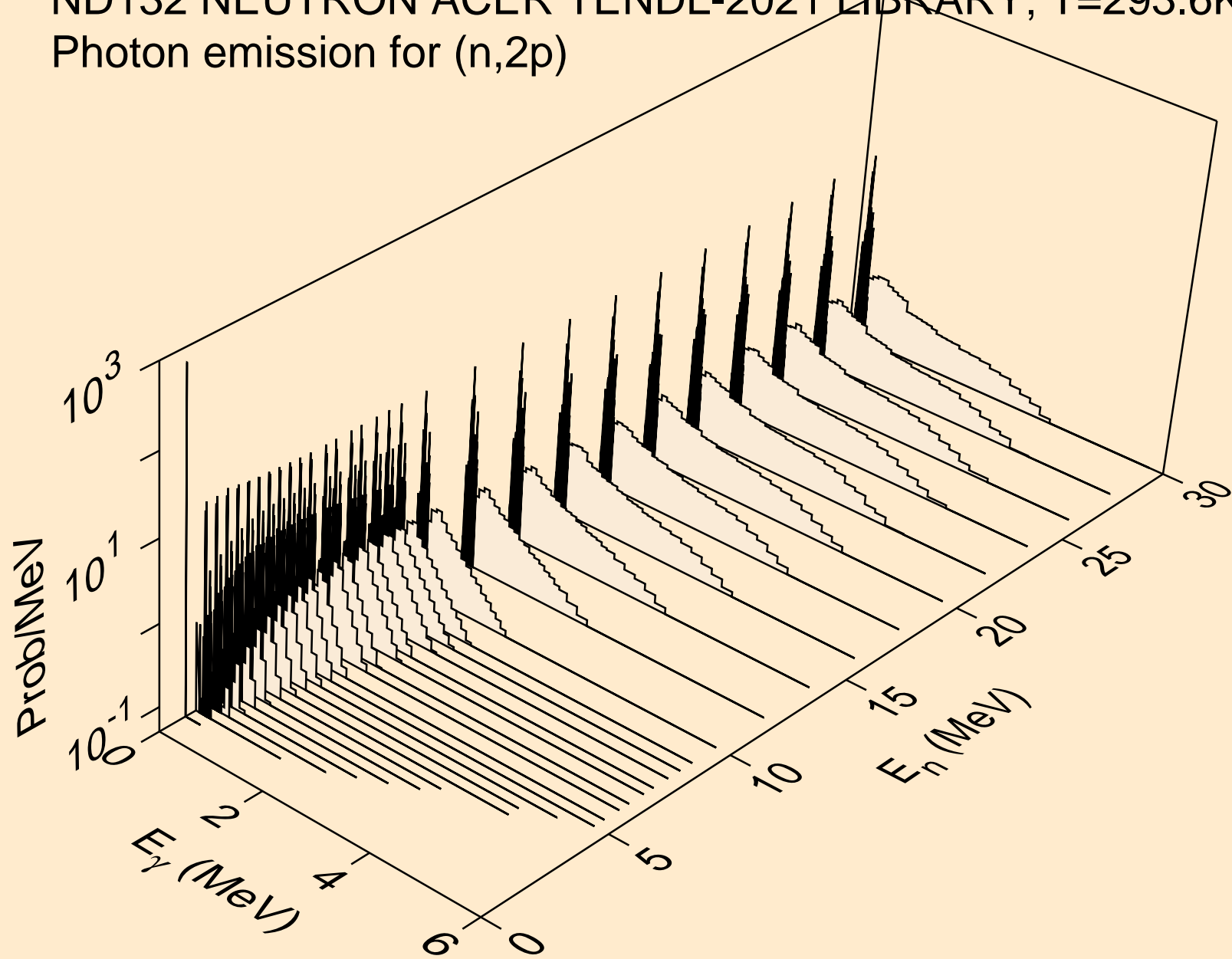

ND132 NEUTRON ACER TENDL-2021 LIBRARY; T=293.6K
Photon emission for (n,p α)

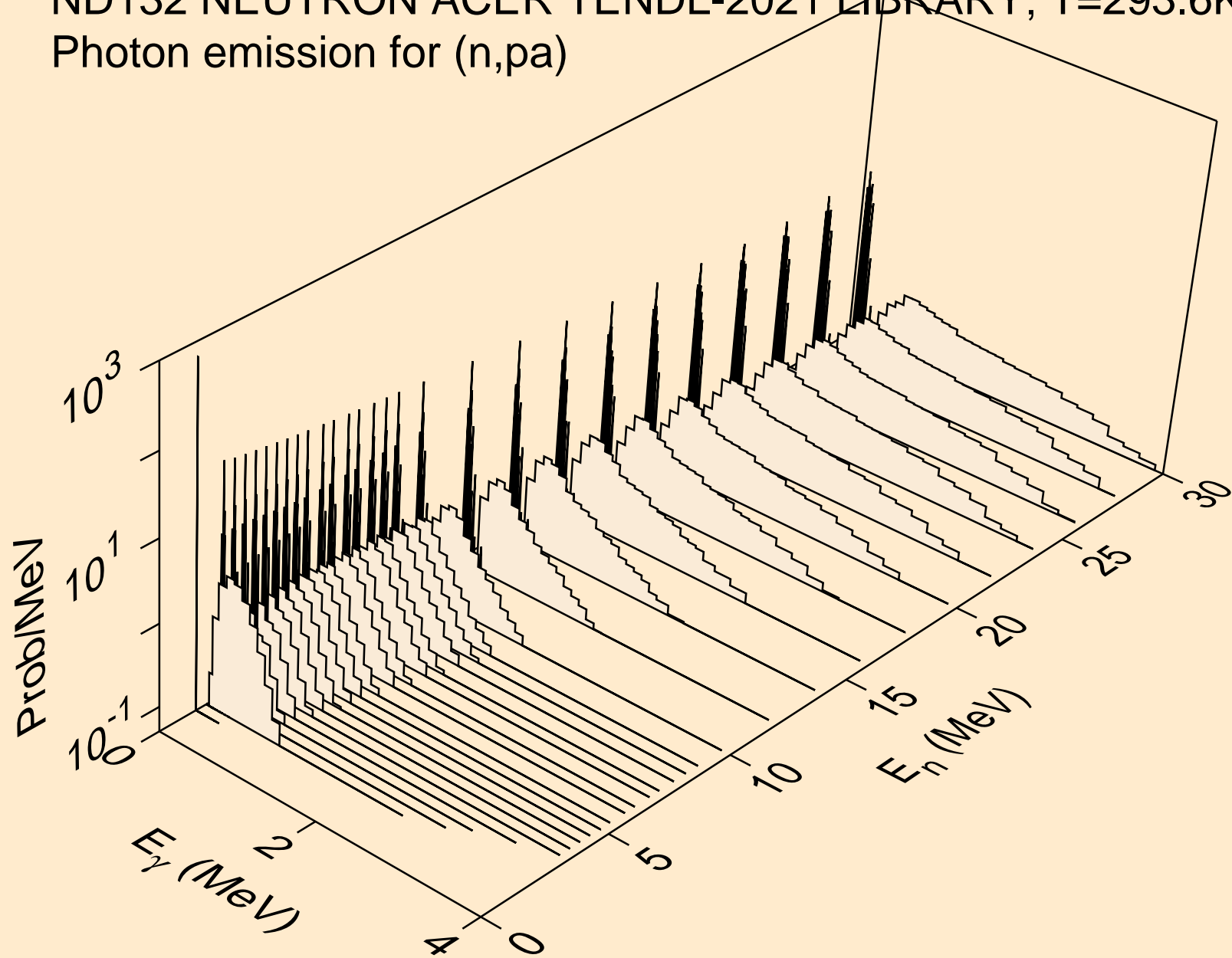

ND132 NEUTRON ACER TENDL-2021 LIBRARY; T=293.6K
Photon emission for (n,pd)

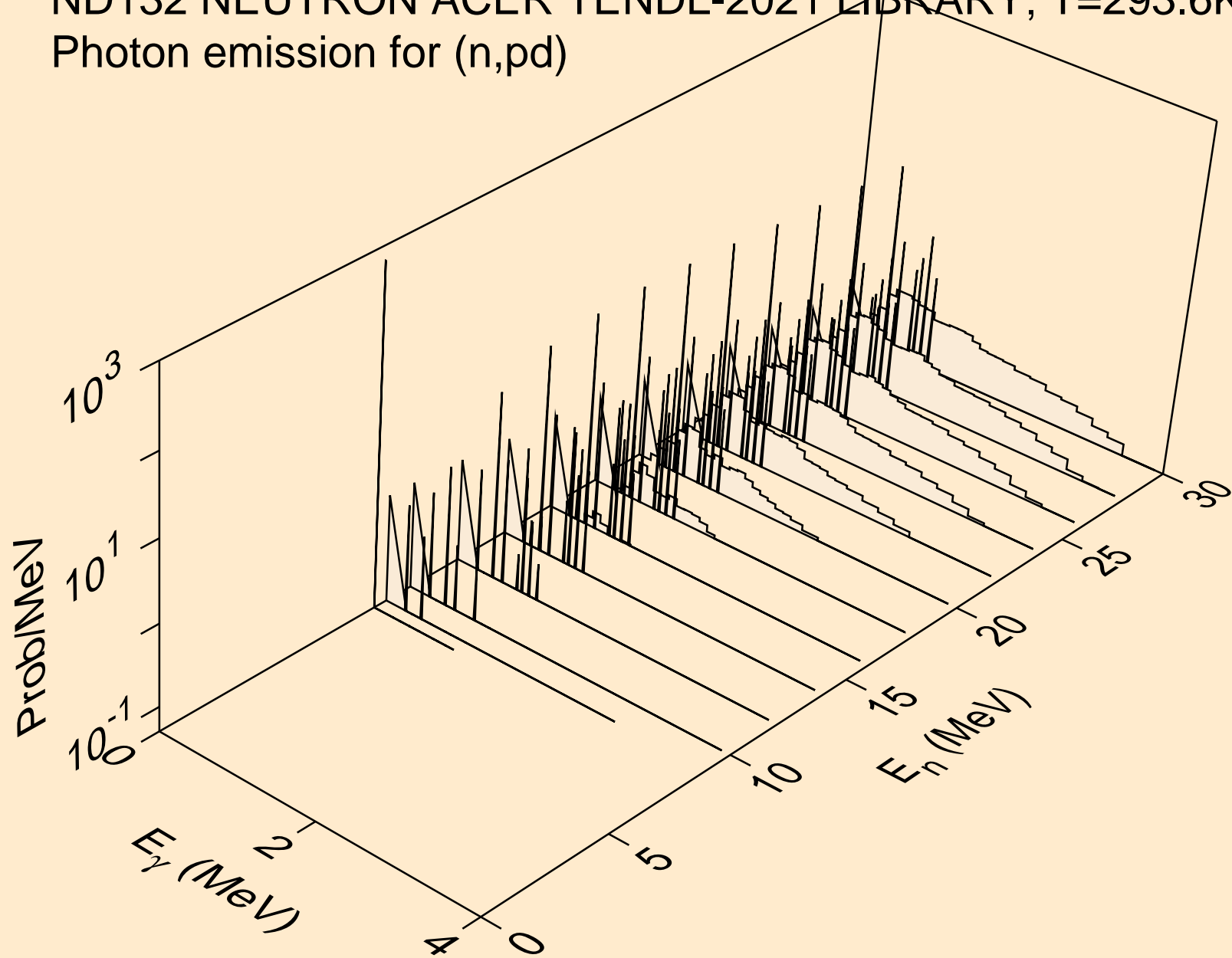

ND132 NEUTRON ACER TENDL-2021 LIBRARY; T=293.6K
Photon emission for (n,pt)

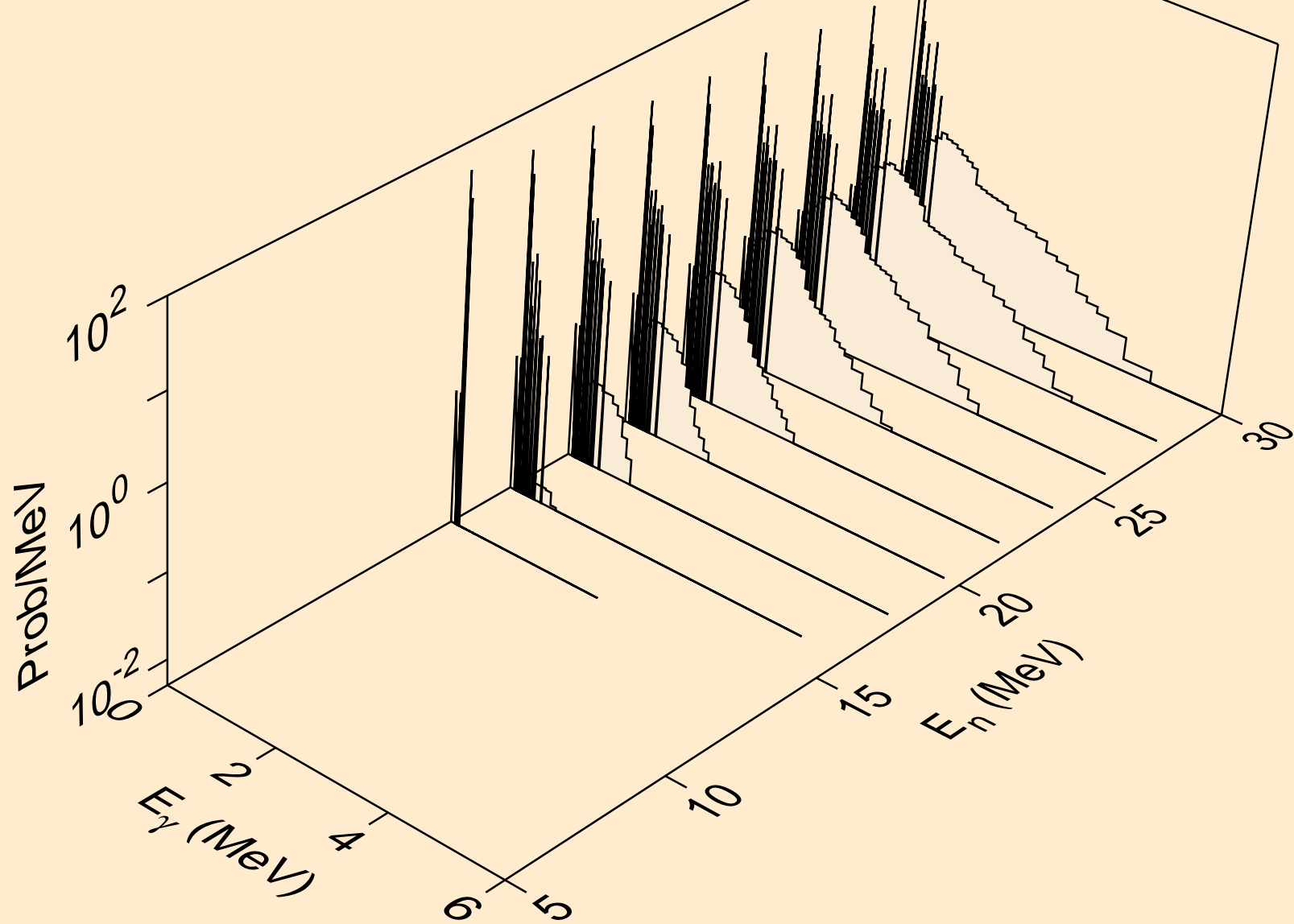

ND132 NEUTRON ACER TENDL-2021 LIBRARY; T=293.6K
Photon emission for (n,da)

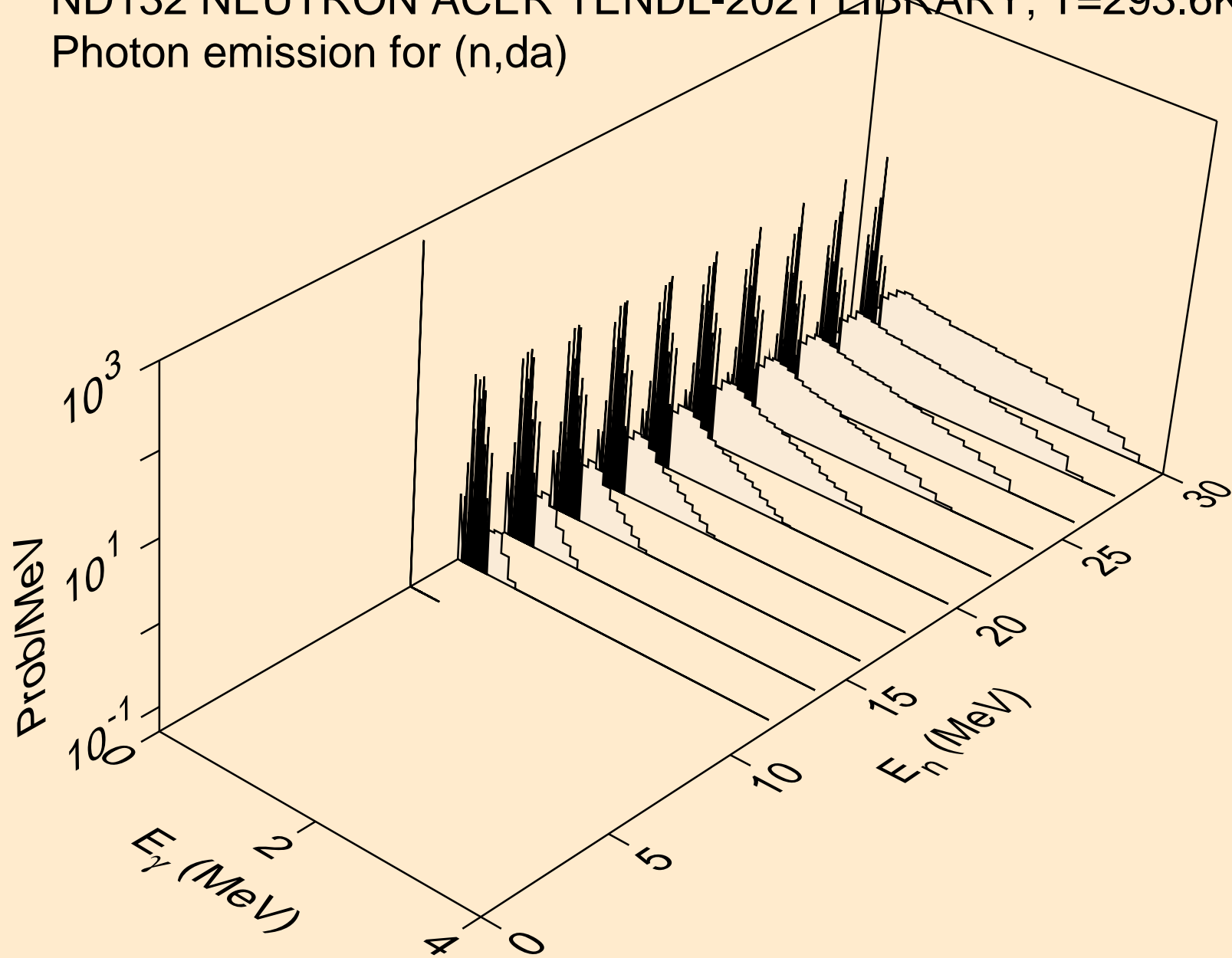

ND132 NEUTRON ACER TENDL-2021 LIBRARY; T=293.6K
thermal capture photon spectrum

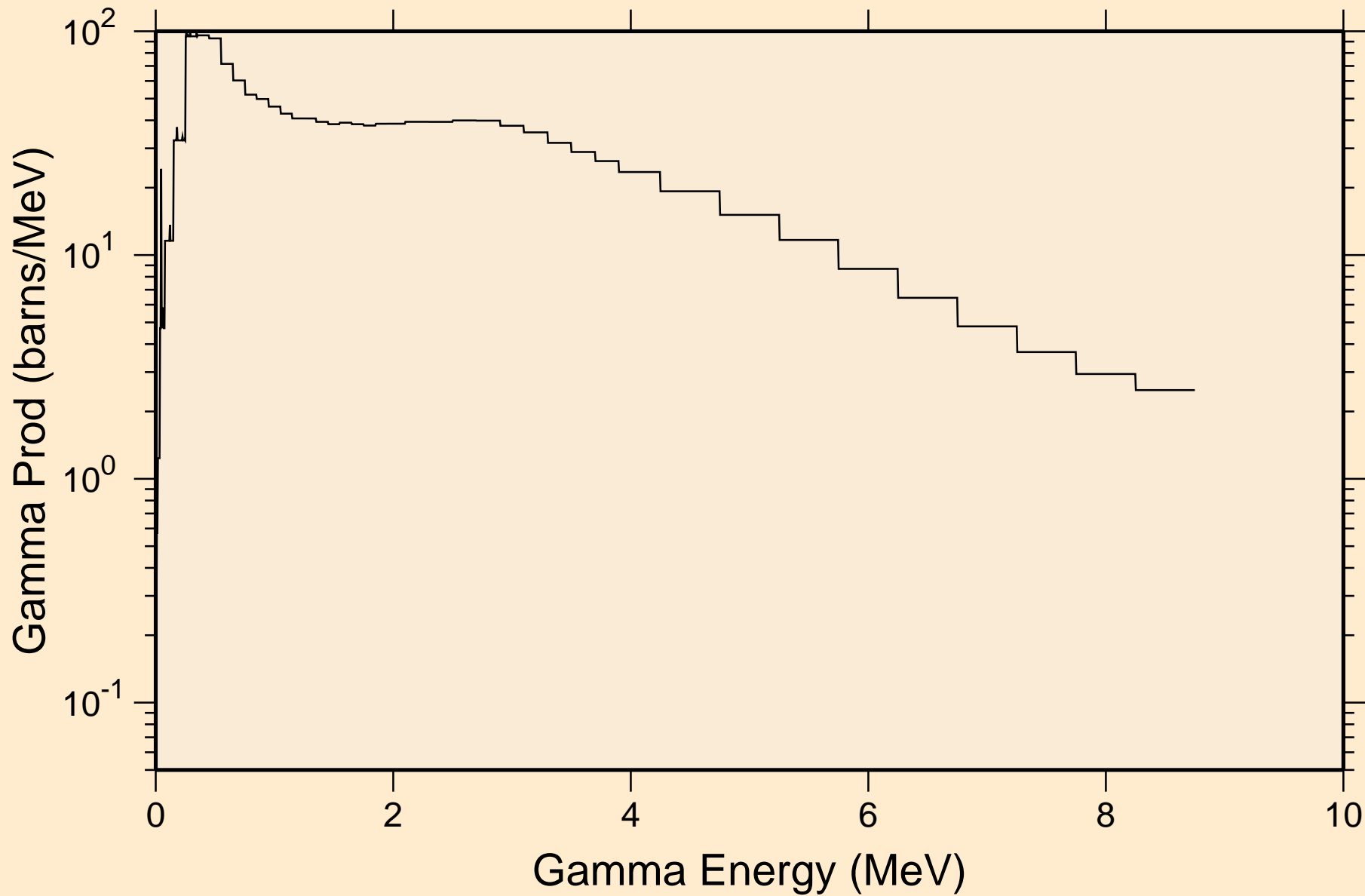

ND132 NEUTRON ACER TENDL-2021 LIBRARY; T=293.6K
14 MeV photon spectrum

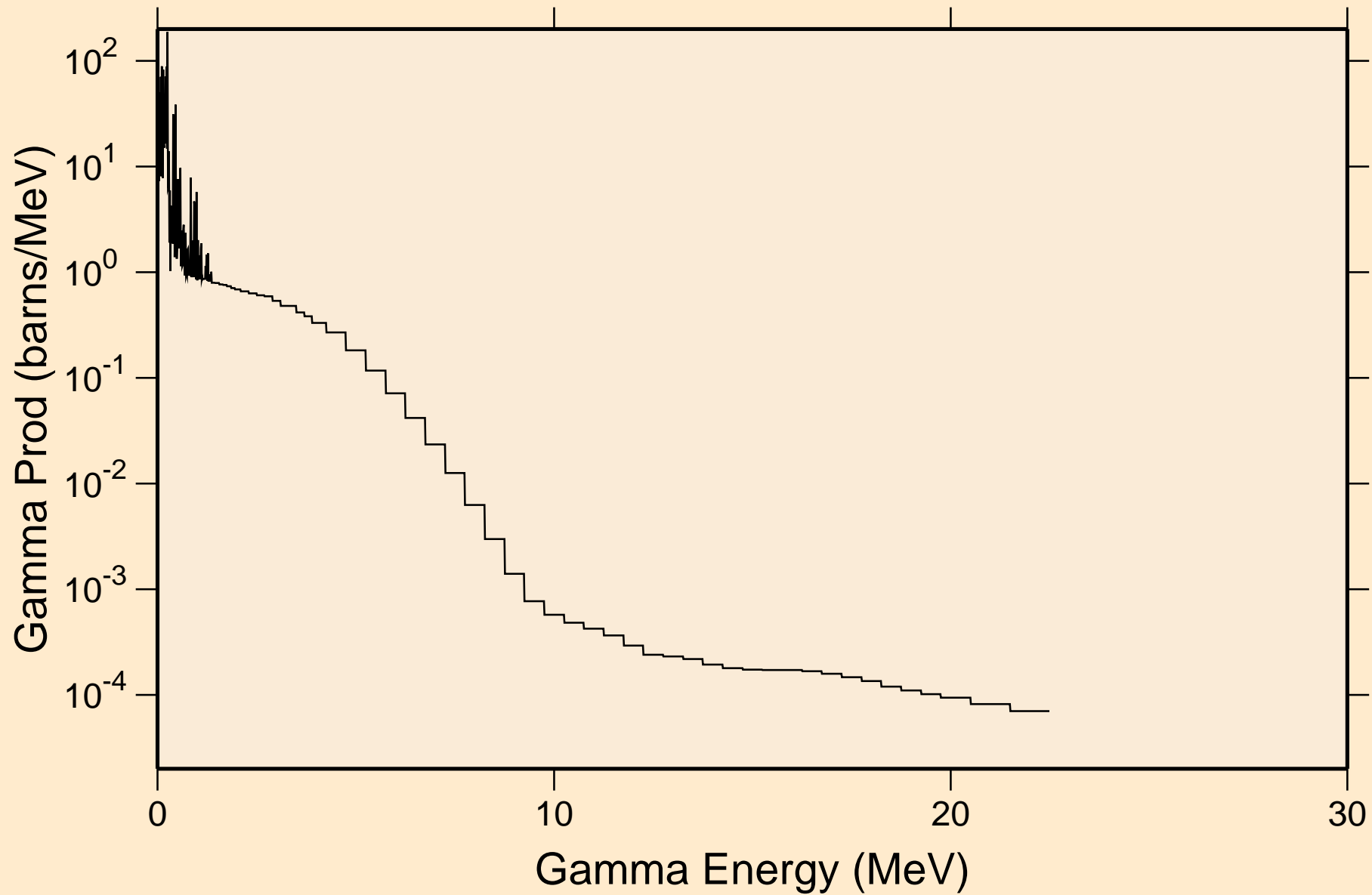

ND132 NEUTRON ACER TENDL-2021 LIBRARY; T=293.6K

Particle heating contributions

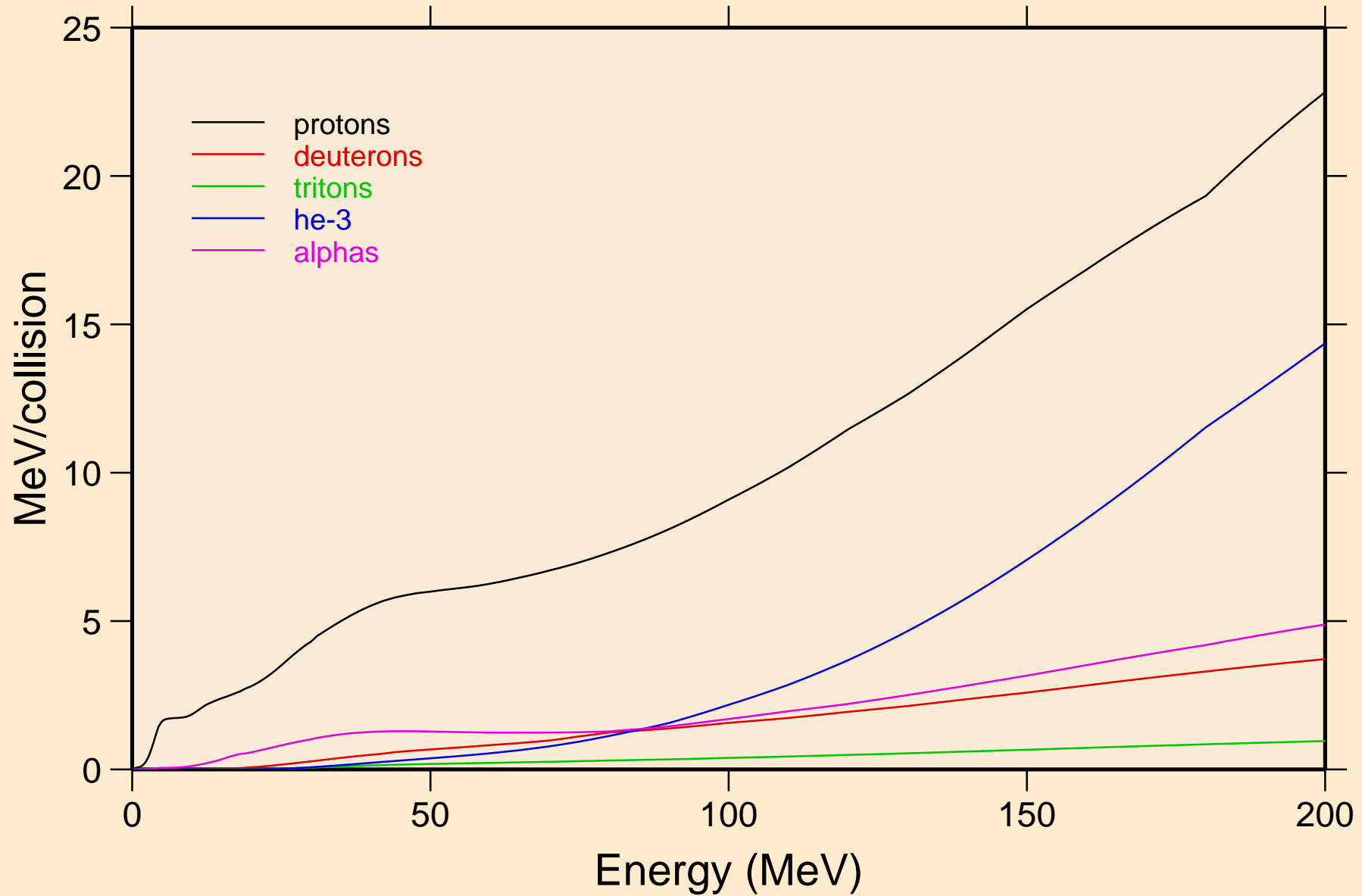

ND132 NEUTRON ACER TENDL-2021 LIBRARY; T=293.6K
Recoil Heating

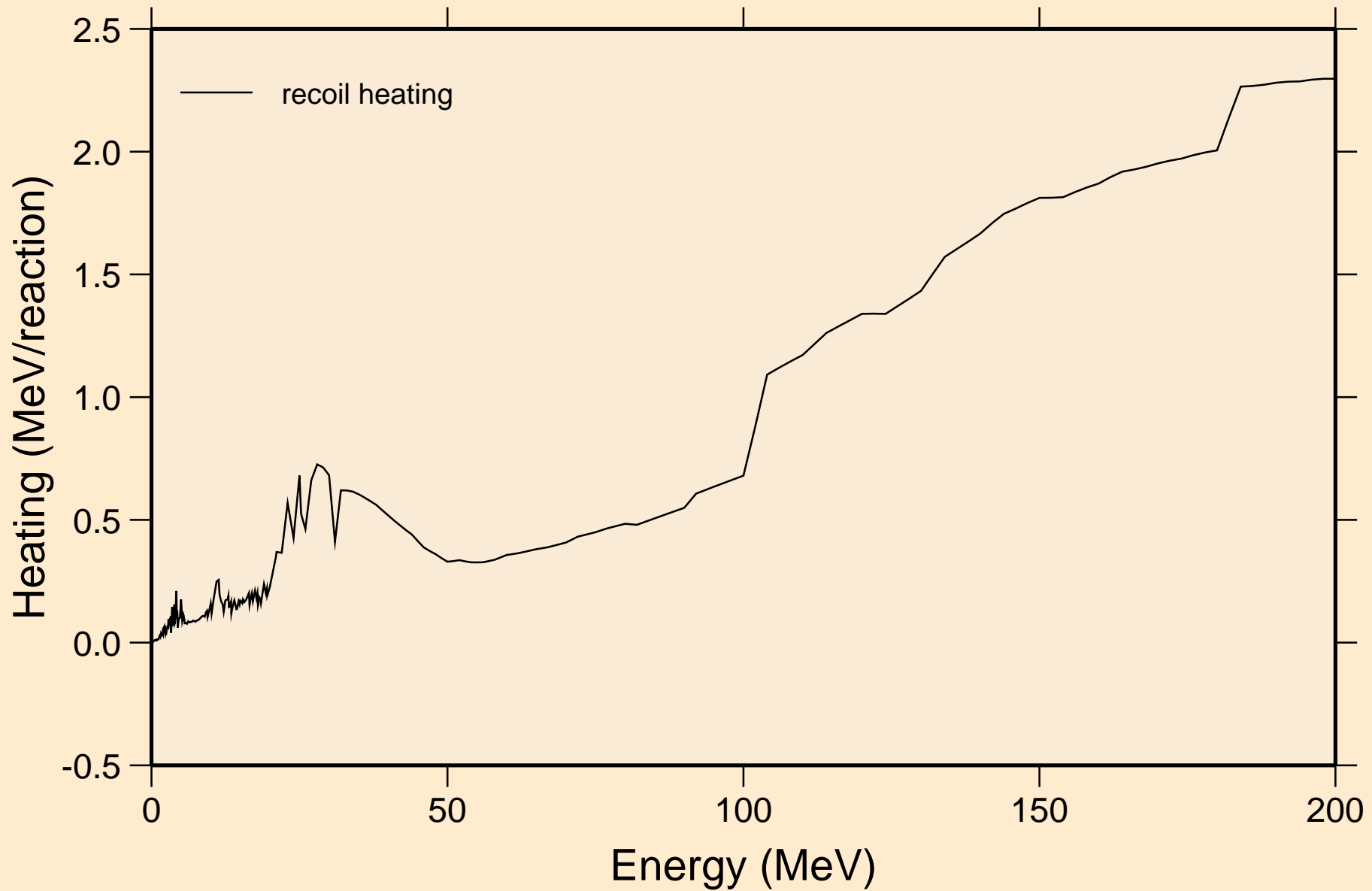

ND132 NEUTRON ACER TENDL-2021 LIBRARY; T=293.6K

Particle production cross sections

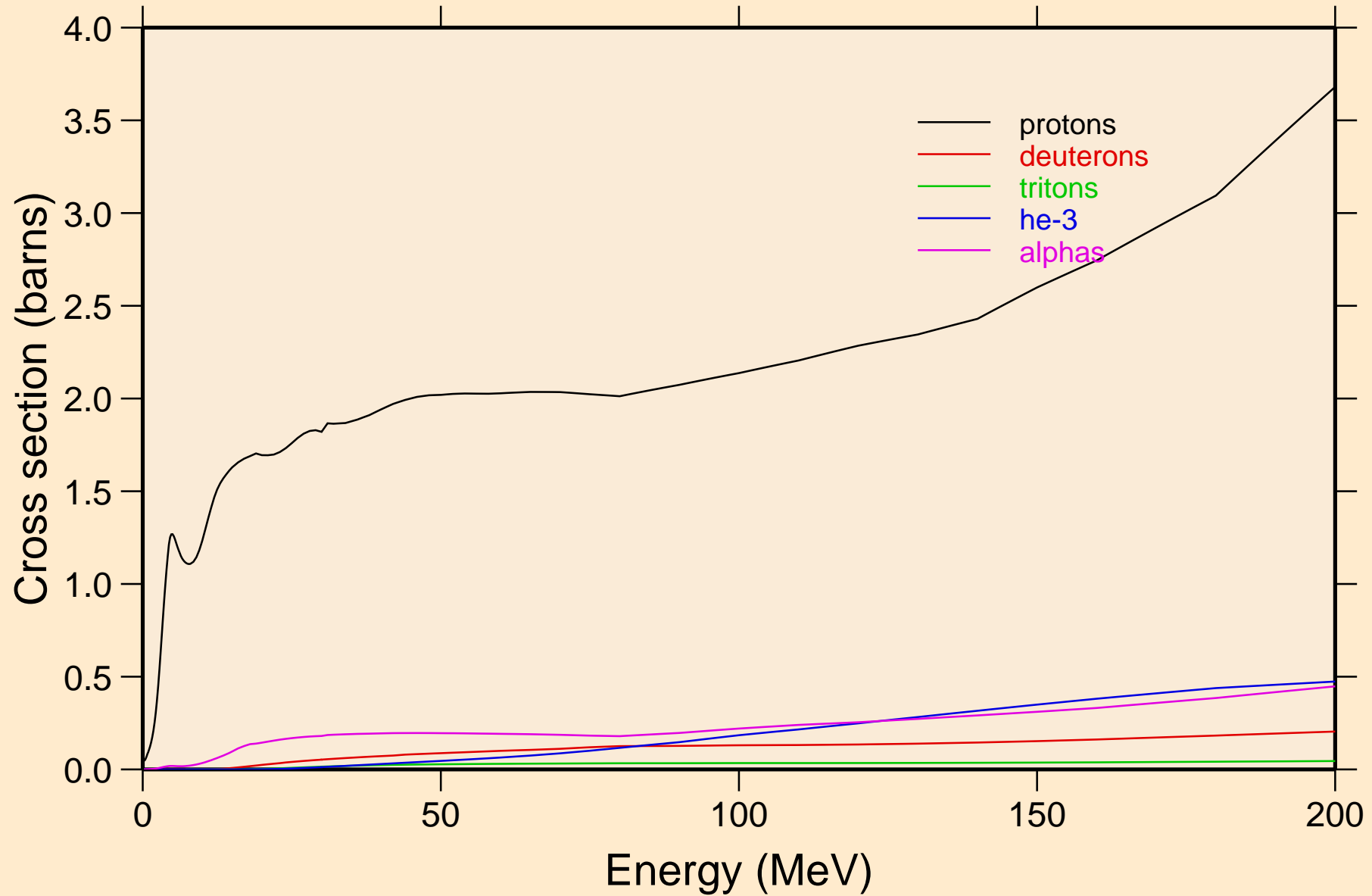

ND132 NEUTRON ACER TENDL-2021 LIBRARY; T=293.6K
protons from (n,x)

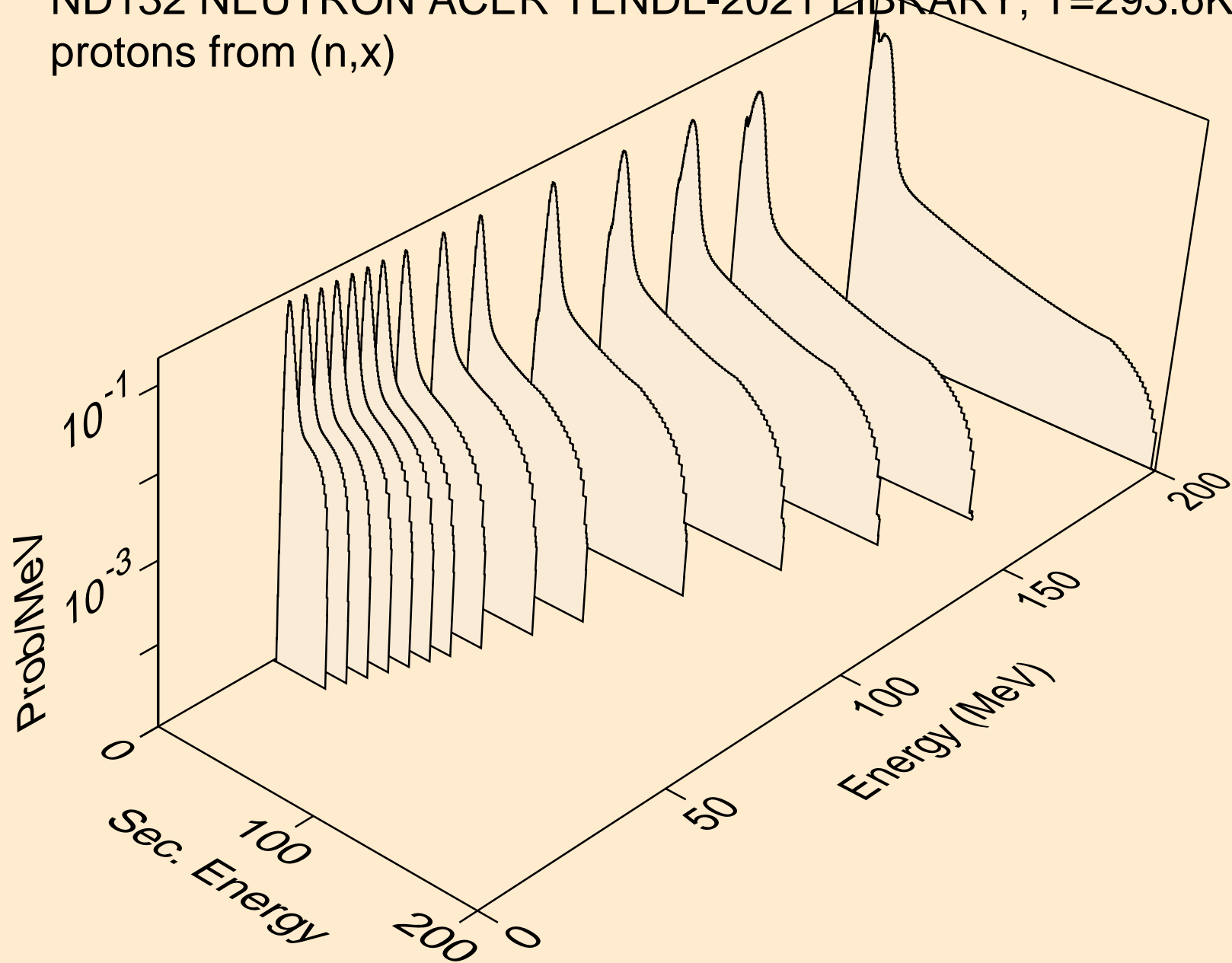

ND132 NEUTRON ACER TENDL-2021 LIBRARY; T=293.6K
protons from (n,n*)p

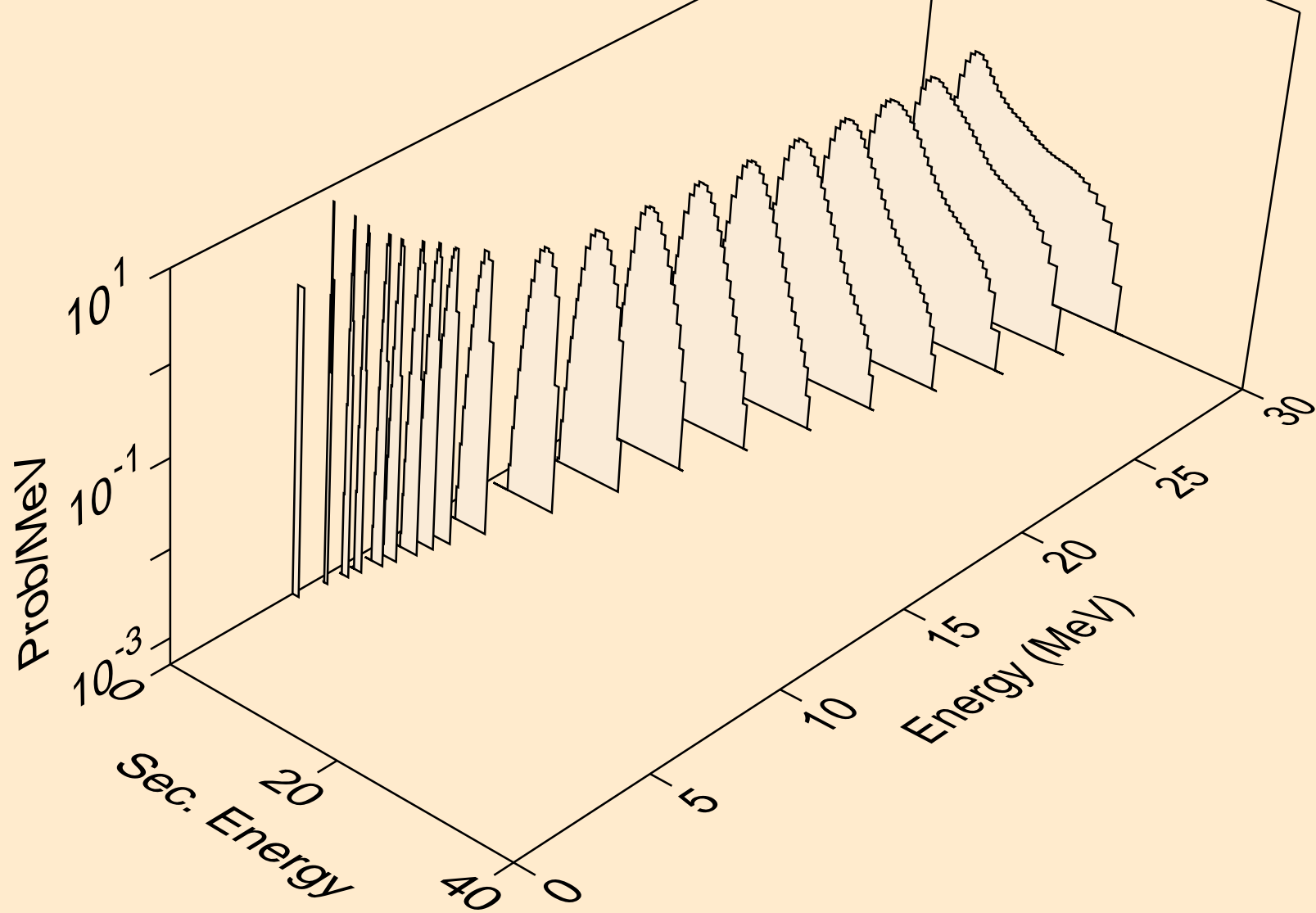

ND132 NEUTRON ACER TENDL-2021 LIBRARY; T=293.6K
protons from (n,2np)

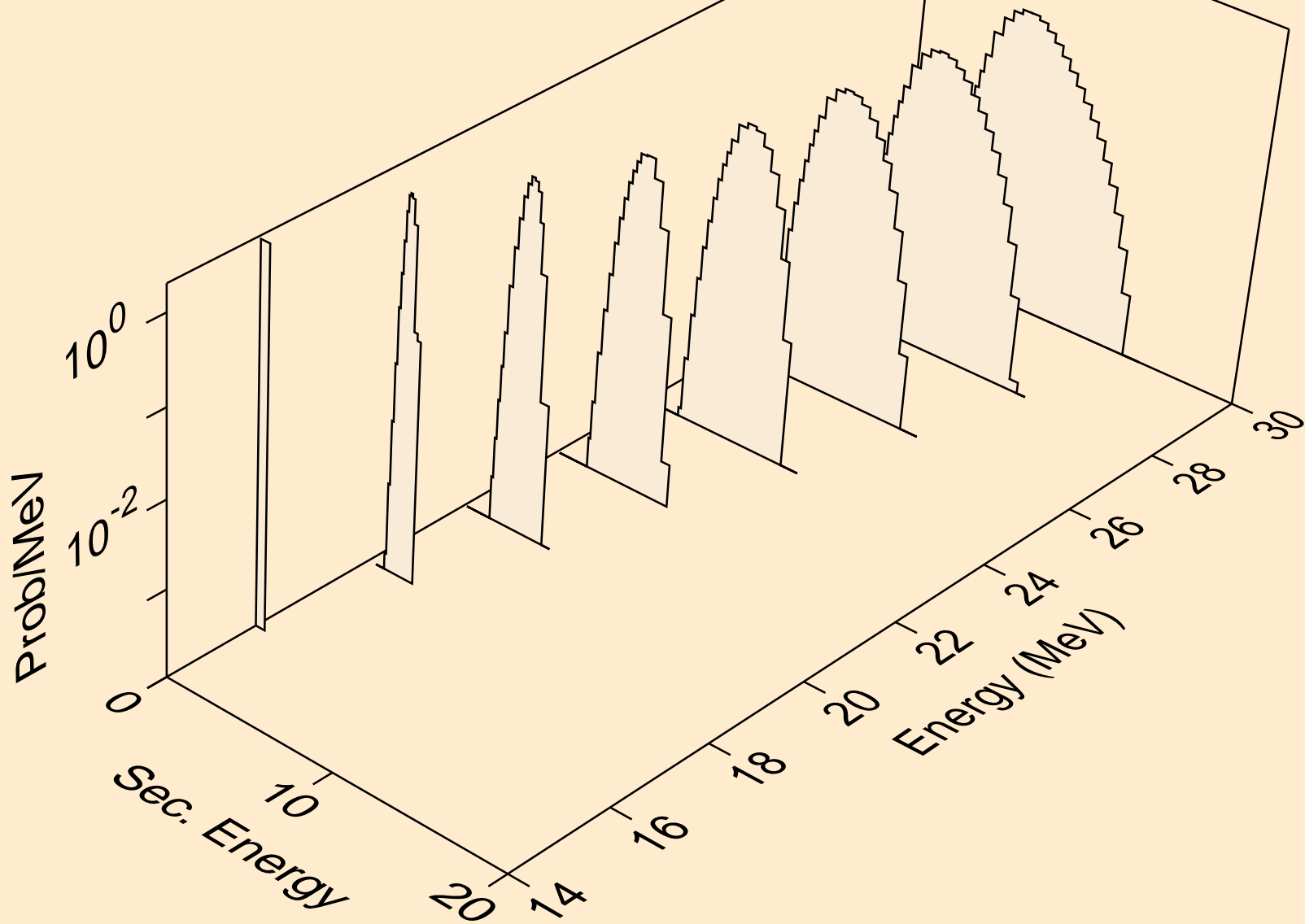

ND132 NEUTRON ACER TENDL-2021 LIBRARY; T=293.6K
protons from (n,3np)

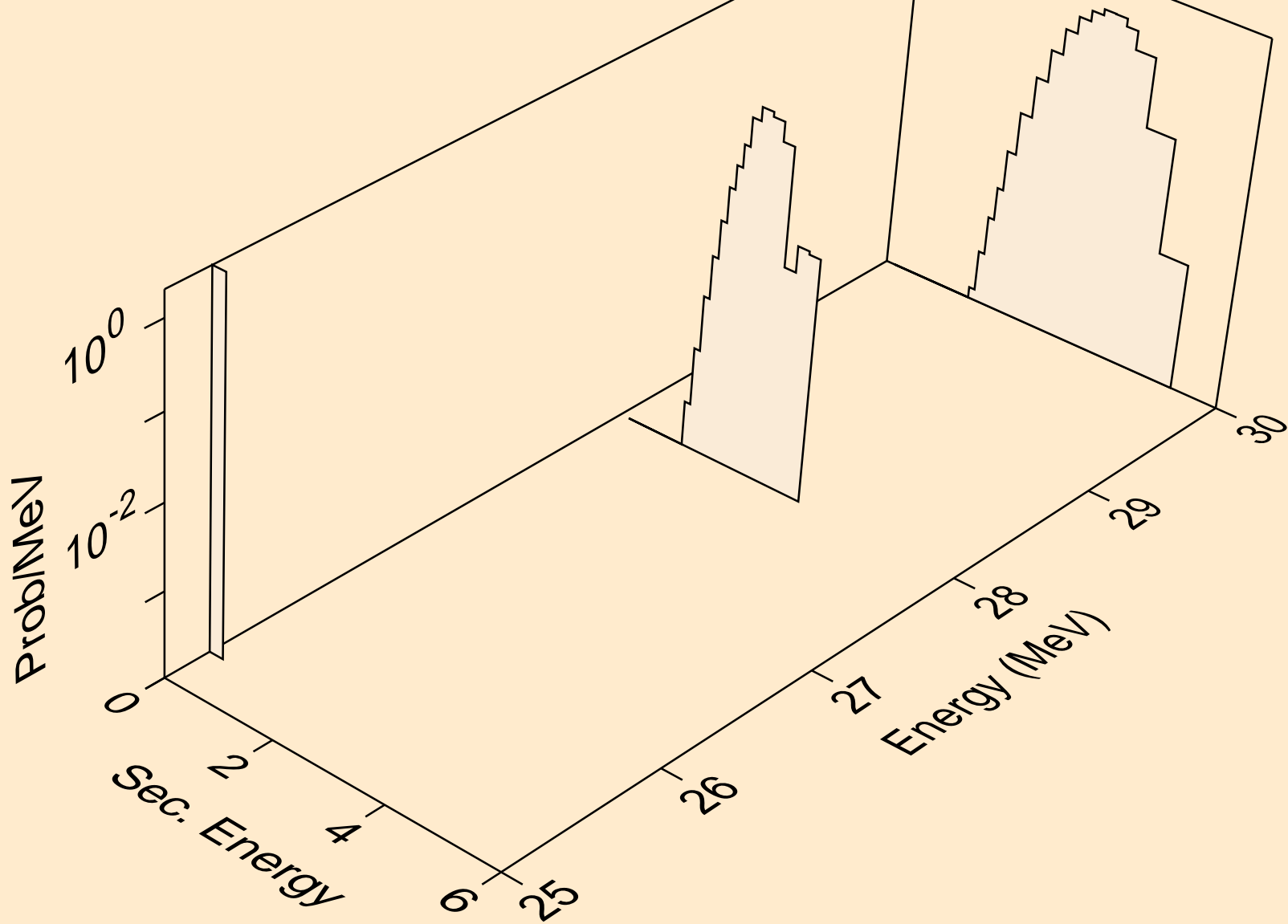

ND132 NEUTRON ACER TENDL-2021 LIBRARY; T=293.6K
protons from (n,2np)

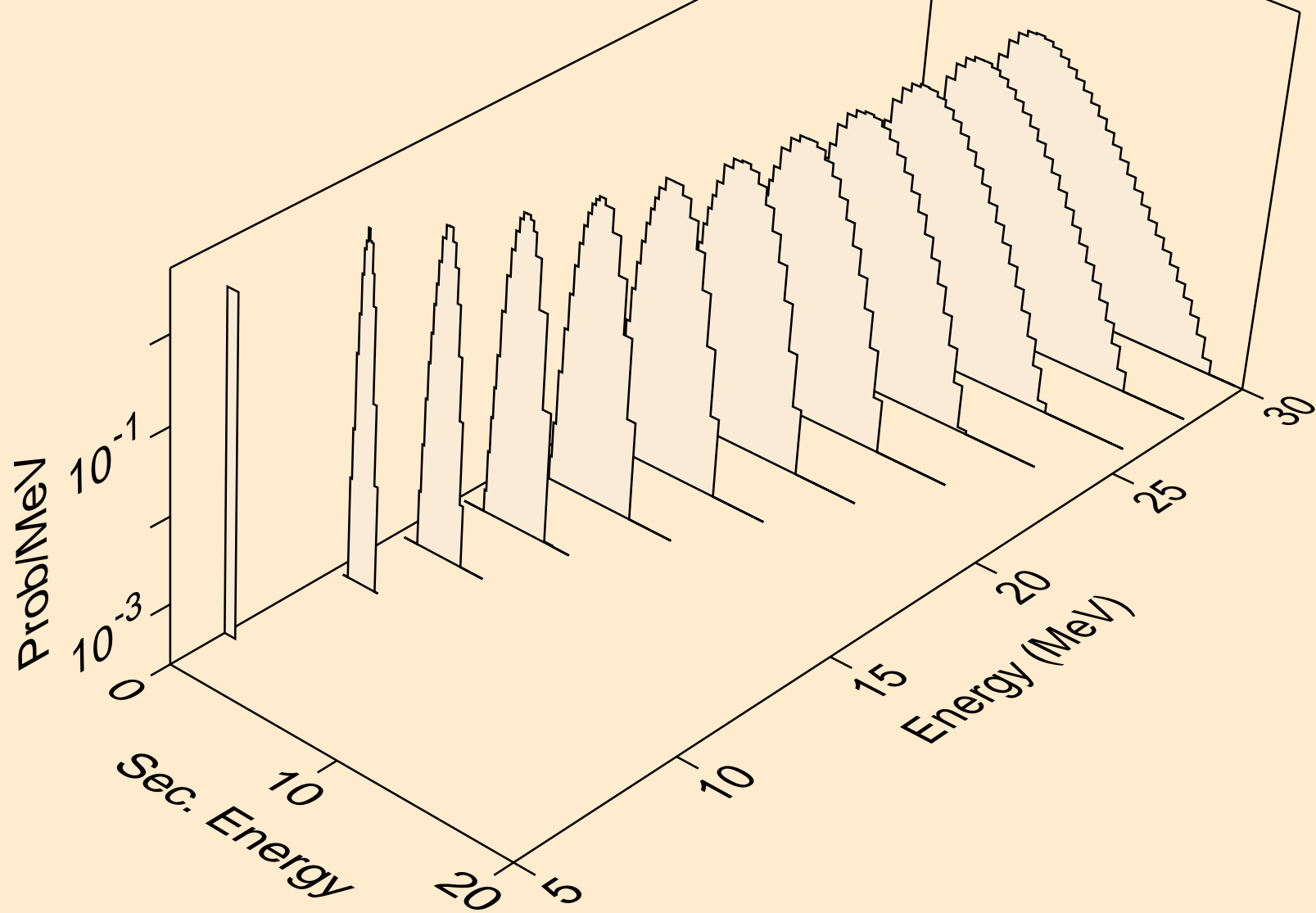

ND132 NEUTRON ACER TENDL-2021 LIBRARY; T=293.6K
protons from (n,npa)

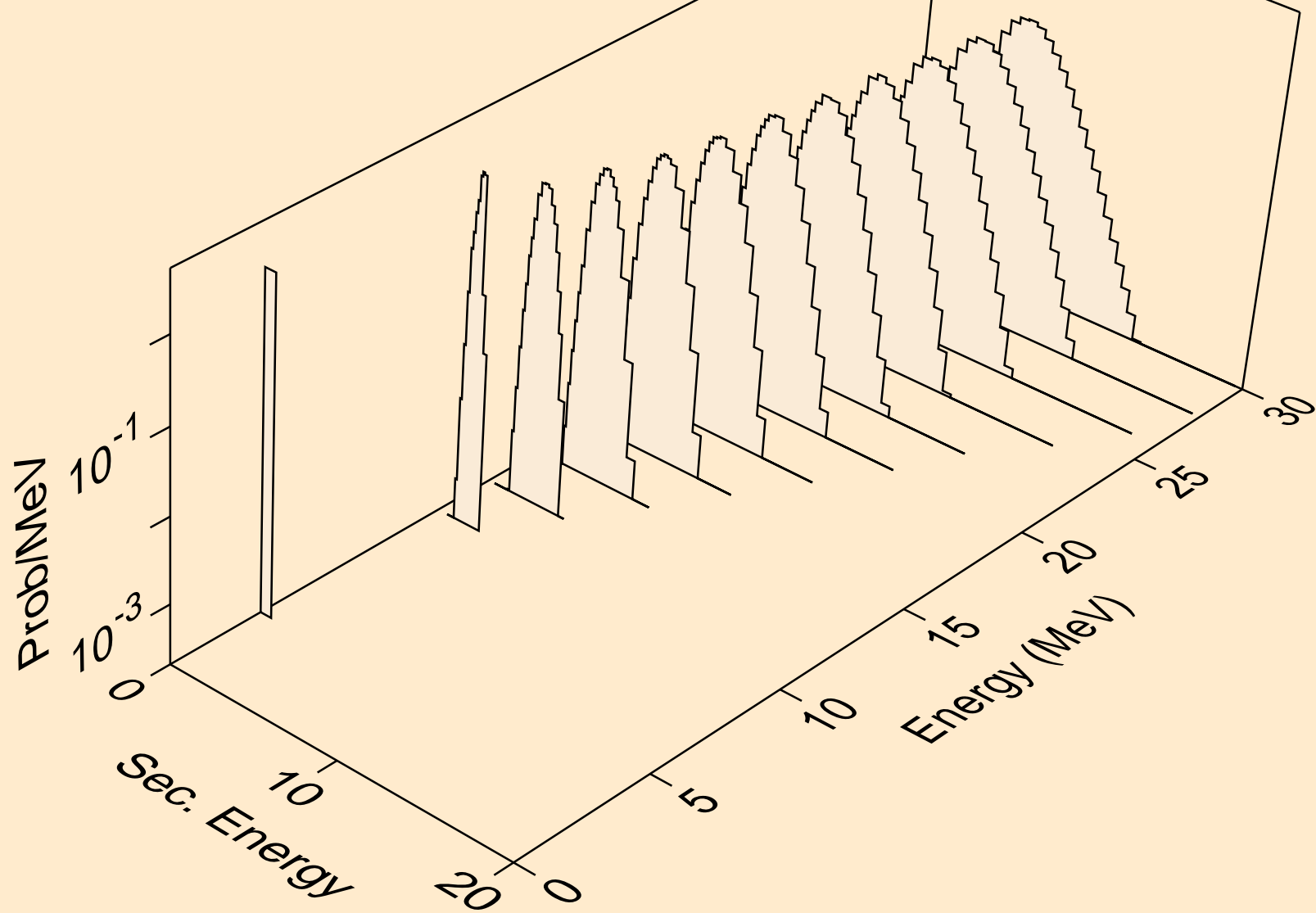

ND132 NEUTRON ACER TENDL-2021 LIBRARY; T=293.6K
protons from (n,p)

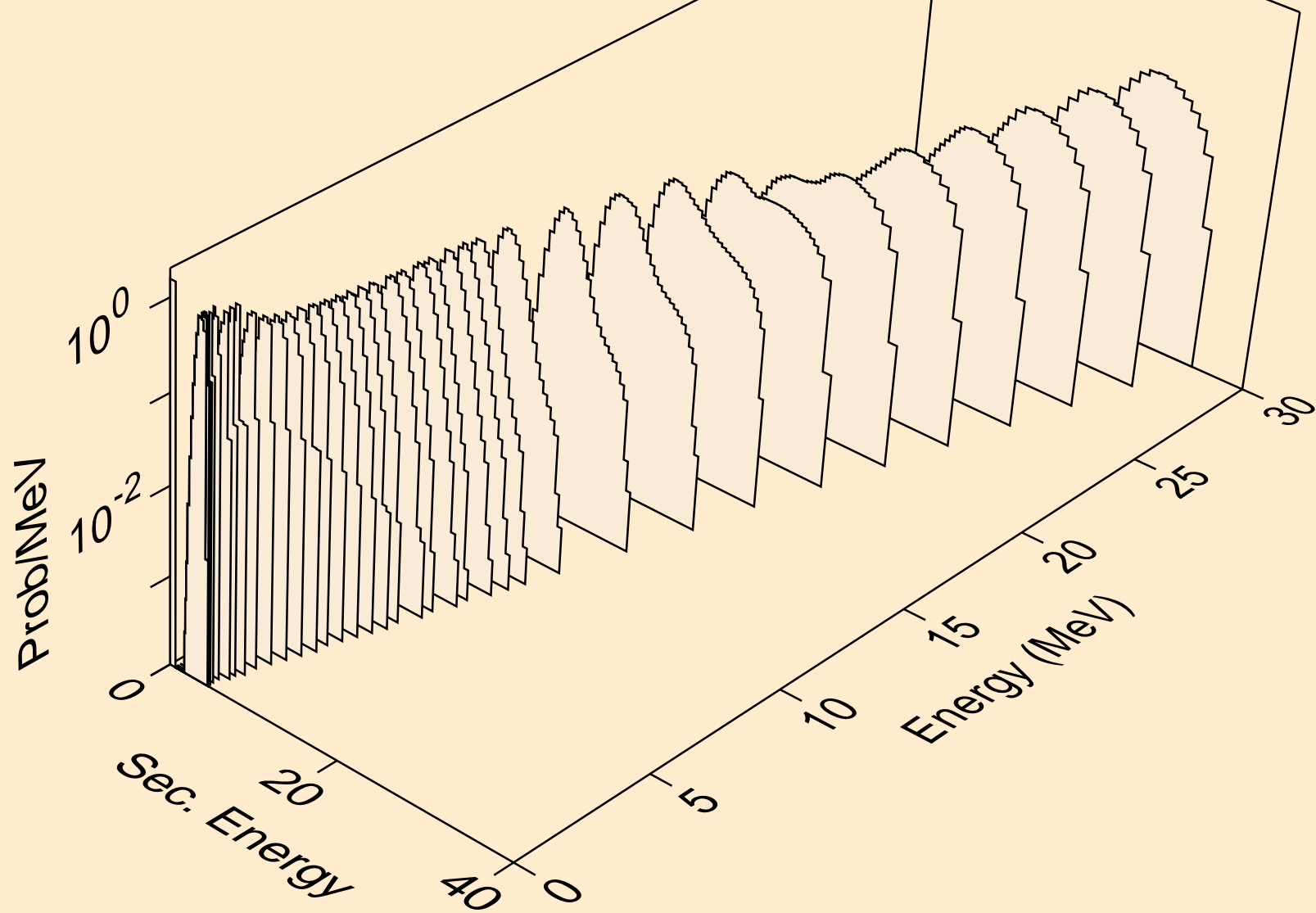

ND132 NEUTRON ACER TENDL-2021 LIBRARY; T=293.6K
protons from (n,2p)

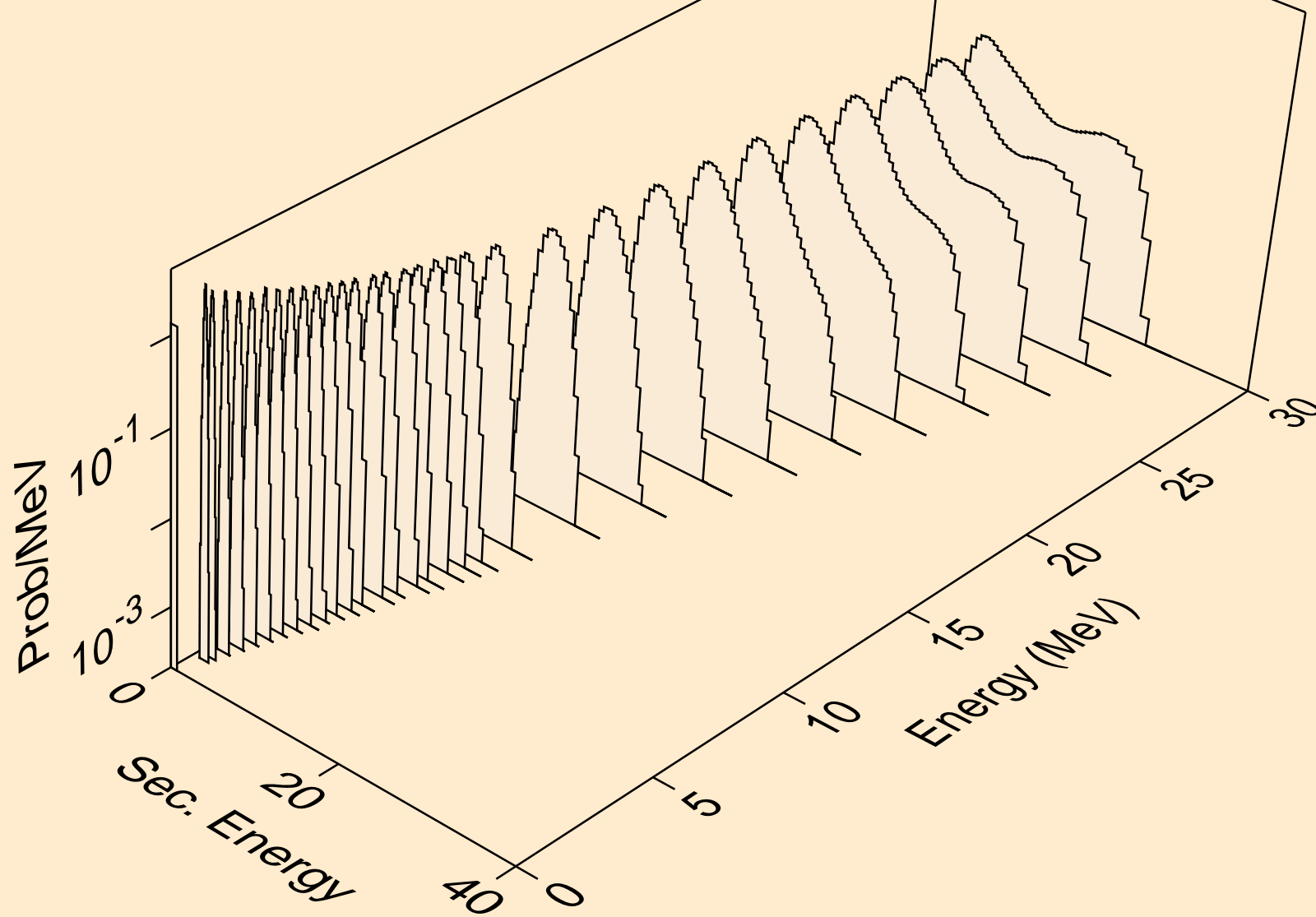

ND132 NEUTRON ACER TENDL-2021 LIBRARY; T=293.6K
protons from (n,p)

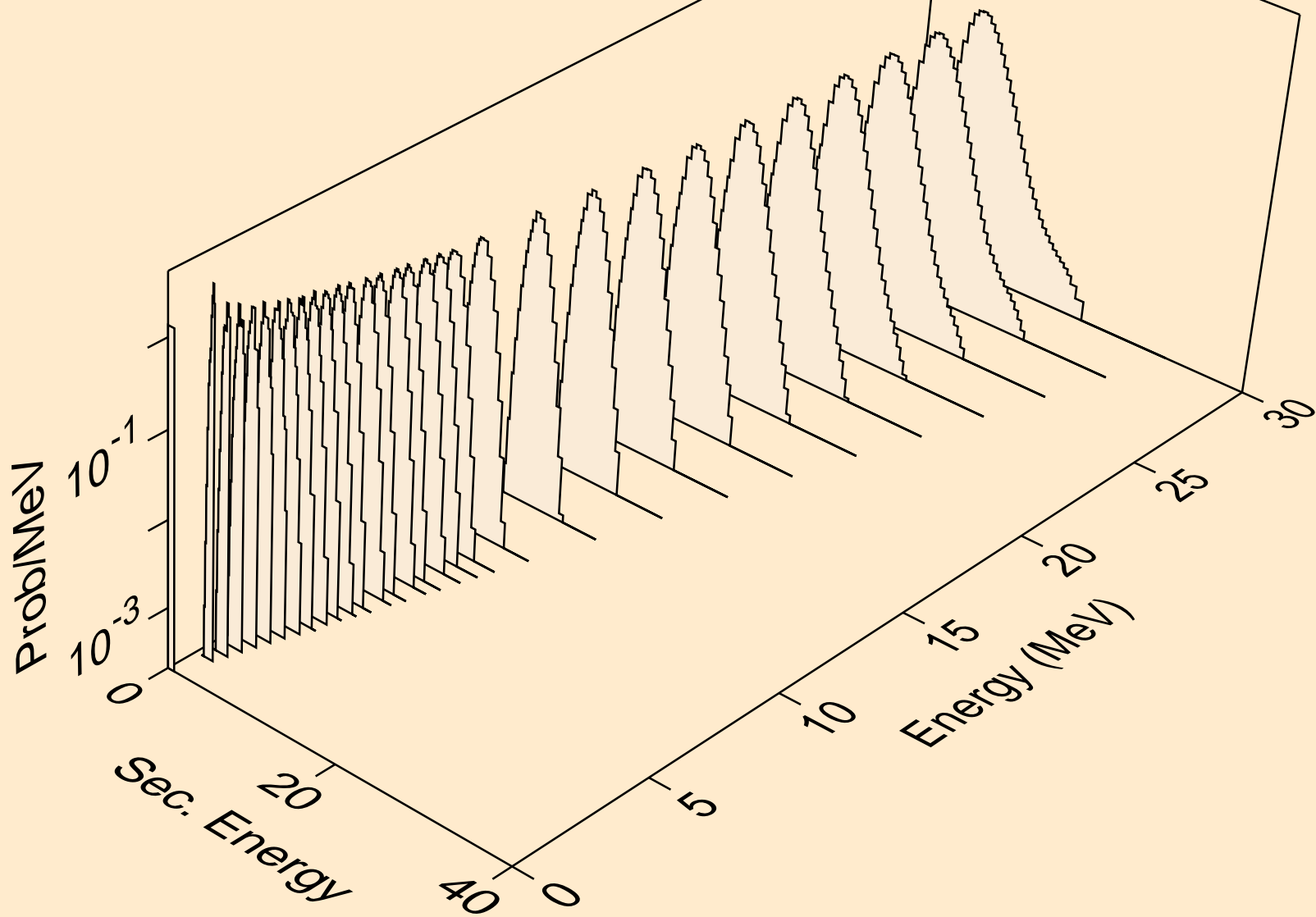

ND132 NEUTRON ACER TENDL-2021 LIBRARY; T=293.6K
protons from (n,pd)

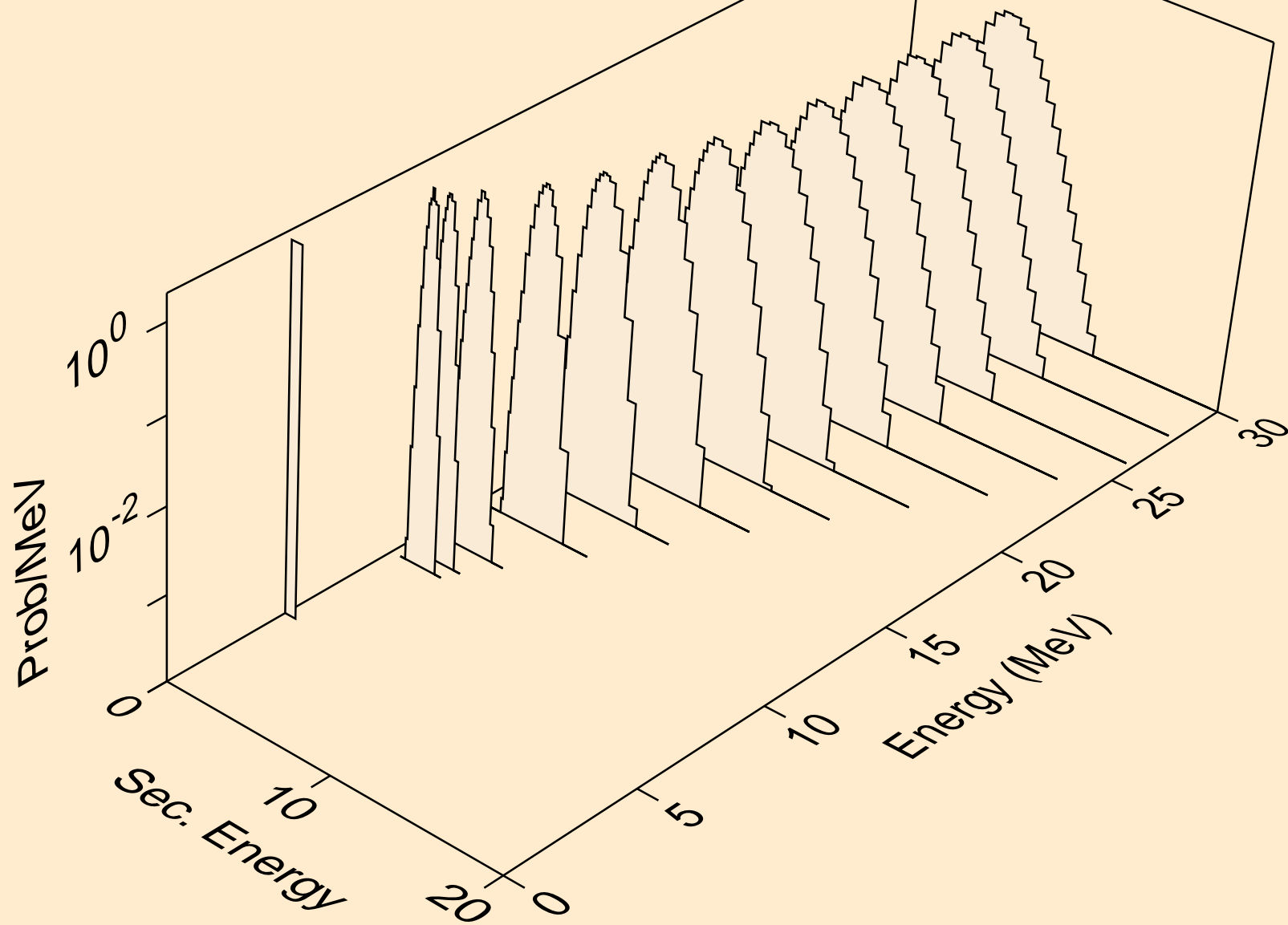

ND132 NEUTRON ACER TENDL-2021 LIBRARY; T=293.6K
protons from (n,pt)

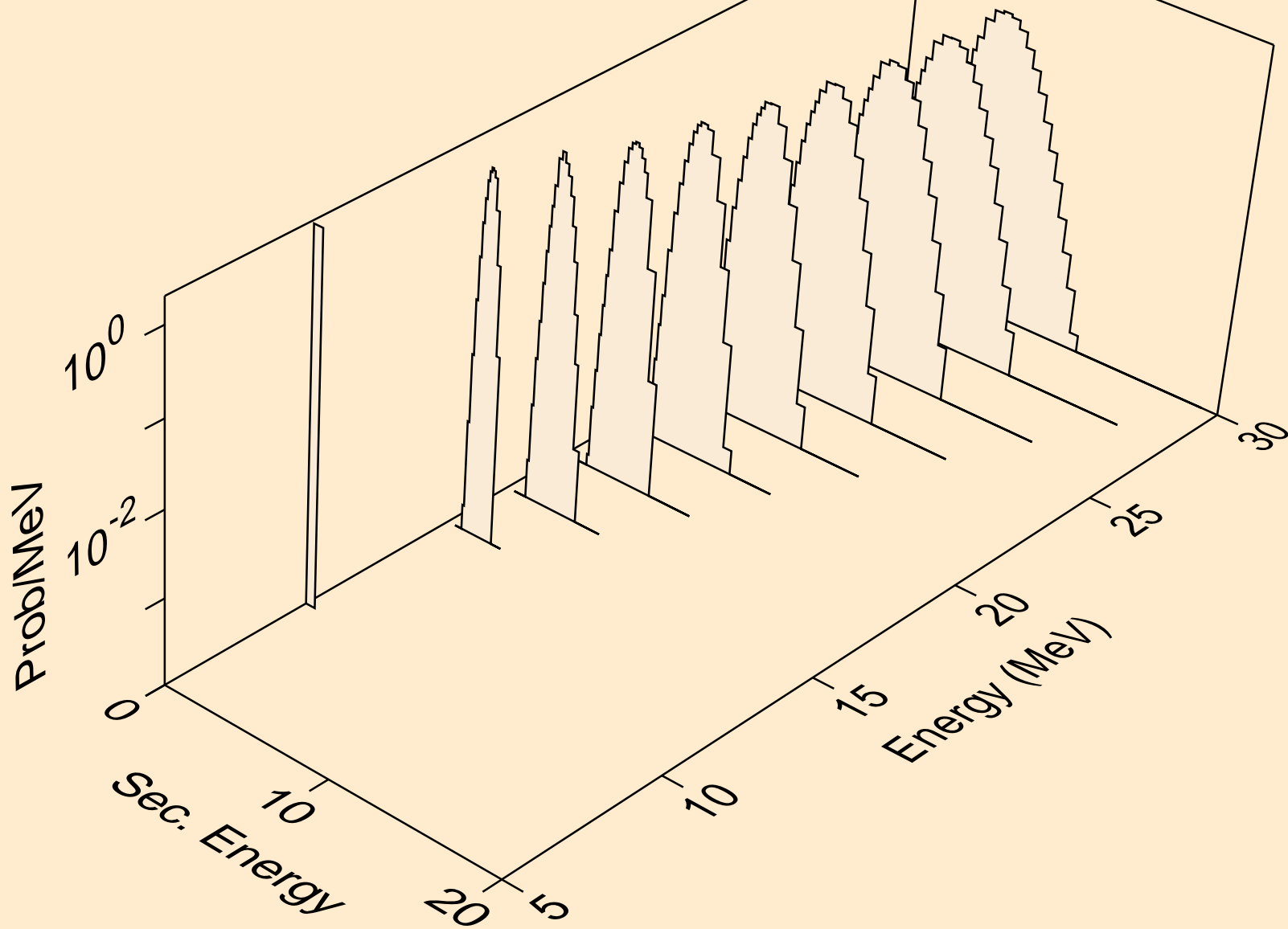

ND132 NEUTRON ACER TENDL-2021 LIBRARY; T=293.6K
deuterons from (n,x)

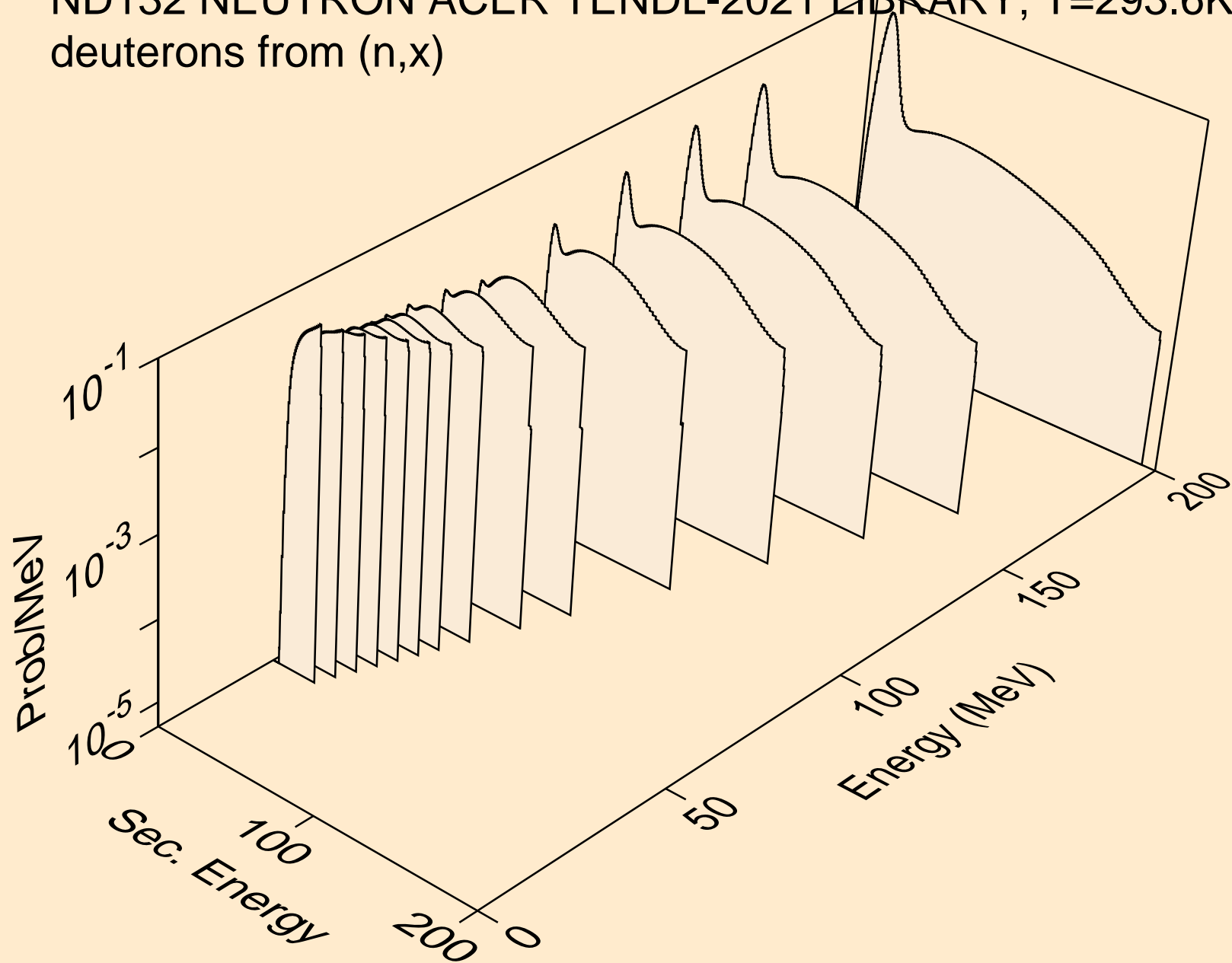

ND132 NEUTRON ACER TENDL-2021 LIBRARY; T=293.6K
deuterons from (n,2nd)

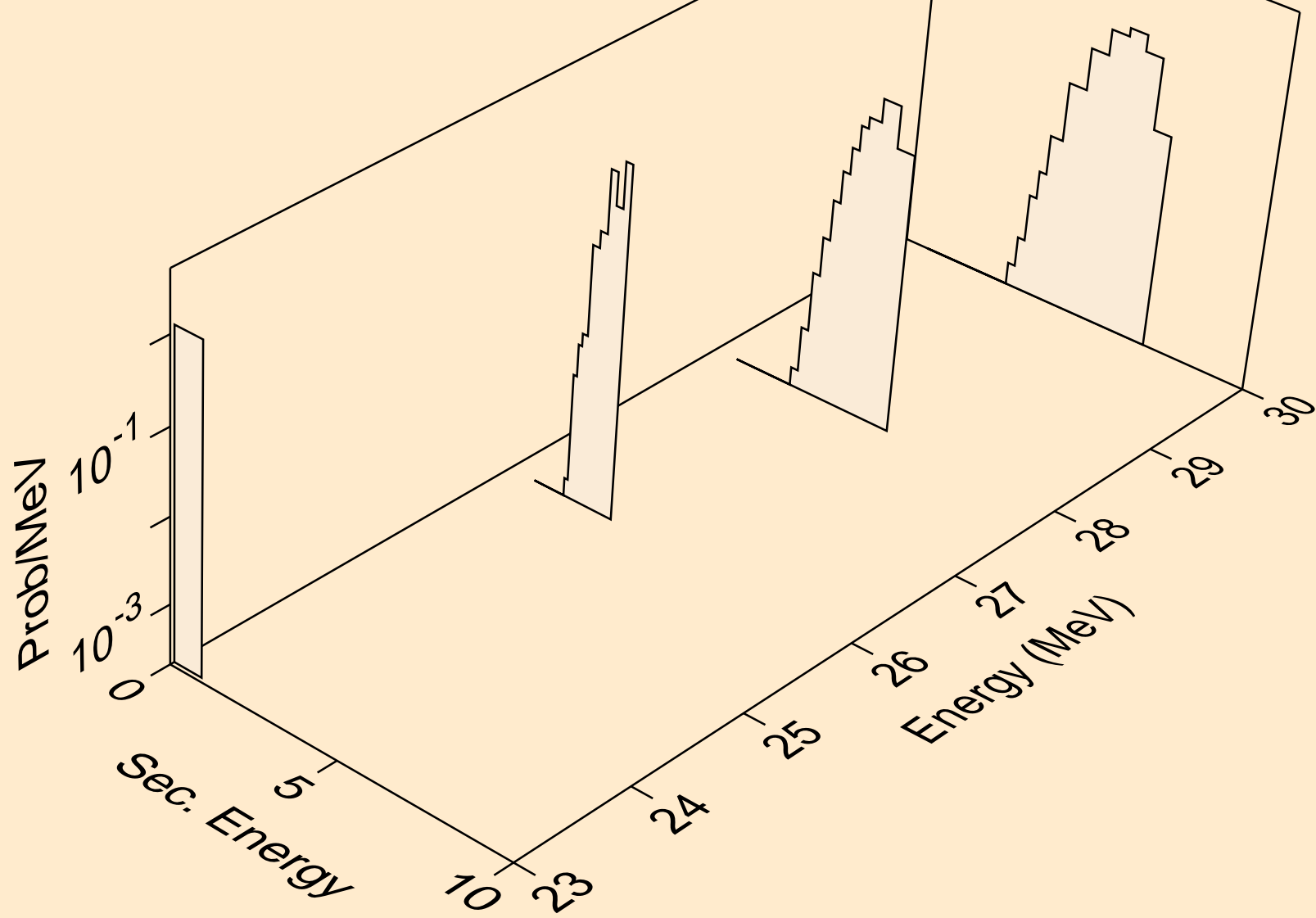

ND132 NEUTRON ACER TENDL-2021 LIBRARY; T=293.6K
deuterons from (n,n*)d

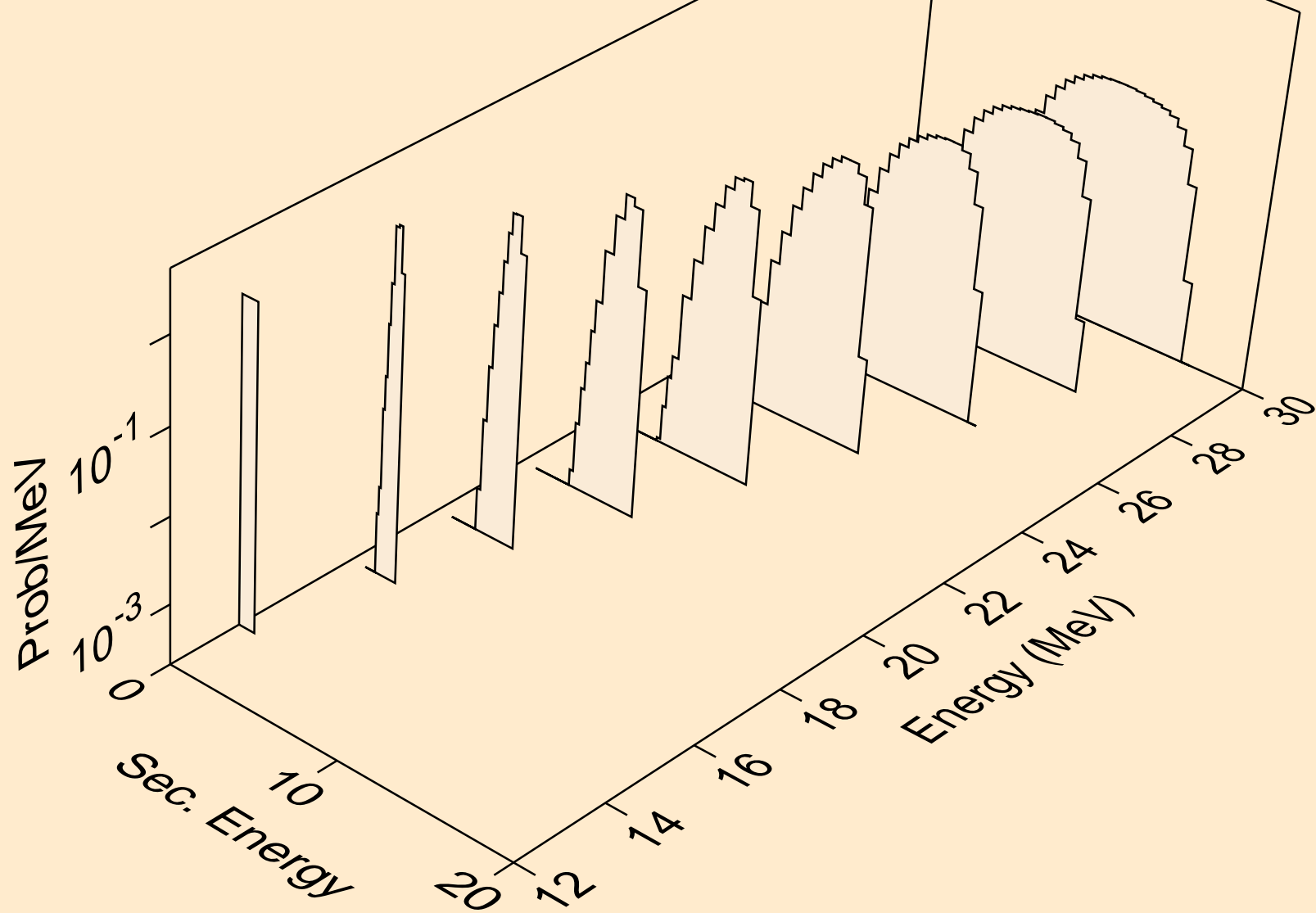

ND132 NEUTRON ACER TENDL-2021 LIBRARY; T=293.6K
deuterons from (n,d)

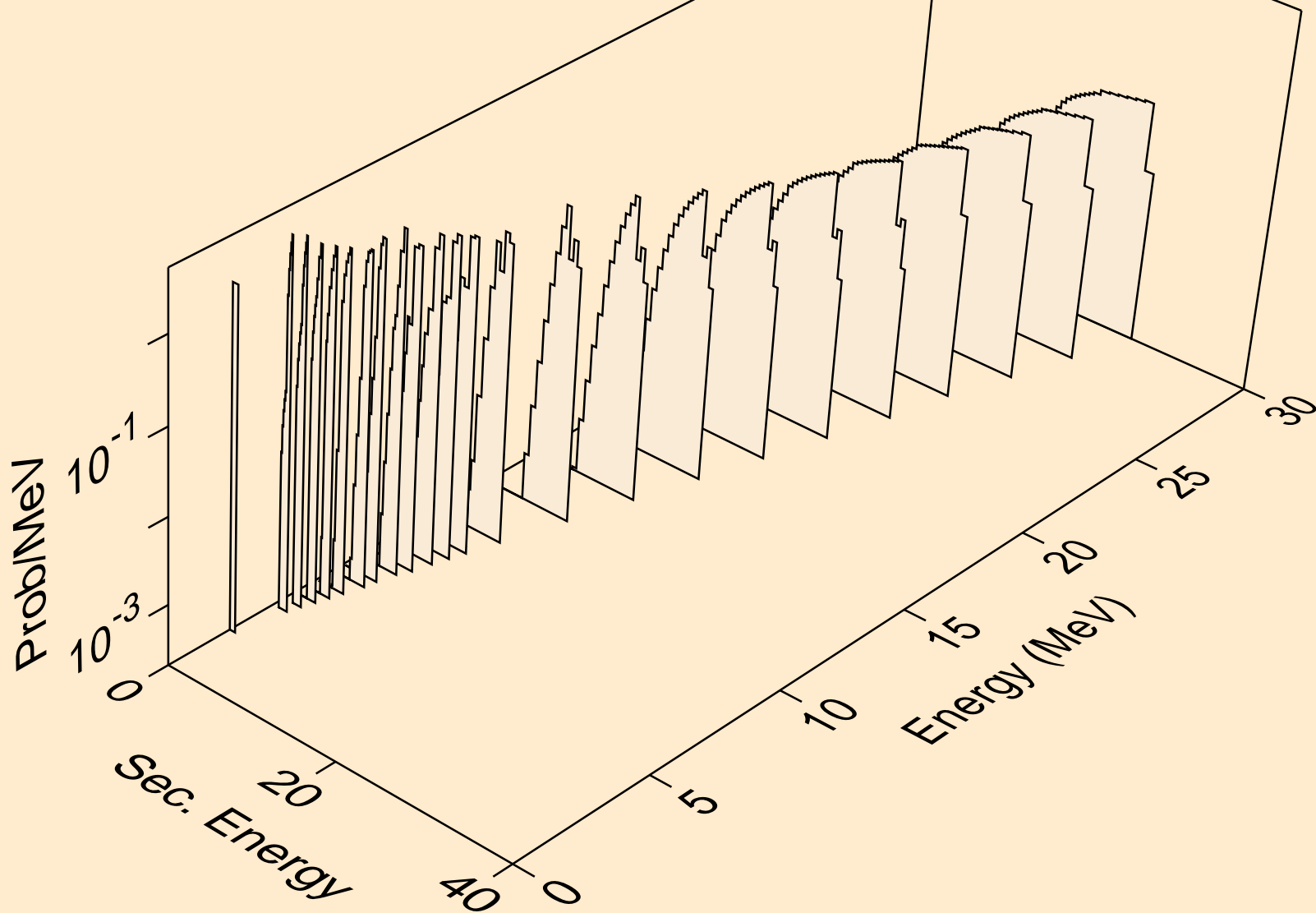

ND132 NEUTRON ACER TENDL-2021 LIBRARY; T=293.6K
deuterons from (n,pd)

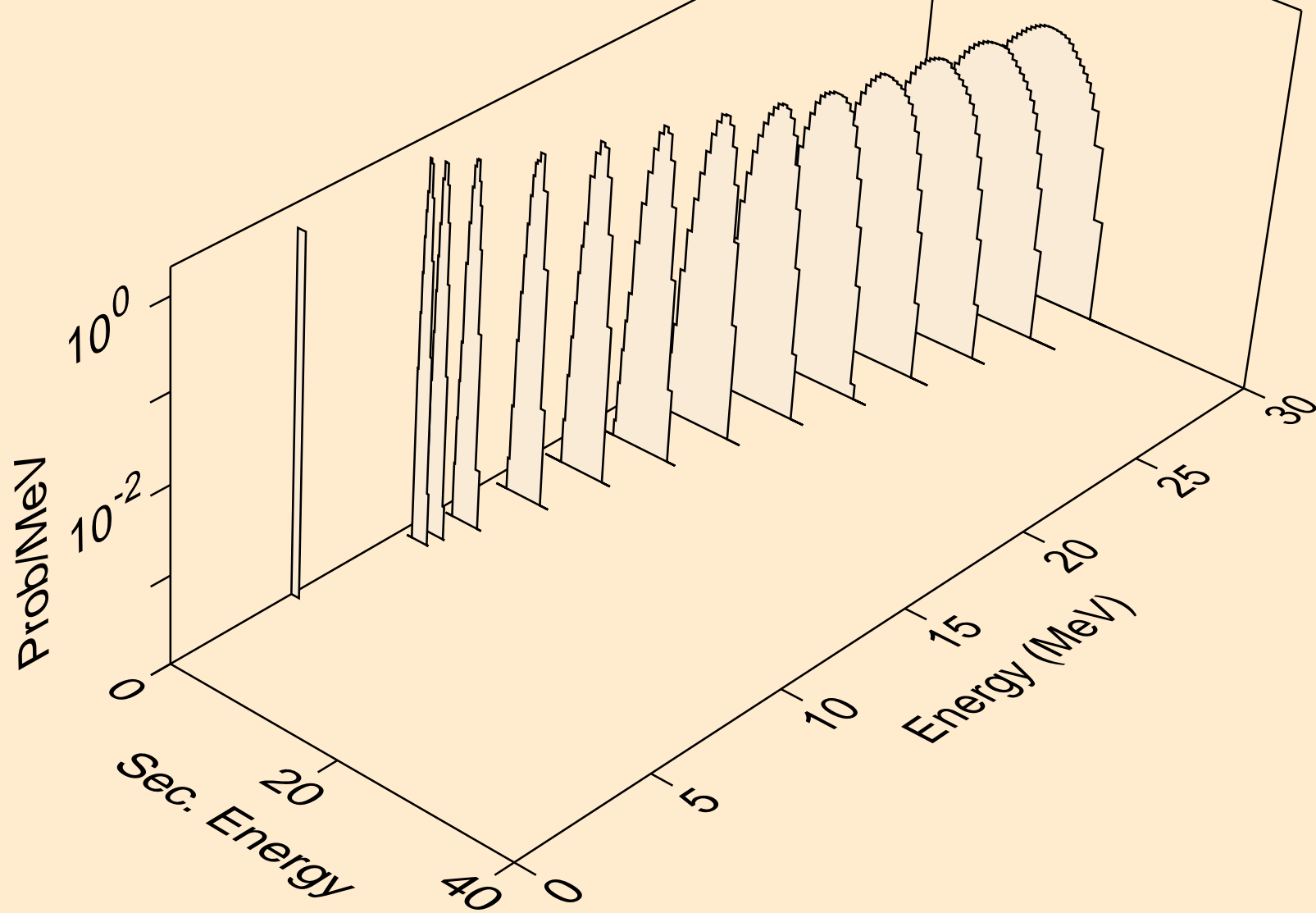

ND132 NEUTRON ACER TENDL-2021 LIBRARY; T=293.6K
deuterons from (n,da)

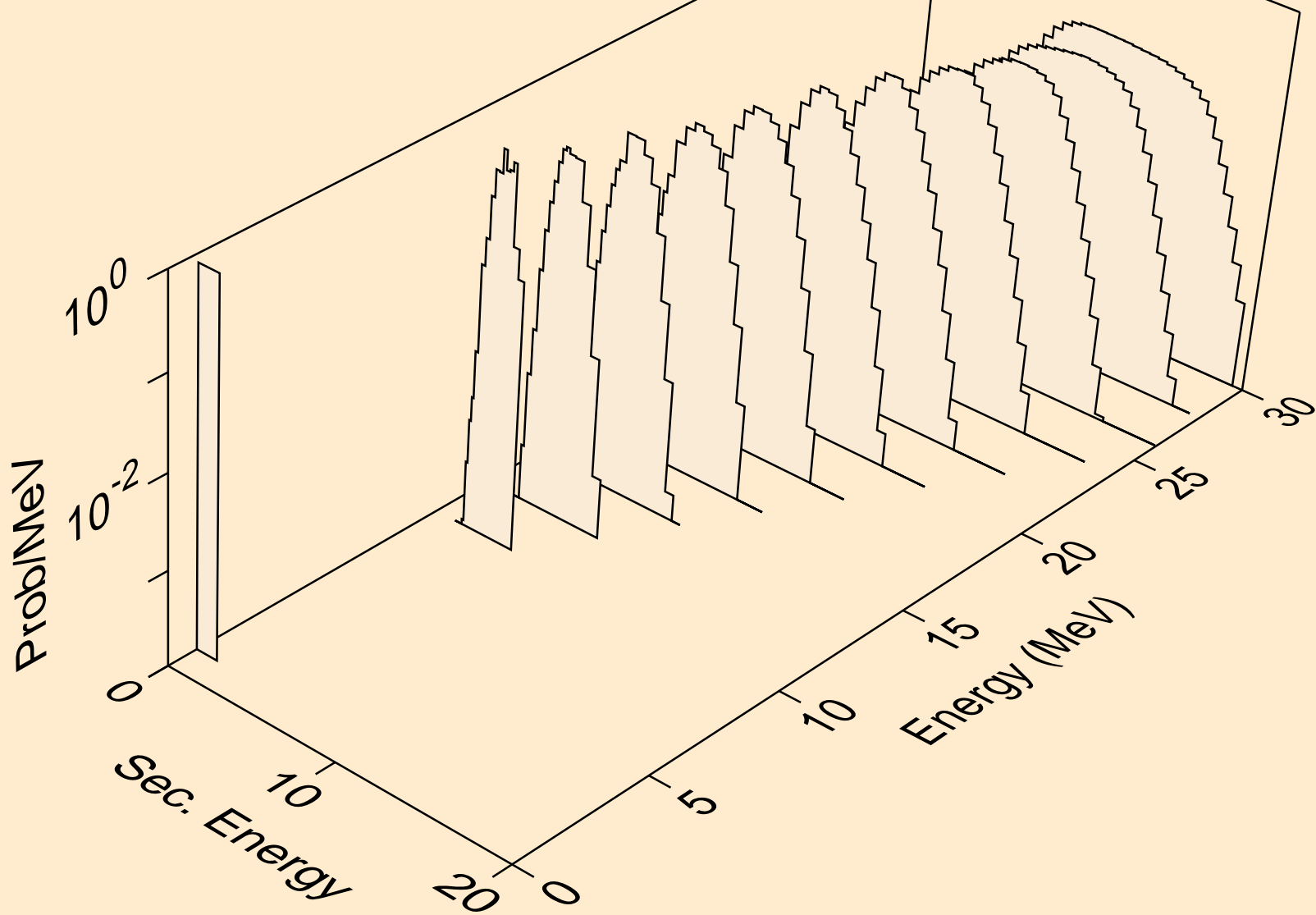

ND132 NEUTRON ACER TENDL-2021 LIBRARY; T=293.6K
tritons from (n,x)

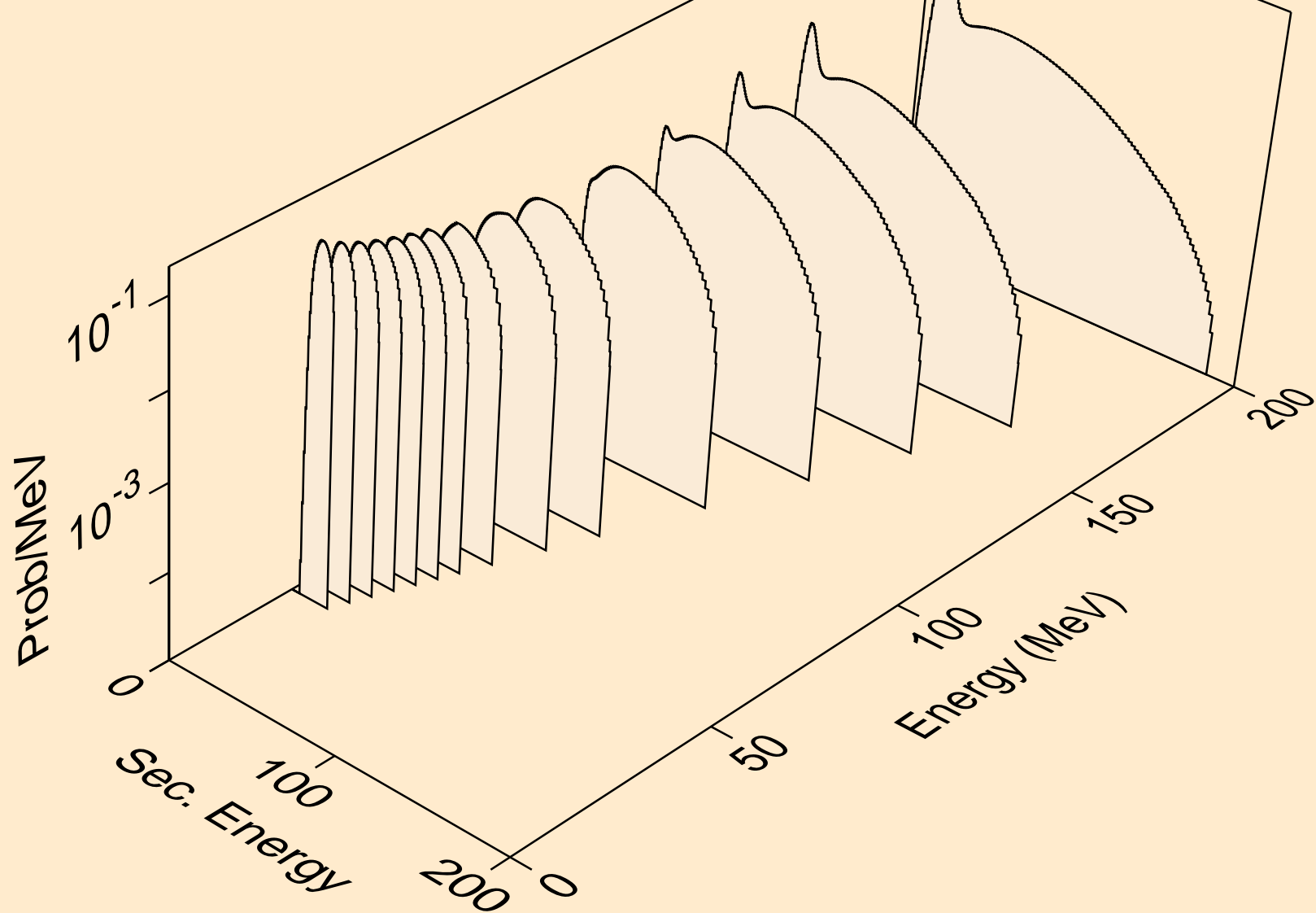

ND132 NEUTRON ACER TENDL-2021 LIBRARY; T=293.6K
tritons from (n,n*)t

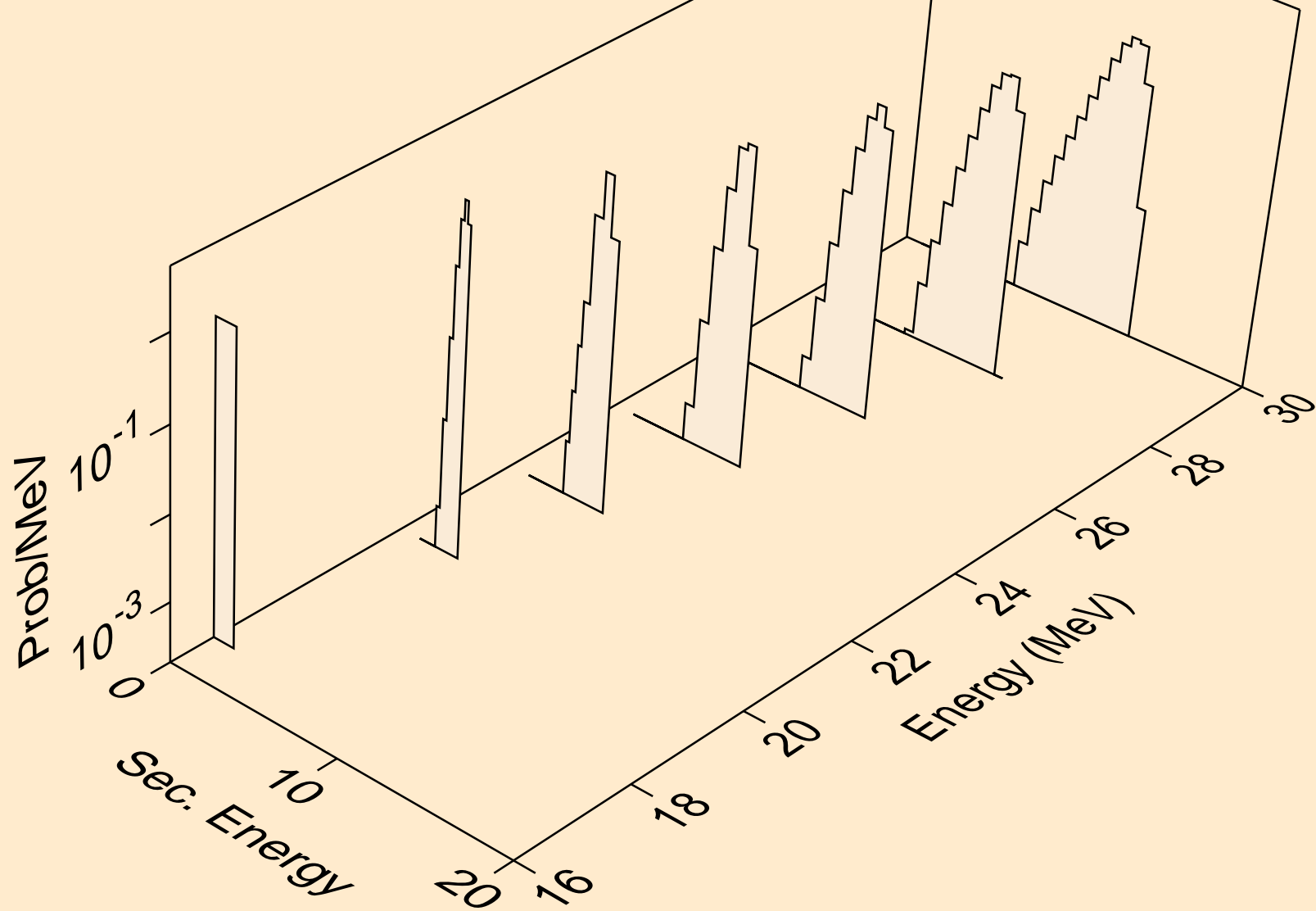

ND132 NEUTRON ACER TENDL-2021 LIBRARY; T=293.6K
tritons from (n,t)

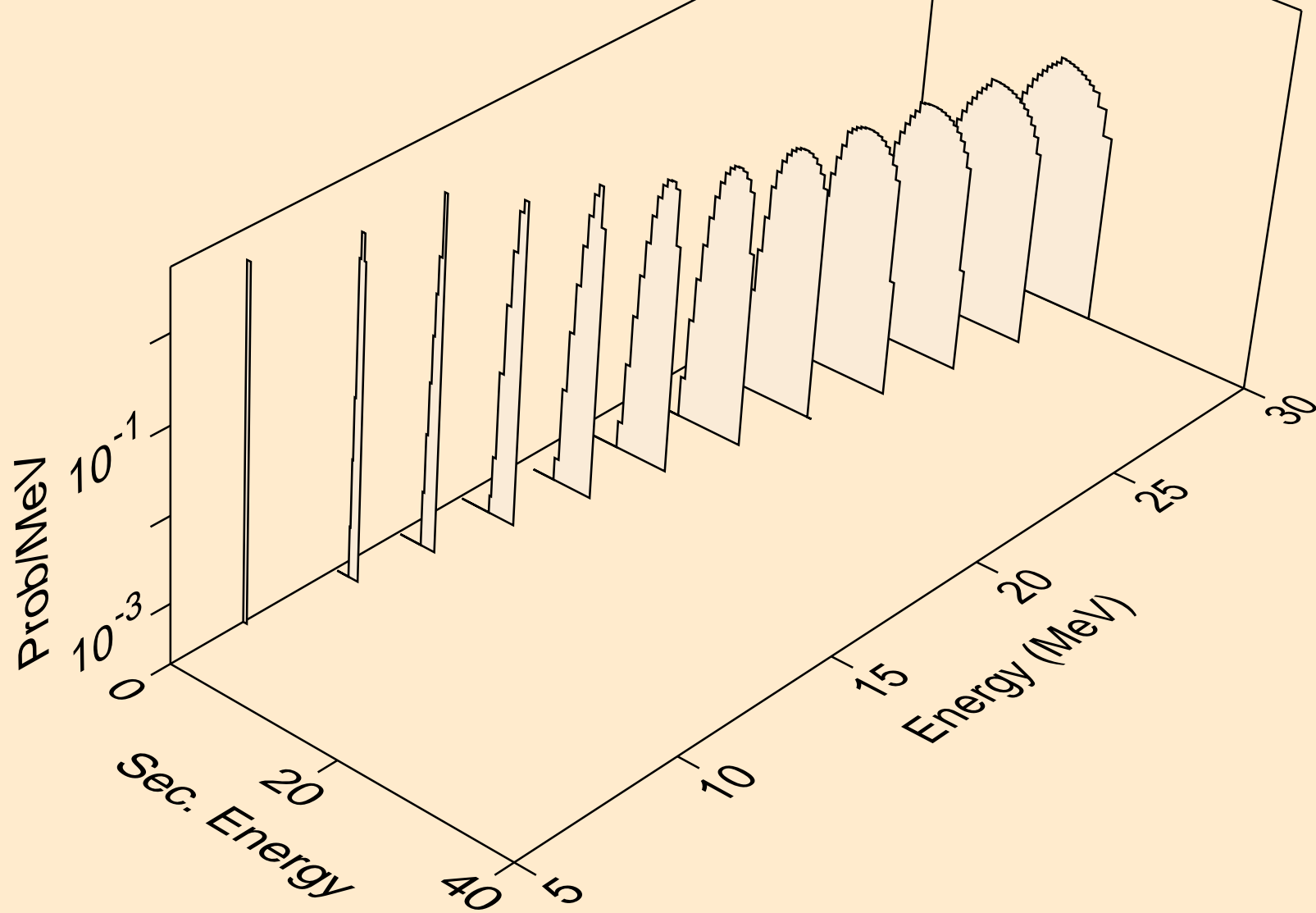

ND132 NEUTRON ACER TENDL-2021 LIBRARY; T=293.6K
tritons from (n,pt)

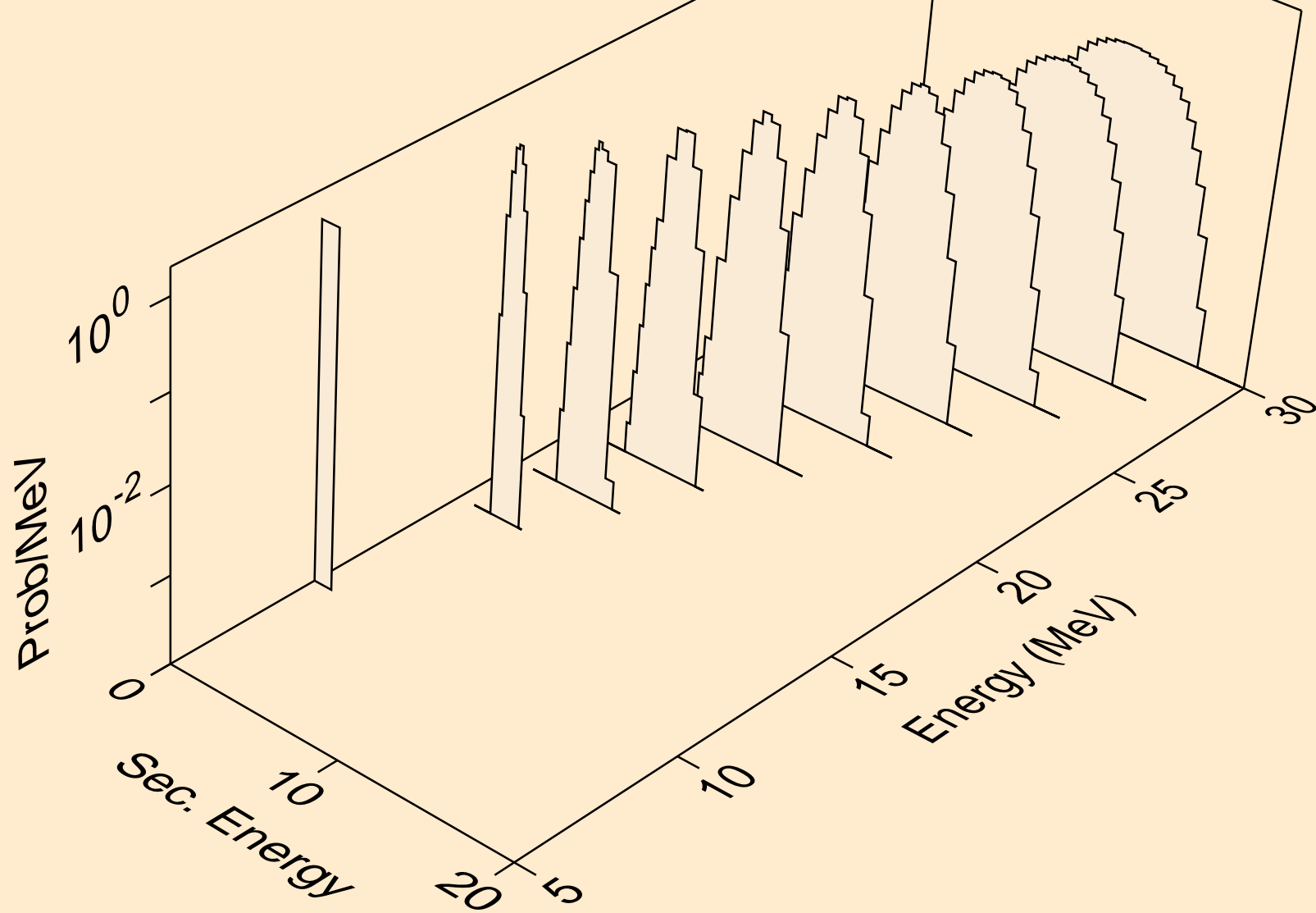

ND132 NEUTRON ACER TENDL-2021 LIBRARY; T=293.6K
he3s from (n,x)

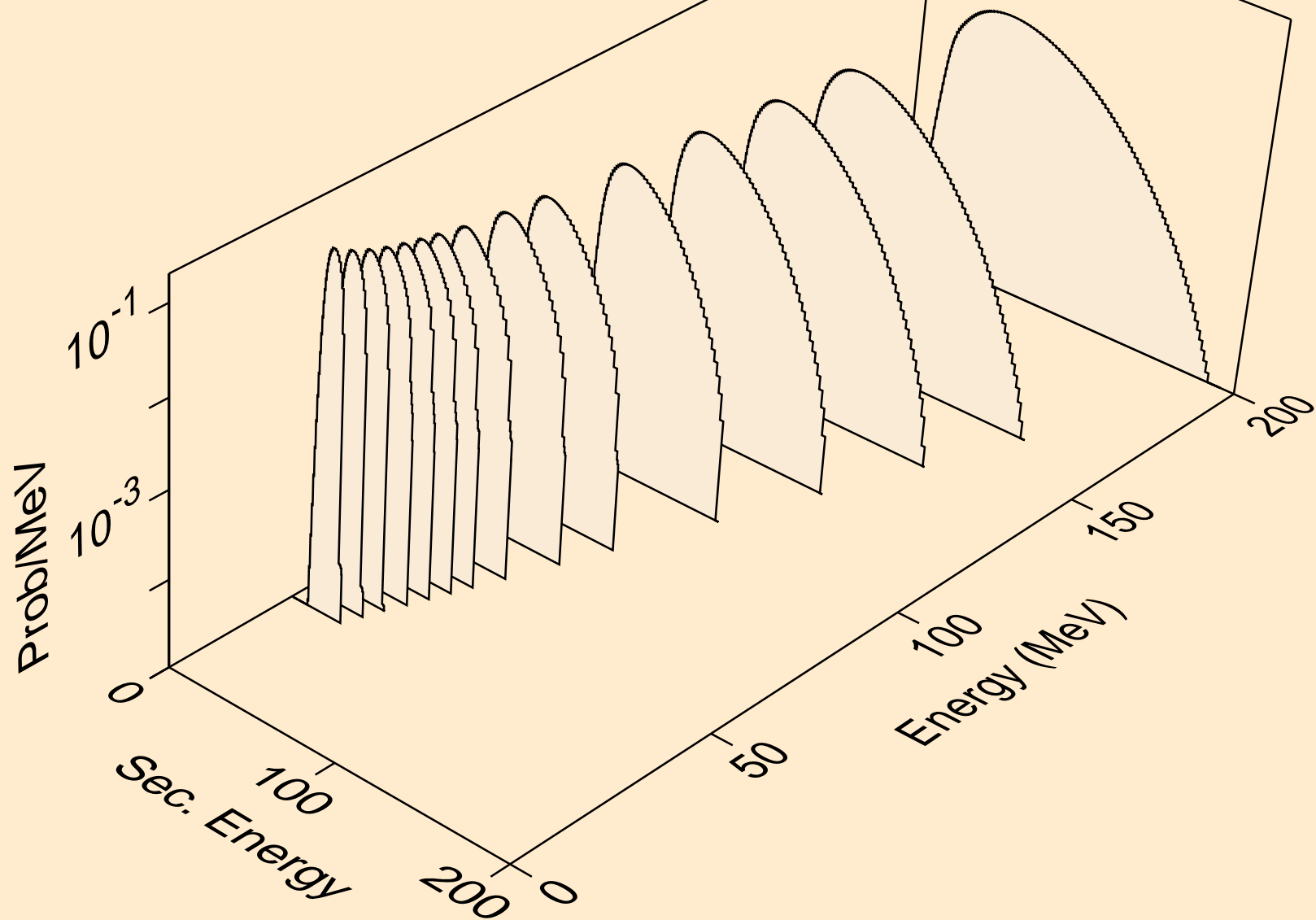

ND132 NEUTRON ACER TENDL-2021 LIBRARY; T=293.6K
he3s from (n,n*)he3

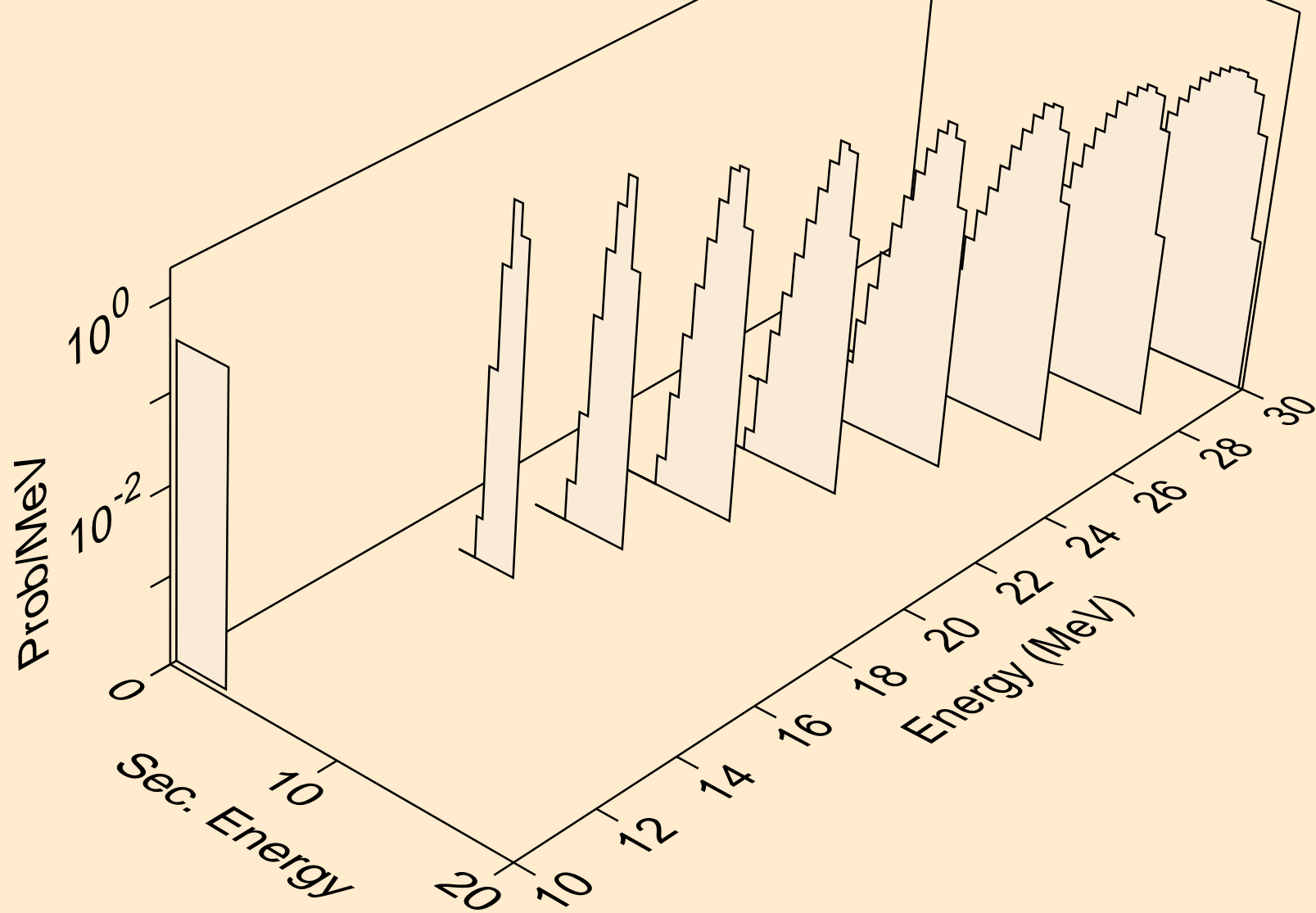

ND132 NEUTRON ACER TENDL-2021 LIBRARY; T=293.6K
he3s from (n,he3)

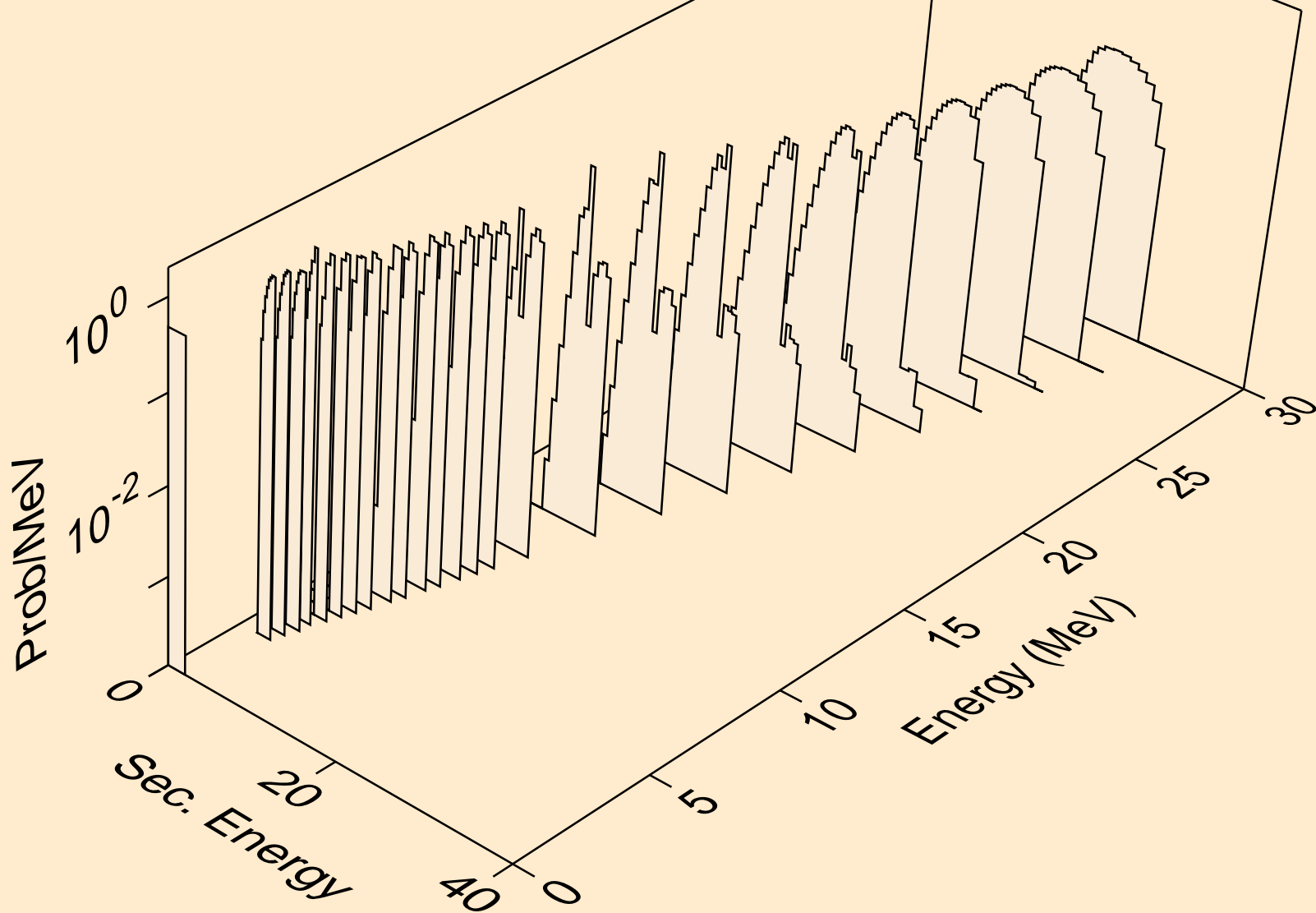

ND132 NEUTRON ACER TENDL-2021 LIBRARY; T=293.6K
alphas from (n,x)

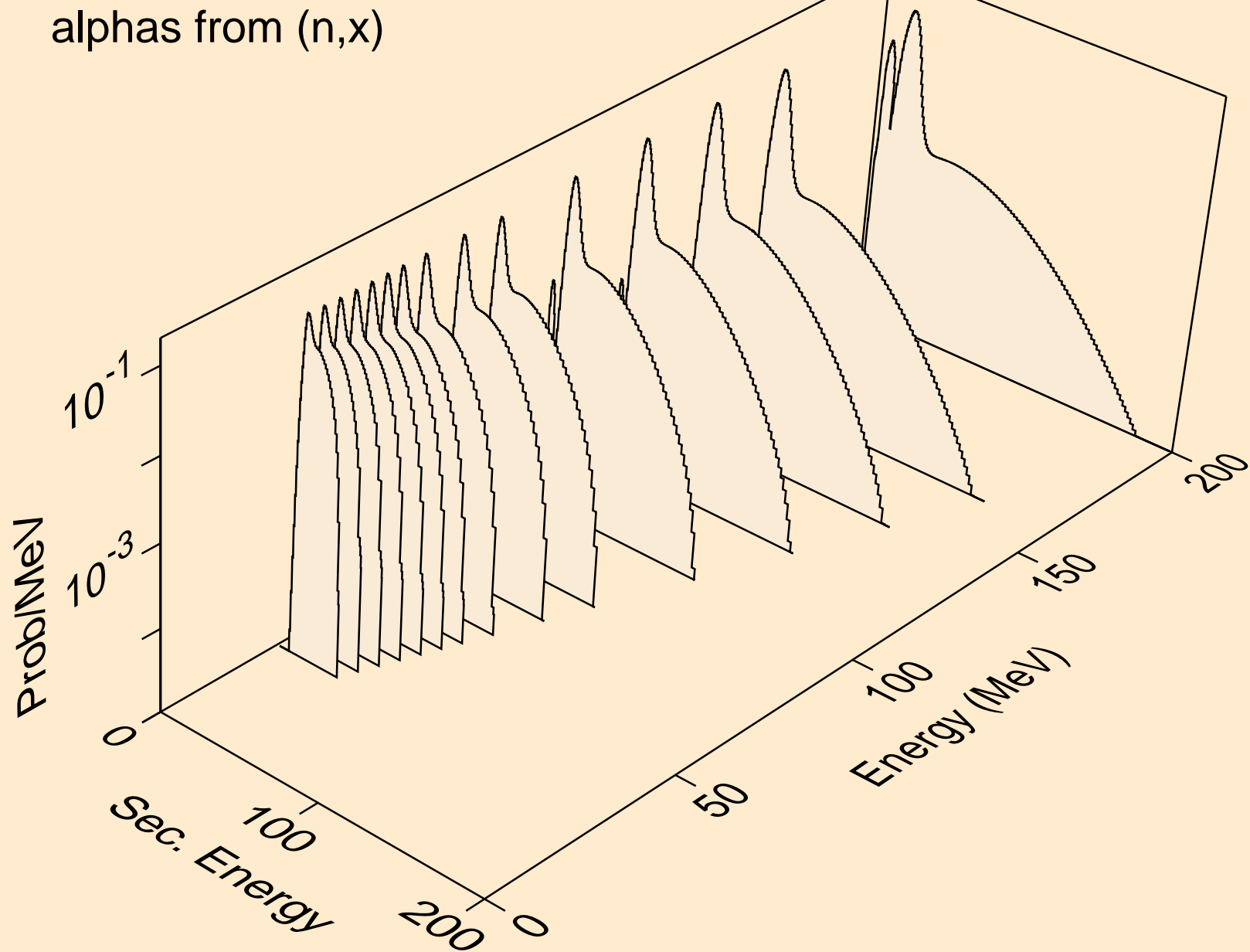

ND132 NEUTRON ACER TENDL-2021 LIBRARY; T=293.6K
alphas from (n,n*)a

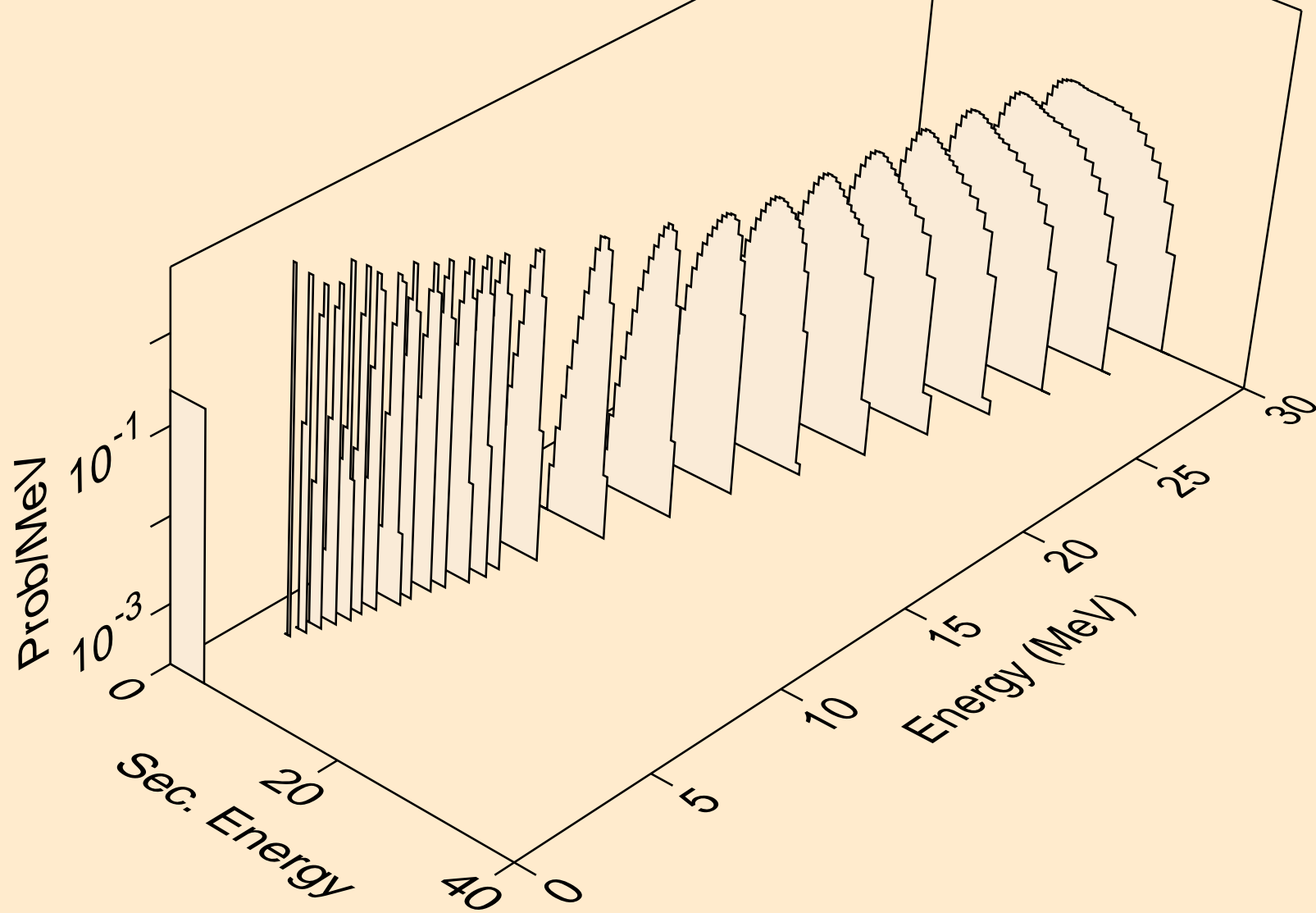

ND132 NEUTRON ACER TENDL-2021 LIBRARY; T=293.6K
alphas from (n,2n)a

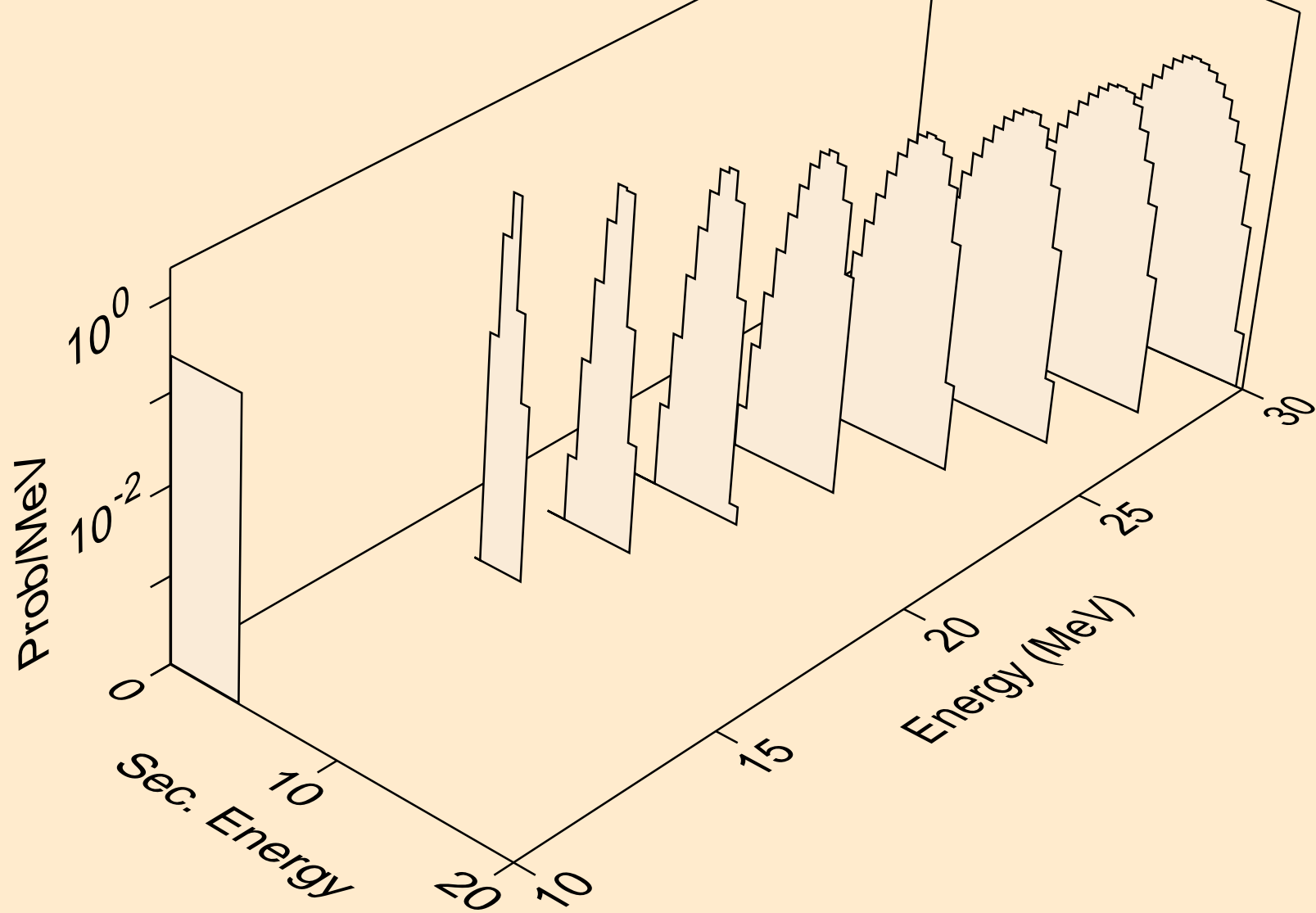

ND132 NEUTRON ACER TENDL-2021 LIBRARY; T=293.6K
alphas from (n,3n)a

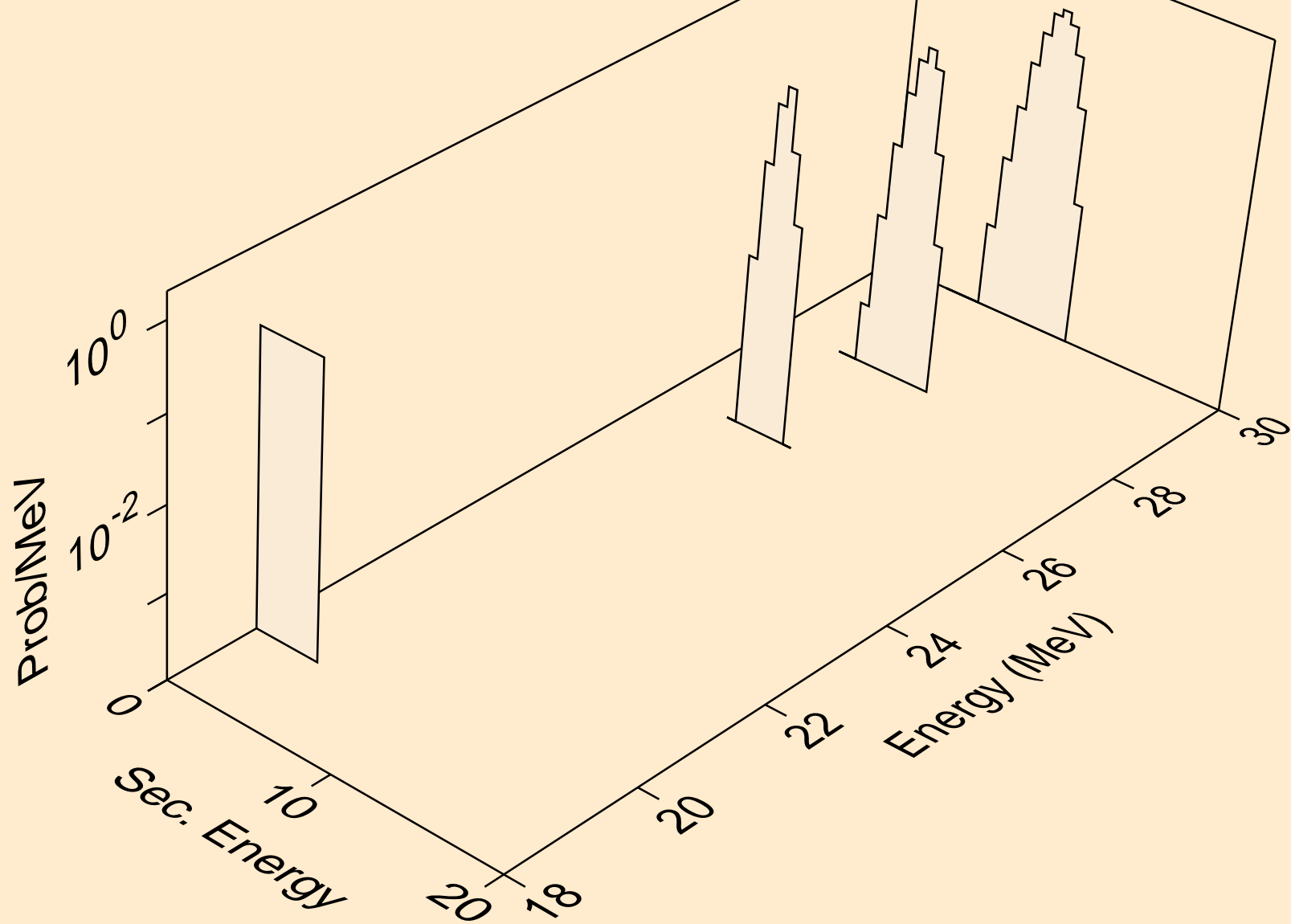

ND132 NEUTRON ACER TENDL-2021 LIBRARY; T=293.6K
alphas from (n,n*)2a

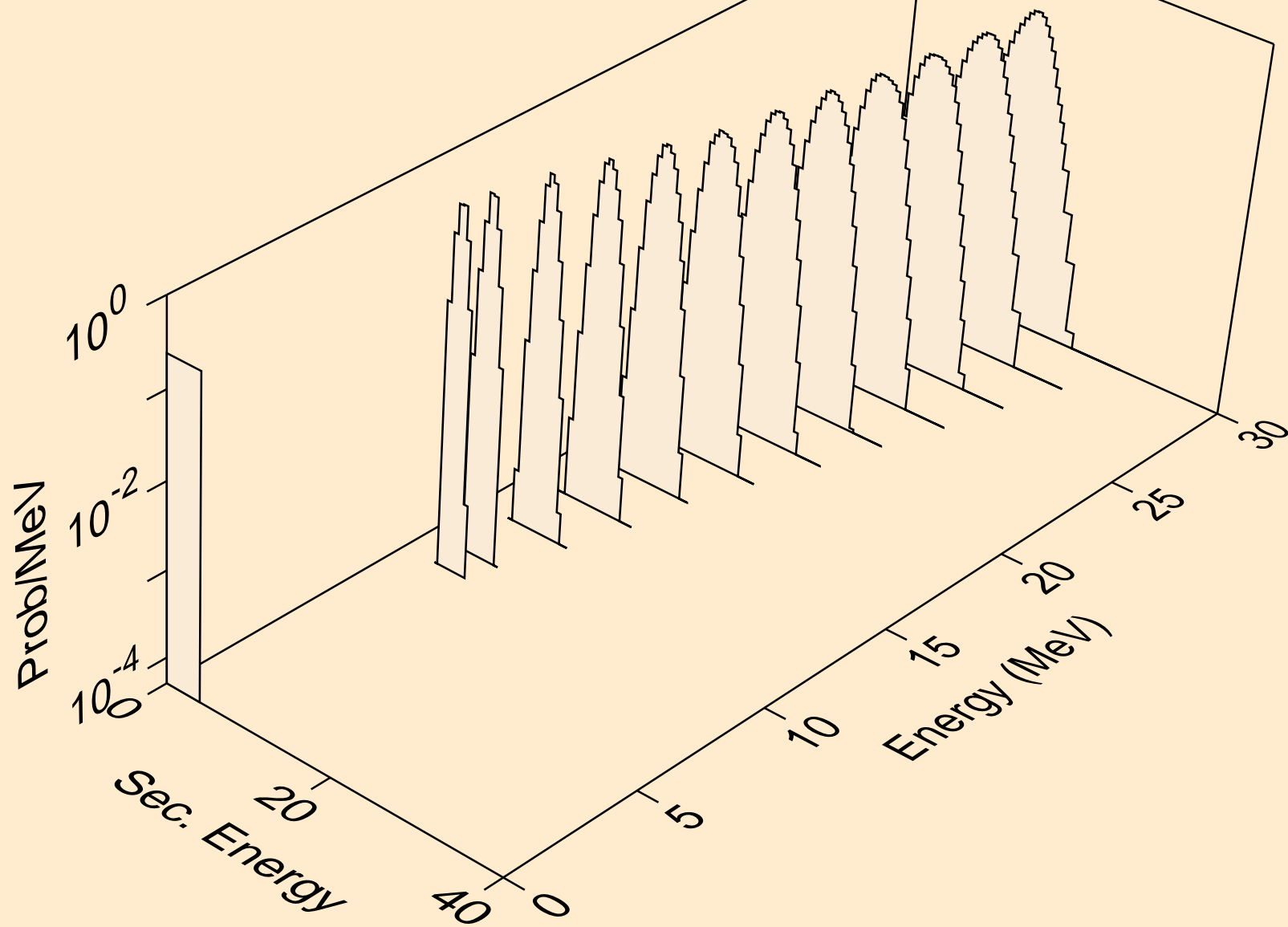

ND132 NEUTRON ACER TENDL-2021 LIBRARY; T=293.6K
alphas from (n,npa)

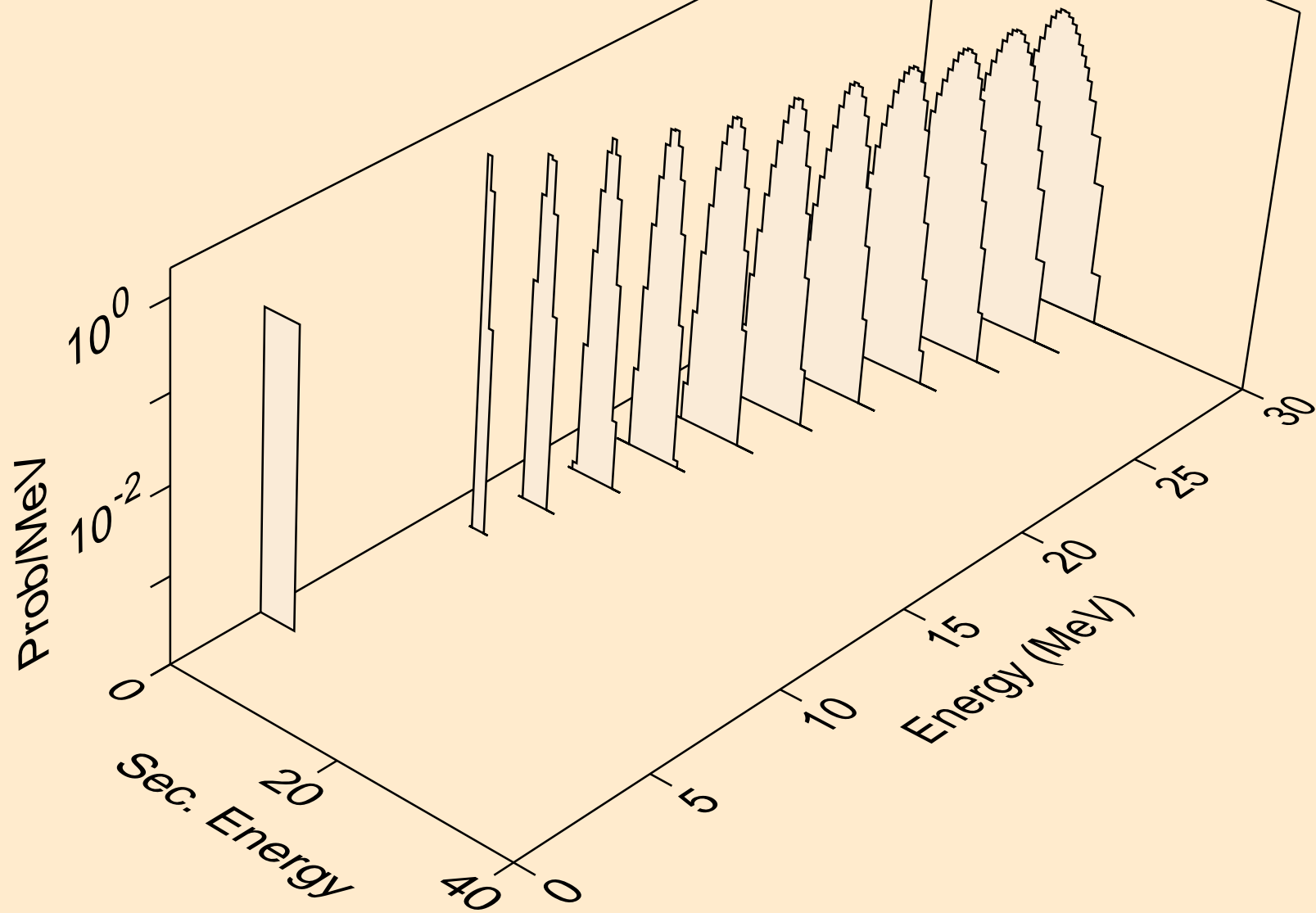

ND132 NEUTRON ACER TENDL-2021 LIBRARY; T=293.6K
alphas from (n,a)

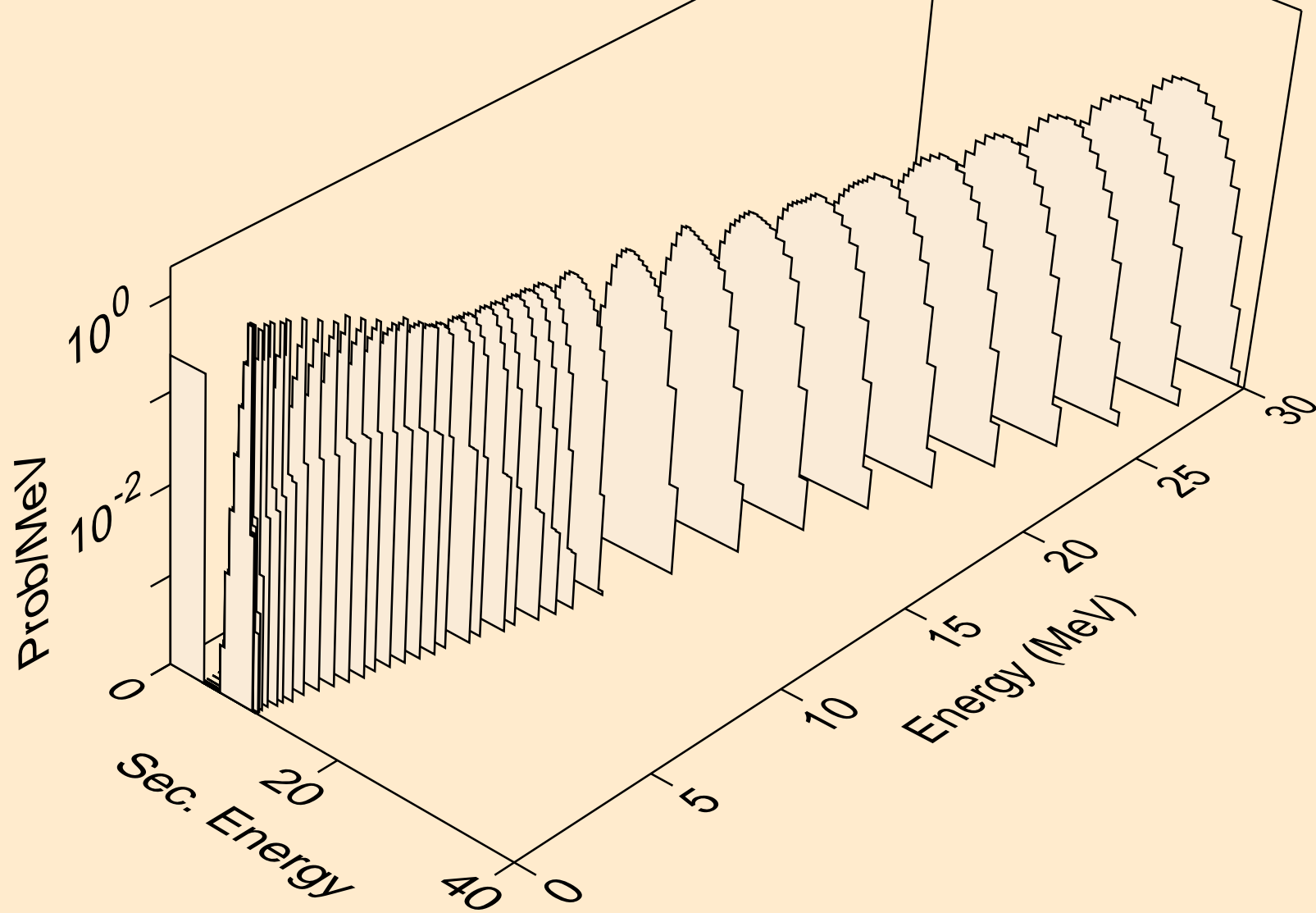

ND132 NEUTRON ACER TENDL-2021 LIBRARY; T=293.6K
alphas from (n,2a)

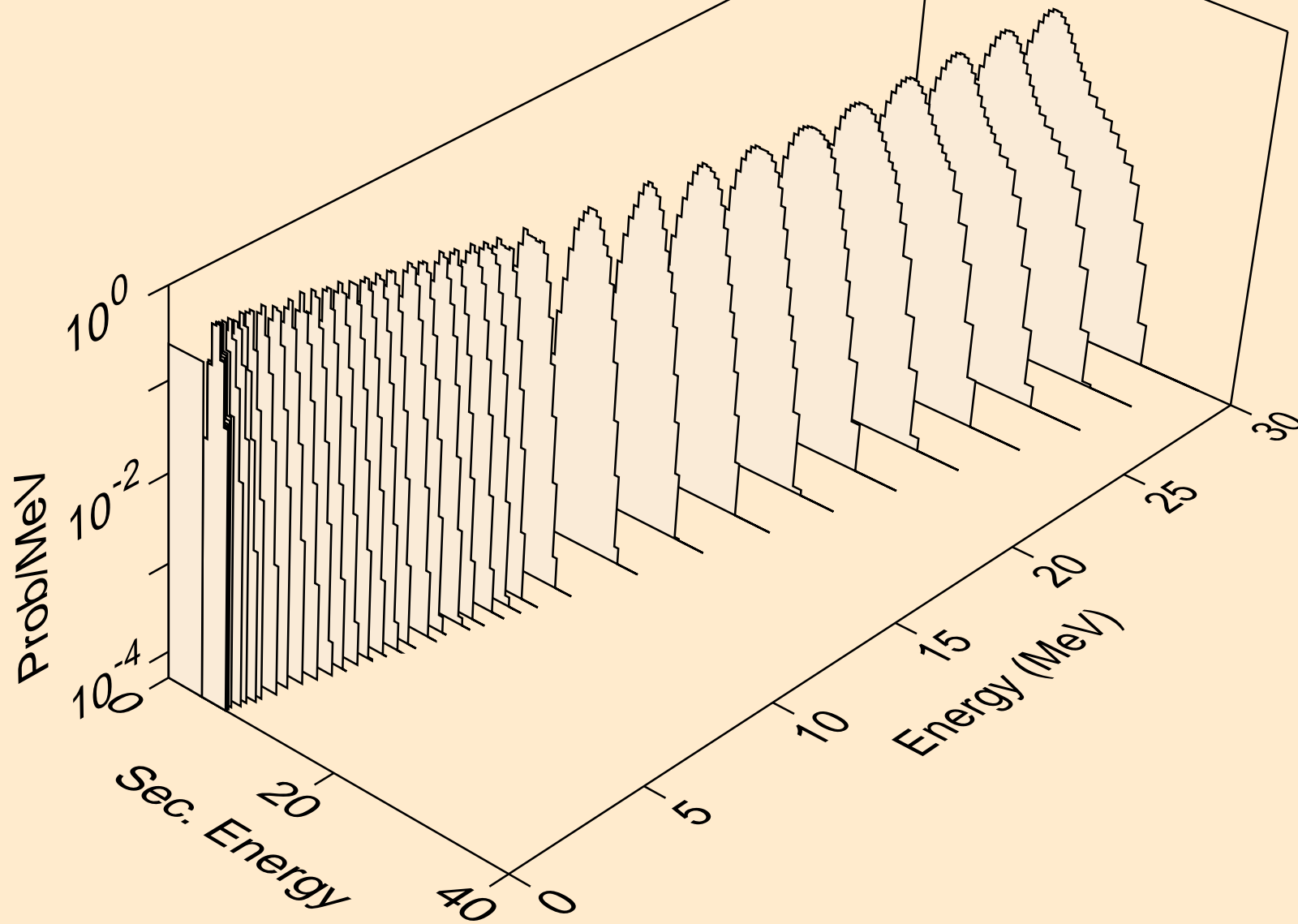

ND132 NEUTRON ACER TENDL-2021 LIBRARY; T=293.6K
alphas from (n,3a)

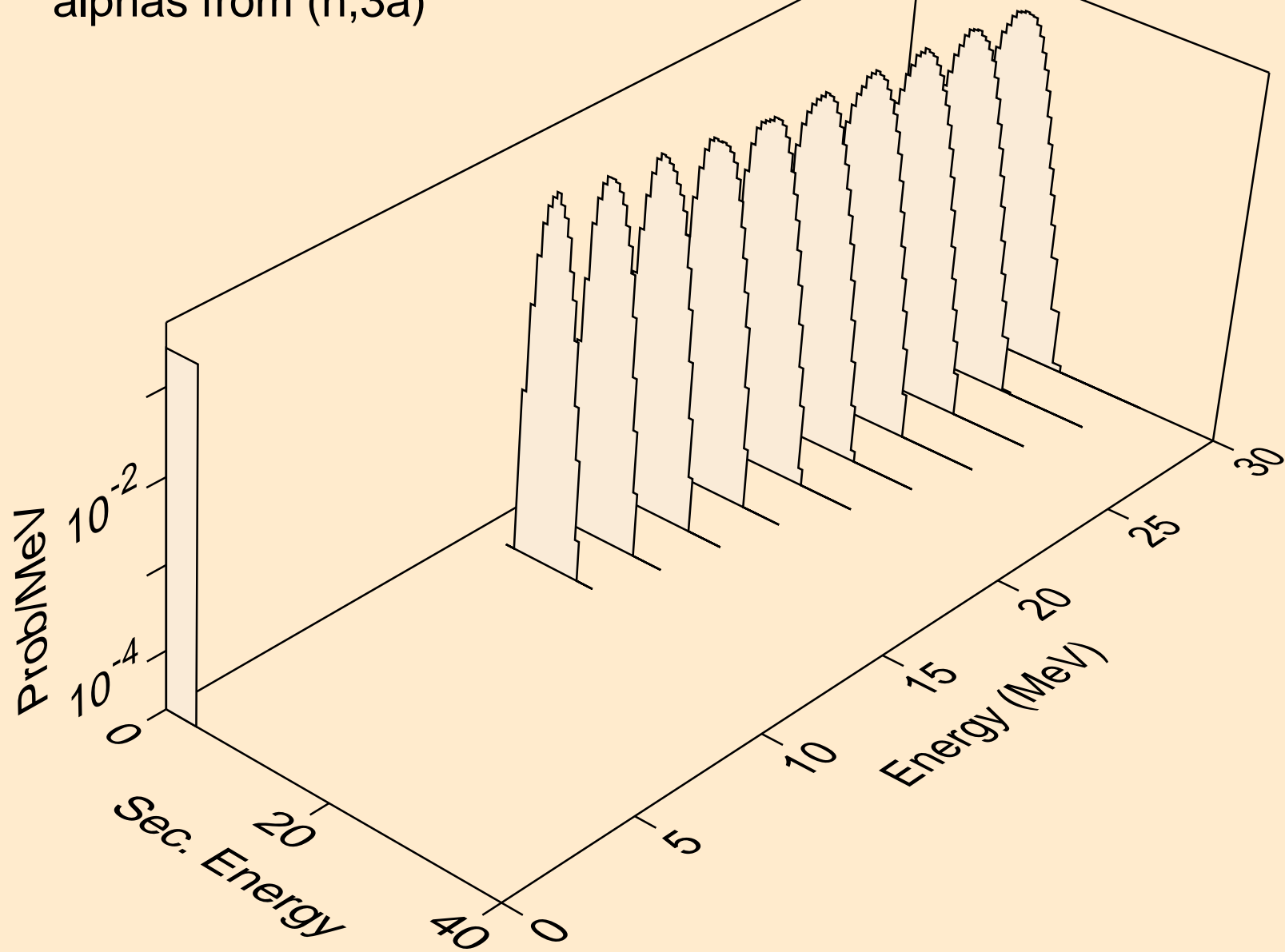

ND132 NEUTRON ACER TENDL-2021 LIBRARY; T=293.6K
alphas from (n,pa)

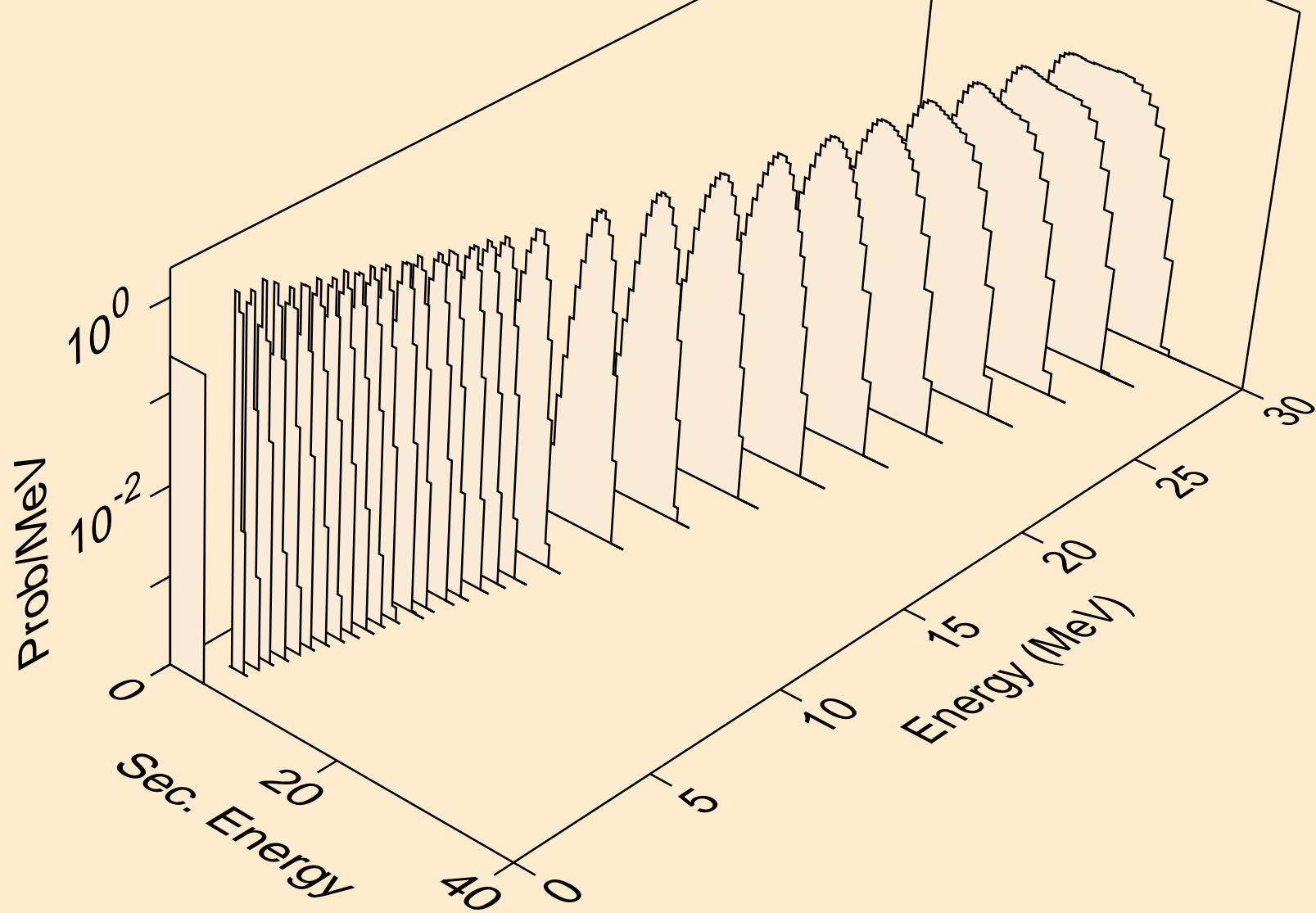

ND132 NEUTRON ACER TENDL-2021 LIBRARY; T=293.6K
alphas from (n,da)

